

TL209 TRITON ACER TENDL-2021 LIBRARY; T=0.K  
Principal cross sections

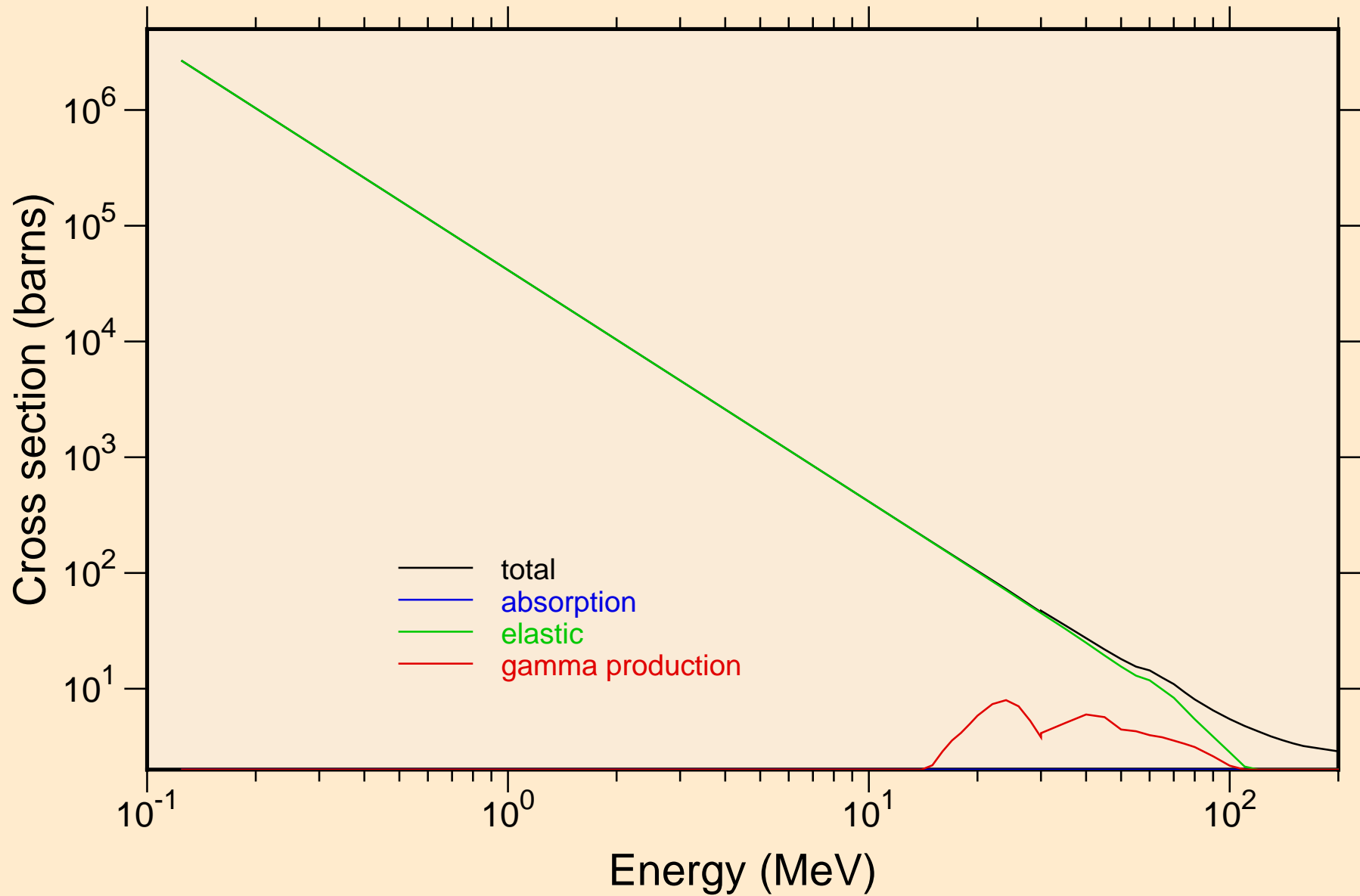

TL209 TRITON ACER TENDL-2021 LIBRARY; T=0.K

Heating

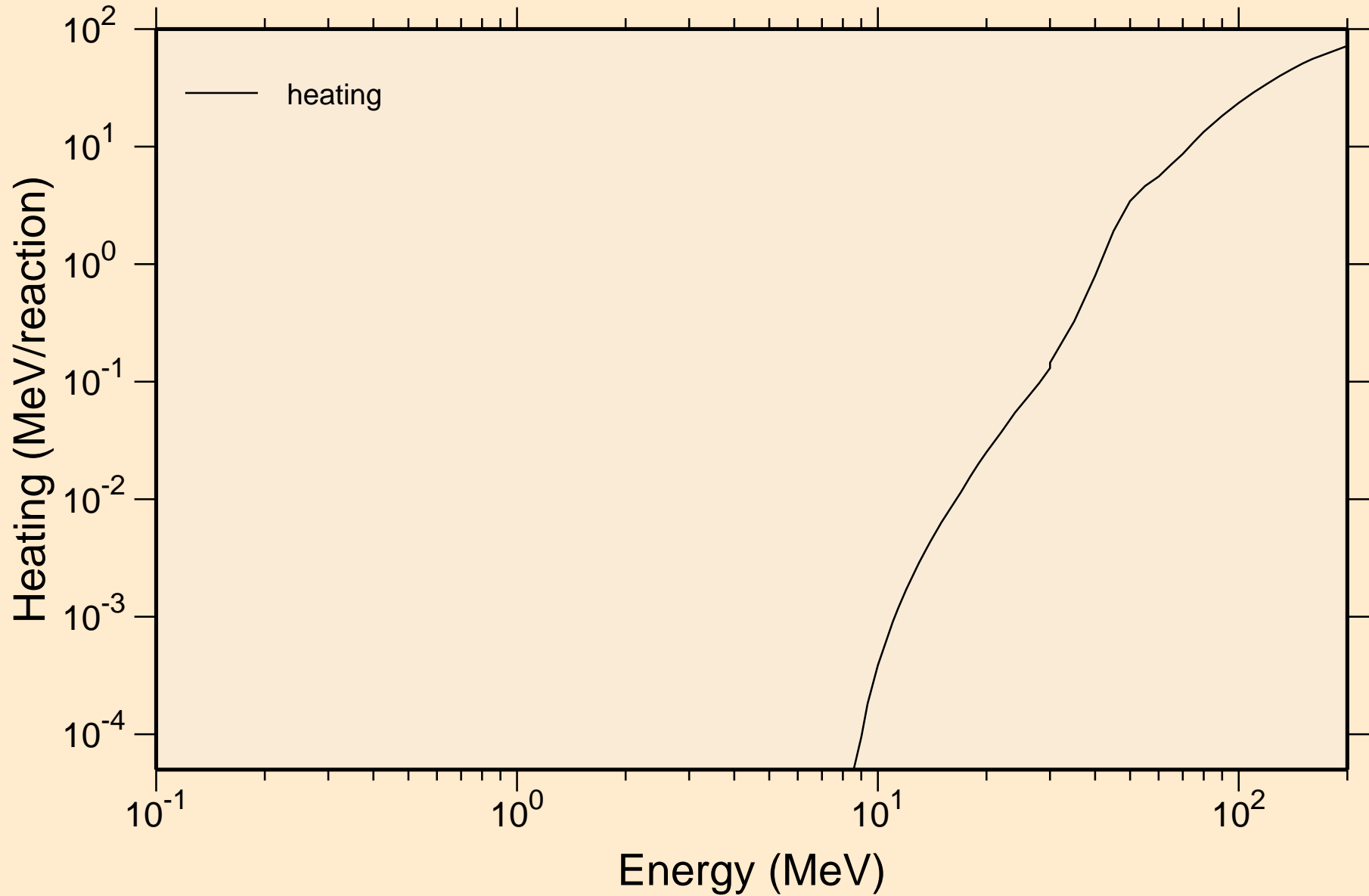

# TL209 TRITON ACER TENDL-2021 LIBRARY; T=0.K

## Principal cross sections

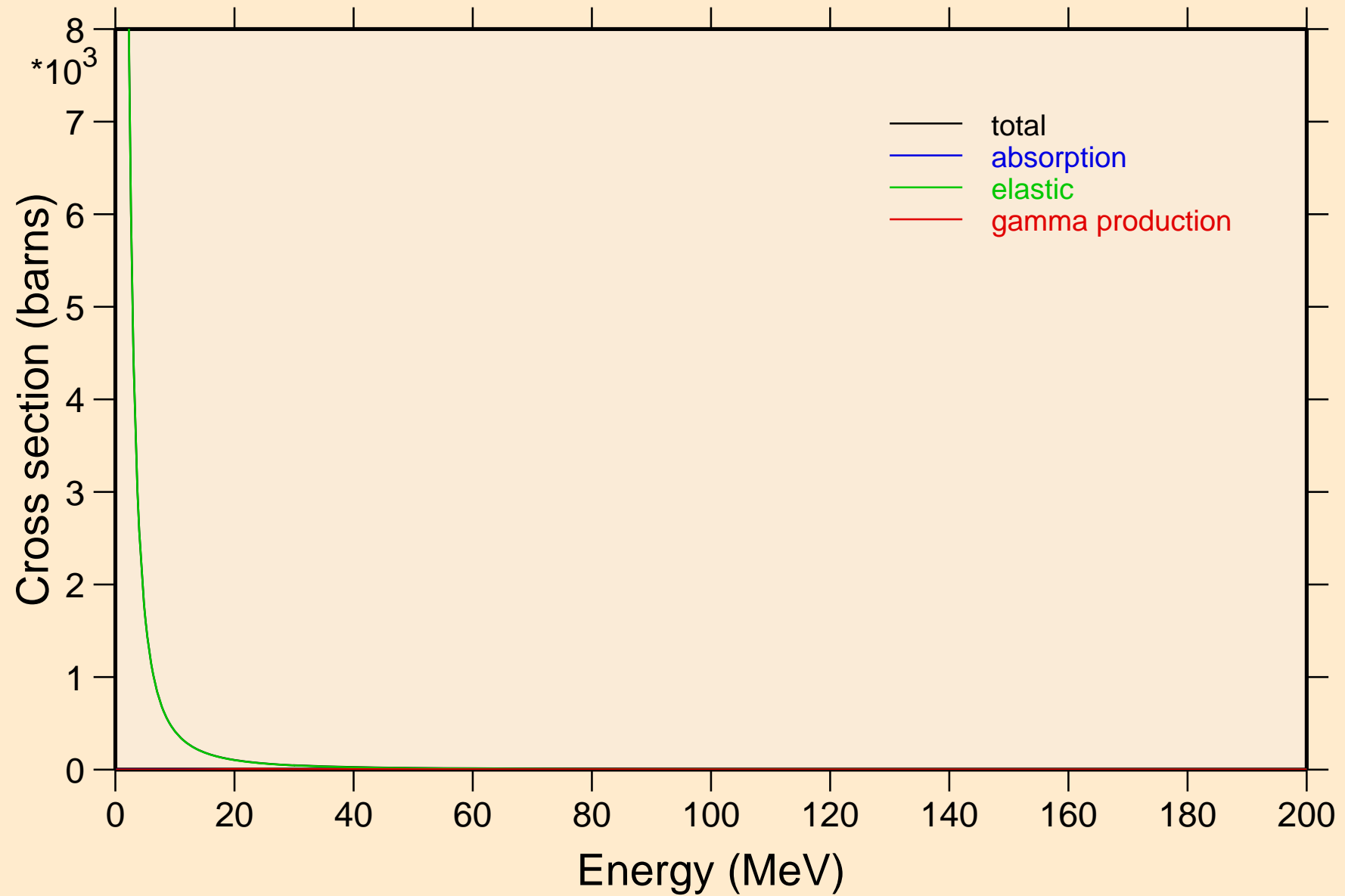

TL209 TRITON ACER TENDL-2021 LIBRARY; T=0.K

Heating

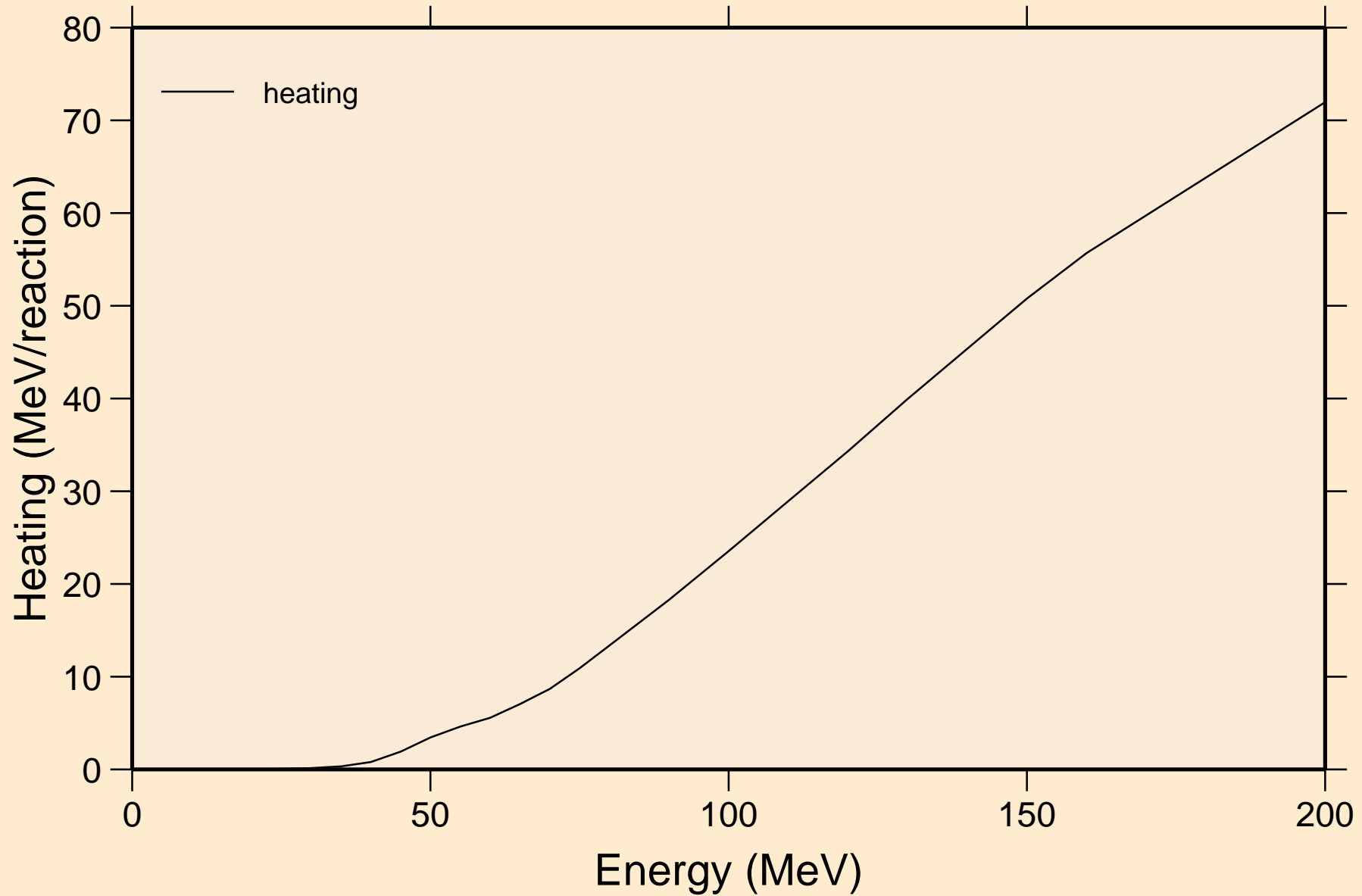

TL209 TRITON ACER TENDL-2021 LIBRARY; T=0.K  
Threshold reactions

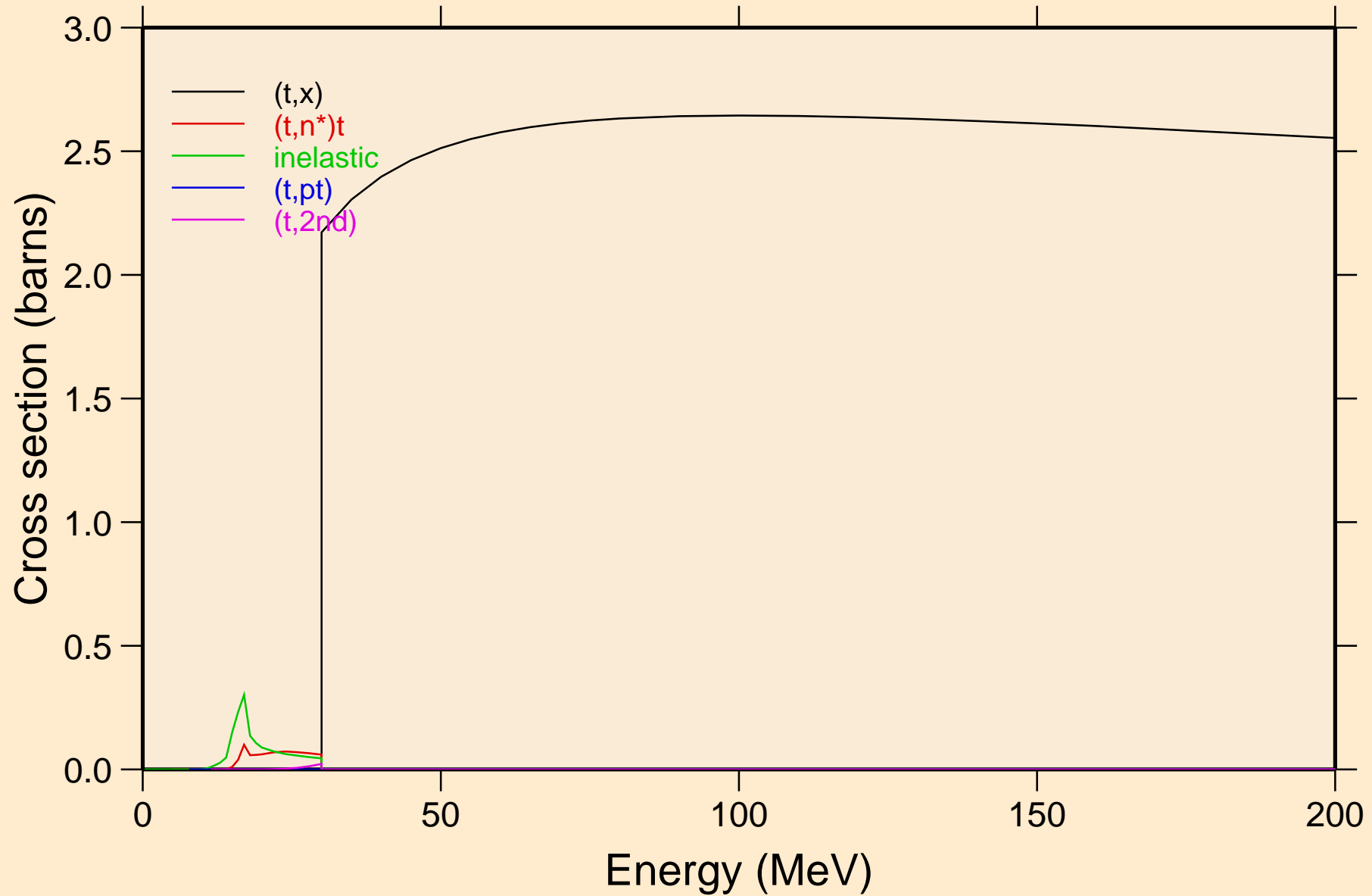

TL209 TRITON ACER TENDL-2021 LIBRARY; T=0.K  
Threshold reactions

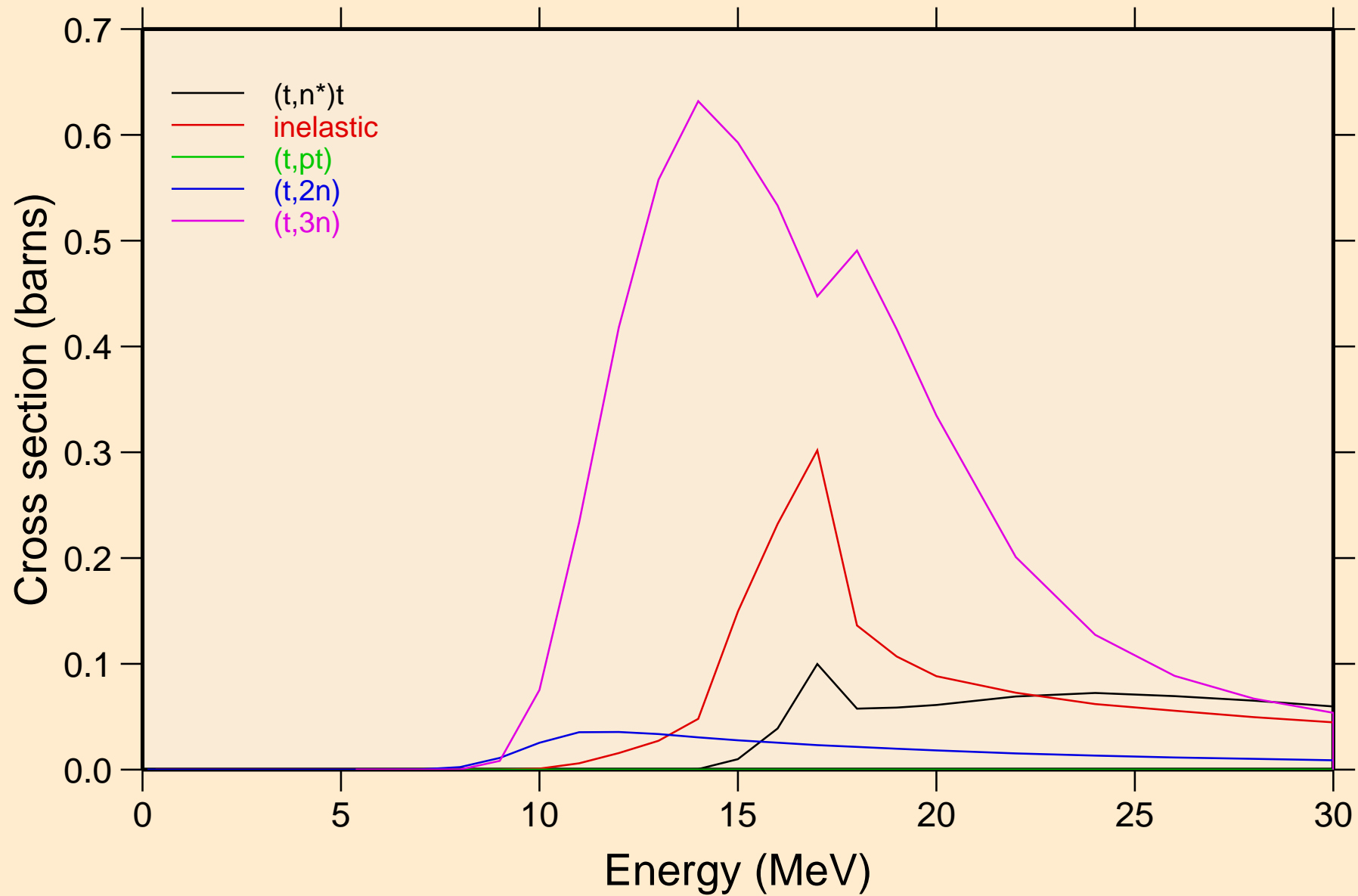

TL209 TRITON ACER TENDL-2021 LIBRARY; T=0.K  
Threshold reactions

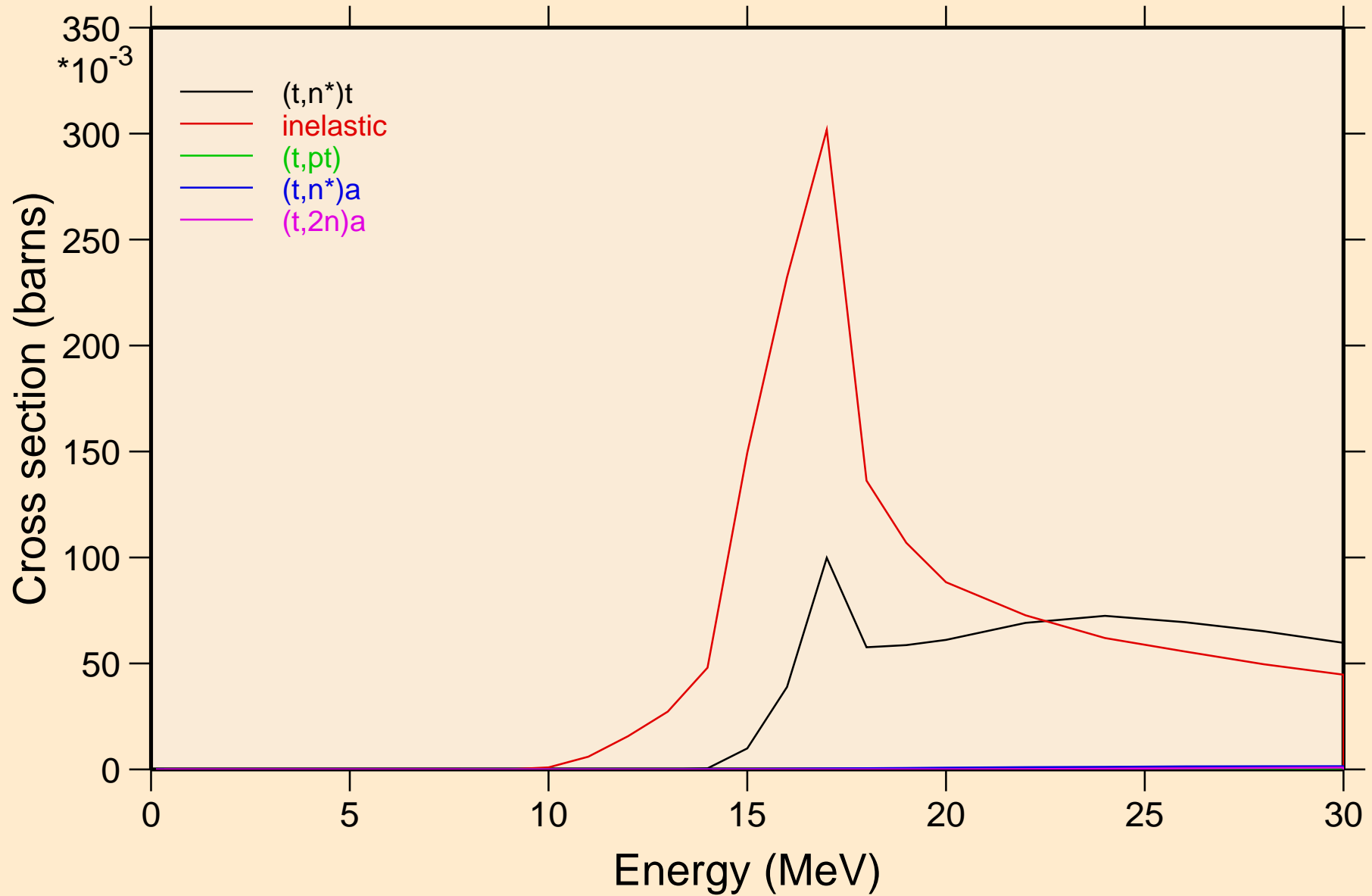

TL209 TRITON ACER TENDL-2021 LIBRARY; T=0.K  
Threshold reactions

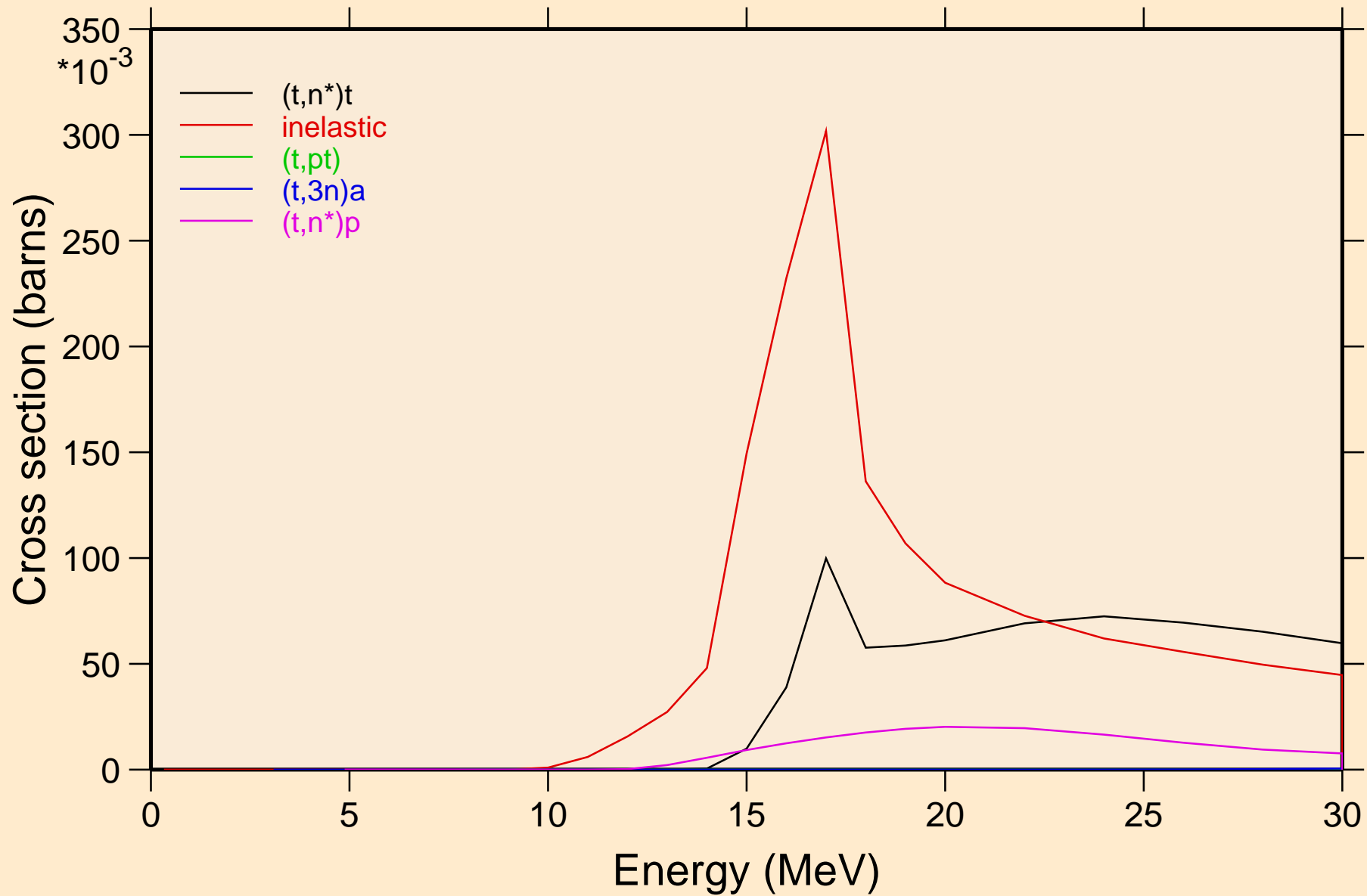



TL209 TRITON ACER TENDL-2021 LIBRARY; T=0.K  
Threshold reactions

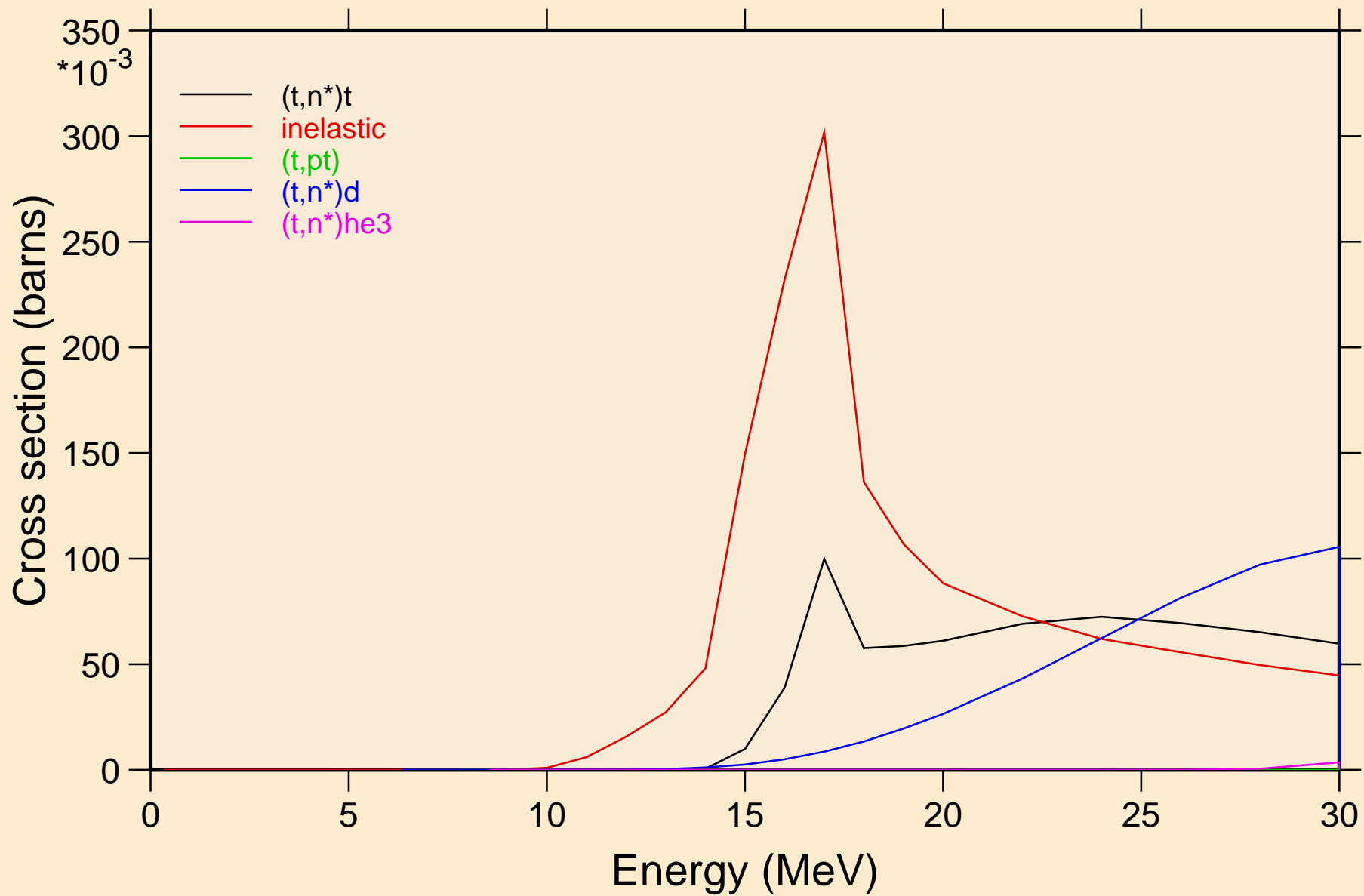

TL209 TRITON ACER TENDL-2021 LIBRARY; T=0.K  
Threshold reactions

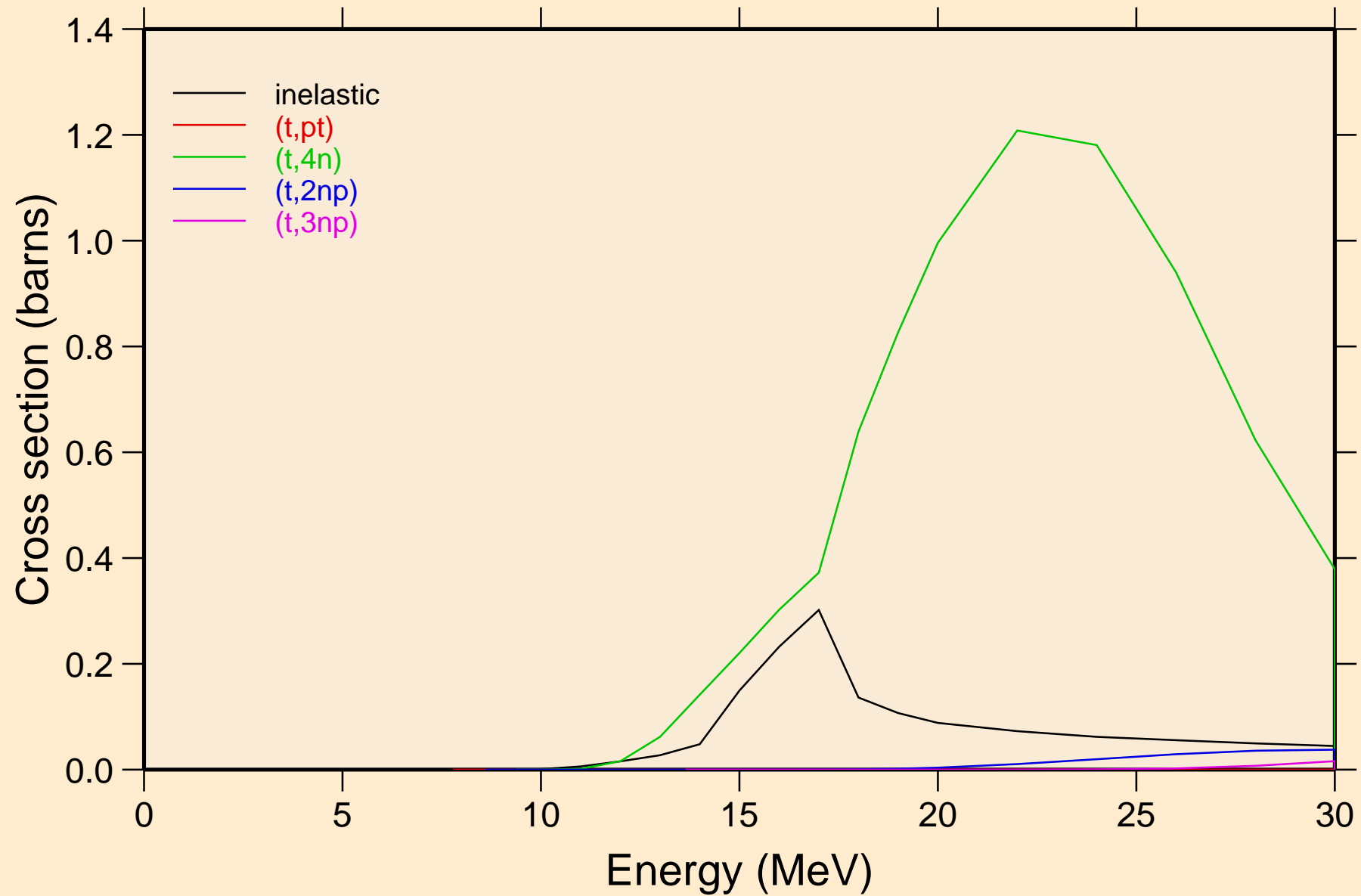

TL209 TRITON ACER TENDL-2021 LIBRARY; T=0.K  
Threshold reactions

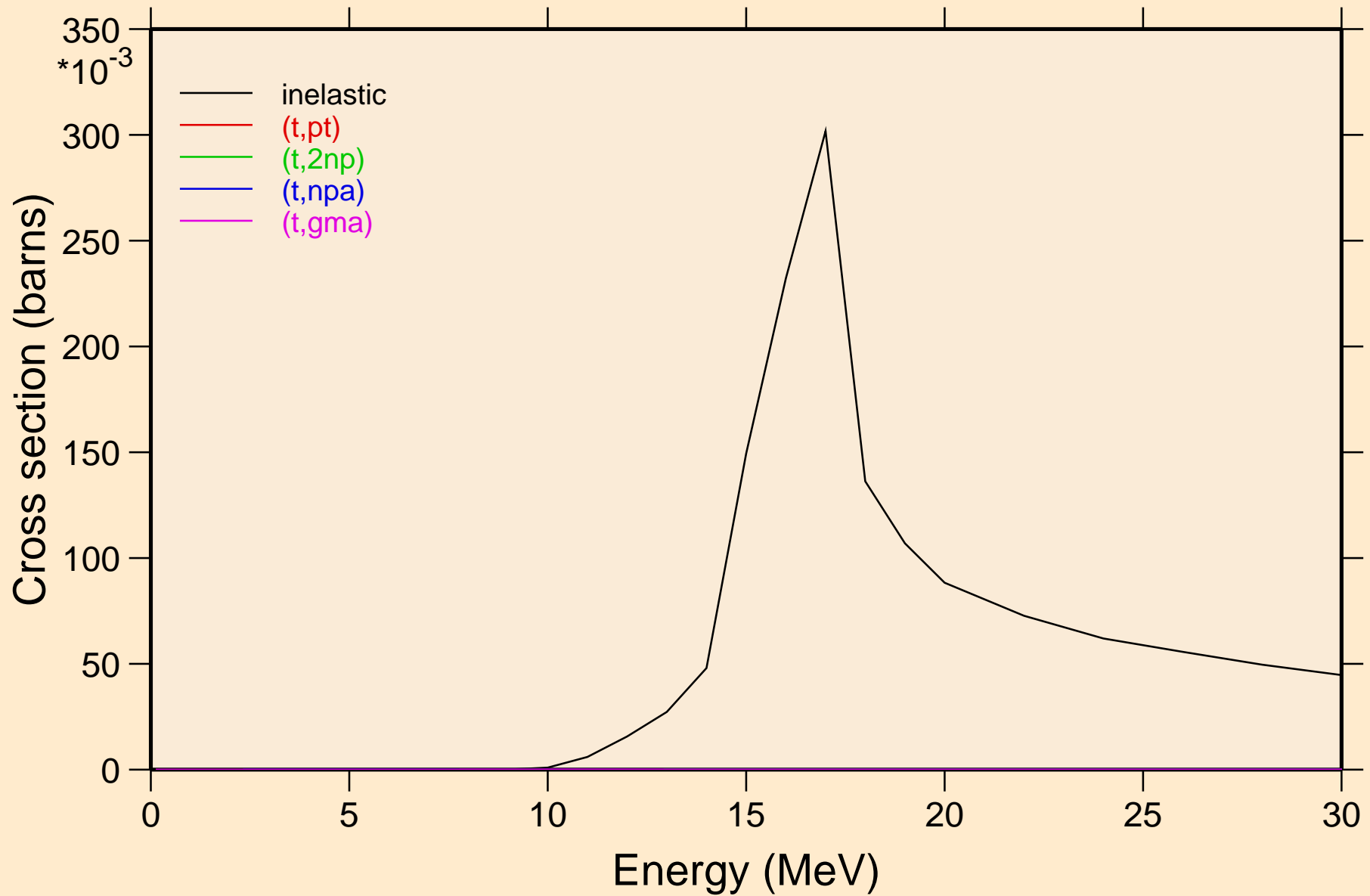

TL209 TRITON ACER TENDL-2021 LIBRARY; T=0.K  
Threshold reactions

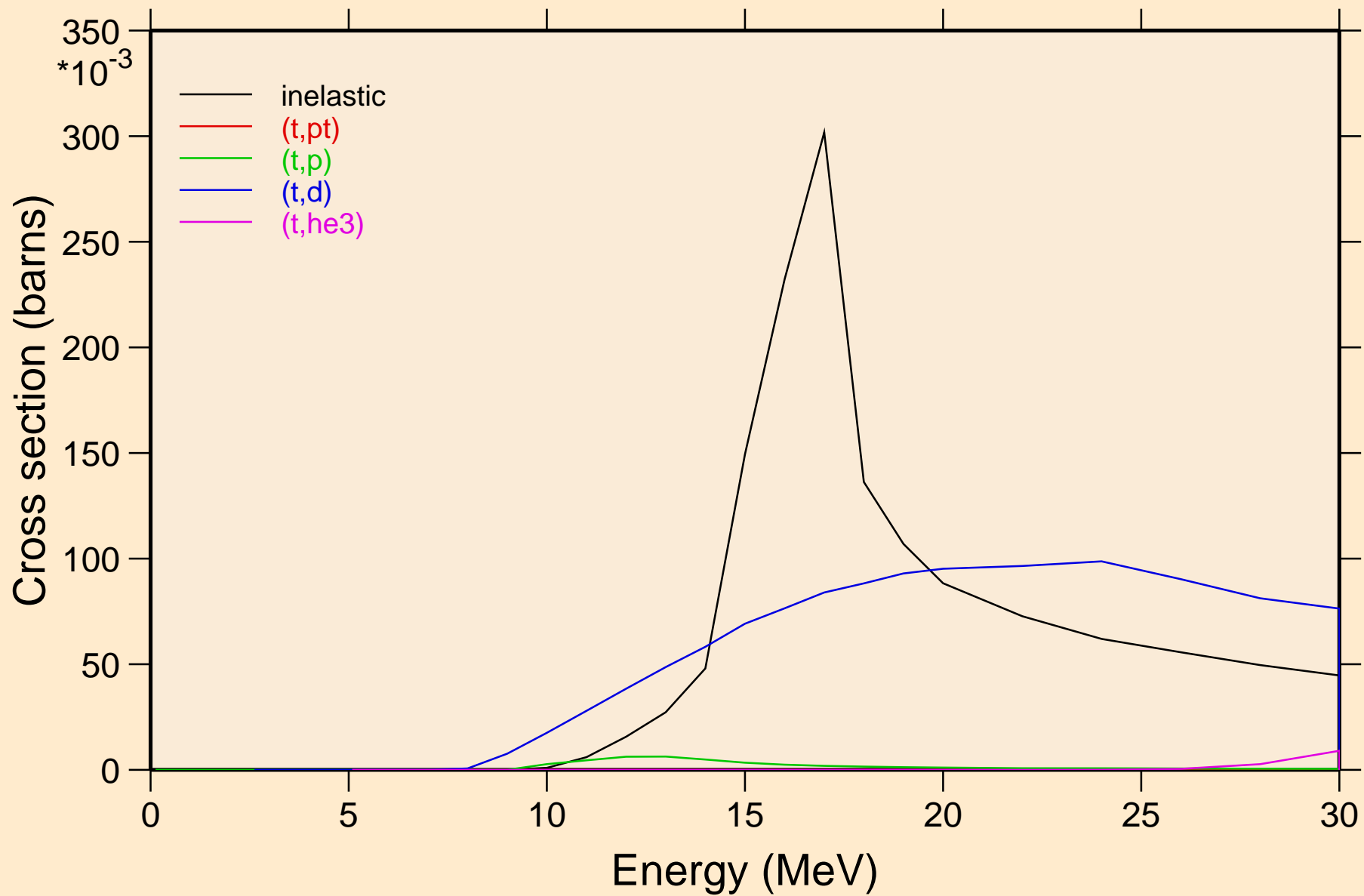

TL209 TRITON ACER TENDL-2021 LIBRARY; T=0.K  
Threshold reactions

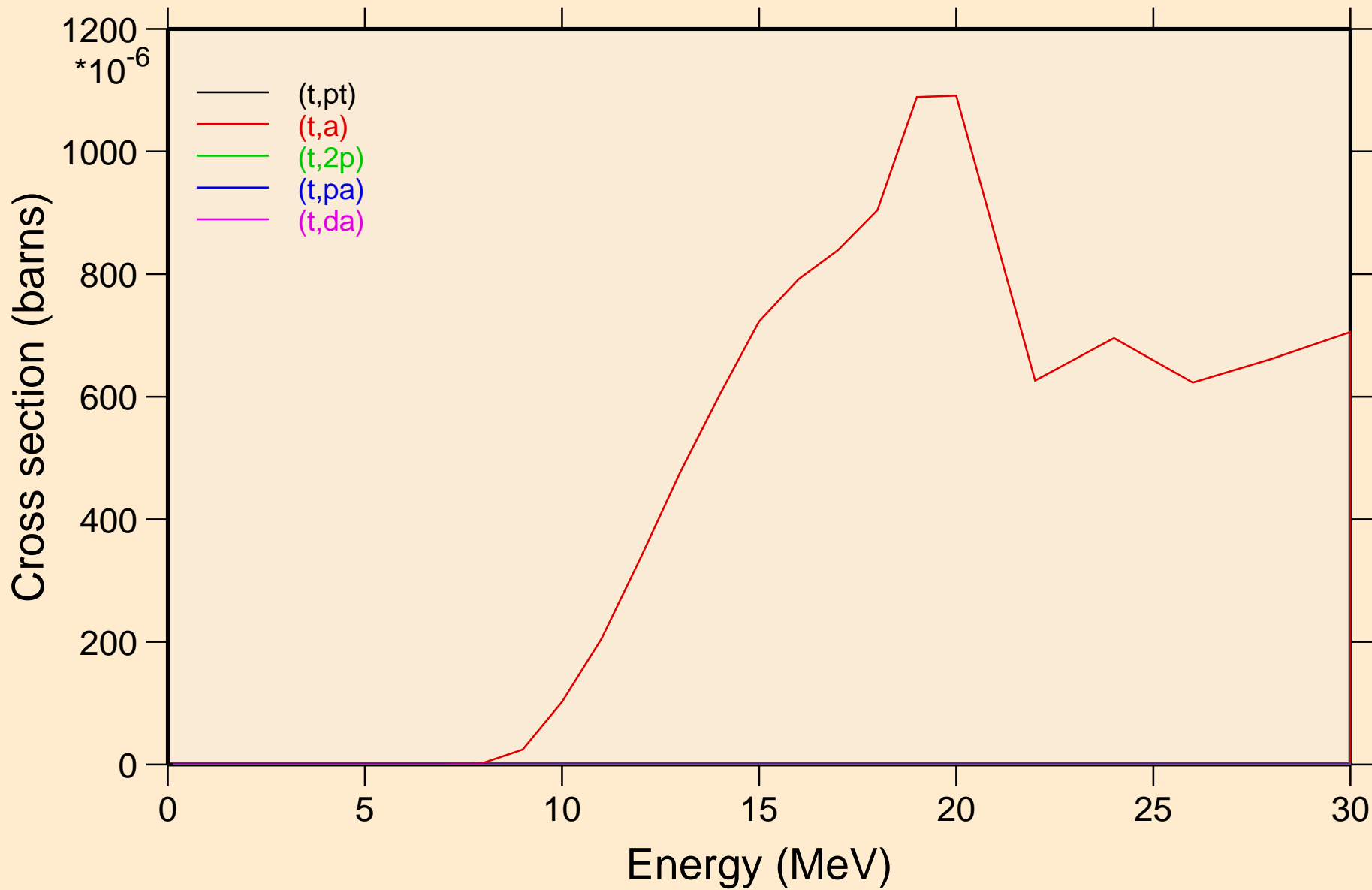

TL209 TRITON ACER TENDL-2021 LIBRARY; T=0.K  
angular distribution for elastic

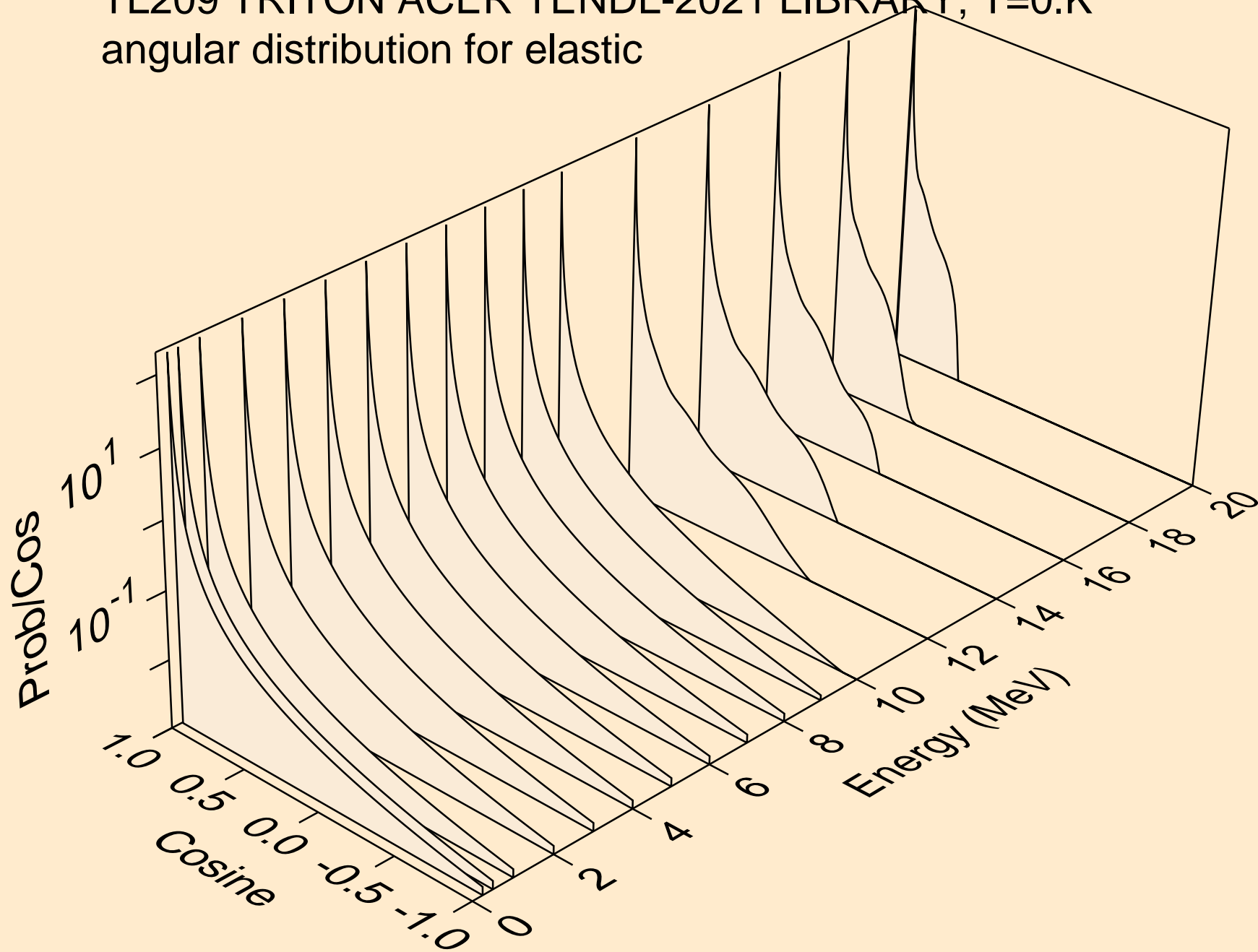

TL209 TRITON ACER TENDL-2021 LIBRARY; T=0.K  
angular distribution for elastic

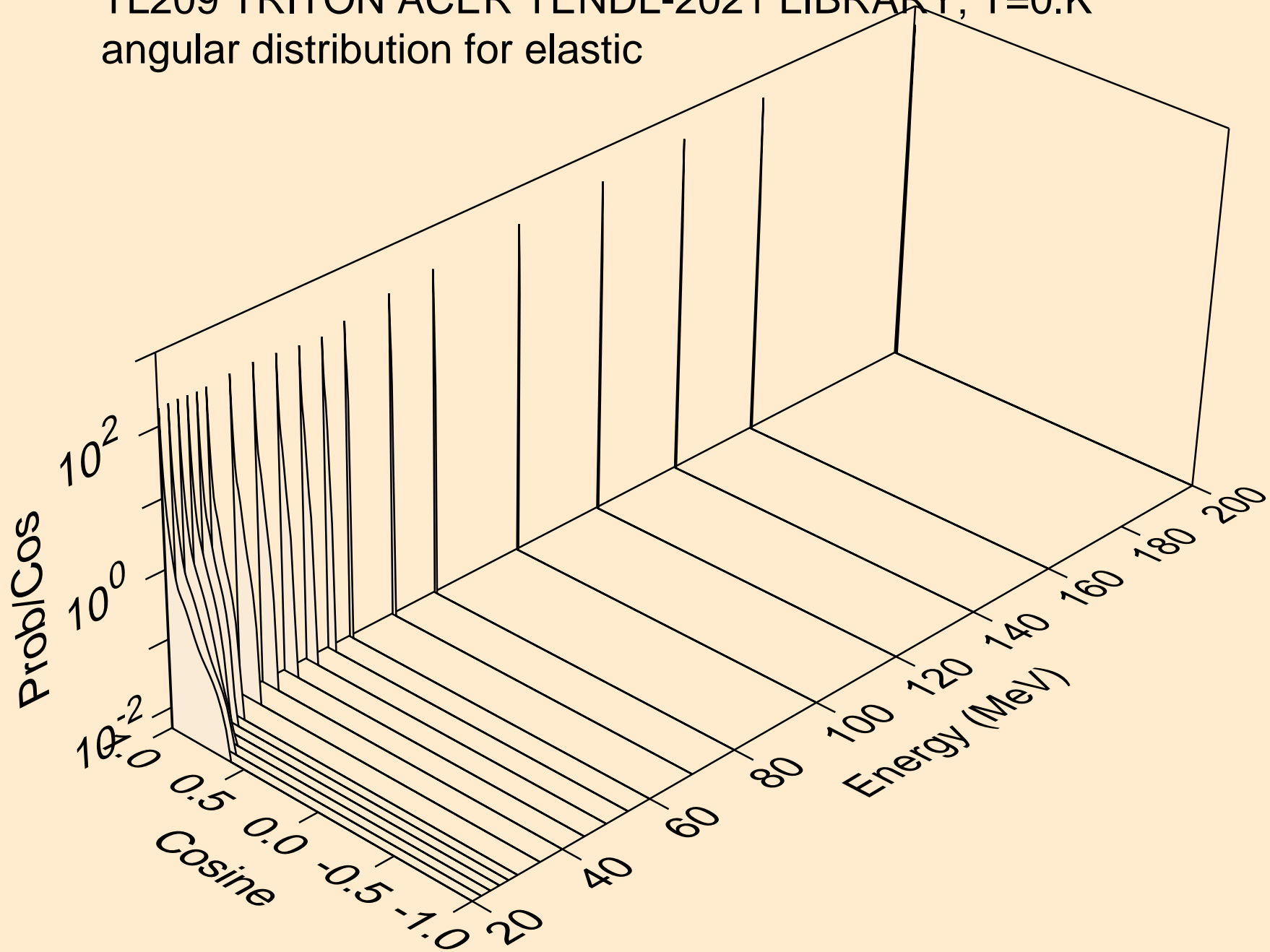

TL209 TRITON ACER TENDL-2021 LIBRARY; T=0.K  
Triton emission for (t,x)

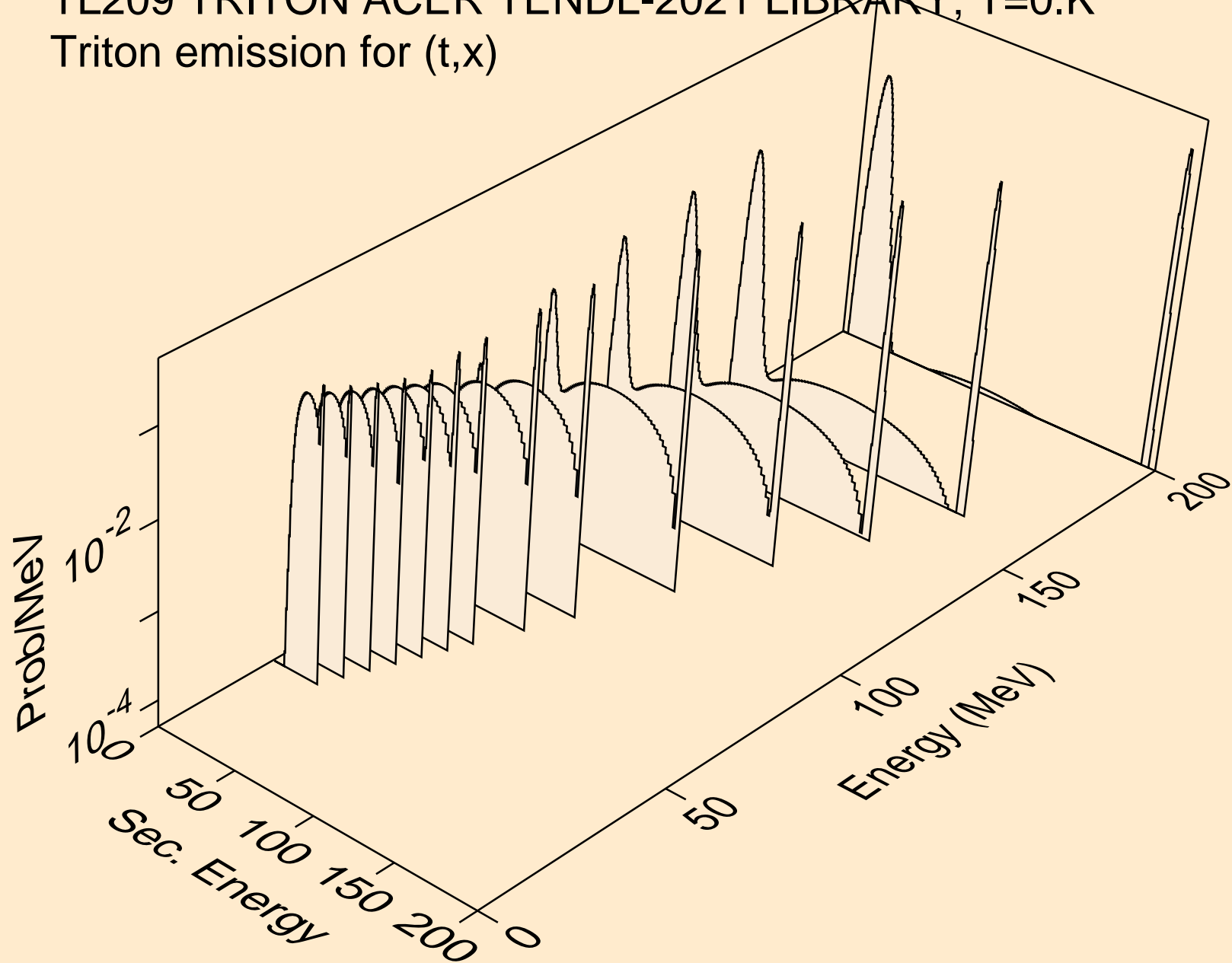



TL209 TRITON ACER TENDL-2021 LIBRARY; T=0.K  
Triton emission for (t,n\*)t

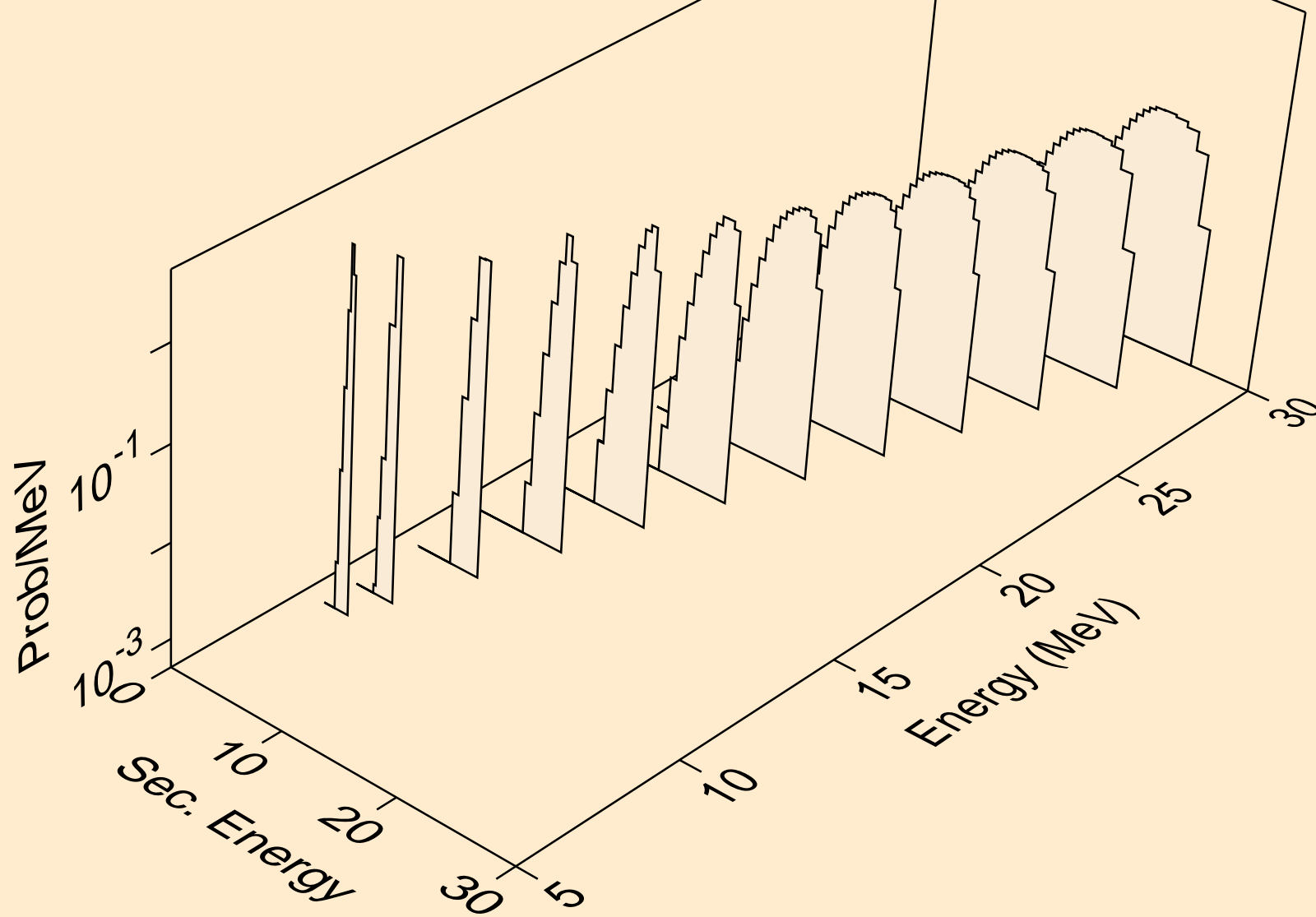

TL209 TRITON ACER TENDL-2021 LIBRARY; T=0.K  
Triton emission for inelastic

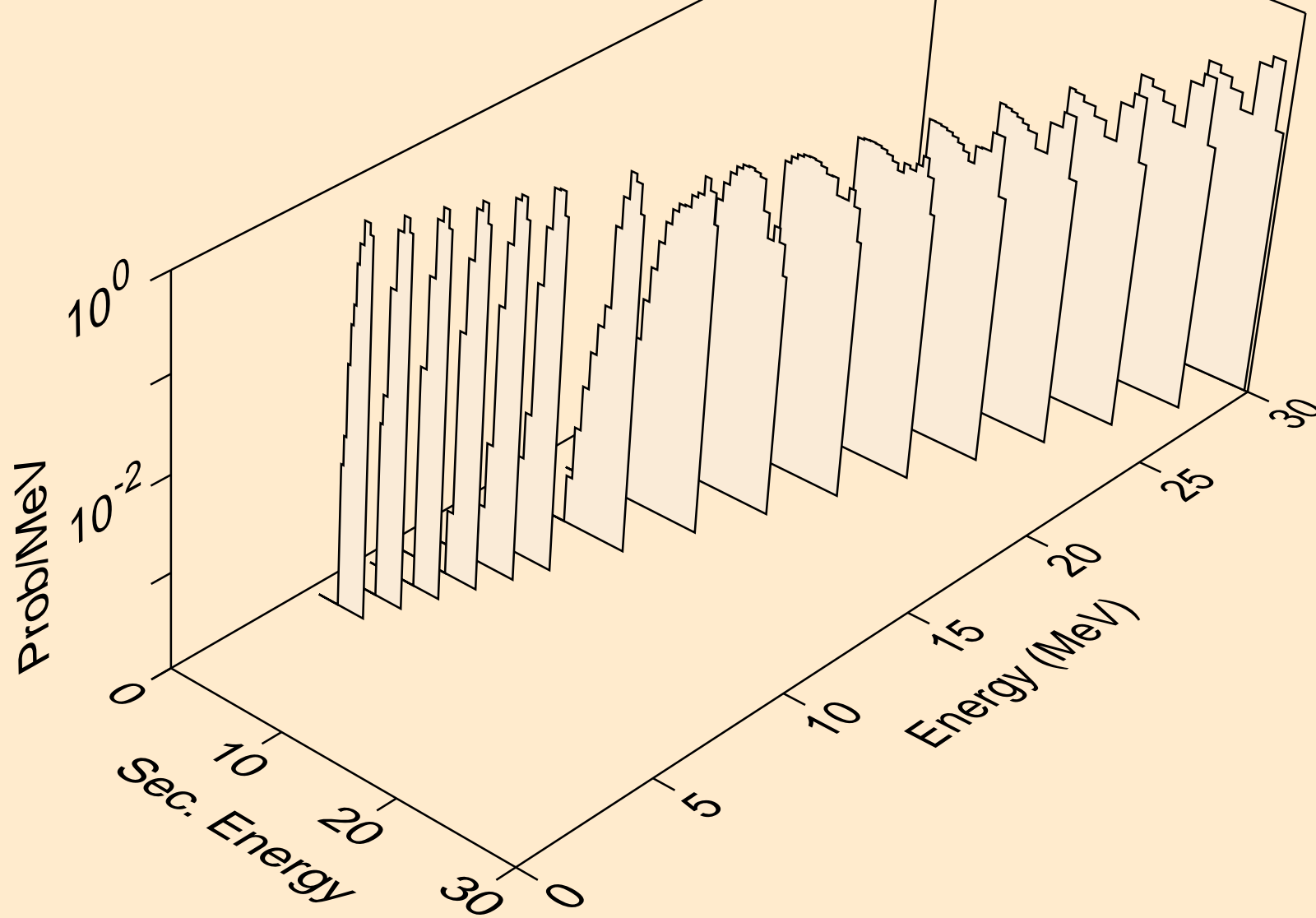

TL209 TRITON ACER TENDL-2021 LIBRARY; T=0.K  
Triton emission for (t,pt)

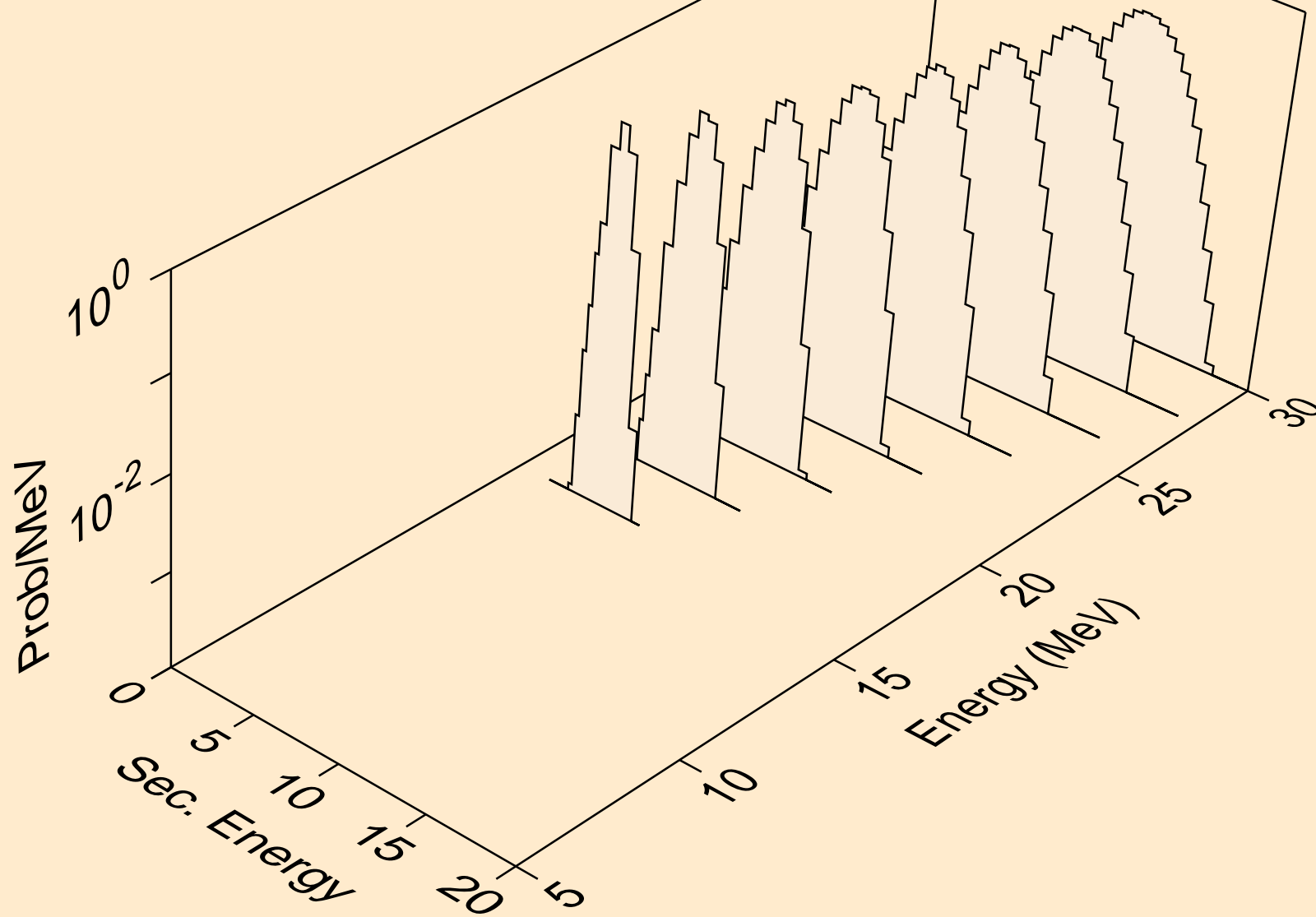

TL209 TRITON ACER TENDL-2021 LIBRARY; T=0.K  
Photon emission for (z,n)

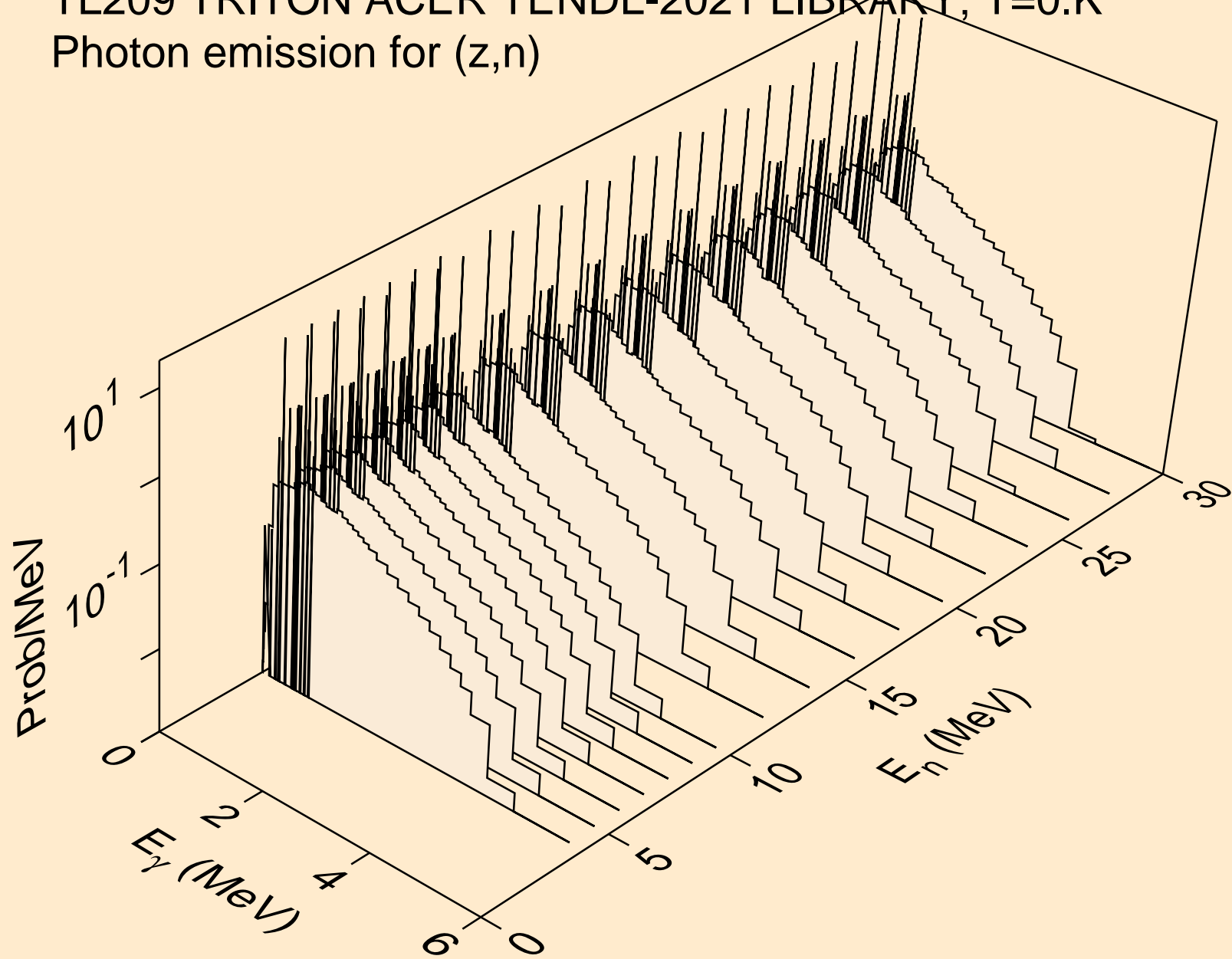

TL209 TRITON ACER TENDL-2021 LIBRARY; T=0.K  
Photon emission for (n,x)

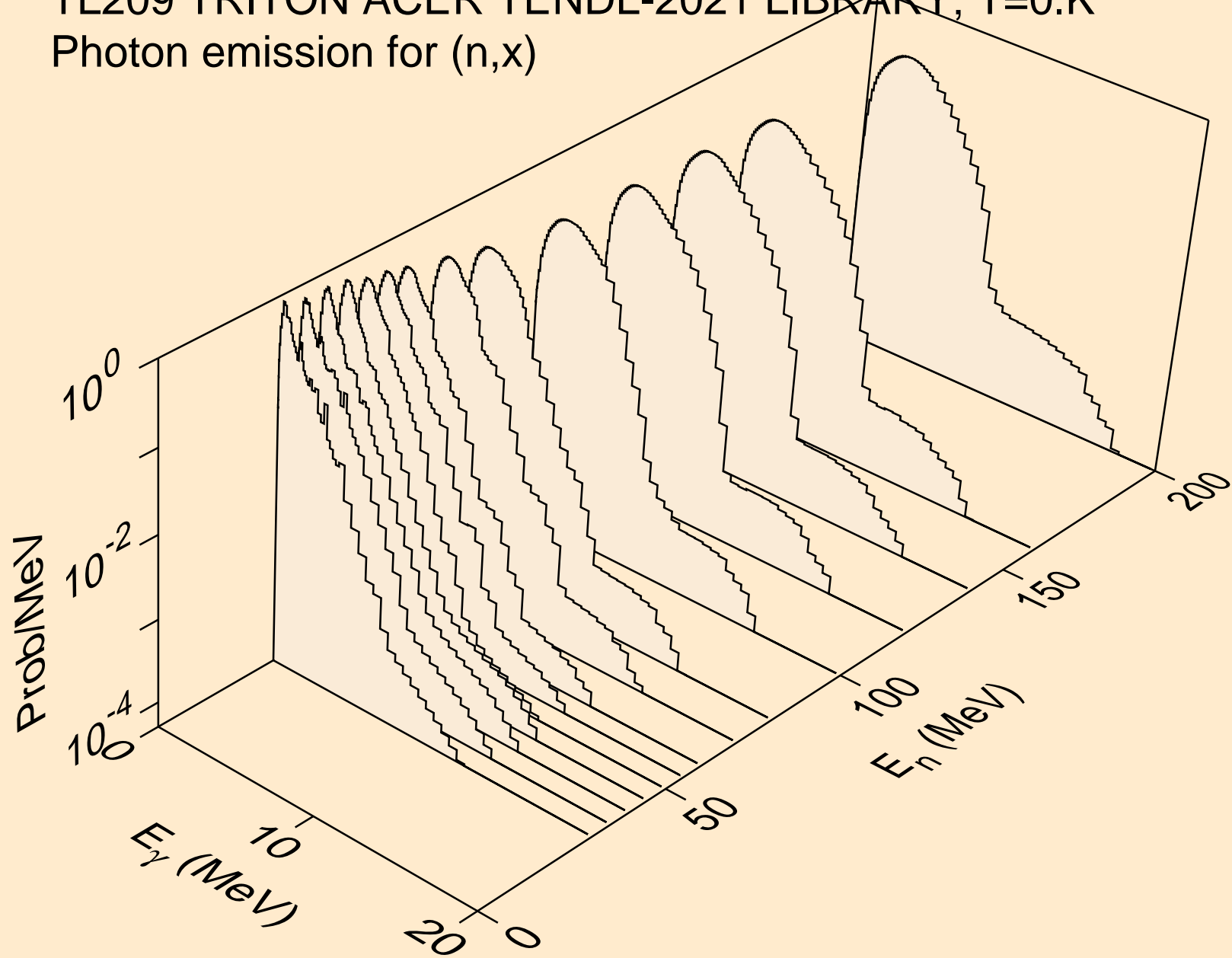

TL209 TRITON ACER TENDL-2021 LIBRARY; T=0.K  
Photon emission for (n,2nd)

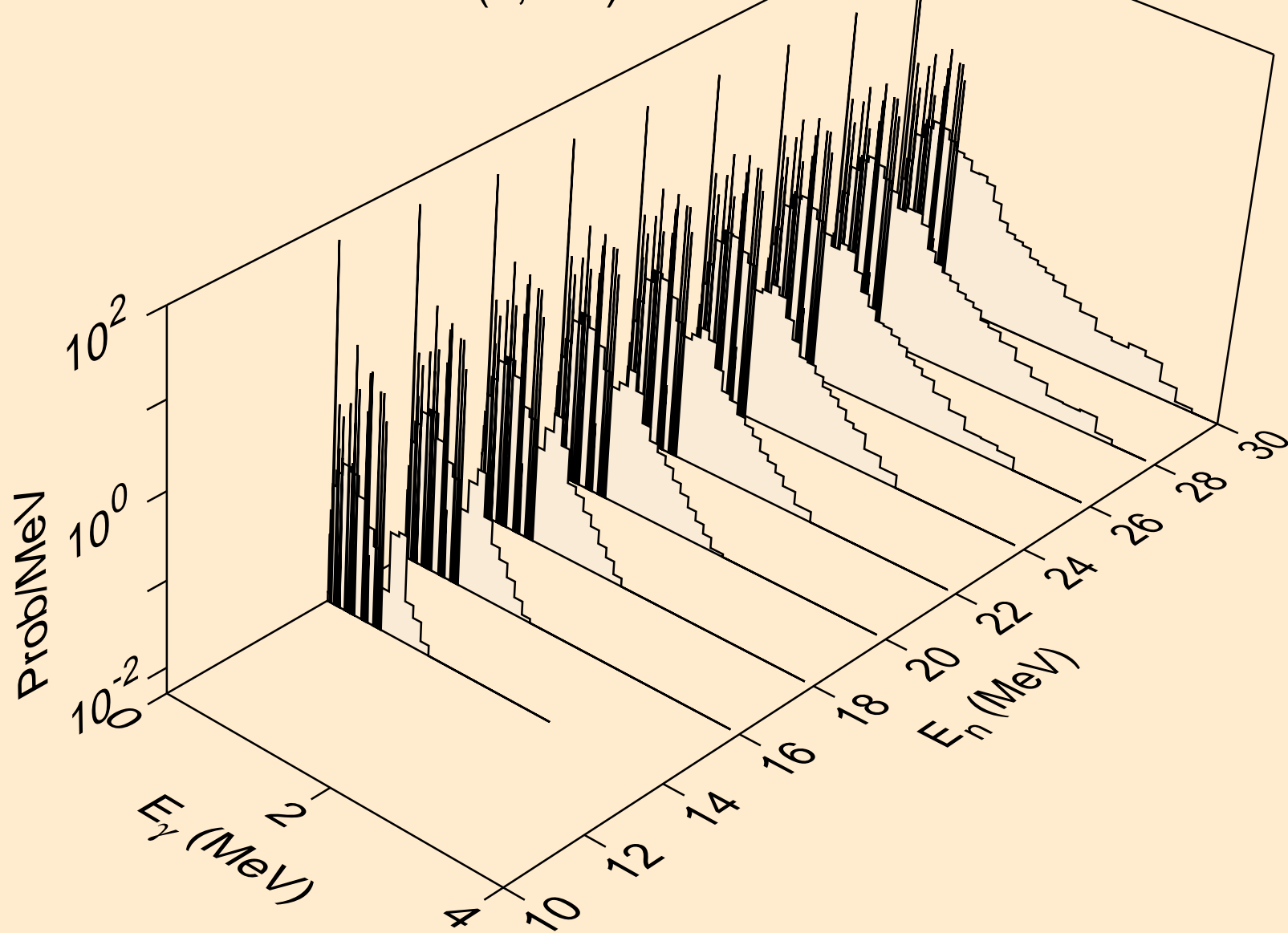

TL209 TRITON ACER TENDL-2021 LIBRARY; T=0.K  
Photon emission for (n,2n)

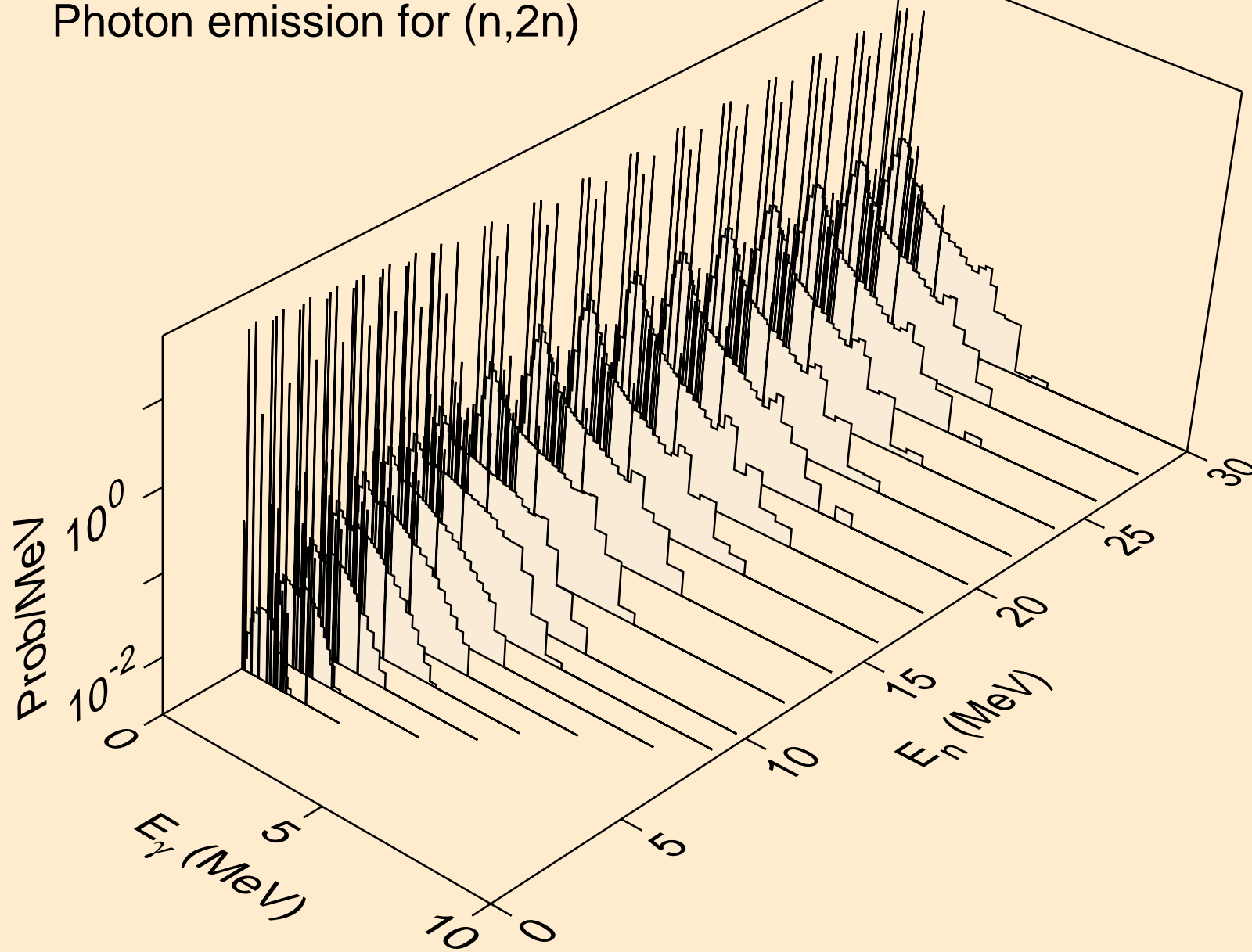

TL209 TRITON ACER TENDL-2021 LIBRARY; T=0.K  
Photon emission for (n,3n)

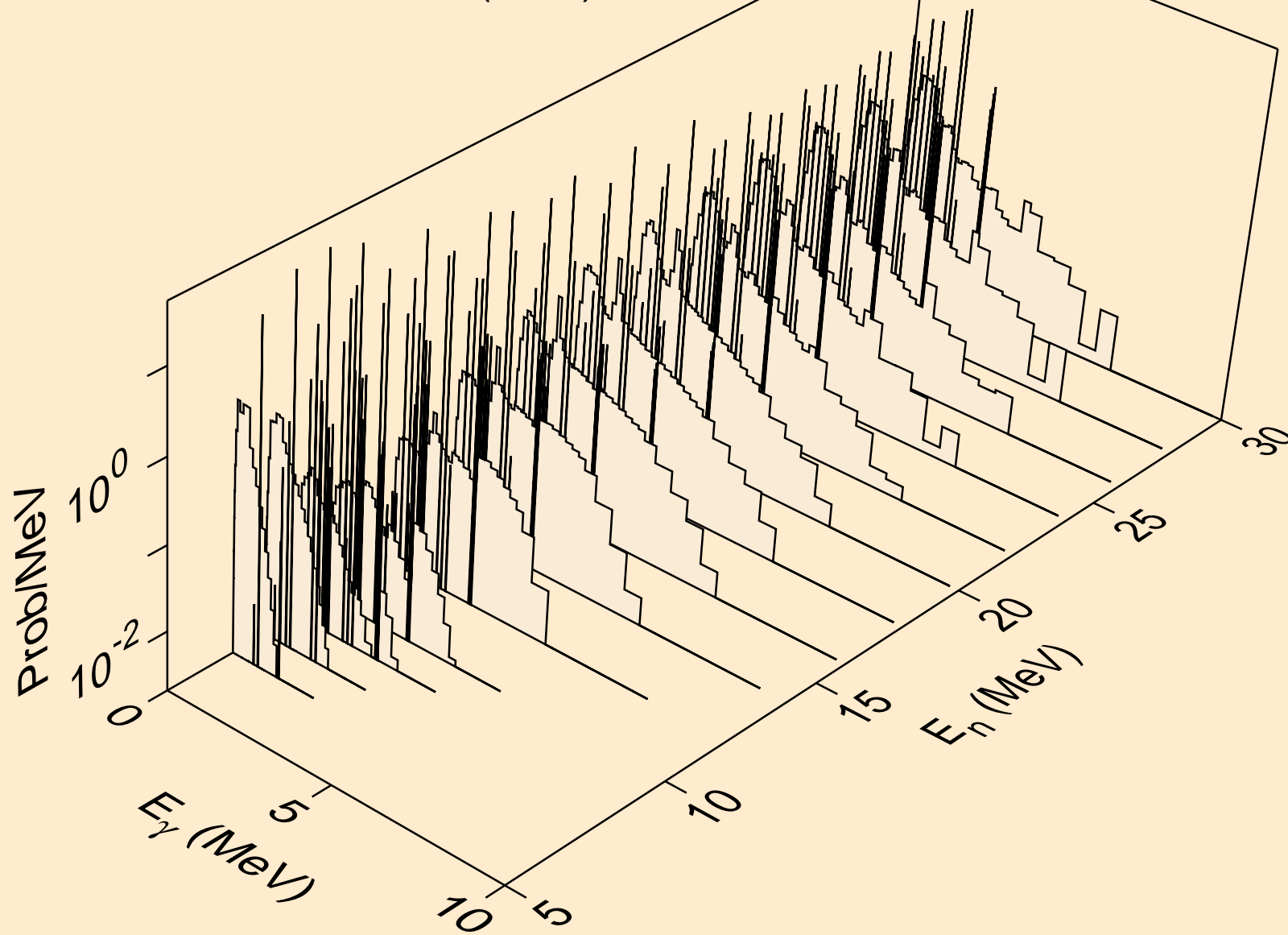



TL209 TRITON ACER TENDL-2021 LIBRARY; T=0.K  
Photon emission for (n,n\*)a

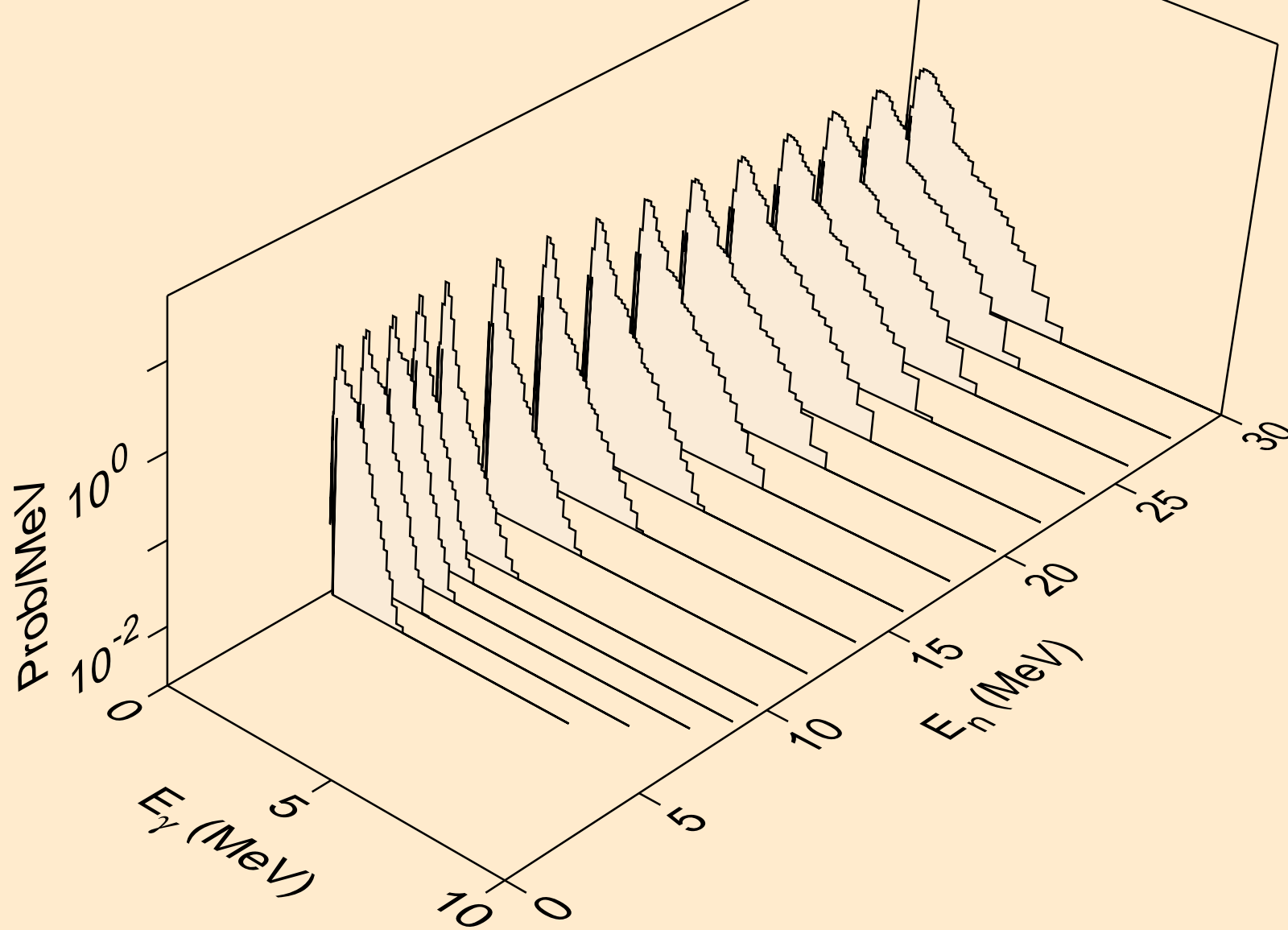

TL209 TRITON ACER TENDL-2021 LIBRARY; T=0.K  
Photon emission for (n,2n)a

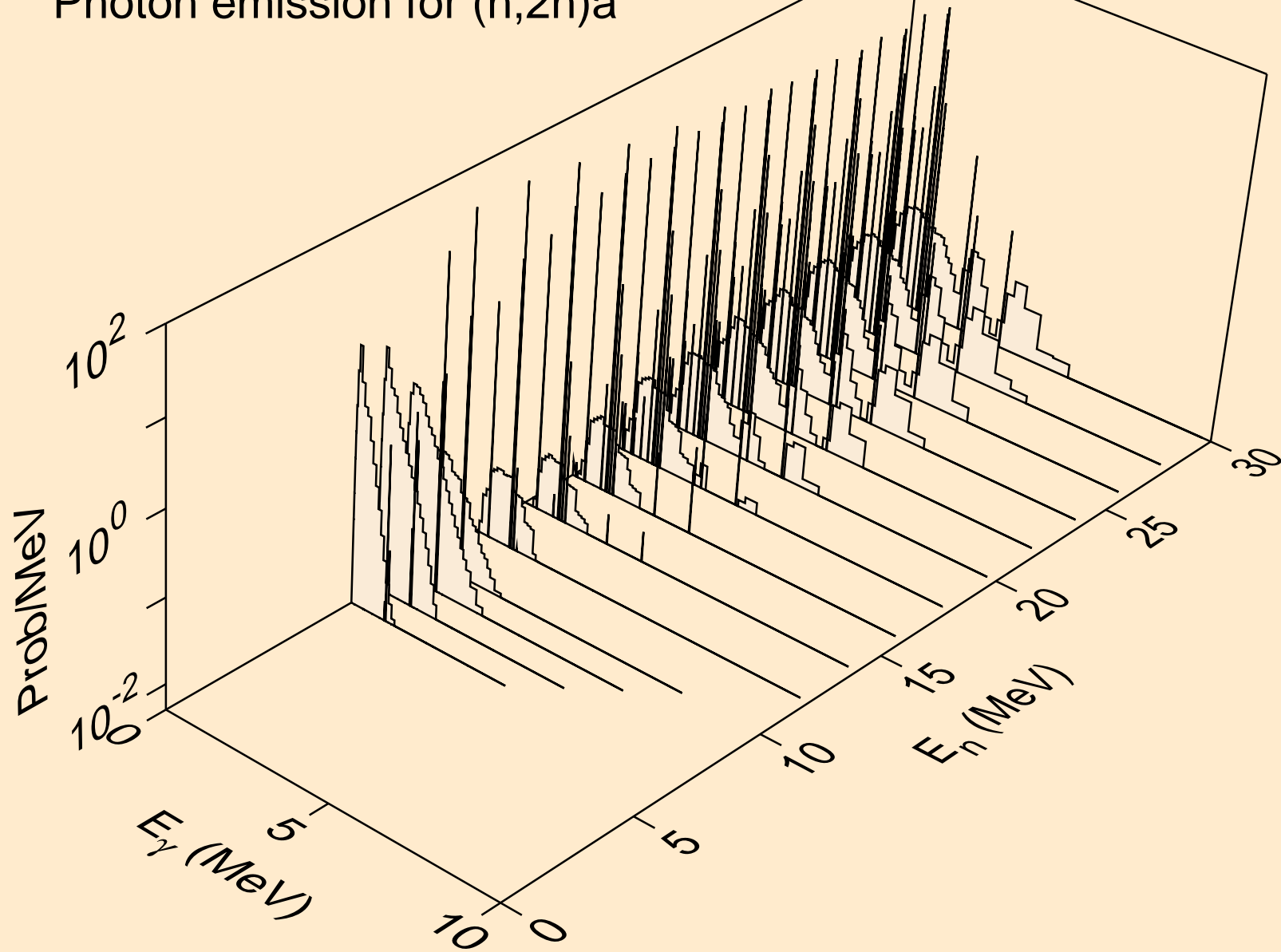

TL209 TRITON ACER TENDL-2021 LIBRARY; T=0.K  
Photon emission for (n,3n)a

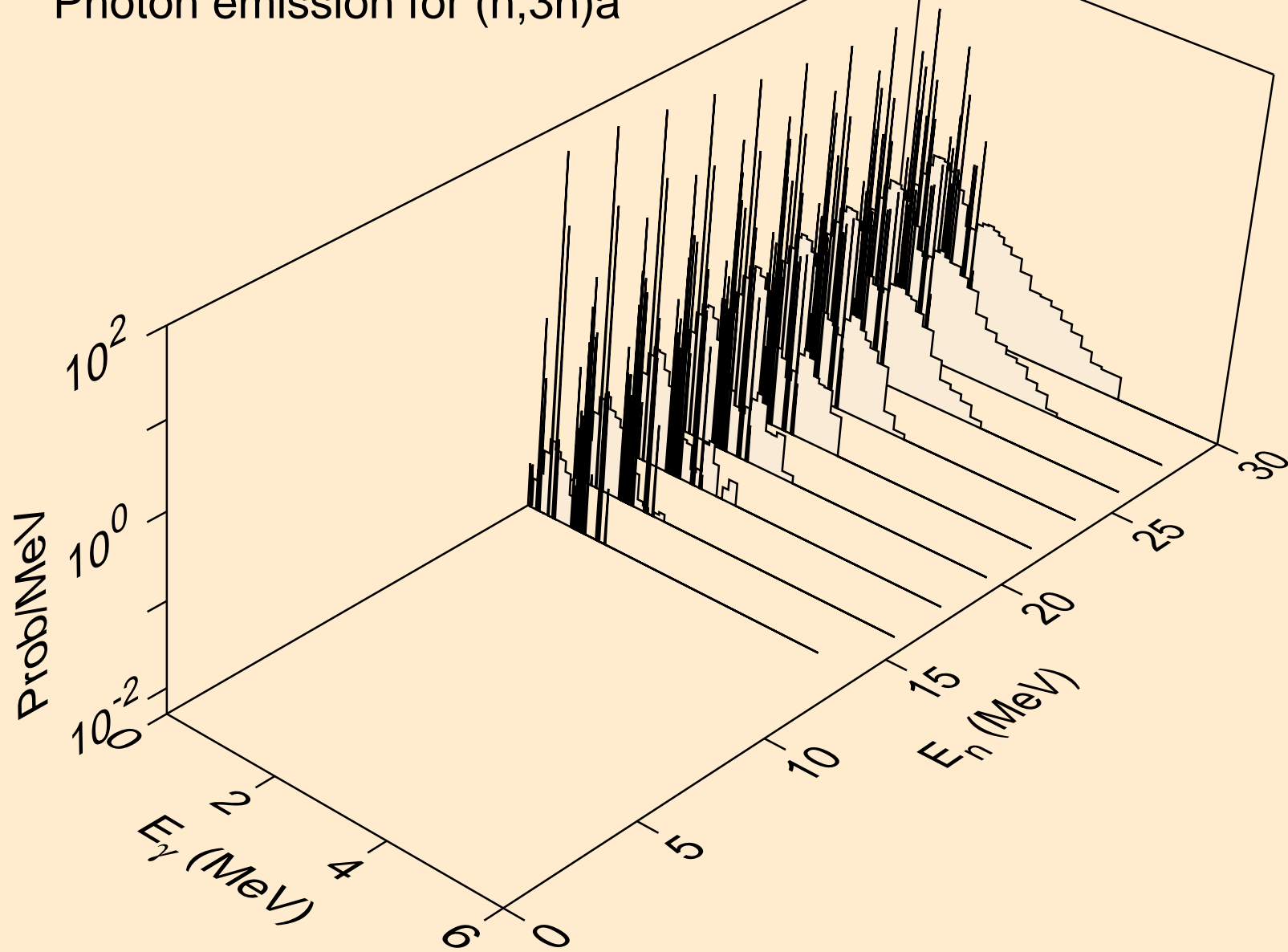

TL209 TRITON ACER TENDL-2021 LIBRARY; T=0.K  
Photon emission for (n,n\*)p

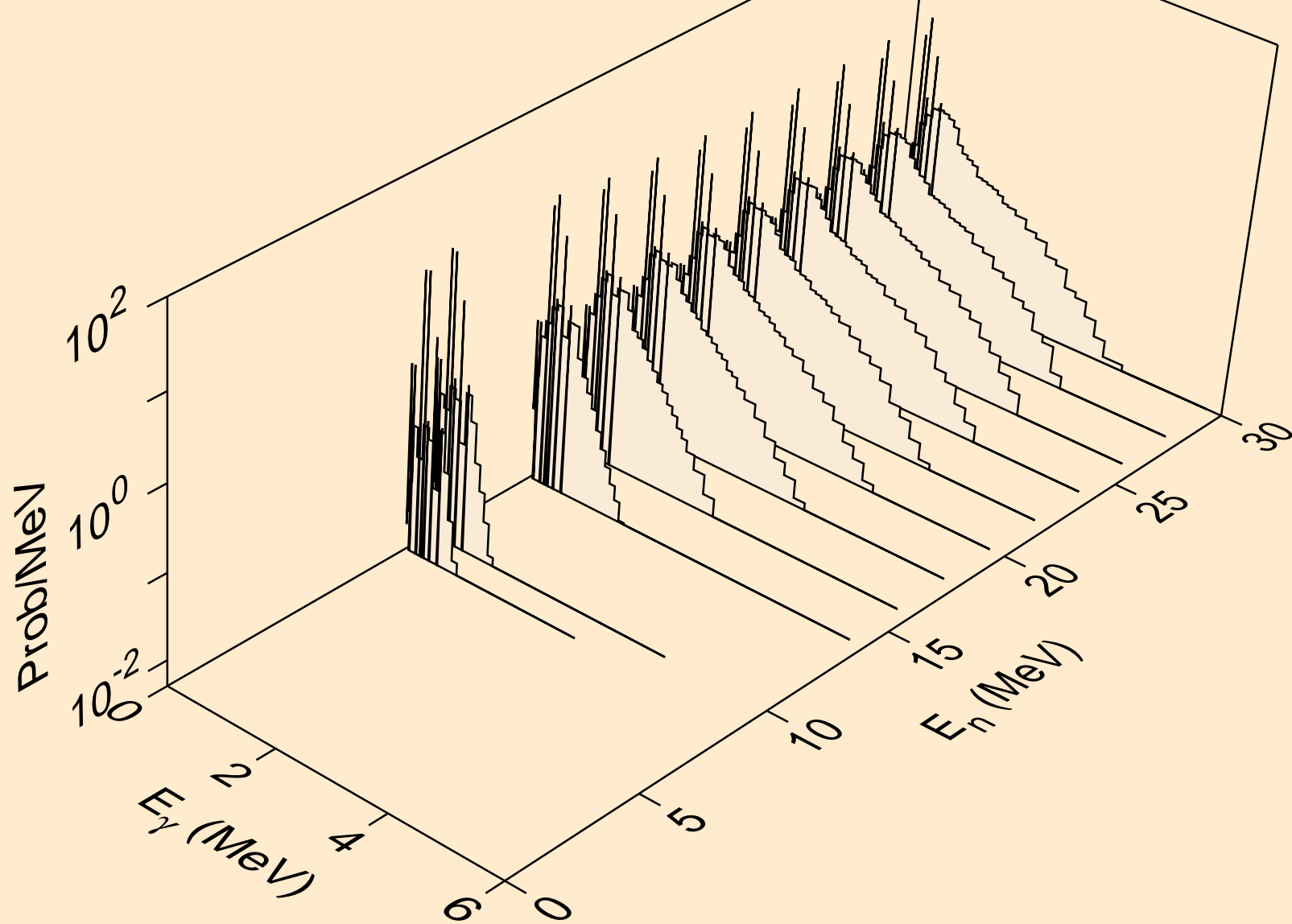

TL209 TRITON ACER TENDL-2021 LIBRARY; T=0.K  
Photon emission for (n,n\*)d

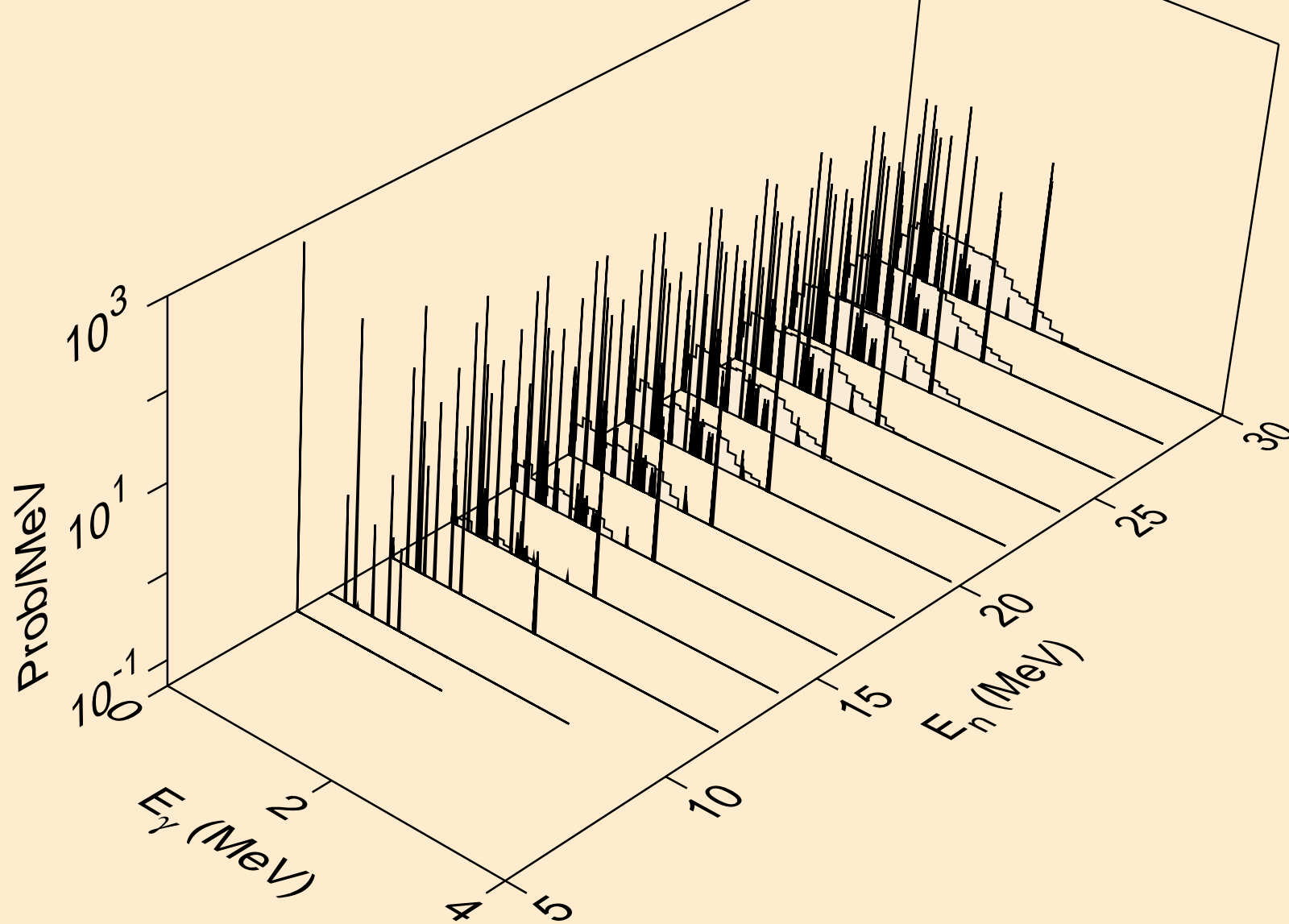

TL209 TRITON ACER TENDL-2021 LIBRARY; T=0.K  
Photon emission for (n,n\*)t

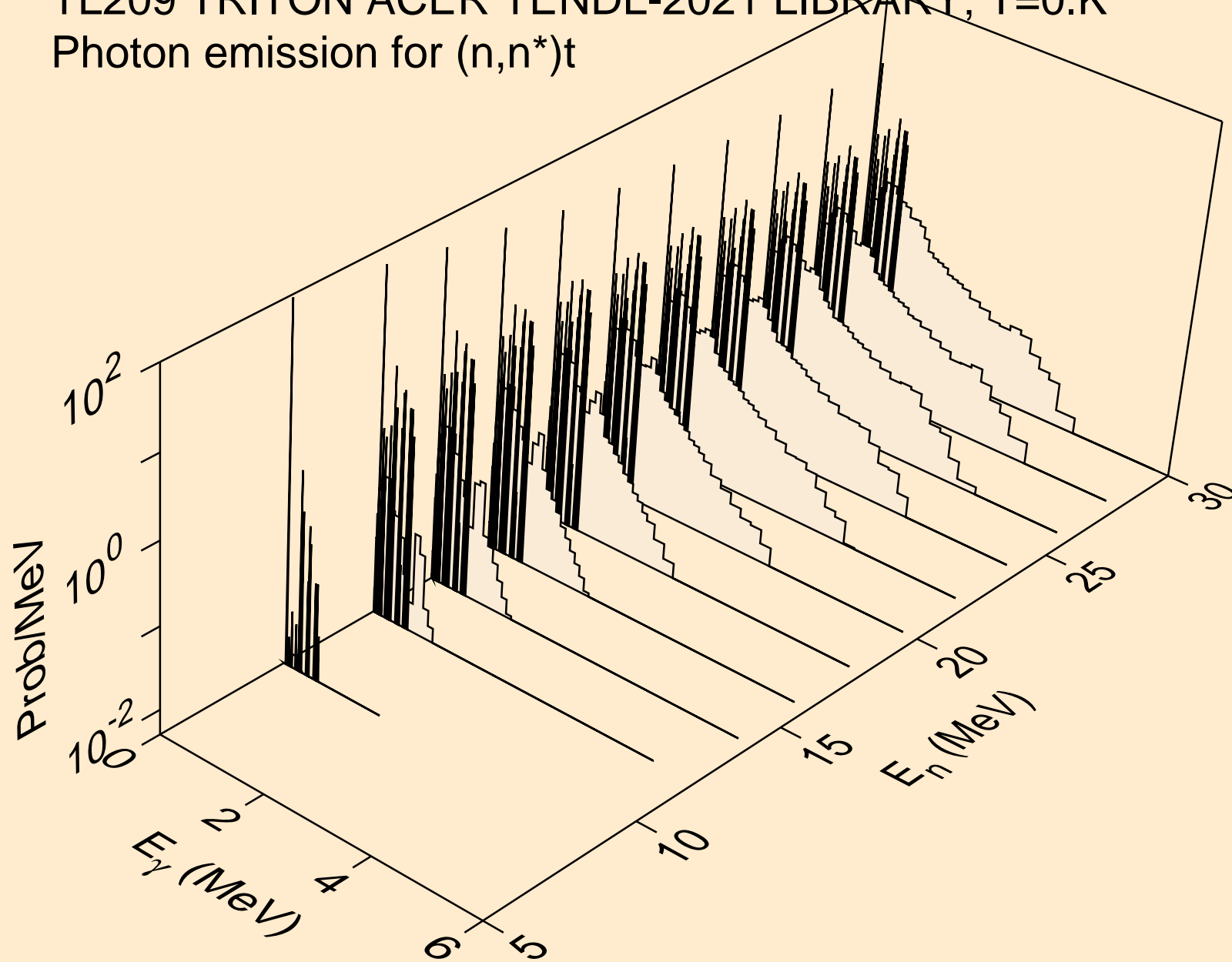

TL209 TRITON ACER TENDL-2021 LIBRARY; T=0.K  
Photon emission for (n,n\*)he3

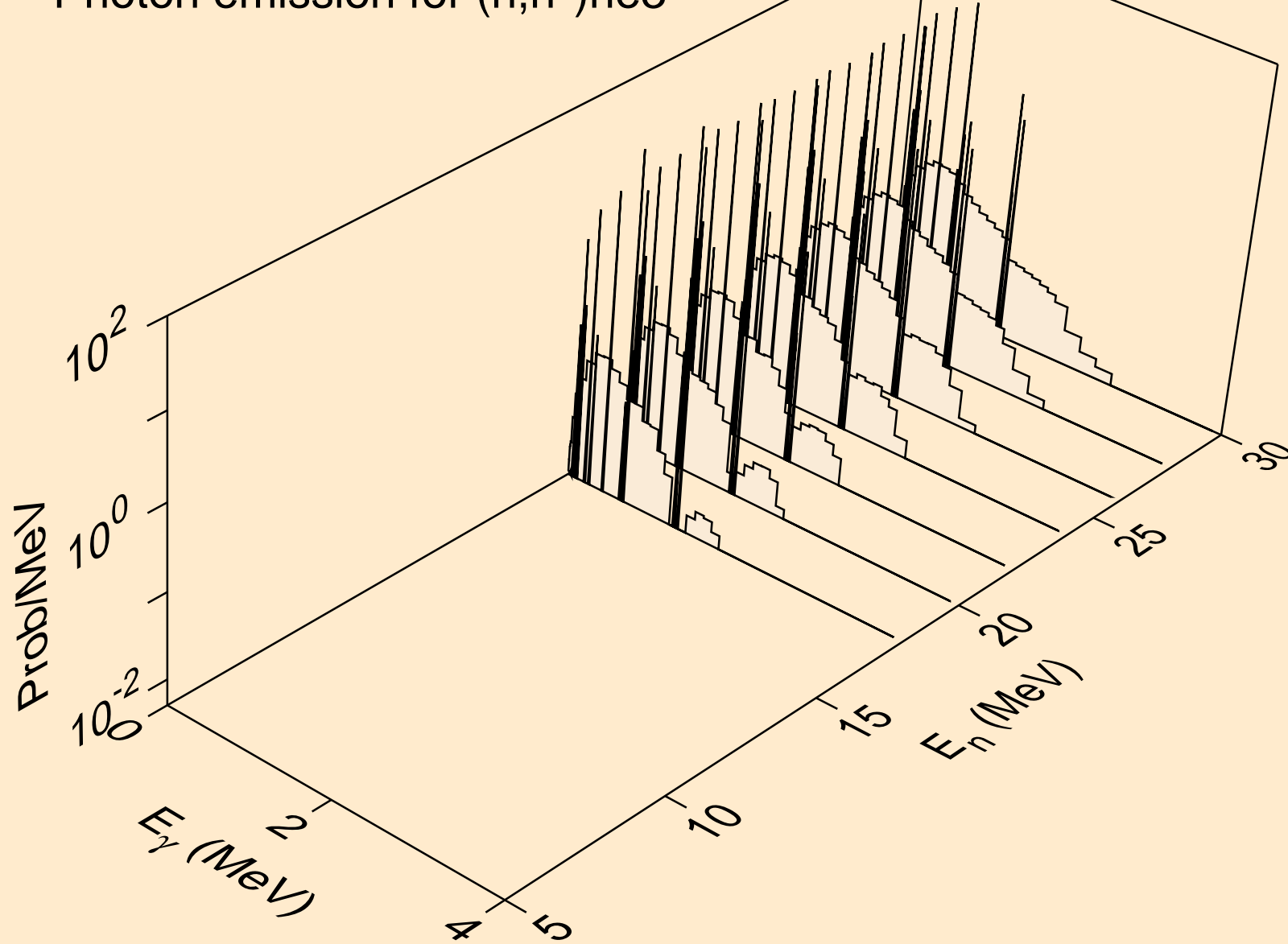

TL209 TRITON ACER TENDL-2021 LIBRARY; T=0.K  
Photon emission for (n,4n)

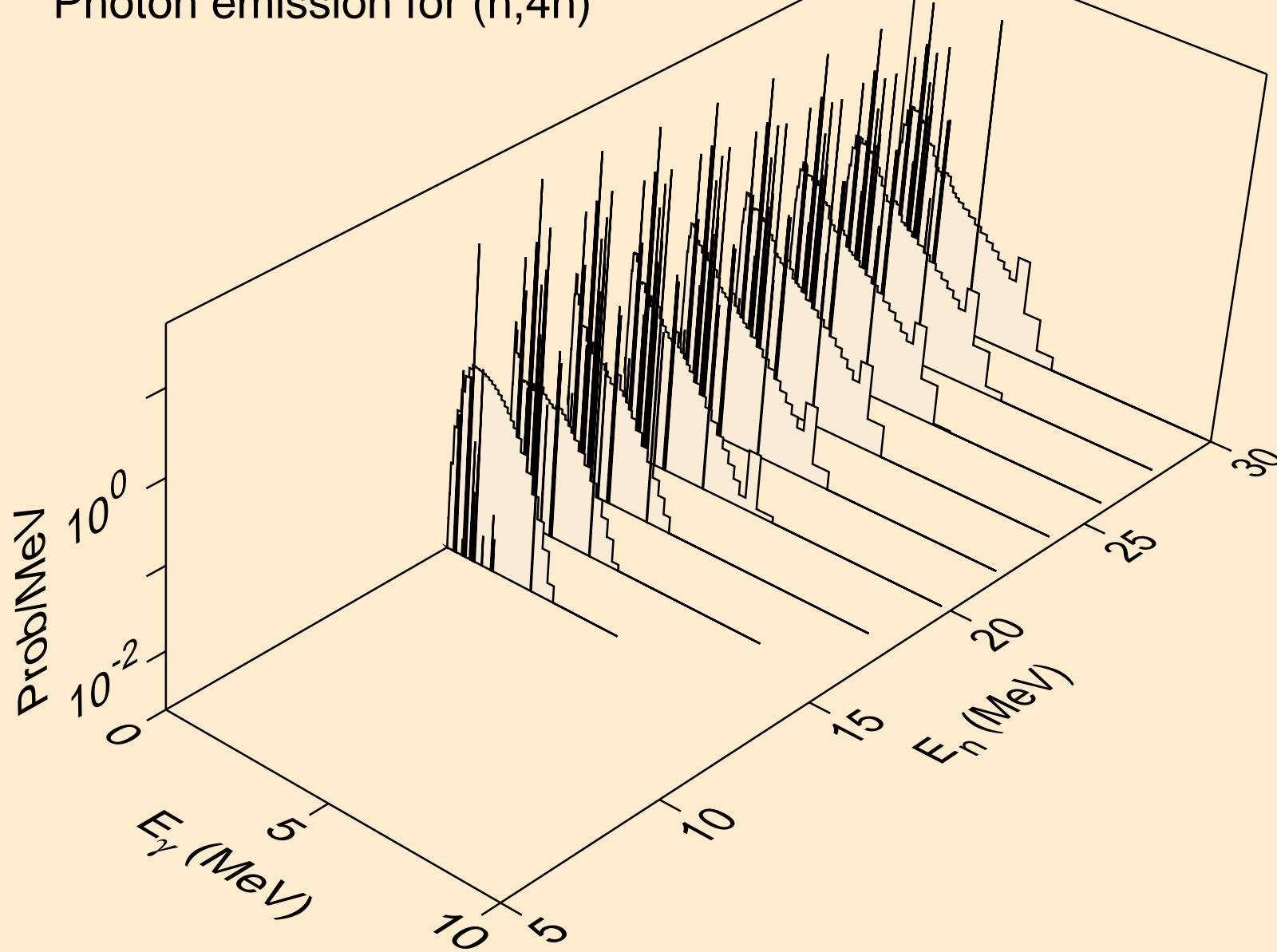



TL209 TRITON ACER TENDL-2021 LIBRARY; T=0.K  
Photon emission for (n,2np)

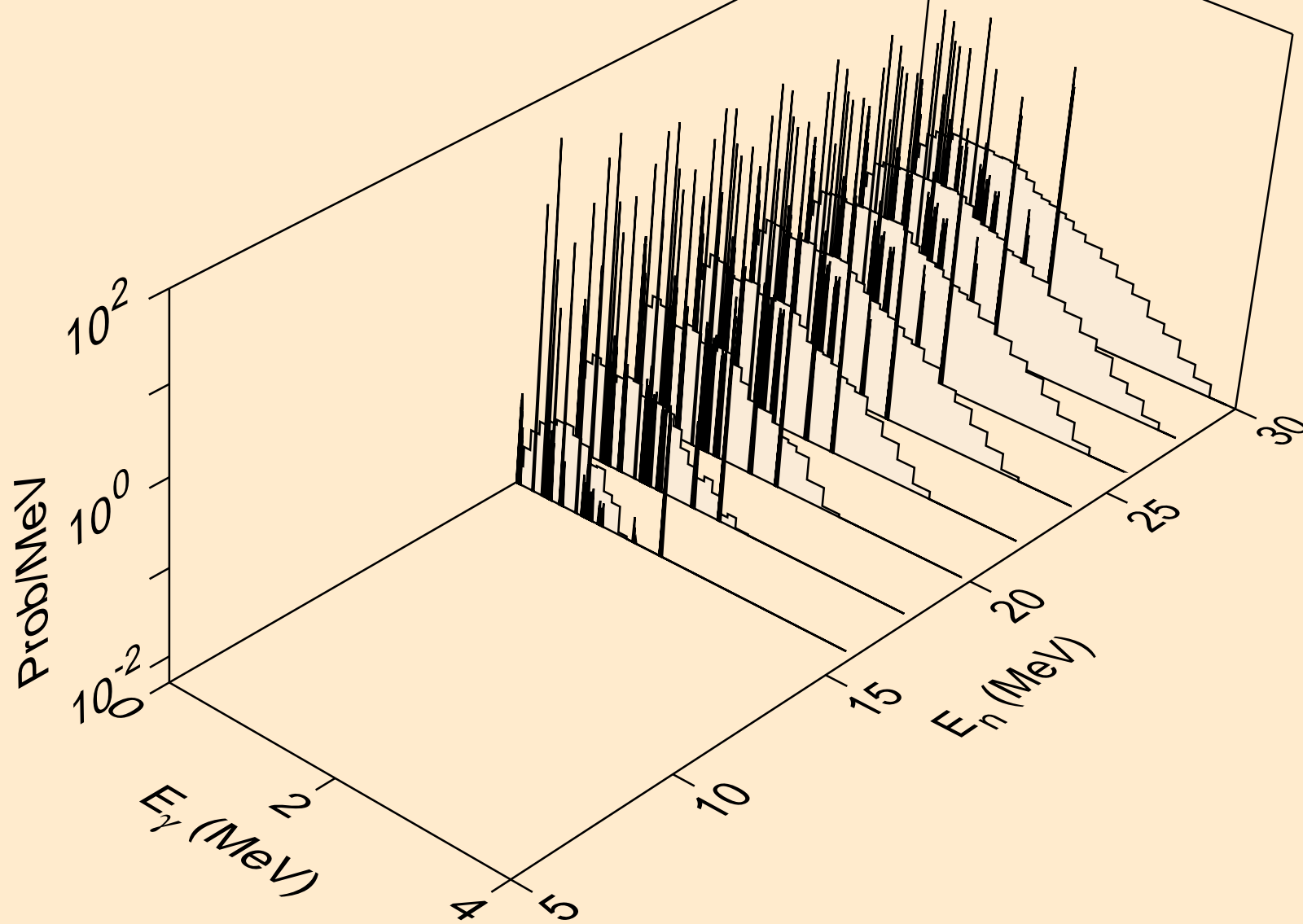

TL209 TRITON ACER TENDL-2021 LIBRARY; T=0.K  
Photon emission for (n,3np)

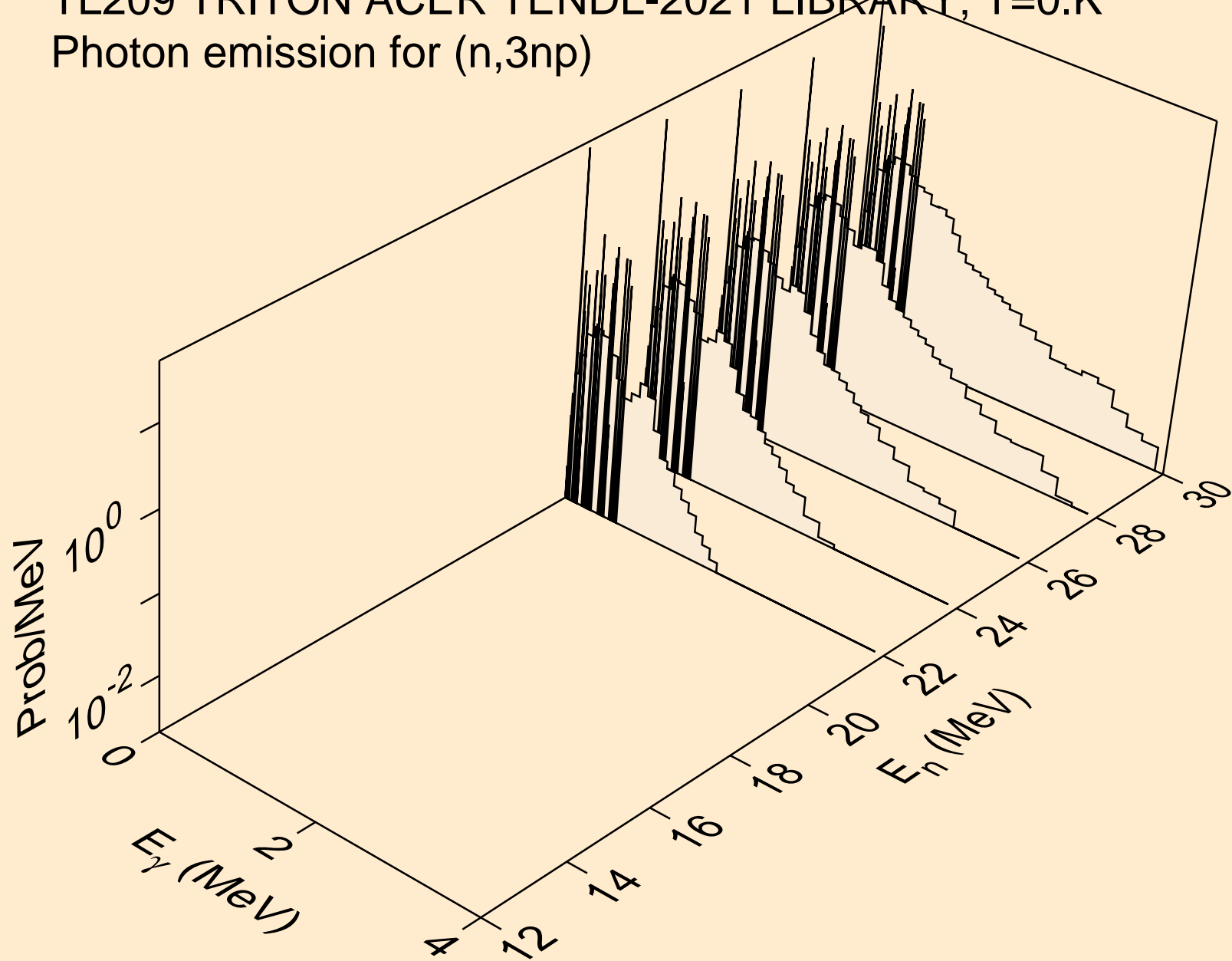

TL209 TRITON ACER TENDL-2021 LIBRARY; T=0.K  
Photon emission for (n,2np)

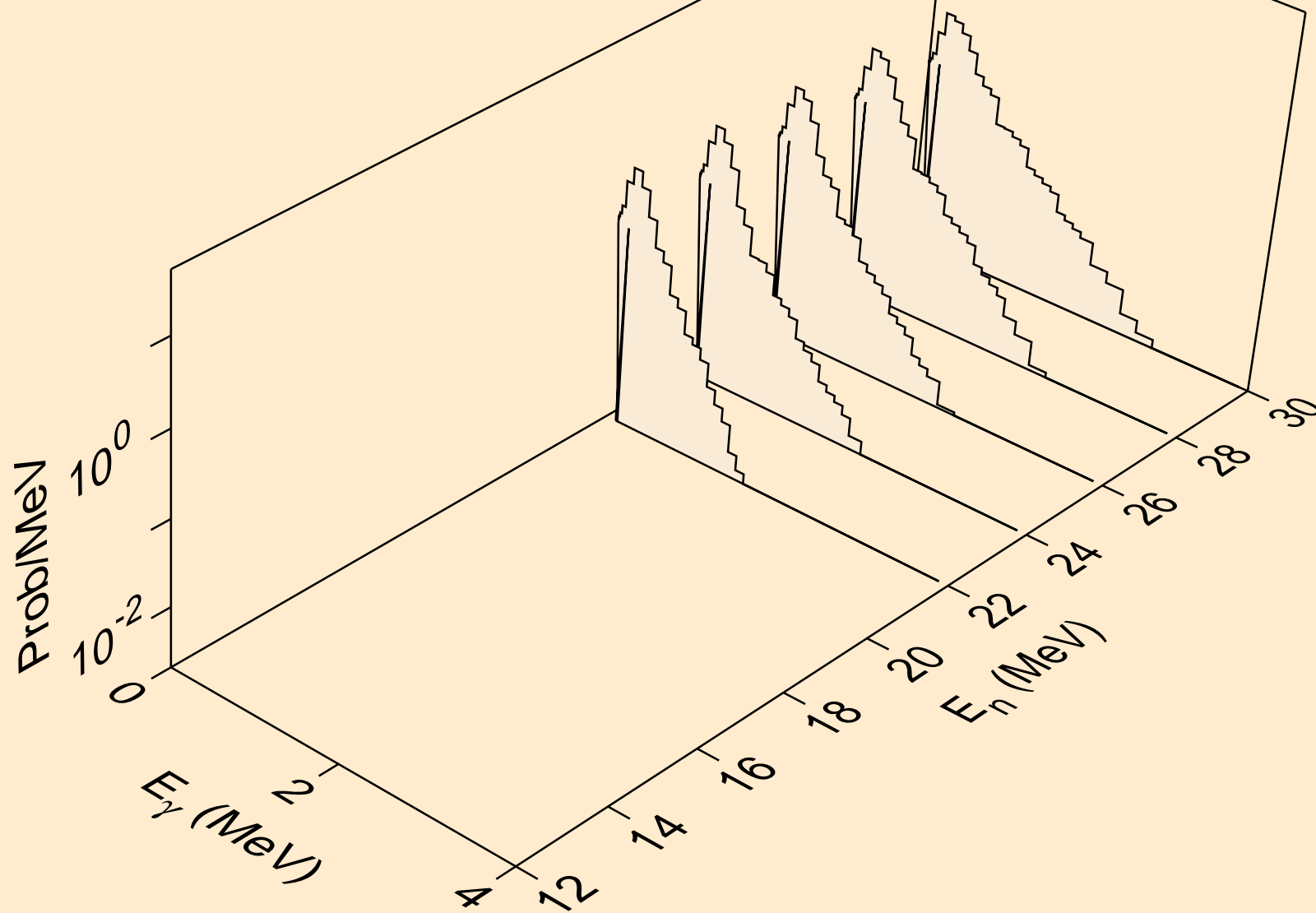

TL209 TRITON ACER TENDL-2021 LIBRARY; T=0.K  
Photon emission for (n,npa)

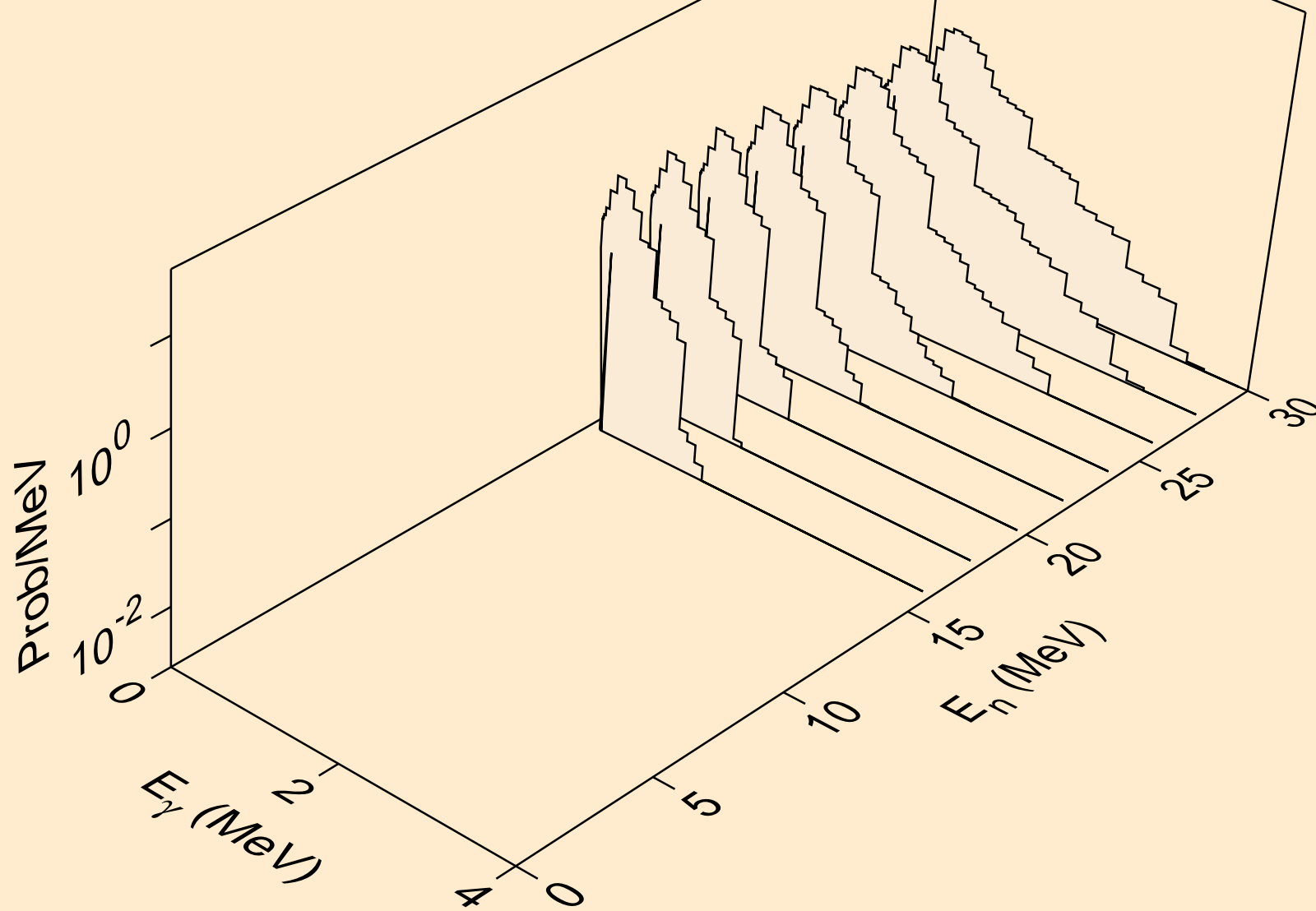

TL209 TRITON ACER TENDL-2021 LIBRARY; T=0.K  
Photon emission for (n,gma)

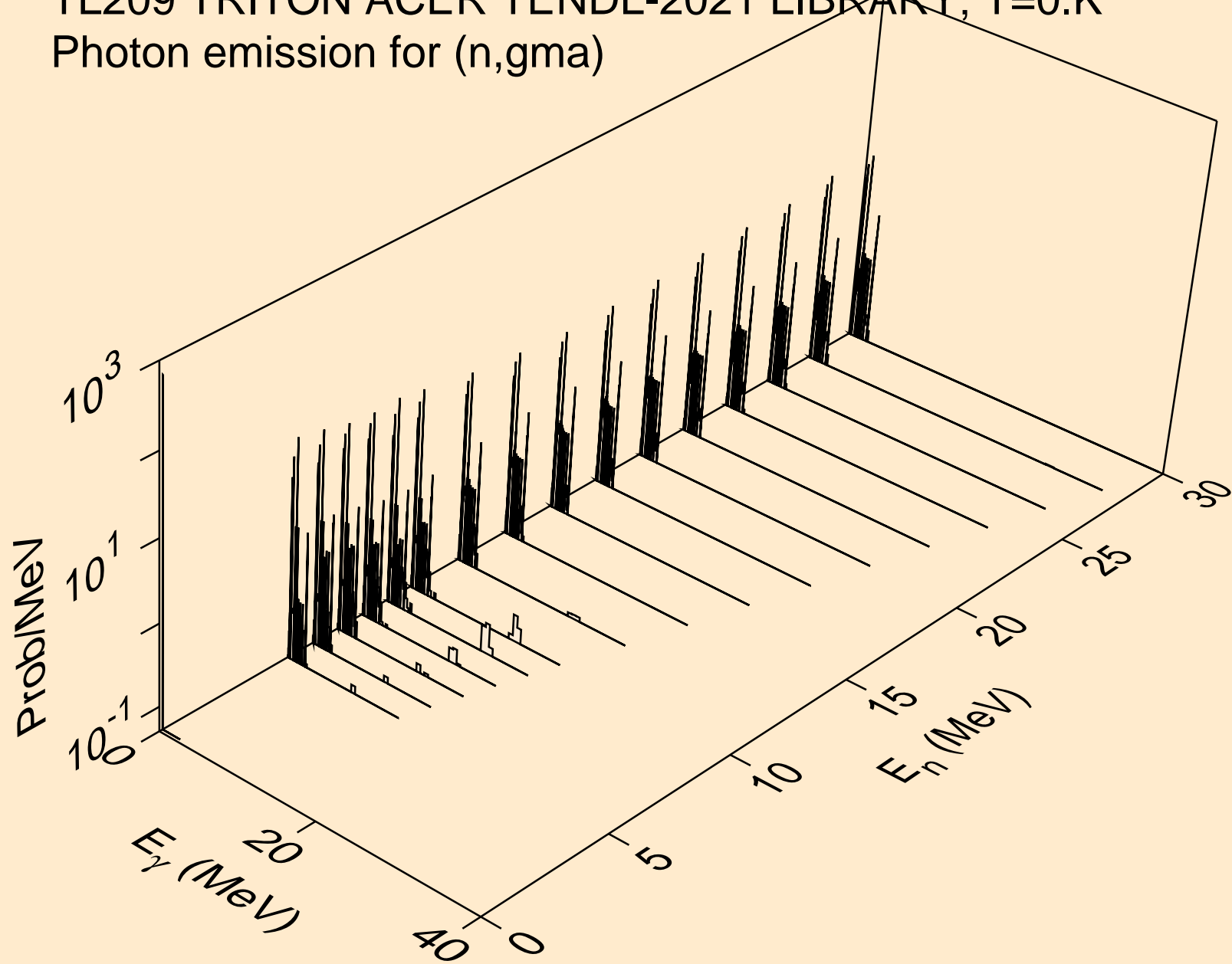

TL209 TRITON ACER TENDL-2021 LIBRARY; T=0.K  
Photon emission for (n,p)

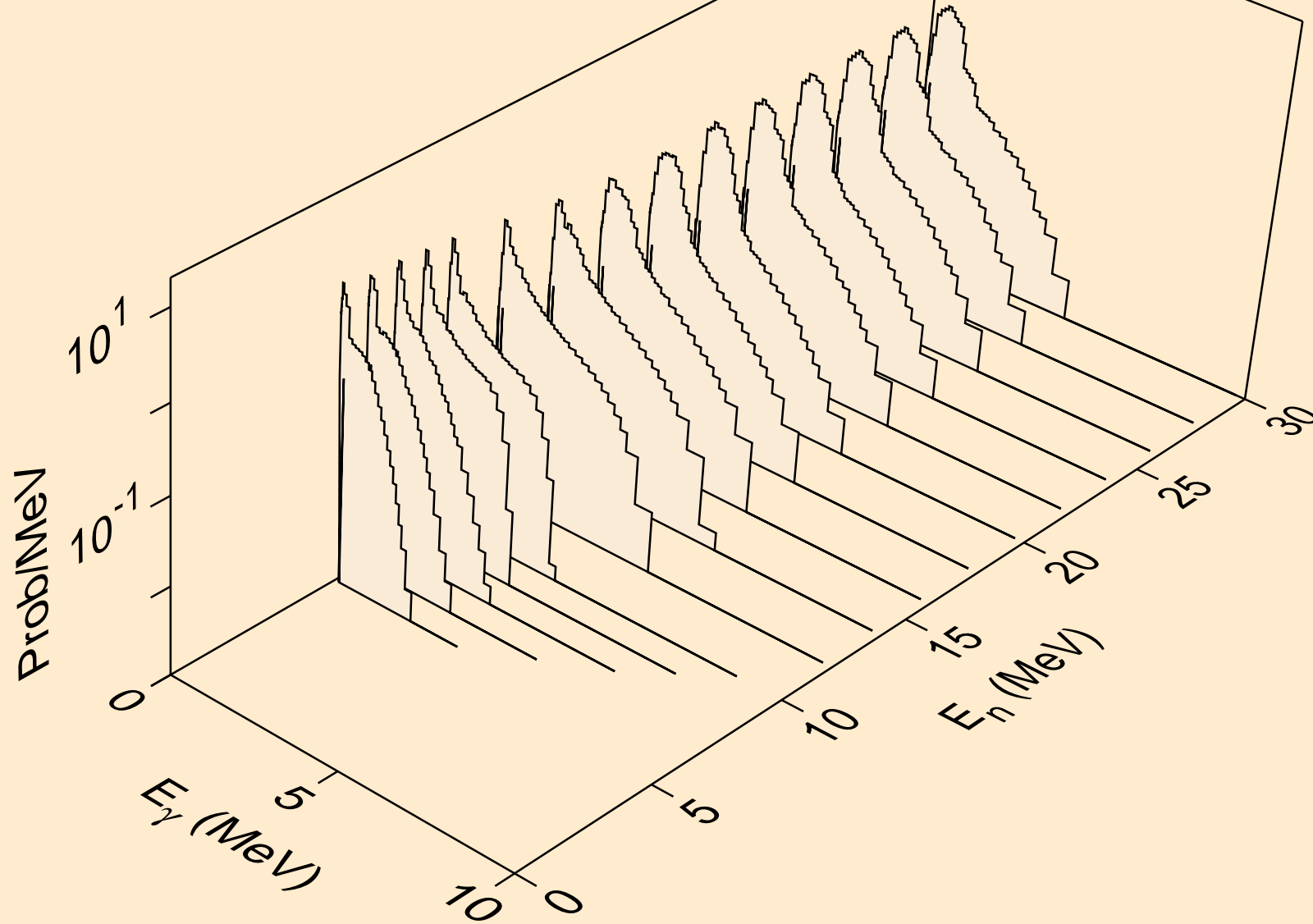

TL209 TRITON ACER TENDL-2021 LIBRARY; T=0.K  
Photon emission for (n,d)

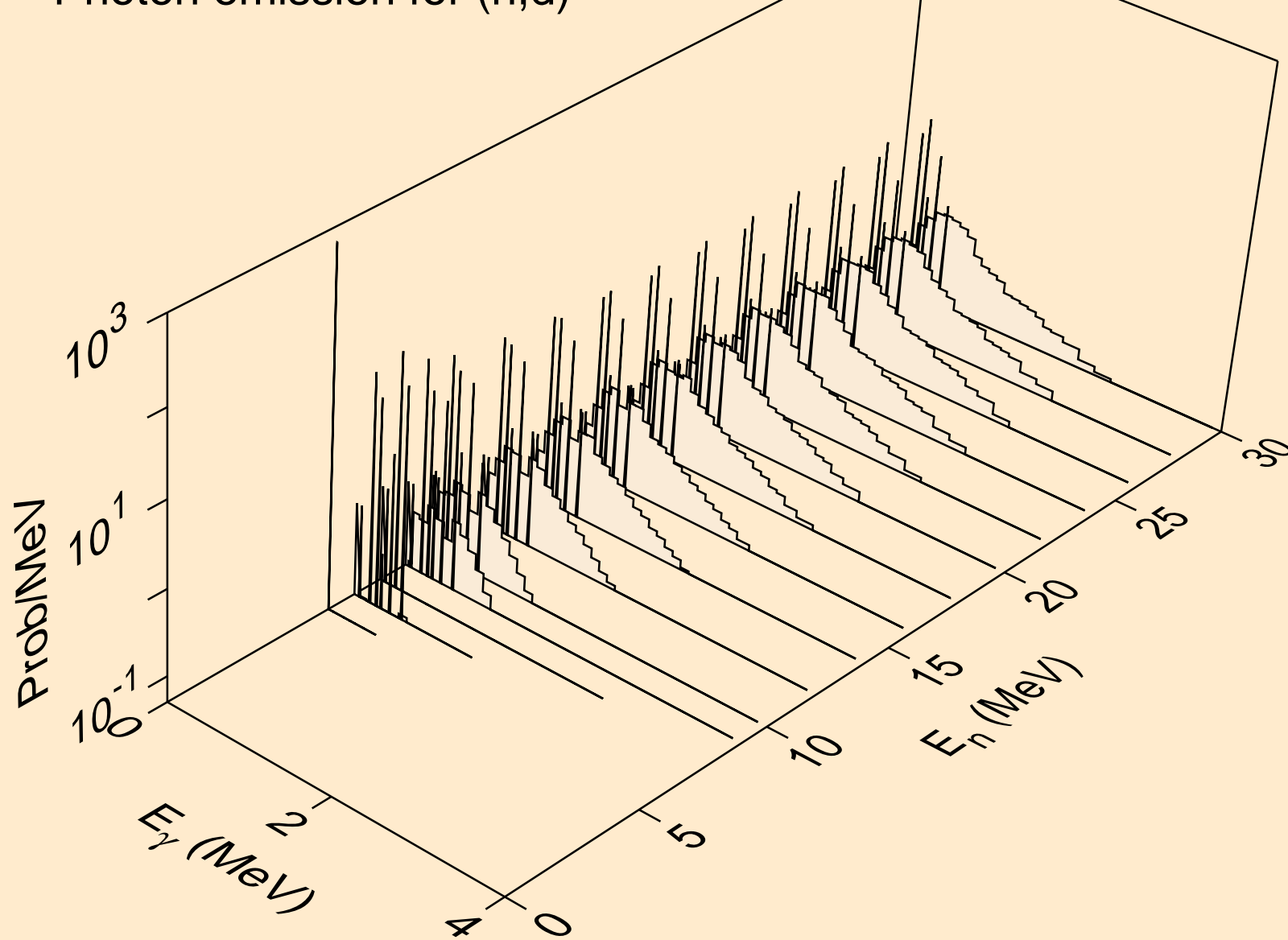

TL209 TRITON ACER TENDL-2021 LIBRARY; T=0.K  
Photon emission for inelastic

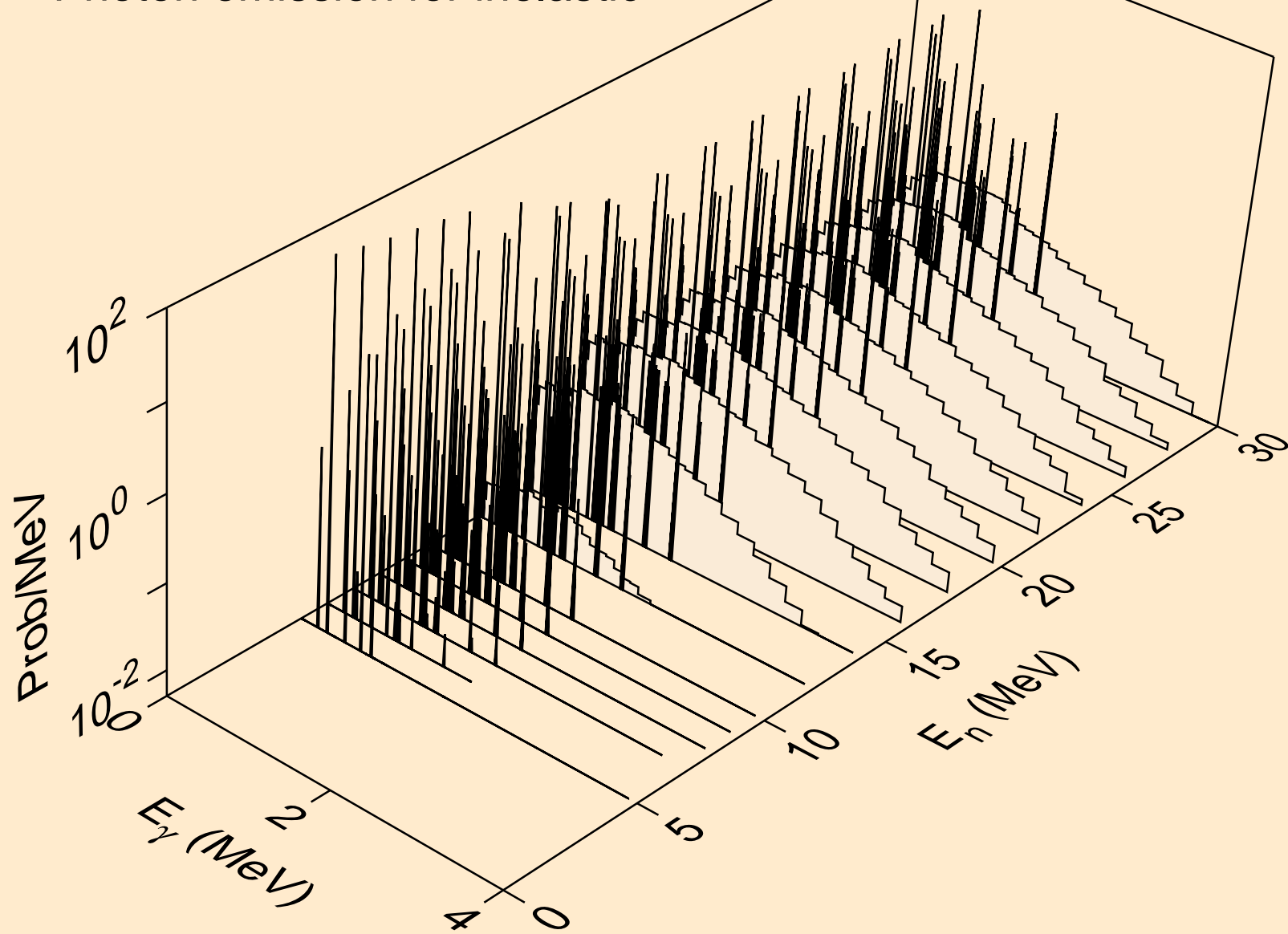



TL209 TRITON ACER TENDL-2021 LIBRARY; T=0.K  
Photon emission for (n,he3)

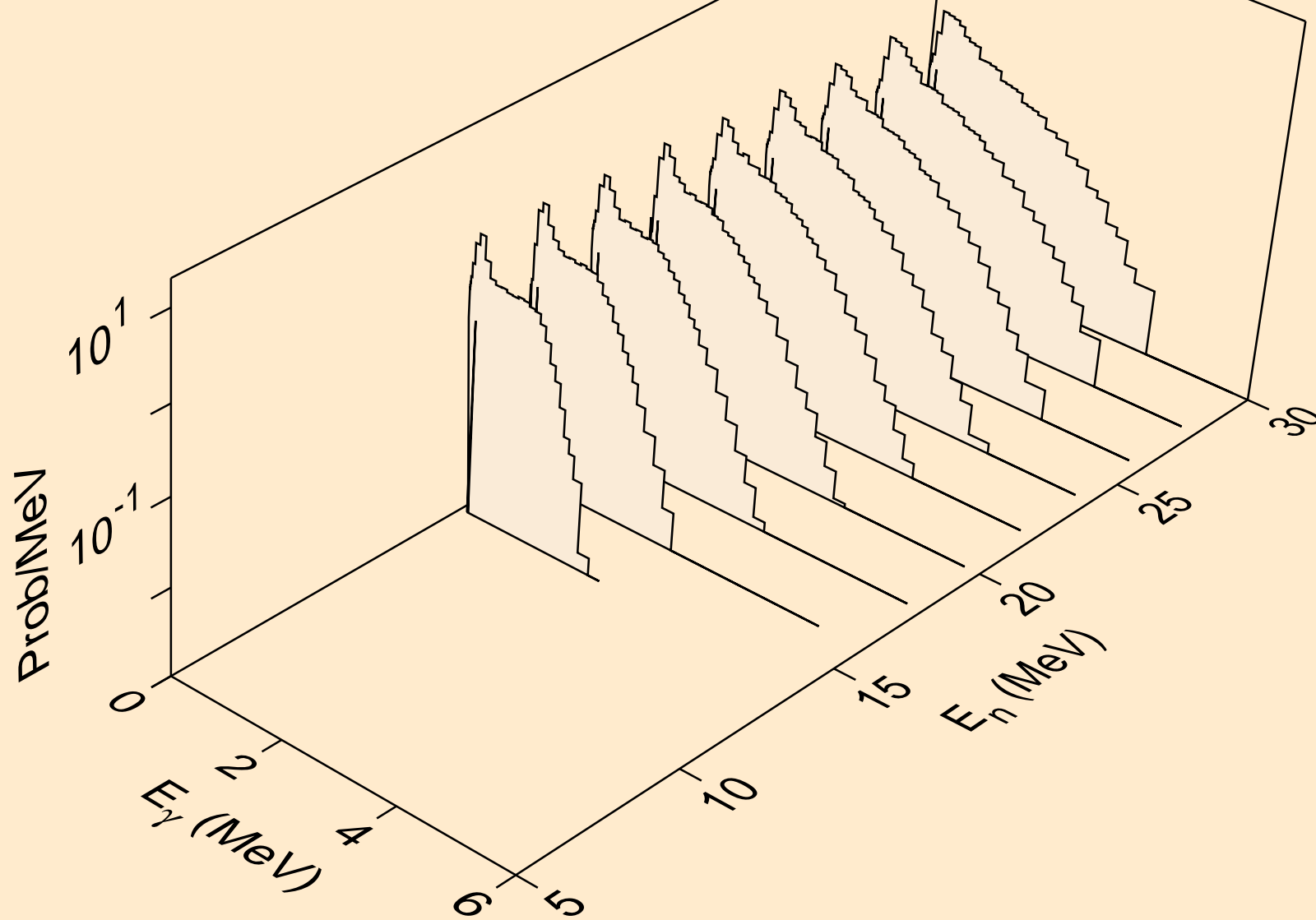

TL209 TRITON ACER TENDL-2021 LIBRARY; T=0.K  
Photon emission for (n,a)

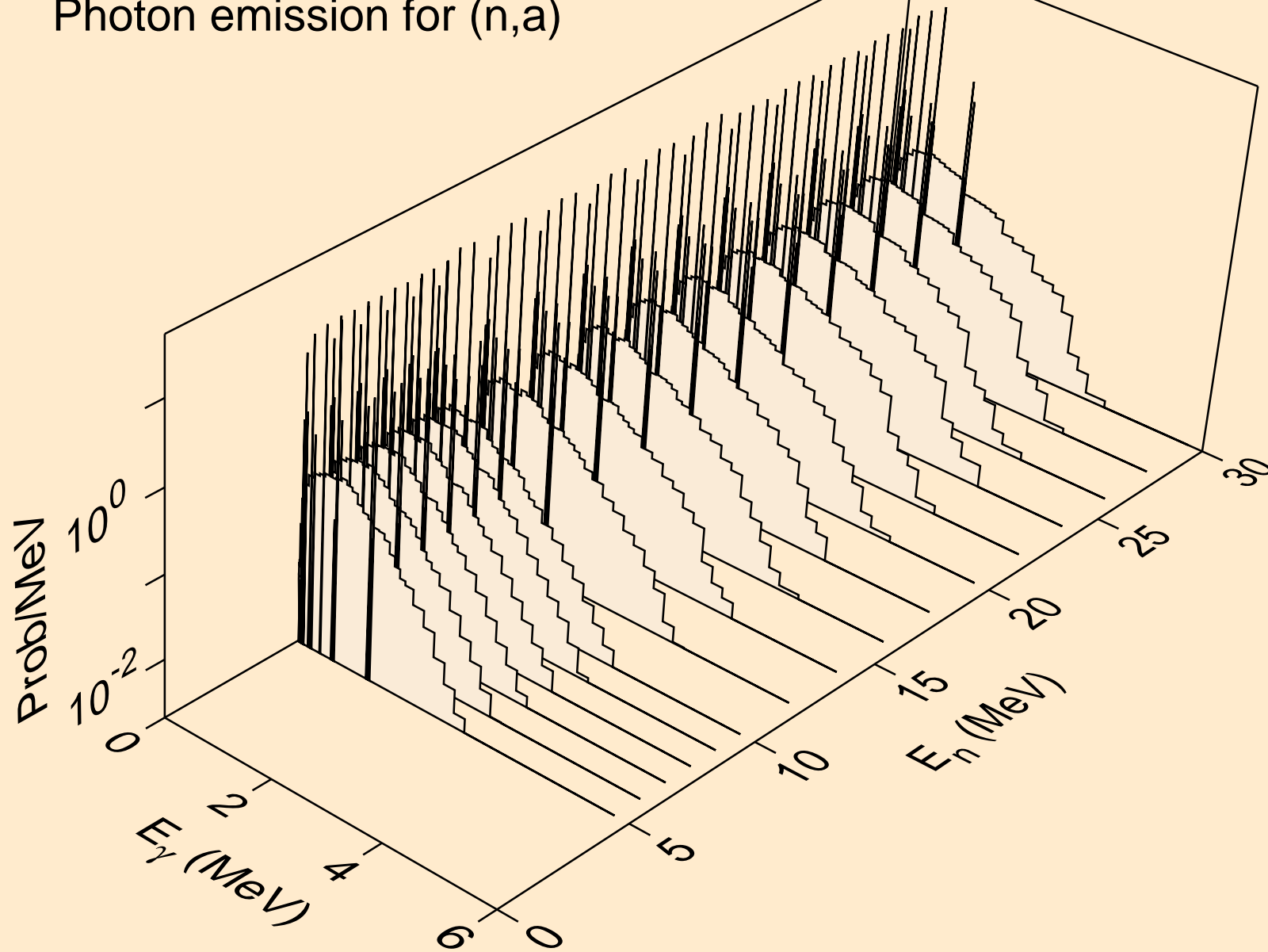

TL209 TRITON ACER TENDL-2021 LIBRARY; T=0.K  
Photon emission for (n,2p)

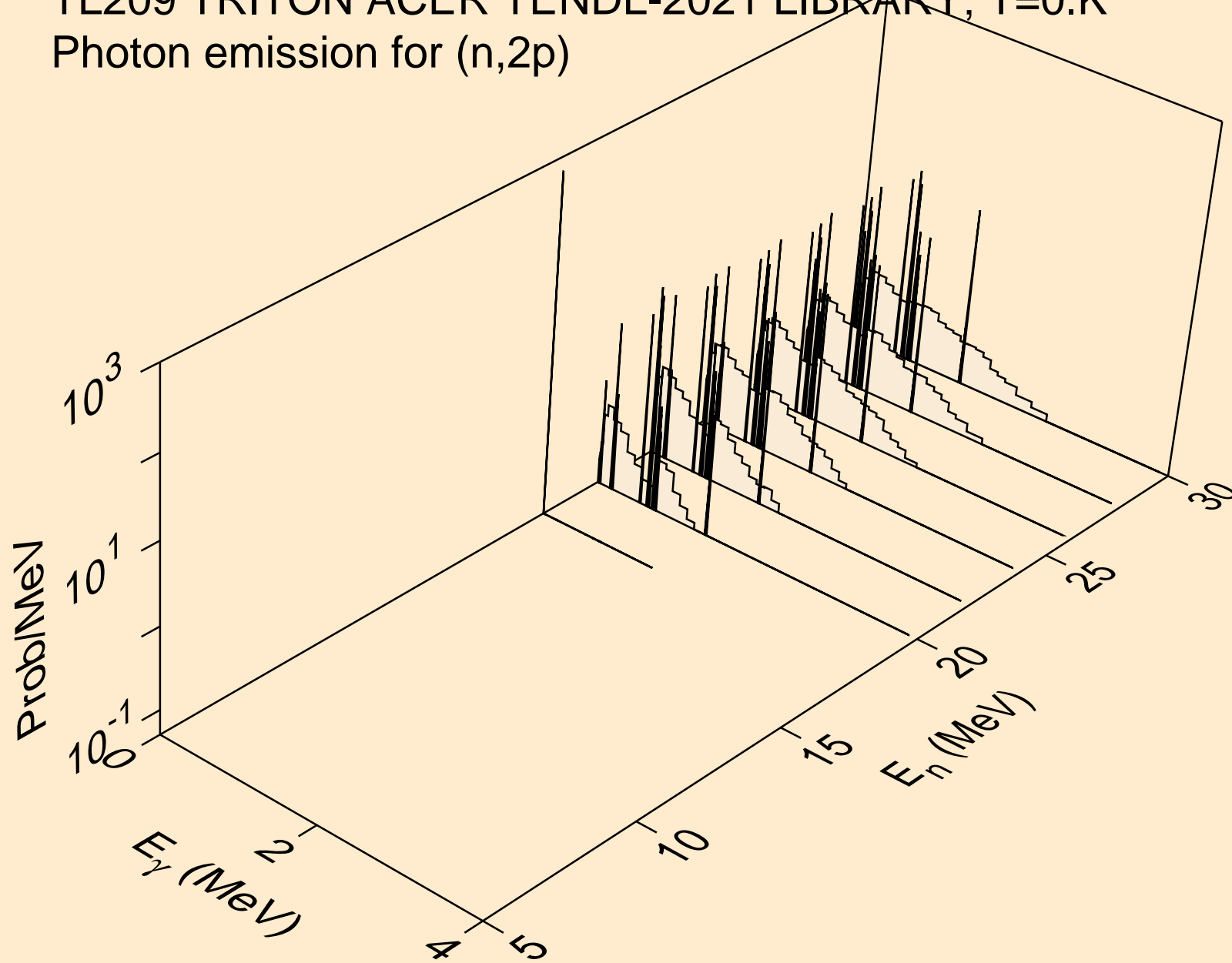

TL209 TRITON ACER TENDL-2021 LIBRARY; T=0.K  
Photon emission for (n,pa)

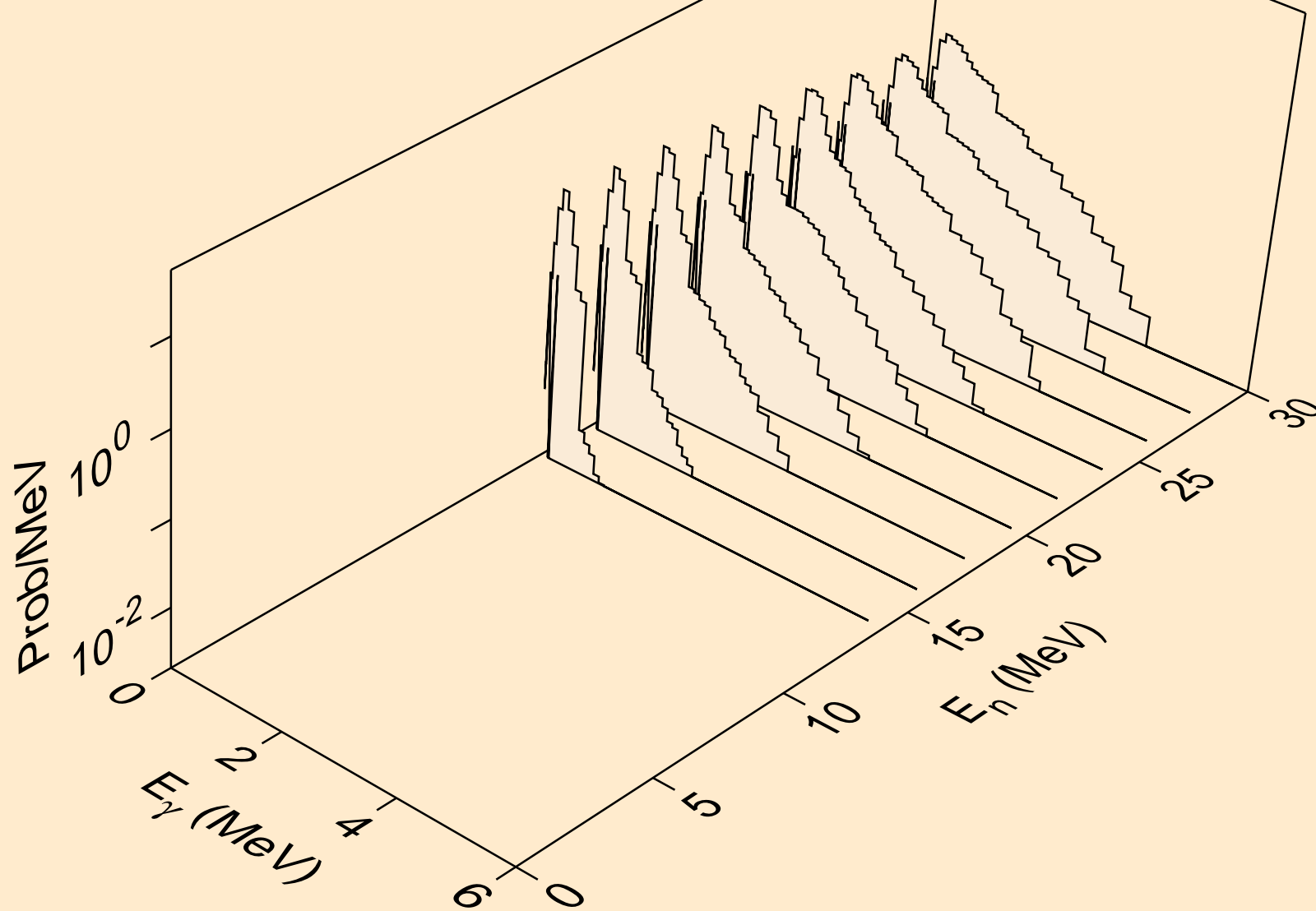

TL209 TRITON ACER TENDL-2021 LIBRARY; T=0.K  
Photon emission for (n,pt)

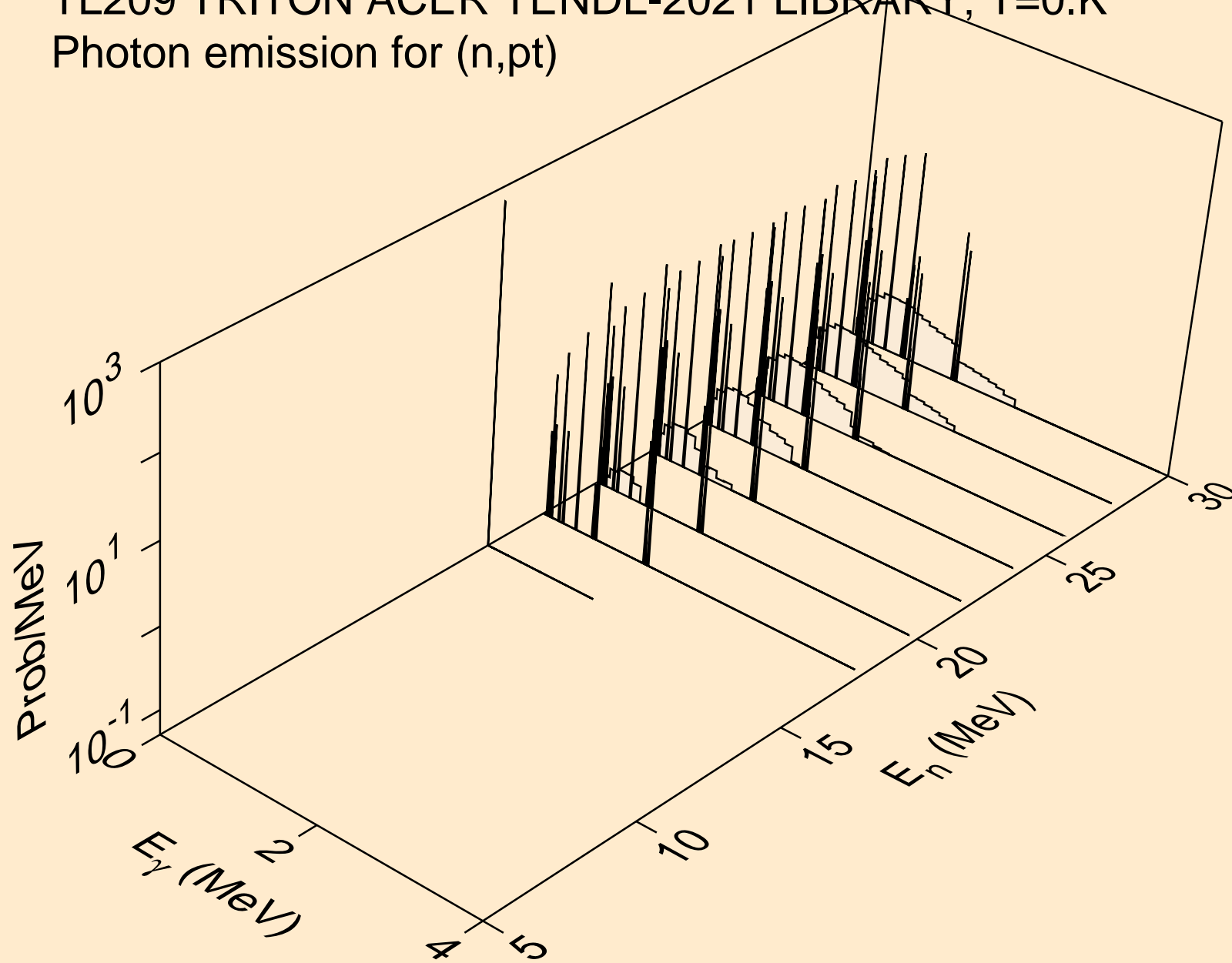

TL209 TRITON ACER TENDL-2021 LIBRARY; T=0.K  
Photon emission for (n,da)

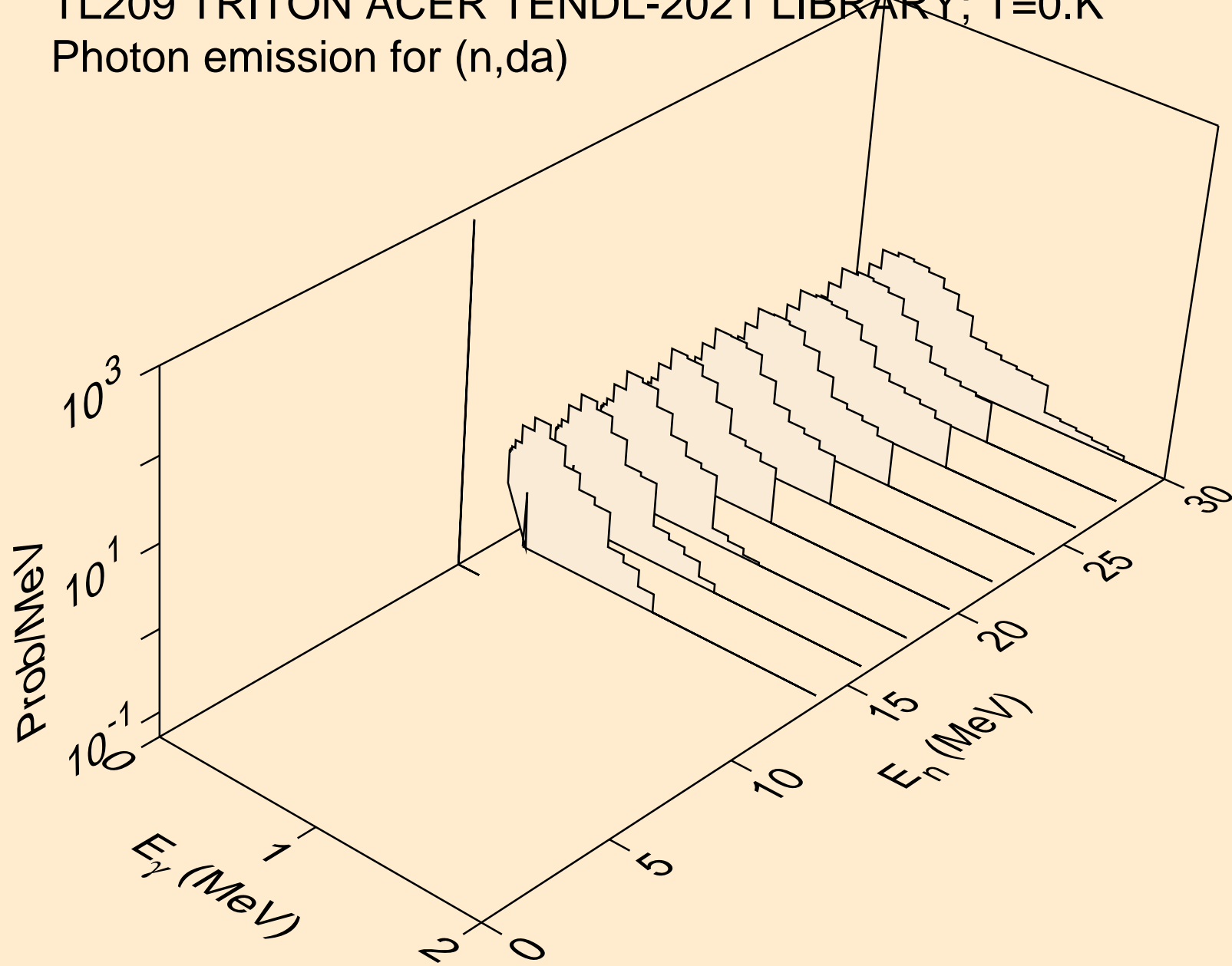

TL209 TRITON ACER TENDL-2021 LIBRARY; T=0.K  
Particle heating contributions

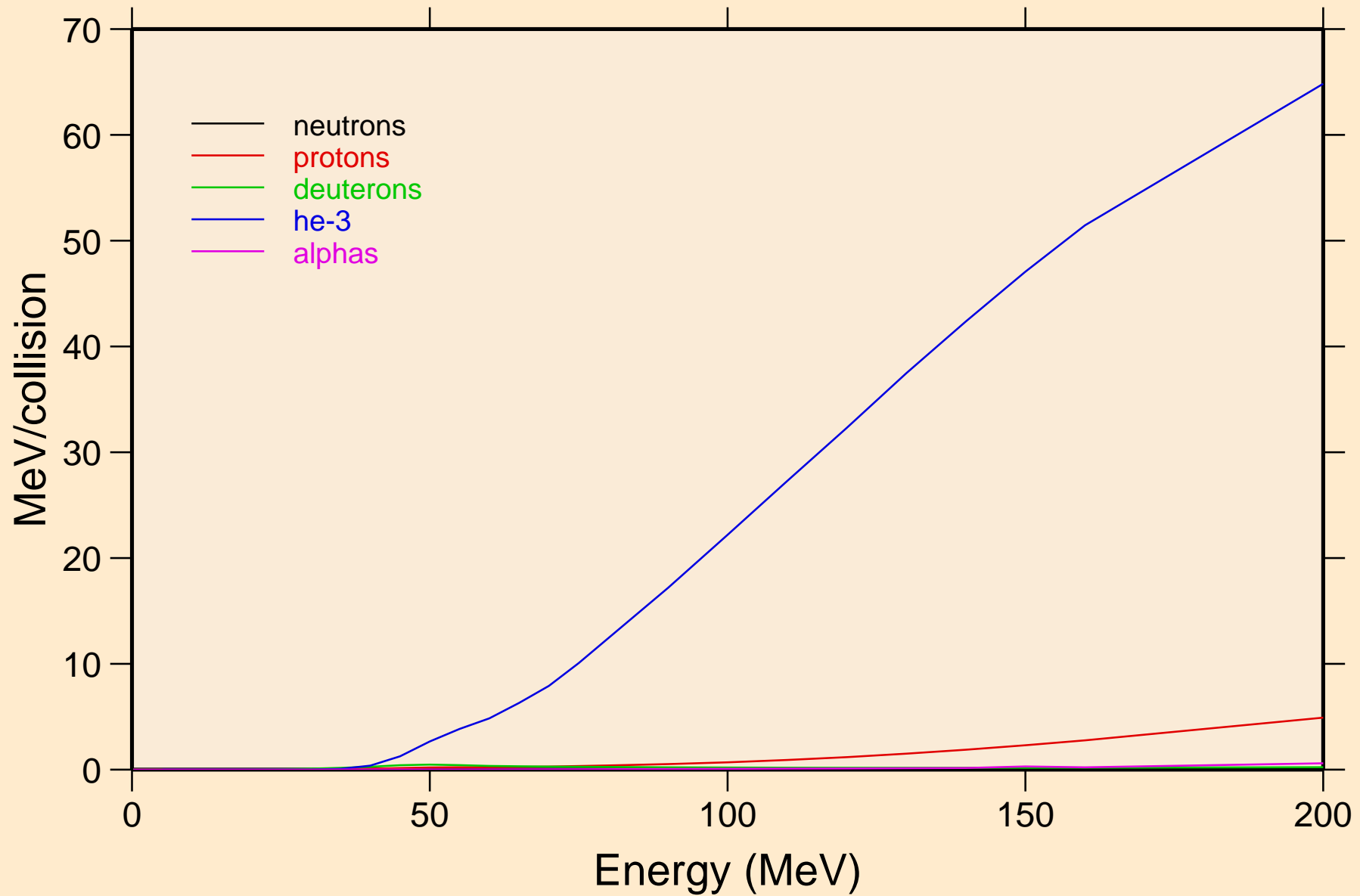

TL209 TRITON ACER TENDL-2021 LIBRARY; T=0.K  
Recoil Heating

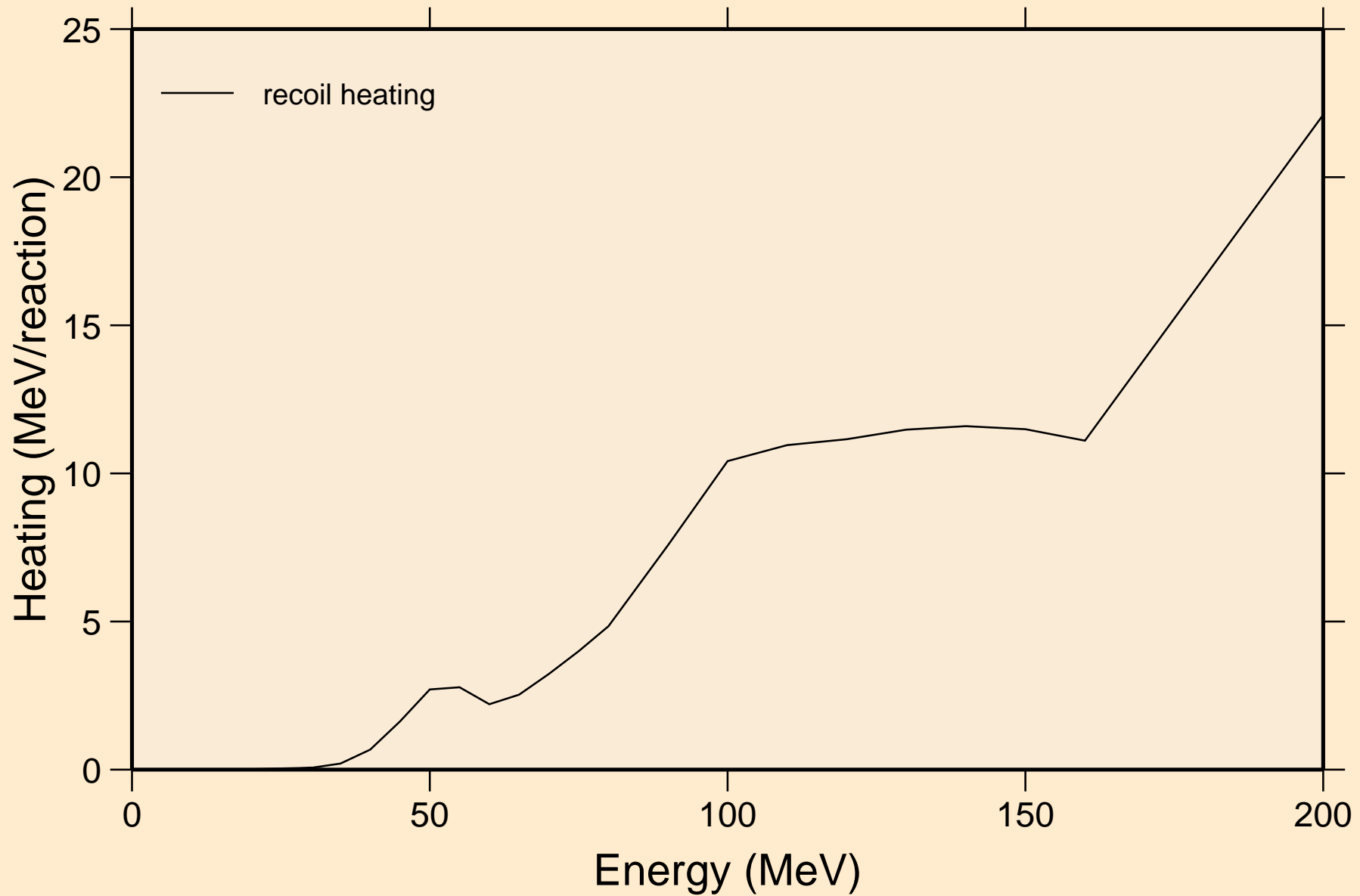



TL209 TRITON ACER TENDL-2021 LIBRARY; T=0.K  
Particle production cross sections

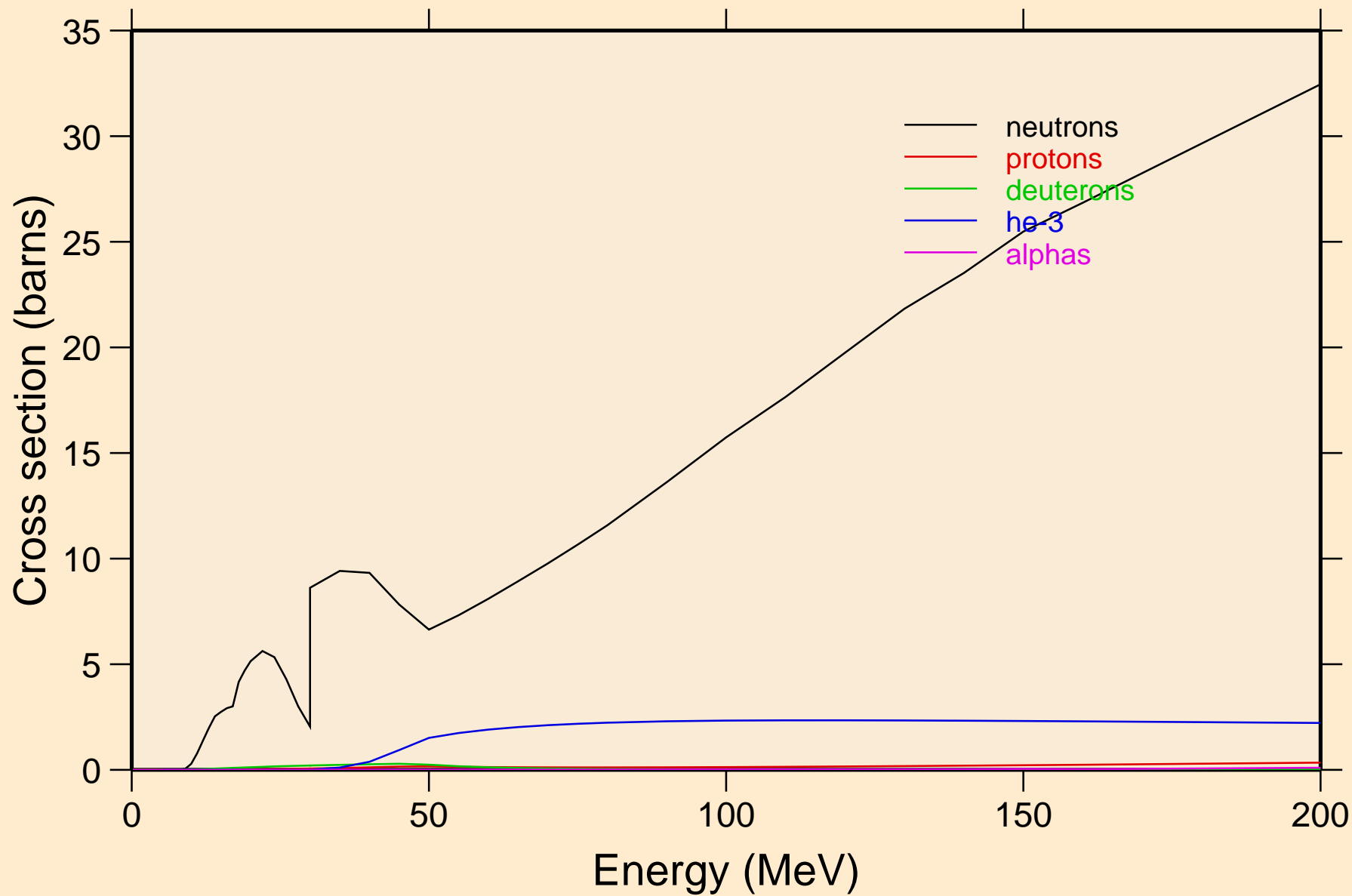

TL209 TRITON ACER TENDL-2021 LIBRARY; T=0.K  
neutrons from (t,n)

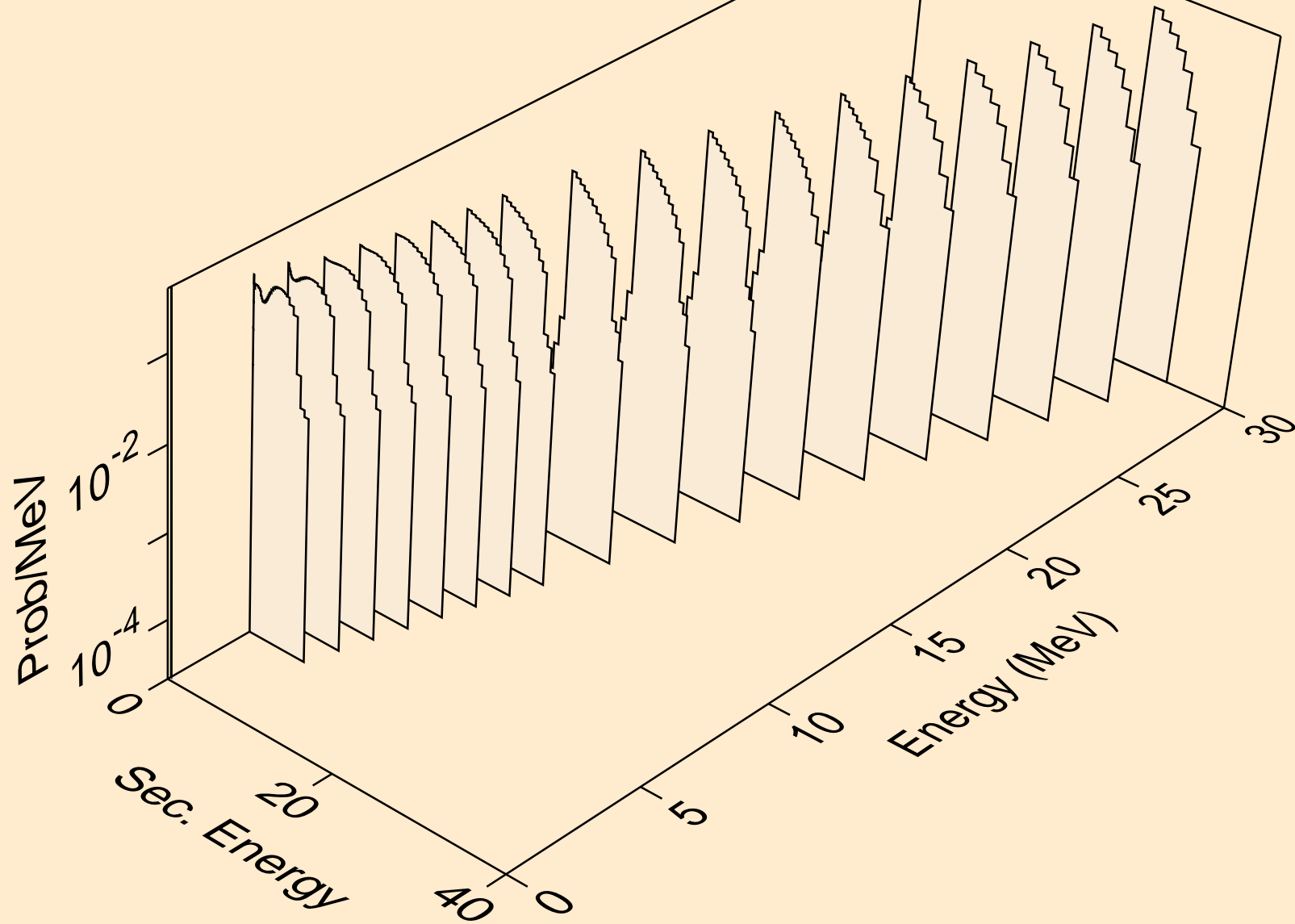

TL209 TRITON ACER TENDL-2021 LIBRARY; T=0.K  
neutrons from (t,x)

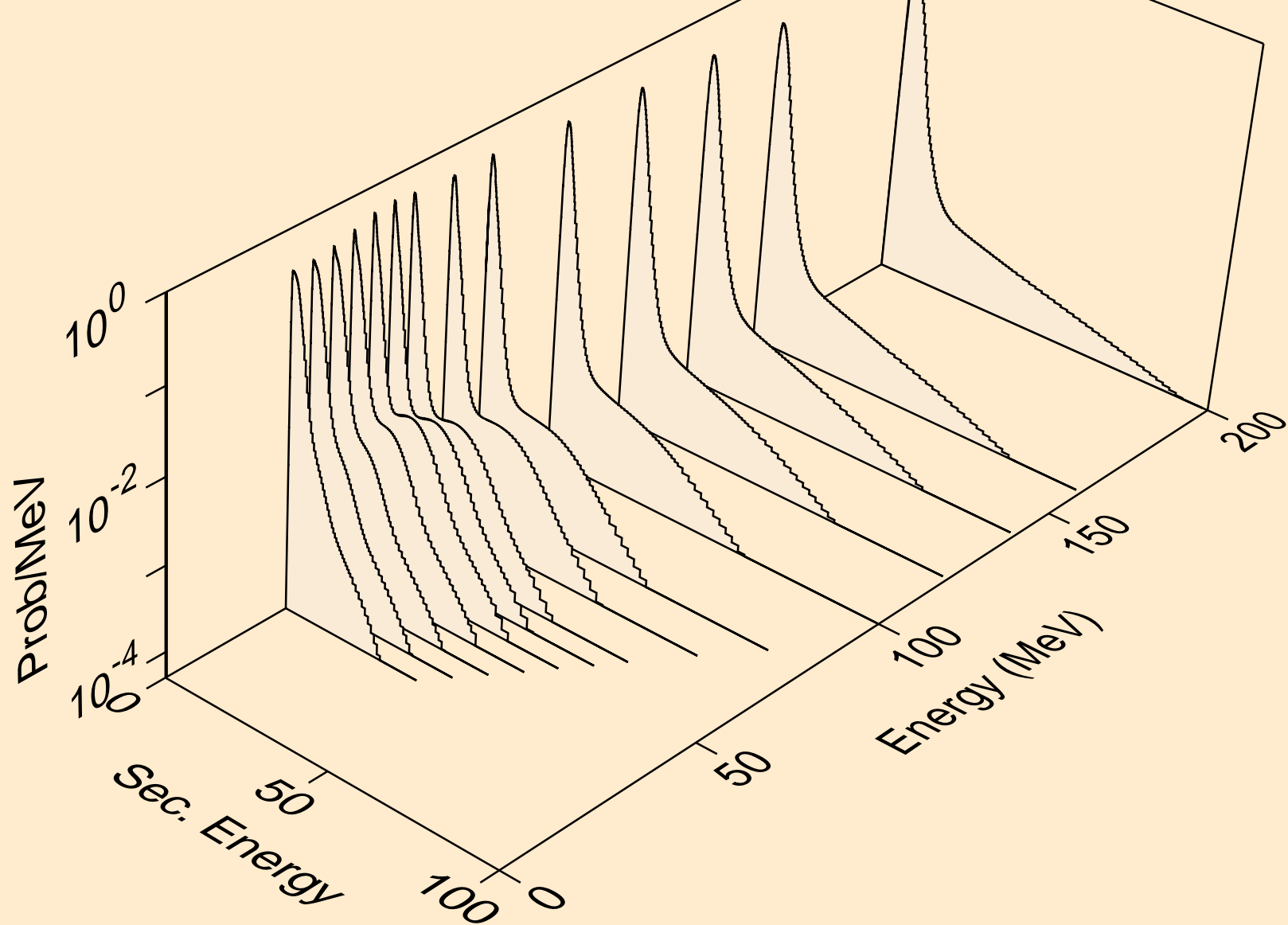

TL209 TRITON ACER TENDL-2021 LIBRARY; T=0.K  
neutrons from (t,2nd)

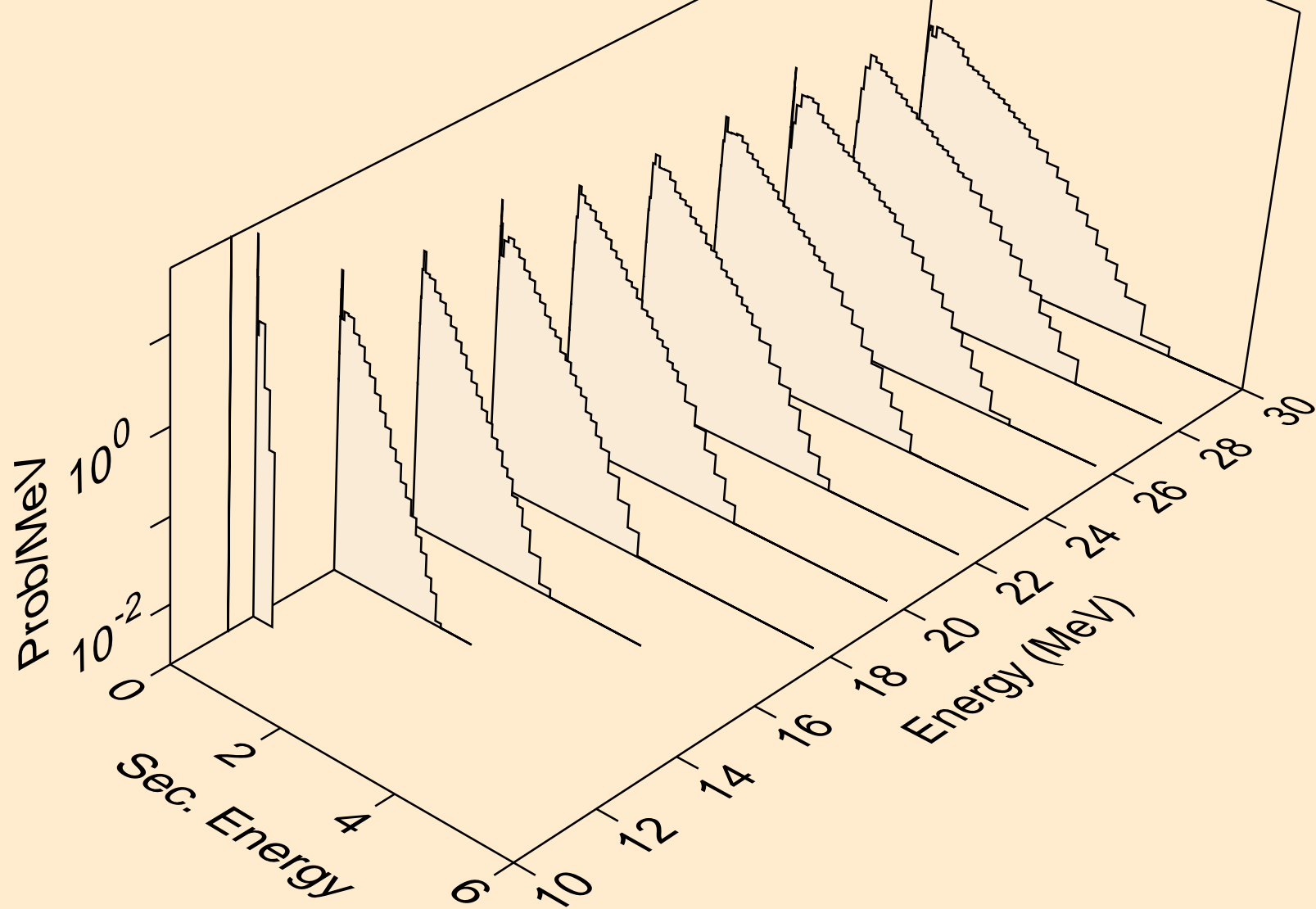

TL209 TRITON ACER TENDL-2021 LIBRARY; T=0.K  
neutrons from (t,2n)

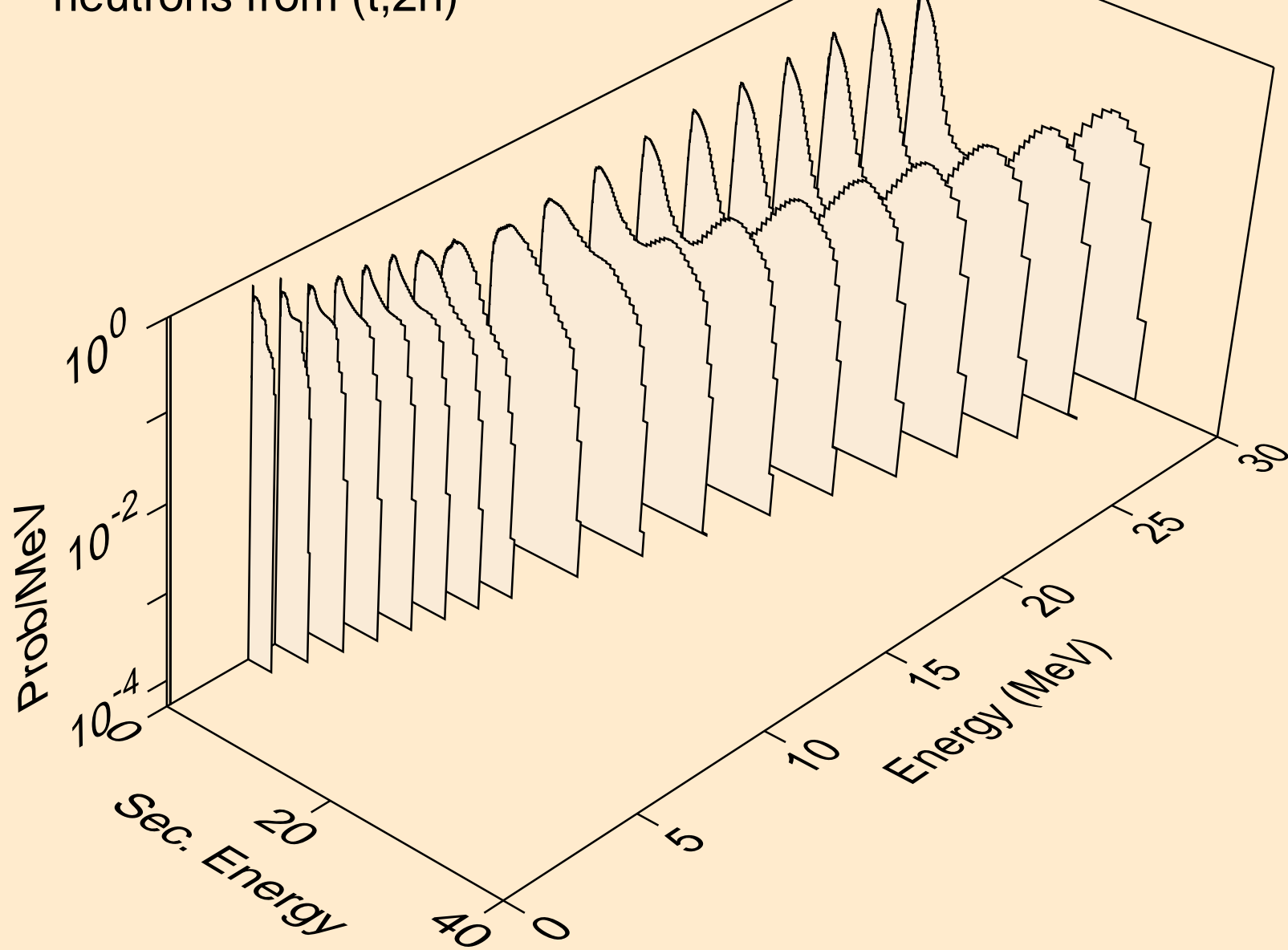

TL209 TRITON ACER TENDL-2021 LIBRARY; T=0.K  
neutrons from (t,3n)

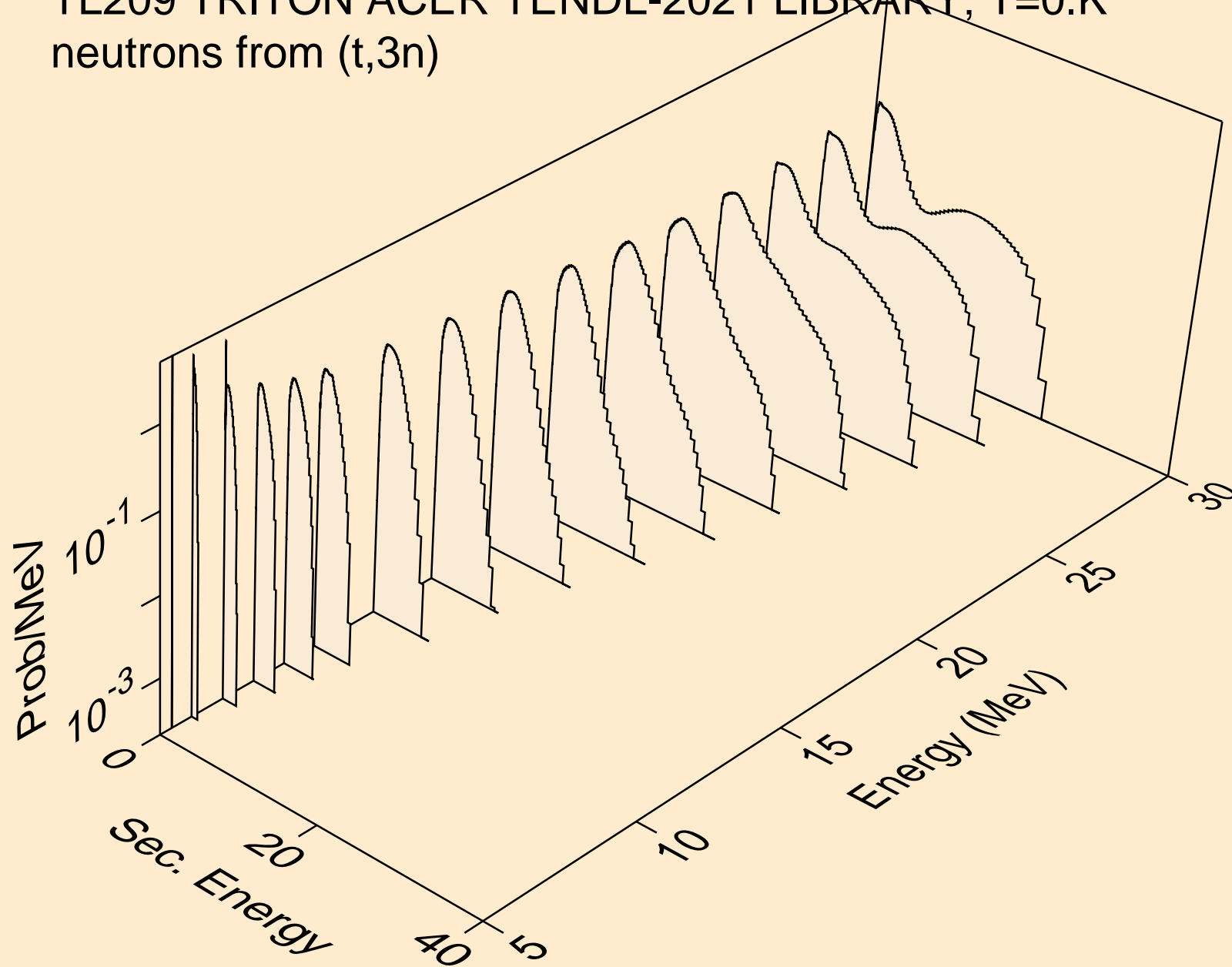

TL209 TRITON ACER TENDL-2021 LIBRARY; T=0.K  
neutrons from (t,n\*)a

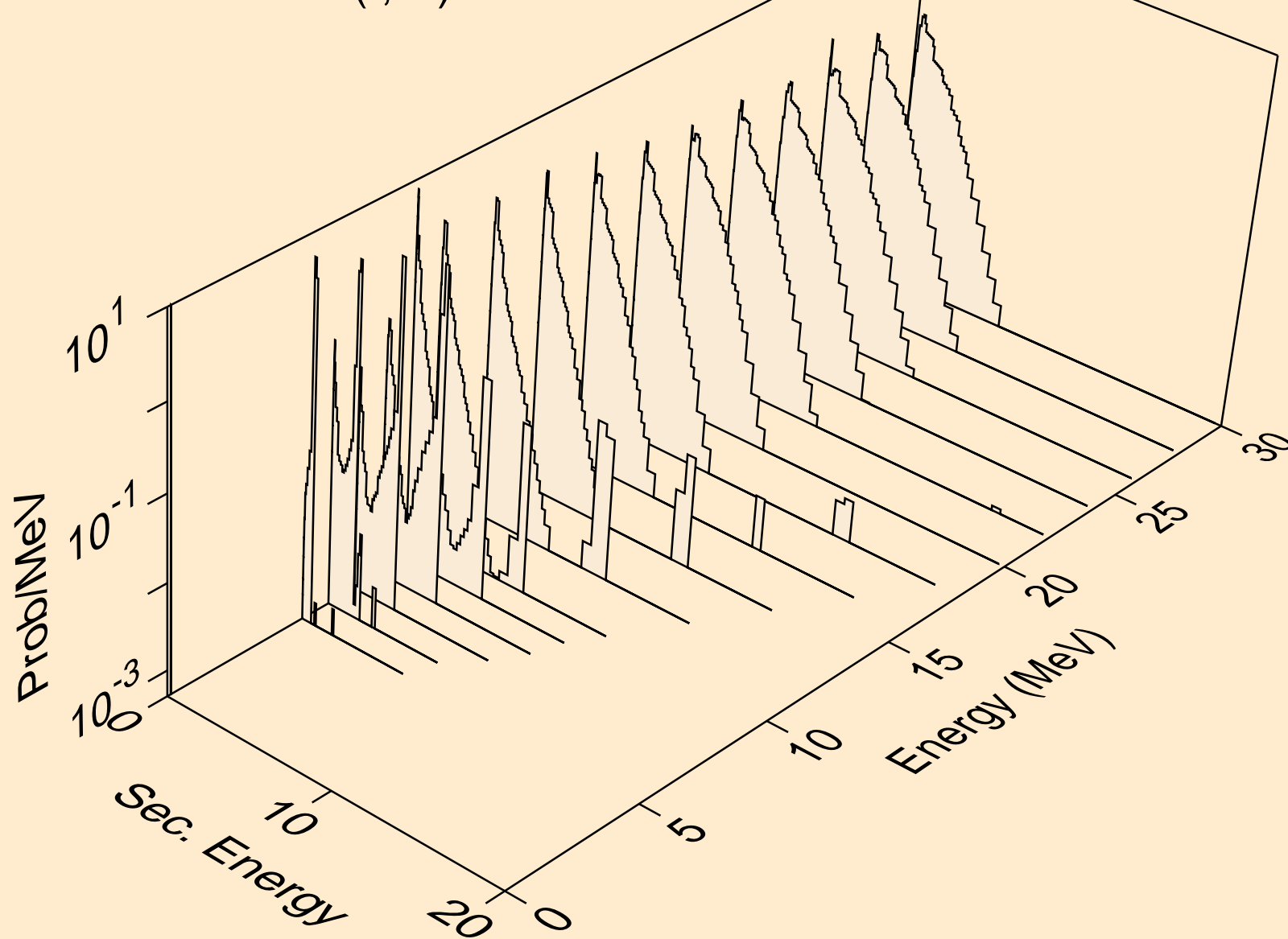

TL209 TRITON ACER TENDL-2021 LIBRARY; T=0.K  
neutrons from (t,2n)a

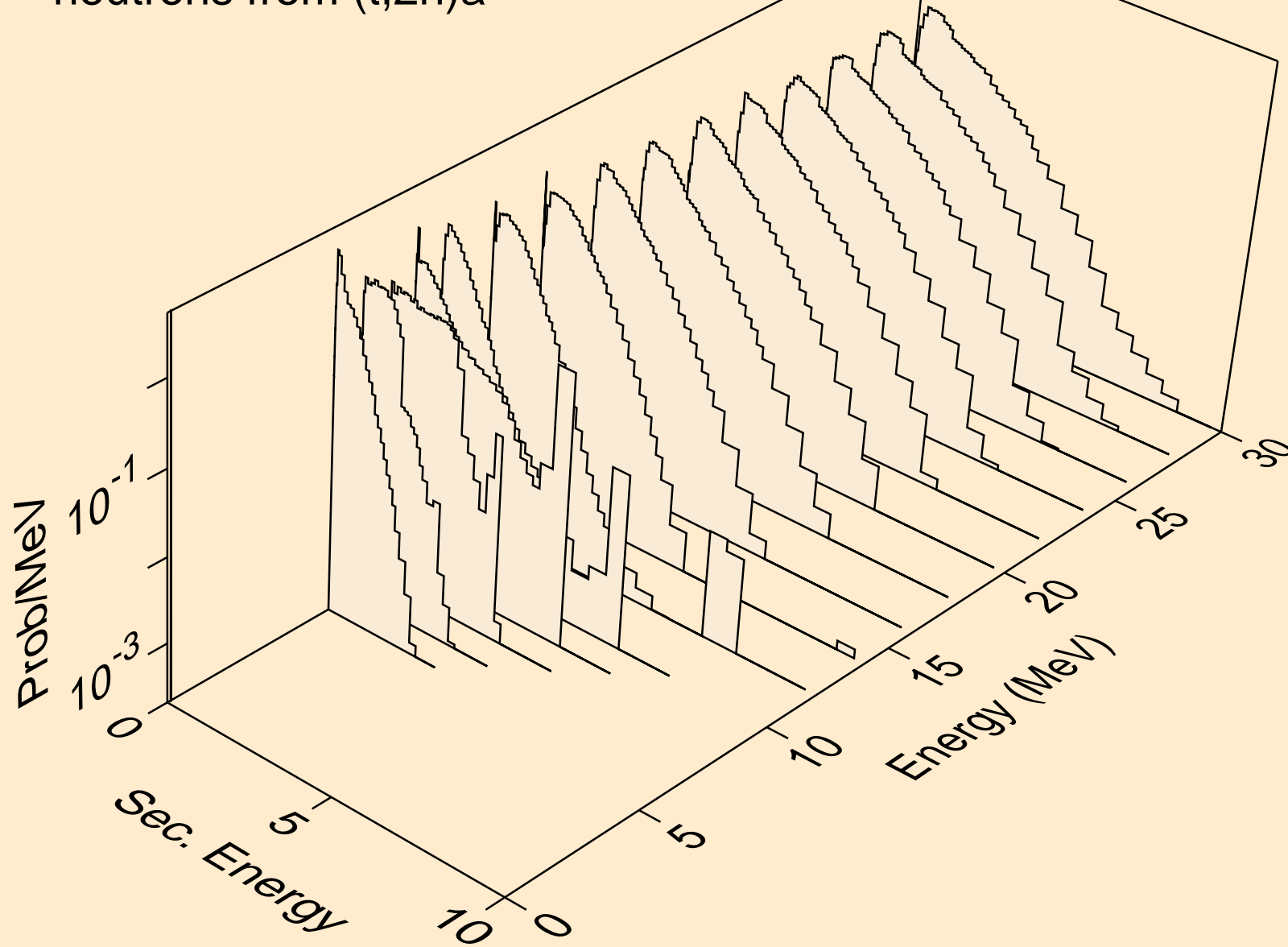



TL209 TRITON ACER TENDL-2021 LIBRARY; T=0.K  
neutrons from (t,3n)a

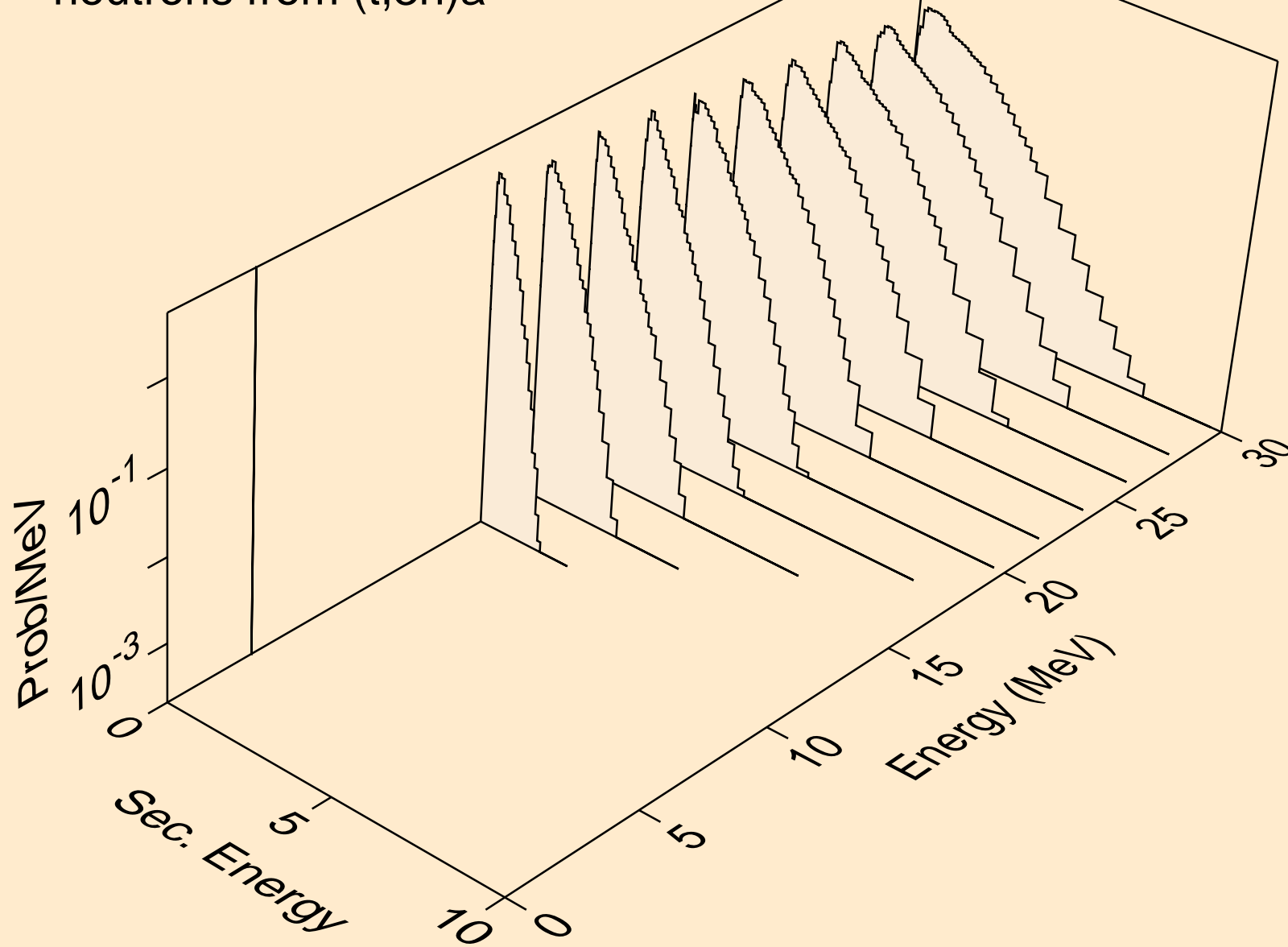

TL209 TRITON ACER TENDL-2021 LIBRARY; T=0.K  
neutrons from (t,n\*)p

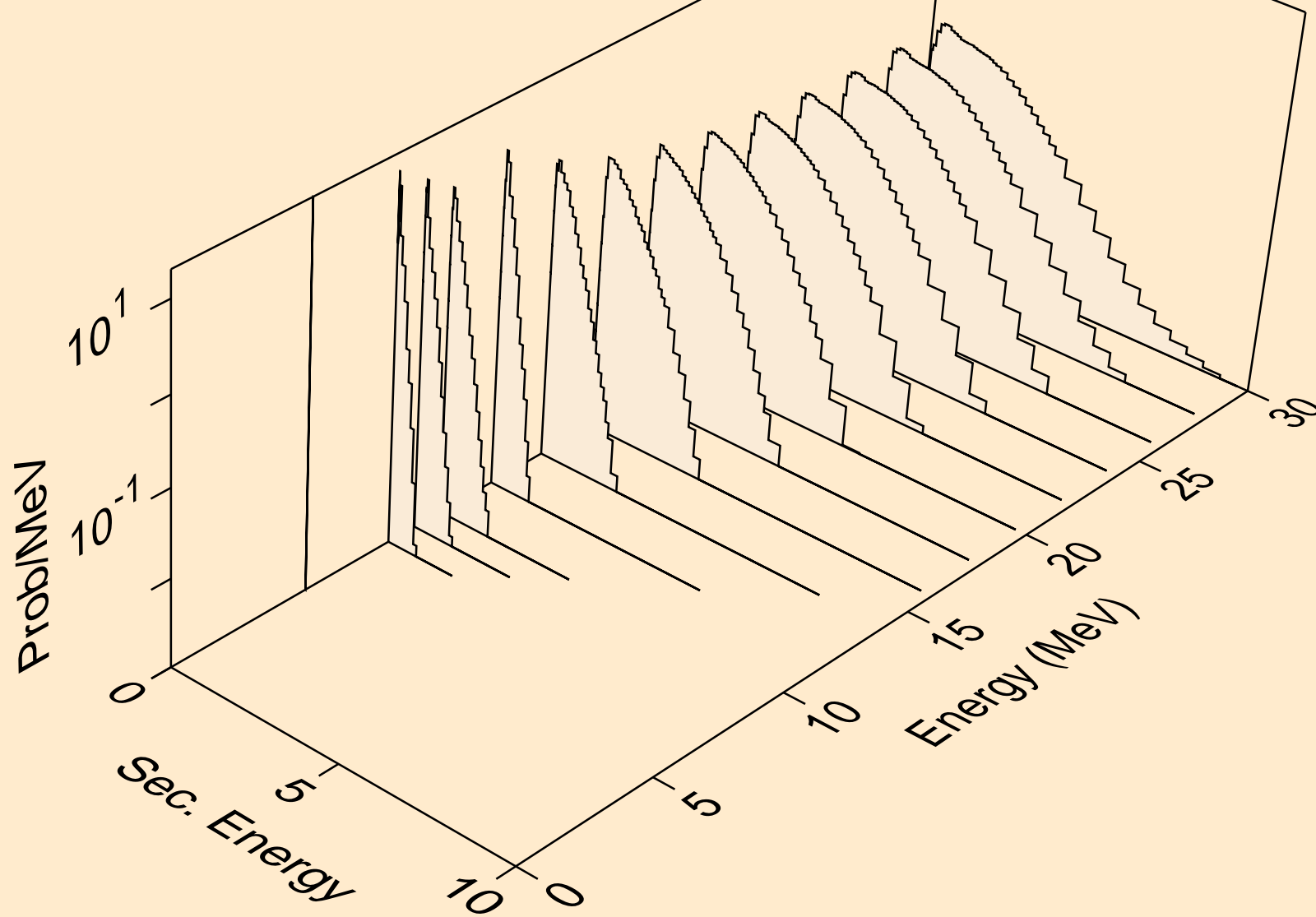

TL209 TRITON ACER TENDL-2021 LIBRARY; T=0.K  
neutrons from (t,n\*)d

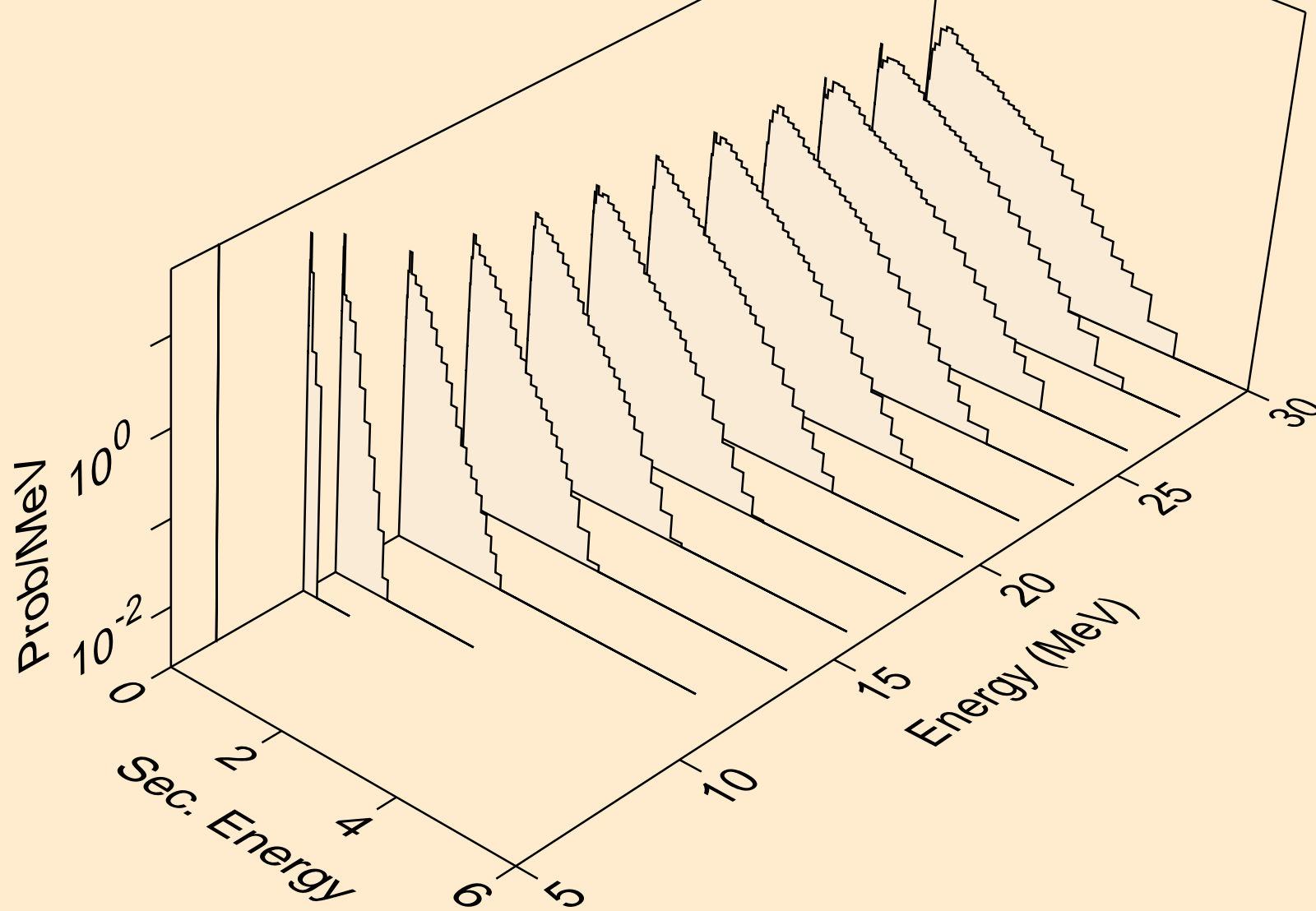

TL209 TRITON ACER TENDL-2021 LIBRARY; T=0.K  
neutrons from (t,n\*)t

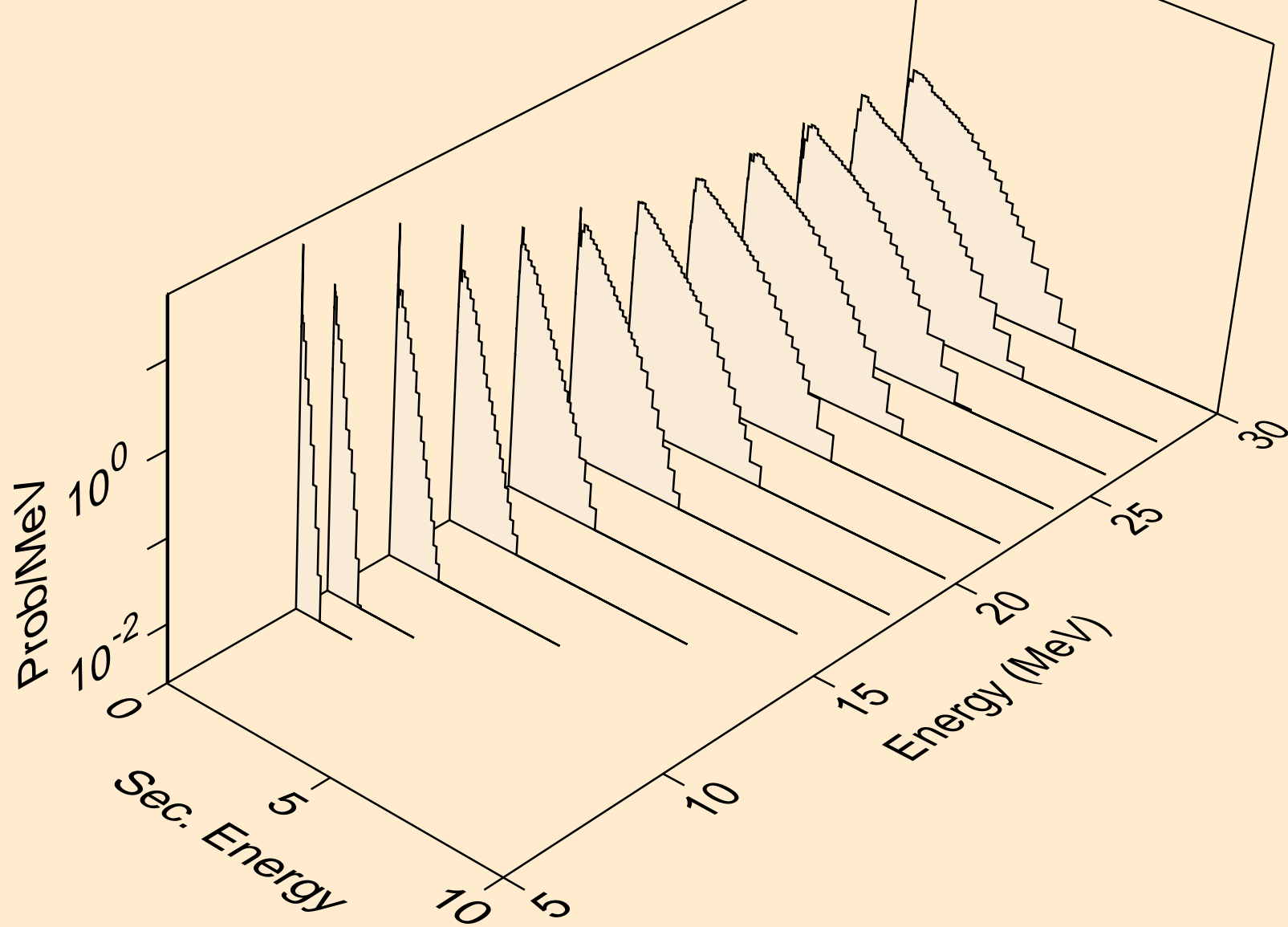

TL209 TRITON ACER TENDL-2021 LIBRARY; T=0.K  
neutrons from (t,n\*)he3

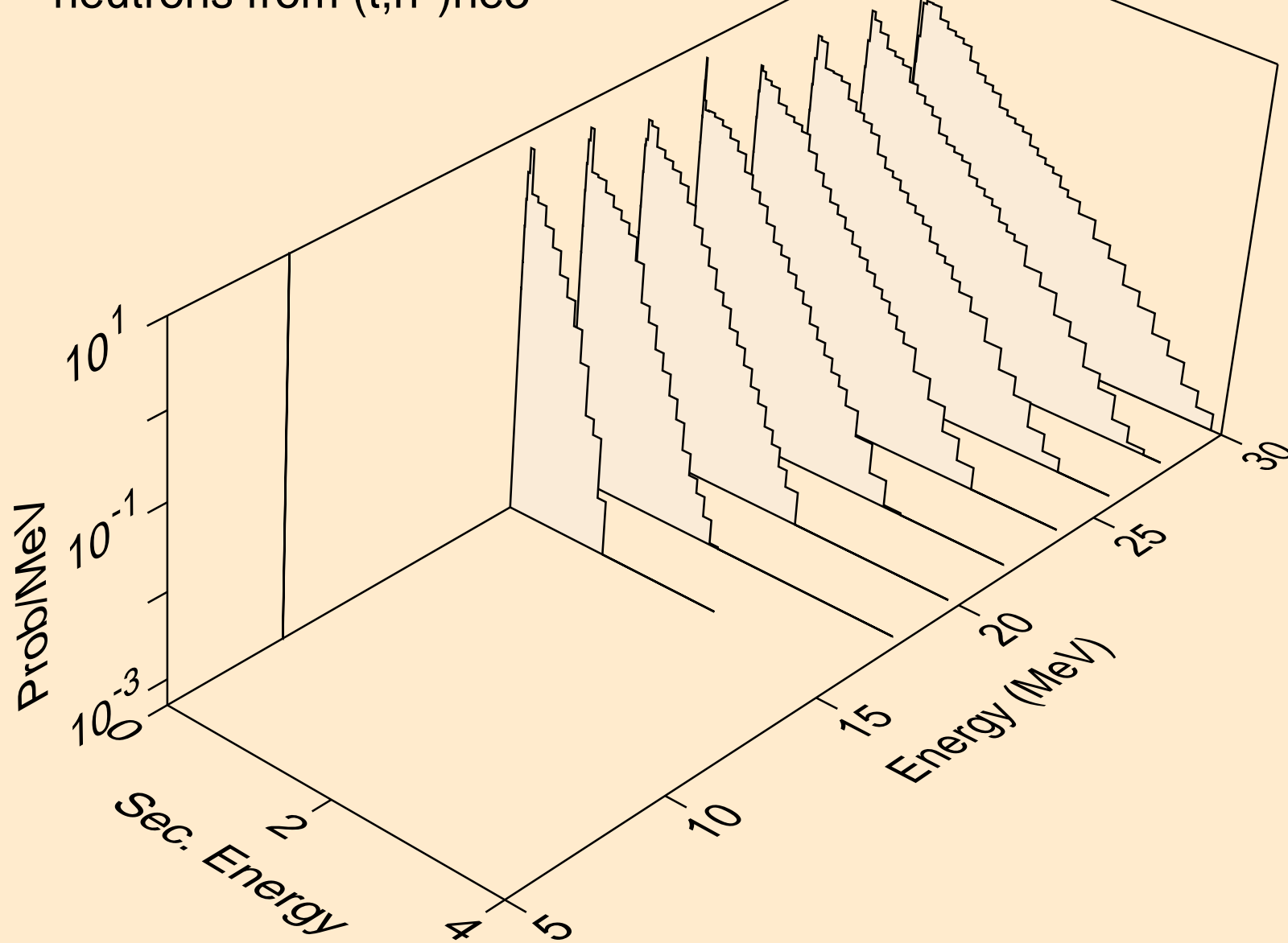

TL209 TRITON ACER TENDL-2021 LIBRARY; T=0.K  
neutrons from (t,4n)

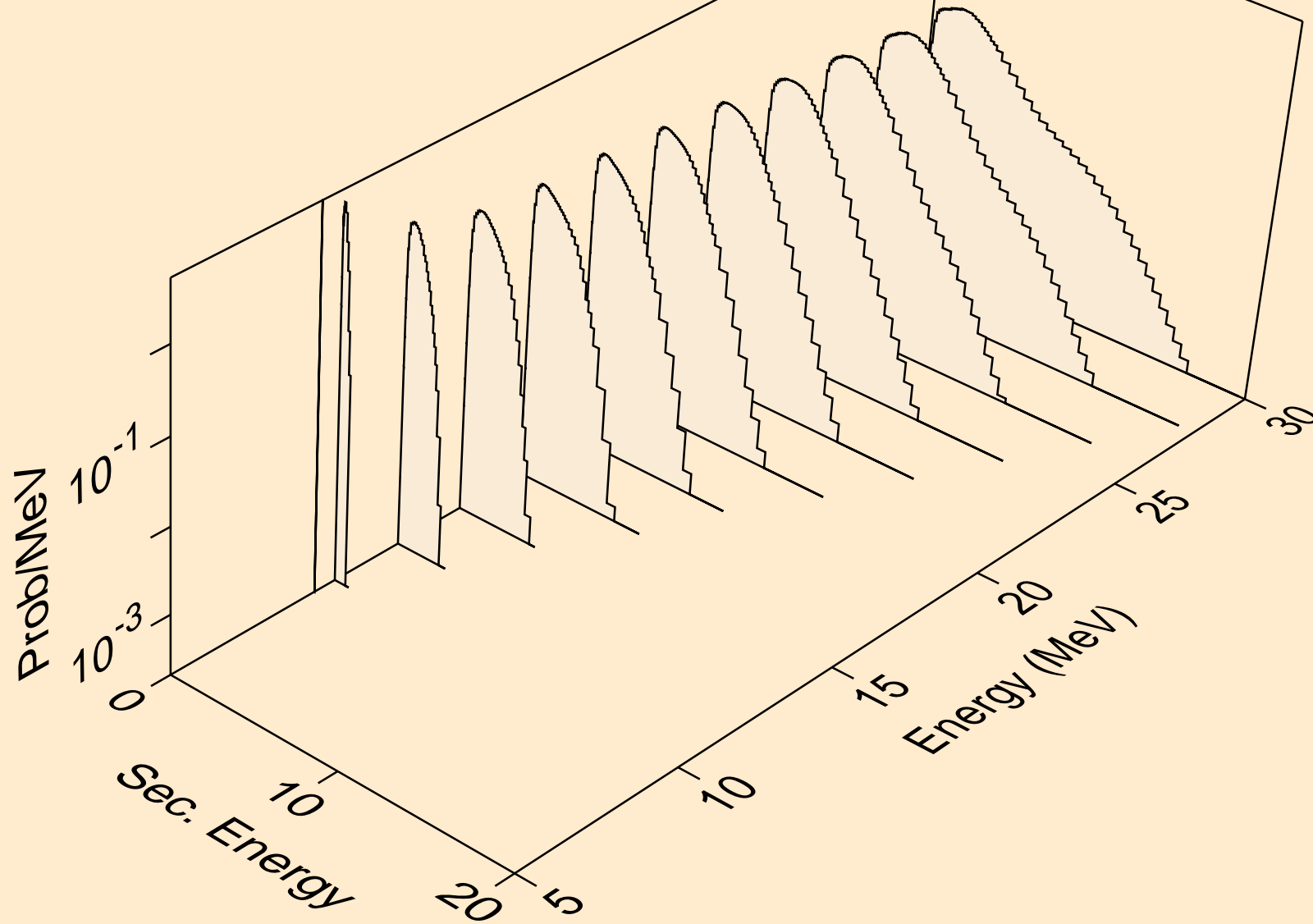

TL209 TRITON ACER TENDL-2021 LIBRARY; T=0.K  
neutrons from (t,2np)

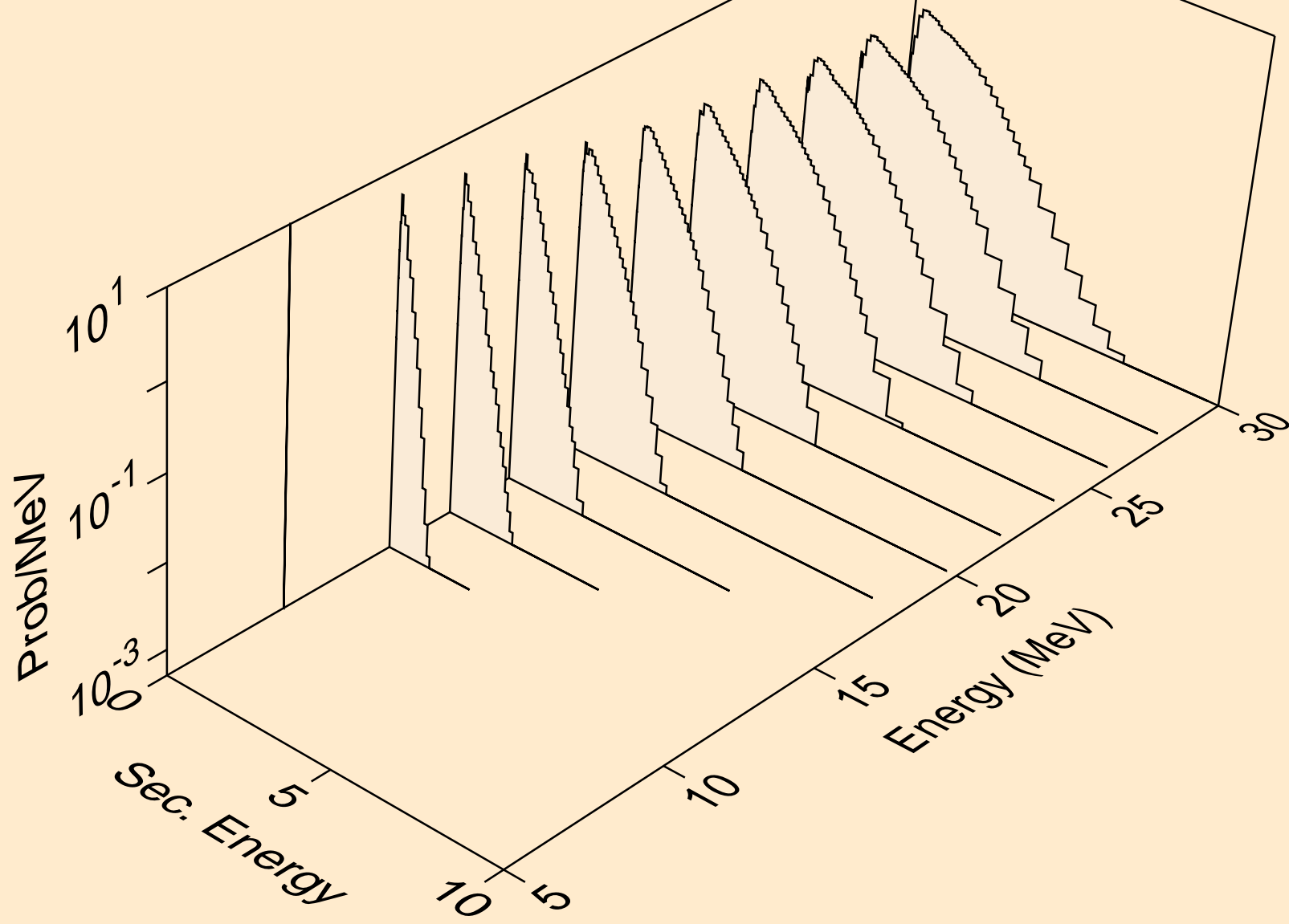

TL209 TRITON ACER TENDL-2021 LIBRARY; T=0.K  
neutrons from (t,3np)

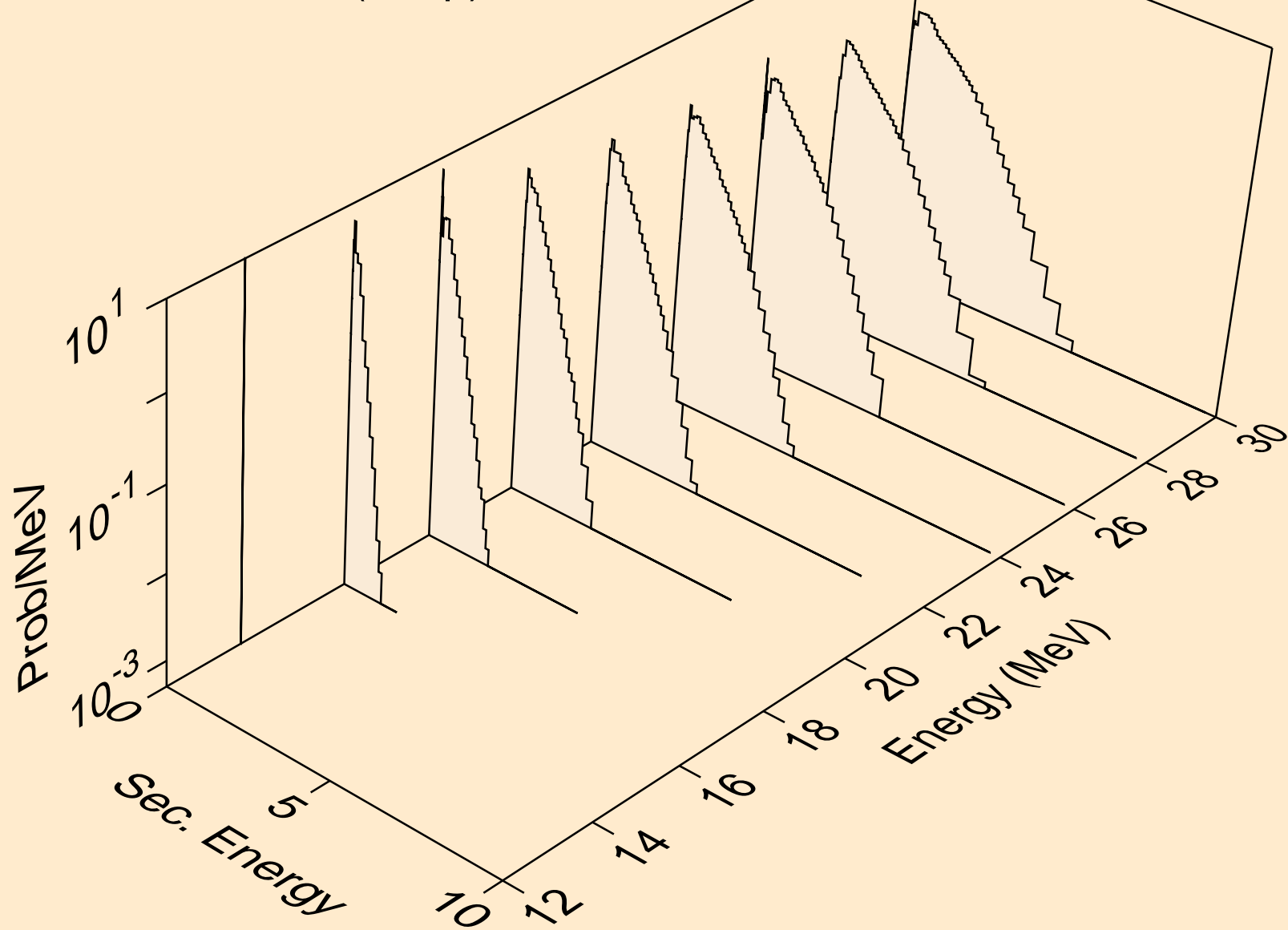



TL209 TRITON ACER TENDL-2021 LIBRARY; T=0.K  
neutrons from (t,2np)

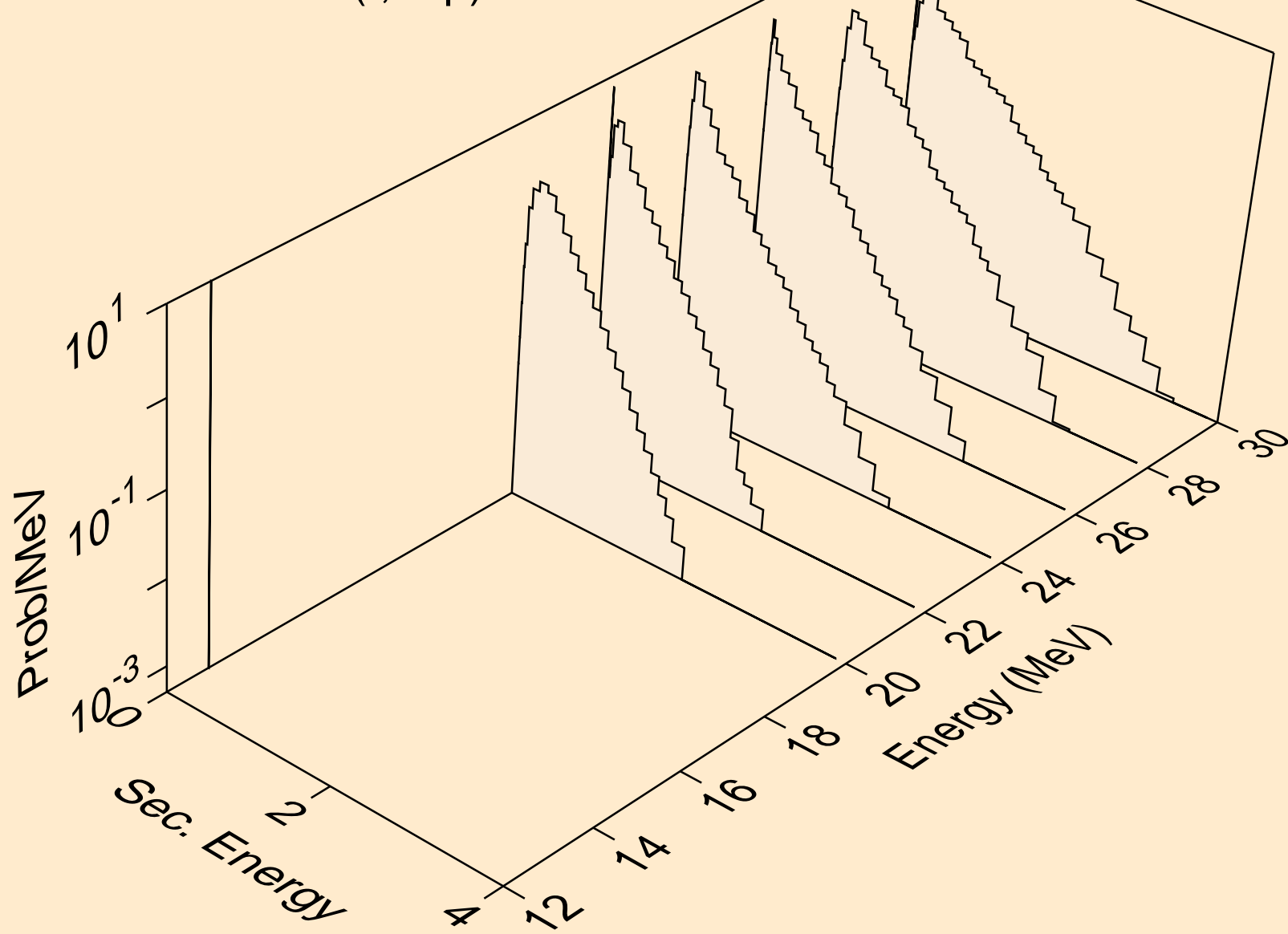

TL209 TRITON ACER TENDL-2021 LIBRARY; T=0.K  
neutrons from (t,npa)

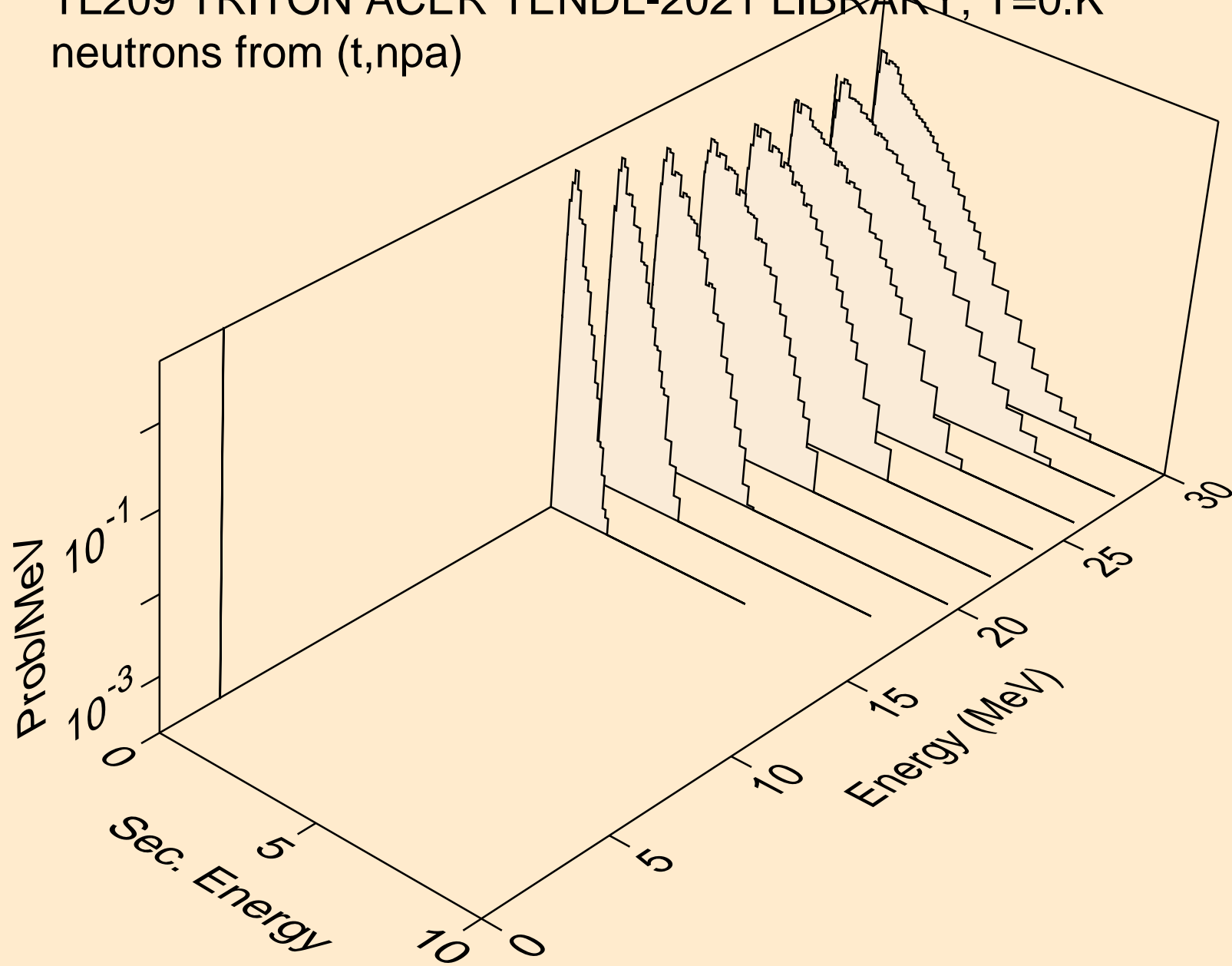

TL209 TRITON ACER TENDL-2021 LIBRARY; T=0.K  
protons from (t,x)

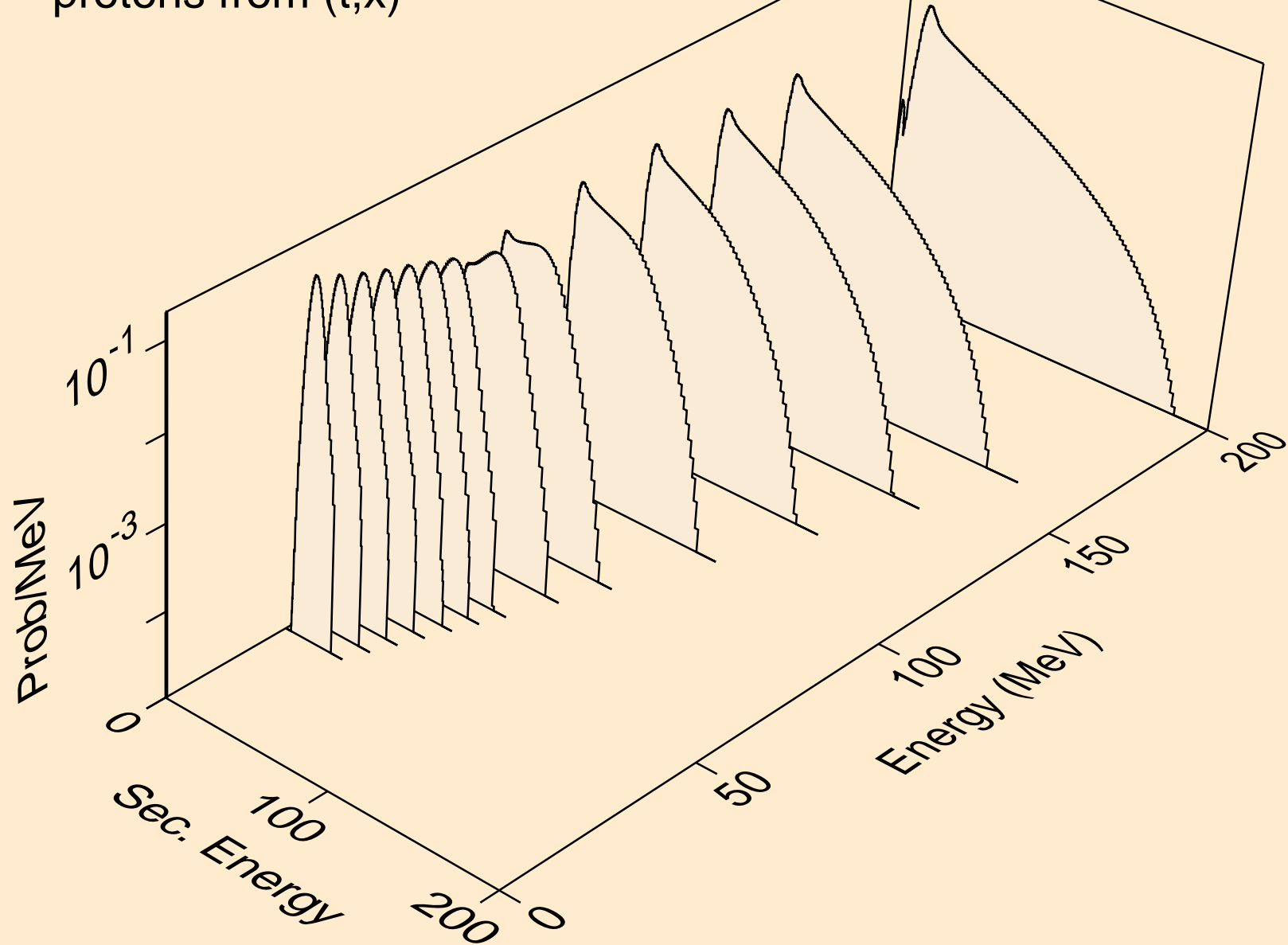

TL209 TRITON ACER TENDL-2021 LIBRARY; T=0.K  
protons from (t,n\*)p

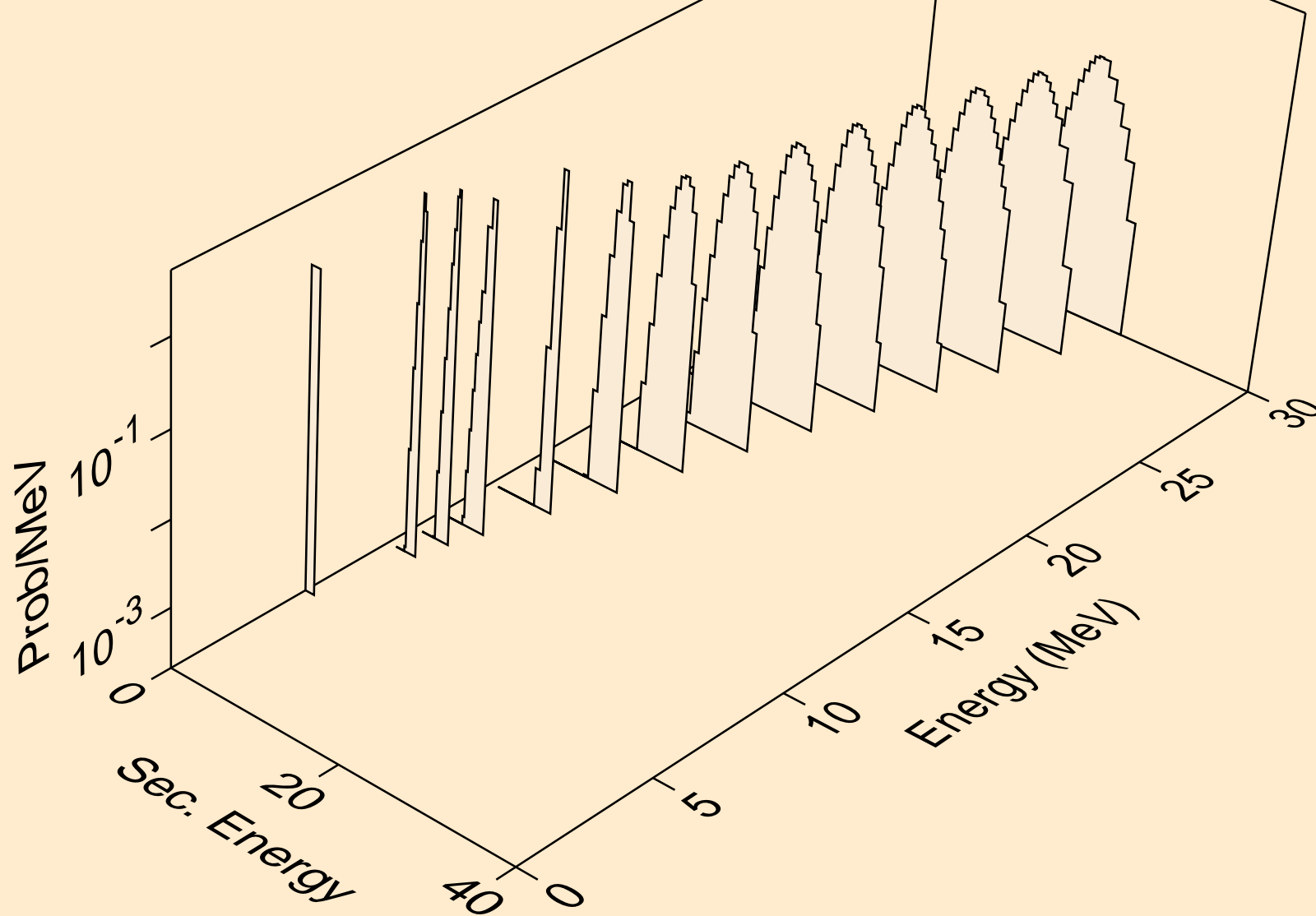

TL209 TRITON ACER TENDL-2021 LIBRARY; T=0.K  
protons from (t,2np)

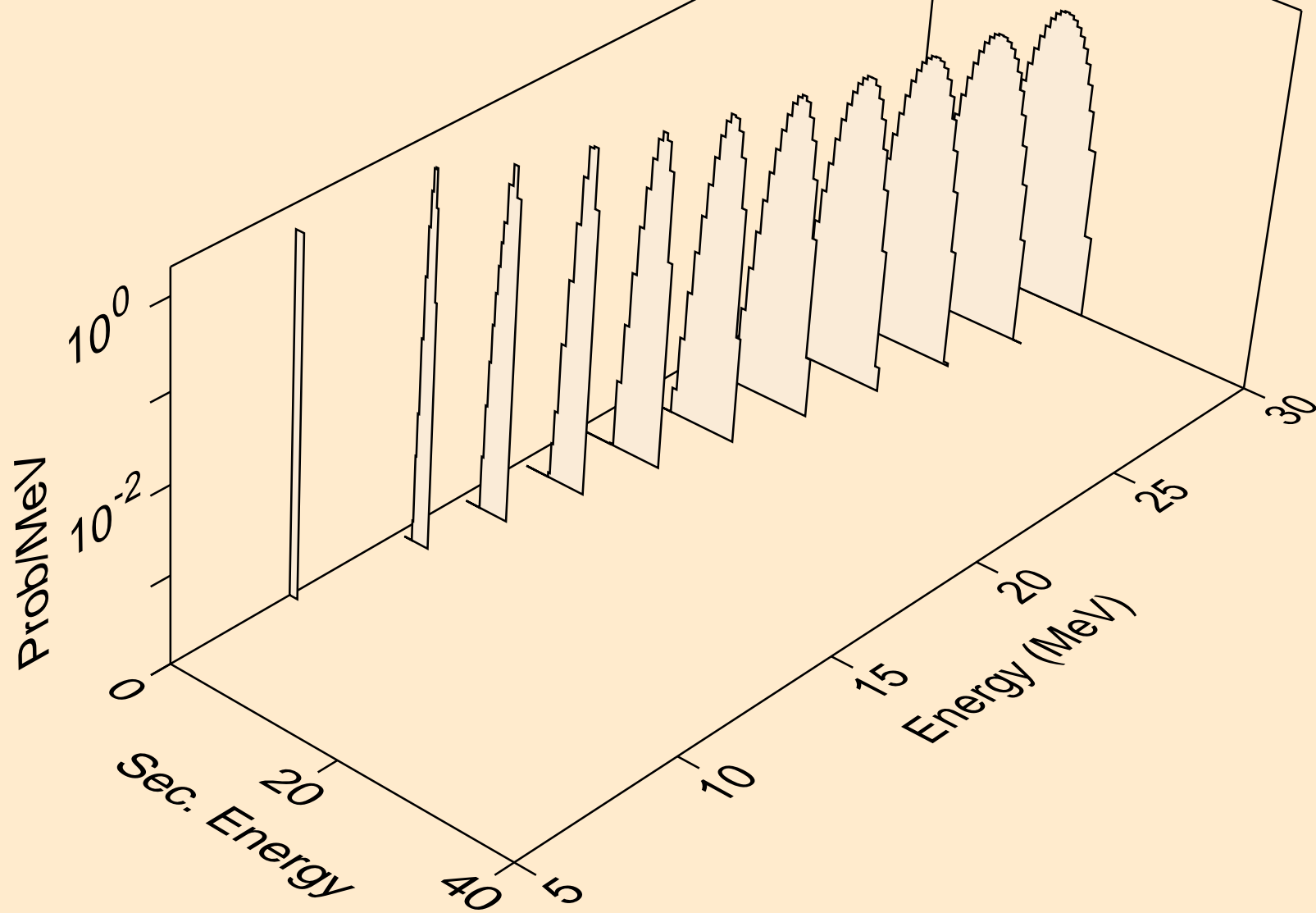

TL209 TRITON ACER TENDL-2021 LIBRARY; T=0.K  
protons from (t,3np)

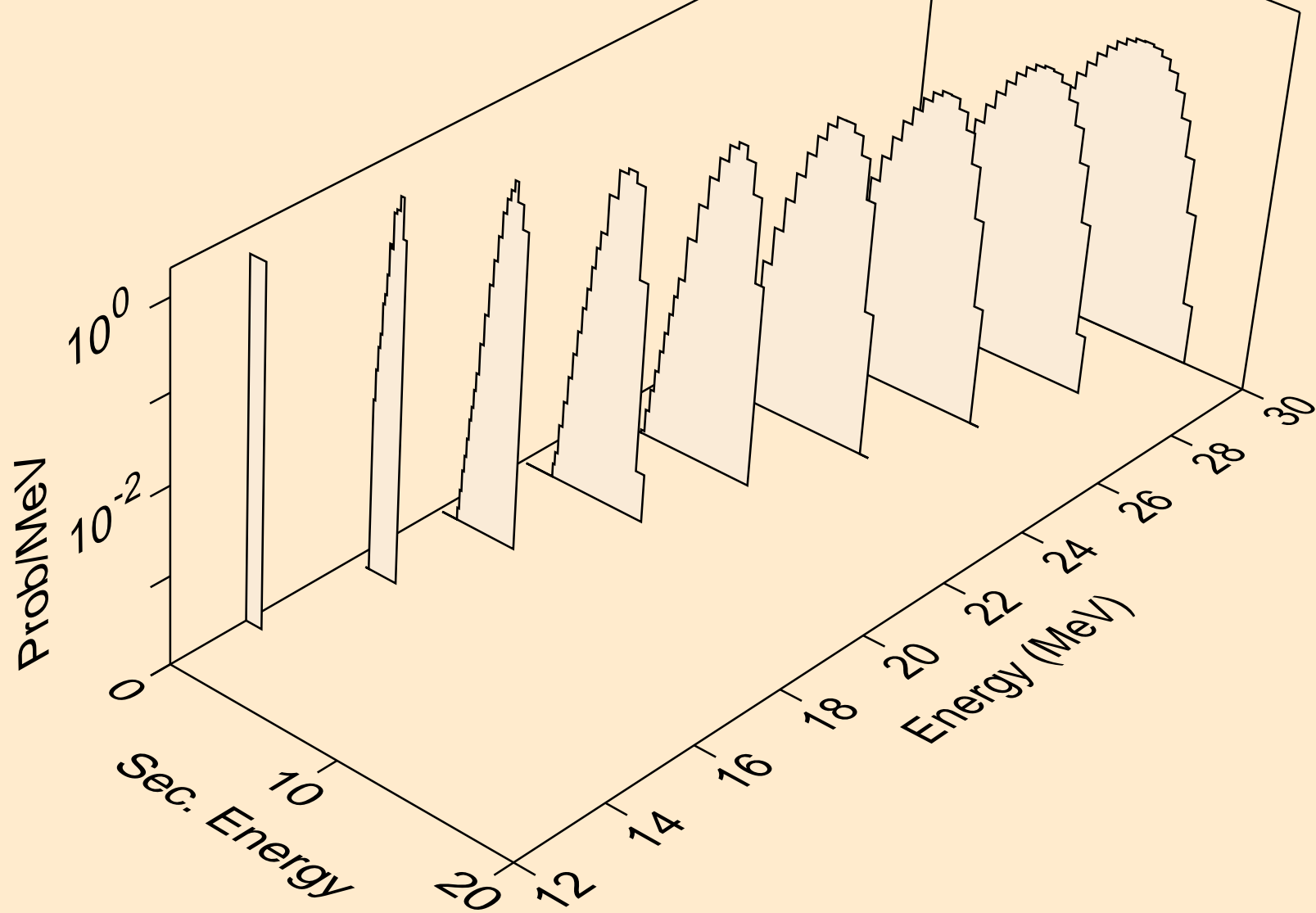

TL209 TRITON ACER TENDL-2021 LIBRARY; T=0.K  
protons from (t,2np)

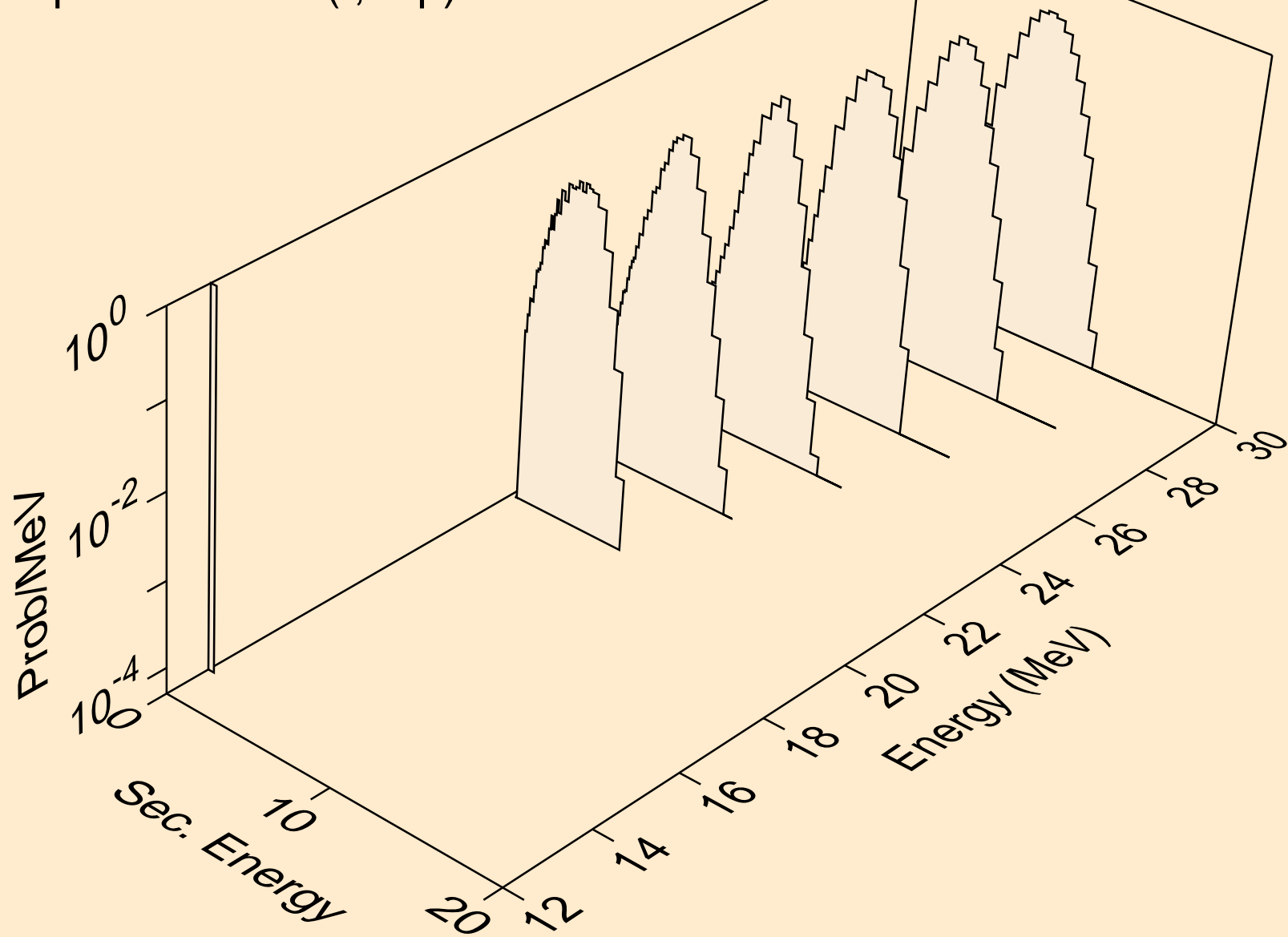

TL209 TRITON ACER TENDL-2021 LIBRARY; T=0.K  
protons from (t,npa)

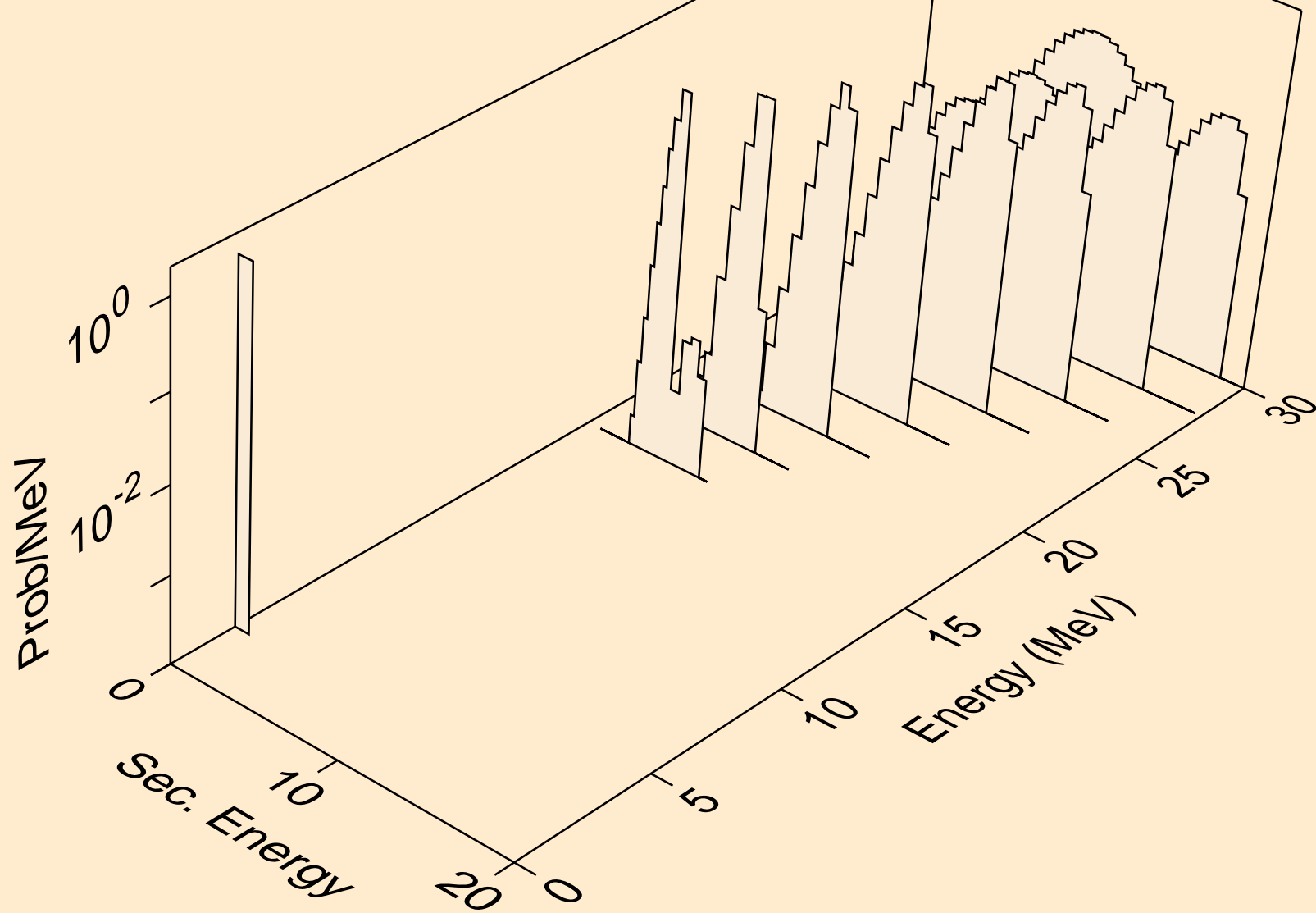



TL209 TRITON ACER TENDL-2021 LIBRARY; T=0.K  
protons from (t,p)

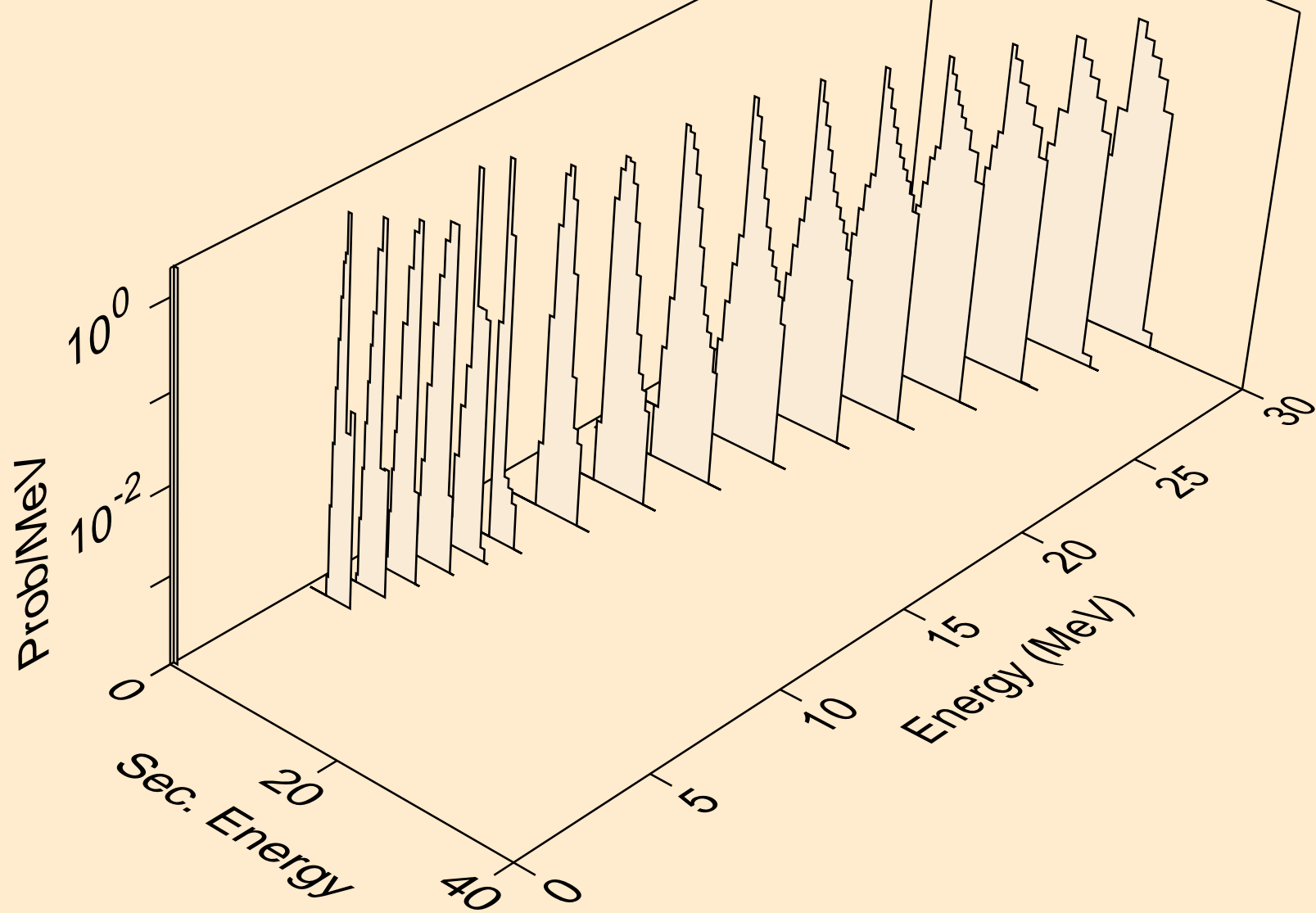

TL209 TRITON ACER TENDL-2021 LIBRARY; T=0.K  
protons from (t,2p)

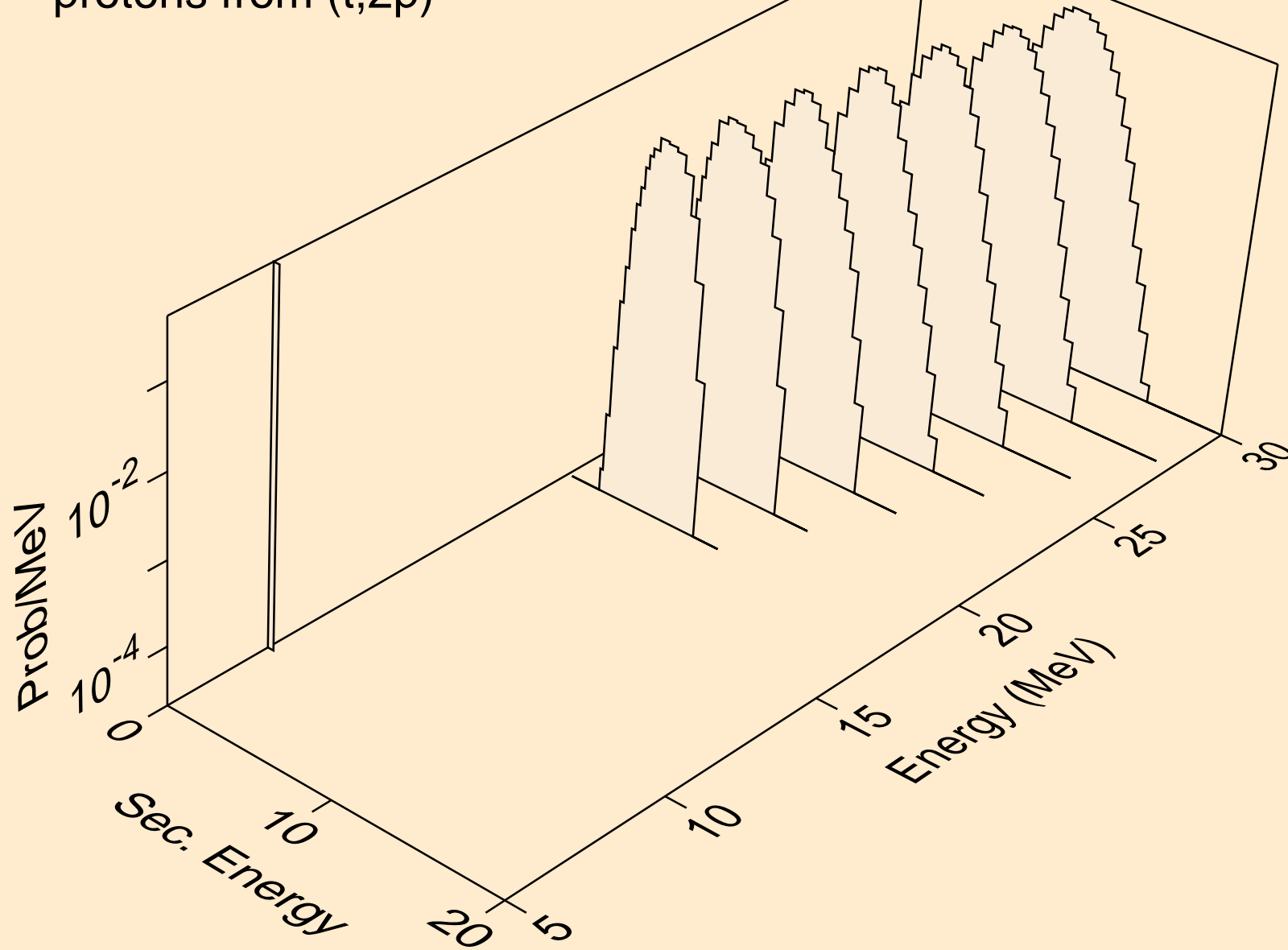

TL209 TRITON ACER TENDL-2021 LIBRARY; T=0.K  
protons from (t,pa)

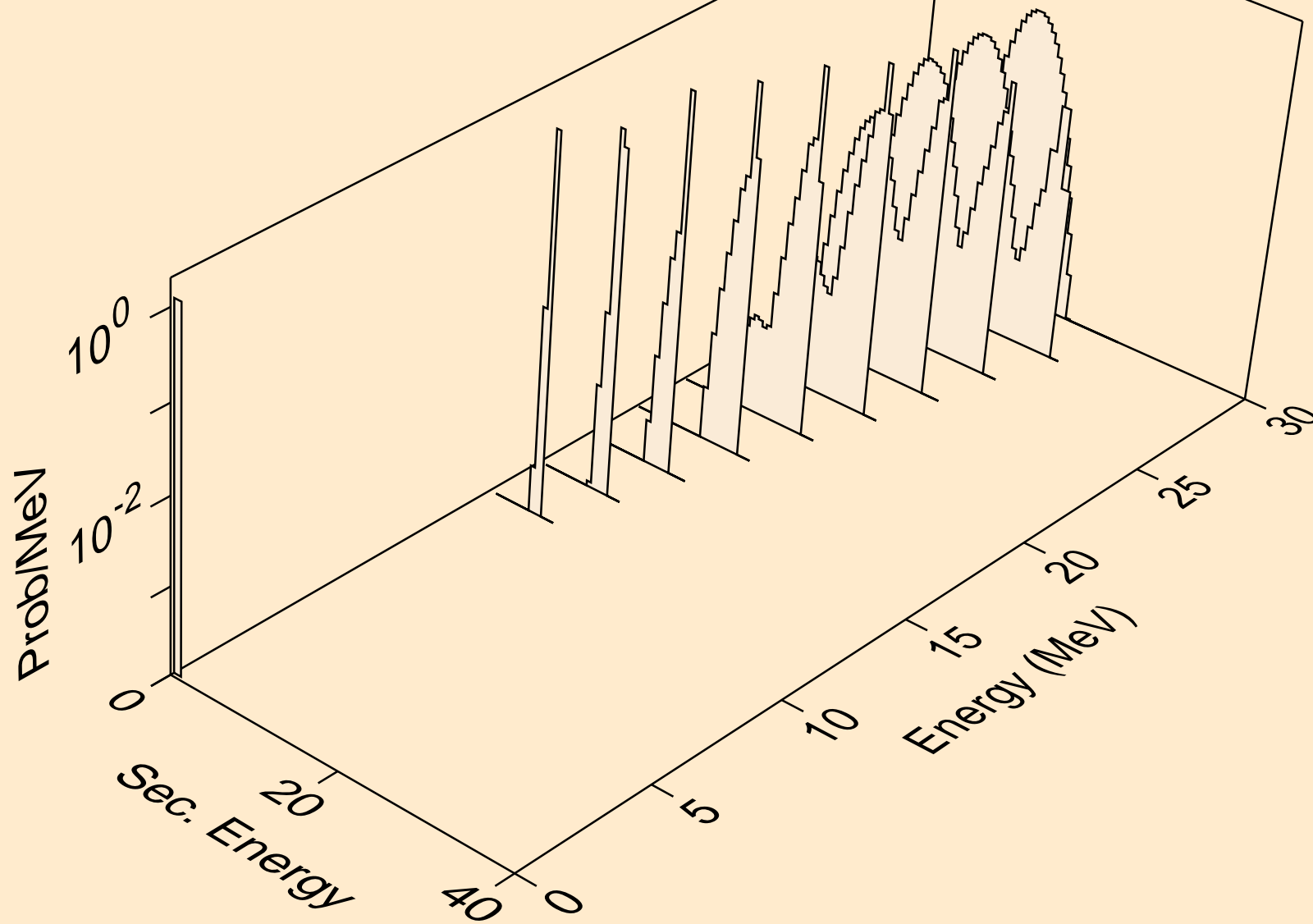

TL209 TRITON ACER TENDL-2021 LIBRARY; T=0.K  
protons from (t,pt)

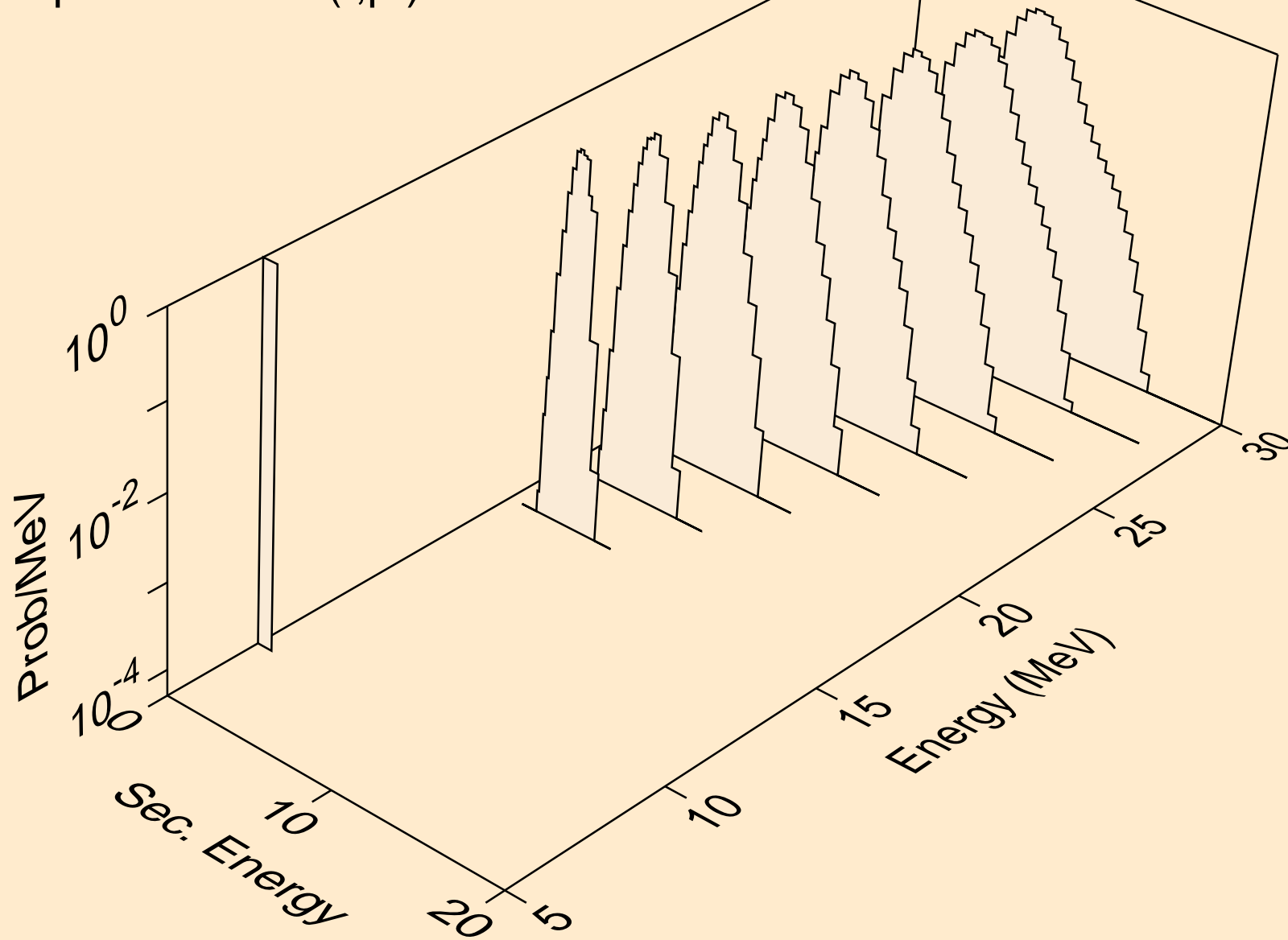

TL209 TRITON ACER TENDL-2021 LIBRARY; T=0.K  
deuterons from (t,x)

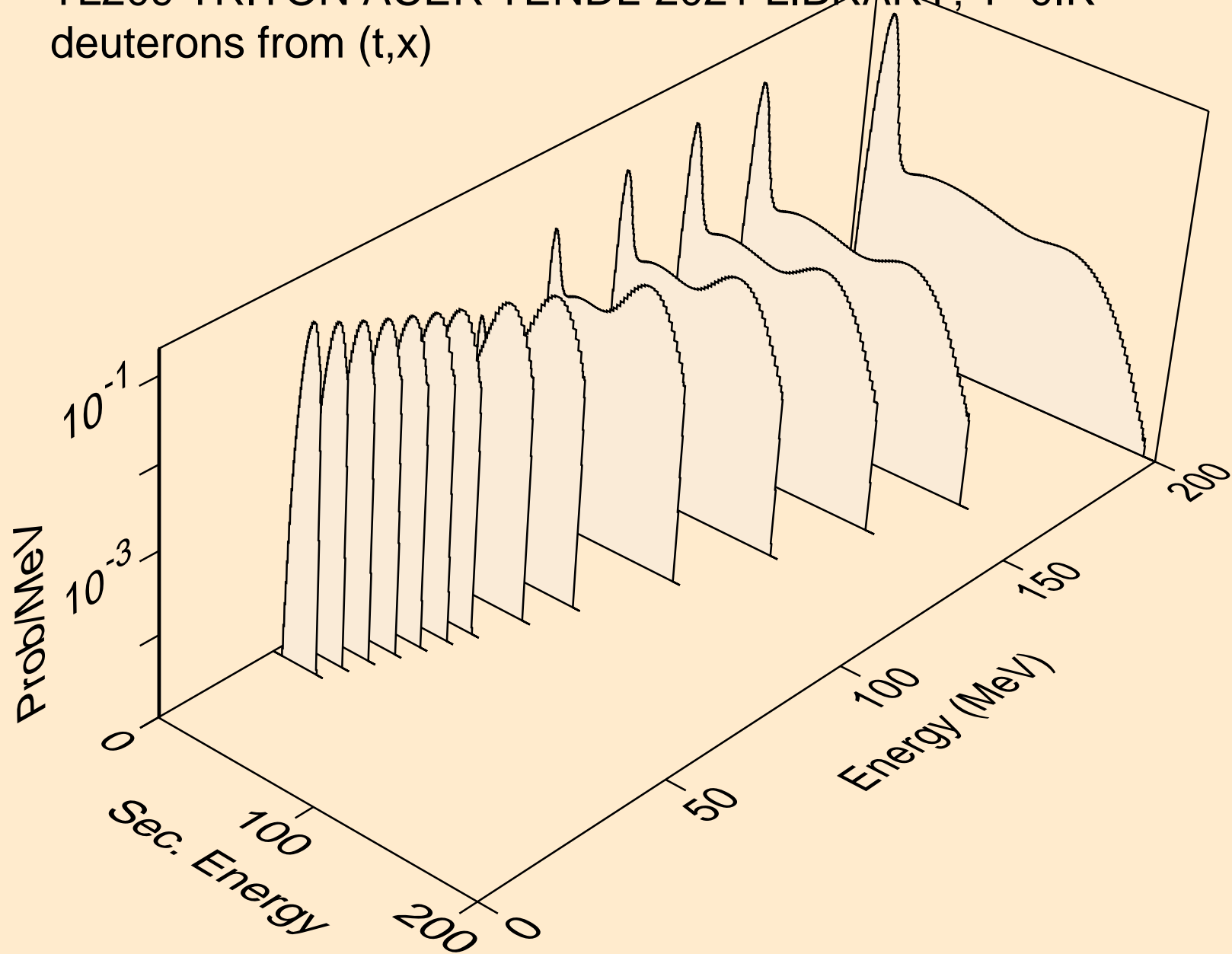

TL209 TRITON ACER TENDL-2021 LIBRARY; T=0.K  
deuterons from (t,2nd)

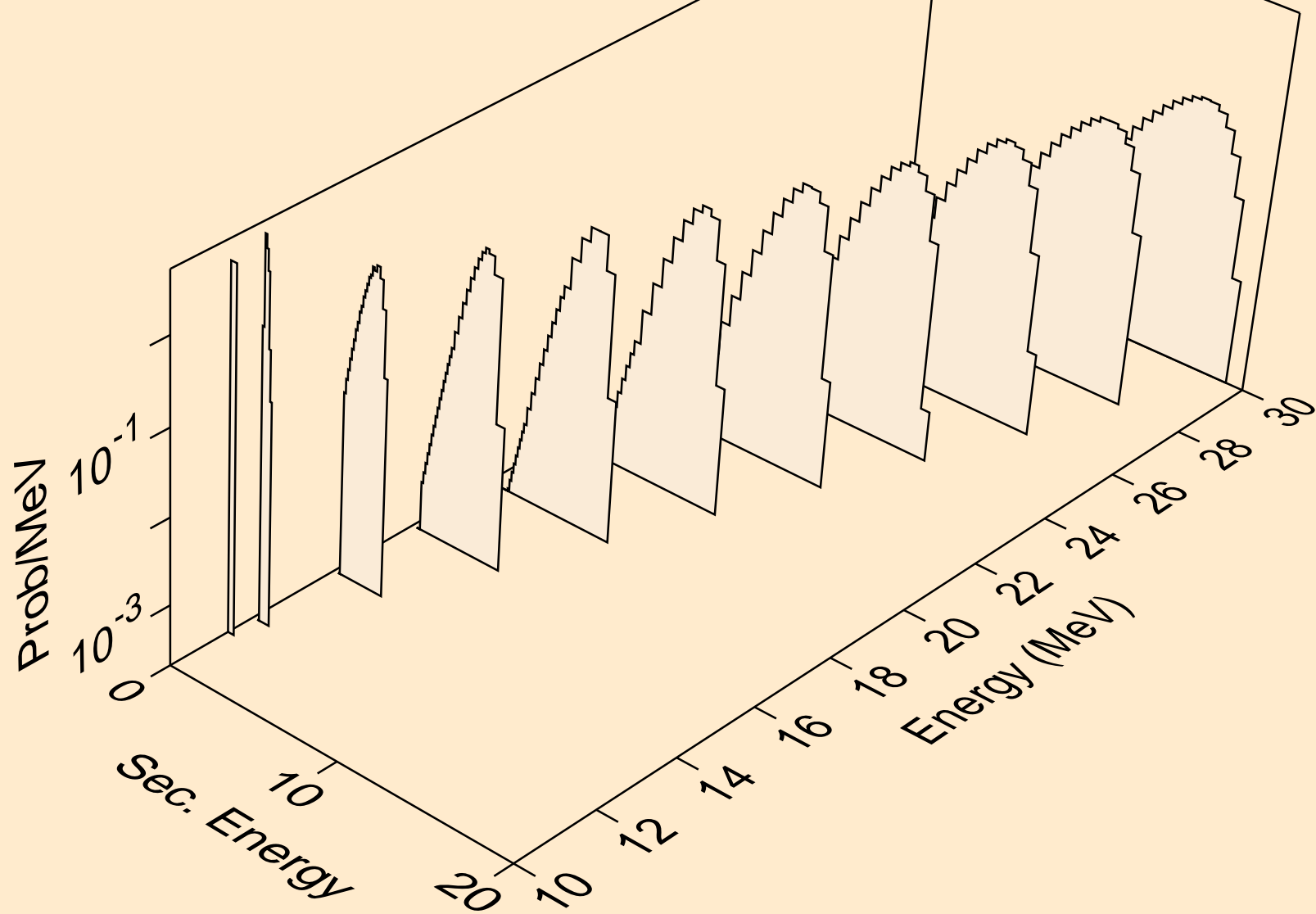

TL209 TRITON ACER TENDL-2021 LIBRARY; T=0.K  
deuterons from (t,n\*)d

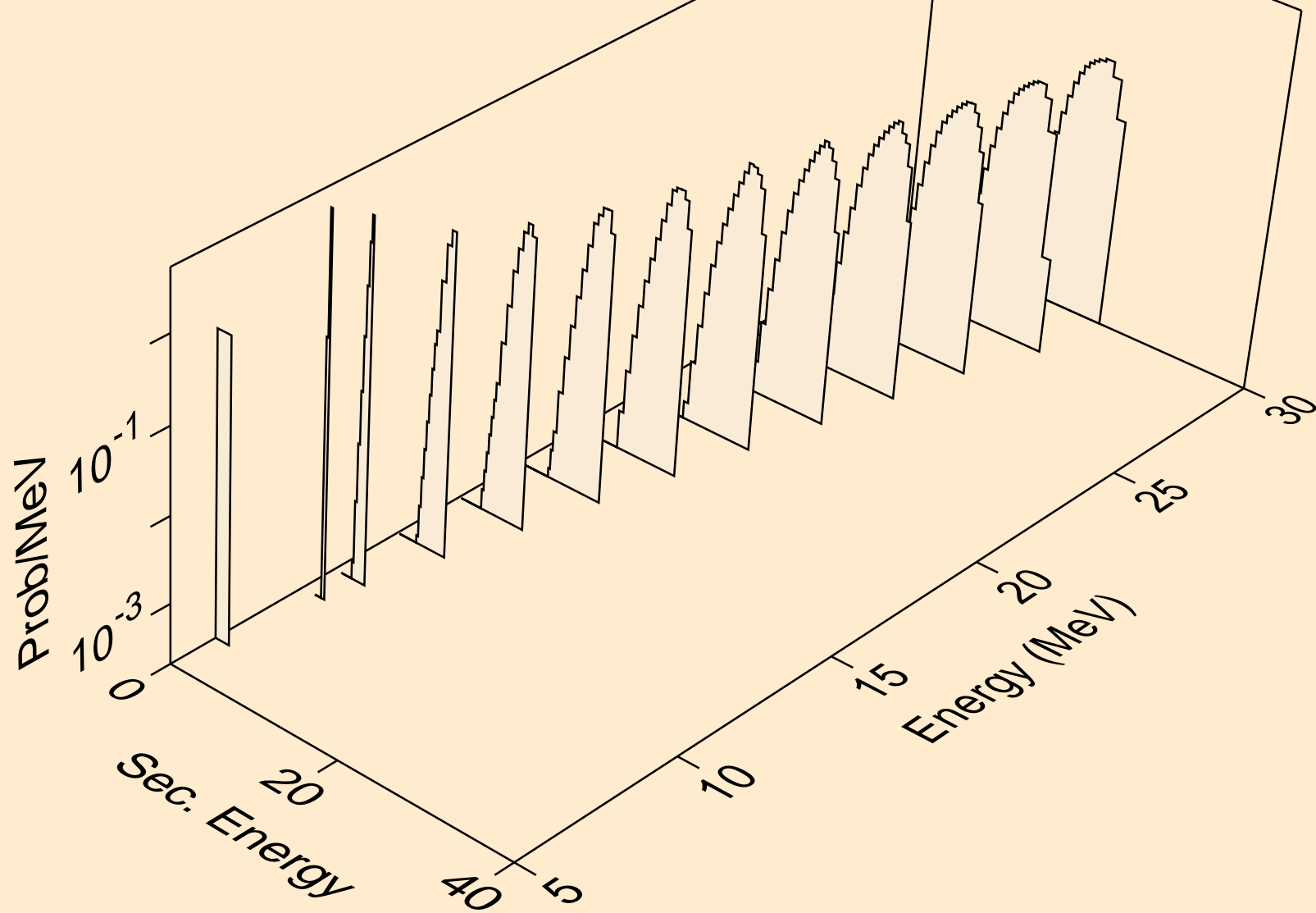

TL209 TRITON ACER TENDL-2021 LIBRARY; T=0.K  
deuterons from (t,d)

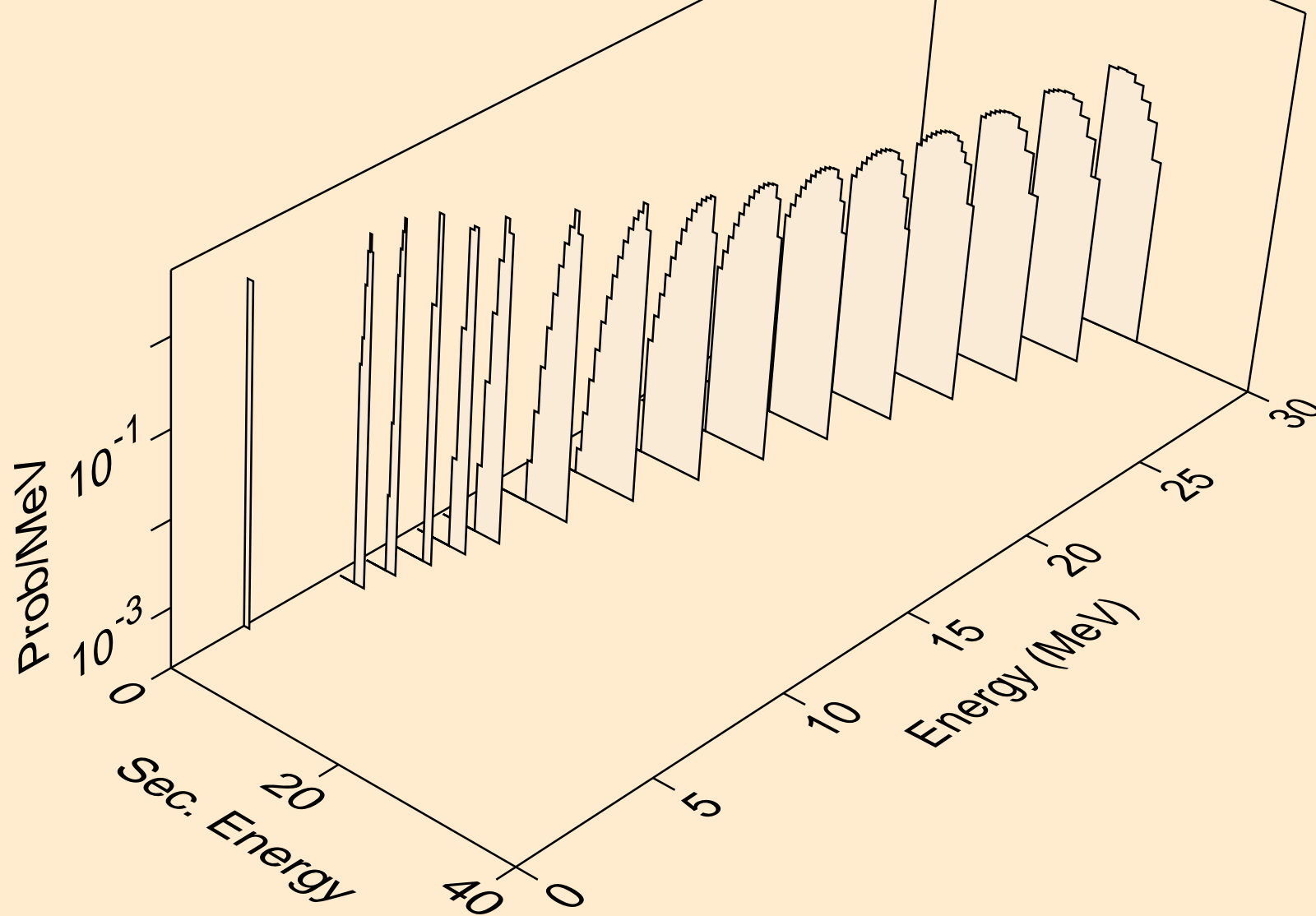



TL209 TRITON ACER TENDL-2021 LIBRARY; T=0.K  
deuterons from (t,da)

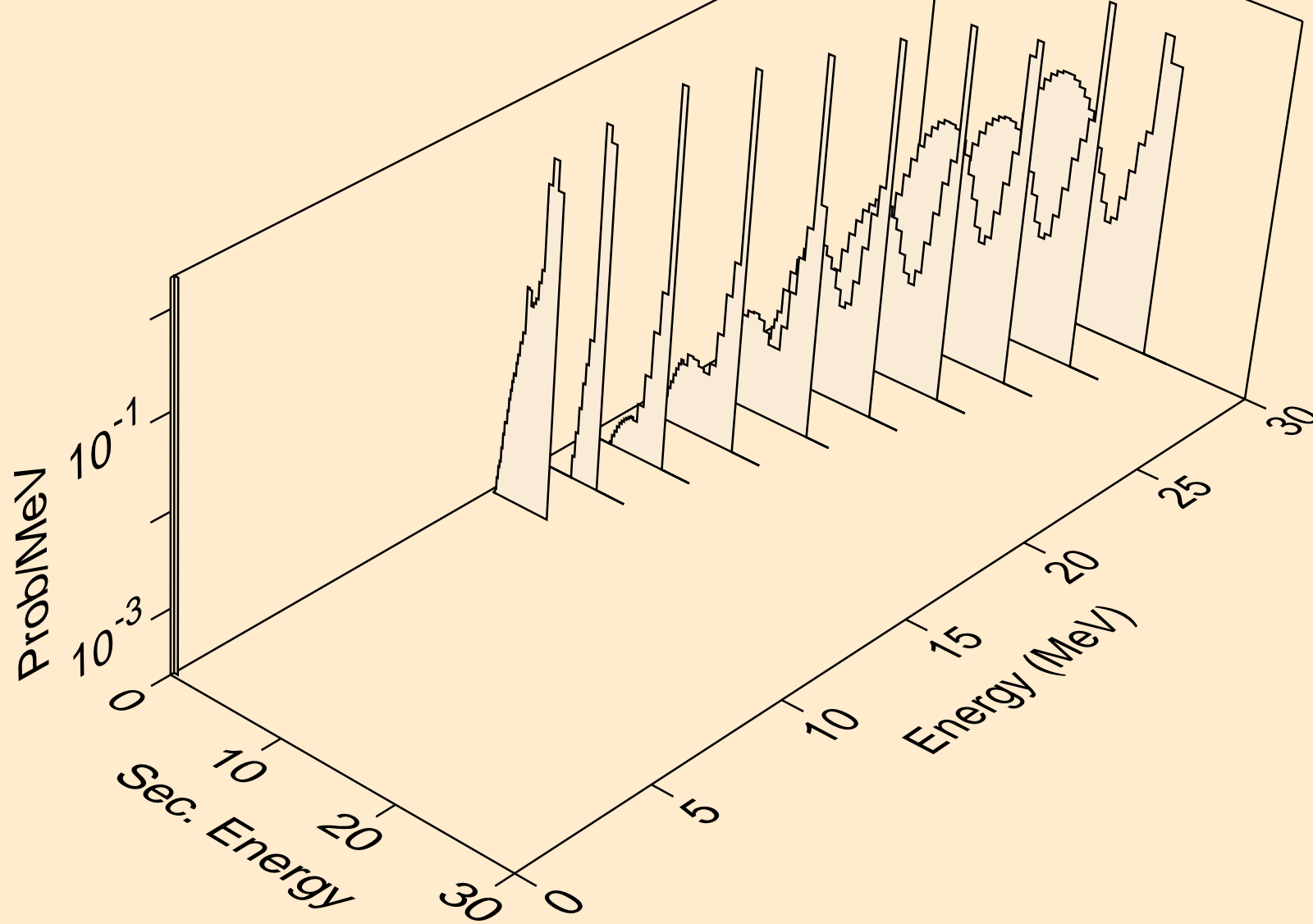

TL209 TRITON ACER TENDL-2021 LIBRARY; T=0.K  
he3s from (t,x)

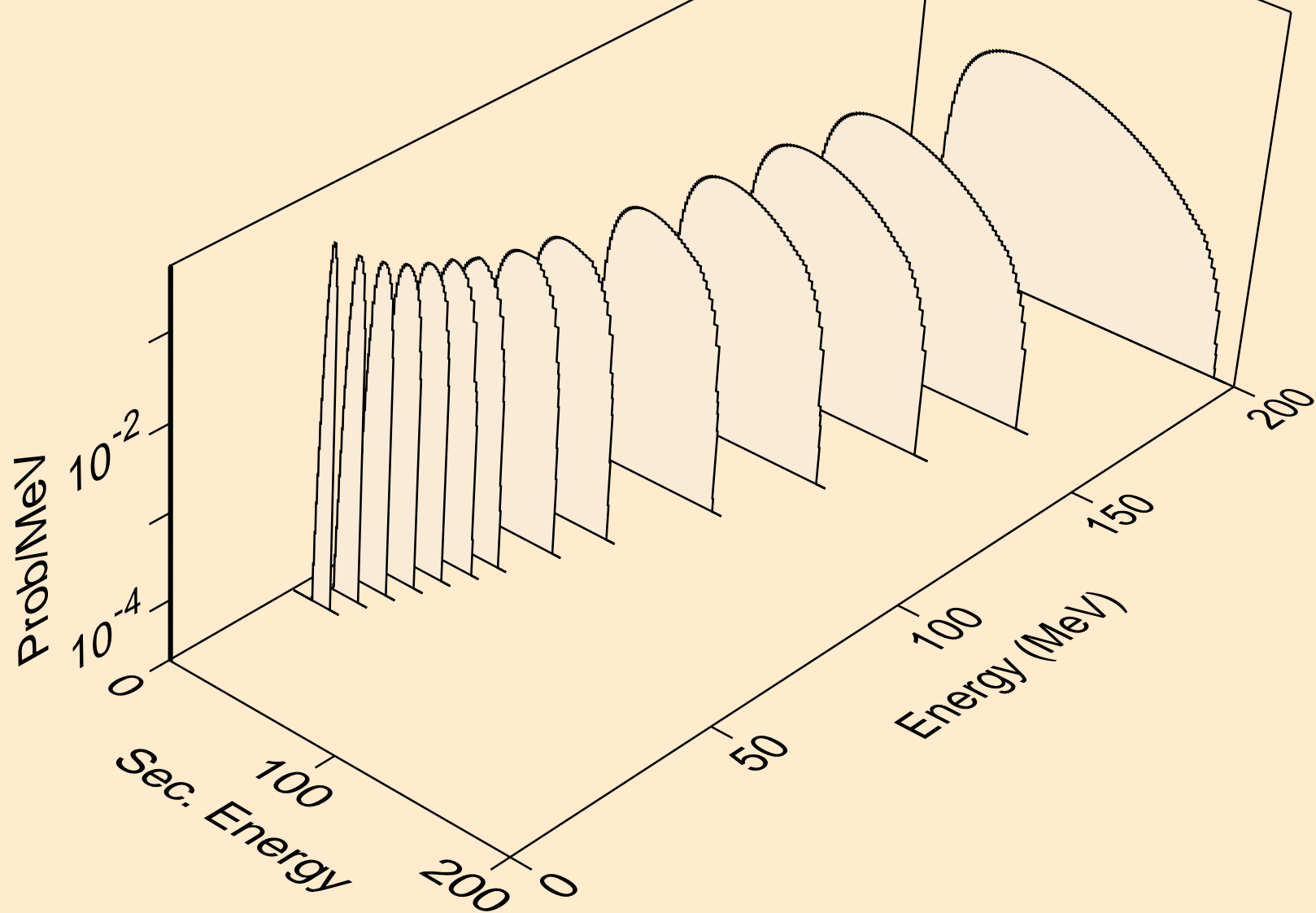

TL209 TRITON ACER TENDL-2021 LIBRARY; T=0.K  
he3s from (t,n\*)he3

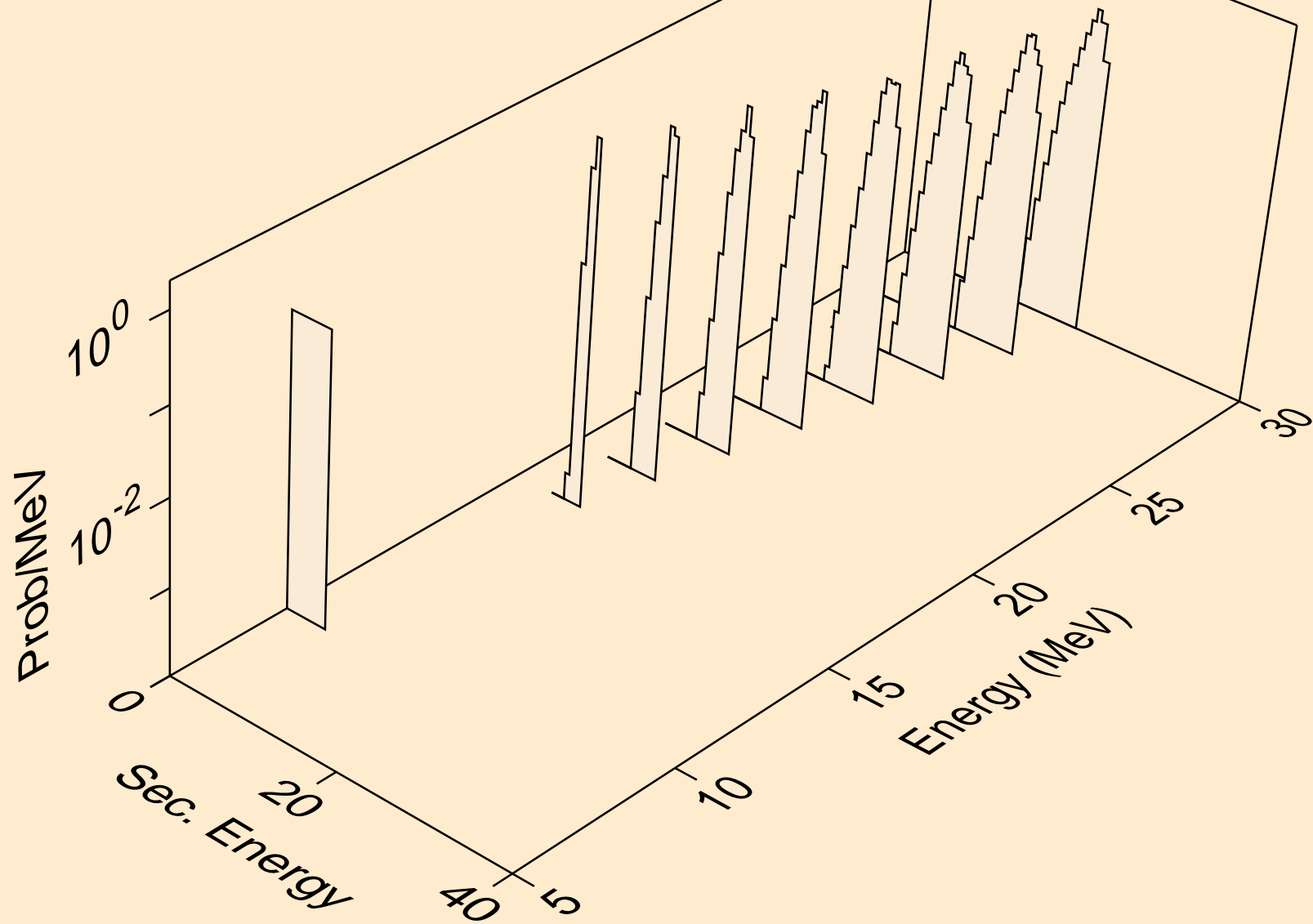

TL209 TRITON ACER TENDL-2021 LIBRARY; T=0.K  
he3s from (t,he3)

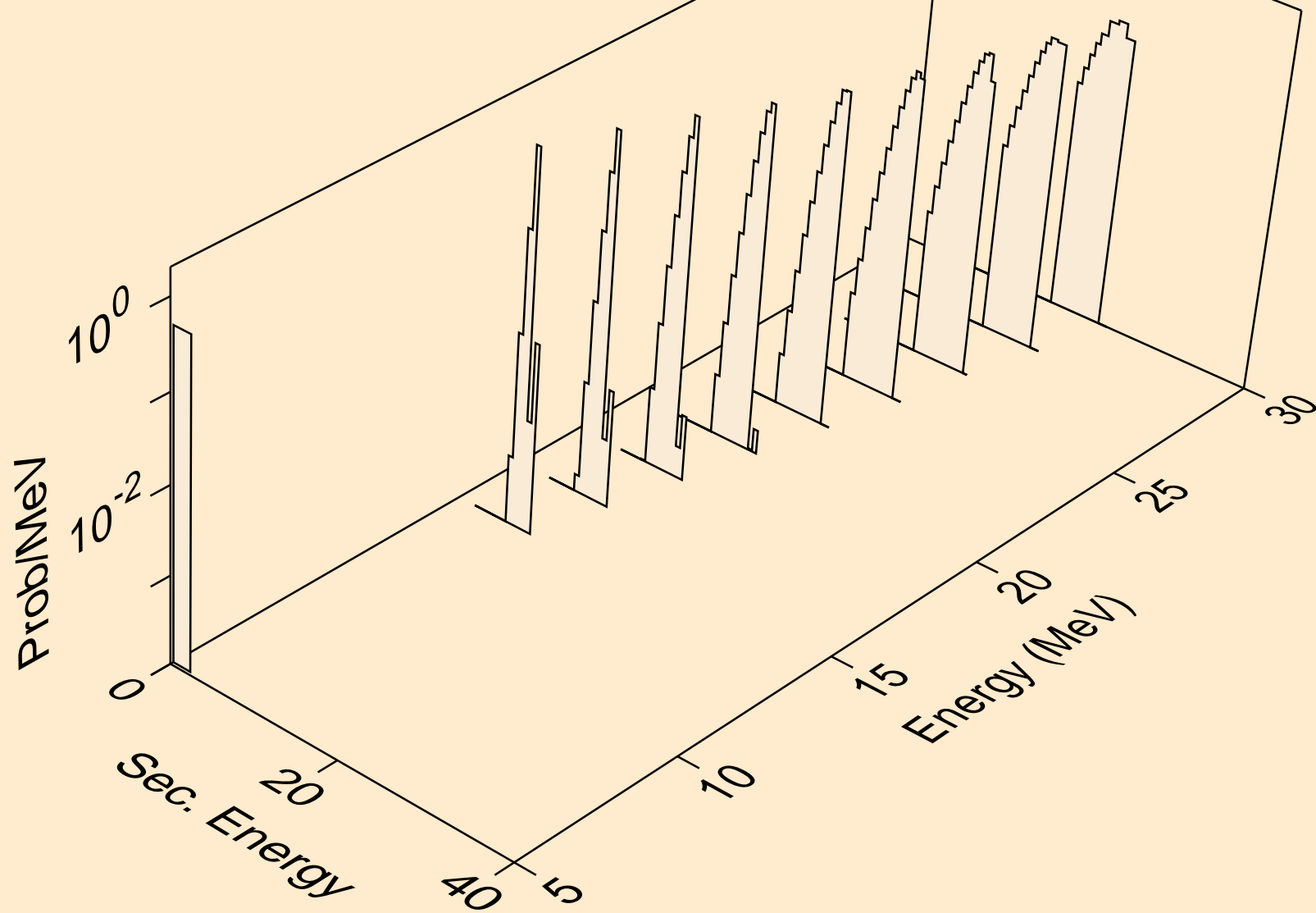

TL209 TRITON ACER TENDL-2021 LIBRARY; T=0.K  
alphas from (t,x)

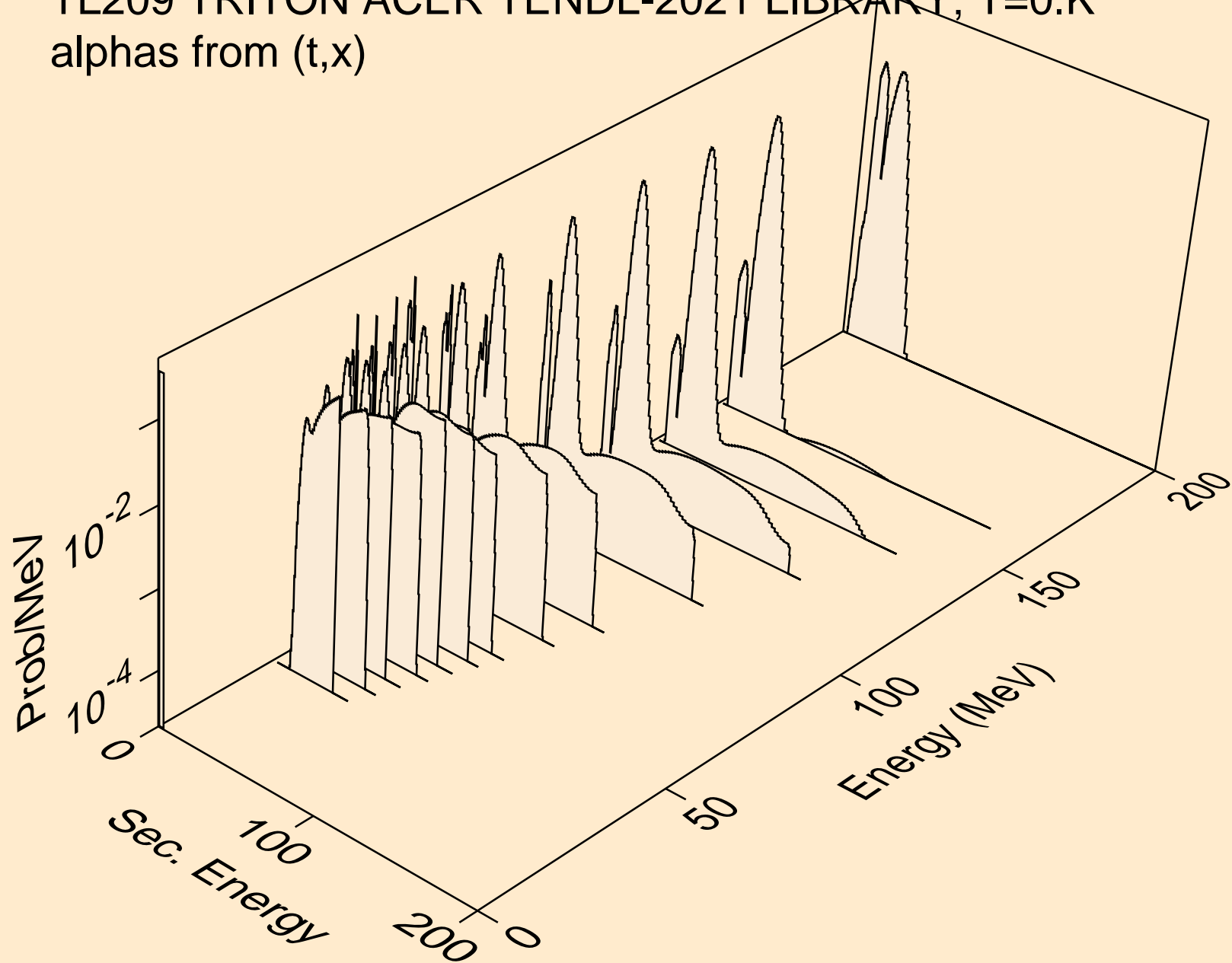

TL209 TRITON ACER TENDL-2021 LIBRARY; T=0.K  
alphas from (t,n\*)a

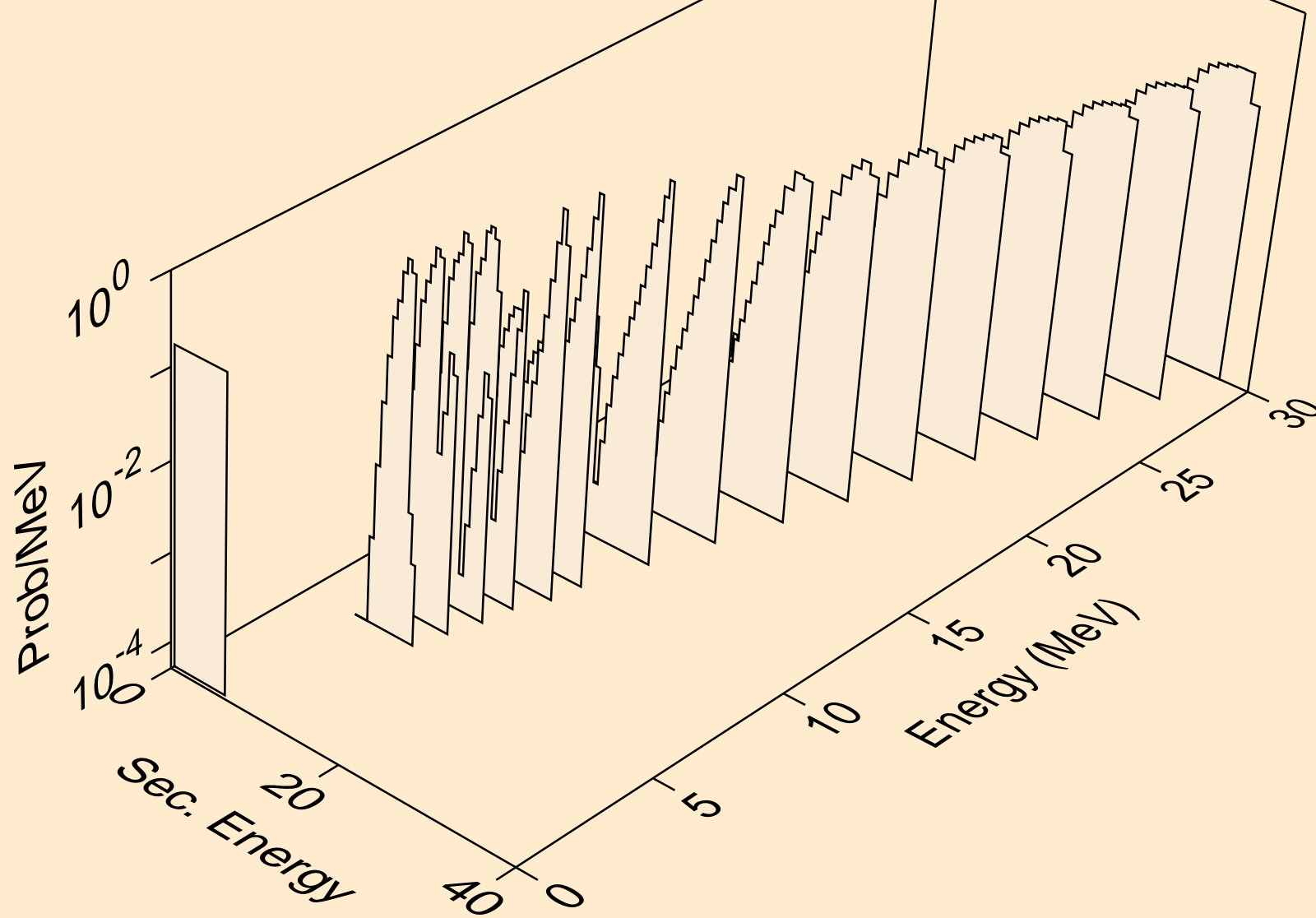

TL209 TRITON ACER TENDL-2021 LIBRARY; T=0.K  
alphas from (t,2n)a

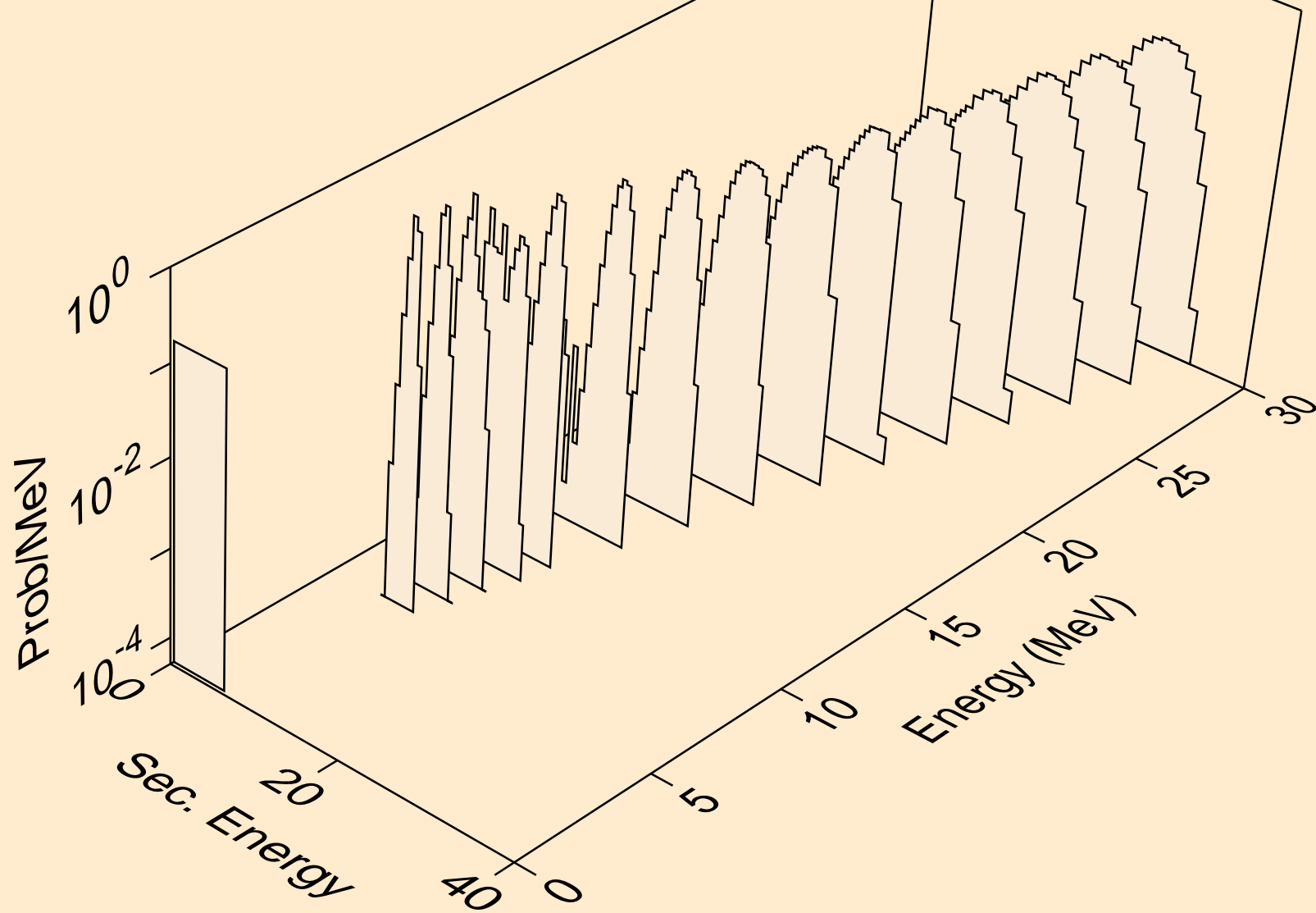

TL209 TRITON ACER TENDL-2021 LIBRARY; T=0.K  
alphas from (t,3n)a

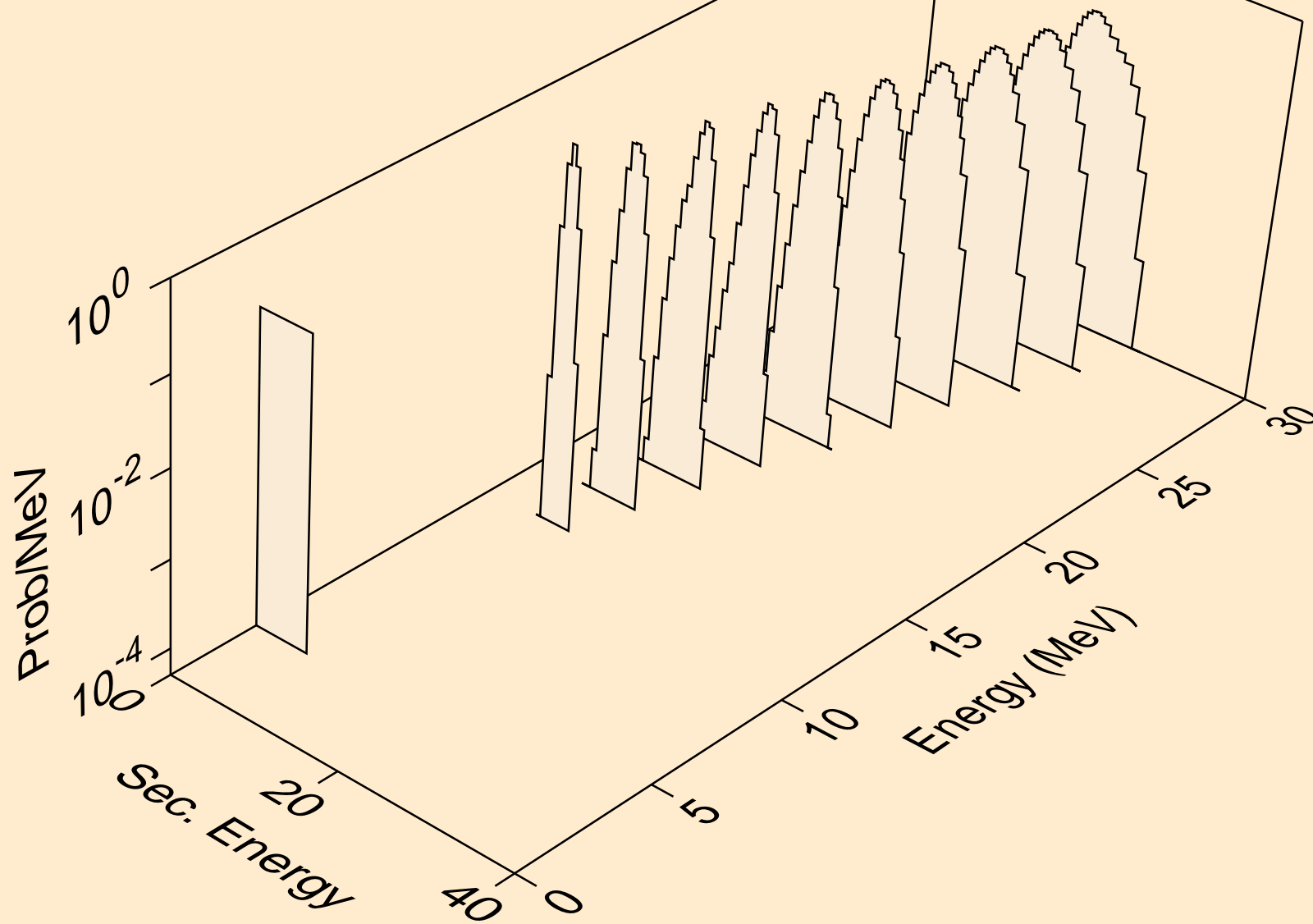



TL209 TRITON ACER TENDL-2021 LIBRARY; T=0.K  
alphas from (t,npa)

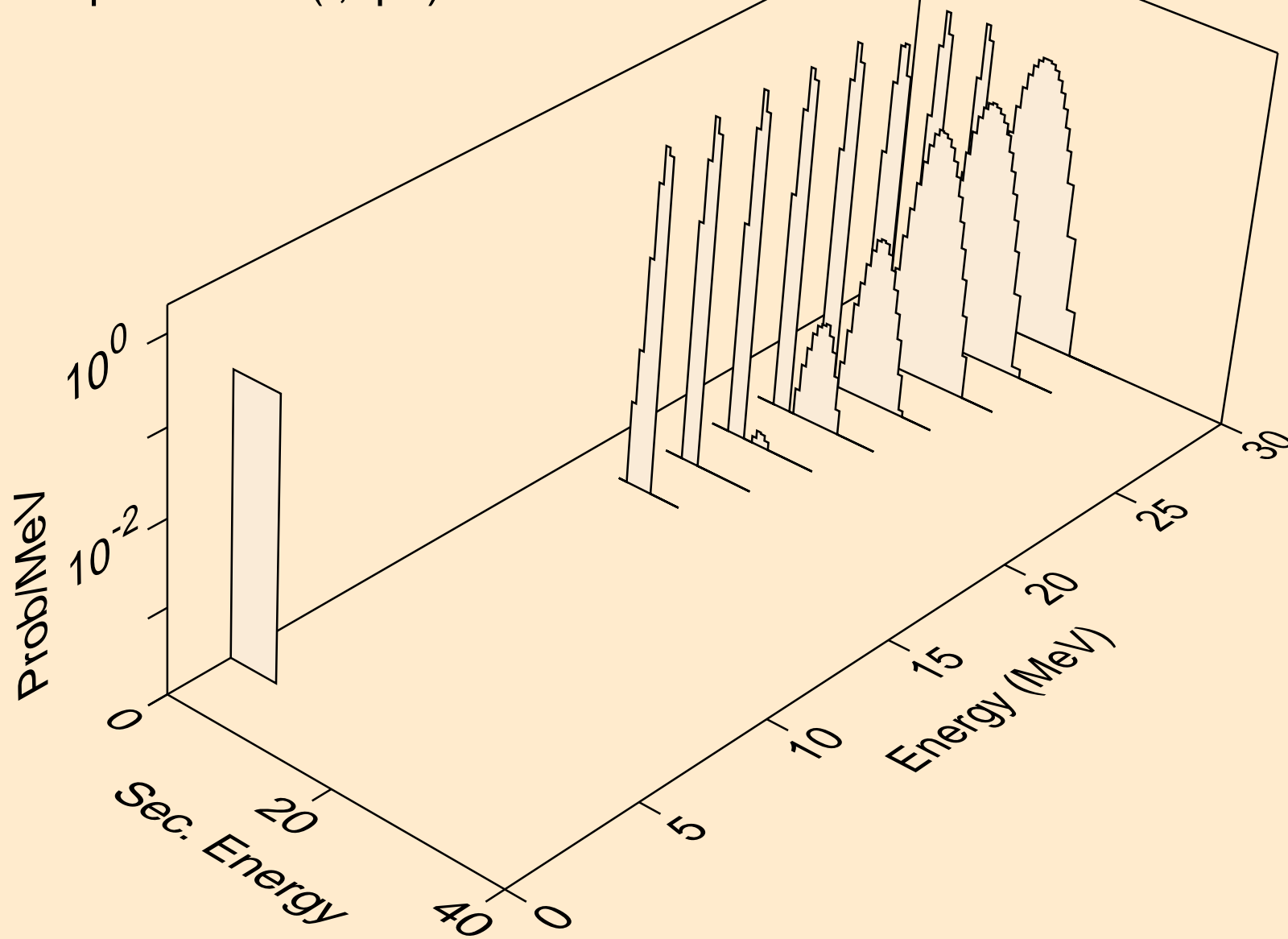

TL209 TRITON ACER TENDL-2021 LIBRARY; T=0.K  
alphas from (t,a)

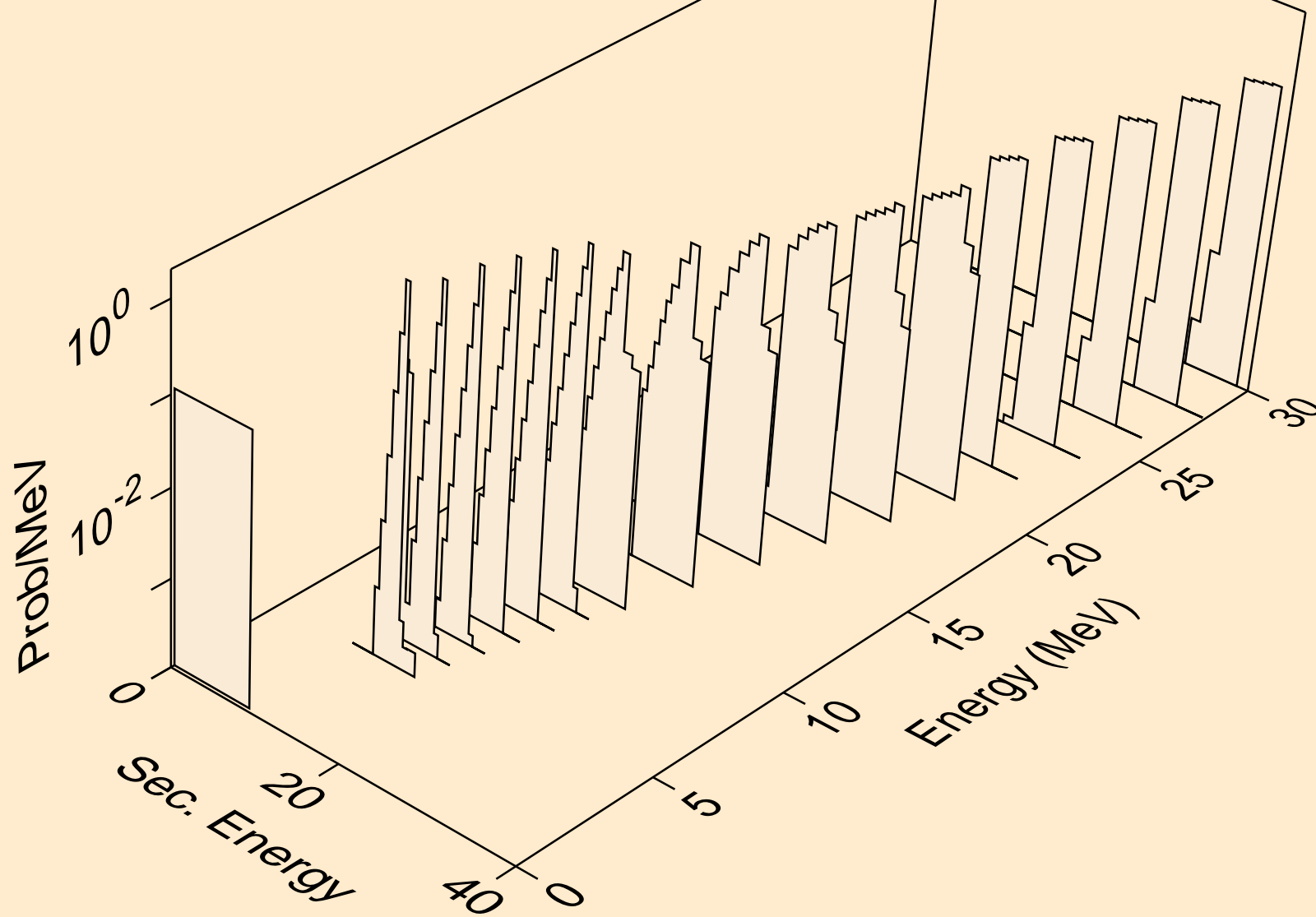

TL209 TRITON ACER TENDL-2021 LIBRARY; T=0.K  
alphas from (t,pa)

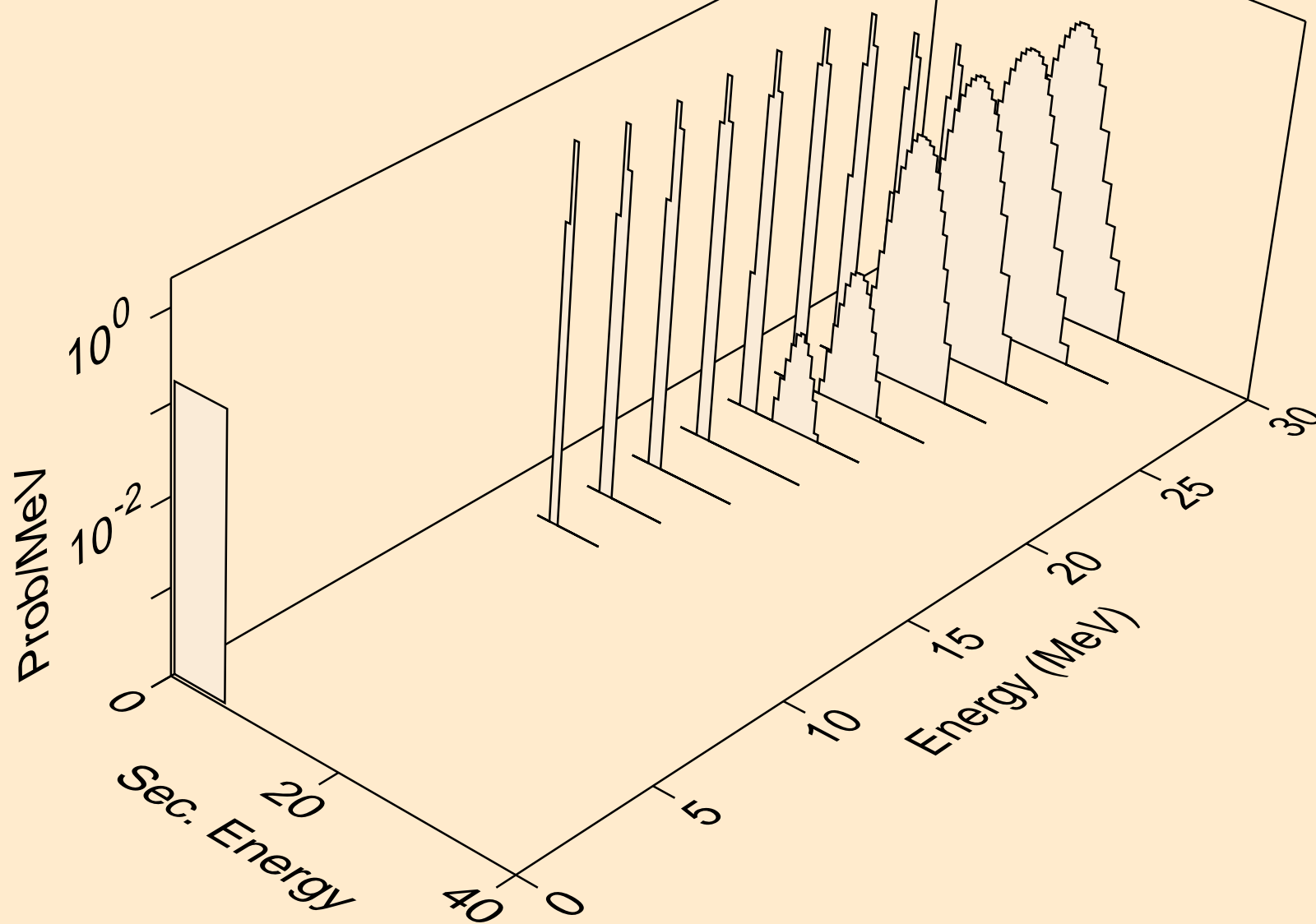

TL209 TRITON ACER TENDL-2021 LIBRARY; T=0.K  
alphas from (t,da)

