

TL211 TRITON ACER TENDL-2021 LIBRARY; T=0.K  
Principal cross sections

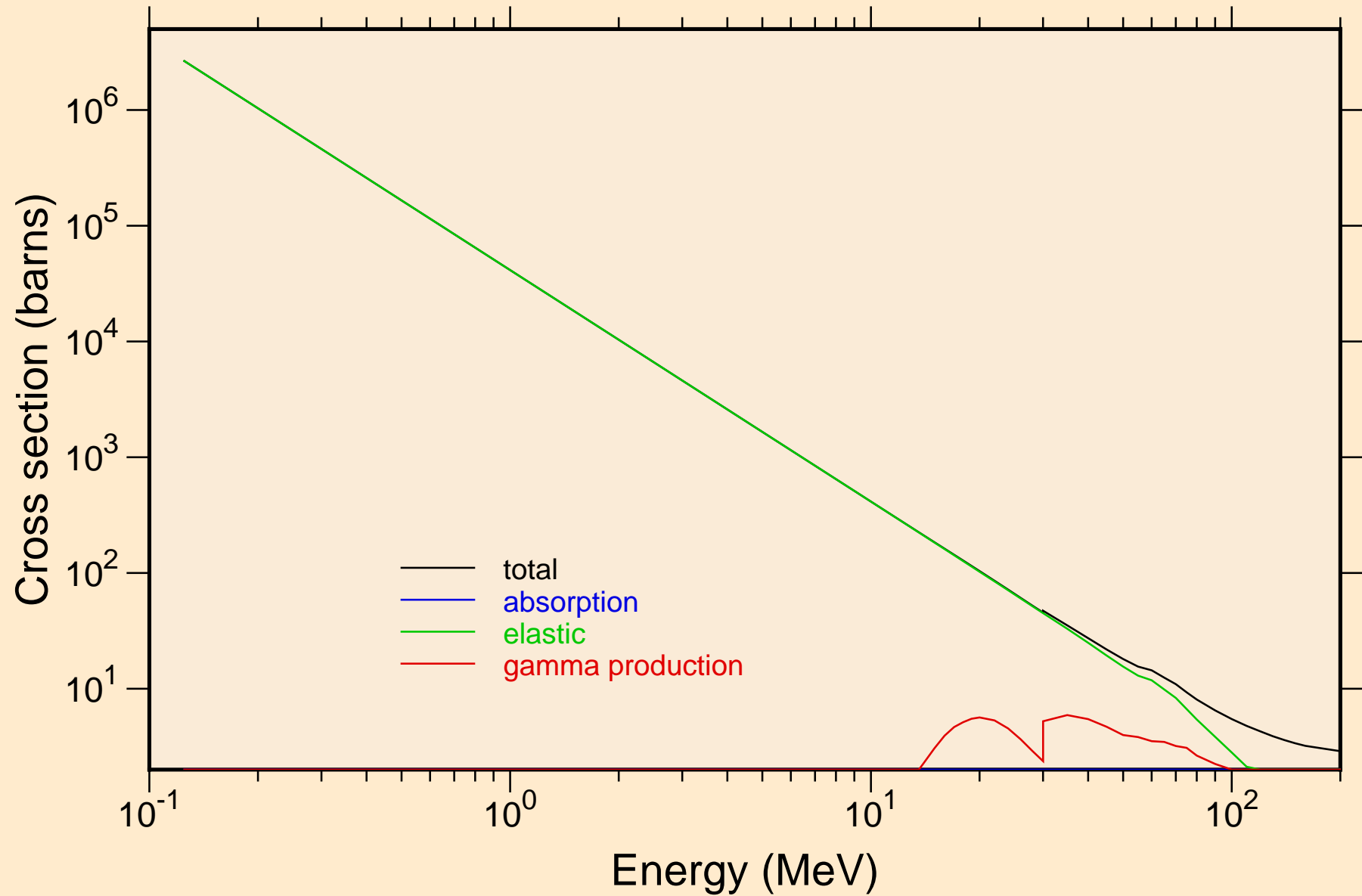

TL211 TRITON ACER TENDL-2021 LIBRARY; T=0.K

Heating

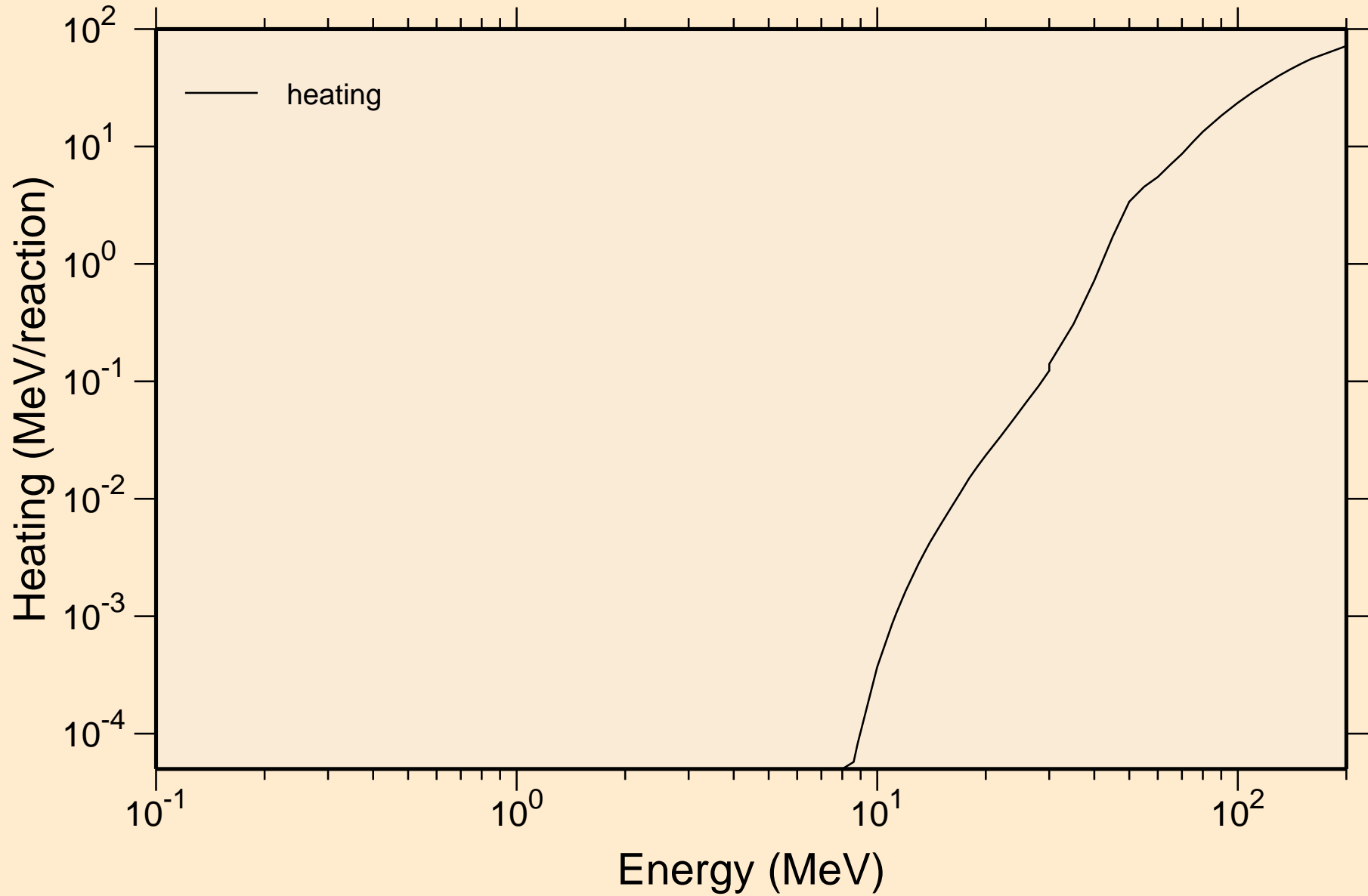

# TL211 TRITON ACER TENDL-2021 LIBRARY; T=0.K

## Principal cross sections

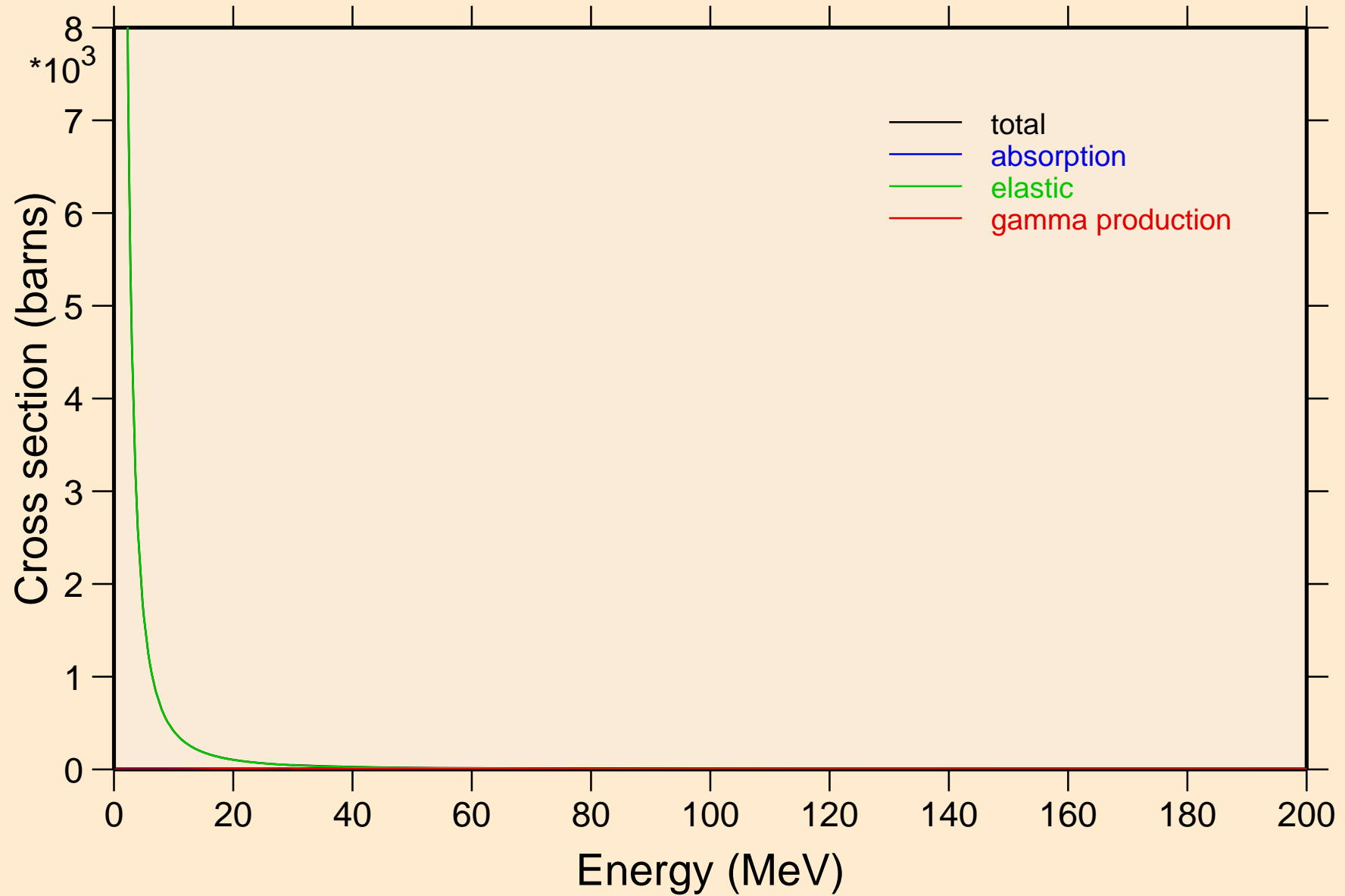

TL211 TRITON ACER TENDL-2021 LIBRARY; T=0.K

Heating

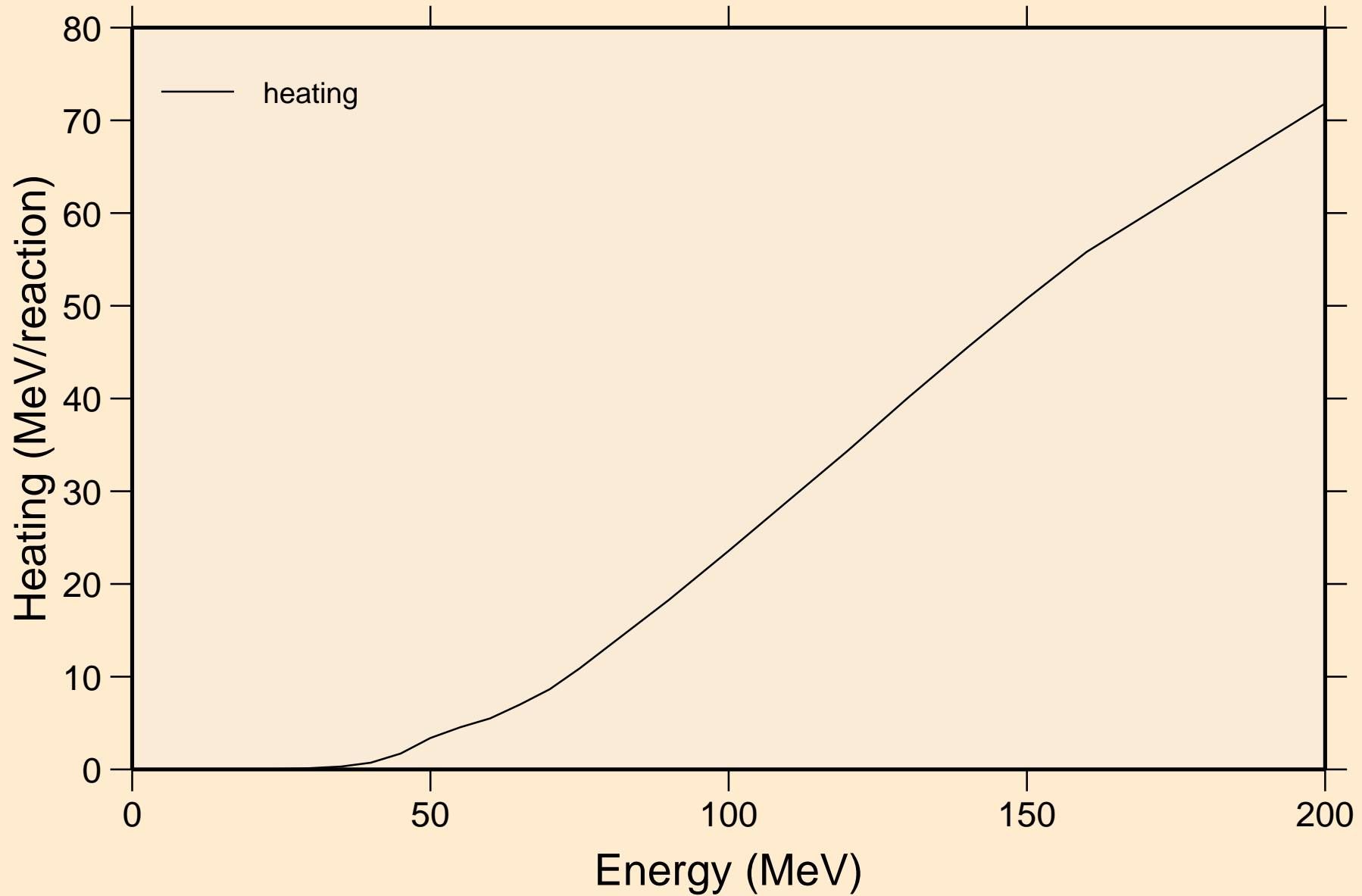

TL211 TRITON ACER TENDL-2021 LIBRARY; T=0.K  
Threshold reactions

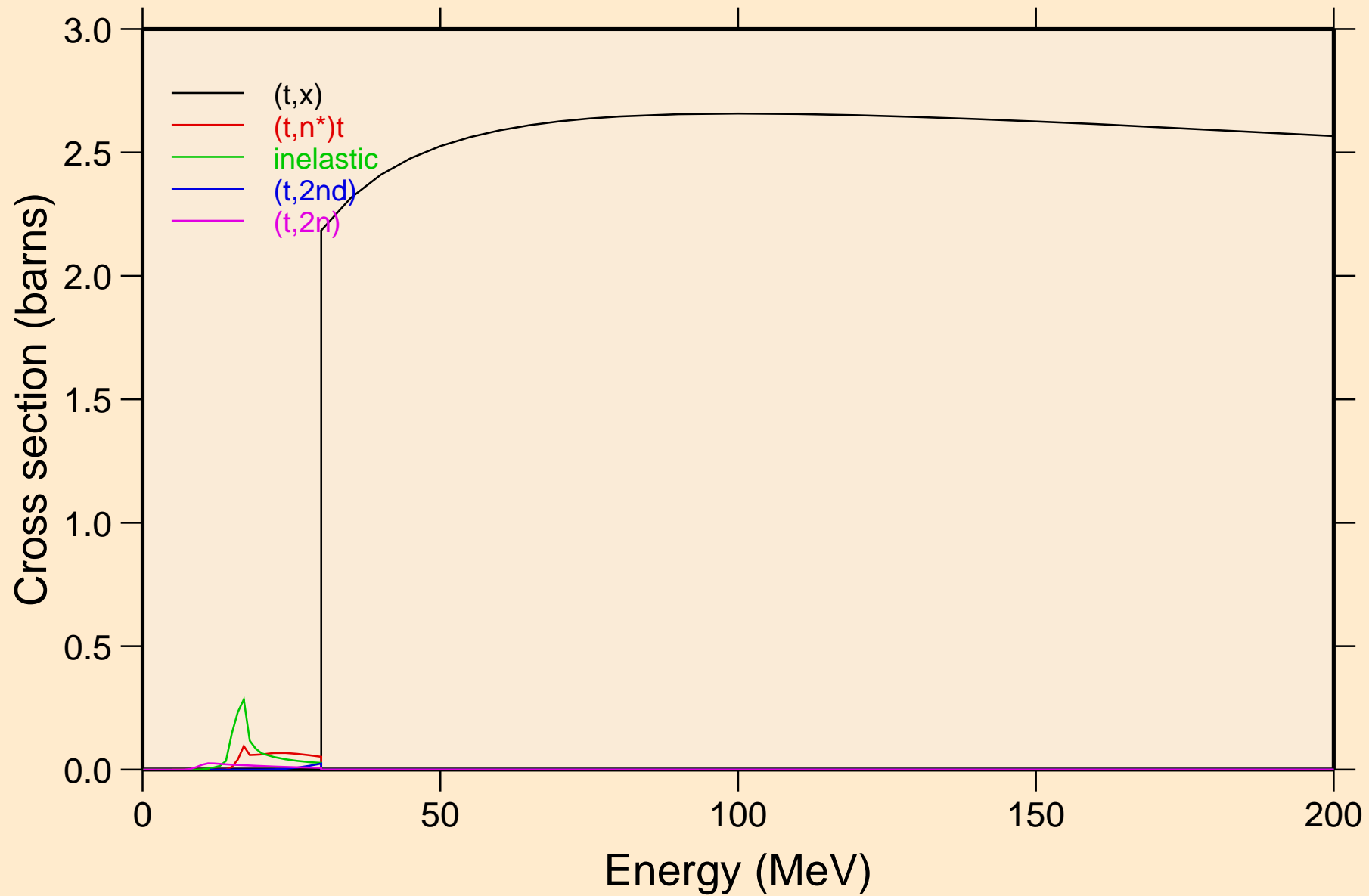

TL211 TRITON ACER TENDL-2021 LIBRARY; T=0.K  
Threshold reactions

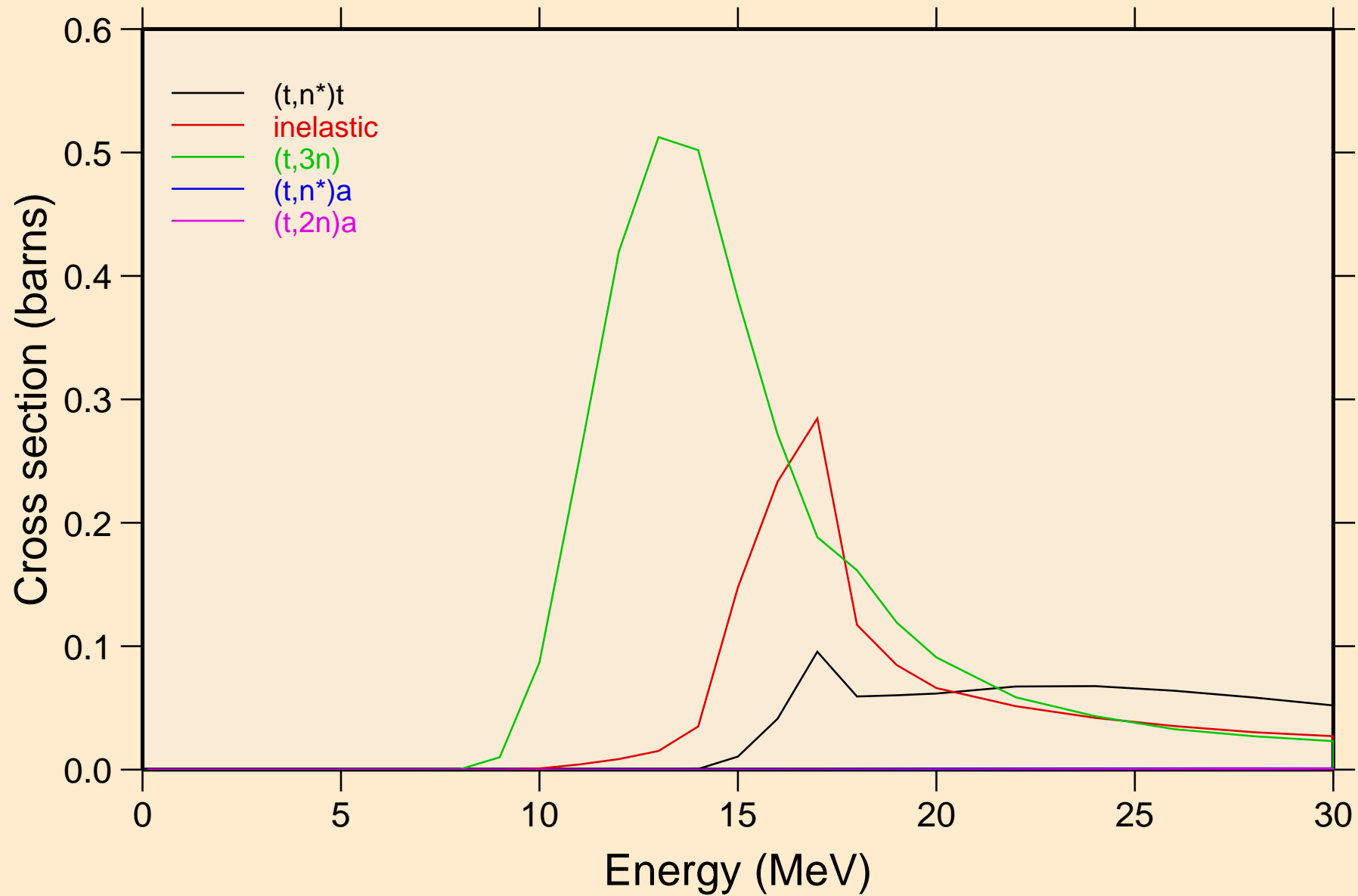

TL211 TRITON ACER TENDL-2021 LIBRARY; T=0.K  
Threshold reactions

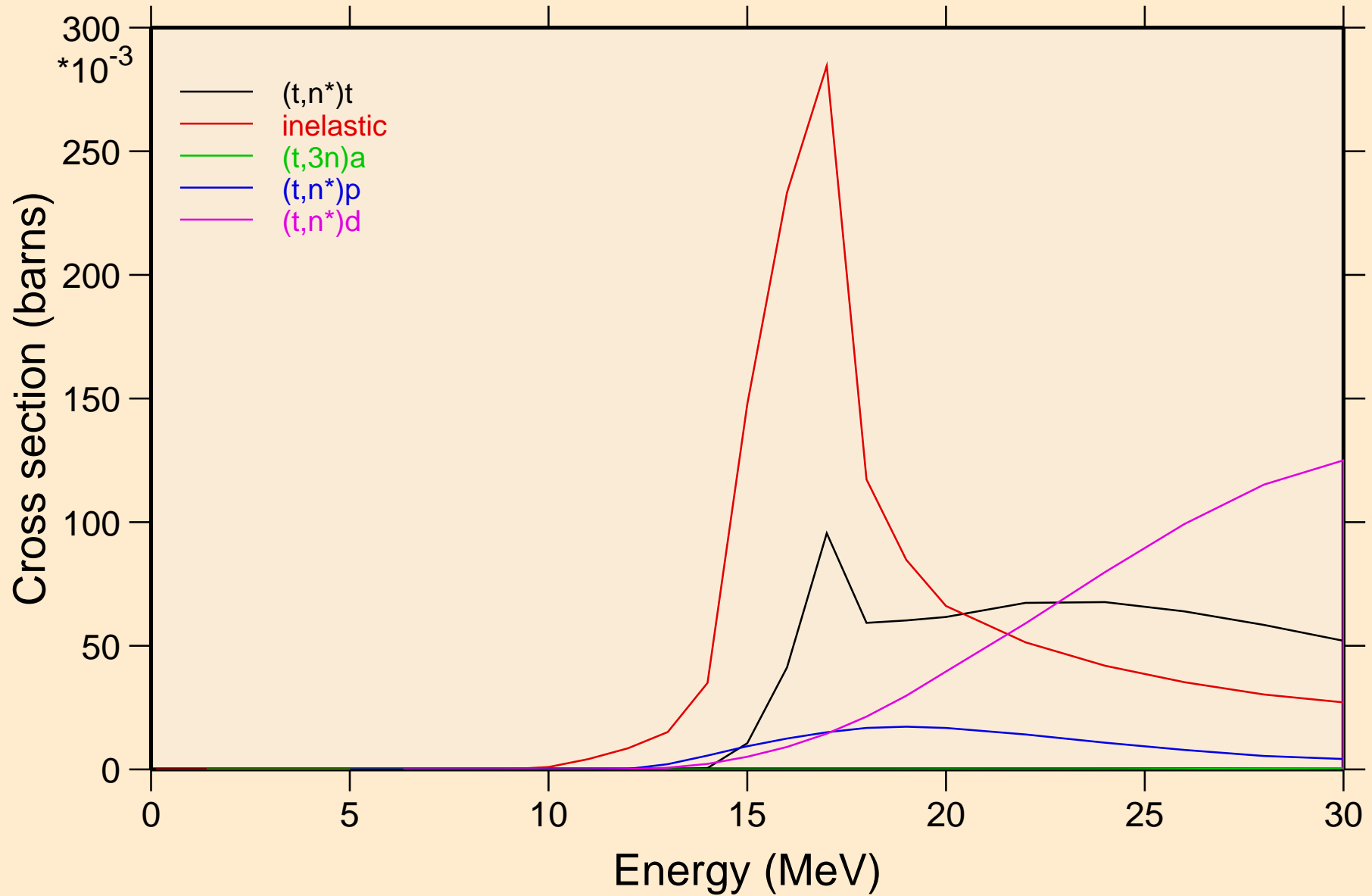

TL211 TRITON ACER TENDL-2021 LIBRARY; T=0.K  
Threshold reactions

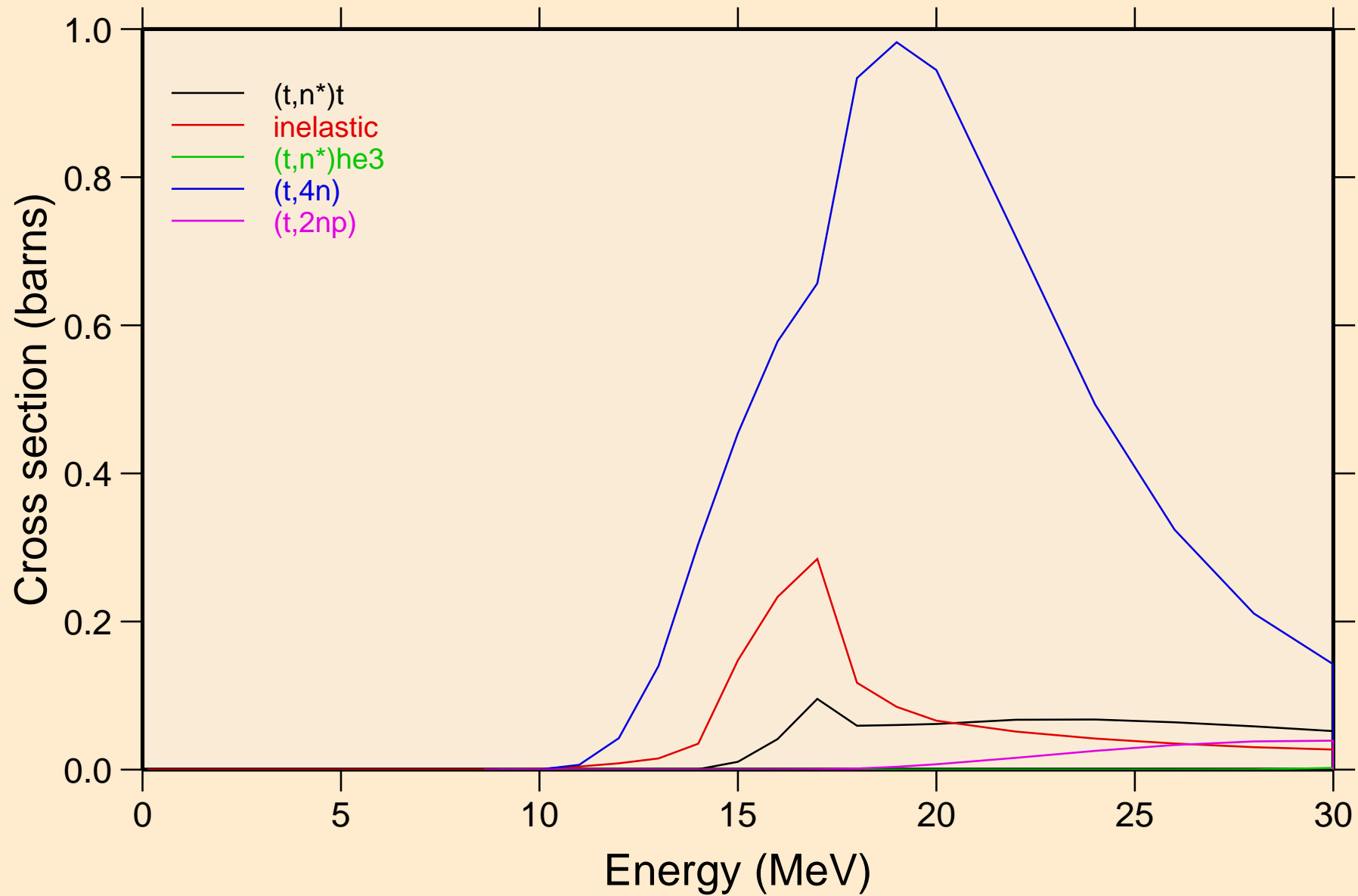



TL211 TRITON ACER TENDL-2021 LIBRARY; T=0.K  
Threshold reactions

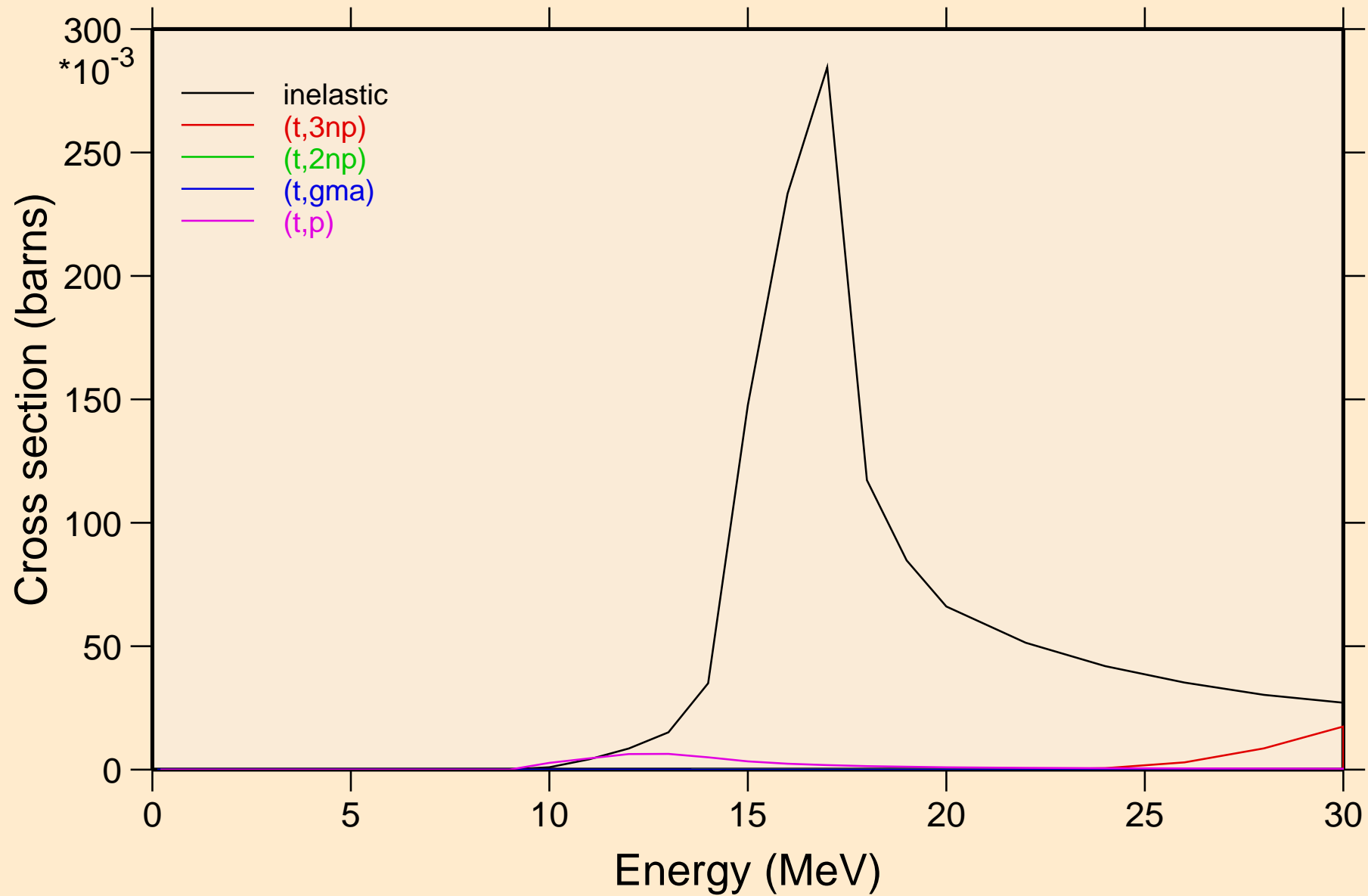

TL211 TRITON ACER TENDL-2021 LIBRARY; T=0.K  
Threshold reactions

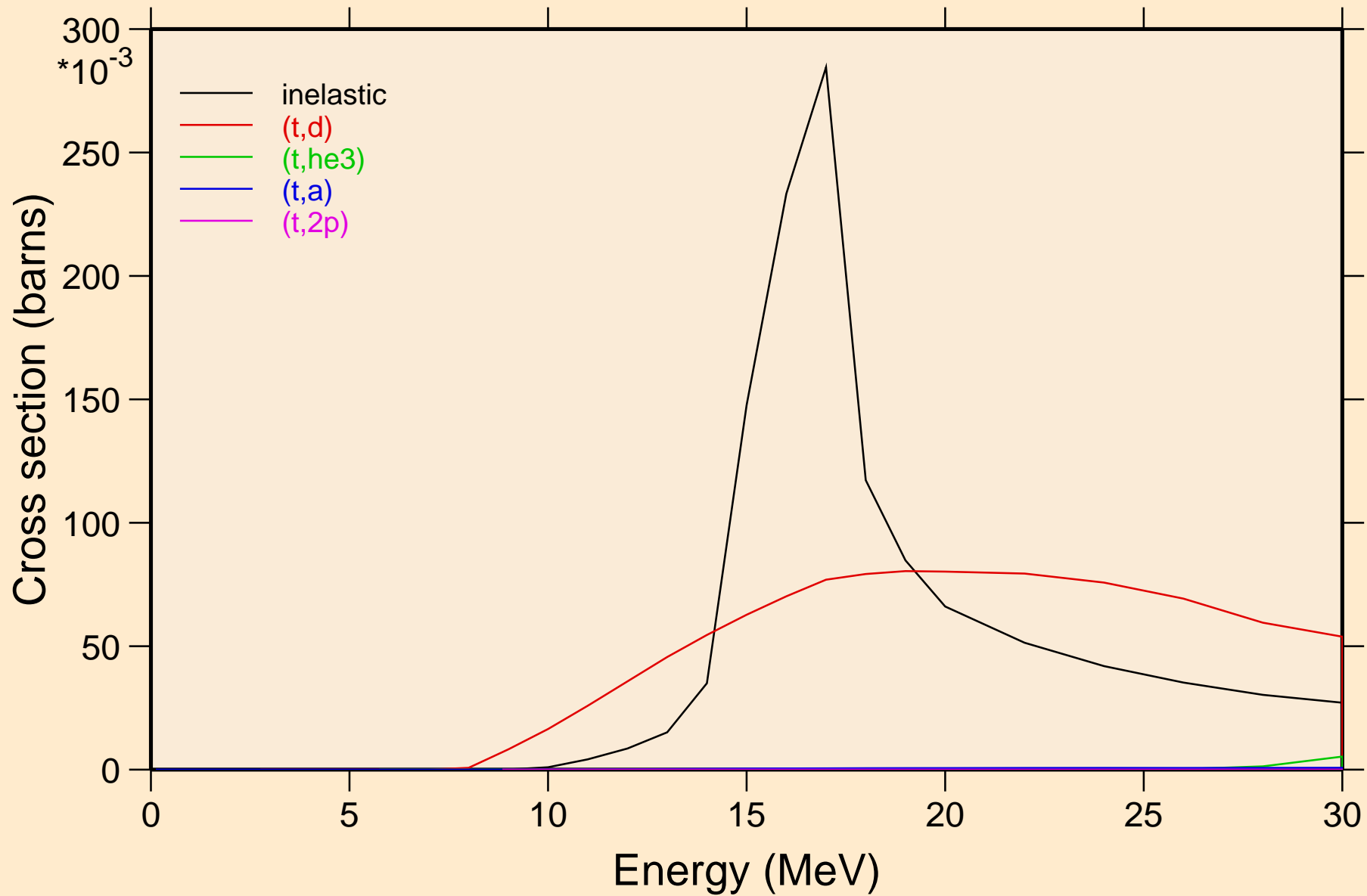

TL211 TRITON ACER TENDL-2021 LIBRARY; T=0.K  
angular distribution for elastic

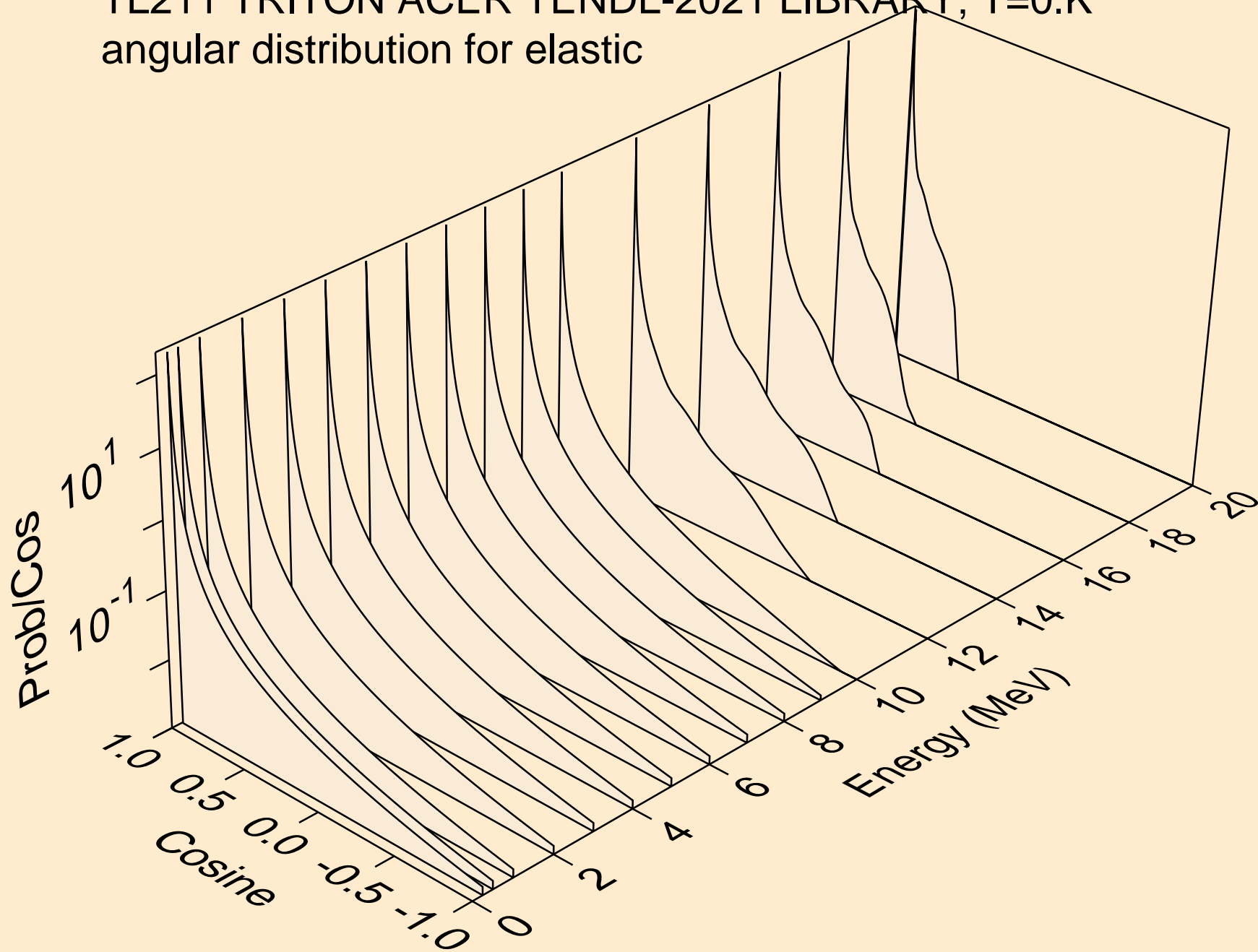

TL211 TRITON ACER TENDL-2021 LIBRARY; T=0.K  
angular distribution for elastic

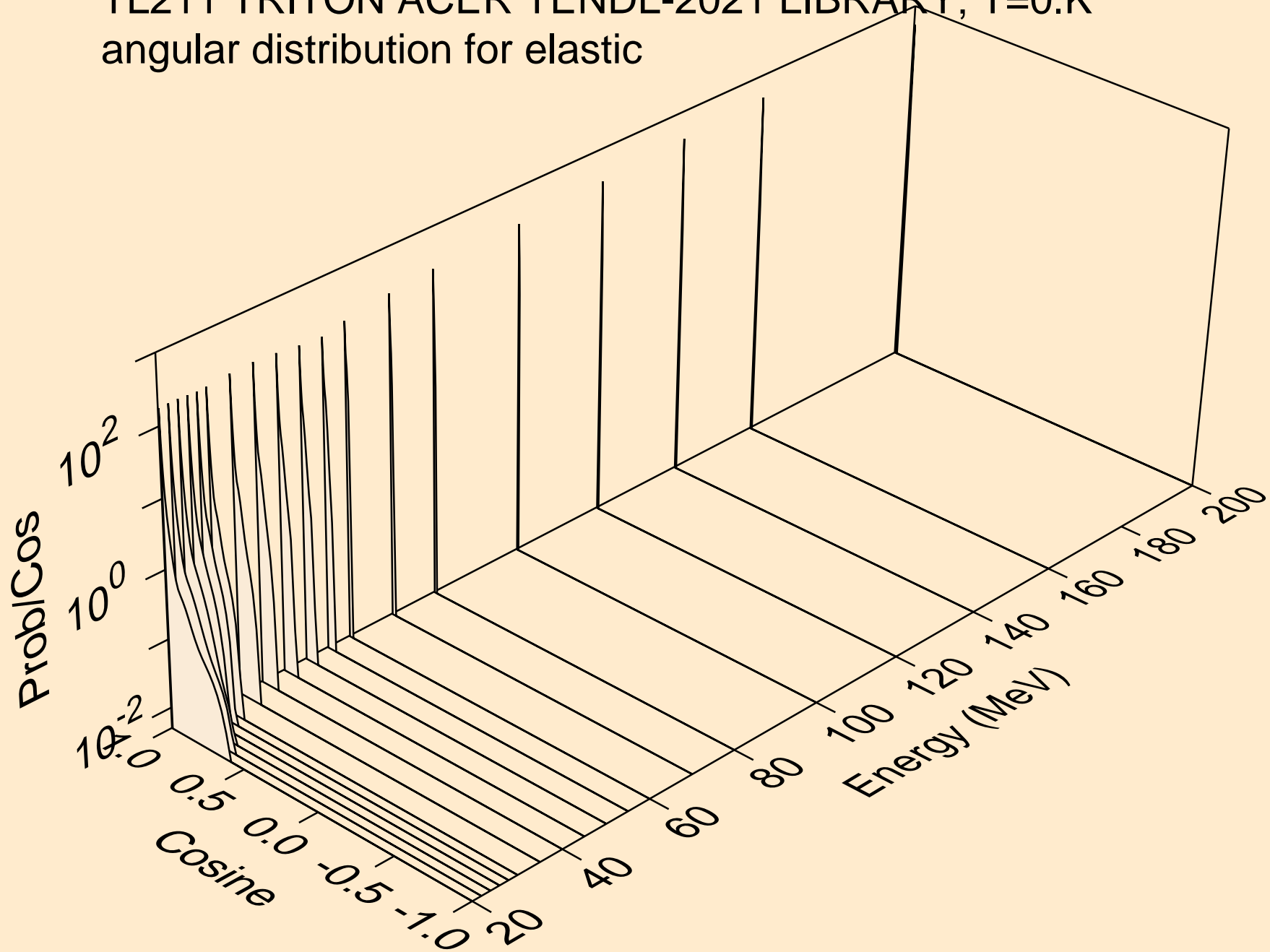

TL211 TRITON ACER TENDL-2021 LIBRARY; T=0.K  
Triton emission for (t,x)

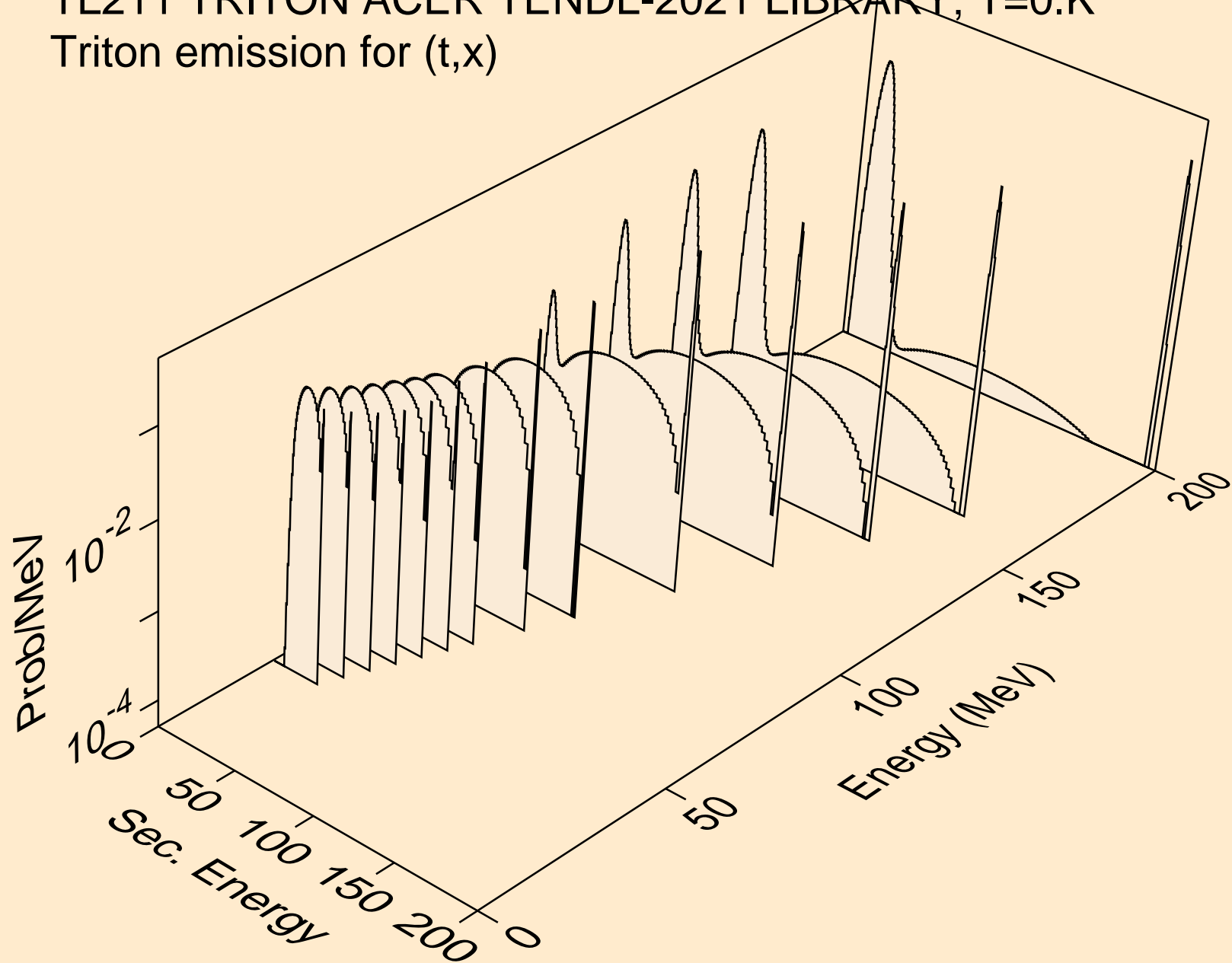

TL211 TRITON ACER TENDL-2021 LIBRARY; T=0.K  
Triton emission for (t,n\*)t

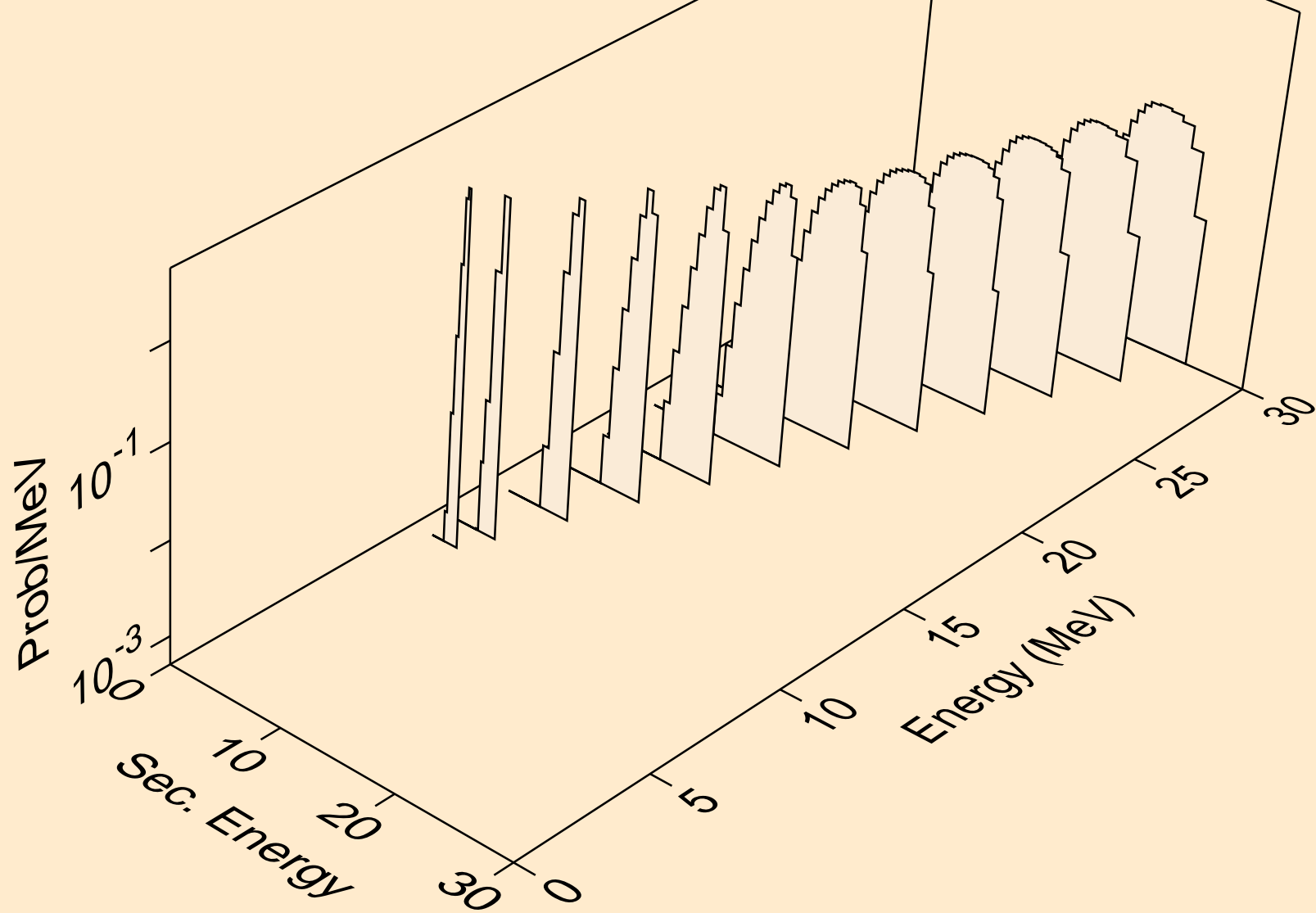

TL211 TRITON ACER TENDL-2021 LIBRARY; T=0.K  
Triton emission for inelastic

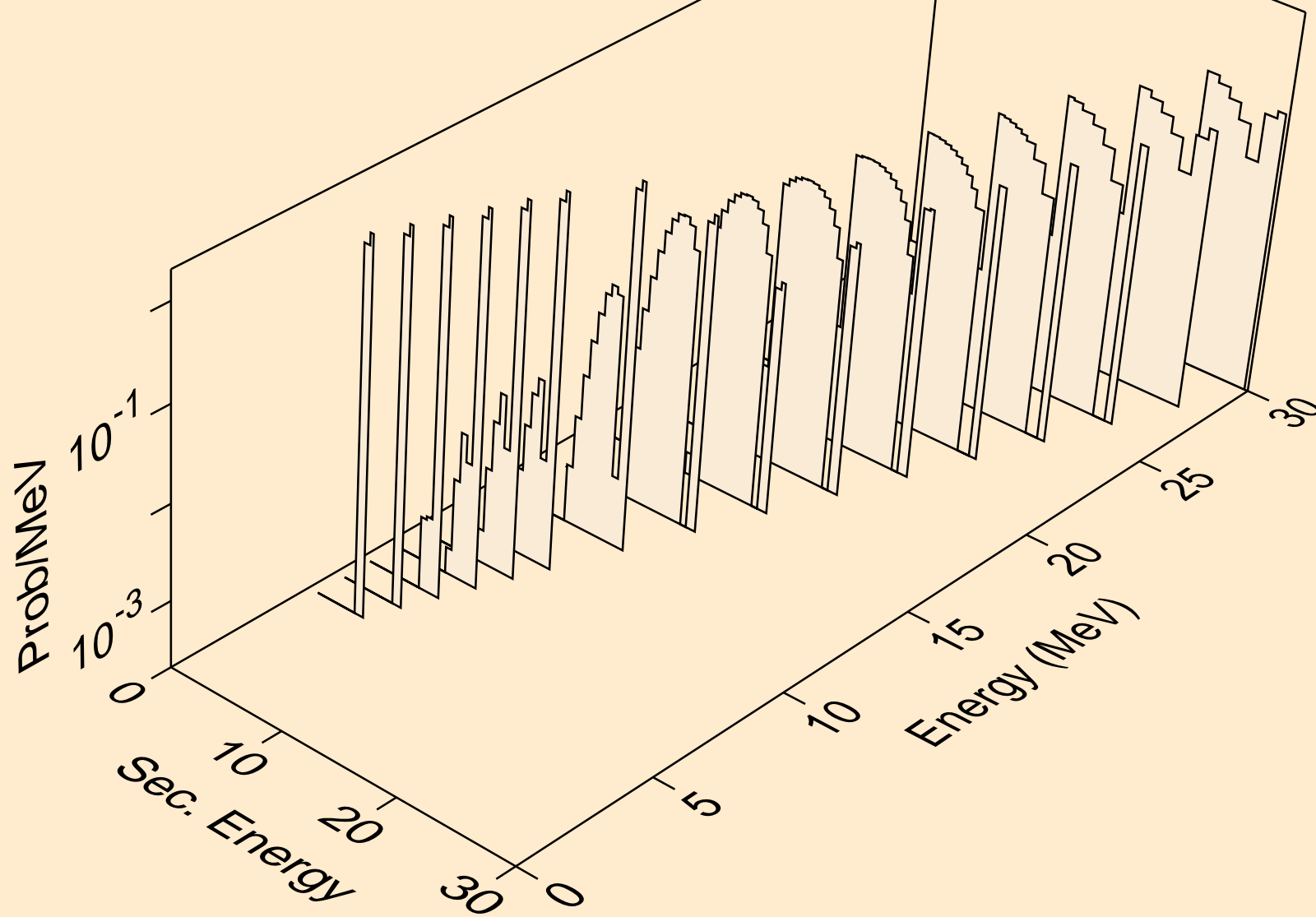

TL211 TRITON ACER TENDL-2021 LIBRARY; T=0.K  
Photon emission for (z,n)

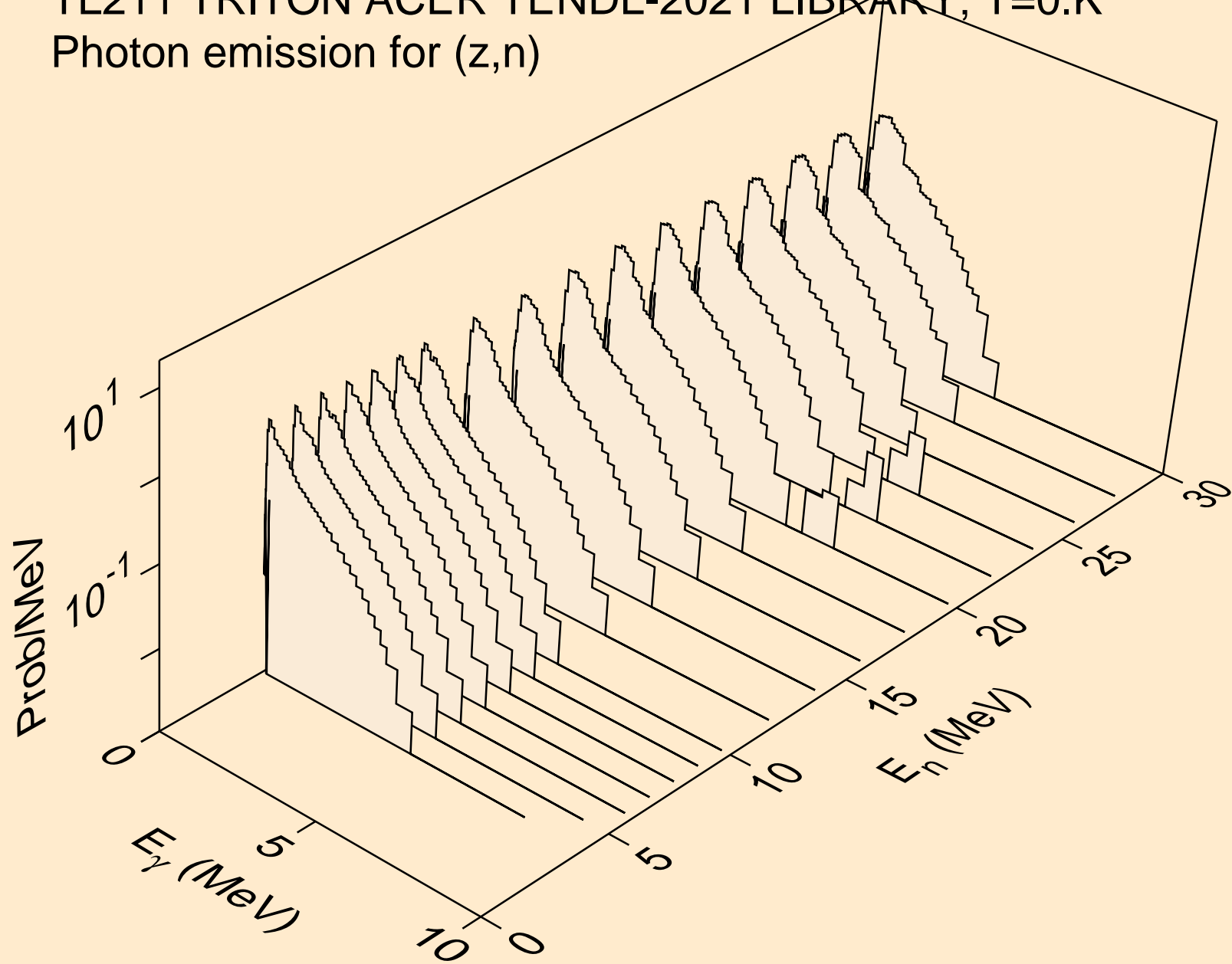



TL211 TRITON ACER TENDL-2021 LIBRARY; T=0.K  
Photon emission for (n,x)

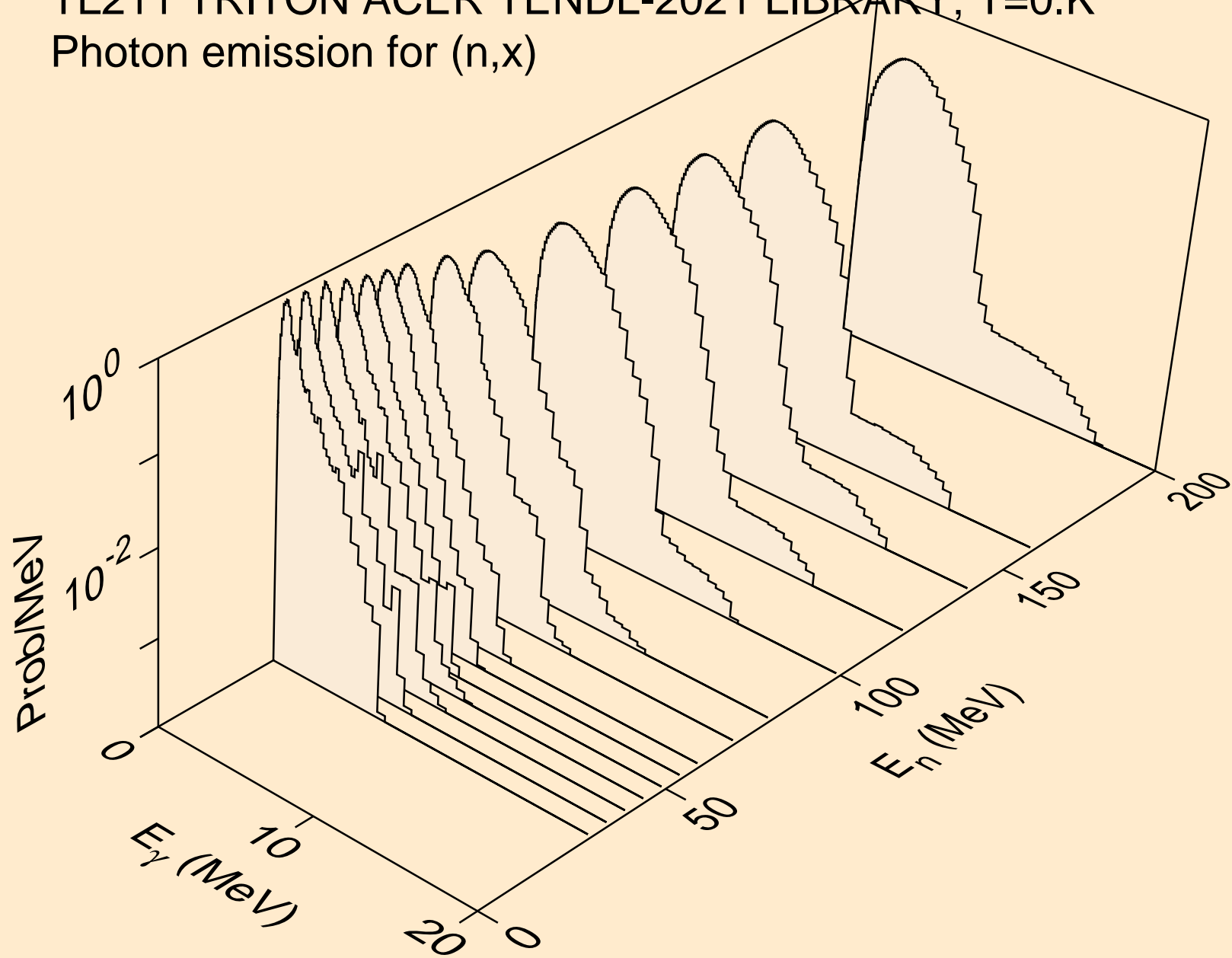

TL211 TRITON ACER TENDL-2021 LIBRARY; T=0.K  
Photon emission for (n,2nd)

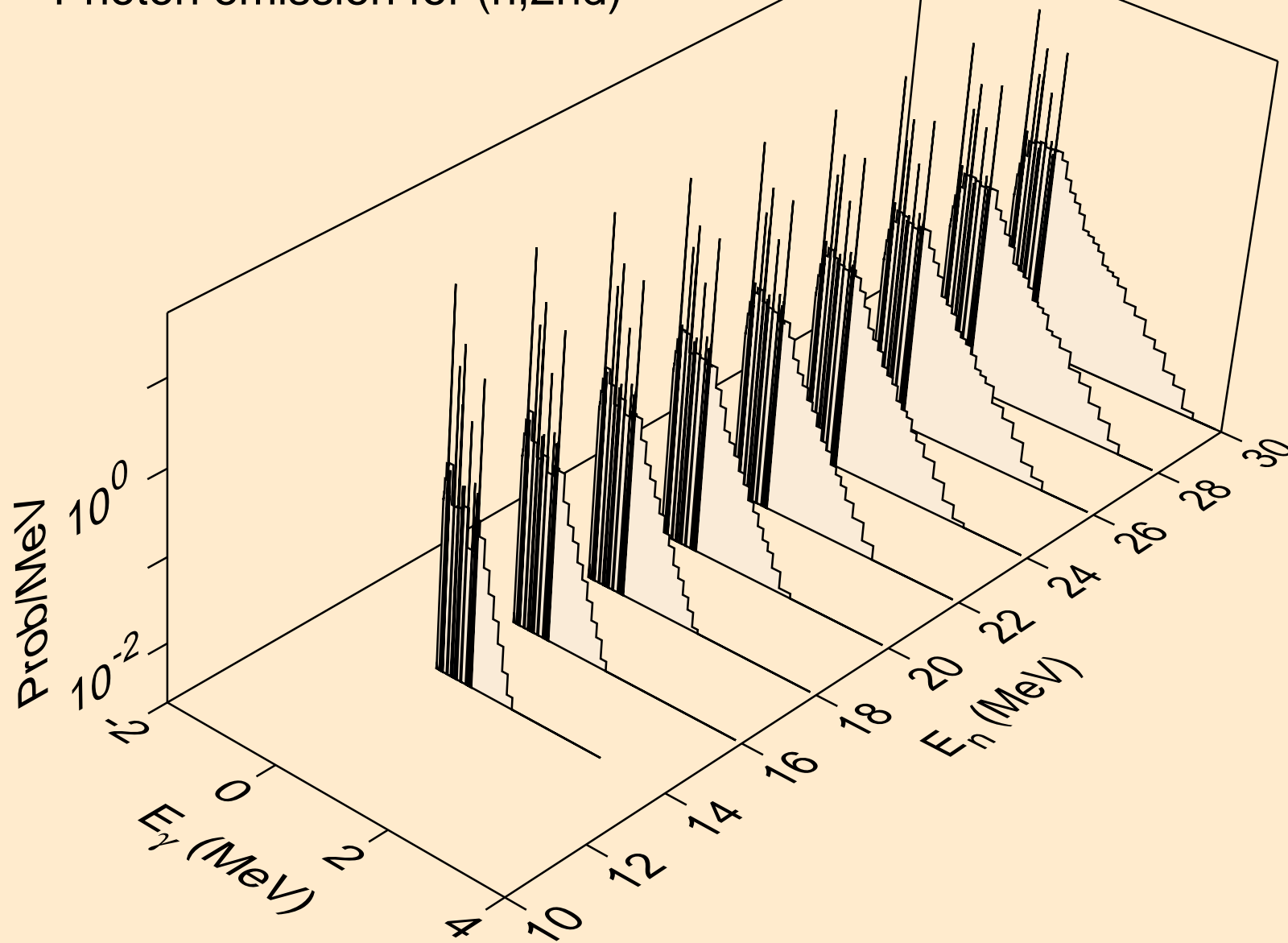

TL211 TRITON ACER TENDL-2021 LIBRARY; T=0.K  
Photon emission for (n,2n)

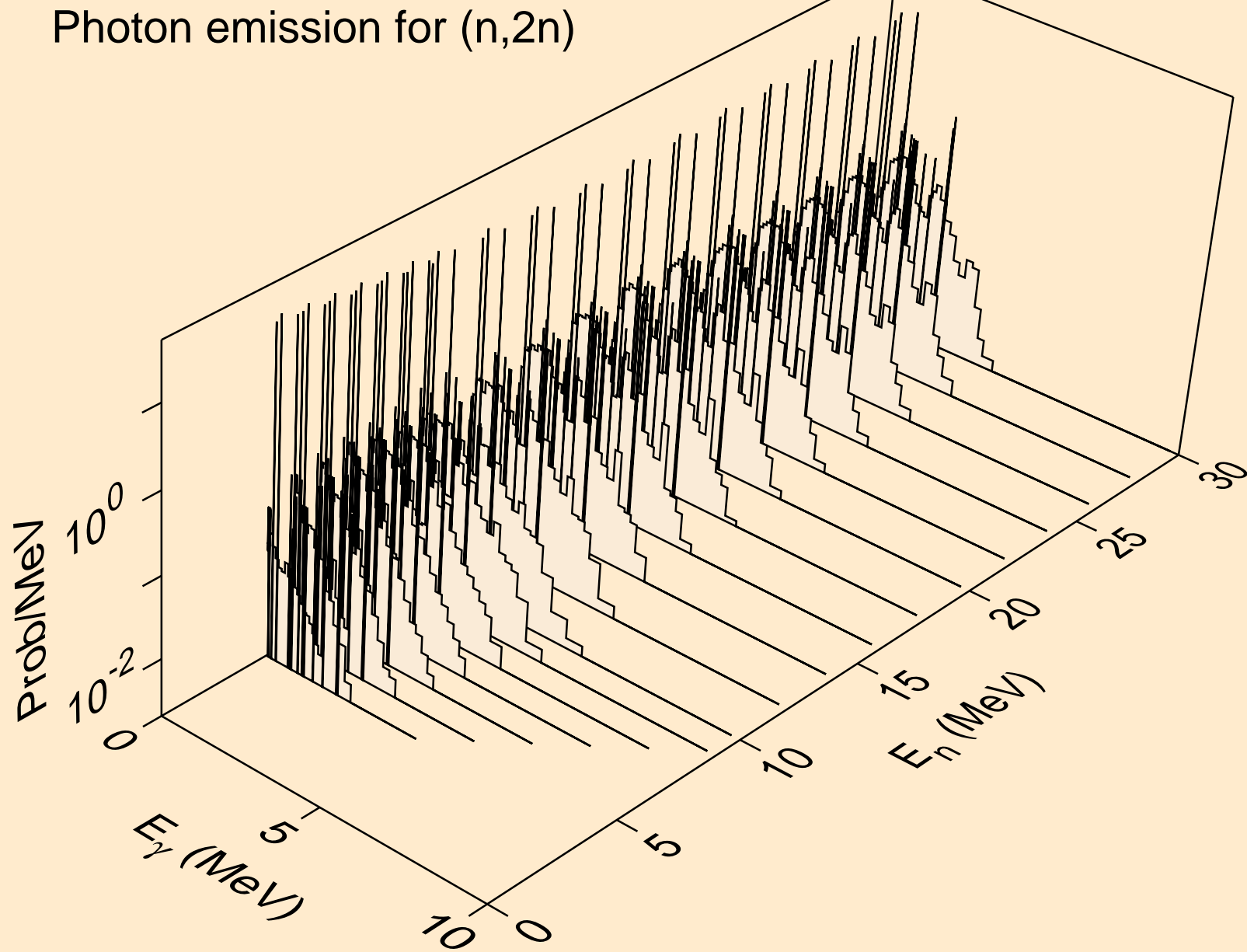

TL211 TRITON ACER TENDL-2021 LIBRARY; T=0.K  
Photon emission for (n,3n)

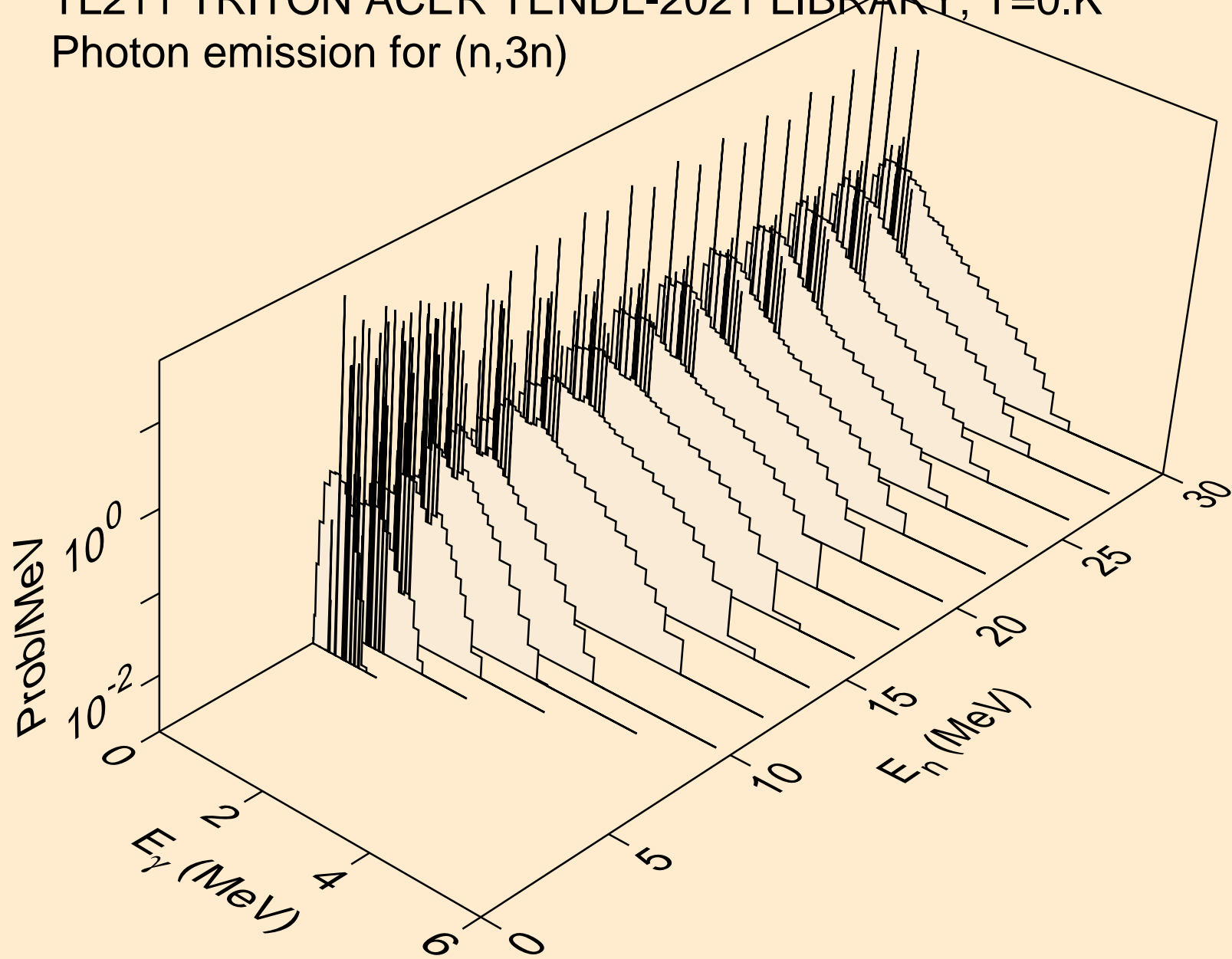

TL211 TRITON ACER TENDL-2021 LIBRARY; T=0.K  
Photon emission for (n,n\*)a

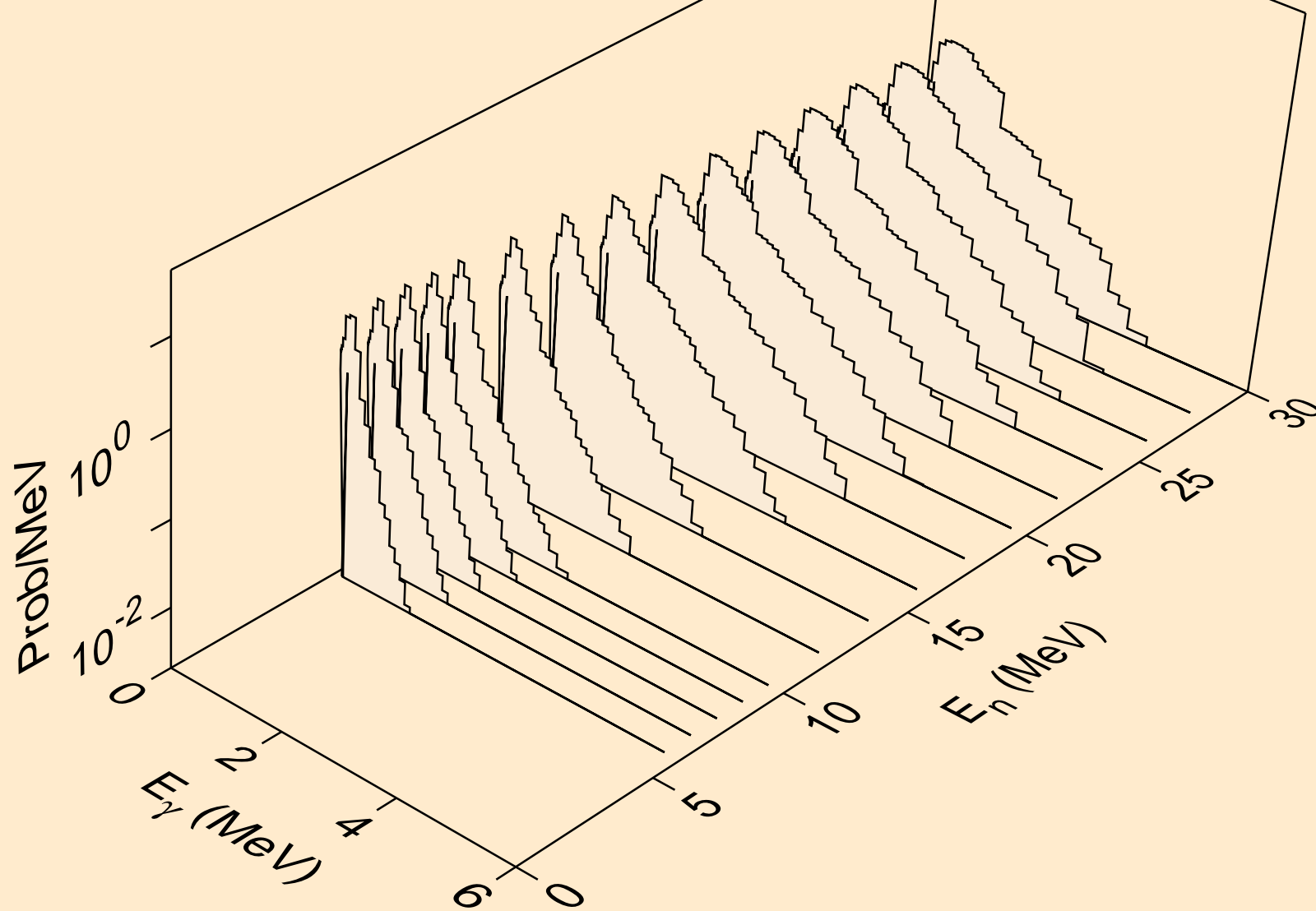

TL211 TRITON ACER TENDL-2021 LIBRARY; T=0.K  
Photon emission for (n,2n)a

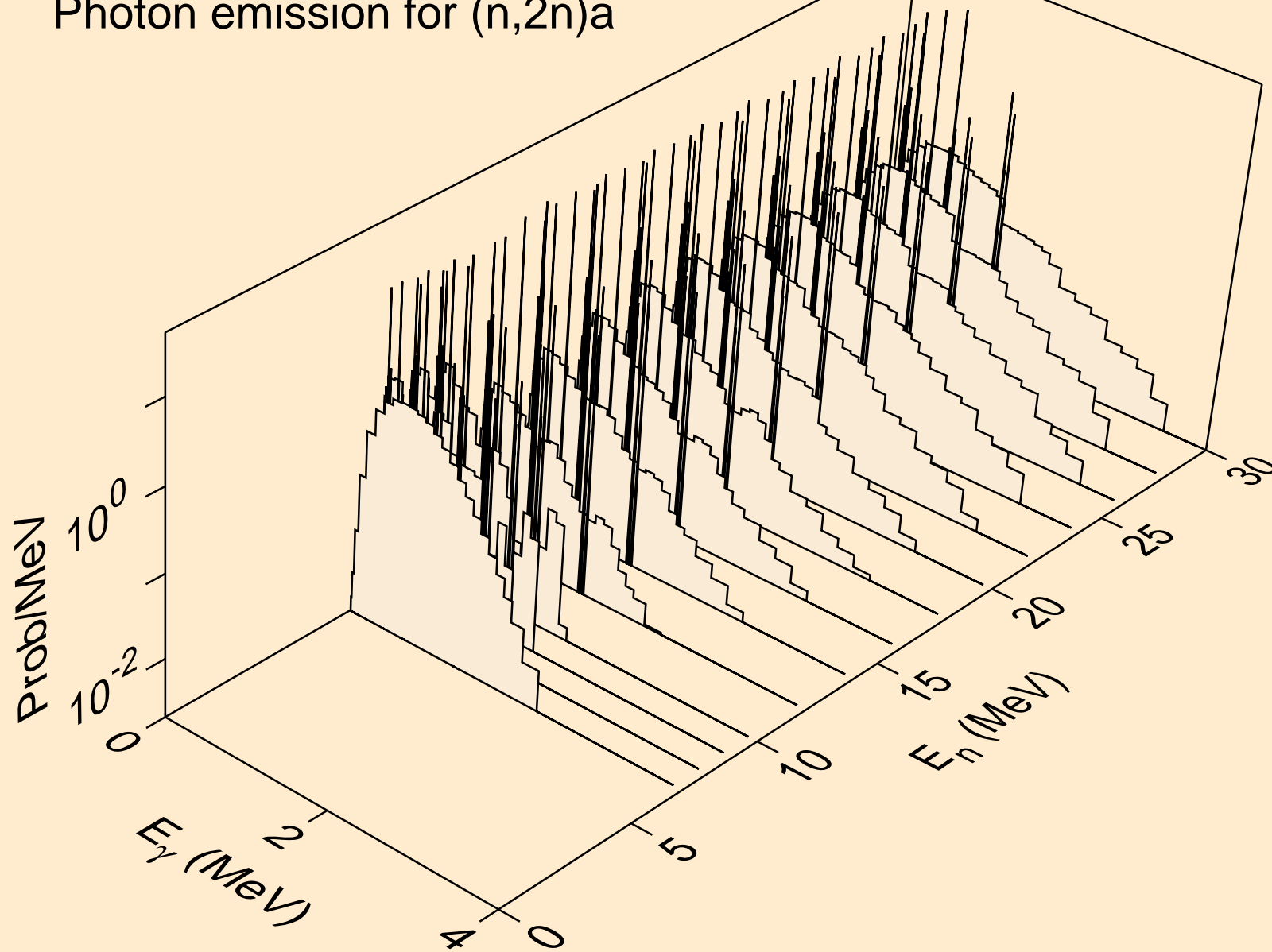

TL211 TRITON ACER TENDL-2021 LIBRARY; T=0.K  
Photon emission for (n,3n)a

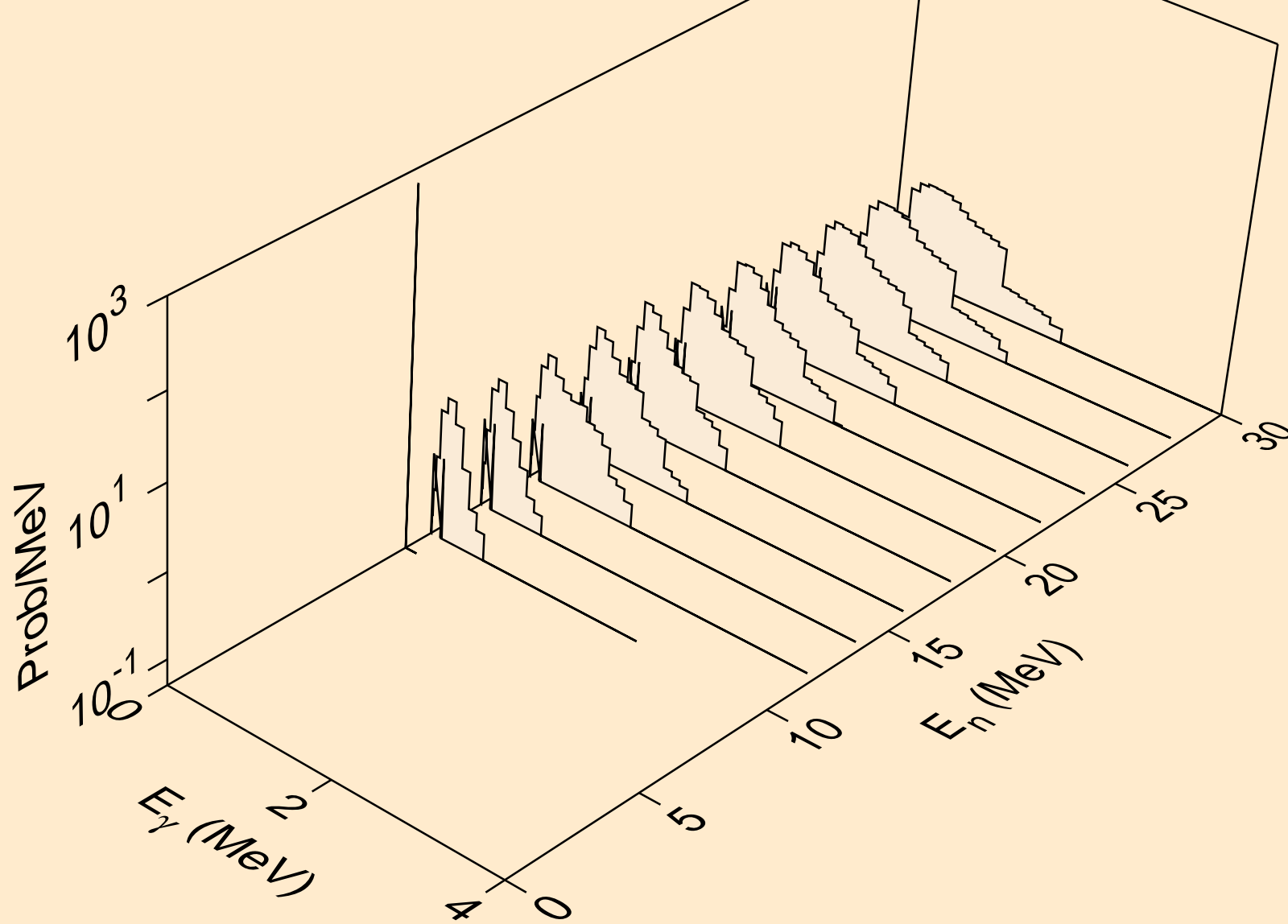

TL211 TRITON ACER TENDL-2021 LIBRARY; T=0.K  
Photon emission for (n,n\*)p

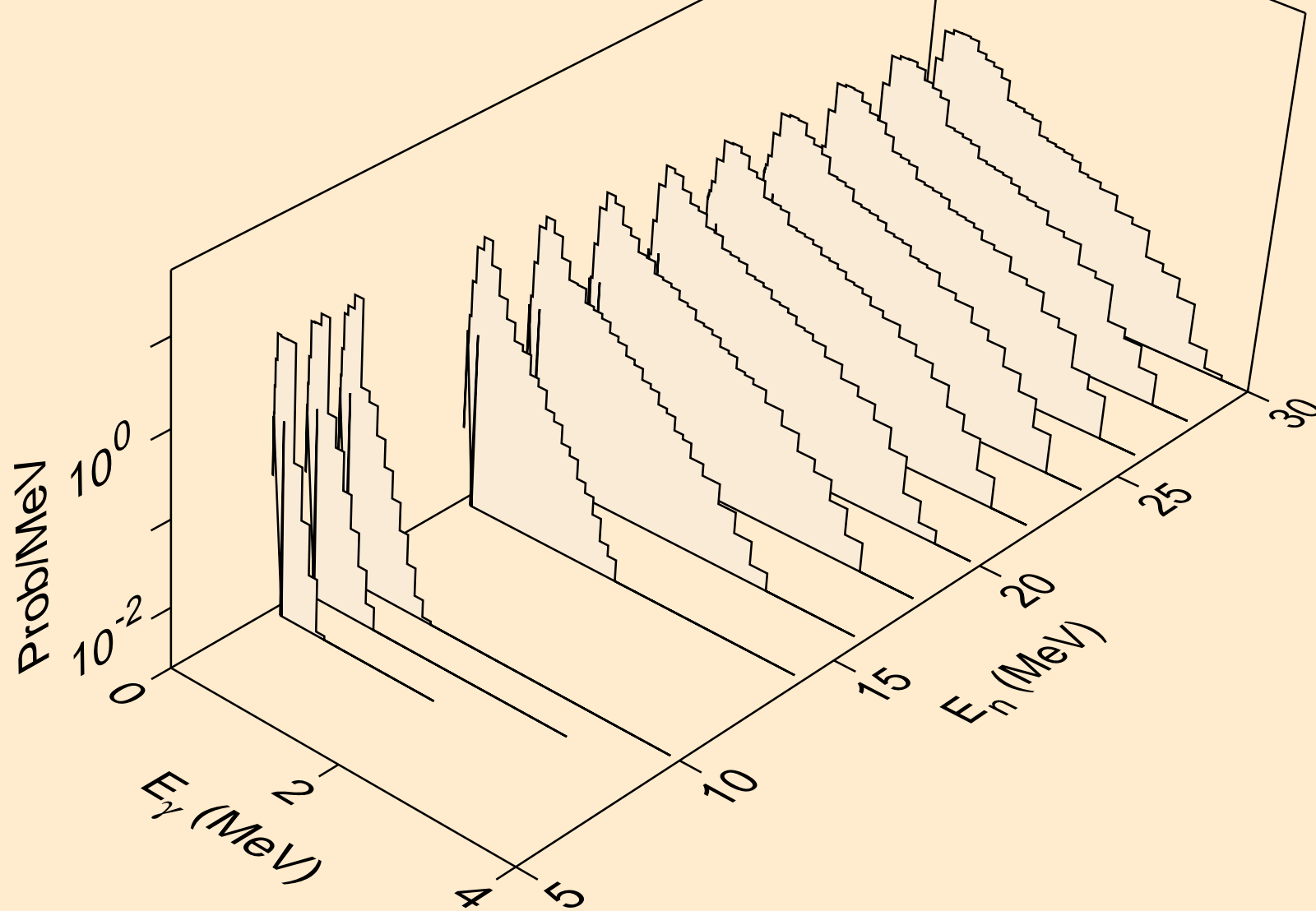



TL211 TRITON ACER TENDL-2021 LIBRARY; T=0.K  
Photon emission for (n,n\*)d

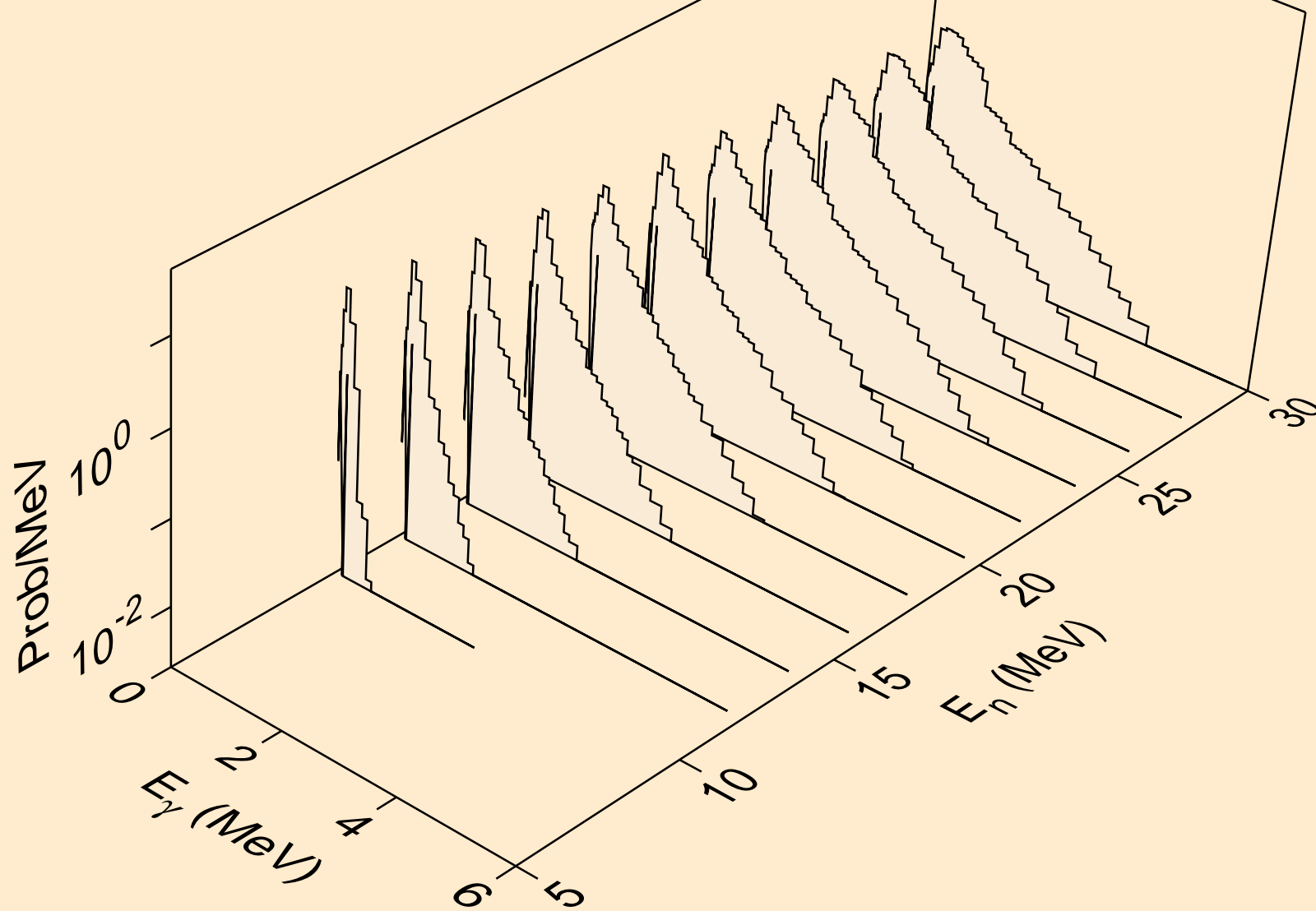

TL211 TRITON ACER TENDL-2021 LIBRARY; T=0.K  
Photon emission for (n,n\*)t

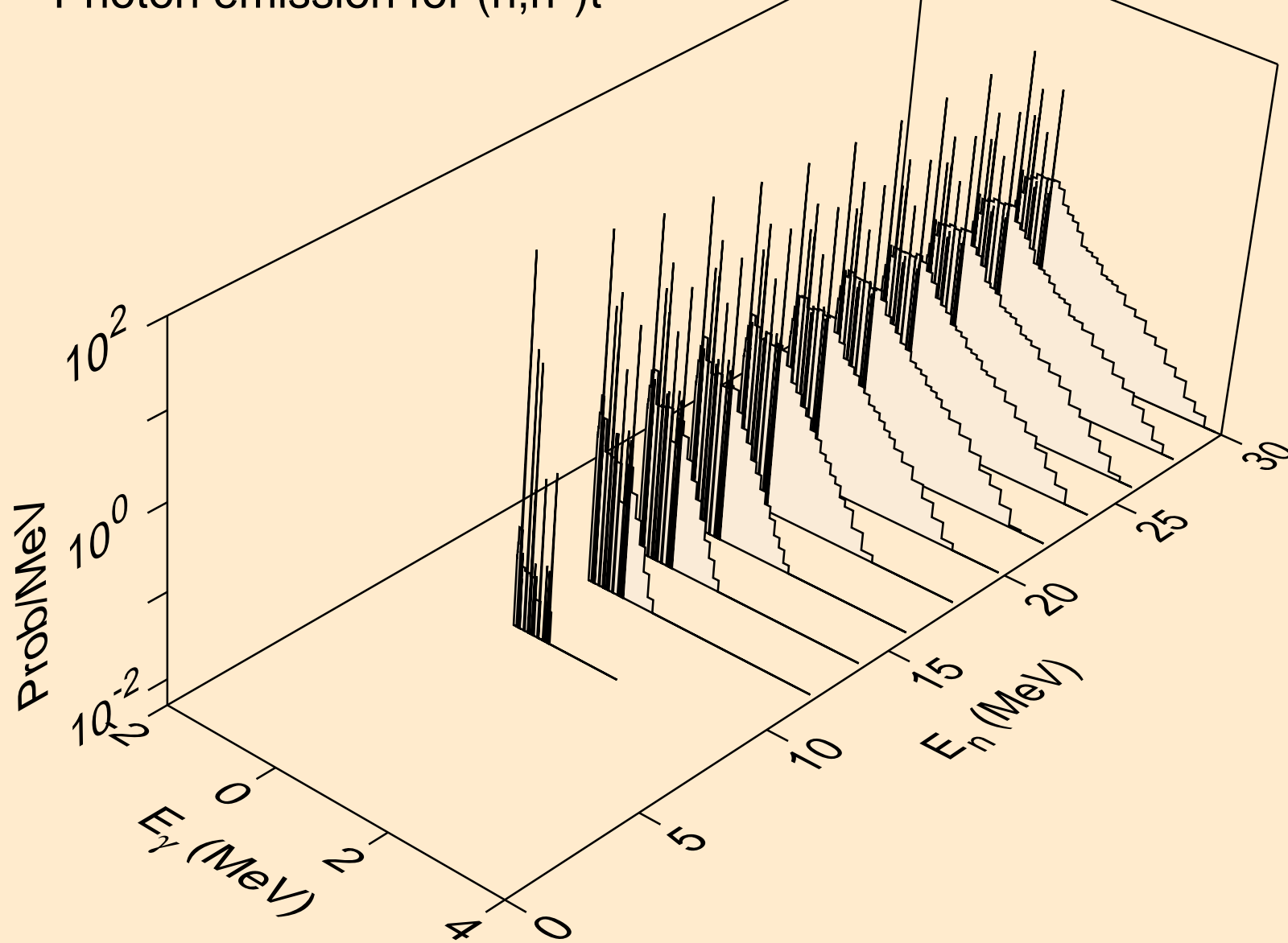

TL211 TRITON ACER TENDL-2021 LIBRARY; T=0.K  
Photon emission for (n,n\*)he3

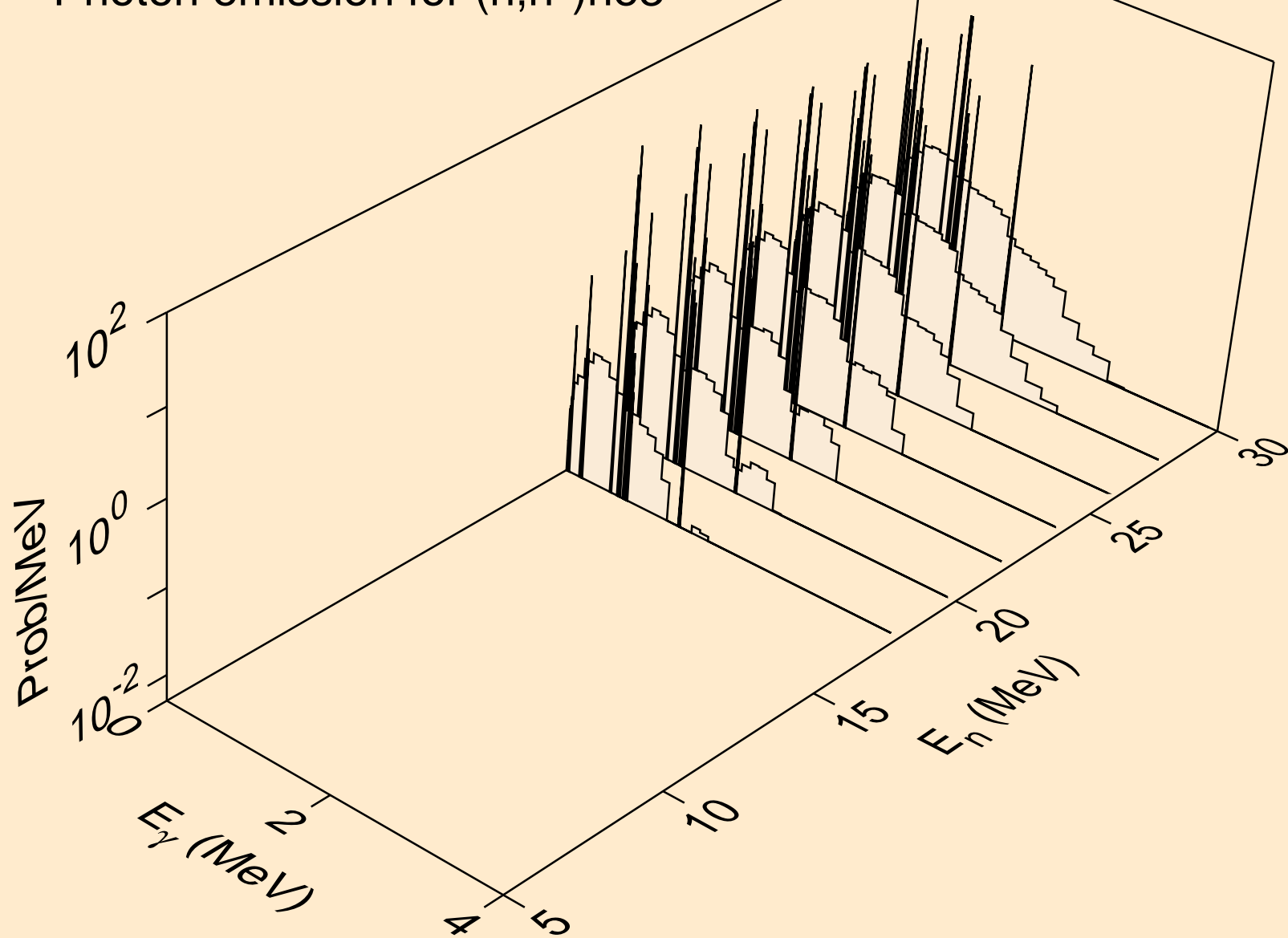

TL211 TRITON ACER TENDL-2021 LIBRARY; T=0.K  
Photon emission for (n,4n)

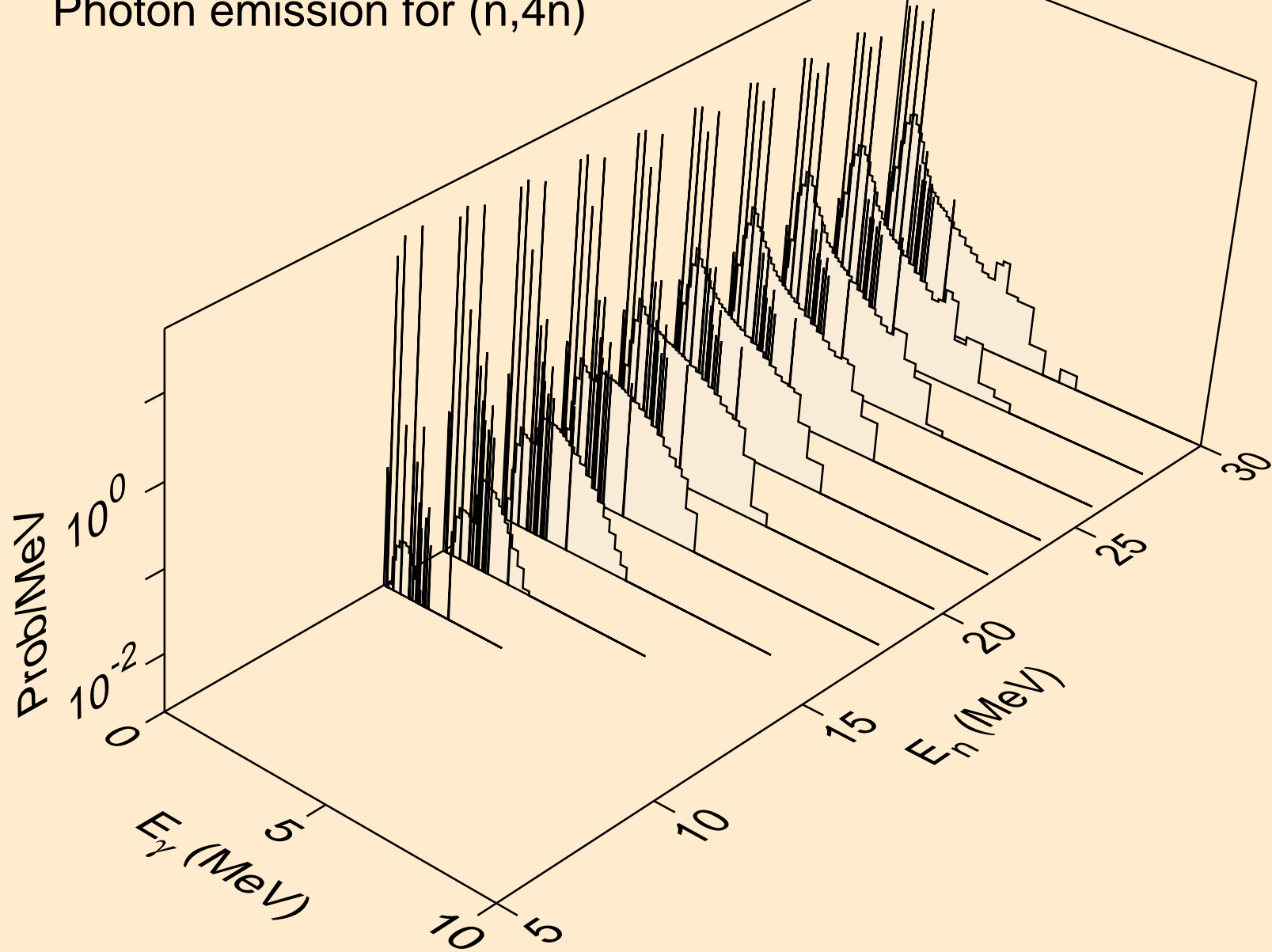

TL211 TRITON ACER TENDL-2021 LIBRARY; T=0.K  
Photon emission for (n,2np)

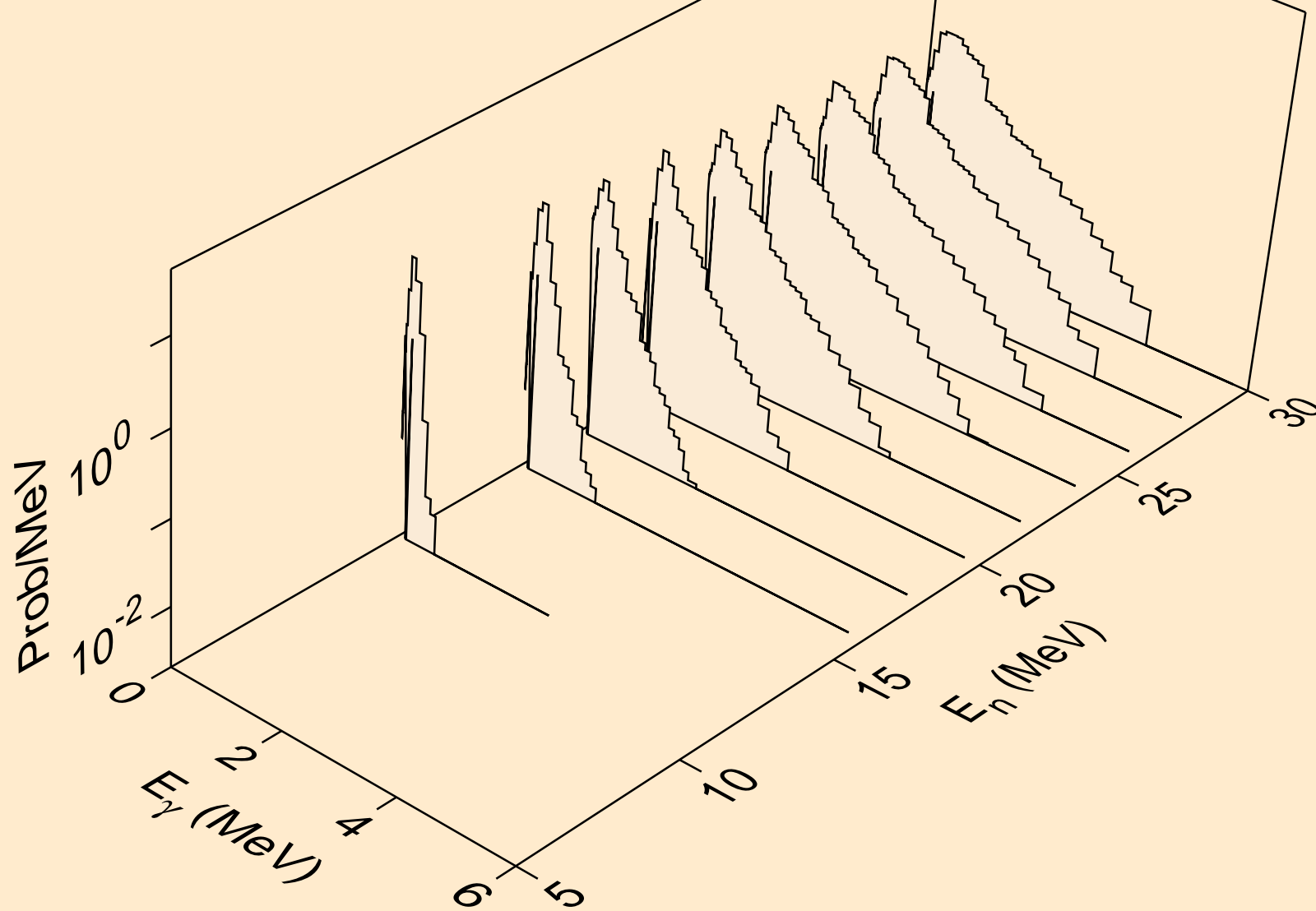

TL211 TRITON ACER TENDL-2021 LIBRARY; T=0.K  
Photon emission for (n,3np)

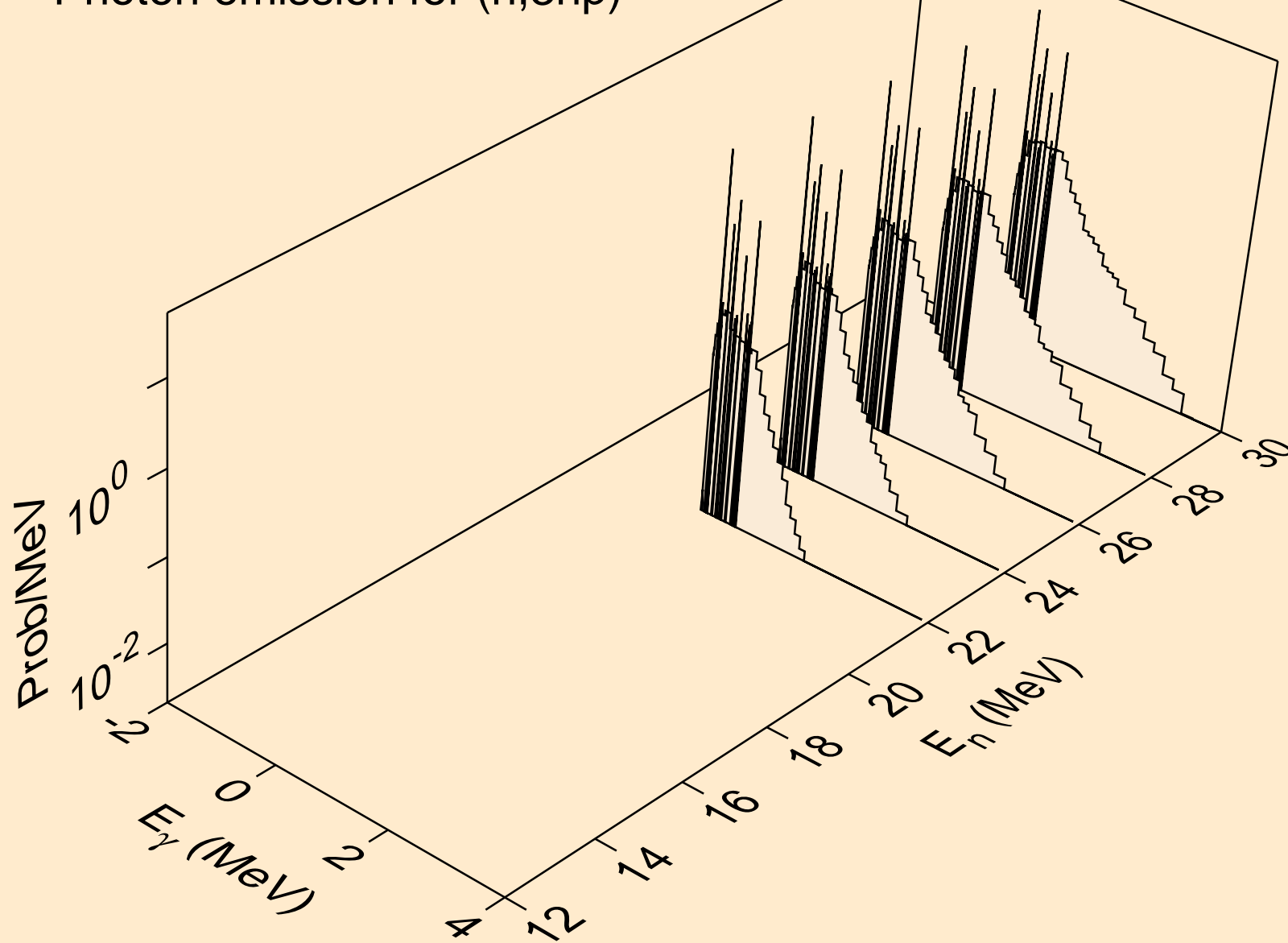

TL211 TRITON ACER TENDL-2021 LIBRARY; T=0.K  
Photon emission for (n,2np)

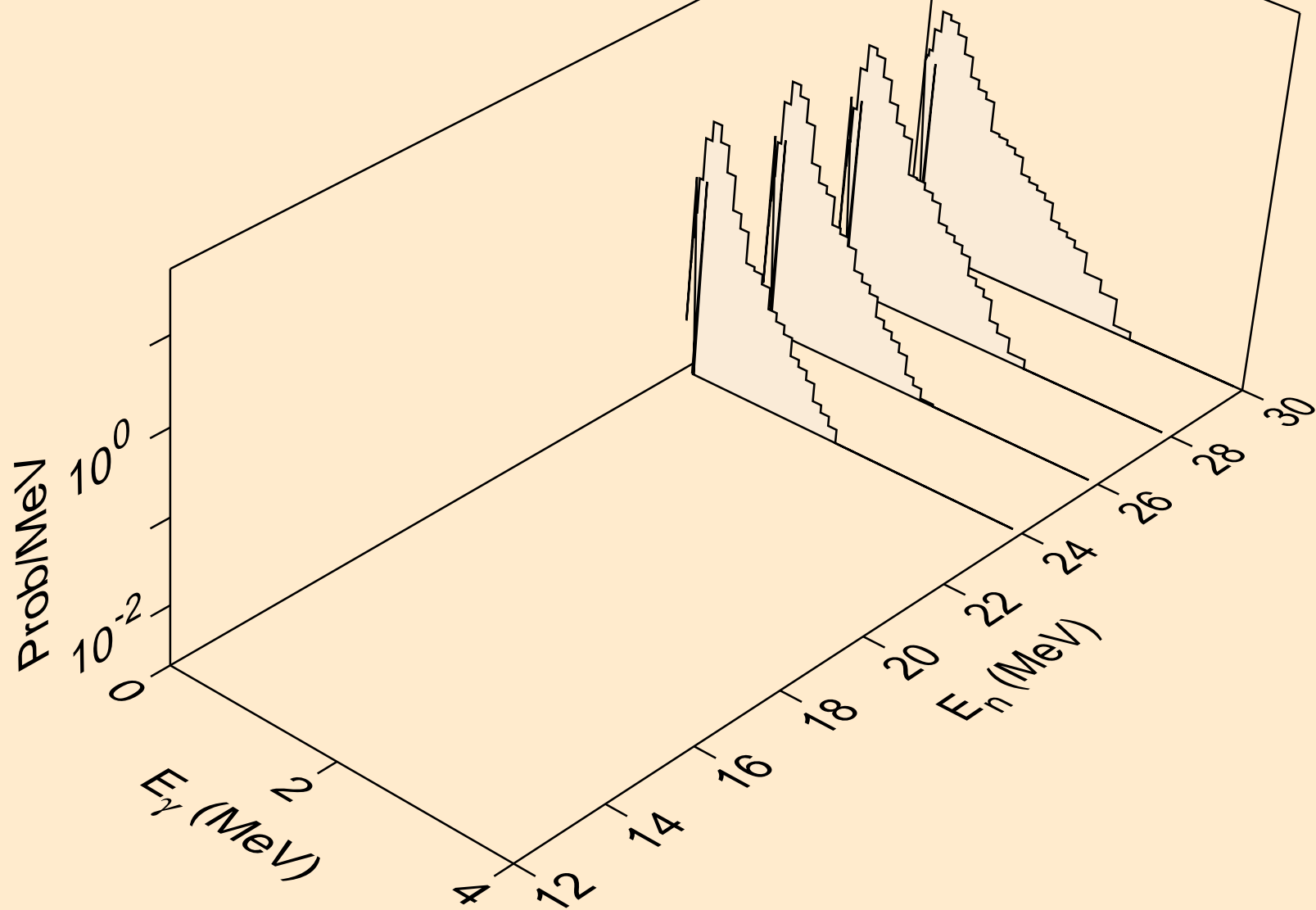

TL211 TRITON ACER TENDL-2021 LIBRARY; T=0.K  
Photon emission for (n,gma)

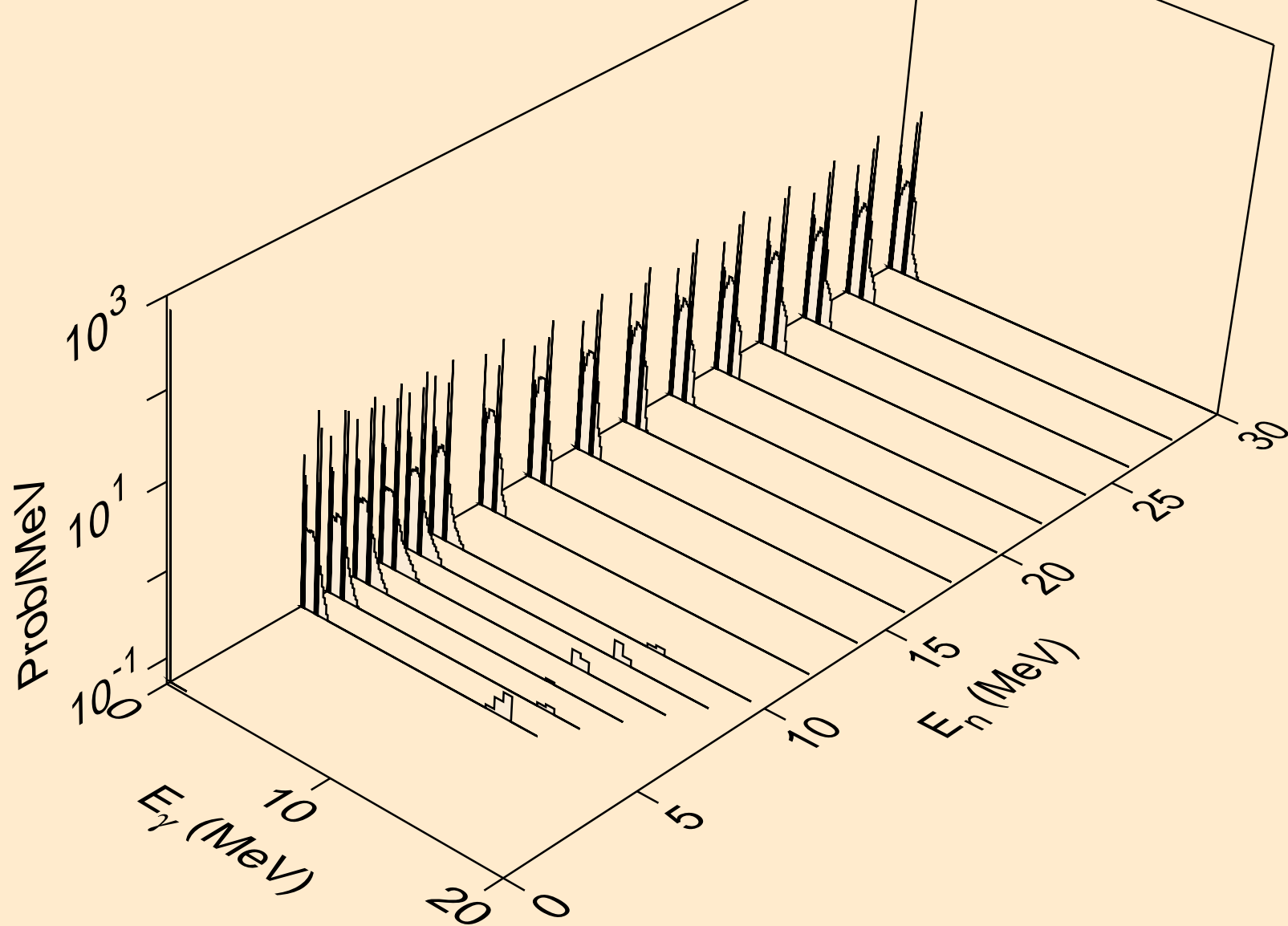



TL211 TRITON ACER TENDL-2021 LIBRARY; T=0.K  
Photon emission for (n,p)

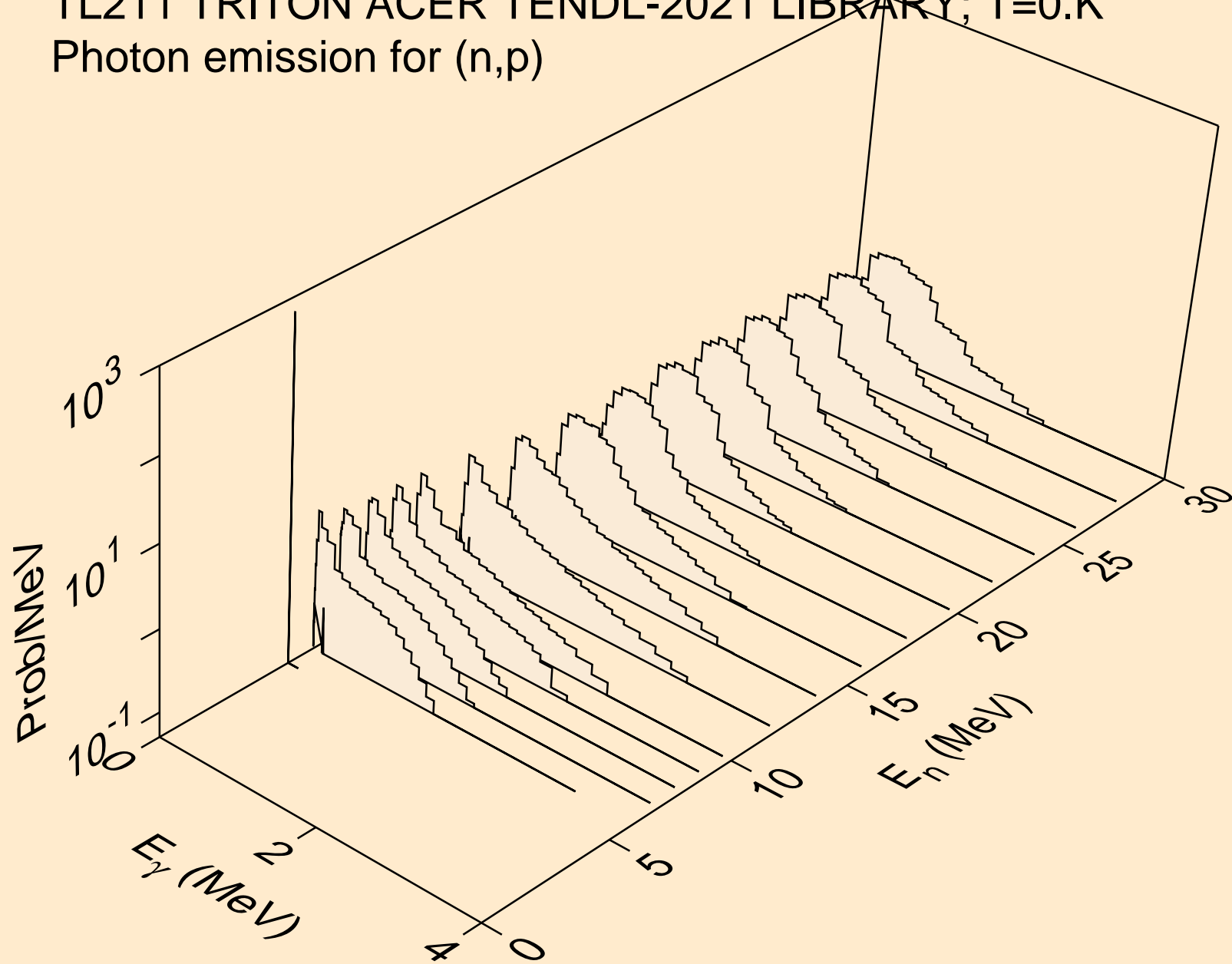

TL211 TRITON ACER TENDL-2021 LIBRARY; T=0.K  
Photon emission for (n,d)

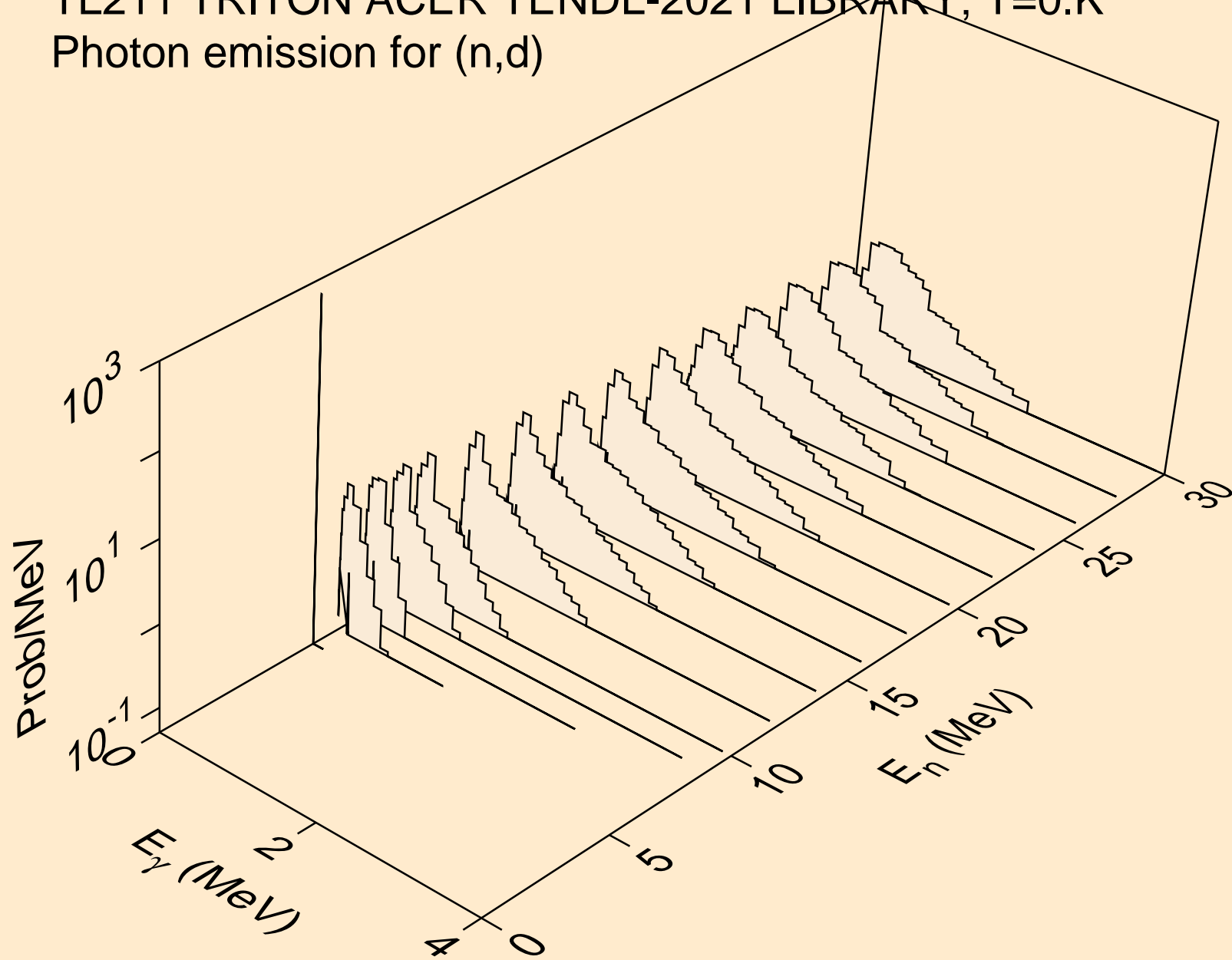

TL211 TRITON ACER TENDL-2021 LIBRARY; T=0.K  
Photon emission for inelastic

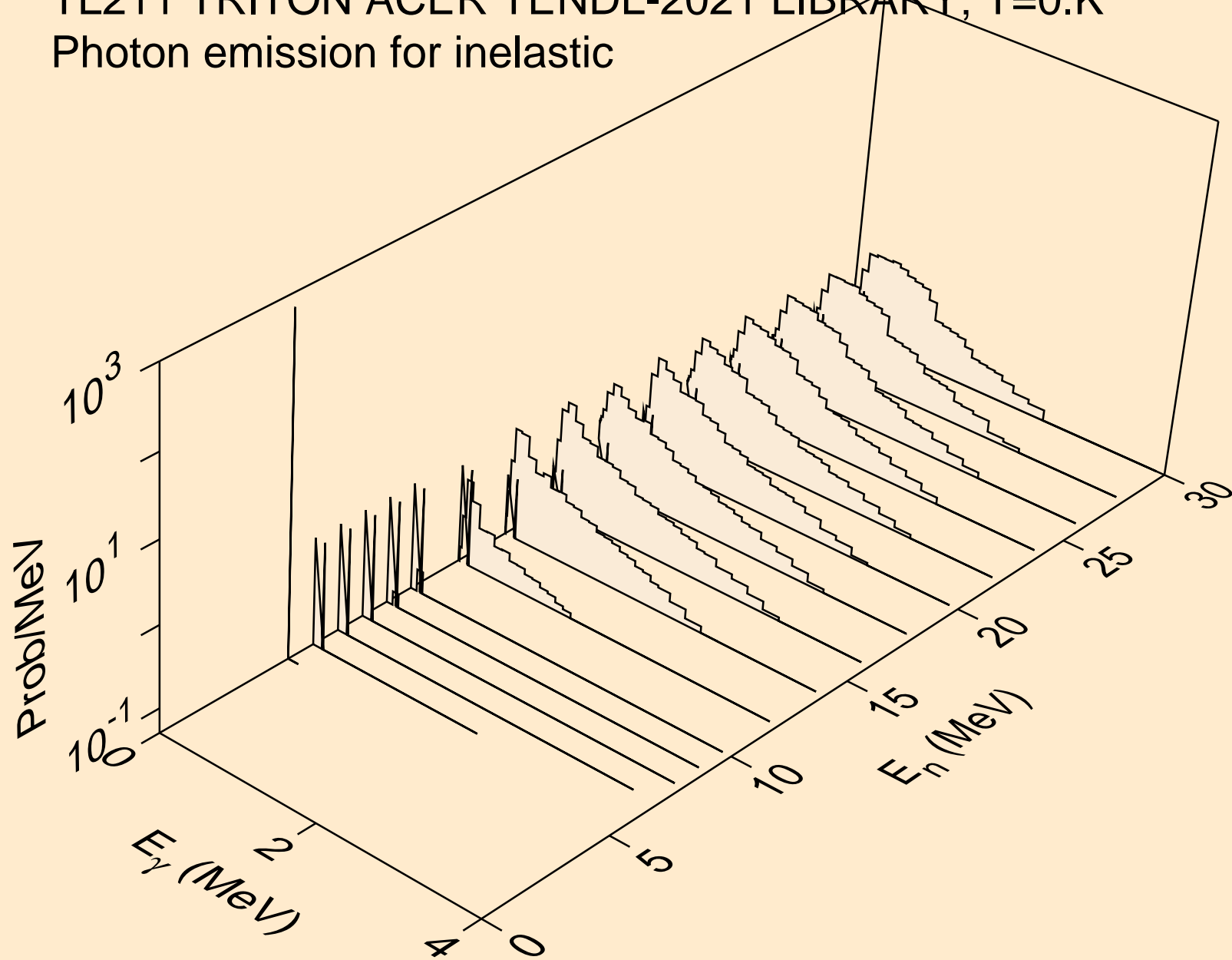

TL211 TRITON ACER TENDL-2021 LIBRARY; T=0.K  
Photon emission for (n,he3)

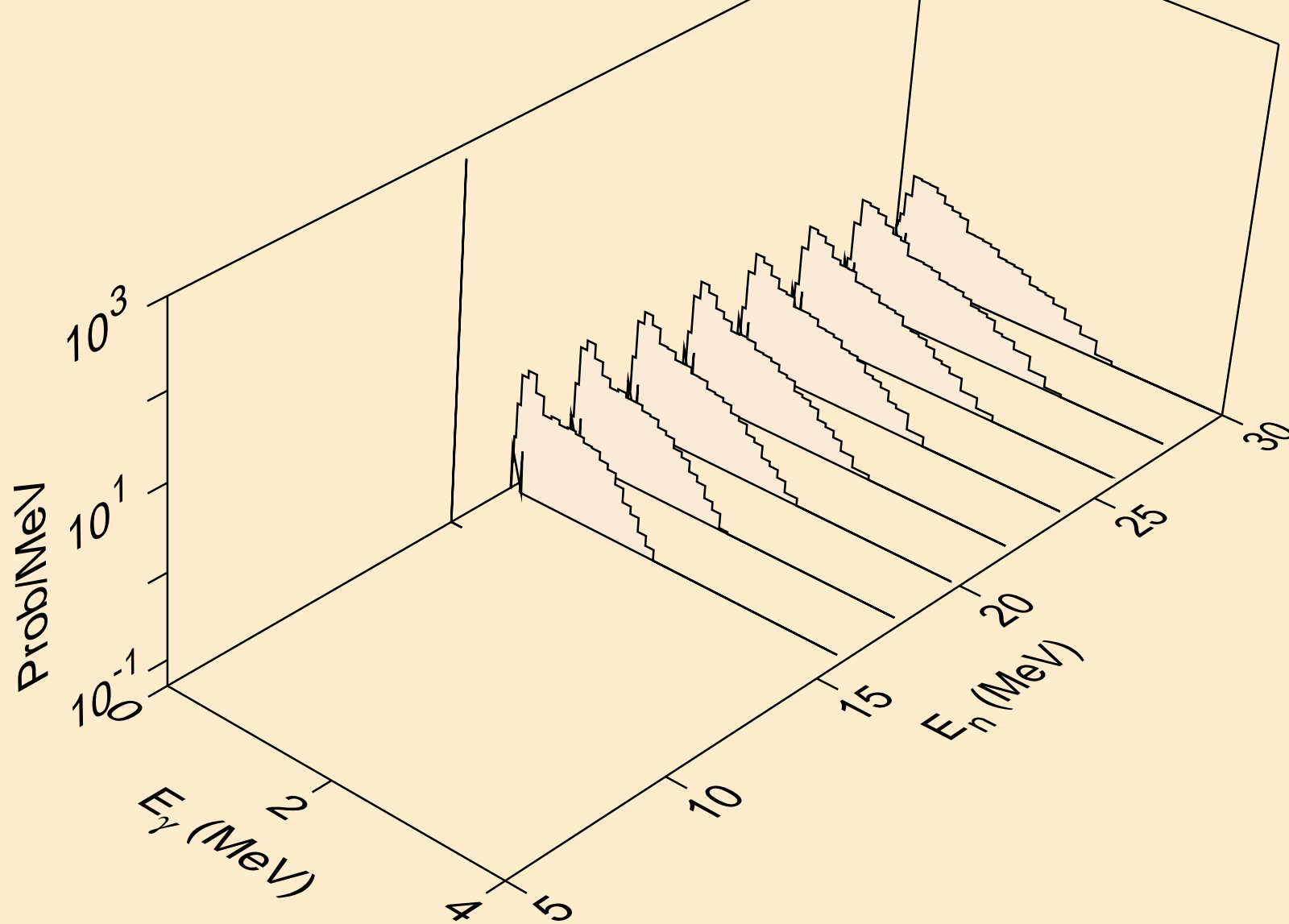

TL211 TRITON ACER TENDL-2021 LIBRARY; T=0.K  
Photon emission for (n,a)

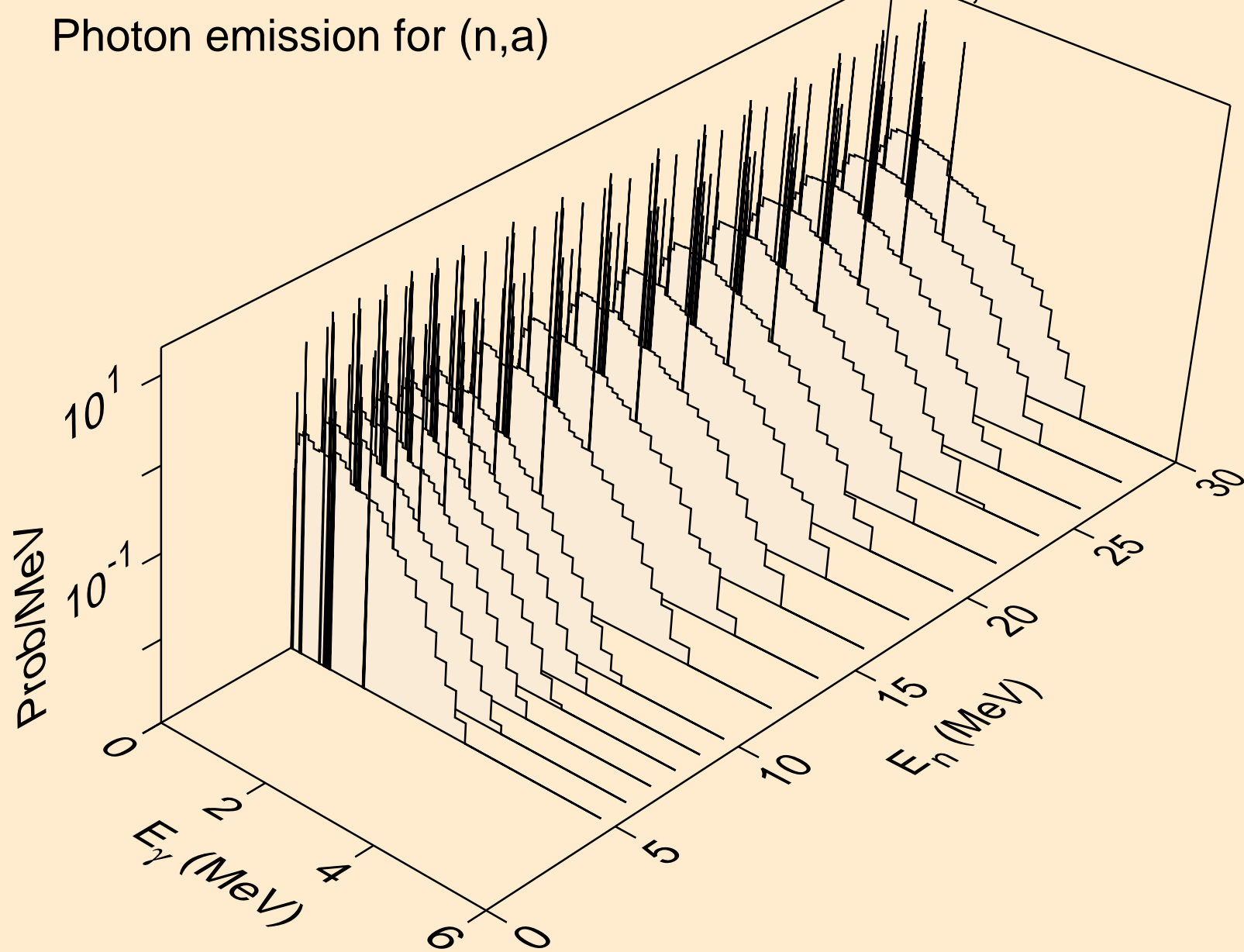

TL211 TRITON ACER TENDL-2021 LIBRARY; T=0.K  
Photon emission for (n,2p)

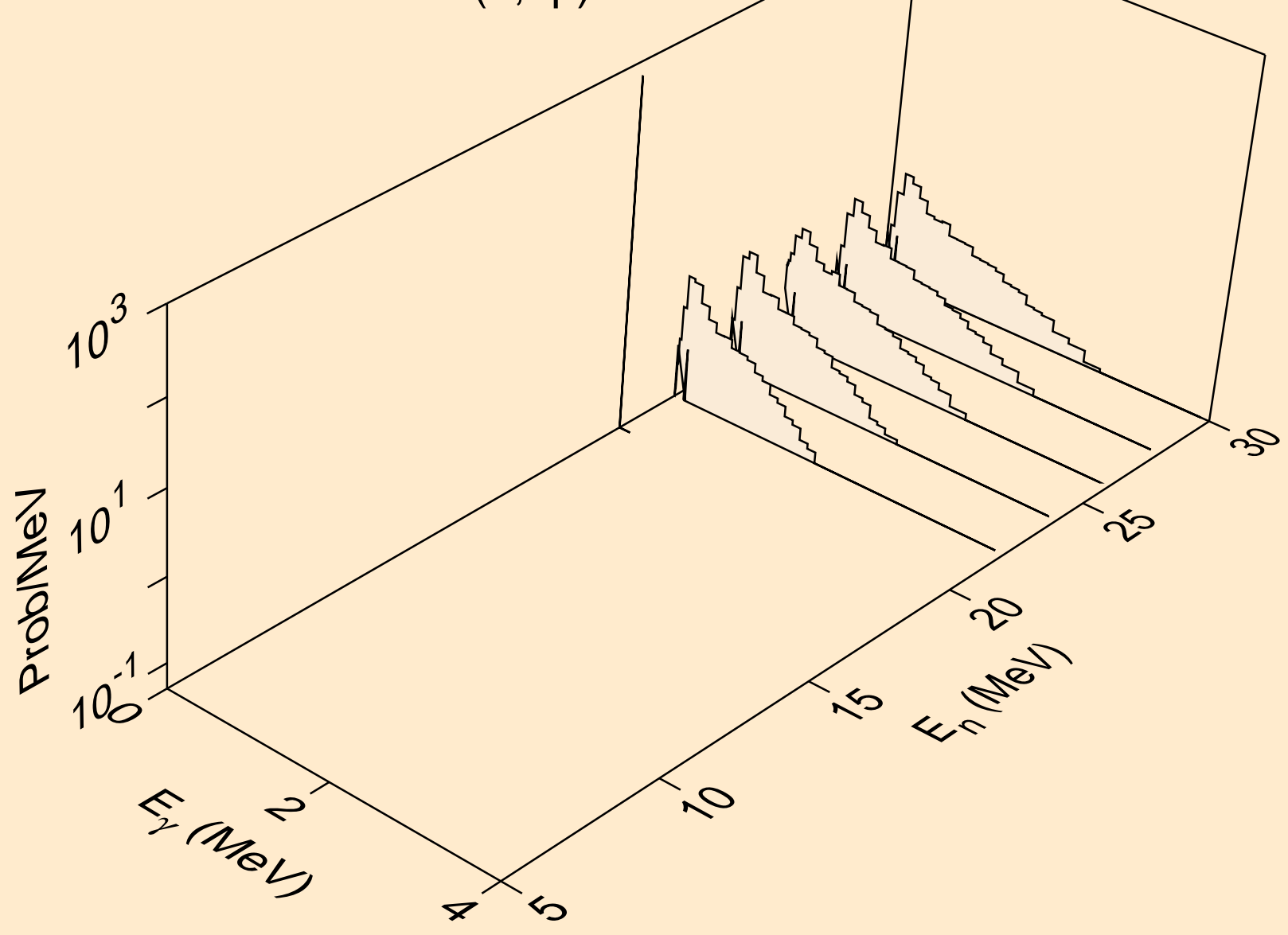

TL211 TRITON ACER TENDL-2021 LIBRARY; T=0.K  
Particle heating contributions

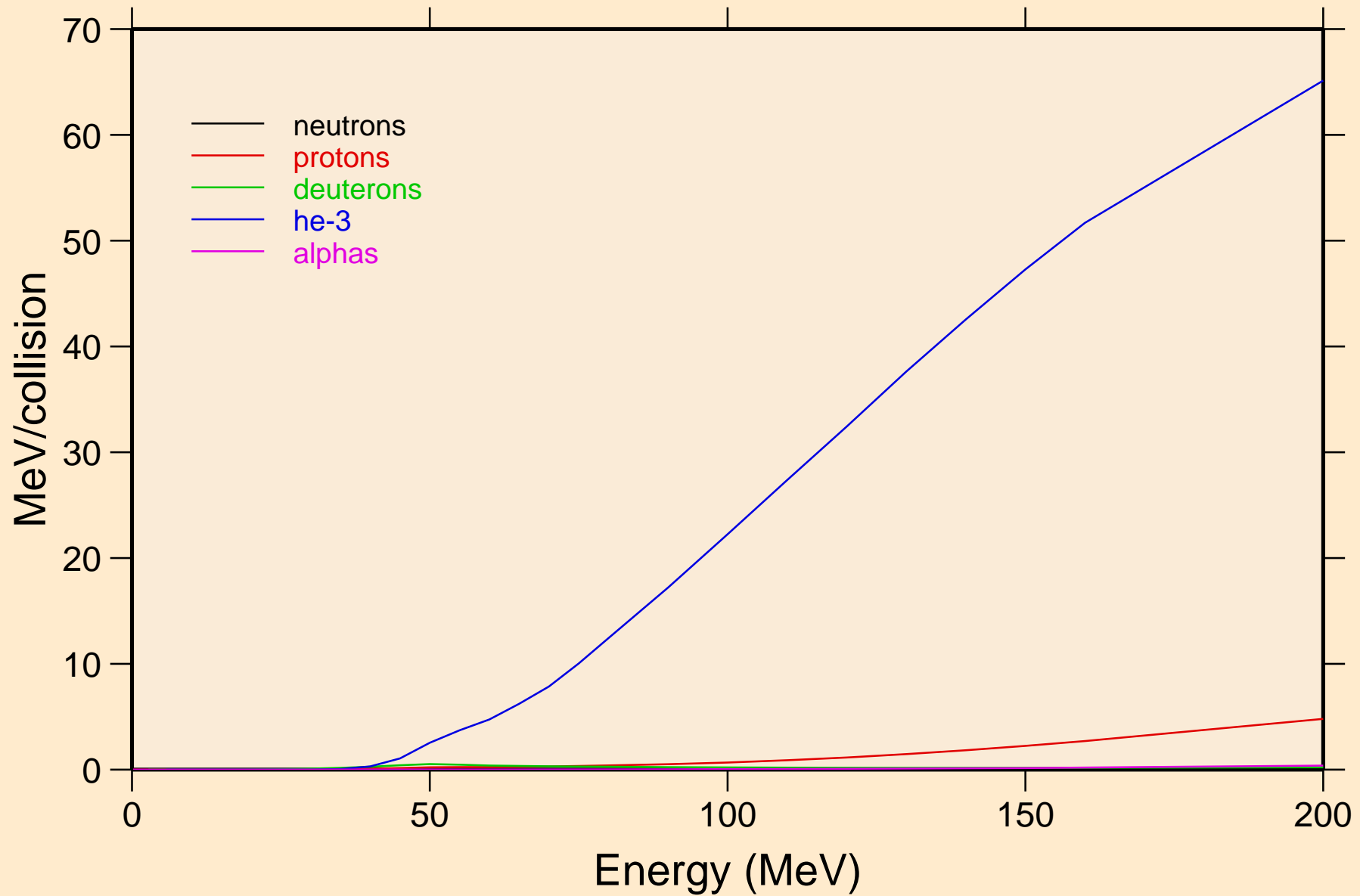

TL211 TRITON ACER TENDL-2021 LIBRARY; T=0.K  
Recoil Heating

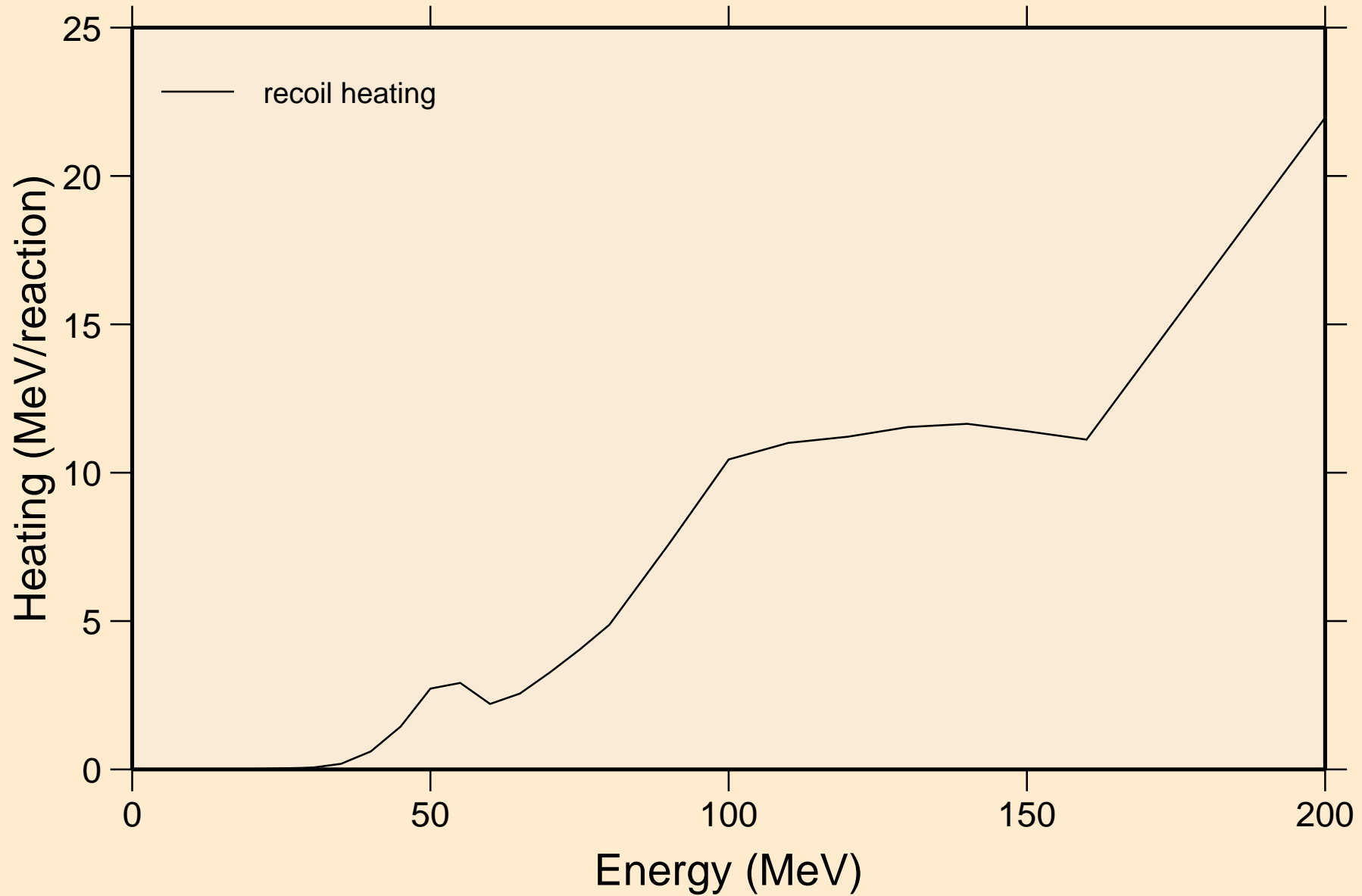



TL211 TRITON ACER TENDL-2021 LIBRARY; T=0.K  
Particle production cross sections

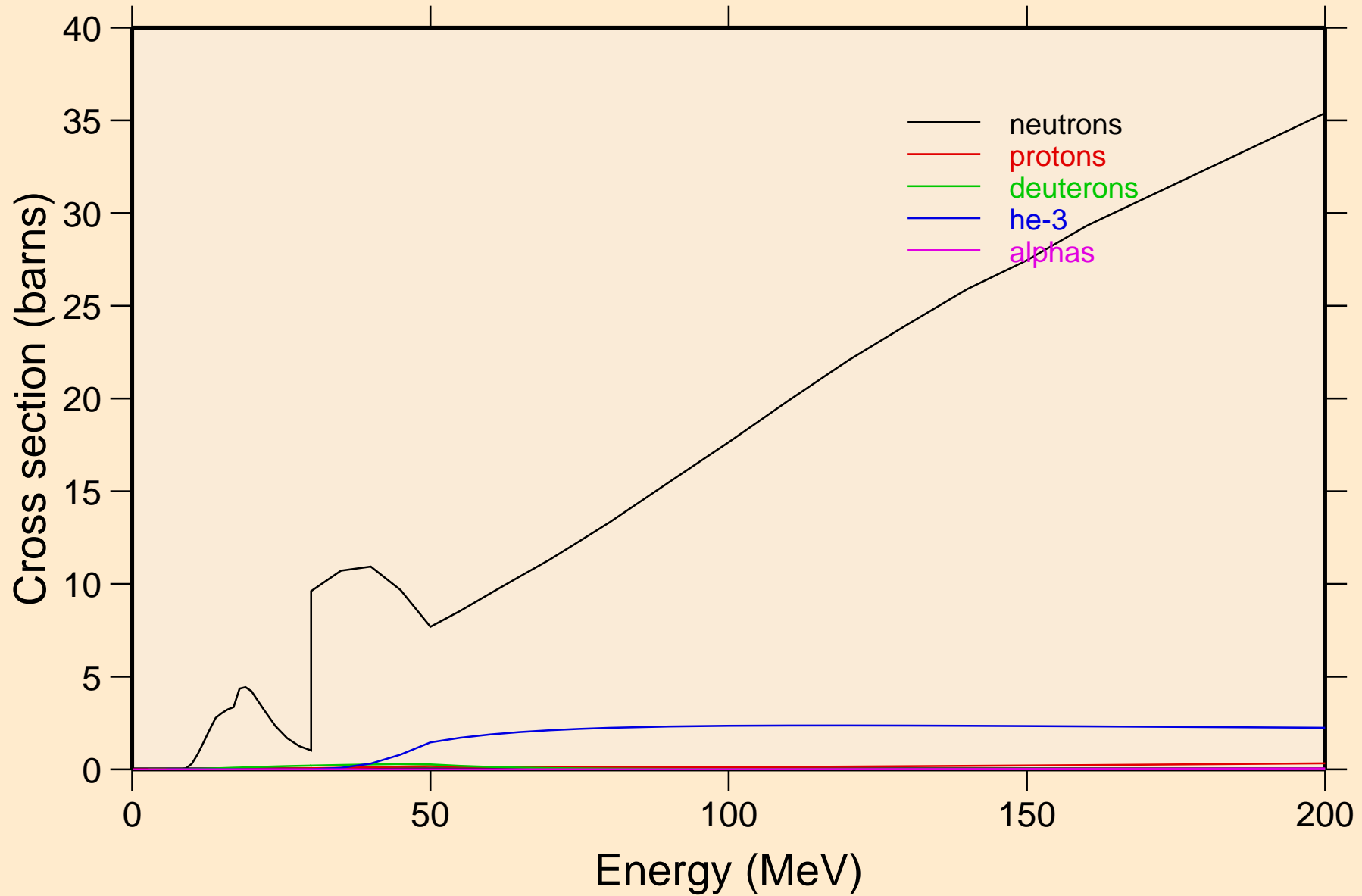

TL211 TRITON ACER TENDL-2021 LIBRARY; T=0.K  
neutrons from (t,n)

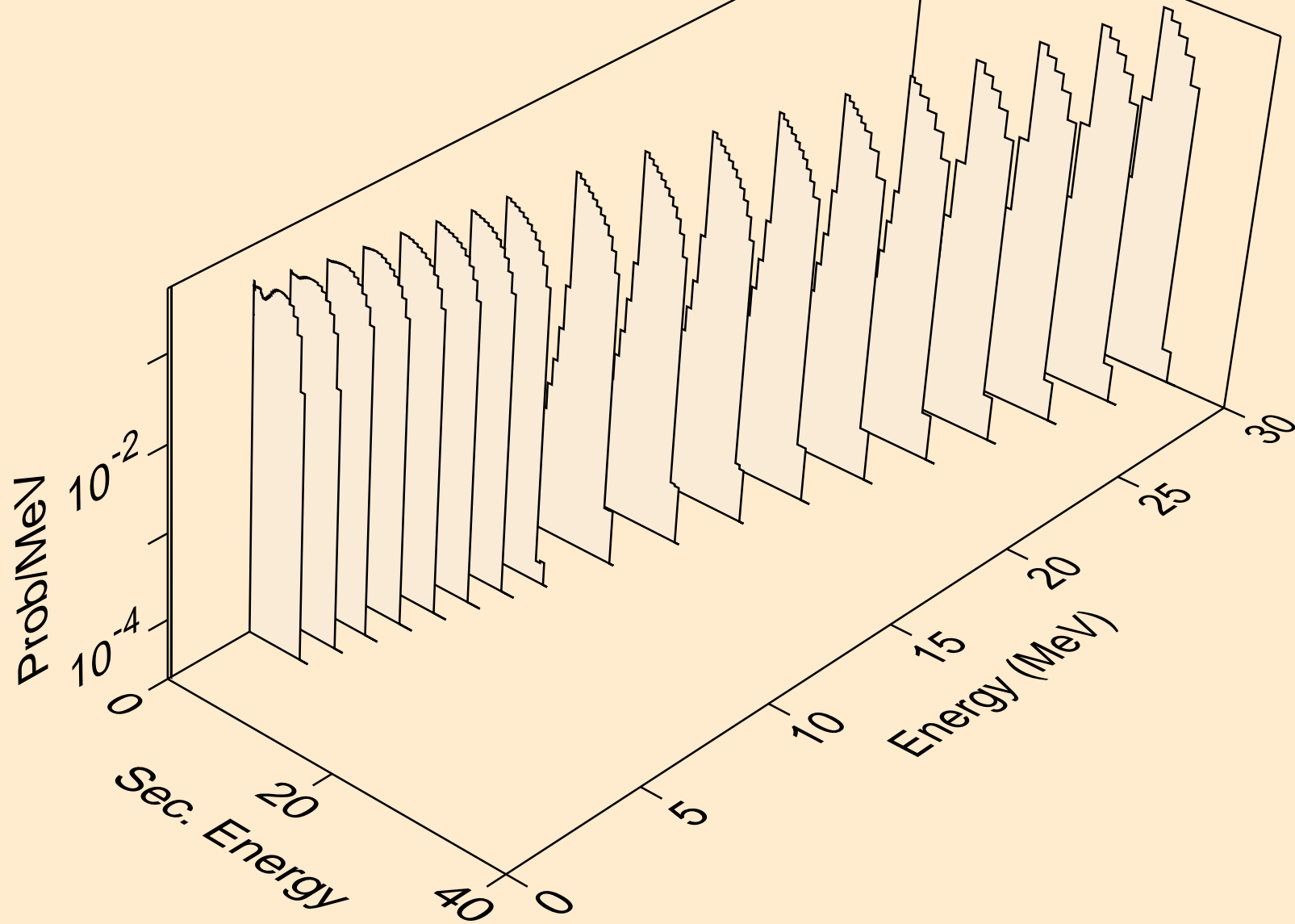

TL211 TRITON ACER TENDL-2021 LIBRARY; T=0.K  
neutrons from (t,x)

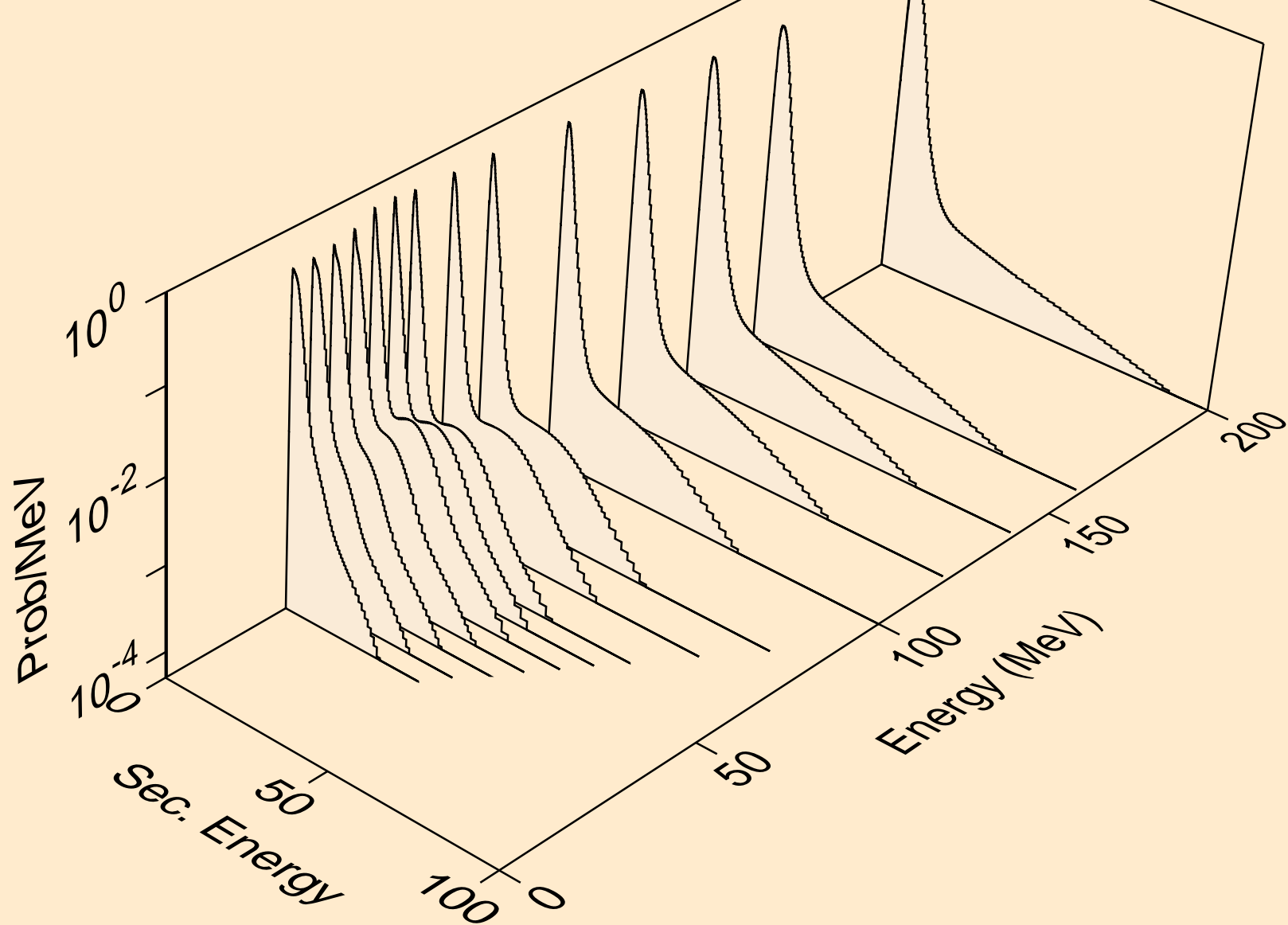

TL211 TRITON ACER TENDL-2021 LIBRARY; T=0.K  
neutrons from (t,2nd)

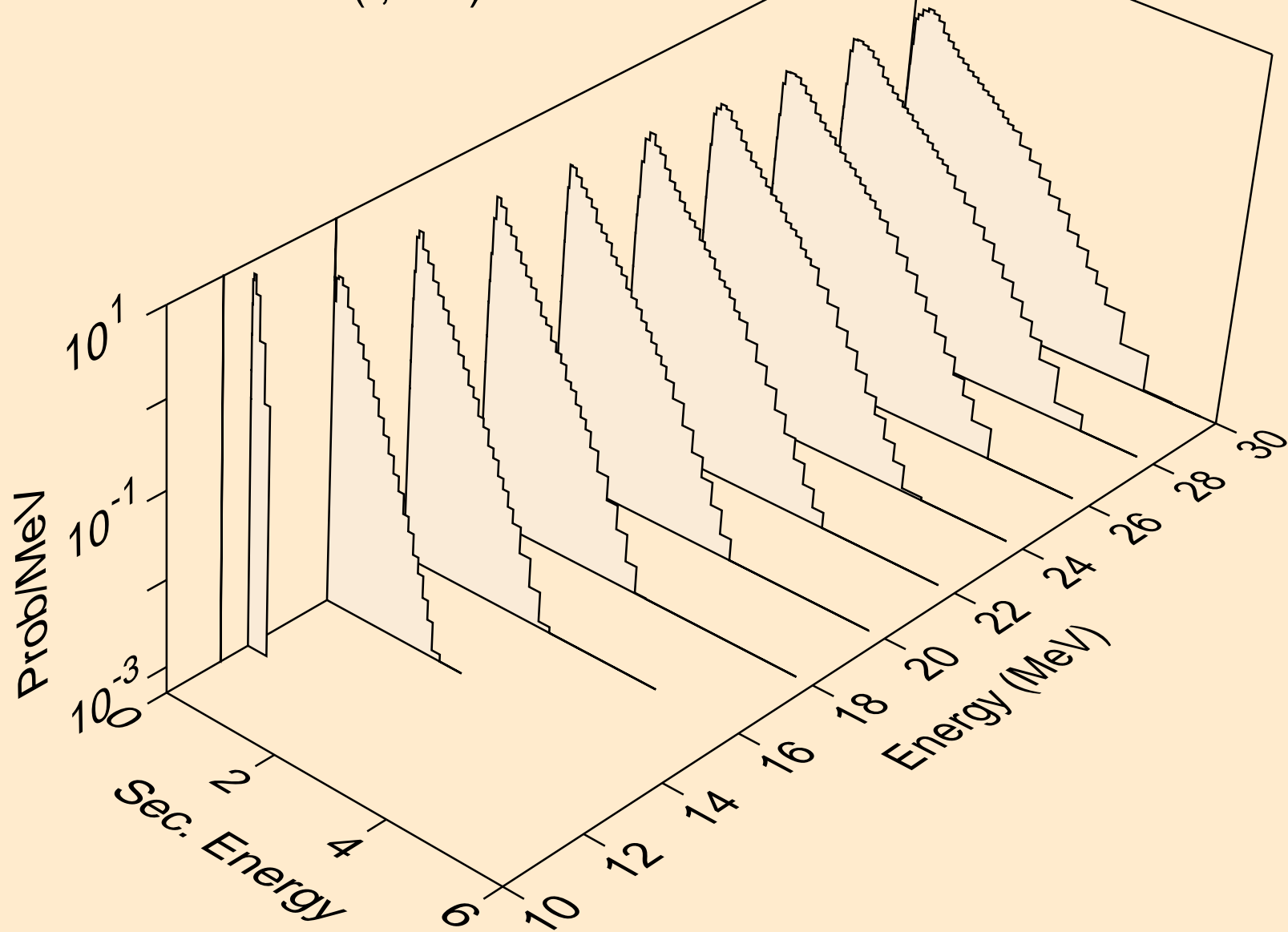

TL211 TRITON ACER TENDL-2021 LIBRARY; T=0.K  
neutrons from (t,2n)

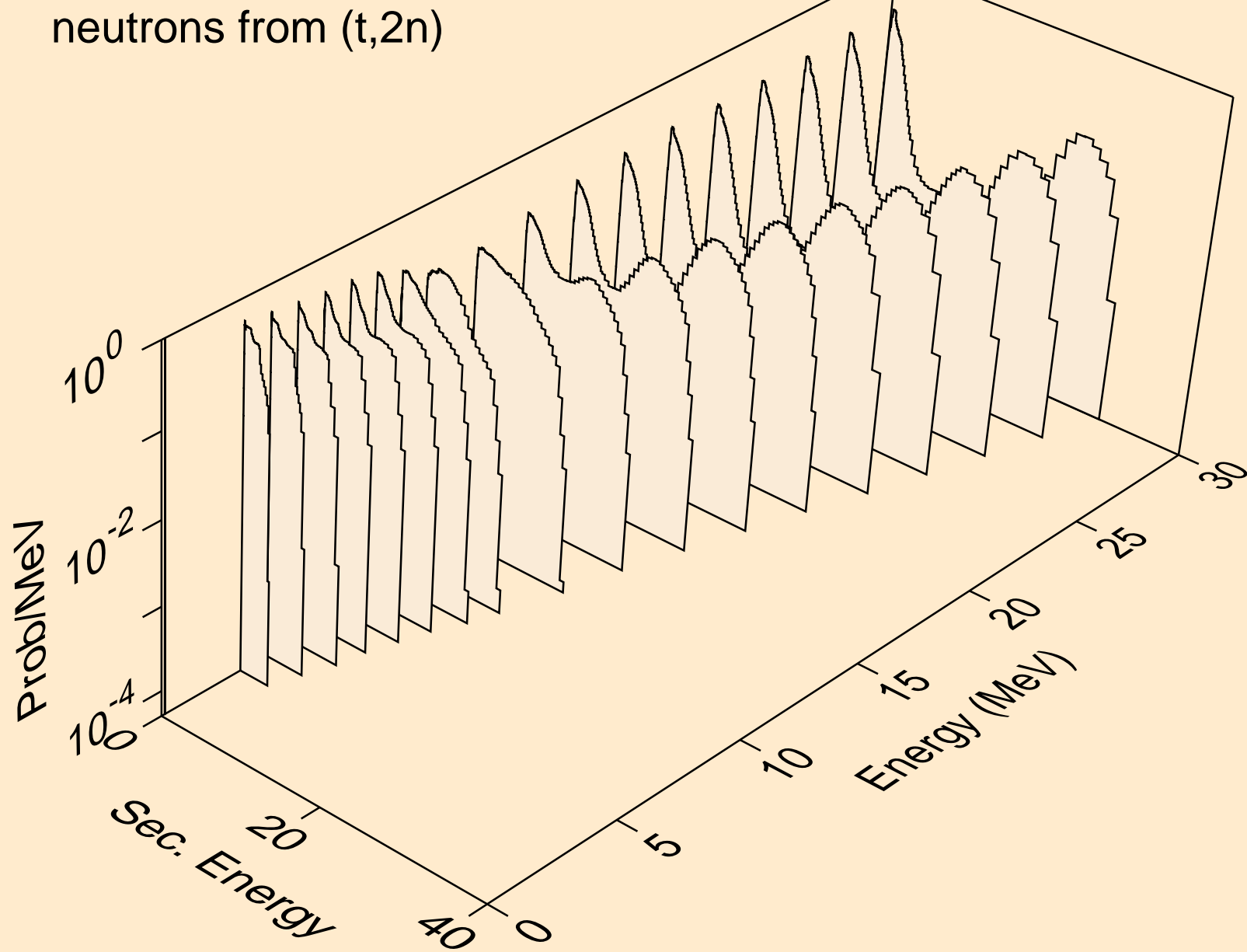

TL211 TRITON ACER TENDL-2021 LIBRARY; T=0.K  
neutrons from (t,3n)

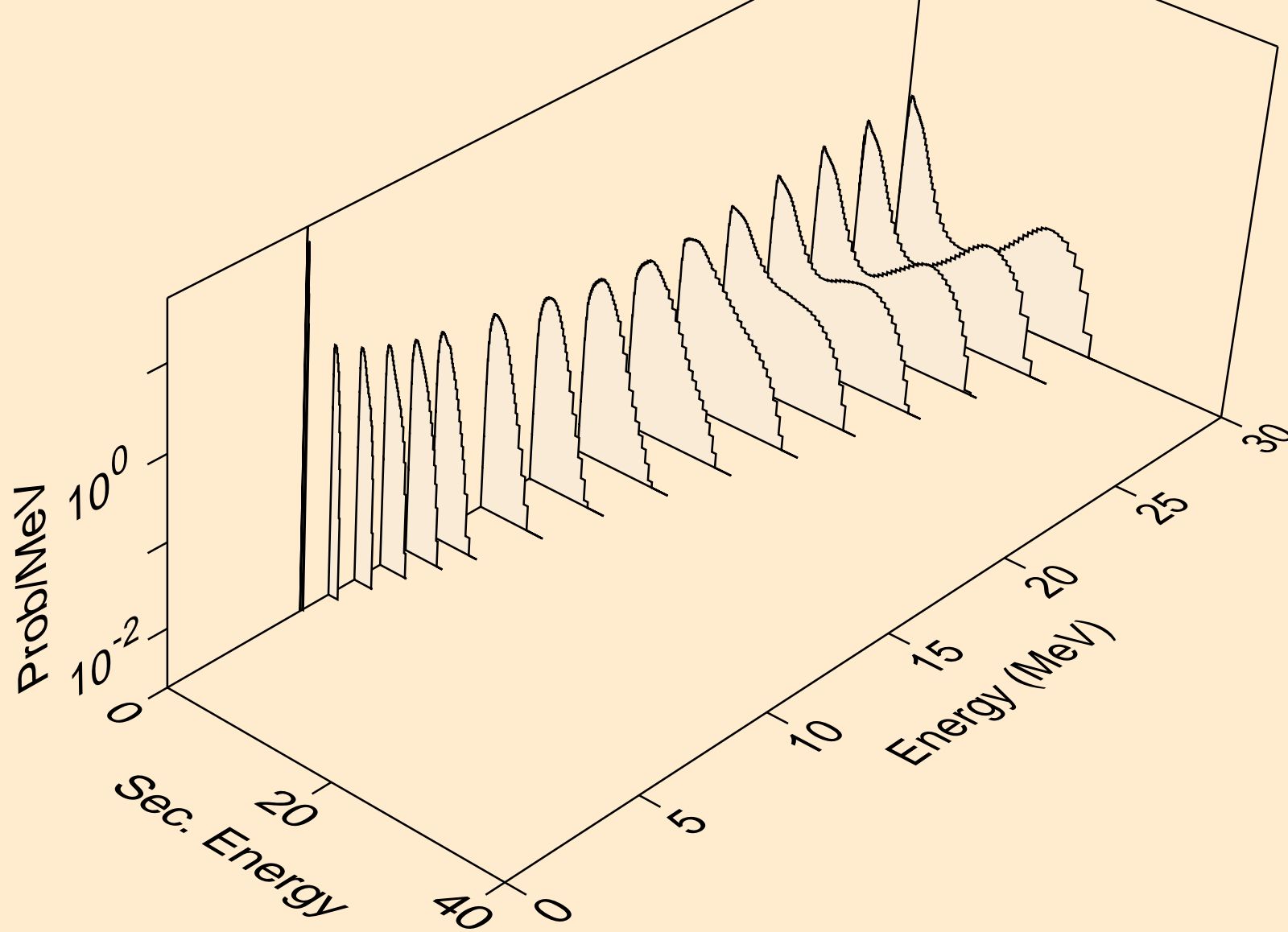

TL211 TRITON ACER TENDL-2021 LIBRARY; T=0.K  
neutrons from (t,n\*)a

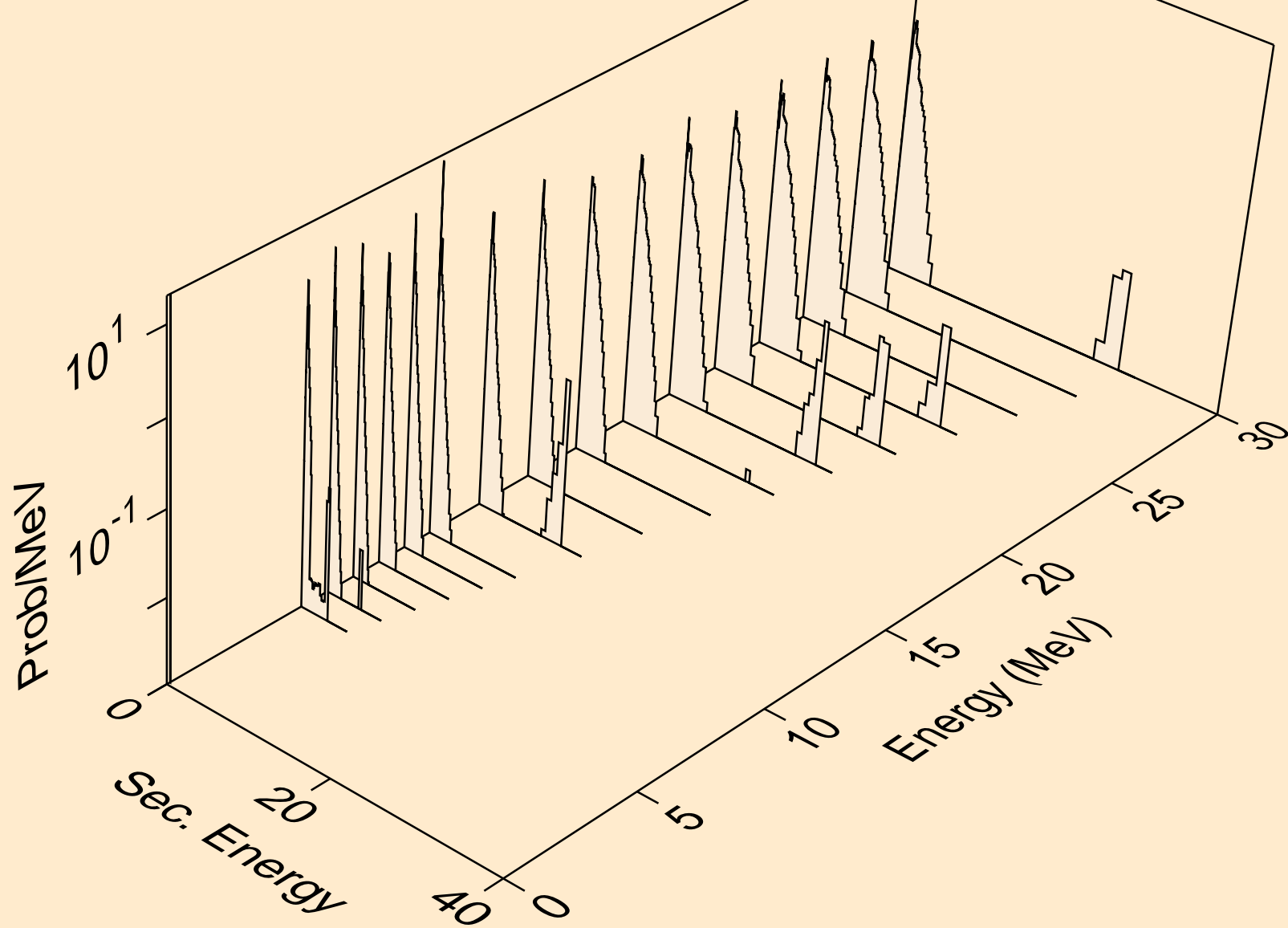

TL211 TRITON ACER TENDL-2021 LIBRARY; T=0.K  
neutrons from (t,2n)a

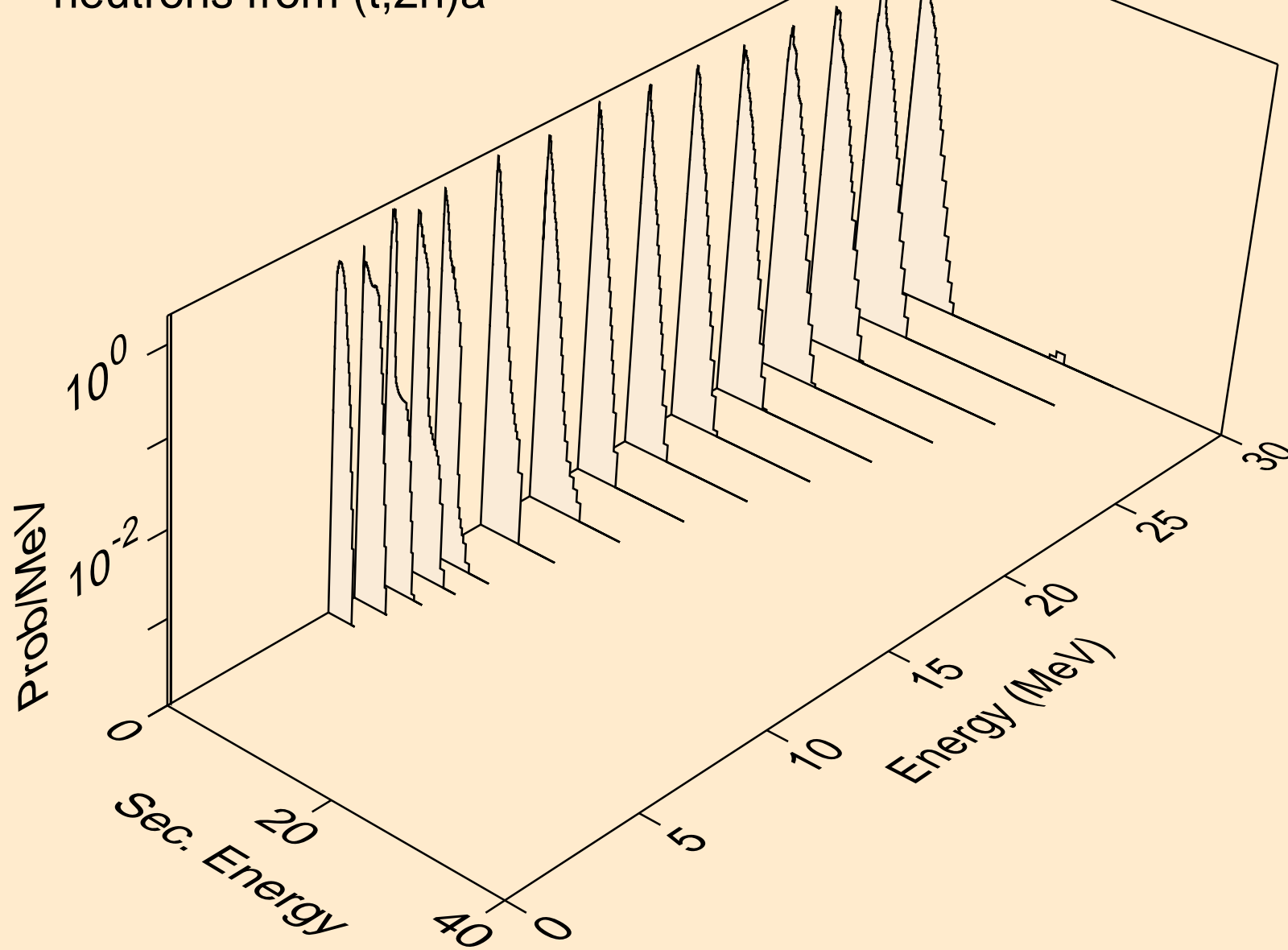



TL211 TRITON ACER TENDL-2021 LIBRARY; T=0.K  
neutrons from (t,3n)a

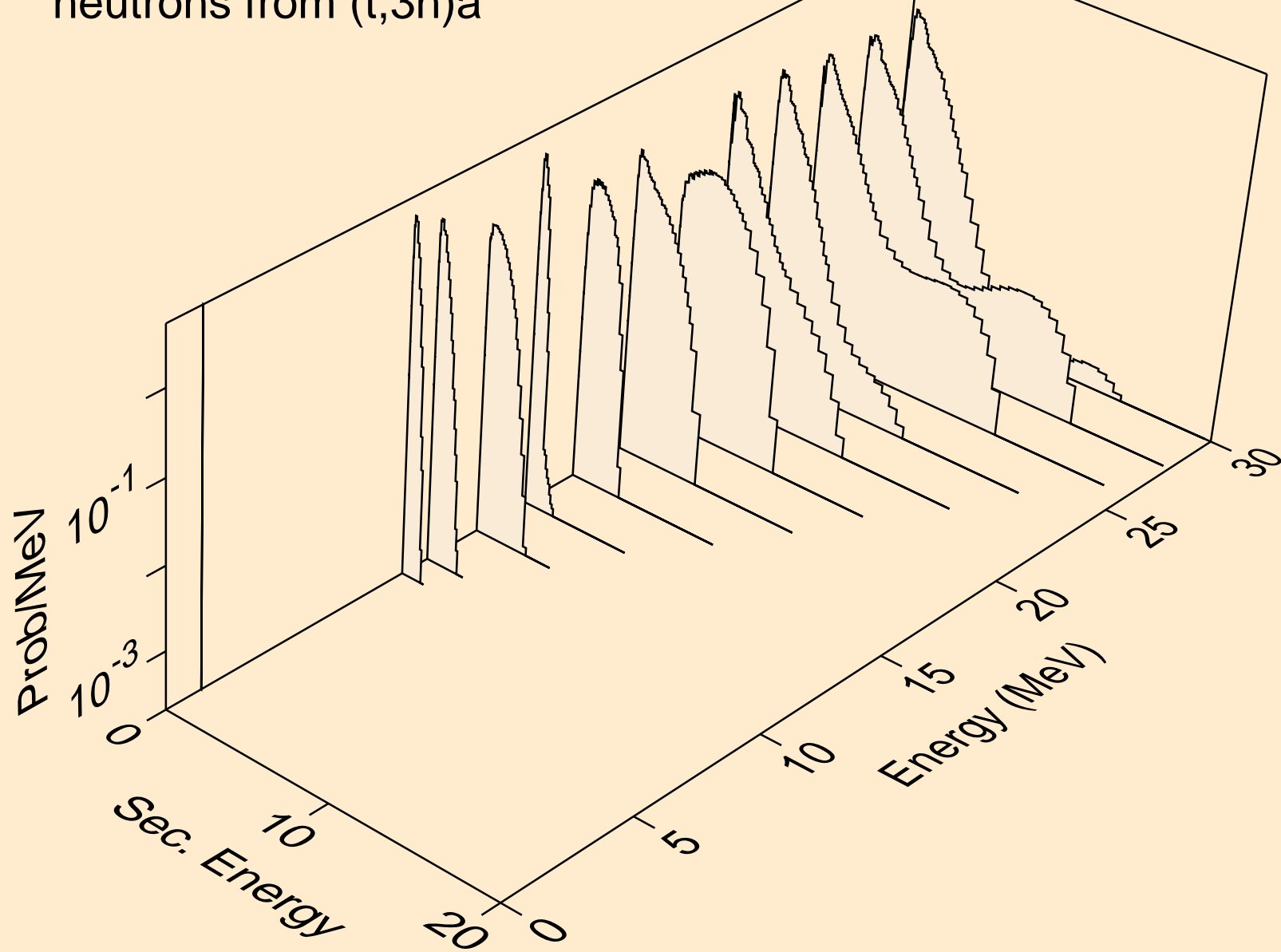

TL211 TRITON ACER TENDL-2021 LIBRARY; T=0.K  
neutrons from (t,n\*)p

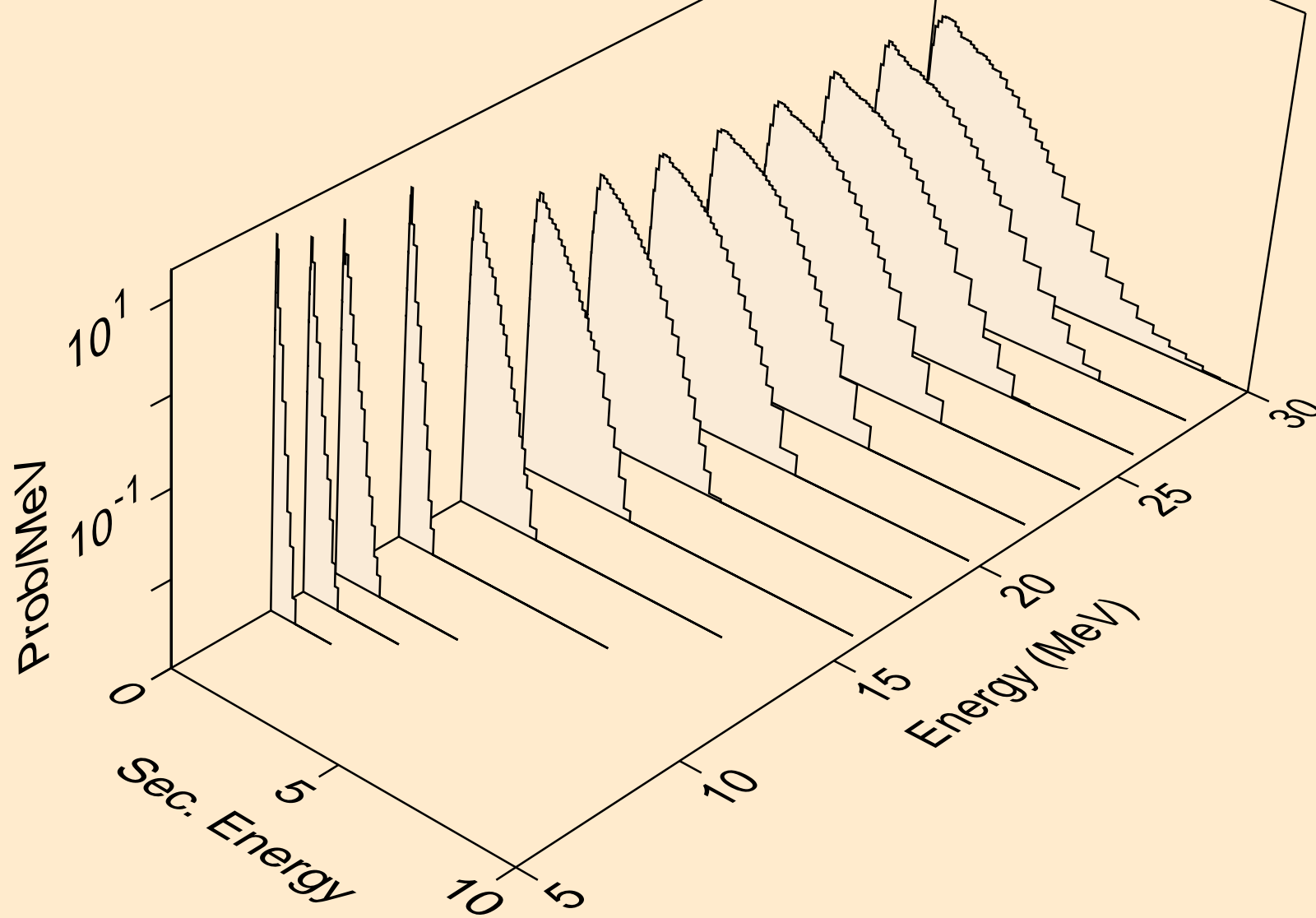

TL211 TRITON ACER TENDL-2021 LIBRARY; T=0.K  
neutrons from (t,n\*)d

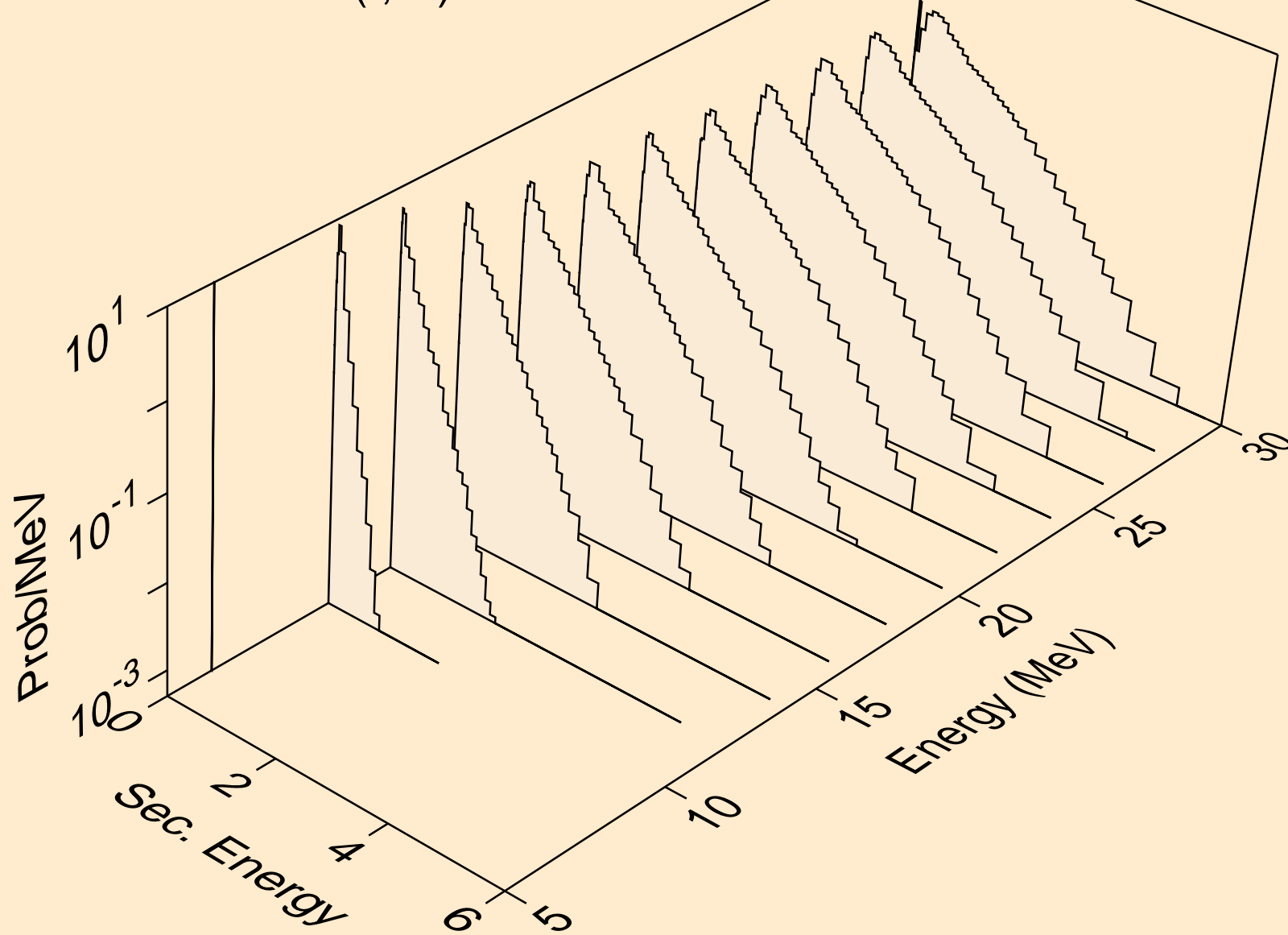

TL211 TRITON ACER TENDL-2021 LIBRARY; T=0.K  
neutrons from (t,n\*)t

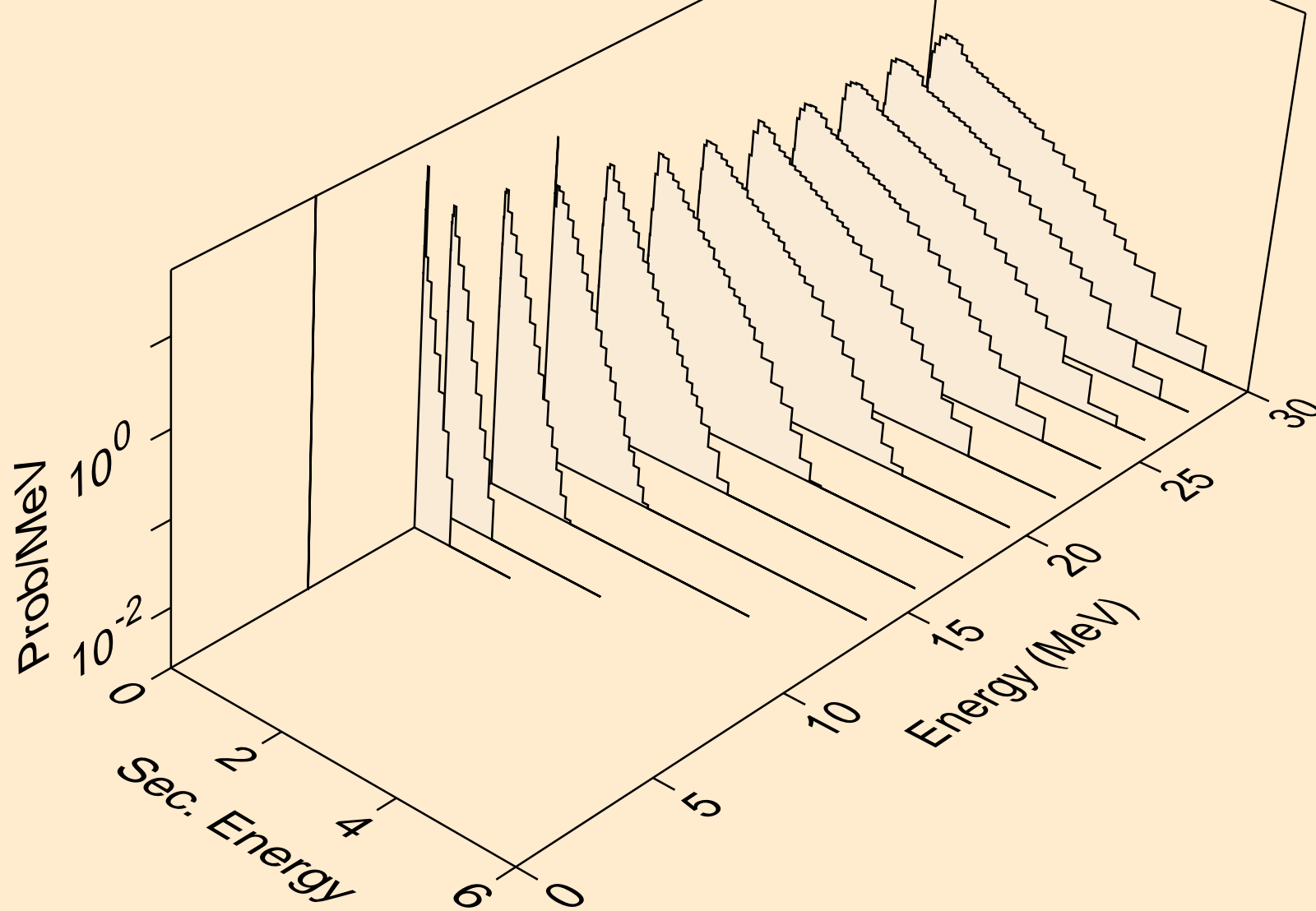

TL211 TRITON ACER TENDL-2021 LIBRARY; T=0.K  
neutrons from (t,n\*)he3

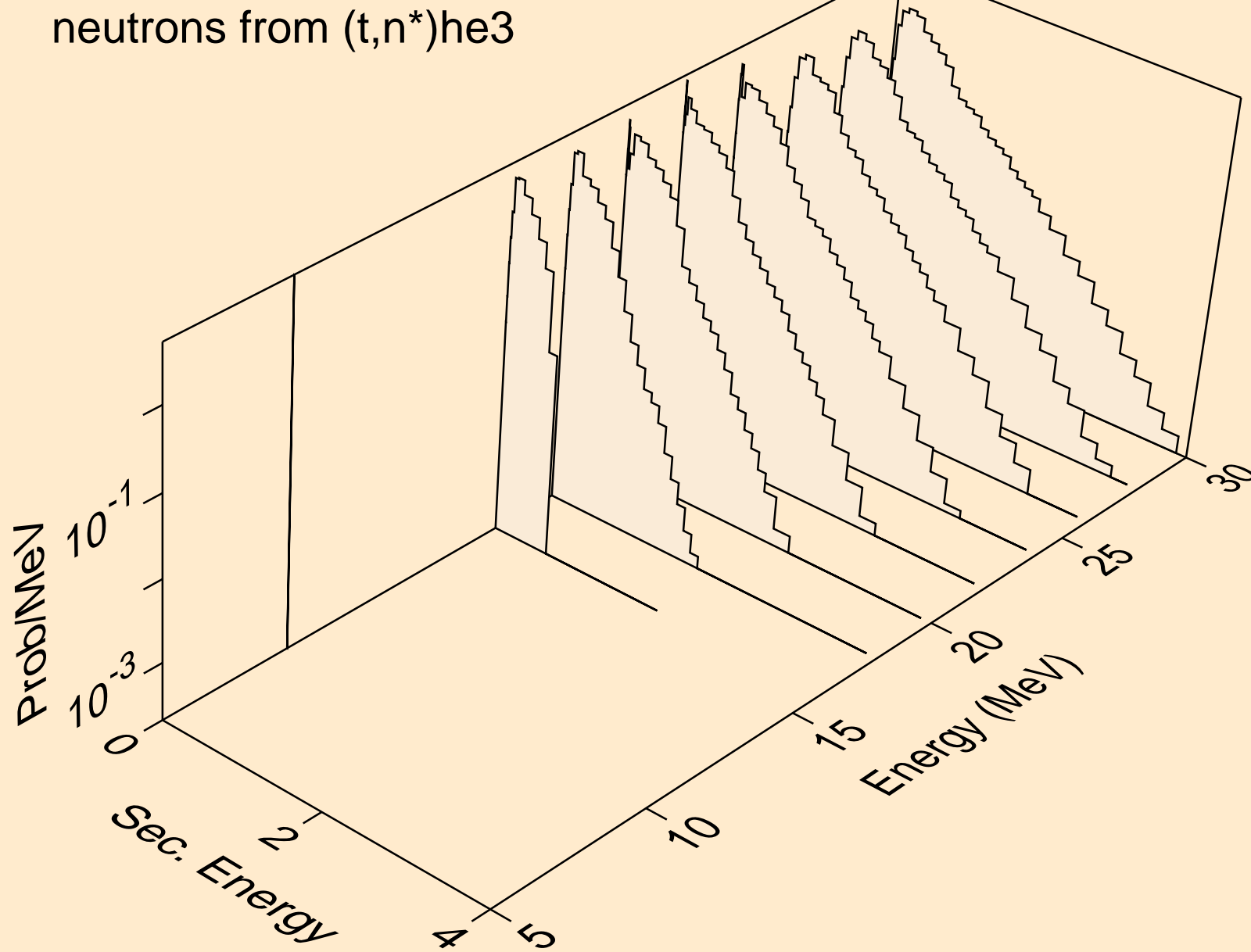

TL211 TRITON ACER TENDL-2021 LIBRARY; T=0.K  
neutrons from (t,4n)

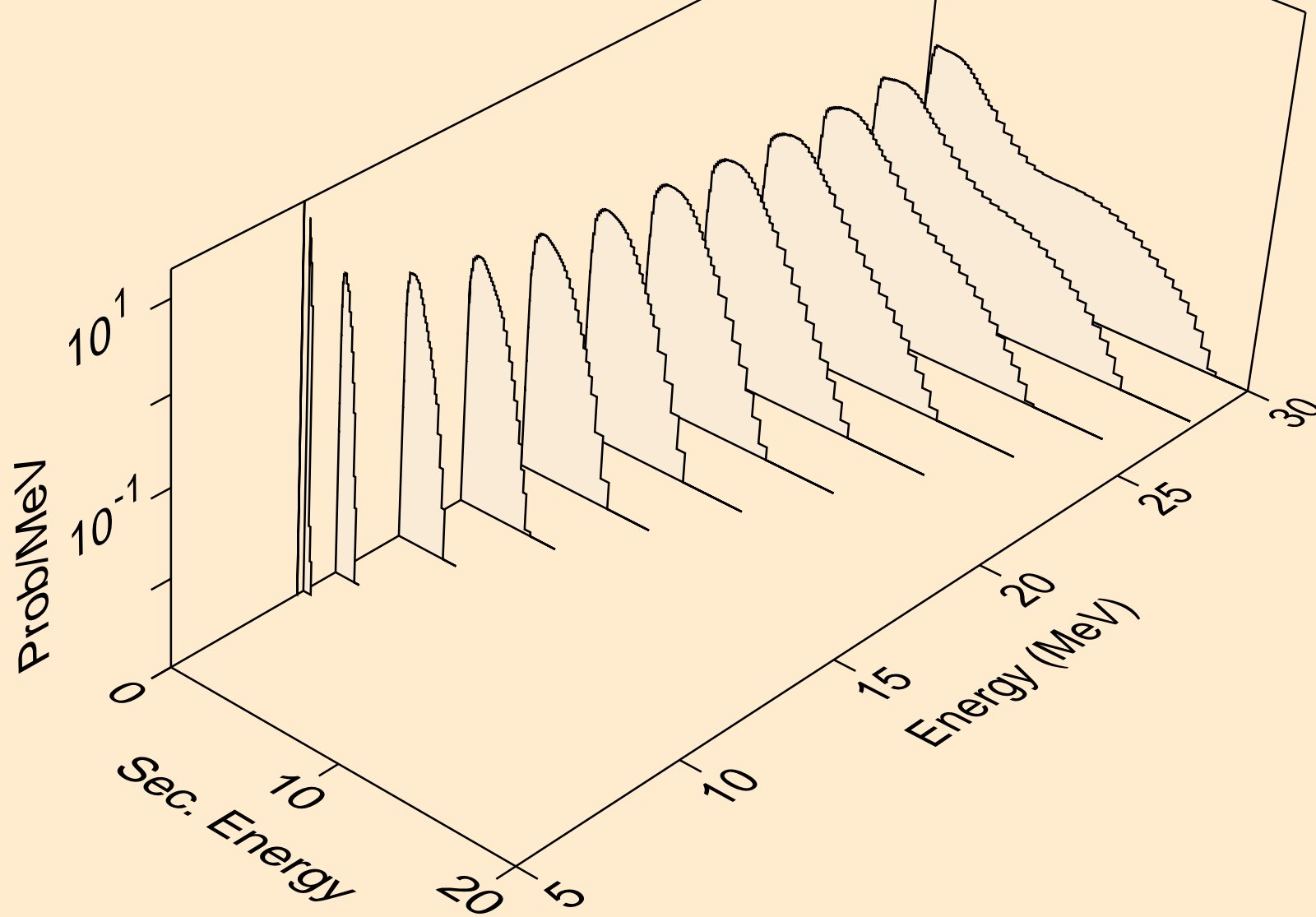

TL211 TRITON ACER TENDL-2021 LIBRARY; T=0.K  
neutrons from (t,2np)

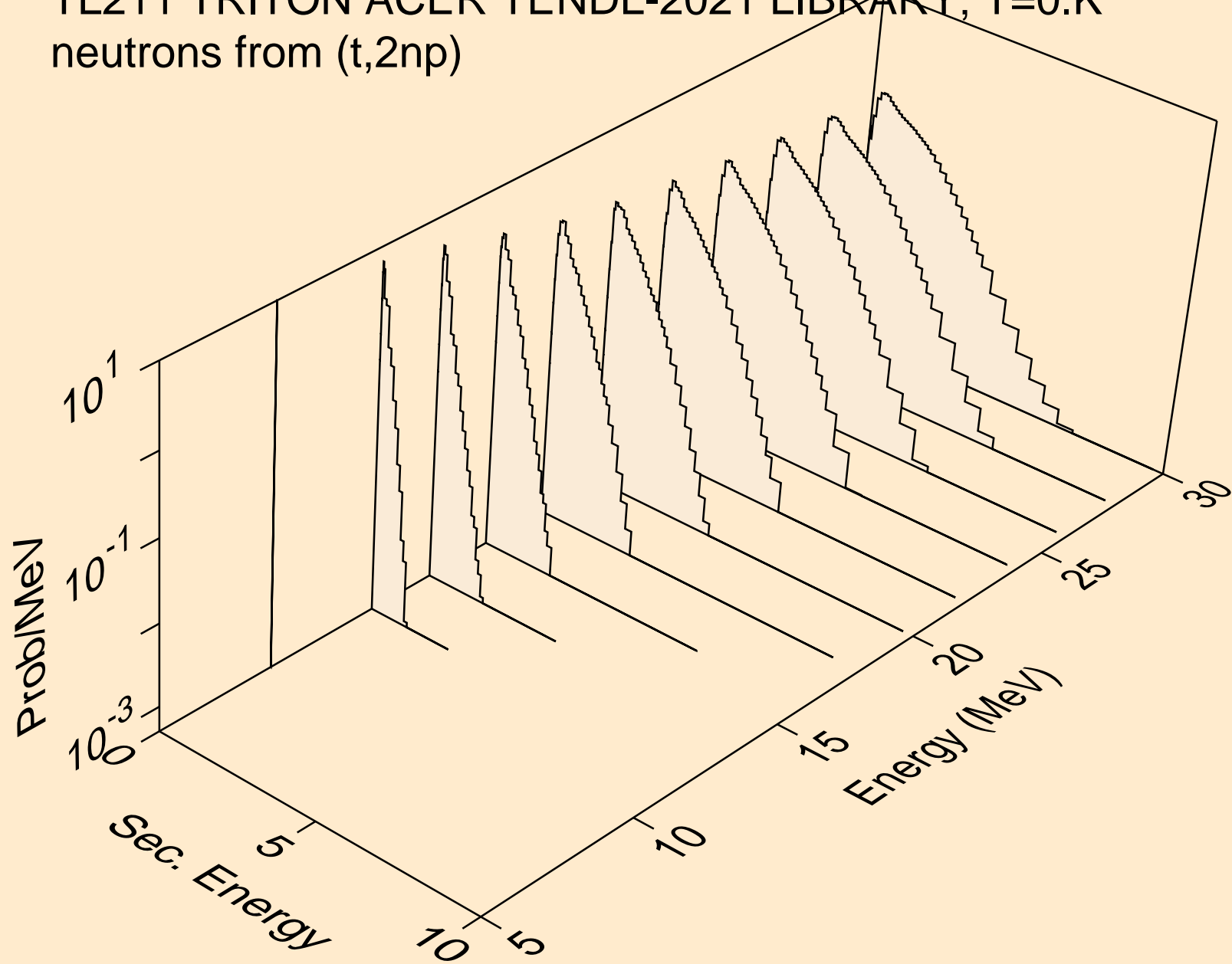

TL211 TRITON ACER TENDL-2021 LIBRARY; T=0.K  
neutrons from (t,3np)

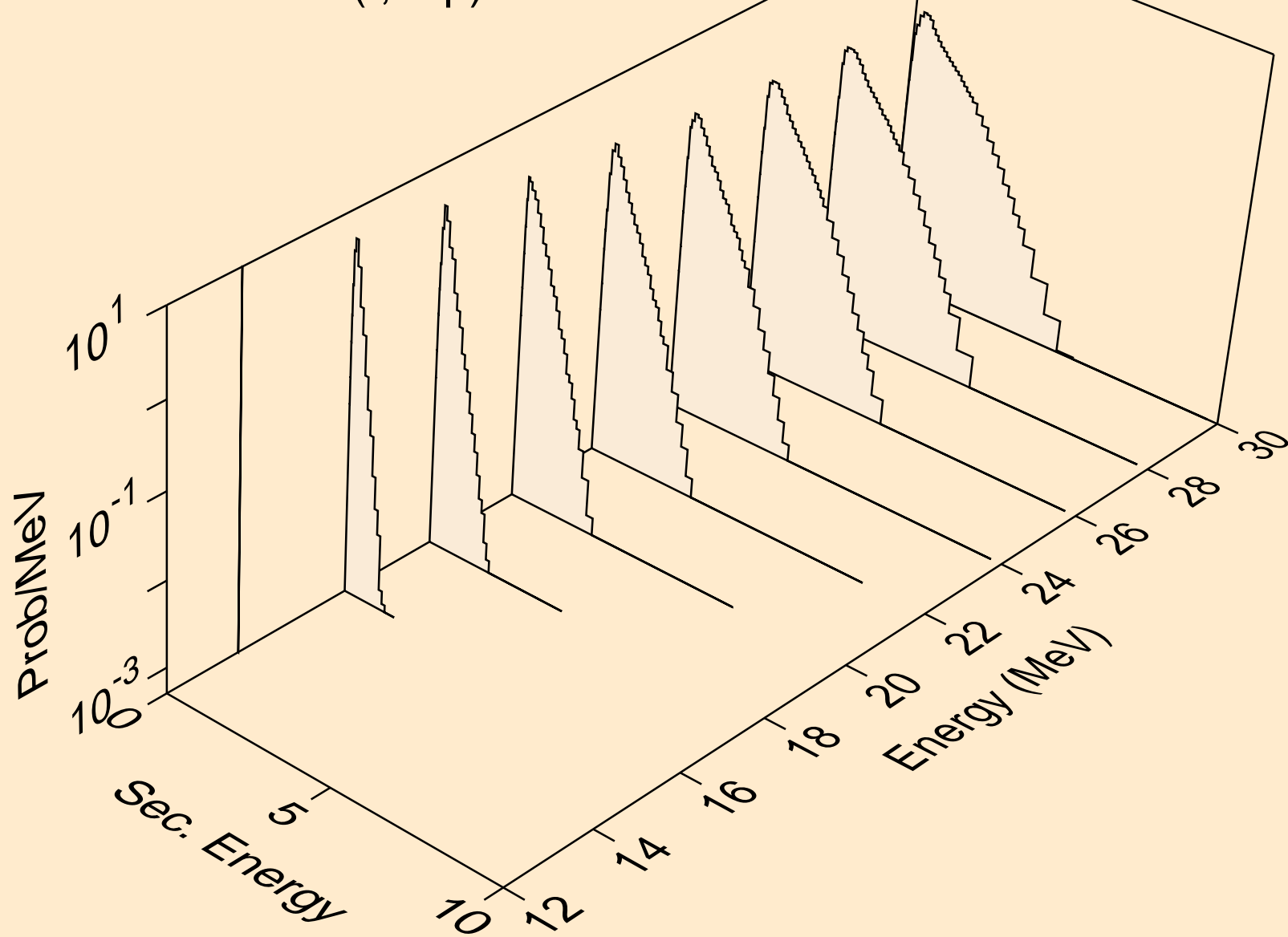



TL211 TRITON ACER TENDL-2021 LIBRARY; T=0.K  
neutrons from (t,2np)

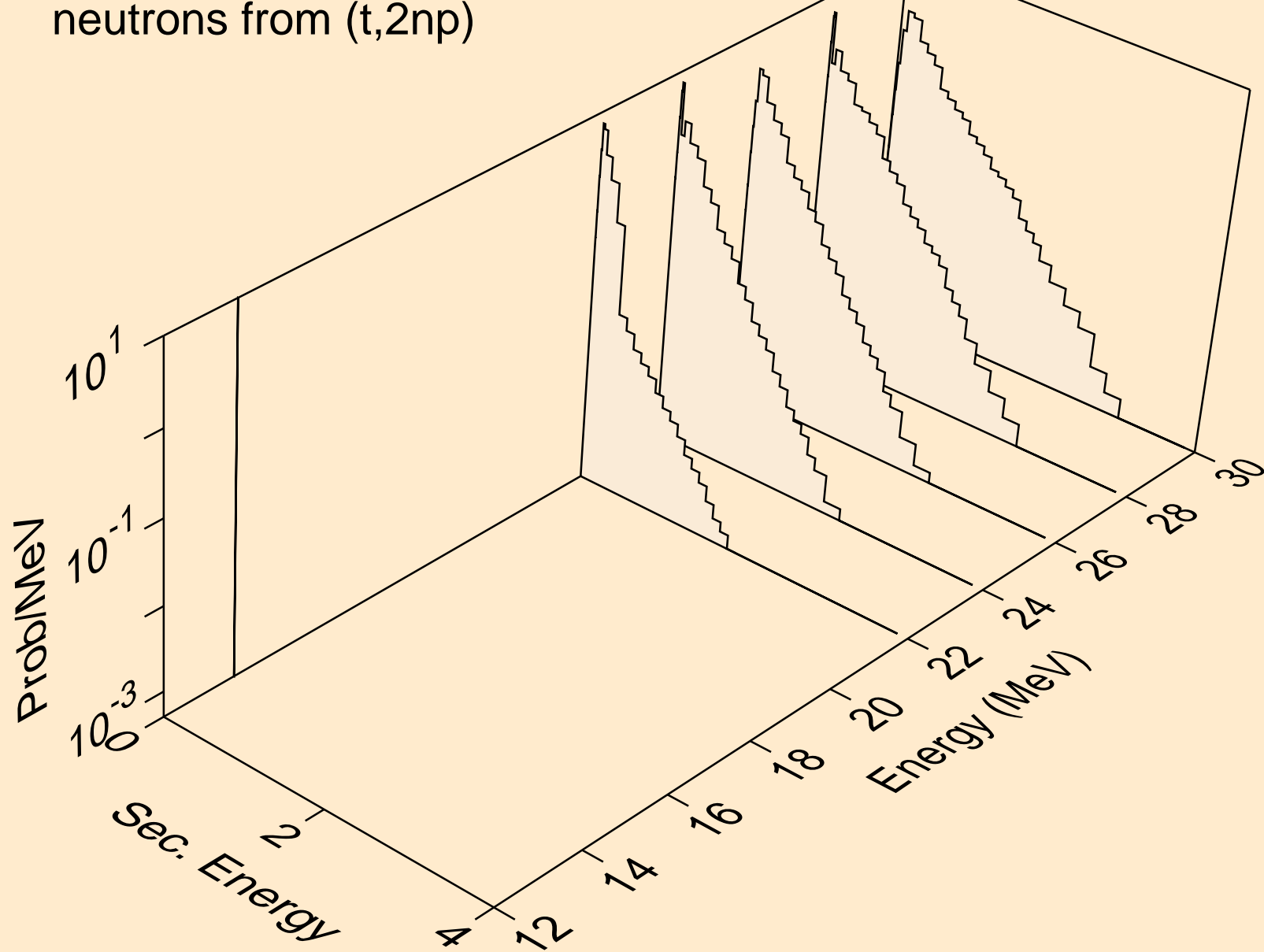

TL211 TRITON ACER TENDL-2021 LIBRARY; T=0.K  
protons from (t,x)

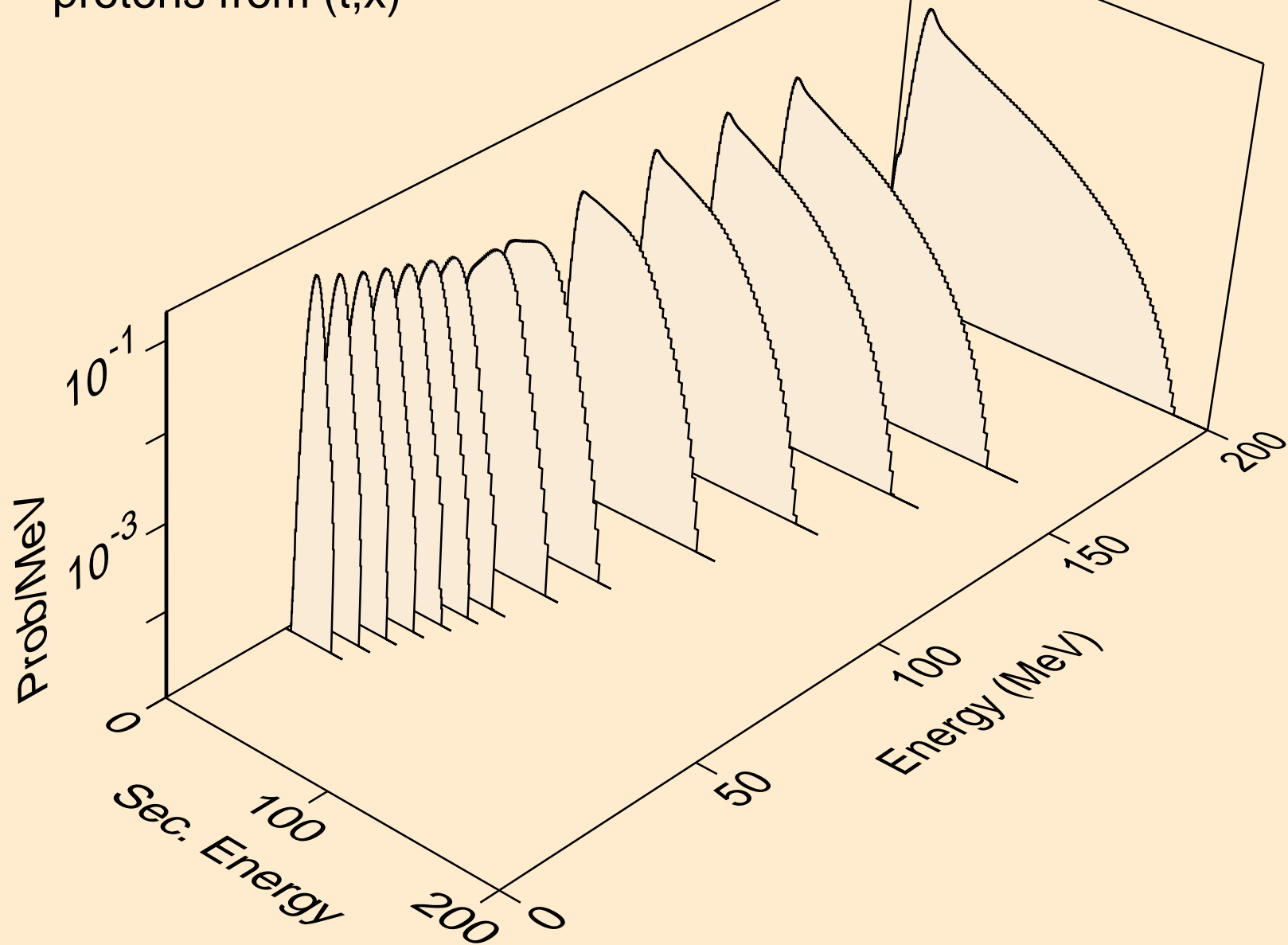

TL211 TRITON ACER TENDL-2021 LIBRARY; T=0.K  
protons from (t,n\*)p

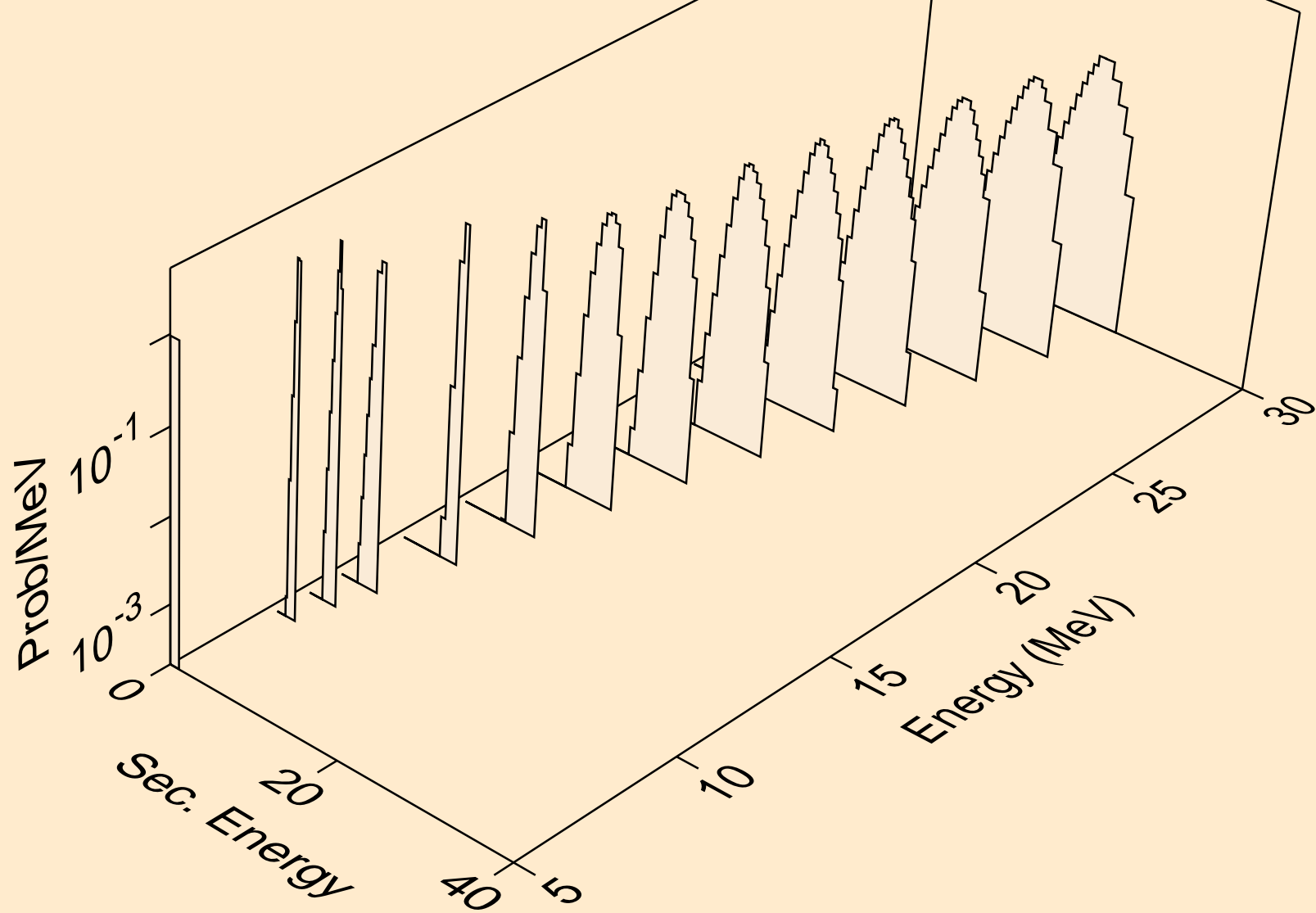

TL211 TRITON ACER TENDL-2021 LIBRARY; T=0.K  
protons from (t,2np)

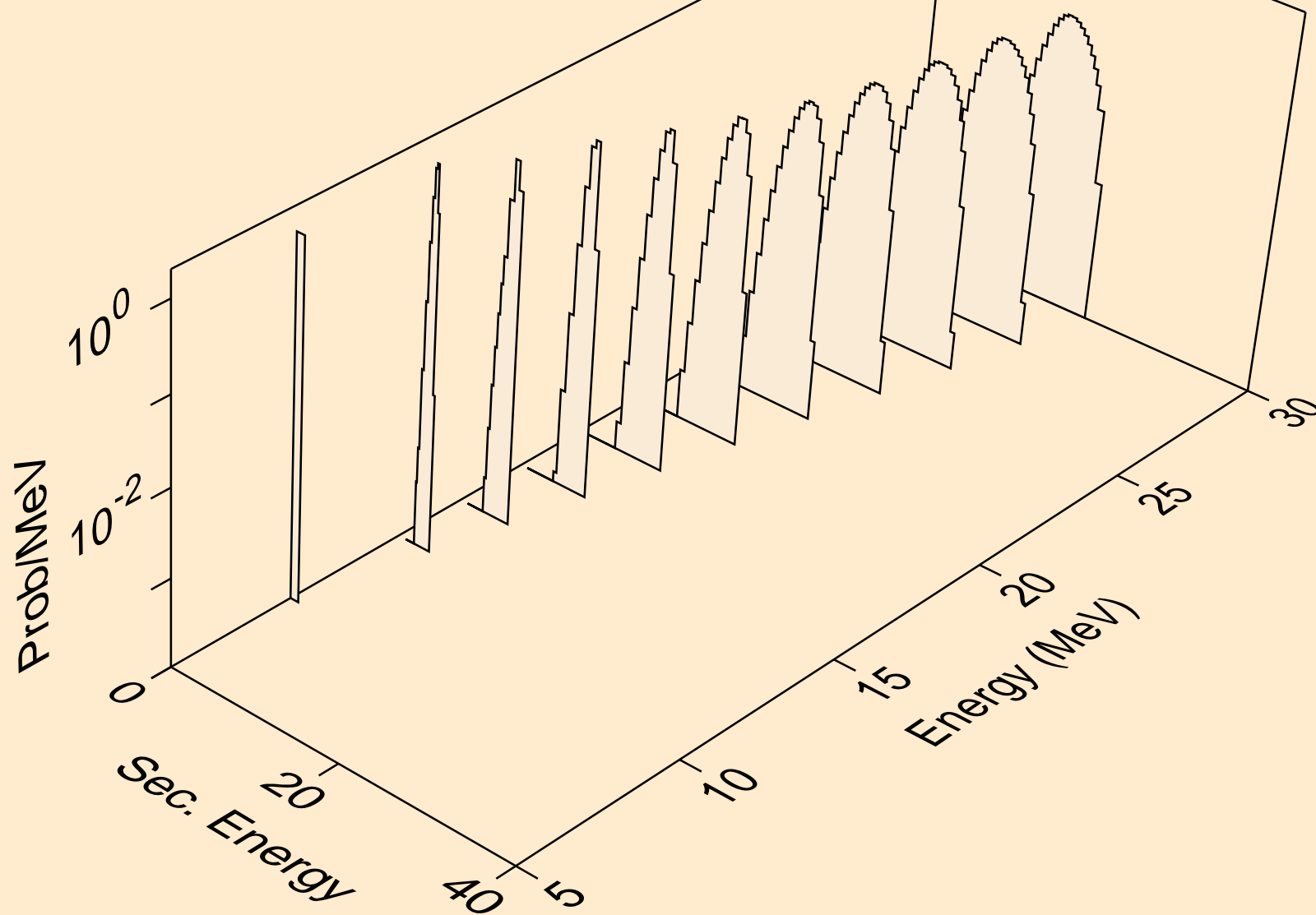

TL211 TRITON ACER TENDL-2021 LIBRARY; T=0.K  
protons from (t,3np)

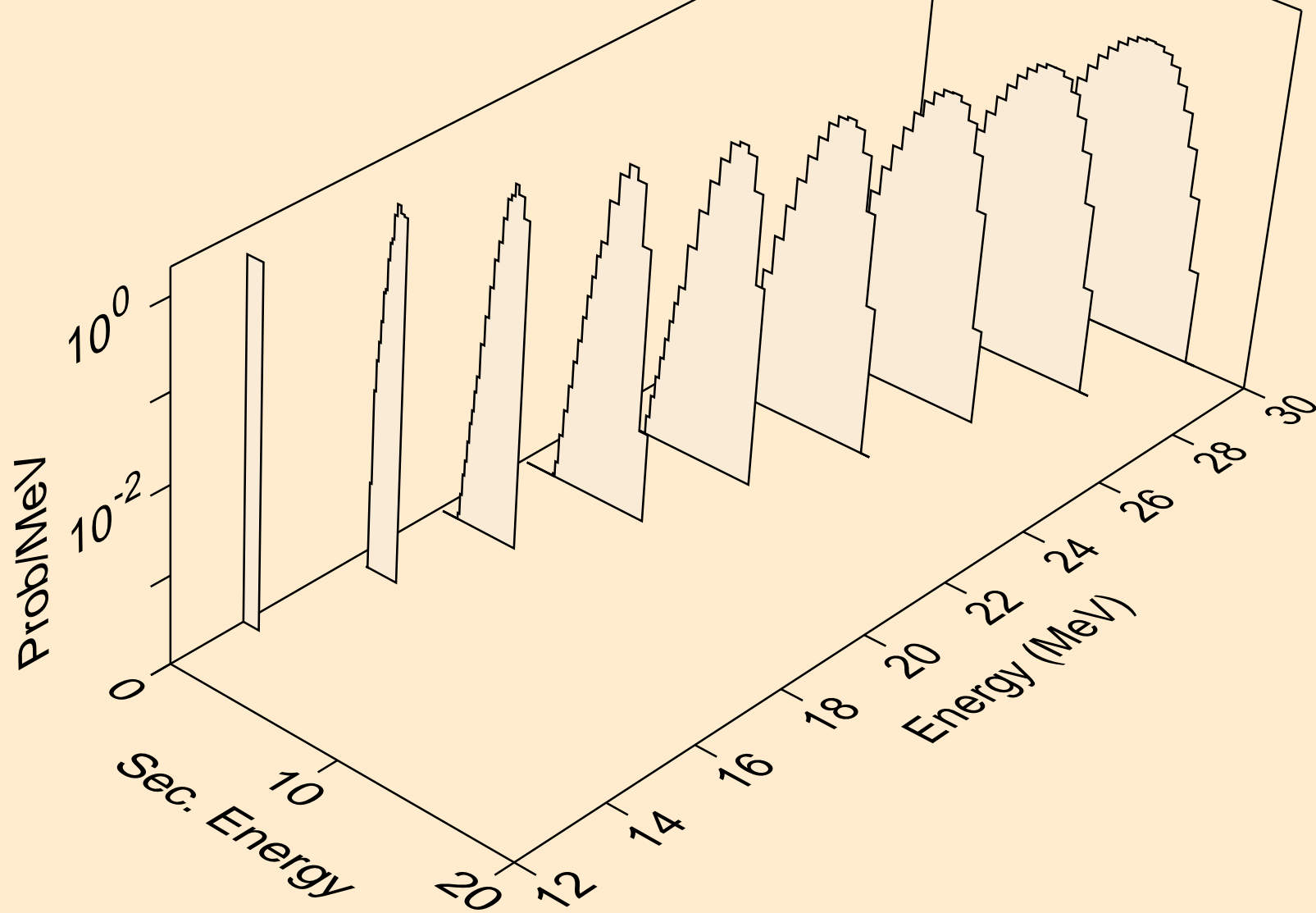

TL211 TRITON ACER TENDL-2021 LIBRARY; T=0.K  
protons from (t,2np)

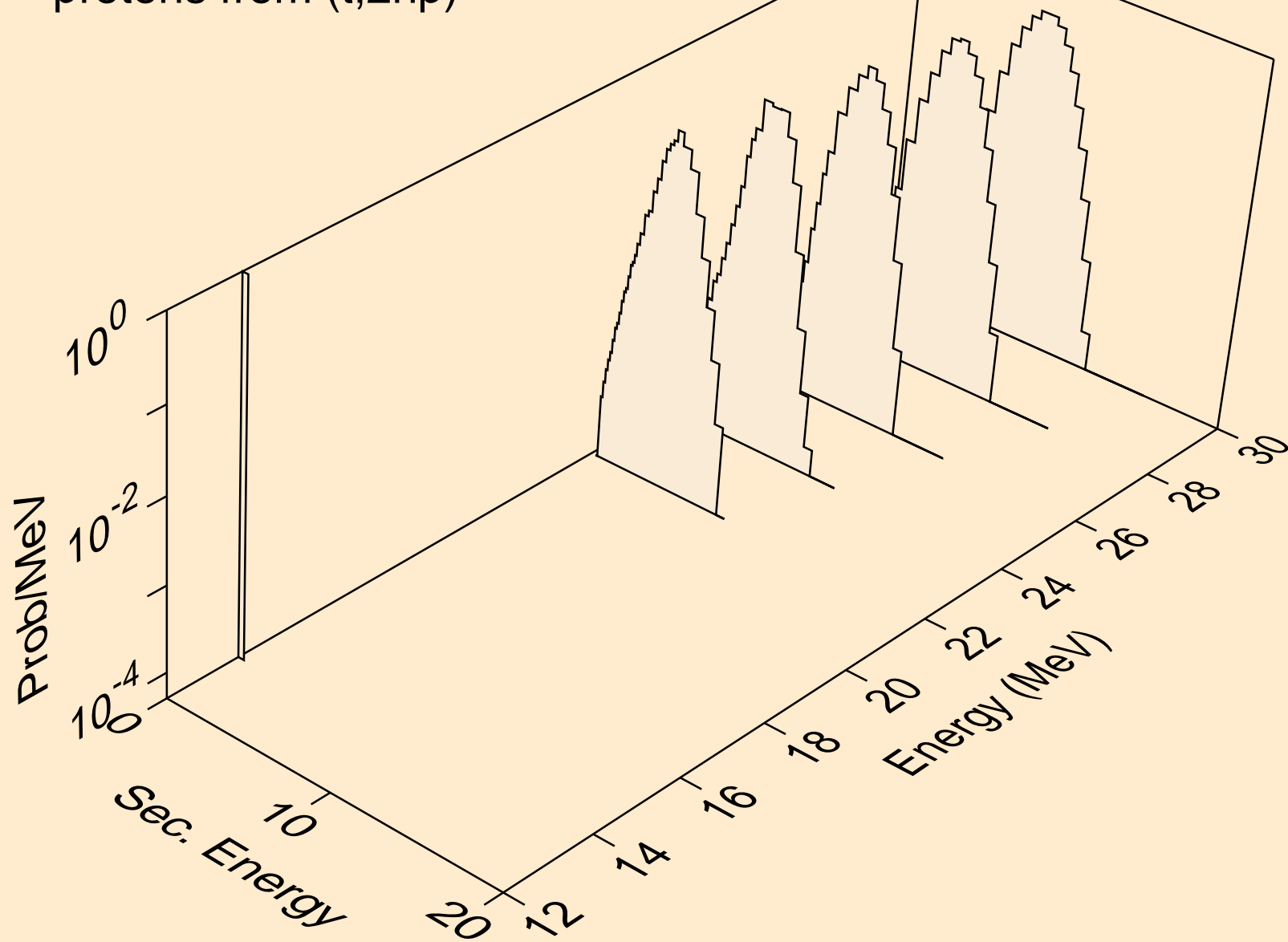

TL211 TRITON ACER TENDL-2021 LIBRARY; T=0.K  
protons from (t,p)

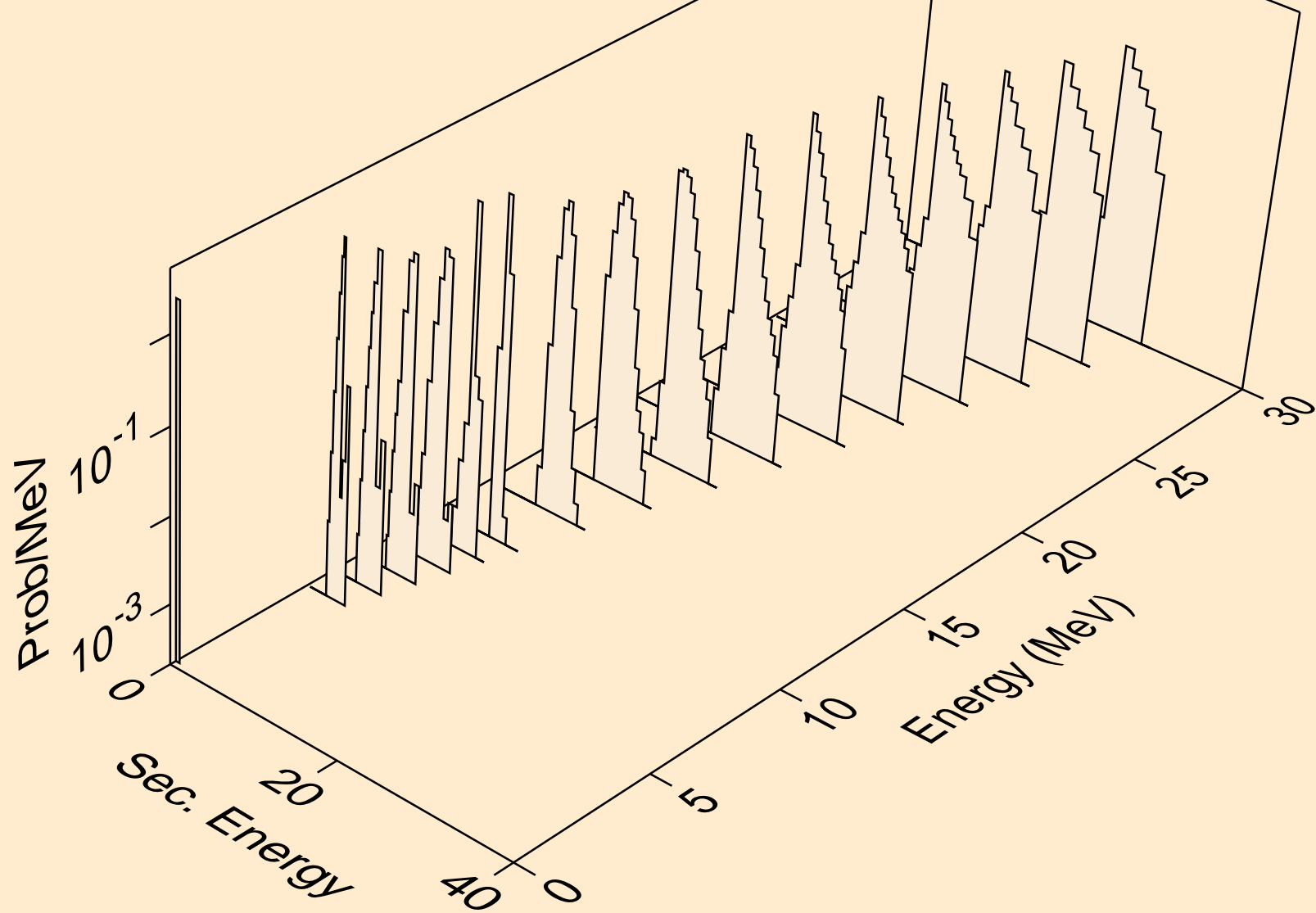

TL211 TRITON ACER TENDL-2021 LIBRARY; T=0.K  
protons from (t,2p)

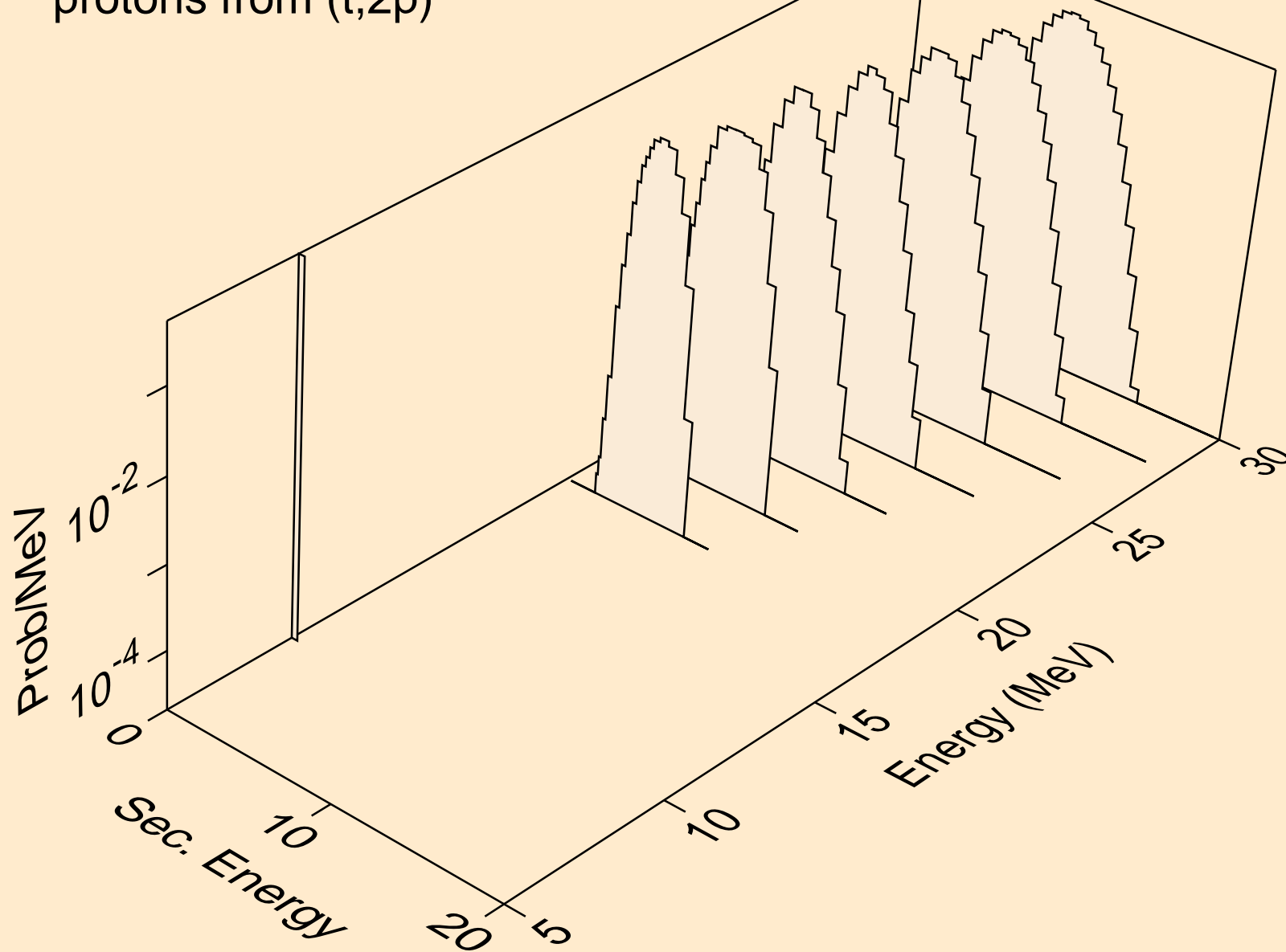



TL211 TRITON ACER TENDL-2021 LIBRARY; T=0.K  
deuterons from (t,x)

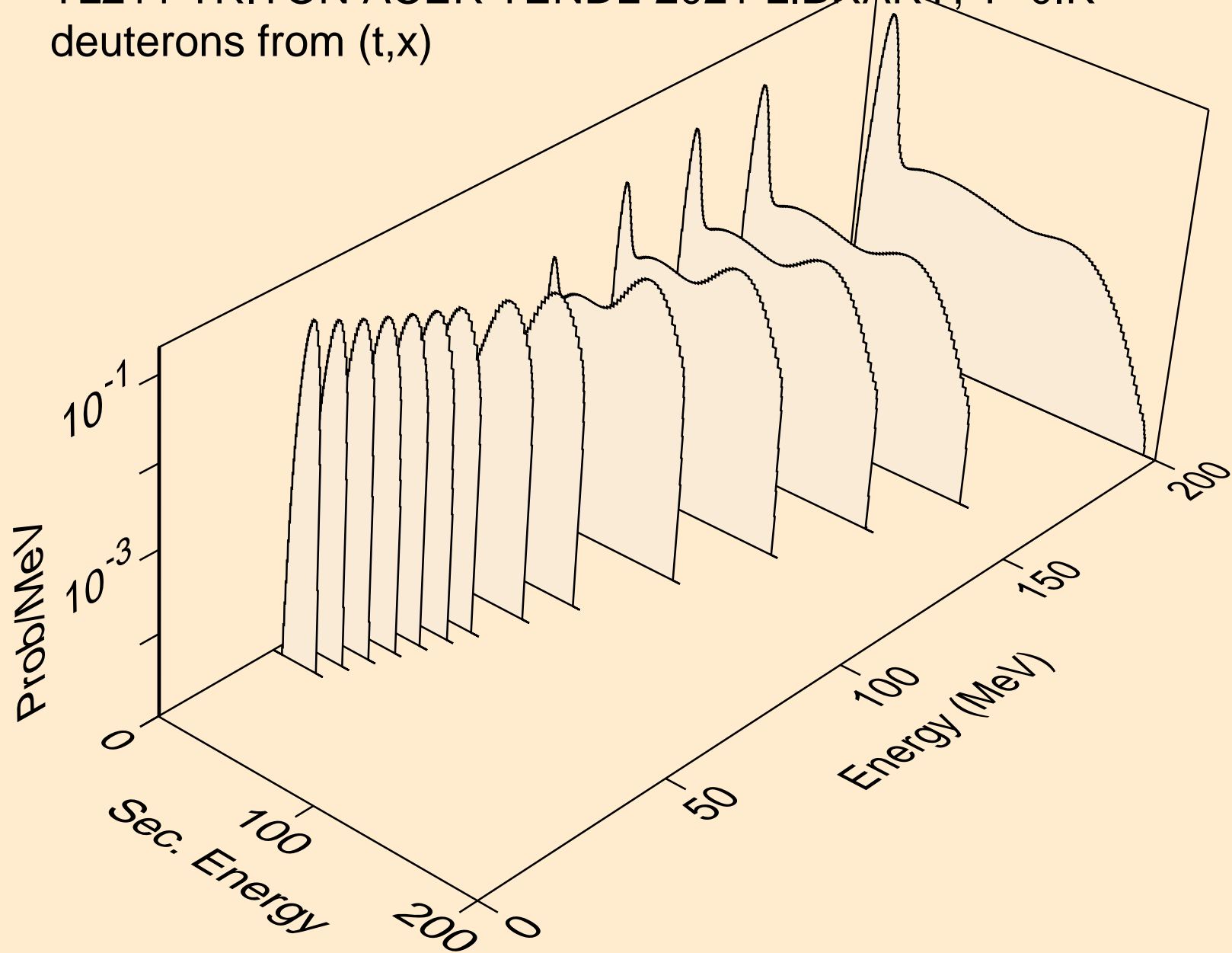

TL211 TRITON ACER TENDL-2021 LIBRARY; T=0.K  
deuterons from (t,2nd)

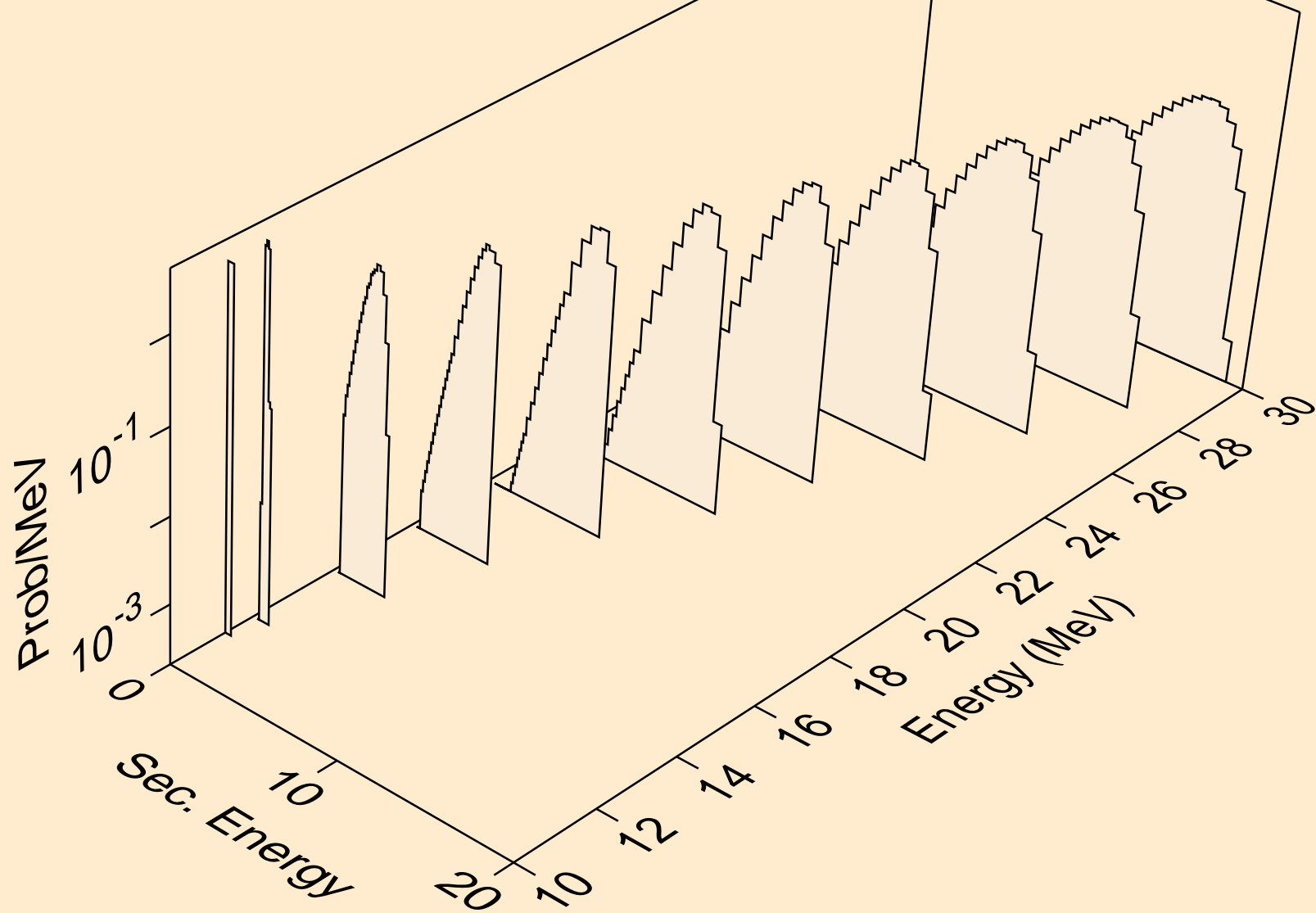

TL211 TRITON ACER TENDL-2021 LIBRARY; T=0.K  
deuterons from (t,n\*)d

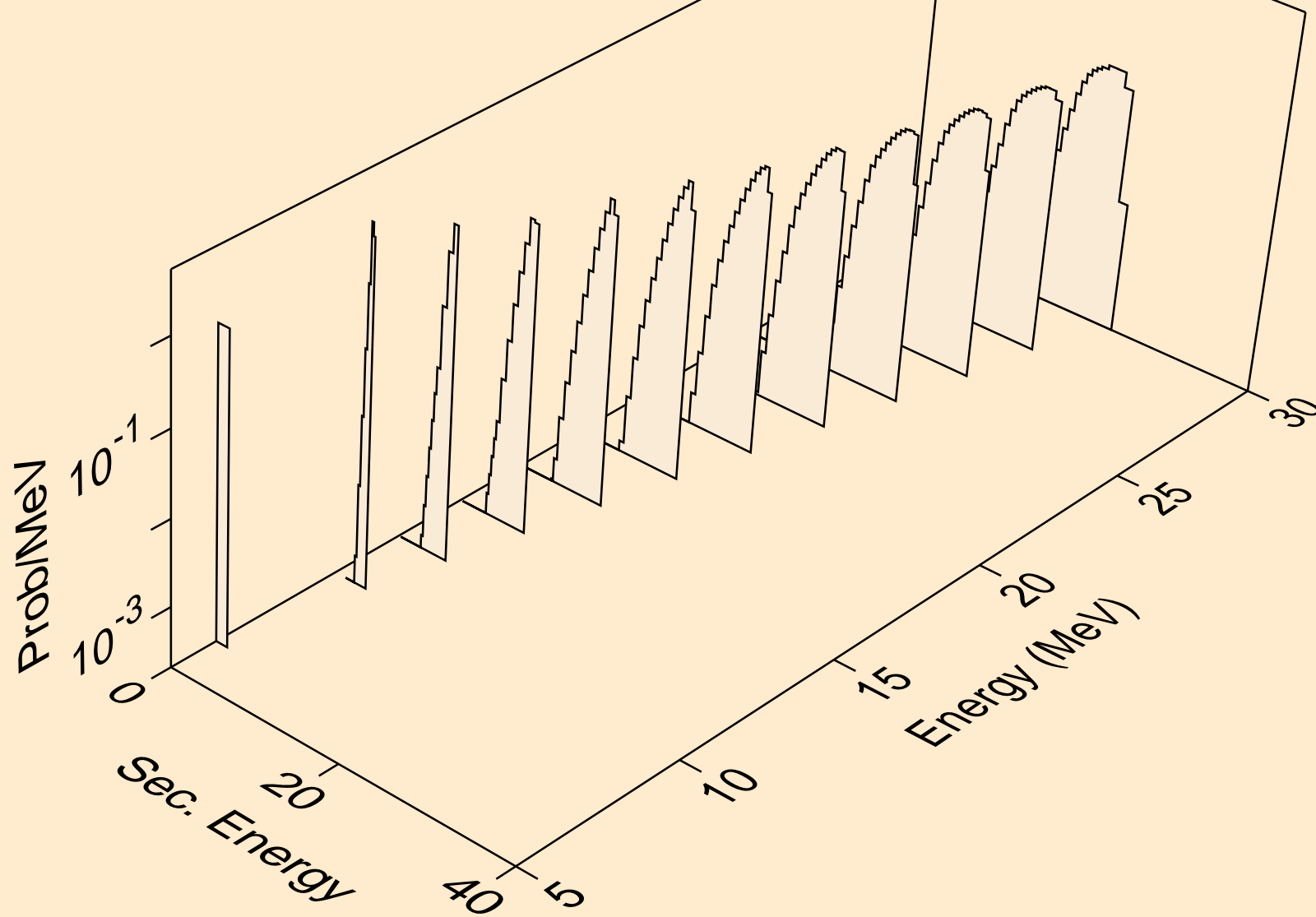

TL211 TRITON ACER TENDL-2021 LIBRARY; T=0.K  
deuterons from (t,d)

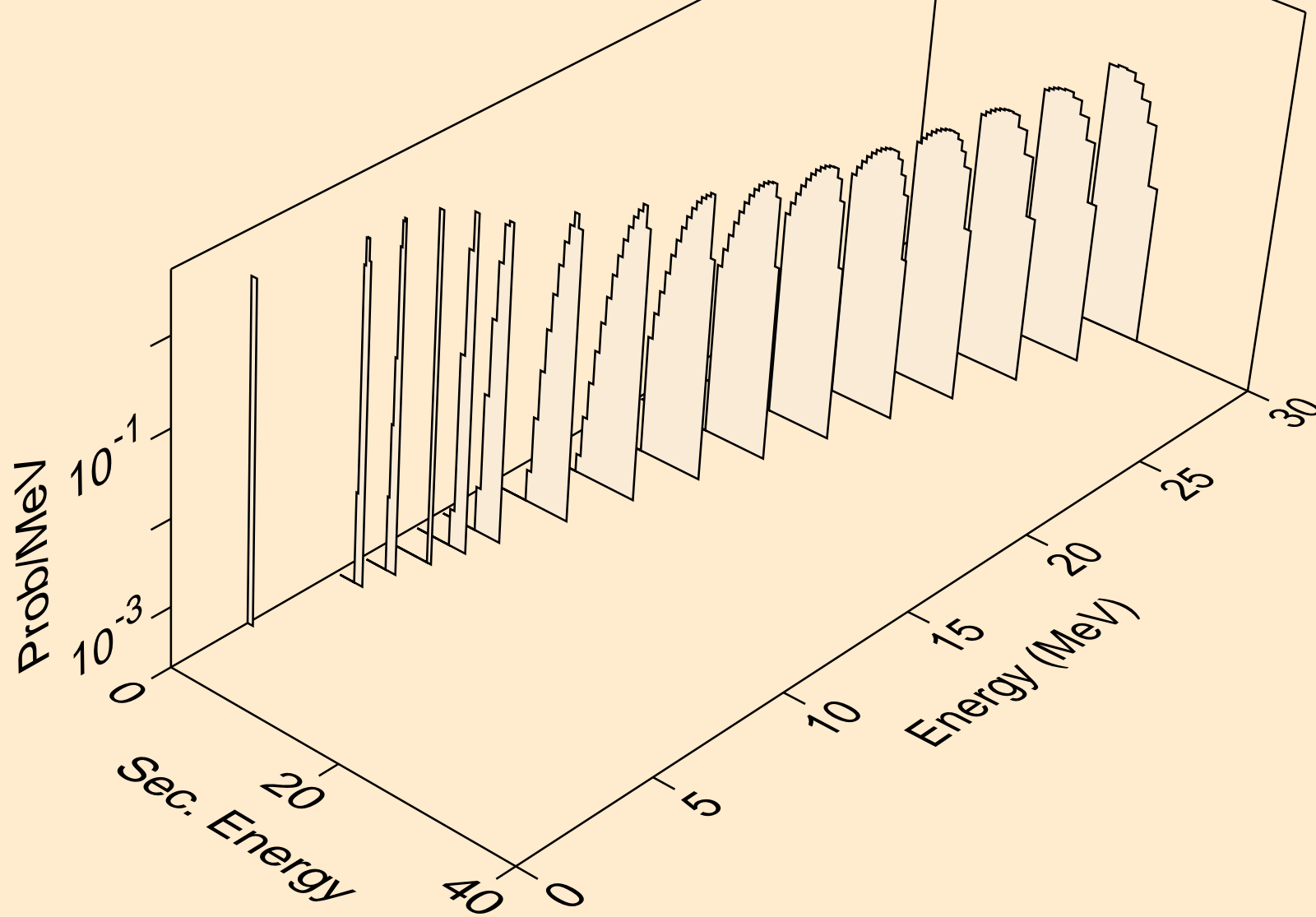

TL211 TRITON ACER TENDL-2021 LIBRARY; T=0.K  
he3s from (t,x)

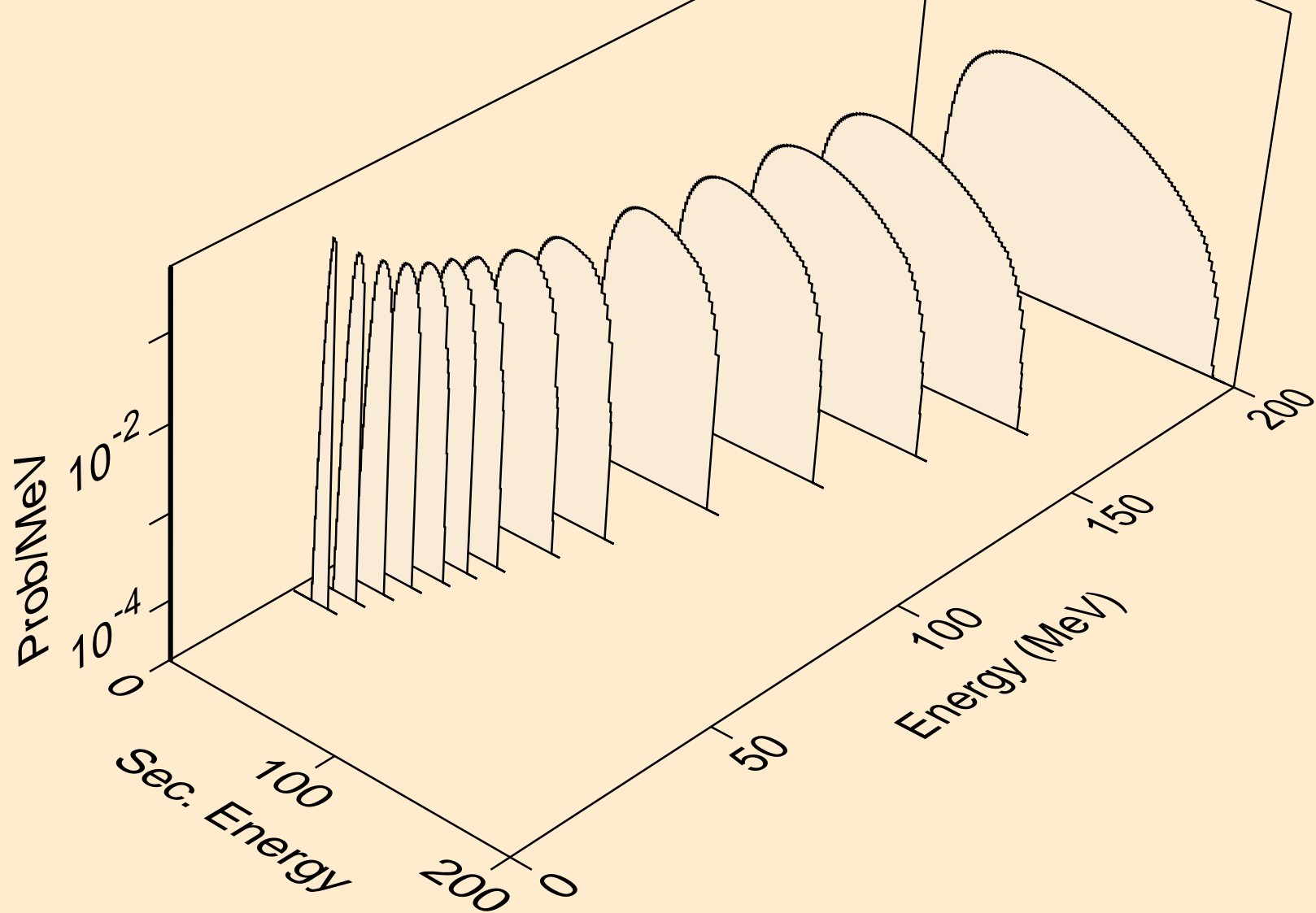

TL211 TRITON ACER TENDL-2021 LIBRARY; T=0.K  
he3s from (t,n\*)he3

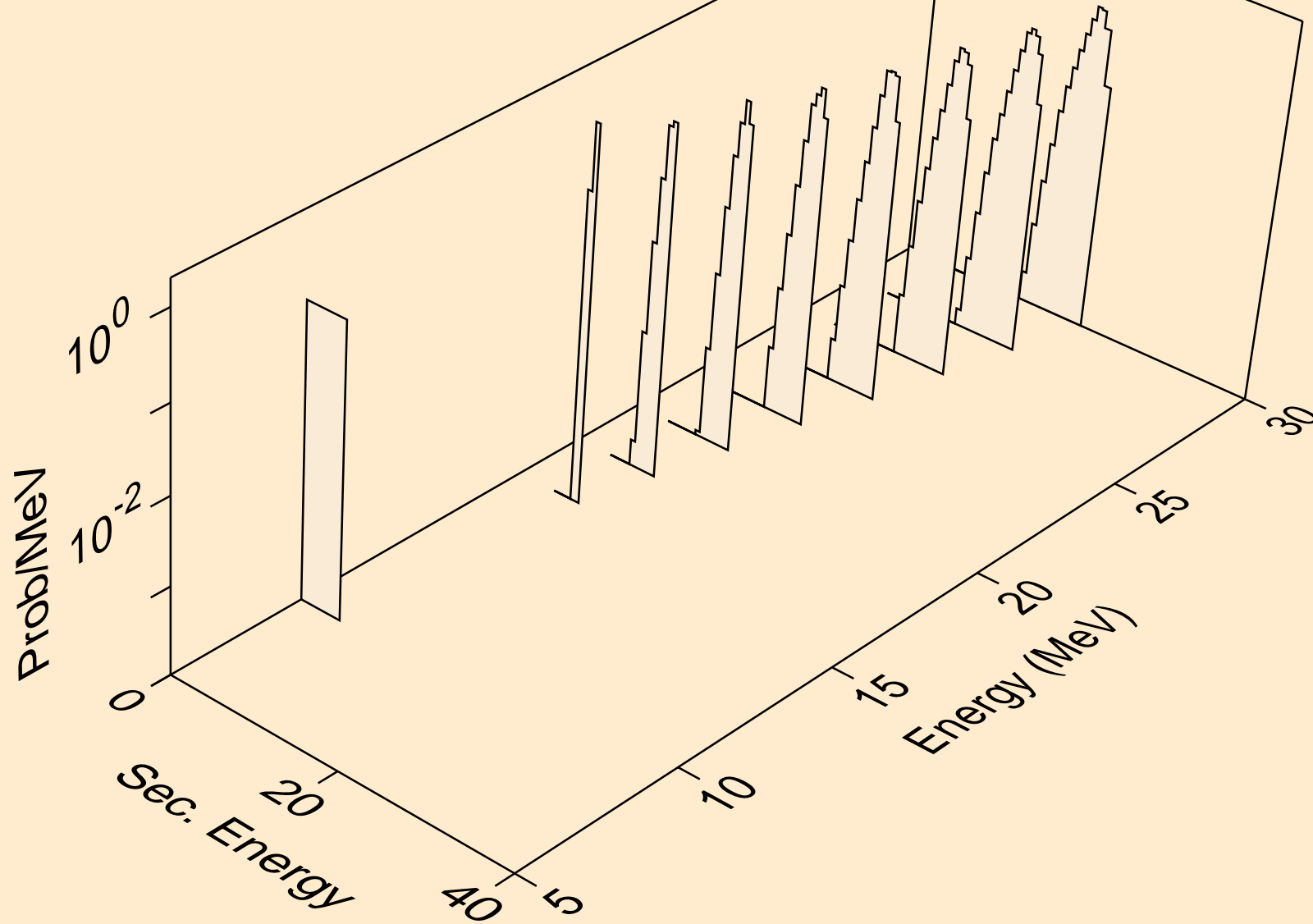

TL211 TRITON ACER TENDL-2021 LIBRARY; T=0.K  
he3s from (t,he3)

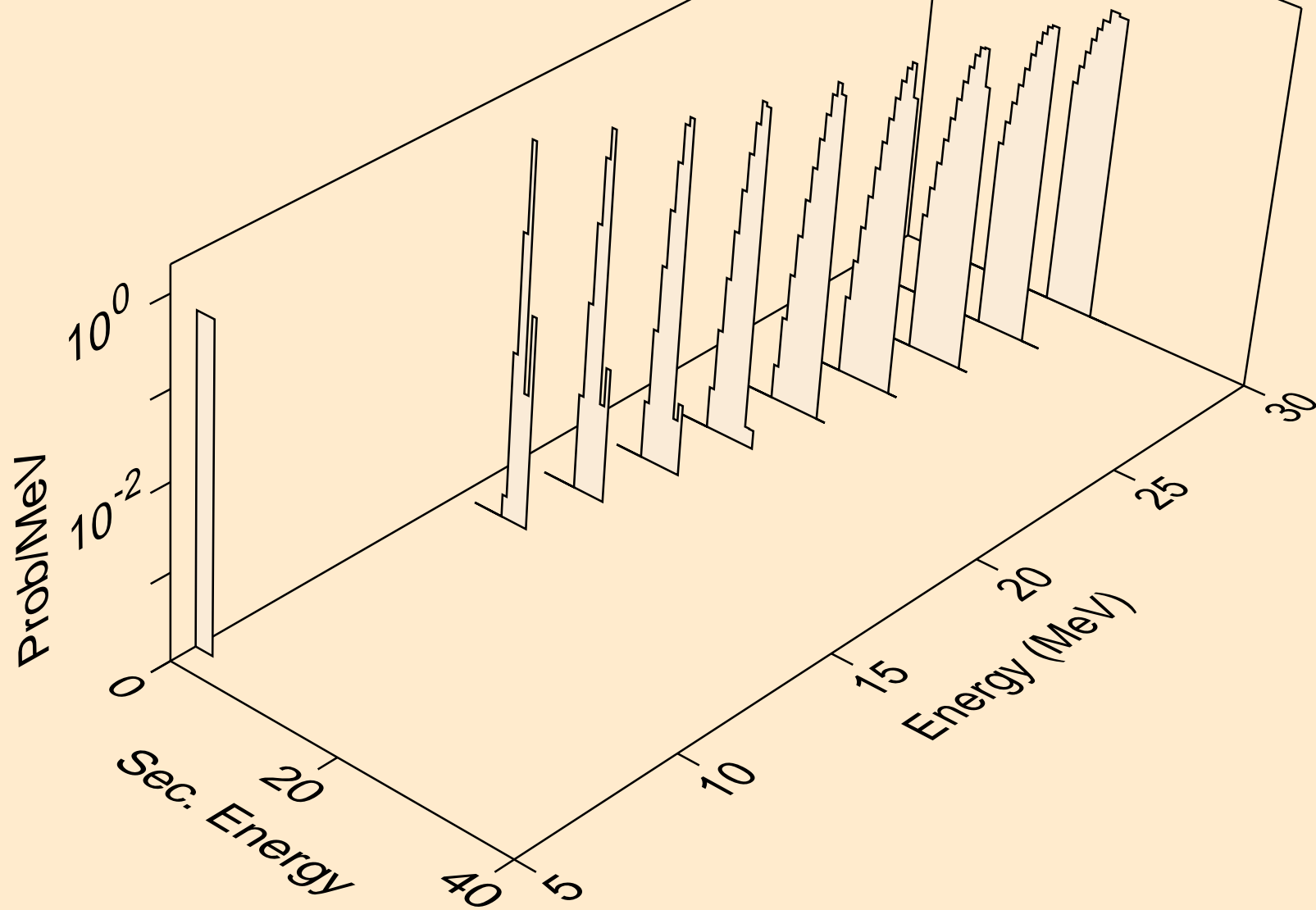

TL211 TRITON ACER TENDL-2021 LIBRARY; T=0.K  
alphas from (t,x)

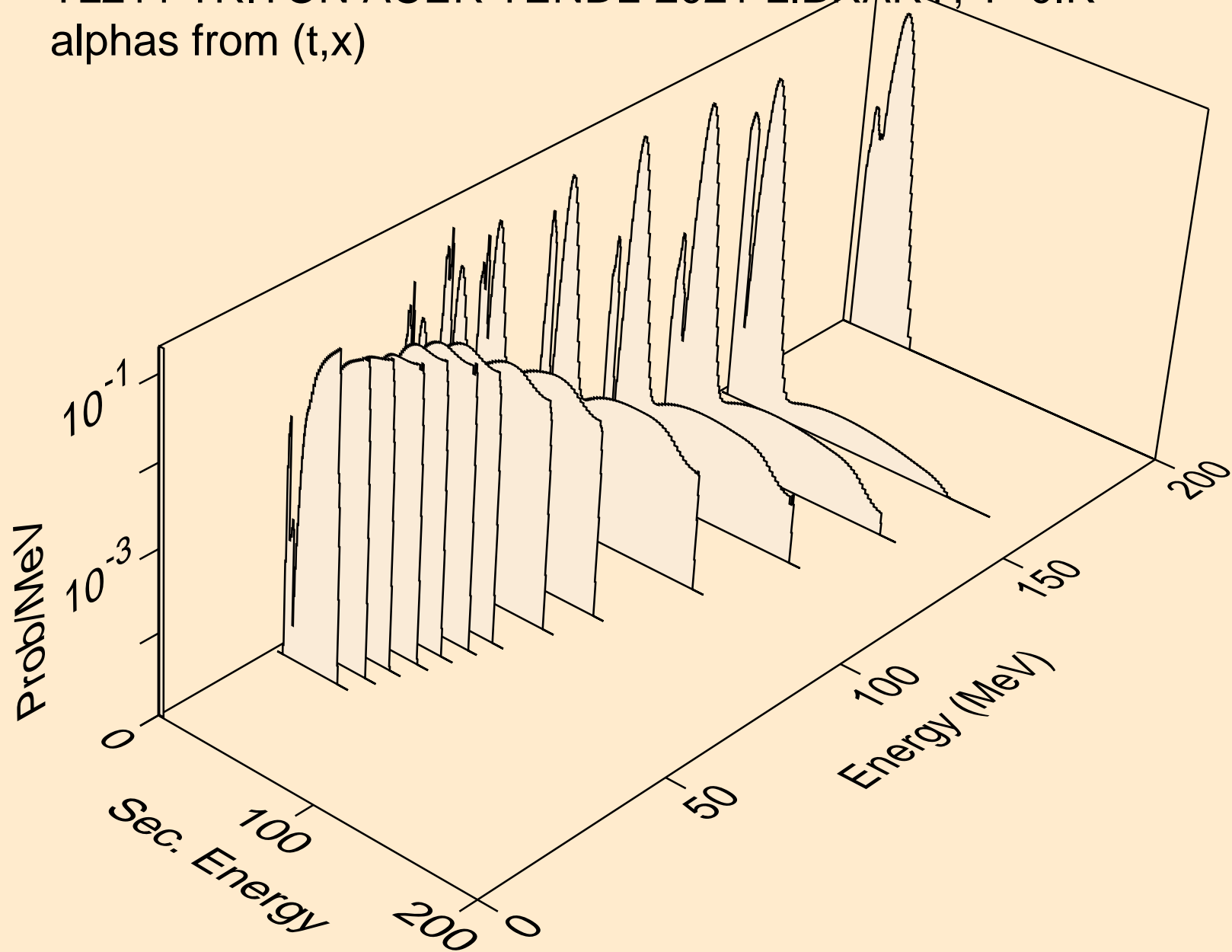



TL211 TRITON ACER TENDL-2021 LIBRARY; T=0.K  
alphas from (t,n\*)a

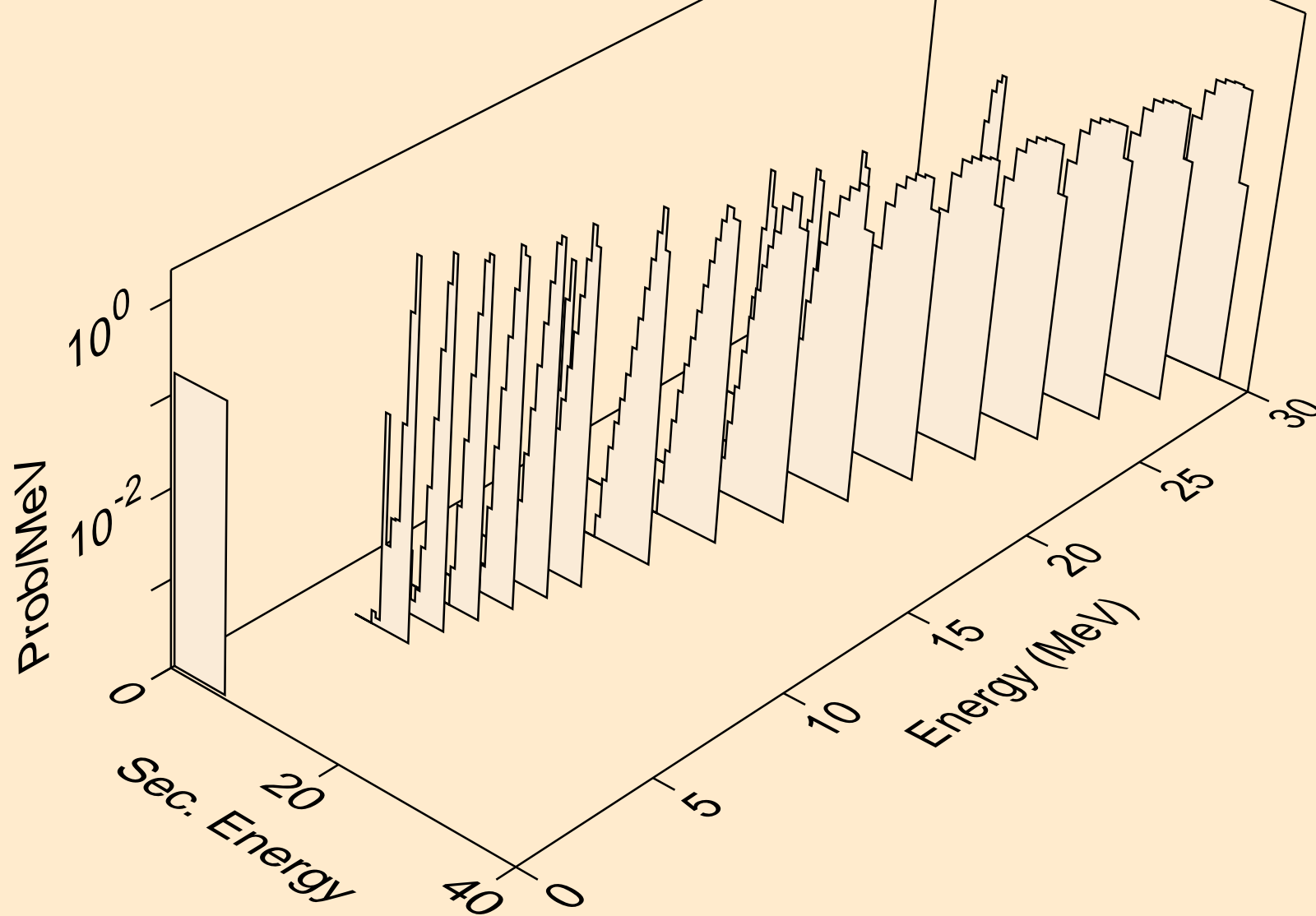

TL211 TRITON ACER TENDL-2021 LIBRARY; T=0.K  
alphas from (t,2n)a

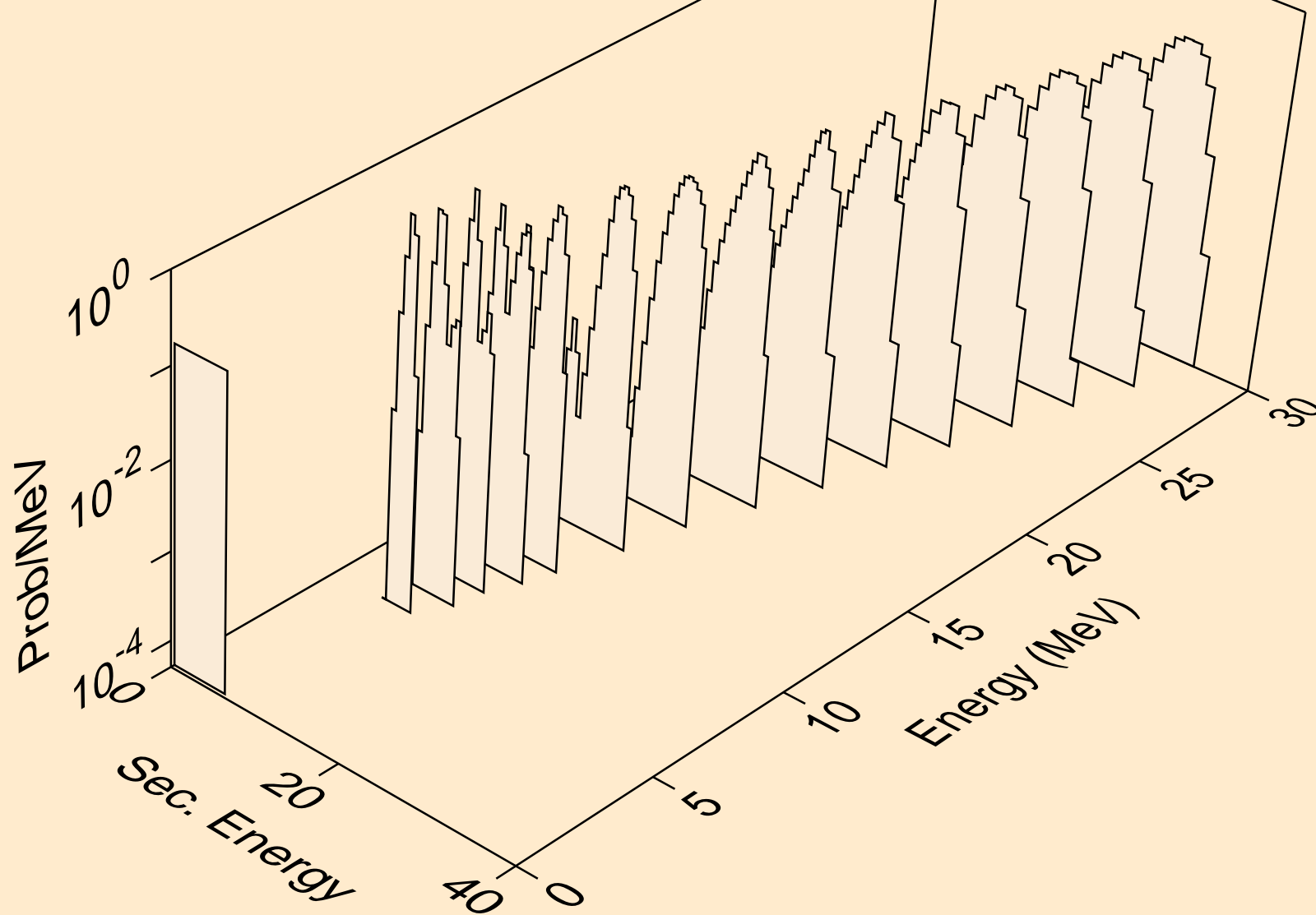

TL211 TRITON ACER TENDL-2021 LIBRARY; T=0.K  
alphas from (t,3n)a

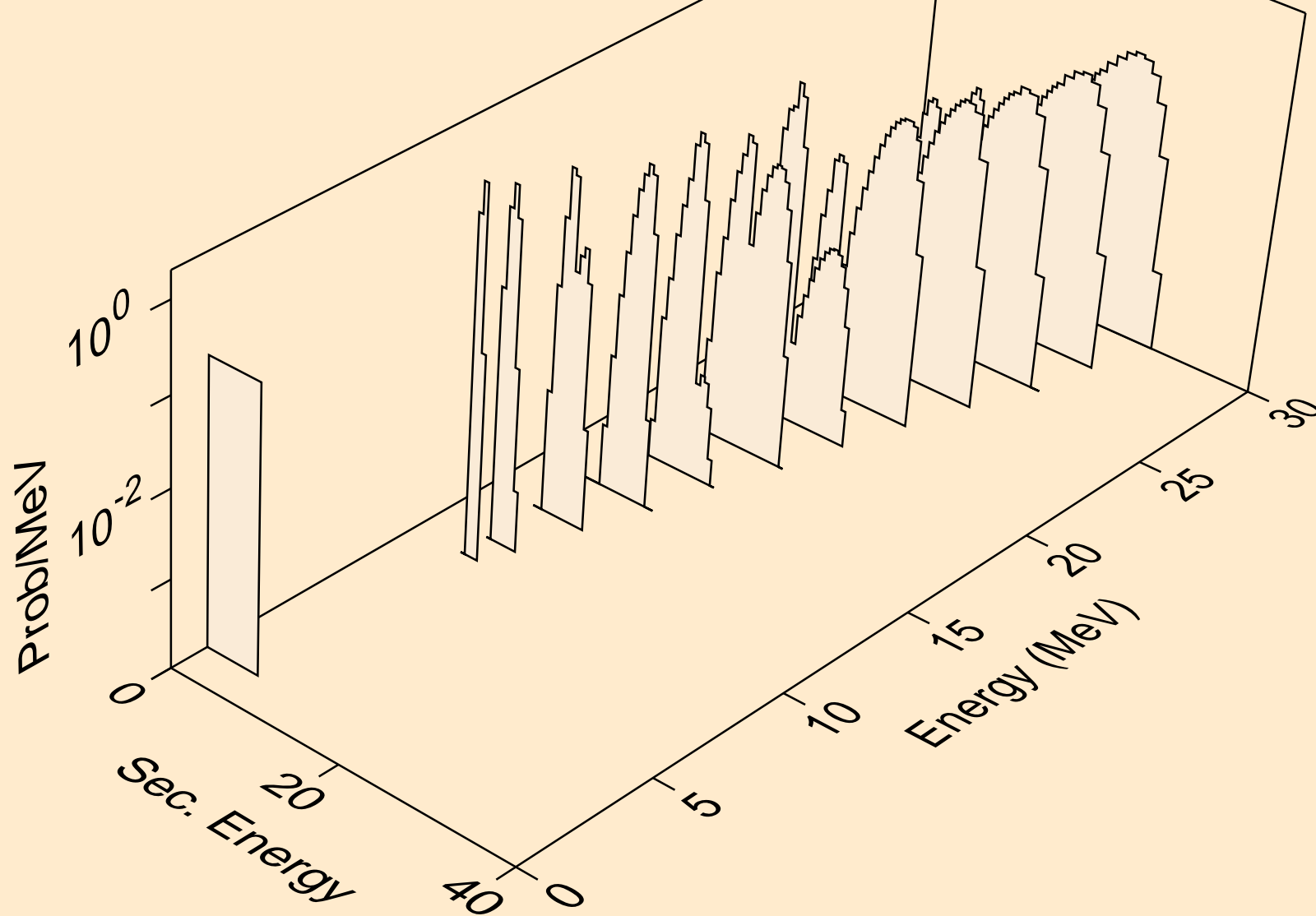

TL211 TRITON ACER TENDL-2021 LIBRARY; T=0.K  
alphas from (t,a)

