

# TM174 TRITON ACER TENDL-2021 LIBRARY; T=0.K

## Principal cross sections

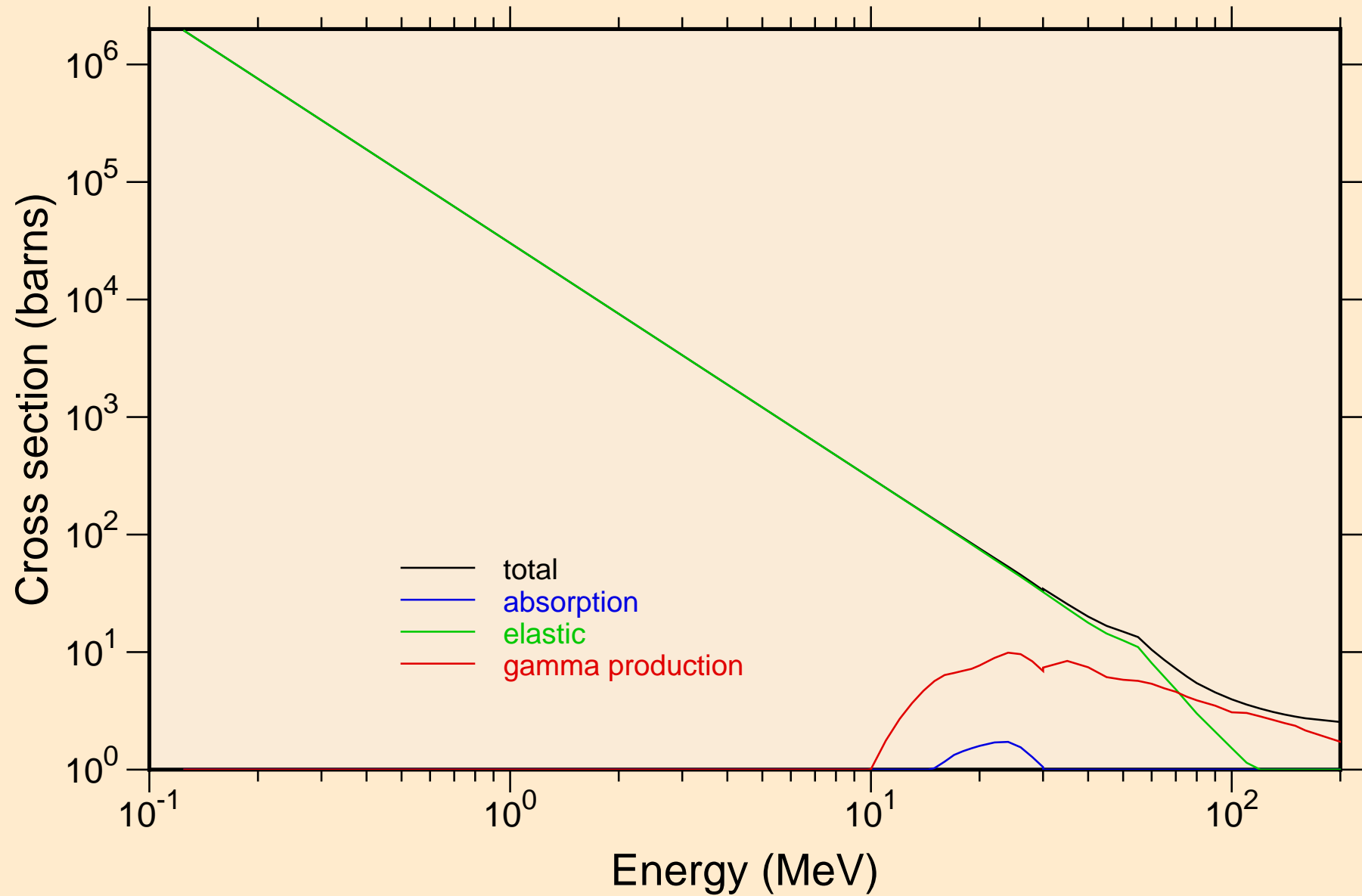

# TM174 TRITON ACER TENDL-2021 LIBRARY; T=0.K

## Heating

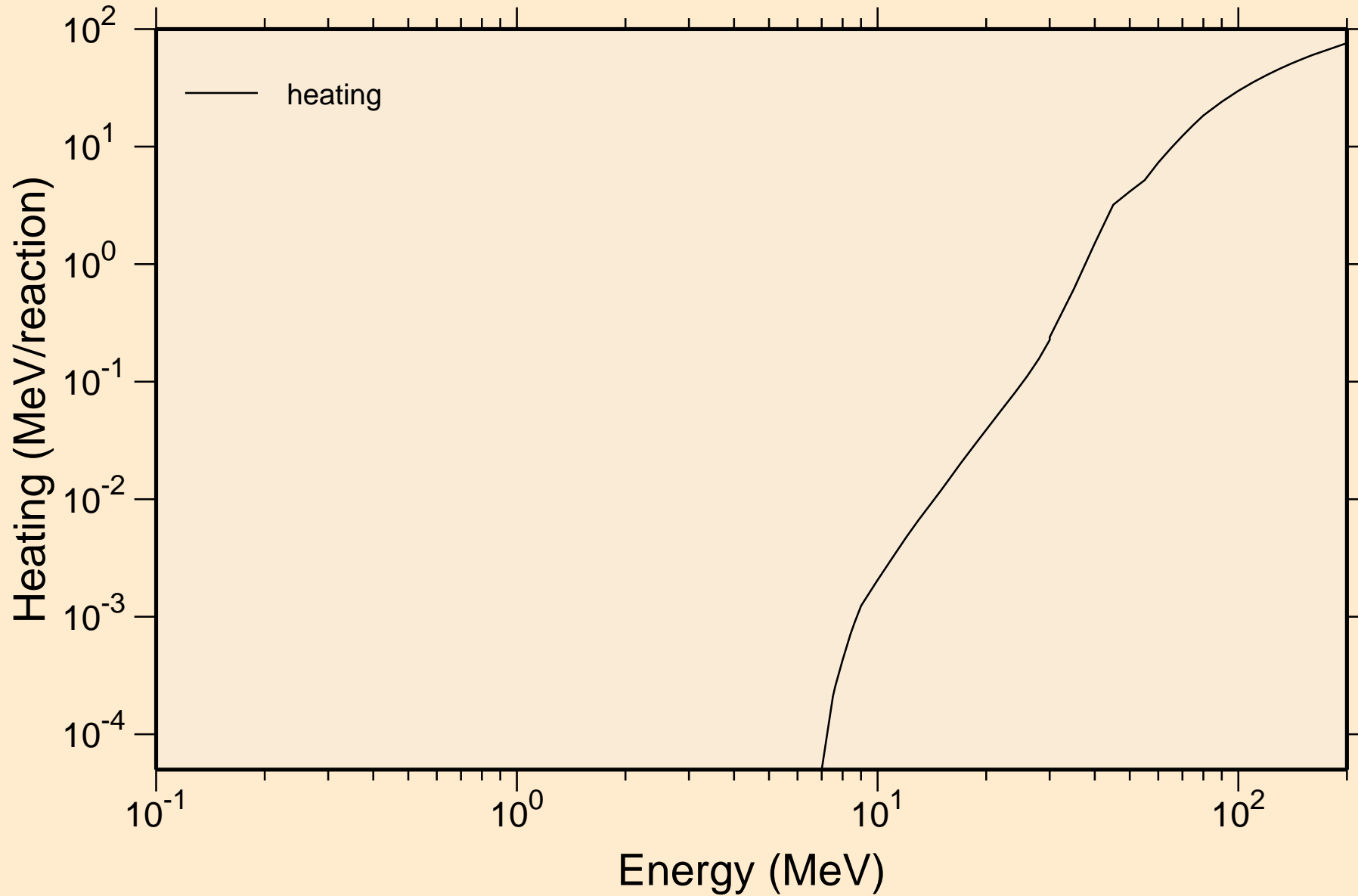

# TM174 TRITON ACER TENDL-2021 LIBRARY; T=0.K

## Principal cross sections

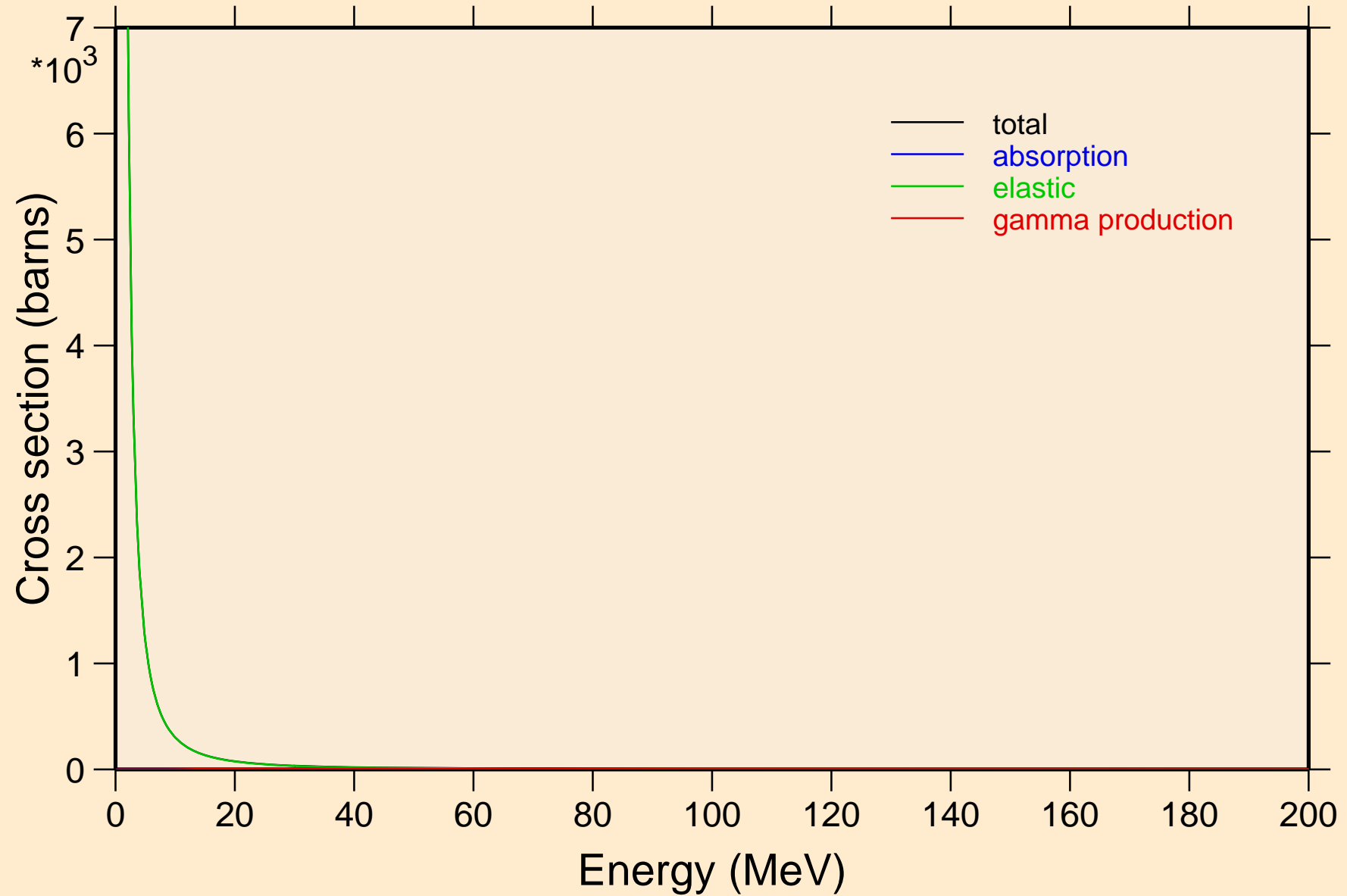

TM174 TRITON ACER TENDL-2021 LIBRARY; T=0.K

Heating

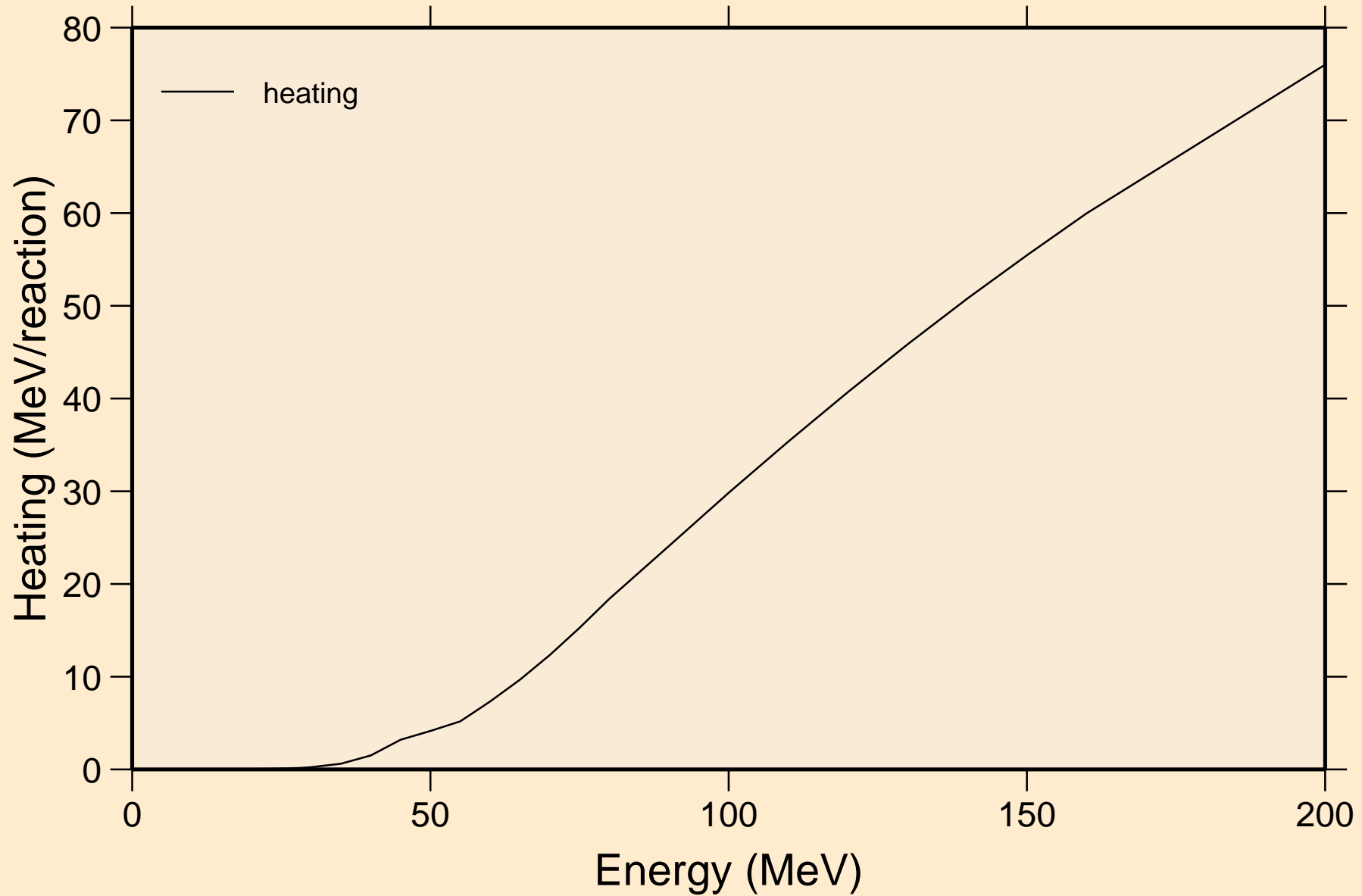

# TM174 TRITON ACER TENDL-2021 LIBRARY; T=0.K

## Threshold reactions

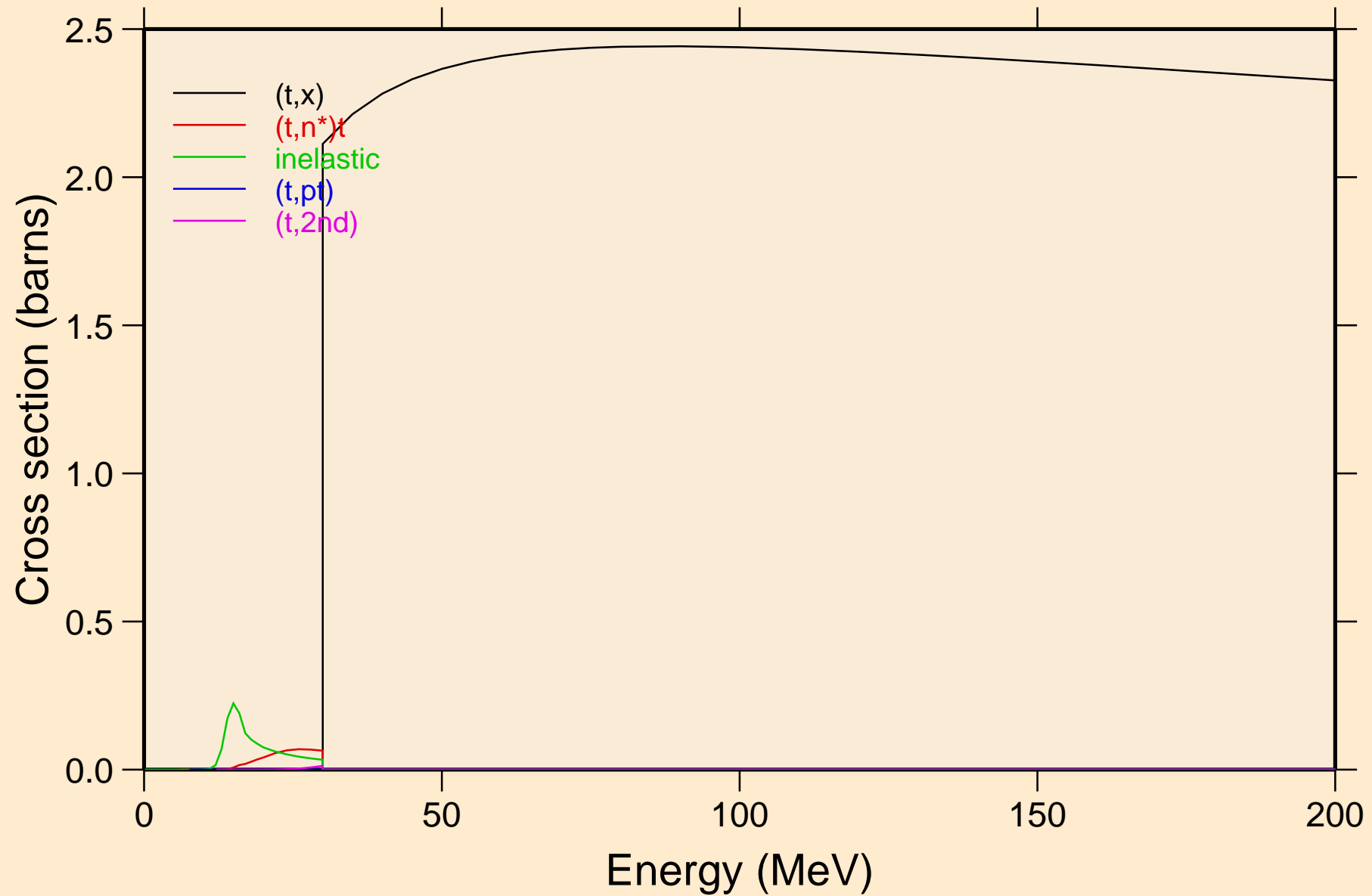

TM174 TRITON ACER TENDL-2021 LIBRARY; T=0.K  
Threshold reactions

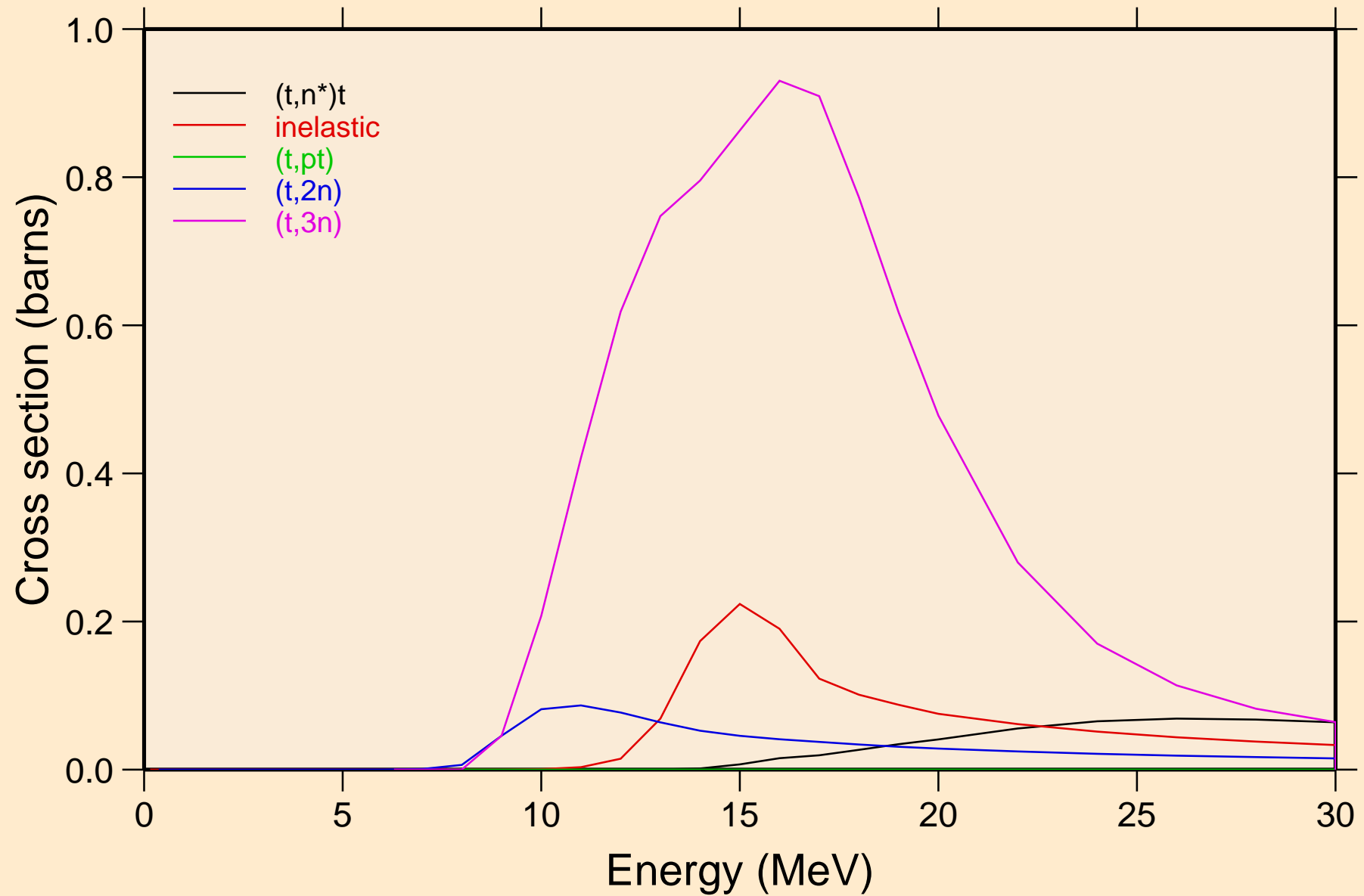

TM174 TRITON ACER TENDL-2021 LIBRARY; T=0.K  
Threshold reactions

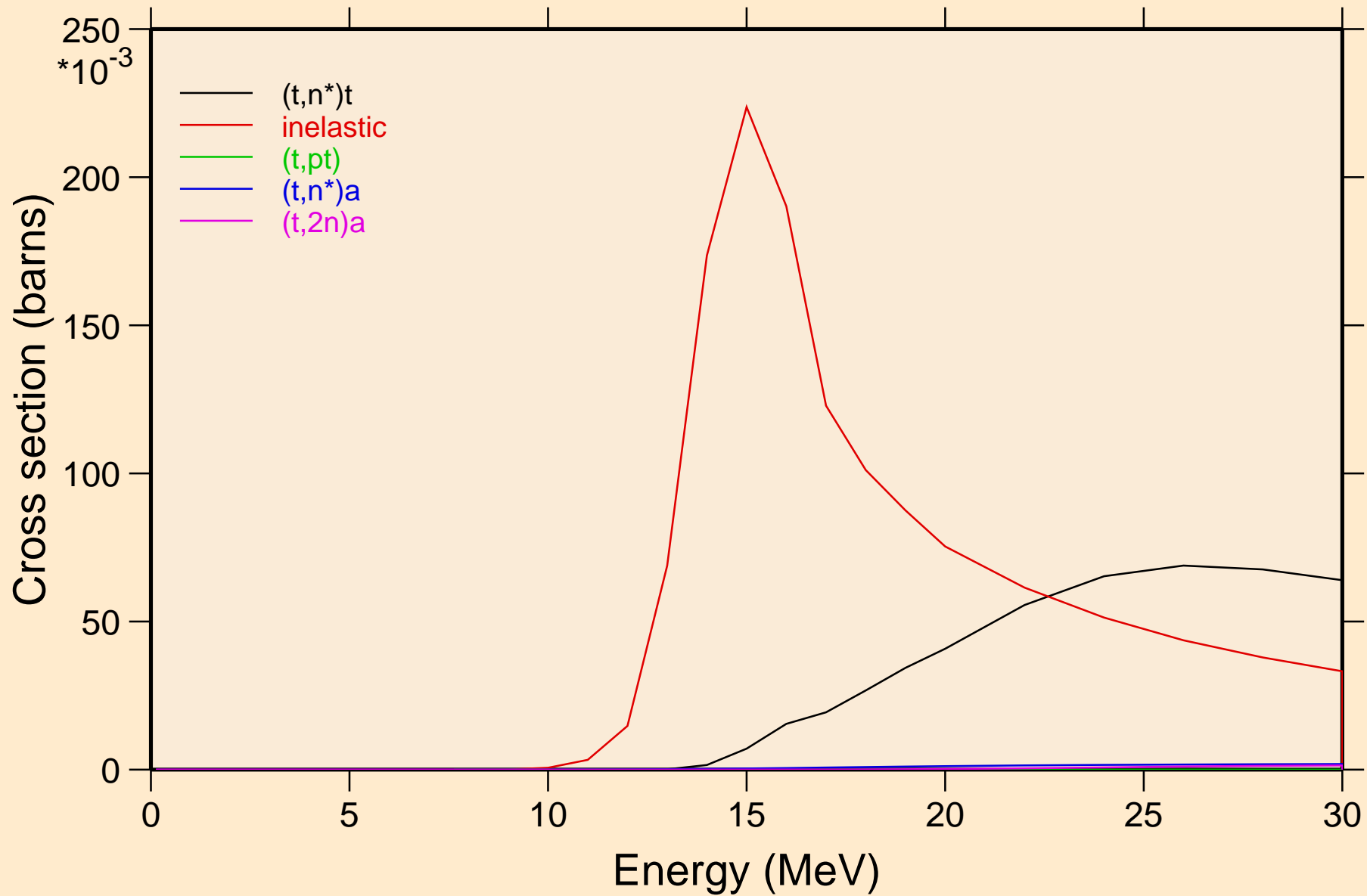

TM174 TRITON ACER TENDL-2021 LIBRARY; T=0.K  
Threshold reactions

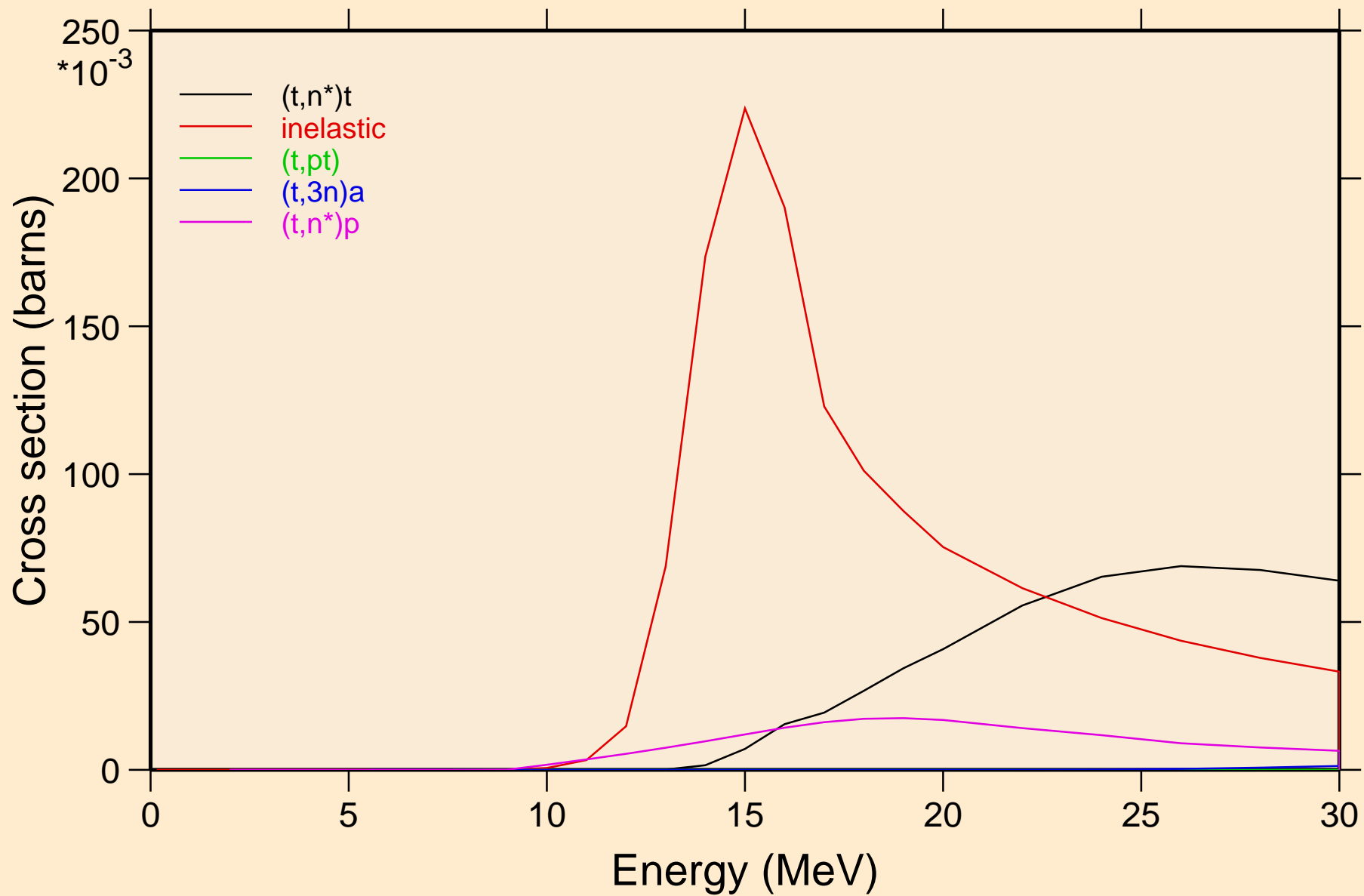



TM174 TRITON ACER TENDL-2021 LIBRARY; T=0.K  
Threshold reactions

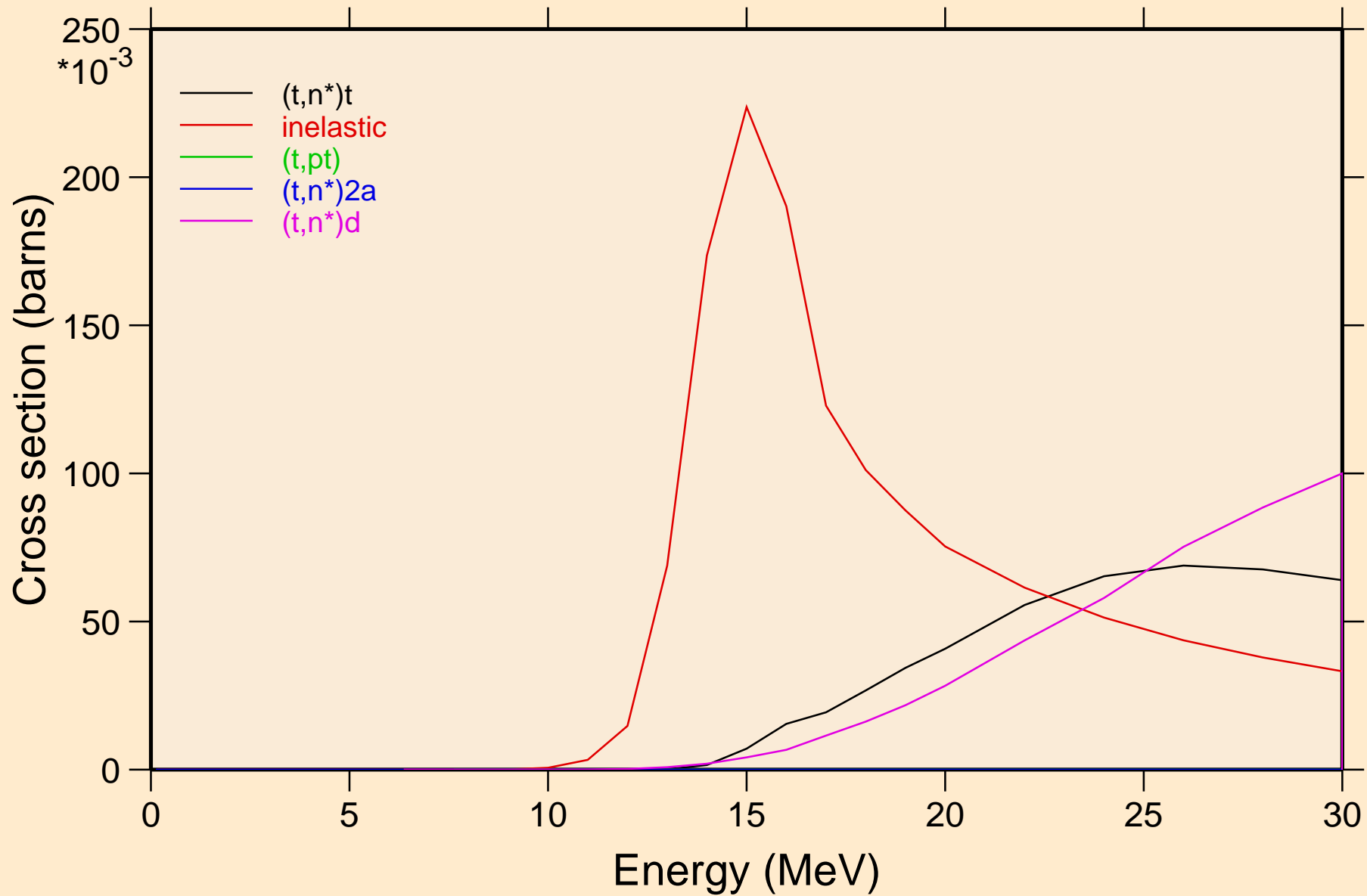

TM174 TRITON ACER TENDL-2021 LIBRARY; T=0.K  
Threshold reactions

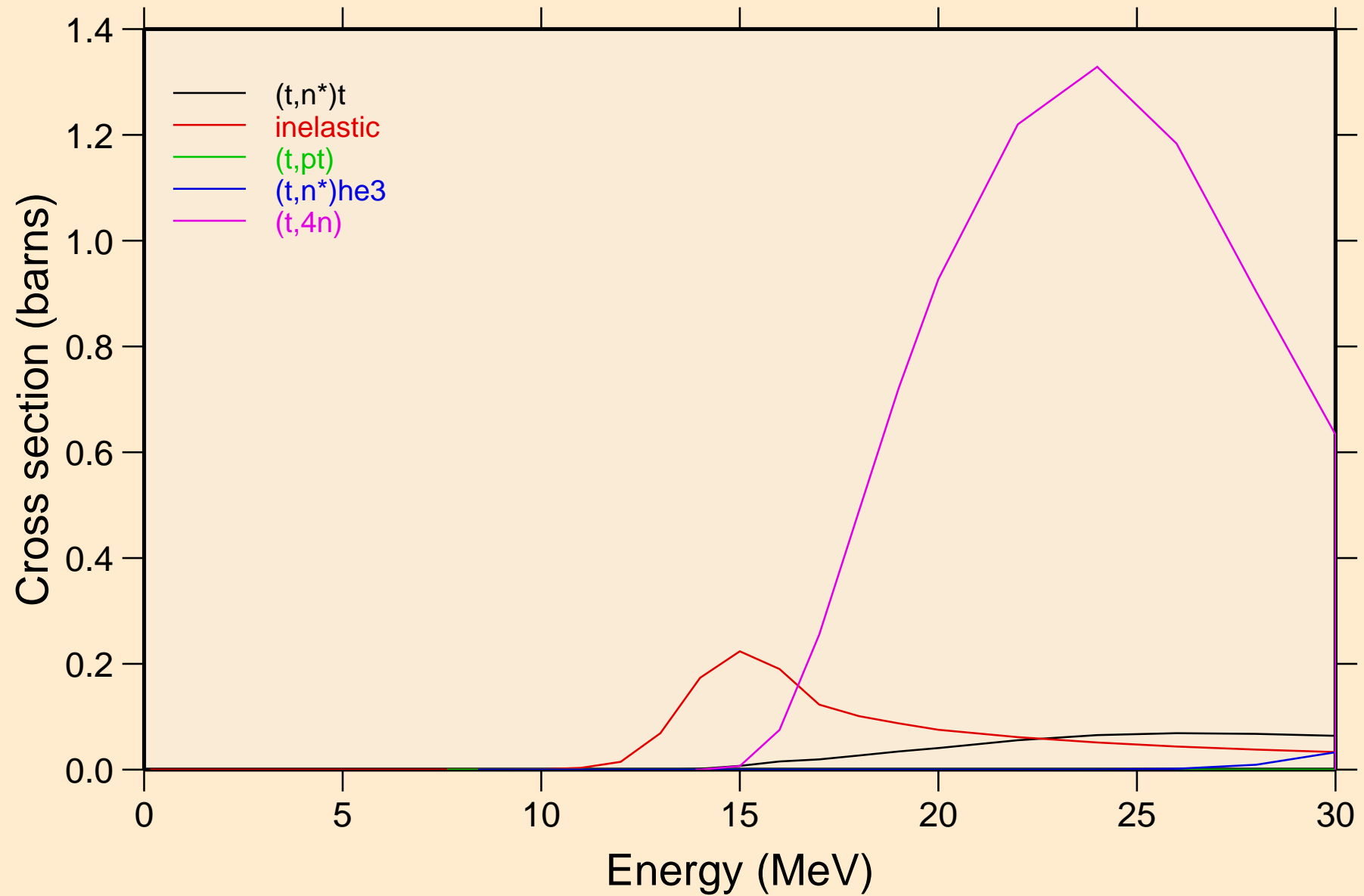

TM174 TRITON ACER TENDL-2021 LIBRARY; T=0.K  
Threshold reactions

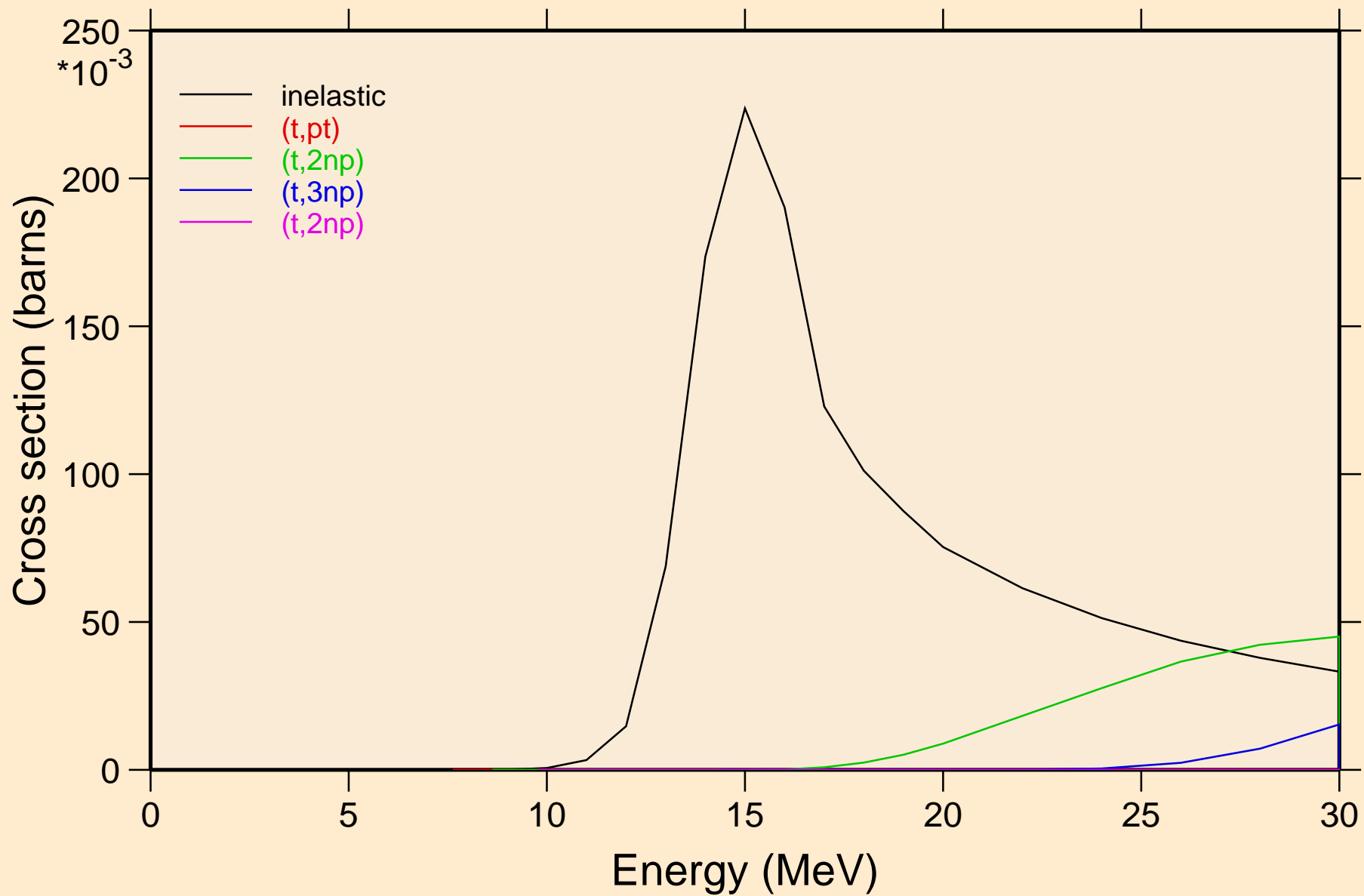

TM174 TRITON ACER TENDL-2021 LIBRARY; T=0.K  
Threshold reactions

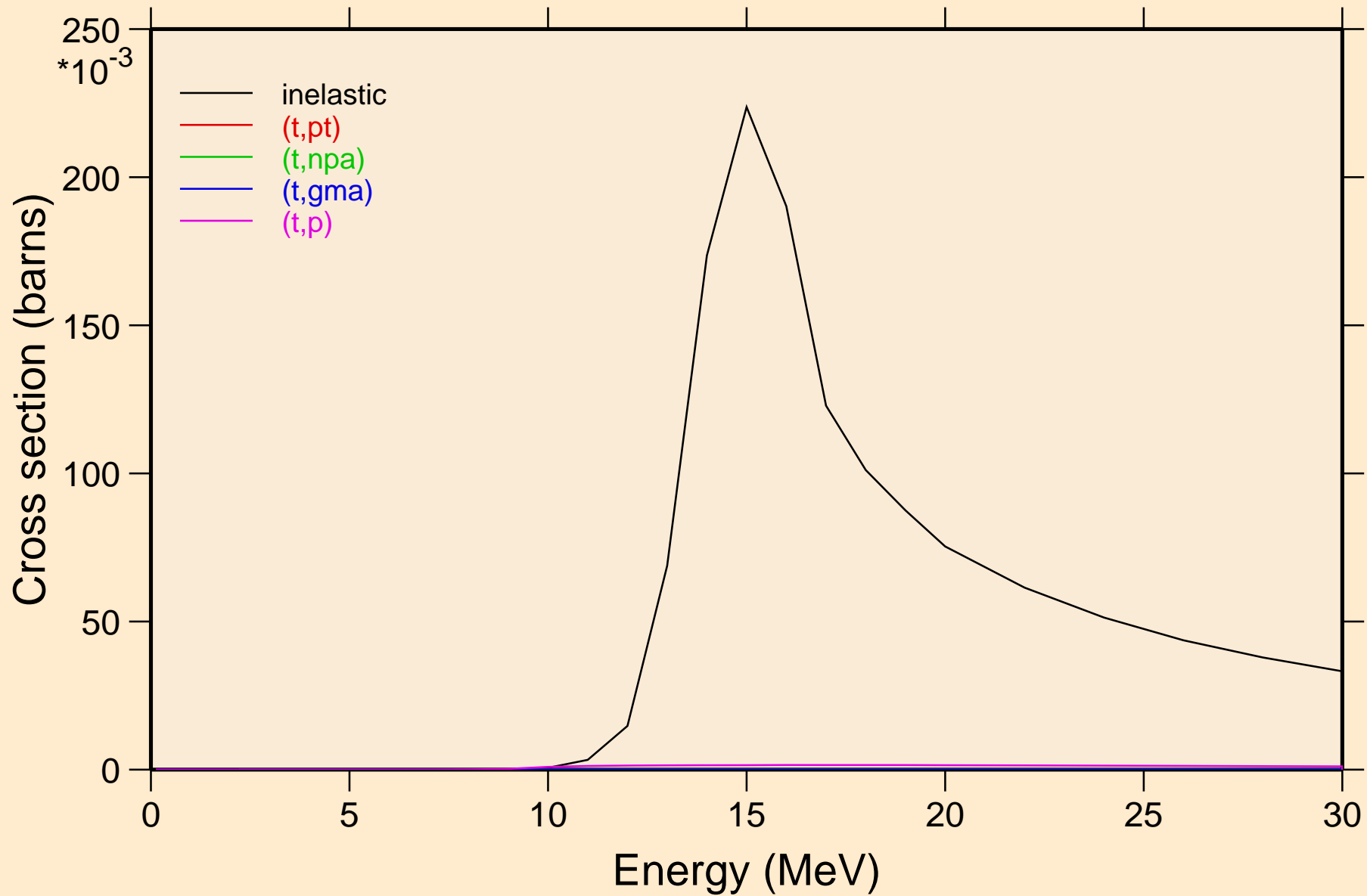

# TM174 TRITON ACER TENDL-2021 LIBRARY; T=0.K

## Threshold reactions

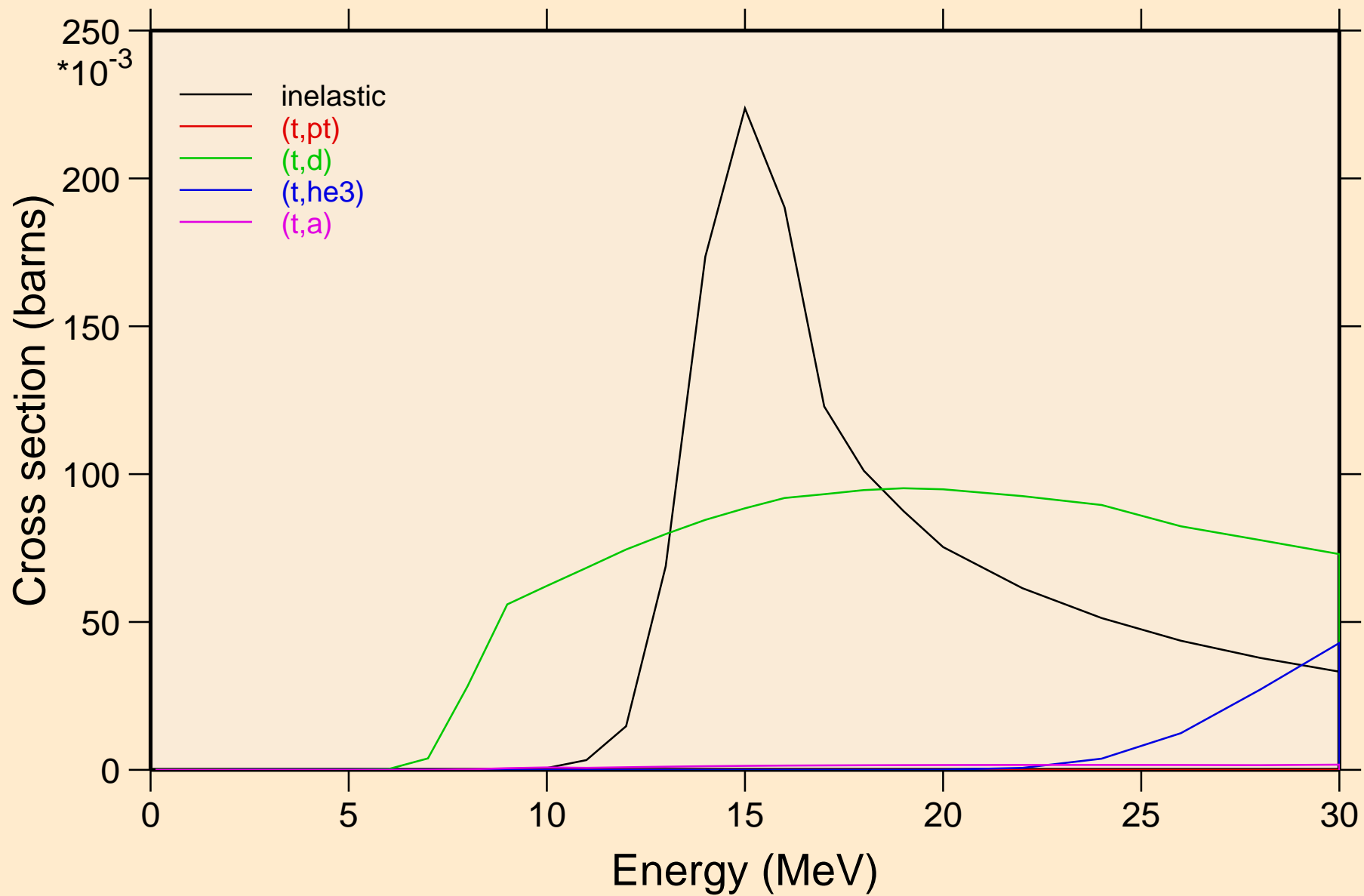

TM174 TRITON ACER TENDL-2021 LIBRARY; T=0.K  
Threshold reactions

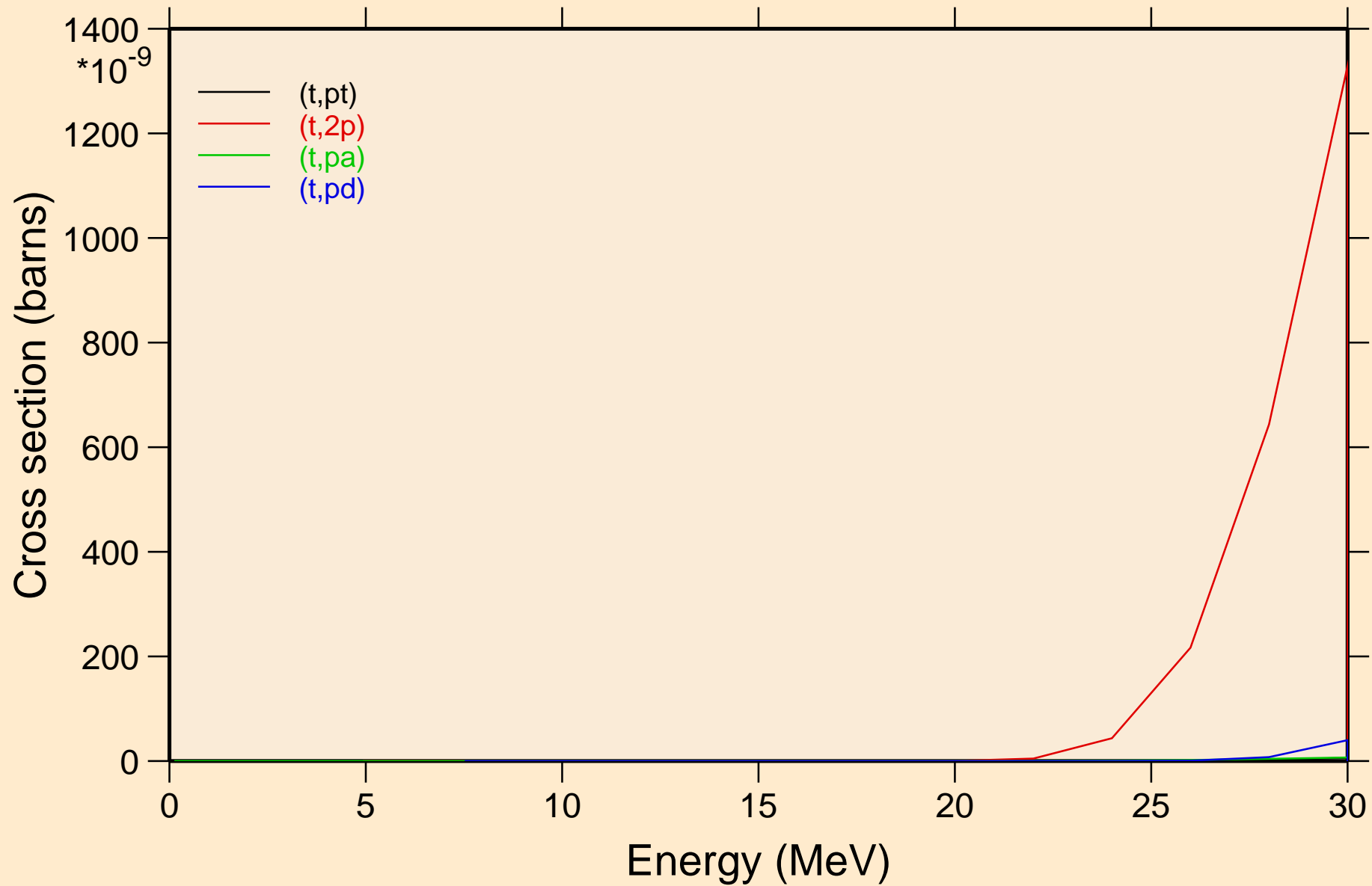

TM174 TRITON ACER TENDL-2021 LIBRARY; T=0.K  
Threshold reactions

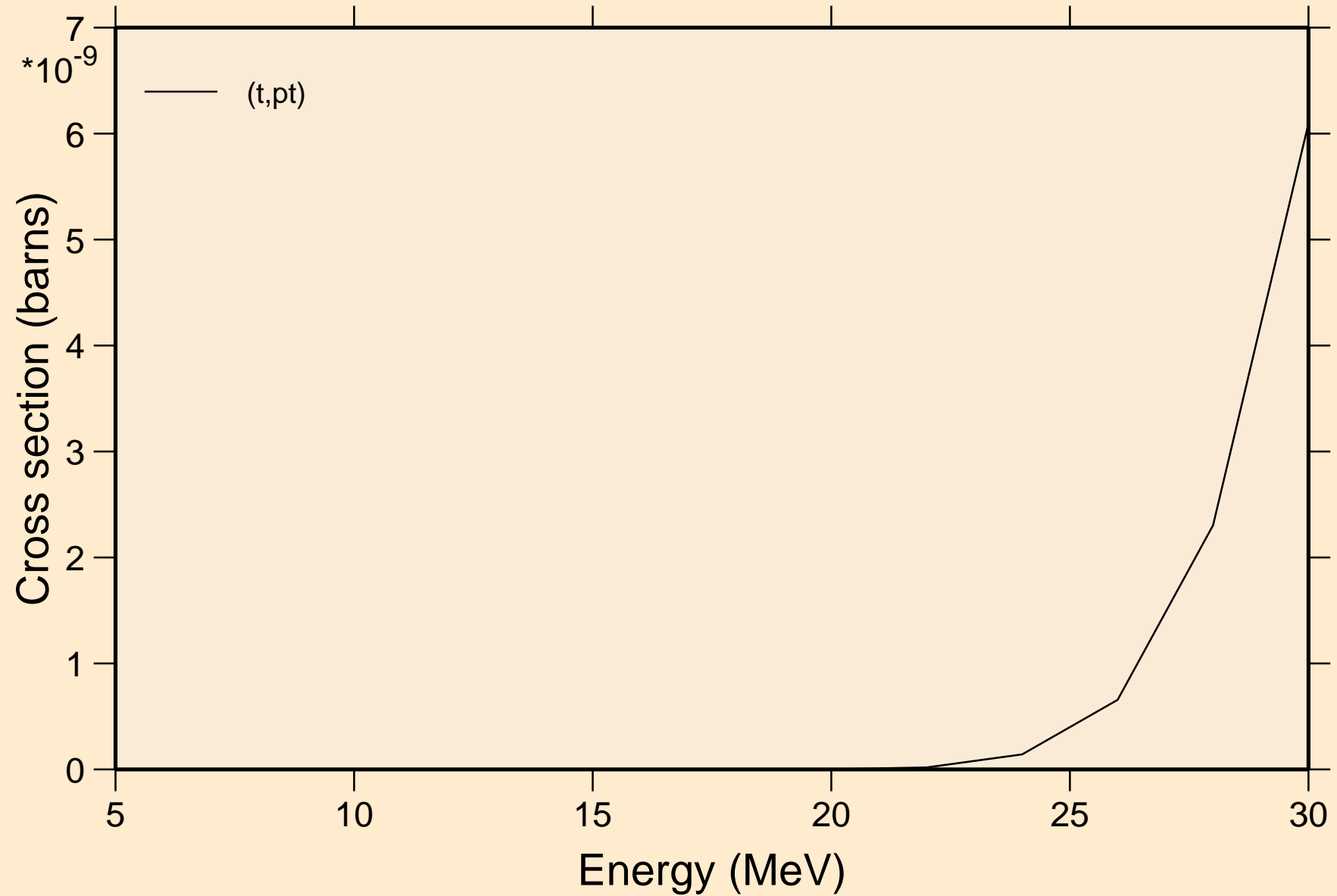

TM174 TRITON ACER TENDL-2021 LIBRARY; T=0.K  
angular distribution for elastic

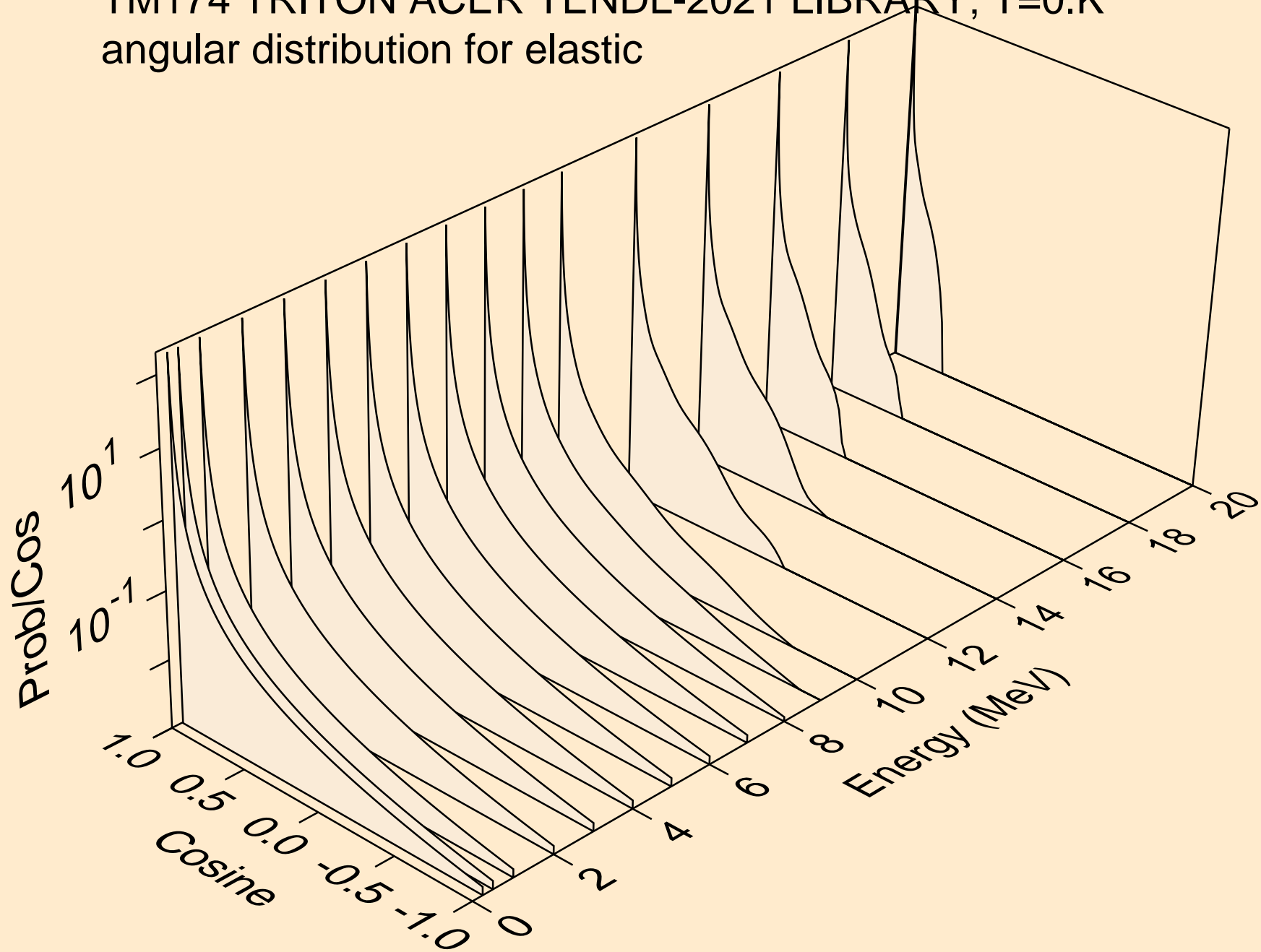



TM174 TRITON ACER TENDL-2021 LIBRARY; T=0.K  
angular distribution for elastic

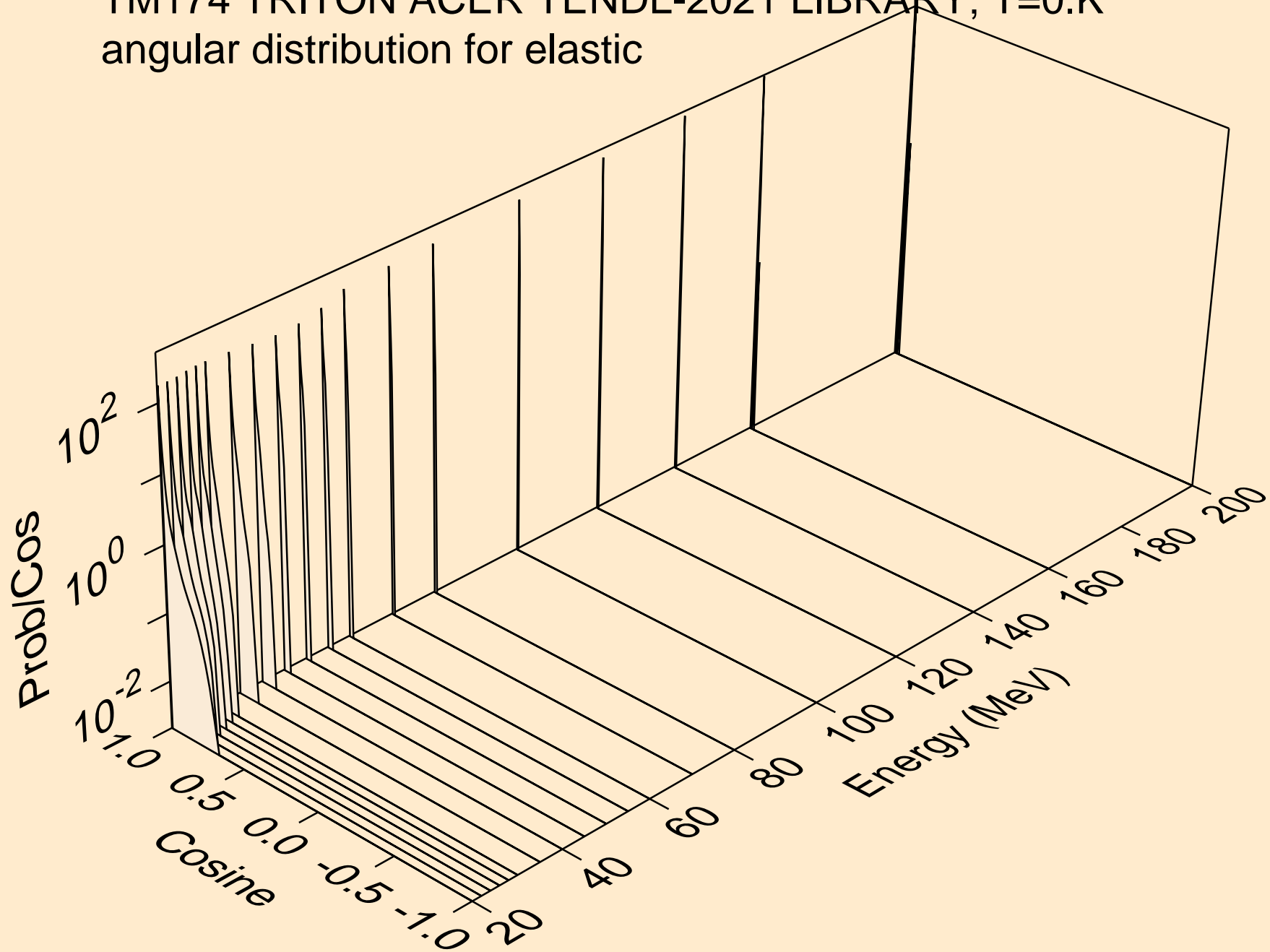

TM174 TRITON ACER TENDL-2021 LIBRARY; T=0.K  
Triton emission for (t,x)

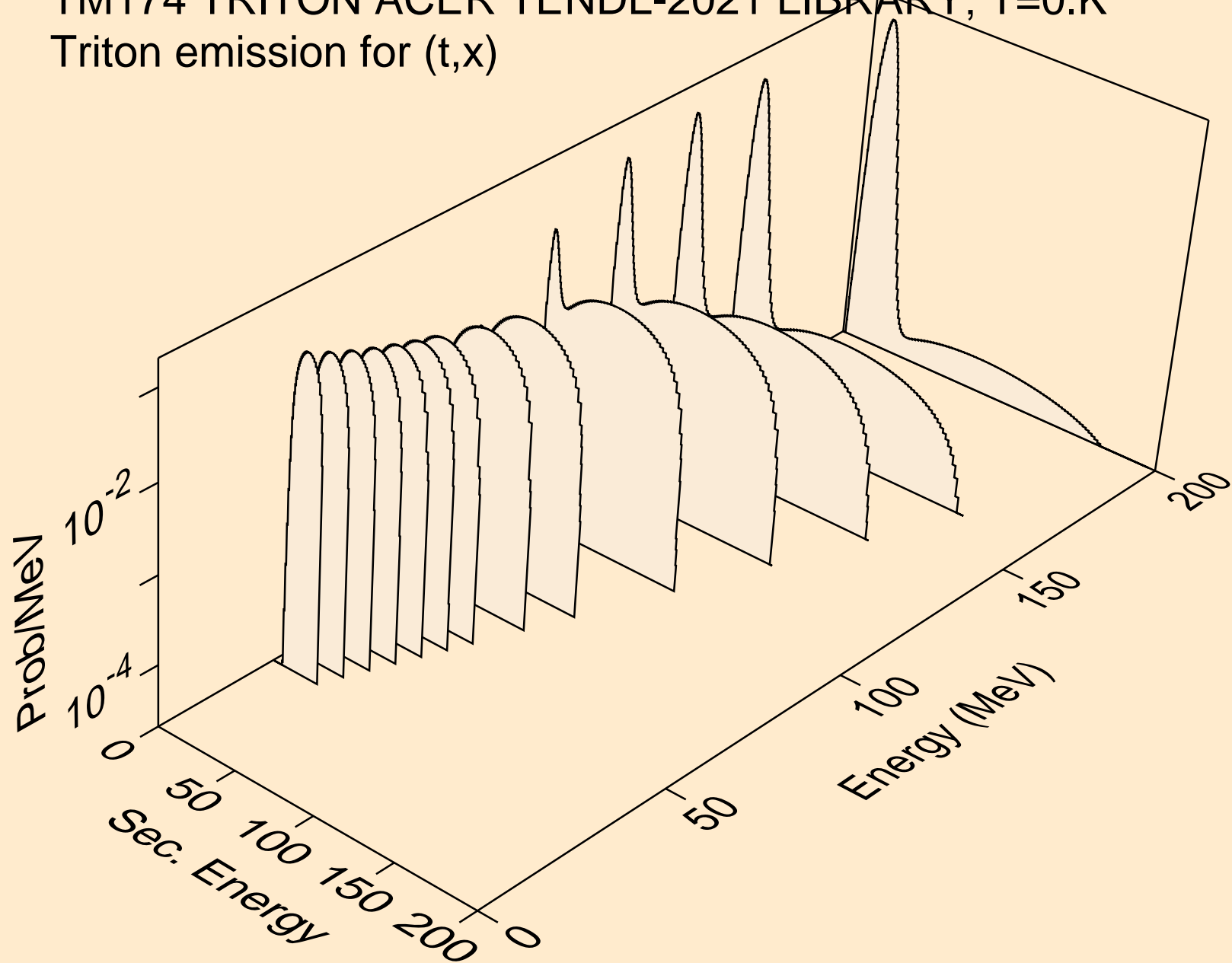

TM174 TRITON ACER TENDL-2021 LIBRARY; T=0.K  
Triton emission for (t,n\*)t

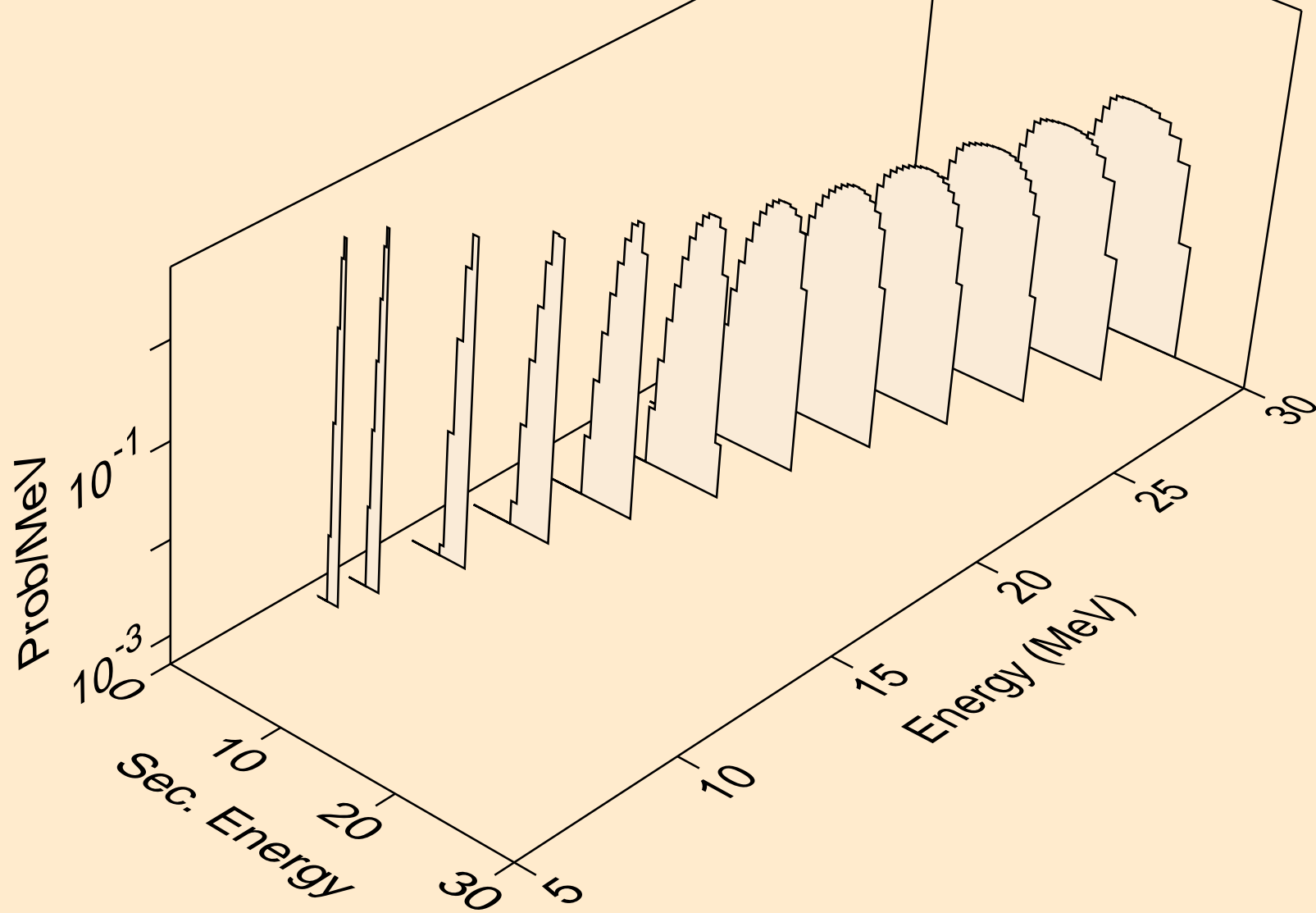

TM174 TRITON ACER TENDL-2021 LIBRARY; T=0.K  
Triton emission for inelastic

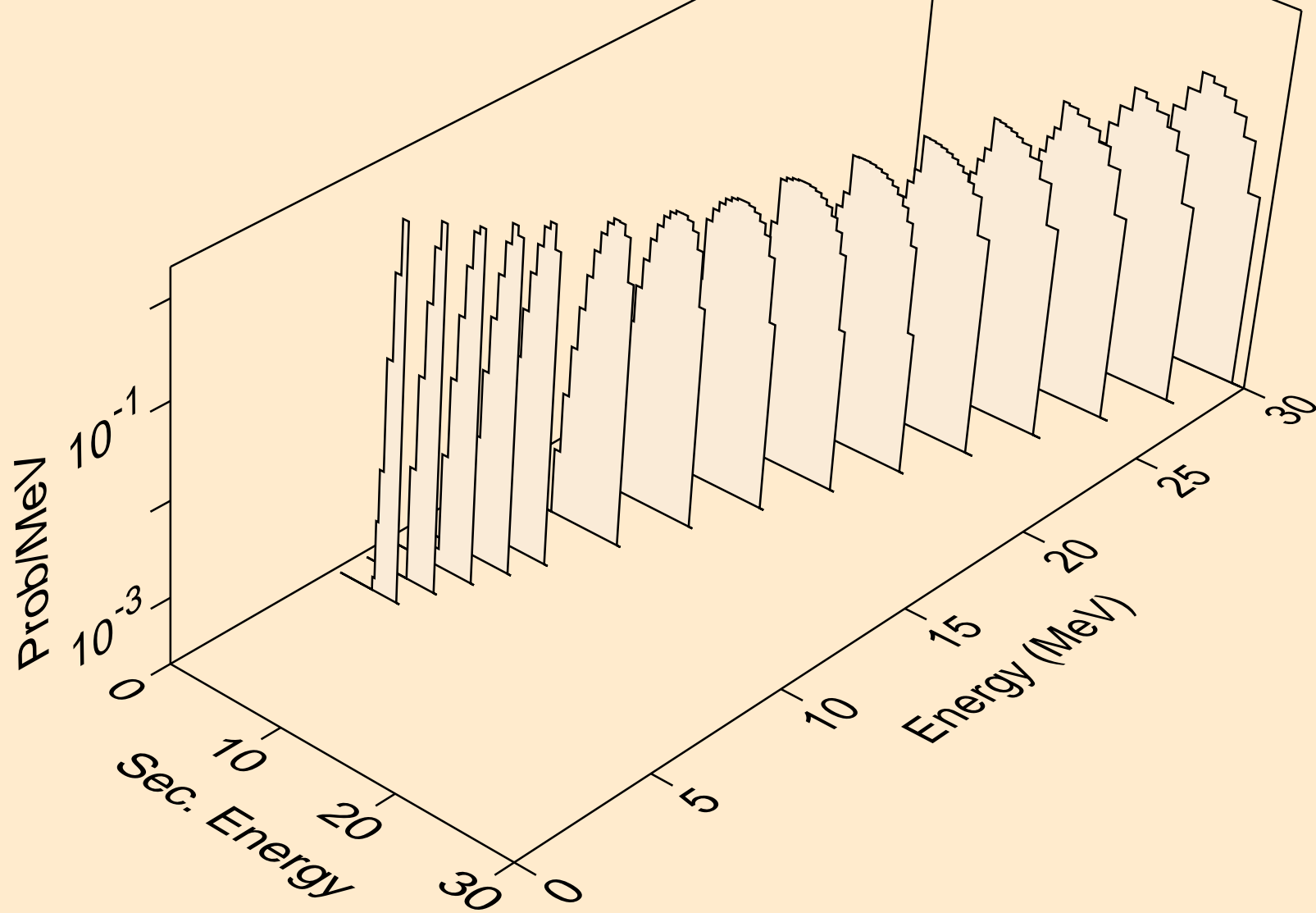

TM174 TRITON ACER TENDL-2021 LIBRARY; T=0.K  
Triton emission for (t,pt)

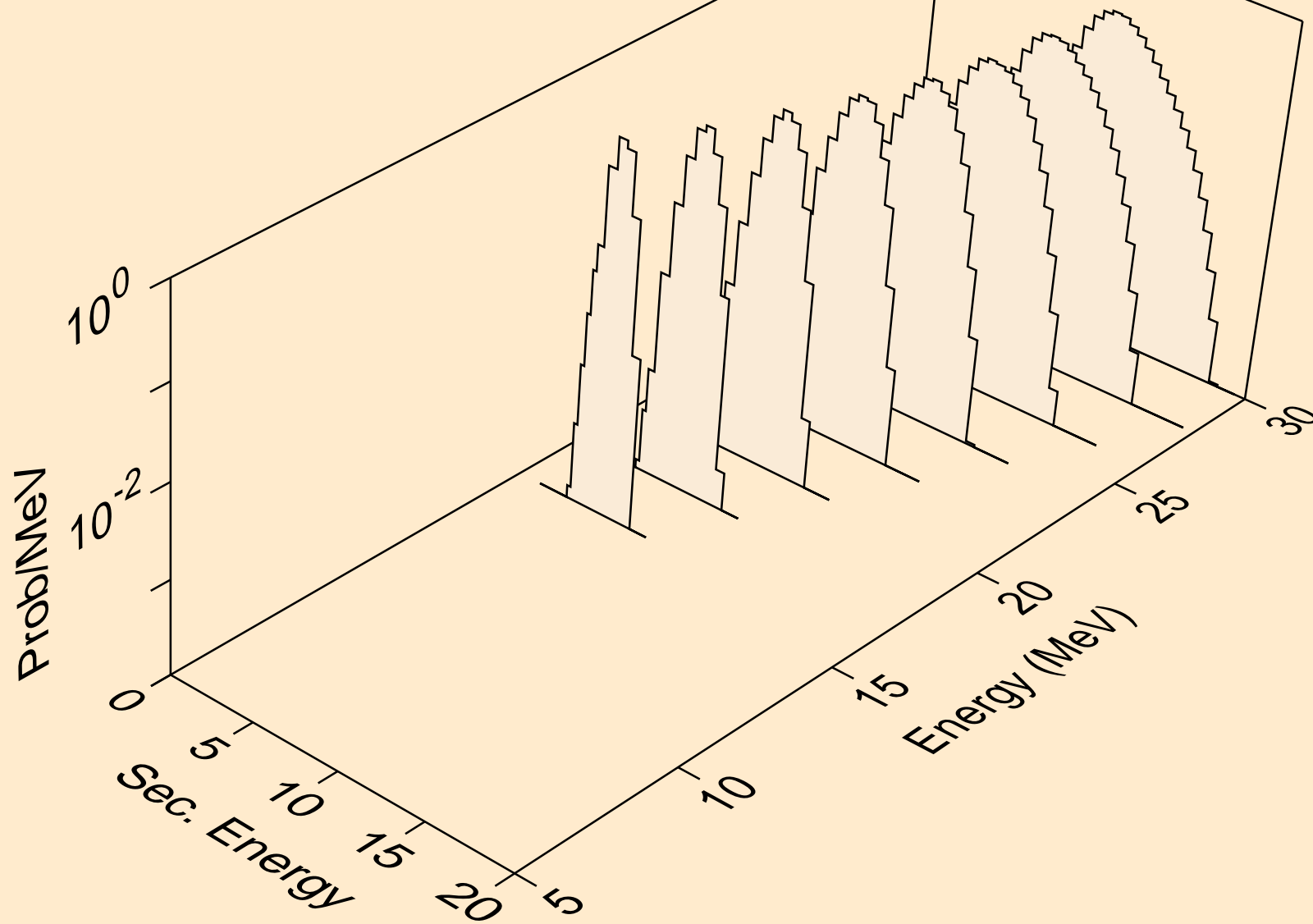

TM174 TRITON ACER TENDL-2021 LIBRARY; T=0.K  
Photon emission for (z,n)

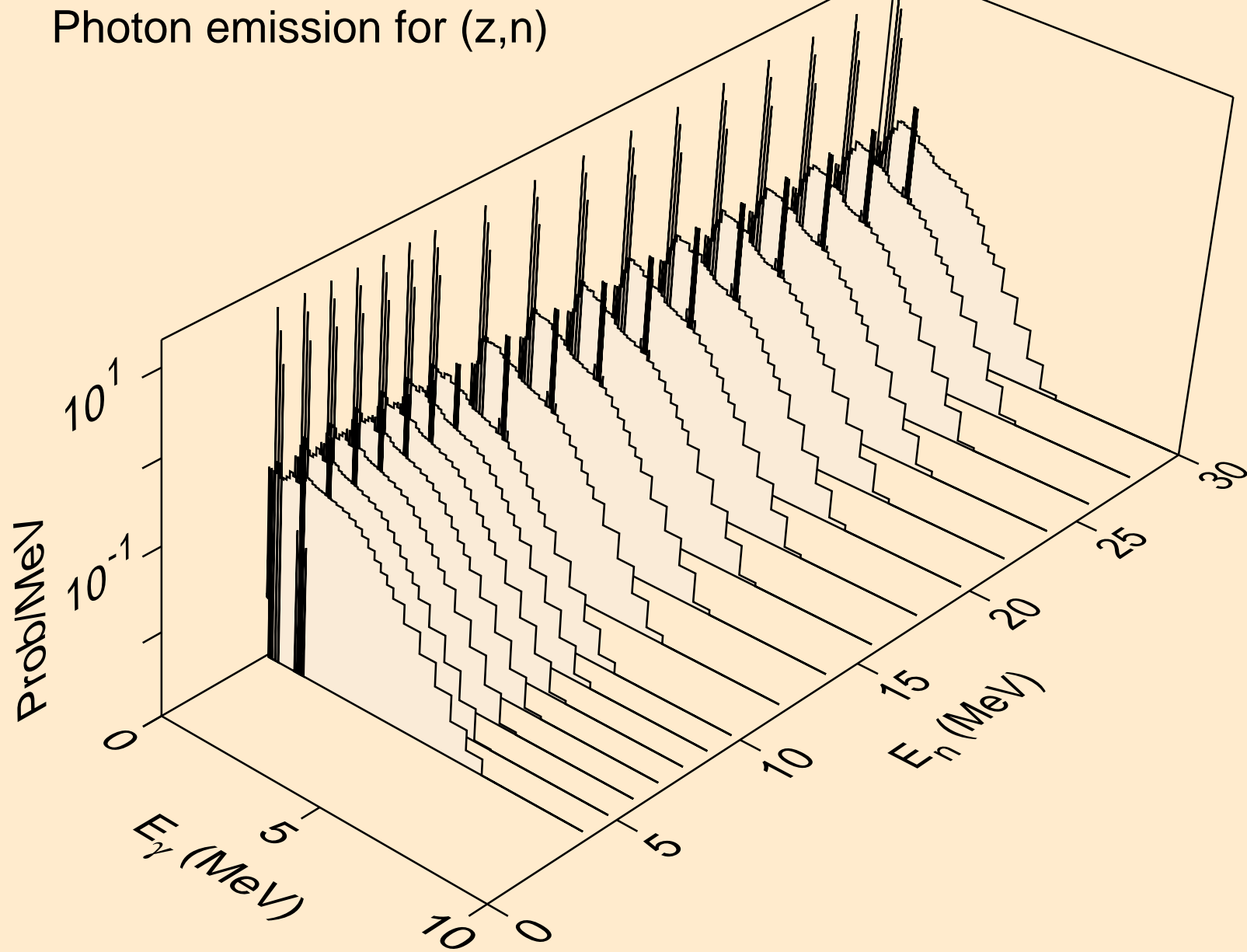

TM174 TRITON ACER TENDL-2021 LIBRARY; T=0.K  
Photon emission for (n,x)

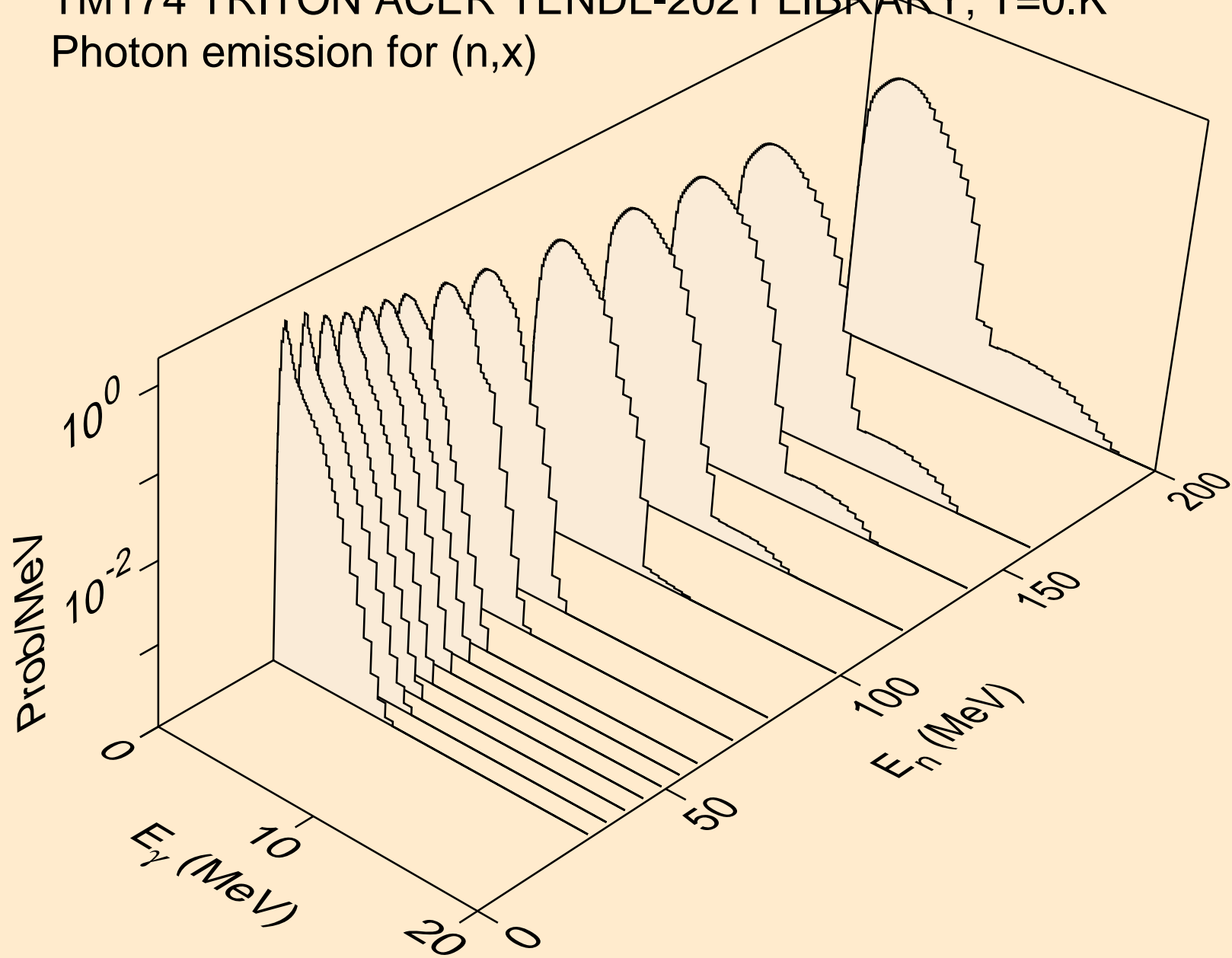

TM174 TRITON ACER TENDL-2021 LIBRARY; T=0.K  
Photon emission for (n,2nd)

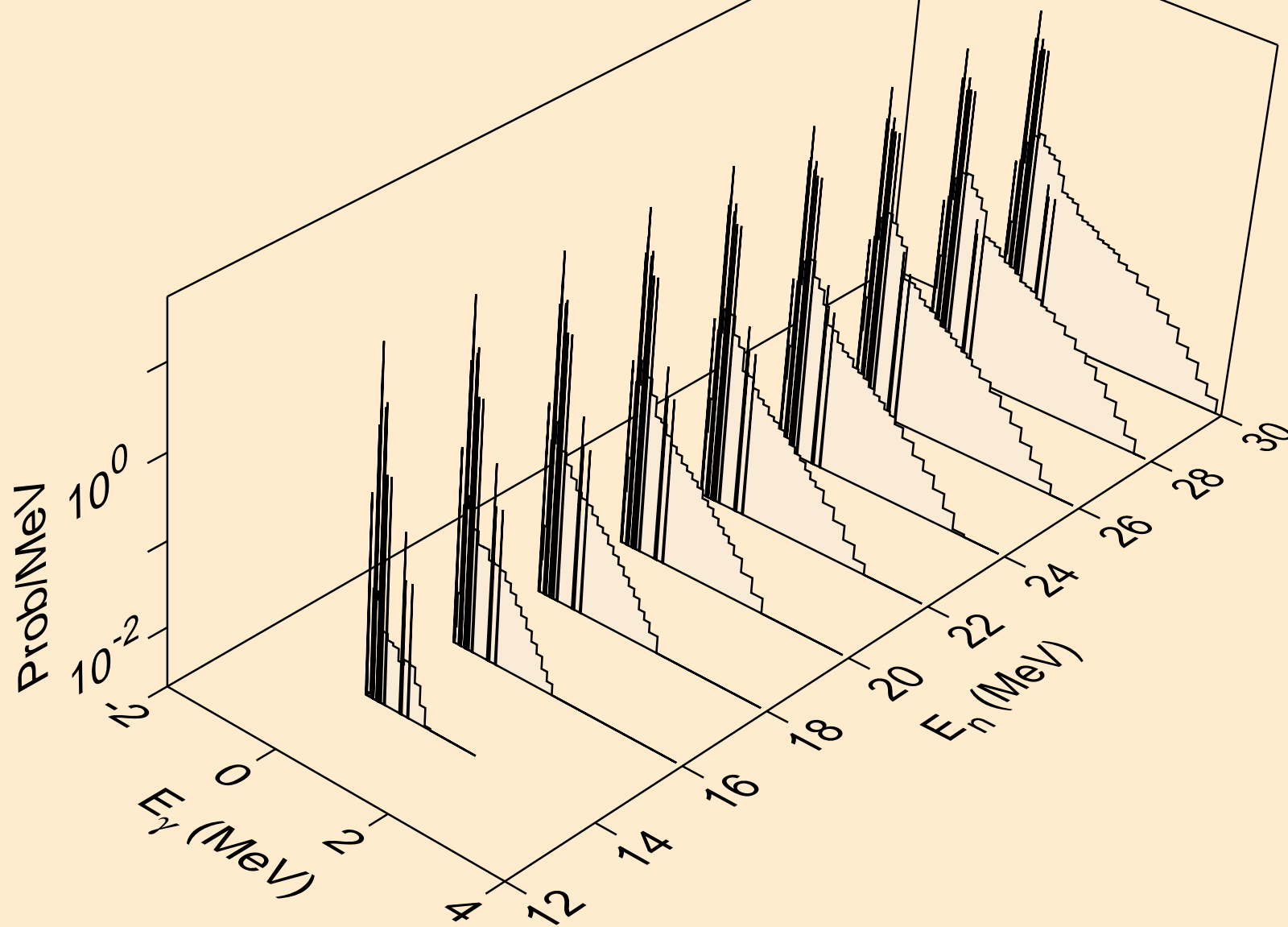



TM174 TRITON ACER TENDL-2021 LIBRARY; T=0.K  
Photon emission for (n,2n)

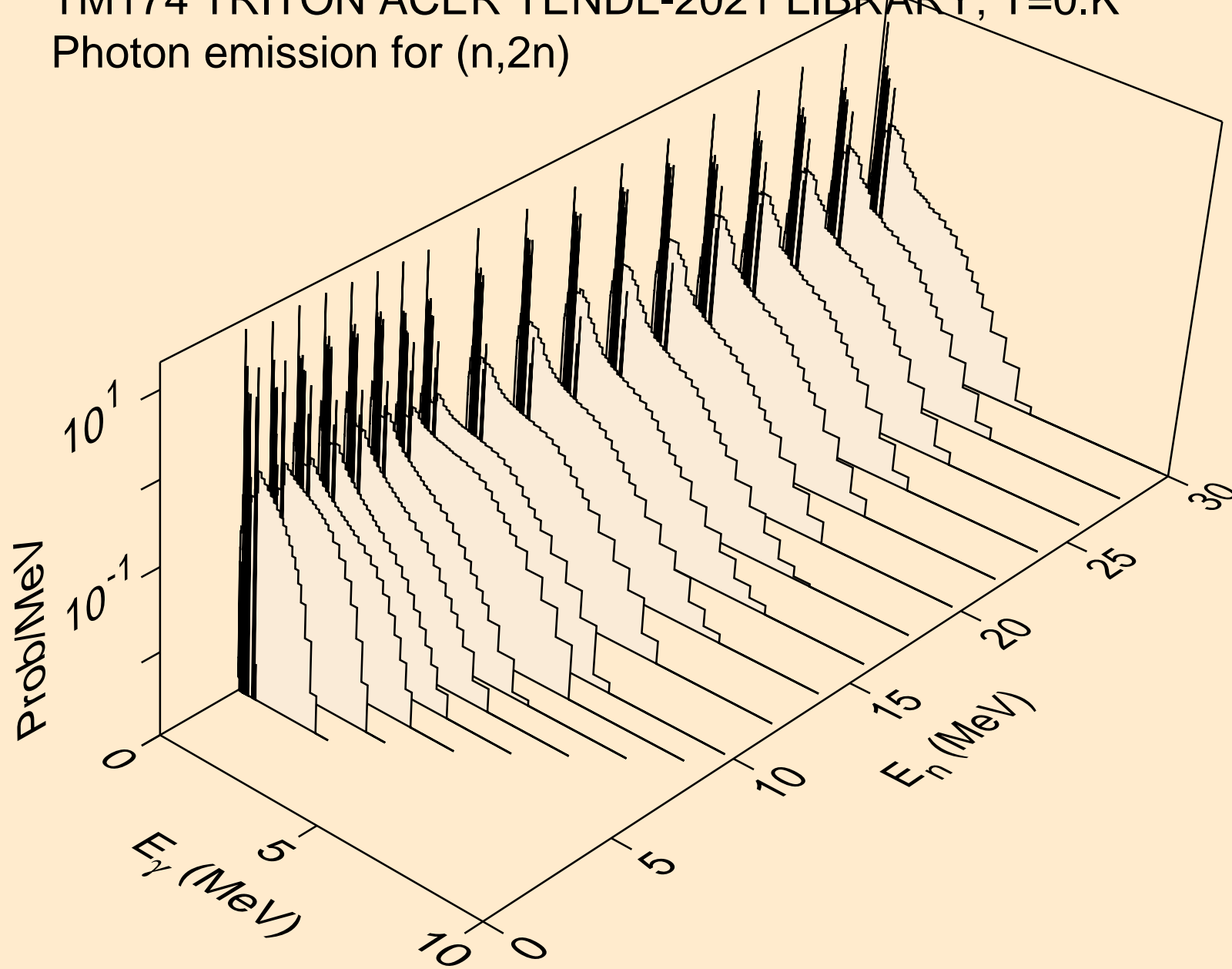

TM174 TRITON ACER TENDL-2021 LIBRARY; T=0.K  
Photon emission for (n,3n)

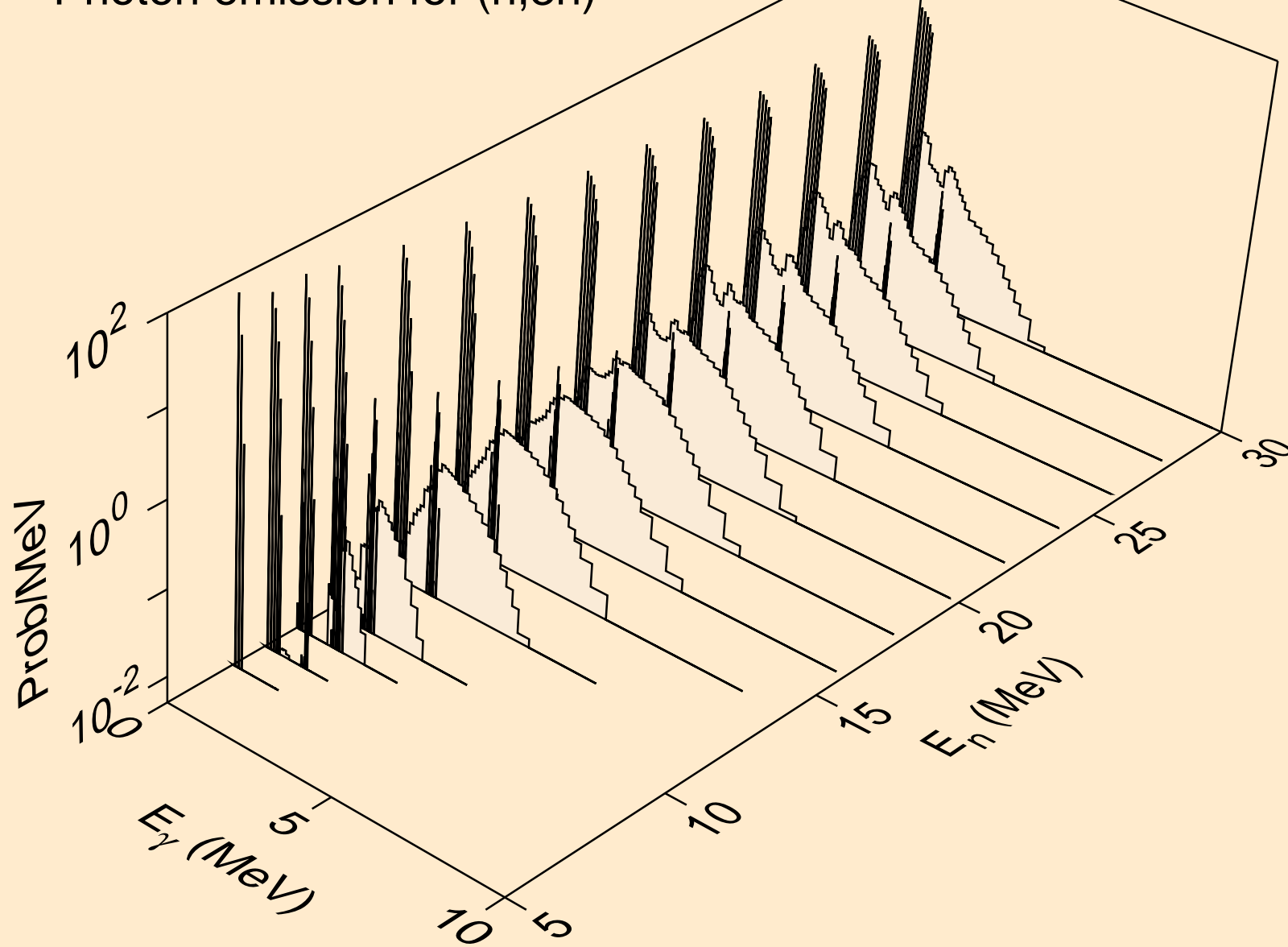

TM174 TRITON ACER TENDL-2021 LIBRARY; T=0.K  
Photon emission for (n,n\*)a

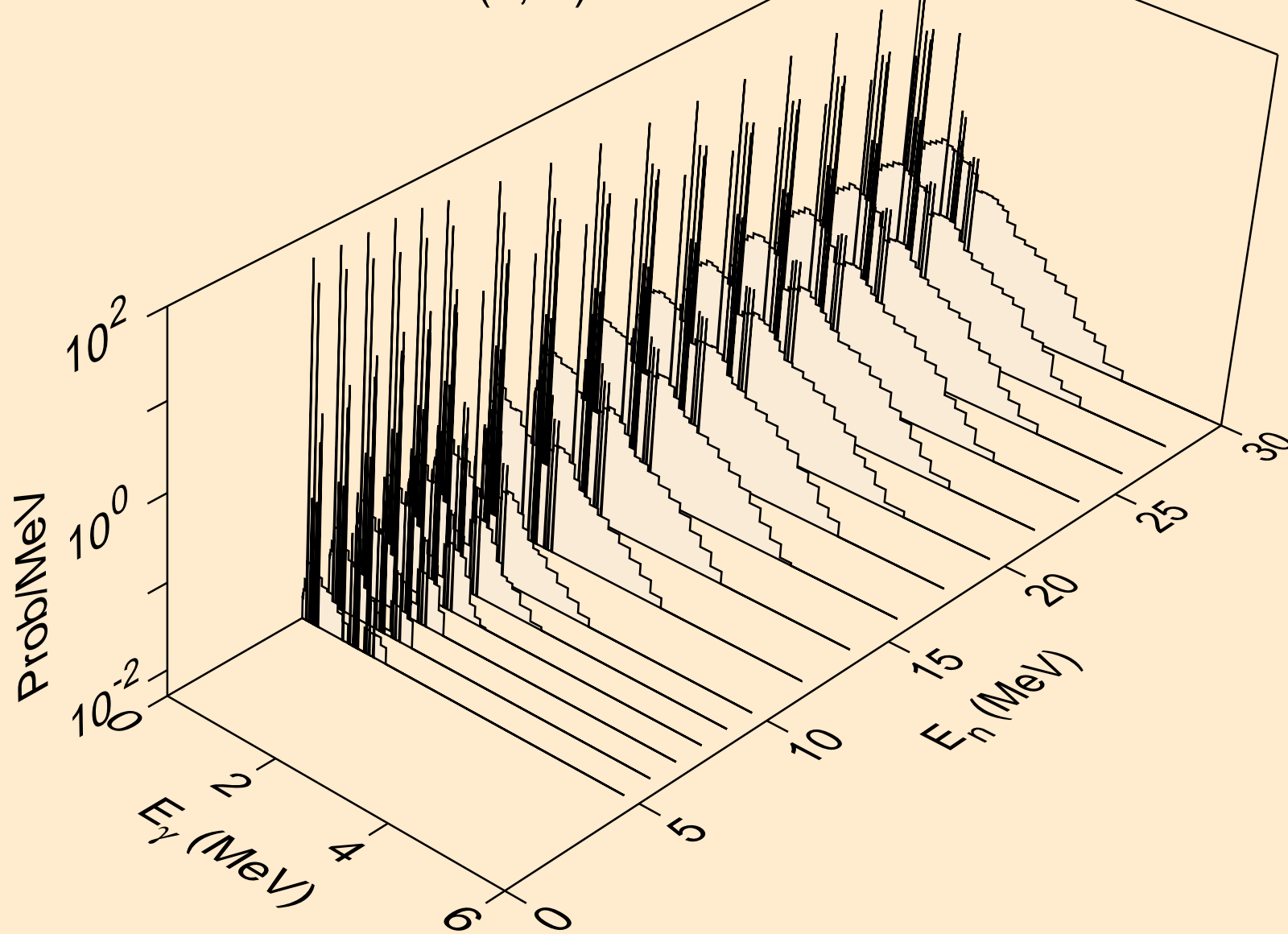

TM174 TRITON ACER TENDL-2021 LIBRARY; T=0.K  
Photon emission for (n,2n)a

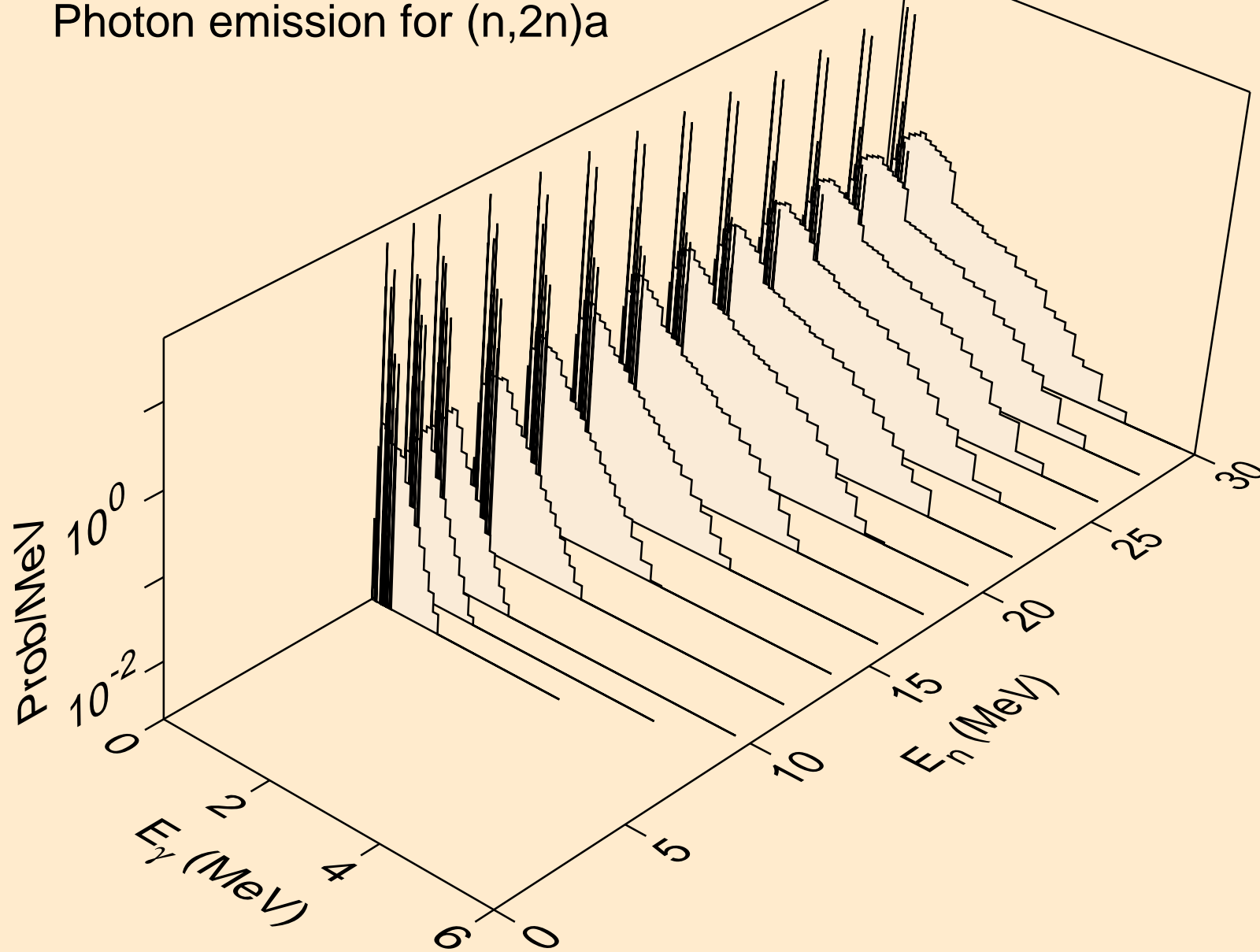

TM174 TRITON ACER TENDL-2021 LIBRARY; T=0.K  
Photon emission for (n,3n)a

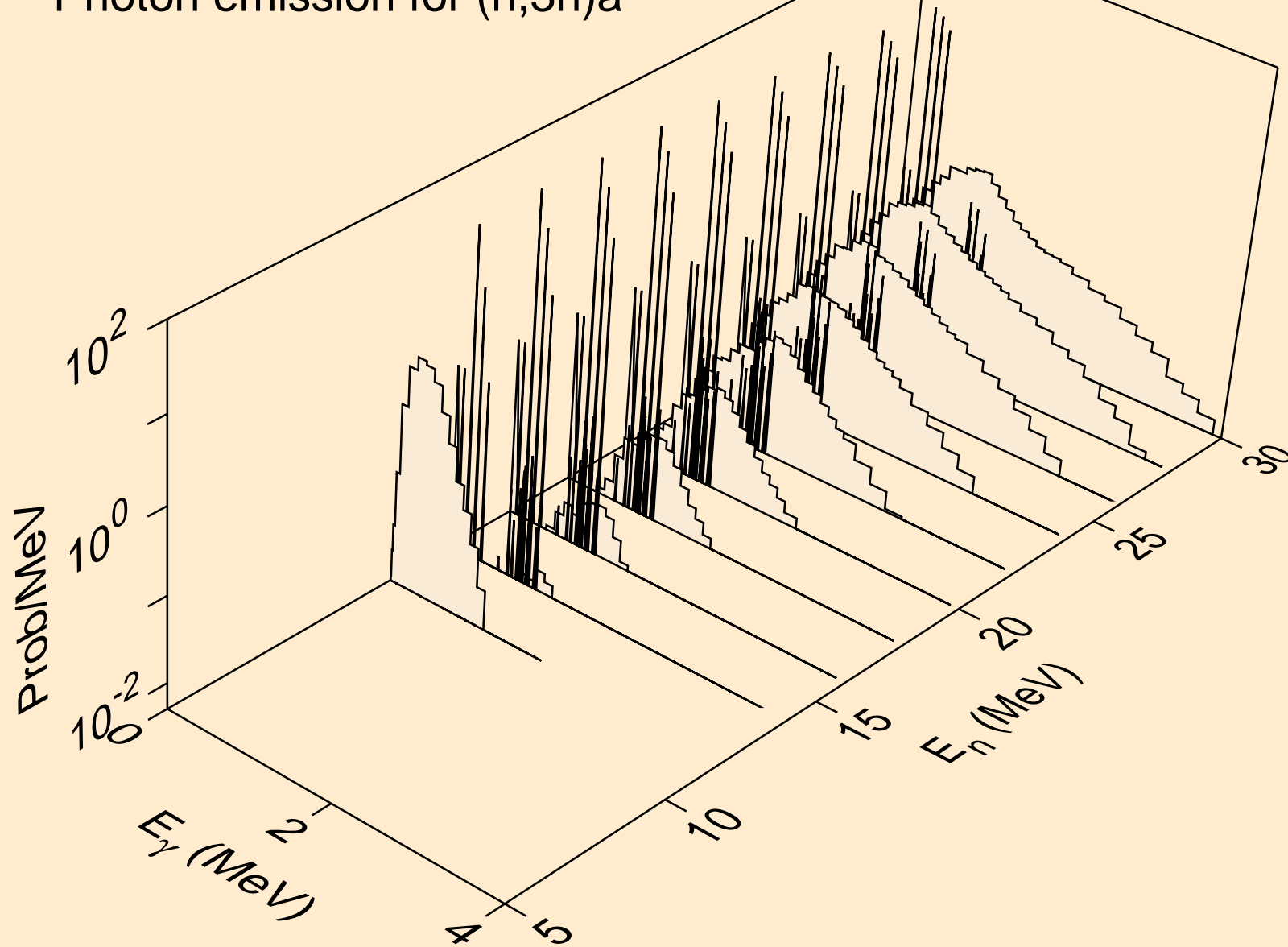

TM174 TRITON ACER TENDL-2021 LIBRARY; T=0.K  
Photon emission for (n,n\*)p

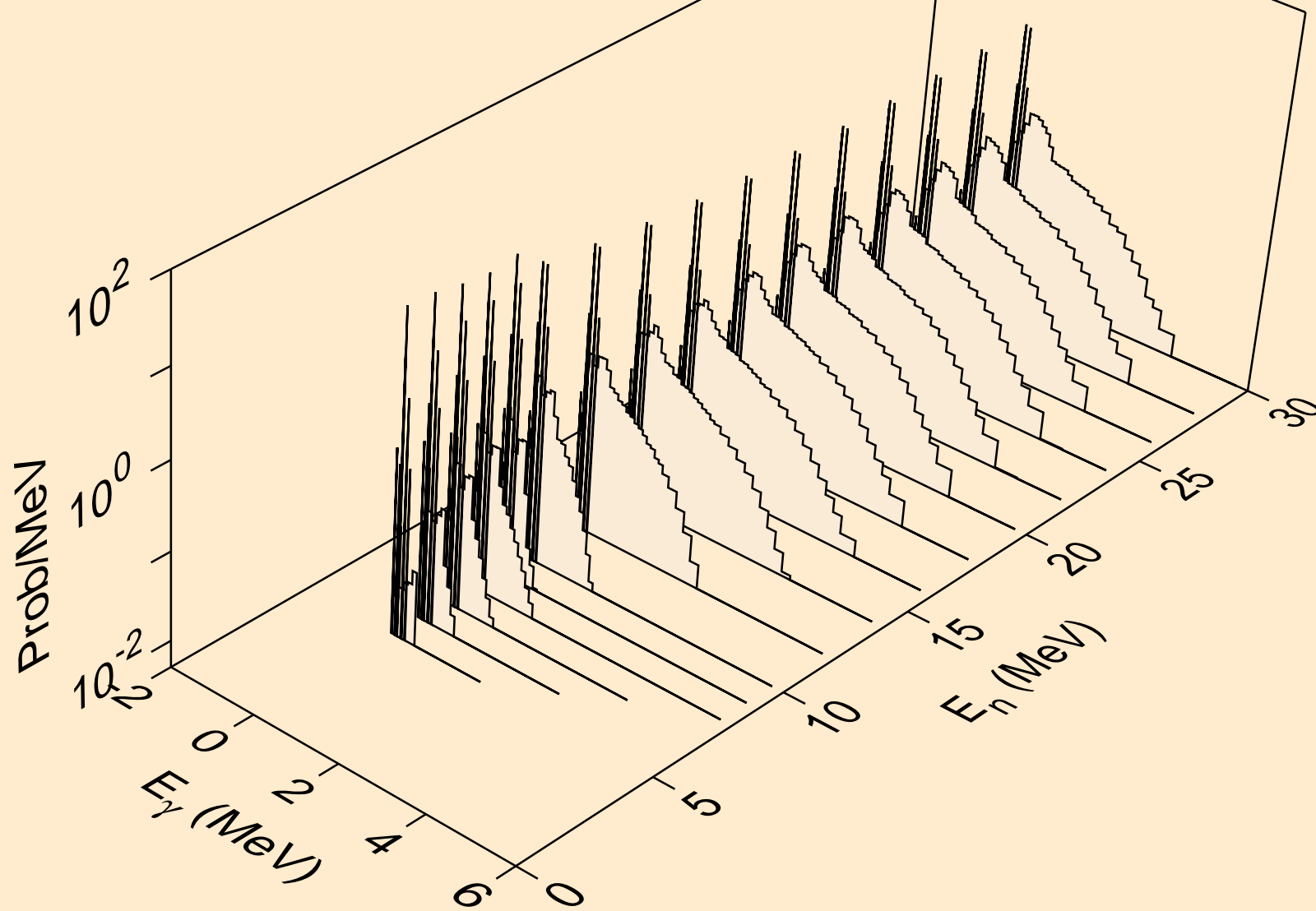

TM174 TRITON ACER TENDL-2021 LIBRARY; T=0.K  
Photon emission for (n,n\*)2a

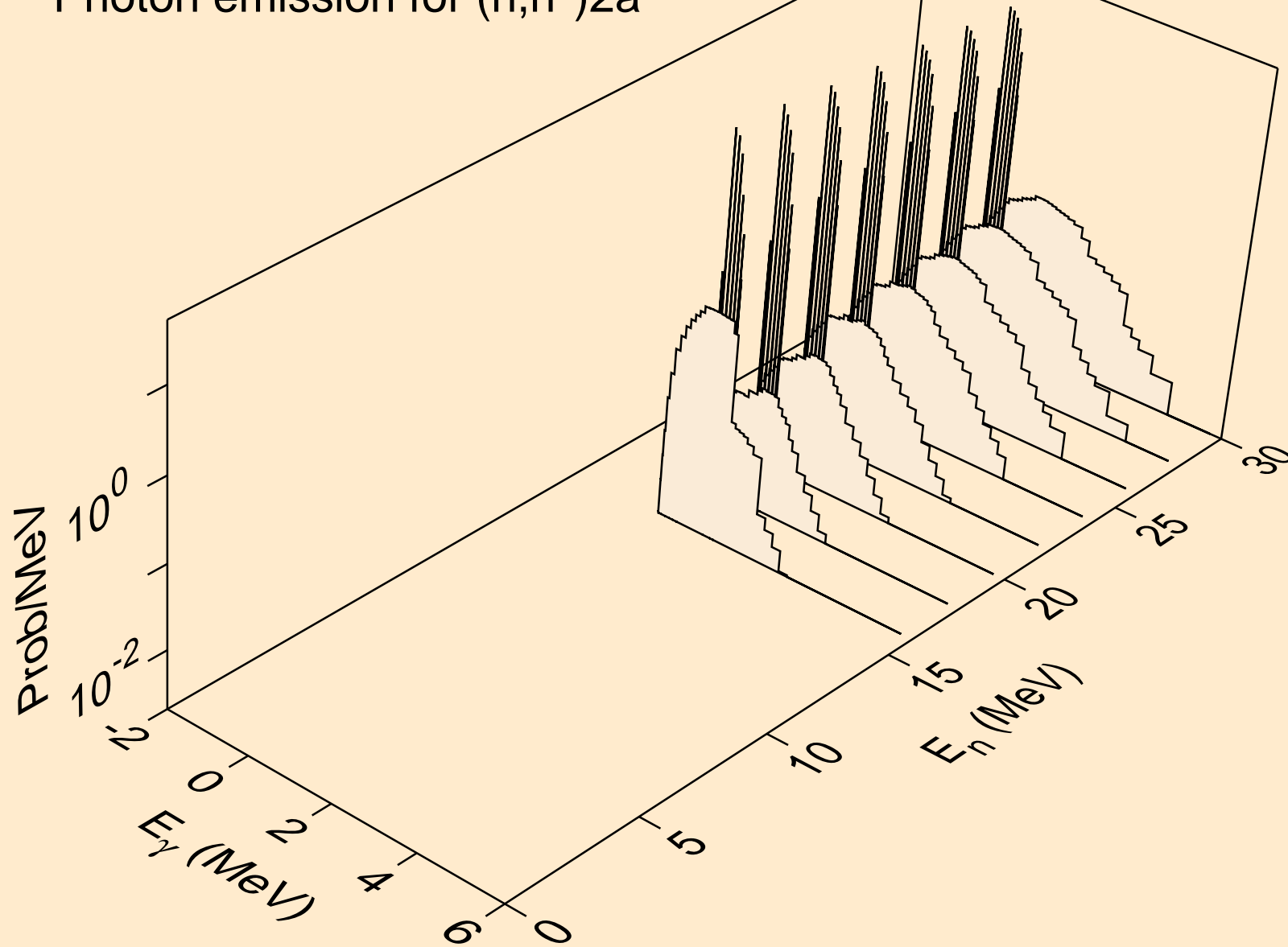

TM174 TRITON ACER TENDL-2021 LIBRARY; T=0.K  
Photon emission for (n,n\*)d

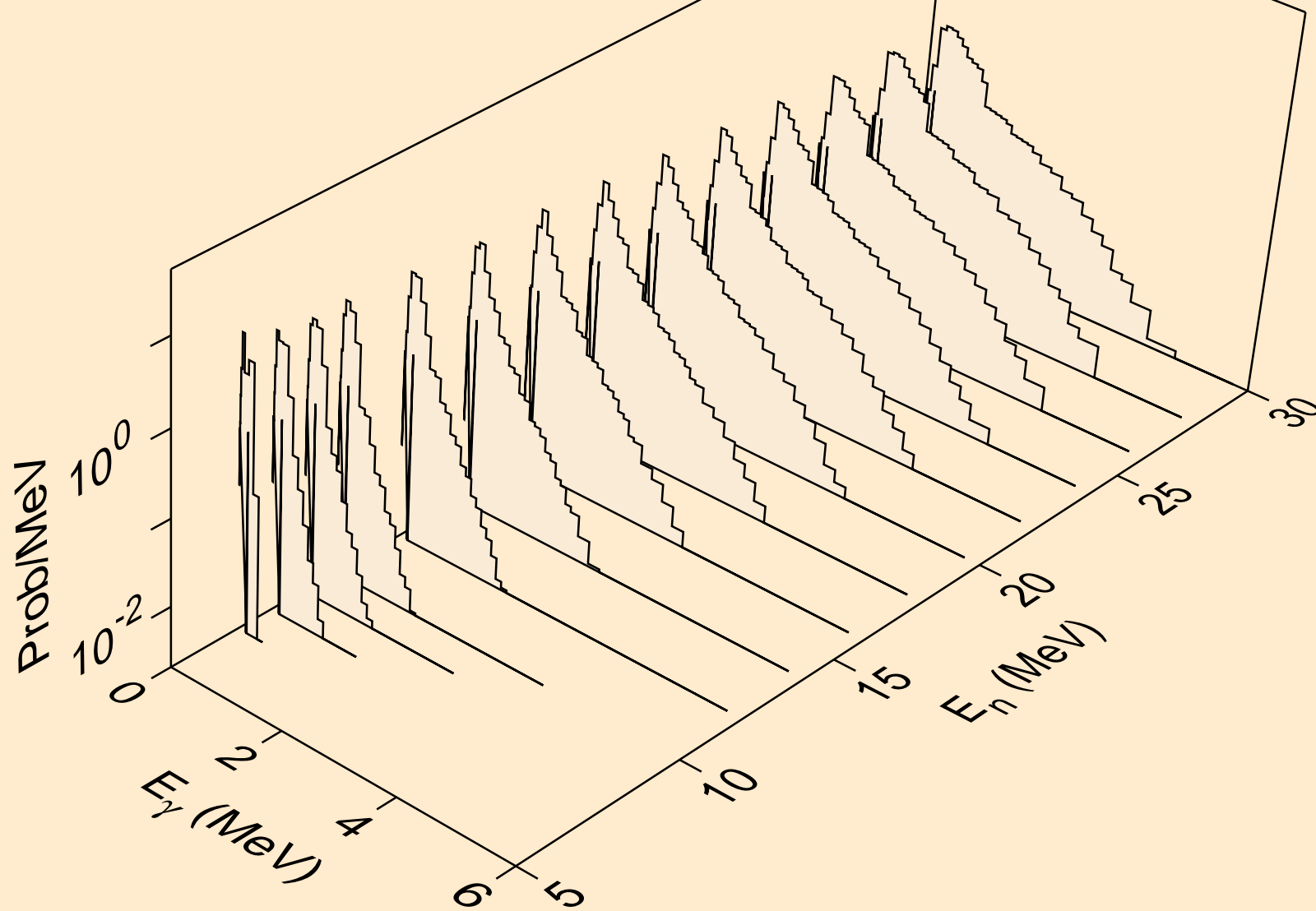



TM174 TRITON ACER TENDL-2021 LIBRARY; T=0.K  
Photon emission for (n,n\*)t

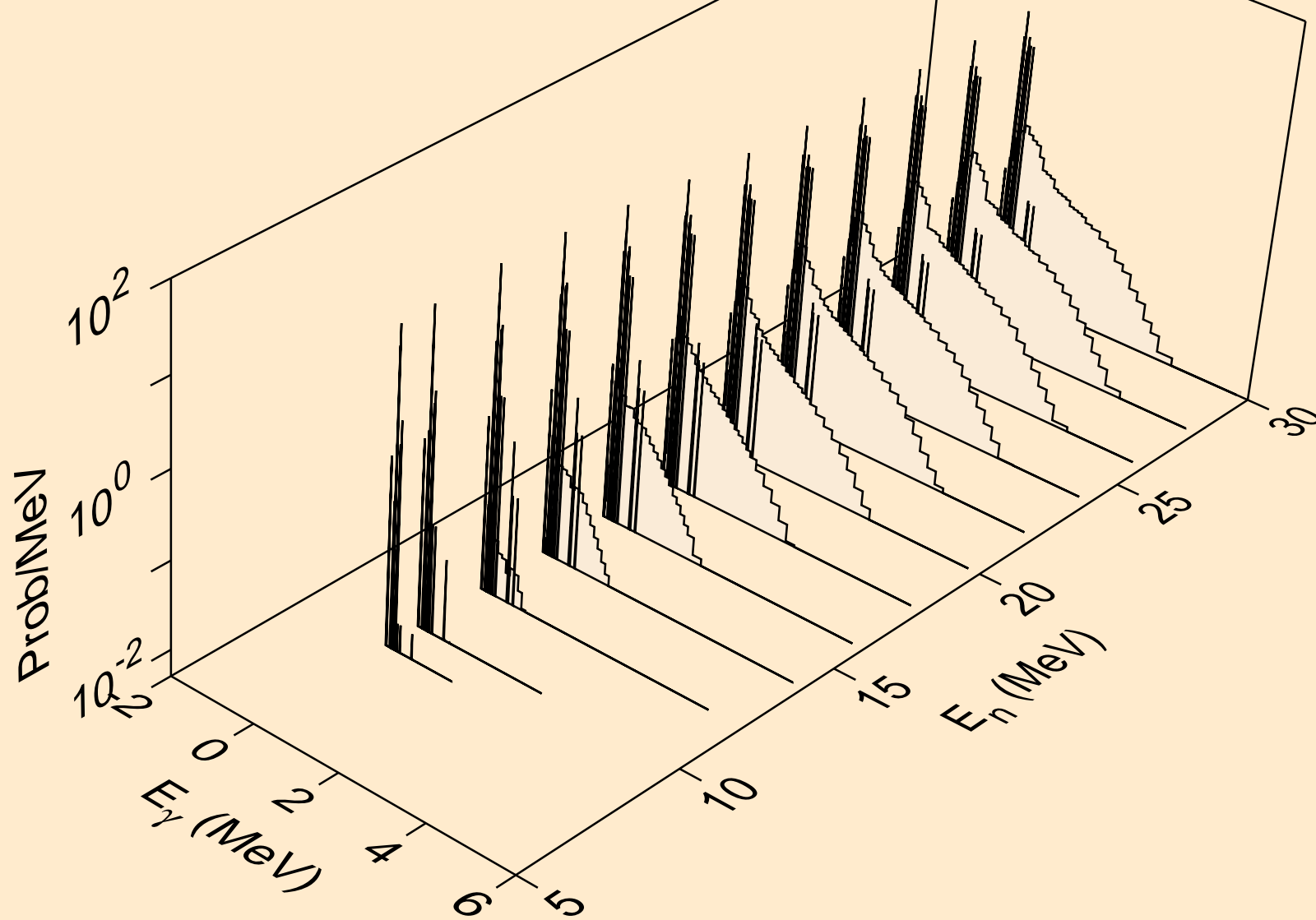

TM174 TRITON ACER TENDL-2021 LIBRARY; T=0.K  
Photon emission for (n,n\*)he3

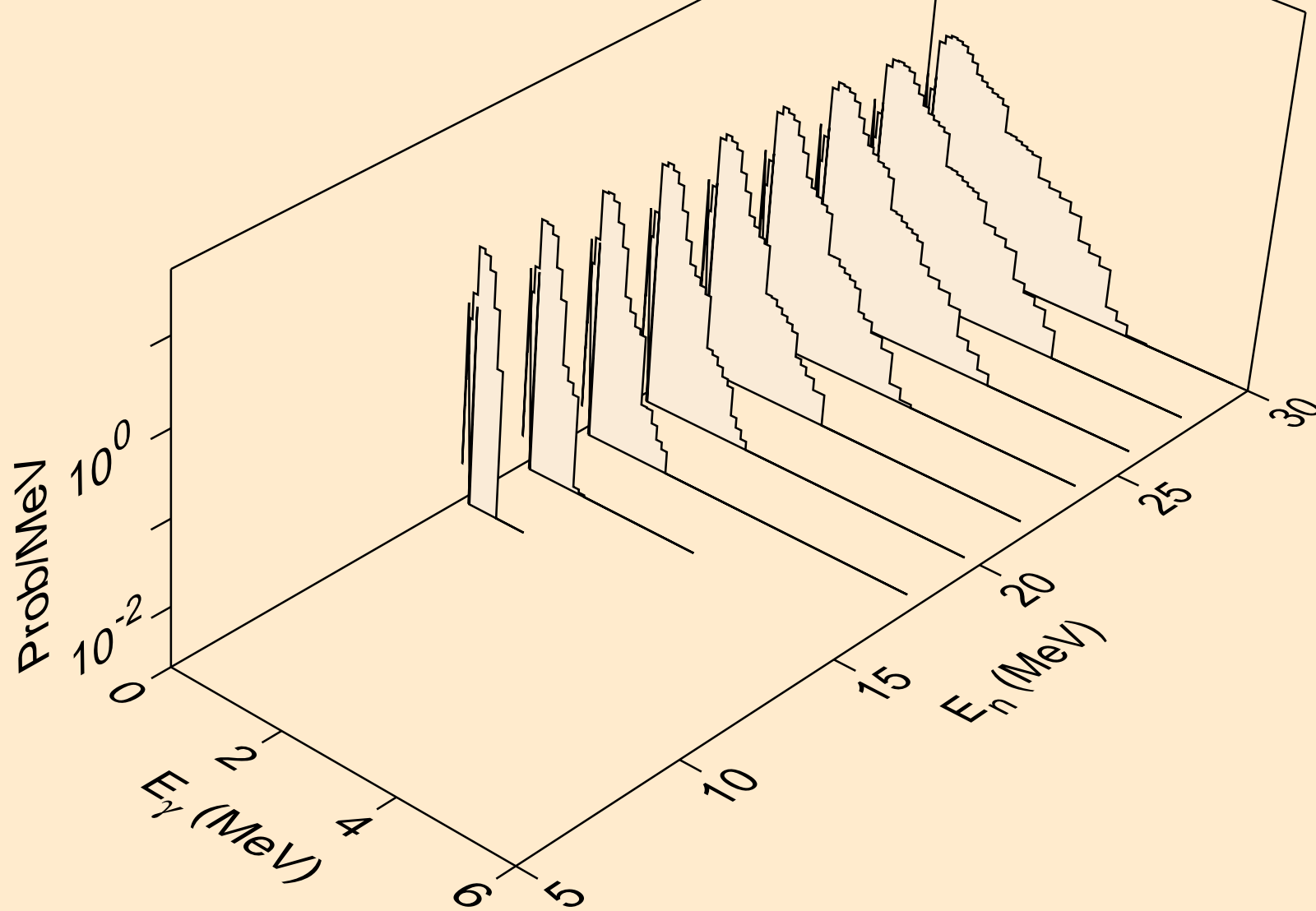

TM174 TRITON ACER TENDL-2021 LIBRARY; T=0.K  
Photon emission for (n,4n)

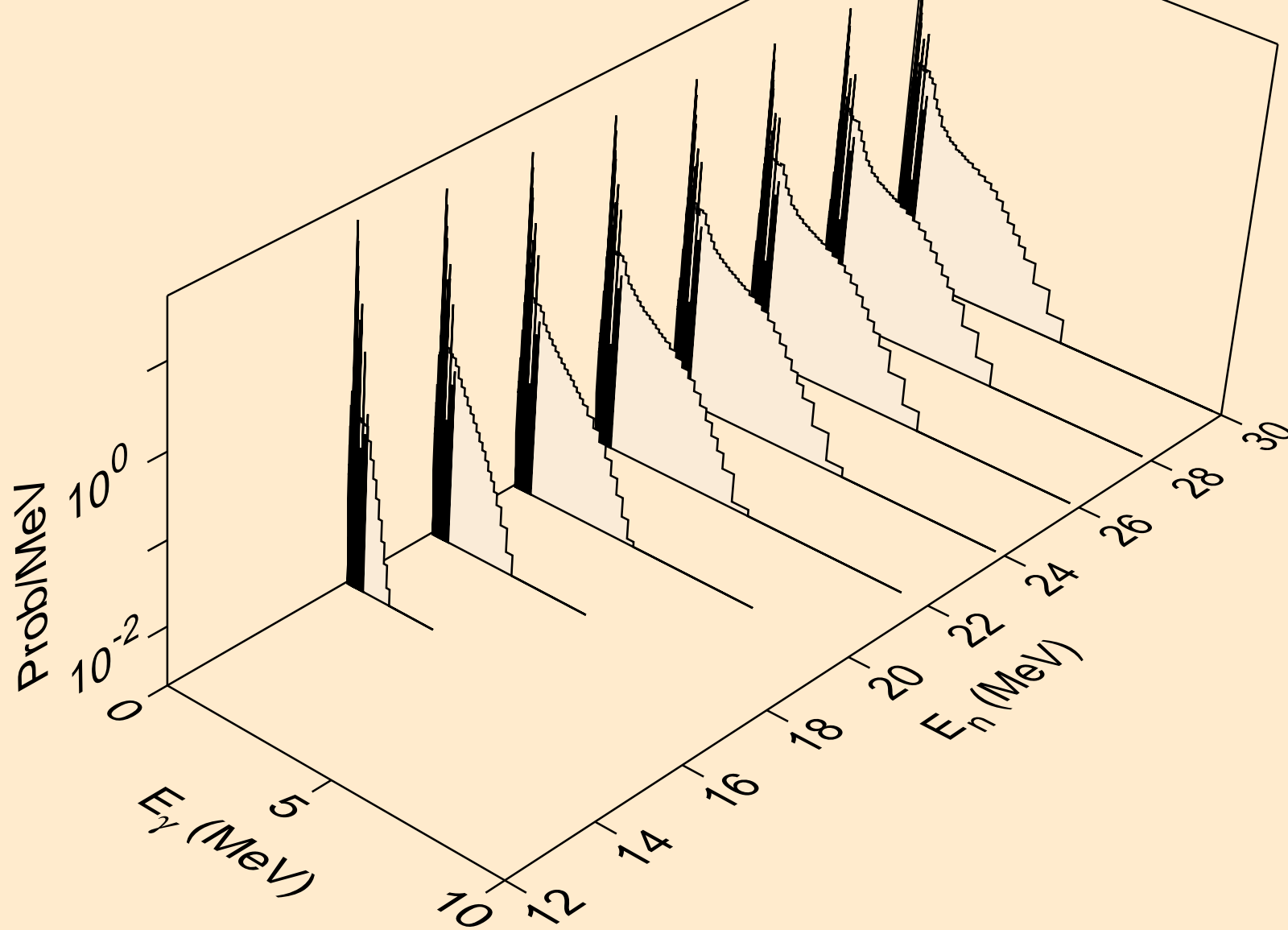

TM174 TRITON ACER TENDL-2021 LIBRARY; T=0.K  
Photon emission for (n,2np)

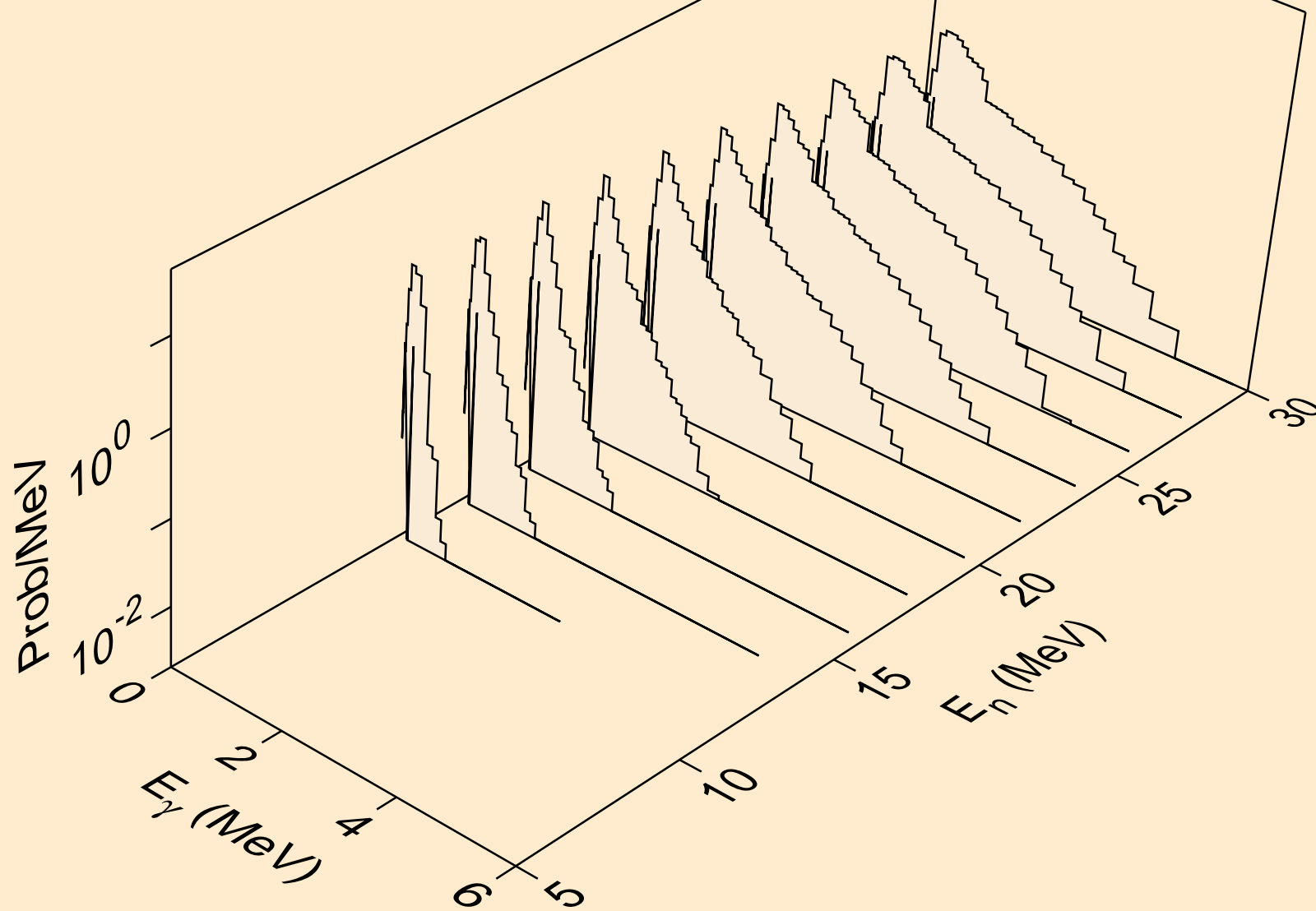

TM174 TRITON ACER TENDL-2021 LIBRARY; T=0.K  
Photon emission for (n,3np)

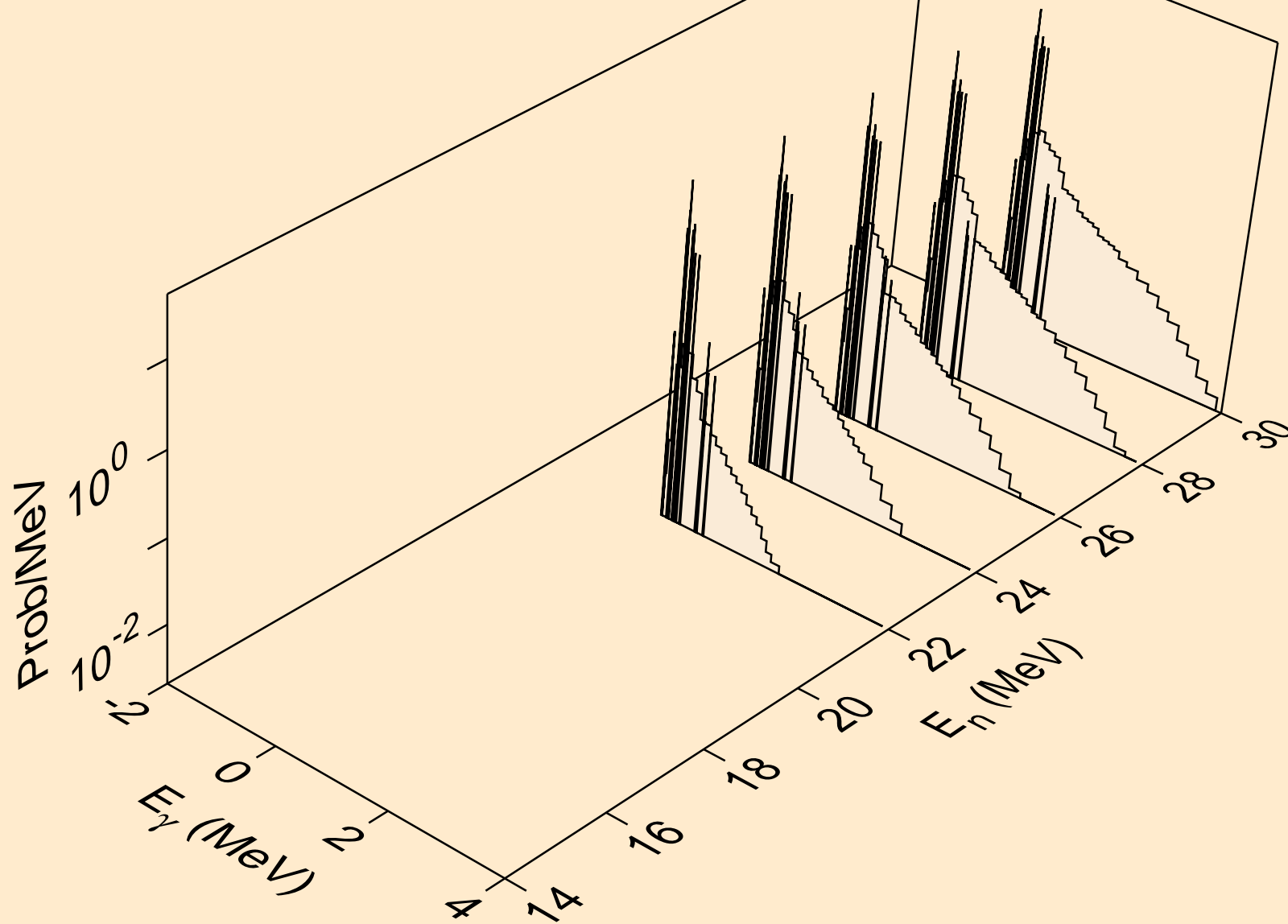

TM174 TRITON ACER TENDL-2021 LIBRARY; T=0.K  
Photon emission for (n,2np)

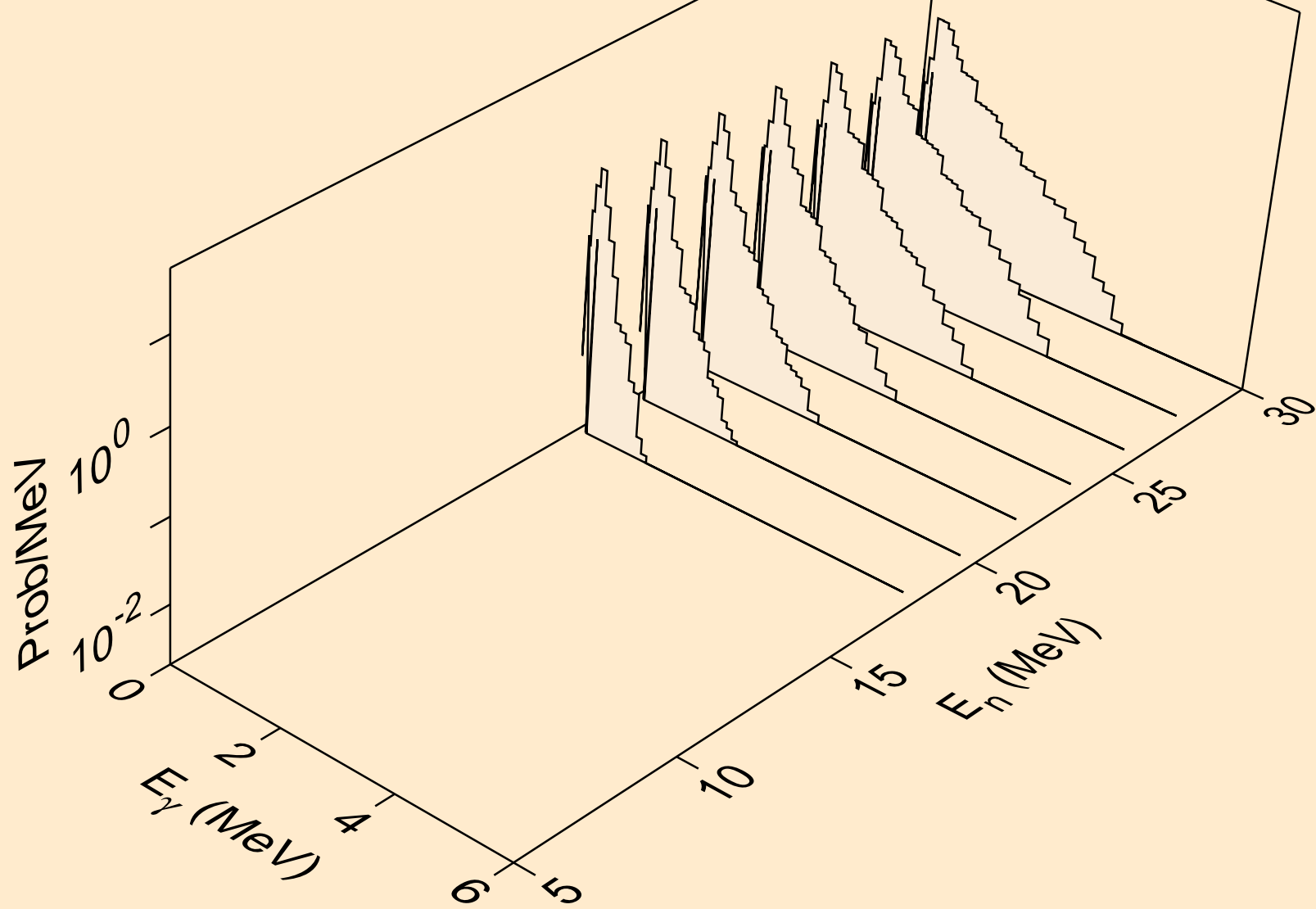

TM174 TRITON ACER TENDL-2021 LIBRARY; T=0.K  
Photon emission for (n,npa)

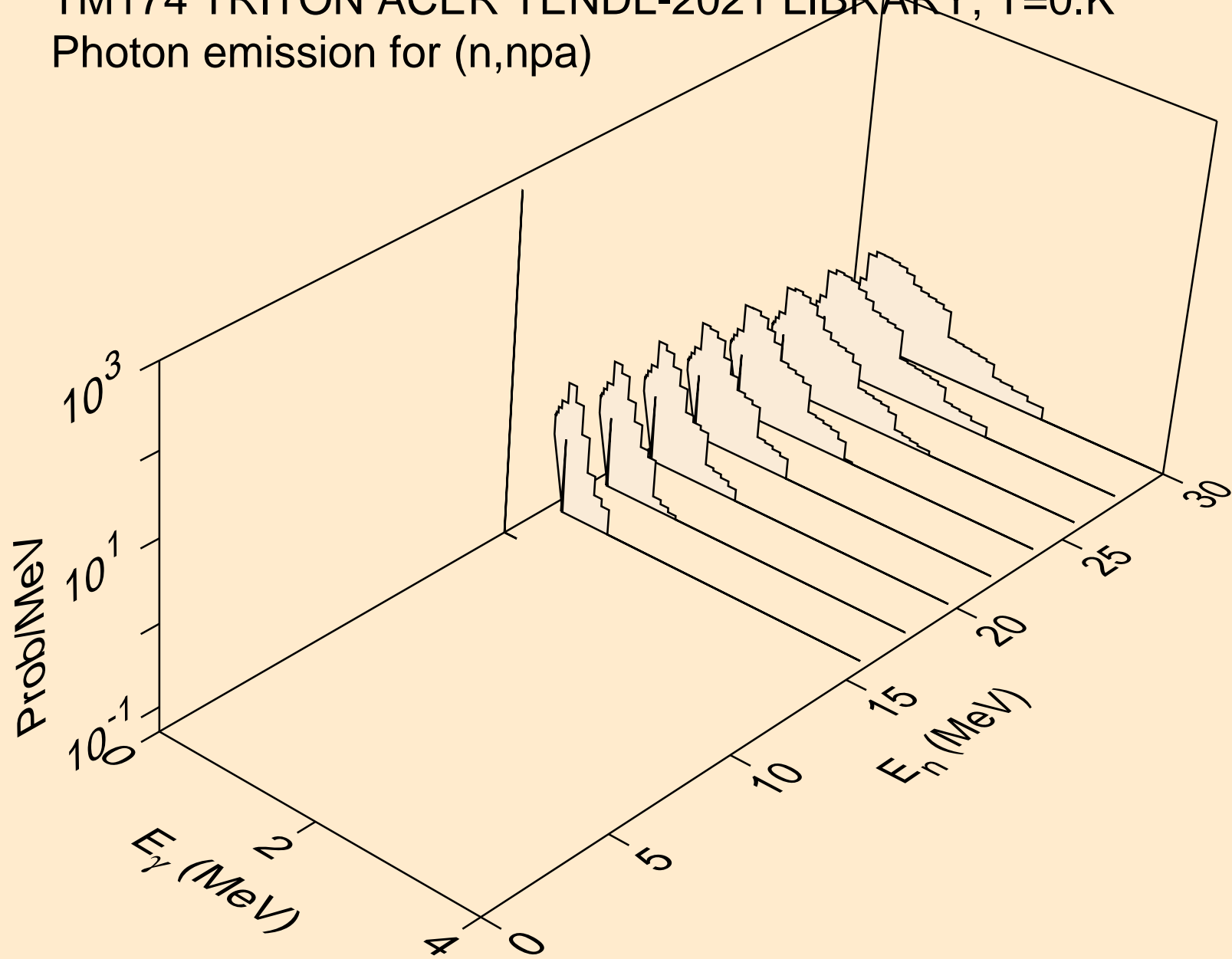

TM174 TRITON ACER TENDL-2021 LIBRARY; T=0.K  
Photon emission for (n,gma)

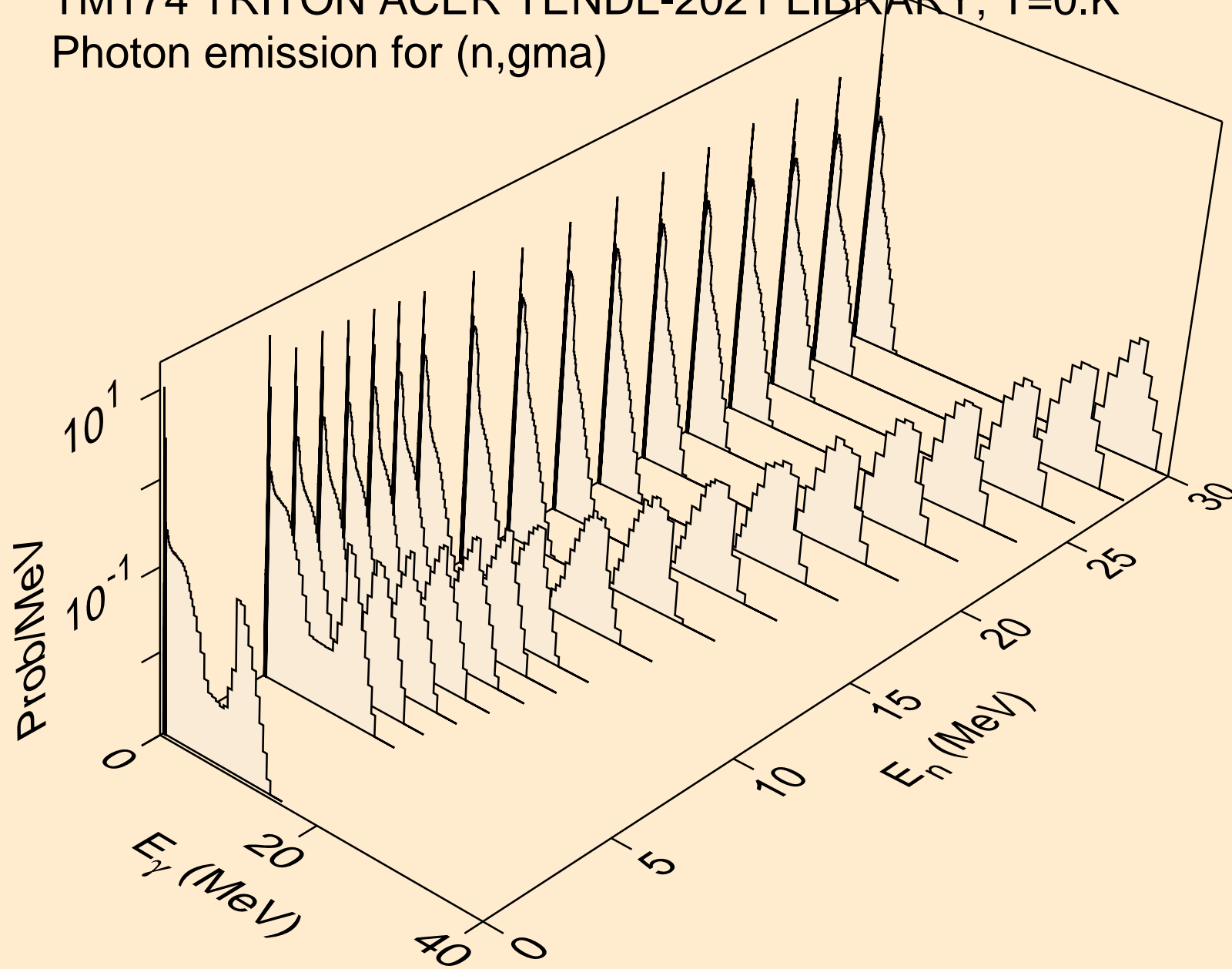



TM174 TRITON ACER TENDL-2021 LIBRARY; T=0.K  
Photon emission for (n,p)

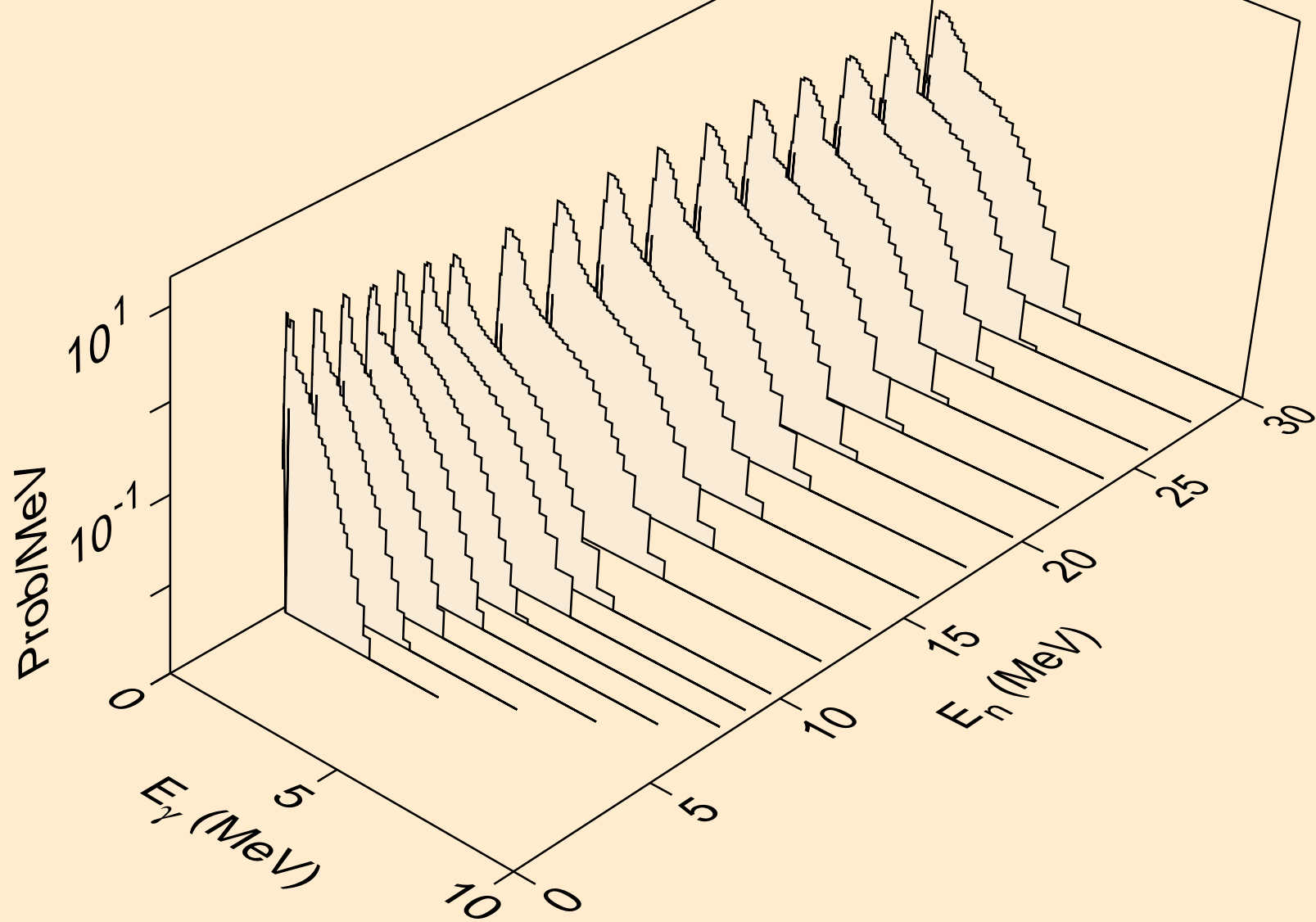

TM174 TRITON ACER TENDL-2021 LIBRARY; T=0.K  
Photon emission for (n,d)

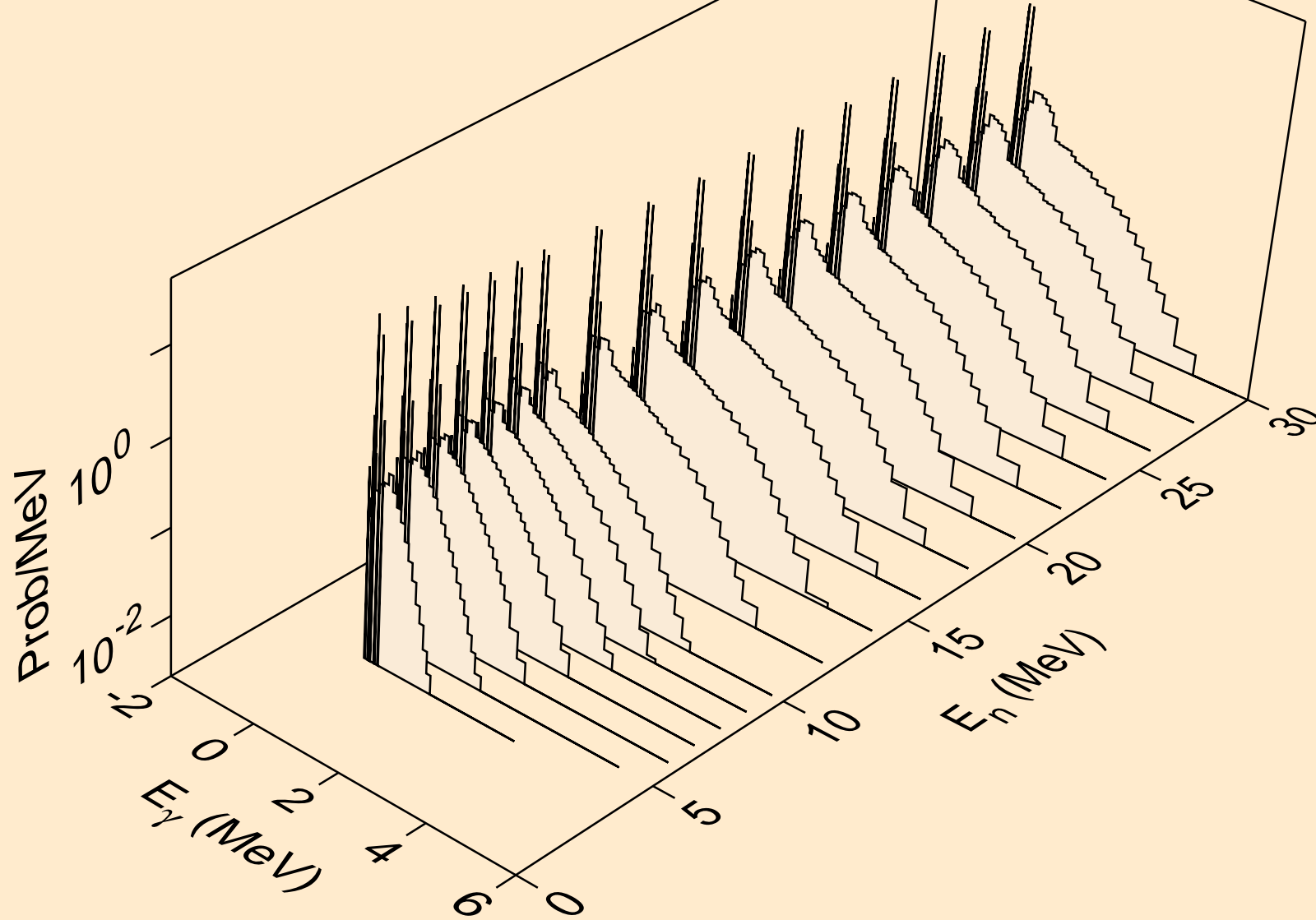

TM174 TRITON ACER TENDL-2021 LIBRARY; T=0.K  
Photon emission for inelastic

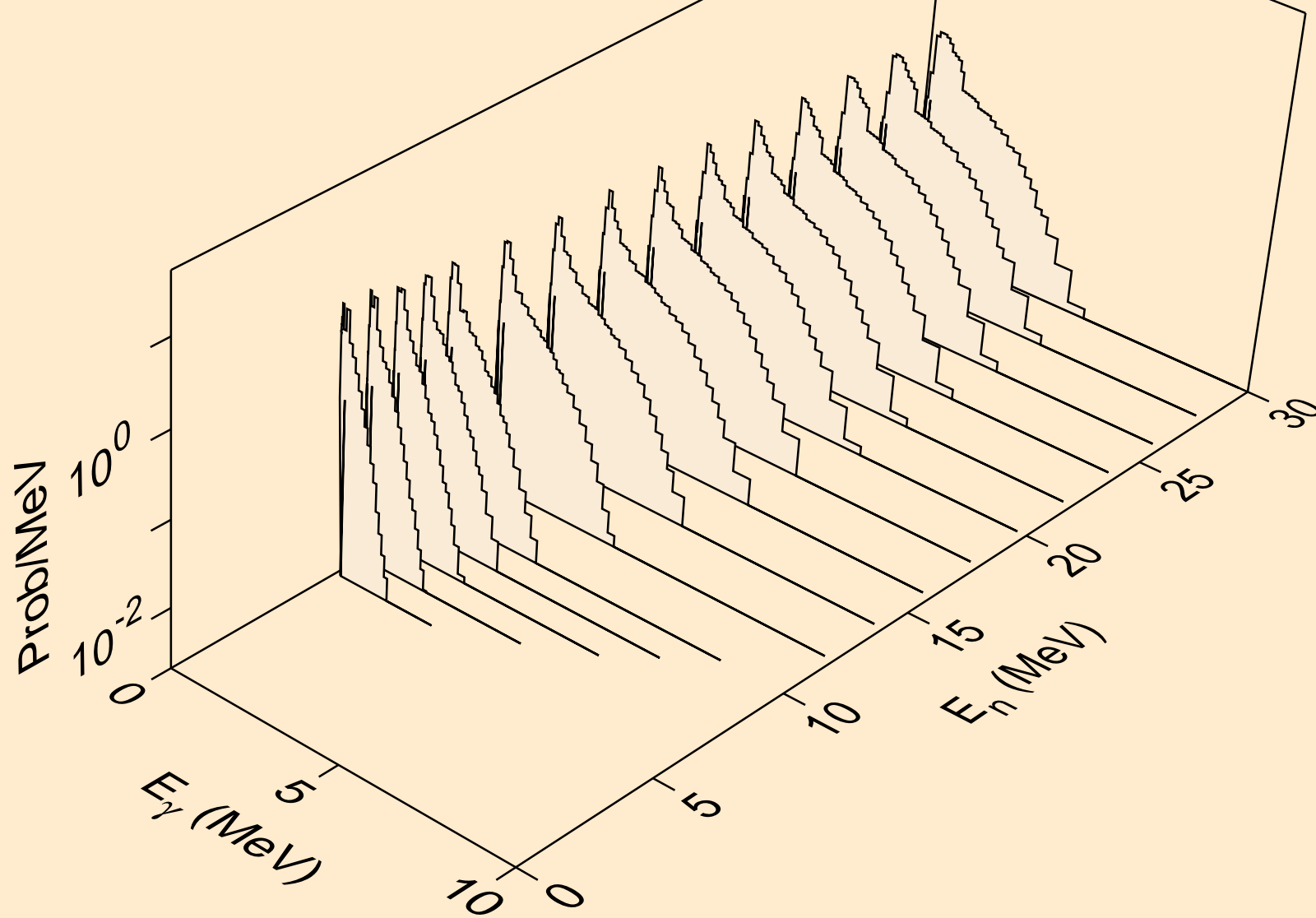

TM174 TRITON ACER TENDL-2021 LIBRARY; T=0.K  
Photon emission for (n,he3)

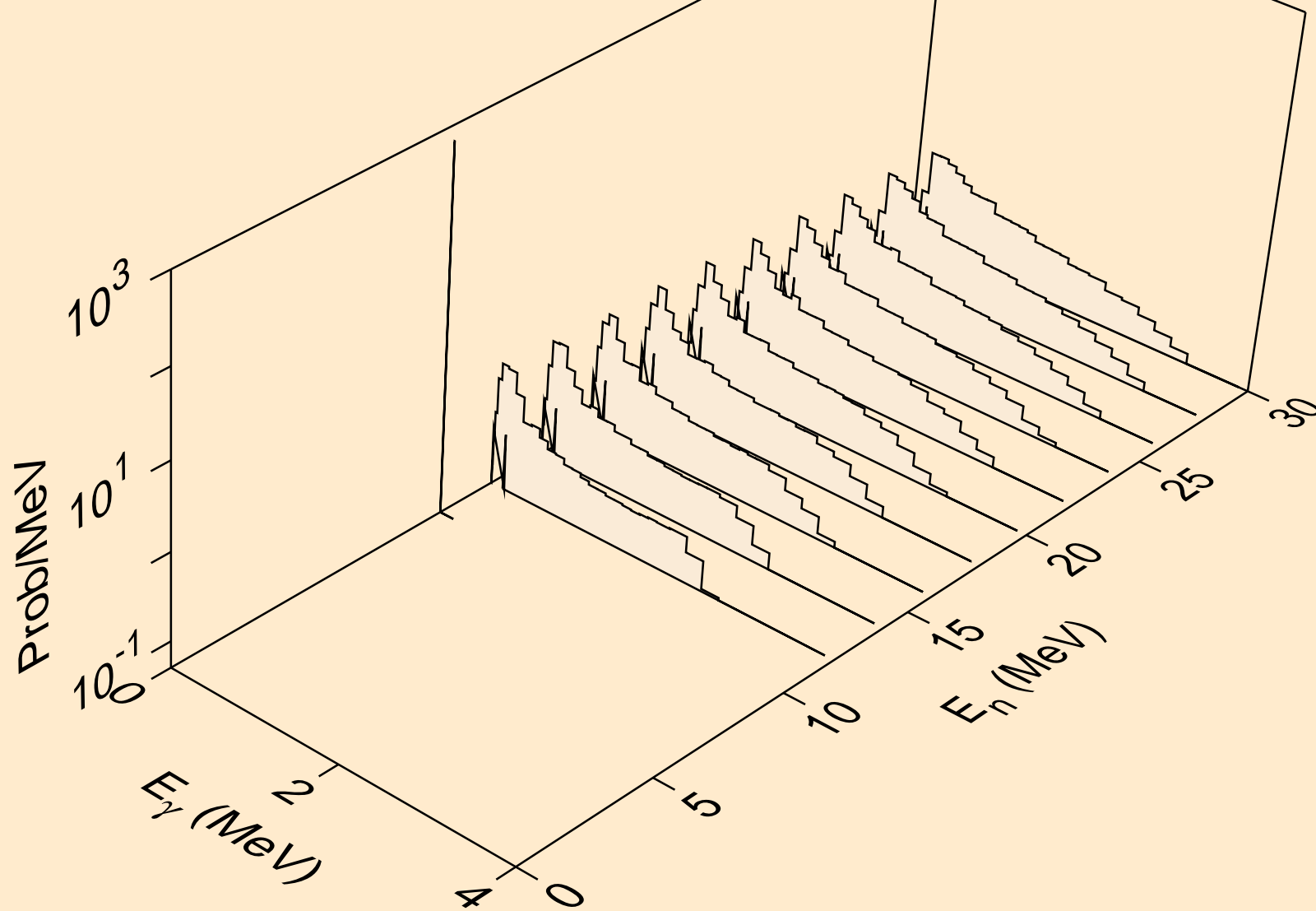

TM174 TRITON ACER TENDL-2021 LIBRARY; T=0.K  
Photon emission for (n,a)

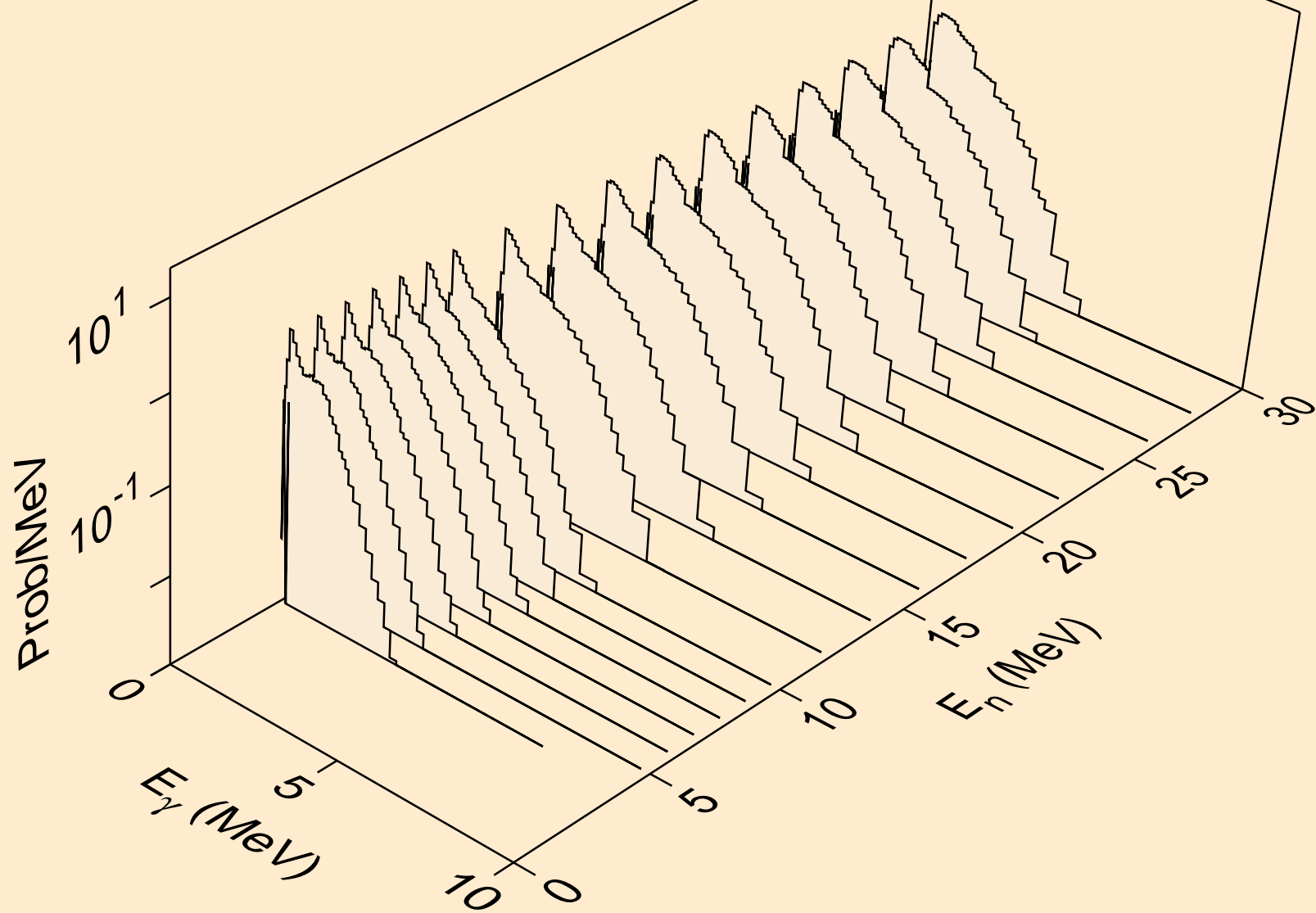

TM174 TRITON ACER TENDL-2021 LIBRARY; T=0.K  
Photon emission for (n,2p)

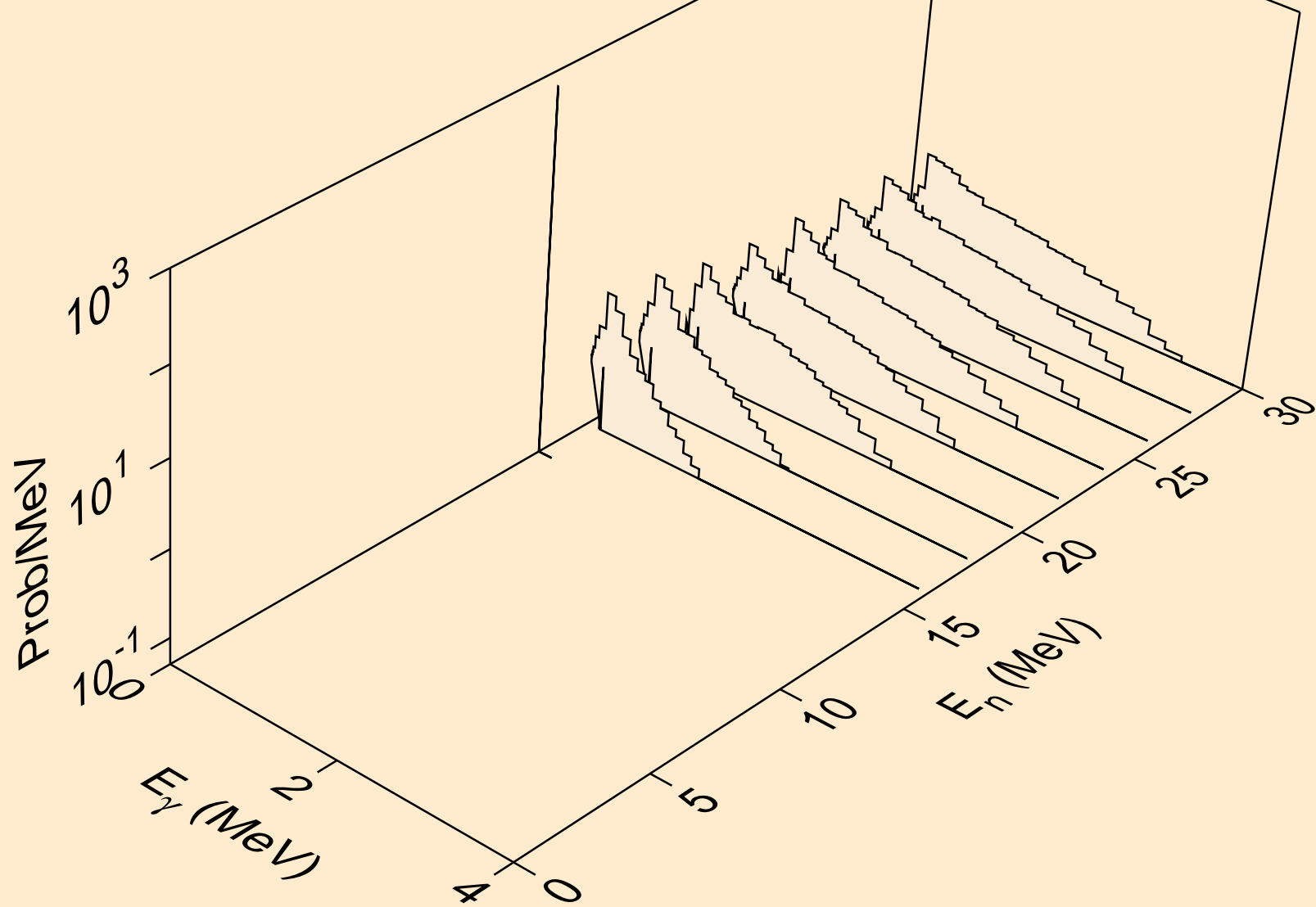

TM174 TRITON ACER TENDL-2021 LIBRARY; T=0.K  
Photon emission for (n,pa)

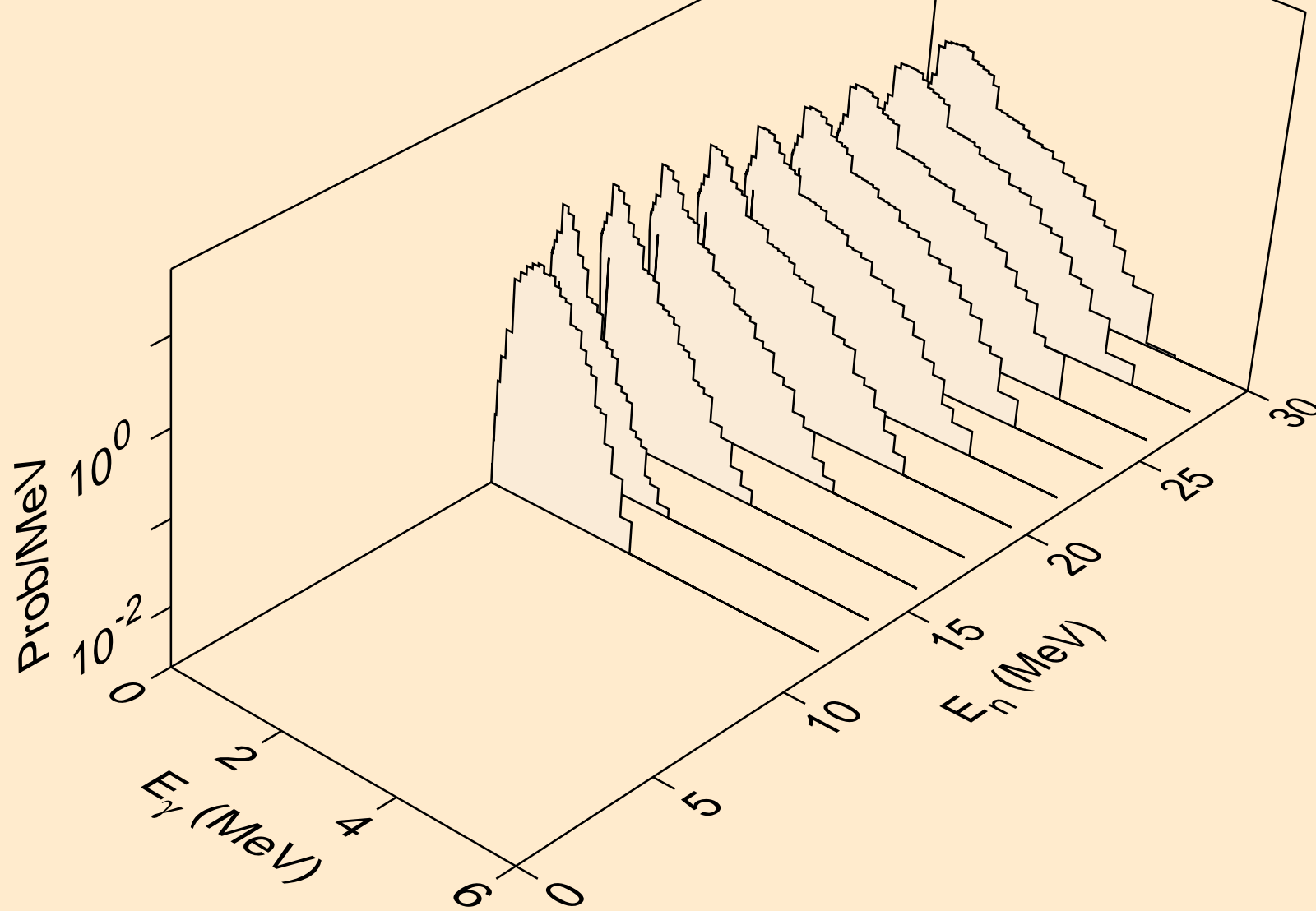

TM174 TRITON ACER TENDL-2021 LIBRARY; T=0.K  
Photon emission for (n,pd)

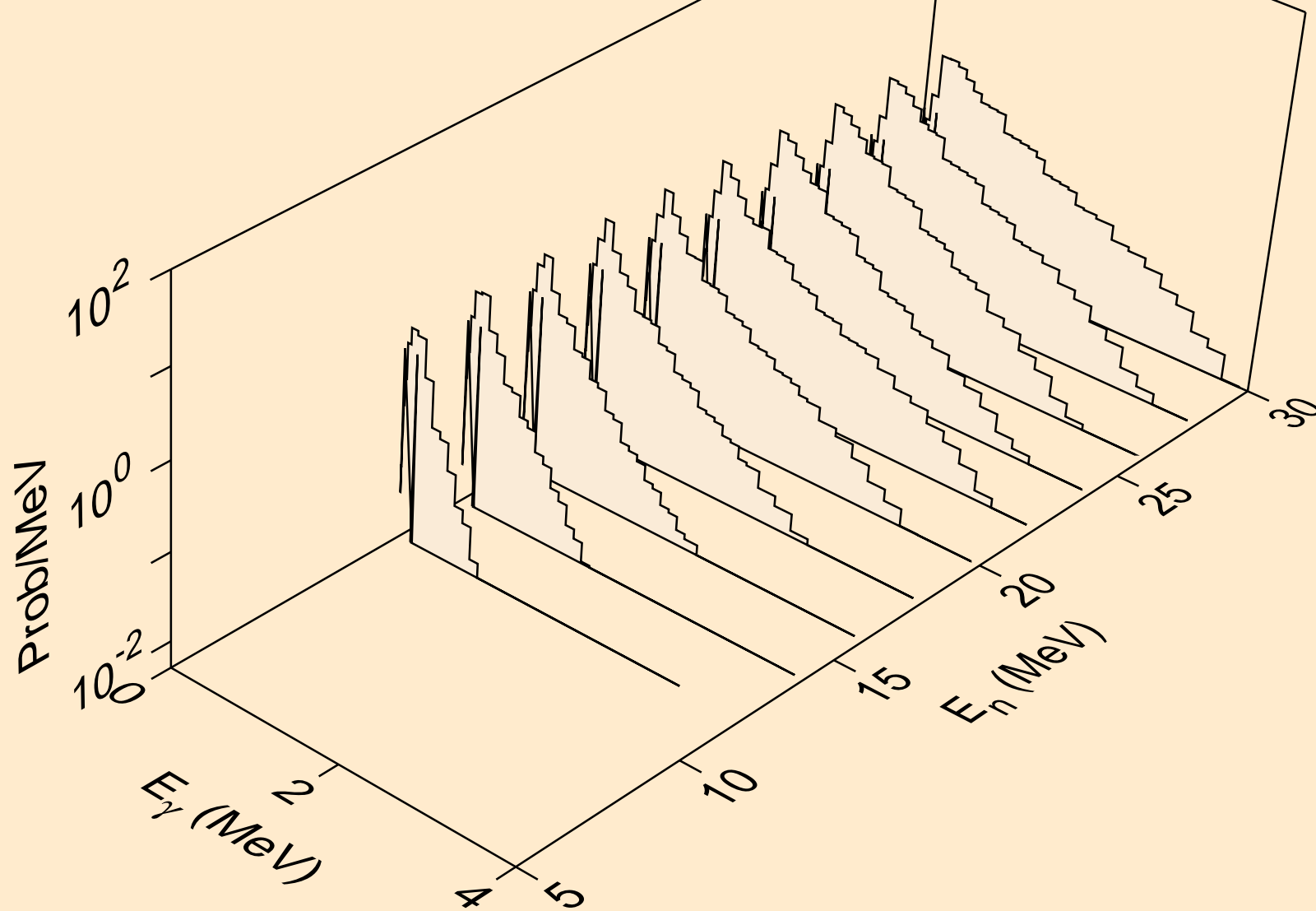



TM174 TRITON ACER TENDL-2021 LIBRARY; T=0.K  
Photon emission for (n,pt)

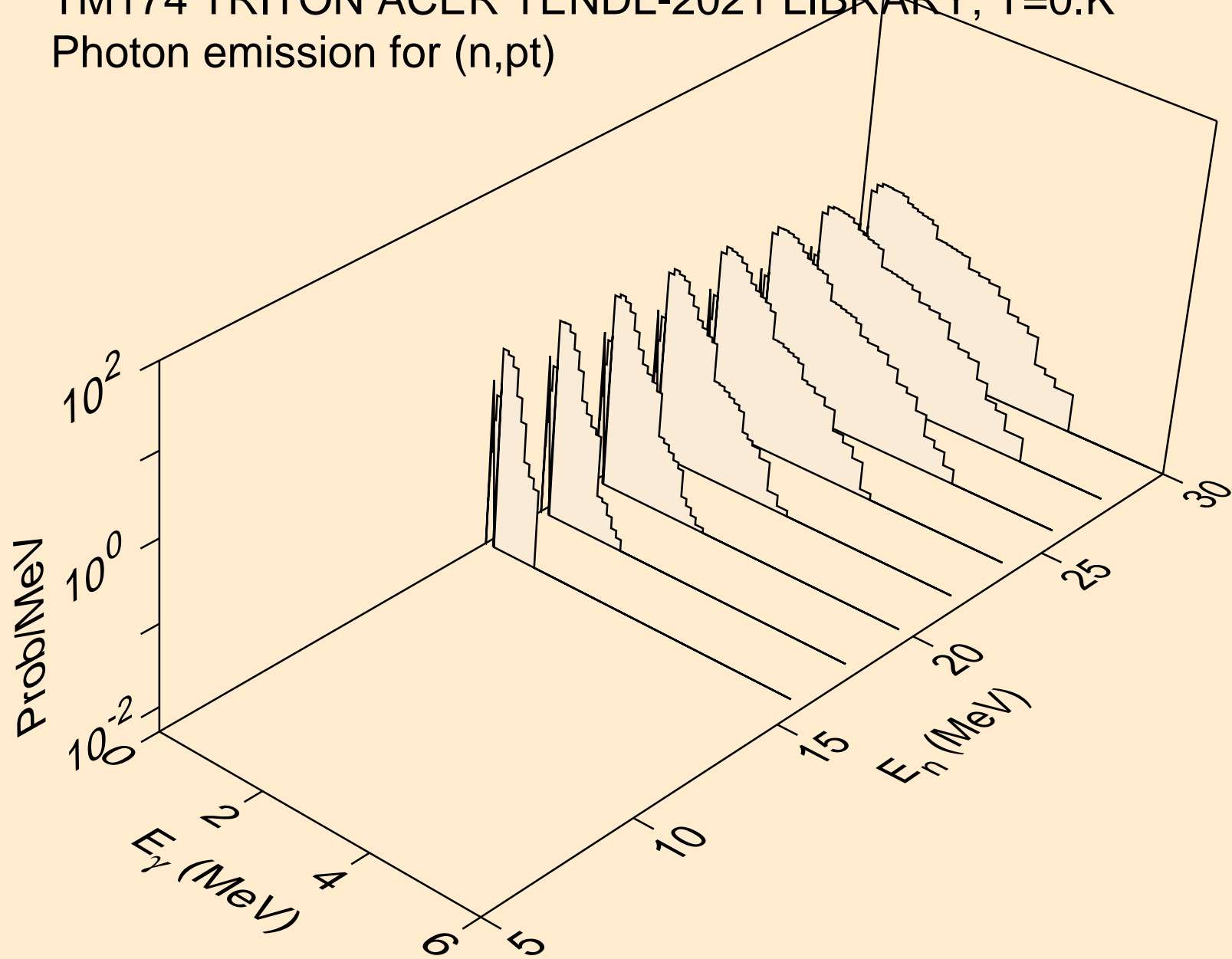

# TM174 TRITON ACER TENDL-2021 LIBRARY; T=0.K

## Particle heating contributions

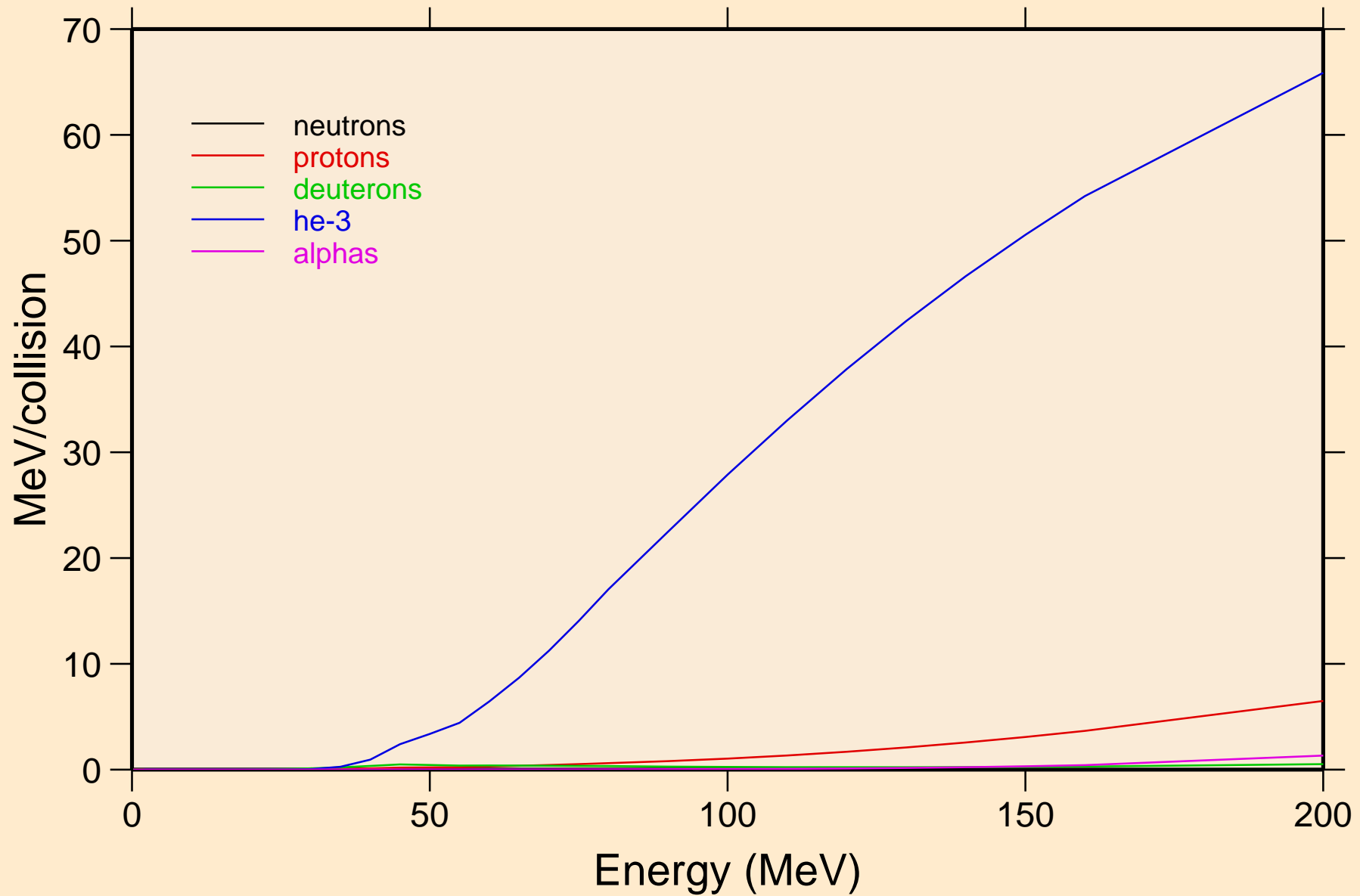

TM174 TRITON ACER TENDL-2021 LIBRARY; T=0.K  
Recoil Heating

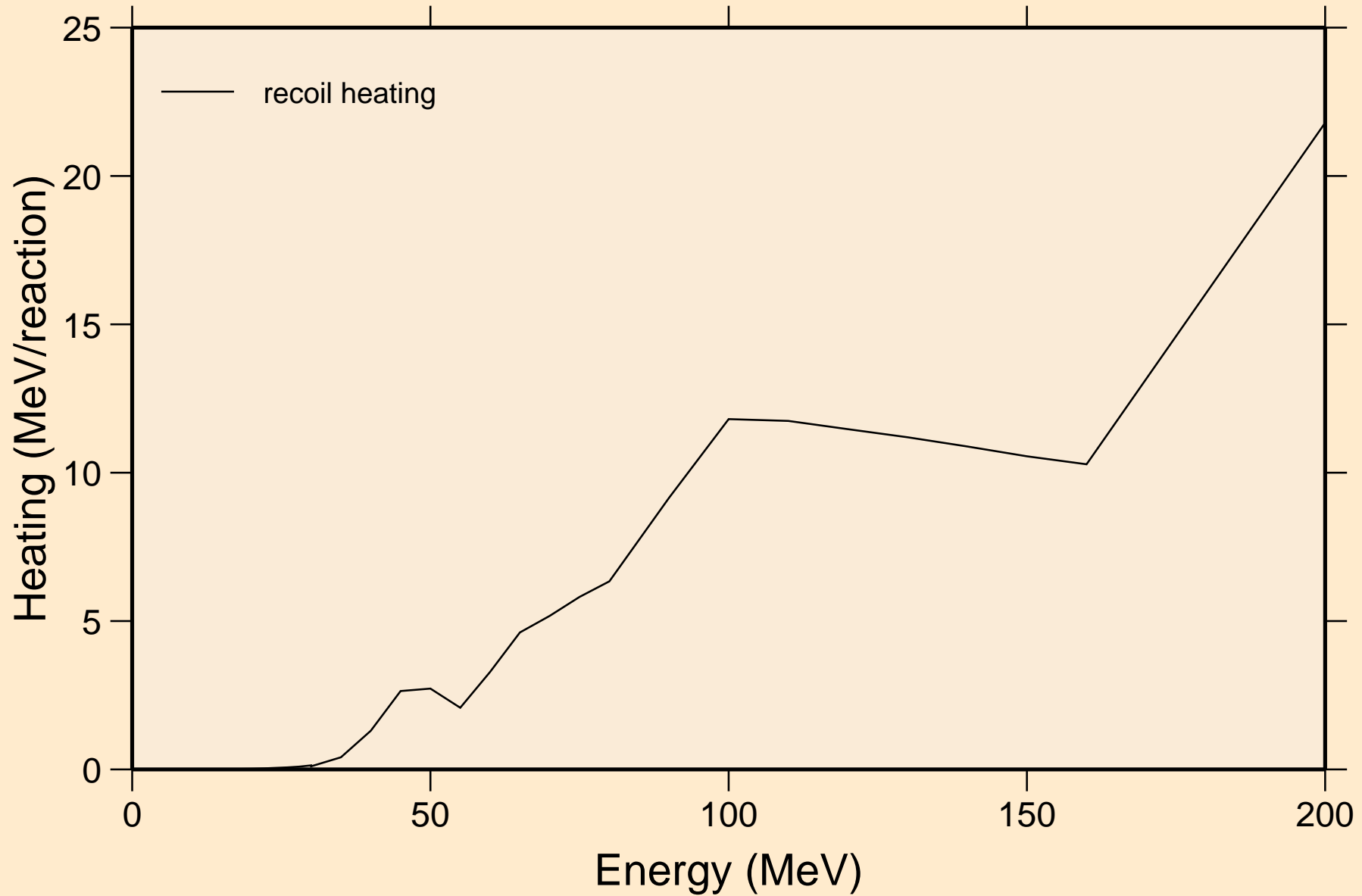

TM174 TRITON ACER TENDL-2021 LIBRARY; T=0.K  
Particle production cross sections

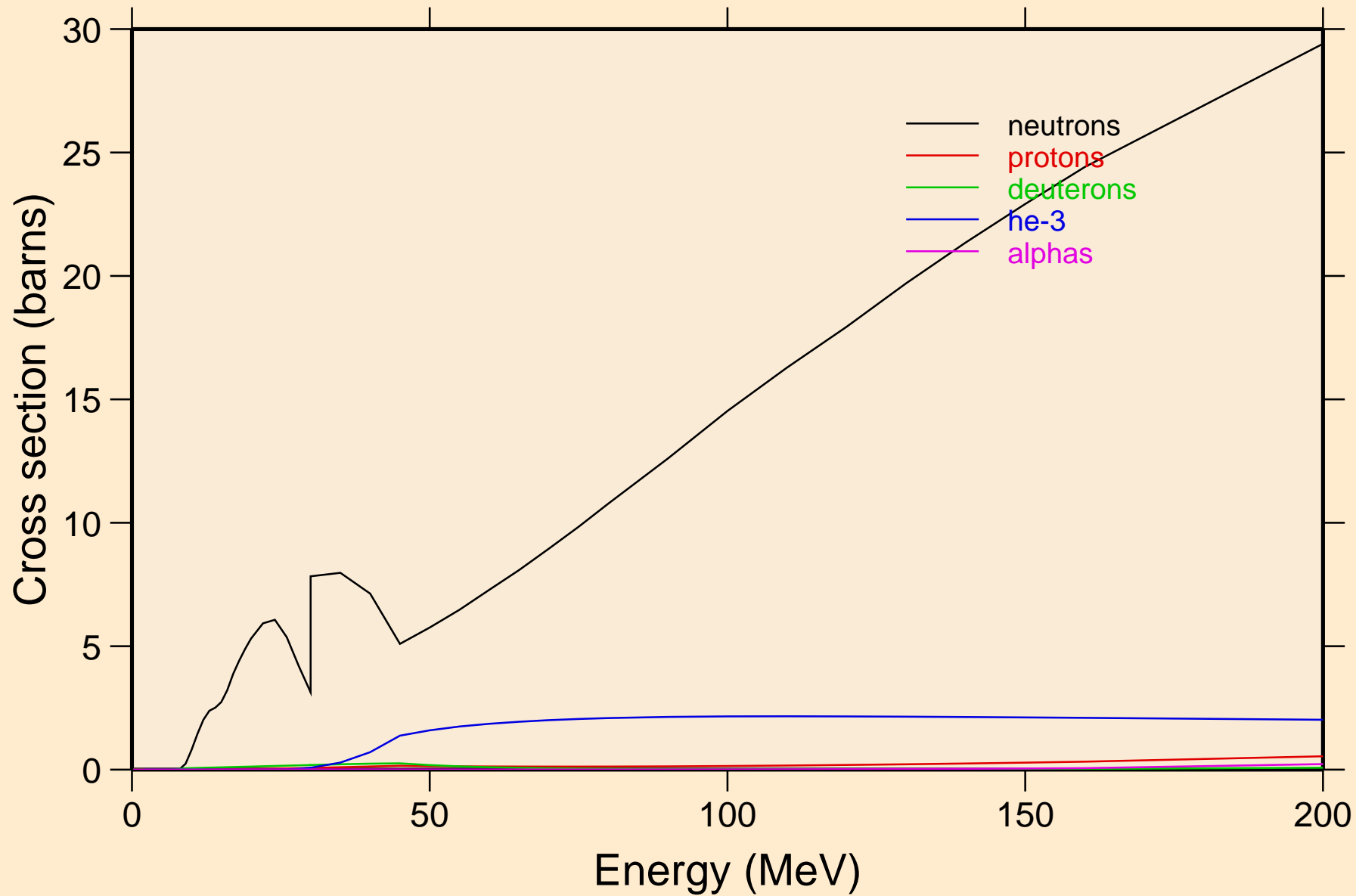

TM174 TRITON ACER TENDL-2021 LIBRARY; T=0.K  
neutrons from (t,n)

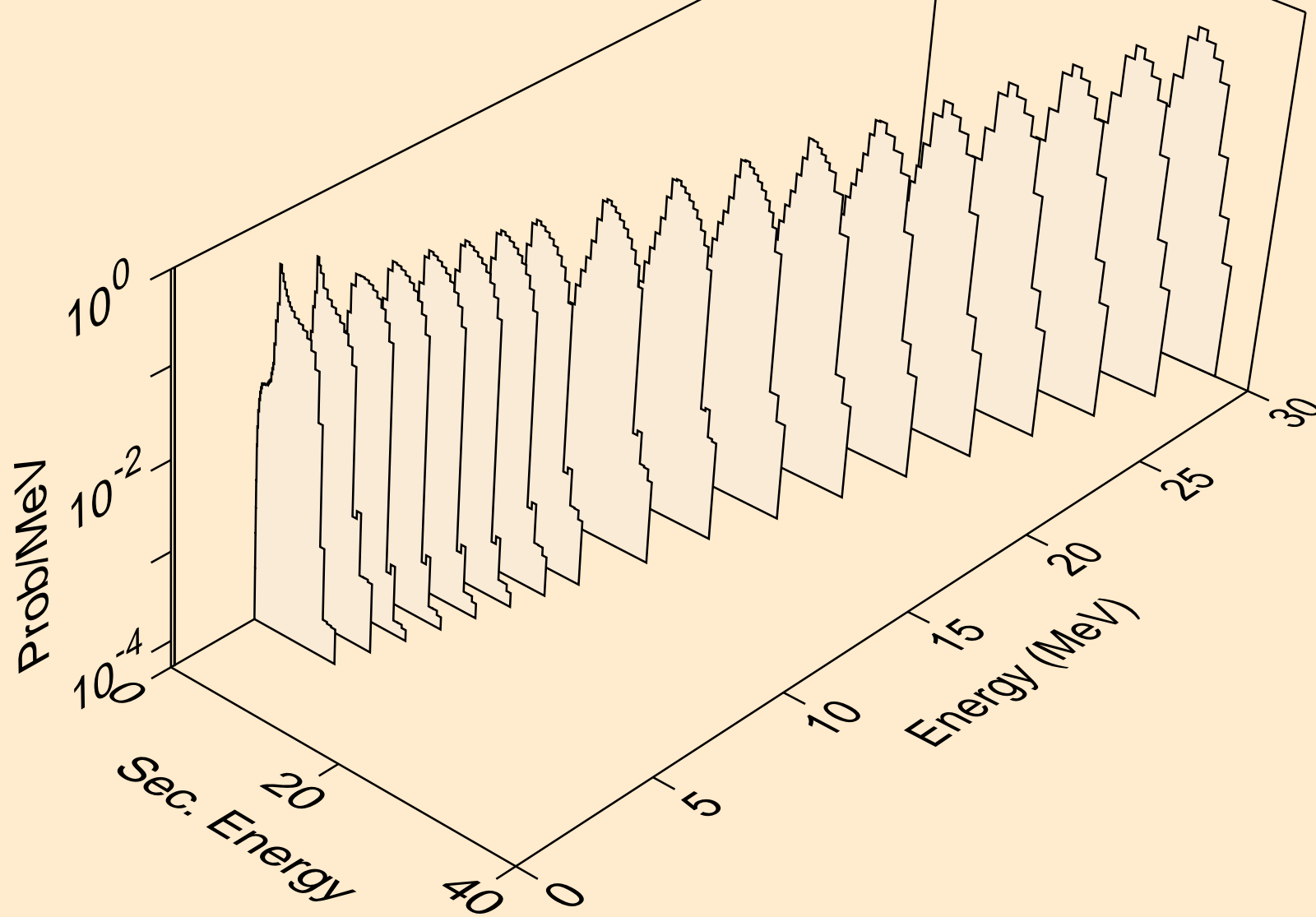

TM174 TRITON ACER TENDL-2021 LIBRARY; T=0.K  
neutrons from (t,x)

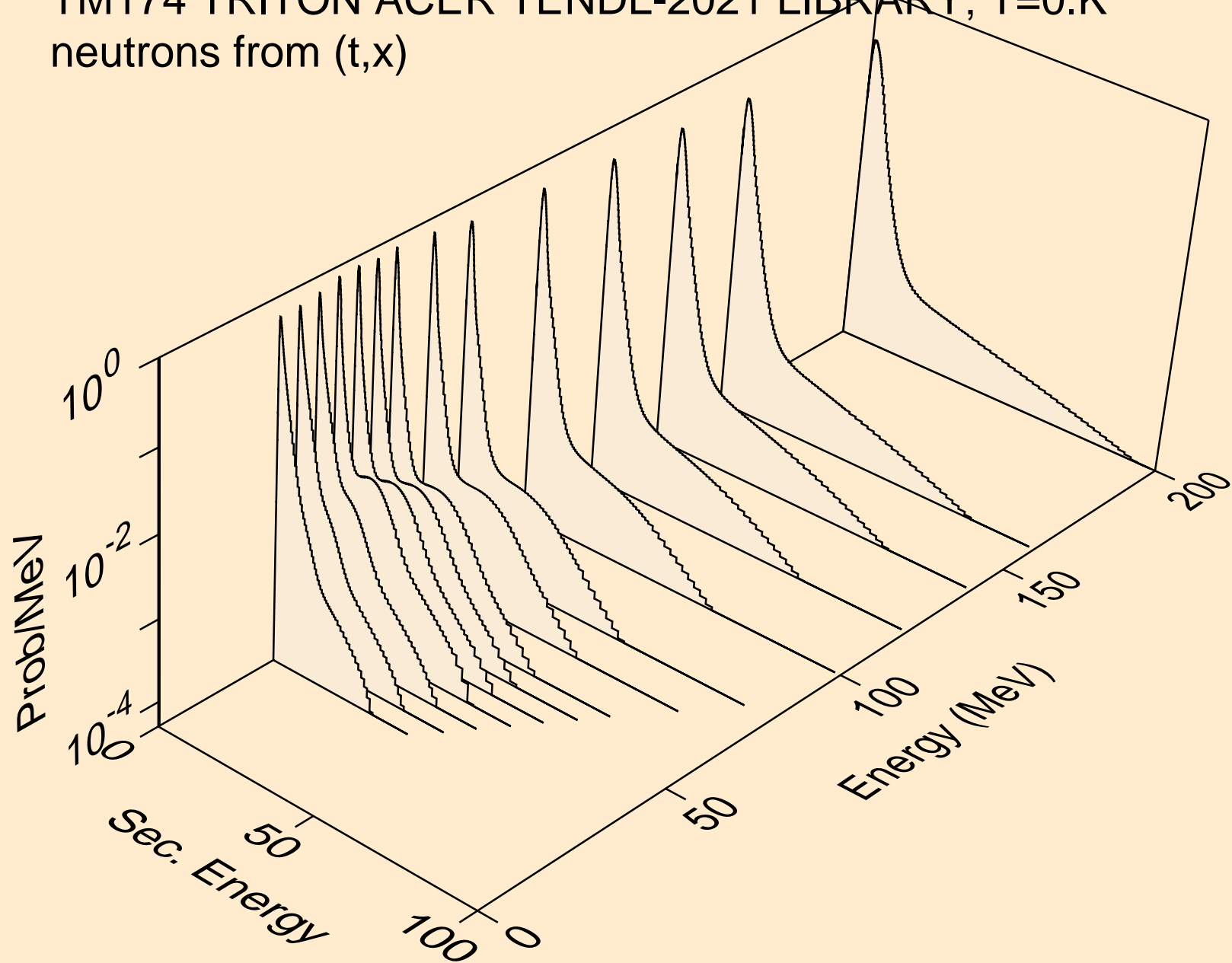

TM174 TRITON ACER TENDL-2021 LIBRARY; T=0.K  
neutrons from (t,2nd)

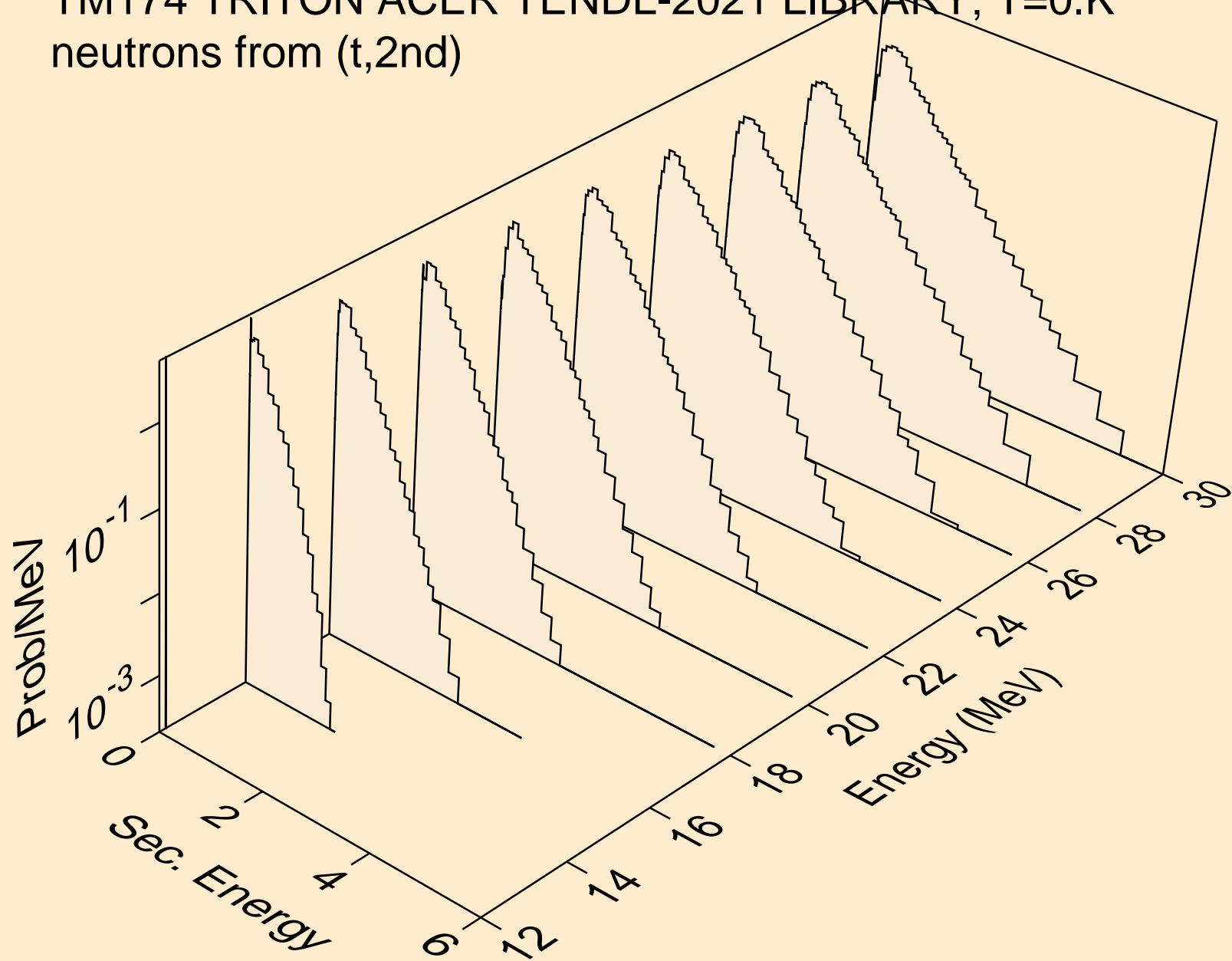

TM174 TRITON ACER TENDL-2021 LIBRARY; T=0.K  
neutrons from (t,2n)

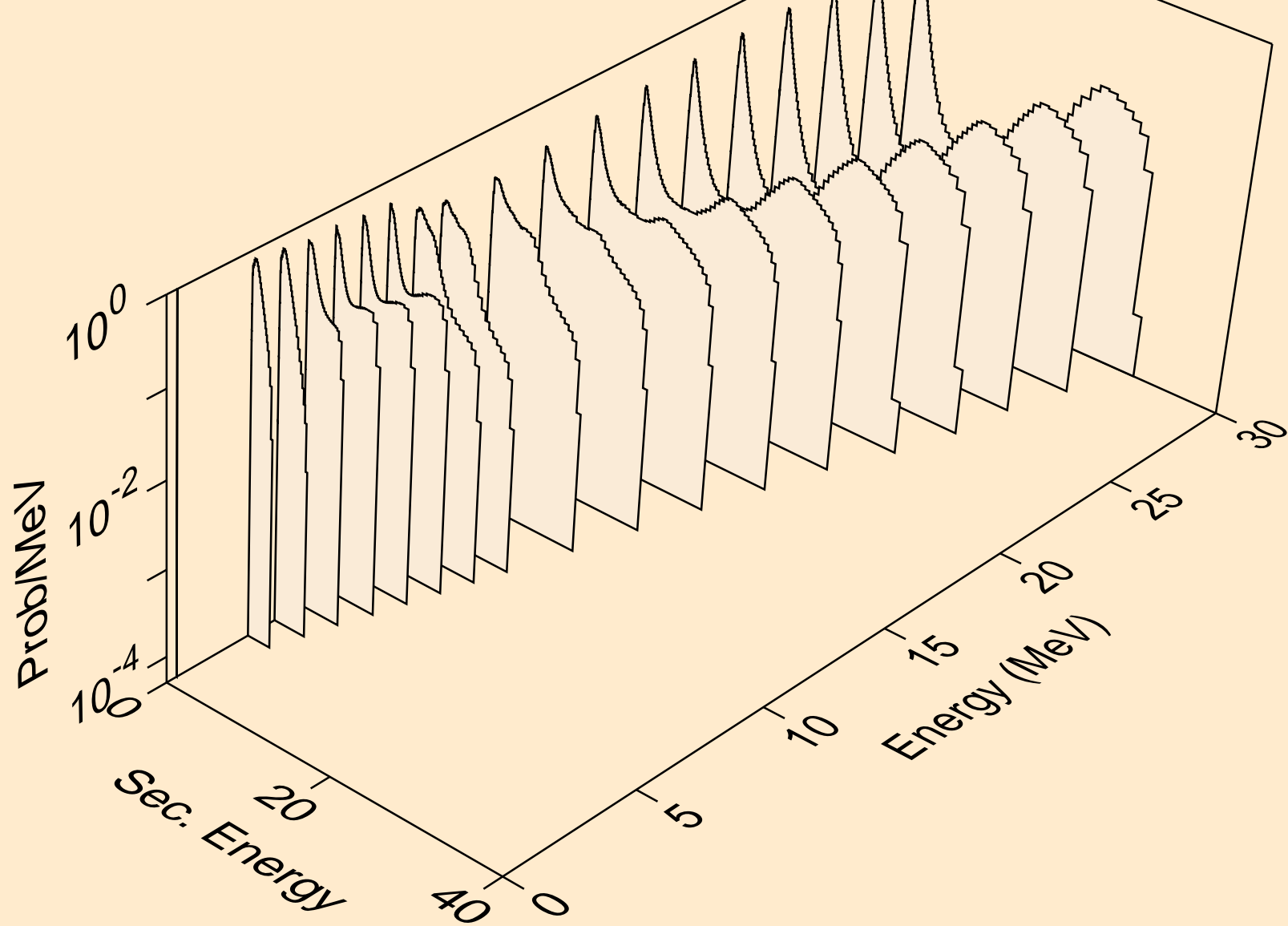



TM174 TRITON ACER TENDL-2021 LIBRARY; T=0.K  
neutrons from (t,3n)

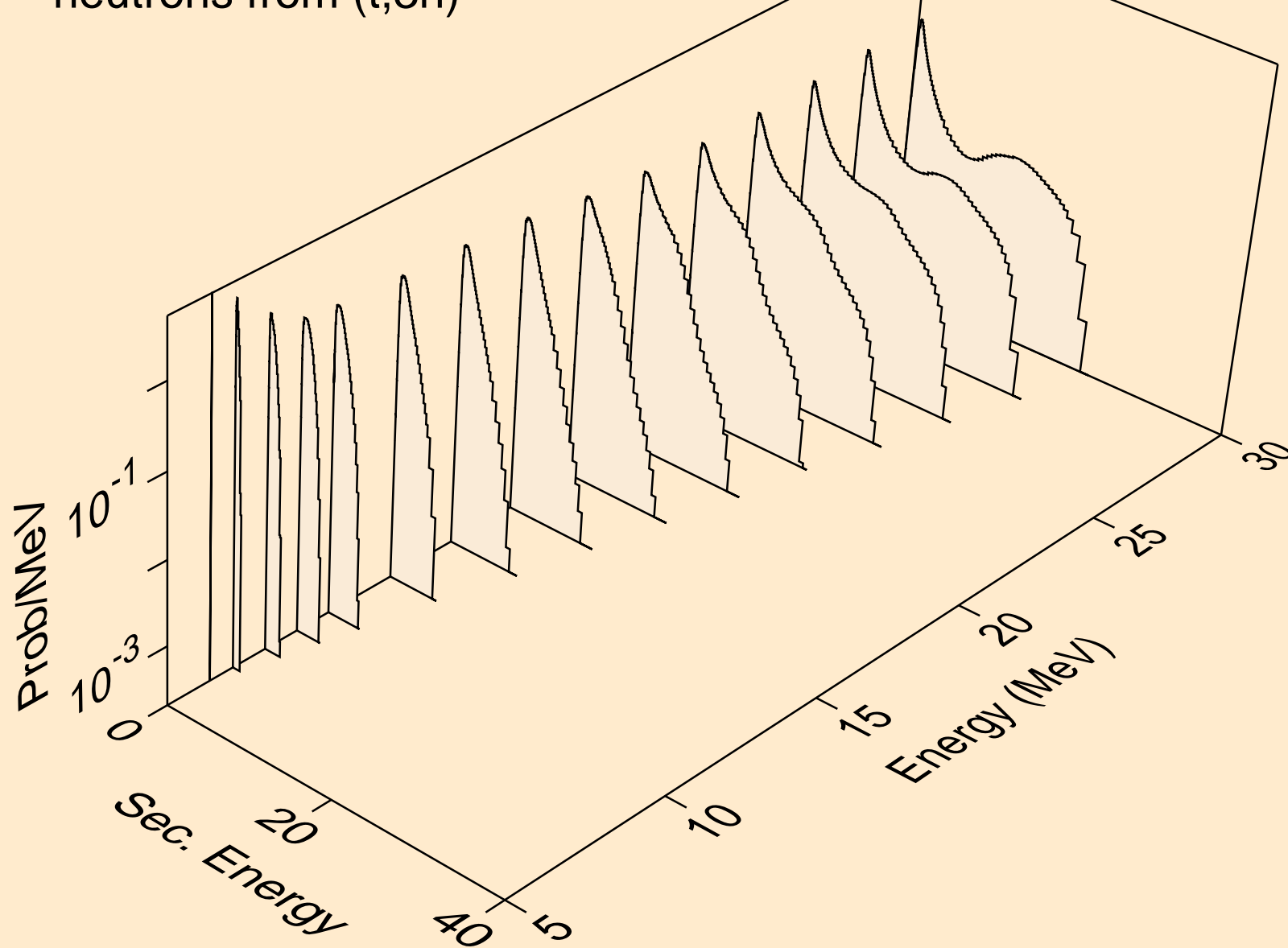

TM174 TRITON ACER TENDL-2021 LIBRARY; T=0.K  
neutrons from (t,n\*)a

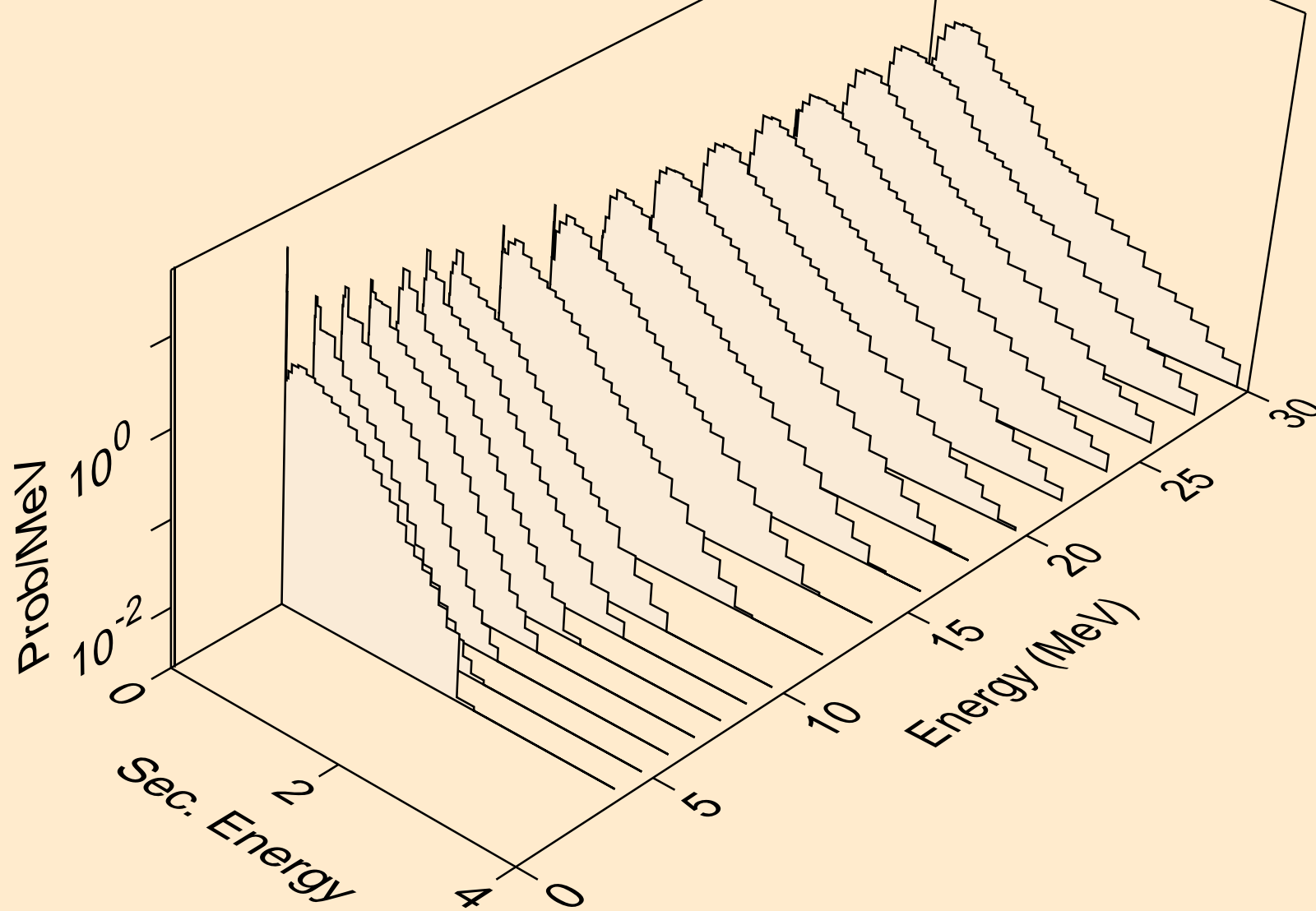

TM174 TRITON ACER TENDL-2021 LIBRARY; T=0.K  
neutrons from (t,2n)a

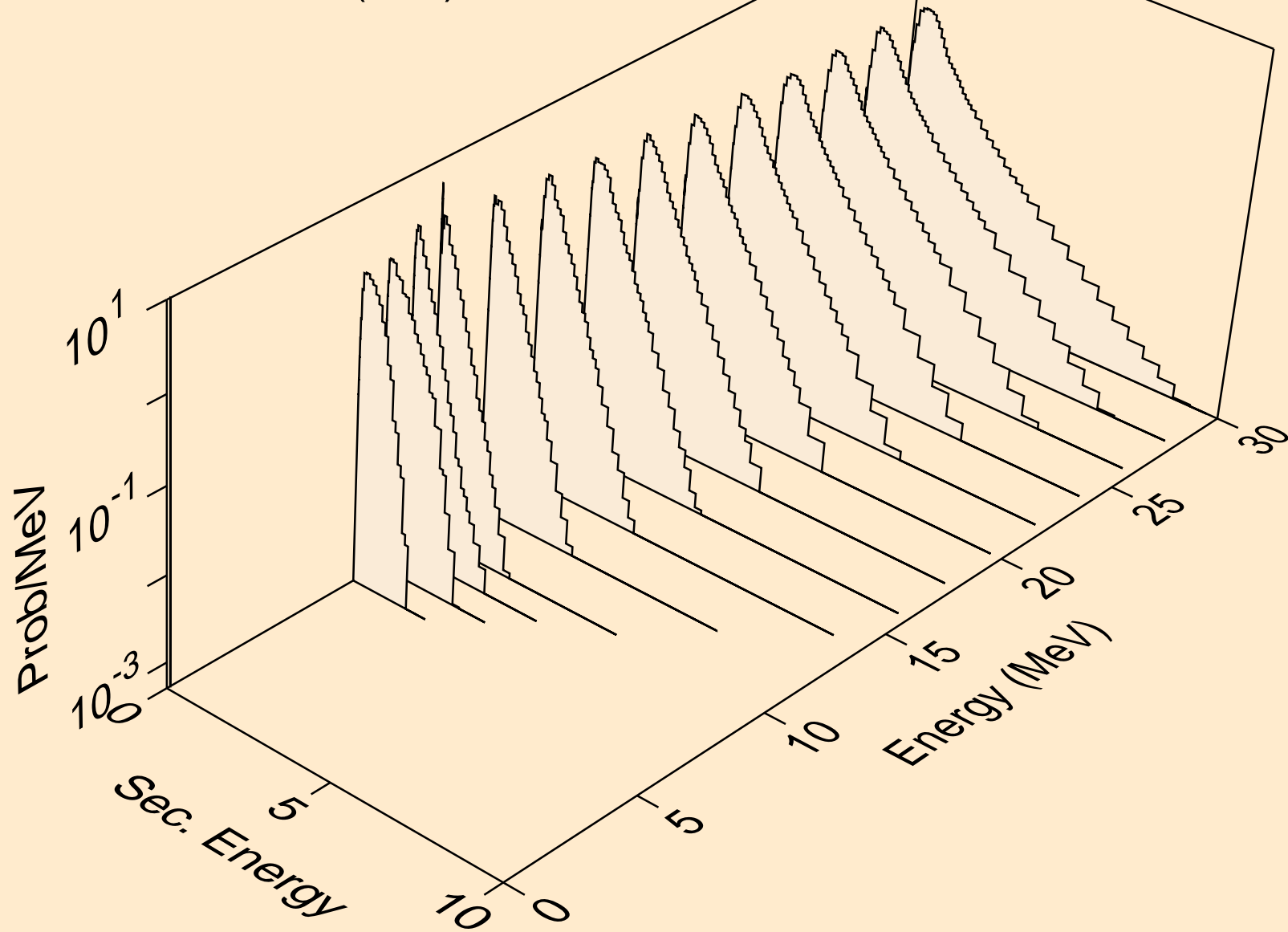

TM174 TRITON ACER TENDL-2021 LIBRARY; T=0.K  
neutrons from (t,3n)a

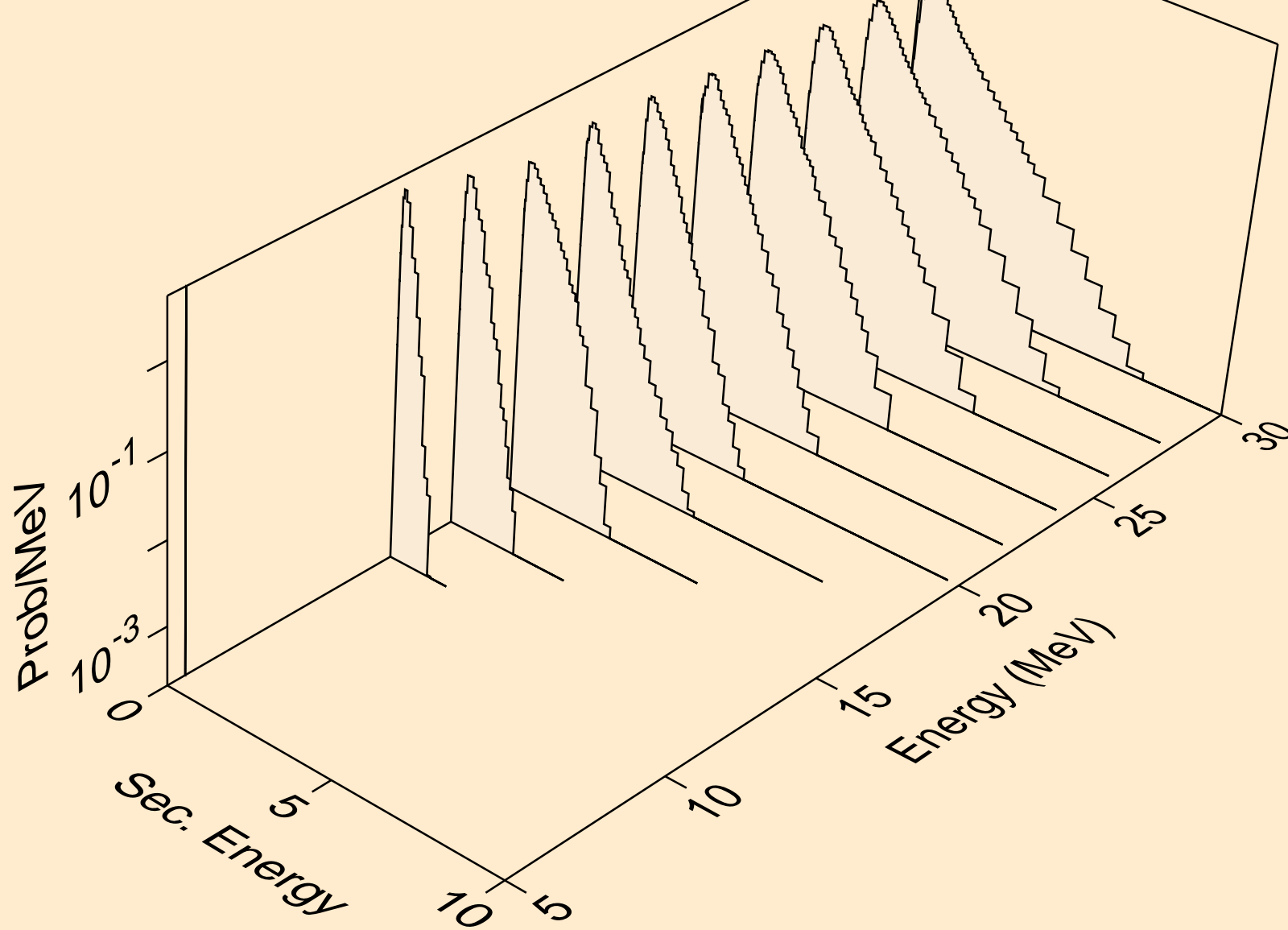

TM174 TRITON ACER TENDL-2021 LIBRARY; T=0.K  
neutrons from (t,n\*)p

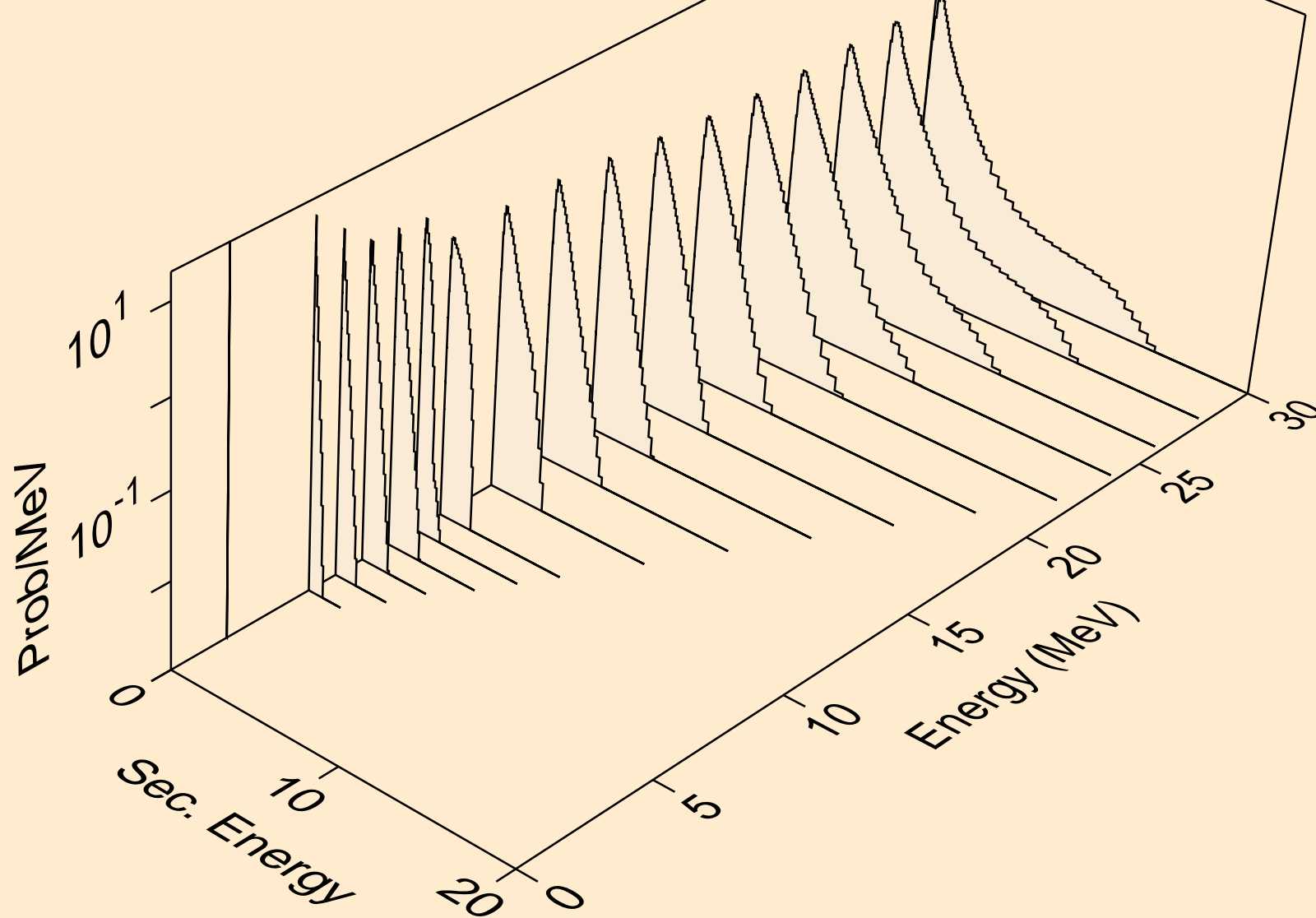

TM174 TRITON ACER TENDL-2021 LIBRARY; T=0.K  
neutrons from (t,n\*)2a

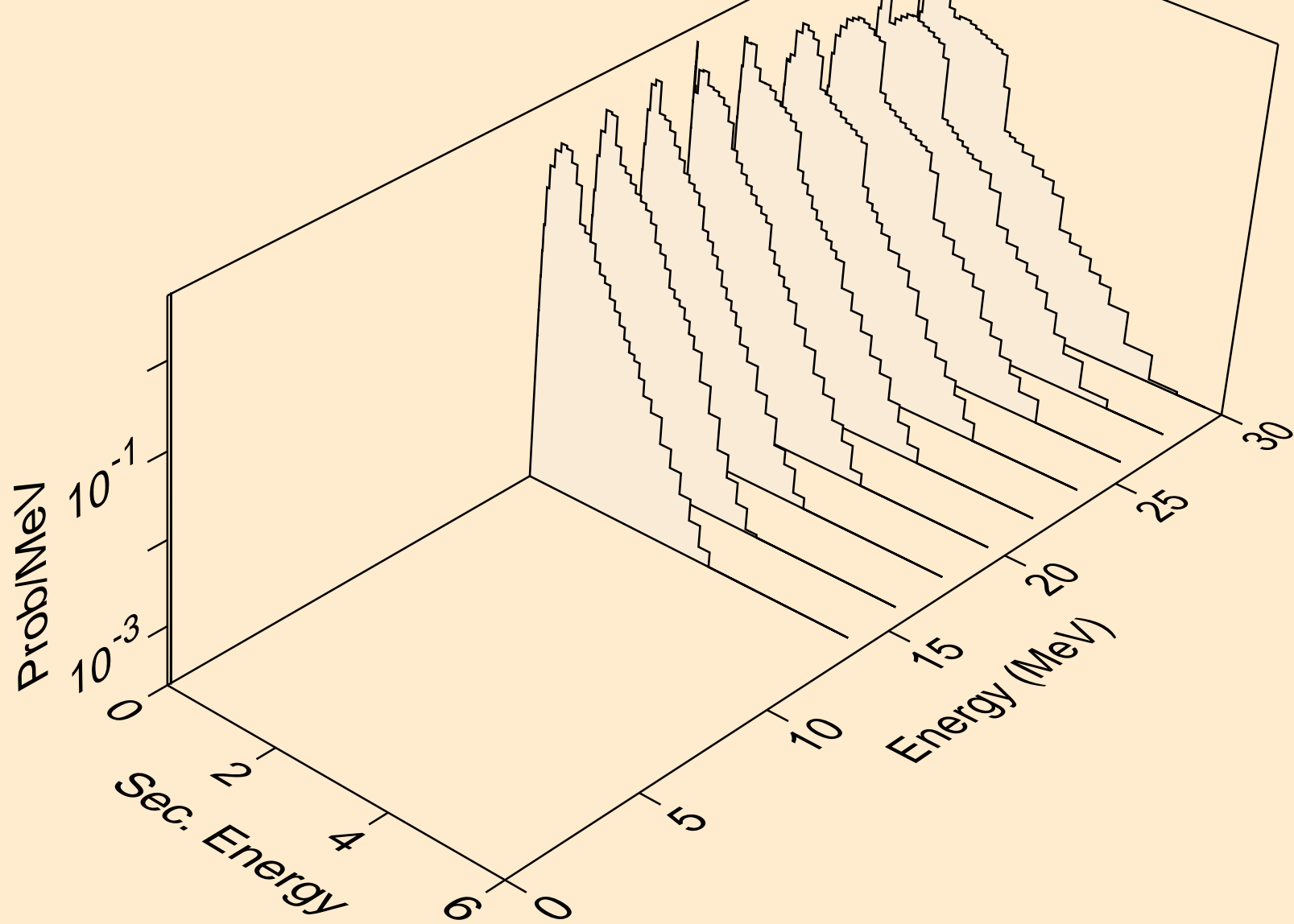

TM174 TRITON ACER TENDL-2021 LIBRARY; T=0.K  
neutrons from (t,n\*)d

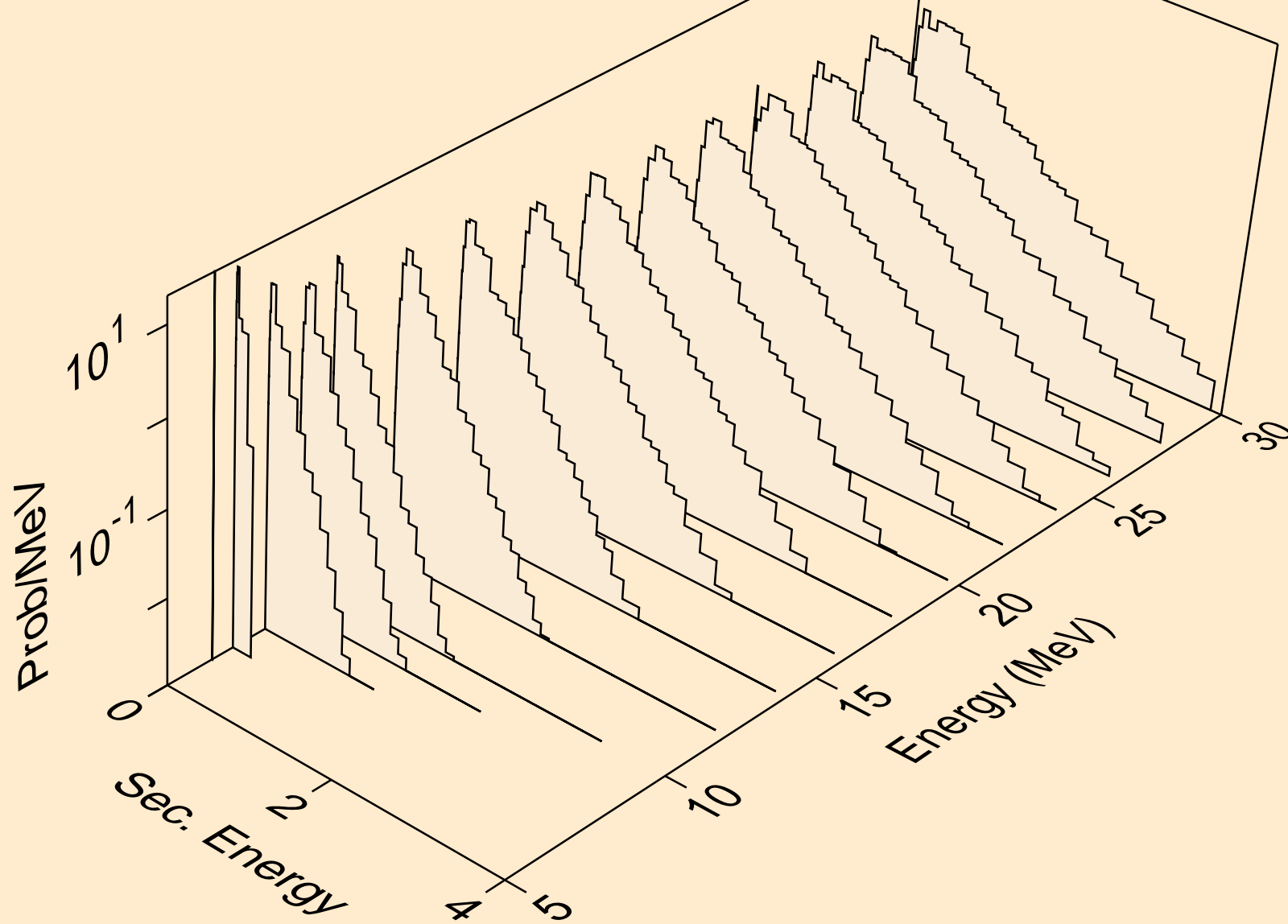

TM174 TRITON ACER TENDL-2021 LIBRARY; T=0.K  
neutrons from (t,n\*)t

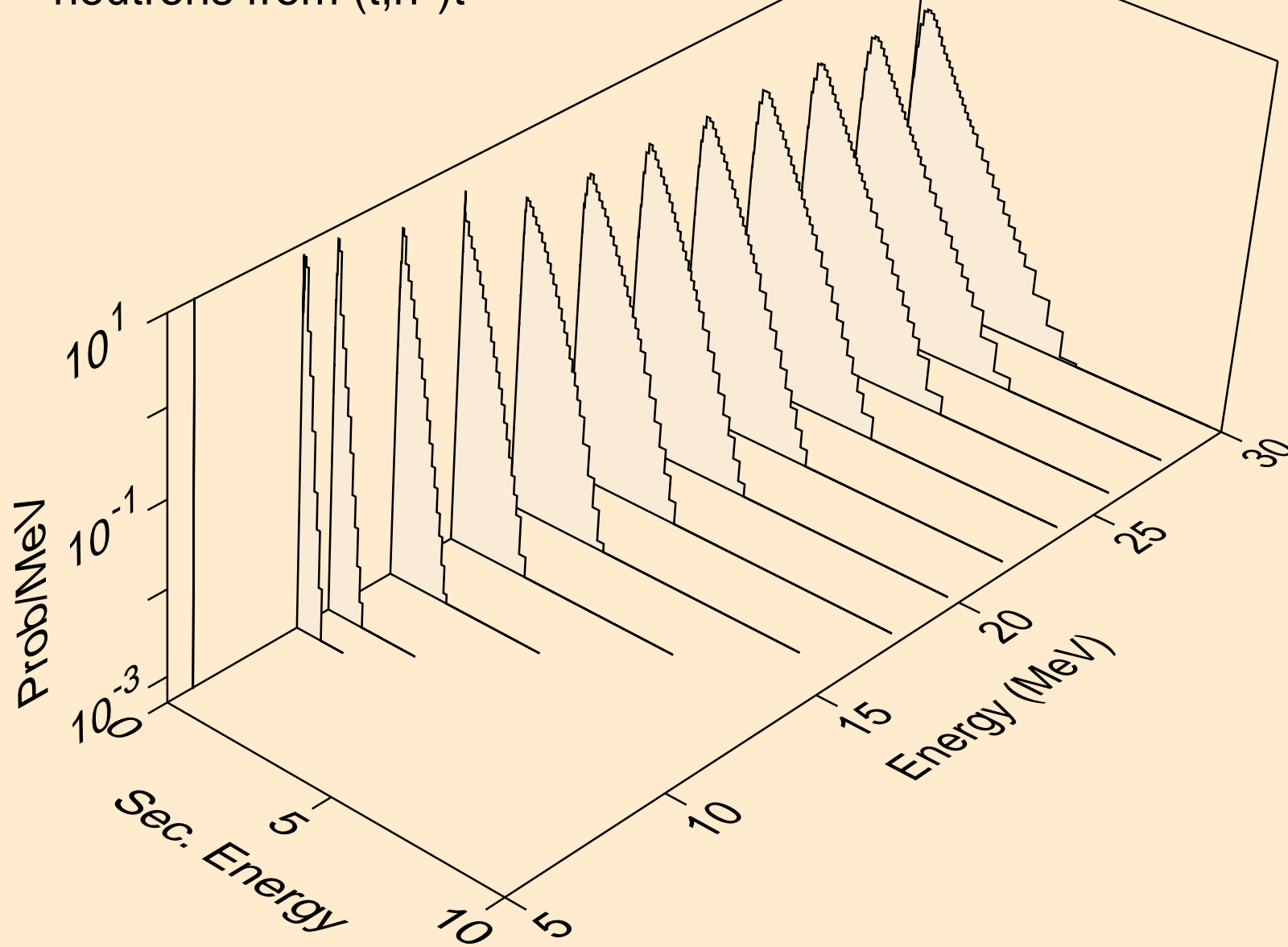



TM174 TRITON ACER TENDL-2021 LIBRARY; T=0.K  
neutrons from (t,n\*)he3

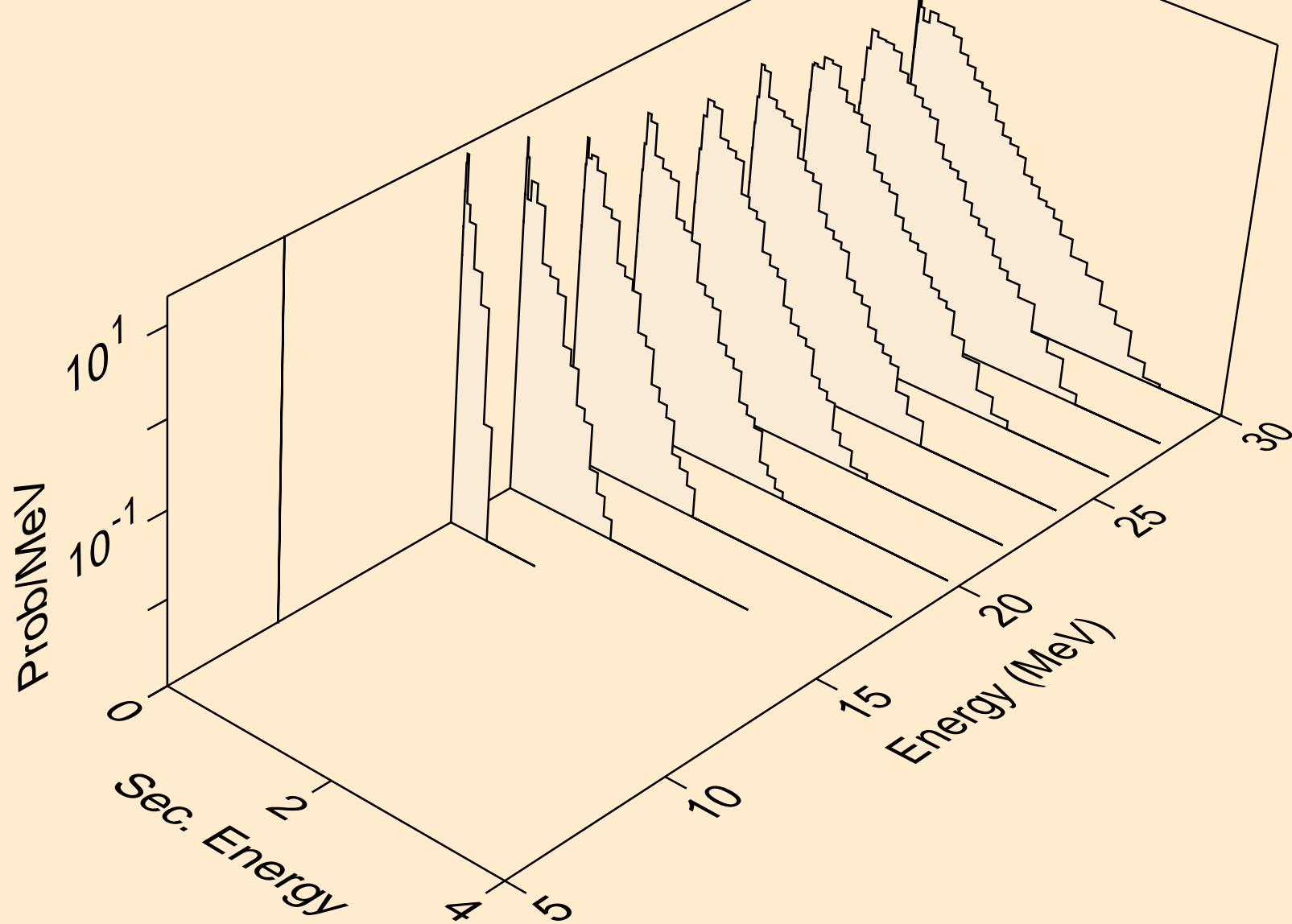

TM174 TRITON ACER TENDL-2021 LIBRARY; T=0.K  
neutrons from (t,4n)

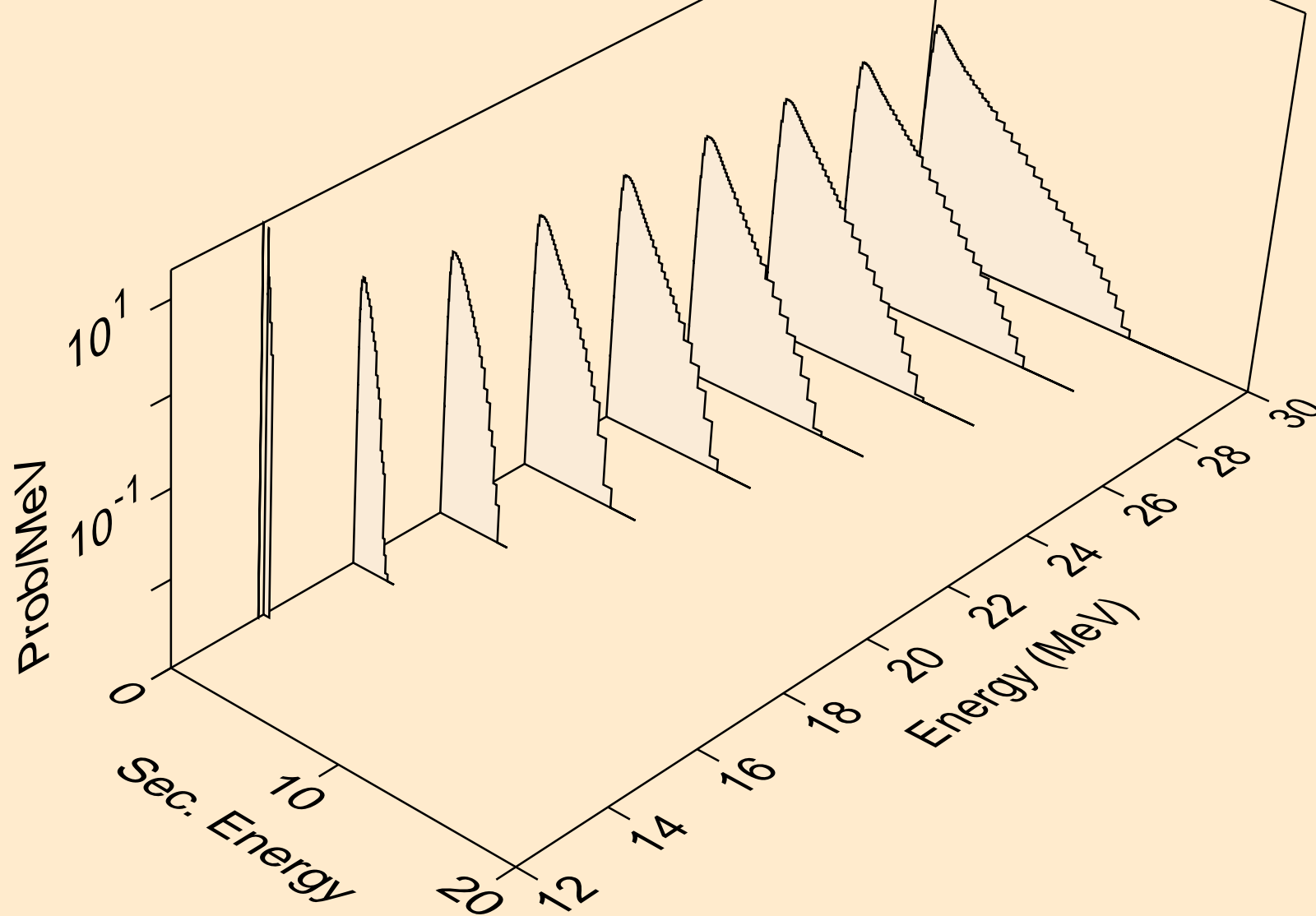

TM174 TRITON ACER TENDL-2021 LIBRARY; T=0.K  
neutrons from (t,2np)

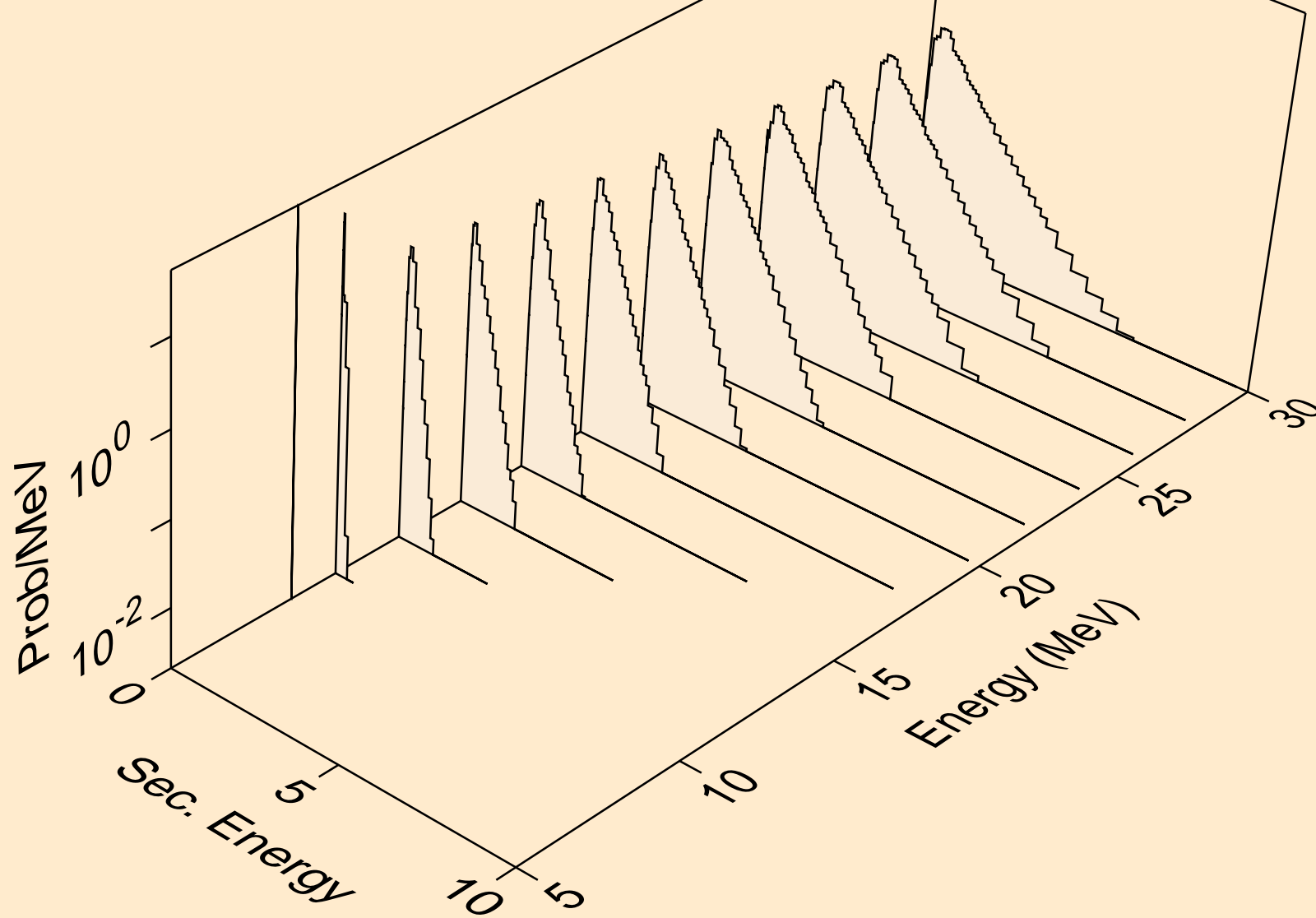

TM174 TRITON ACER TENDL-2021 LIBRARY; T=0.K  
neutrons from (t,3np)

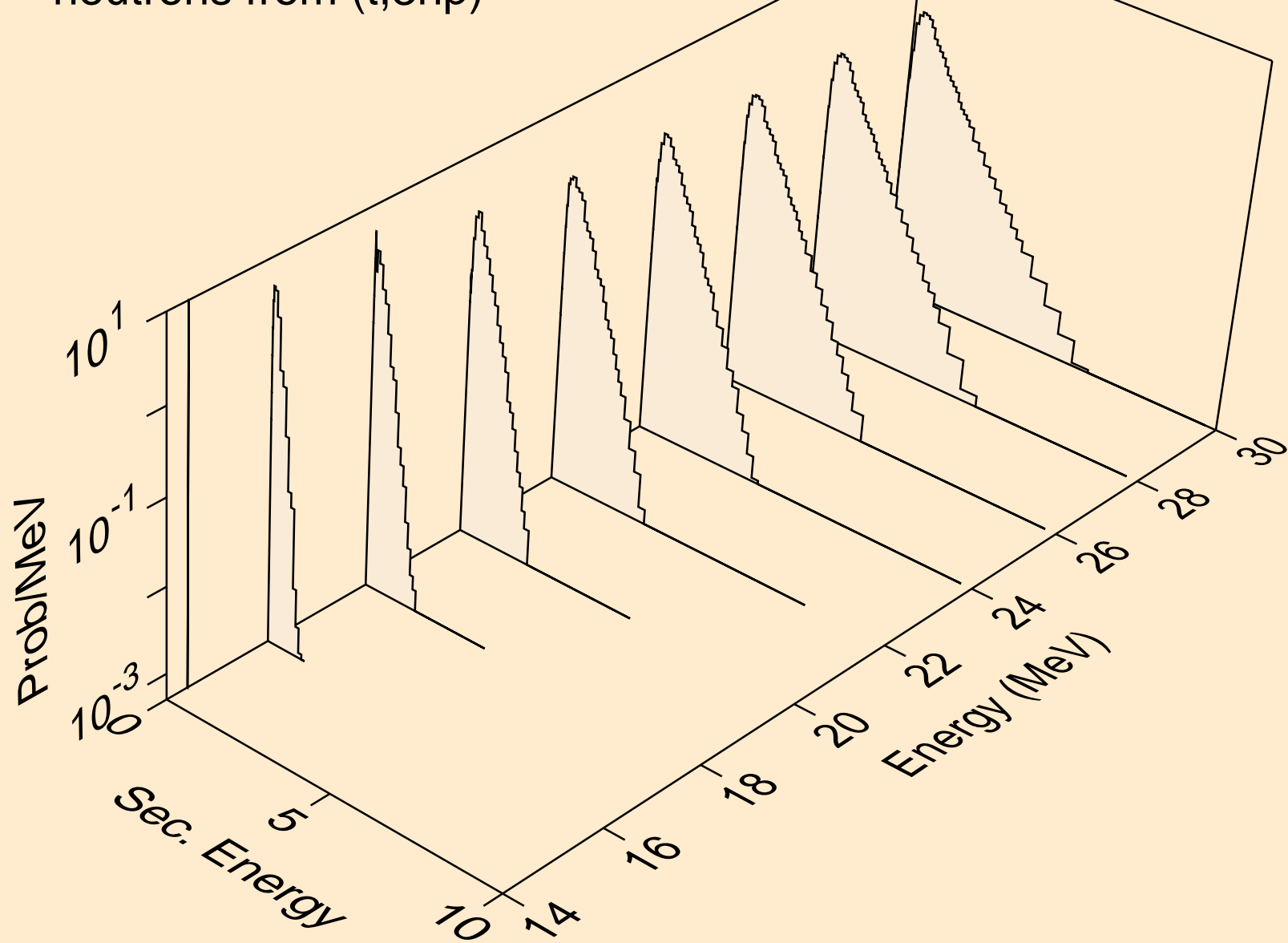

TM174 TRITON ACER TENDL-2021 LIBRARY; T=0.K  
neutrons from (t,2np)

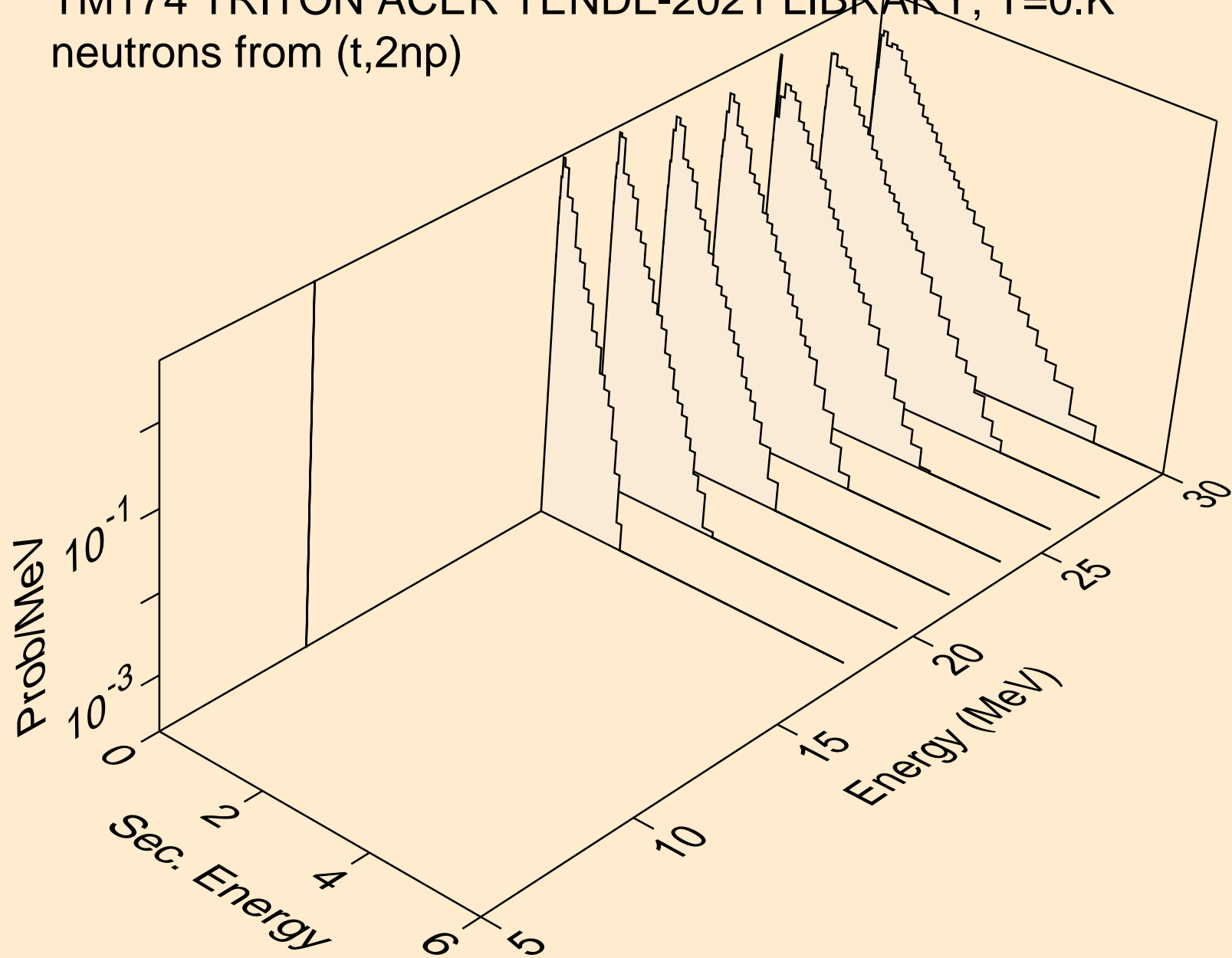

TM174 TRITON ACER TENDL-2021 LIBRARY; T=0.K  
neutrons from (t,npa)

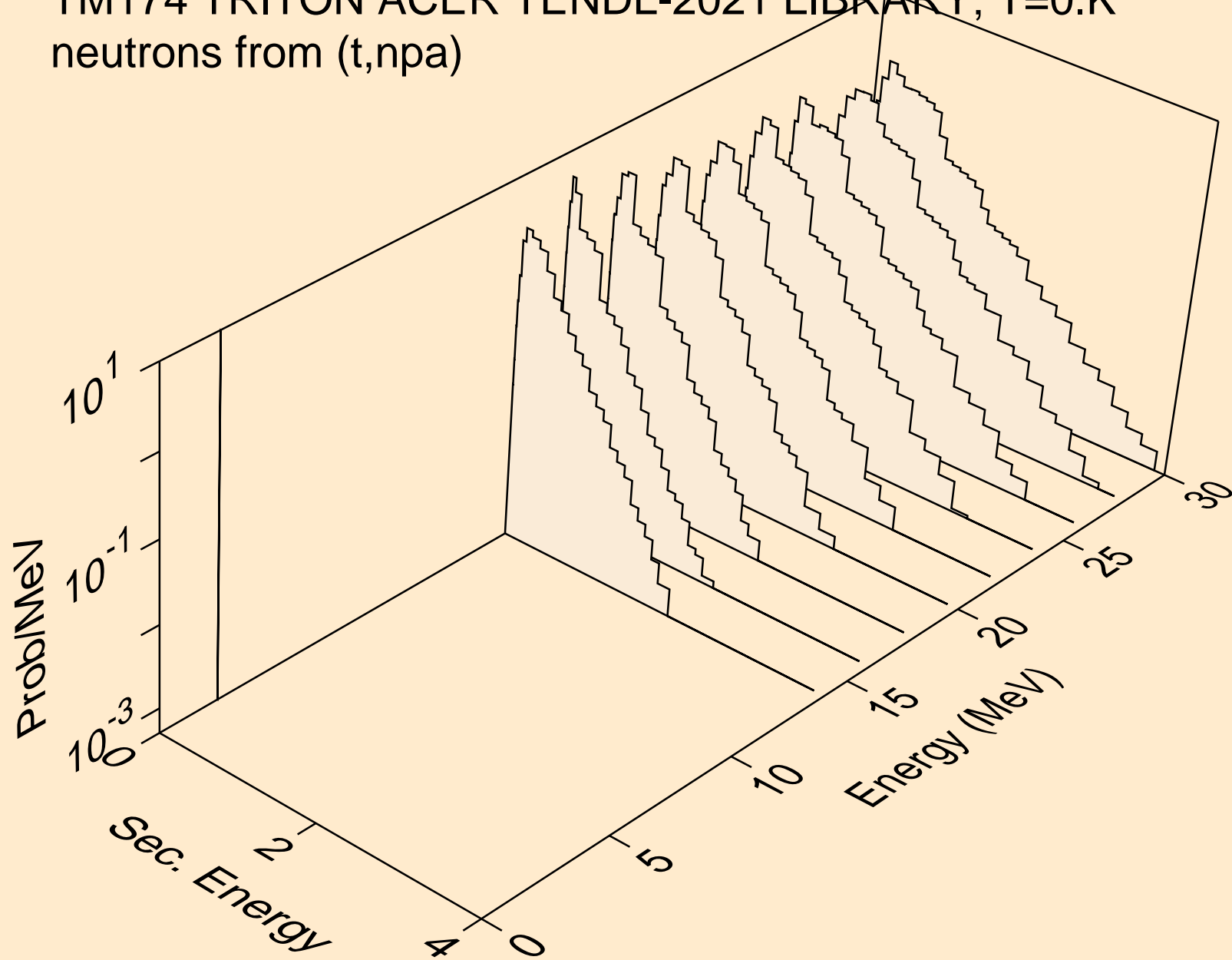

TM174 TRITON ACER TENDL-2021 LIBRARY; T=0.K  
protons from (t,x)

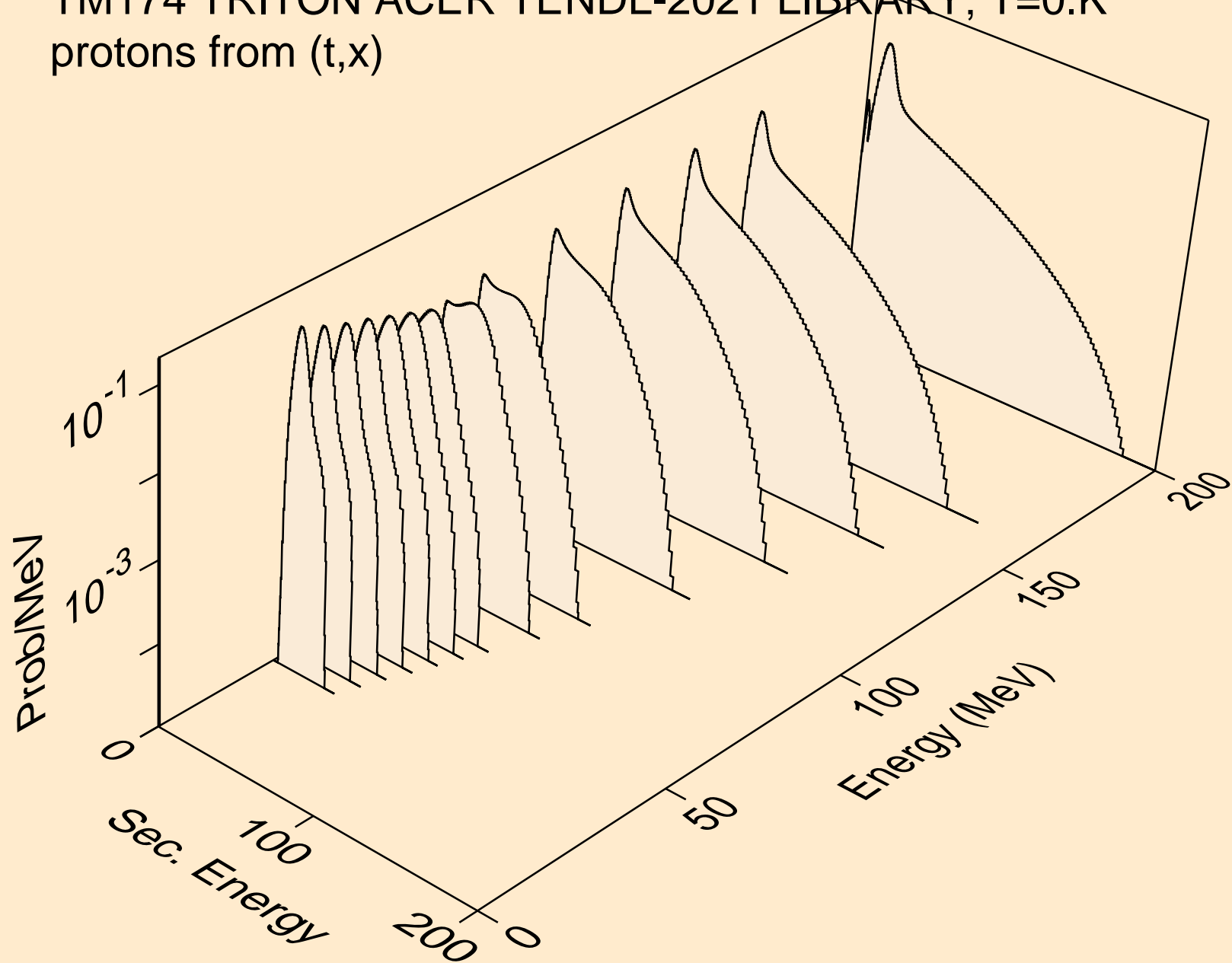

TM174 TRITON ACER TENDL-2021 LIBRARY; T=0.K  
protons from (t,n\*)p

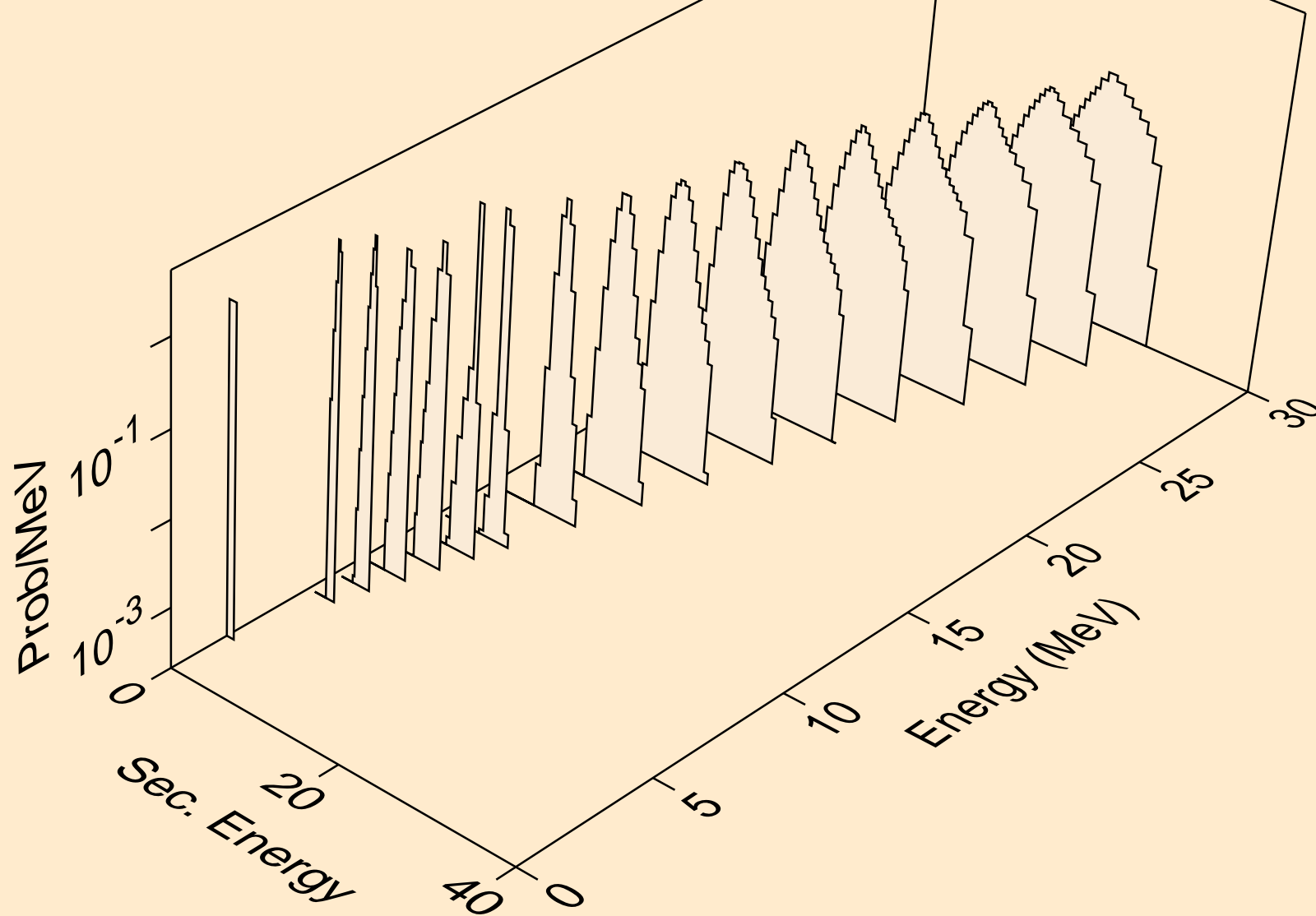



TM174 TRITON ACER TENDL-2021 LIBRARY; T=0.K  
protons from (t,2np)

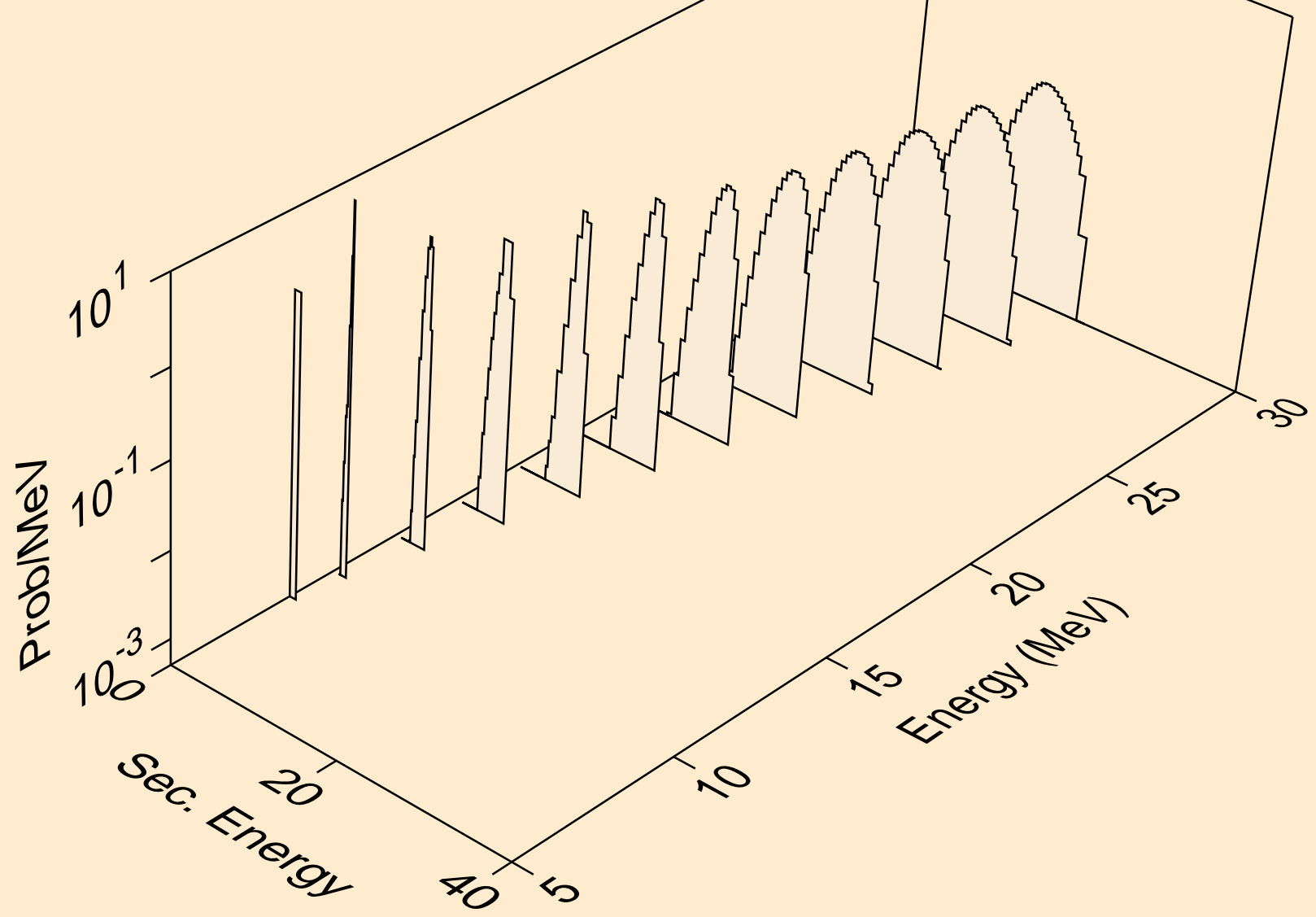

TM174 TRITON ACER TENDL-2021 LIBRARY; T=0.K  
protons from (t,3np)

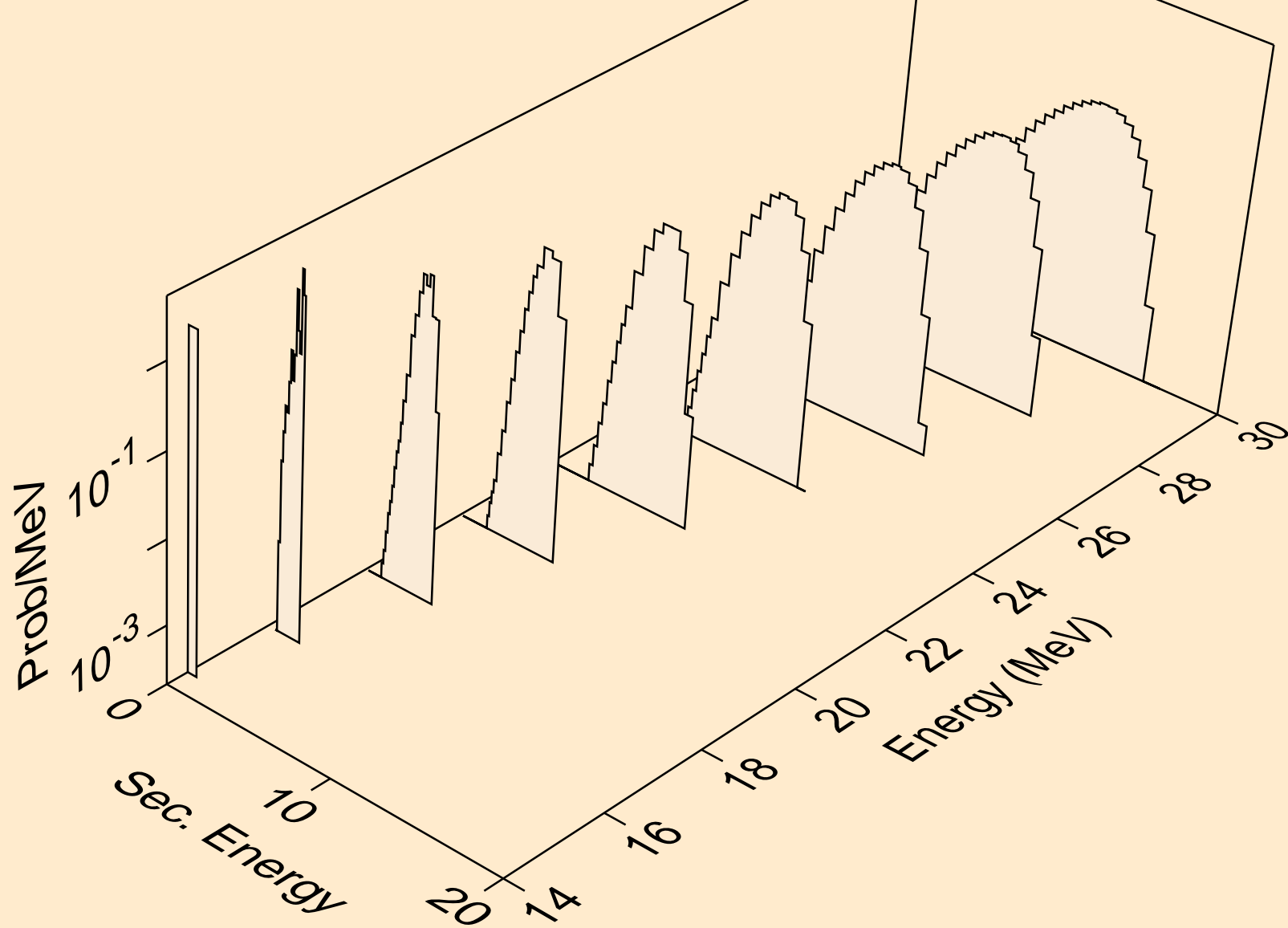

TM174 TRITON ACER TENDL-2021 LIBRARY; T=0.K  
protons from (t,2np)

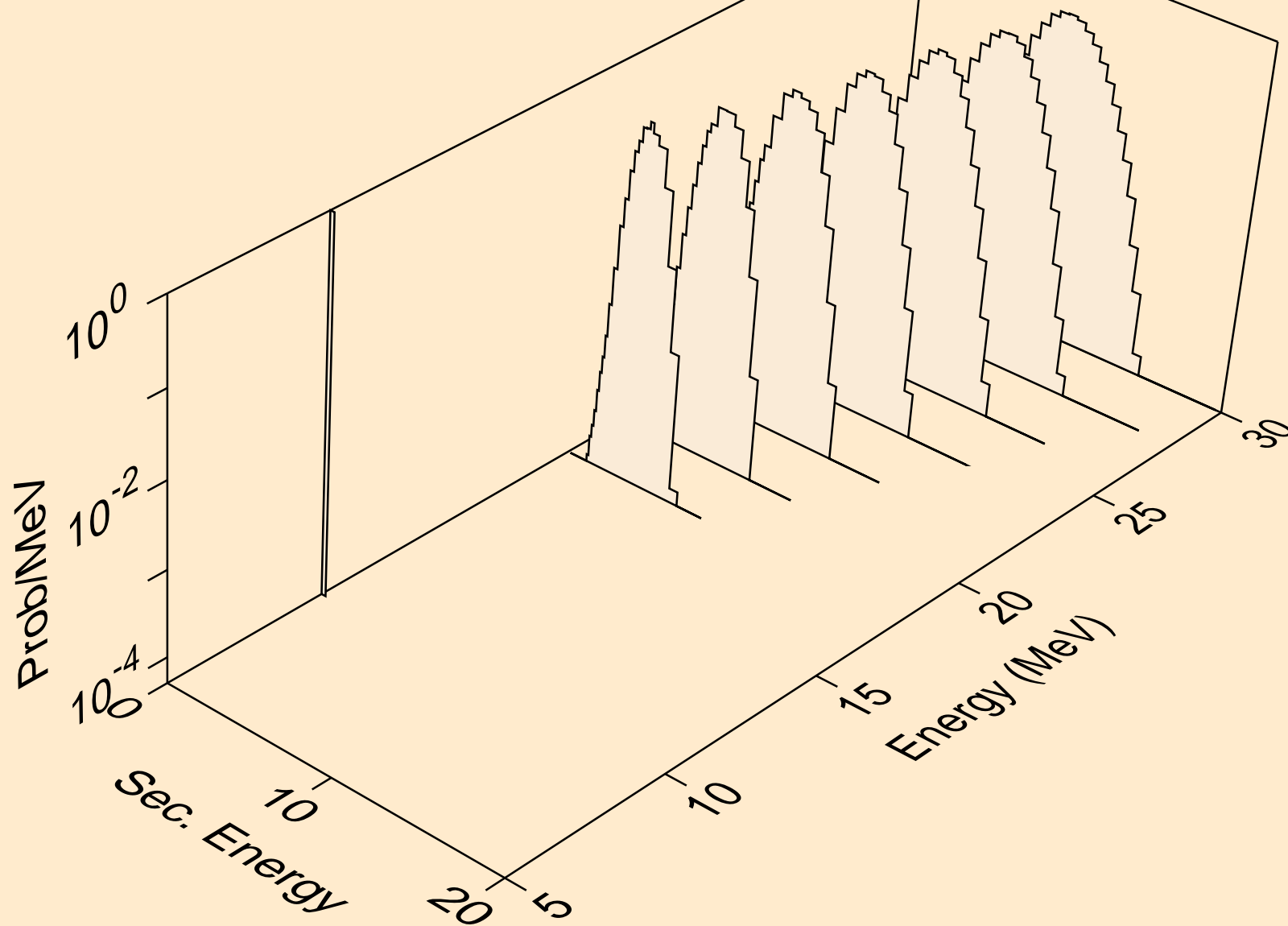

TM174 TRITON ACER TENDL-2021 LIBRARY; T=0.K  
protons from (t,npa)

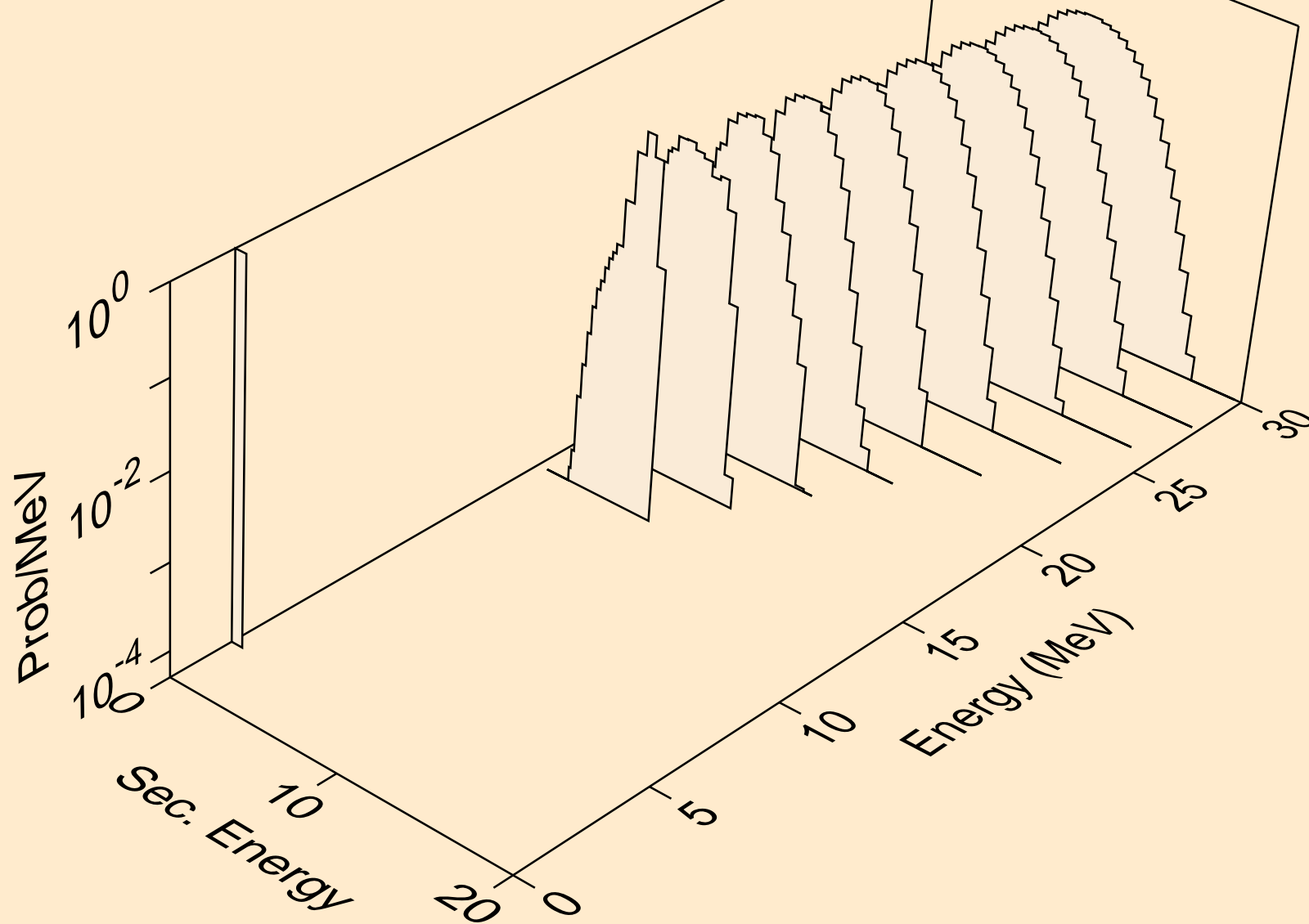

TM174 TRITON ACER TENDL-2021 LIBRARY; T=0.K  
protons from (t,p)

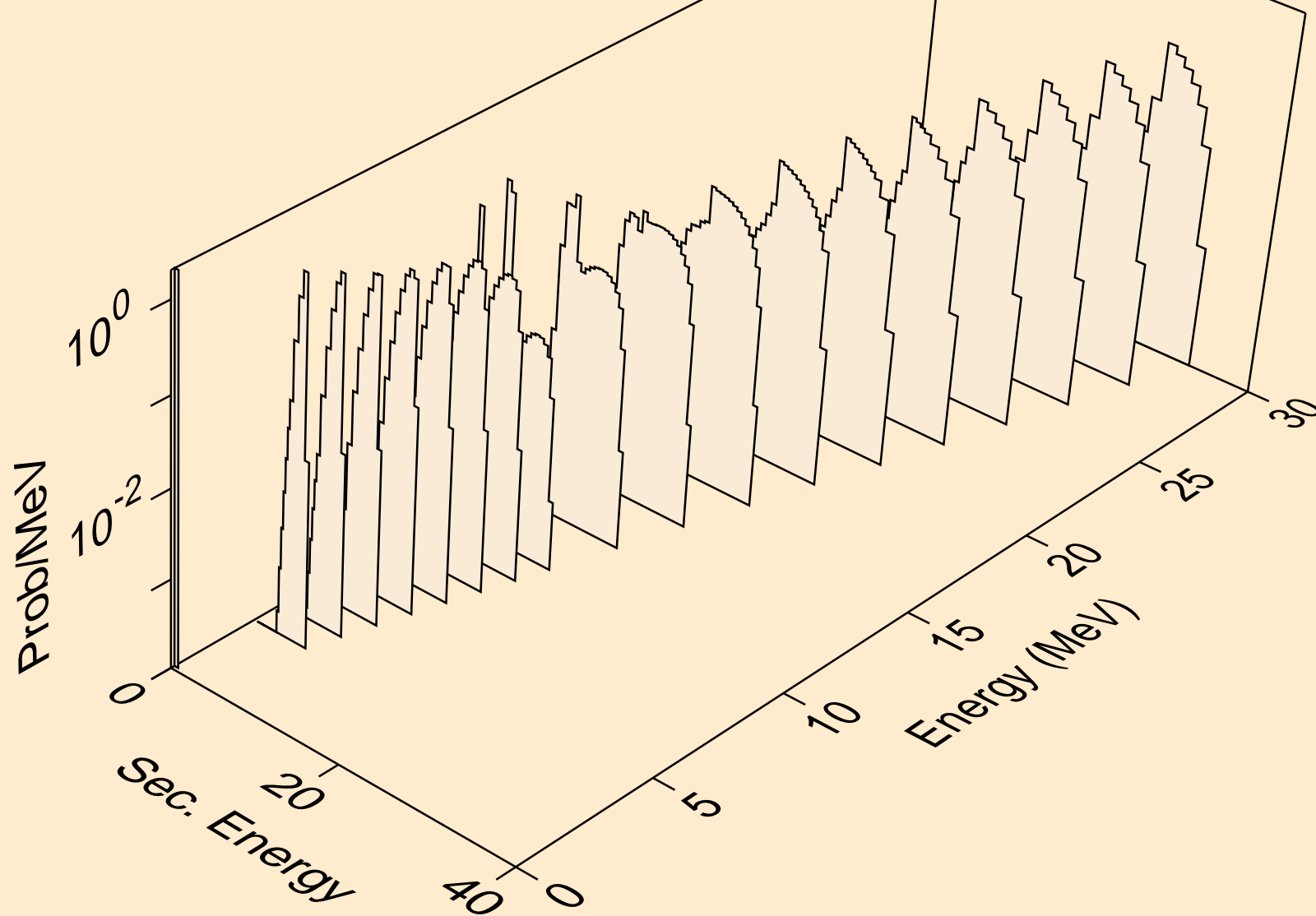

TM174 TRITON ACER TENDL-2021 LIBRARY; T=0.K  
protons from (t,2p)

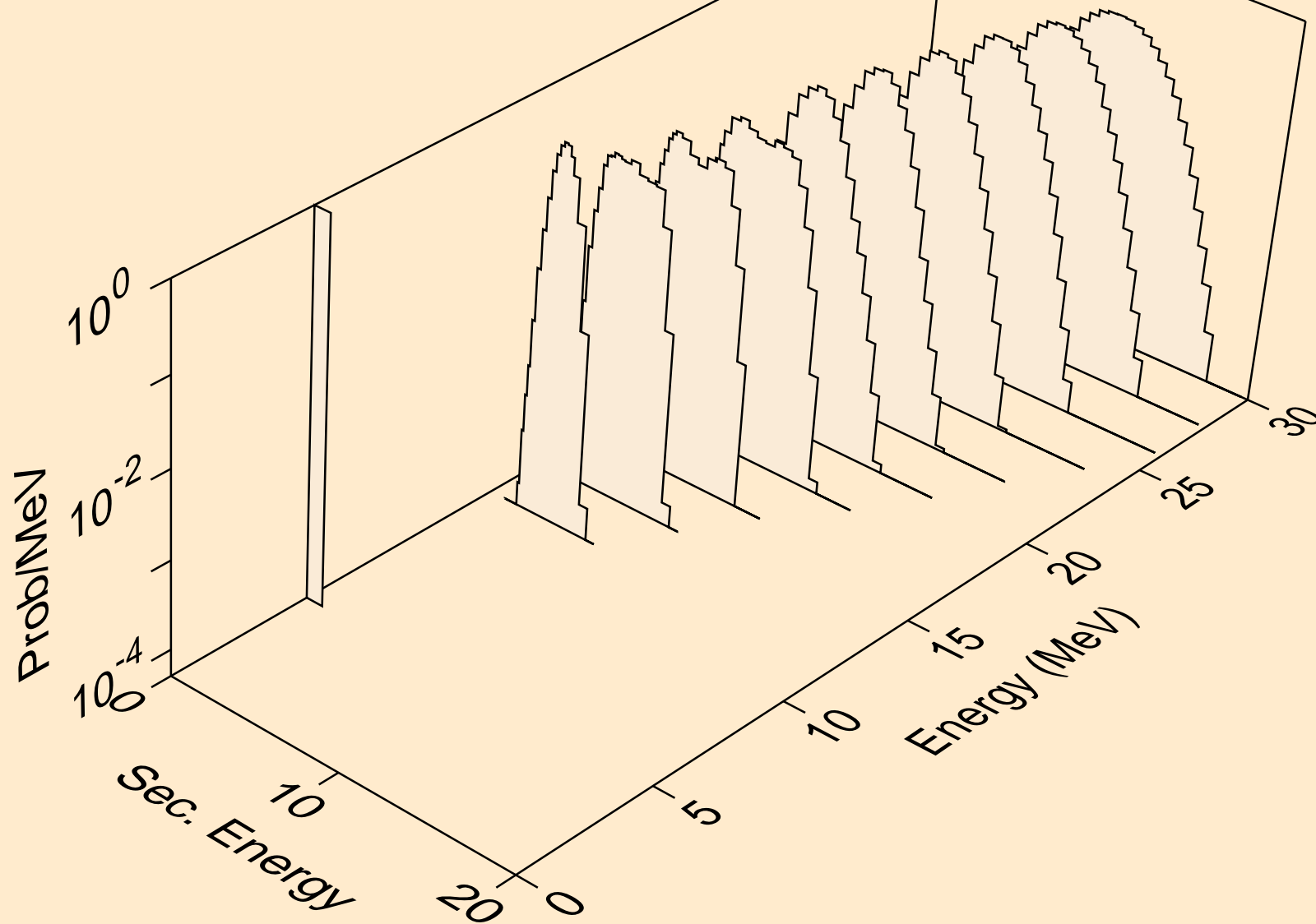

TM174 TRITON ACER TENDL-2021 LIBRARY; T=0.K  
protons from (t,pa)

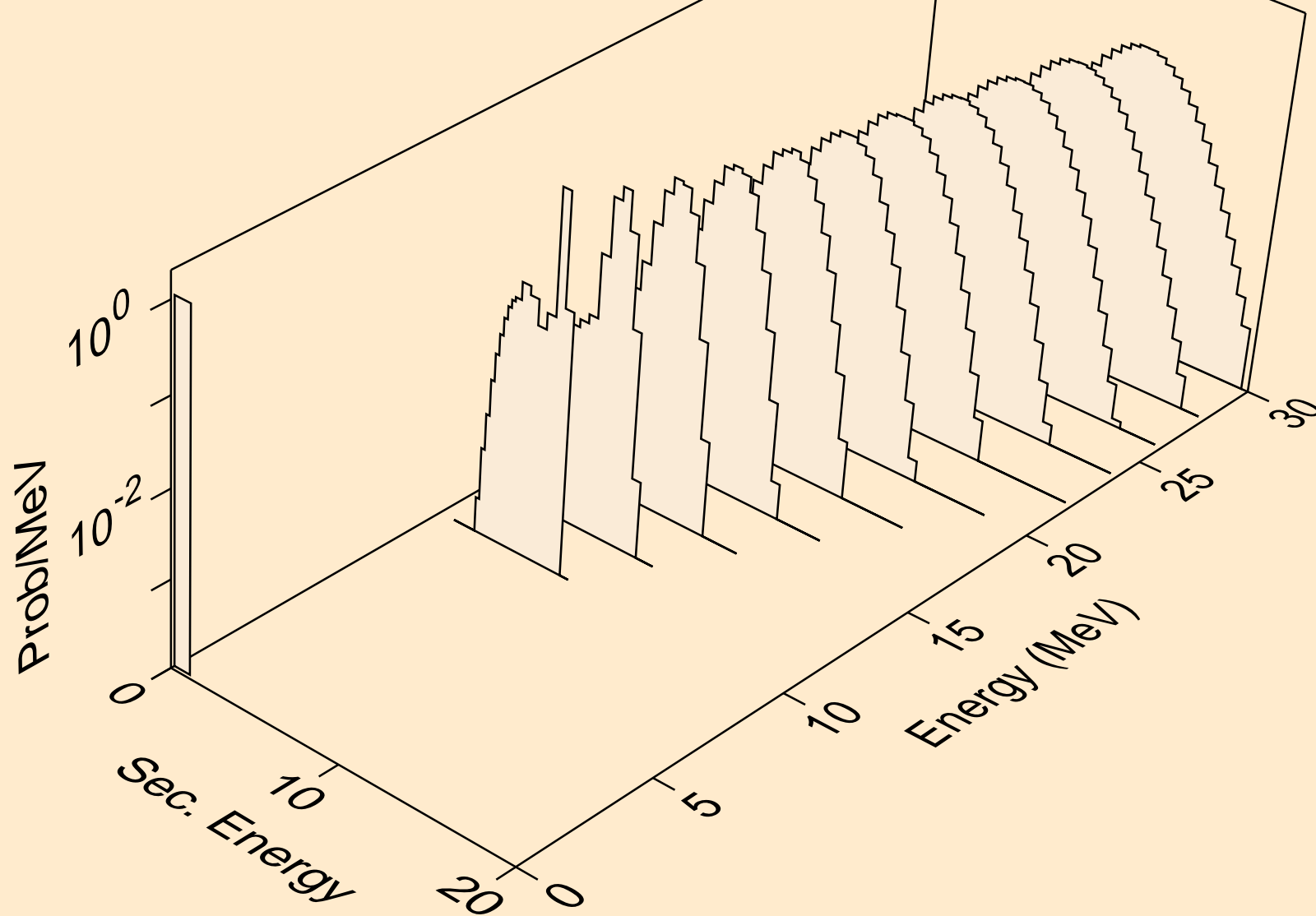

TM174 TRITON ACER TENDL-2021 LIBRARY; T=0.K  
protons from (t,pd)

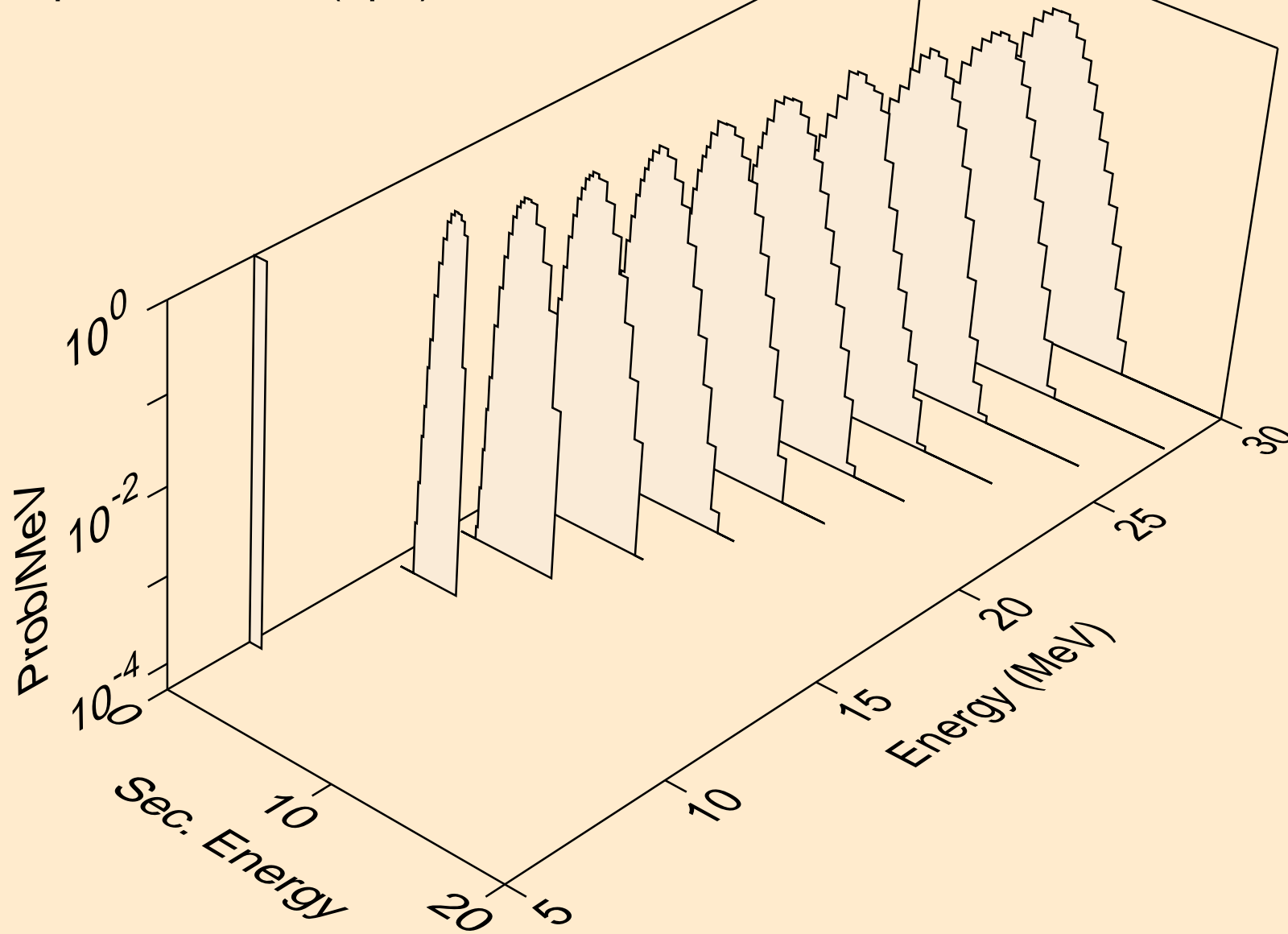



TM174 TRITON ACER TENDL-2021 LIBRARY; T=0.K  
protons from (t,pt)

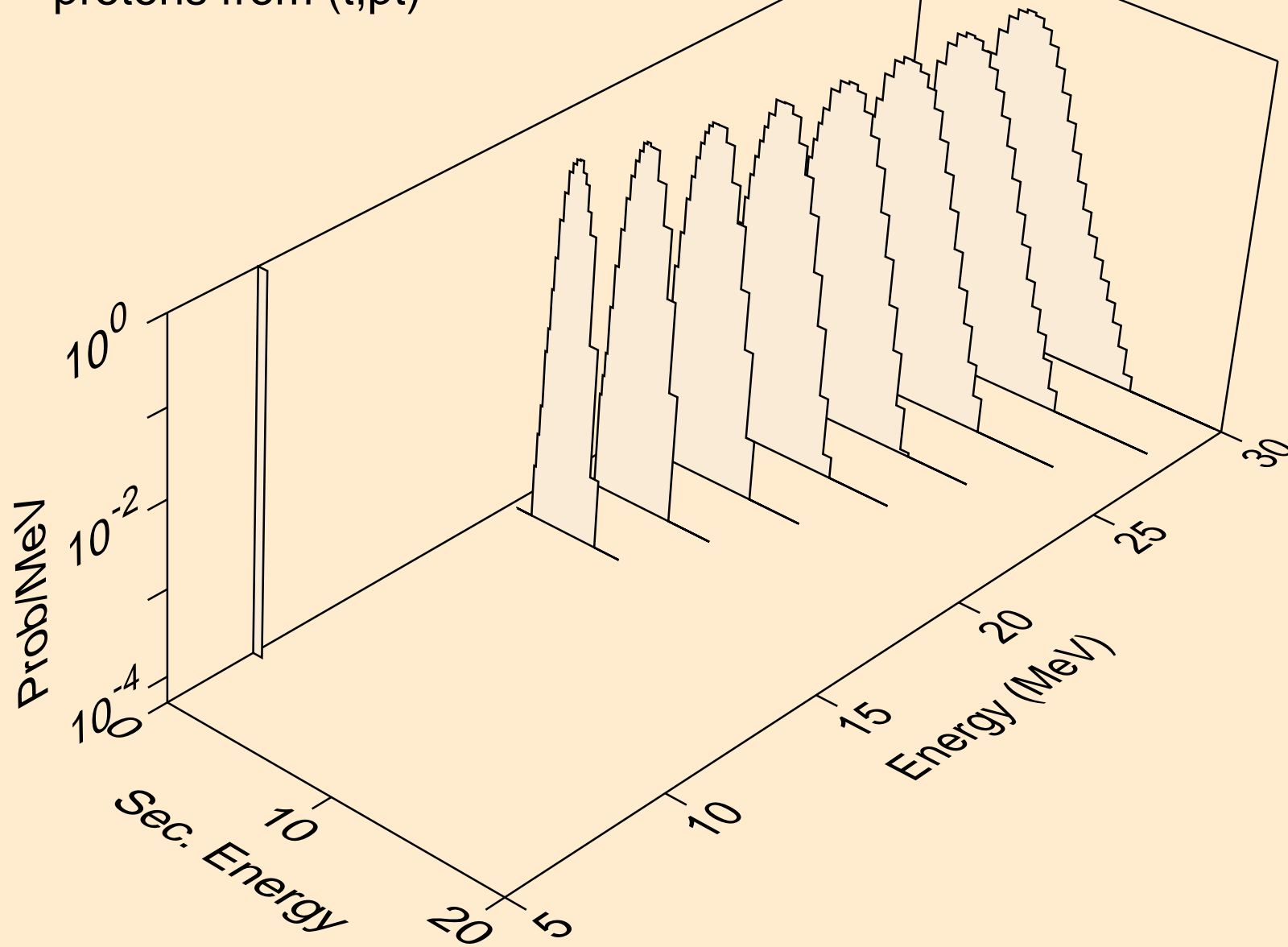

TM174 TRITON ACER TENDL-2021 LIBRARY; T=0.K  
deuterons from (t,x)

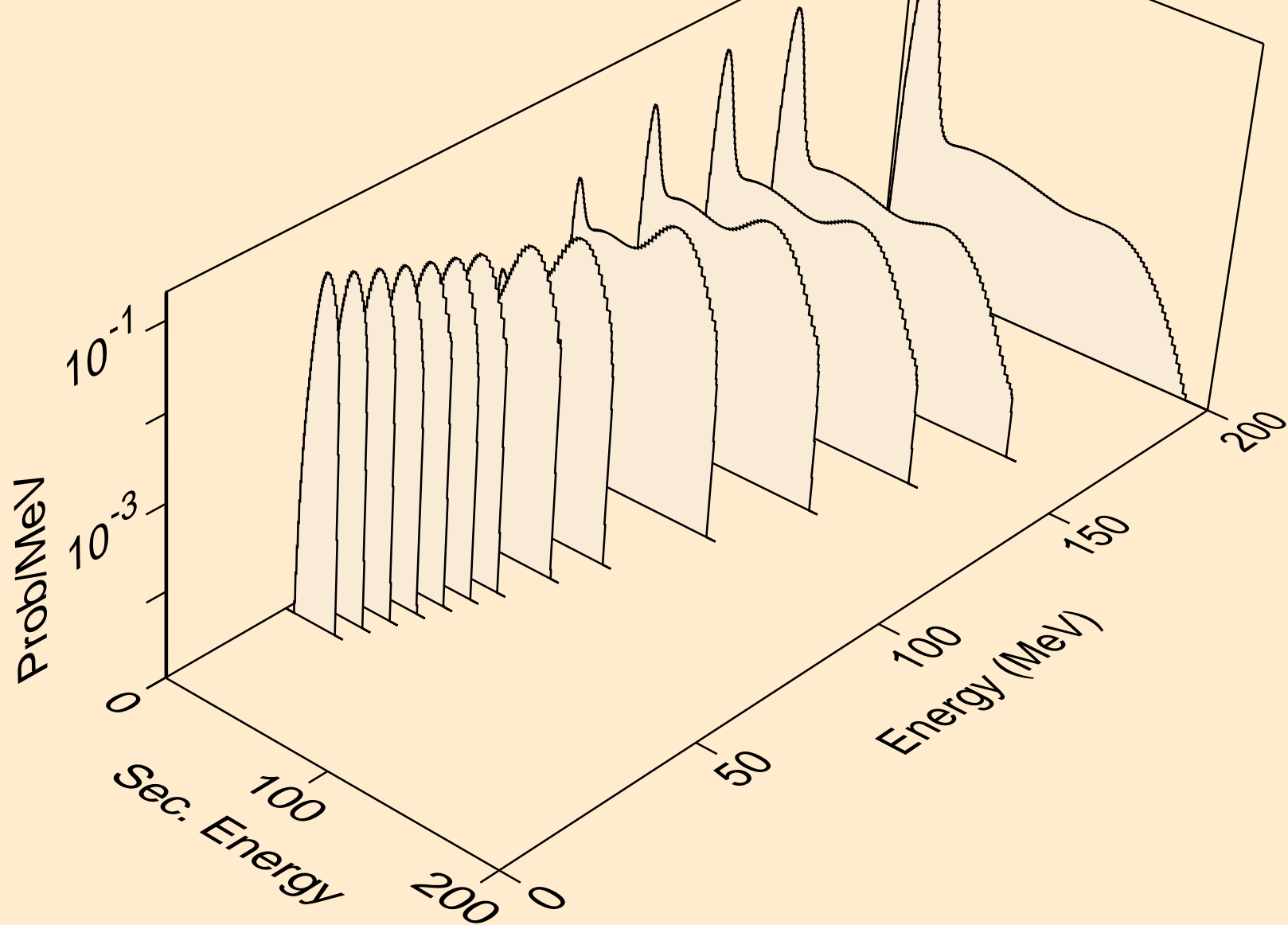

TM174 TRITON ACER TENDL-2021 LIBRARY; T=0.K  
deuterons from (t,2nd)

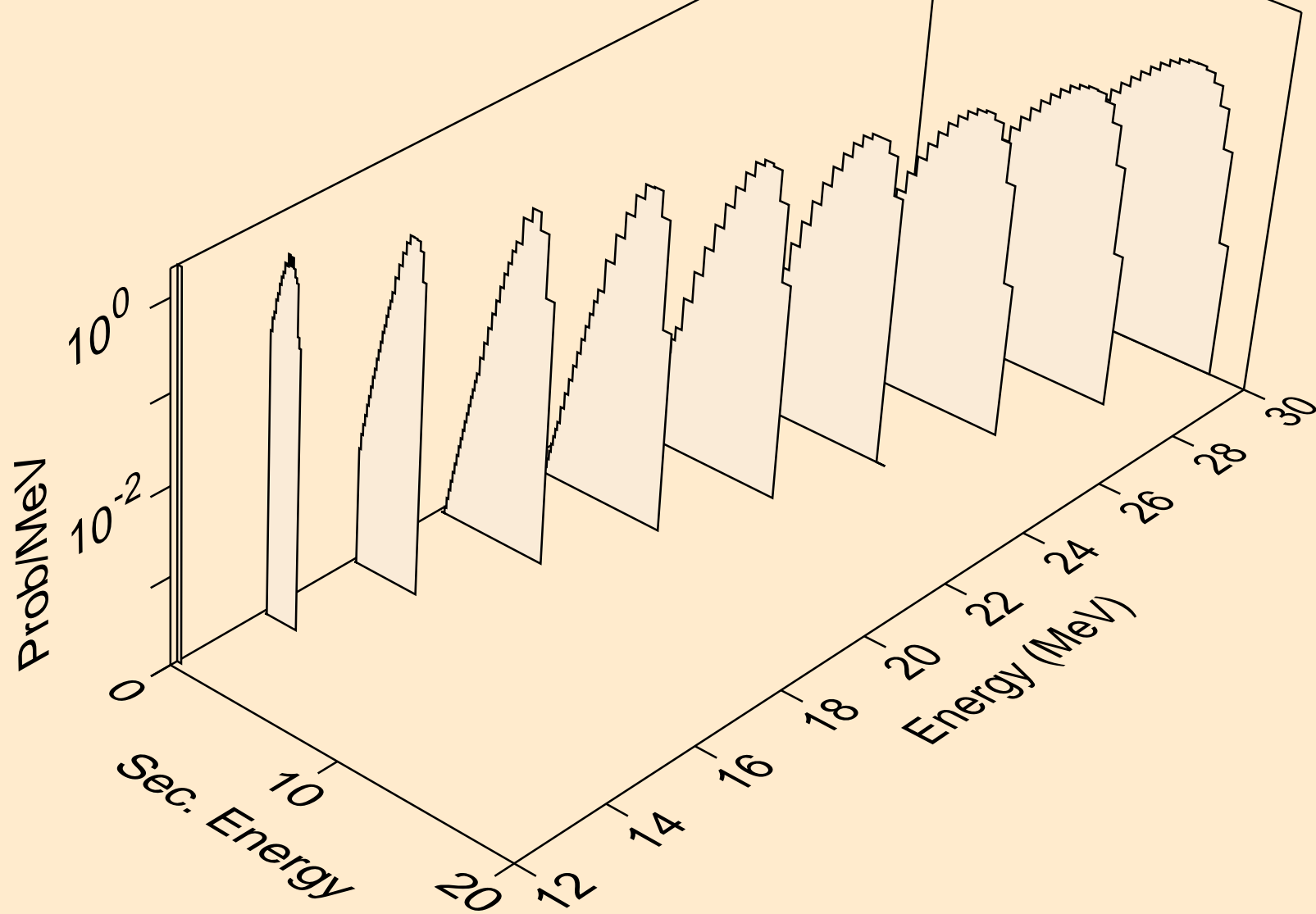

TM174 TRITON ACER TENDL-2021 LIBRARY; T=0.K  
deuterons from (t,n\*)d

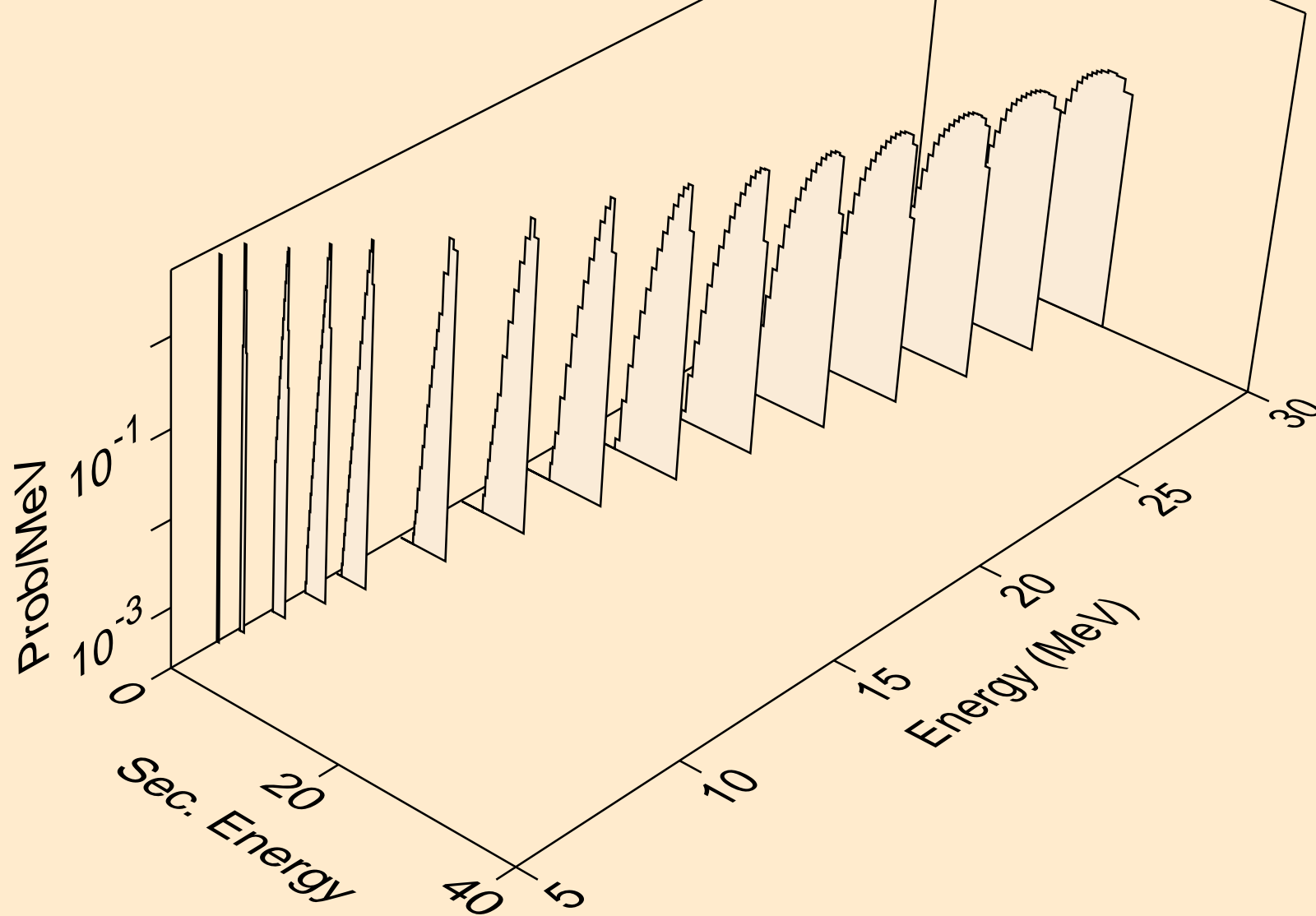

TM174 TRITON ACER TENDL-2021 LIBRARY; T=0.K  
deuterons from (t,d)

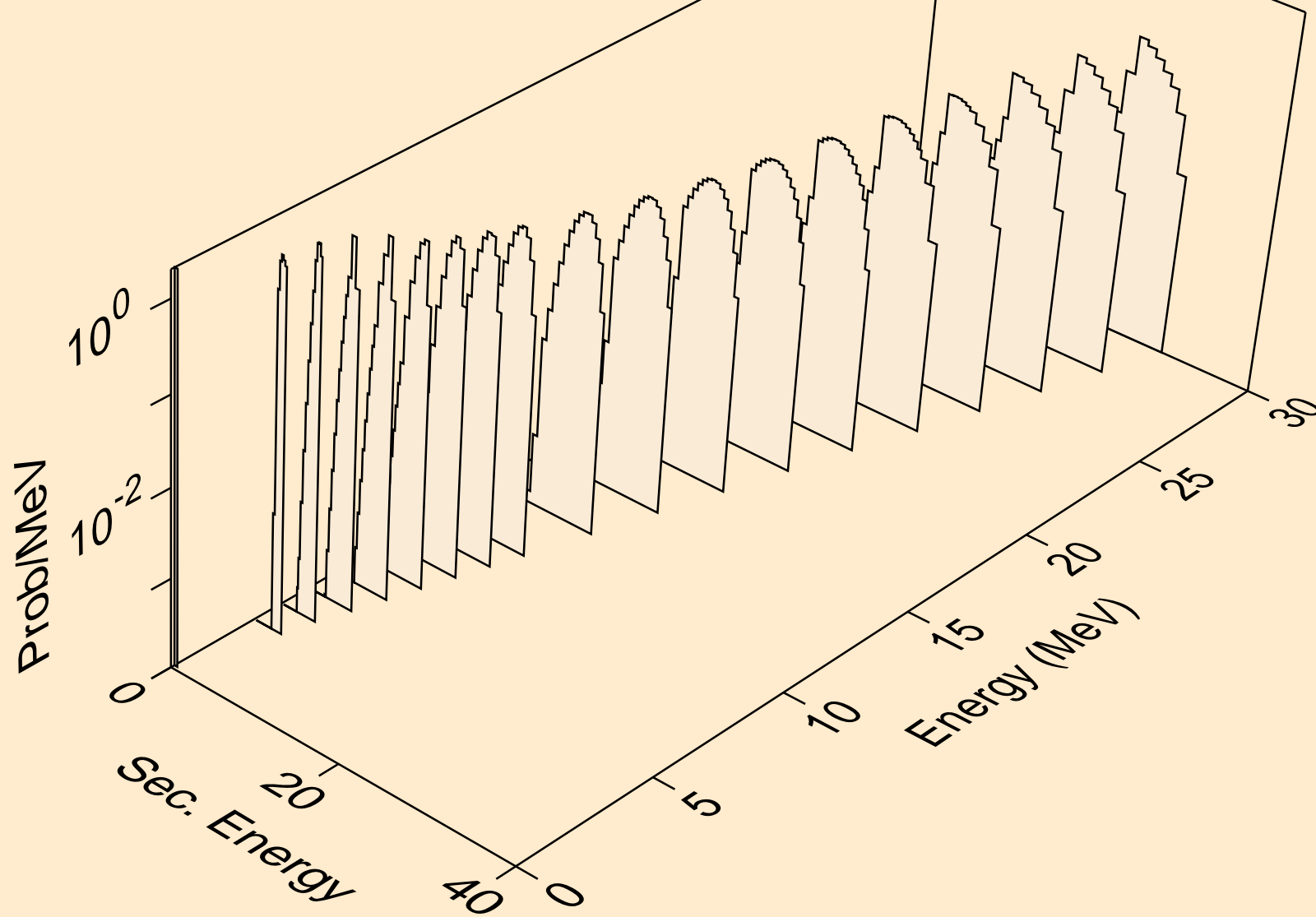

TM174 TRITON ACER TENDL-2021 LIBRARY; T=0.K  
deuterons from (t,pd)

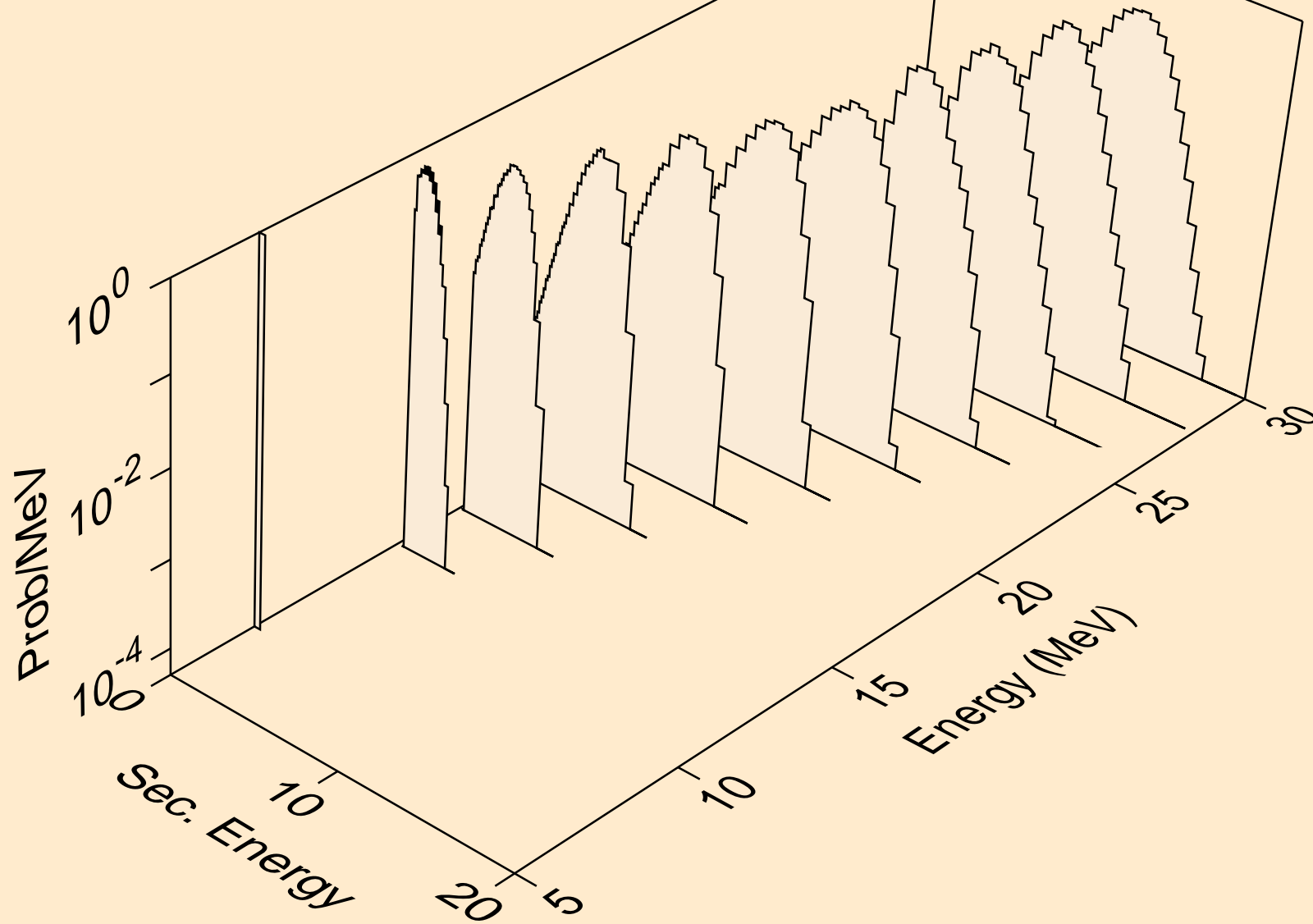

TM174 TRITON ACER TENDL-2021 LIBRARY; T=0.K  
he3s from (t,x)

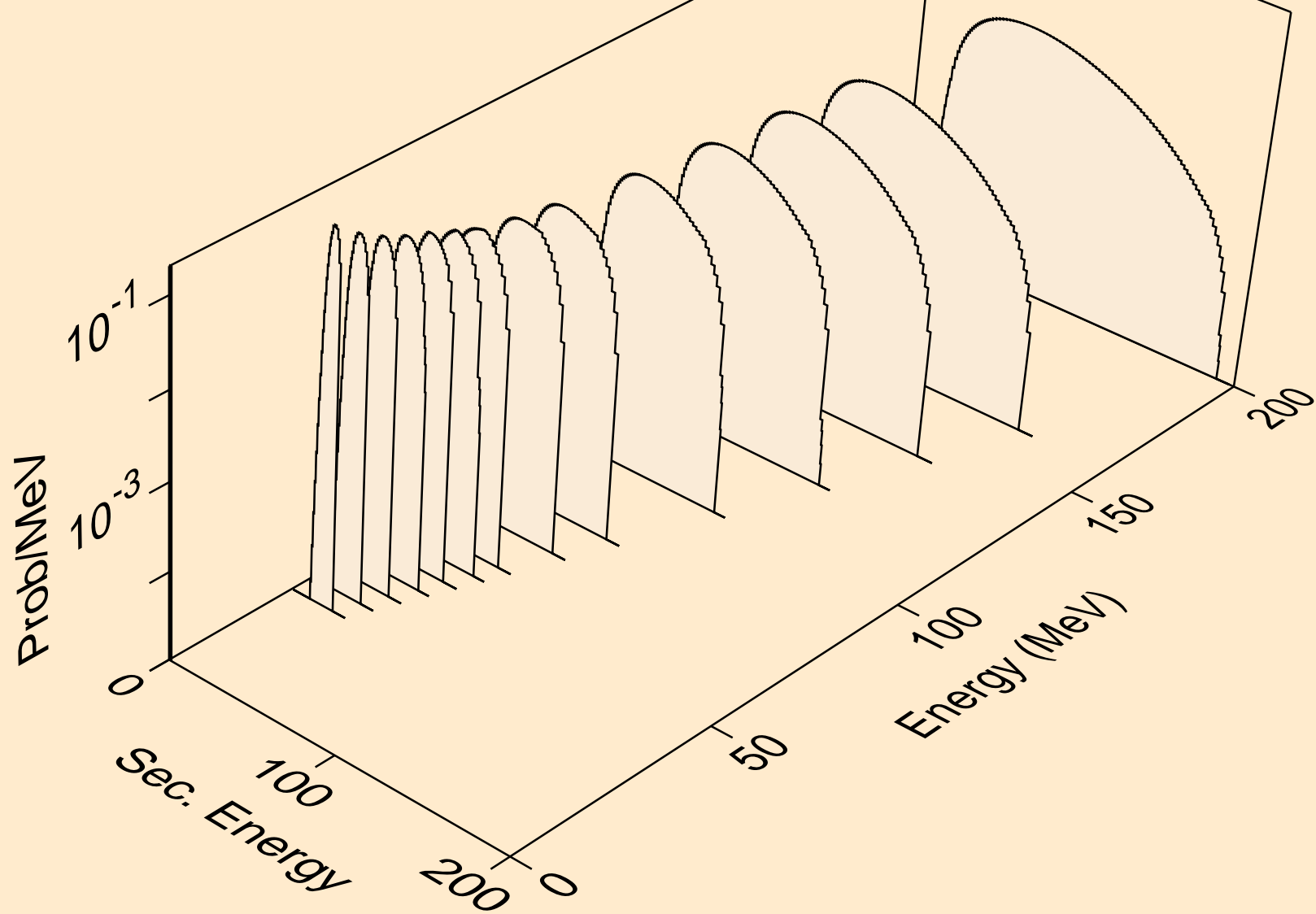

TM174 TRITON ACER TENDL-2021 LIBRARY; T=0.K  
he3s from (t,n\*)he3

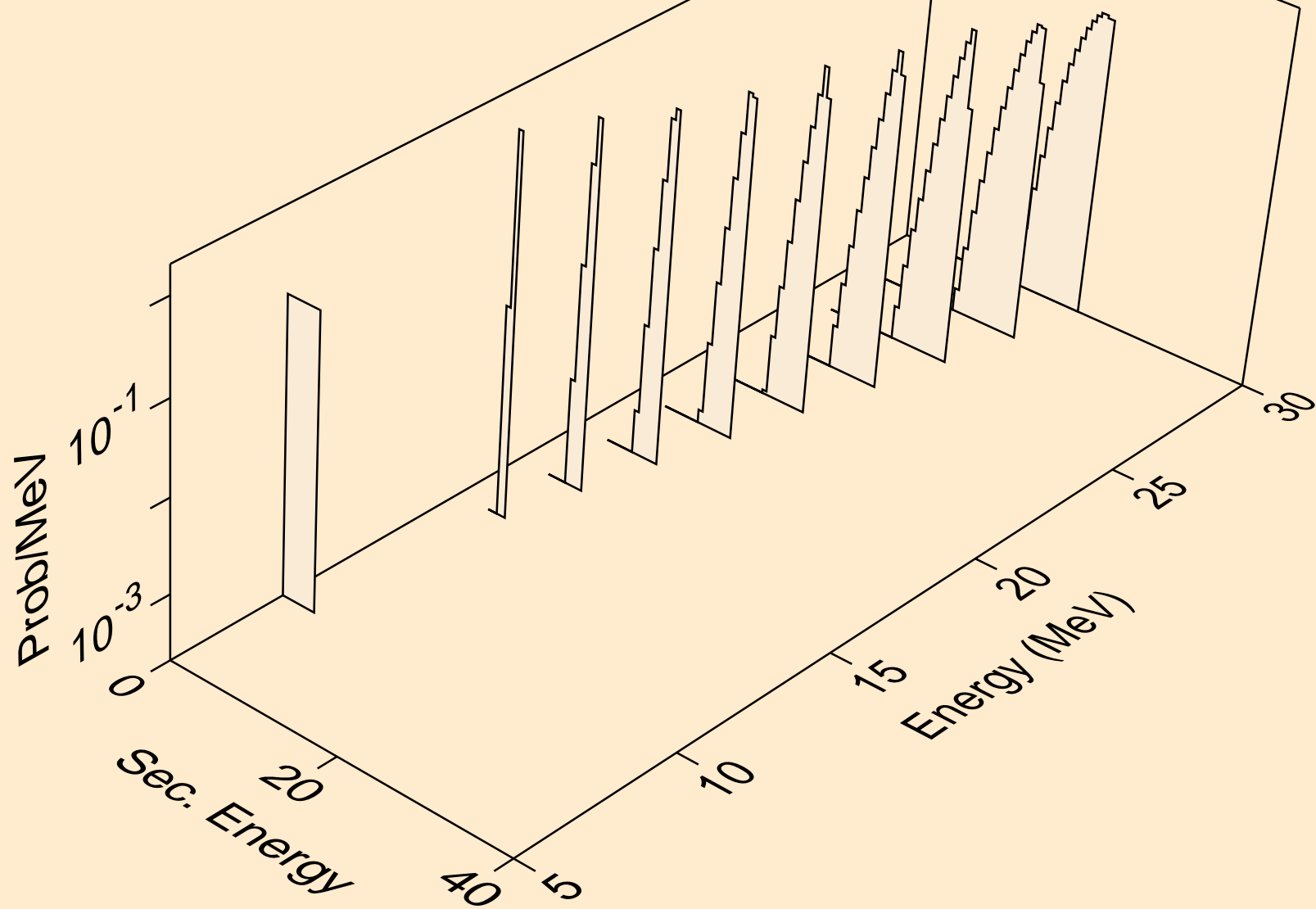



TM174 TRITON ACER TENDL-2021 LIBRARY; T=0.K  
he3s from (t,he3)

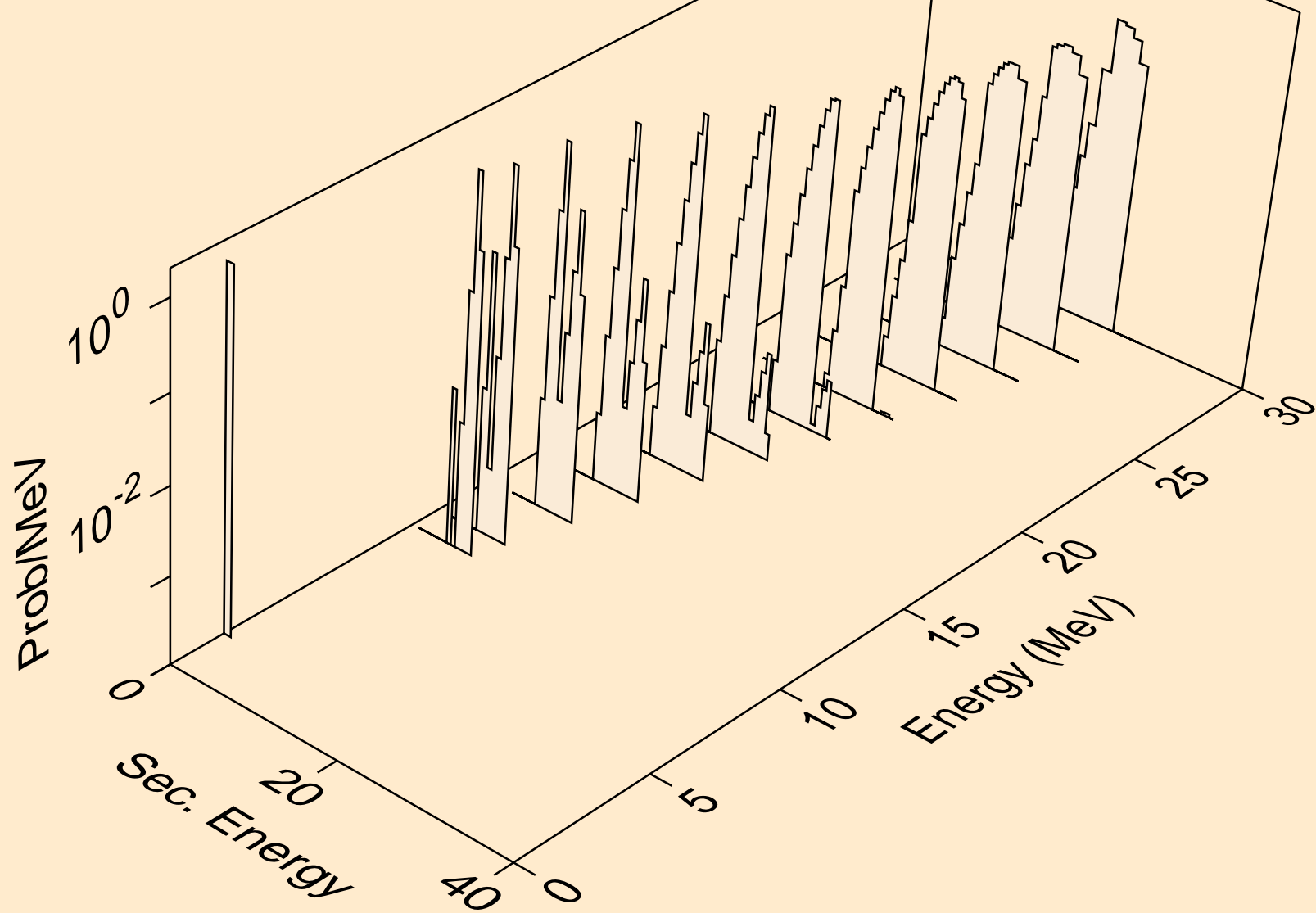

TM174 TRITON ACER TENDL-2021 LIBRARY; T=0.K  
alphas from (t,x)

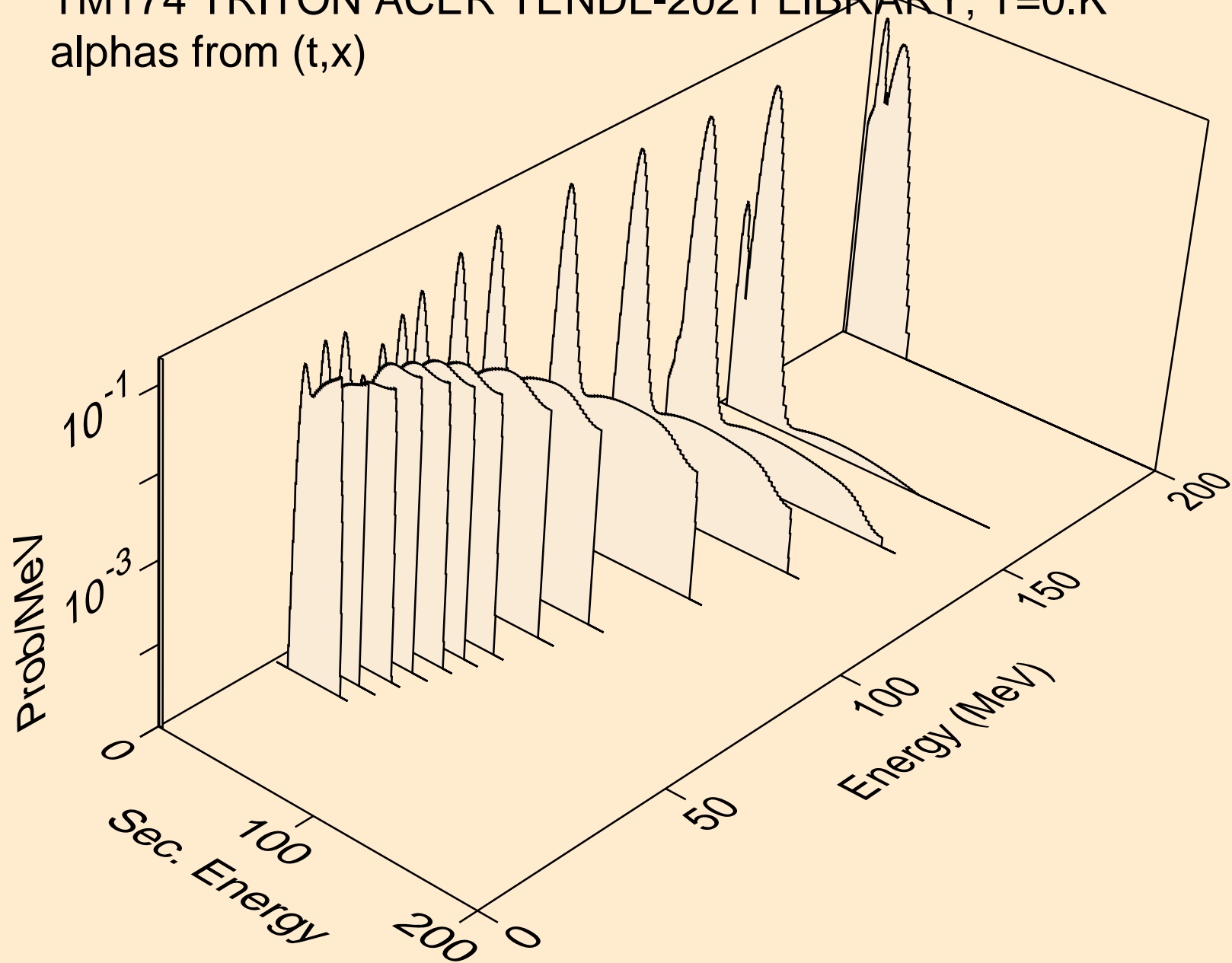

TM174 TRITON ACER TENDL-2021 LIBRARY; T=0.K  
alphas from (t,n\*)a

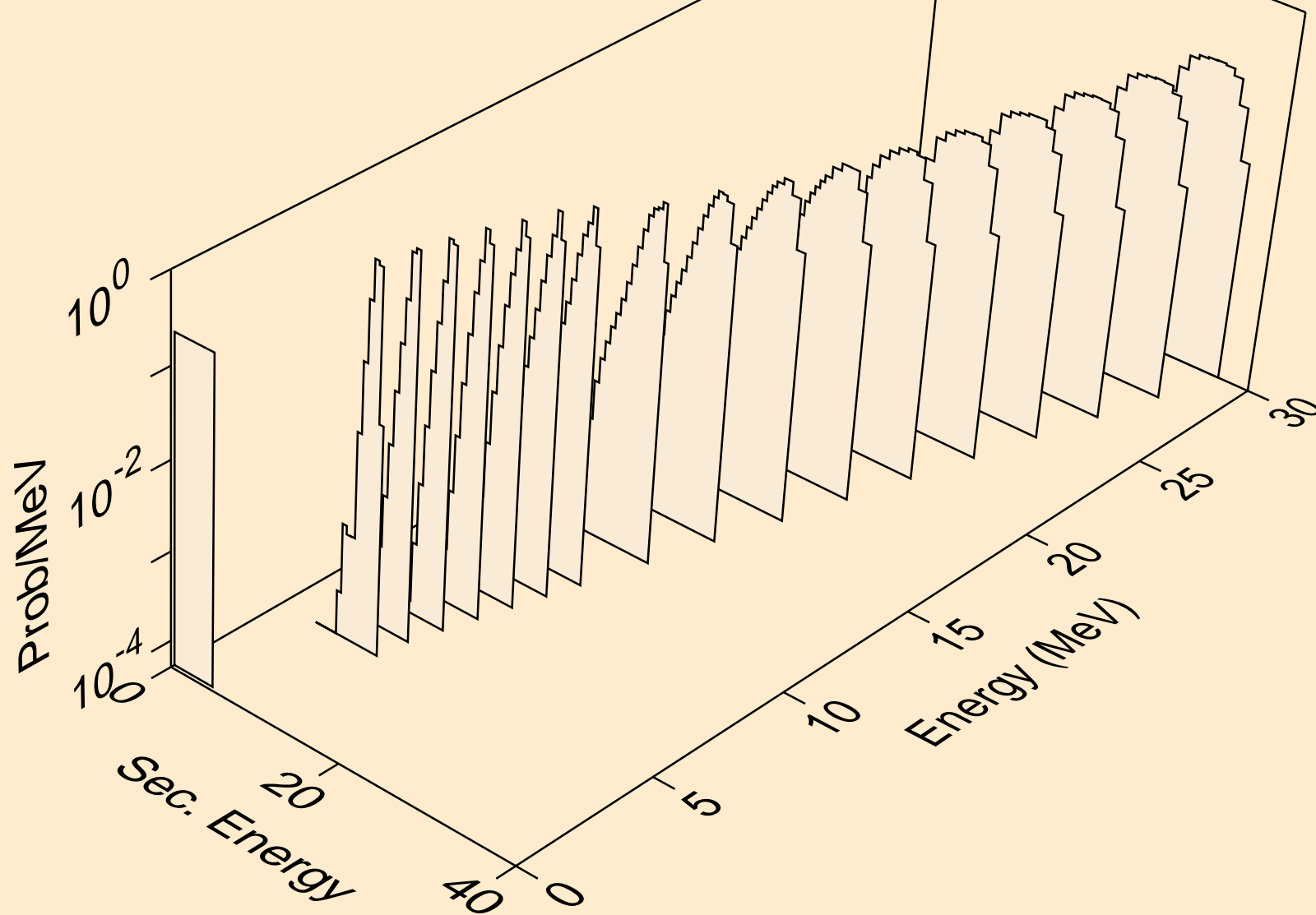

TM174 TRITON ACER TENDL-2021 LIBRARY; T=0.K  
alphas from (t,2n)a

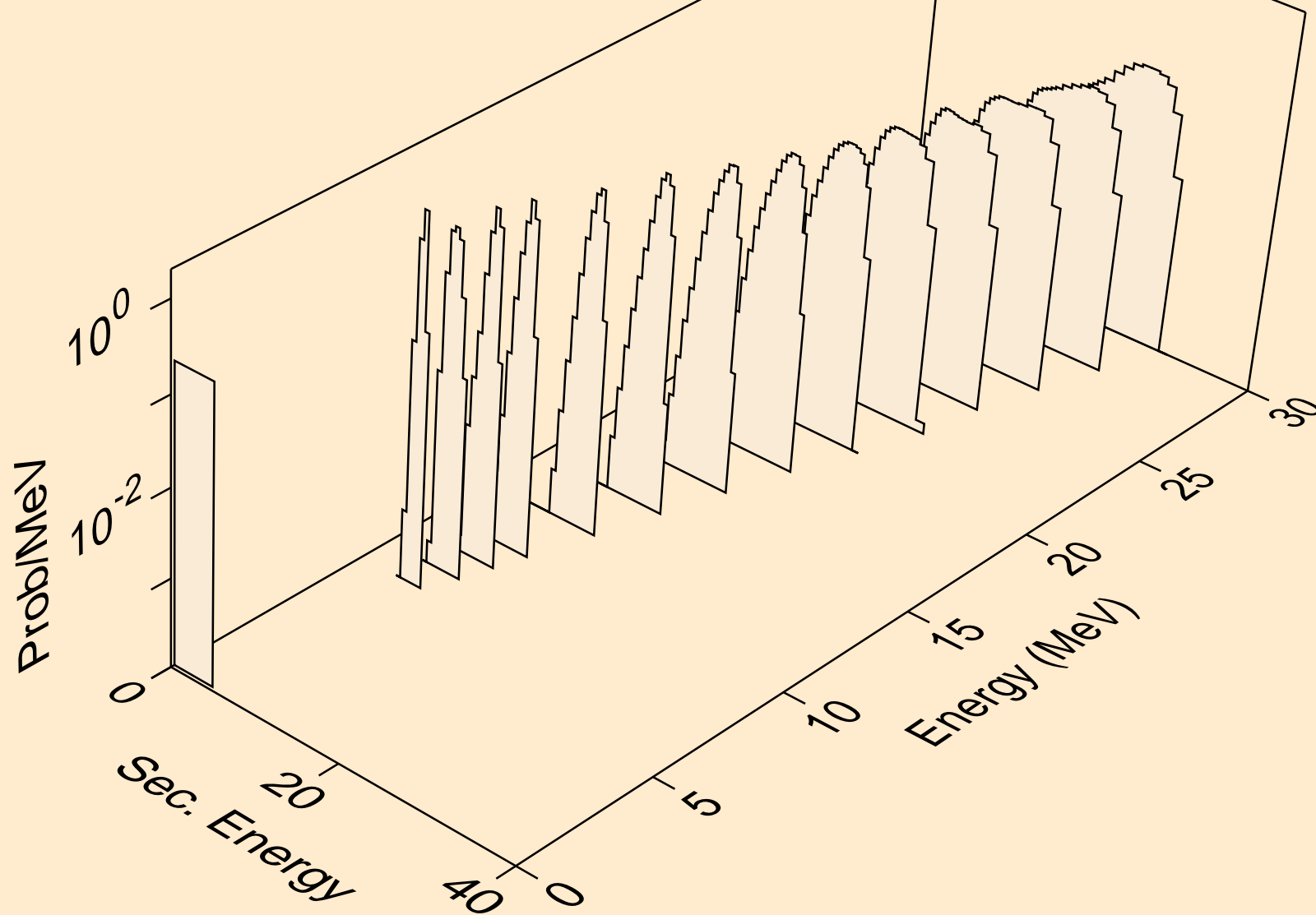

TM174 TRITON ACER TENDL-2021 LIBRARY; T=0.K  
alphas from (t,3n)a

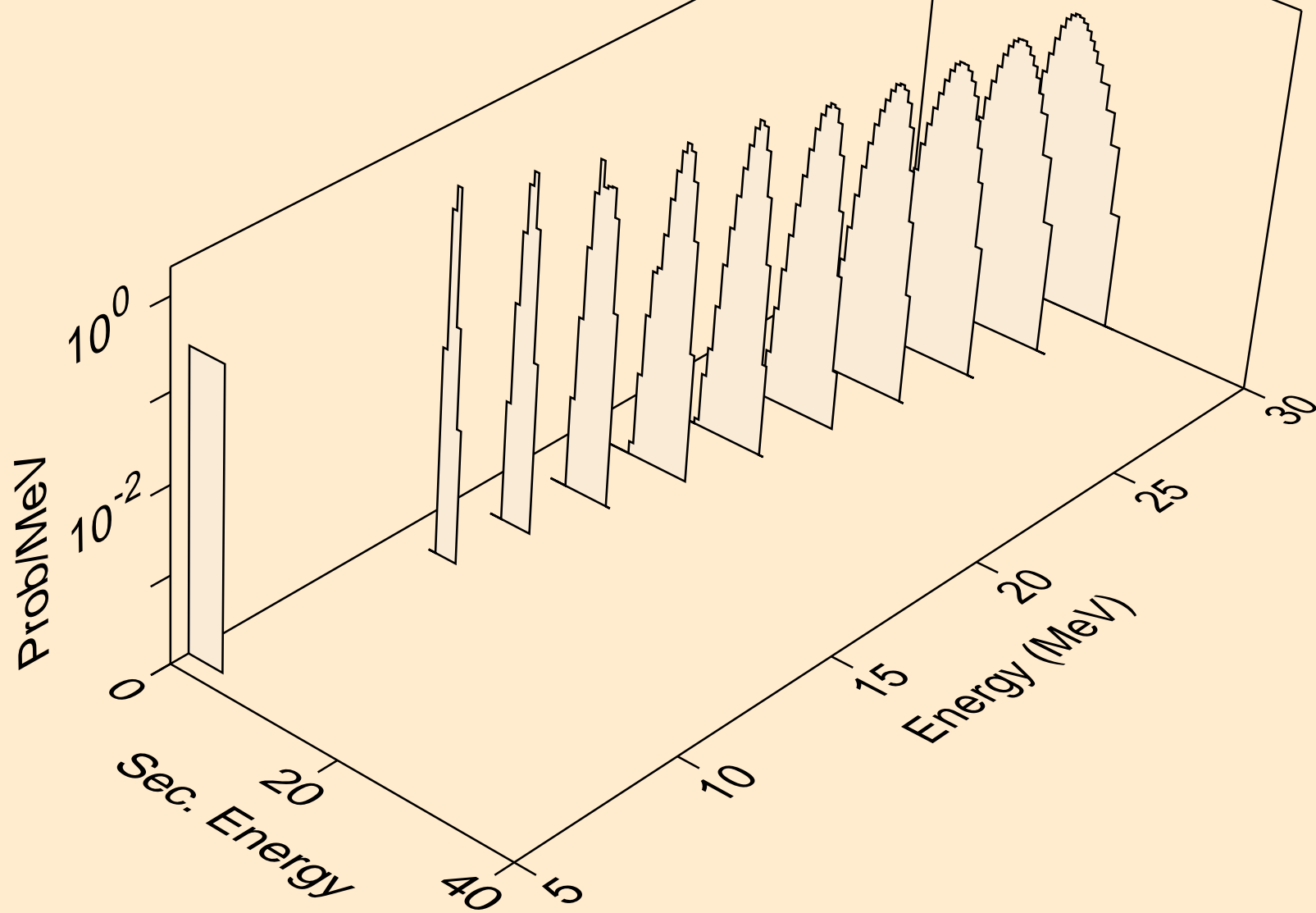

TM174 TRITON ACER TENDL-2021 LIBRARY; T=0.K  
alphas from (t,n\*)2a

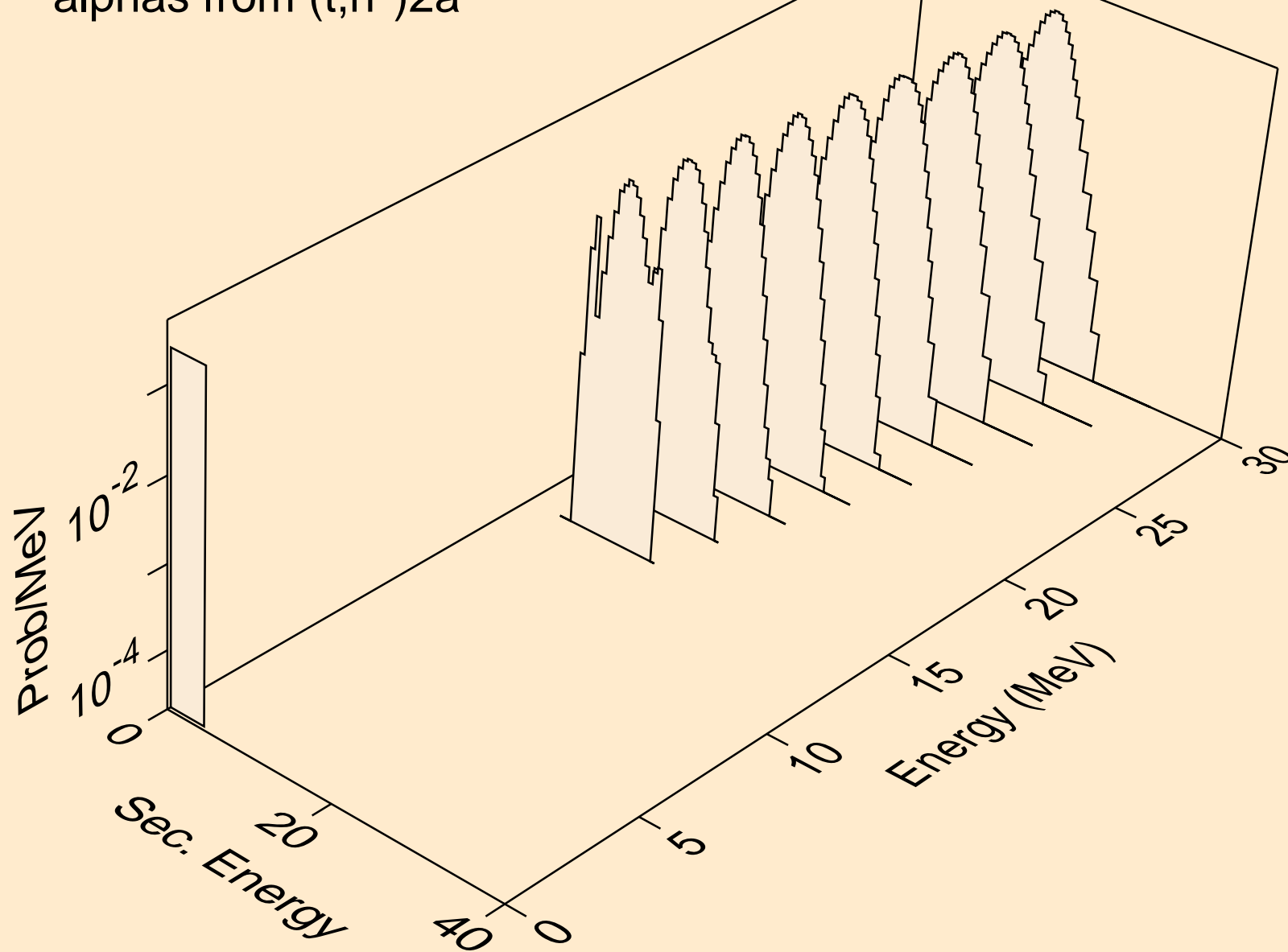

TM174 TRITON ACER TENDL-2021 LIBRARY; T=0.K  
alphas from (t,npa)

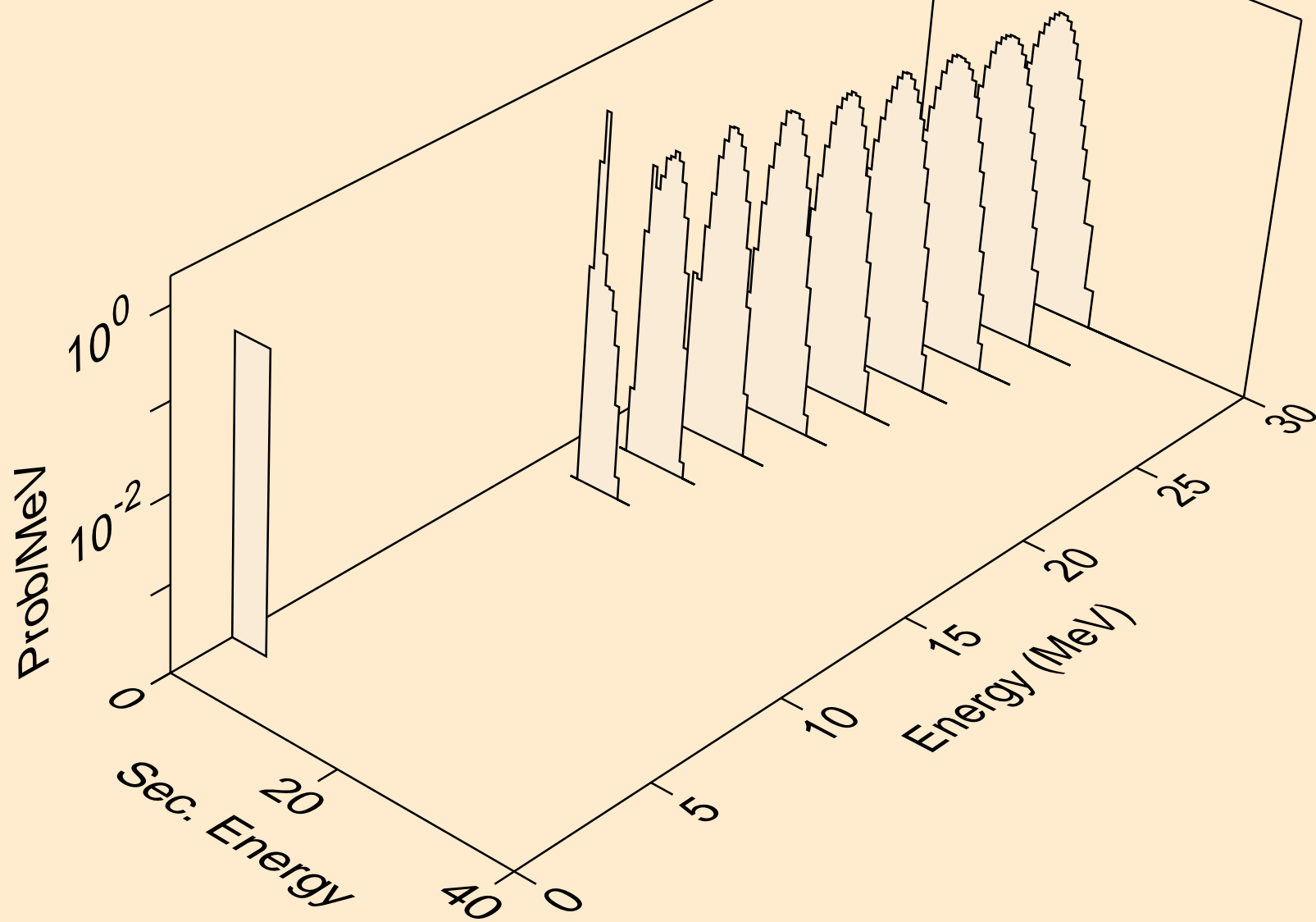

TM174 TRITON ACER TENDL-2021 LIBRARY; T=0.K  
alphas from (t,a)

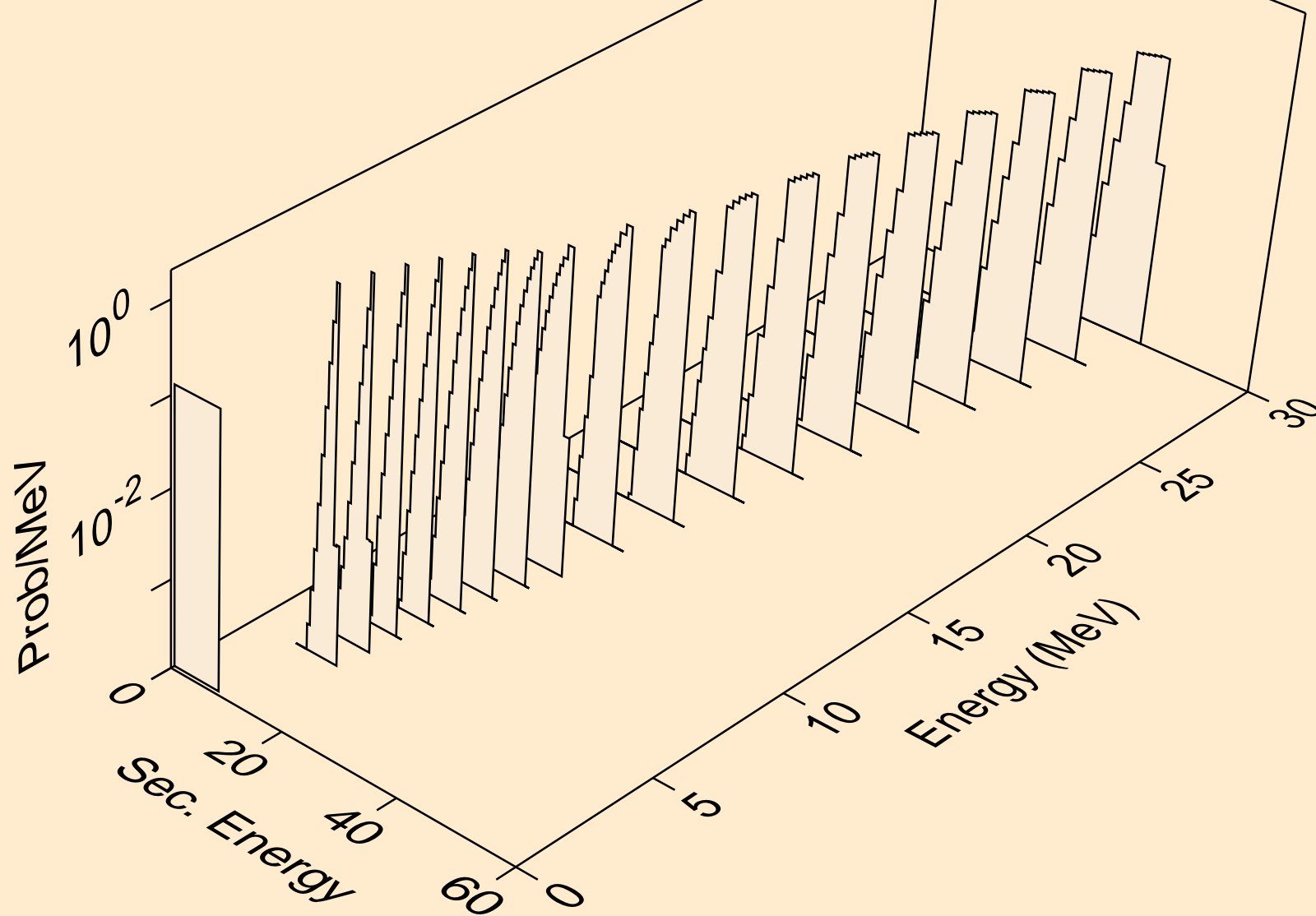



TM174 TRITON ACER TENDL-2021 LIBRARY; T=0.K  
alphas from (t,pa)

