

XE129 TRITON ACER TENDL-2021 LIBRARY; T=0.K  
Principal cross sections

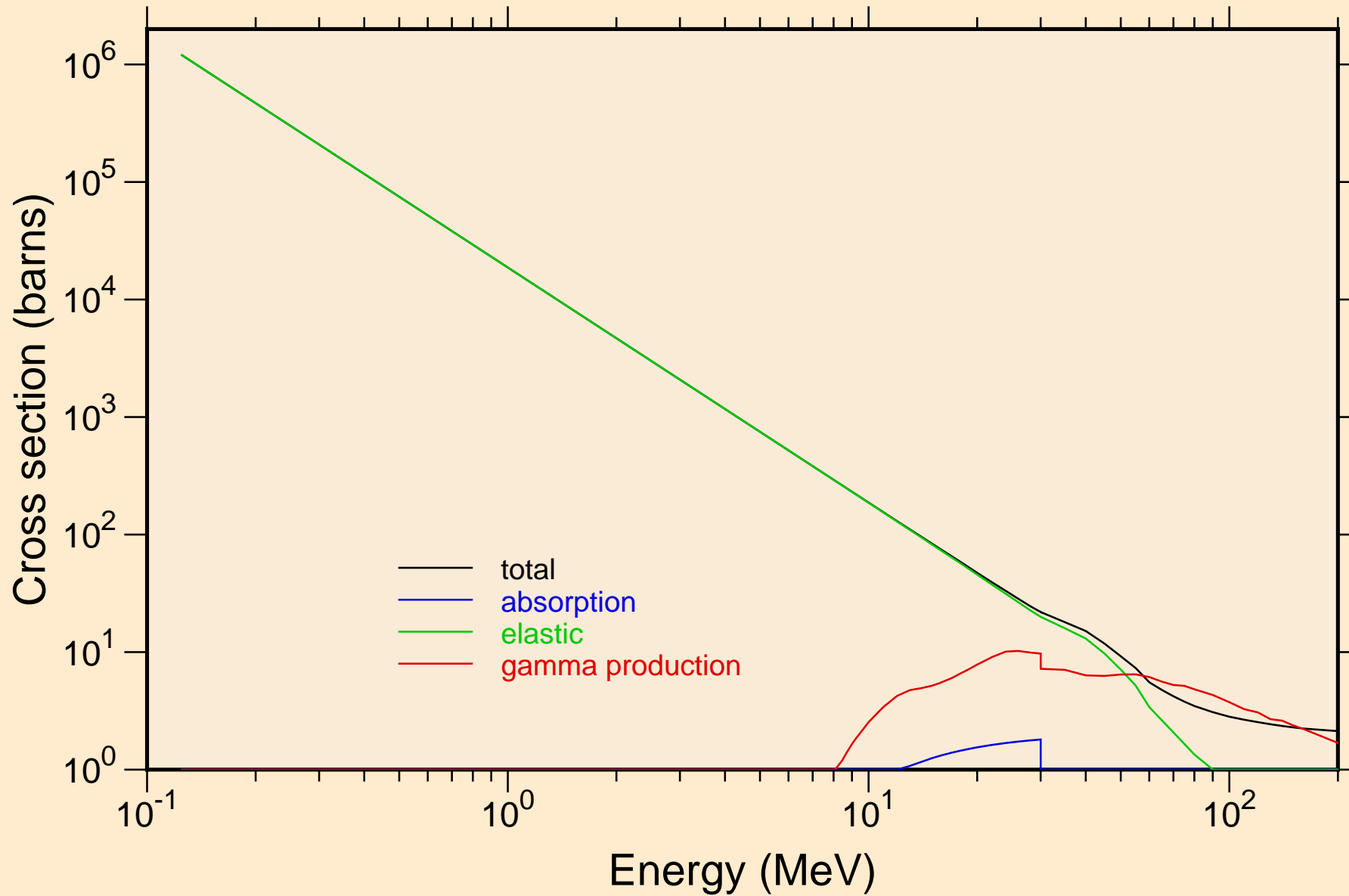

XE129 TRITON ACER TENDL-2021 LIBRARY; T=0.K

Heating

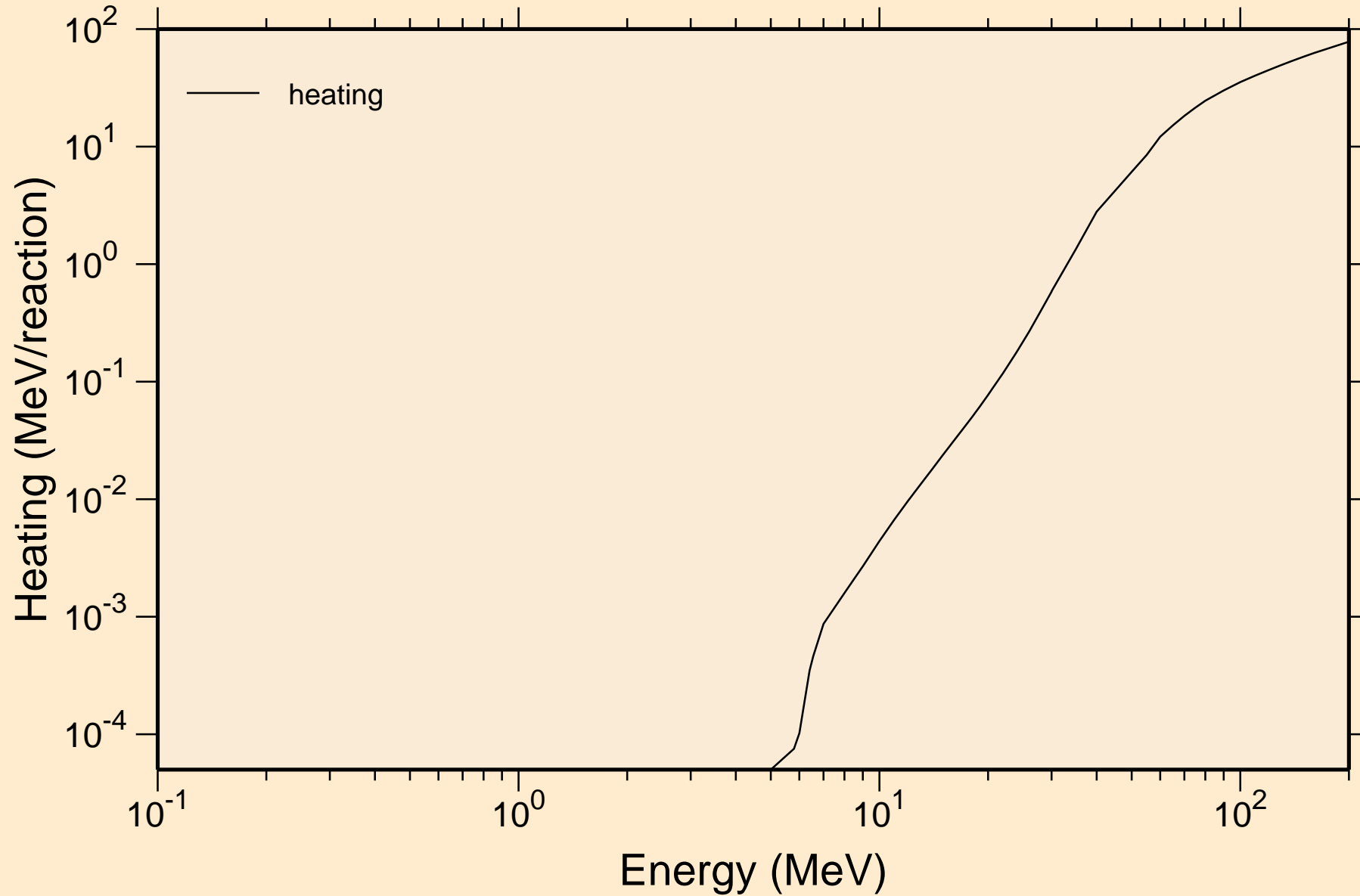

# XE129 TRITON ACER TENDL-2021 LIBRARY; T=0.K

## Principal cross sections

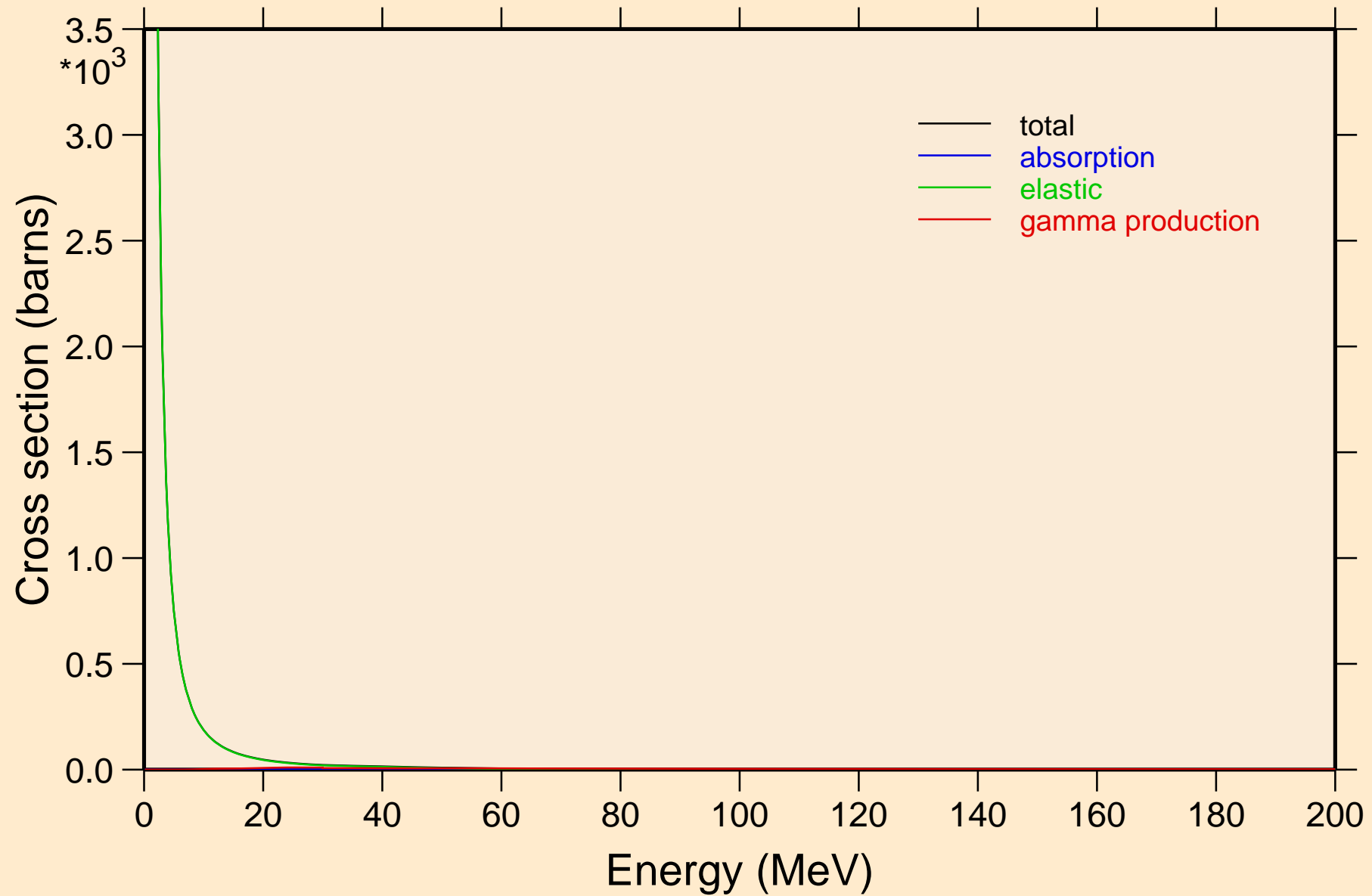

XE129 TRITON ACER TENDL-2021 LIBRARY; T=0.K

Heating

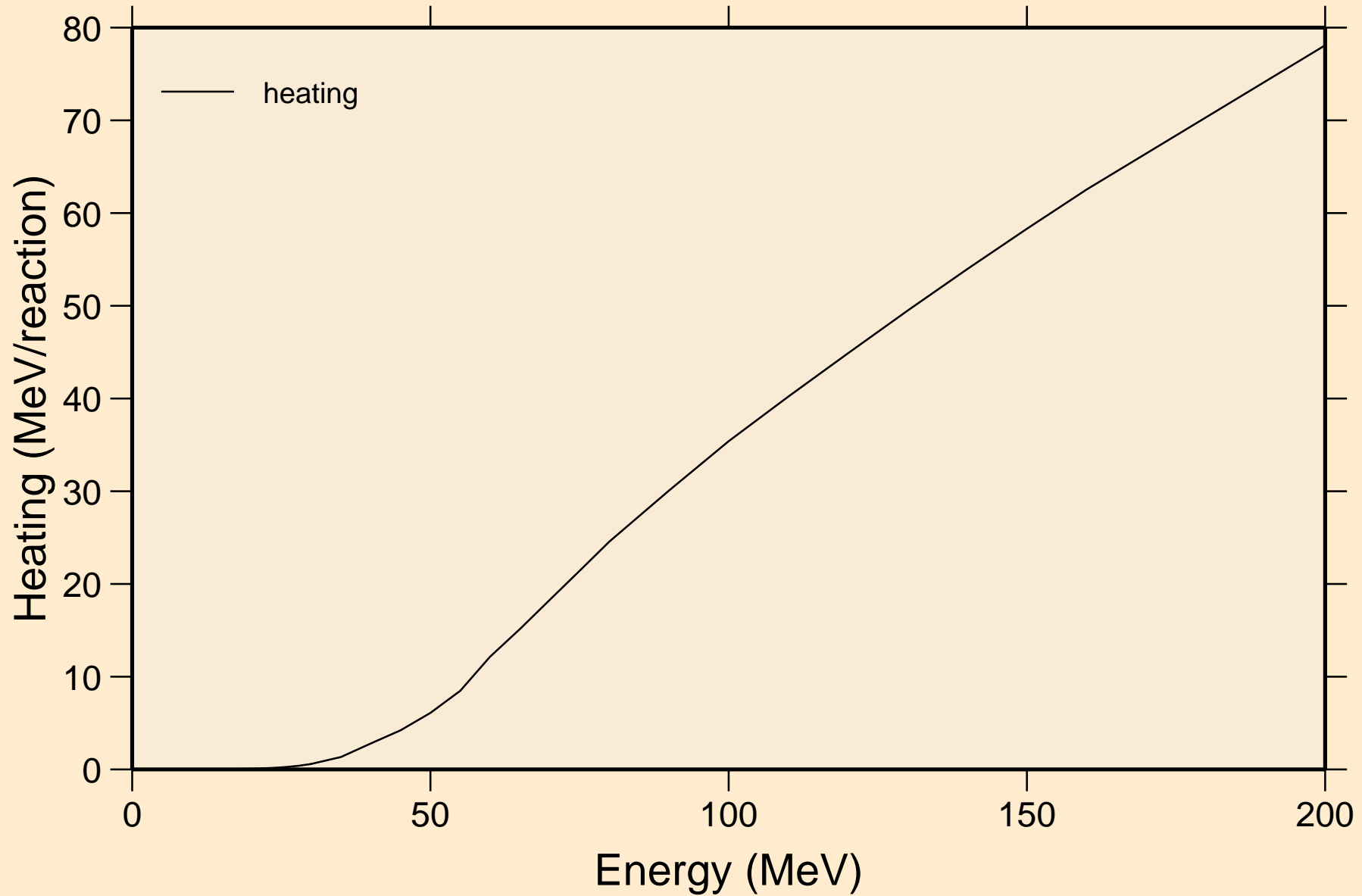

XE129 TRITON ACER TENDL-2021 LIBRARY; T=0.K  
Threshold reactions

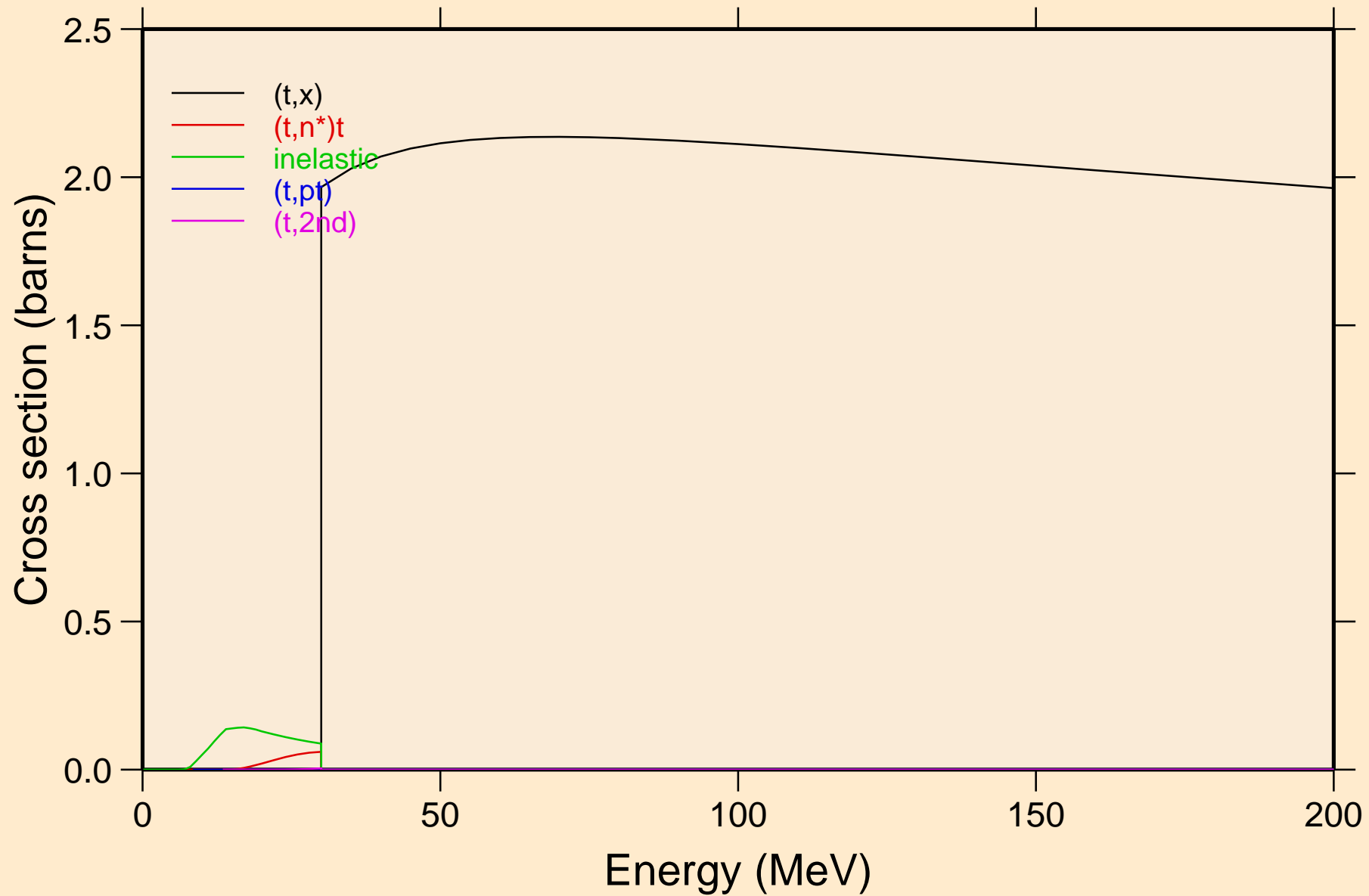

XE129 TRITON ACER TENDL-2021 LIBRARY; T=0.K  
Threshold reactions

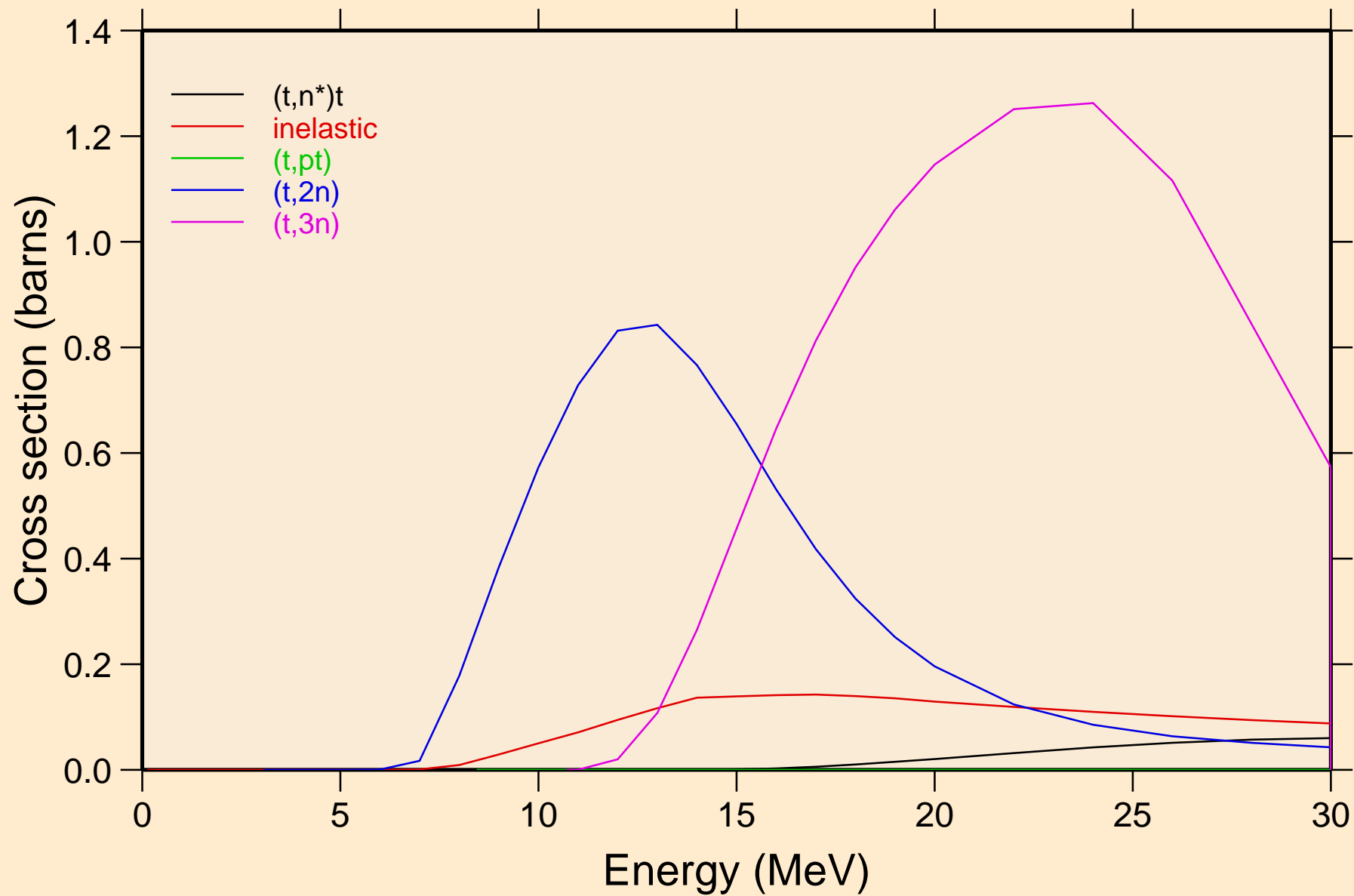

XE129 TRITON ACER TENDL-2021 LIBRARY; T=0.K  
Threshold reactions

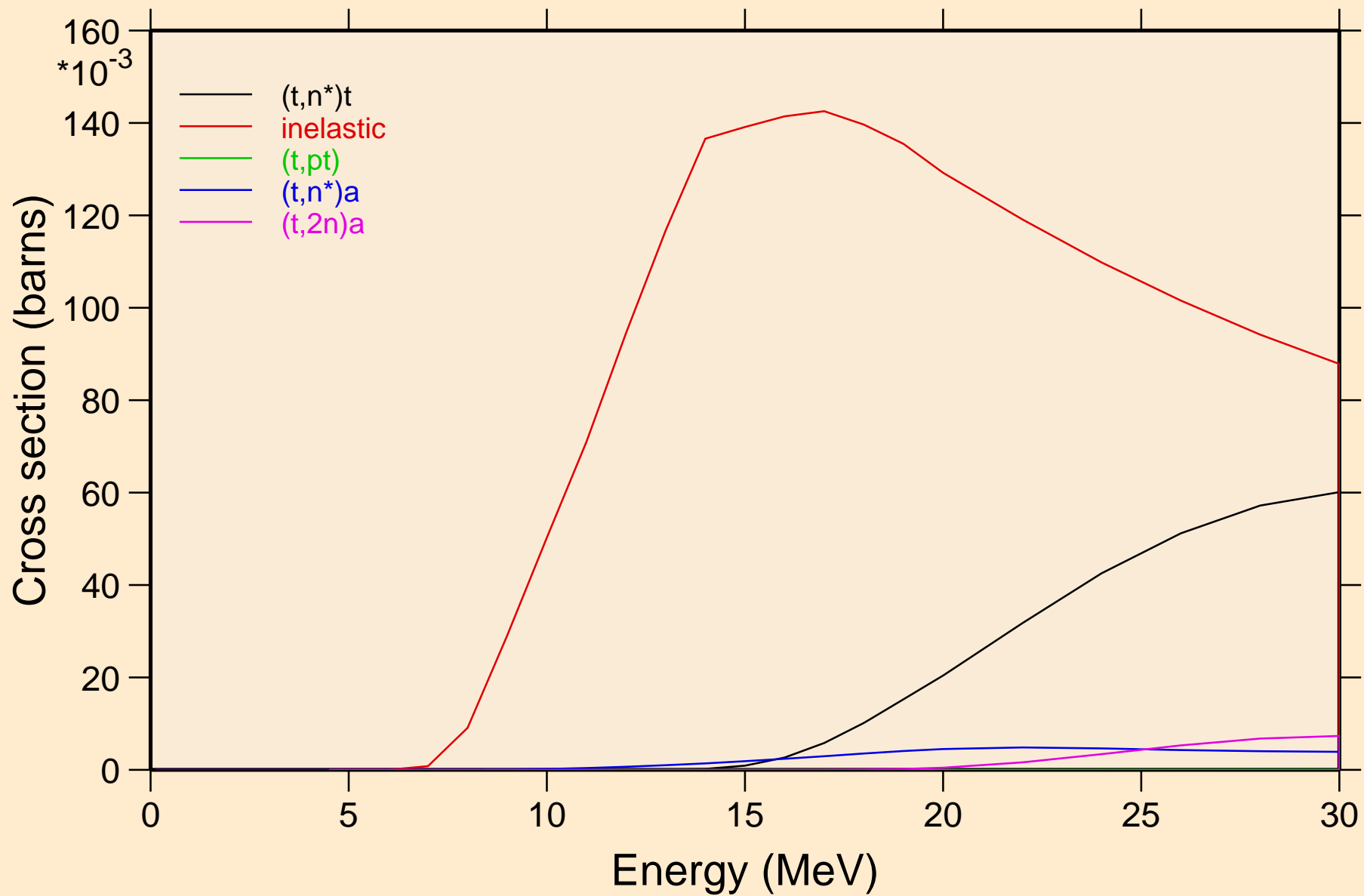

XE129 TRITON ACER TENDL-2021 LIBRARY; T=0.K  
Threshold reactions

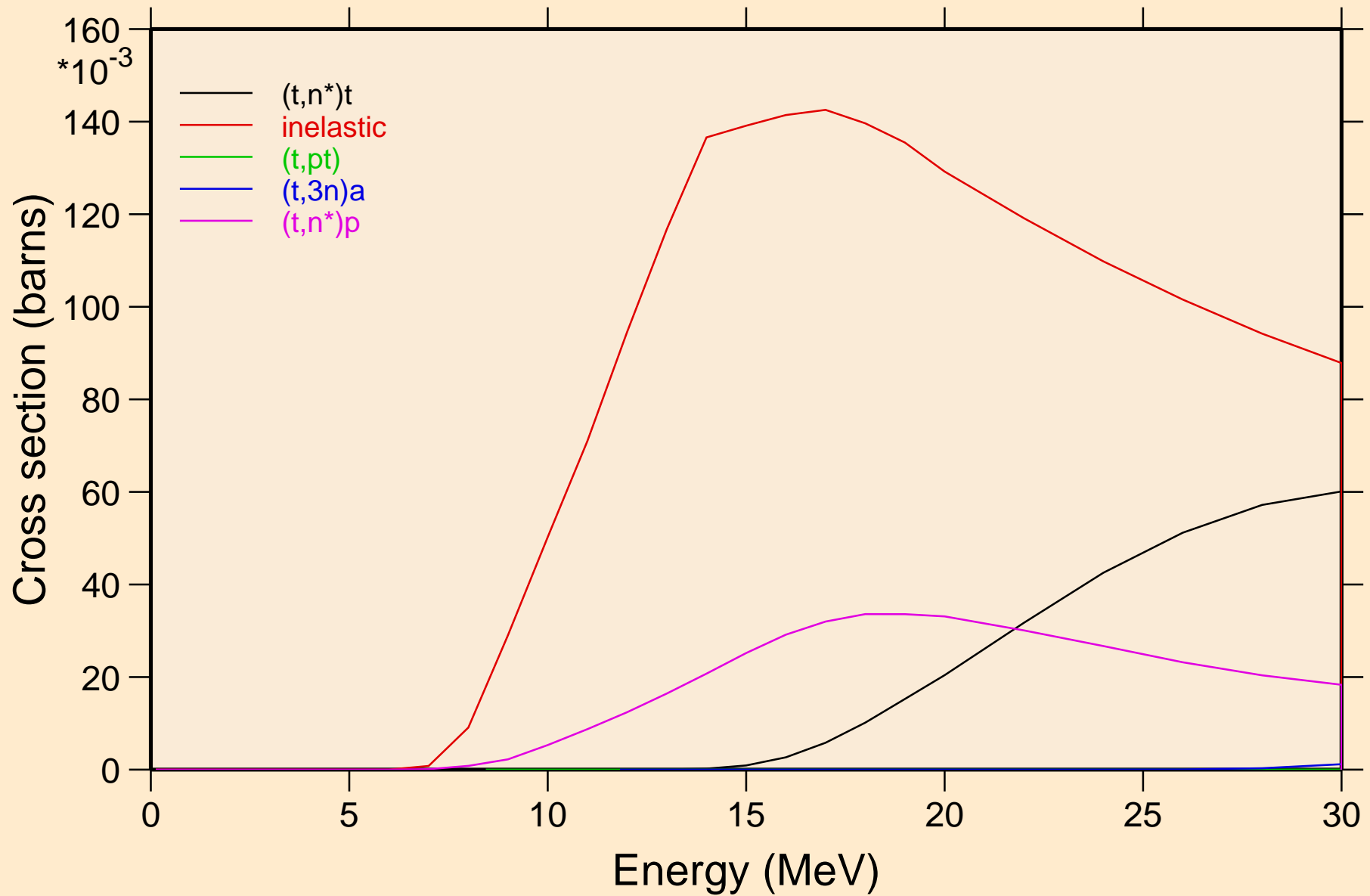



XE129 TRITON ACER TENDL-2021 LIBRARY; T=0.K  
Threshold reactions

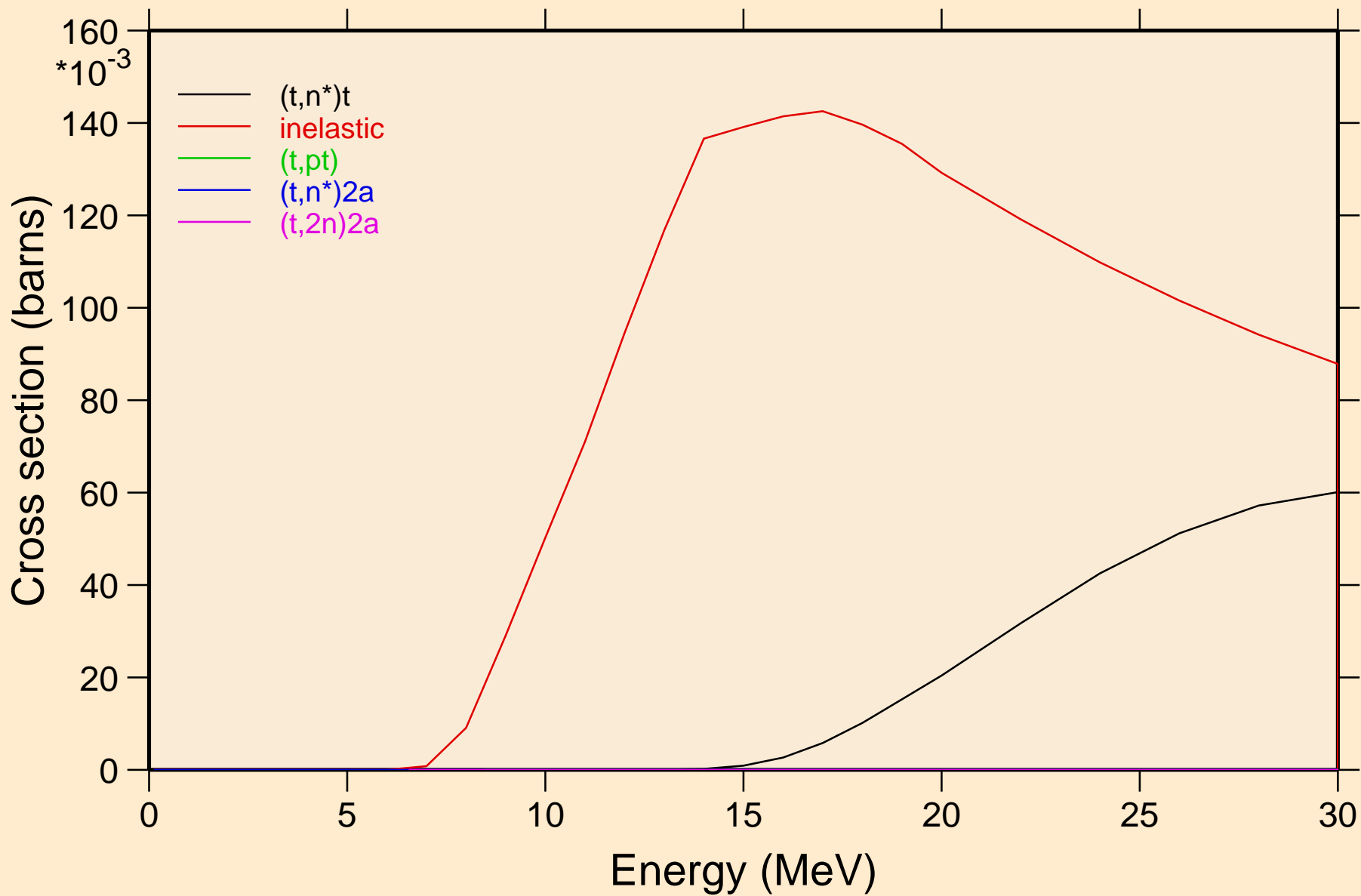

XE129 TRITON ACER TENDL-2021 LIBRARY; T=0.K  
Threshold reactions

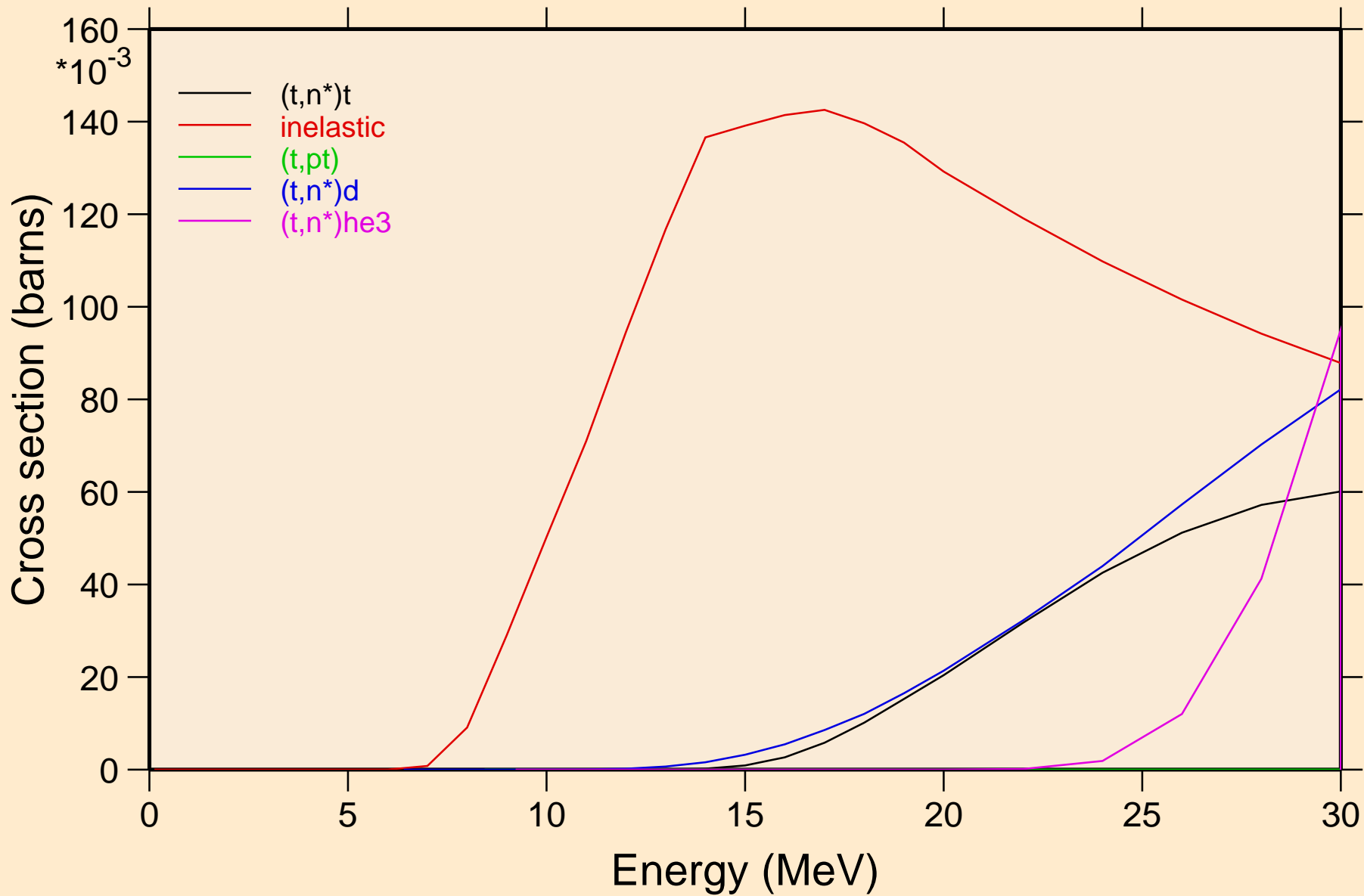

XE129 TRITON ACER TENDL-2021 LIBRARY; T=0.K  
Threshold reactions

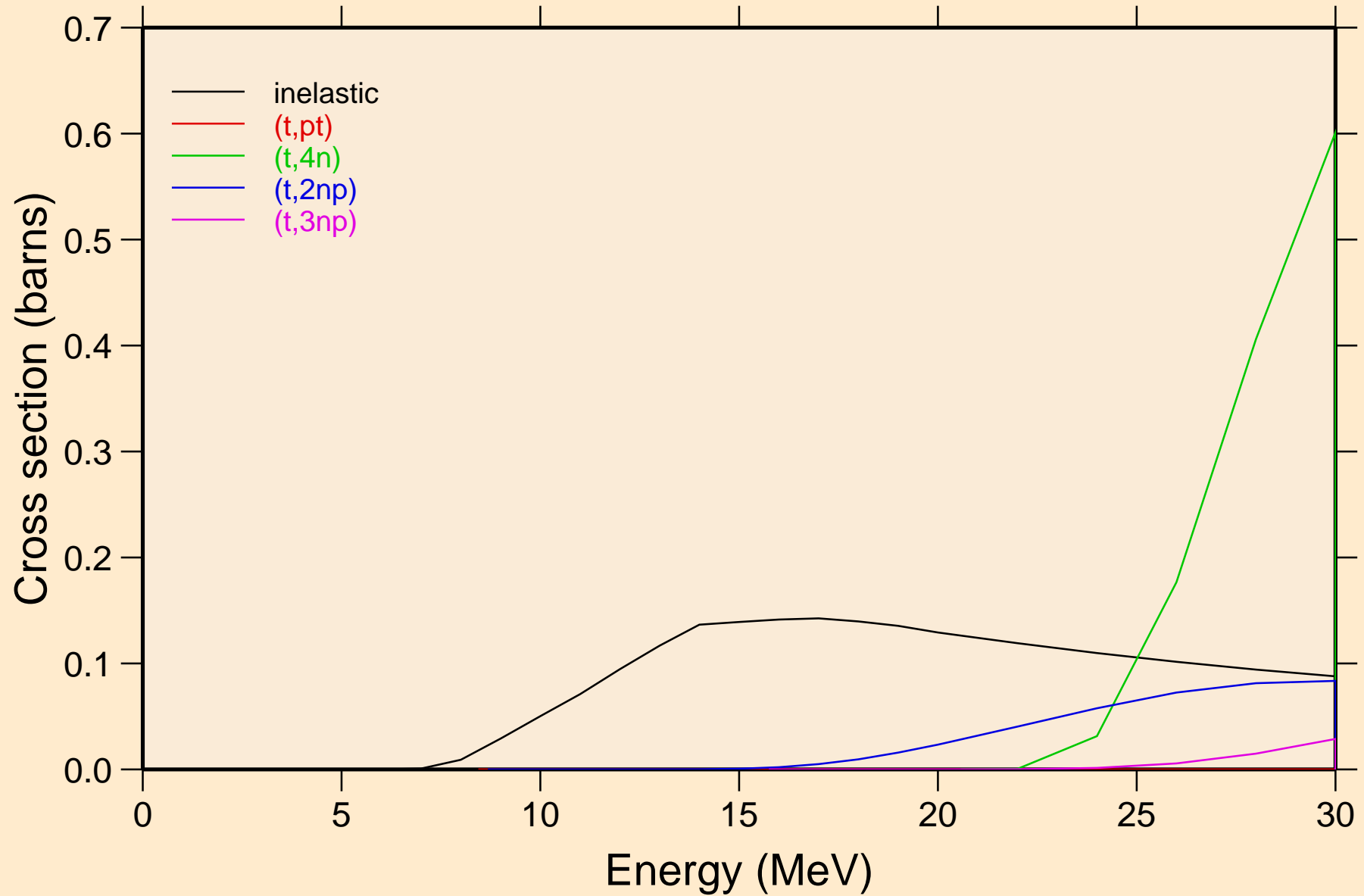

XE129 TRITON ACER TENDL-2021 LIBRARY; T=0.K  
Threshold reactions

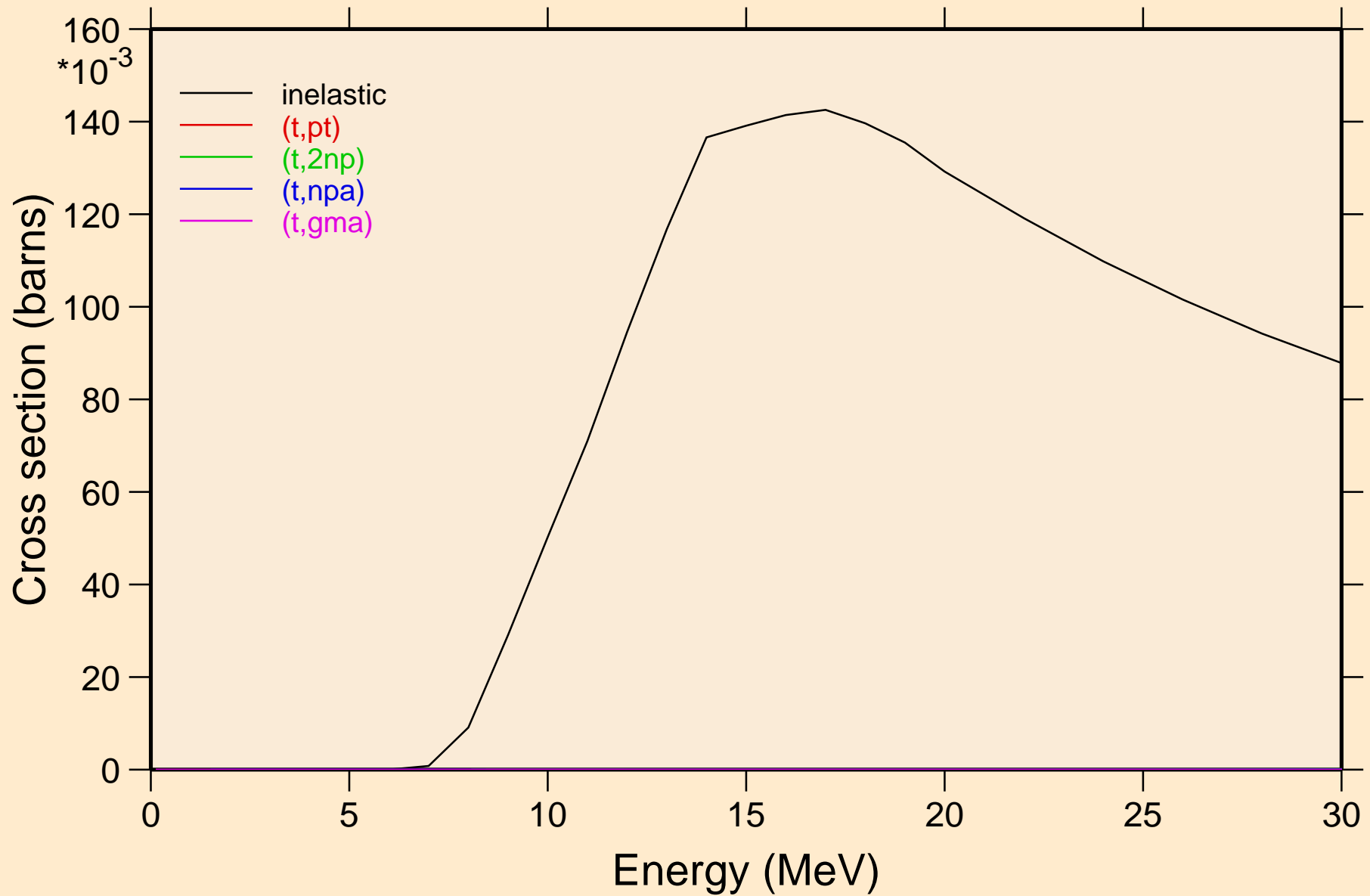

XE129 TRITON ACER TENDL-2021 LIBRARY; T=0.K  
Threshold reactions

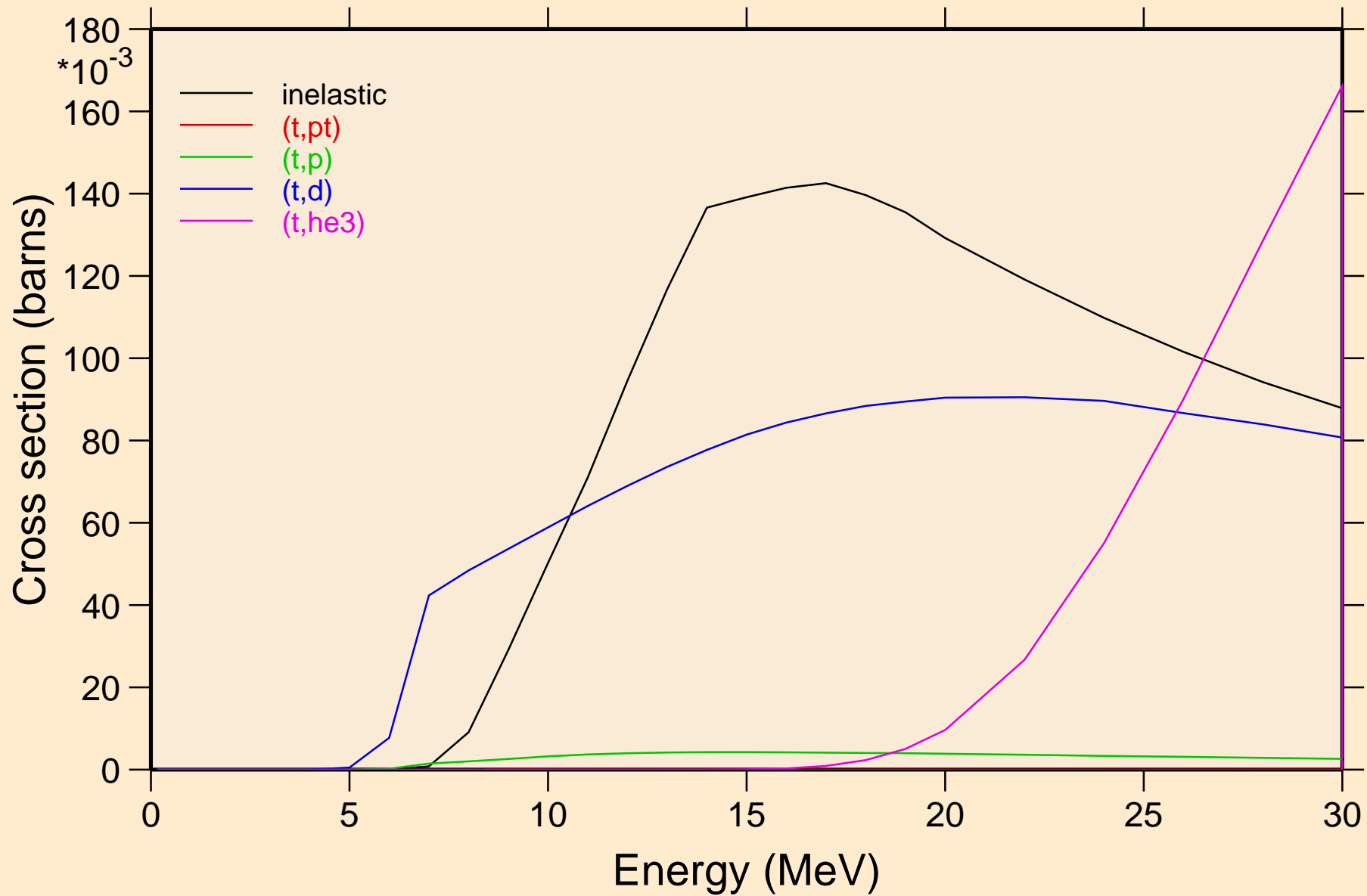

XE129 TRITON ACER TENDL-2021 LIBRARY; T=0.K  
Threshold reactions

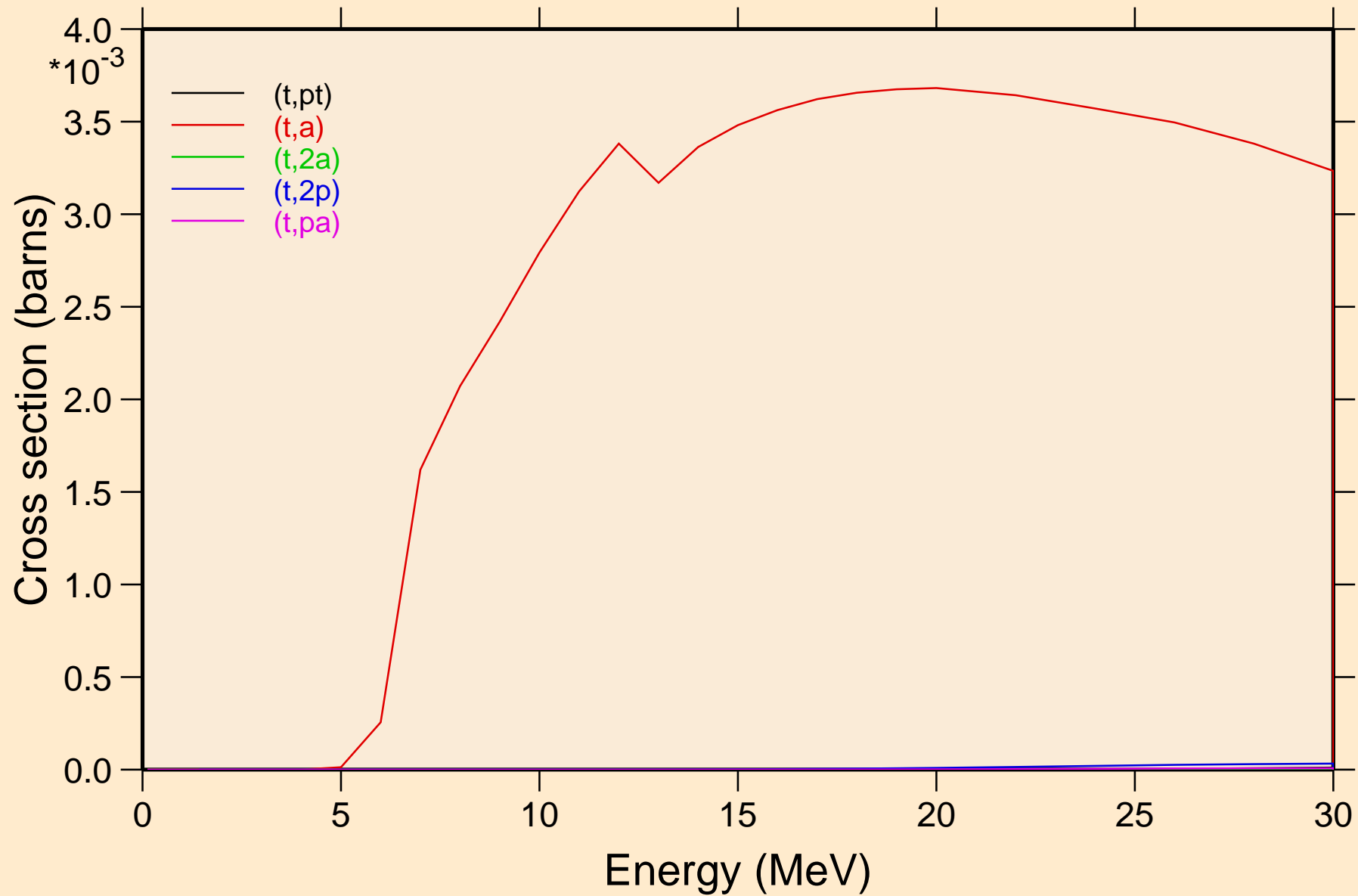

XE129 TRITON ACER TENDL-2021 LIBRARY; T=0.K  
Threshold reactions

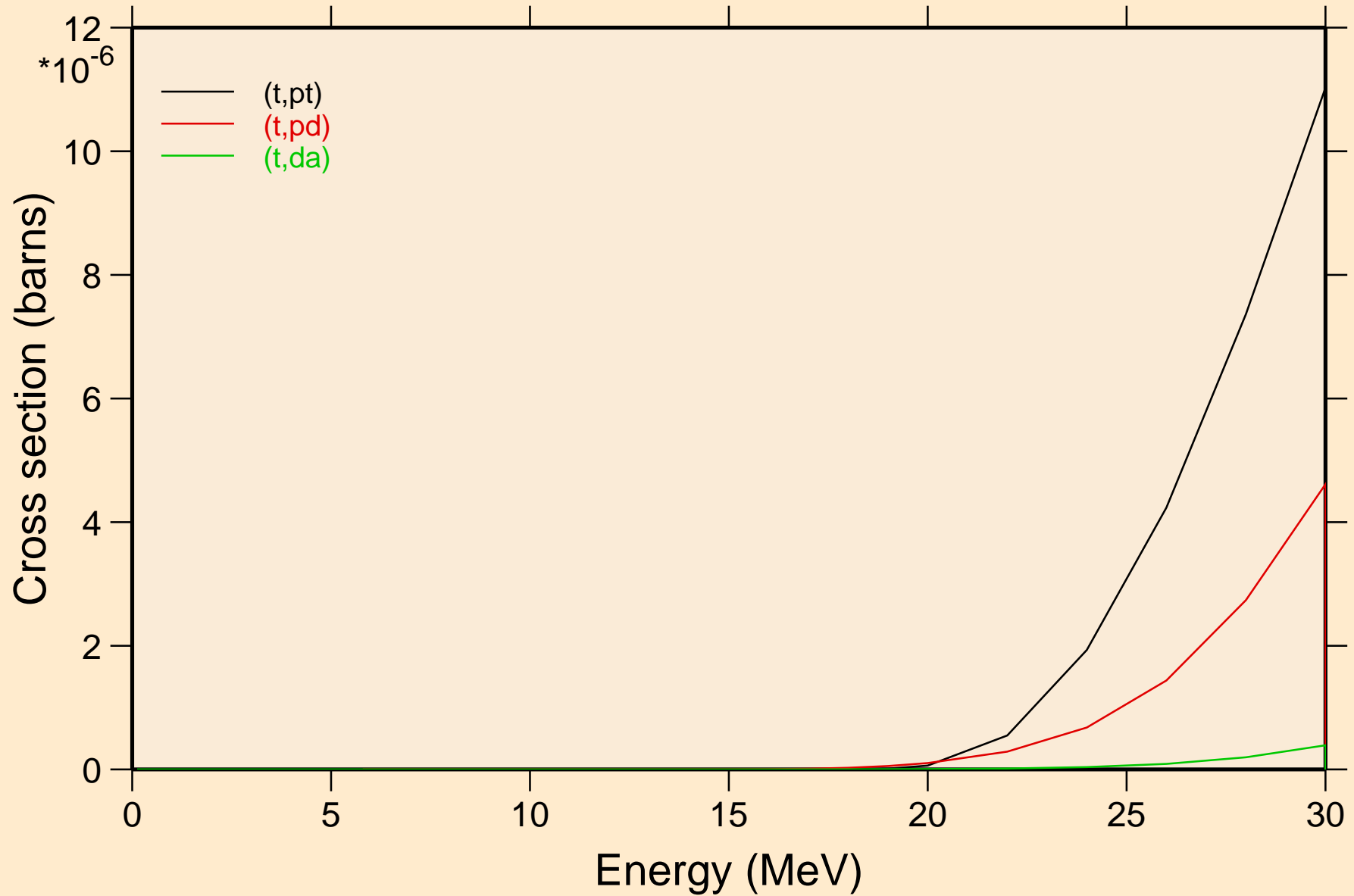

XE129 TRITON ACER TENDL-2021 LIBRARY; T=0.K  
angular distribution for elastic

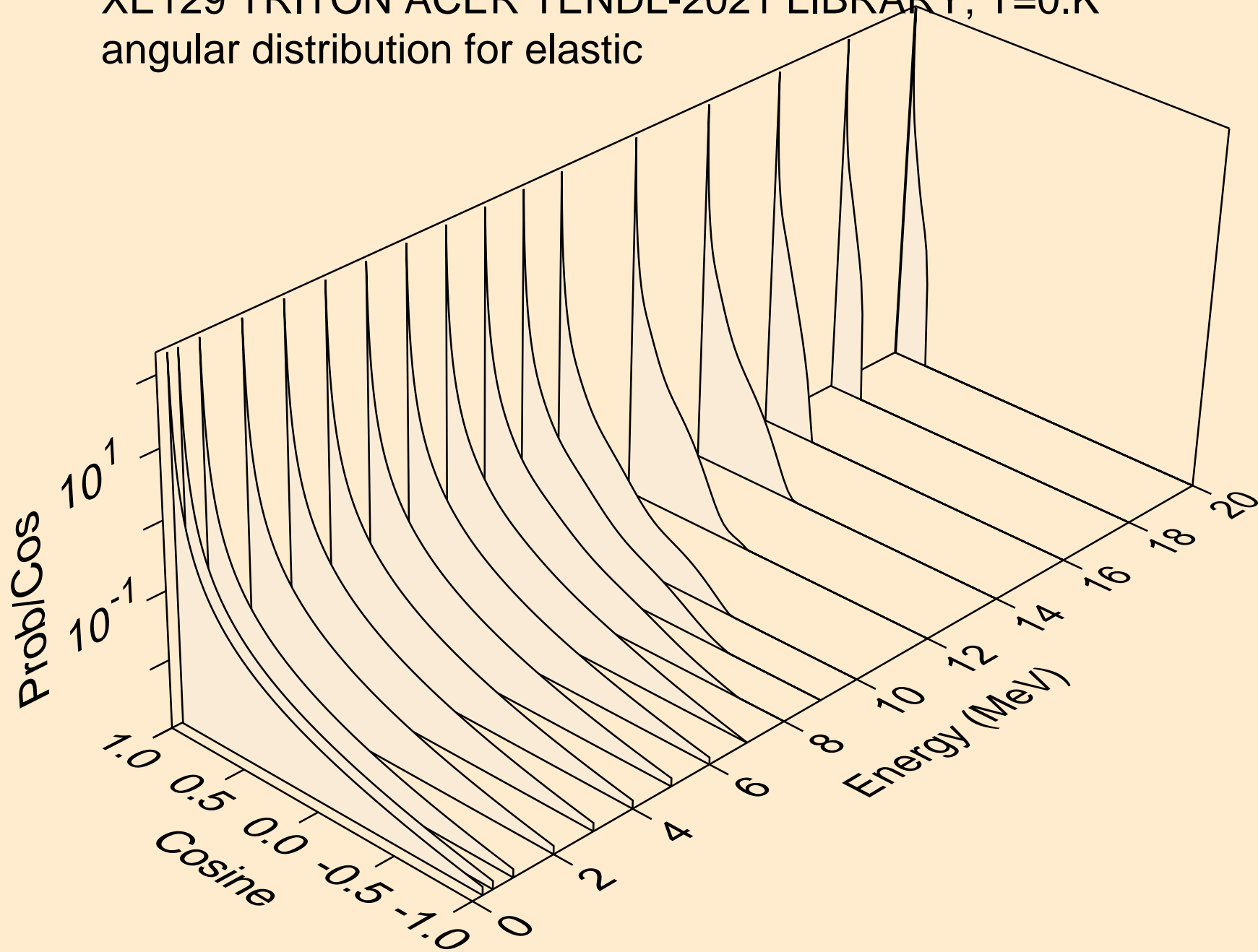



XE129 TRITON ACER TENDL-2021 LIBRARY; T=0.K  
angular distribution for elastic

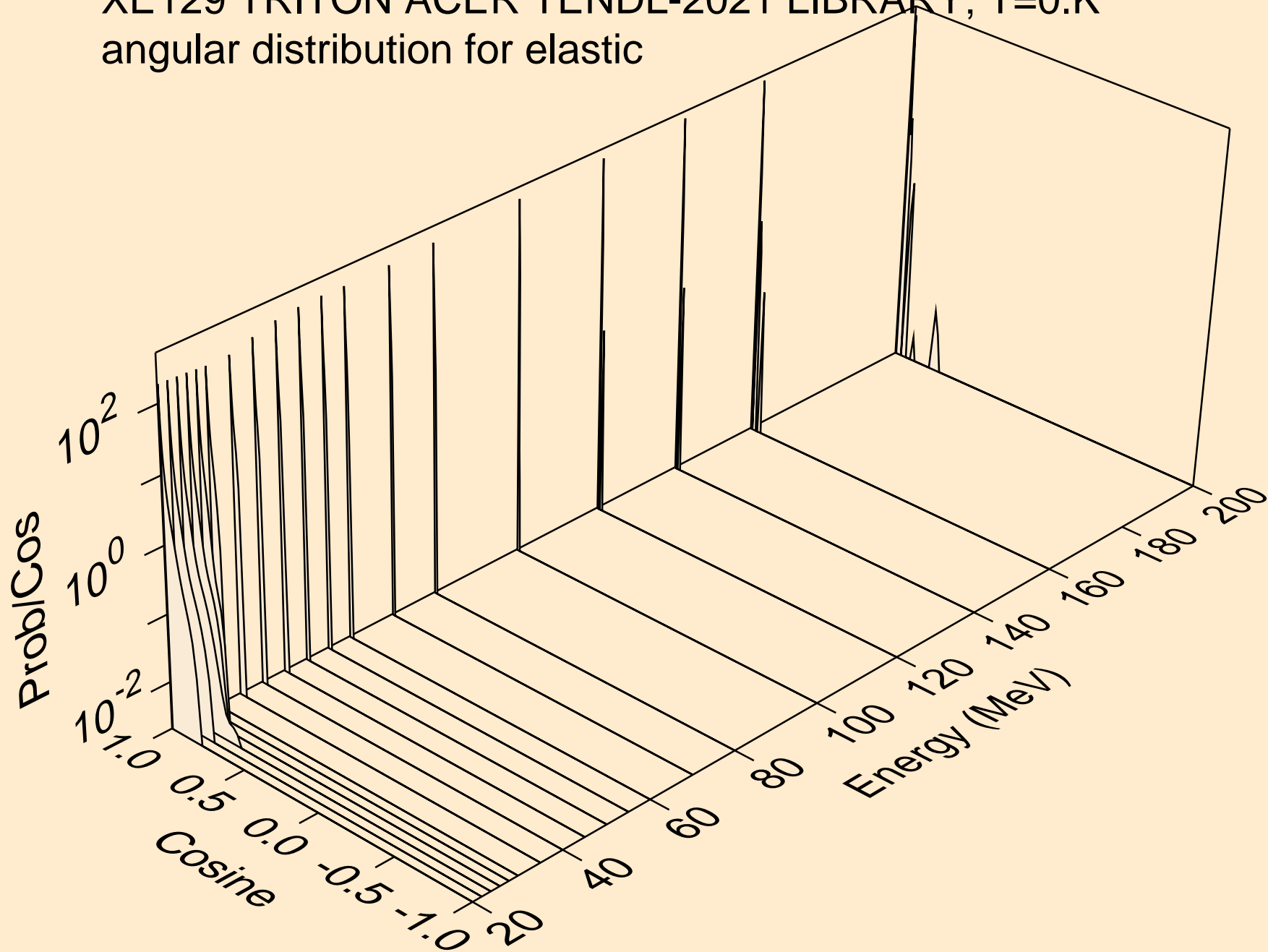

XE129 TRITON ACER TENDL-2021 LIBRARY; T=0.K  
Triton emission for (t,x)

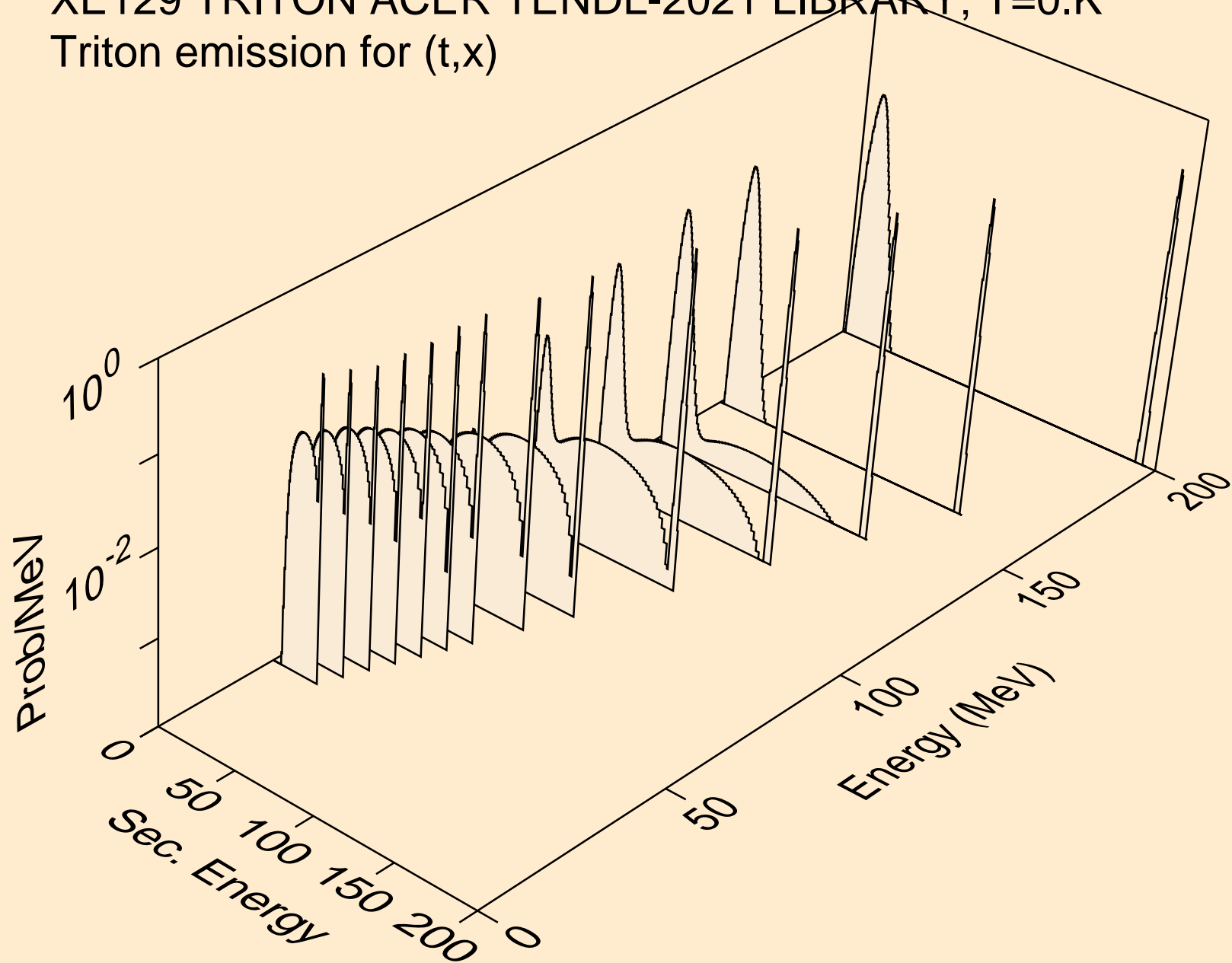

XE129 TRITON ACER TENDL-2021 LIBRARY; T=0.K  
Triton emission for (t,n\*)t

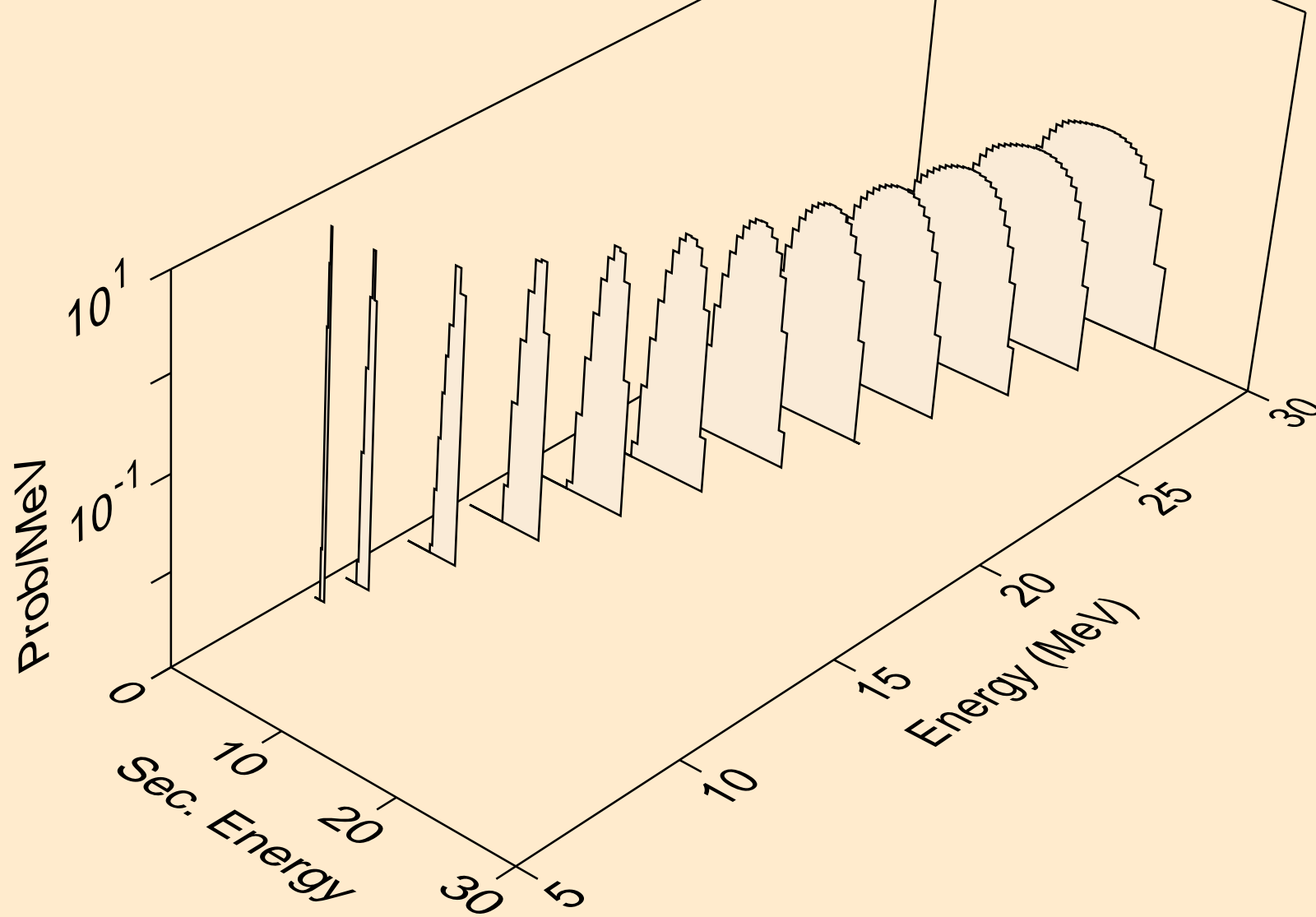

XE129 TRITON ACER TENDL-2021 LIBRARY; T=0.K  
Triton emission for inelastic

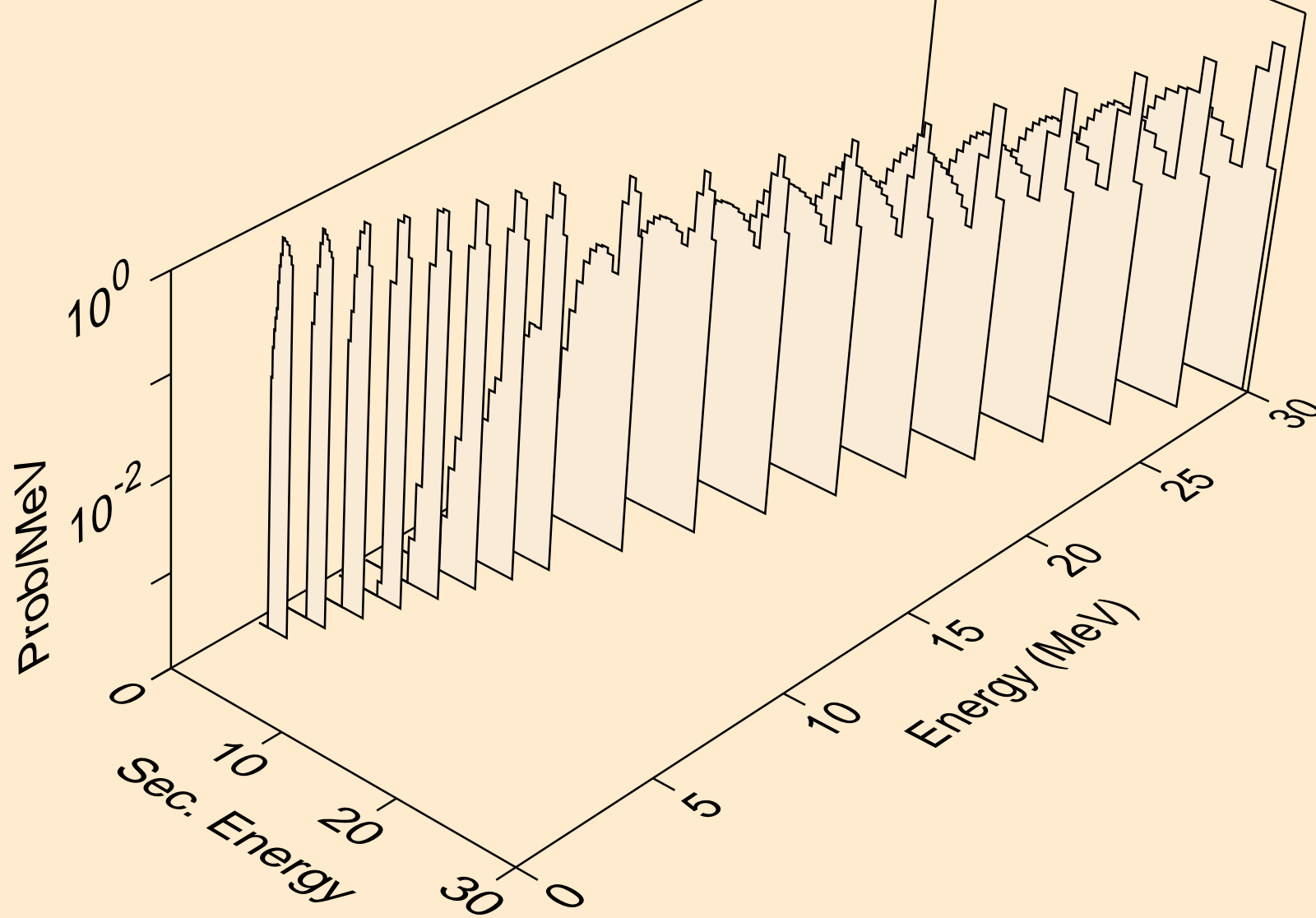

XE129 TRITON ACER TENDL-2021 LIBRARY; T=0.K  
Triton emission for (t,pt)

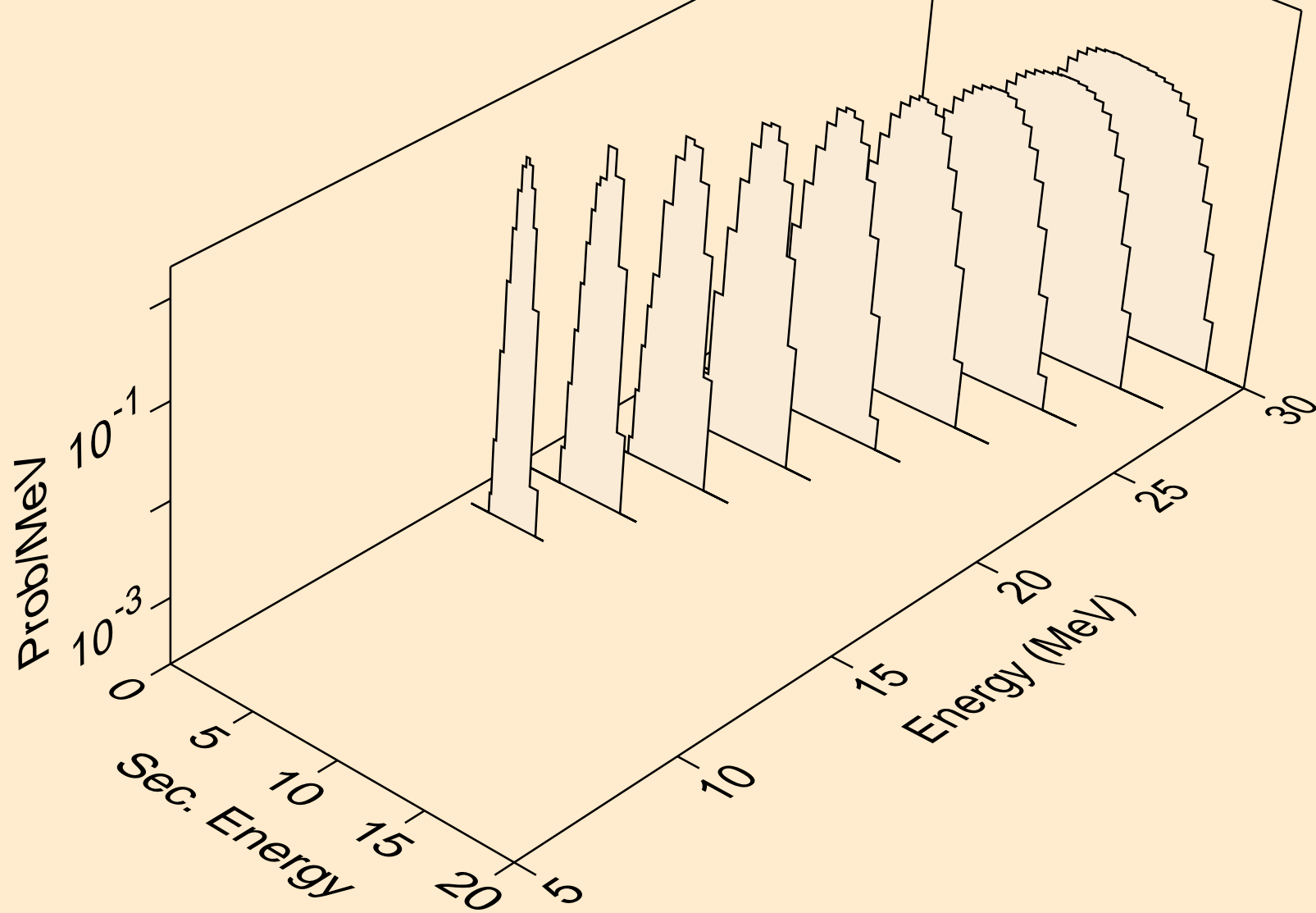

XE129 TRITON ACER TENDL-2021 LIBRARY; T=0.K  
Photon emission for (z,n)

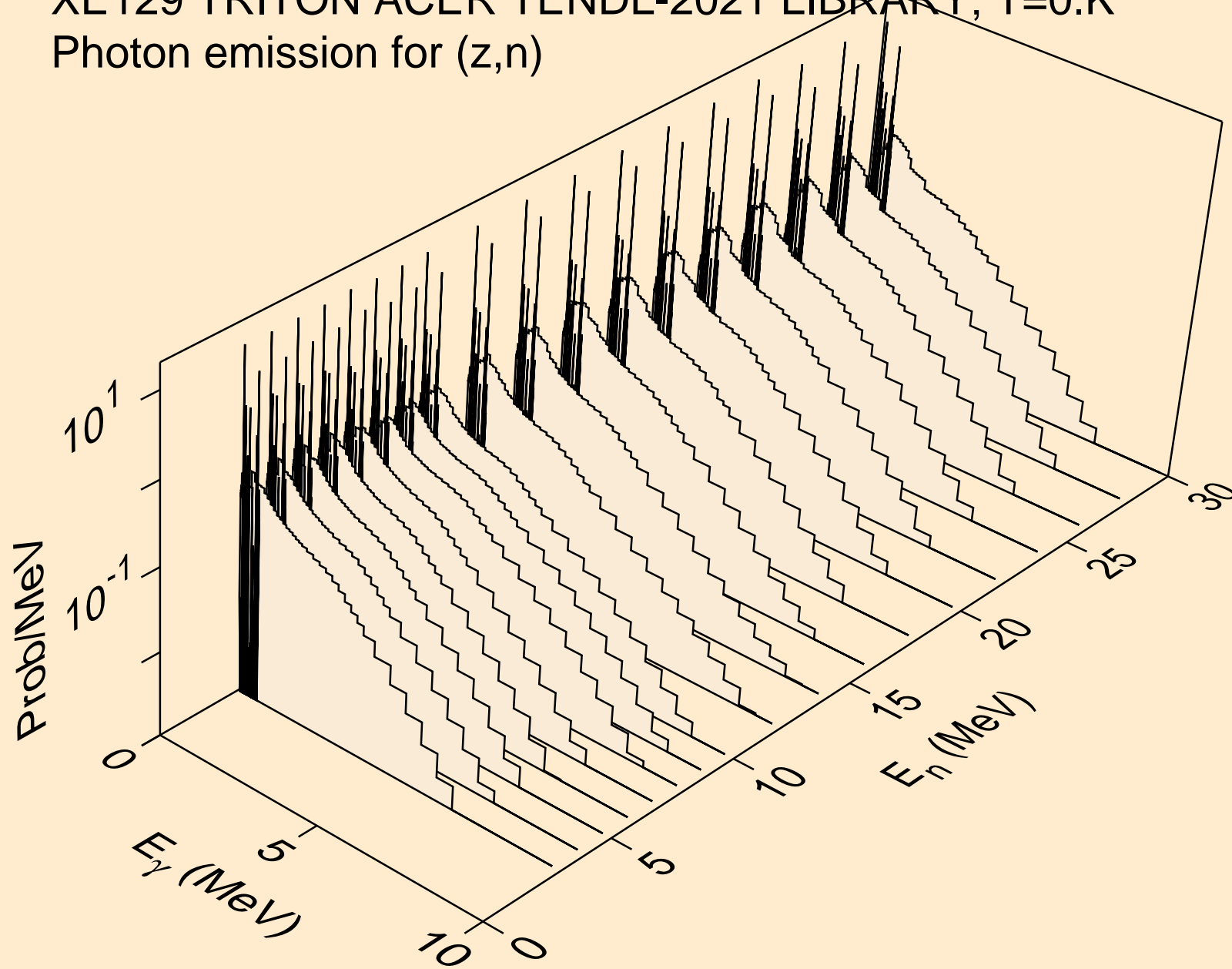

XE129 TRITON ACER TENDL-2021 LIBRARY; T=0.K  
Photon emission for (n,x)

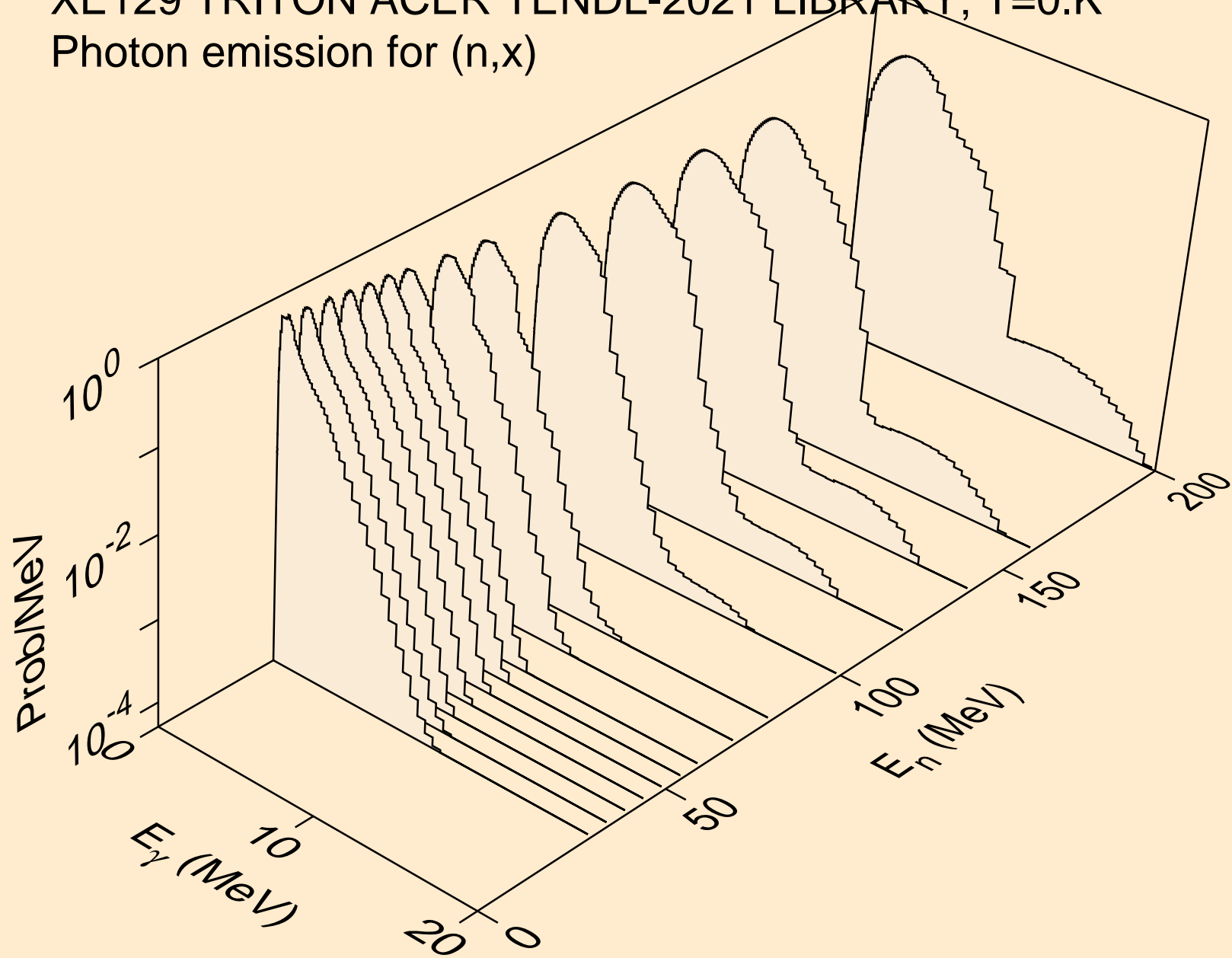

XE129 TRITON ACER TENDL-2021 LIBRARY; T=0.K  
Photon emission for (n,2nd)

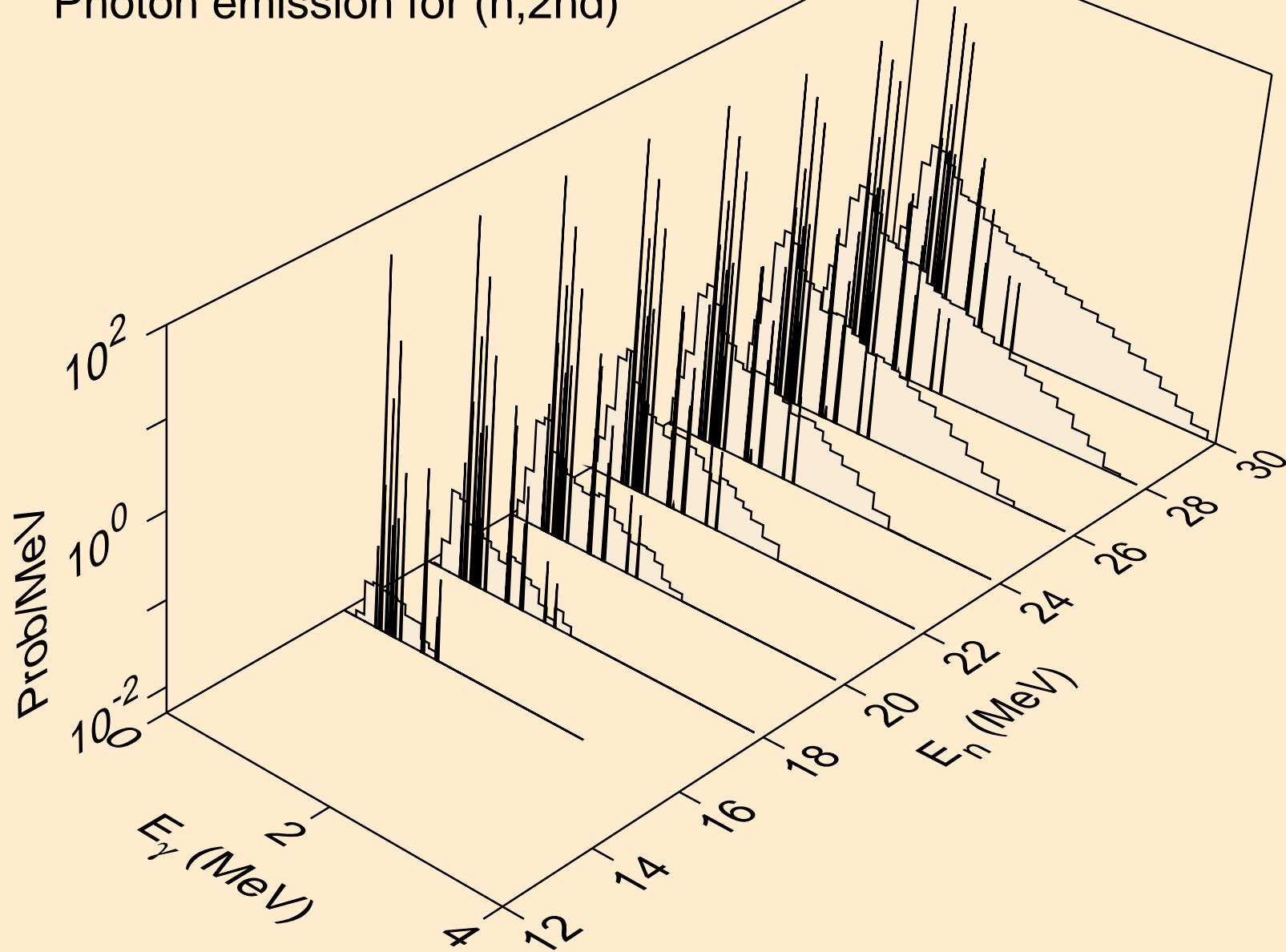



XE129 TRITON ACER TENDL-2021 LIBRARY; T=0.K  
Photon emission for (n,2n)

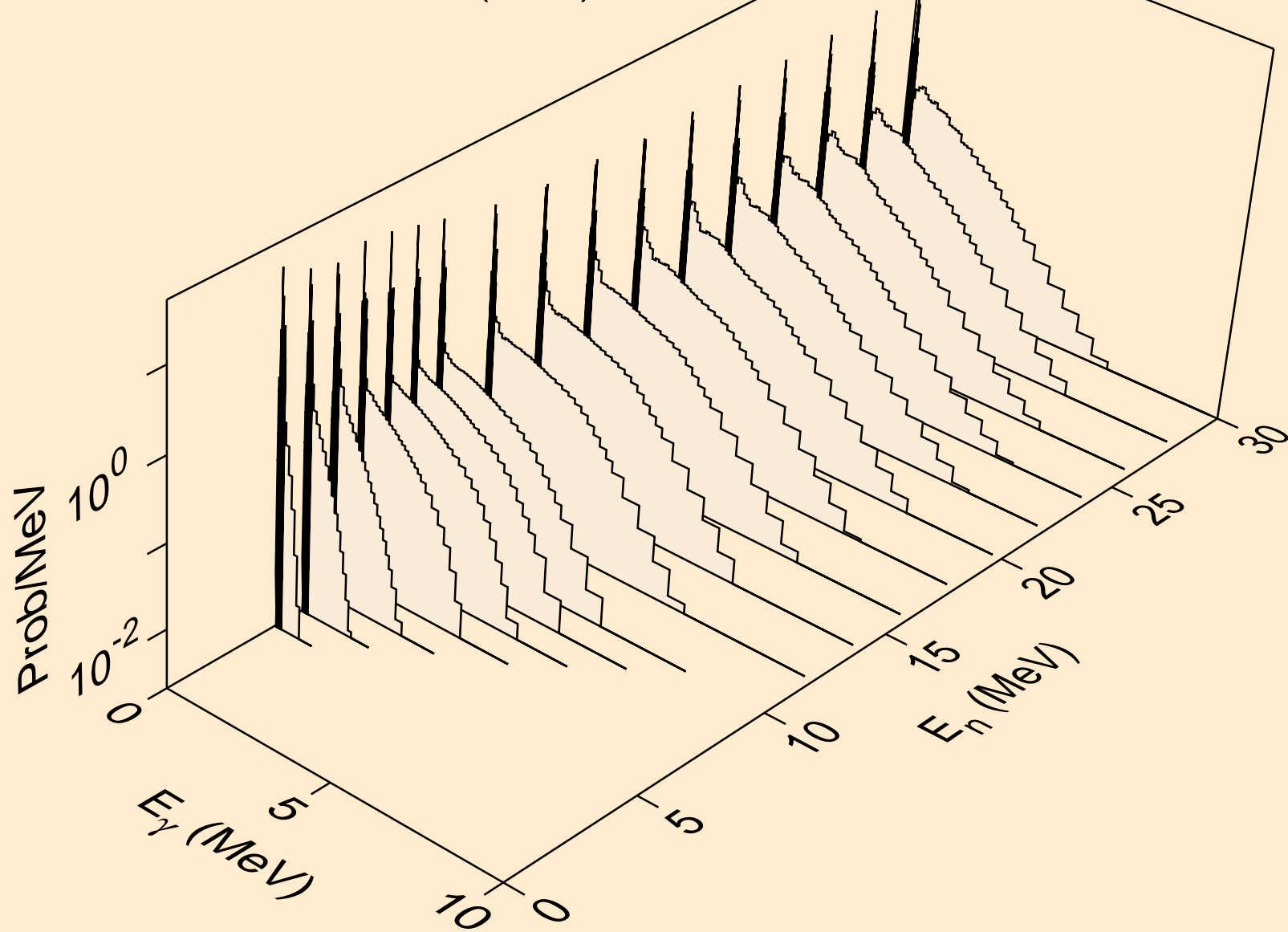

XE129 TRITON ACER TENDL-2021 LIBRARY; T=0.K  
Photon emission for (n,3n)

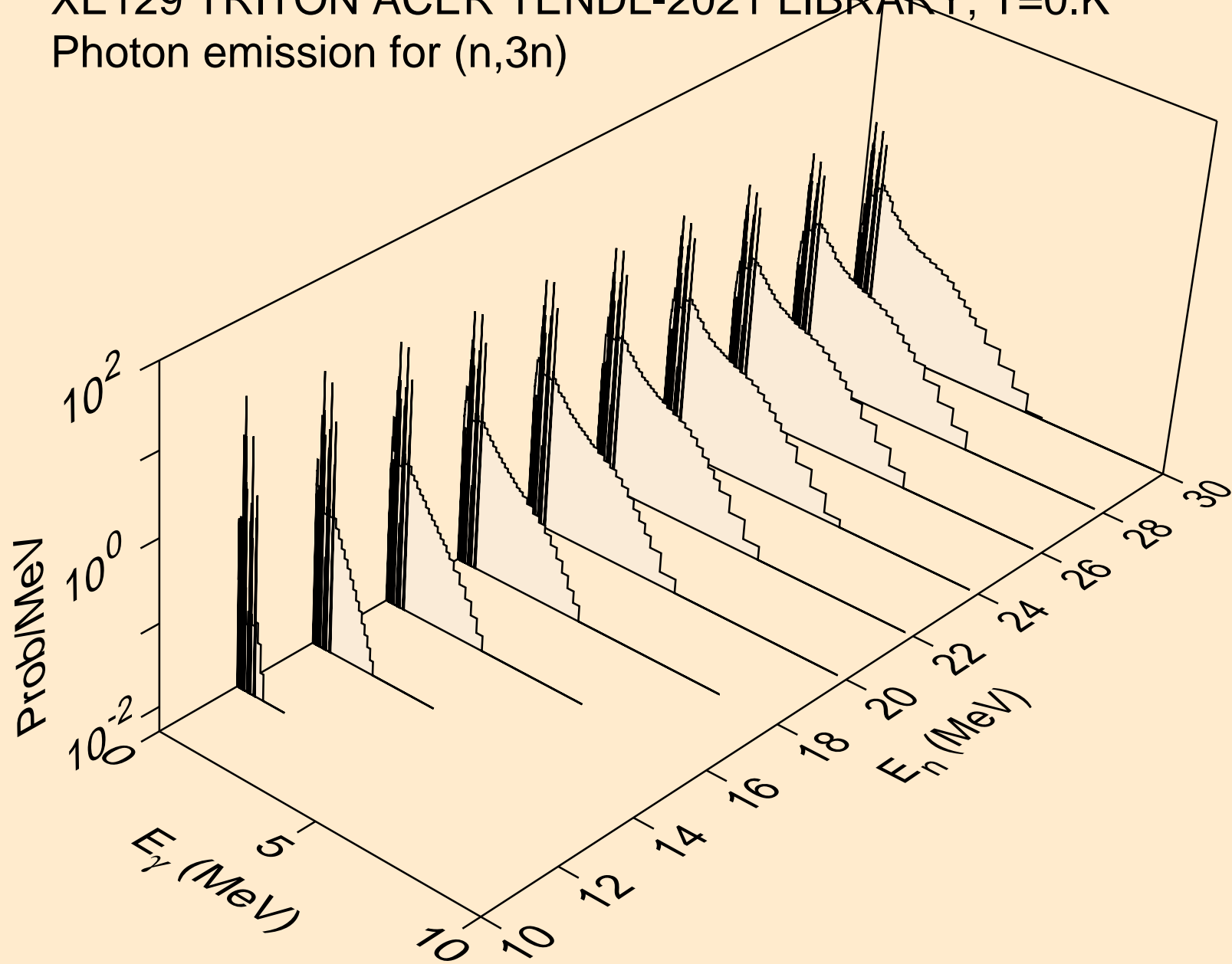

XE129 TRITON ACER TENDL-2021 LIBRARY; T=0.K  
Photon emission for (n,n\*)a

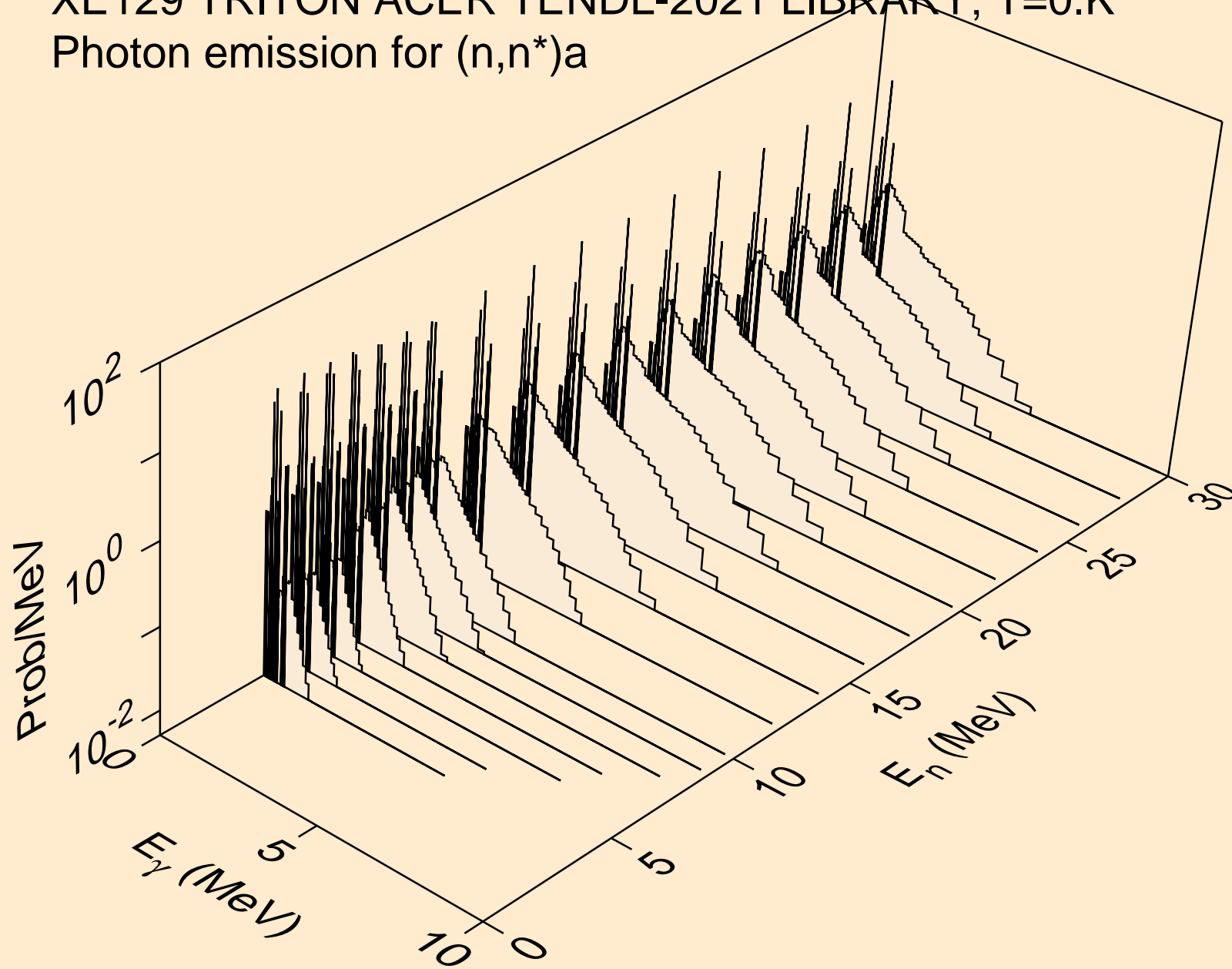

XE129 TRITON ACER TENDL-2021 LIBRARY; T=0.K  
Photon emission for (n,2n)a

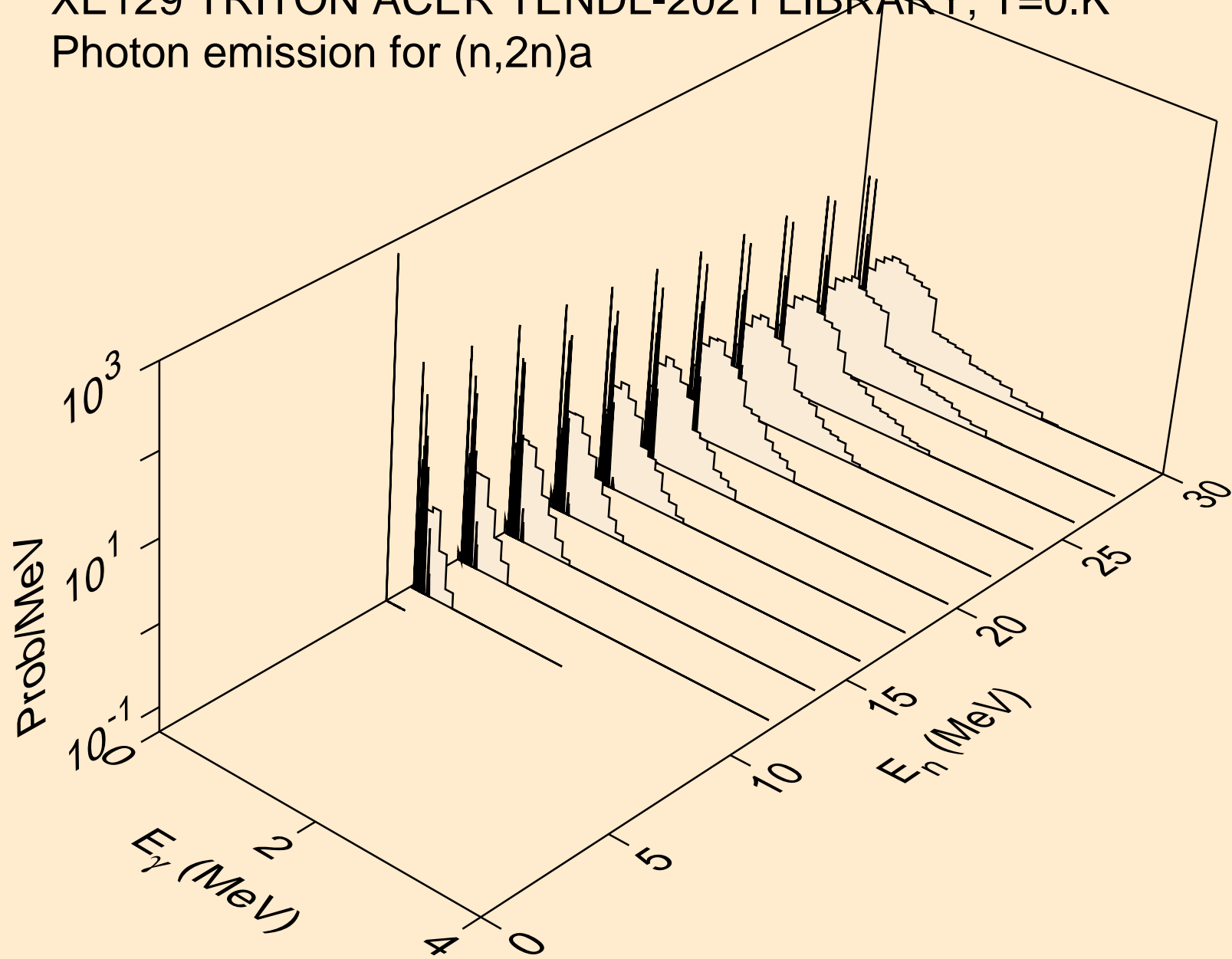

XE129 TRITON ACER TENDL-2021 LIBRARY; T=0.K  
Photon emission for (n,3n)a

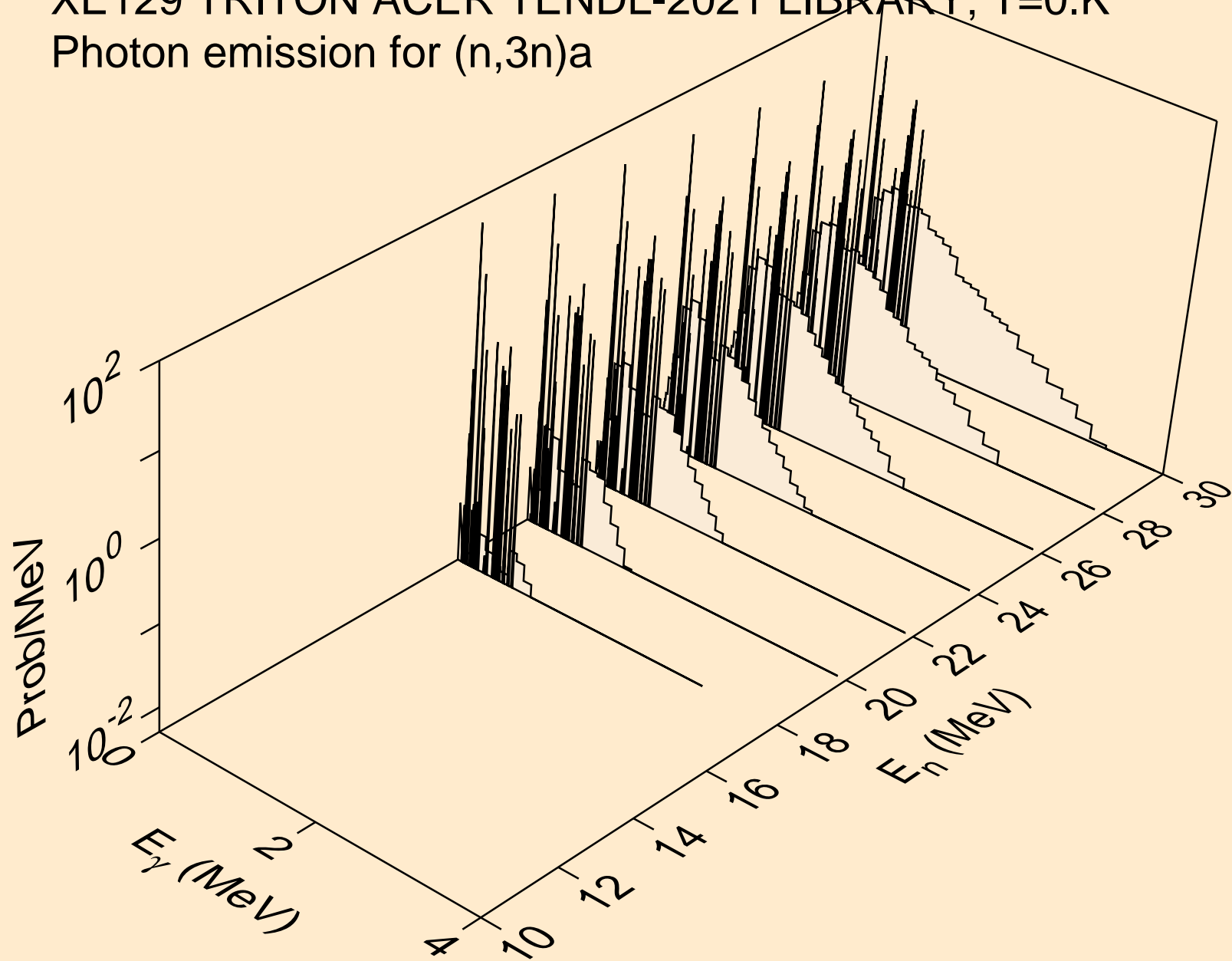

XE129 TRITON ACER TENDL-2021 LIBRARY; T=0.K  
Photon emission for (n,n\*)p

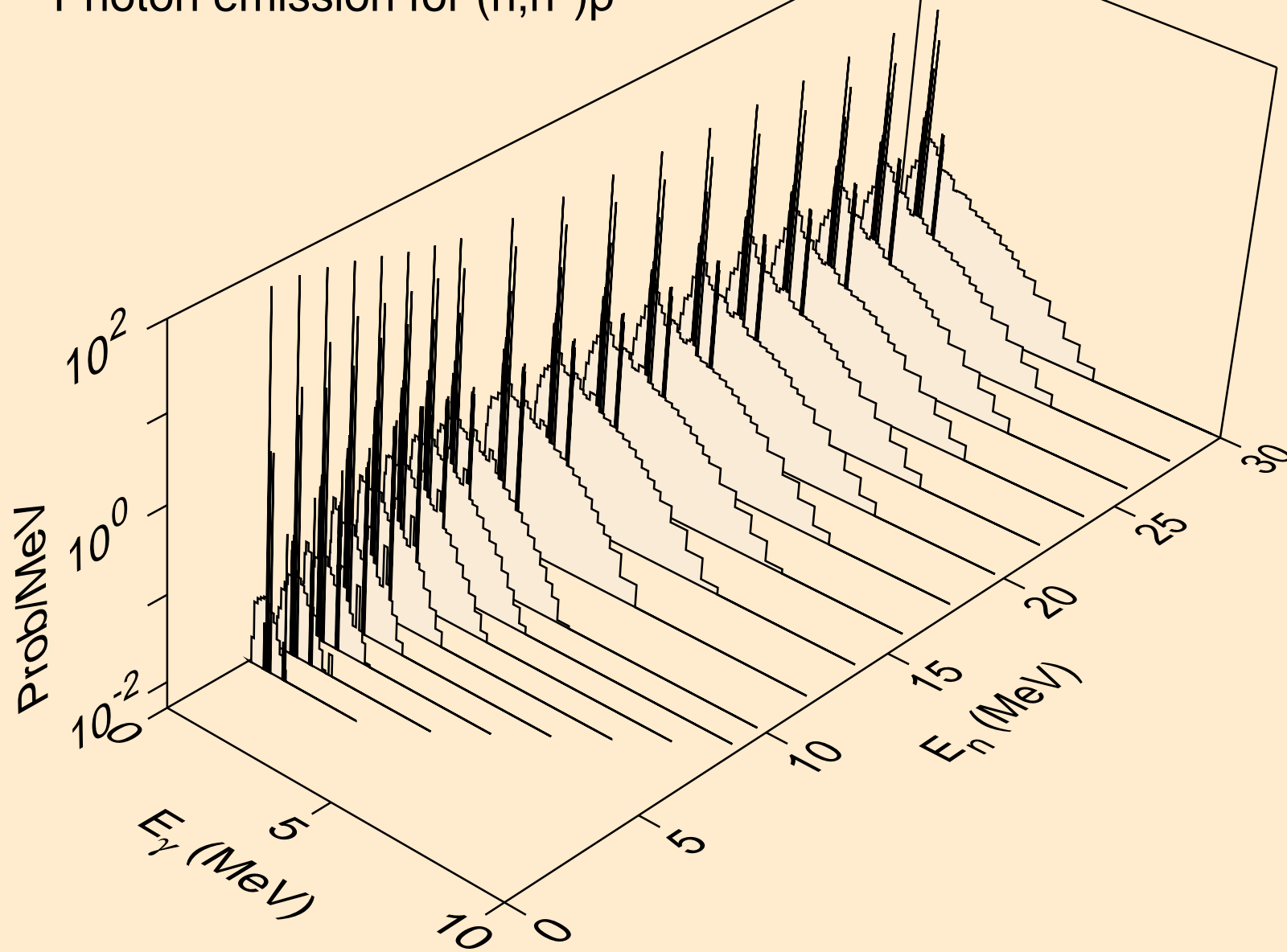

XE129 TRITON ACER TENDL-2021 LIBRARY; T=0.K  
Photon emission for (n,n\*)2a

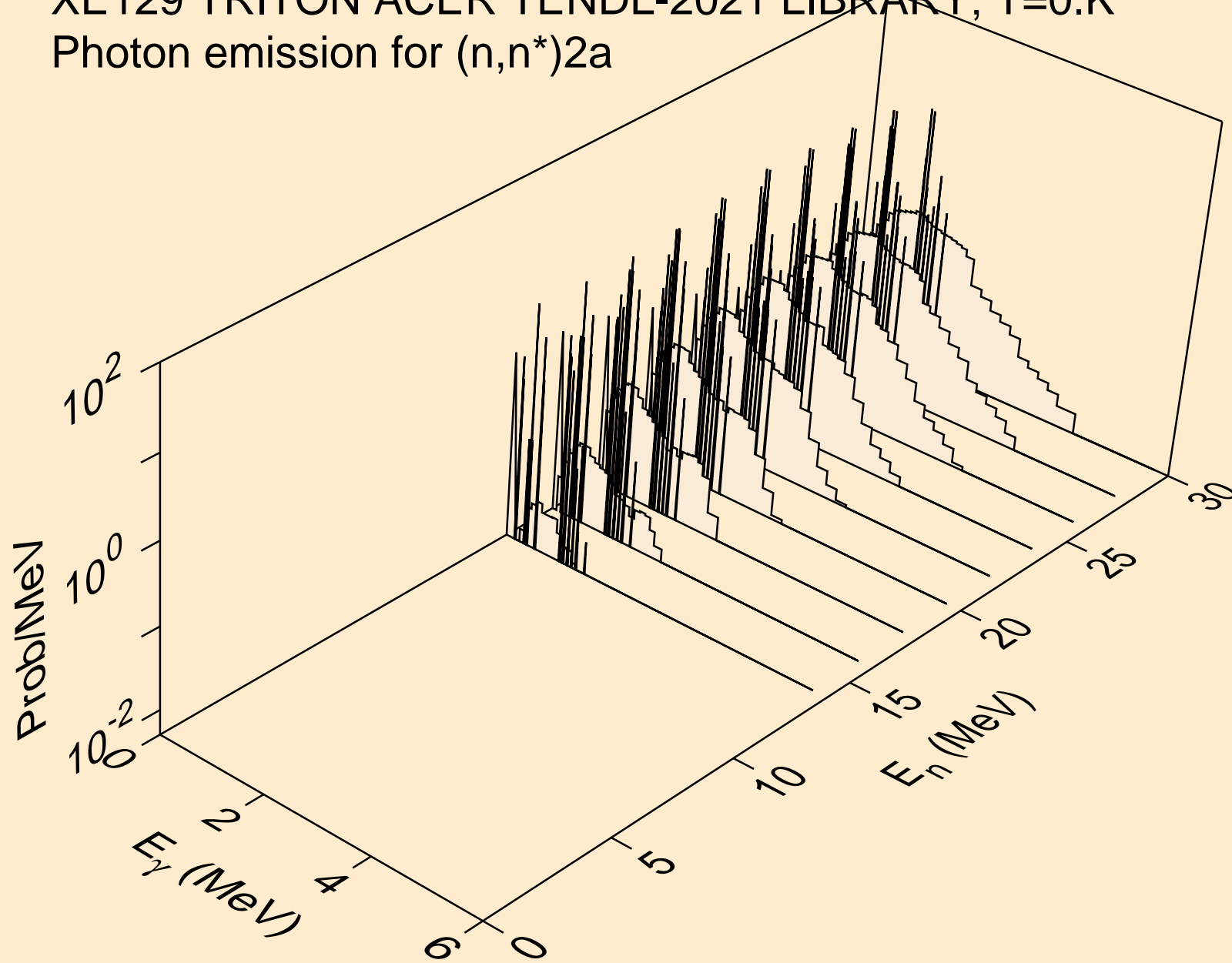

XE129 TRITON ACER TENDL-2021 LIBRARY; T=0.K  
Photon emission for (n,2n)2a

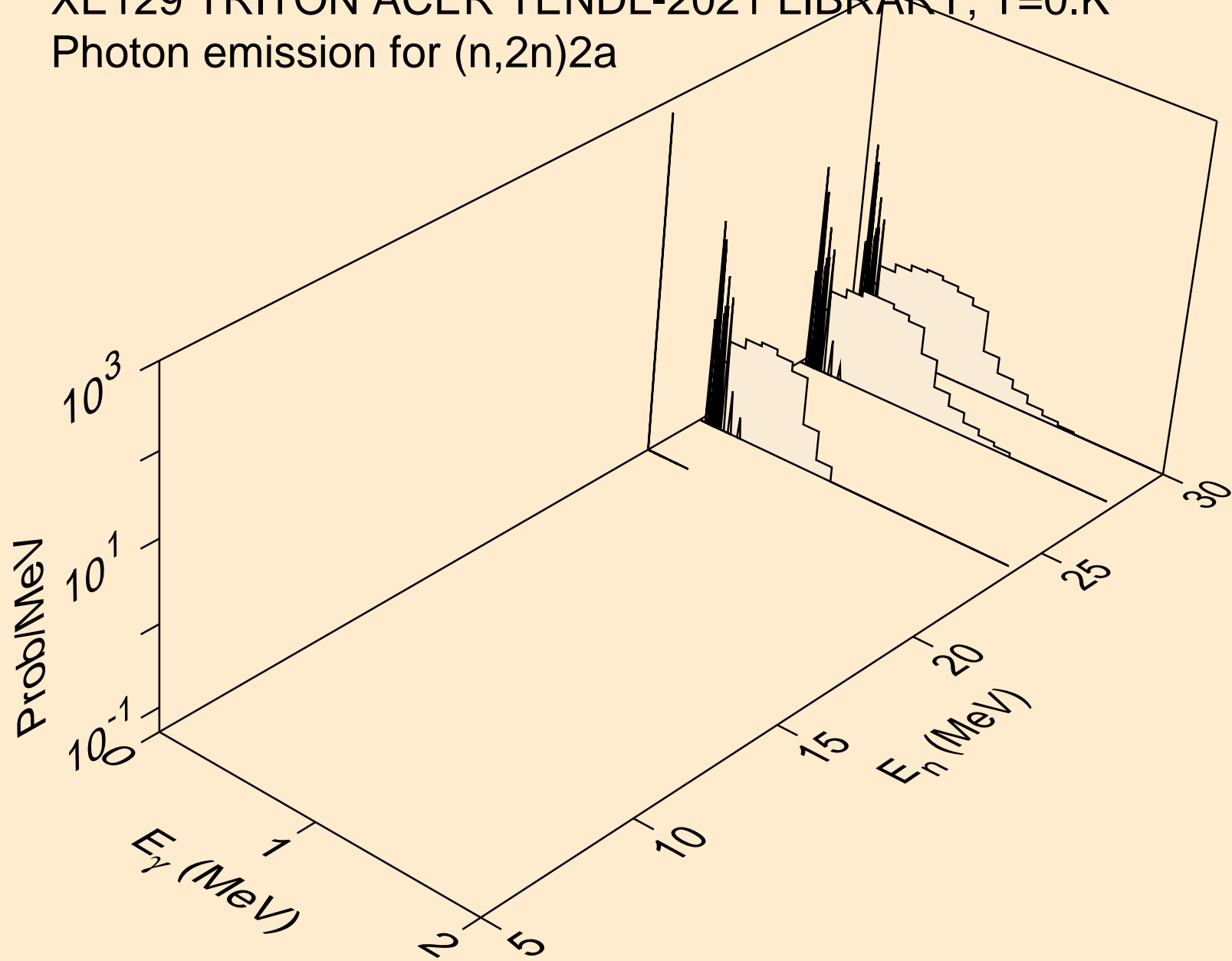



XE129 TRITON ACER TENDL-2021 LIBRARY; T=0.K  
Photon emission for (n,n\*)d

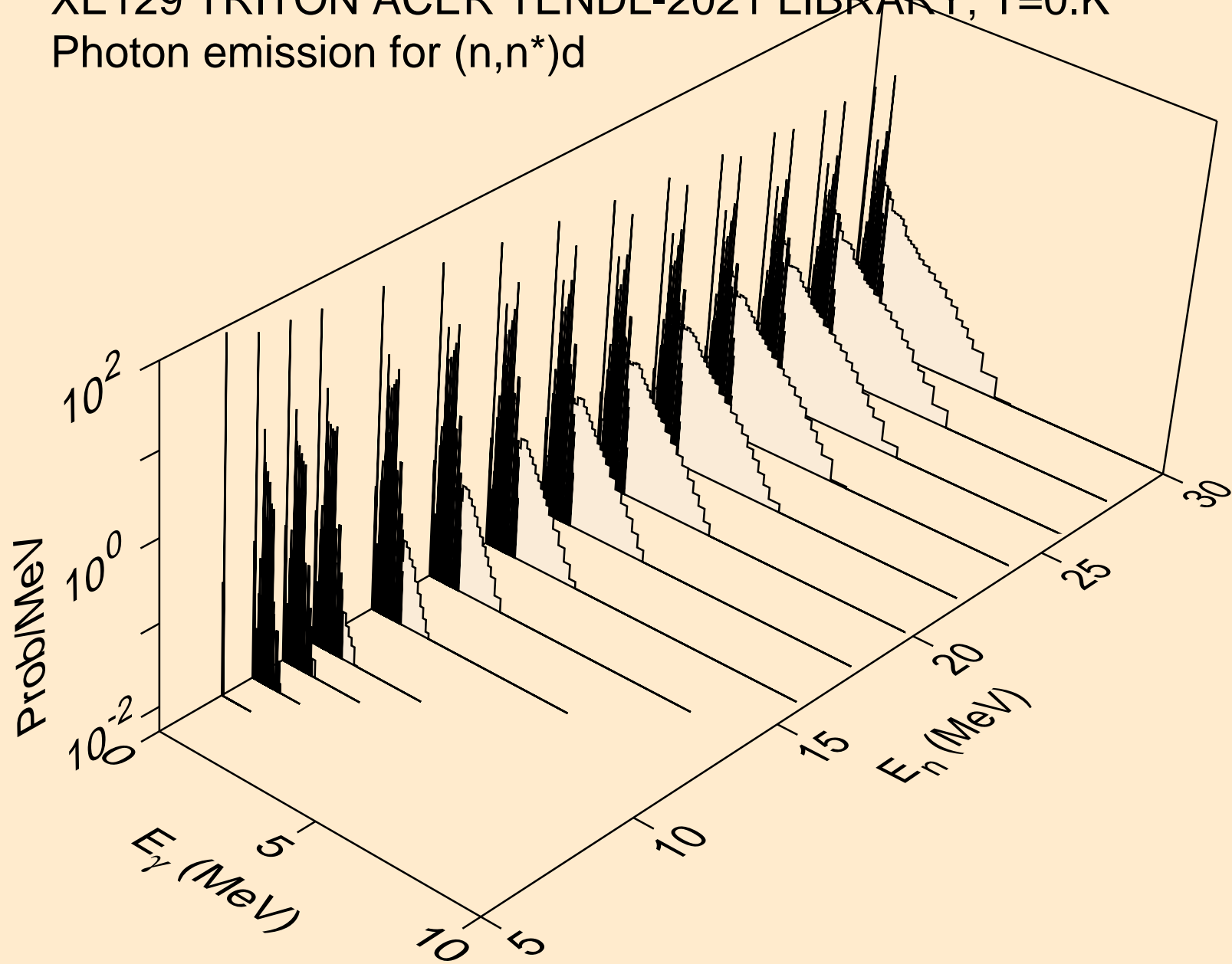

XE129 TRITON ACER TENDL-2021 LIBRARY; T=0.K  
Photon emission for (n,n\*)t

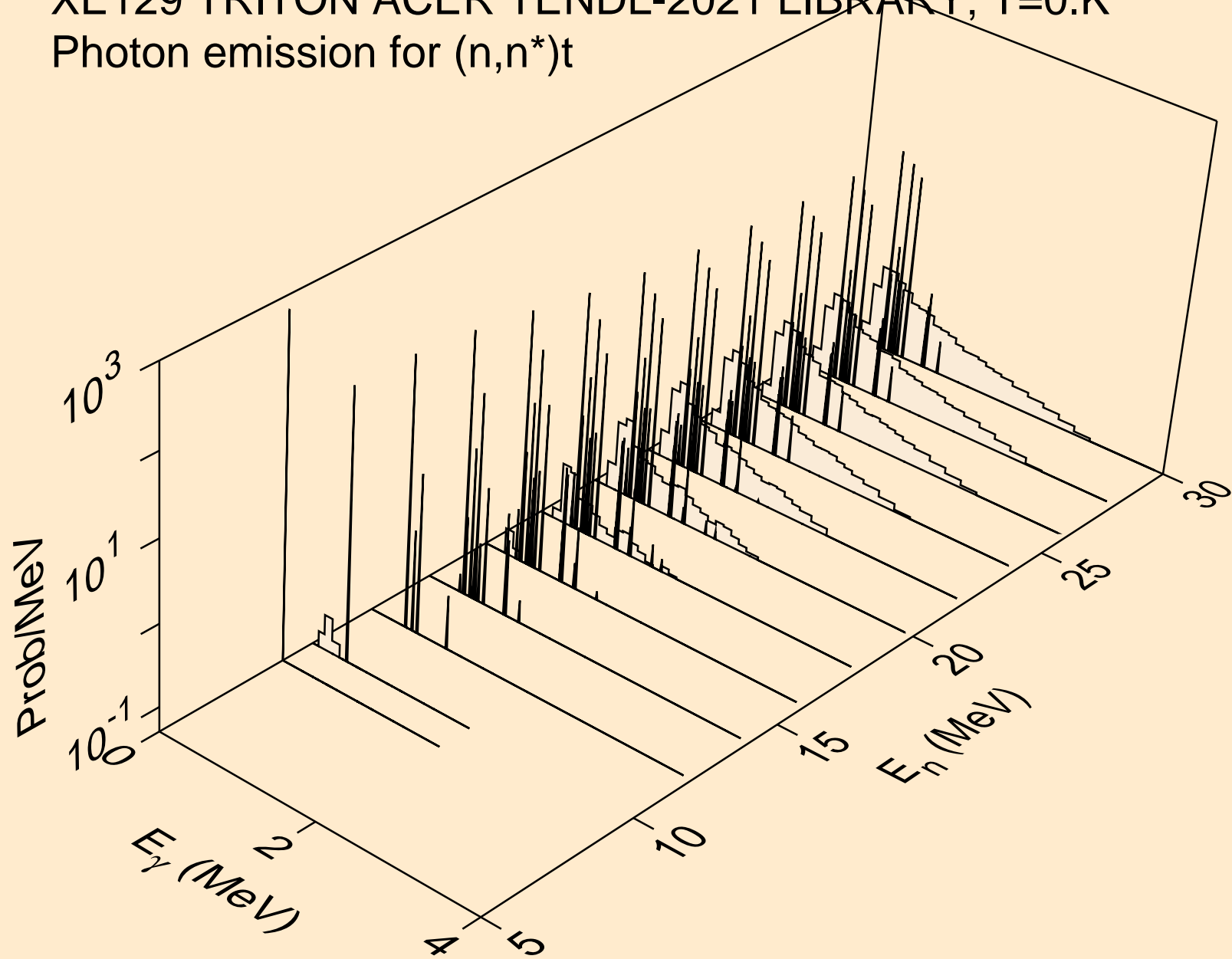

XE129 TRITON ACER TENDL-2021 LIBRARY; T=0.K  
Photon emission for (n,n\*)he3

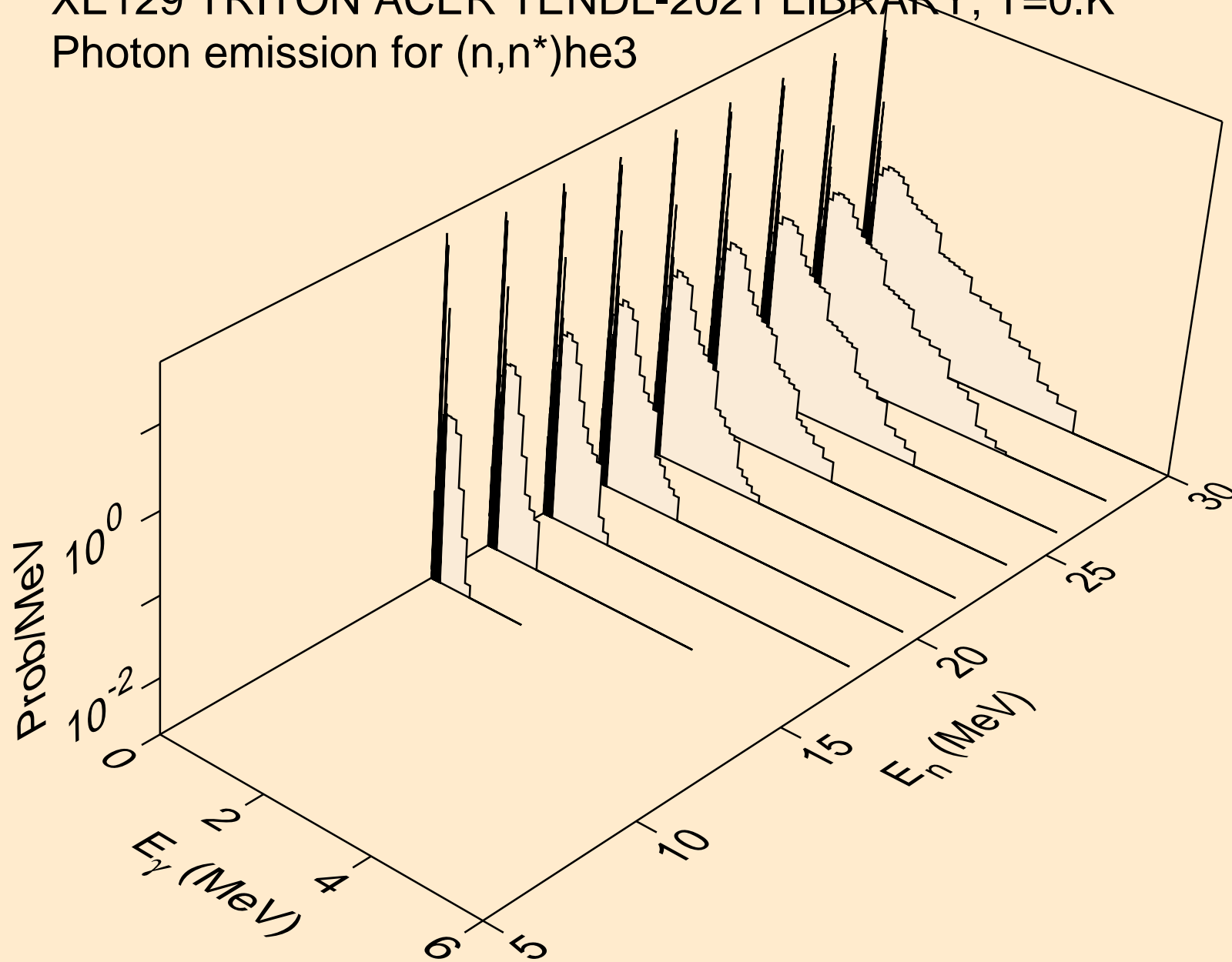

XE129 TRITON ACER TENDL-2021 LIBRARY; T=0.K  
Photon emission for (n,4n)

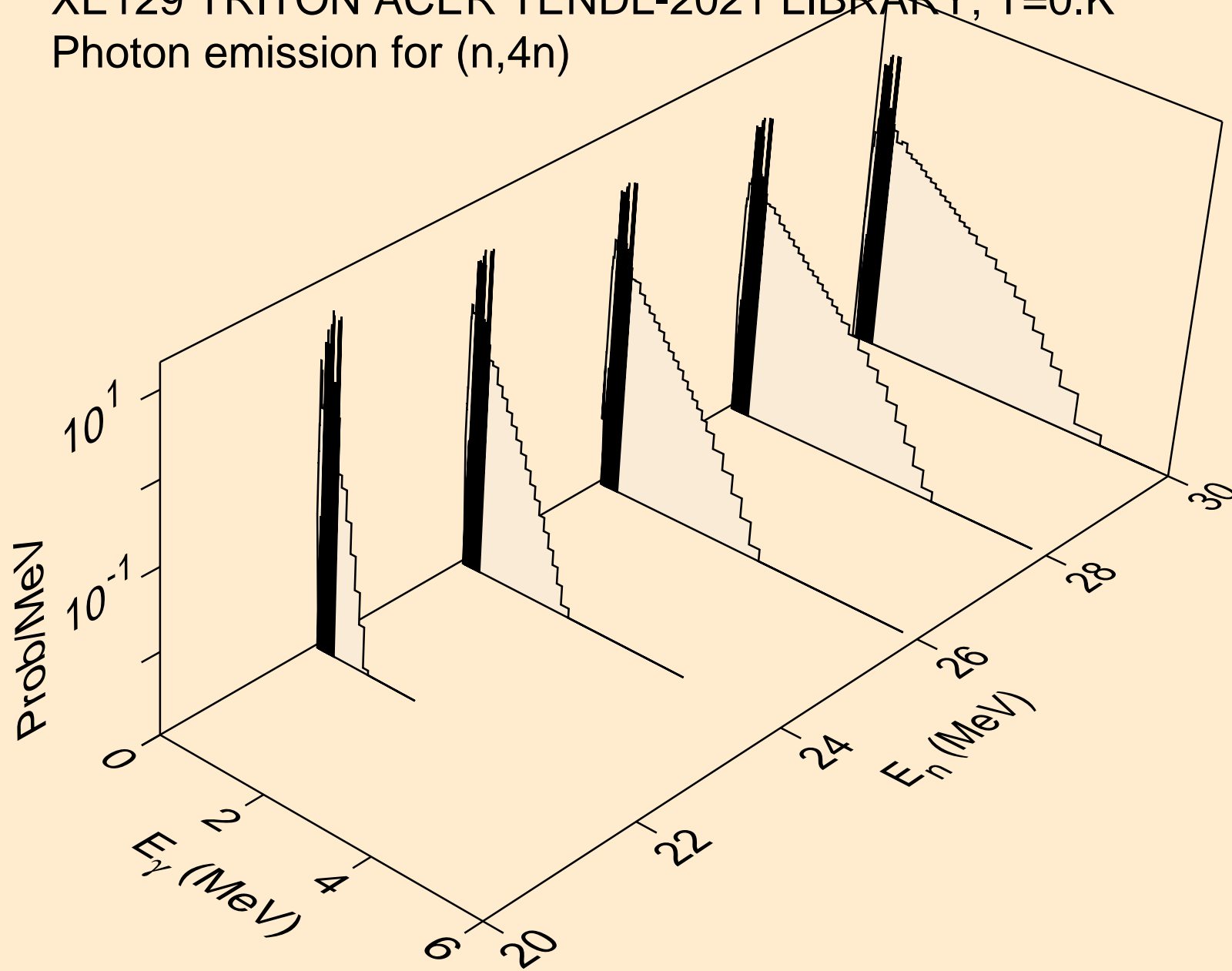

XE129 TRITON ACER TENDL-2021 LIBRARY; T=0.K  
Photon emission for (n,2np)

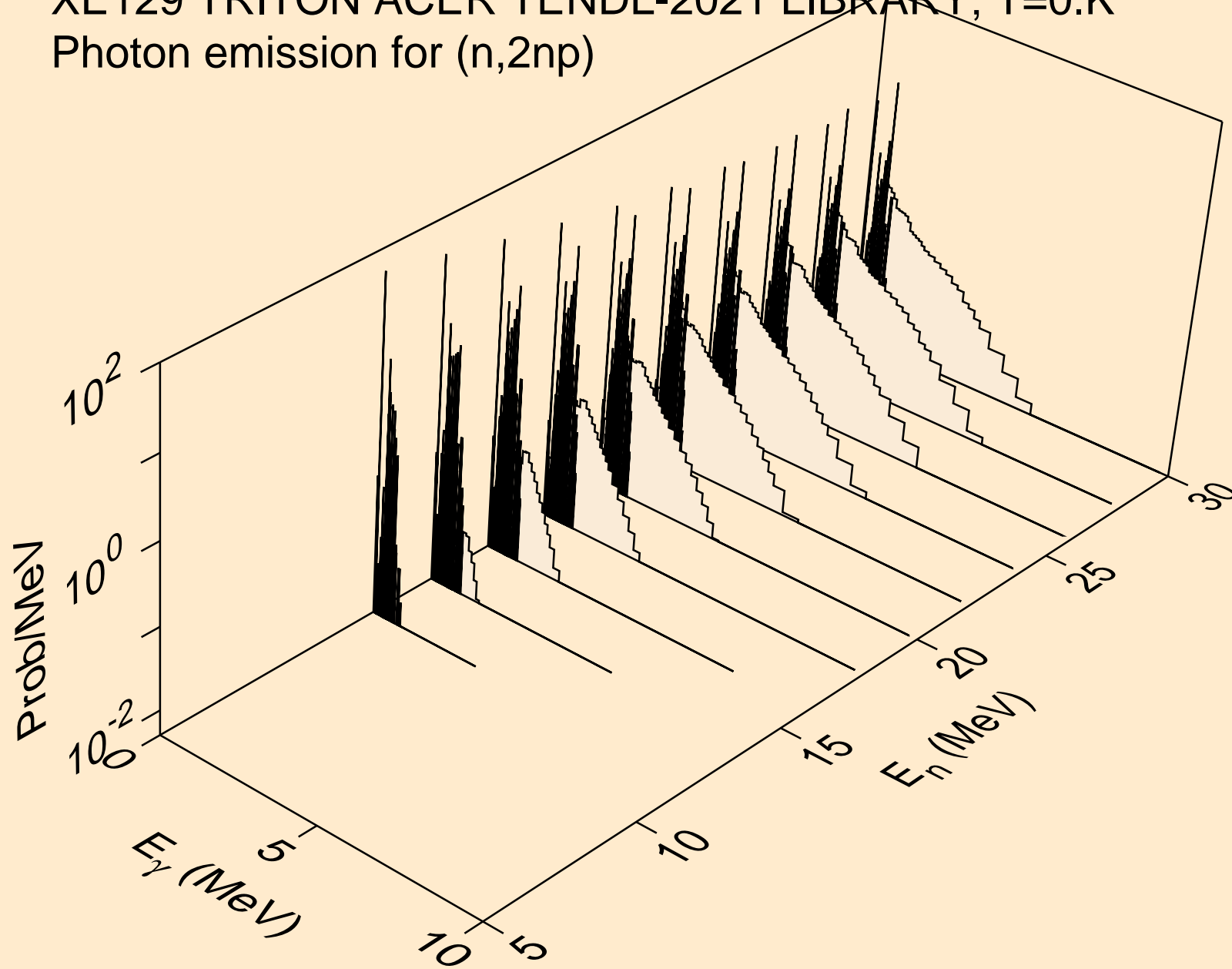

XE129 TRITON ACER TENDL-2021 LIBRARY; T=0.K  
Photon emission for (n,3np)

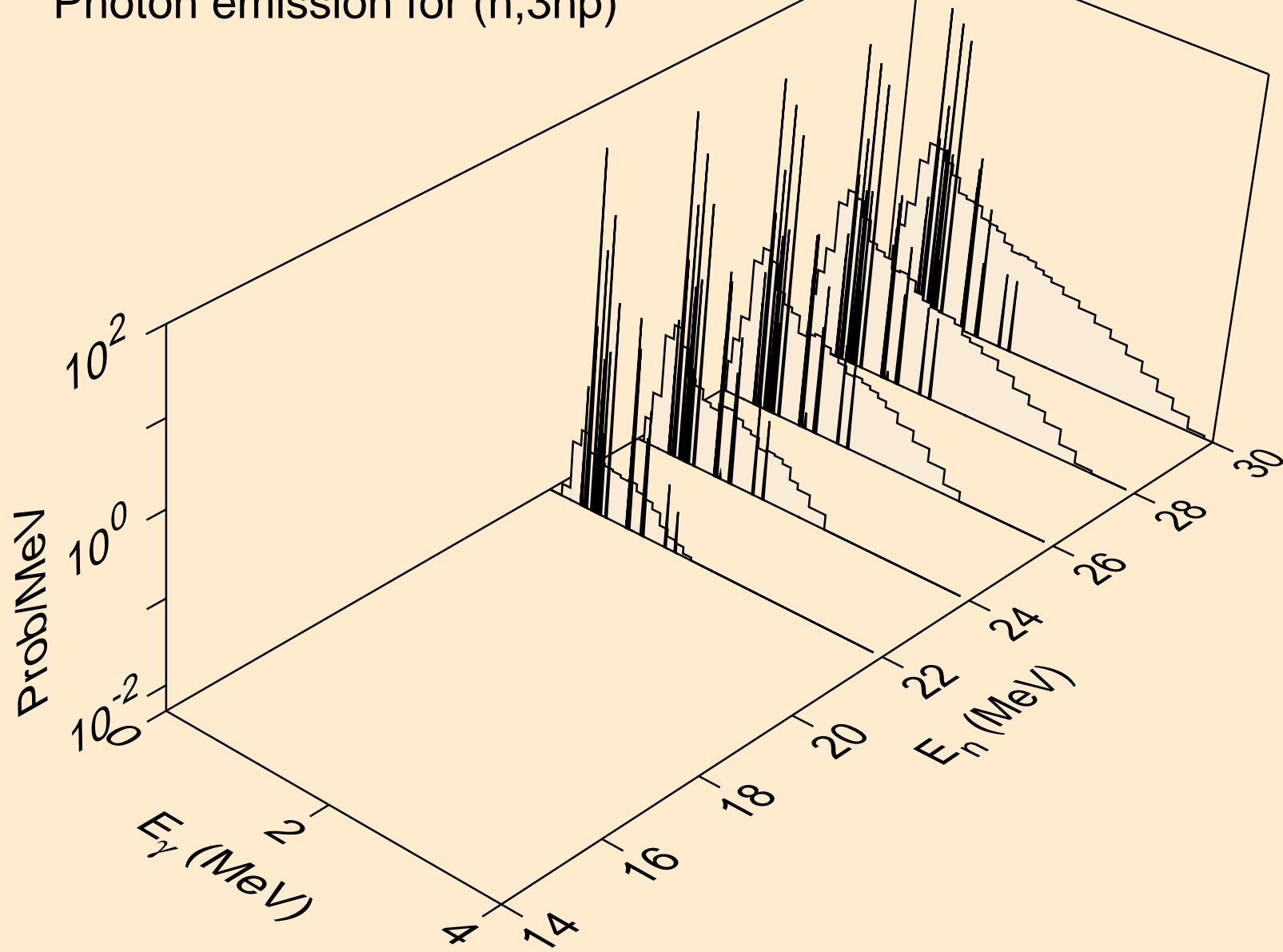

XE129 TRITON ACER TENDL-2021 LIBRARY; T=0.K  
Photon emission for (n,2np)

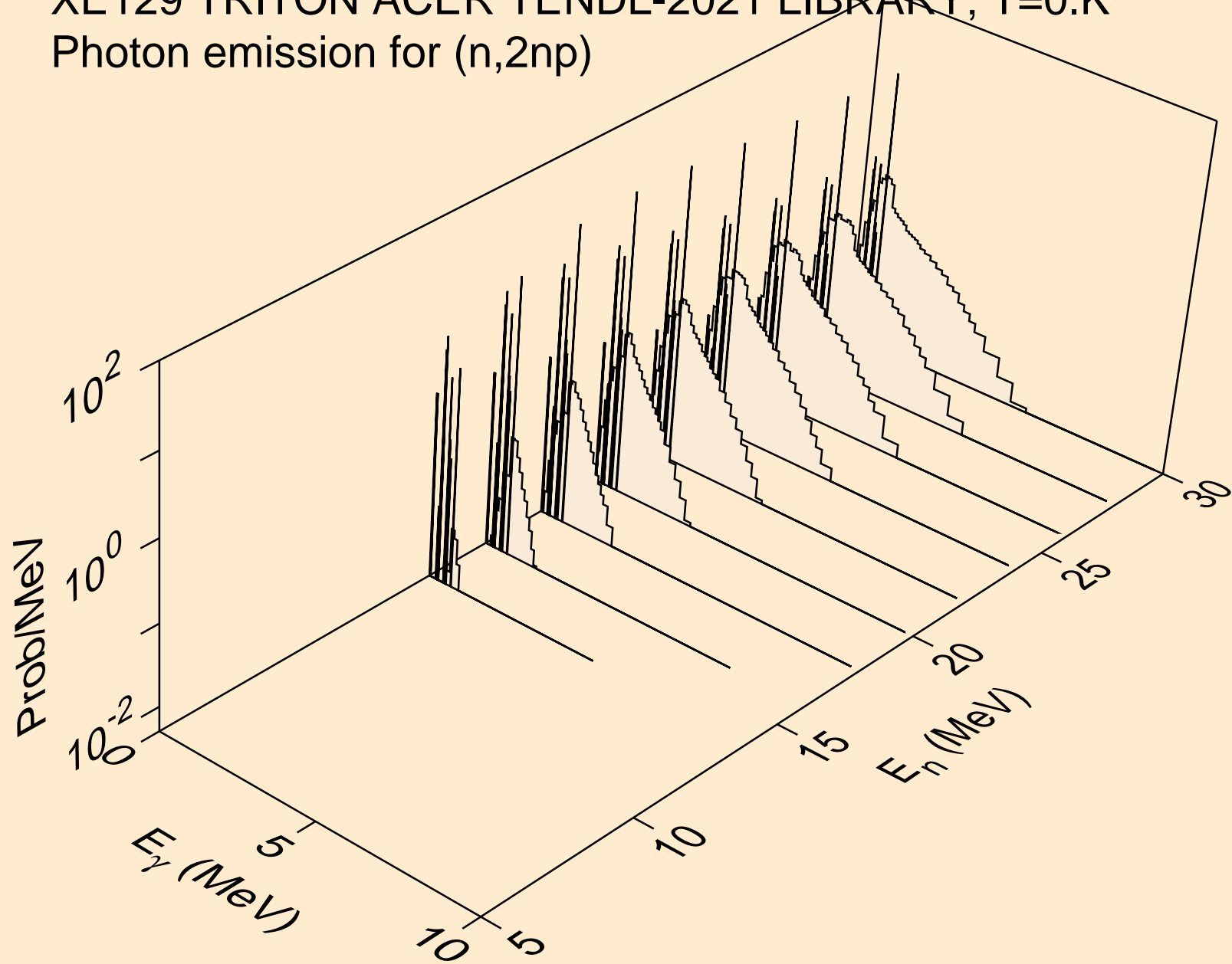

XE129 TRITON ACER TENDL-2021 LIBRARY; T=0.K  
Photon emission for (n,npa)

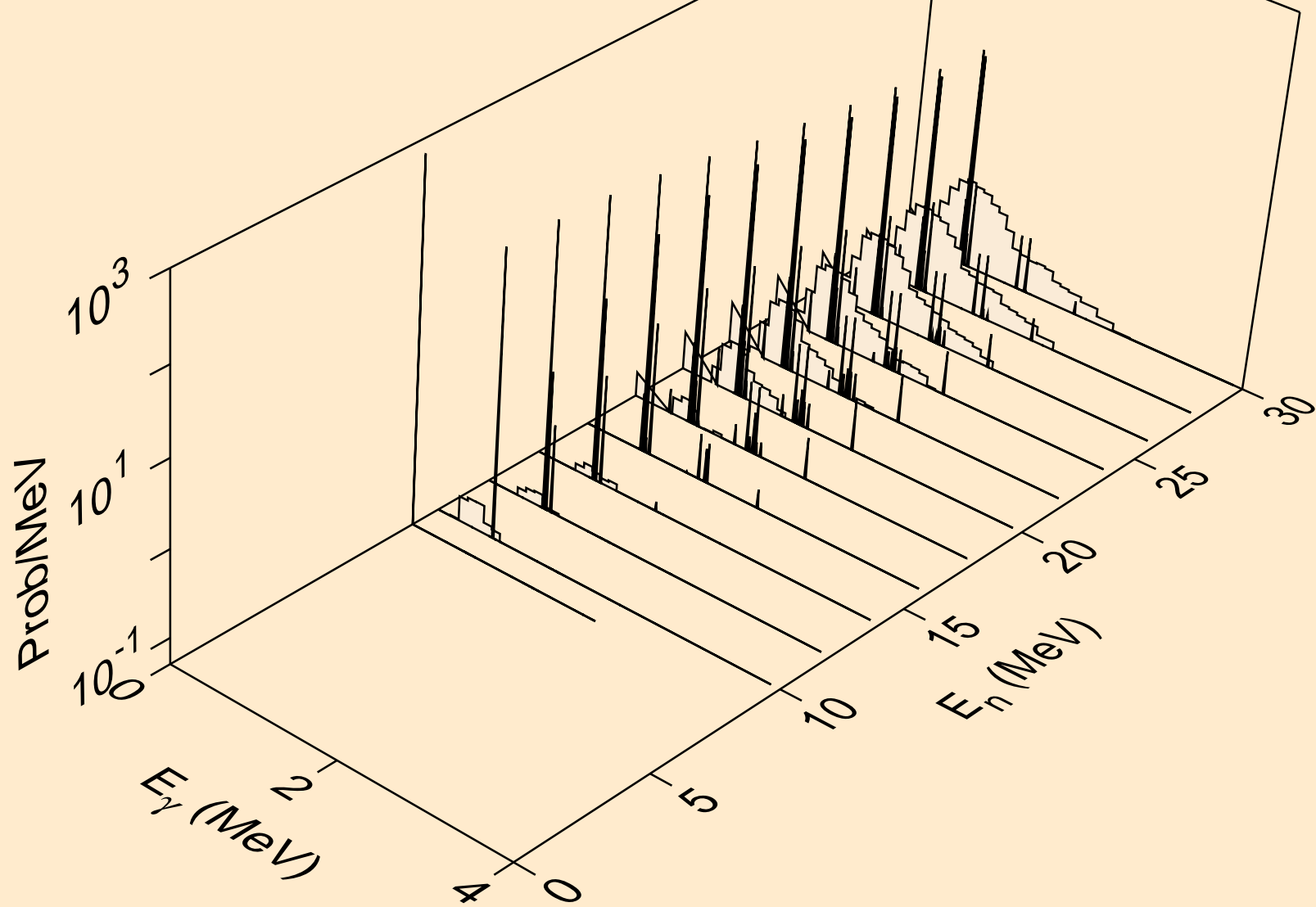



XE129 TRITON ACER TENDL-2021 LIBRARY; T=0.K  
Photon emission for (n,gma)

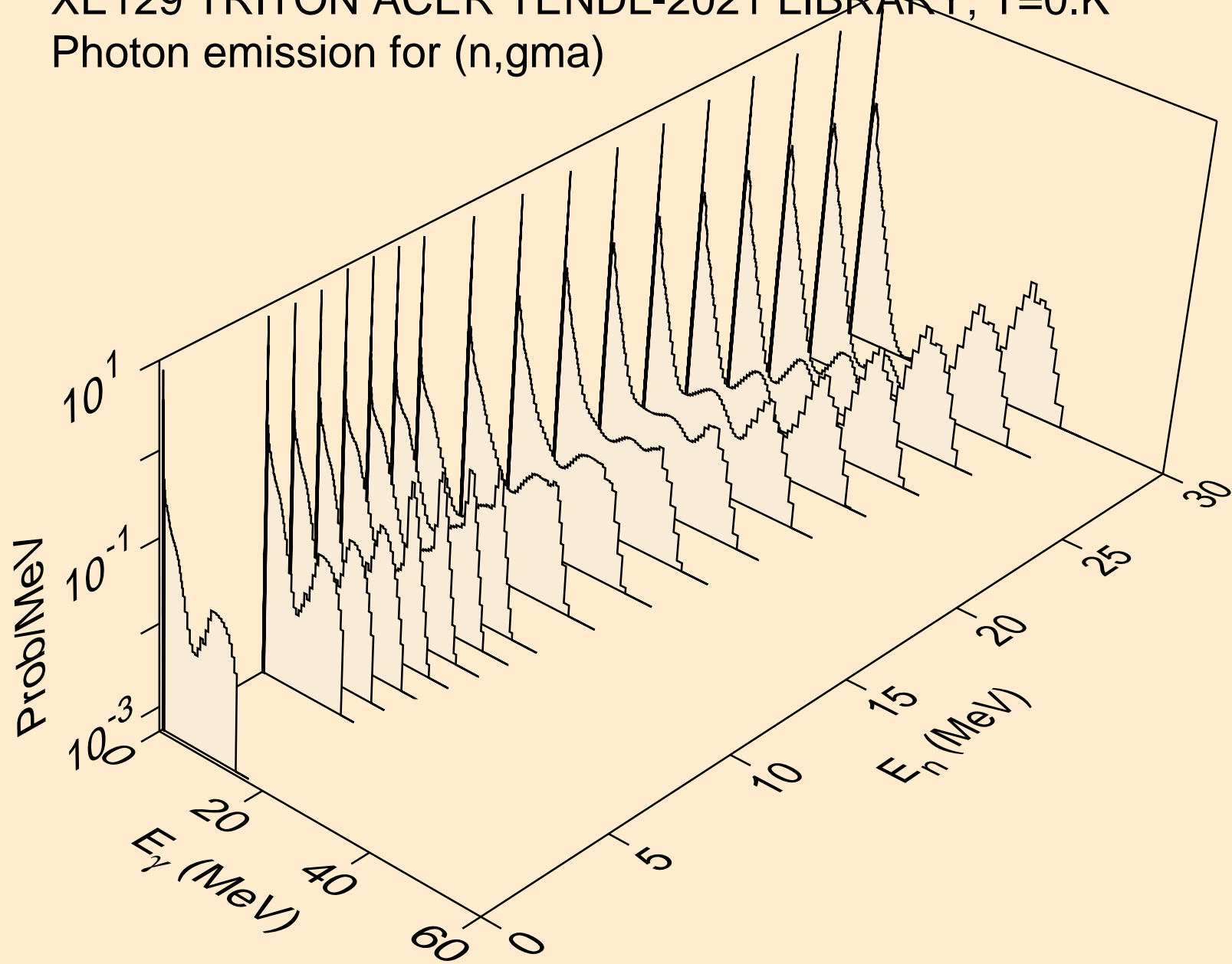

XE129 TRITON ACER TENDL-2021 LIBRARY; T=0.K  
Photon emission for (n,p)

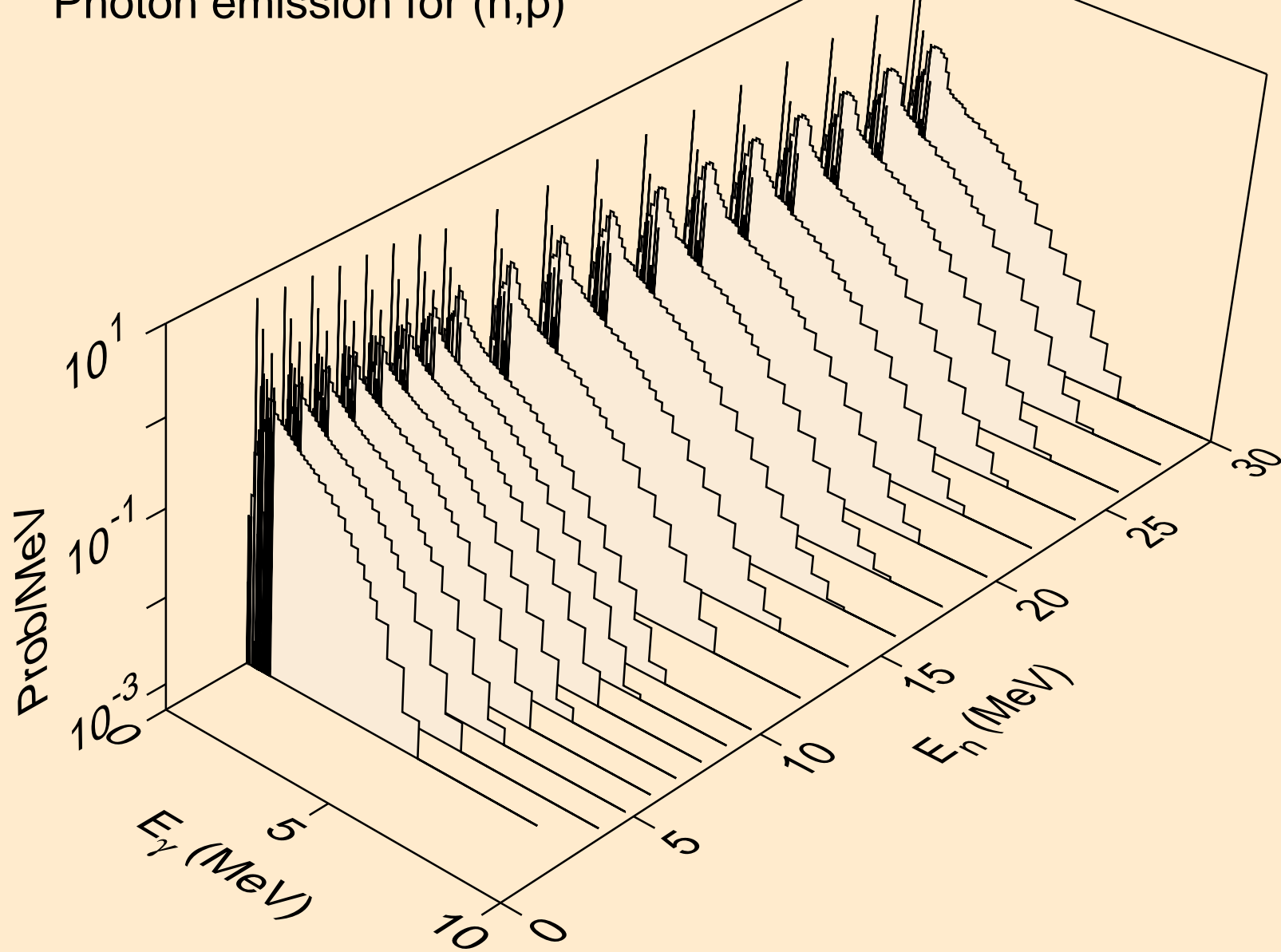

XE129 TRITON ACER TENDL-2021 LIBRARY; T=0.K  
Photon emission for (n,d)

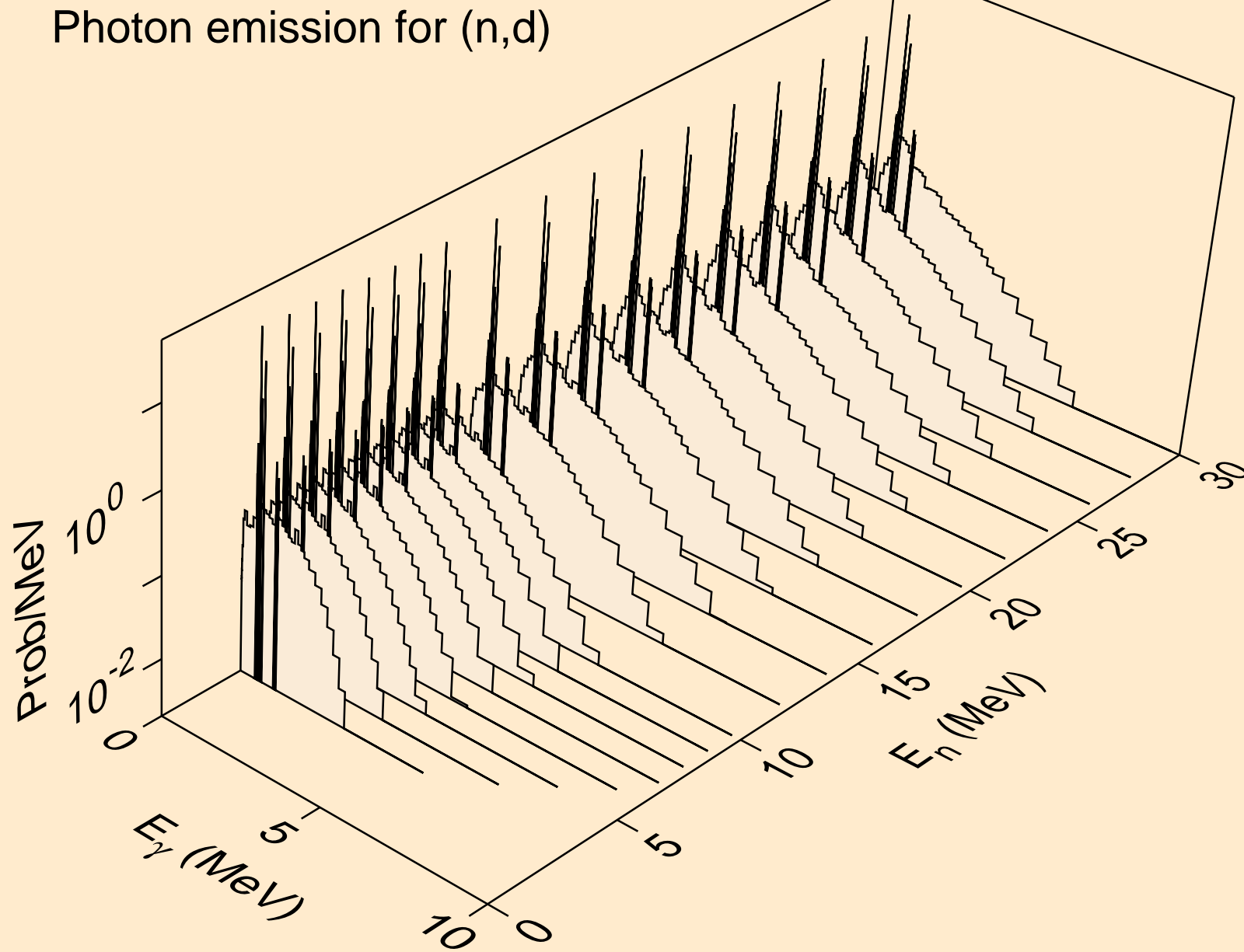

XE129 TRITON ACER TENDL-2021 LIBRARY; T=0.K  
Photon emission for inelastic

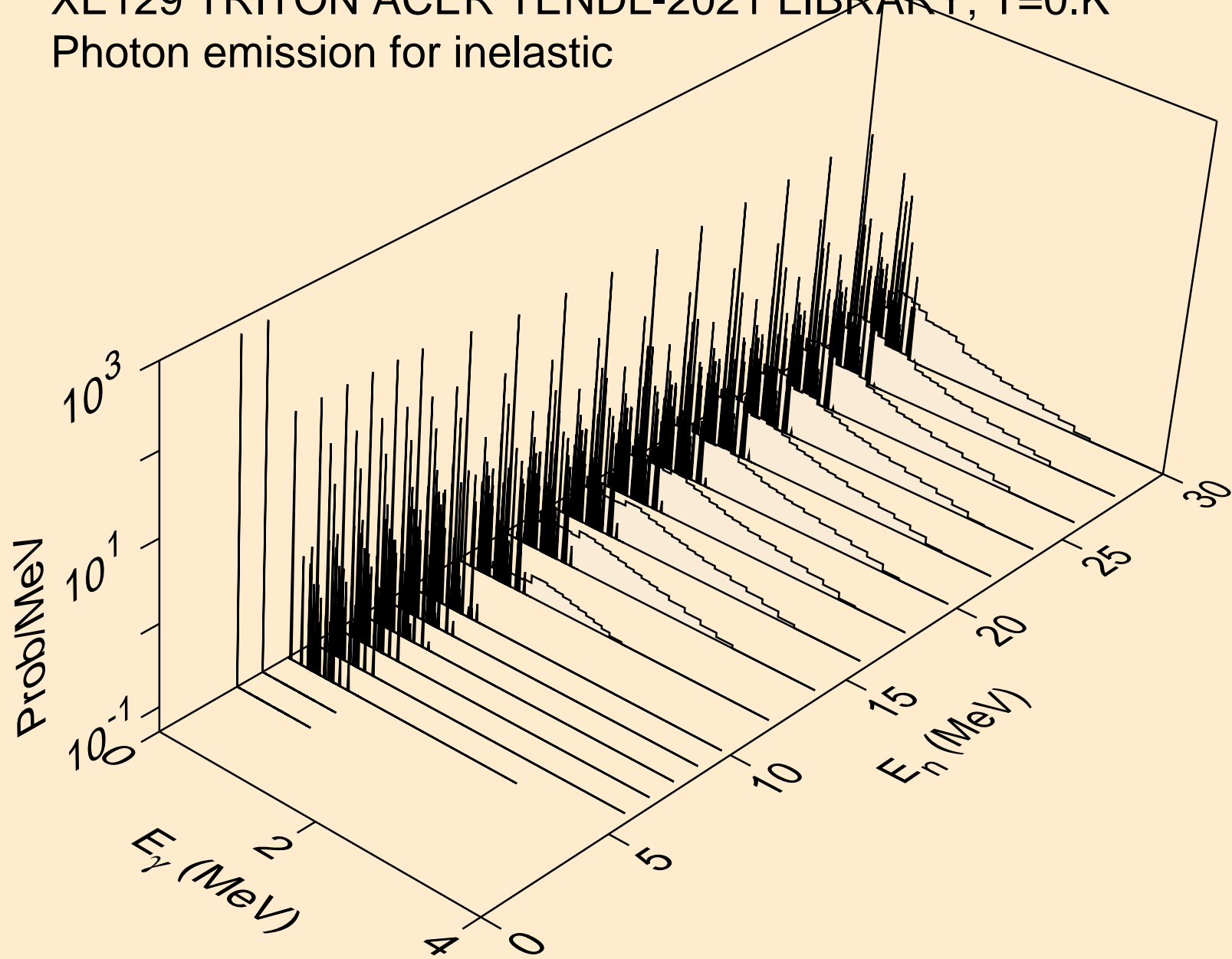

XE129 TRITON ACER TENDL-2021 LIBRARY; T=0.K  
Photon emission for (n,he3)

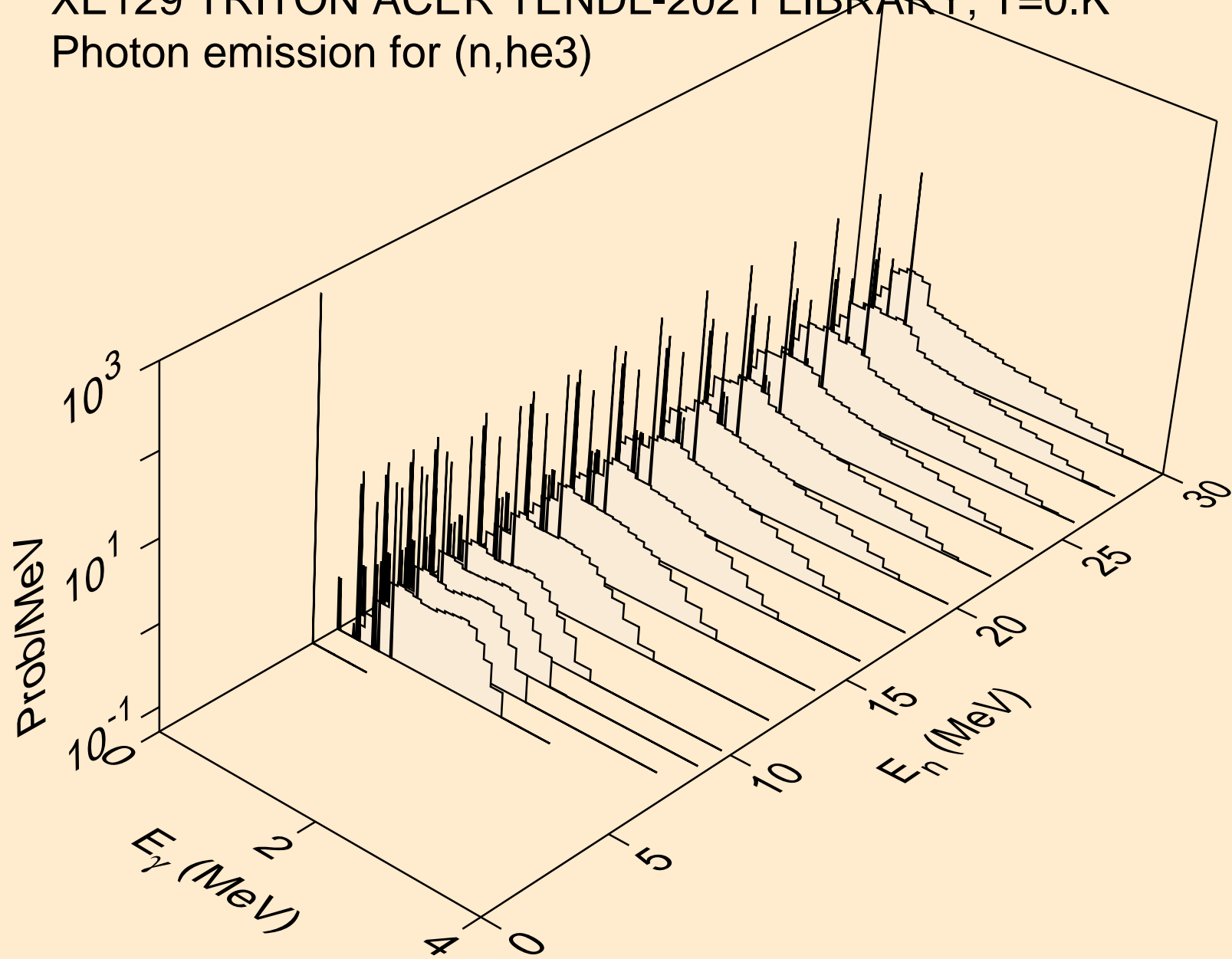

XE129 TRITON ACER TENDL-2021 LIBRARY; T=0.K  
Photon emission for (n,a)

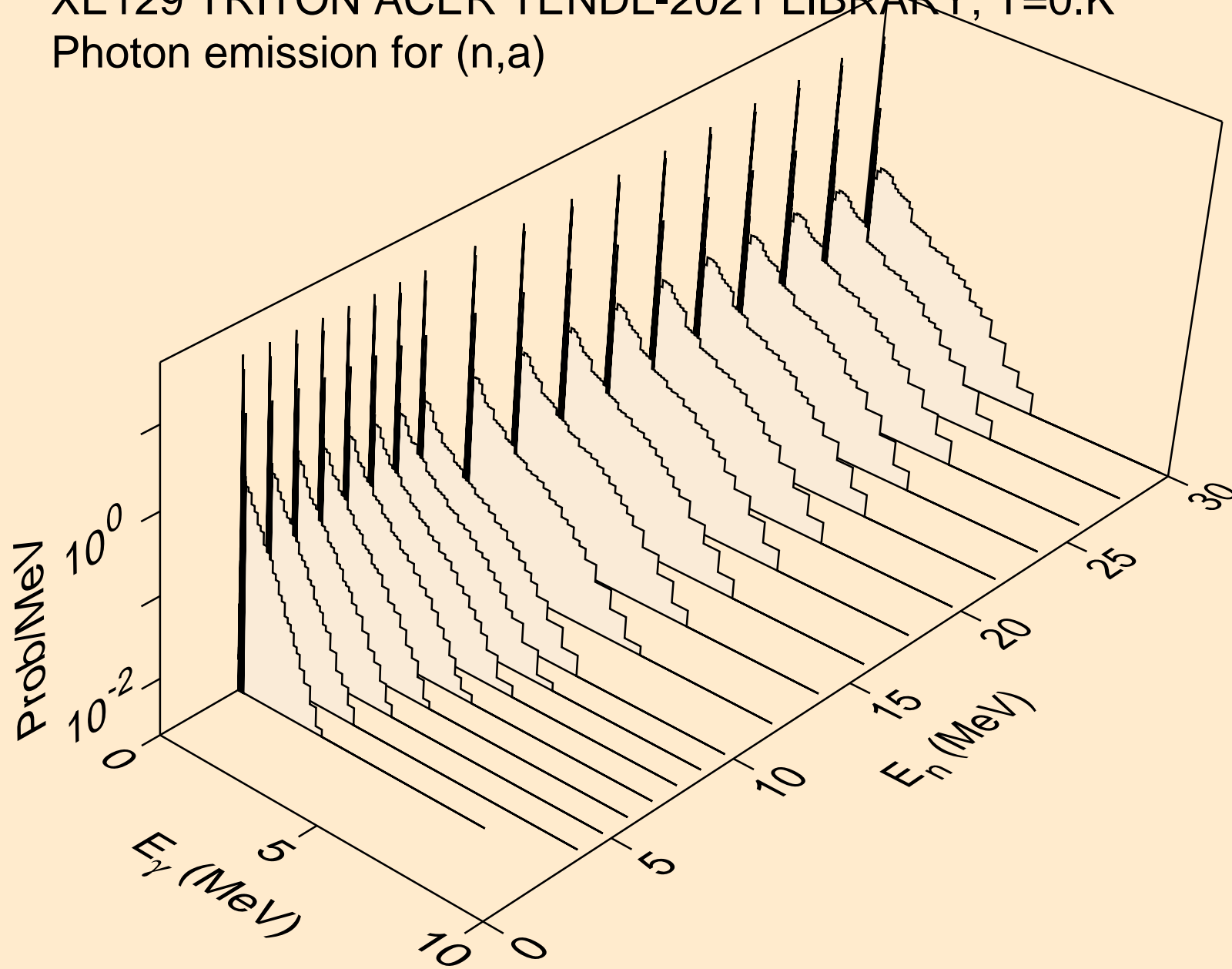

XE129 TRITON ACER TENDL-2021 LIBRARY; T=0.K  
Photon emission for (n,2a)

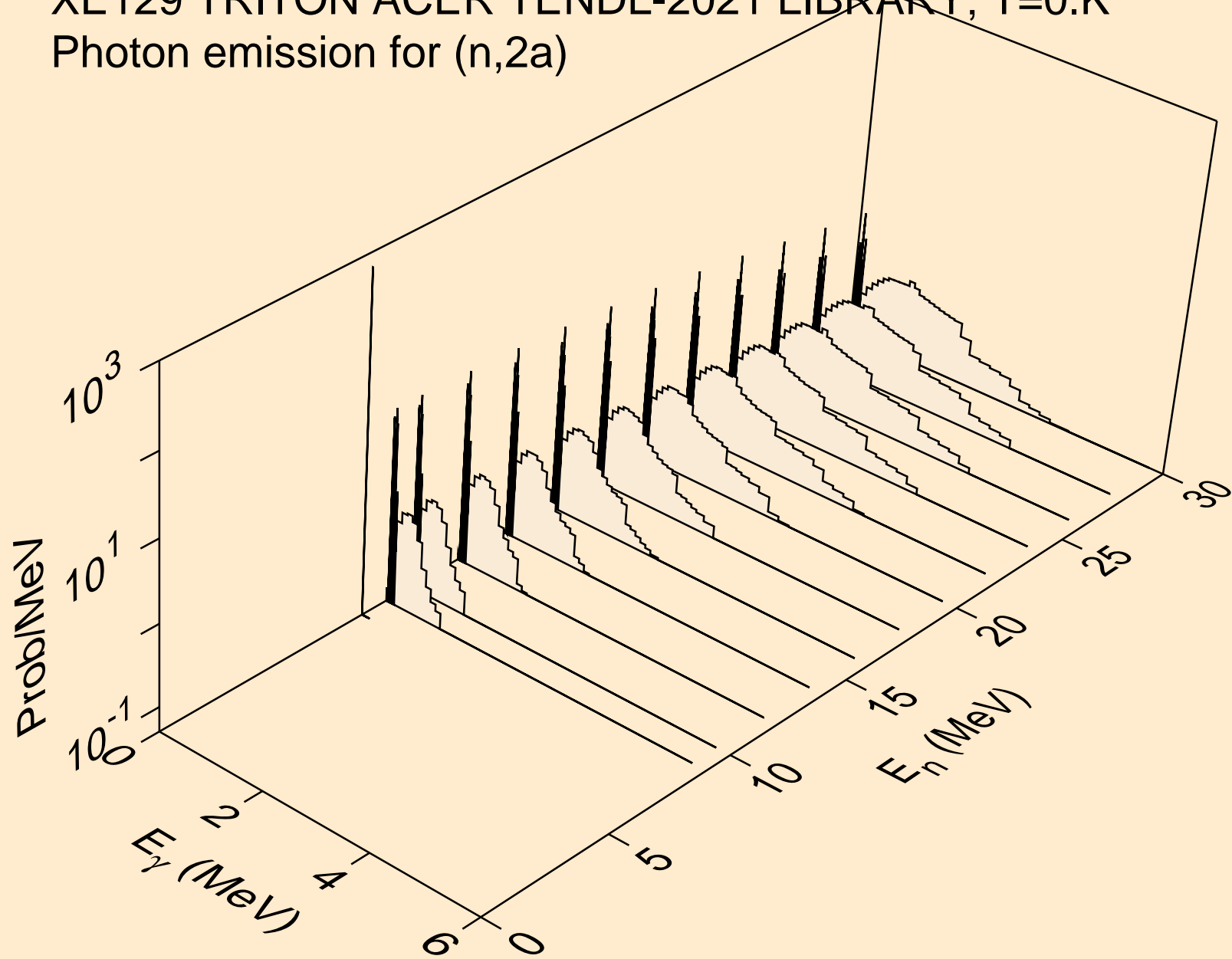

XE129 TRITON ACER TENDL-2021 LIBRARY; T=0.K  
Photon emission for (n,2p)

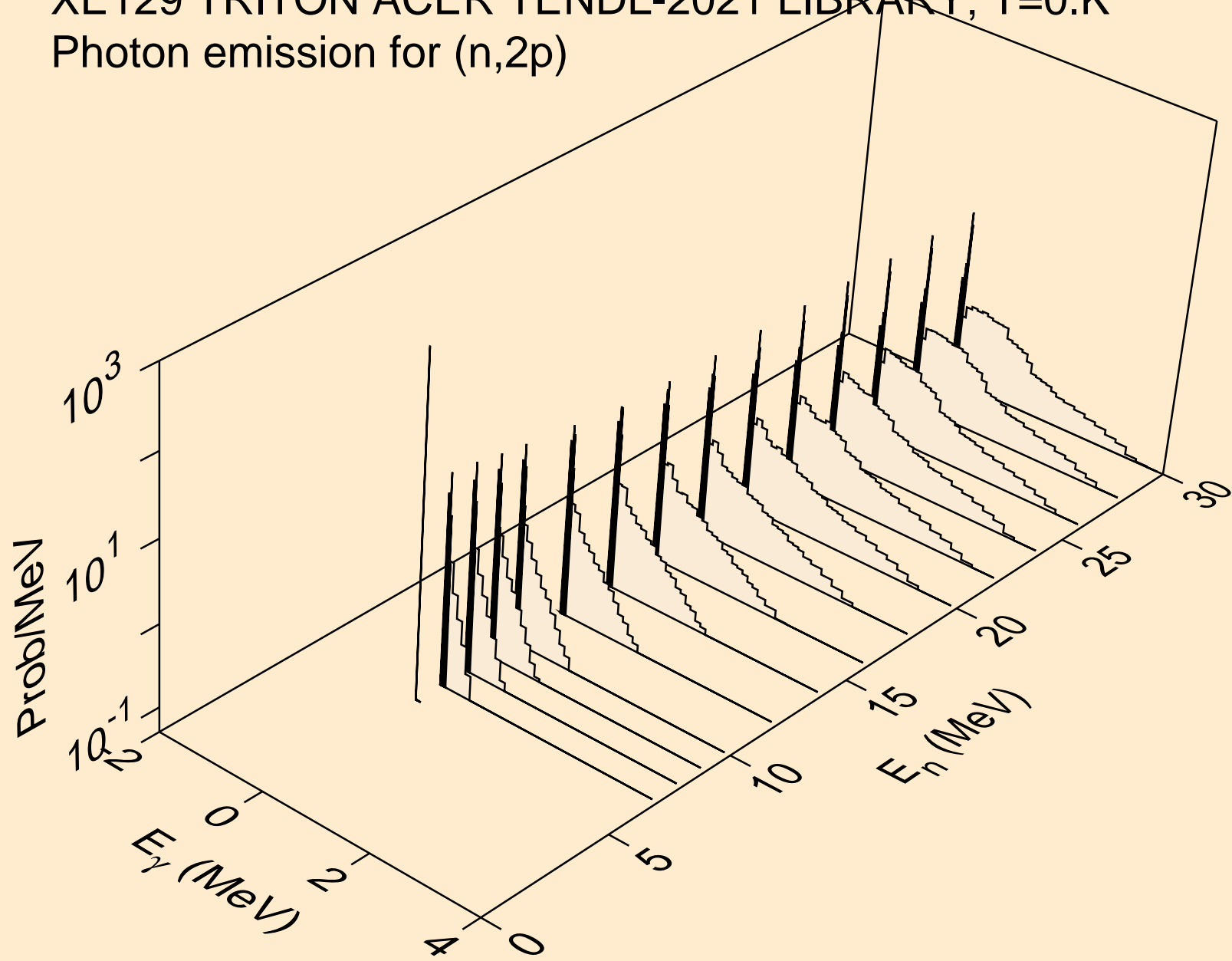



XE129 TRITON ACER TENDL-2021 LIBRARY; T=0.K  
Photon emission for (n,pa)

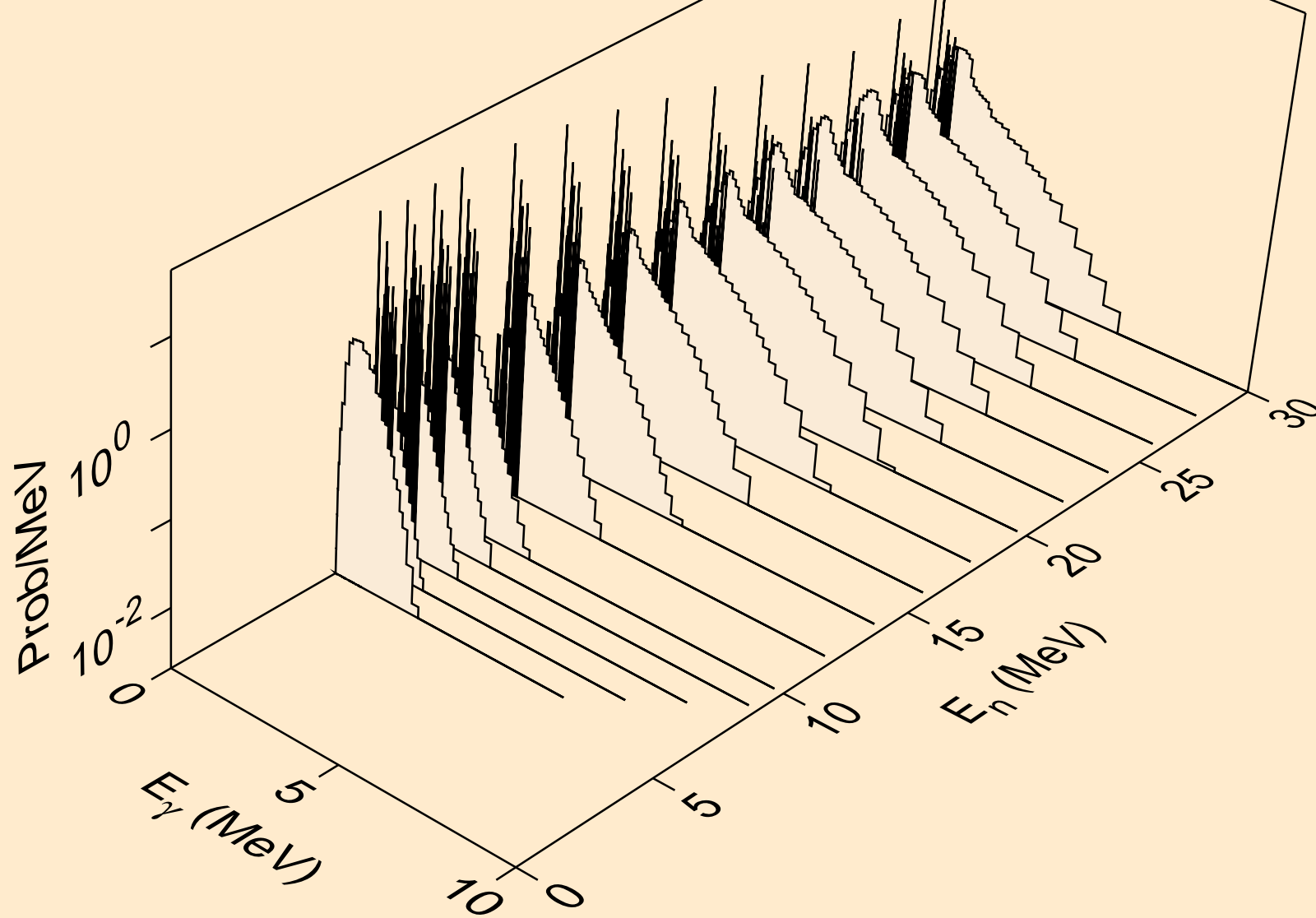

XE129 TRITON ACER TENDL-2021 LIBRARY; T=0.K  
Photon emission for (n,pd)

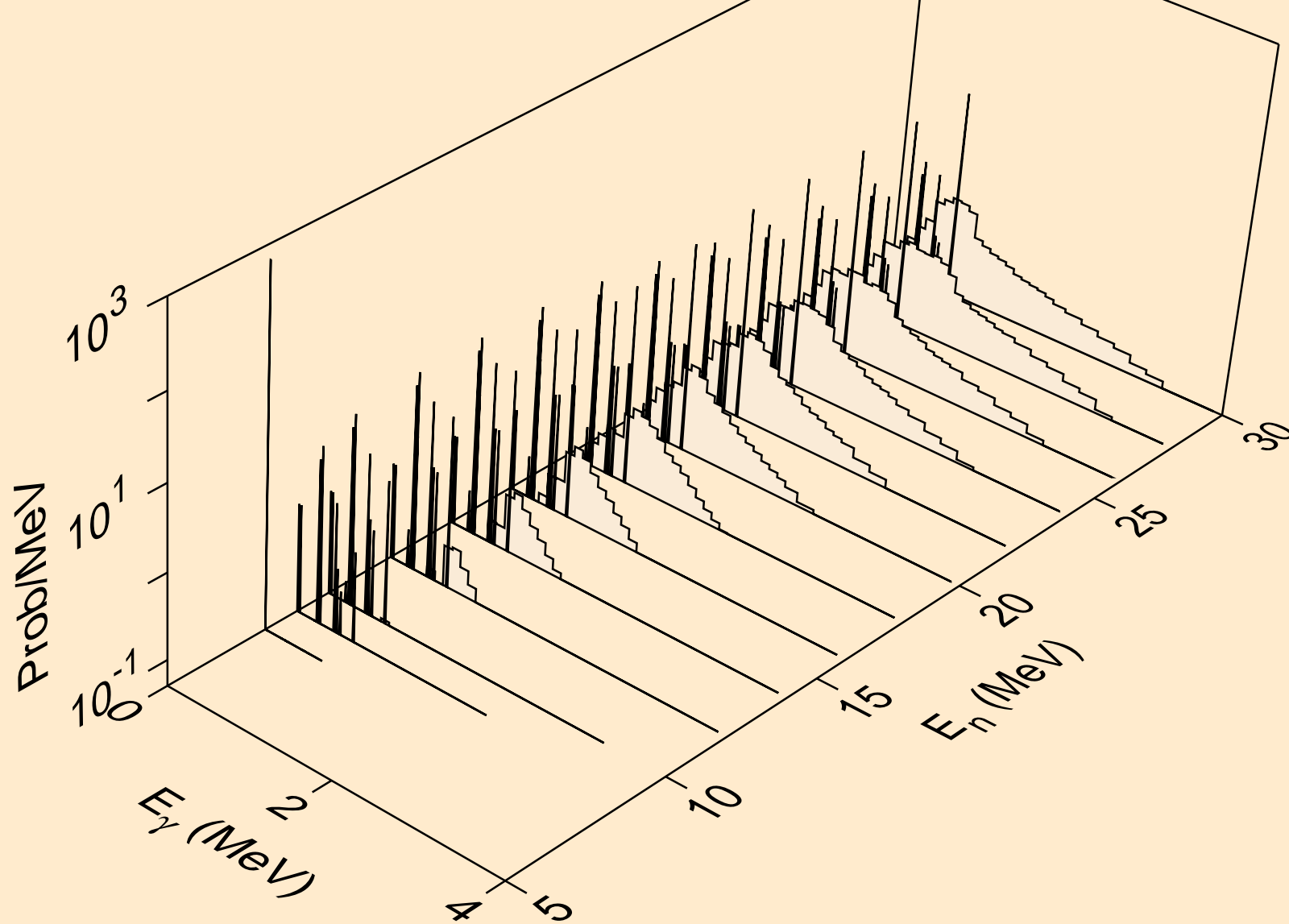

XE129 TRITON ACER TENDL-2021 LIBRARY; T=0.K  
Photon emission for (n,pt)

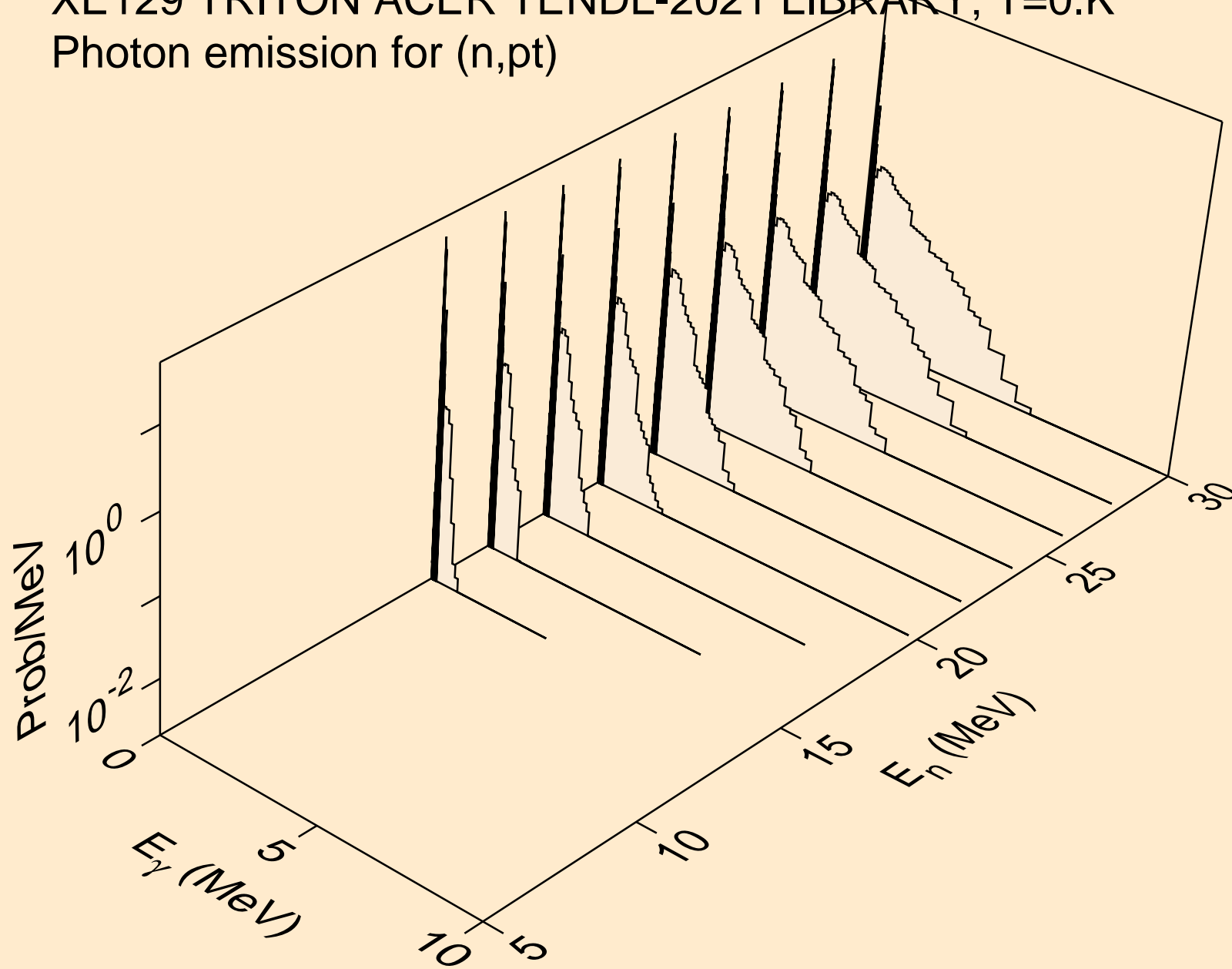

XE129 TRITON ACER TENDL-2021 LIBRARY; T=0.K  
Photon emission for (n,da)

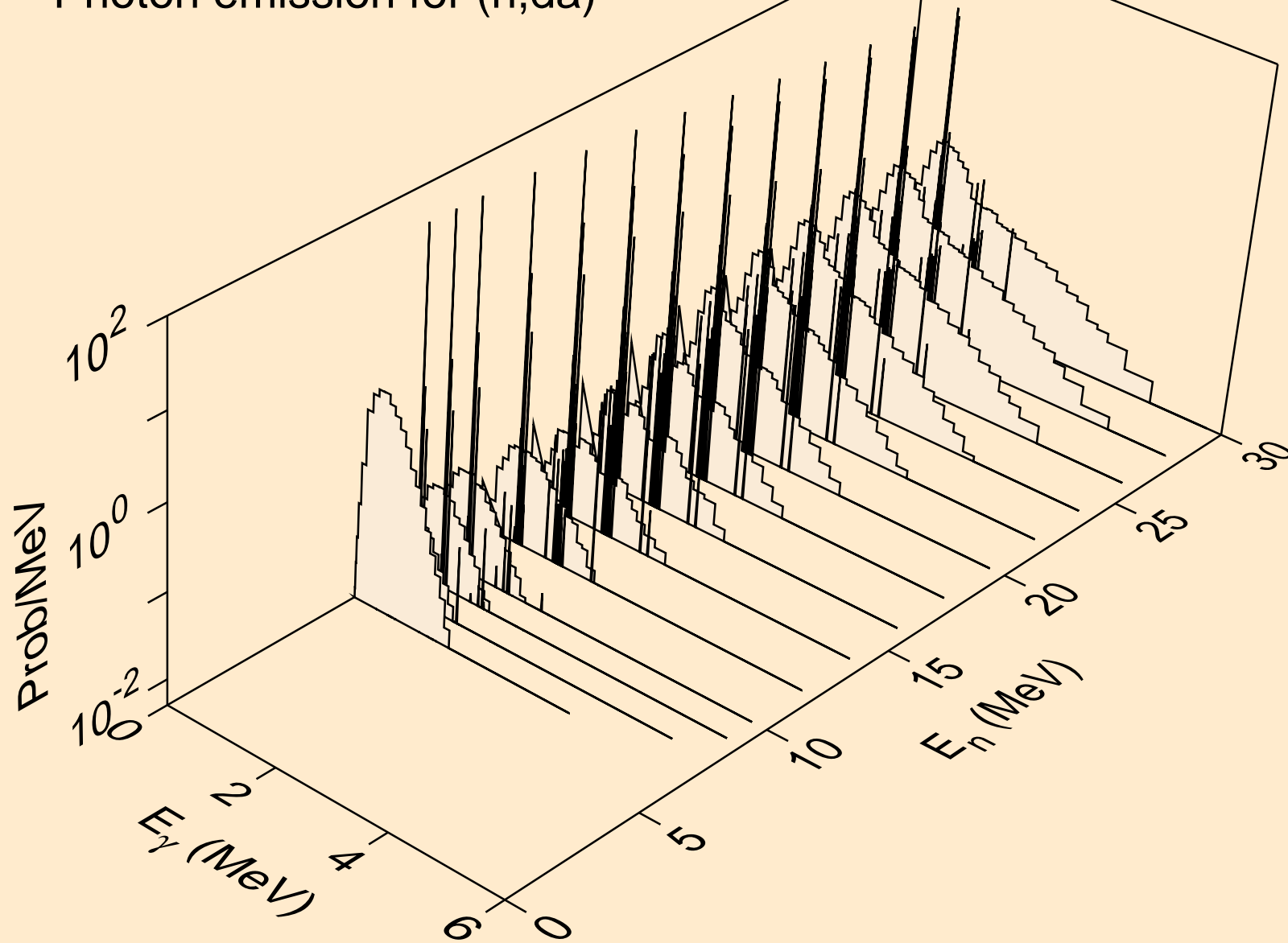

XE129 TRITON ACER TENDL-2021 LIBRARY; T=0.K  
Particle heating contributions

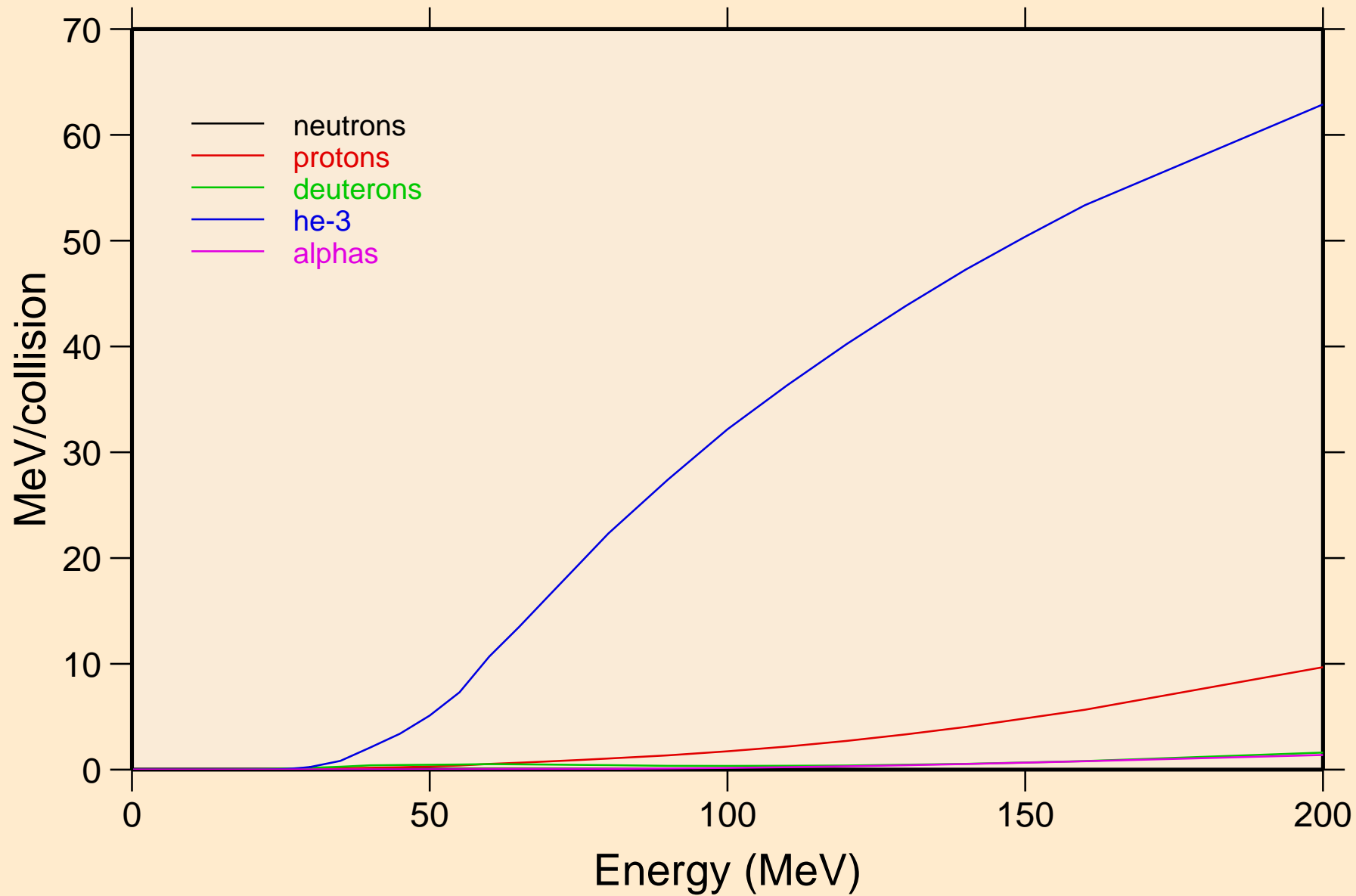

XE129 TRITON ACER TENDL-2021 LIBRARY; T=0.K  
Recoil Heating

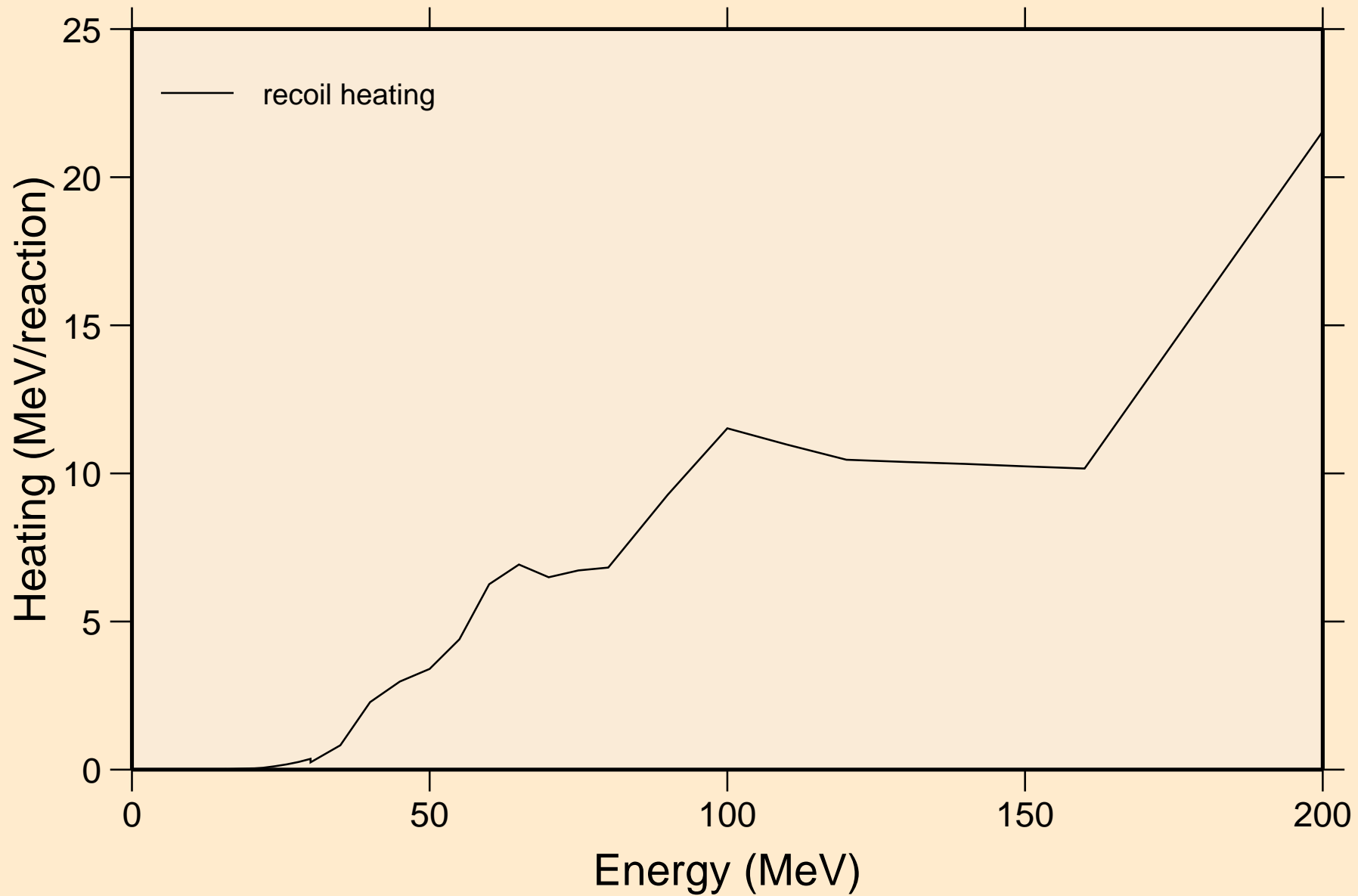

XE129 TRITON ACER TENDL-2021 LIBRARY; T=0.K  
Particle production cross sections

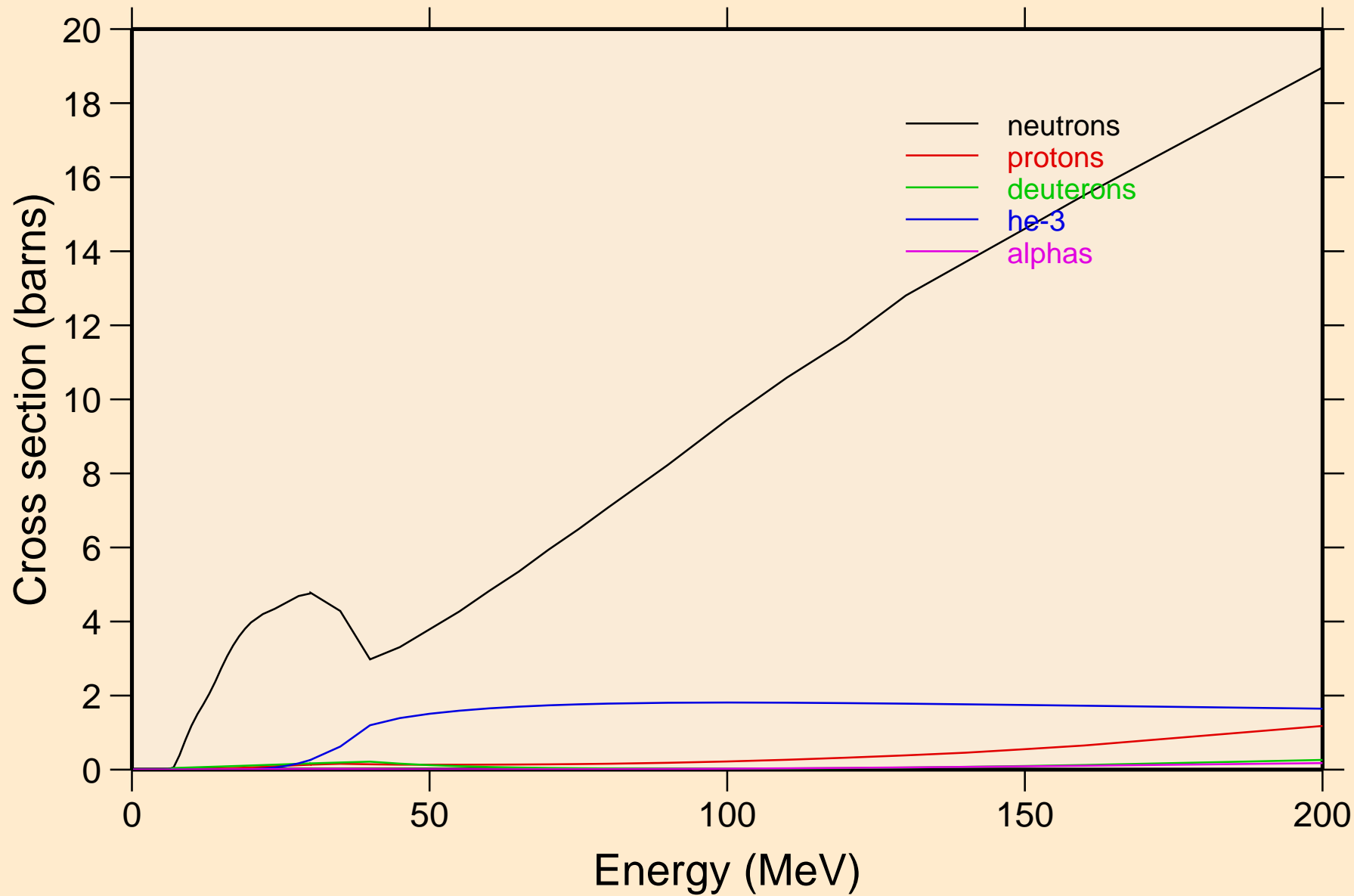

XE129 TRITON ACER TENDL-2021 LIBRARY; T=0.K  
neutrons from (t,n)

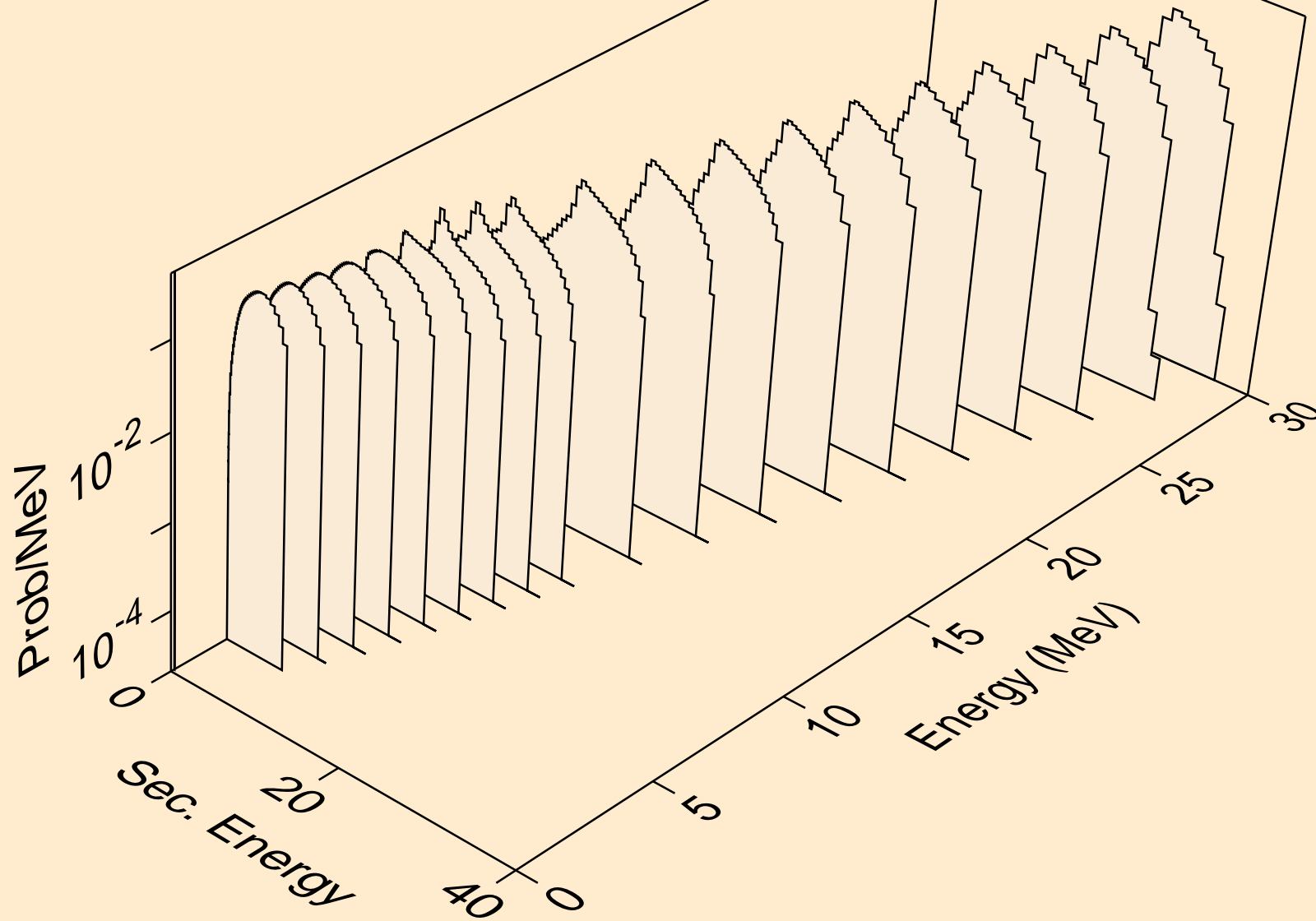



XE129 TRITON ACER TENDL-2021 LIBRARY; T=0.K  
neutrons from (t,x)

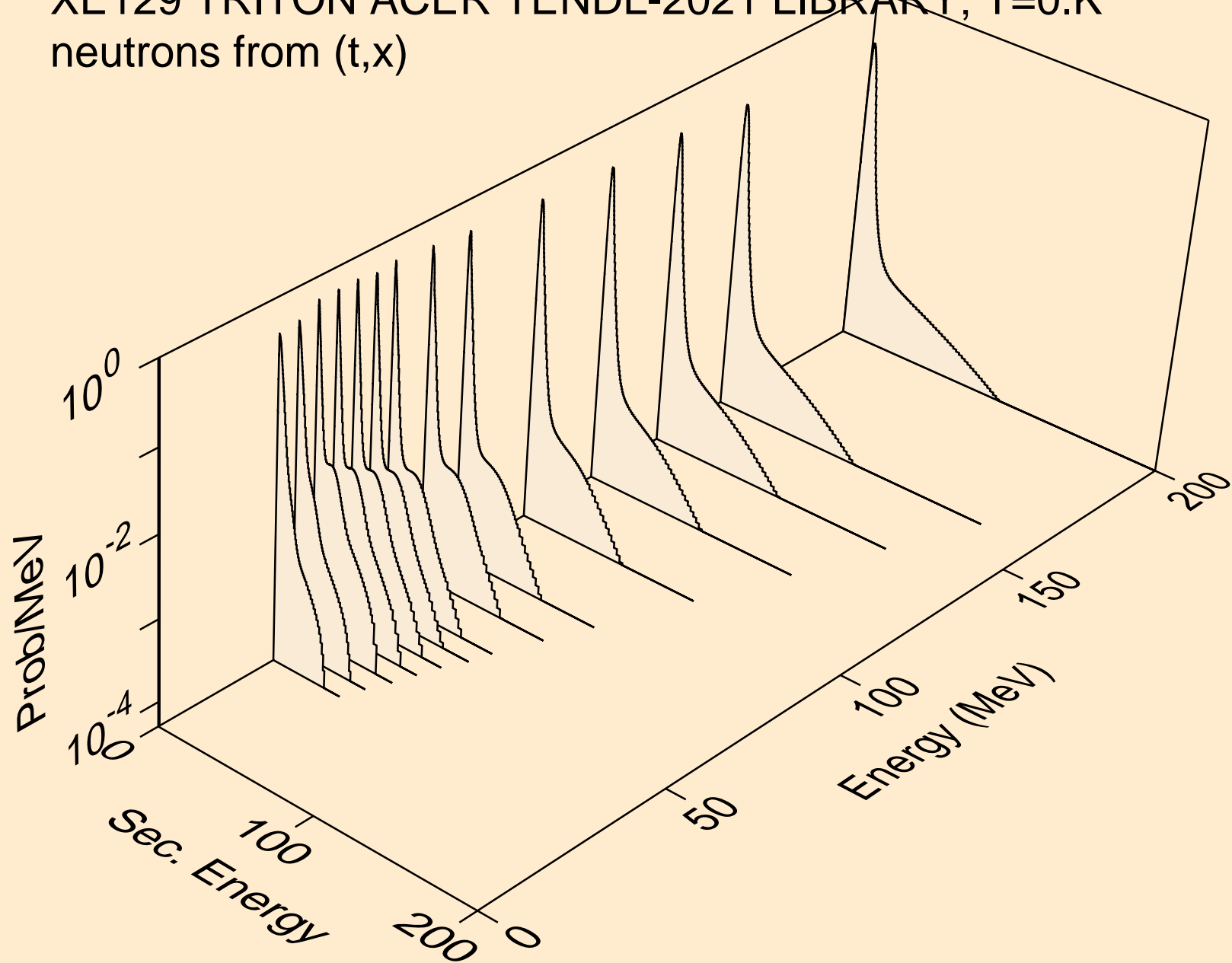

XE129 TRITON ACER TENDL-2021 LIBRARY; T=0.K  
neutrons from (t,2nd)

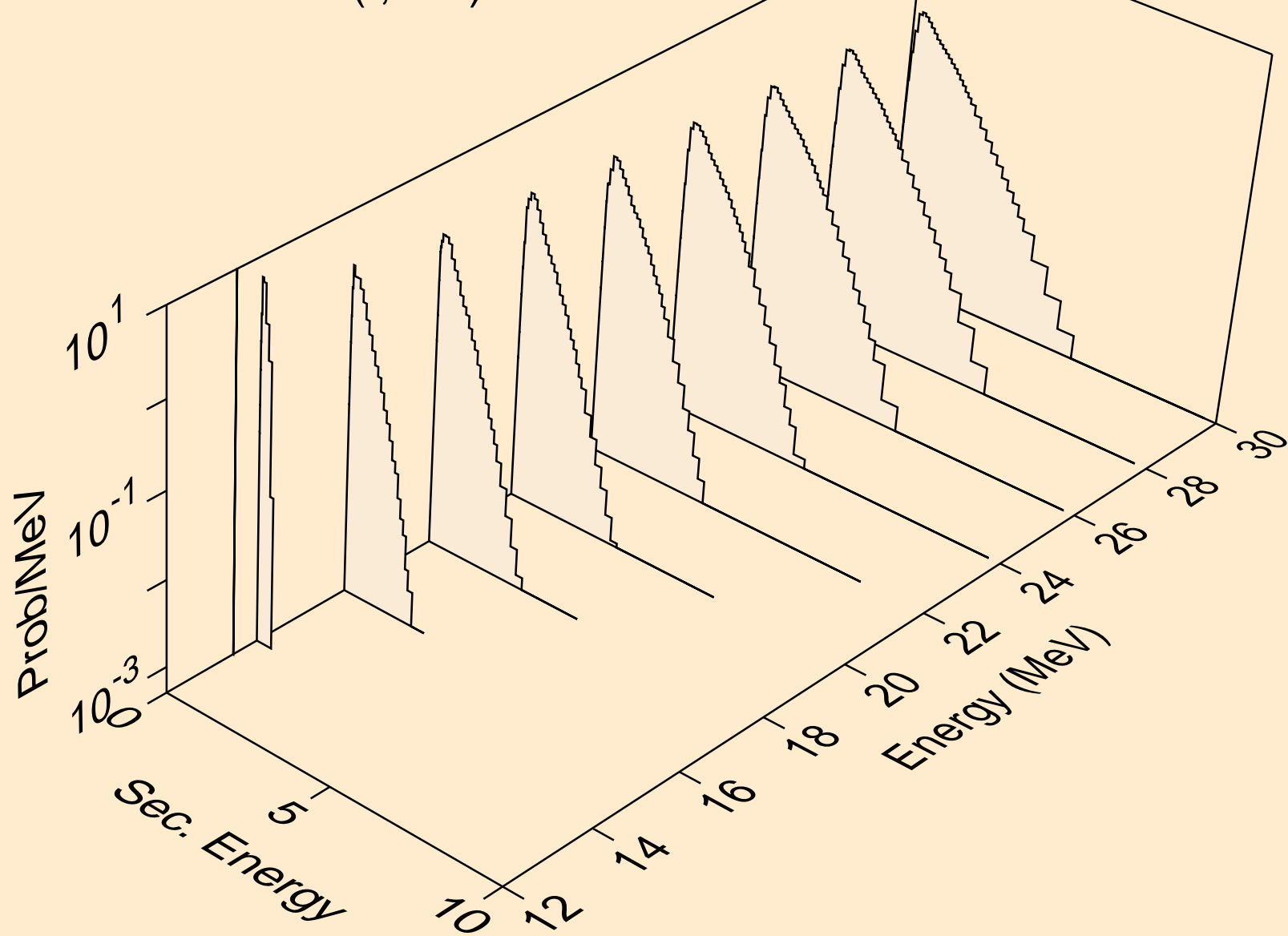

XE129 TRITON ACER TENDL-2021 LIBRARY; T=0.K  
neutrons from (t,2n)

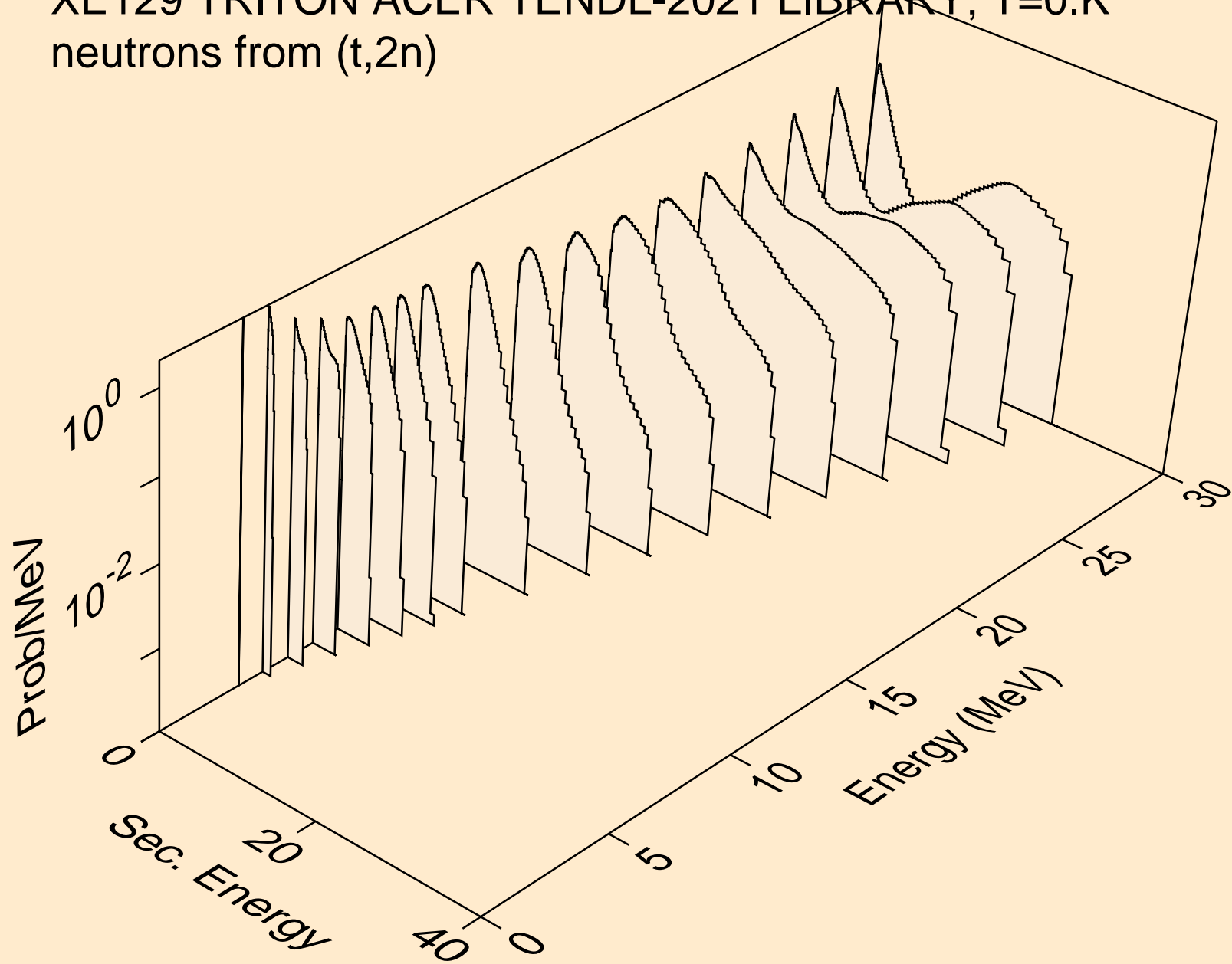

XE129 TRITON ACER TENDL-2021 LIBRARY; T=0.K  
neutrons from (t,3n)

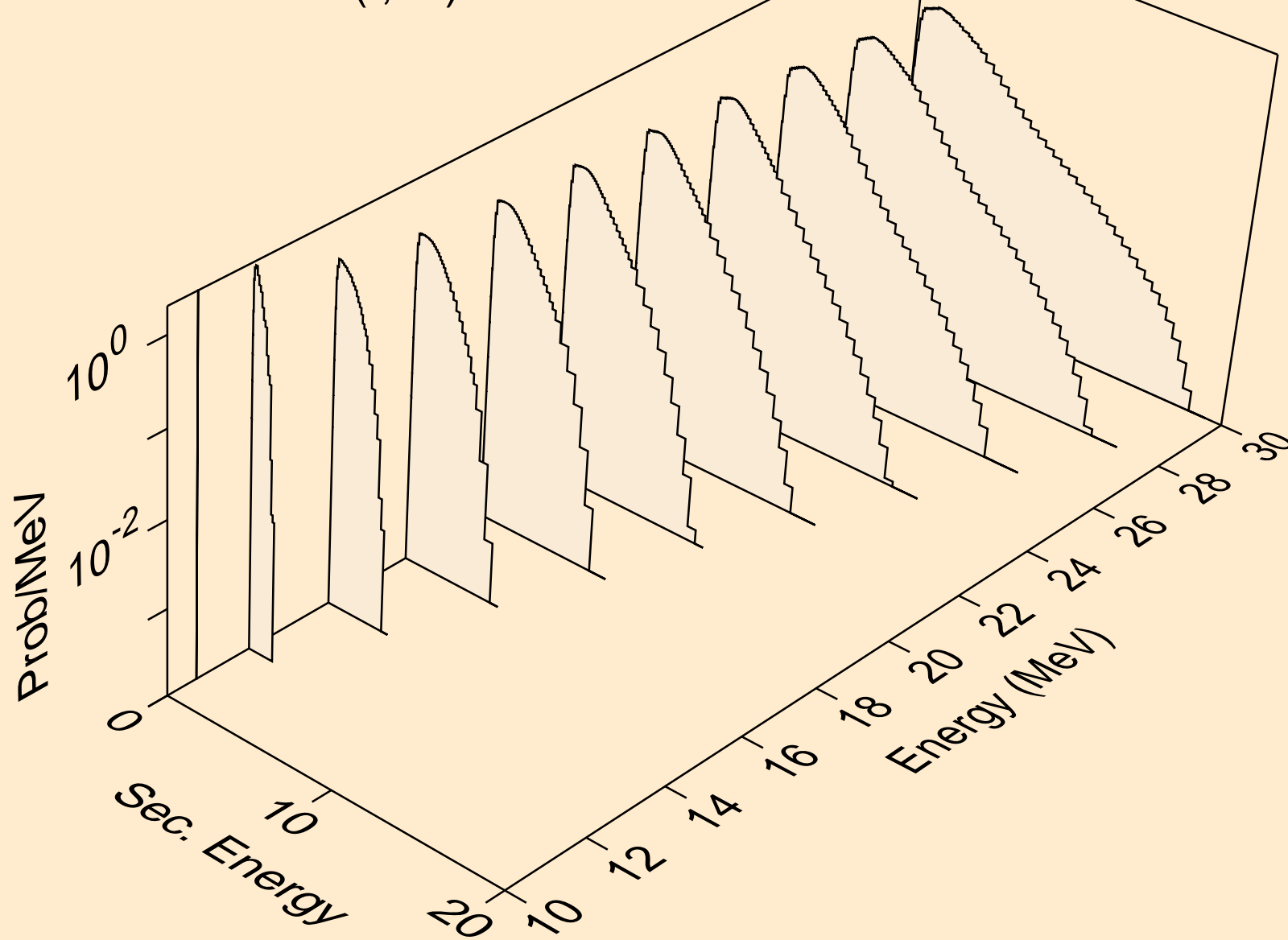

XE129 TRITON ACER TENDL-2021 LIBRARY; T=0.K  
neutrons from (t,n\*)a

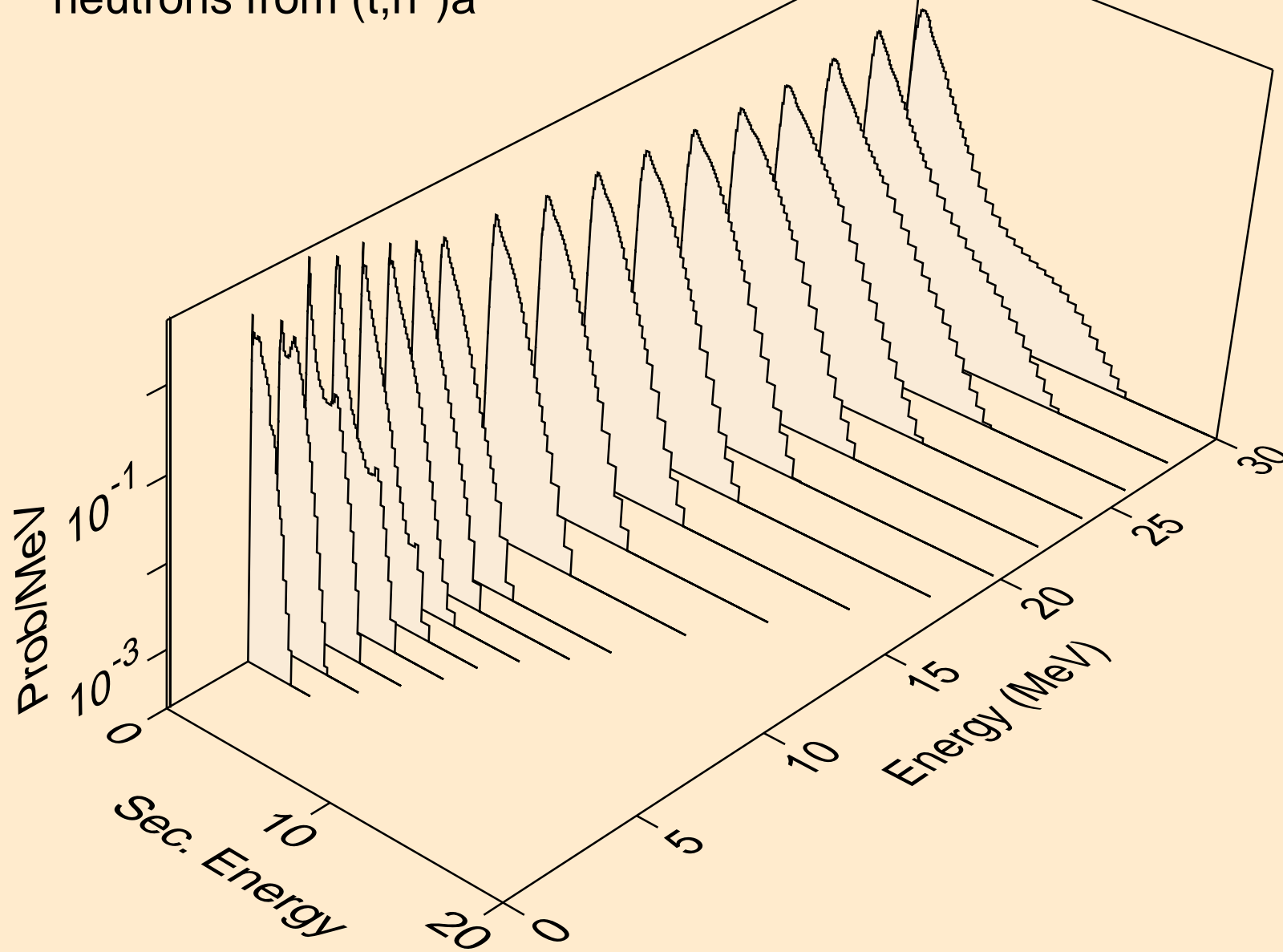

XE129 TRITON ACER TENDL-2021 LIBRARY; T=0.K  
neutrons from (t,2n)a

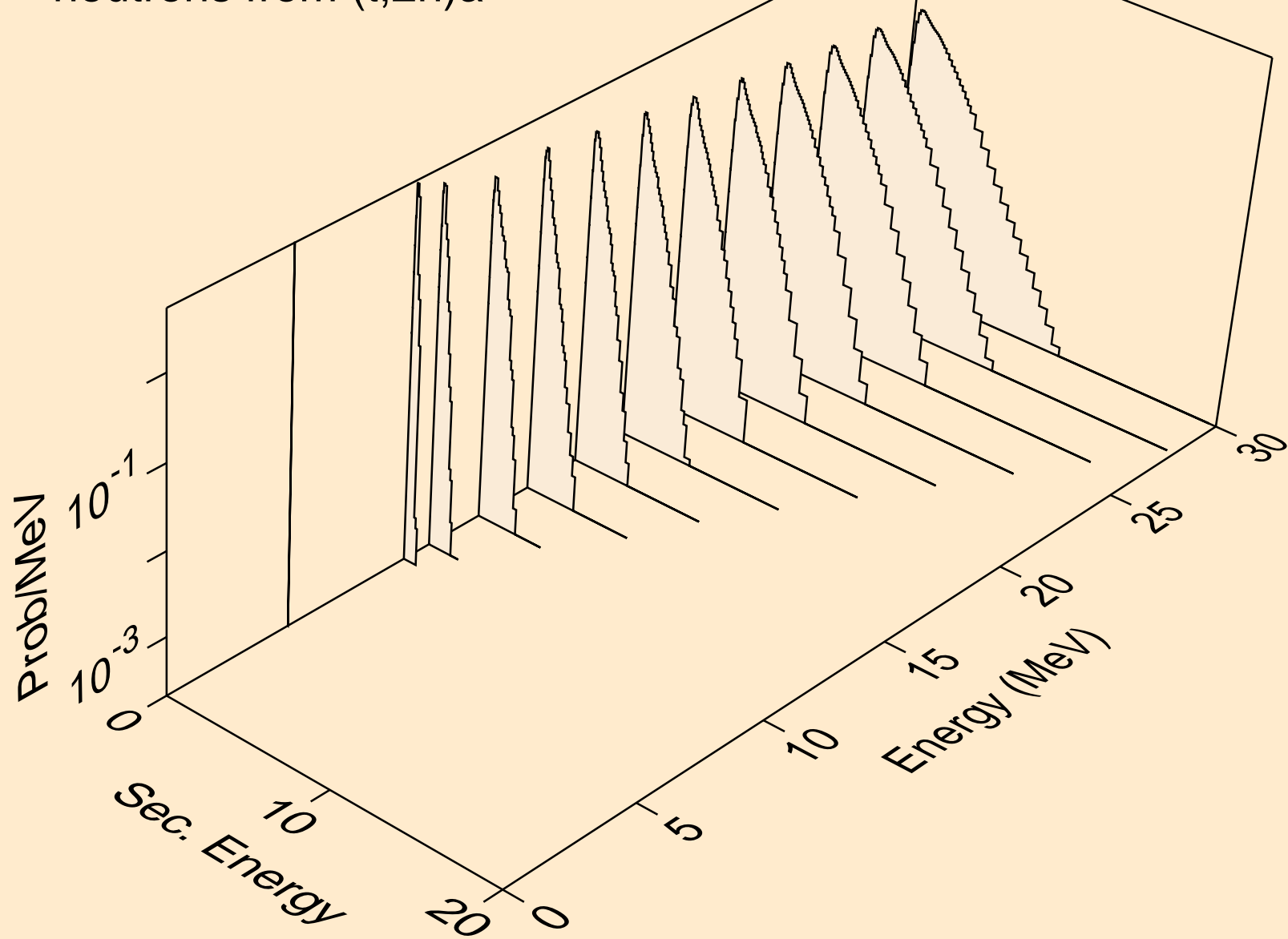

XE129 TRITON ACER TENDL-2021 LIBRARY; T=0.K  
neutrons from (t,3n)a

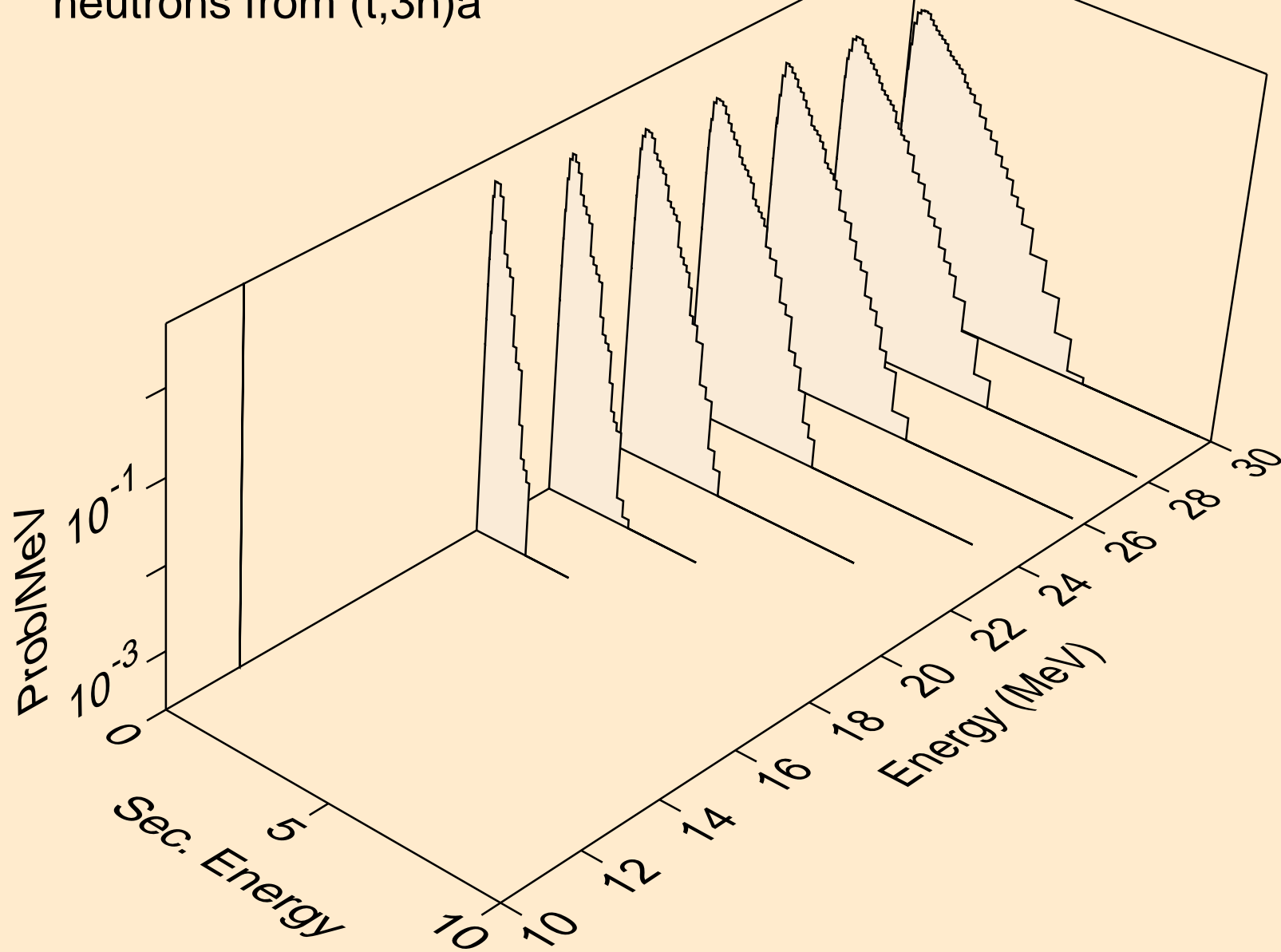

XE129 TRITON ACER TENDL-2021 LIBRARY; T=0.K  
neutrons from (t,n\*)p

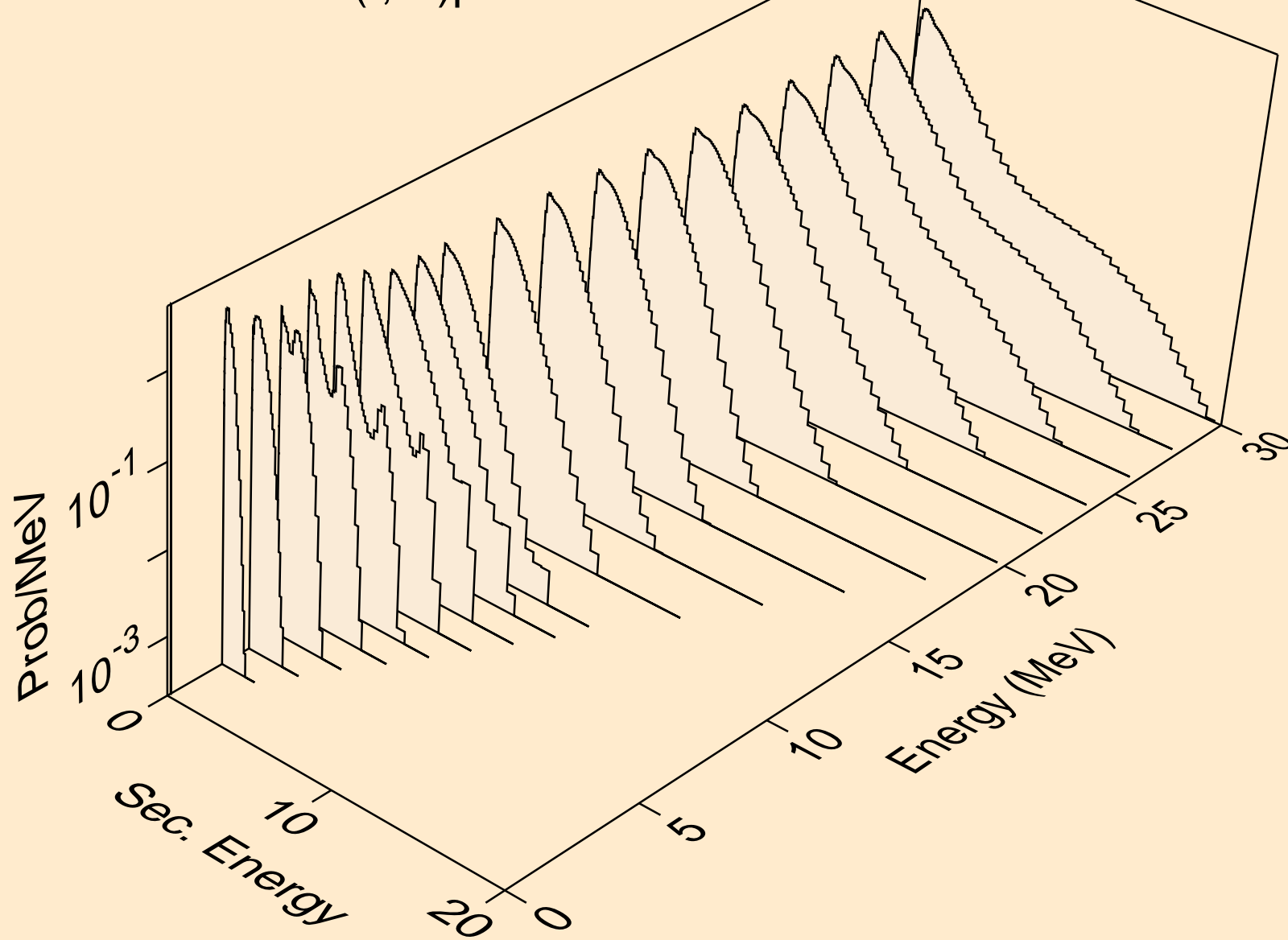



XE129 TRITON ACER TENDL-2021 LIBRARY; T=0.K  
neutrons from (t,n\*)2a

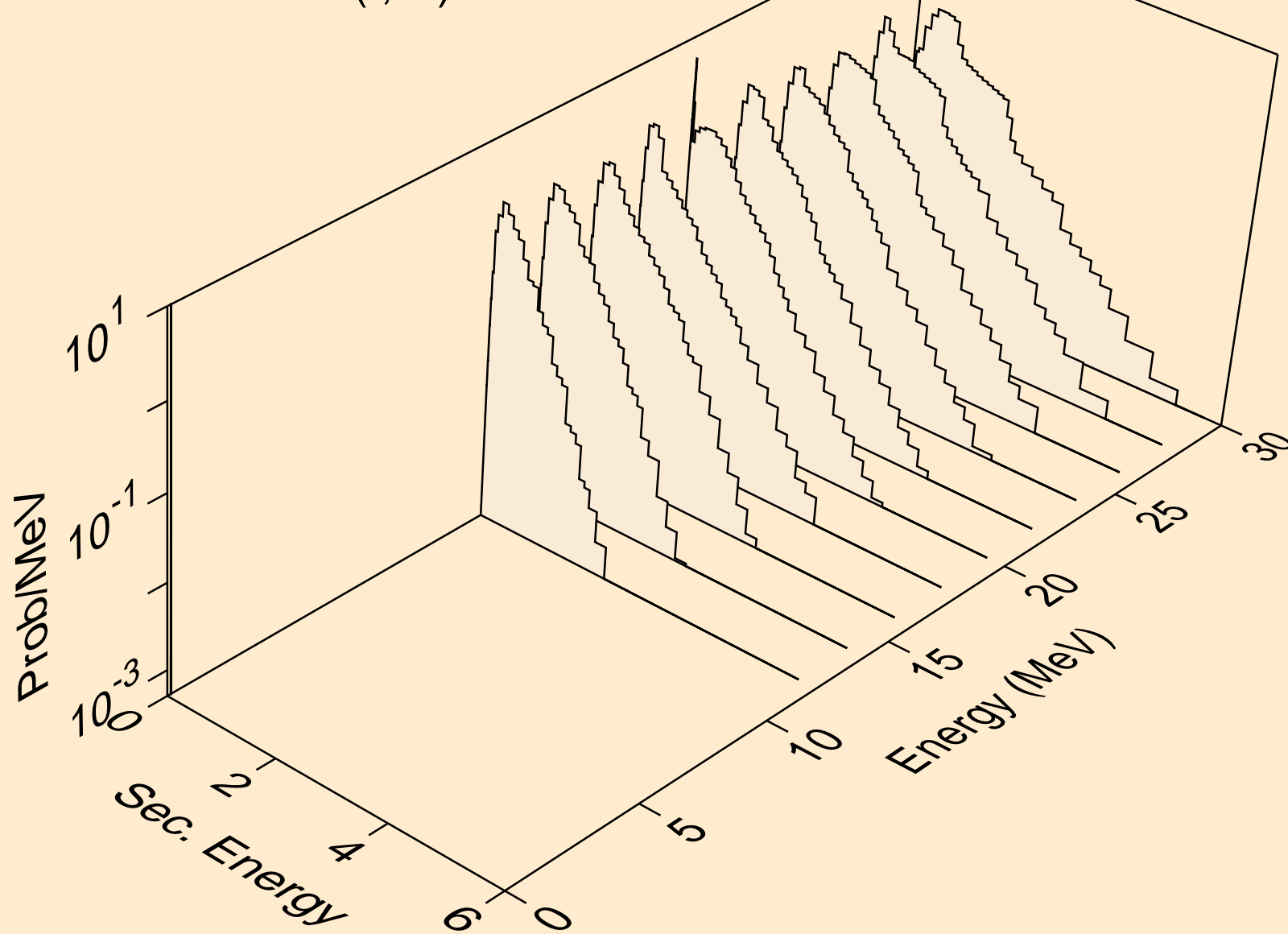

XE129 TRITON ACER TENDL-2021 LIBRARY; T=0.K  
neutrons from (t,2n)2a

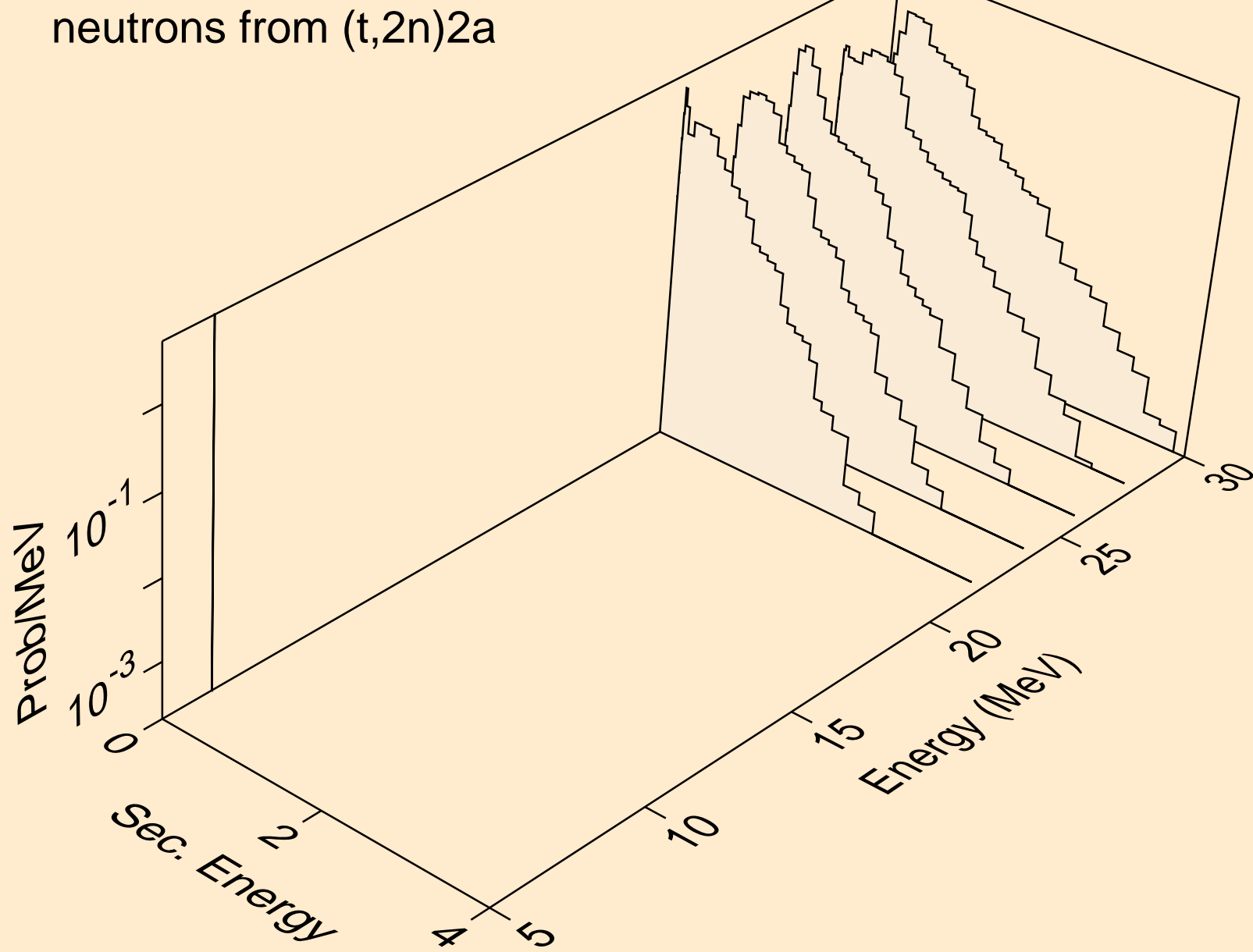

XE129 TRITON ACER TENDL-2021 LIBRARY; T=0.K  
neutrons from (t,n\*)d

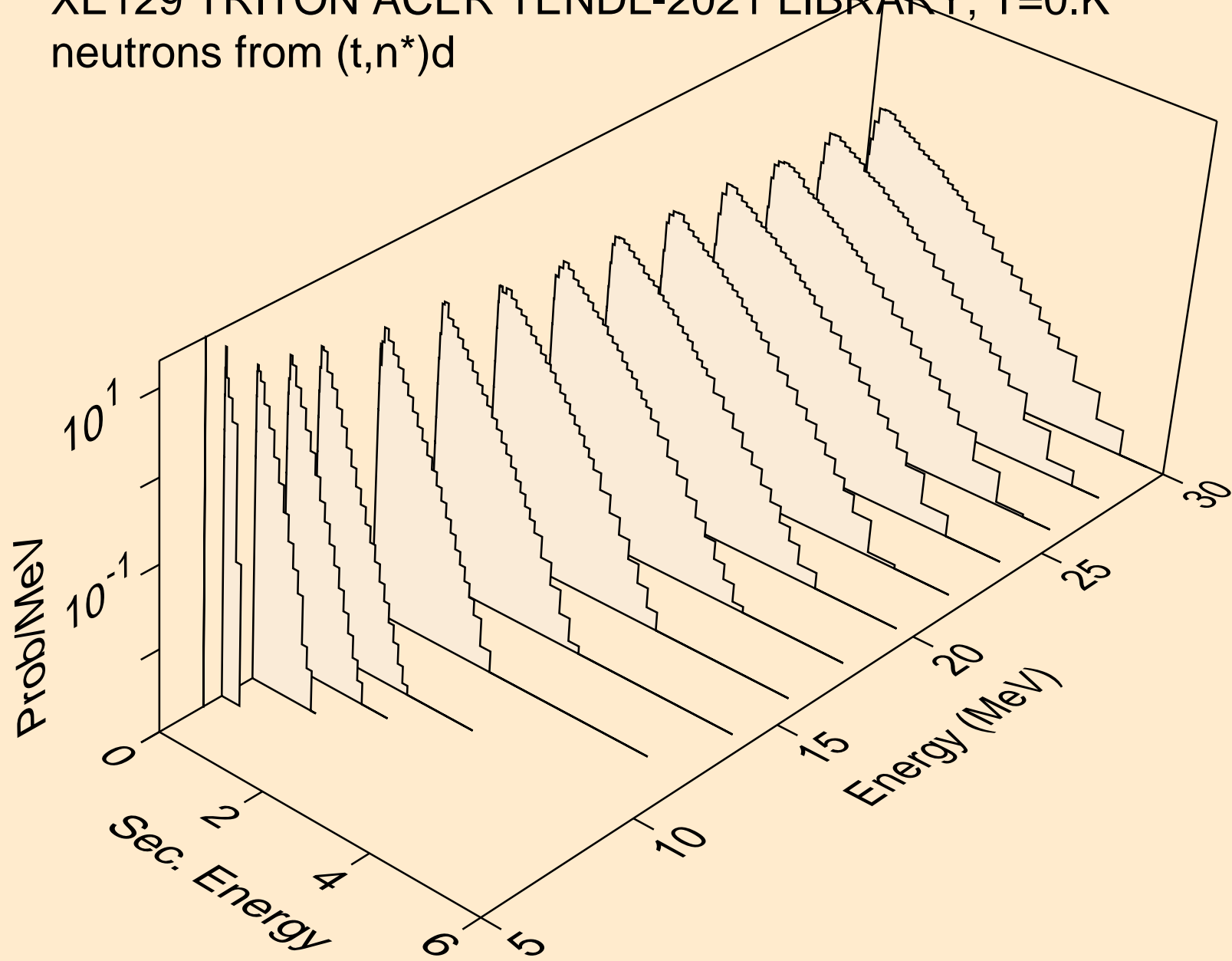

XE129 TRITON ACER TENDL-2021 LIBRARY; T=0.K  
neutrons from (t,n\*)t

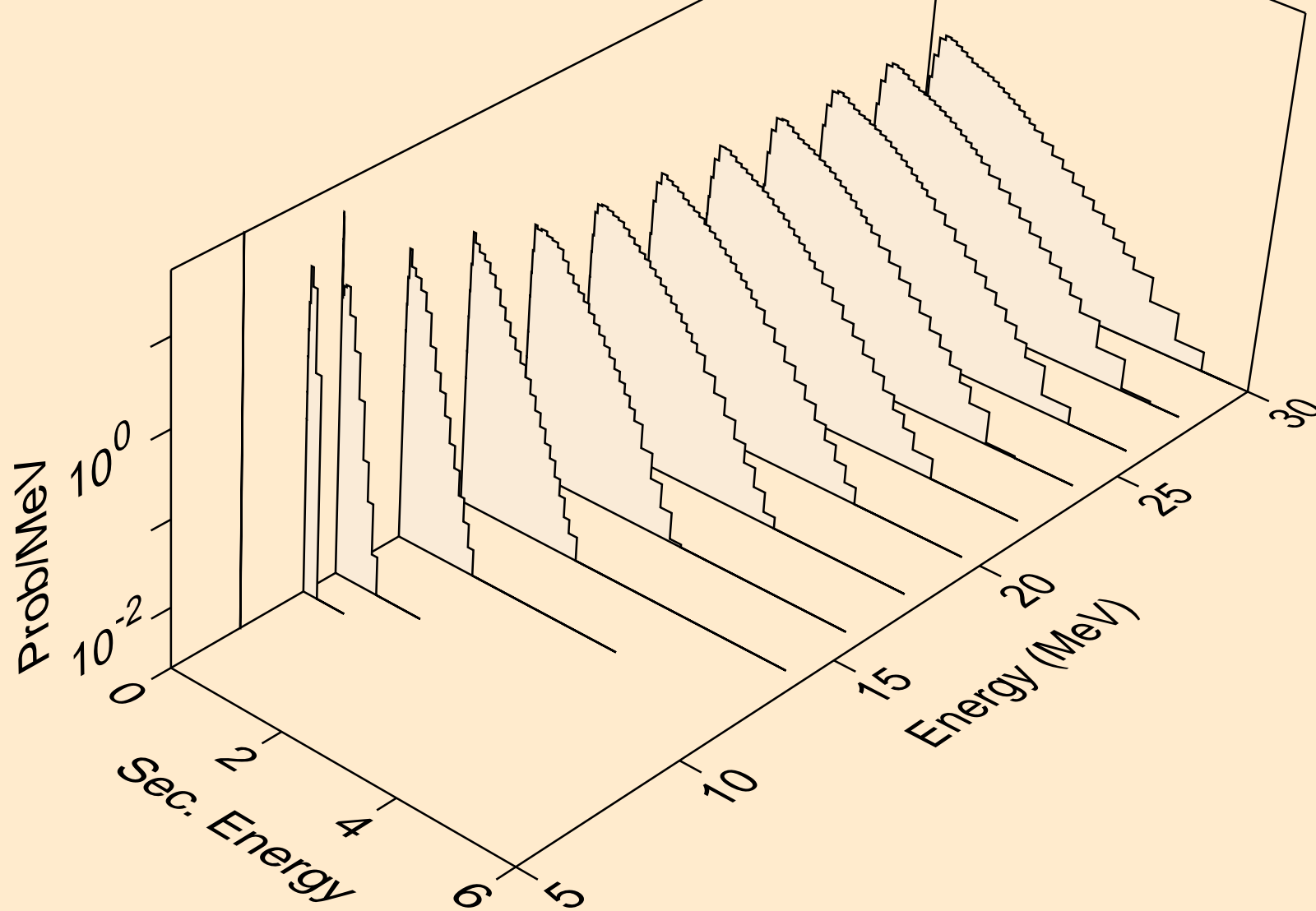

XE129 TRITON ACER TENDL-2021 LIBRARY; T=0.K  
neutrons from (t,n\*)he3

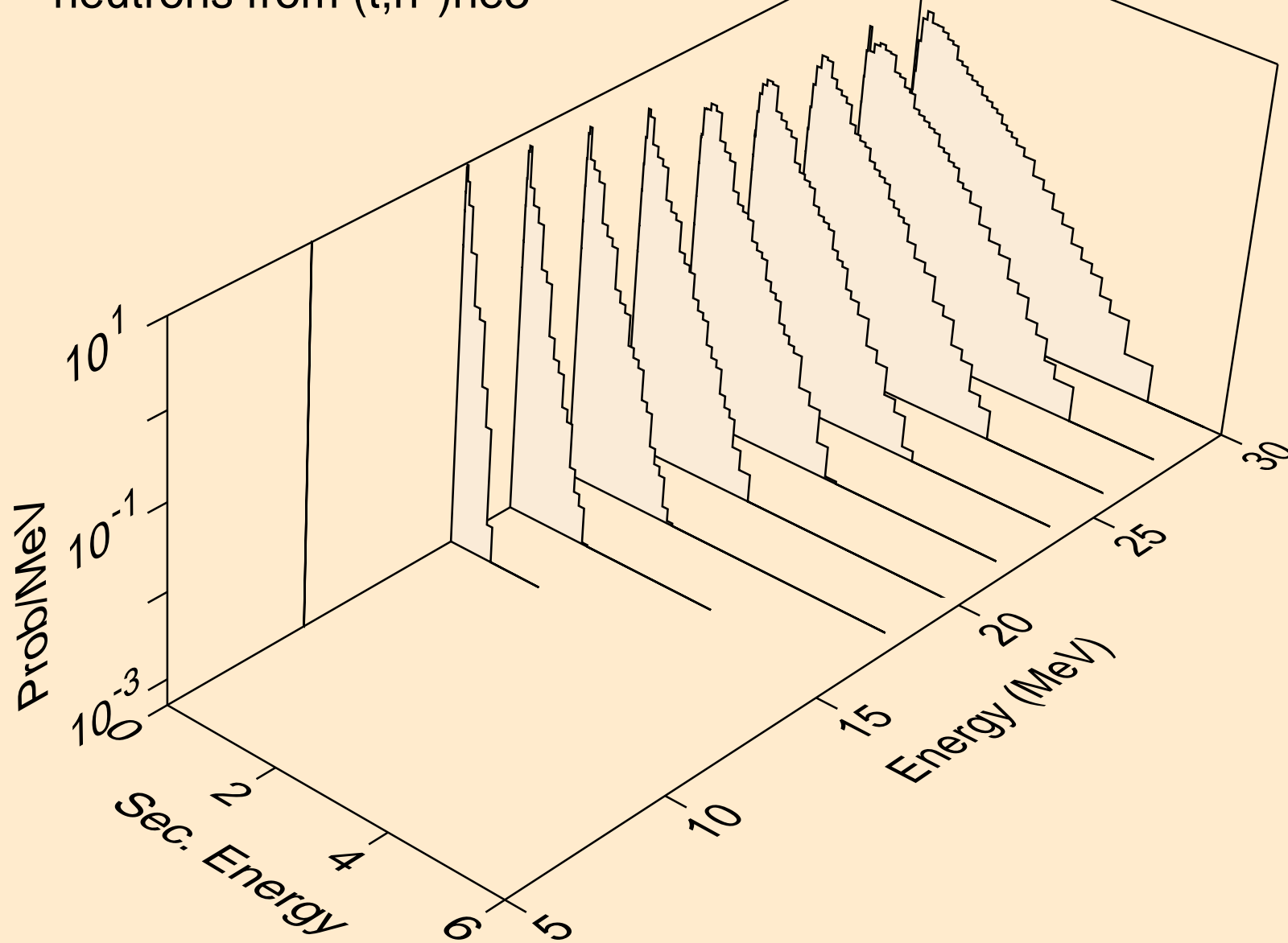

XE129 TRITON ACER TENDL-2021 LIBRARY; T=0.K  
neutrons from (t,4n)

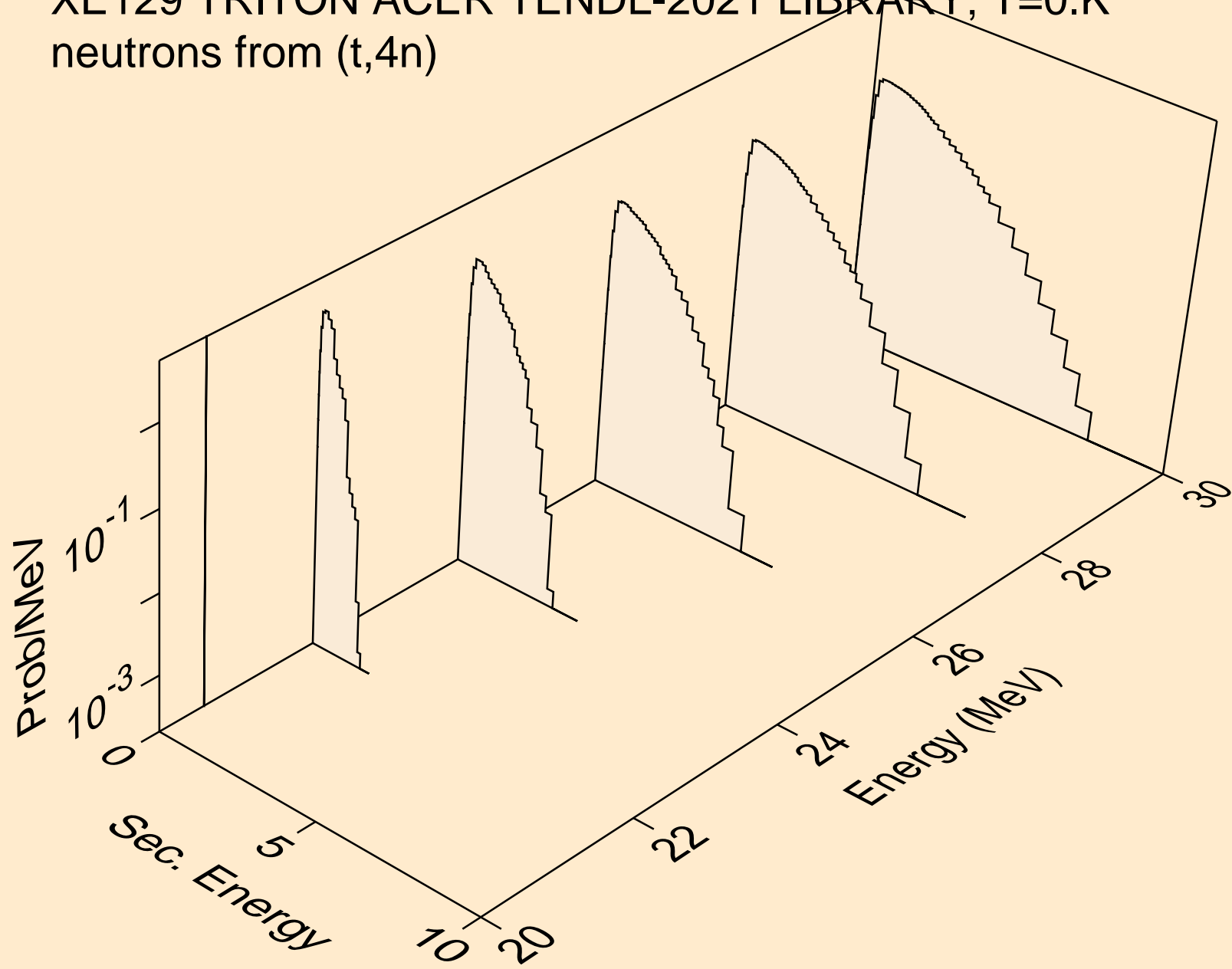

XE129 TRITON ACER TENDL-2021 LIBRARY; T=0.K  
neutrons from (t,2np)

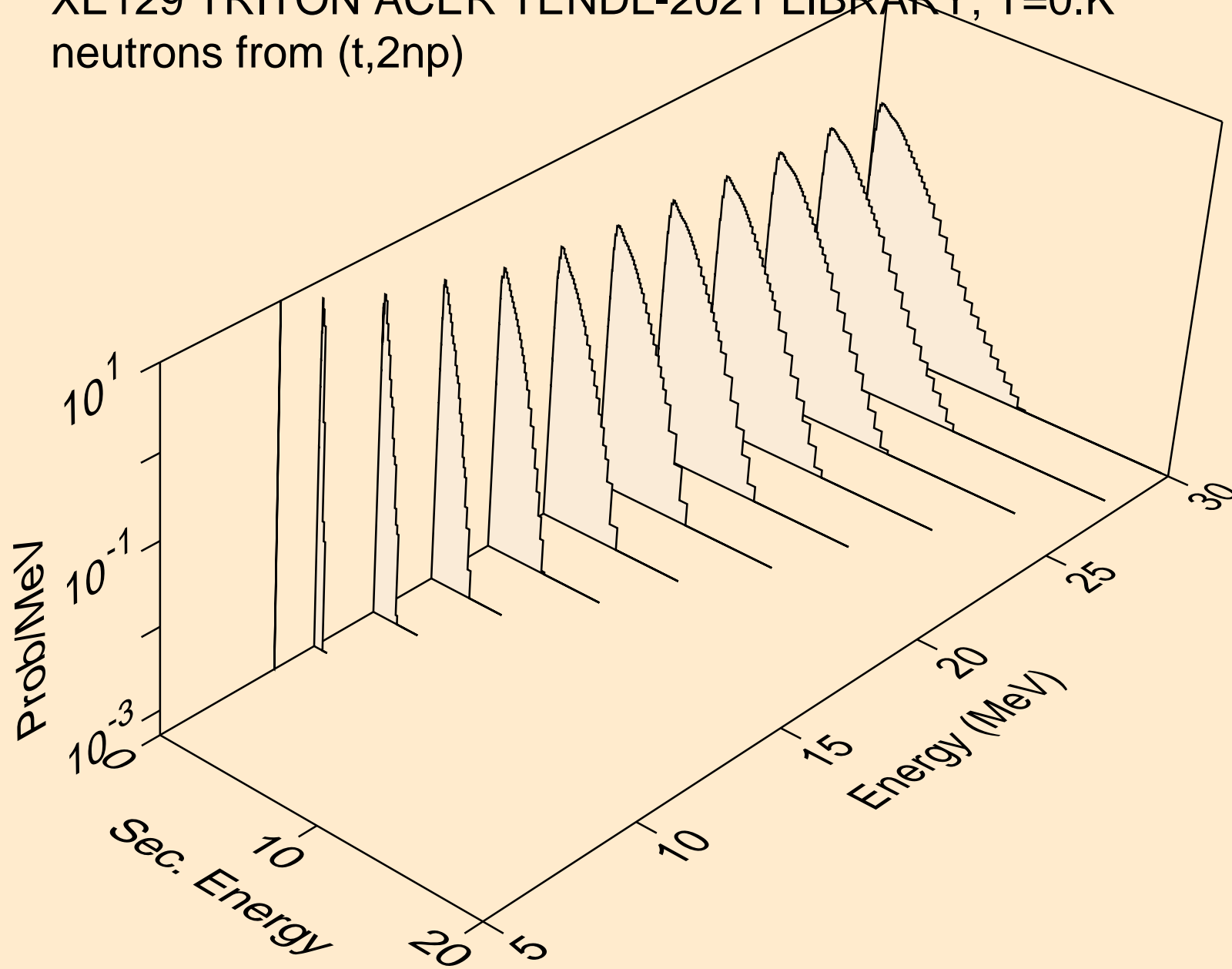

XE129 TRITON ACER TENDL-2021 LIBRARY; T=0.K  
neutrons from (t,3np)

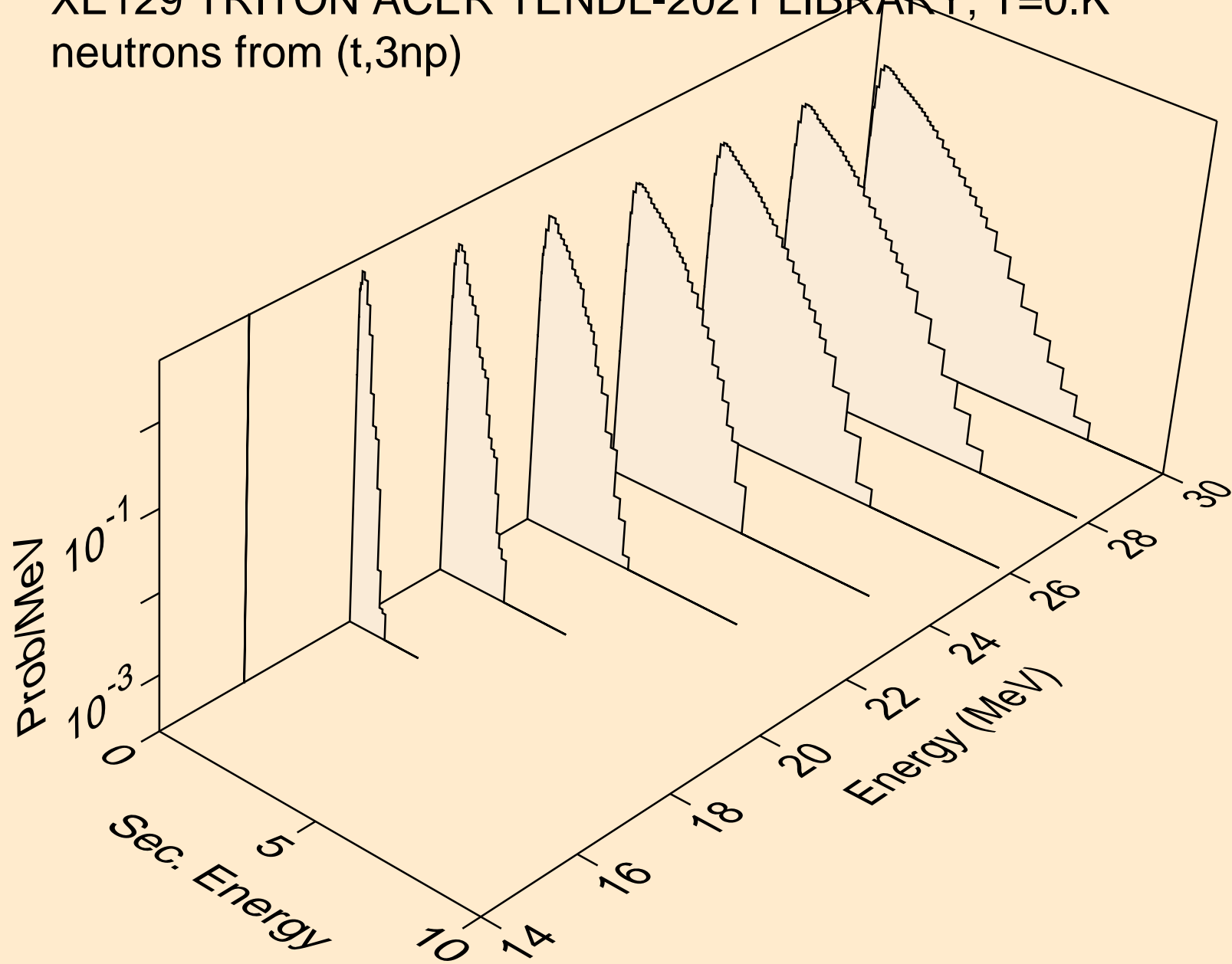



XE129 TRITON ACER TENDL-2021 LIBRARY; T=0.K  
neutrons from (t,2np)

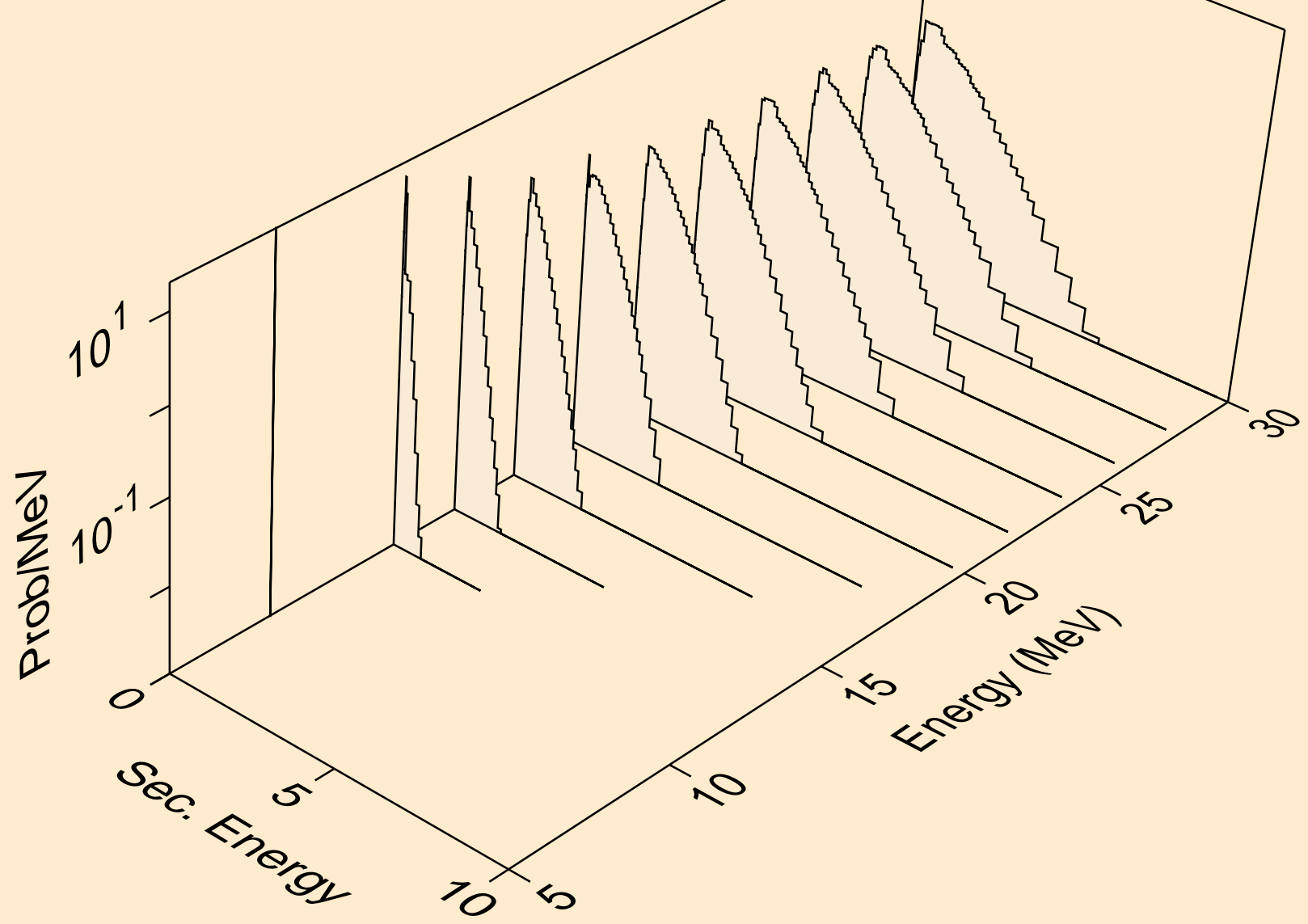

XE129 TRITON ACER TENDL-2021 LIBRARY; T=0.K  
neutrons from (t,npa)

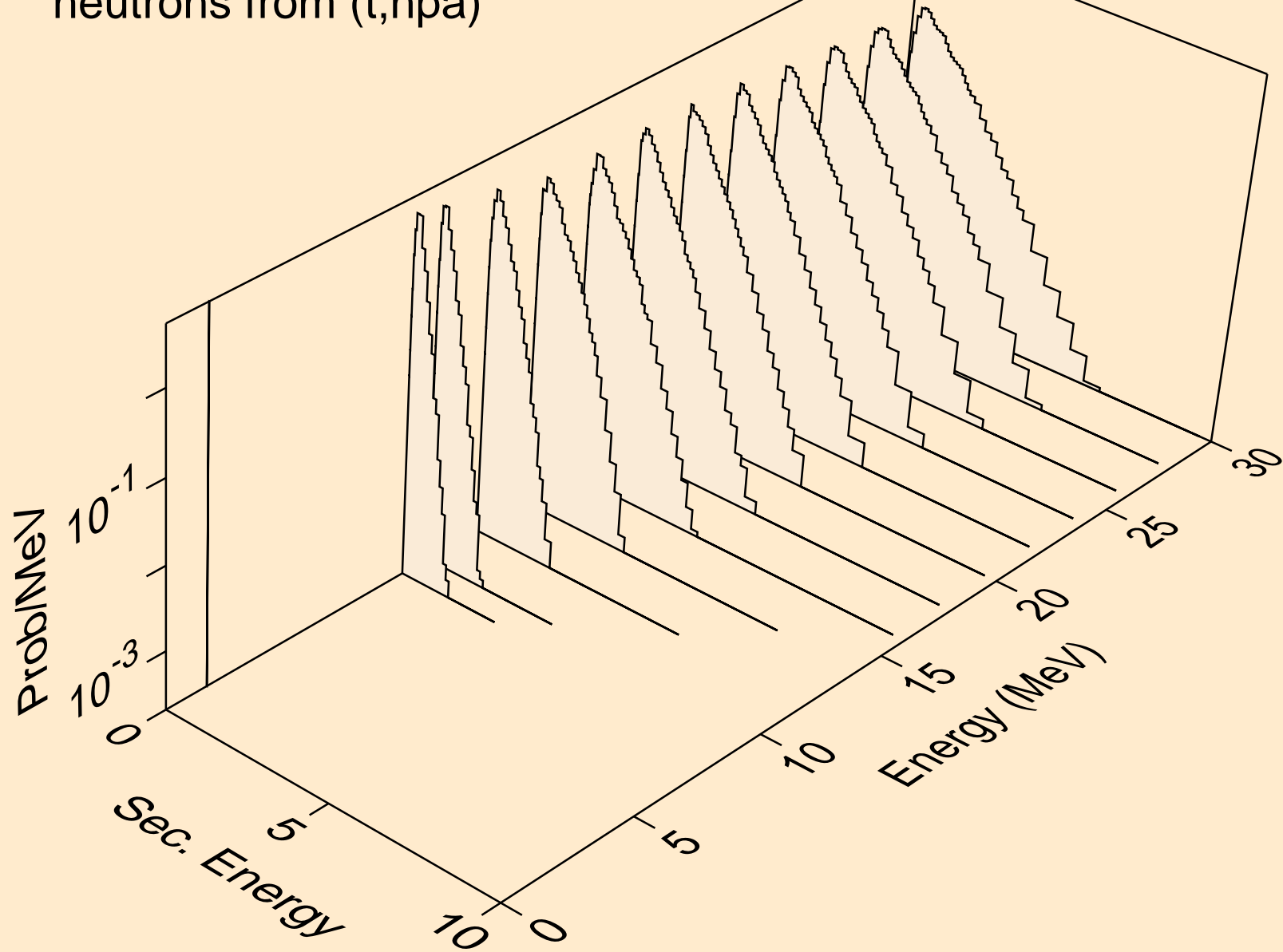

XE129 TRITON ACER TENDL-2021 LIBRARY; T=0.K  
protons from (t,x)

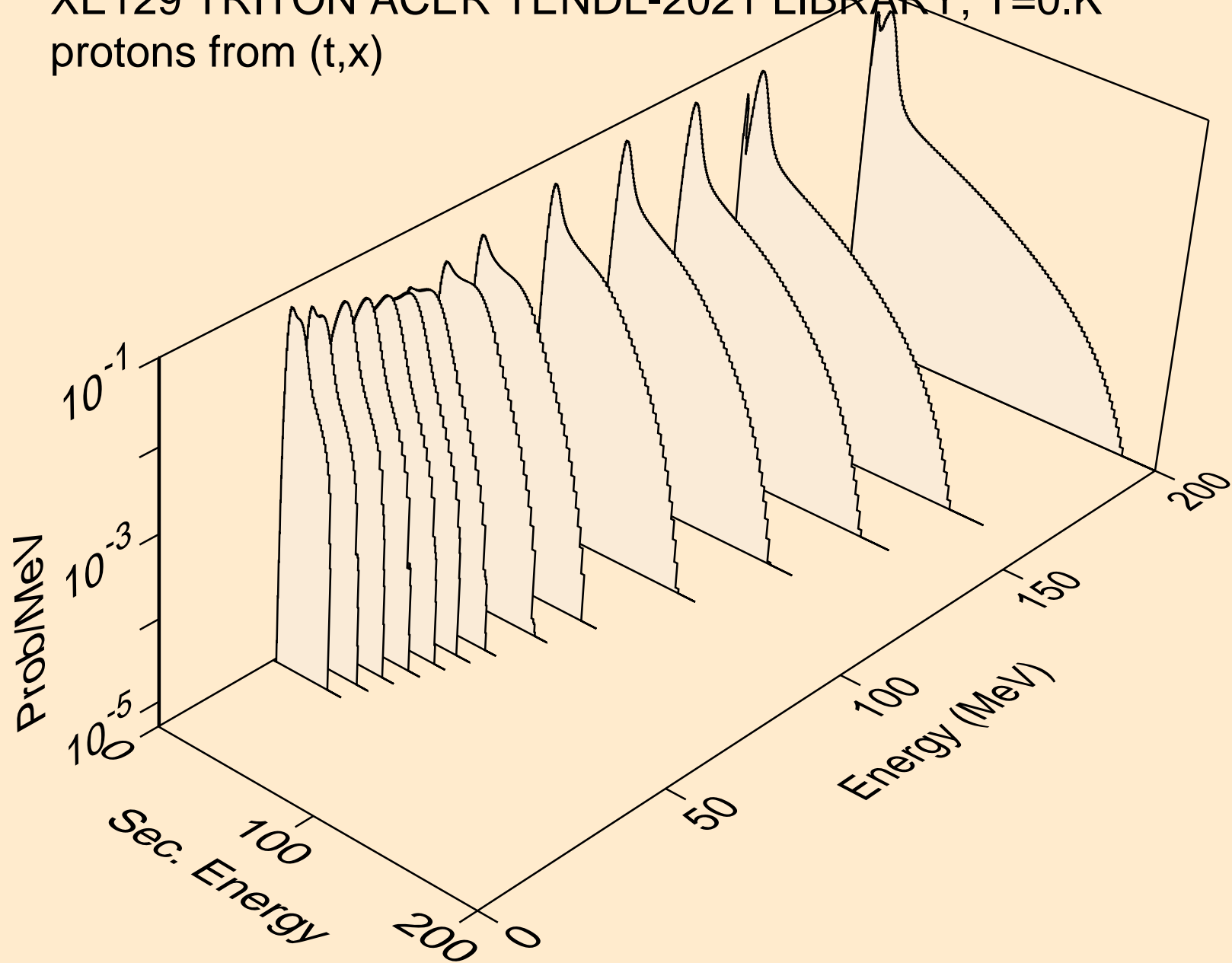

XE129 TRITON ACER TENDL-2021 LIBRARY; T=0.K  
protons from (t,n\*)p

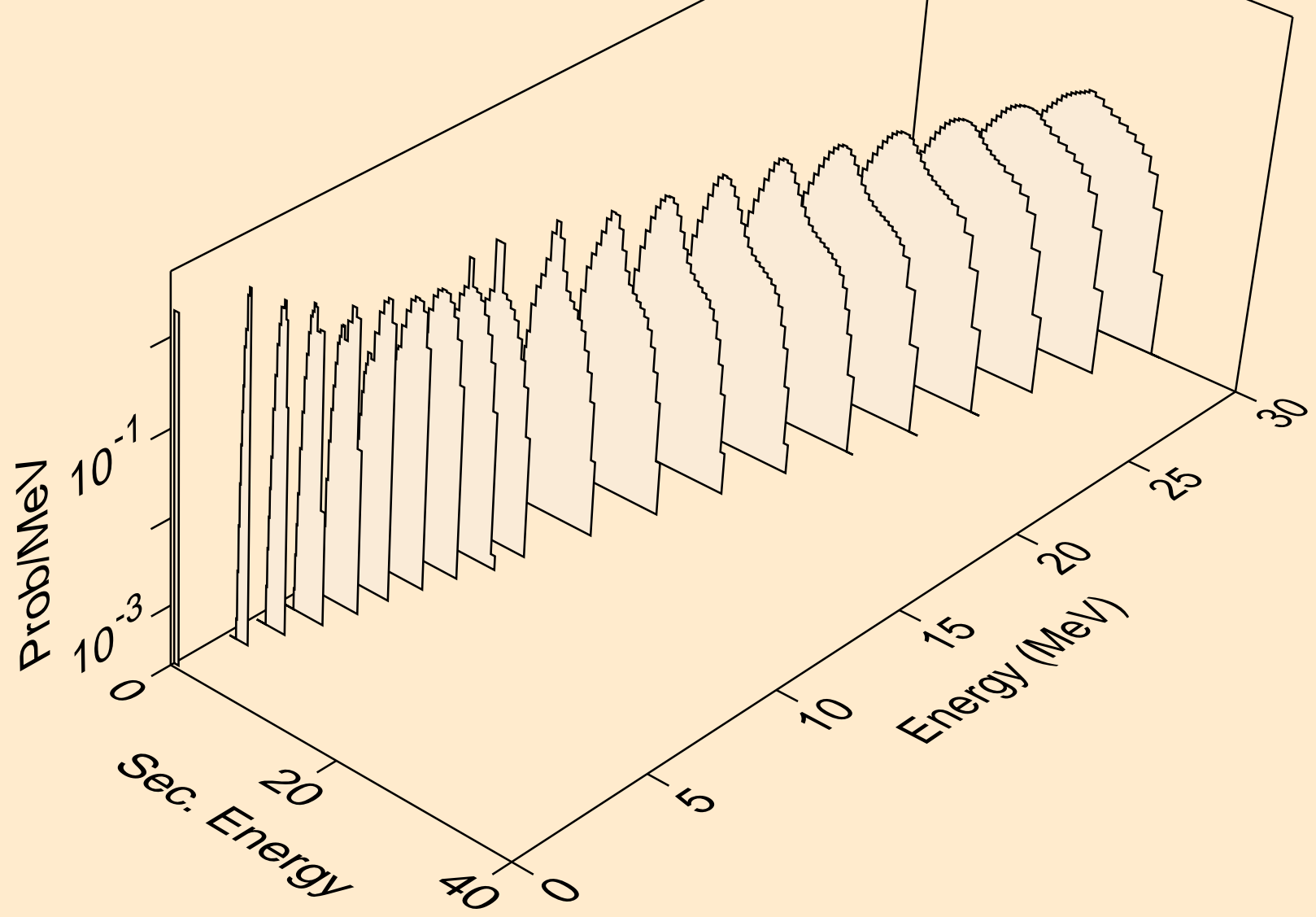

XE129 TRITON ACER TENDL-2021 LIBRARY; T=0.K  
protons from (t,2np)

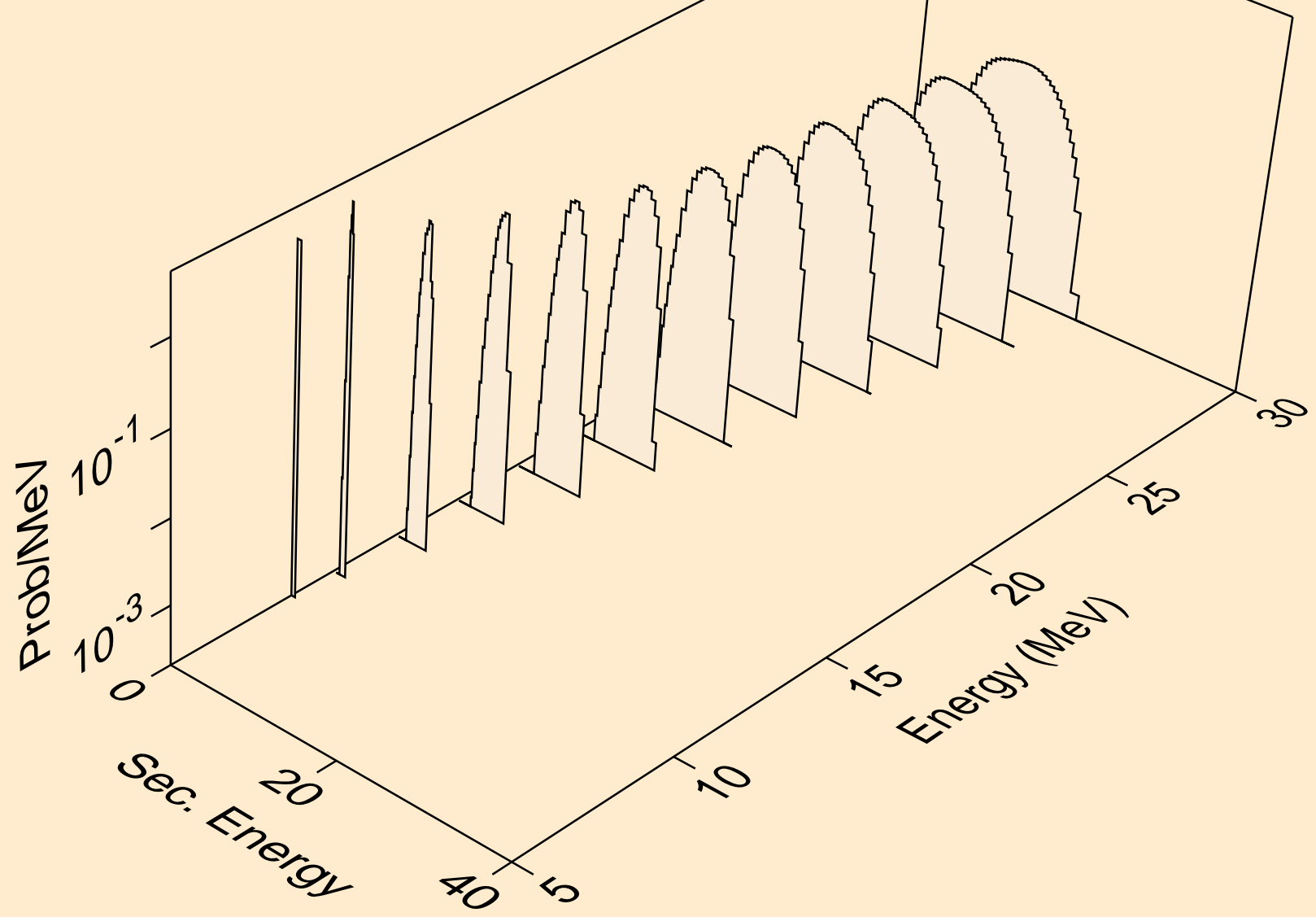

XE129 TRITON ACER TENDL-2021 LIBRARY; T=0.K  
protons from (t,3np)

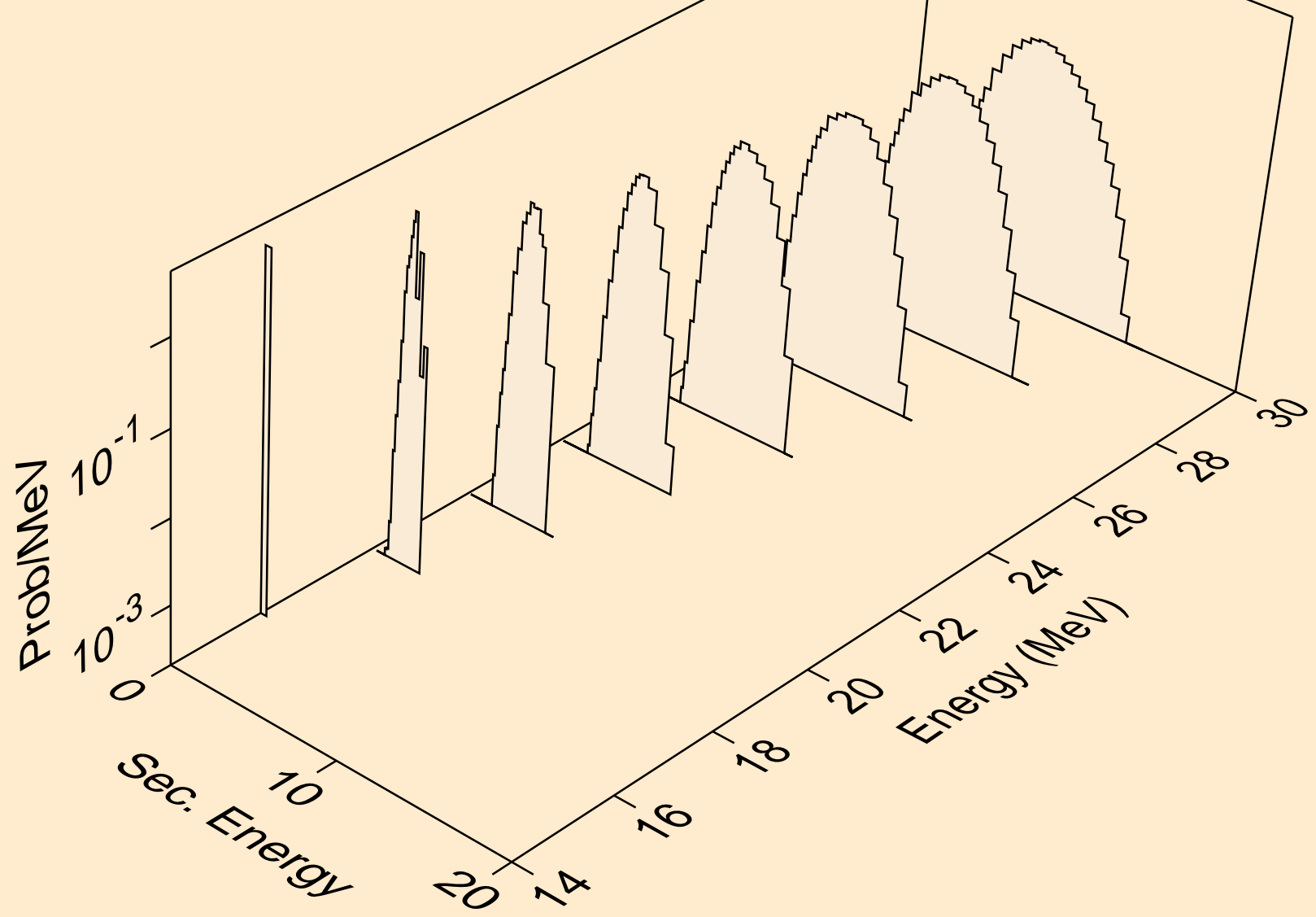

XE129 TRITON ACER TENDL-2021 LIBRARY; T=0.K  
protons from (t,2np)

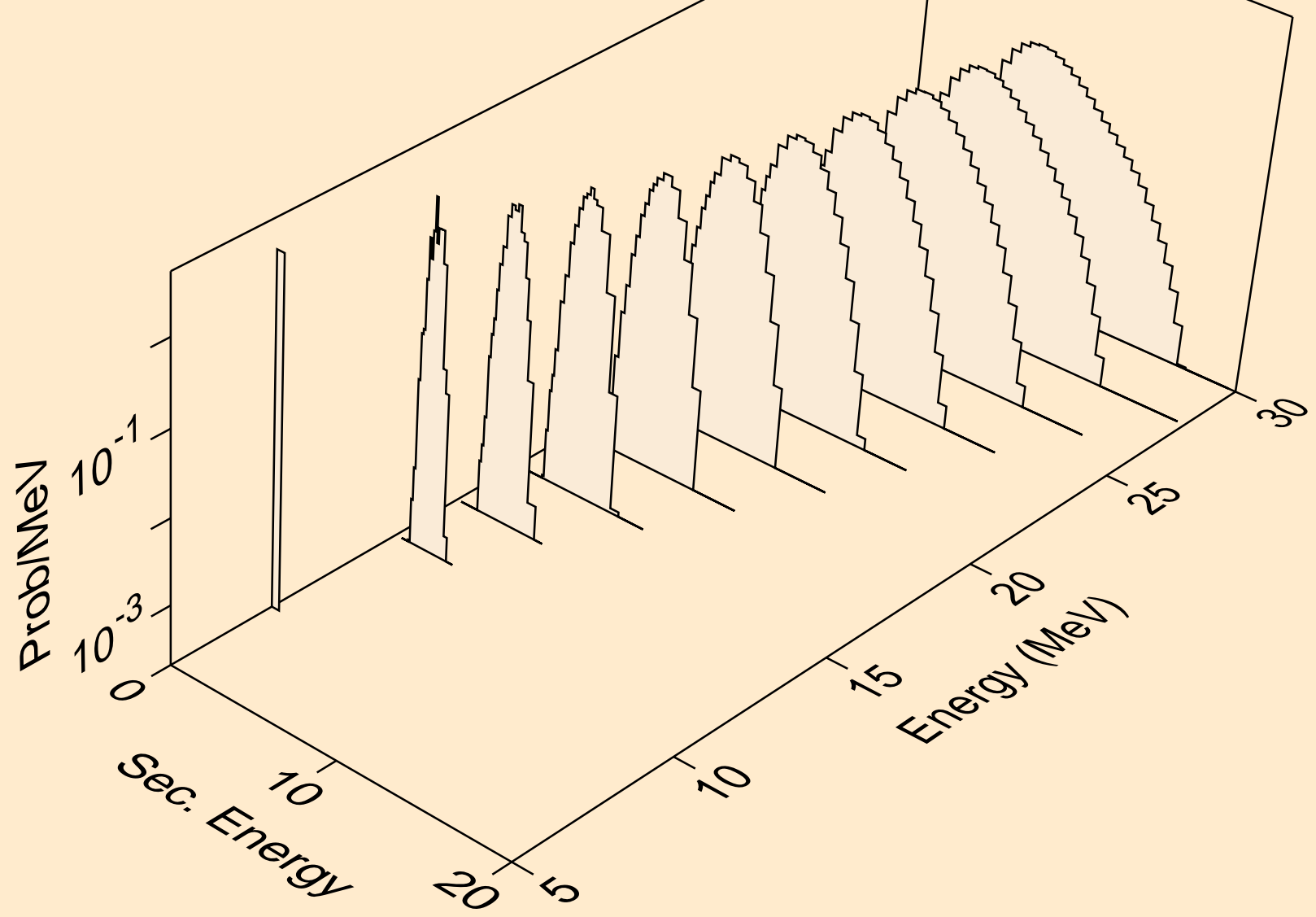

XE129 TRITON ACER TENDL-2021 LIBRARY; T=0.K  
protons from (t,npa)

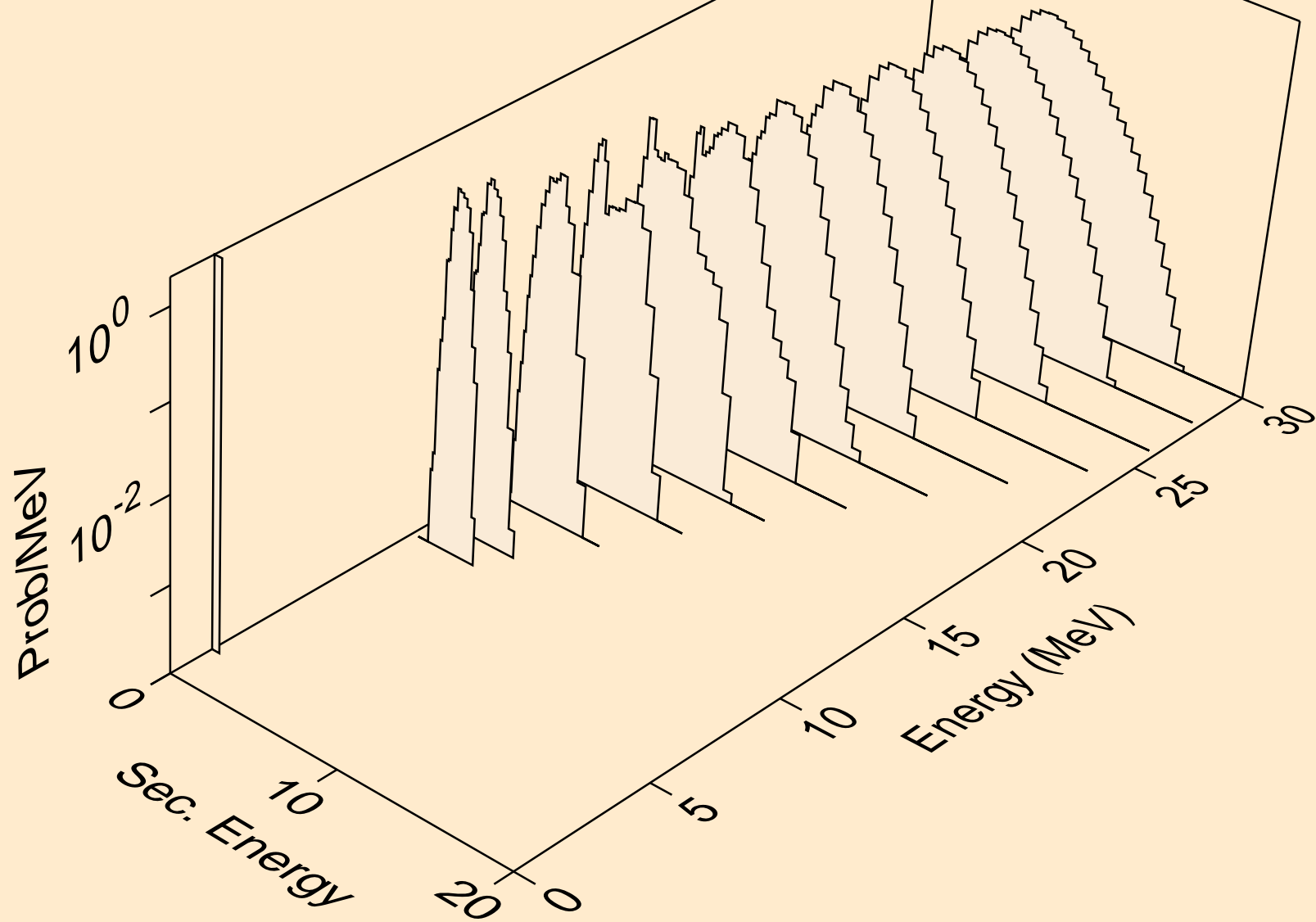



XE129 TRITON ACER TENDL-2021 LIBRARY; T=0.K  
protons from (t,p)

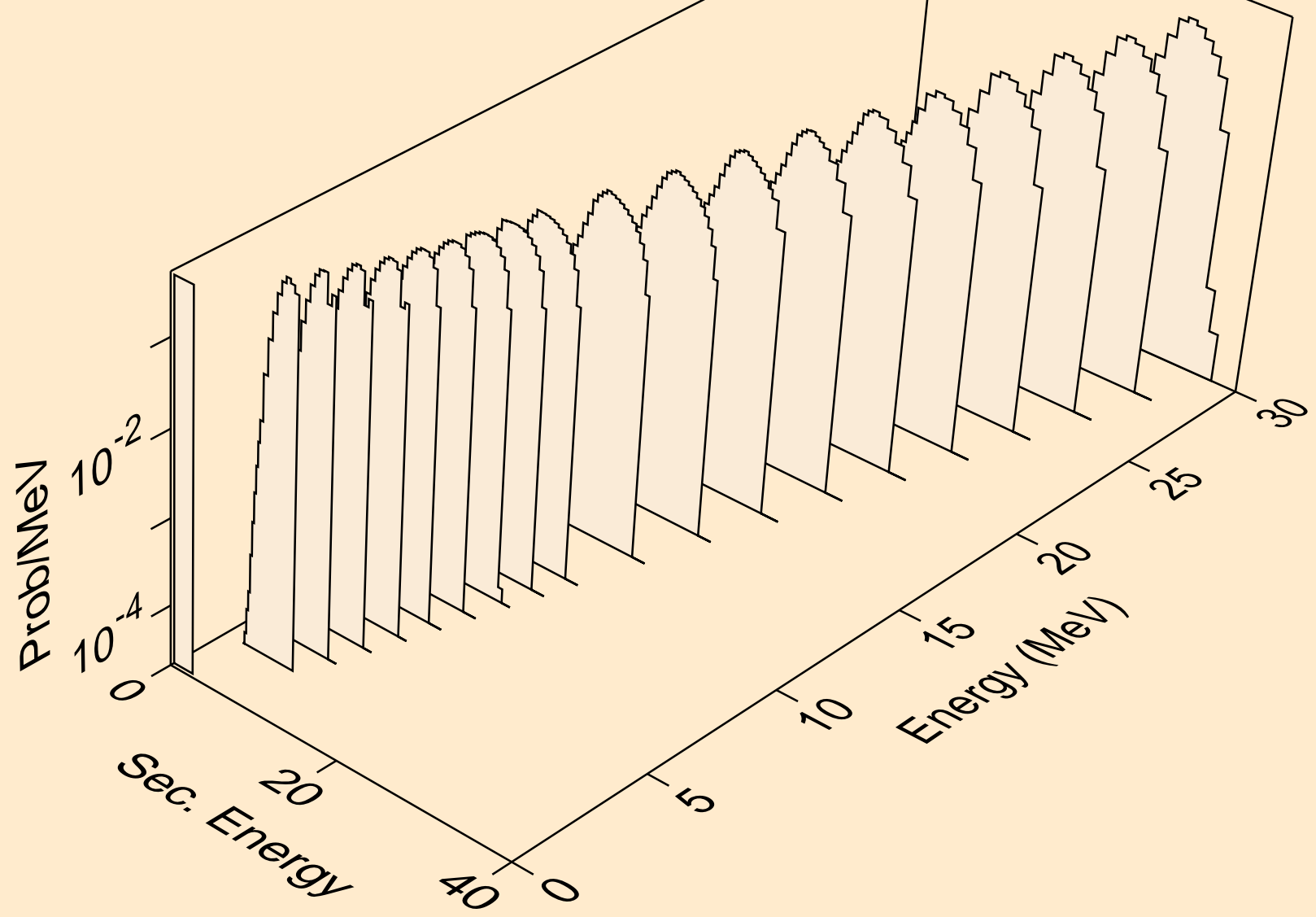

XE129 TRITON ACER TENDL-2021 LIBRARY; T=0.K  
protons from (t,2p)

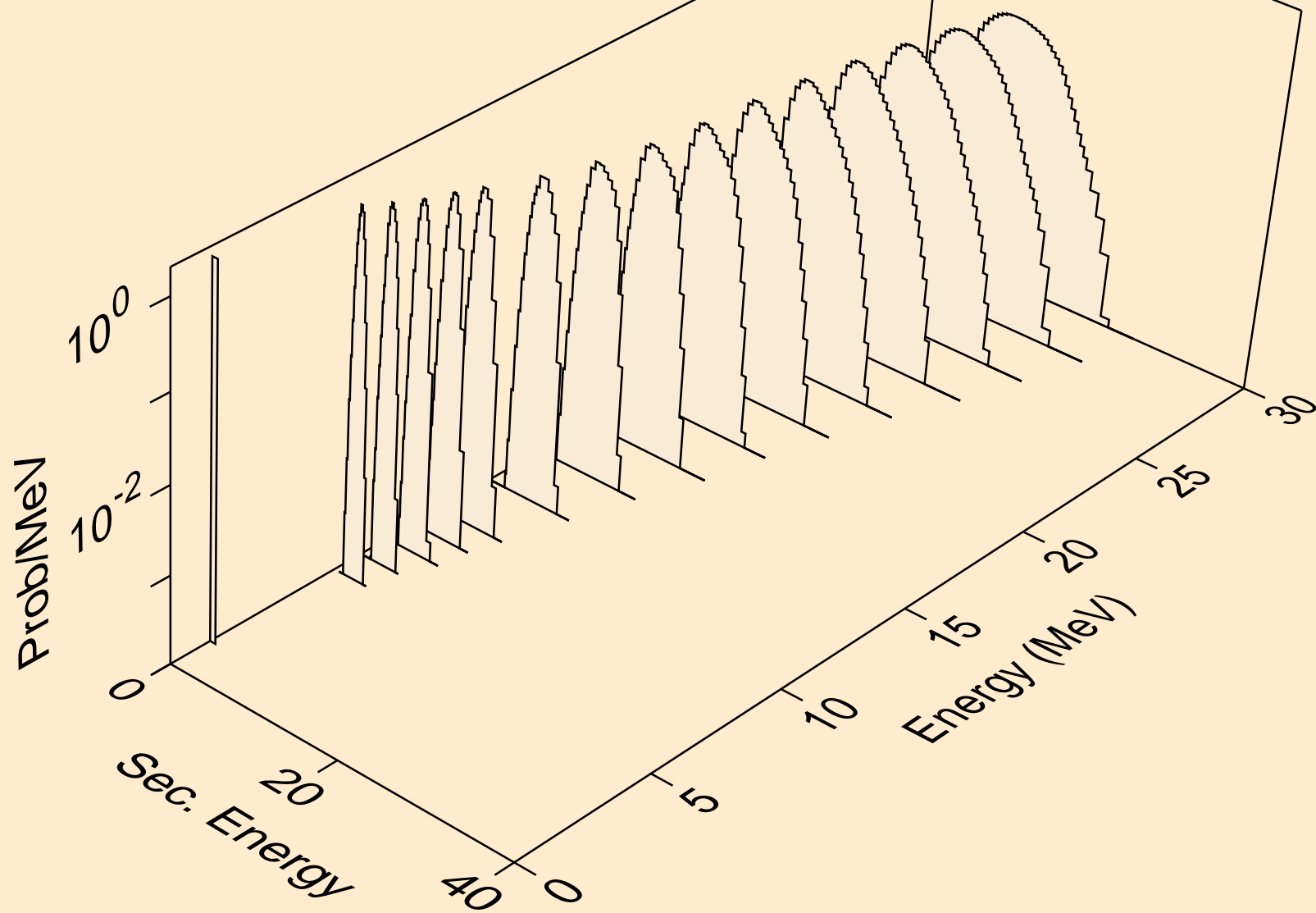

XE129 TRITON ACER TENDL-2021 LIBRARY; T=0.K  
protons from (t,pa)

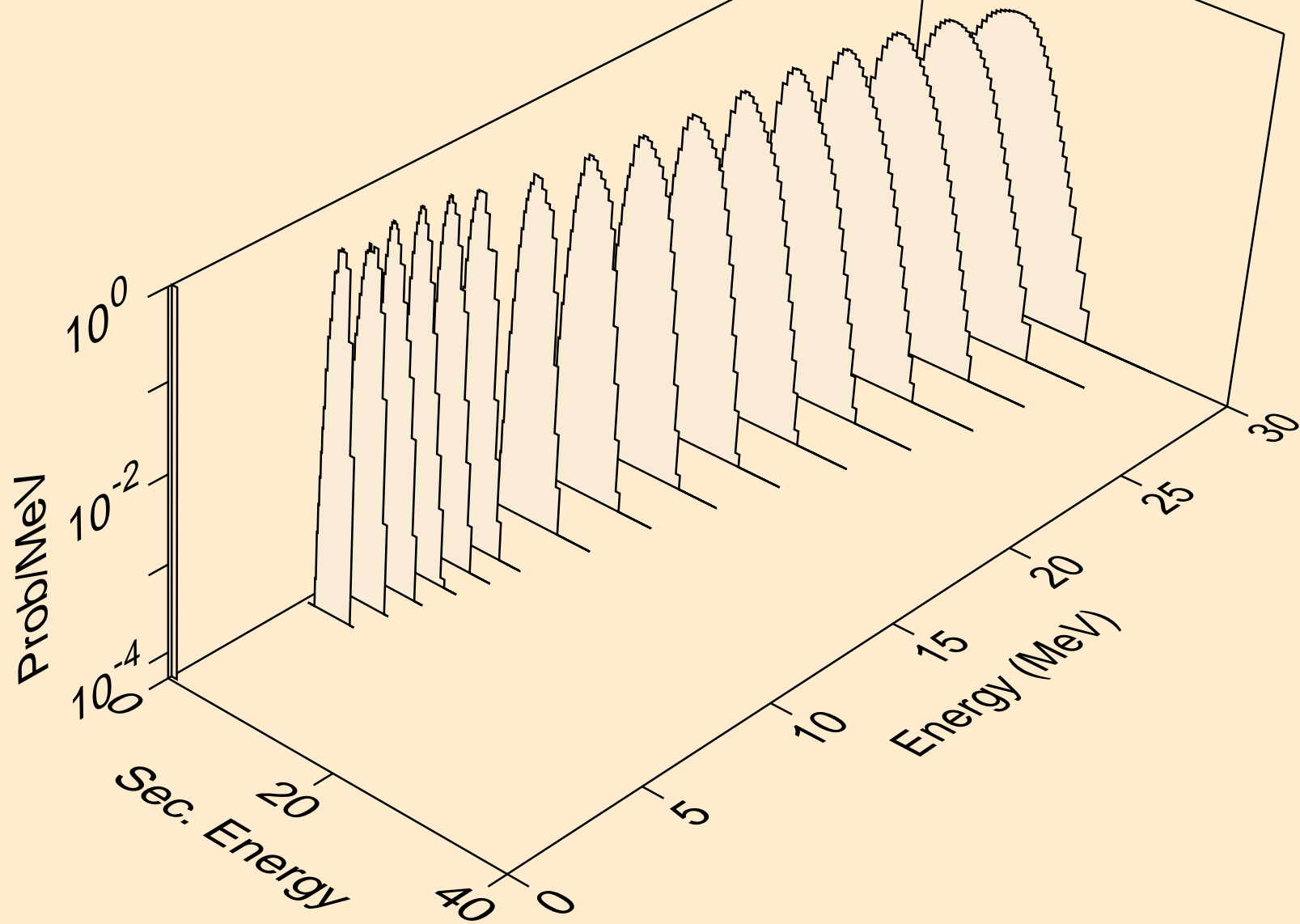

XE129 TRITON ACER TENDL-2021 LIBRARY; T=0.K  
protons from (t,pd)

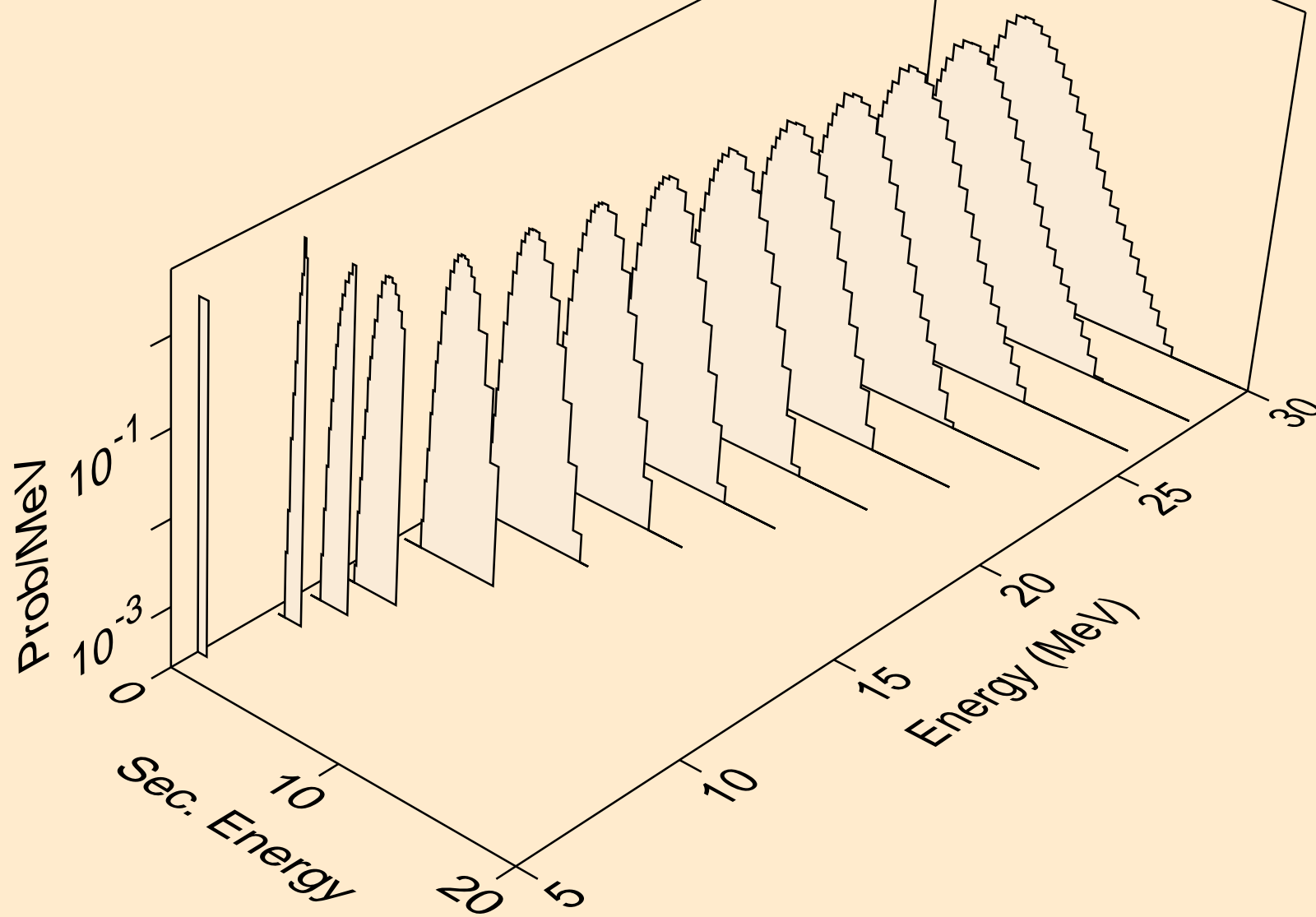

XE129 TRITON ACER TENDL-2021 LIBRARY; T=0.K  
protons from (t,pt)

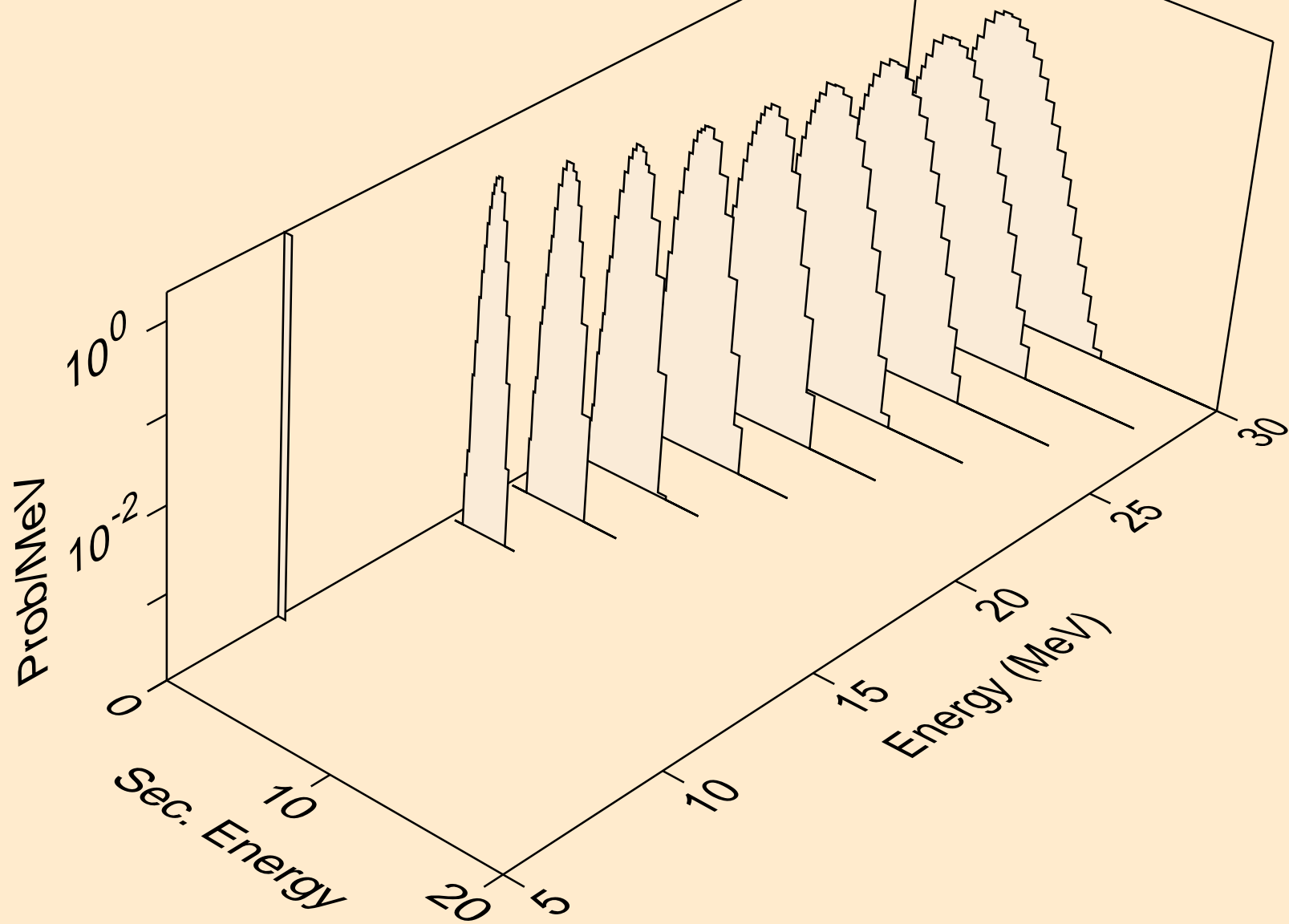

XE129 TRITON ACER TENDL-2021 LIBRARY; T=0.K  
deuterons from (t,x)

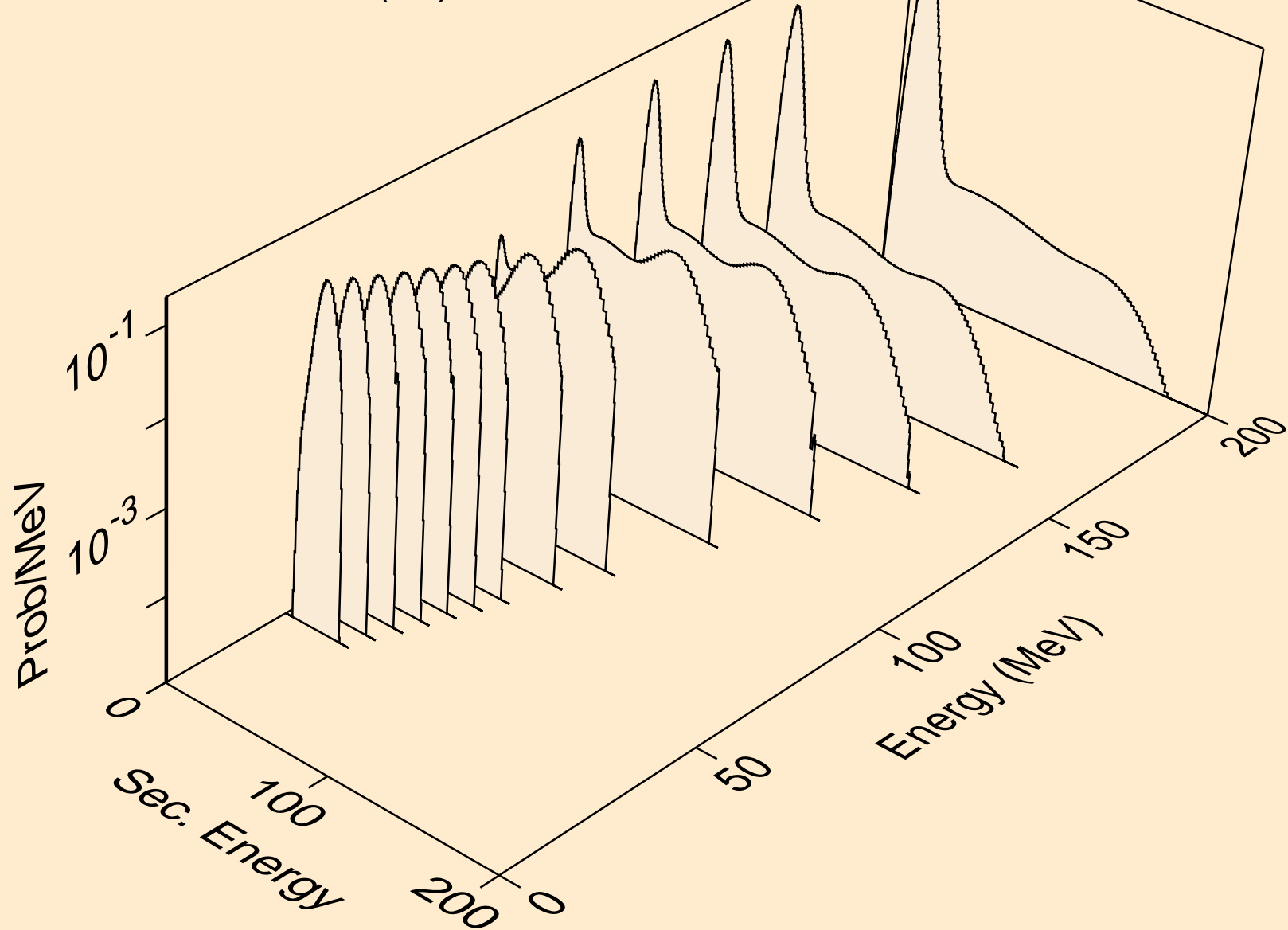

XE129 TRITON ACER TENDL-2021 LIBRARY; T=0.K  
deuterons from (t,2nd)

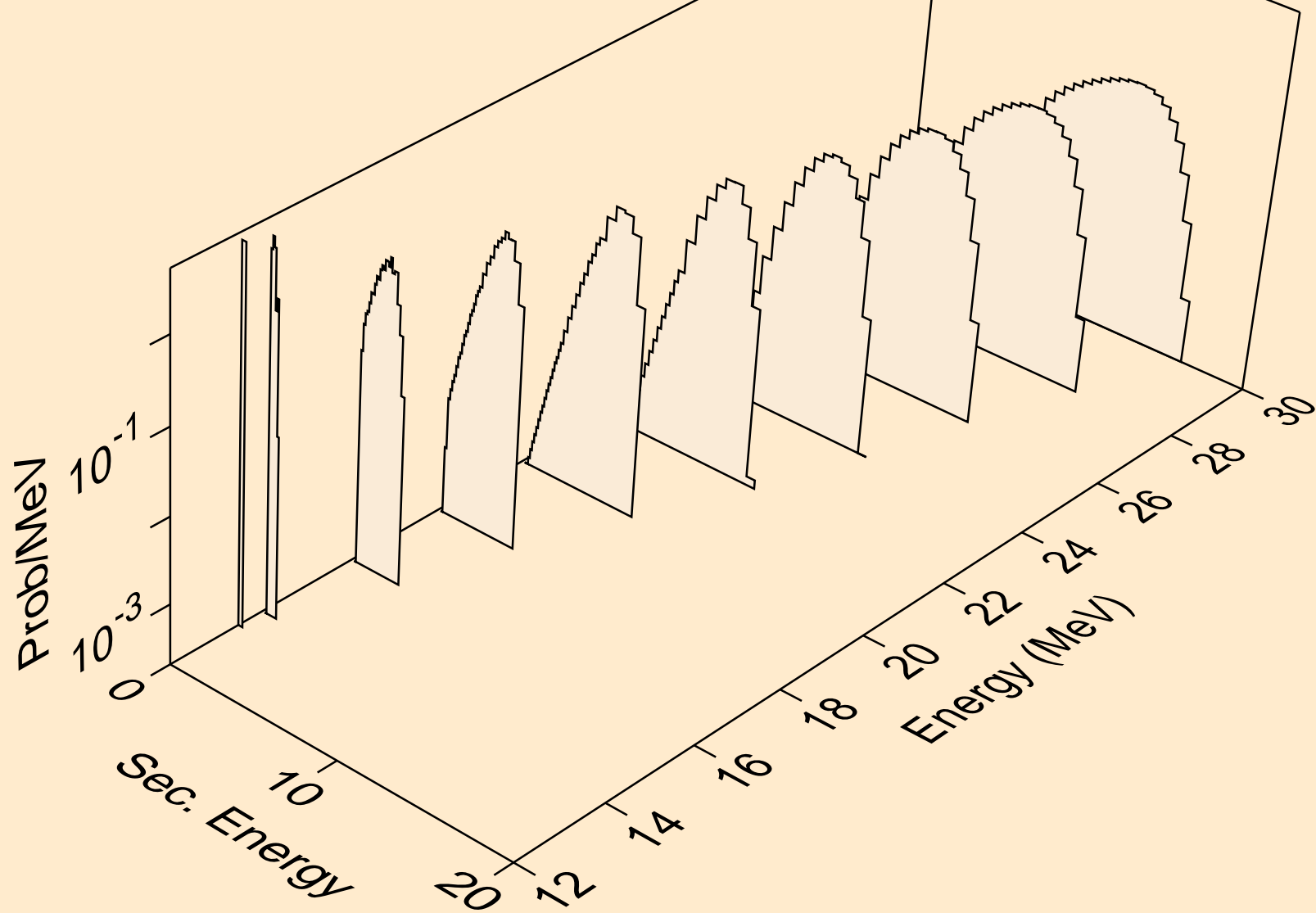

XE129 TRITON ACER TENDL-2021 LIBRARY; T=0.K  
deuterons from (t,n\*)d

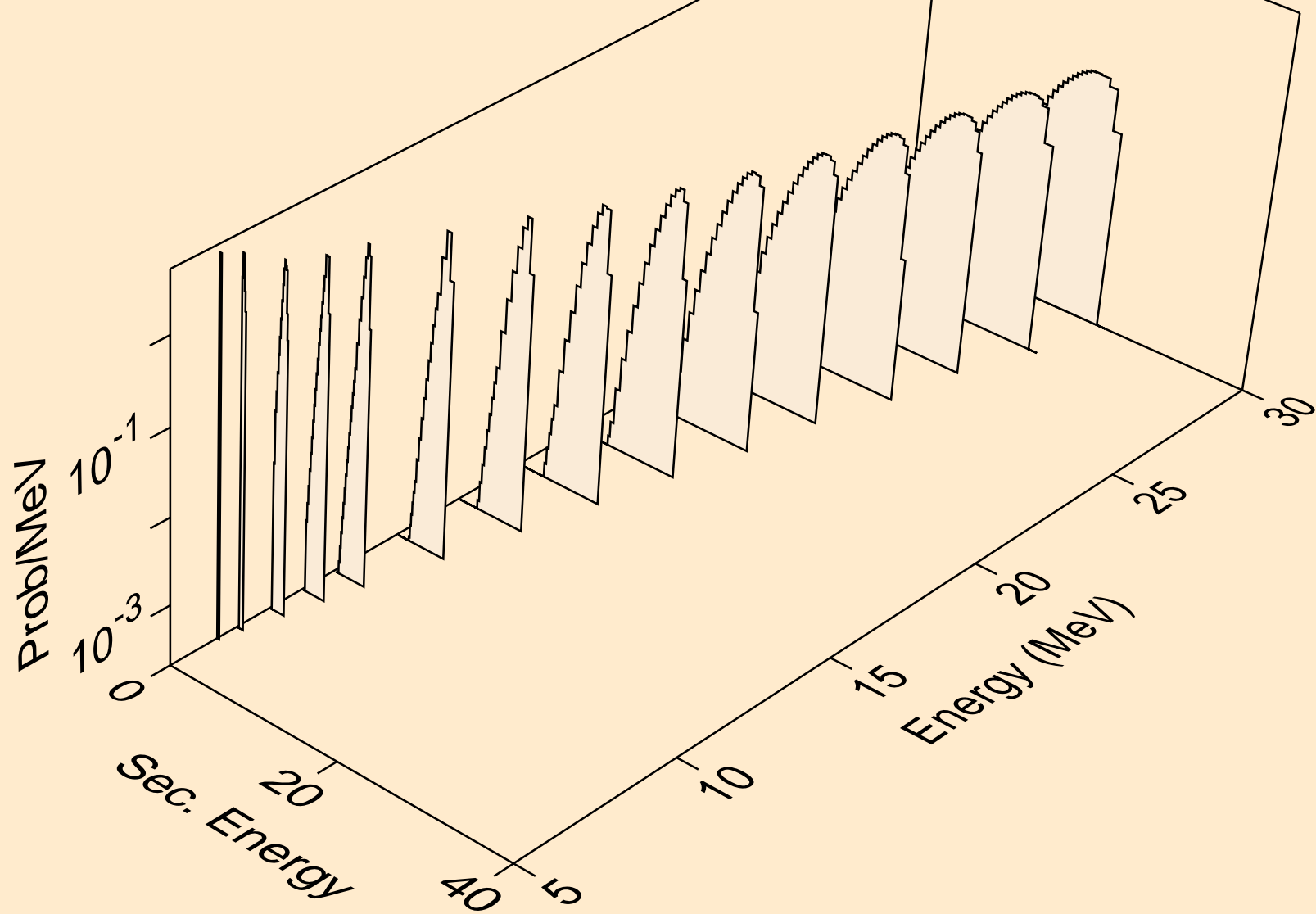



XE129 TRITON ACER TENDL-2021 LIBRARY; T=0.K  
deuterons from (t,d)

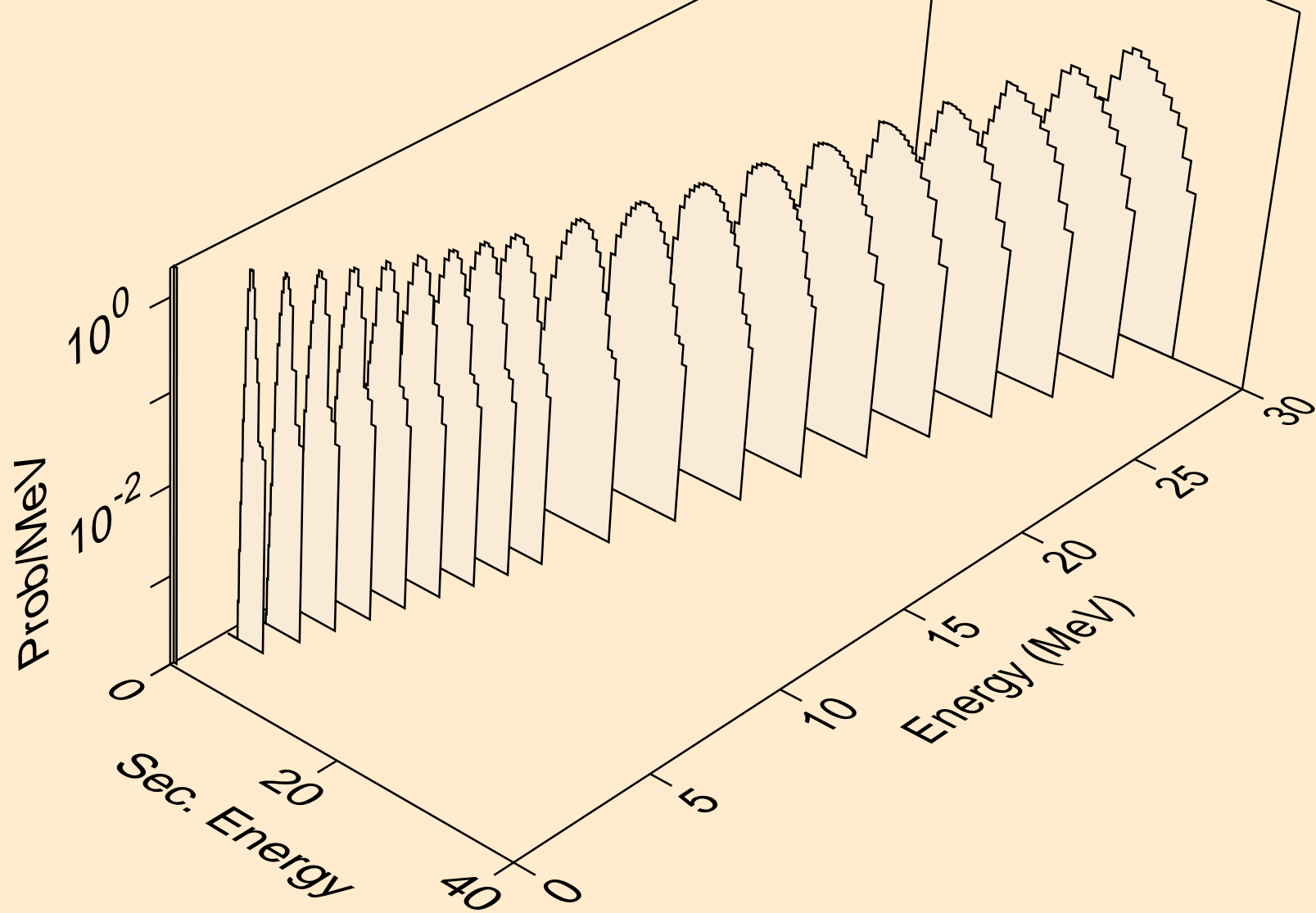

XE129 TRITON ACER TENDL-2021 LIBRARY; T=0.K  
deuterons from (t,pd)

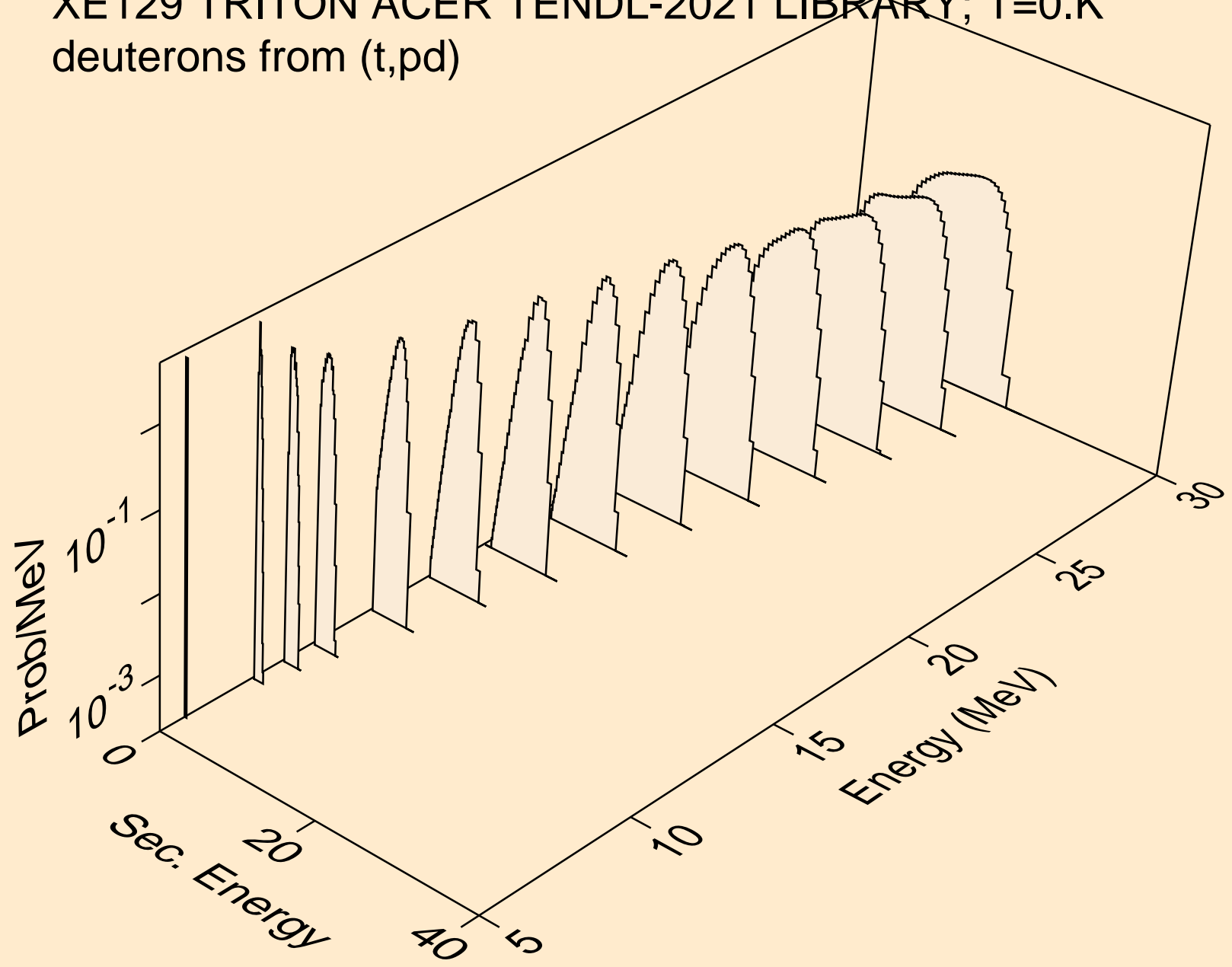

XE129 TRITON ACER TENDL-2021 LIBRARY; T=0.K  
deuterons from (t,da)

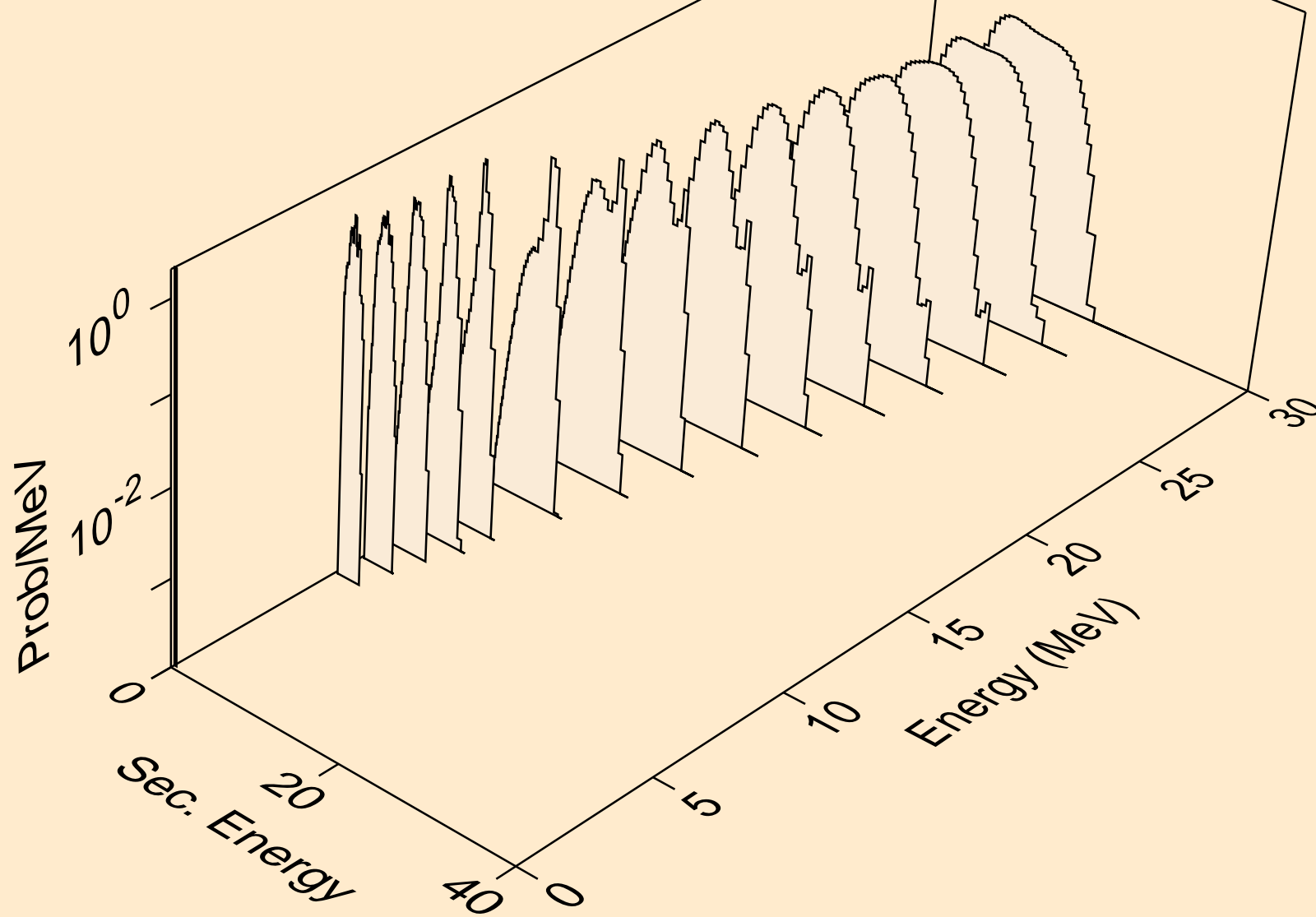

XE129 TRITON ACER TENDL-2021 LIBRARY; T=0.K  
he3s from (t,x)

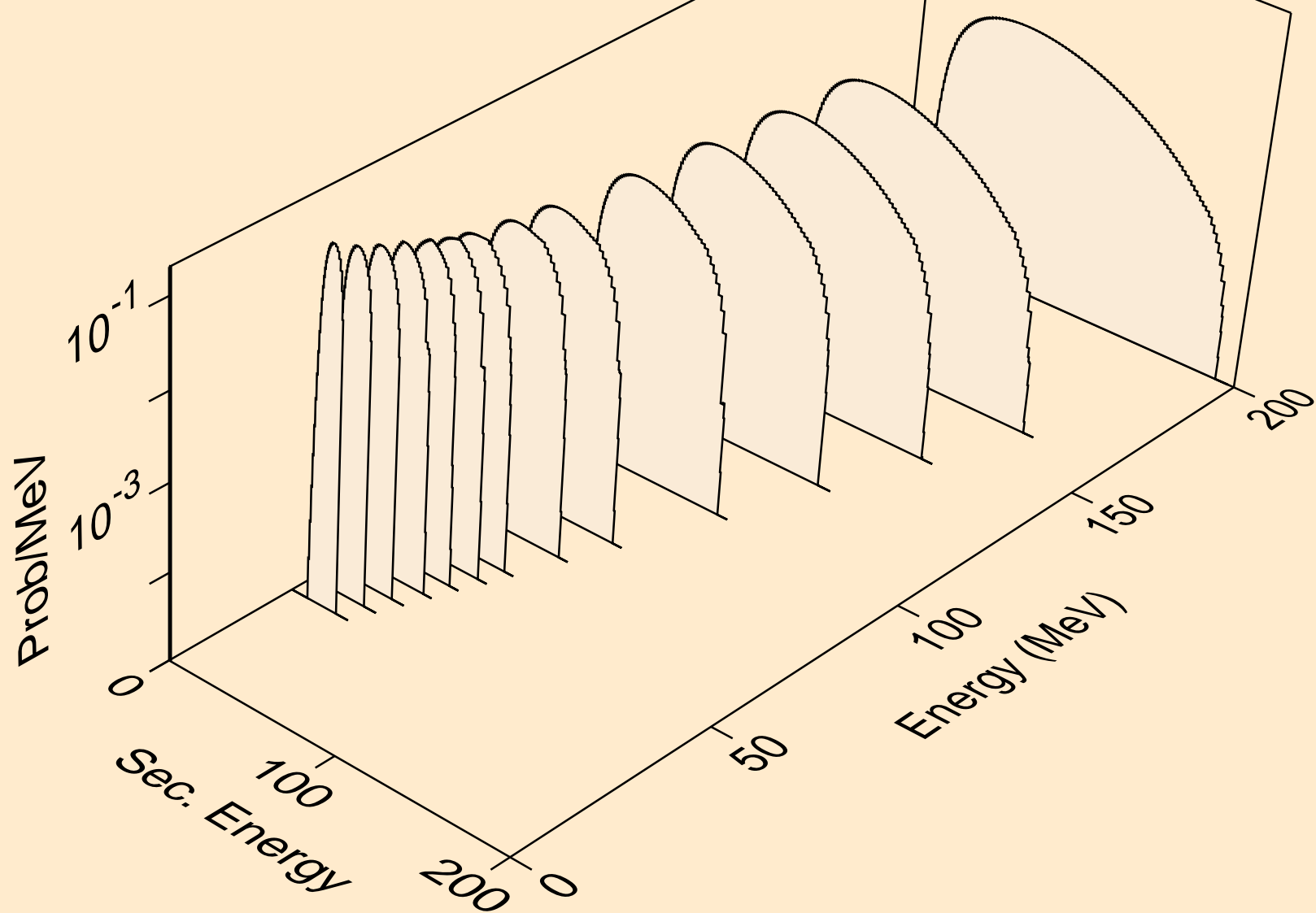

XE129 TRITON ACER TENDL-2021 LIBRARY; T=0.K  
he3s from (t,n\*)he3

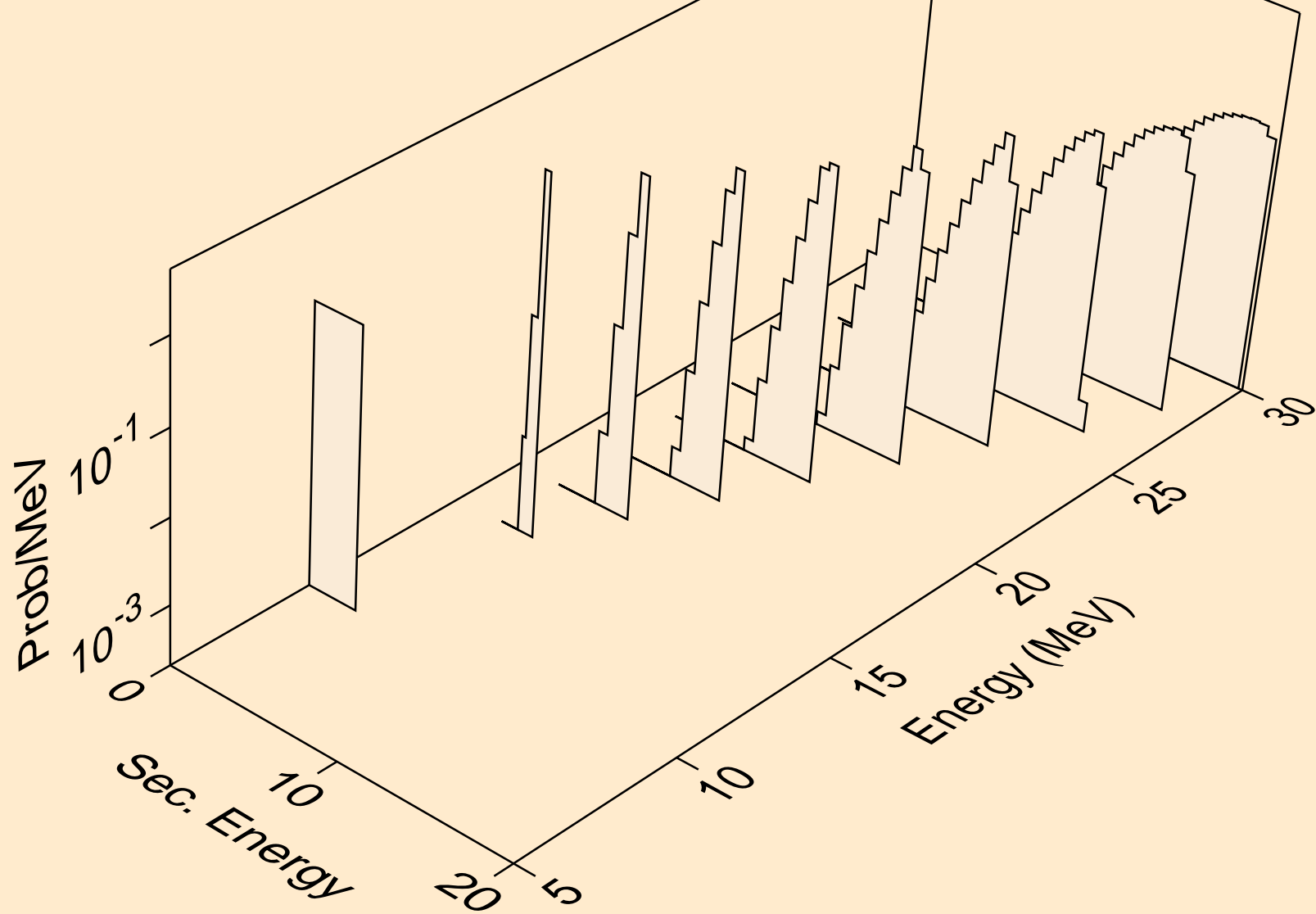

XE129 TRITON ACER TENDL-2021 LIBRARY; T=0.K  
he3s from (t,he3)

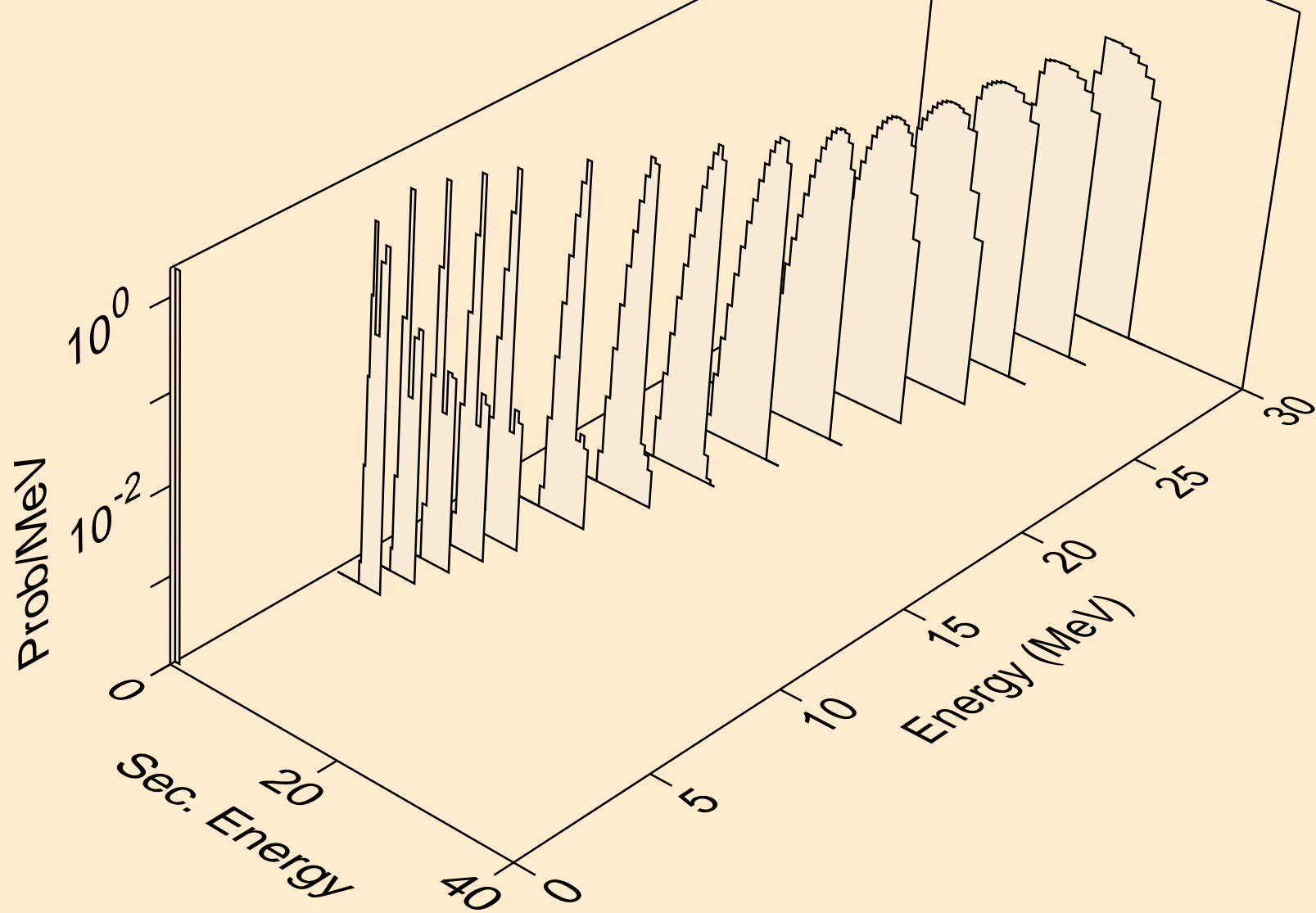

XE129 TRITON ACER TENDL-2021 LIBRARY; T=0.K  
alphas from (t,x)

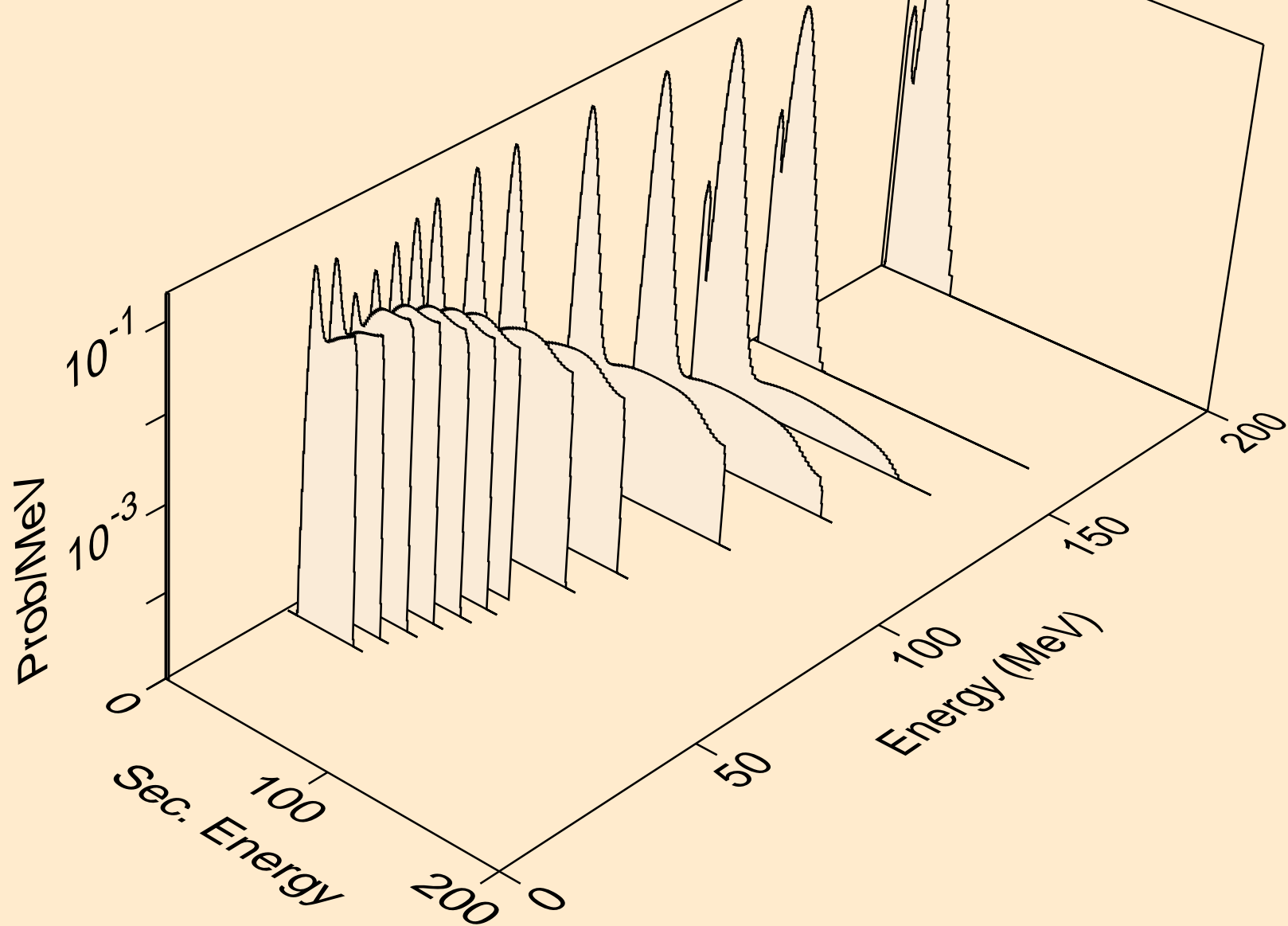

XE129 TRITON ACER TENDL-2021 LIBRARY; T=0.K  
alphas from (t,n\*)a

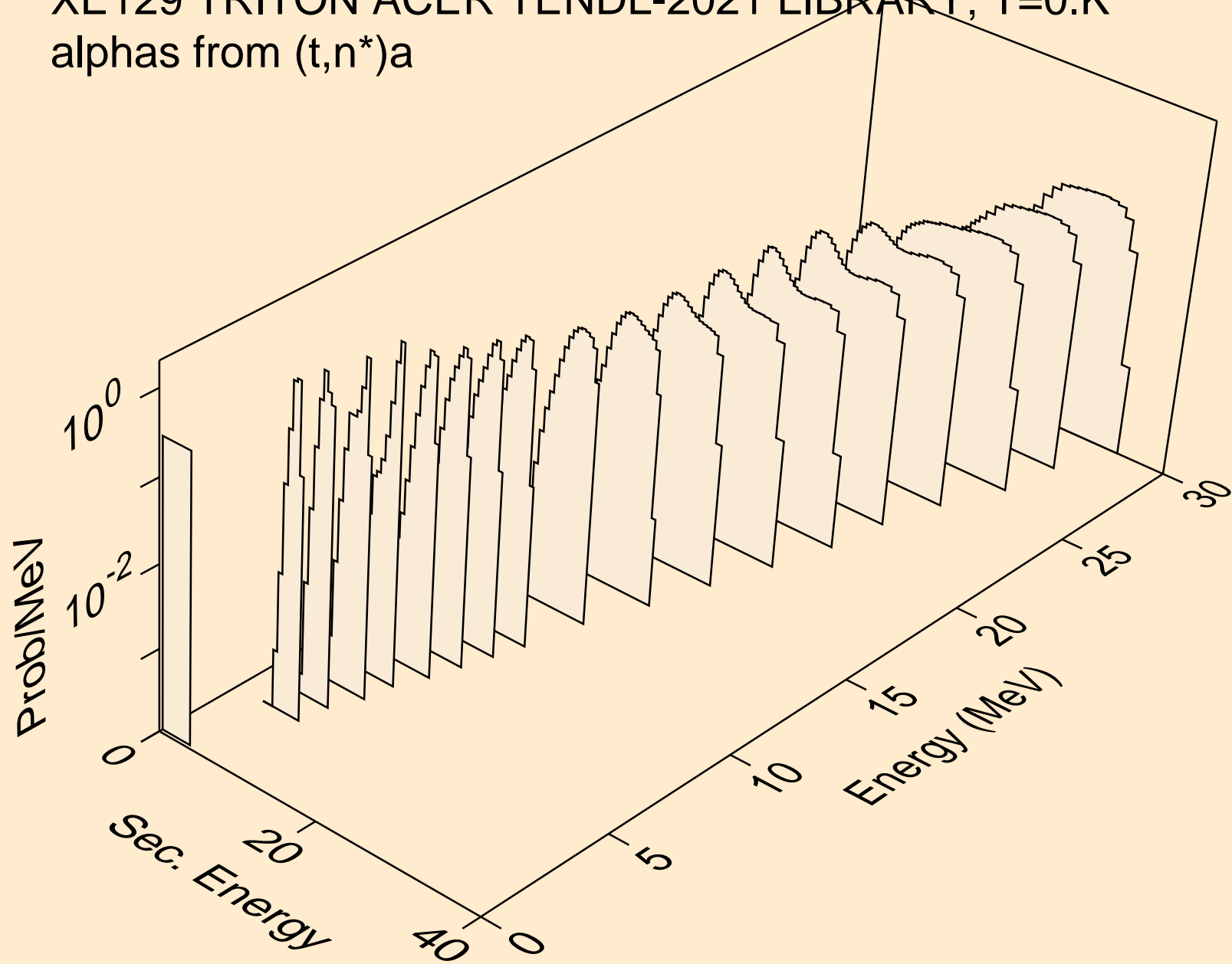



XE129 TRITON ACER TENDL-2021 LIBRARY; T=0.K  
alphas from (t,2n)a

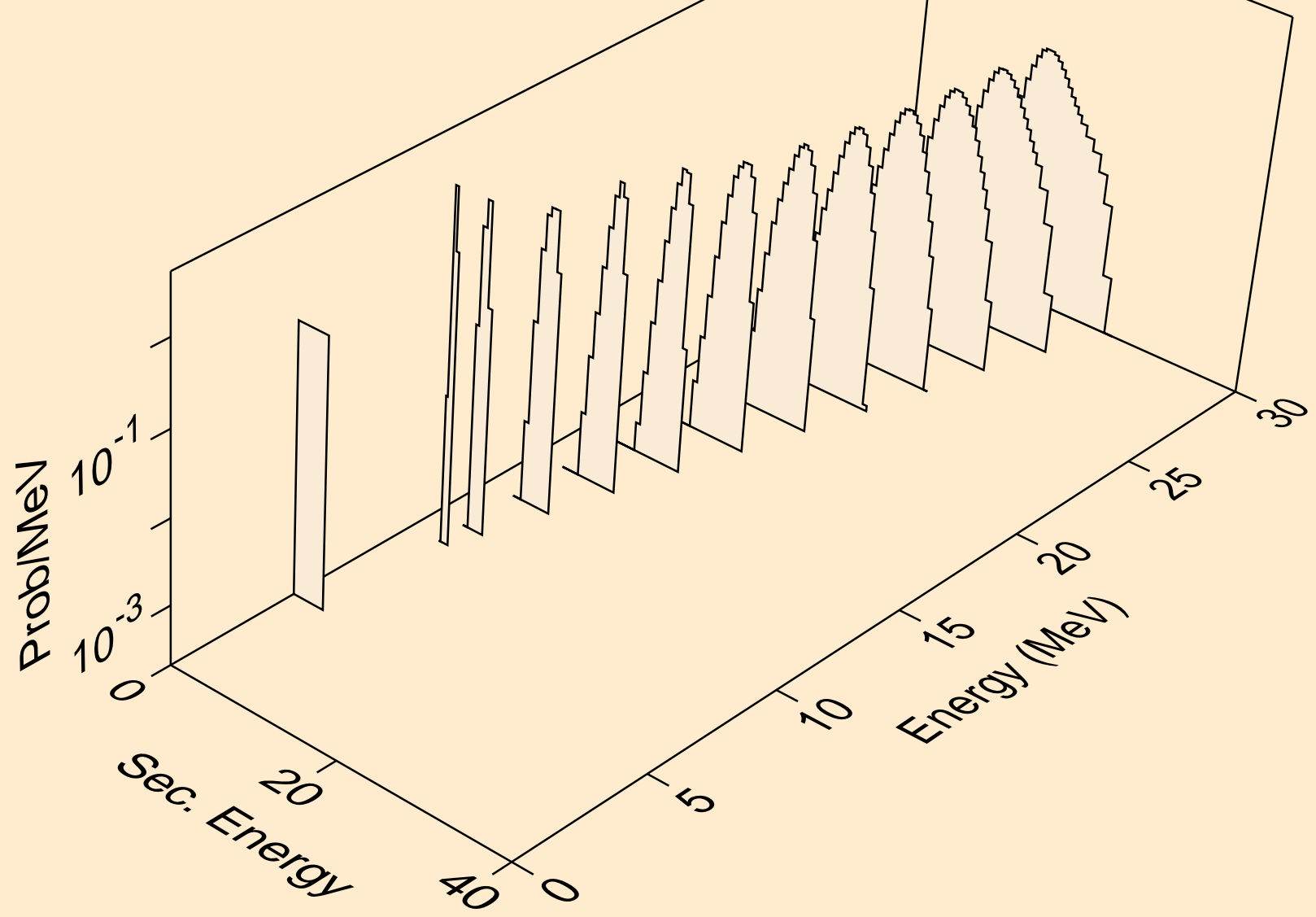

XE129 TRITON ACER TENDL-2021 LIBRARY; T=0.K  
alphas from (t,3n)a

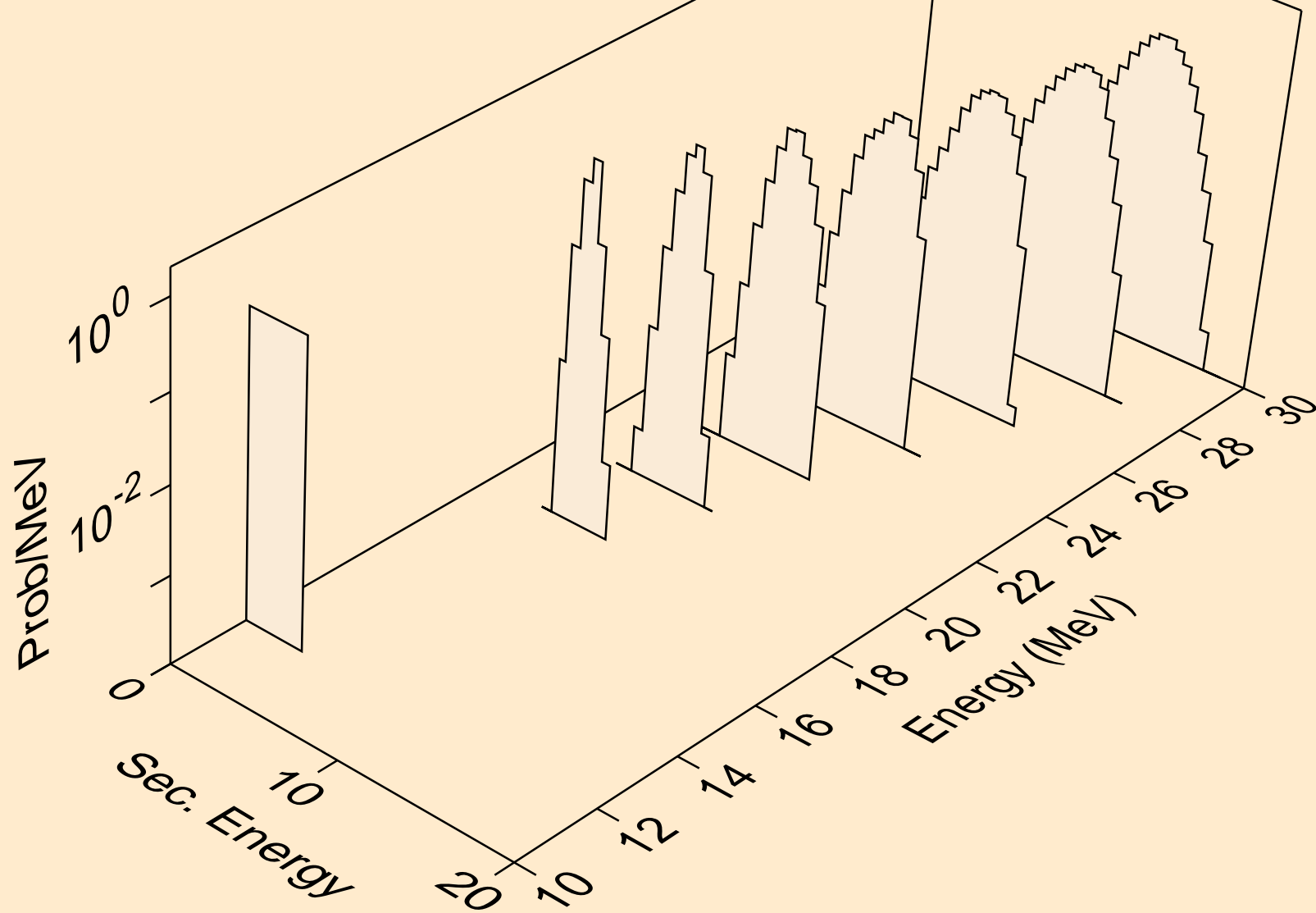

XE129 TRITON ACER TENDL-2021 LIBRARY; T=0.K  
alphas from (t,n\*)2a

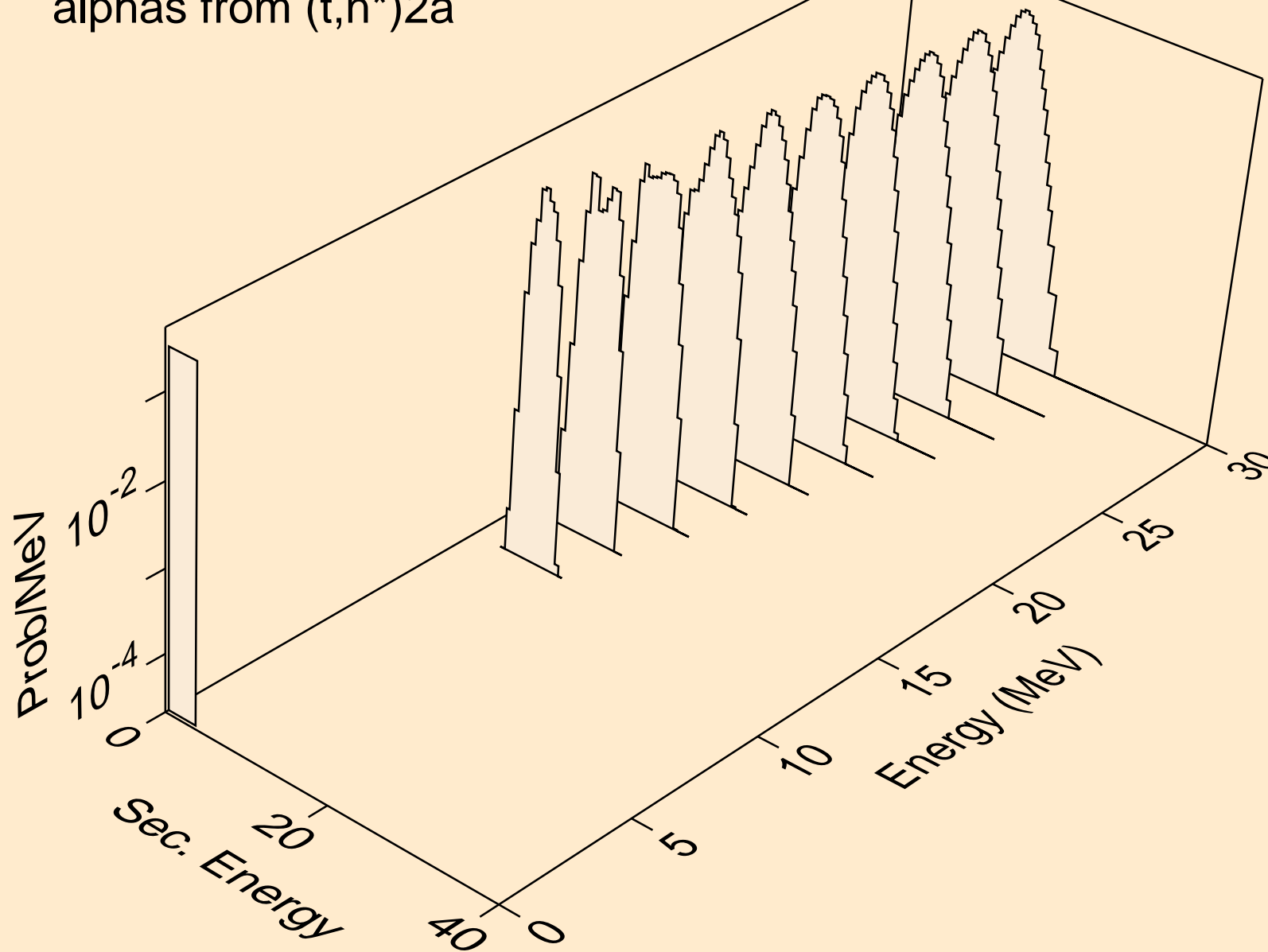

XE129 TRITON ACER TENDL-2021 LIBRARY; T=0.K  
alphas from (t,2n)2a

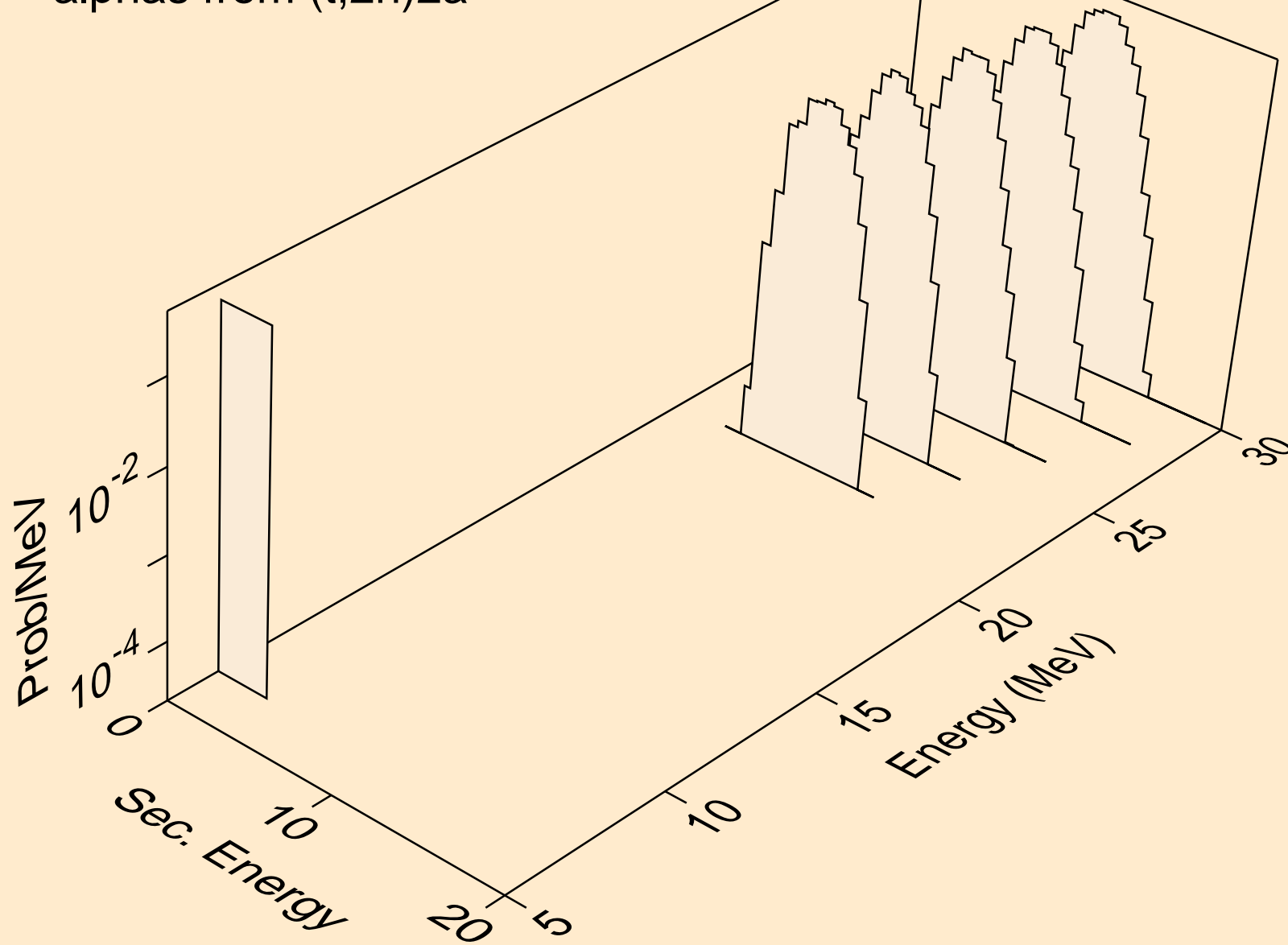

XE129 TRITON ACER TENDL-2021 LIBRARY; T=0.K  
alphas from (t,npa)

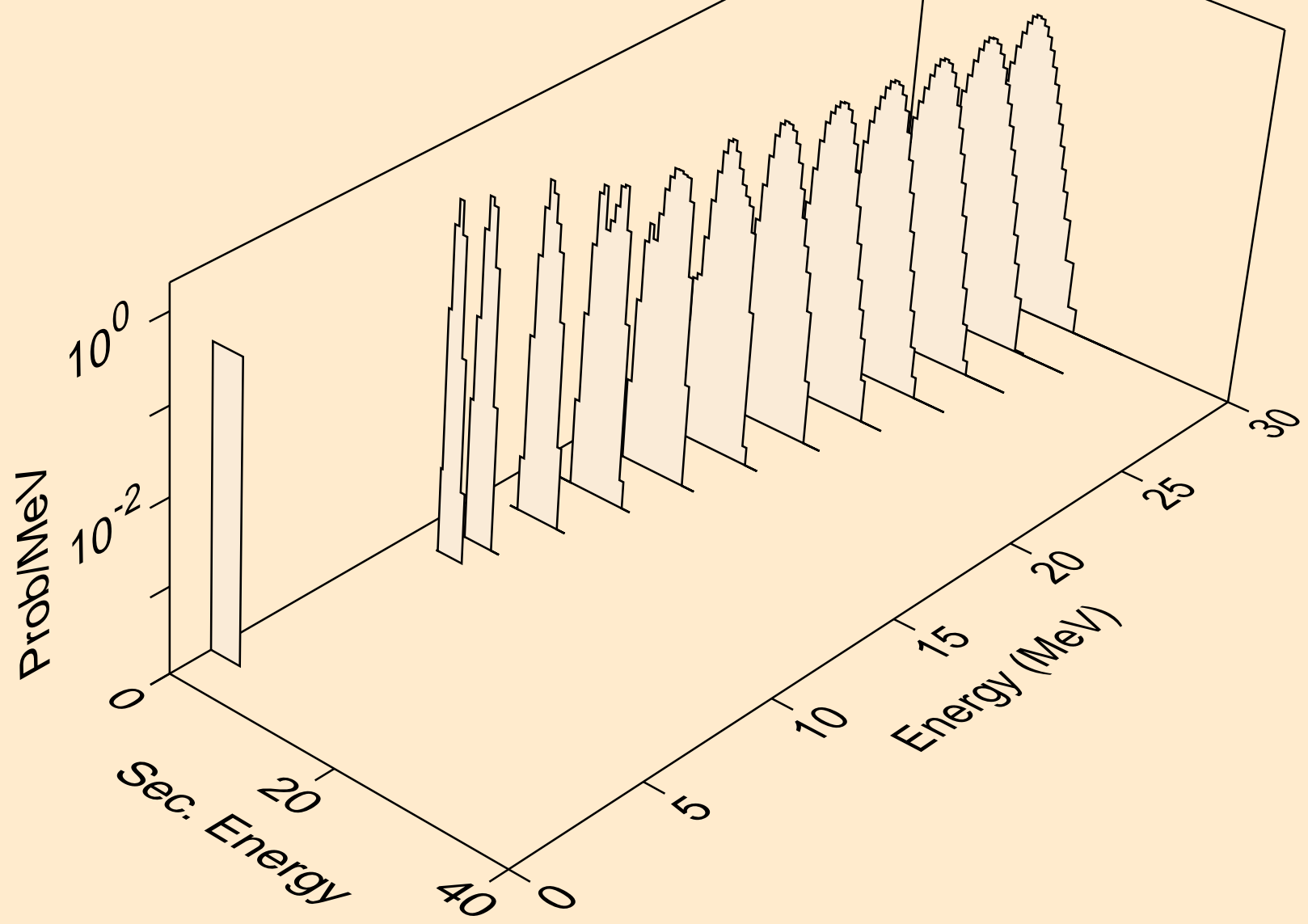

XE129 TRITON ACER TENDL-2021 LIBRARY; T=0.K  
alphas from (t,a)

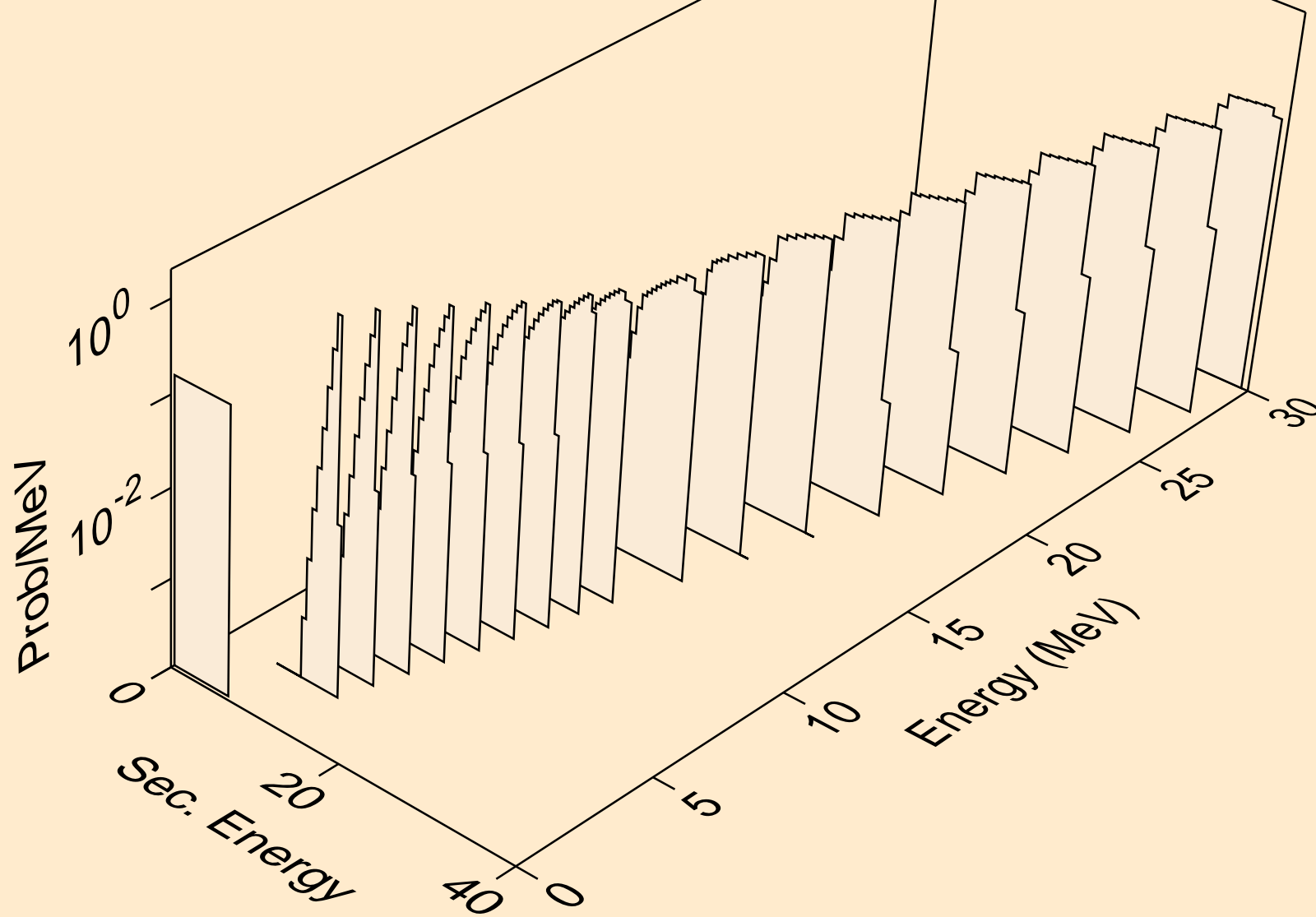

XE129 TRITON ACER TENDL-2021 LIBRARY; T=0.K  
alphas from (t,2a)

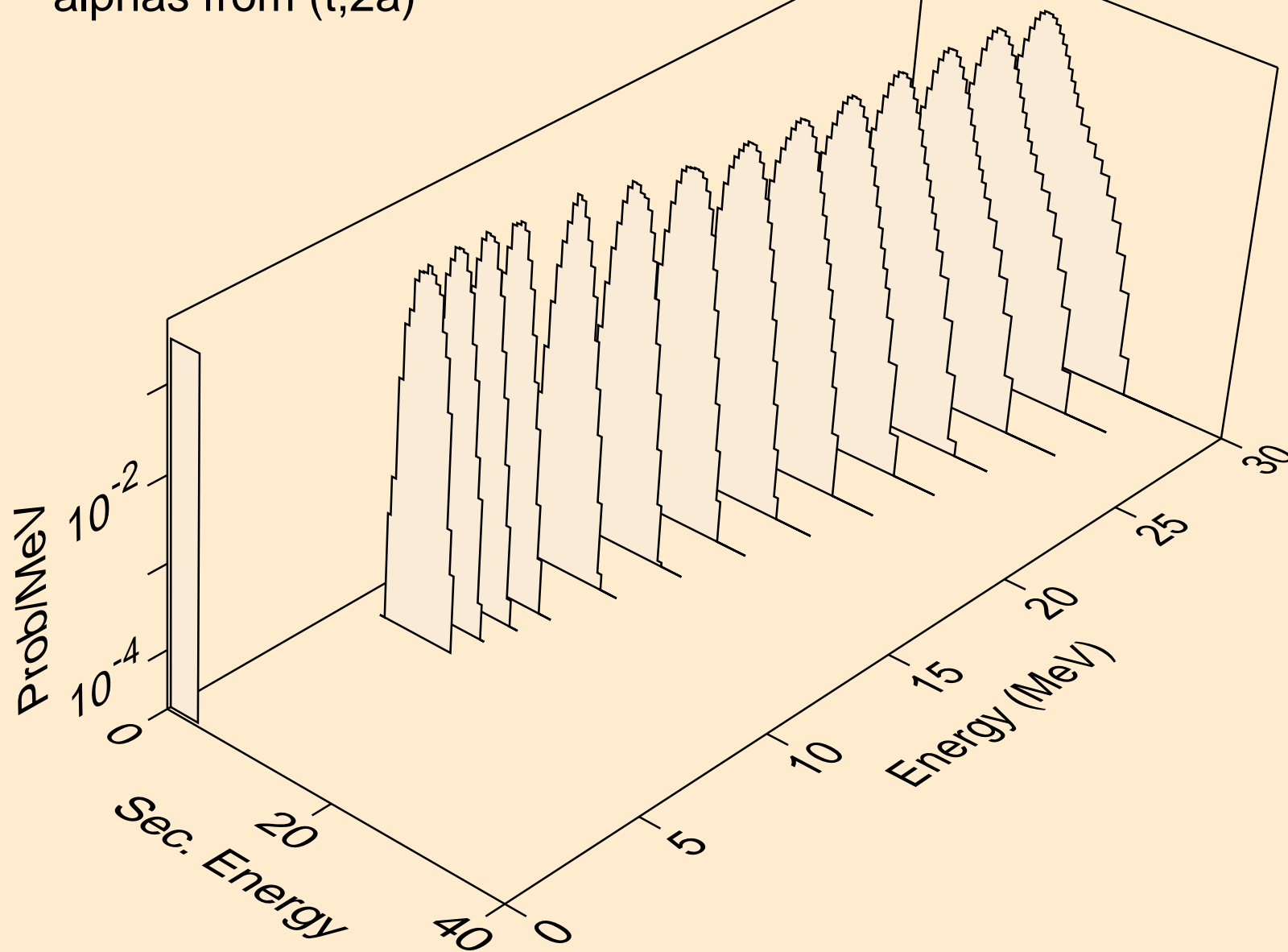

XE129 TRITON ACER TENDL-2021 LIBRARY; T=0.K  
alphas from (t,pa)

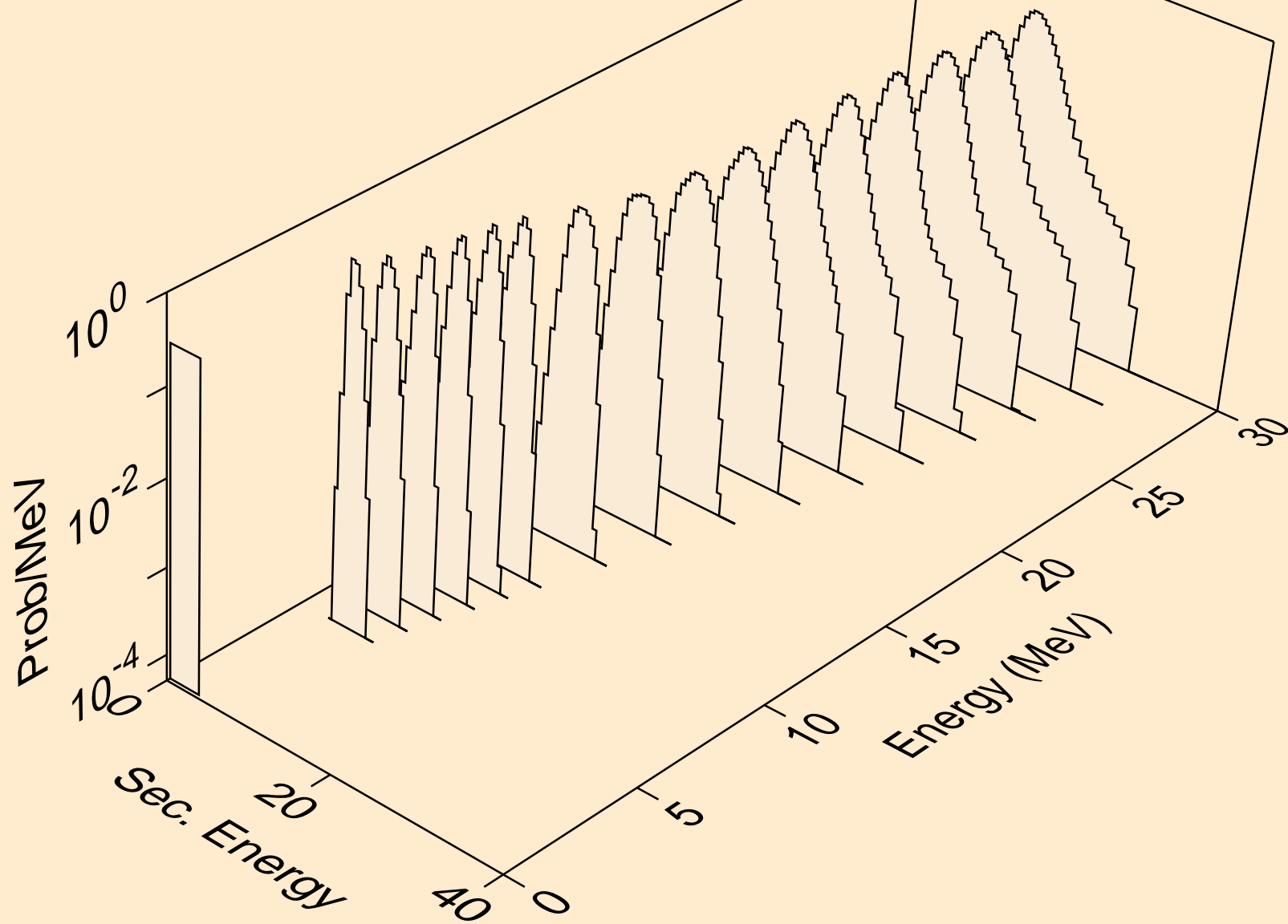



XE129 TRITON ACER TENDL-2021 LIBRARY; T=0.K  
alphas from (t,da)

