

YB151M TRITON ACER TENDL-2021 LIBRARY; T=0.K  
Principal cross sections

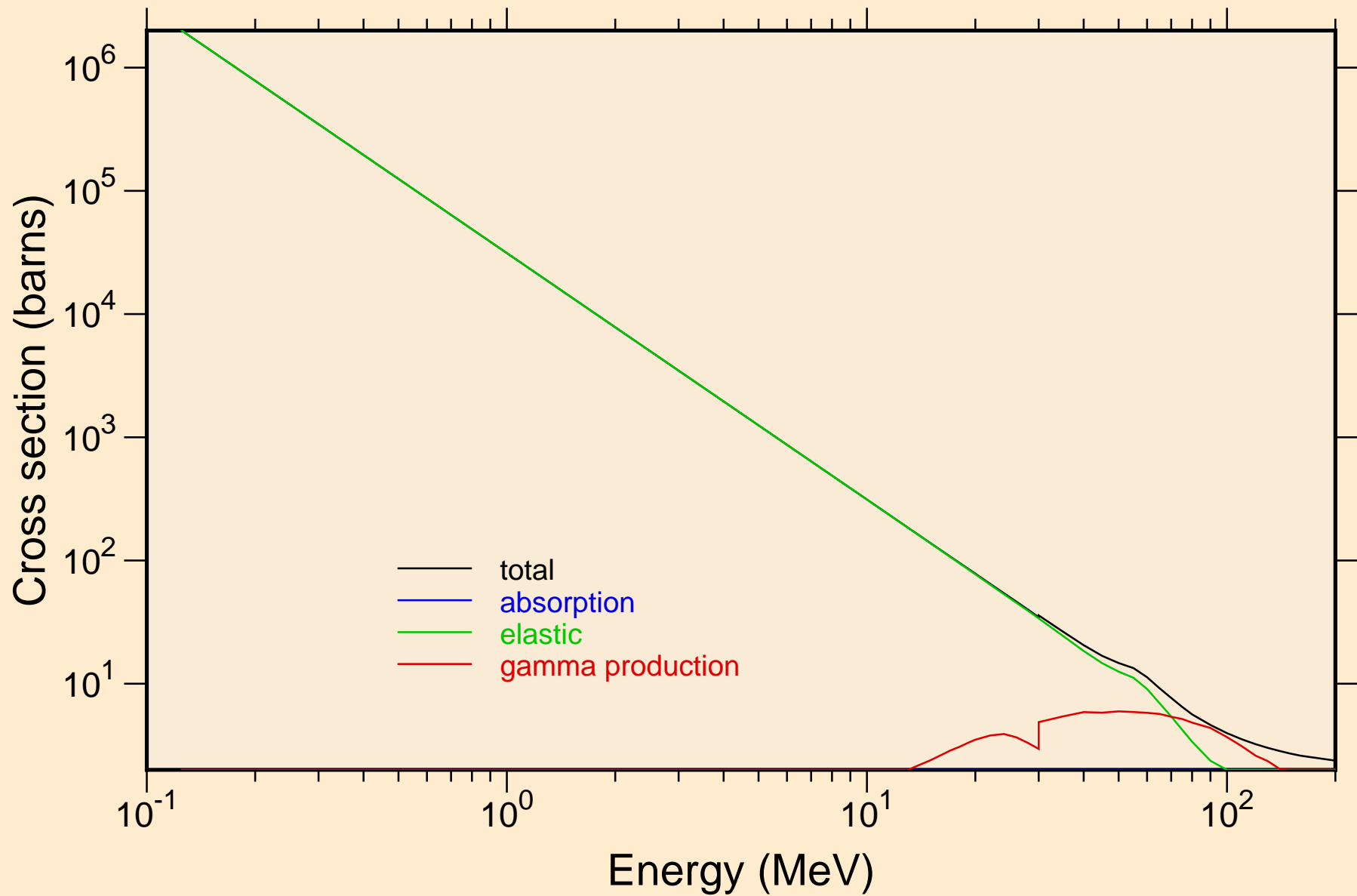

YB151M TRITON ACER TENDL-2021 LIBRARY; T=0.K  
Heating

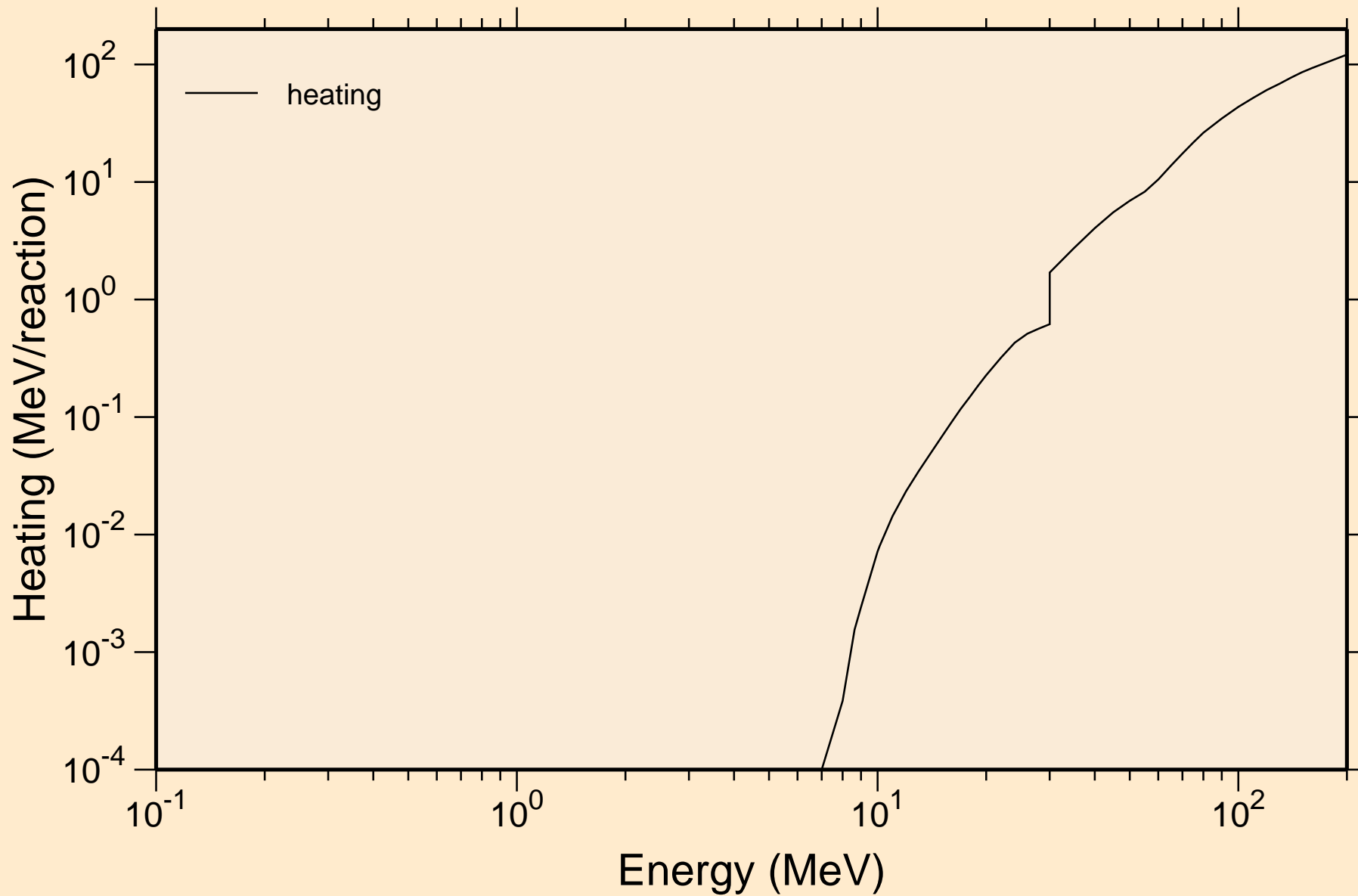

# YB151M TRITON ACER TENDL-2021 LIBRARY; T=0.K

## Principal cross sections

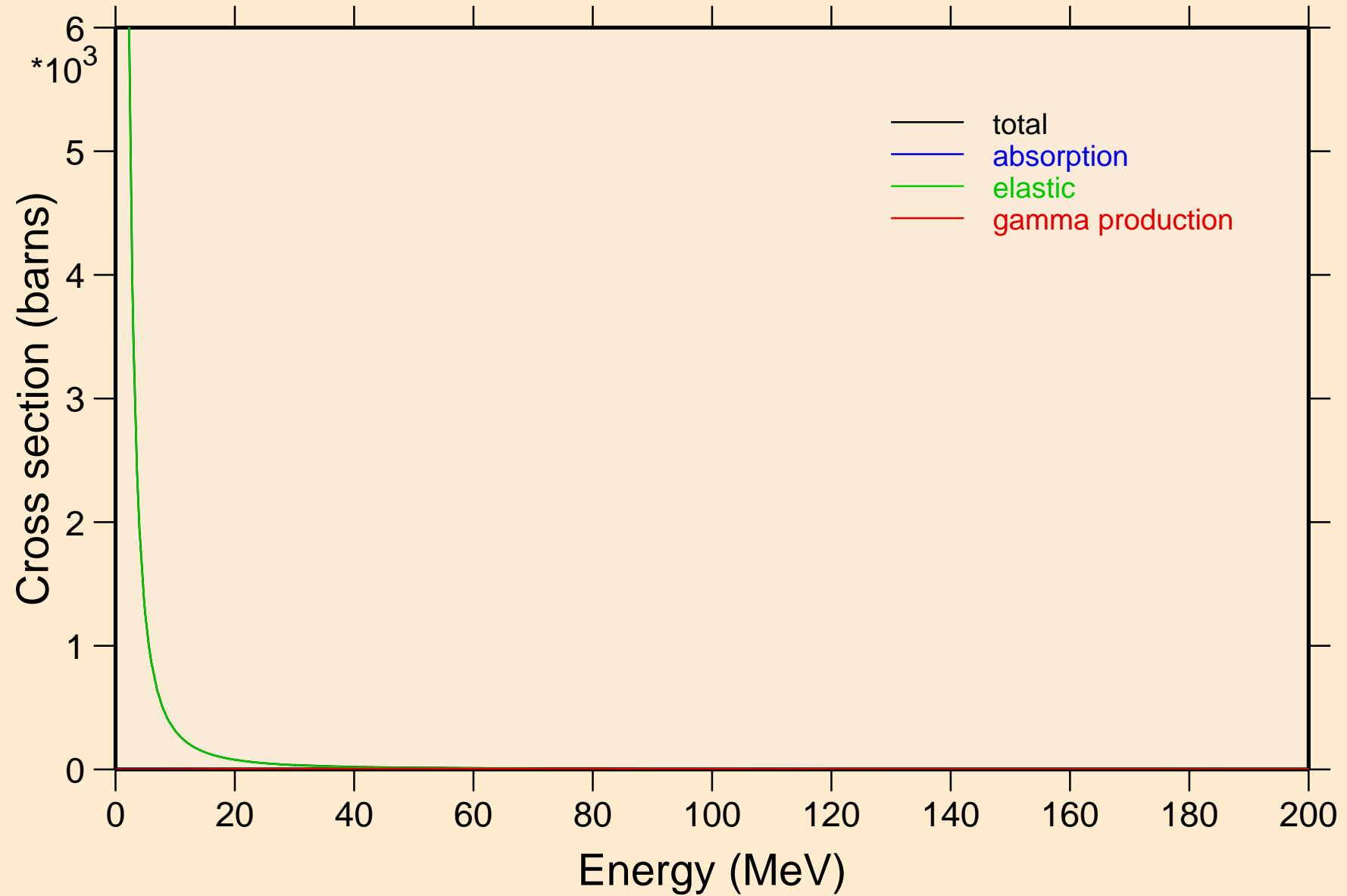

YB151M TRITON ACER TENDL-2021 LIBRARY; T=0.K

Heating

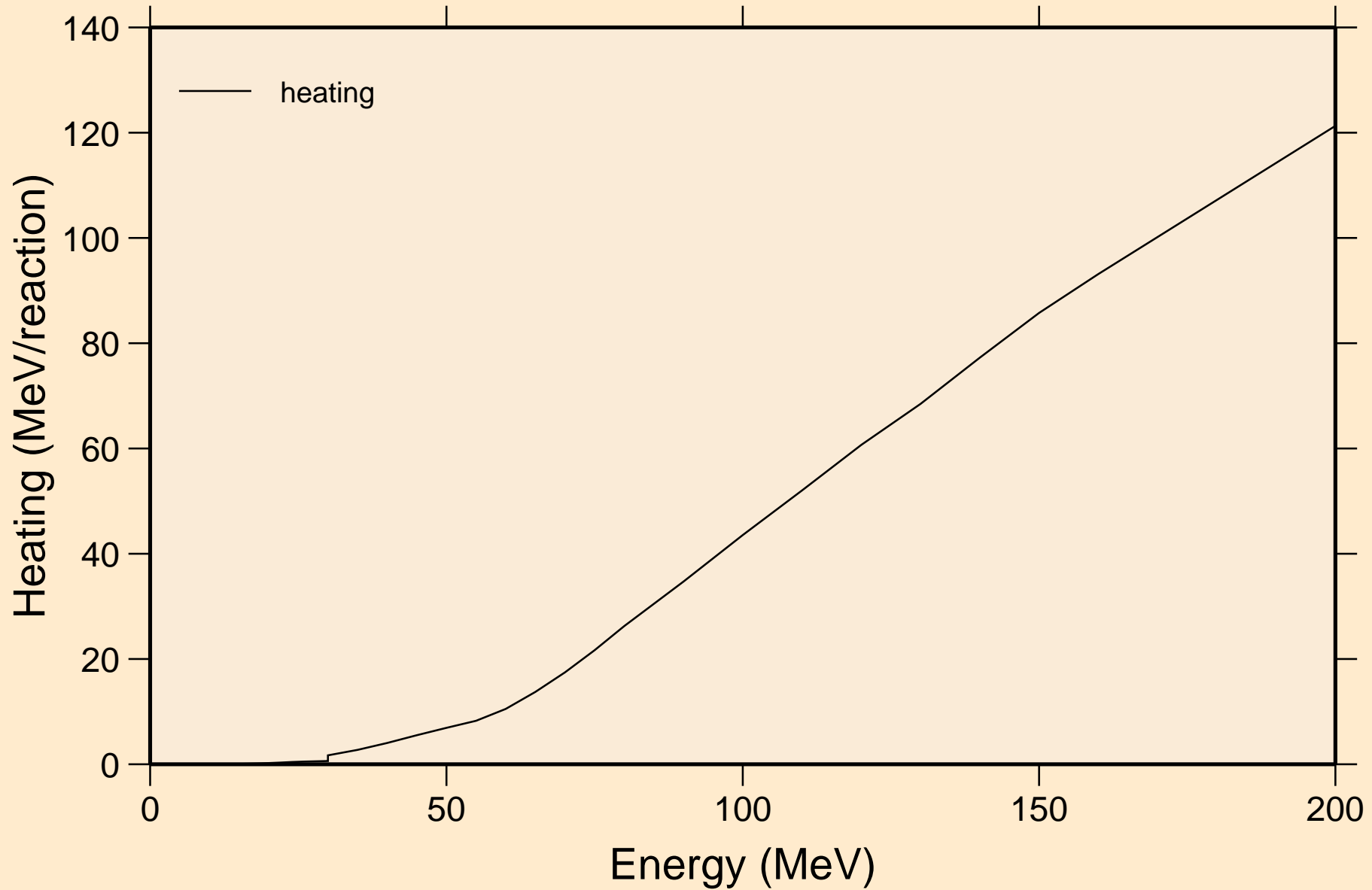

YB151M TRITON ACER TENDL-2021 LIBRARY; T=0.K  
Threshold reactions

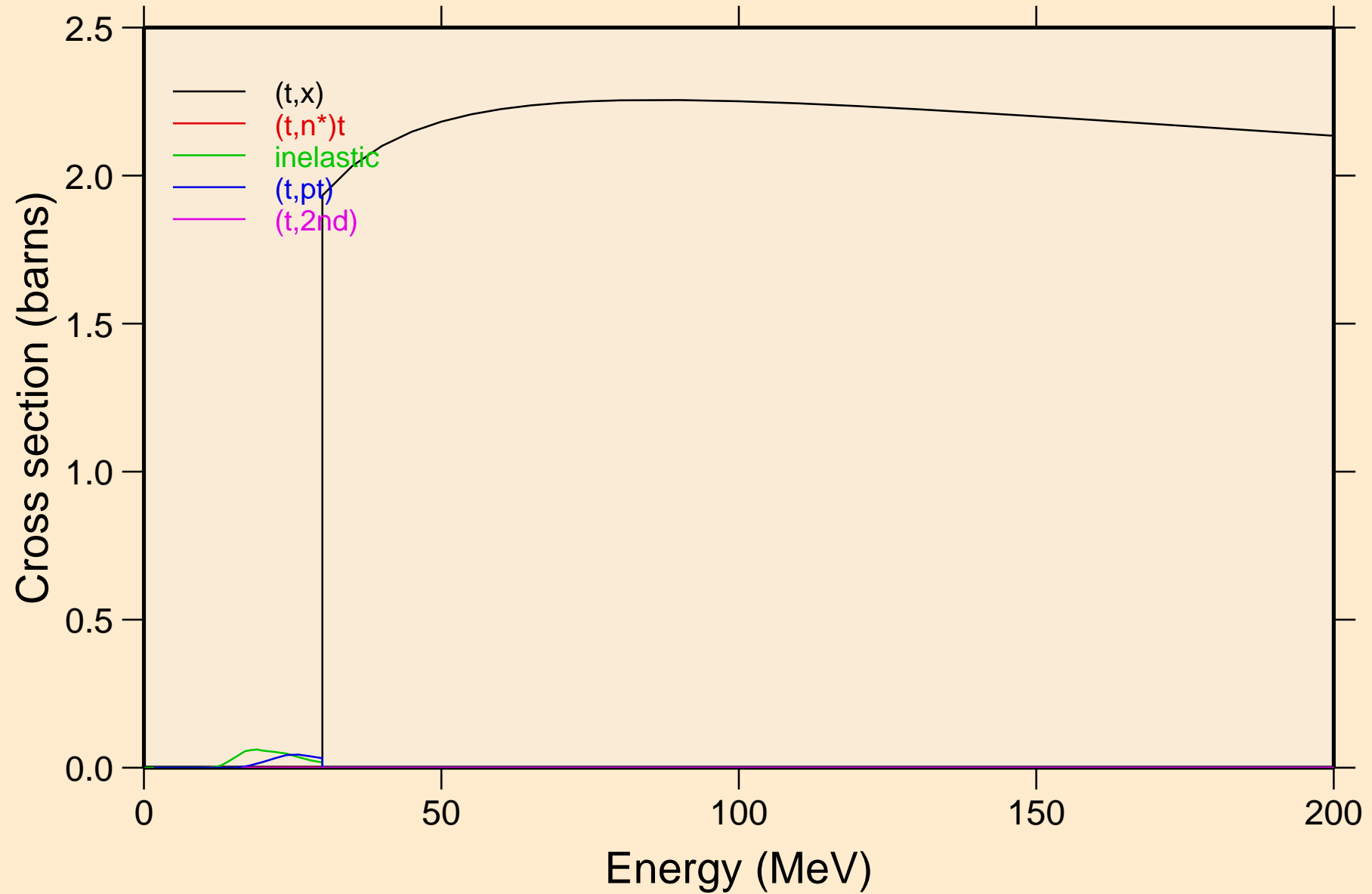

YB151M TRITON ACER TENDL-2021 LIBRARY; T=0.K  
Threshold reactions

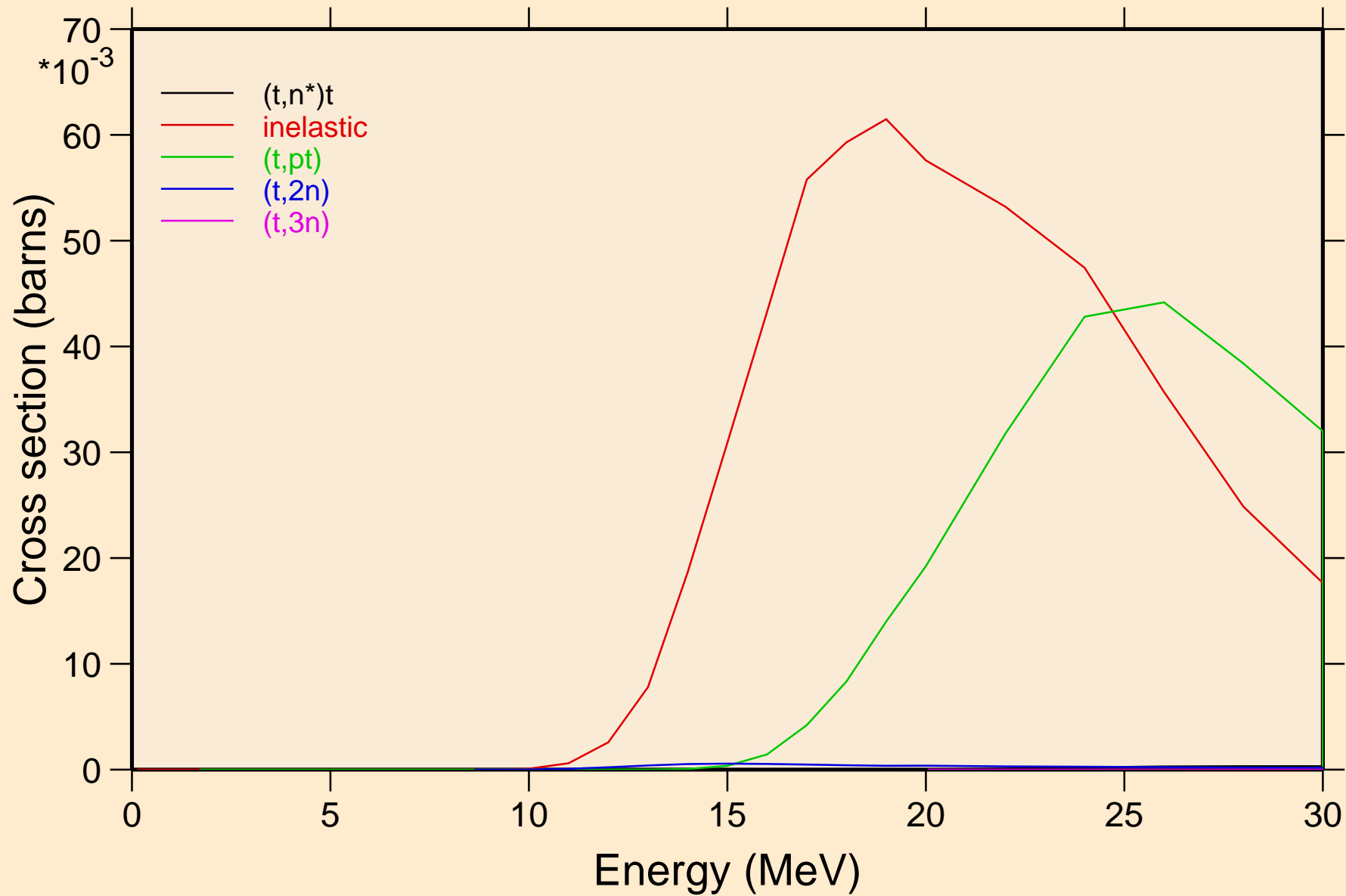

YB151M TRITON ACER TENDL-2021 LIBRARY; T=0.K  
Threshold reactions

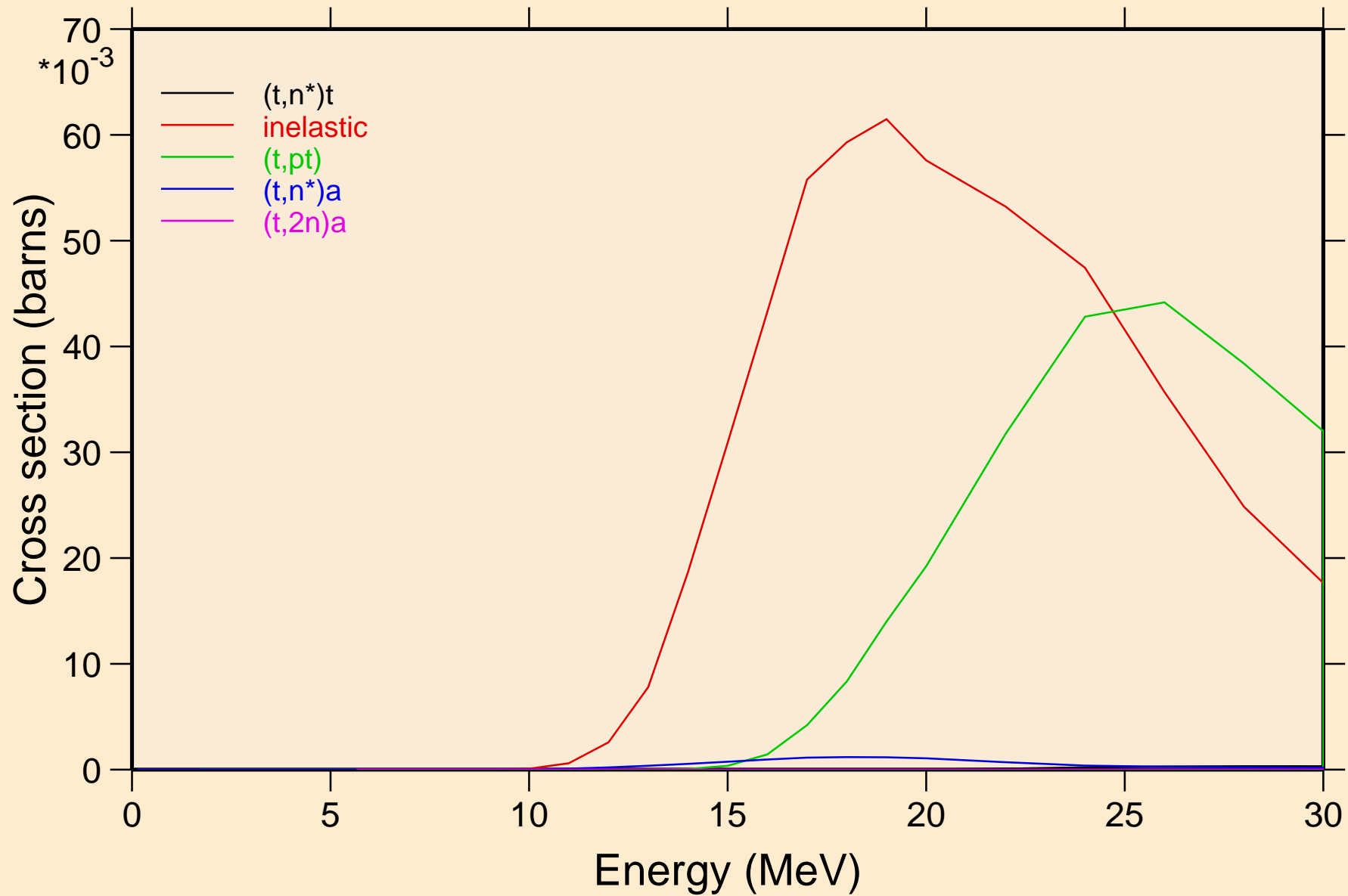

YB151M TRITON ACER TENDL-2021 LIBRARY; T=0.K  
Threshold reactions

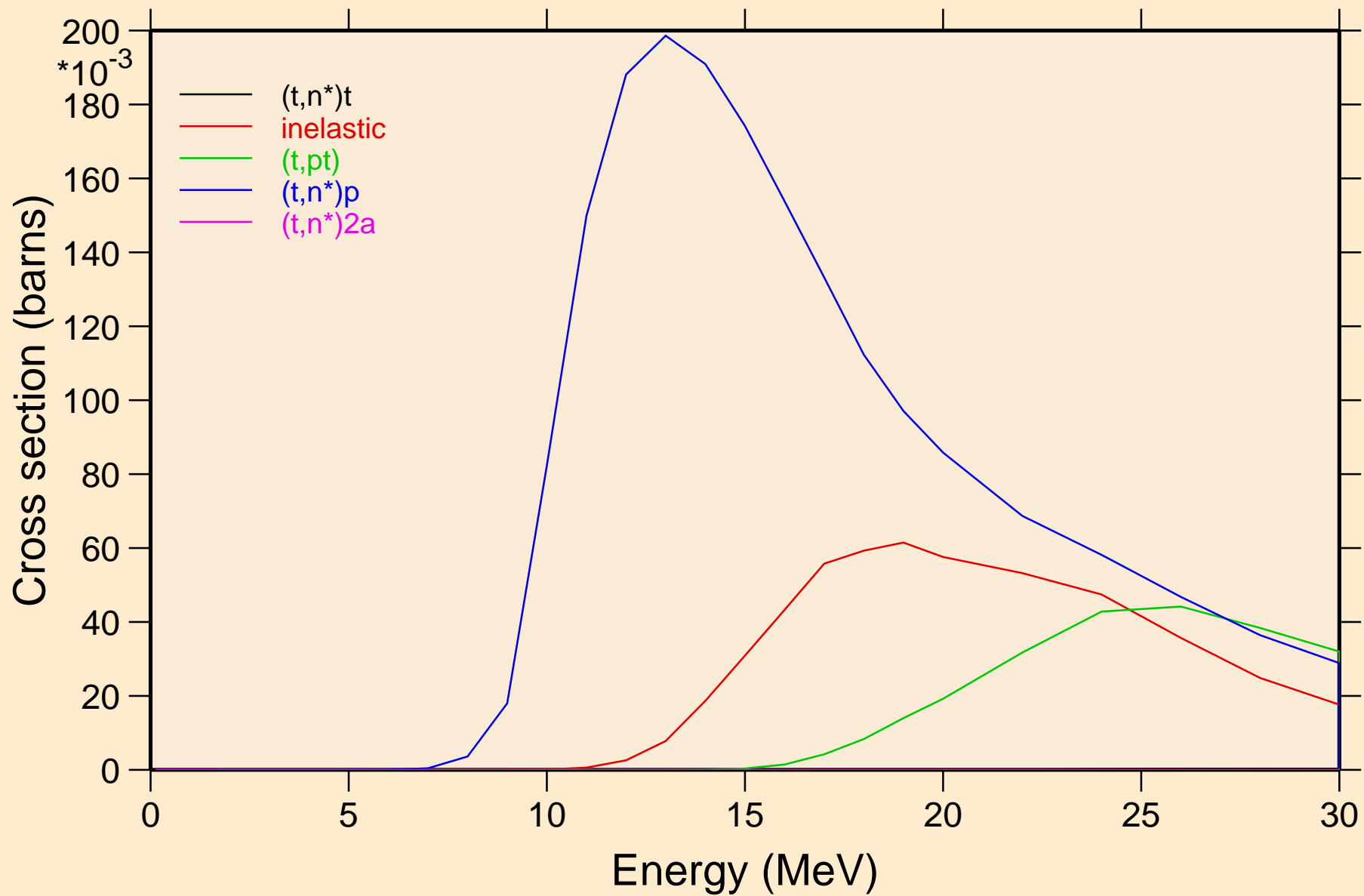



YB151M TRITON ACER TENDL-2021 LIBRARY; T=0.K  
Threshold reactions

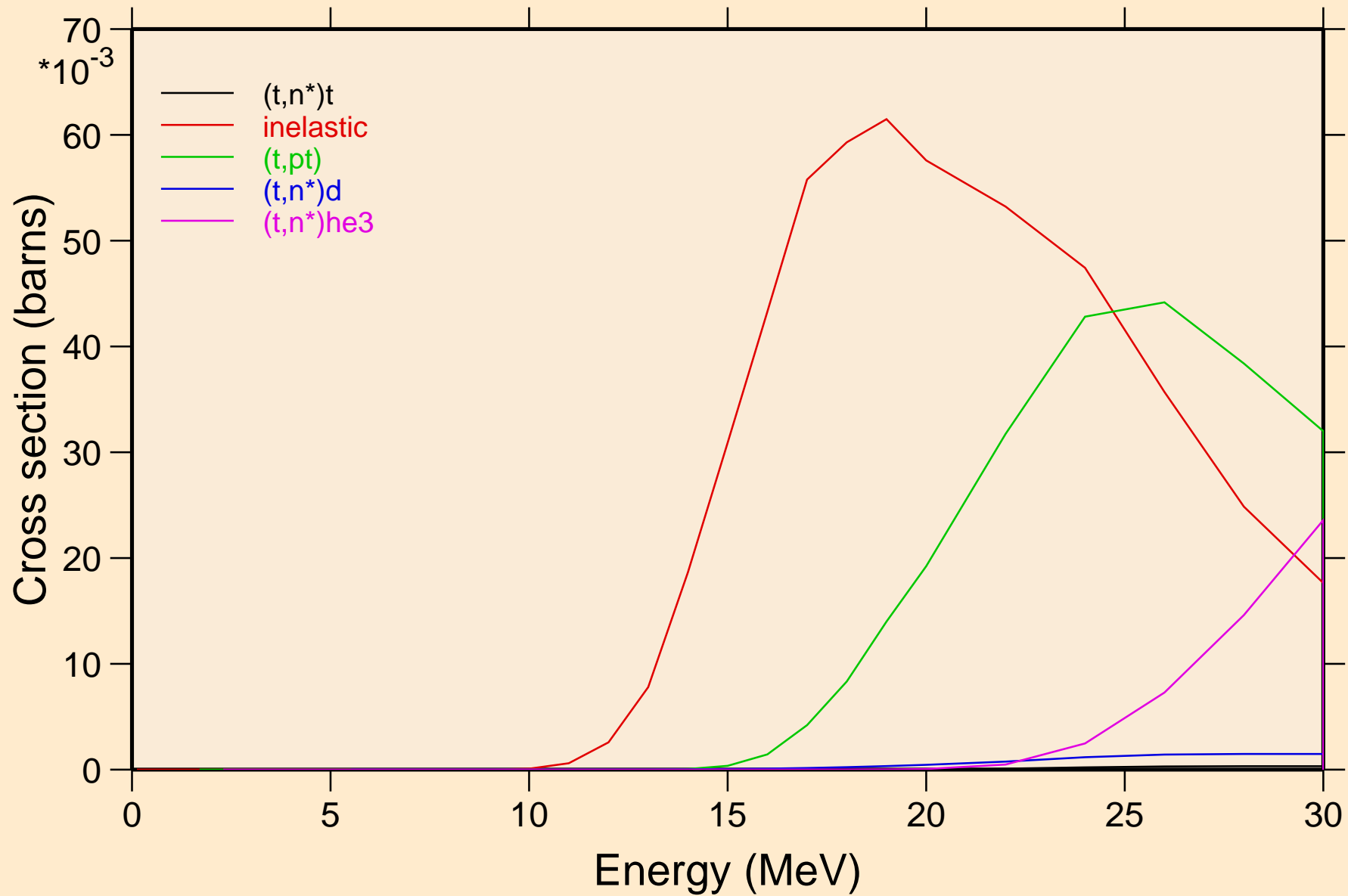

YB151M TRITON ACER TENDL-2021 LIBRARY; T=0.K  
Threshold reactions

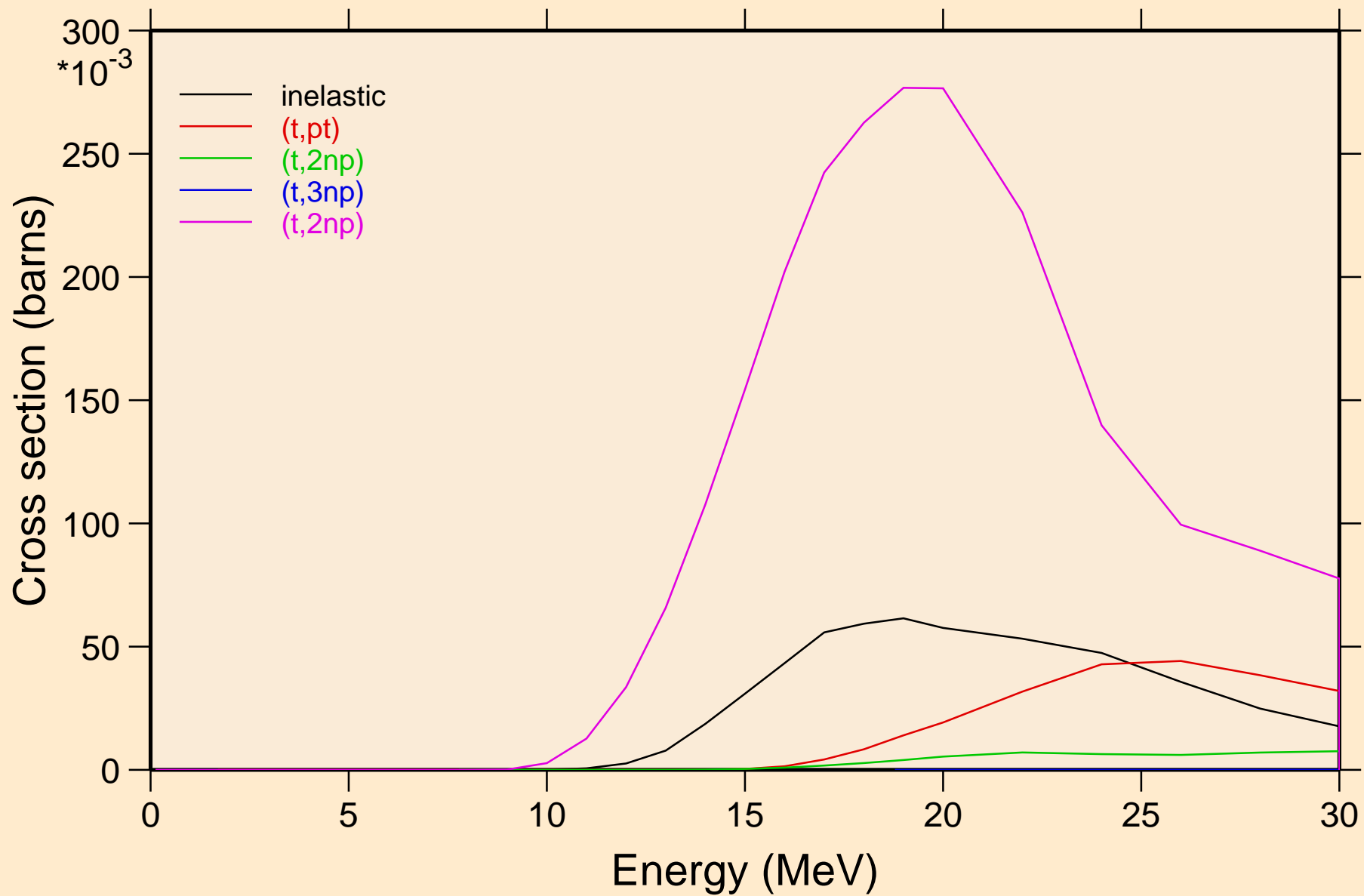

YB151M TRITON ACER TENDL-2021 LIBRARY; T=0.K  
Threshold reactions

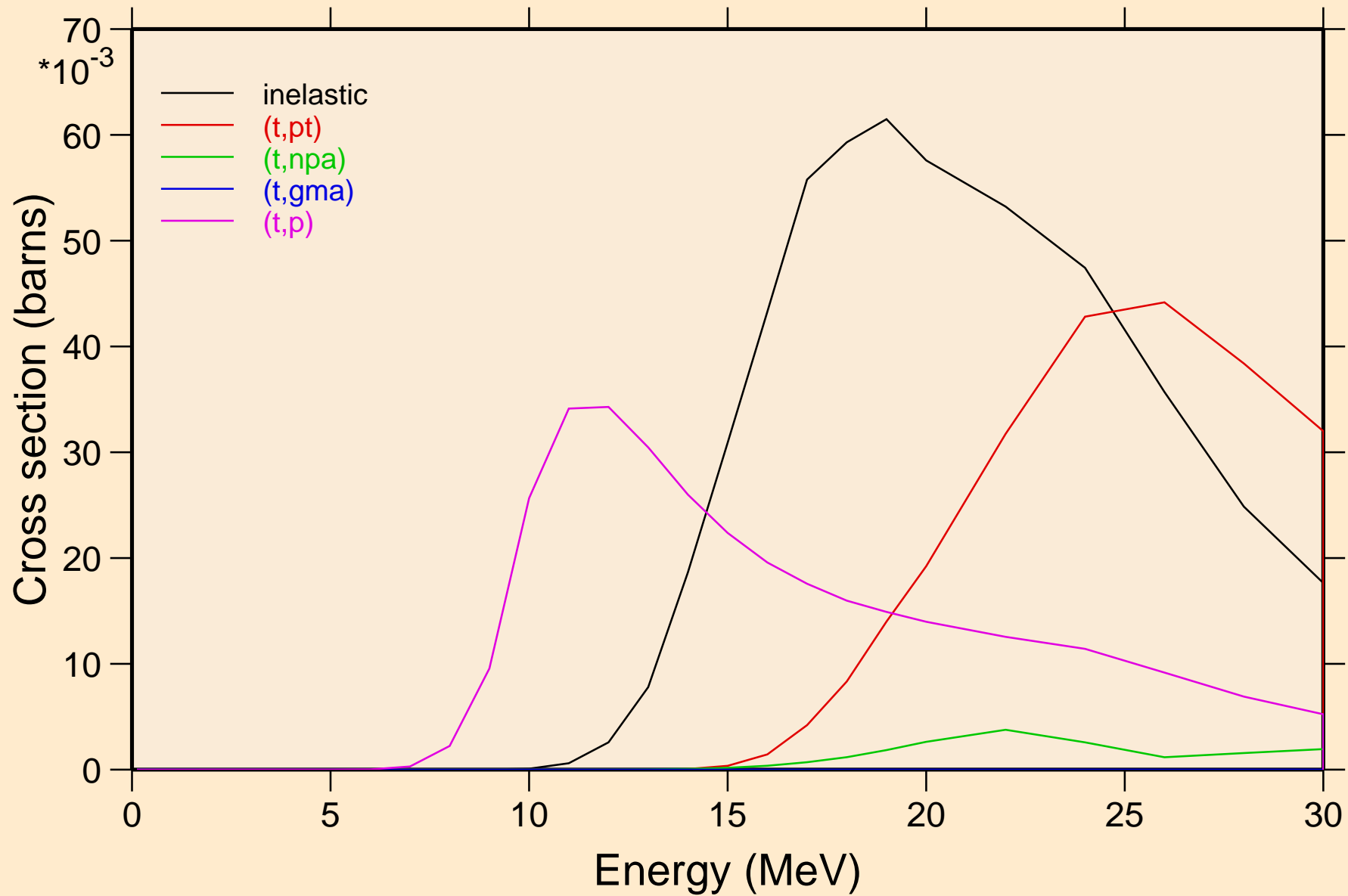

YB151M TRITON ACER TENDL-2021 LIBRARY; T=0.K  
Threshold reactions

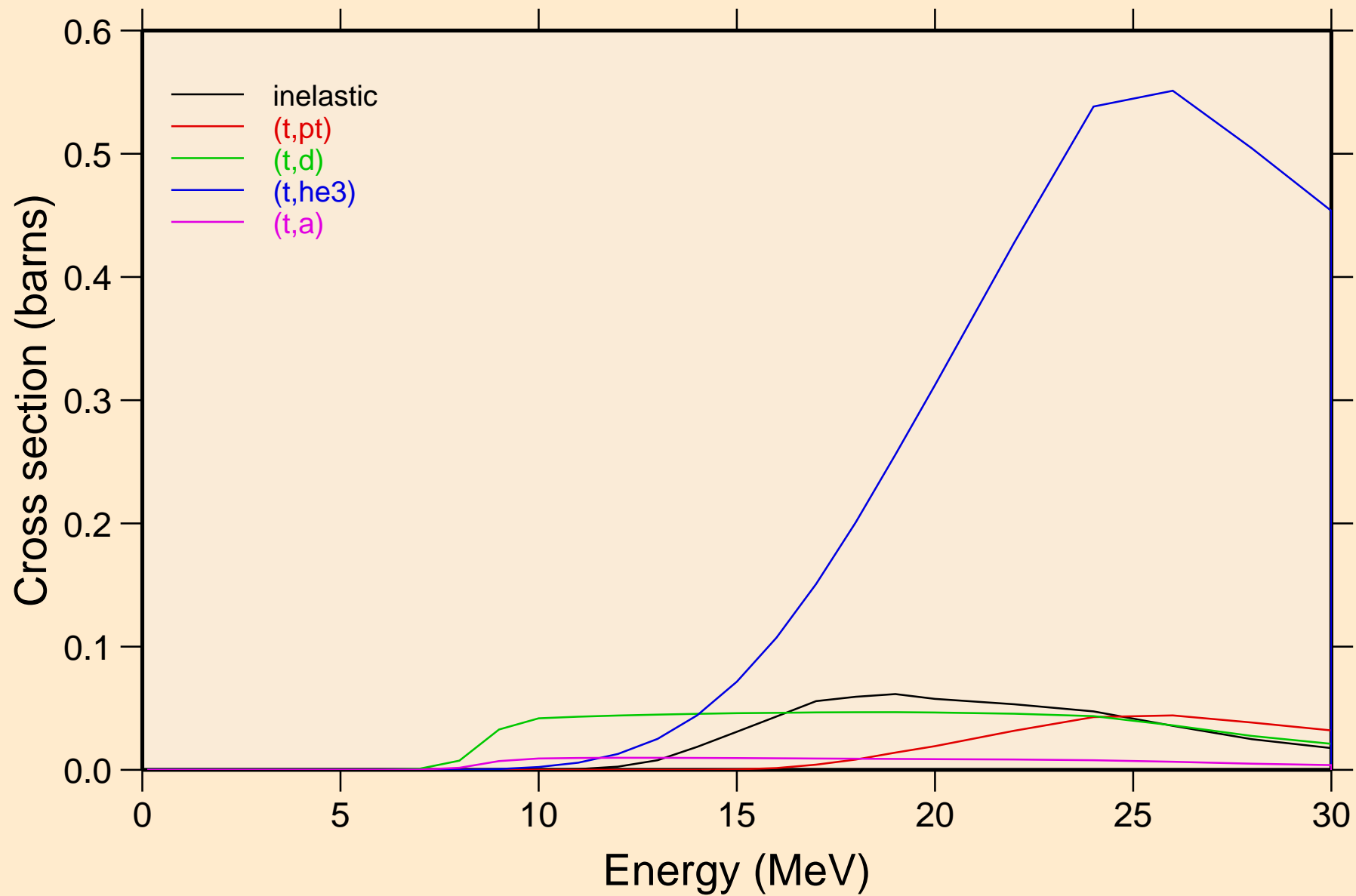

YB151M TRITON ACER TENDL-2021 LIBRARY; T=0.K  
Threshold reactions

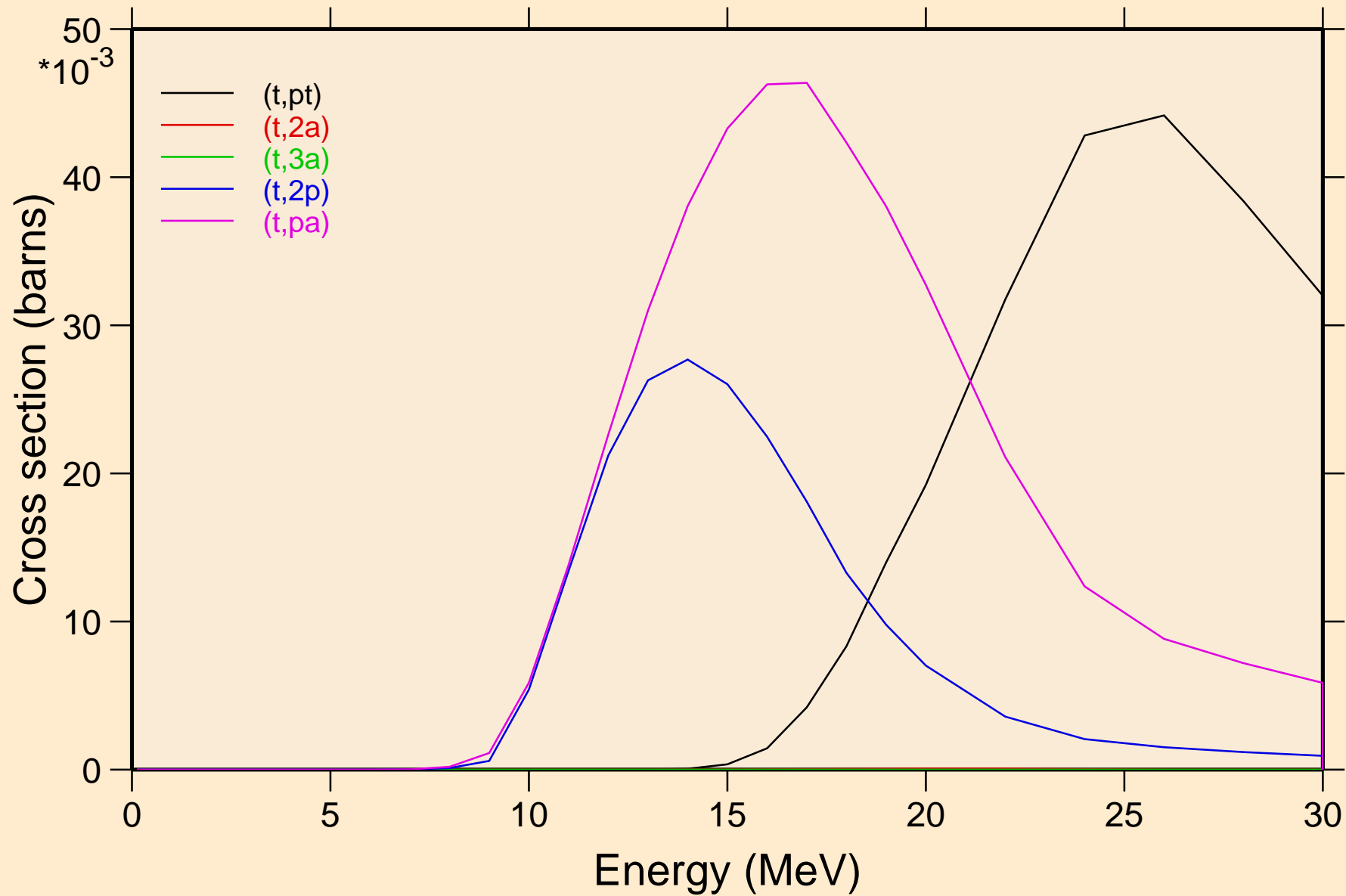

YB151M TRITON ACER TENDL-2021 LIBRARY; T=0.K  
Threshold reactions

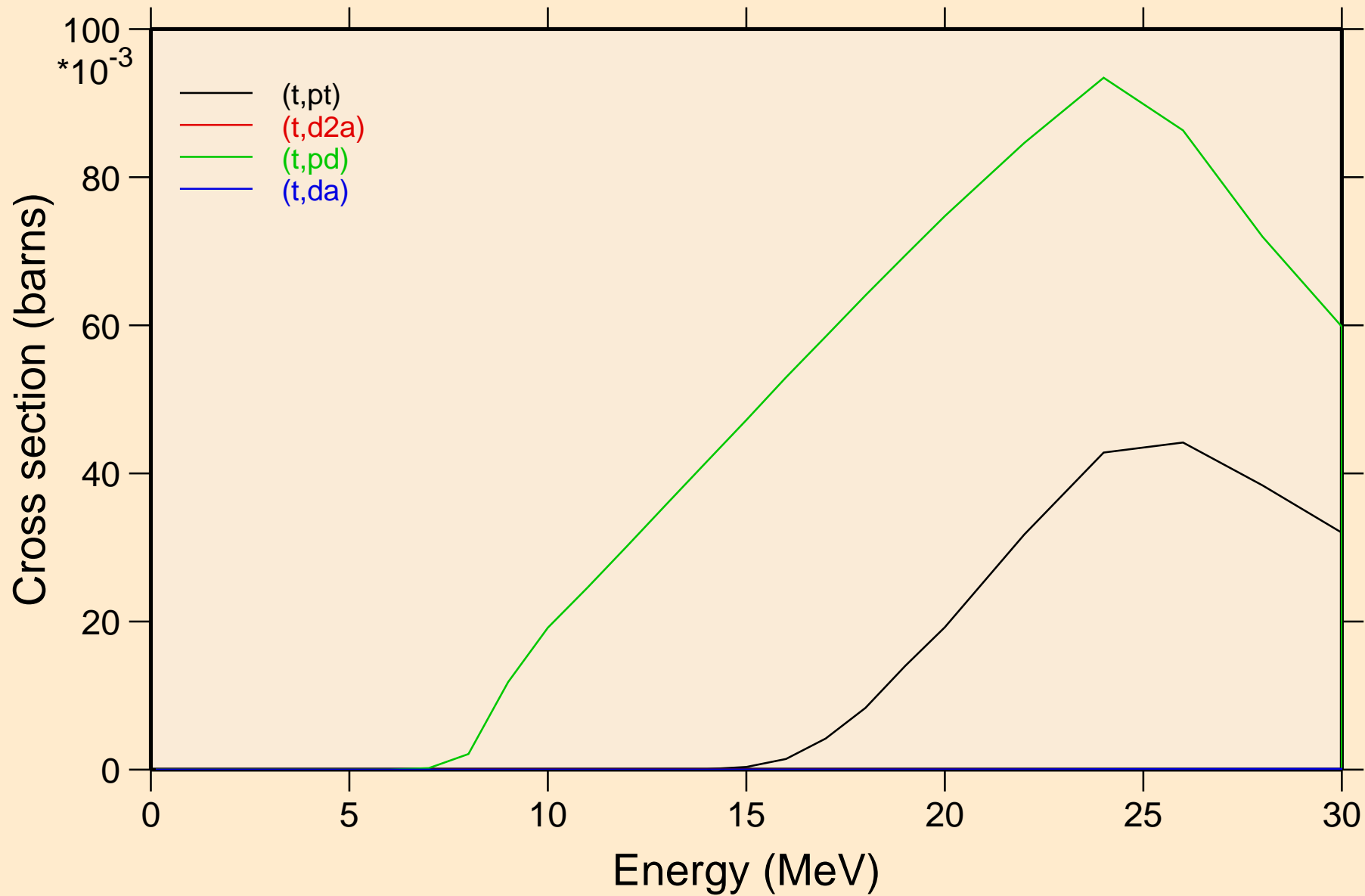

YB151M TRITON ACER TENDL-2021 LIBRARY; T=0.K  
angular distribution for elastic

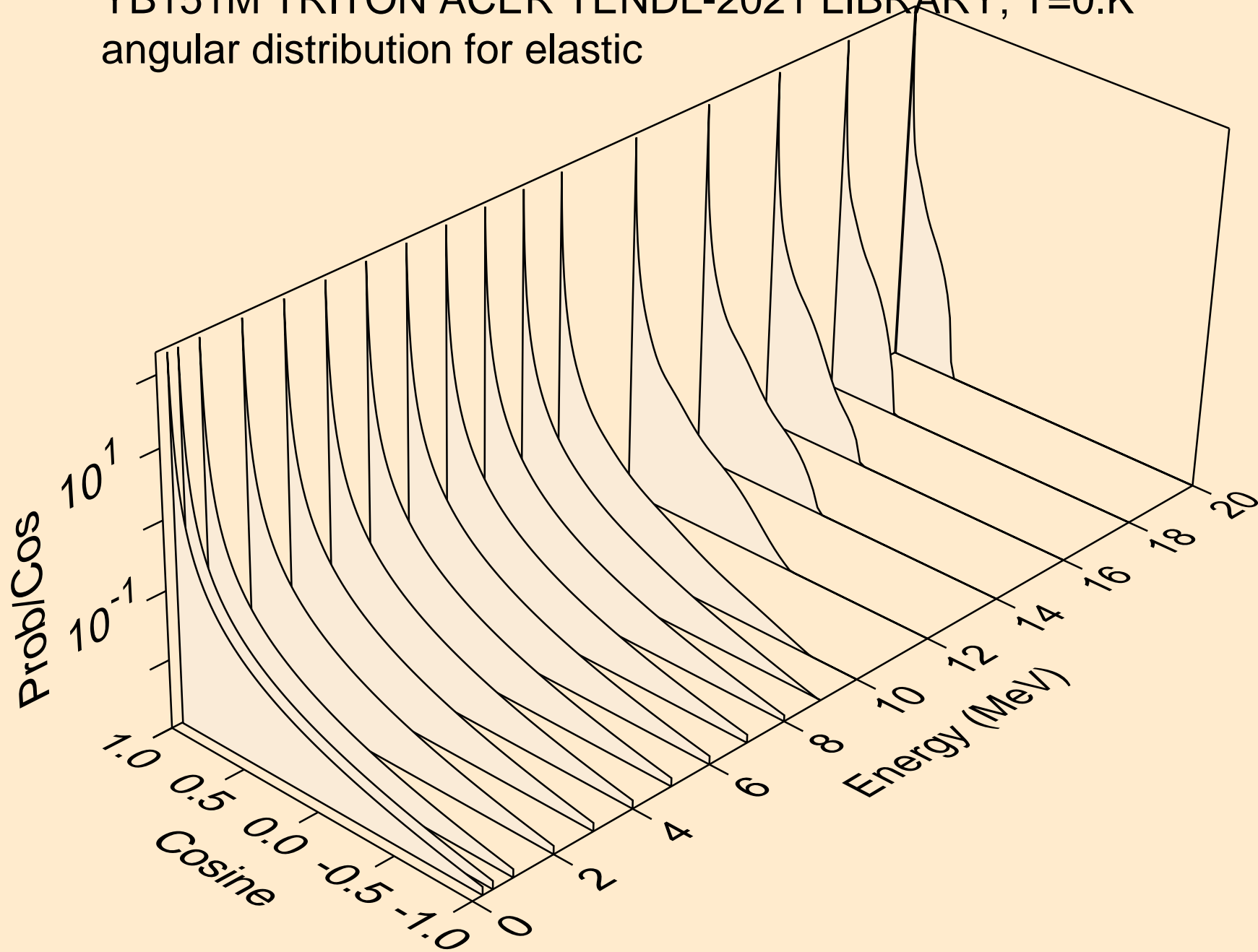

YB151M TRITON ACER TENDL-2021 LIBRARY; T=0.K  
angular distribution for elastic

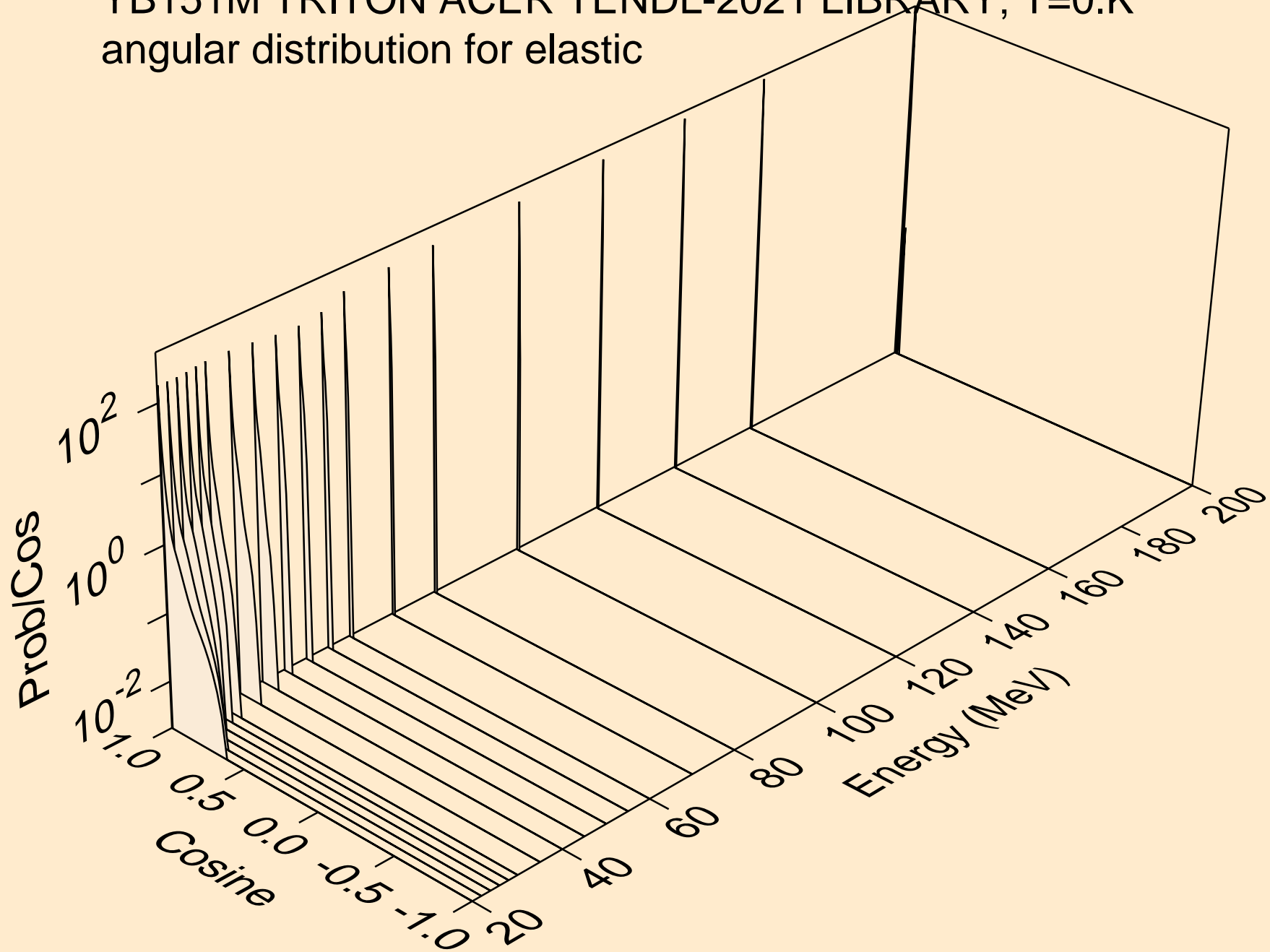



YB151M TRITON ACER TENDL-2021 LIBRARY; T=0.K  
Triton emission for (t,x)

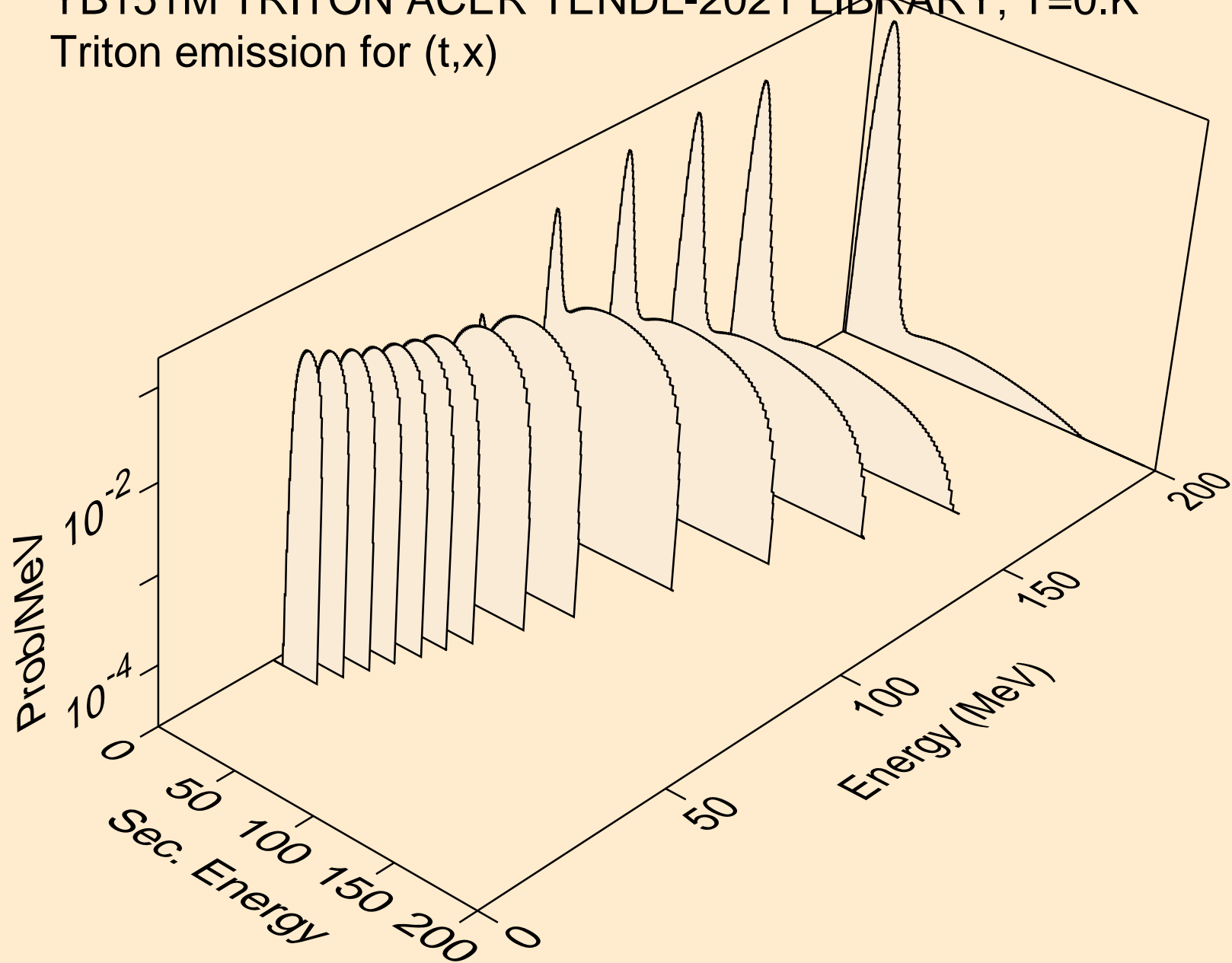

YB151M TRITON ACER TENDL-2021 LIBRARY; T=0.K  
Triton emission for (t,n\*)t

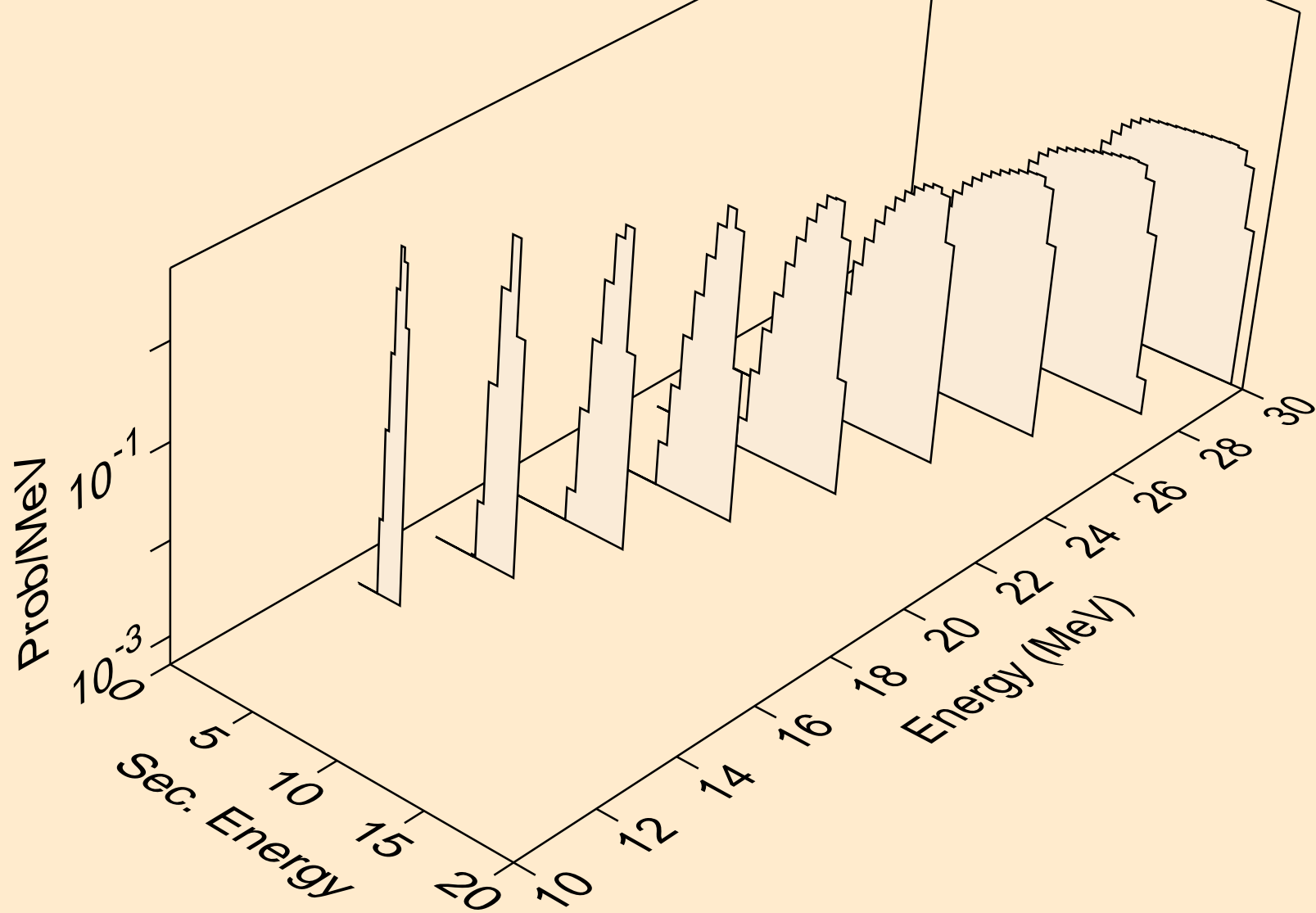

YB151M TRITON ACER TENDL-2021 LIBRARY; T=0.K  
Triton emission for inelastic

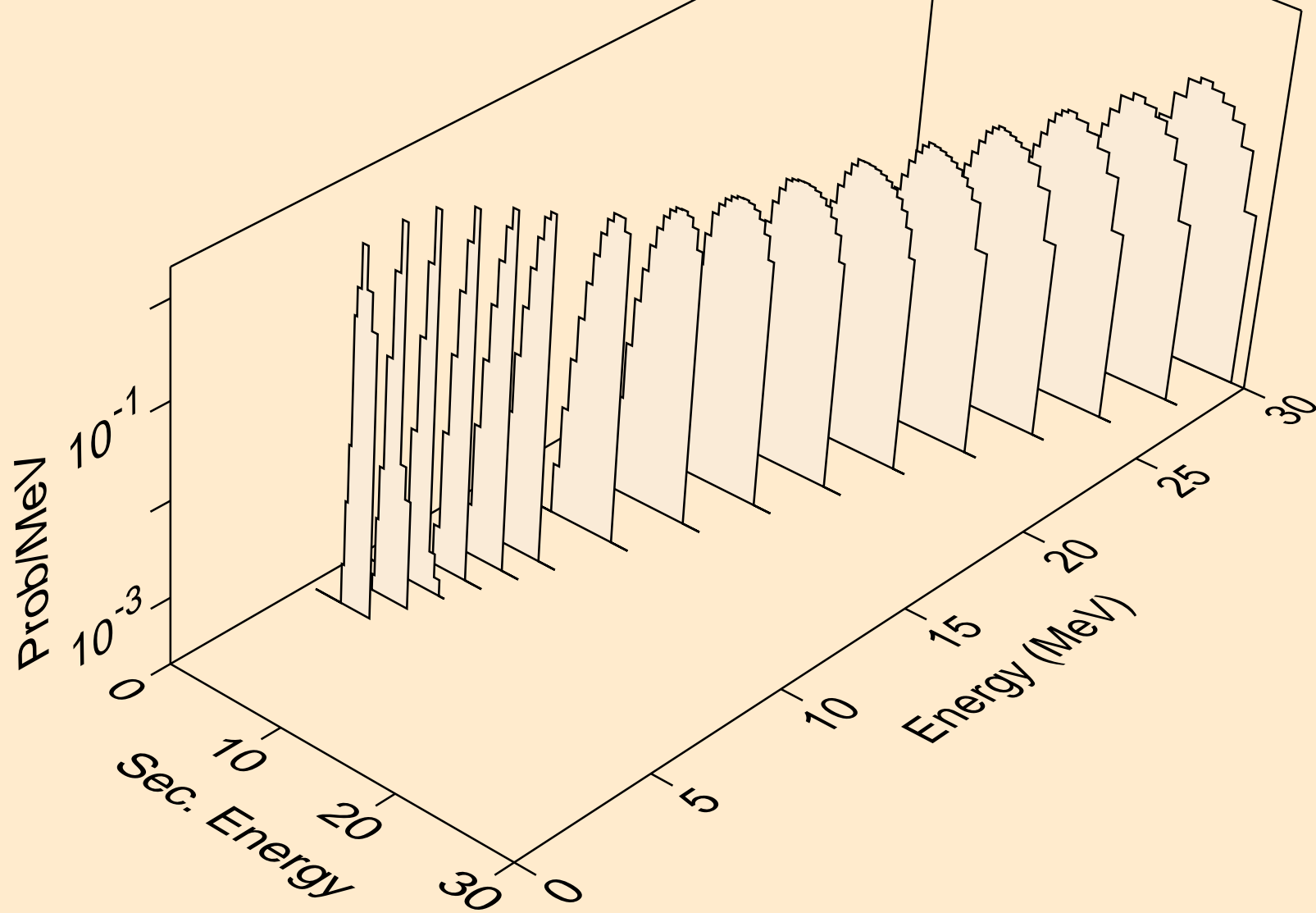

YB151M TRITON ACER TENDL-2021 LIBRARY; T=0.K  
Triton emission for (t,pt)

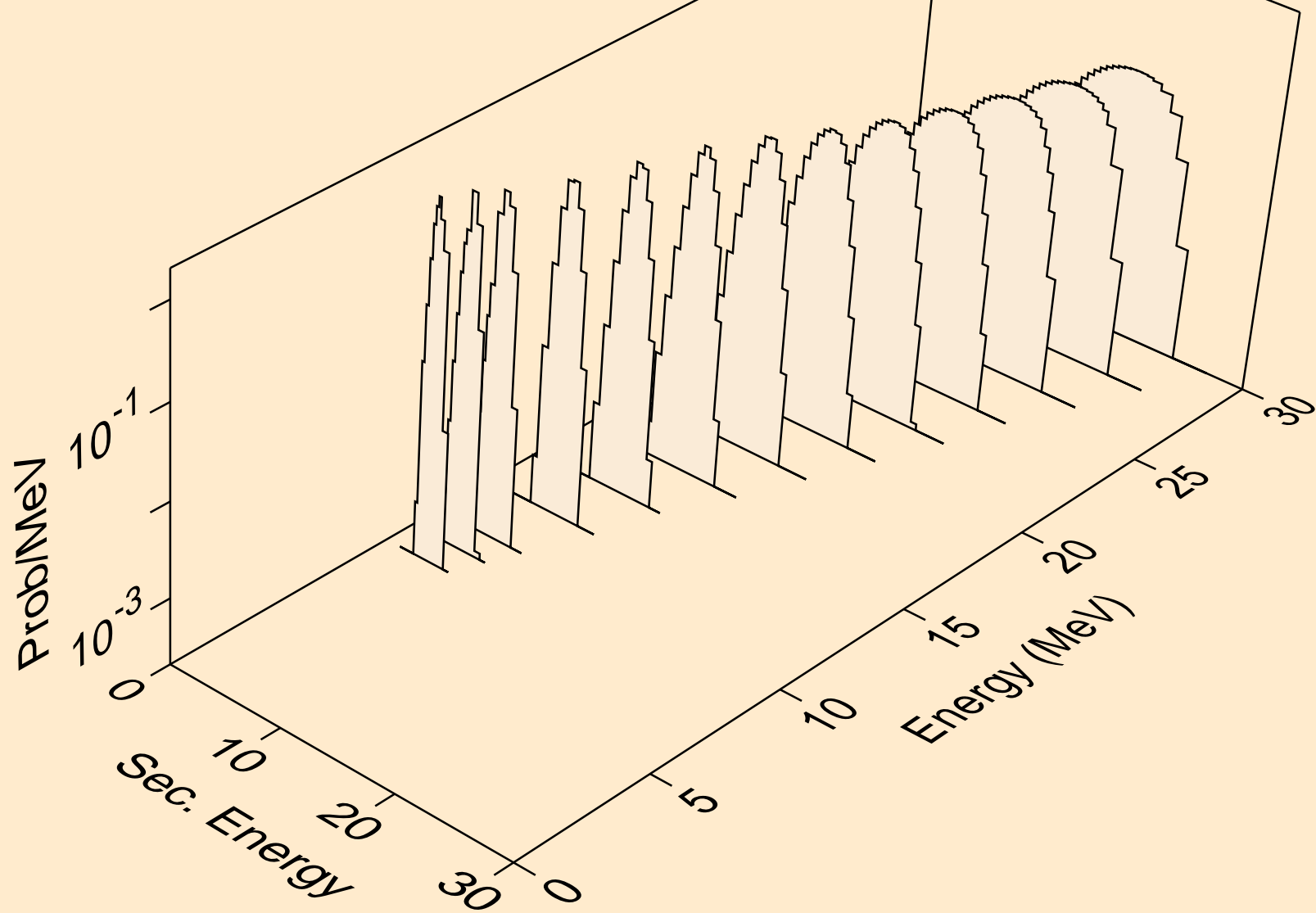

YB151M TRITON ACER TENDL-2021 LIBRARY; T=0.K  
Photon emission for (z,n)

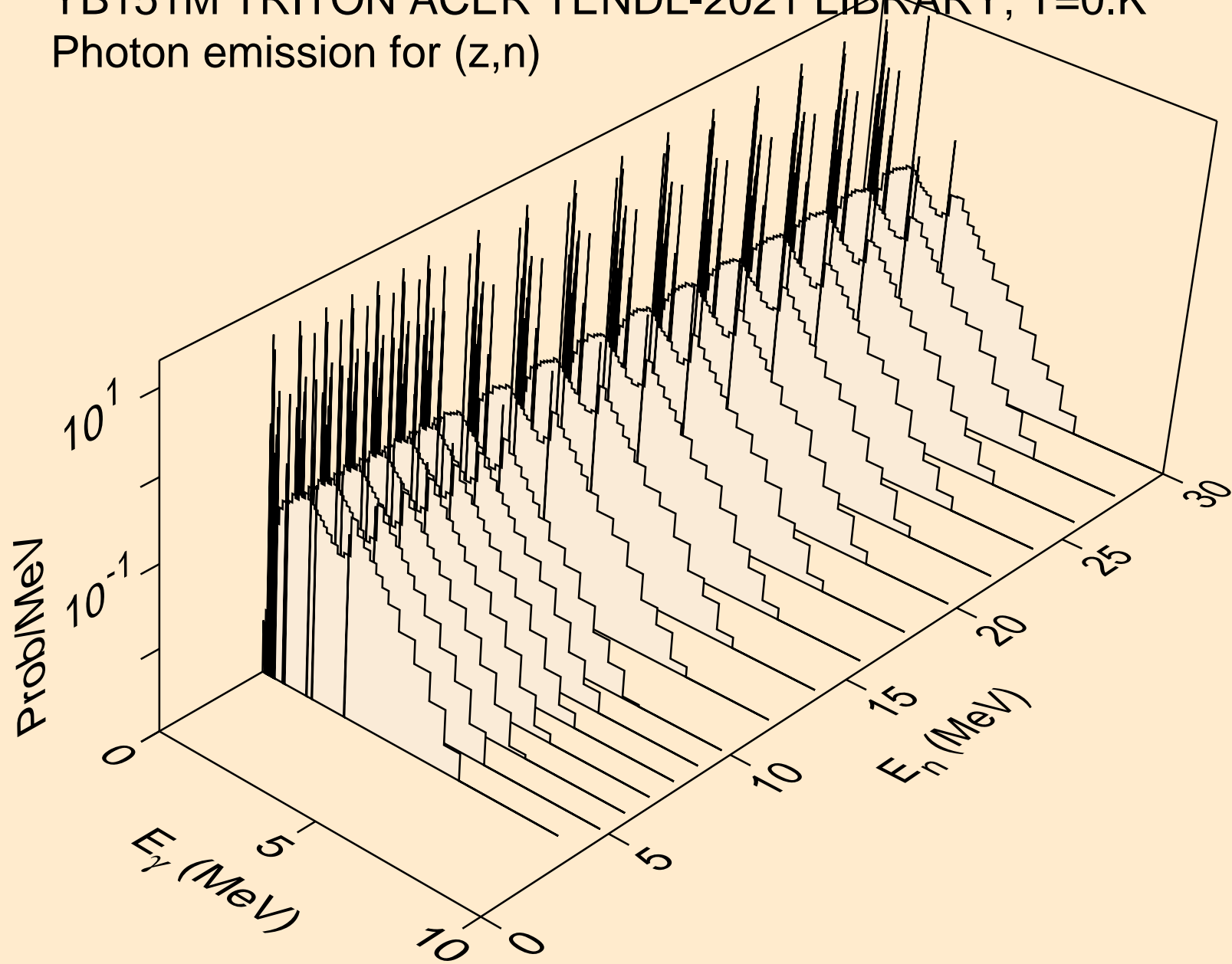

YB151M TRITON ACER TENDL-2021 LIBRARY; T=0.K  
Photon emission for (n,x)

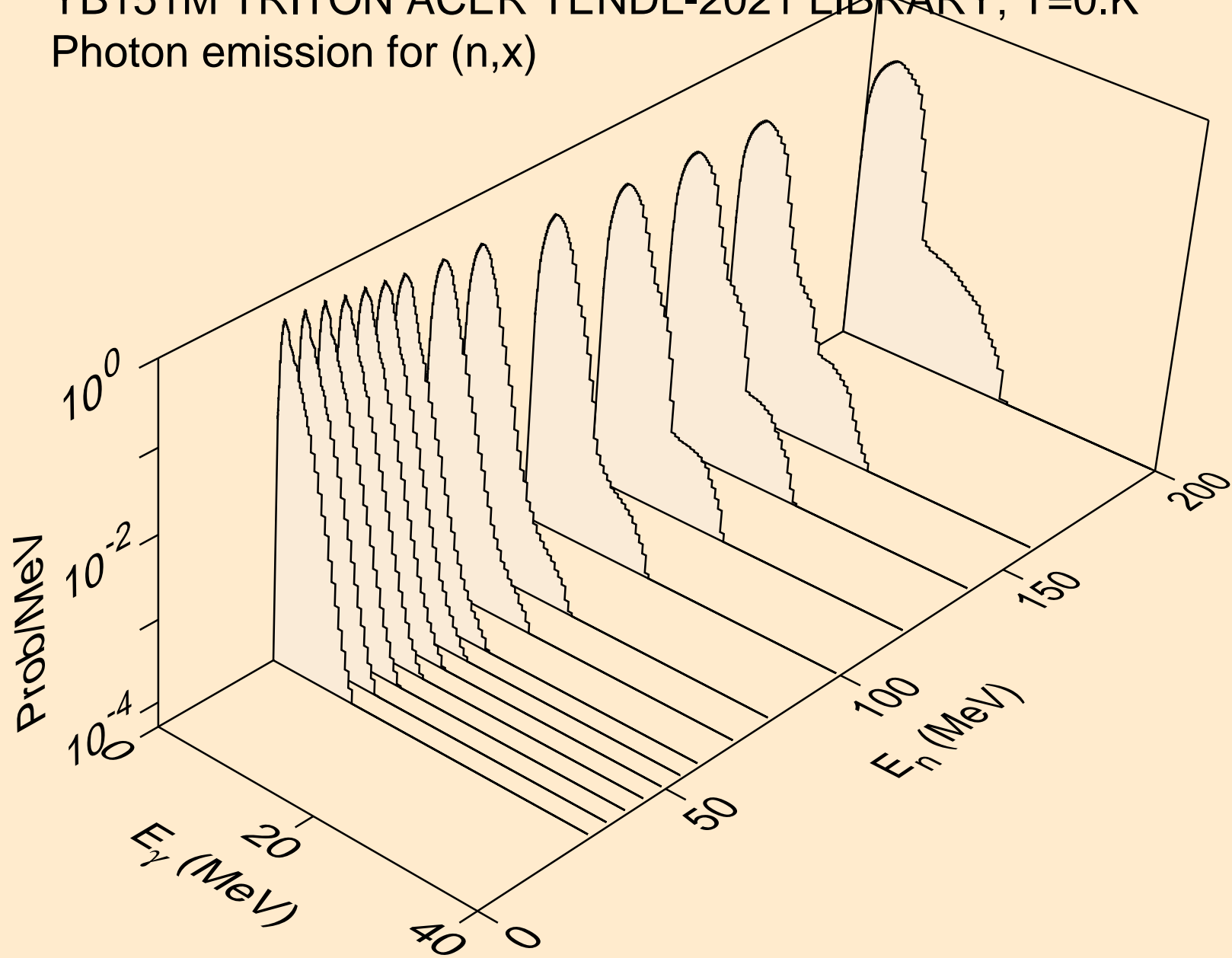

YB151M TRITON ACER TENDL-2021 LIBRARY; T=0.K  
Photon emission for (n,2nd)

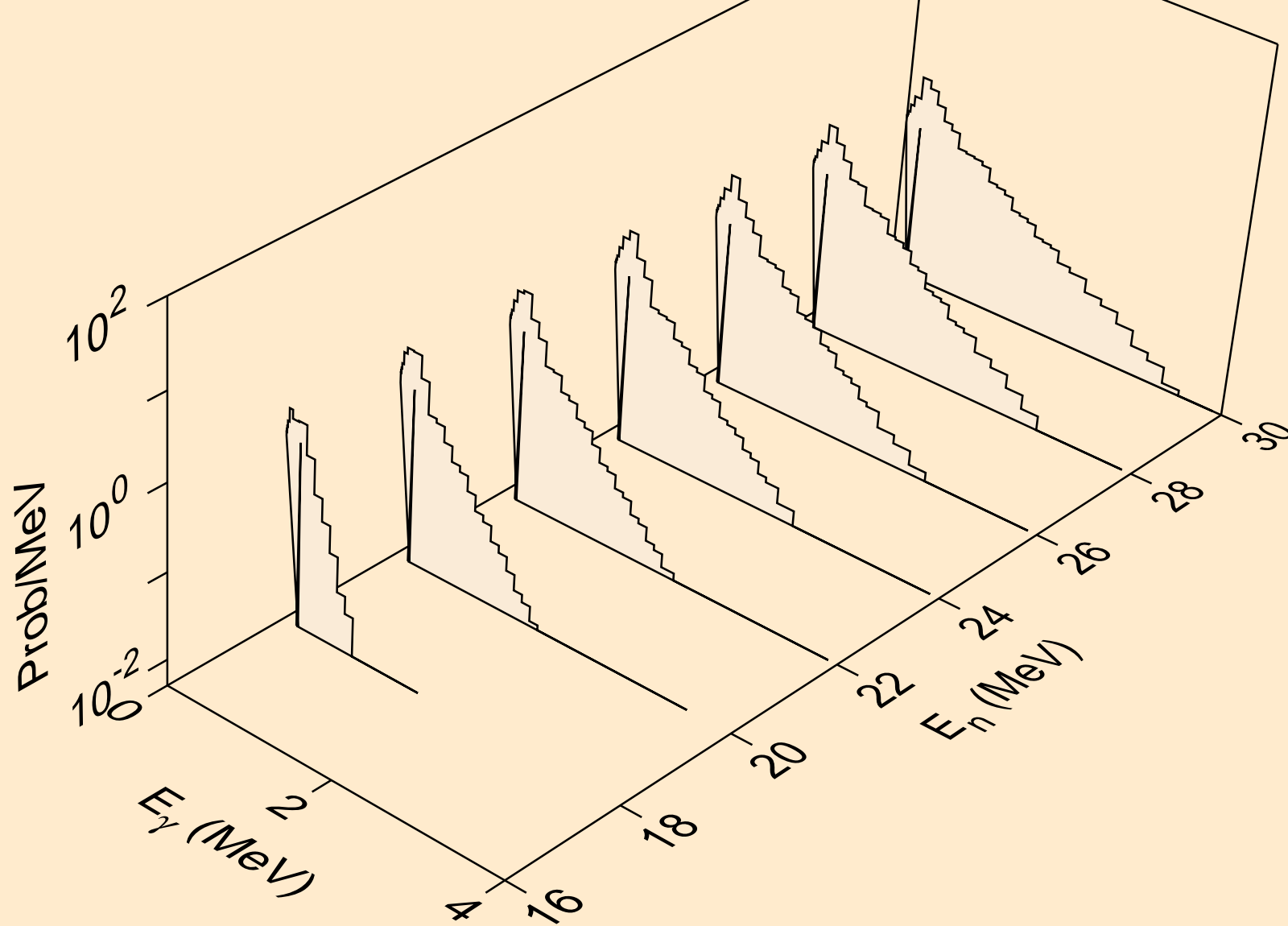

YB151M TRITON ACER TENDL-2021 LIBRARY; T=0.K  
Photon emission for (n,2n)

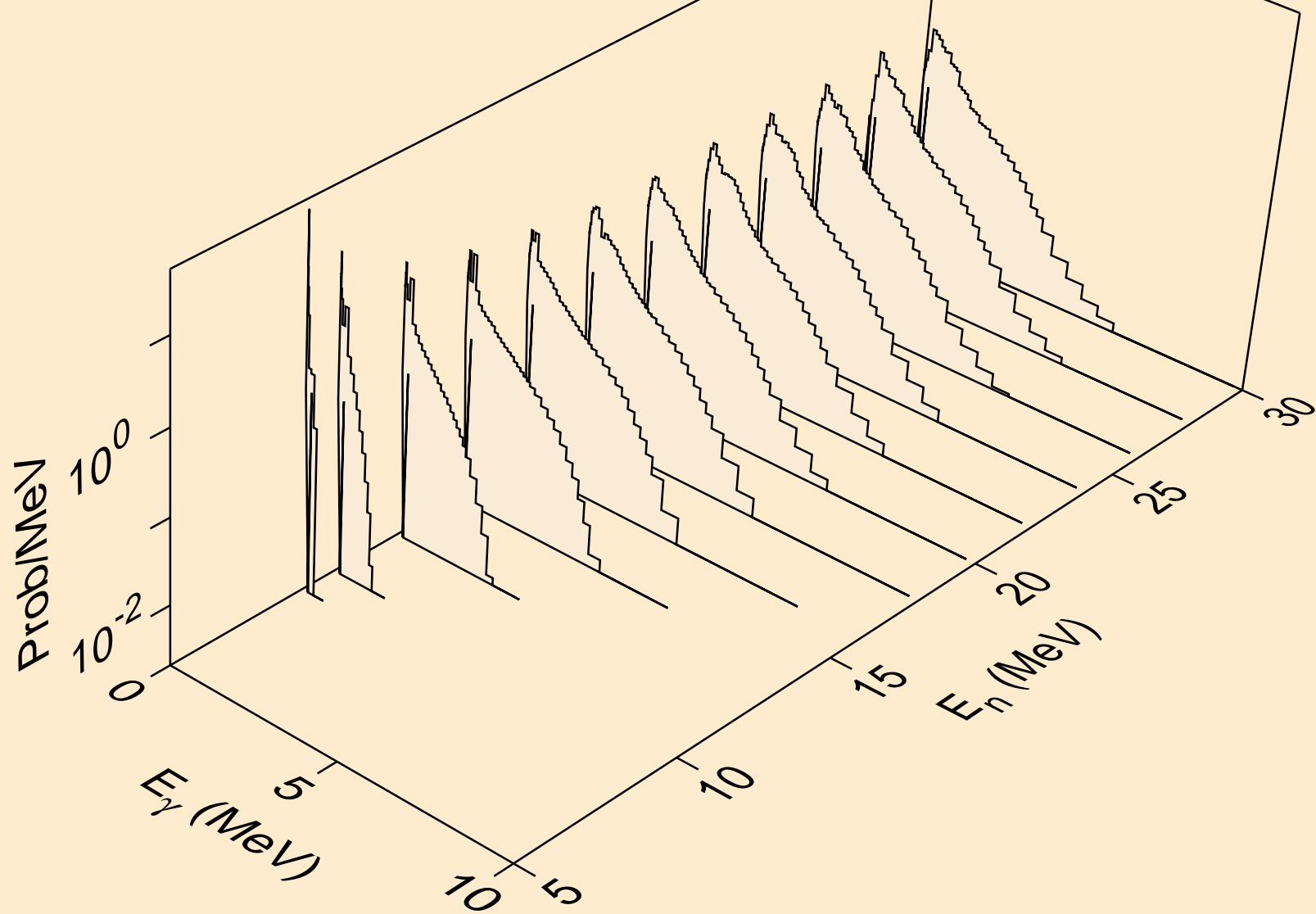



YB151M TRITON ACER TENDL-2021 LIBRARY; T=0.K  
Photon emission for (n,3n)

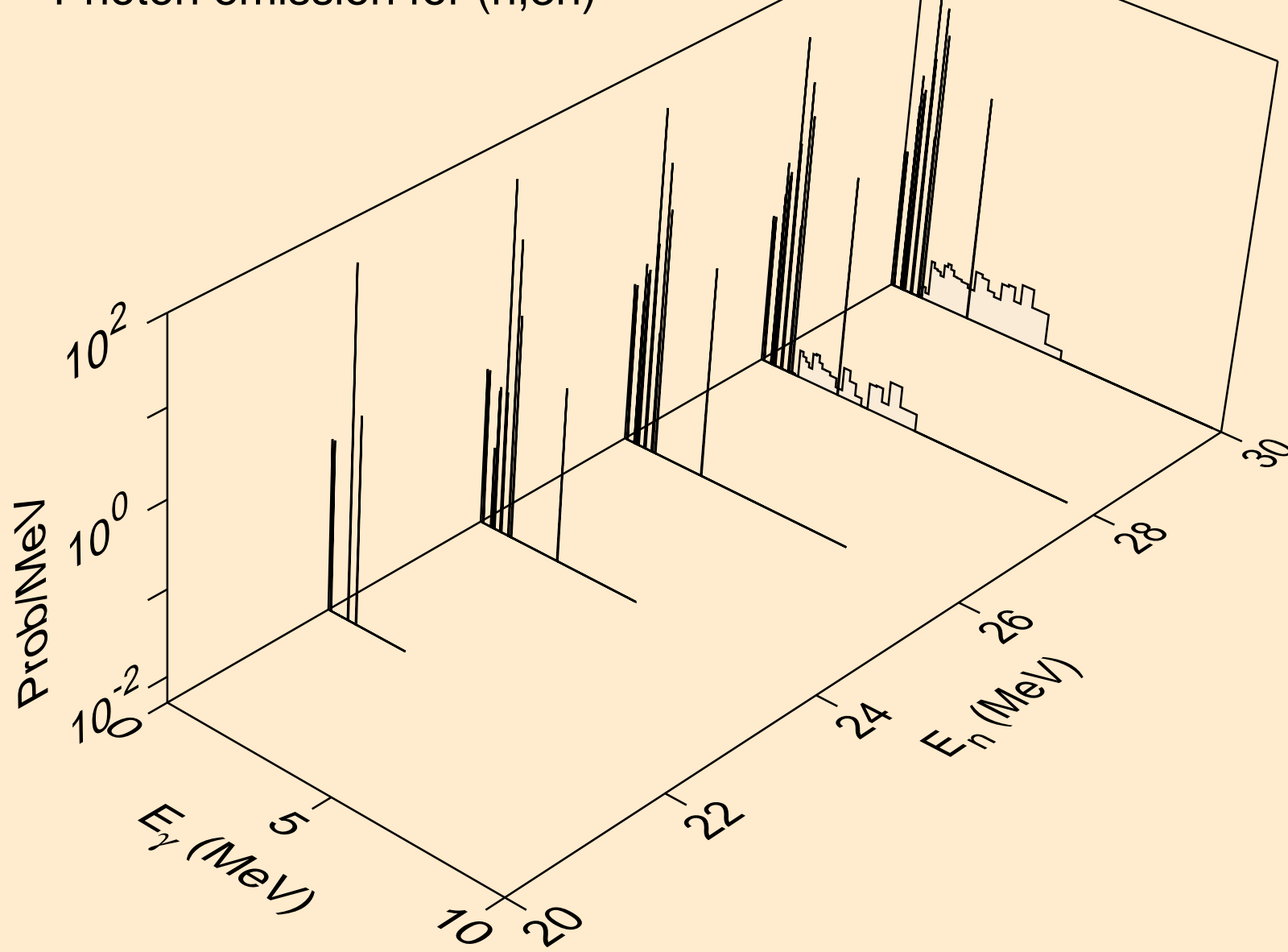

YB151M TRITON ACER TENDL-2021 LIBRARY; T=0.K  
Photon emission for (n,n\*)a

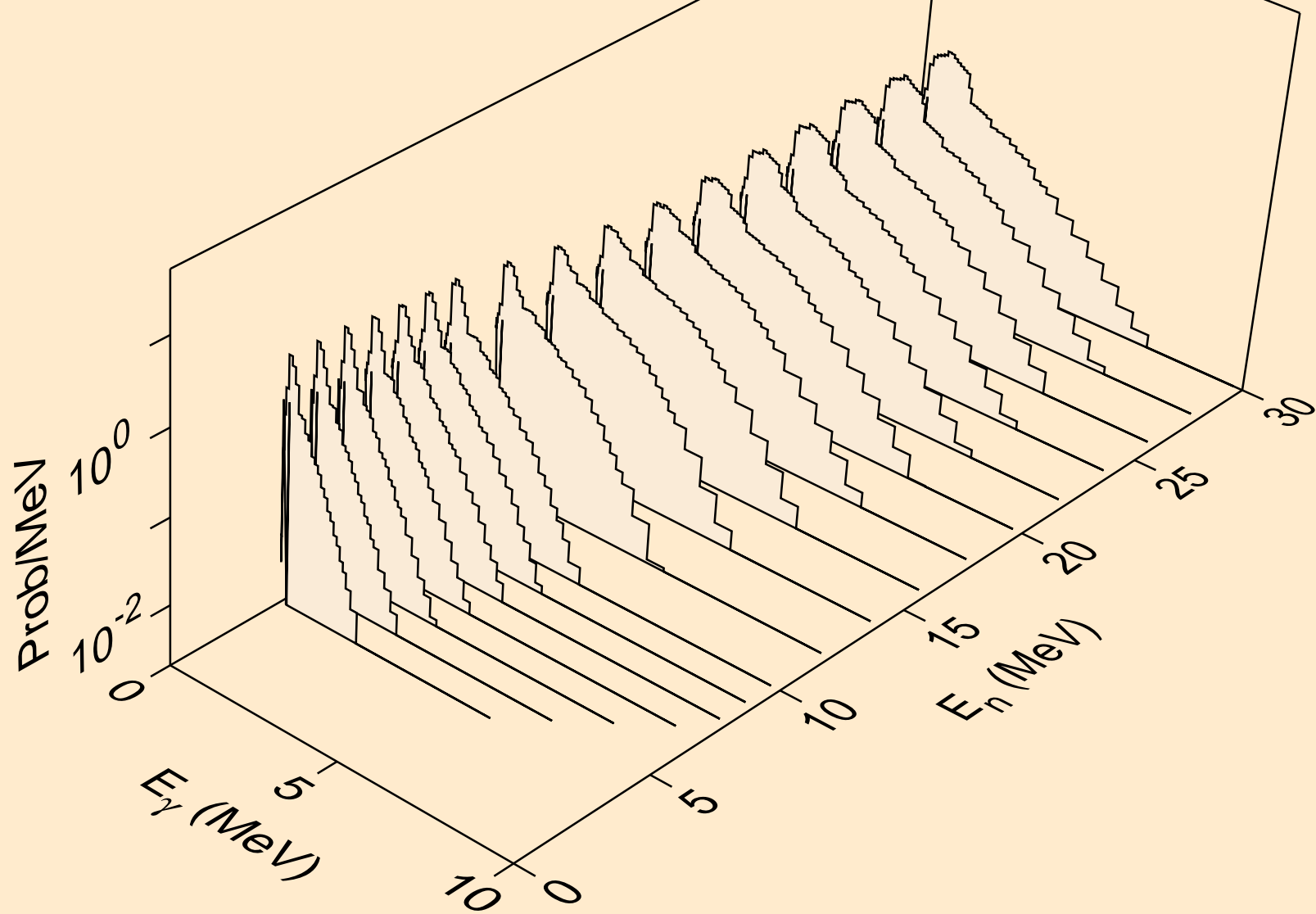

YB151M TRITON ACER TENDL-2021 LIBRARY; T=0.K  
Photon emission for (n,2n)a

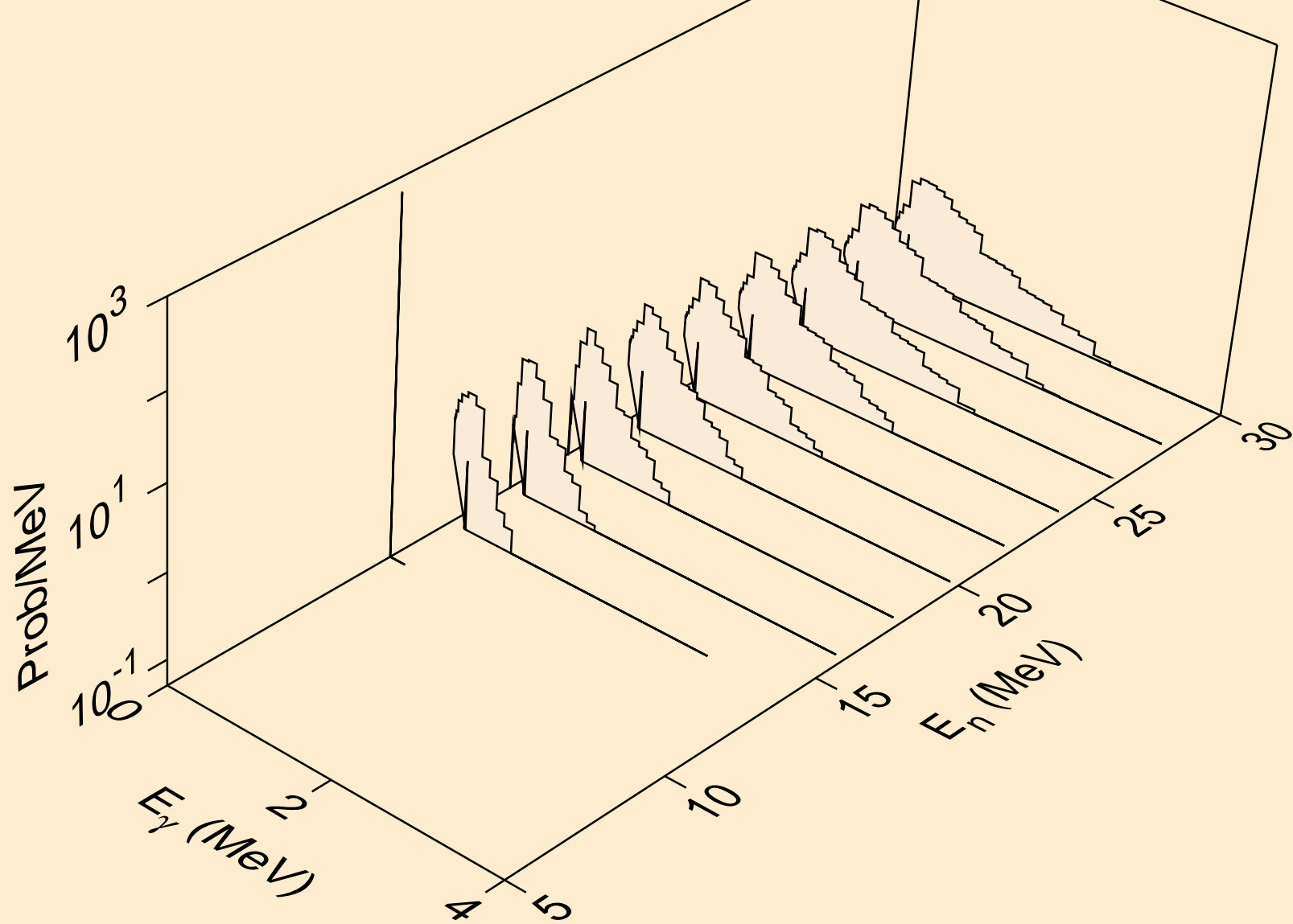

YB151M TRITON ACER TENDL-2021 LIBRARY; T=0.K  
Photon emission for (n,n\*)p

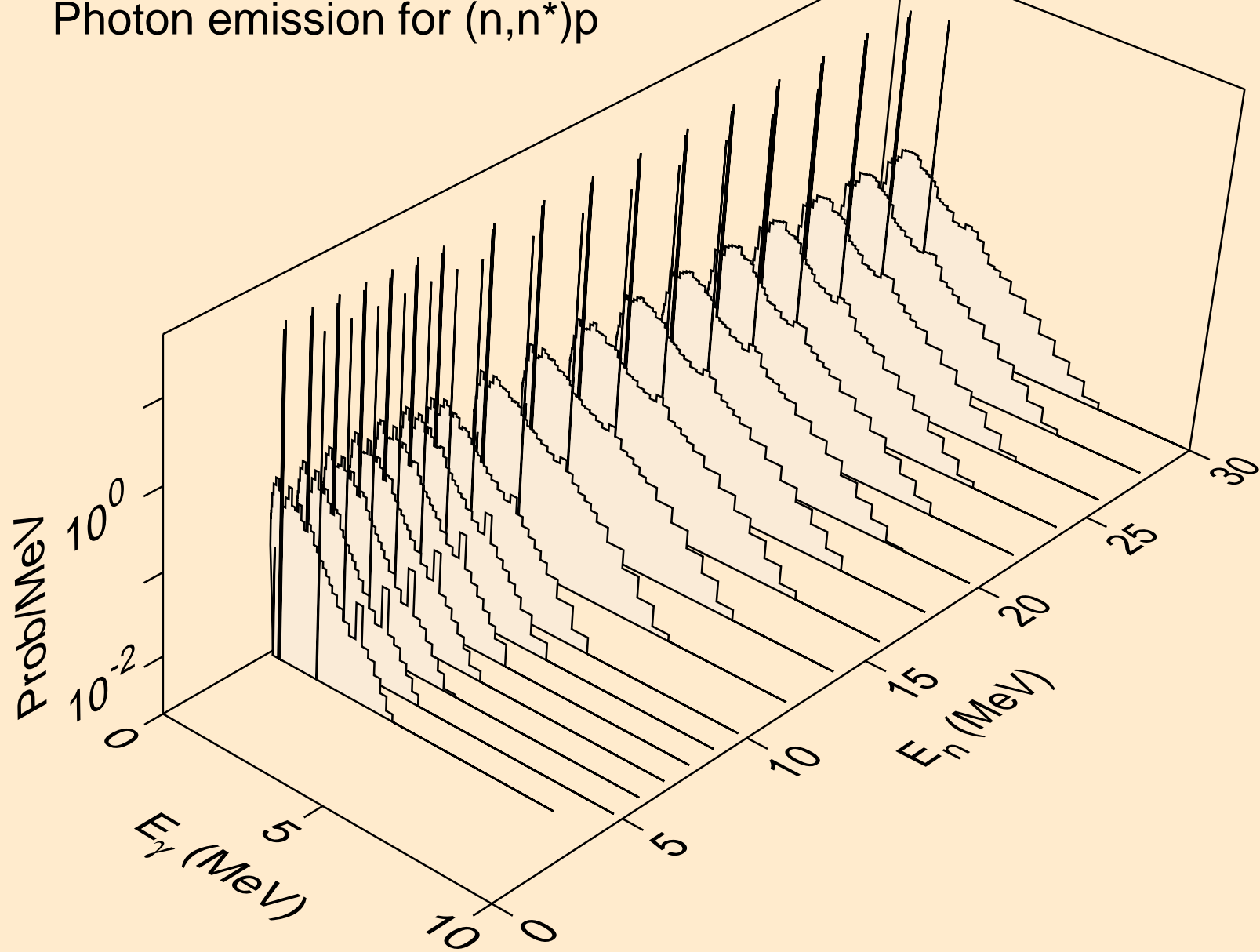

YB151M TRITON ACER TENDL-2021 LIBRARY; T=0.K  
Photon emission for (n,n\*)2a

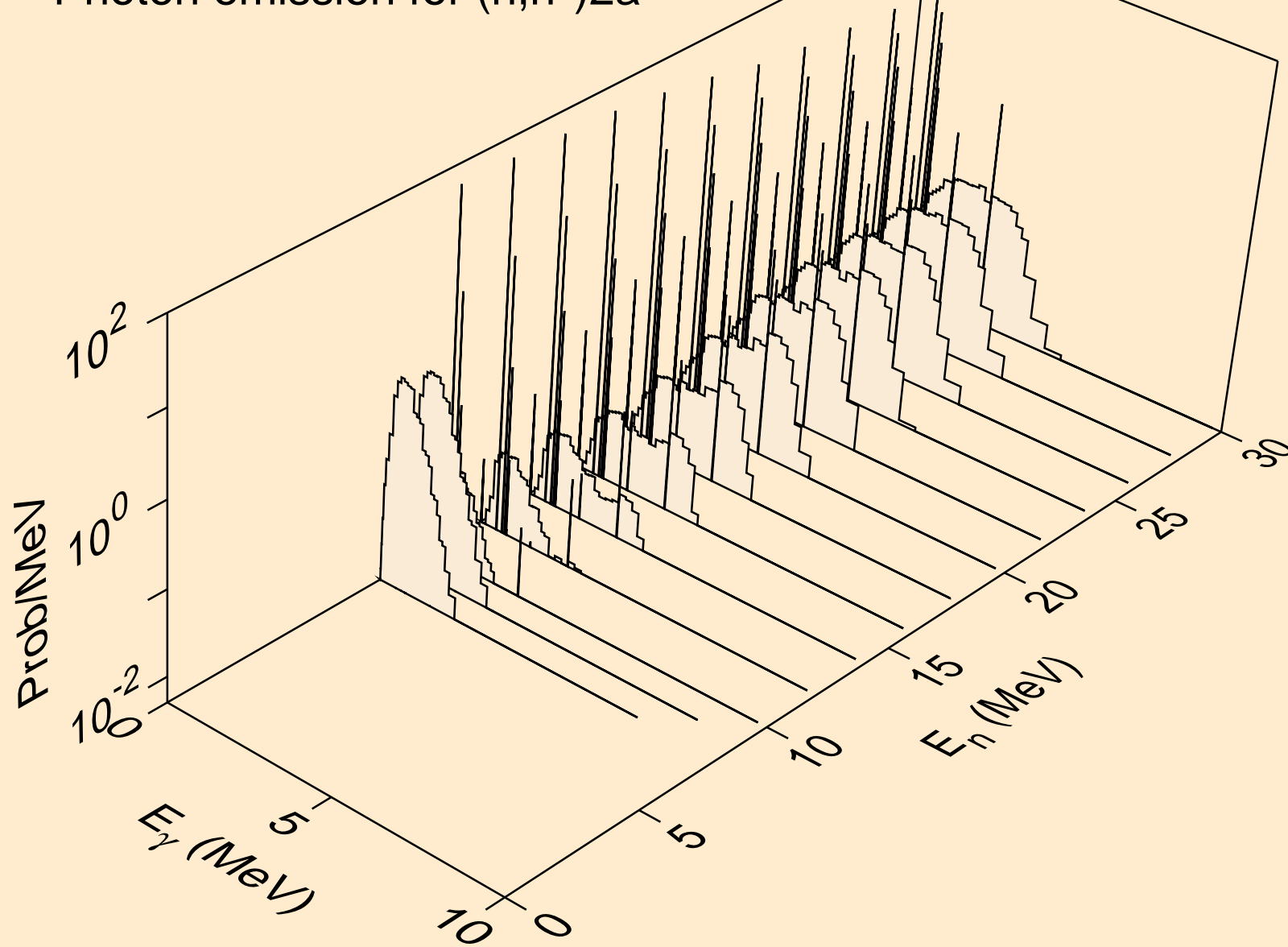

YB151M TRITON ACER TENDL-2021 LIBRARY; T=0.K  
Photon emission for (n,n\*)d

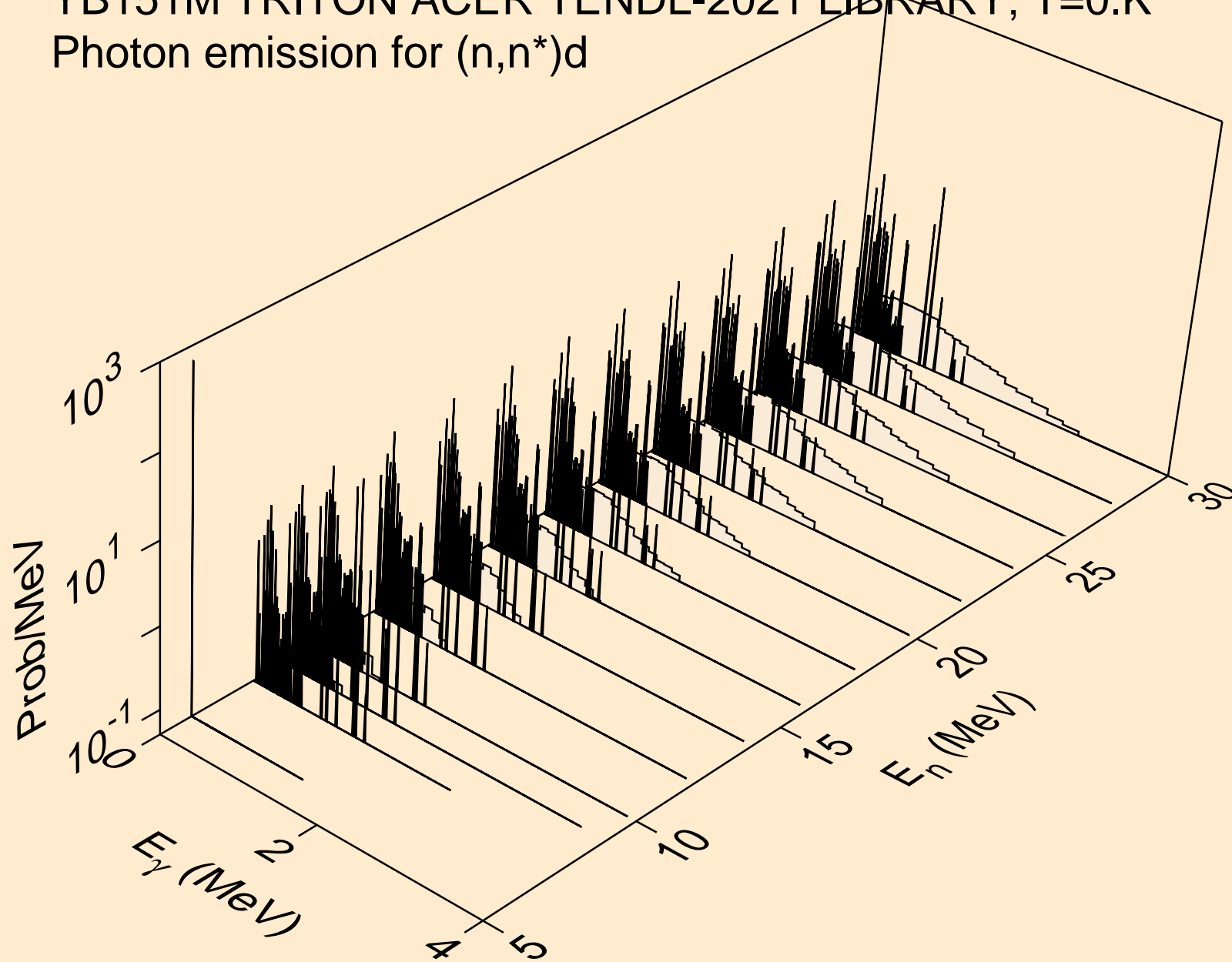

YB151M TRITON ACER TENDL-2021 LIBRARY; T=0.K  
Photon emission for (n,n\*)t

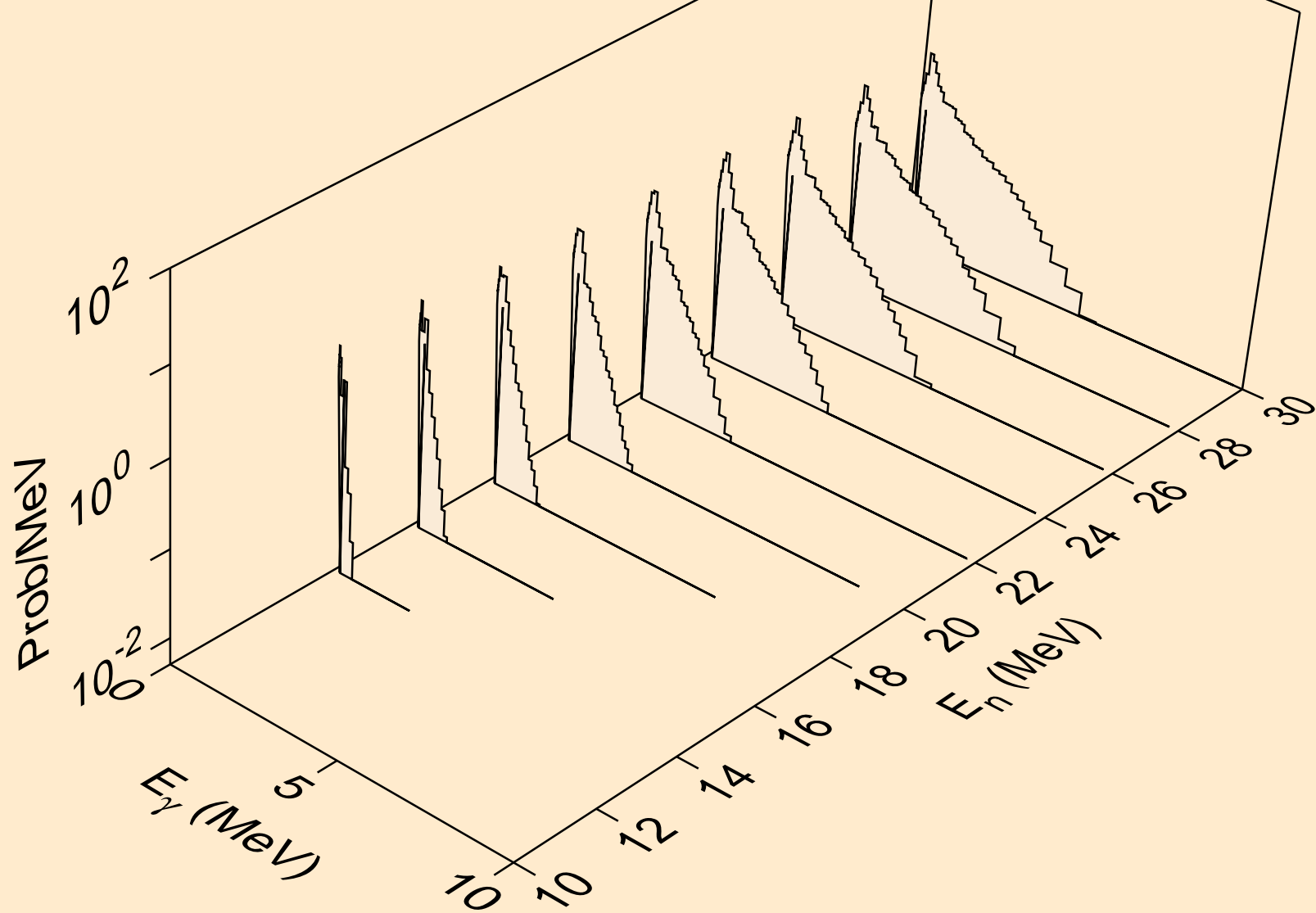

YB151M TRITON ACER TENDL-2021 LIBRARY; T=0.K  
Photon emission for (n,n\*)he3

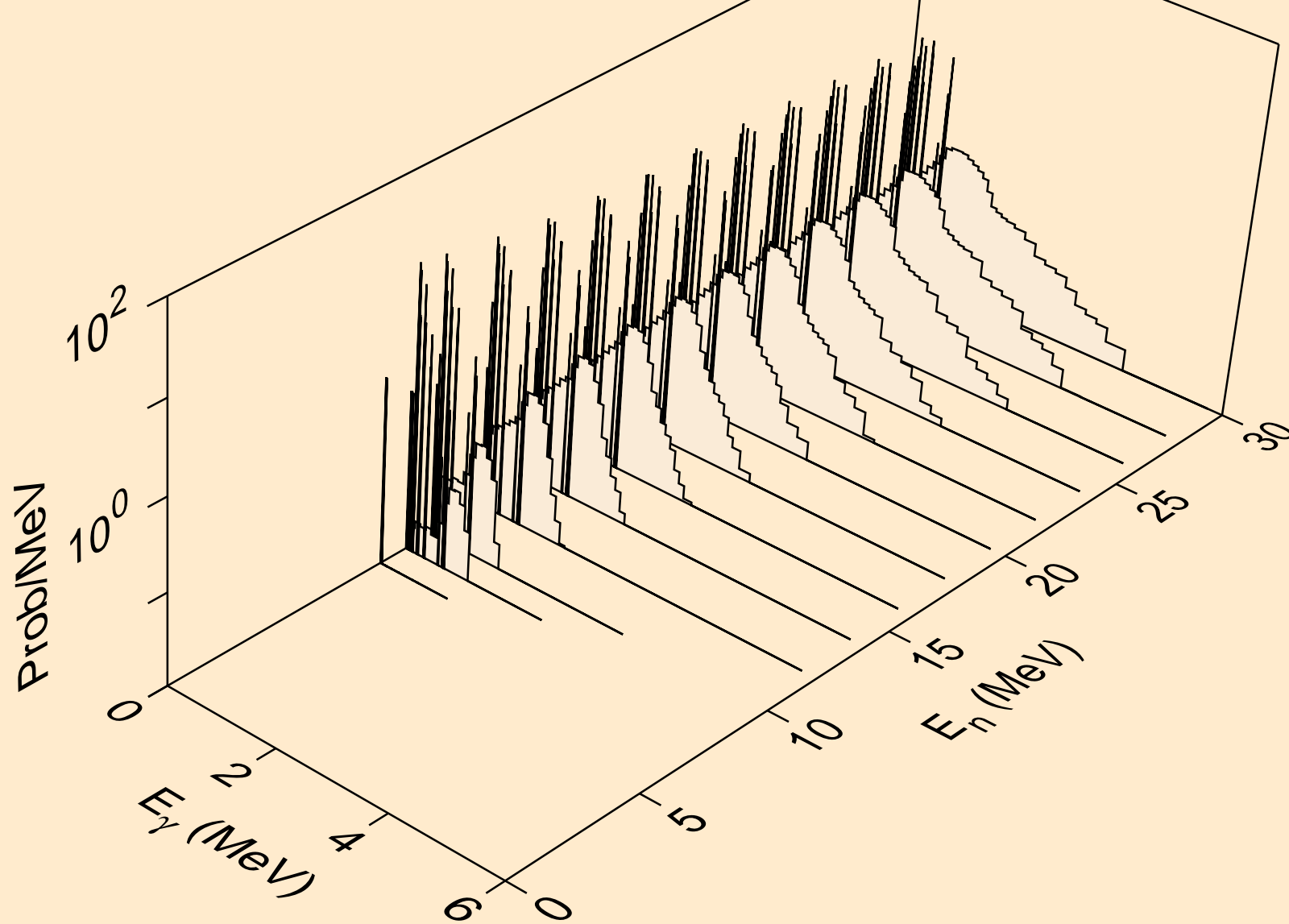



YB151M TRITON ACER TENDL-2021 LIBRARY; T=0.K  
Photon emission for (n,2np)

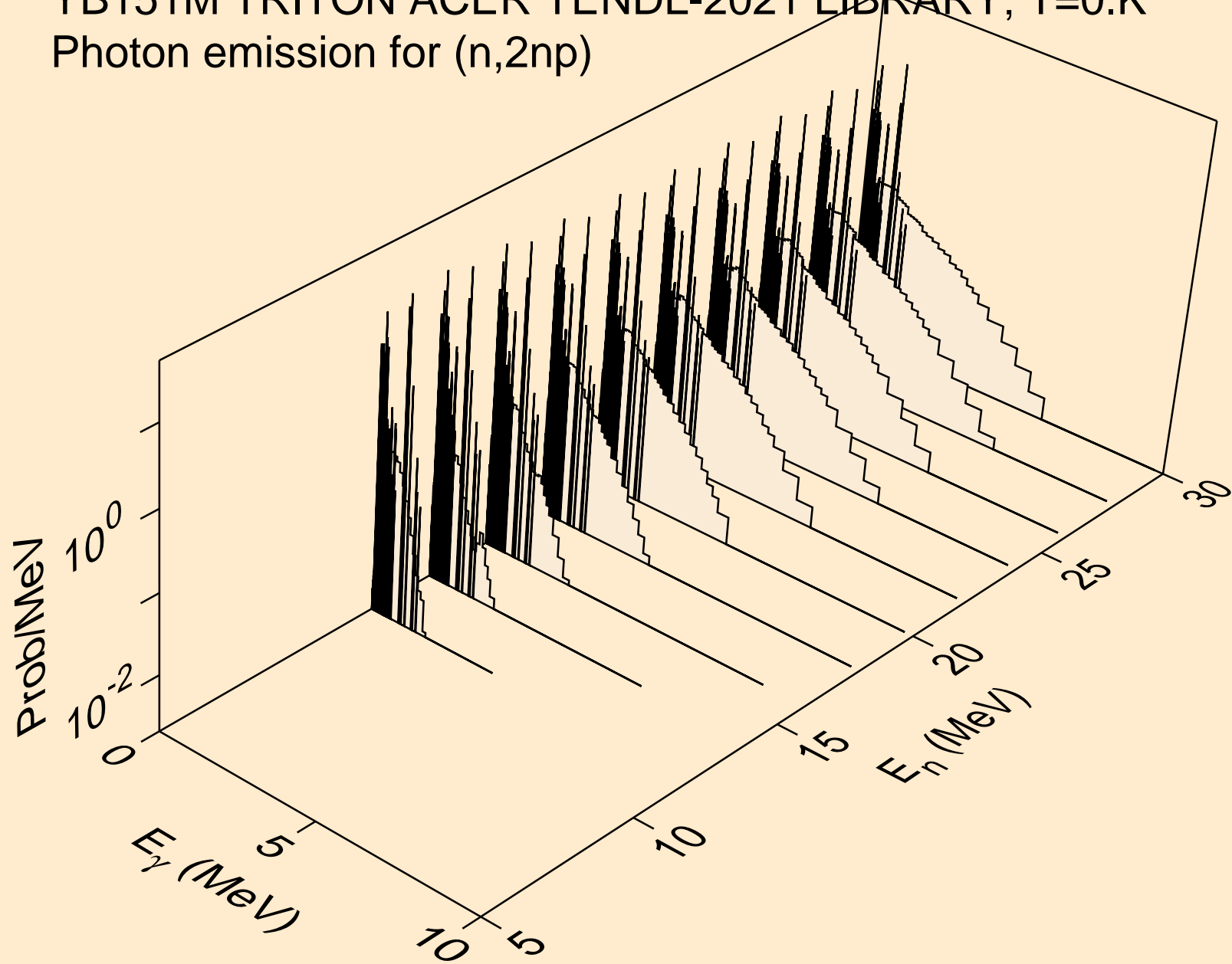

YB151M TRITON ACER TENDL-2021 LIBRARY; T=0.K  
Photon emission for (n,3np)

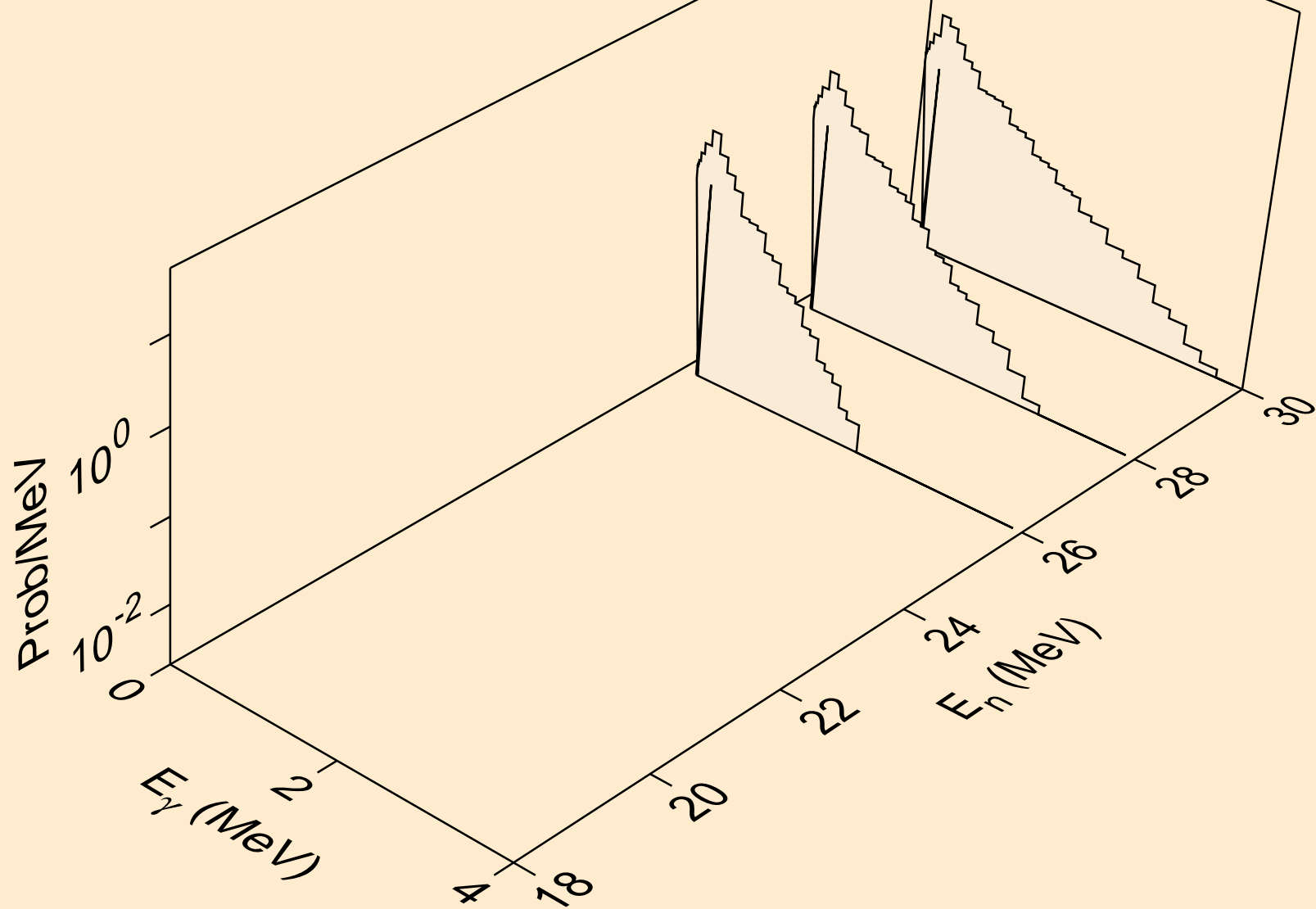

YB151M TRITON ACER TENDL-2021 LIBRARY; T=0.K  
Photon emission for (n,2np)

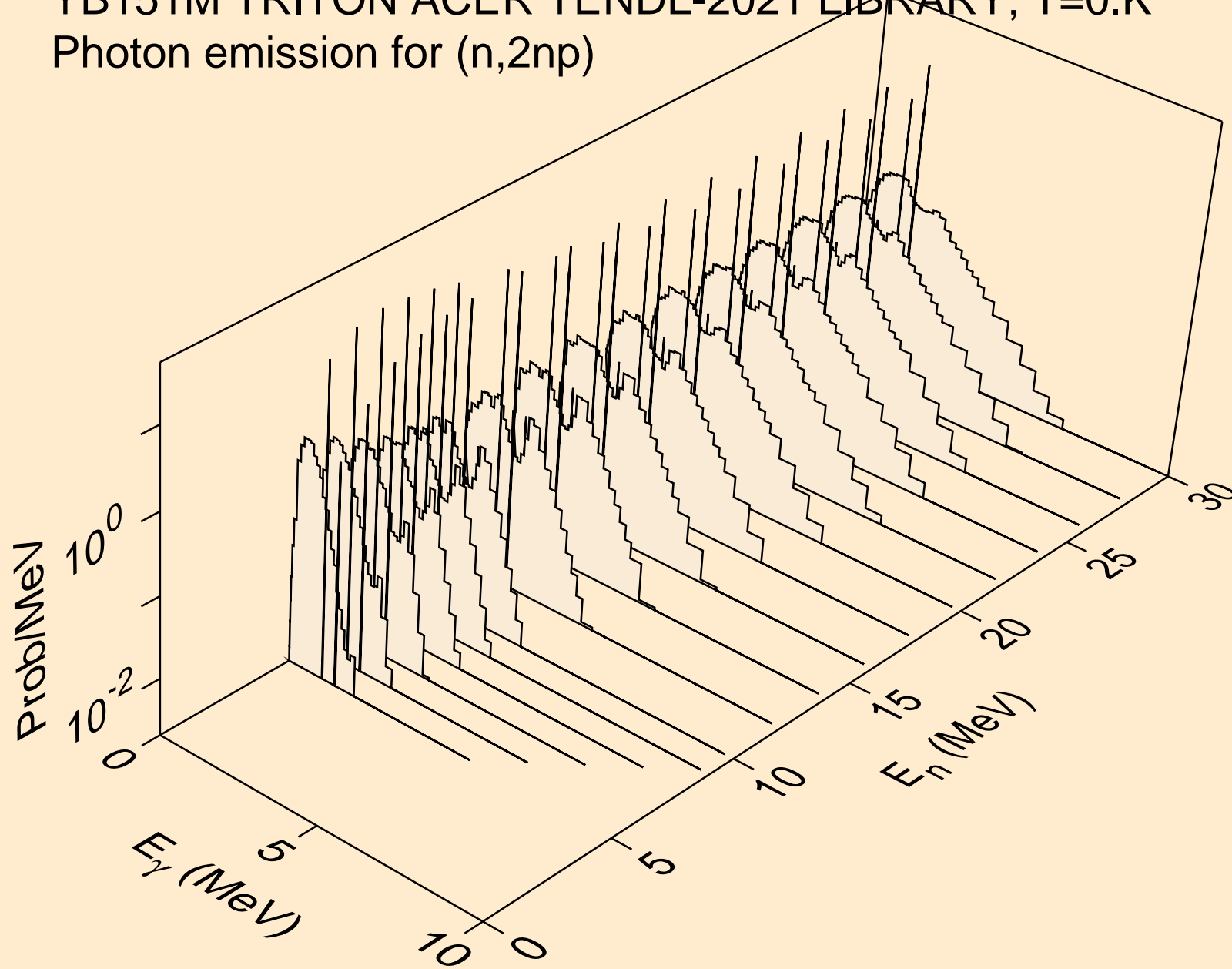

YB151M TRITON ACER TENDL-2021 LIBRARY; T=0.K  
Photon emission for (n,npa)

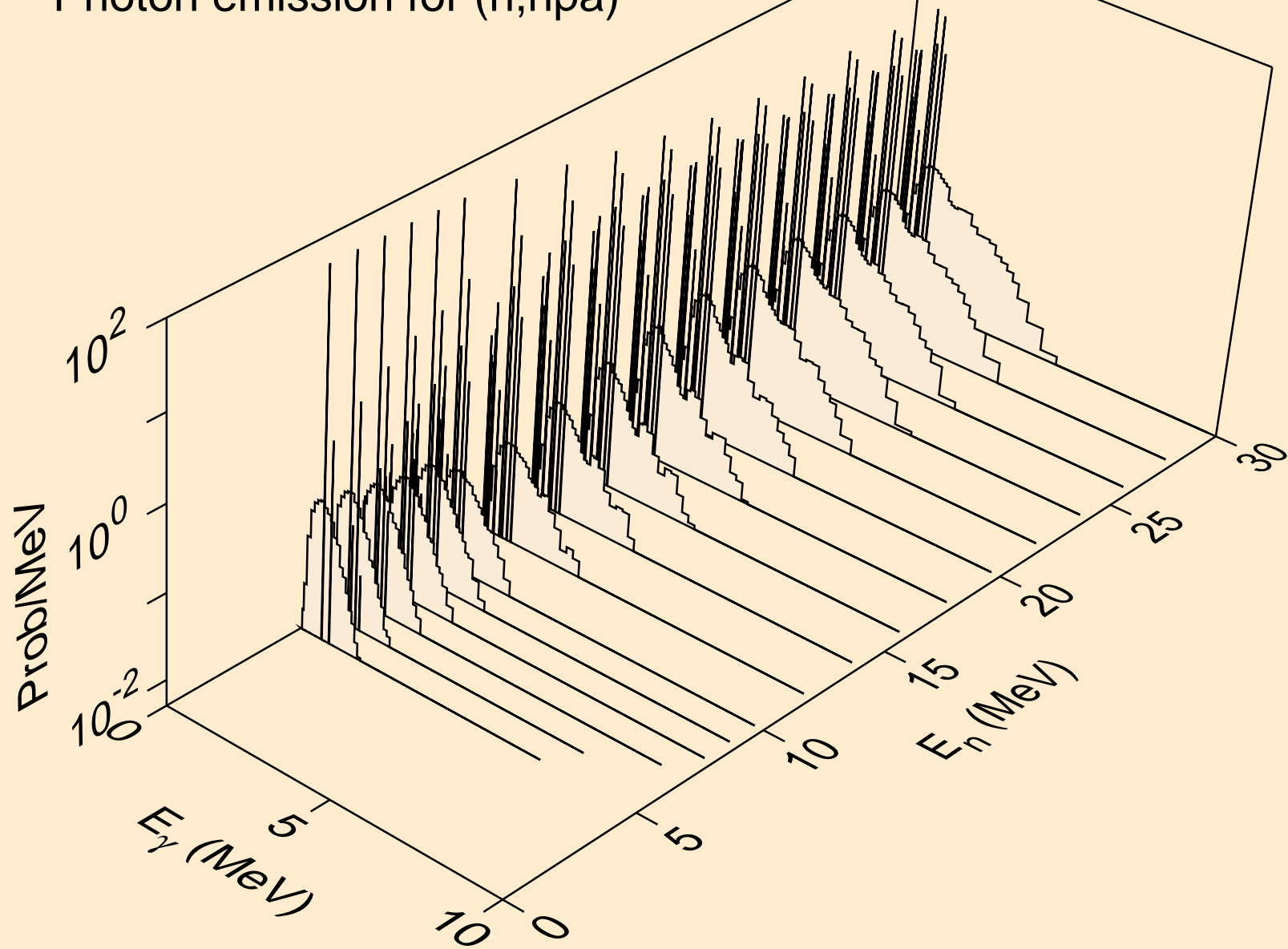

YB151M TRITON ACER TENDL-2021 LIBRARY; T=0.K  
Photon emission for (n,gma)

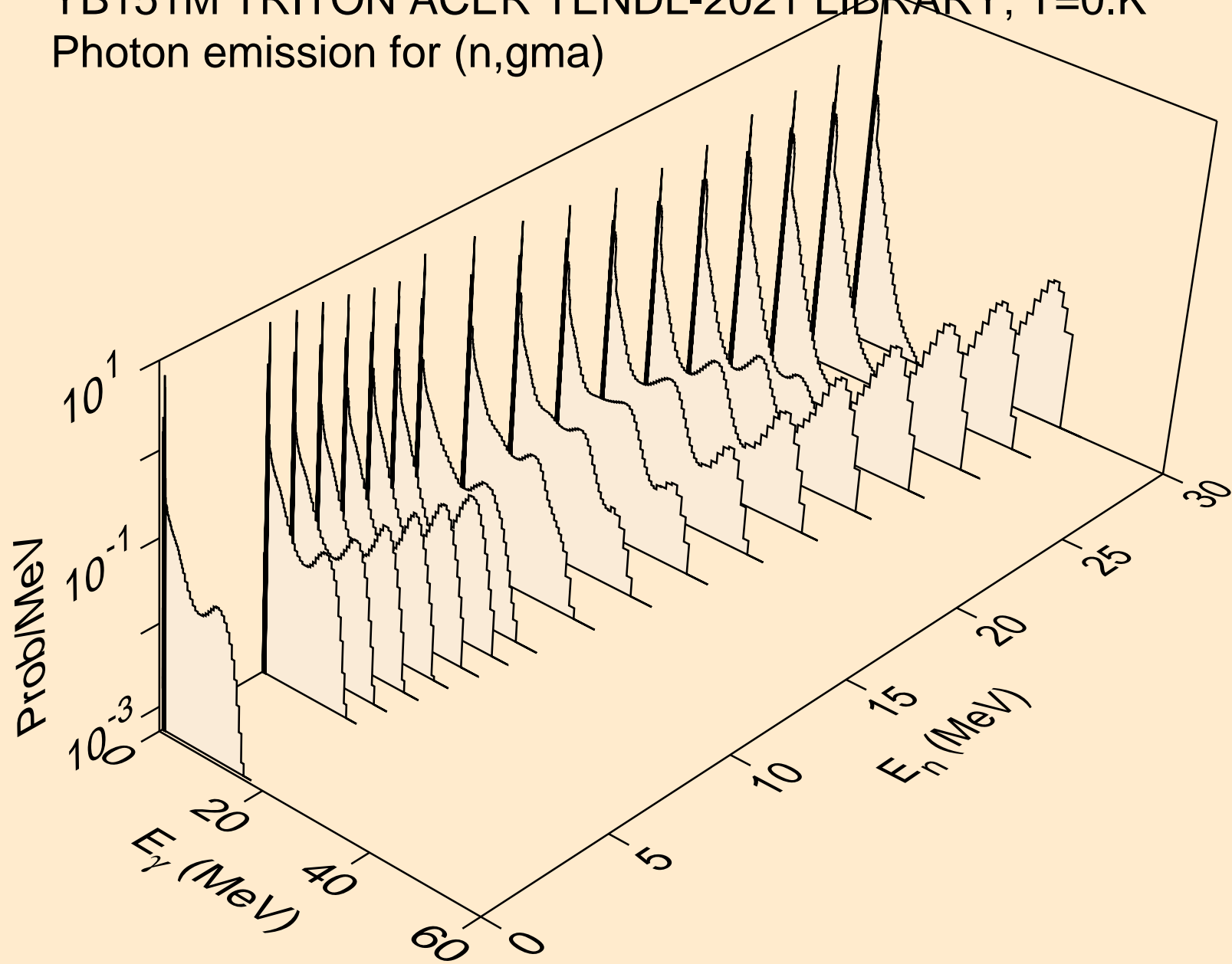

YB151M TRITON ACER TENDL-2021 LIBRARY; T=0.K  
Photon emission for (n,p)

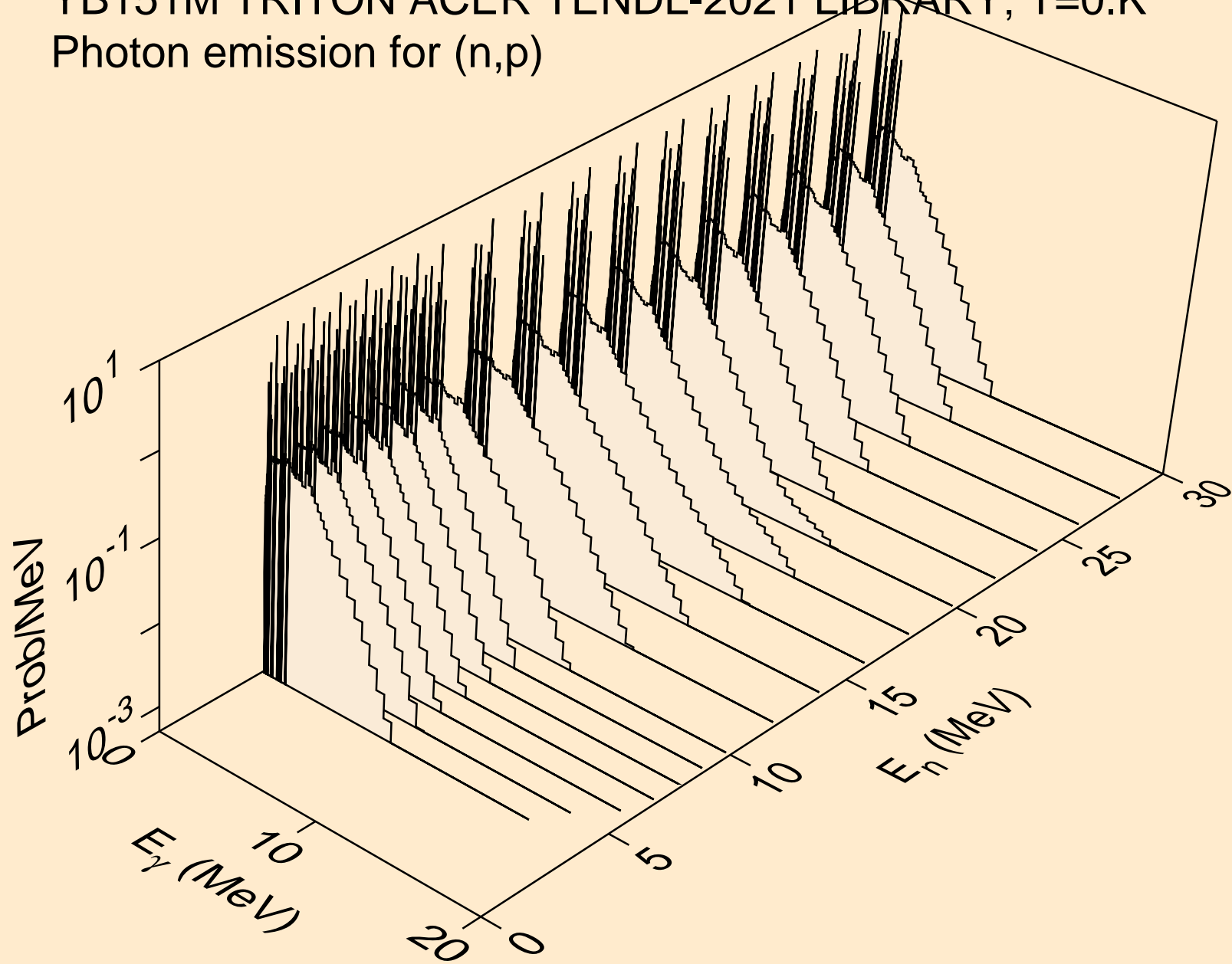

YB151M TRITON ACER TENDL-2021 LIBRARY; T=0.K  
Photon emission for (n,d)

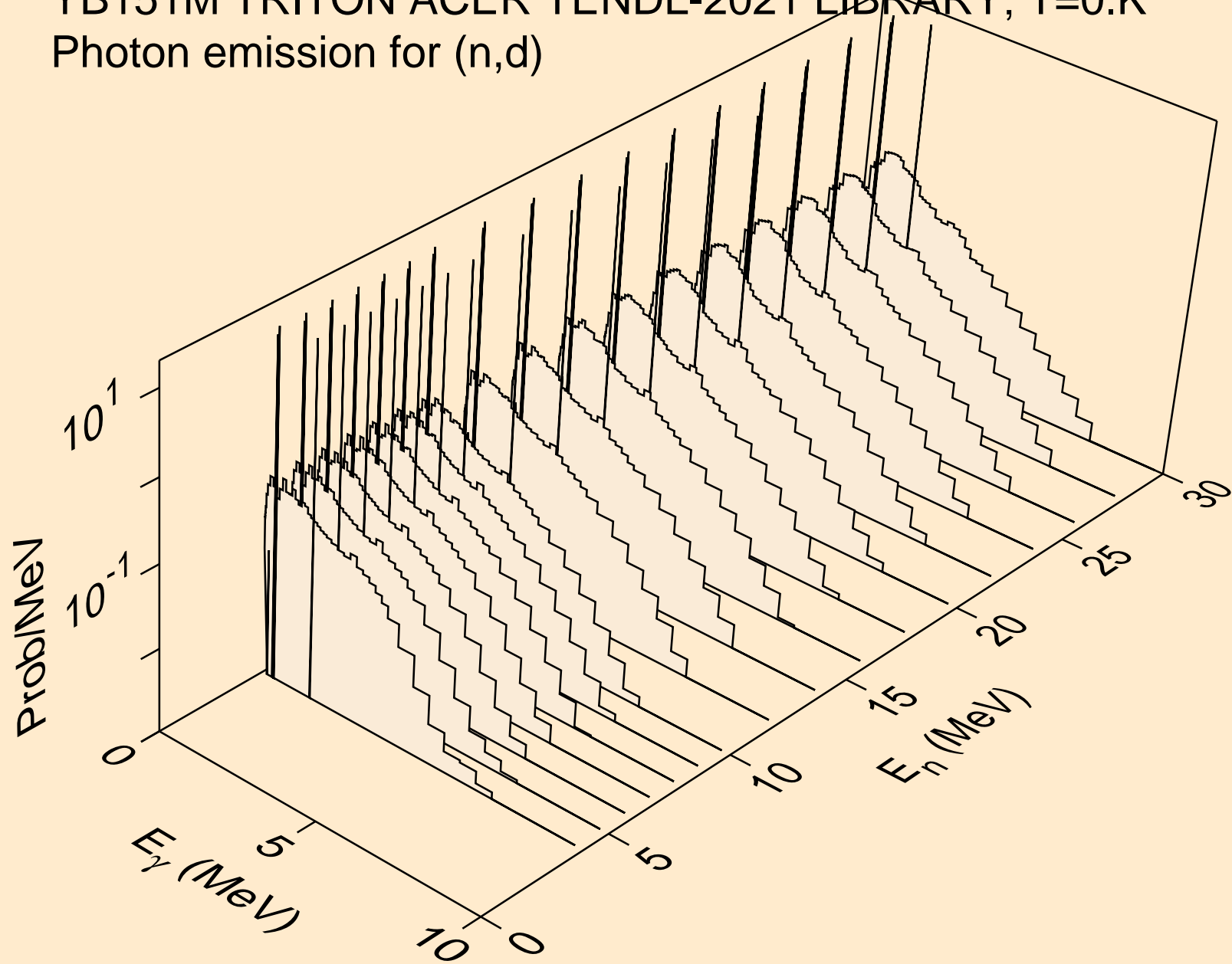

YB151M TRITON ACER TENDL-2021 LIBRARY; T=0.K  
Photon emission for inelastic

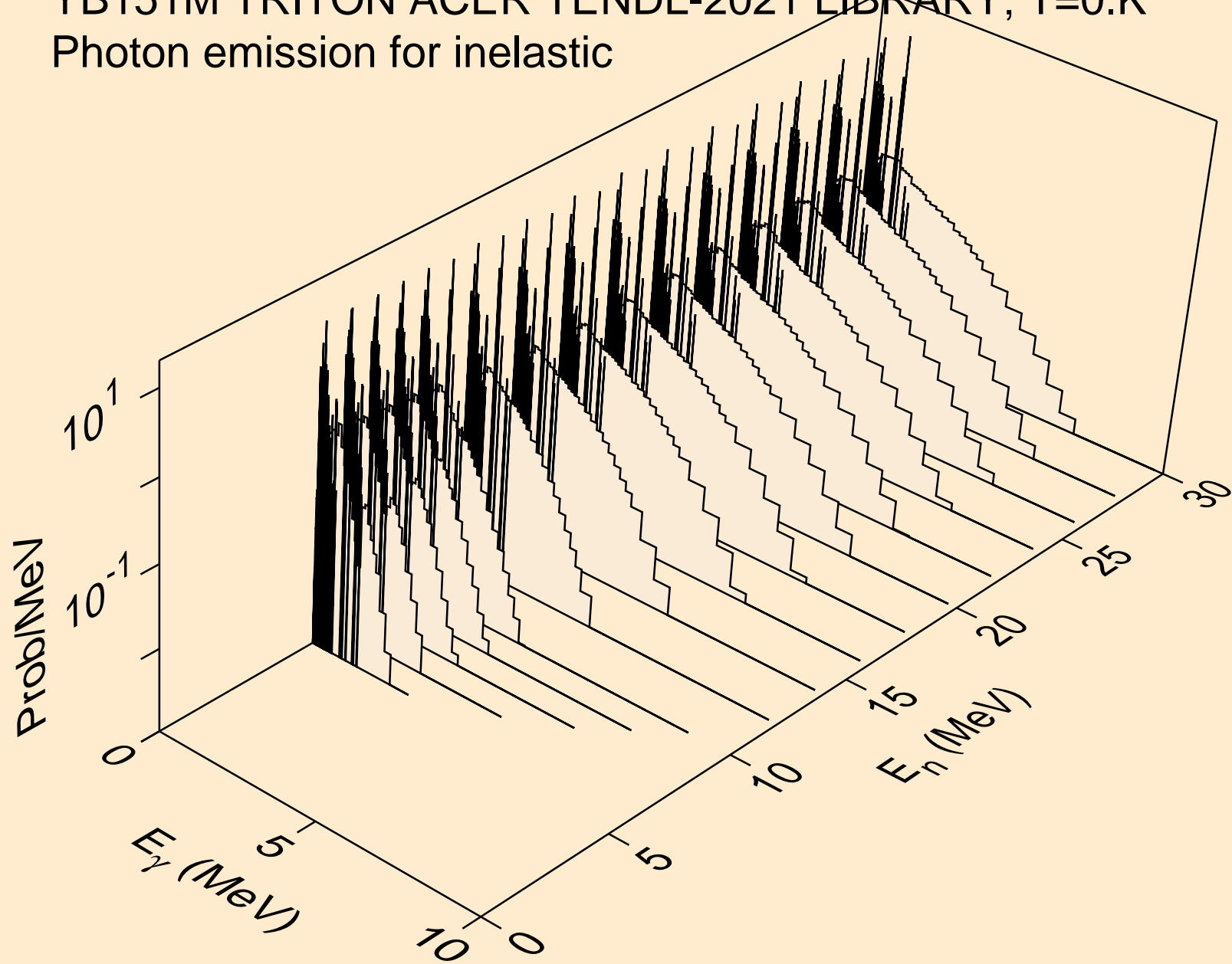



YB151M TRITON ACER TENDL-2021 LIBRARY; T=0.K  
Photon emission for (n,he3)

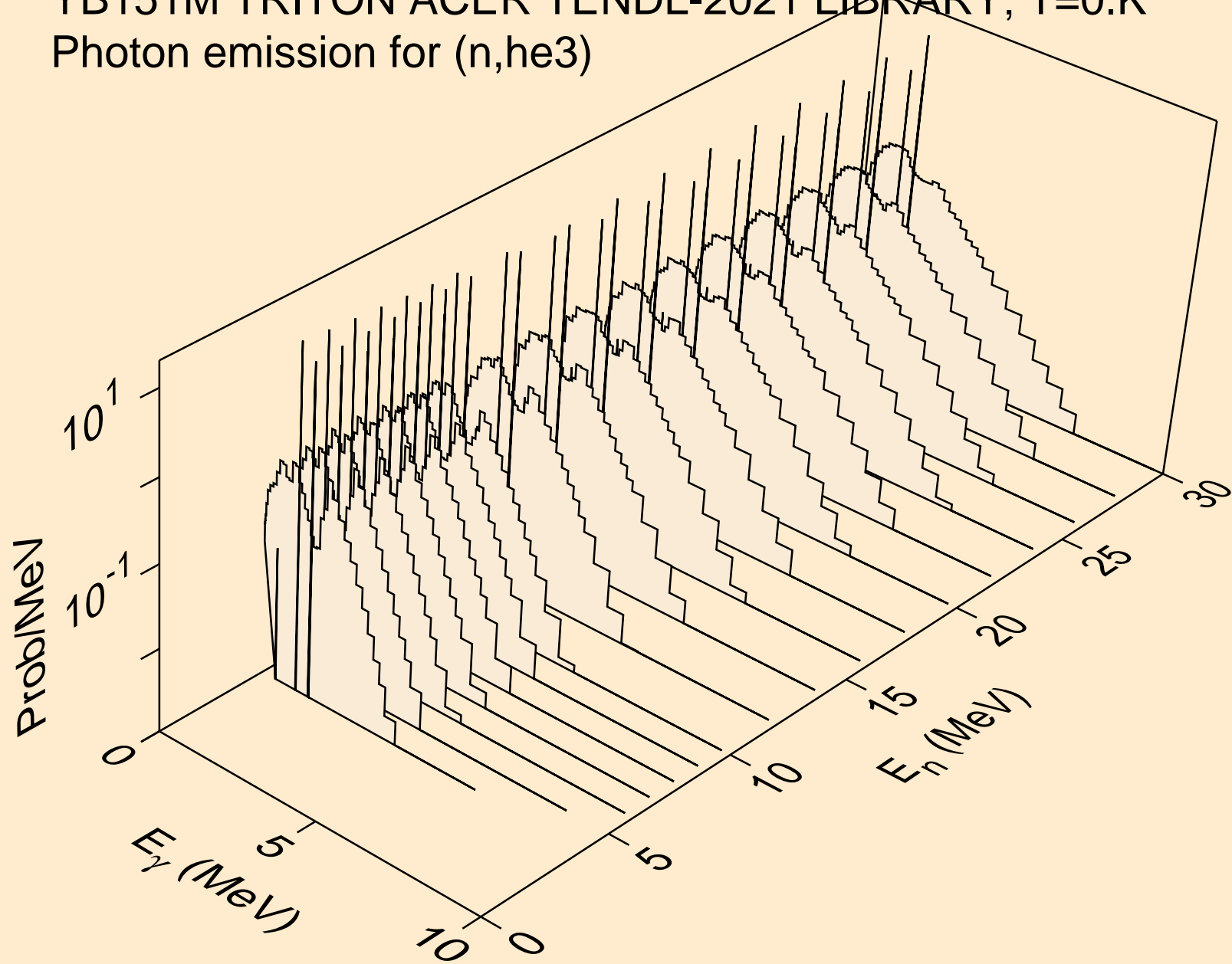

YB151M TRITON ACER TENDL-2021 LIBRARY; T=0.K  
Photon emission for (n,a)

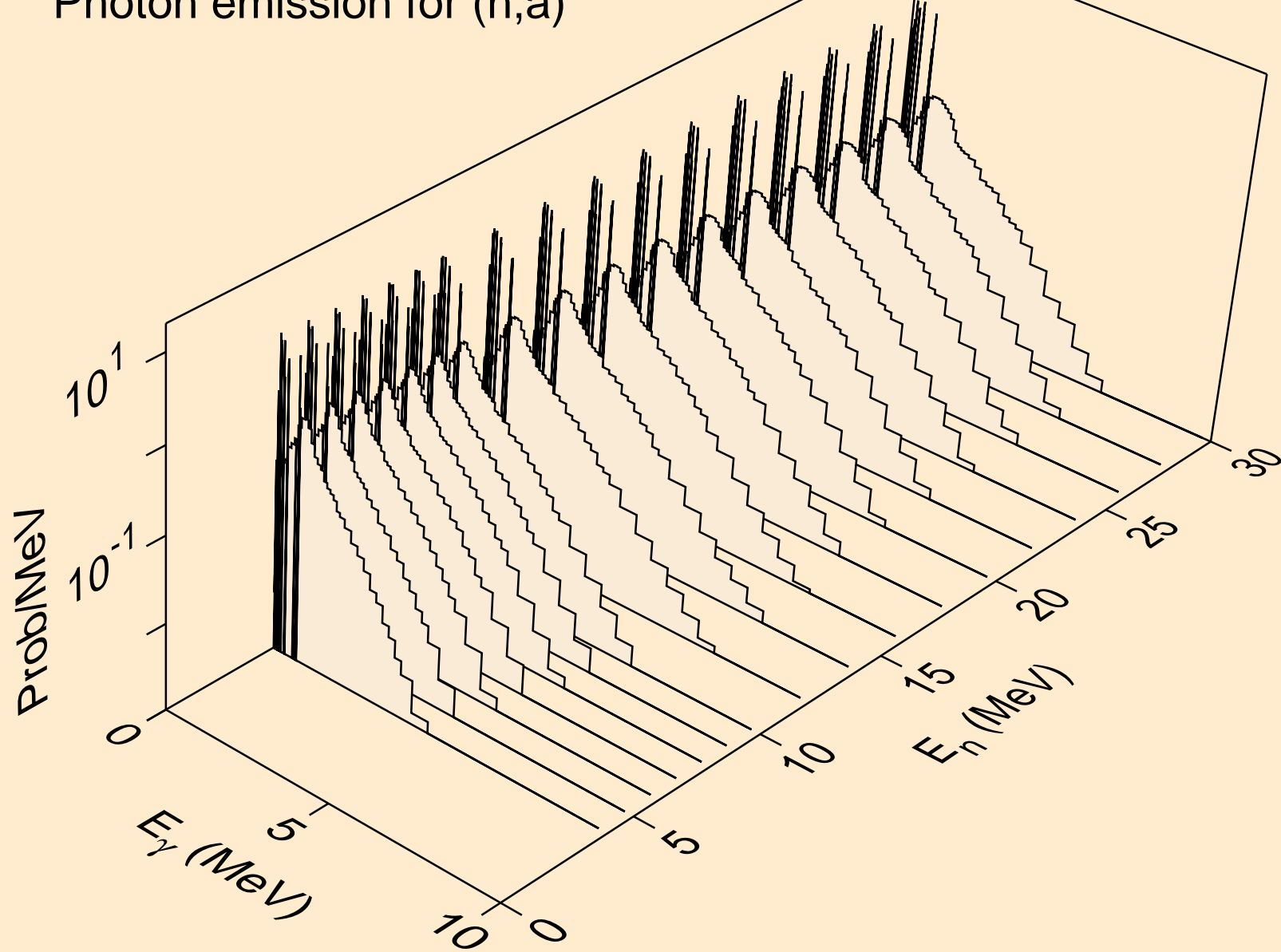

YB151M TRITON ACER TENDL-2021 LIBRARY; T=0.K  
Photon emission for (n,2a)

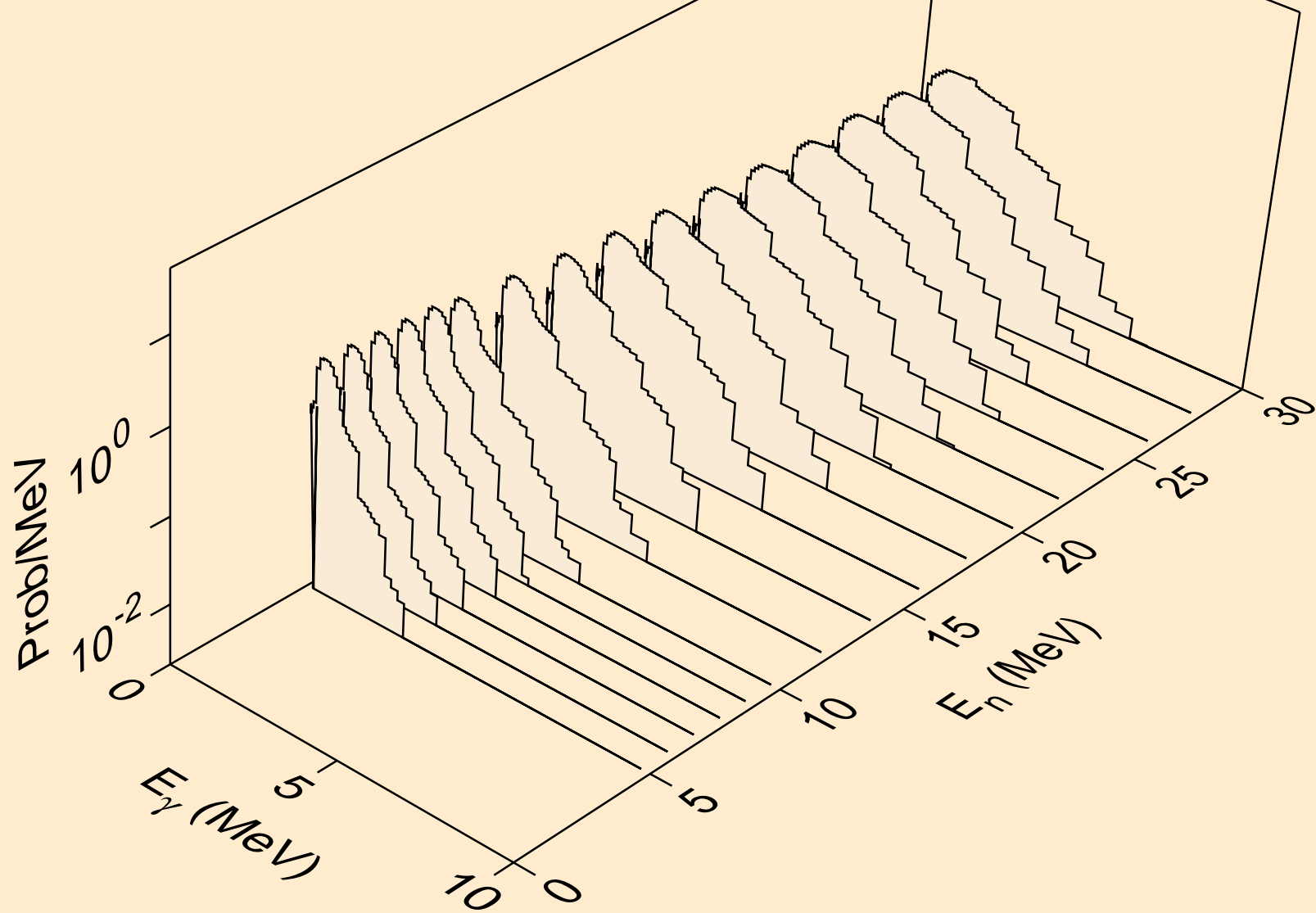

YB151M TRITON ACER TENDL-2021 LIBRARY; T=0.K  
Photon emission for (n,3a)

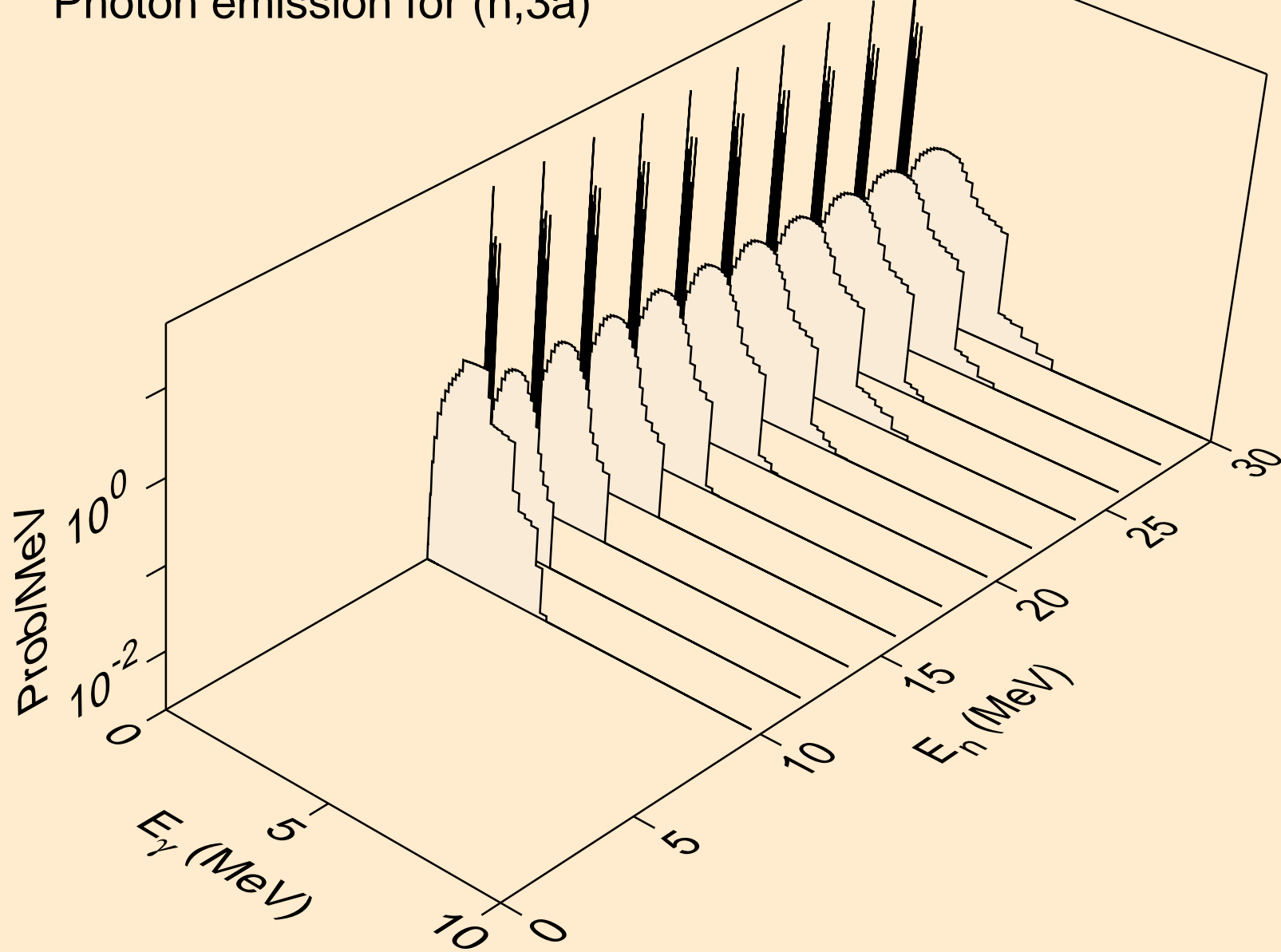

YB151M TRITON ACER TENDL-2021 LIBRARY; T=0.K  
Photon emission for (n,2p)

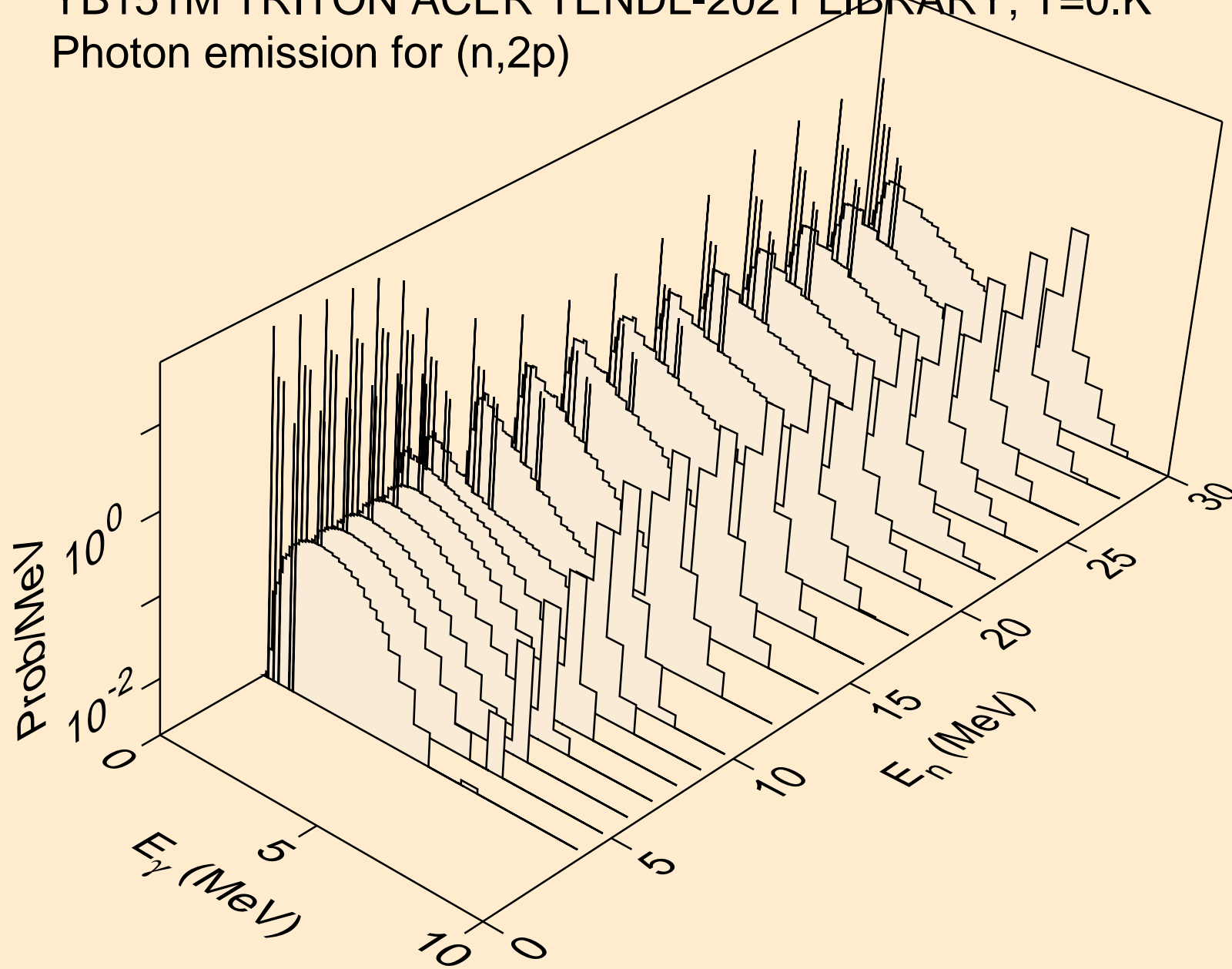

YB151M TRITON ACER TENDL-2021 LIBRARY; T=0.K  
Photon emission for (n,pa)

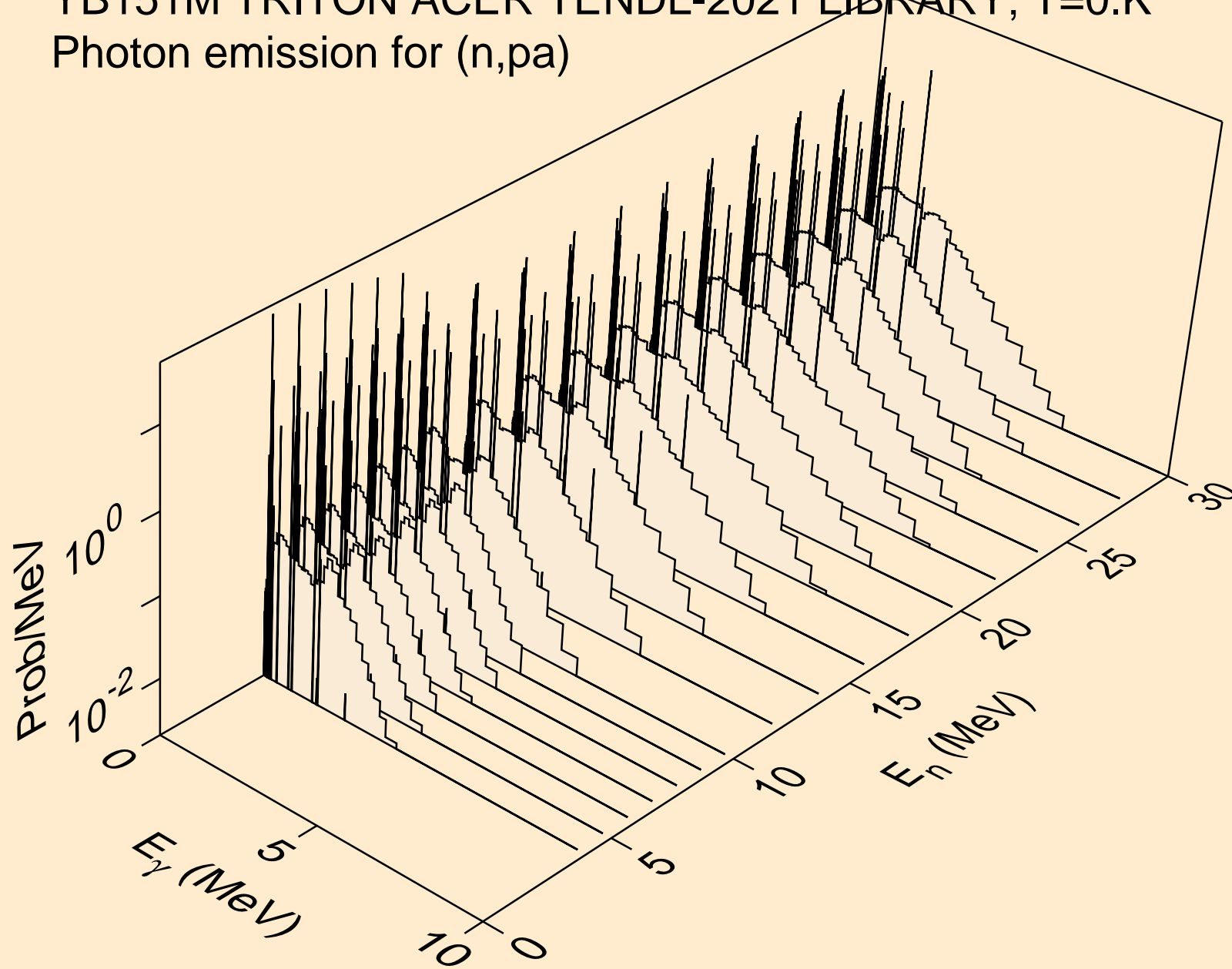

YB151M TRITON ACER TENDL-2021 LIBRARY; T=0.K  
Photon emission for (n,d2a)

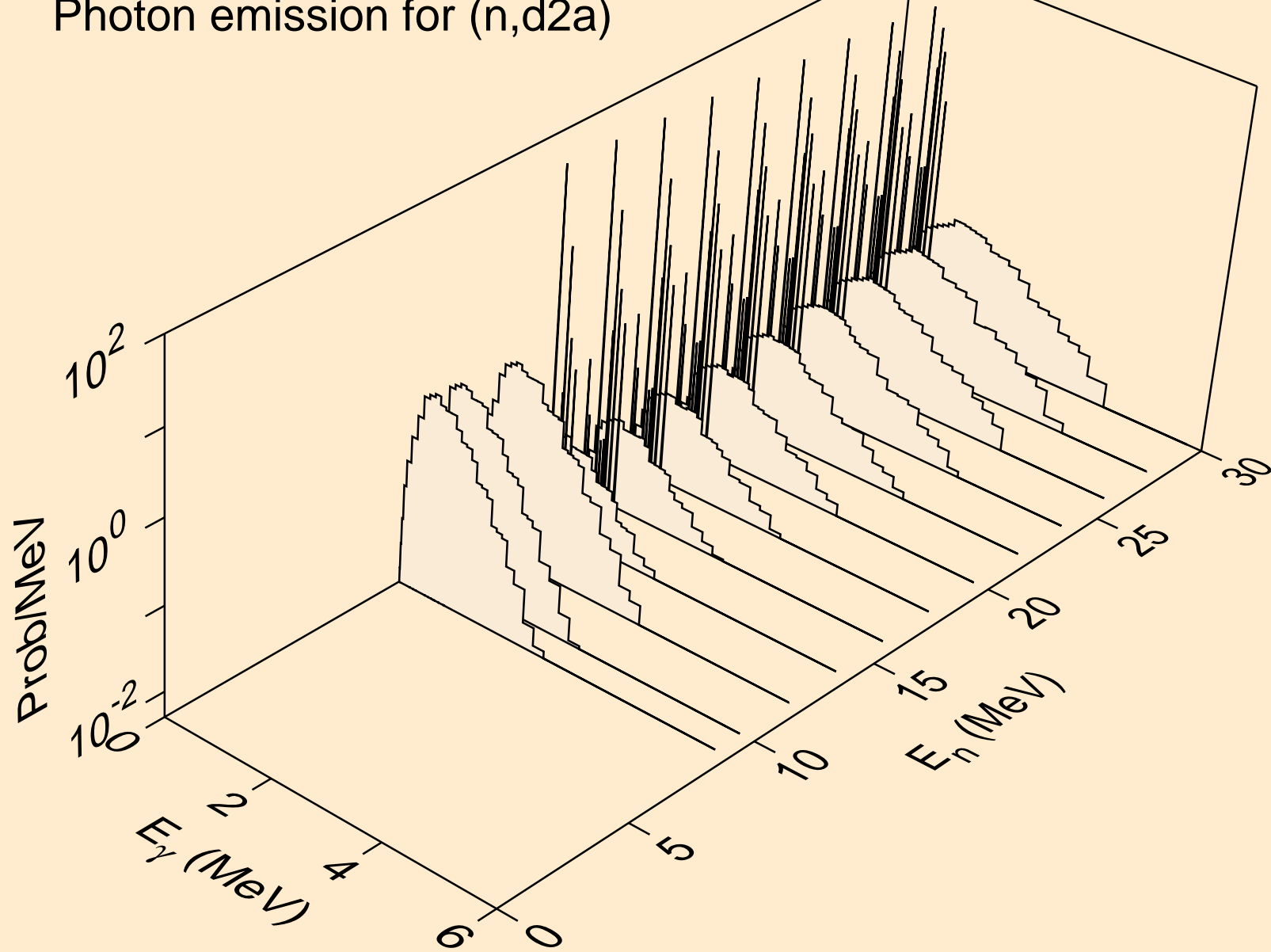

YB151M TRITON ACER TENDL-2021 LIBRARY; T=0.K  
Photon emission for (n,pd)

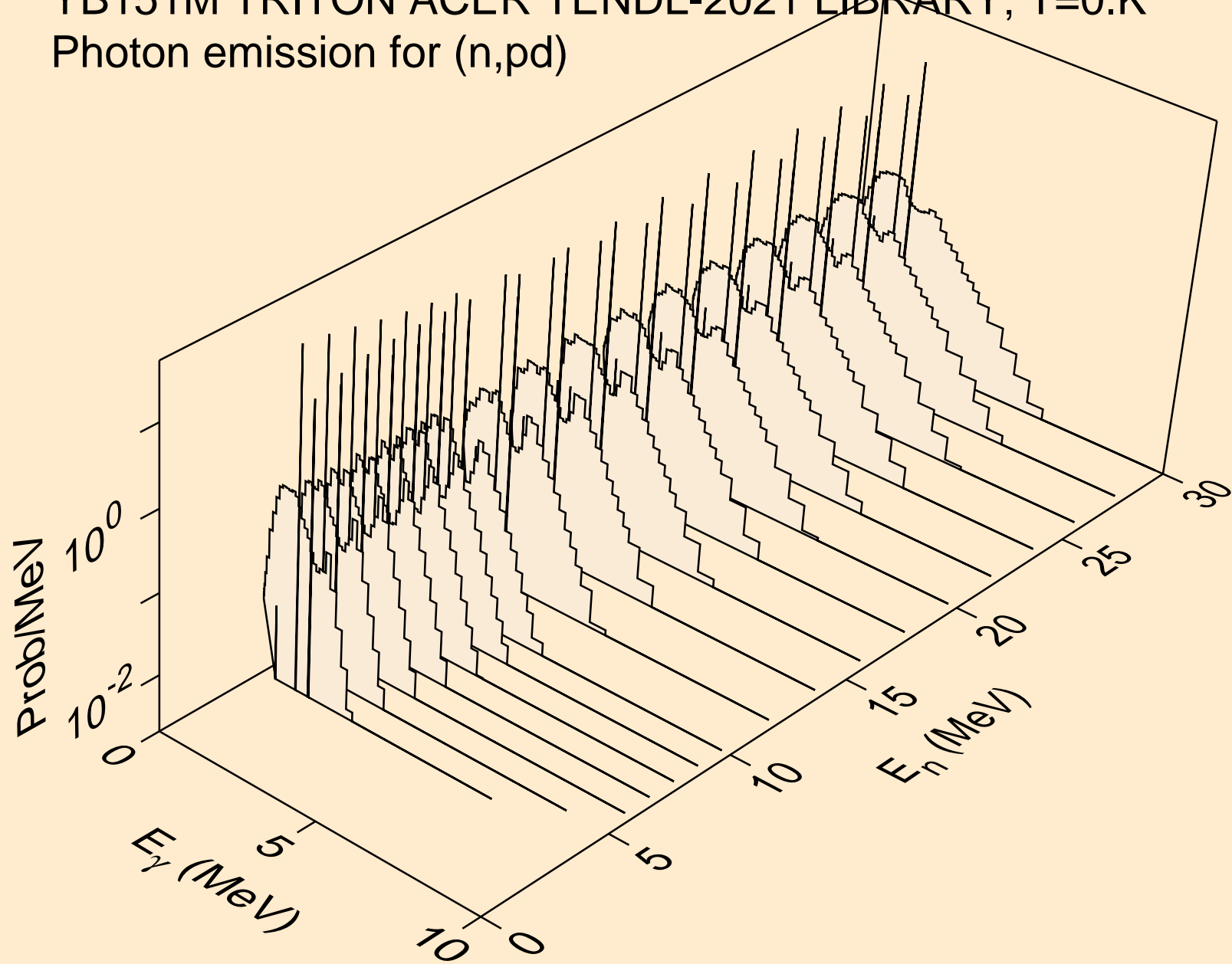



YB151M TRITON ACER TENDL-2021 LIBRARY; T=0.K  
Photon emission for (n,pt)

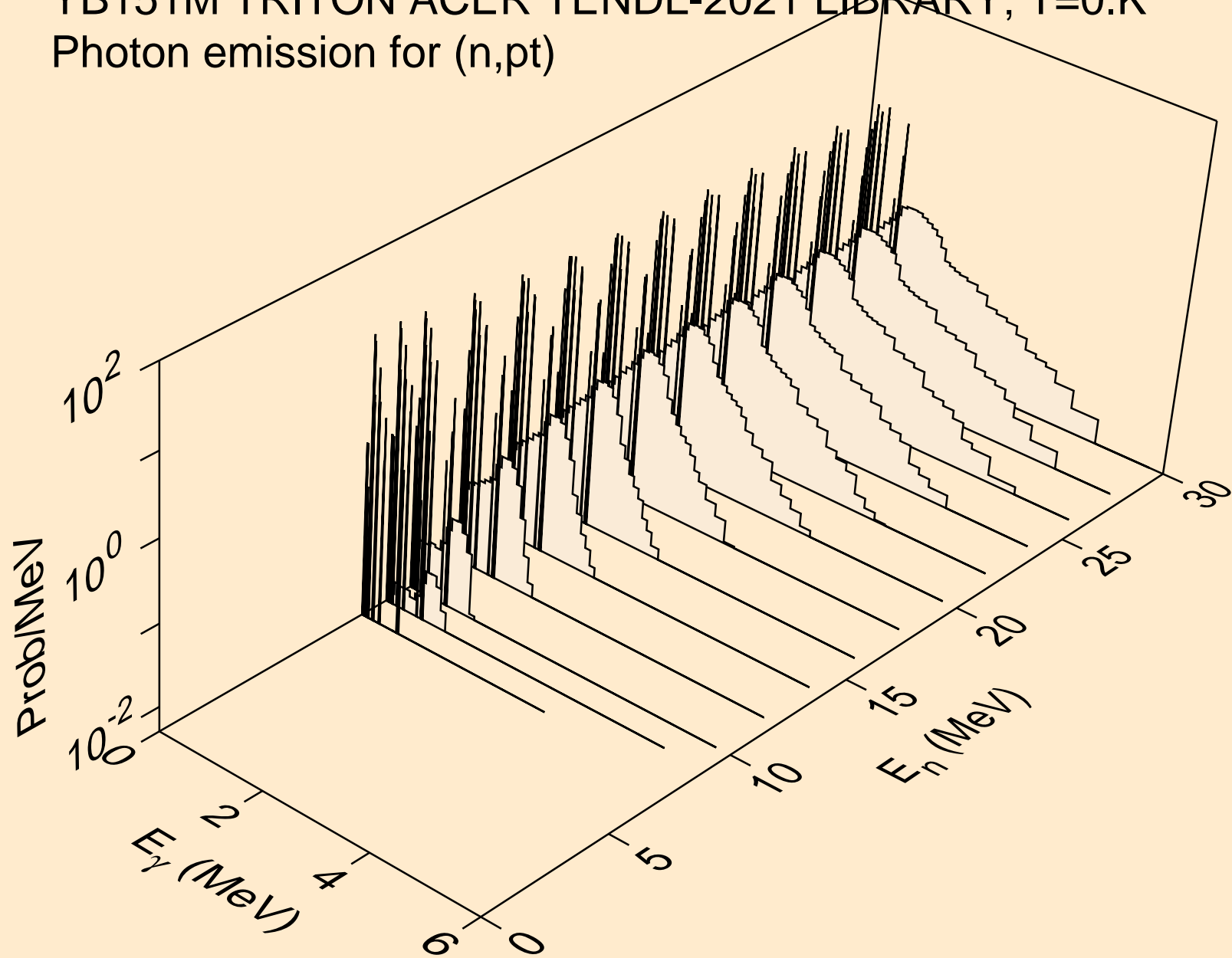

YB151M TRITON ACER TENDL-2021 LIBRARY; T=0.K  
Photon emission for (n,da)

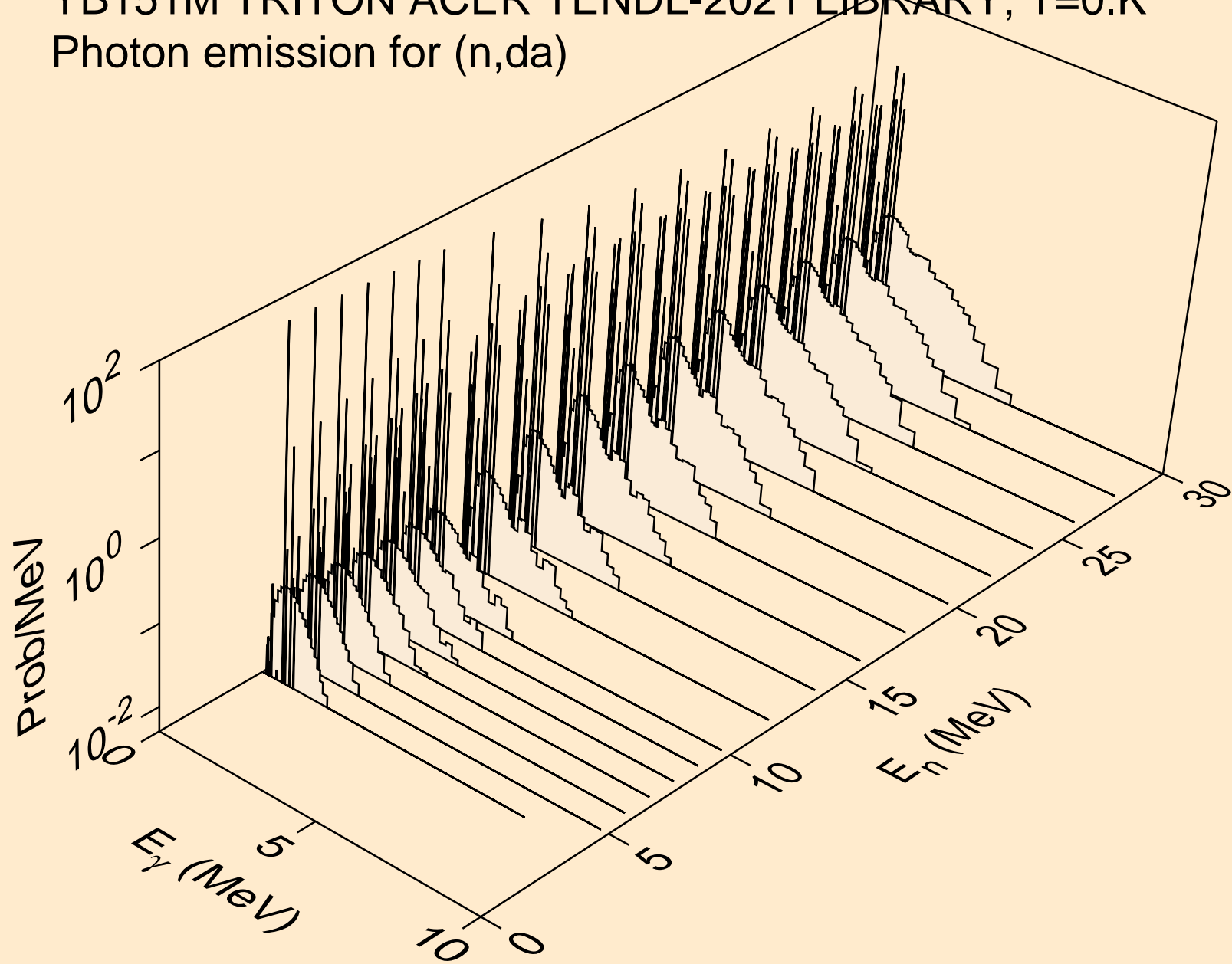

YB151M TRITON ACER TENDL-2021 LIBRARY; T=0.K  
Particle heating contributions

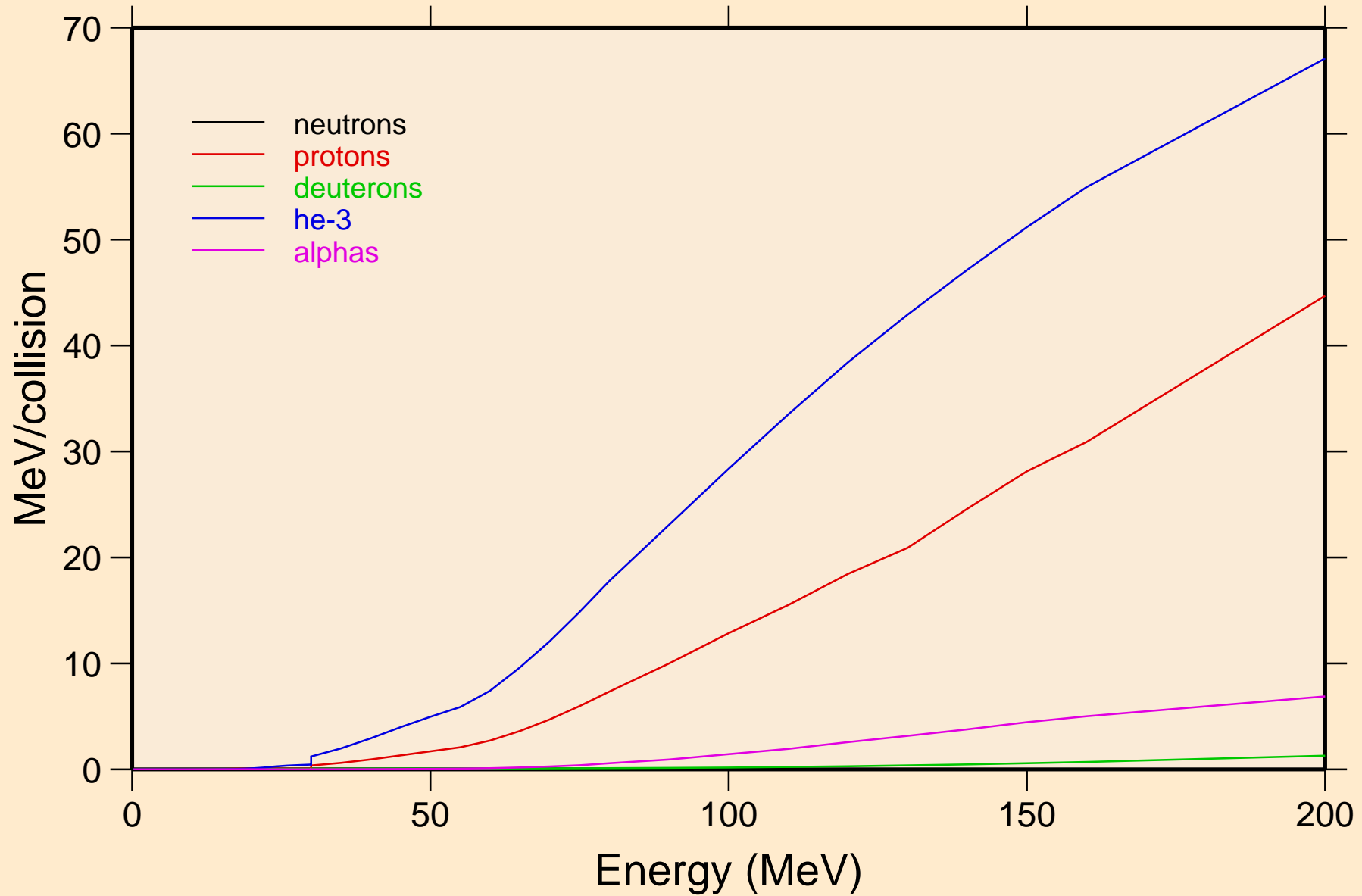

YB151M TRITON ACER TENDL-2021 LIBRARY; T=0.K  
Recoil Heating

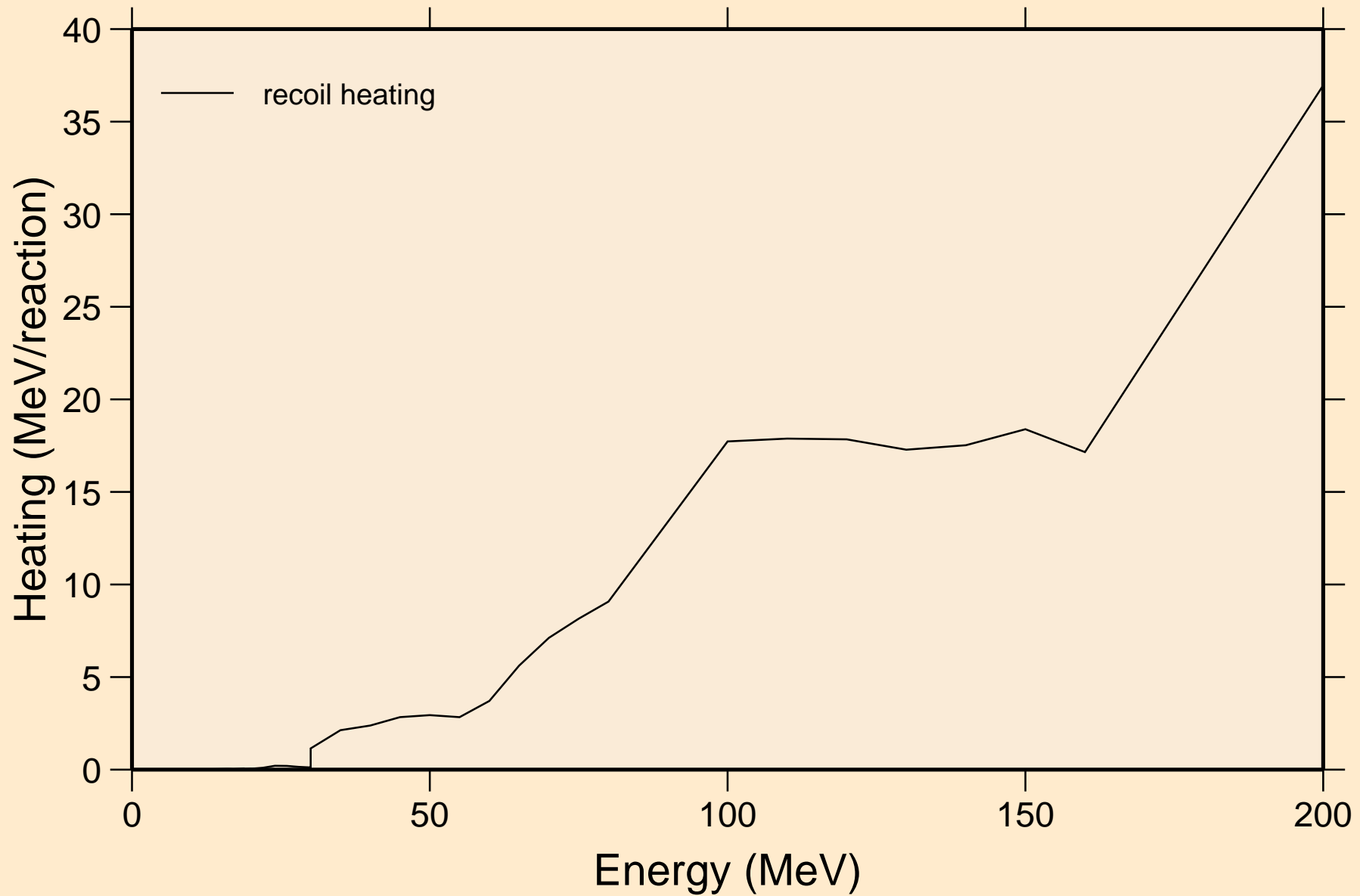

YB151M TRITON ACER TENDL-2021 LIBRARY; T=0.K  
Particle production cross sections

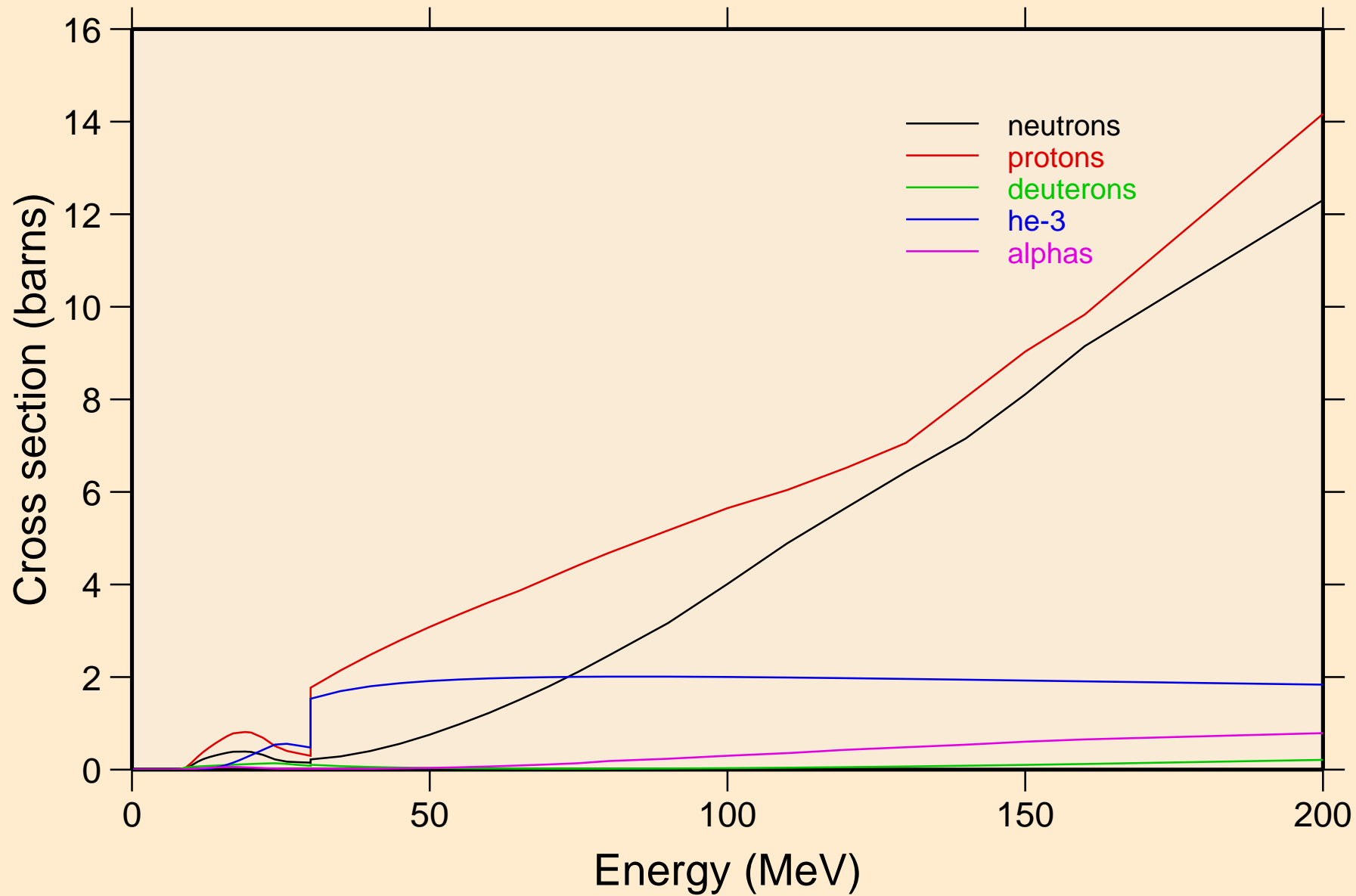

YB151M TRITON ACER TENDL-2021 LIBRARY; T=0.K  
neutrons from (t,n)

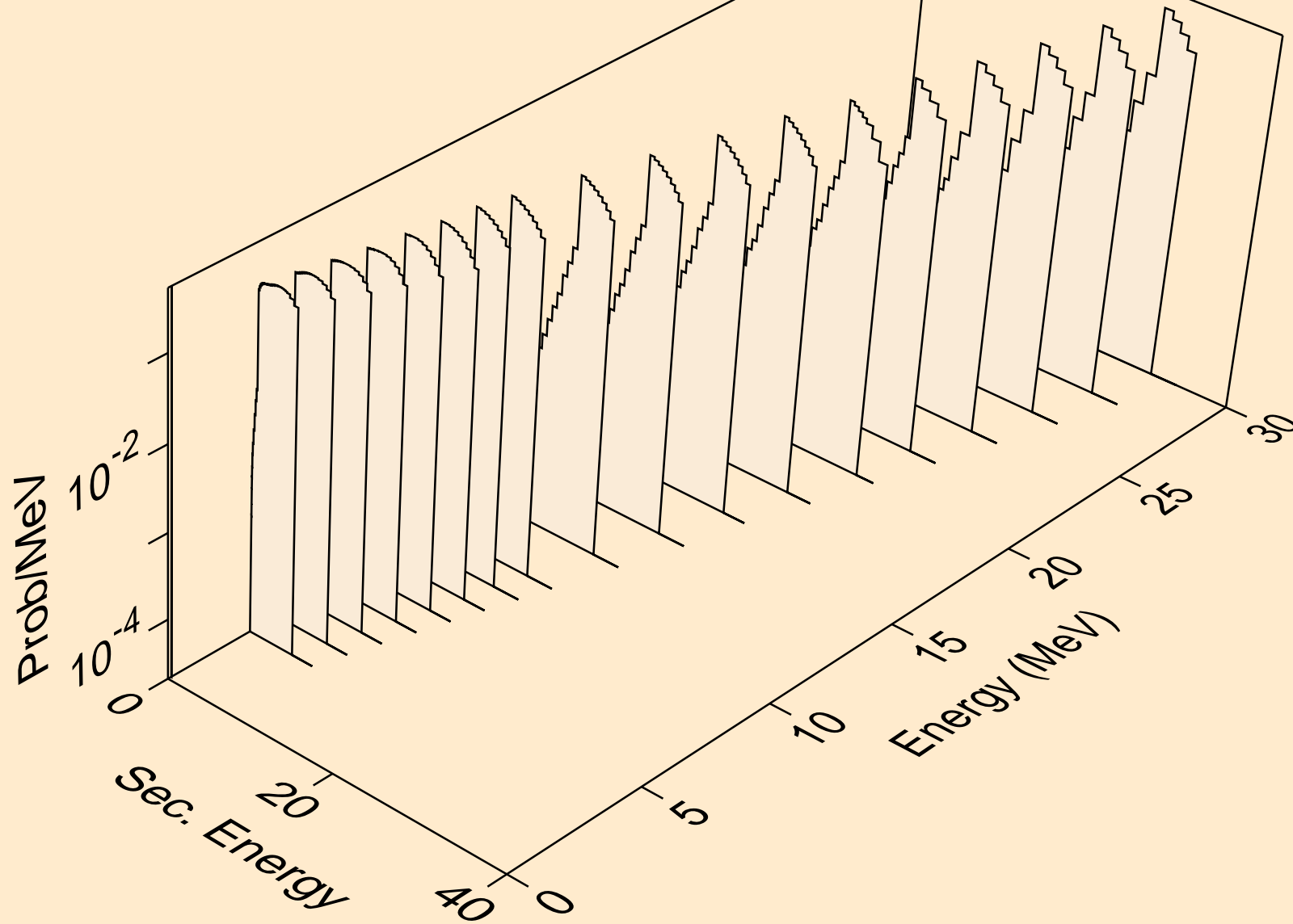

YB151M TRITON ACER TENDL-2021 LIBRARY; T=0.K  
neutrons from (t,x)

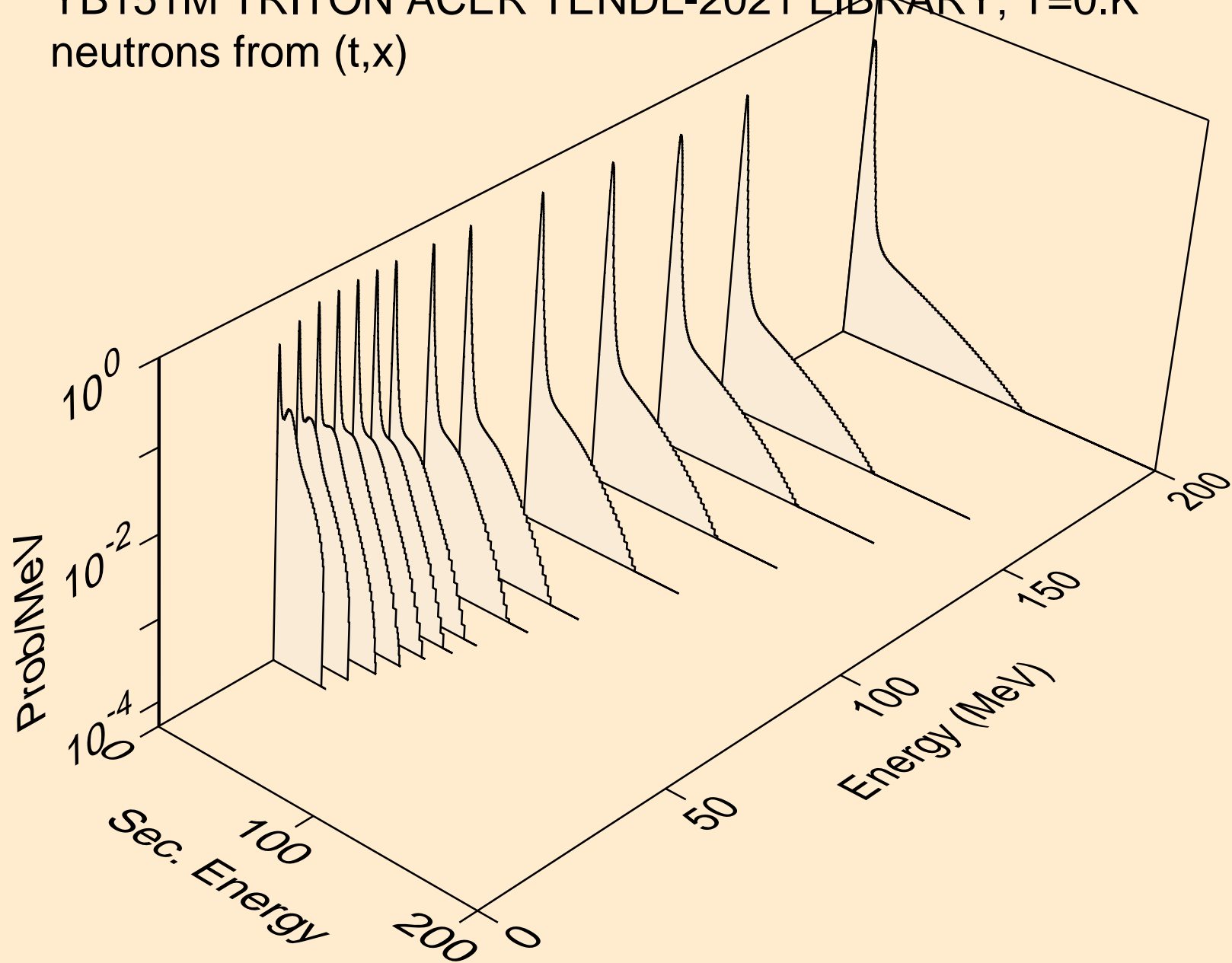

YB151M TRITON ACER TENDL-2021 LIBRARY; T=0.K  
neutrons from (t,2nd)

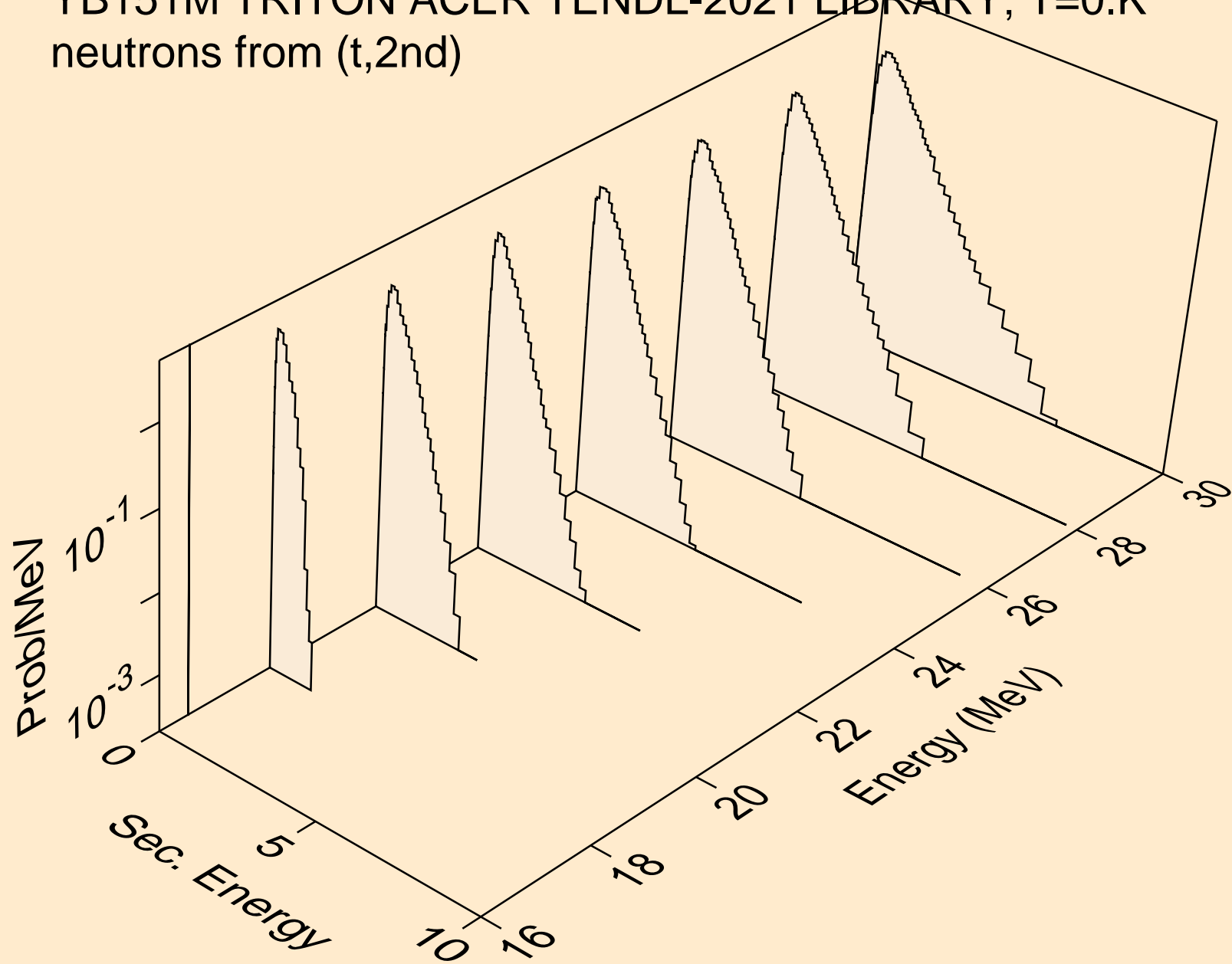



YB151M TRITON ACER TENDL-2021 LIBRARY; T=0.K  
neutrons from (t,2n)

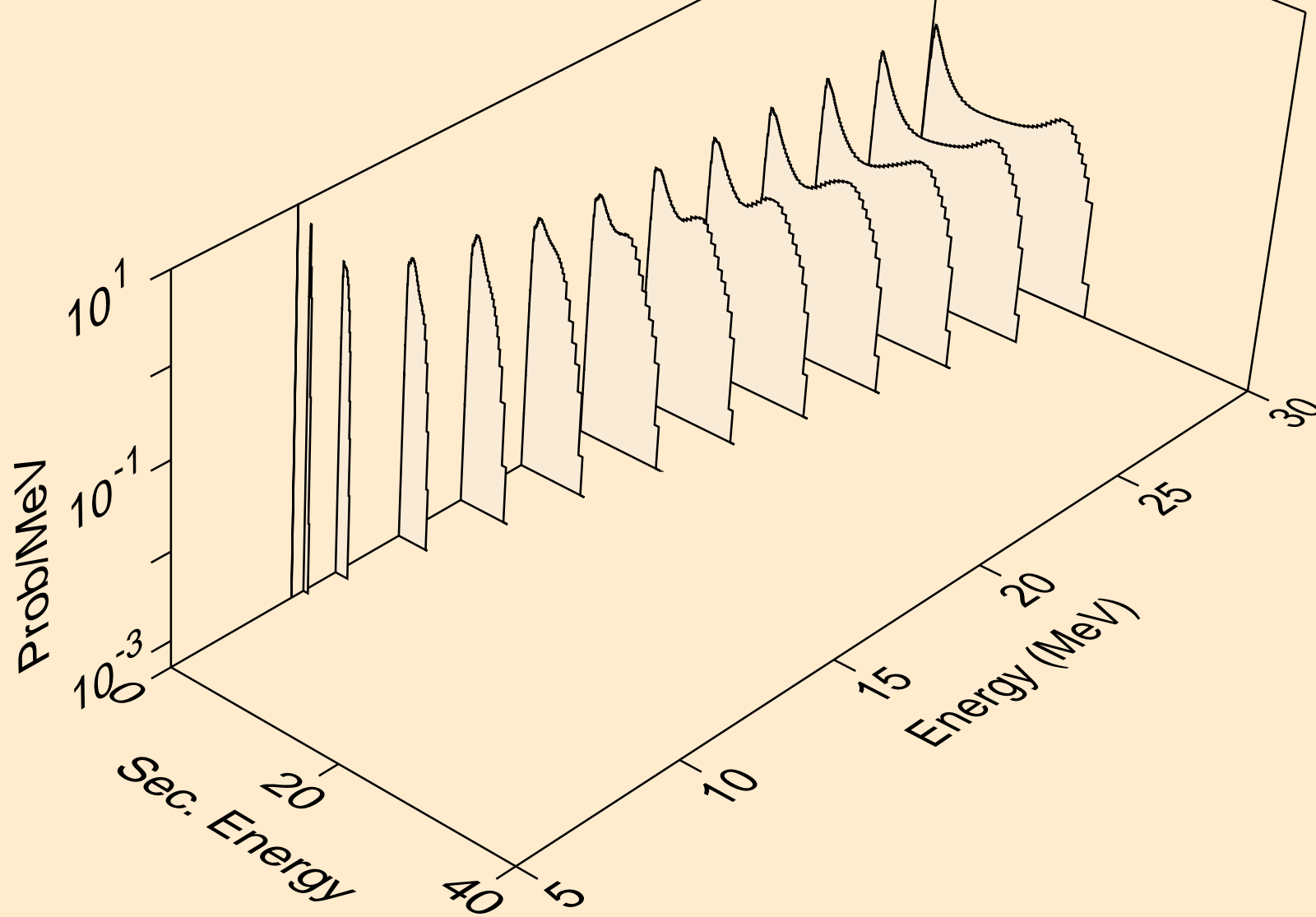

YB151M TRITON ACER TENDL-2021 LIBRARY; T=0.K  
neutrons from (t,3n)

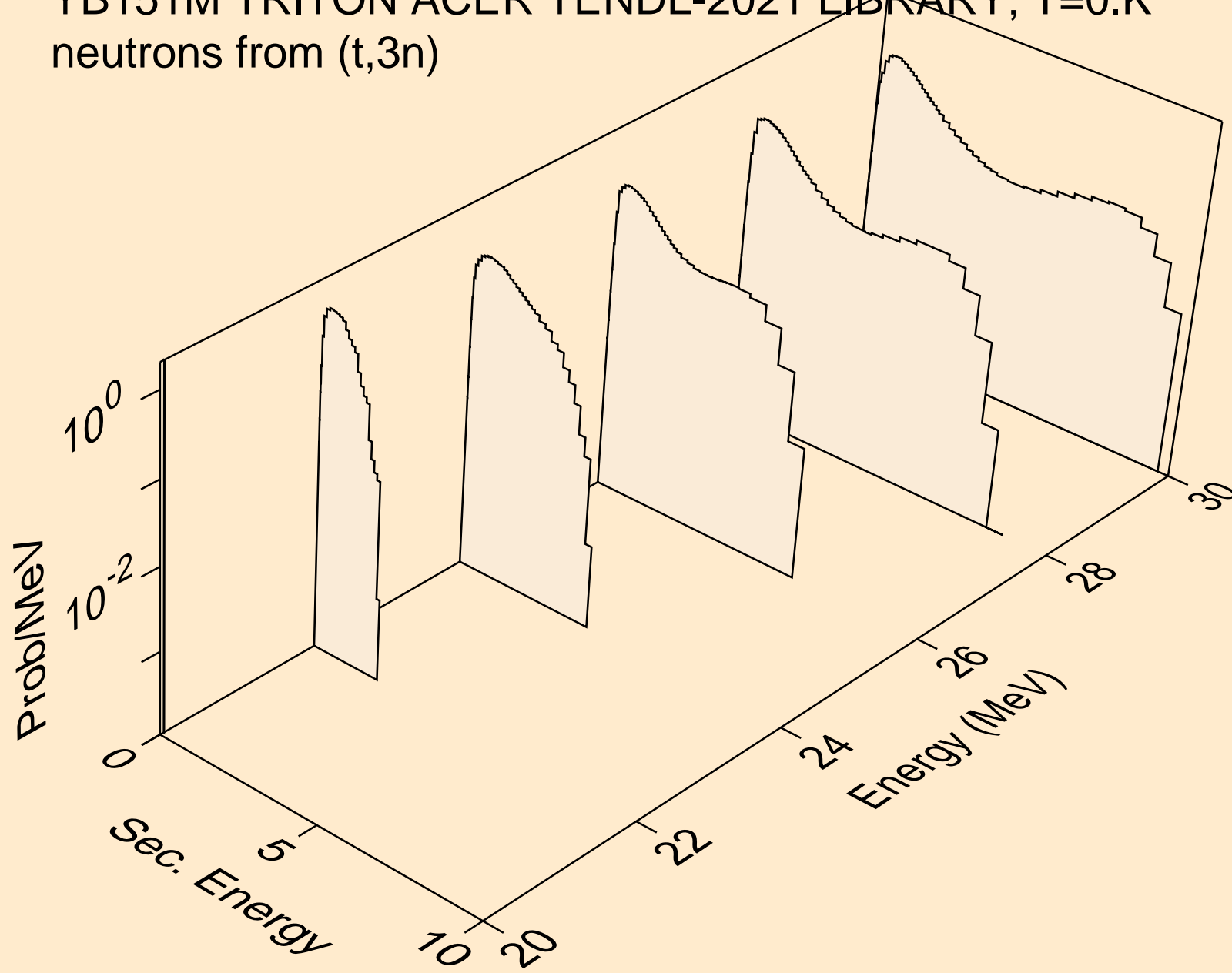

YB151M TRITON ACER TENDL-2021 LIBRARY; T=0.K  
neutrons from (t,n\*)a

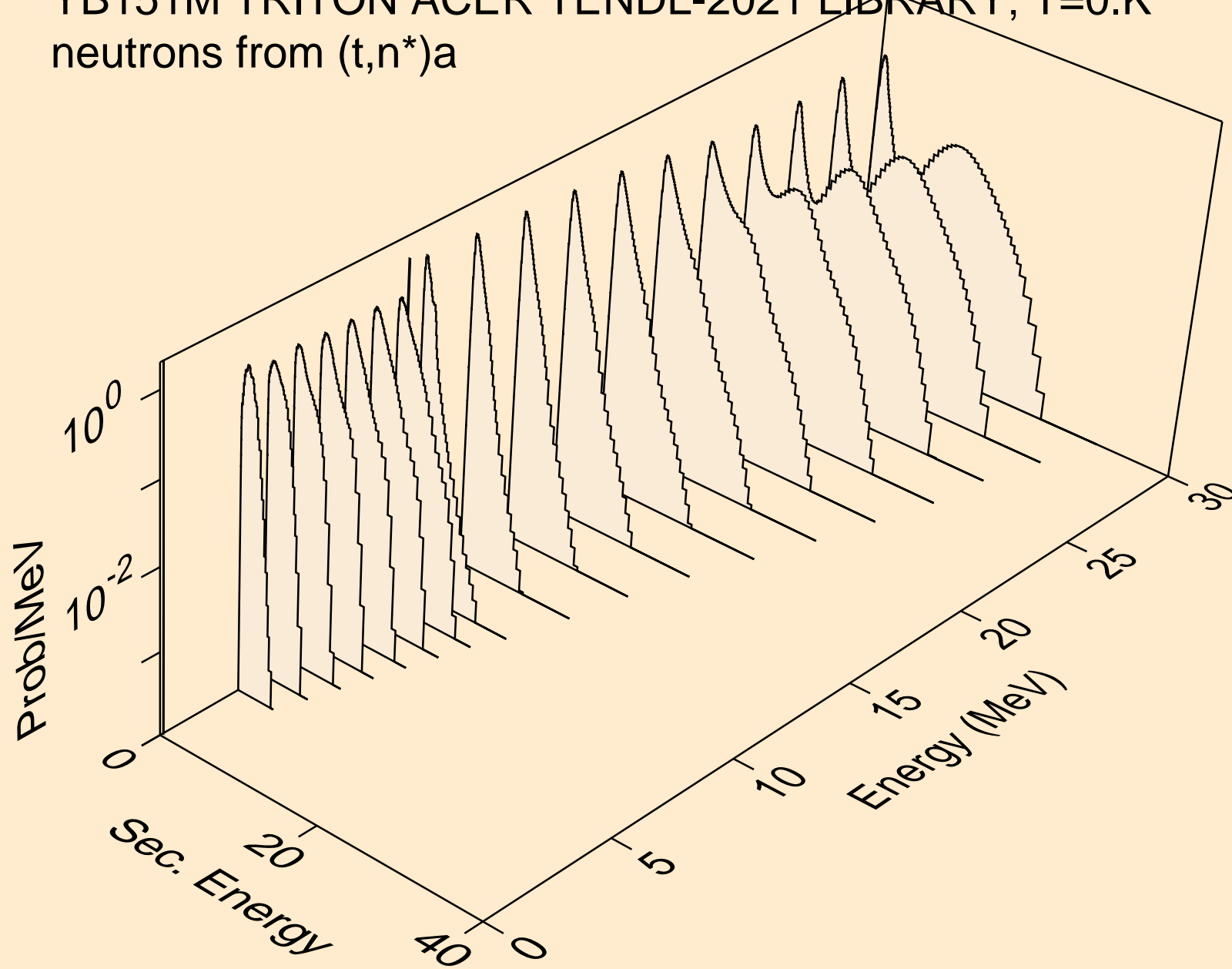

YB151M TRITON ACER TENDL-2021 LIBRARY; T=0.K  
neutrons from (t,2n)a

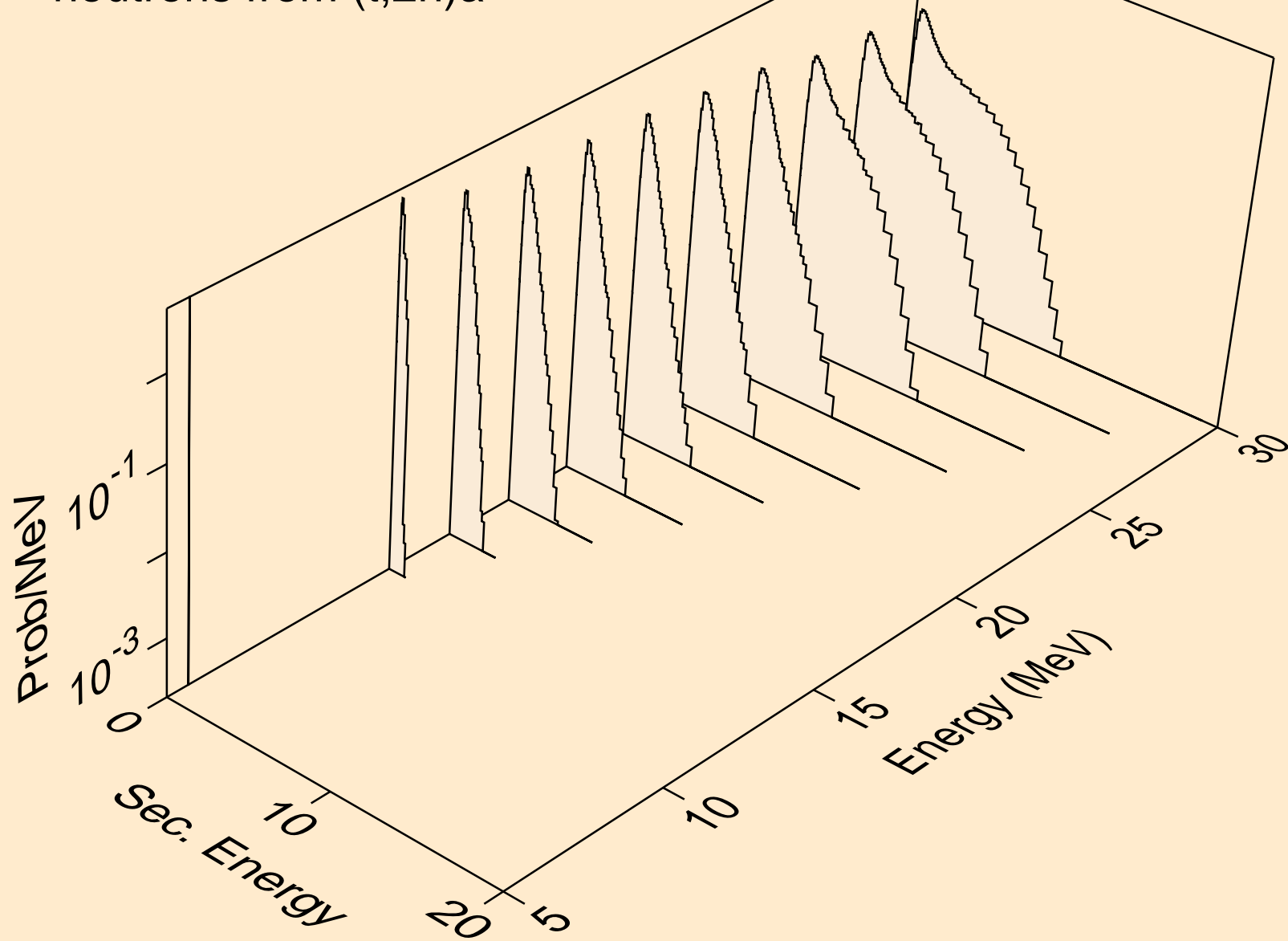

YB151M TRITON ACER TENDL-2021 LIBRARY; T=0.K  
neutrons from (t,n\*)p

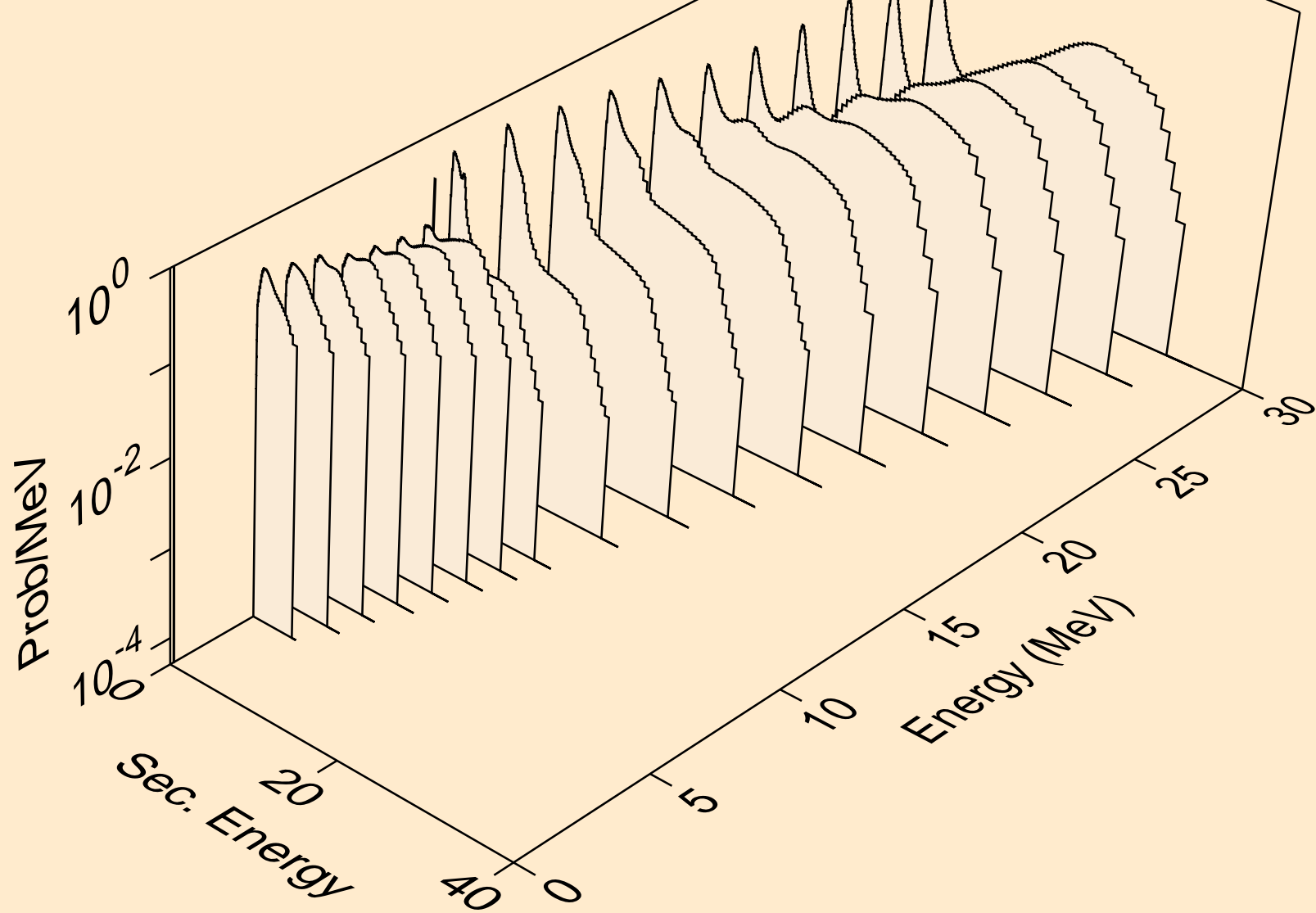

YB151M TRITON ACER TENDL-2021 LIBRARY; T=0.K  
neutrons from (t,n\*)2a

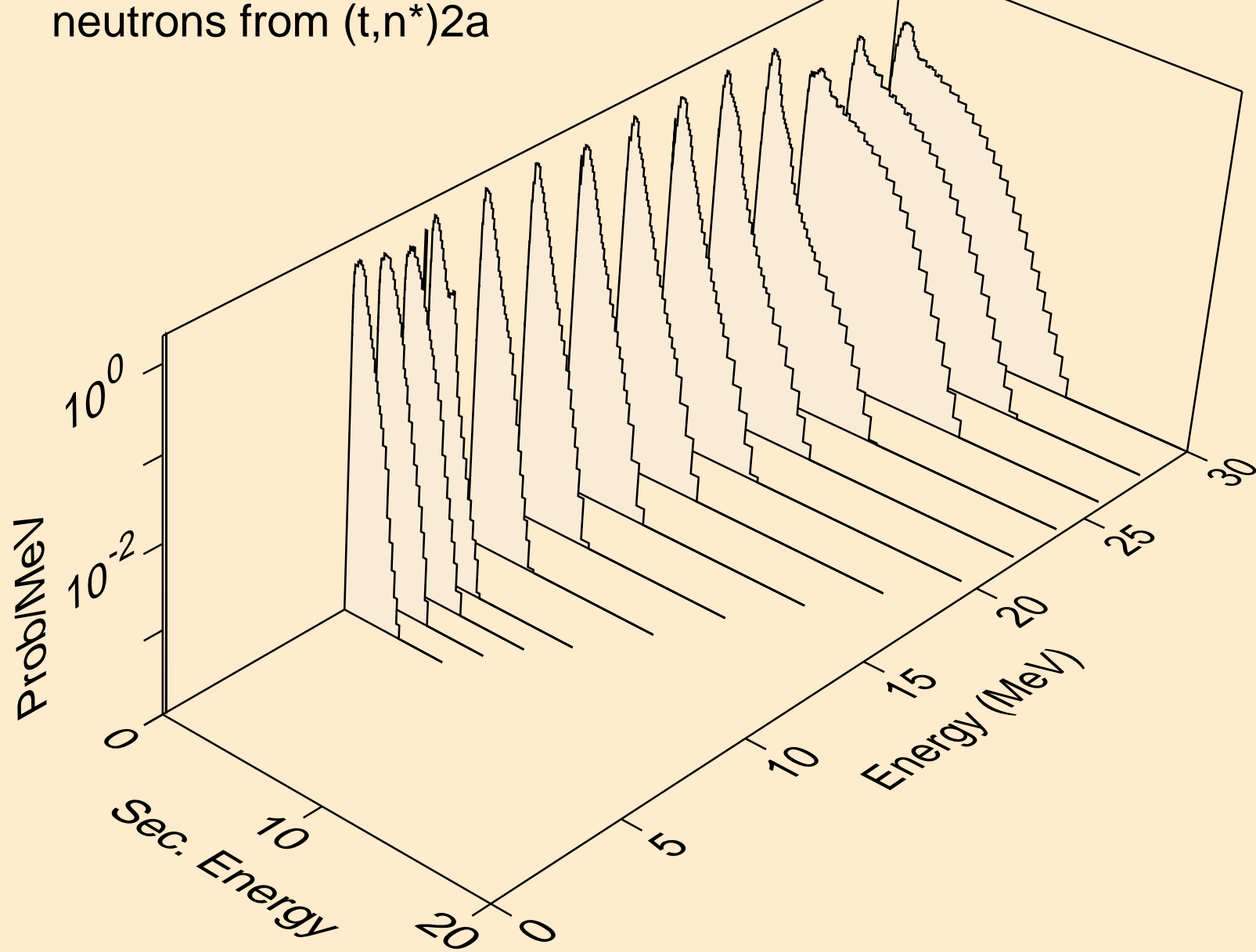

YB151M TRITON ACER TENDL-2021 LIBRARY; T=0.K  
neutrons from (t,n\*)d

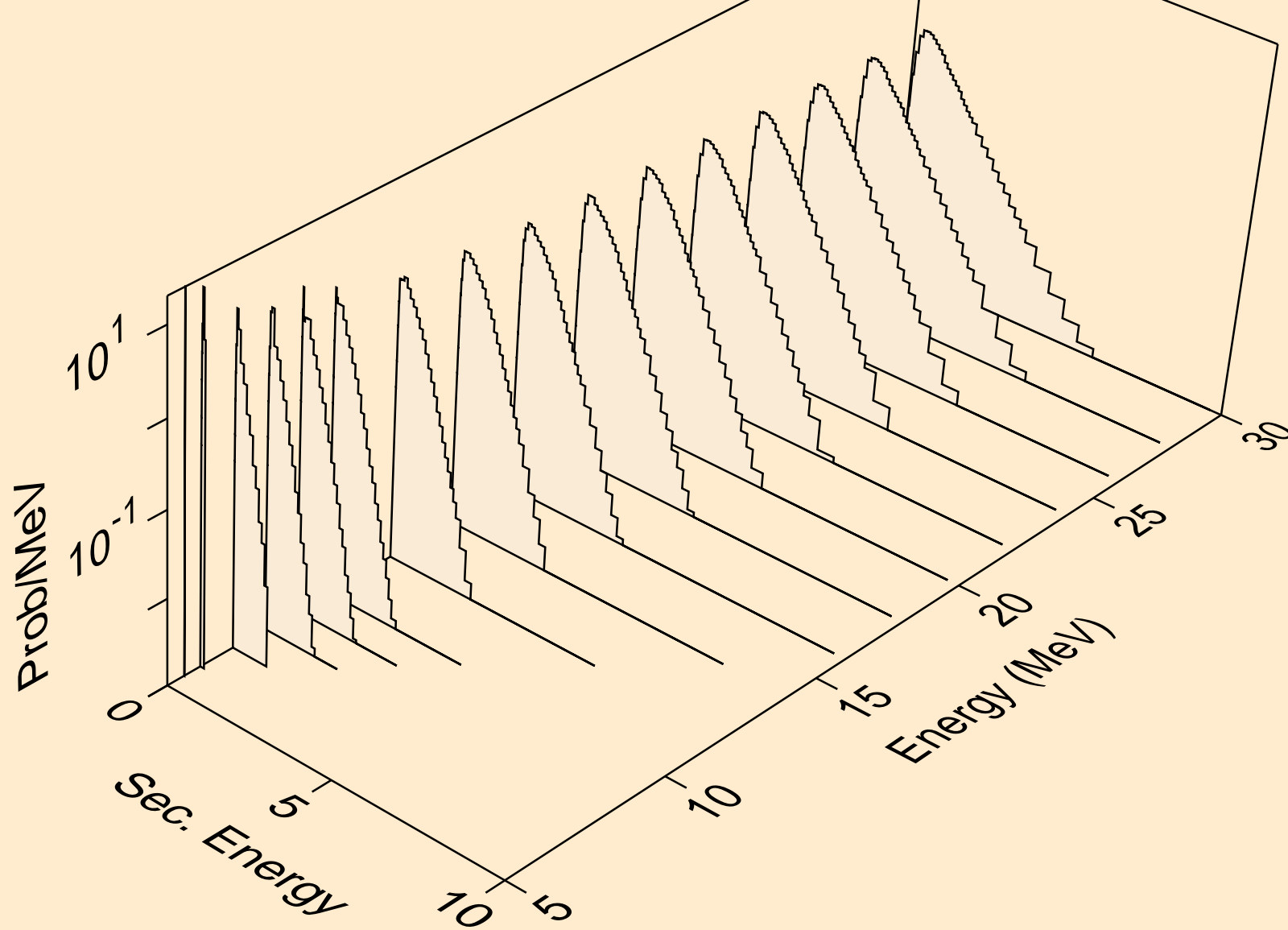

YB151M TRITON ACER TENDL-2021 LIBRARY; T=0.K  
neutrons from (t,n\*)t

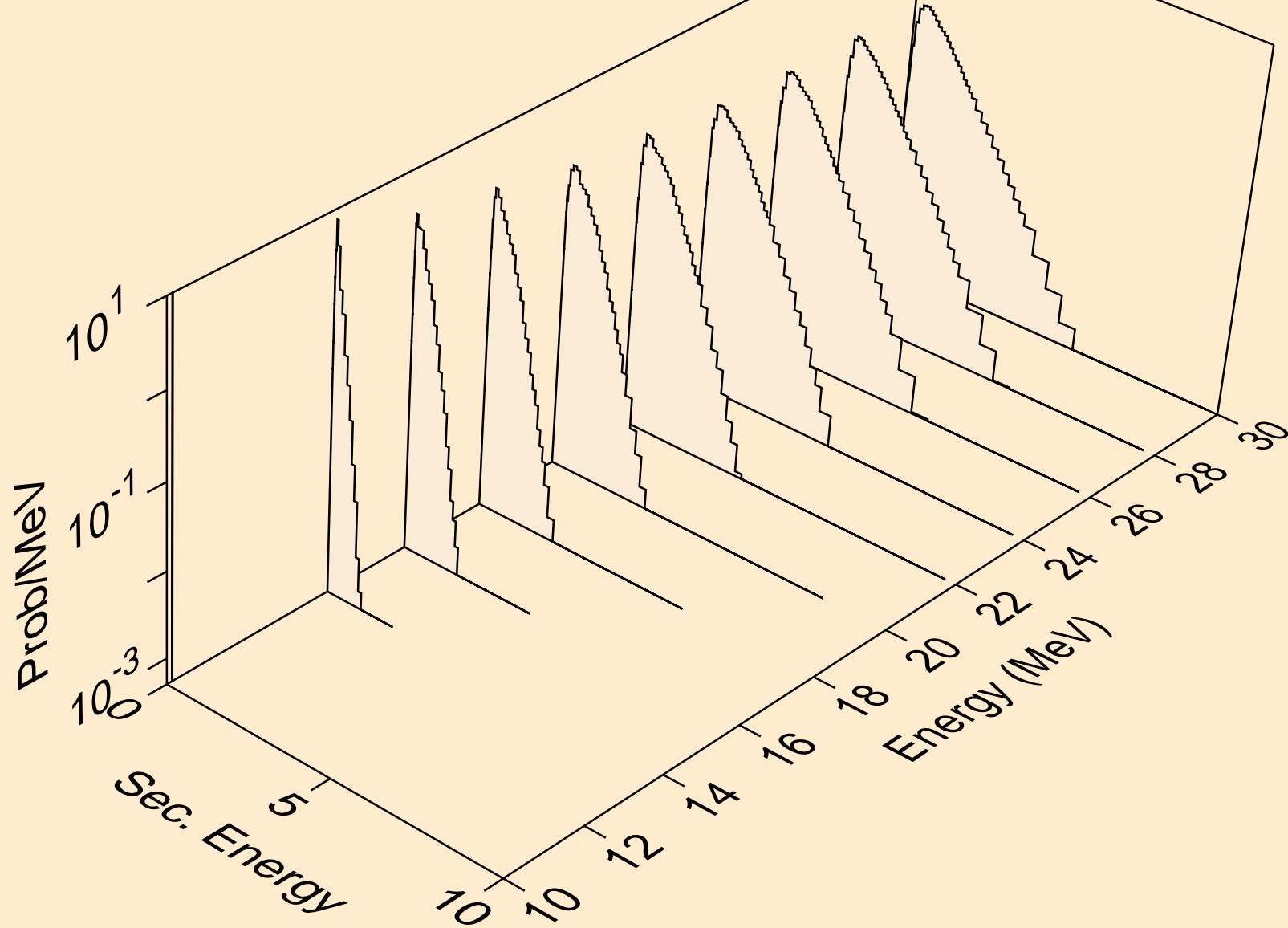



YB151M TRITON ACER TENDL-2021 LIBRARY; T=0.K  
neutrons from (t,n\*)he3

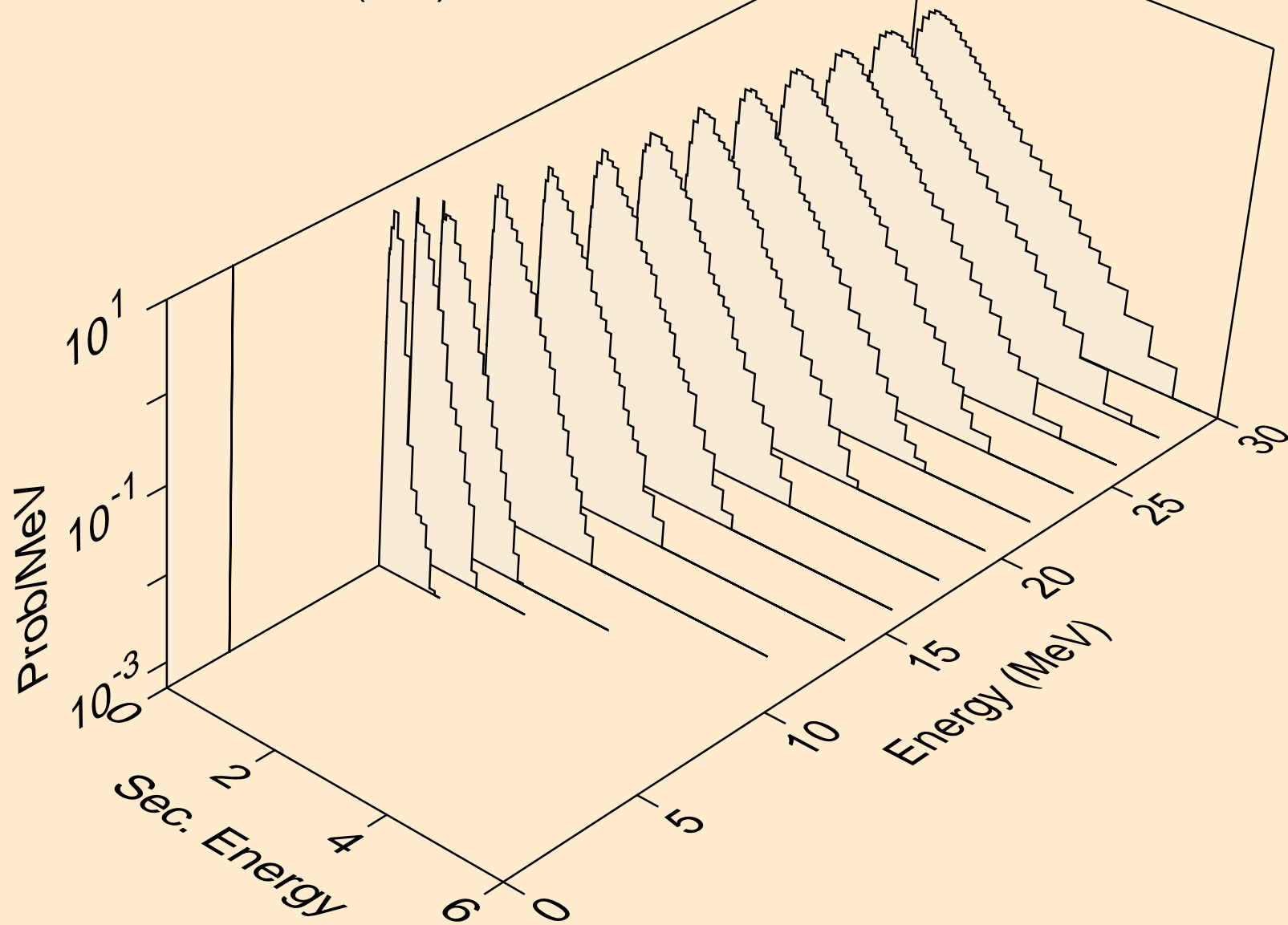

YB151M TRITON ACER TENDL-2021 LIBRARY; T=0.K  
neutrons from (t,2np)

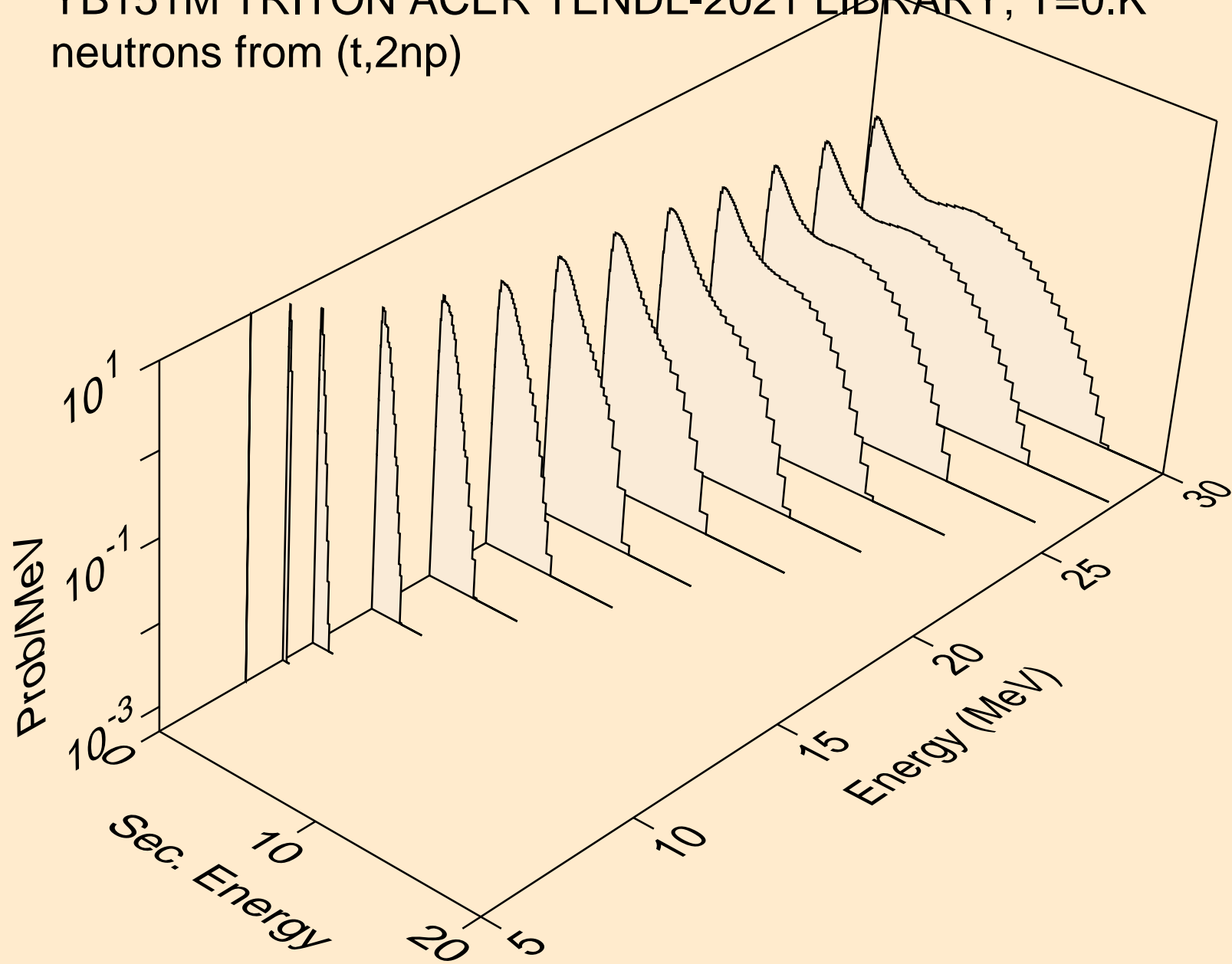

YB151M TRITON ACER TENDL-2021 LIBRARY; T=0.K  
neutrons from (t,3np)

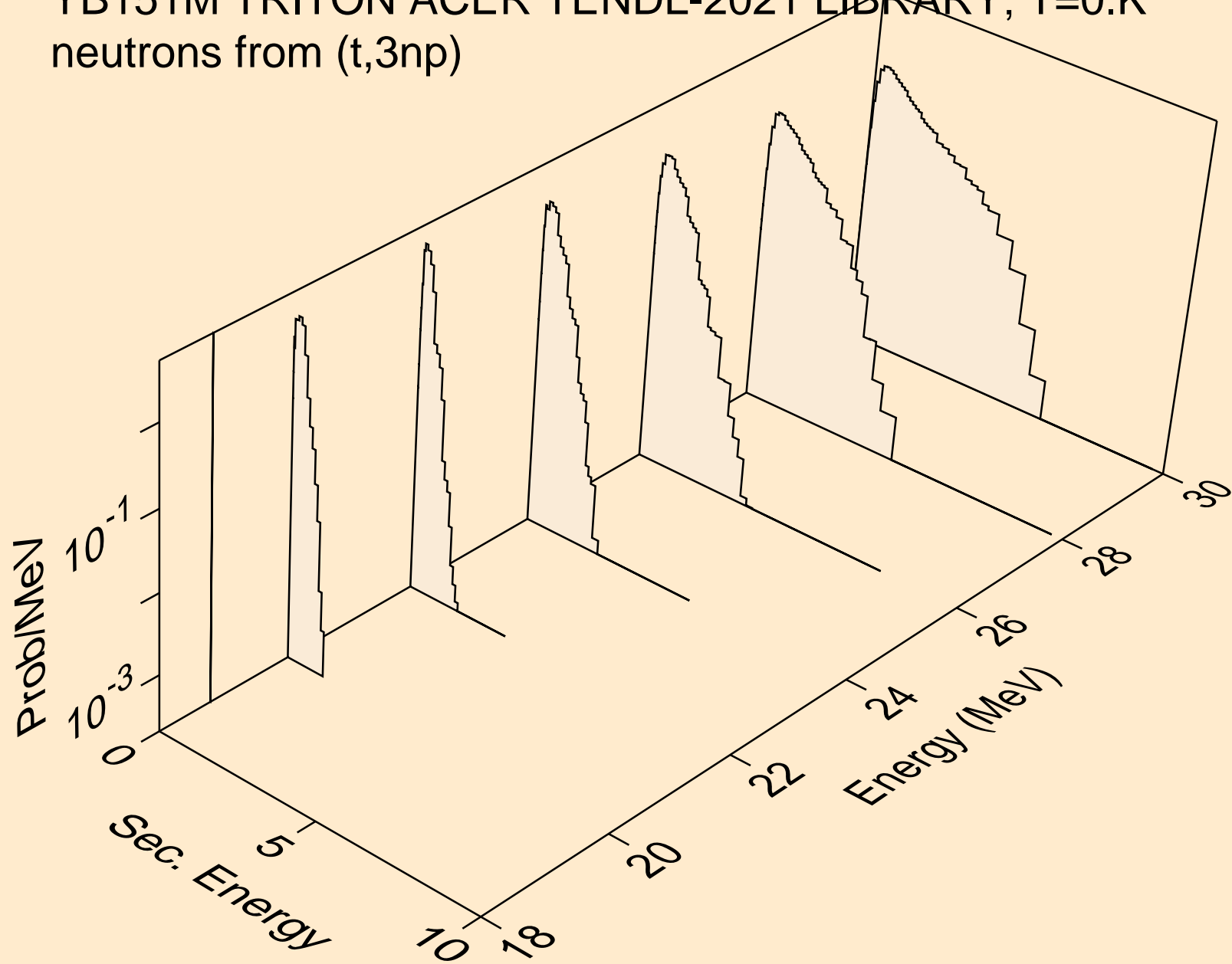

YB151M TRITON ACER TENDL-2021 LIBRARY; T=0.K  
neutrons from (t,2np)

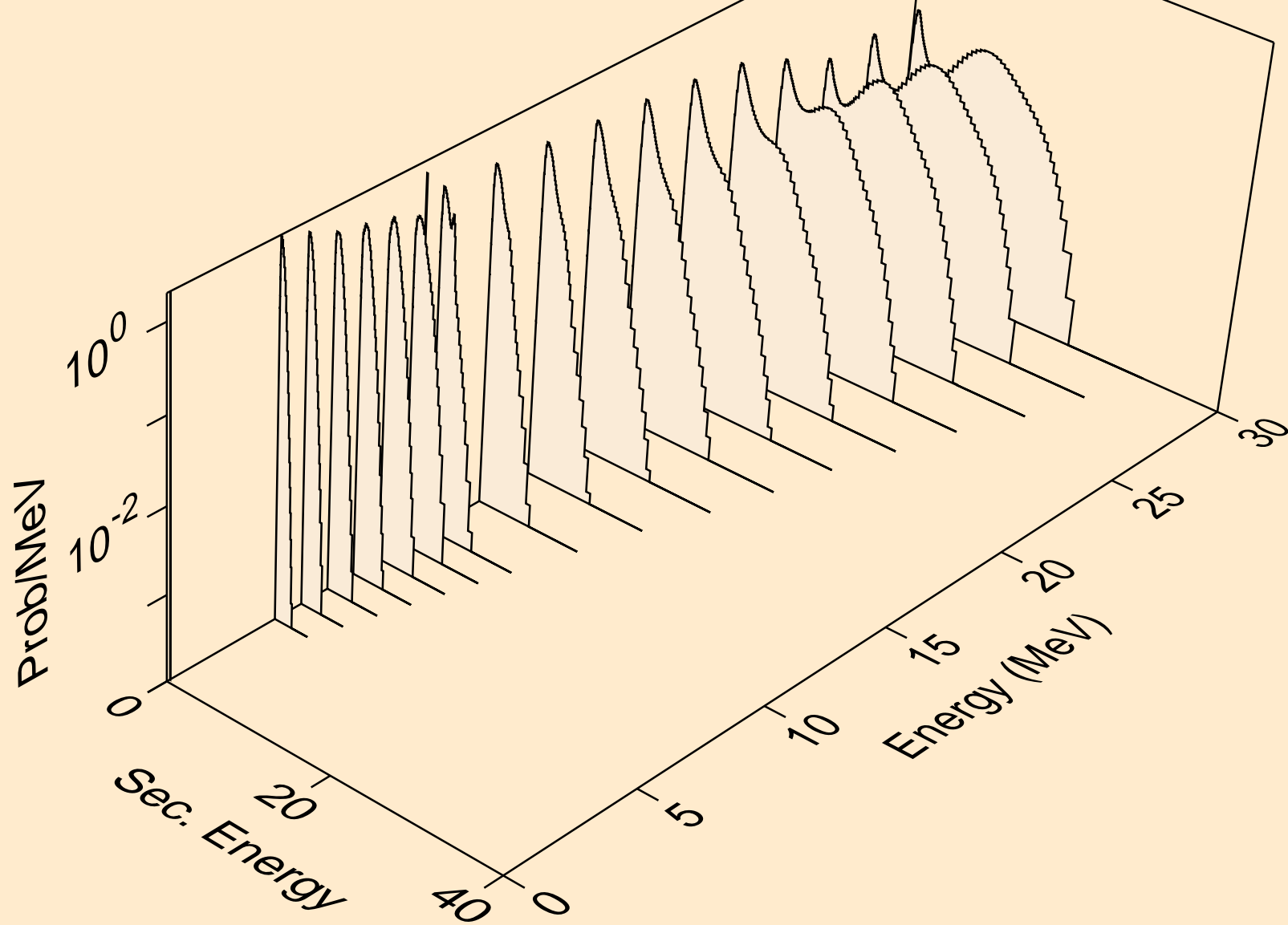

YB151M TRITON ACER TENDL-2021 LIBRARY; T=0.K  
neutrons from (t,npa)

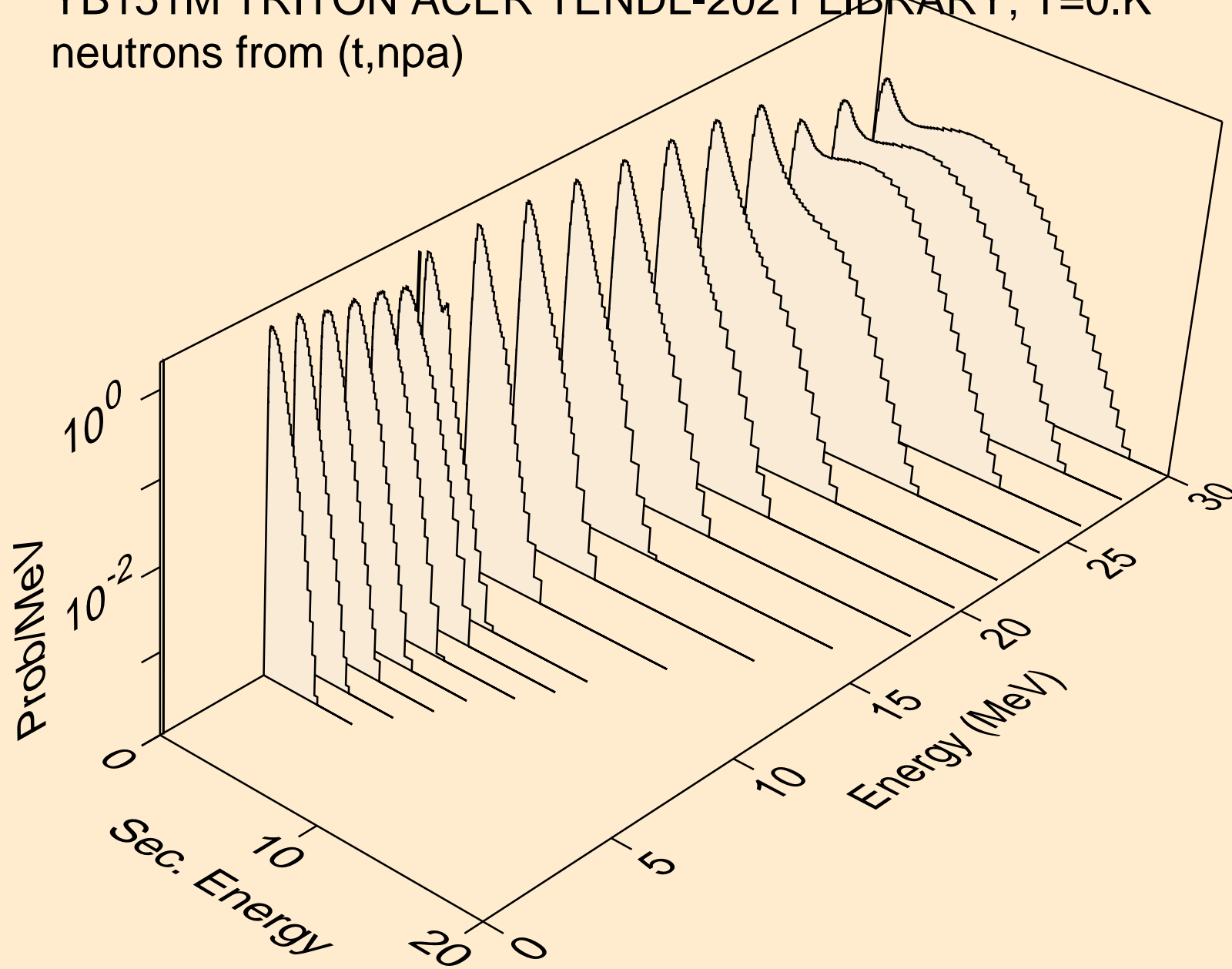

YB151M TRITON ACER TENDL-2021 LIBRARY; T=0.K  
protons from (t,x)

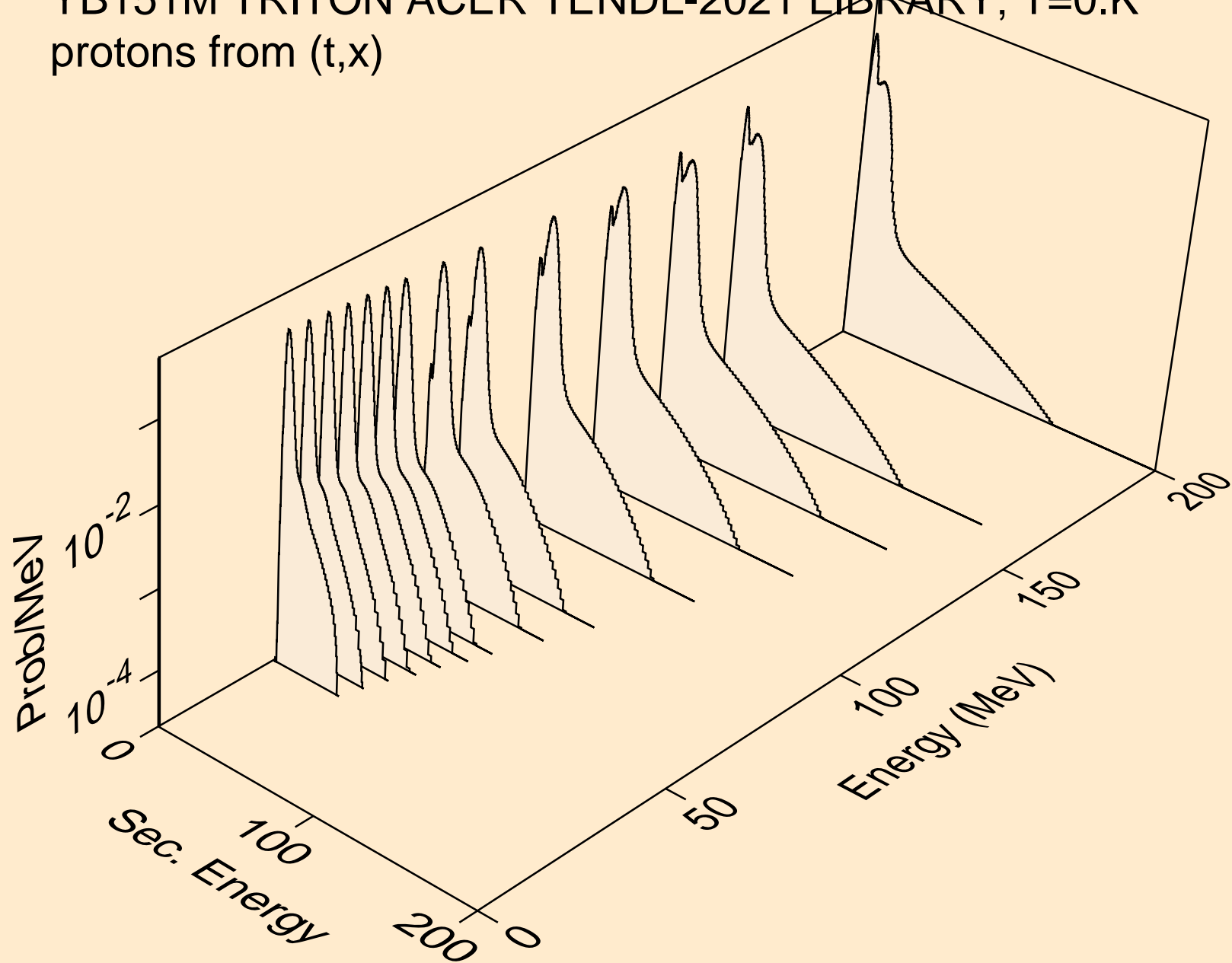

YB151M TRITON ACER TENDL-2021 LIBRARY; T=0.K  
protons from (t,n\*)p

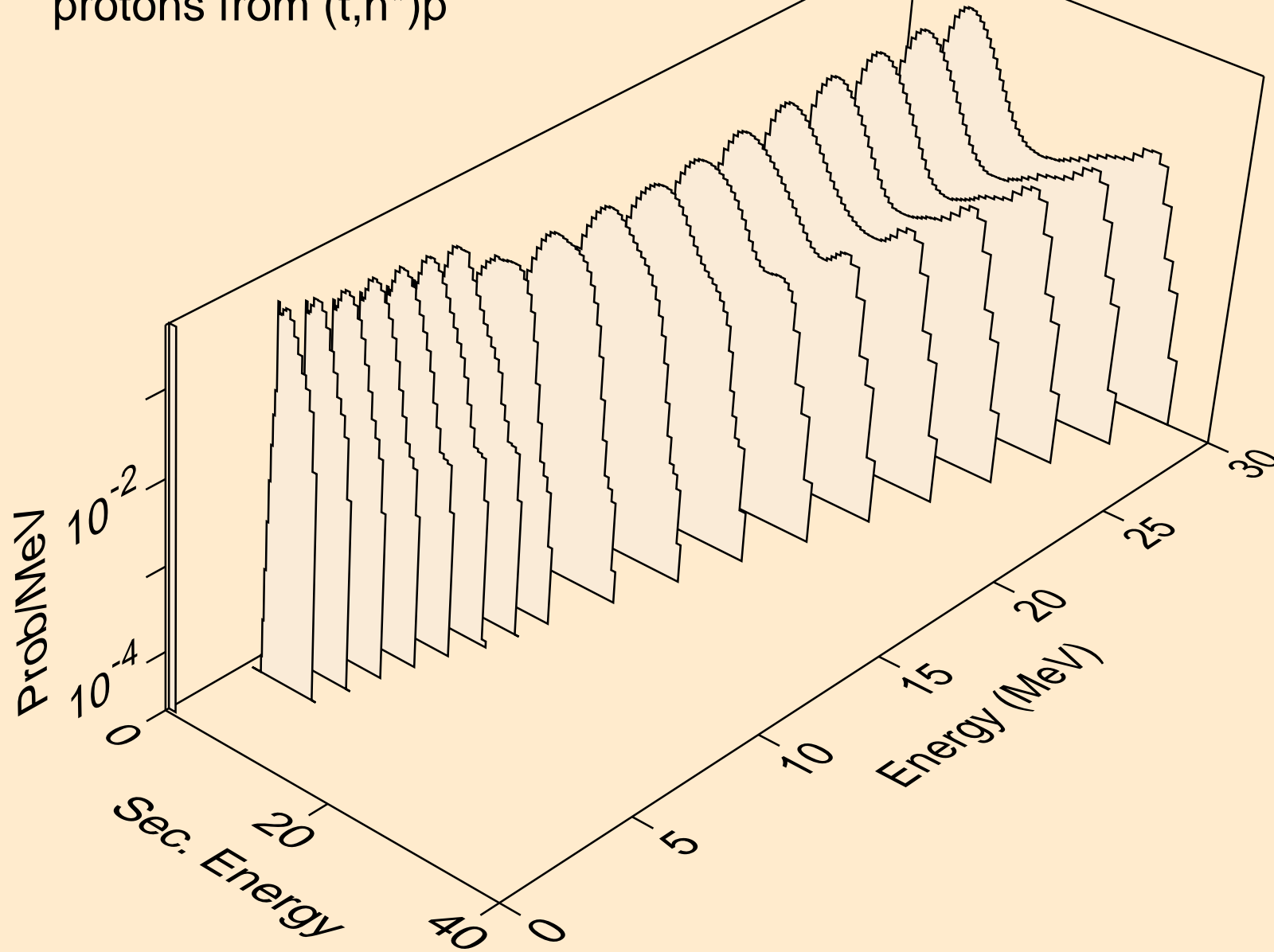

YB151M TRITON ACER TENDL-2021 LIBRARY; T=0.K  
protons from (t,2np)

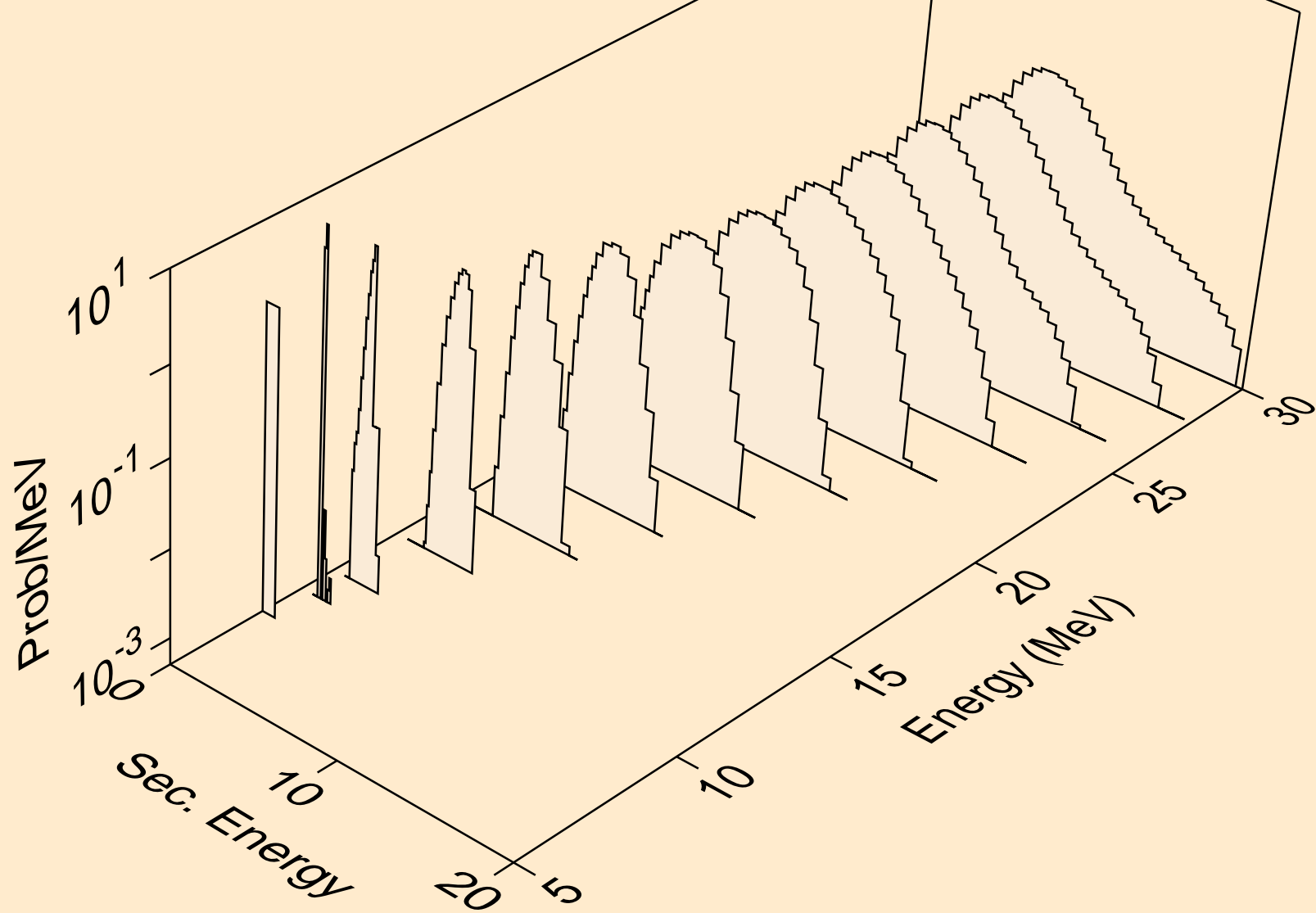



YB151M TRITON ACER TENDL-2021 LIBRARY; T=0.K  
protons from (t,3np)

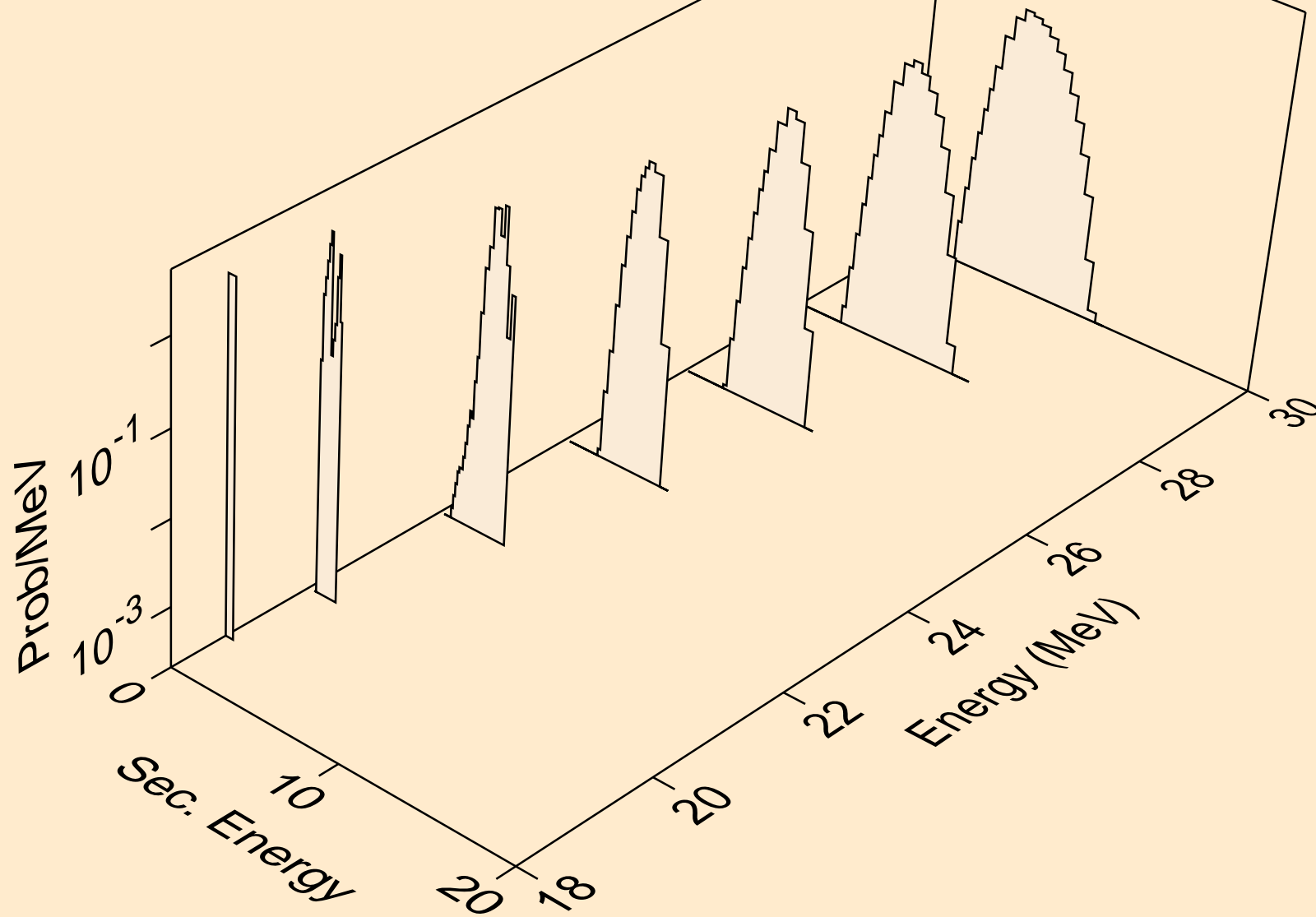

YB151M TRITON ACER TENDL-2021 LIBRARY; T=0.K  
protons from (t,2np)

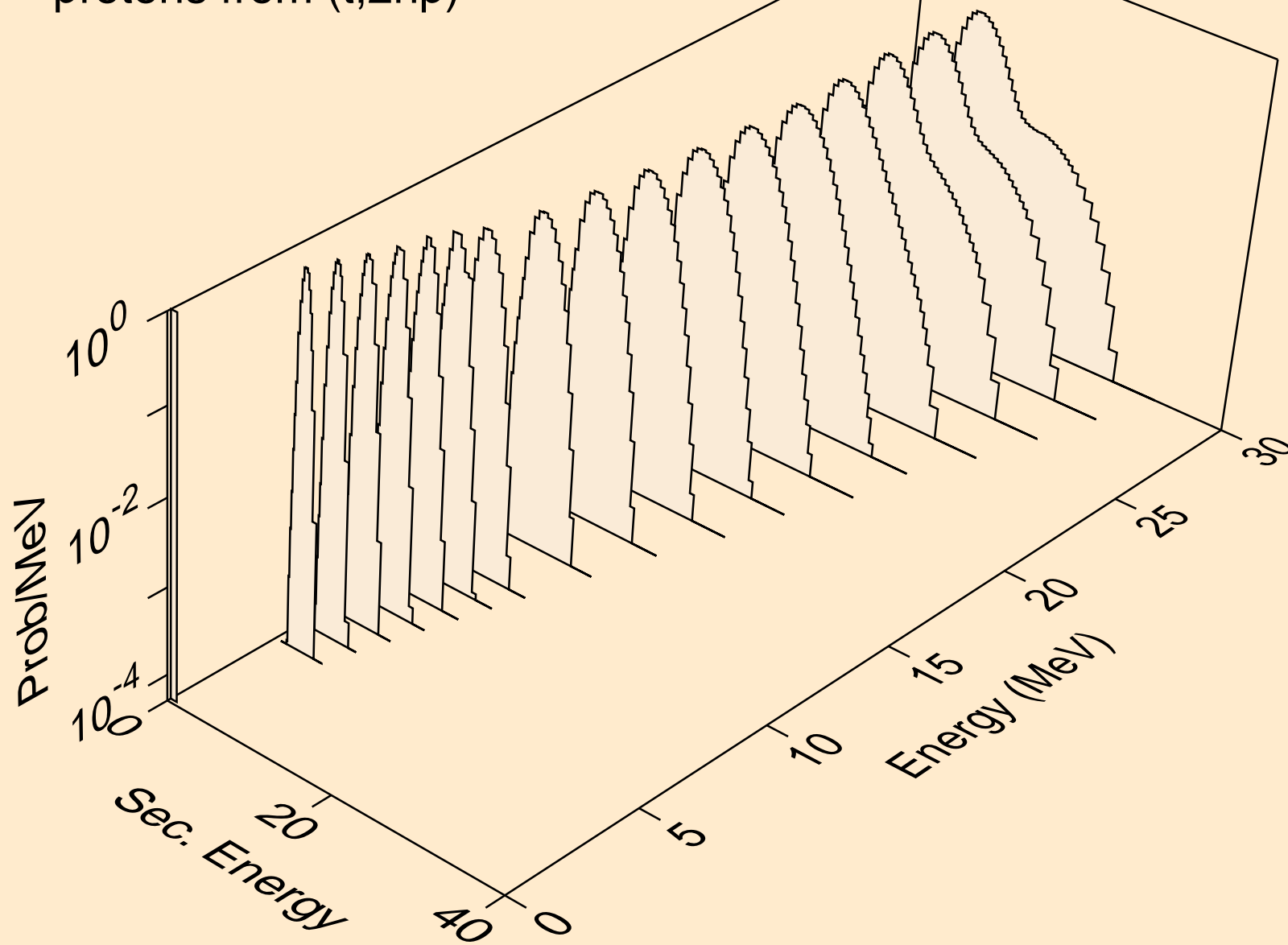

YB151M TRITON ACER TENDL-2021 LIBRARY; T=0.K  
protons from (t,npa)

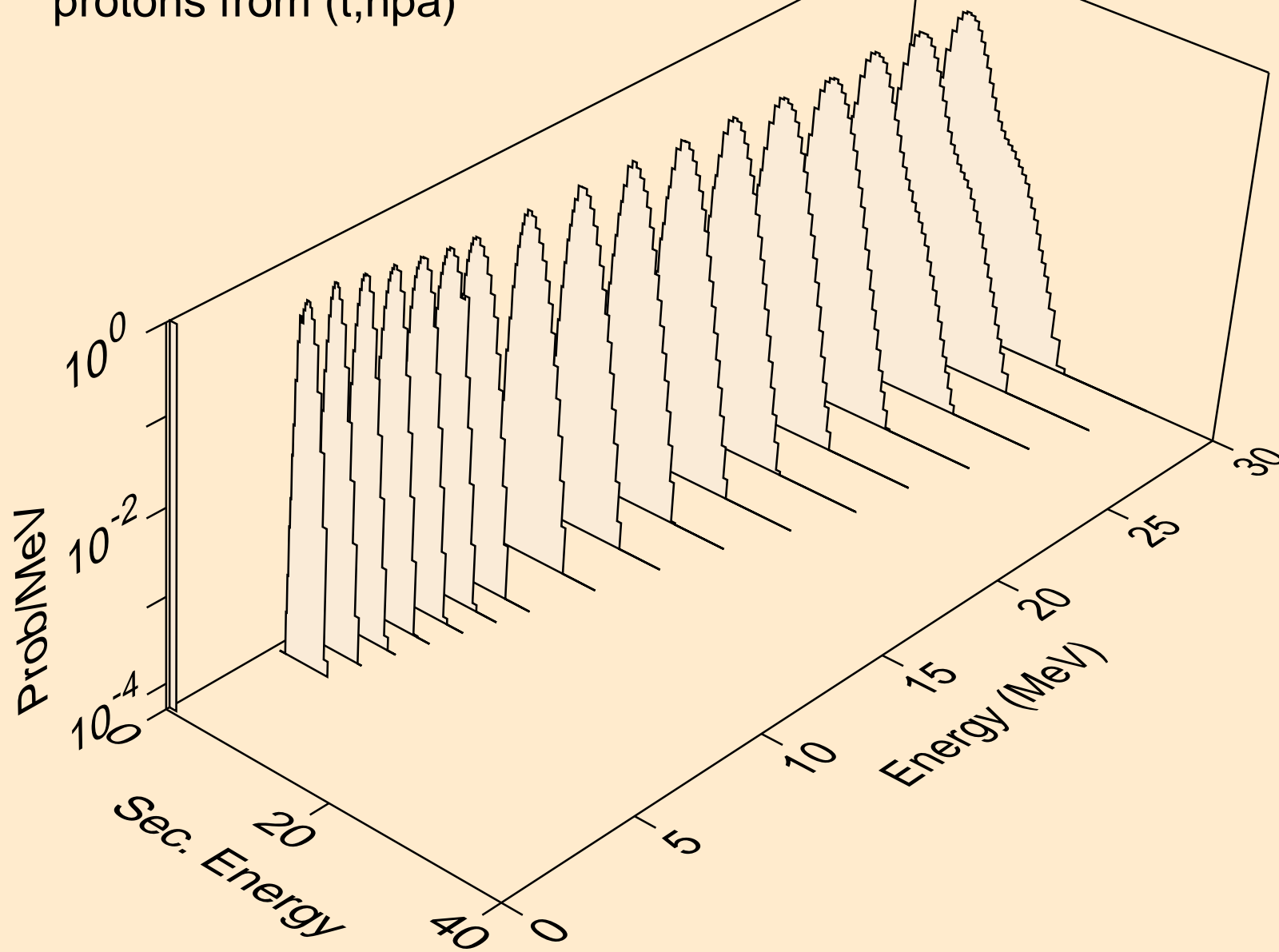

YB151M TRITON ACER TENDL-2021 LIBRARY; T=0.K  
protons from (t,p)

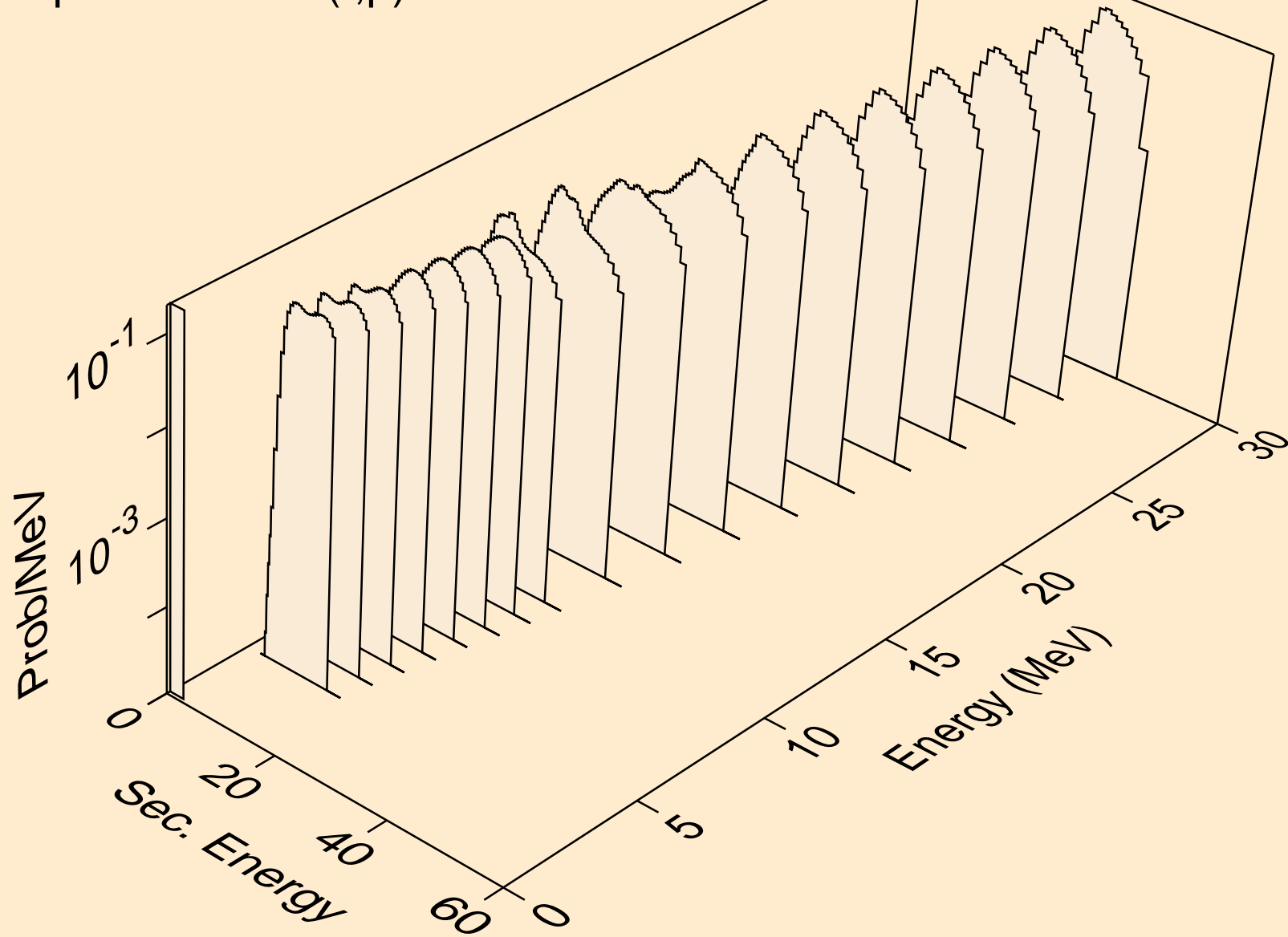

YB151M TRITON ACER TENDL-2021 LIBRARY; T=0.K  
protons from (t,2p)

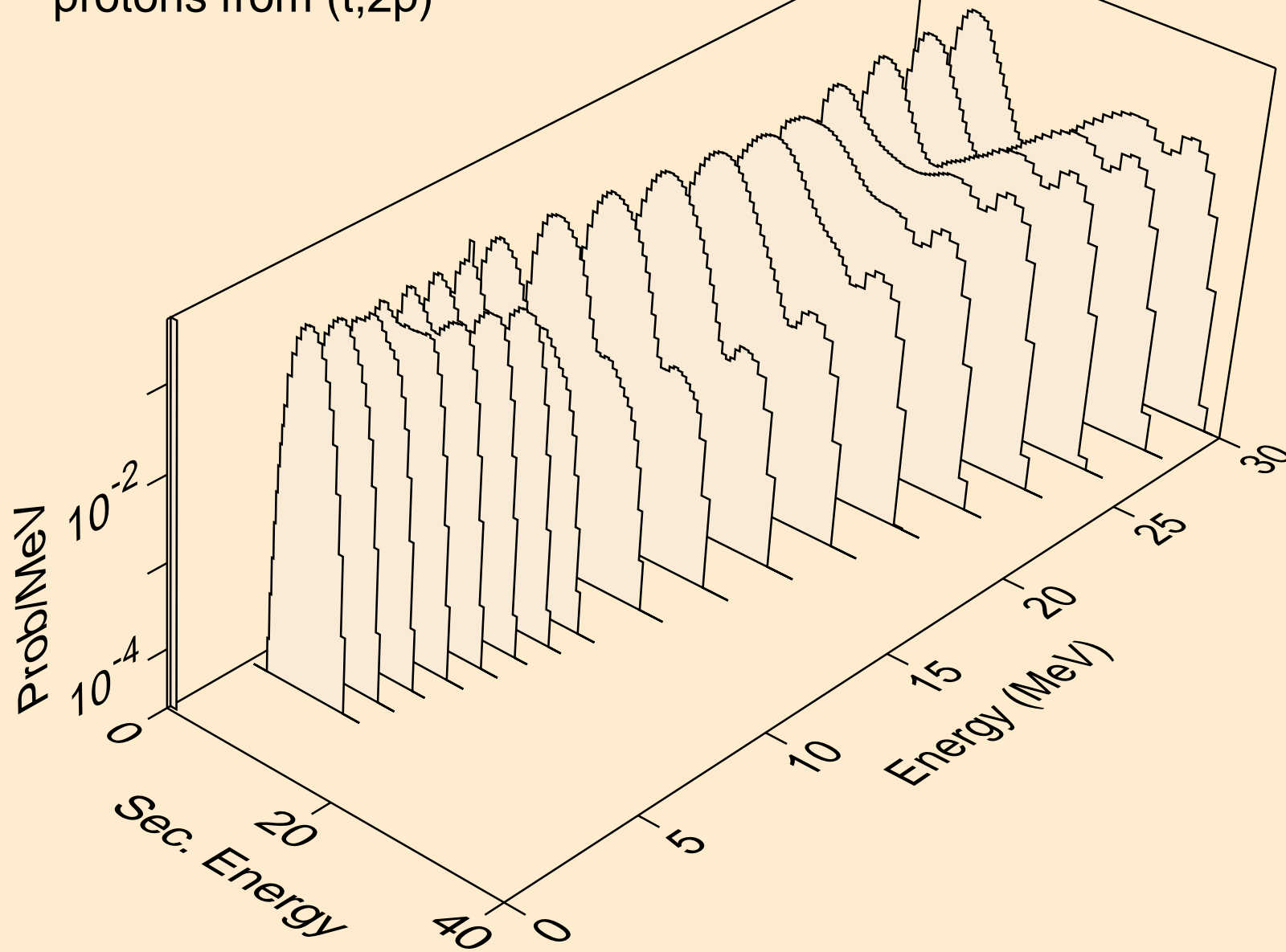

YB151M TRITON ACER TENDL-2021 LIBRARY; T=0.K  
protons from (t,pa)

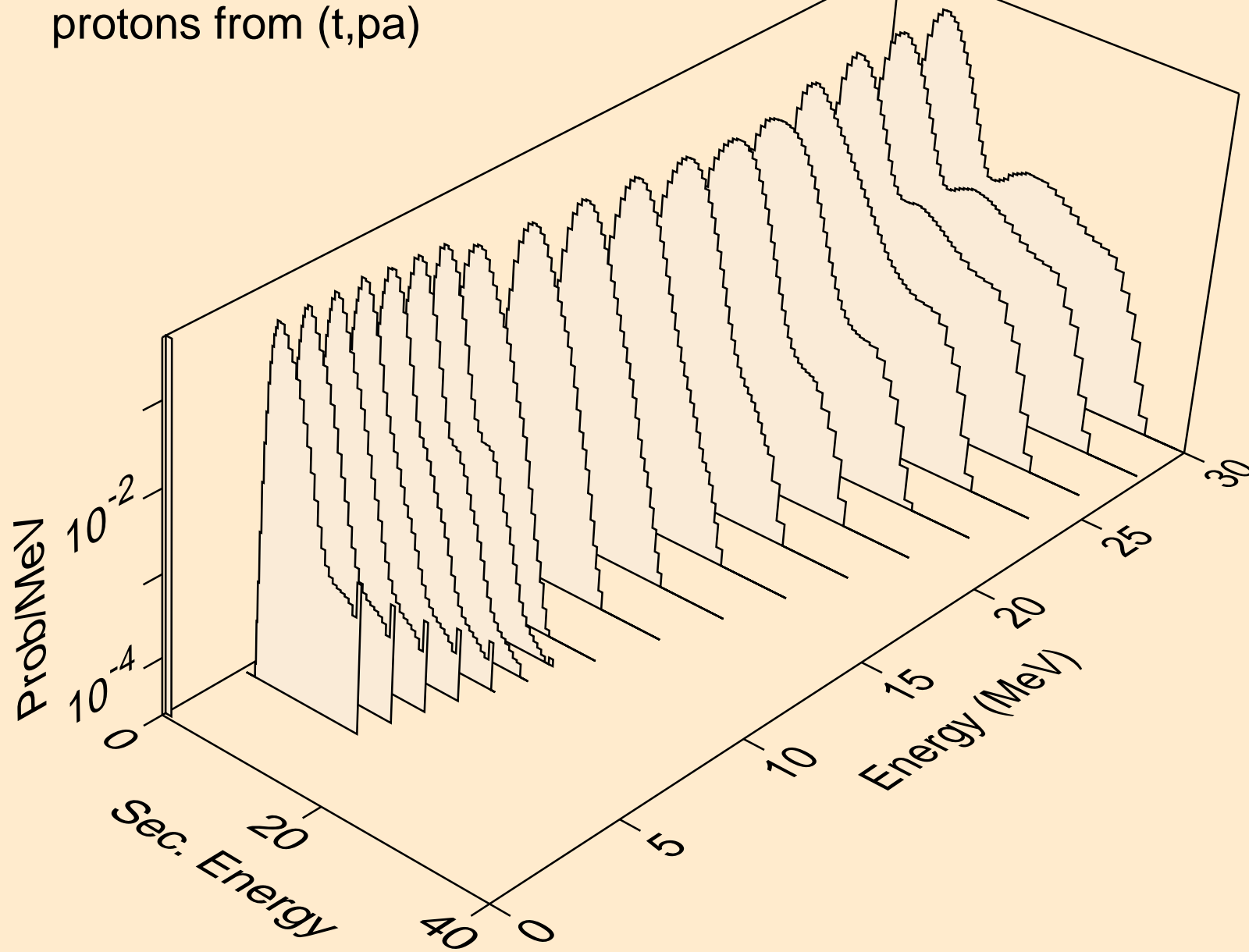

YB151M TRITON ACER TENDL-2021 LIBRARY; T=0.K  
protons from (t,pd)

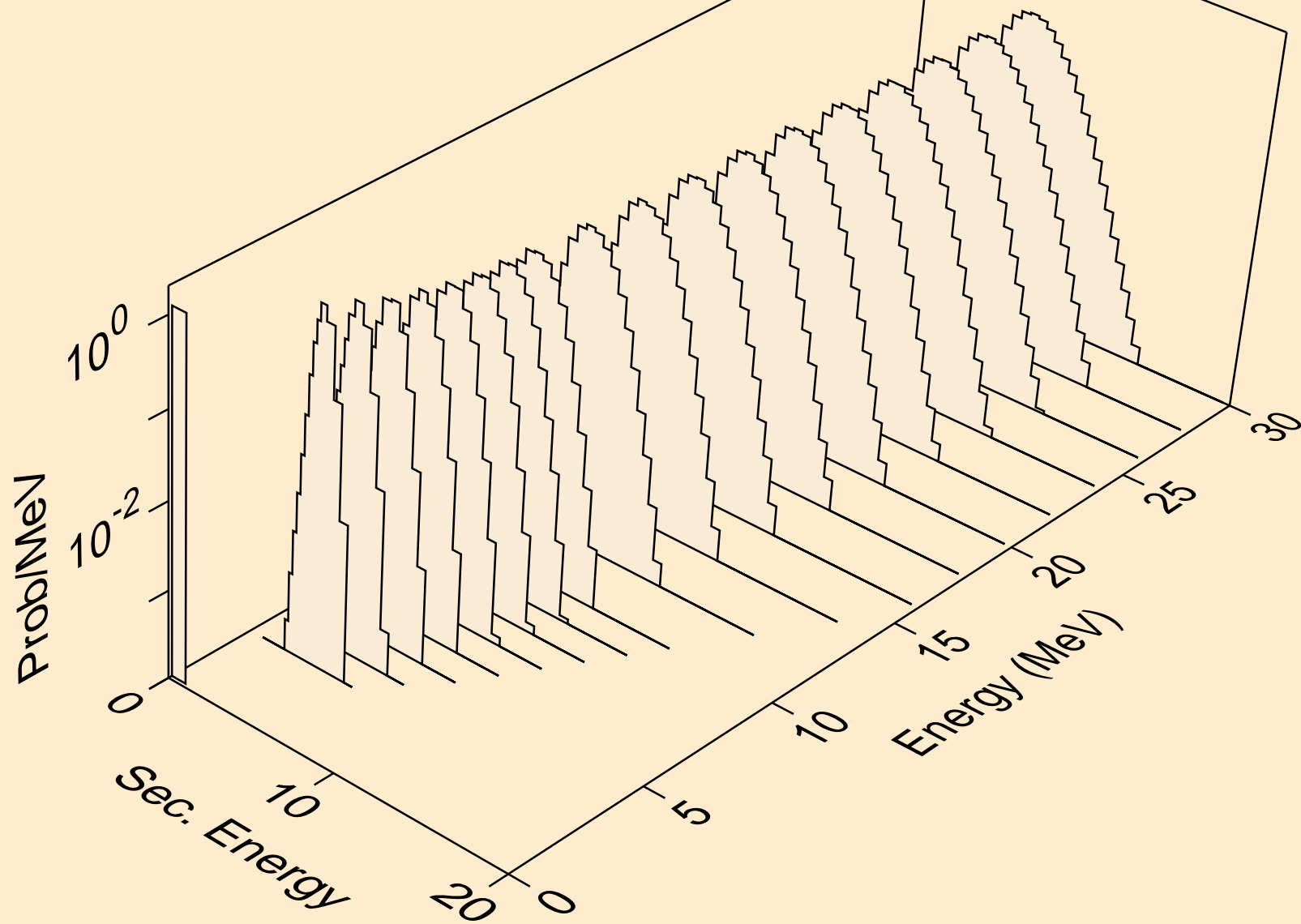

YB151M TRITON ACER TENDL-2021 LIBRARY; T=0.K  
protons from (t,pt)

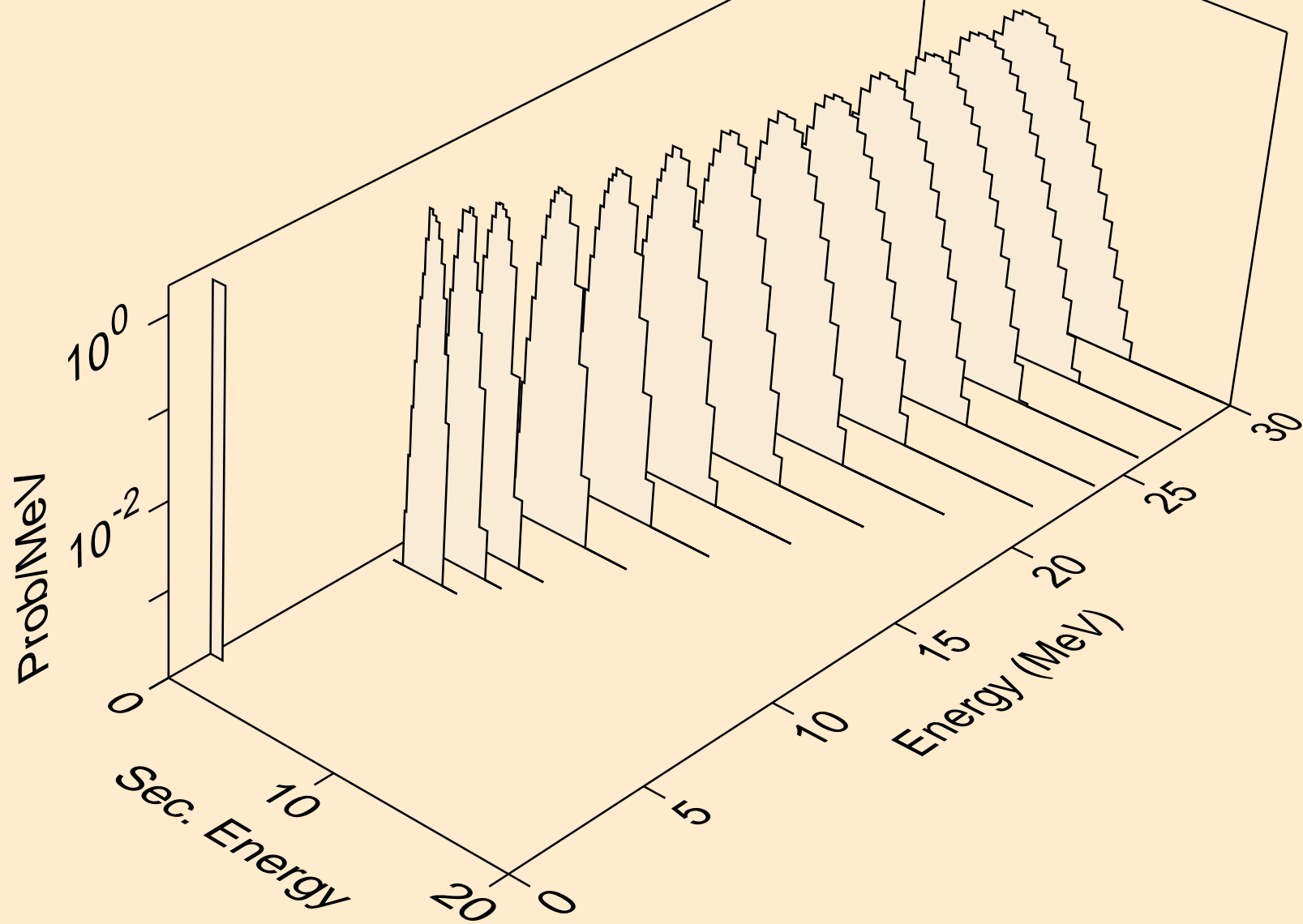



YB151M TRITON ACER TENDL-2021 LIBRARY; T=0.K  
deuterons from (t,x)

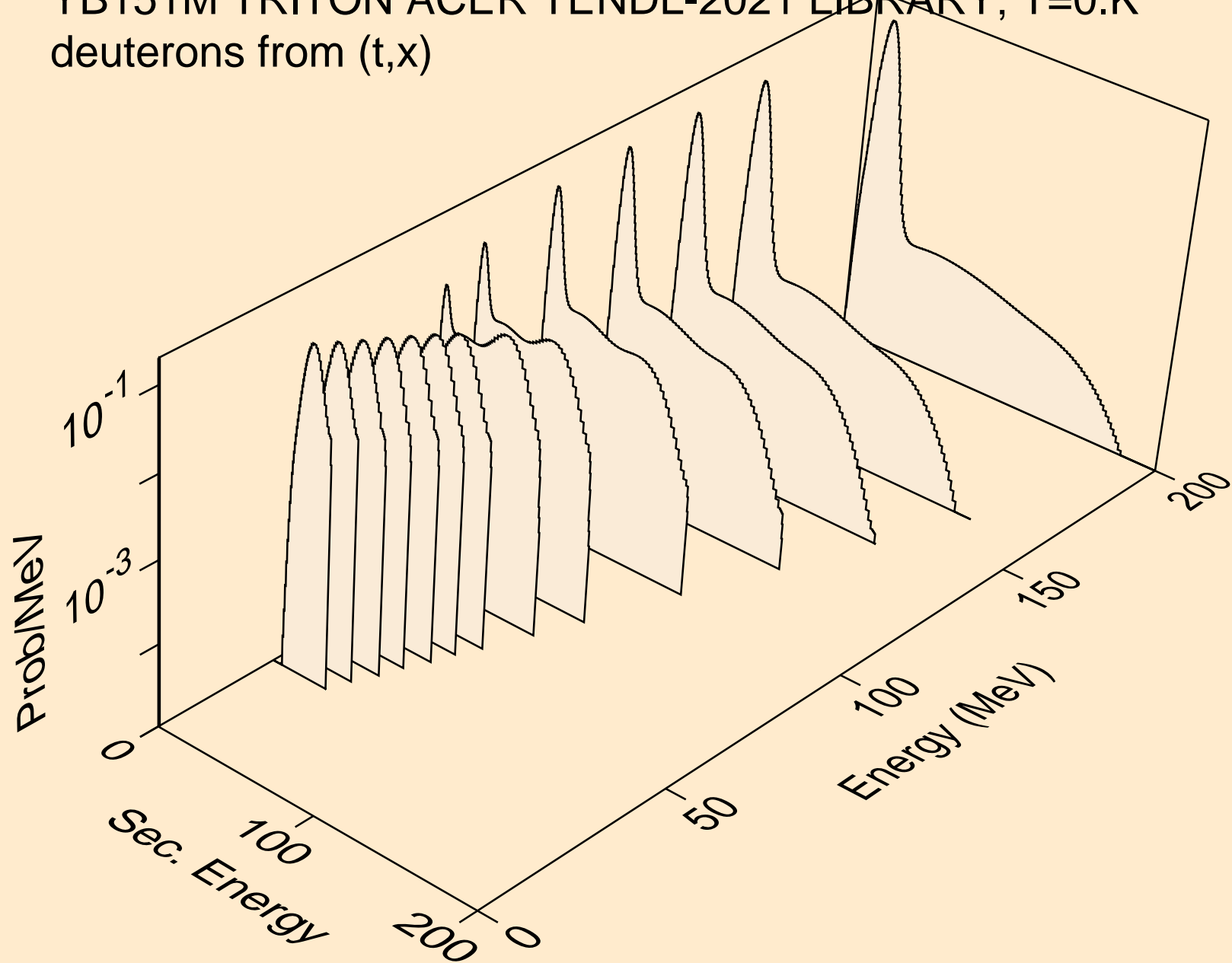

YB151M TRITON ACER TENDL-2021 LIBRARY; T=0.K  
deuterons from (t,2nd)

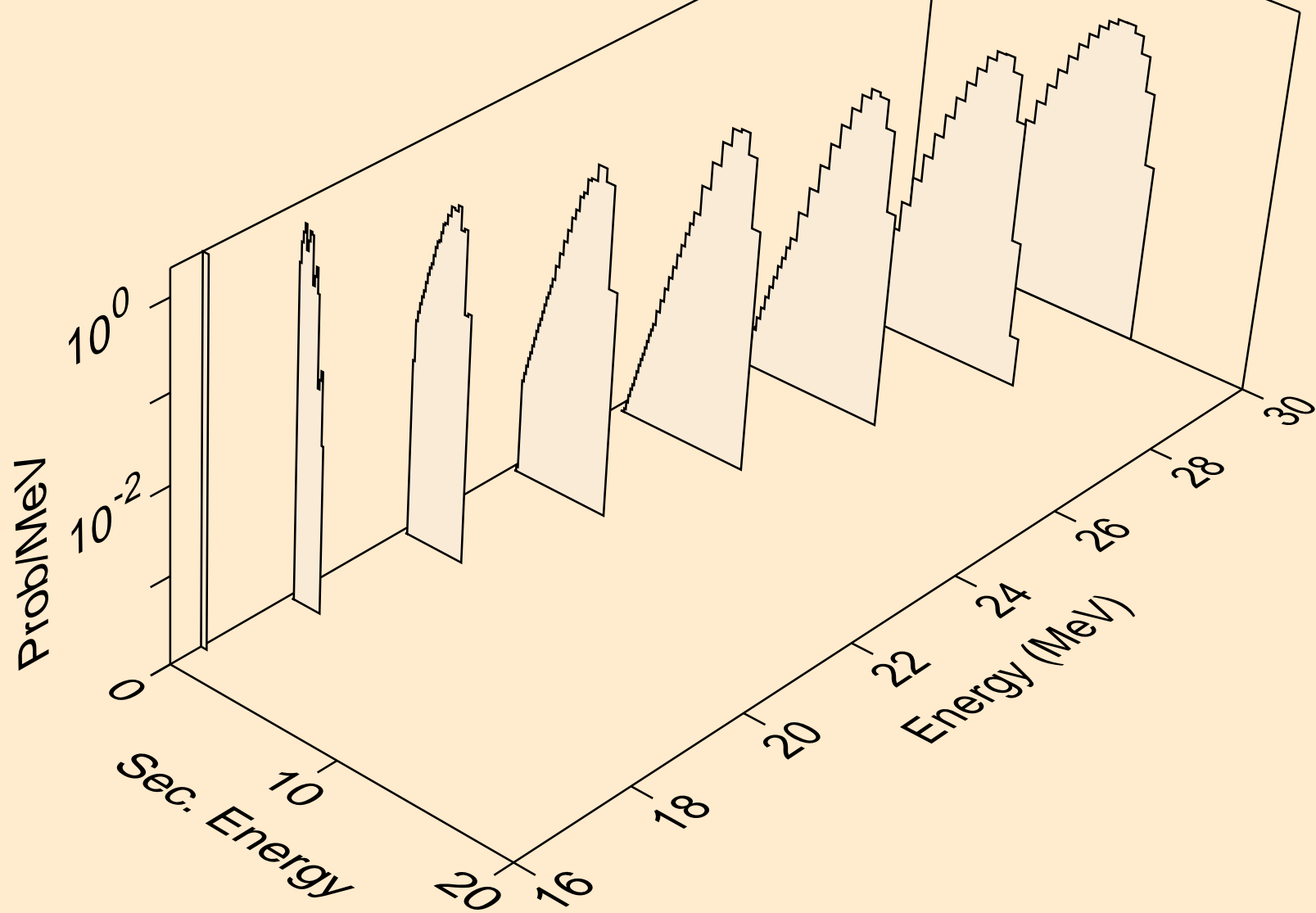

YB151M TRITON ACER TENDL-2021 LIBRARY; T=0.K  
deuterons from (t,n\*)d

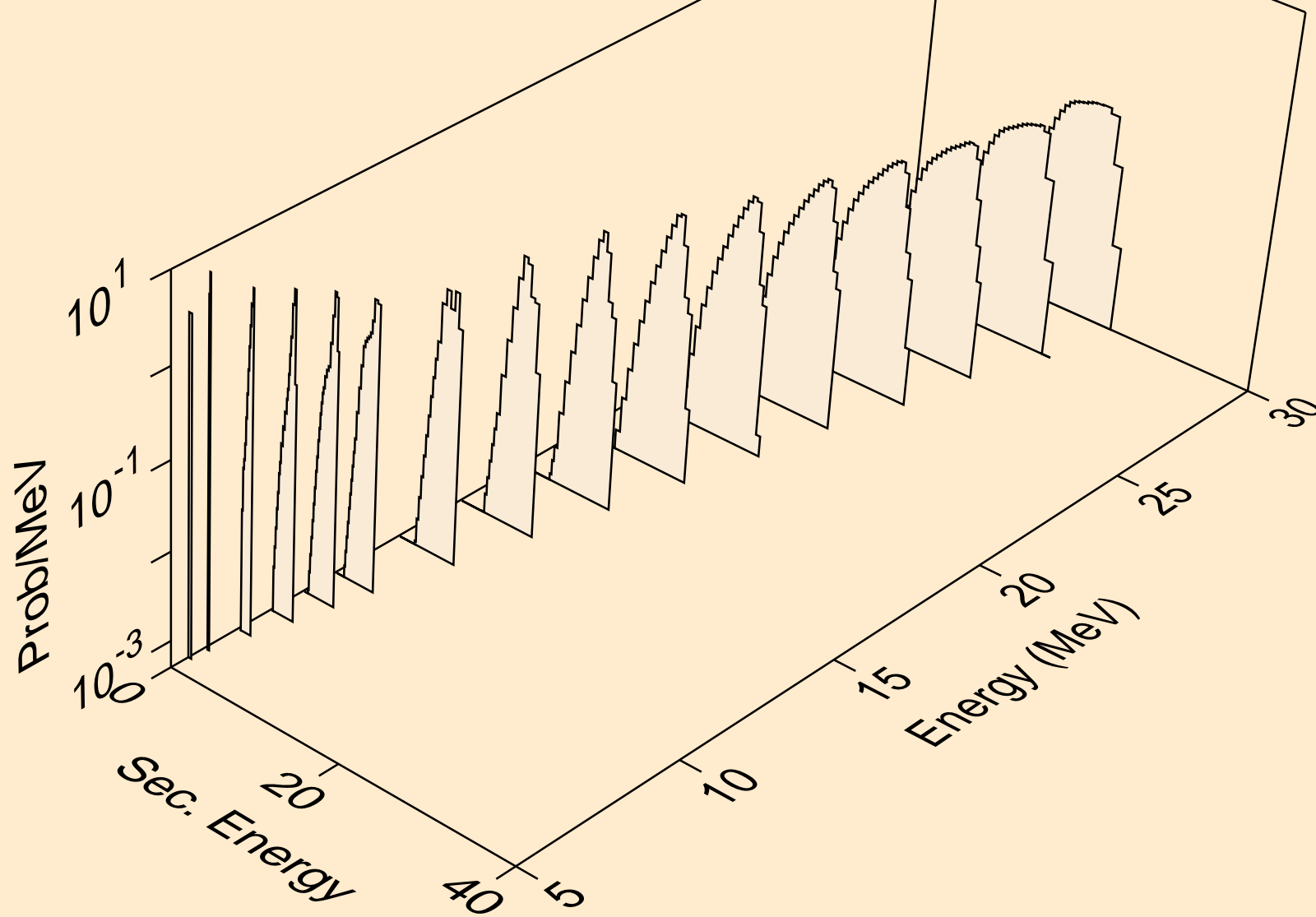

YB151M TRITON ACER TENDL-2021 LIBRARY; T=0.K  
deuterons from (t,d)

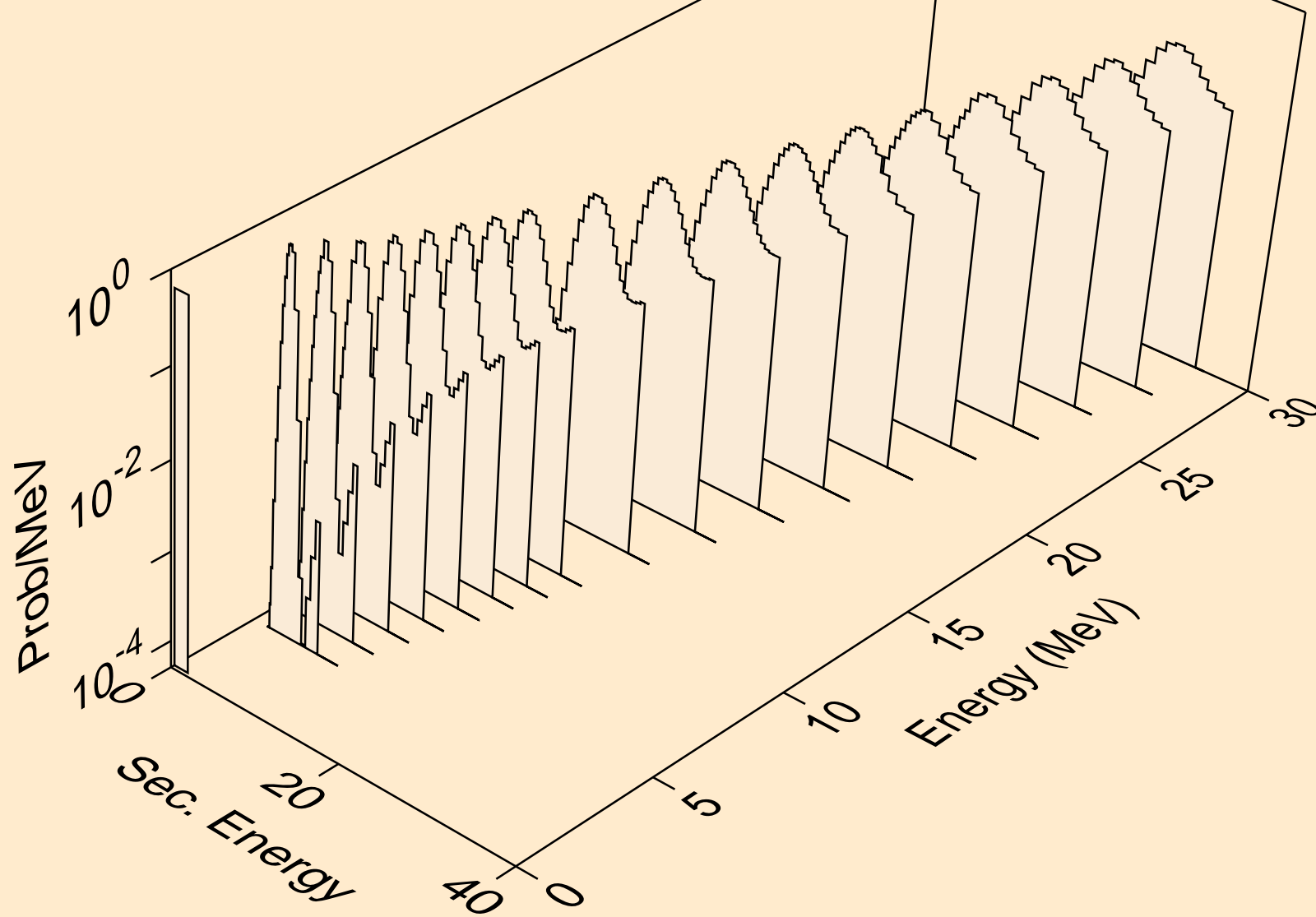

YB151M TRITON ACER TENDL-2021 LIBRARY; T=0.K  
deuterons from (t,d2a)

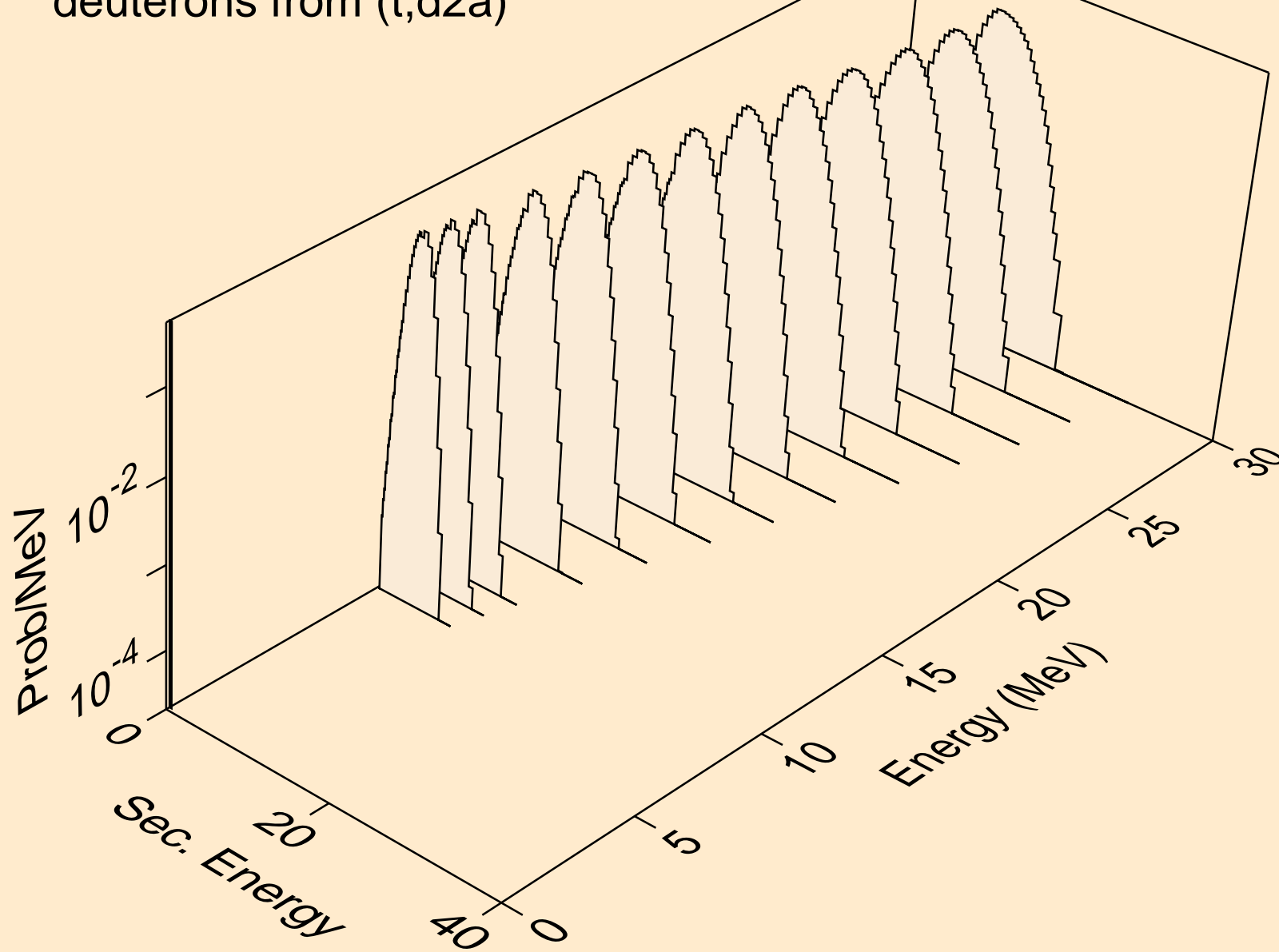

YB151M TRITON ACER TENDL-2021 LIBRARY; T=0.K  
deuterons from (t,pd)

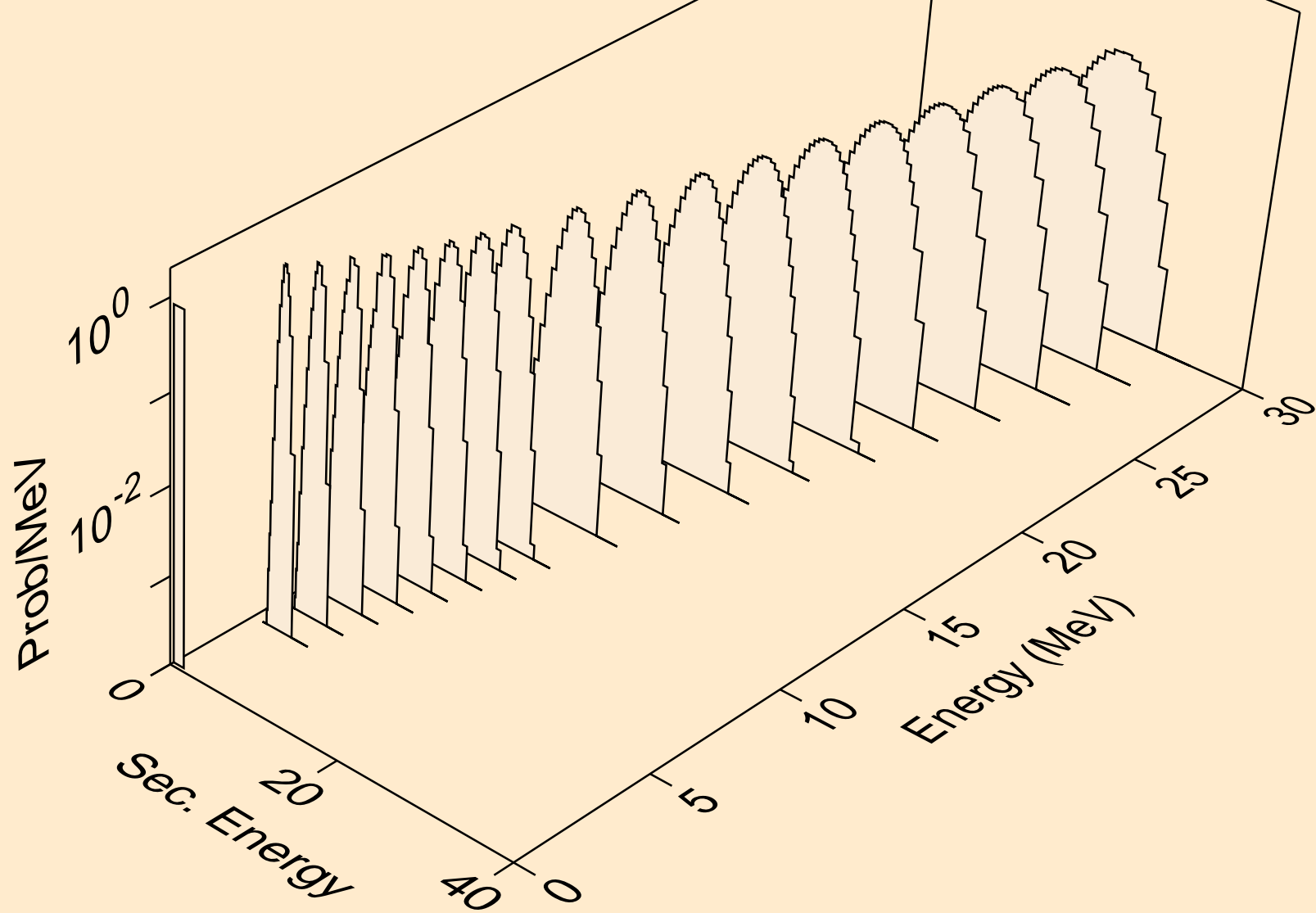

YB151M TRITON ACER TENDL-2021 LIBRARY; T=0.K  
deuterons from (t,da)

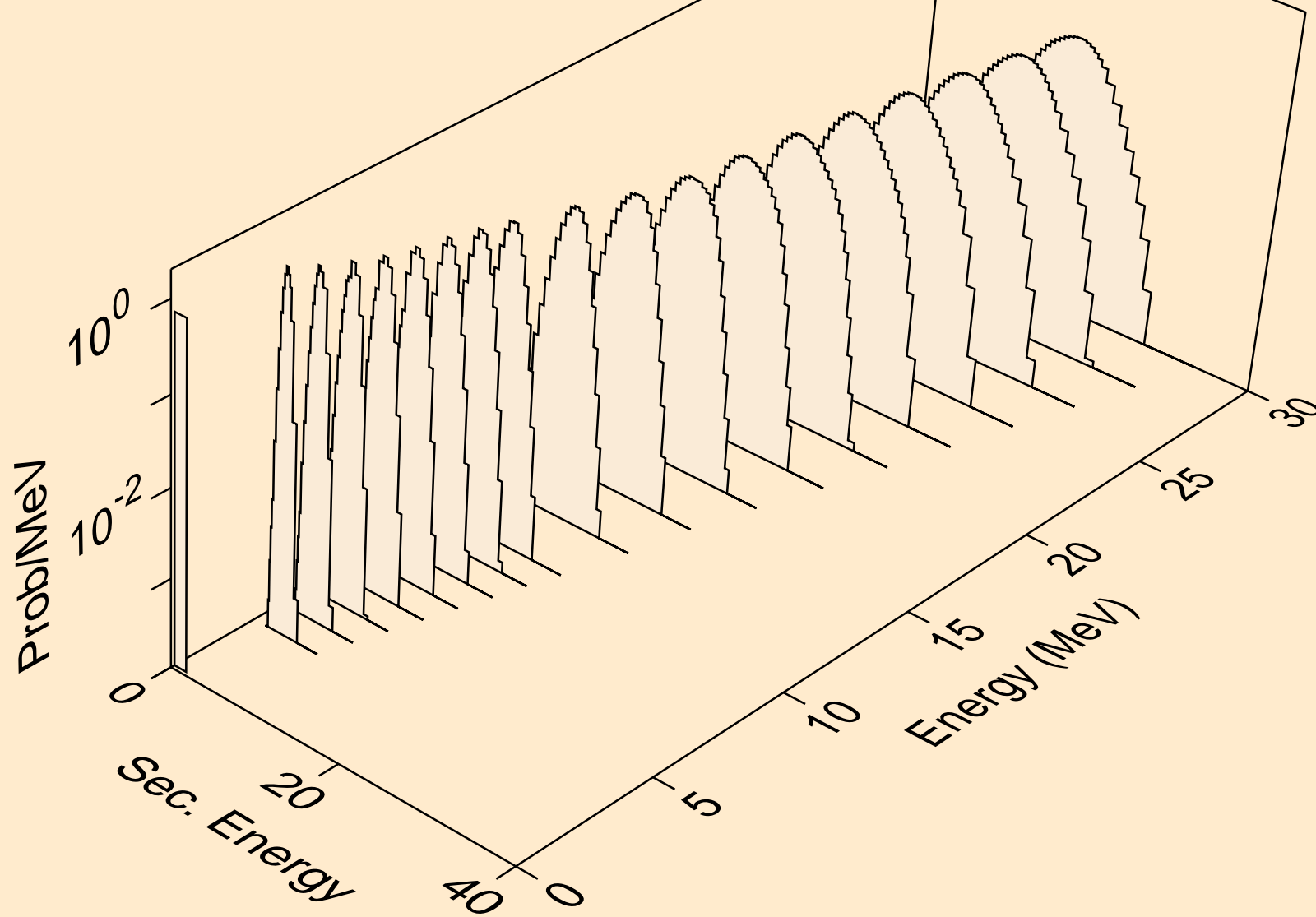

YB151M TRITON ACER TENDL-2021 LIBRARY; T=0.K  
he3s from (t,x)

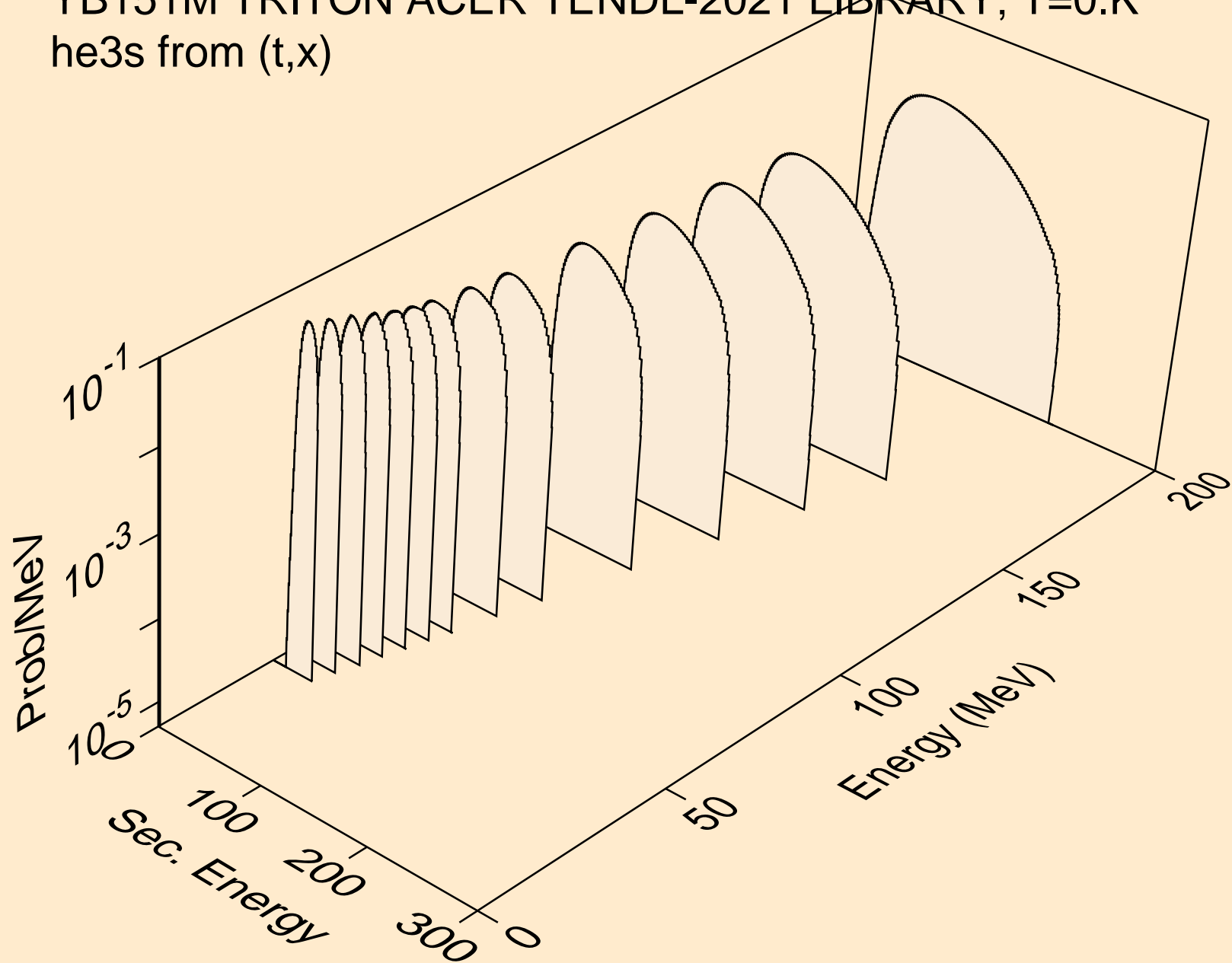



YB151M TRITON ACER TENDL-2021 LIBRARY; T=0.K  
he3s from (t,n\*)he3

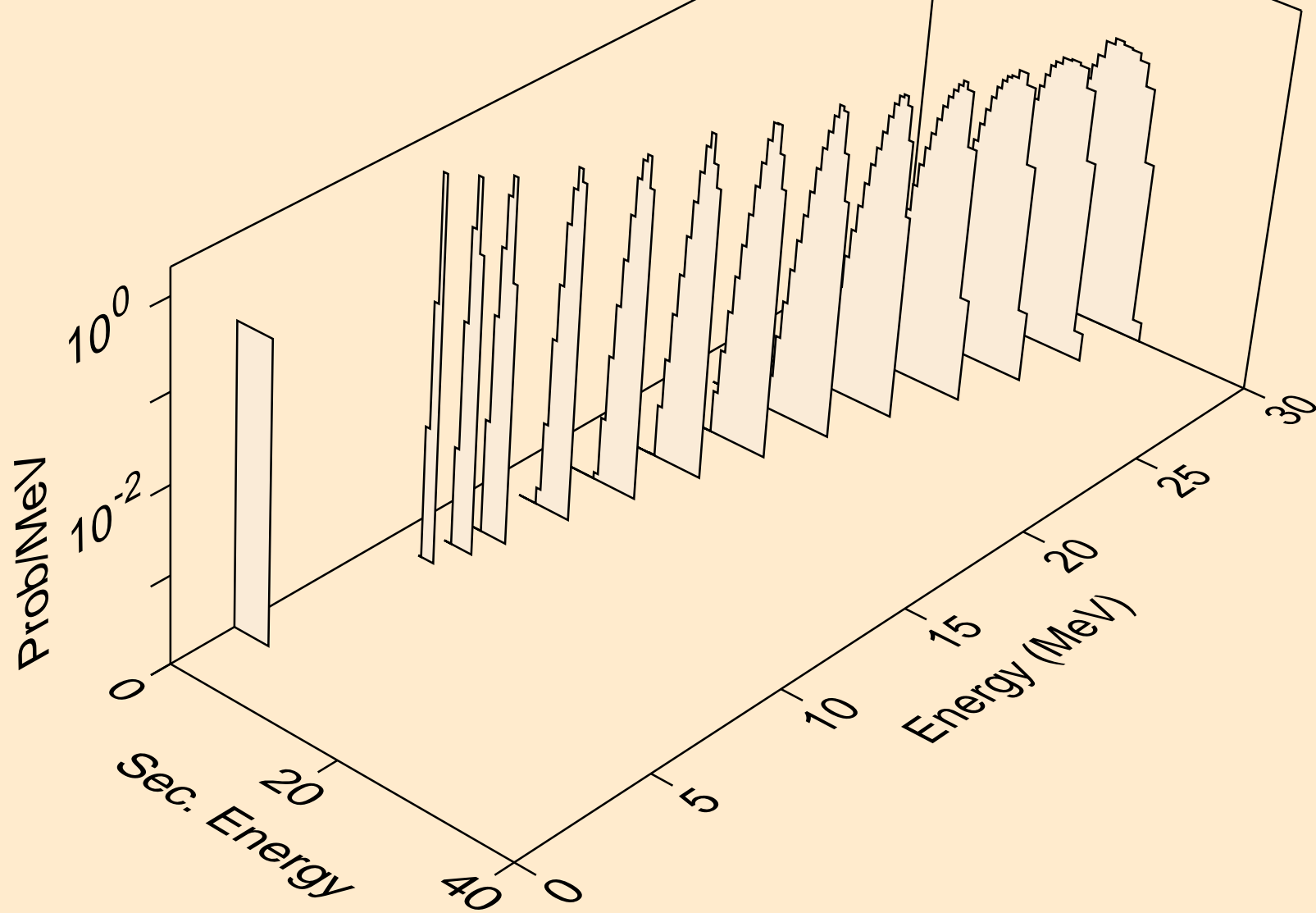

YB151M TRITON ACER TENDL-2021 LIBRARY; T=0.K  
he3s from (t,he3)

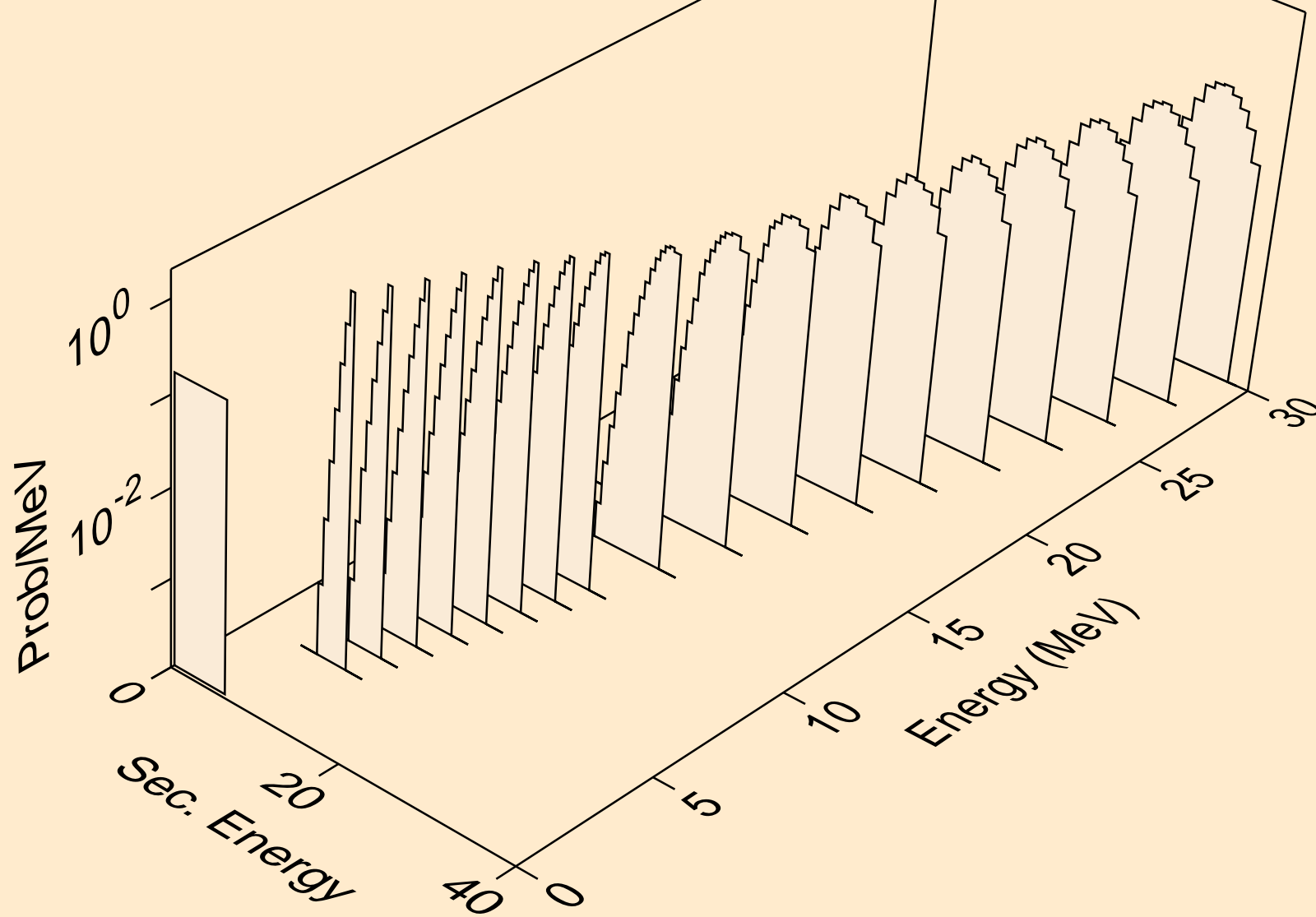

YB151M TRITON ACER TENDL-2021 LIBRARY; T=0.K  
alphas from (t,x)

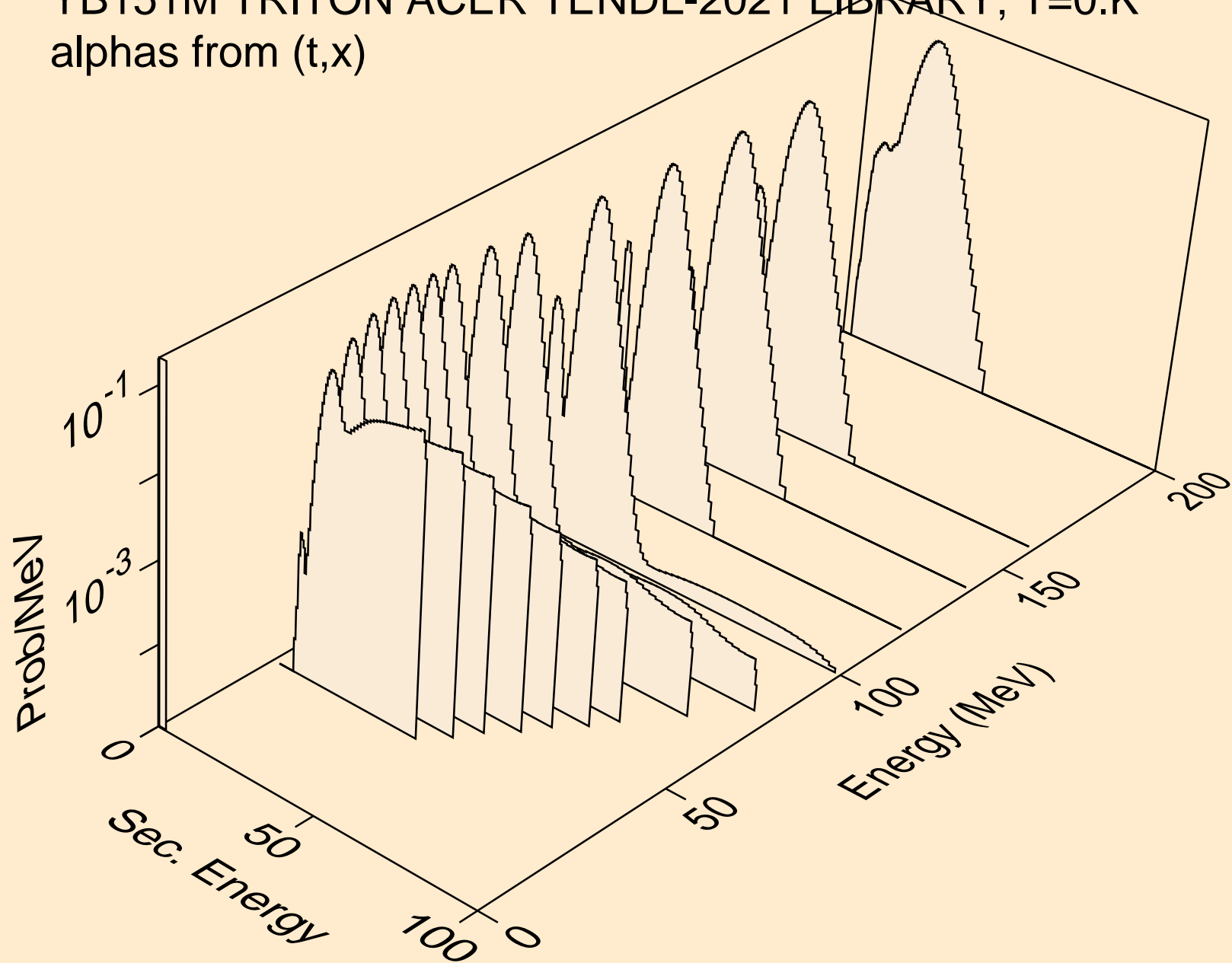

YB151M TRITON ACER TENDL-2021 LIBRARY; T=0.K  
alphas from (t,n\*)a

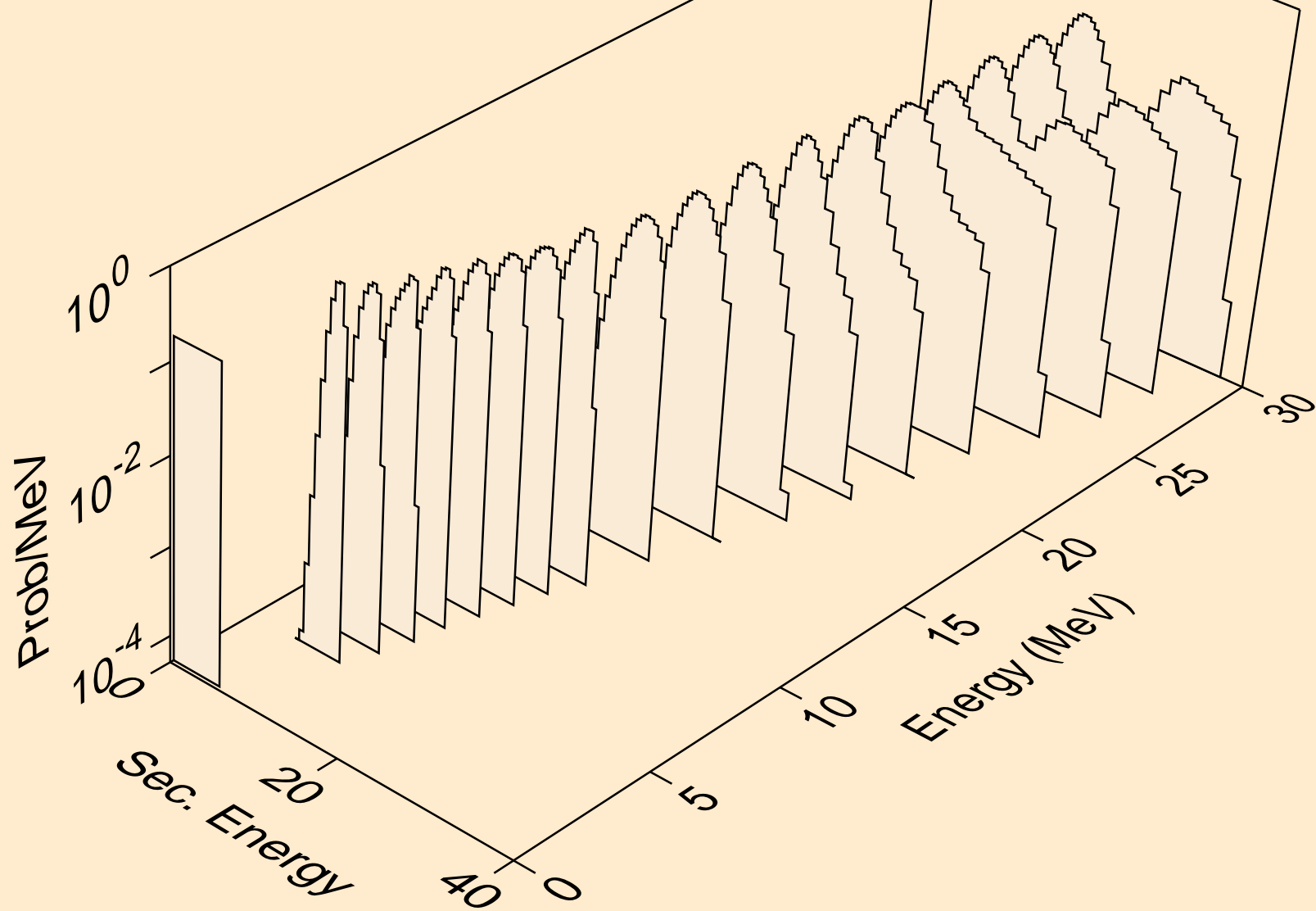

YB151M TRITON ACER TENDL-2021 LIBRARY; T=0.K  
alphas from (t,2n)a

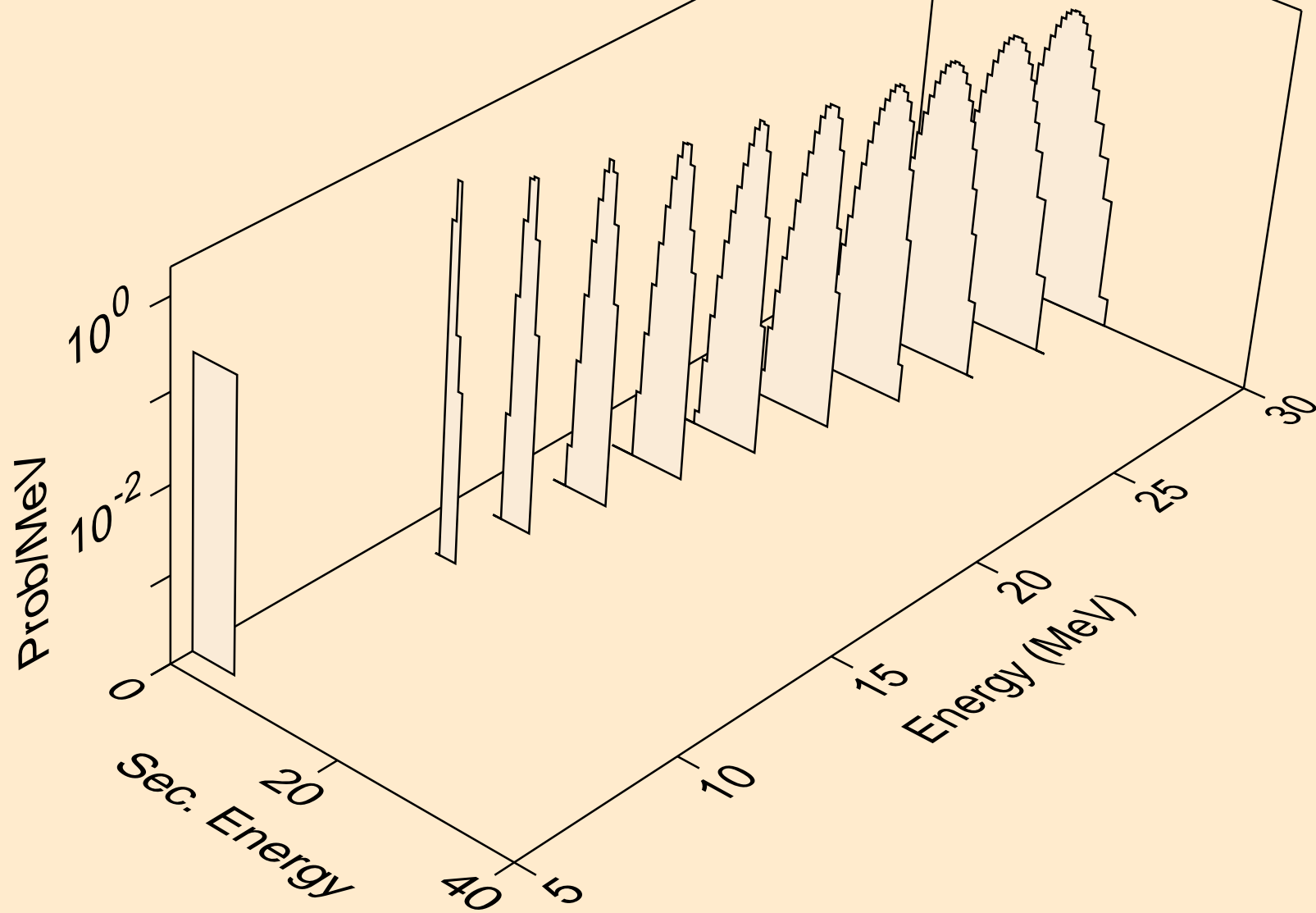

YB151M TRITON ACER TENDL-2021 LIBRARY; T=0.K  
alphas from (t,n\*)2a

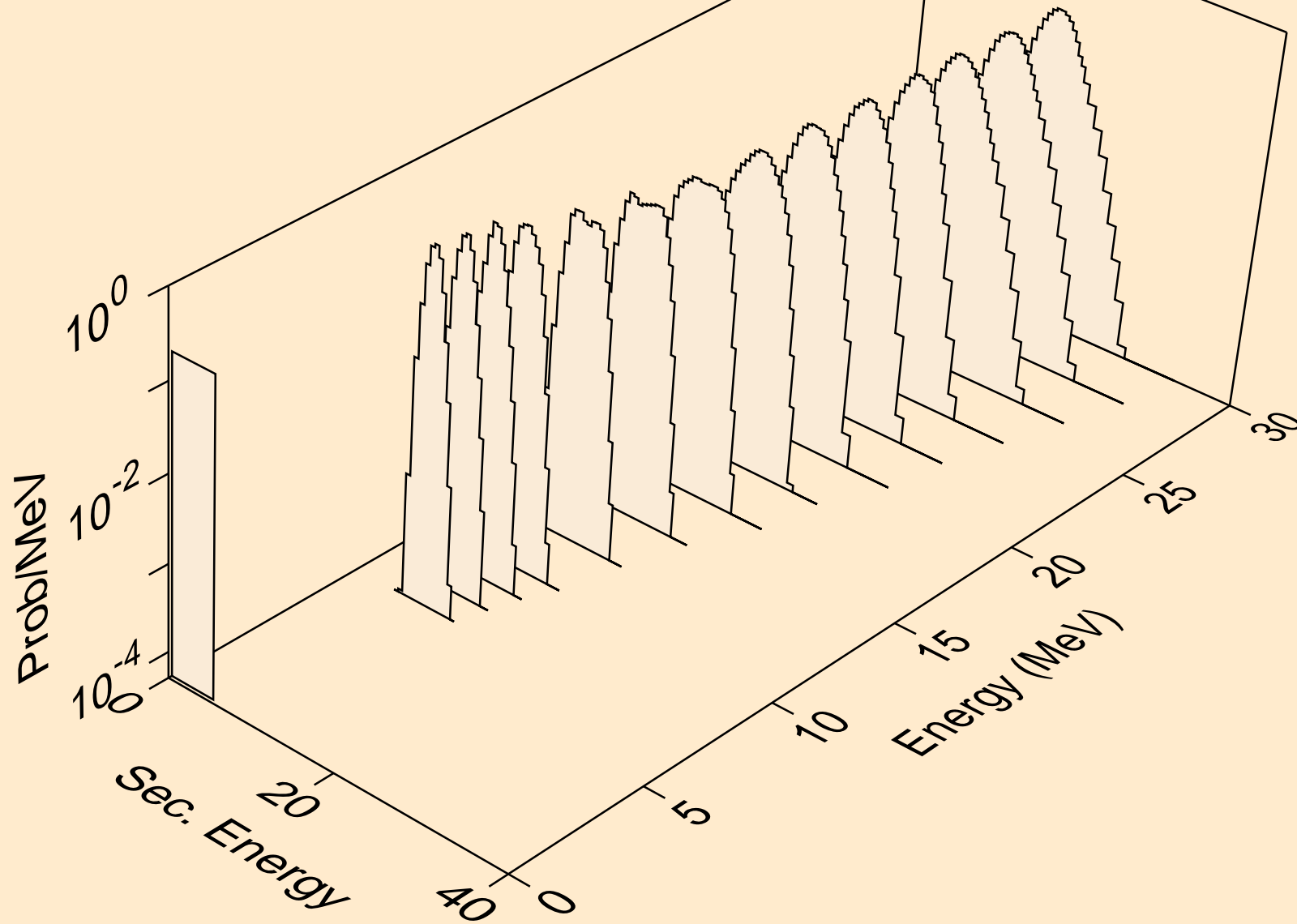

YB151M TRITON ACER TENDL-2021 LIBRARY; T=0.K  
alphas from (t,npa)

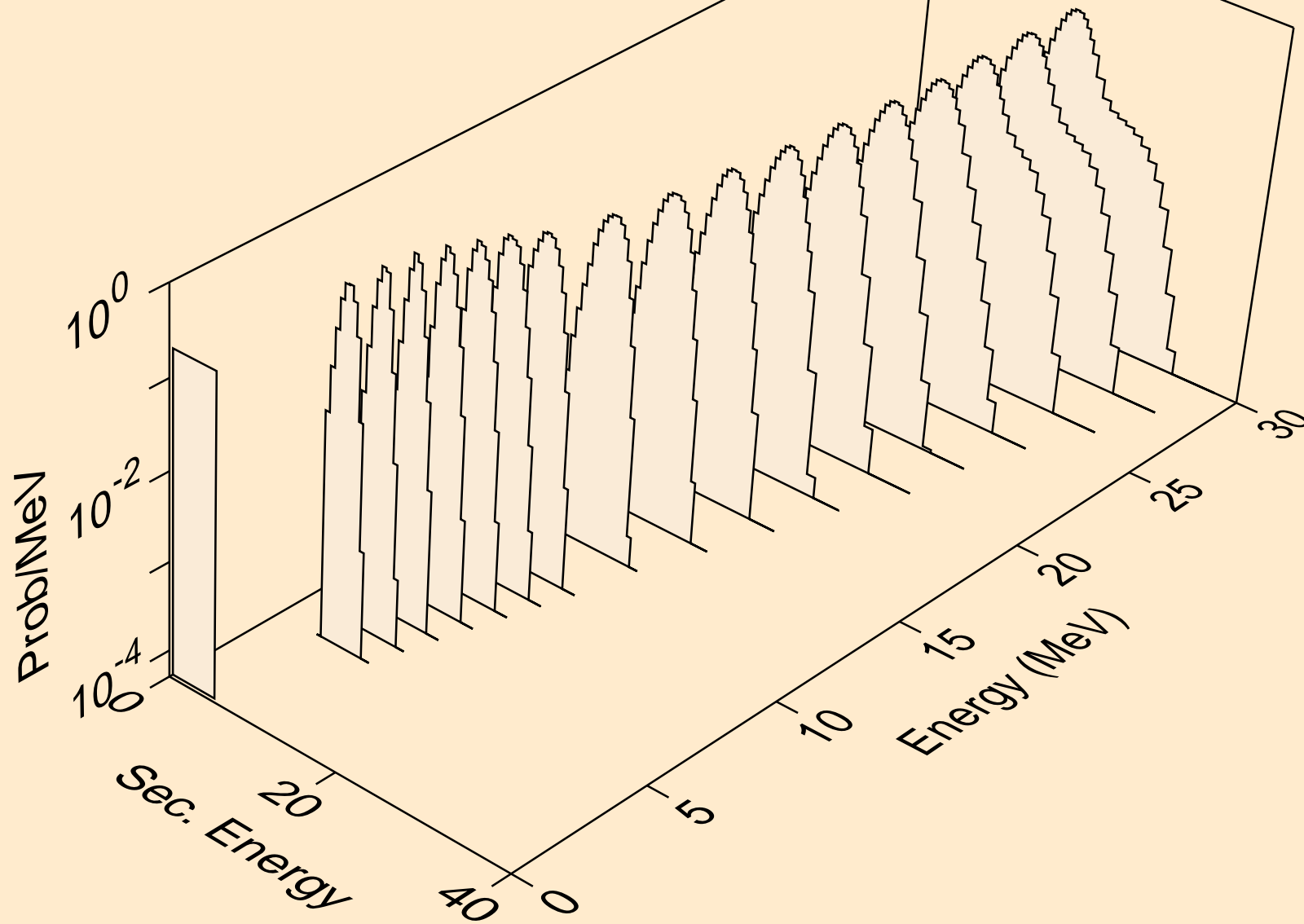

YB151M TRITON ACER TENDL-2021 LIBRARY; T=0.K  
alphas from (t,a)

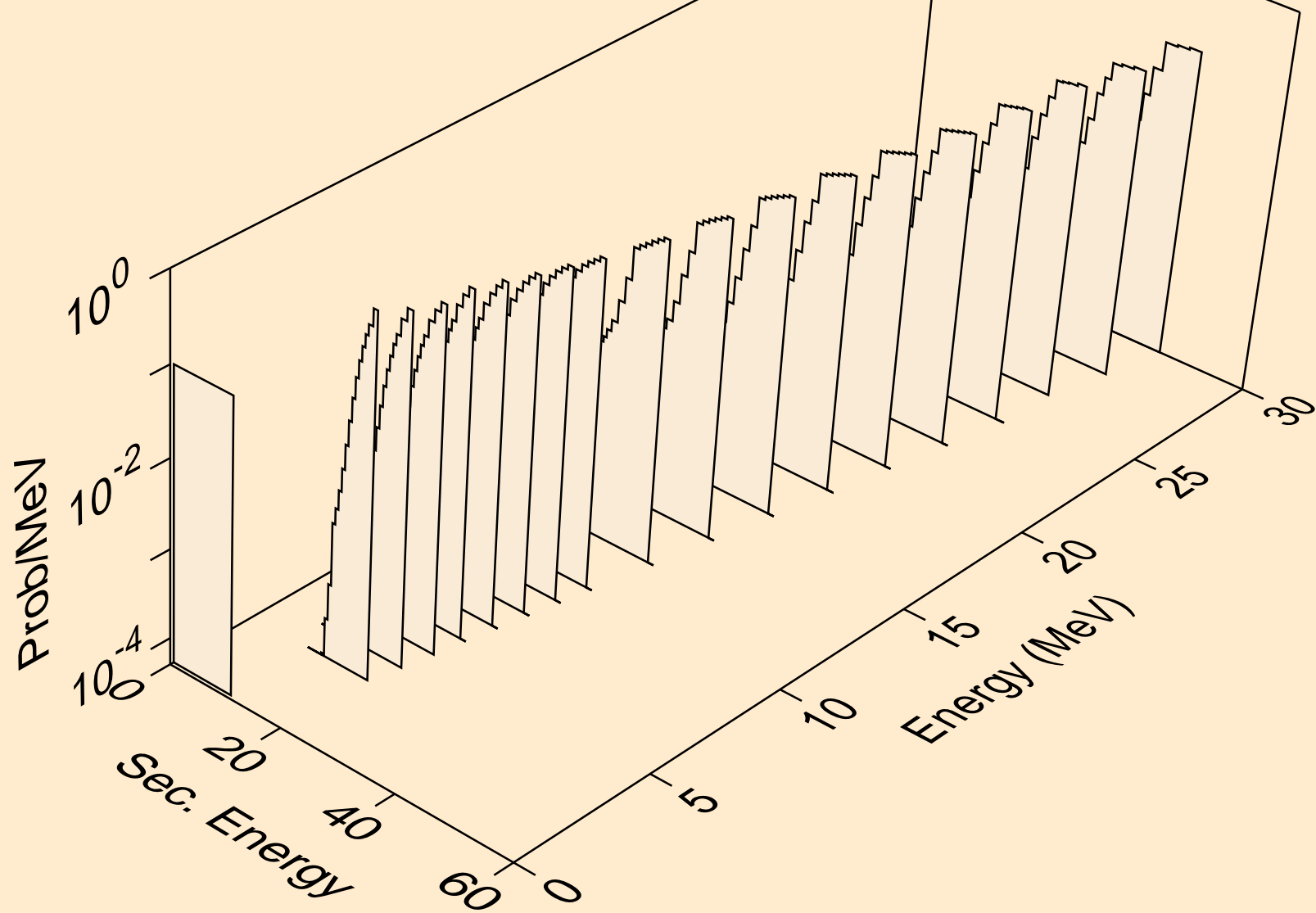



YB151M TRITON ACER TENDL-2021 LIBRARY; T=0.K  
alphas from (t,2a)

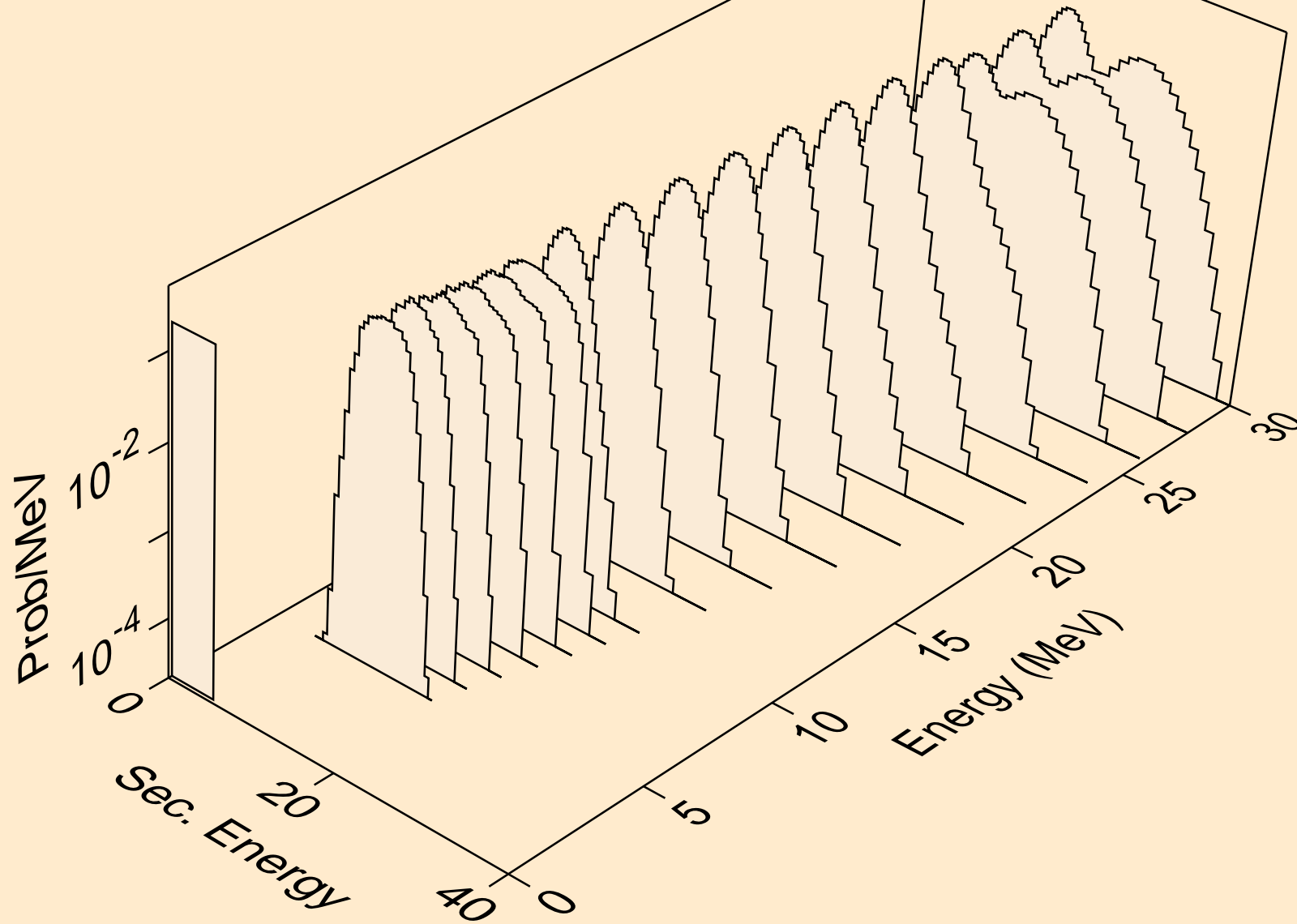

YB151M TRITON ACER TENDL-2021 LIBRARY; T=0.K  
alphas from (t,3a)

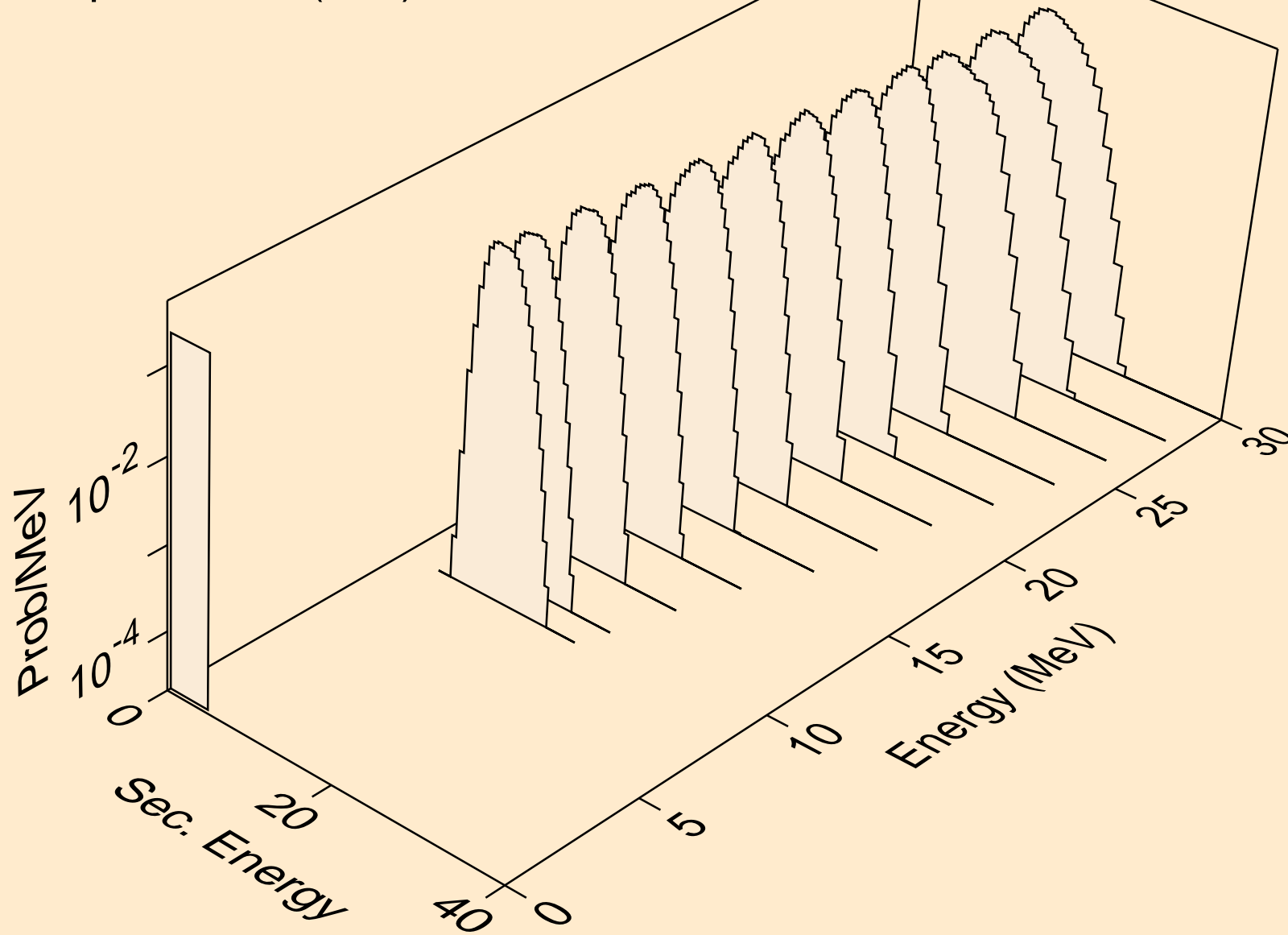

YB151M TRITON ACER TENDL-2021 LIBRARY; T=0.K  
alphas from (t,pa)

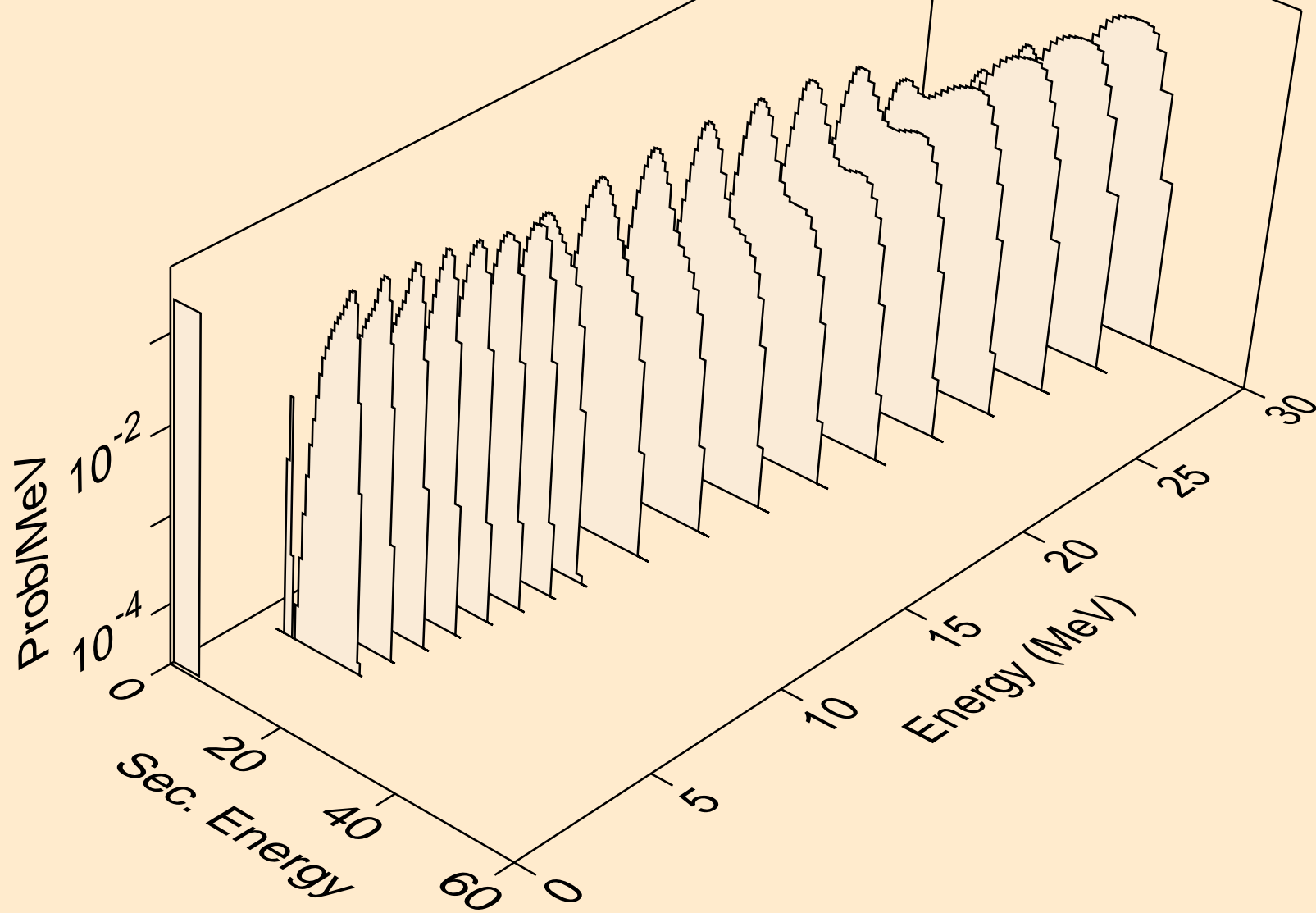

YB151M TRITON ACER TENDL-2021 LIBRARY; T=0.K  
alphas from (t,d2a)

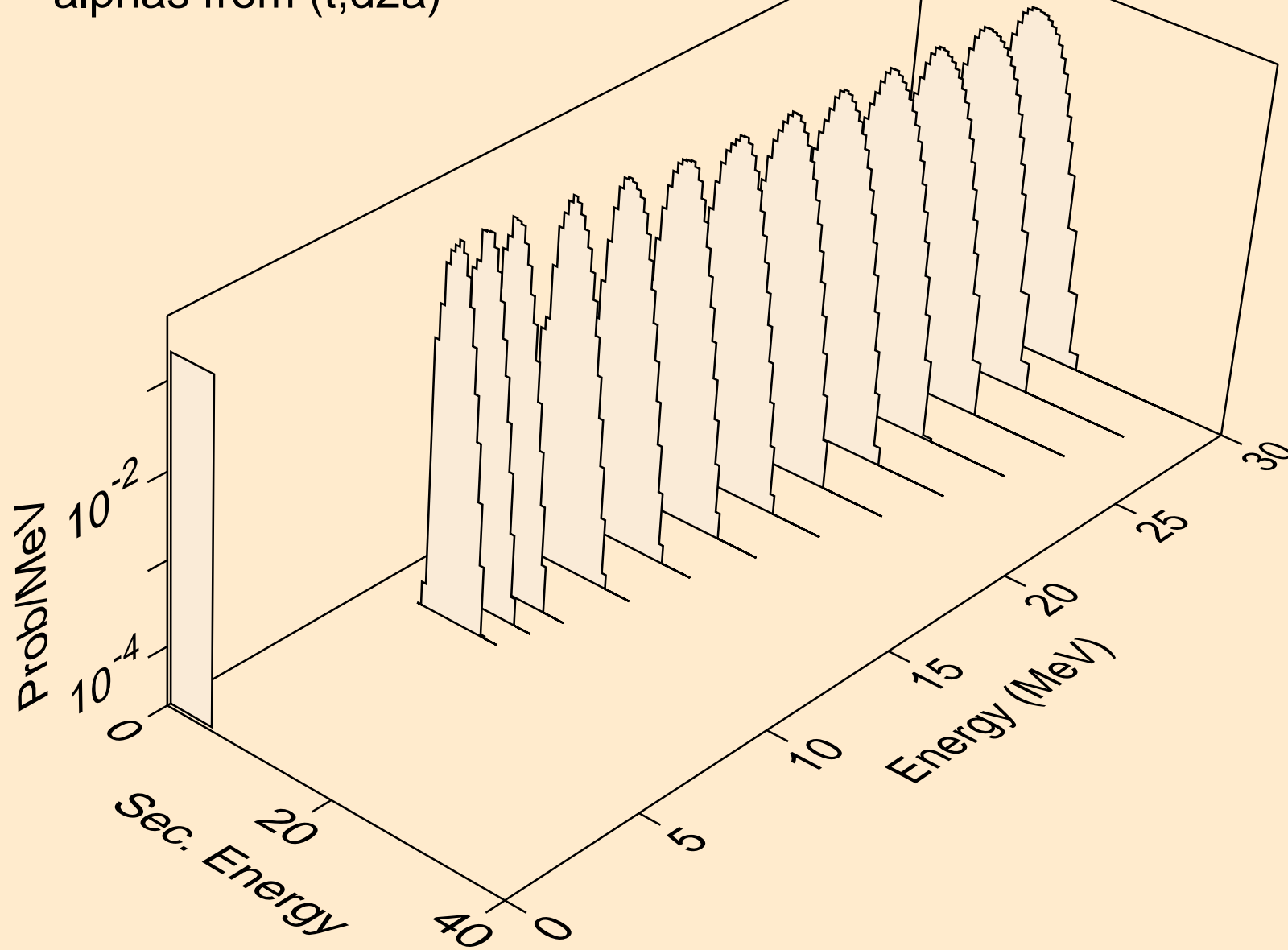

YB151M TRITON ACER TENDL-2021 LIBRARY; T=0.K  
alphas from (t,da)

