

ZN077 TRITON ACER TENDL-2021 LIBRARY; T=0.K  
Principal cross sections

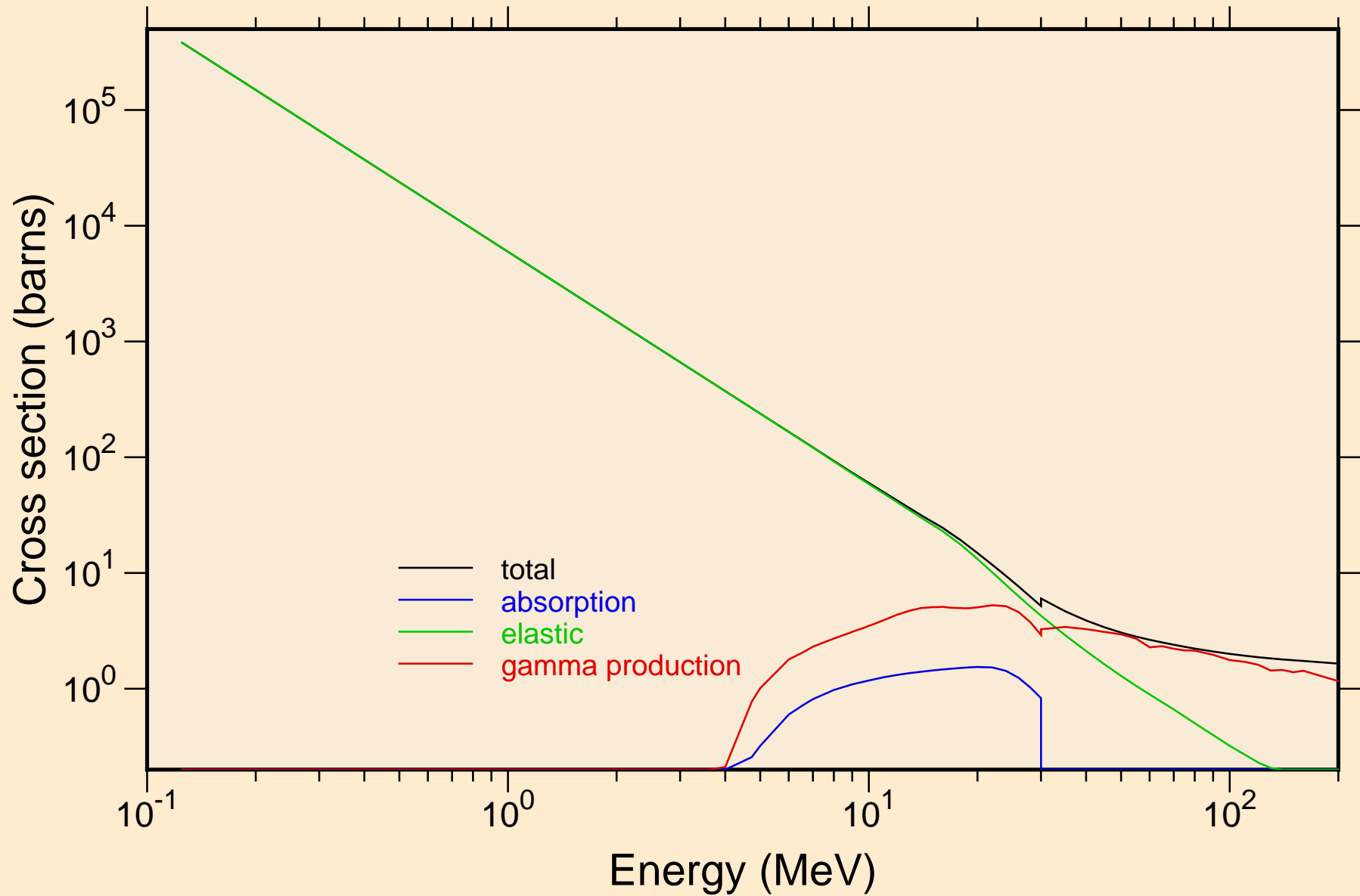

ZN077 TRITON ACER TENDL-2021 LIBRARY; T=0.K

Heating

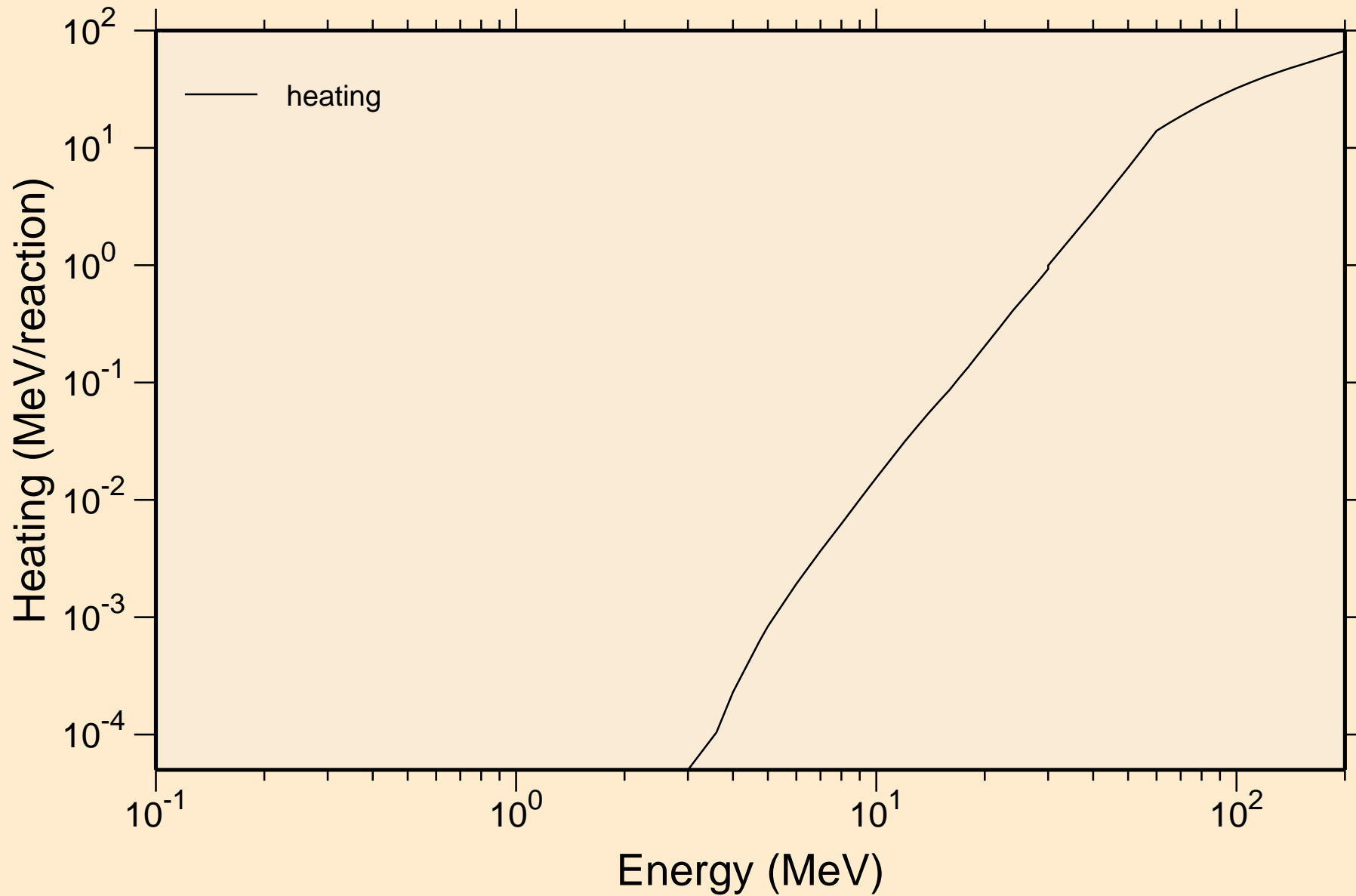

# ZN077 TRITON ACER TENDL-2021 LIBRARY; T=0.K

## Principal cross sections

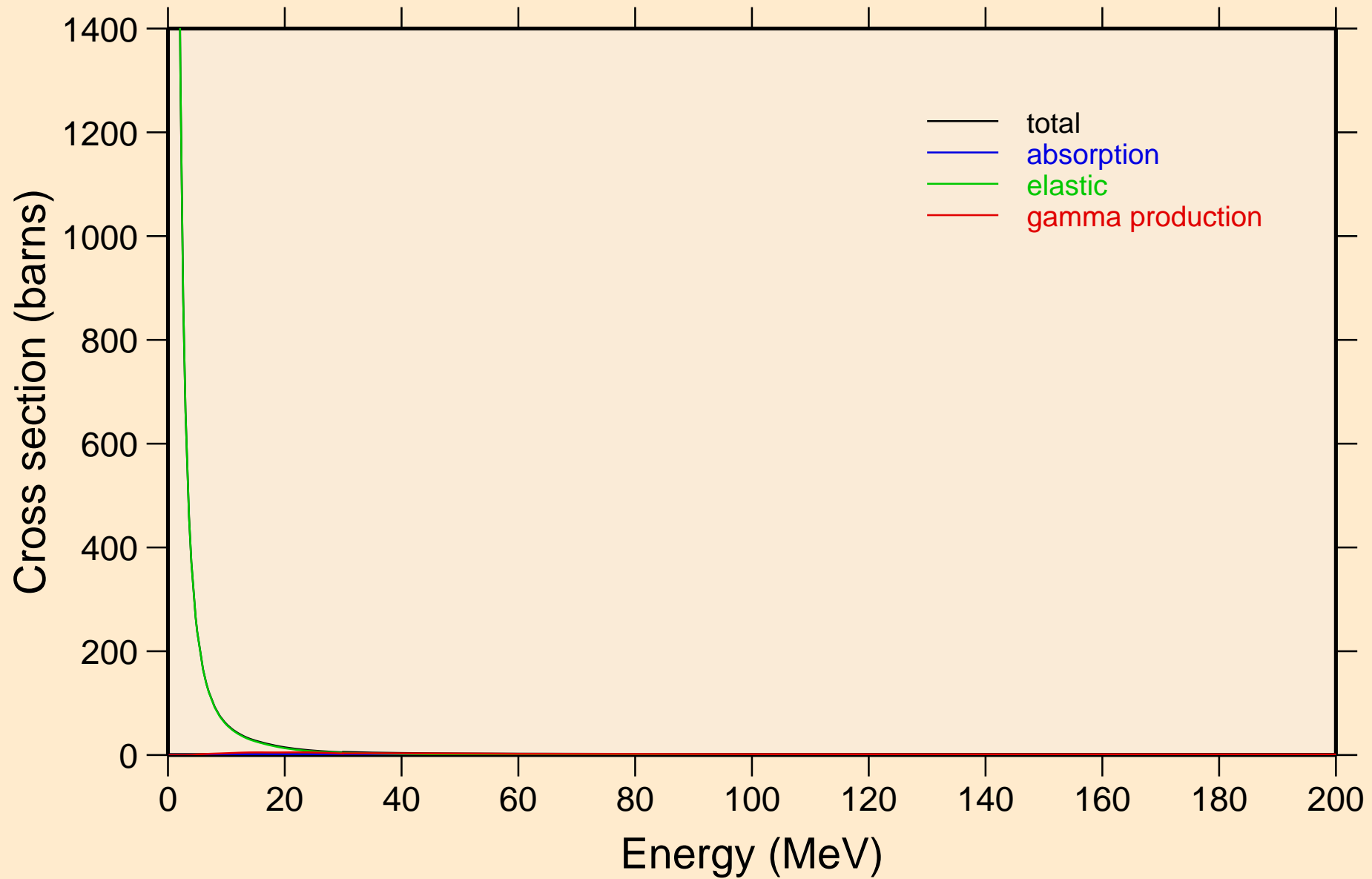

ZN077 TRITON ACER TENDL-2021 LIBRARY; T=0.K

Heating

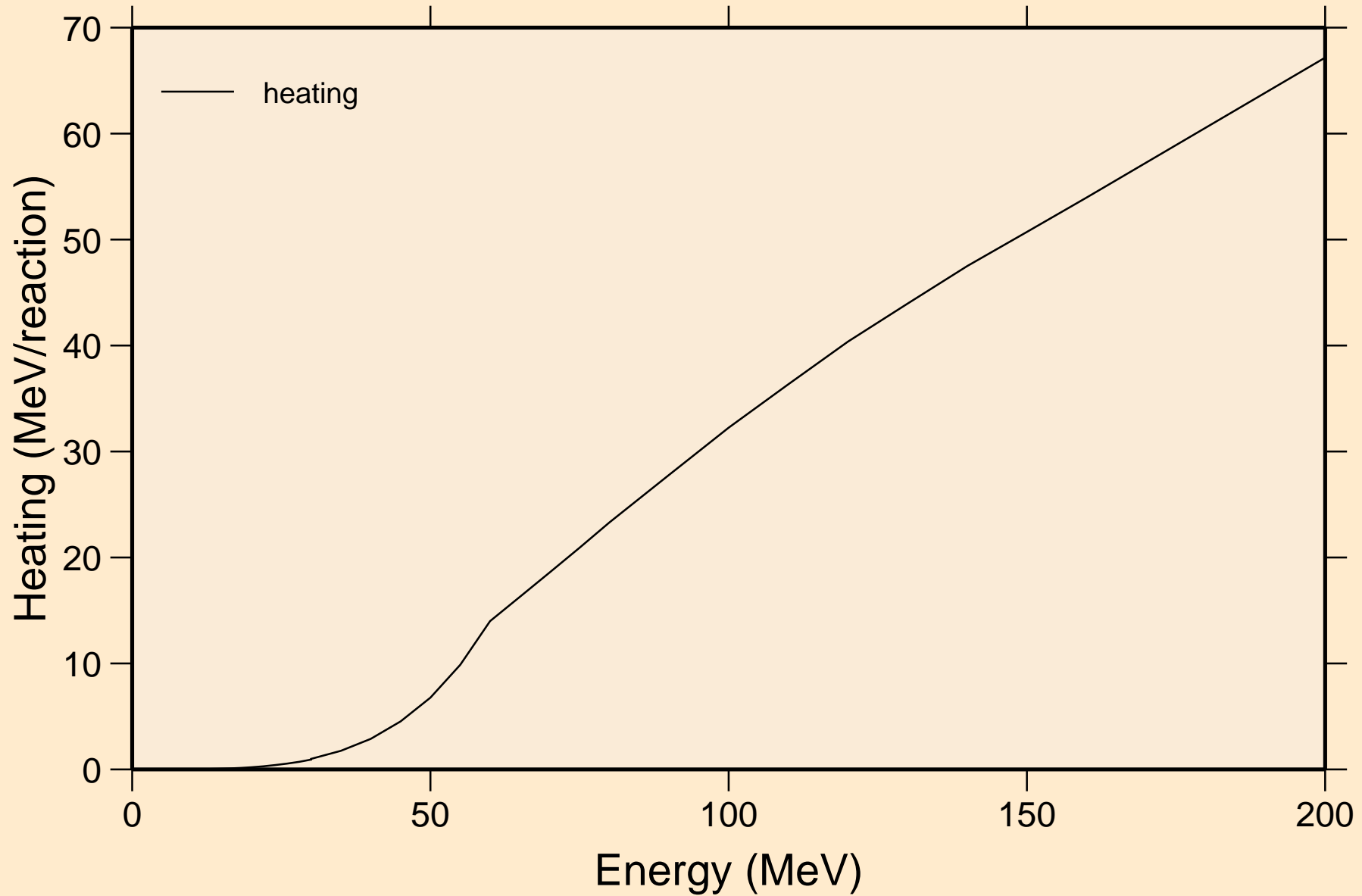

ZN077 TRITON ACER TENDL-2021 LIBRARY; T=0.K  
Threshold reactions

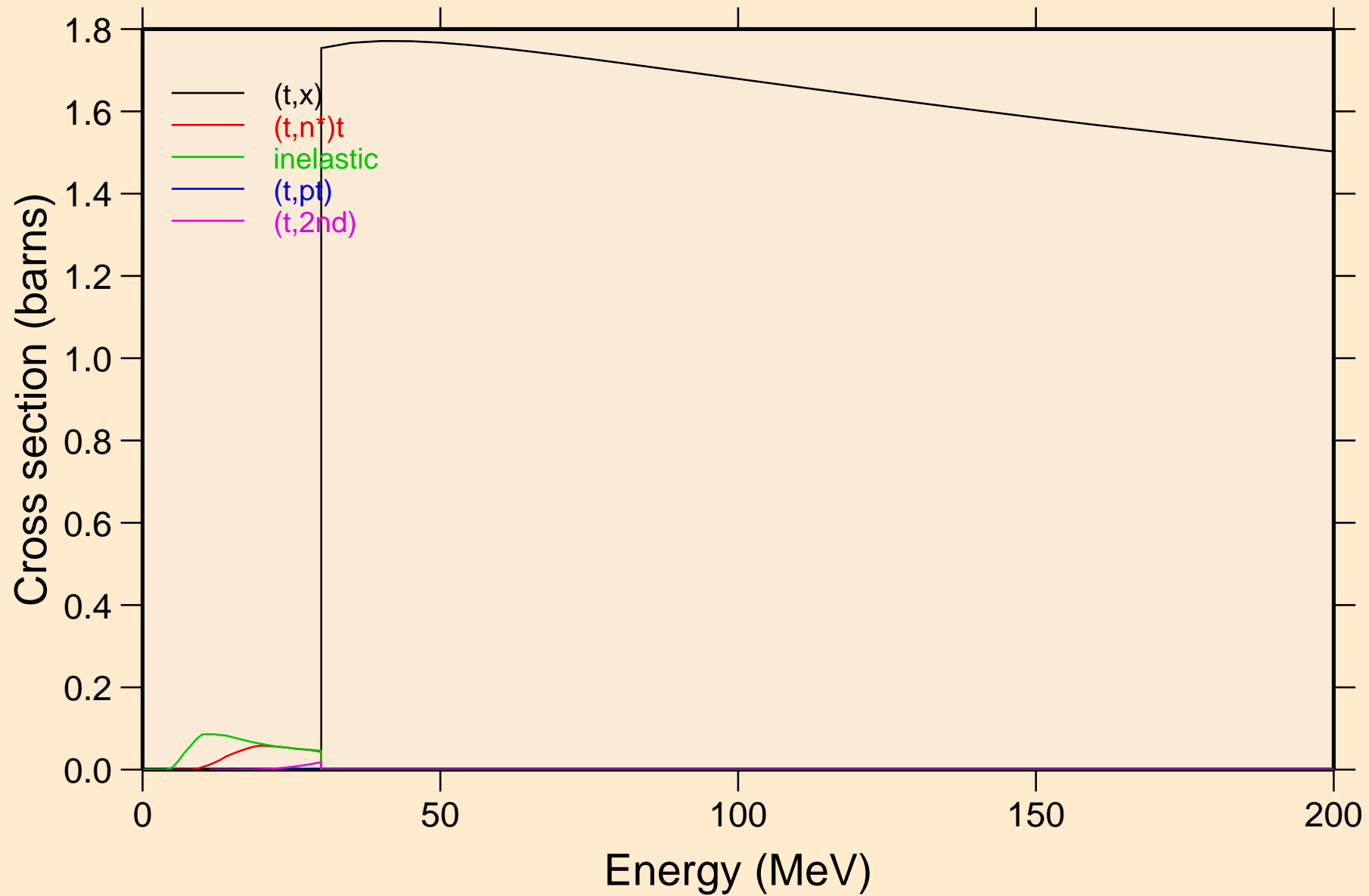

ZN077 TRITON ACER TENDL-2021 LIBRARY; T=0.K  
Threshold reactions

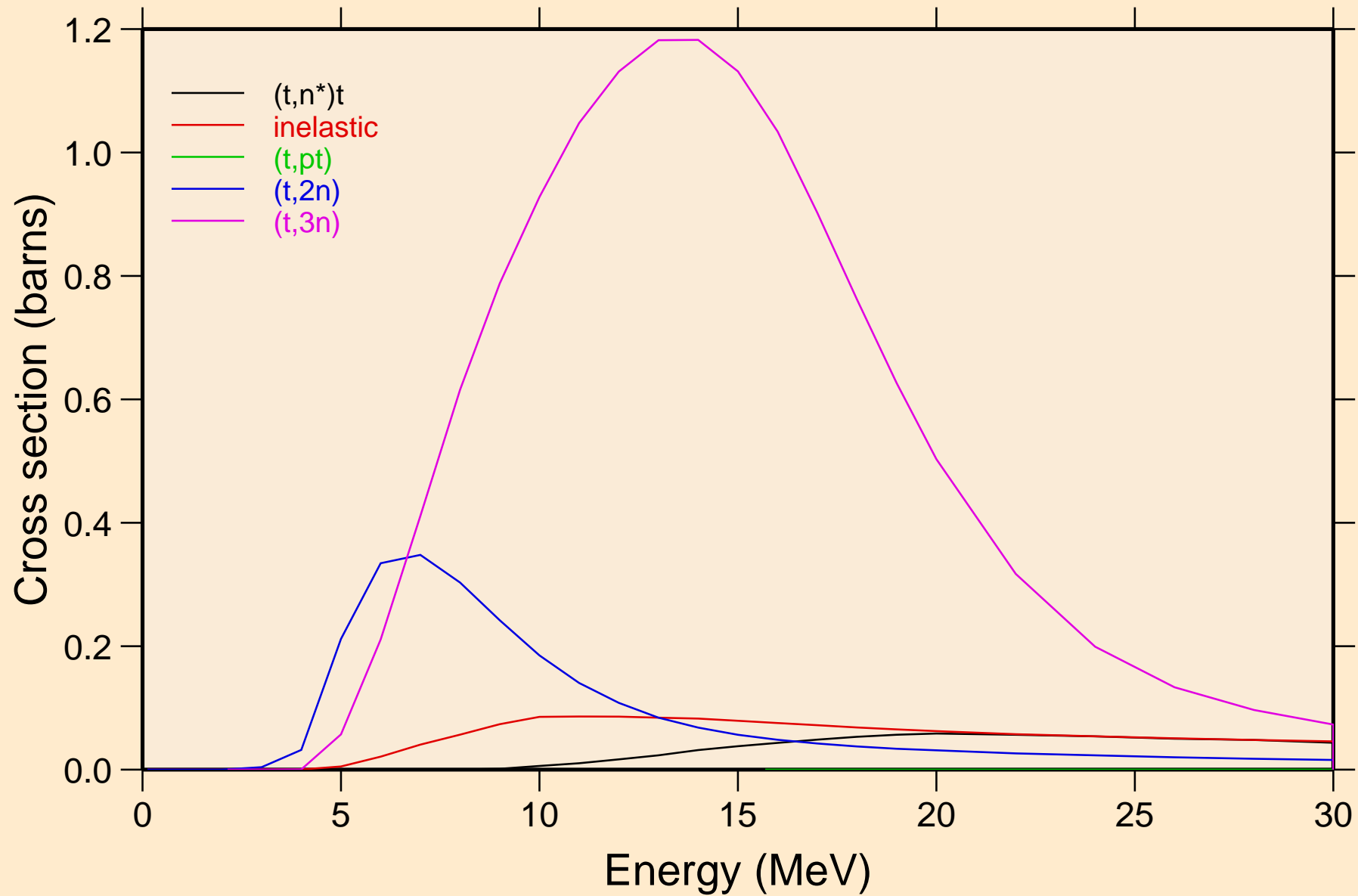

ZN077 TRITON ACER TENDL-2021 LIBRARY; T=0.K  
Threshold reactions

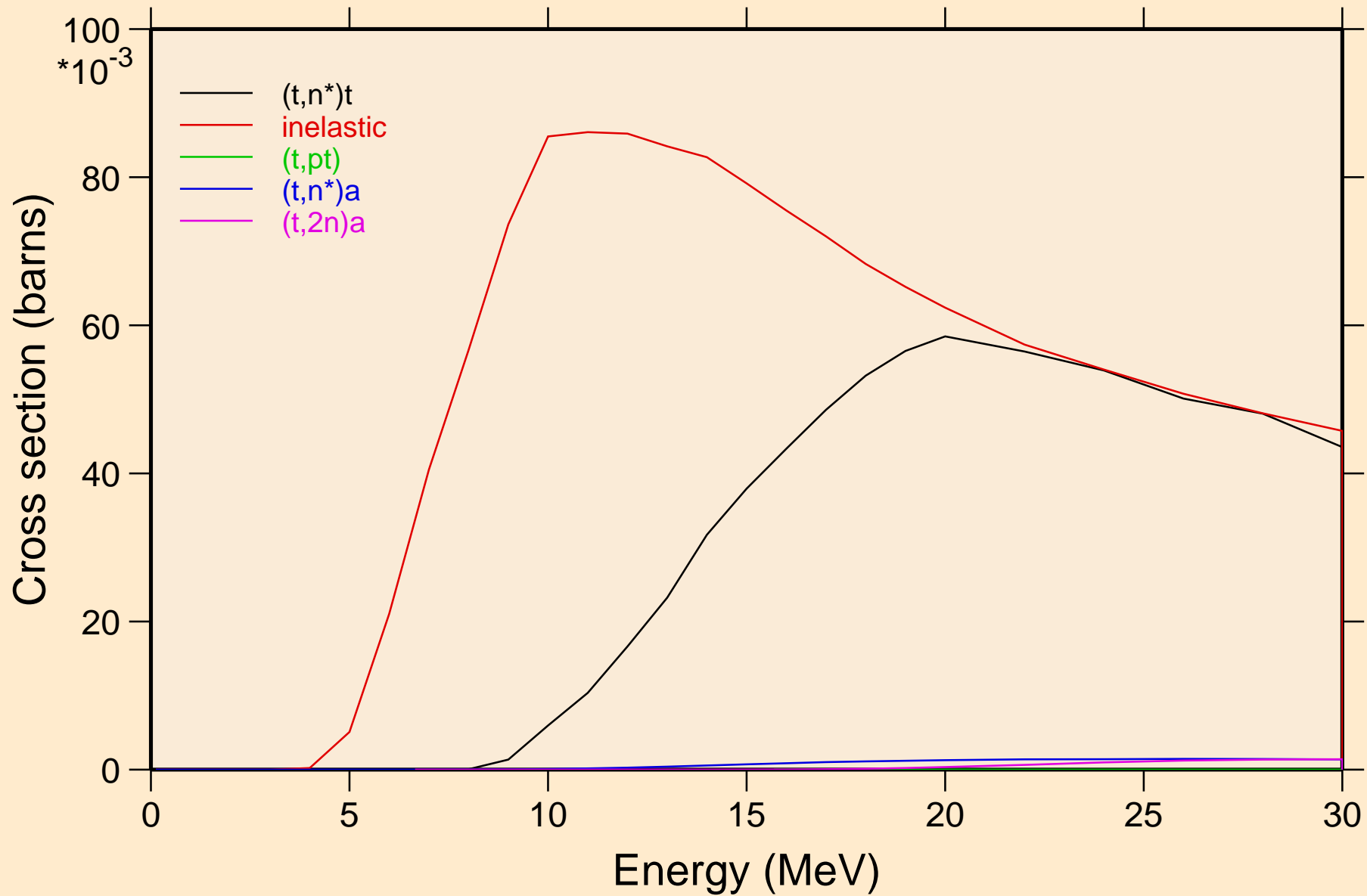

ZN077 TRITON ACER TENDL-2021 LIBRARY; T=0.K  
Threshold reactions

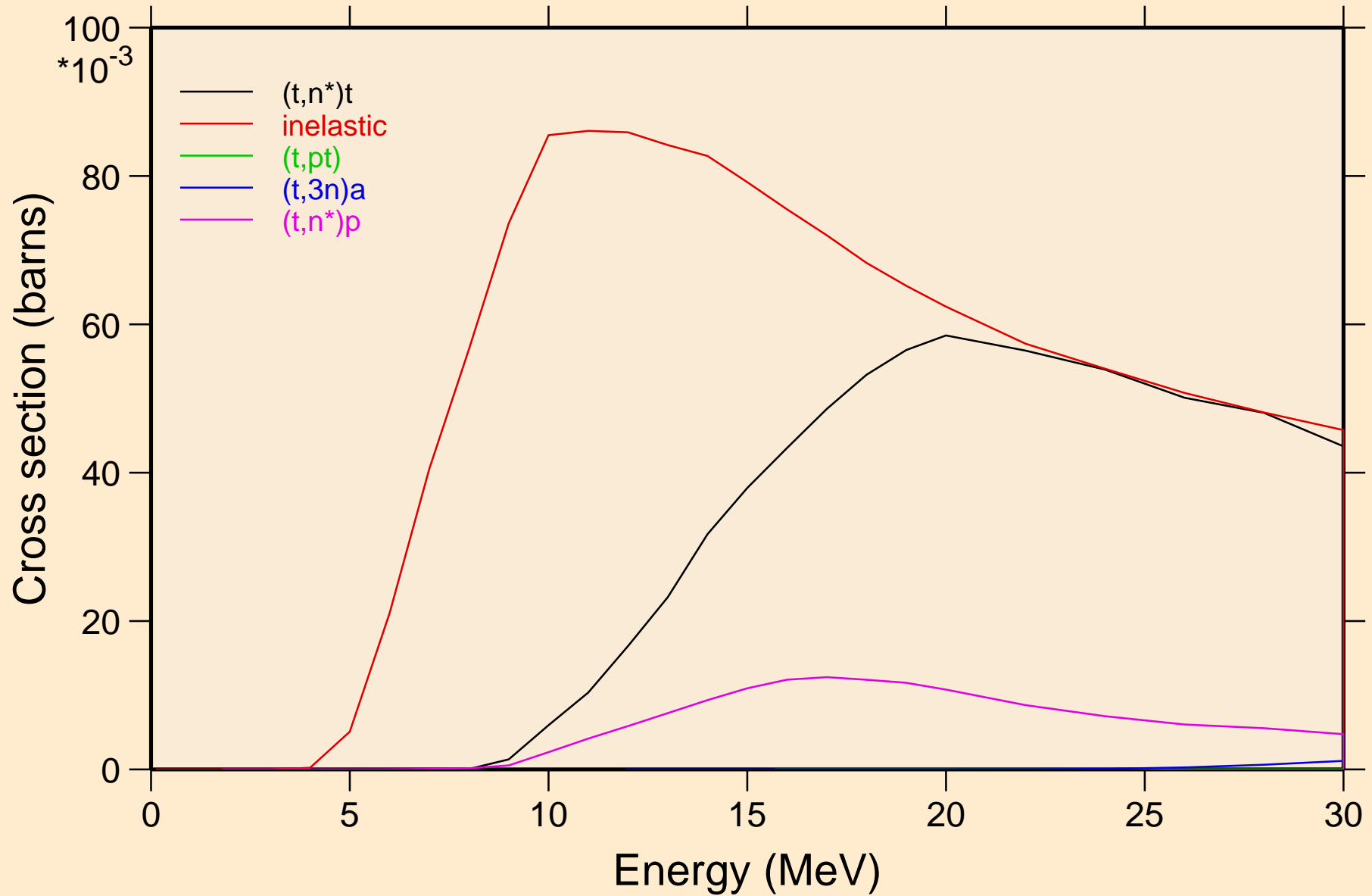



ZN077 TRITON ACER TENDL-2021 LIBRARY; T=0.K  
Threshold reactions

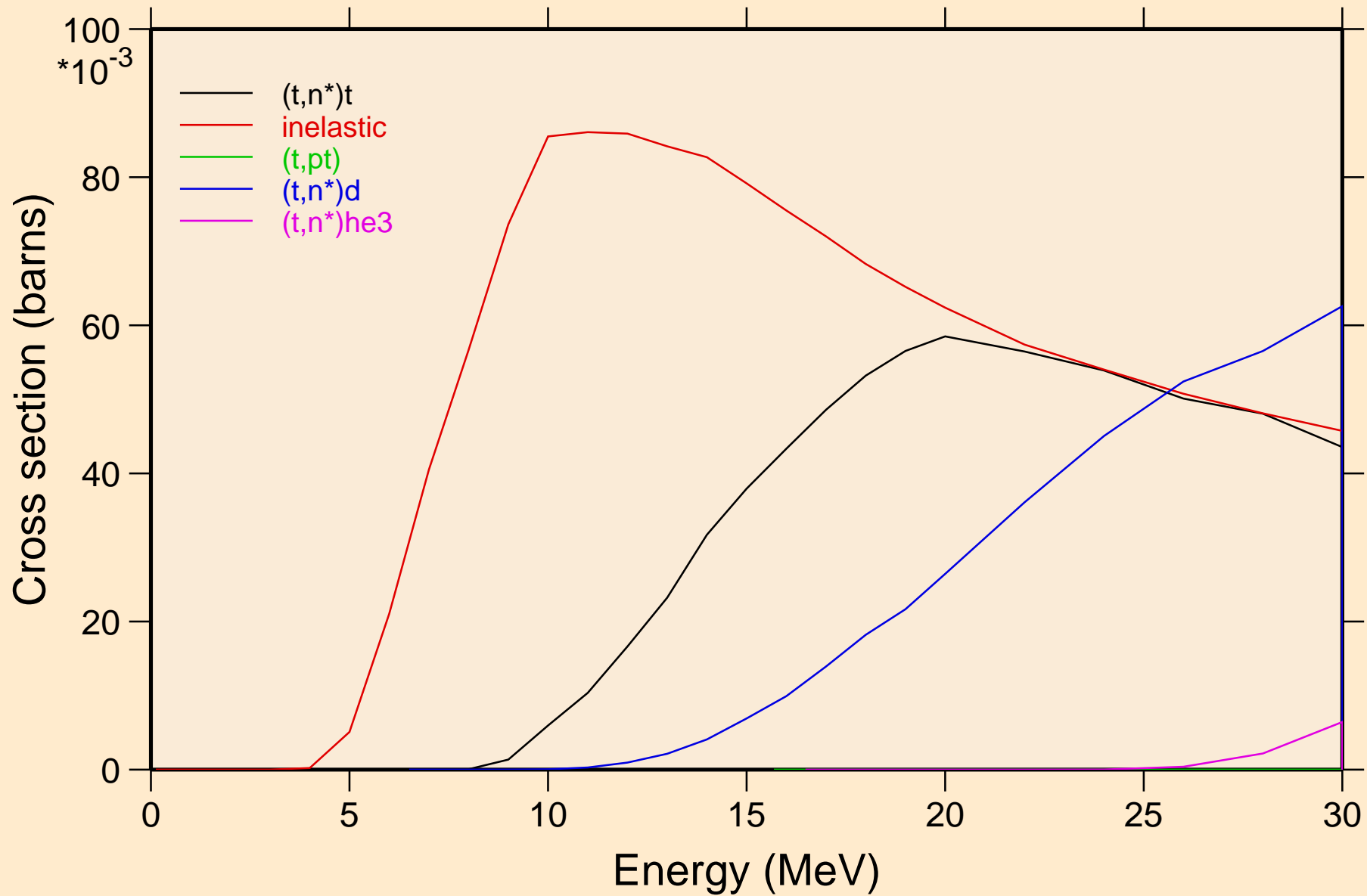

ZN077 TRITON ACER TENDL-2021 LIBRARY; T=0.K  
Threshold reactions

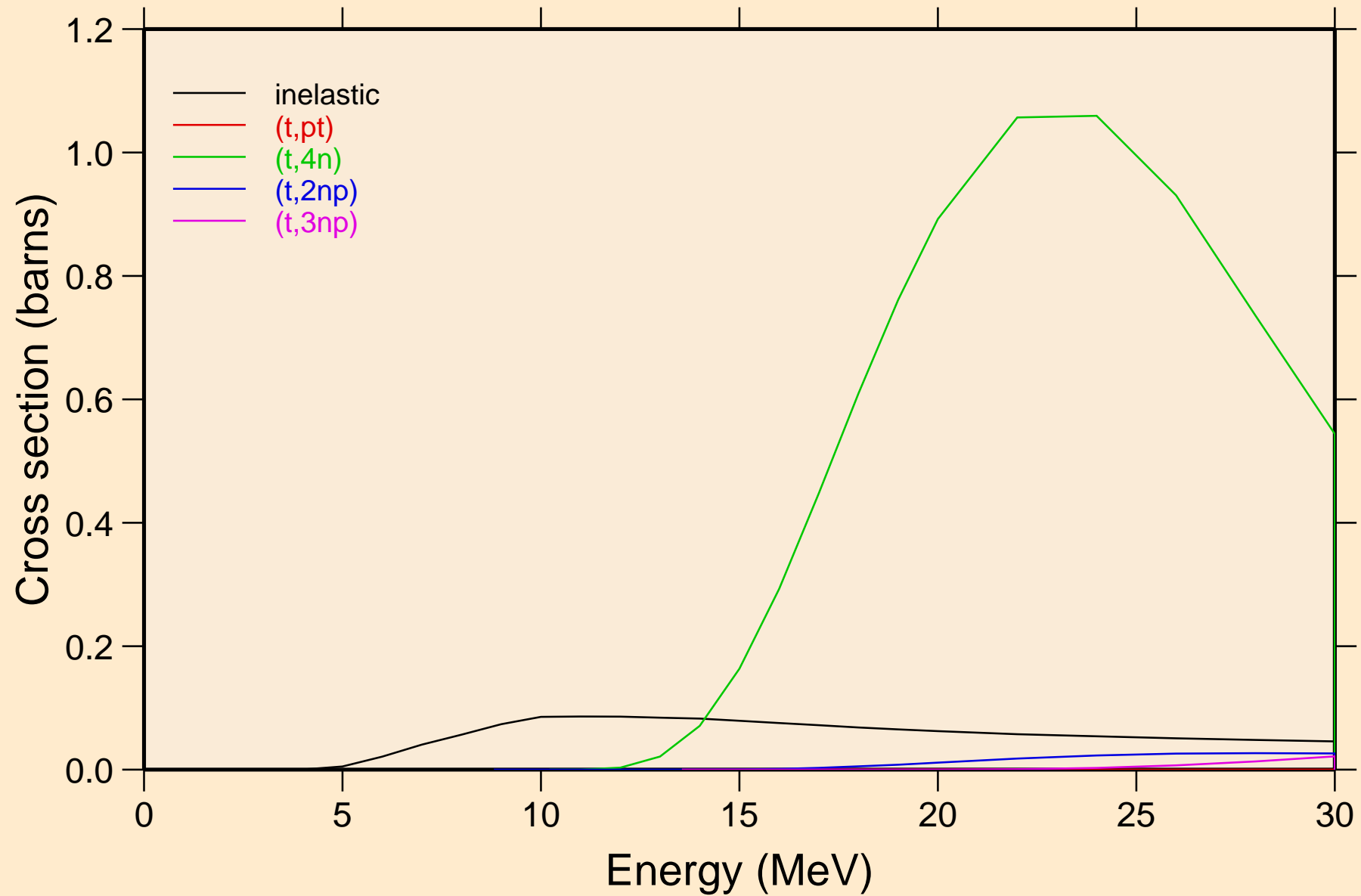

ZN077 TRITON ACER TENDL-2021 LIBRARY; T=0.K  
Threshold reactions

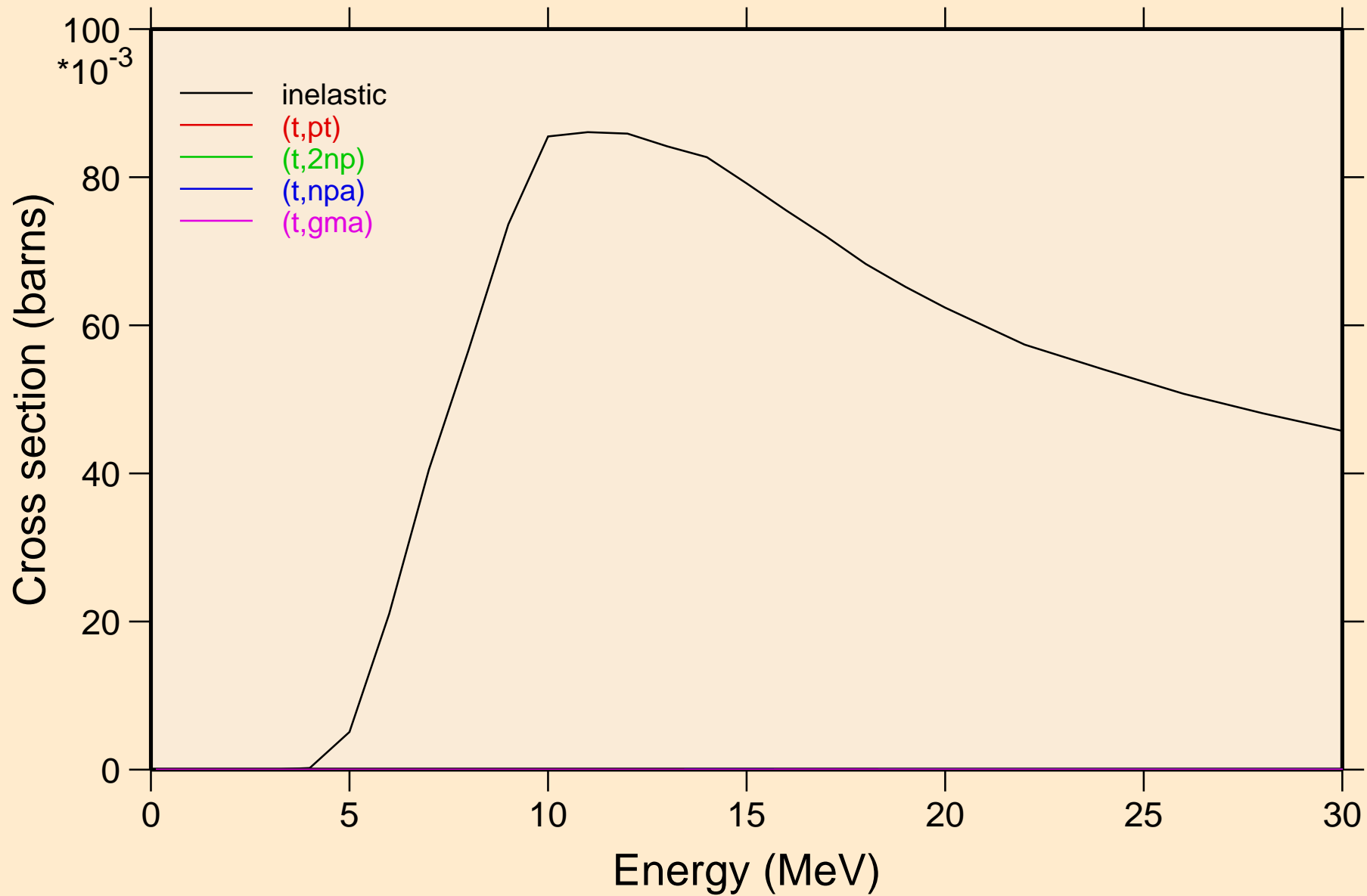

ZN077 TRITON ACER TENDL-2021 LIBRARY; T=0.K  
Threshold reactions

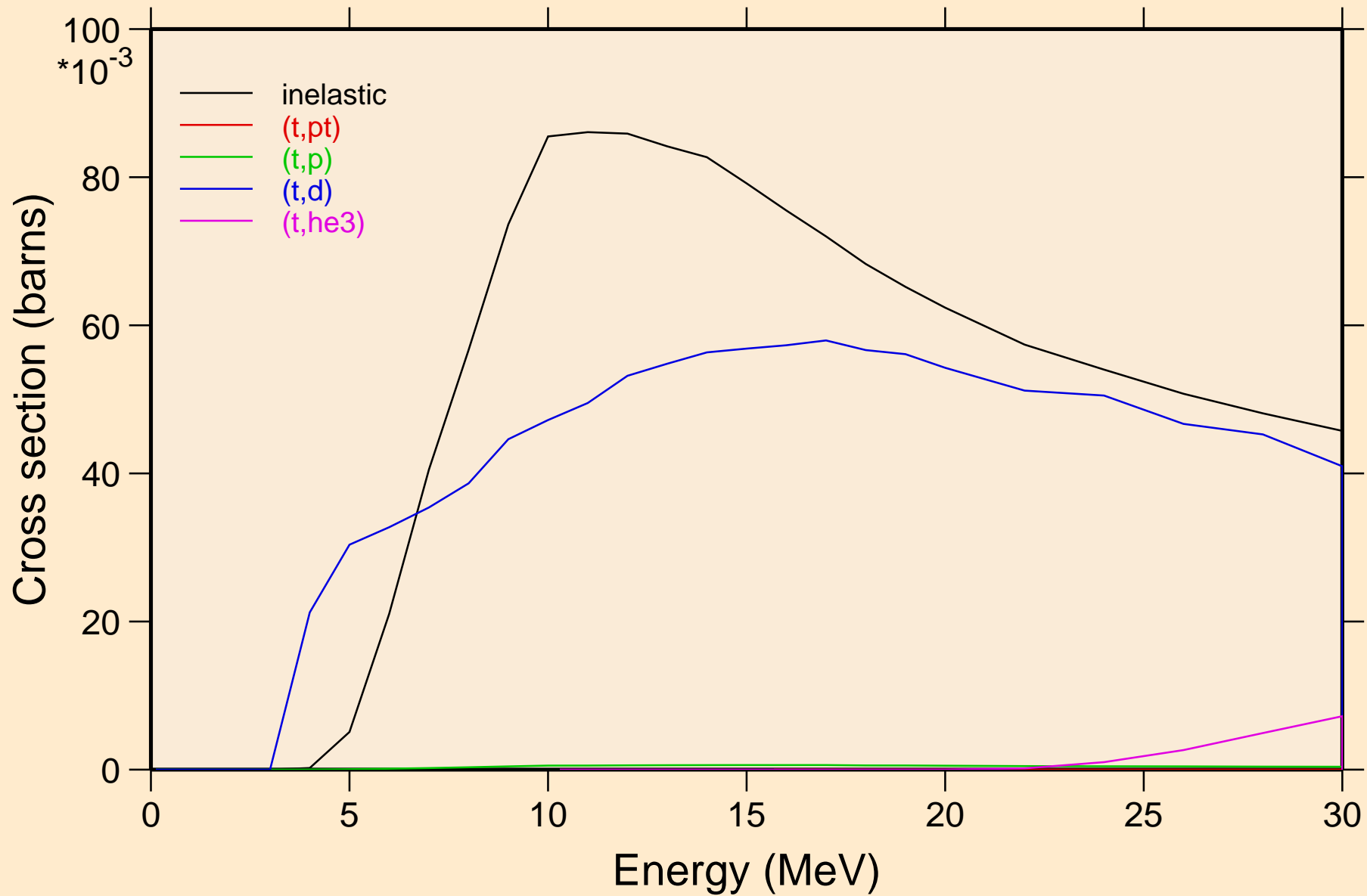

ZN077 TRITON ACER TENDL-2021 LIBRARY; T=0.K  
Threshold reactions

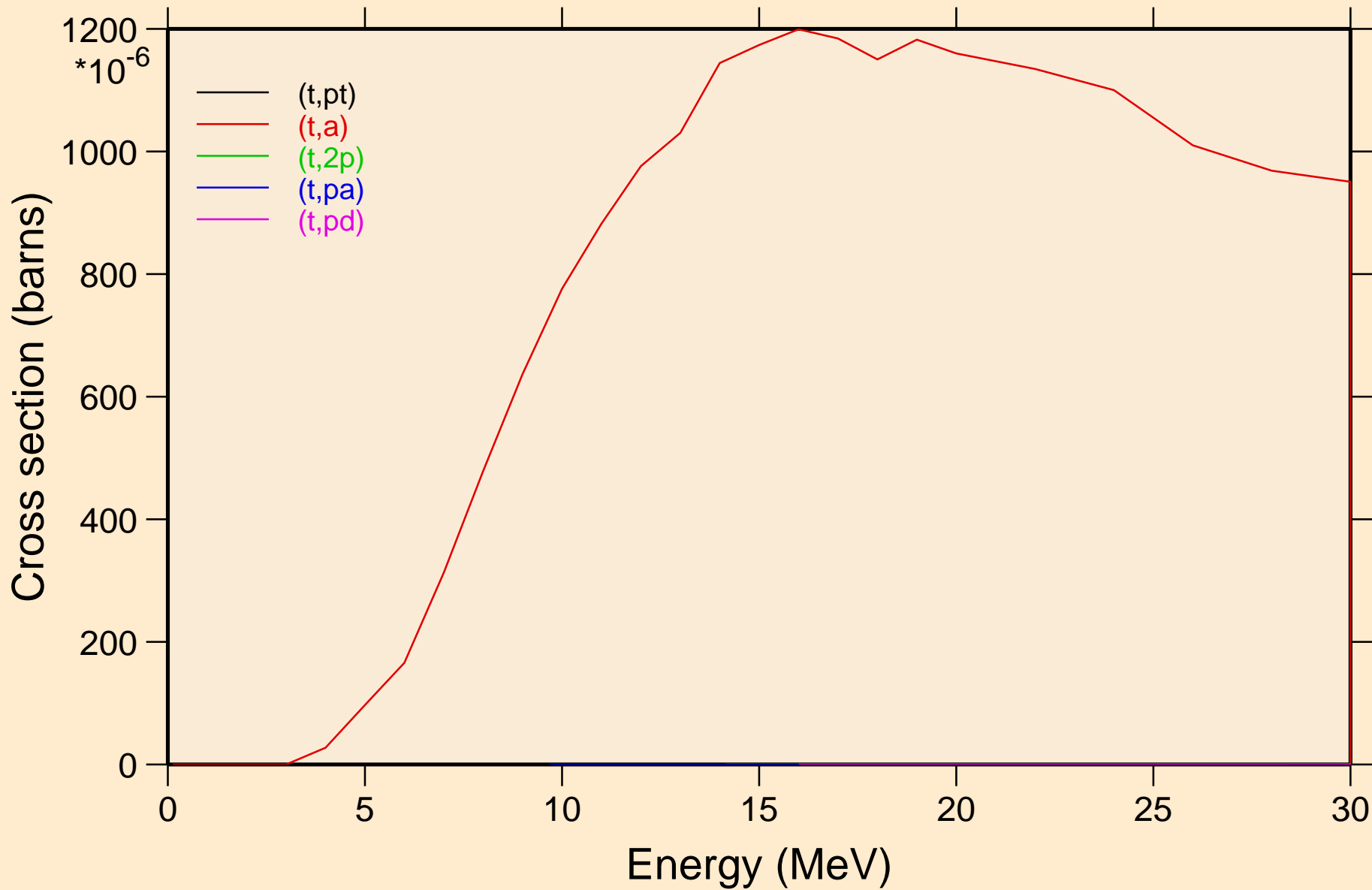

ZN077 TRITON ACER TENDL-2021 LIBRARY; T=0.K  
Threshold reactions

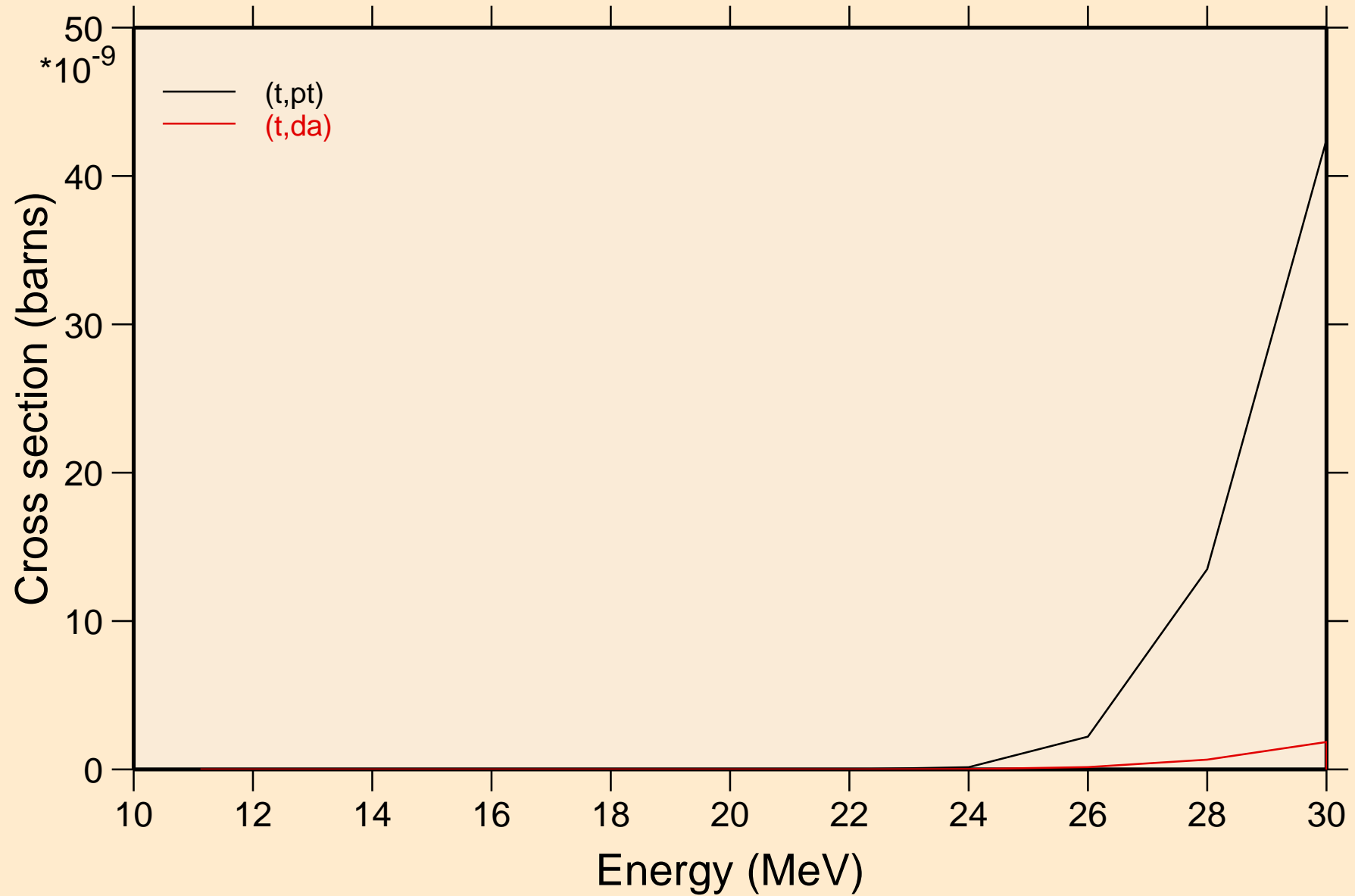

ZN077 TRITON ACER TENDL-2021 LIBRARY; T=0.K  
angular distribution for elastic

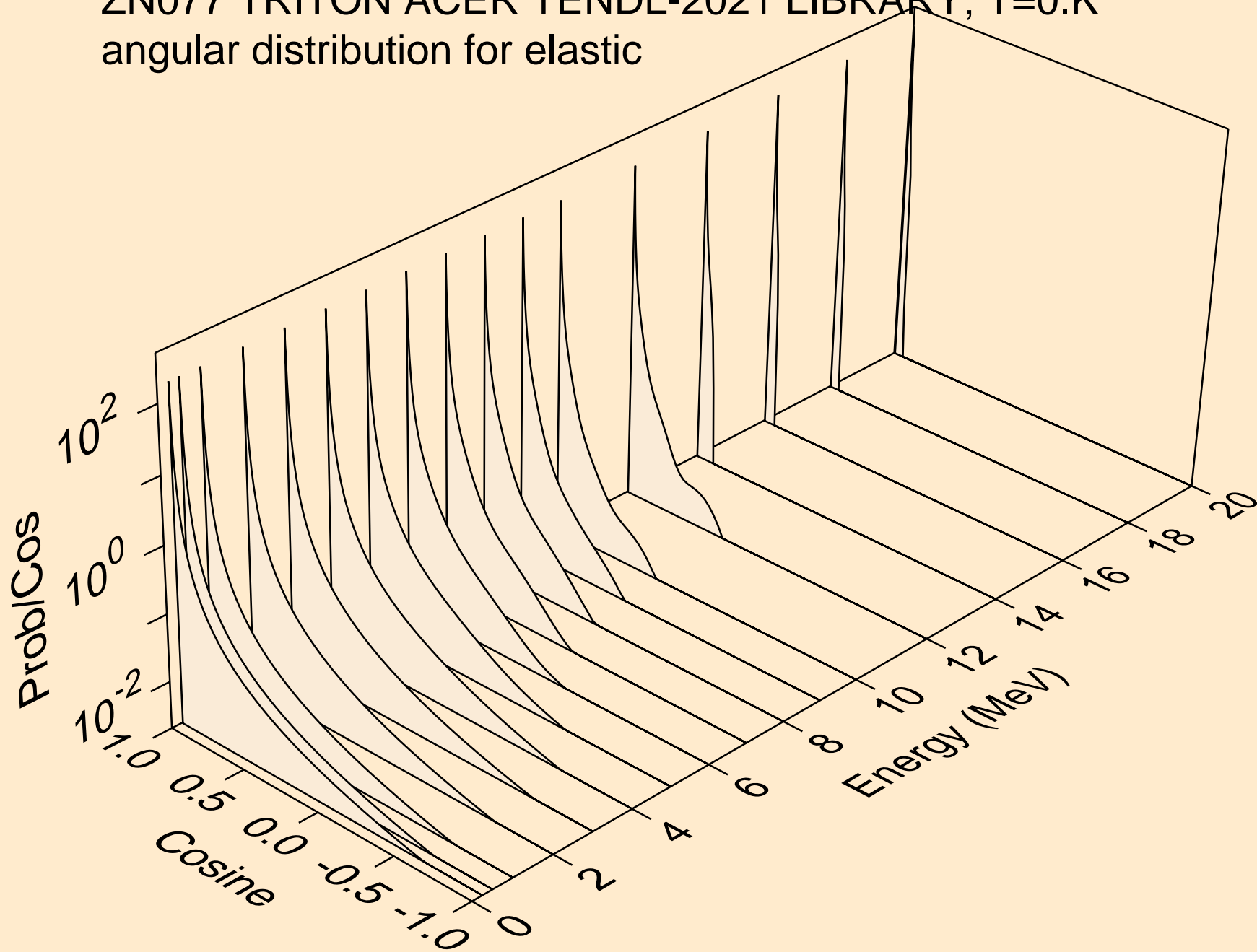

ZN077 TRITON ACER TENDL-2021 LIBRARY; T=0.K  
angular distribution for elastic

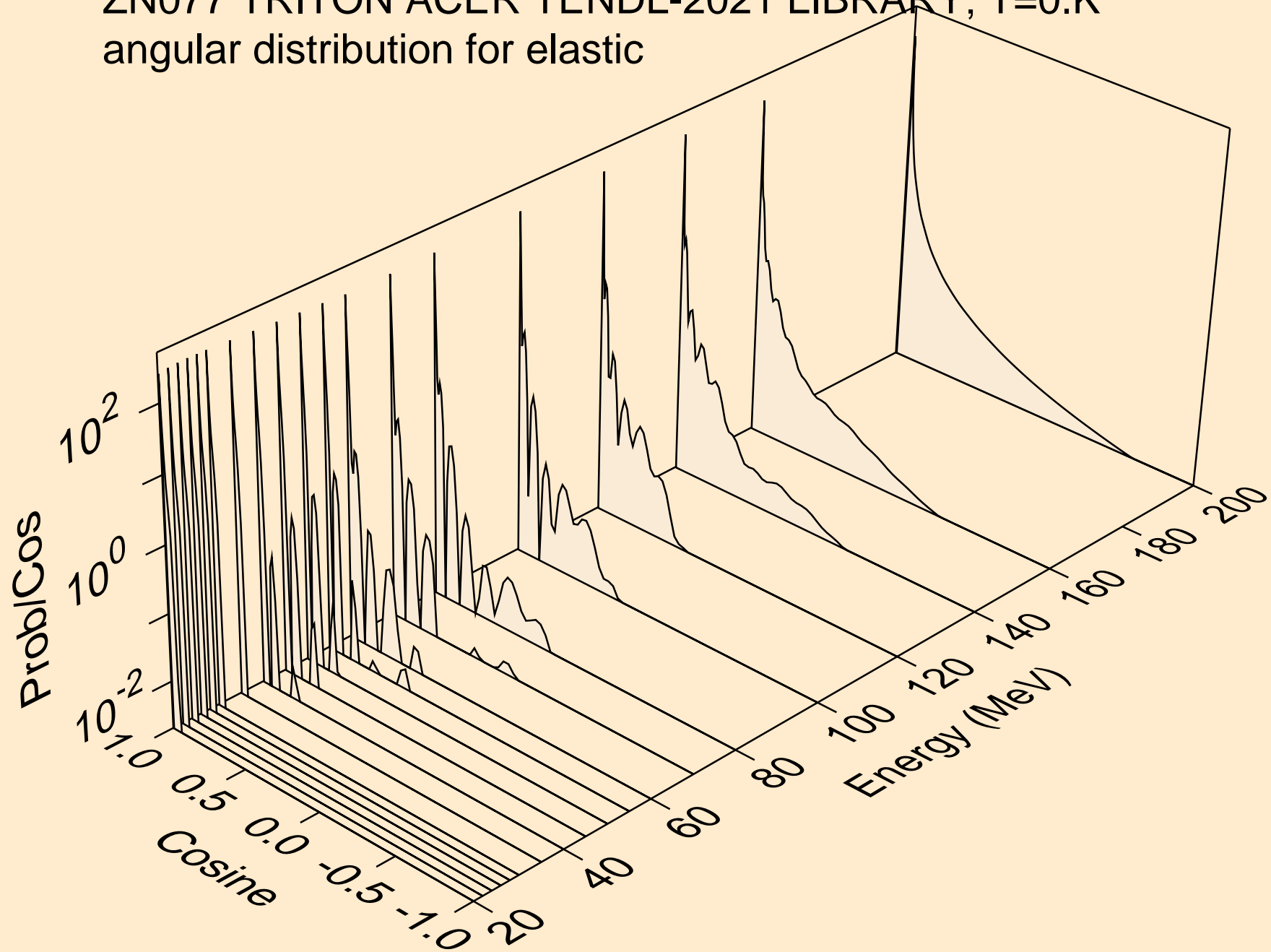



ZN077 TRITON ACER TENDL-2021 LIBRARY; T=0.K  
Triton emission for (t,x)

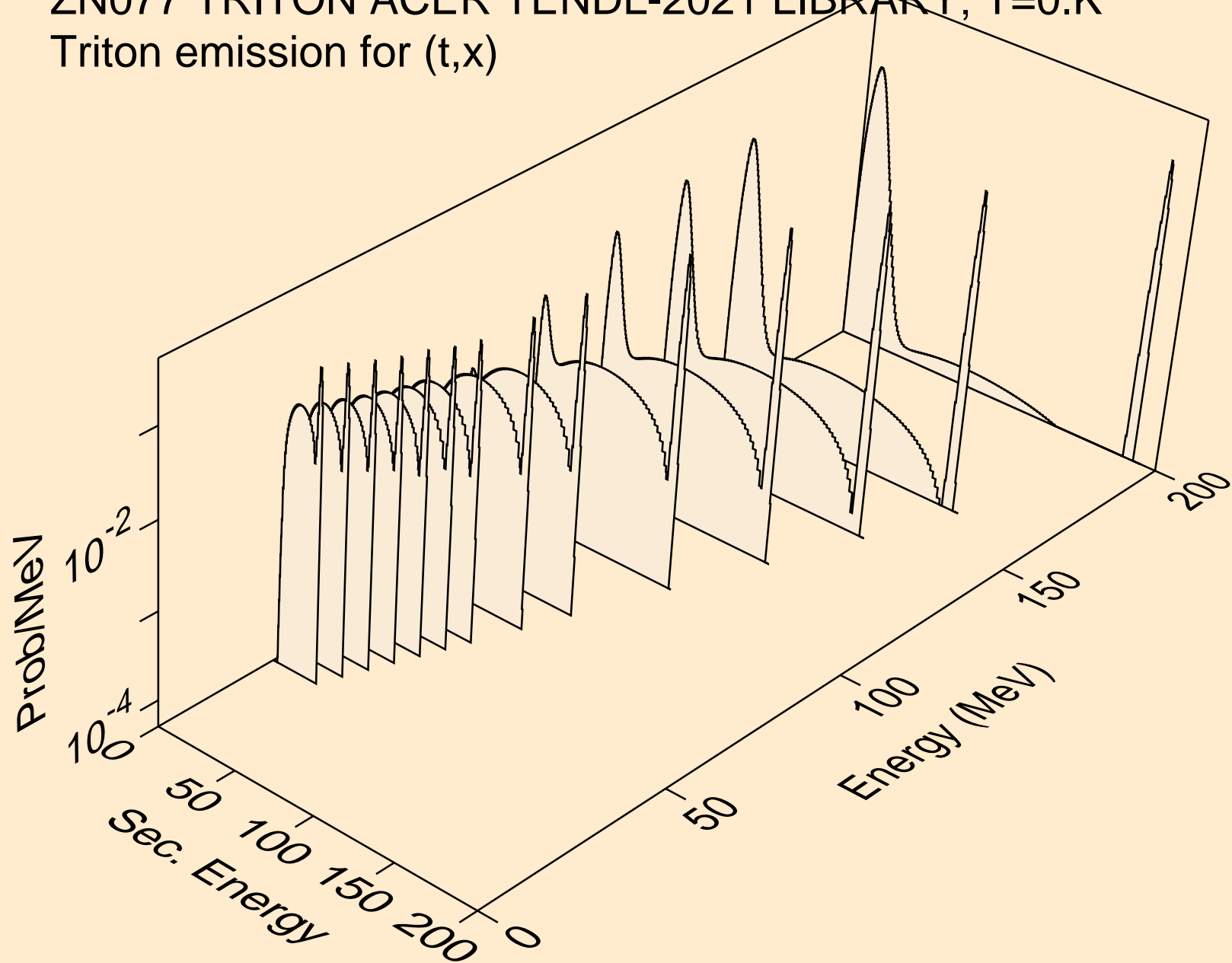

ZN077 TRITON ACER TENDL-2021 LIBRARY; T=0.K  
Triton emission for (t,n\*)t

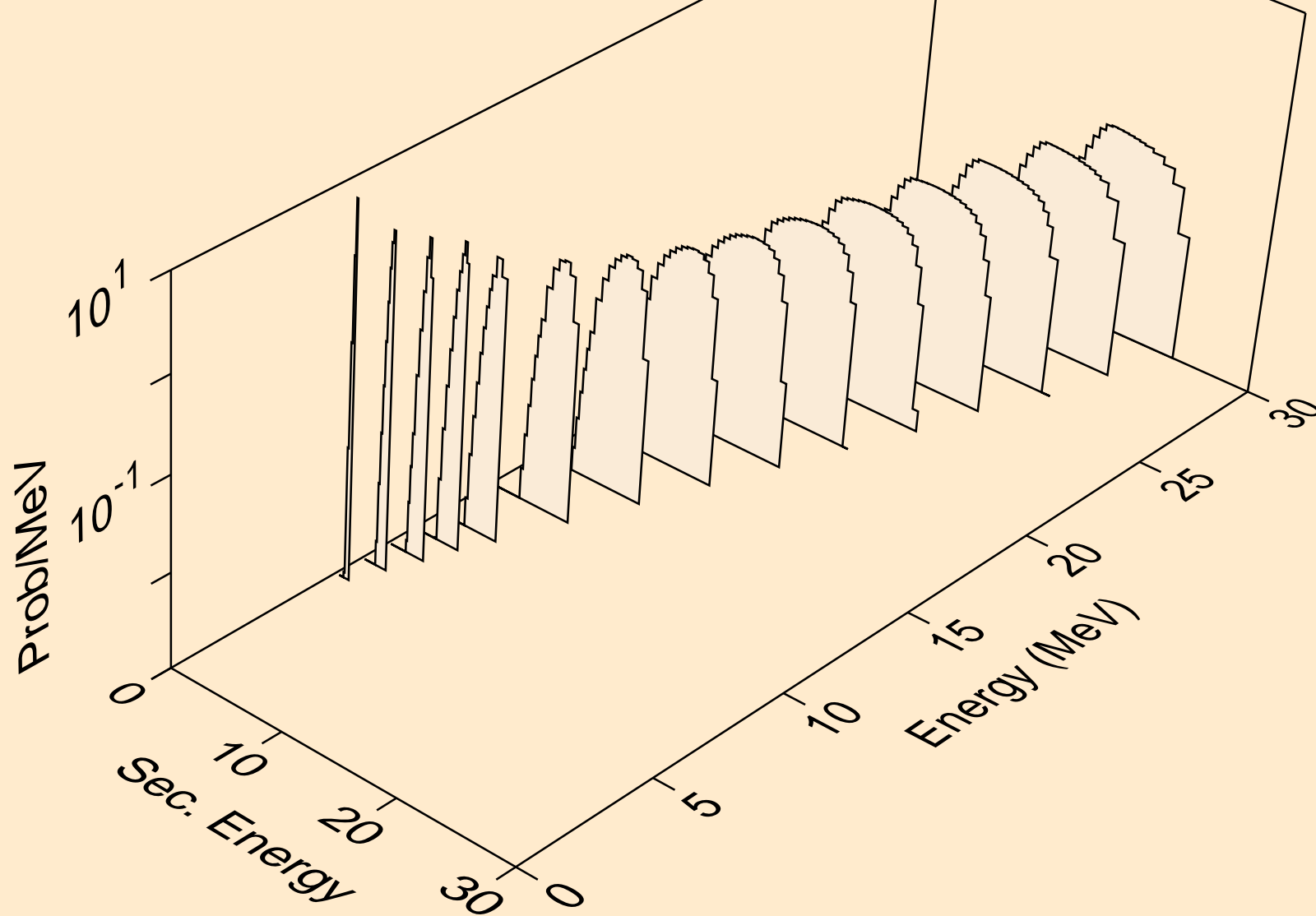

ZN077 TRITON ACER TENDL-2021 LIBRARY; T=0.K  
Triton emission for inelastic

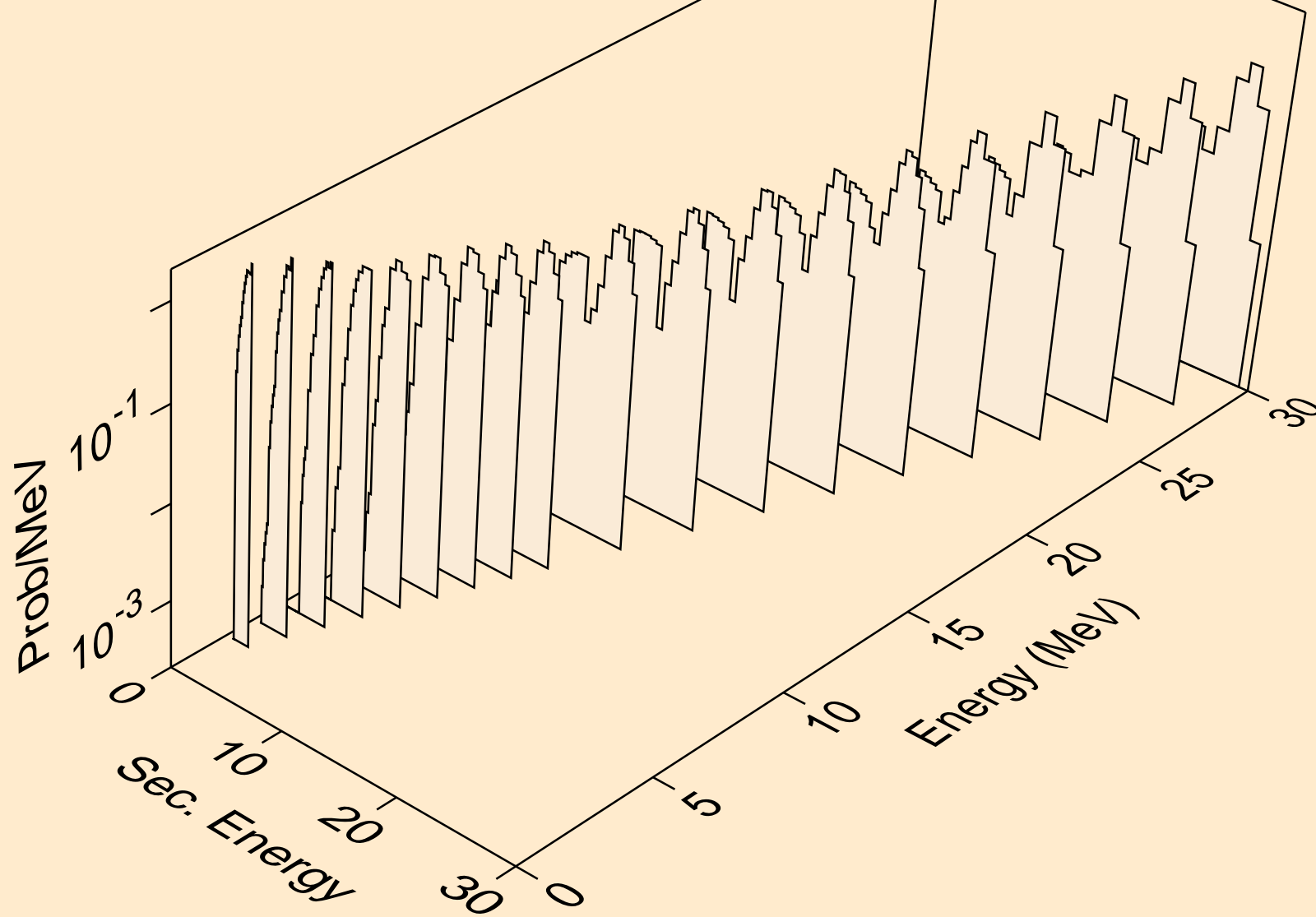

ZN077 TRITON ACER TENDL-2021 LIBRARY; T=0.K  
Triton emission for (t,pt)

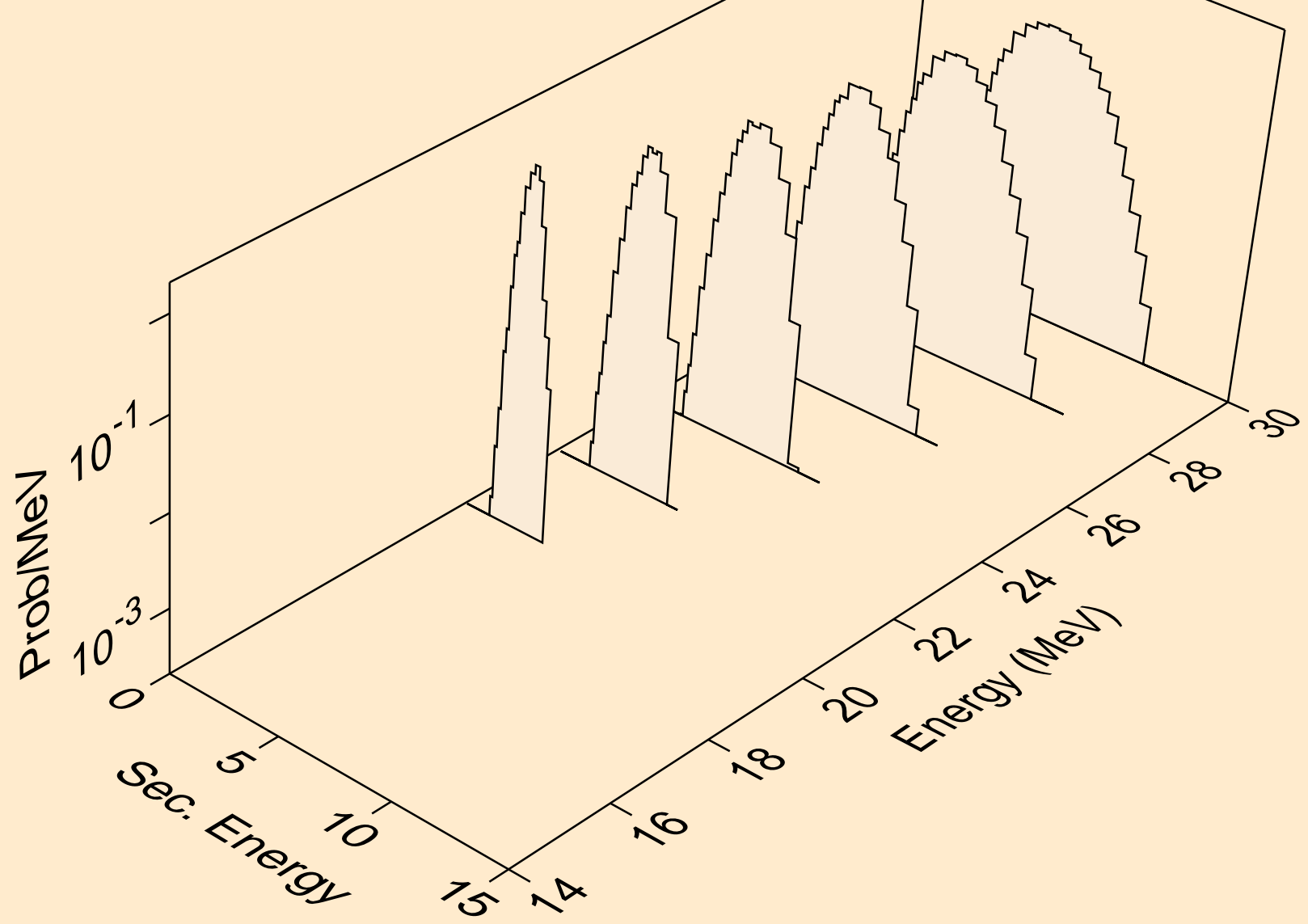

ZN077 TRITON ACER TENDL-2021 LIBRARY; T=0.K  
Photon emission for (z,n)

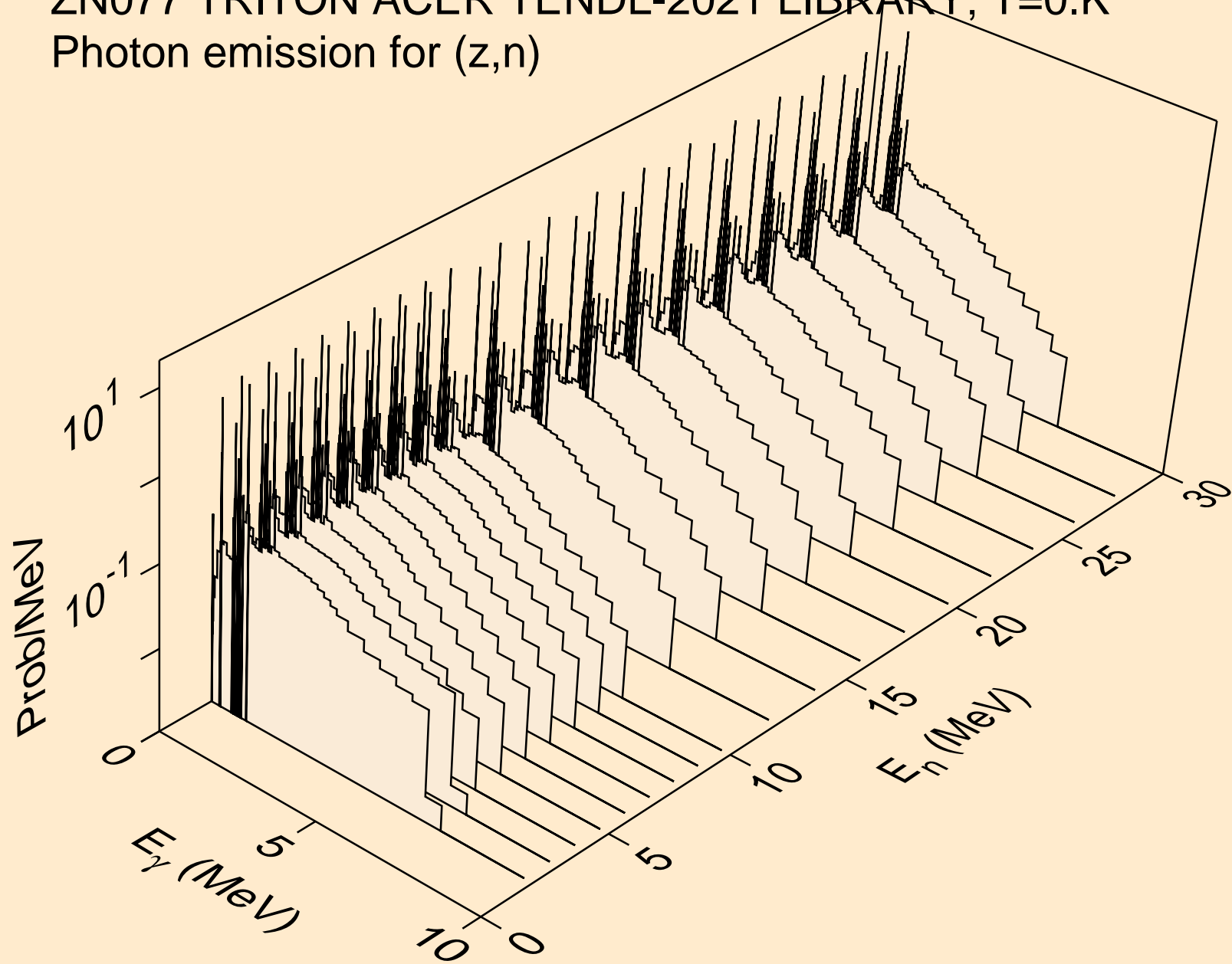

ZN077 TRITON ACER TENDL-2021 LIBRARY; T=0.K  
Photon emission for (n,x)

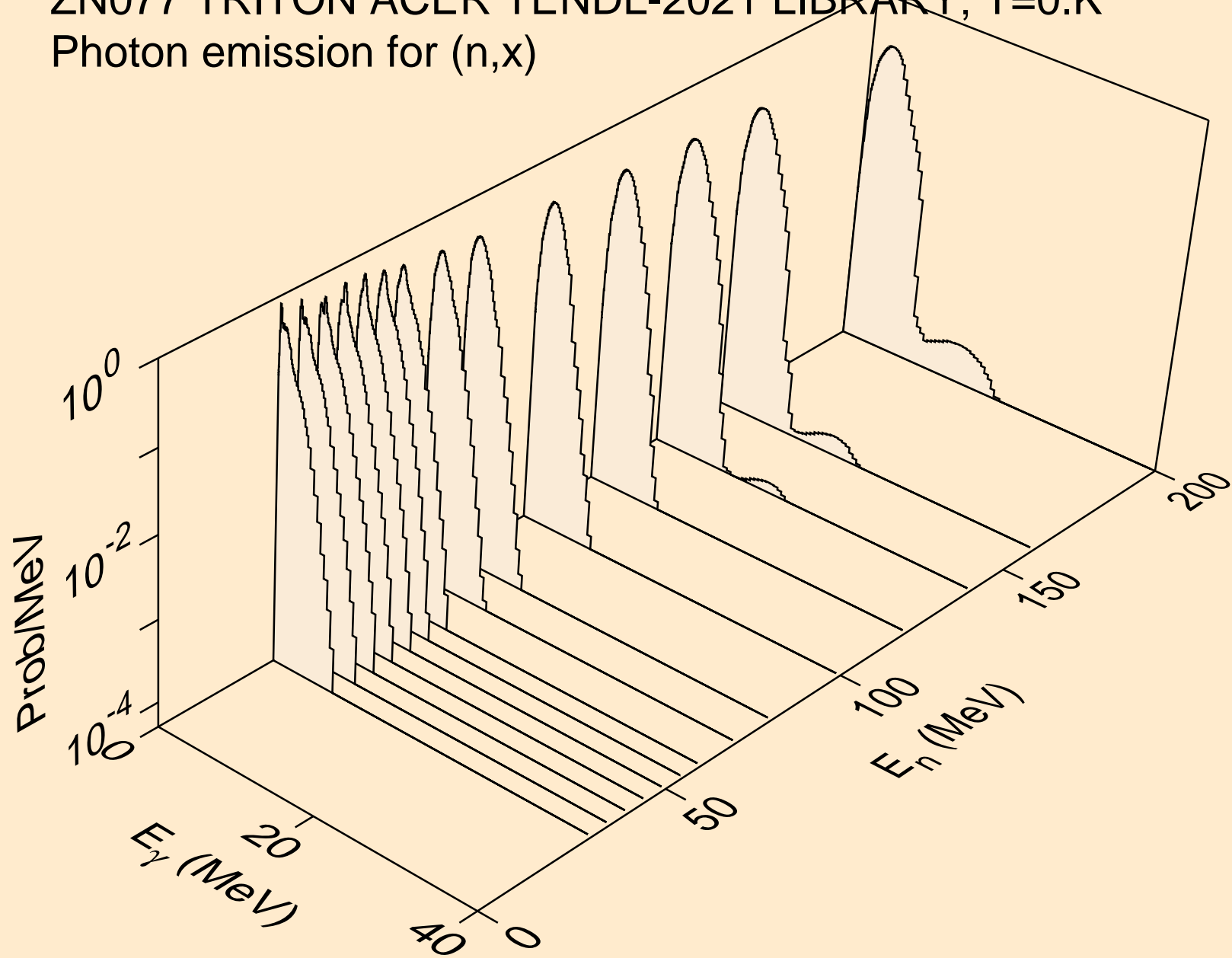

ZN077 TRITON ACER TENDL-2021 LIBRARY; T=0.K  
Photon emission for (n,2nd)

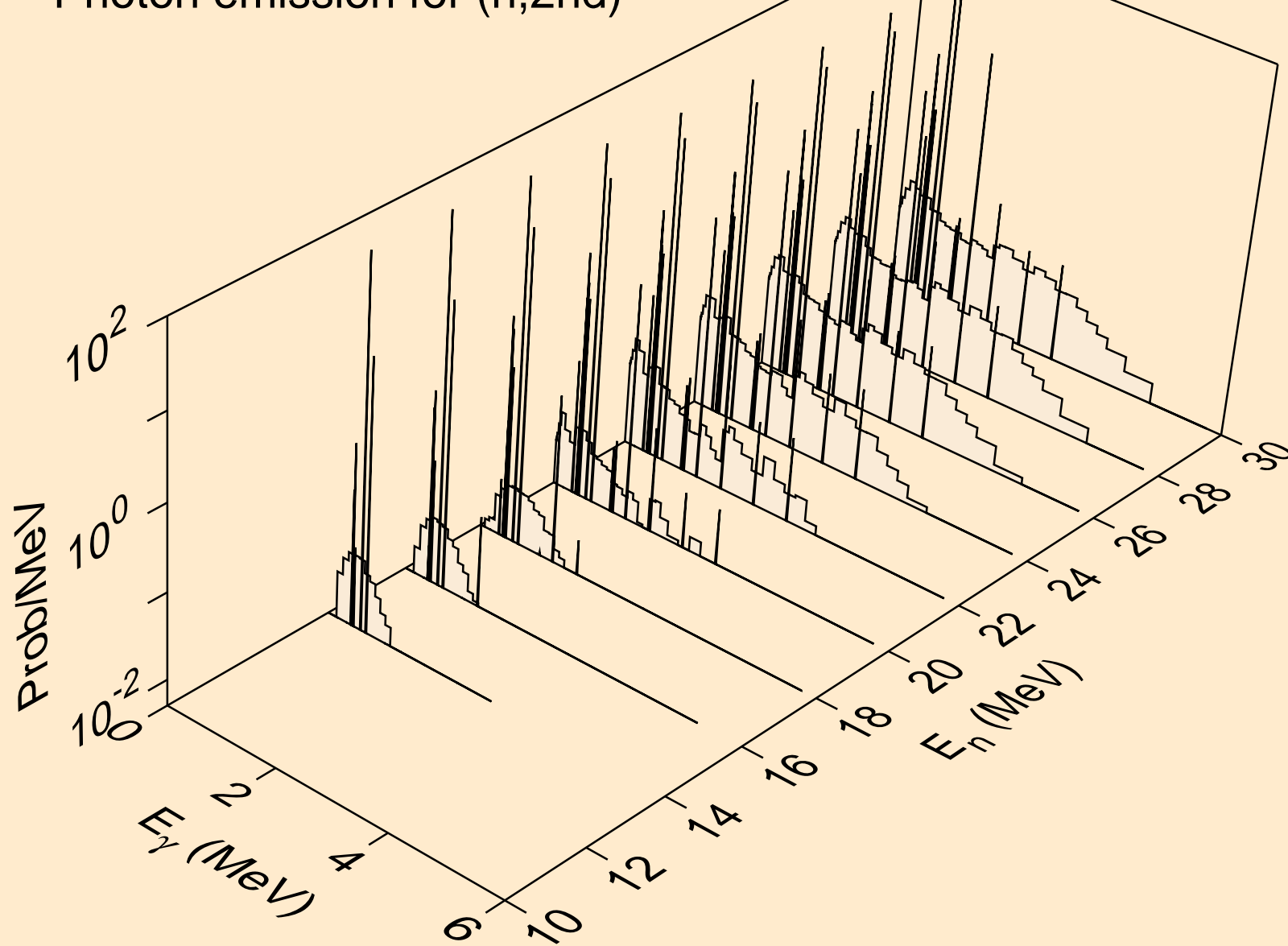

ZN077 TRITON ACER TENDL-2021 LIBRARY; T=0.K  
Photon emission for (n,2n)

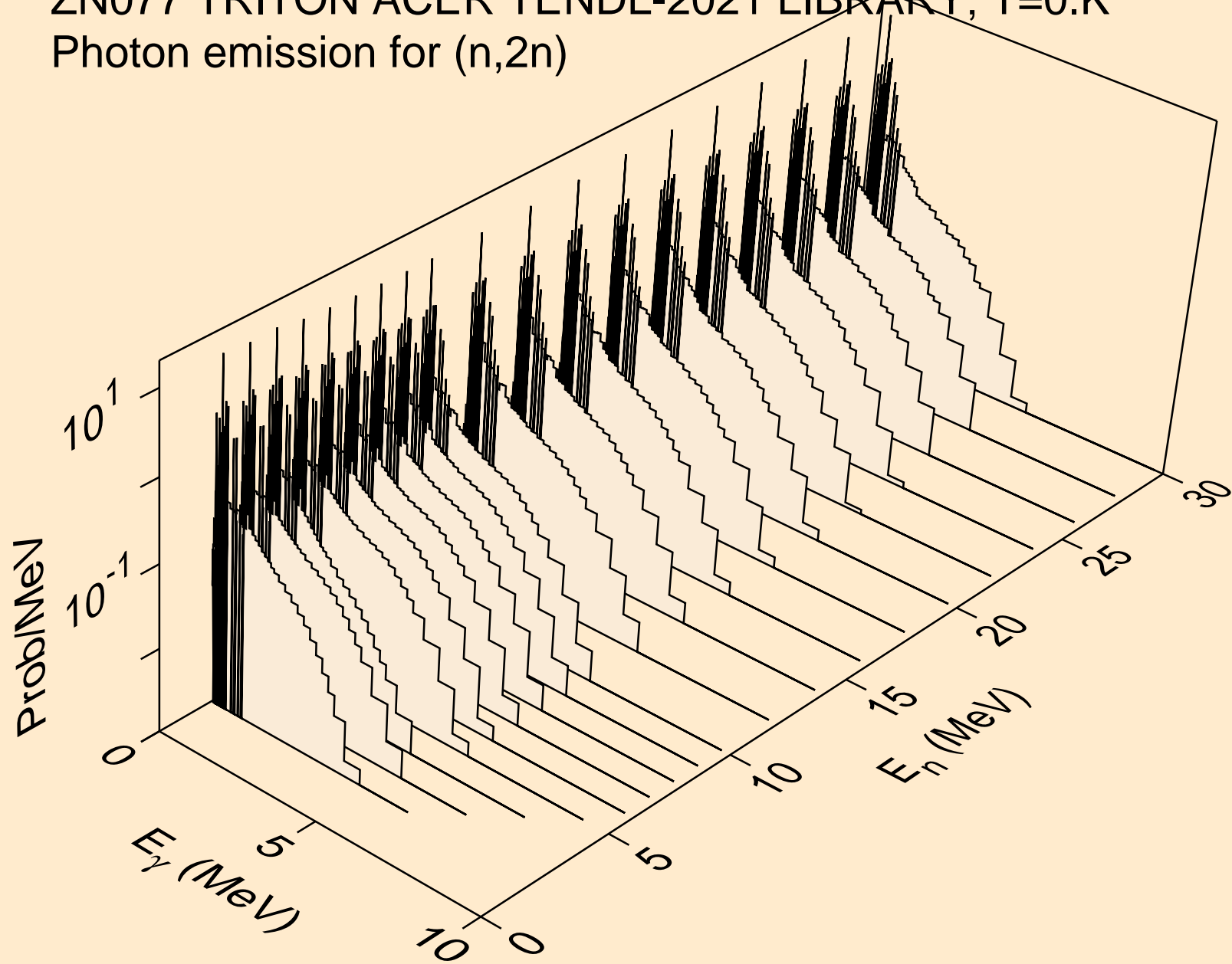



ZN077 TRITON ACER TENDL-2021 LIBRARY; T=0.K  
Photon emission for (n,3n)

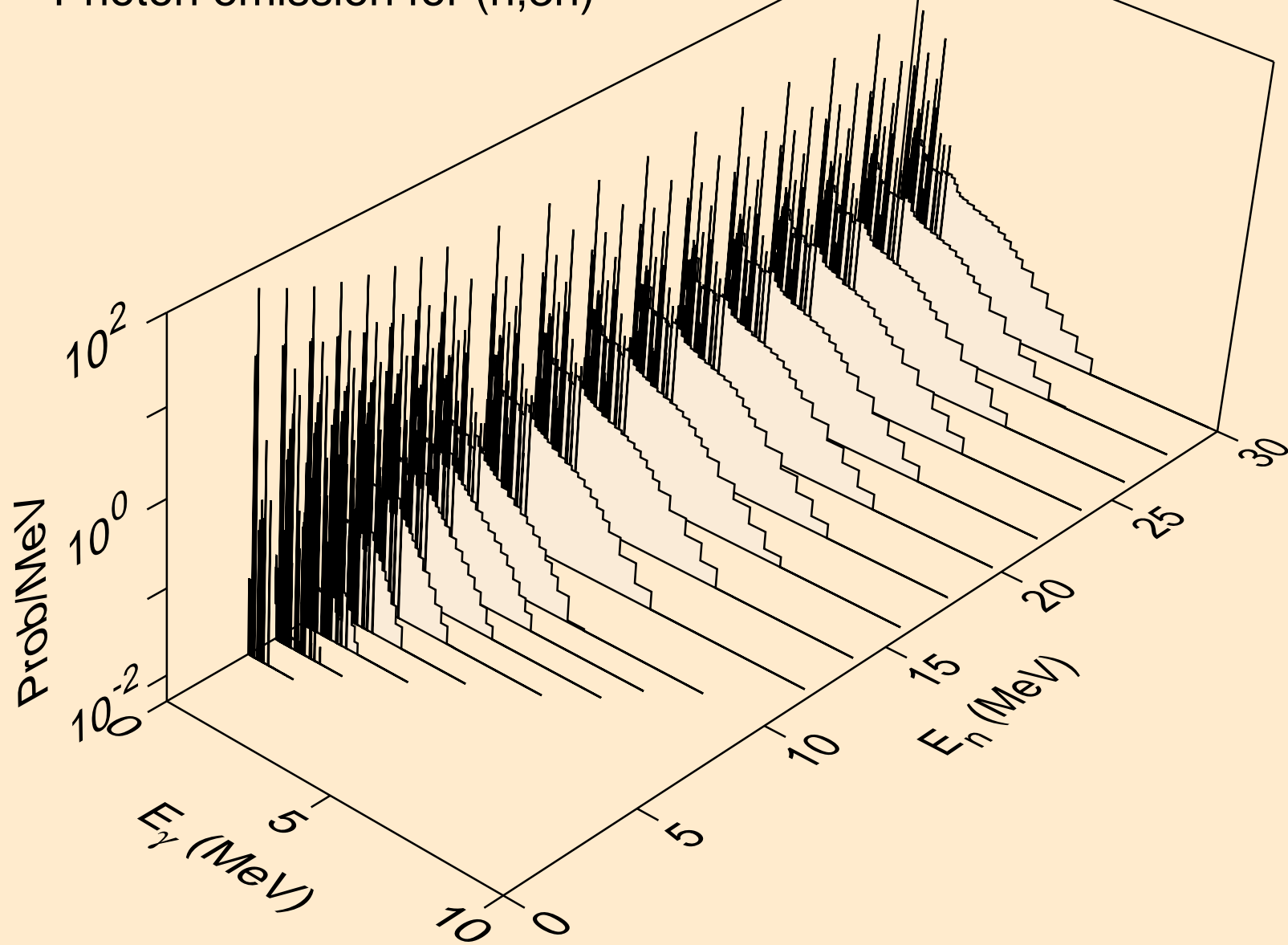

ZN077 TRITON ACER TENDL-2021 LIBRARY; T=0.K  
Photon emission for (n,n\*)a

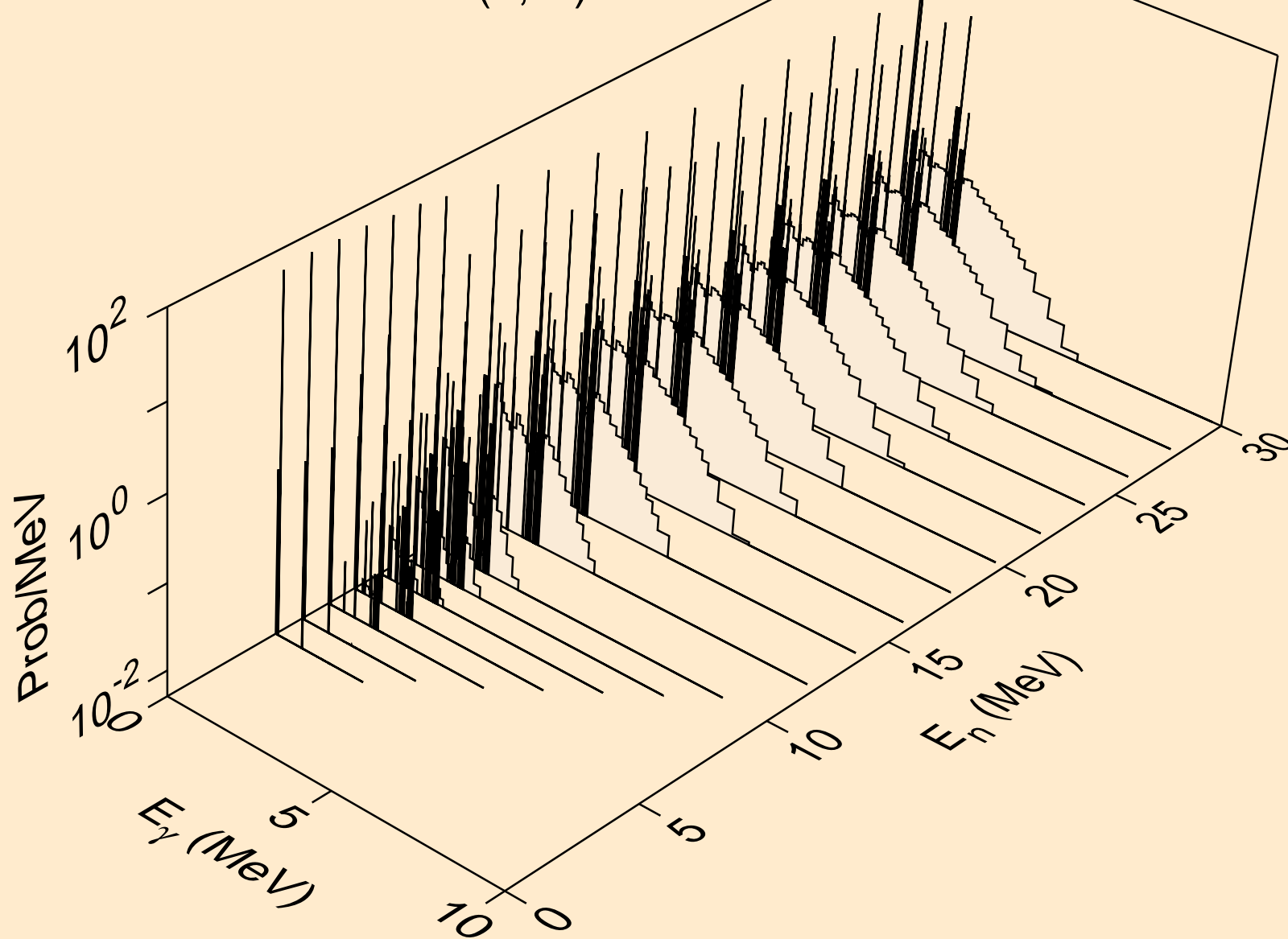

ZN077 TRITON ACER TENDL-2021 LIBRARY; T=0.K  
Photon emission for (n,2n)a

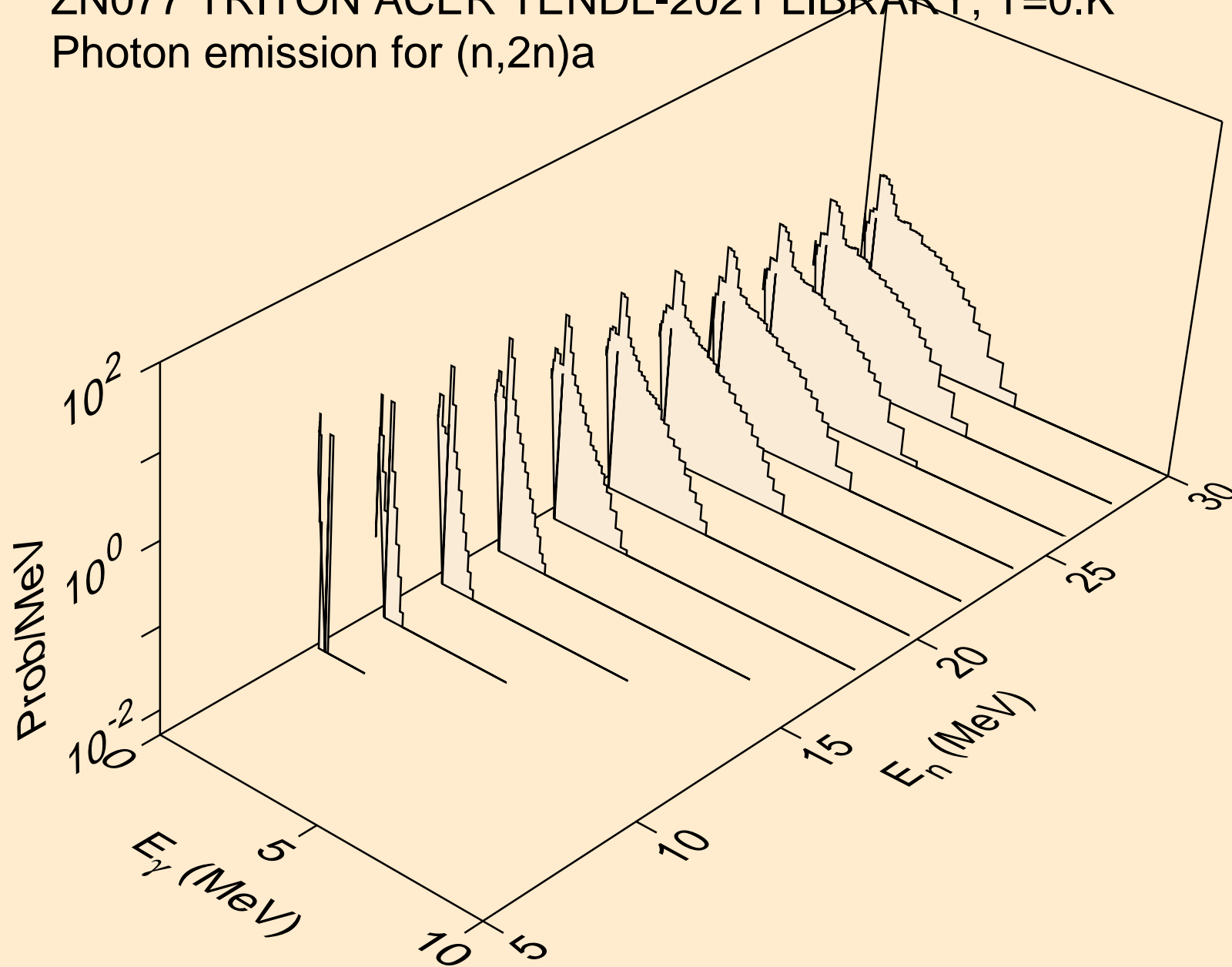

ZN077 TRITON ACER TENDL-2021 LIBRARY; T=0.K  
Photon emission for (n,3n)a

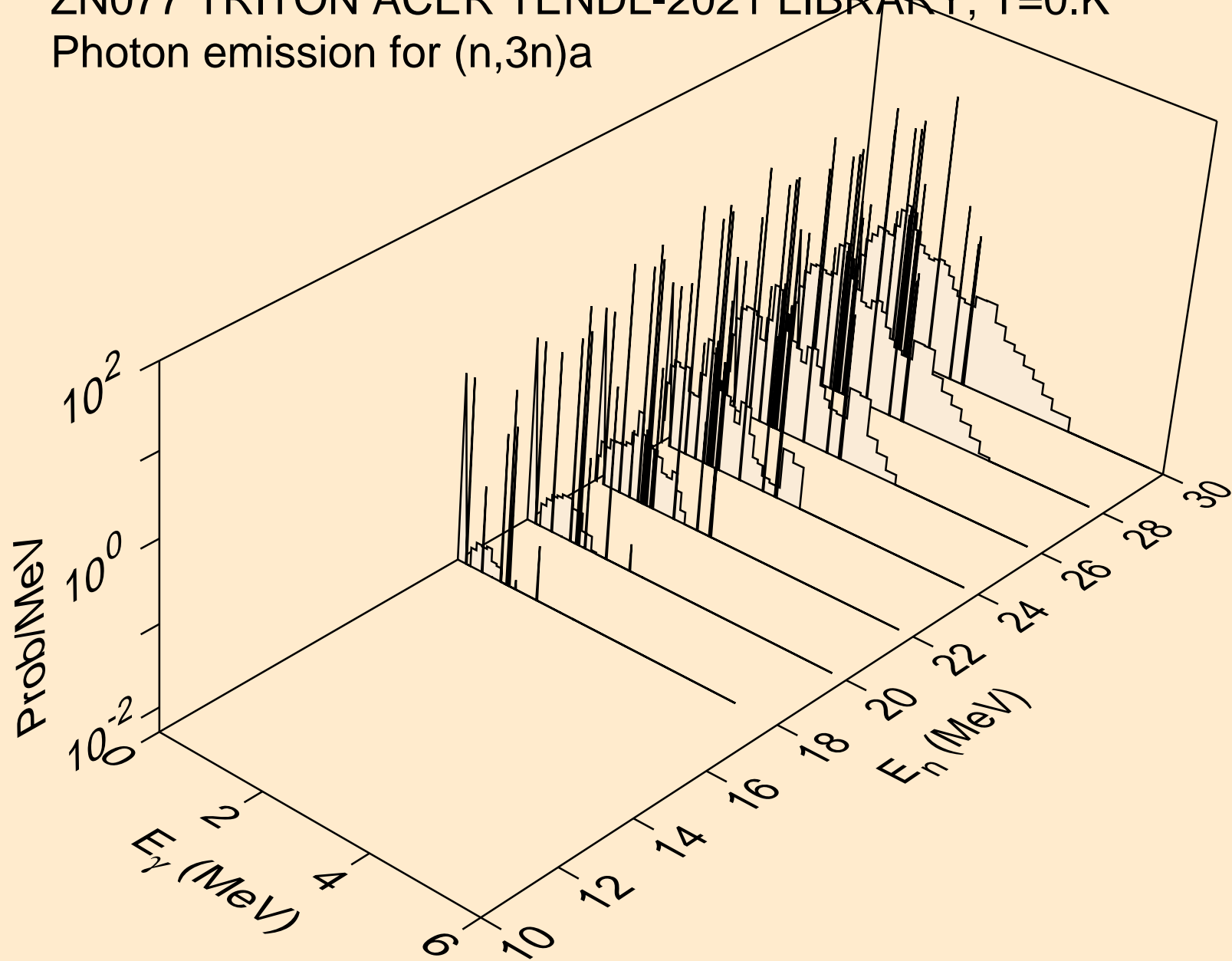

ZN077 TRITON ACER TENDL-2021 LIBRARY; T=0.K  
Photon emission for (n,n\*)p

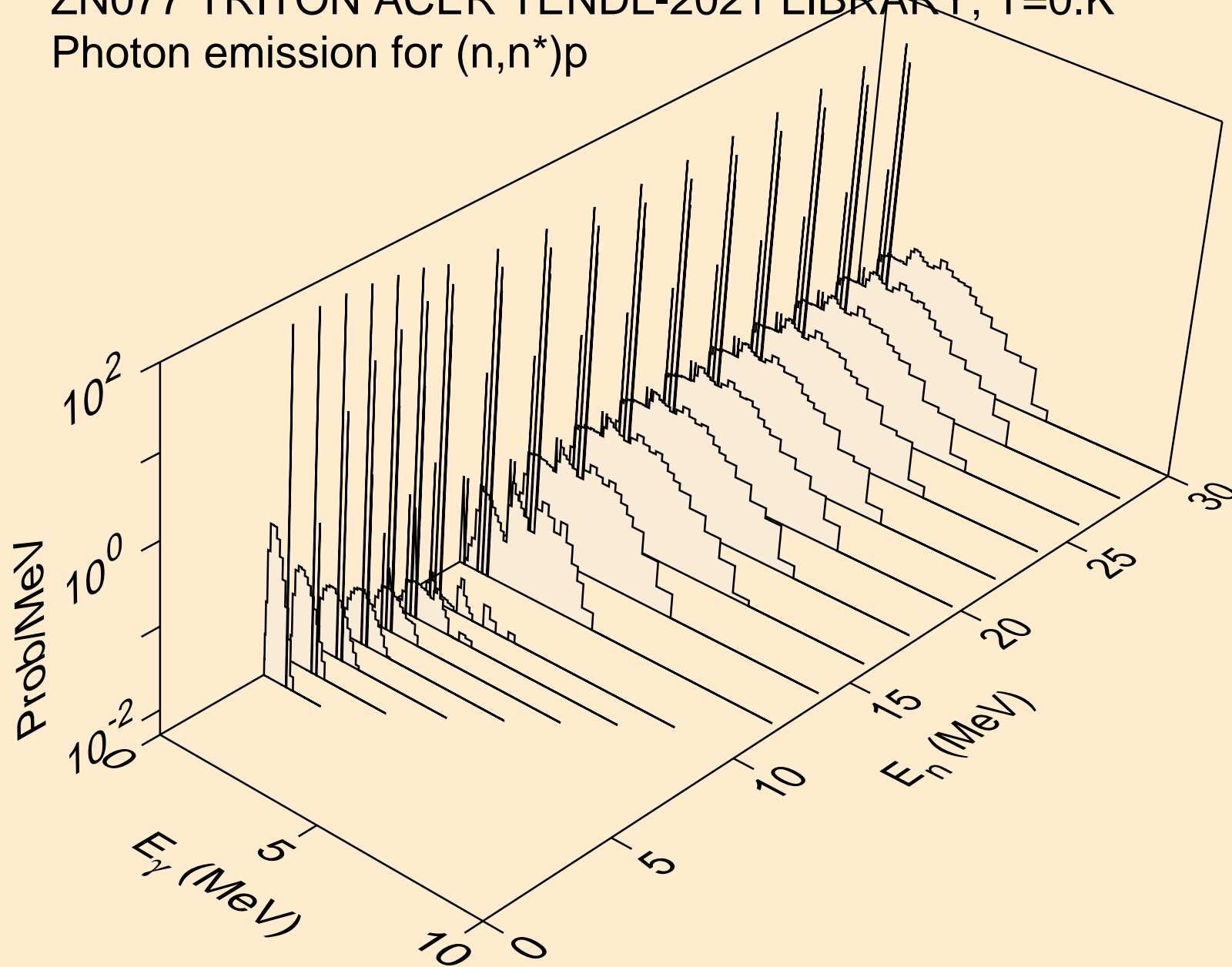

ZN077 TRITON ACER TENDL-2021 LIBRARY; T=0.K  
Photon emission for (n,n\*)d

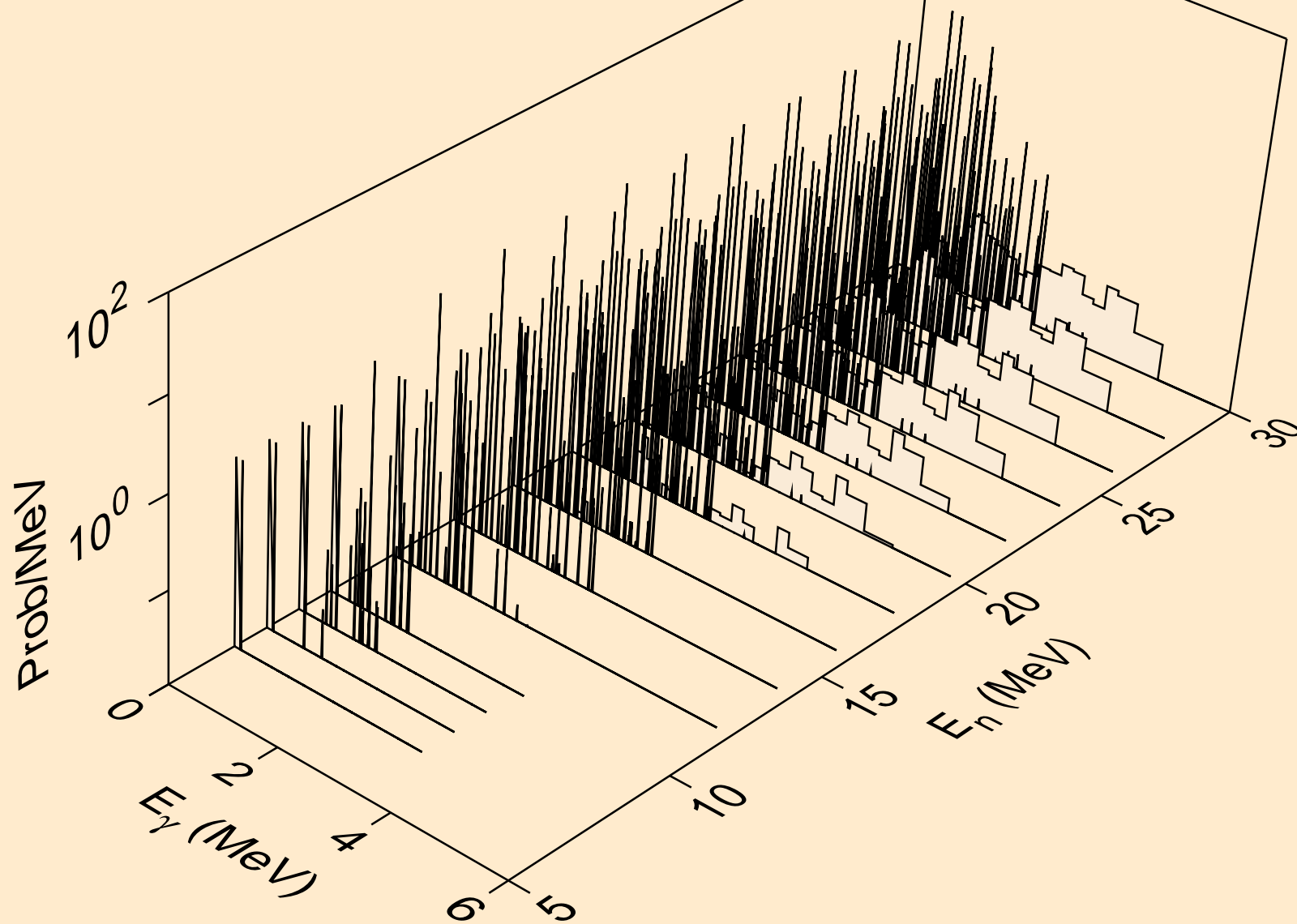

ZN077 TRITON ACER TENDL-2021 LIBRARY; T=0.K  
Photon emission for (n,n\*)t

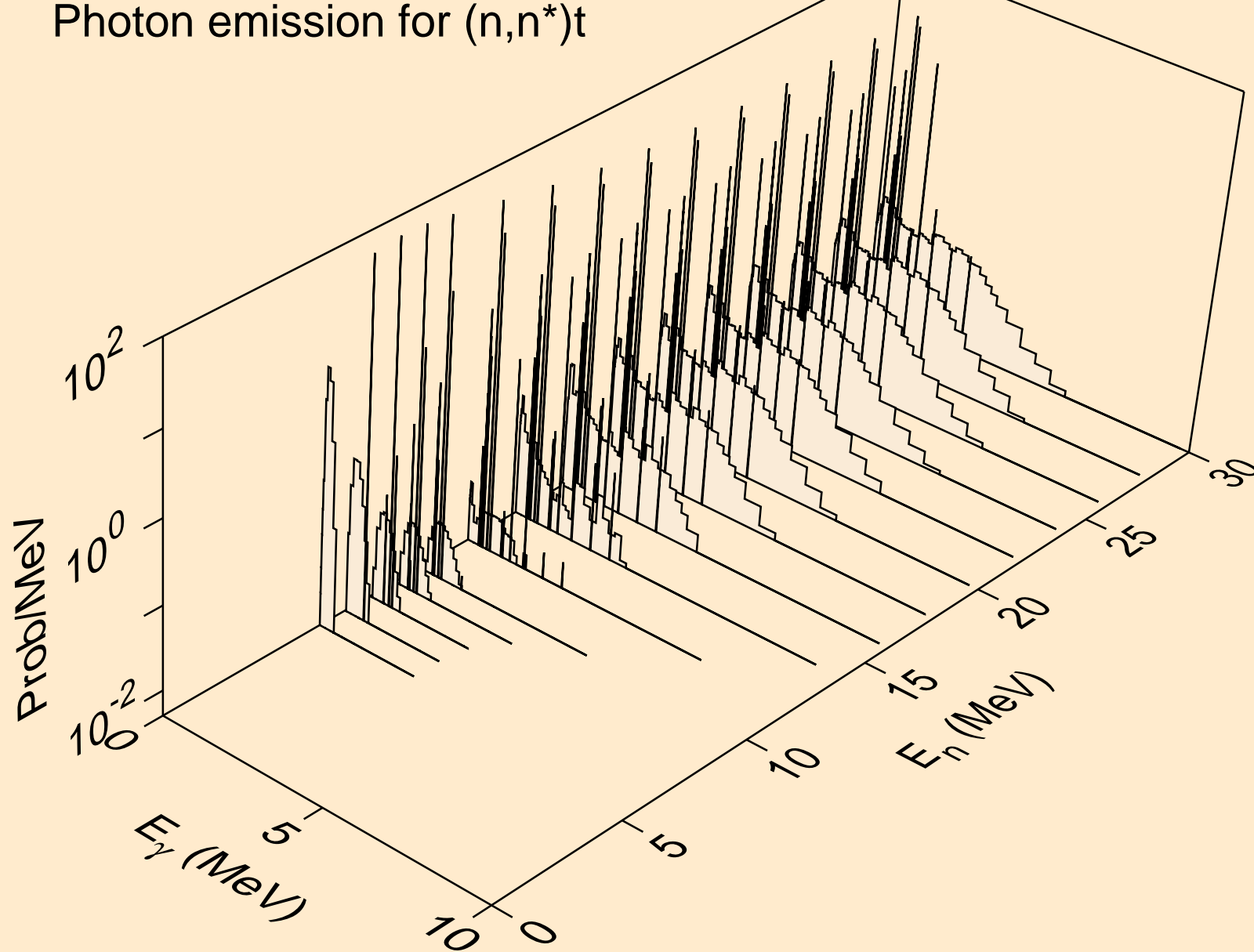

ZN077 TRITON ACER TENDL-2021 LIBRARY; T=0.K  
Photon emission for (n,n\*)he3

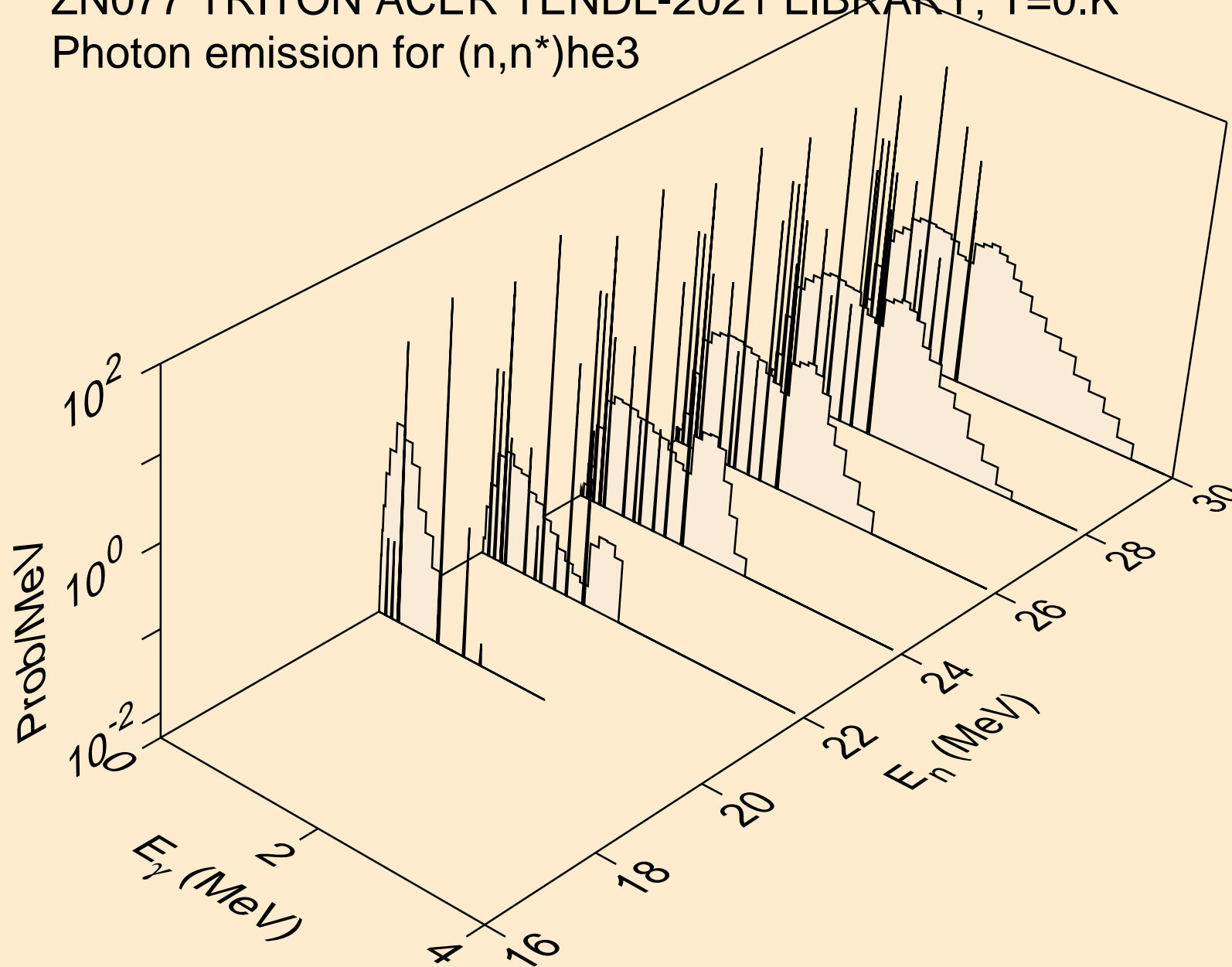



ZN077 TRITON ACER TENDL-2021 LIBRARY; T=0.K  
Photon emission for (n,4n)

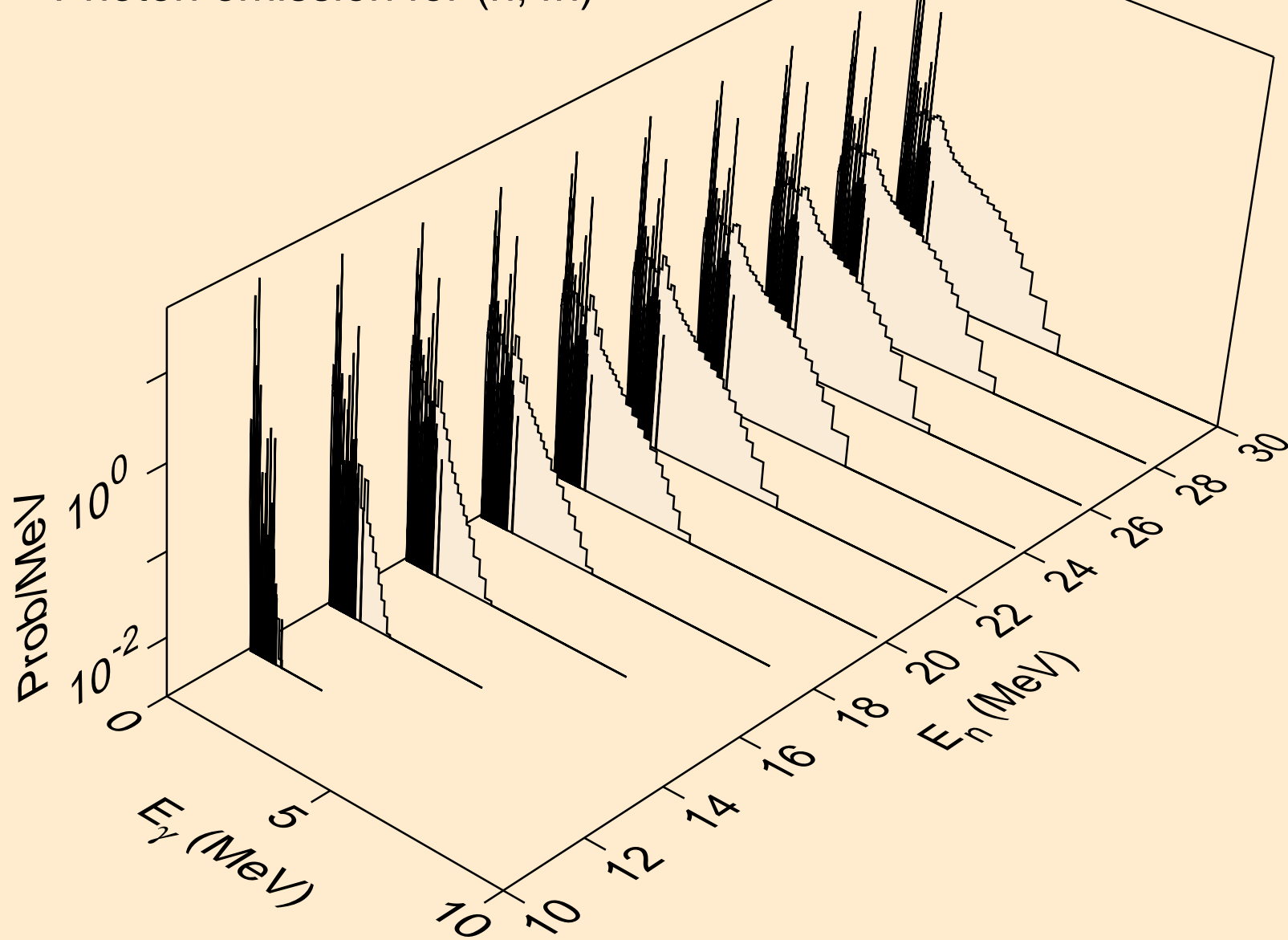

ZN077 TRITON ACER TENDL-2021 LIBRARY; T=0.K  
Photon emission for (n,2np)

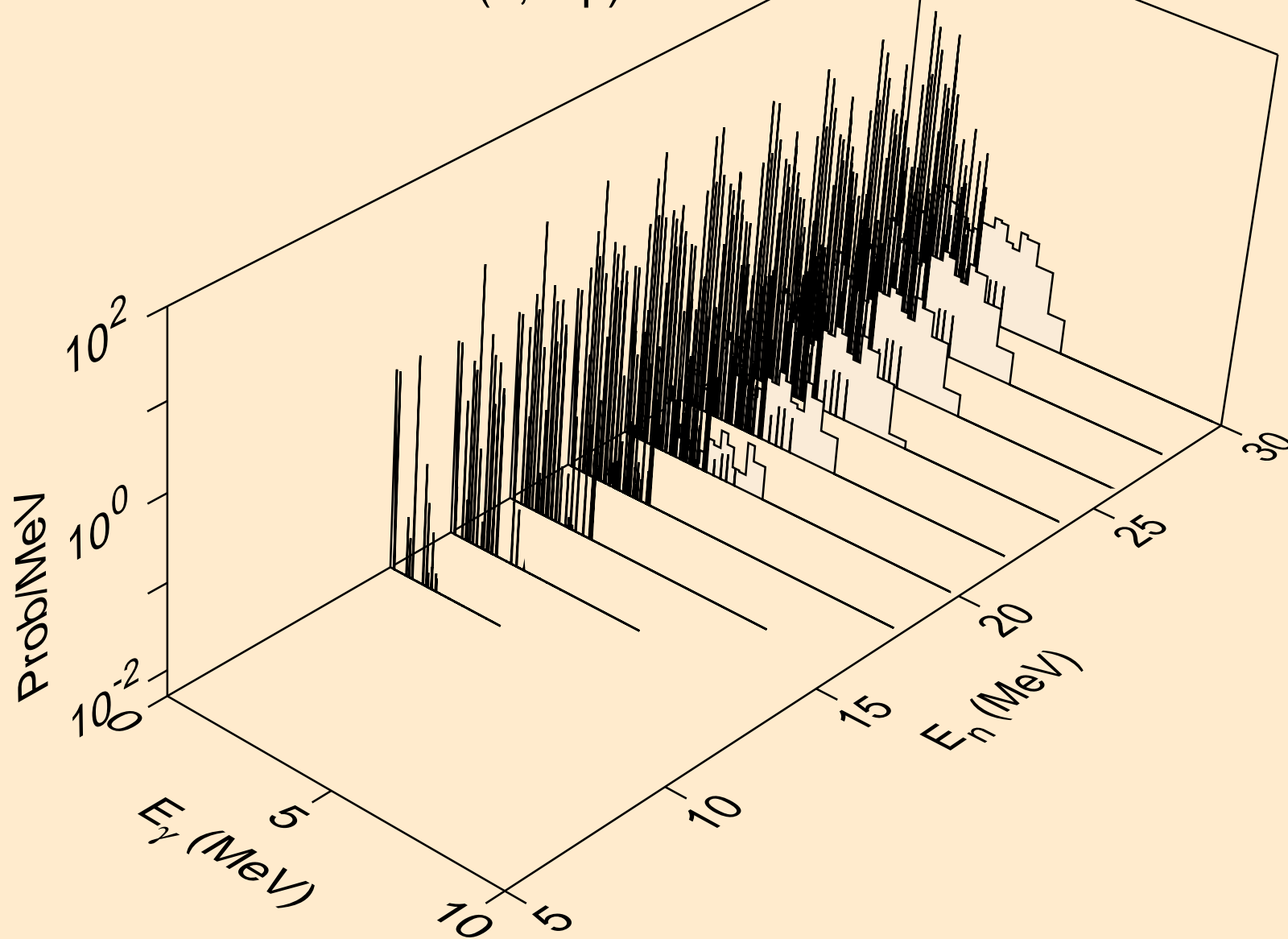

ZN077 TRITON ACER TENDL-2021 LIBRARY; T=0.K  
Photon emission for (n,3np)

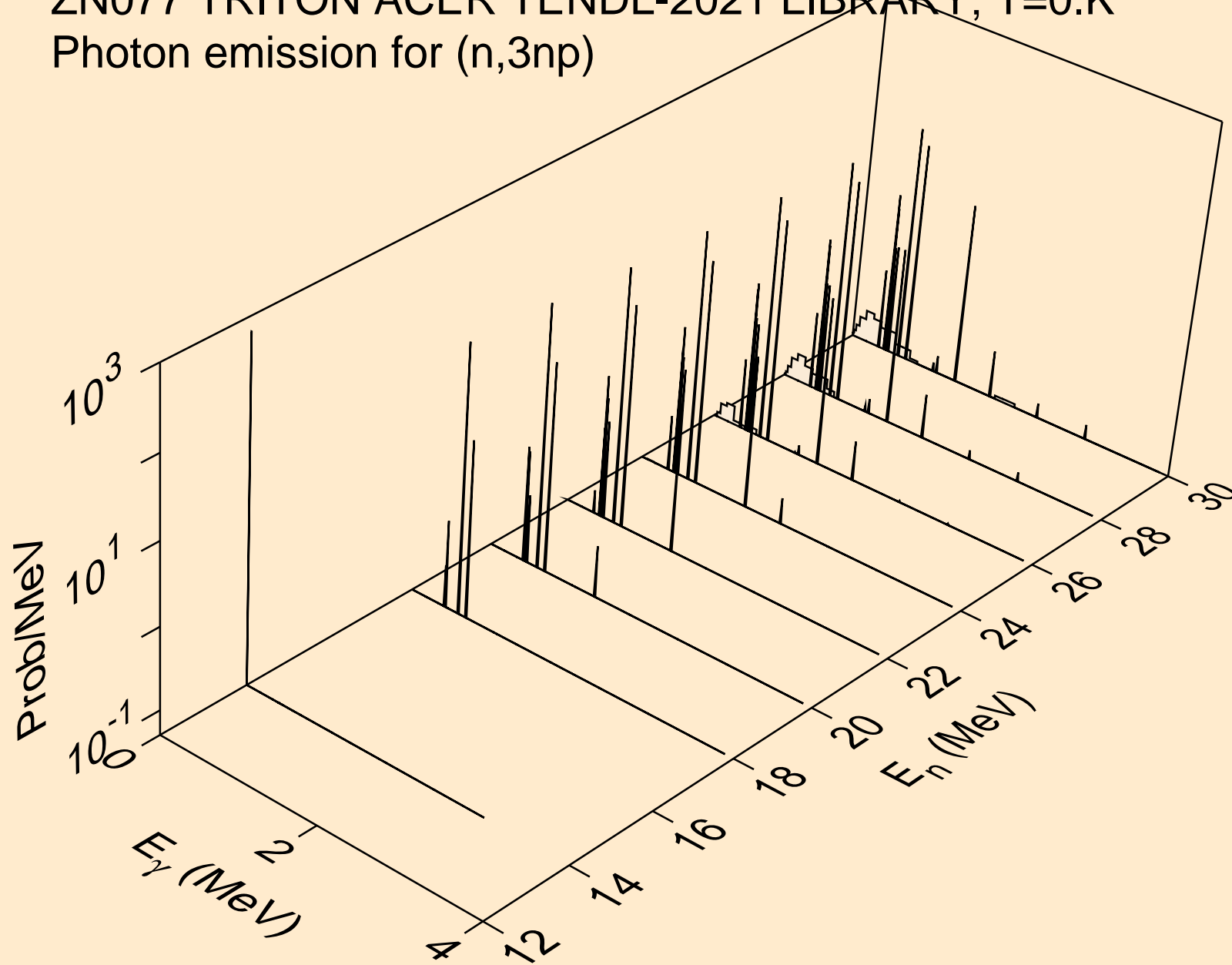

ZN077 TRITON ACER TENDL-2021 LIBRARY; T=0.K  
Photon emission for (n,2np)

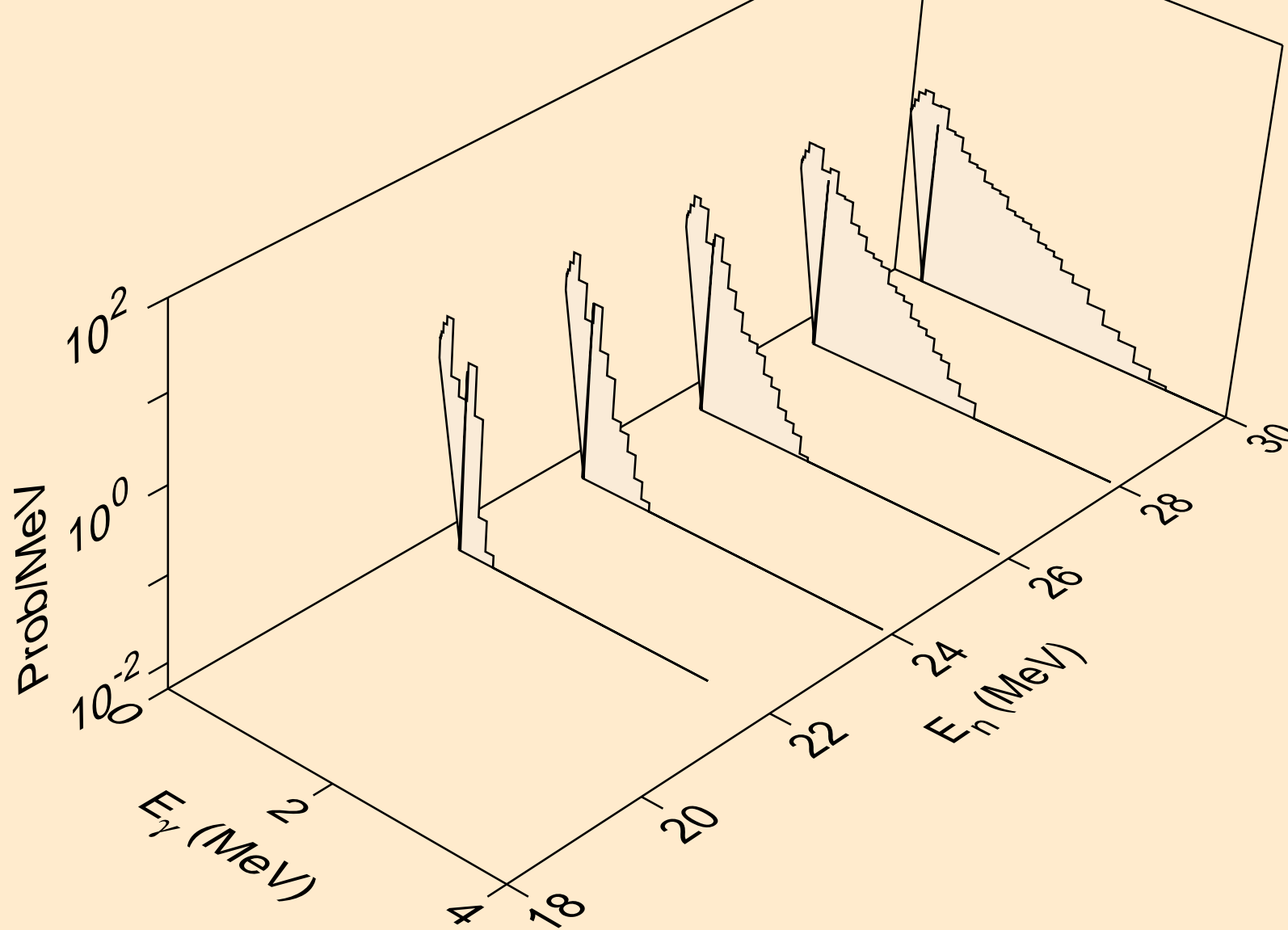

ZN077 TRITON ACER TENDL-2021 LIBRARY; T=0.K  
Photon emission for (n,npa)

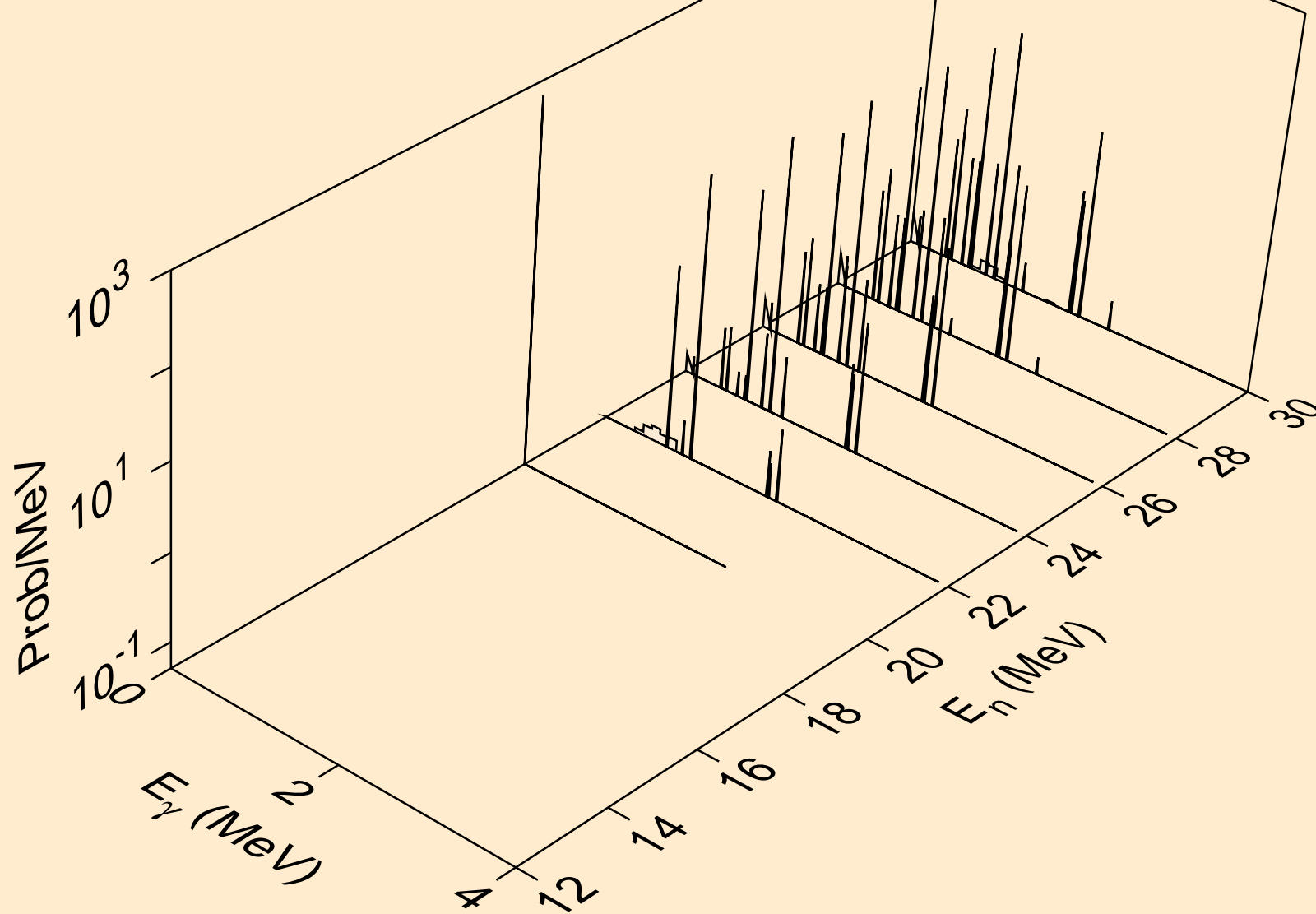

ZN077 TRITON ACER TENDL-2021 LIBRARY; T=0.K  
Photon emission for (n,gma)

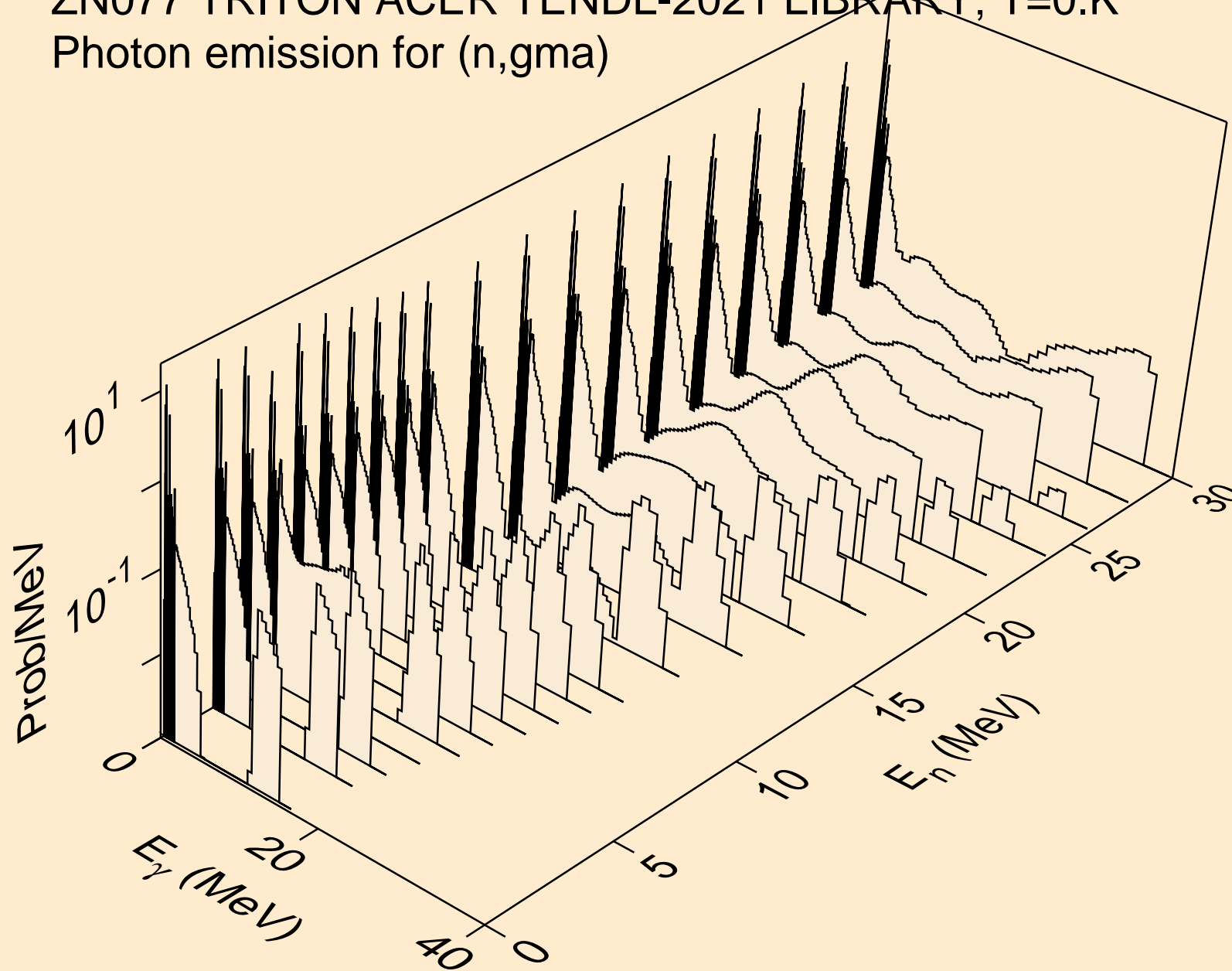

ZN077 TRITON ACER TENDL-2021 LIBRARY; T=0.K  
Photon emission for (n,p)

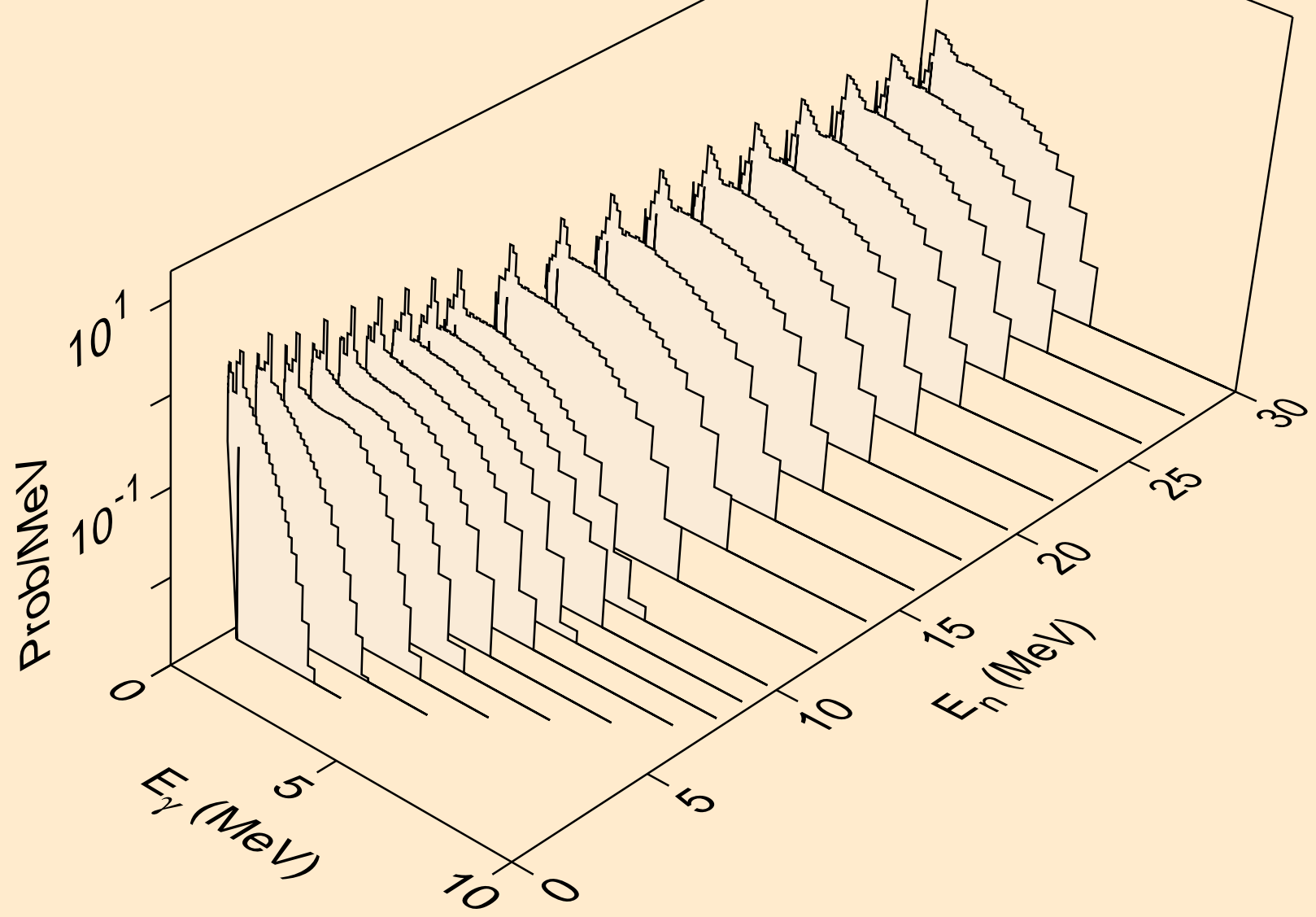

ZN077 TRITON ACER TENDL-2021 LIBRARY; T=0.K  
Photon emission for (n,d)

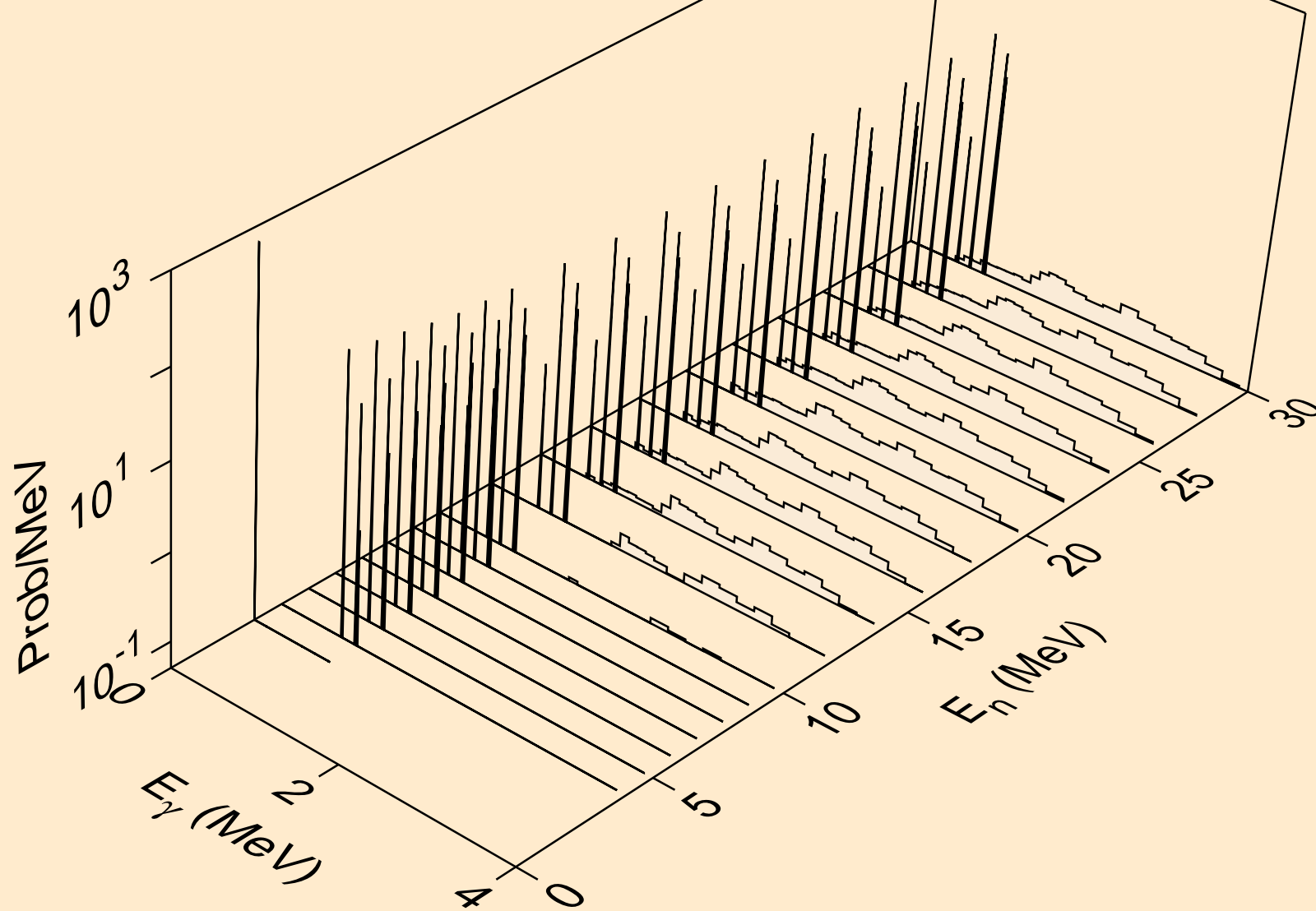



ZN077 TRITON ACER TENDL-2021 LIBRARY; T=0.K  
Photon emission for inelastic

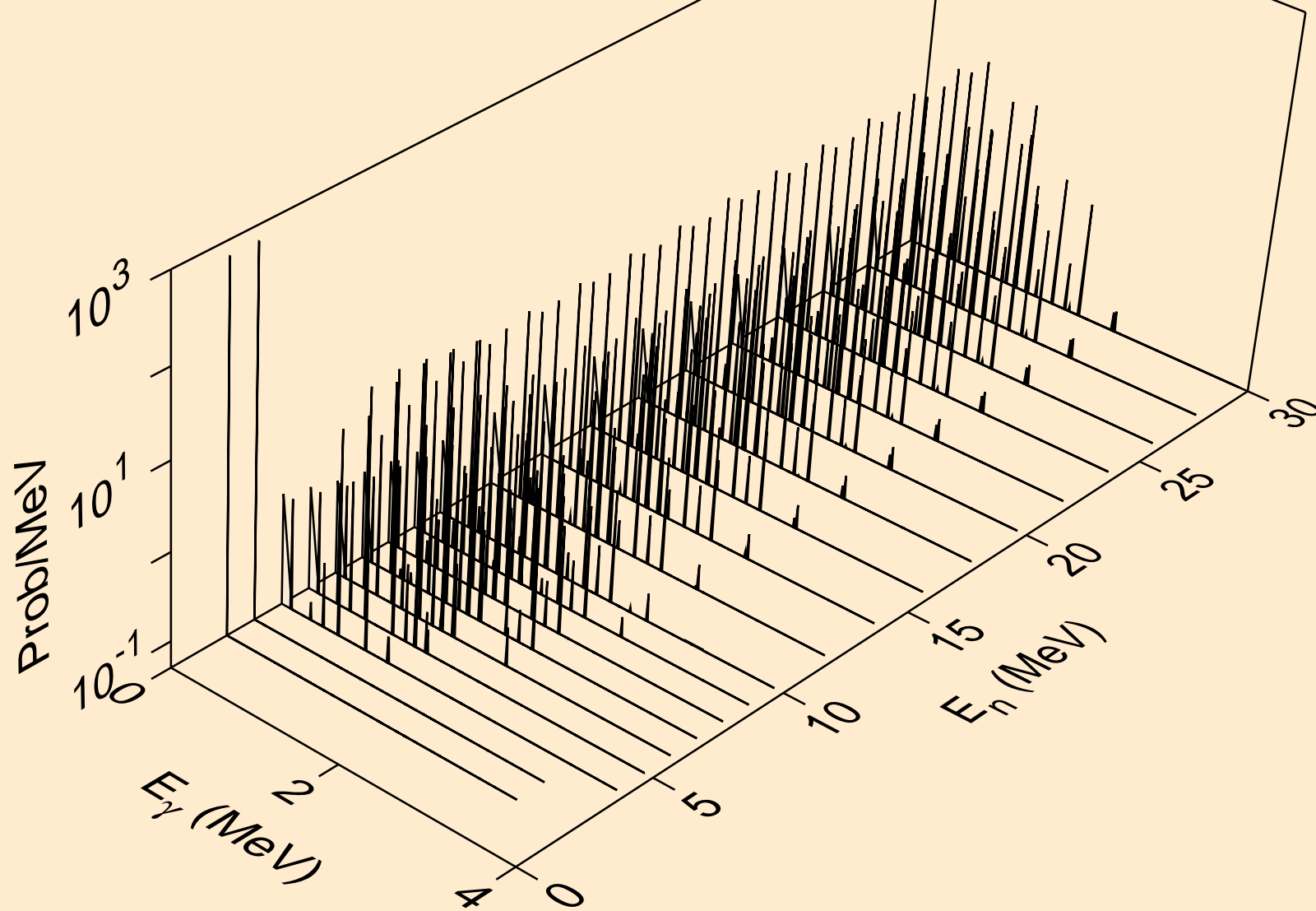

ZN077 TRITON ACER TENDL-2021 LIBRARY; T=0.K  
Photon emission for (n,he3)

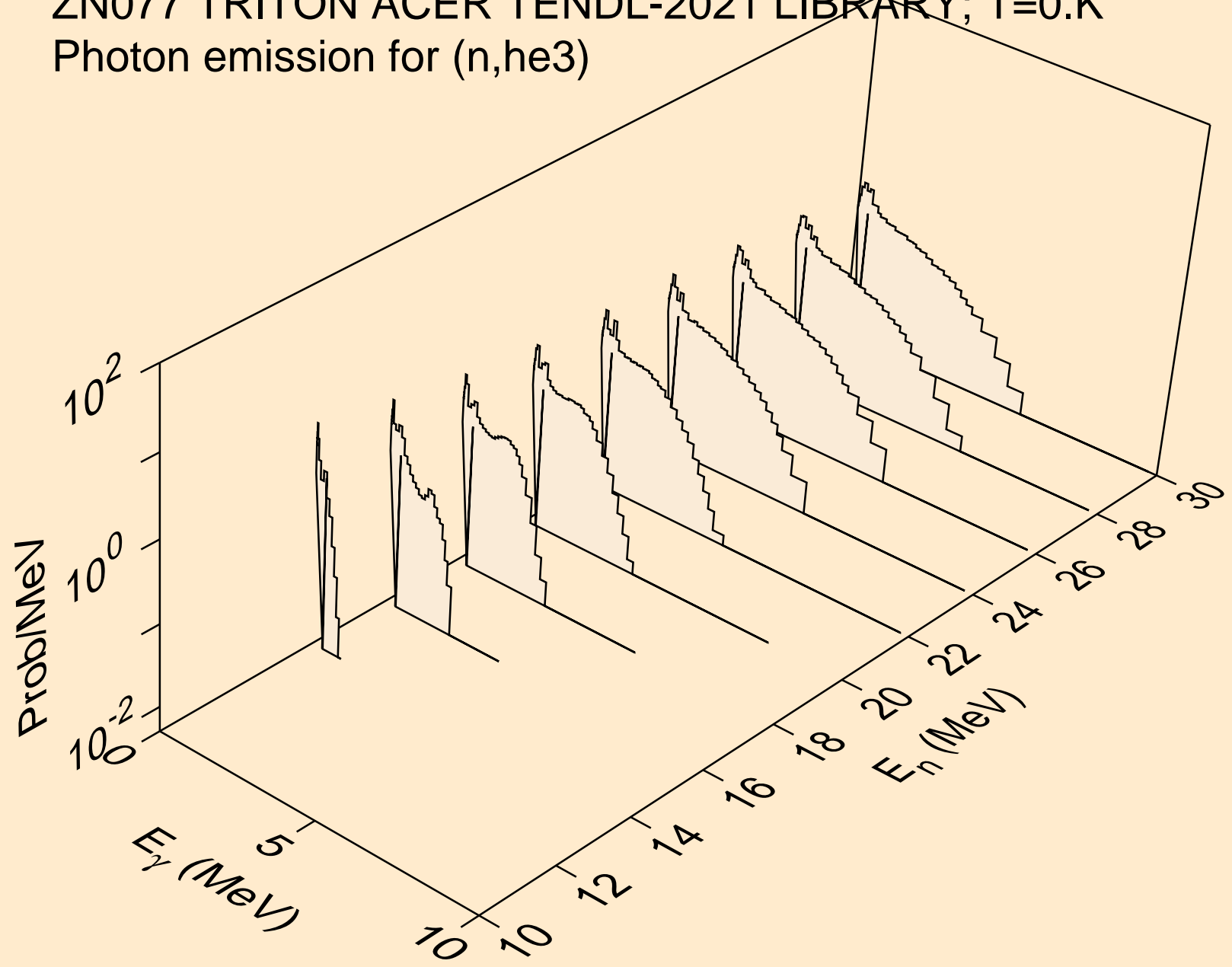

ZN077 TRITON ACER TENDL-2021 LIBRARY; T=0.K  
Photon emission for (n,a)

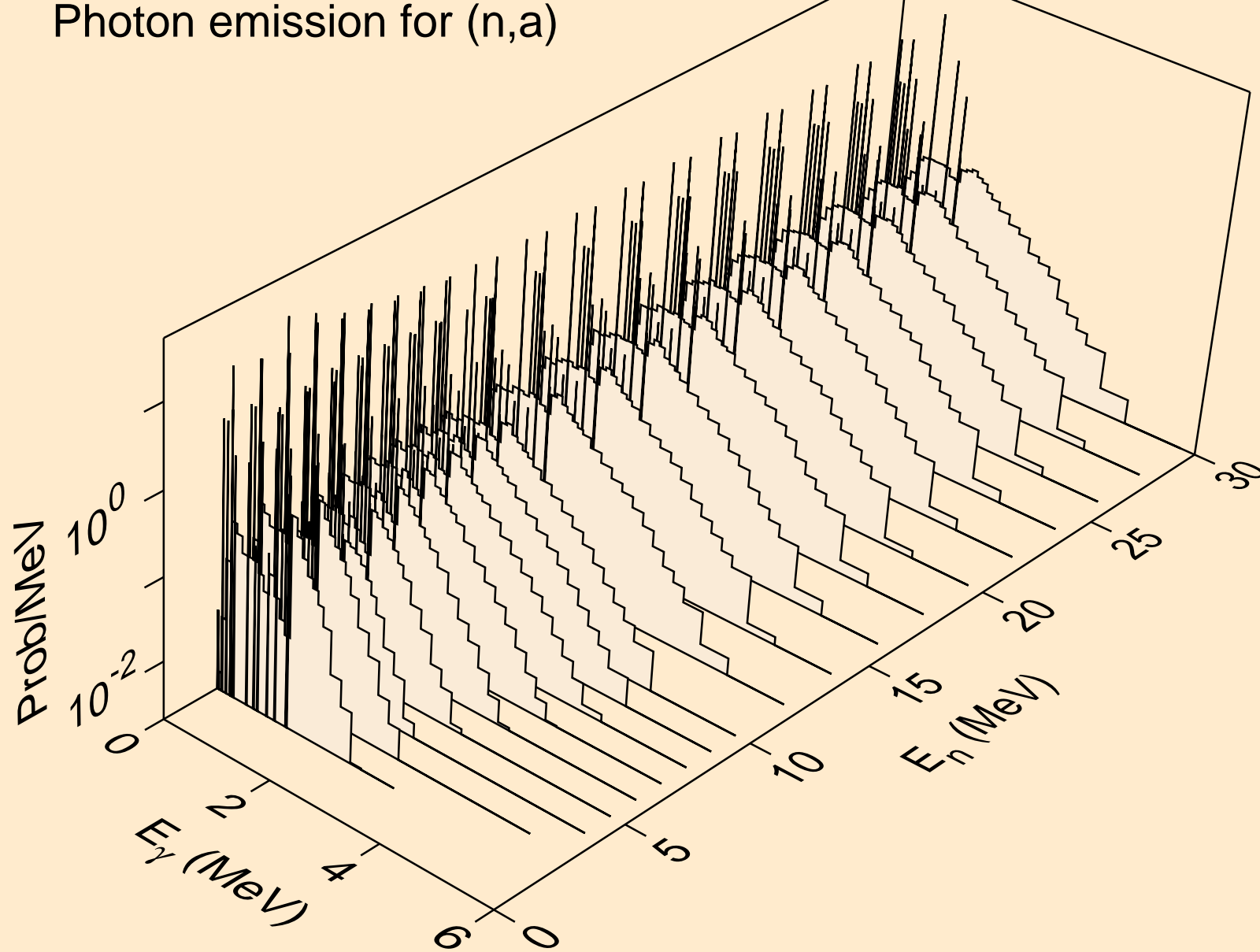

ZN077 TRITON ACER TENDL-2021 LIBRARY; T=0.K  
Photon emission for (n,2p)

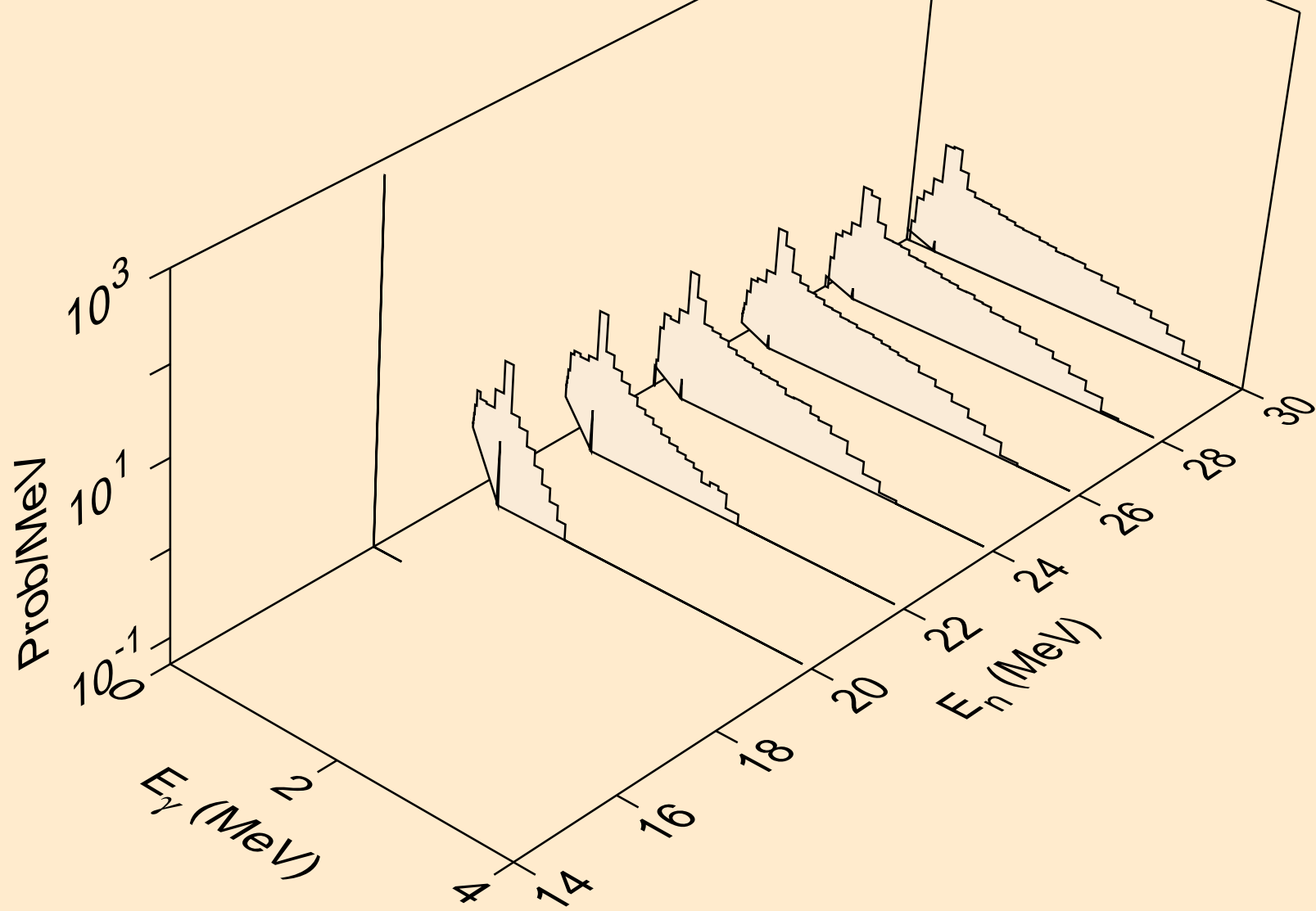

ZN077 TRITON ACER TENDL-2021 LIBRARY; T=0.K  
Photon emission for (n,pa)

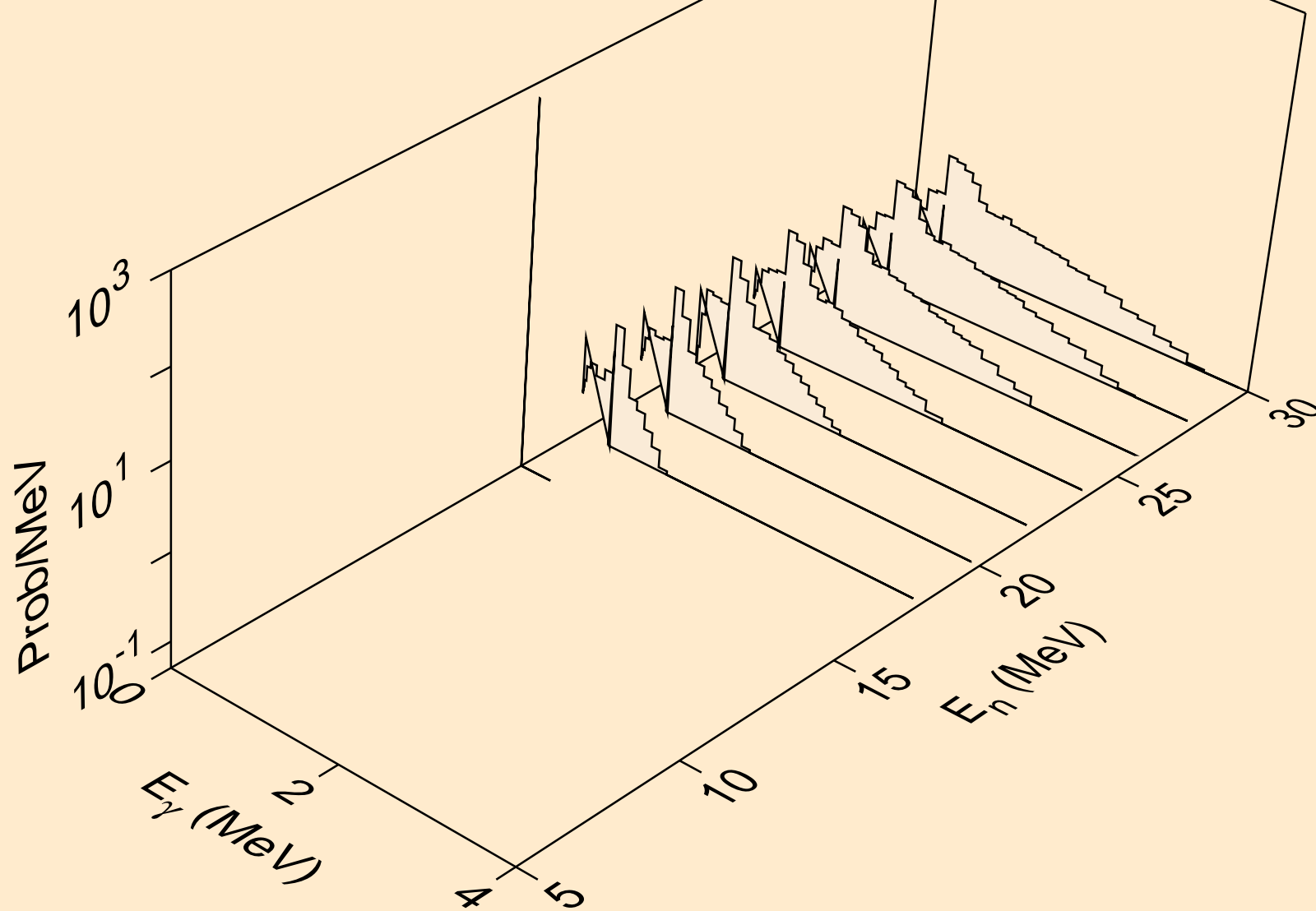

ZN077 TRITON ACER TENDL-2021 LIBRARY; T=0.K  
Photon emission for (n,pd)

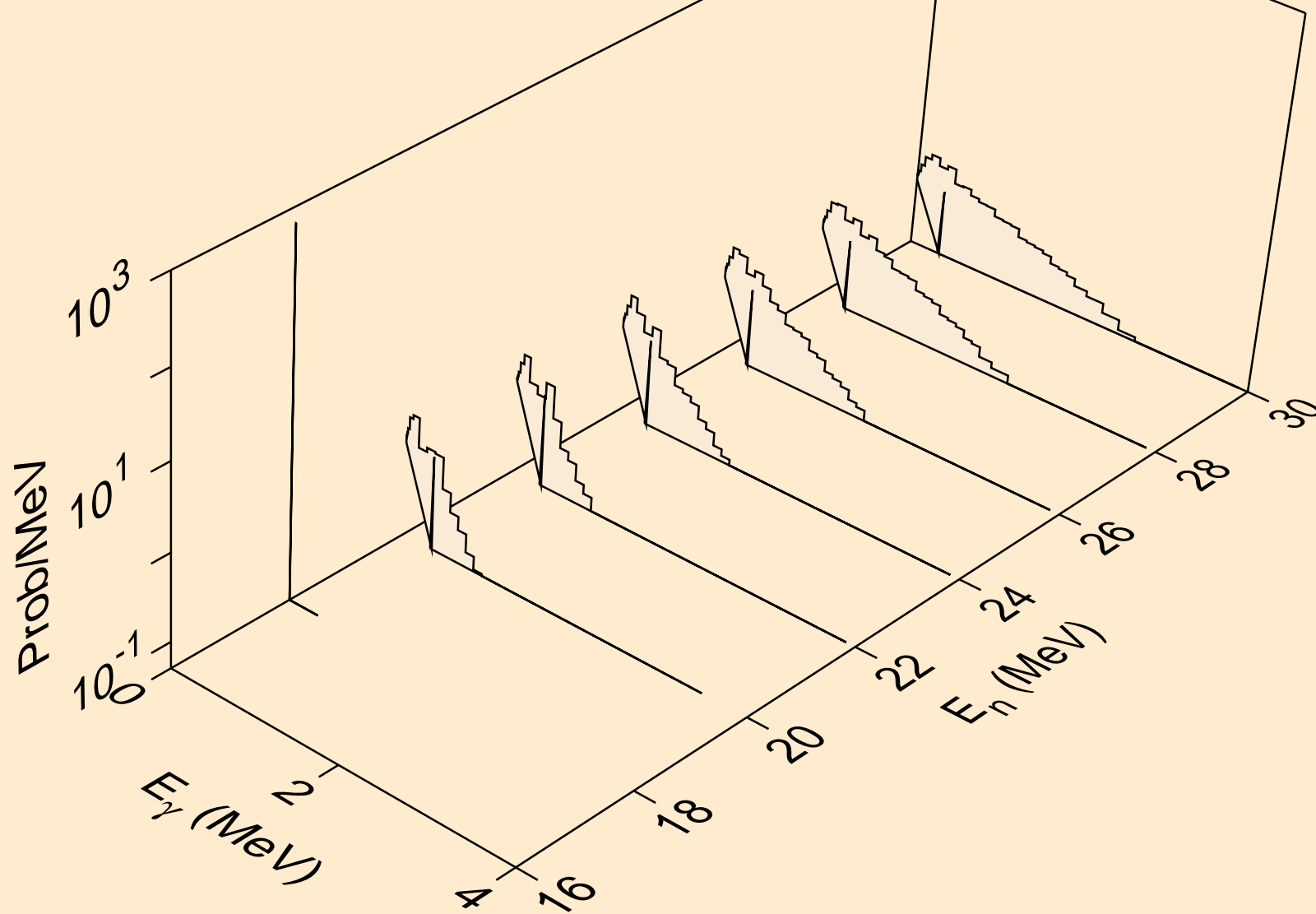

ZN077 TRITON ACER TENDL-2021 LIBRARY; T=0.K  
Photon emission for (n,pt)

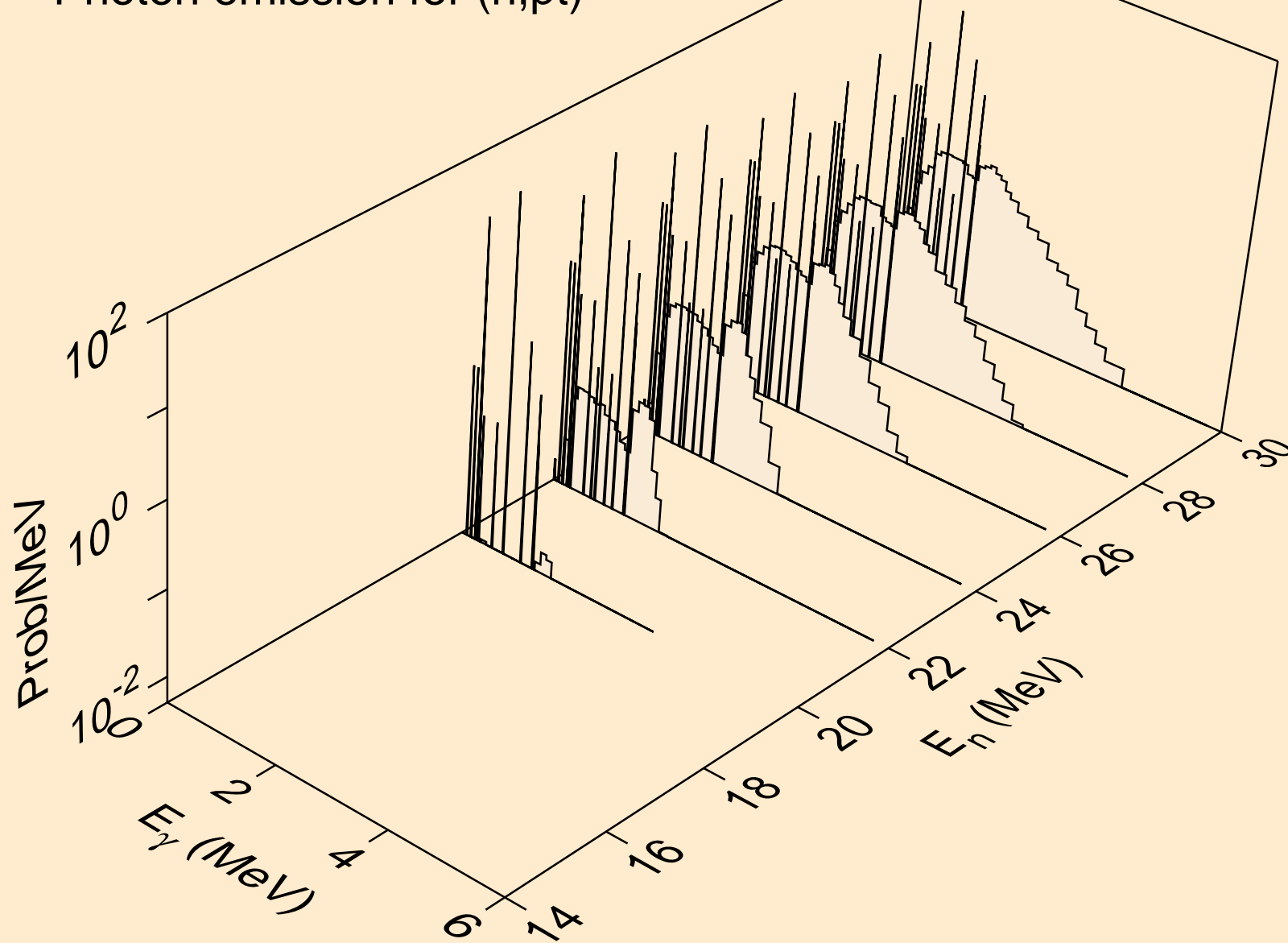

ZN077 TRITON ACER TENDL-2021 LIBRARY; T=0.K  
Photon emission for (n,da)

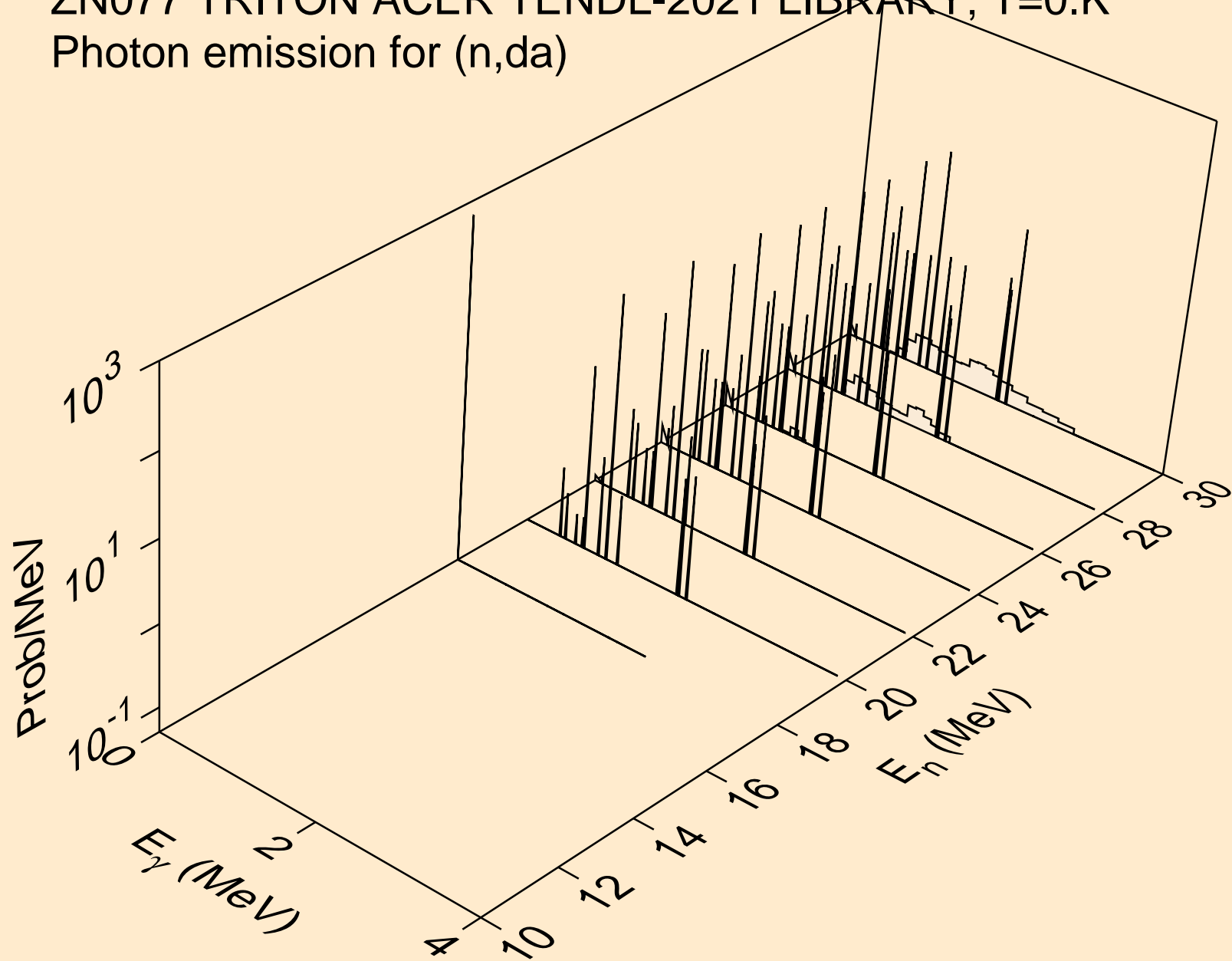



ZN077 TRITON ACER TENDL-2021 LIBRARY; T=0.K  
Particle heating contributions

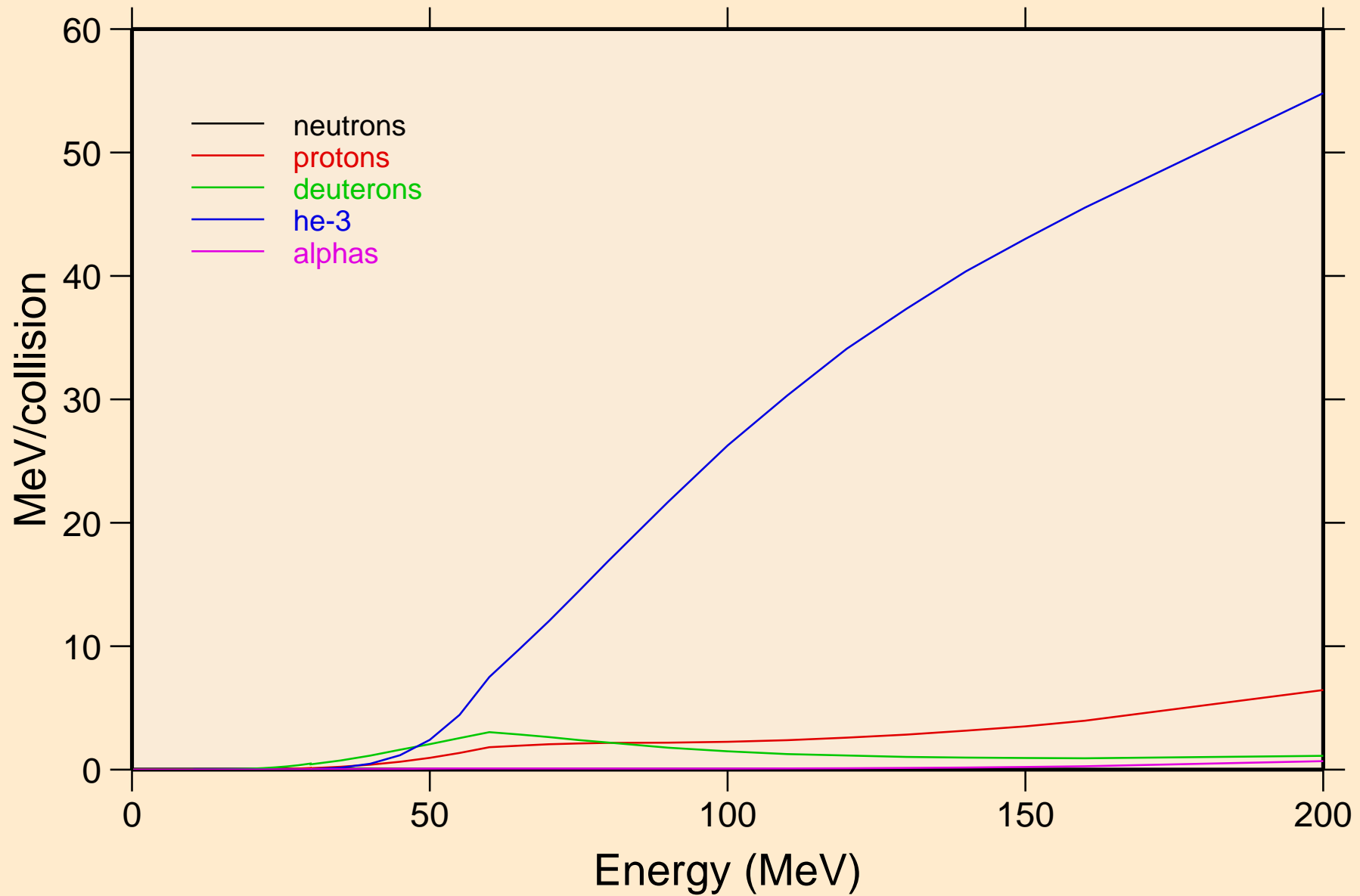

ZN077 TRITON ACER TENDL-2021 LIBRARY; T=0.K  
Recoil Heating

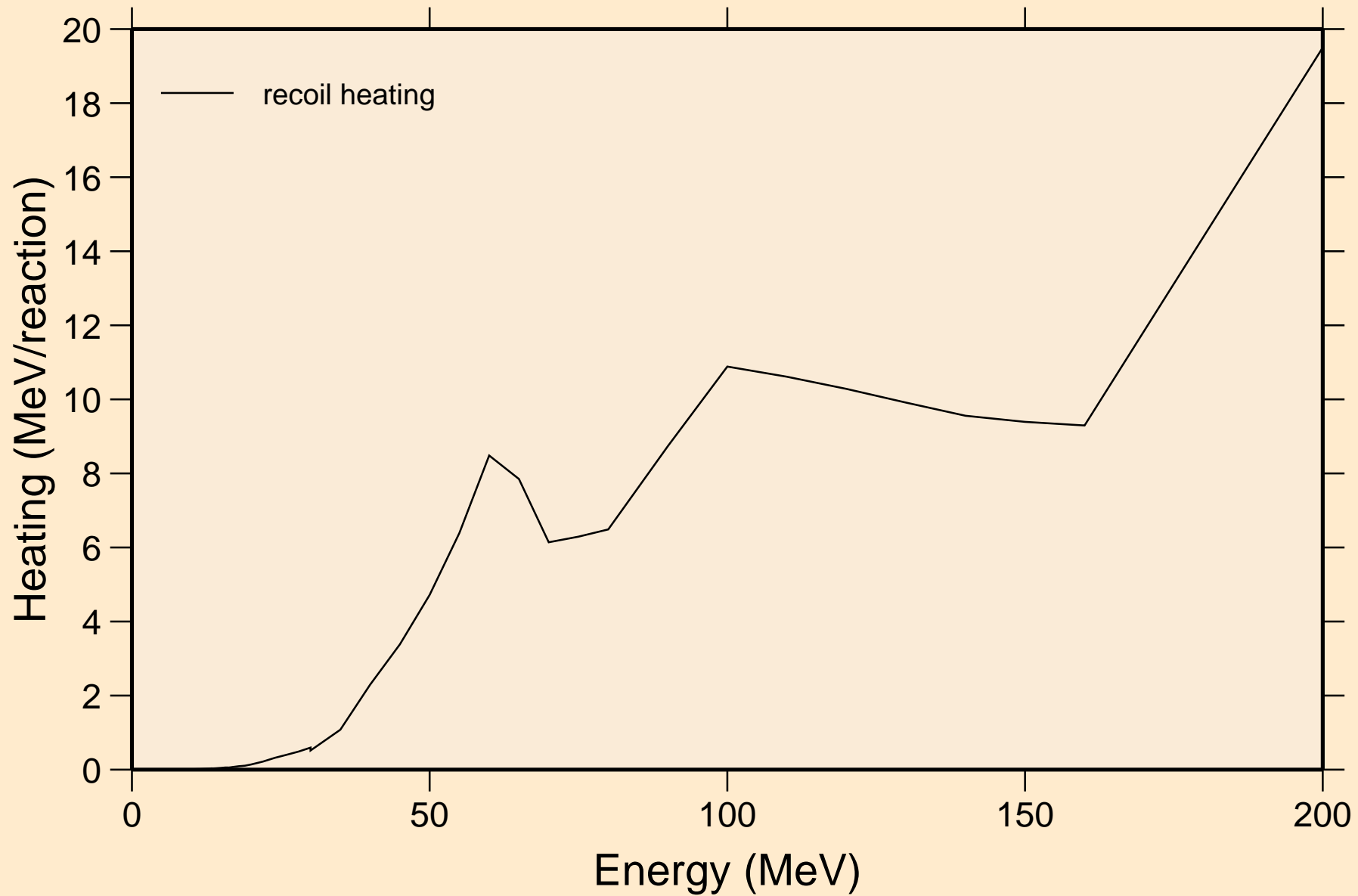

ZN077 TRITON ACER TENDL-2021 LIBRARY; T=0.K  
Particle production cross sections

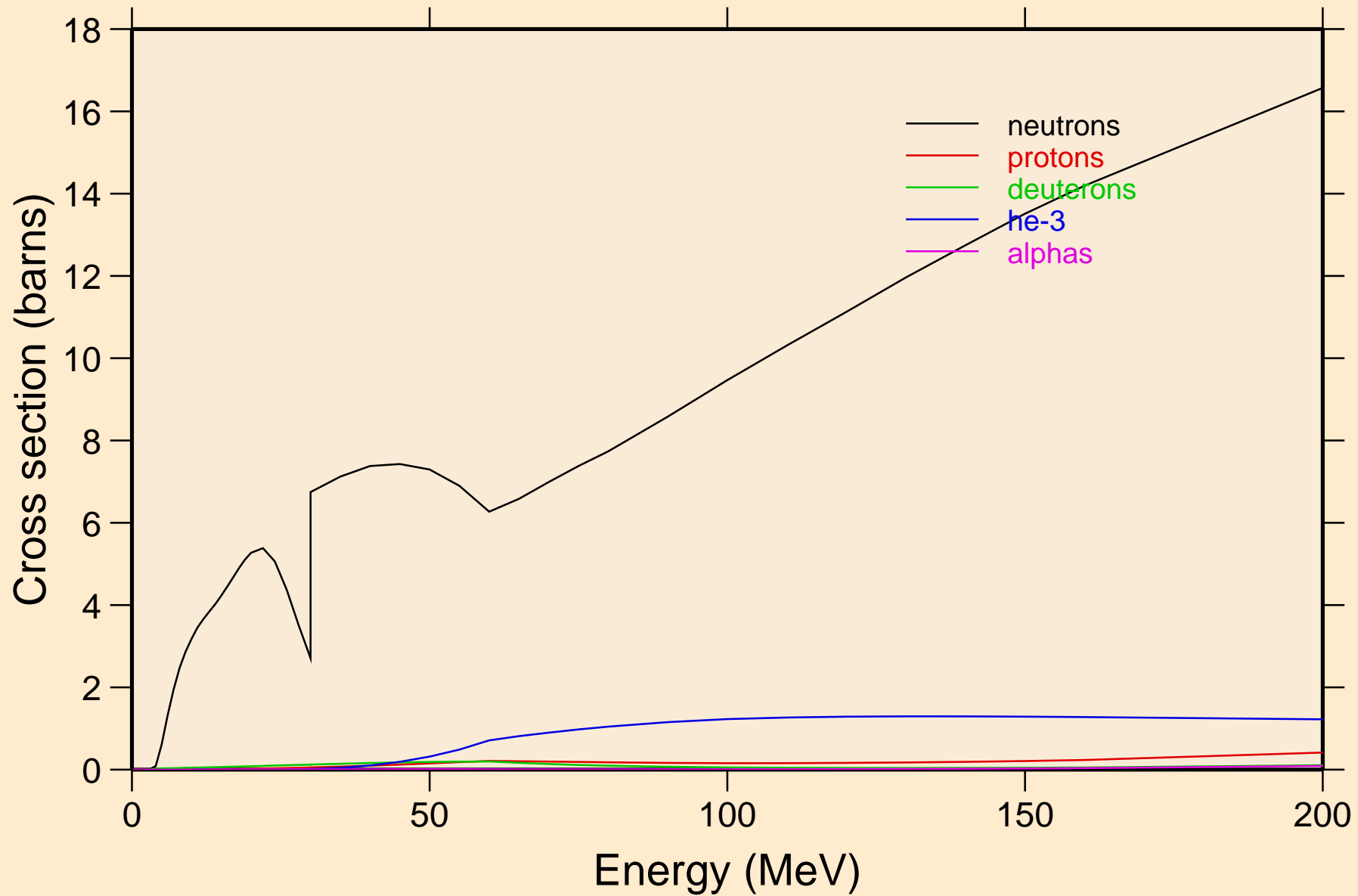

ZN077 TRITON ACER TENDL-2021 LIBRARY; T=0.K  
neutrons from (t,n)

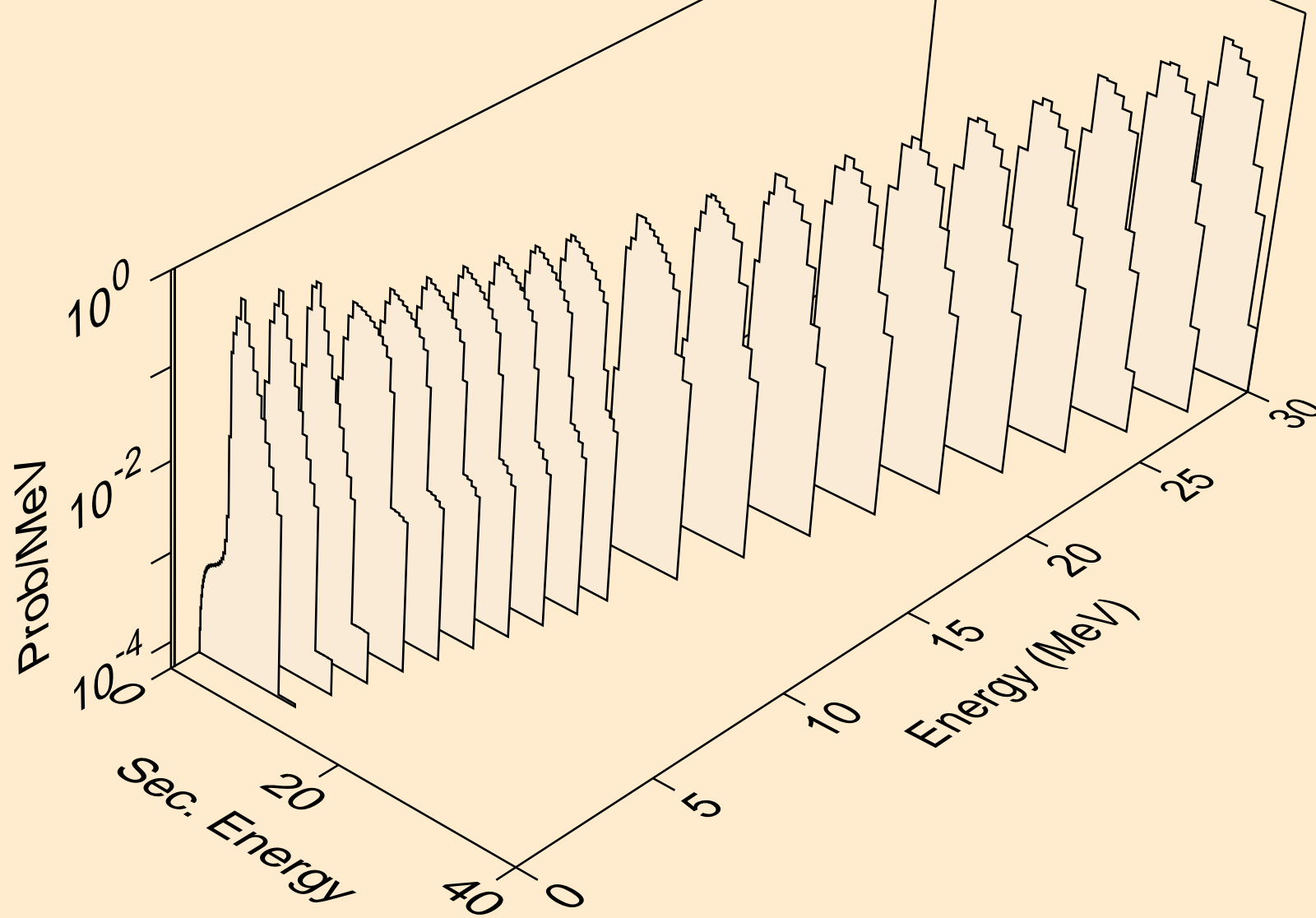

ZN077 TRITON ACER TENDL-2021 LIBRARY; T=0.K  
neutrons from (t,x)

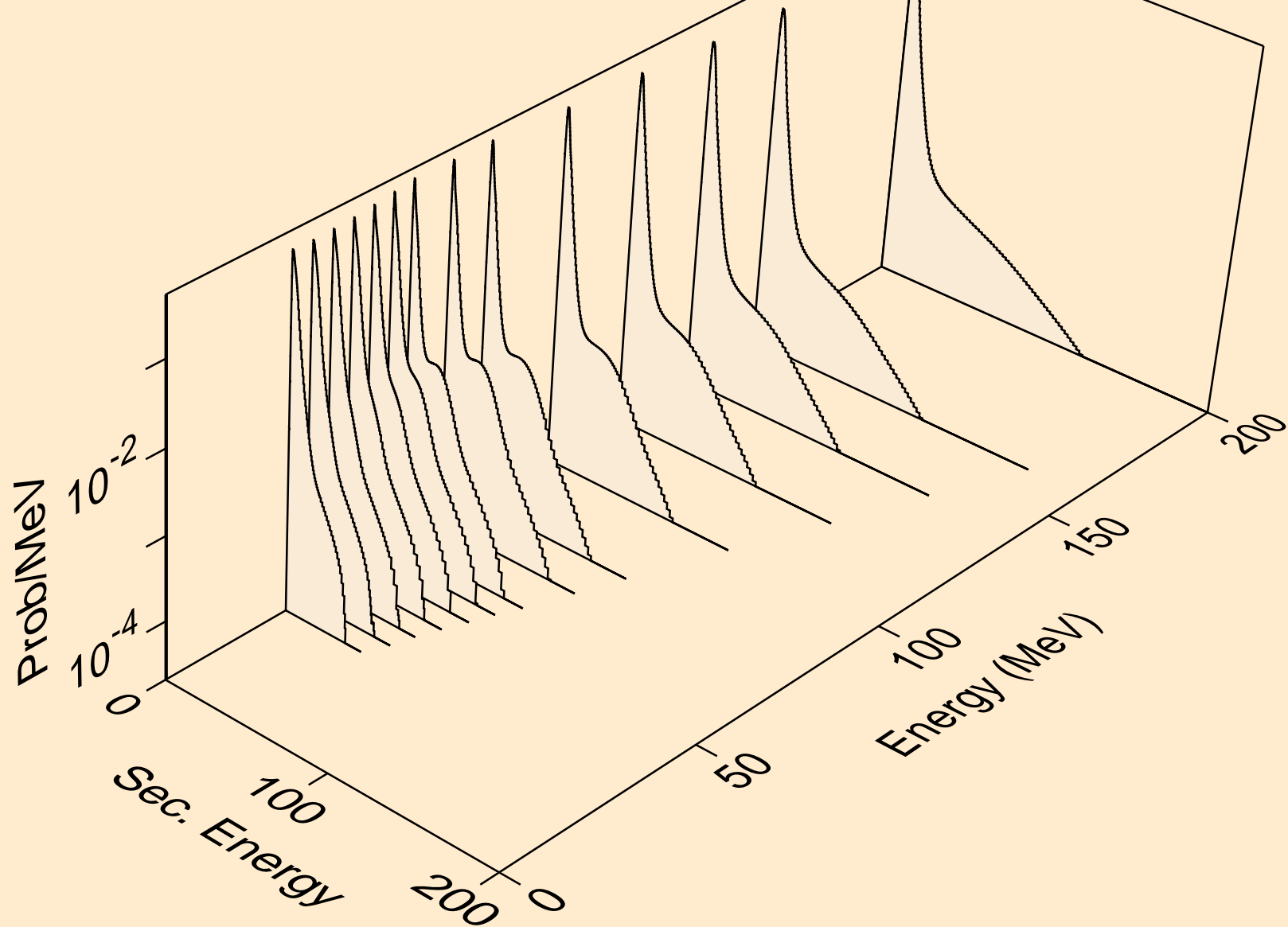

ZN077 TRITON ACER TENDL-2021 LIBRARY; T=0.K  
neutrons from (t,2nd)

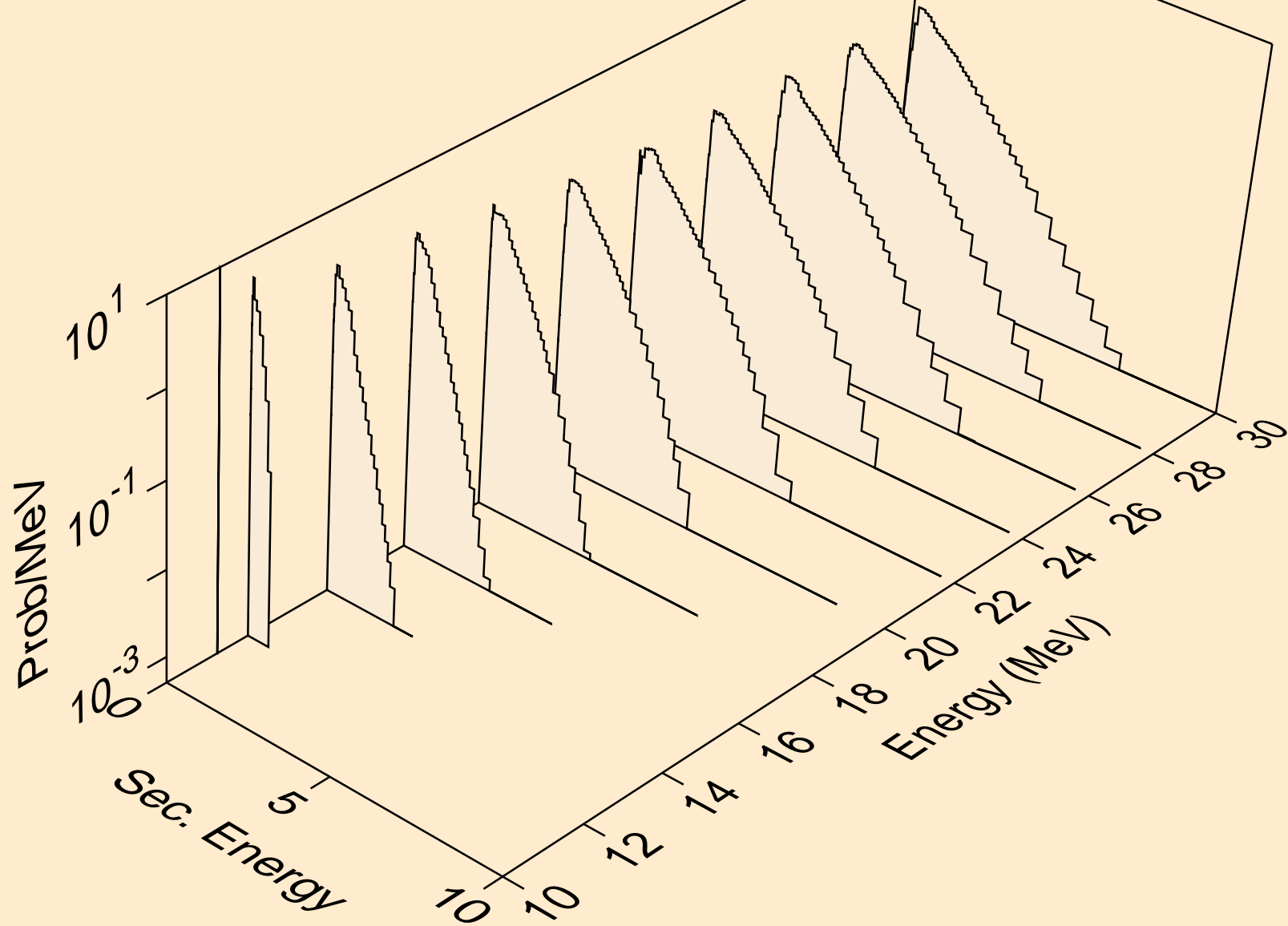

ZN077 TRITON ACER TENDL-2021 LIBRARY; T=0.K  
neutrons from (t,2n)

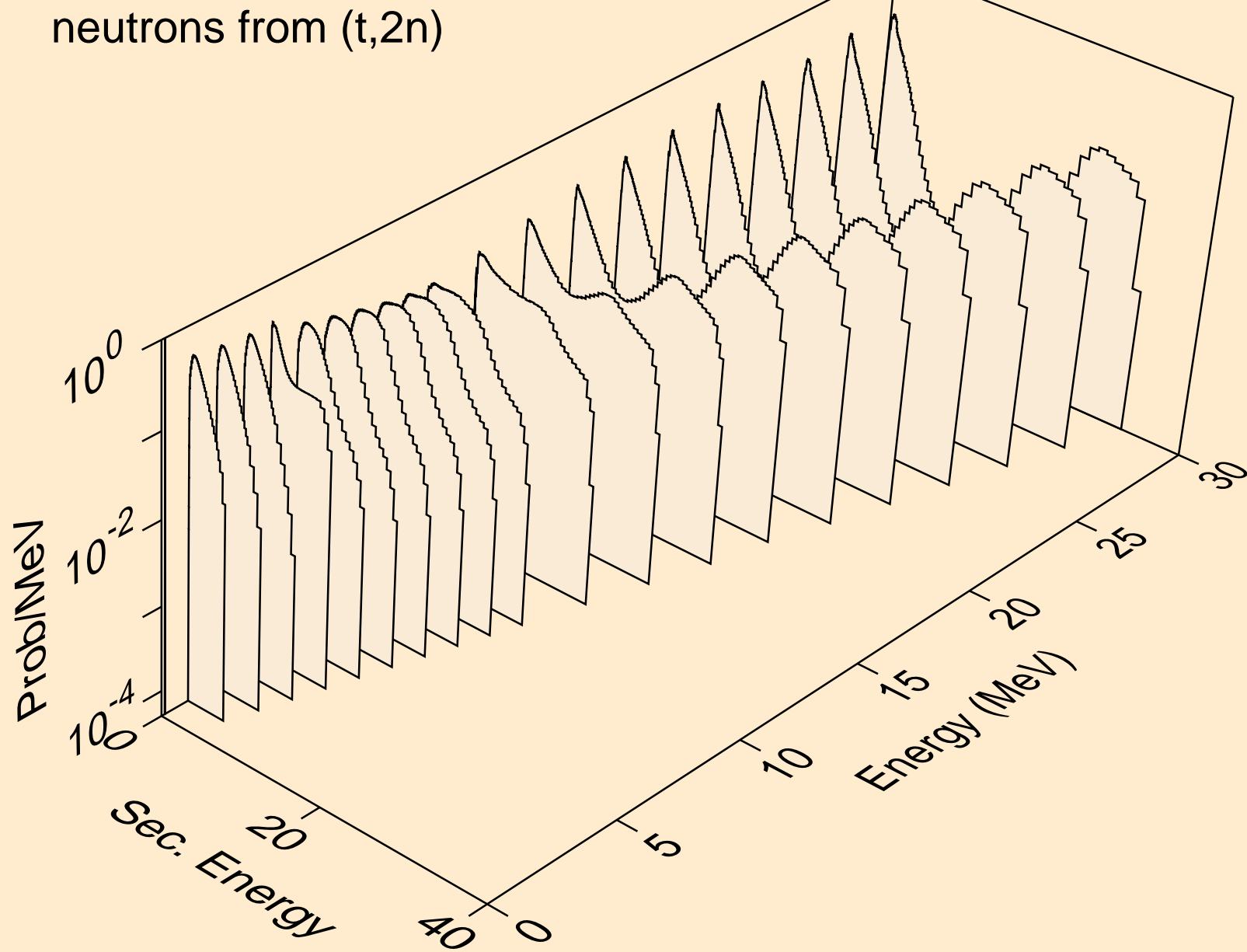

ZN077 TRITON ACER TENDL-2021 LIBRARY; T=0.K  
neutrons from (t,3n)

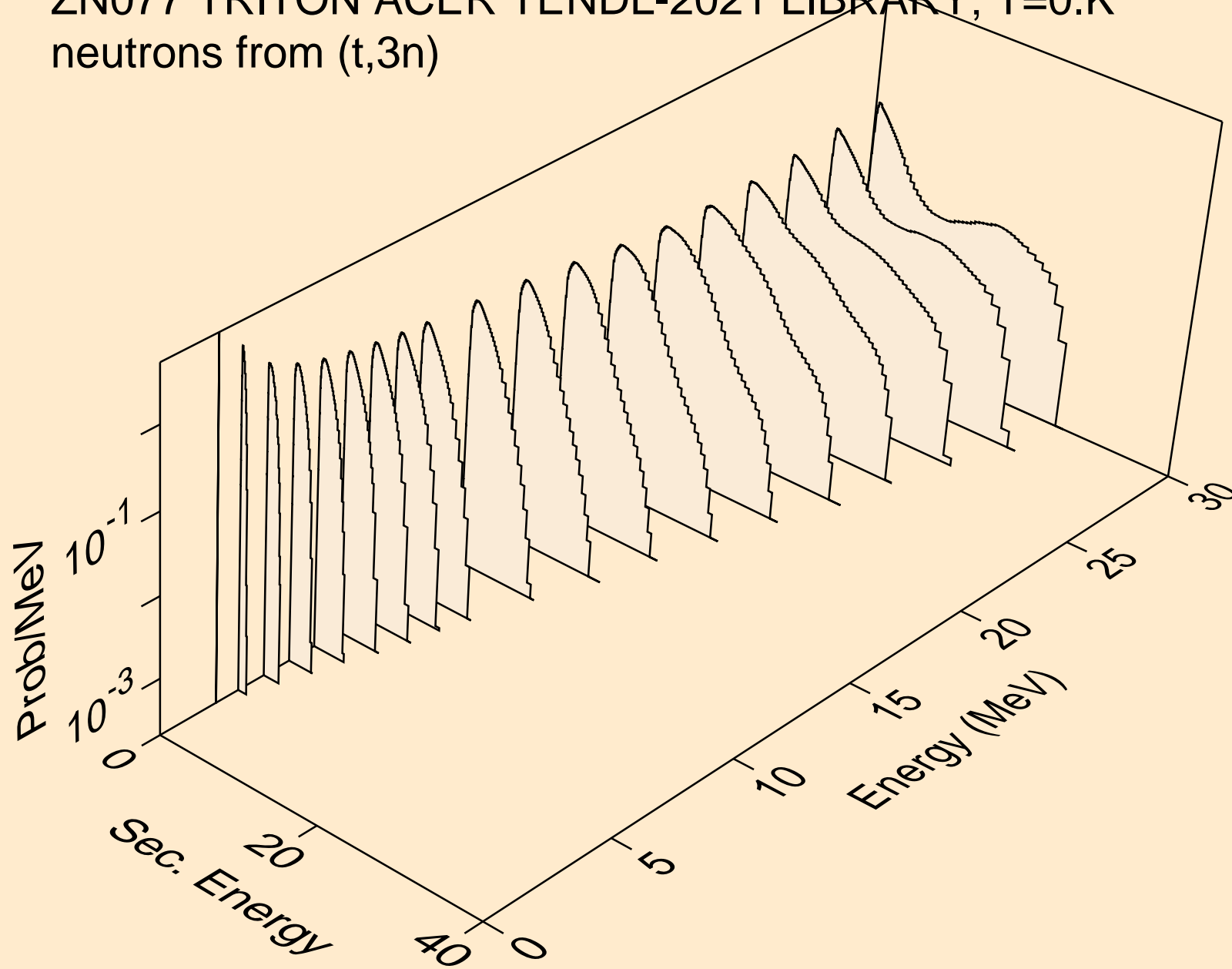



ZN077 TRITON ACER TENDL-2021 LIBRARY; T=0.K  
neutrons from (t,n\*)a

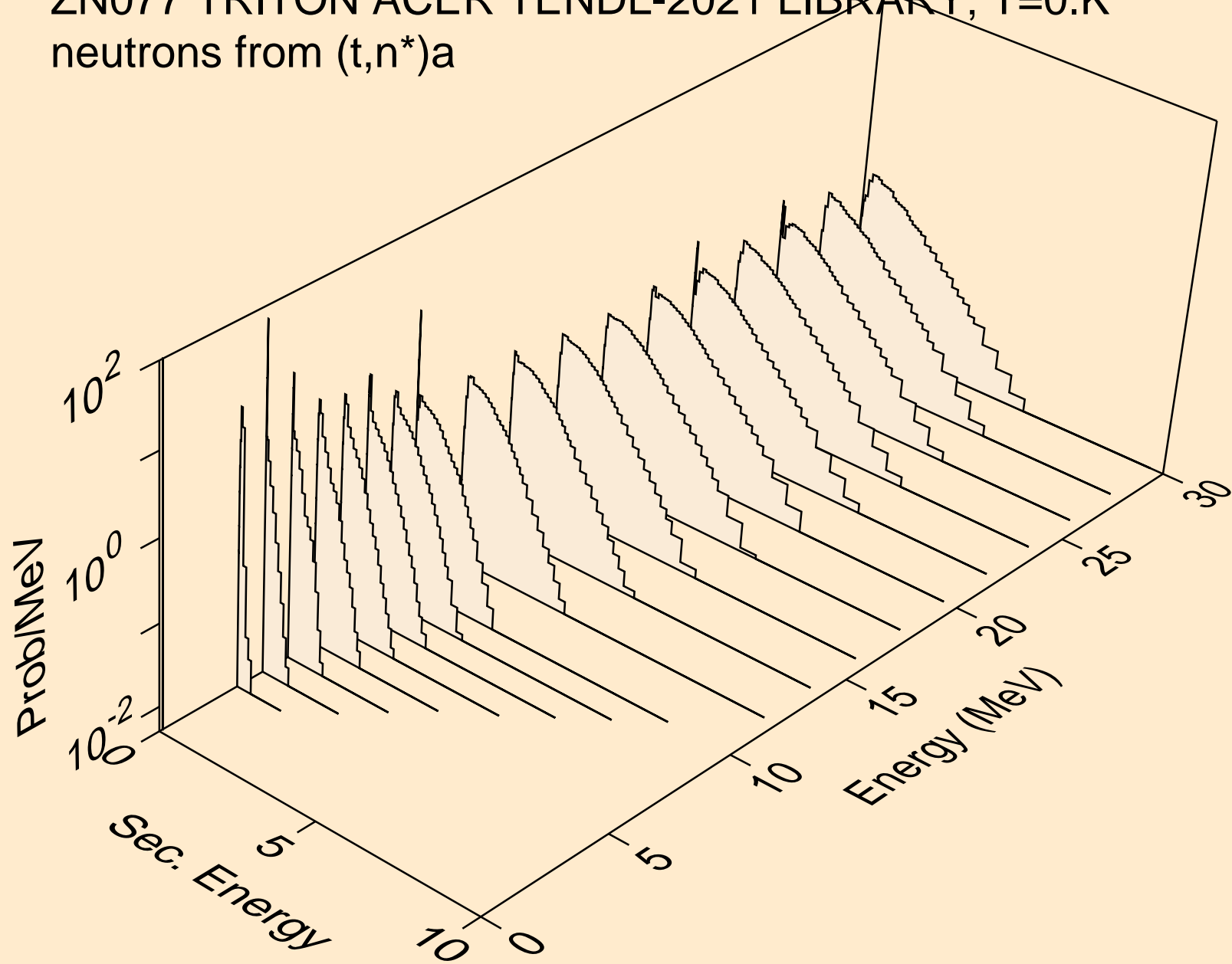

ZN077 TRITON ACER TENDL-2021 LIBRARY; T=0.K  
neutrons from (t,2n)a

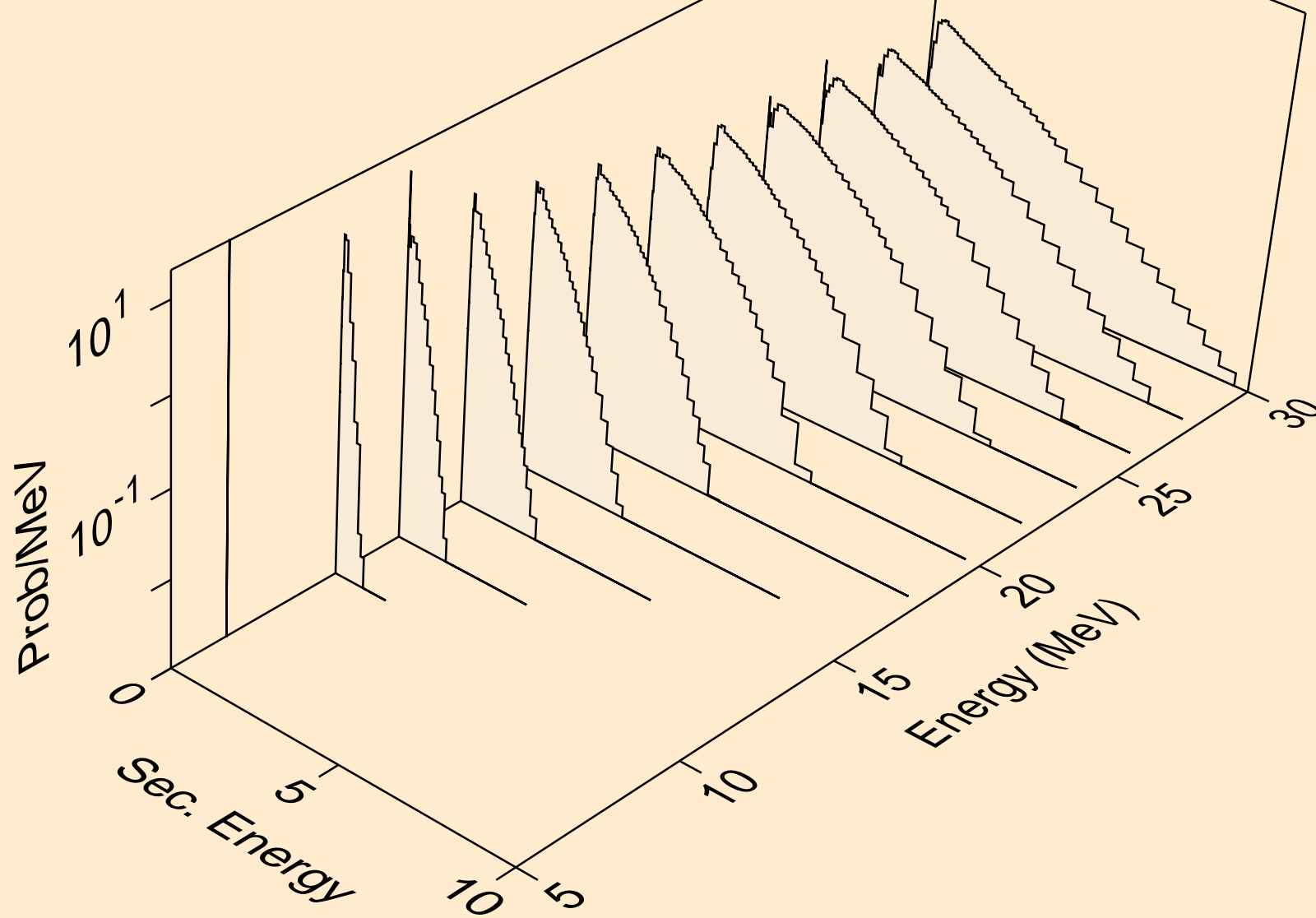

ZN077 TRITON ACER TENDL-2021 LIBRARY; T=0.K  
neutrons from (t,3n)a

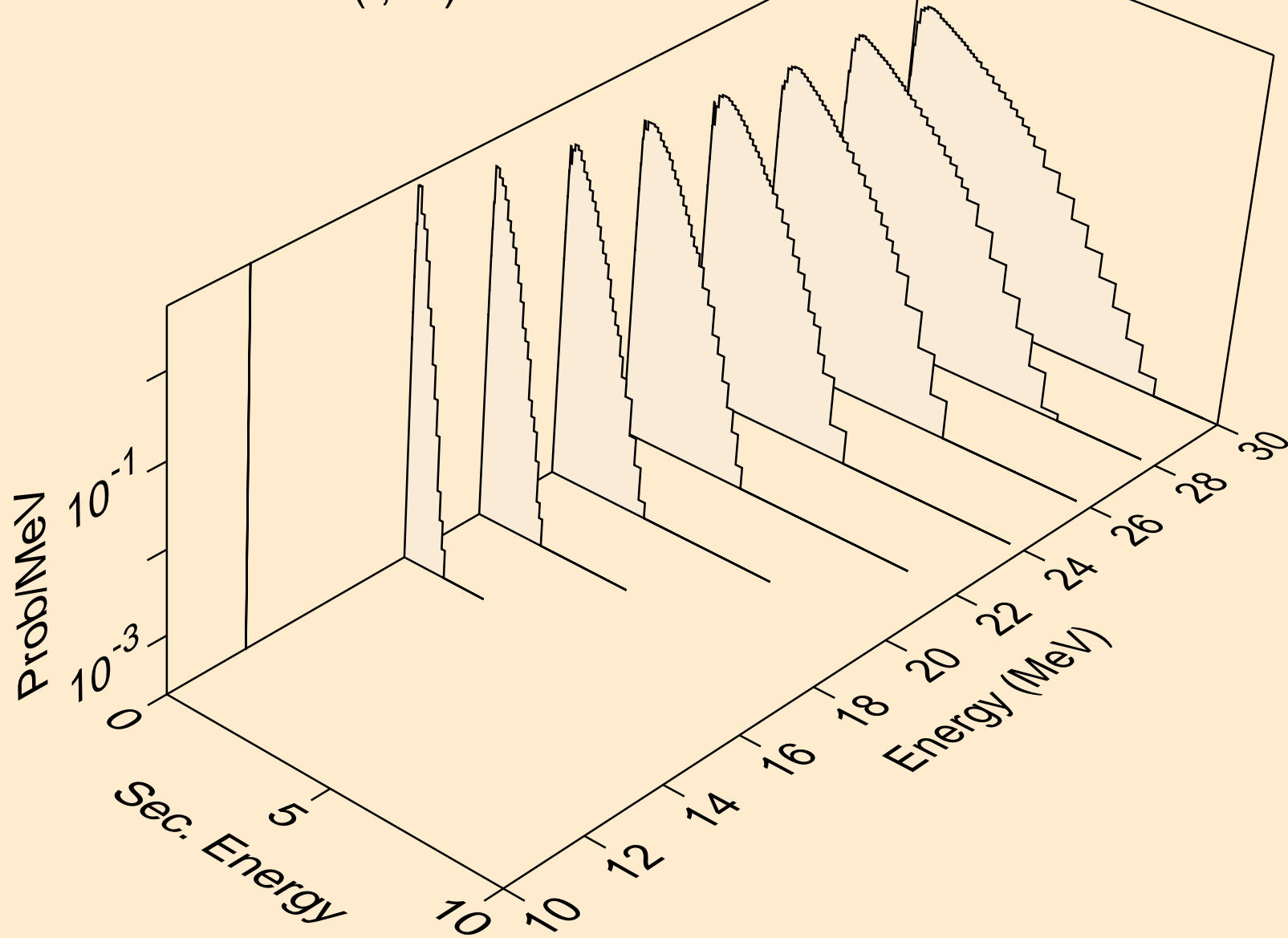

ZN077 TRITON ACER TENDL-2021 LIBRARY; T=0.K  
neutrons from (t,n\*)p

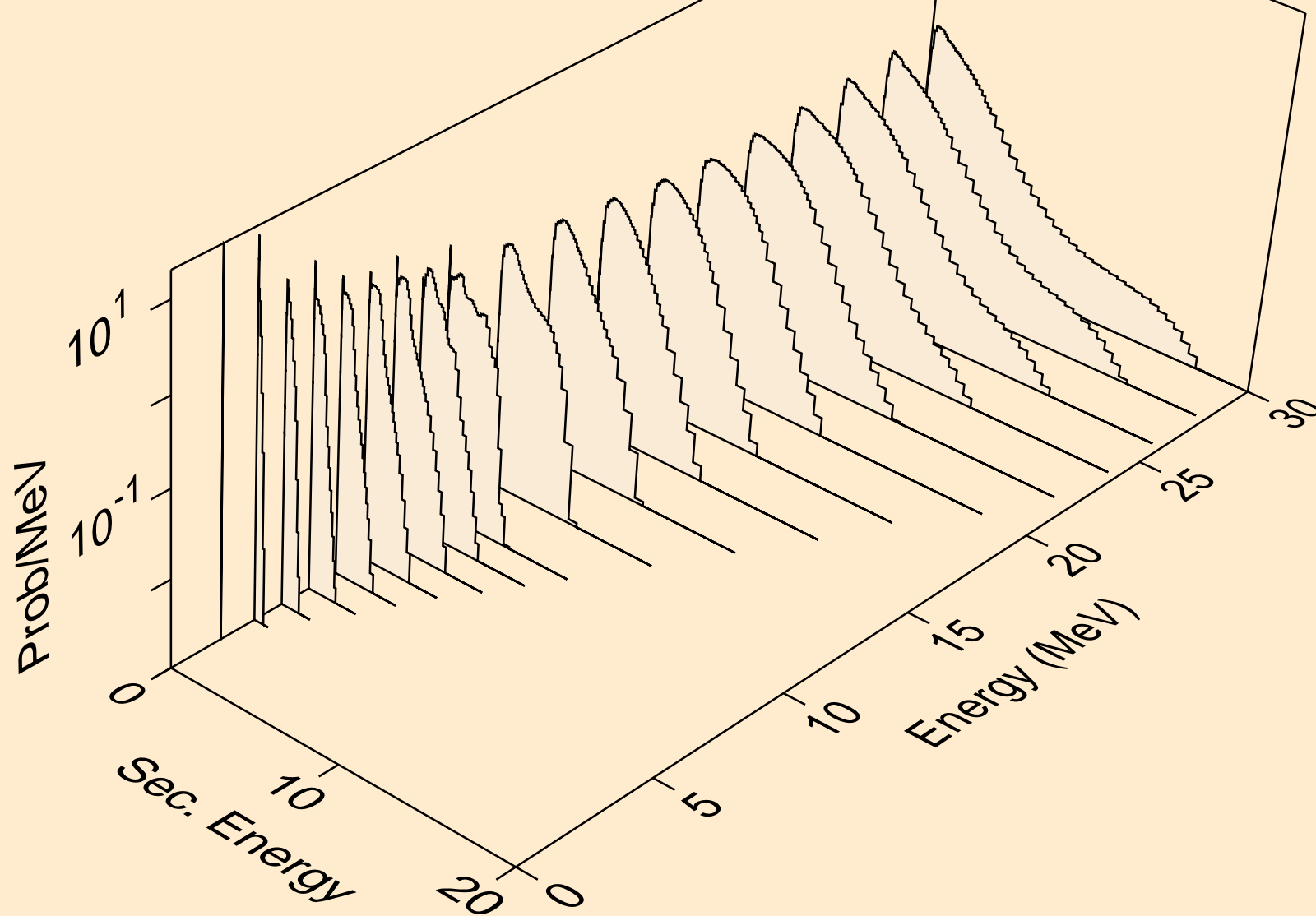

ZN077 TRITON ACER TENDL-2021 LIBRARY; T=0.K  
neutrons from (t,n\*)d

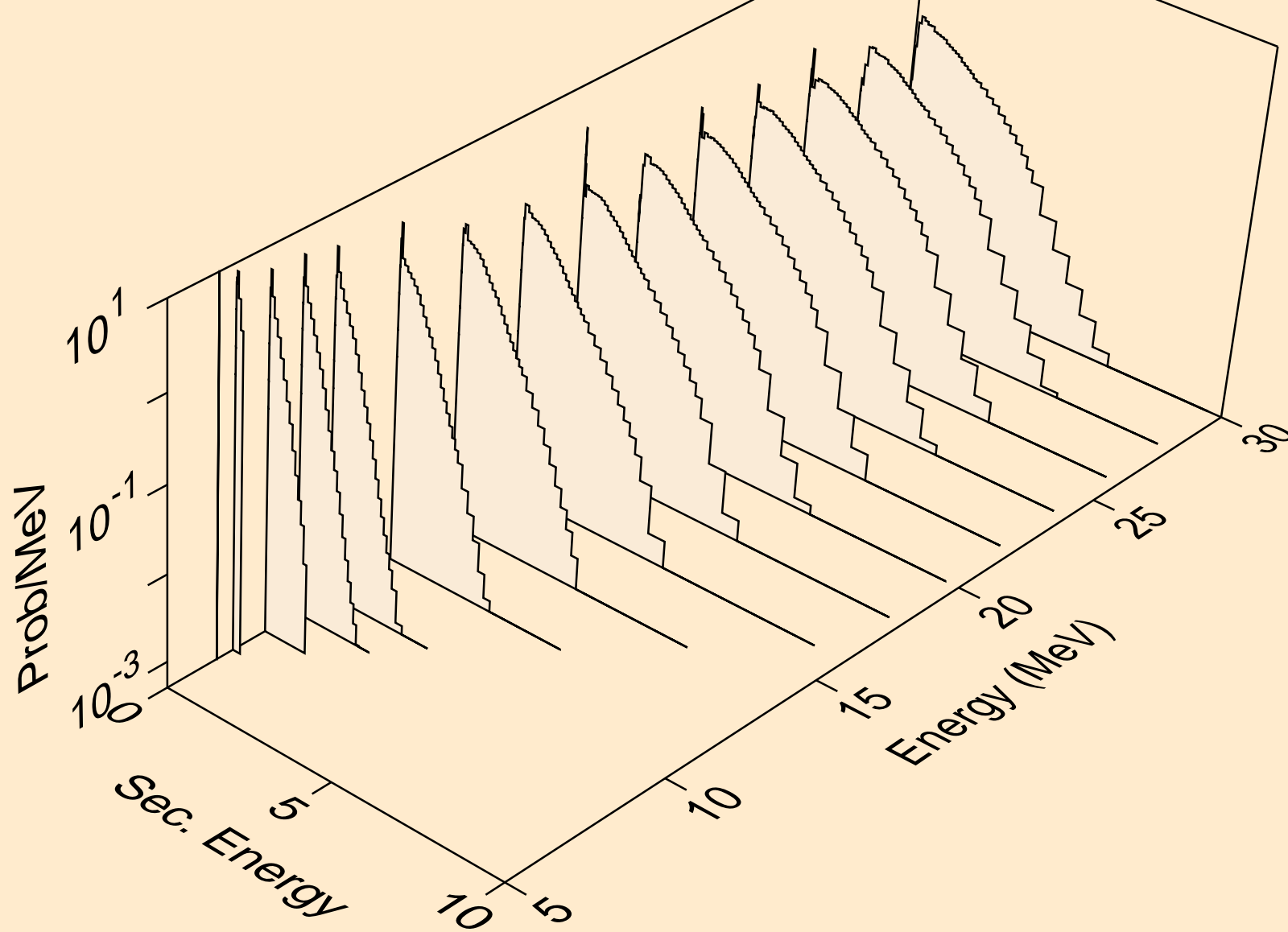

ZN077 TRITON ACER TENDL-2021 LIBRARY; T=0.K  
neutrons from (t,n\*)t

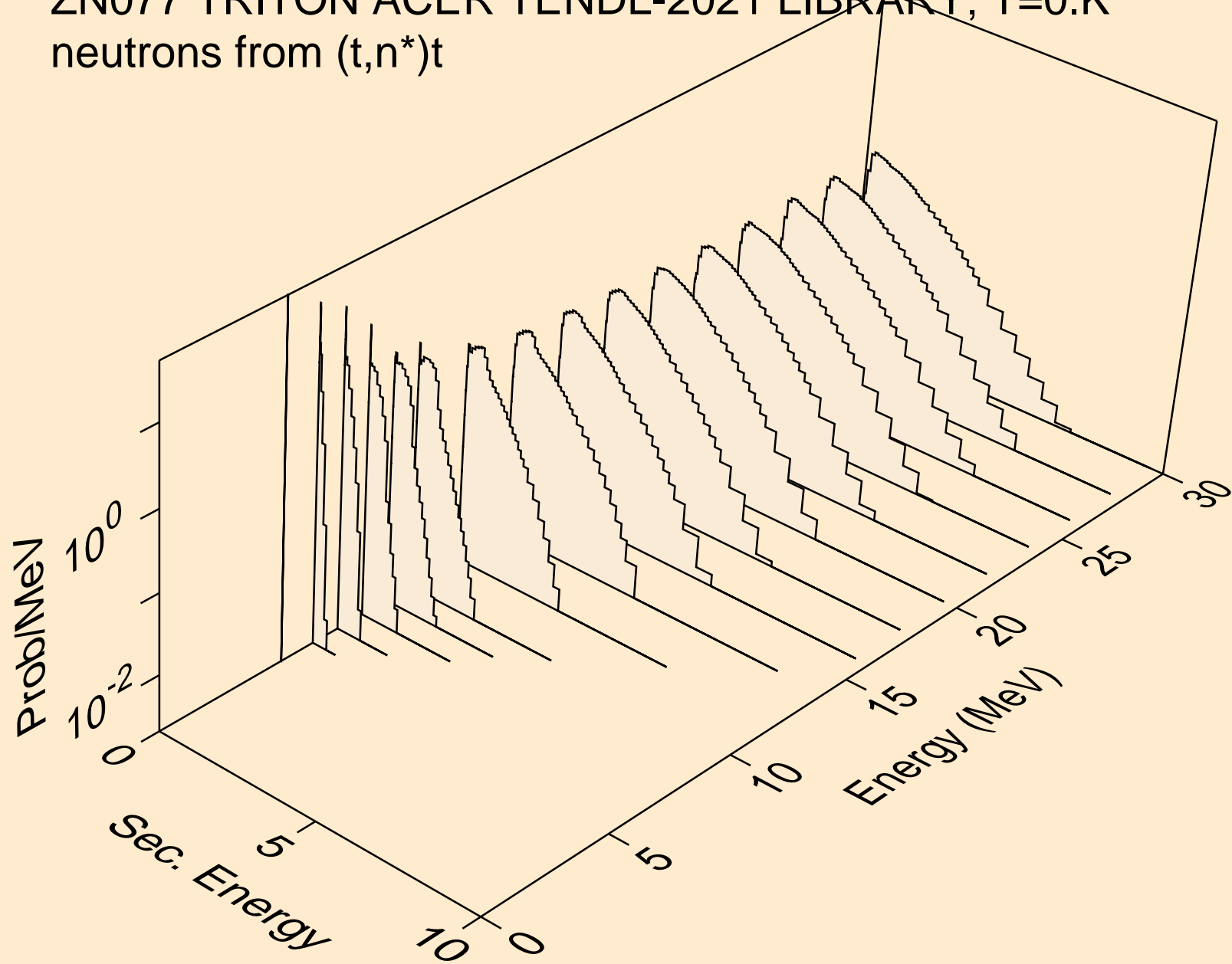

ZN077 TRITON ACER TENDL-2021 LIBRARY; T=0.K  
neutrons from (t,n\*)he3

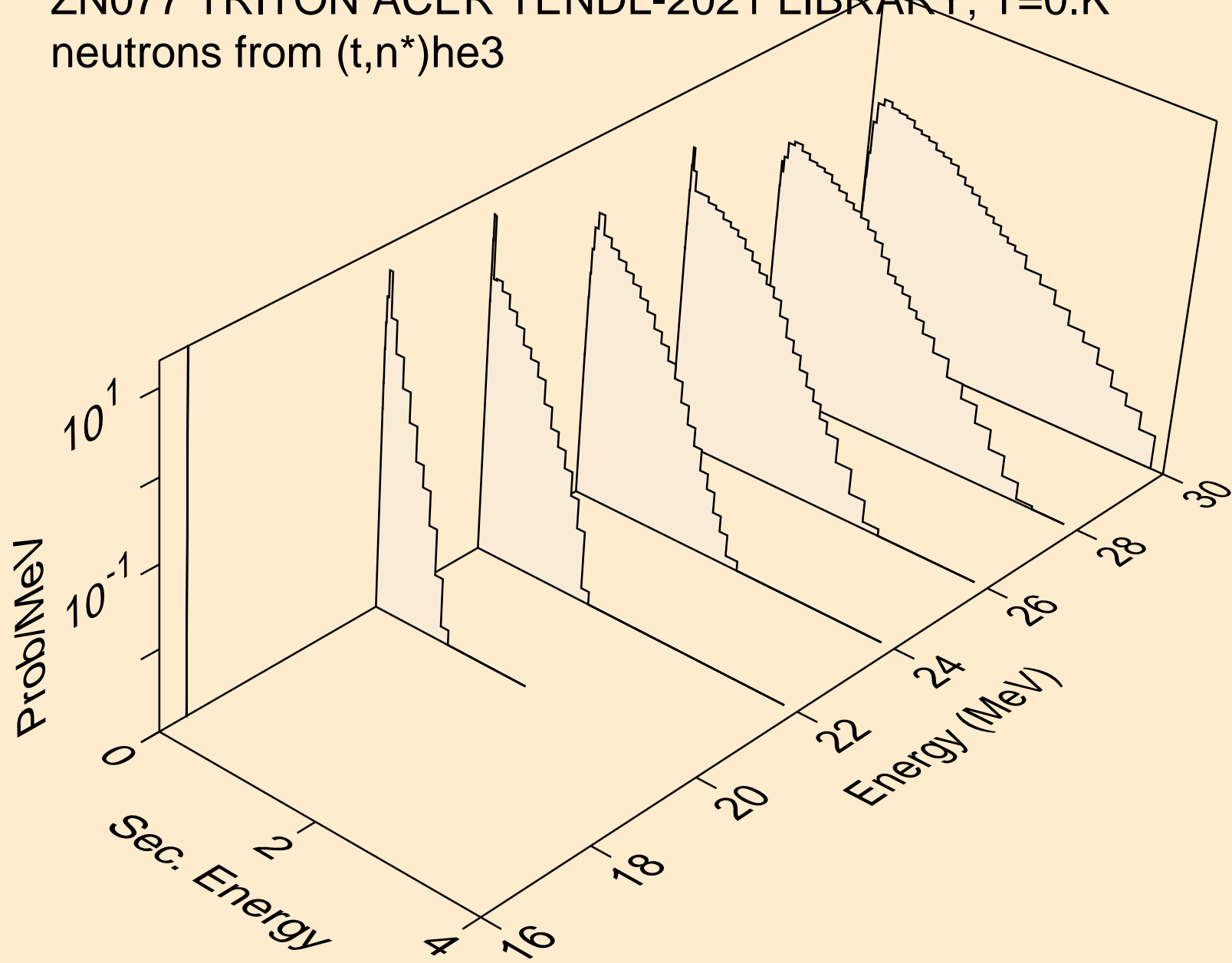

ZN077 TRITON ACER TENDL-2021 LIBRARY; T=0.K  
neutrons from (t,4n)

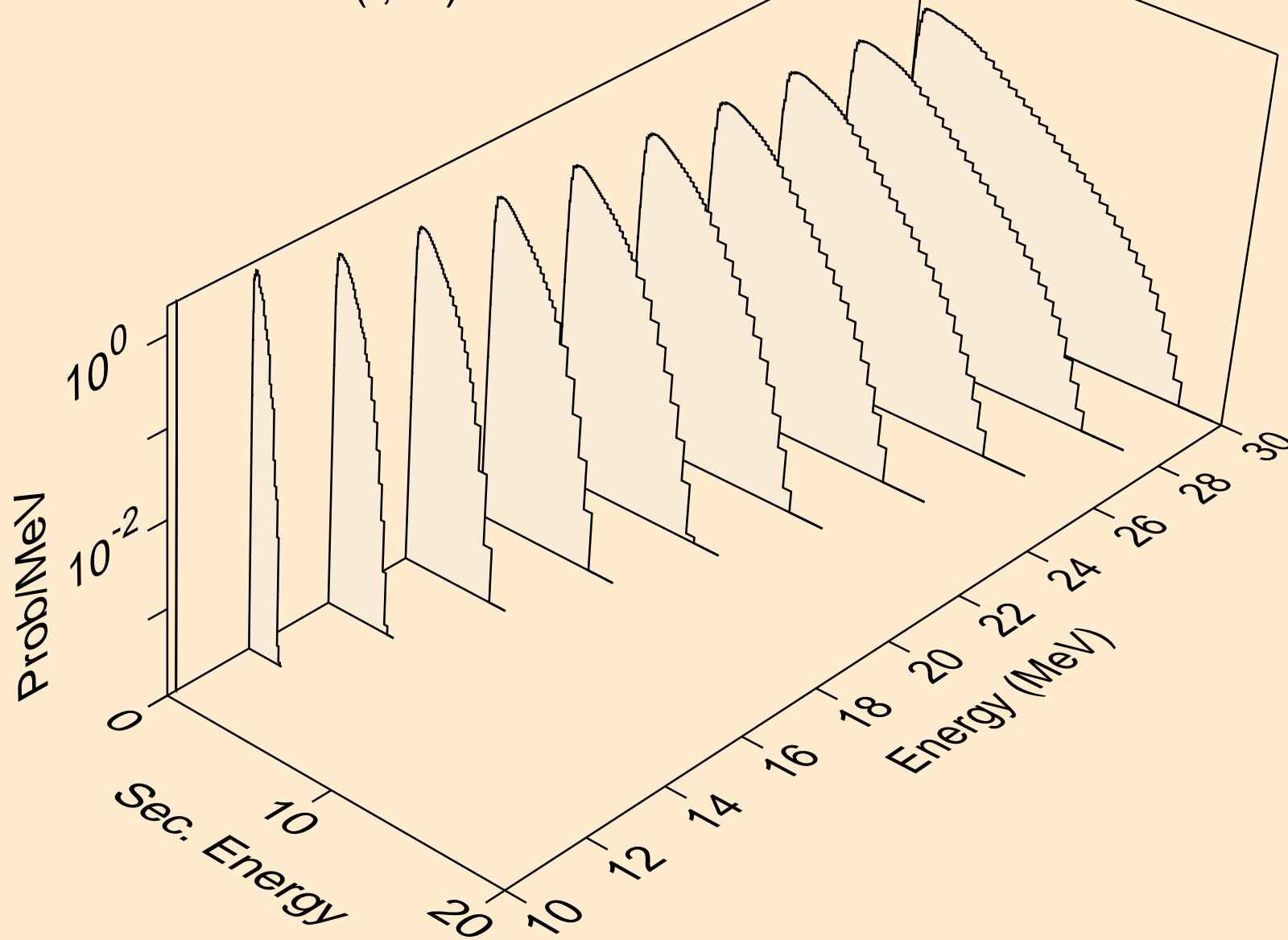



ZN077 TRITON ACER TENDL-2021 LIBRARY; T=0.K  
neutrons from (t,2np)

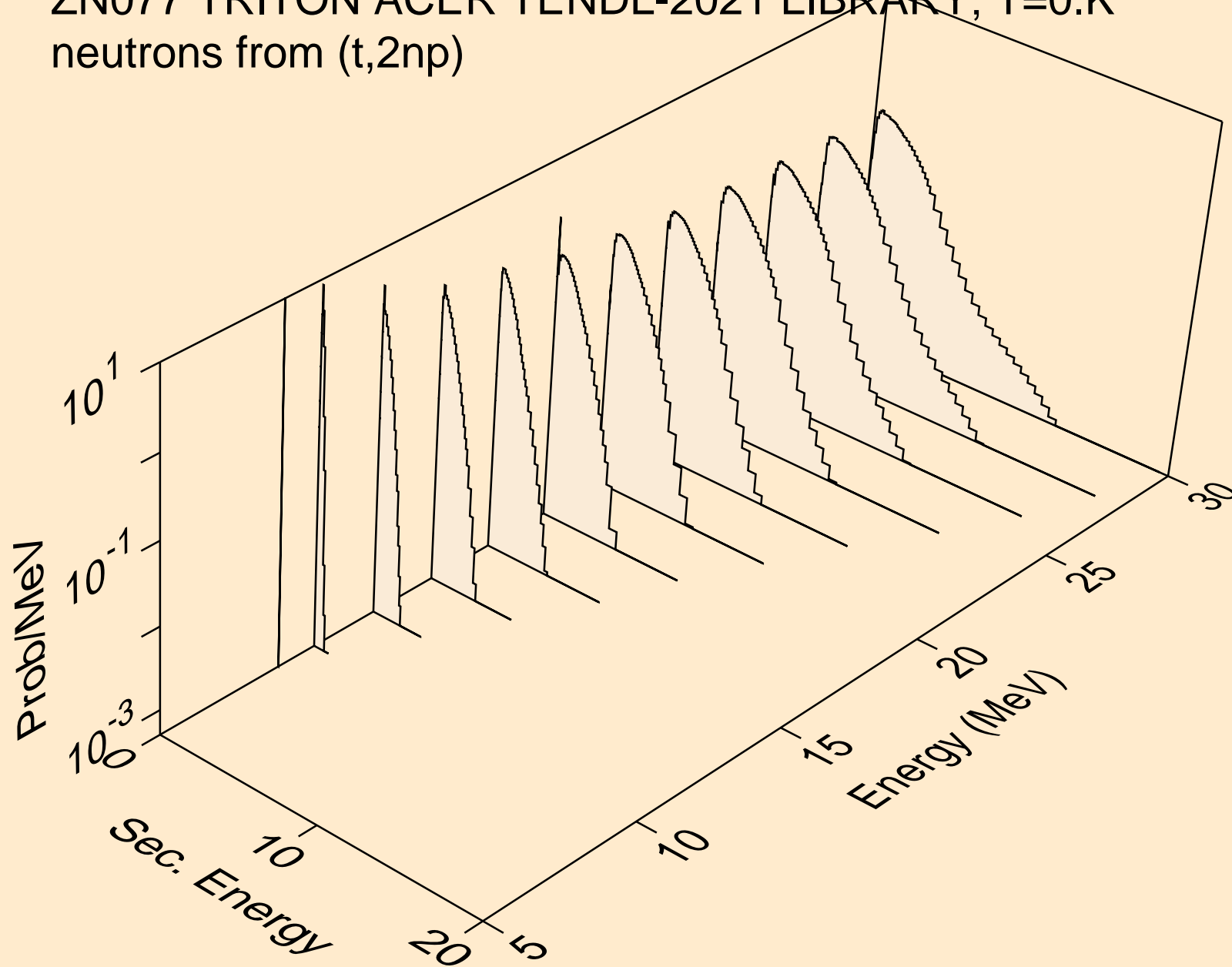

ZN077 TRITON ACER TENDL-2021 LIBRARY; T=0.K  
neutrons from (t,3np)

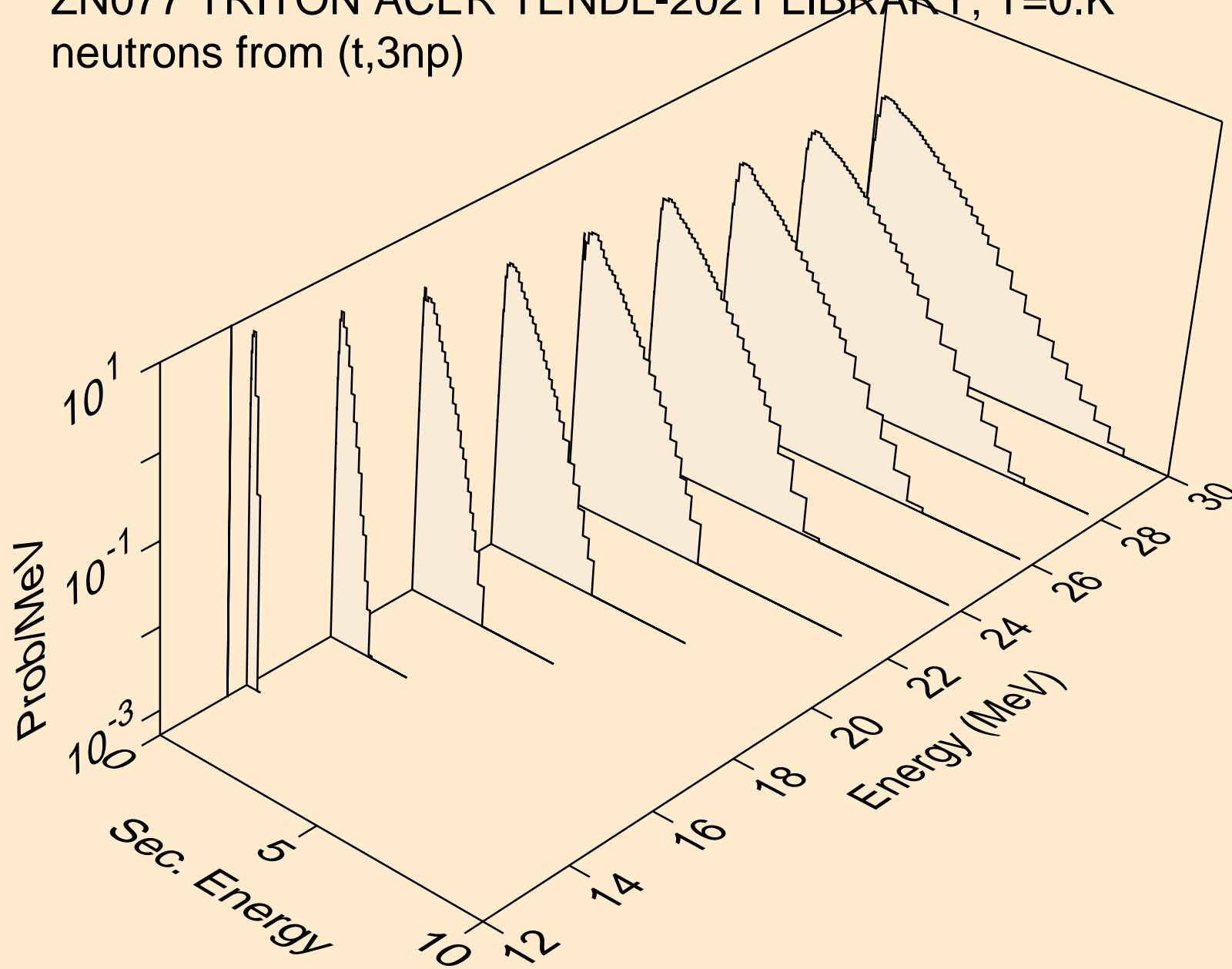

ZN077 TRITON ACER TENDL-2021 LIBRARY; T=0.K  
neutrons from (t,2np)

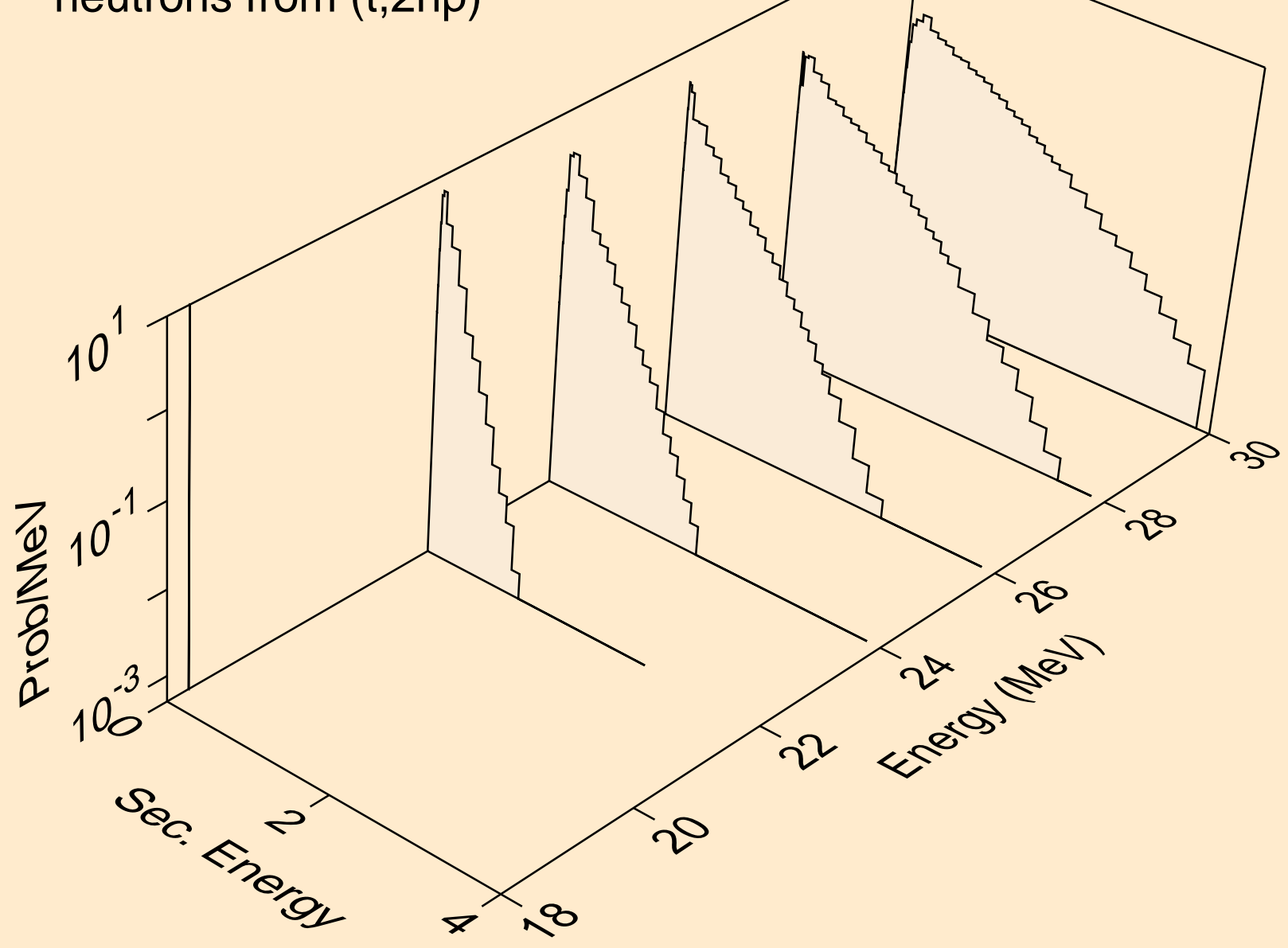

ZN077 TRITON ACER TENDL-2021 LIBRARY; T=0.K  
neutrons from (t,npa)

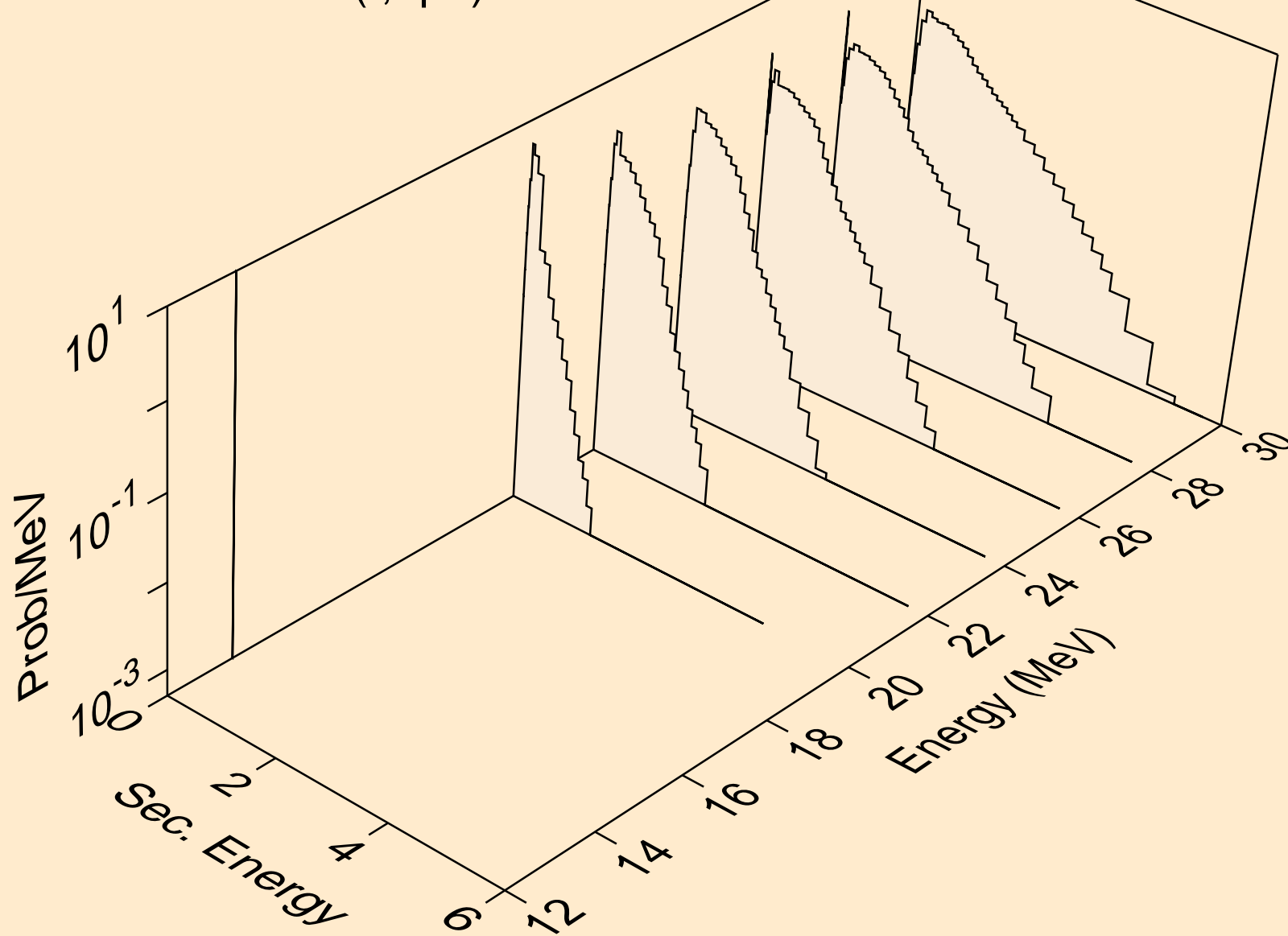

ZN077 TRITON ACER TENDL-2021 LIBRARY; T=0.K  
protons from (t,x)

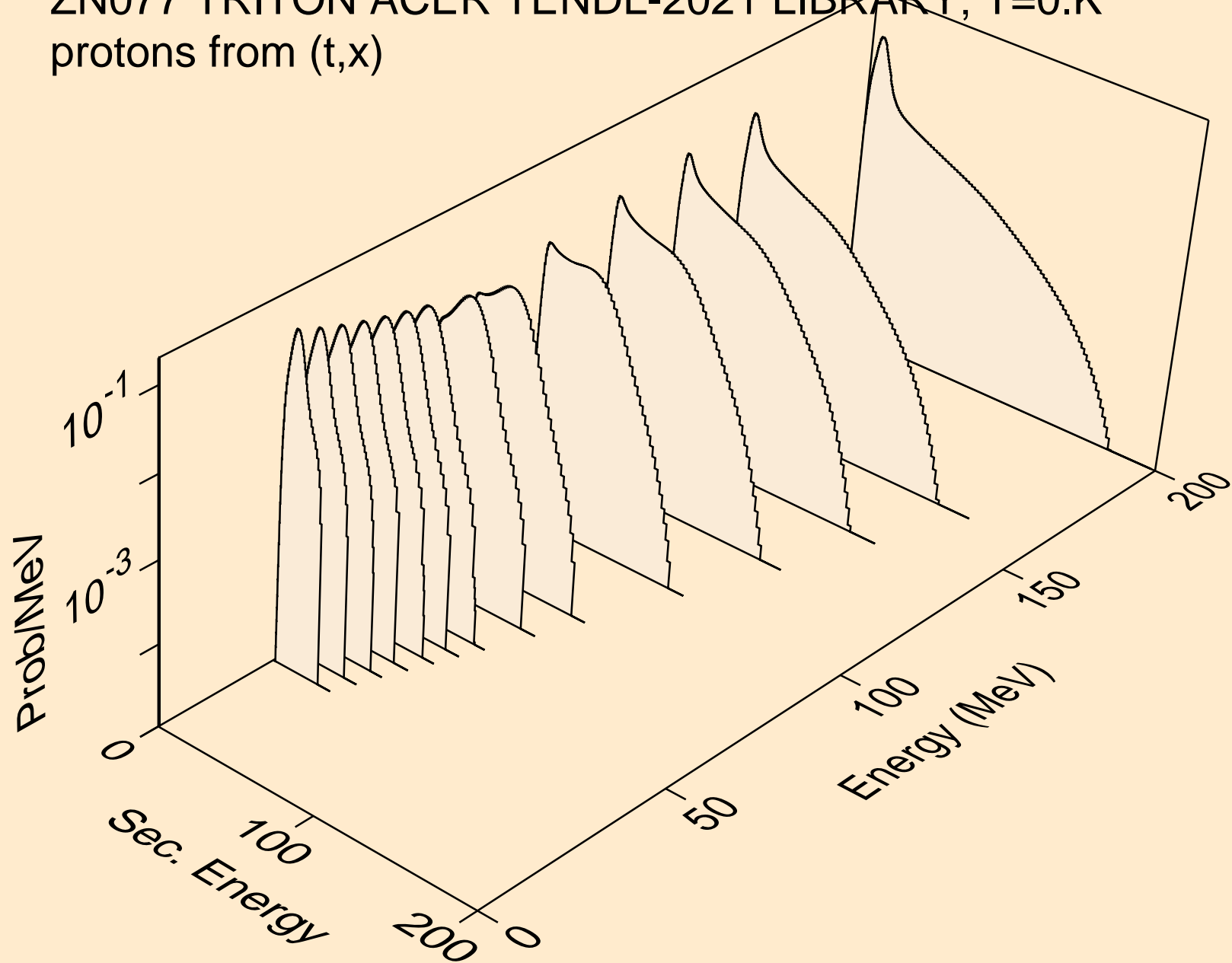

ZN077 TRITON ACER TENDL-2021 LIBRARY; T=0.K  
protons from (t,n\*)p

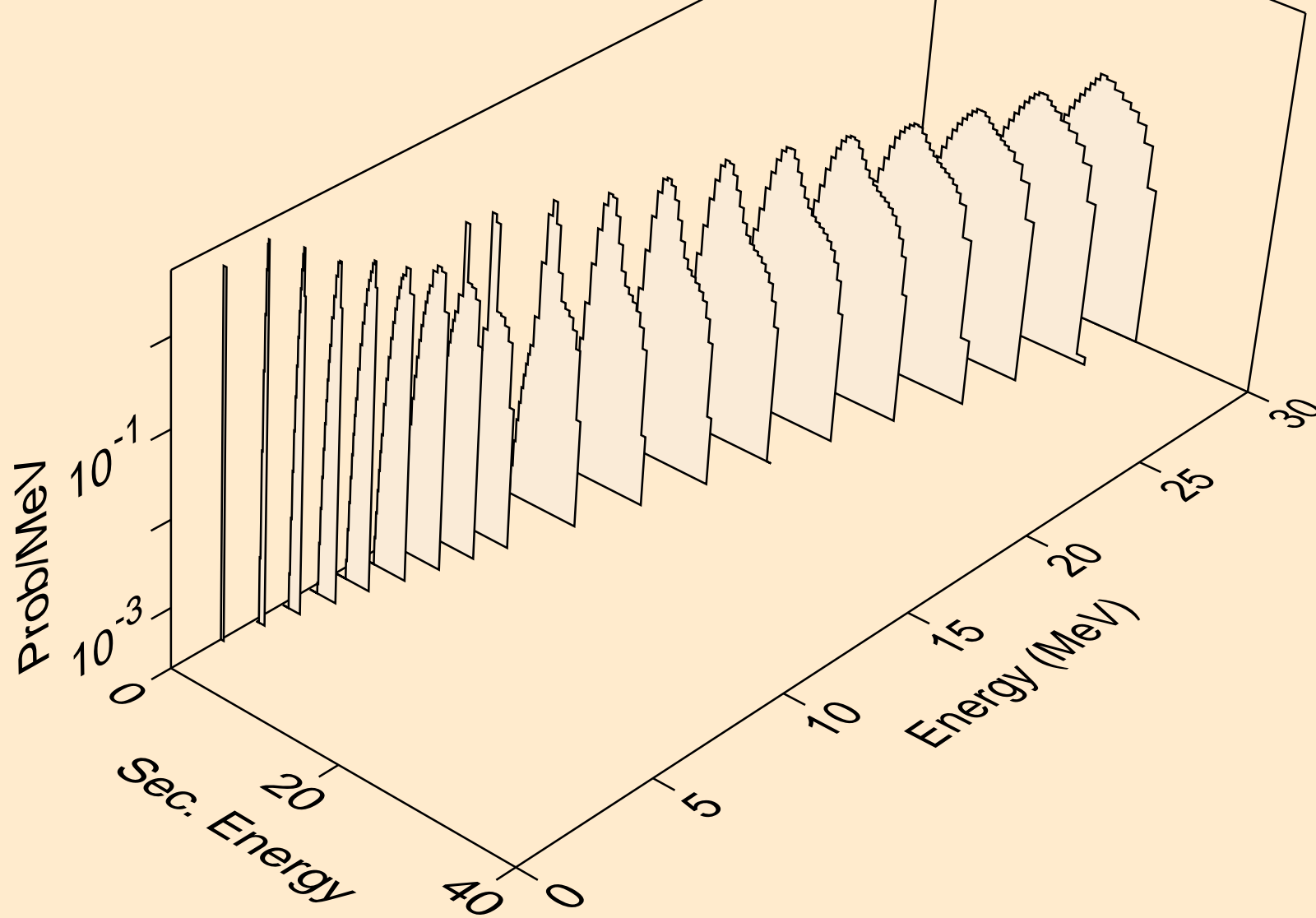

ZN077 TRITON ACER TENDL-2021 LIBRARY; T=0.K  
protons from (t,2np)

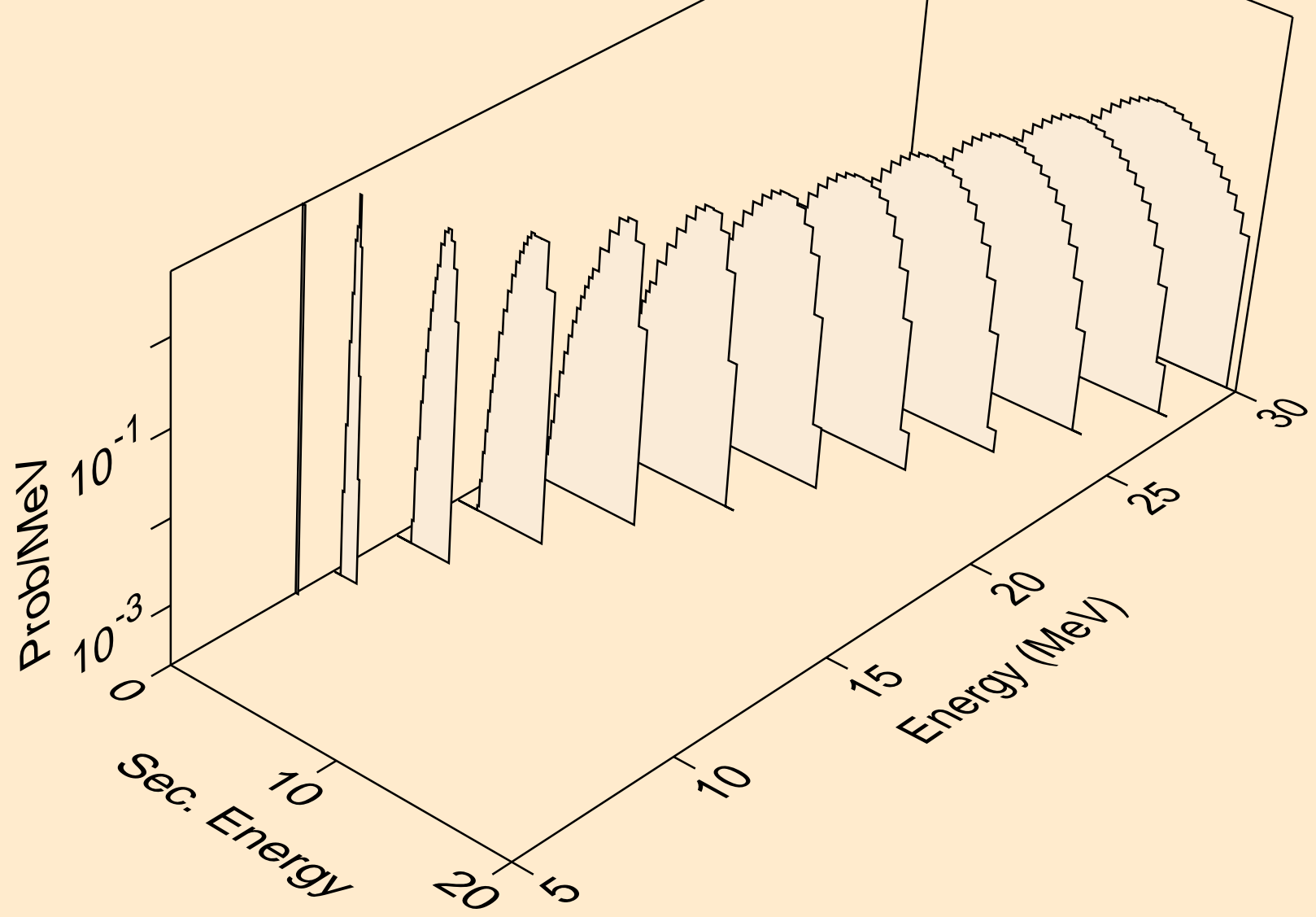

ZN077 TRITON ACER TENDL-2021 LIBRARY; T=0.K  
protons from (t,3np)

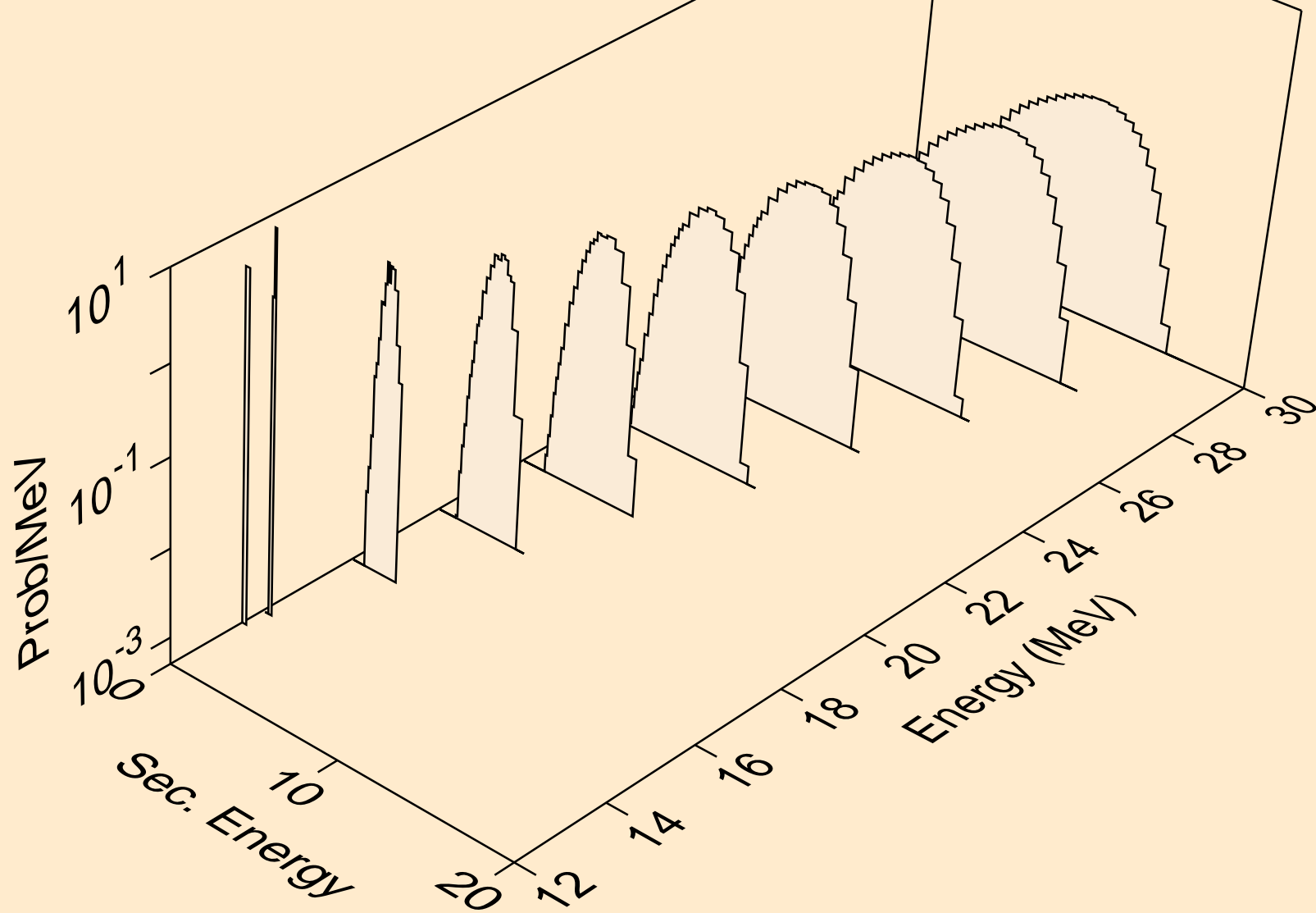



ZN077 TRITON ACER TENDL-2021 LIBRARY; T=0.K  
protons from (t,2np)

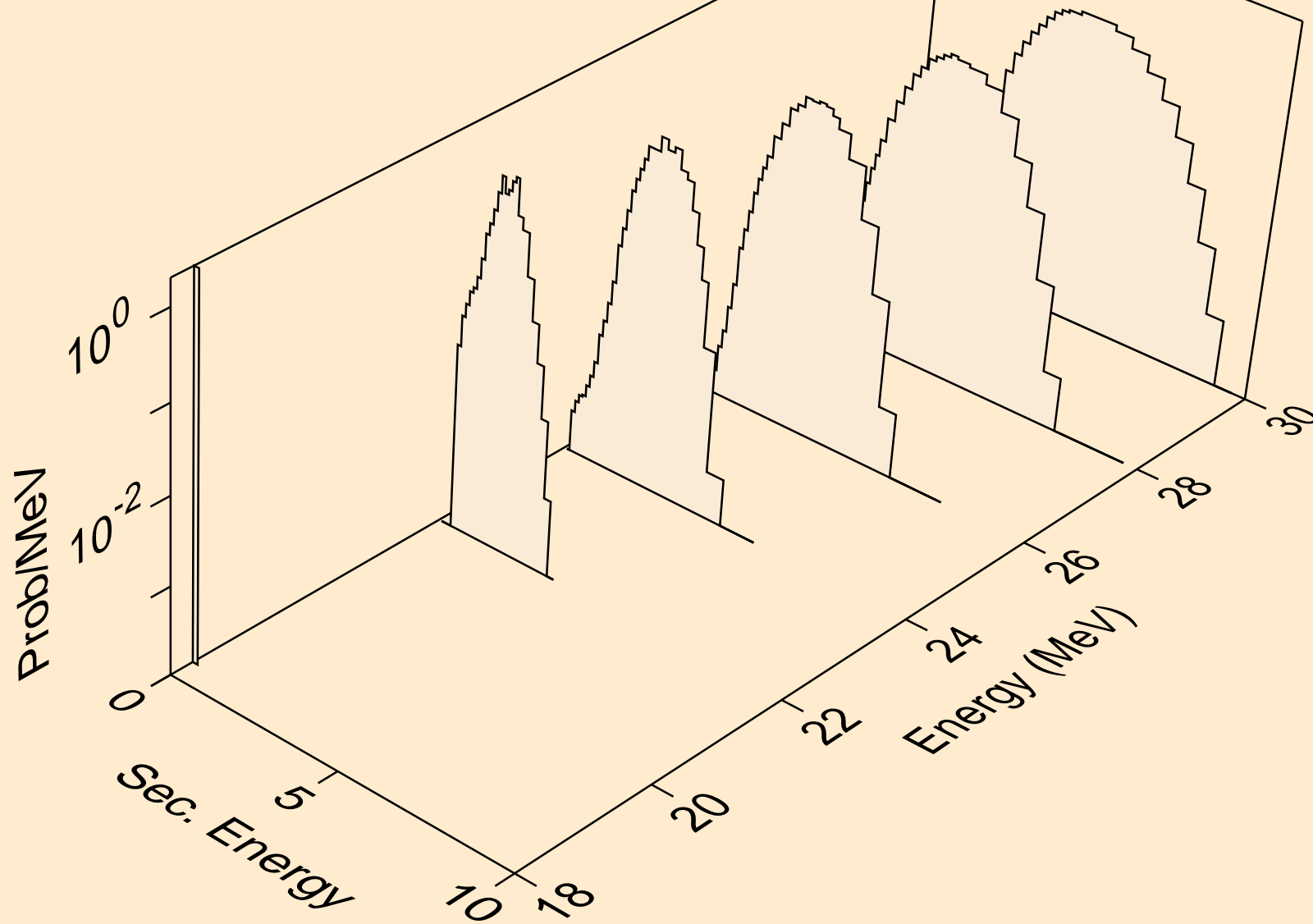

ZN077 TRITON ACER TENDL-2021 LIBRARY; T=0.K  
protons from (t,npa)

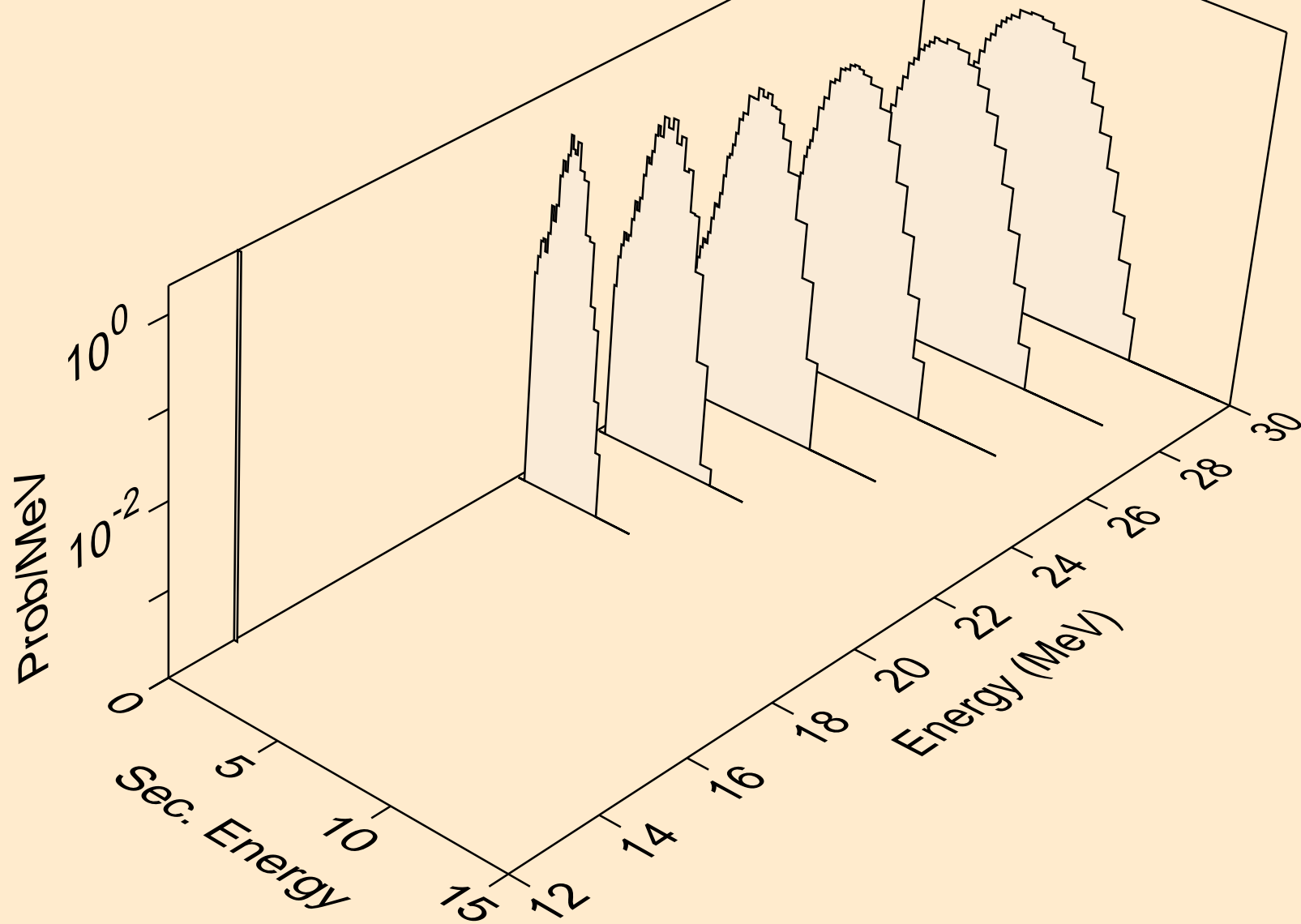

ZN077 TRITON ACER TENDL-2021 LIBRARY; T=0.K  
protons from (t,p)

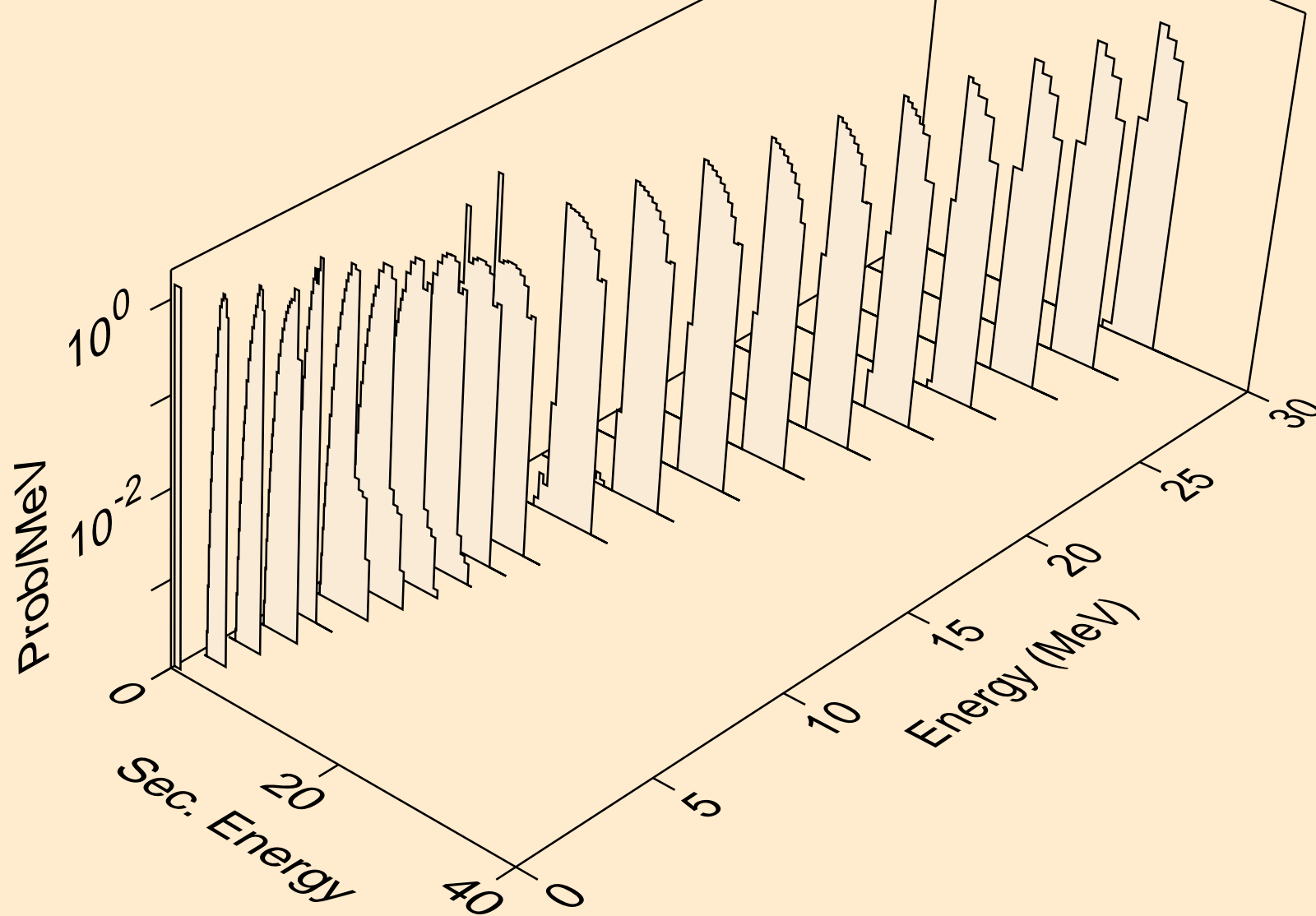

ZN077 TRITON ACER TENDL-2021 LIBRARY; T=0.K  
protons from (t,2p)

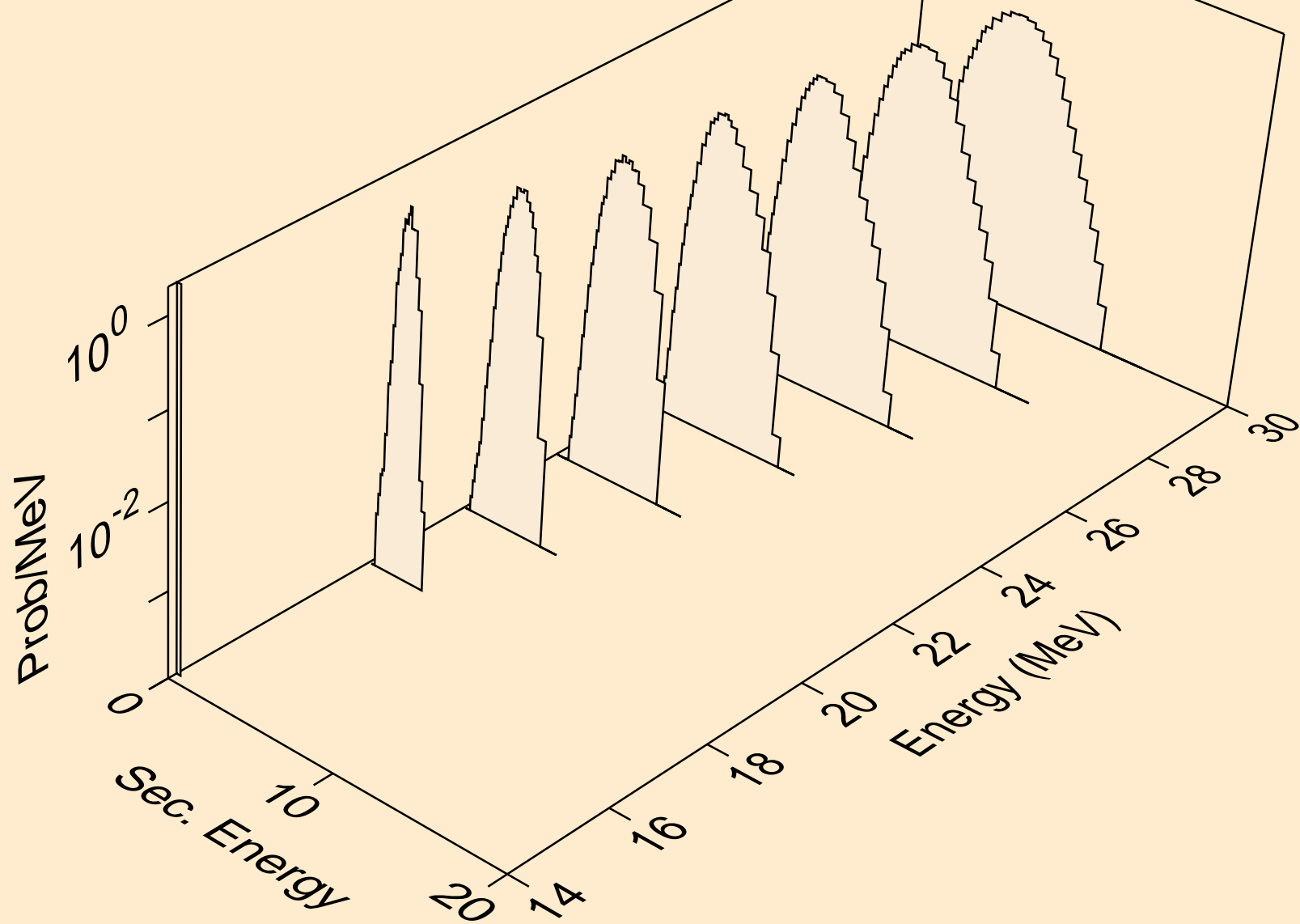

ZN077 TRITON ACER TENDL-2021 LIBRARY; T=0.K  
protons from (t,pa)

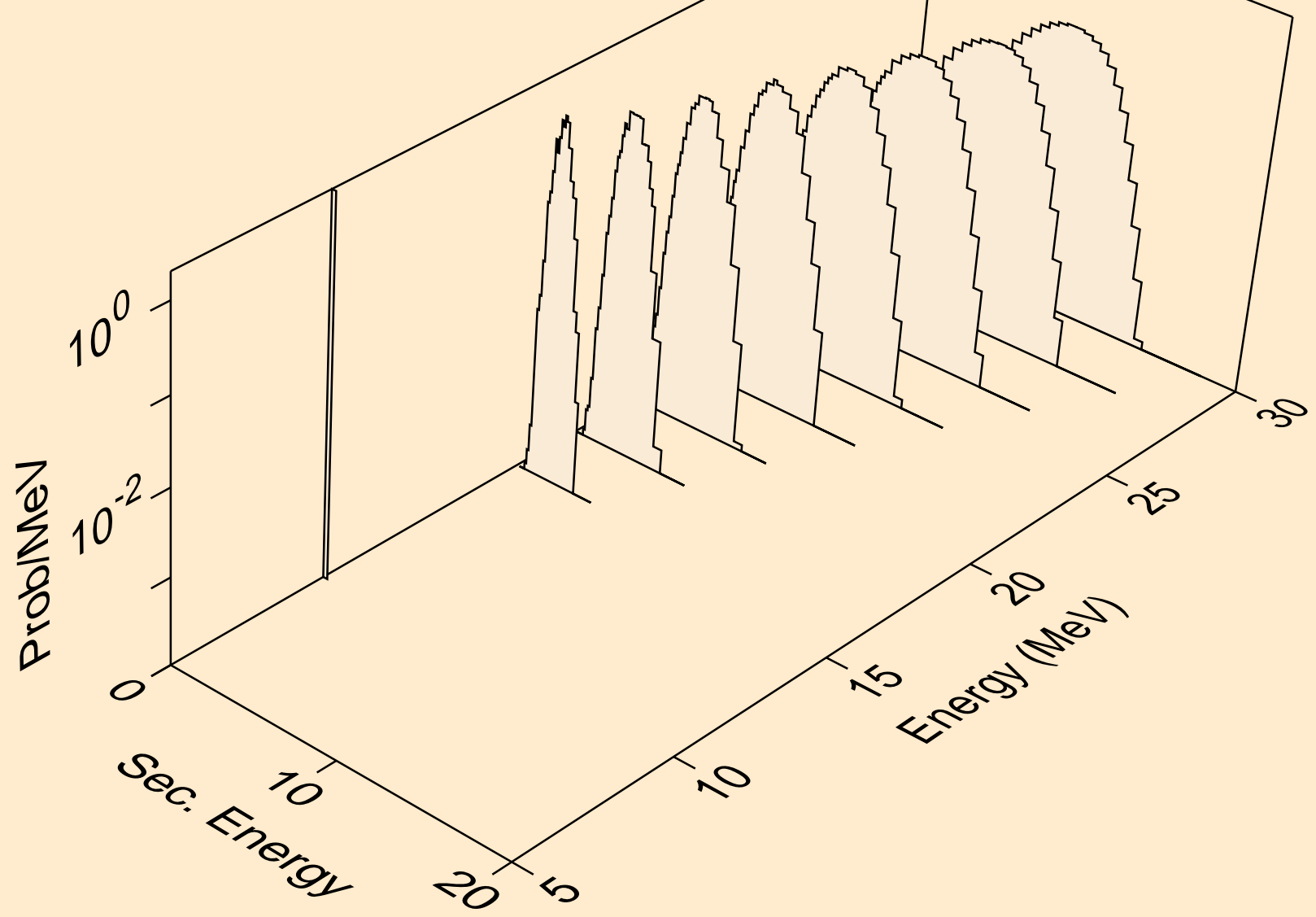

ZN077 TRITON ACER TENDL-2021 LIBRARY; T=0.K  
protons from (t,pd)

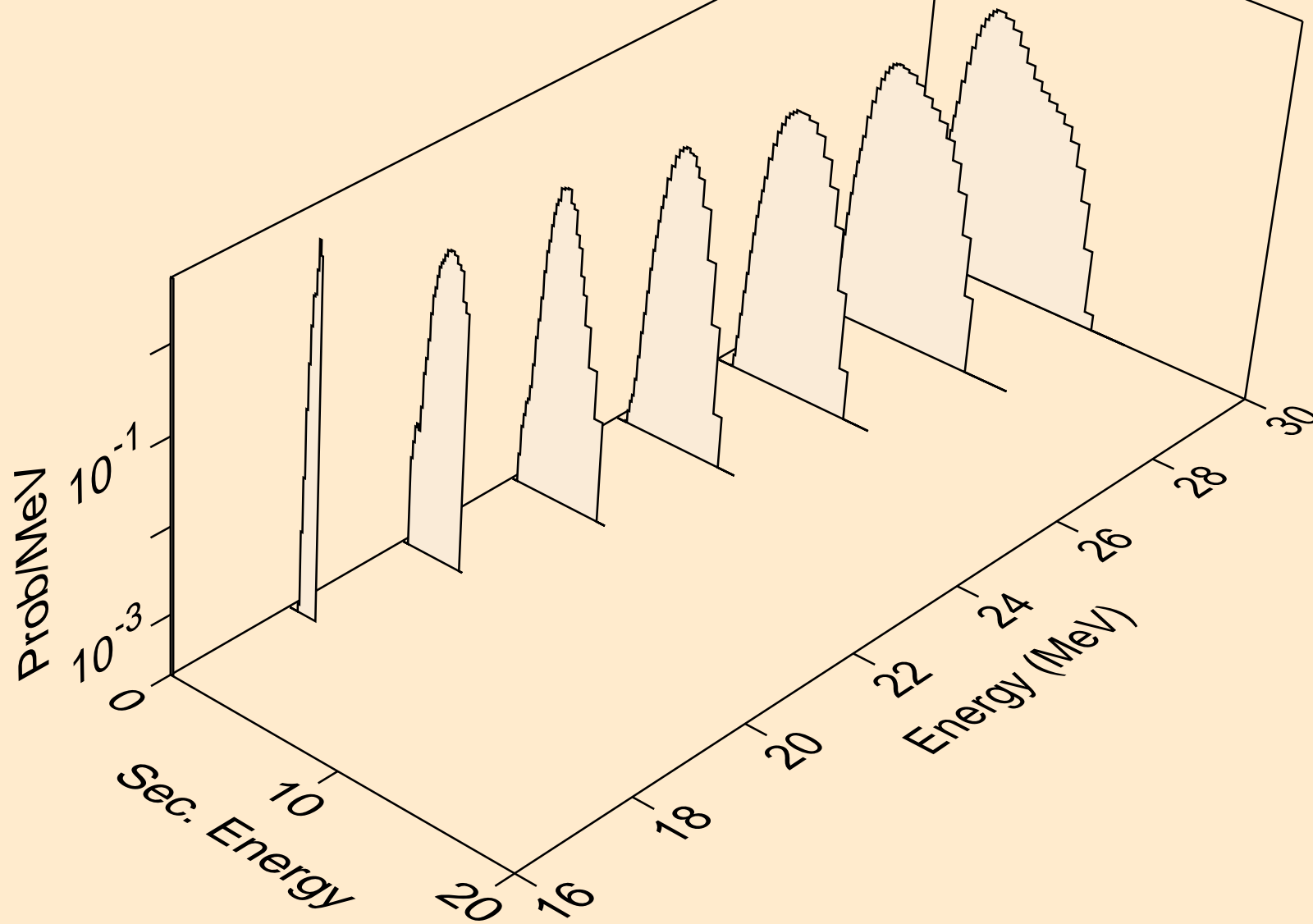

ZN077 TRITON ACER TENDL-2021 LIBRARY; T=0.K  
protons from (t,pt)

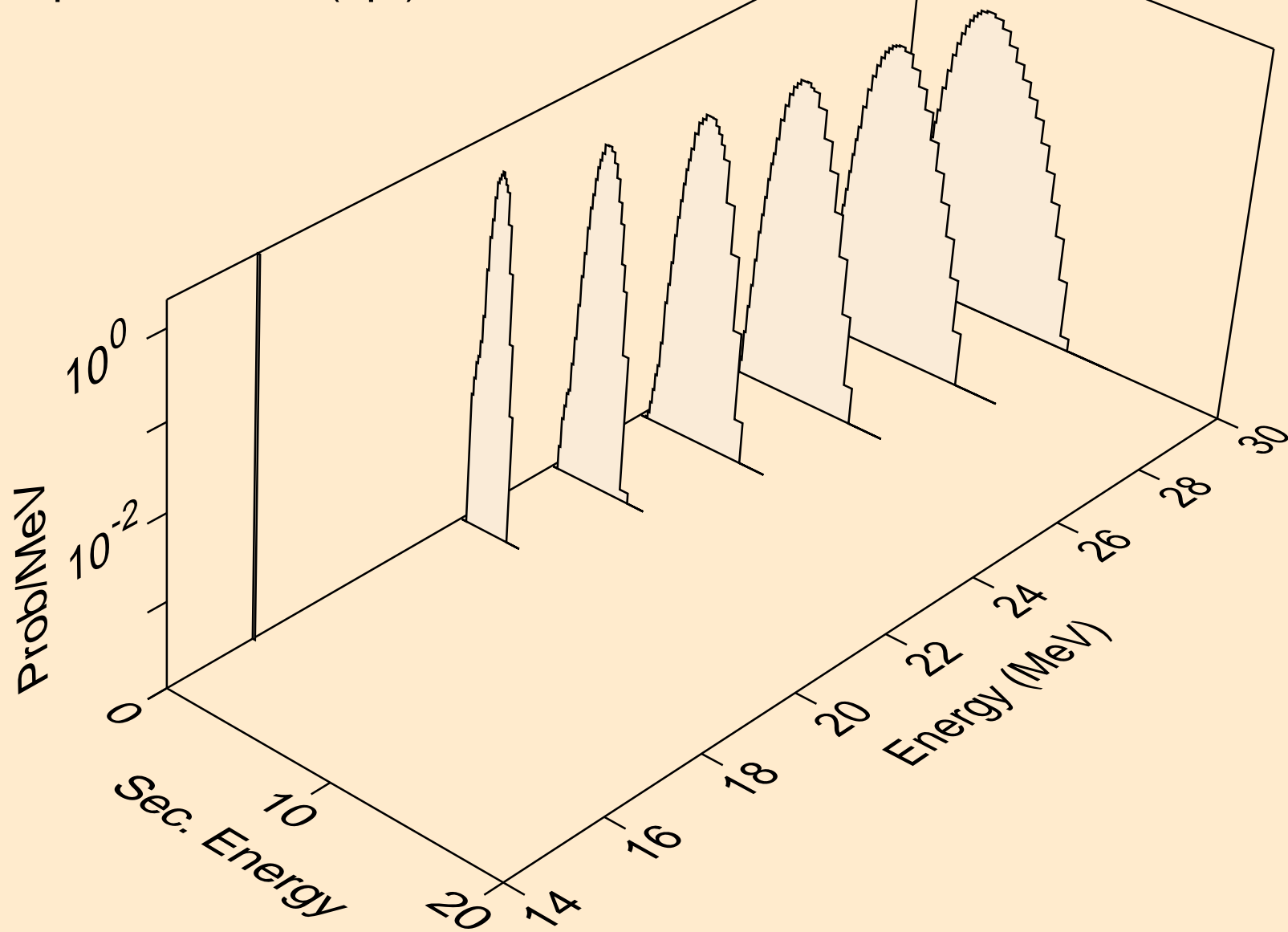

ZN077 TRITON ACER TENDL-2021 LIBRARY; T=0.K  
deuterons from (t,x)

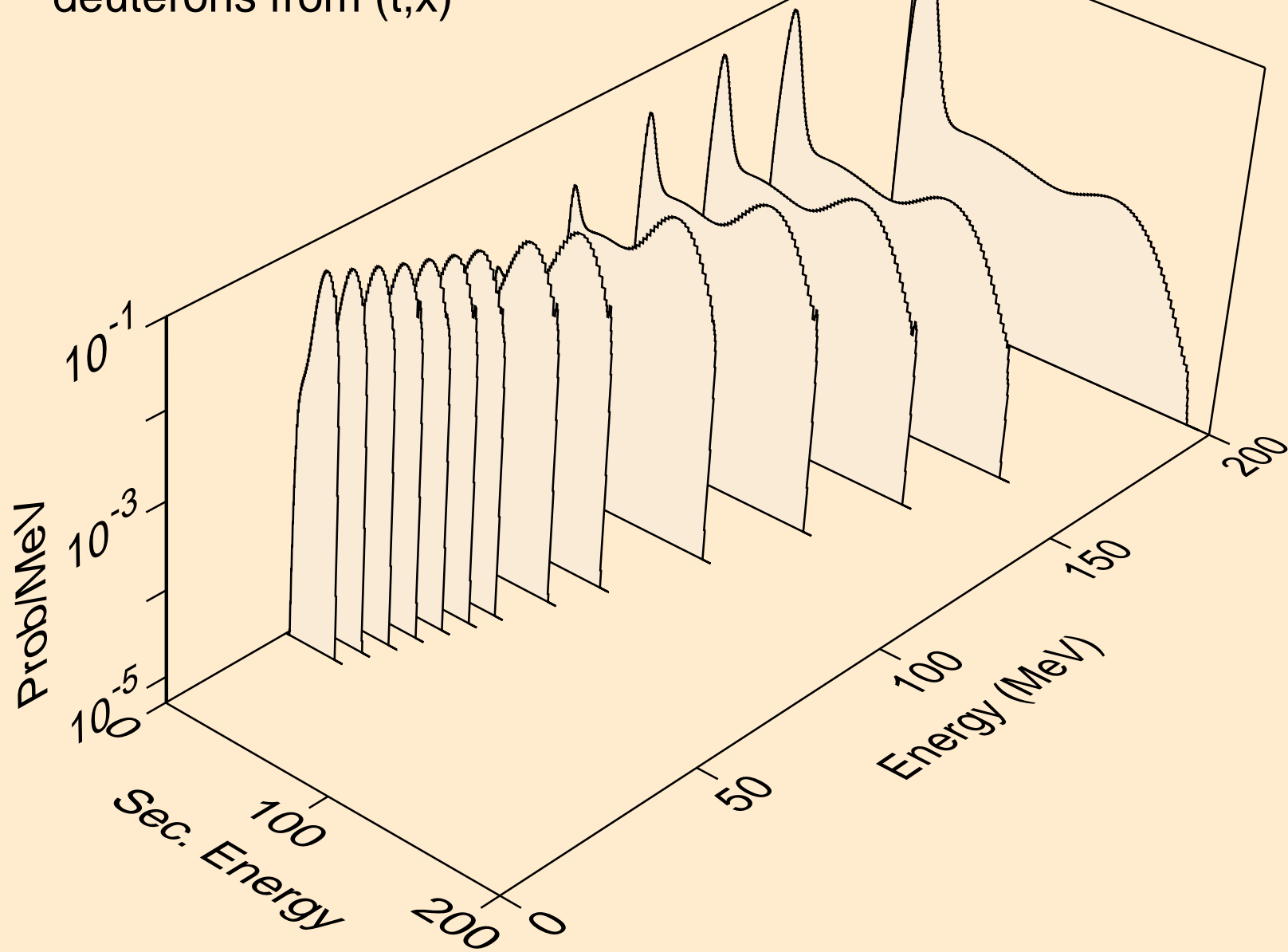



ZN077 TRITON ACER TENDL-2021 LIBRARY; T=0.K  
deuterons from (t,2nd)

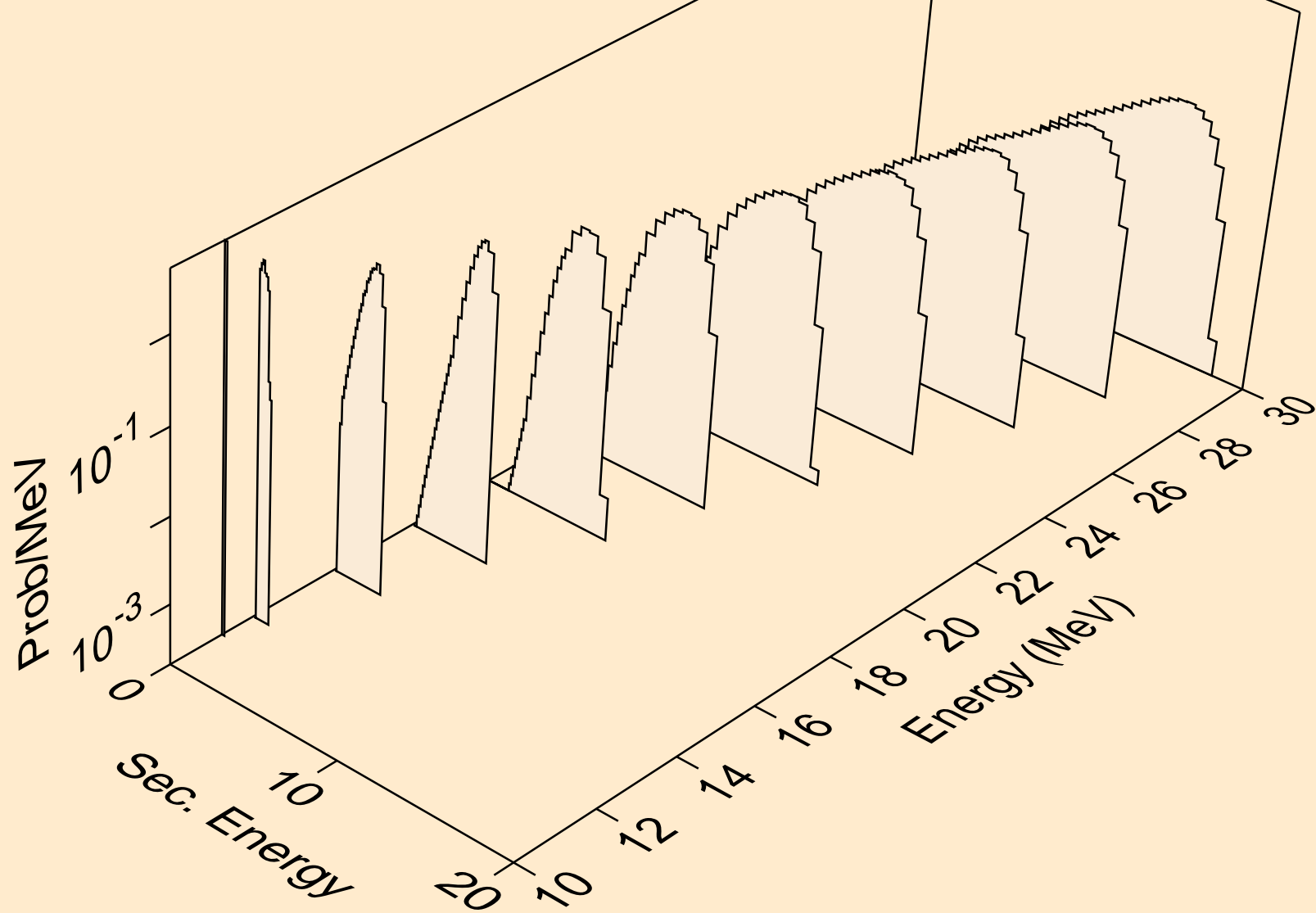

ZN077 TRITON ACER TENDL-2021 LIBRARY; T=0.K  
deuterons from (t,n\*)d

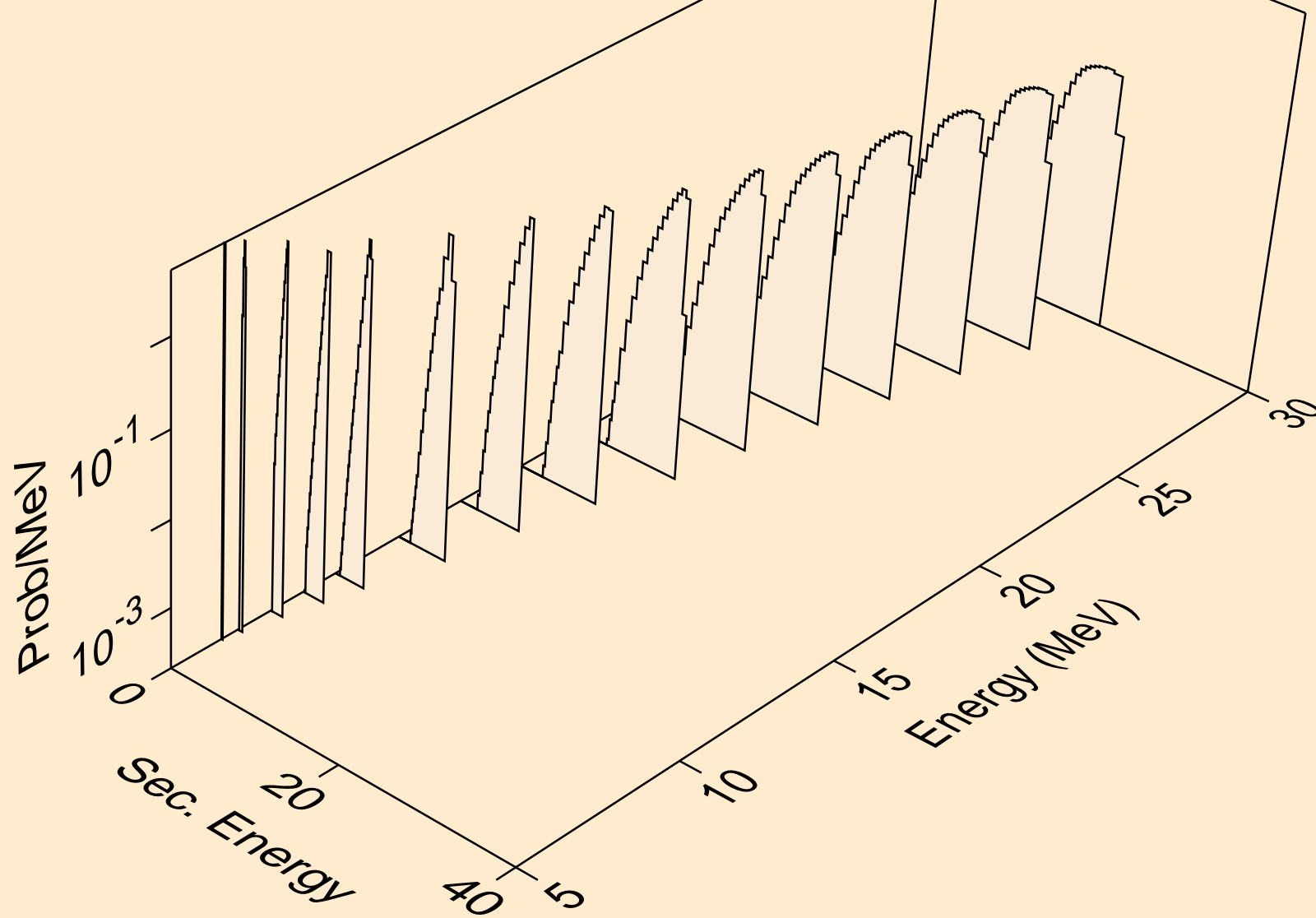

ZN077 TRITON ACER TENDL-2021 LIBRARY; T=0.K  
deuterons from (t,d)

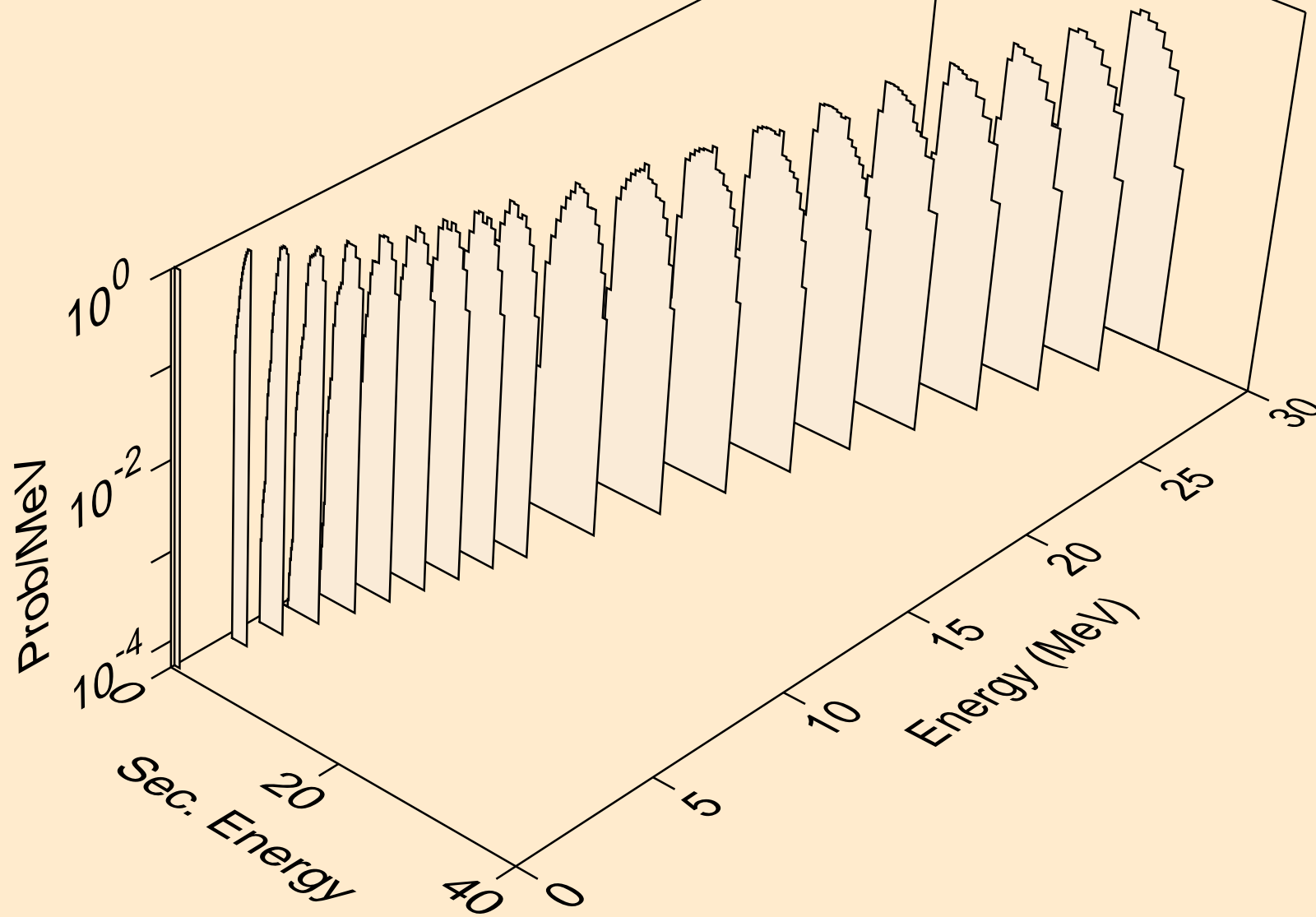

ZN077 TRITON ACER TENDL-2021 LIBRARY; T=0.K  
deuterons from (t,pd)

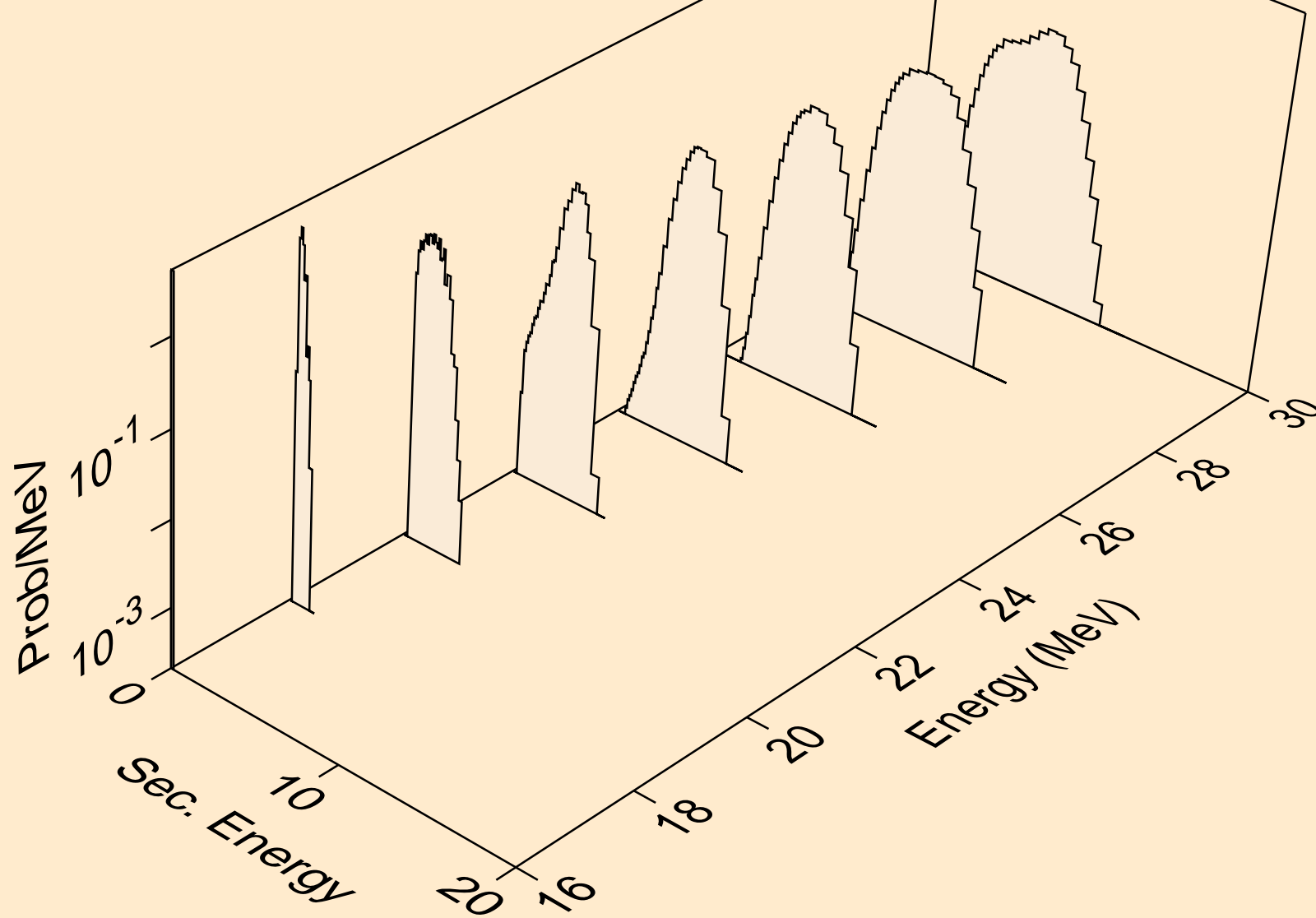

ZN077 TRITON ACER TENDL-2021 LIBRARY; T=0.K  
deuterons from (t,da)

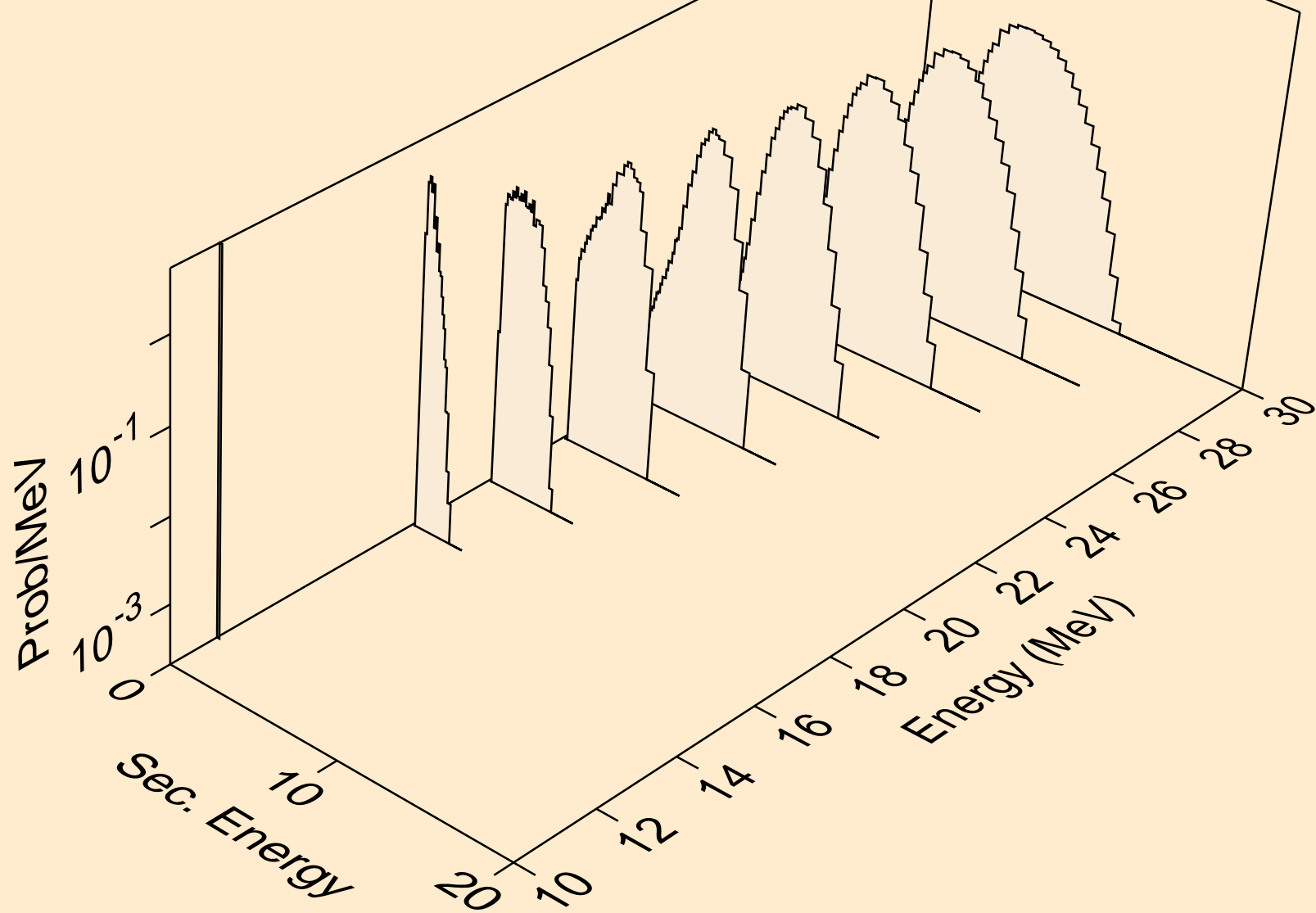

ZN077 TRITON ACER TENDL-2021 LIBRARY; T=0.K  
he3s from (t,x)

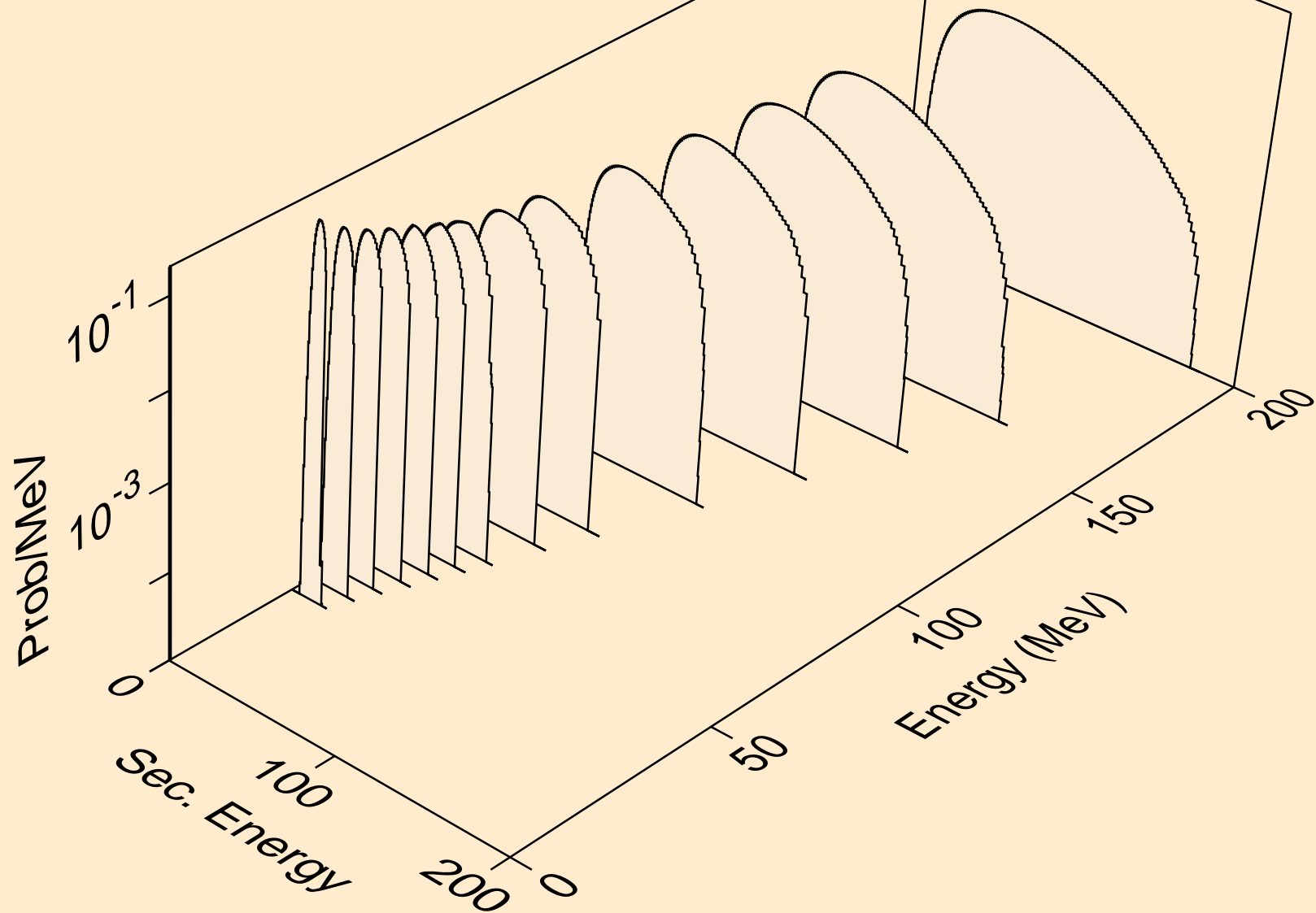

ZN077 TRITON ACER TENDL-2021 LIBRARY; T=0.K  
he3s from (t,n\*)he3

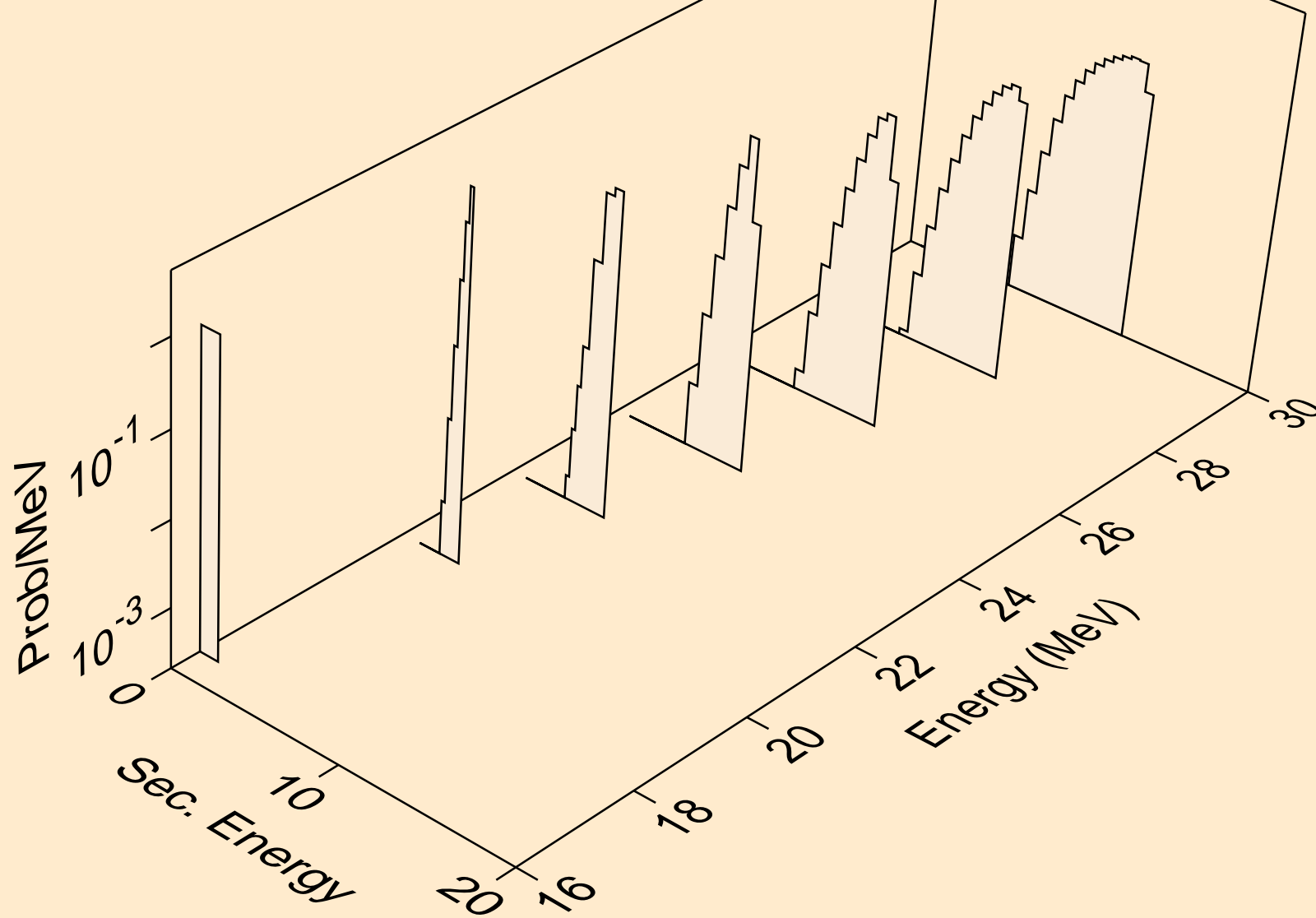

ZN077 TRITON ACER TENDL-2021 LIBRARY; T=0.K  
he3s from (t,he3)

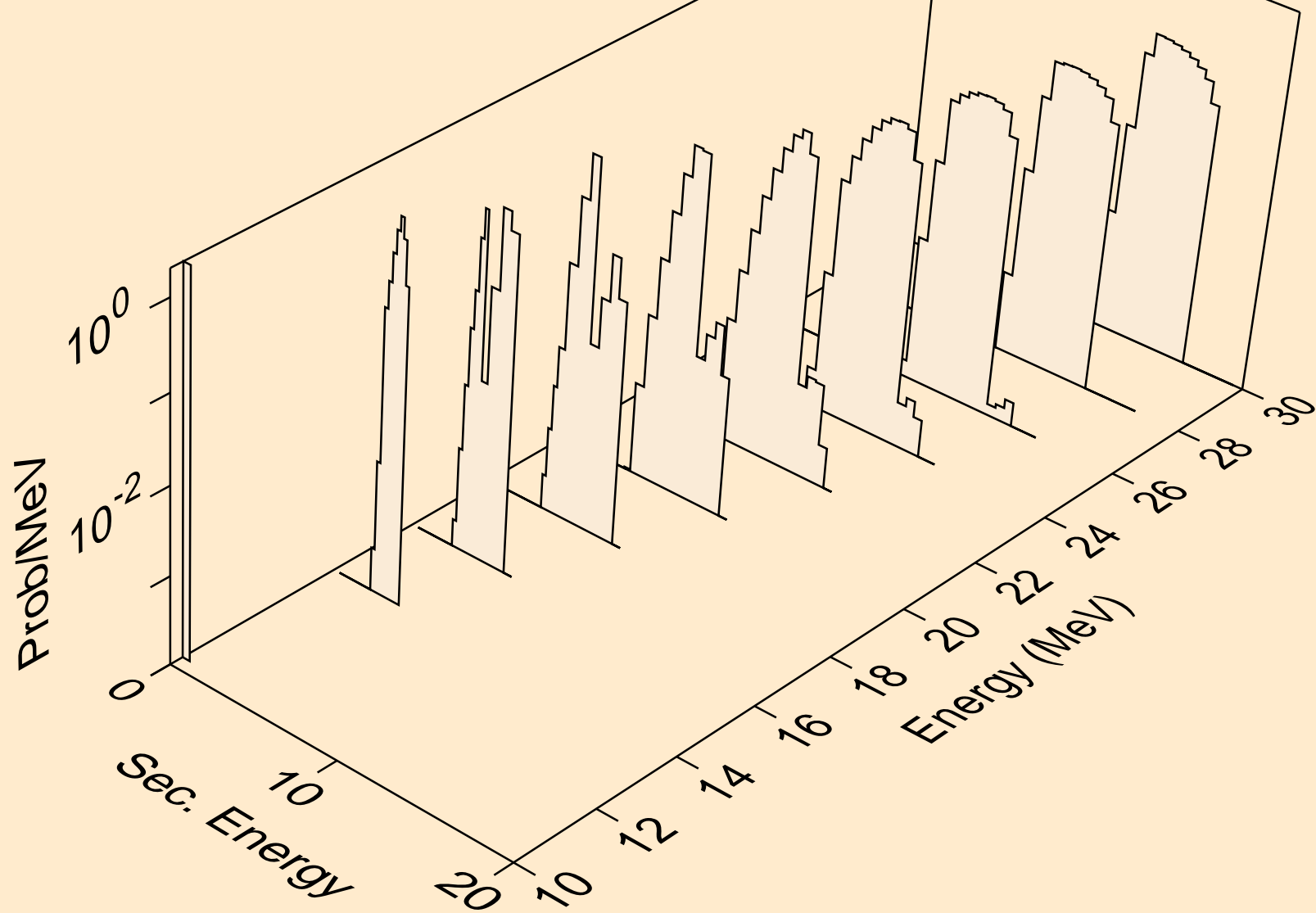



ZN077 TRITON ACER TENDL-2021 LIBRARY; T=0.K  
alphas from (t,x)

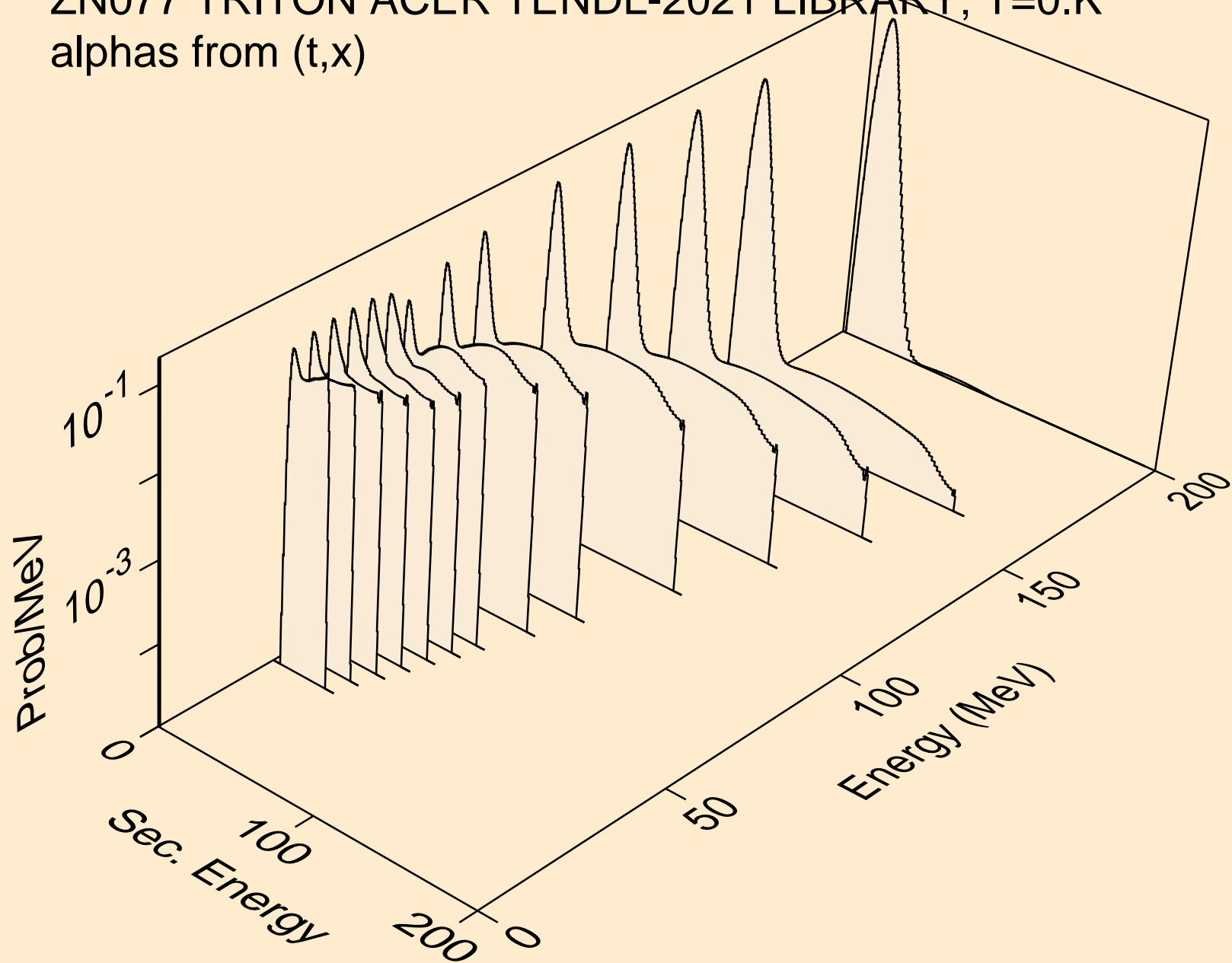

ZN077 TRITON ACER TENDL-2021 LIBRARY; T=0.K  
alphas from (t,n\*)a

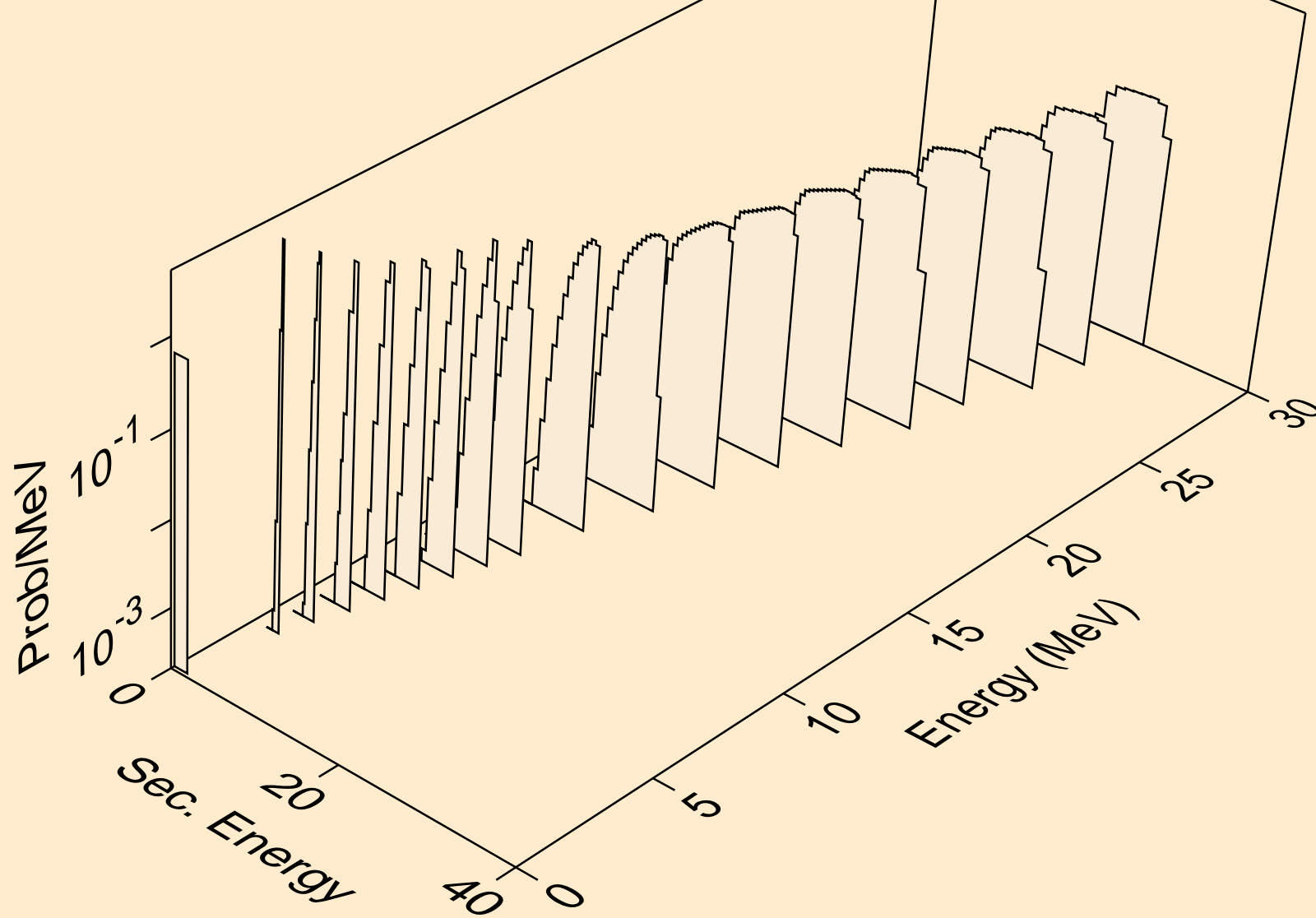

ZN077 TRITON ACER TENDL-2021 LIBRARY; T=0.K  
alphas from (t,2n)a

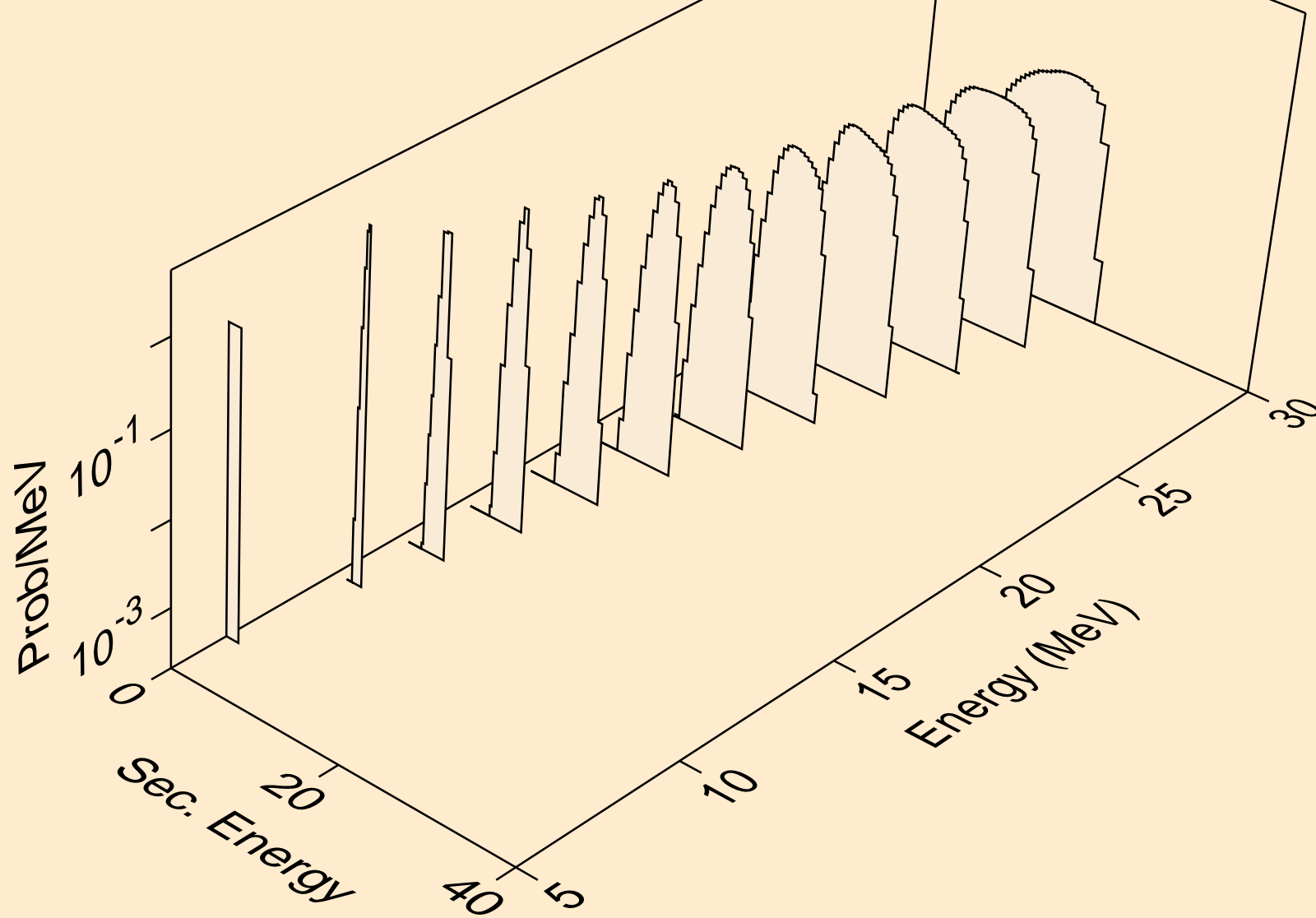

ZN077 TRITON ACER TENDL-2021 LIBRARY; T=0.K  
alphas from (t,3n)a

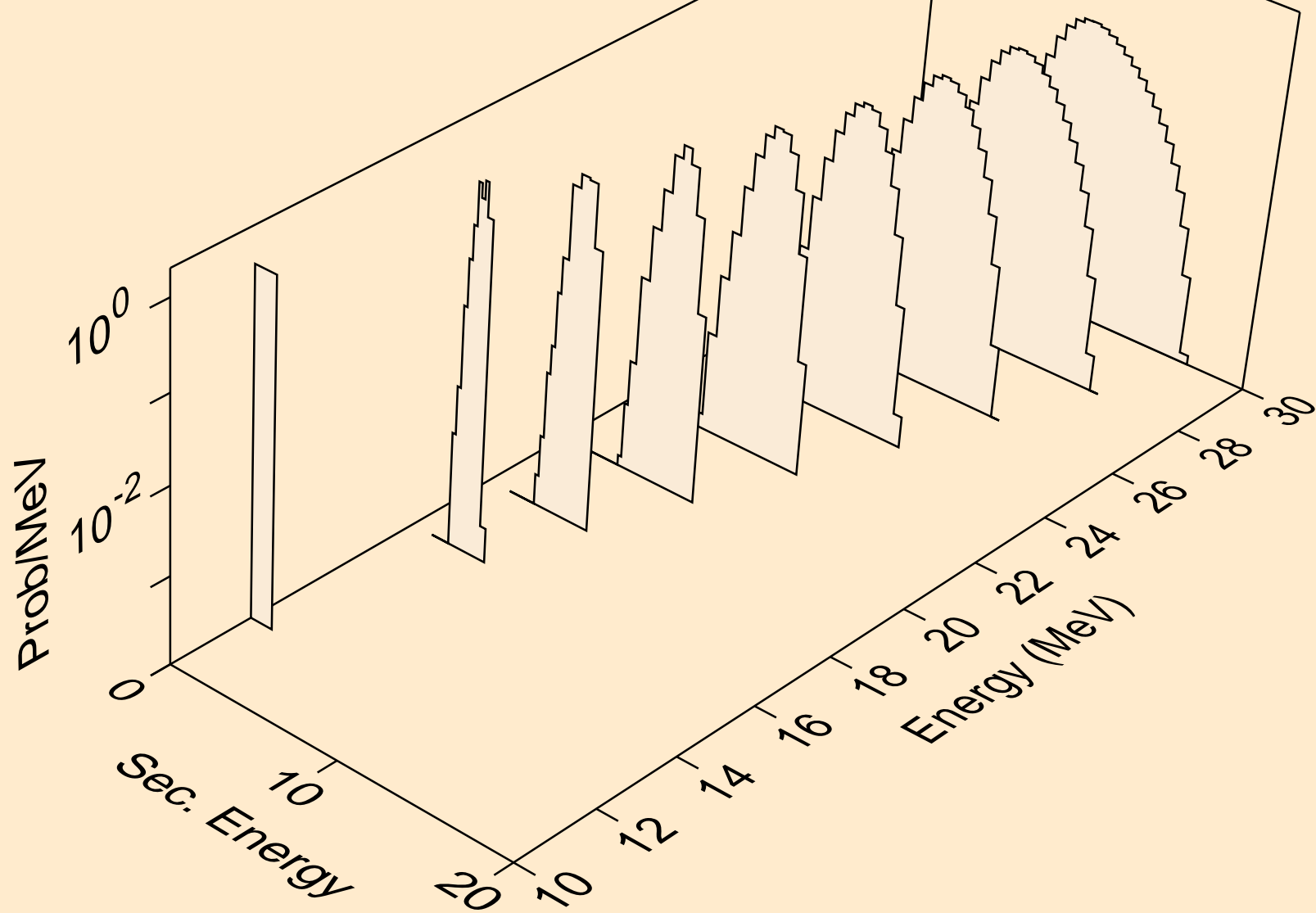

ZN077 TRITON ACER TENDL-2021 LIBRARY; T=0.K  
alphas from (t,npa)

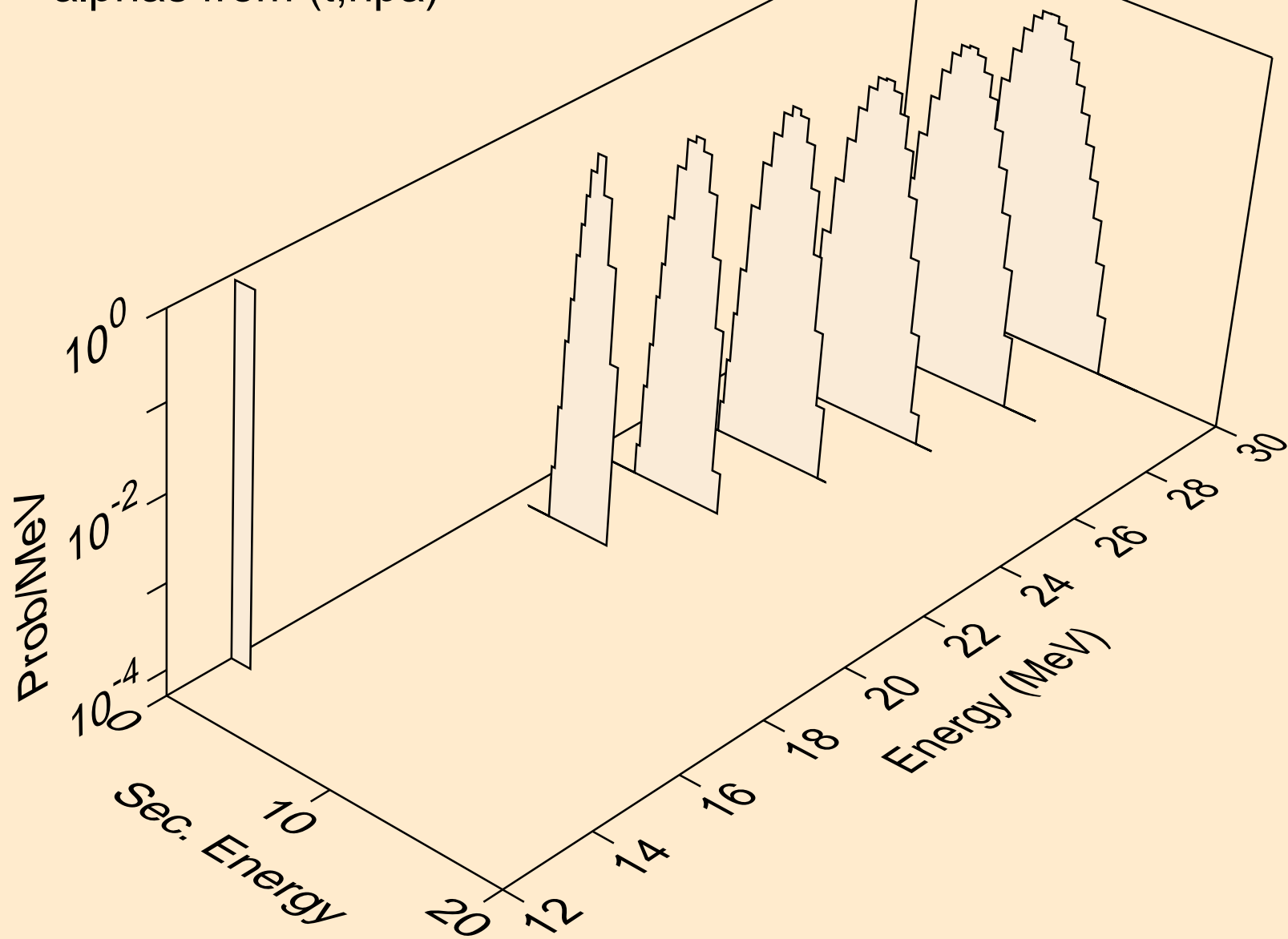

ZN077 TRITON ACER TENDL-2021 LIBRARY; T=0.K  
alphas from (t,a)

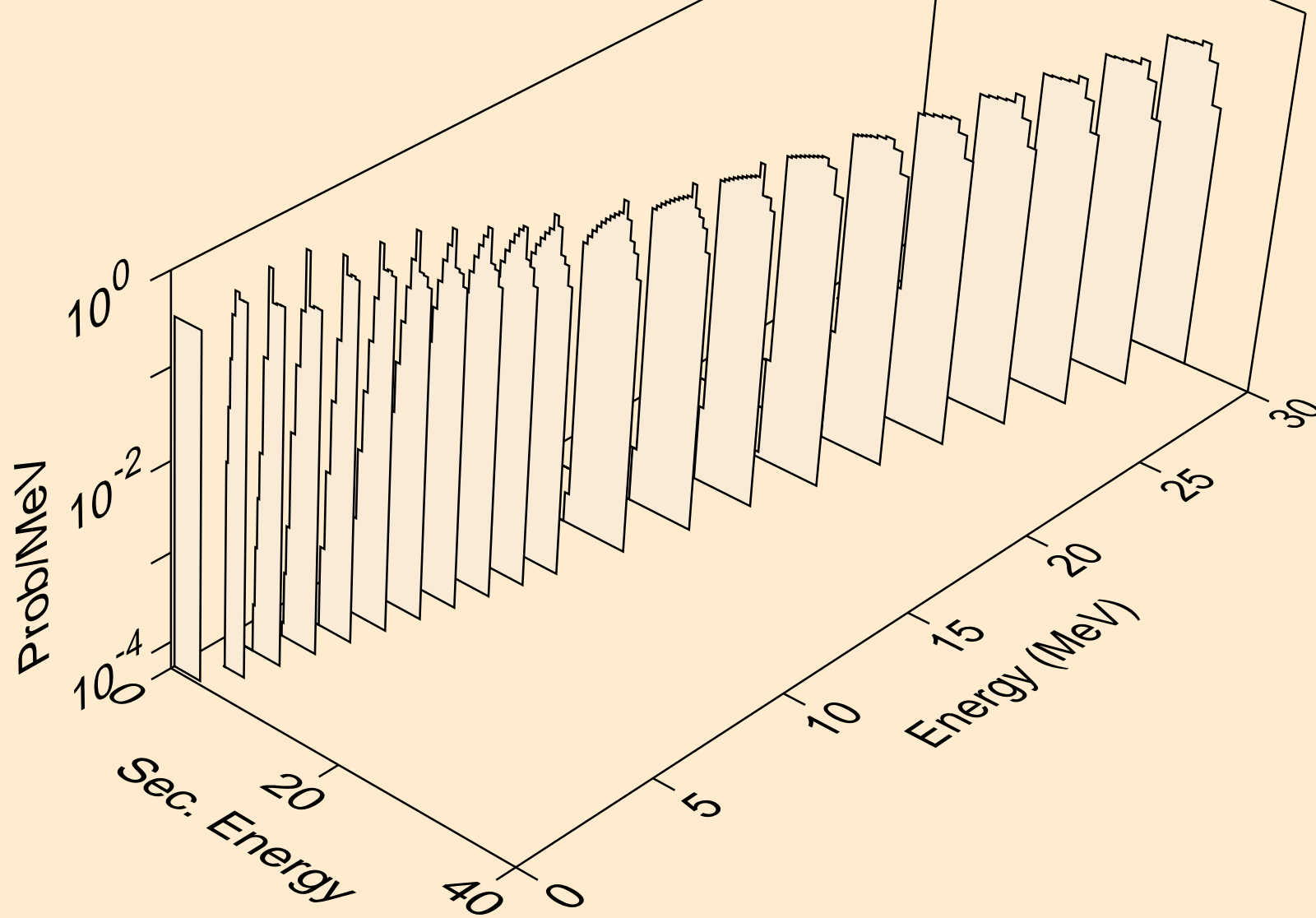

ZN077 TRITON ACER TENDL-2021 LIBRARY; T=0.K  
alphas from (t,pa)

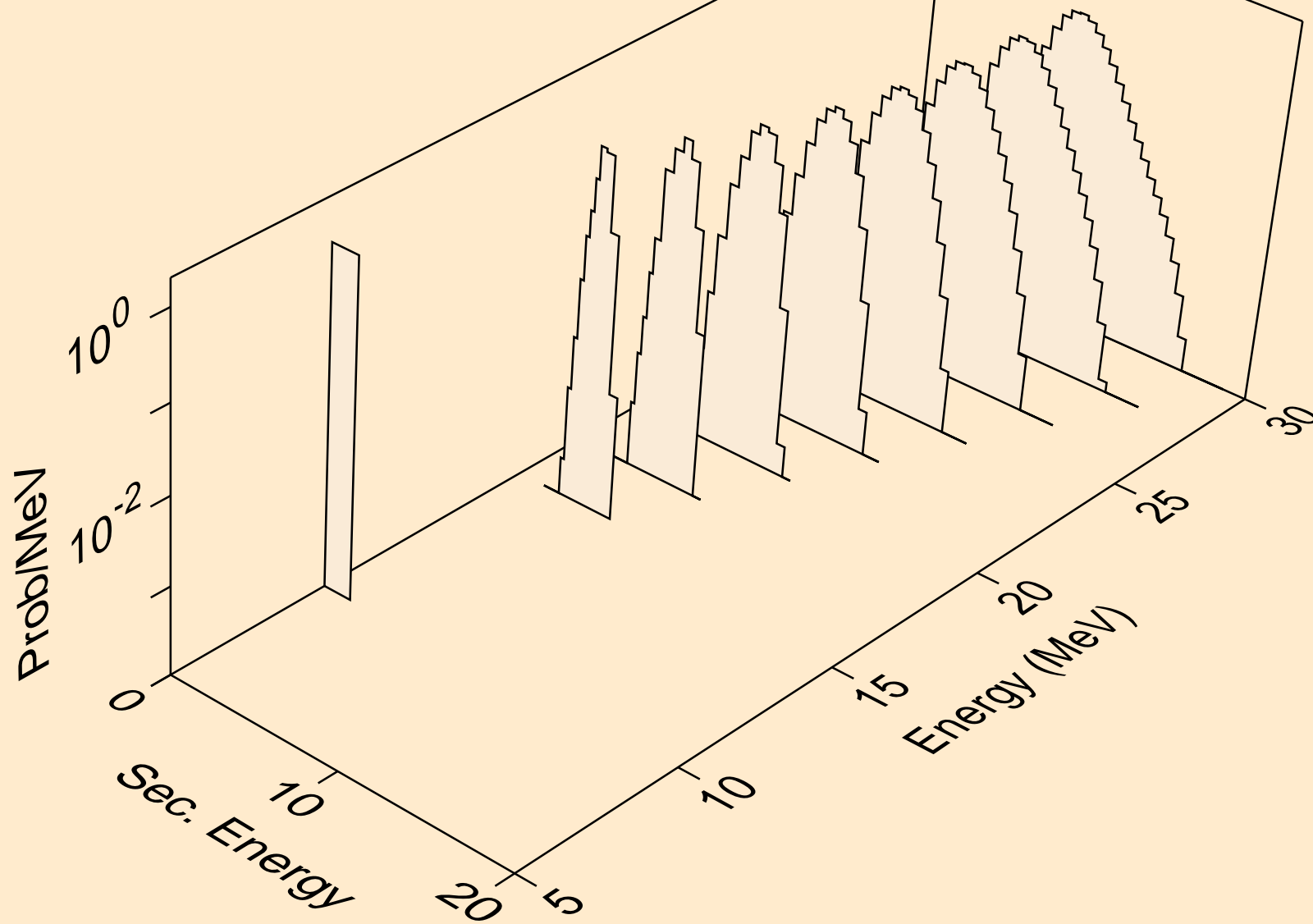

ZN077 TRITON ACER TENDL-2021 LIBRARY; T=0.K  
alphas from (t,da)

