

AC237 ALPHA ACER TENDL-2023 LIBRARY; T=0.K  
Principal cross sections

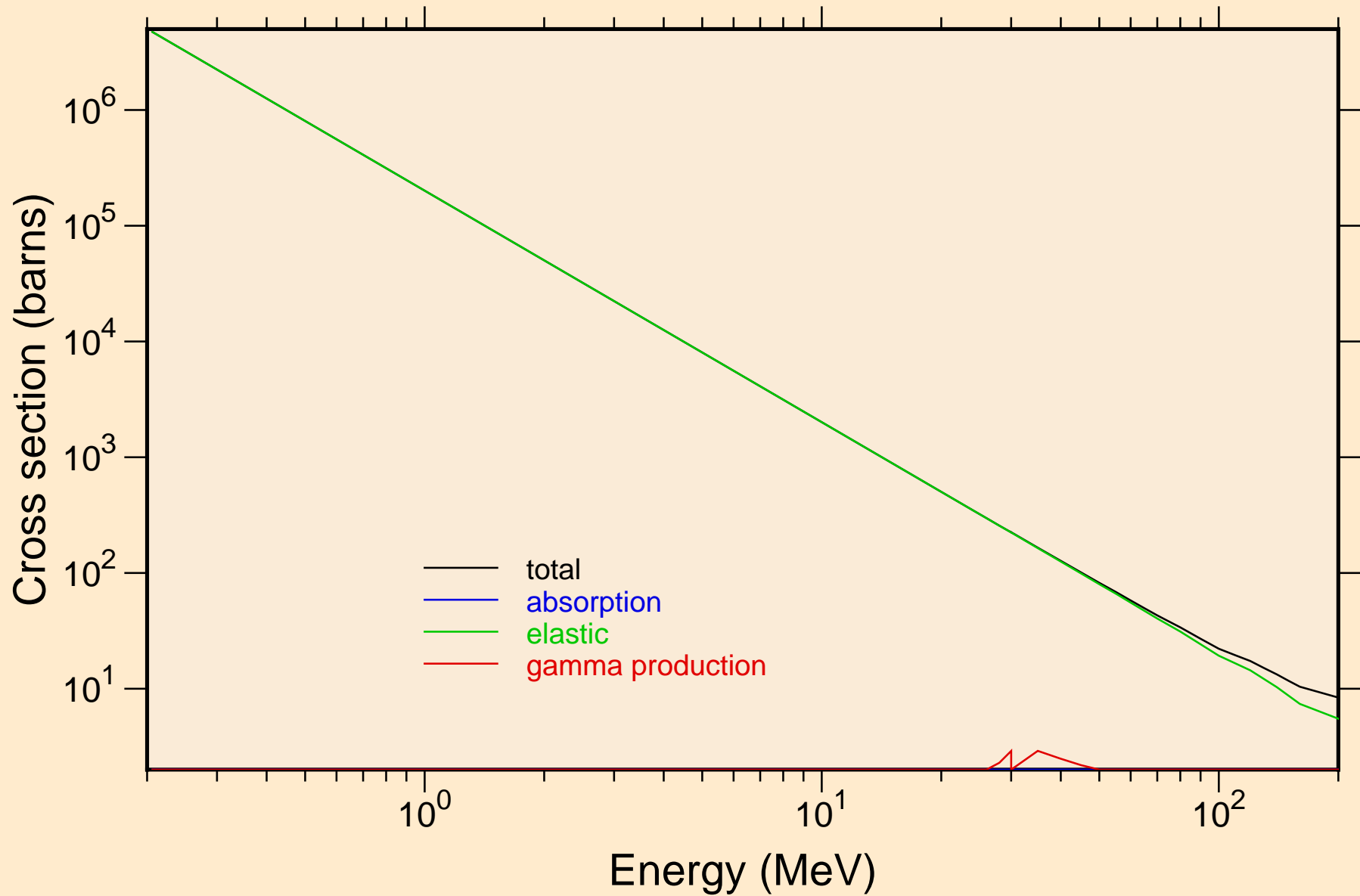

# AC237 ALPHA ACER TENDL-2023 LIBRARY; T=0.K

## Heating

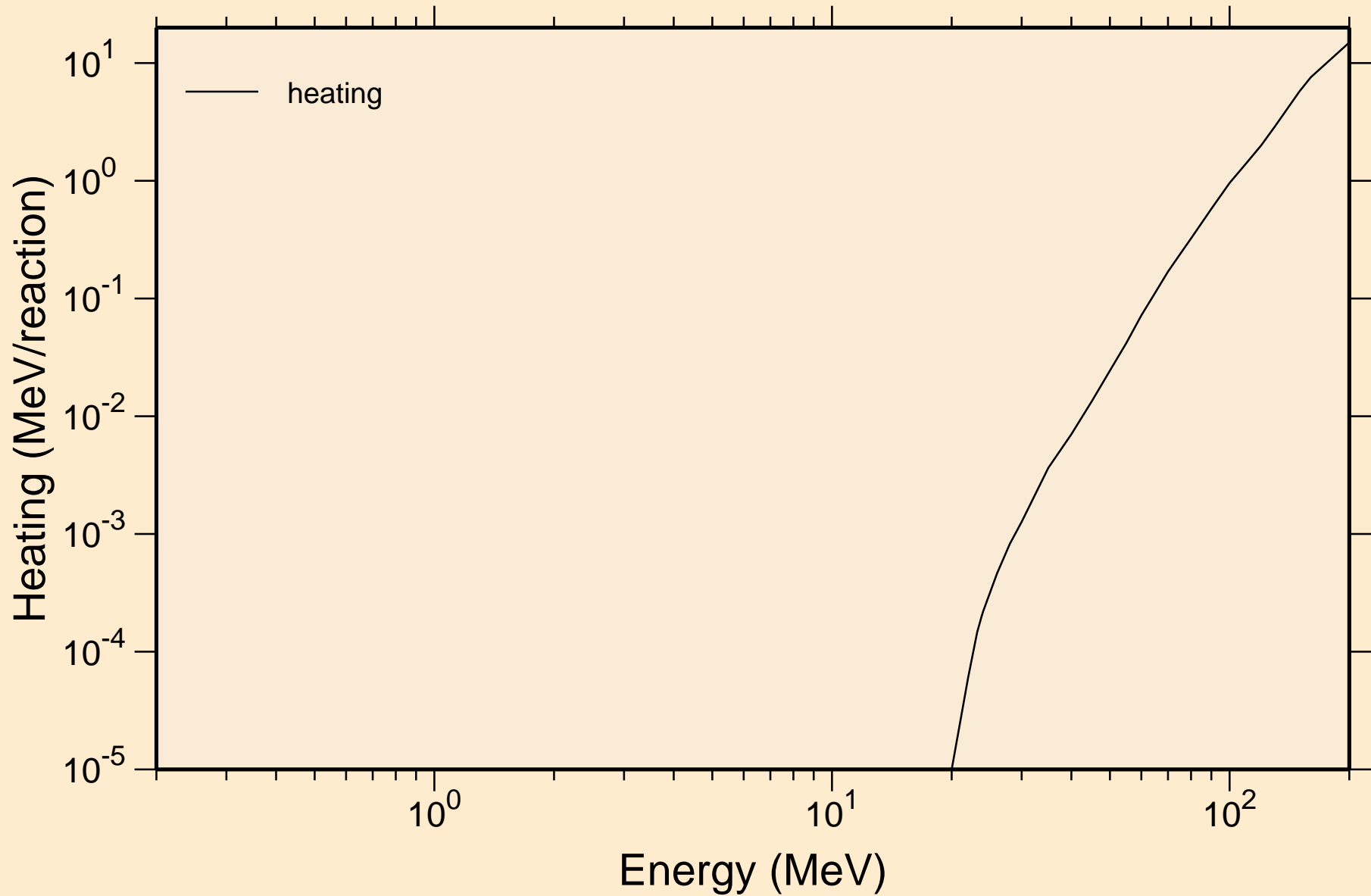

# AC237 ALPHA ACER TENDL-2023 LIBRARY; T=0.K

## Principal cross sections

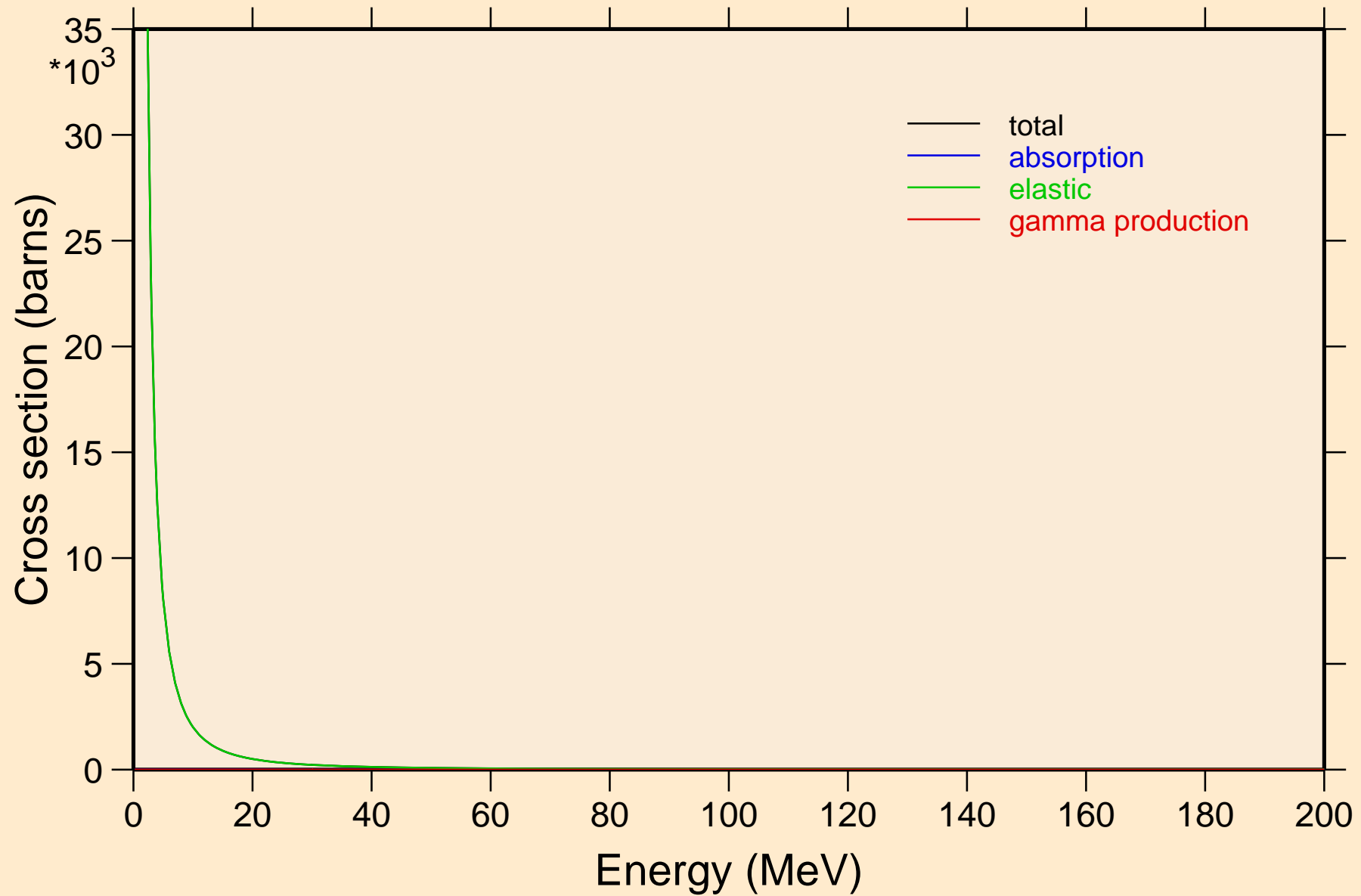

AC237 ALPHA ACER TENDL-2023 LIBRARY; T=0.K

Heating

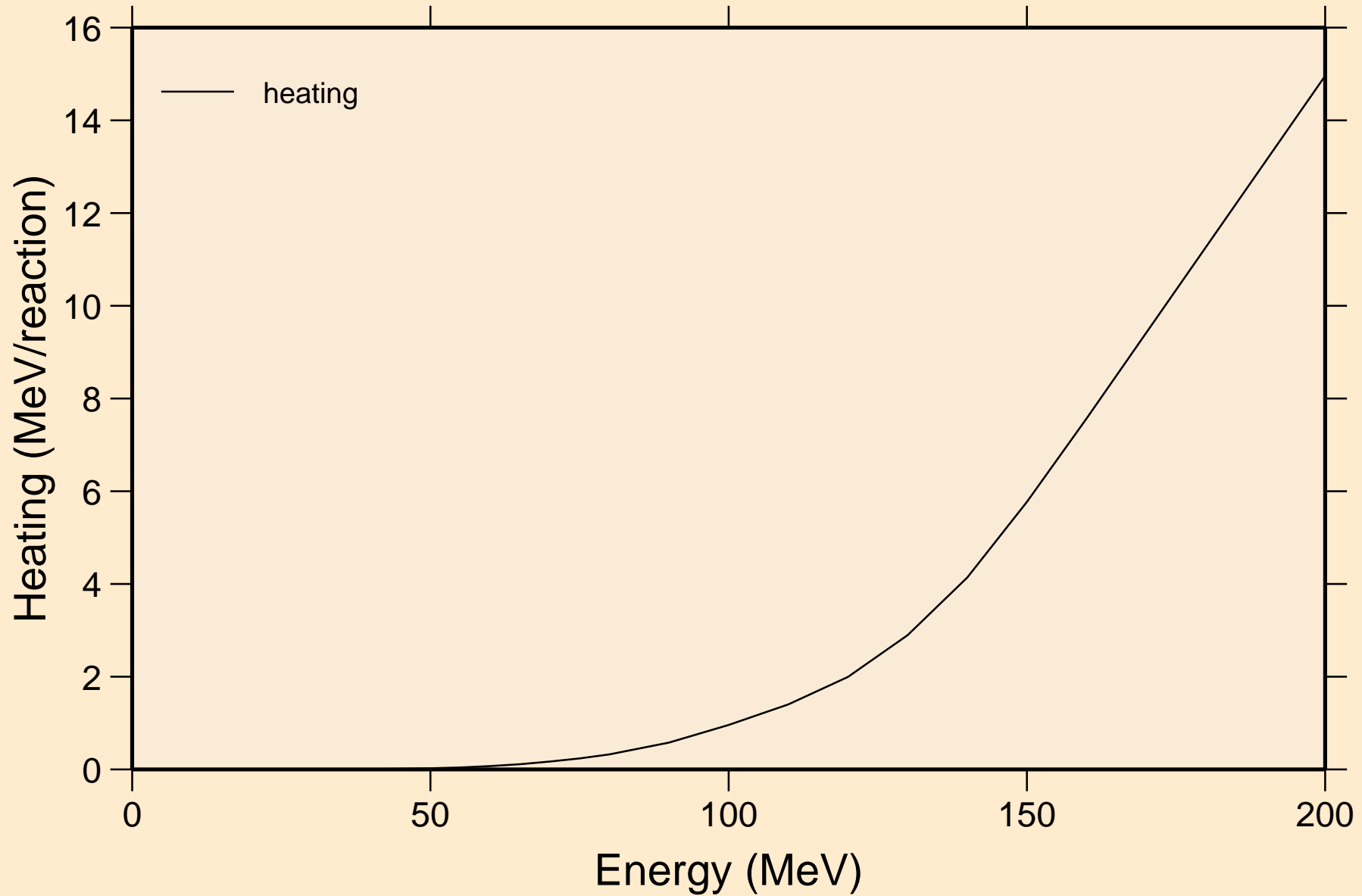

AC237 ALPHA ACER TENDL-2023 LIBRARY; T=0.K  
Threshold reactions

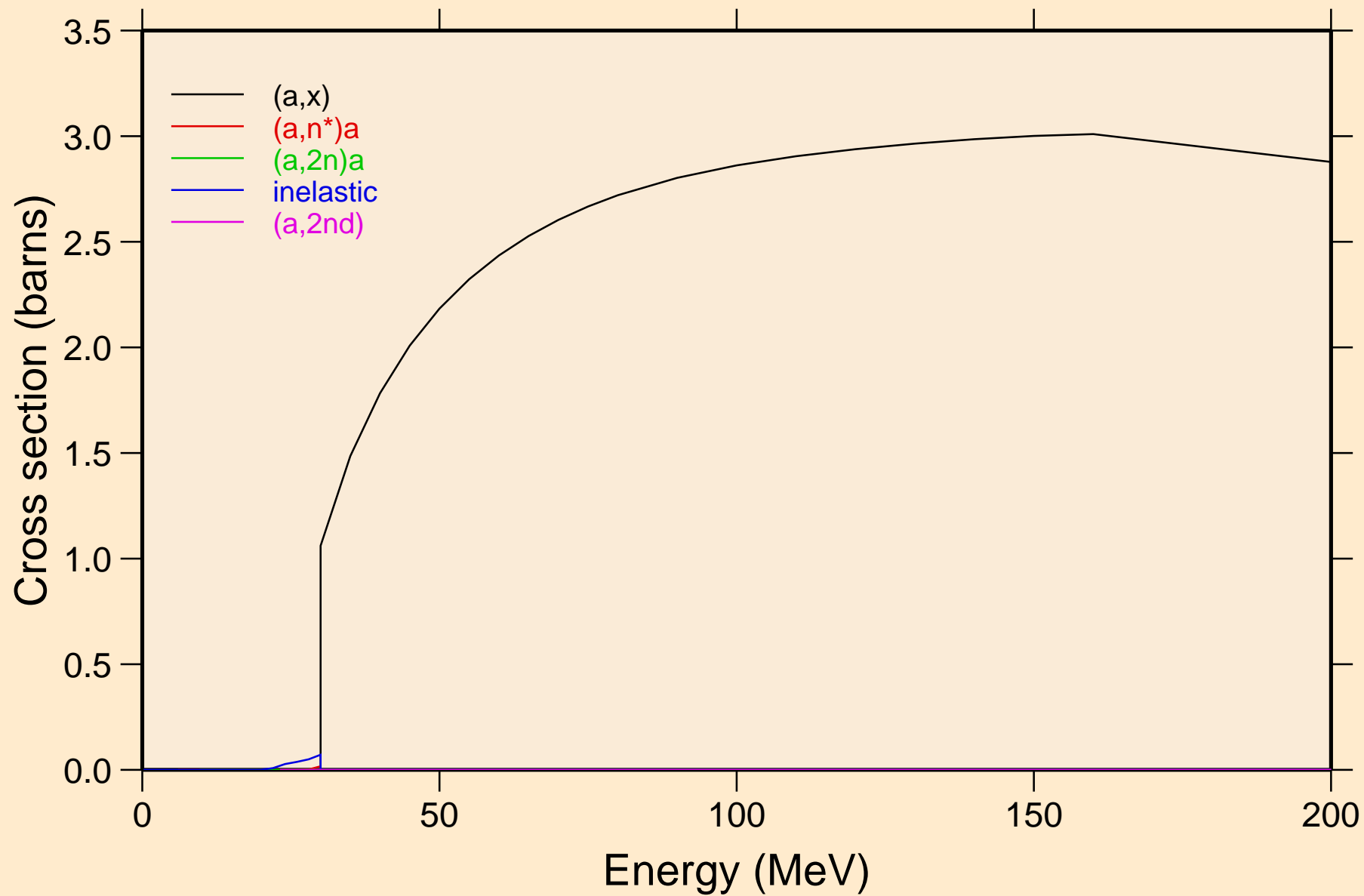

AC237 ALPHA ACER TENDL-2023 LIBRARY; T=0.K  
Threshold reactions

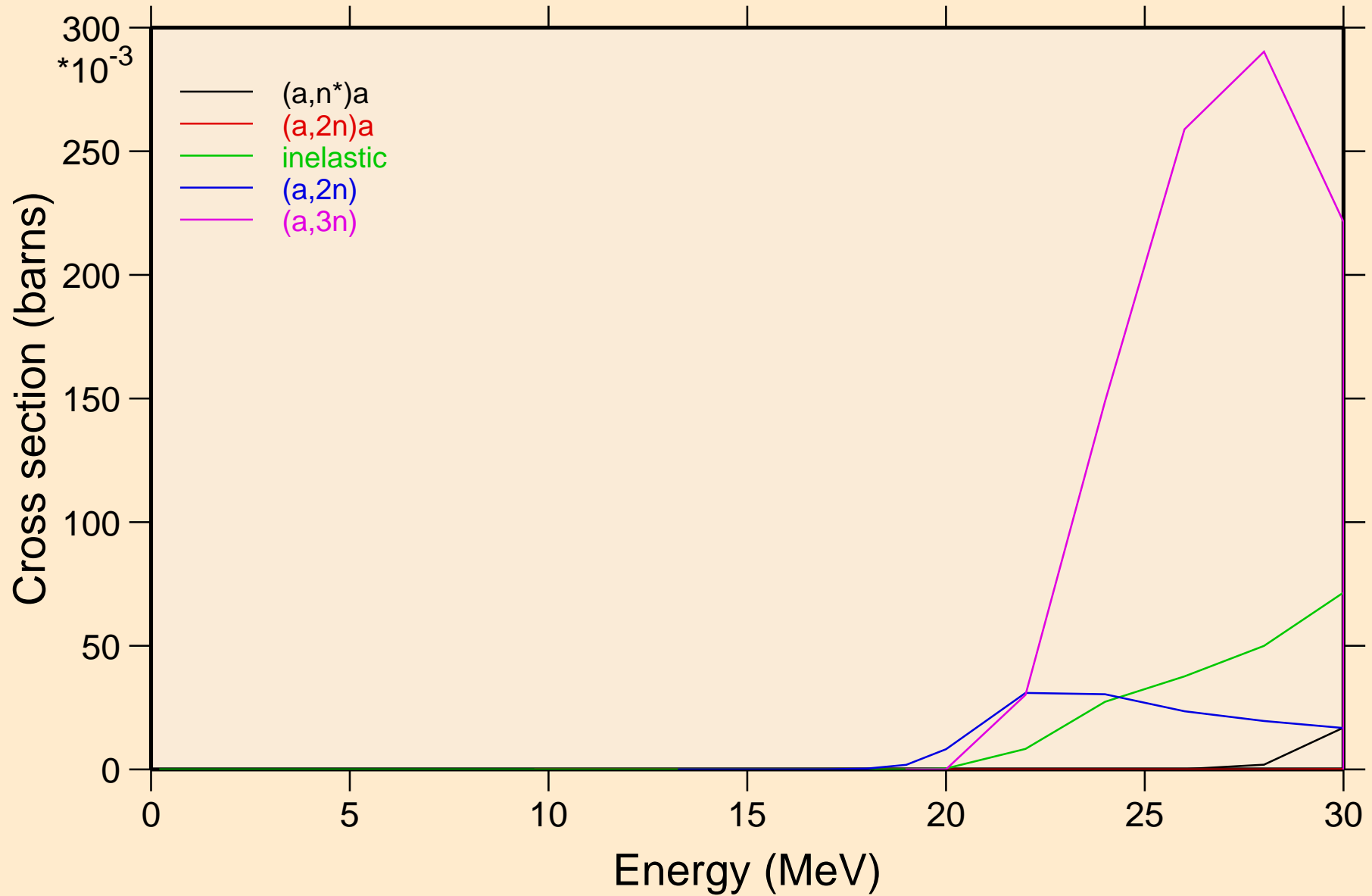

AC237 ALPHA ACER TENDL-2023 LIBRARY; T=0.K  
Threshold reactions

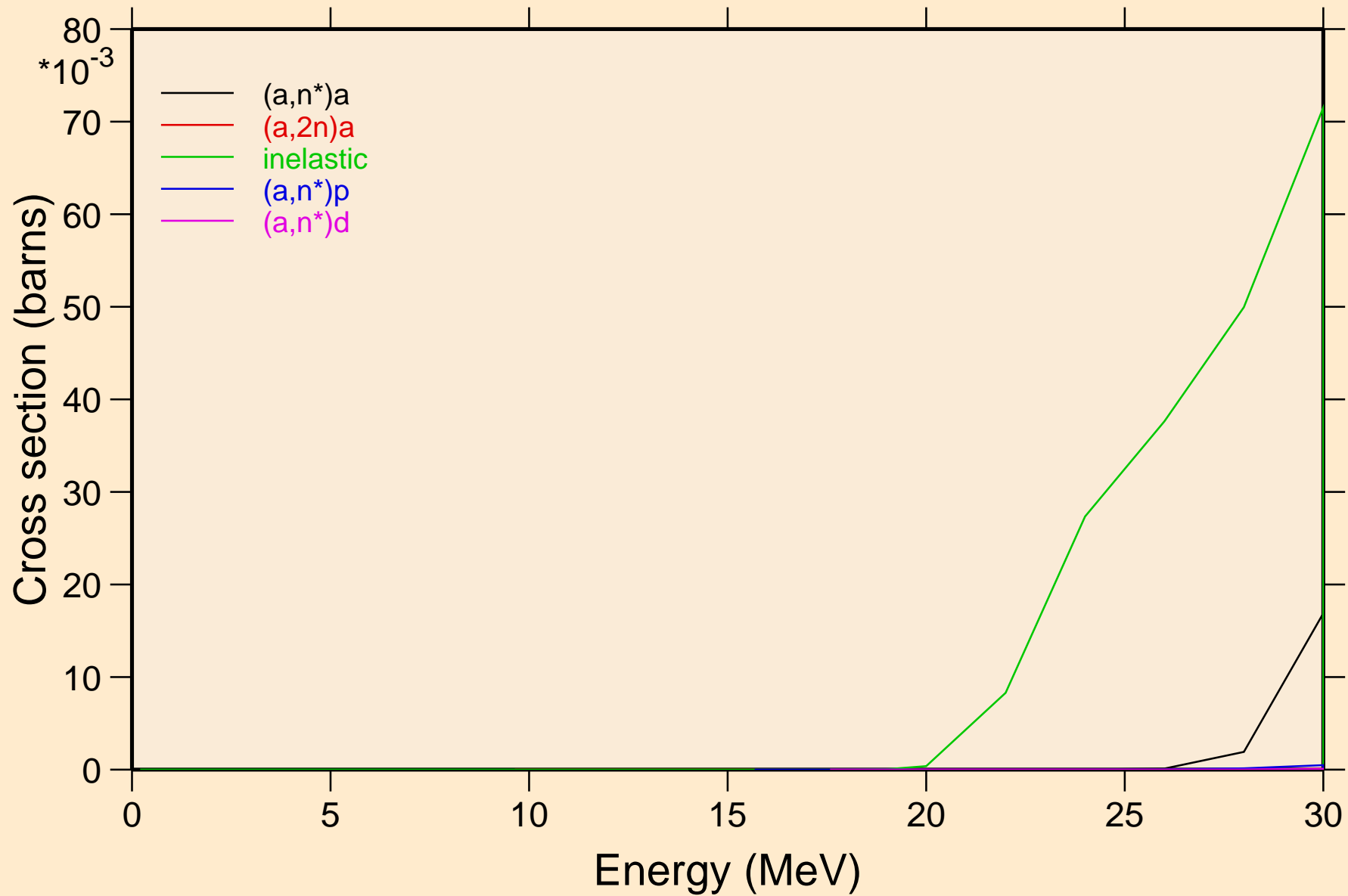

AC237 ALPHA ACER TENDL-2023 LIBRARY; T=0.K  
Threshold reactions

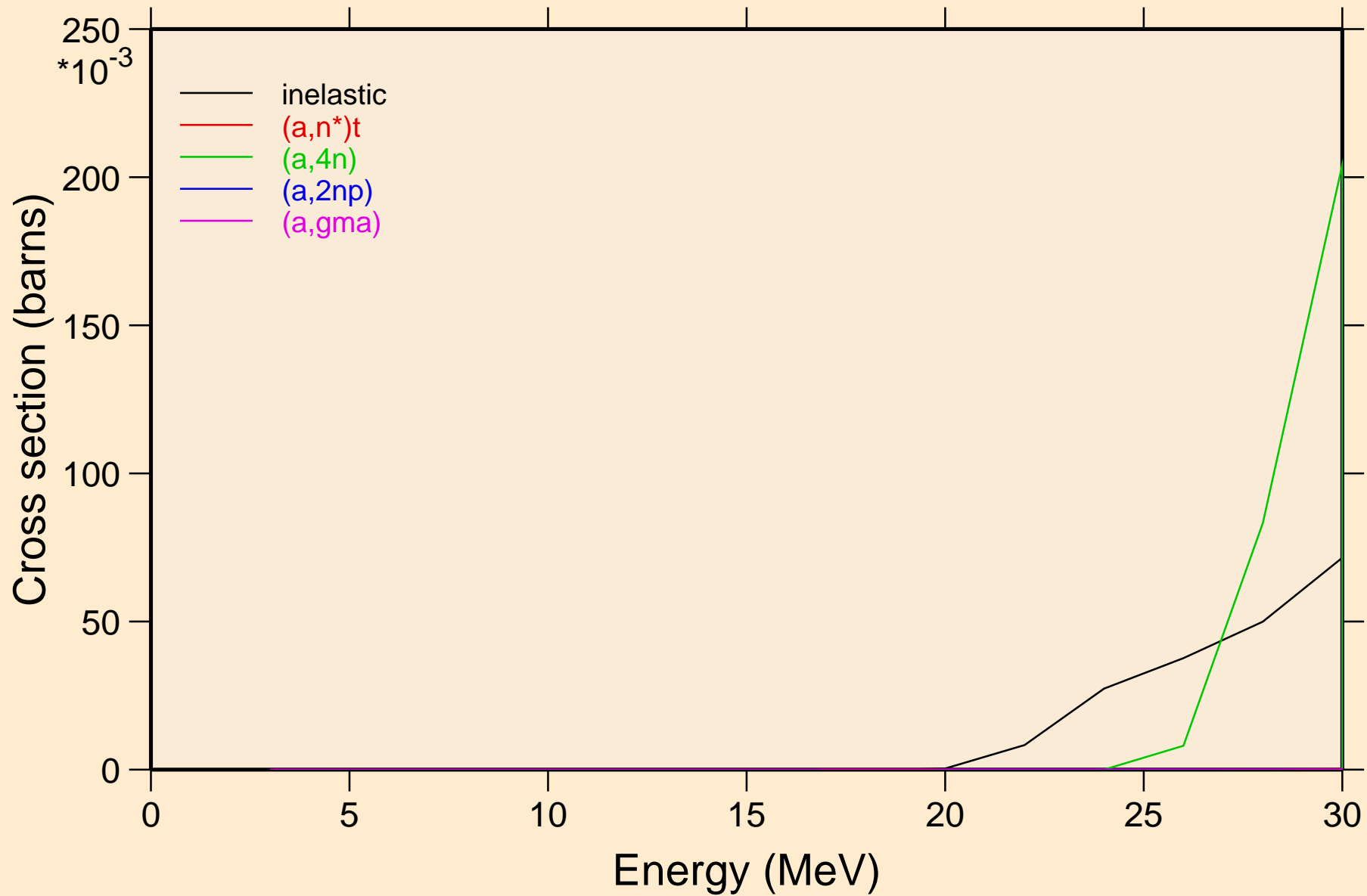



AC237 ALPHA ACER TENDL-2023 LIBRARY; T=0.K  
Threshold reactions

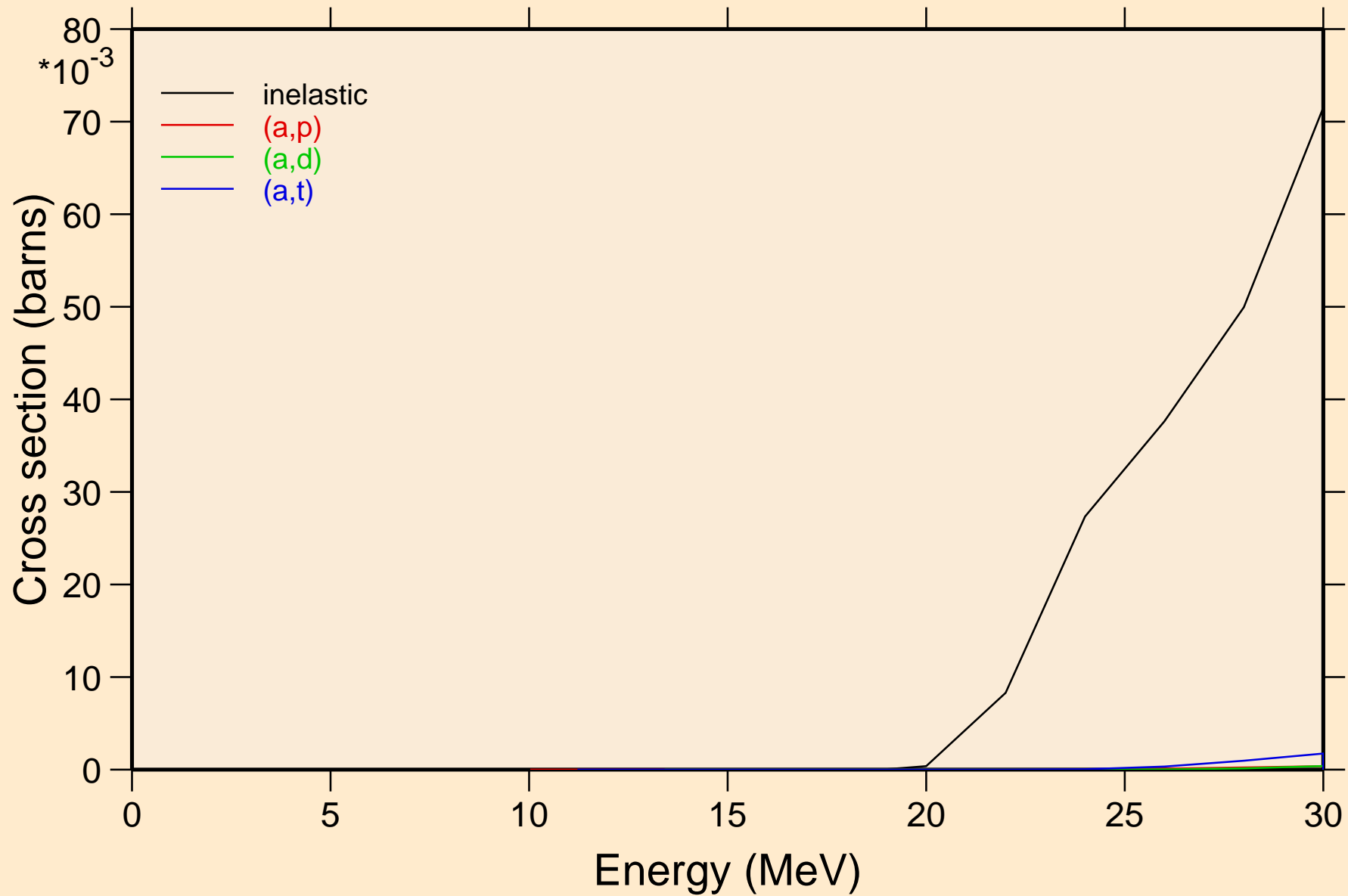

AC237 ALPHA ACER TENDL-2023 LIBRARY; T=0.K  
Threshold reactions

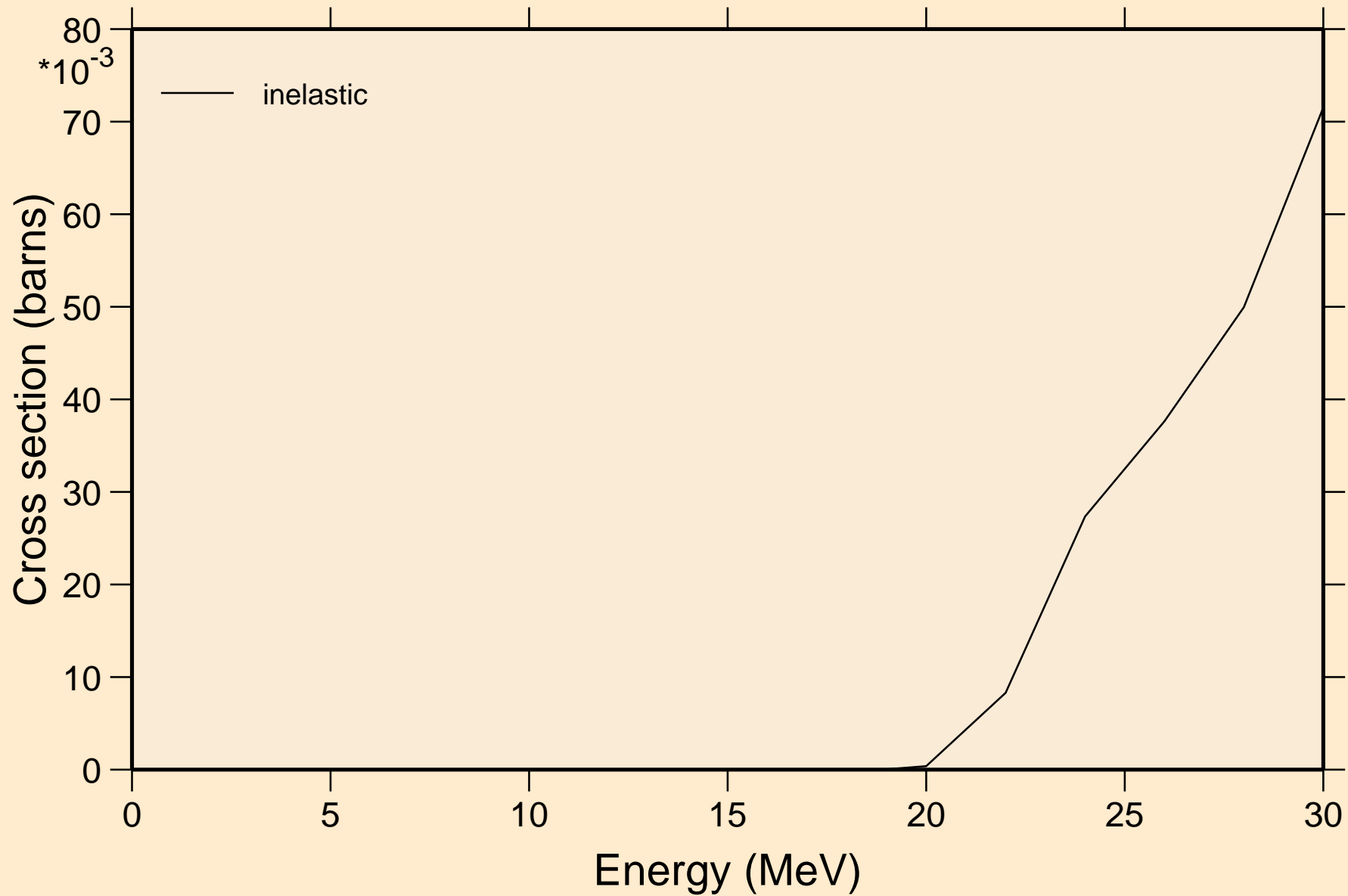

AC237 ALPHA ACER TENDL-2023 LIBRARY; T=0.K  
angular distribution for elastic

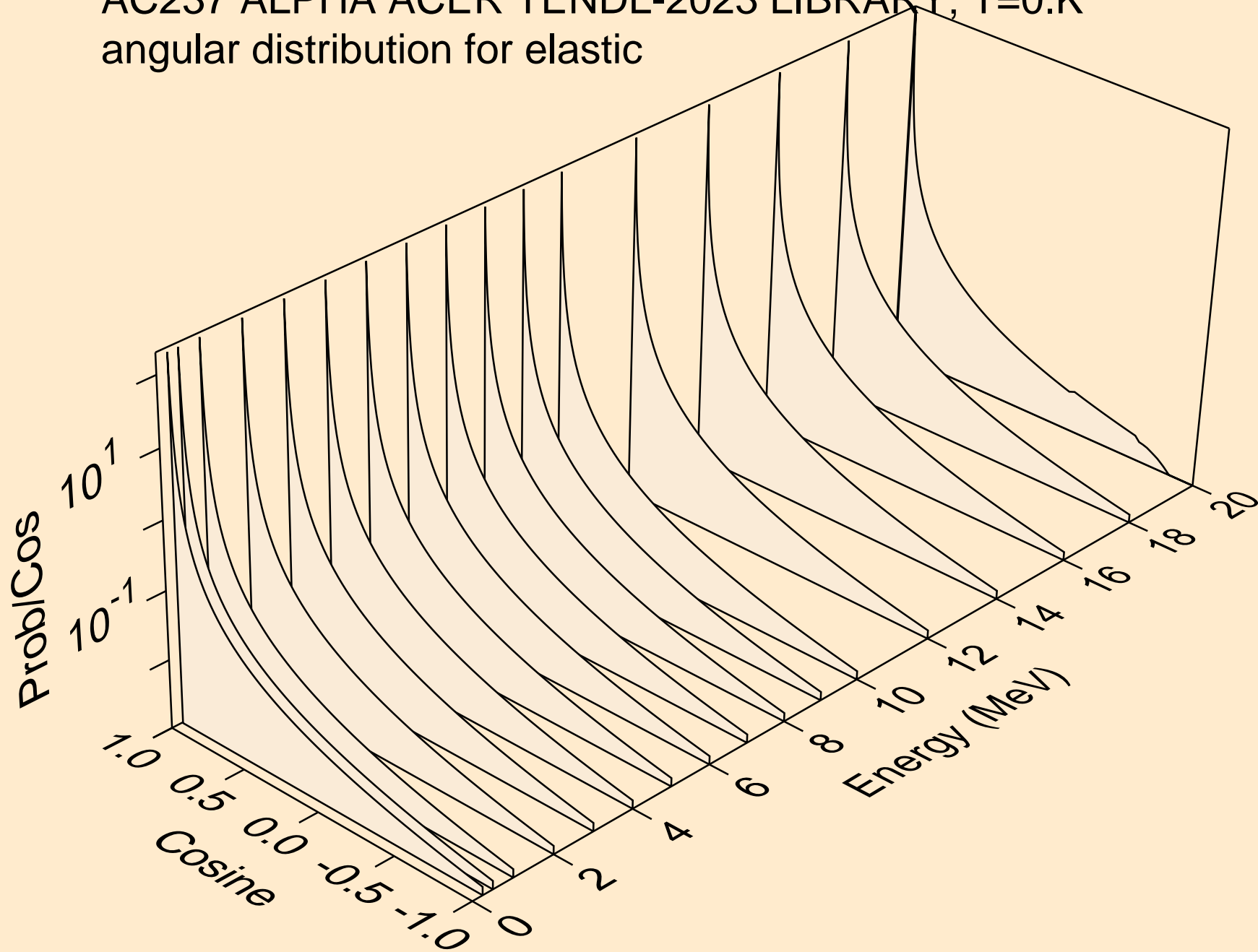

AC237 ALPHA ACER TENDL-2023 LIBRARY; T=0.K  
angular distribution for elastic

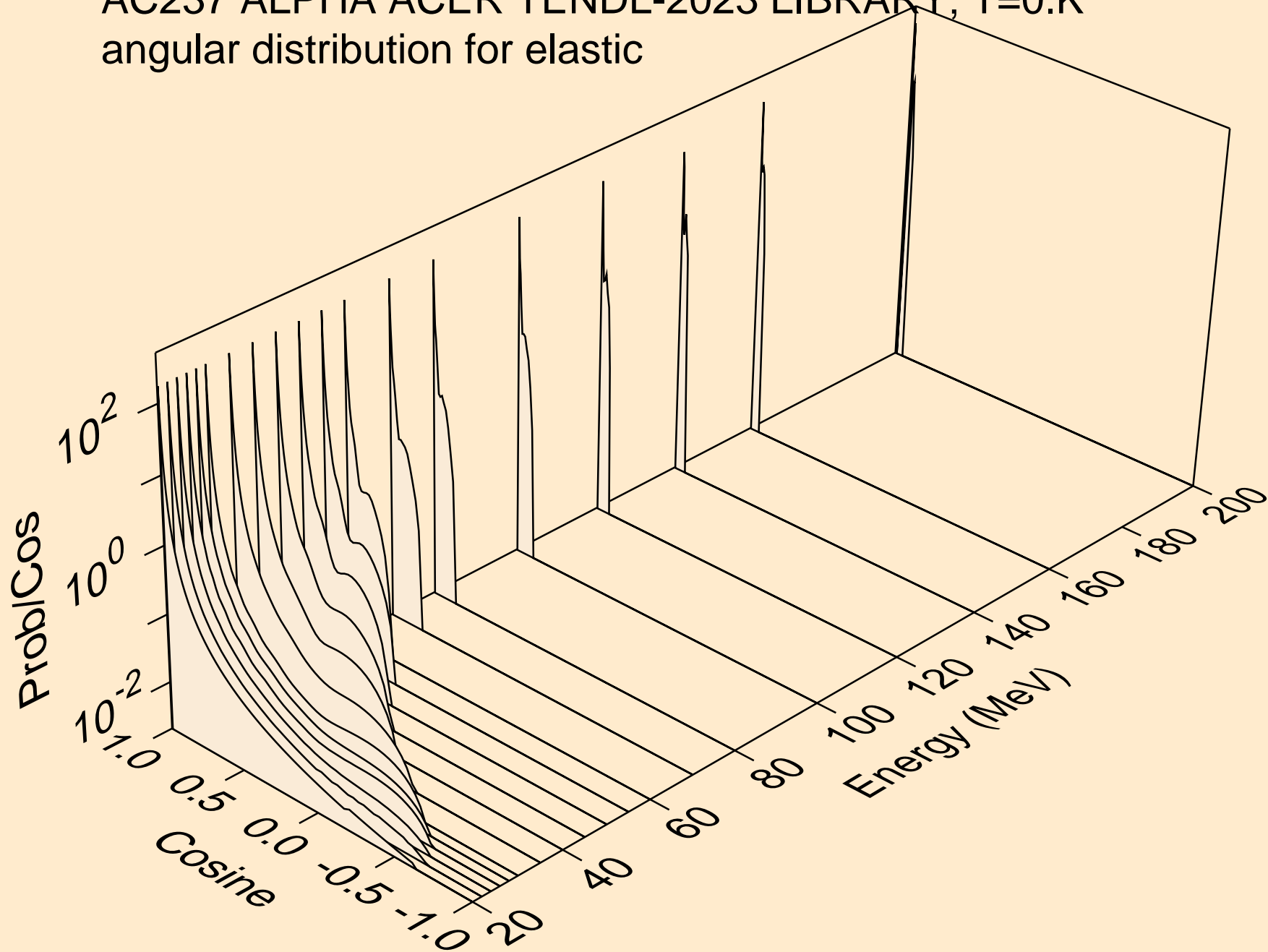

AC237 ALPHA ACER TENDL-2023 LIBRARY; T=0.K  
Alpha emission for (a,x)

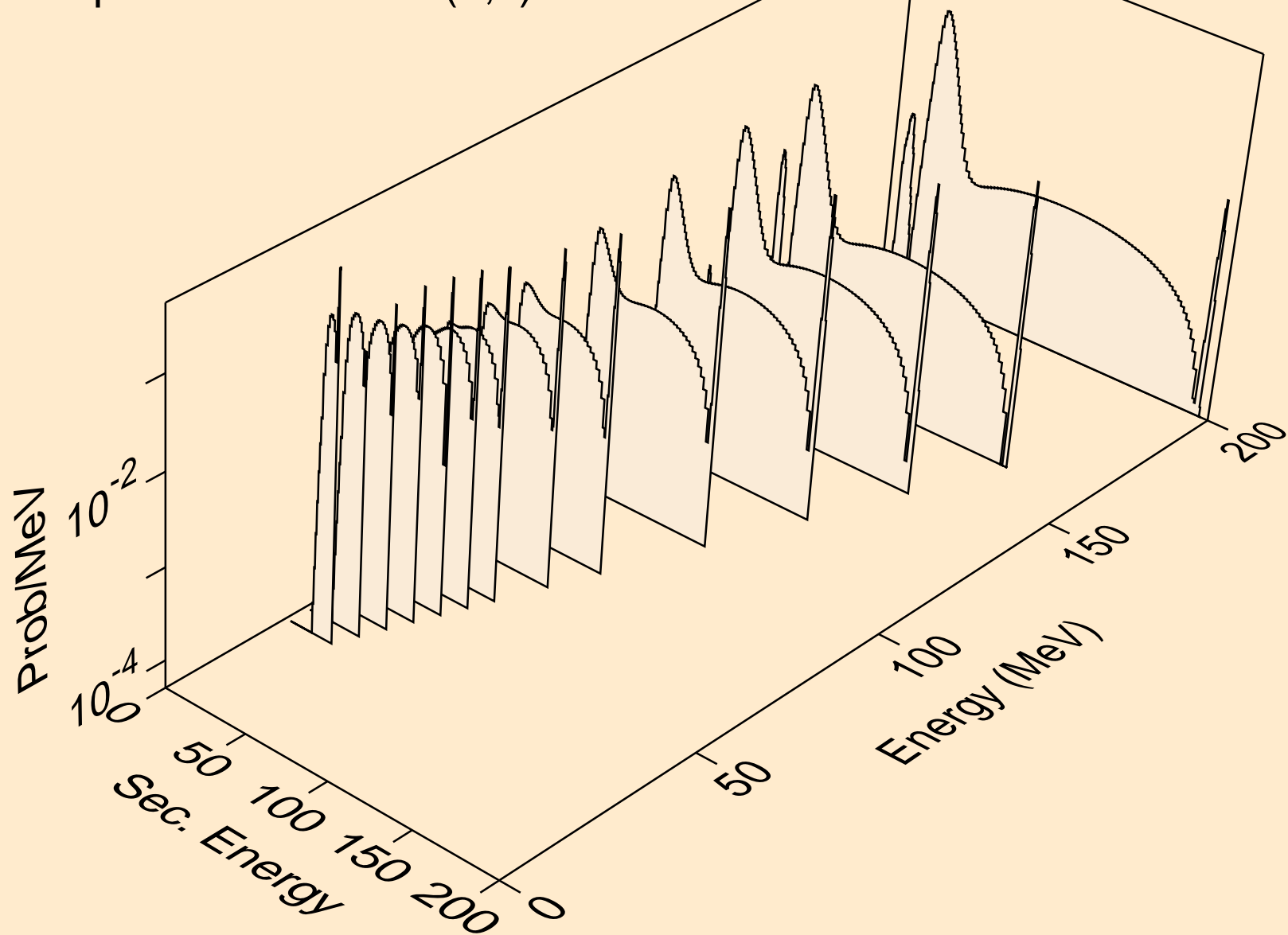

AC237 ALPHA ACER TENDL-2023 LIBRARY; T=0.K  
Alpha emission for (a,n\*)a

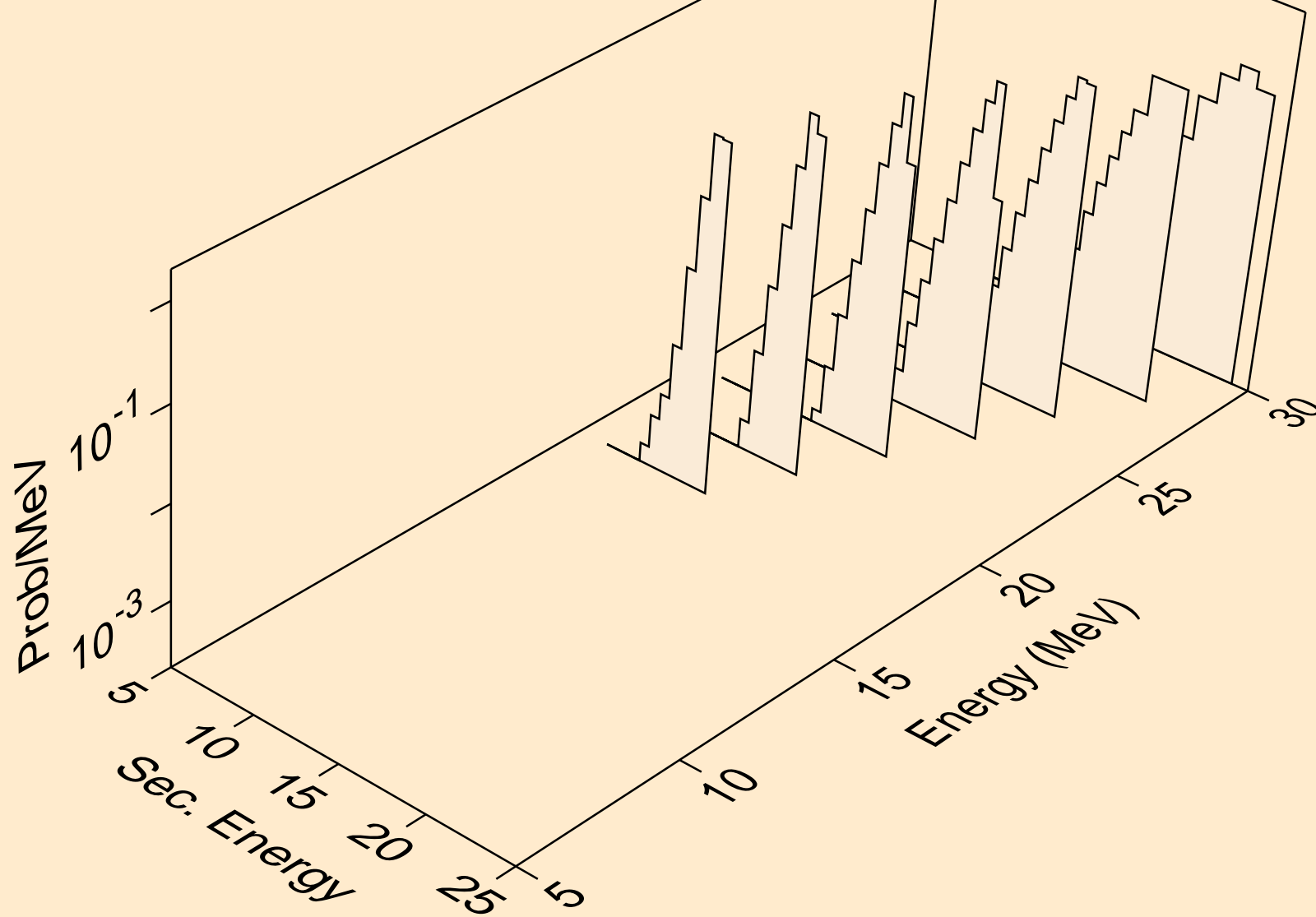

AC237 ALPHA ACER TENDL-2023 LIBRARY; T=0.K  
Alpha emission for (a,2n)a

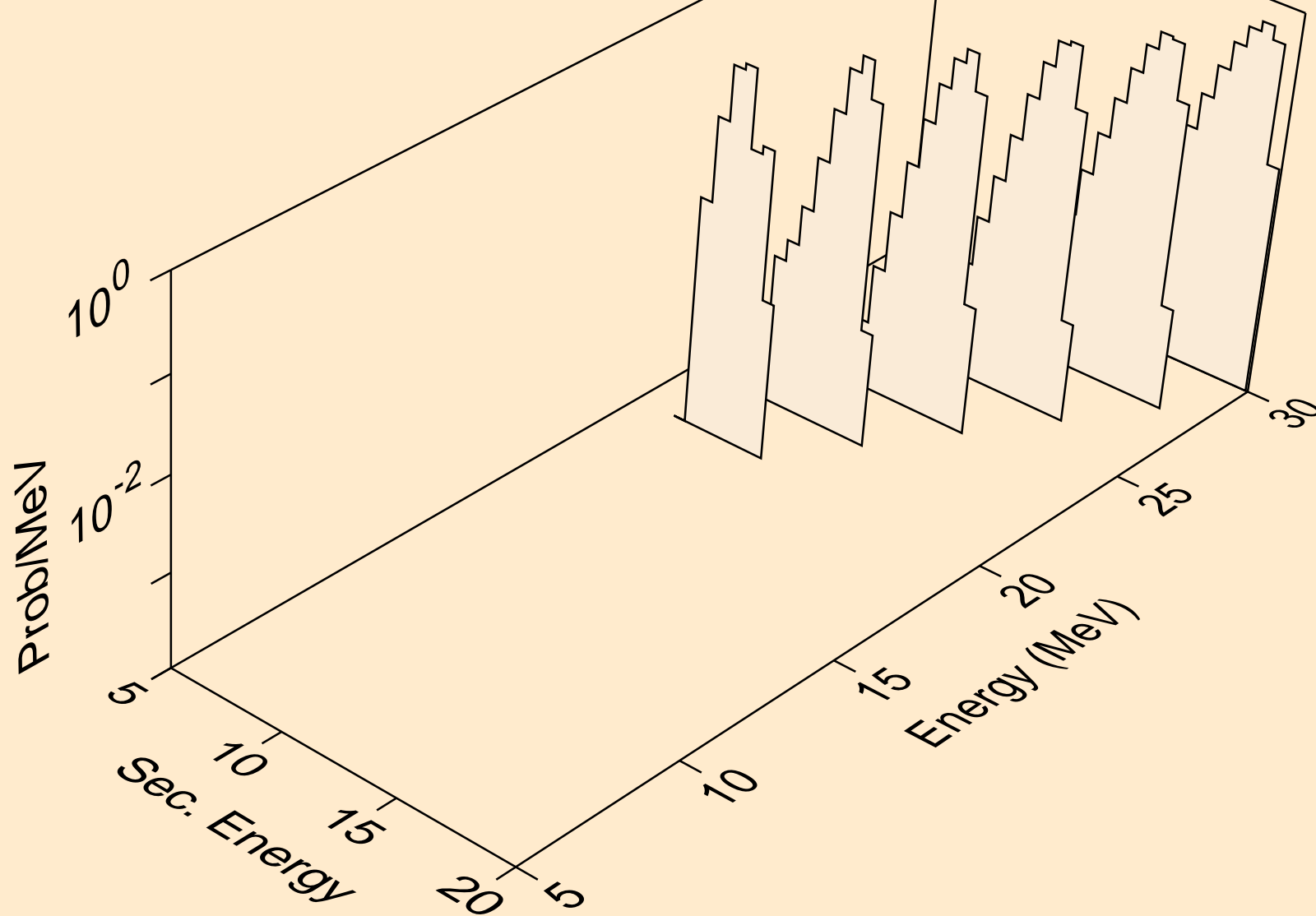

AC237 ALPHA ACER TENDL-2023 LIBRARY; T=0.K  
Alpha emission for inelastic

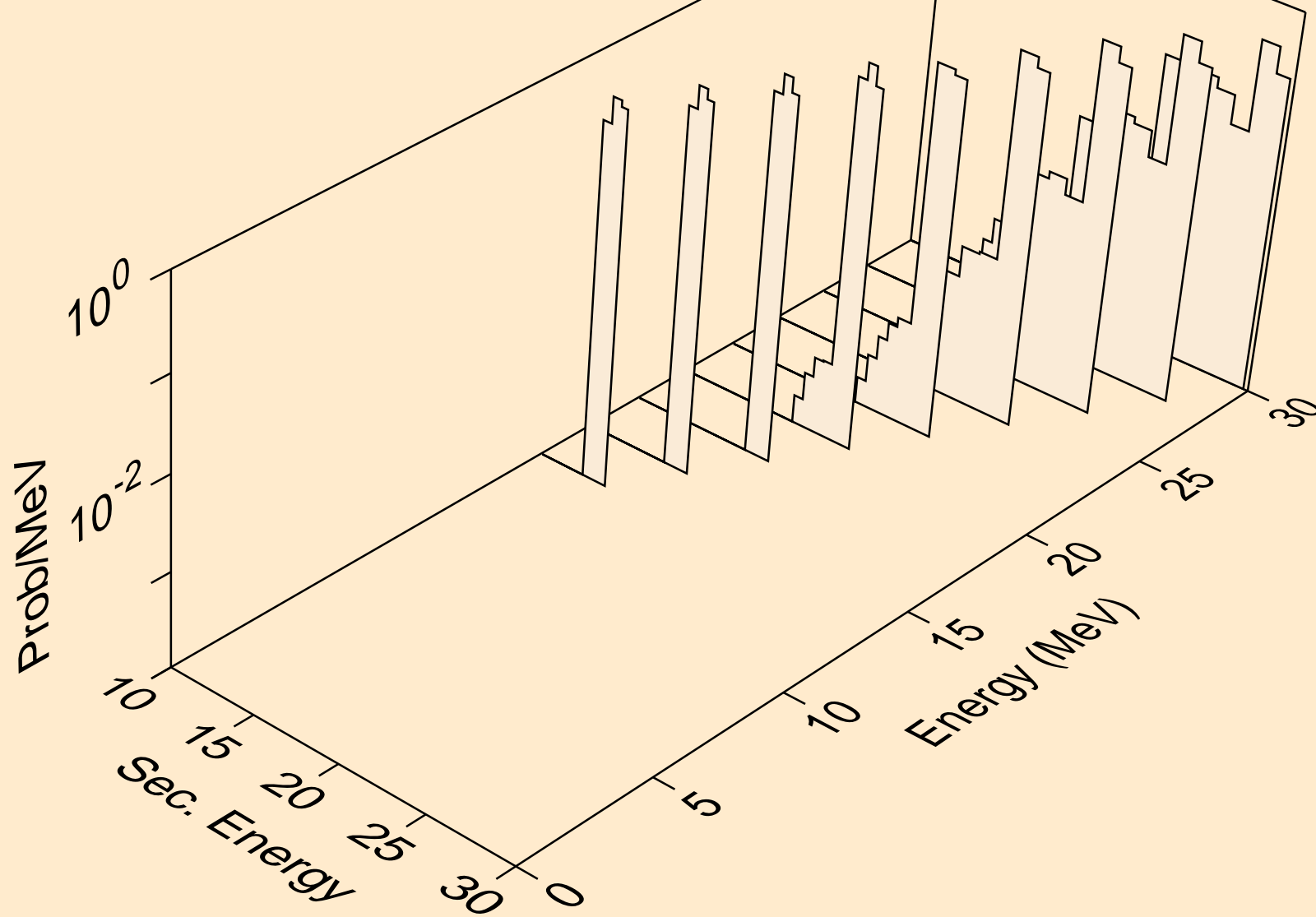



AC237 ALPHA ACER TENDL-2023 LIBRARY; T=0.K  
Photon emission for (z,n)

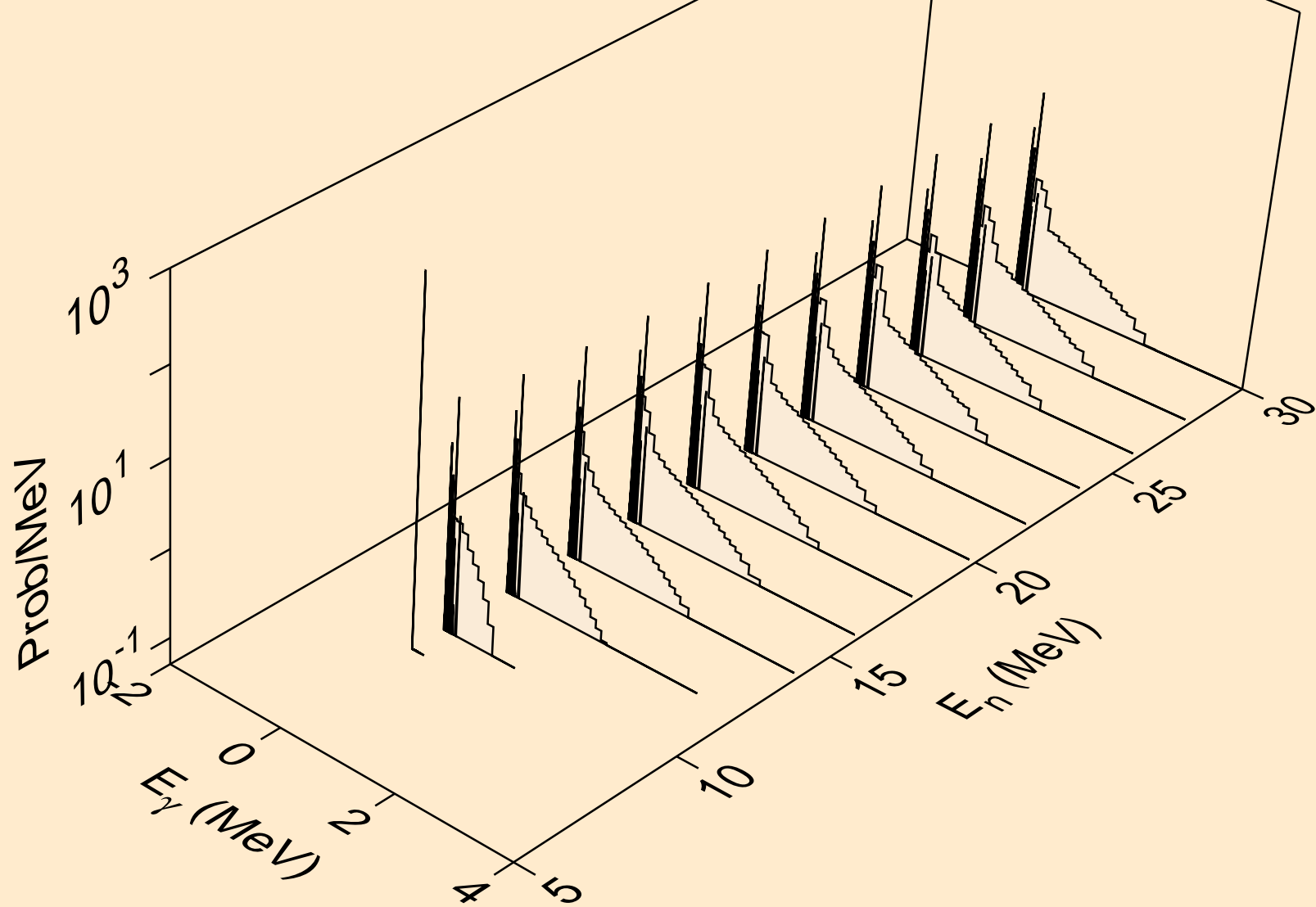

AC237 ALPHA ACER TENDL-2023 LIBRARY; T=0.K  
Photon emission for (z,x)

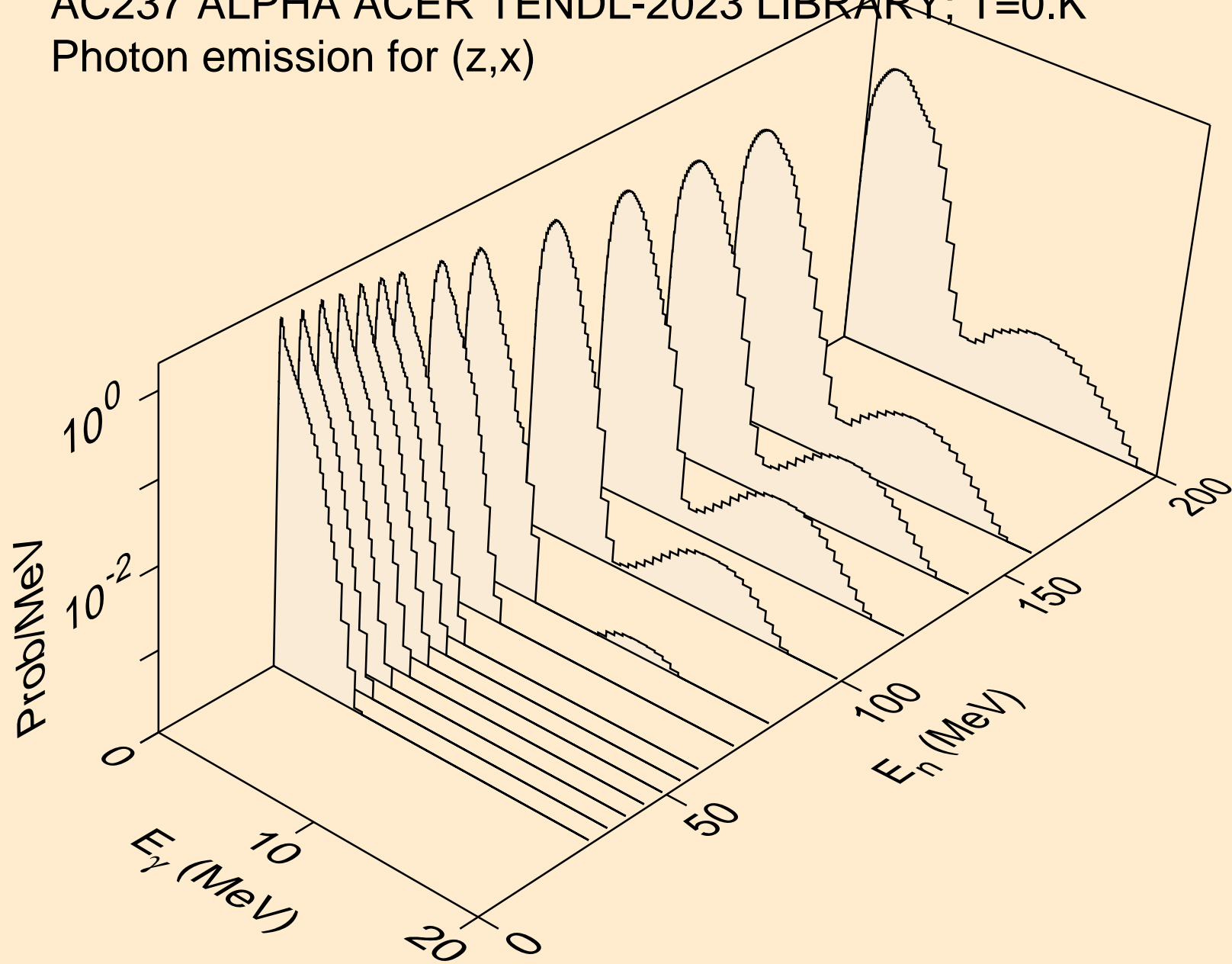

AC237 ALPHA ACER TENDL-2023 LIBRARY; T=0.K  
Photon emission for (n,2nd)

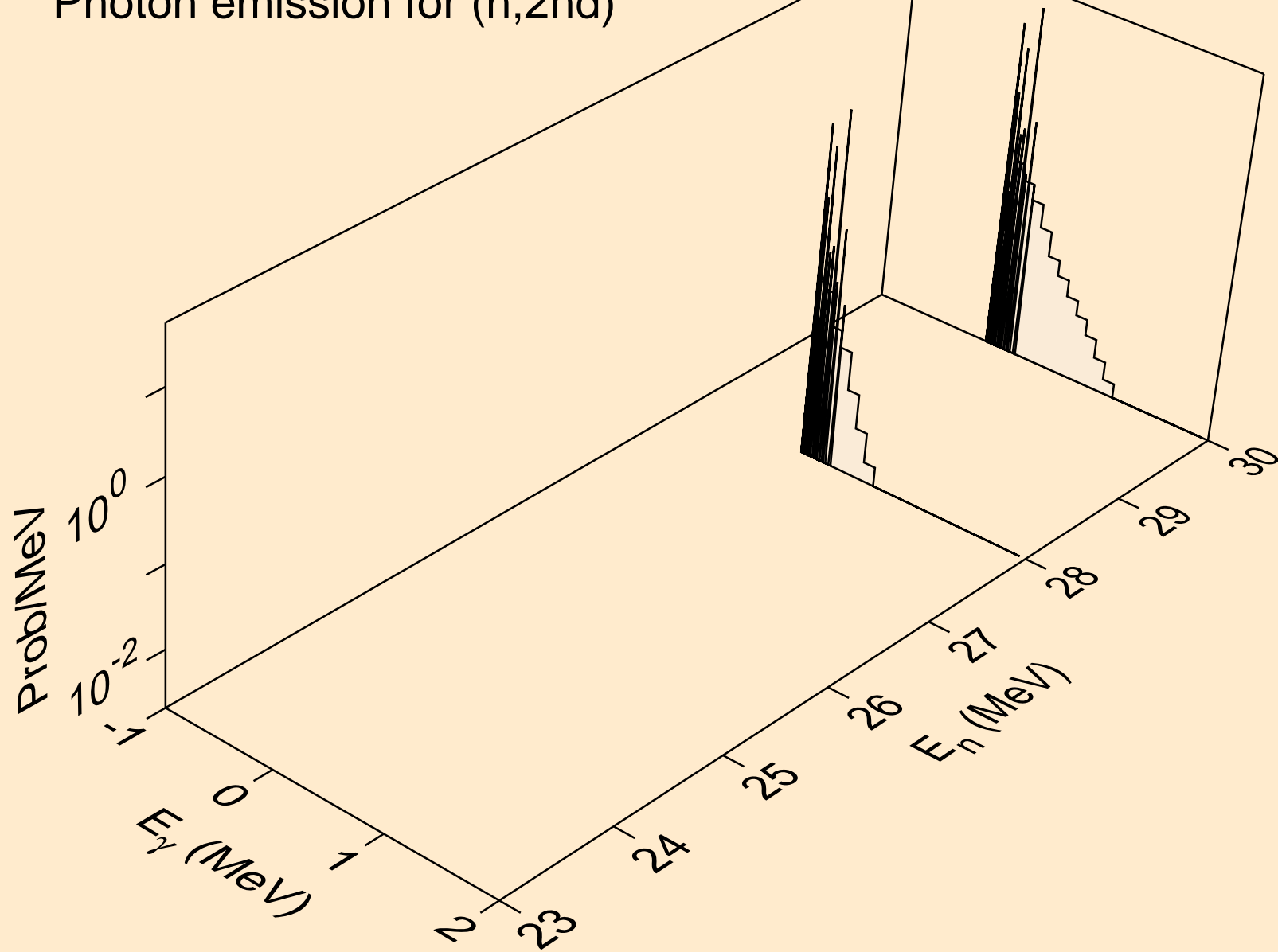

AC237 ALPHA ACER TENDL-2023 LIBRARY; T=0.K  
Photon emission for (n,2n)

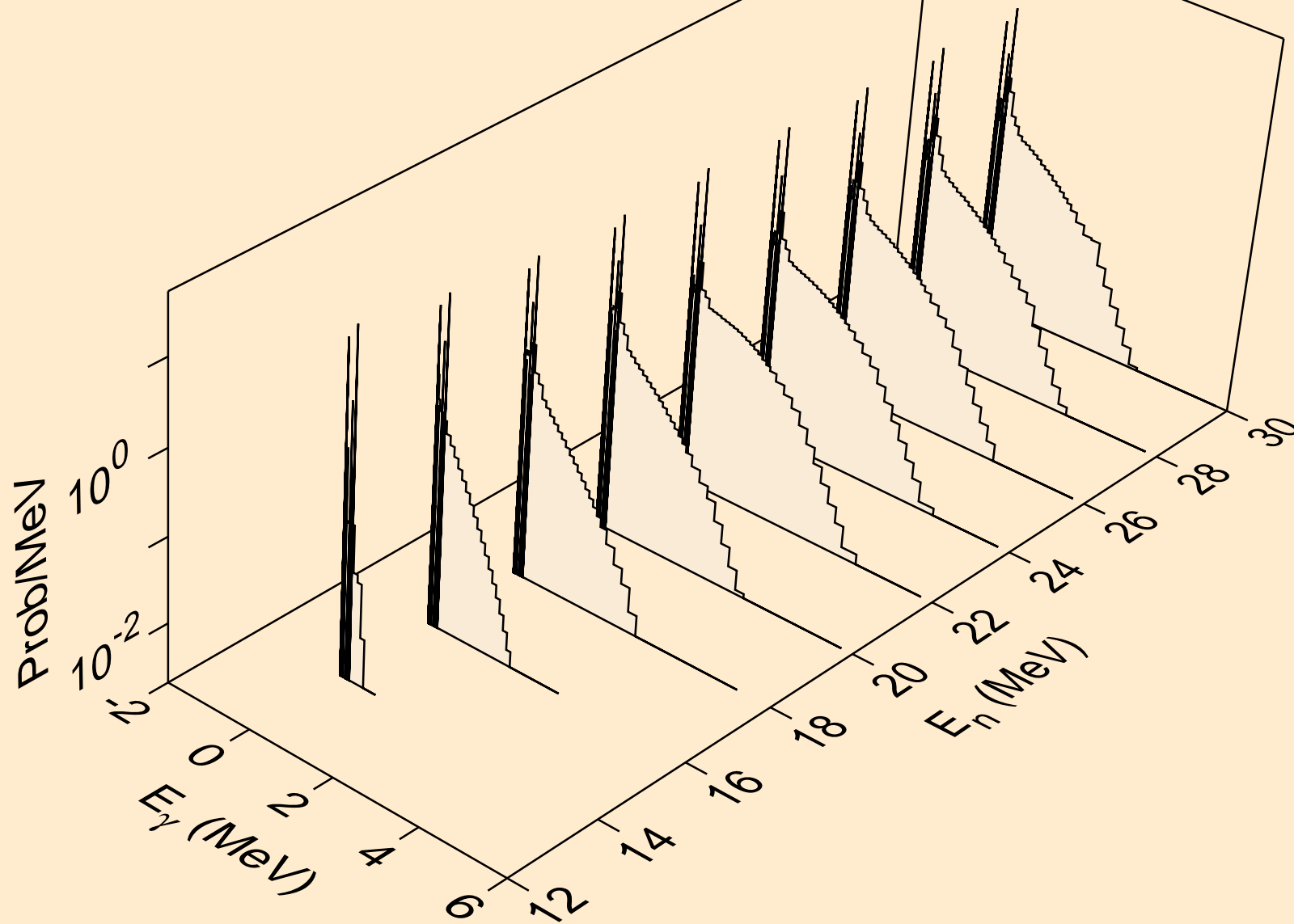

AC237 ALPHA ACER TENDL-2023 LIBRARY; T=0.K  
Photon emission for (n,3n)

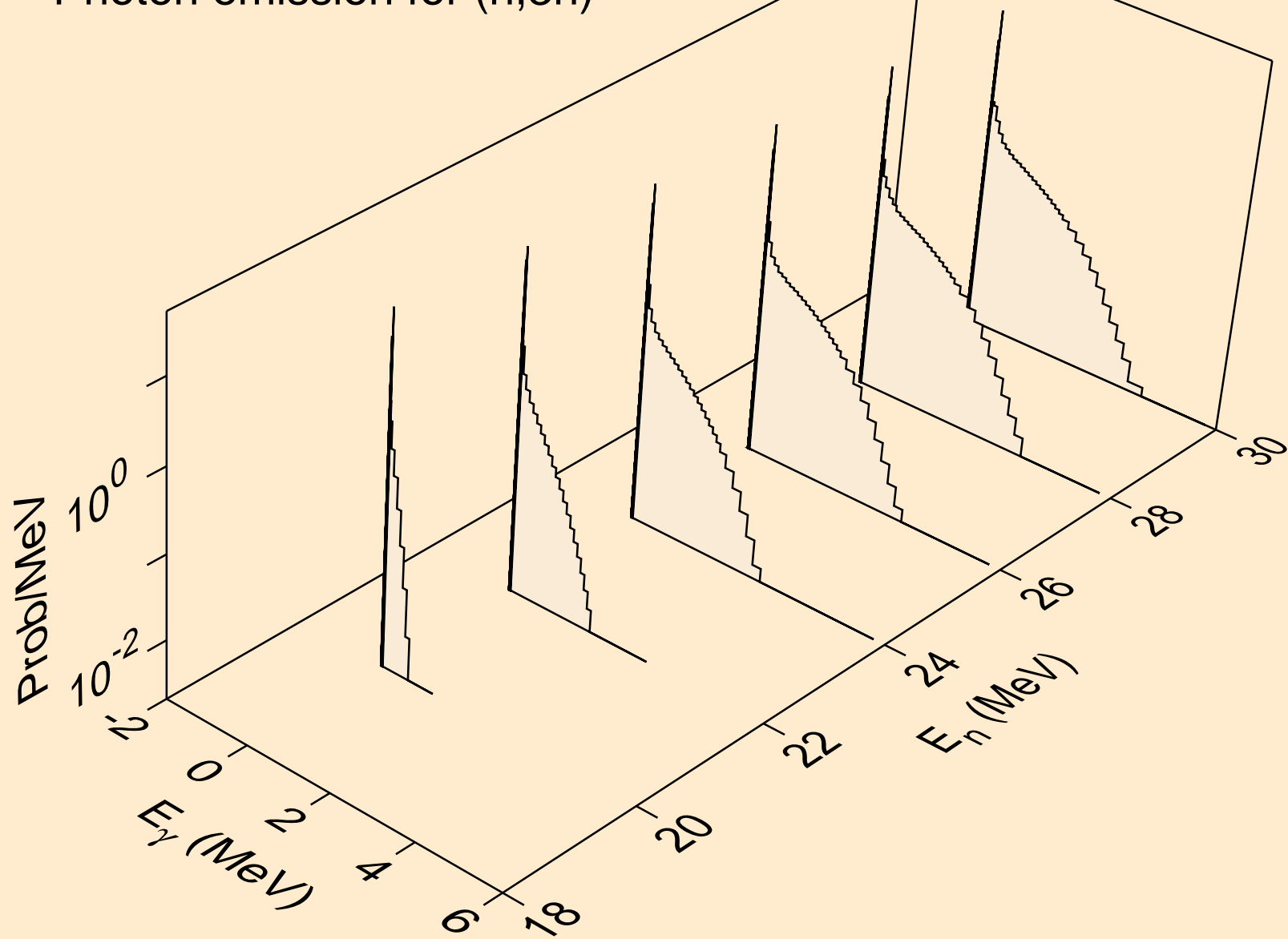

AC237 ALPHA ACER TENDL-2023 LIBRARY; T=0.K  
Photon emission for (n,n\*)a

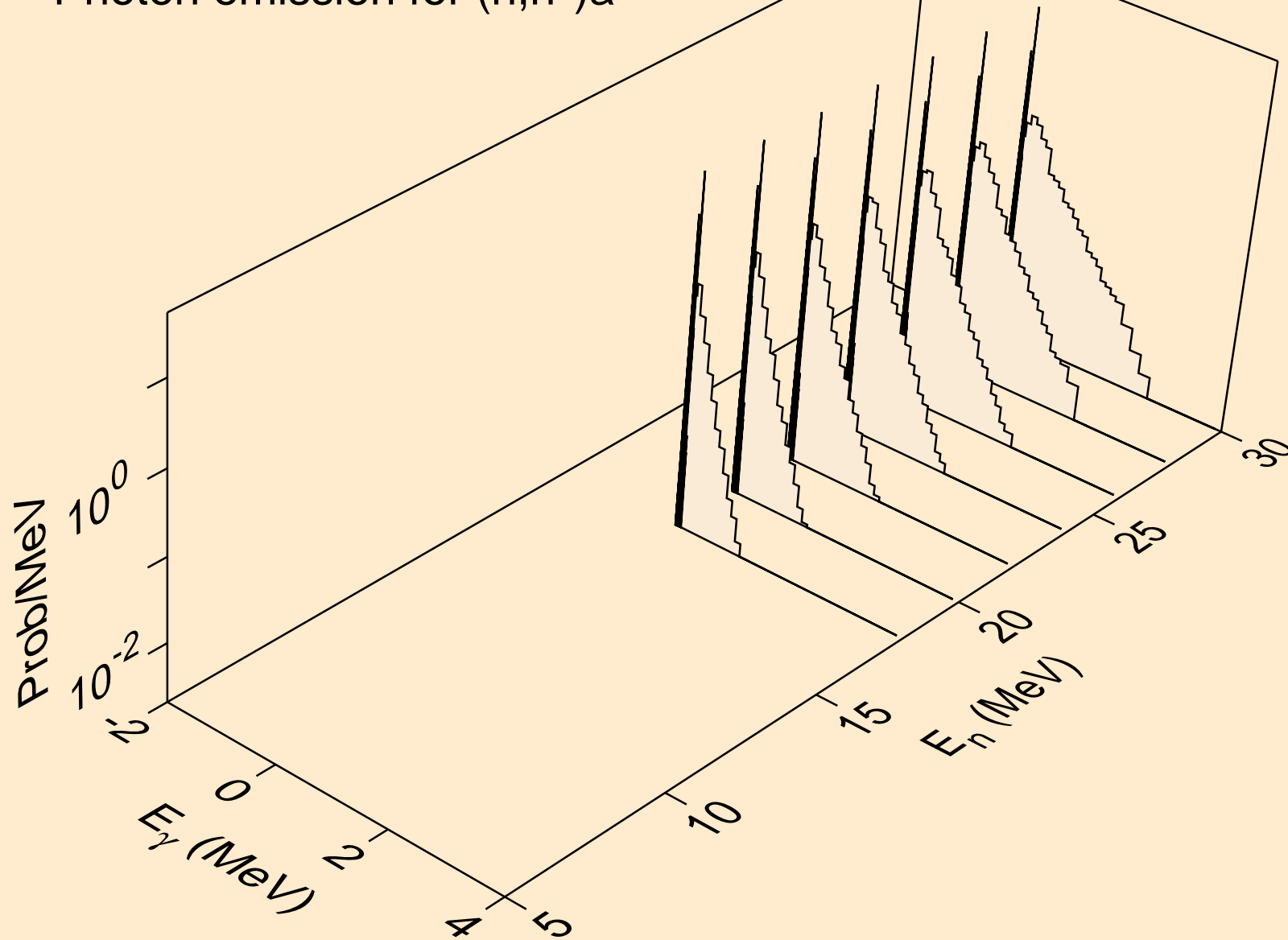

AC237 ALPHA ACER TENDL-2023 LIBRARY; T=0.K  
Photon emission for (n,2n)a

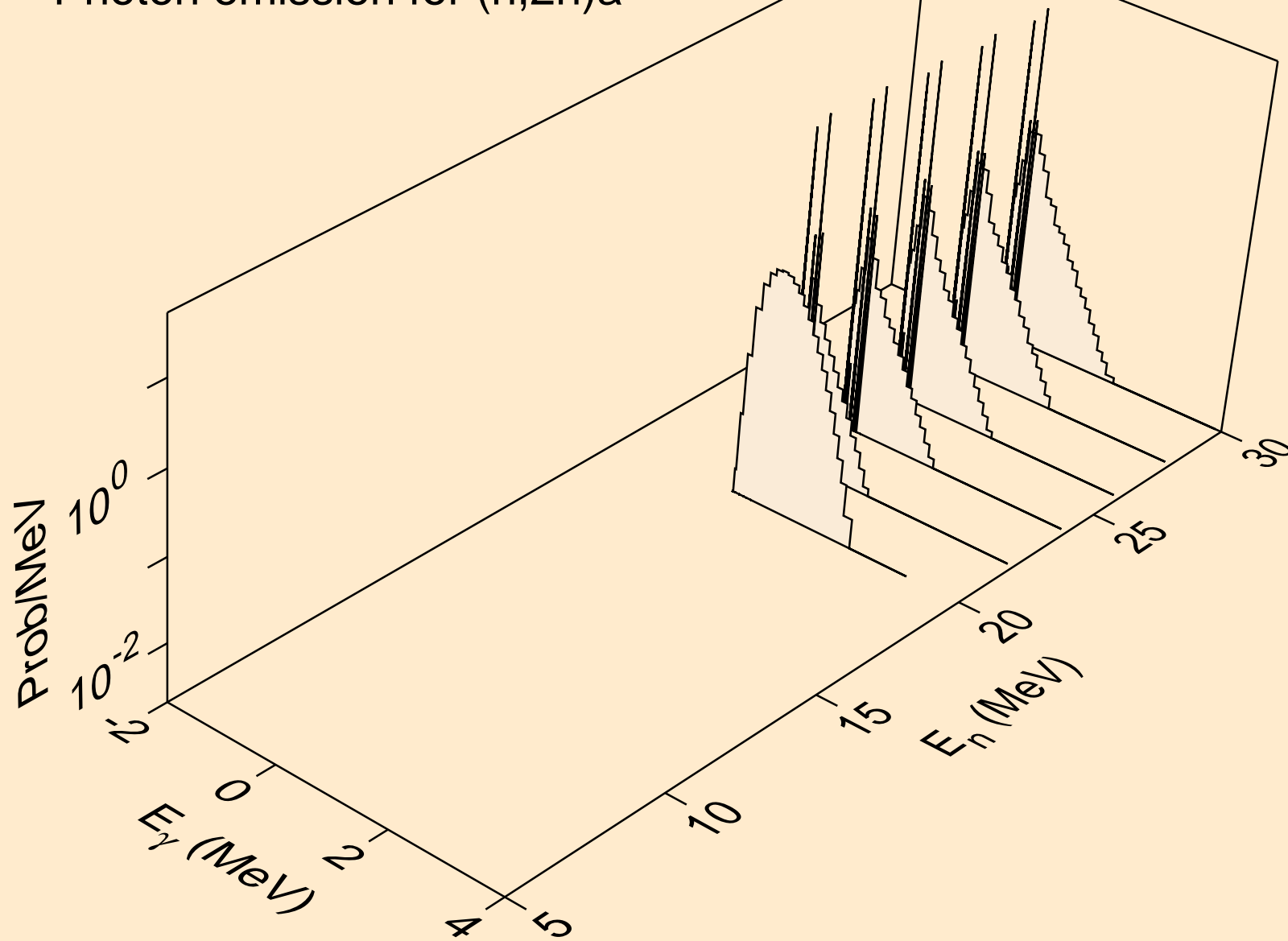

AC237 ALPHA ACER TENDL-2023 LIBRARY; T=0.K  
Photon emission for (n,n\*)p

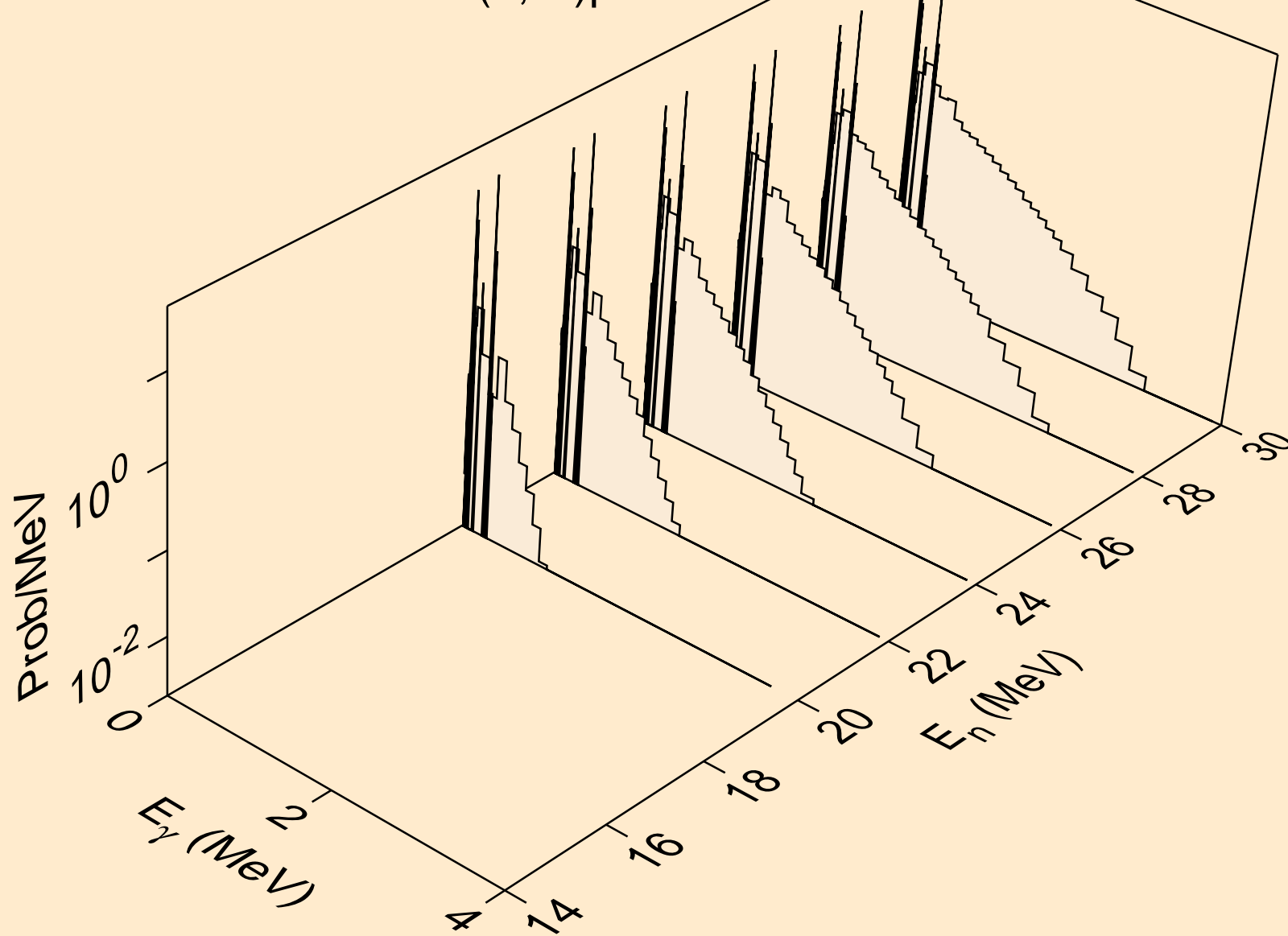



AC237 ALPHA ACER TENDL-2023 LIBRARY; T=0.K  
Photon emission for (n,n\*)d

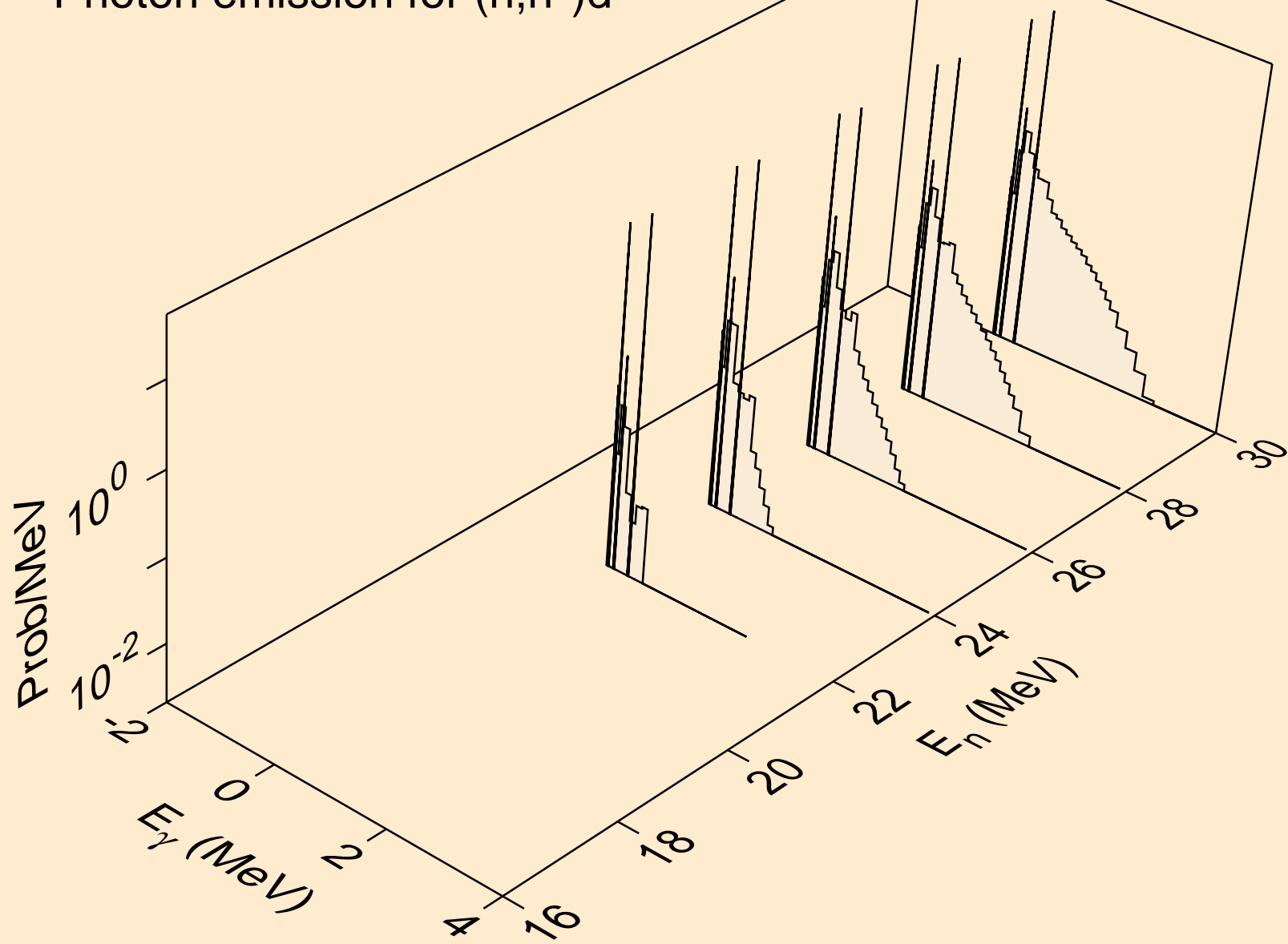

AC237 ALPHA ACER TENDL-2023 LIBRARY; T=0.K  
Photon emission for (n,n\*)t

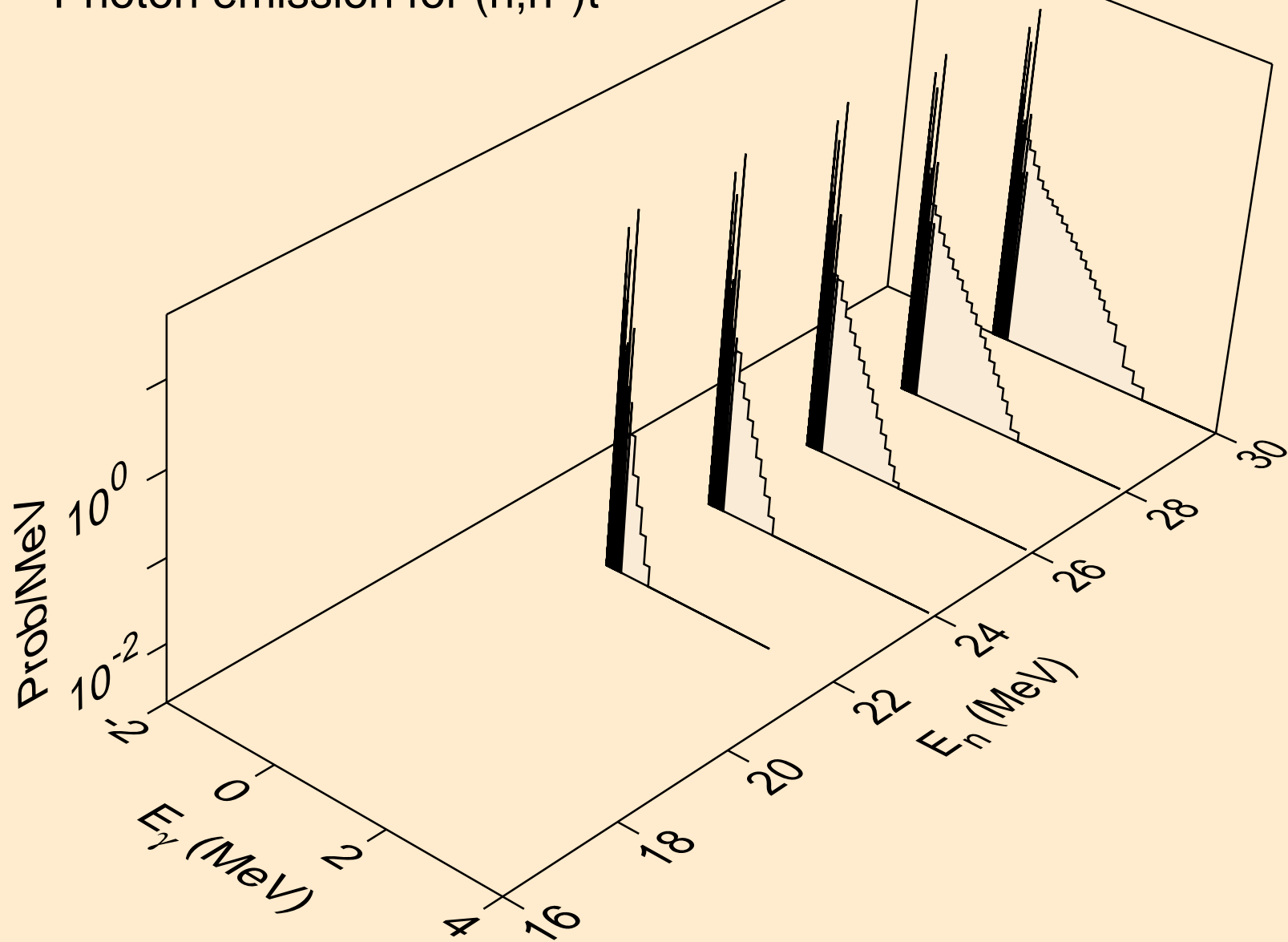

AC237 ALPHA ACER TENDL-2023 LIBRARY; T=0.K  
Photon emission for (n,4n)

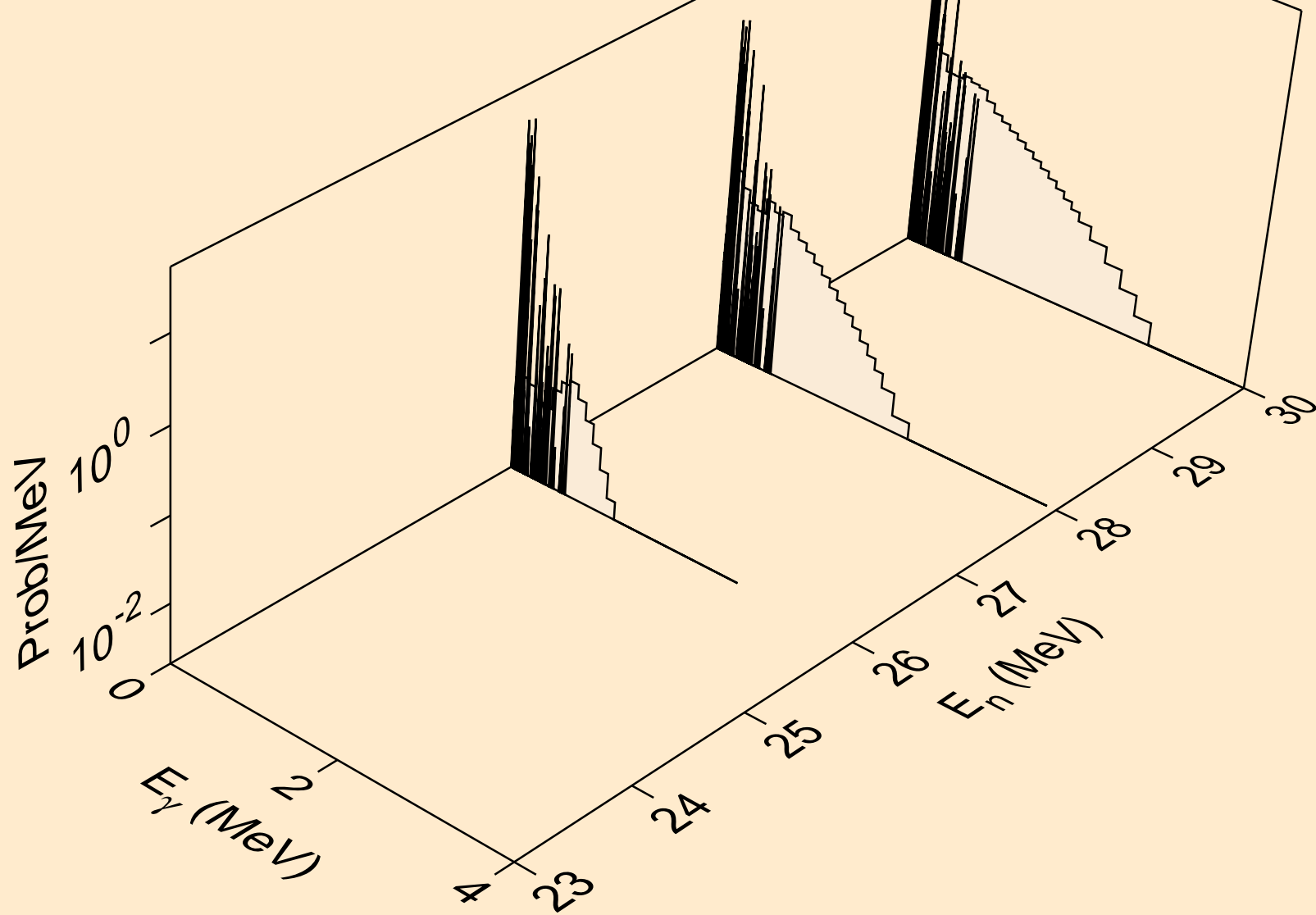

AC237 ALPHA ACER TENDL-2023 LIBRARY; T=0.K  
Photon emission for (n,2np)

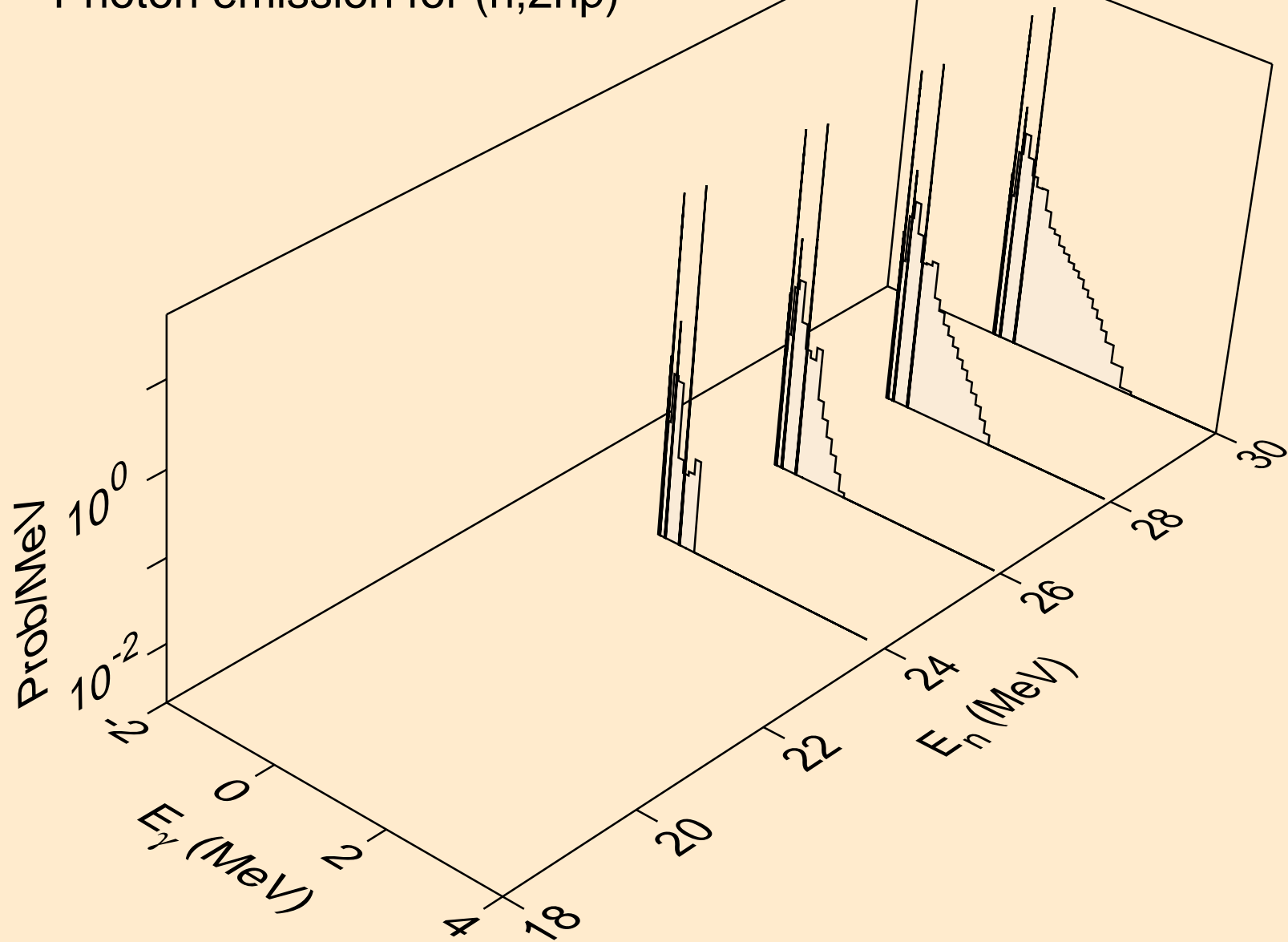

AC237 ALPHA ACER TENDL-2023 LIBRARY; T=0.K  
Photon emission for (n,gma)

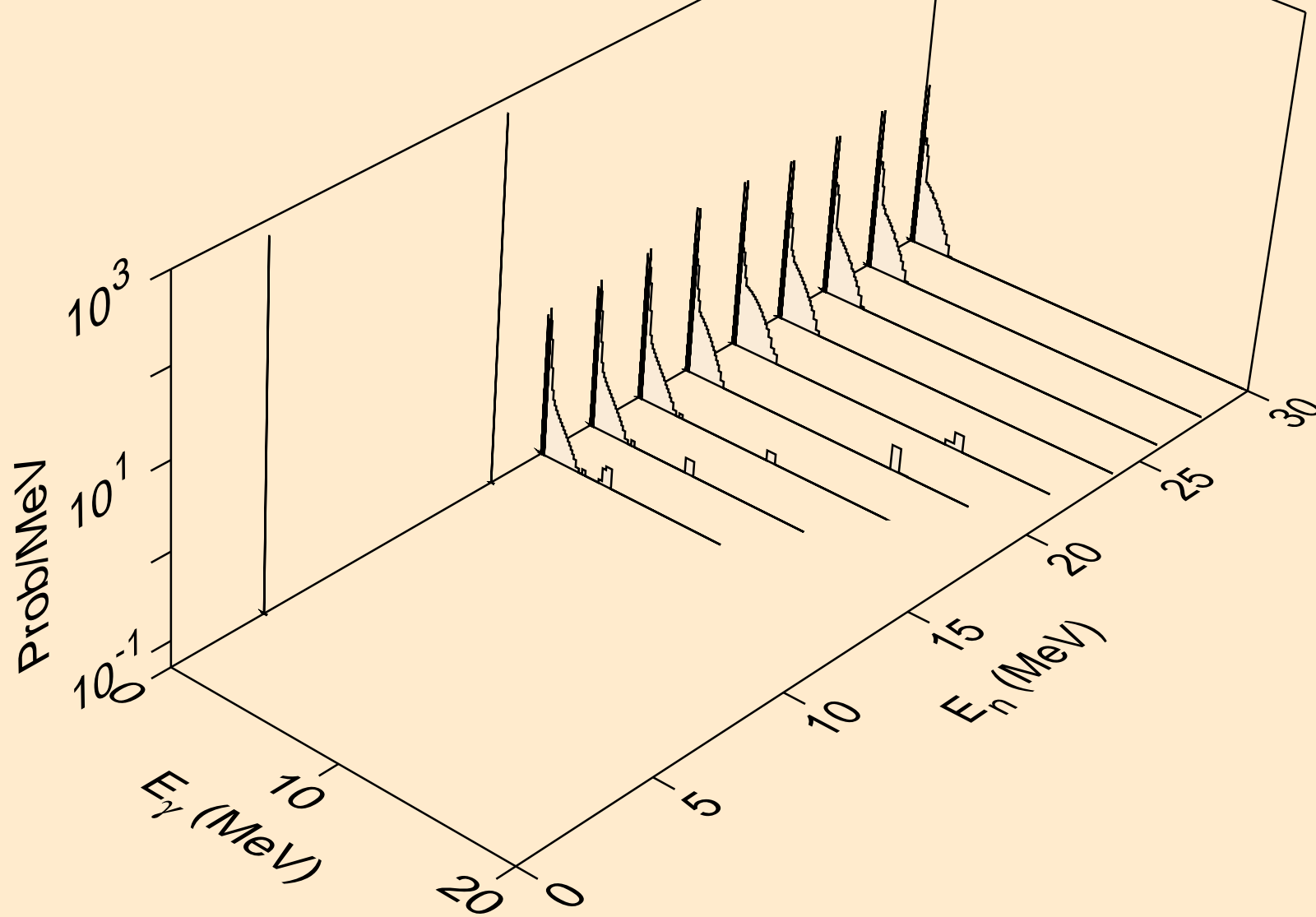

AC237 ALPHA ACER TENDL-2023 LIBRARY; T=0.K  
Photon emission for (n,p)

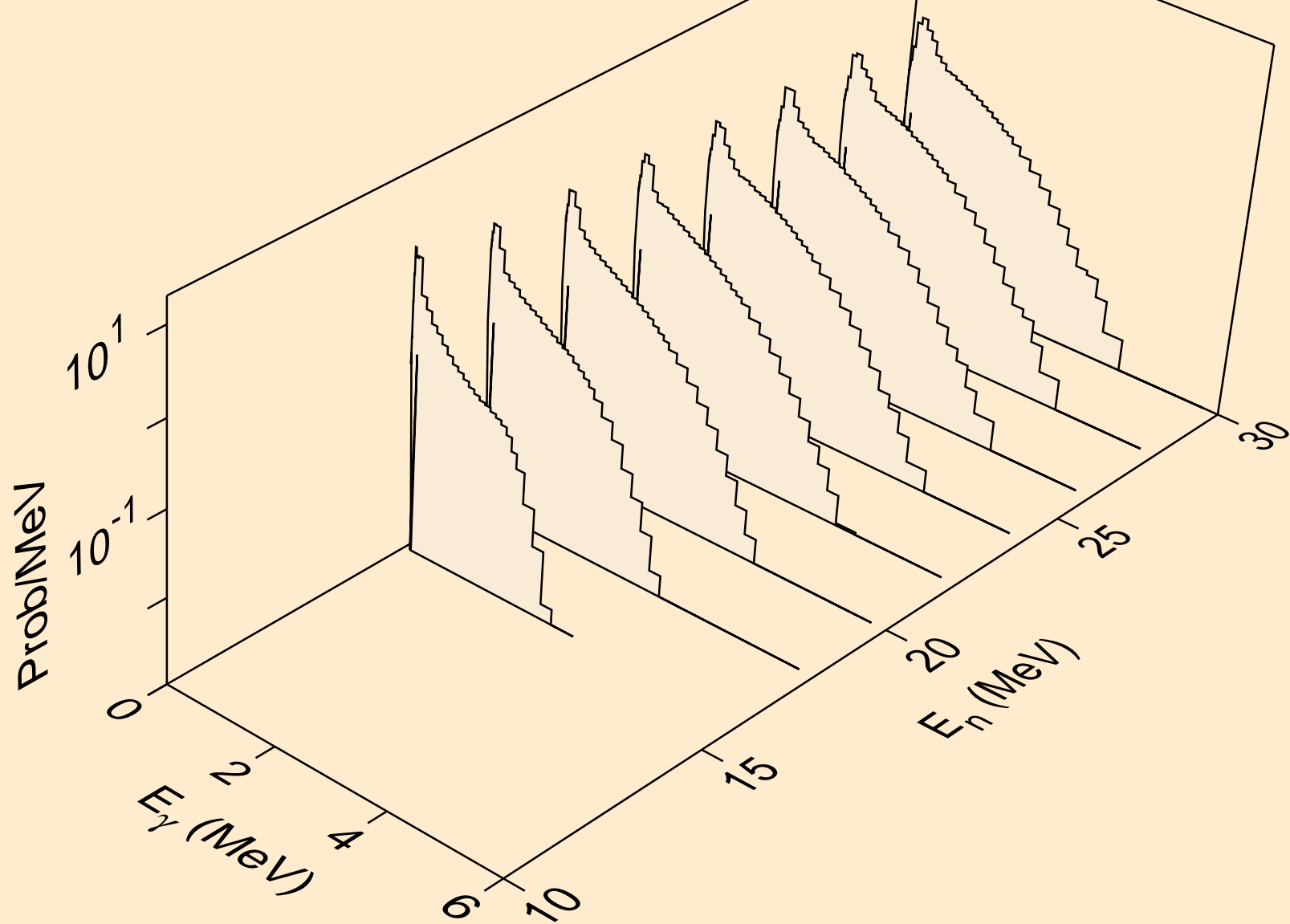

AC237 ALPHA ACER TENDL-2023 LIBRARY; T=0.K  
Photon emission for (n,d)

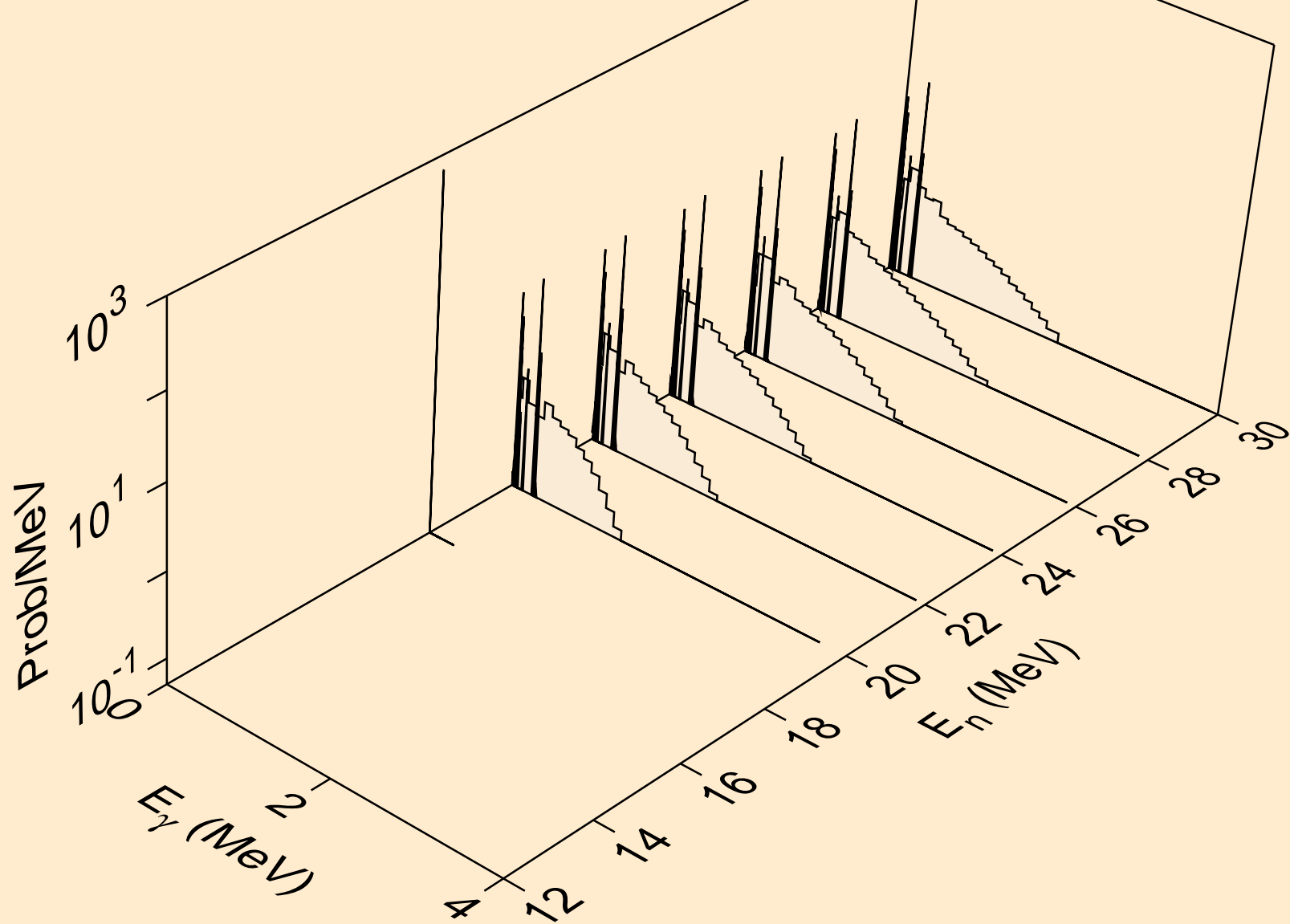

AC237 ALPHA ACER TENDL-2023 LIBRARY; T=0.K  
Photon emission for (n,t)

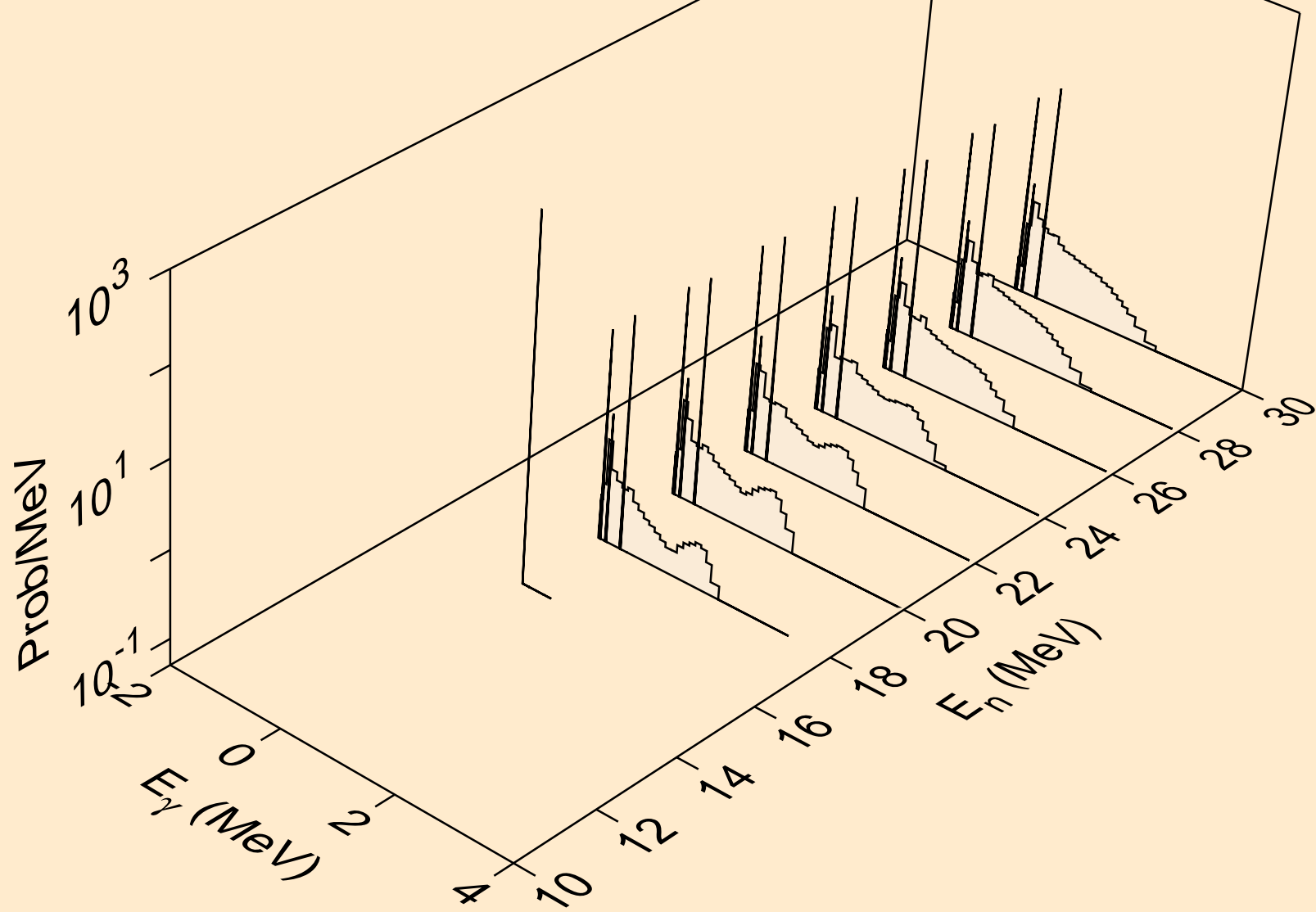



AC237 ALPHA ACER TENDL-2023 LIBRARY; T=0.K  
Photon emission for inelastic

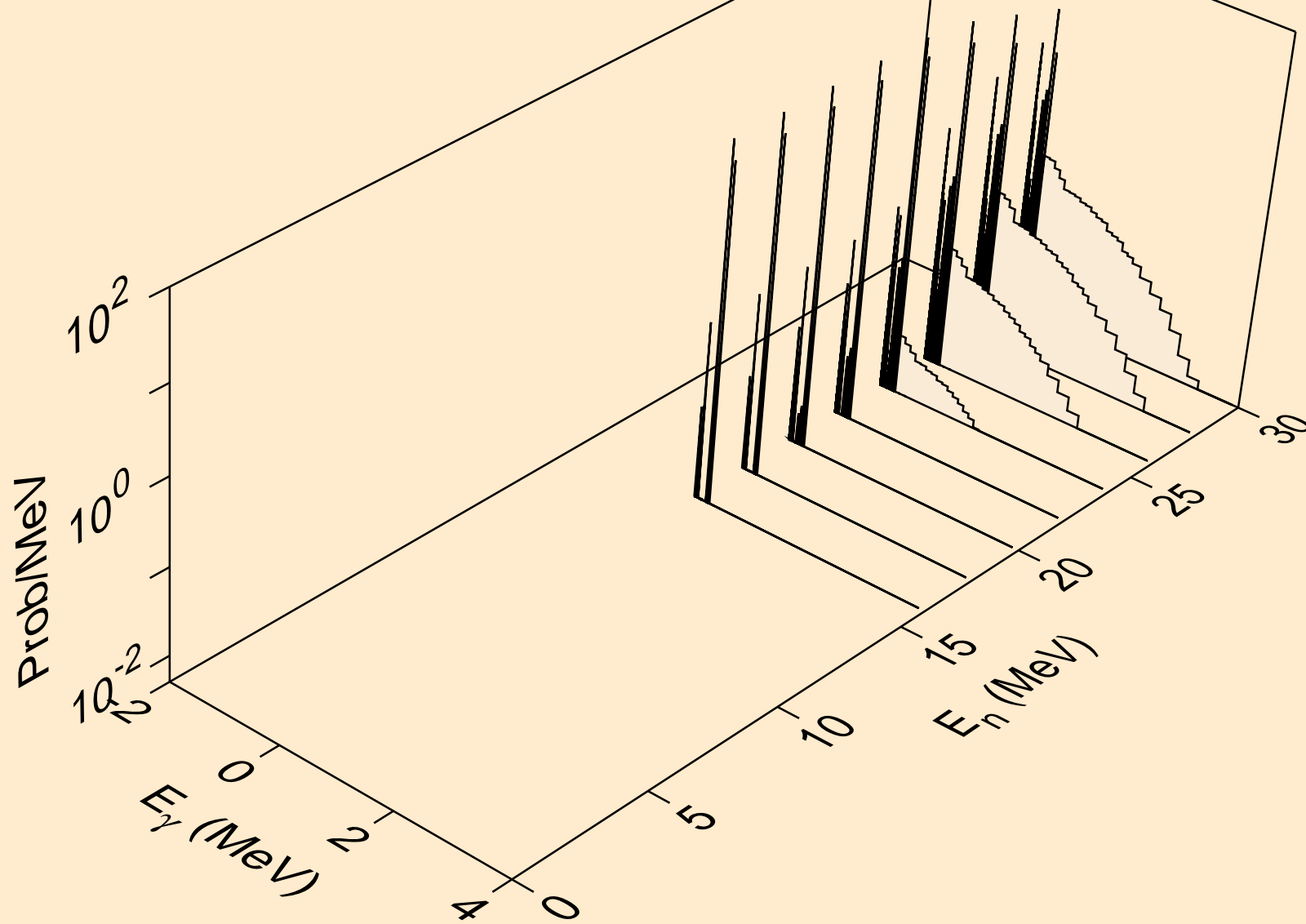

# AC237 ALPHA ACER TENDL-2023 LIBRARY; T=0.K

## Particle heating contributions

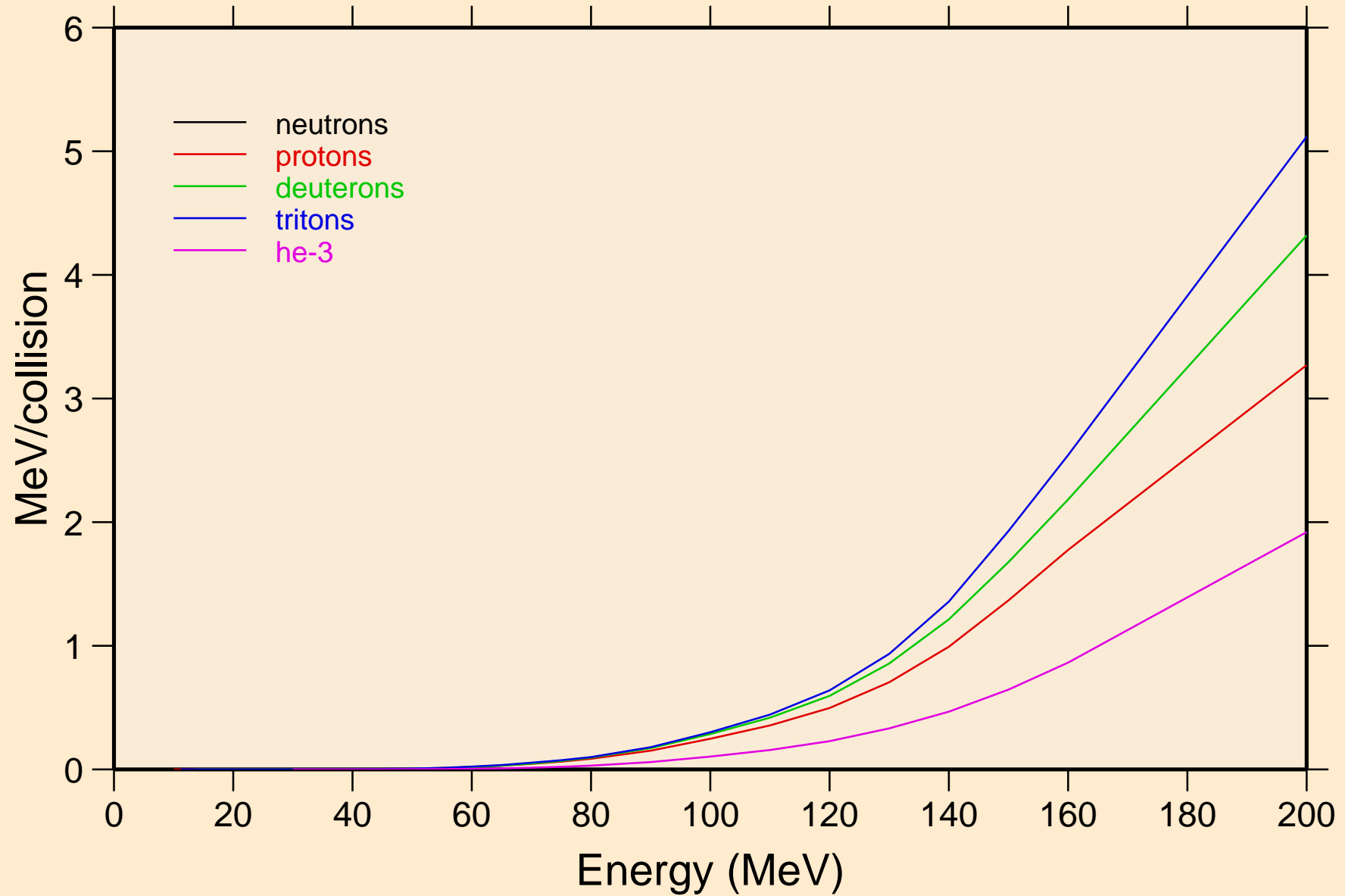

AC237 ALPHA ACER TENDL-2023 LIBRARY; T=0.K  
Recoil Heating

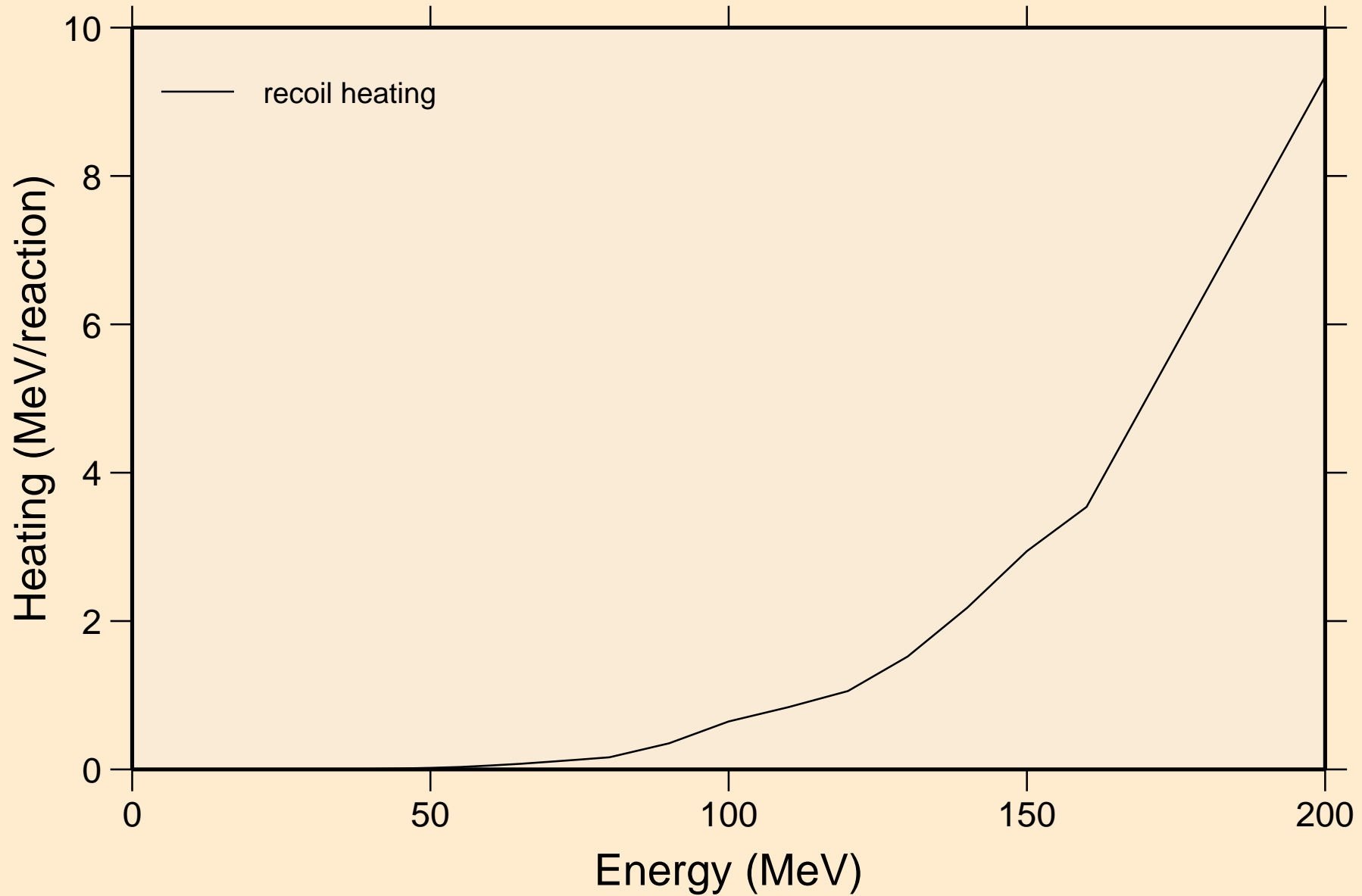

# AC237 ALPHA ACER TENDL-2023 LIBRARY; T=0.K

## Particle production cross sections

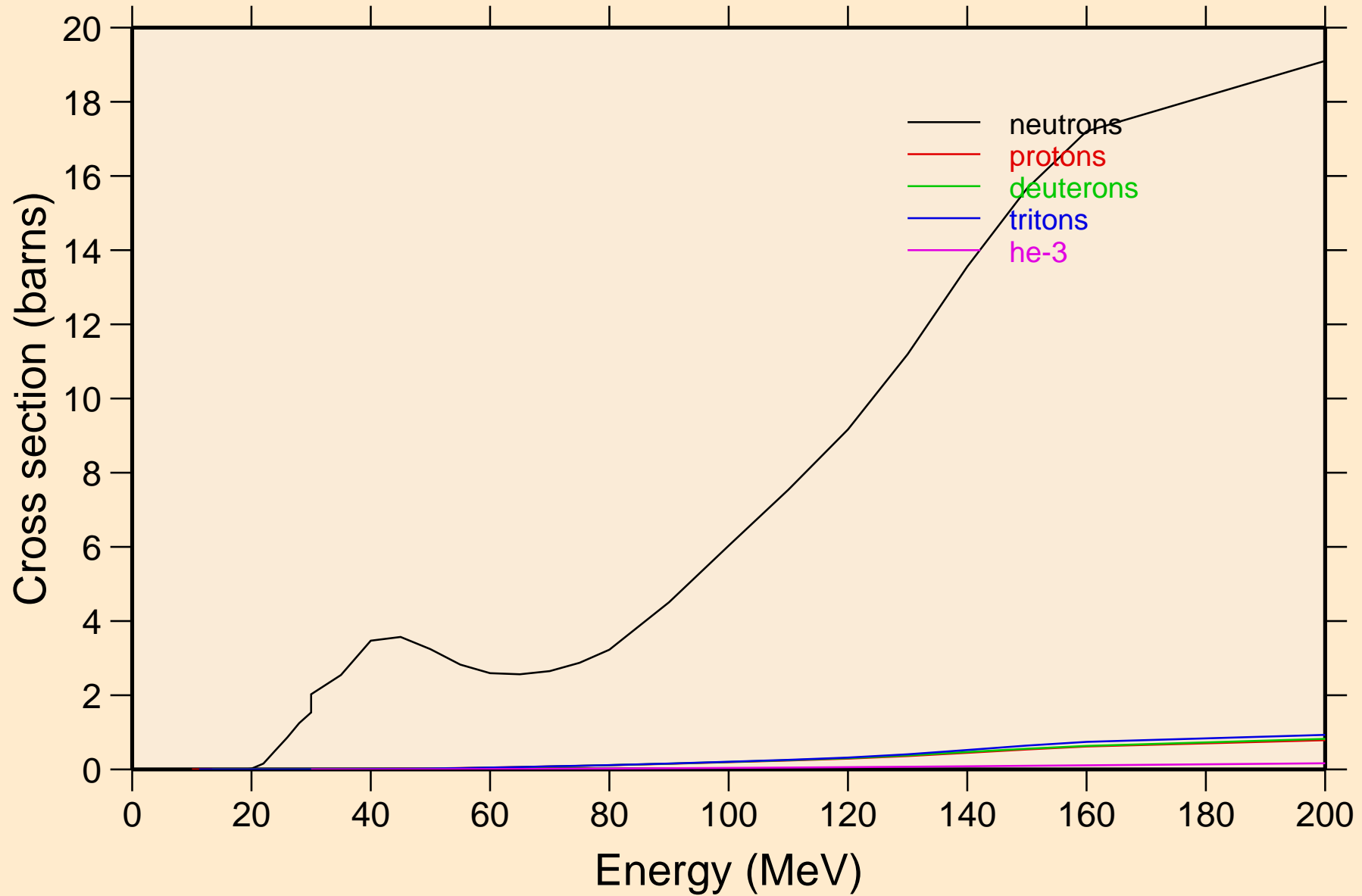

AC237 ALPHA ACER TENDL-2023 LIBRARY; T=0.K  
neutrons from (a,n)

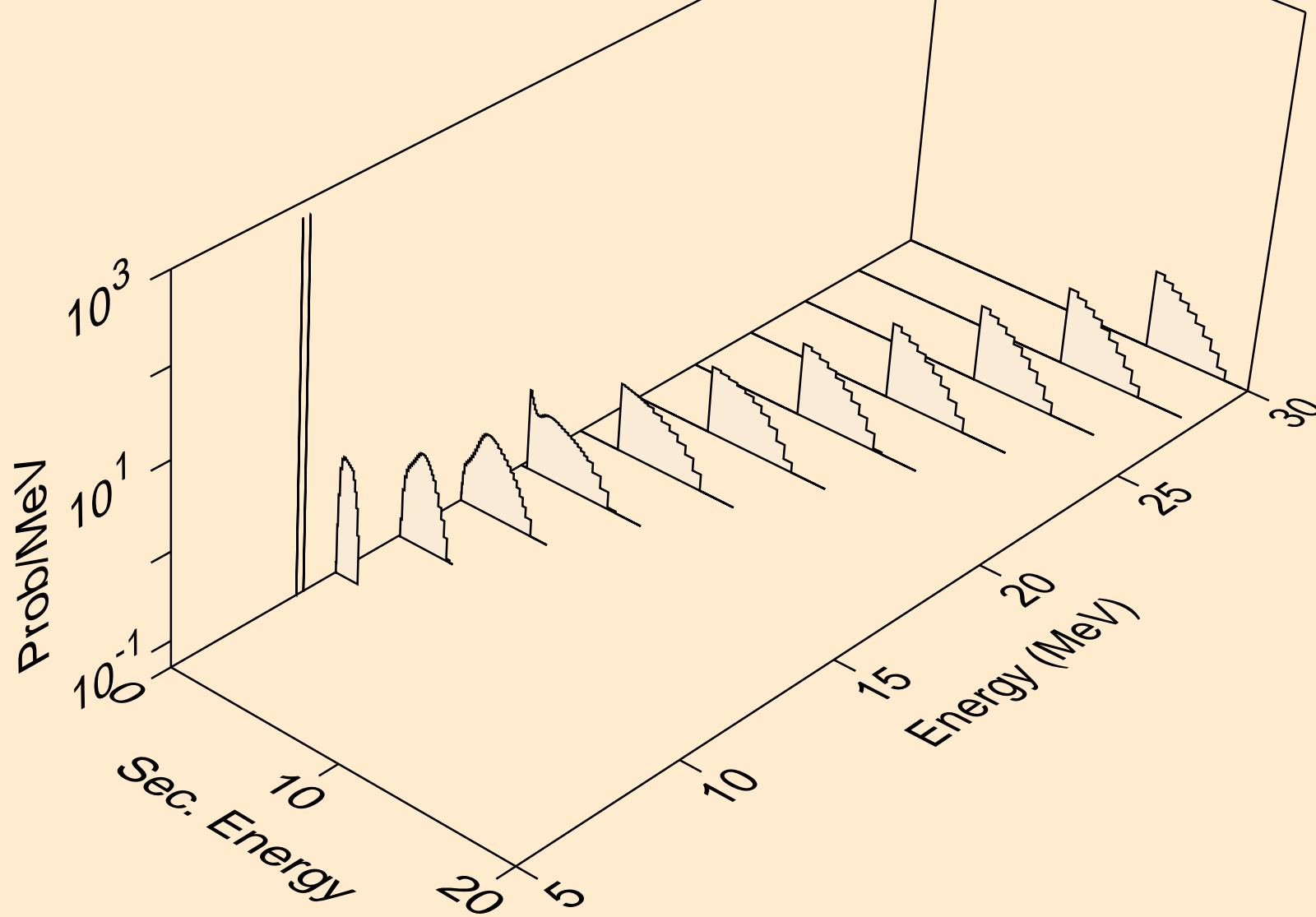

AC237 ALPHA ACER TENDL-2023 LIBRARY; T=0.K  
neutrons from (a,x)

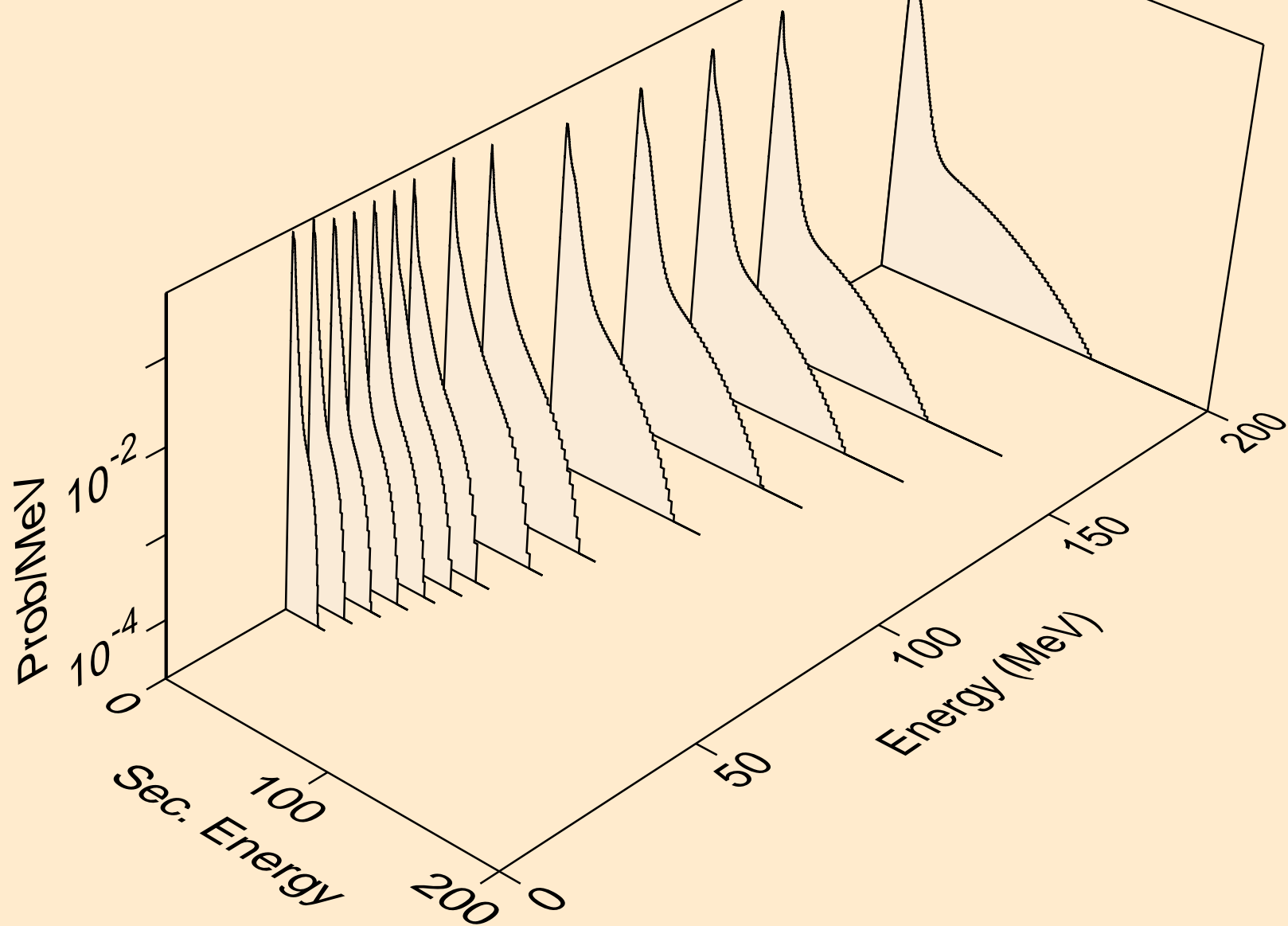

AC237 ALPHA ACER TENDL-2023 LIBRARY; T=0.K  
neutrons from (a,2nd)

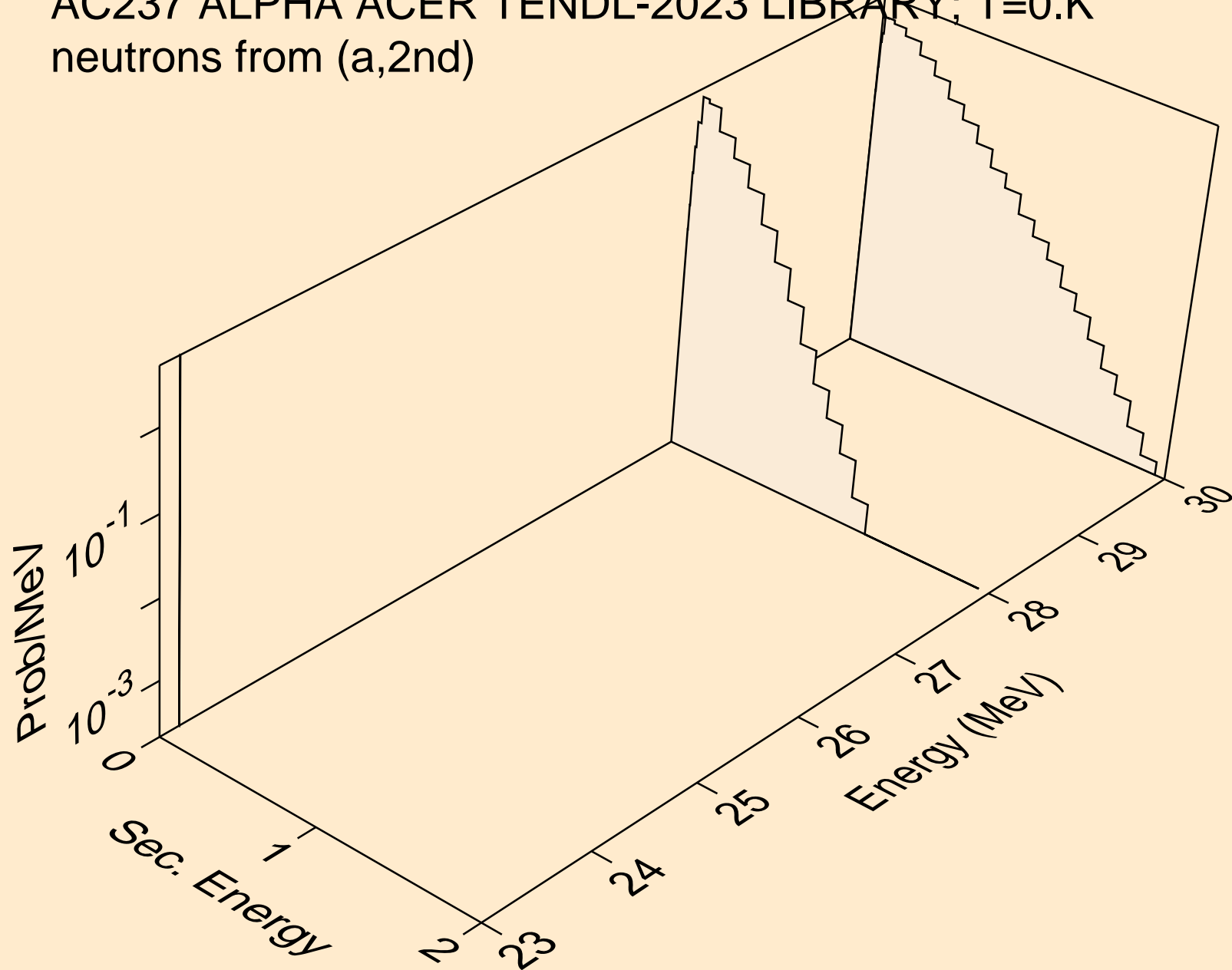

AC237 ALPHA ACER TENDL-2023 LIBRARY; T=0.K  
neutrons from (a,2n)

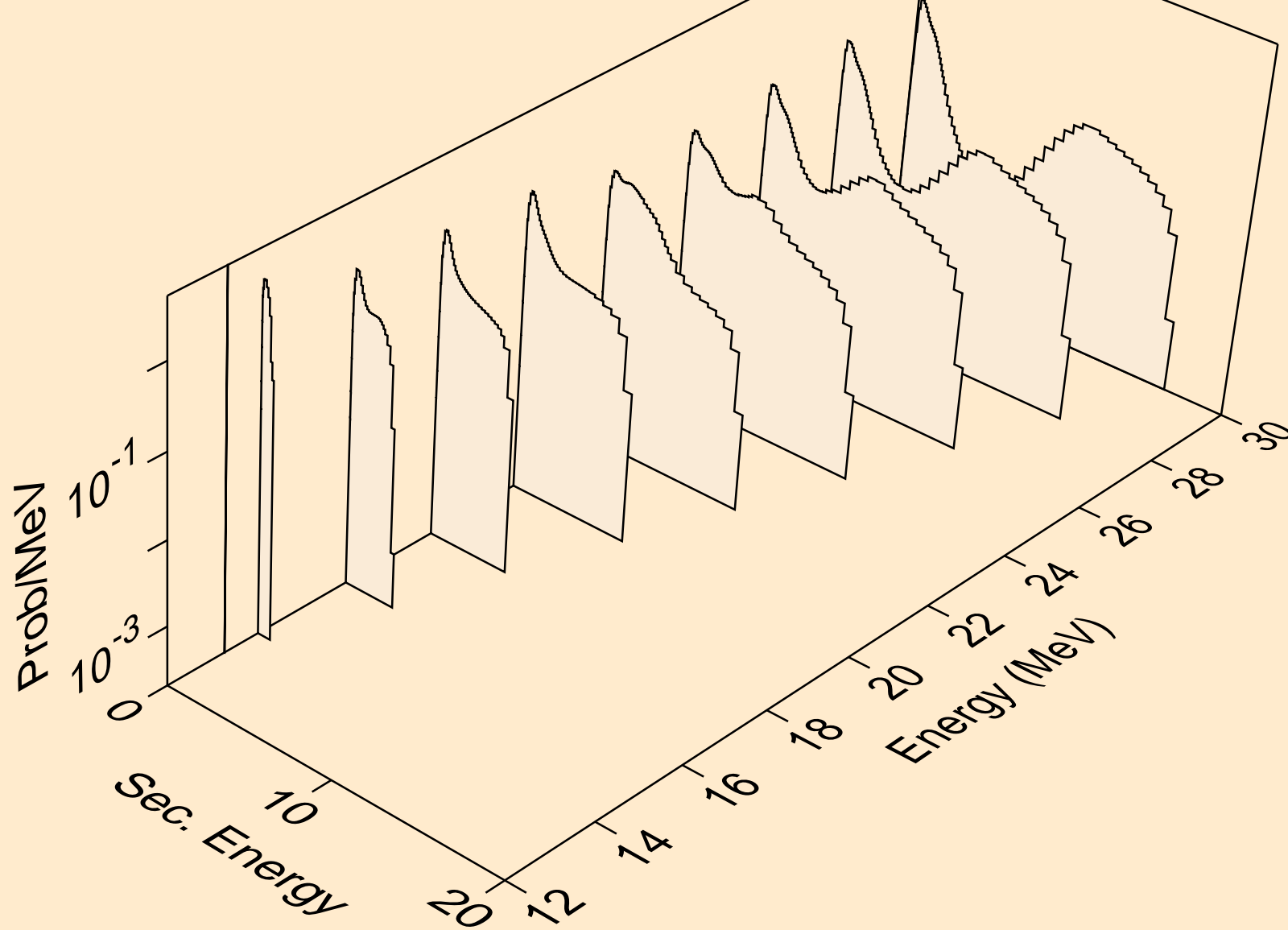



AC237 ALPHA ACER TENDL-2023 LIBRARY; T=0.K  
neutrons from (a,3n)

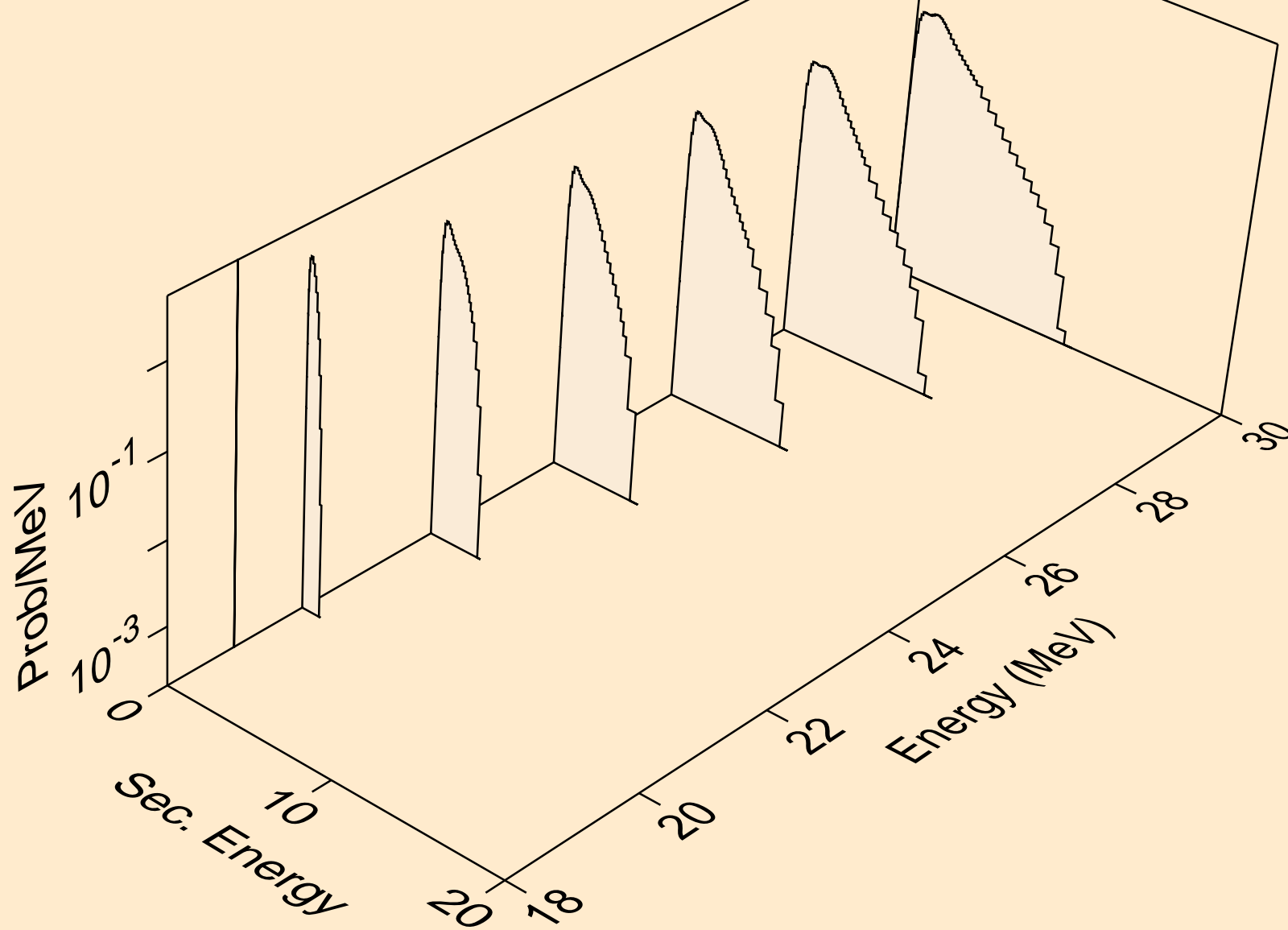

AC237 ALPHA ACER TENDL-2023 LIBRARY; T=0.K  
neutrons from (a,n\*)a

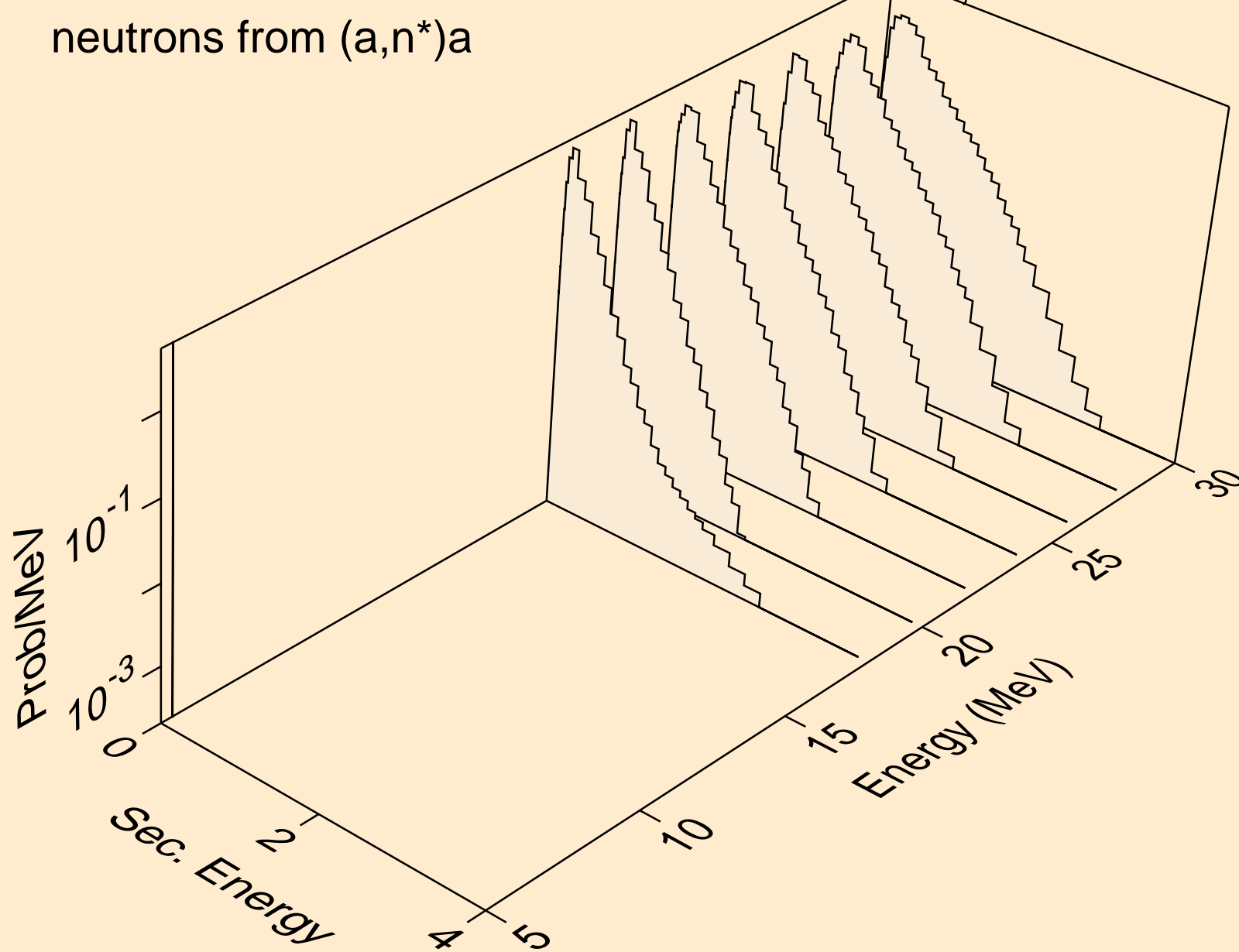

AC237 ALPHA ACER TENDL-2023 LIBRARY; T=0.K  
neutrons from (a,2n)a

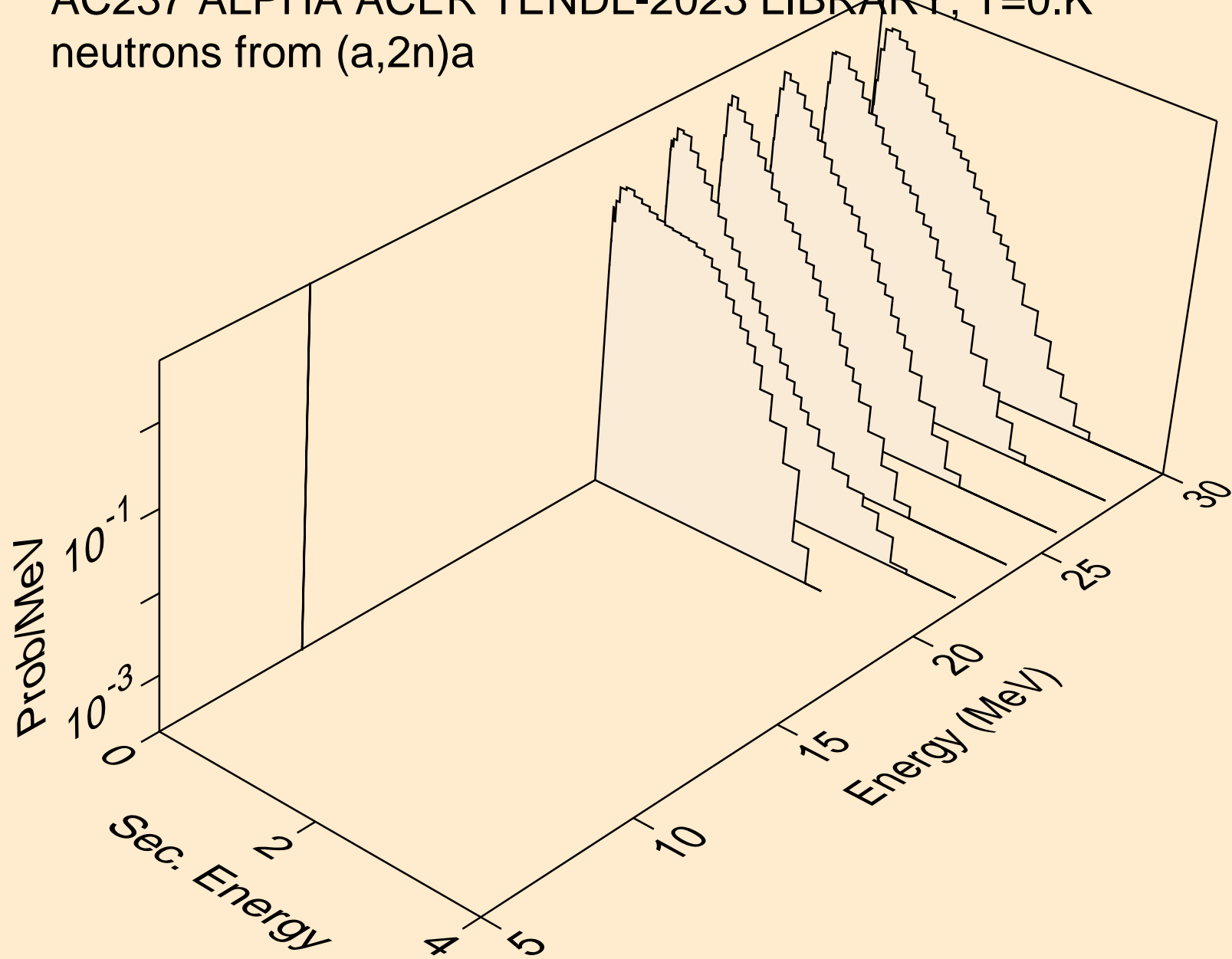

AC237 ALPHA ACER TENDL-2023 LIBRARY; T=0.K  
neutrons from (a,n\*)p

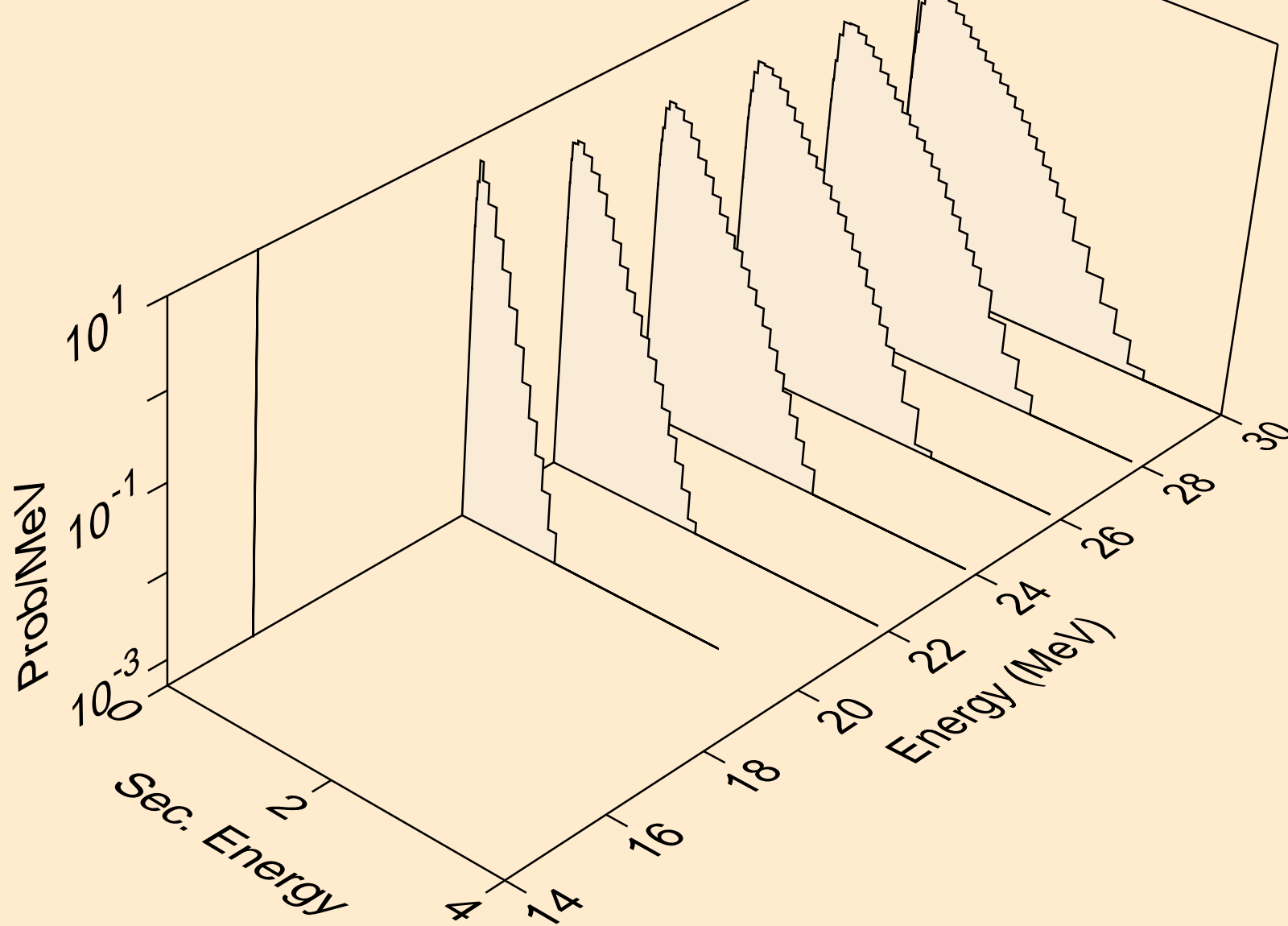

AC237 ALPHA ACER TENDL-2023 LIBRARY; T=0.K  
neutrons from (a,n\*)d

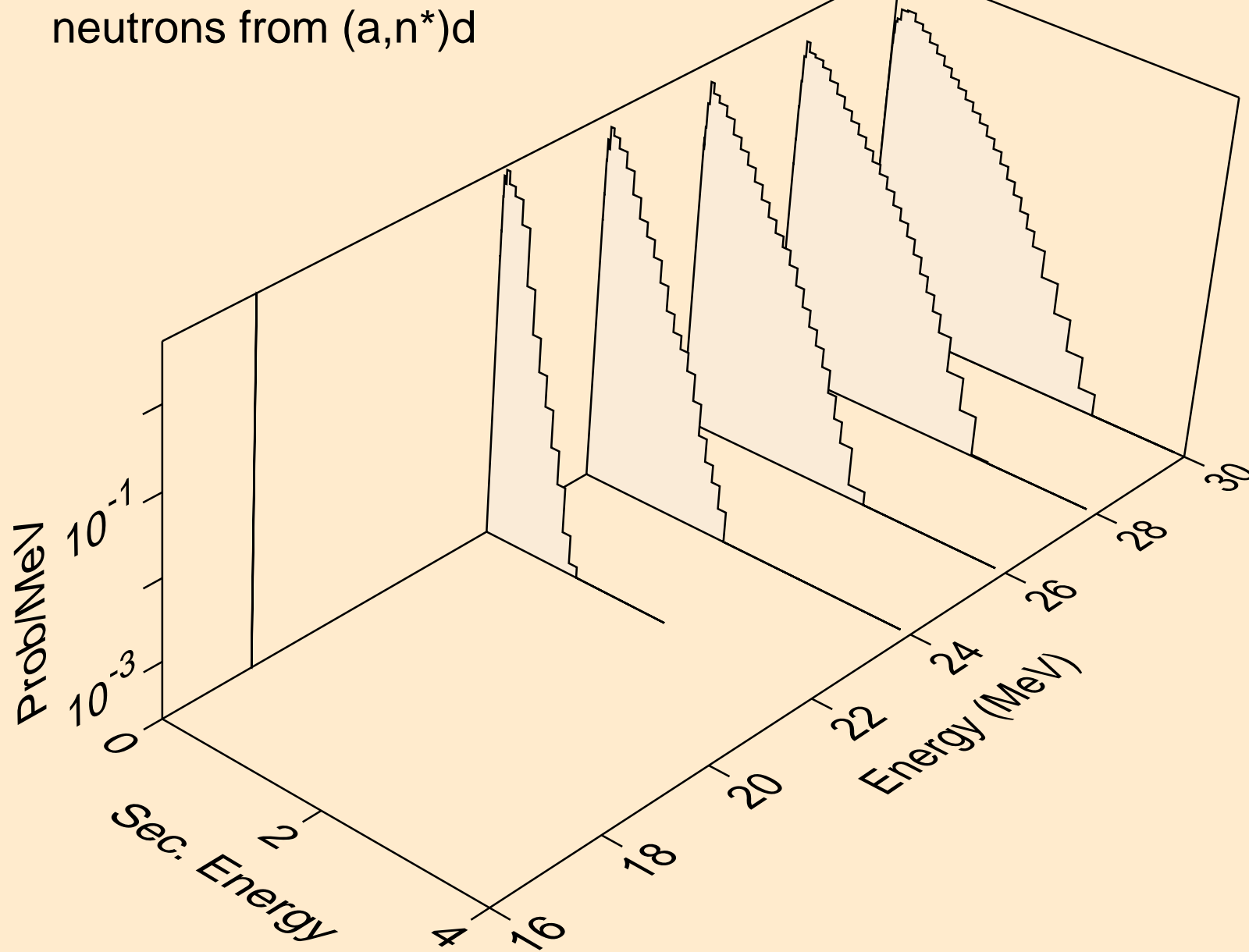

AC237 ALPHA ACER TENDL-2023 LIBRARY; T=0.K  
neutrons from (a,n\*)t

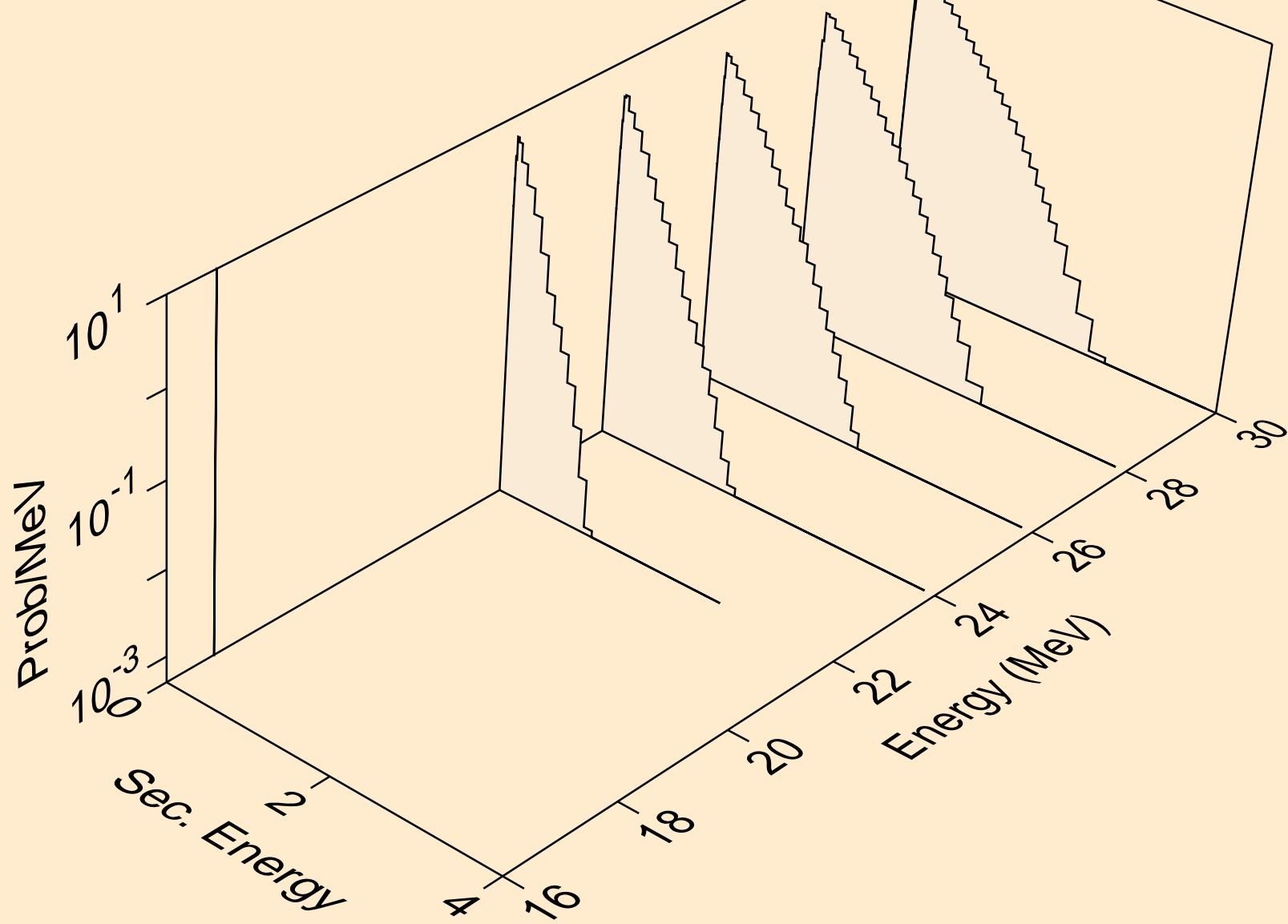

AC237 ALPHA ACER TENDL-2023 LIBRARY; T=0.K  
neutrons from (a,4n)

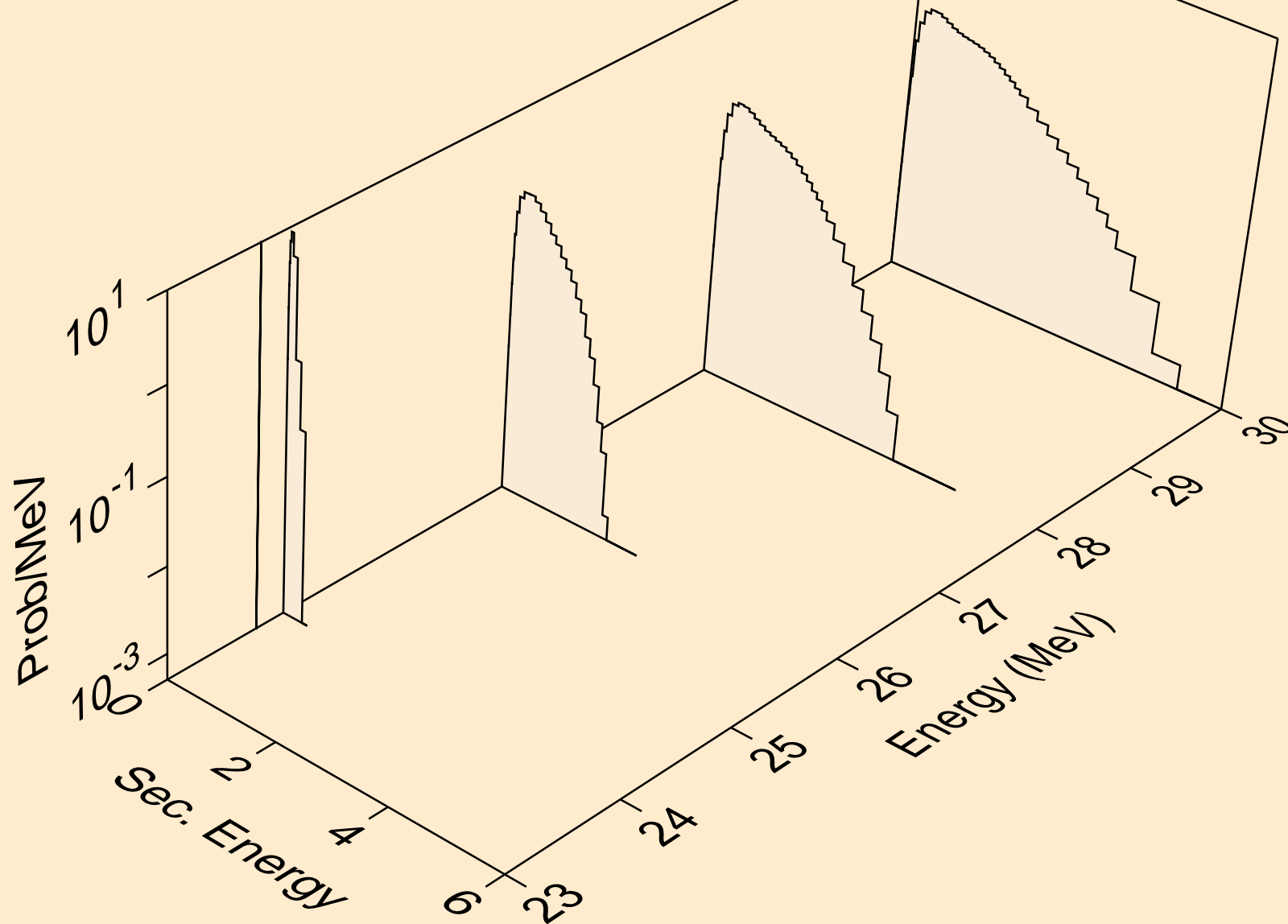

AC237 ALPHA ACER TENDL-2023 LIBRARY; T=0.K  
neutrons from (a,2np)

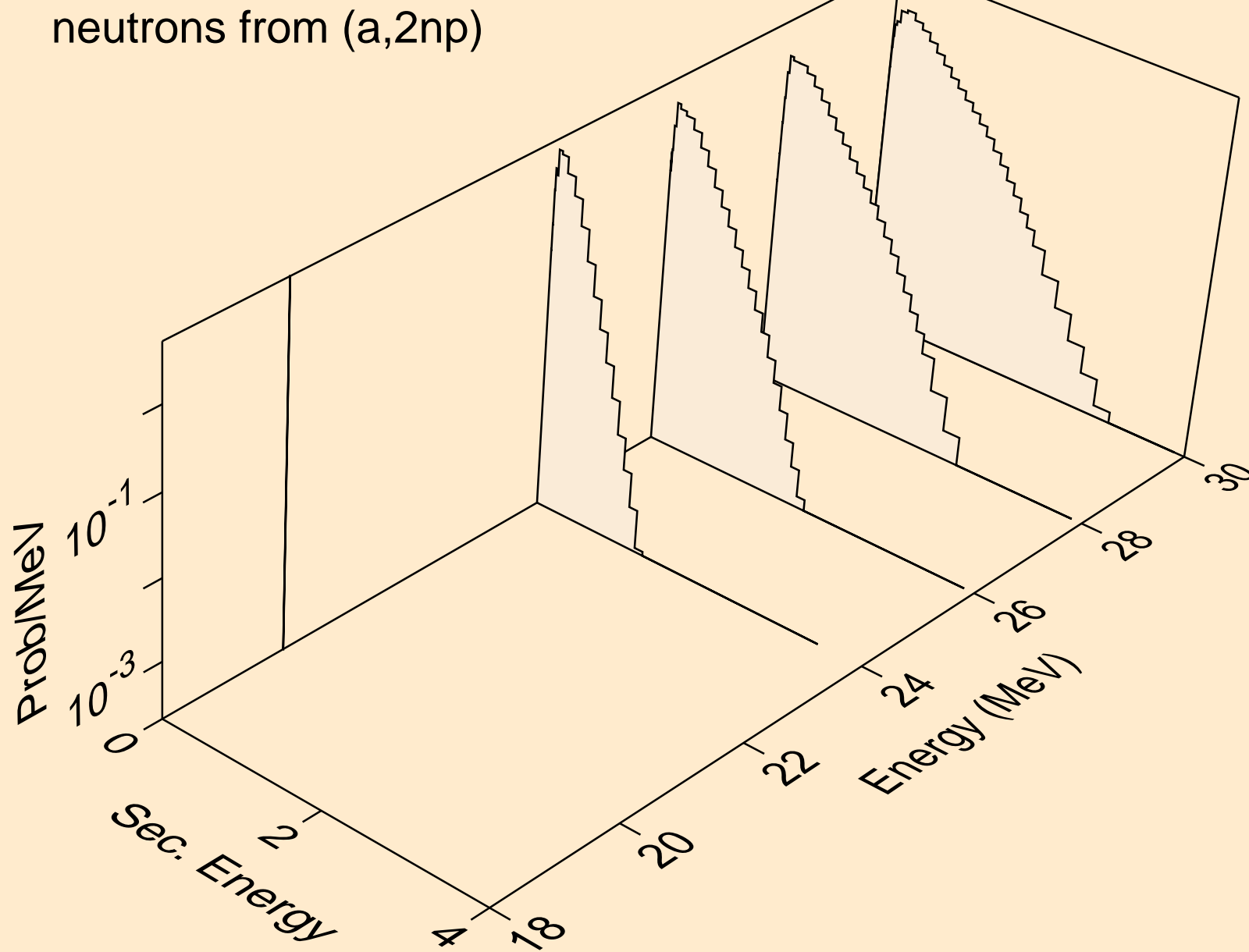



AC237 ALPHA ACER TENDL-2023 LIBRARY; T=0.K  
protons from (a,x)

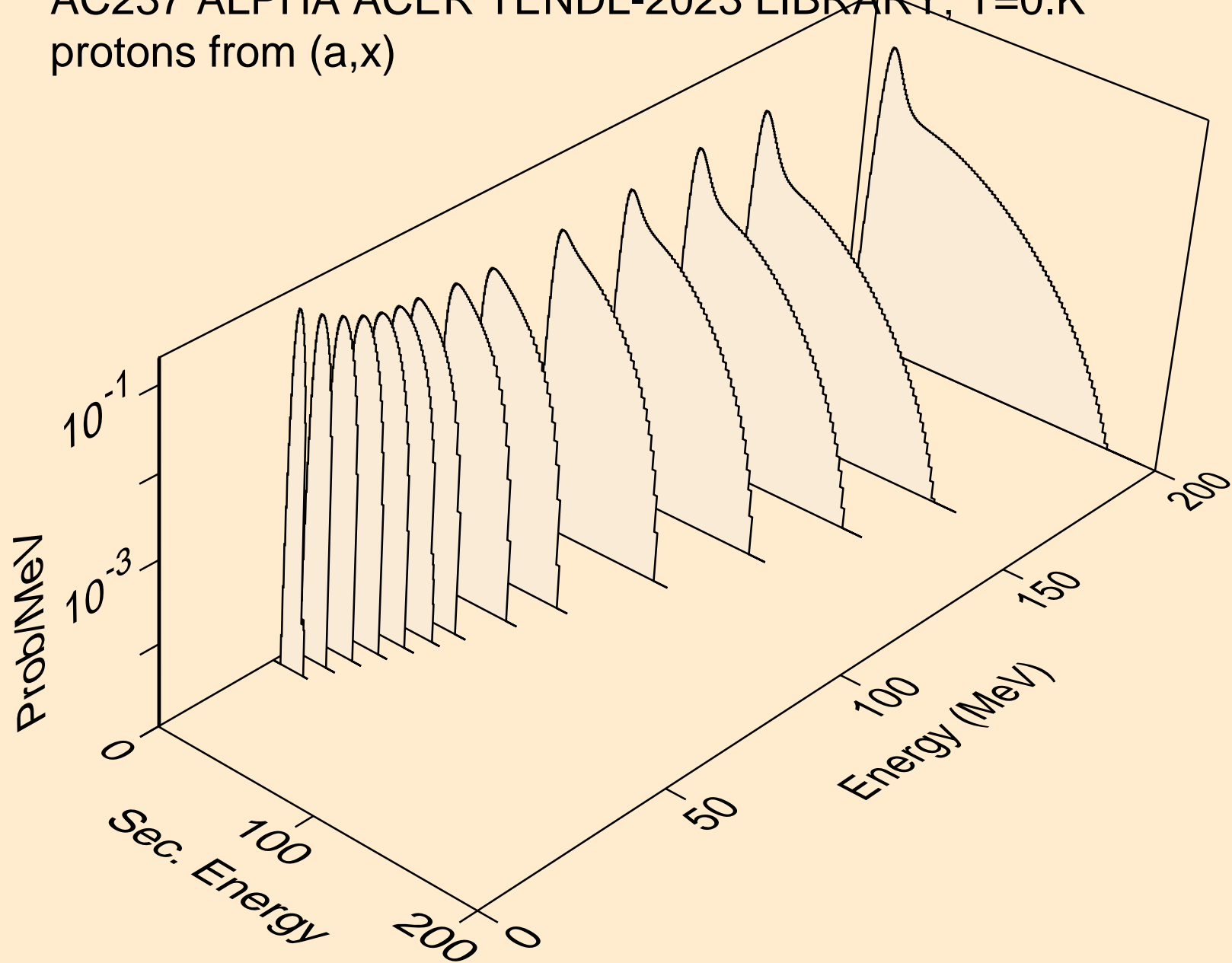

AC237 ALPHA ACER TENDL-2023 LIBRARY; T=0.K  
protons from (a,n\*)p

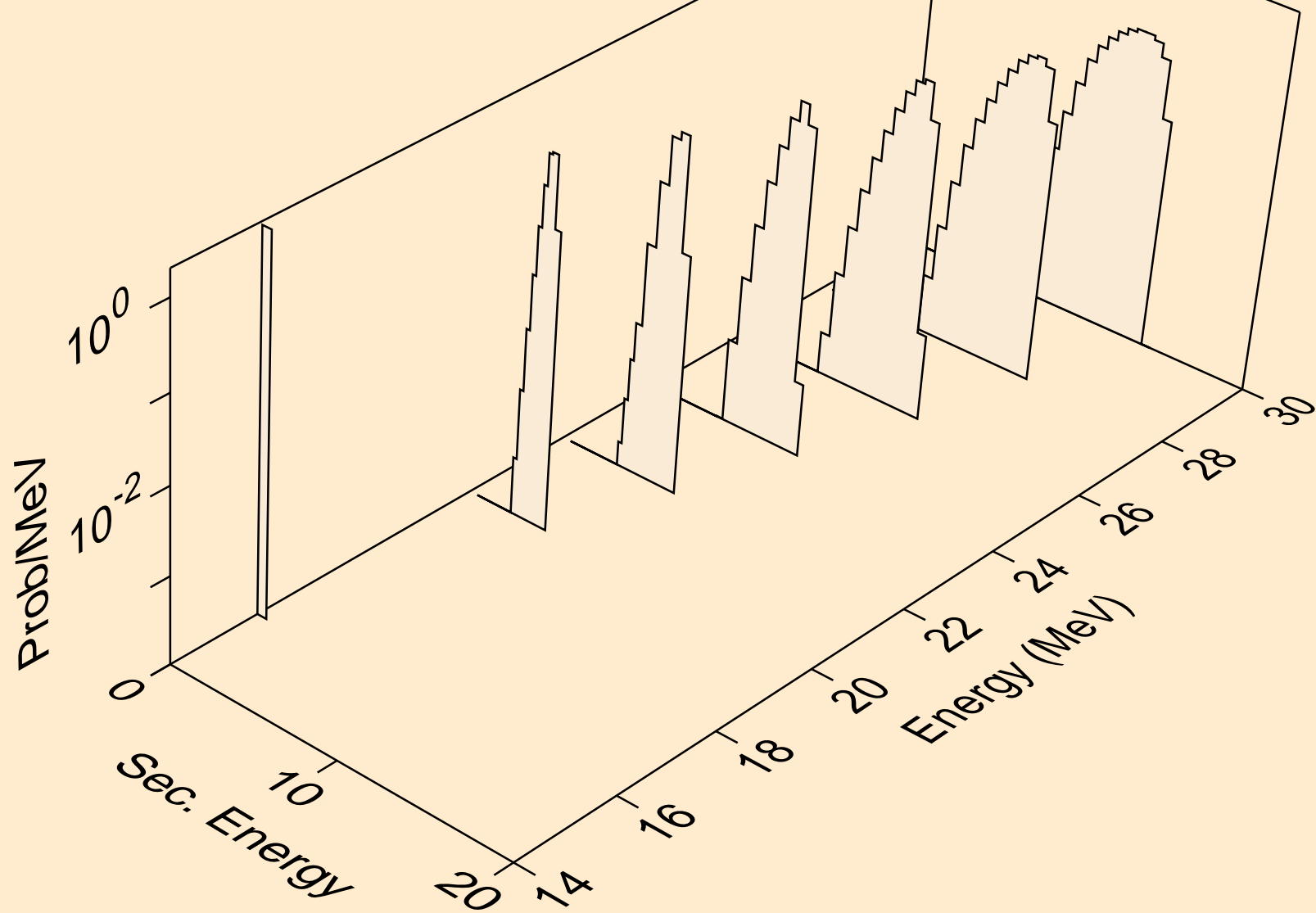

AC237 ALPHA ACER TENDL-2023 LIBRARY; T=0.K  
protons from (a,2np)

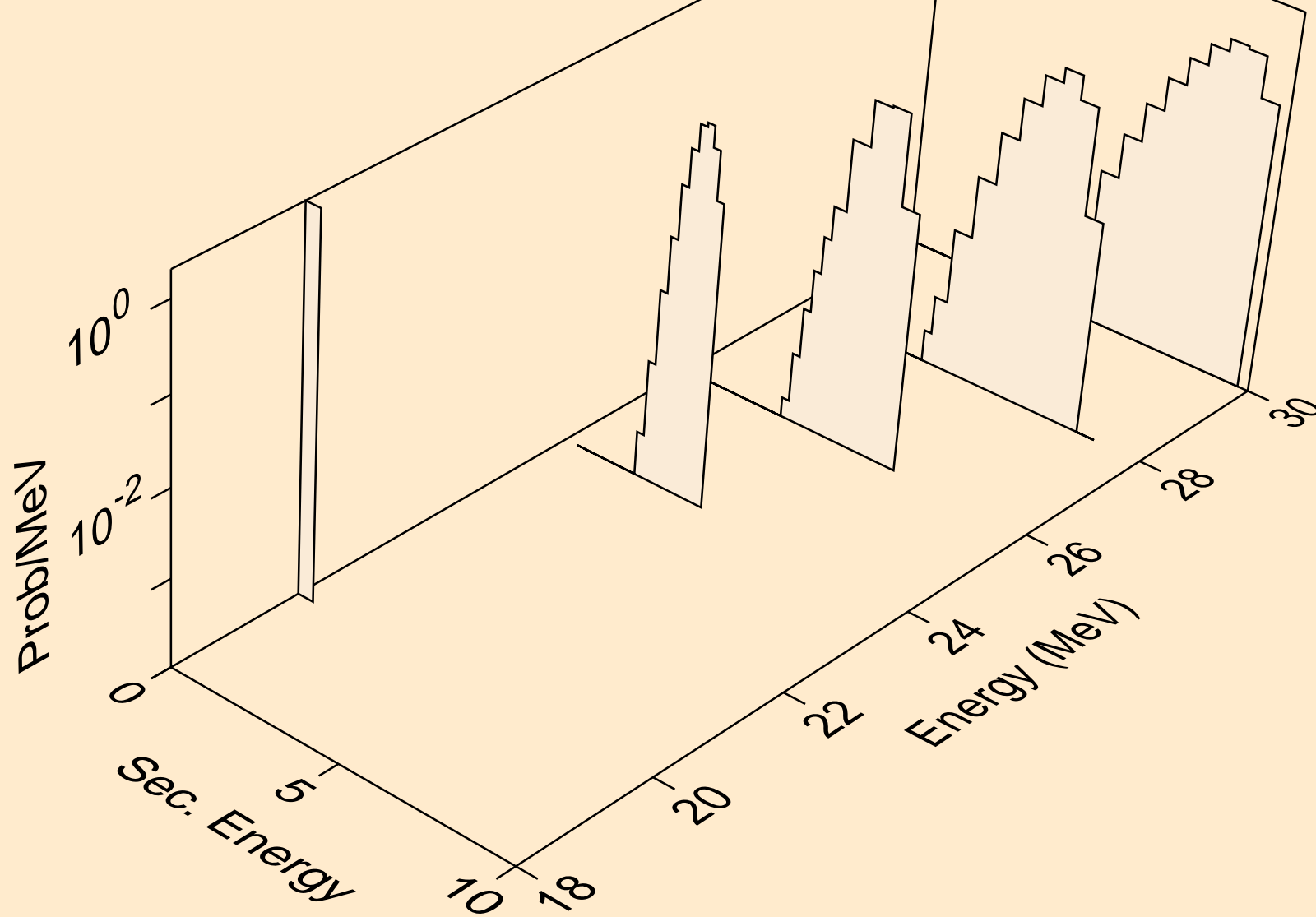

AC237 ALPHA ACER TENDL-2023 LIBRARY; T=0.K  
protons from (a,p)

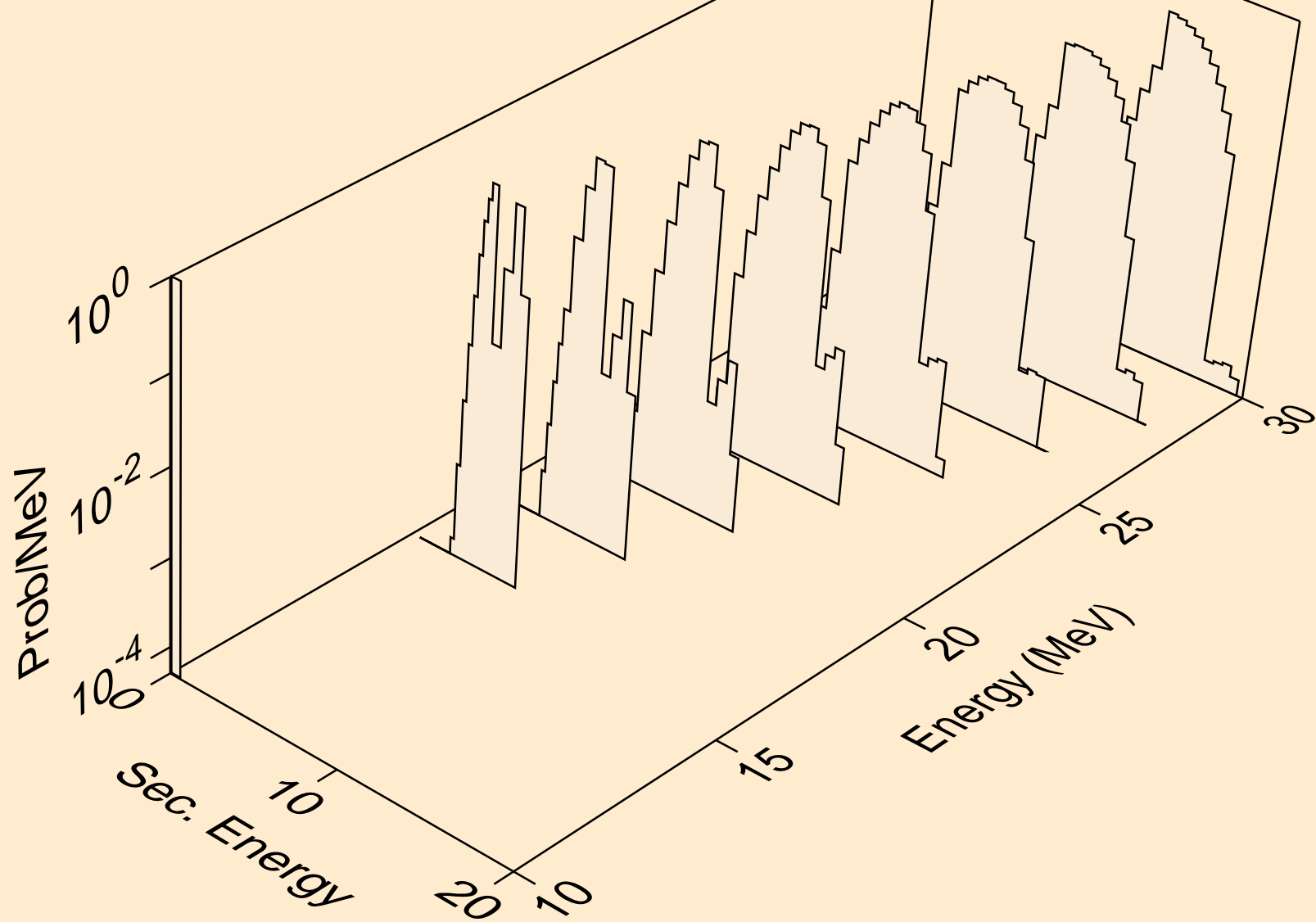

AC237 ALPHA ACER TENDL-2023 LIBRARY; T=0.K  
deuterons from (a,x)

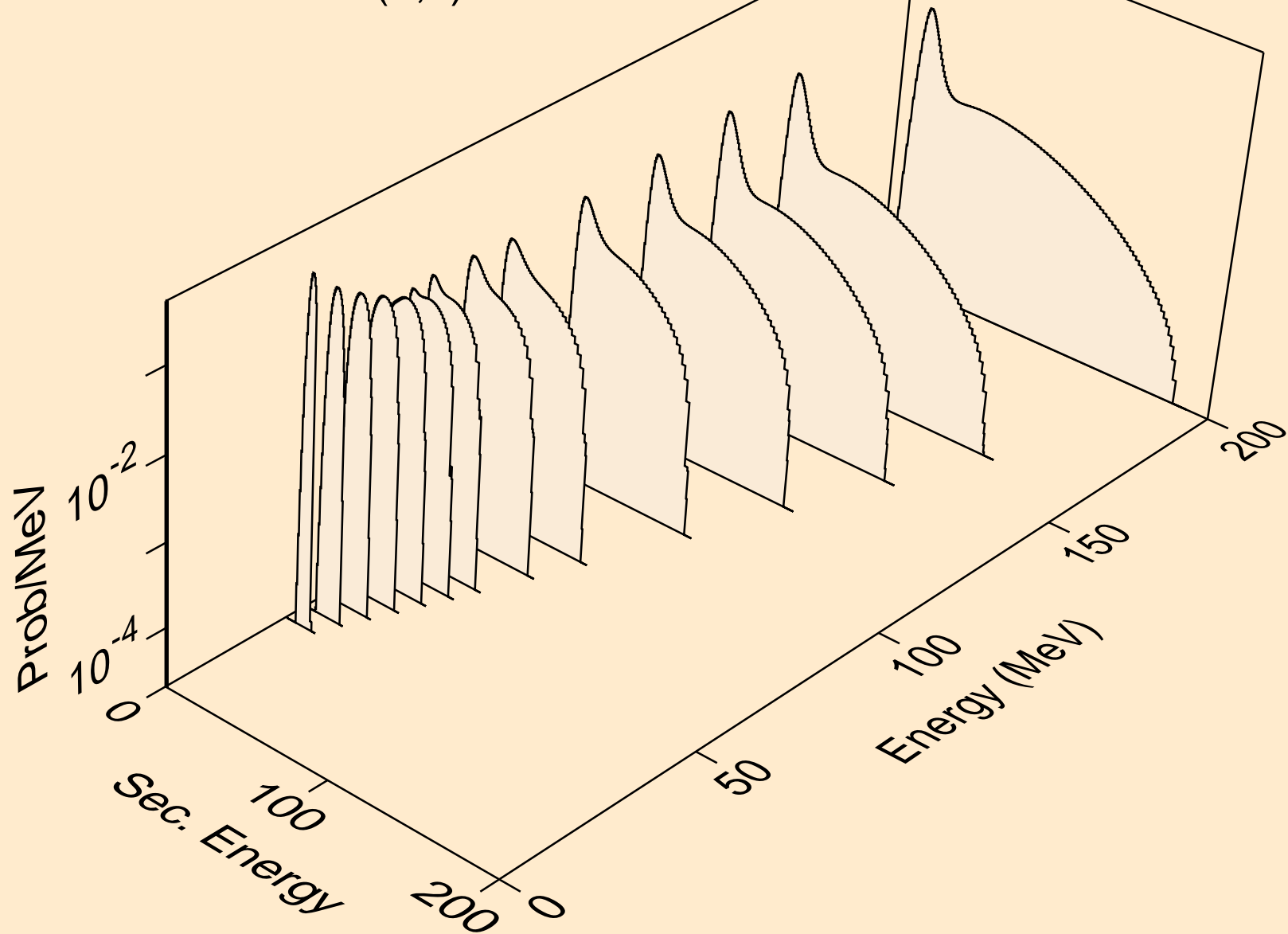

AC237 ALPHA ACER TENDL-2023 LIBRARY; T=0.K  
deuterons from (a,2nd)

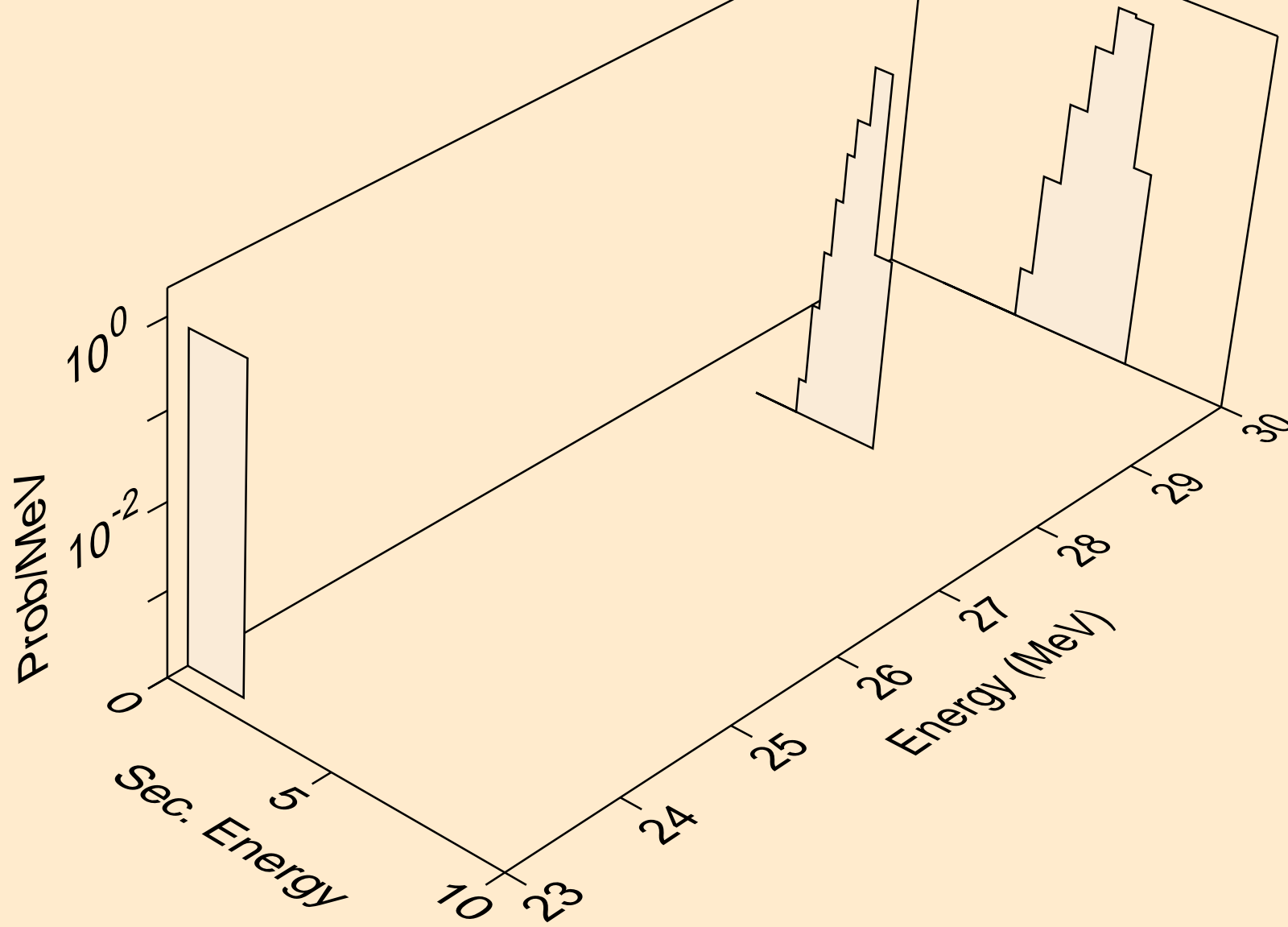

AC237 ALPHA ACER TENDL-2023 LIBRARY; T=0.K  
deuterons from (a,n\*)d

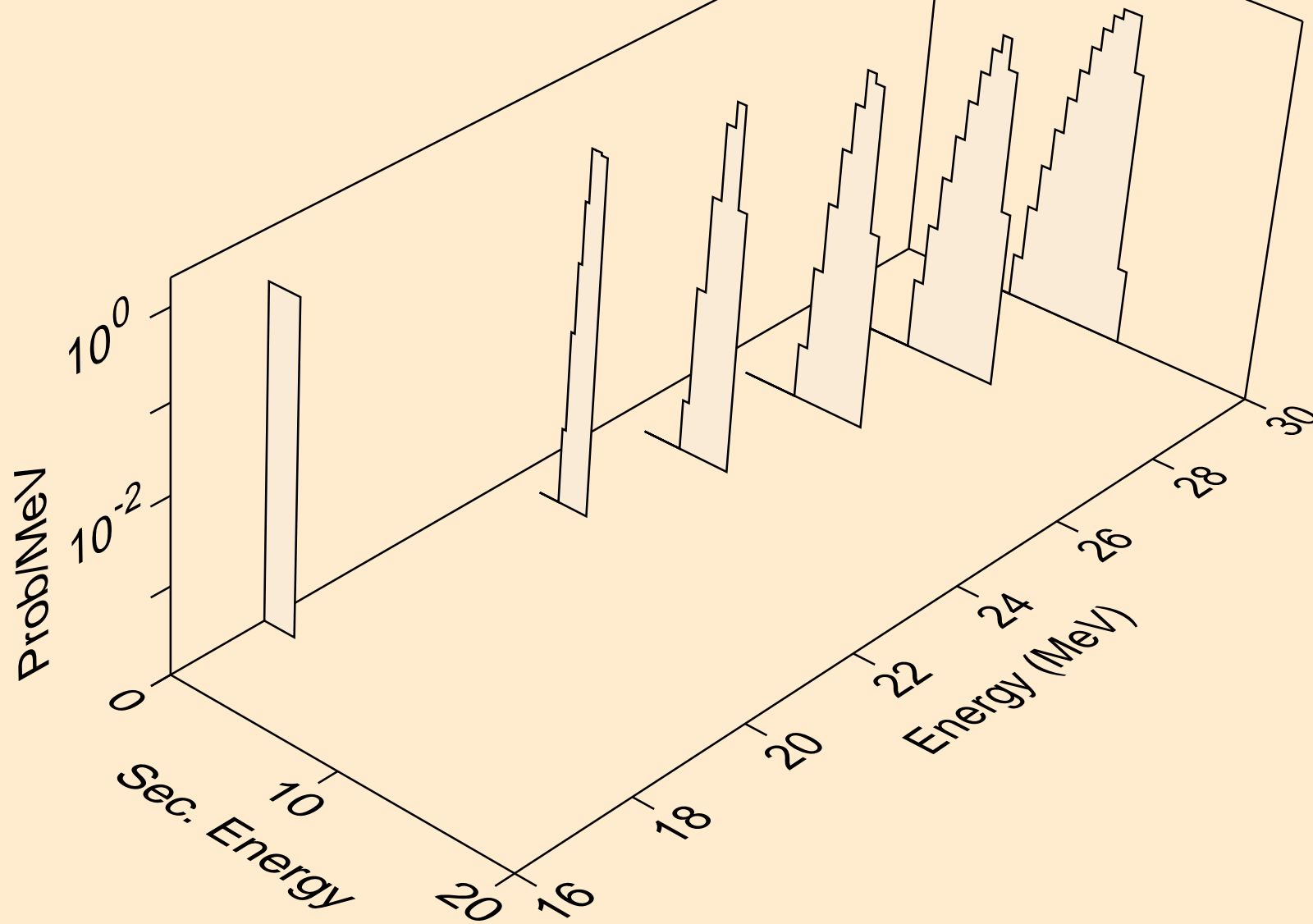

AC237 ALPHA ACER TENDL-2023 LIBRARY; T=0.K  
deuterons from (a,d)

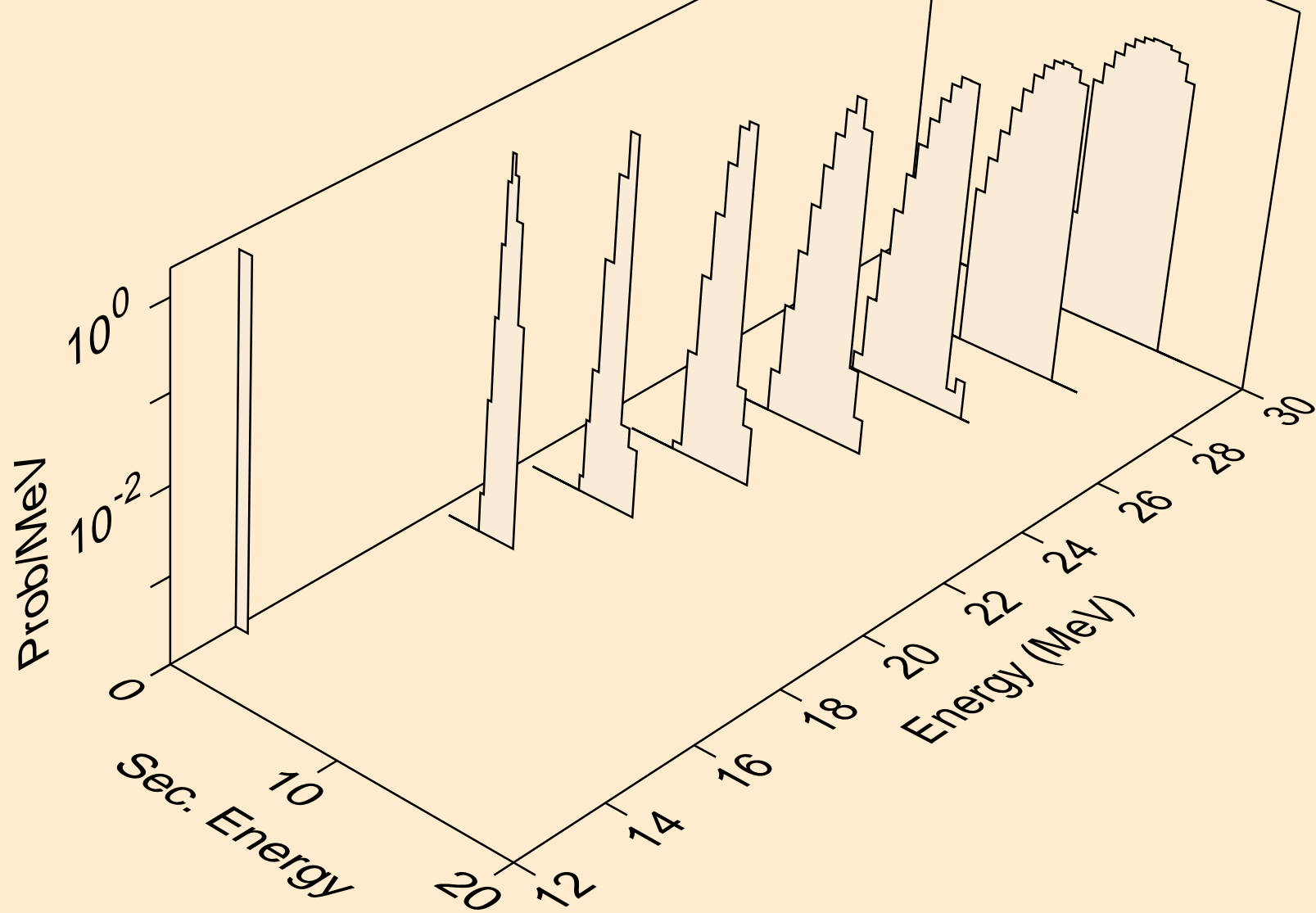



AC237 ALPHA ACER TENDL-2023 LIBRARY; T=0.K  
tritons from (a,x)

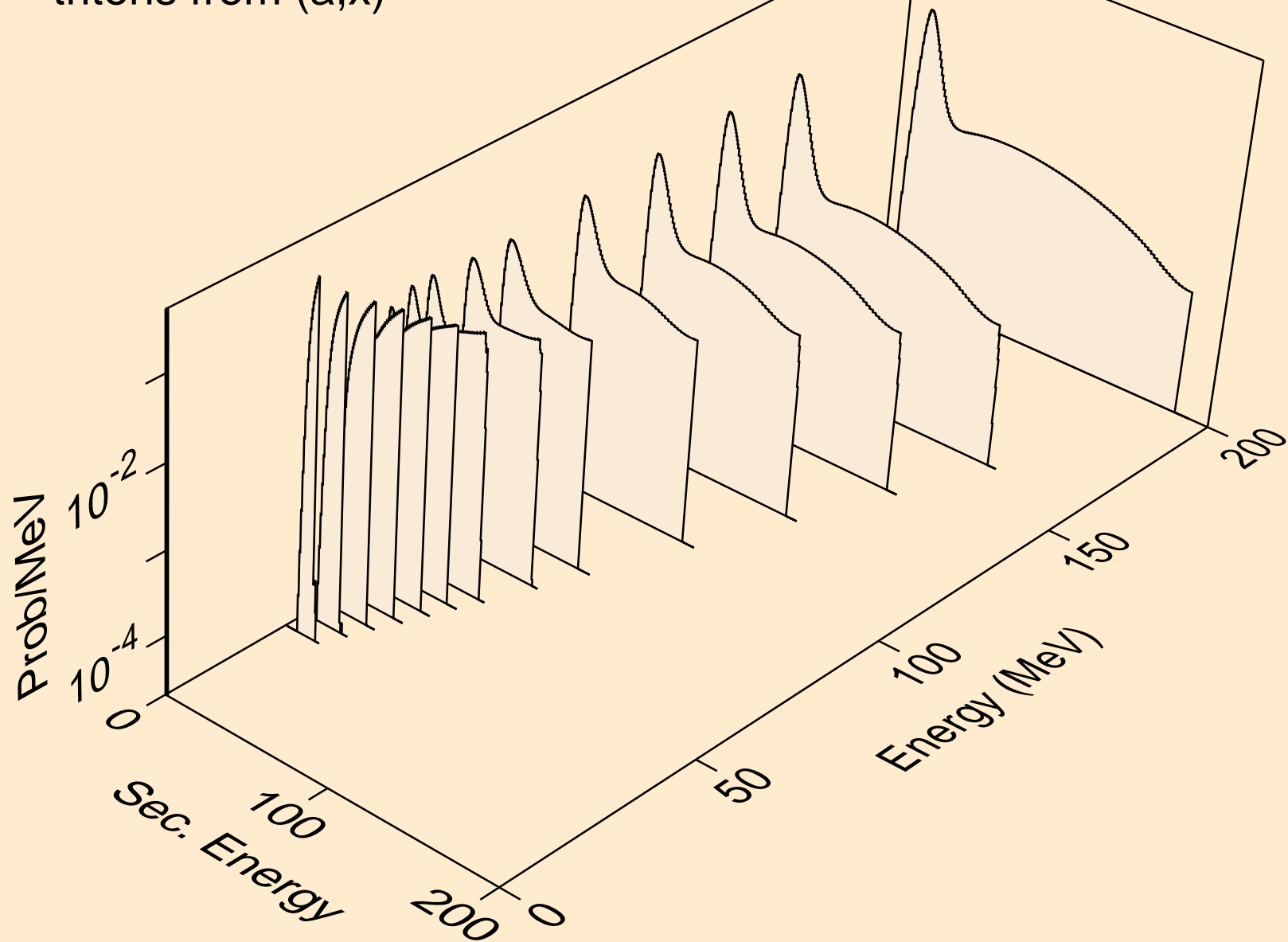

AC237 ALPHA ACER TENDL-2023 LIBRARY; T=0.K  
tritons from (a,n\*)t

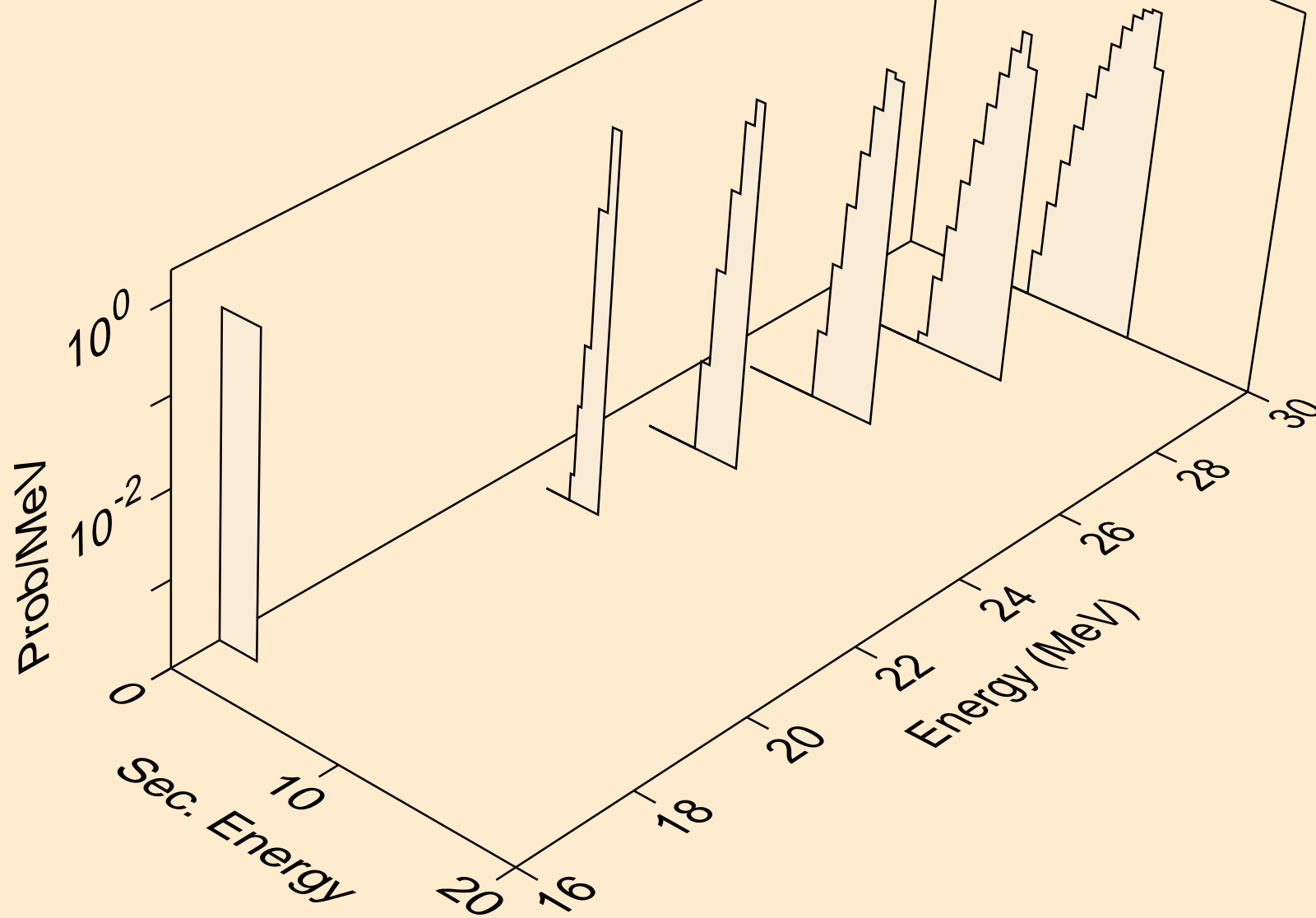

AC237 ALPHA ACER TENDL-2023 LIBRARY; T=0.K  
tritons from (a,t)

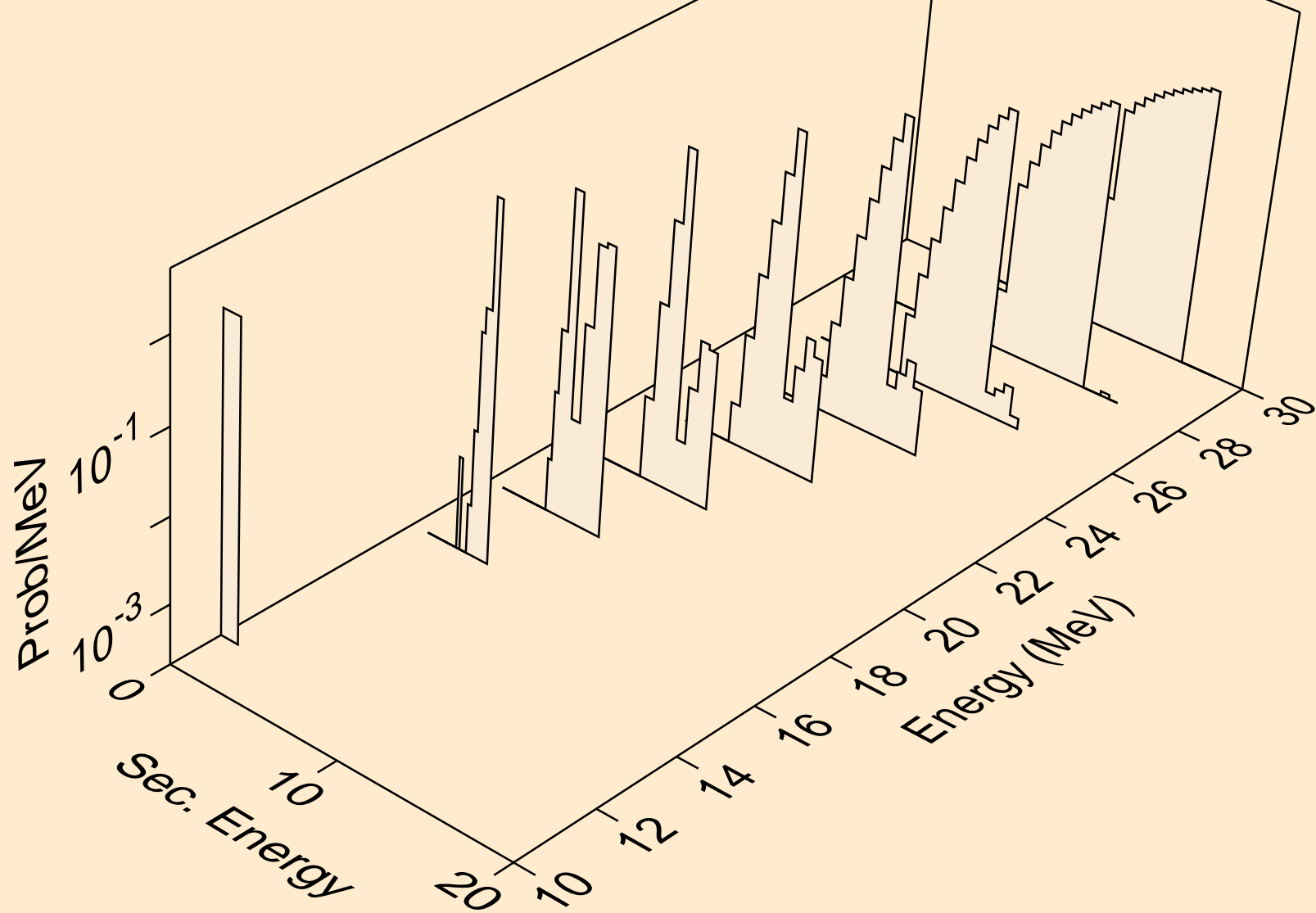

AC237 ALPHA ACER TENDL-2023 LIBRARY; T=0.K  
he3s from (a,x)

