

AU196 ALPHA ACER TENDL-2023 LIBRARY; T=0.K
Principal cross sections

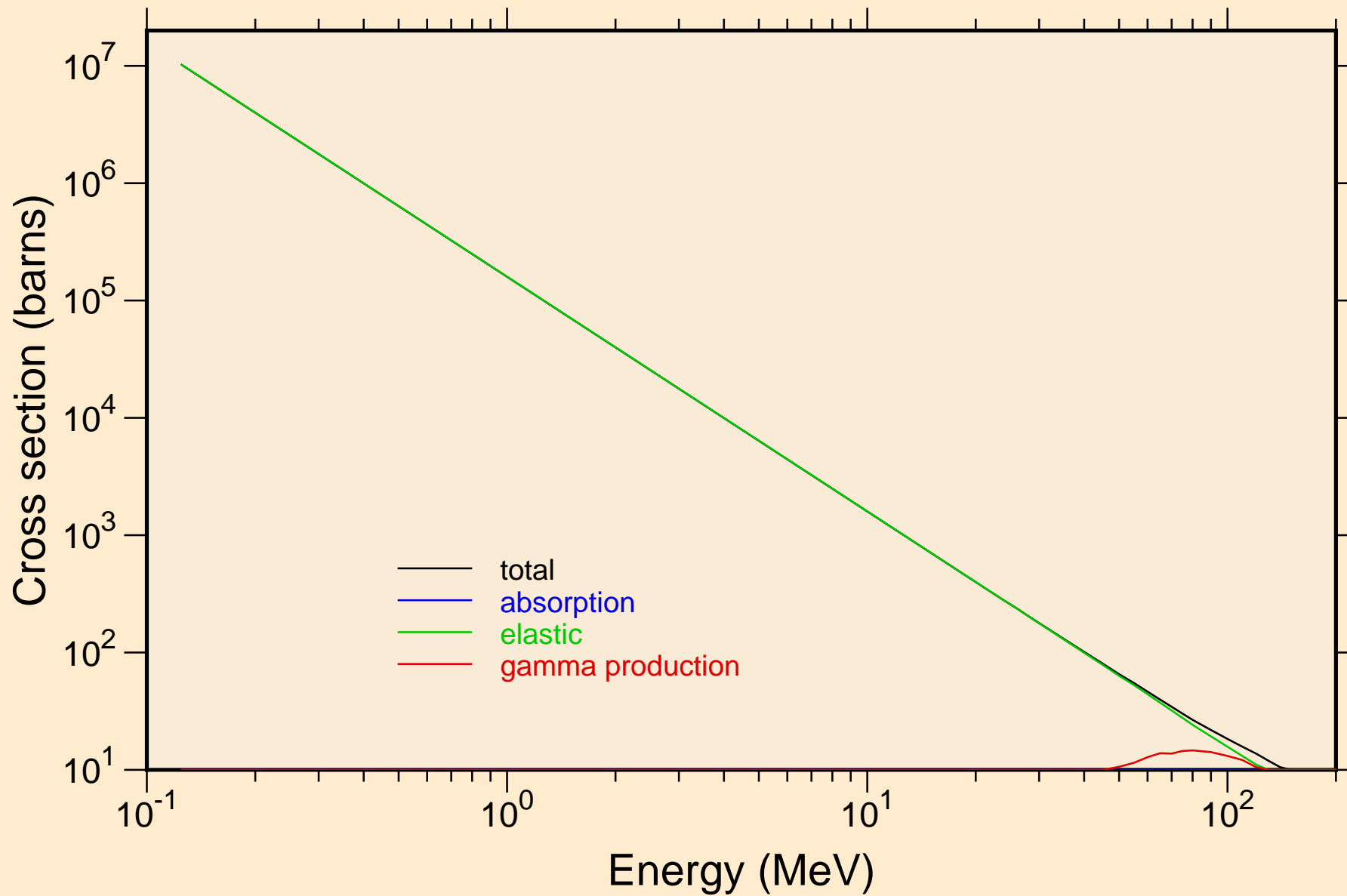

AU196 ALPHA ACER TENDL-2023 LIBRARY; T=0.K
Heating

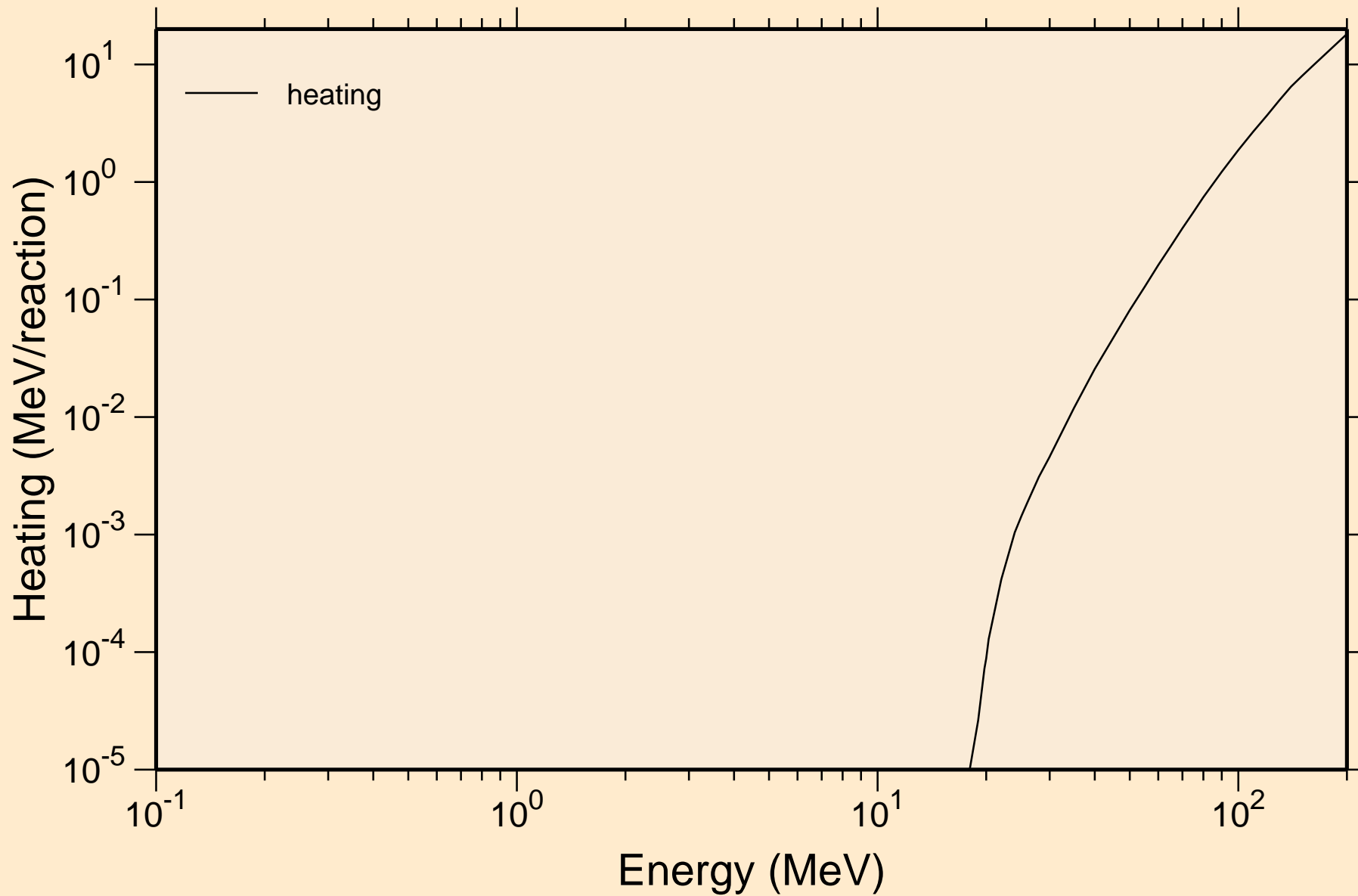

AU196 ALPHA ACER TENDL-2023 LIBRARY; T=0.K

Principal cross sections

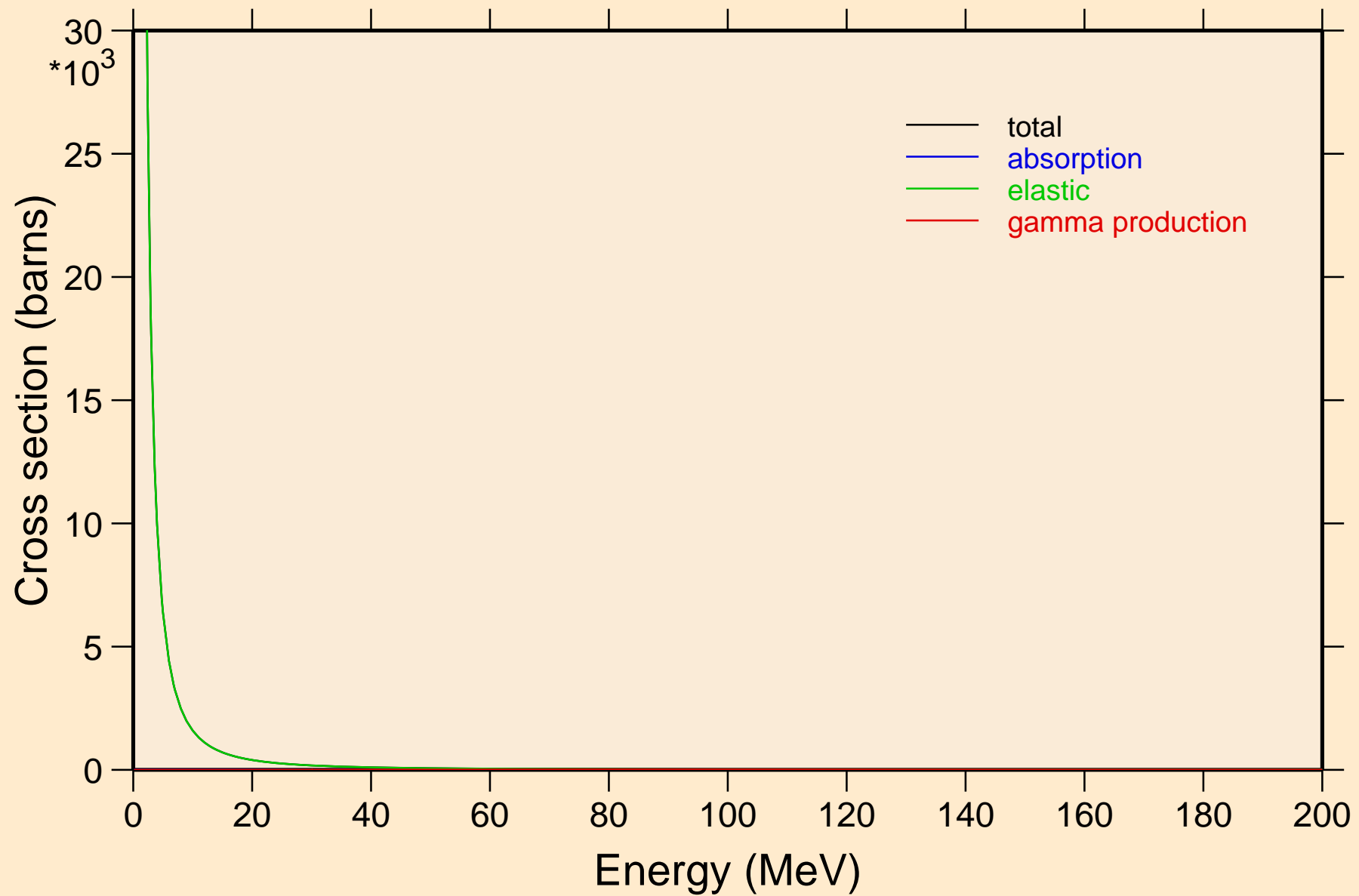

AU196 ALPHA ACER TENDL-2023 LIBRARY; T=0.K

Heating

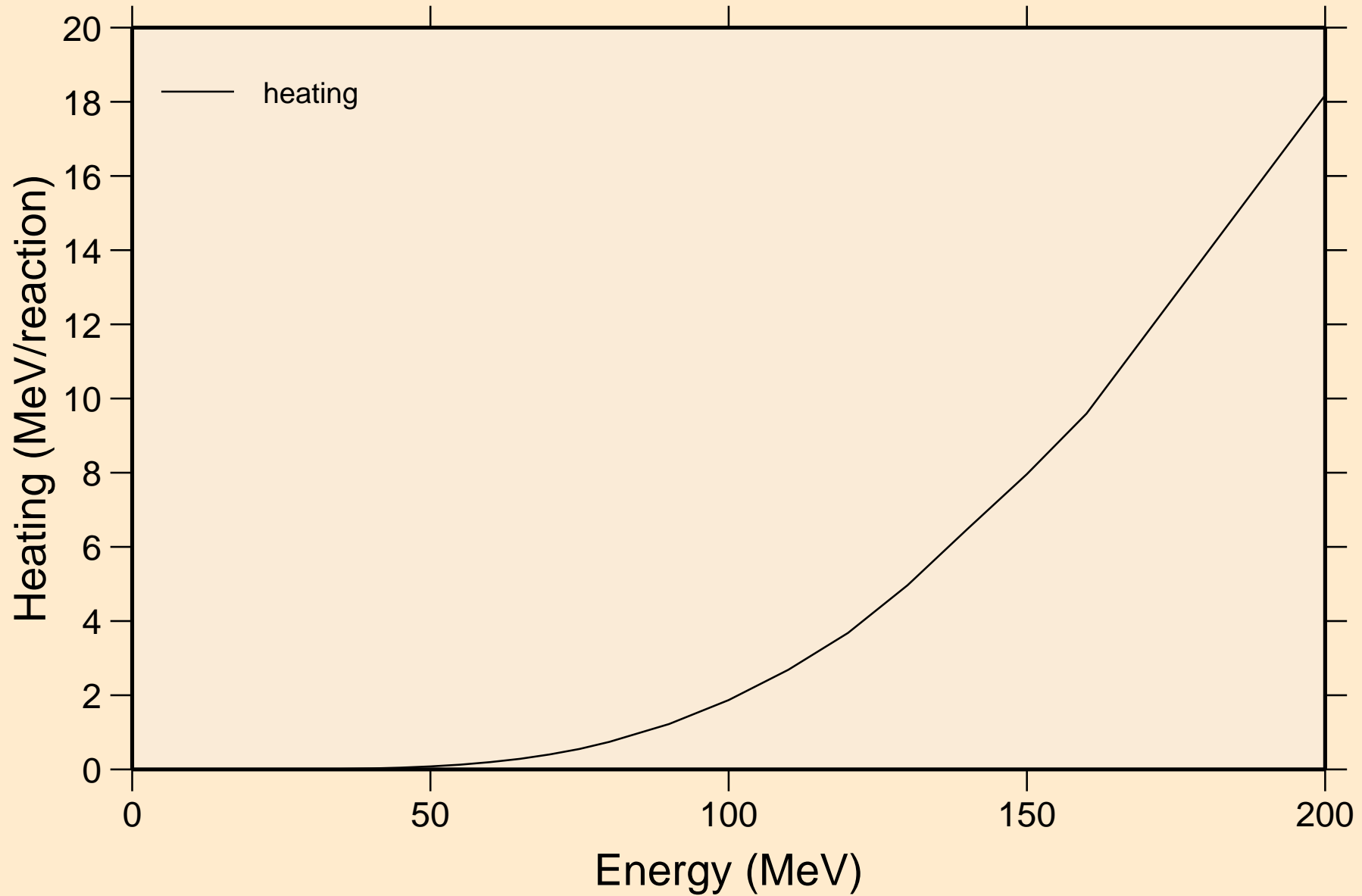

AU196 ALPHA ACER TENDL-2023 LIBRARY; T=0.K
Threshold reactions

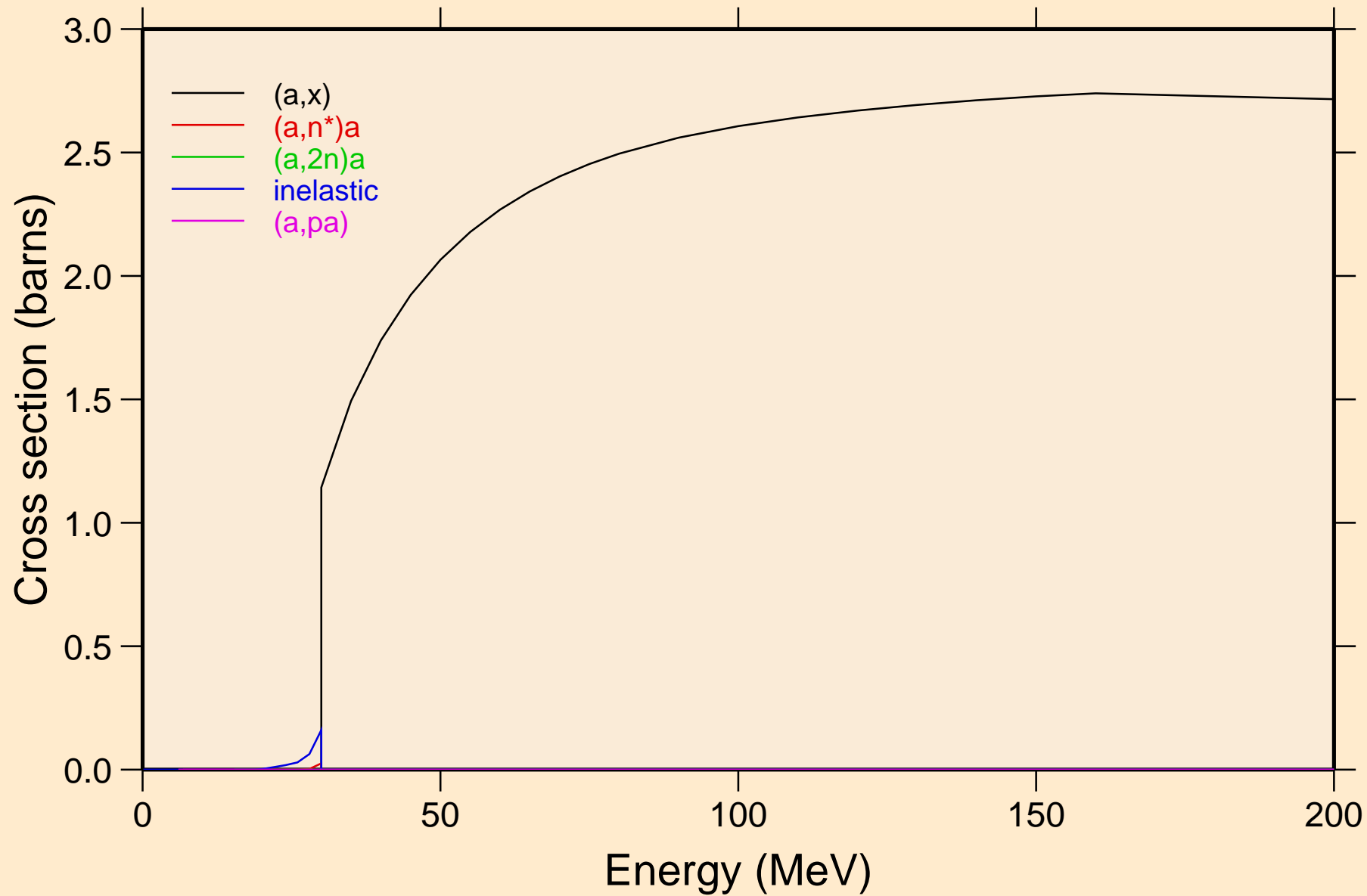

AU196 ALPHA ACER TENDL-2023 LIBRARY; T=0.K
angular distribution for elastic

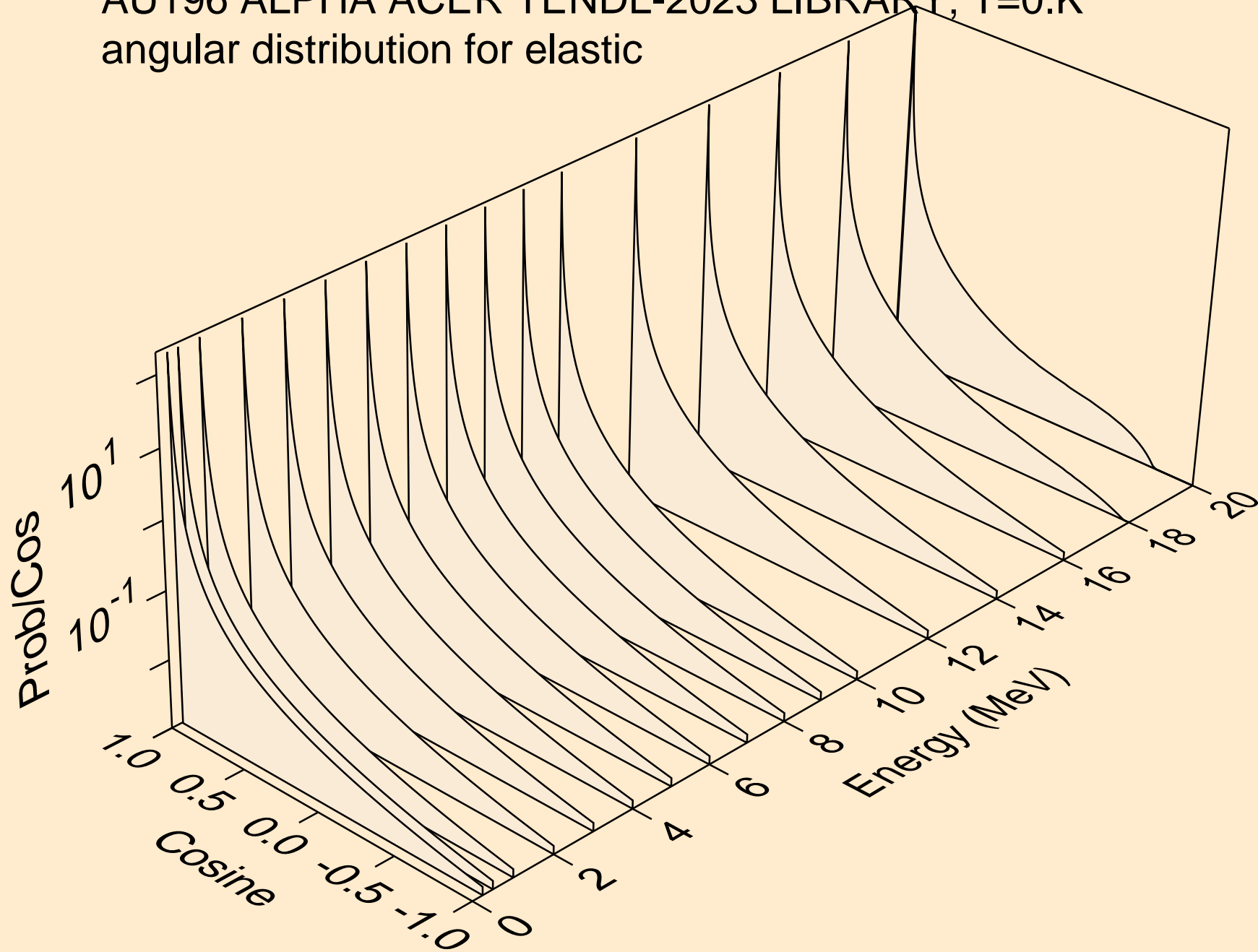

AU196 ALPHA ACER TENDL-2023 LIBRARY; T=0.K
angular distribution for elastic

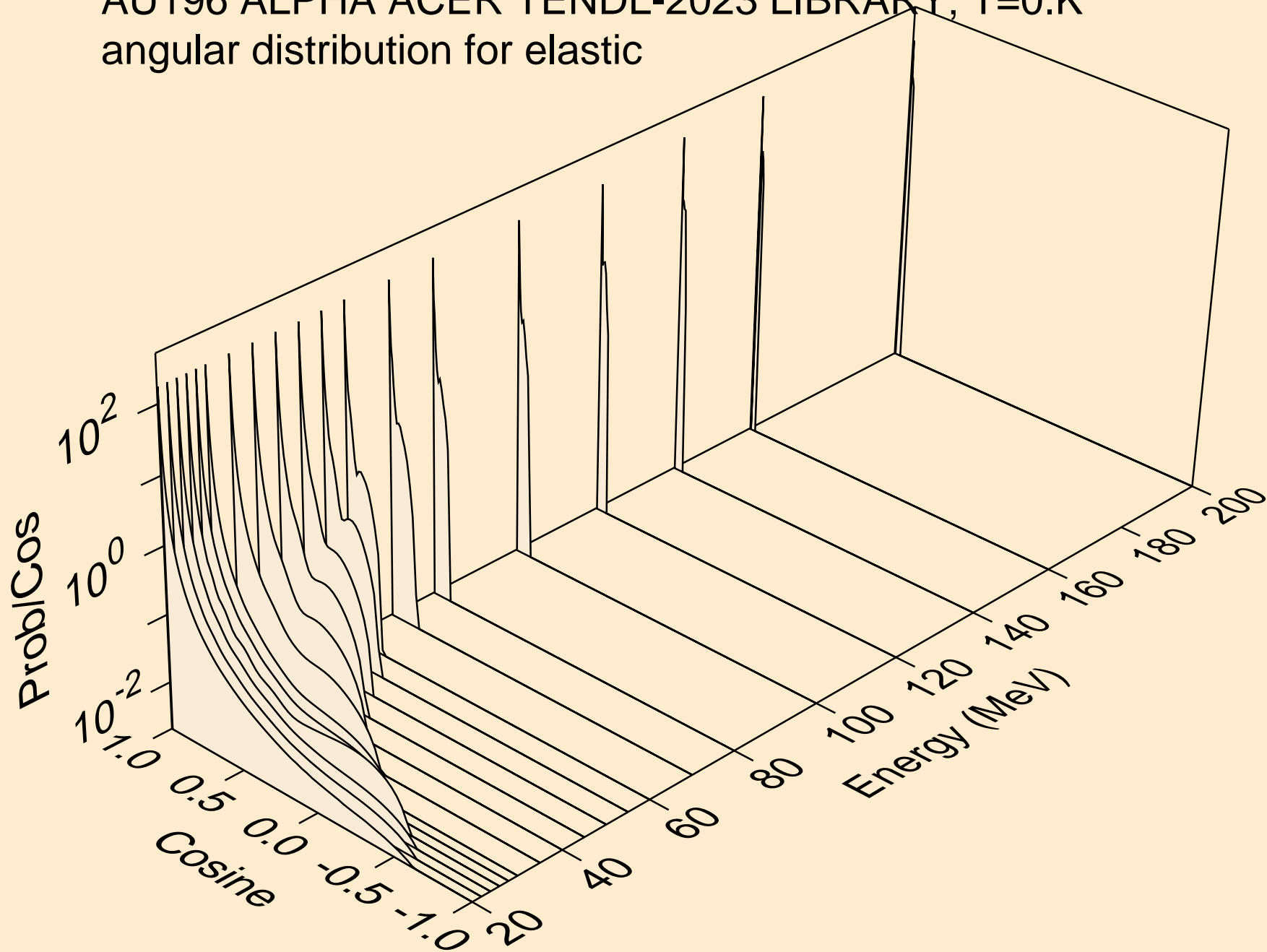

AU196 ALPHA ACER TENDL-2023 LIBRARY; T=0.K
Alpha emission for (a,x)

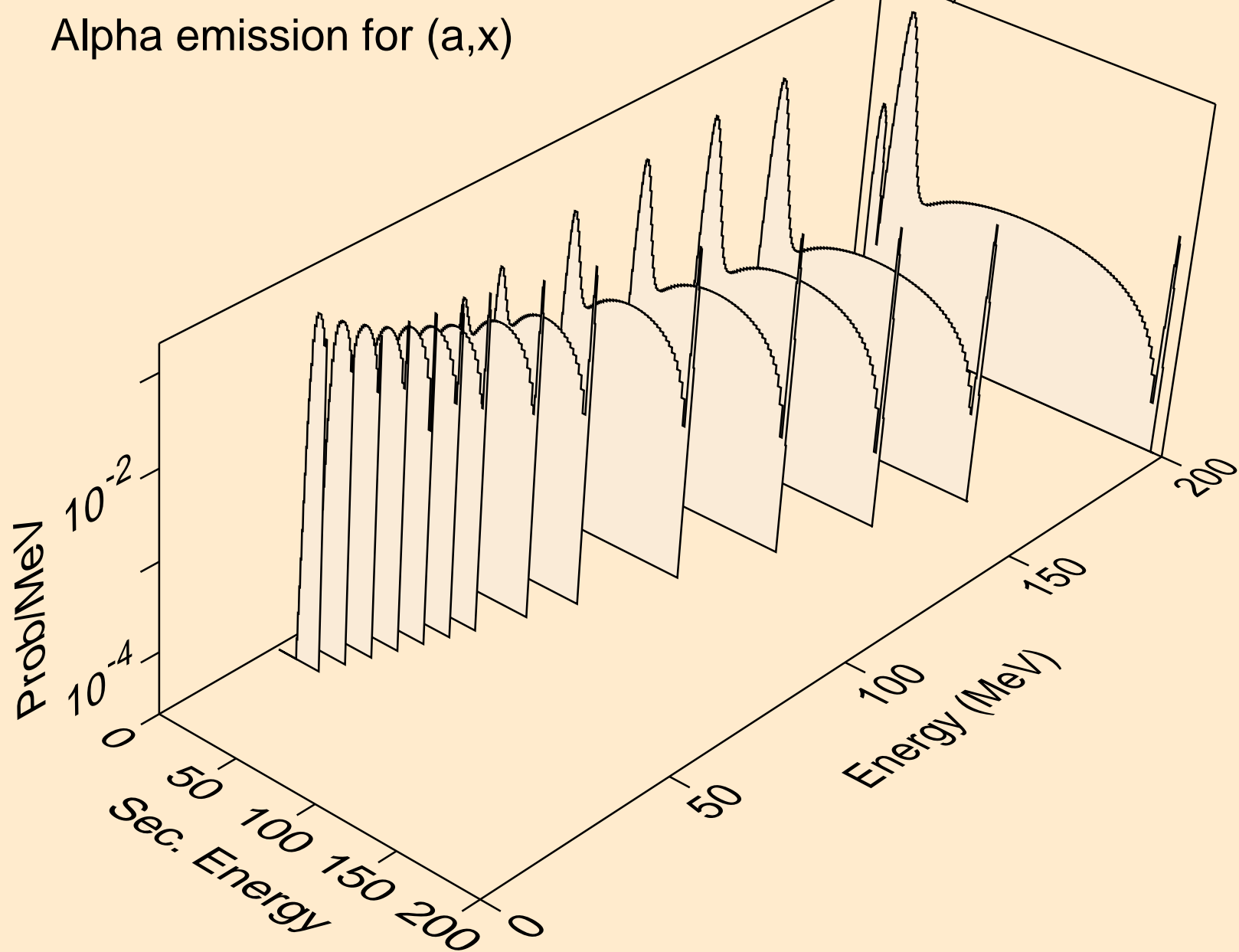

AU196 ALPHA ACER TENDL-2023 LIBRARY; T=0.K
Alpha emission for (a,n*)a

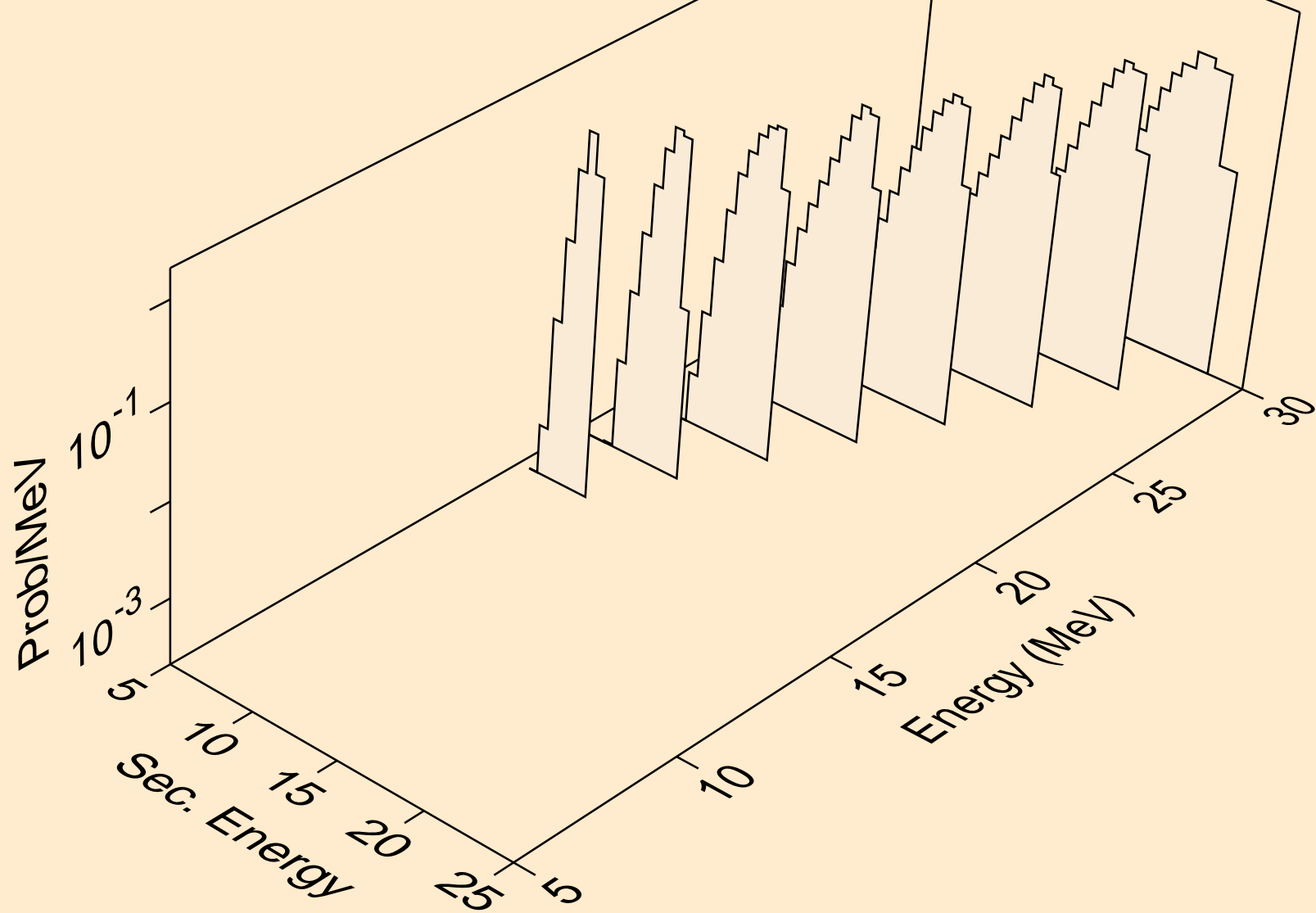

AU196 ALPHA ACER TENDL-2023 LIBRARY; T=0.K
Alpha emission for (a,2n)a

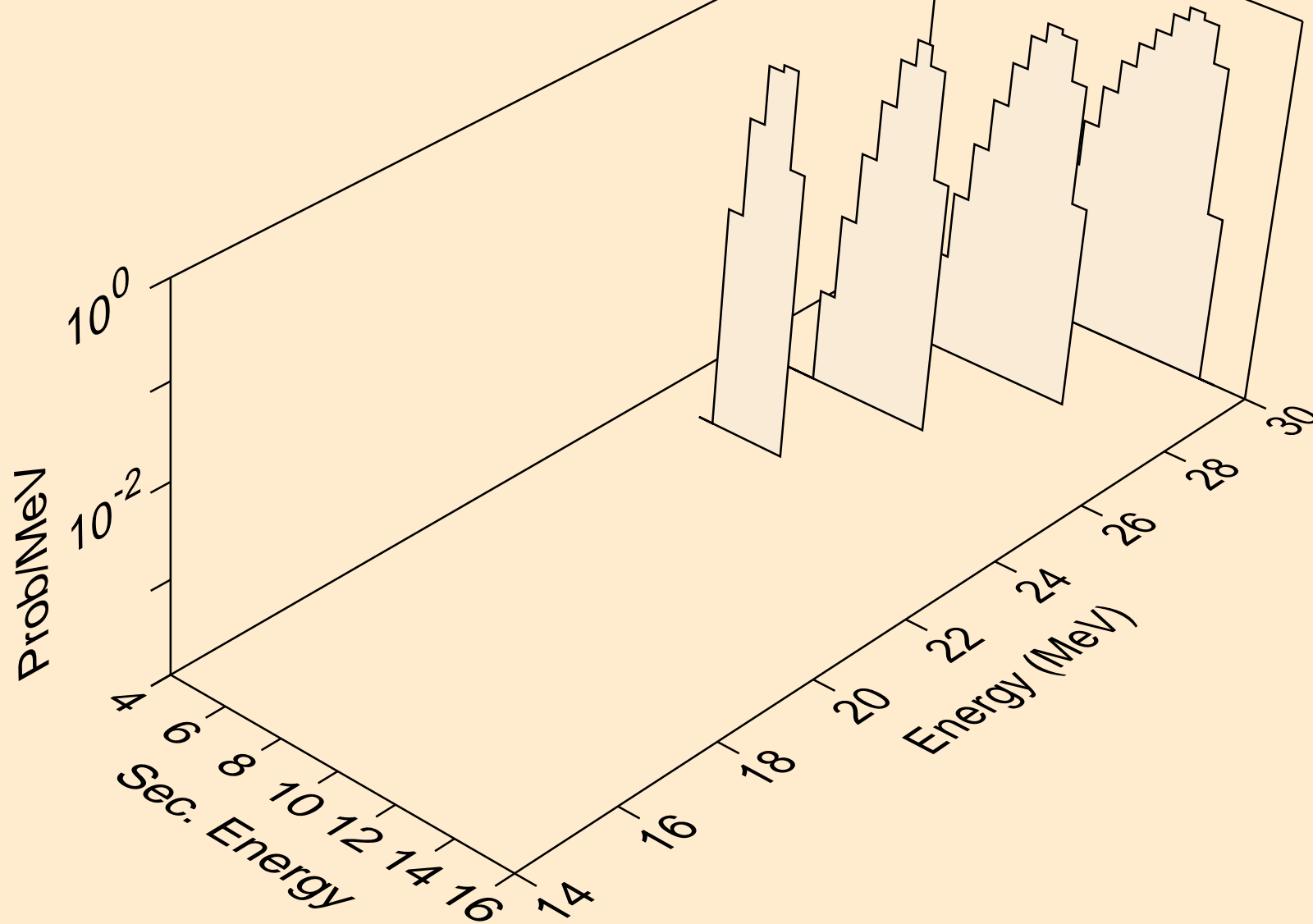

AU196 ALPHA ACER TENDL-2023 LIBRARY; T=0.K
Alpha emission for inelastic

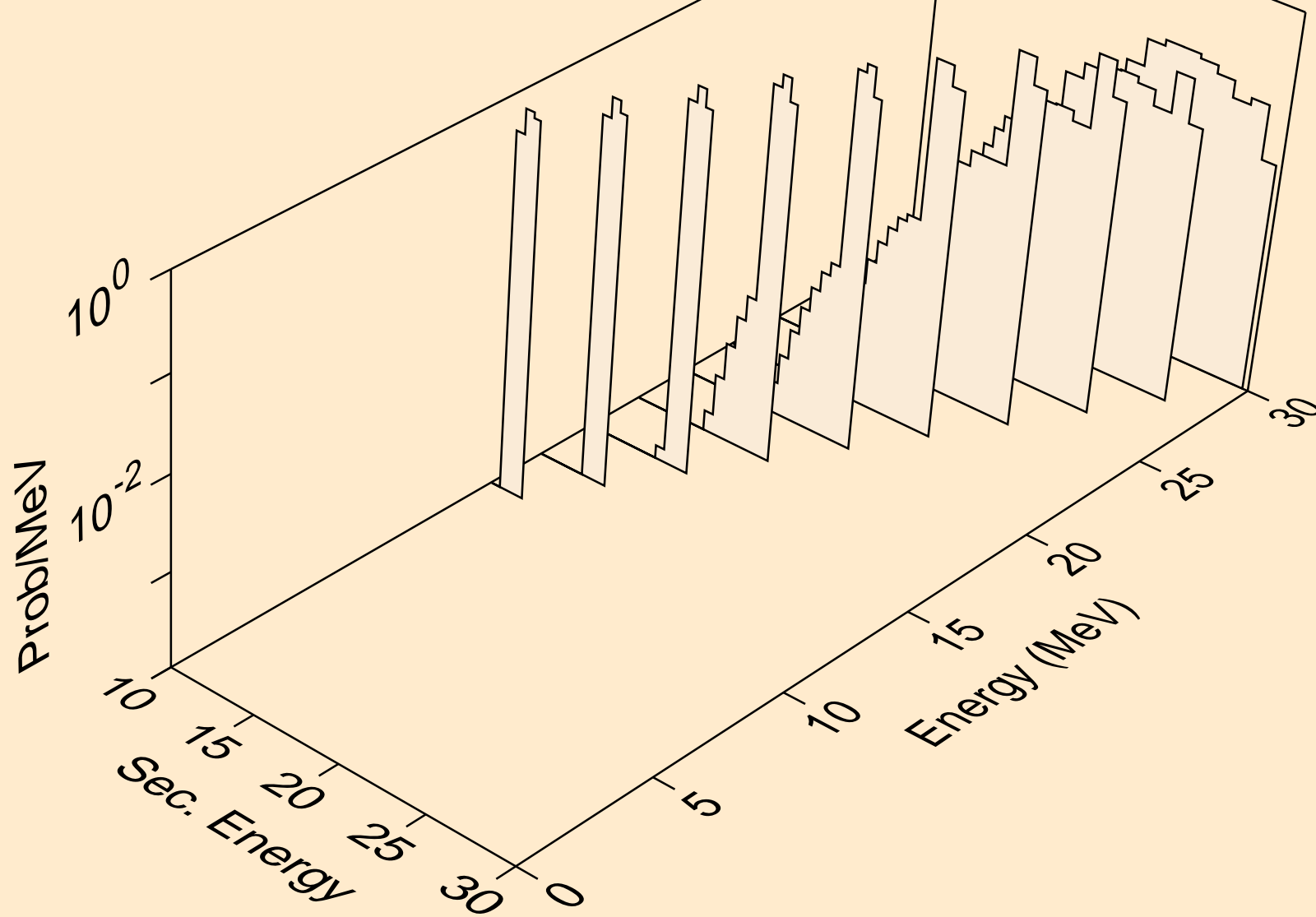

AU196 ALPHA ACER TENDL-2023 LIBRARY; T=0.K
Alpha emission for (a,pa)

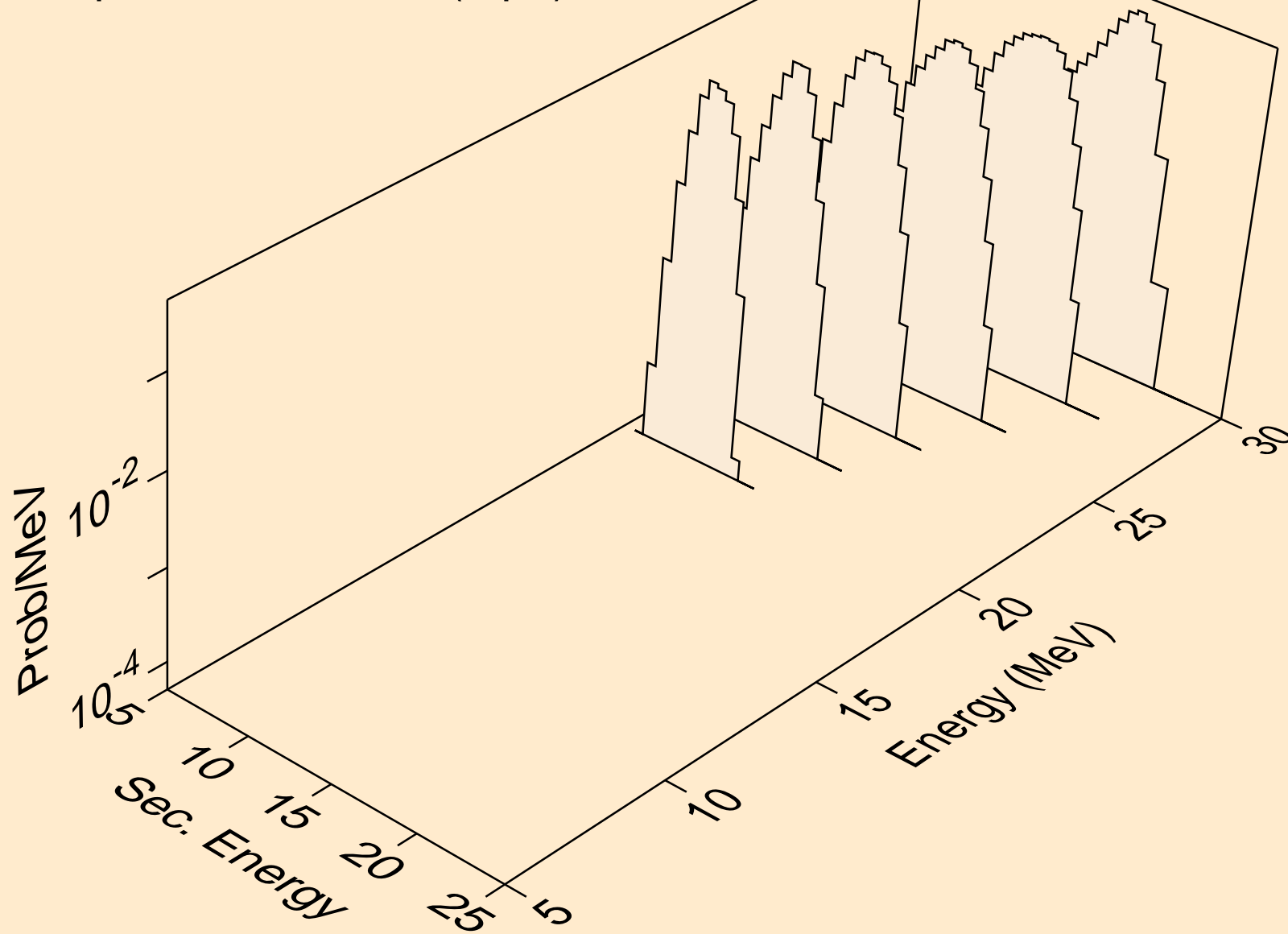

AU196 ALPHA ACER TENDL-2023 LIBRARY; T=0.K
Photon emission for (z,n)

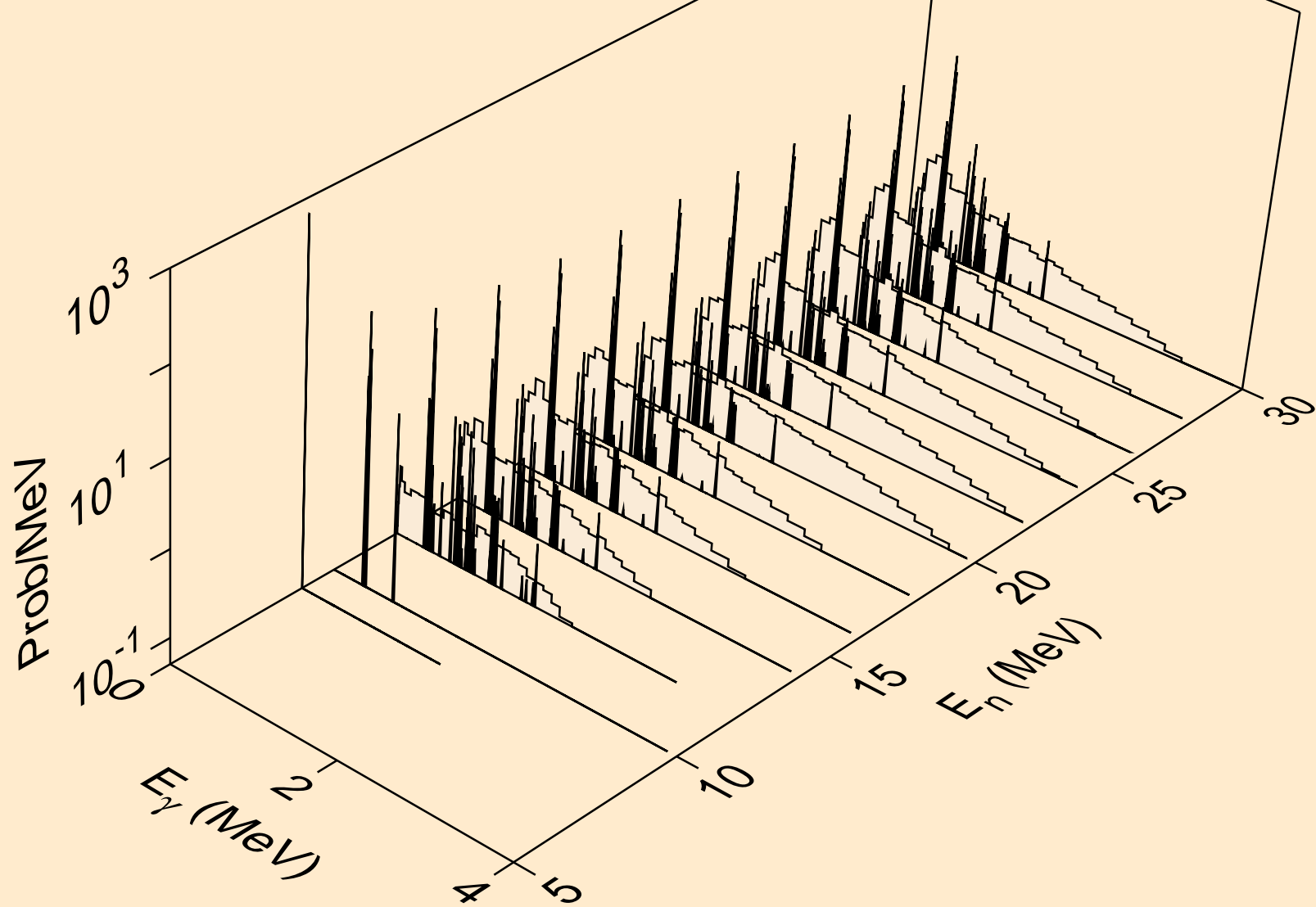

AU196 ALPHA ACER TENDL-2023 LIBRARY; T=0.K
Photon emission for (z,x)

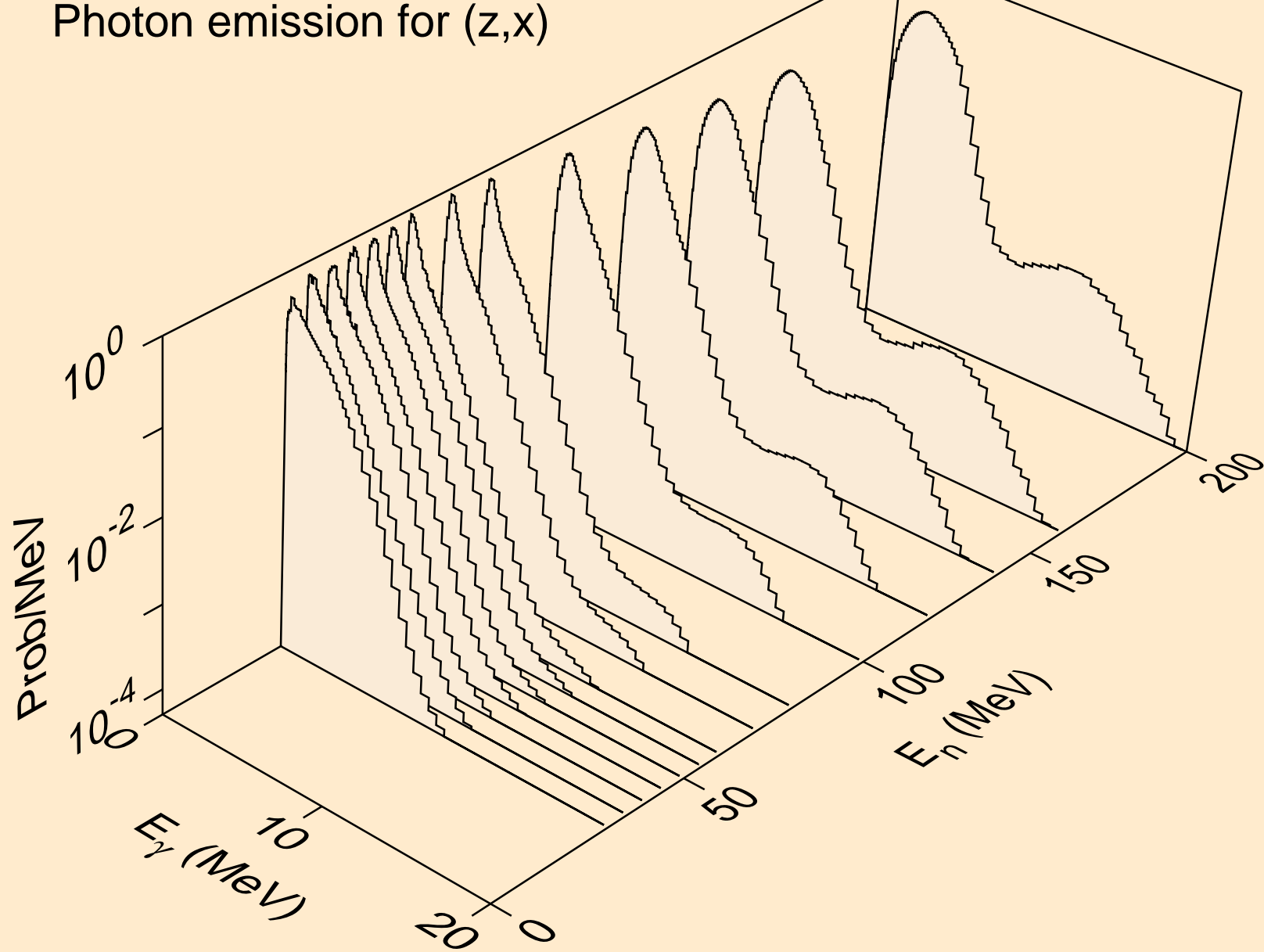

AU196 ALPHA ACER TENDL-2023 LIBRARY; T=0.K
Photon emission for (n,2n)

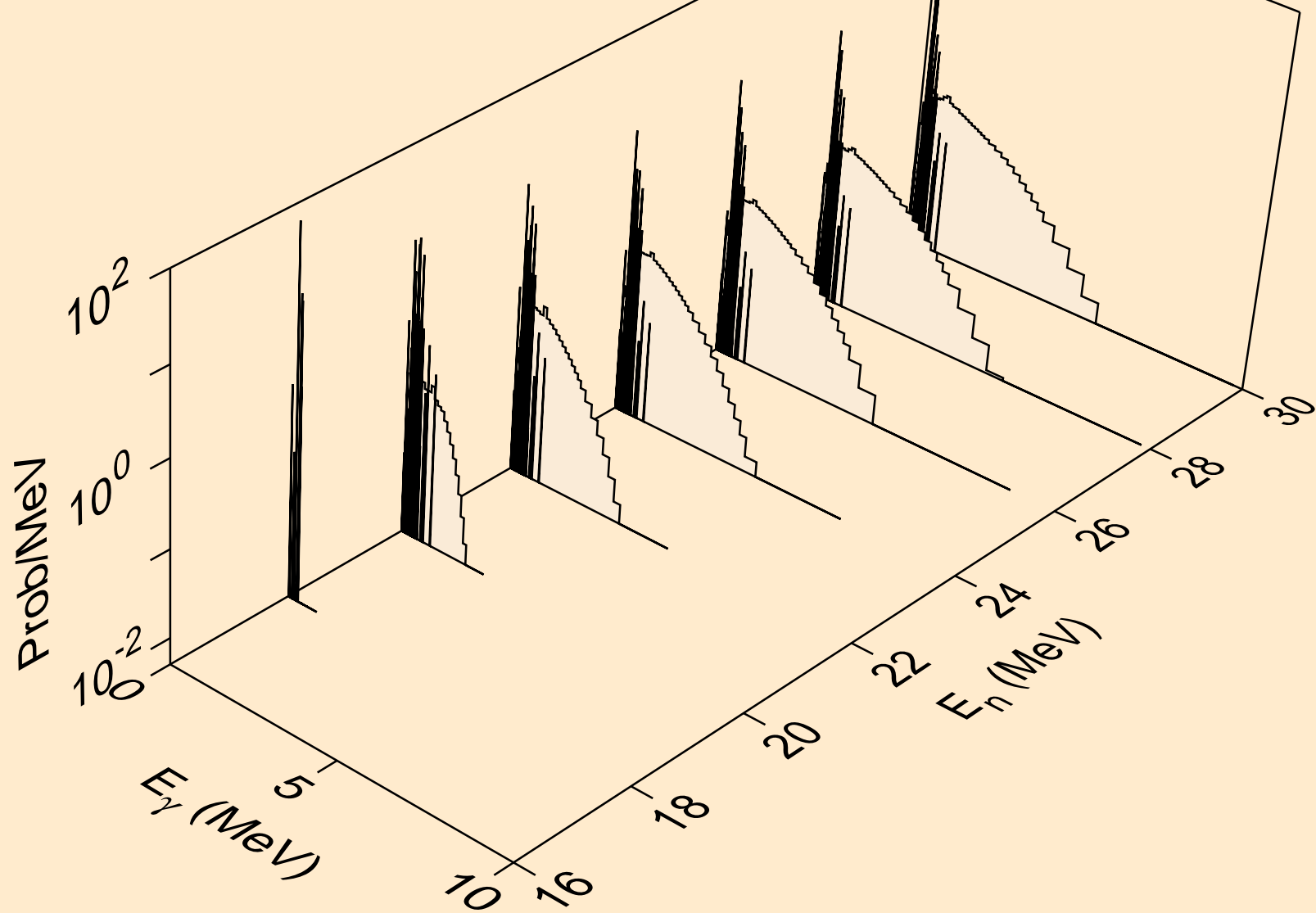

AU196 ALPHA ACER TENDL-2023 LIBRARY; T=0.K
Photon emission for (n,3n)

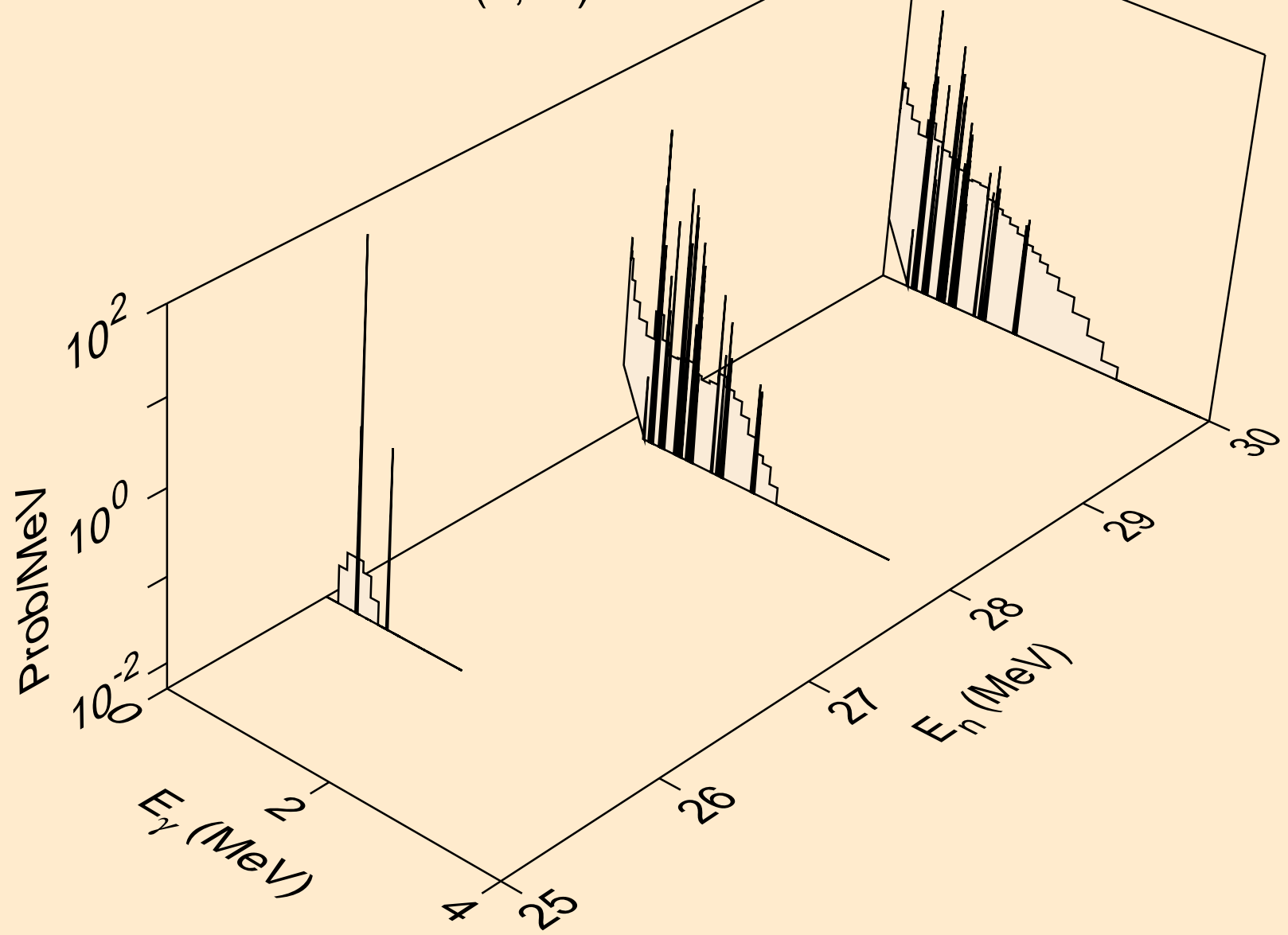

AU196 ALPHA ACER TENDL-2023 LIBRARY; T=0.K
Photon emission for (n,n*)a

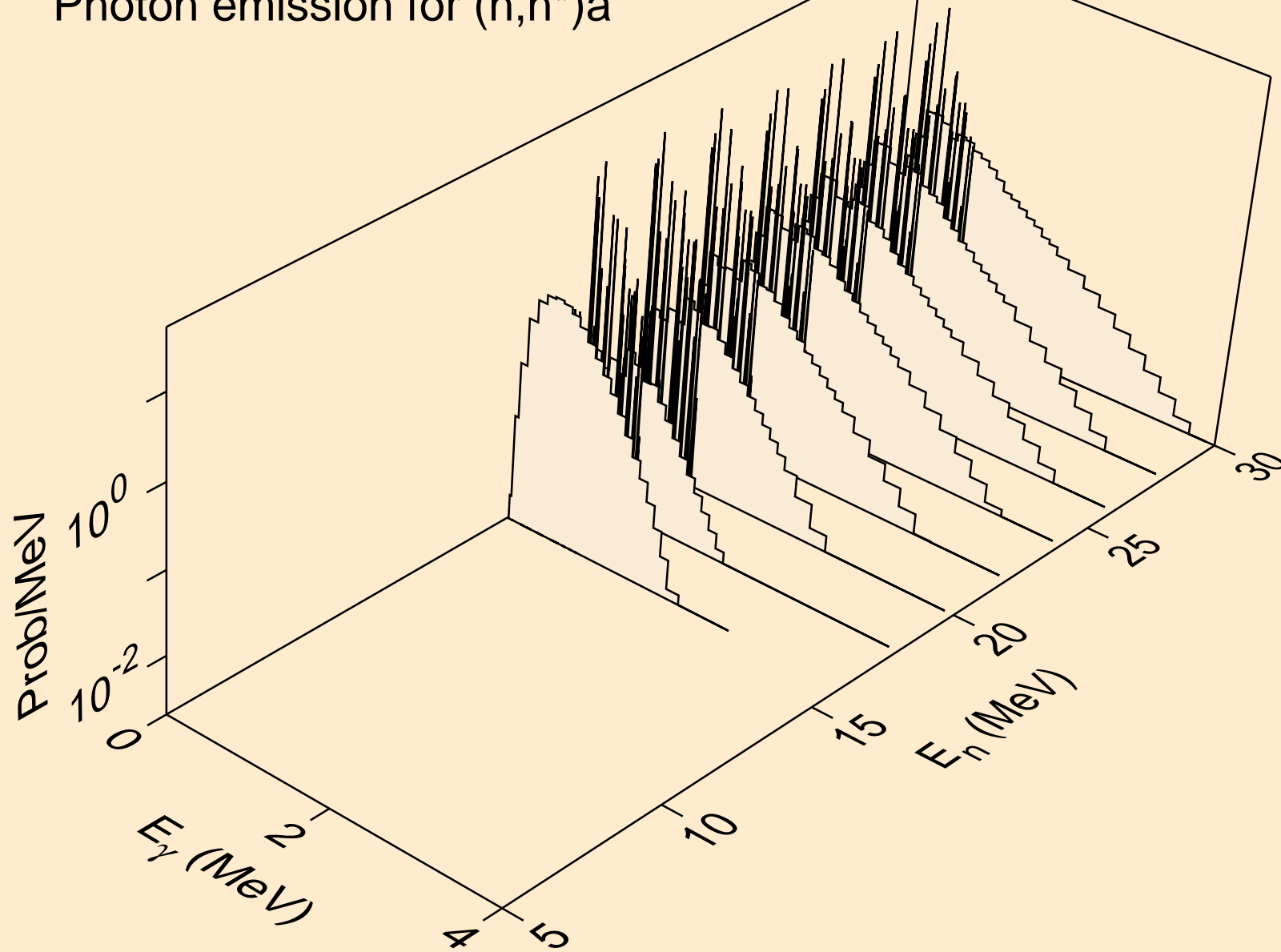

AU196 ALPHA ACER TENDL-2023 LIBRARY; T=0.K
Photon emission for (n,2n)a

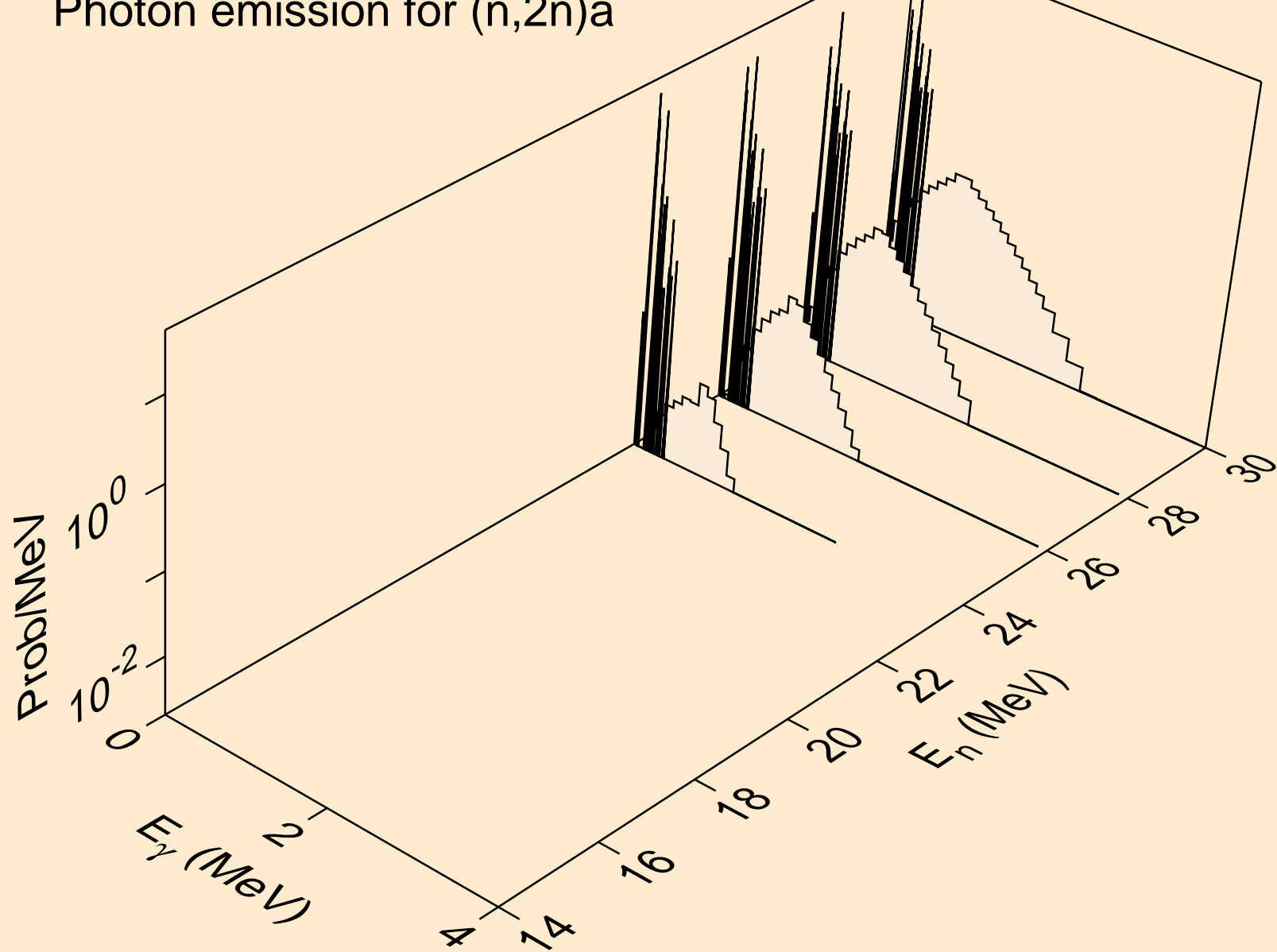

AU196 ALPHA ACER TENDL-2023 LIBRARY; T=0.K
Photon emission for (n,n*)p

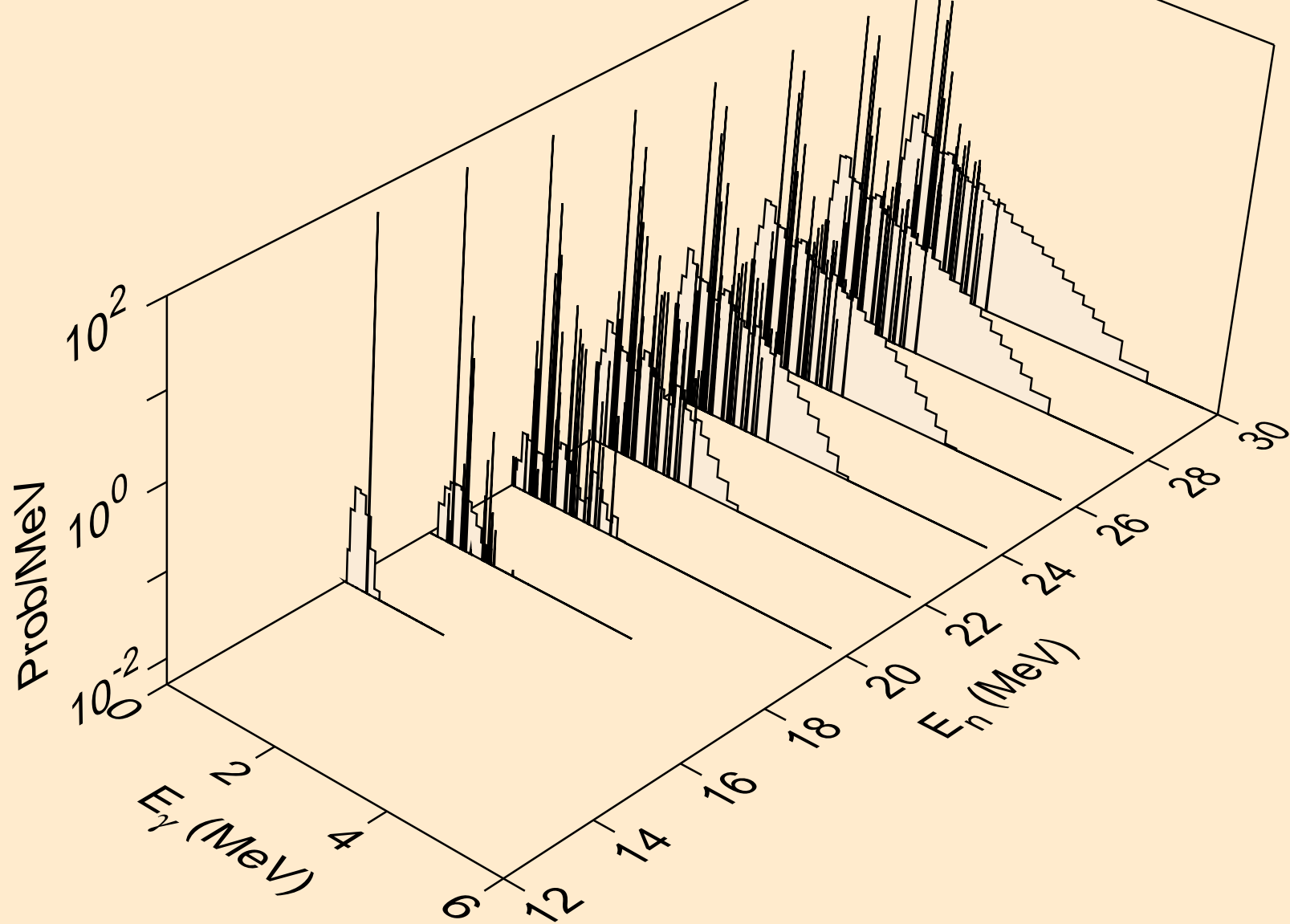

AU196 ALPHA ACER TENDL-2023 LIBRARY; T=0.K
Photon emission for (n,n*)d

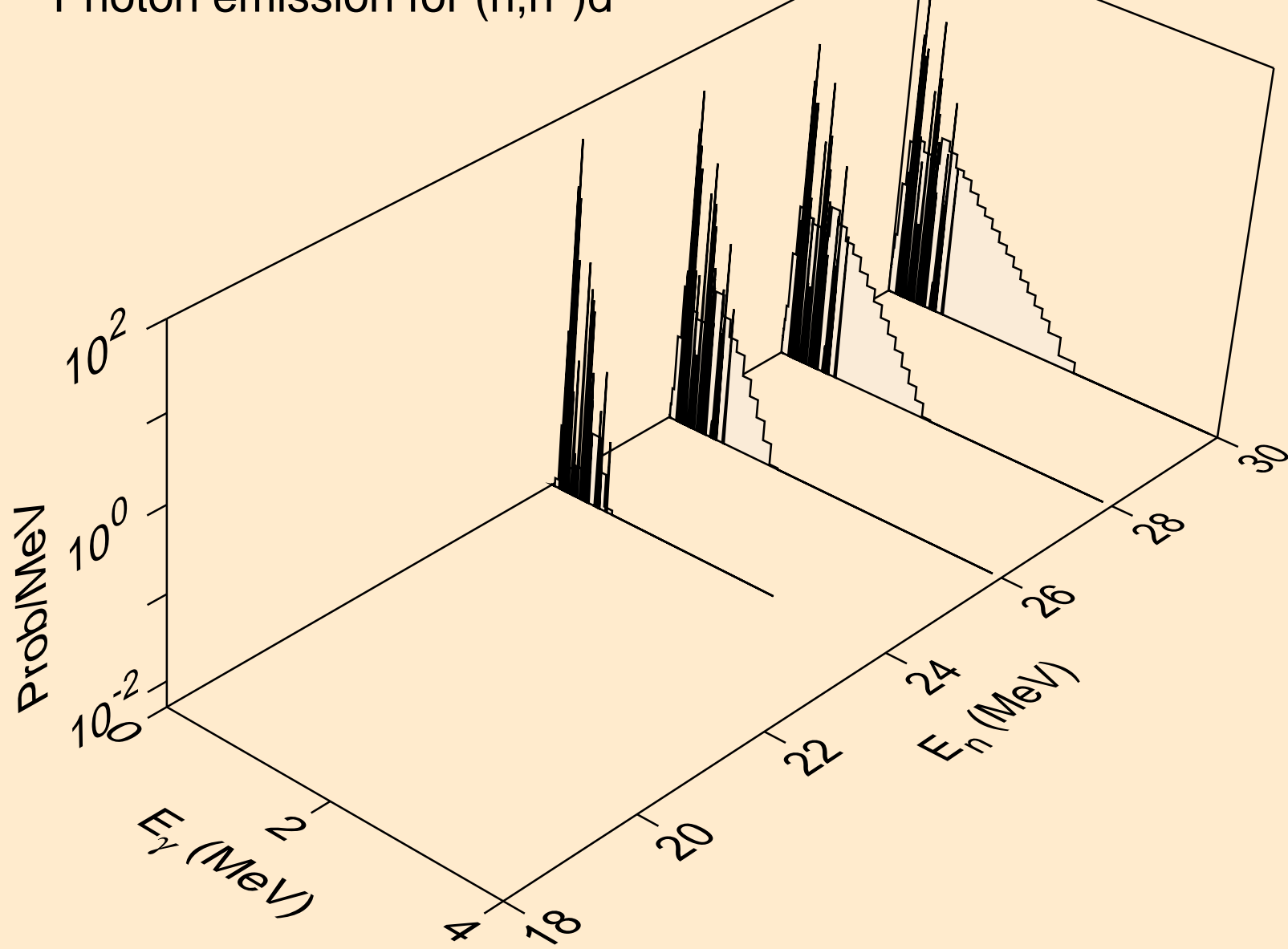

AU196 ALPHA ACER TENDL-2023 LIBRARY; T=0.K
Photon emission for (n,n*)t

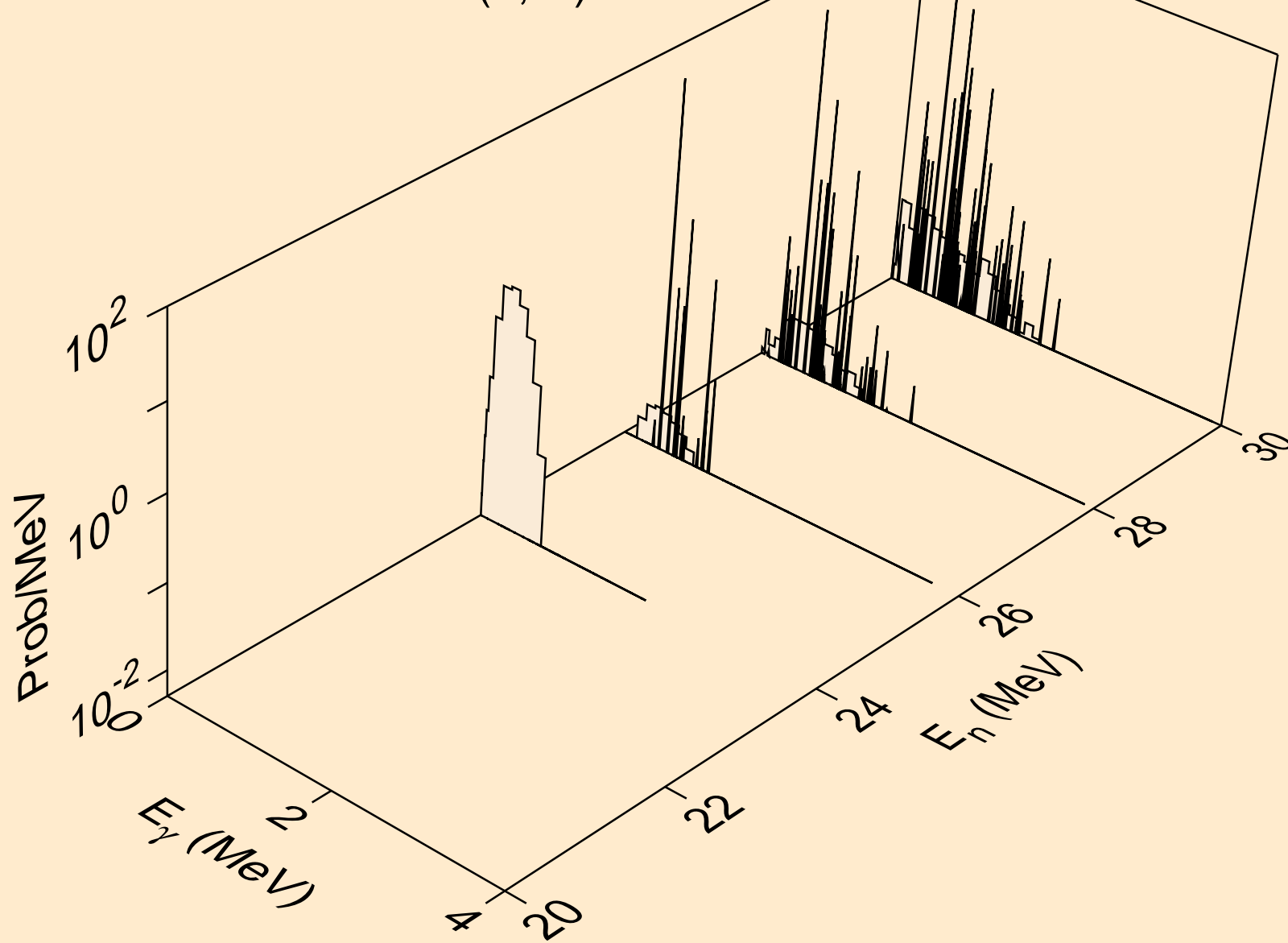

AU196 ALPHA ACER TENDL-2023 LIBRARY; T=0.K
Photon emission for (n,2np)

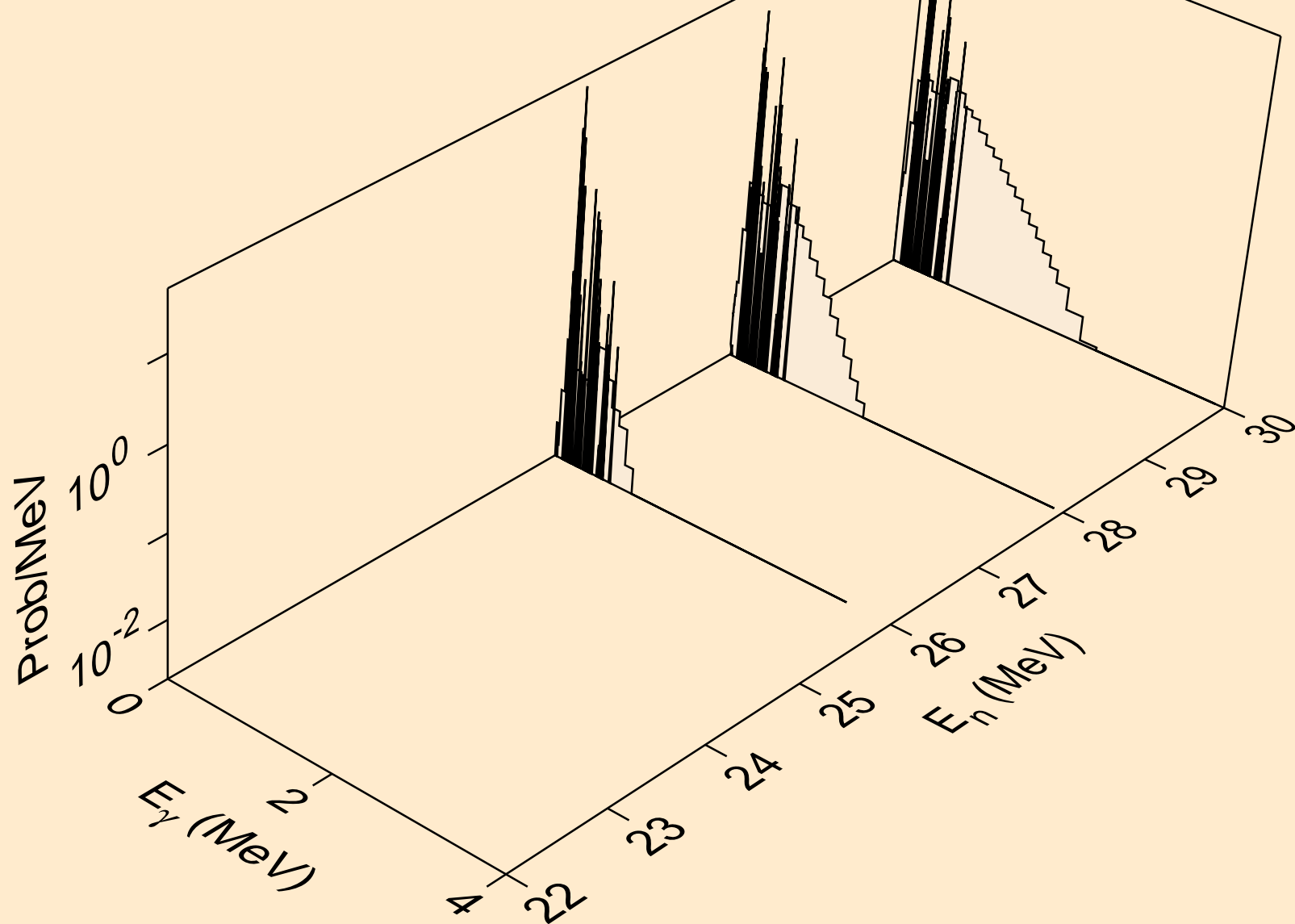

AU196 ALPHA ACER TENDL-2023 LIBRARY; T=0.K
Photon emission for (n,gma)

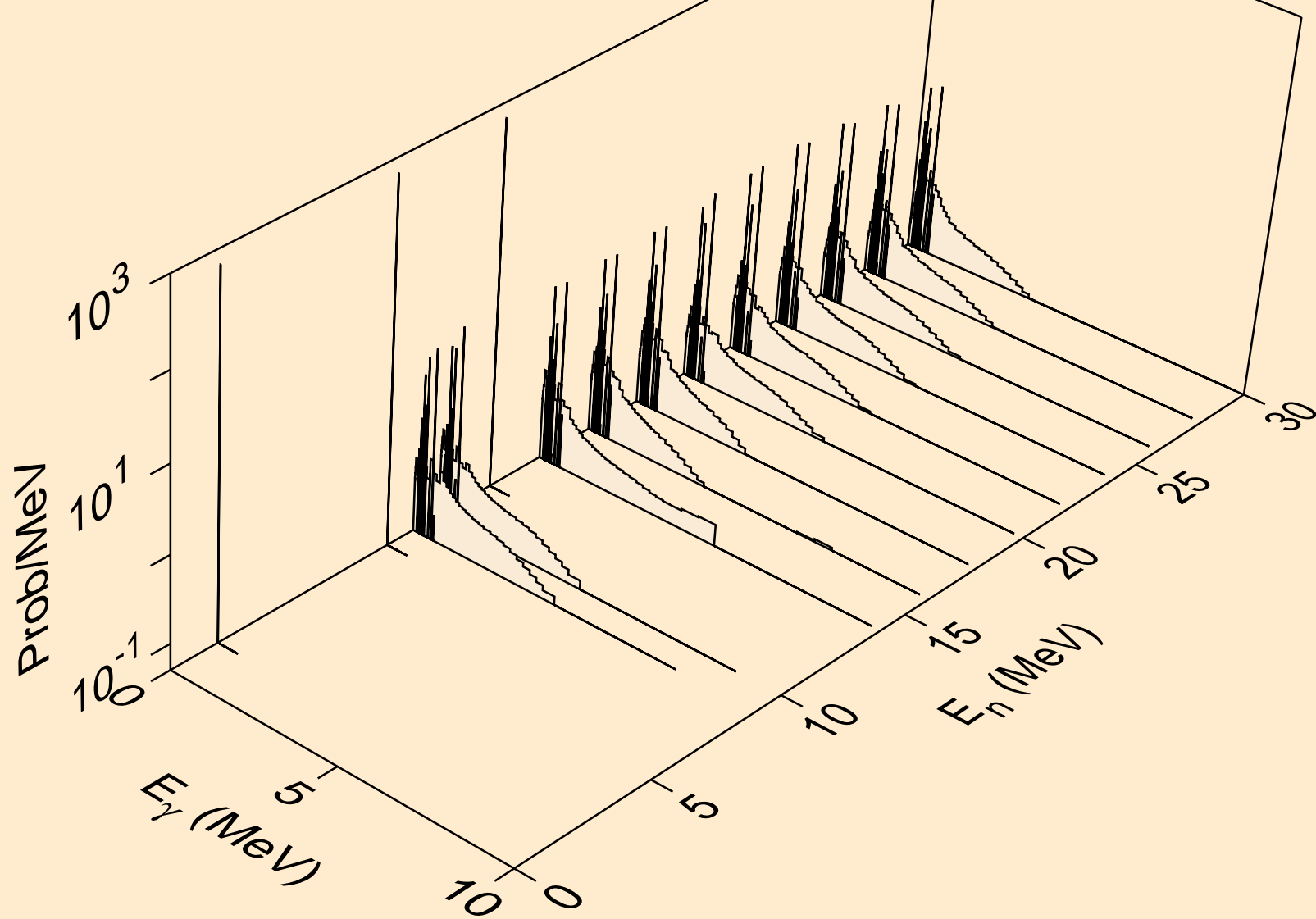

AU196 ALPHA ACER TENDL-2023 LIBRARY; T=0.K
Photon emission for (n,p)

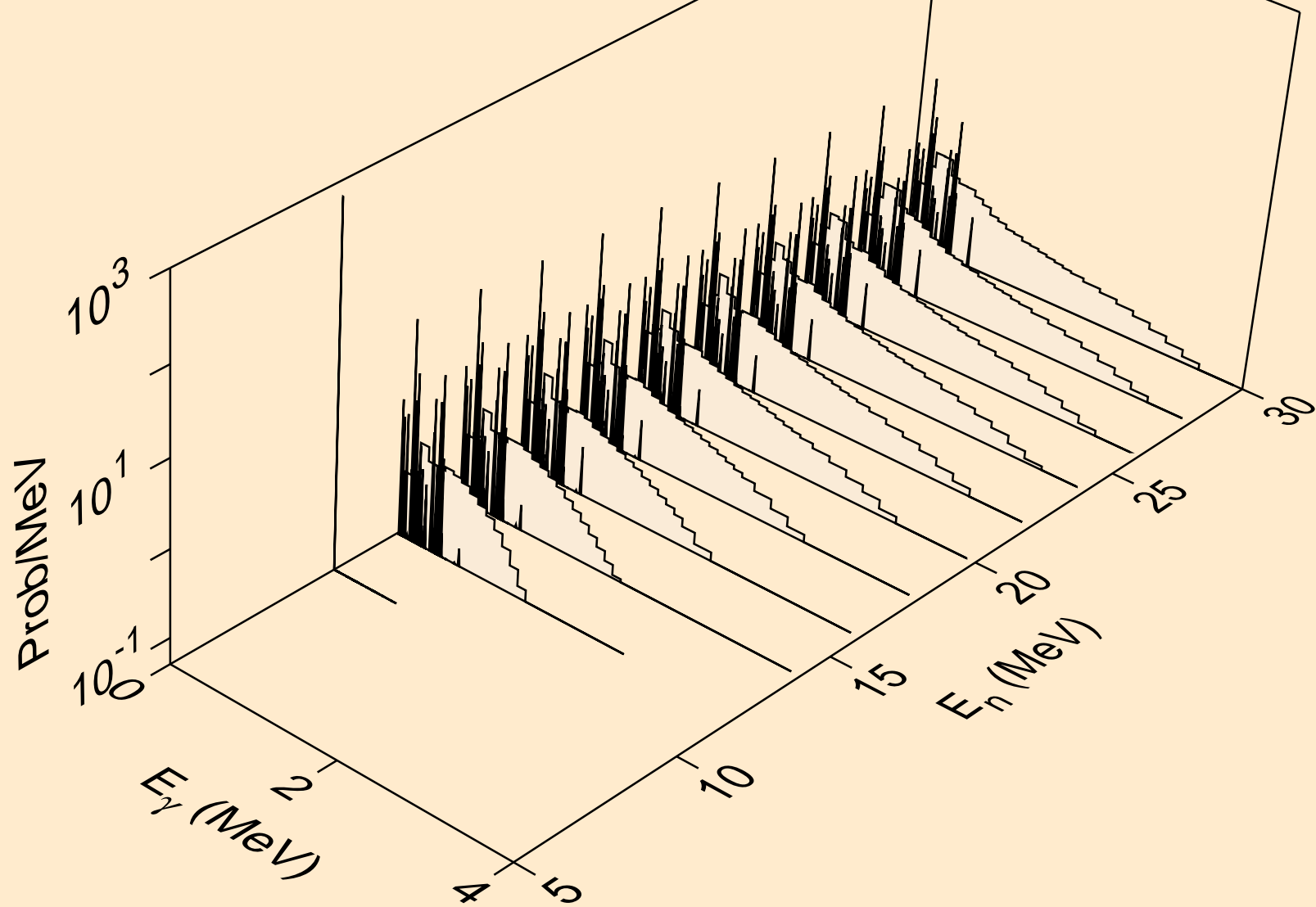

AU196 ALPHA ACER TENDL-2023 LIBRARY; T=0.K
Photon emission for (n,d)

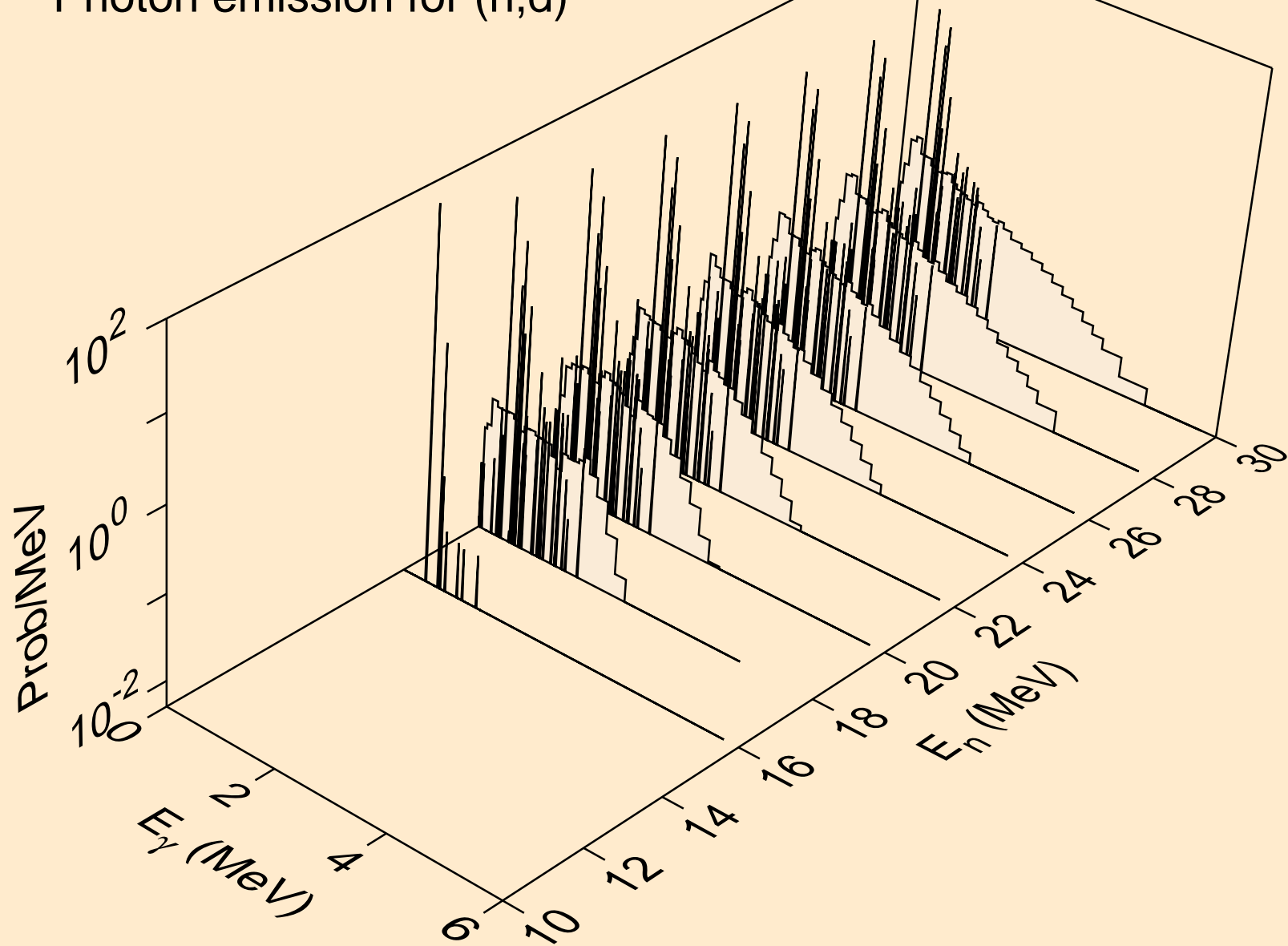

AU196 ALPHA ACER TENDL-2023 LIBRARY; T=0.K
Photon emission for (n,t)

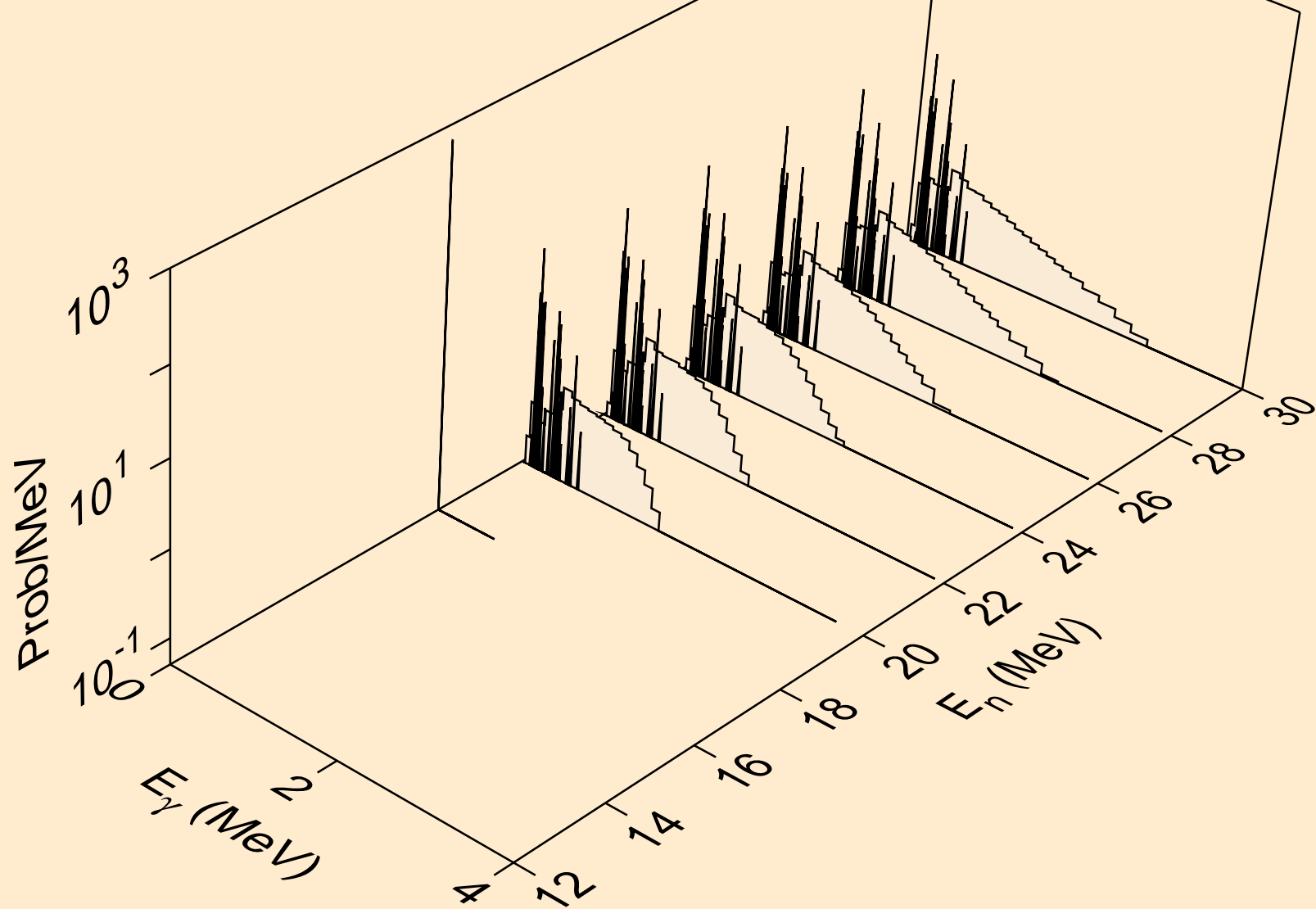

AU196 ALPHA ACER TENDL-2023 LIBRARY; T=0.K
Photon emission for (n,he3)

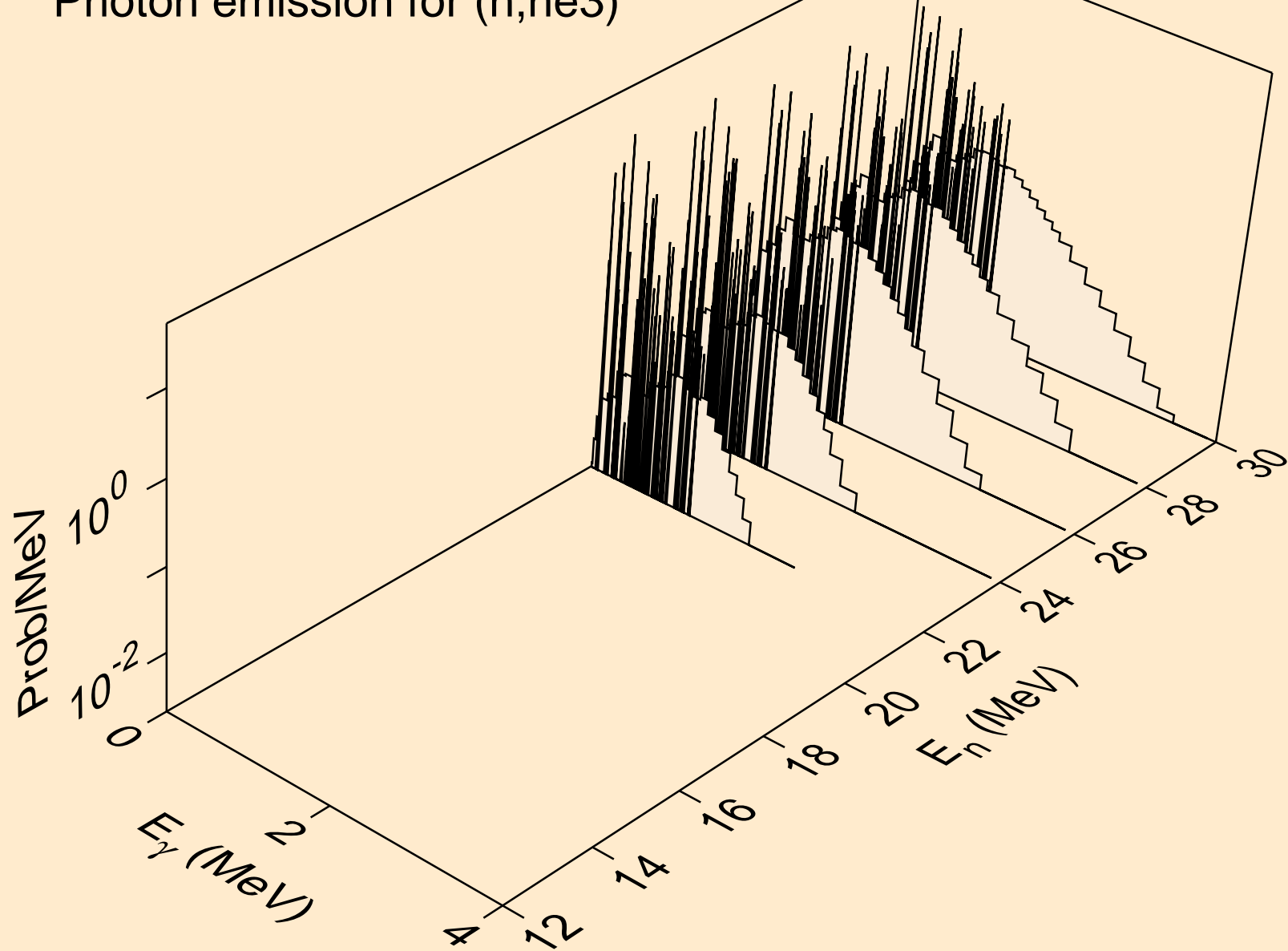

AU196 ALPHA ACER TENDL-2023 LIBRARY; T=0.K
Photon emission for inelastic

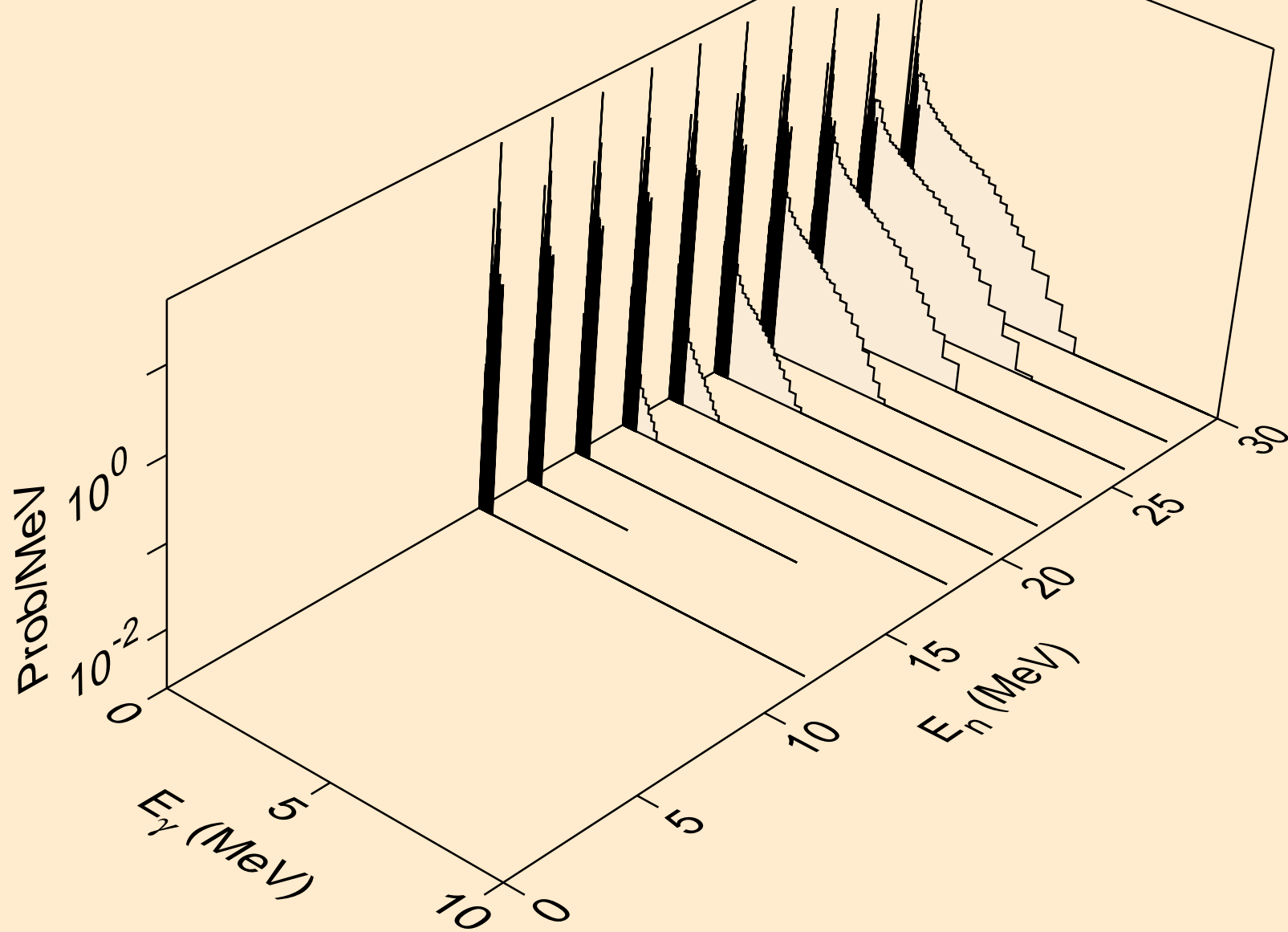

AU196 ALPHA ACER TENDL-2023 LIBRARY; T=0.K
Photon emission for (n,2p)

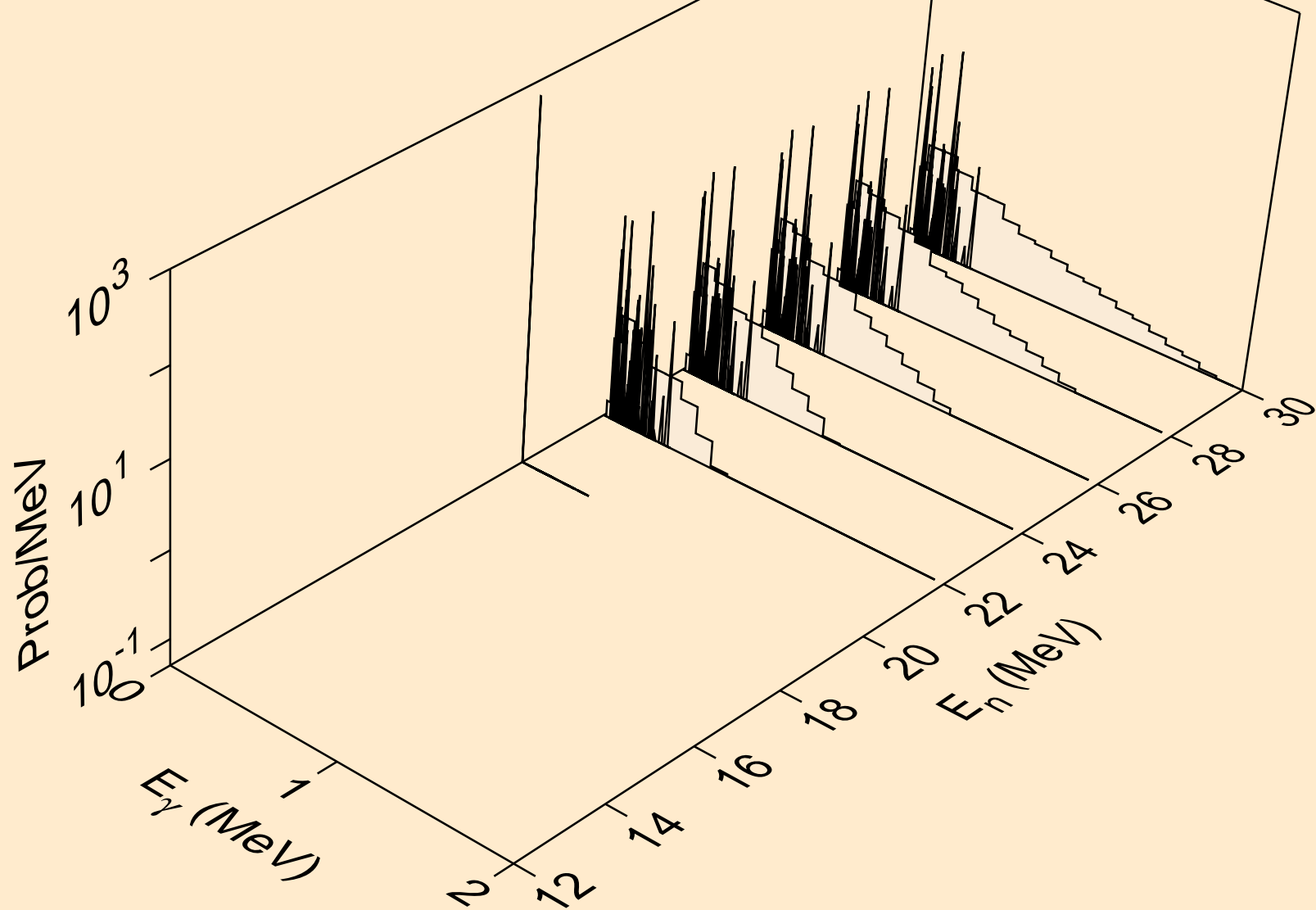

AU196 ALPHA ACER TENDL-2023 LIBRARY; T=0.K
Photon emission for (n,pa)

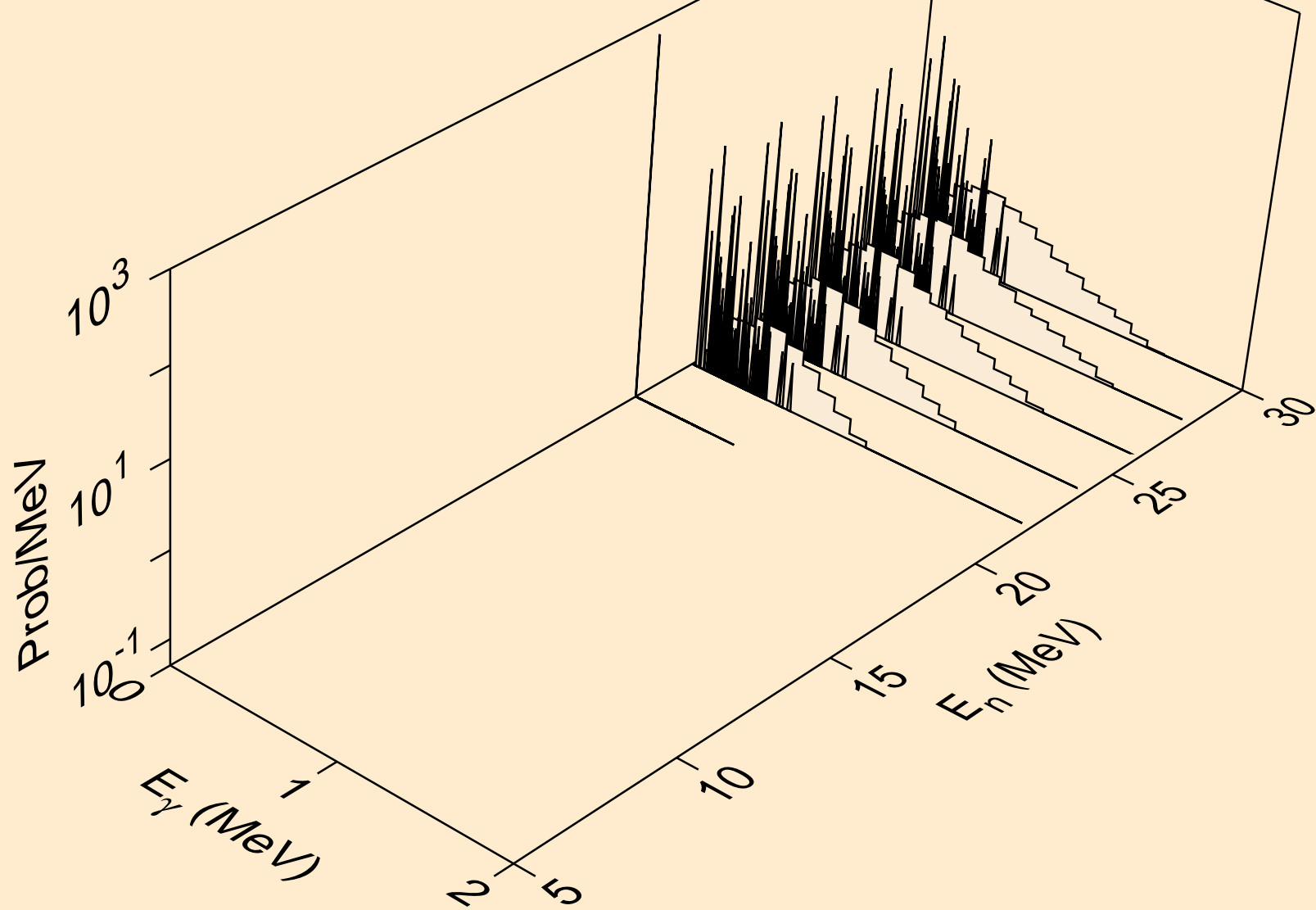

AU196 ALPHA ACER TENDL-2023 LIBRARY; T=0.K
Particle heating contributions

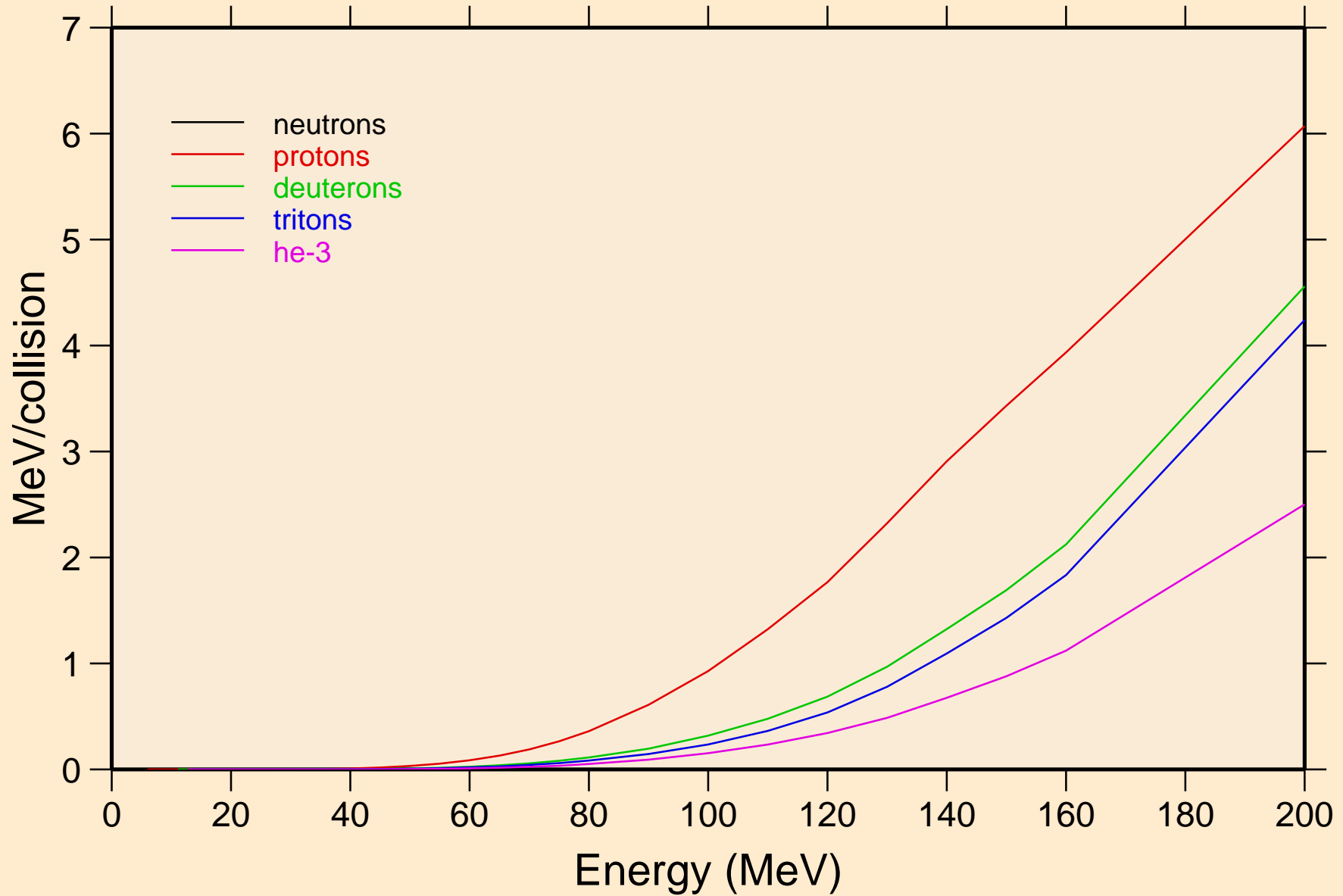

AU196 ALPHA ACER TENDL-2023 LIBRARY; T=0.K
Recoil Heating

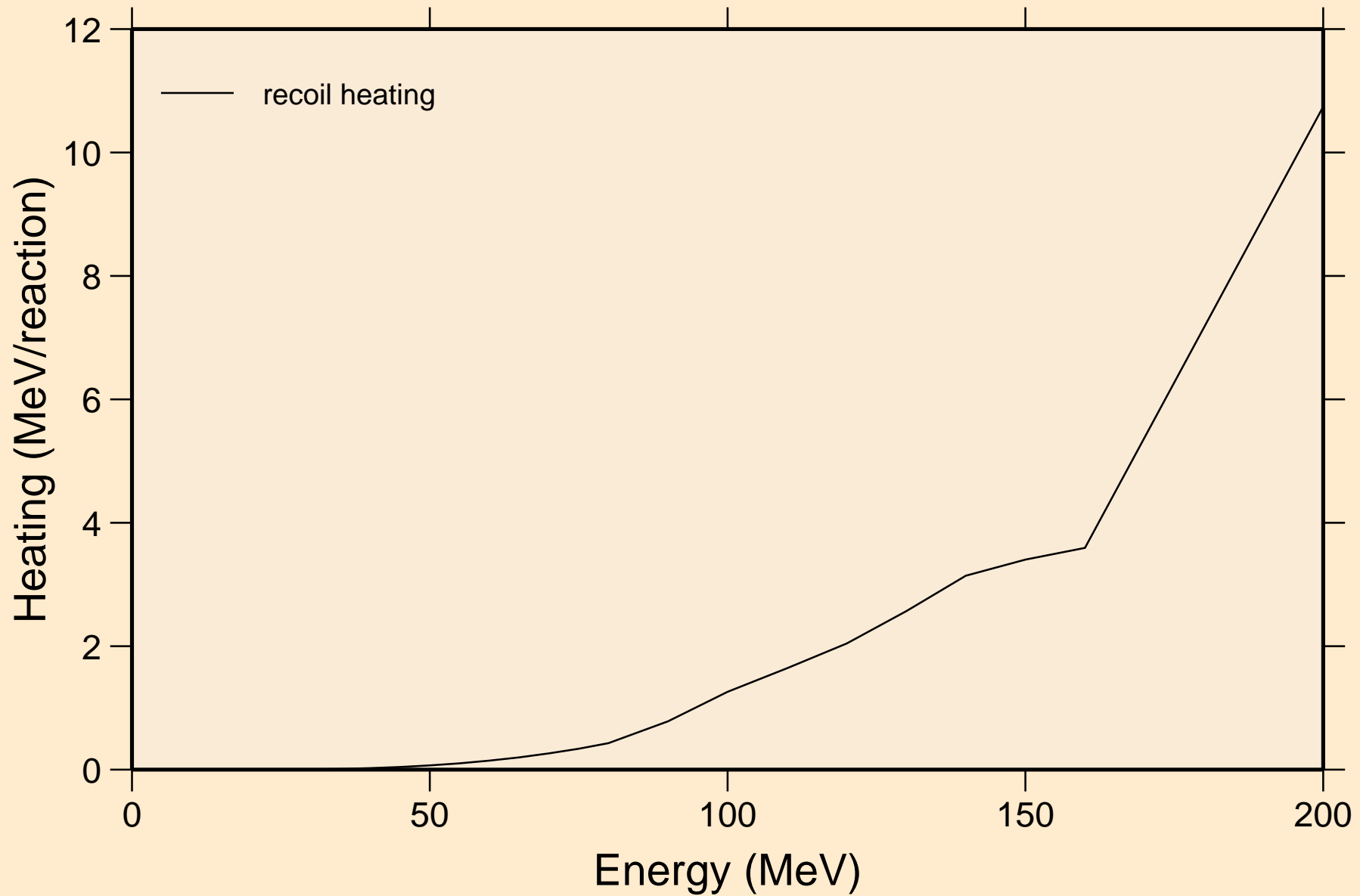

AU196 ALPHA ACER TENDL-2023 LIBRARY; T=0.K
Particle production cross sections

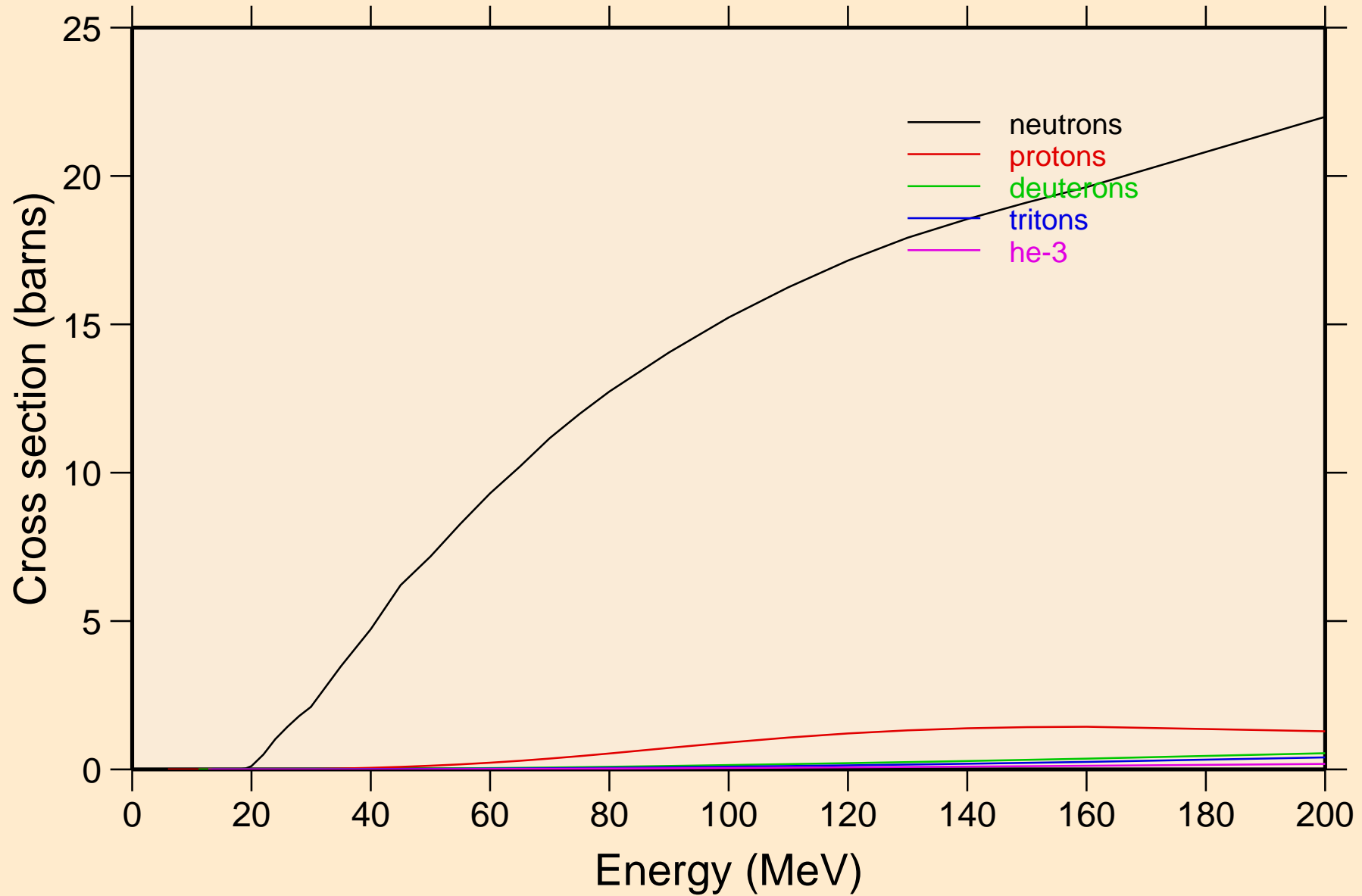

AU196 ALPHA ACER TENDL-2023 LIBRARY; T=0.K
neutrons from (a,n)

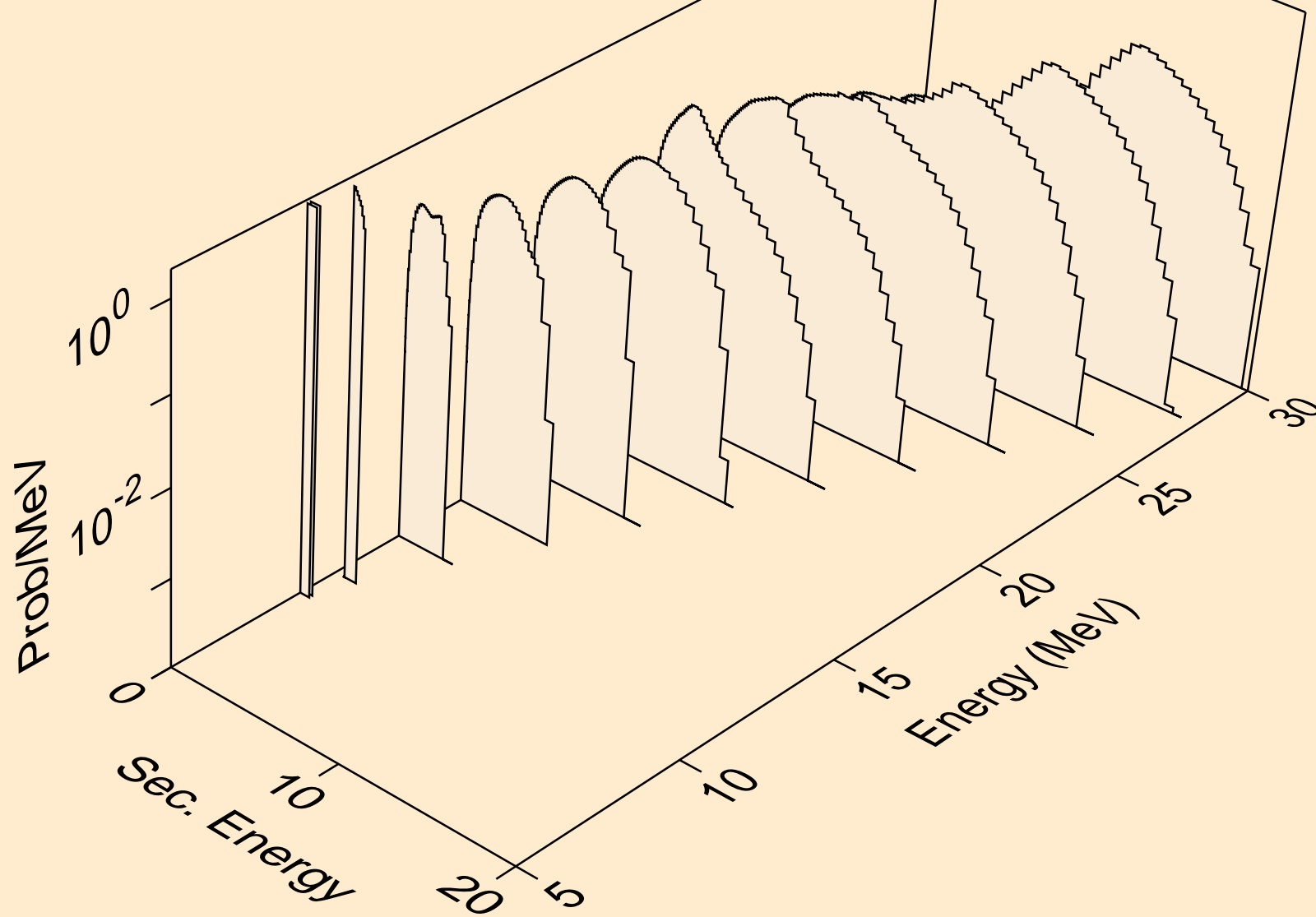

AU196 ALPHA ACER TENDL-2023 LIBRARY; T=0.K
neutrons from (a,x)

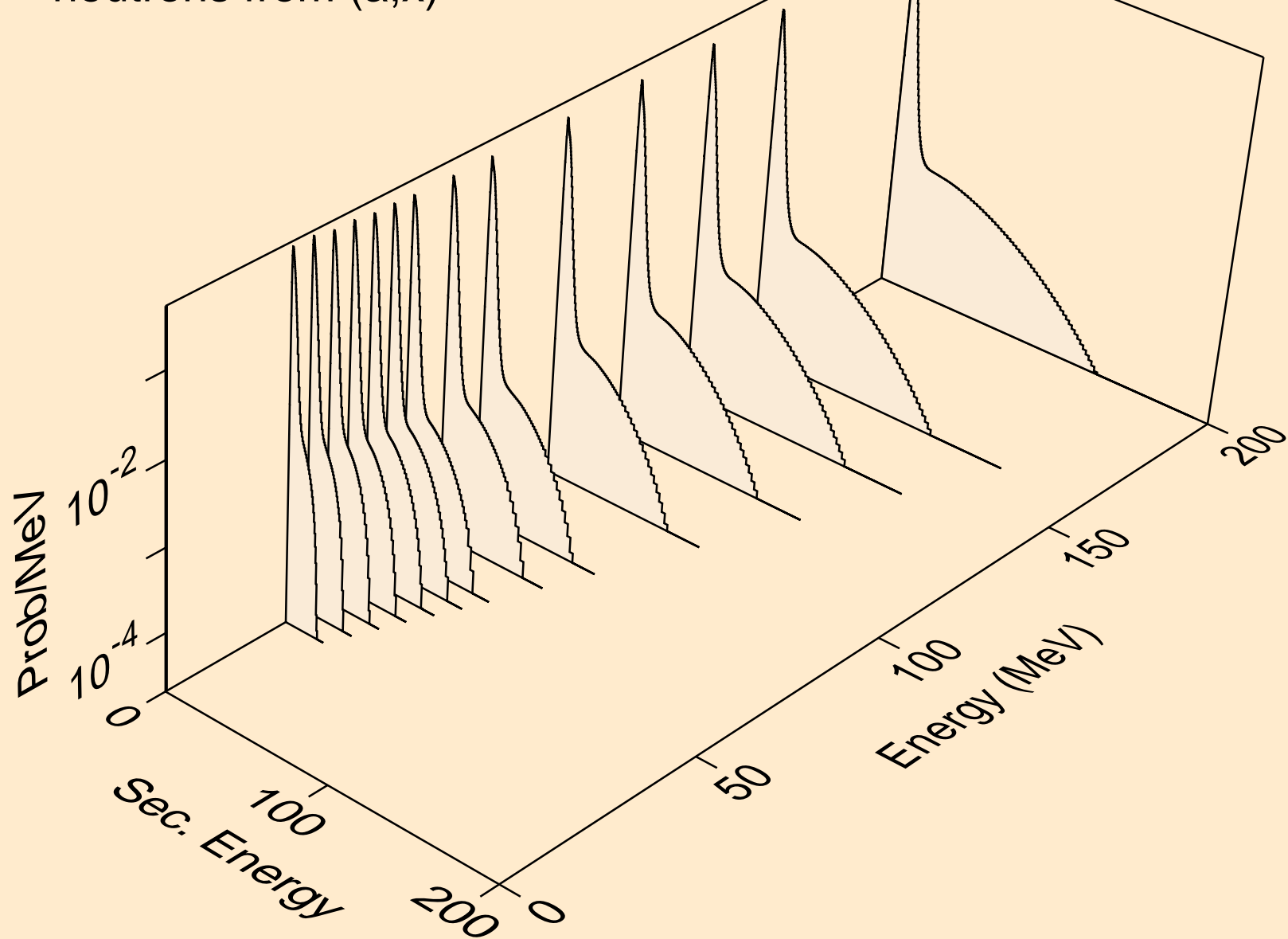

AU196 ALPHA ACER TENDL-2023 LIBRARY; T=0.K
neutrons from (a,2n)

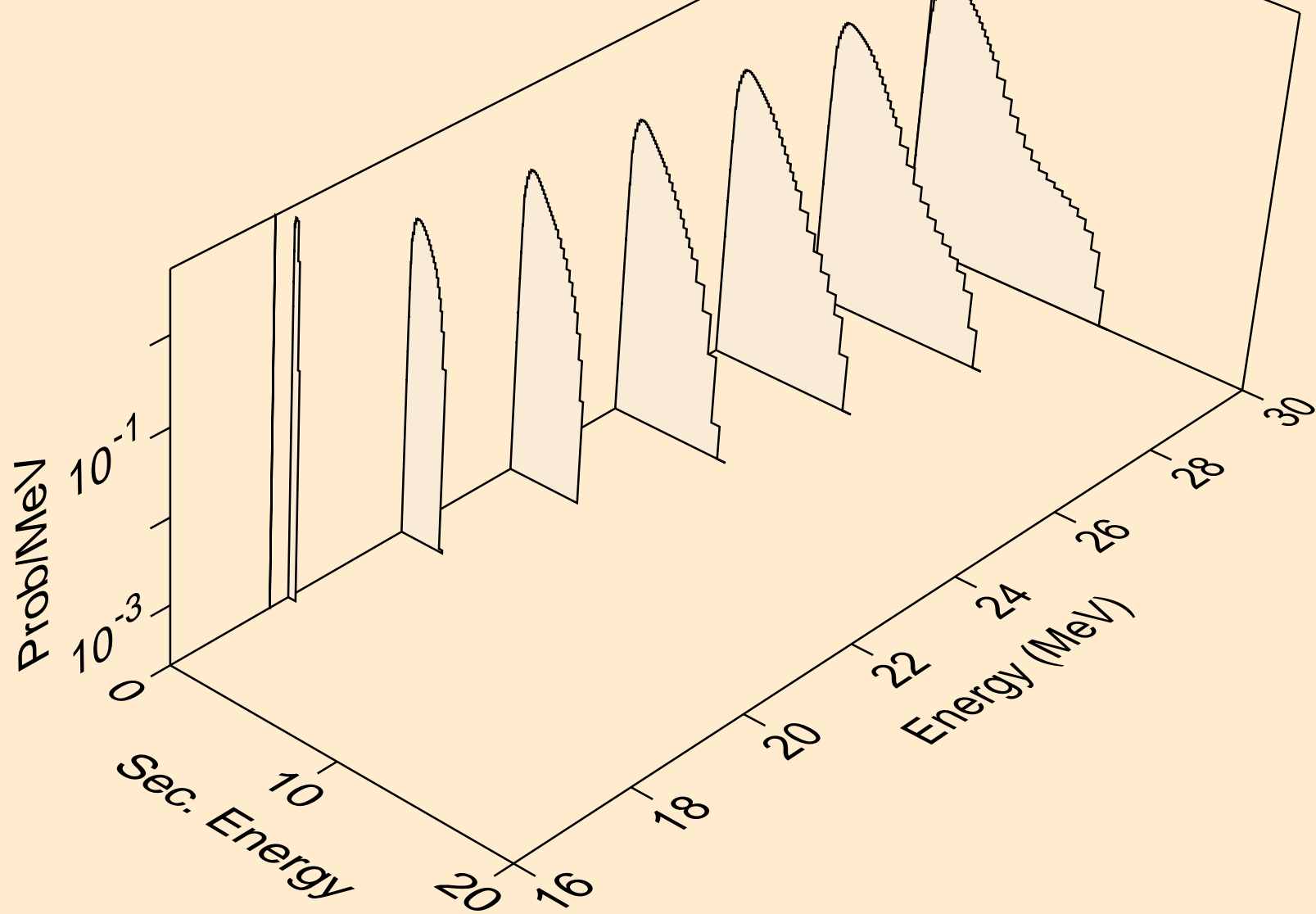

AU196 ALPHA ACER TENDL-2023 LIBRARY; T=0.K
neutrons from (a,3n)

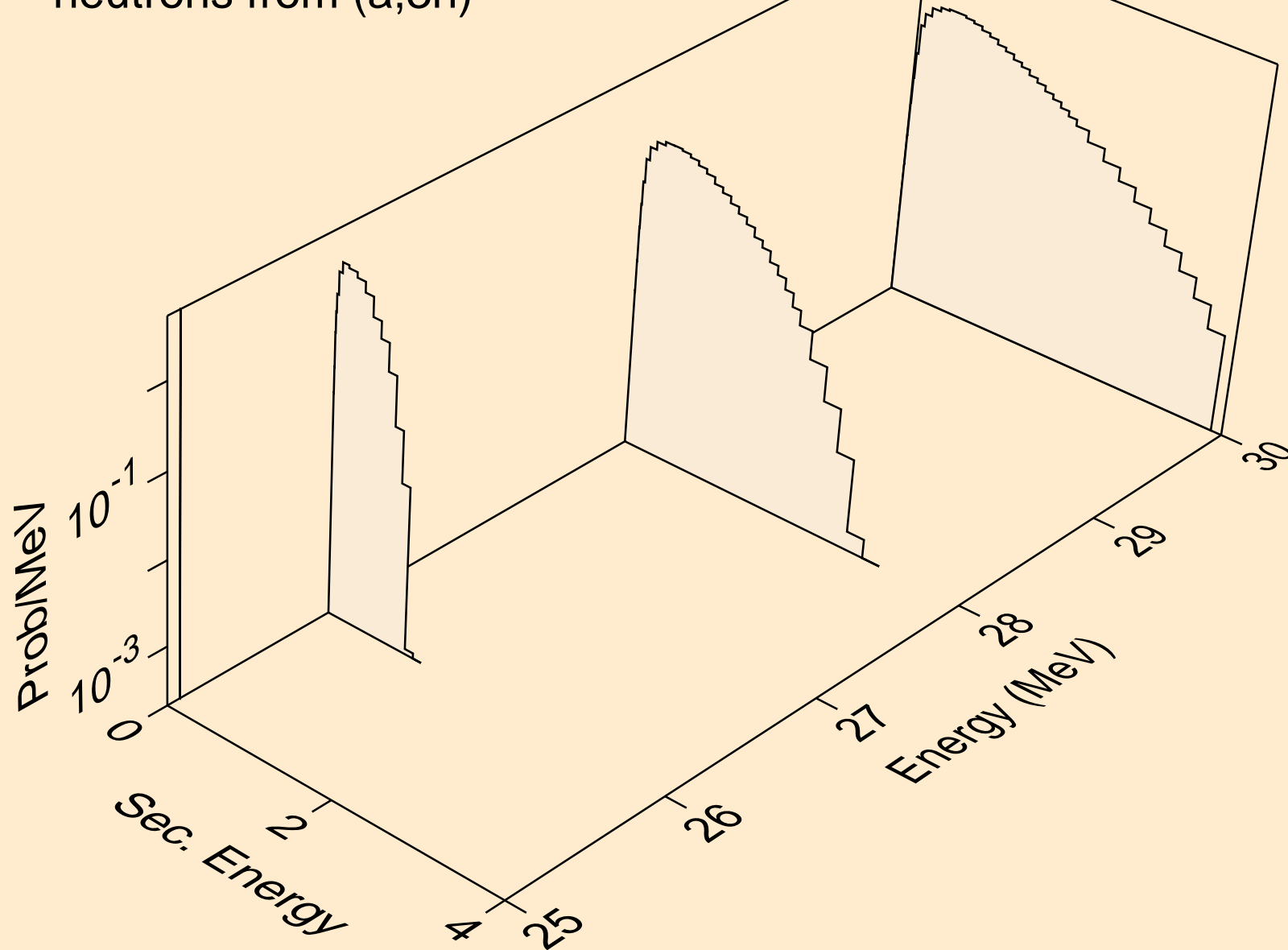

AU196 ALPHA ACER TENDL-2023 LIBRARY; T=0.K
neutrons from (a,n*)a

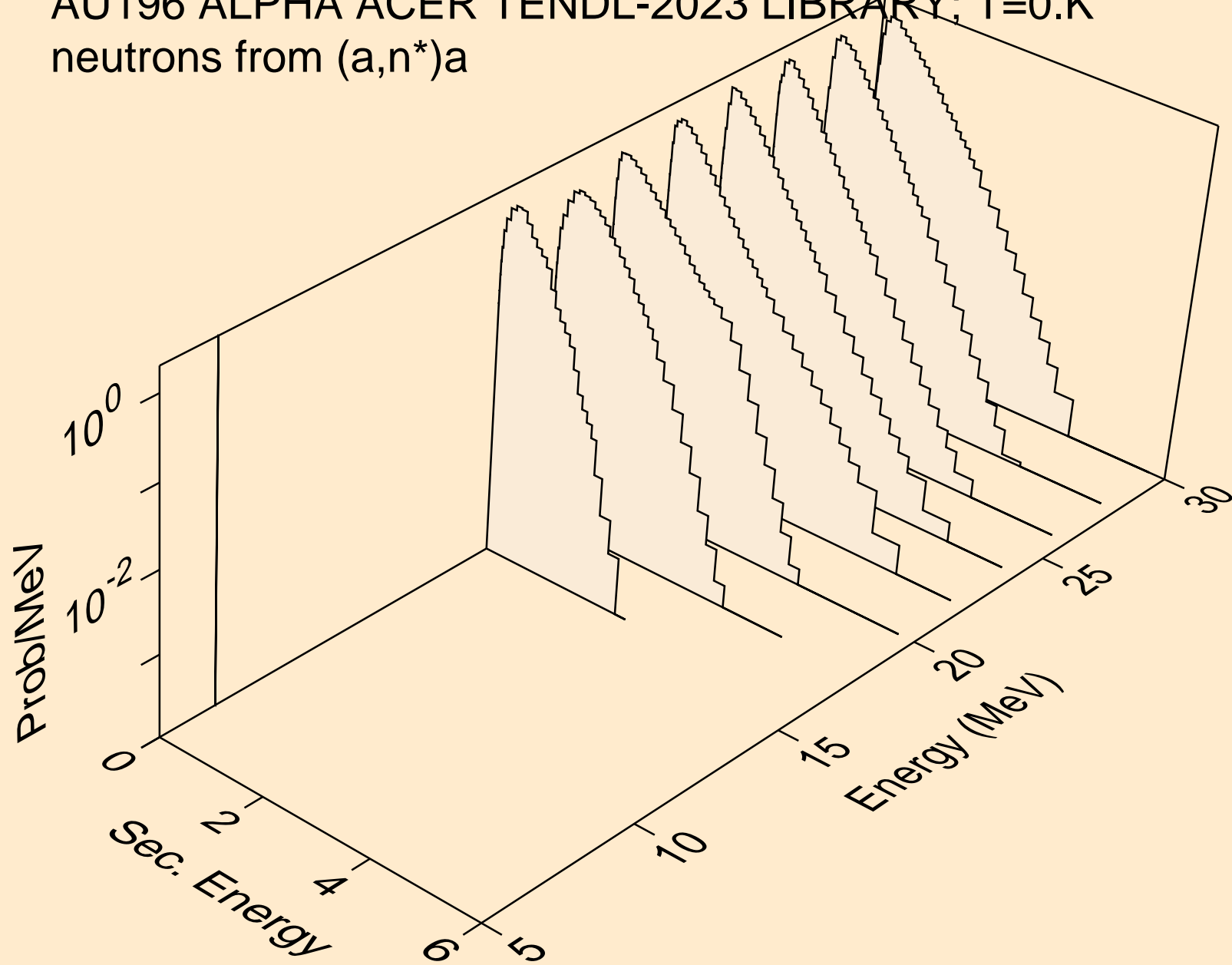

AU196 ALPHA ACER TENDL-2023 LIBRARY; T=0.K
neutrons from (a,2n)a

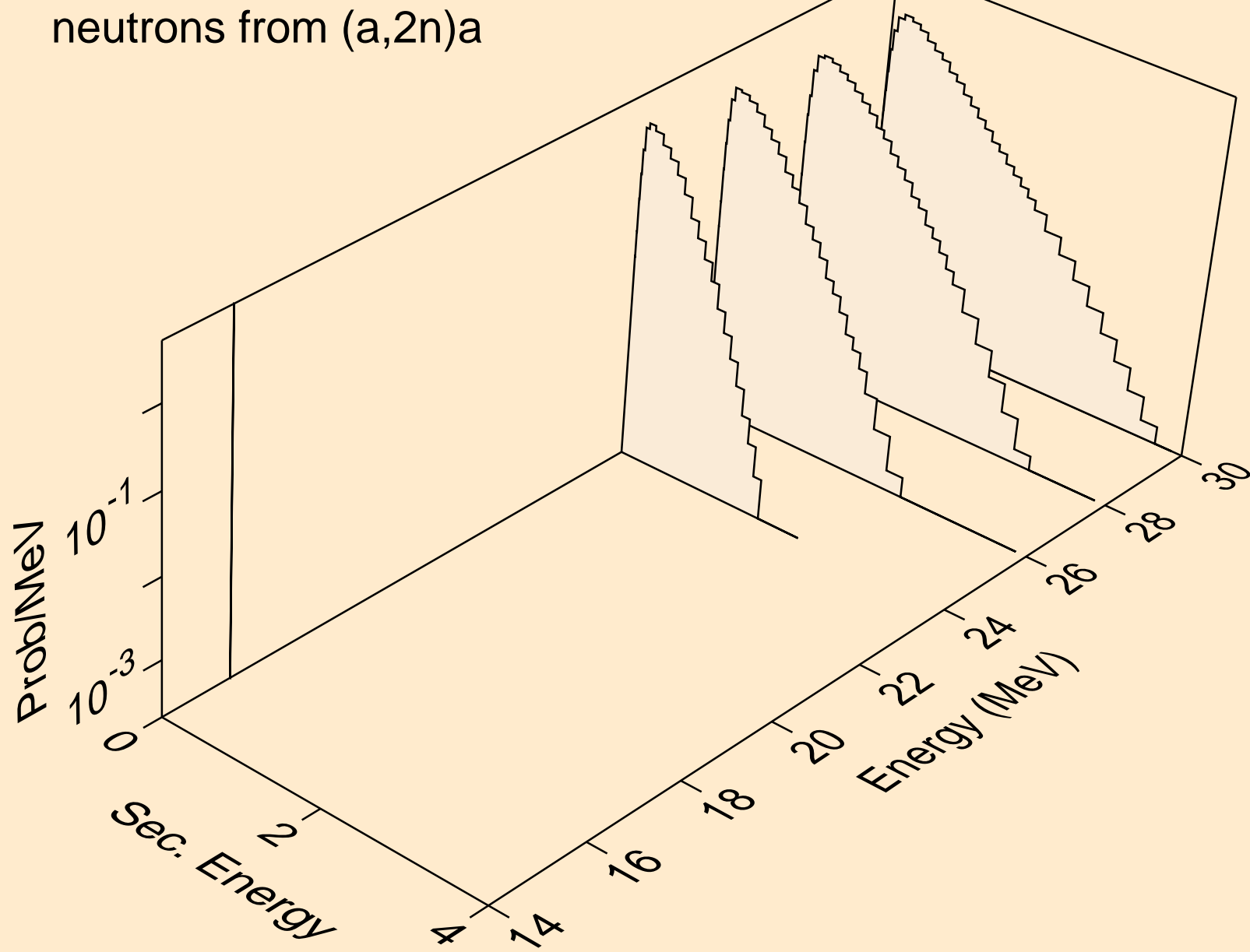

AU196 ALPHA ACER TENDL-2023 LIBRARY; T=0.K
neutrons from (a,n*)p

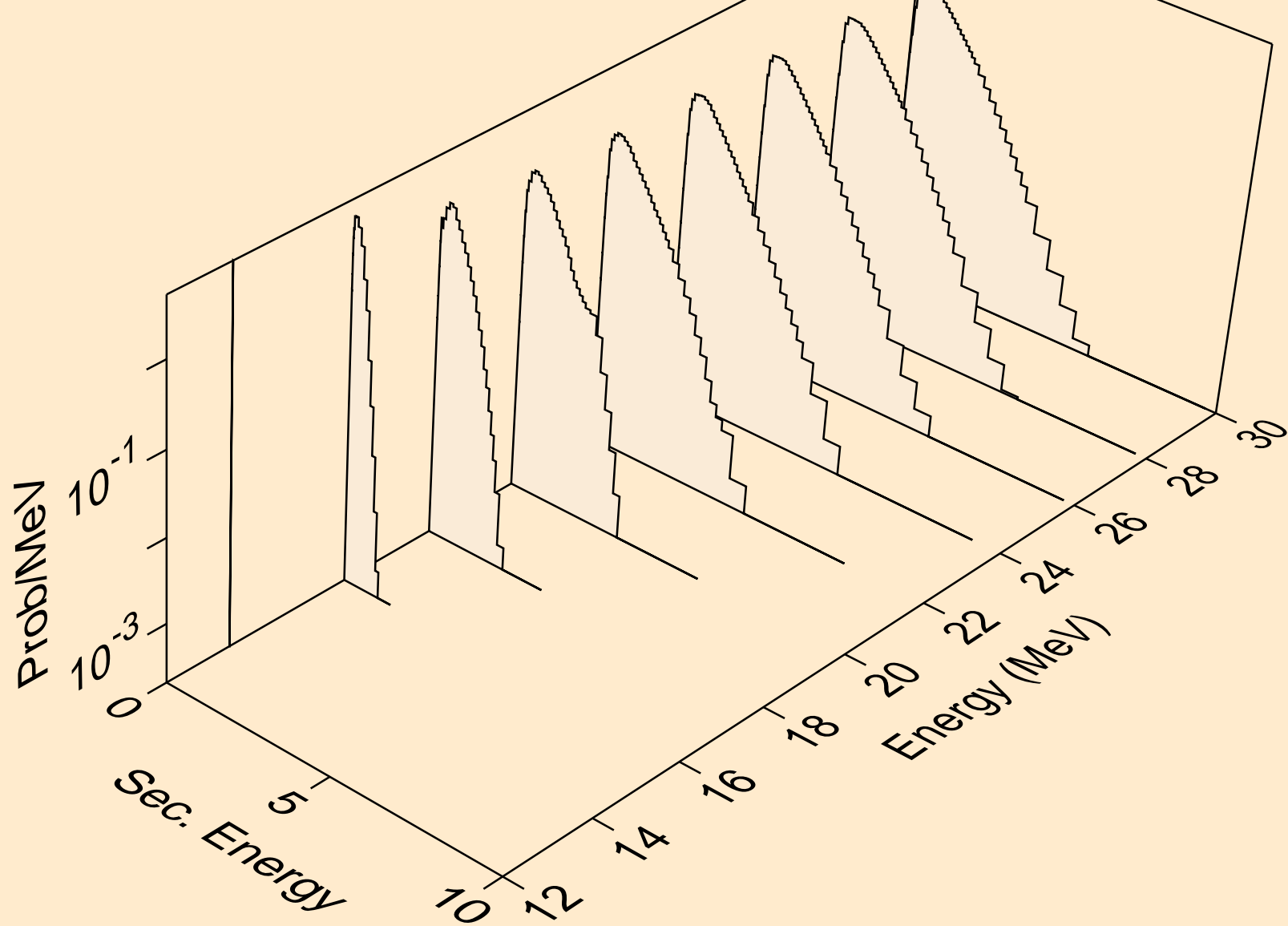

AU196 ALPHA ACER TENDL-2023 LIBRARY; T=0.K
neutrons from (a,n*)d

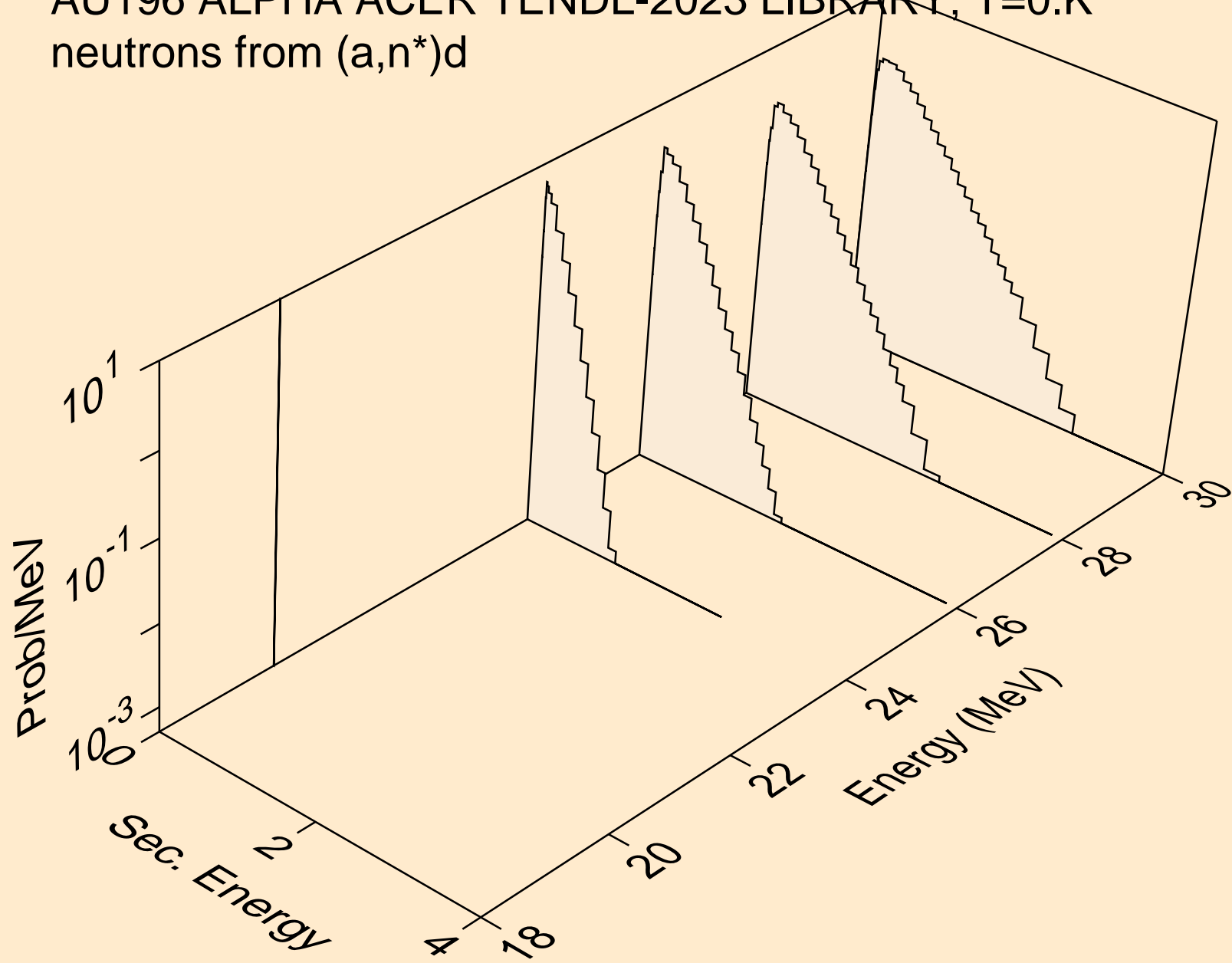

AU196 ALPHA ACER TENDL-2023 LIBRARY; T=0.K
neutrons from (a,n*)t

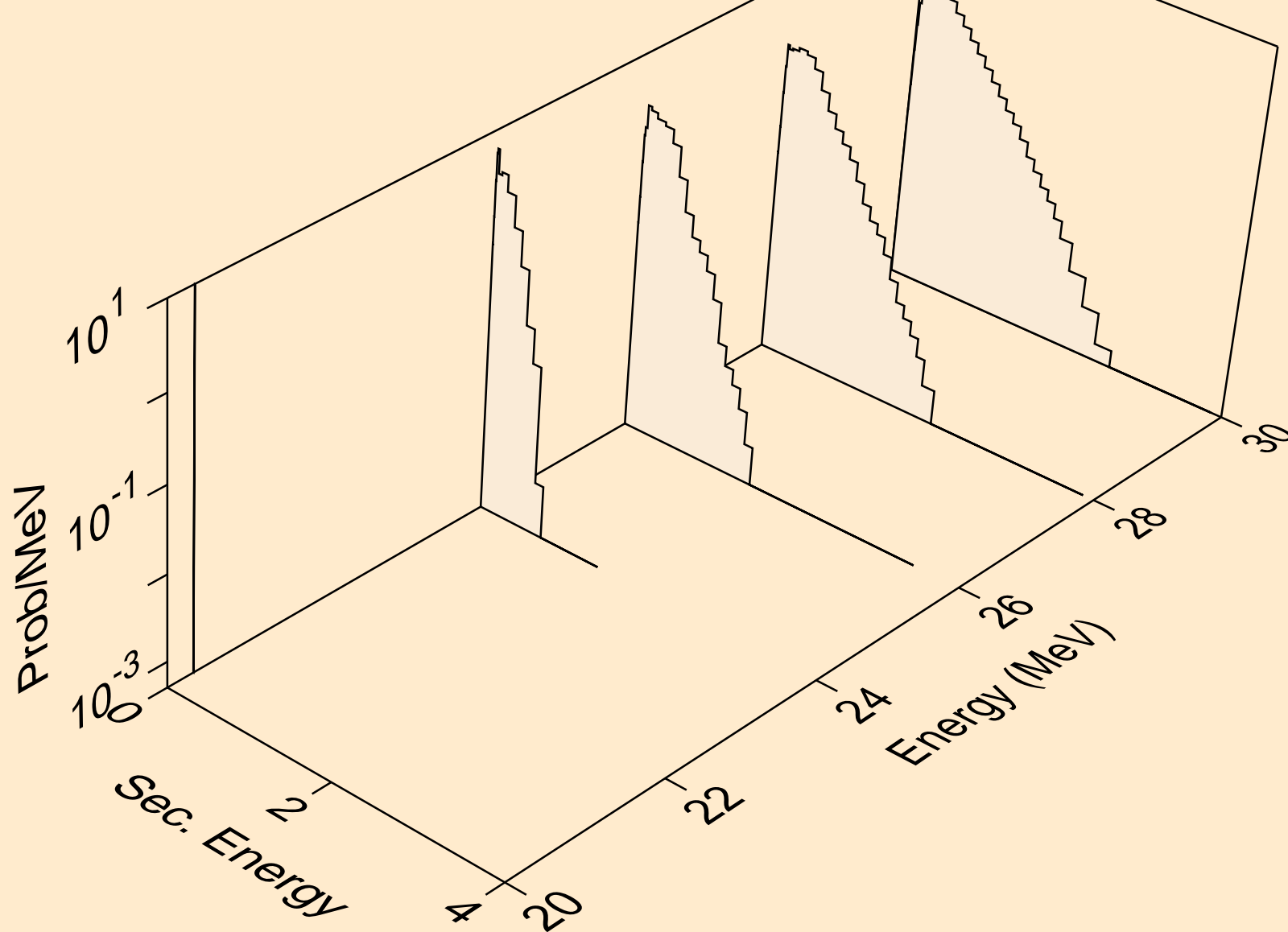

AU196 ALPHA ACER TENDL-2023 LIBRARY; T=0.K
neutrons from (a,2np)

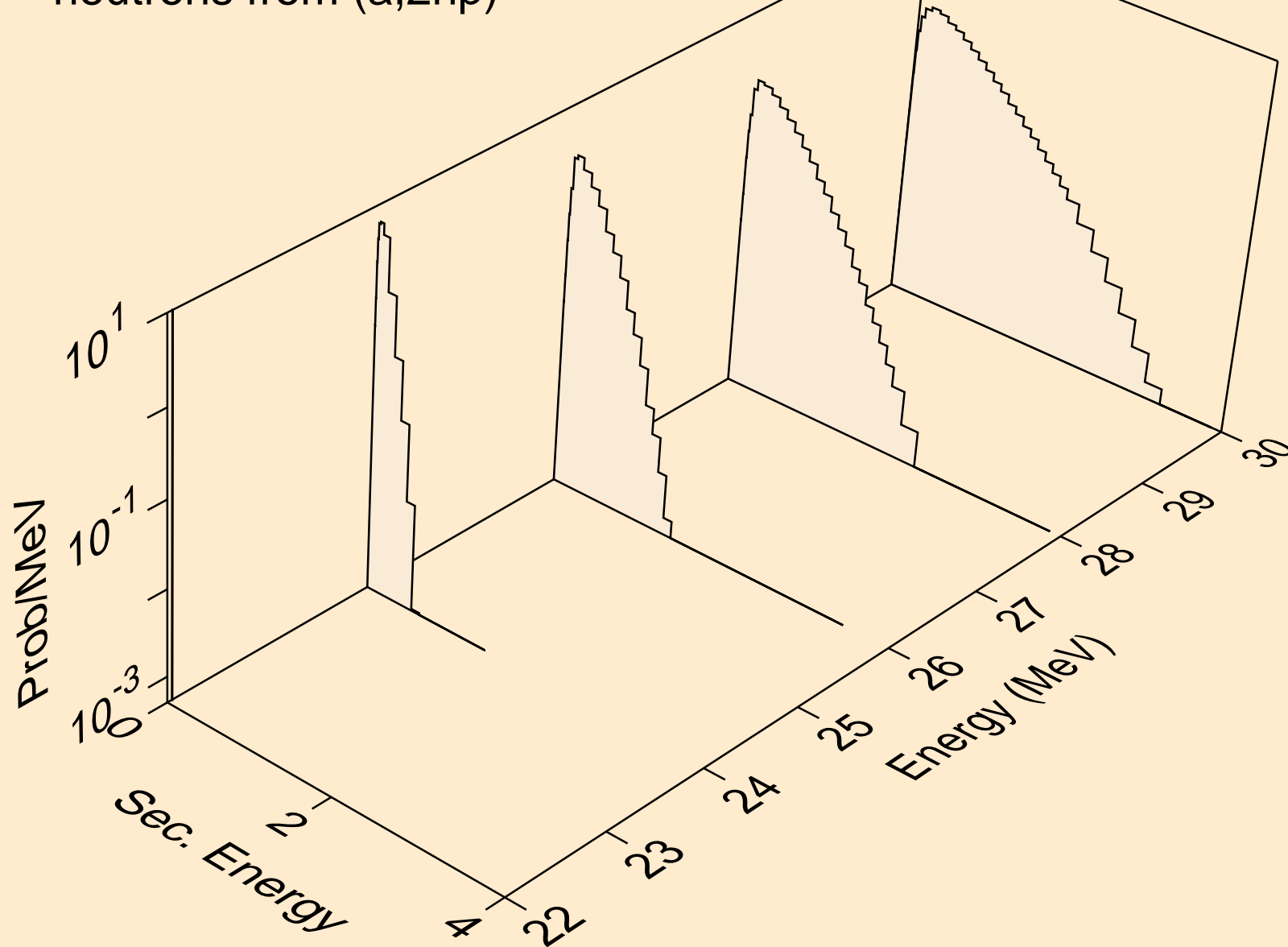

AU196 ALPHA ACER TENDL-2023 LIBRARY; T=0.K
protons from (a,x)

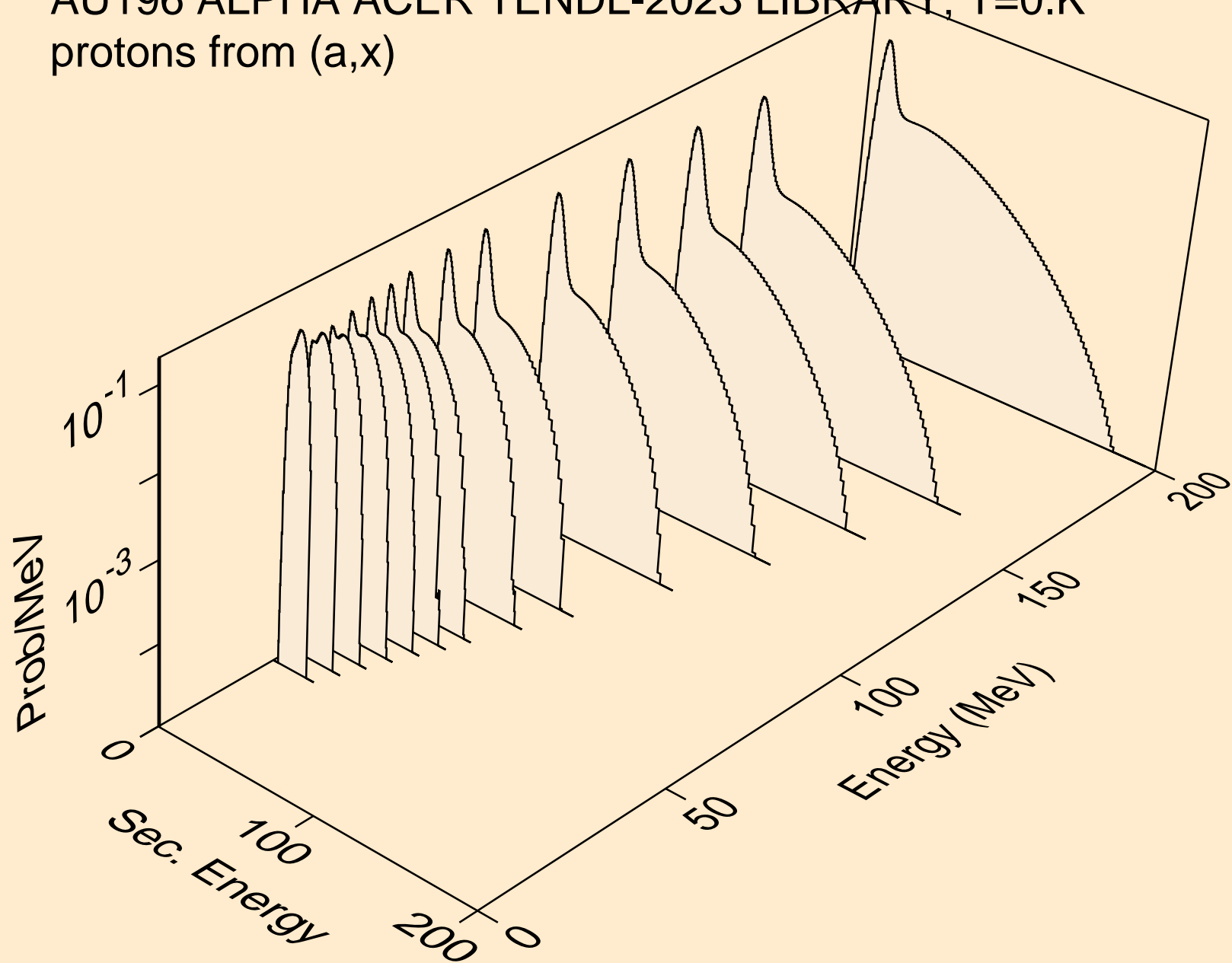

AU196 ALPHA ACER TENDL-2023 LIBRARY; T=0.K
protons from (a,n*)p

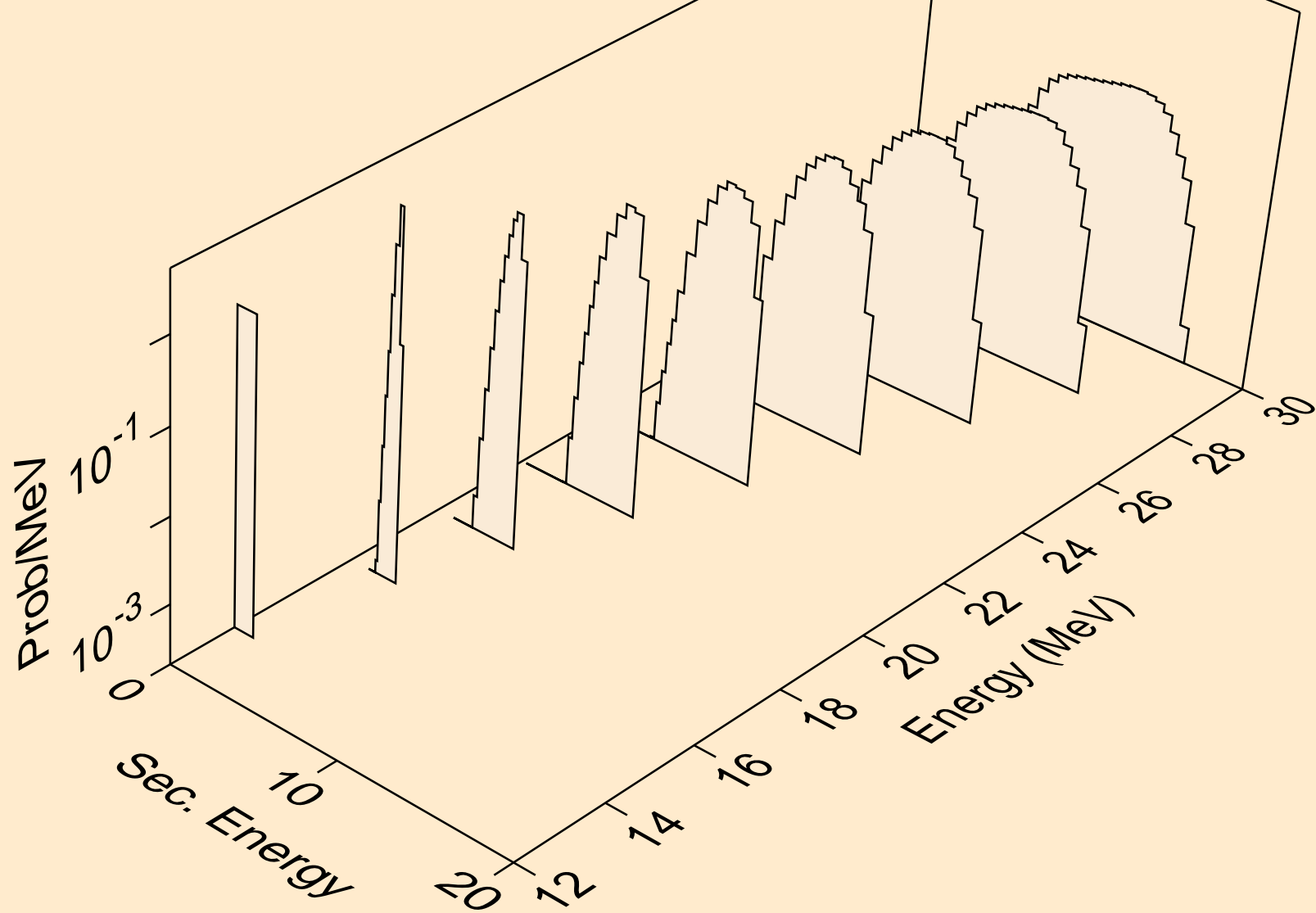

AU196 ALPHA ACER TENDL-2023 LIBRARY; T=0.K
protons from (a,2np)

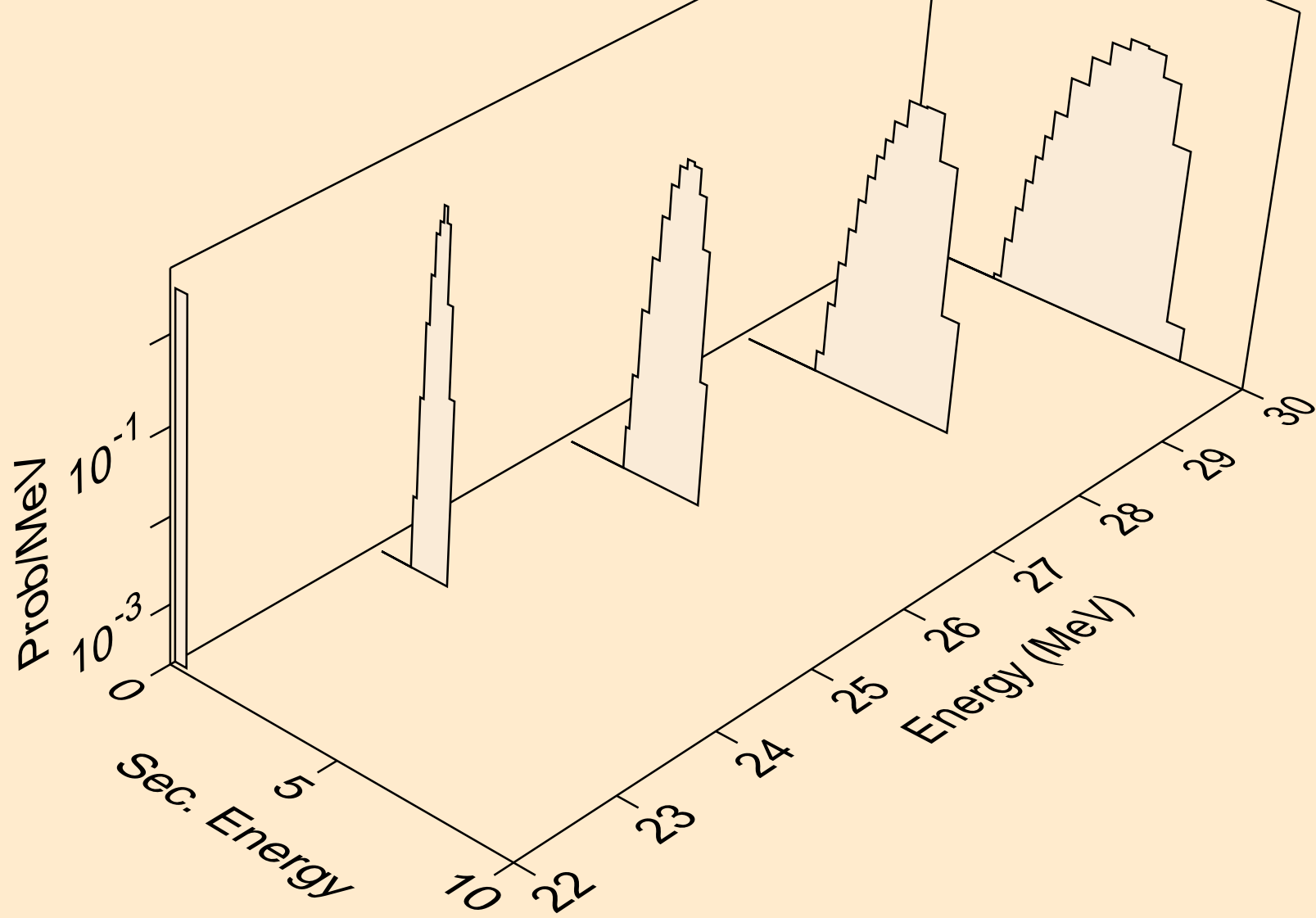

AU196 ALPHA ACER TENDL-2023 LIBRARY; T=0.K
protons from (a,p)

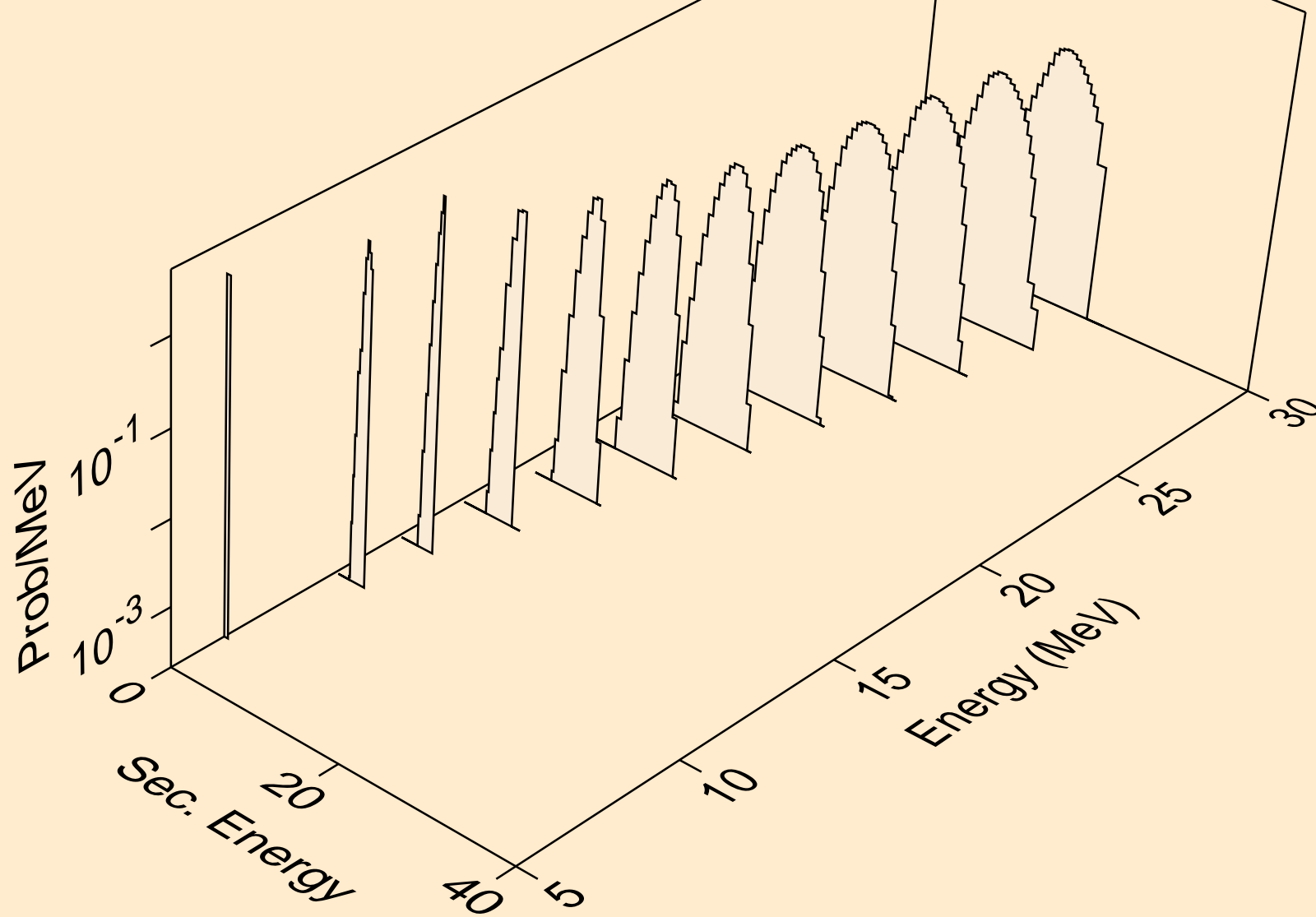

AU196 ALPHA ACER TENDL-2023 LIBRARY; T=0.K
protons from (a,2p)

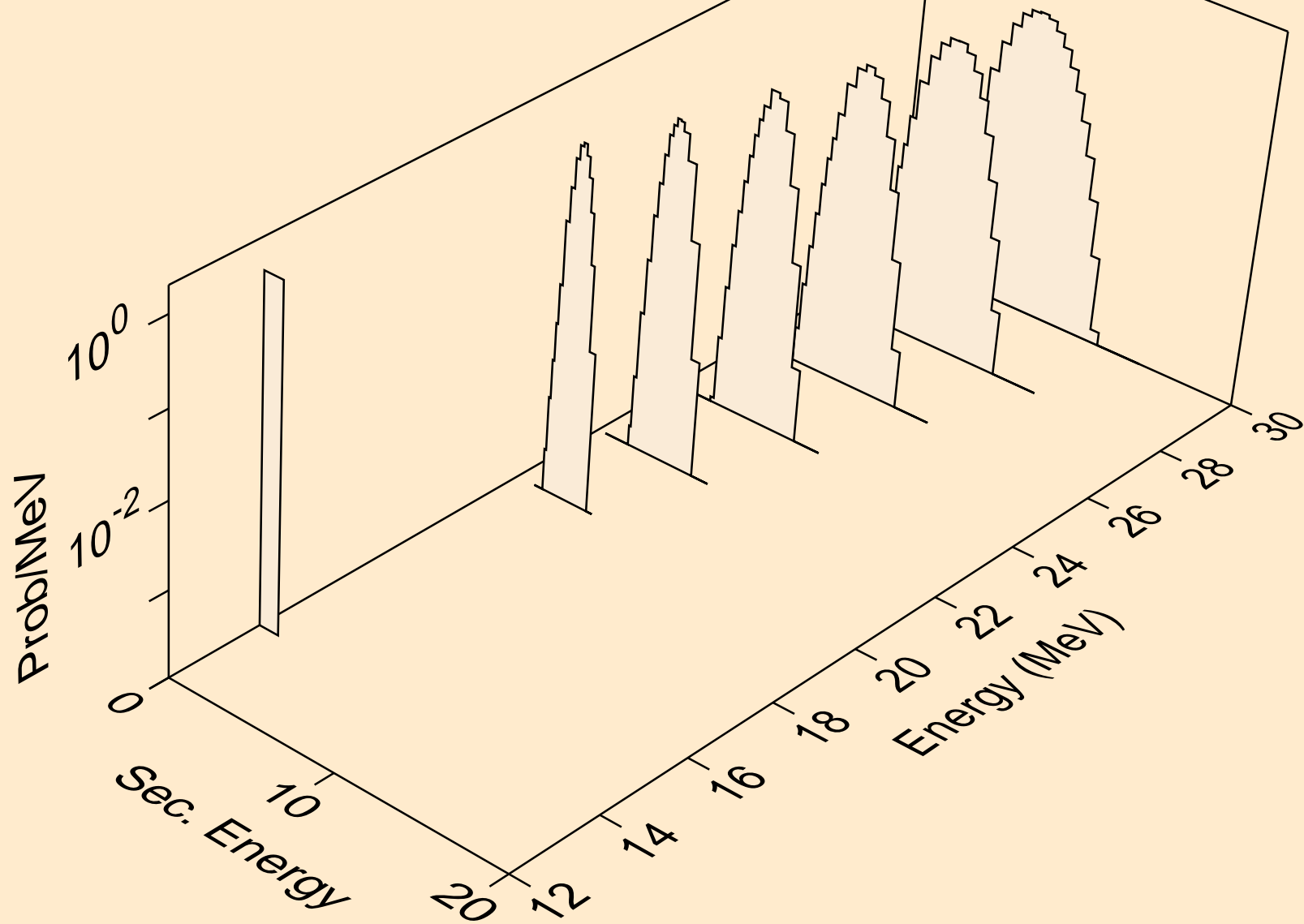

AU196 ALPHA ACER TENDL-2023 LIBRARY; T=0.K
protons from (a,pa)

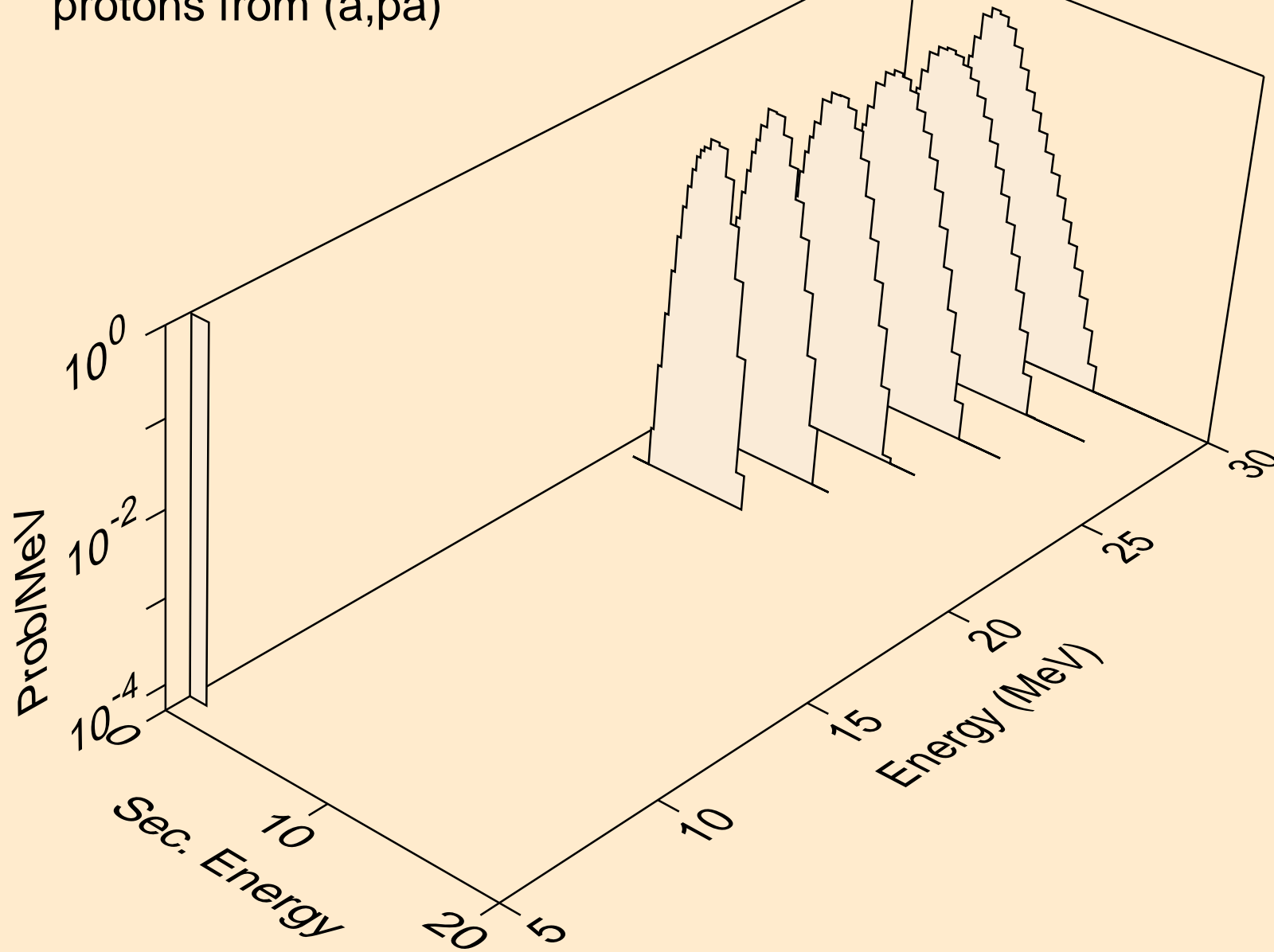

AU196 ALPHA ACER TENDL-2023 LIBRARY; T=0.K
deuterons from (a,x)

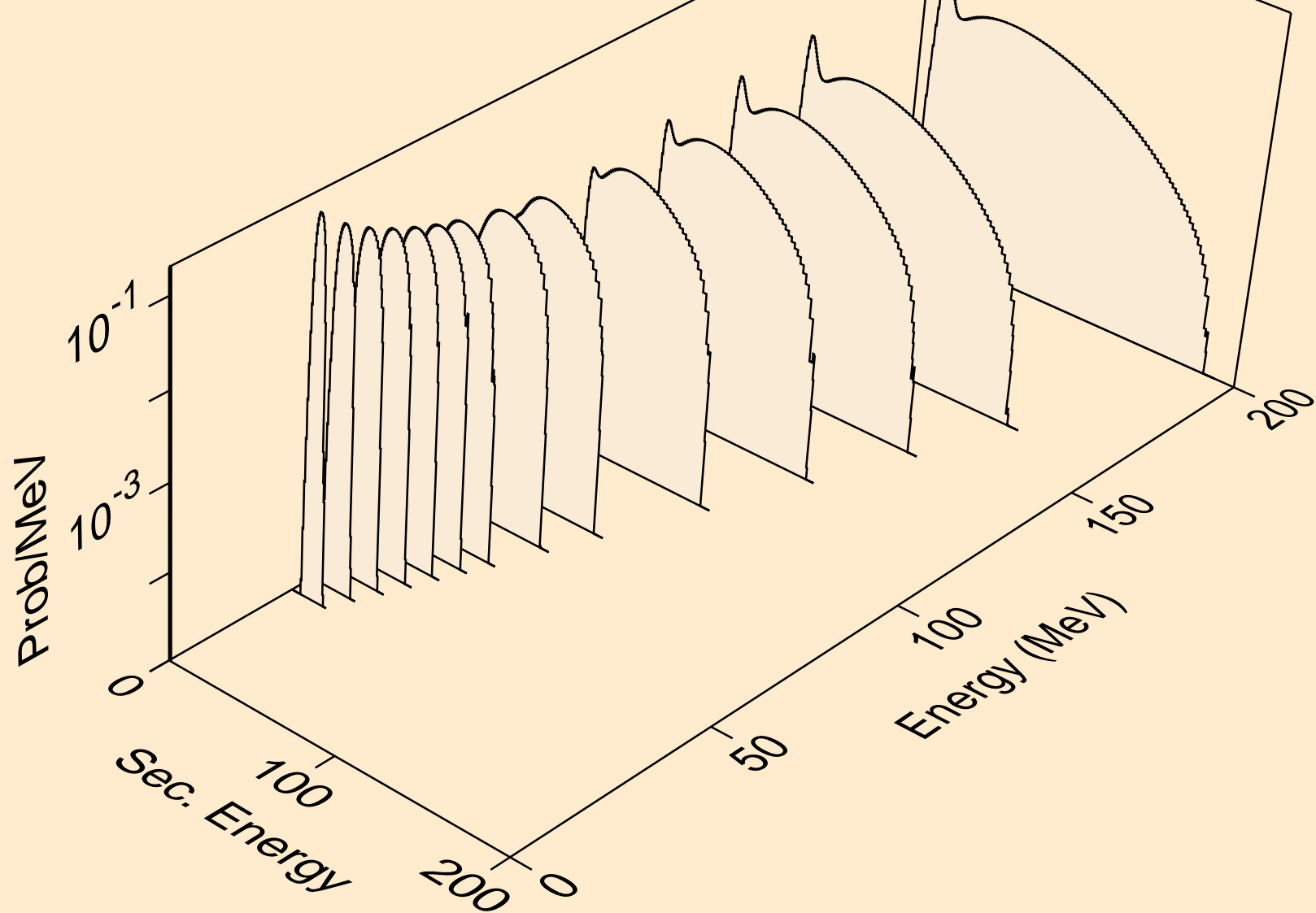

AU196 ALPHA ACER TENDL-2023 LIBRARY; T=0.K
deuterons from (a,n*)d

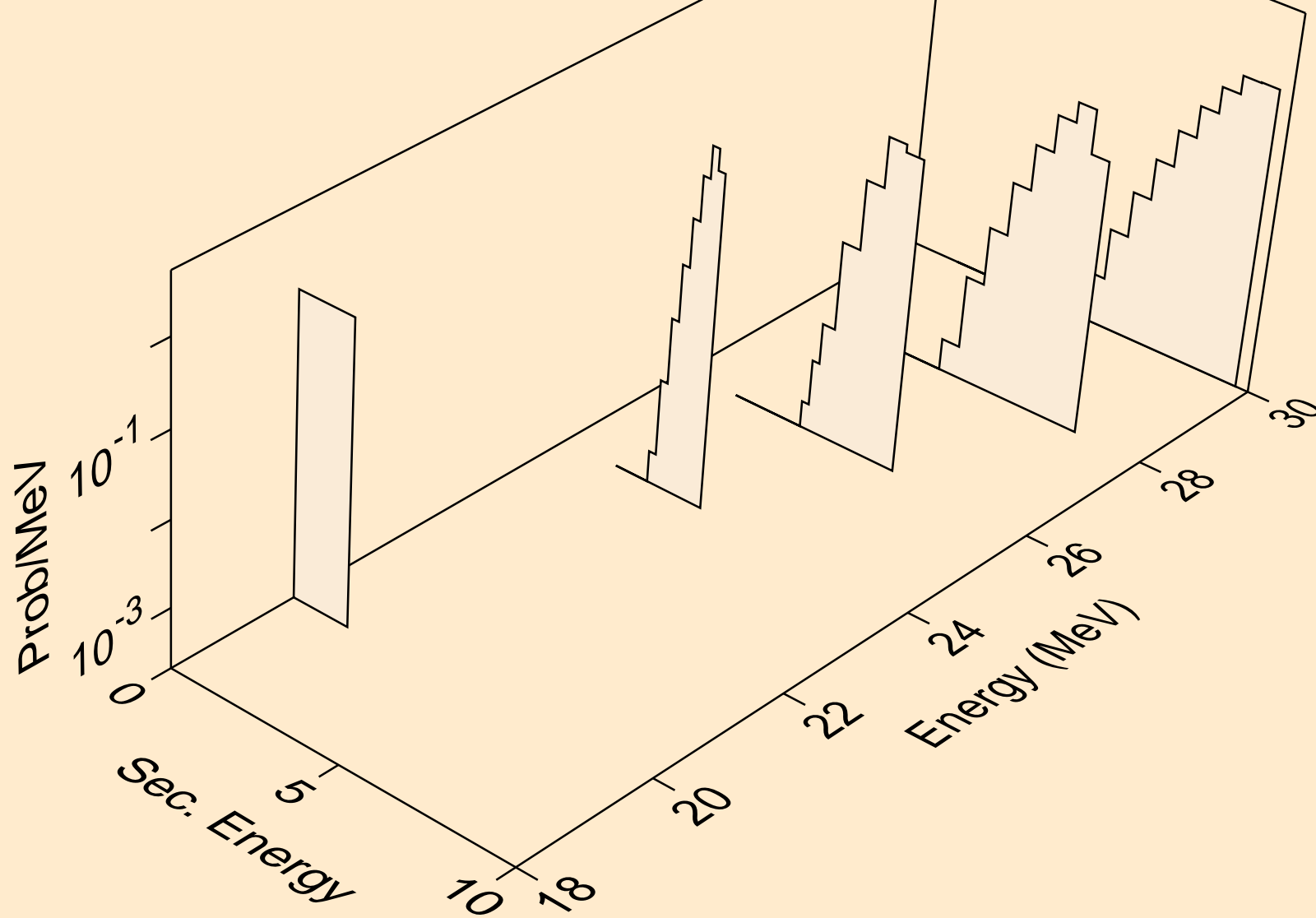

AU196 ALPHA ACER TENDL-2023 LIBRARY; T=0.K
deuterons from (a,d)

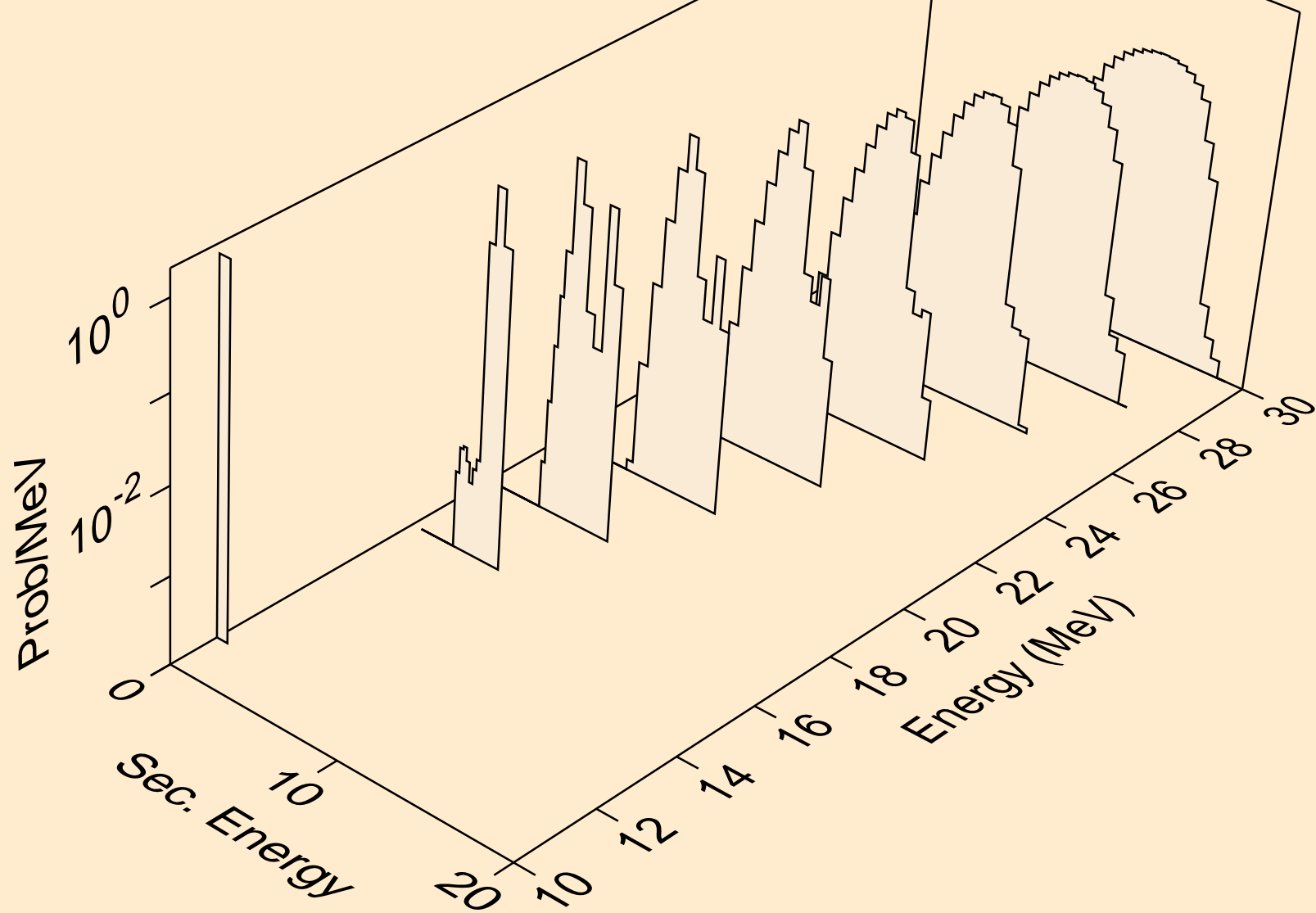

AU196 ALPHA ACER TENDL-2023 LIBRARY; T=0.K
tritons from (a,x)

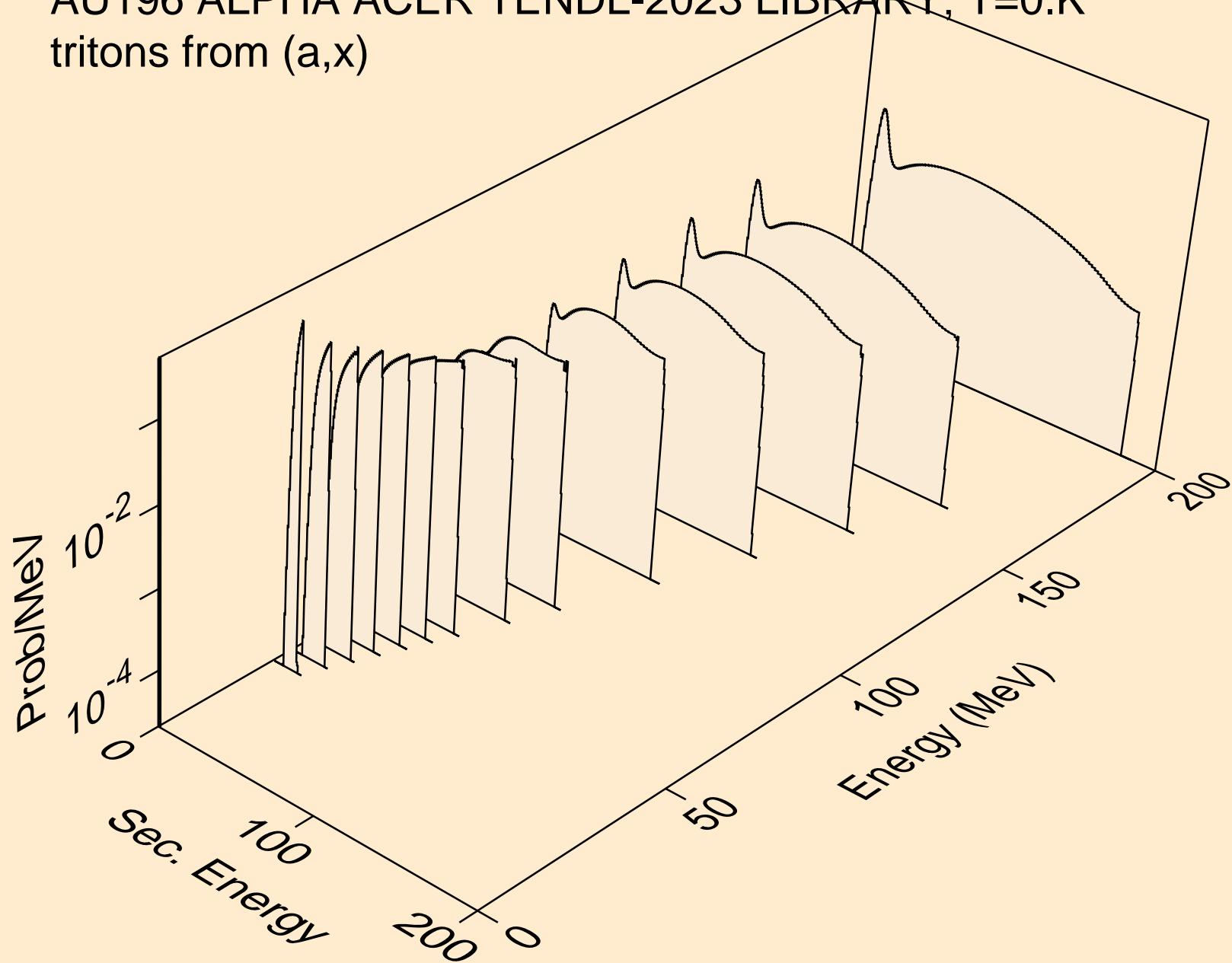

AU196 ALPHA ACER TENDL-2023 LIBRARY; T=0.K
tritons from (a,n*)t

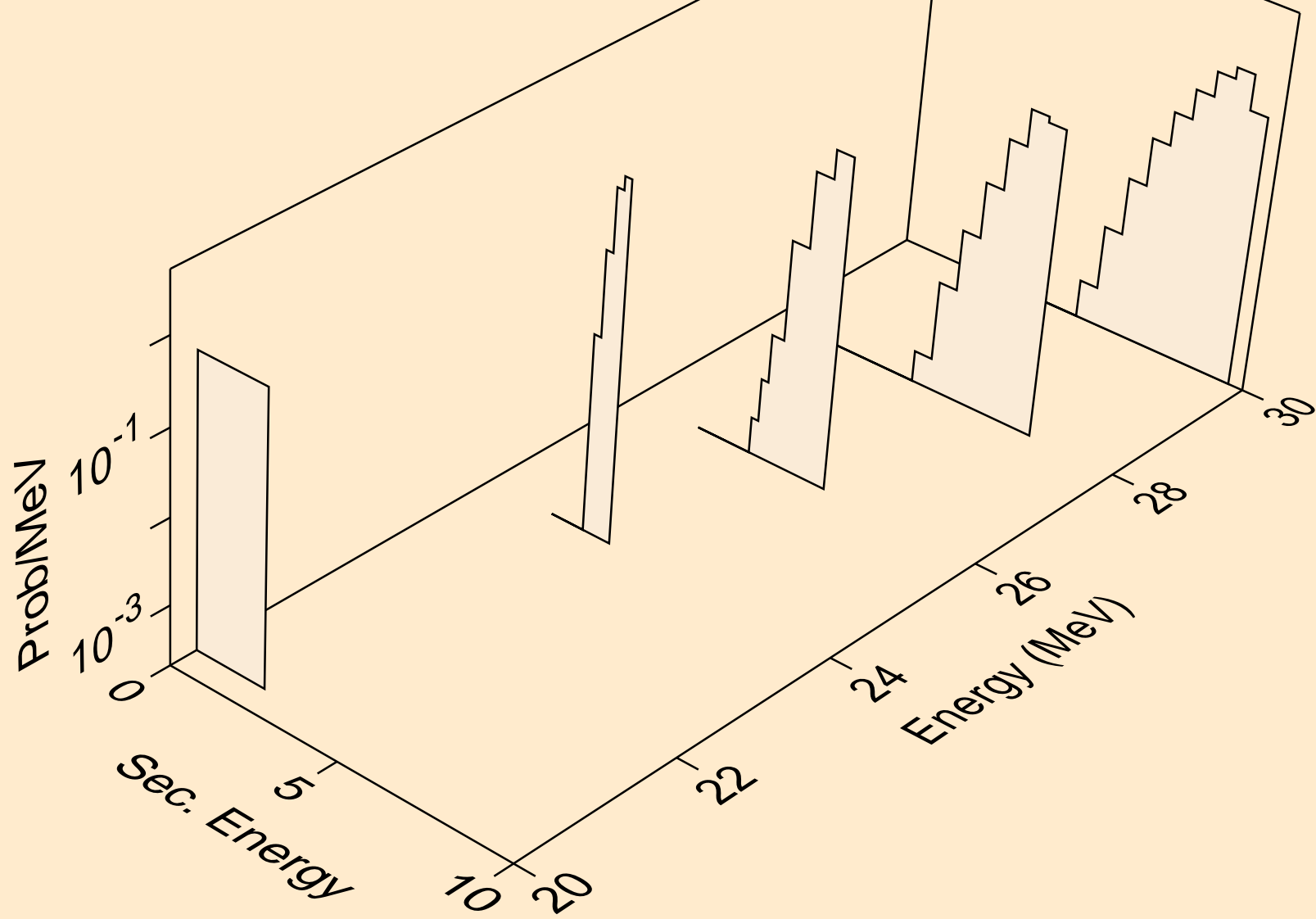

AU196 ALPHA ACER TENDL-2023 LIBRARY; T=0.K
tritons from (a,t)

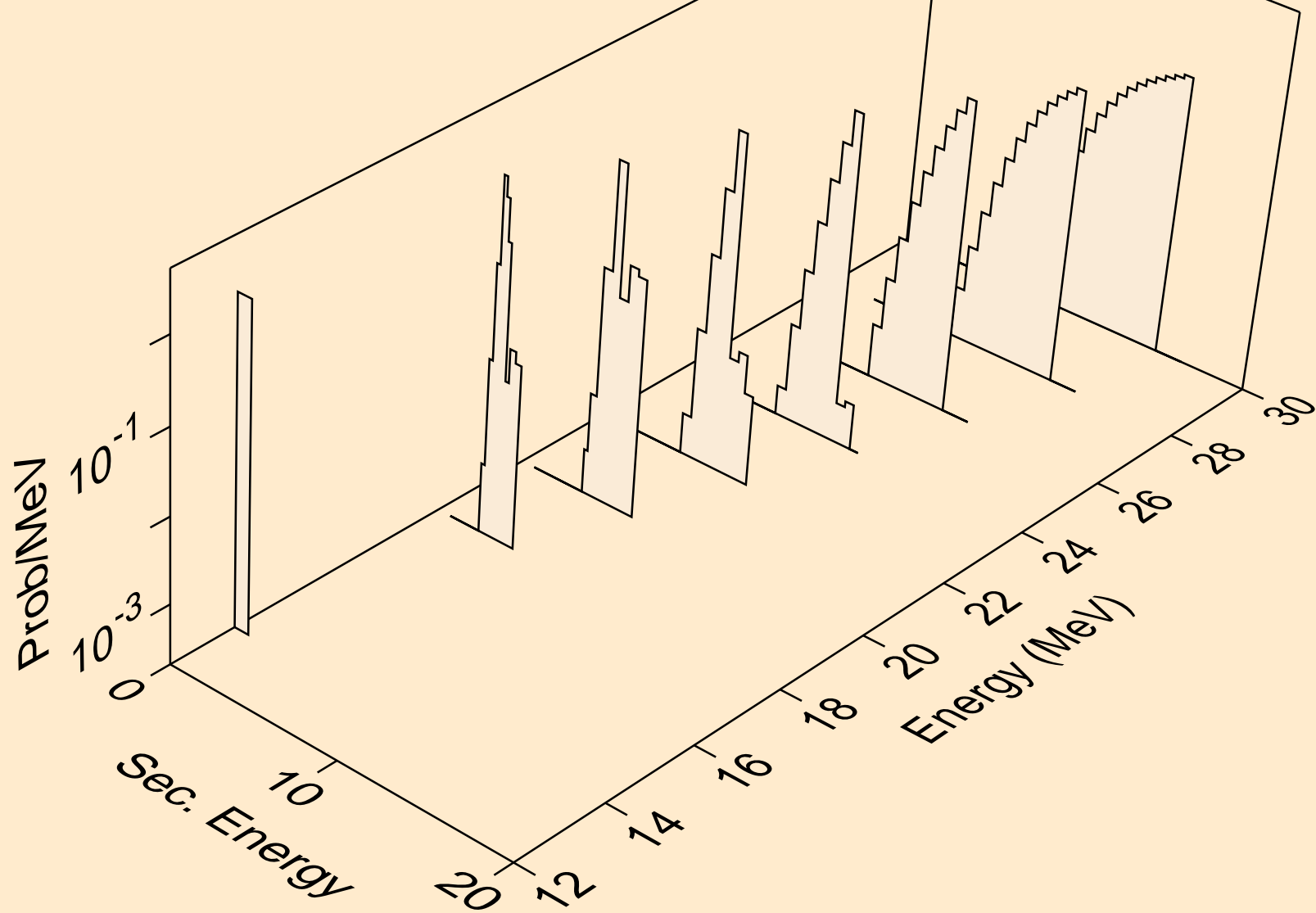

AU196 ALPHA ACER TENDL-2023 LIBRARY; T=0.K
he3s from (a,x)

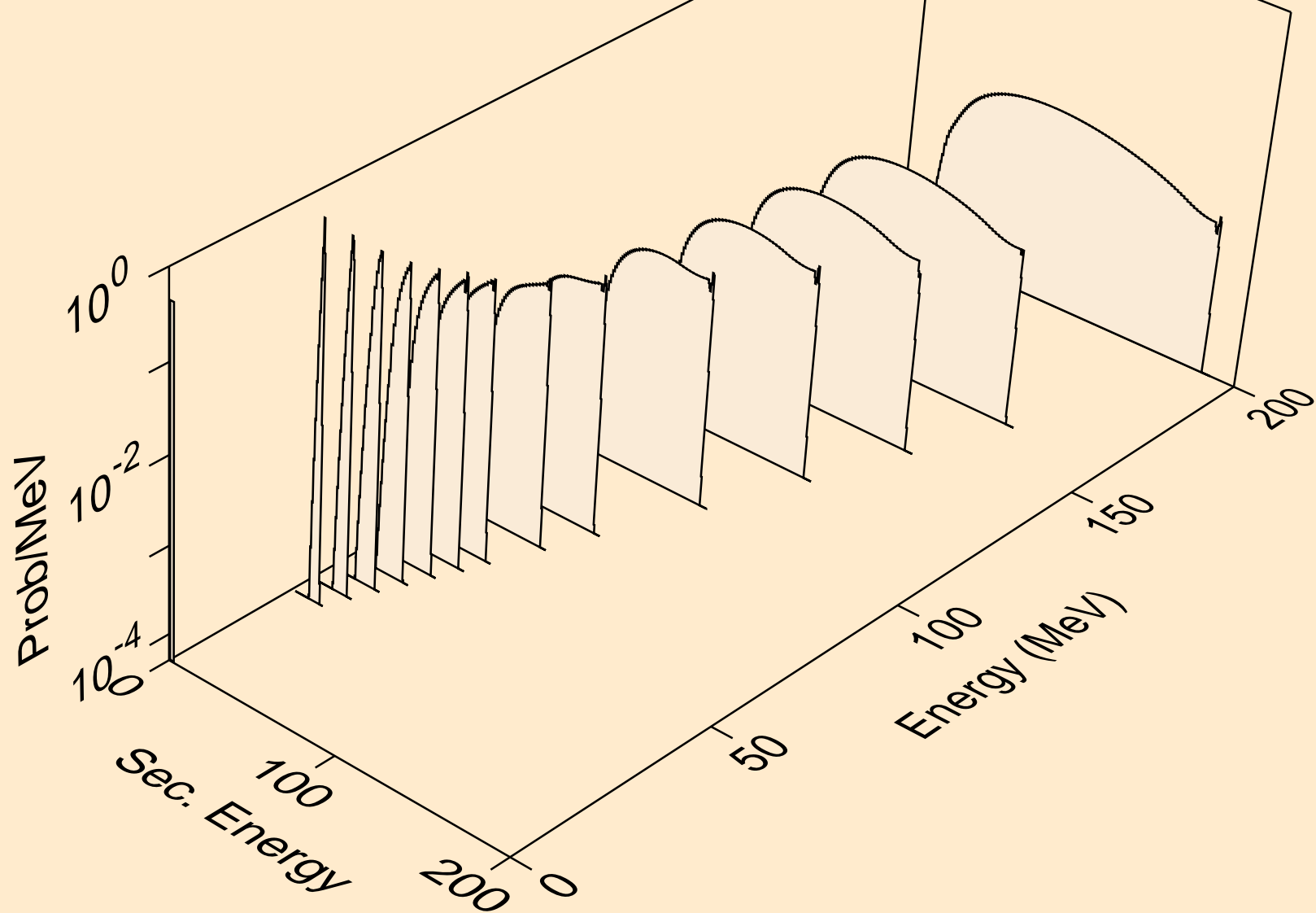

AU196 ALPHA ACER TENDL-2023 LIBRARY; T=0.K
he3s from (a,he3)

