

EU162 ALPHA ACER TENDL-2023 LIBRARY; T=0.K

Principal cross sections

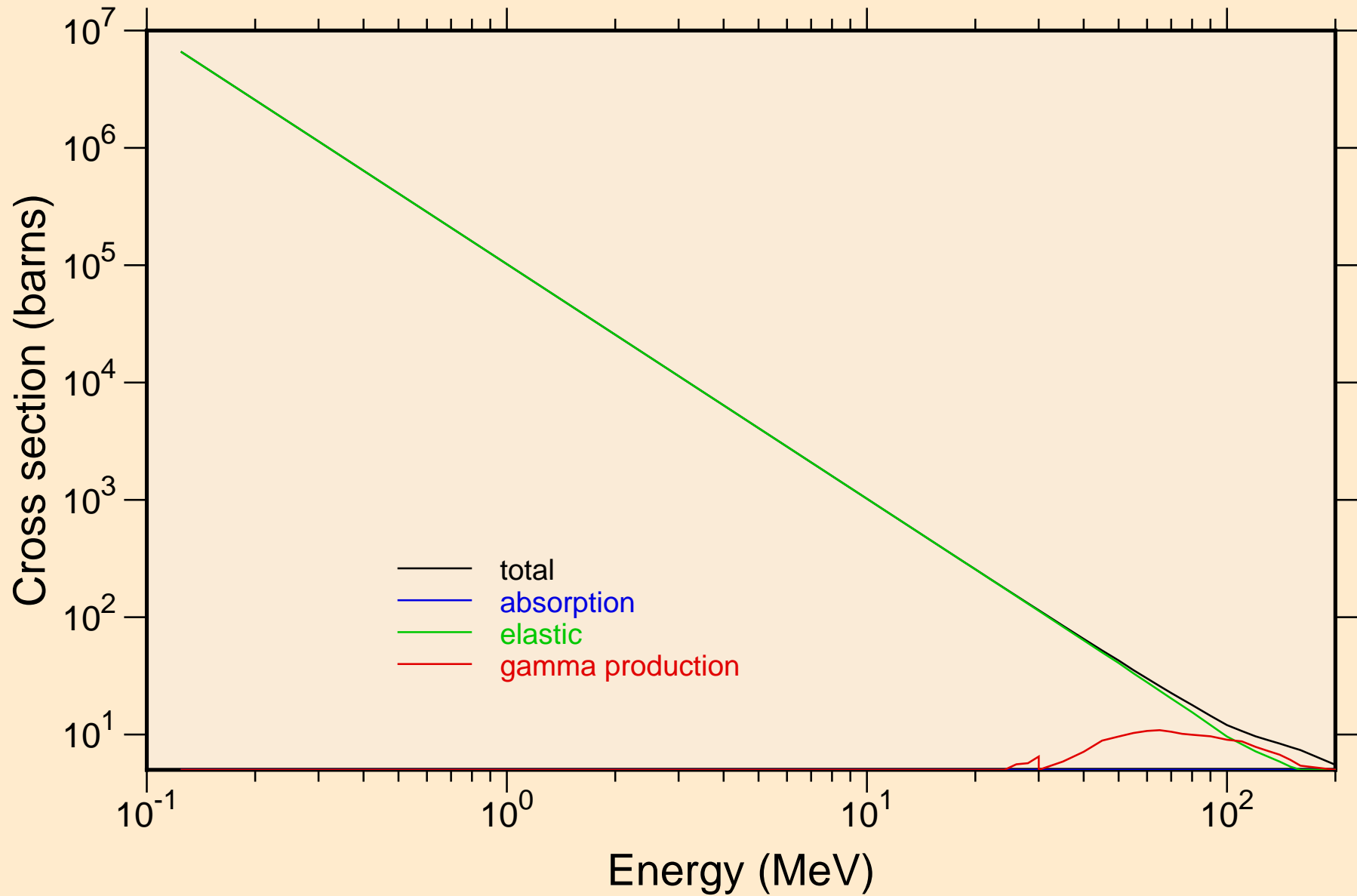

EU162 ALPHA ACER TENDL-2023 LIBRARY; T=0.K

Heating

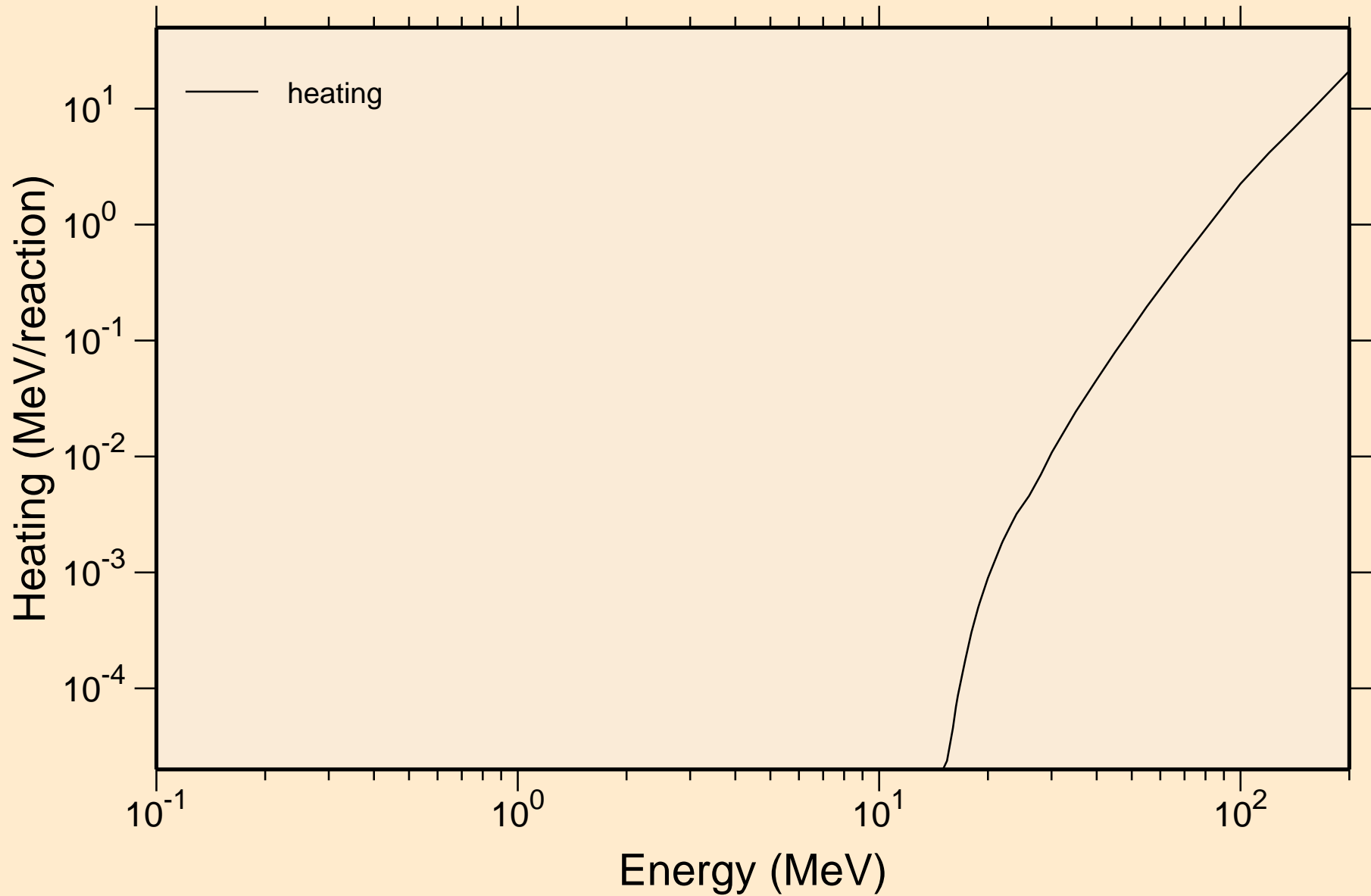

EU162 ALPHA ACER TENDL-2023 LIBRARY; T=0.K

Principal cross sections

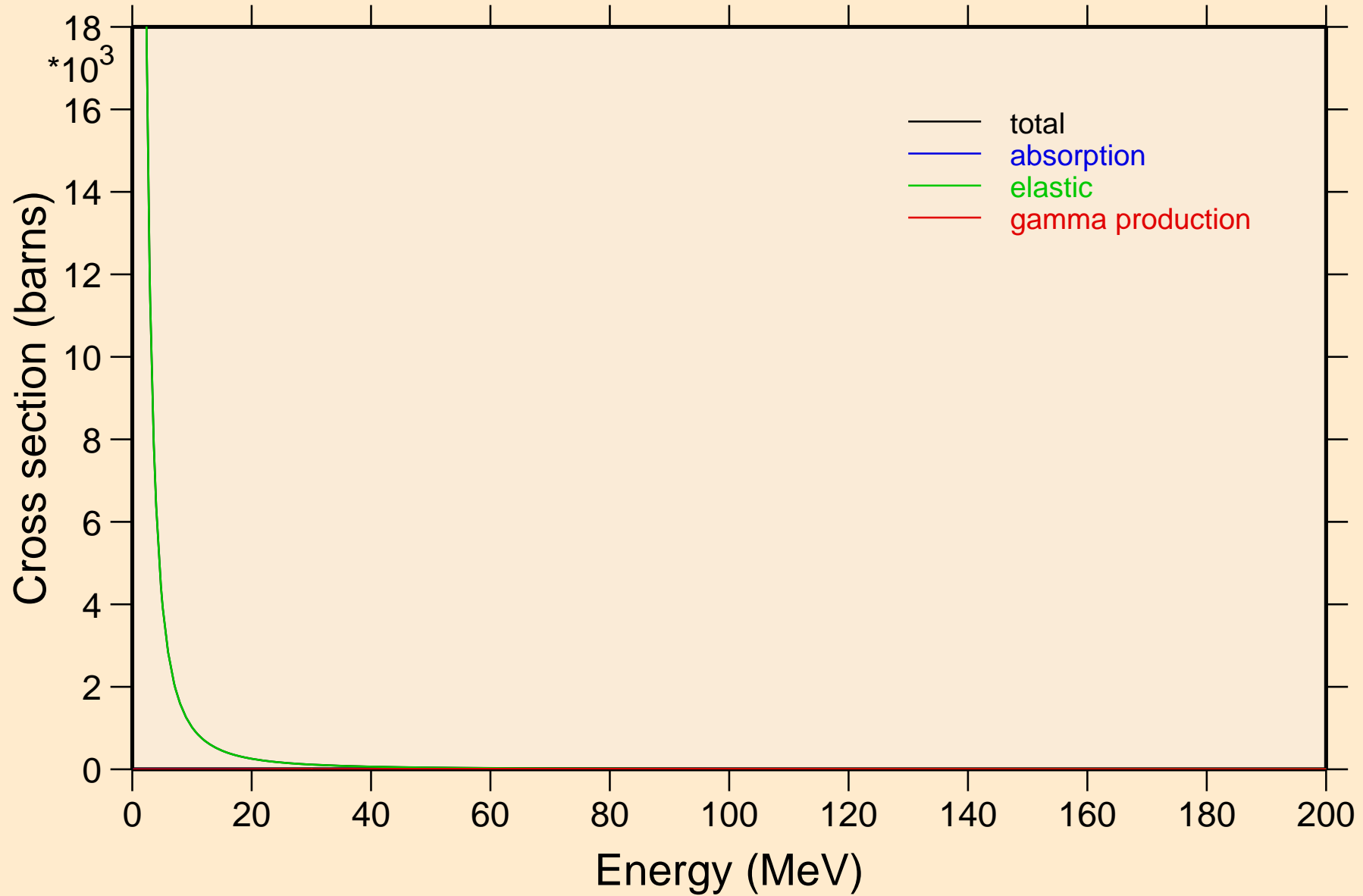

EU162 ALPHA ACER TENDL-2023 LIBRARY; T=0.K

Heating

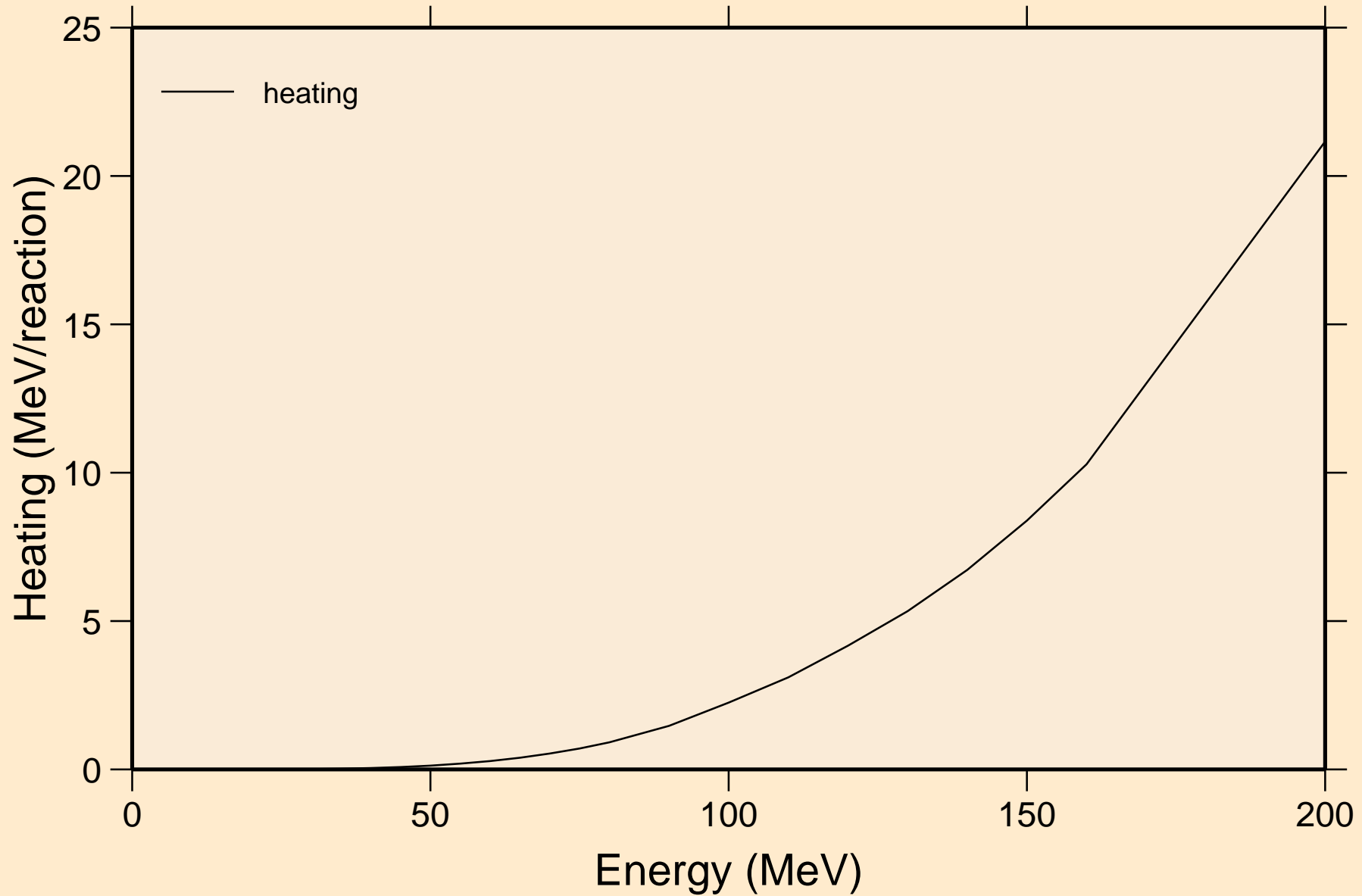

EU162 ALPHA ACER TENDL-2023 LIBRARY; T=0.K
Threshold reactions

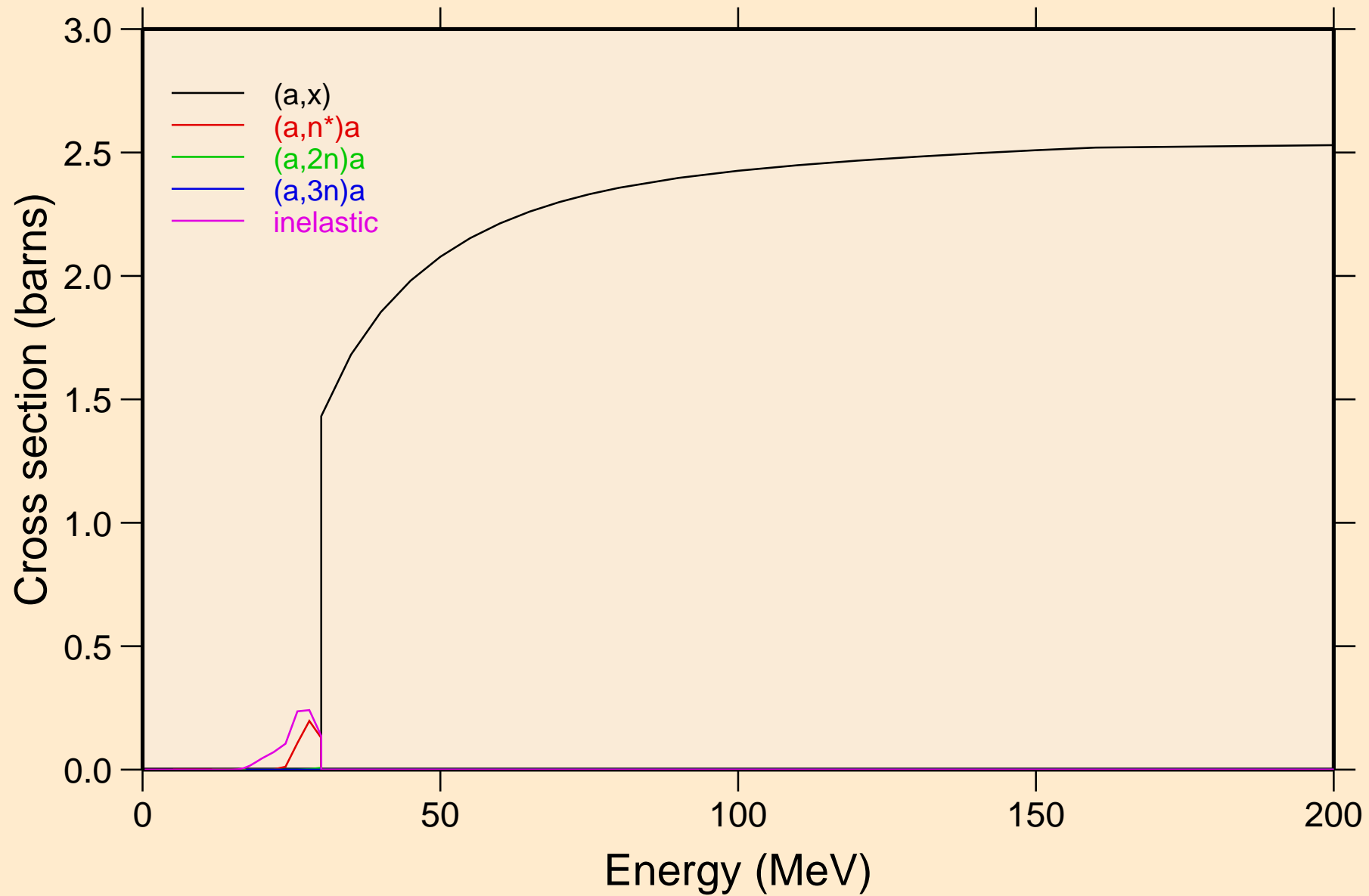

EU162 ALPHA ACER TENDL-2023 LIBRARY; T=0.K
angular distribution for elastic

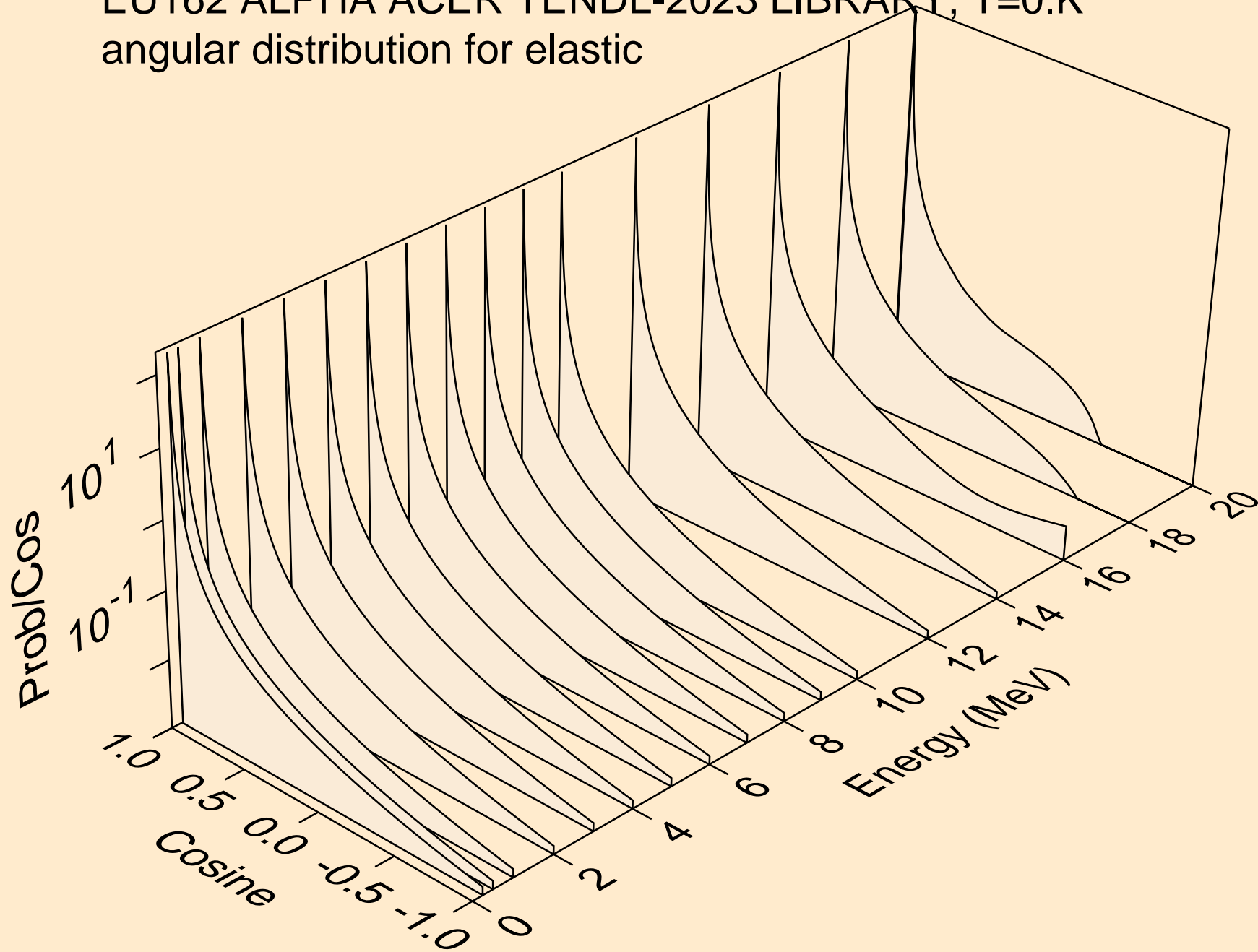

EU162 ALPHA ACER TENDL-2023 LIBRARY; T=0.K
angular distribution for elastic

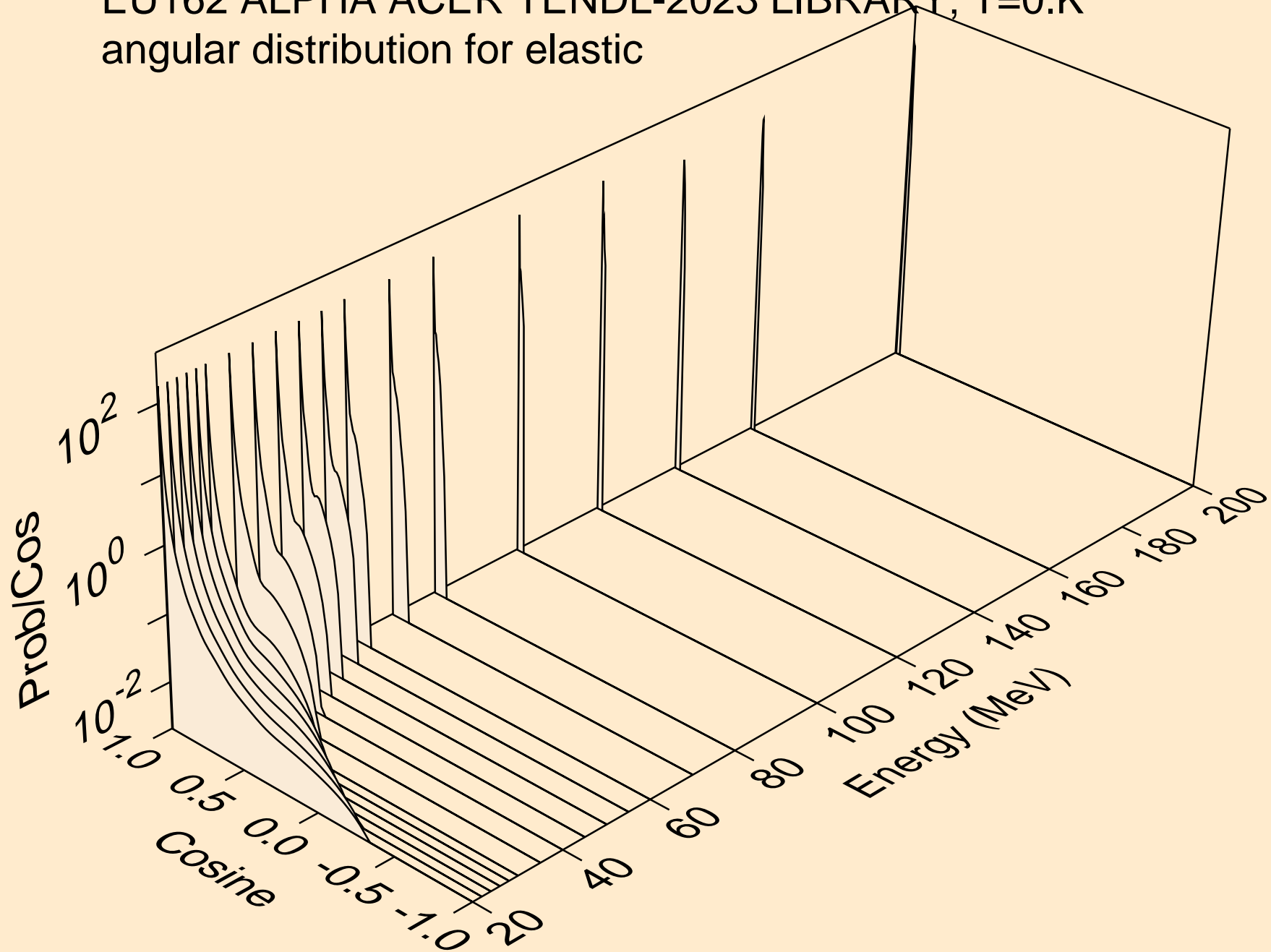

EU162 ALPHA ACER TENDL-2023 LIBRARY; T=0.K
Alpha emission for (a,x)

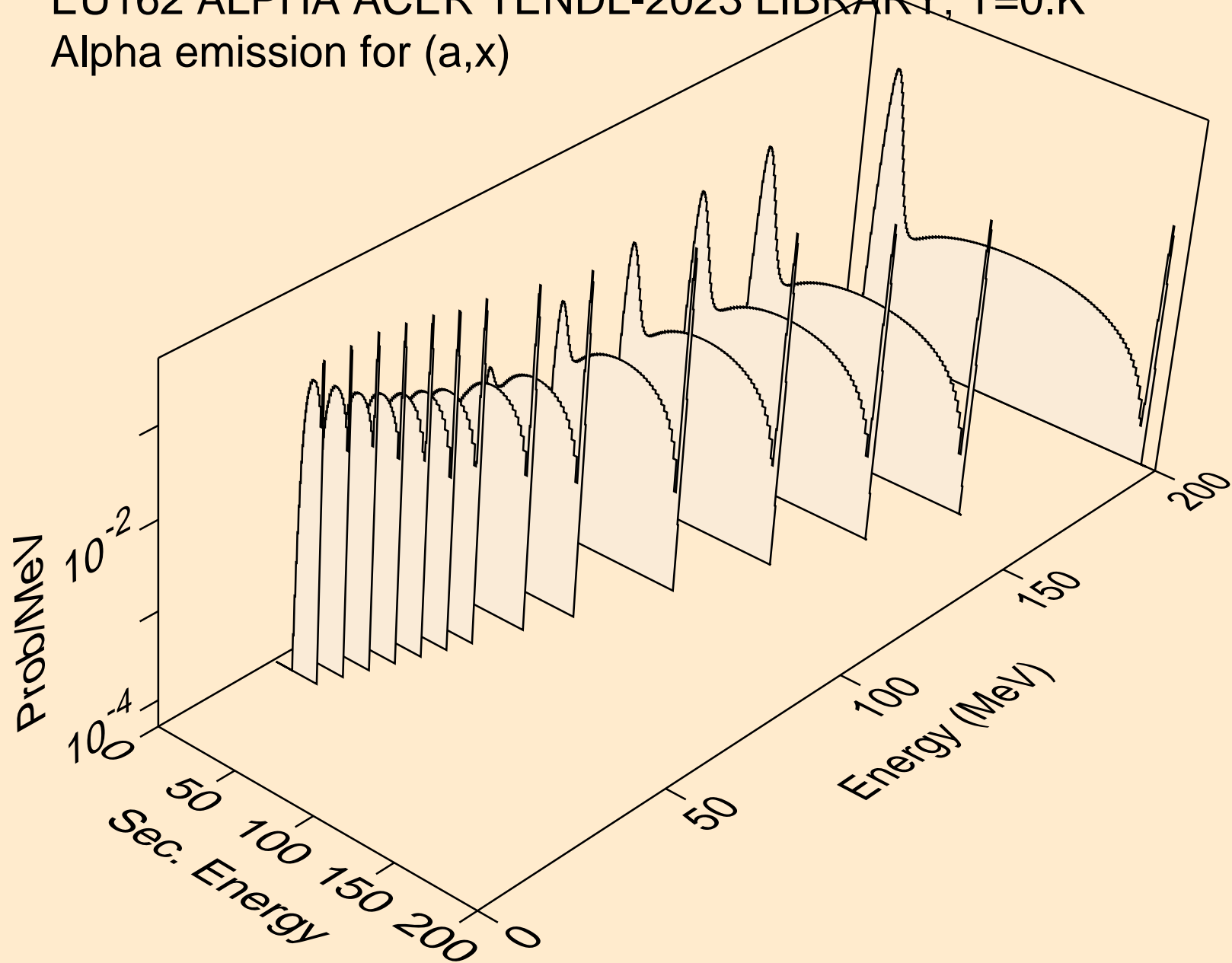

EU162 ALPHA ACER TENDL-2023 LIBRARY; T=0.K
Alpha emission for (a,n*)a

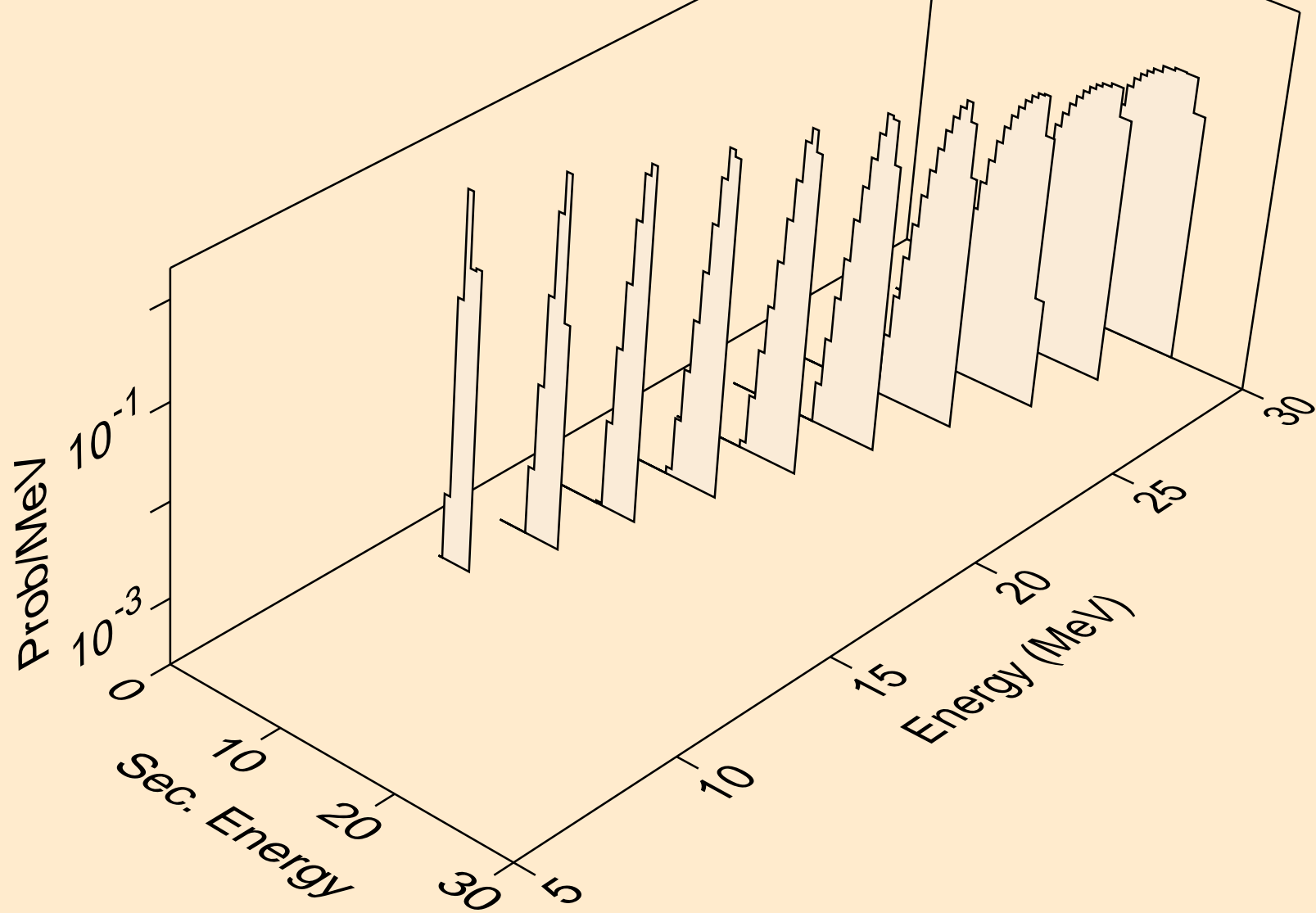

EU162 ALPHA ACER TENDL-2023 LIBRARY; T=0.K
Alpha emission for (a,2n)a

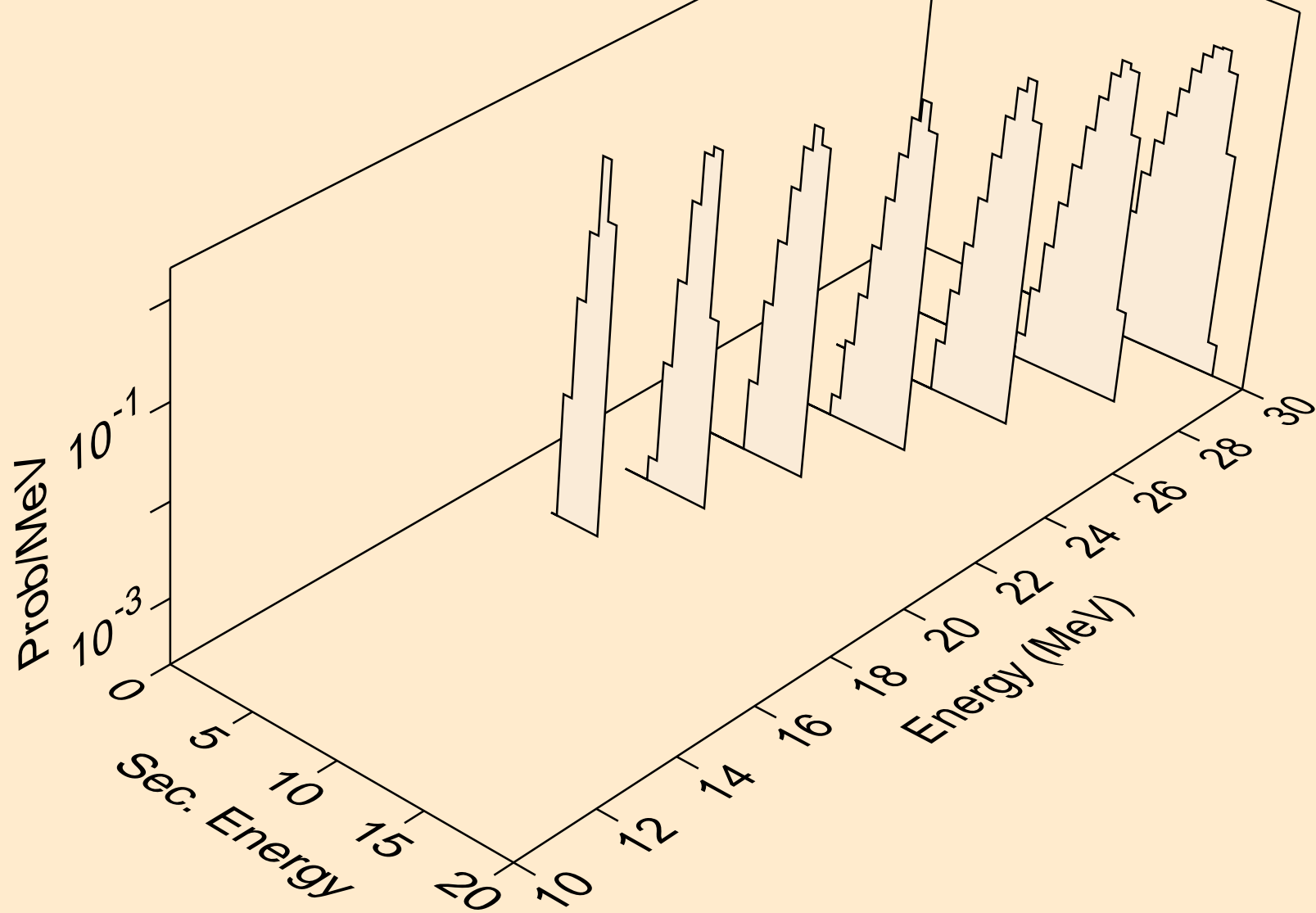

EU162 ALPHA ACER TENDL-2023 LIBRARY; T=0.K
Alpha emission for (a,3n)a

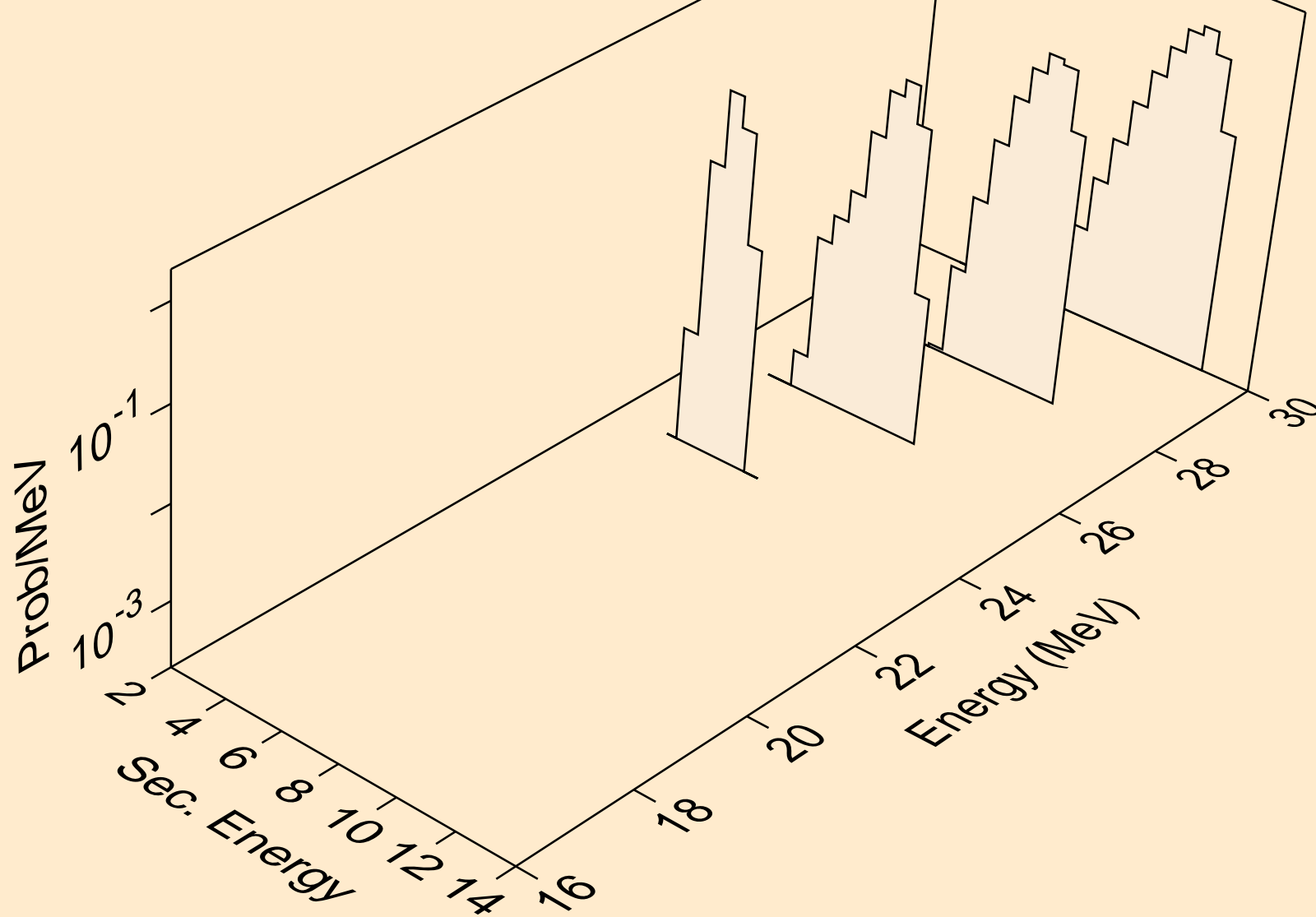

EU162 ALPHA ACER TENDL-2023 LIBRARY; T=0.K
Alpha emission for inelastic

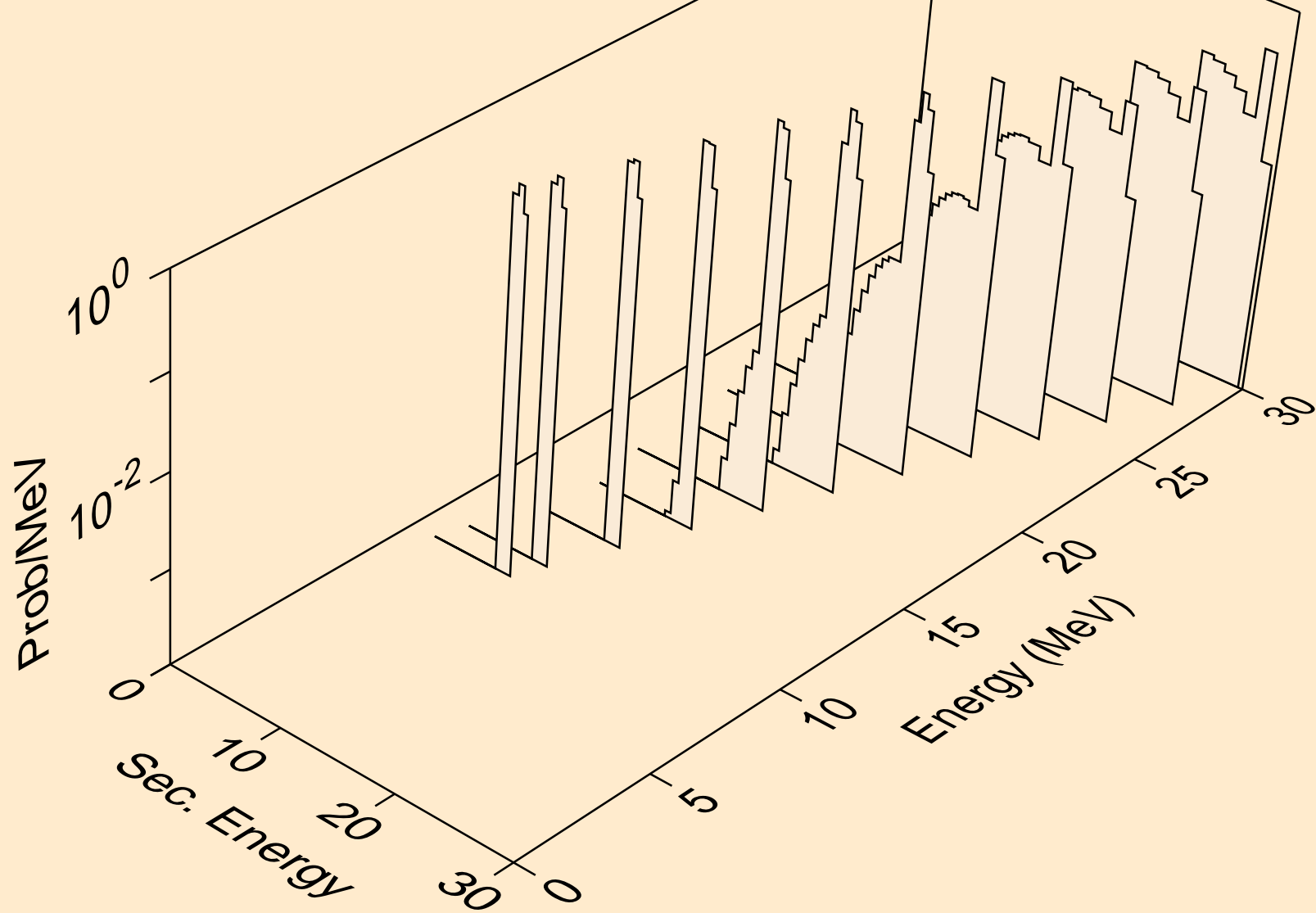

EU162 ALPHA ACER TENDL-2023 LIBRARY; T=0.K
Photon emission for (z,n)

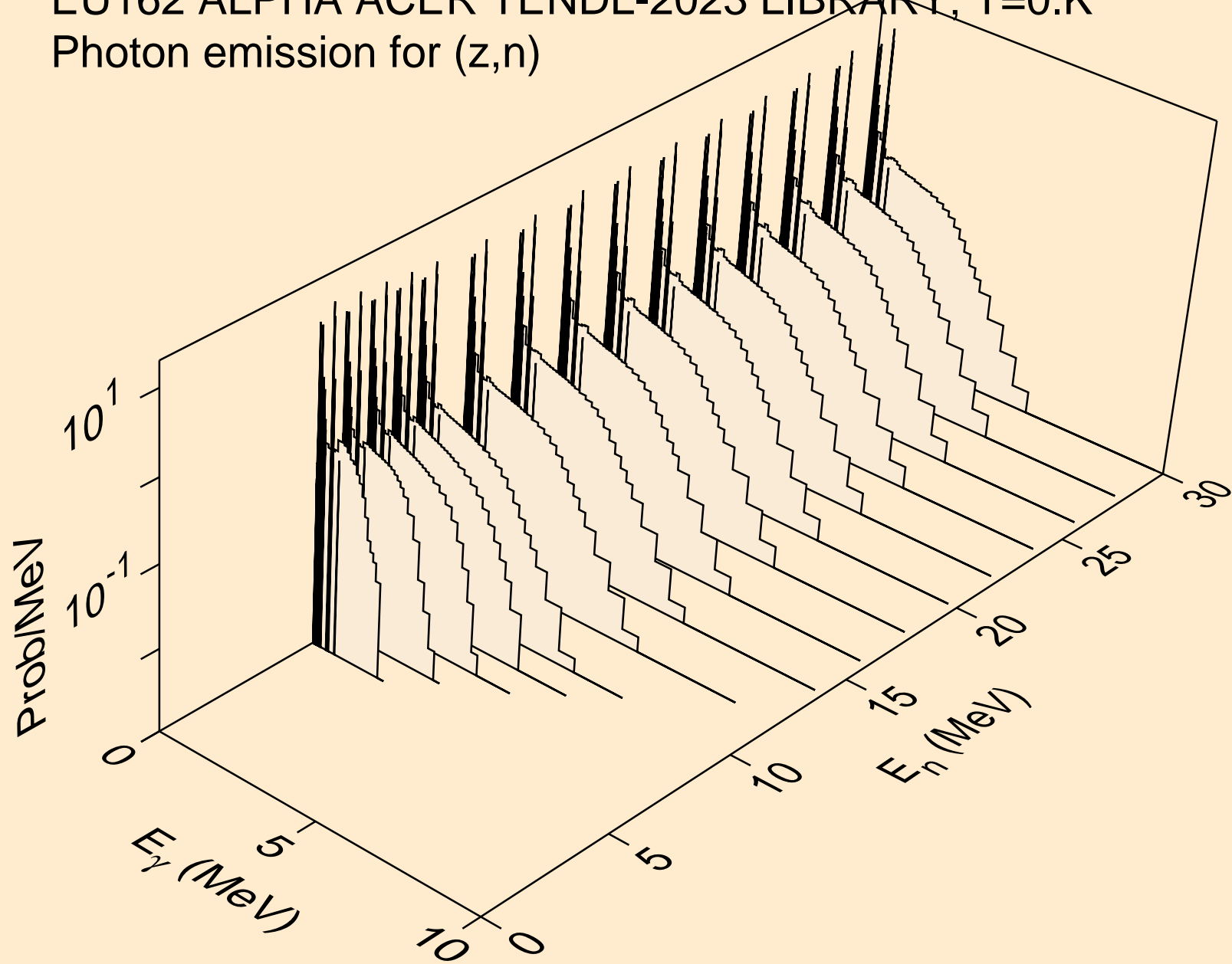

EU162 ALPHA ACER TENDL-2023 LIBRARY; T=0.K
Photon emission for (z,x)

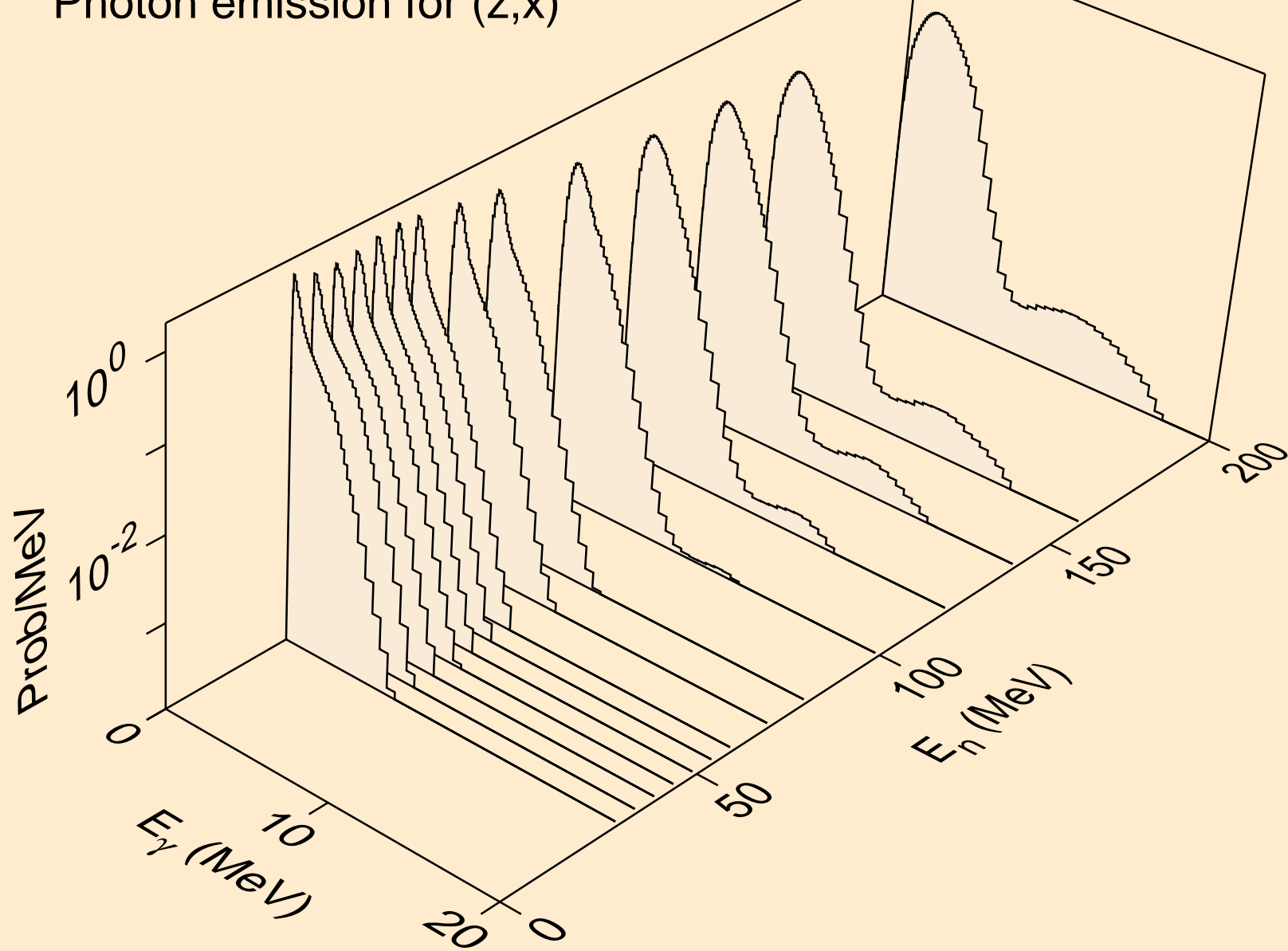

EU162 ALPHA ACER TENDL-2023 LIBRARY; T=0.K
Photon emission for (n,2nd)

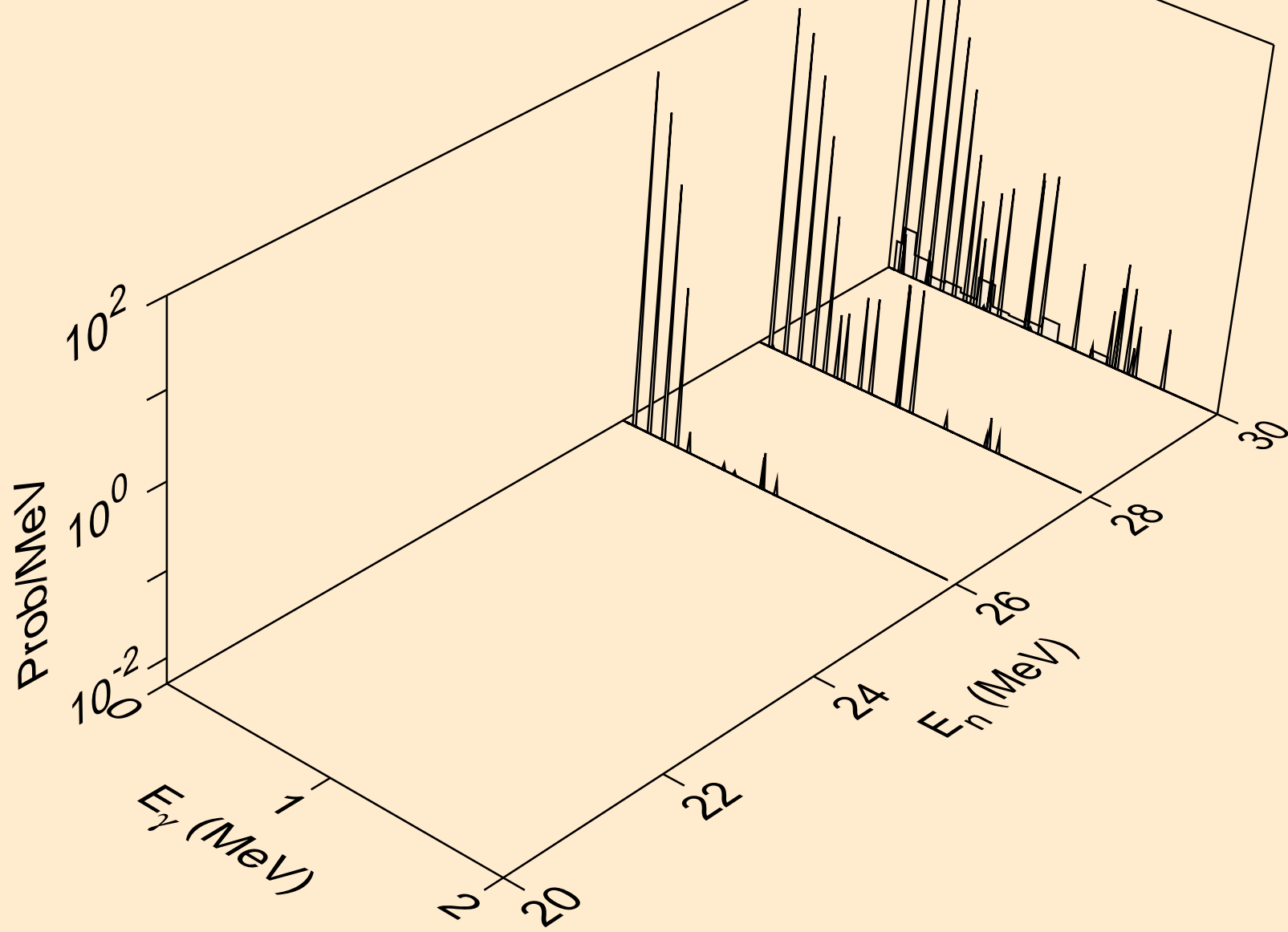

EU162 ALPHA ACER TENDL-2023 LIBRARY; T=0.K
Photon emission for (n,2n)

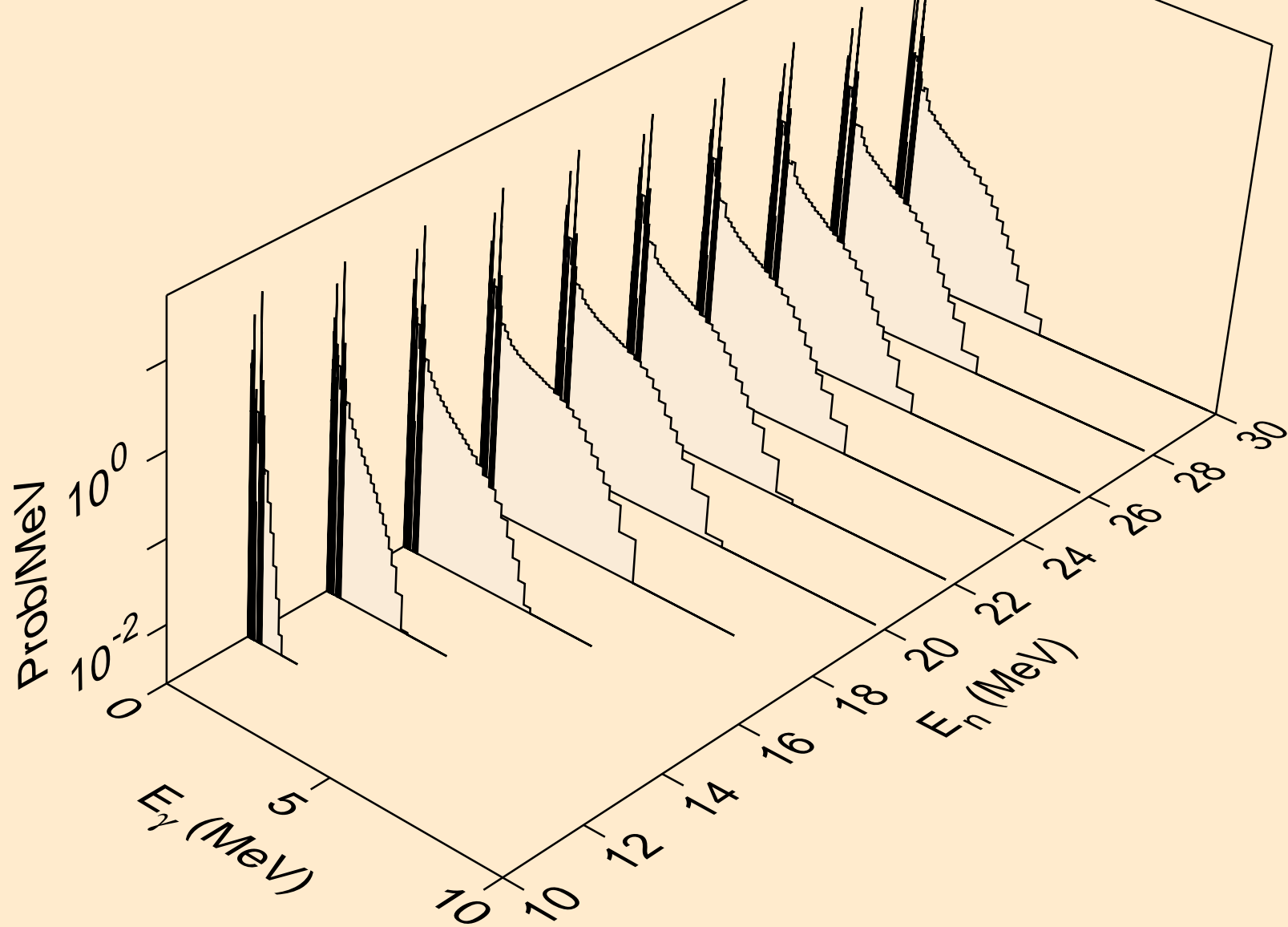

EU162 ALPHA ACER TENDL-2023 LIBRARY; T=0.K
Photon emission for (n,3n)

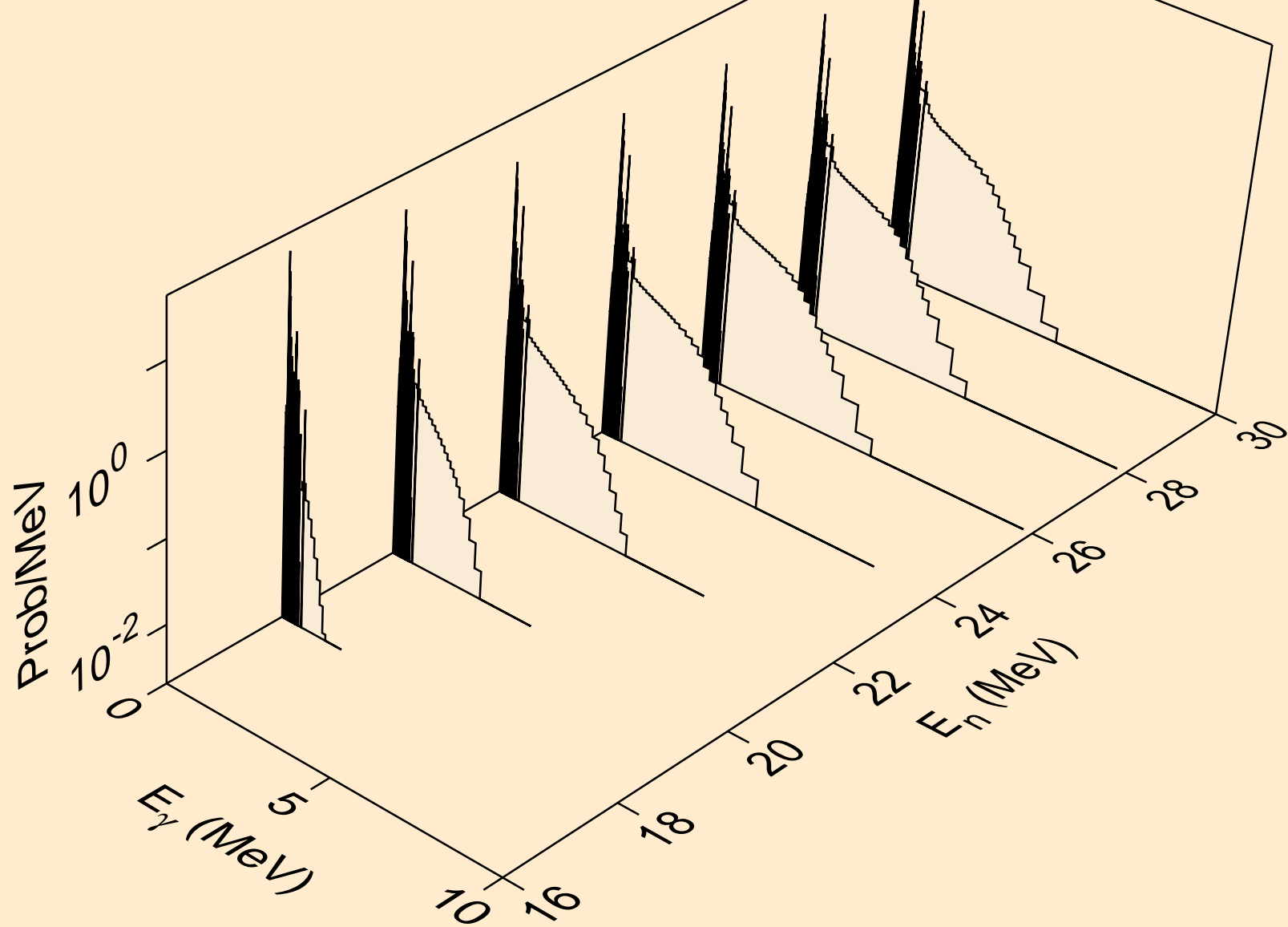

EU162 ALPHA ACER TENDL-2023 LIBRARY; T=0.K
Photon emission for (n,n*)a

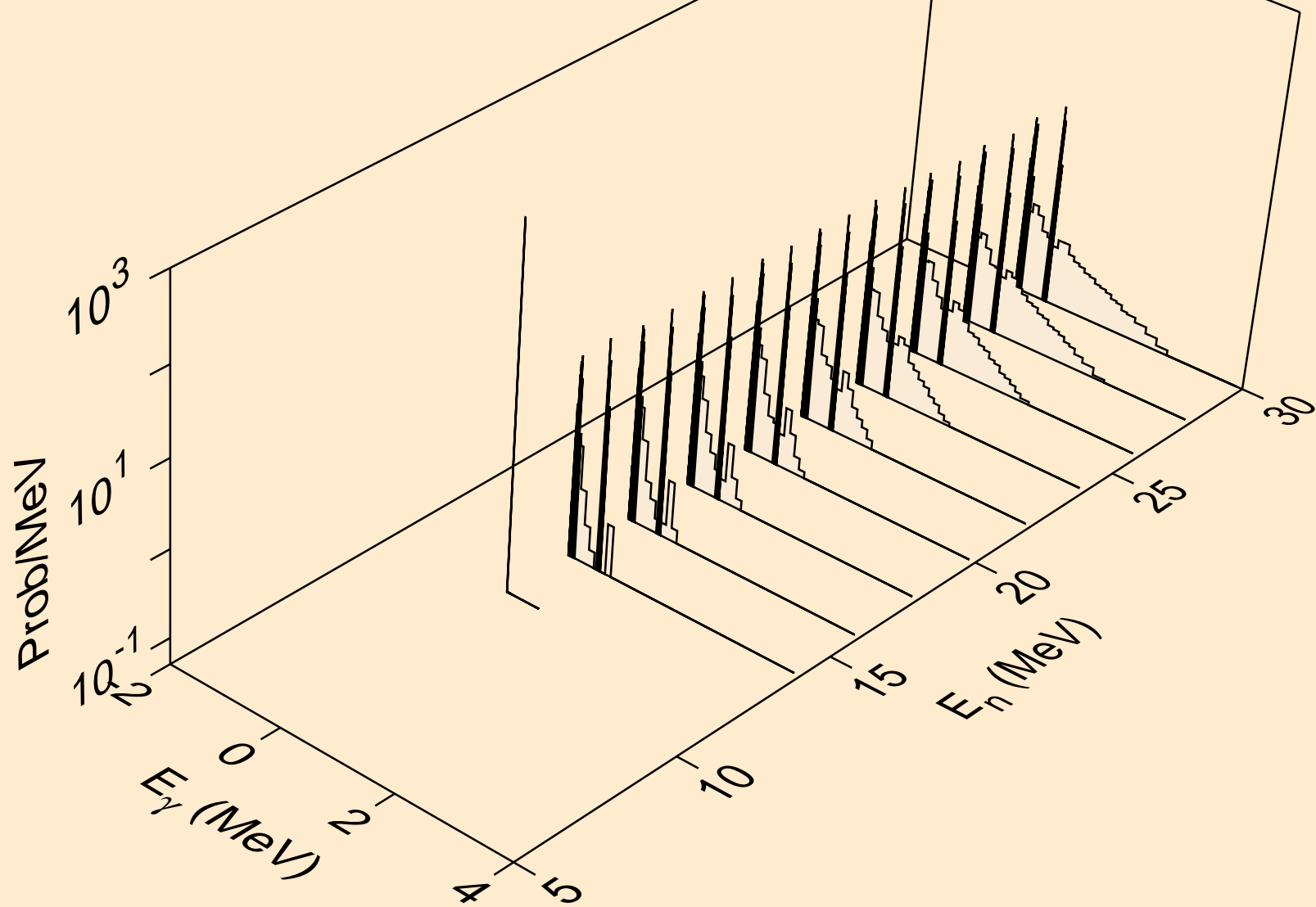

EU162 ALPHA ACER TENDL-2023 LIBRARY; T=0.K
Photon emission for (n,2n)a

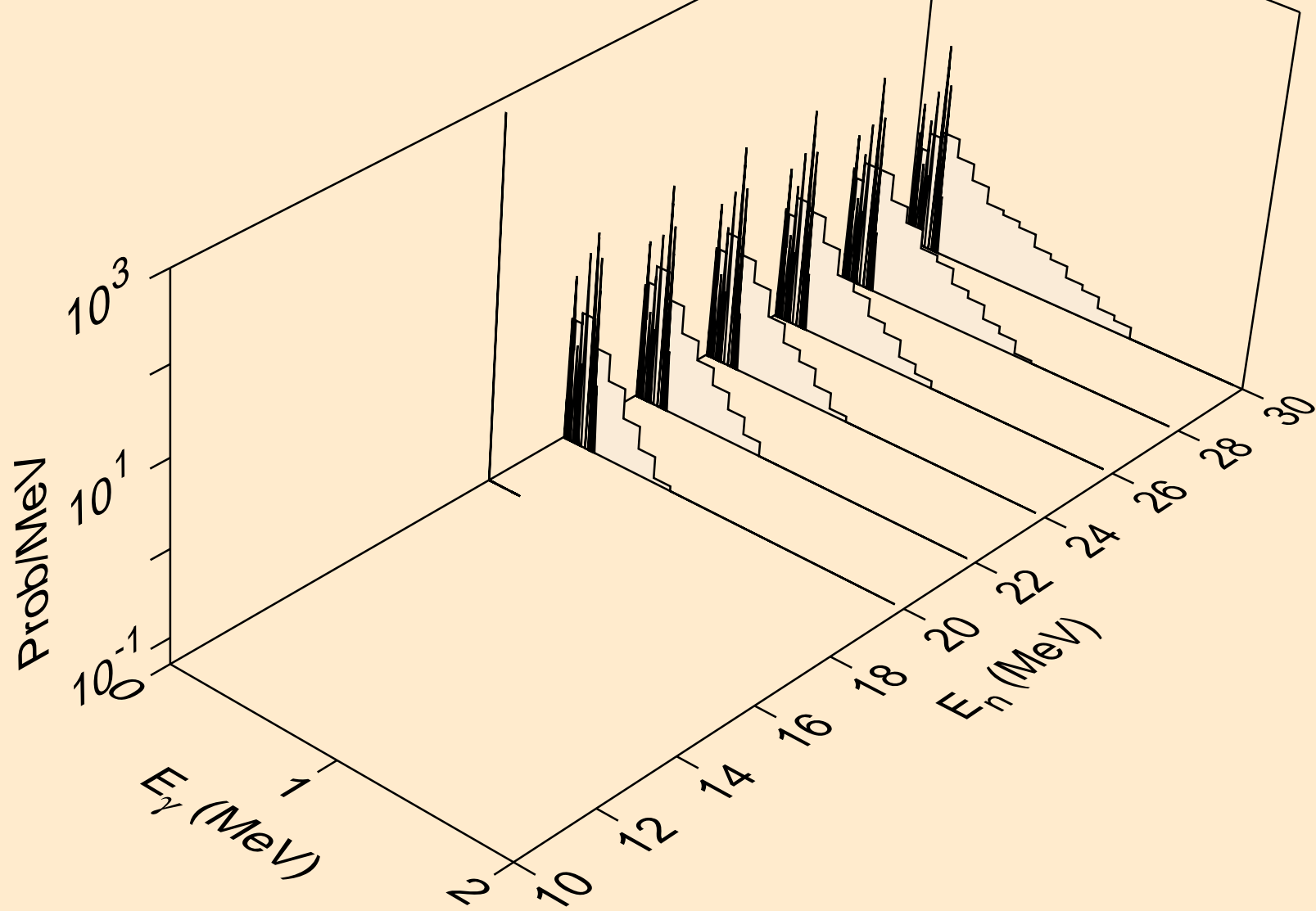

EU162 ALPHA ACER TENDL-2023 LIBRARY; T=0.K
Photon emission for (n,3n)a

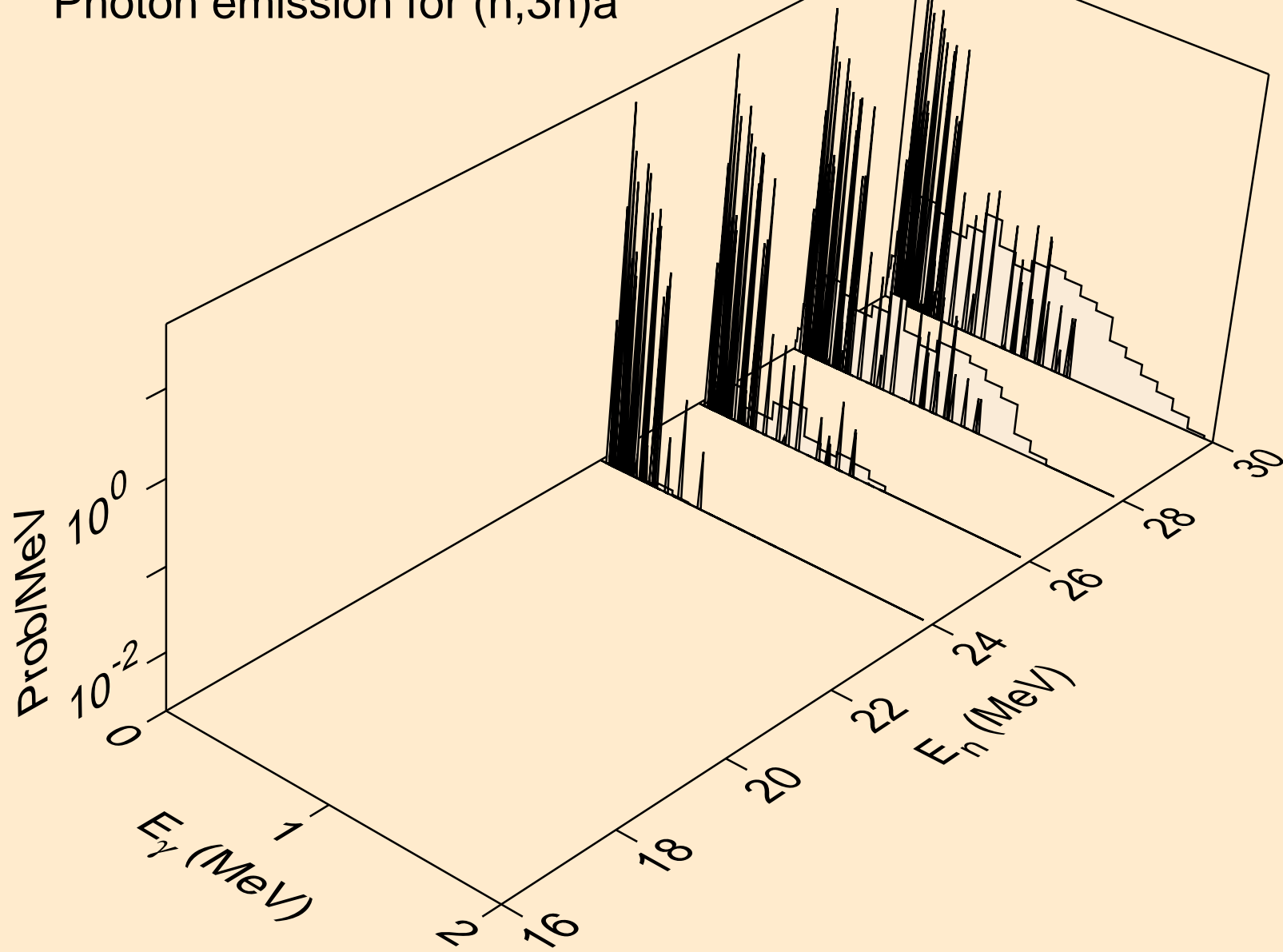

EU162 ALPHA ACER TENDL-2023 LIBRARY; T=0.K
Photon emission for (n,n*)p

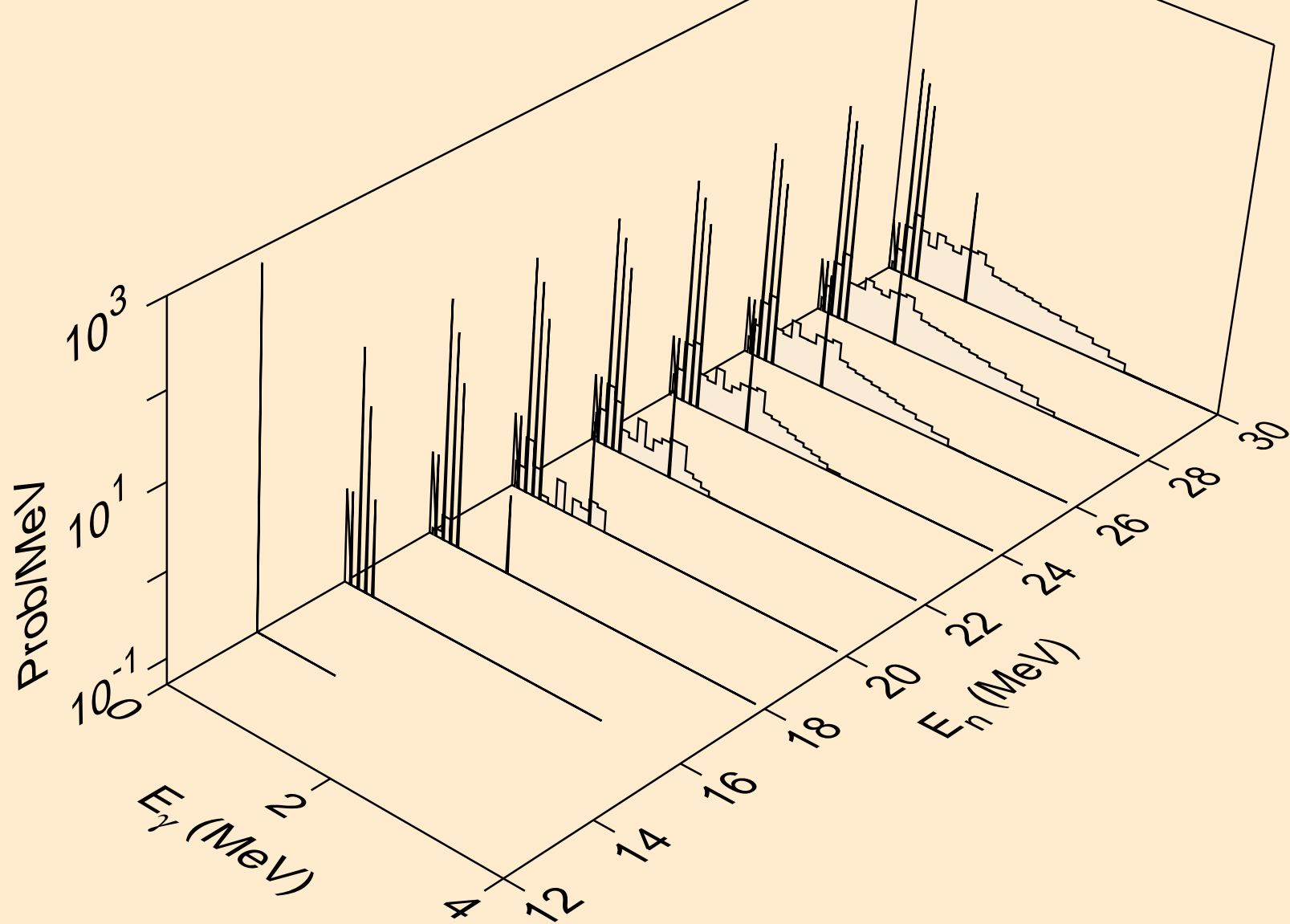

EU162 ALPHA ACER TENDL-2023 LIBRARY; T=0.K
Photon emission for (n,n*)d

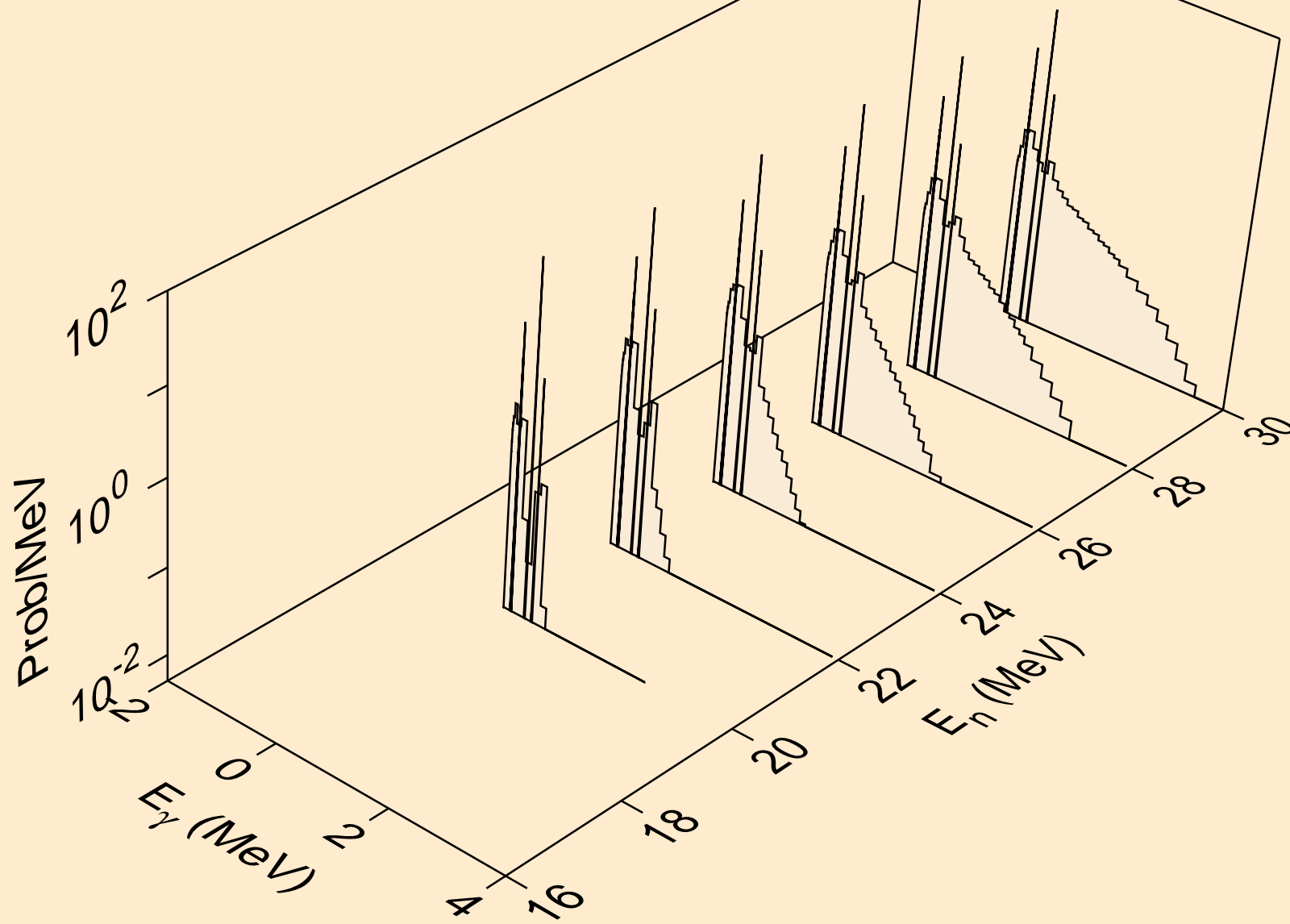

EU162 ALPHA ACER TENDL-2023 LIBRARY; T=0.K
Photon emission for (n,n*)t

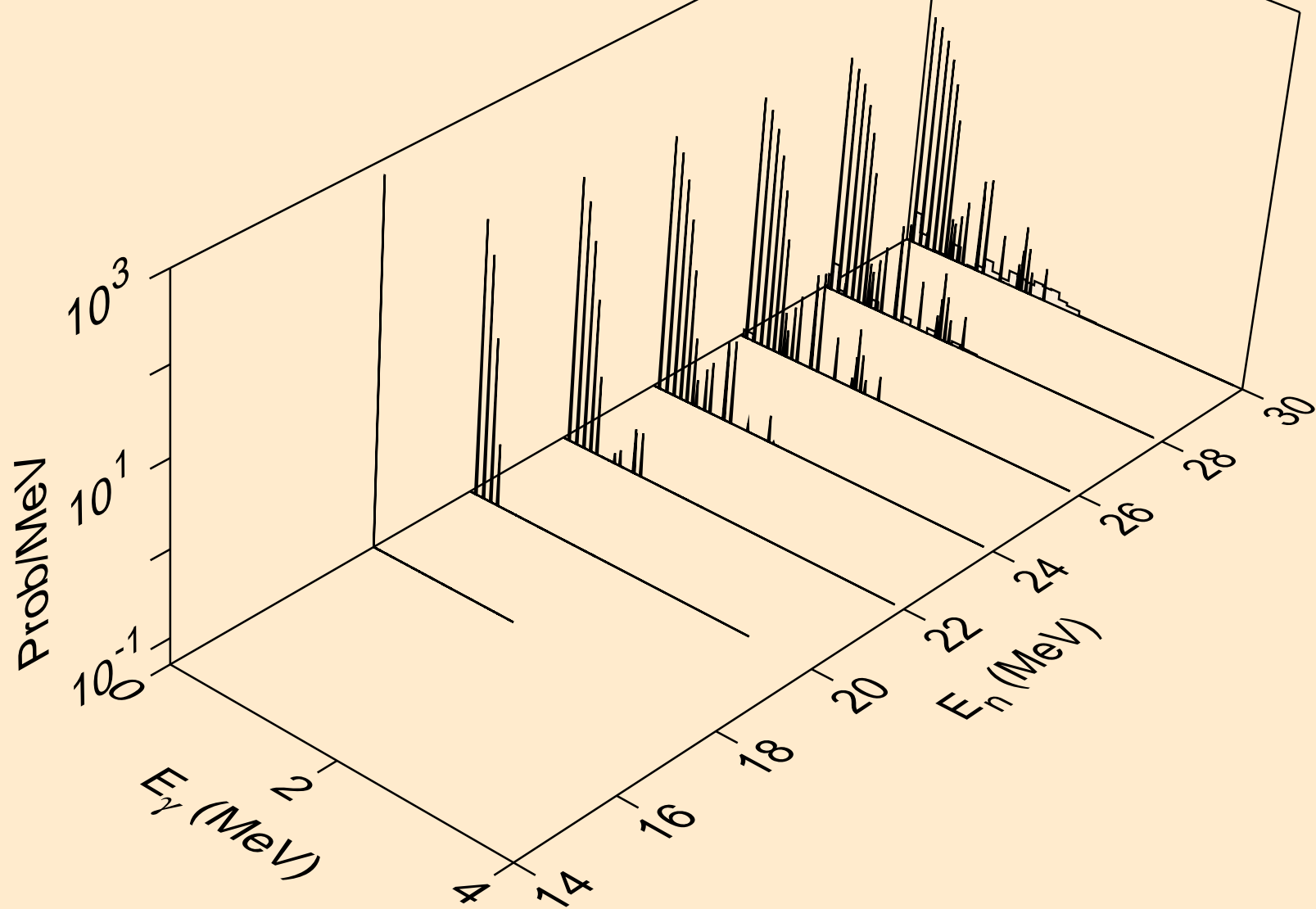

EU162 ALPHA ACER TENDL-2023 LIBRARY; T=0.K
Photon emission for (n,4n)

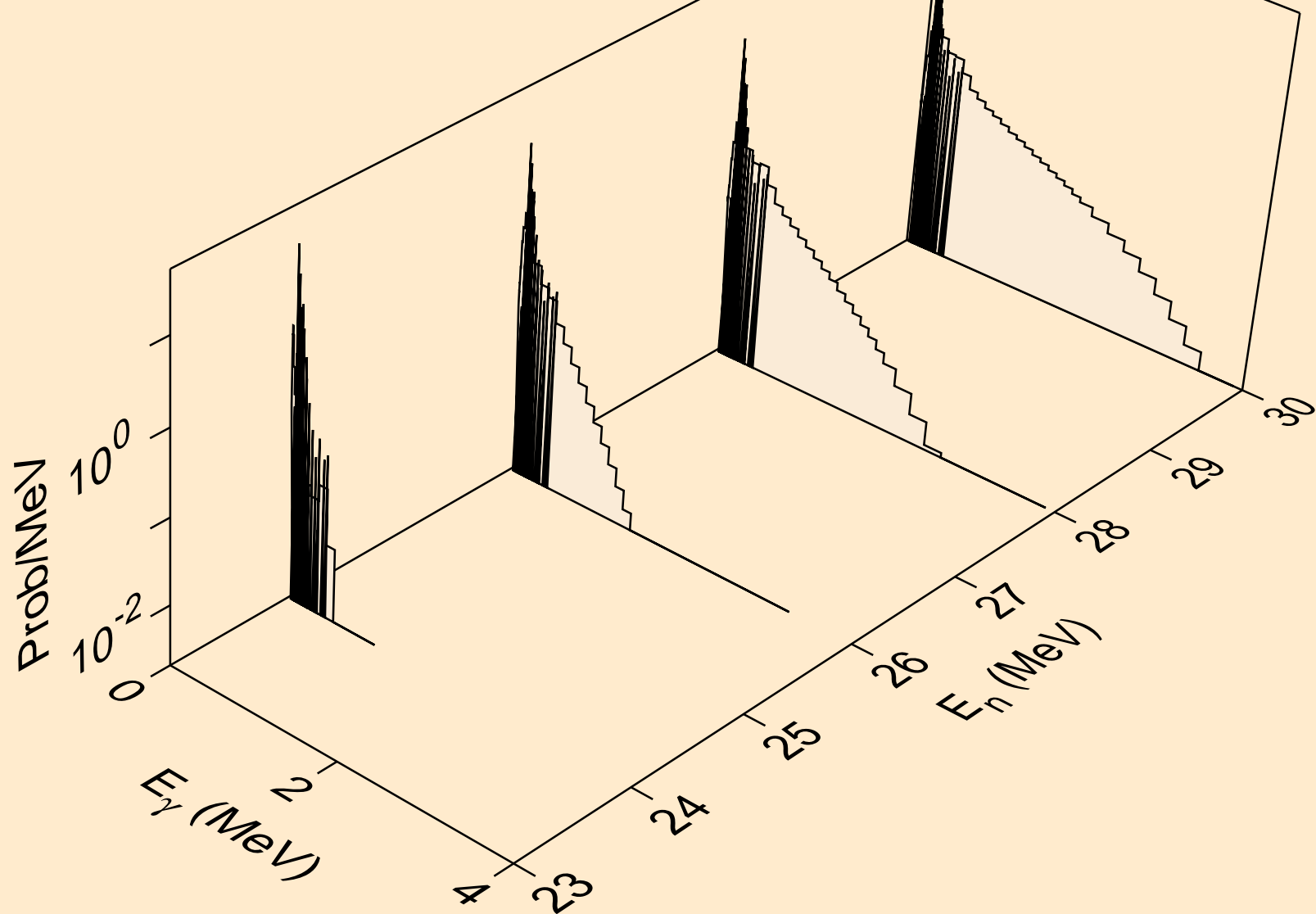

EU162 ALPHA ACER TENDL-2023 LIBRARY; T=0.K
Photon emission for (n,2np)

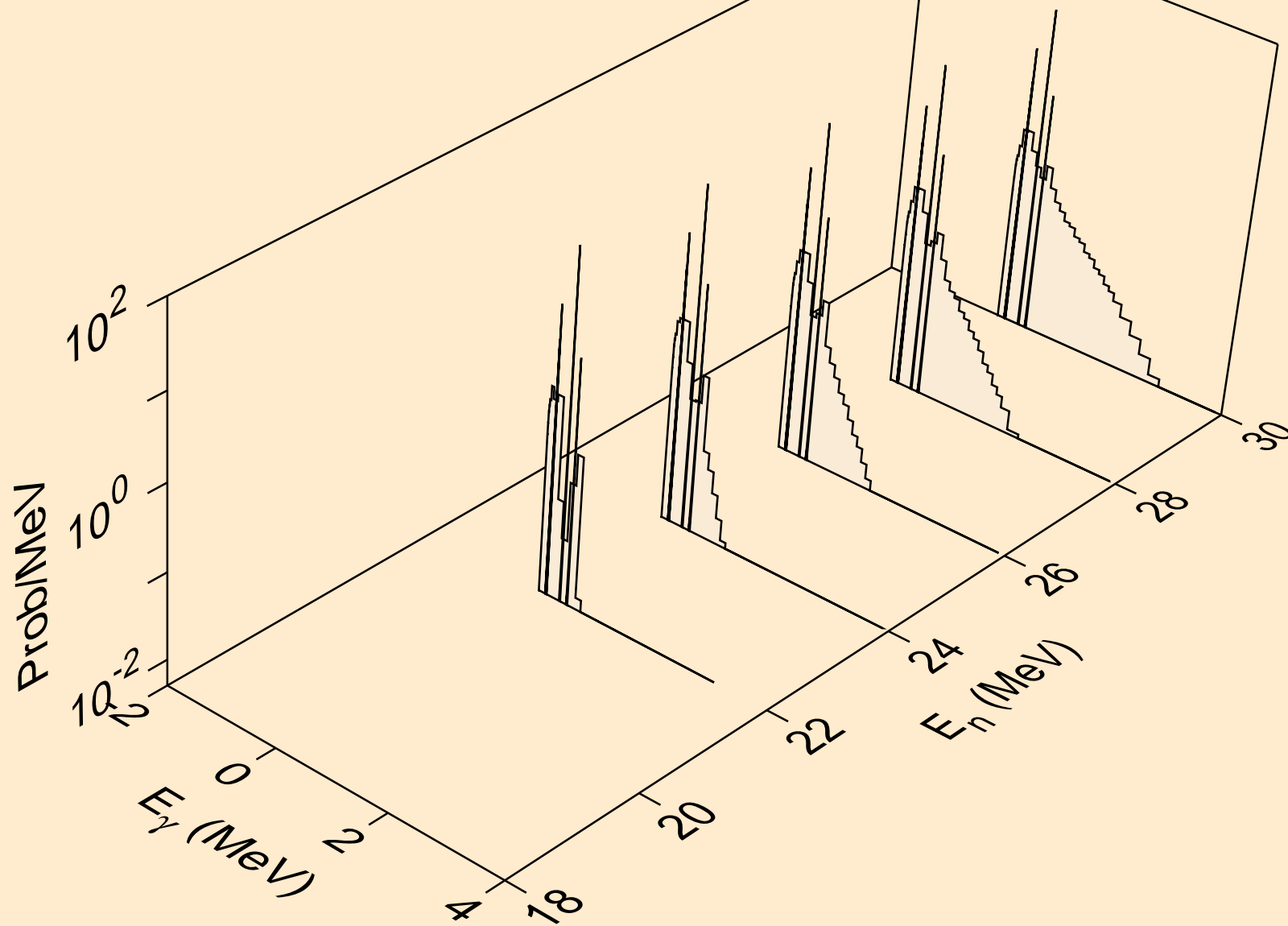

EU162 ALPHA ACER TENDL-2023 LIBRARY; T=0.K
Photon emission for (n,3np)

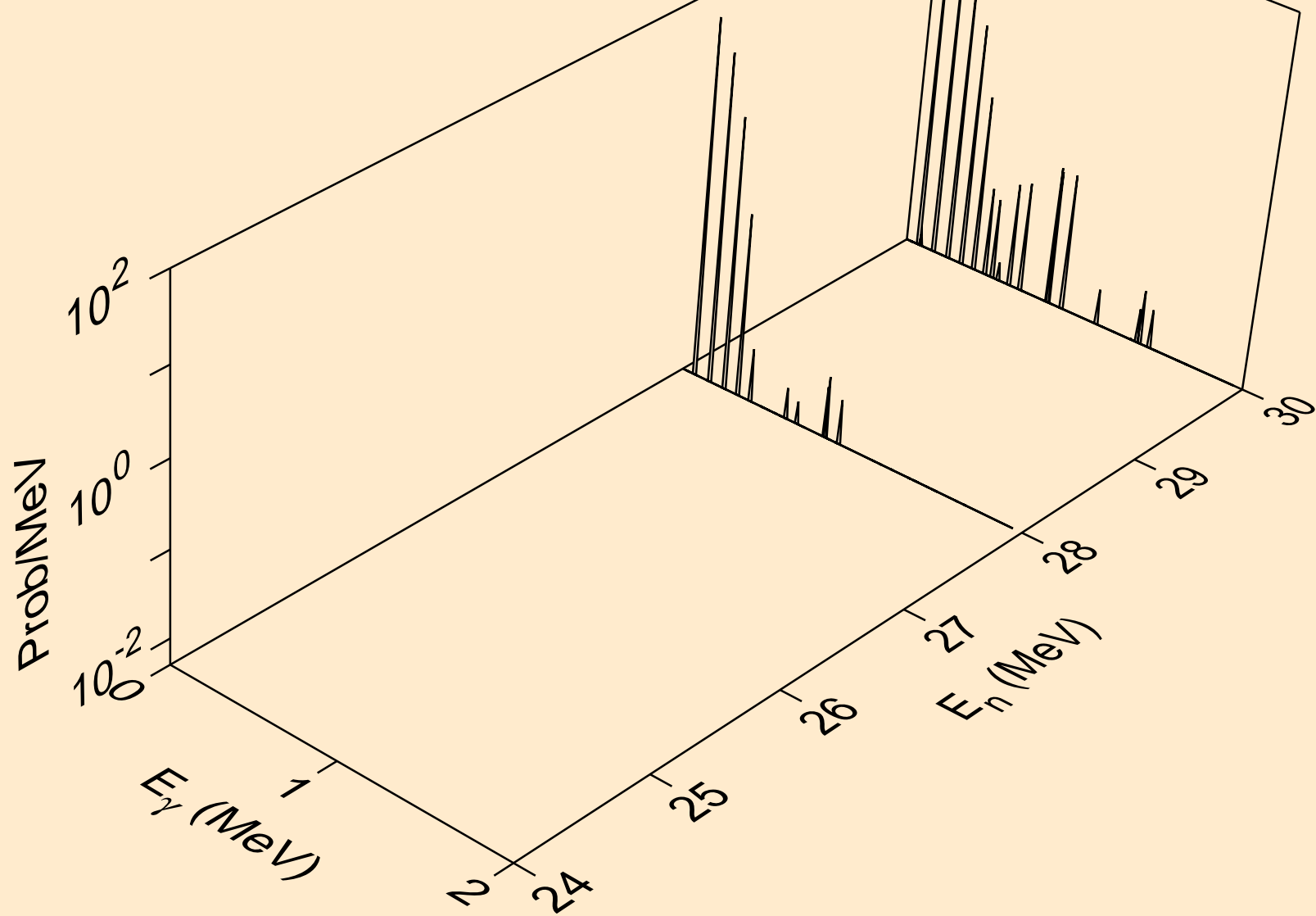

EU162 ALPHA ACER TENDL-2023 LIBRARY; T=0.K
Photon emission for (n,gma)

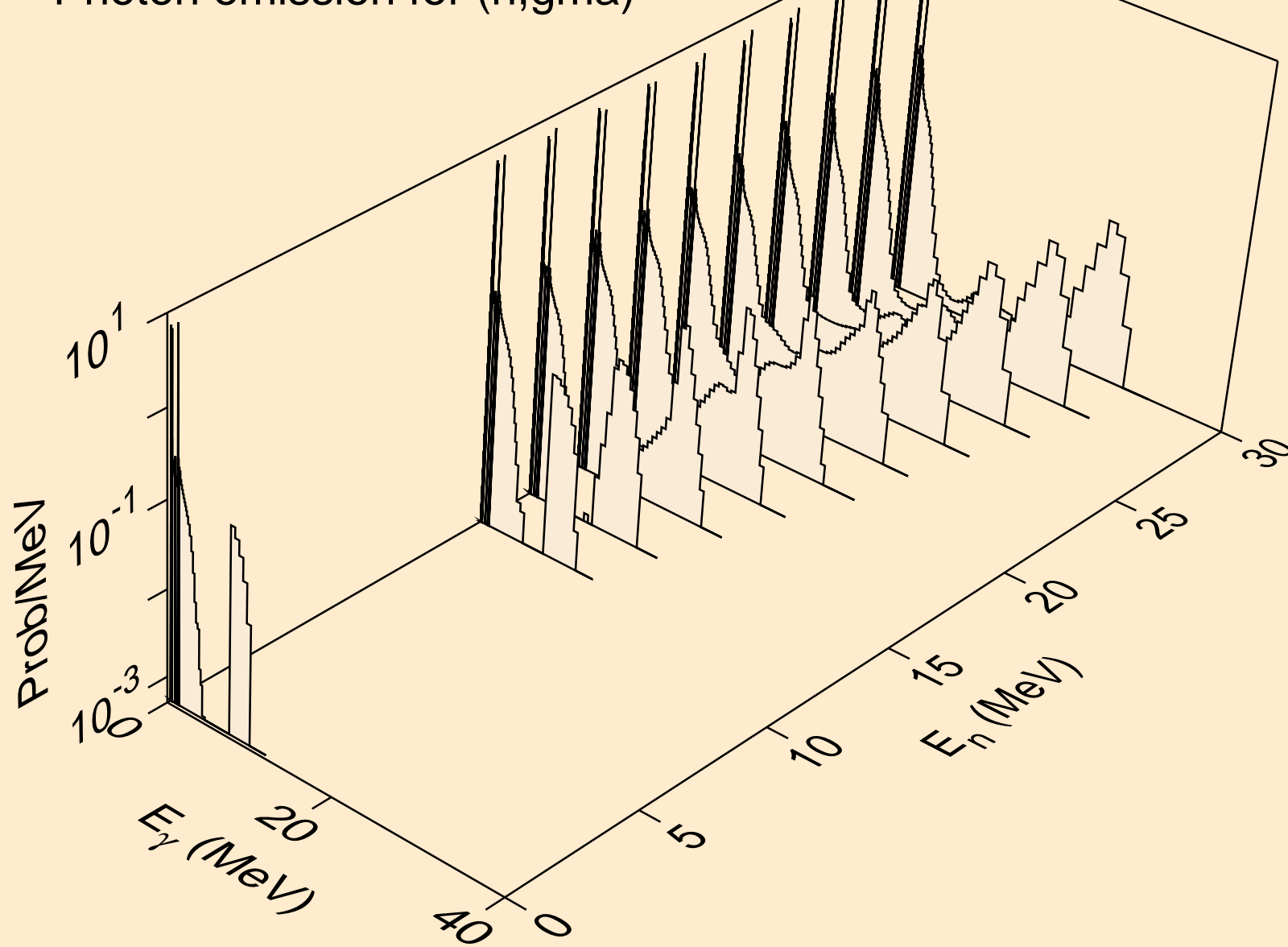

EU162 ALPHA ACER TENDL-2023 LIBRARY; T=0.K
Photon emission for (n,p)

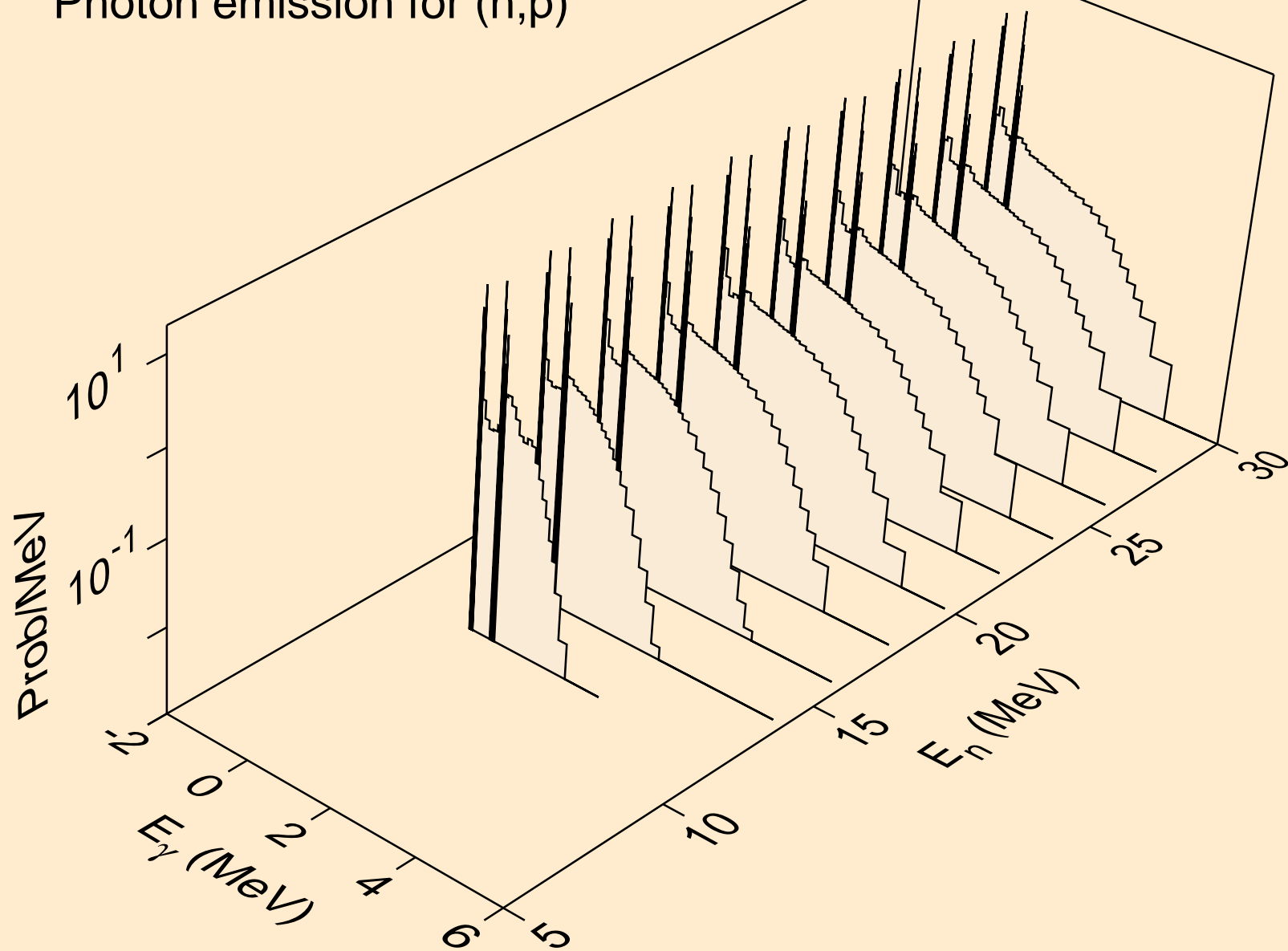

EU162 ALPHA ACER TENDL-2023 LIBRARY; T=0.K
Photon emission for (n,d)

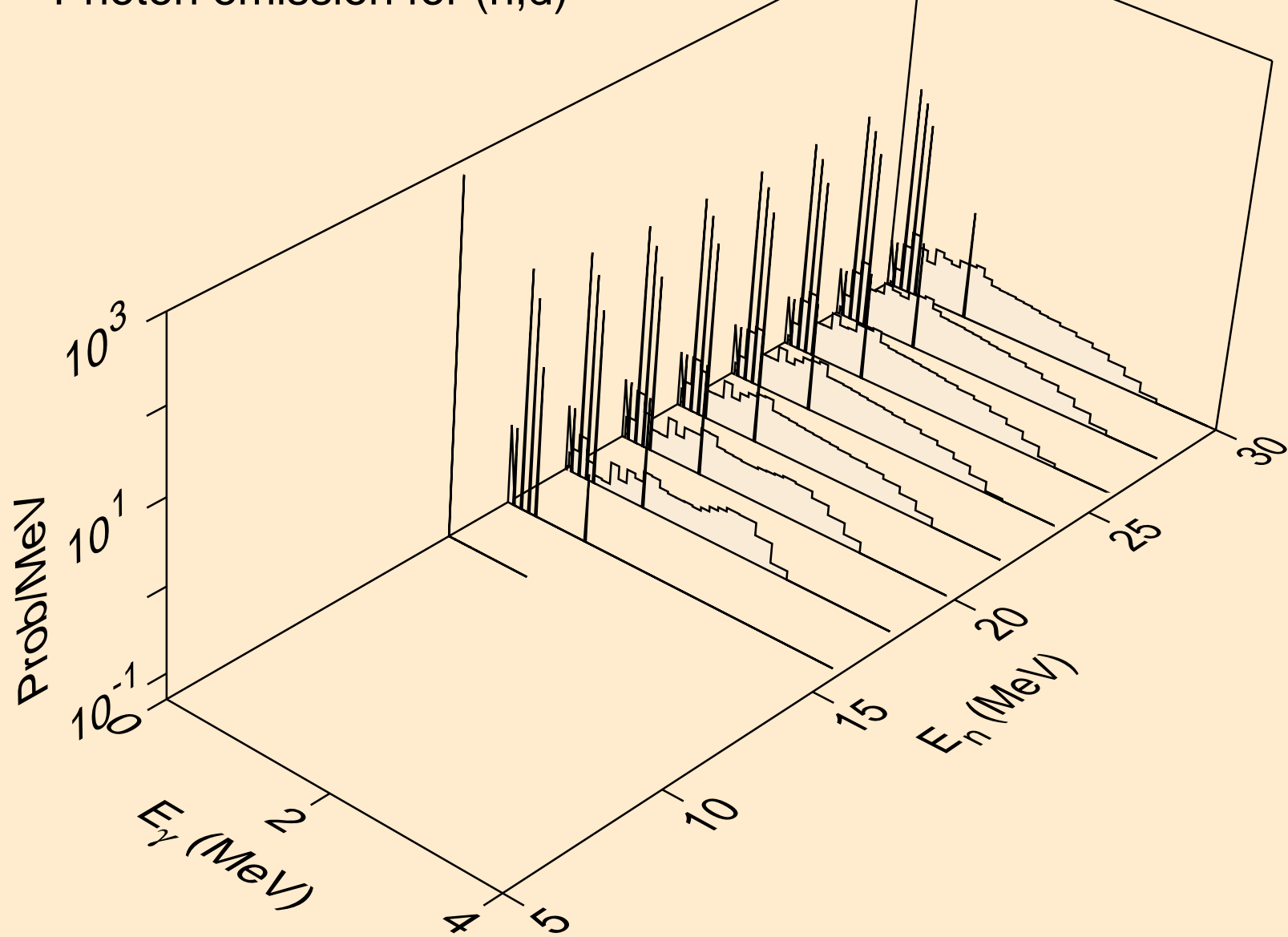

EU162 ALPHA ACER TENDL-2023 LIBRARY; T=0.K
Photon emission for (n,t)

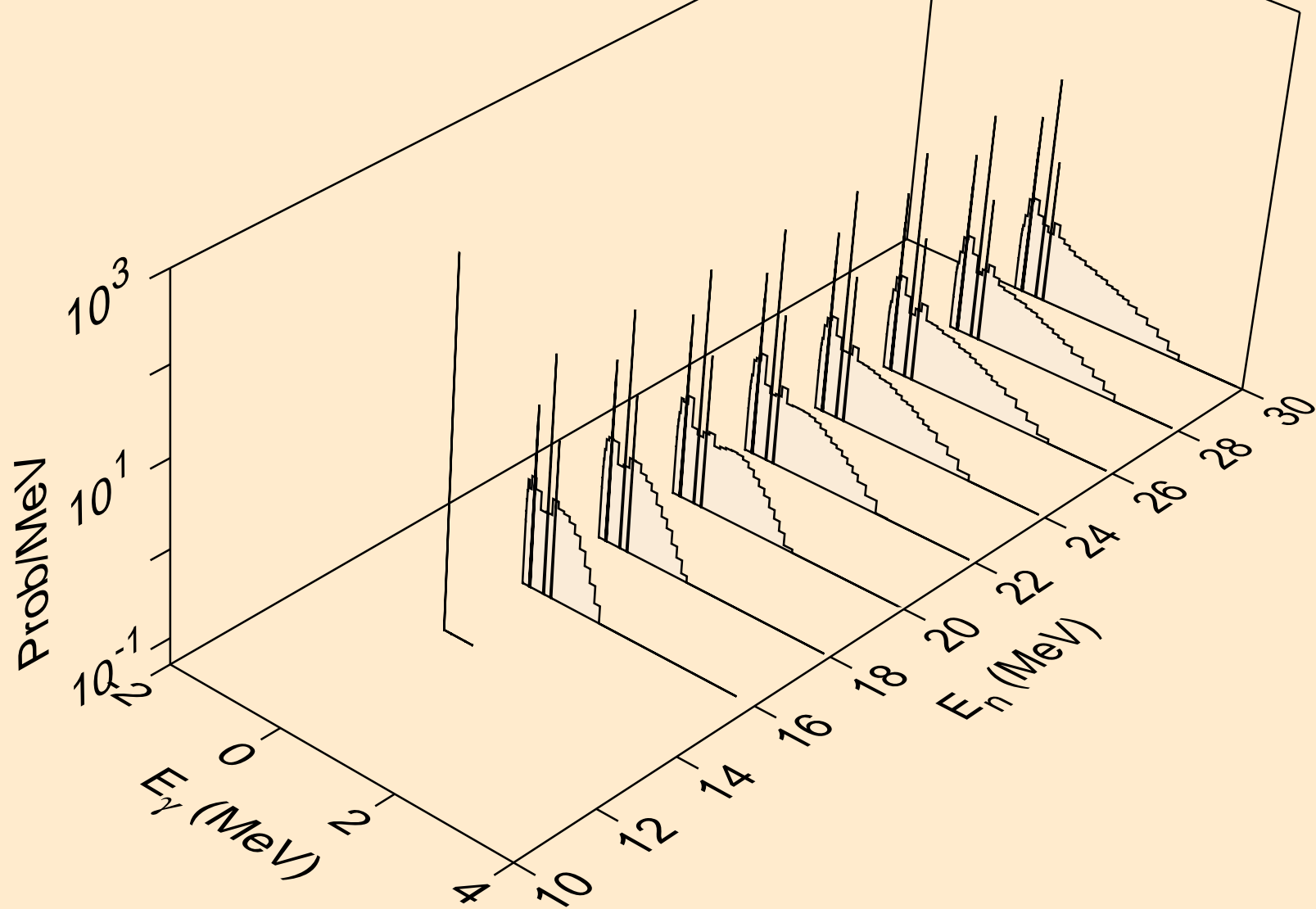

EU162 ALPHA ACER TENDL-2023 LIBRARY; T=0.K
Photon emission for (n,he3)

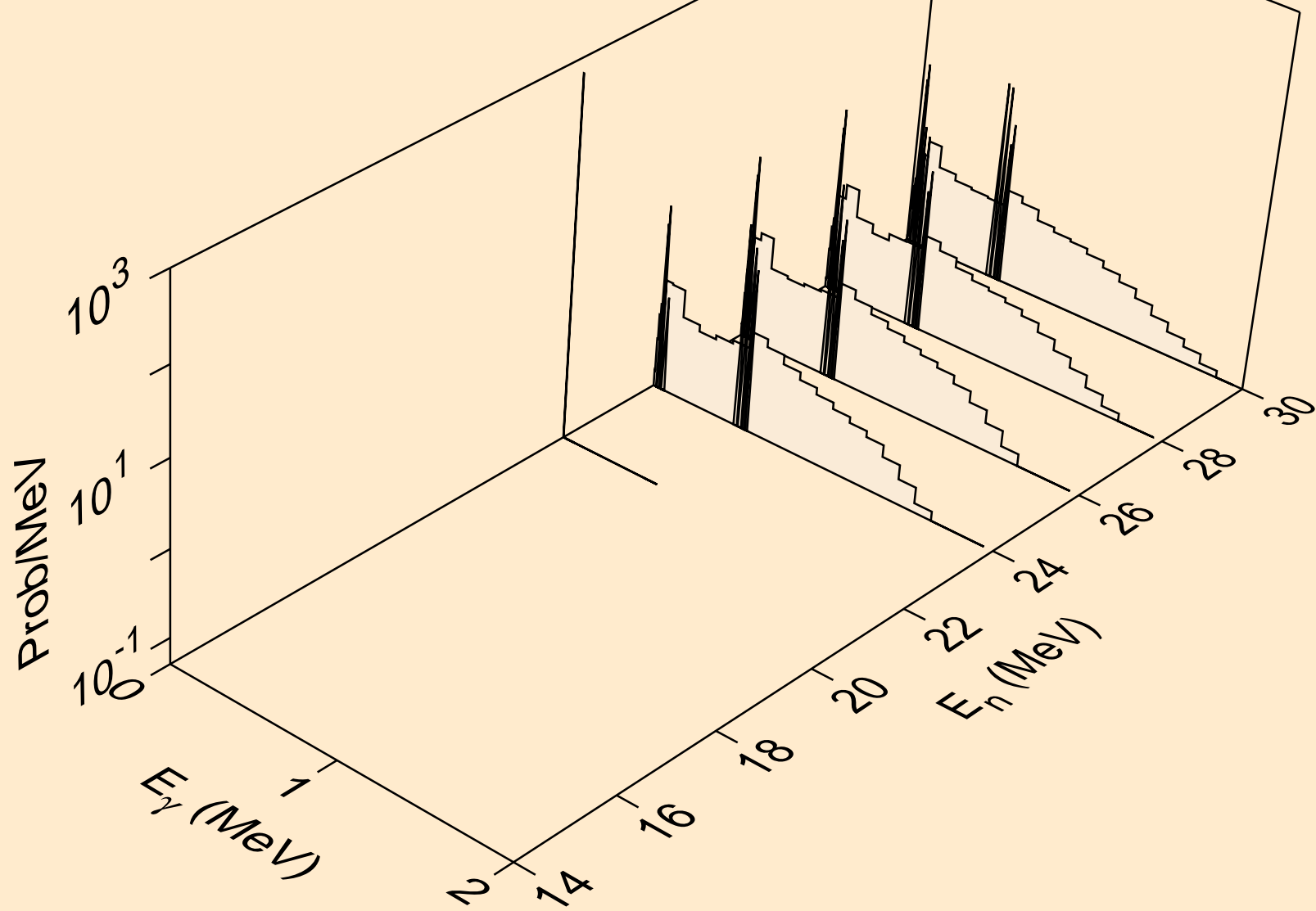

EU162 ALPHA ACER TENDL-2023 LIBRARY; T=0.K
Photon emission for inelastic

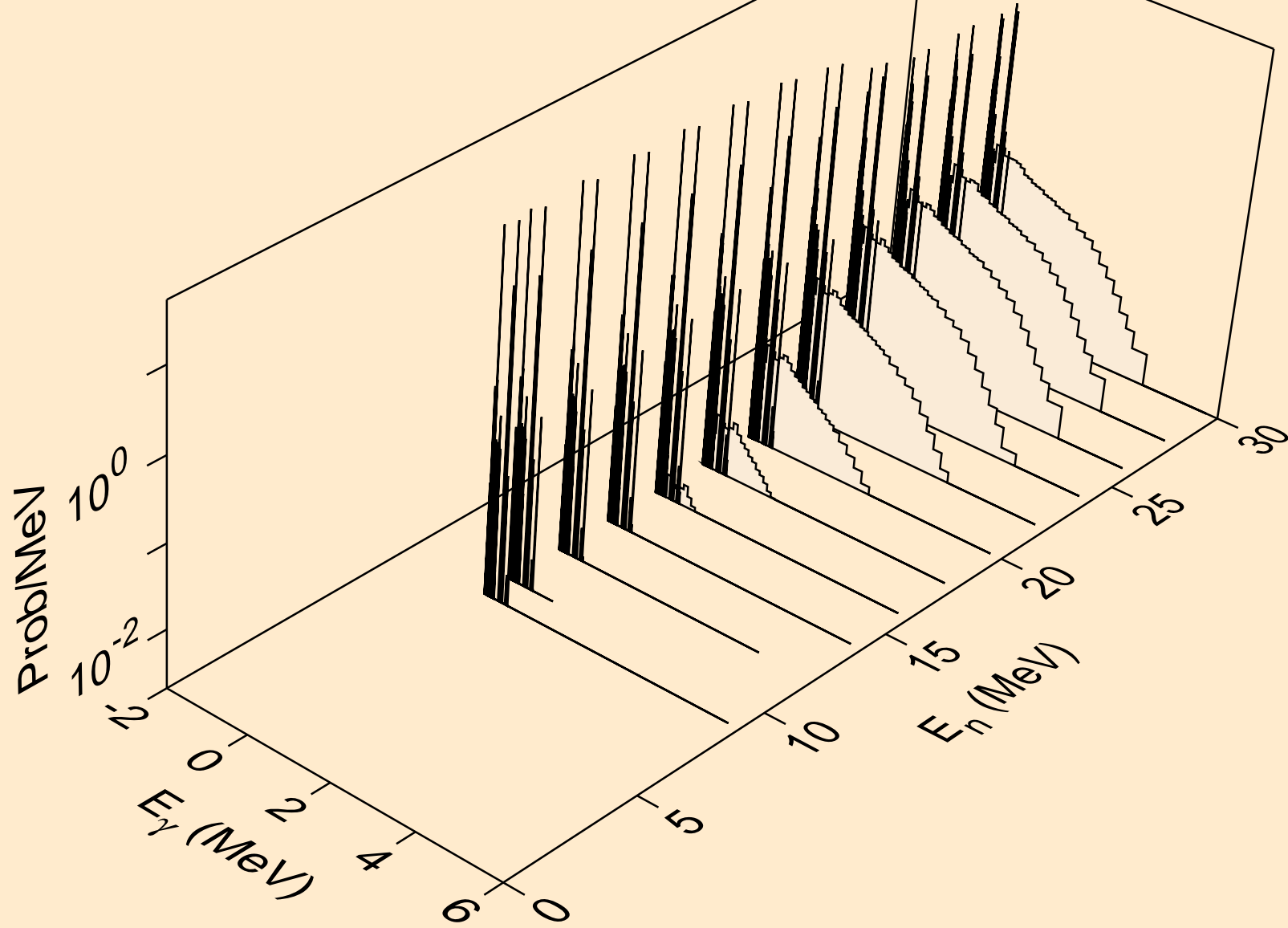

EU162 ALPHA ACER TENDL-2023 LIBRARY; T=0.K
Particle heating contributions

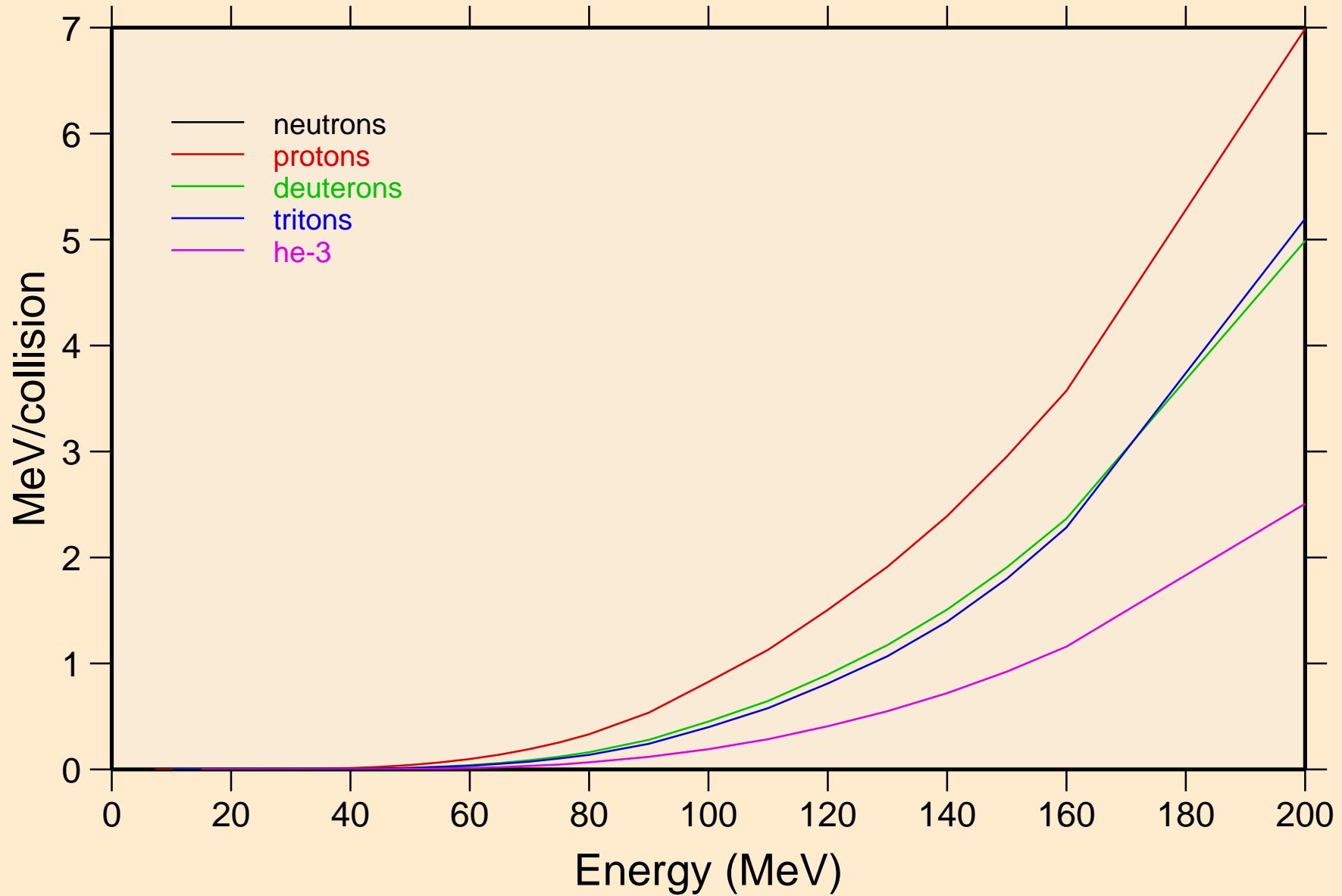

EU162 ALPHA ACER TENDL-2023 LIBRARY; T=0.K
Recoil Heating

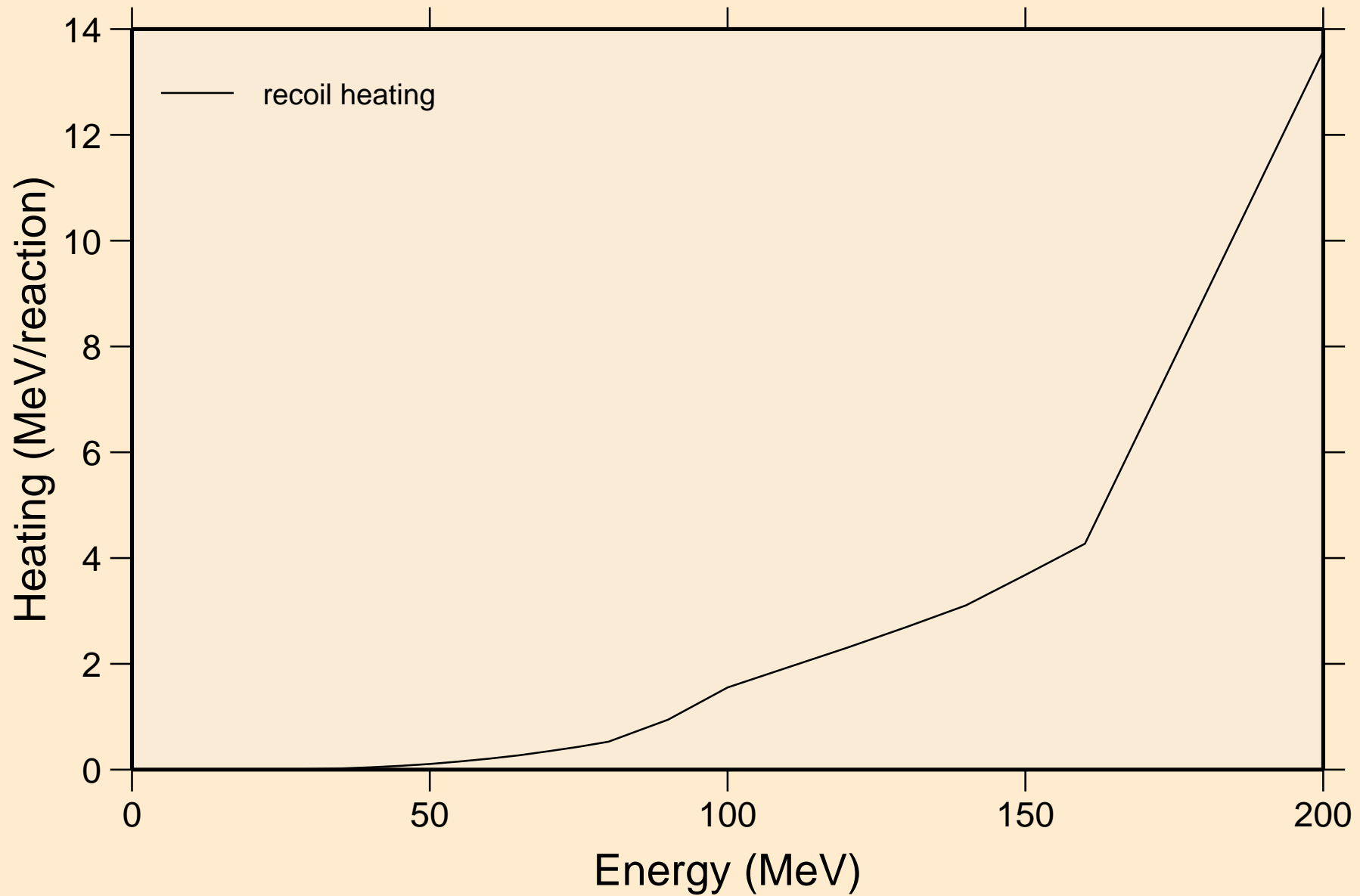

EU162 ALPHA ACER TENDL-2023 LIBRARY; T=0.K
Particle production cross sections

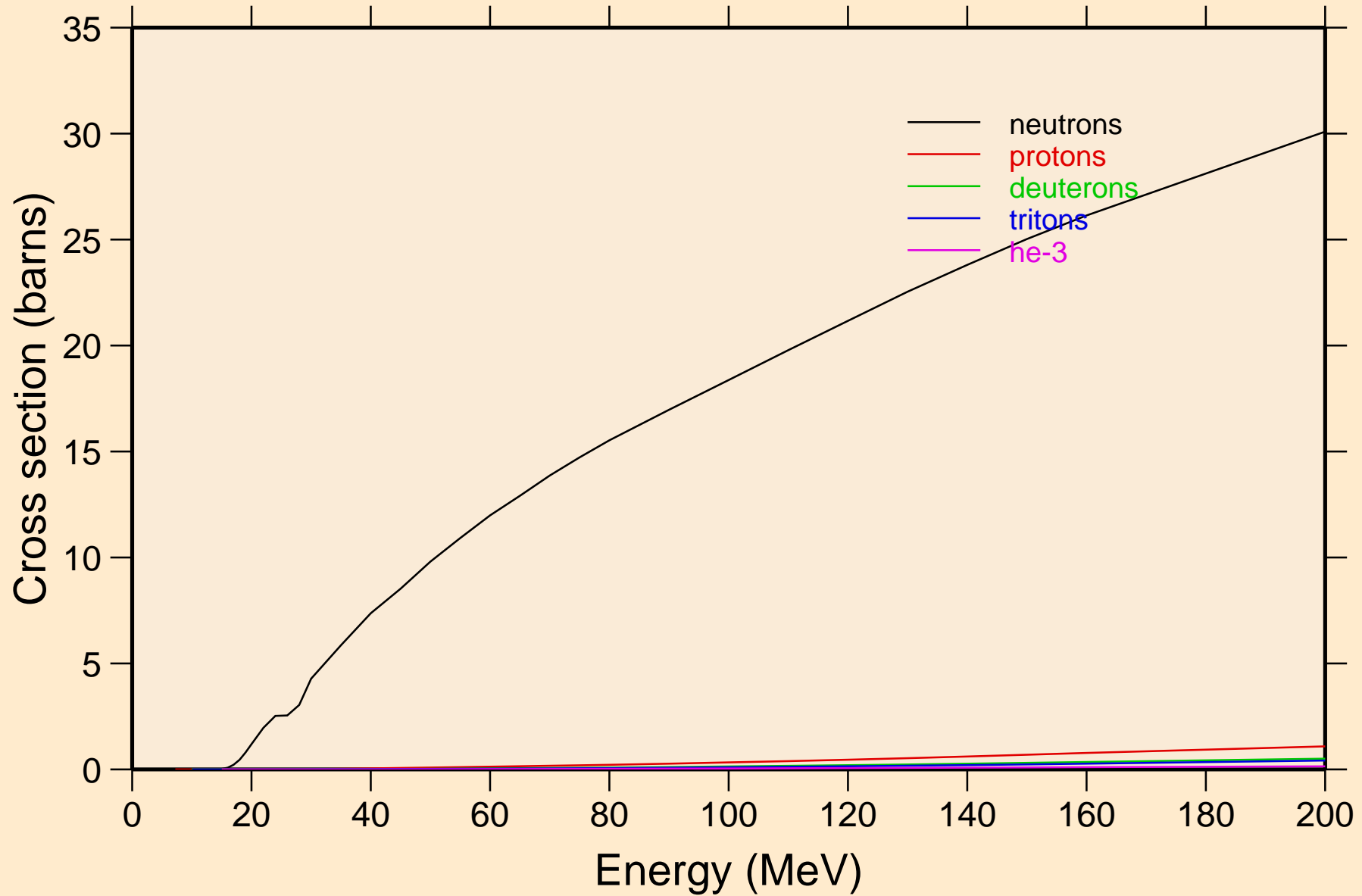

EU162 ALPHA ACER TENDL-2023 LIBRARY; T=0.K
neutrons from (a,n)

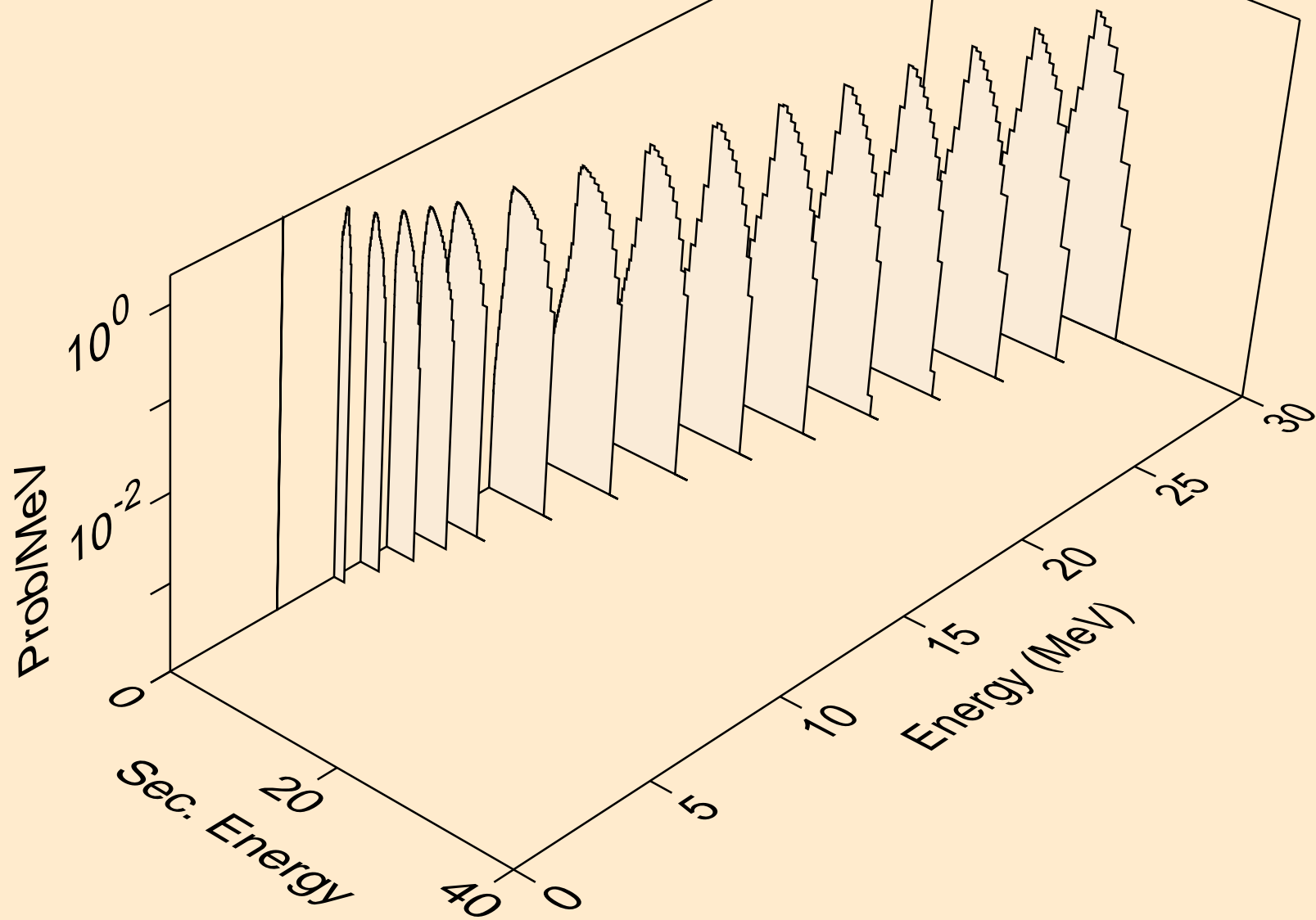

EU162 ALPHA ACER TENDL-2023 LIBRARY; T=0.K
neutrons from (a,x)

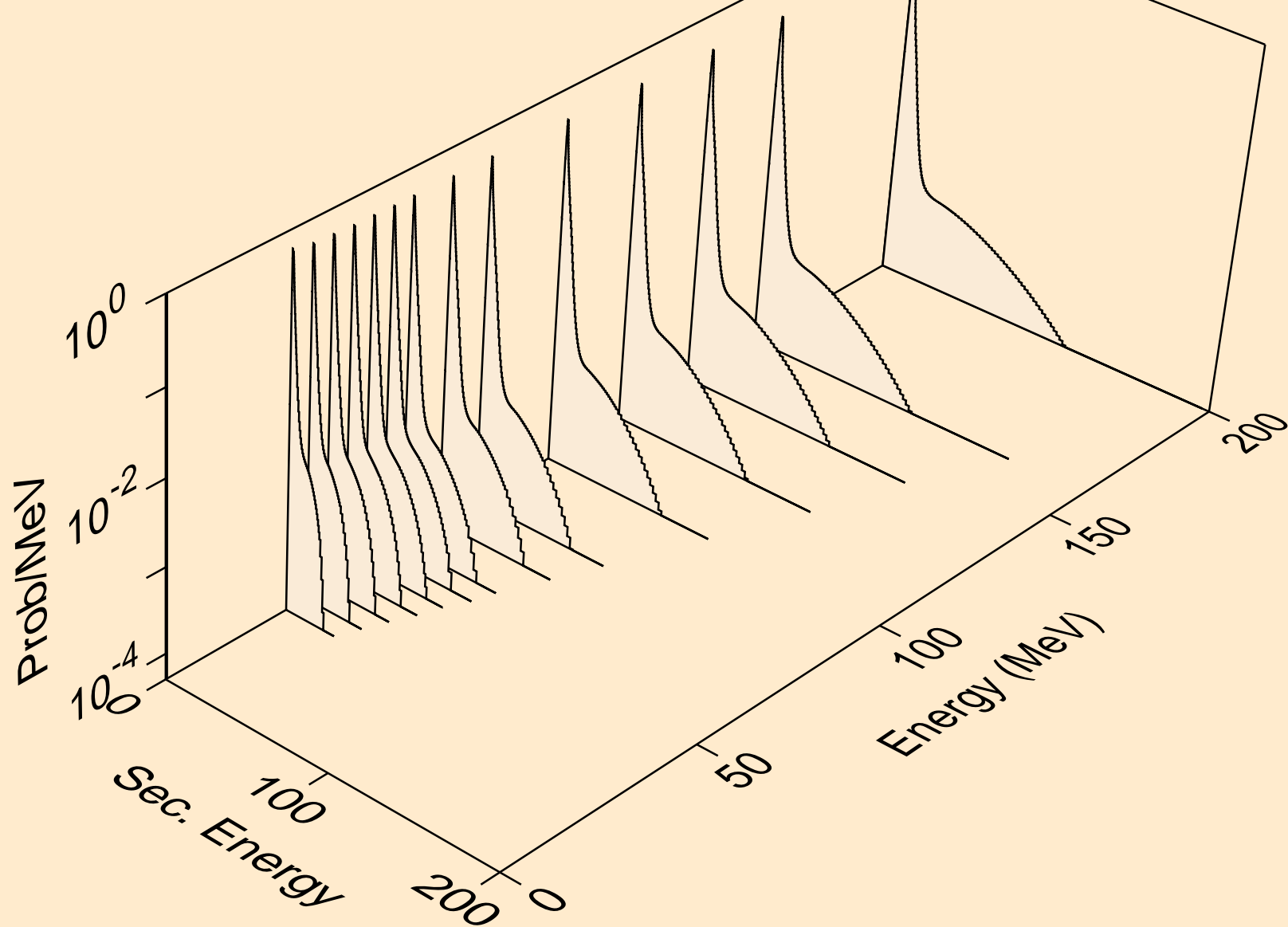

EU162 ALPHA ACER TENDL-2023 LIBRARY; T=0.K
neutrons from (a,2nd)

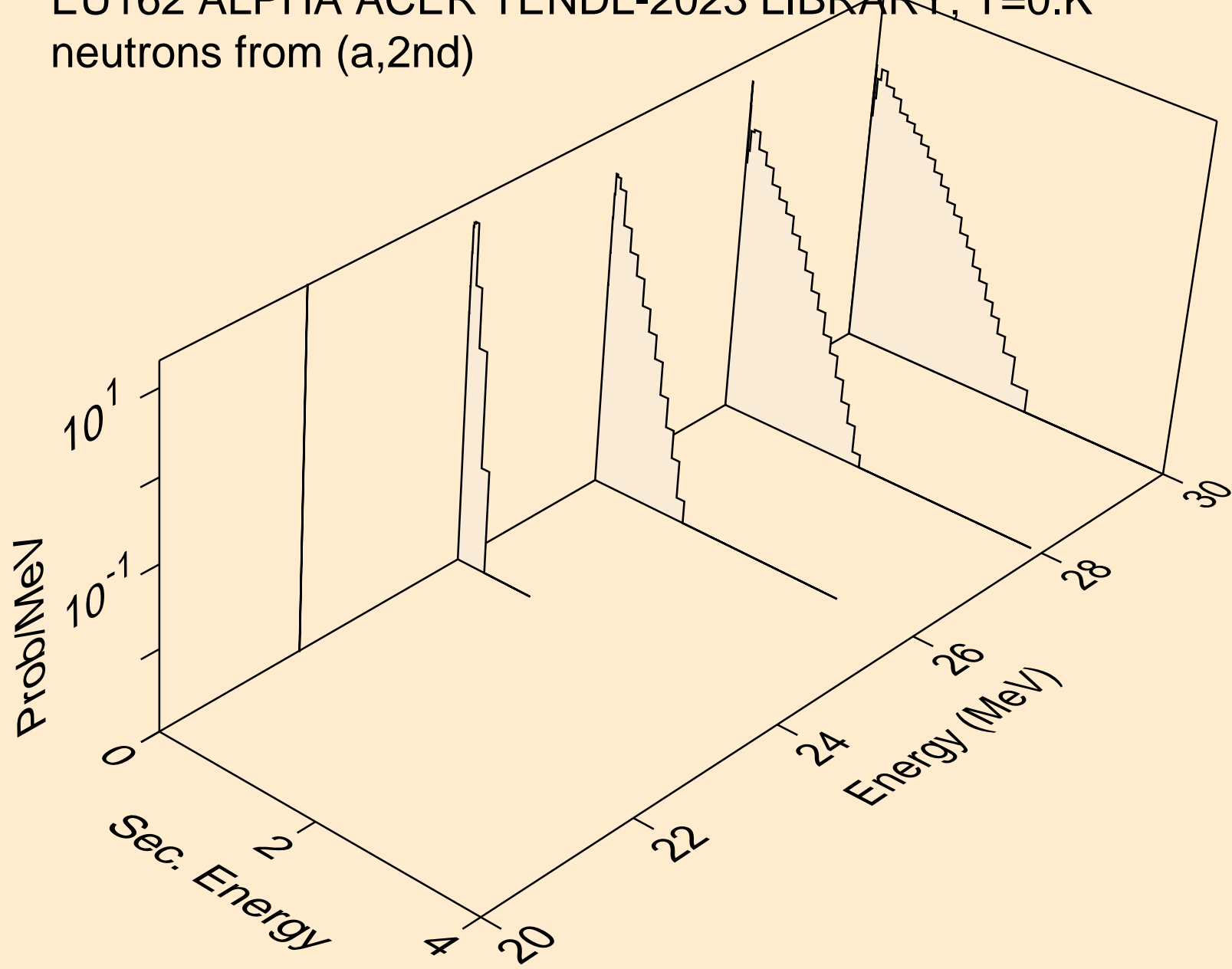

EU162 ALPHA ACER TENDL-2023 LIBRARY; T=0.K
neutrons from (a,2n)

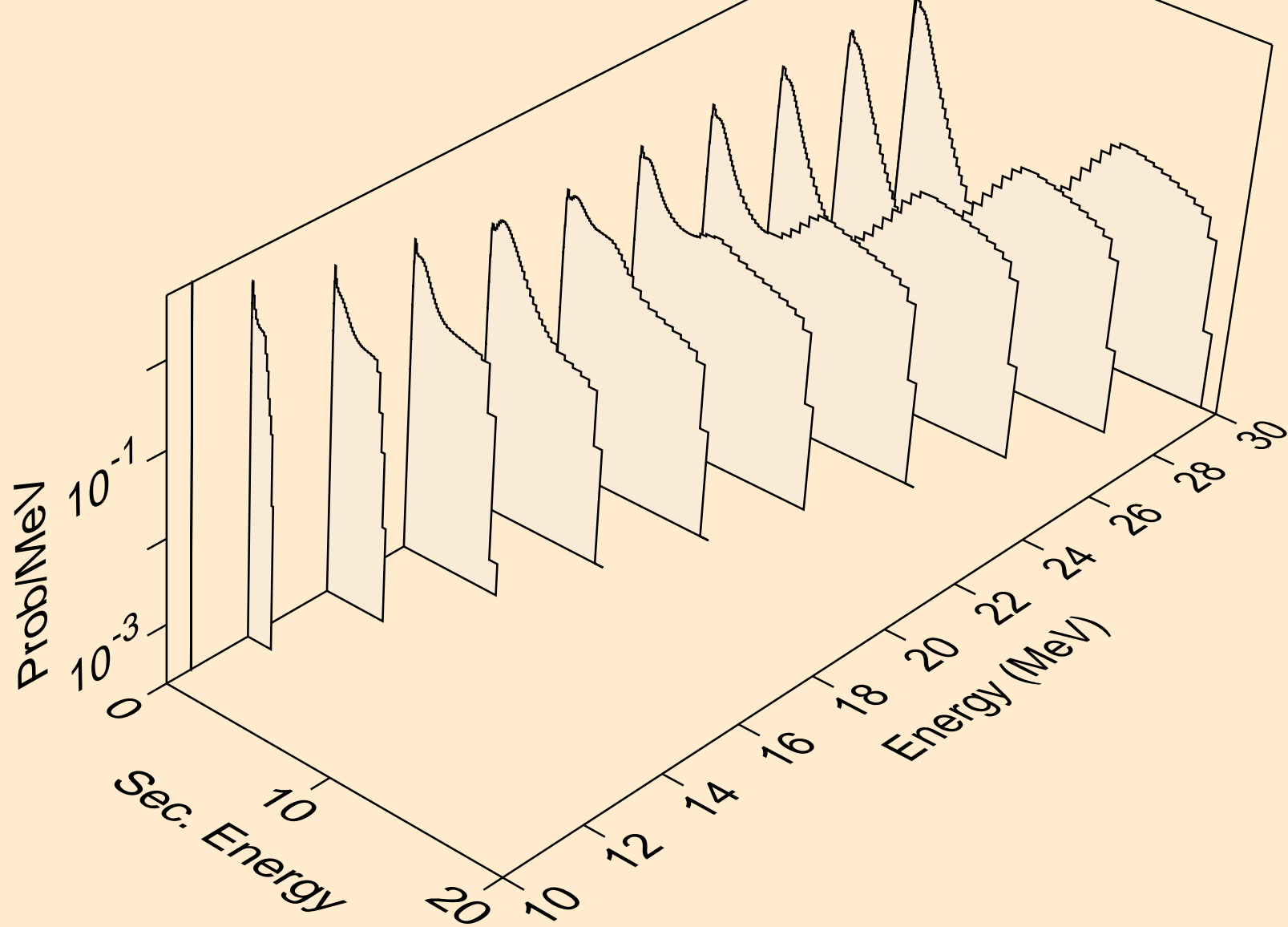

EU162 ALPHA ACER TENDL-2023 LIBRARY; T=0.K
neutrons from (a,3n)

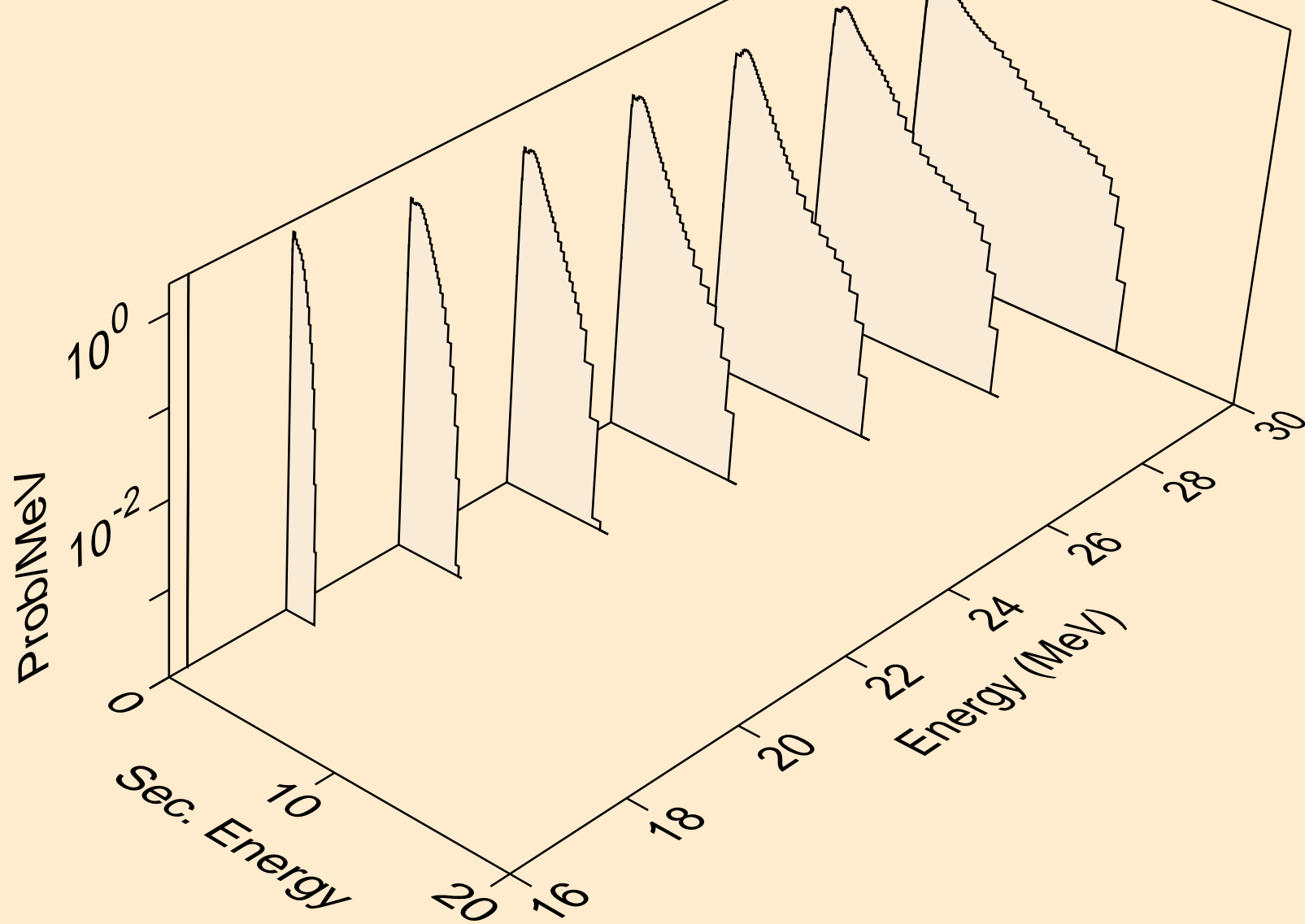

EU162 ALPHA ACER TENDL-2023 LIBRARY; T=0.K
neutrons from (a,n*)a

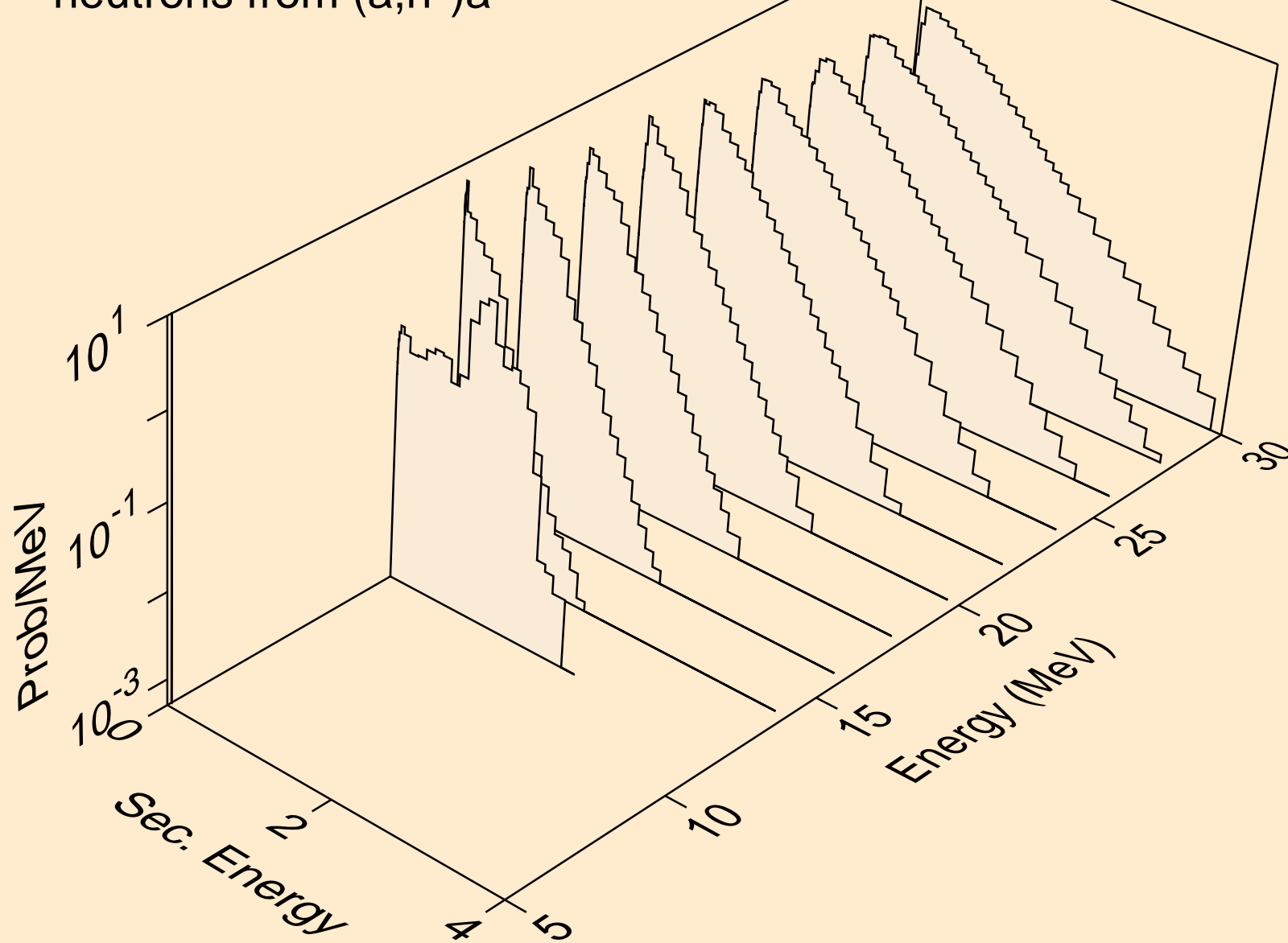

EU162 ALPHA ACER TENDL-2023 LIBRARY; T=0.K
neutrons from (a,2n)a

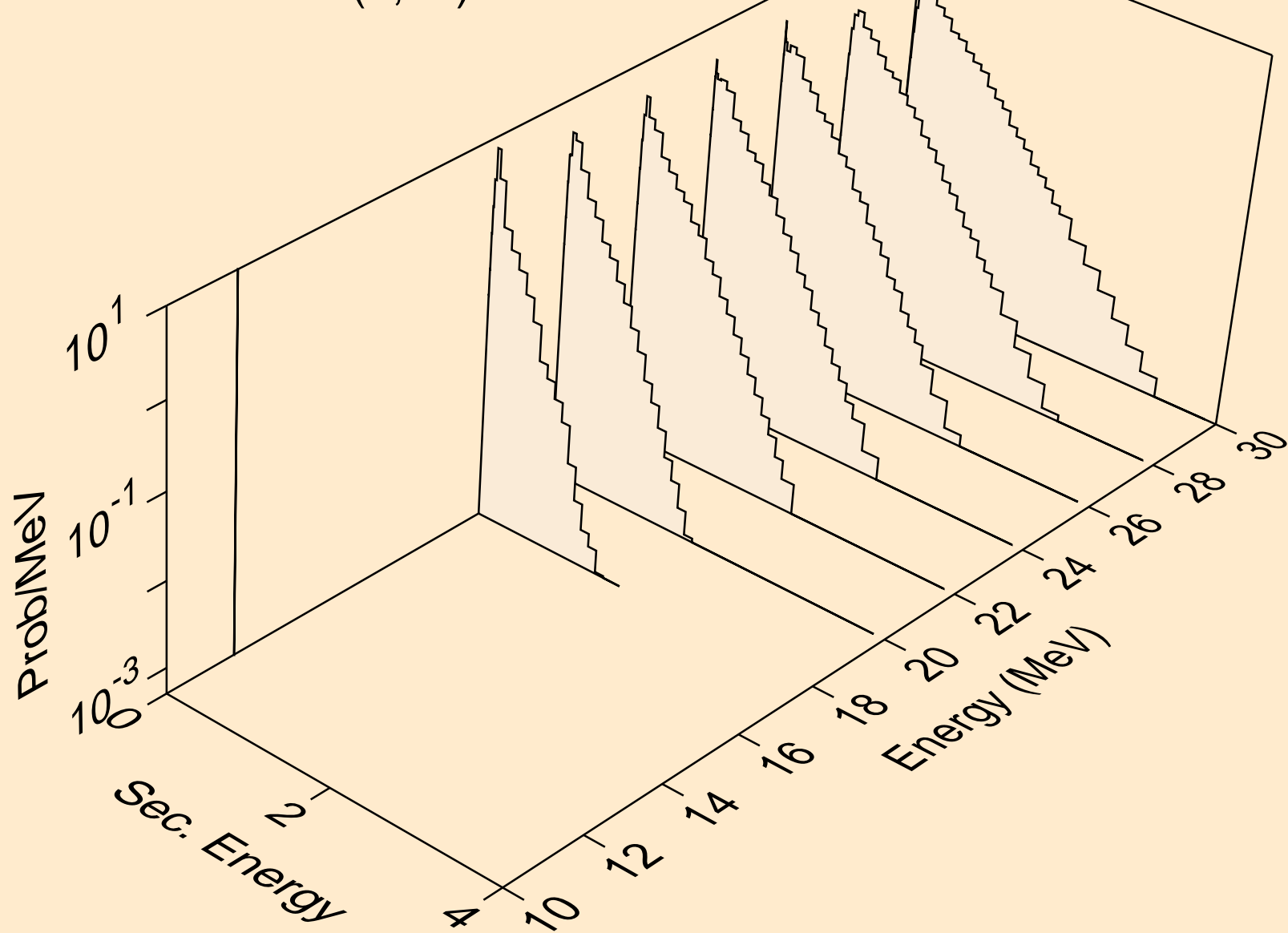

EU162 ALPHA ACER TENDL-2023 LIBRARY; T=0.K
neutrons from (a,3n)a

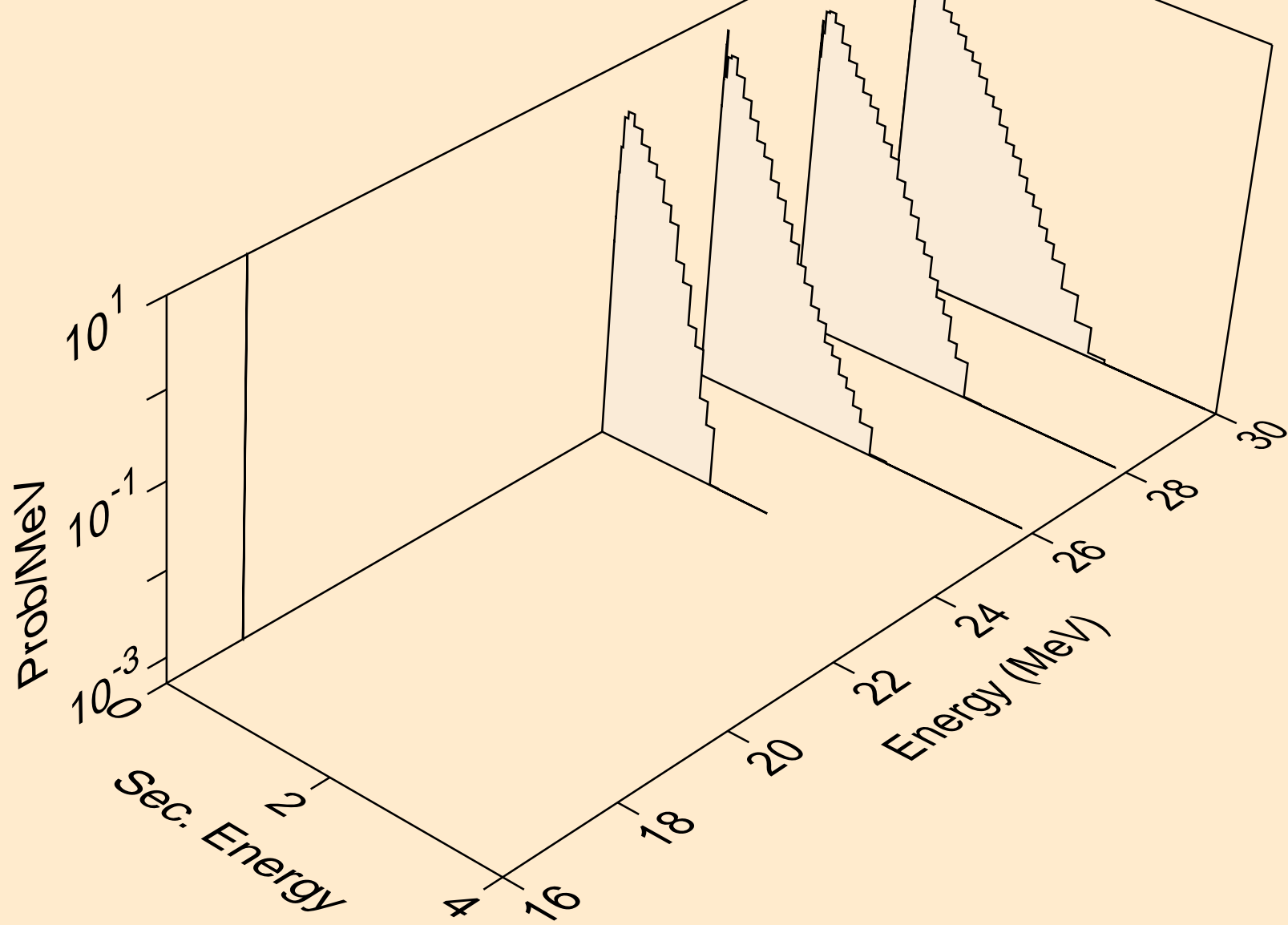

EU162 ALPHA ACER TENDL-2023 LIBRARY; T=0.K
neutrons from (a,n*)p

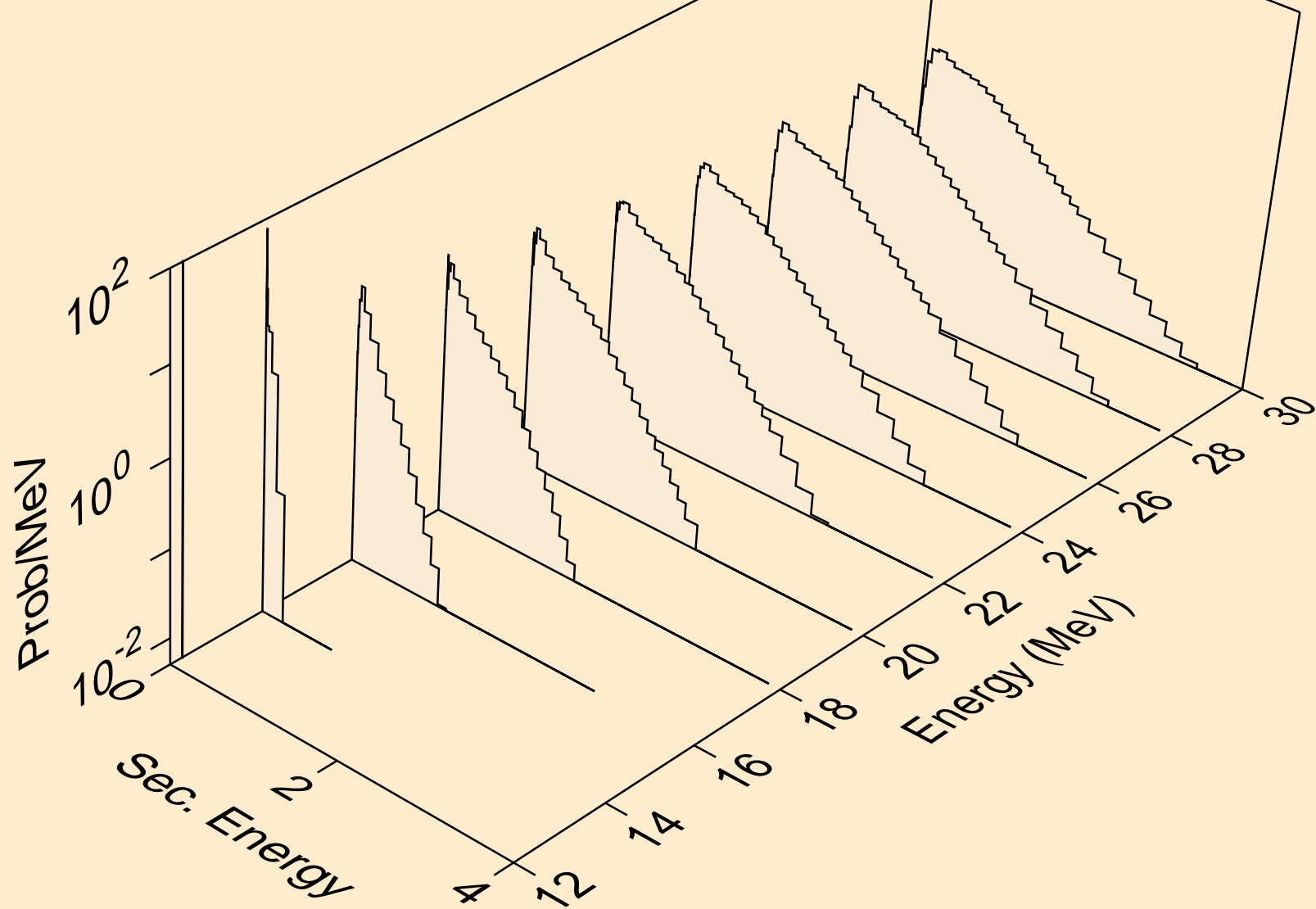

EU162 ALPHA ACER TENDL-2023 LIBRARY; T=0.K
neutrons from (a,n*)d

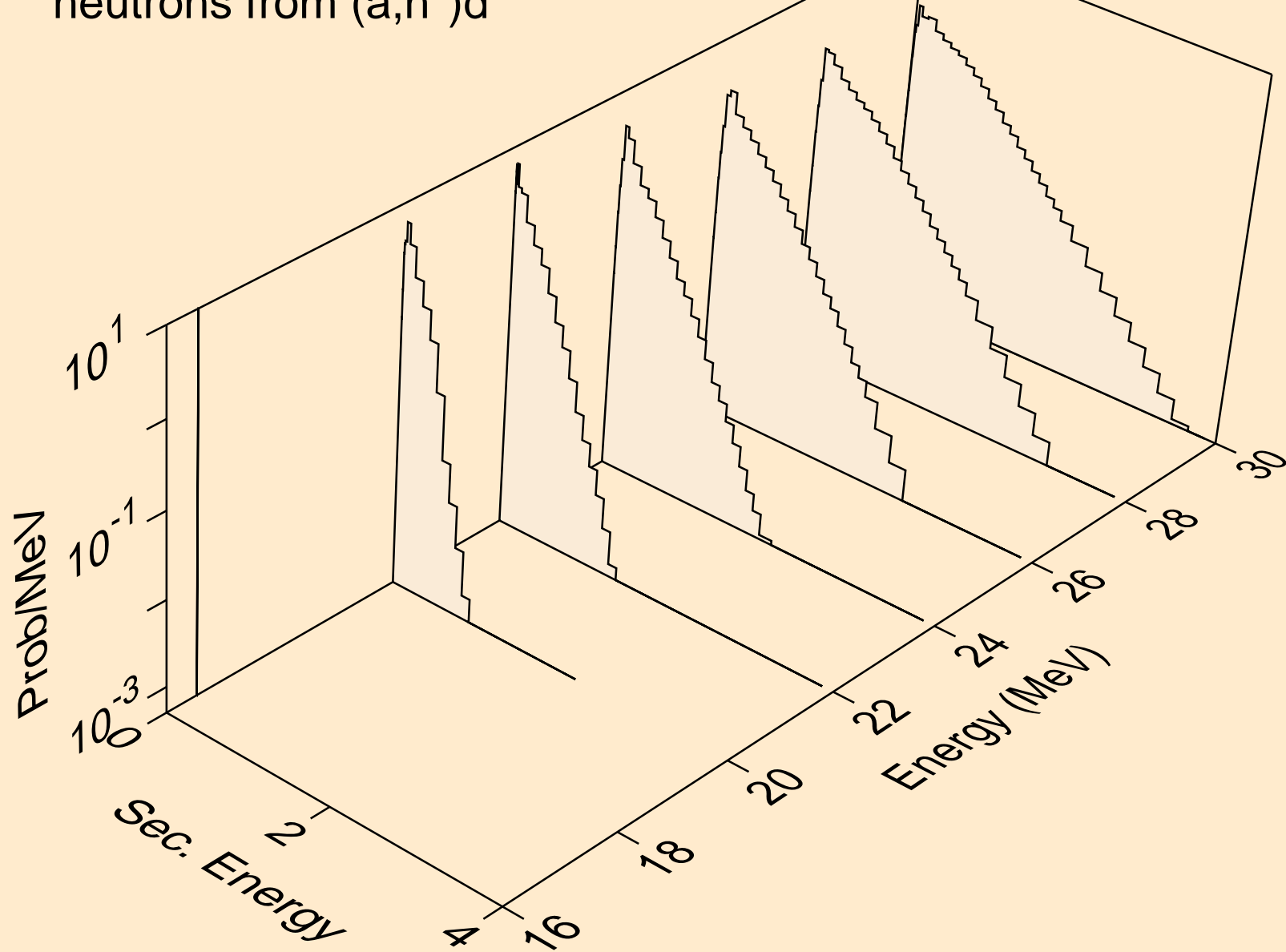

EU162 ALPHA ACER TENDL-2023 LIBRARY; T=0.K
neutrons from (a,n*)t

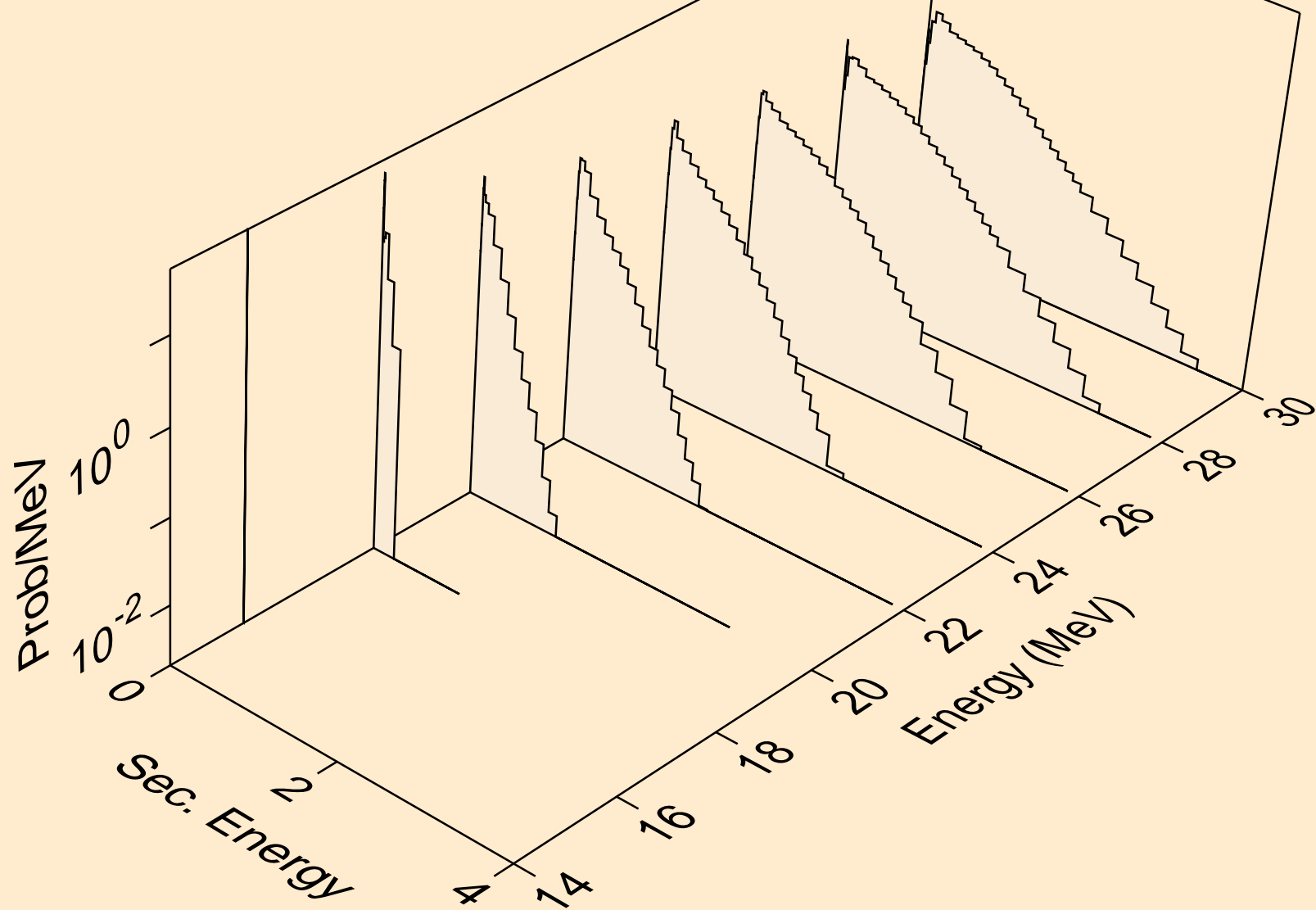

EU162 ALPHA ACER TENDL-2023 LIBRARY; T=0.K
neutrons from (a,4n)

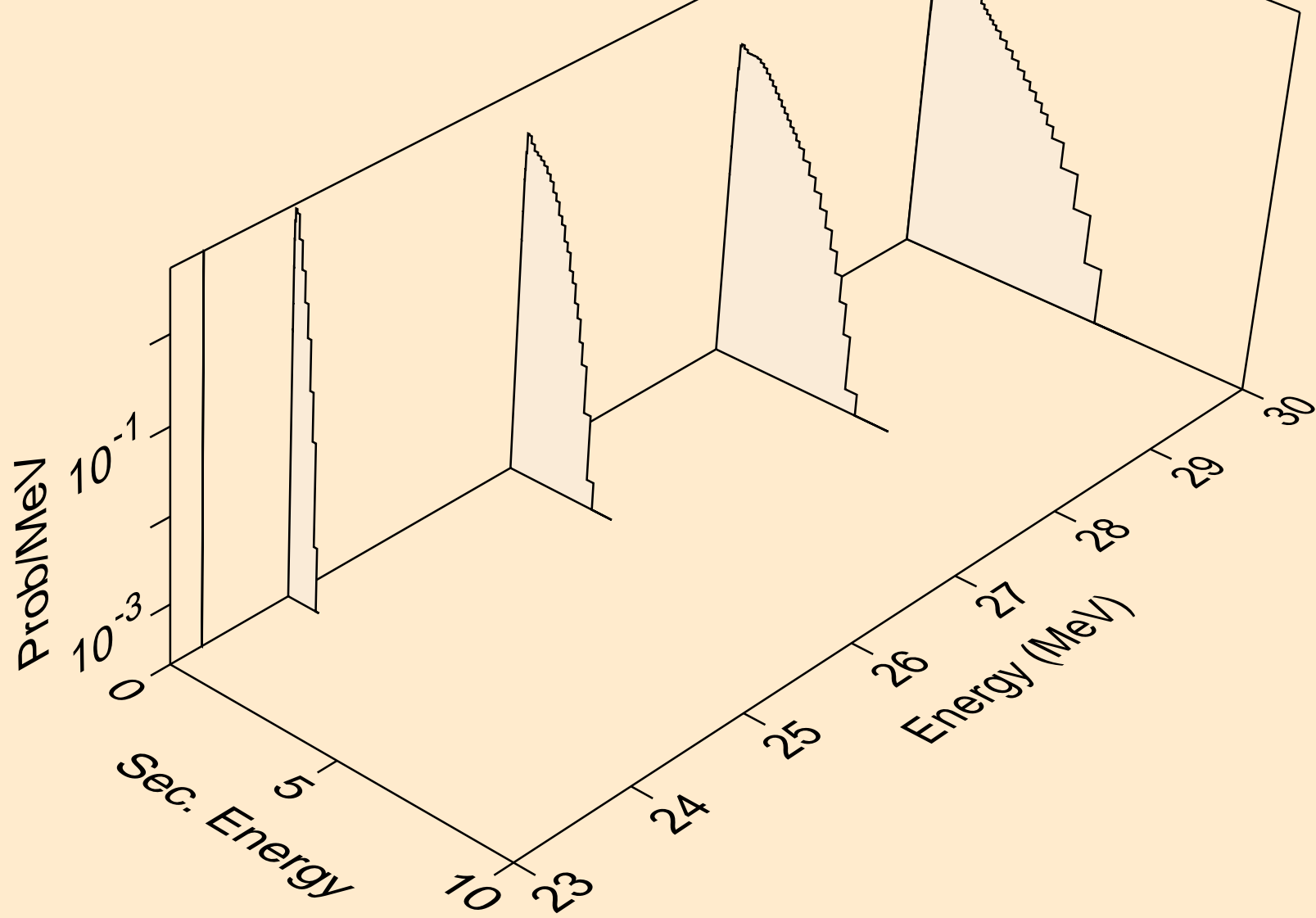

EU162 ALPHA ACER TENDL-2023 LIBRARY; T=0.K
neutrons from (a,2np)

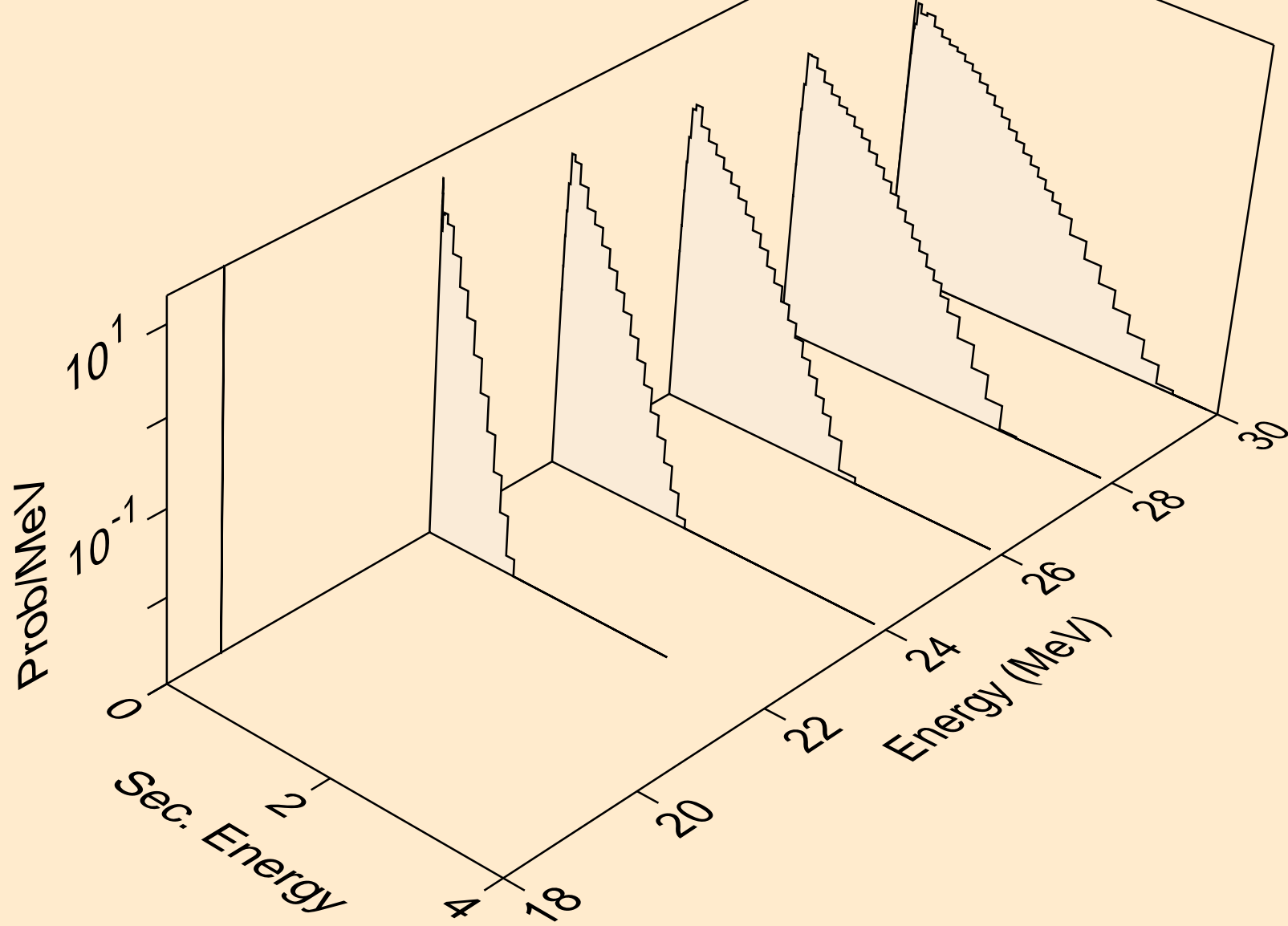

EU162 ALPHA ACER TENDL-2023 LIBRARY; T=0.K
neutrons from (a,3np)

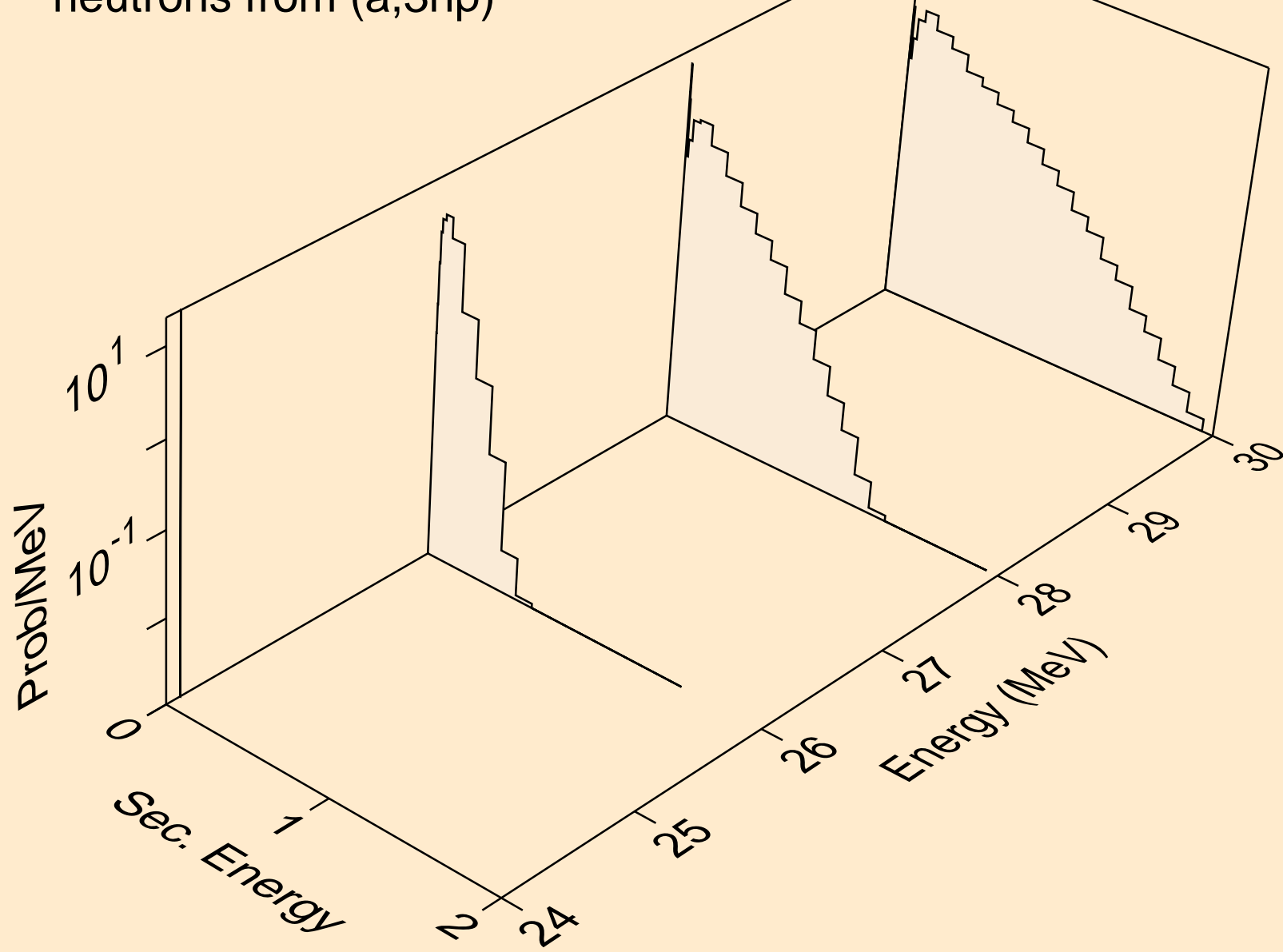

EU162 ALPHA ACER TENDL-2023 LIBRARY; T=0.K
protons from (a,x)

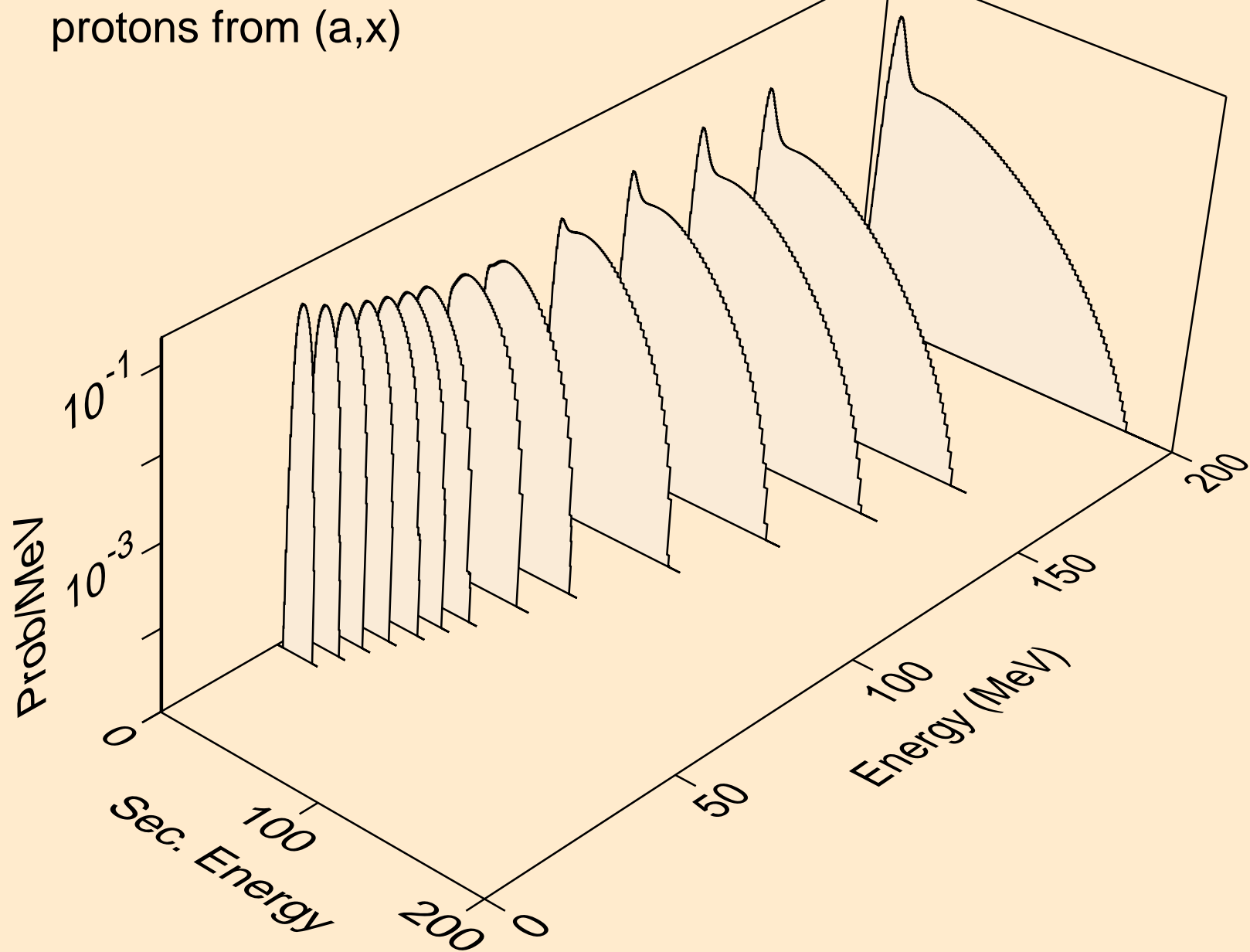

EU162 ALPHA ACER TENDL-2023 LIBRARY; T=0.K
protons from (a,n*)p

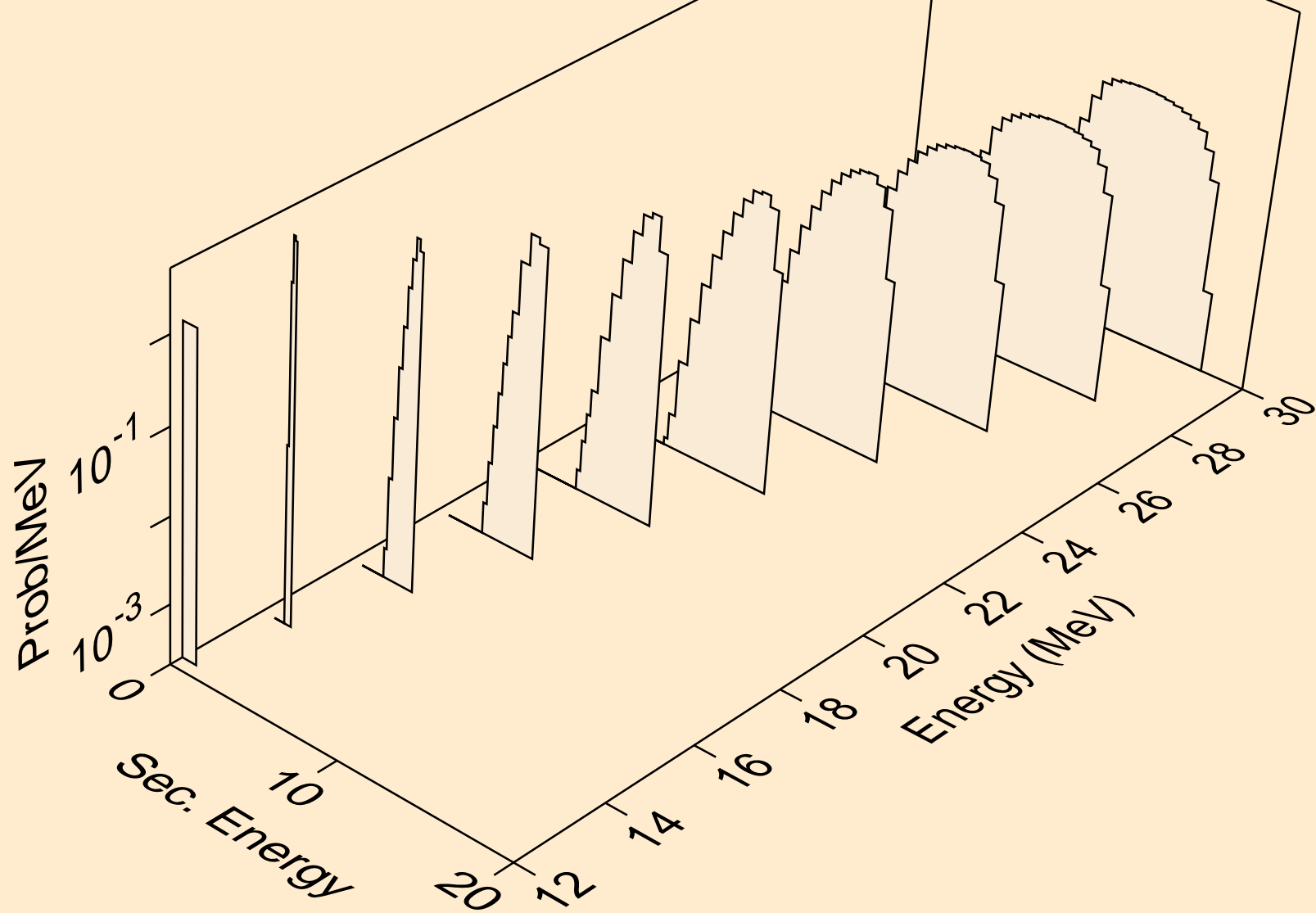

EU162 ALPHA ACER TENDL-2023 LIBRARY; T=0.K
protons from (a,2np)

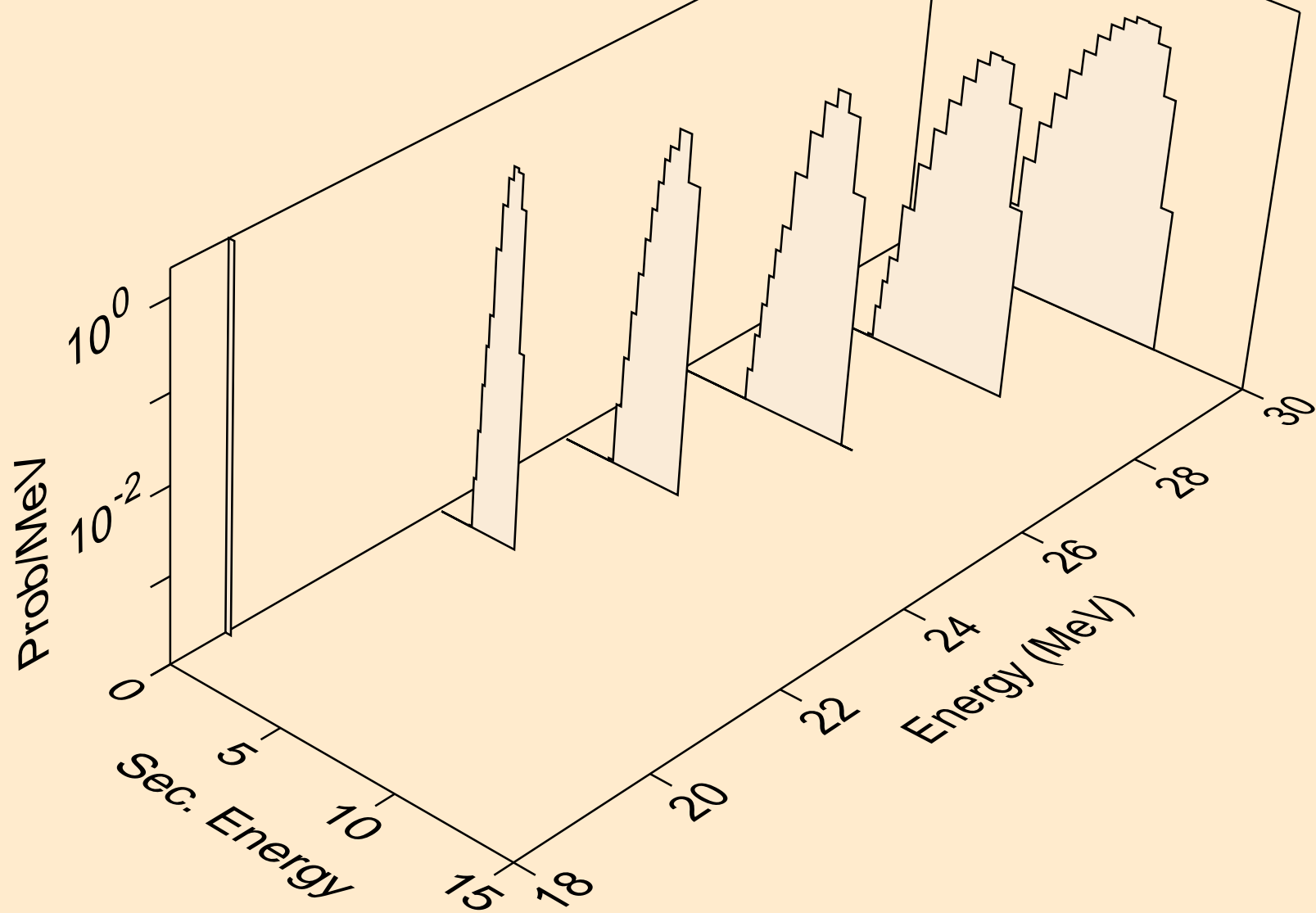

EU162 ALPHA ACER TENDL-2023 LIBRARY; T=0.K
protons from (a,3np)

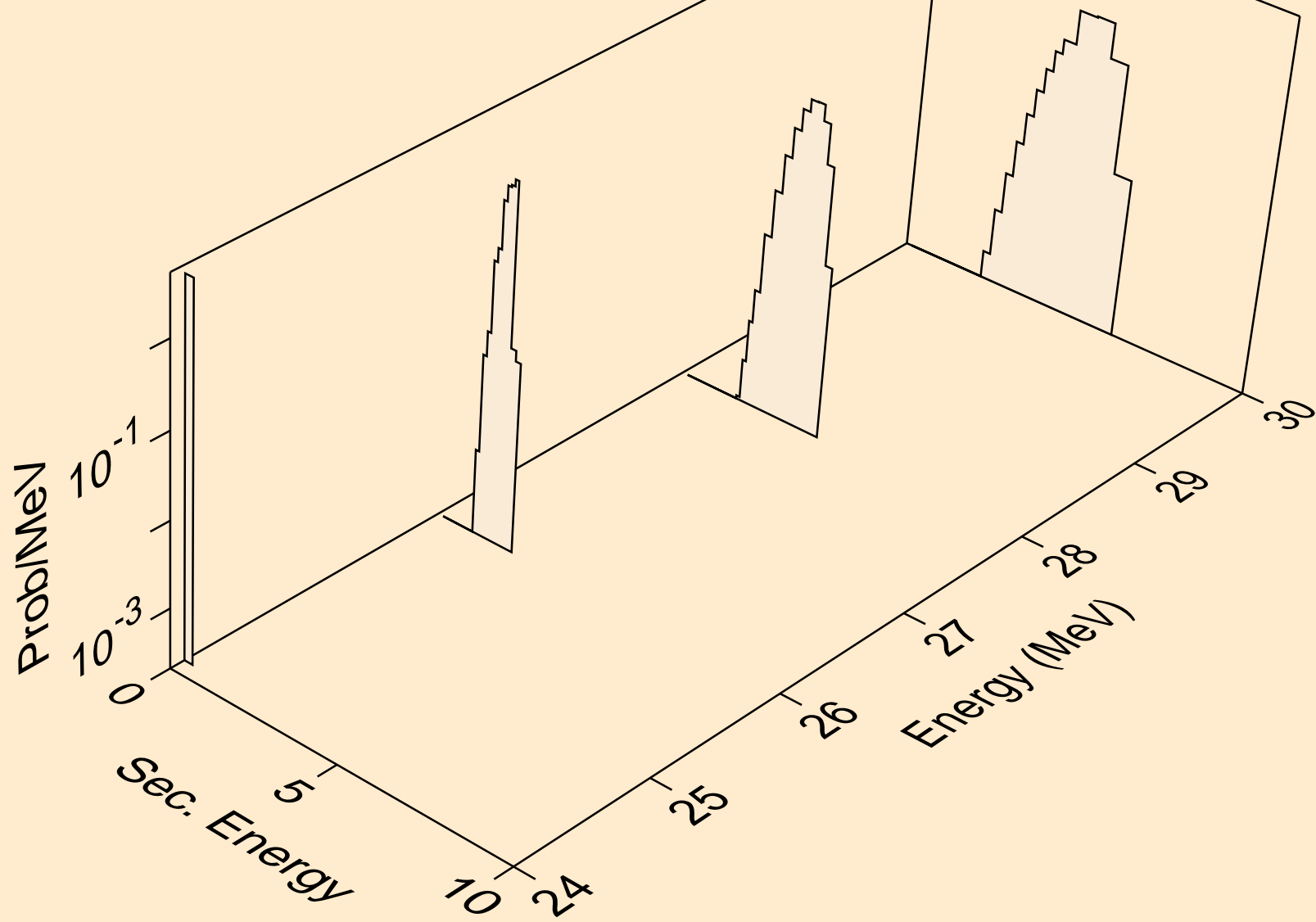

EU162 ALPHA ACER TENDL-2023 LIBRARY; T=0.K
protons from (a,p)

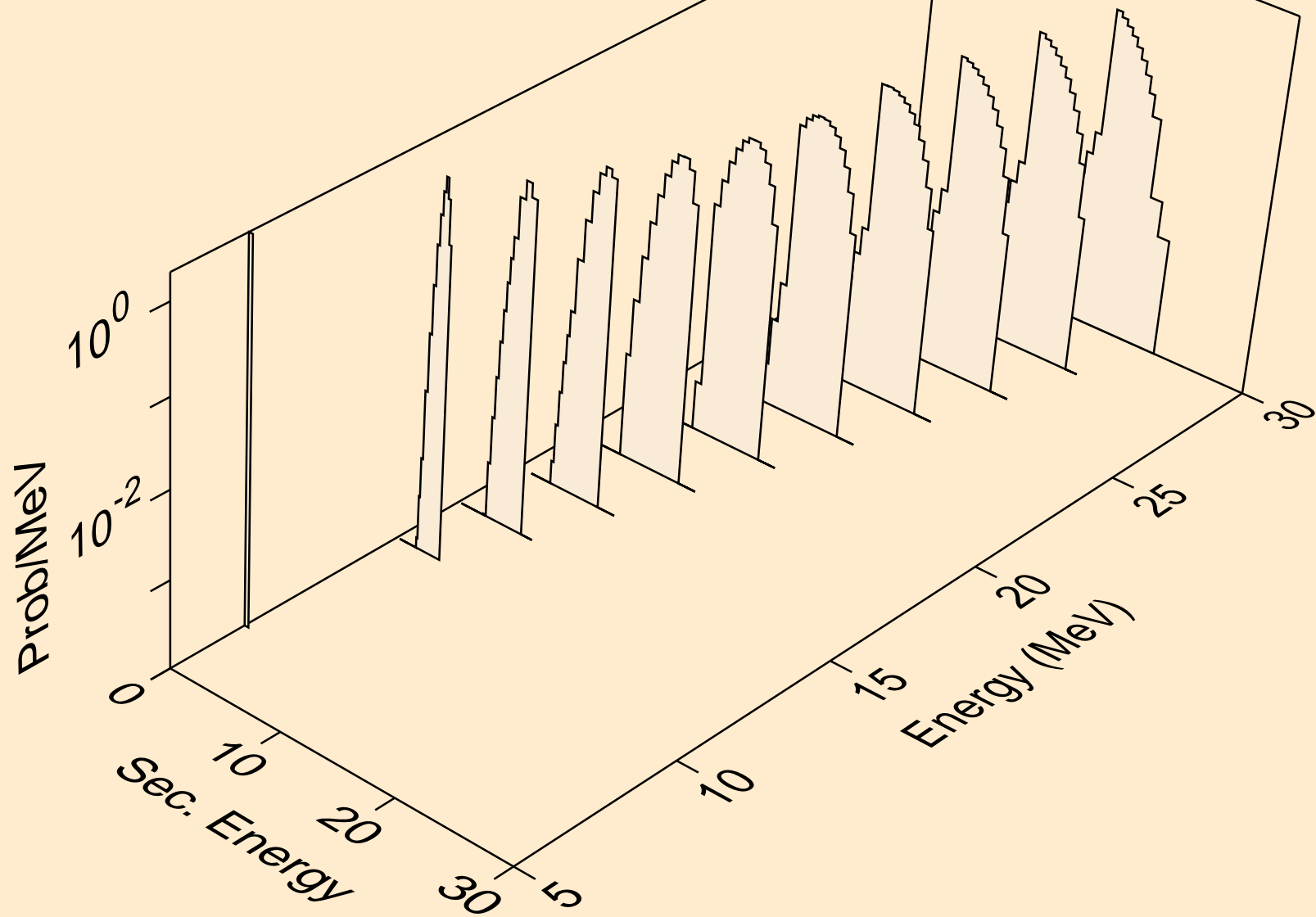

EU162 ALPHA ACER TENDL-2023 LIBRARY; T=0.K
deuterons from (a,x)

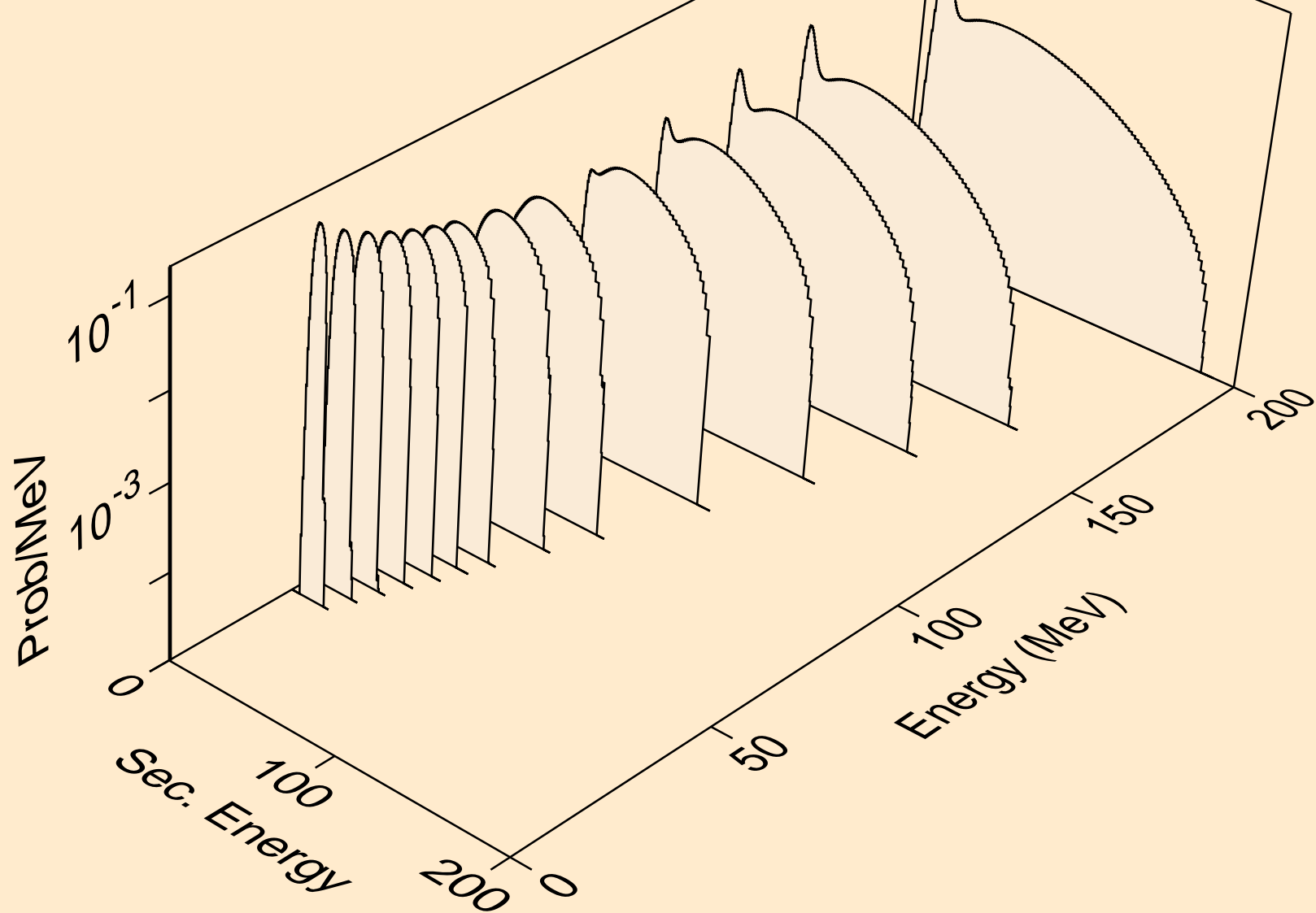

EU162 ALPHA ACER TENDL-2023 LIBRARY; T=0.K
deuterons from (a,2nd)

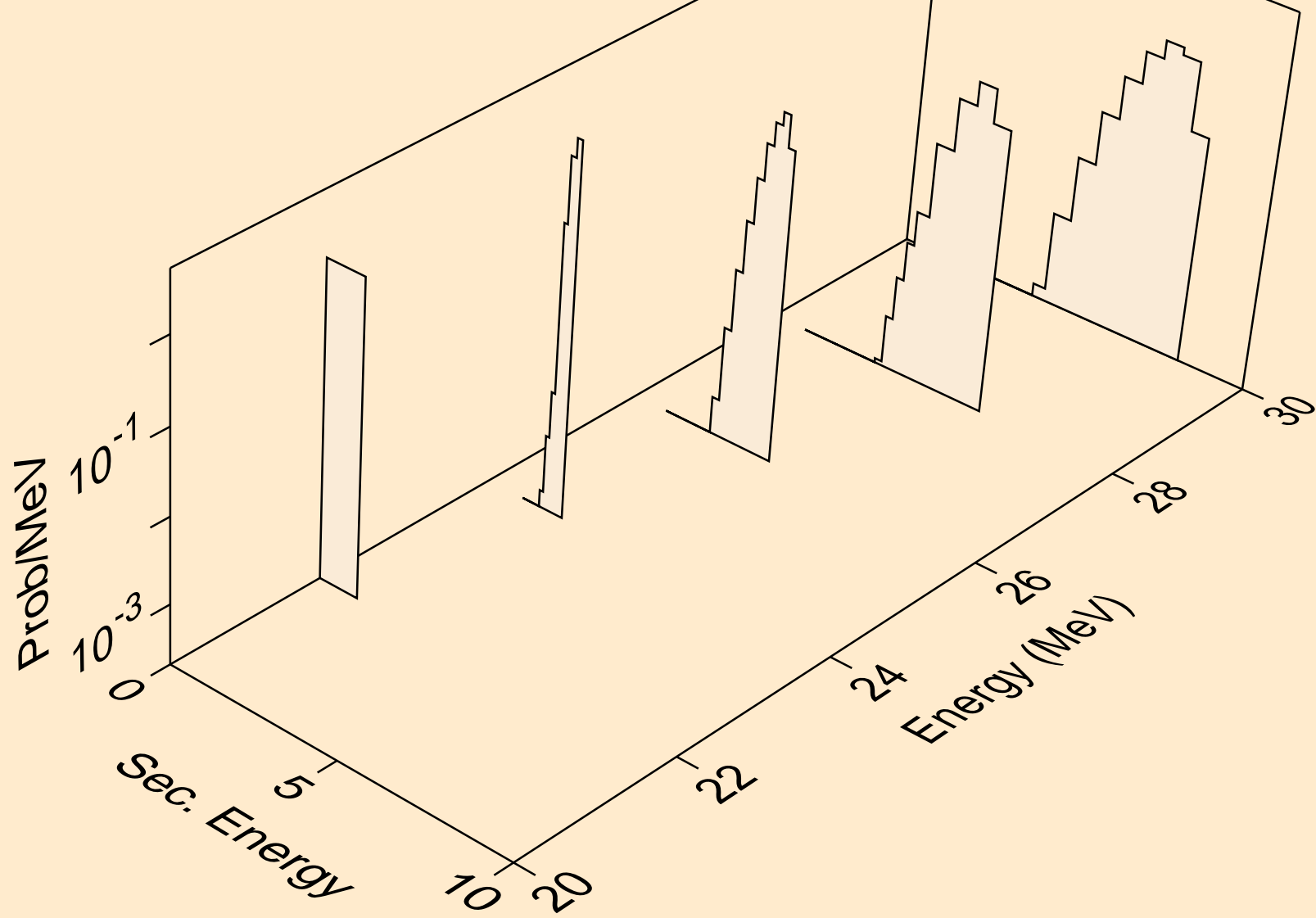

EU162 ALPHA ACER TENDL-2023 LIBRARY; T=0.K
deuterons from (a,n*)d

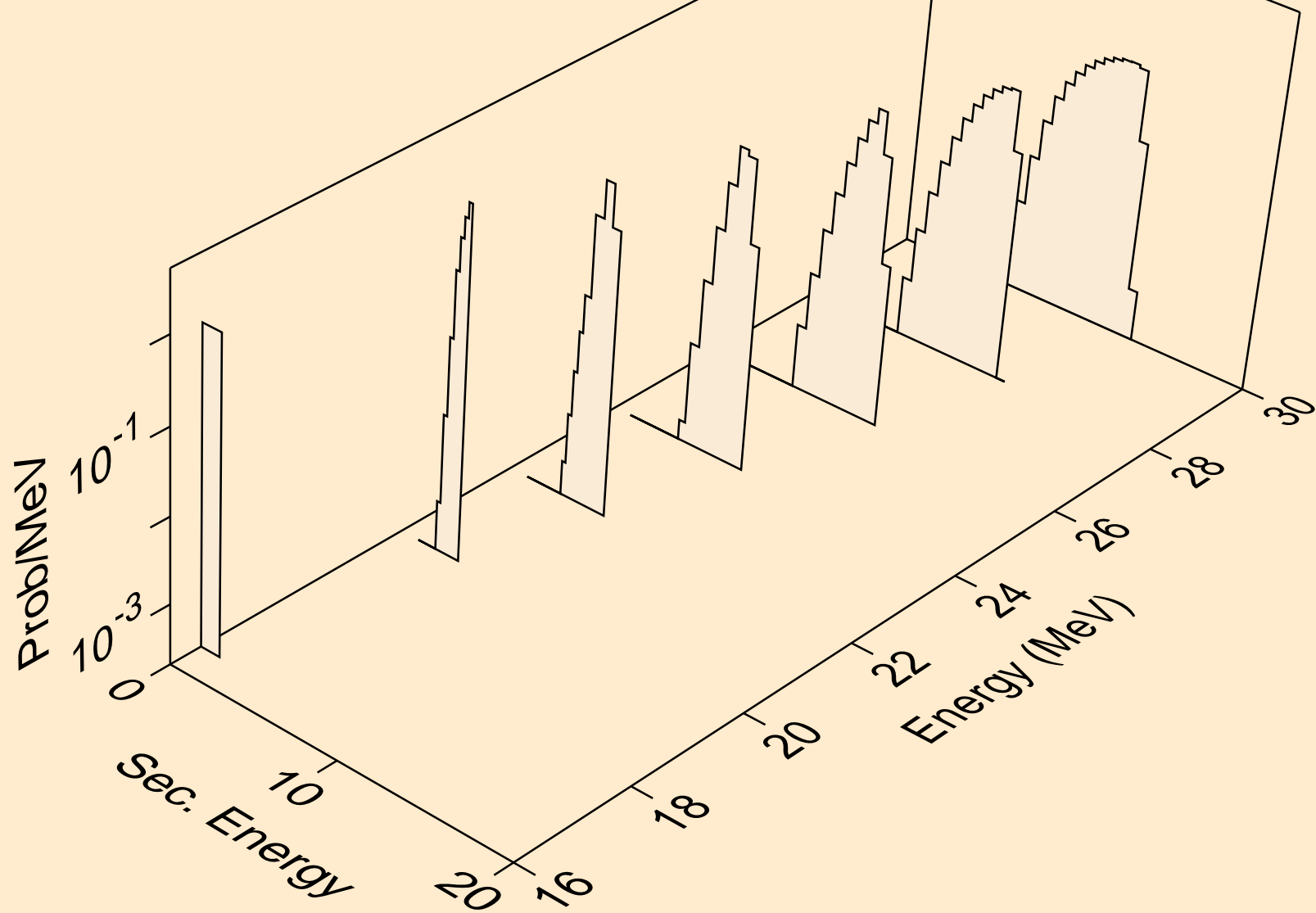

EU162 ALPHA ACER TENDL-2023 LIBRARY; T=0.K
deuterons from (a,d)

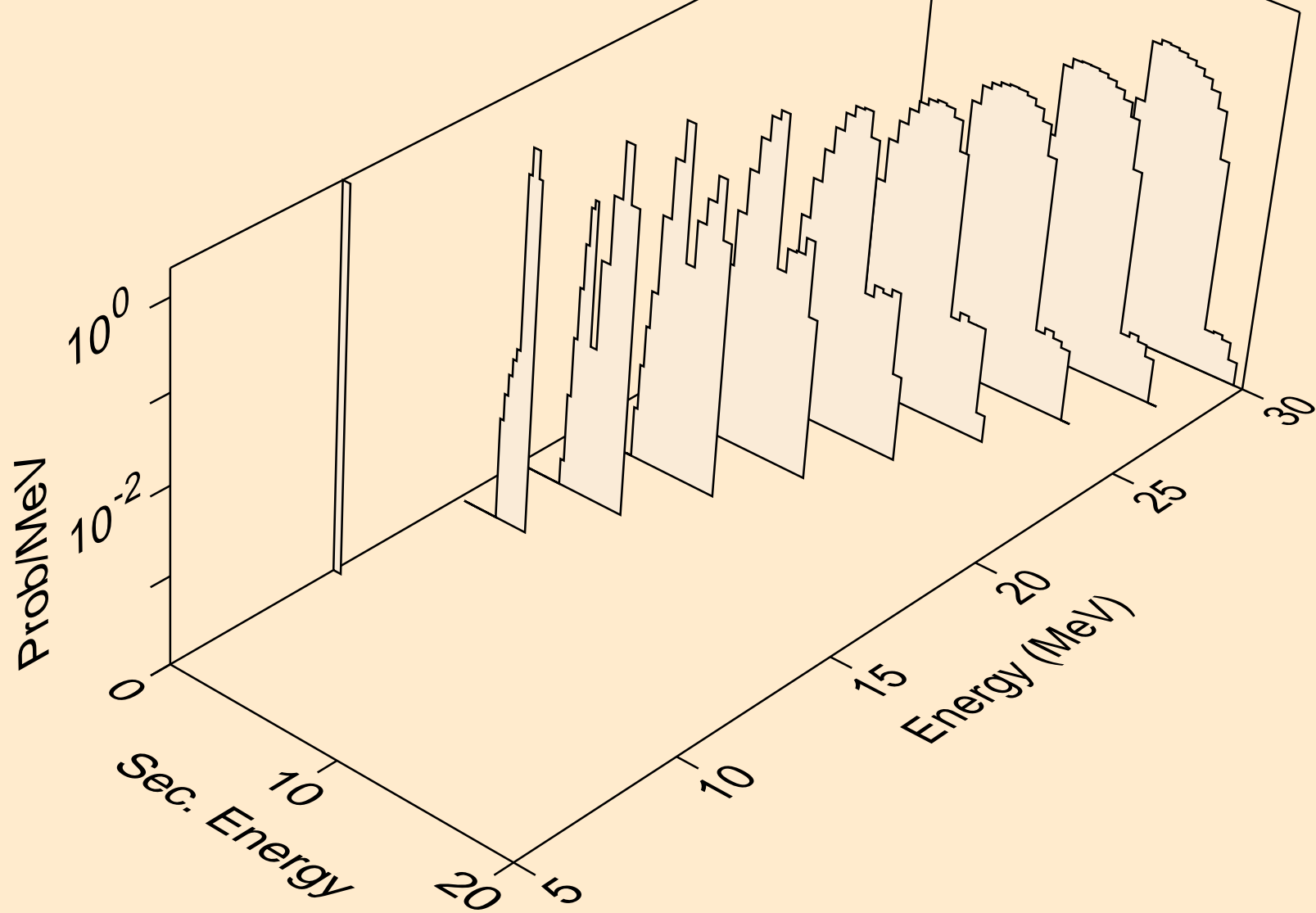

EU162 ALPHA ACER TENDL-2023 LIBRARY; T=0.K
tritons from (a,x)

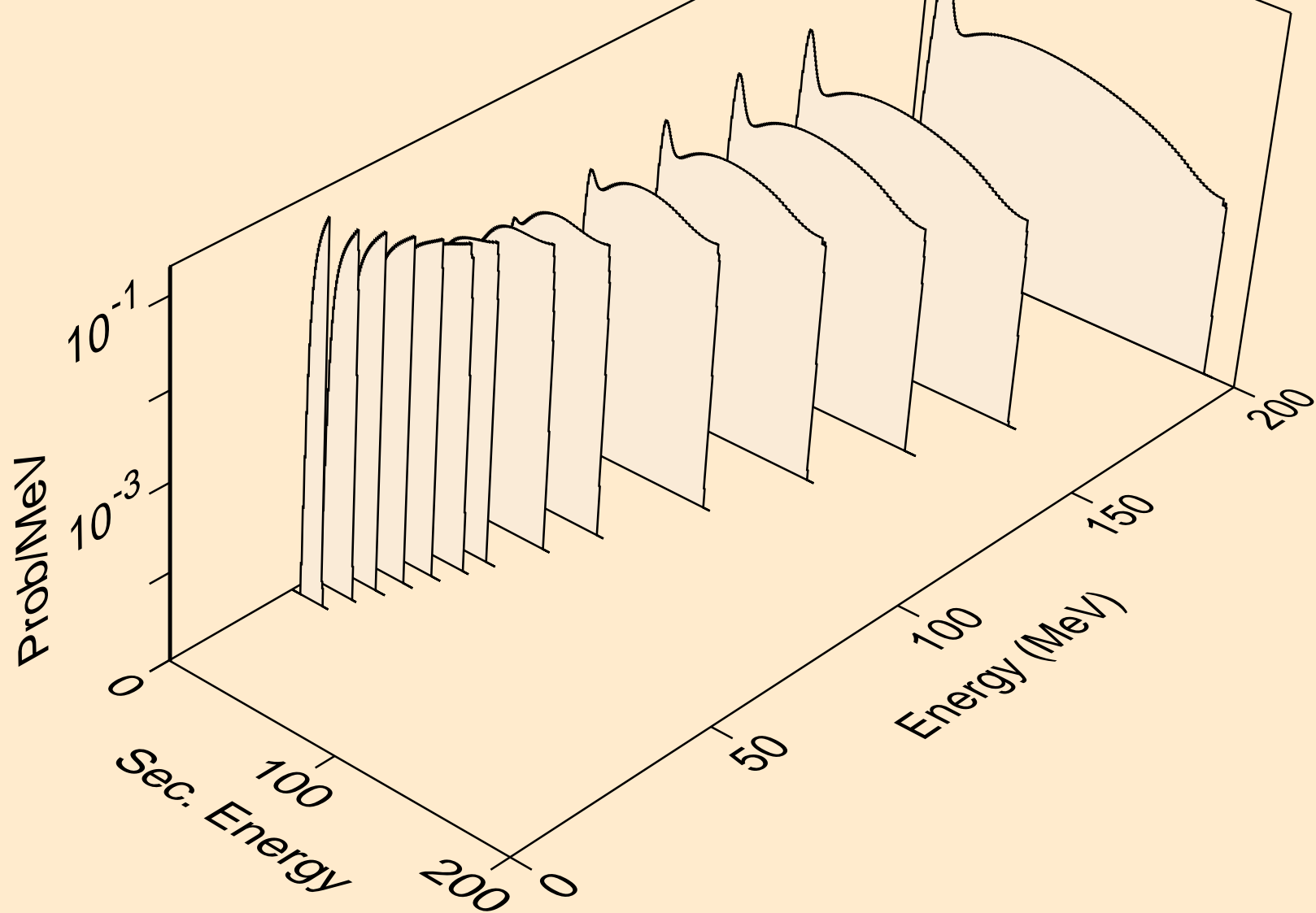

EU162 ALPHA ACER TENDL-2023 LIBRARY; T=0.K
tritons from (a,n*)t

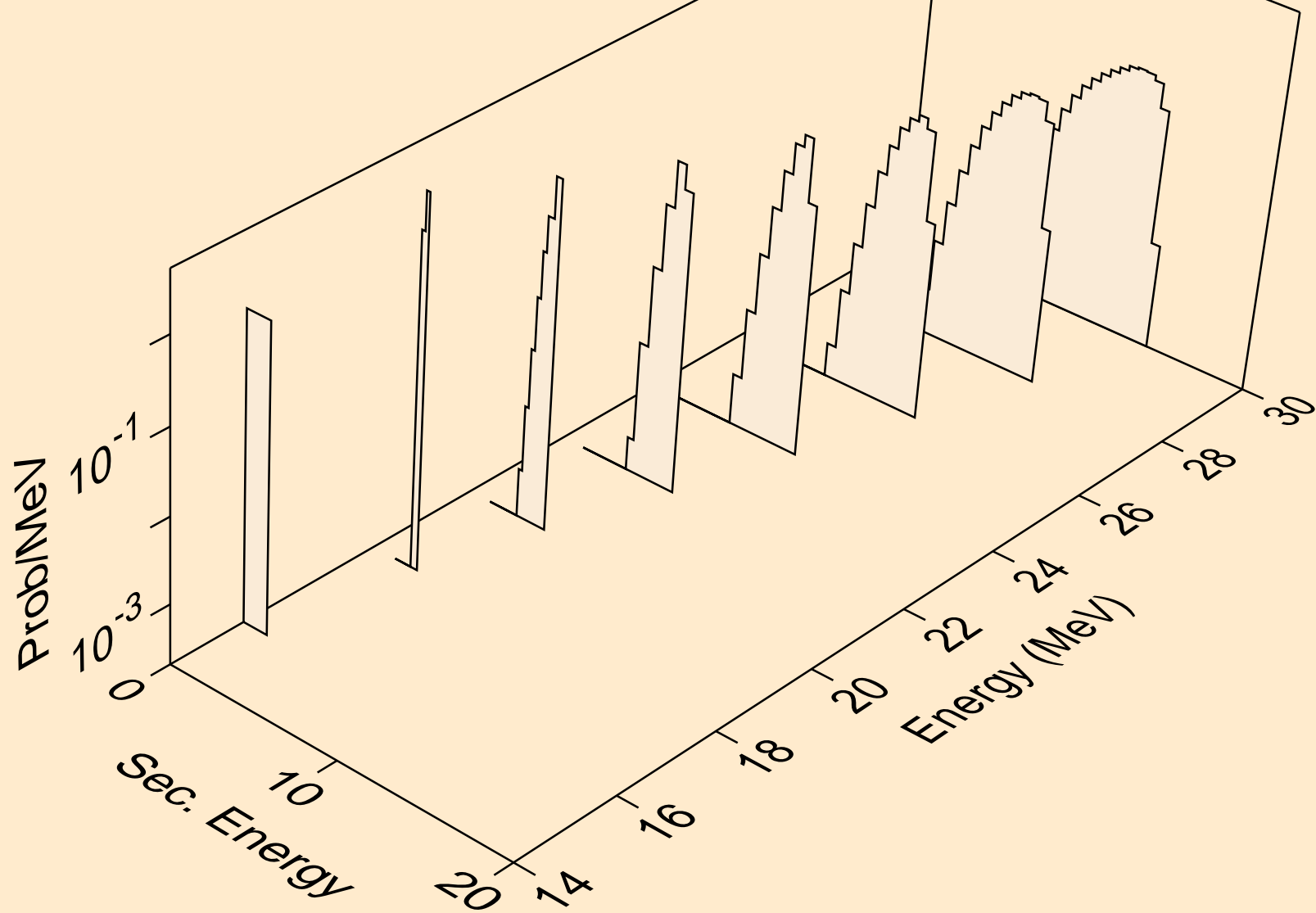

EU162 ALPHA ACER TENDL-2023 LIBRARY; T=0.K
tritons from (a,t)

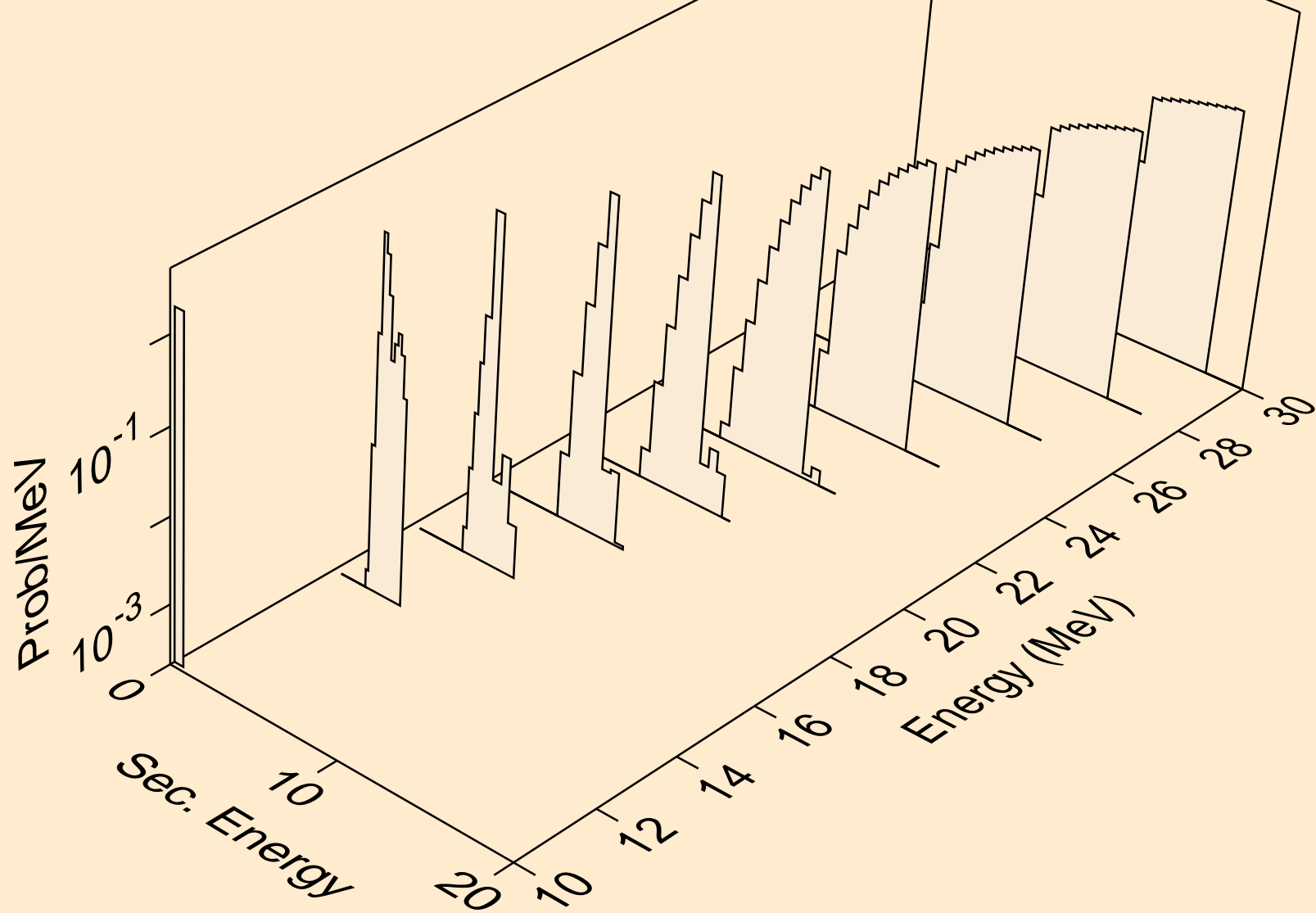

EU162 ALPHA ACER TENDL-2023 LIBRARY; T=0.K
he3s from (a,x)

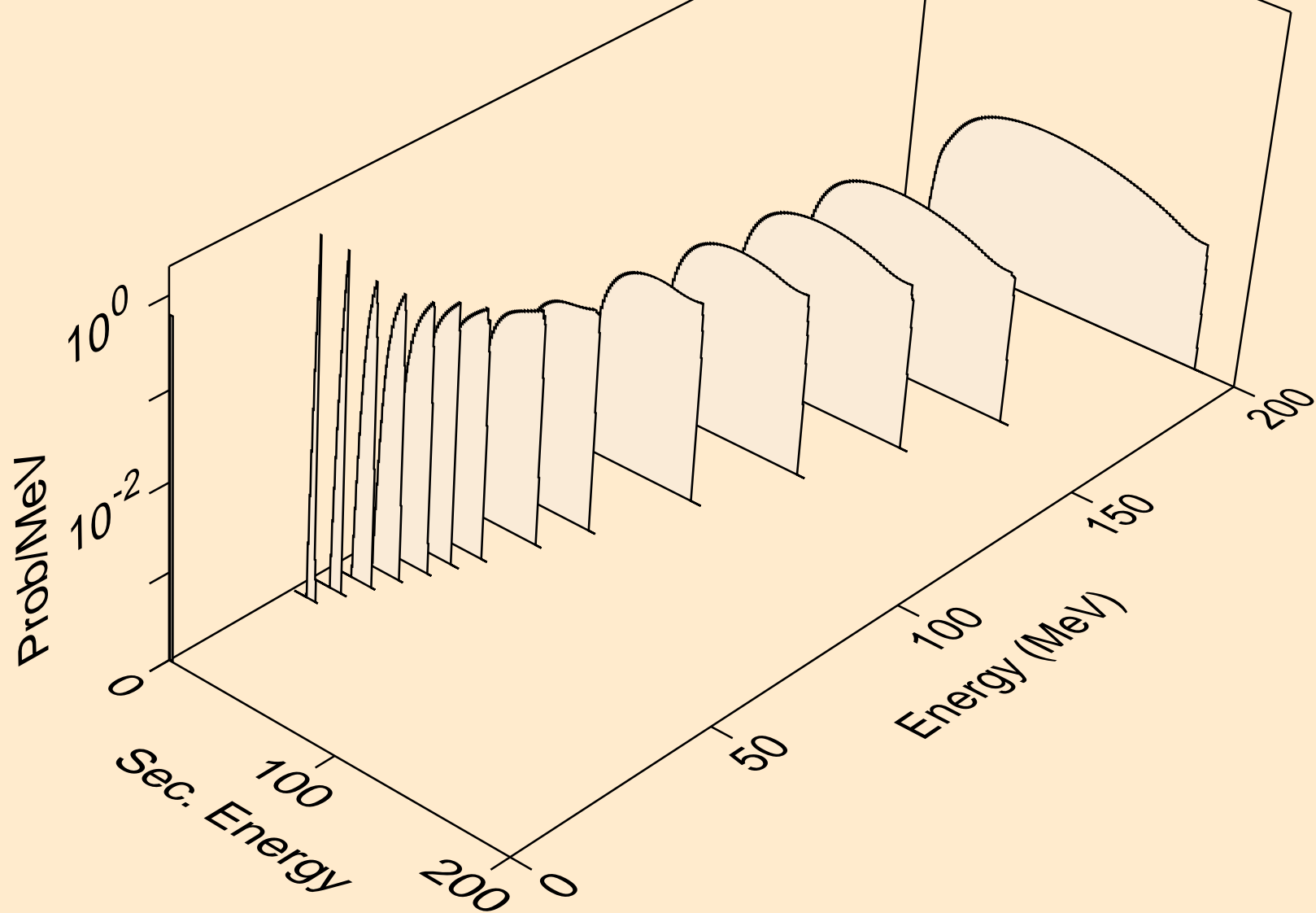

EU162 ALPHA ACER TENDL-2023 LIBRARY; T=0.K
he3s from (a,he3)

