

FR209 ALPHA ACER TENDL-2023 LIBRARY; T=0.K  
Principal cross sections

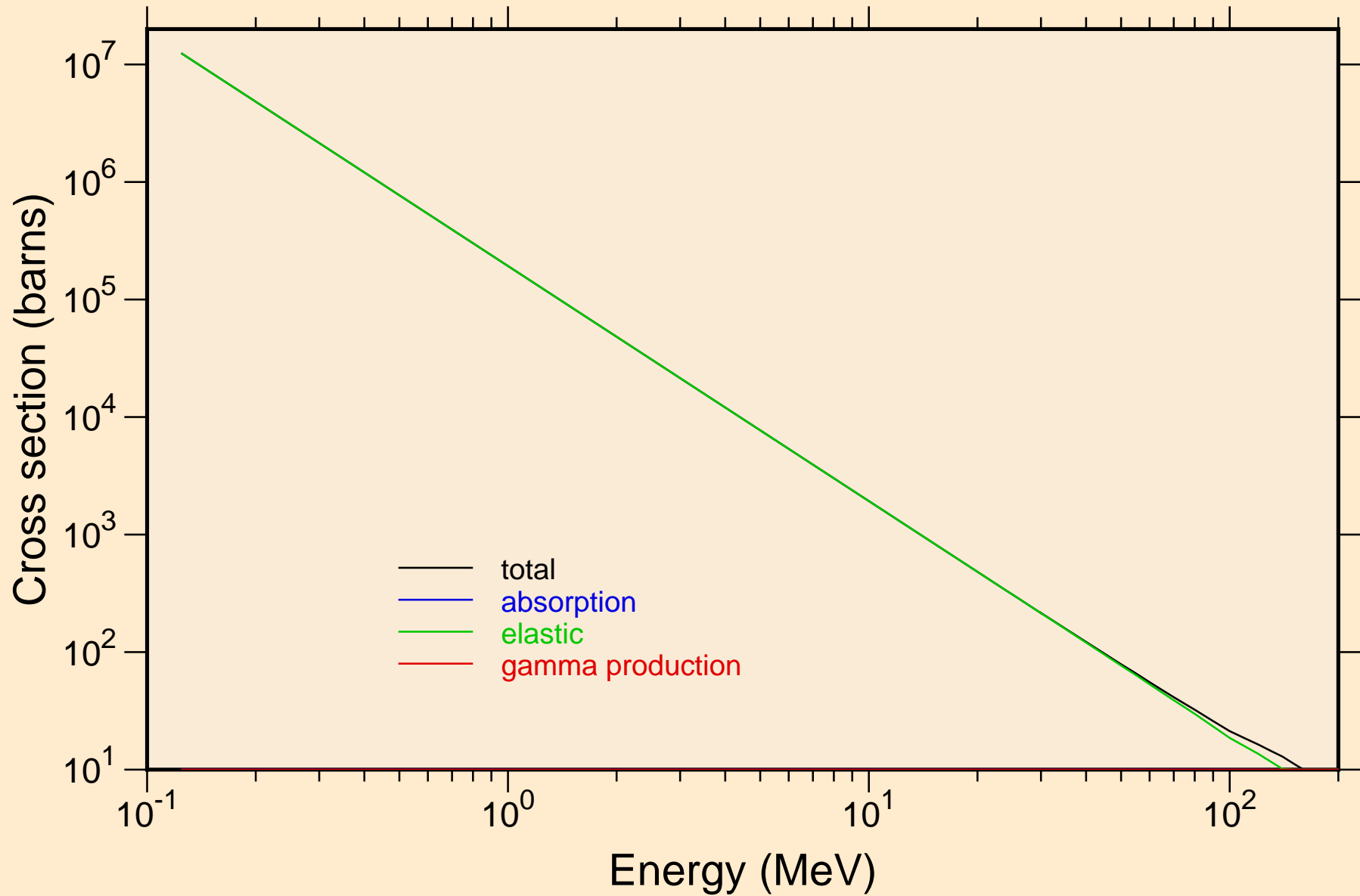

# FR209 ALPHA ACER TENDL-2023 LIBRARY; T=0.K

## Heating

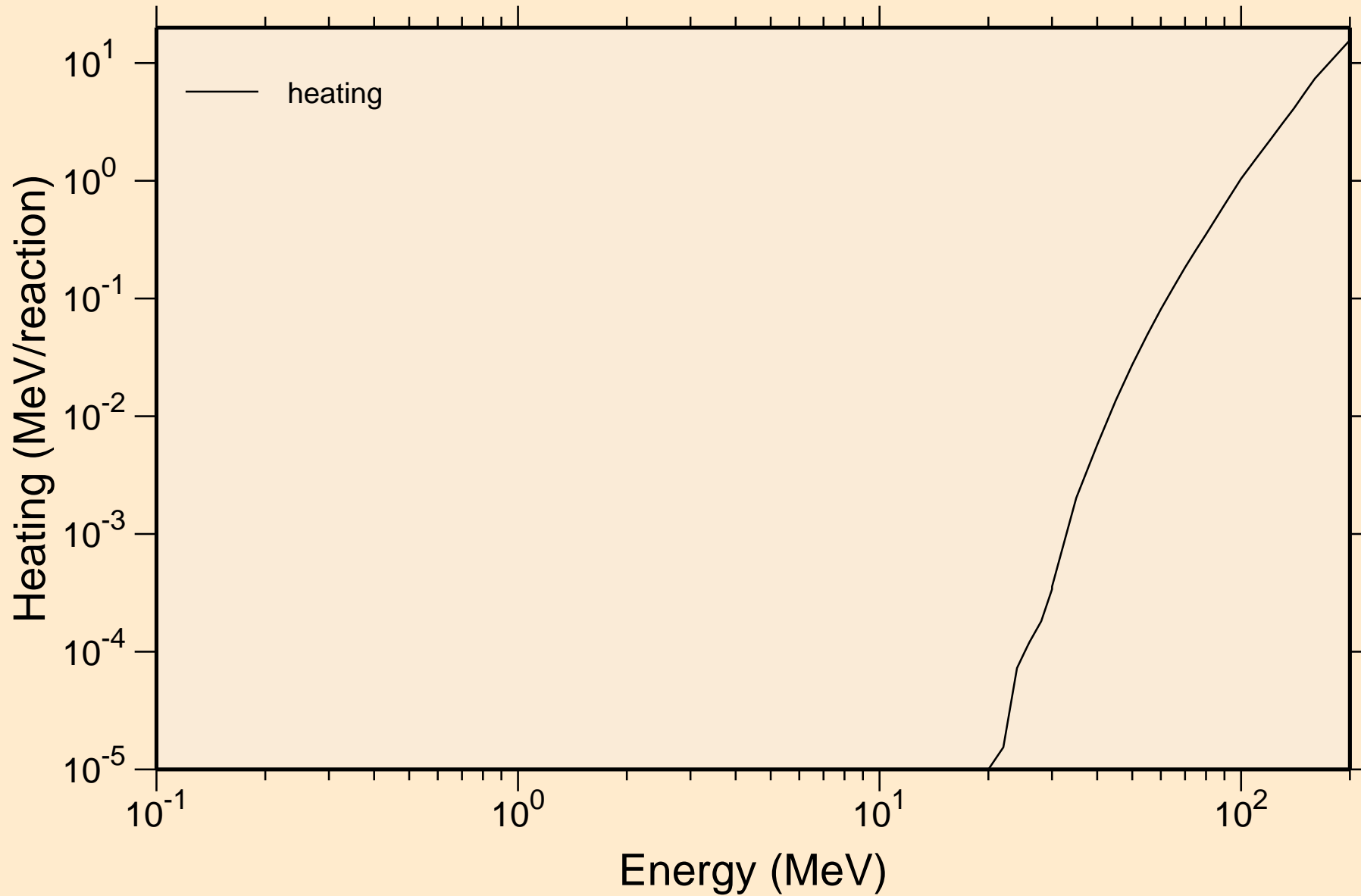

# FR209 ALPHA ACER TENDL-2023 LIBRARY; T=0.K

## Principal cross sections

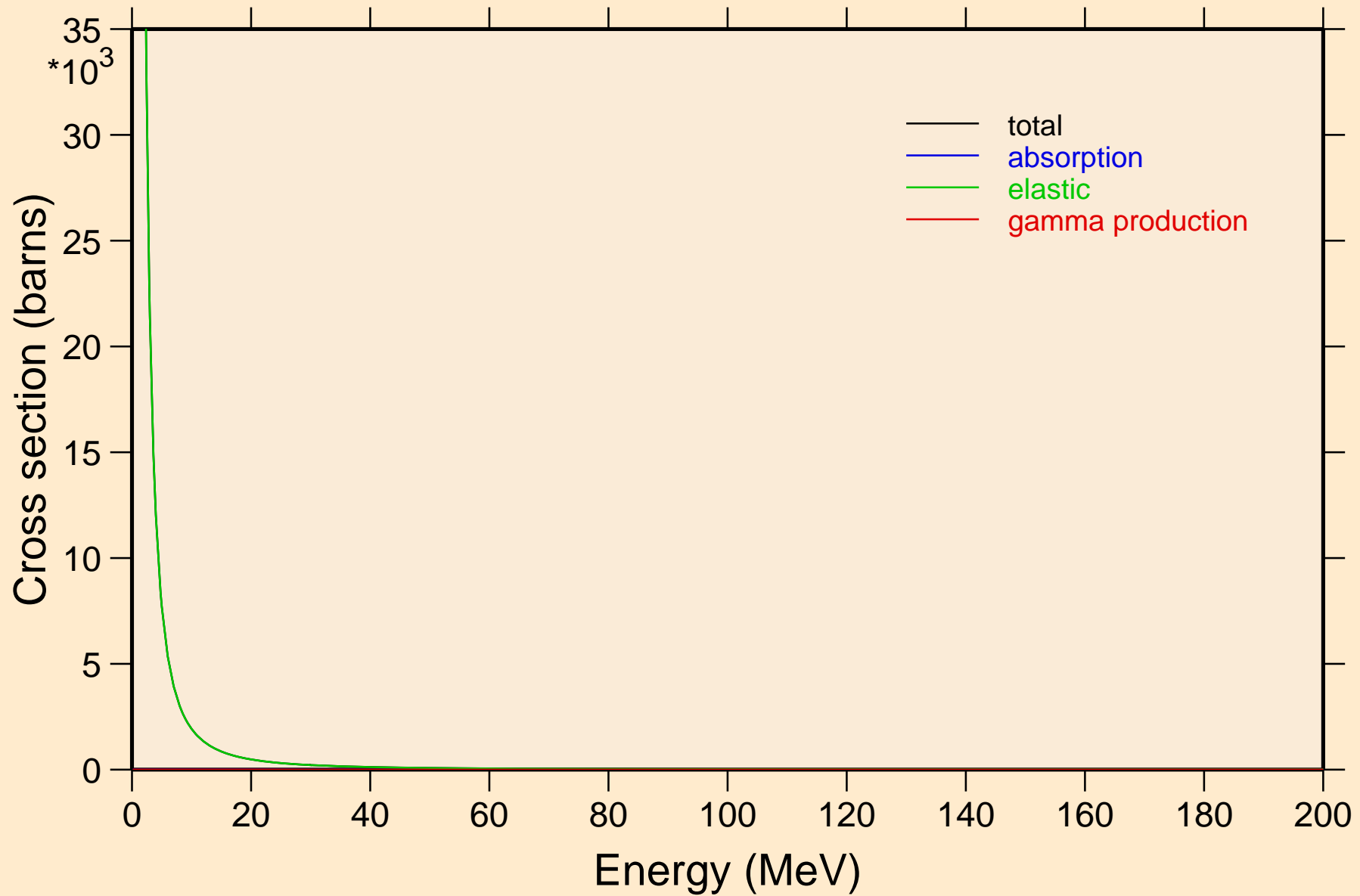

FR209 ALPHA ACER TENDL-2023 LIBRARY; T=0.K

Heating

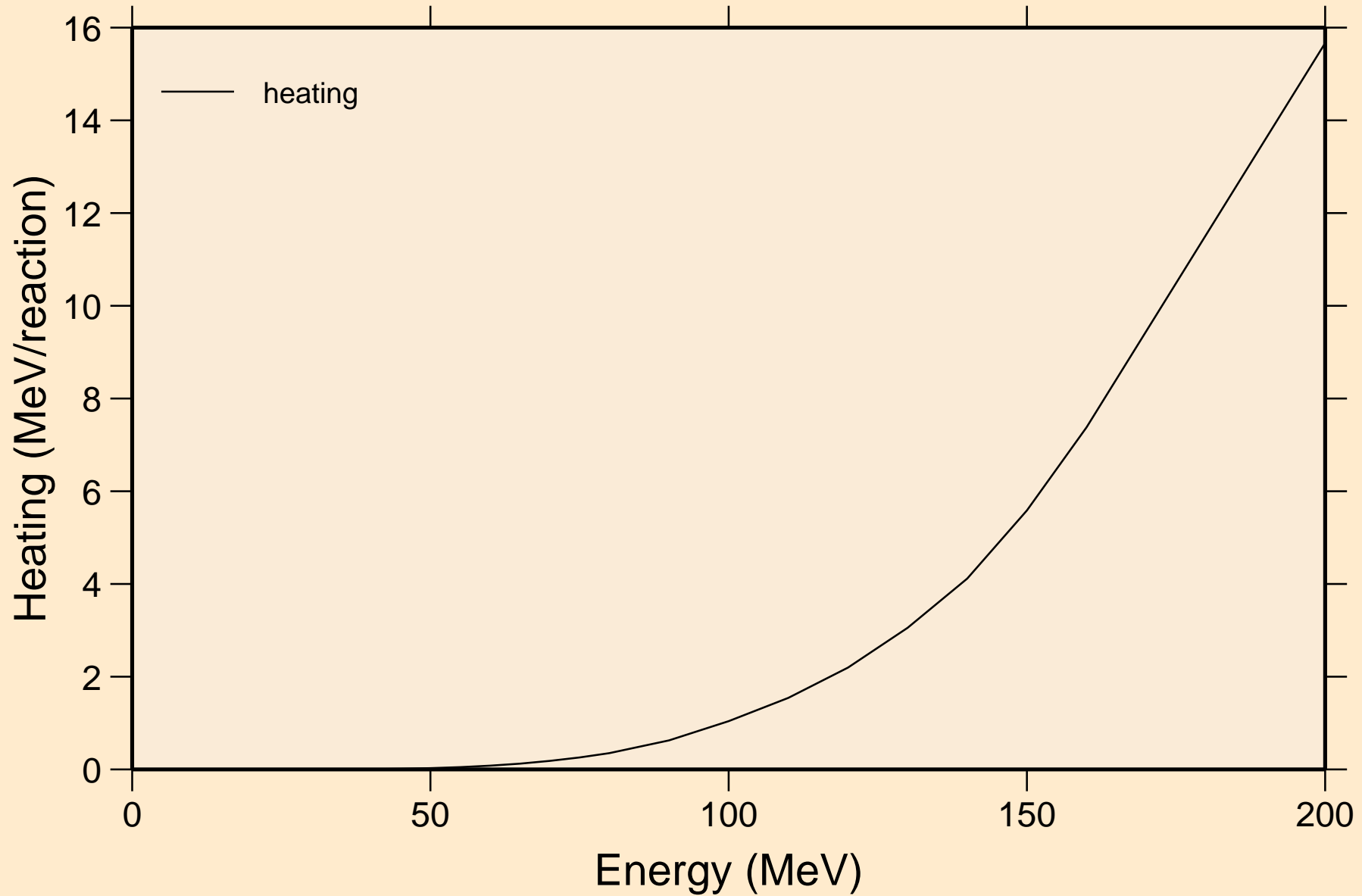

FR209 ALPHA ACER TENDL-2023 LIBRARY; T=0.K  
Threshold reactions

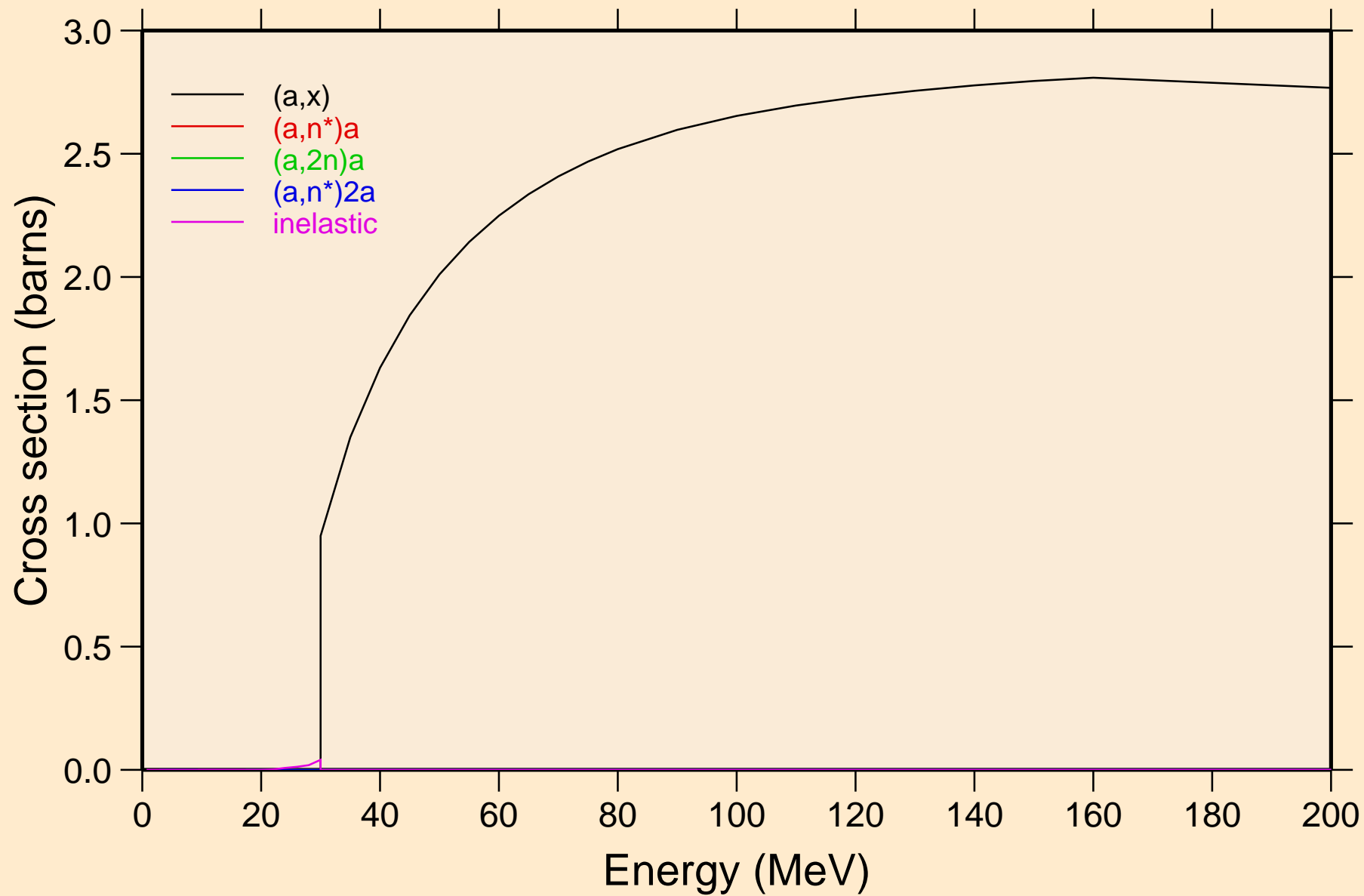

FR209 ALPHA ACER TENDL-2023 LIBRARY; T=0.K  
Threshold reactions

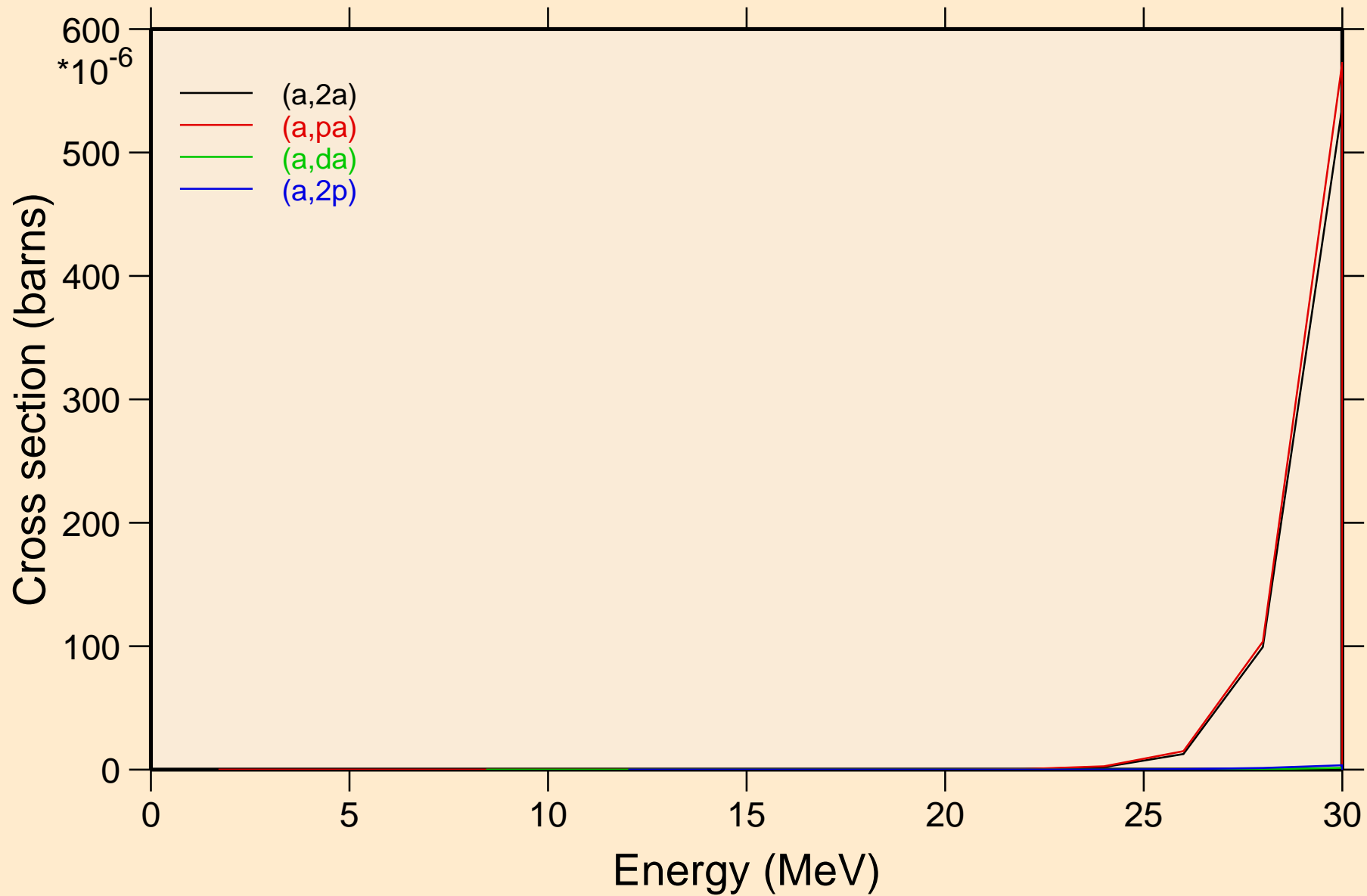

FR209 ALPHA ACER TENDL-2023 LIBRARY; T=0.K  
Threshold reactions

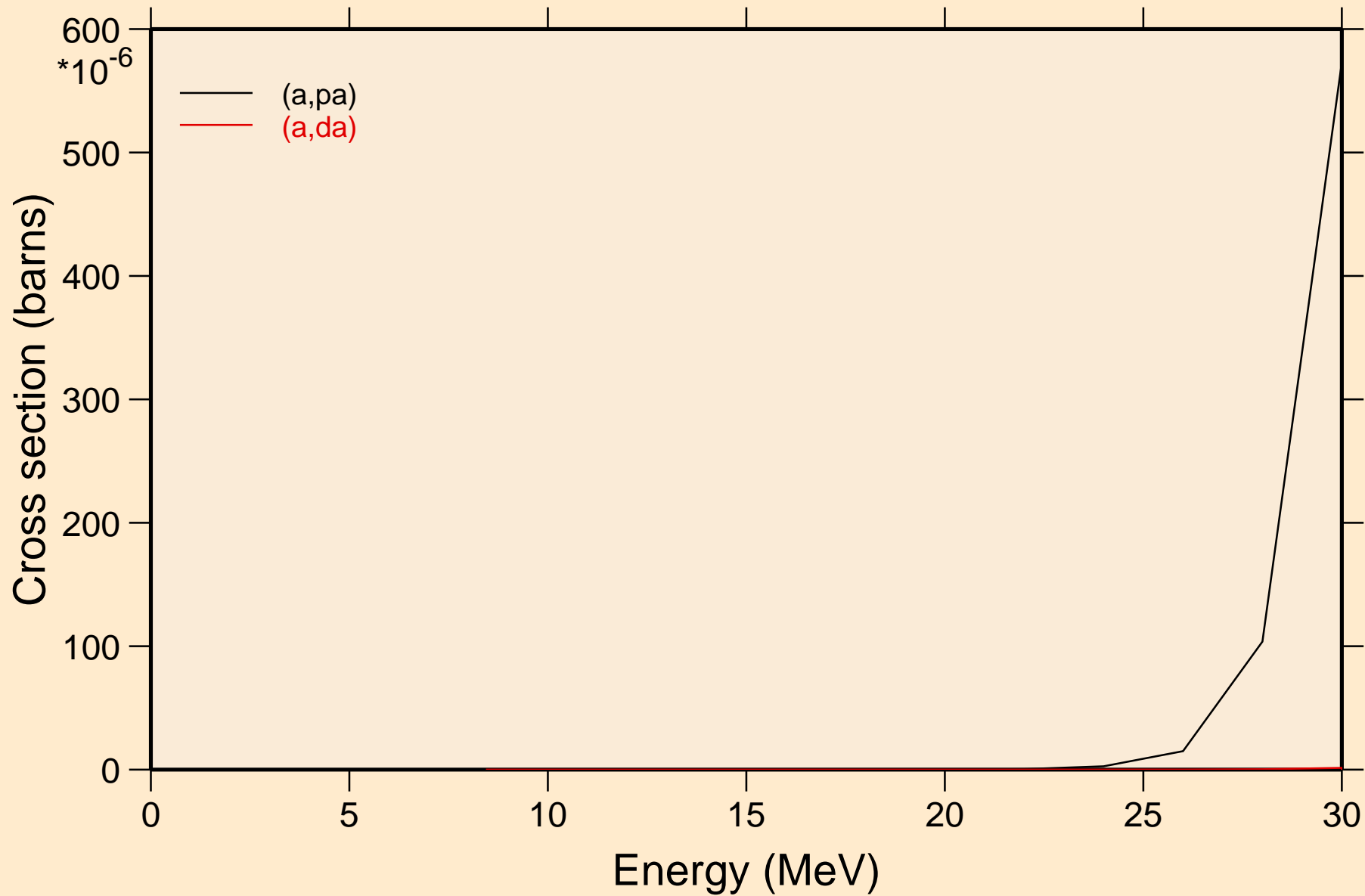

FR209 ALPHA ACER TENDL-2023 LIBRARY; T=0.K  
angular distribution for elastic

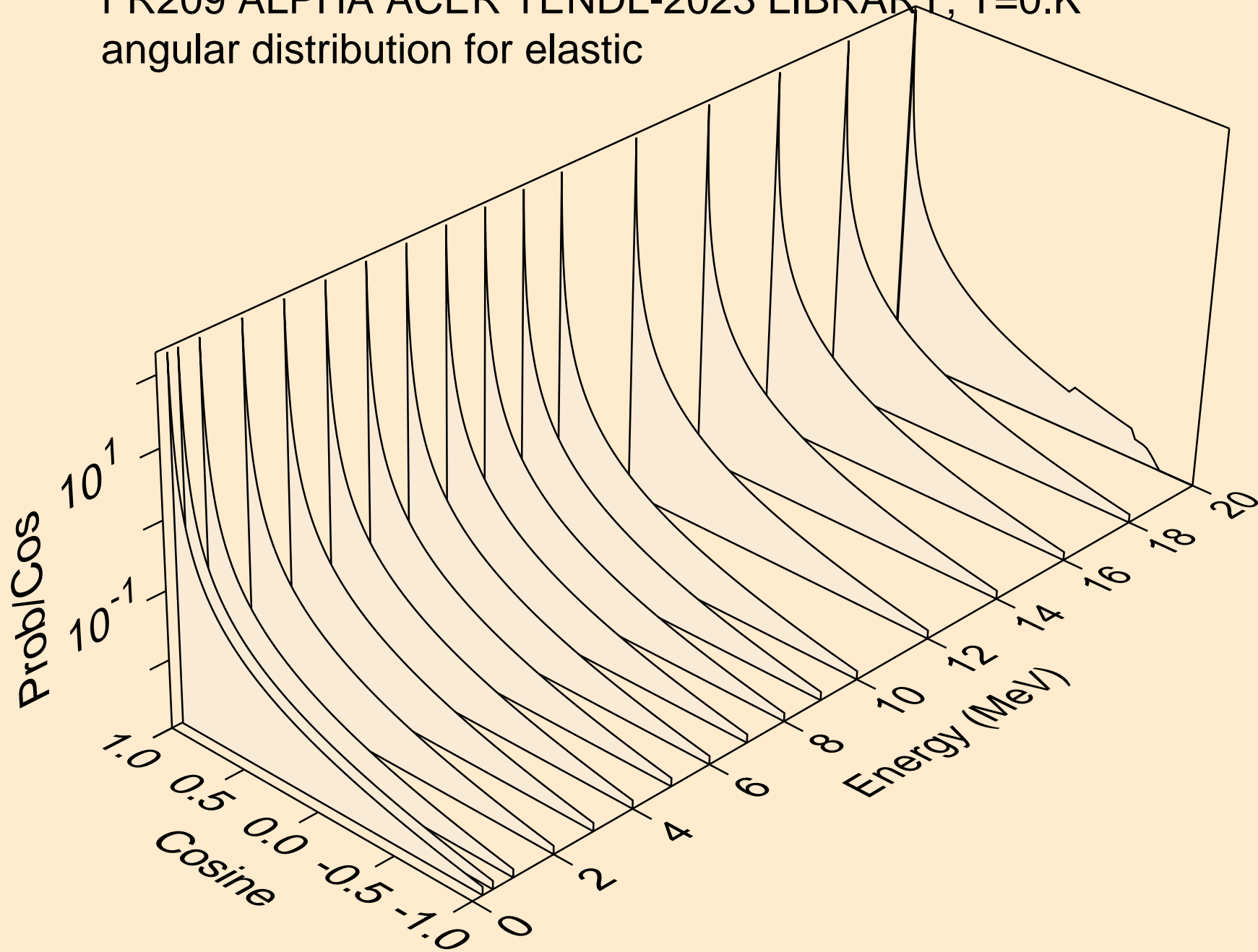



FR209 ALPHA ACER TENDL-2023 LIBRARY; T=0.K  
angular distribution for elastic

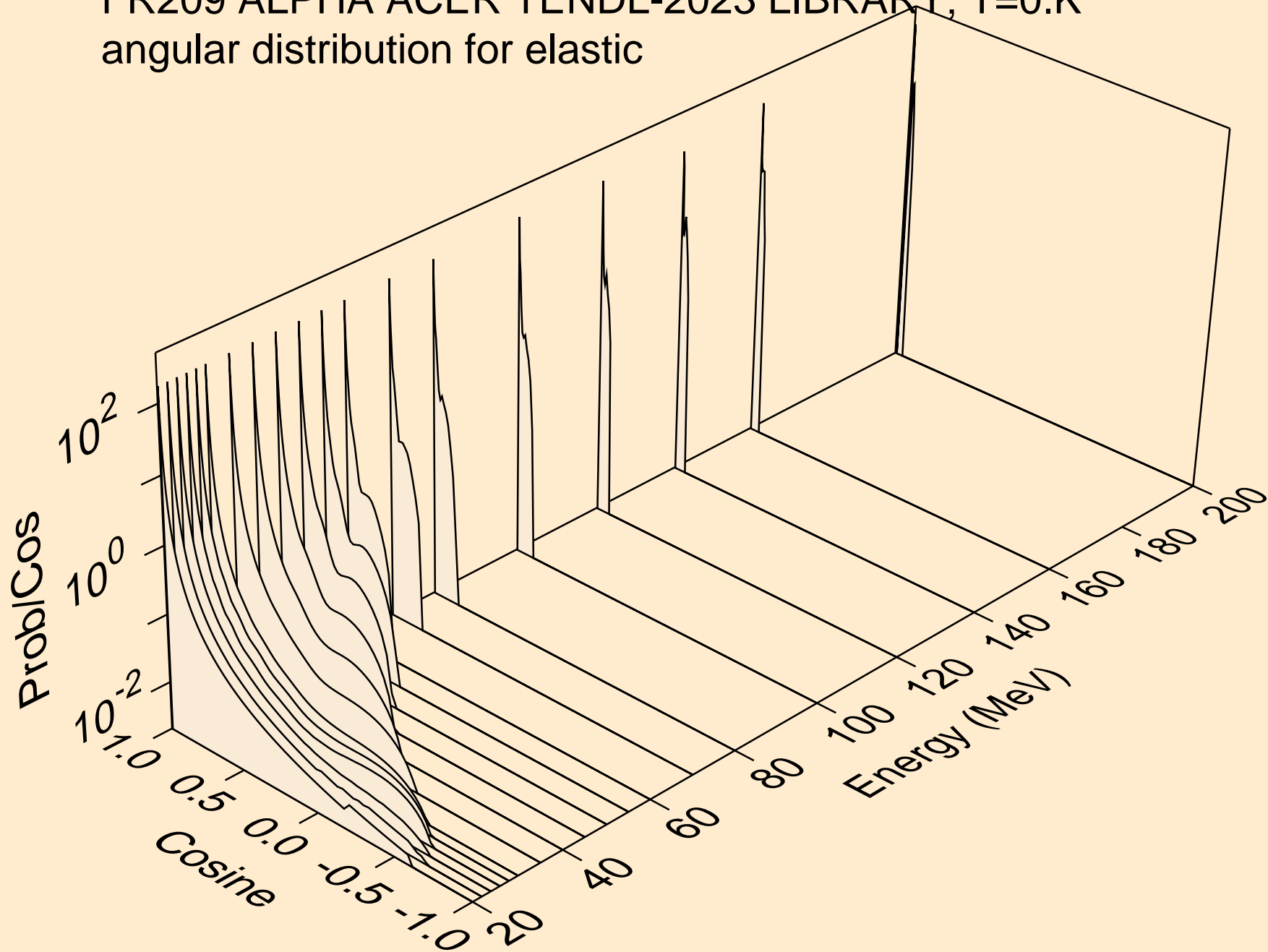

FR209 ALPHA ACER TENDL-2023 LIBRARY; T=0.K

Alpha emission for (a,x)

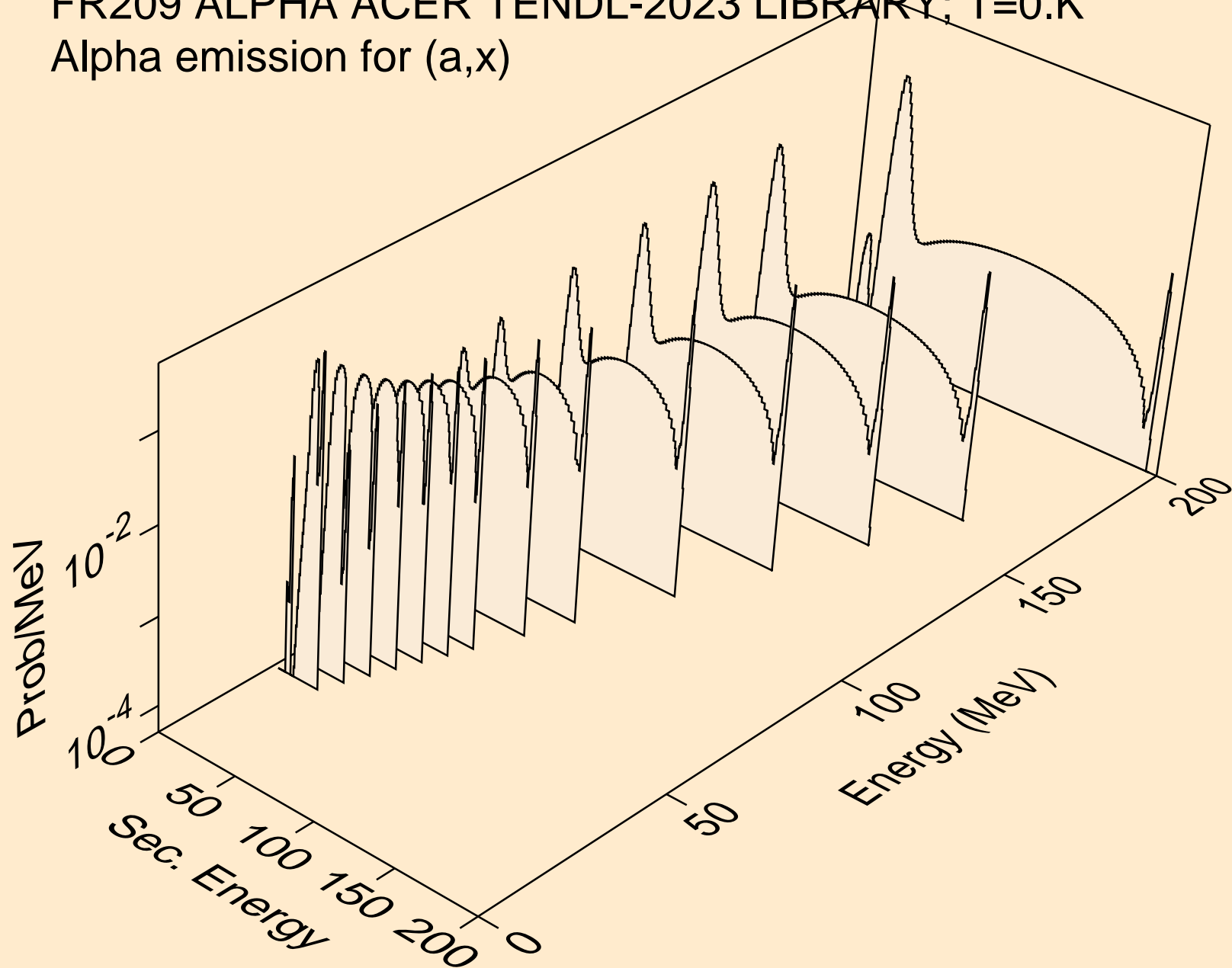

FR209 ALPHA ACER TENDL-2023 LIBRARY; T=0.K  
Alpha emission for (a,n\*)a

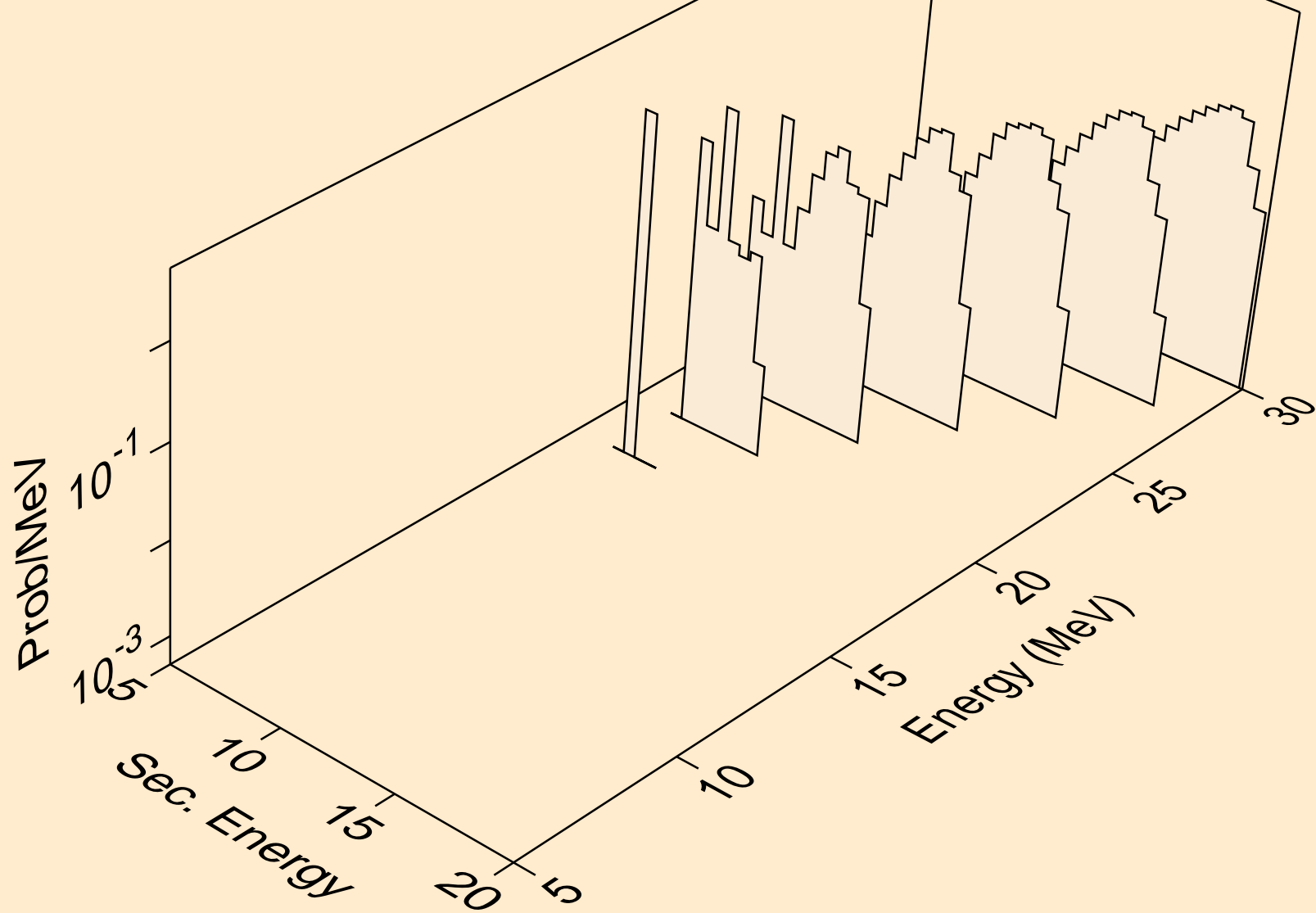

FR209 ALPHA ACER TENDL-2023 LIBRARY; T=0.K  
Alpha emission for (a,2n)a

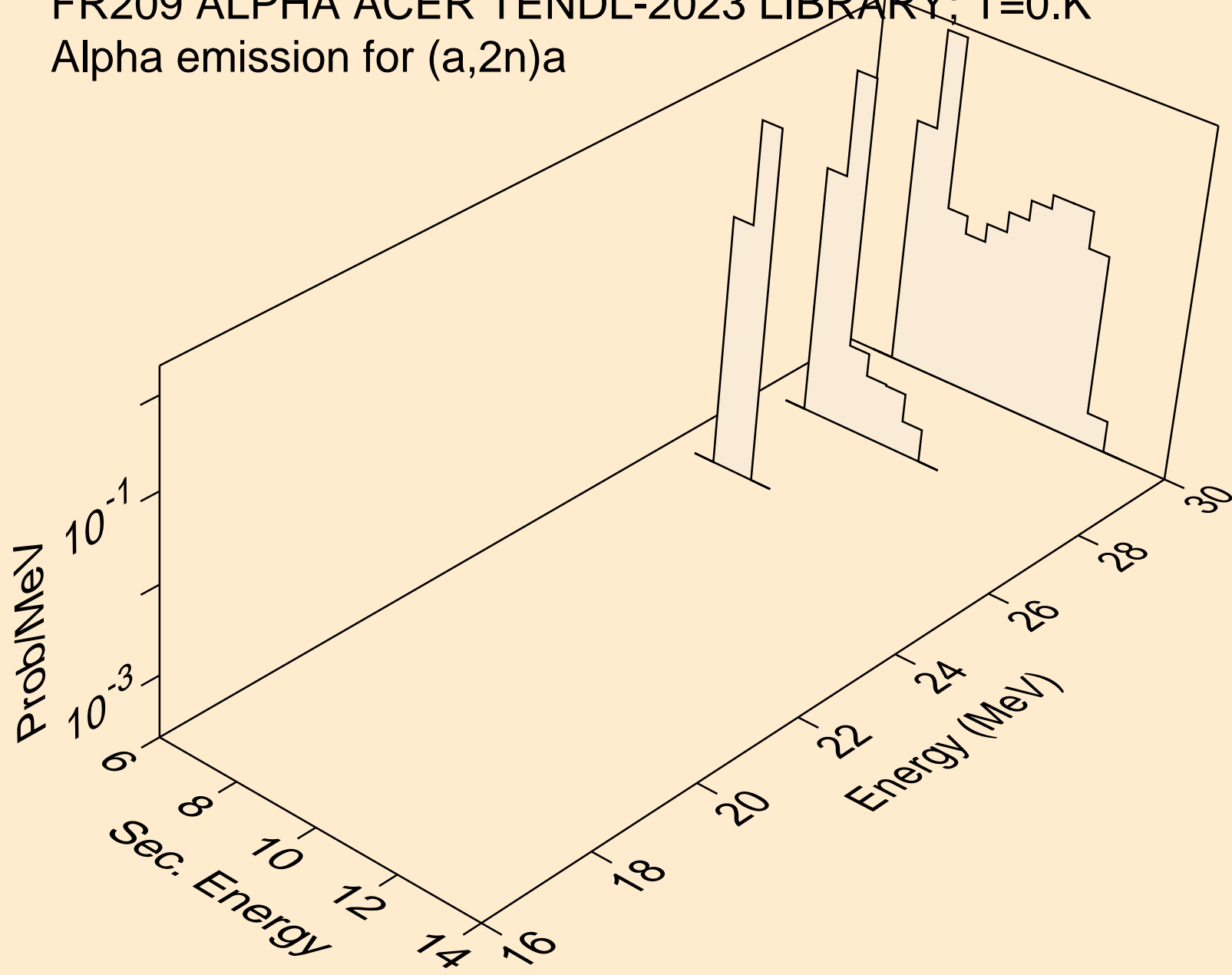

FR209 ALPHA ACER TENDL-2023 LIBRARY; T=0.K  
Alpha emission for (a,n\*)2a

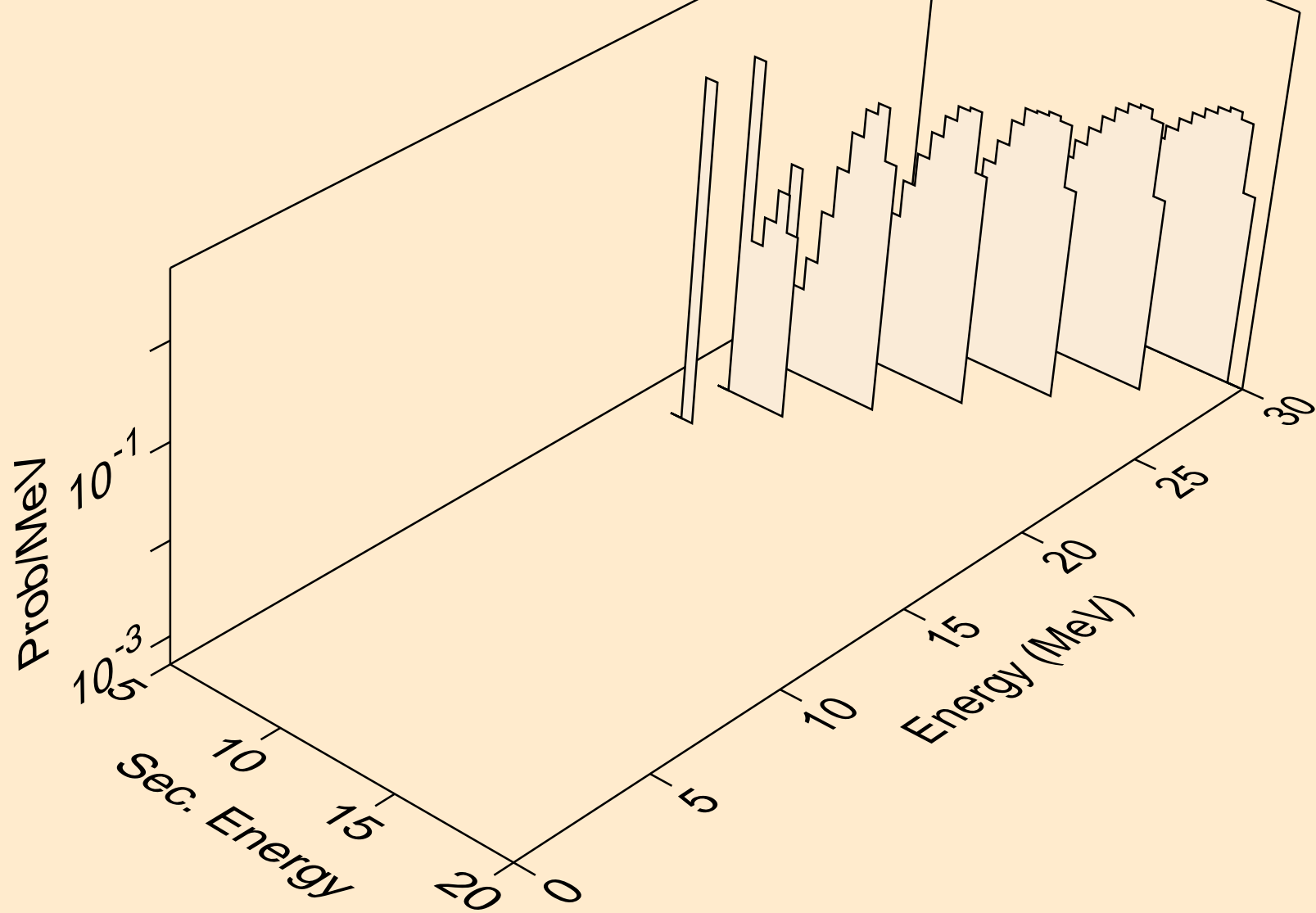

FR209 ALPHA ACER TENDL-2023 LIBRARY; T=0.K  
Alpha emission for inelastic

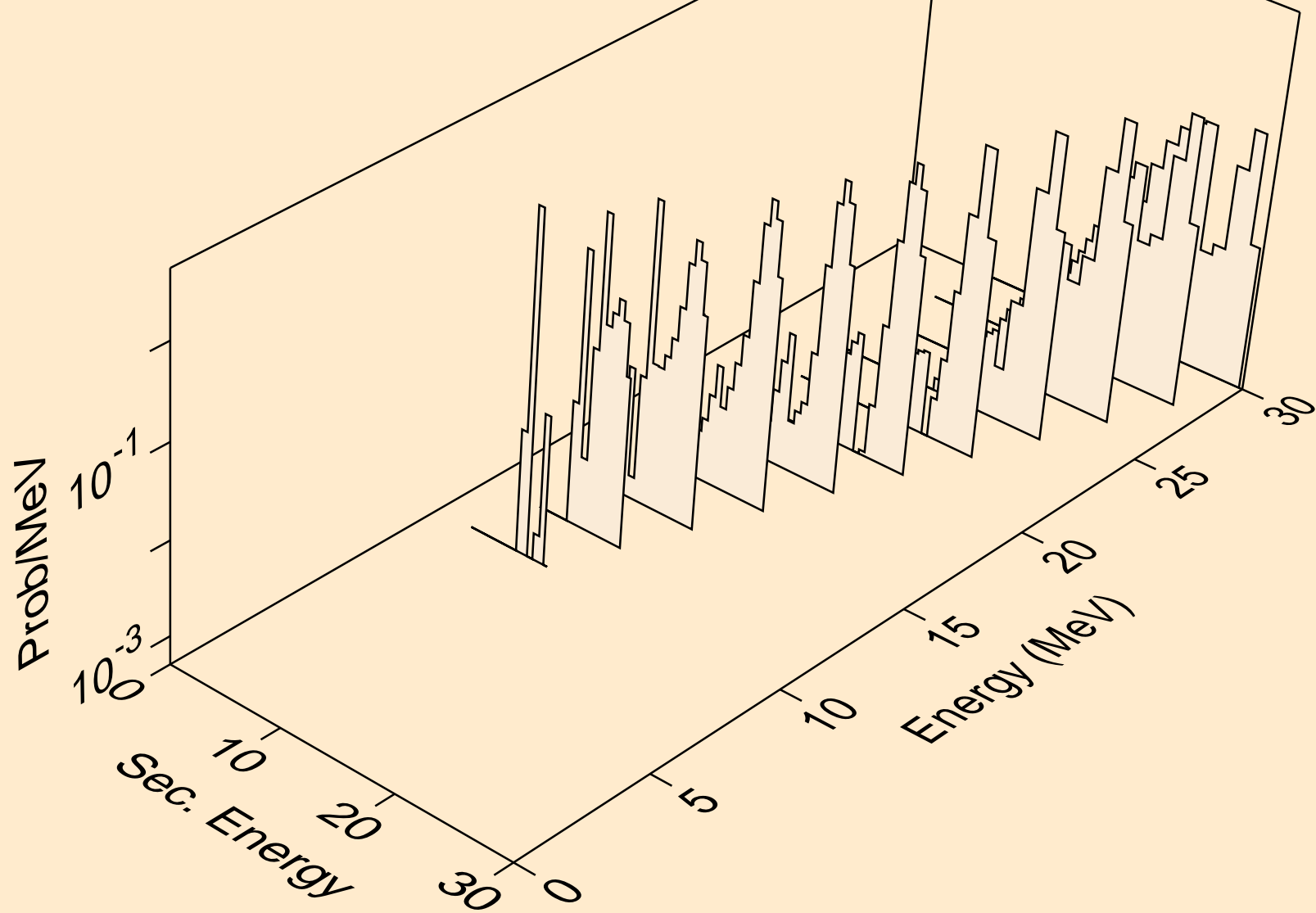

# FR209 ALPHA ACER TENDL-2023 LIBRARY; T=0.K

Alpha emission for (a,2a)

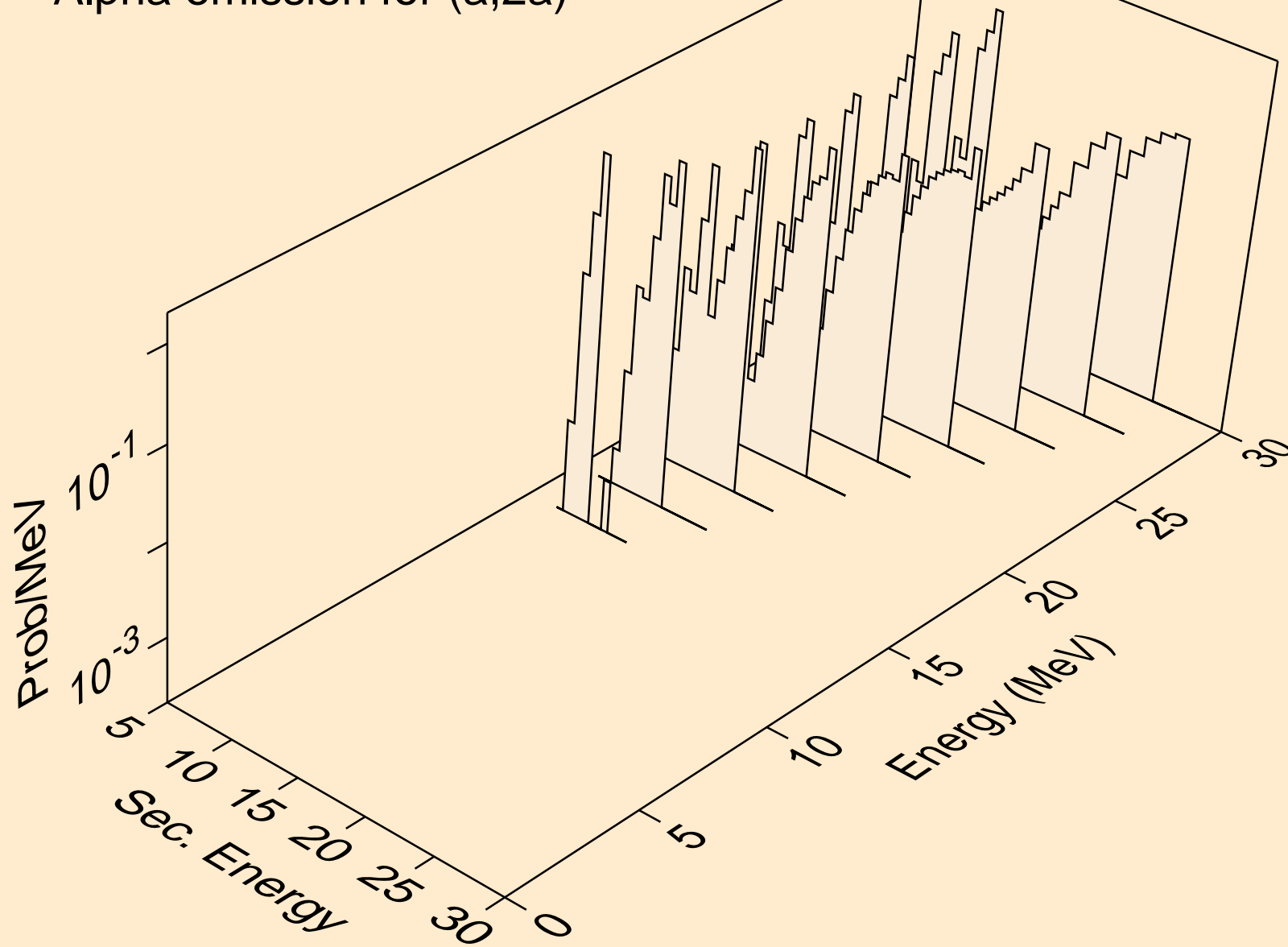

FR209 ALPHA ACER TENDL-2023 LIBRARY; T=0.K  
Alpha emission for (a,pa)

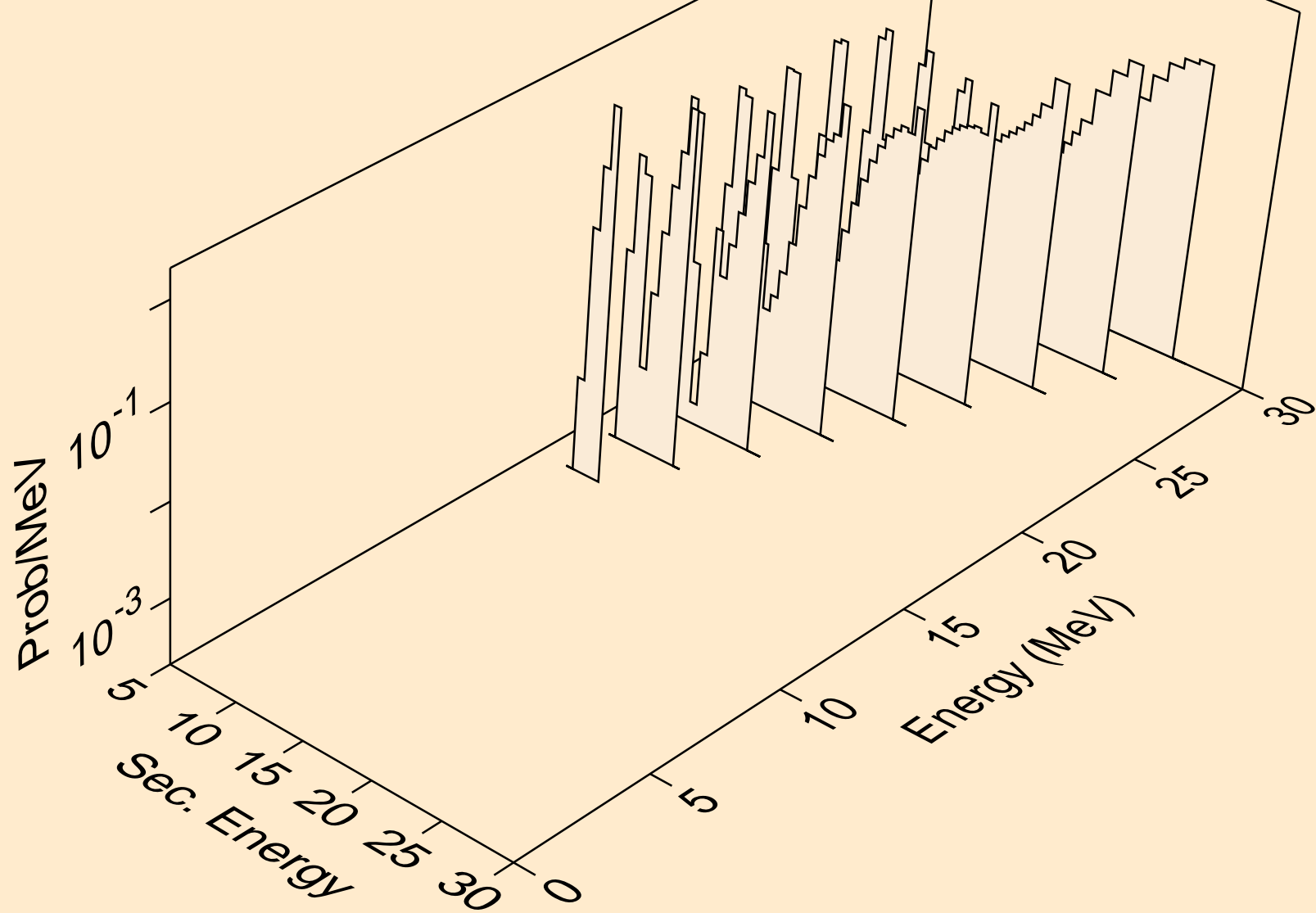



FR209 ALPHA ACER TENDL-2023 LIBRARY; T=0.K  
Alpha emission for (a,da)

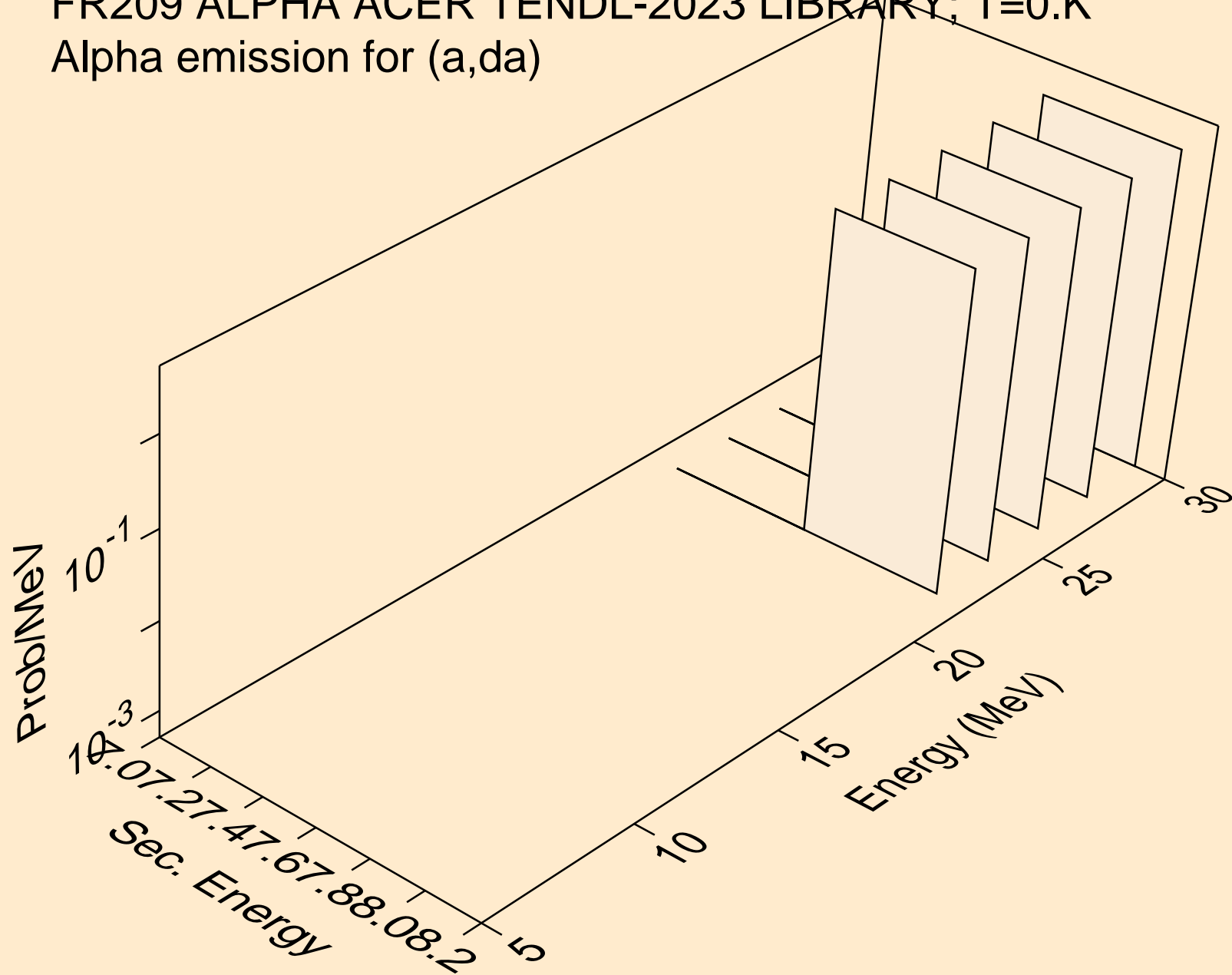

FR209 ALPHA ACER TENDL-2023 LIBRARY; T=0.K  
Photon emission for (z,n)

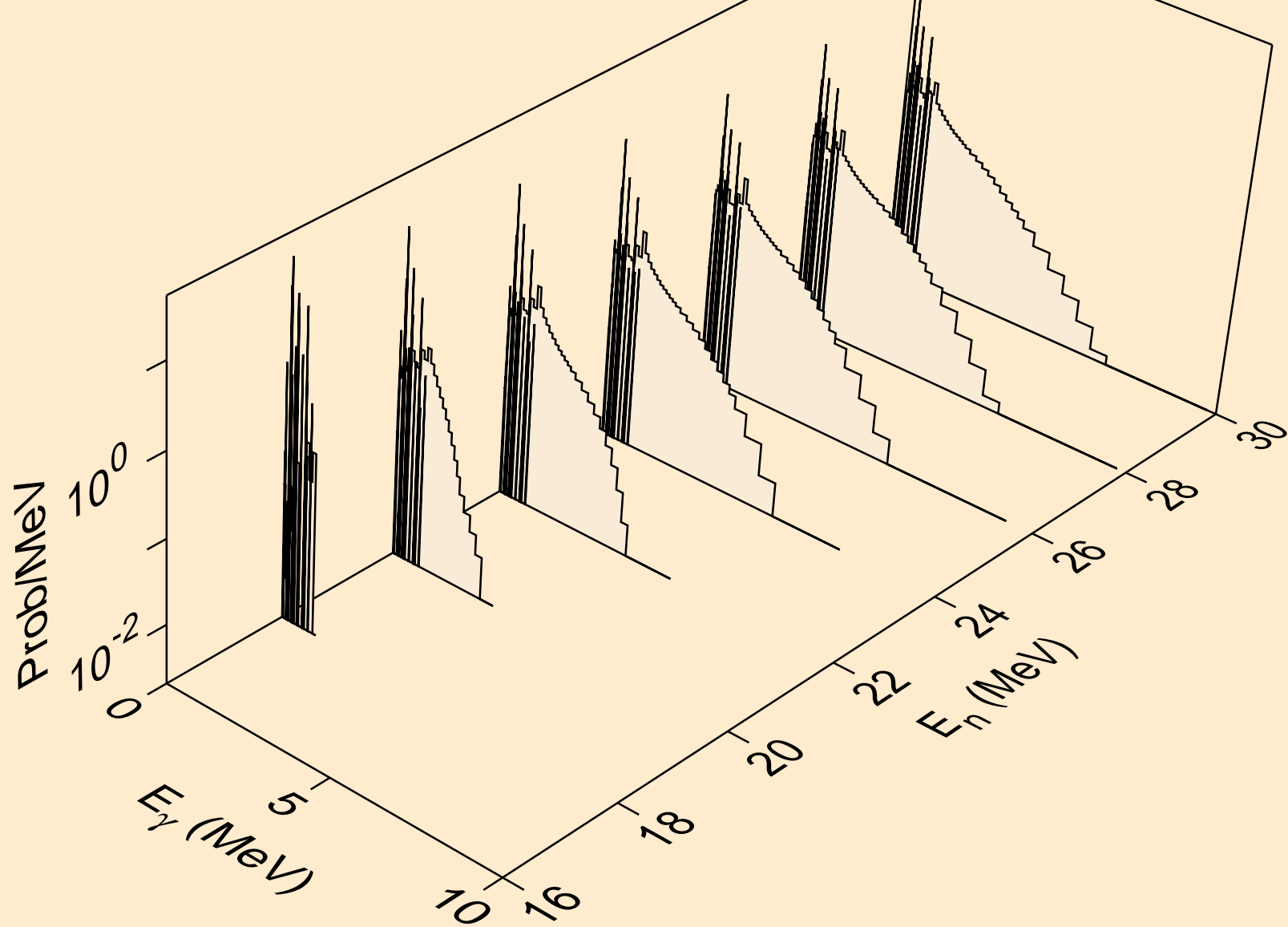

FR209 ALPHA ACER TENDL-2023 LIBRARY; T=0.K  
Photon emission for (z,x)

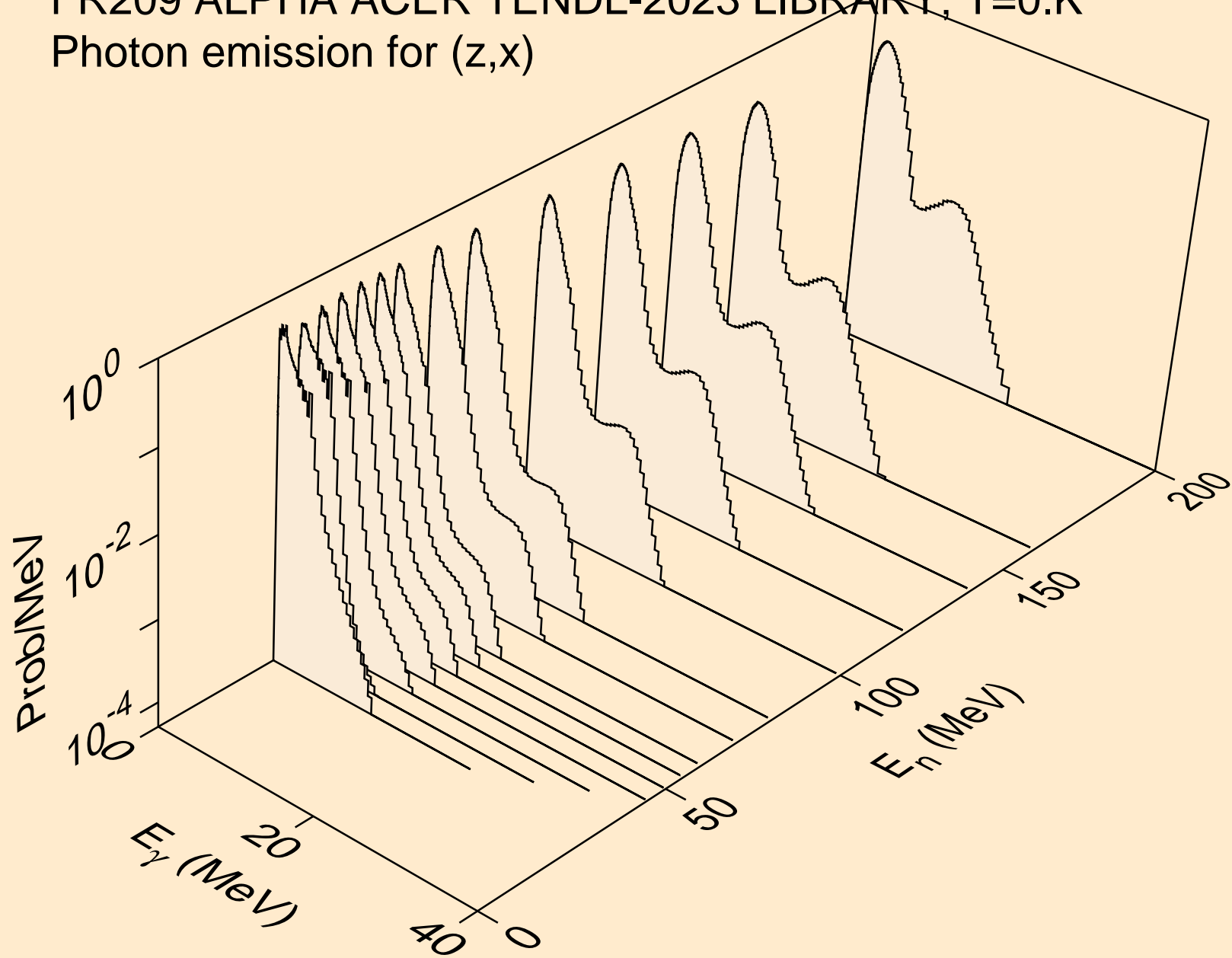

FR209 ALPHA ACER TENDL-2023 LIBRARY; T=0.K  
Photon emission for (n,2n)

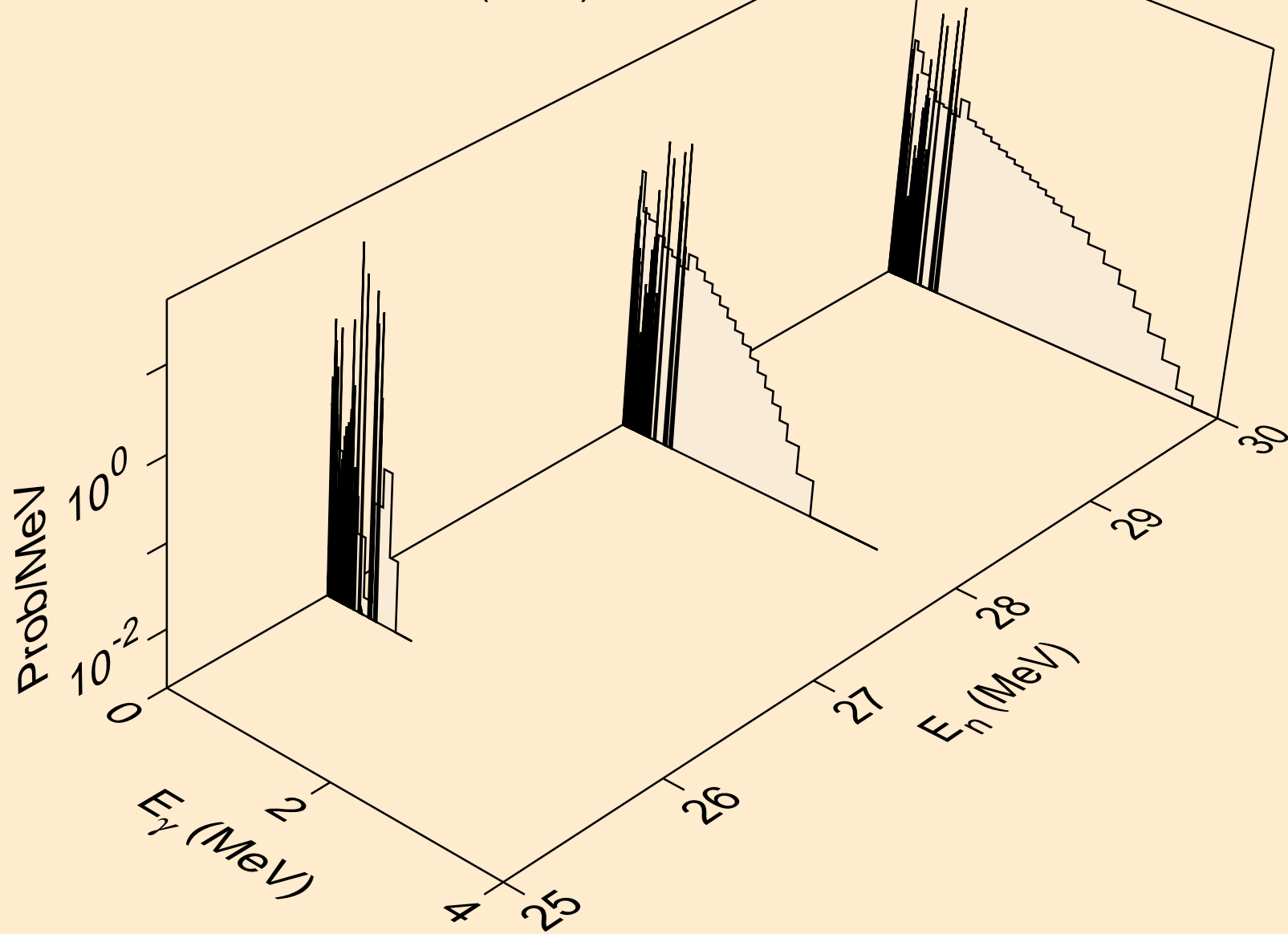

FR209 ALPHA ACER TENDL-2023 LIBRARY; T=0.K  
Photon emission for (n,n\*)a

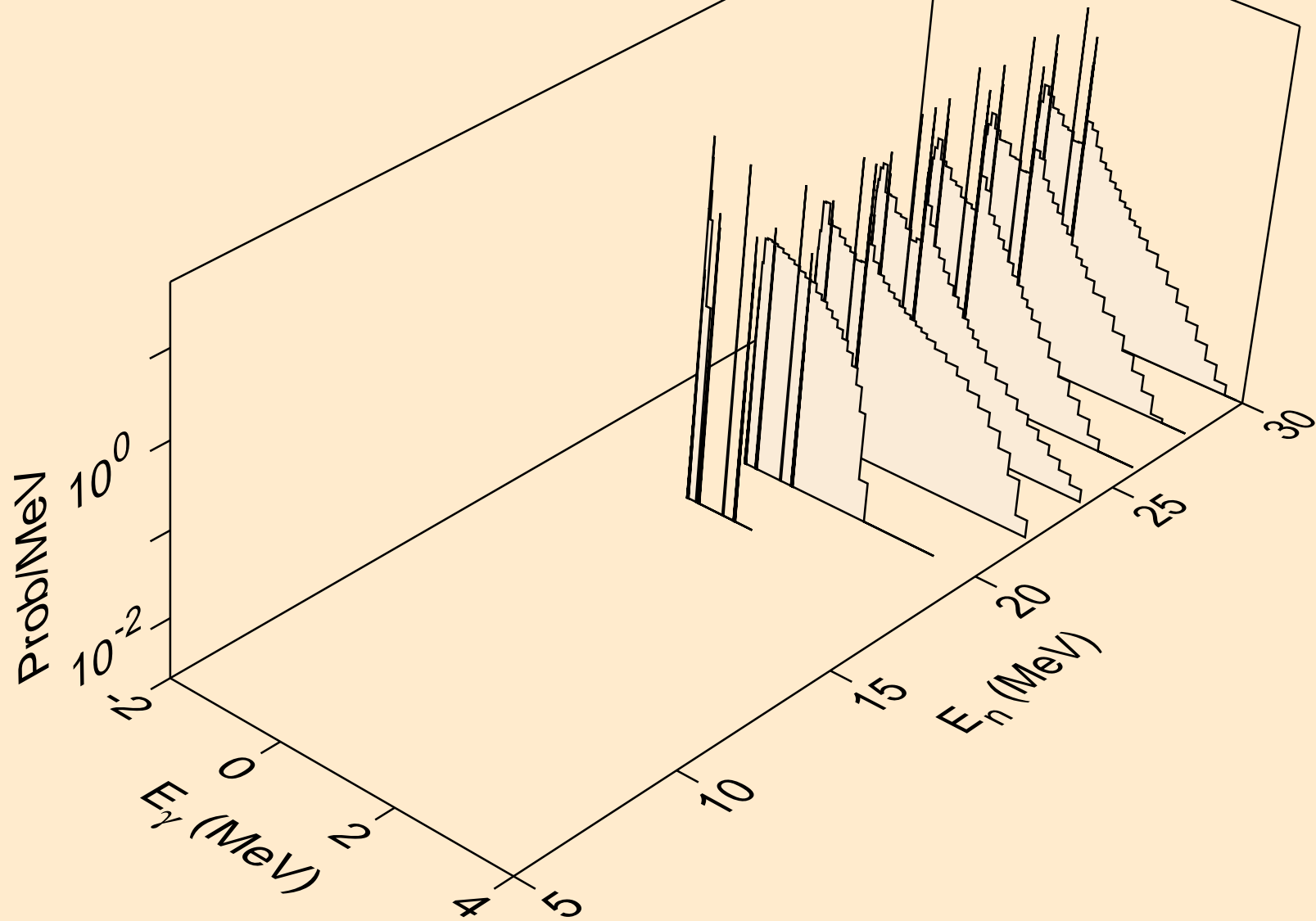

FR209 ALPHA ACER TENDL-2023 LIBRARY; T=0.K  
Photon emission for (n,2n)a

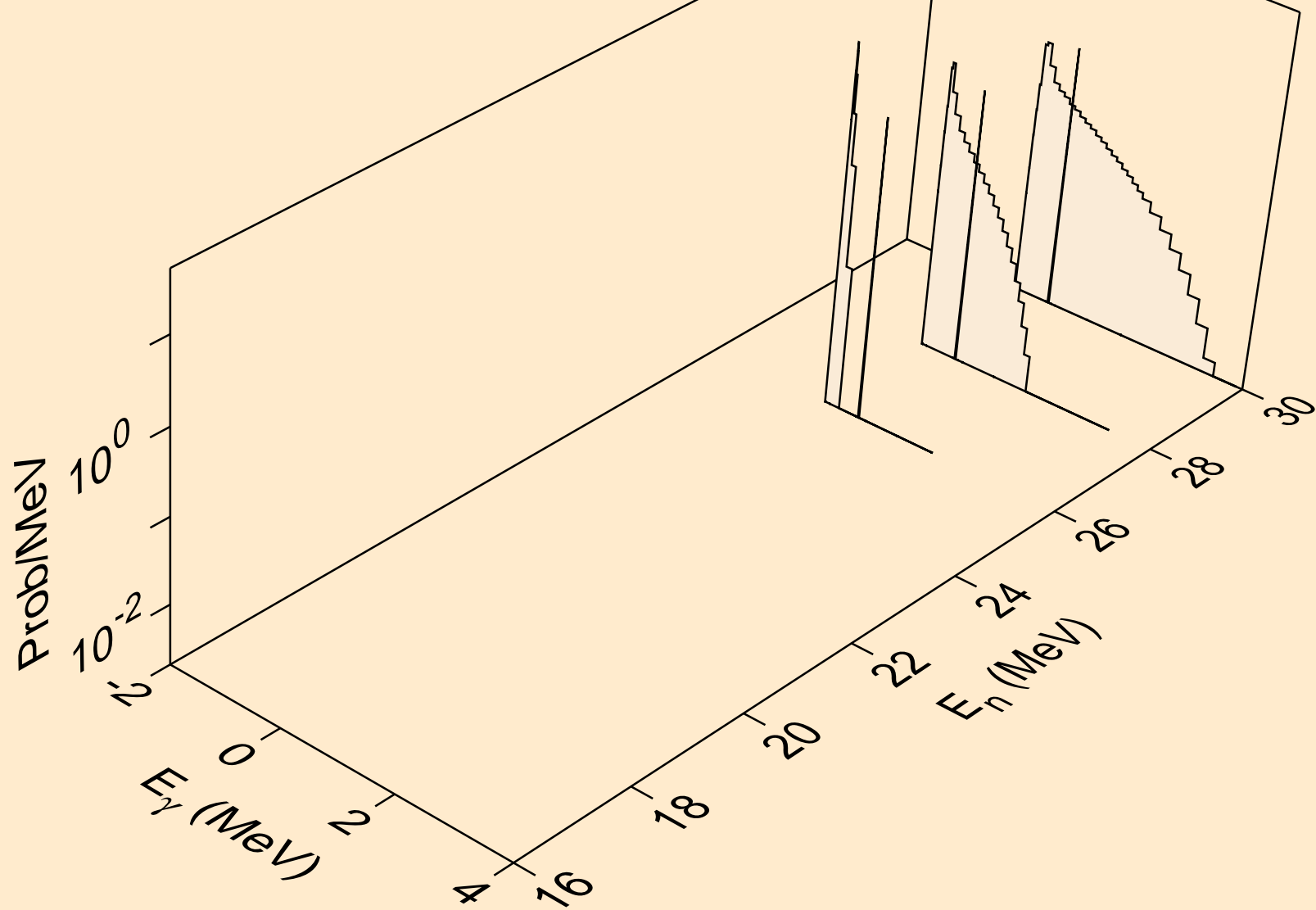

FR209 ALPHA ACER TENDL-2023 LIBRARY; T=0.K  
Photon emission for (n,n\*)p

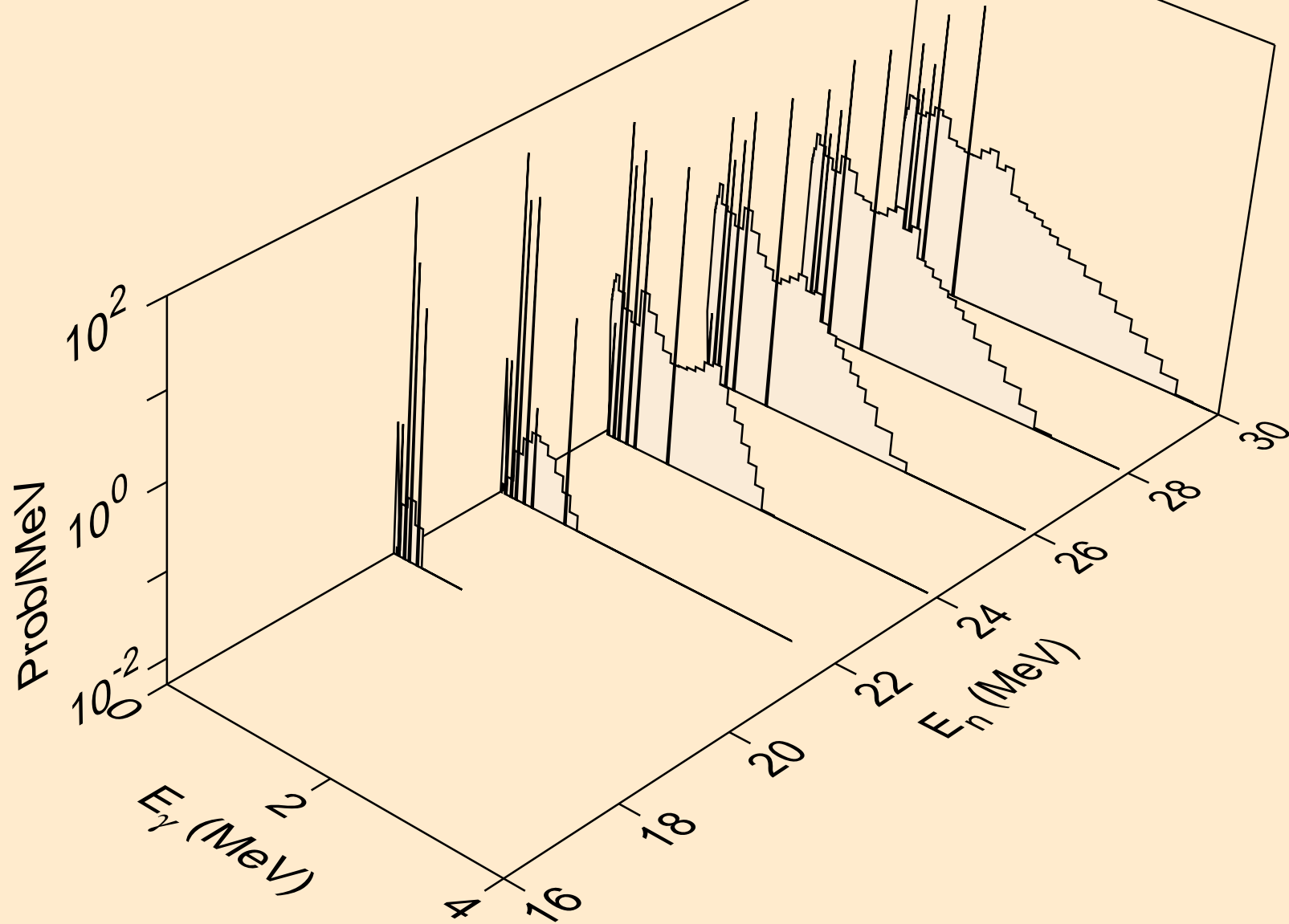

FR209 ALPHA ACER TENDL-2023 LIBRARY; T=0.K  
Photon emission for (n,n\*)2a

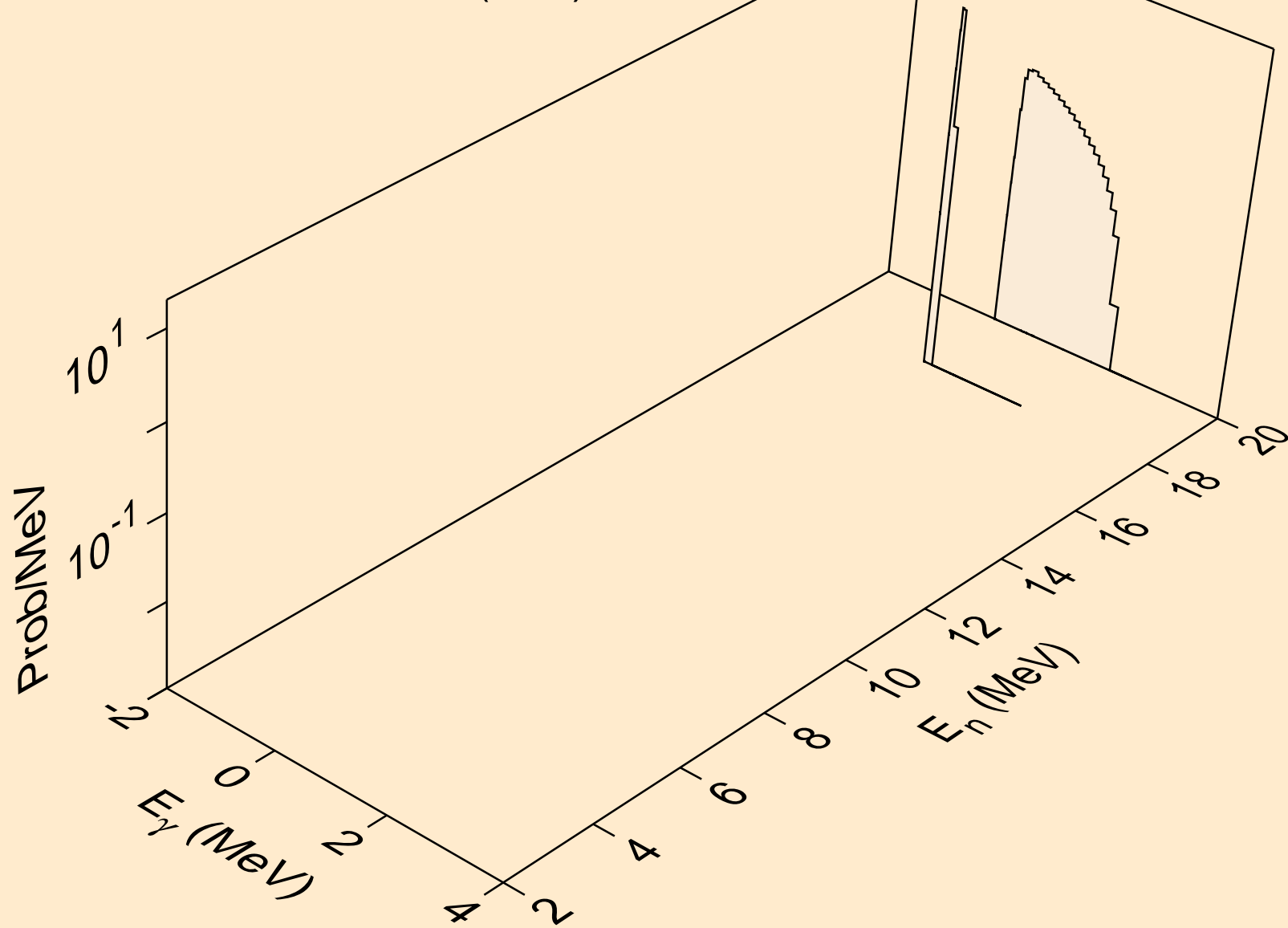



FR209 ALPHA ACER TENDL-2023 LIBRARY; T=0.K  
Photon emission for (n,2np)

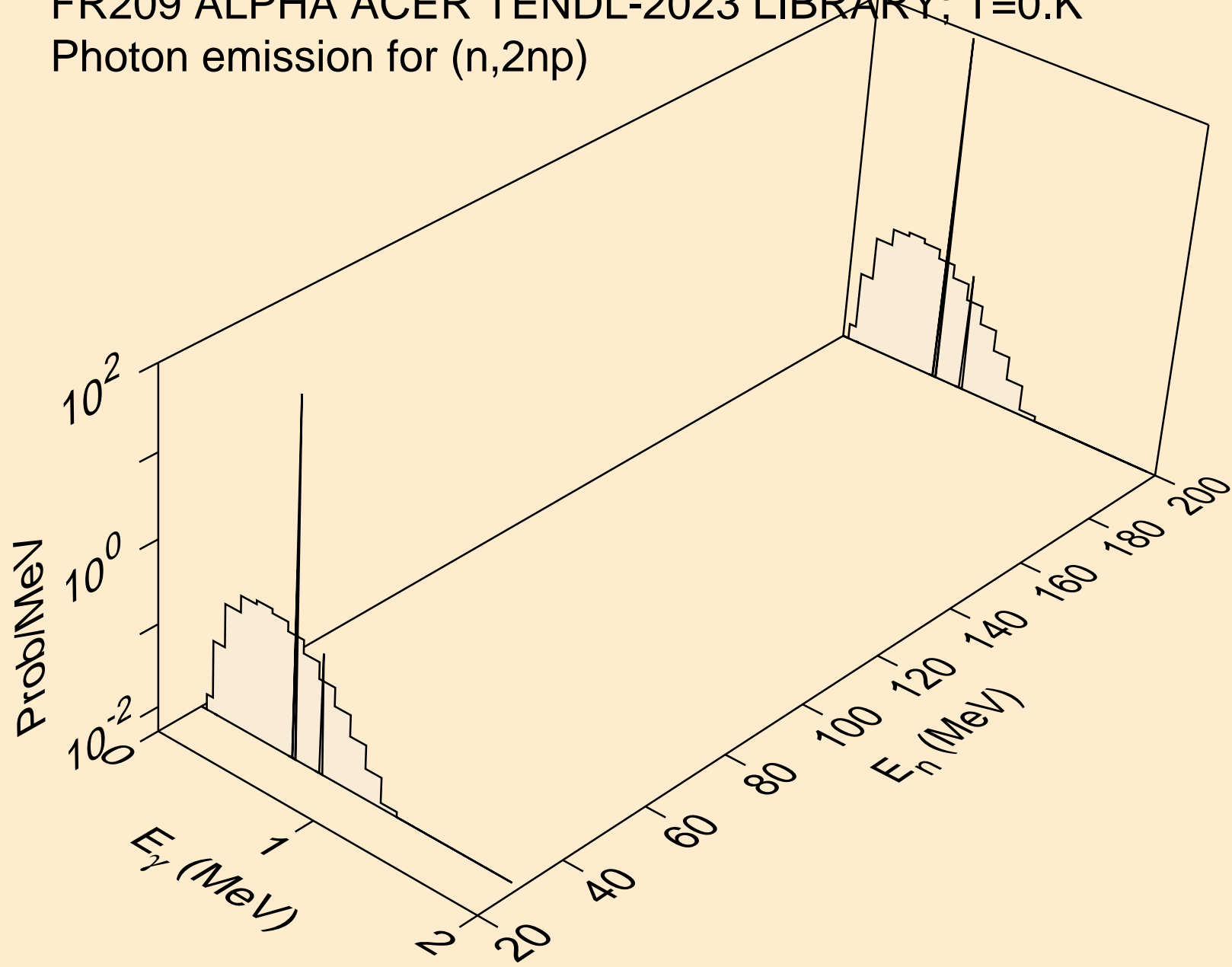

FR209 ALPHA ACER TENDL-2023 LIBRARY; T=0.K  
Photon emission for (n,npa)

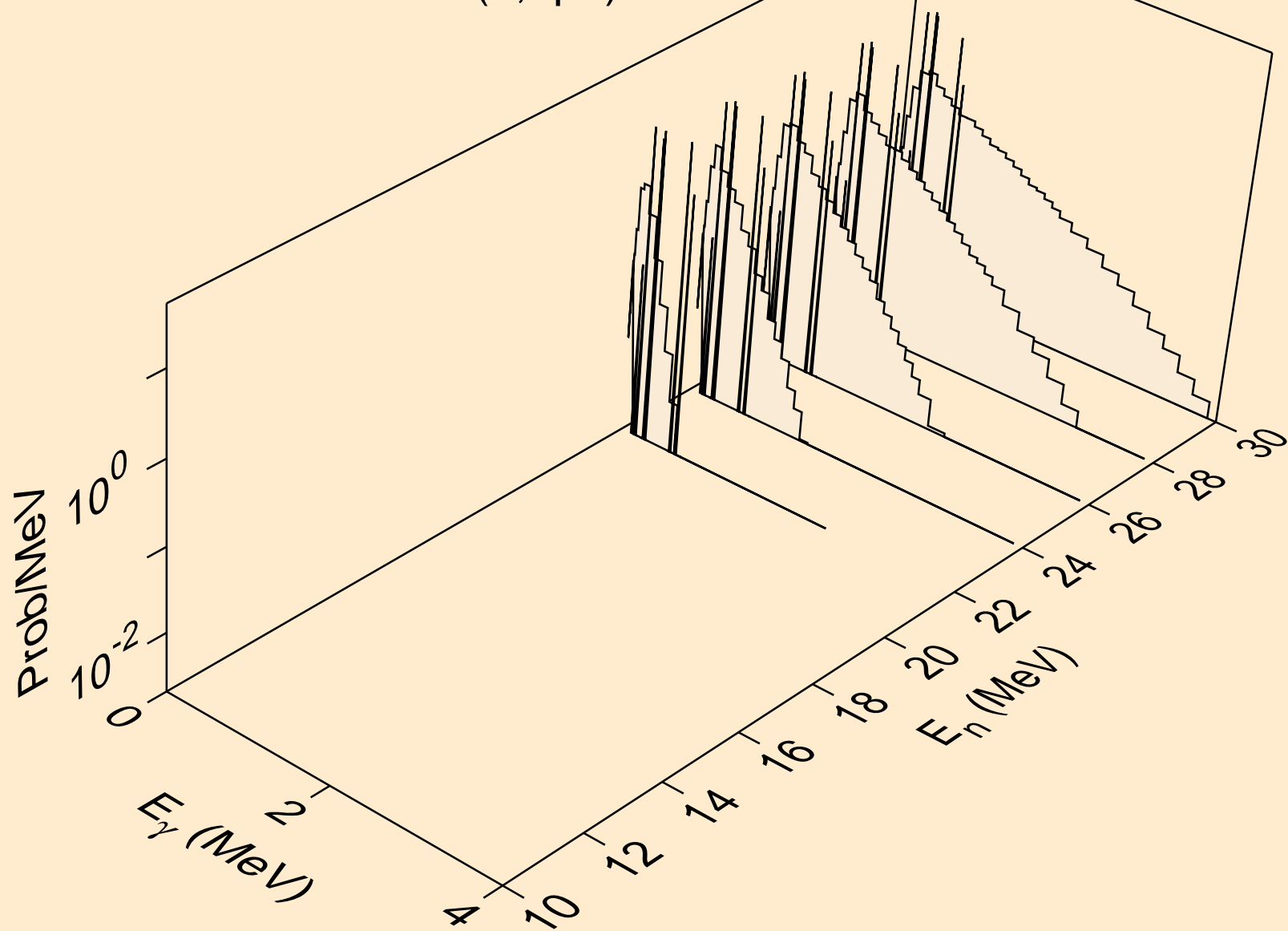

FR209 ALPHA ACER TENDL-2023 LIBRARY; T=0.K  
Photon emission for (n,gma)

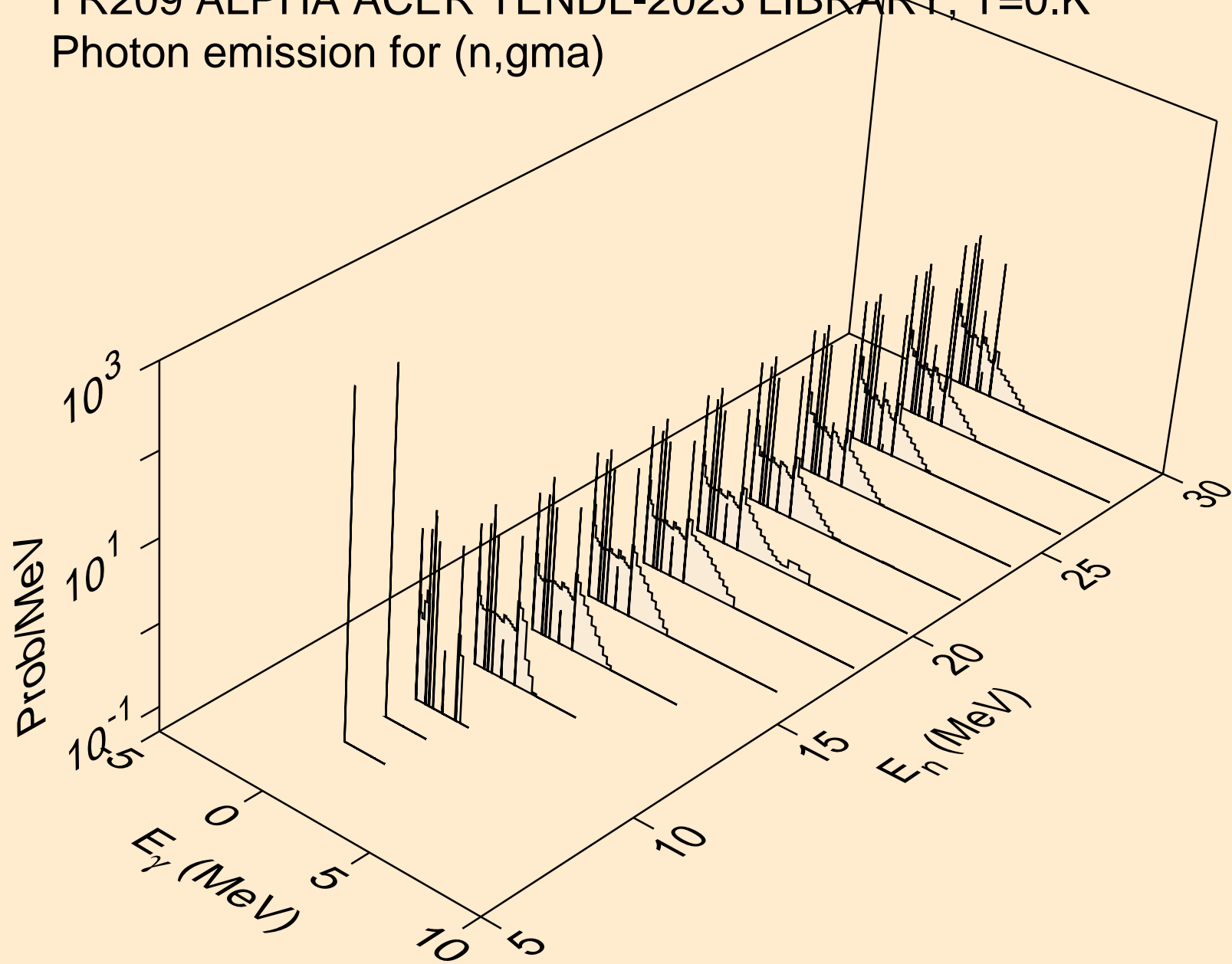

FR209 ALPHA ACER TENDL-2023 LIBRARY; T=0.K  
Photon emission for (n,p)

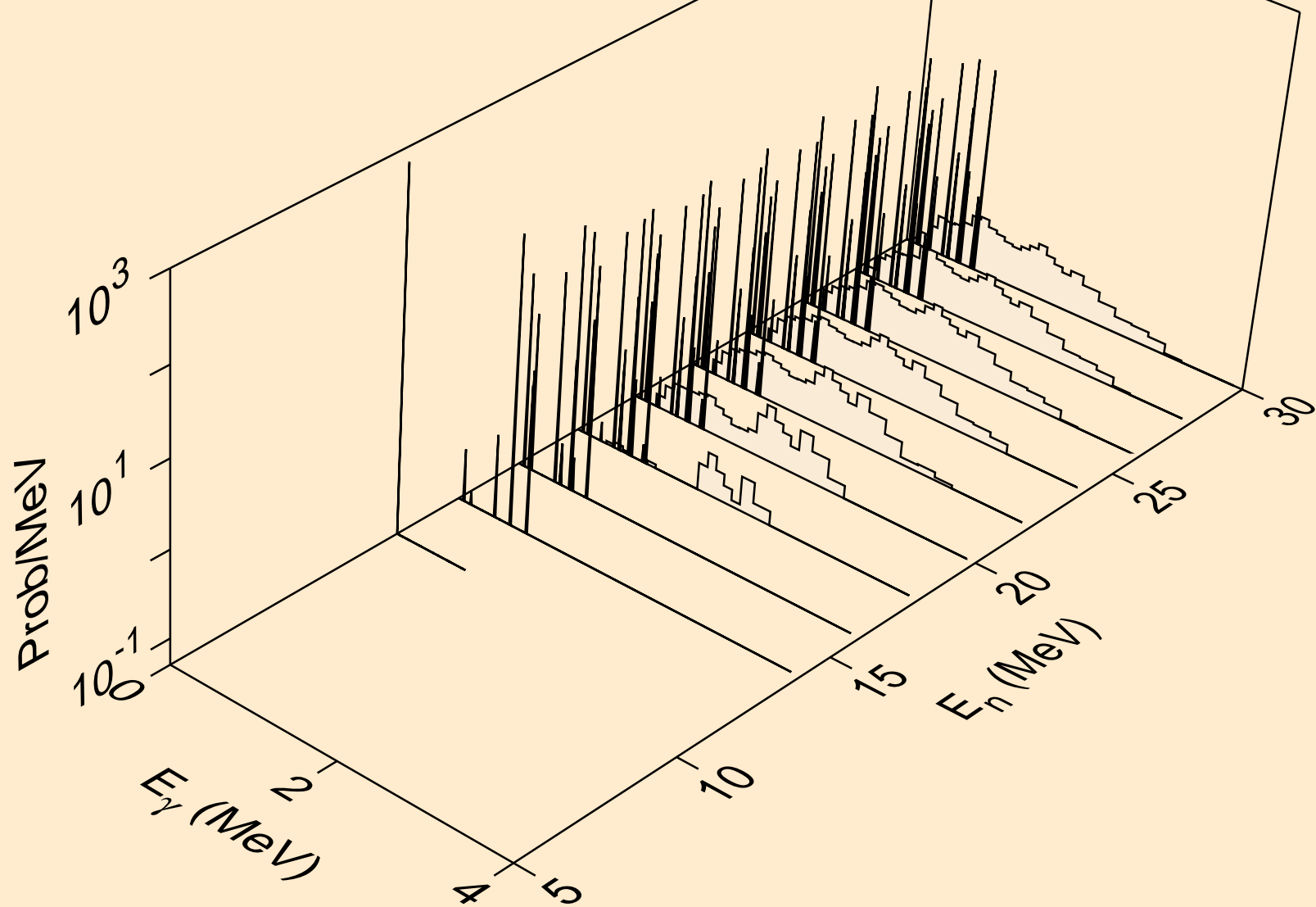

FR209 ALPHA ACER TENDL-2023 LIBRARY; T=0.K  
Photon emission for (n,d)

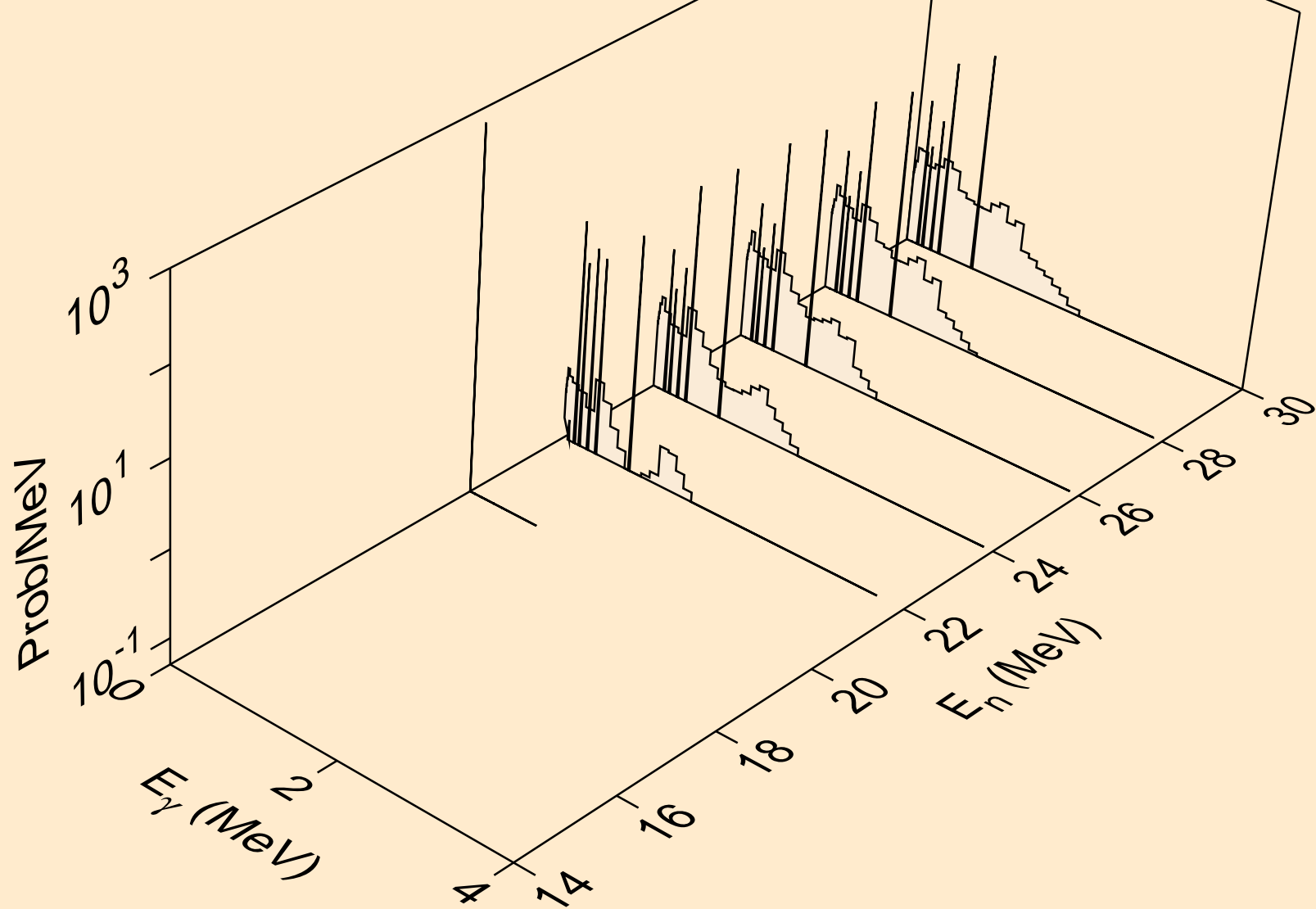

FR209 ALPHA ACER TENDL-2023 LIBRARY; T=0.K  
Photon emission for (n,t)

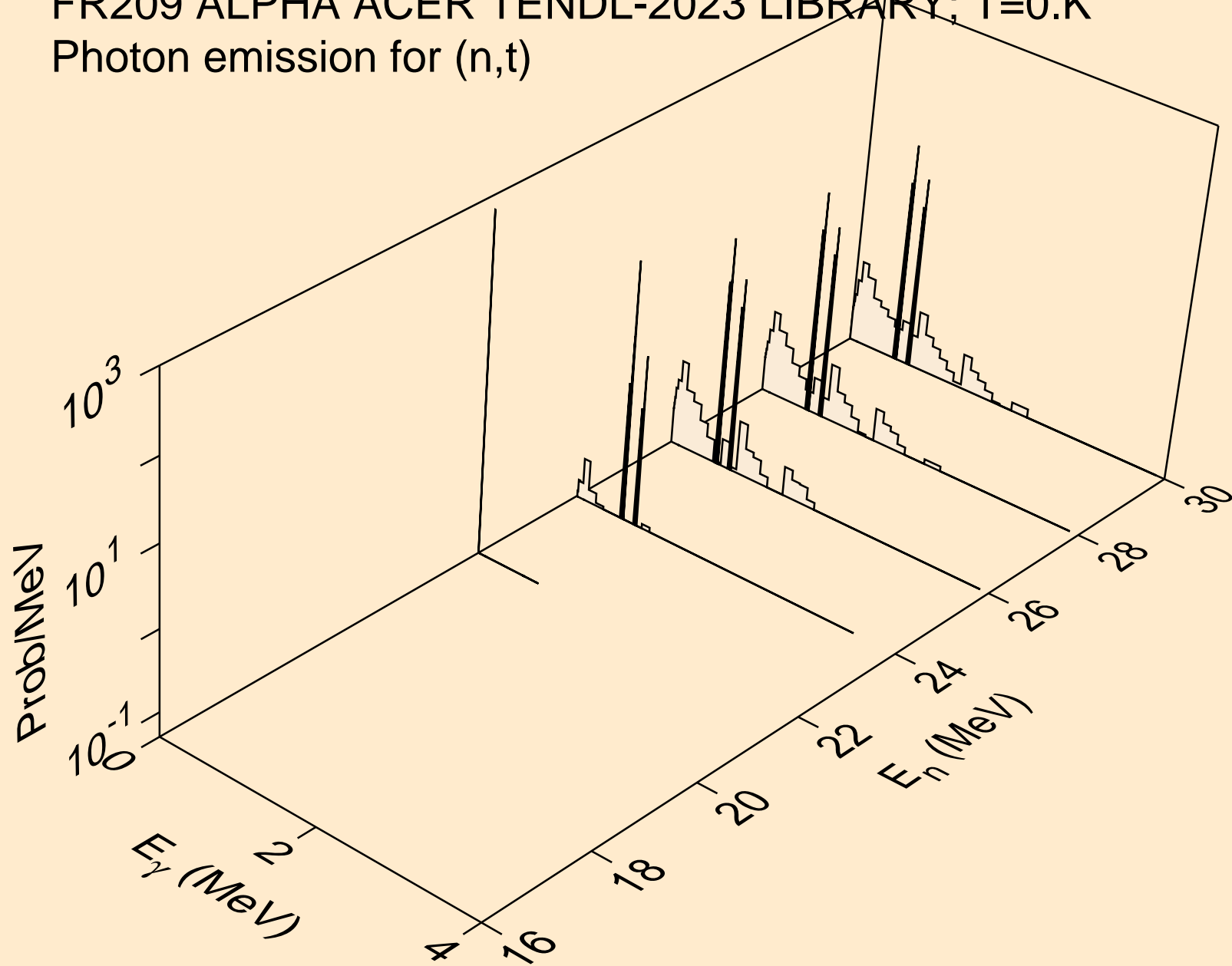

FR209 ALPHA ACER TENDL-2023 LIBRARY; T=0.K  
Photon emission for (n,he3)

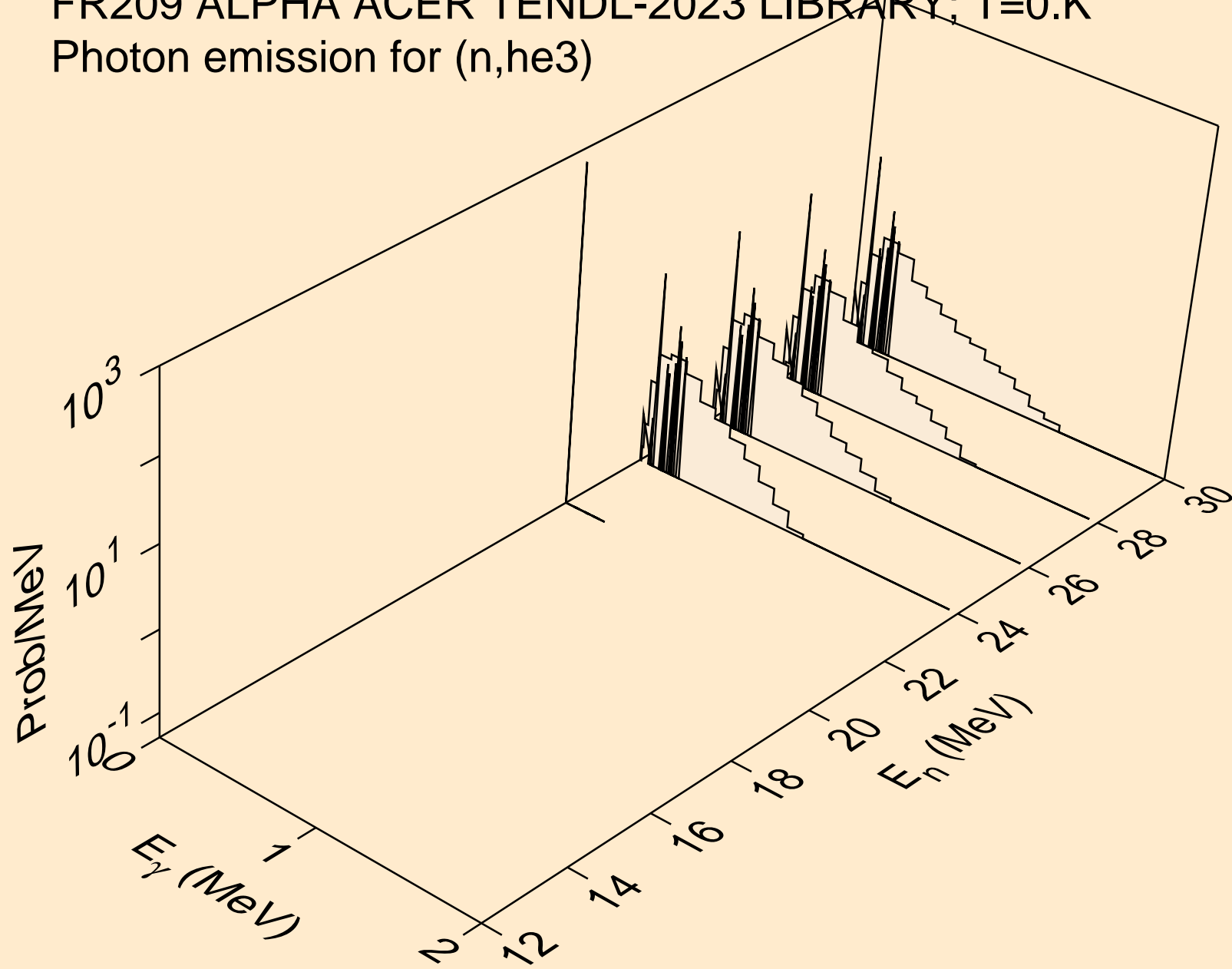

FR209 ALPHA ACER TENDL-2023 LIBRARY; T=0.K  
Photon emission for inelastic

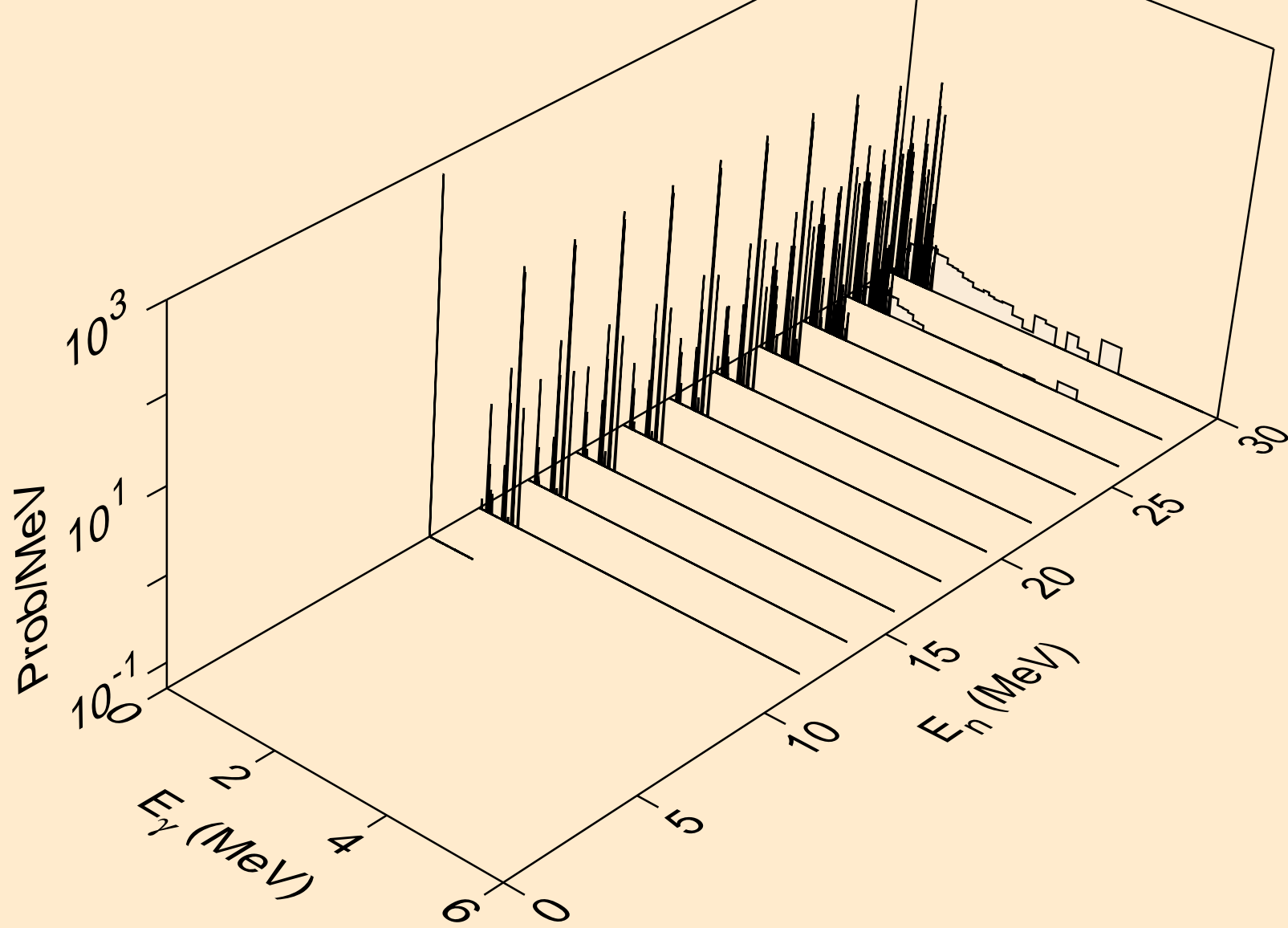



FR209 ALPHA ACER TENDL-2023 LIBRARY; T=0.K  
Photon emission for (n,2a)

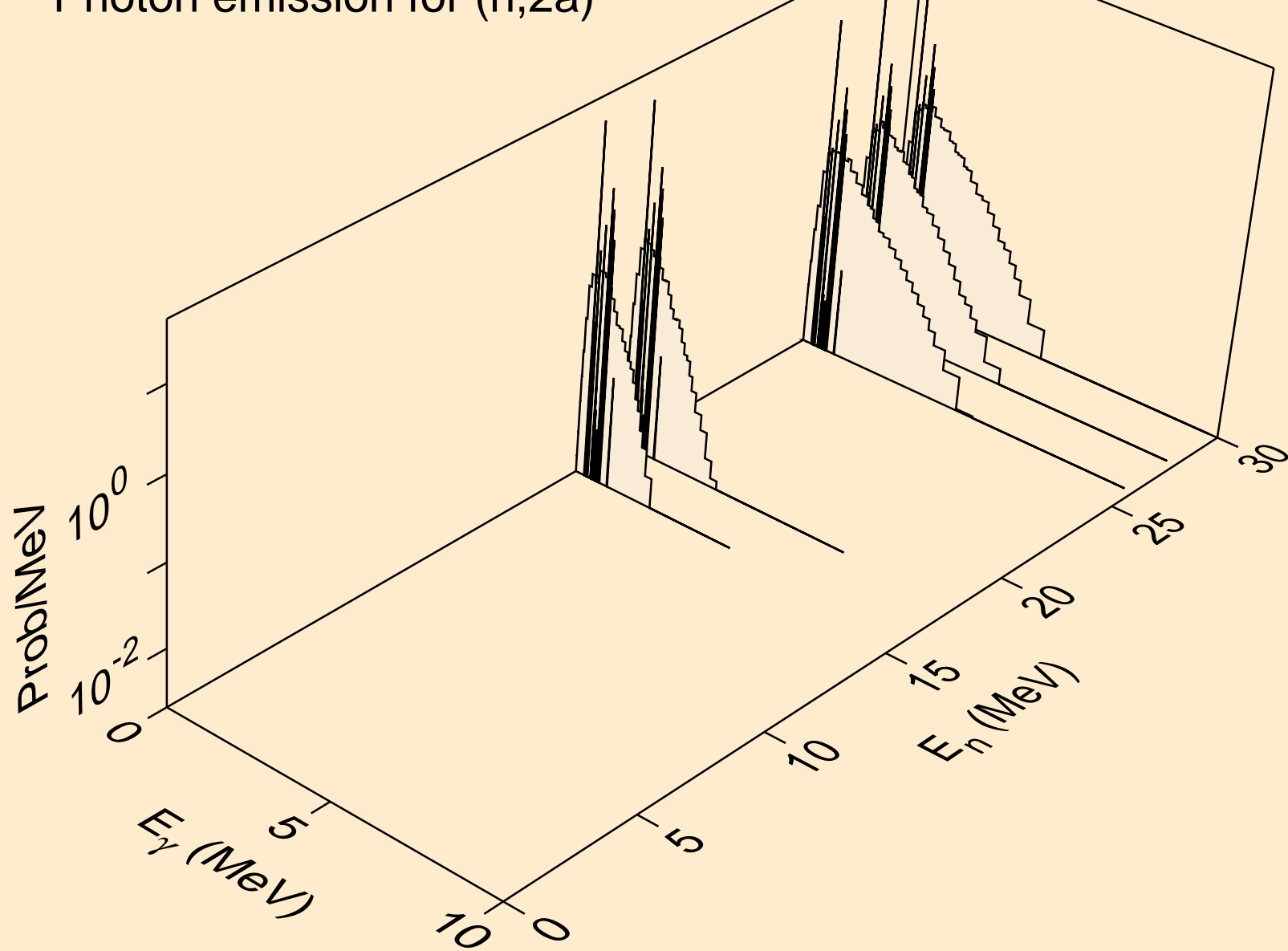

FR209 ALPHA ACER TENDL-2023 LIBRARY; T=0.K  
Photon emission for (n,2p)

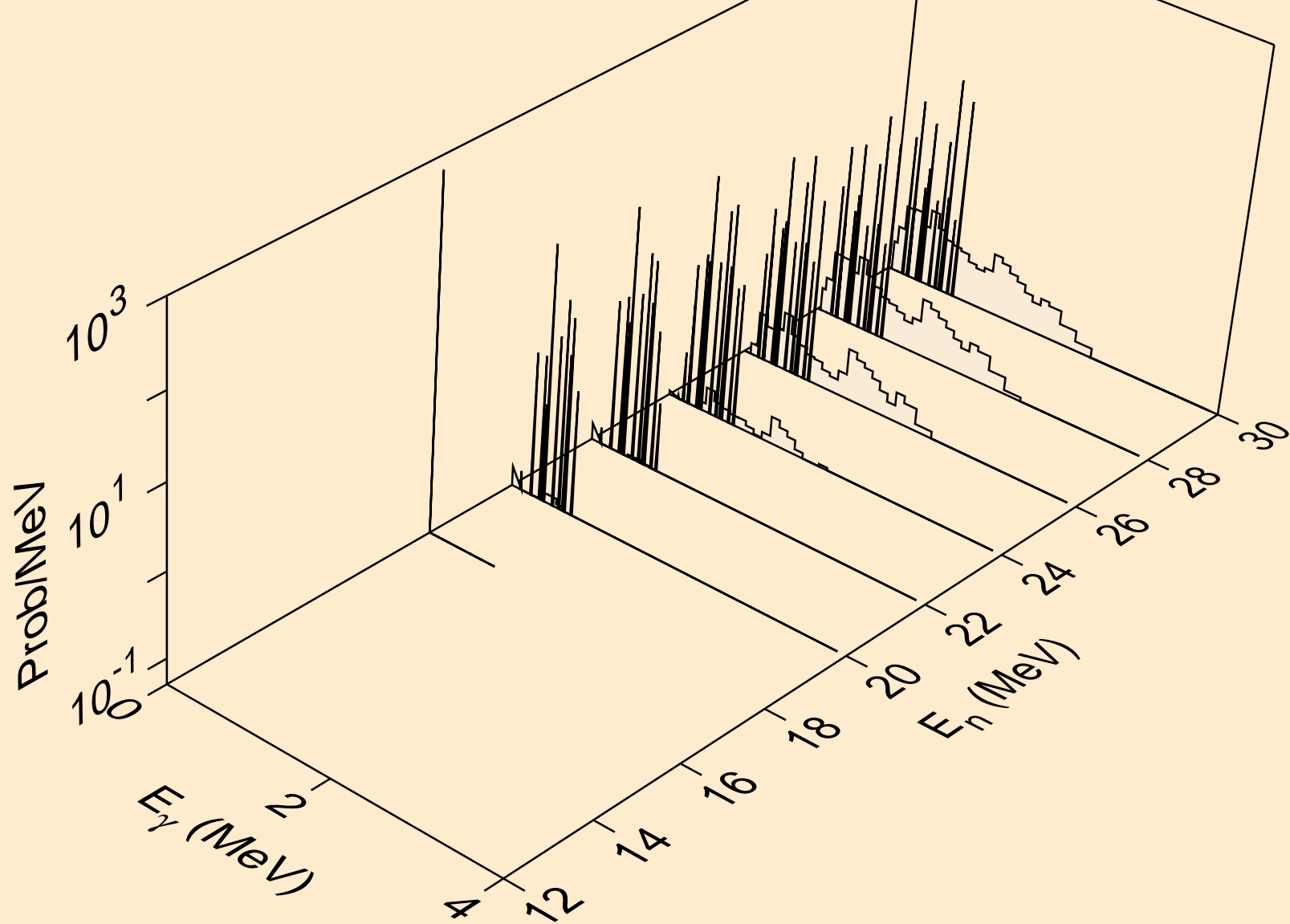

FR209 ALPHA ACER TENDL-2023 LIBRARY; T=0.K  
Photon emission for (n,pa)

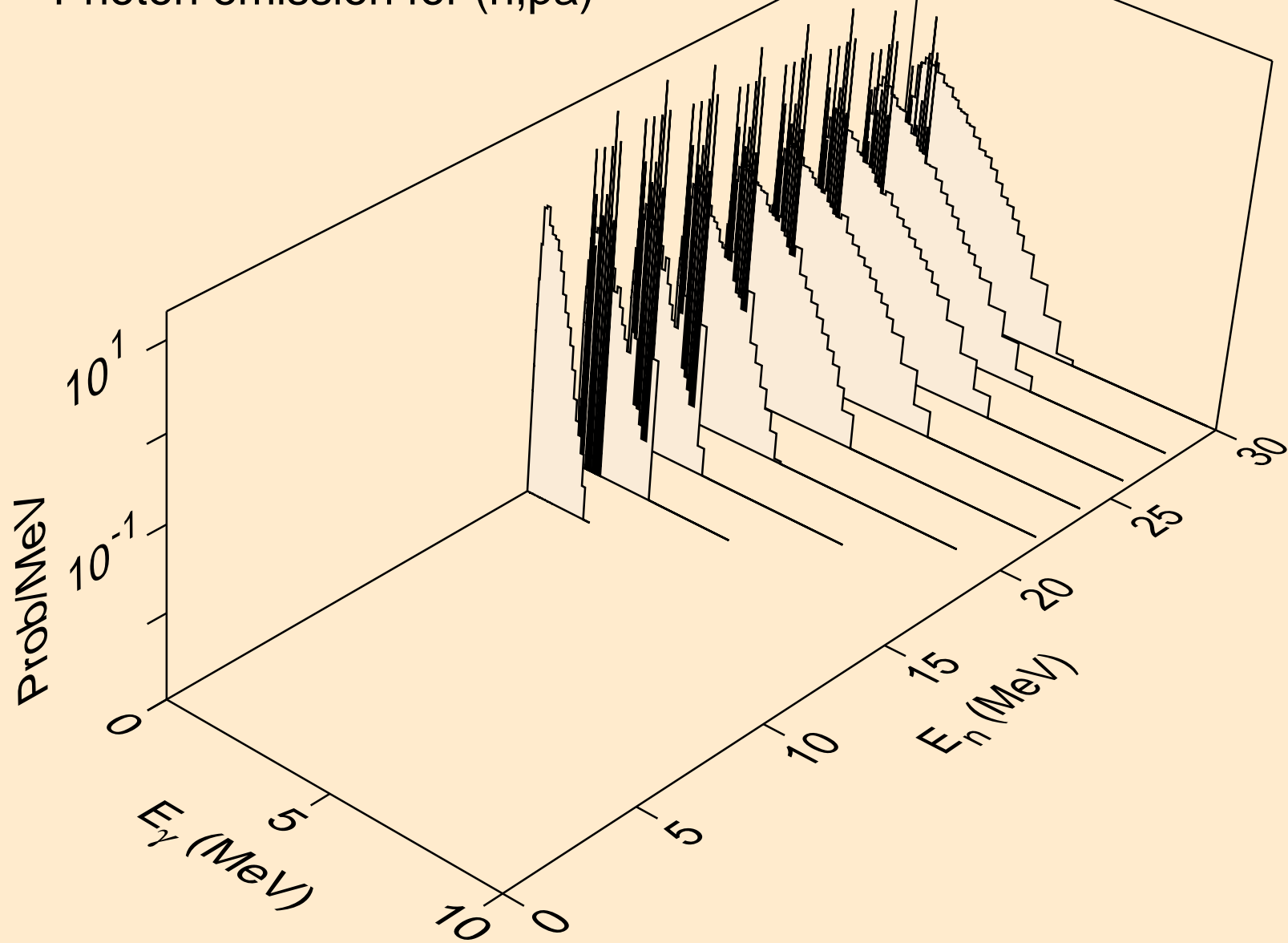

FR209 ALPHA ACER TENDL-2023 LIBRARY; T=0.K  
Photon emission for (n,da)

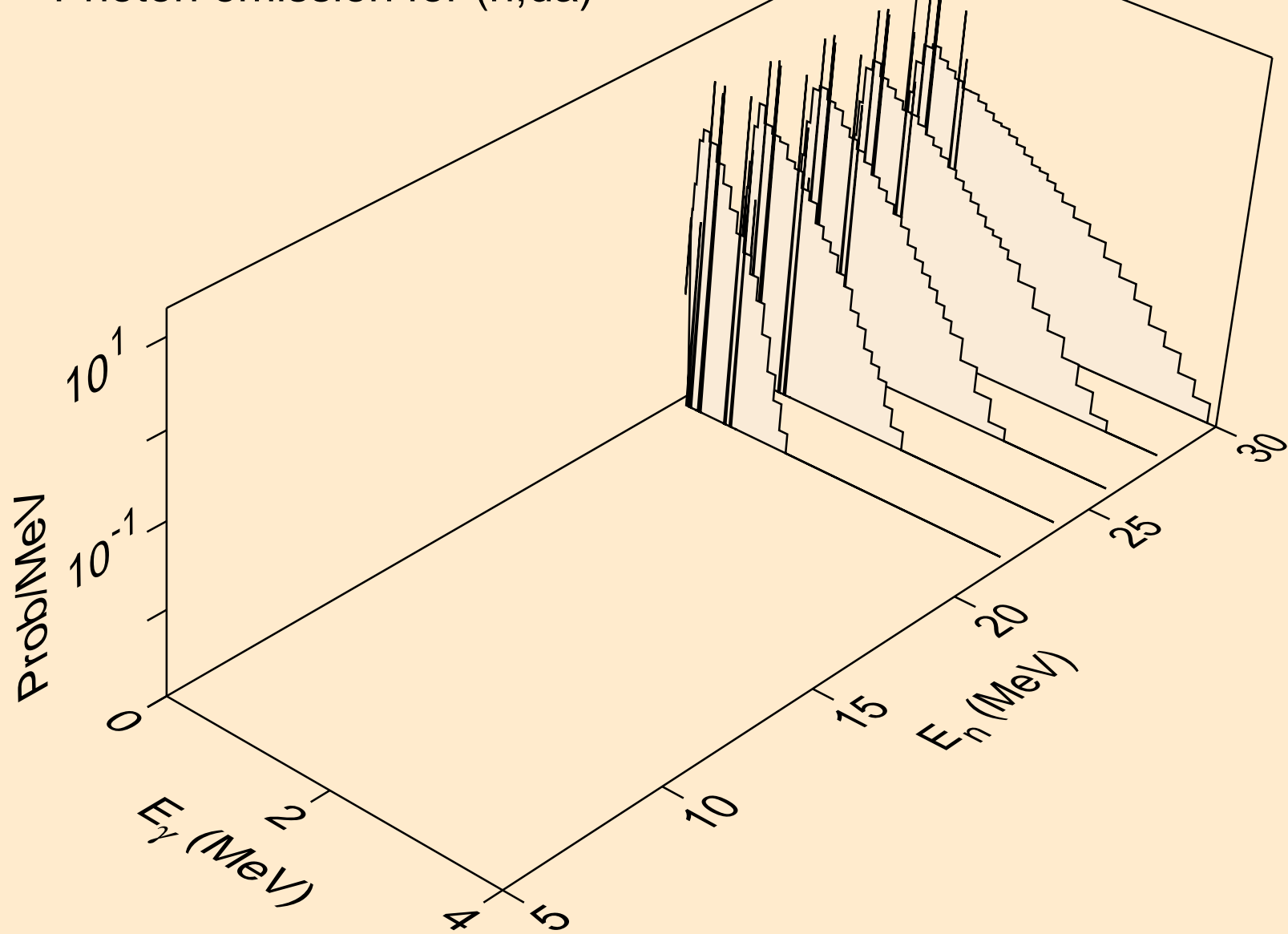

FR209 ALPHA ACER TENDL-2023 LIBRARY; T=0.K  
Particle heating contributions

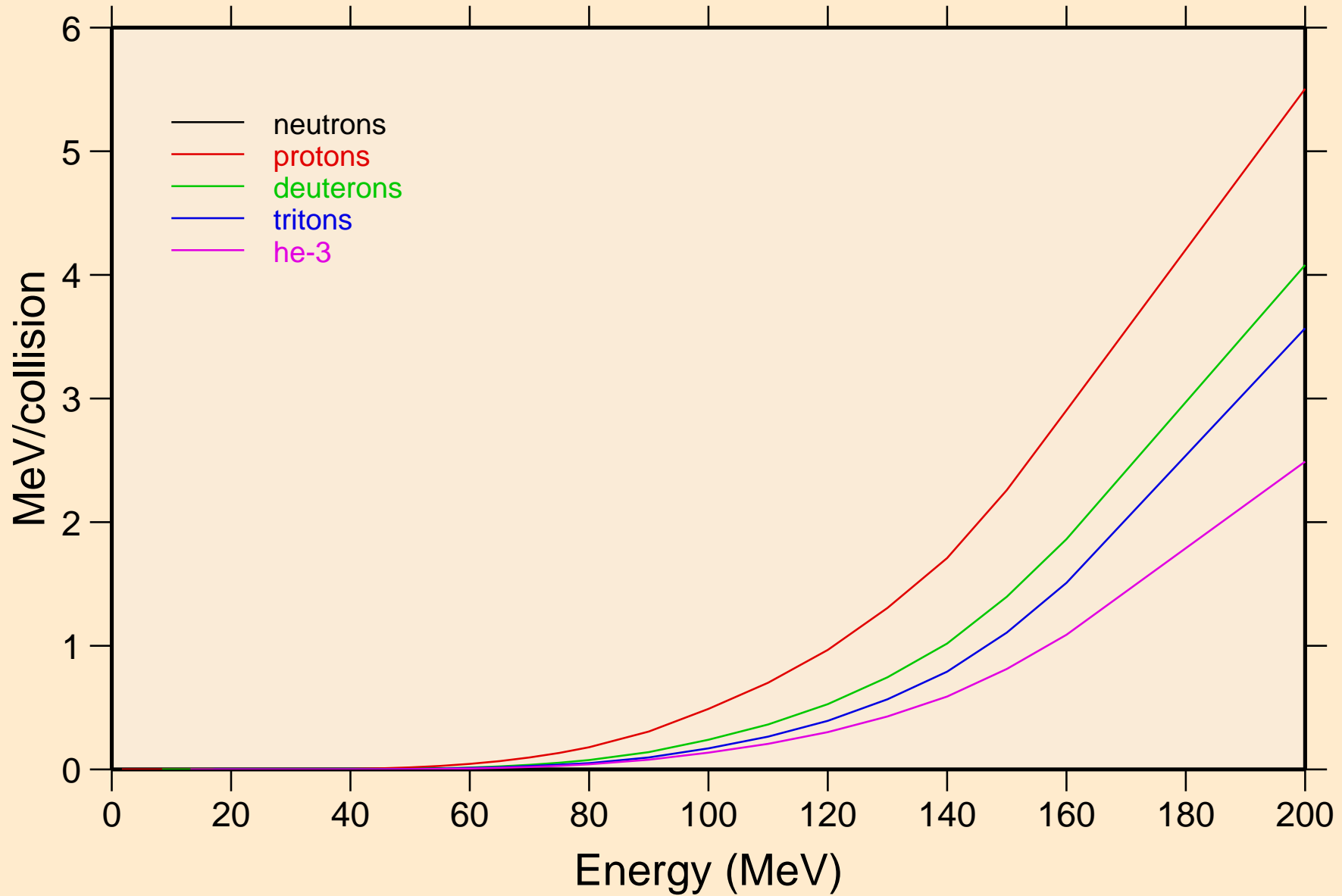

FR209 ALPHA ACER TENDL-2023 LIBRARY; T=0.K  
Recoil Heating

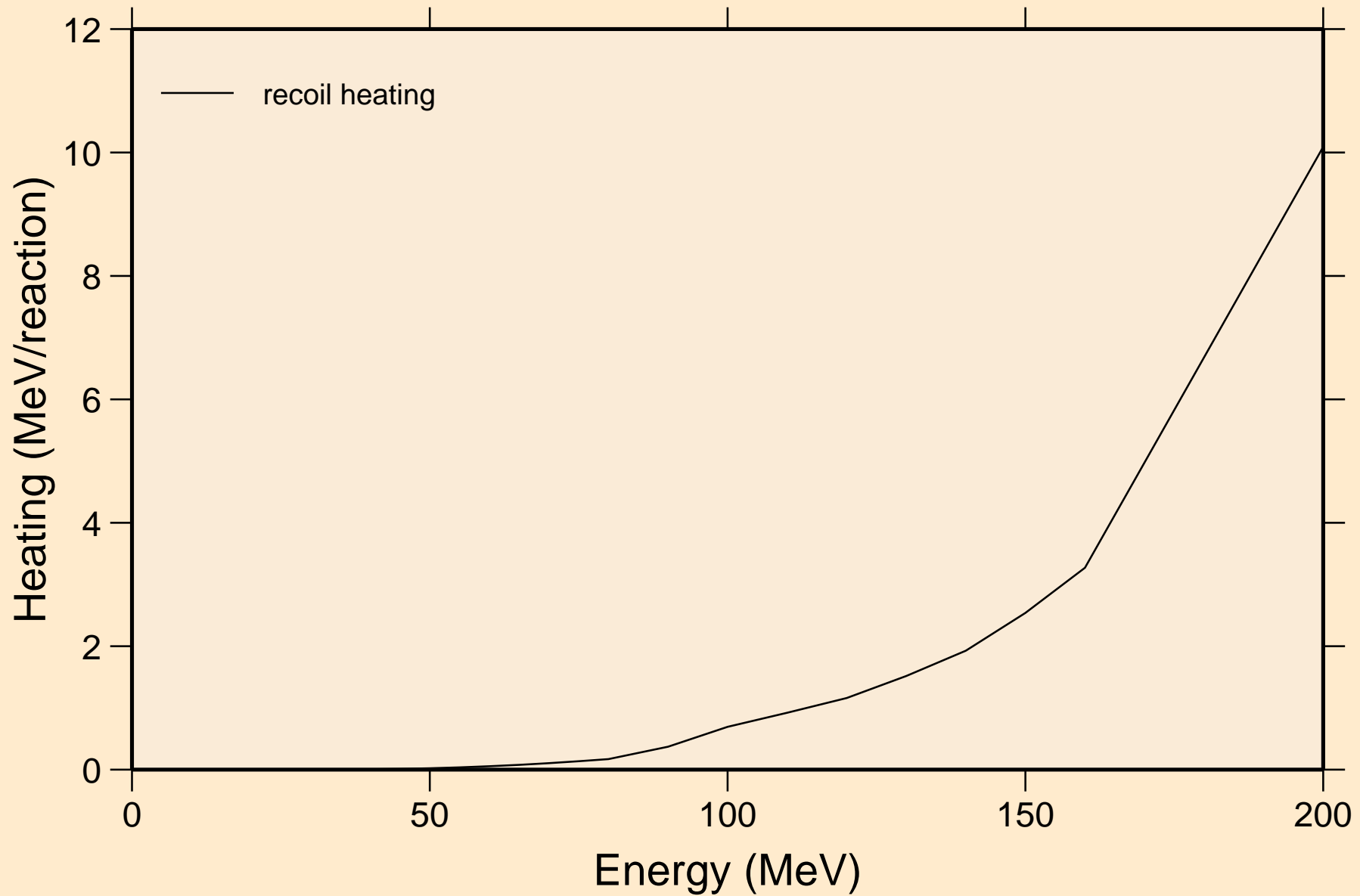

FR209 ALPHA ACER TENDL-2023 LIBRARY; T=0.K  
Particle production cross sections

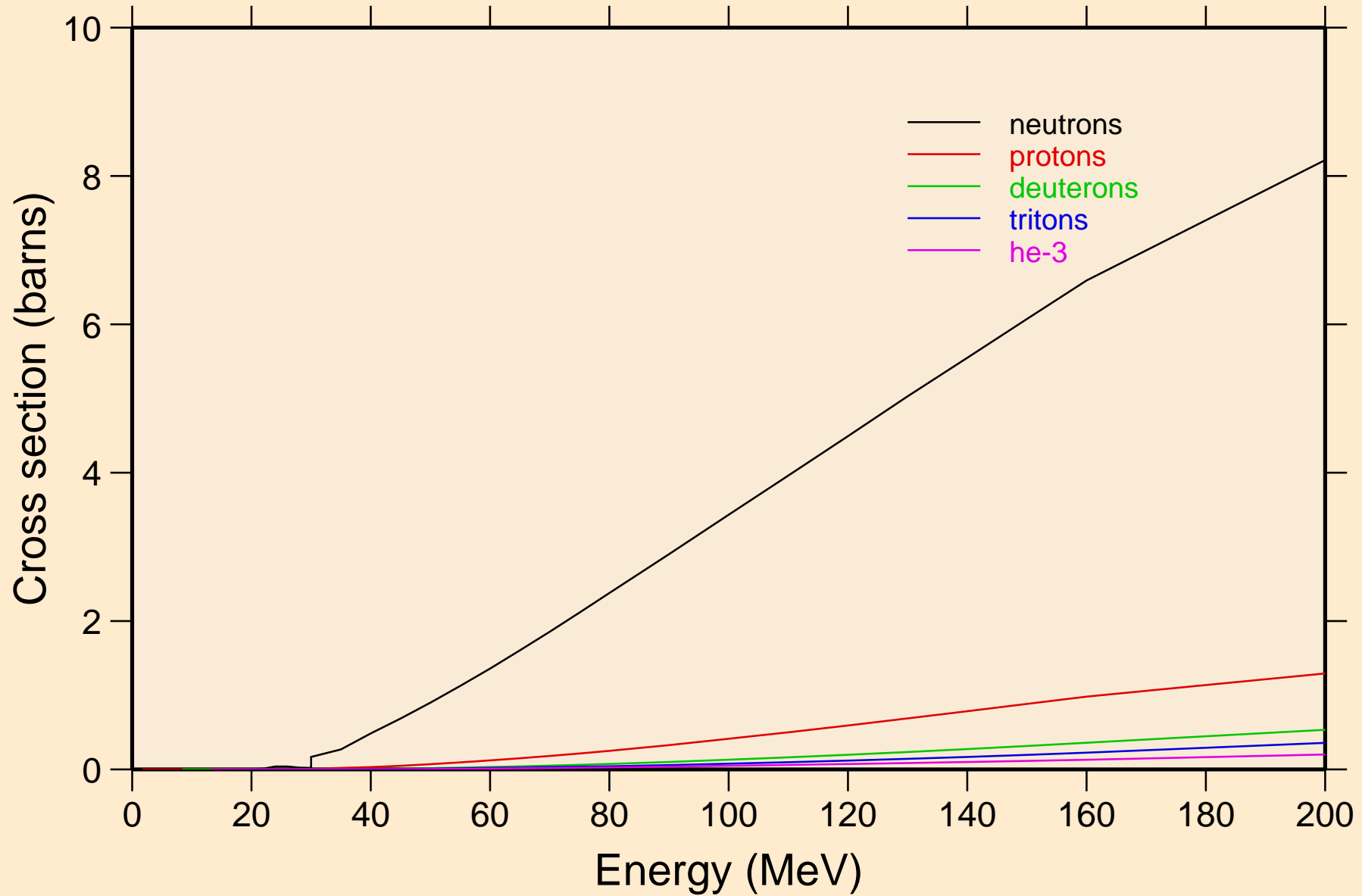

FR209 ALPHA ACER TENDL-2023 LIBRARY; T=0.K  
neutrons from (a,n)

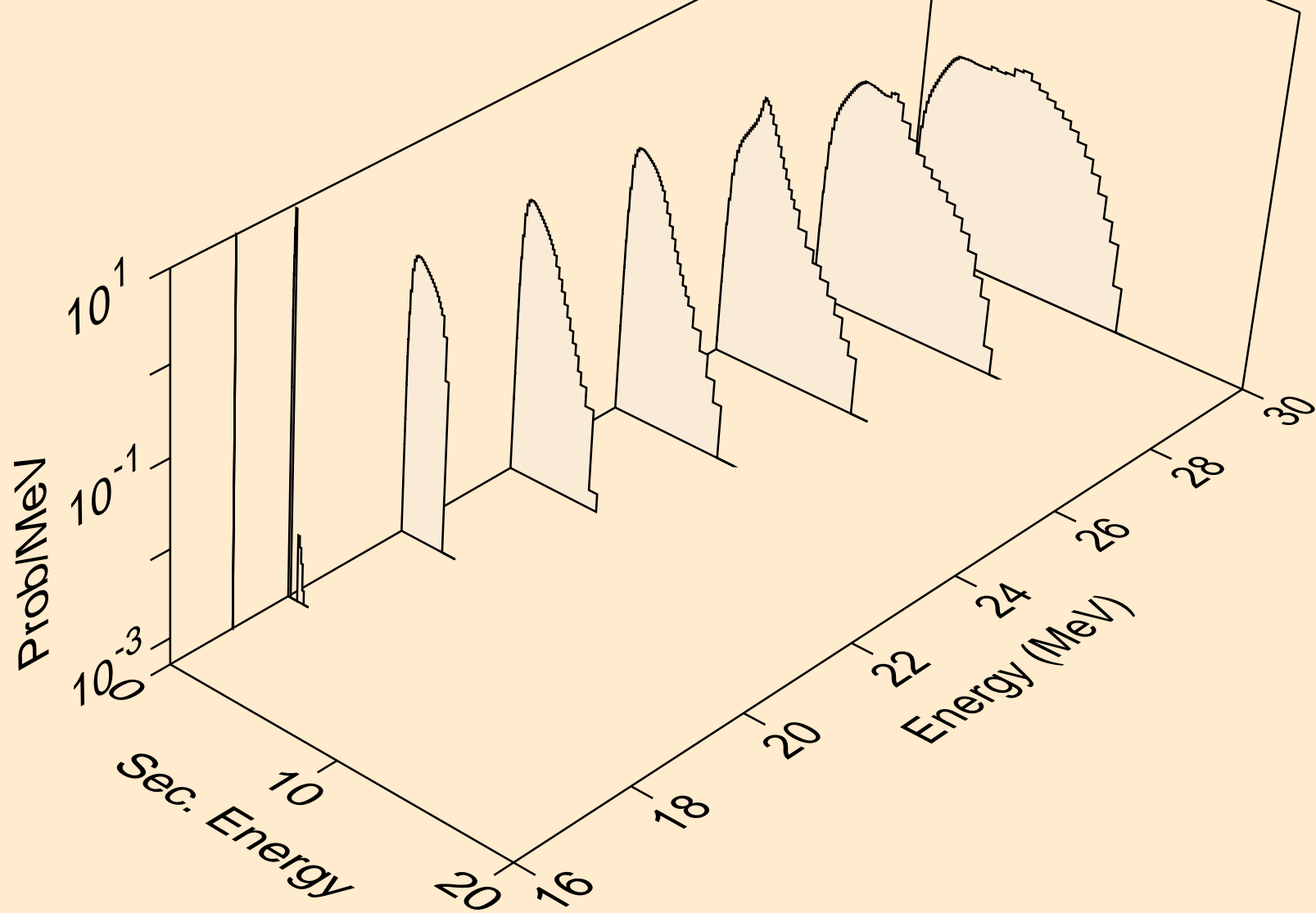



FR209 ALPHA ACER TENDL-2023 LIBRARY; T=0.K  
neutrons from (a,x)

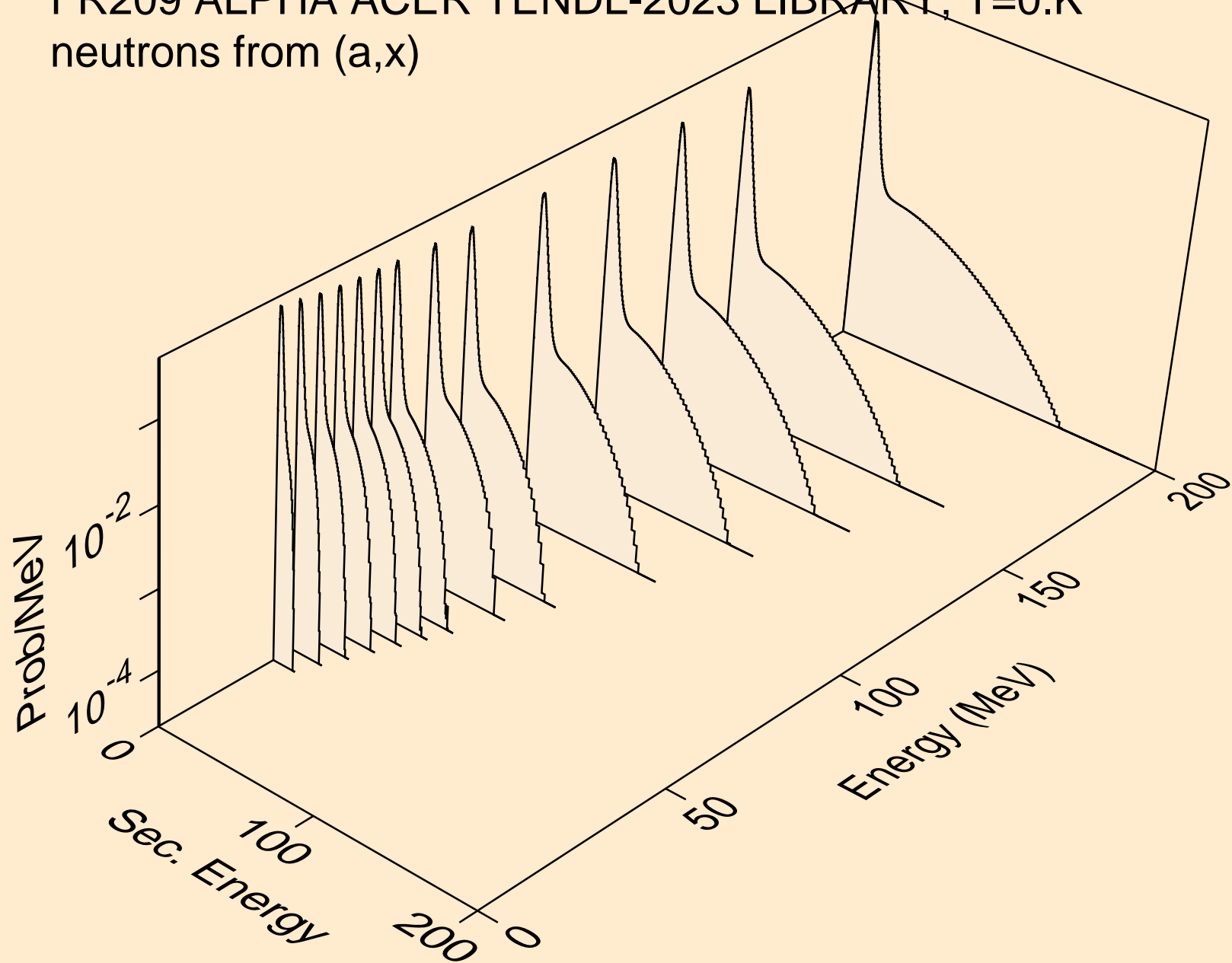

FR209 ALPHA ACER TENDL-2023 LIBRARY; T=0.K  
neutrons from (a,2n)

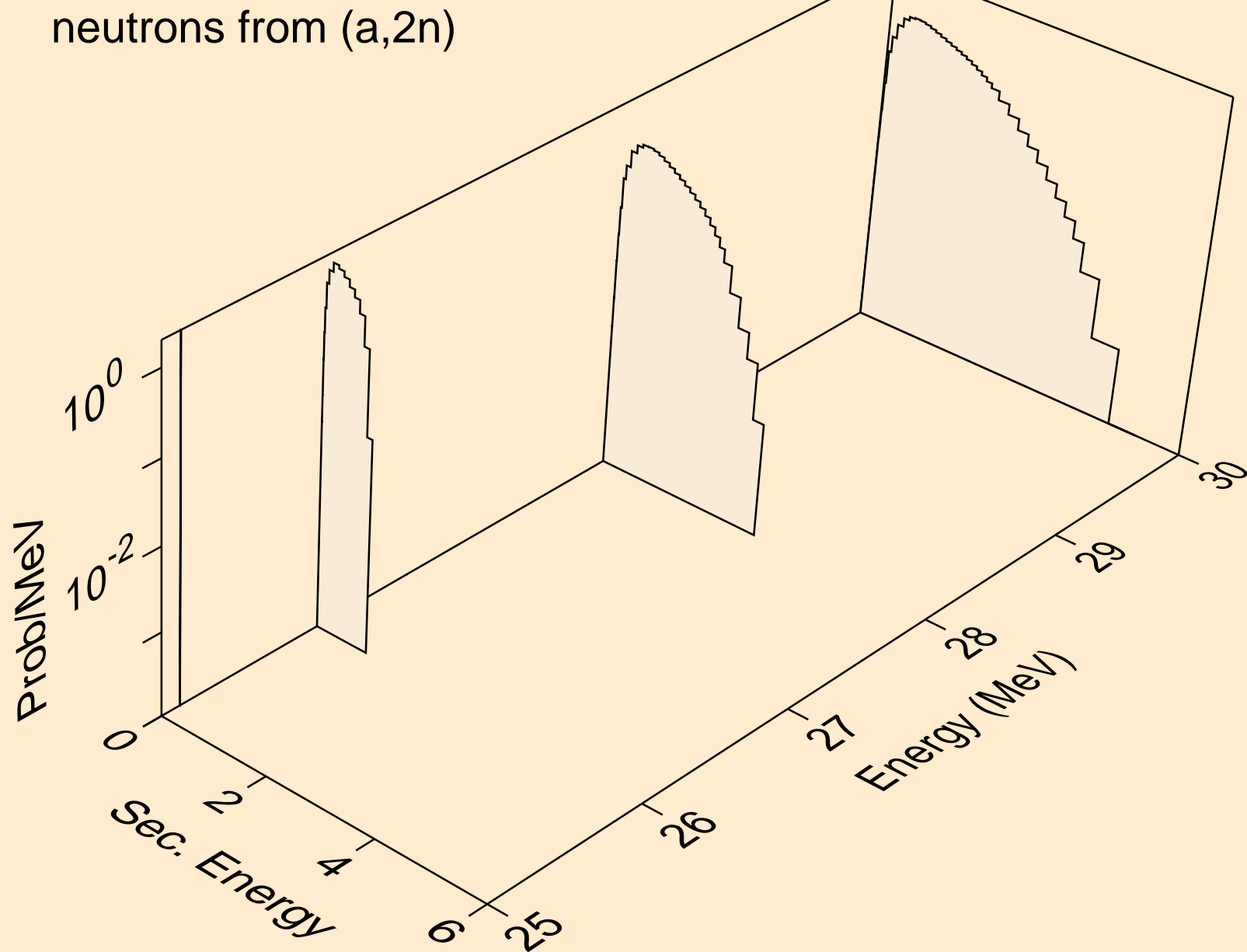

FR209 ALPHA ACER TENDL-2023 LIBRARY; T=0.K  
neutrons from (a,n\*)a

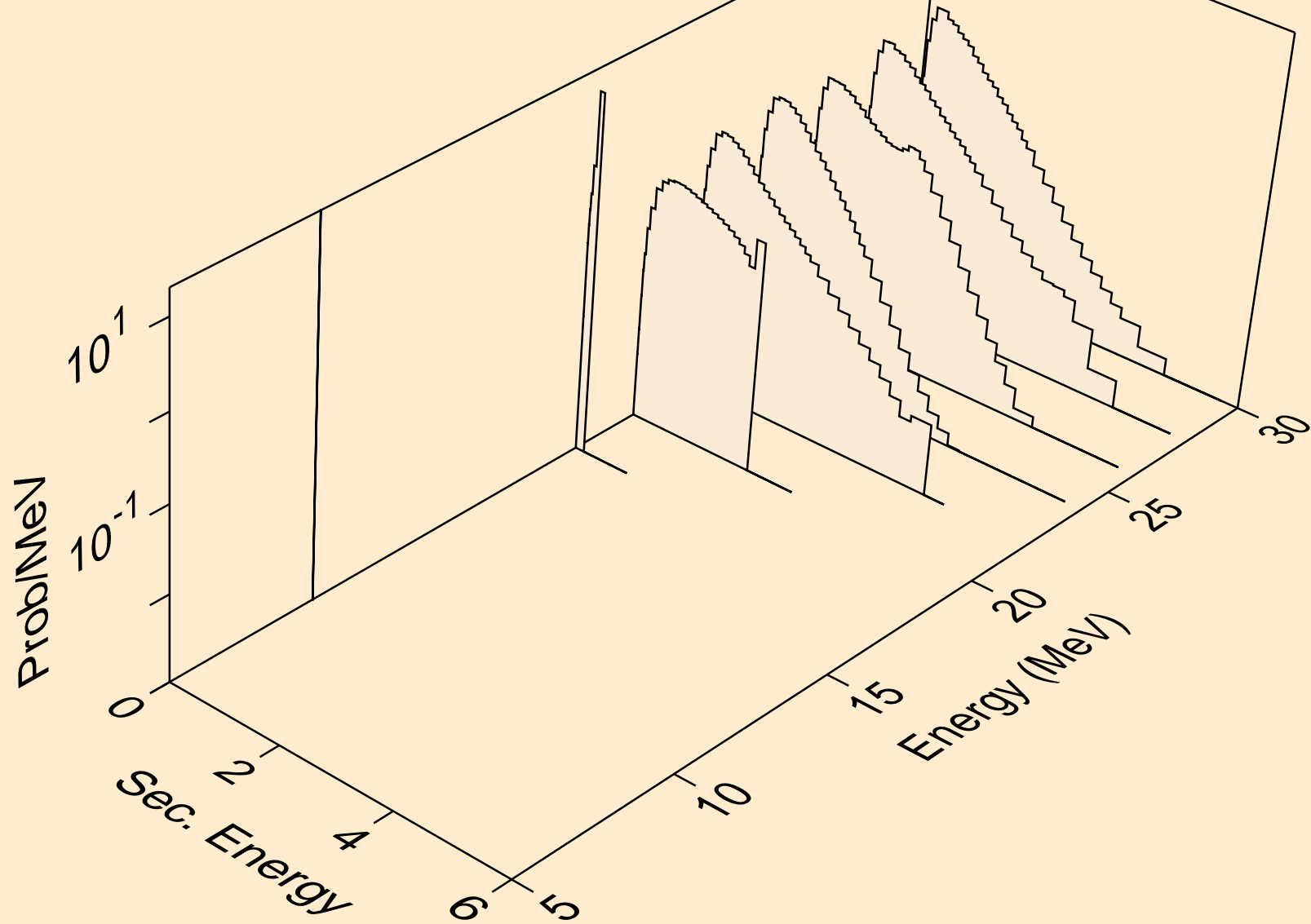

FR209 ALPHA ACER TENDL-2023 LIBRARY; T=0.K  
neutrons from (a,2n)a

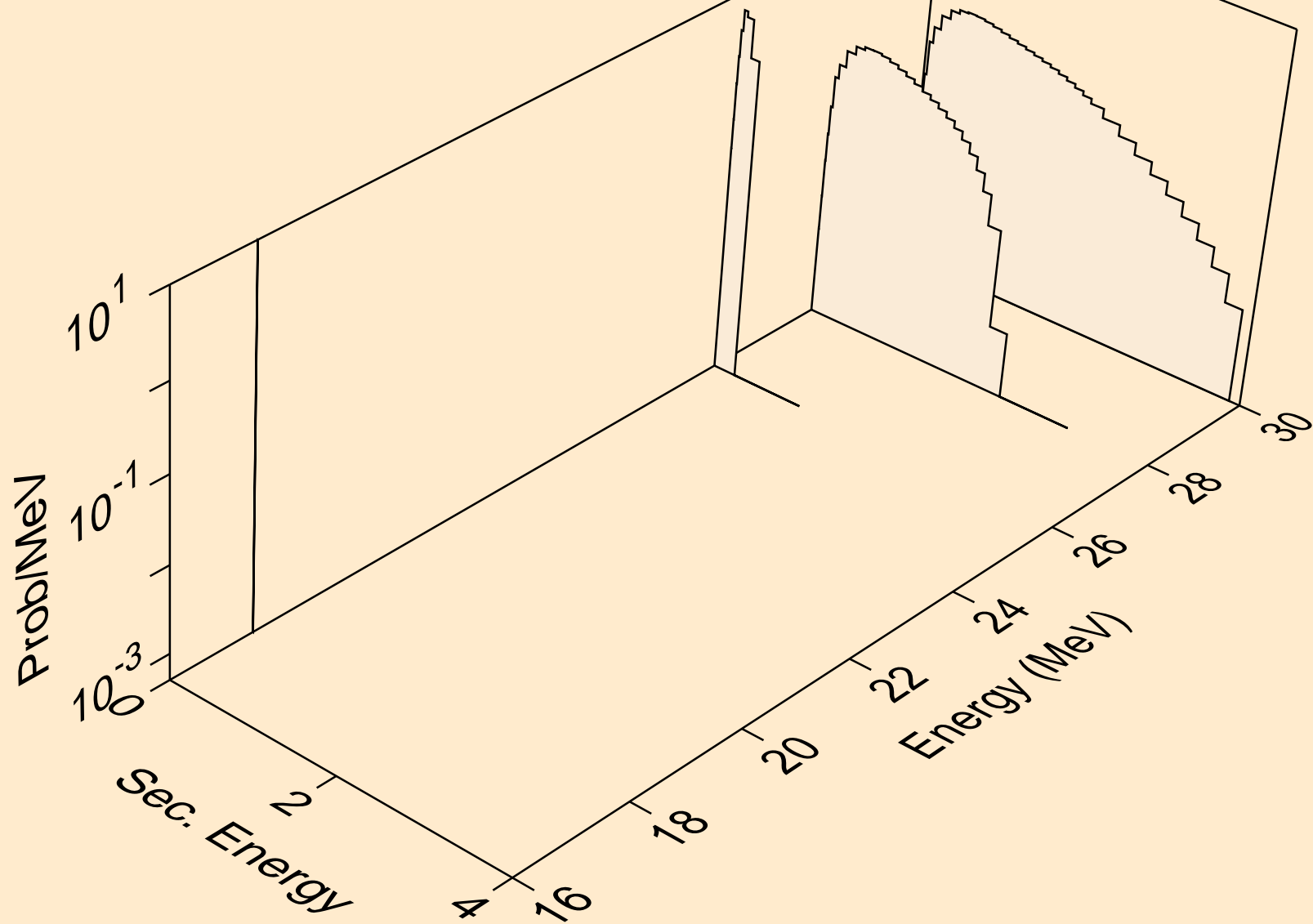

FR209 ALPHA ACER TENDL-2023 LIBRARY; T=0.K  
neutrons from (a,n\*)p

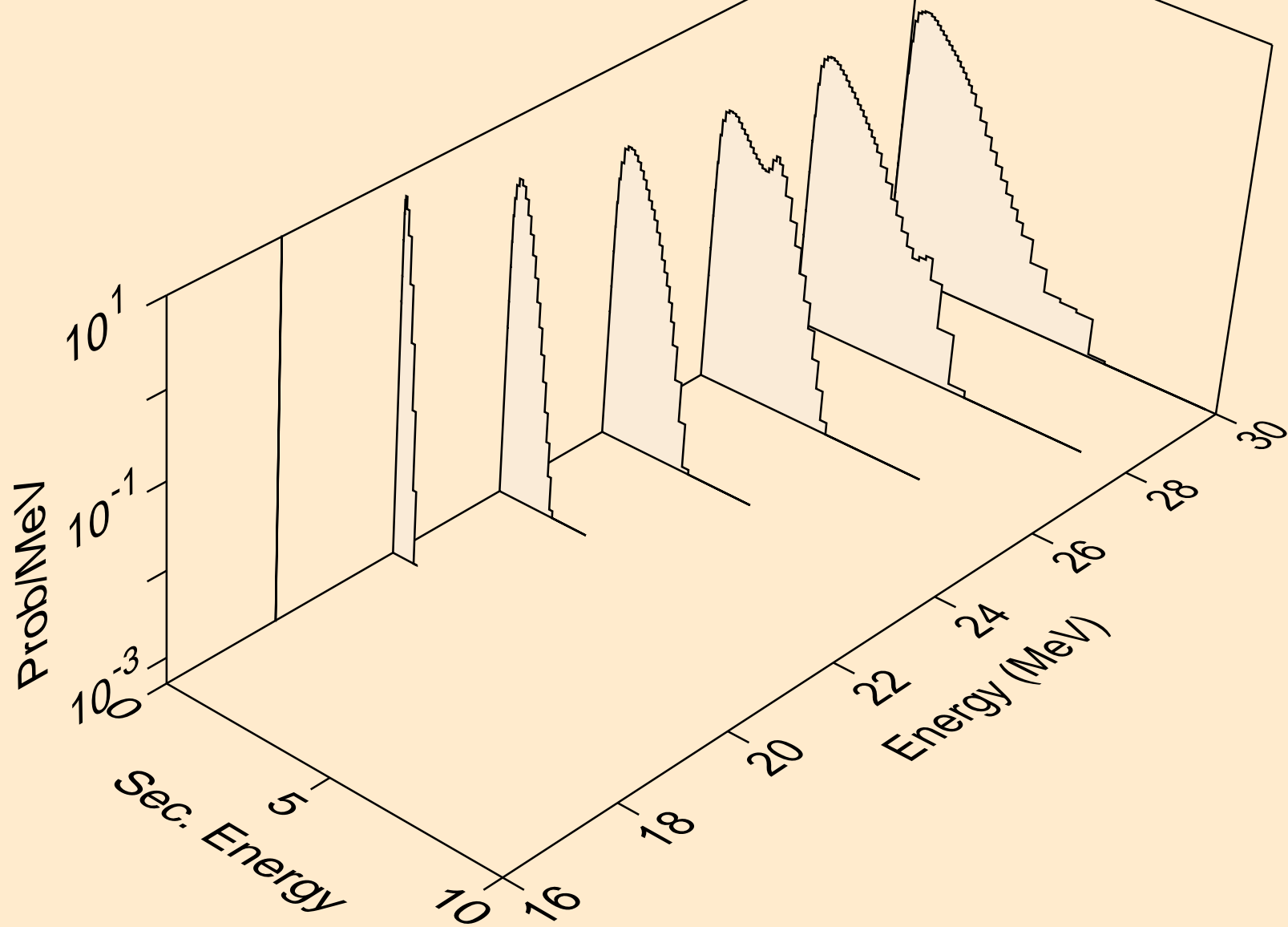

FR209 ALPHA ACER TENDL-2023 LIBRARY; T=0.K  
neutrons from (a,n\*)2a

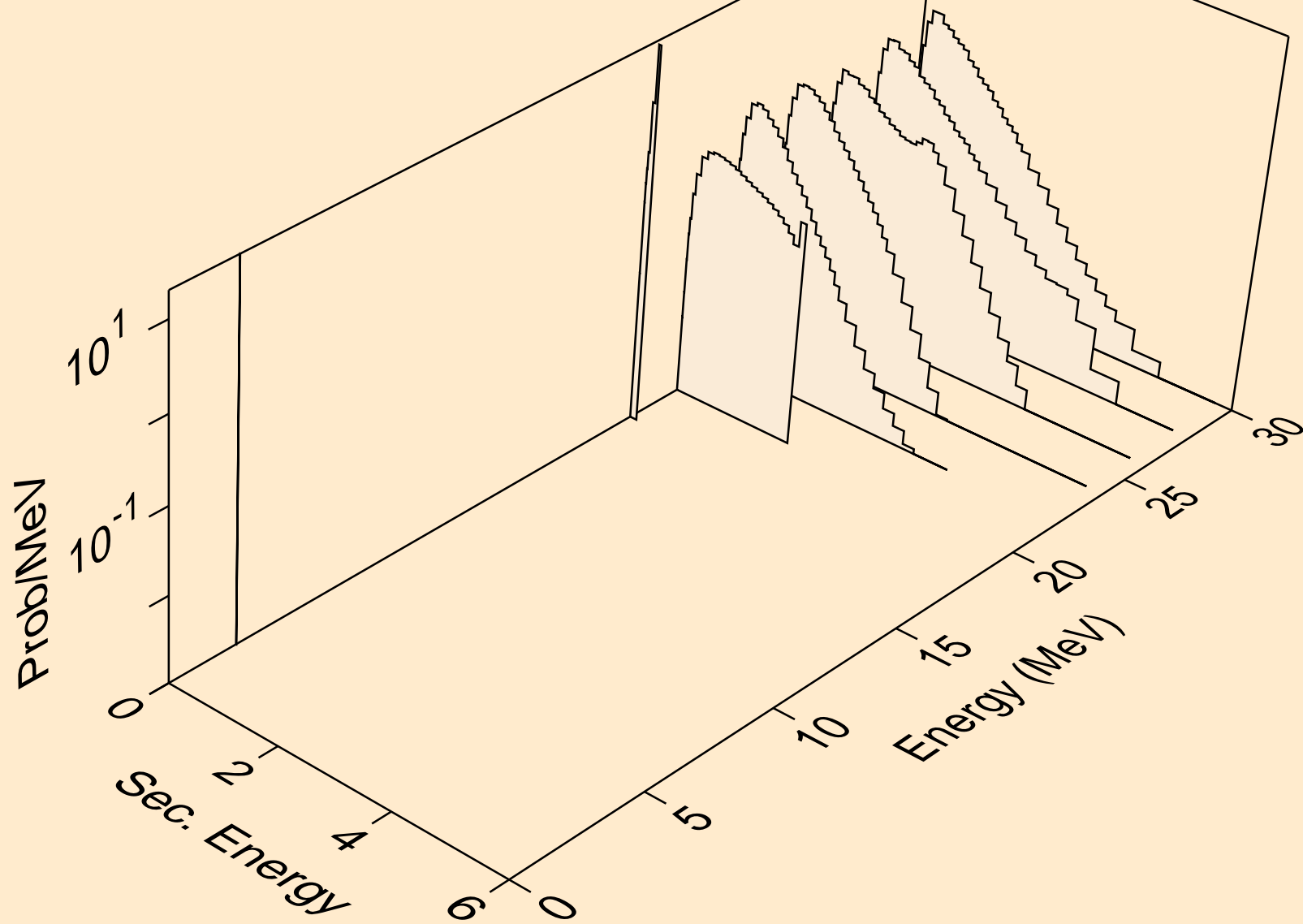

FR209 ALPHA ACER TENDL-2023 LIBRARY; T=0.K  
neutrons from (a,2np)

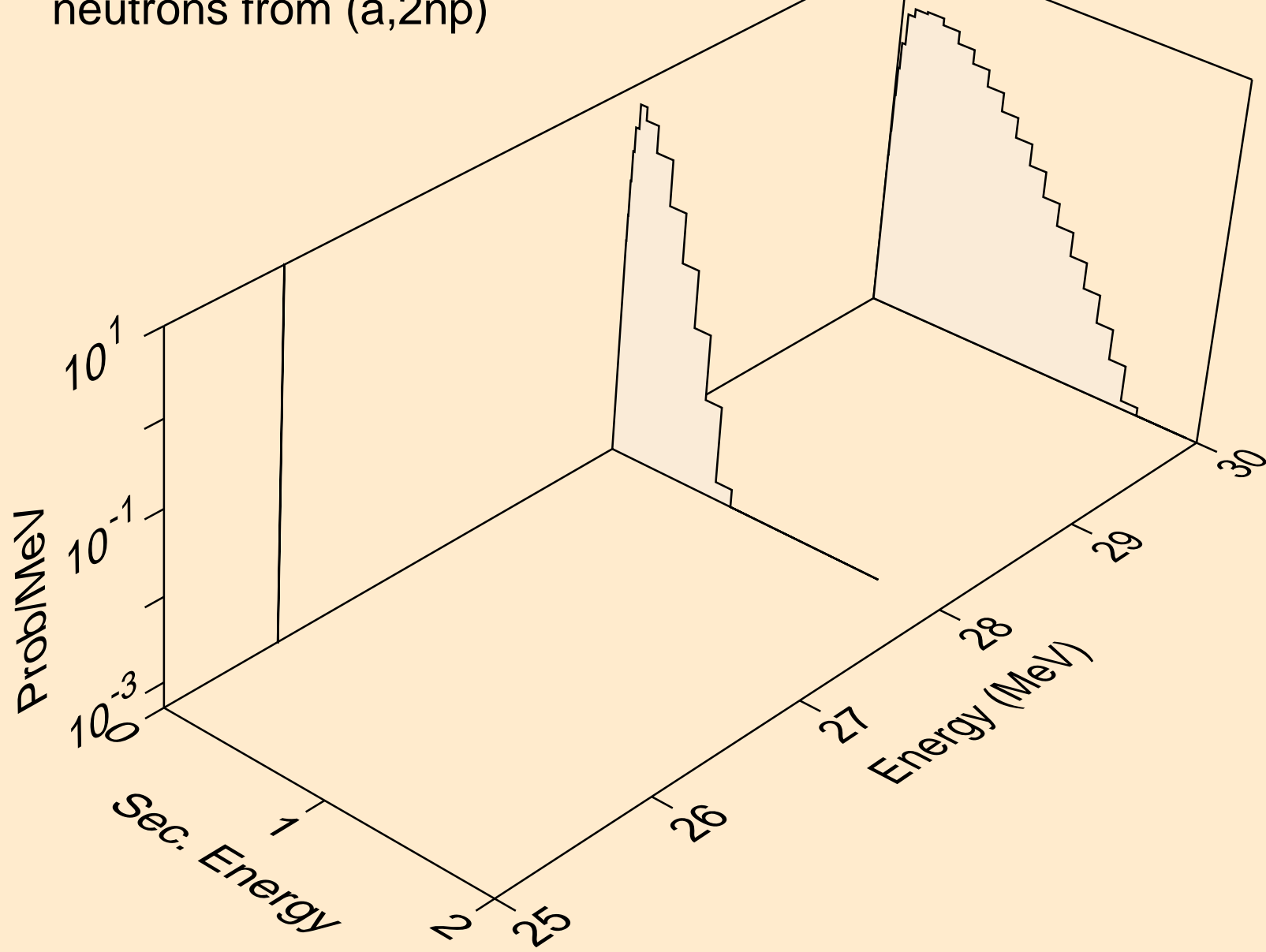

FR209 ALPHA ACER TENDL-2023 LIBRARY; T=0.K  
neutrons from (a,npa)

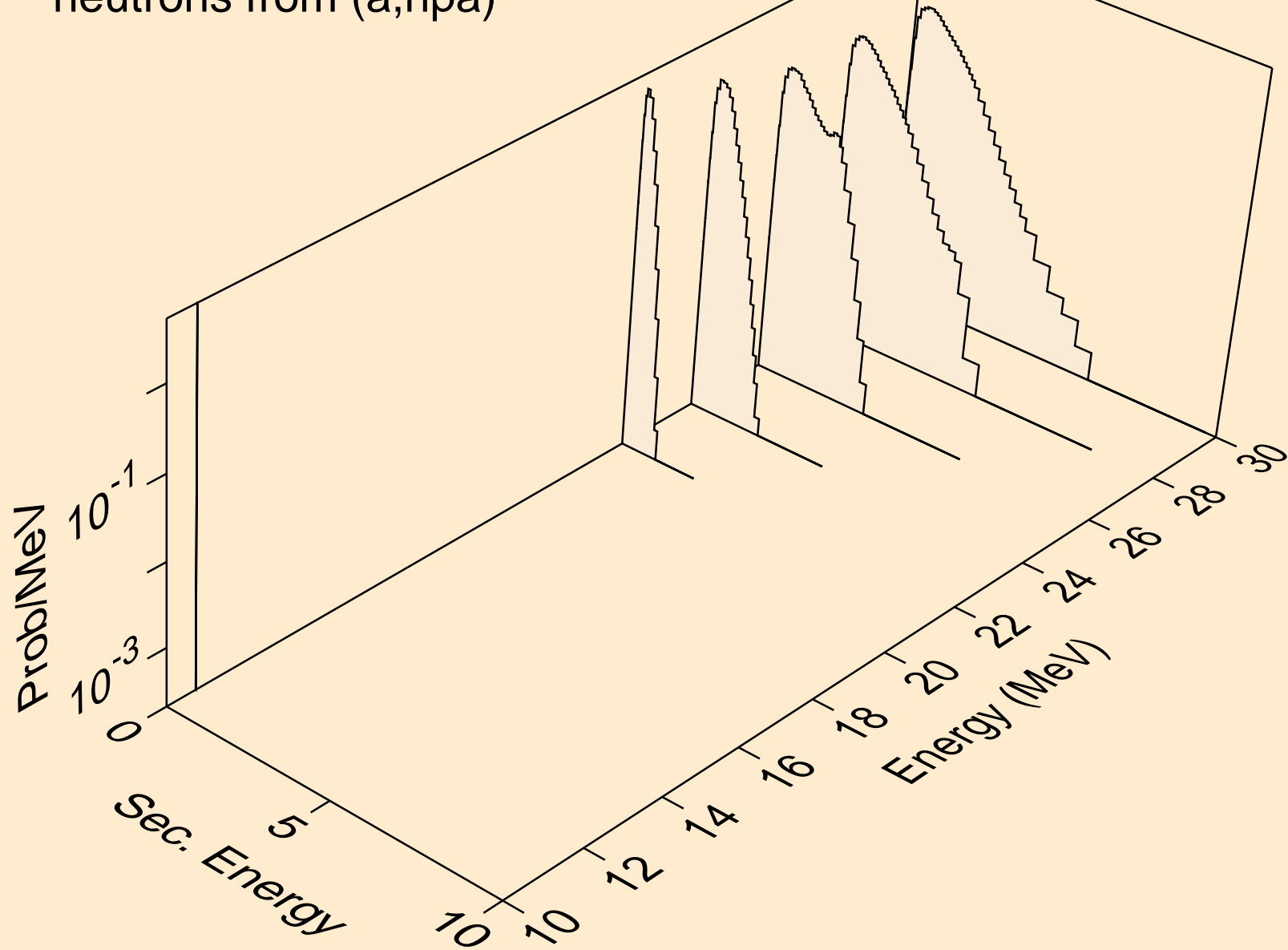



FR209 ALPHA ACER TENDL-2023 LIBRARY; T=0.K  
protons from (a,x)

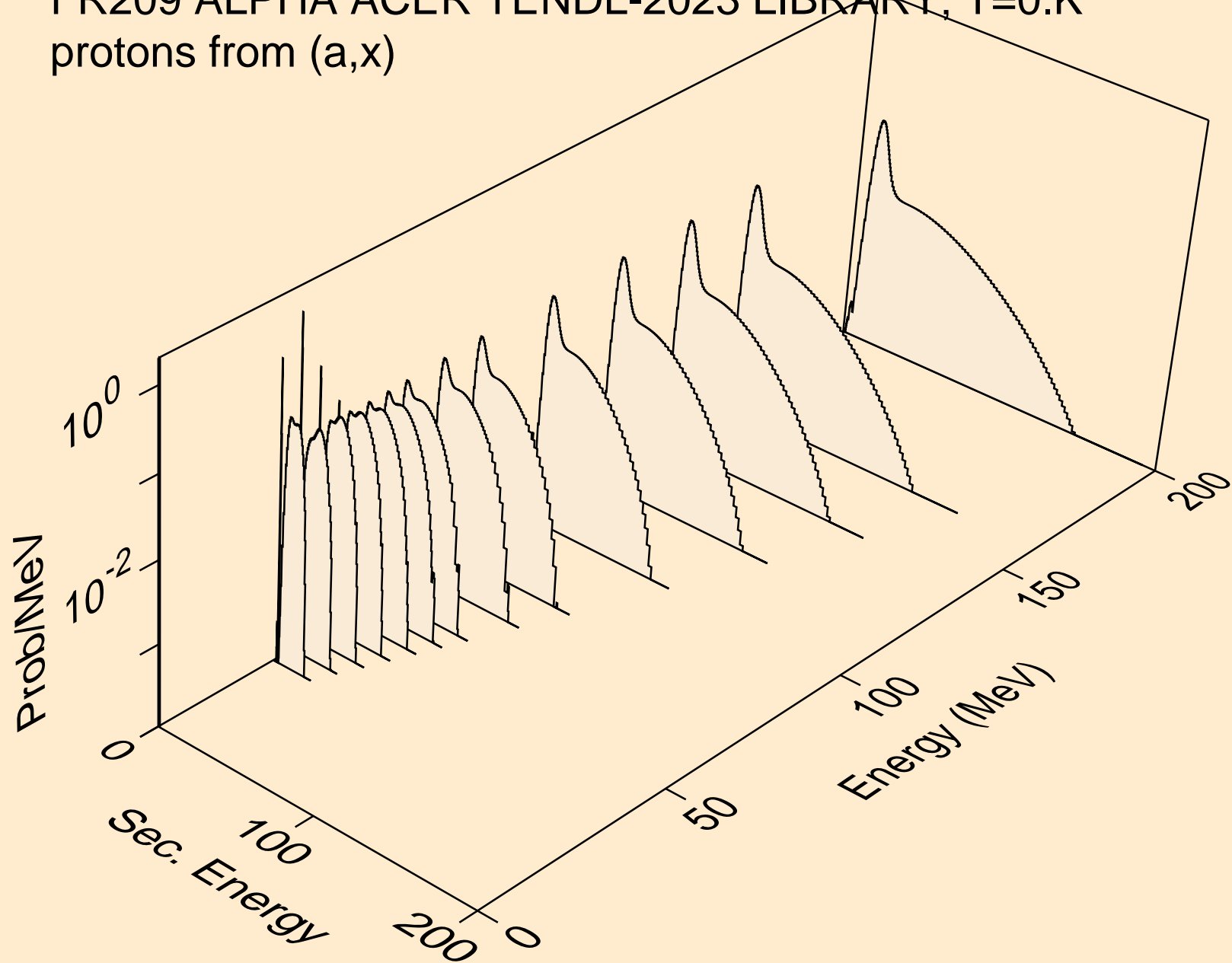

FR209 ALPHA ACER TENDL-2023 LIBRARY; T=0.K  
protons from (a,n\*)p

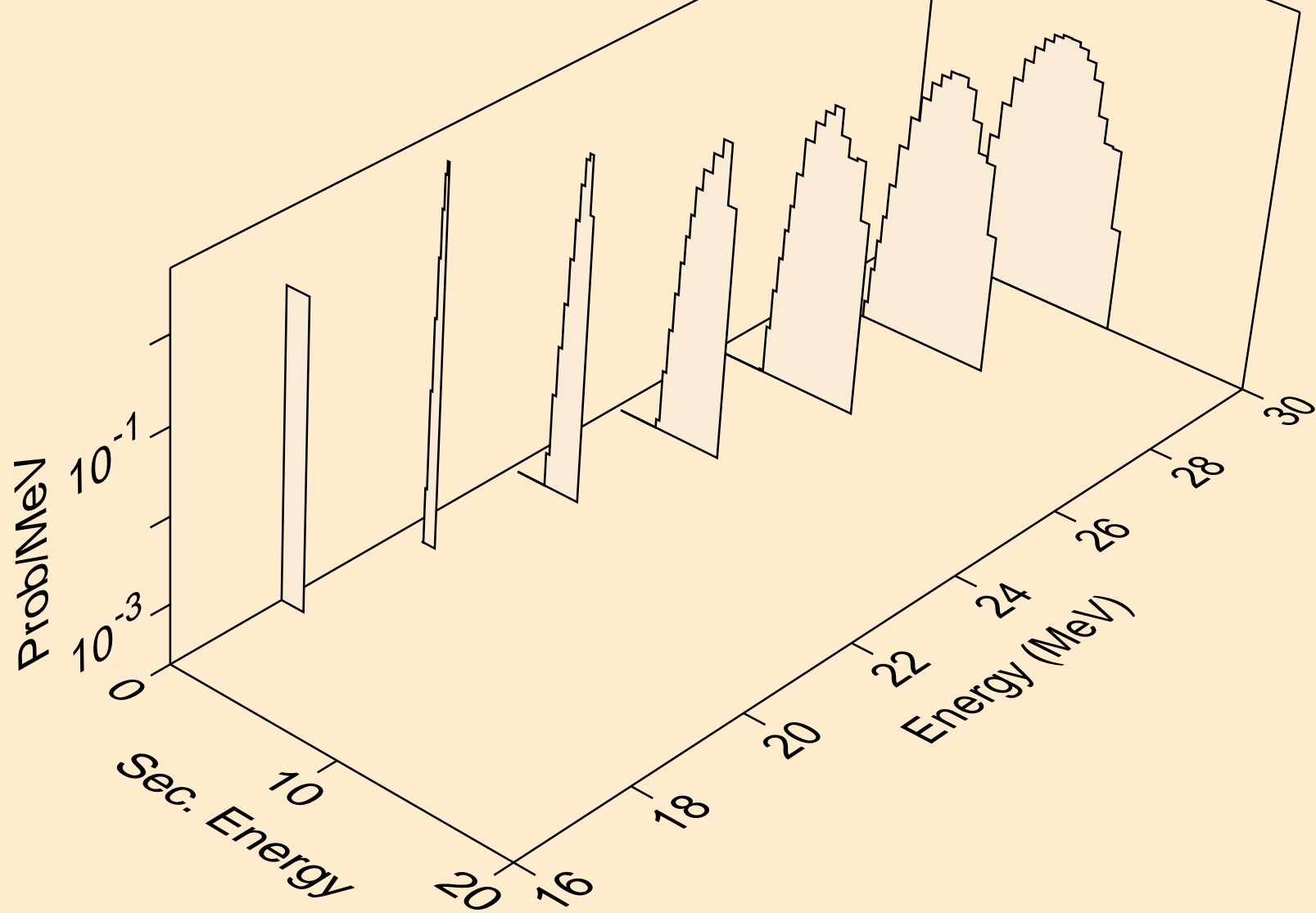

FR209 ALPHA ACER TENDL-2023 LIBRARY; T=0.K  
protons from (a,2np)

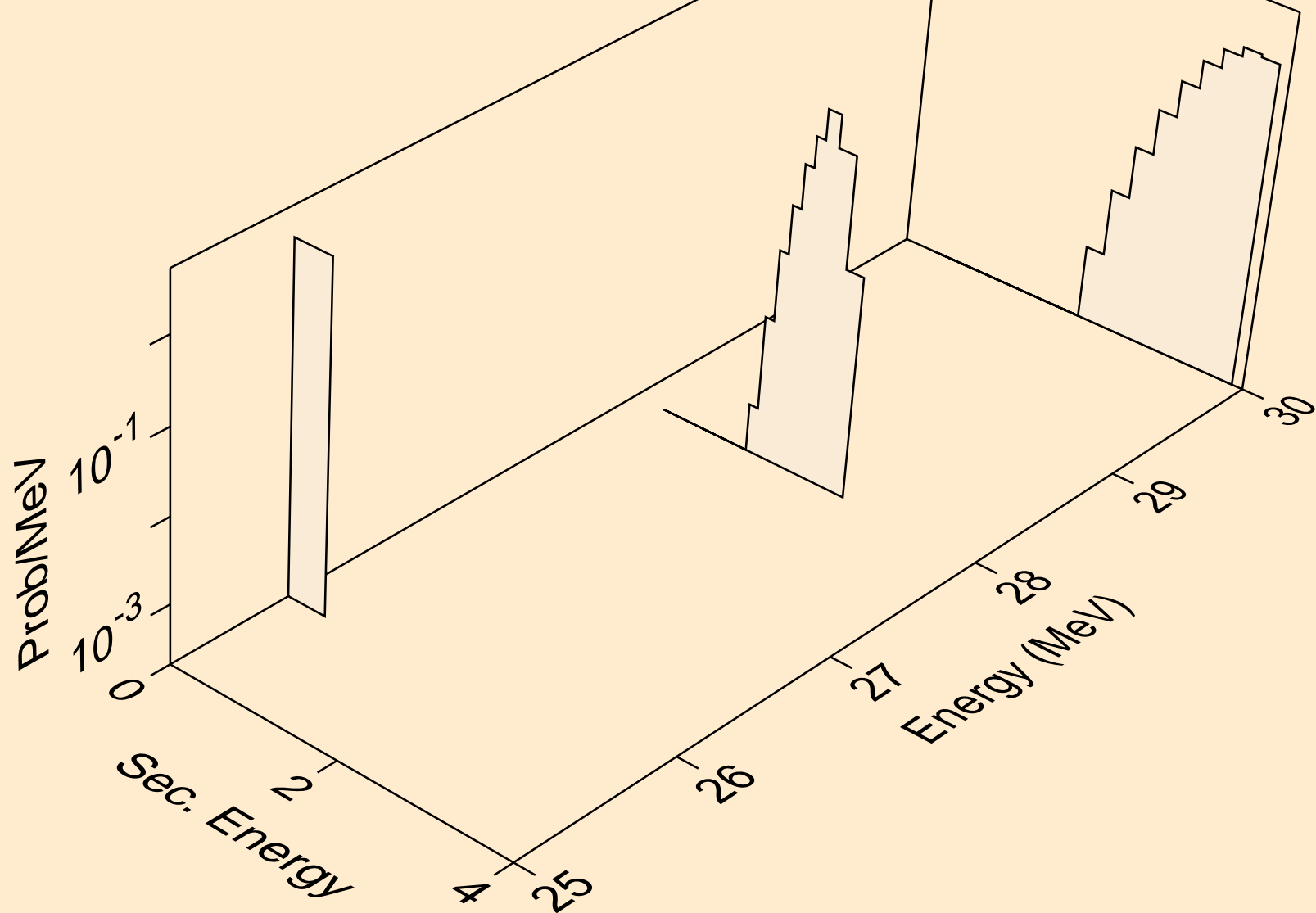

FR209 ALPHA ACER TENDL-2023 LIBRARY; T=0.K  
protons from (a,npa)

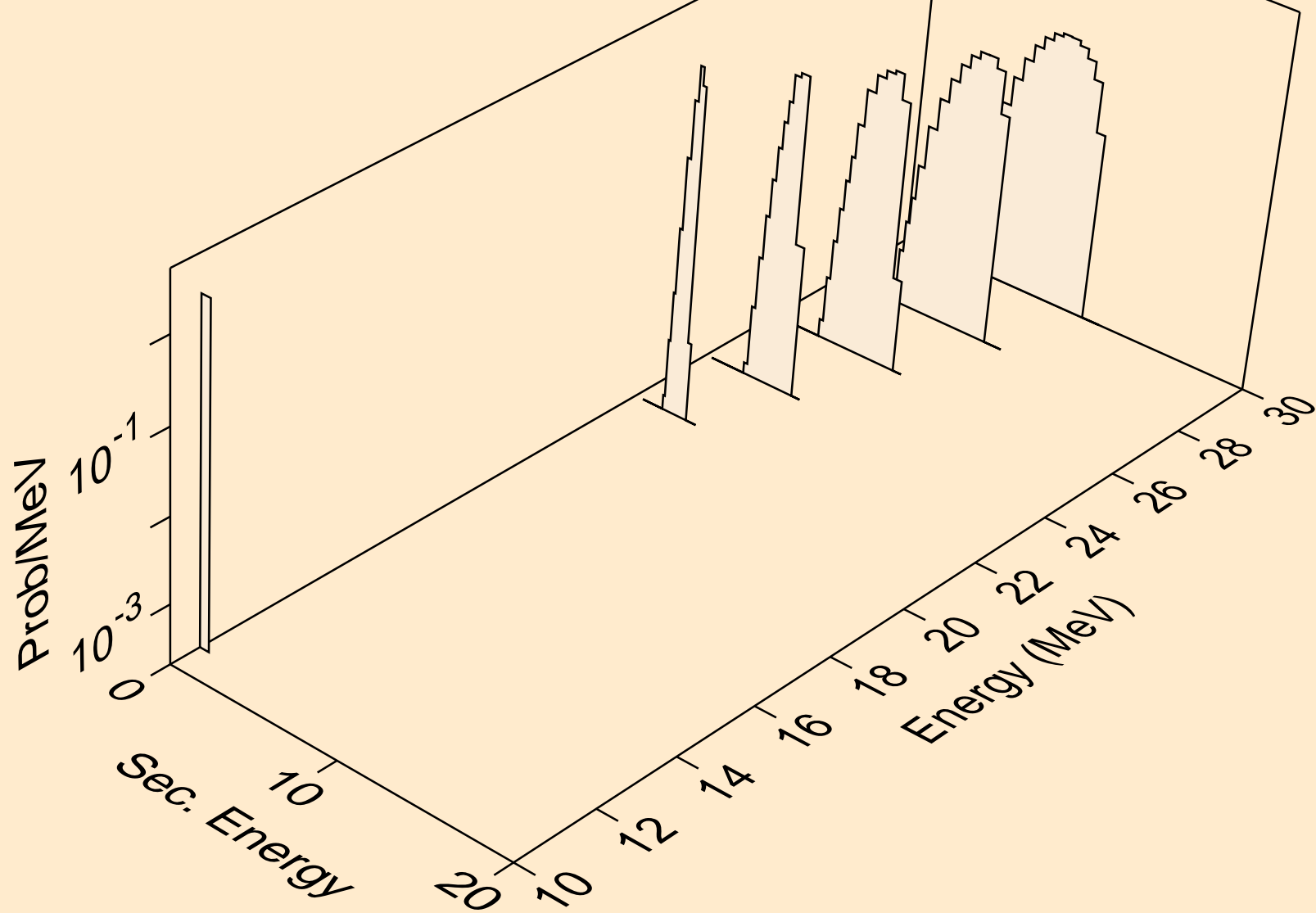

FR209 ALPHA ACER TENDL-2023 LIBRARY; T=0.K  
protons from (a,p)

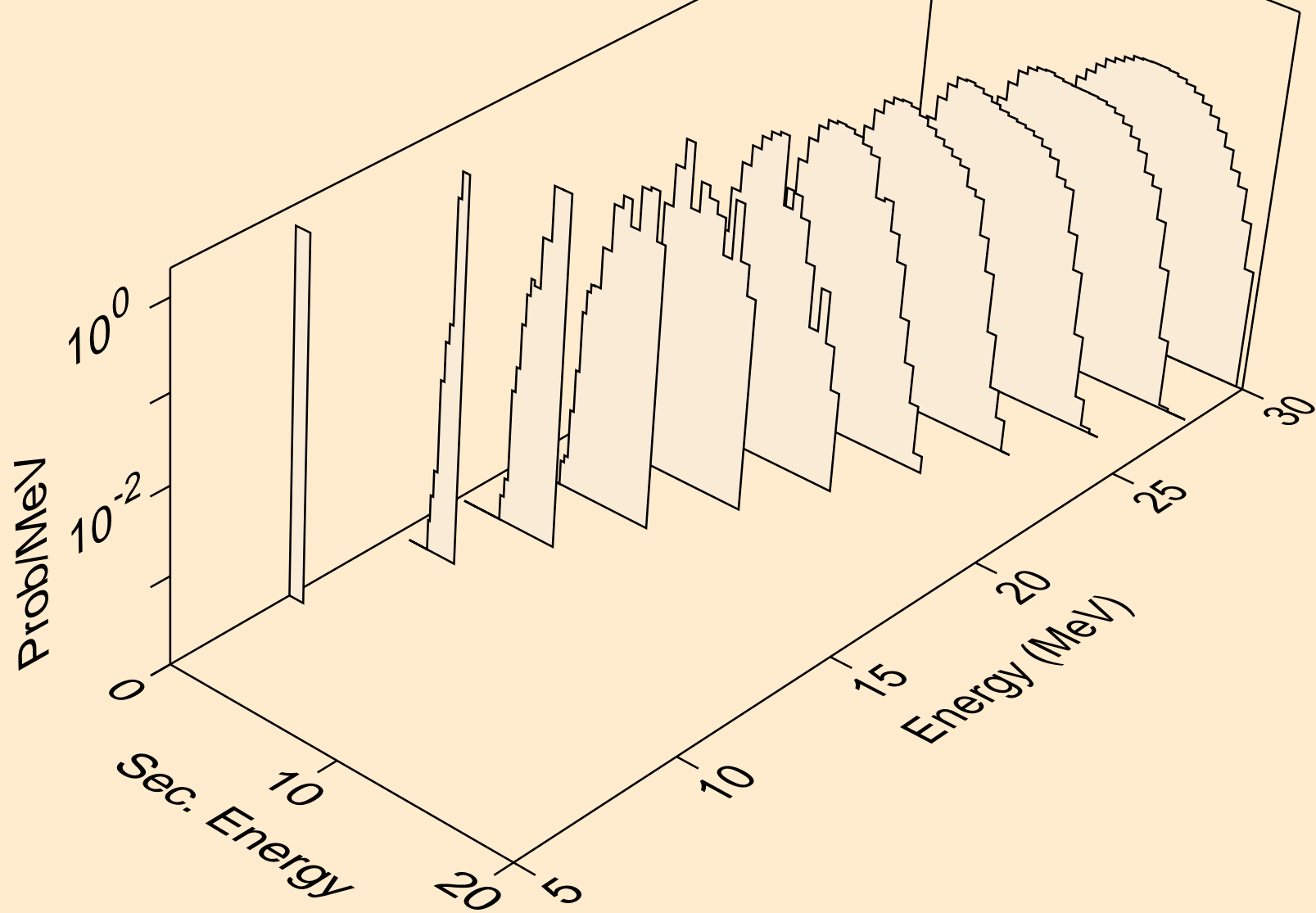

FR209 ALPHA ACER TENDL-2023 LIBRARY; T=0.K  
protons from (a,2p)

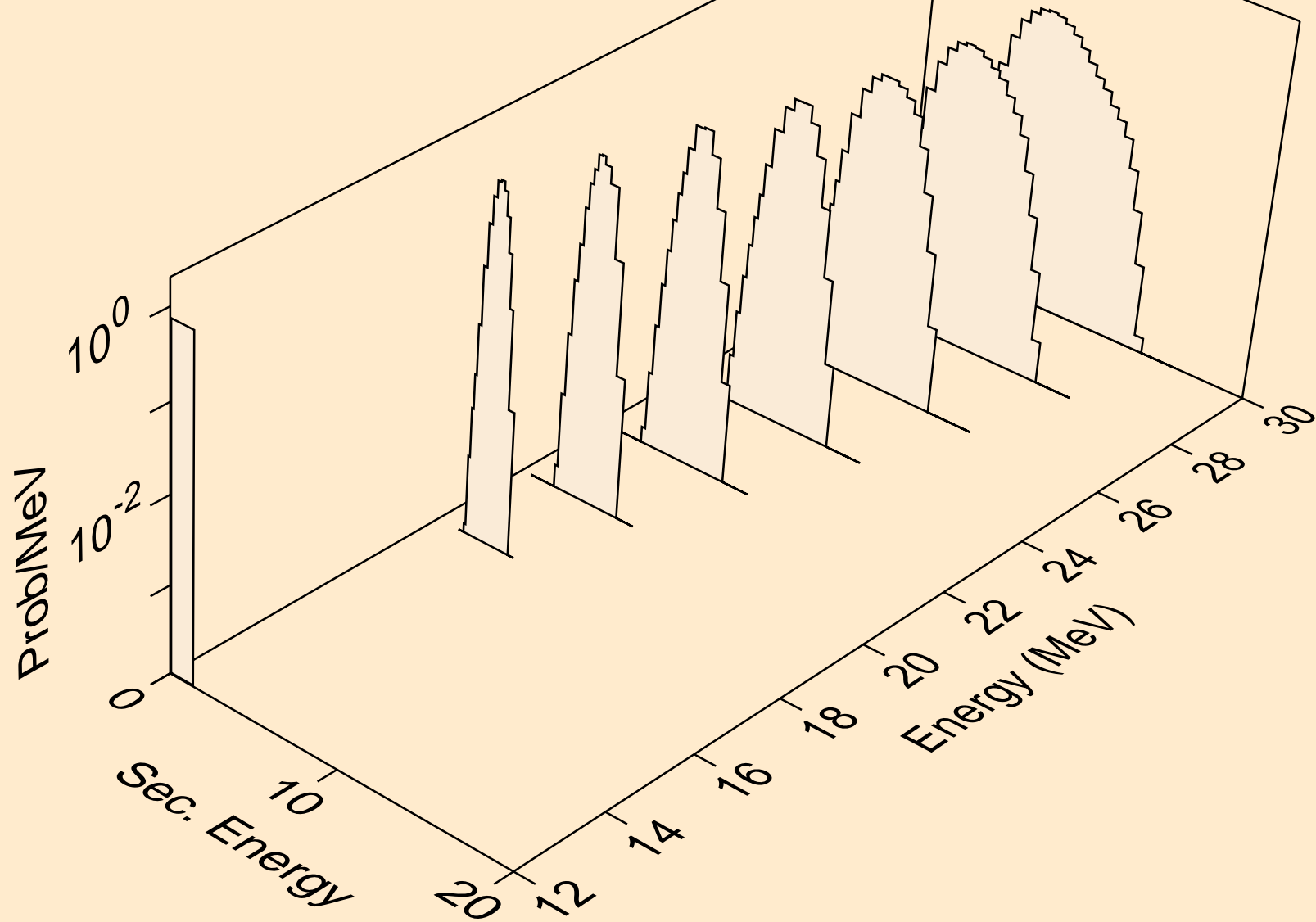

FR209 ALPHA ACER TENDL-2023 LIBRARY; T=0.K  
protons from (a,pa)

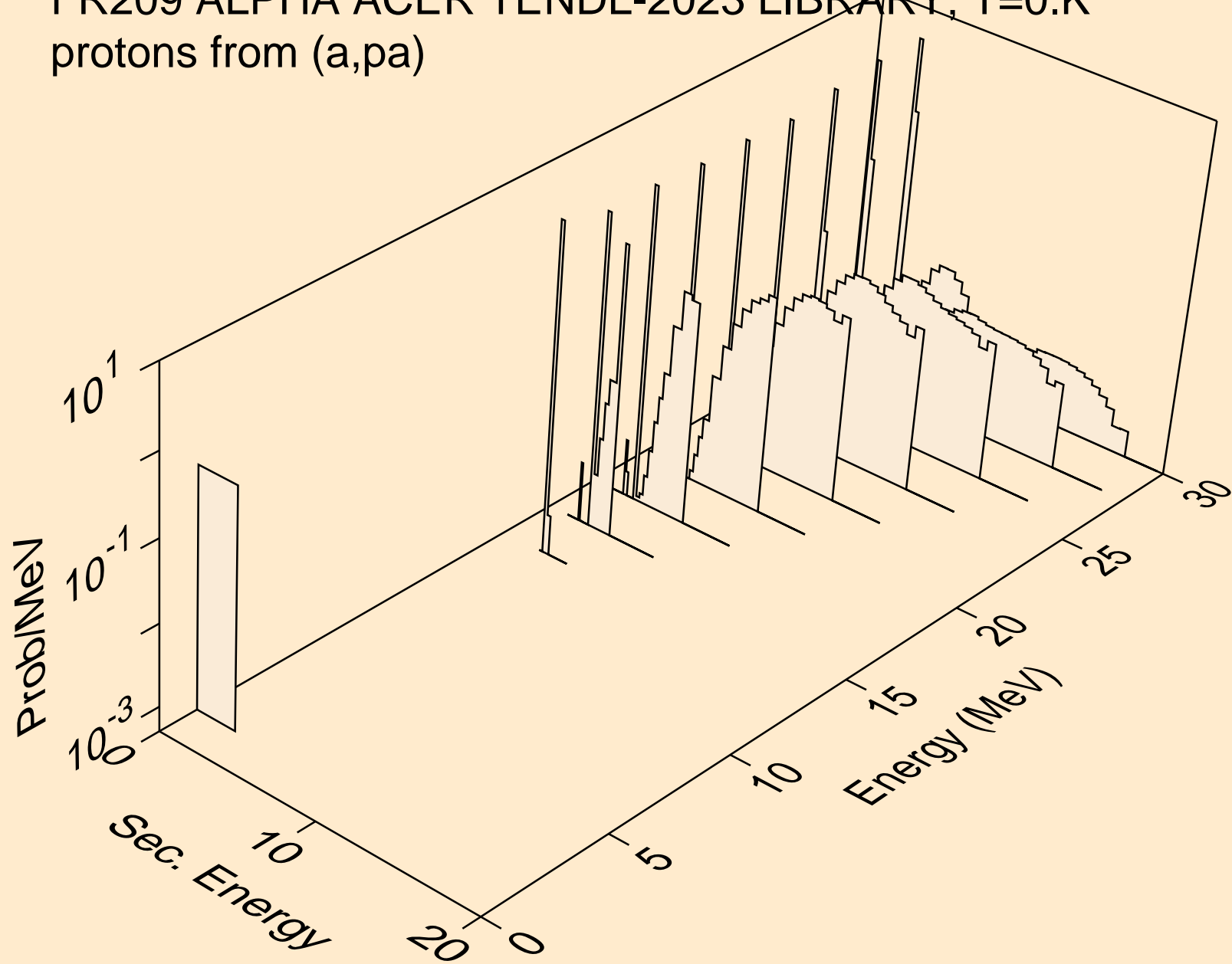

FR209 ALPHA ACER TENDL-2023 LIBRARY; T=0.K  
deuterons from (a,x)

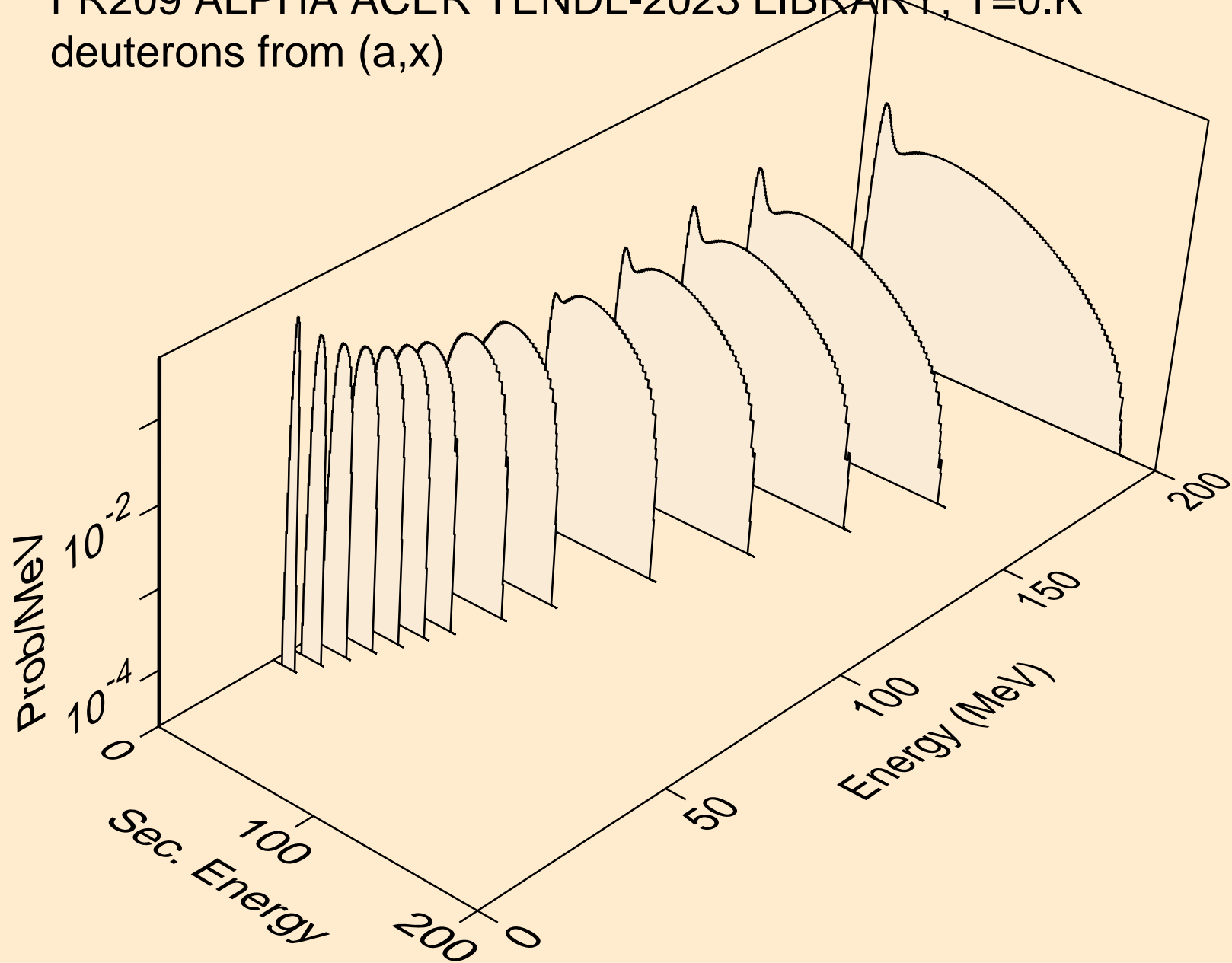



FR209 ALPHA ACER TENDL-2023 LIBRARY; T=0.K  
deuterons from (a,d)

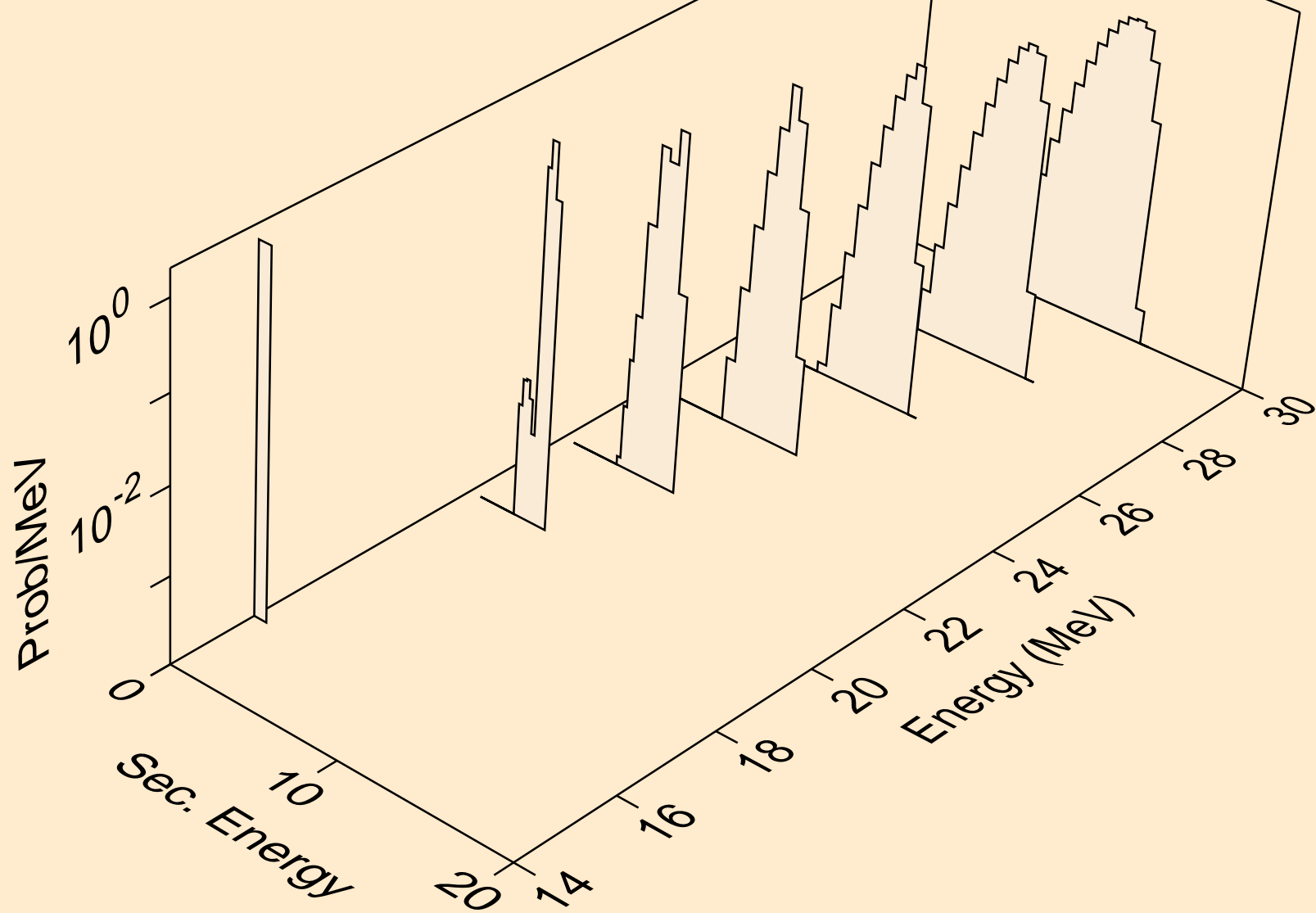

FR209 ALPHA ACER TENDL-2023 LIBRARY; T=0.K  
deuterons from (a,da)

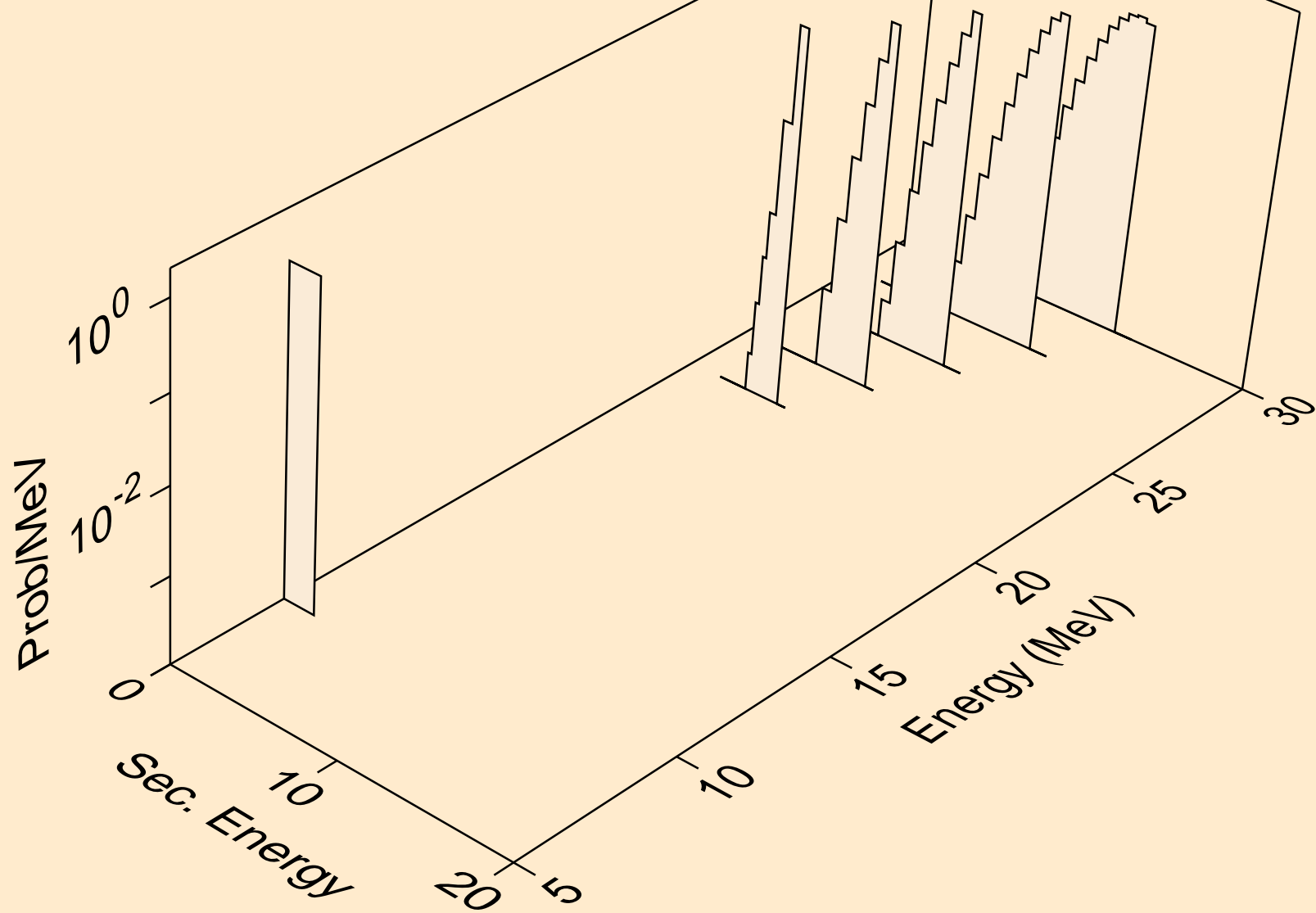

FR209 ALPHA ACER TENDL-2023 LIBRARY; T=0.K  
tritons from (a,x)

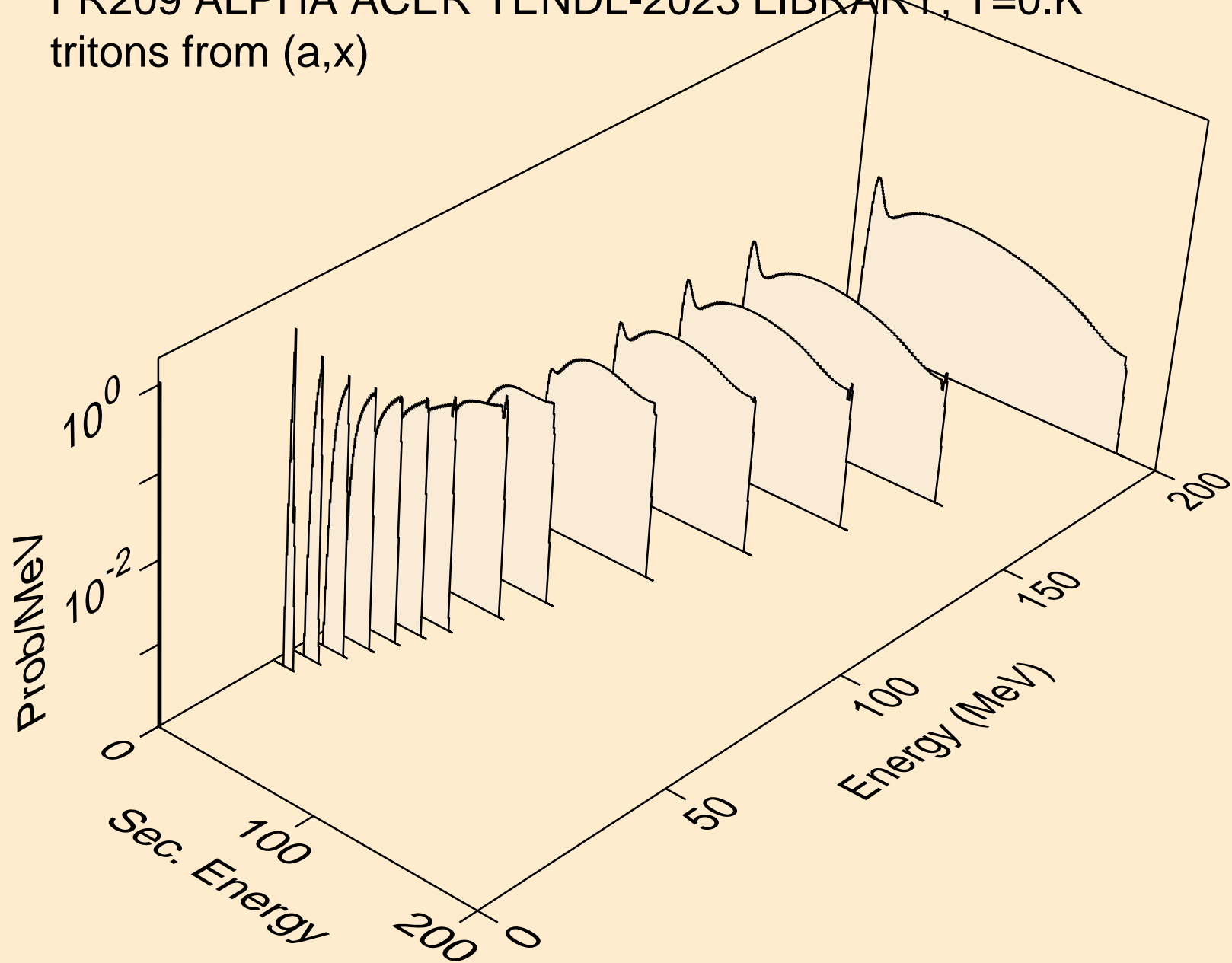

FR209 ALPHA ACER TENDL-2023 LIBRARY; T=0.K  
tritons from (a,t)

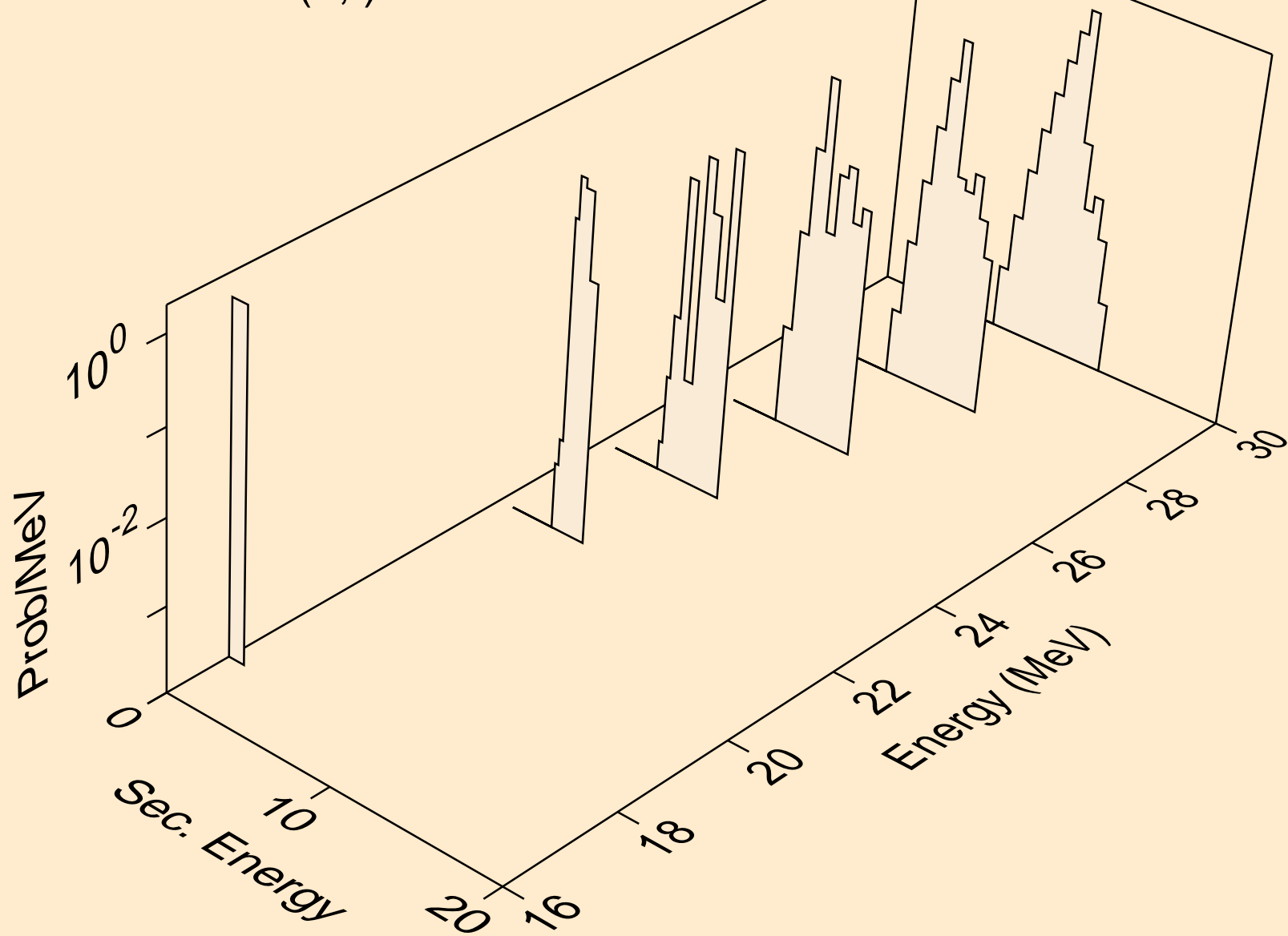

FR209 ALPHA ACER TENDL-2023 LIBRARY; T=0.K  
he3s from (a,x)

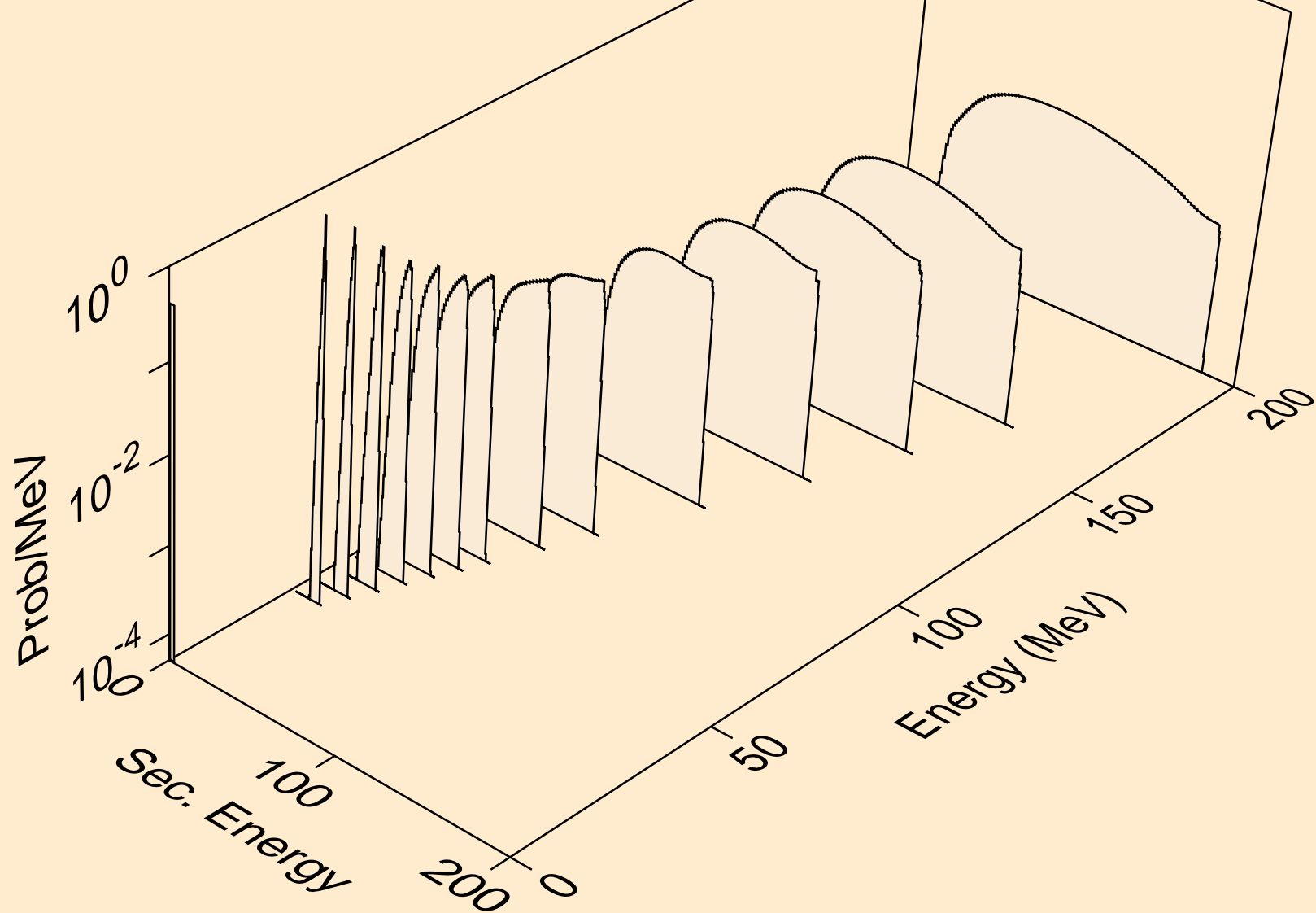

FR209 ALPHA ACER TENDL-2023 LIBRARY; T=0.K  
he3s from (a,he3)

