

MD248 ALPHA ACER TENDL-2023 LIBRARY; T=0.K
Principal cross sections

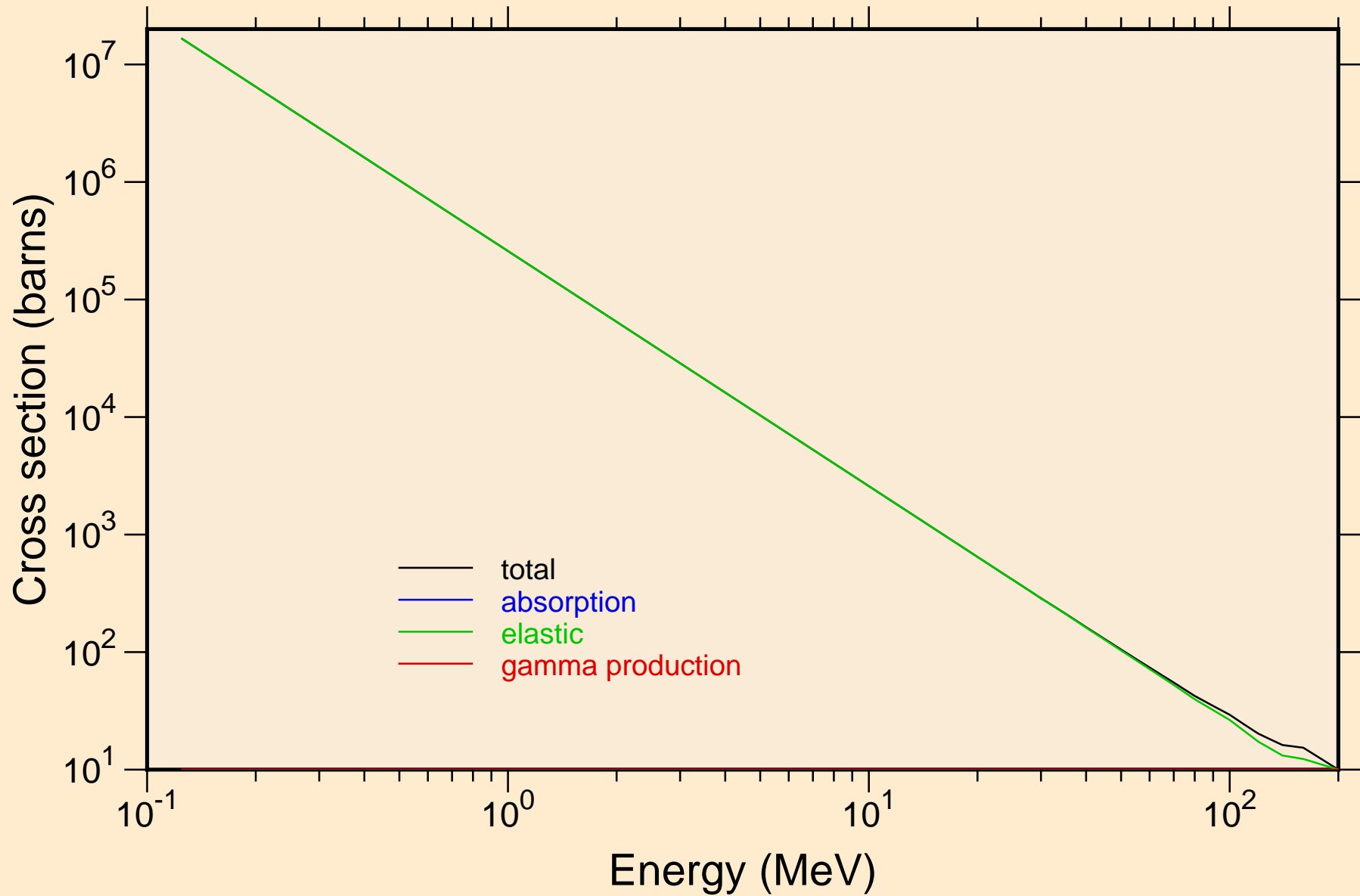

MD248 ALPHA ACER TENDL-2023 LIBRARY; T=0.K
Heating

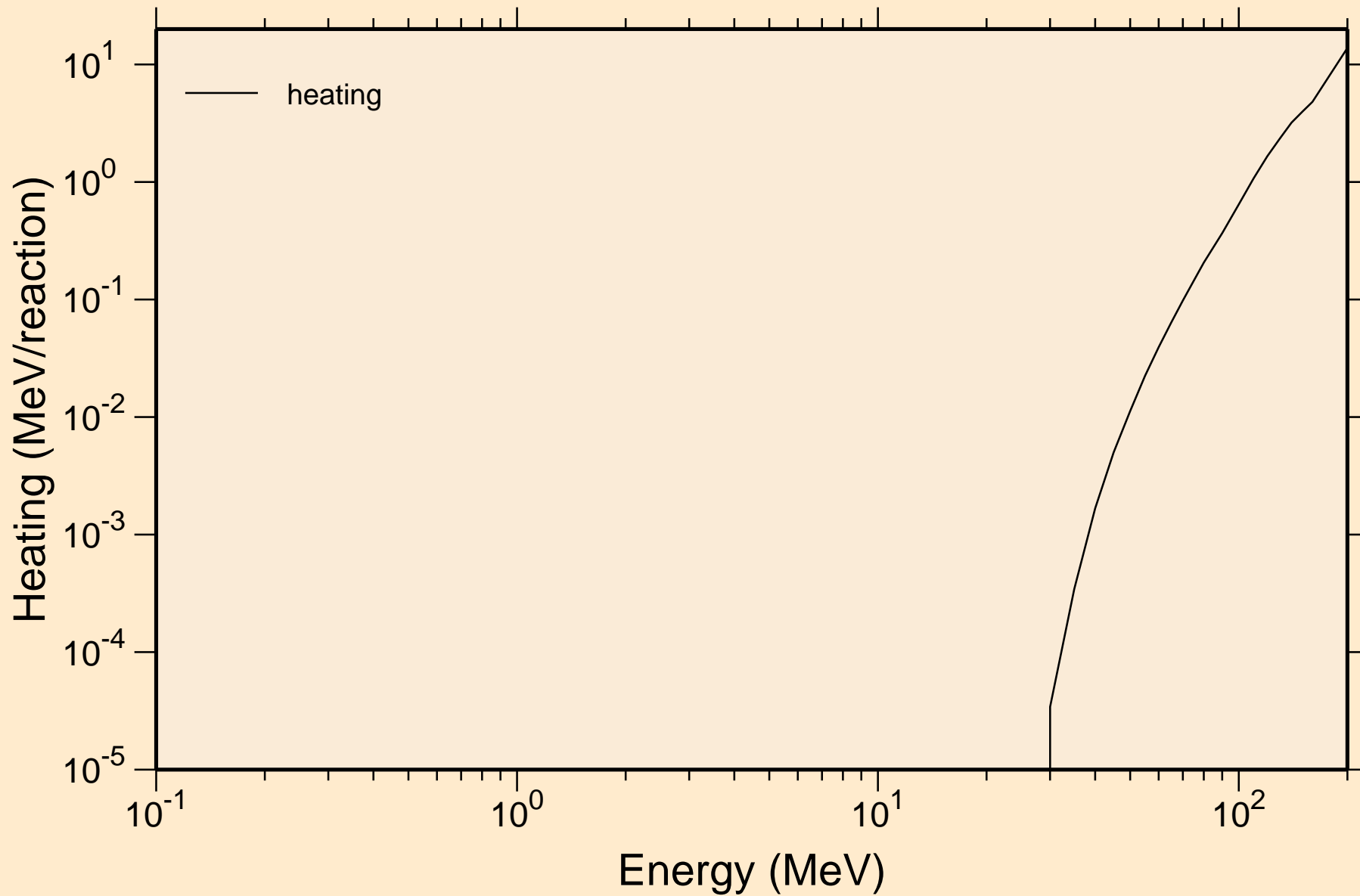

MD248 ALPHA ACER TENDL-2023 LIBRARY; T=0.K

Principal cross sections

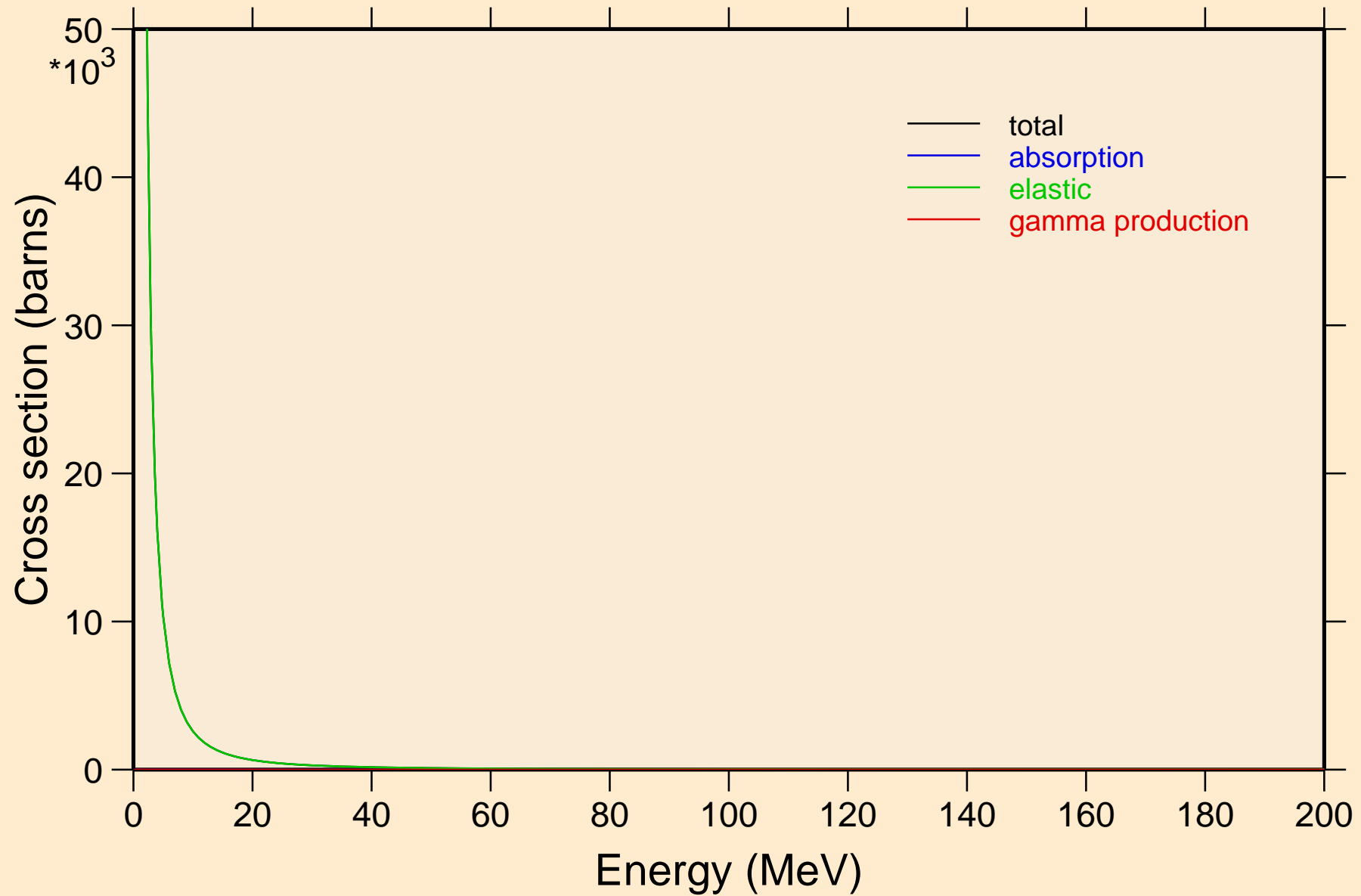

MD248 ALPHA ACER TENDL-2023 LIBRARY; T=0.K

Heating

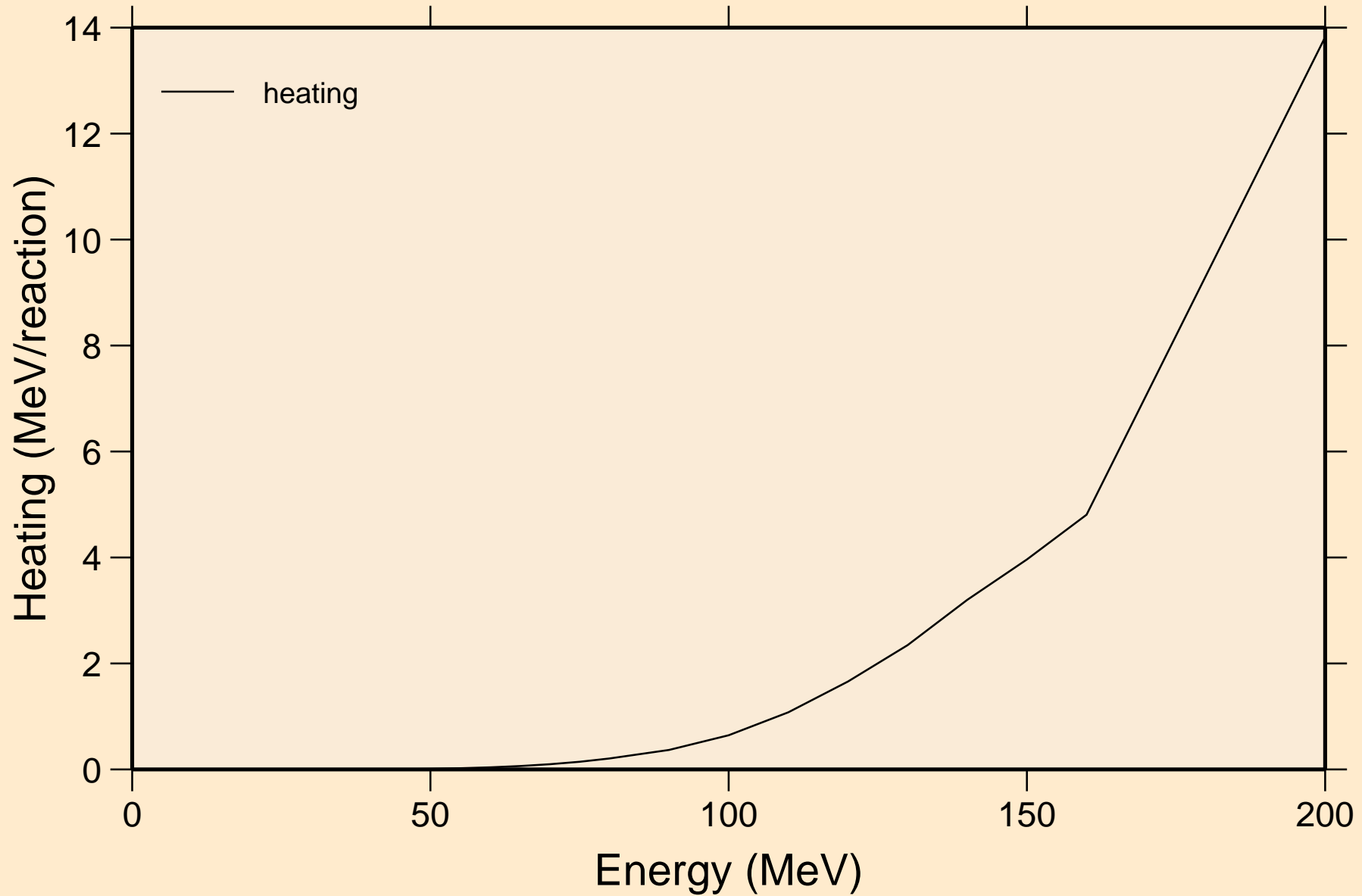

MD248 ALPHA ACER TENDL-2023 LIBRARY; T=0.K
Threshold reactions

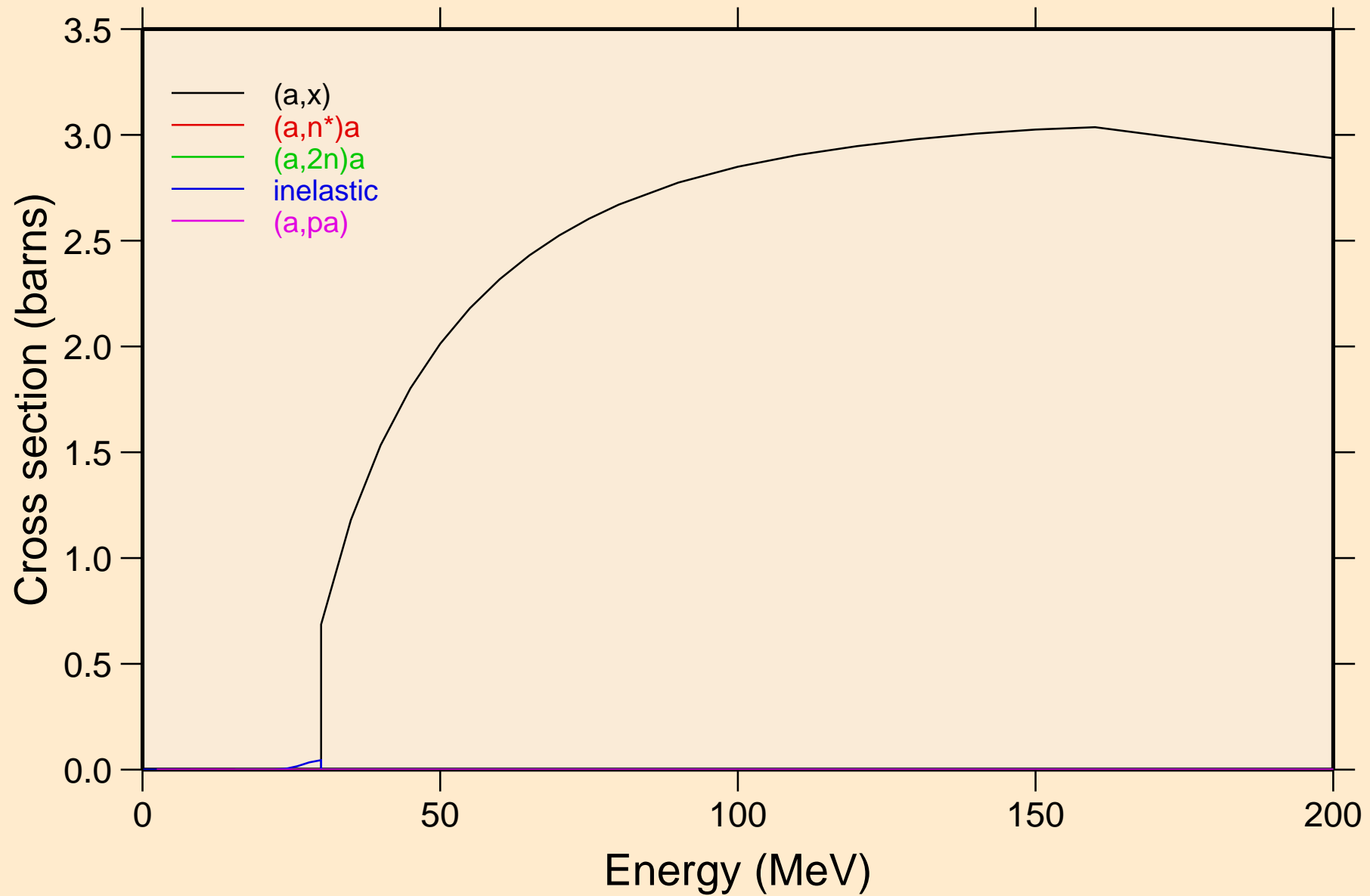

MD248 ALPHA ACER TENDL-2023 LIBRARY; T=0.K
Threshold reactions

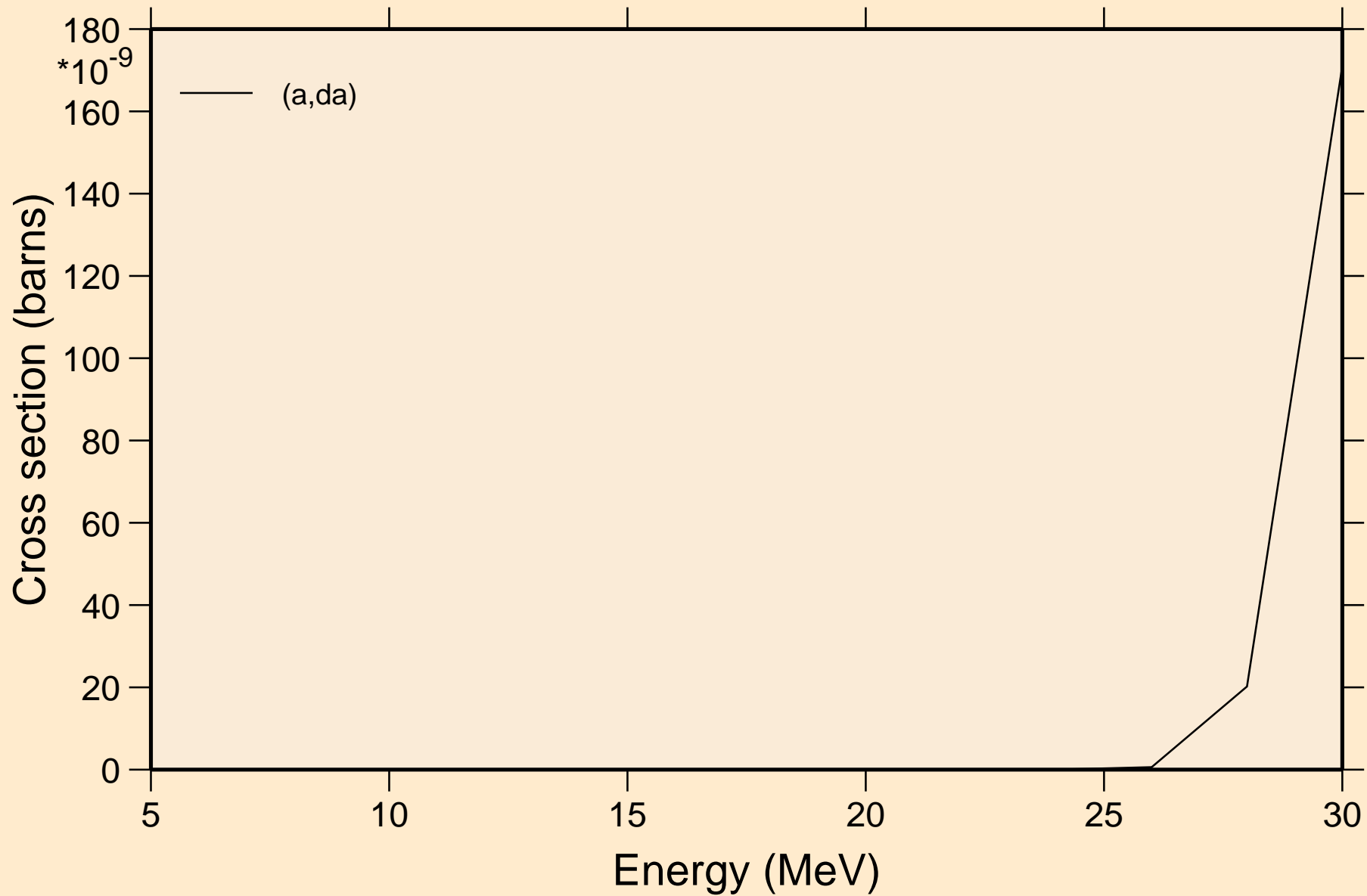

MD248 ALPHA ACER TENDL-2023 LIBRARY; T=0.K
angular distribution for elastic

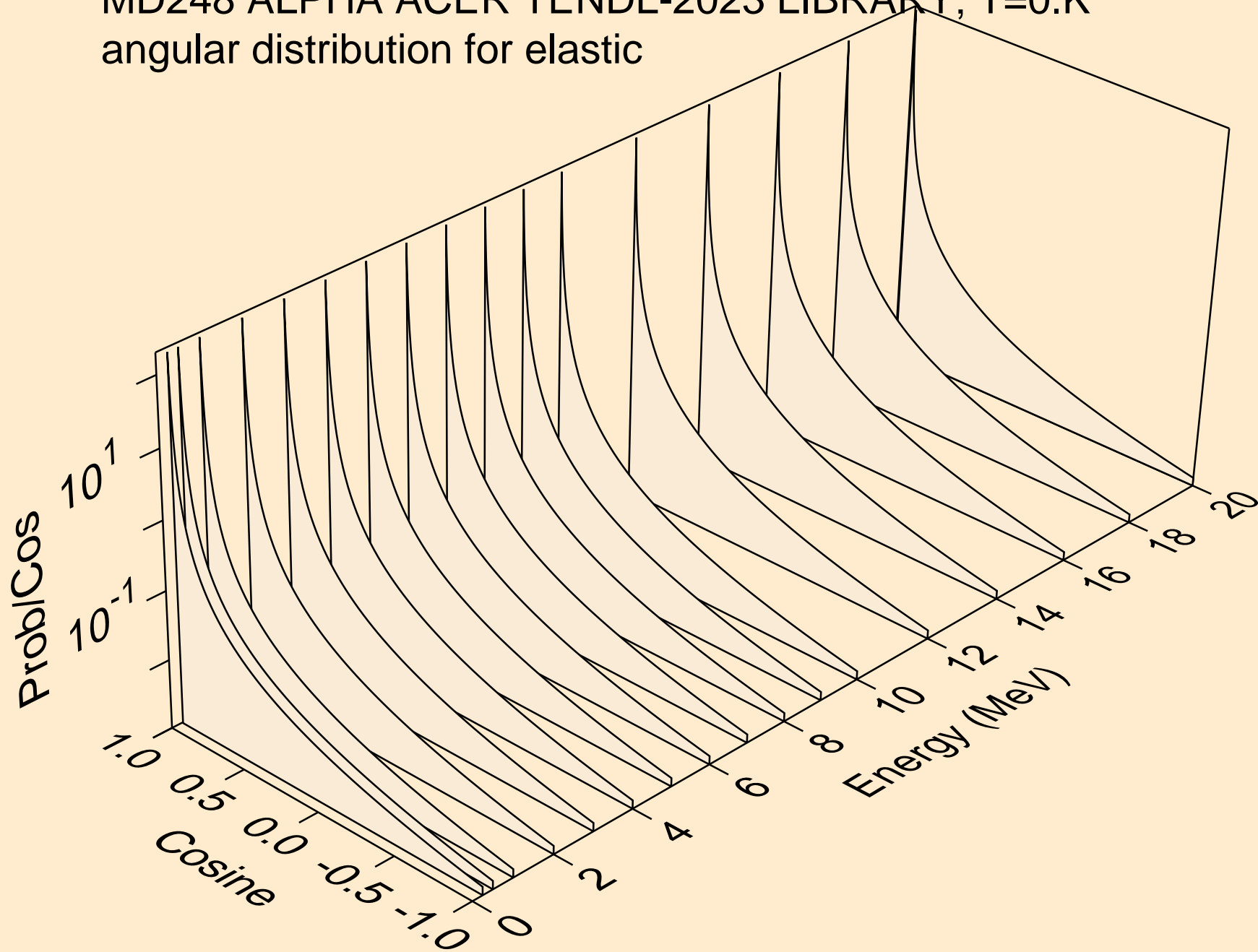

MD248 ALPHA ACER TENDL-2023 LIBRARY; T=0.K
angular distribution for elastic

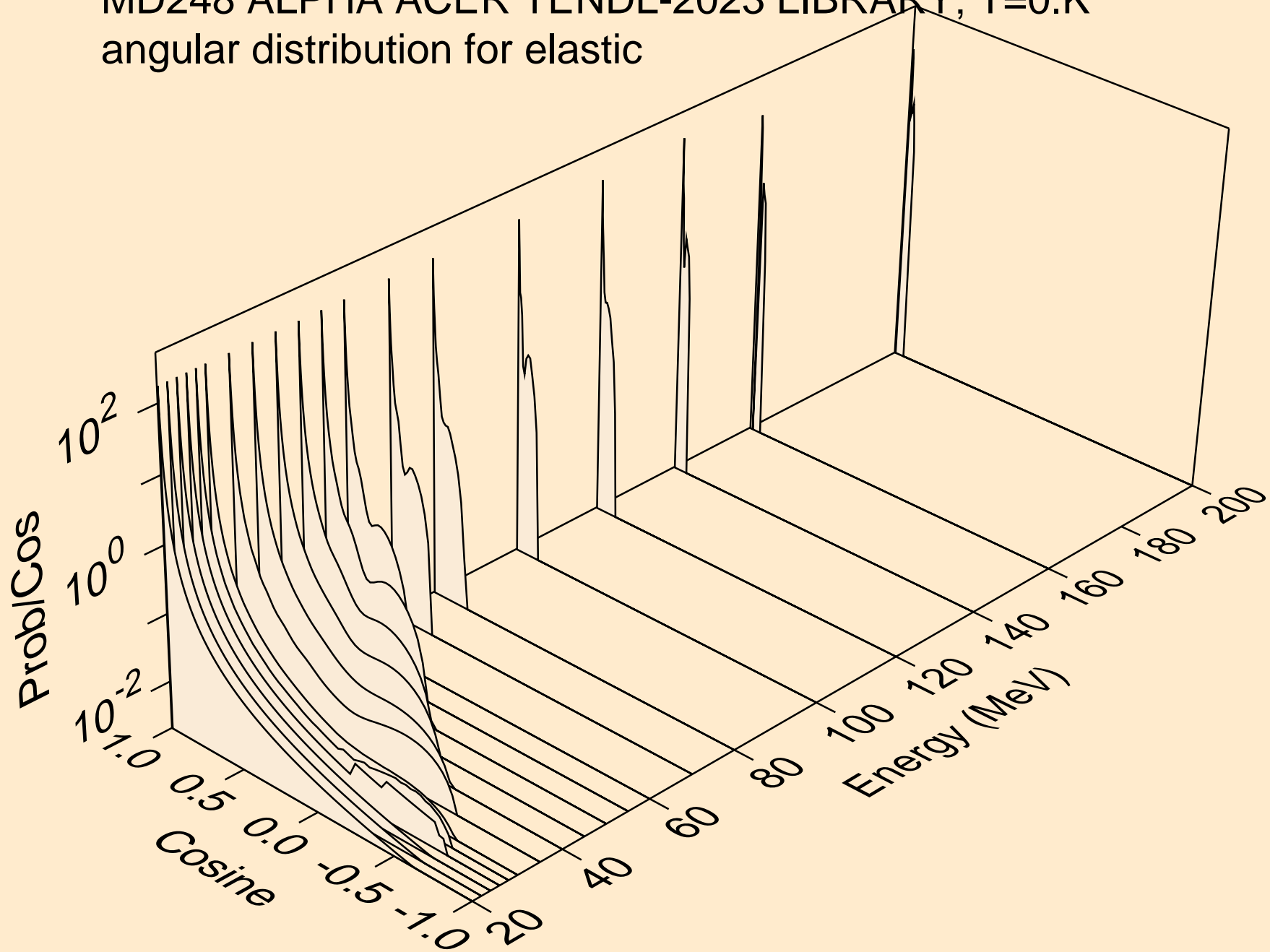

MD248 ALPHA ACER TENDL-2023 LIBRARY; T=0.K
Alpha emission for (a,x)

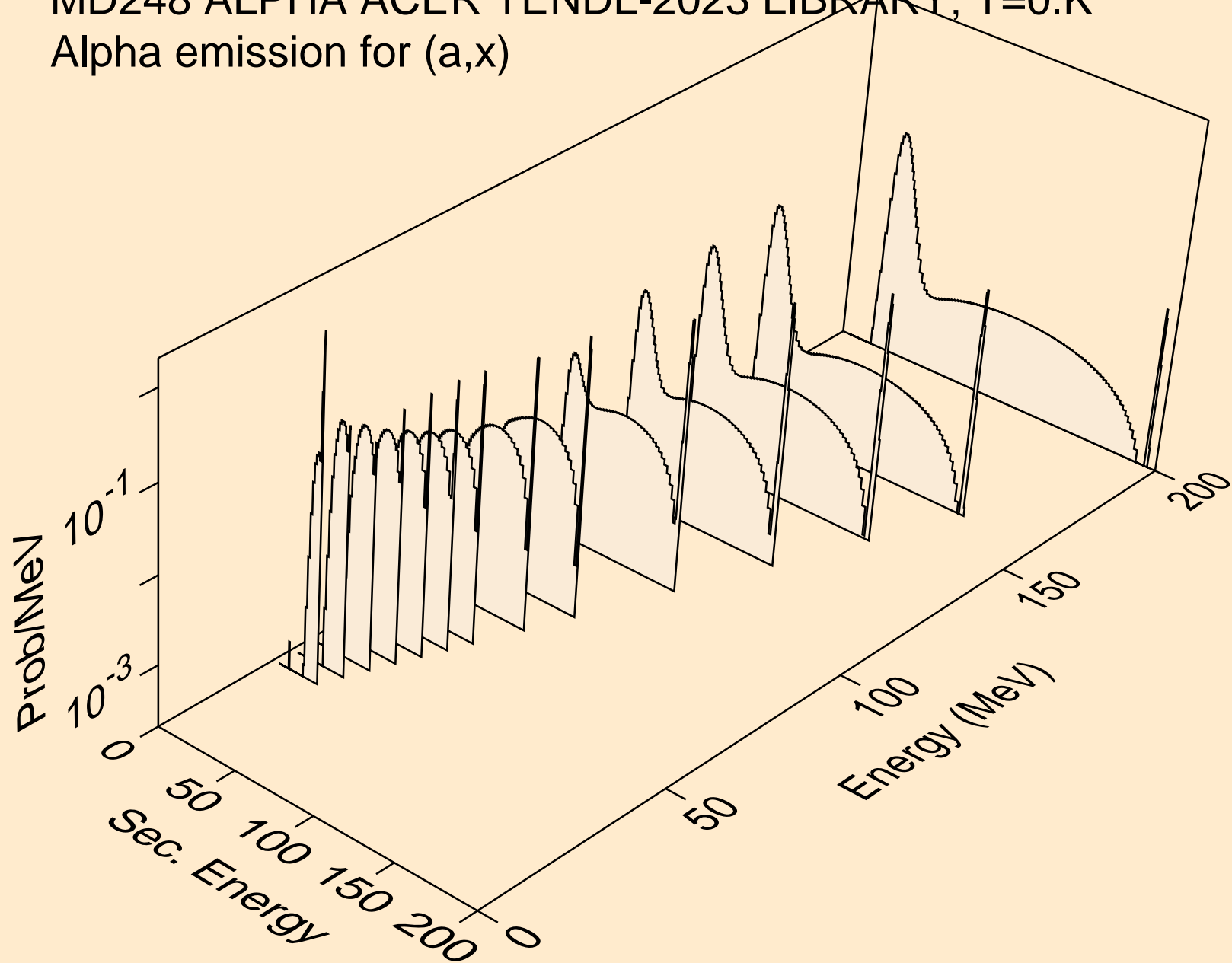

MD248 ALPHA ACER TENDL-2023 LIBRARY; T=0.K
Alpha emission for (a,n*)a

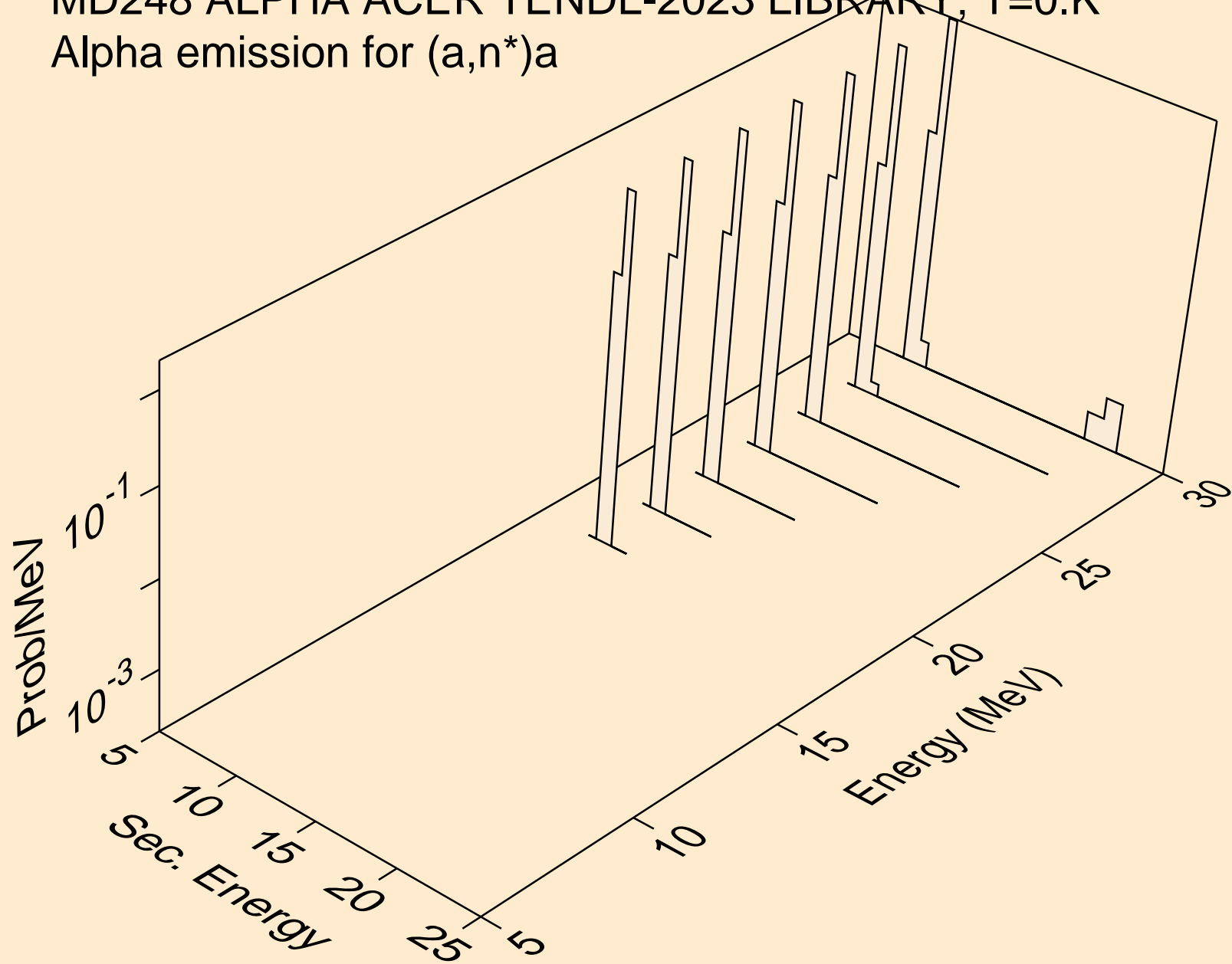

MD248 ALPHA ACER TENDL-2023 LIBRARY; T=0.K
Alpha emission for (a,2n)a

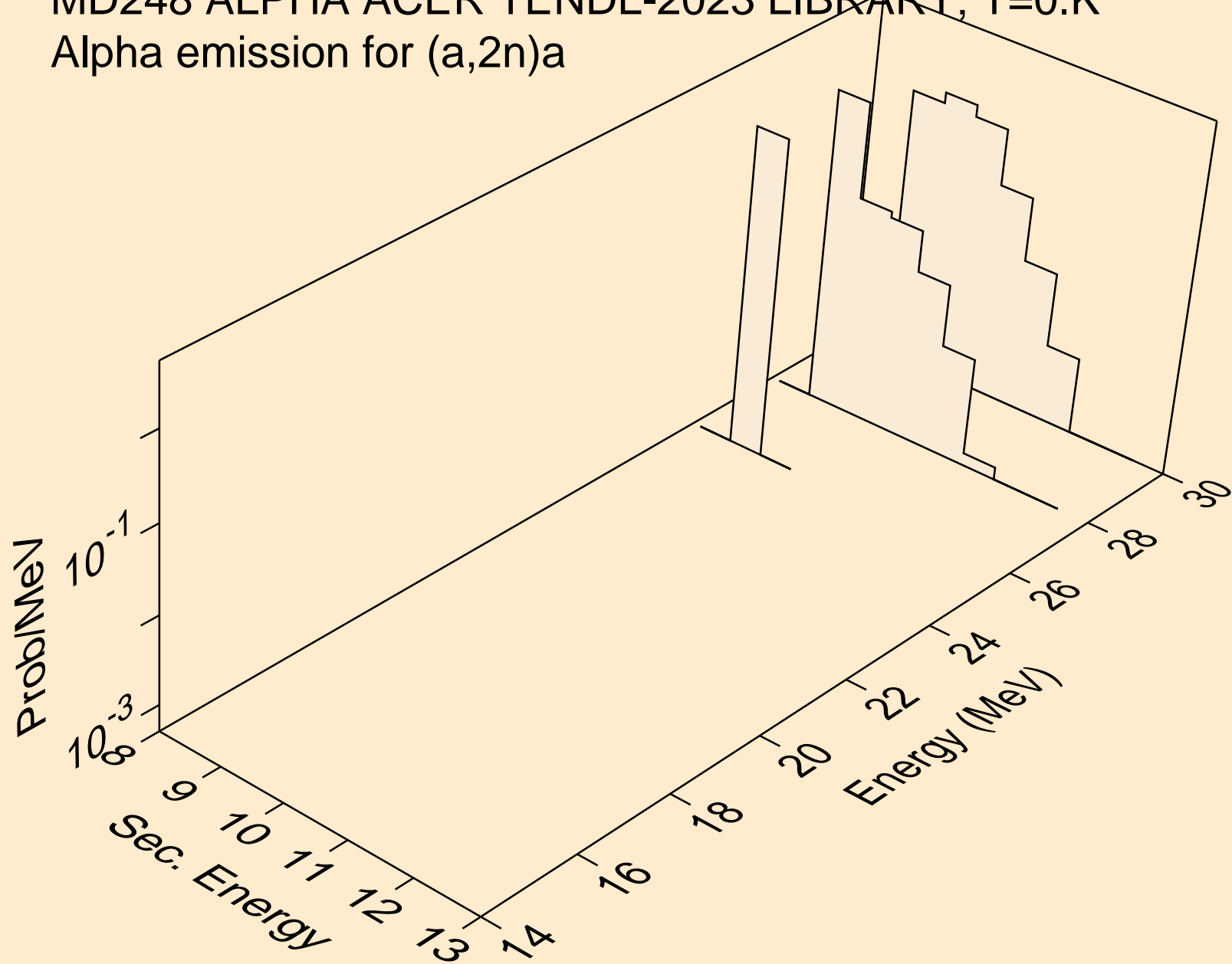

MD248 ALPHA ACER TENDL-2023 LIBRARY; T=0.K
Alpha emission for inelastic

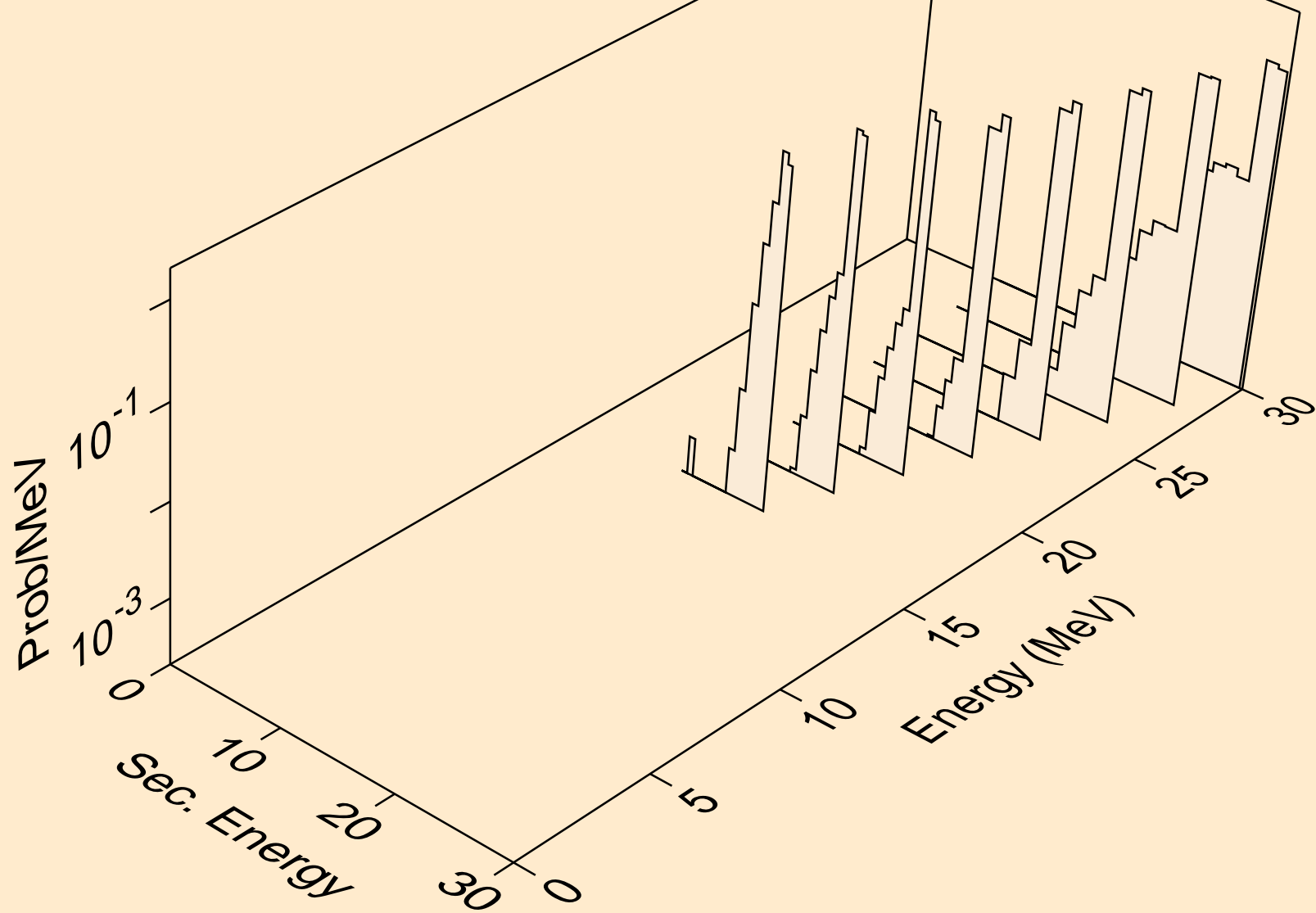

MD248 ALPHA ACER TENDL-2023 LIBRARY; T=0.K
Alpha emission for (a,pa)

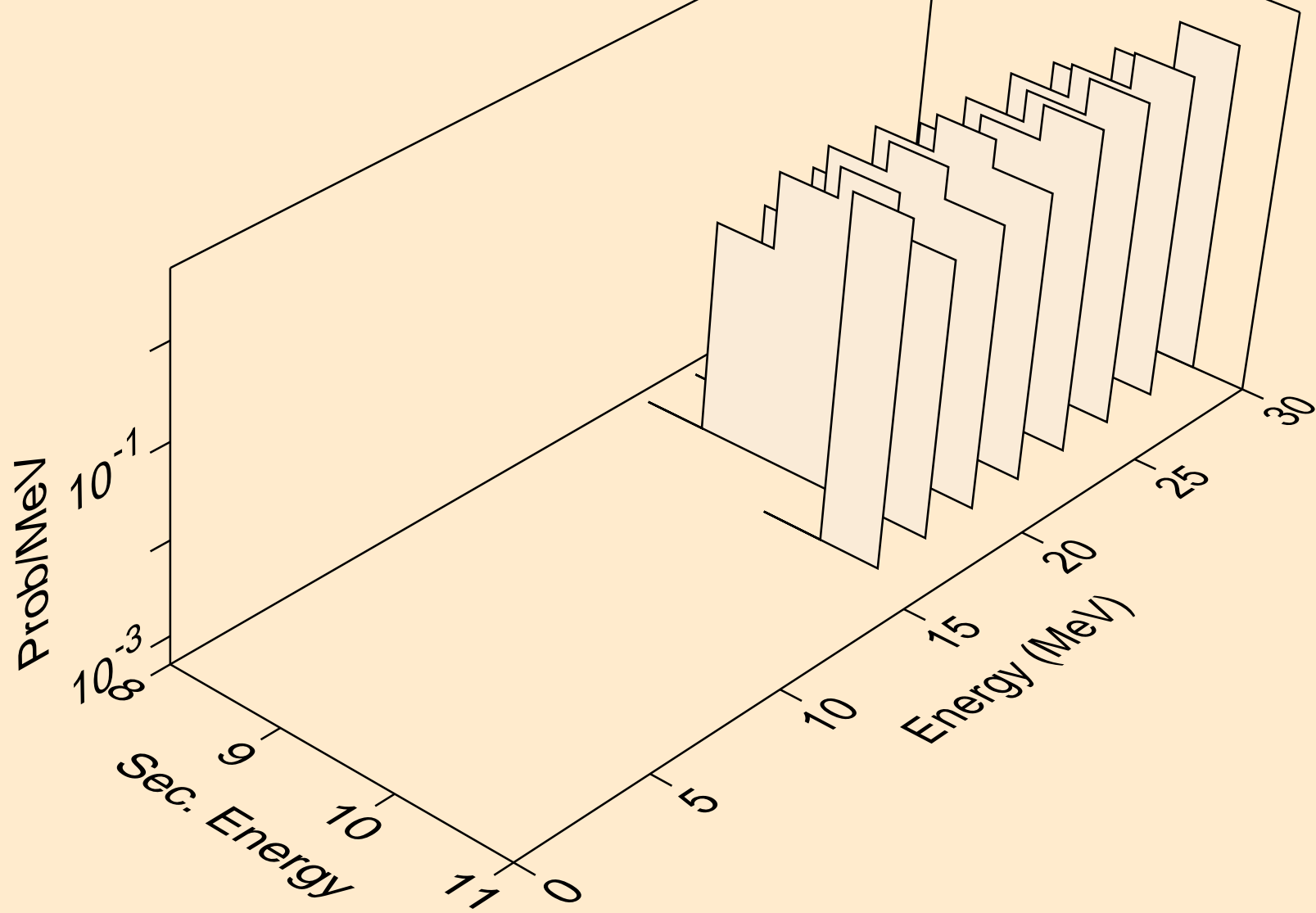

MD248 ALPHA ACER TENDL-2023 LIBRARY; T=0.K
Alpha emission for (a,da)

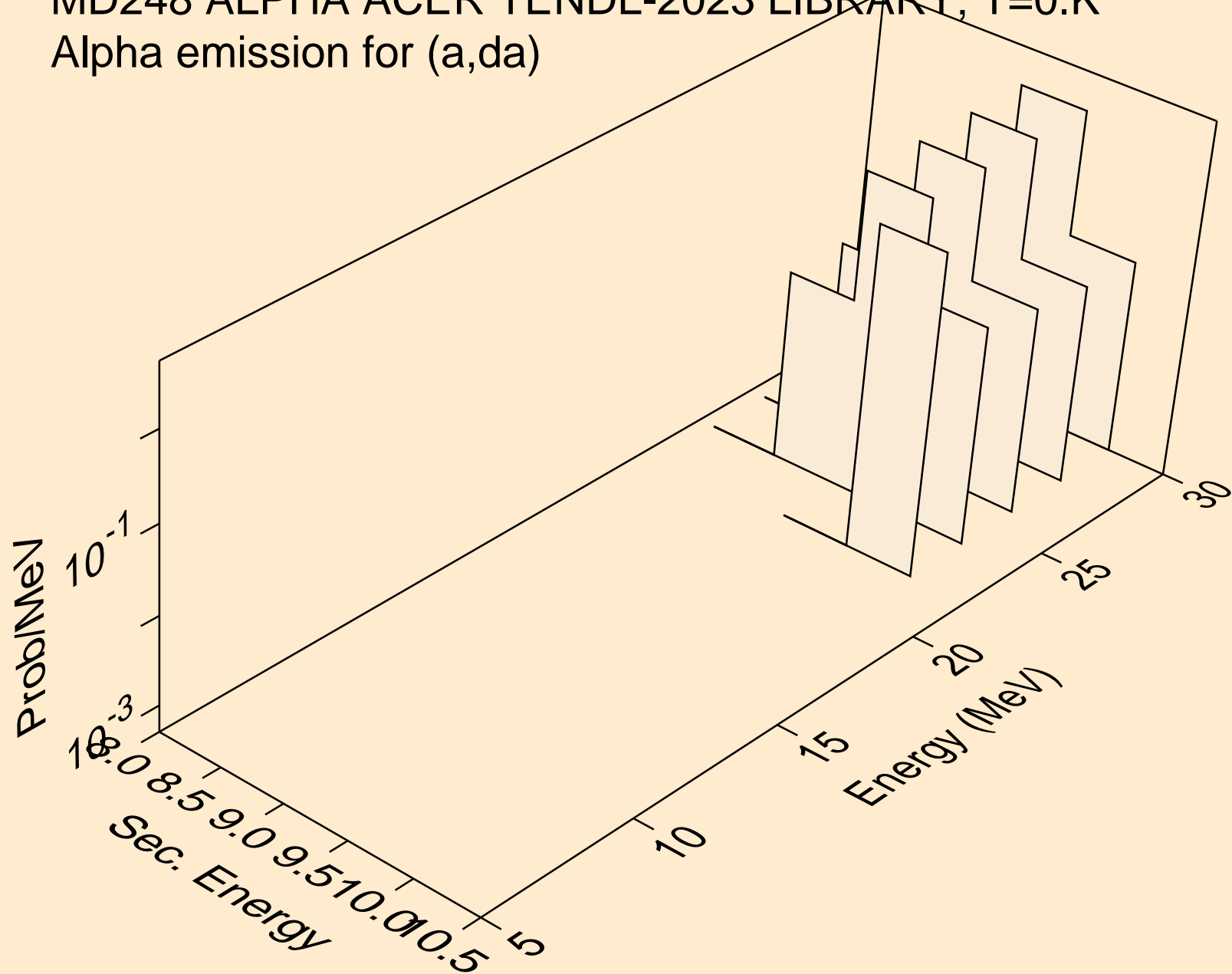

MD248 ALPHA ACER TENDL-2023 LIBRARY; T=0.K
Photon emission for (z,n)

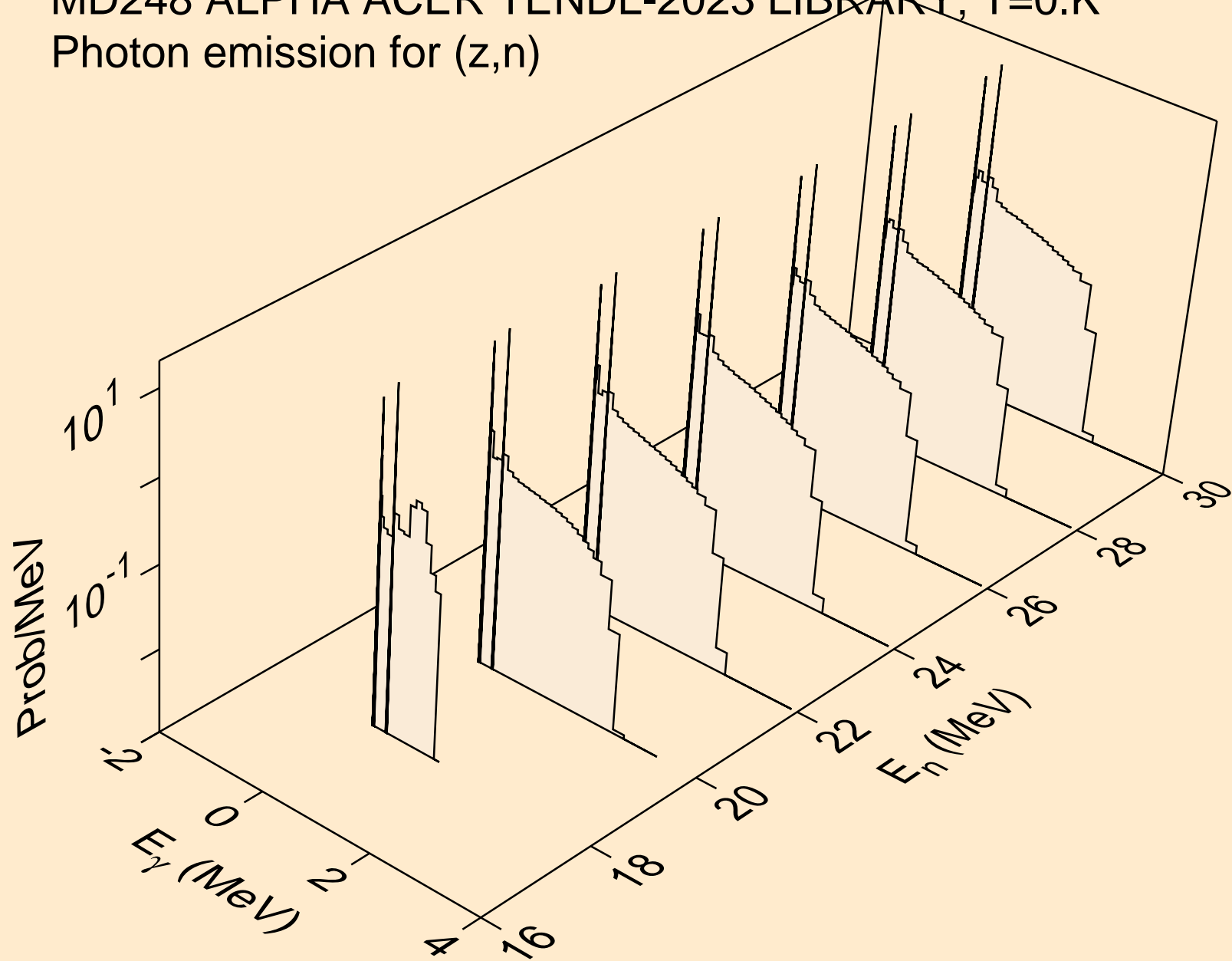

MD248 ALPHA ACER TENDL-2023 LIBRARY; T=0.K
Photon emission for (z,x)

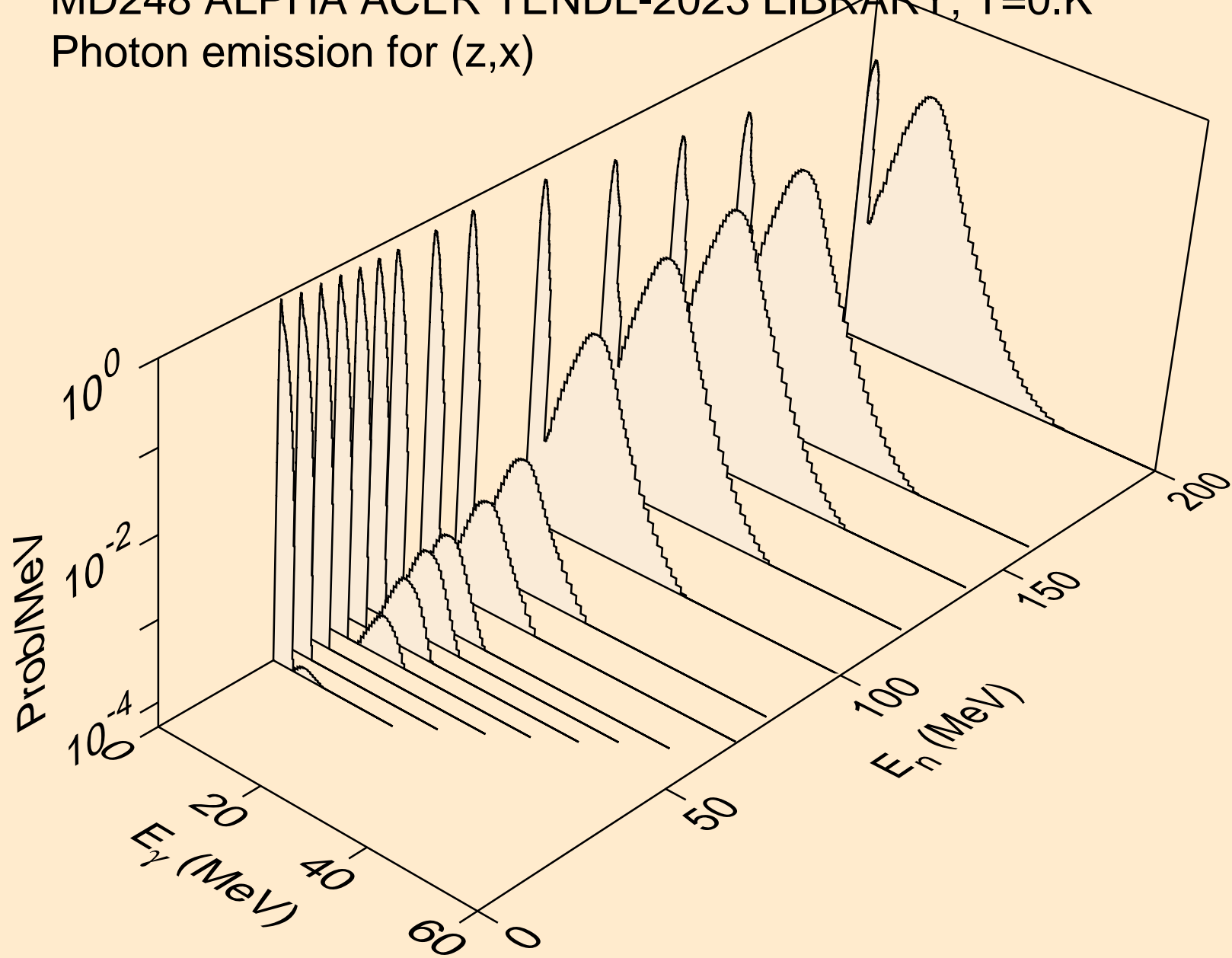

MD248 ALPHA ACER TENDL-2023 LIBRARY; T=0.K
Photon emission for (n,2n)

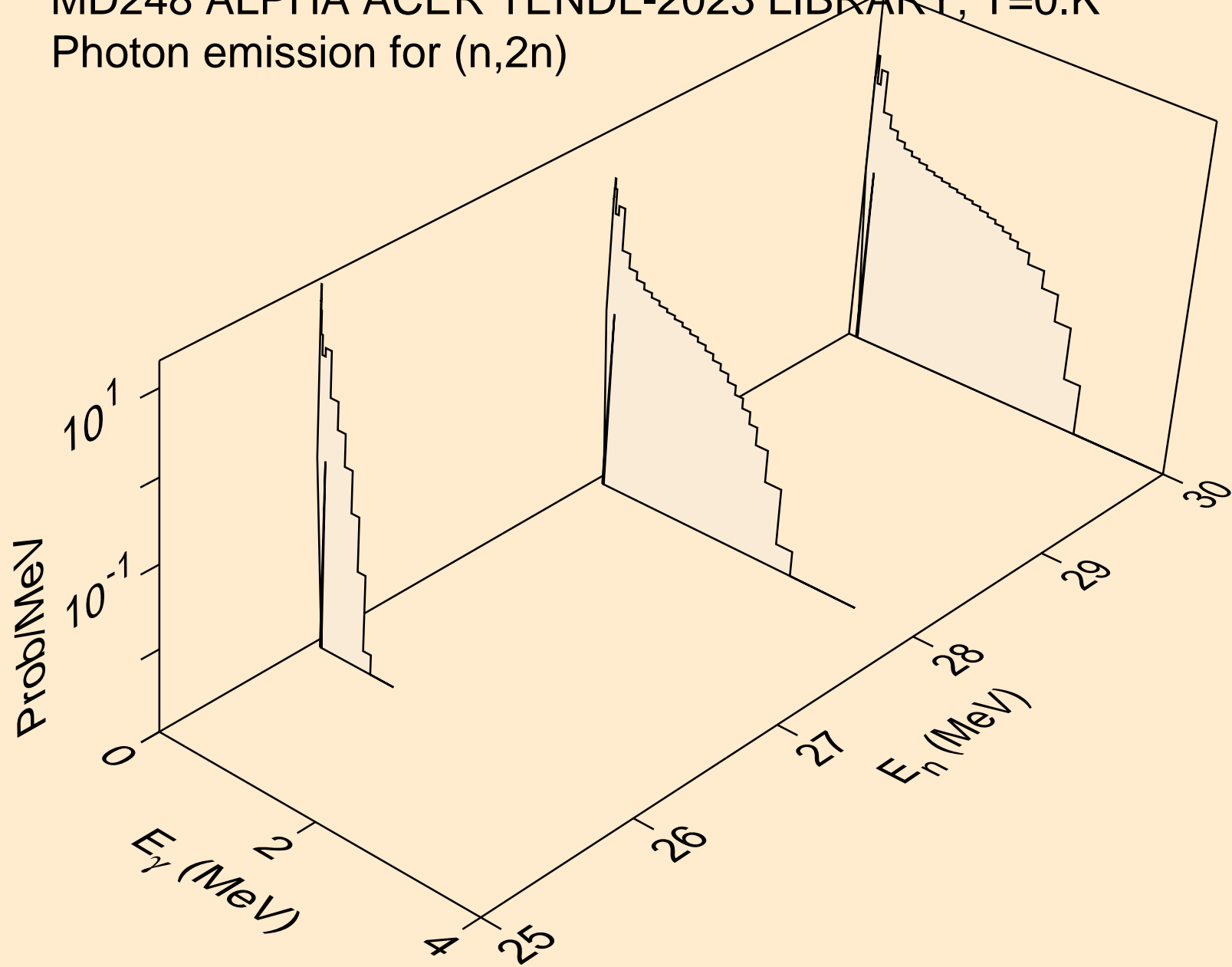

MD248 ALPHA ACER TENDL-2023 LIBRARY; T=0.K
Photon emission for (n,n*)a

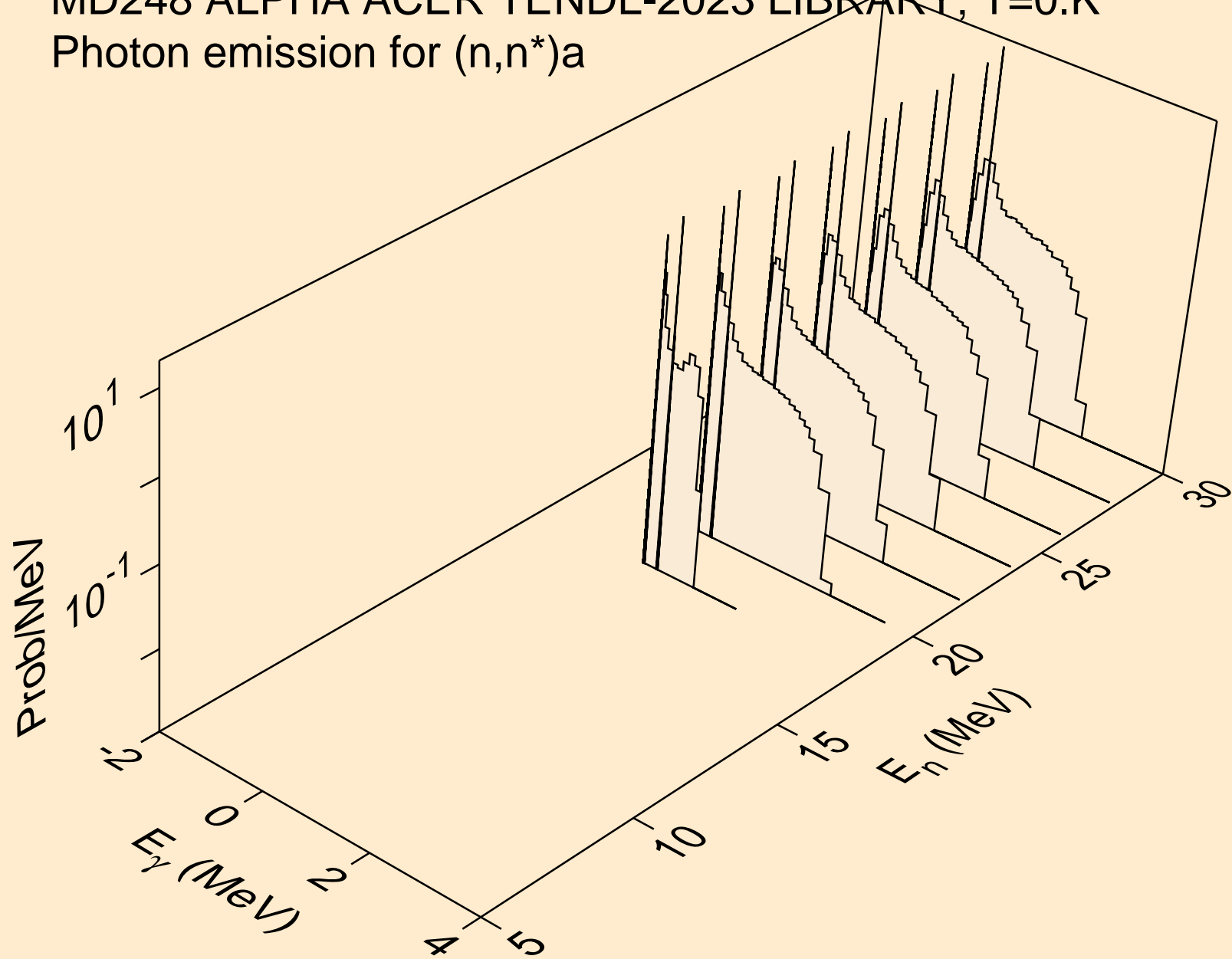

MD248 ALPHA ACER TENDL-2023 LIBRARY; T=0.K
Photon emission for (n,2n)a

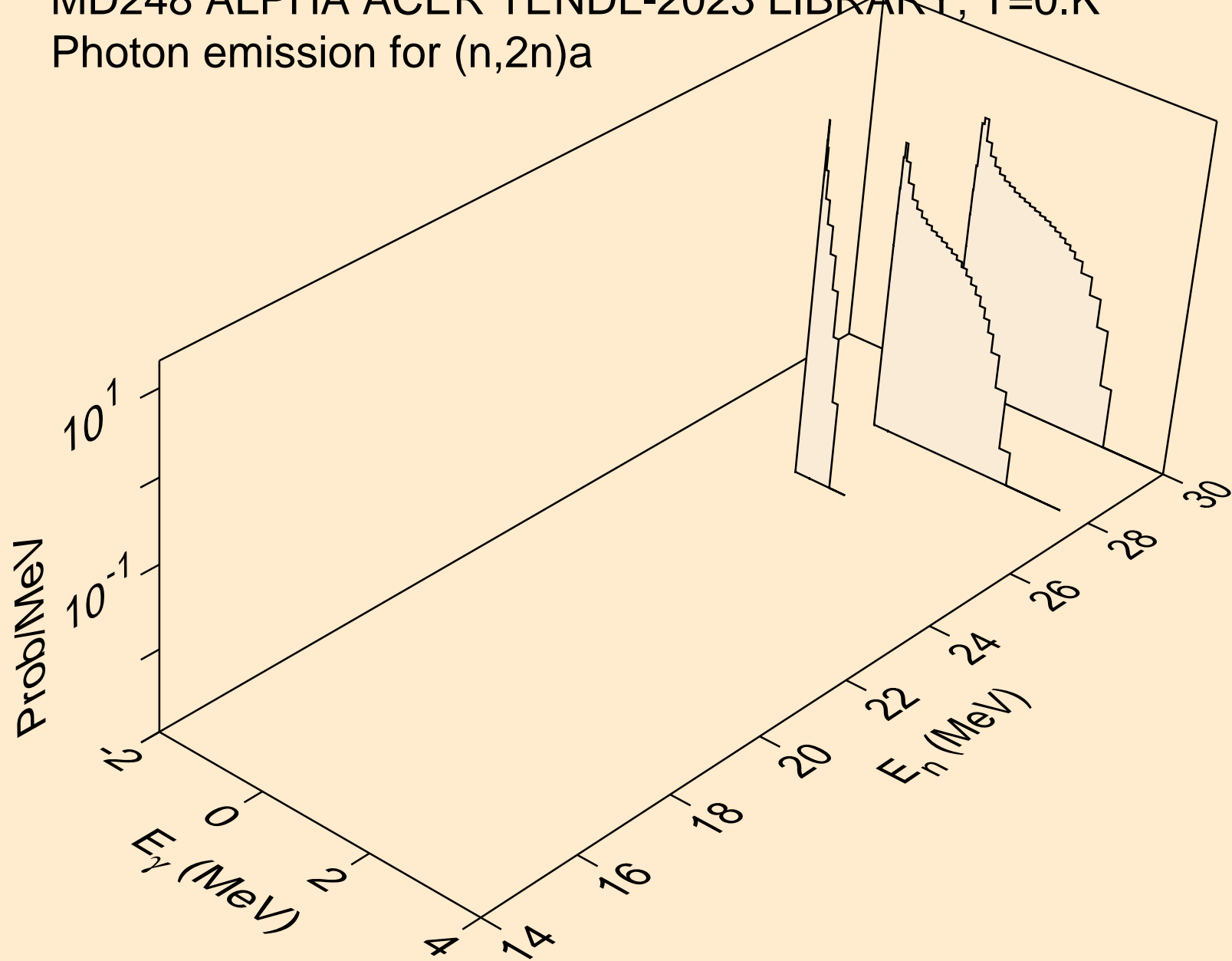

MD248 ALPHA ACER TENDL-2023 LIBRARY; T=0.K
Photon emission for (n,n*)p

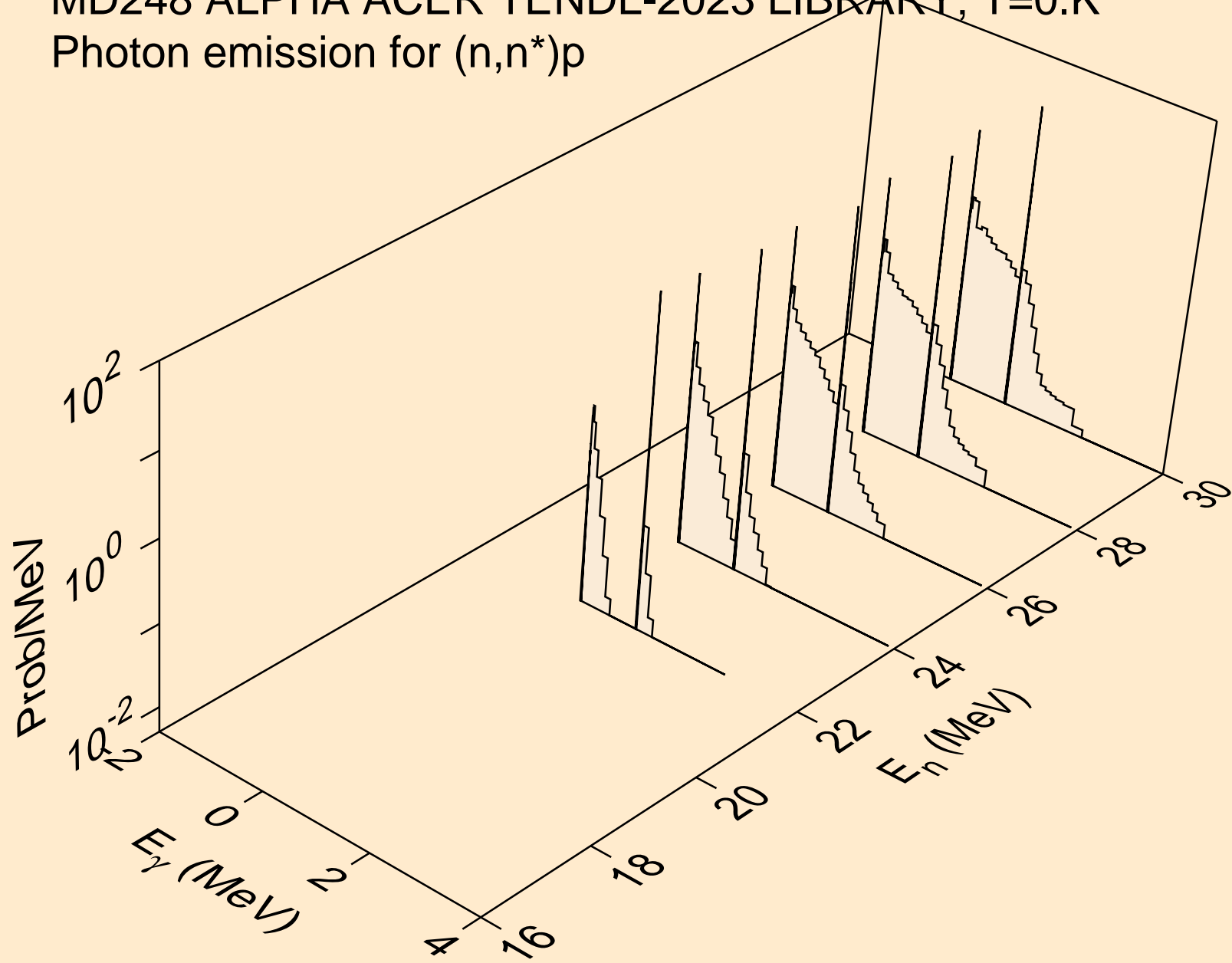

MD248 ALPHA ACER TENDL-2023 LIBRARY; T=0.K
Photon emission for (n,gma)

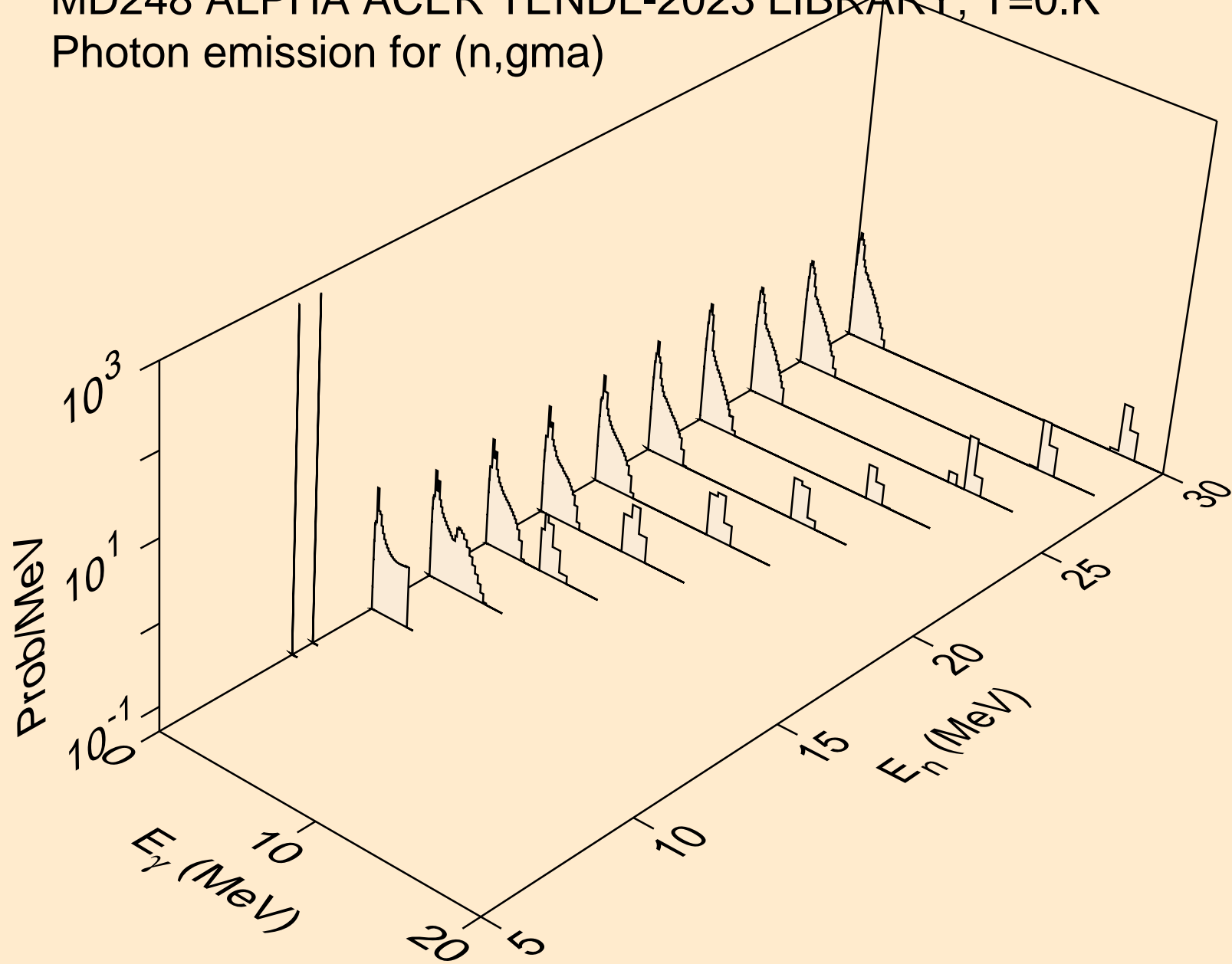

MD248 ALPHA ACER TENDL-2023 LIBRARY; T=0.K
Photon emission for (n,p)

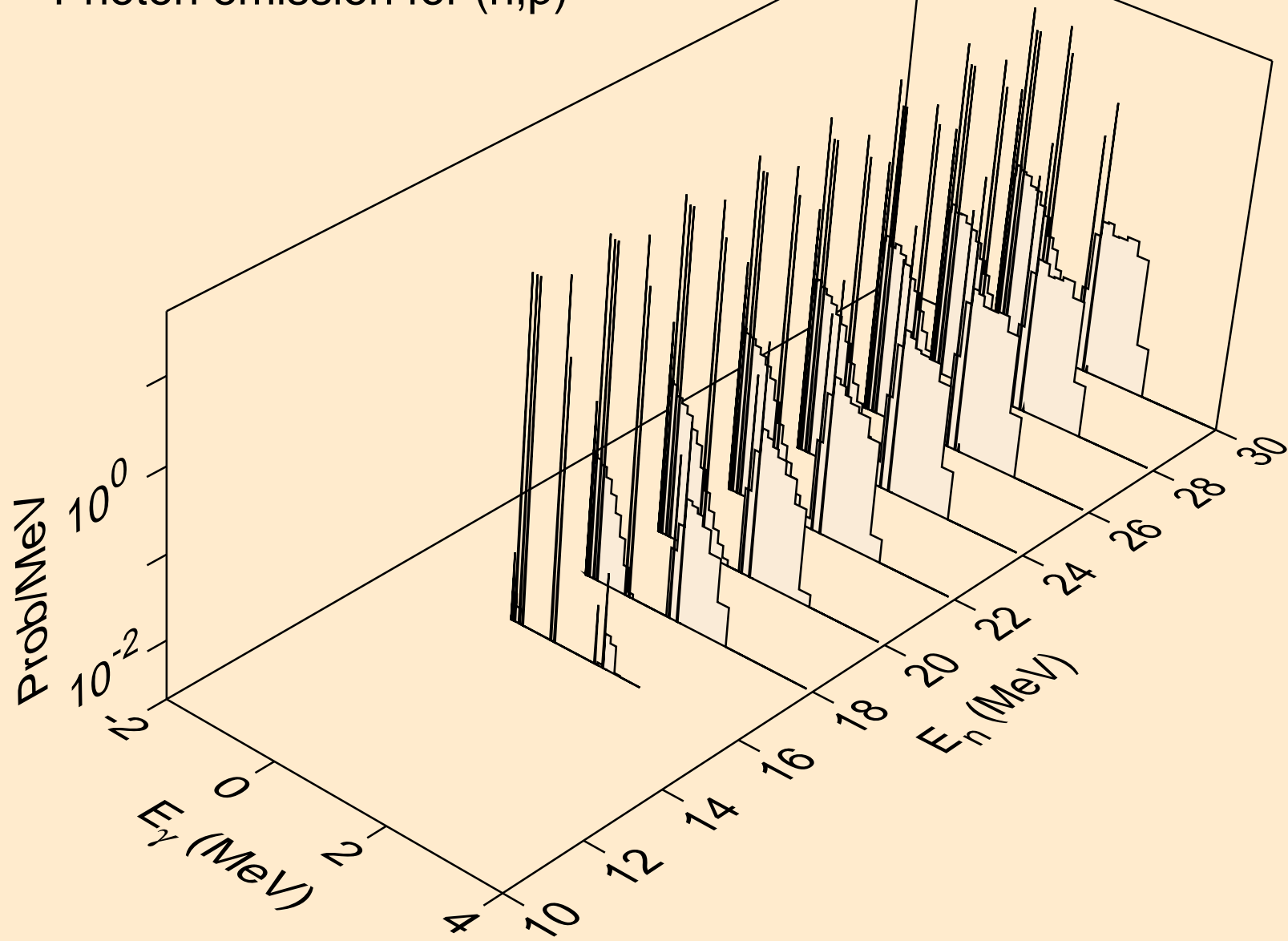

MD248 ALPHA ACER TENDL-2023 LIBRARY; T=0.K
Photon emission for (n,d)

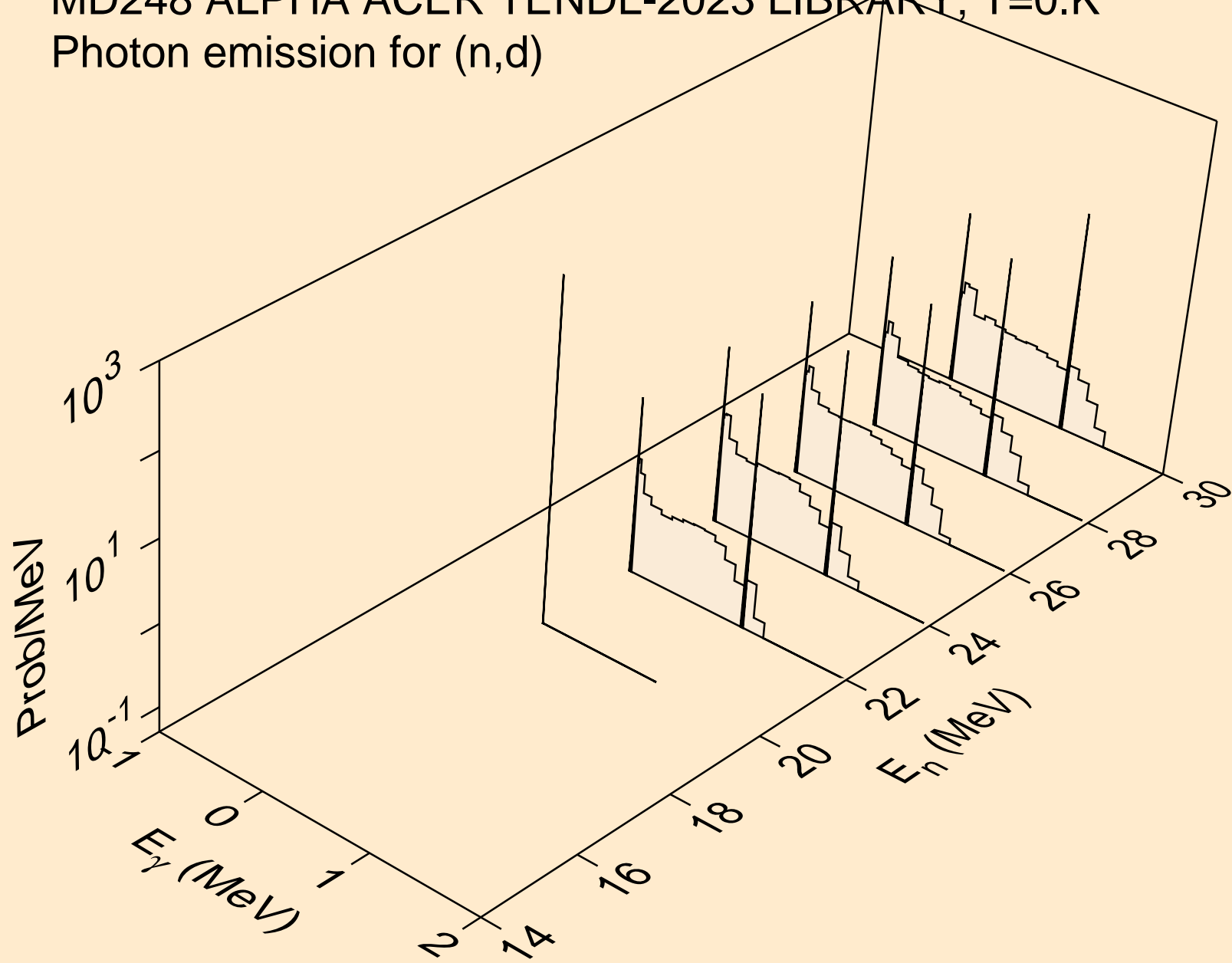

MD248 ALPHA ACER TENDL-2023 LIBRARY; T=0.K
Photon emission for (n,t)

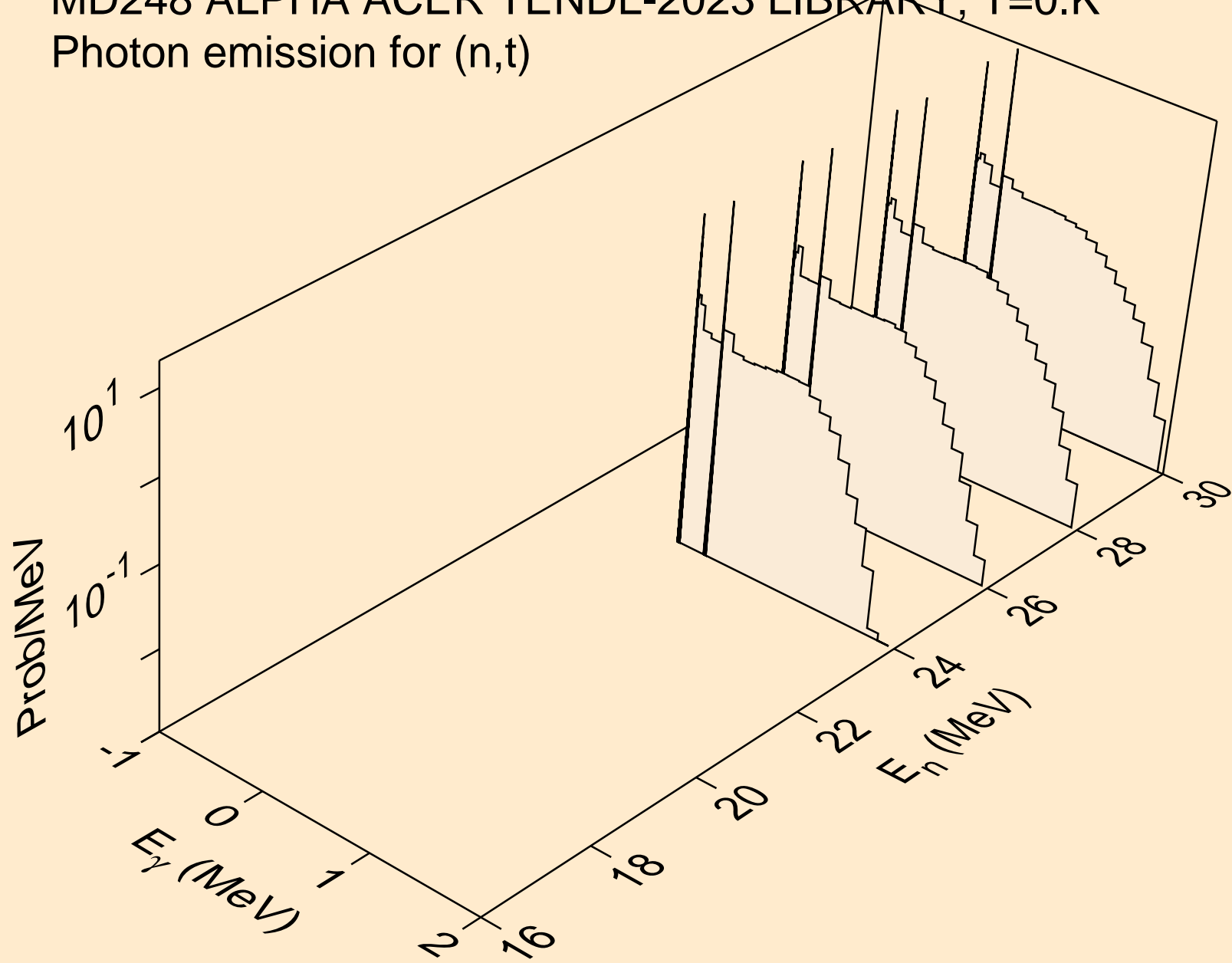

MD248 ALPHA ACER TENDL-2023 LIBRARY; T=0.K
Photon emission for (n,he3)

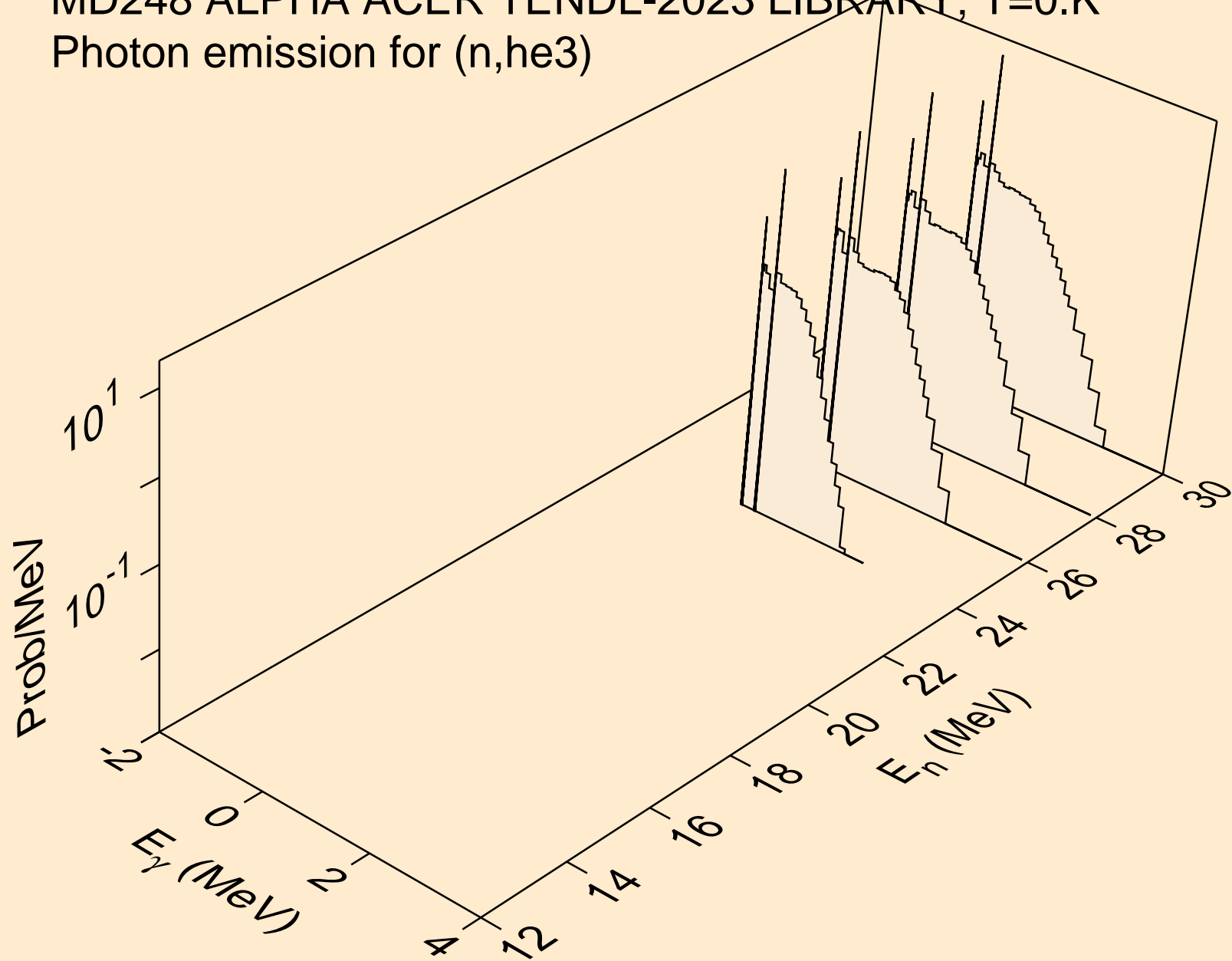

MD248 ALPHA ACER TENDL-2023 LIBRARY; T=0.K
Photon emission for inelastic

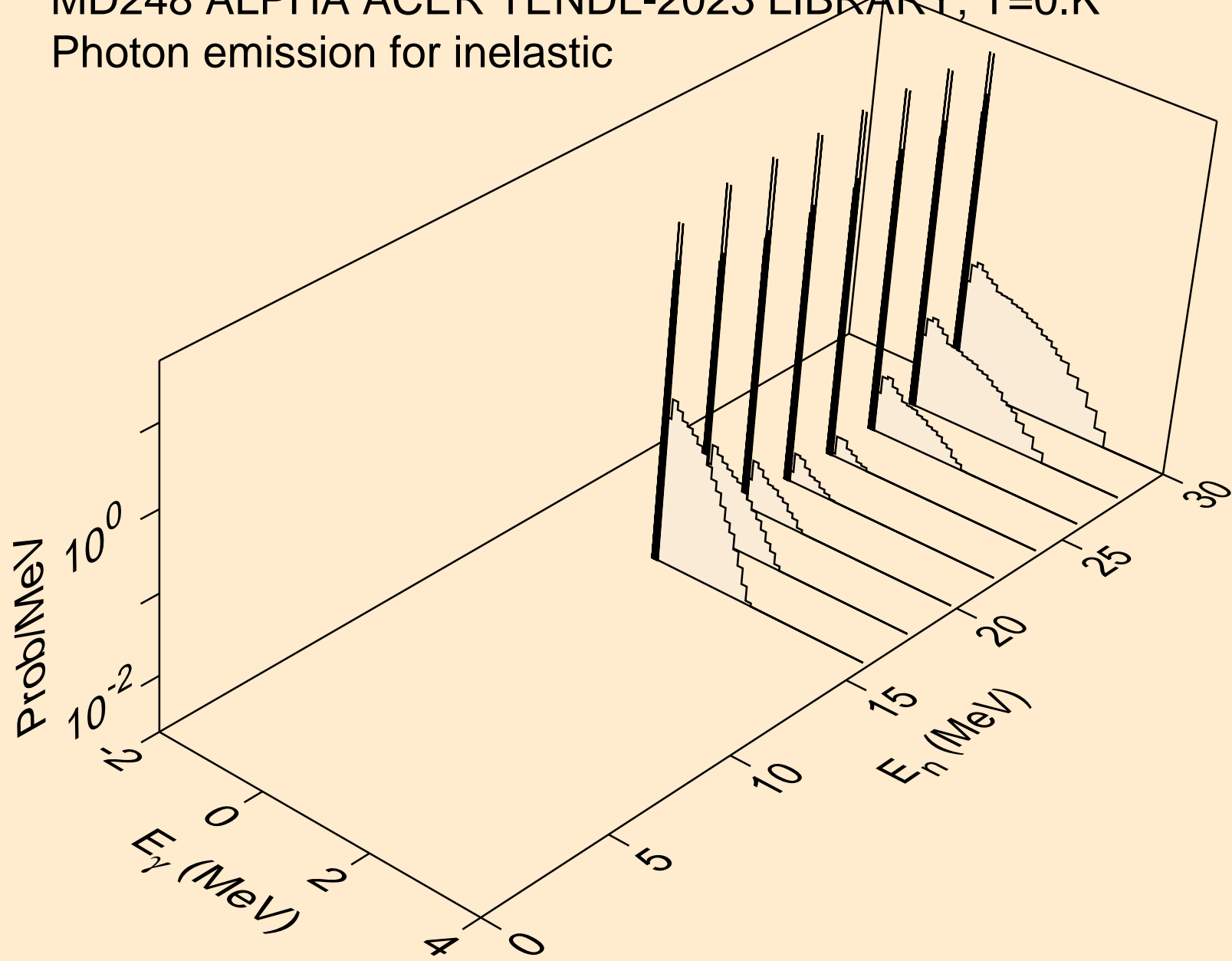

MD248 ALPHA ACER TENDL-2023 LIBRARY; T=0.K
Photon emission for (n,pa)

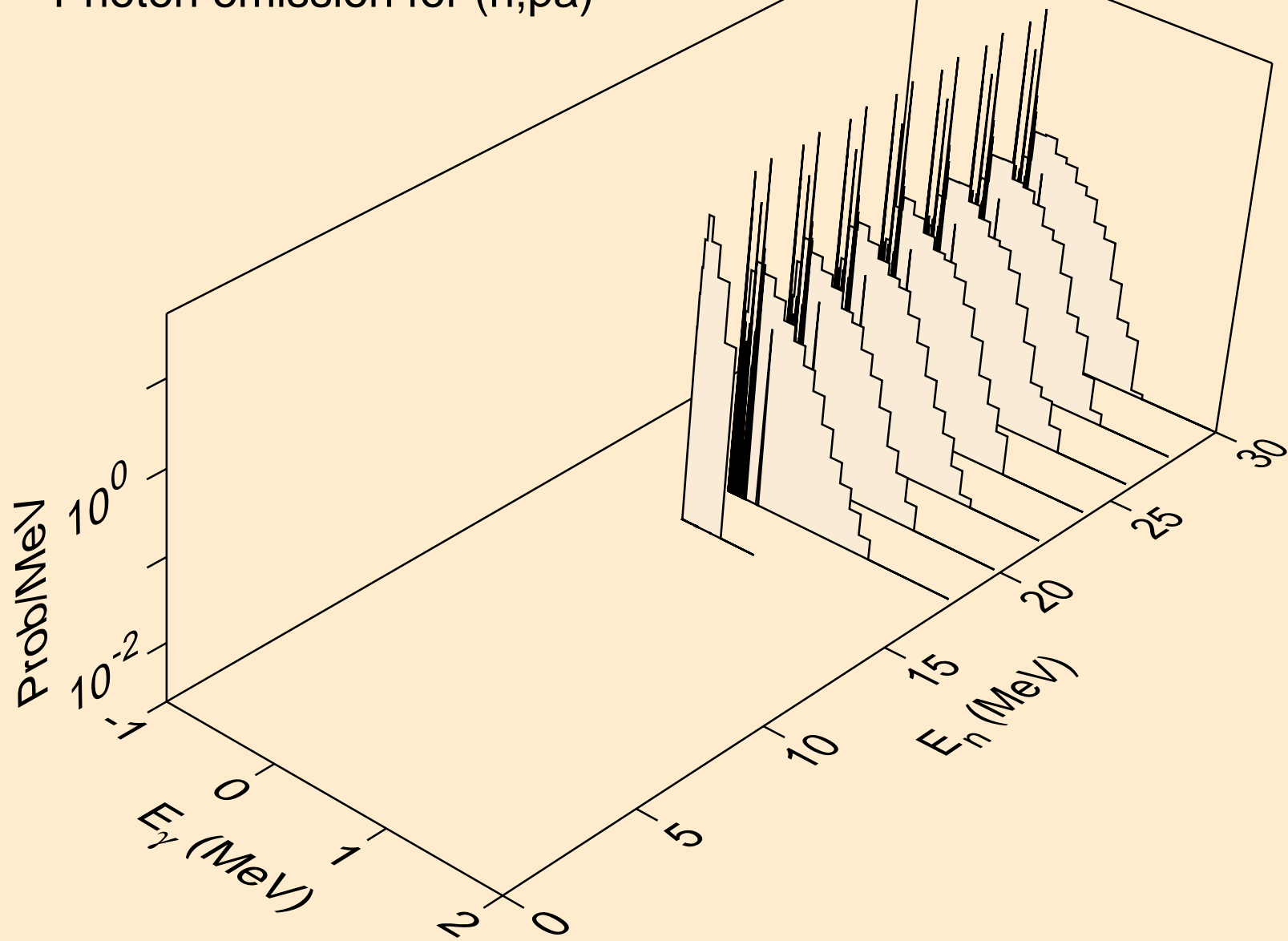

MD248 ALPHA ACER TENDL-2023 LIBRARY; T=0.K
Photon emission for (n,da)

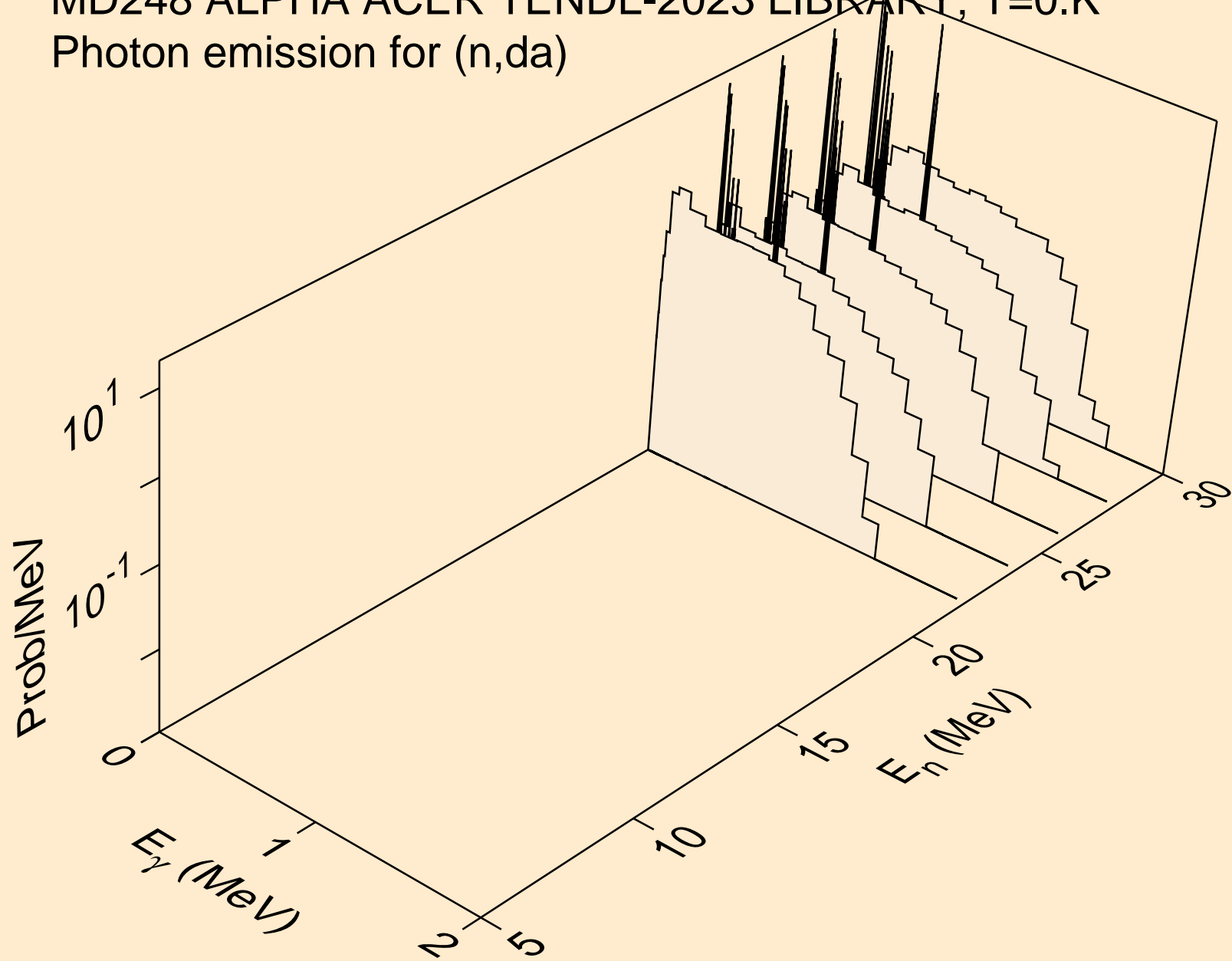

MD248 ALPHA ACER TENDL-2023 LIBRARY; T=0.K
Particle heating contributions

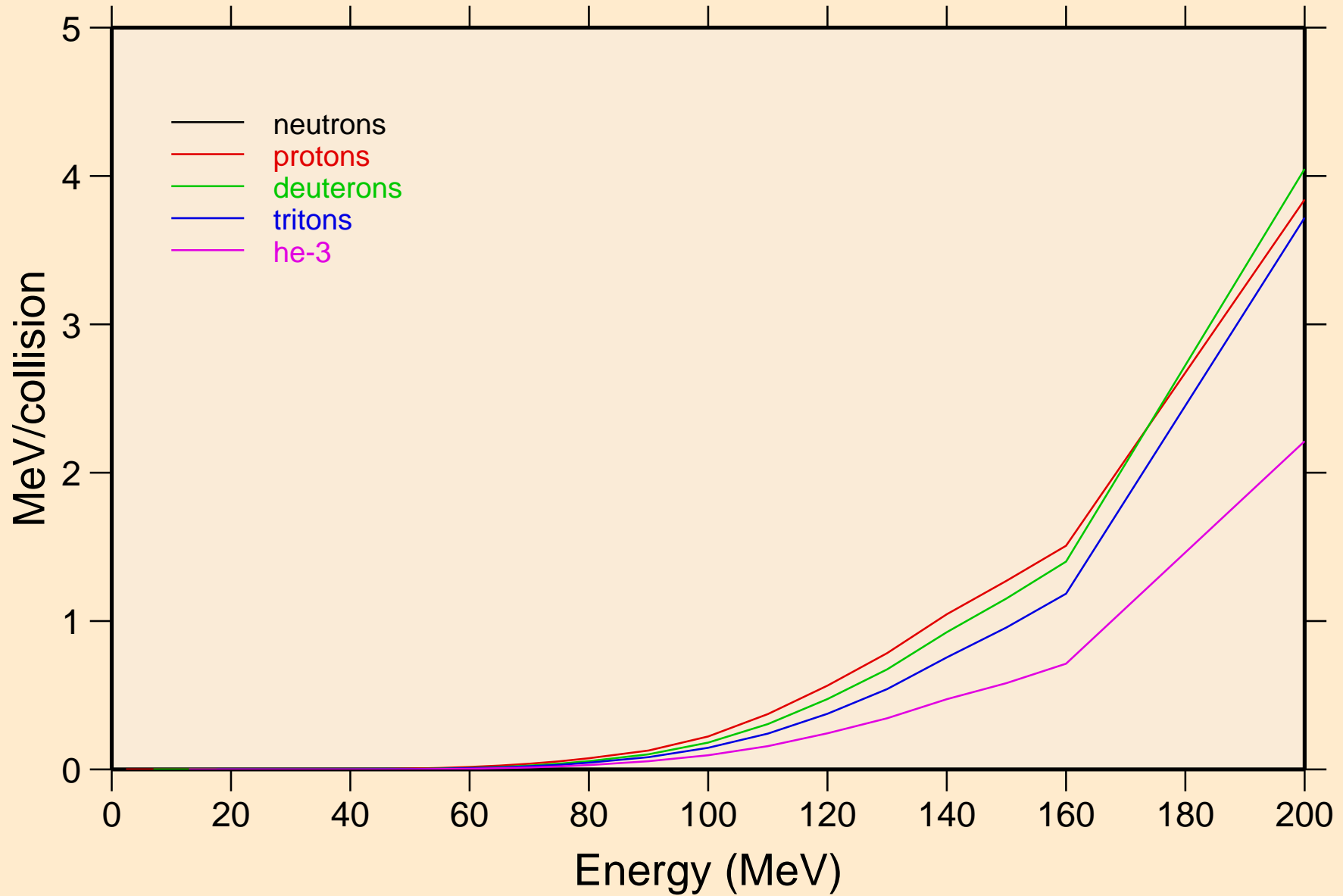

MD248 ALPHA ACER TENDL-2023 LIBRARY; T=0.K
Recoil Heating

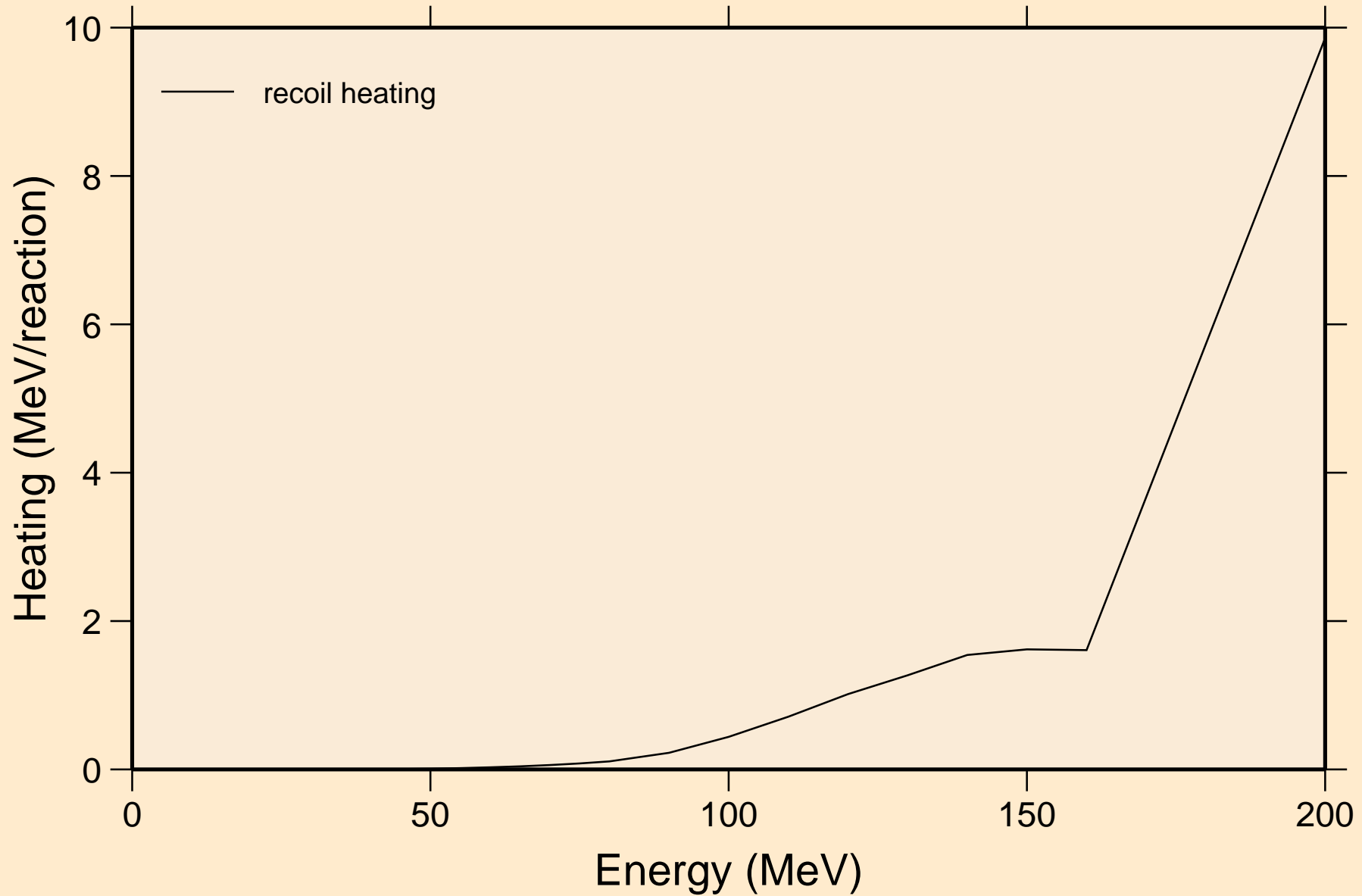

MD248 ALPHA ACER TENDL-2023 LIBRARY; T=0.K

Particle production cross sections

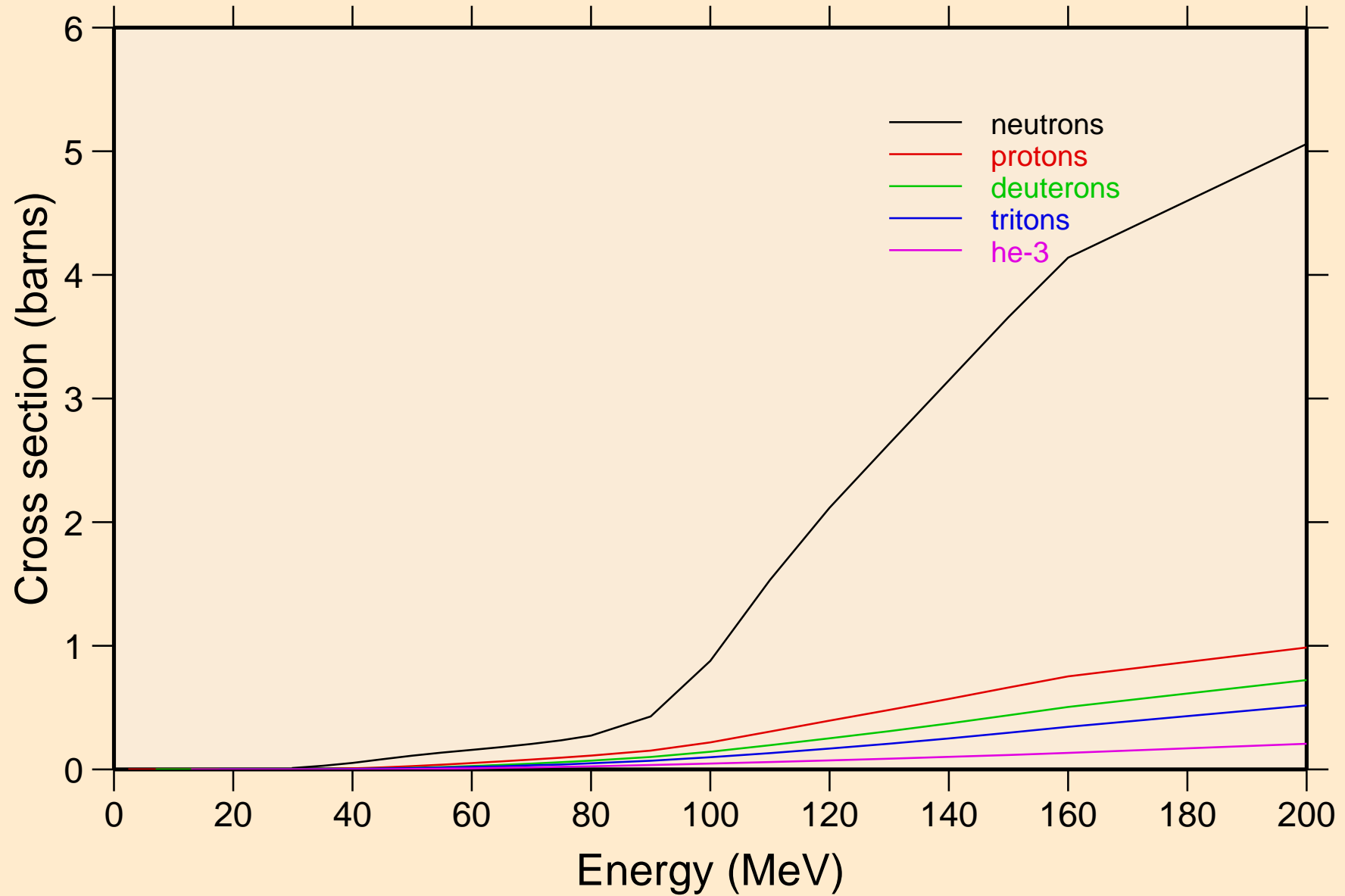

MD248 ALPHA ACER TENDL-2023 LIBRARY; T=0.K
neutrons from (a,n)

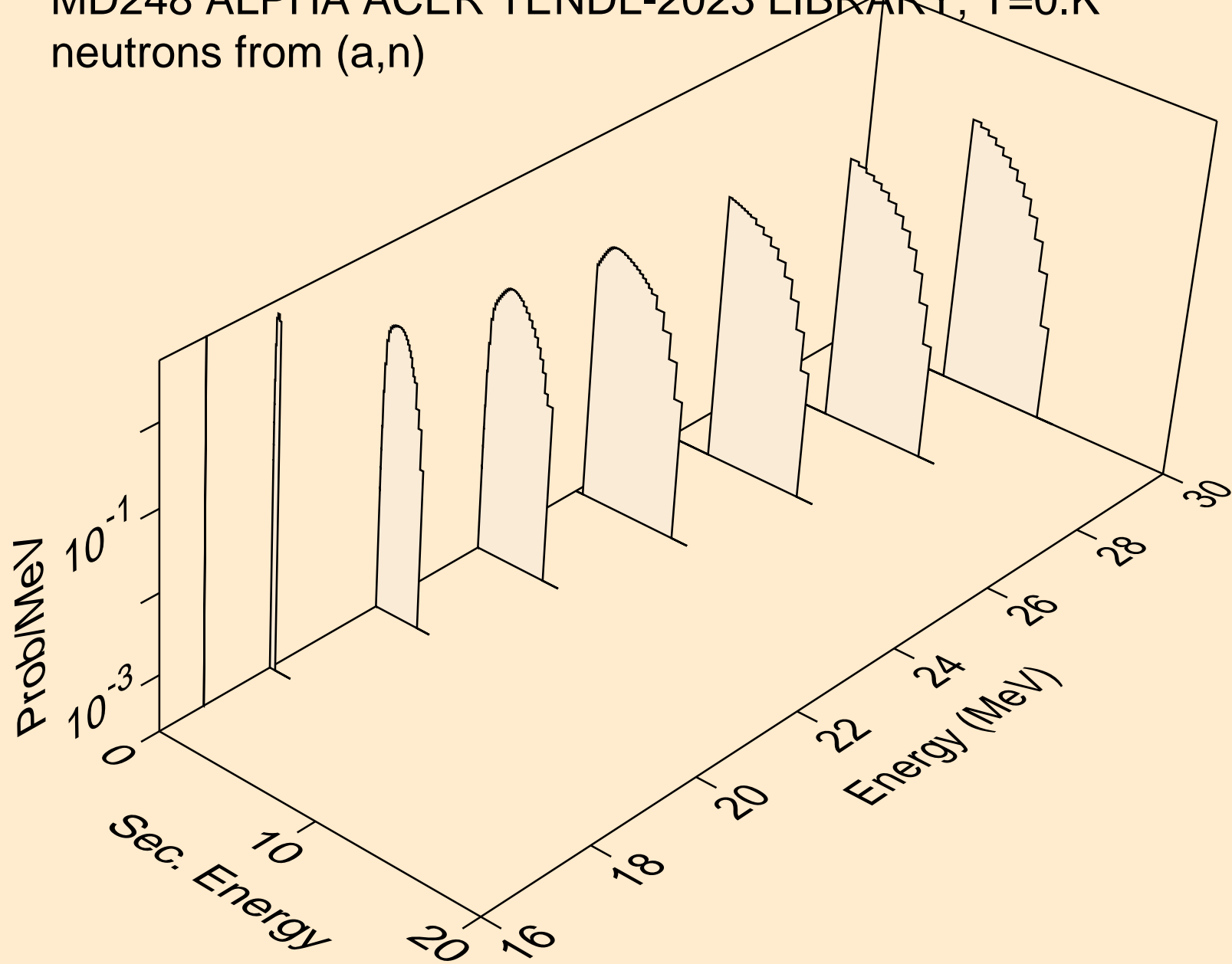

MD248 ALPHA ACER TENDL-2023 LIBRARY; T=0.K
neutrons from (a,x)

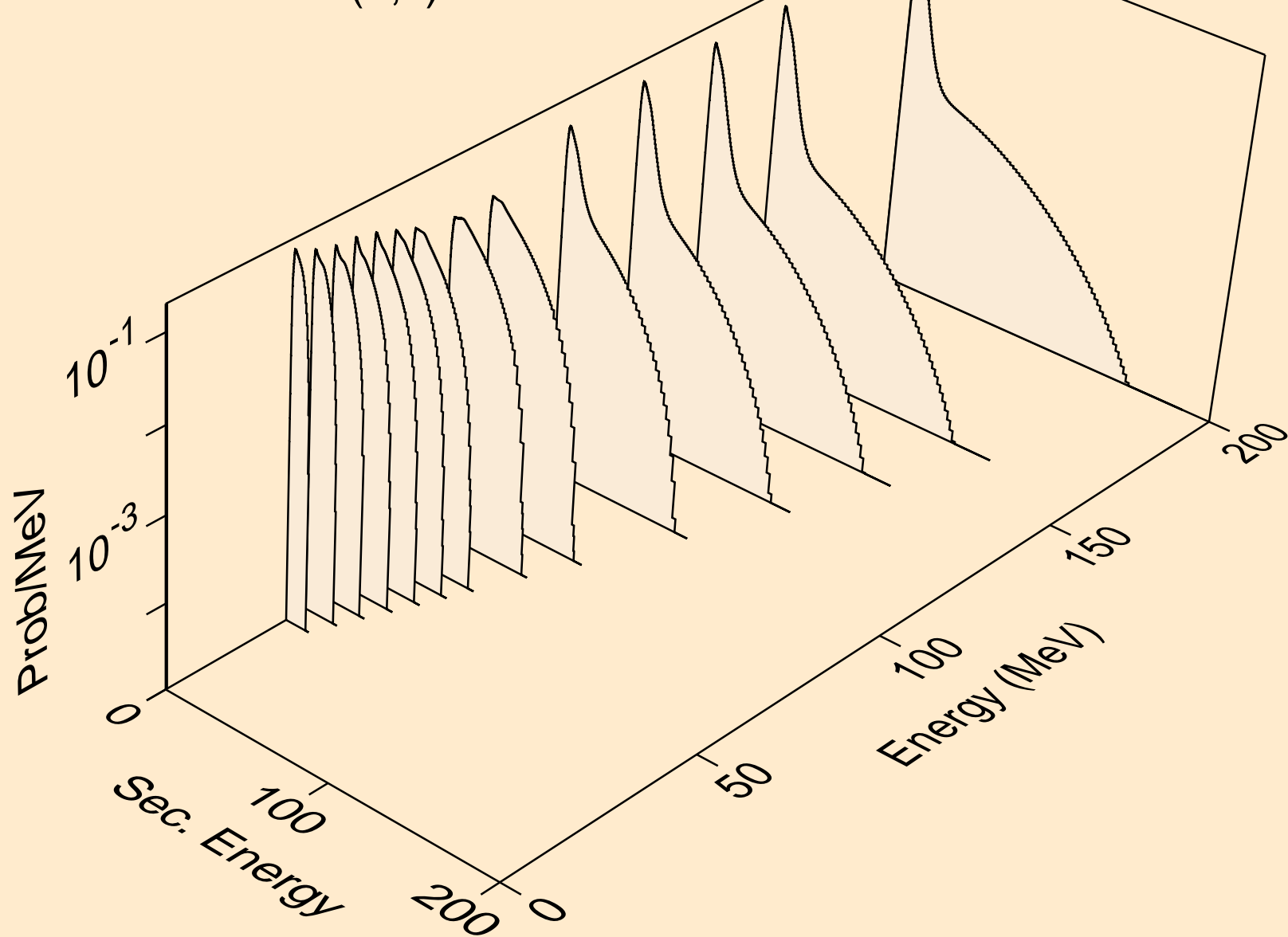

MD248 ALPHA ACER TENDL-2023 LIBRARY; T=0.K
neutrons from (a,2n)

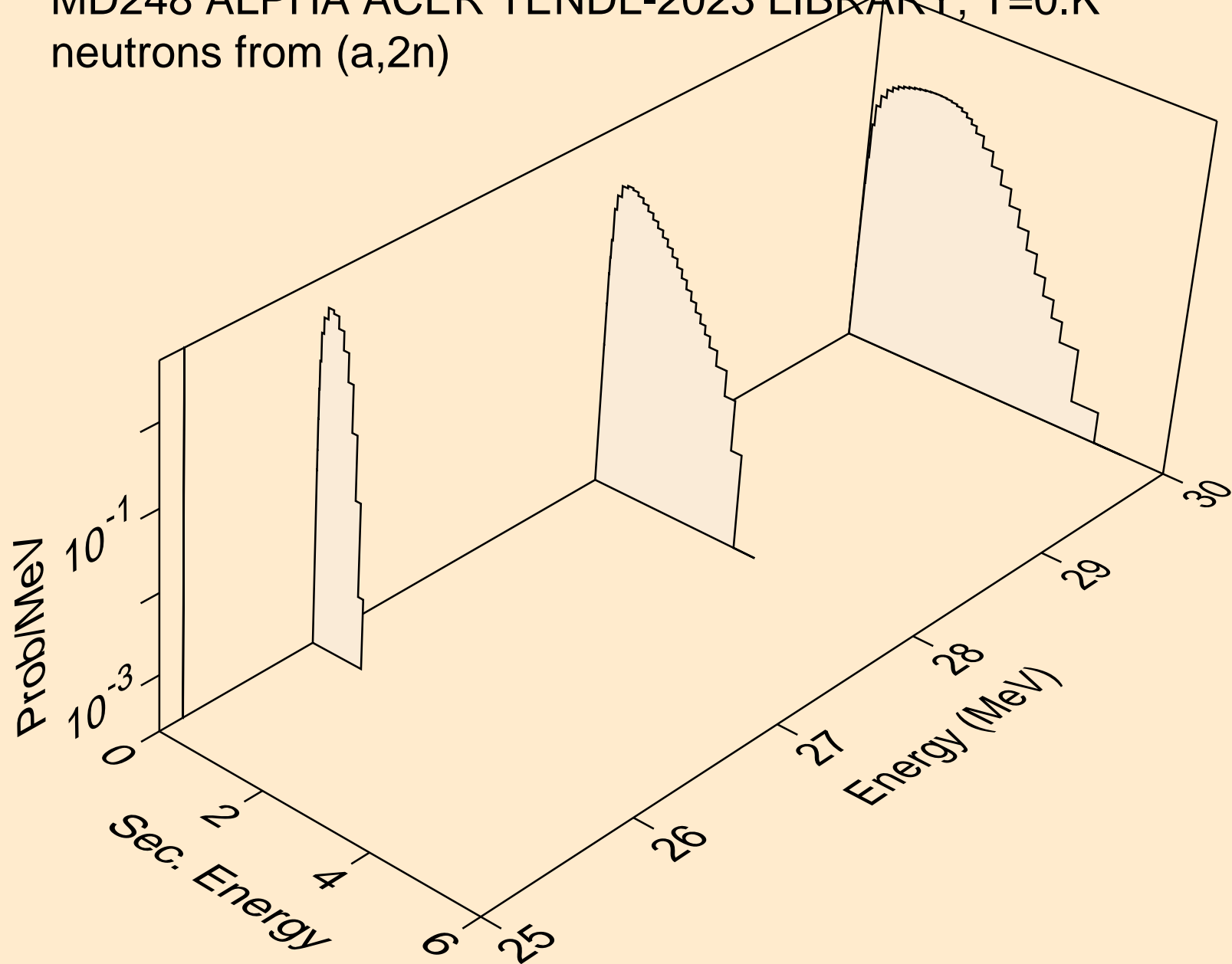

MD248 ALPHA ACER TENDL-2023 LIBRARY; T=0.K
neutrons from (a,n*)a

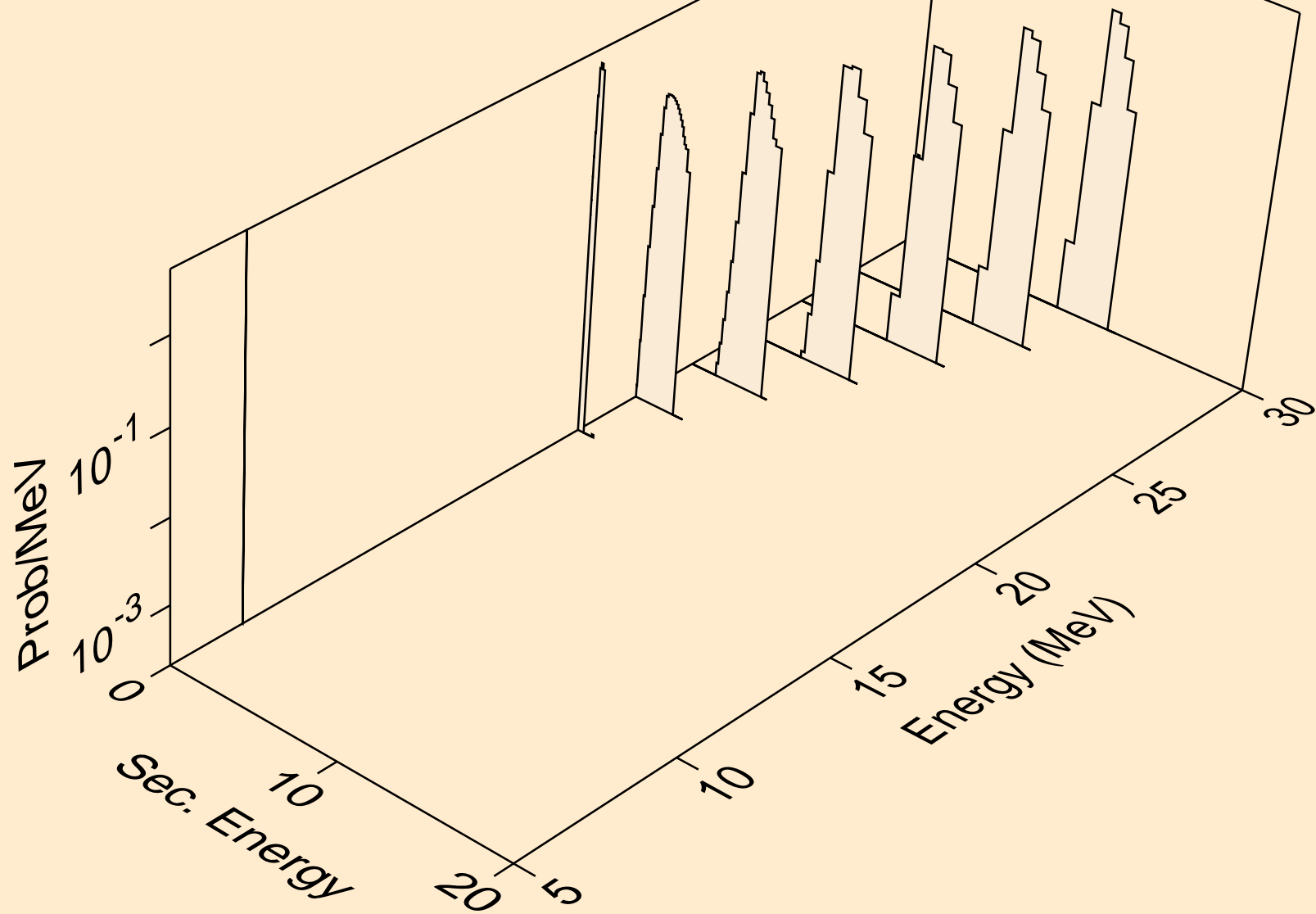

MD248 ALPHA ACER TENDL-2023 LIBRARY; T=0.K
neutrons from (a,2n)a

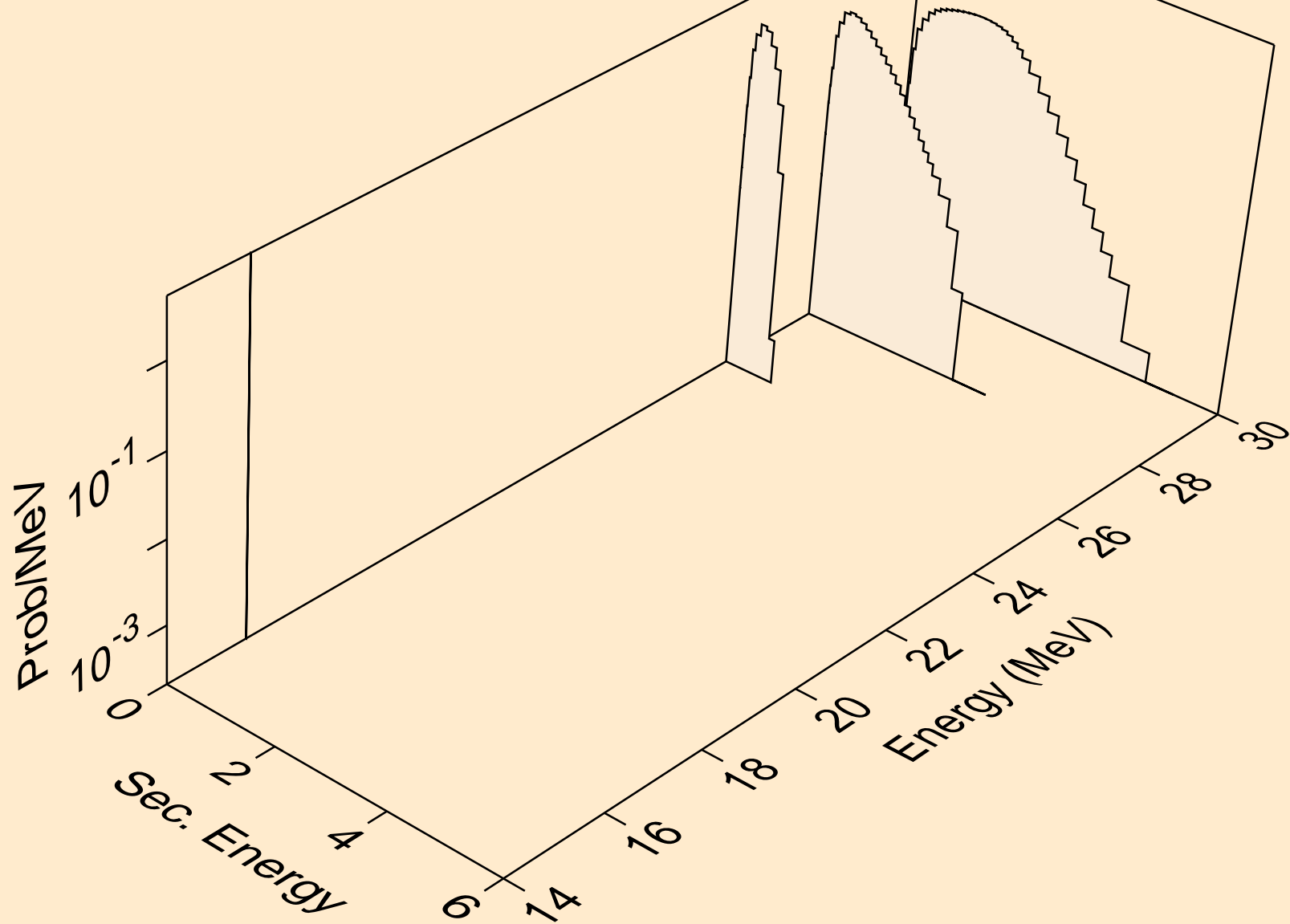

MD248 ALPHA ACER TENDL-2023 LIBRARY; T=0.K
neutrons from (a,n*)p

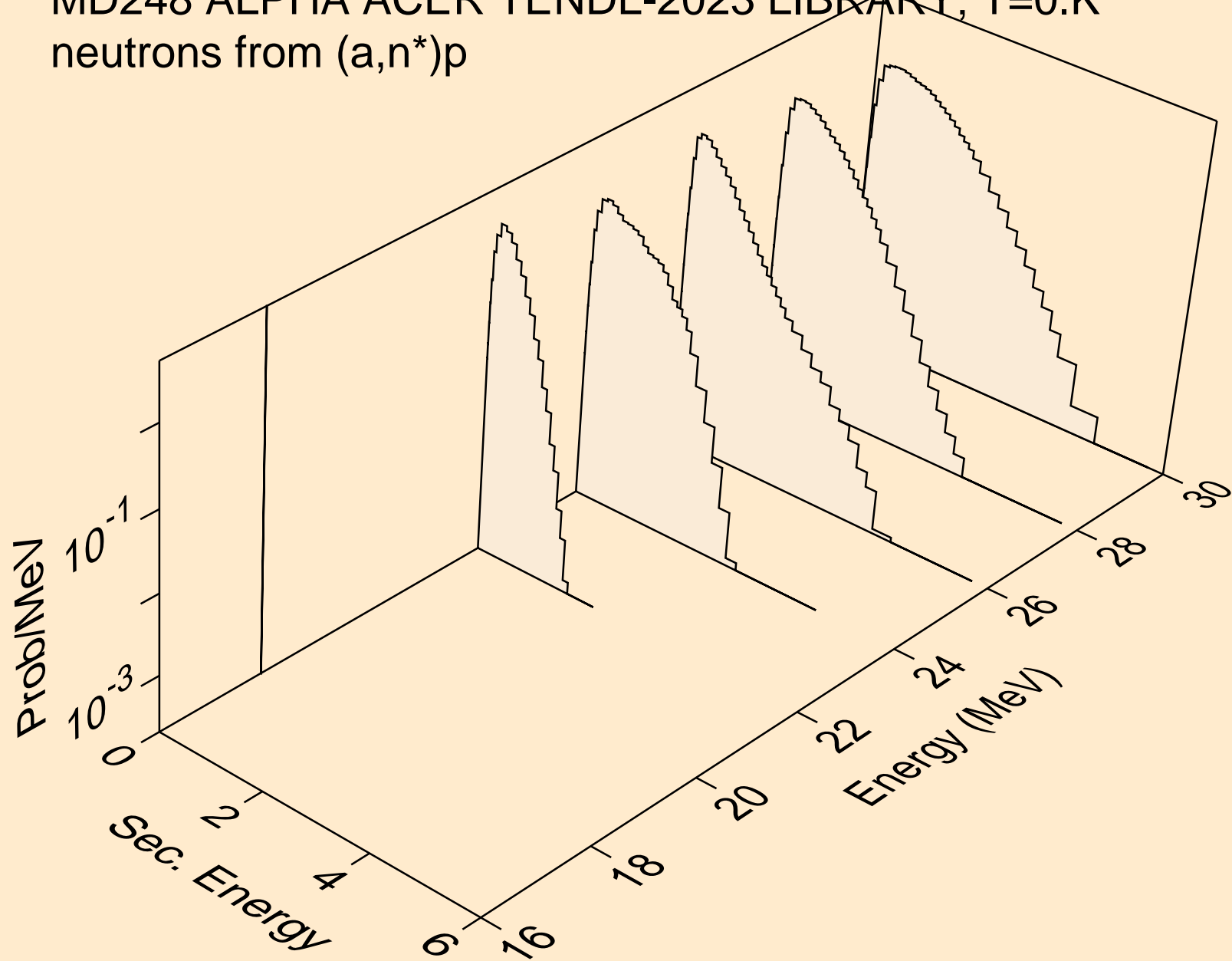

MD248 ALPHA ACER TENDL-2023 LIBRARY; T=0.K
protons from (a,x)

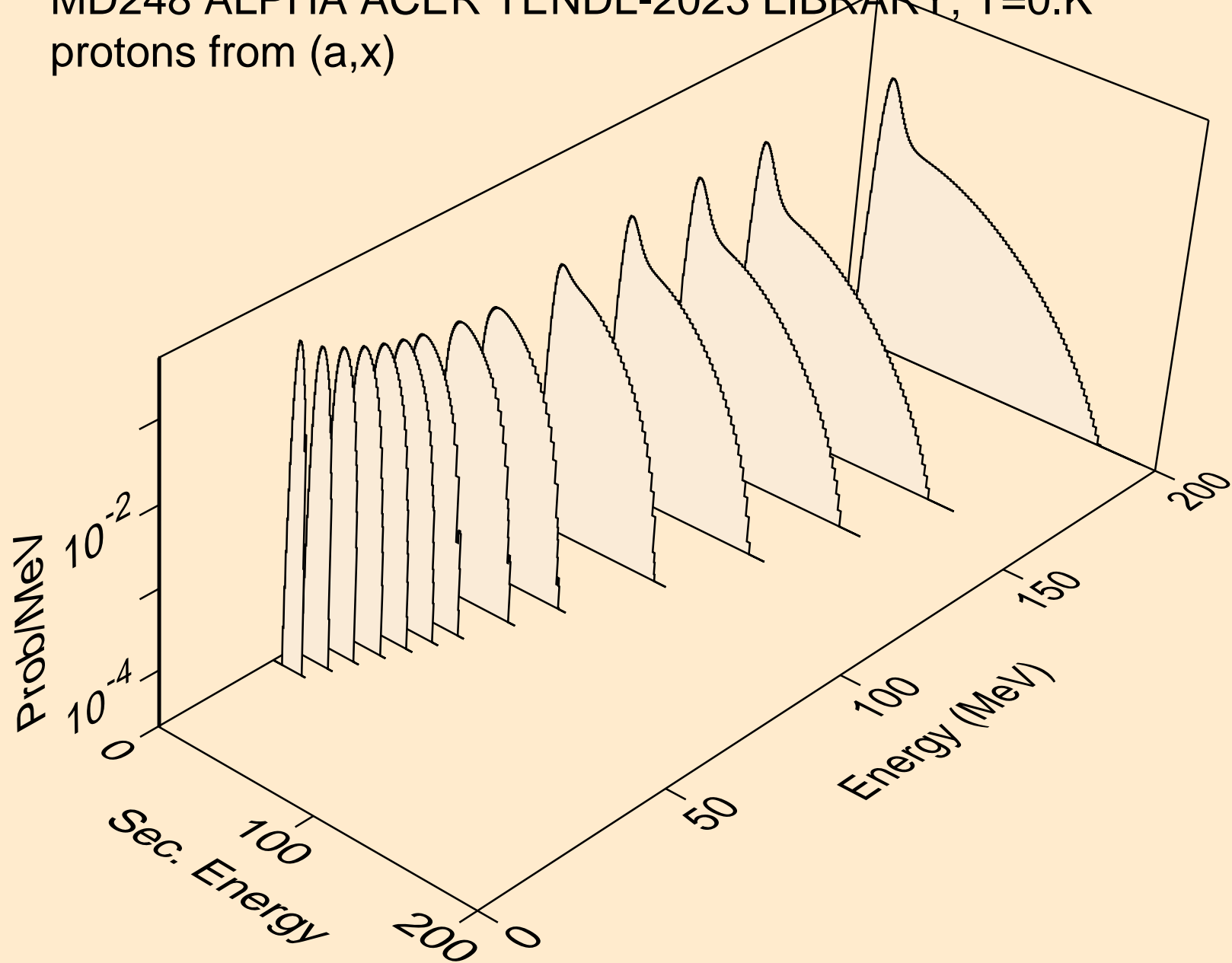

MD248 ALPHA ACER TENDL-2023 LIBRARY; T=0.K
protons from (a,n*)p

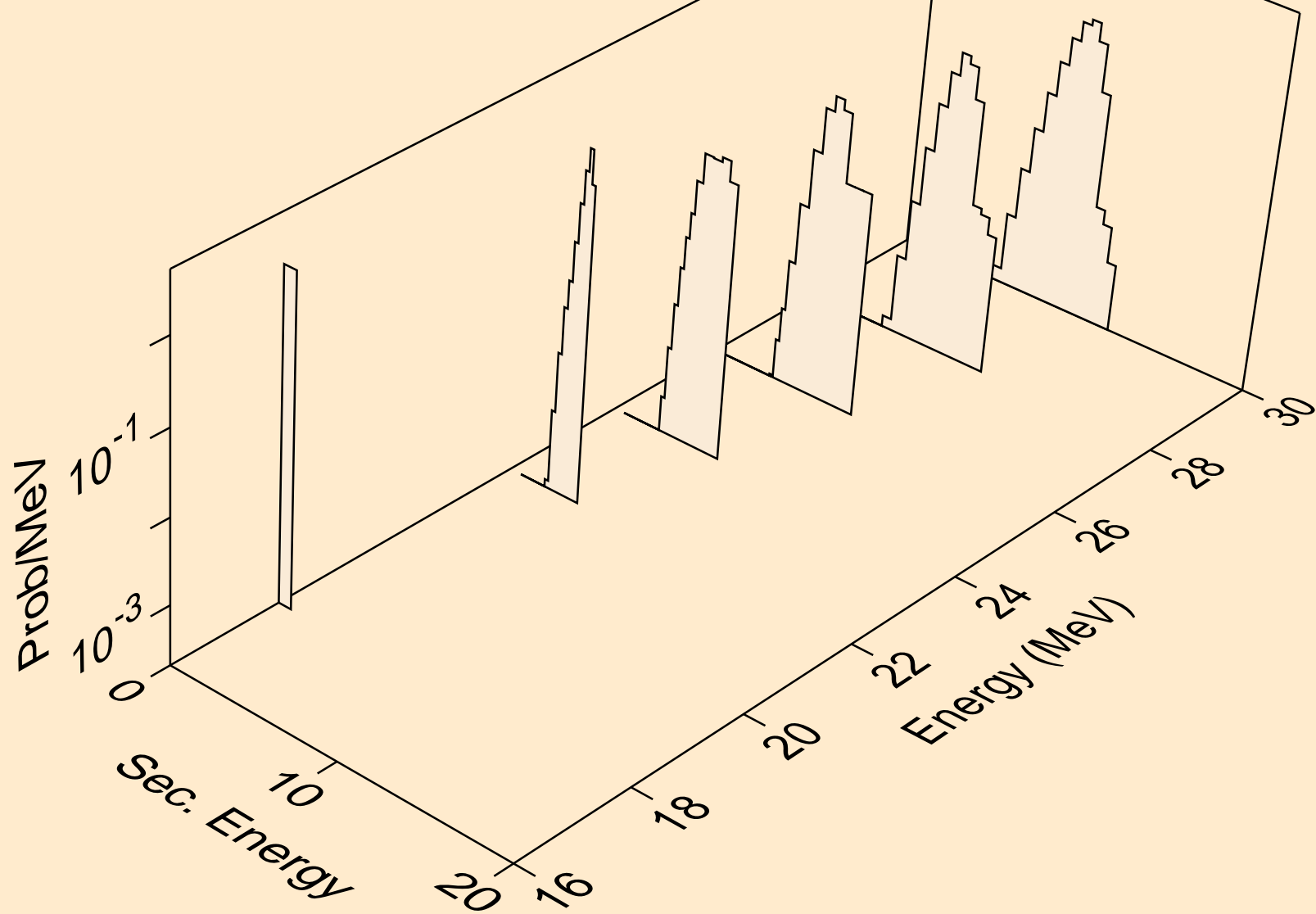

MD248 ALPHA ACER TENDL-2023 LIBRARY; T=0.K
protons from (a,p)

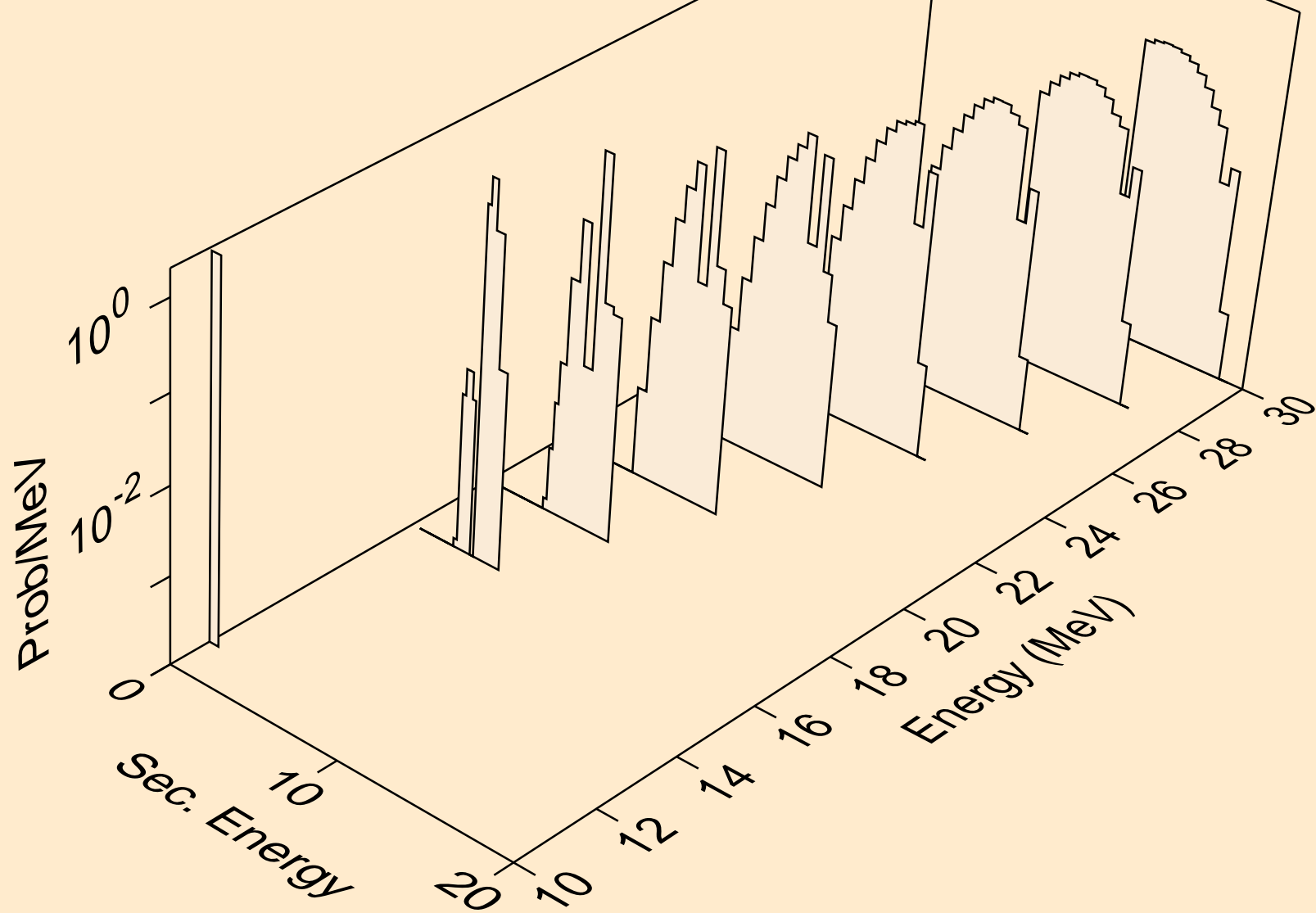

MD248 ALPHA ACER TENDL-2023 LIBRARY; T=0.K
protons from (a,pa)

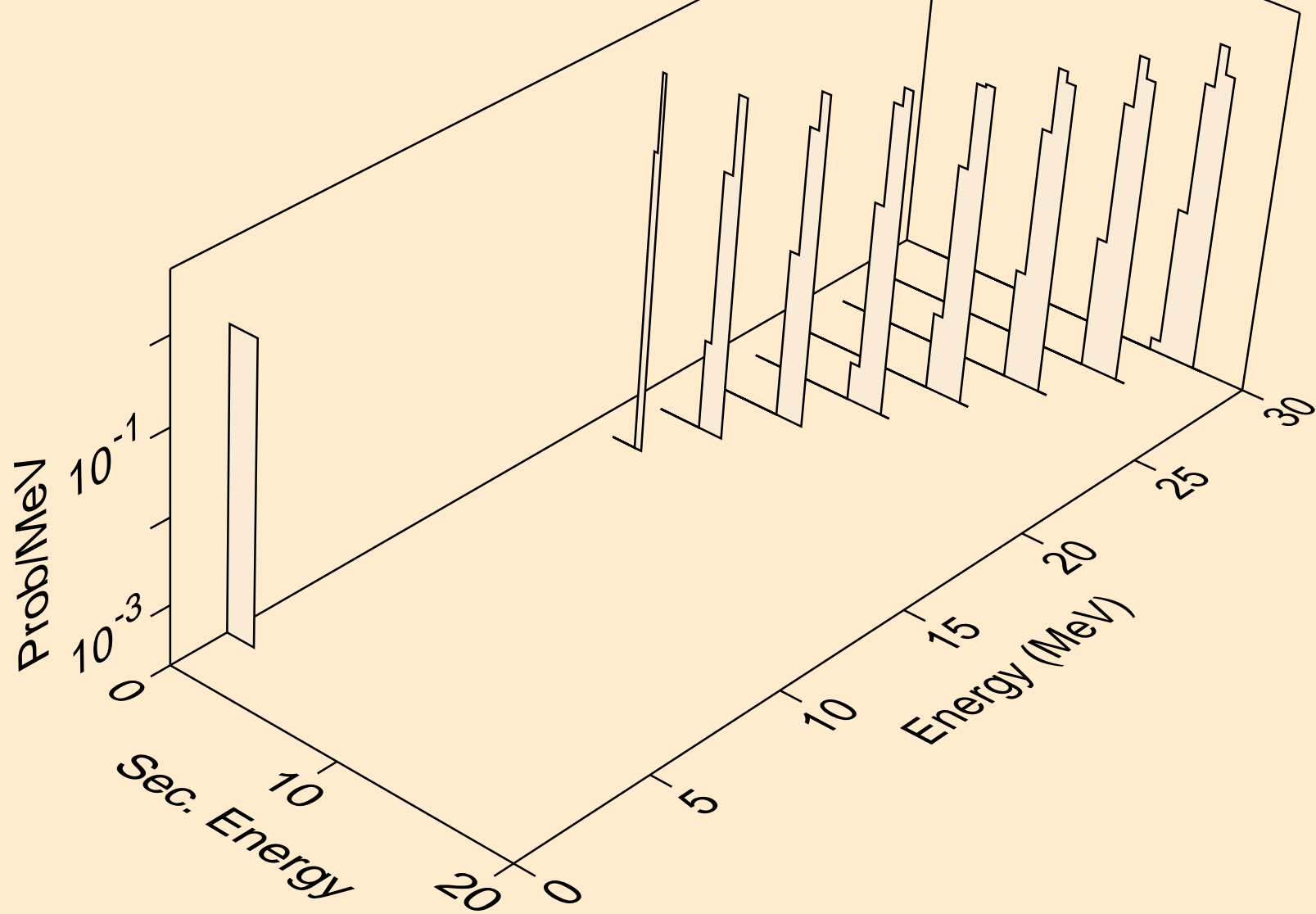

MD248 ALPHA ACER TENDL-2023 LIBRARY; T=0.K
deuterons from (a,x)

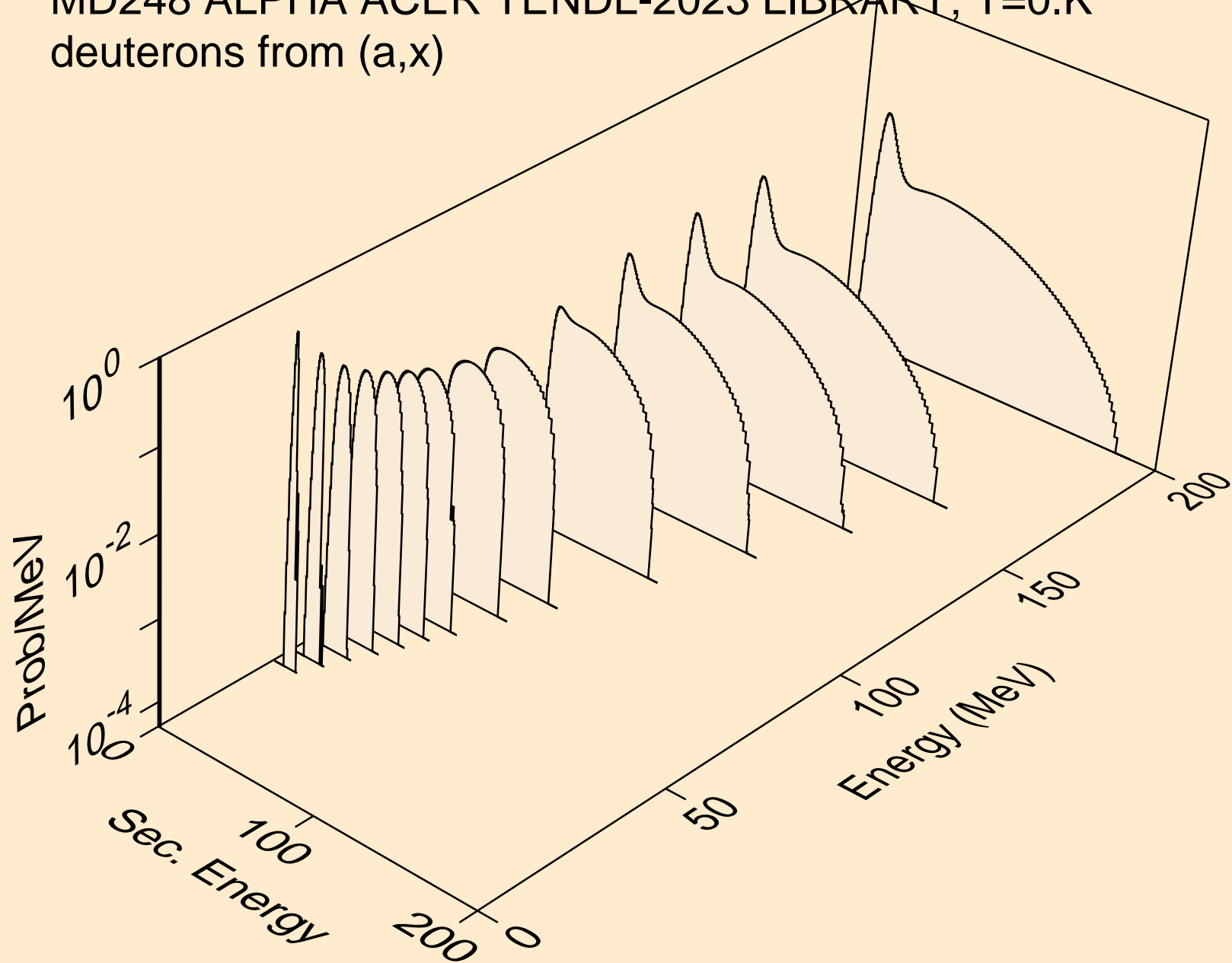

MD248 ALPHA ACER TENDL-2023 LIBRARY; T=0.K
deuterons from (a,d)

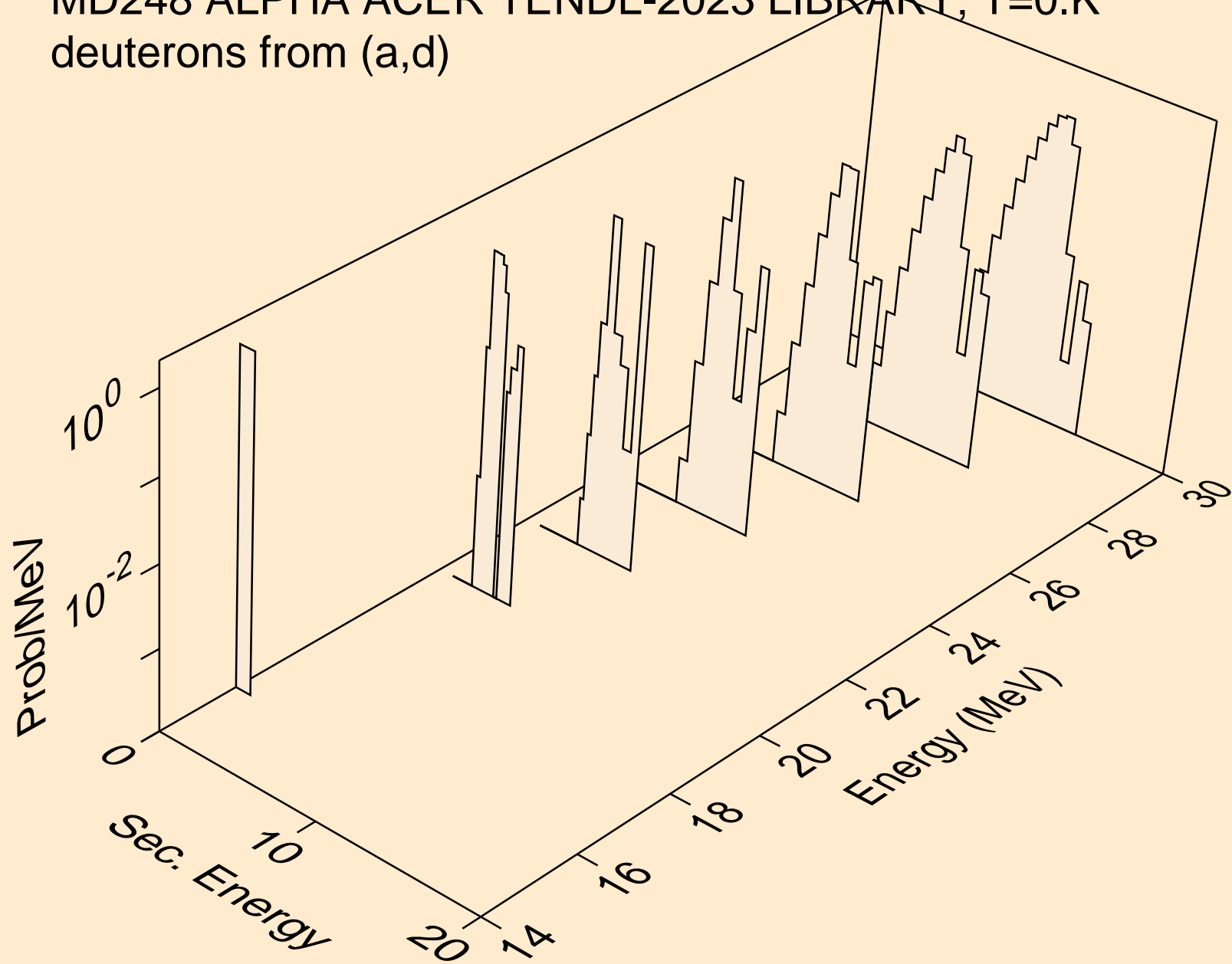

MD248 ALPHA ACER TENDL-2023 LIBRARY; T=0.K
deuterons from (a,da)

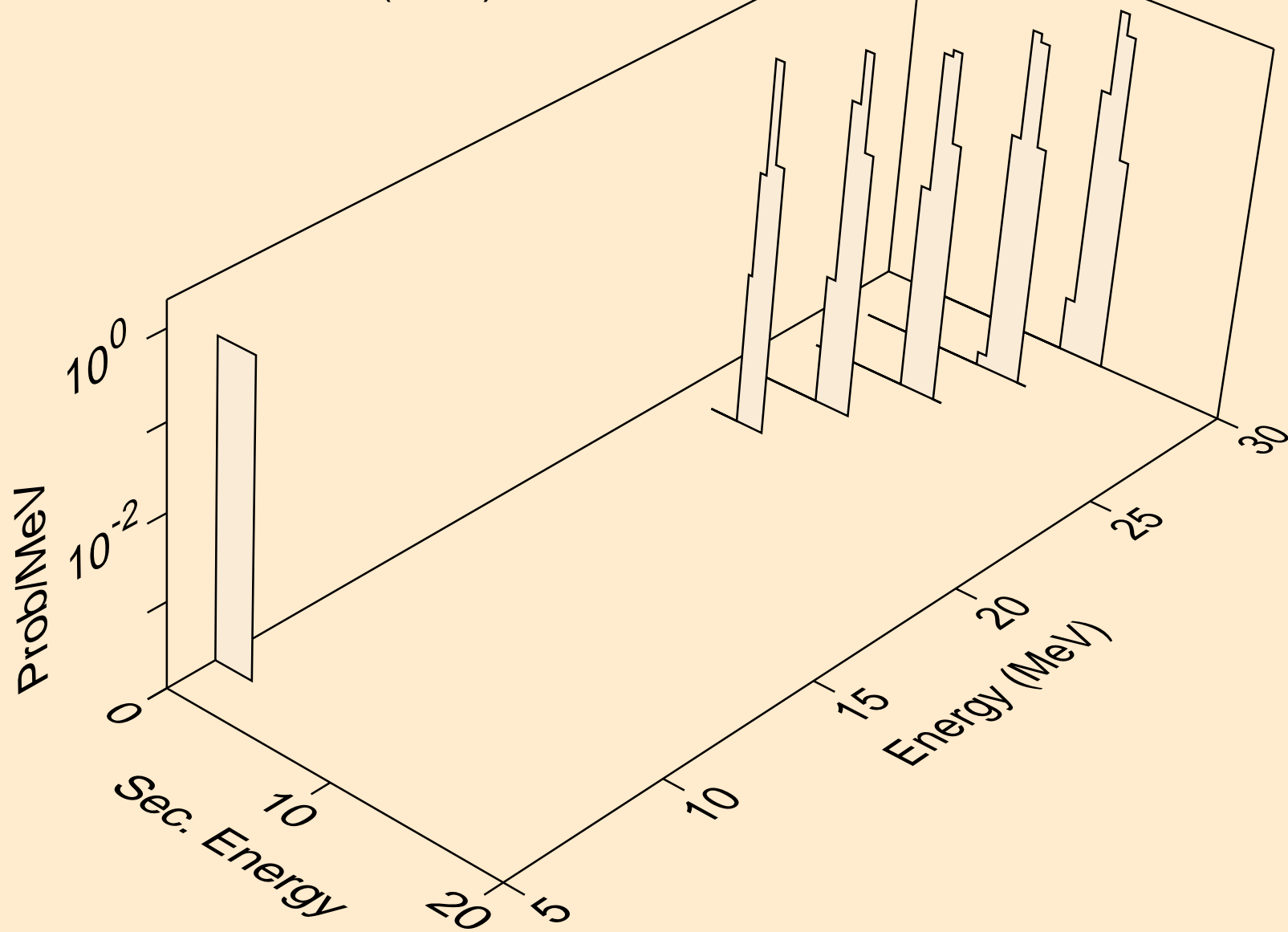

MD248 ALPHA ACER TENDL-2023 LIBRARY; T=0.K
tritons from (a,x)

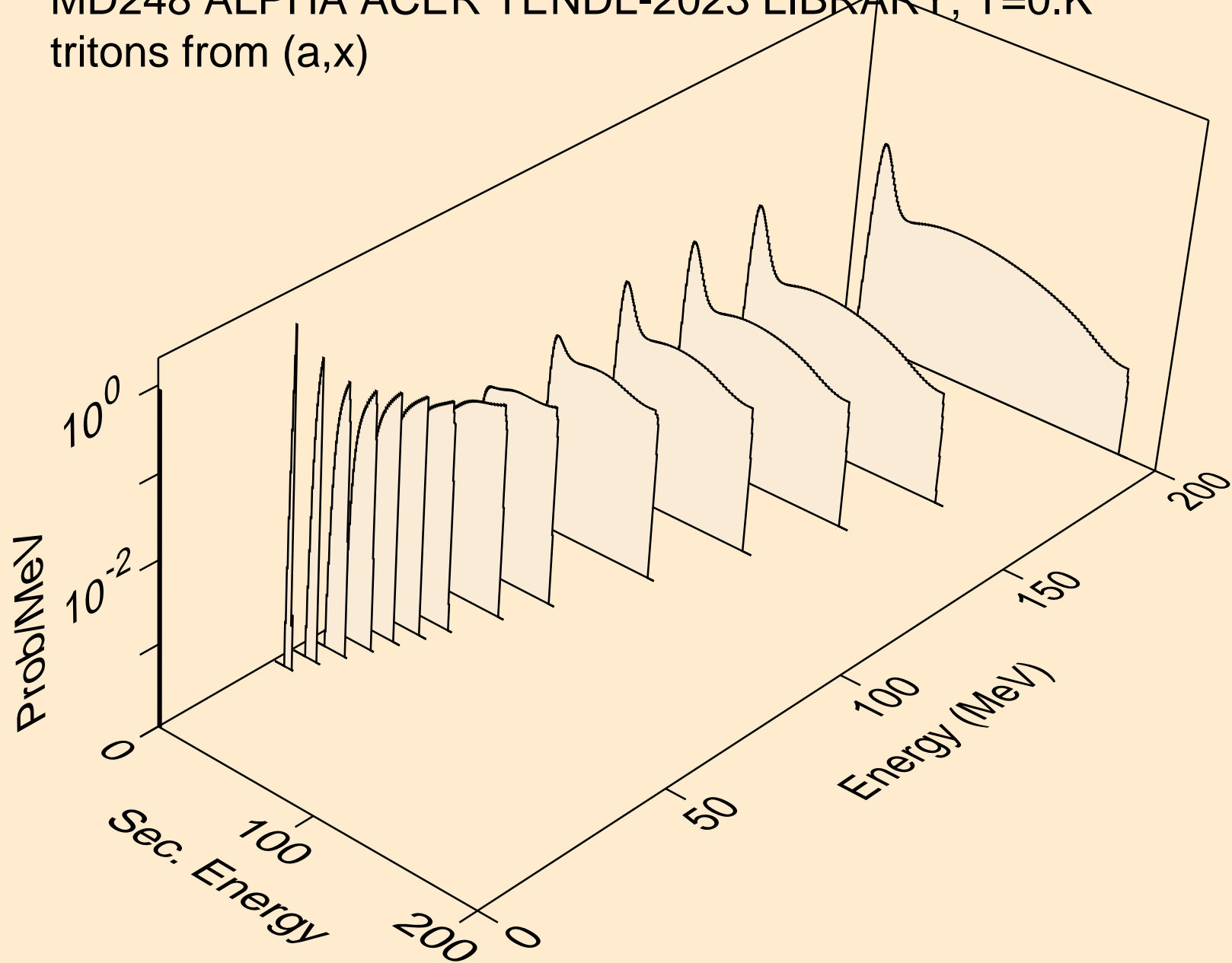

MD248 ALPHA ACER TENDL-2023 LIBRARY; T=0.K
tritons from (a,t)

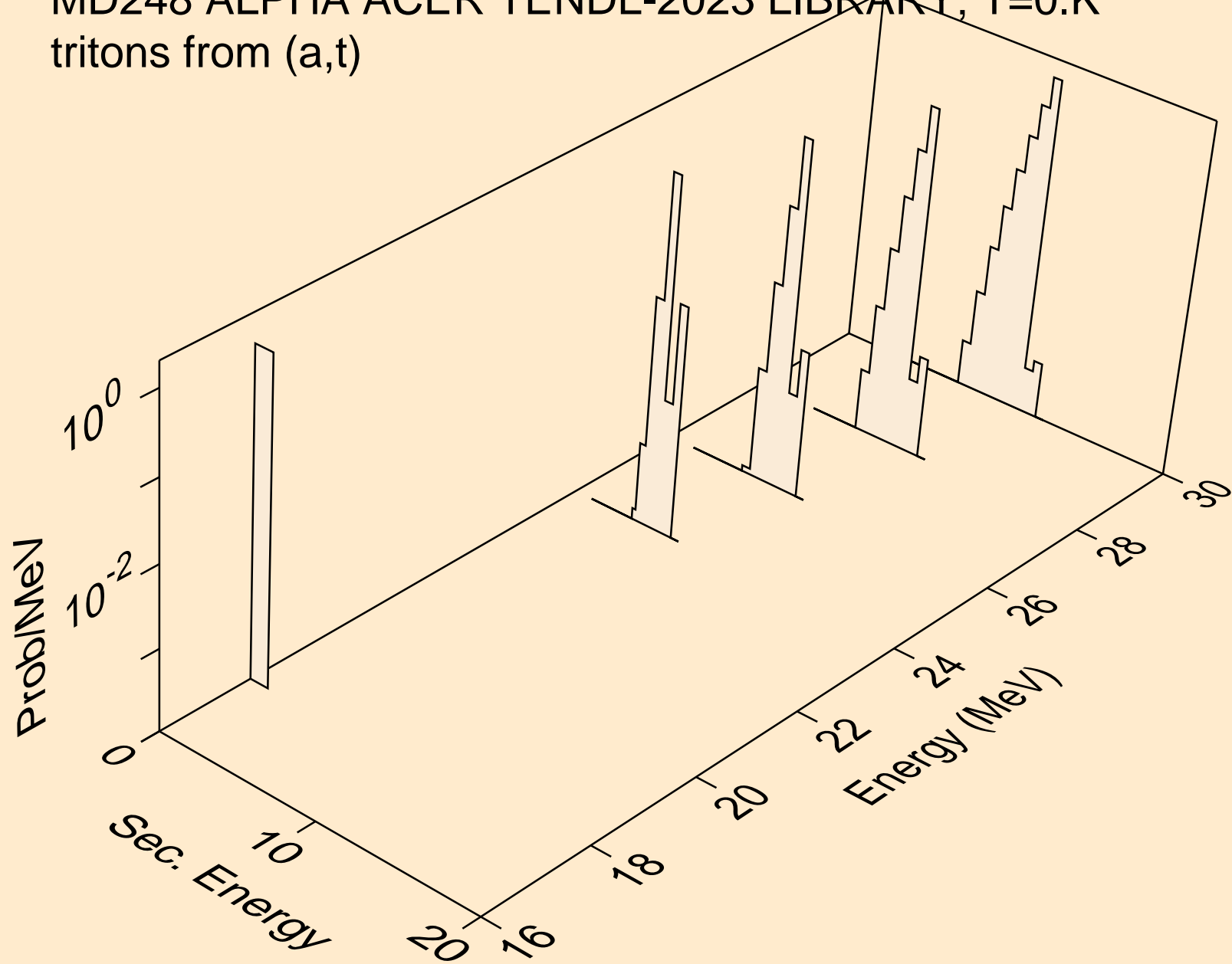

MD248 ALPHA ACER TENDL-2023 LIBRARY; T=0.K
he3s from (a,x)

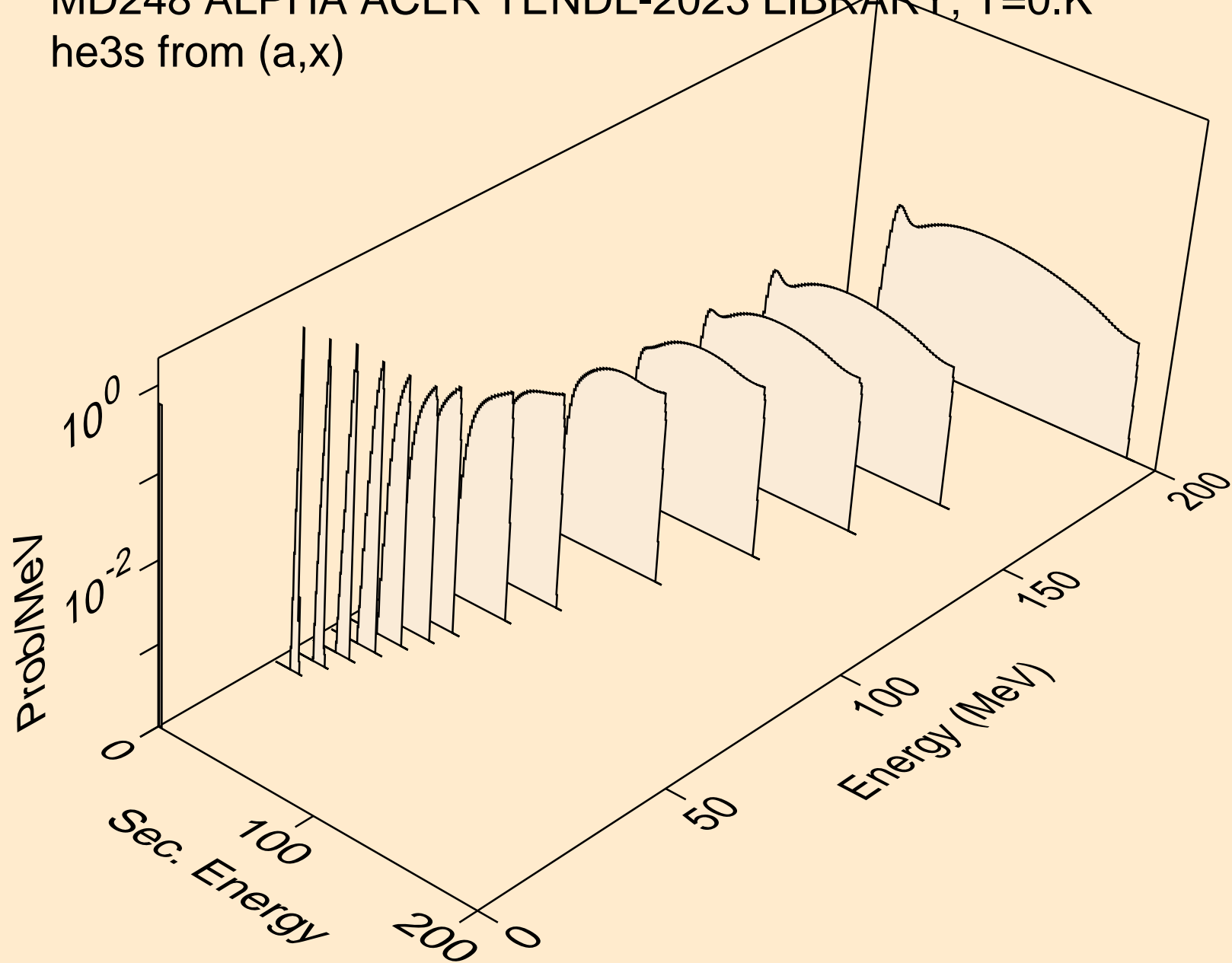

MD248 ALPHA ACER TENDL-2023 LIBRARY; T=0.K
he3s from (a,he3)

