

ZN078 ALPHA ACER TENDL-2023 LIBRARY; T=0.K

Principal cross sections

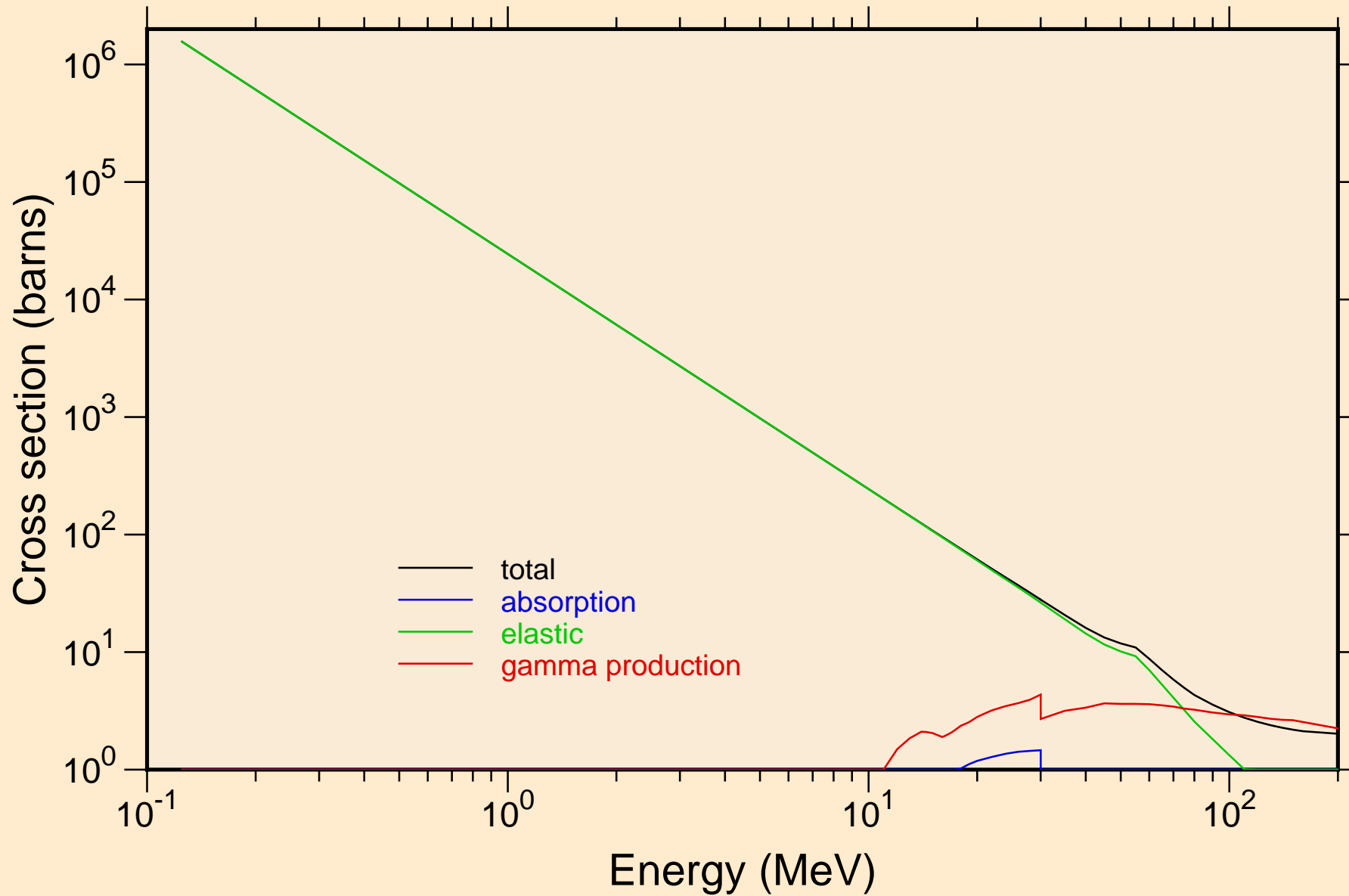

ZN078 ALPHA ACER TENDL-2023 LIBRARY; T=0.K

Heating

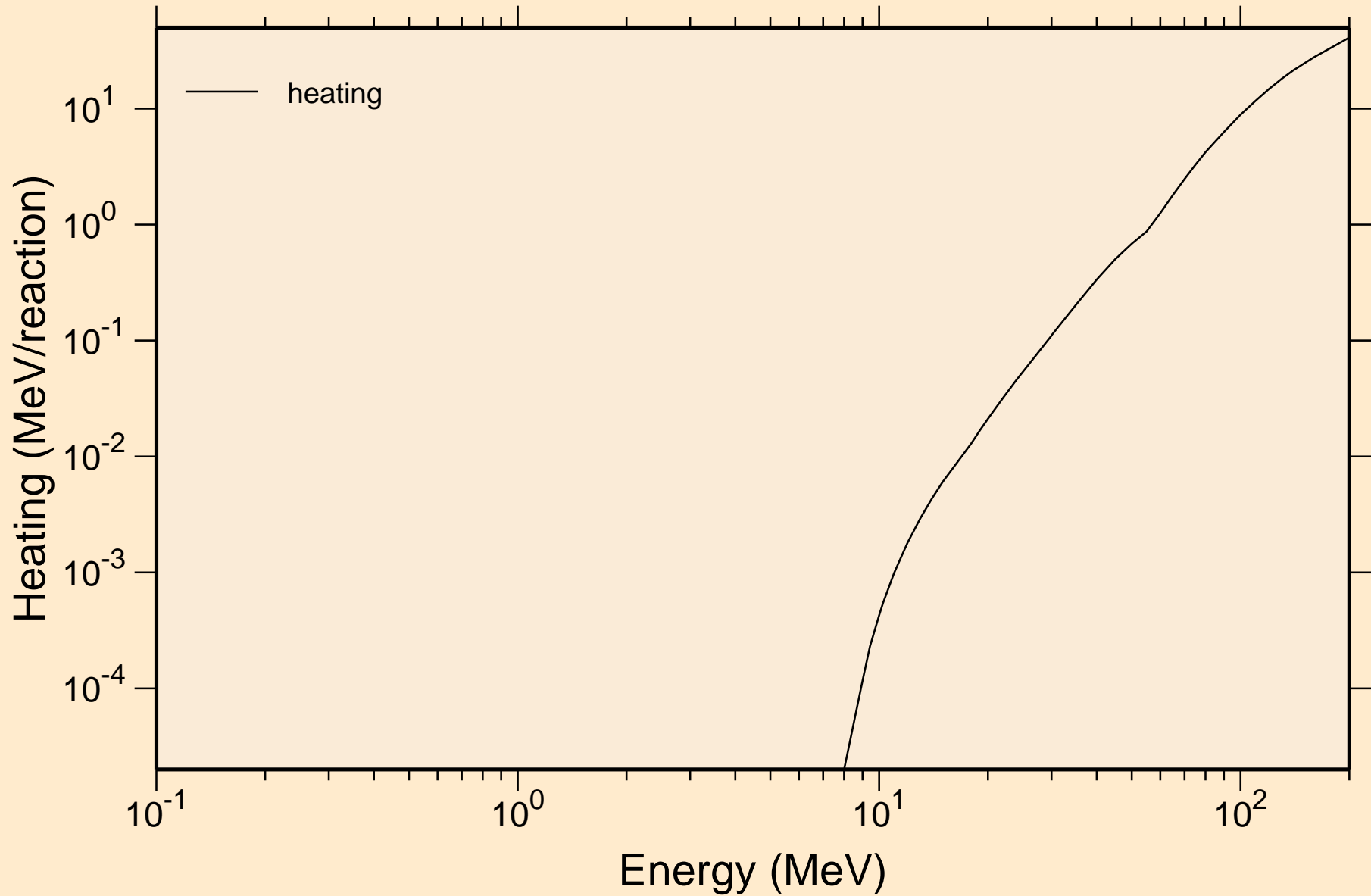

ZN078 ALPHA ACER TENDL-2023 LIBRARY; T=0.K

Principal cross sections

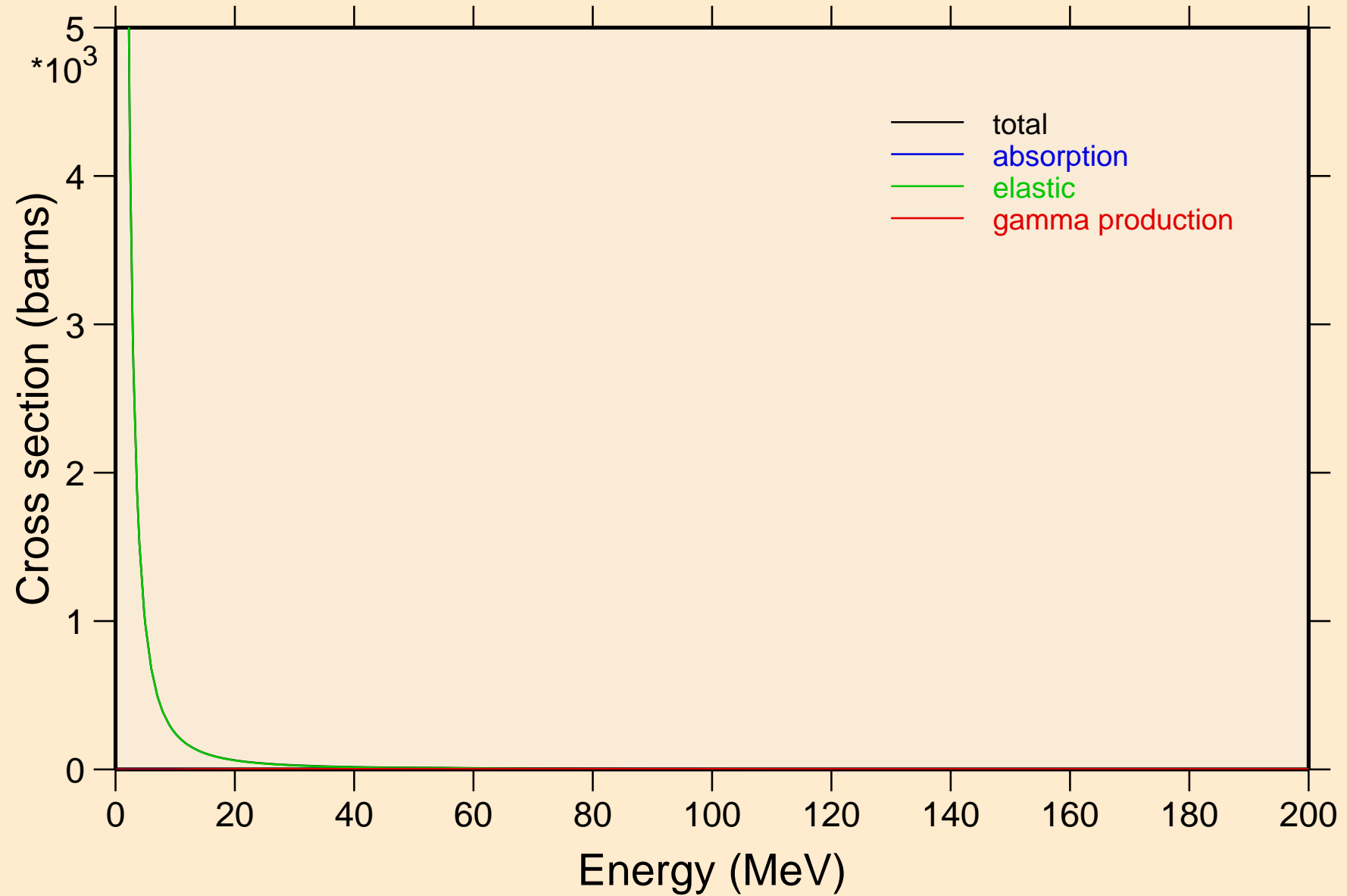

ZN078 ALPHA ACER TENDL-2023 LIBRARY; T=0.K

Heating

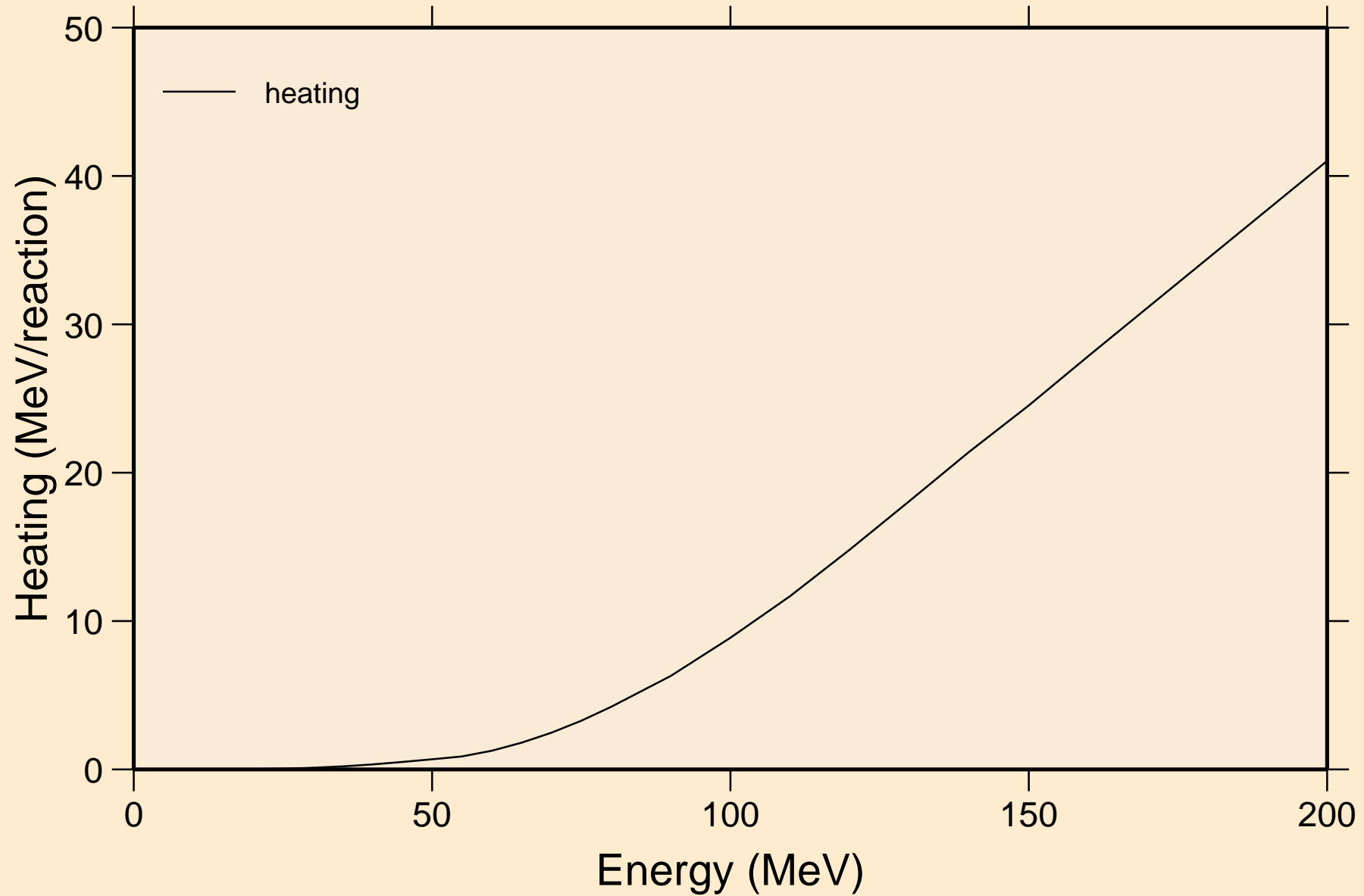

ZN078 ALPHA ACER TENDL-2023 LIBRARY; T=0.K

Threshold reactions

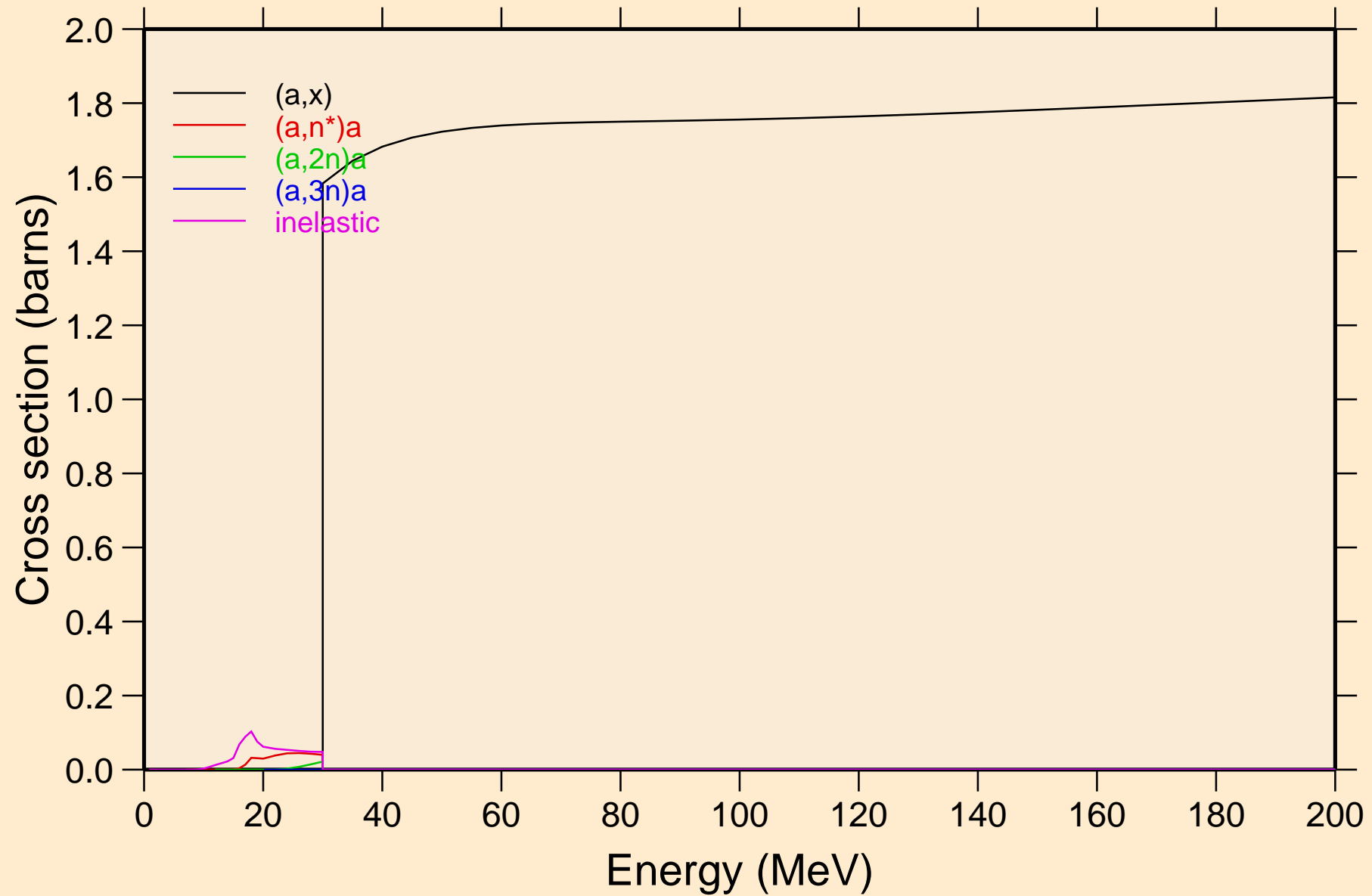

ZN078 ALPHA ACER TENDL-2023 LIBRARY; T=0.K
Threshold reactions

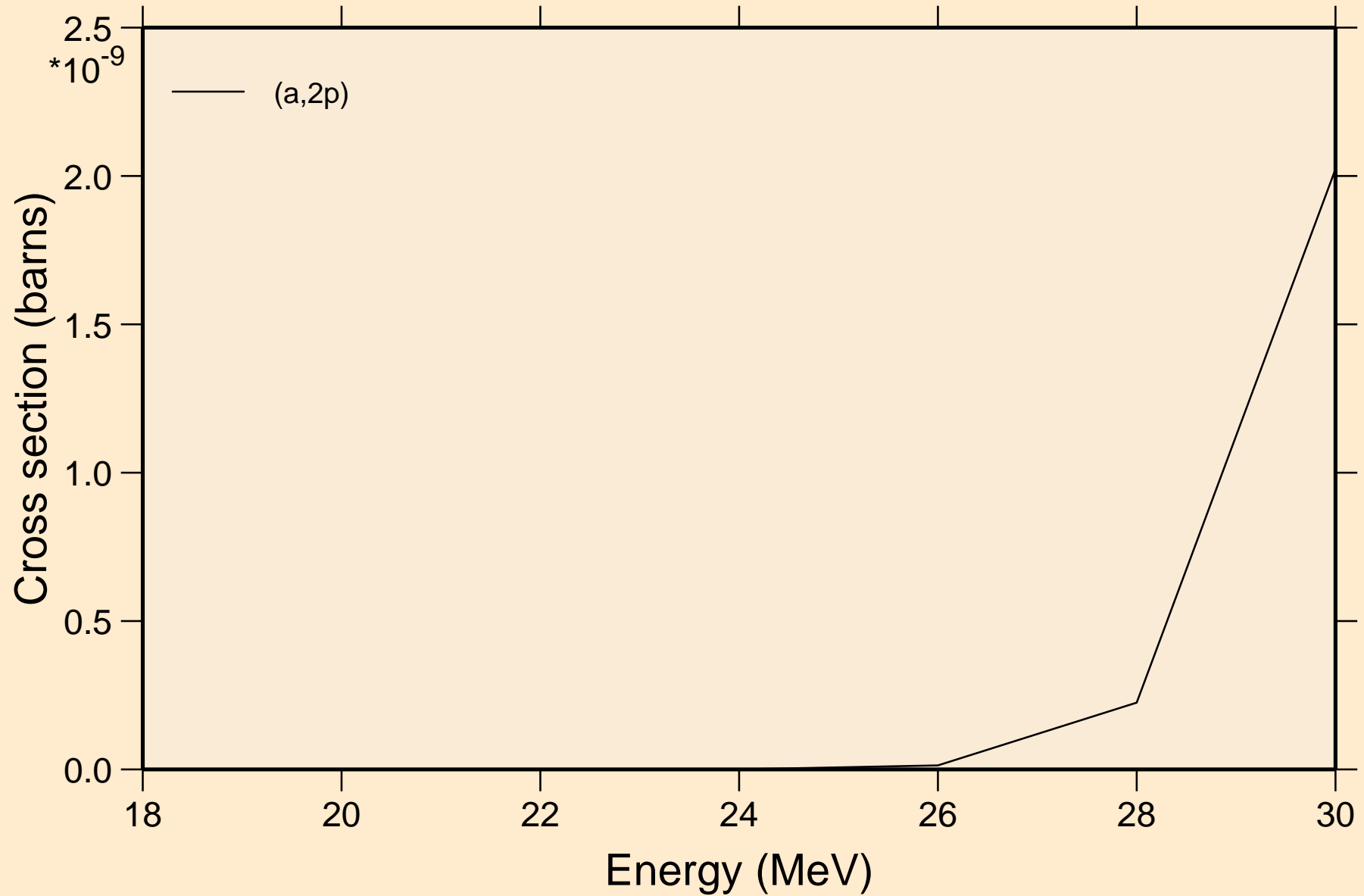

ZN078 ALPHA ACER TENDL-2023 LIBRARY; T=0.K
angular distribution for elastic

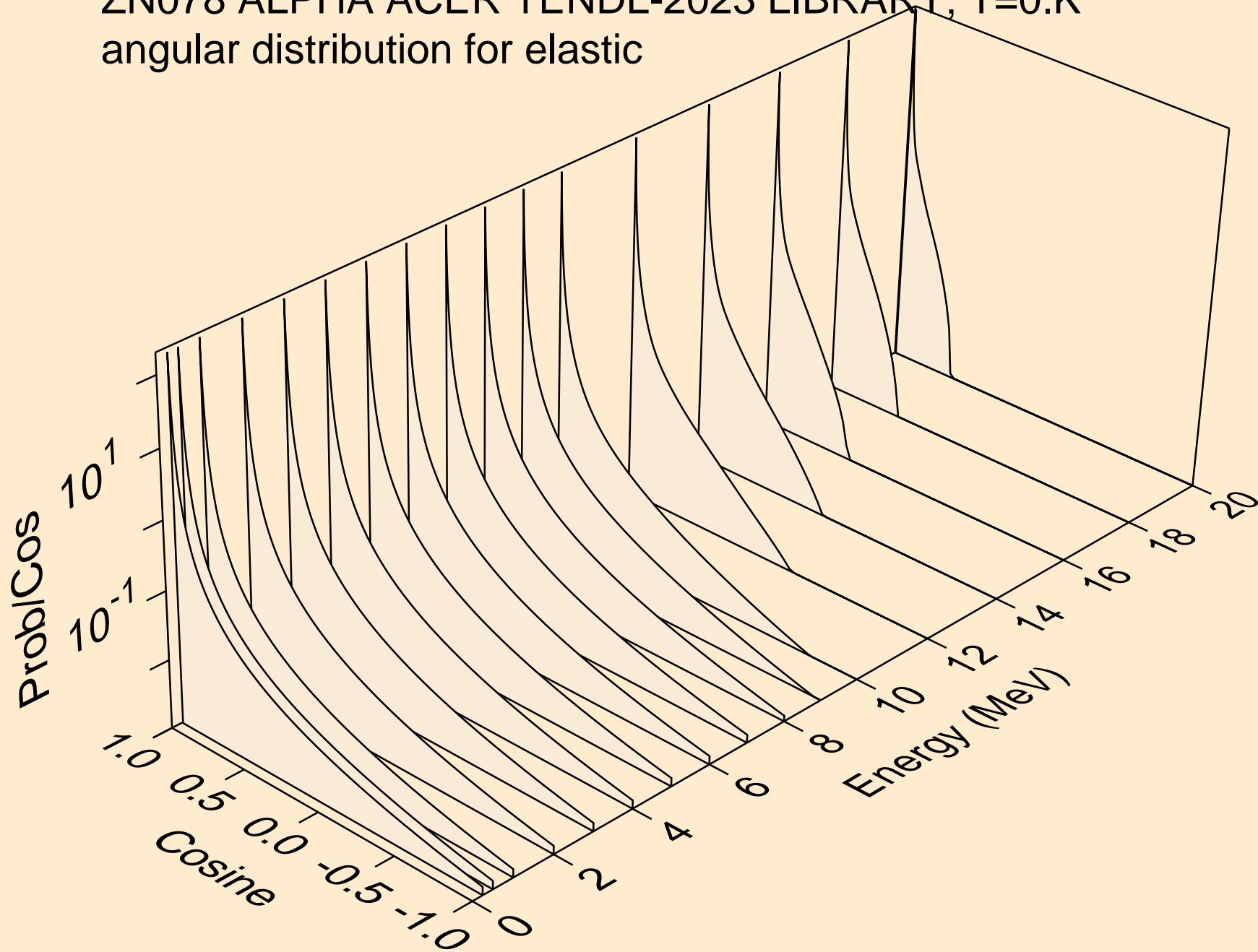

ZN078 ALPHA ACER TENDL-2023 LIBRARY; T=0.K
angular distribution for elastic

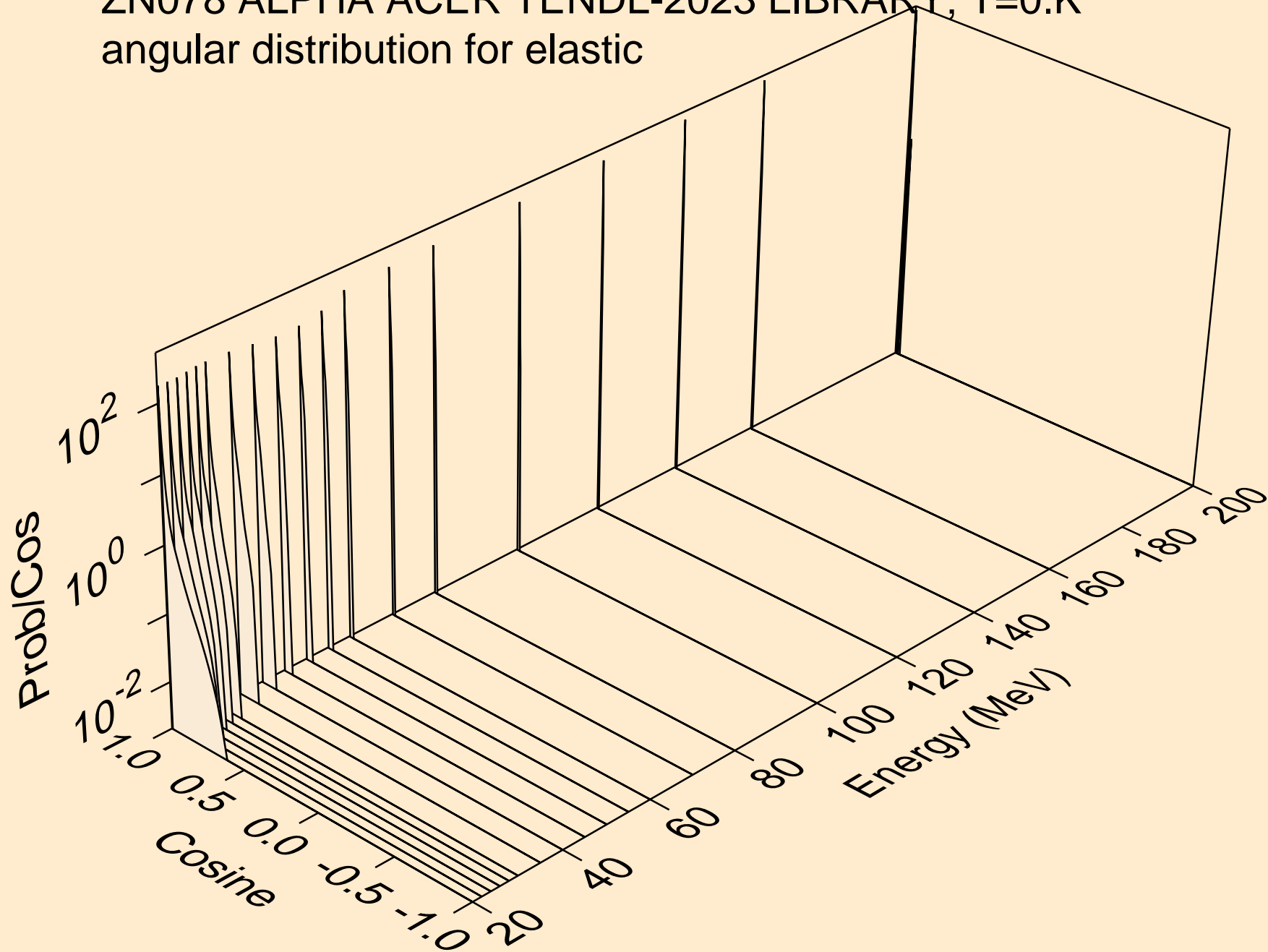

ZN078 ALPHA ACER TENDL-2023 LIBRARY; T=0.K
Alpha emission for (a,x)

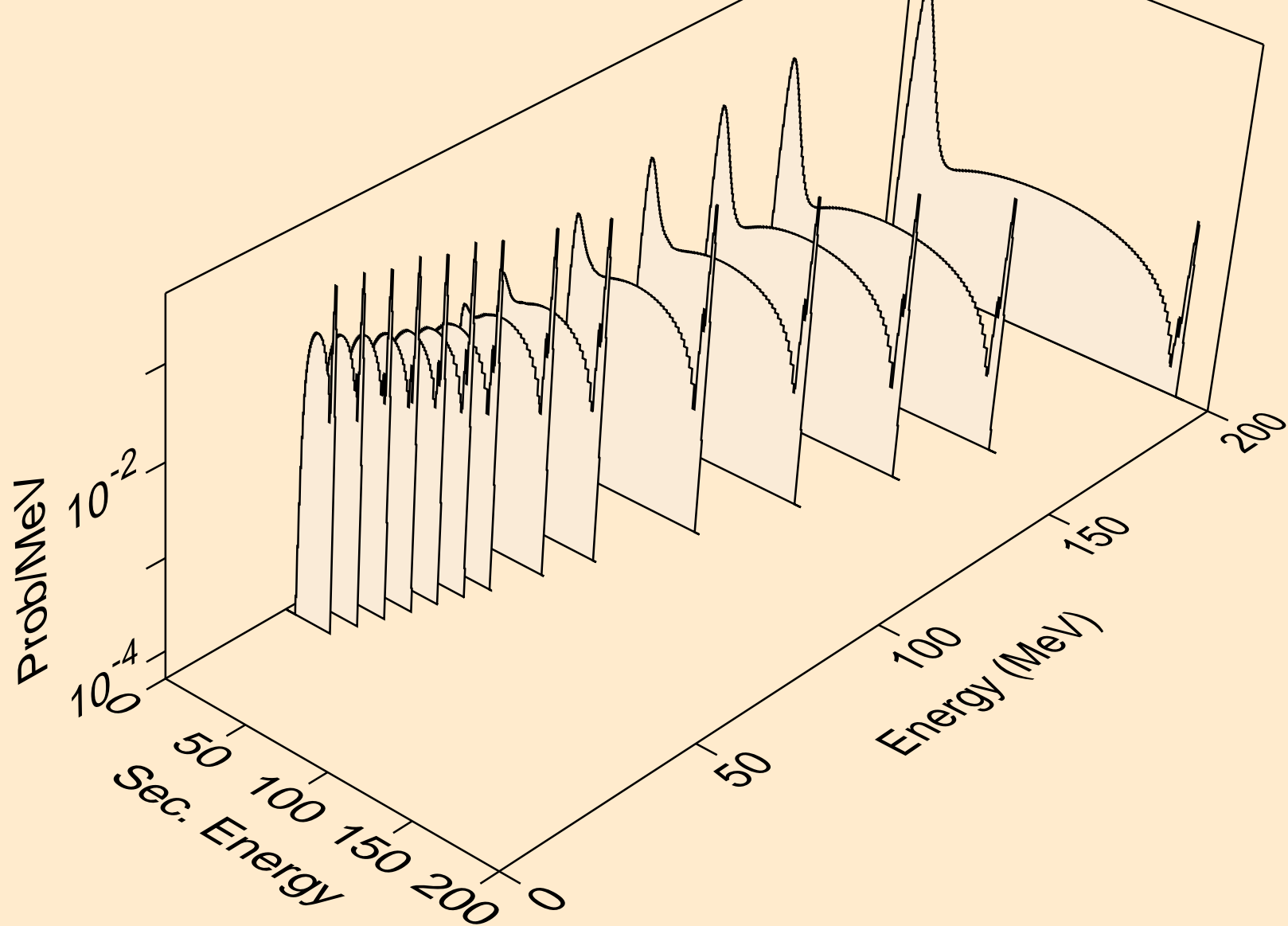

ZN078 ALPHA ACER TENDL-2023 LIBRARY; T=0.K
Alpha emission for (a,n*)a

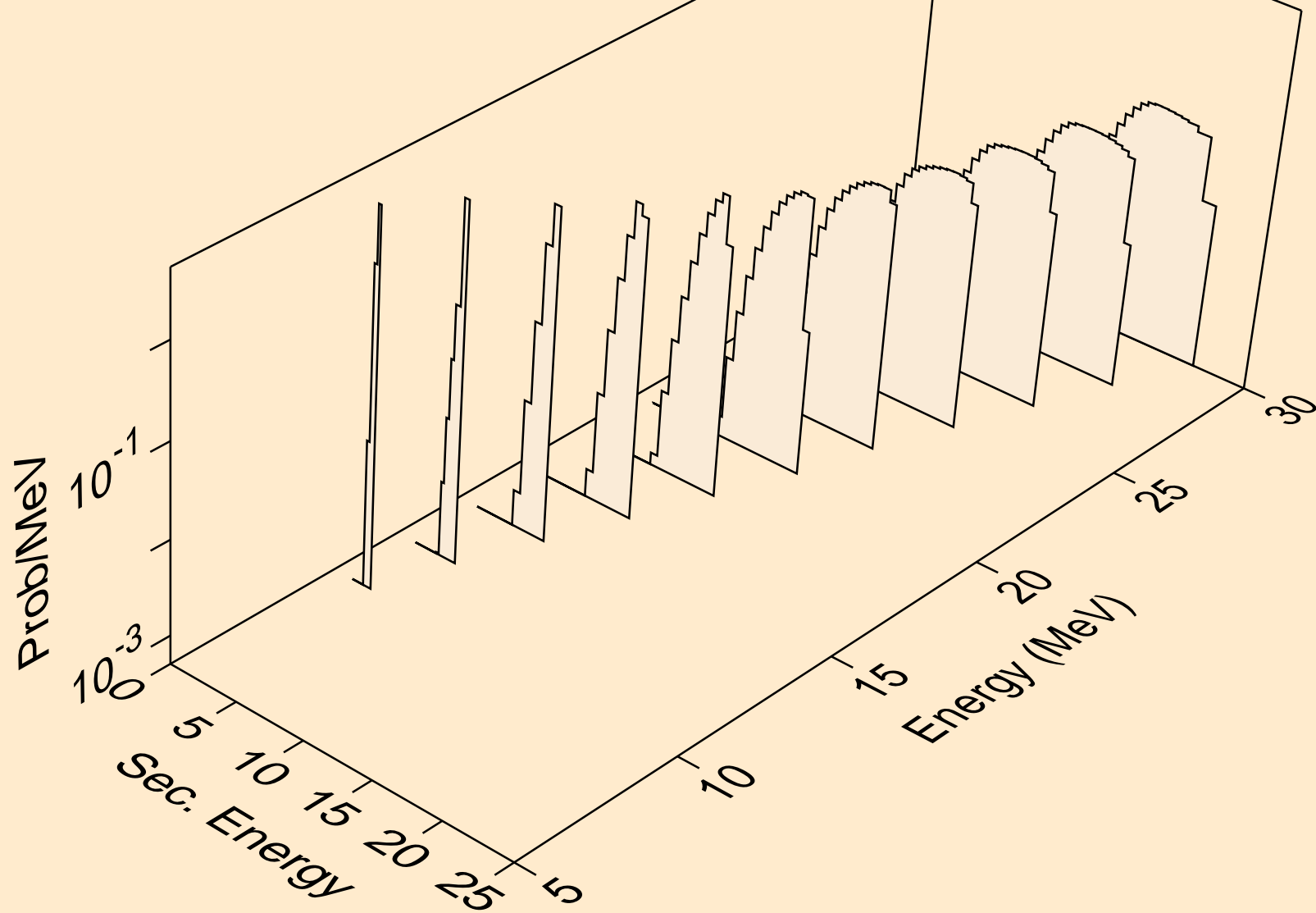

ZN078 ALPHA ACER TENDL-2023 LIBRARY; T=0.K
Alpha emission for (a,2n)a

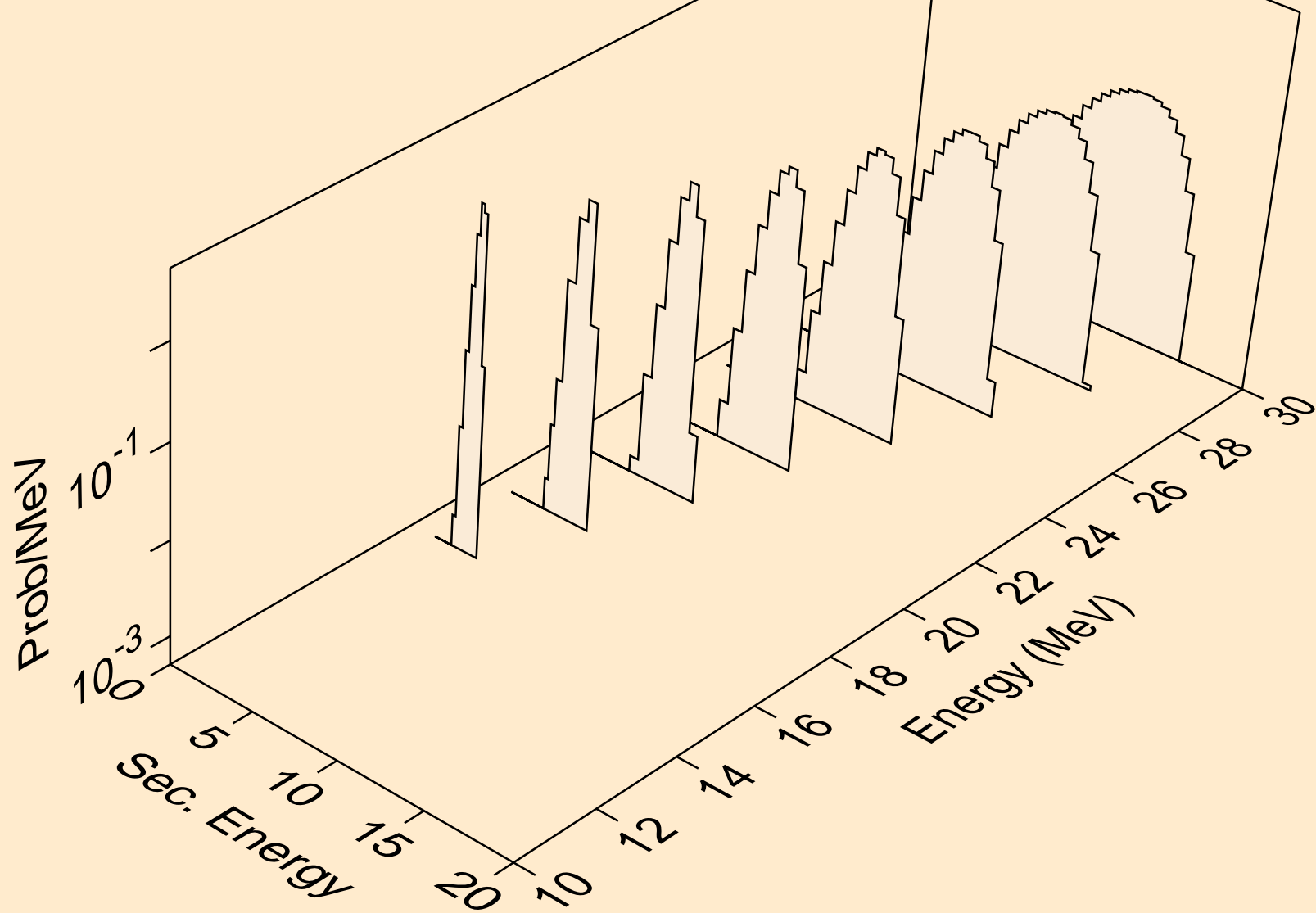

ZN078 ALPHA ACER TENDL-2023 LIBRARY; T=0.K
Alpha emission for (a,3n)a

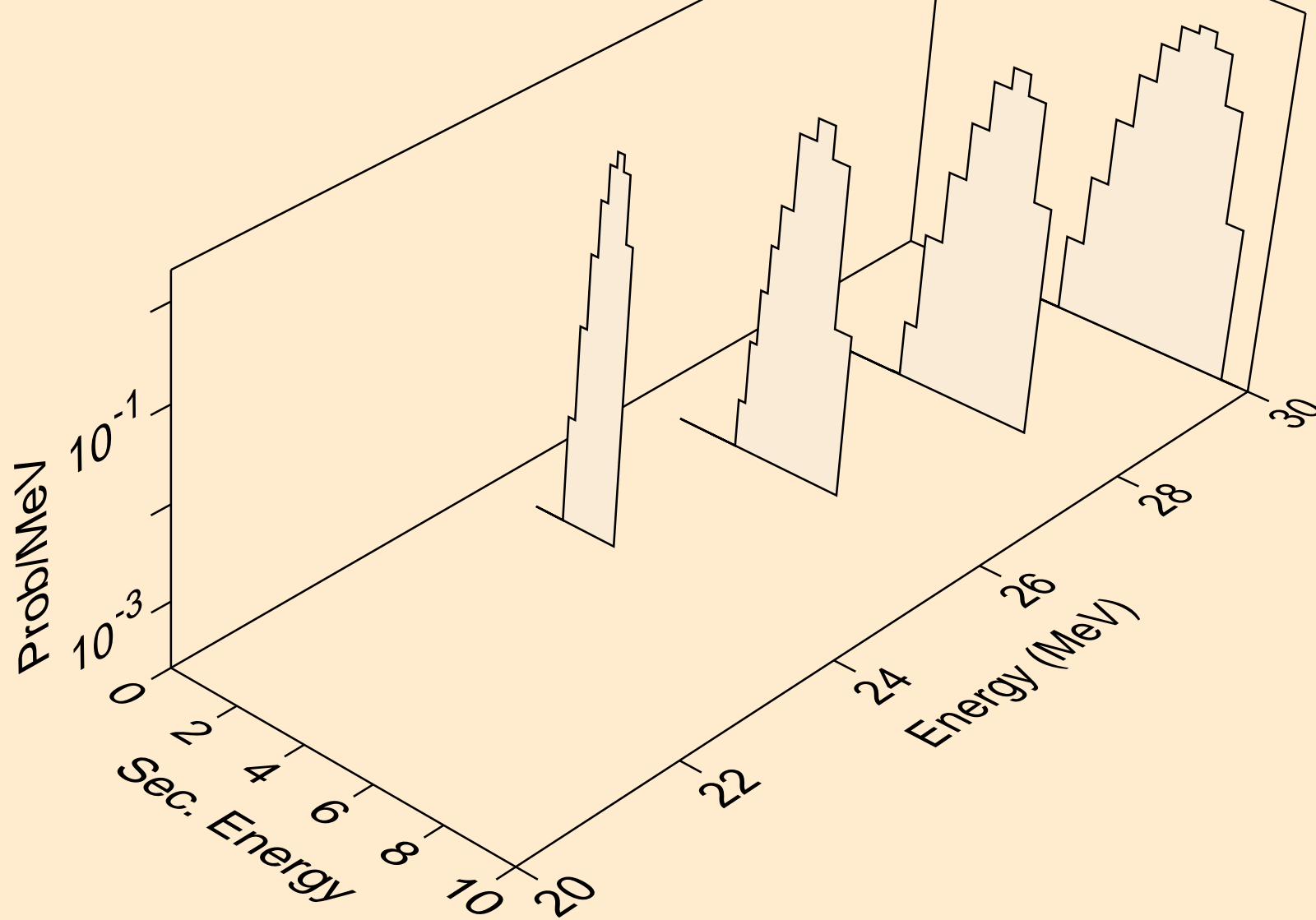

ZN078 ALPHA ACER TENDL-2023 LIBRARY; T=0.K
Alpha emission for inelastic

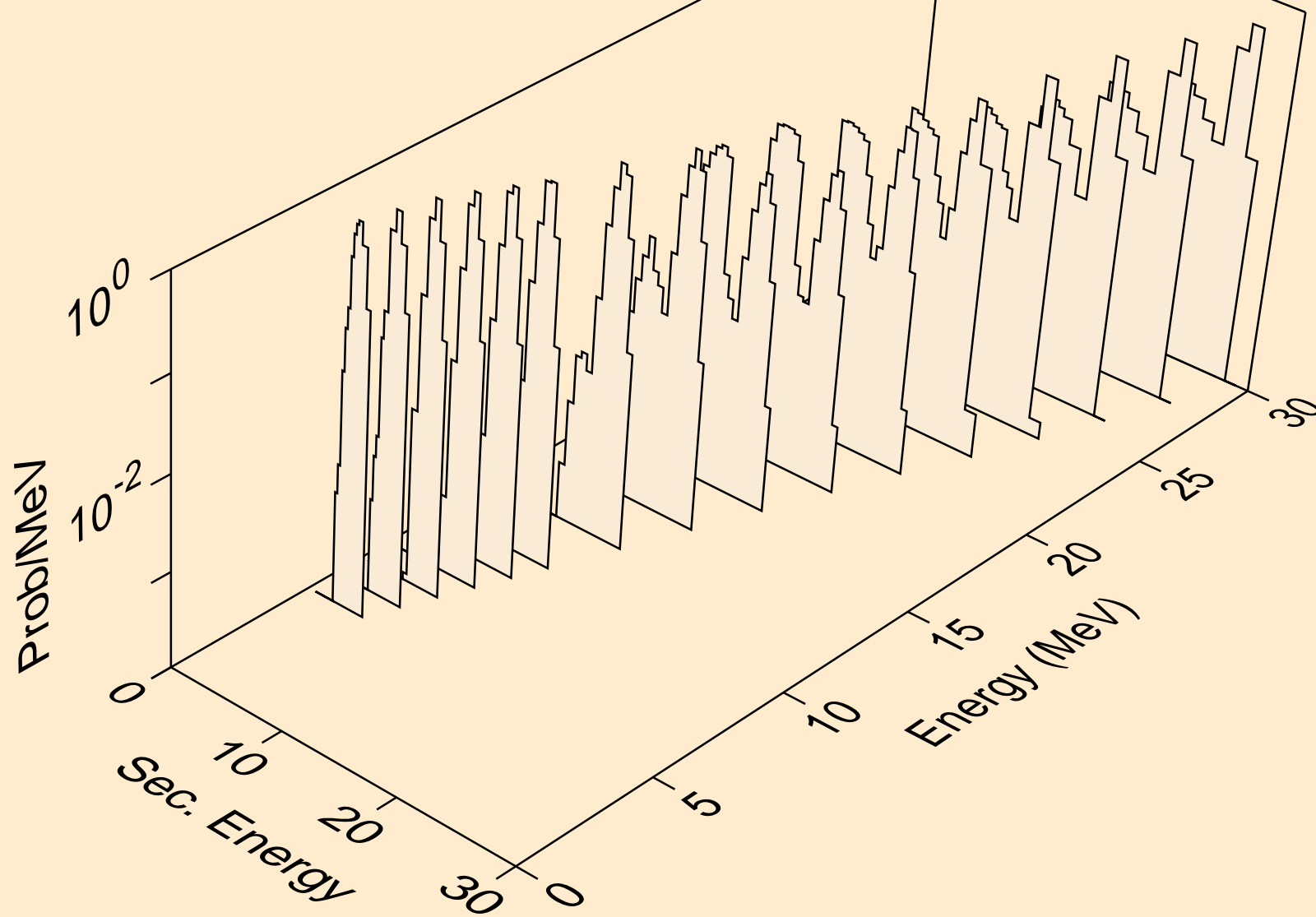

ZN078 ALPHA ACER TENDL-2023 LIBRARY; T=0.K
Photon emission for (z,n)

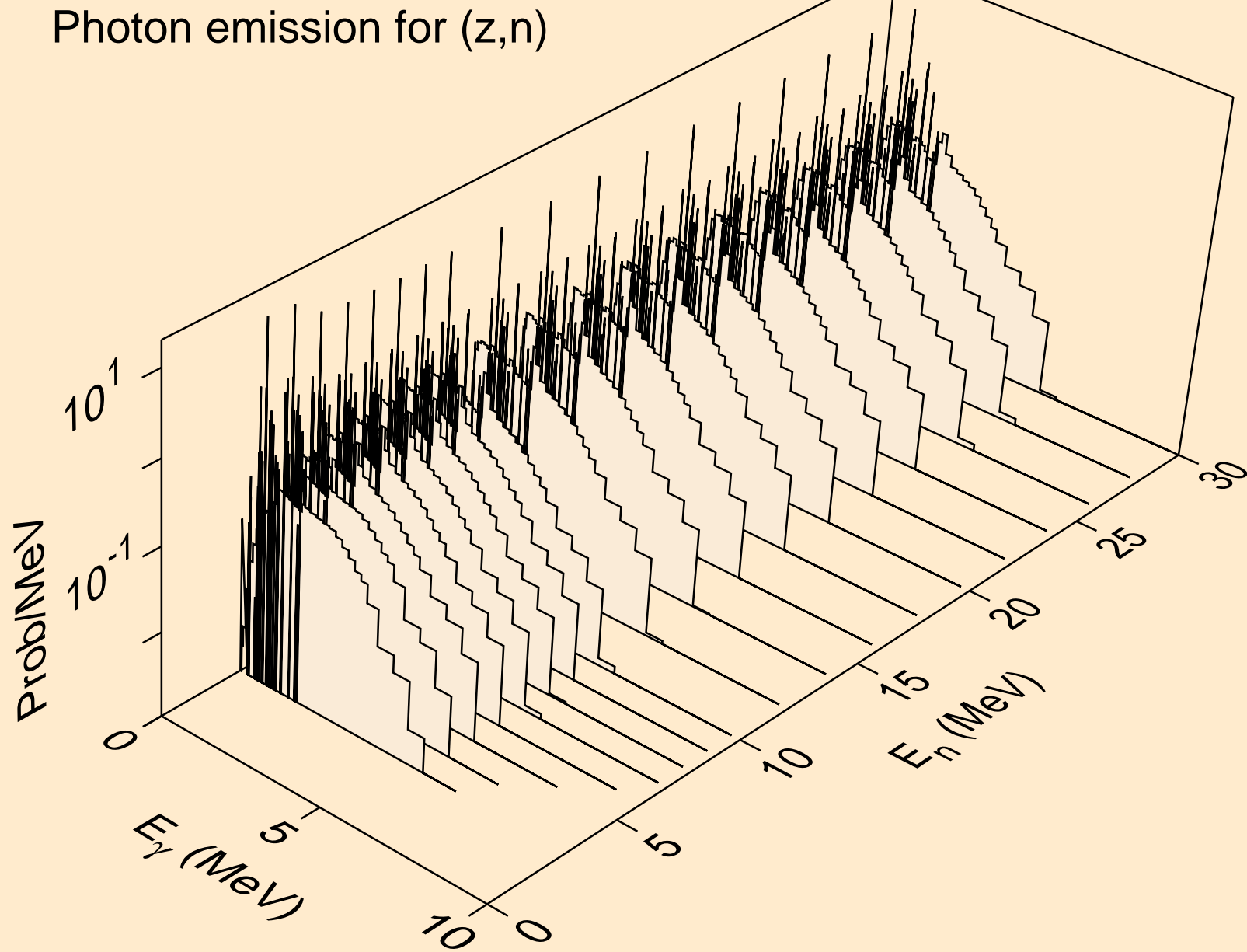

ZN078 ALPHA ACER TENDL-2023 LIBRARY; T=0.K

Photon emission for (z,x)

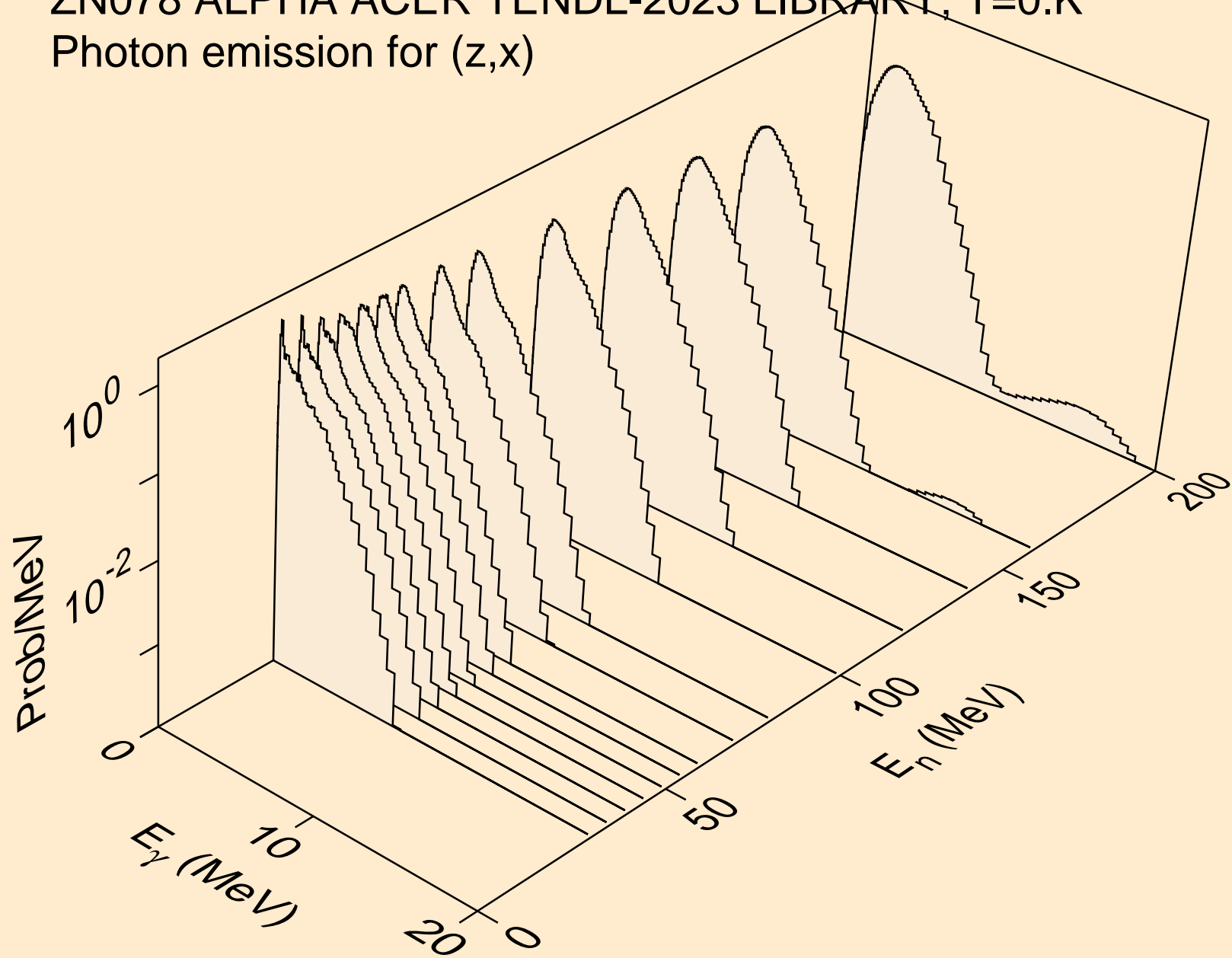

ZN078 ALPHA ACER TENDL-2023 LIBRARY; T=0.K
Photon emission for (n,2nd)

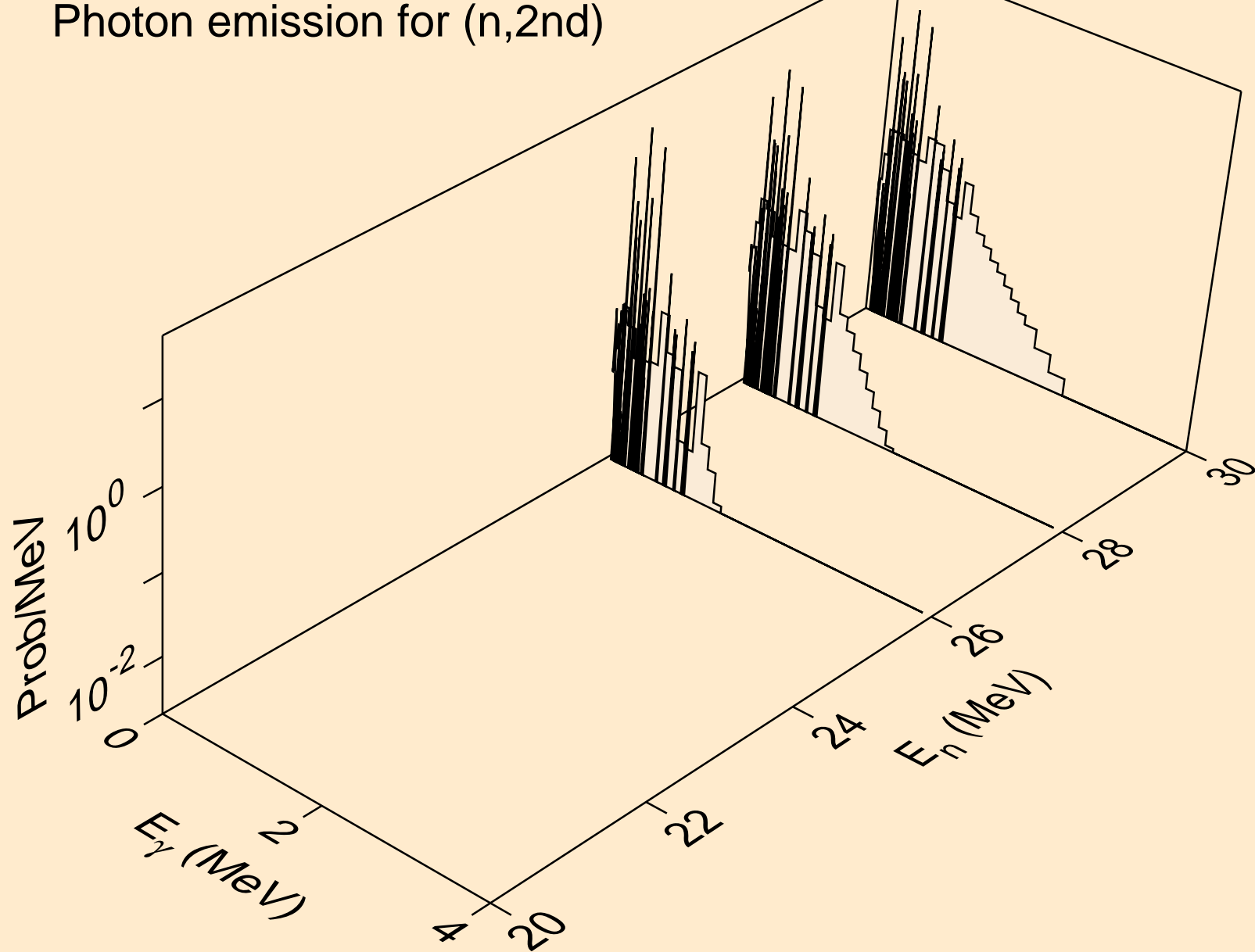

ZN078 ALPHA ACER TENDL-2023 LIBRARY; T=0.K
Photon emission for (n,2n)

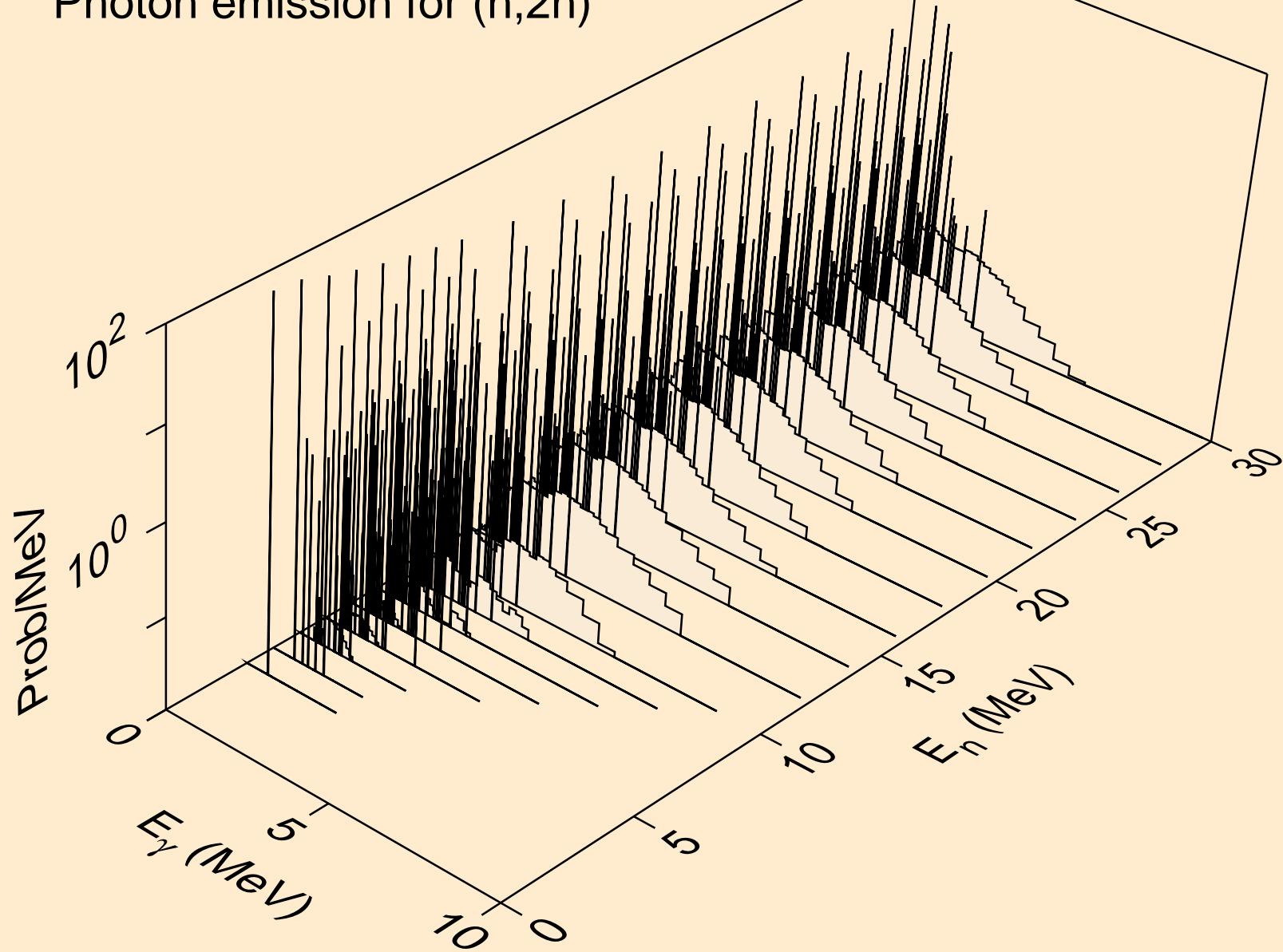

ZN078 ALPHA ACER TENDL-2023 LIBRARY; T=0.K
Photon emission for (n,3n)

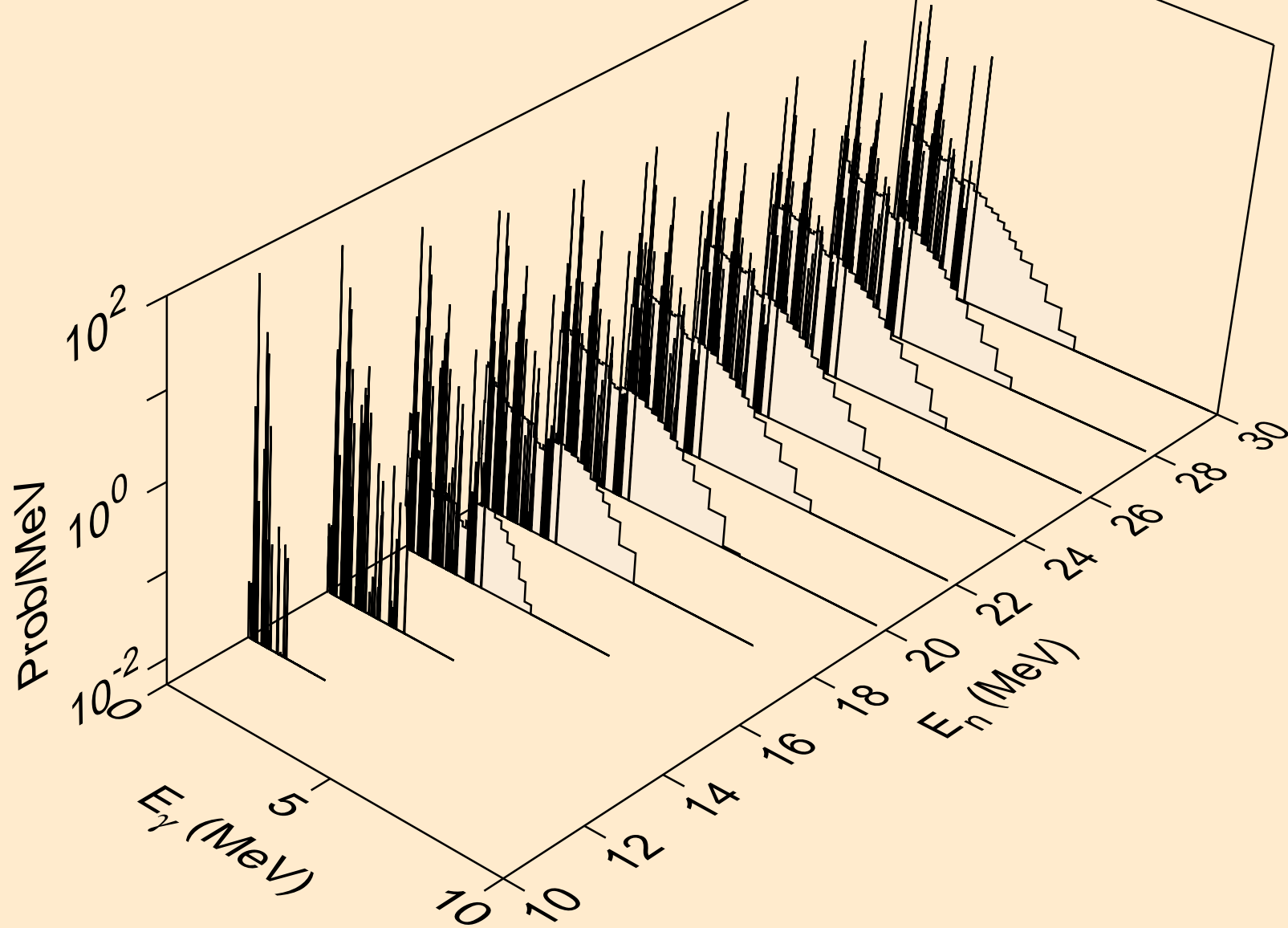

ZN078 ALPHA ACER TENDL-2023 LIBRARY; T=0.K
Photon emission for (n,n*)a

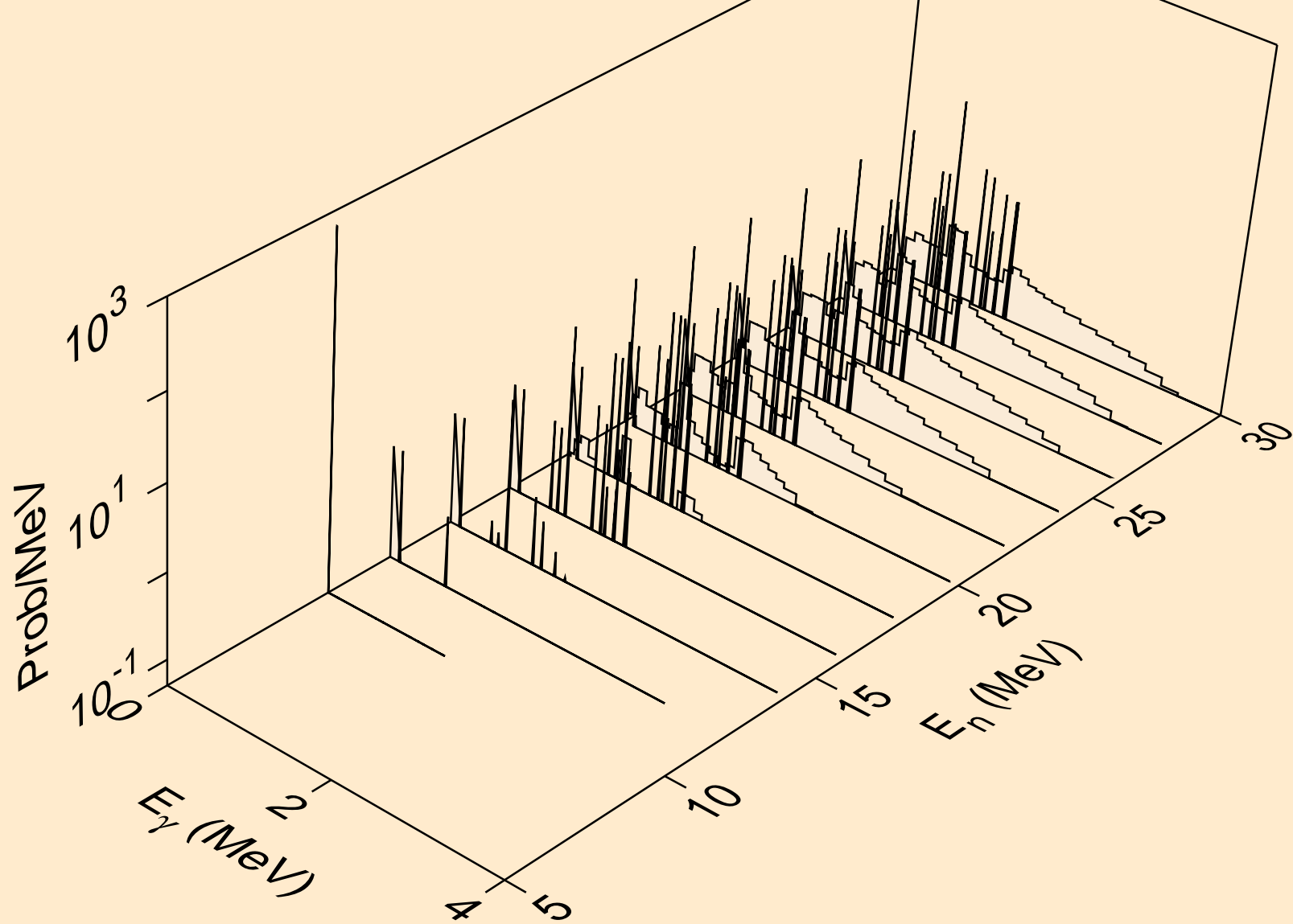

ZN078 ALPHA ACER TENDL-2023 LIBRARY; T=0.K
Photon emission for (n,2n)a

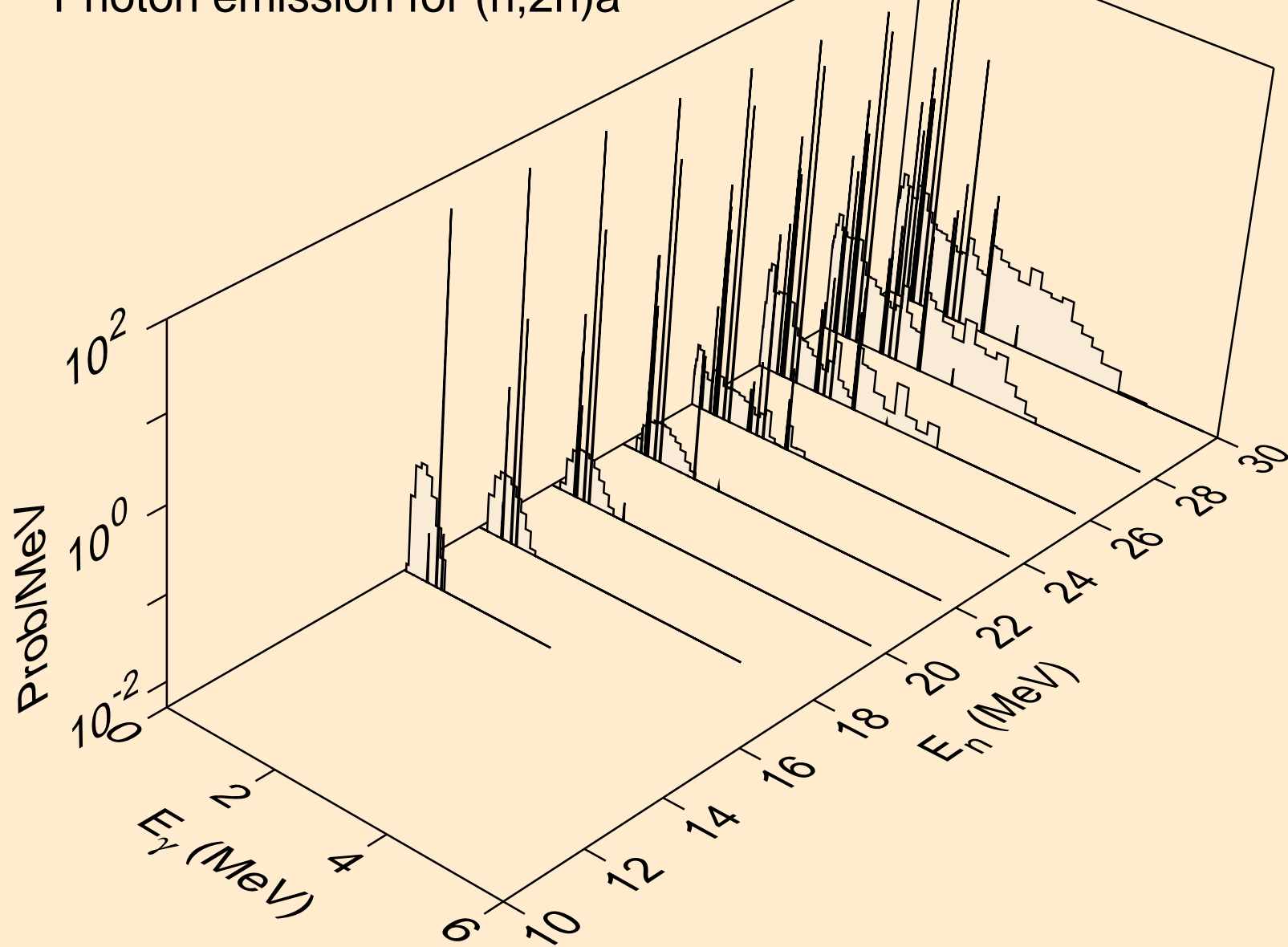

ZN078 ALPHA ACER TENDL-2023 LIBRARY; T=0.K
Photon emission for (n,3n)a

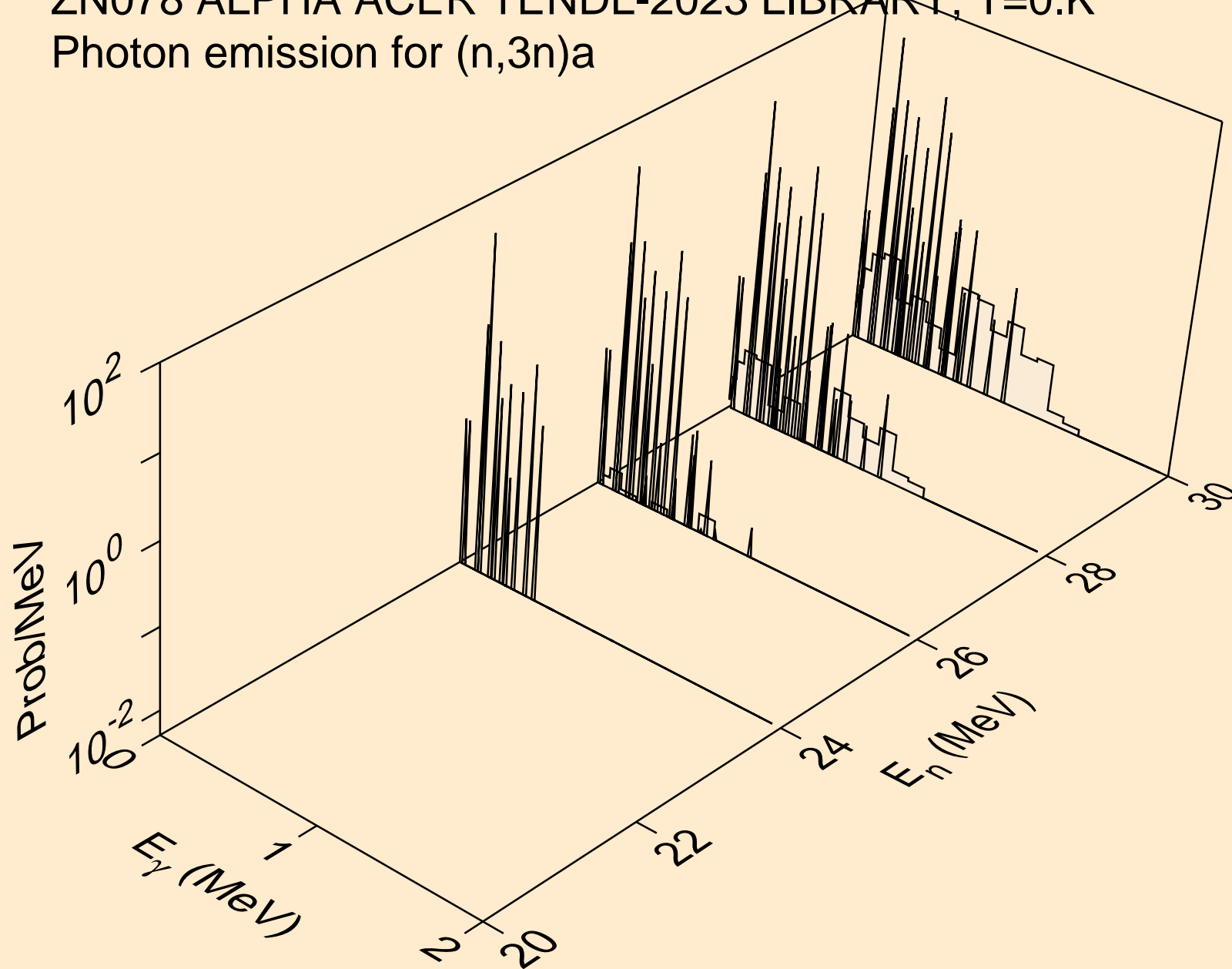

ZN078 ALPHA ACER TENDL-2023 LIBRARY; T=0.K
Photon emission for (n,n*)p

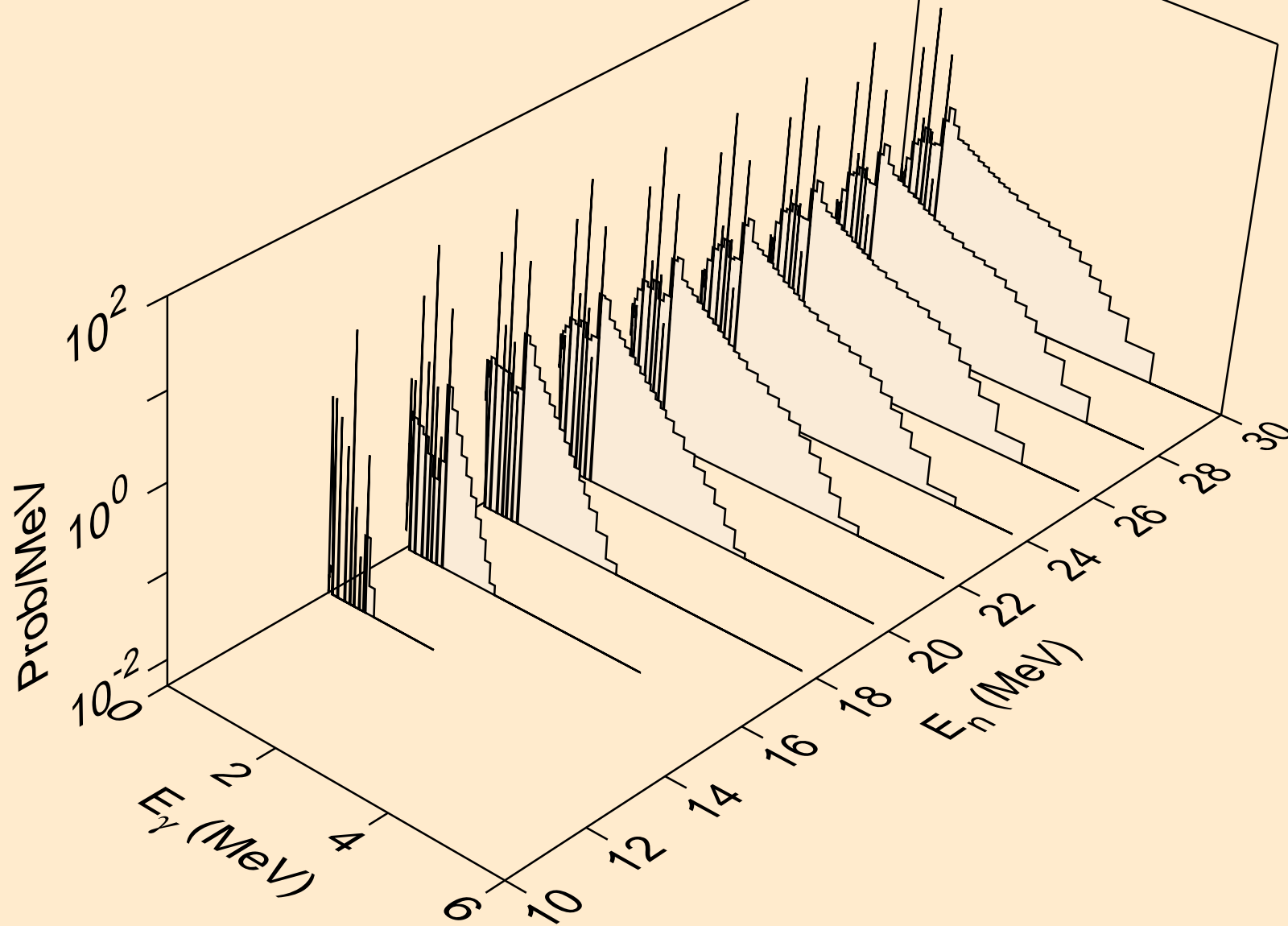

ZN078 ALPHA ACER TENDL-2023 LIBRARY; T=0.K
Photon emission for (n,n*)d

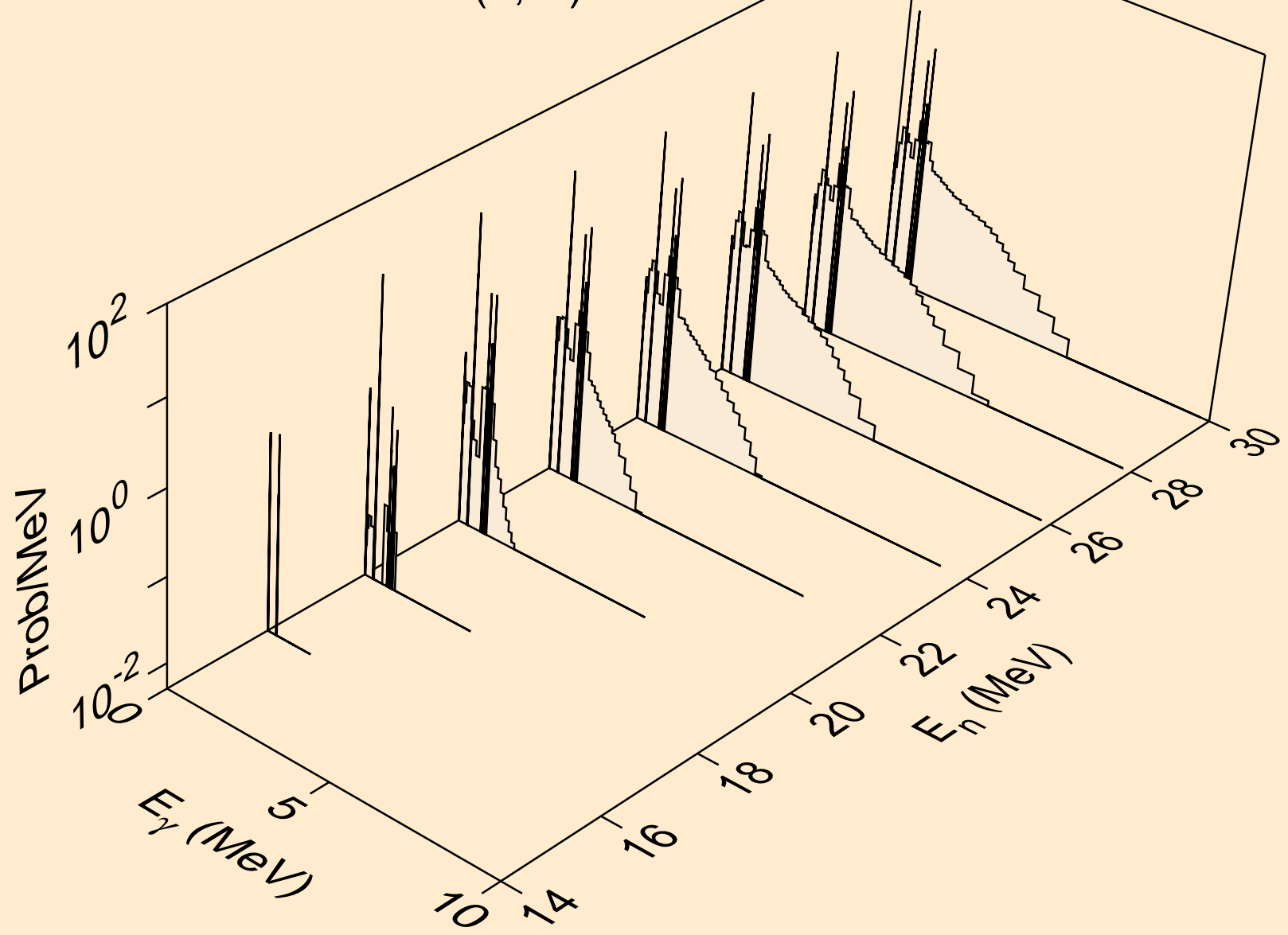

ZN078 ALPHA ACER TENDL-2023 LIBRARY; T=0.K
Photon emission for (n,n*)t

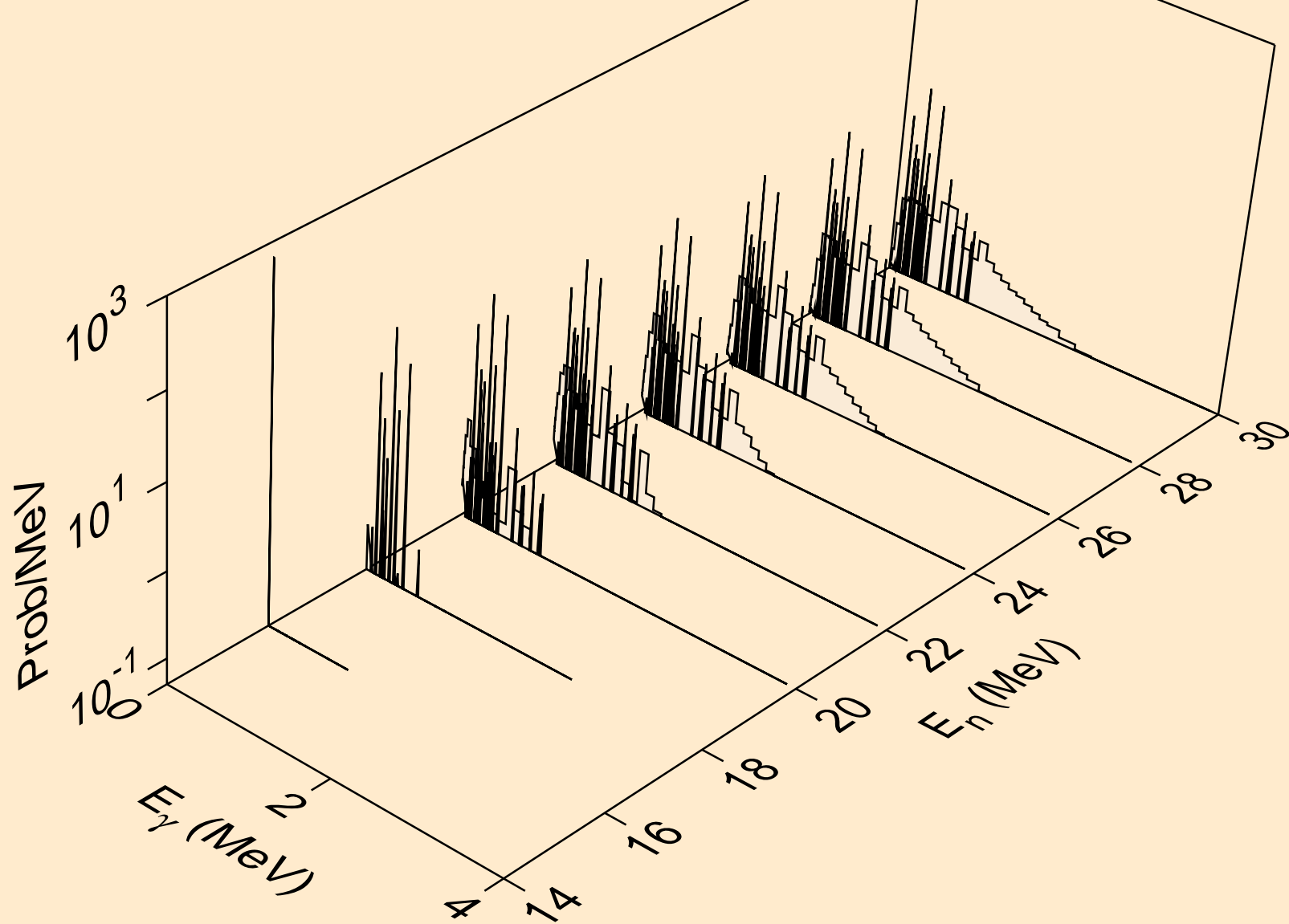

ZN078 ALPHA ACER TENDL-2023 LIBRARY; T=0.K
Photon emission for (n,n*)he3

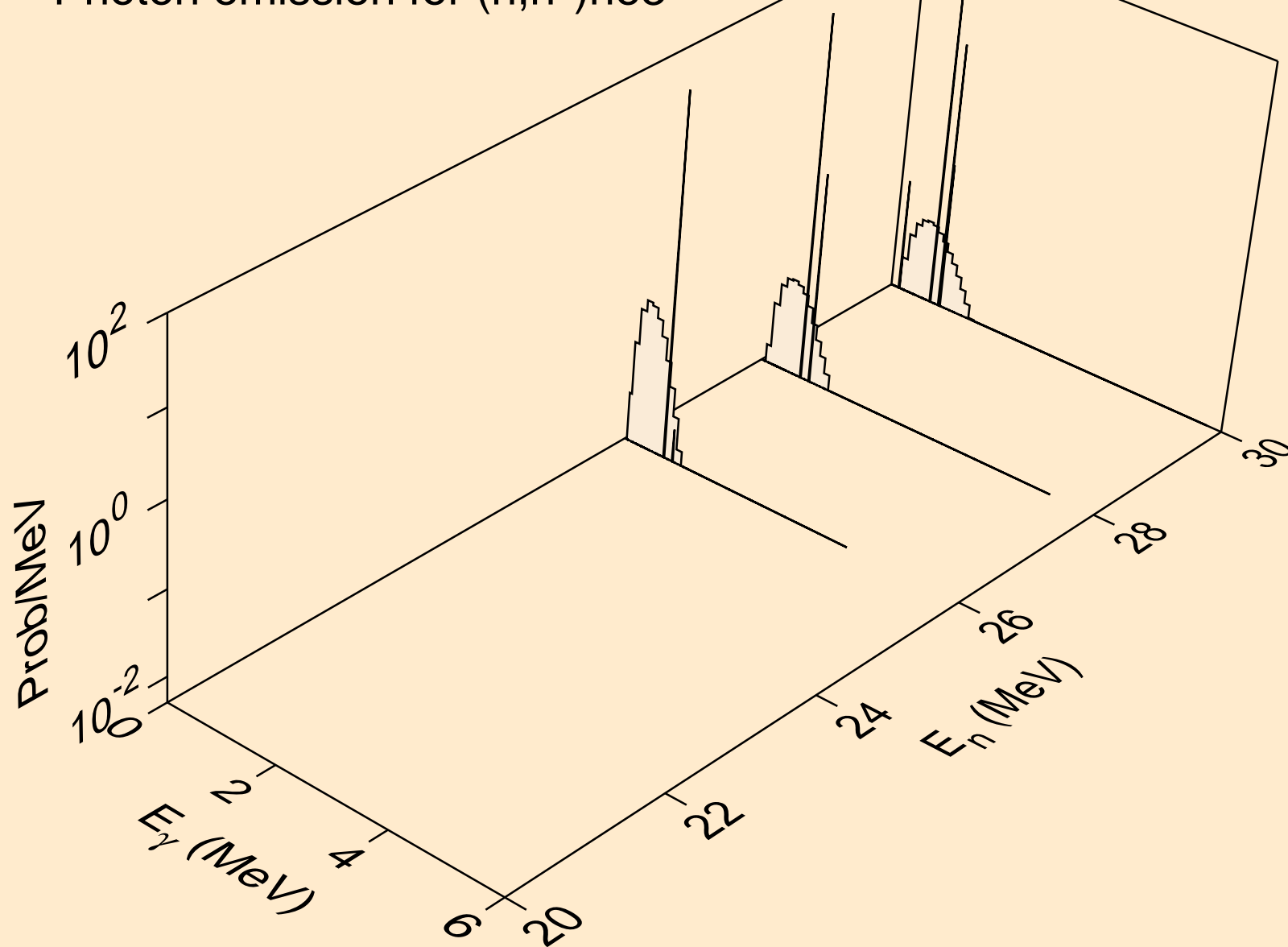

ZN078 ALPHA ACER TENDL-2023 LIBRARY; T=0.K
Photon emission for (n,4n)

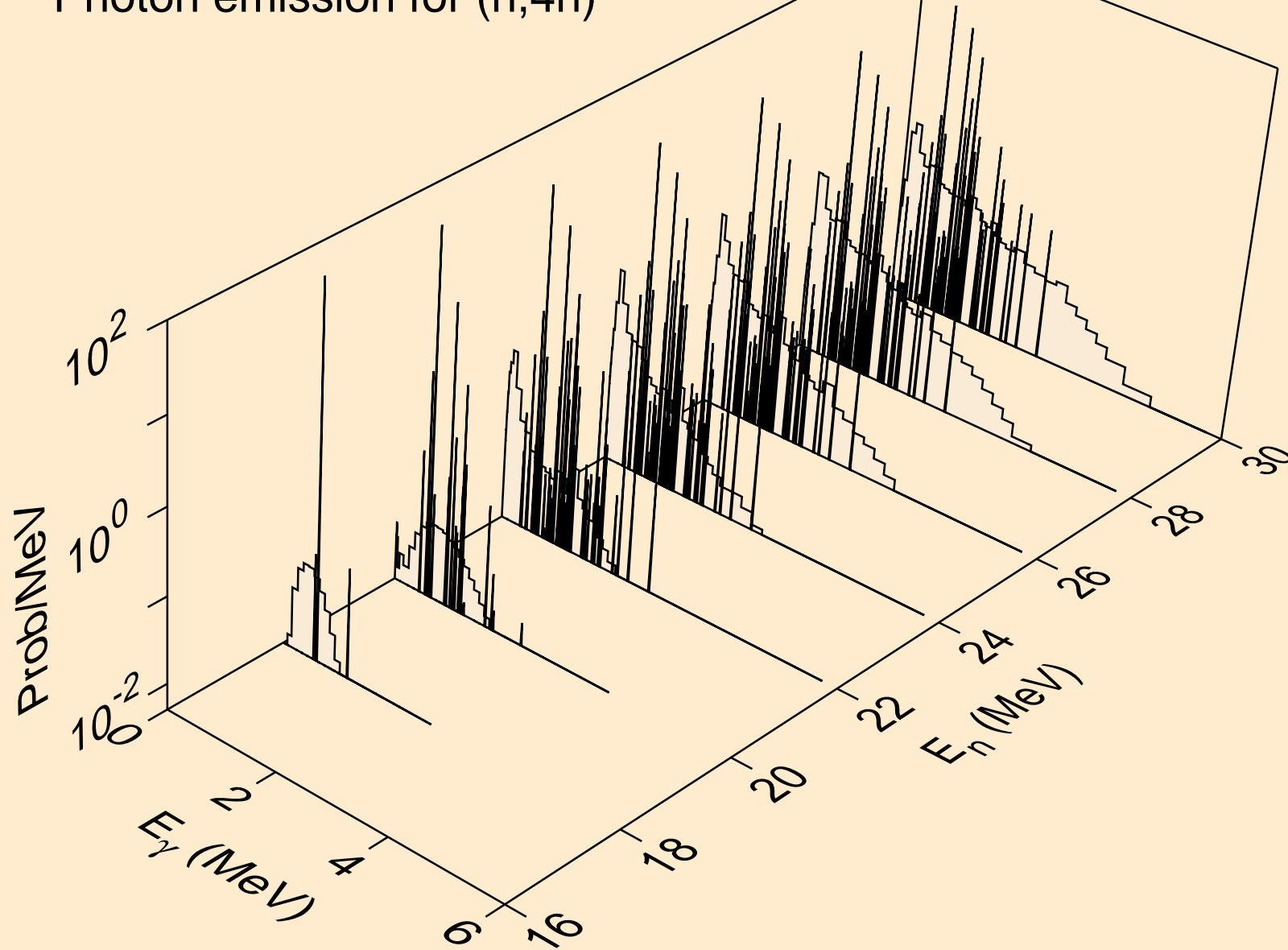

ZN078 ALPHA ACER TENDL-2023 LIBRARY; T=0.K
Photon emission for (n,2np)

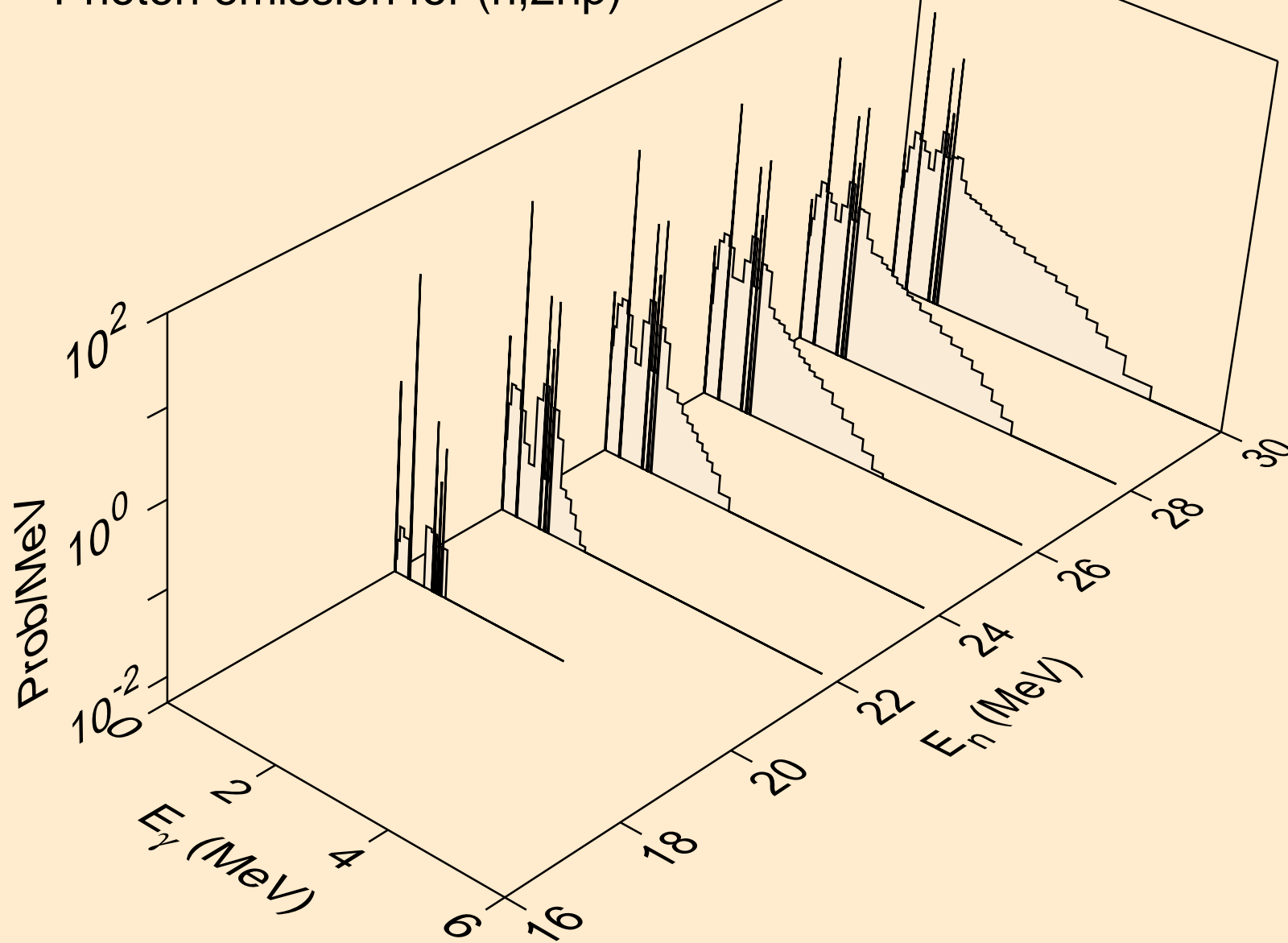

ZN078 ALPHA ACER TENDL-2023 LIBRARY; T=0.K
Photon emission for (n,3np)

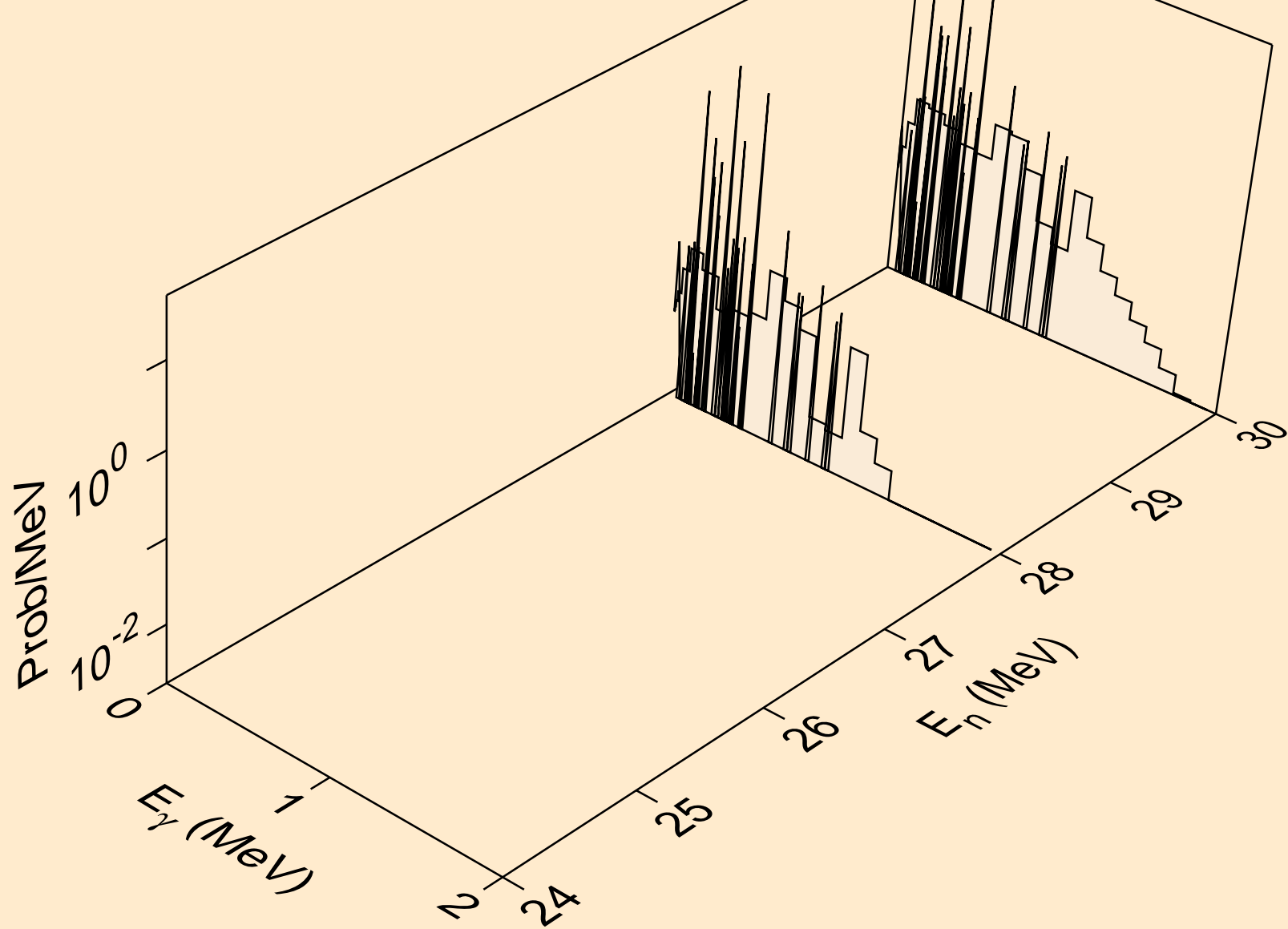

ZN078 ALPHA ACER TENDL-2023 LIBRARY; T=0.K
Photon emission for (n,gma)

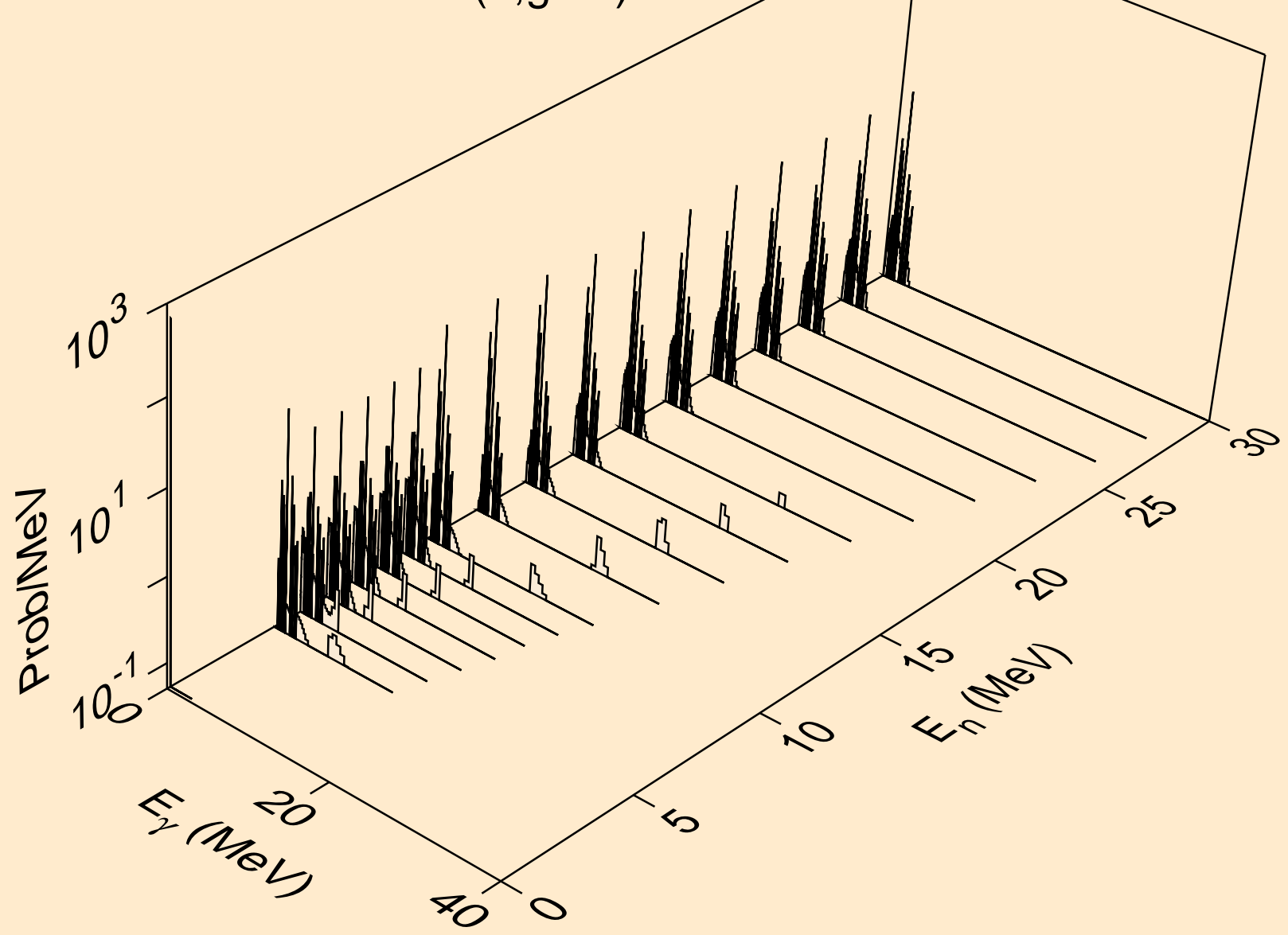

ZN078 ALPHA ACER TENDL-2023 LIBRARY; T=0.K
Photon emission for (n,p)

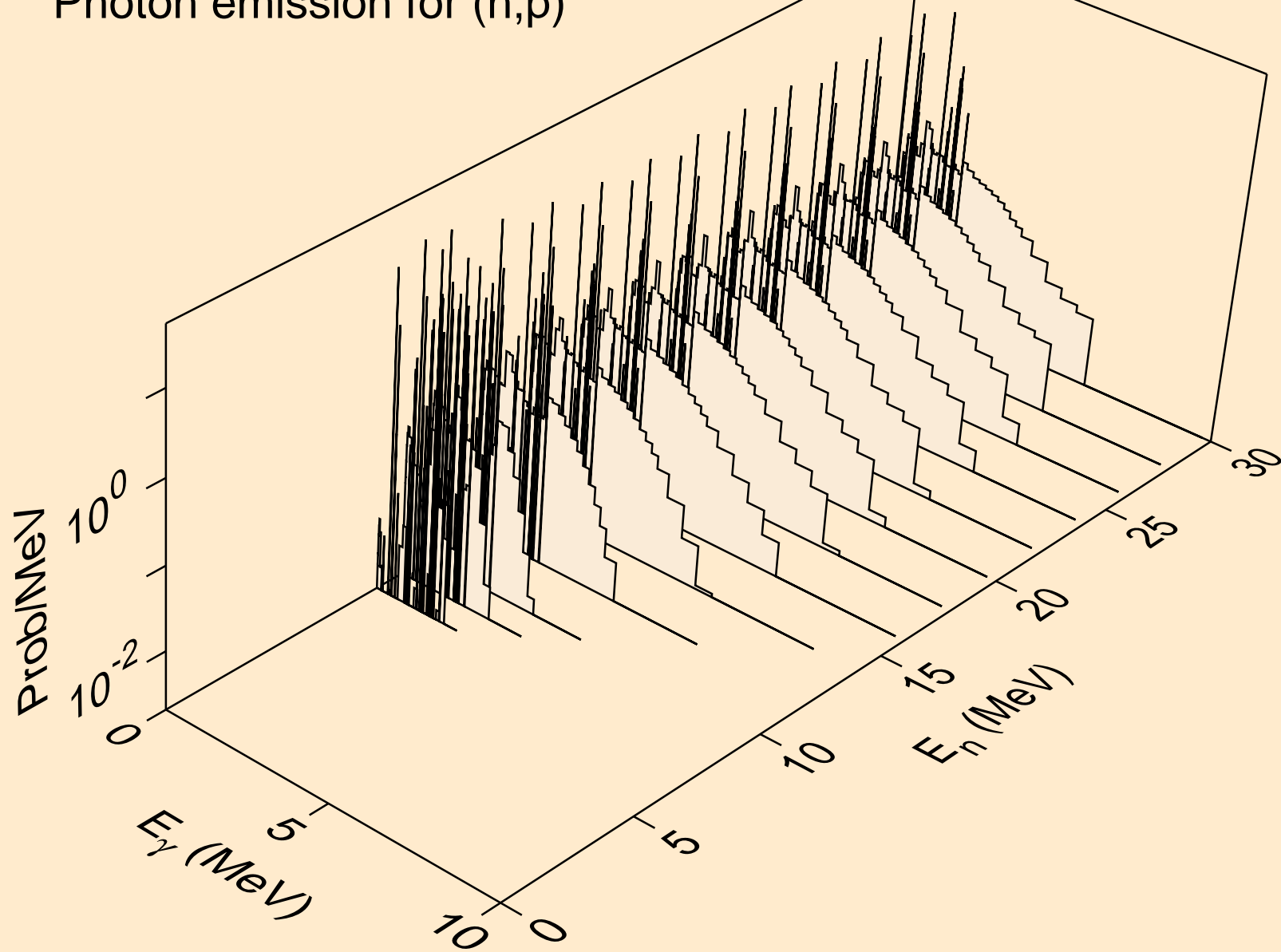

ZN078 ALPHA ACER TENDL-2023 LIBRARY; T=0.K
Photon emission for (n,d)

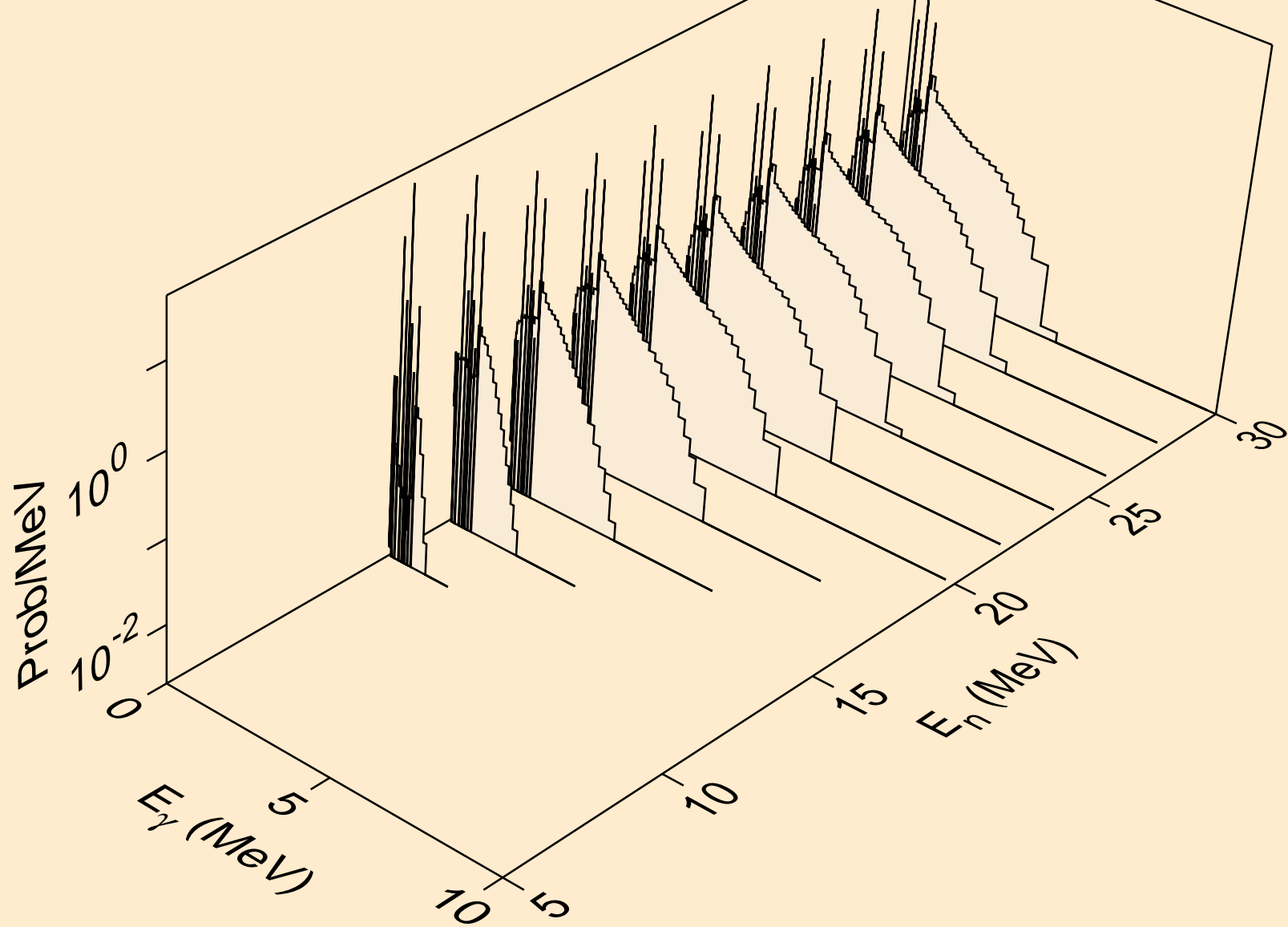

ZN078 ALPHA ACER TENDL-2023 LIBRARY; T=0.K
Photon emission for (n,t)

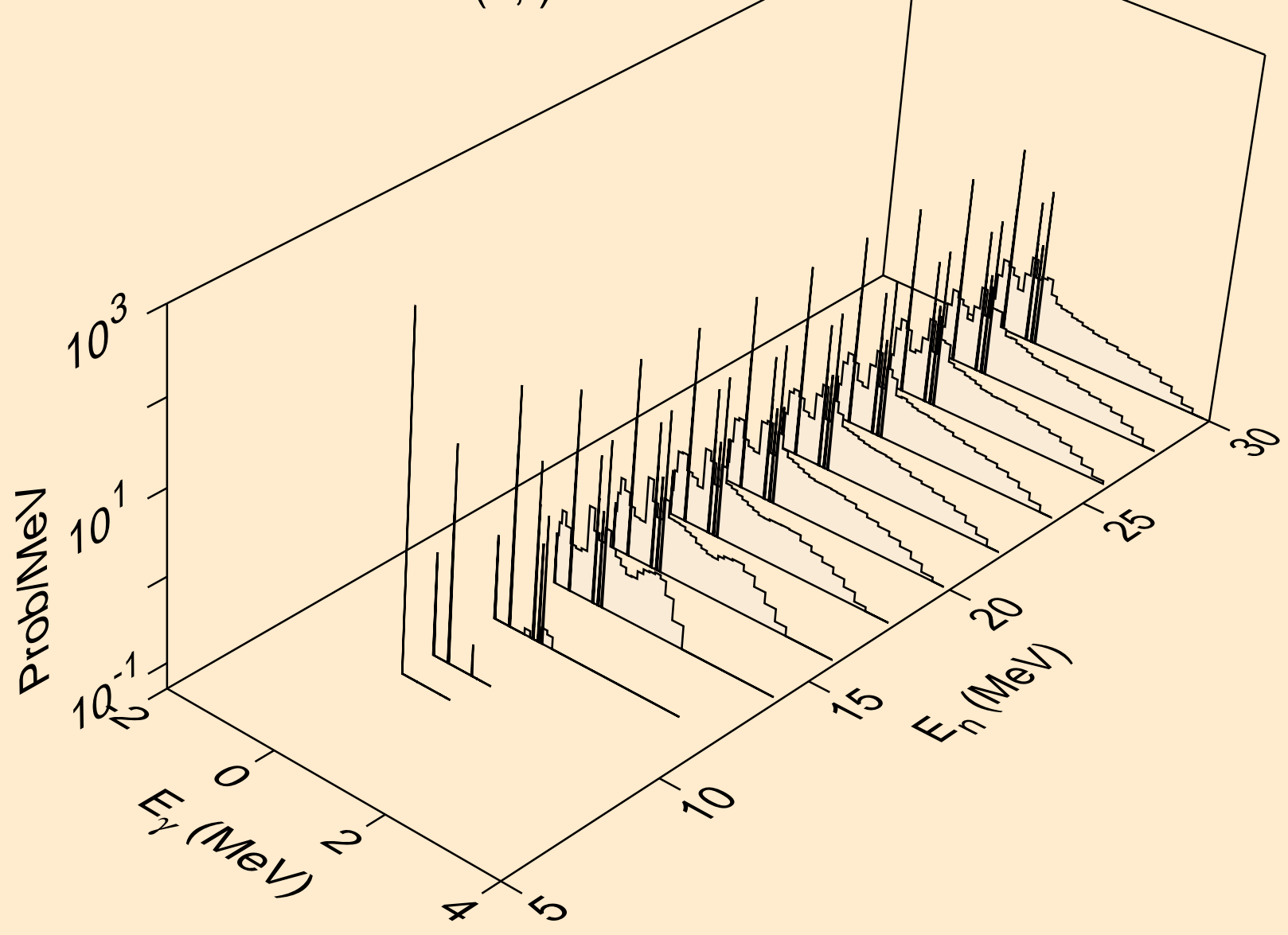

ZN078 ALPHA ACER TENDL-2023 LIBRARY; T=0.K
Photon emission for (n,he3)

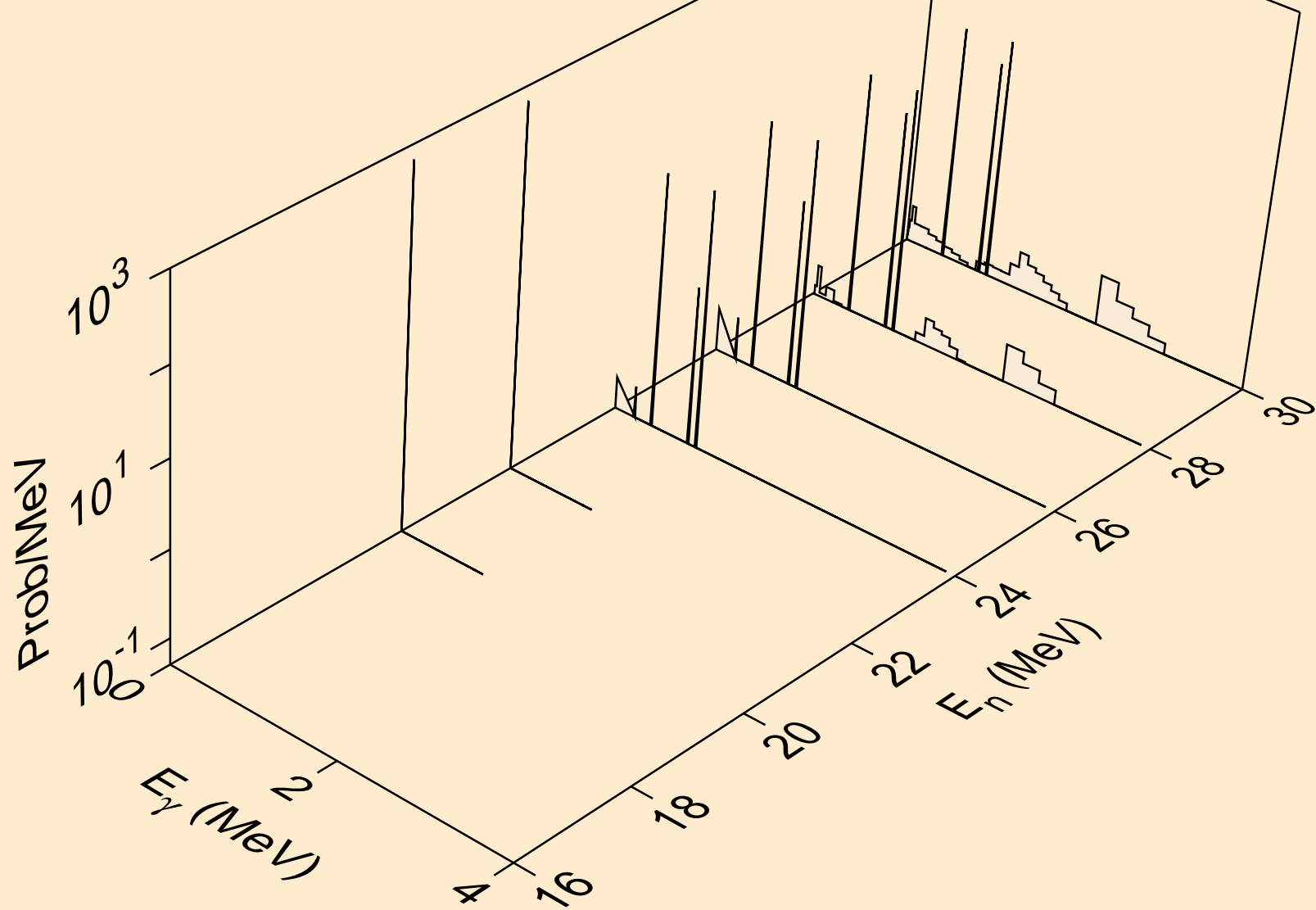

ZN078 ALPHA ACER TENDL-2023 LIBRARY; T=0.K
Photon emission for inelastic

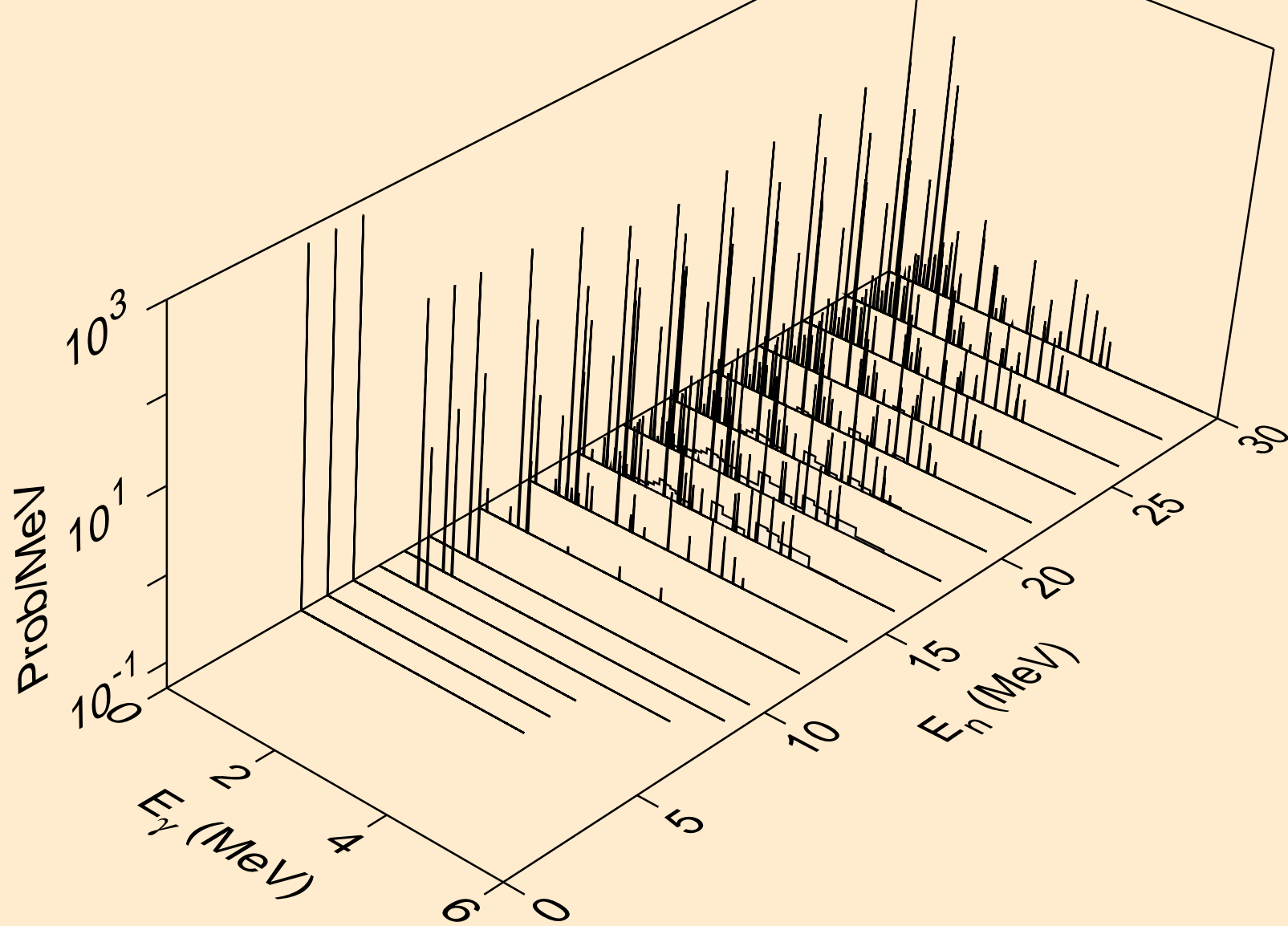

ZN078 ALPHA ACER TENDL-2023 LIBRARY; T=0.K
Photon emission for (n,2p)

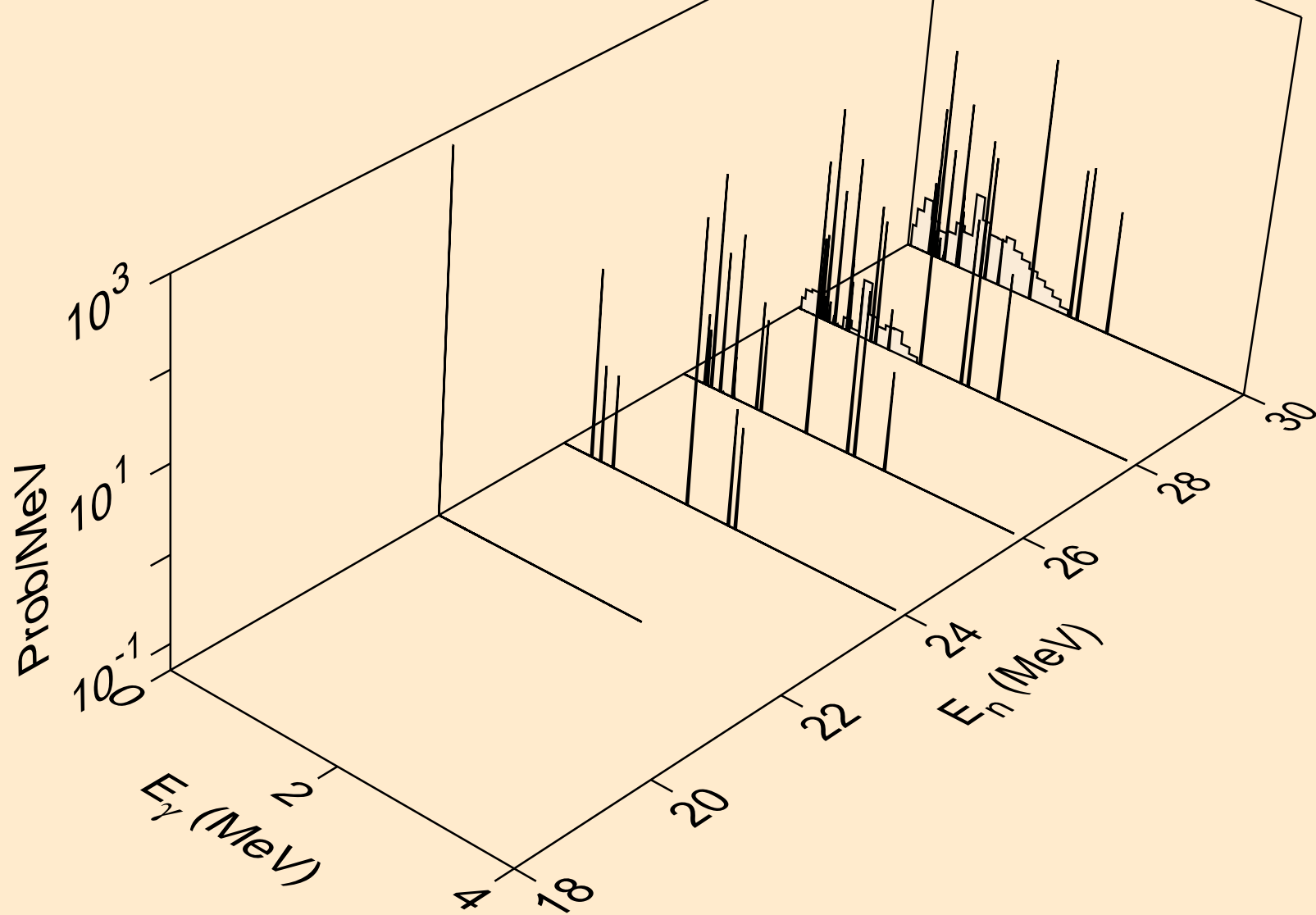

ZN078 ALPHA ACER TENDL-2023 LIBRARY; T=0.K
Particle heating contributions

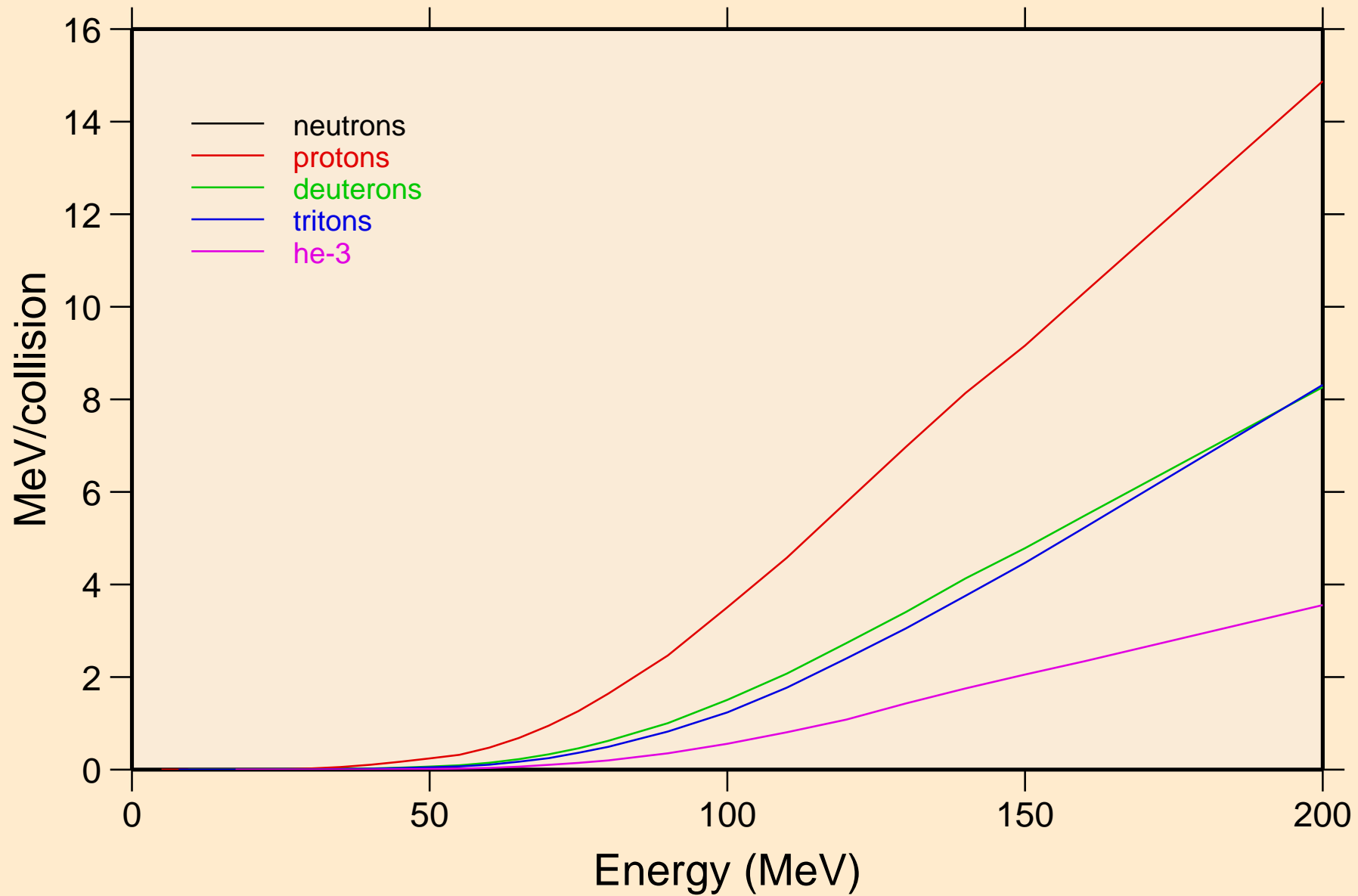

ZN078 ALPHA ACER TENDL-2023 LIBRARY; T=0.K
Recoil Heating

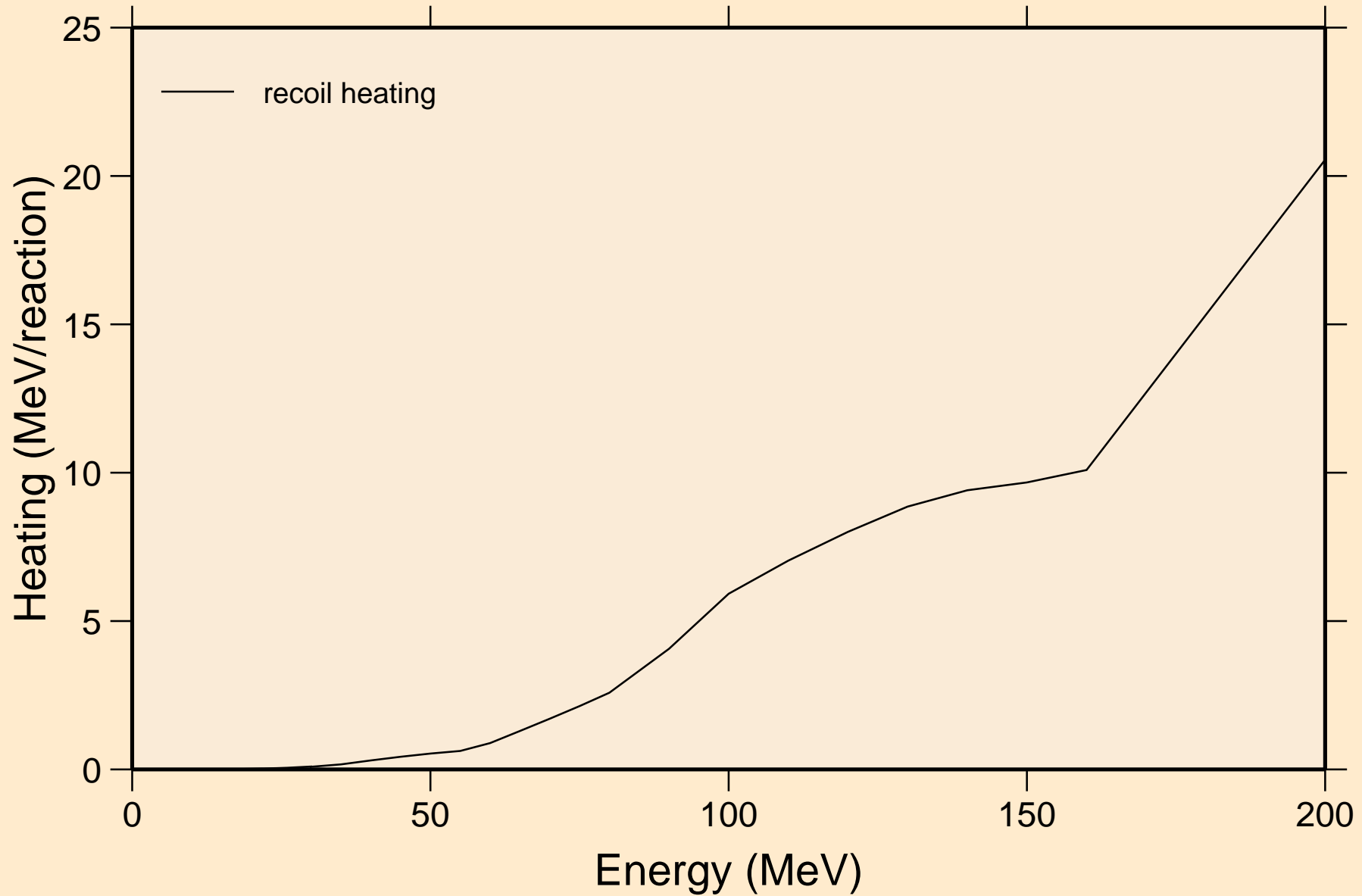

ZN078 ALPHA ACER TENDL-2023 LIBRARY; T=0.K
Particle production cross sections

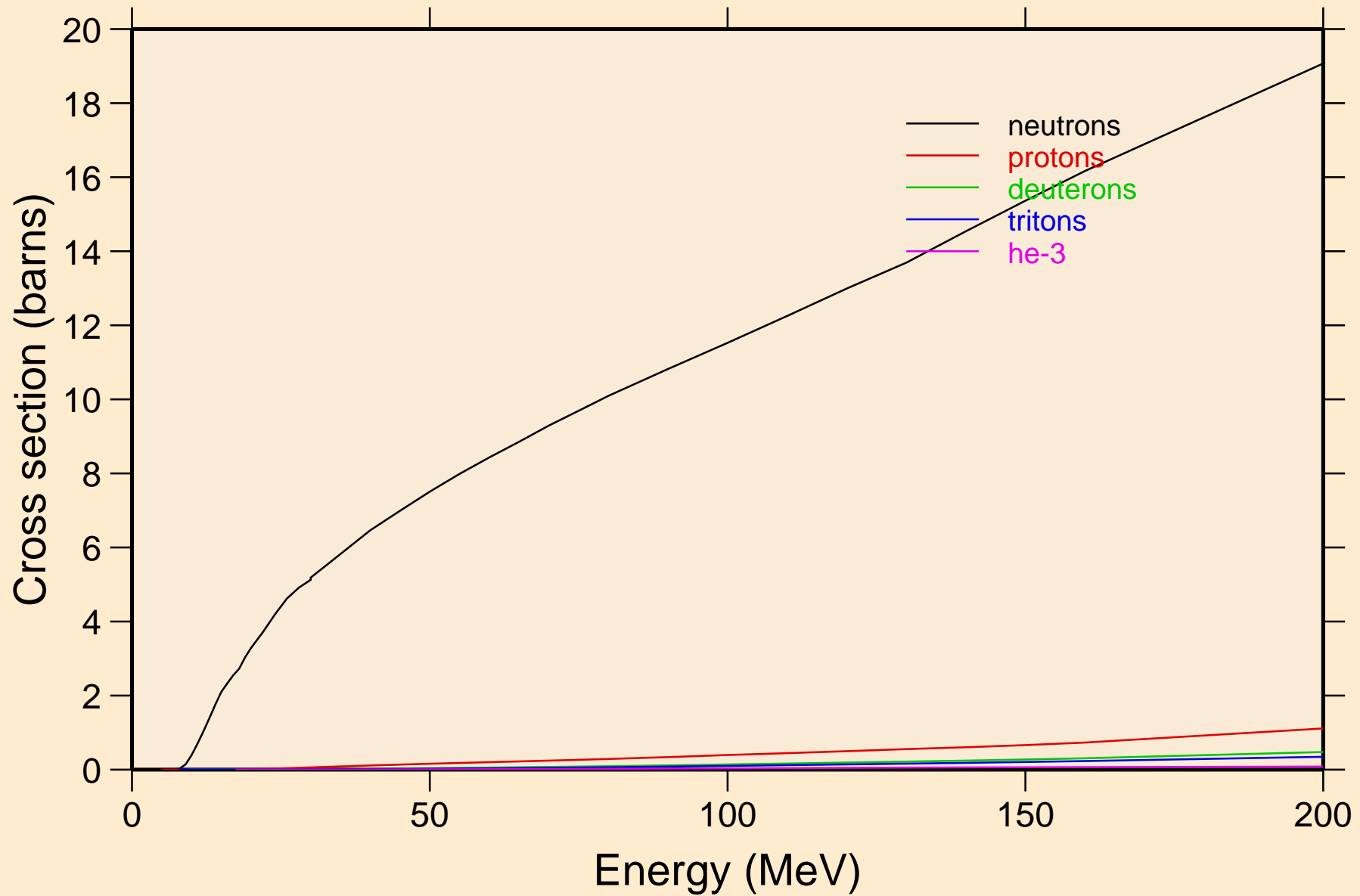

ZN078 ALPHA ACER TENDL-2023 LIBRARY; T=0.K
neutrons from (a,n)

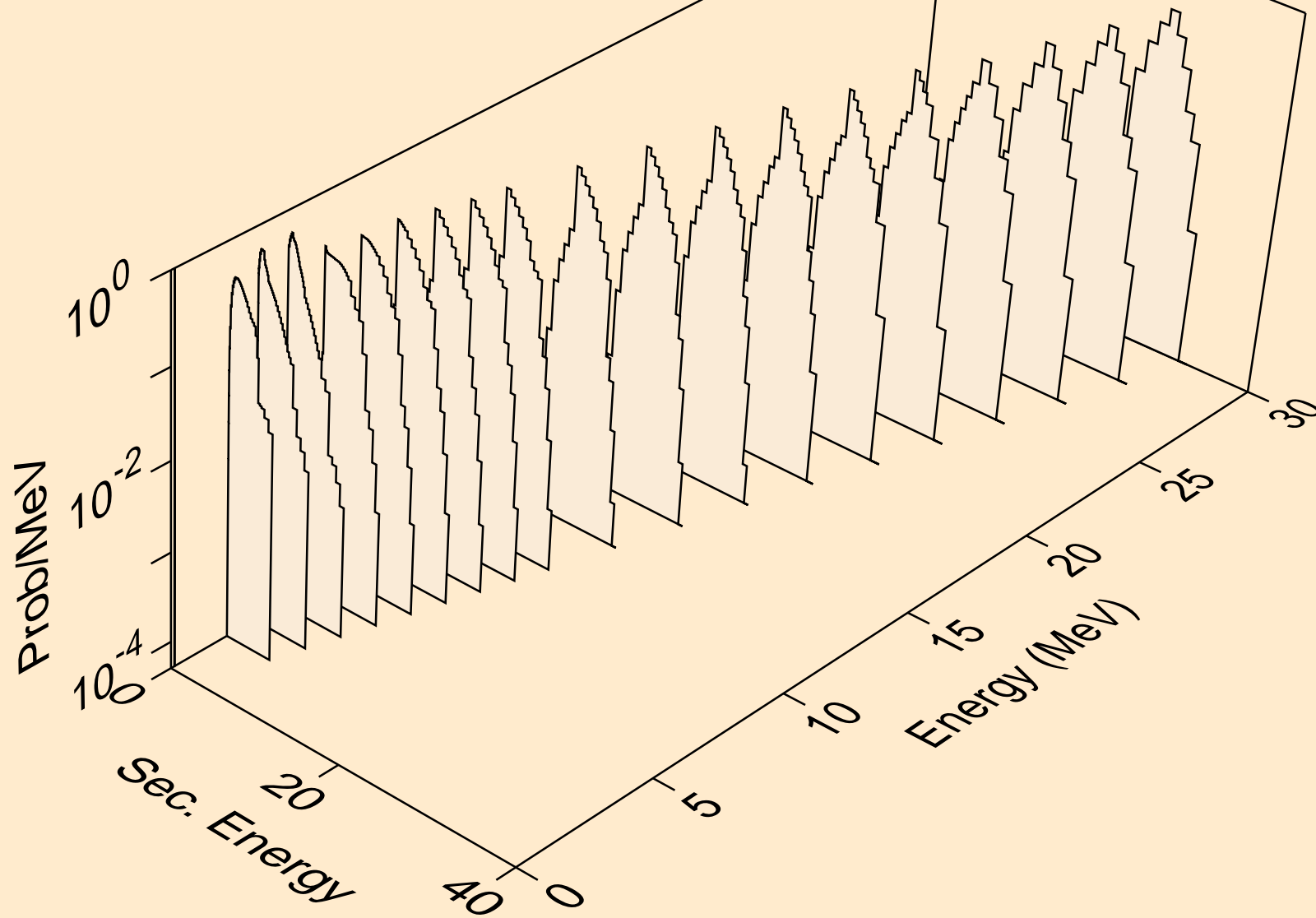

ZN078 ALPHA ACER TENDL-2023 LIBRARY; T=0.K
neutrons from (a,x)

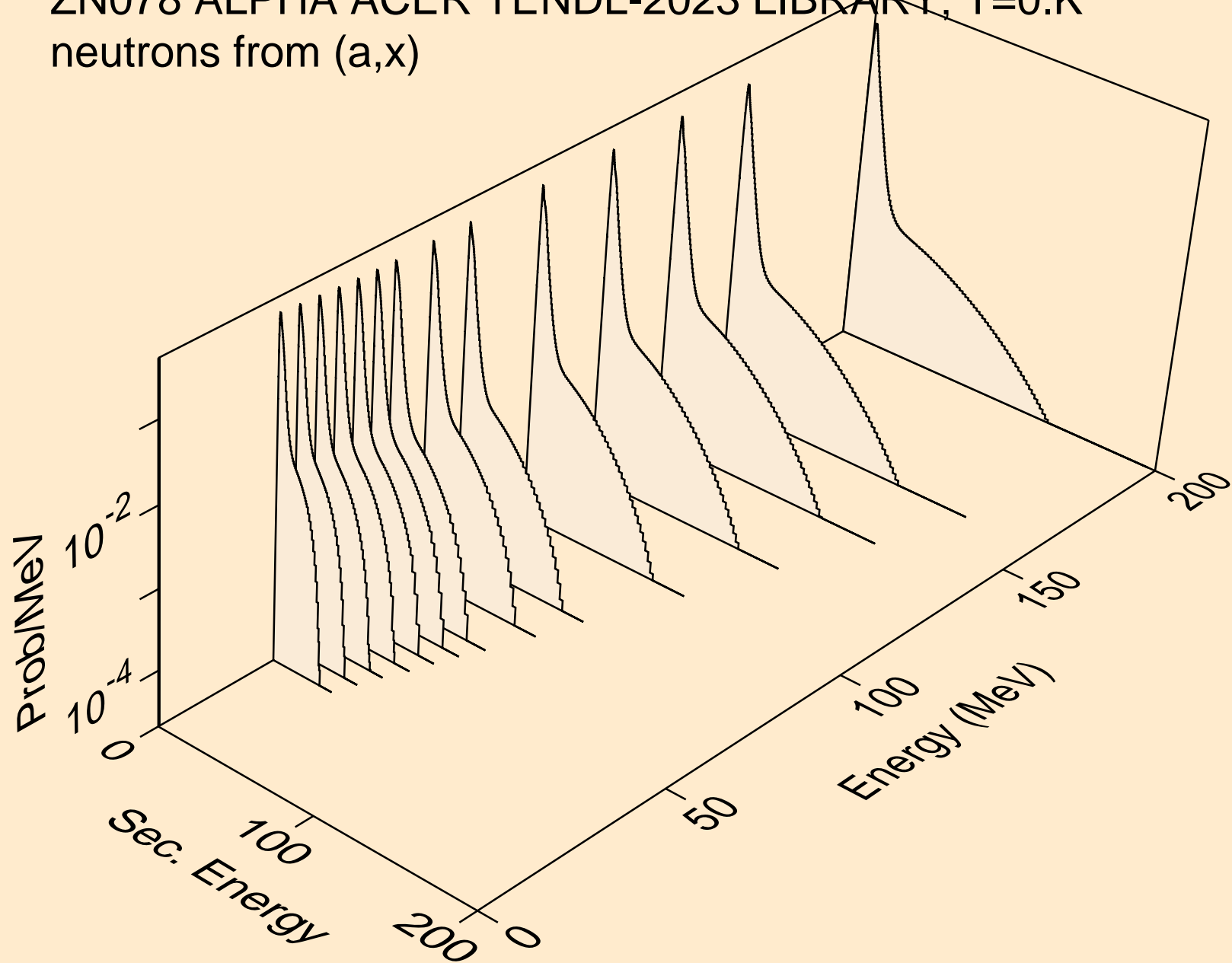

ZN078 ALPHA ACER TENDL-2023 LIBRARY; T=0.K
neutrons from (a,2nd)

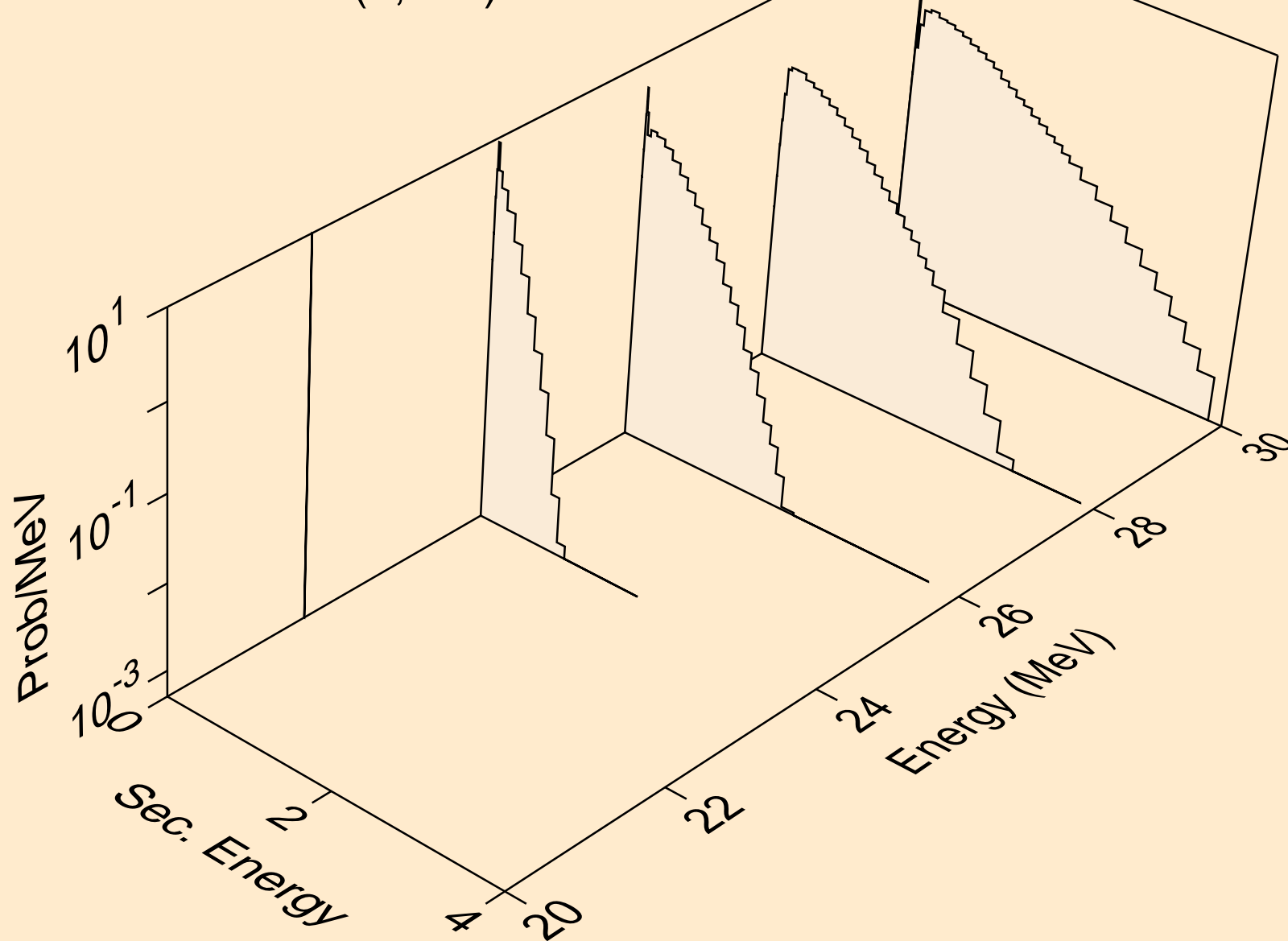

ZN078 ALPHA ACER TENDL-2023 LIBRARY; T=0.K
neutrons from (a,2n)

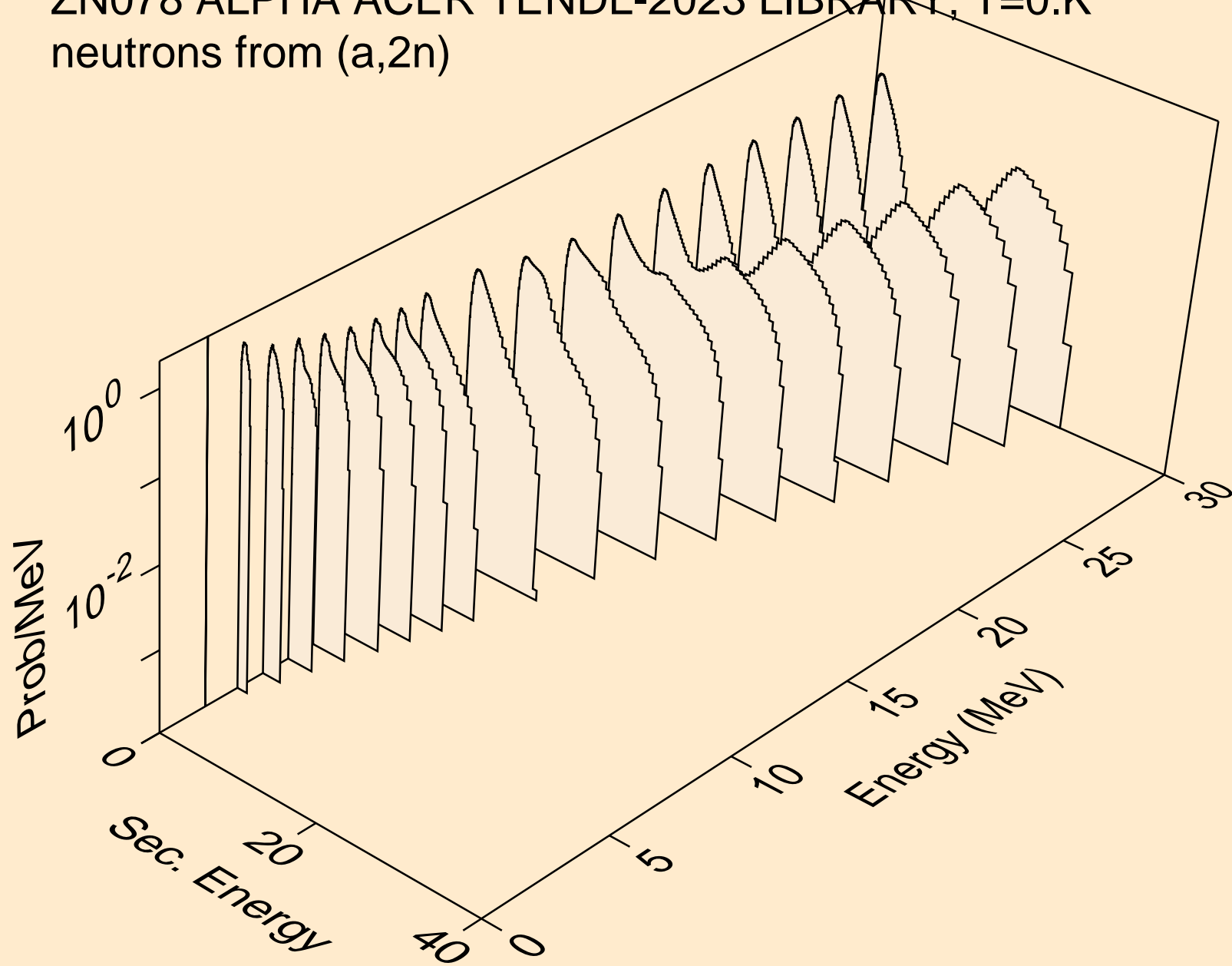

ZN078 ALPHA ACER TENDL-2023 LIBRARY; T=0.K
neutrons from (a,3n)

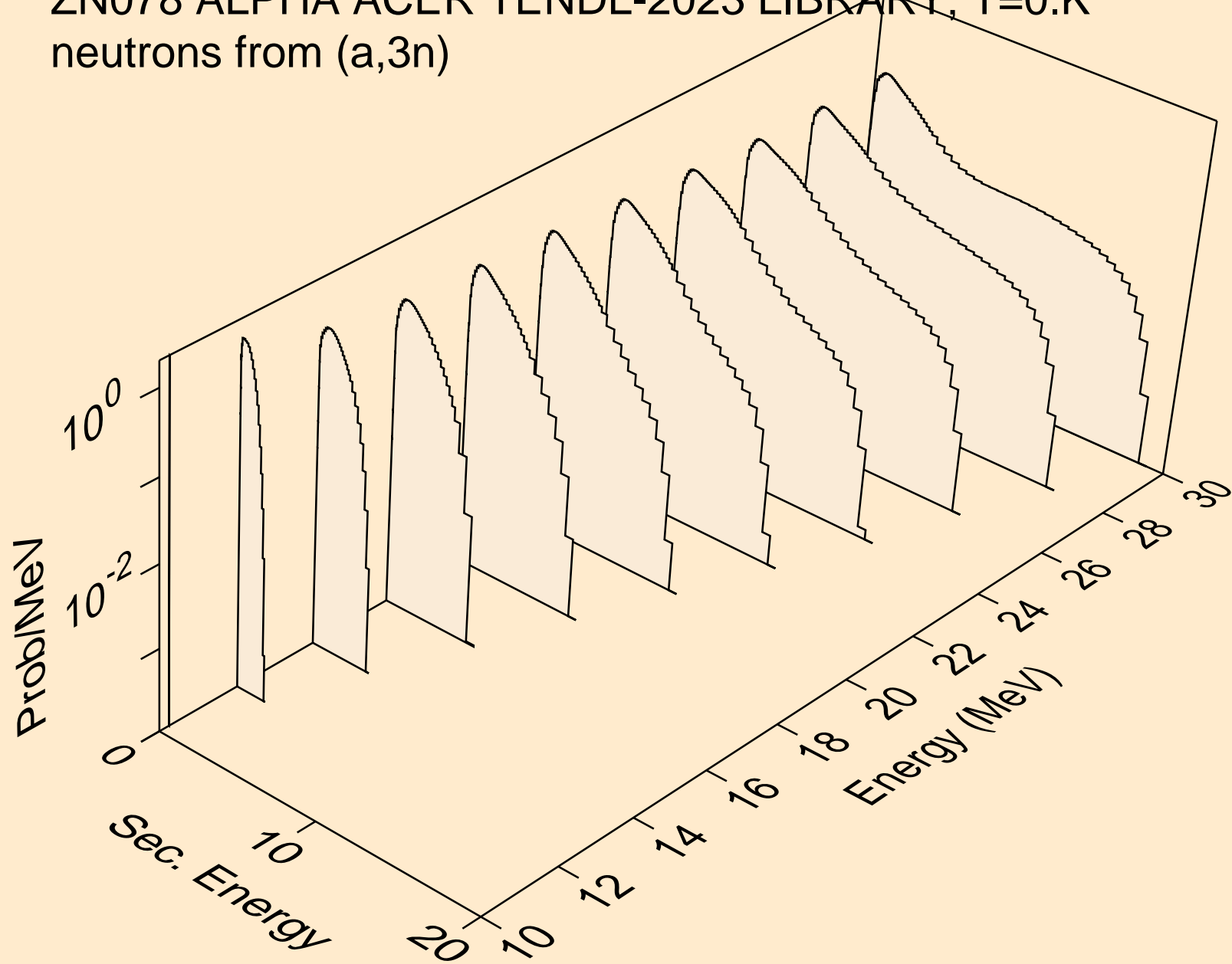

ZN078 ALPHA ACER TENDL-2023 LIBRARY; T=0.K
neutrons from (a,n*)a

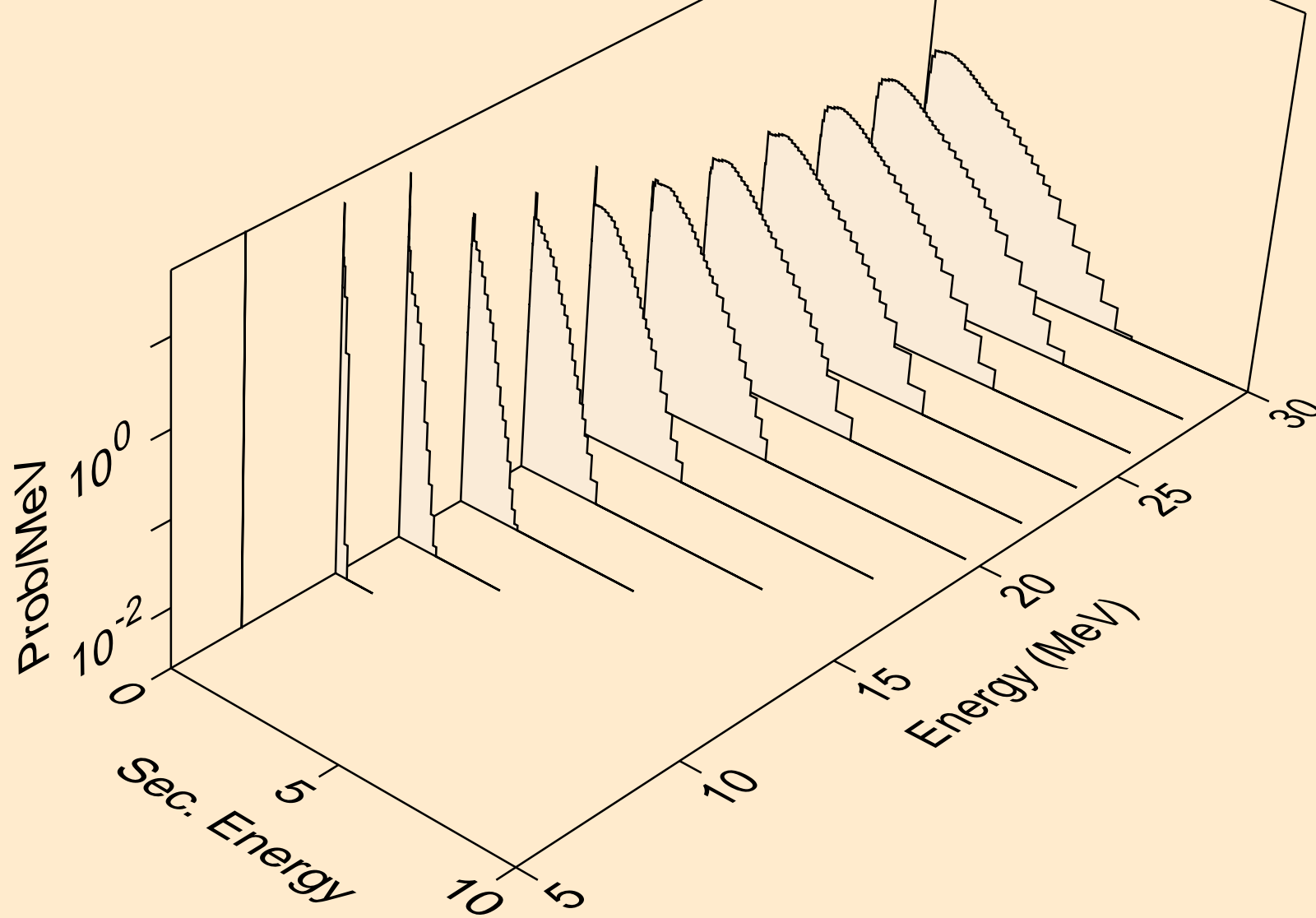

ZN078 ALPHA ACER TENDL-2023 LIBRARY; T=0.K
neutrons from (a,2n)a

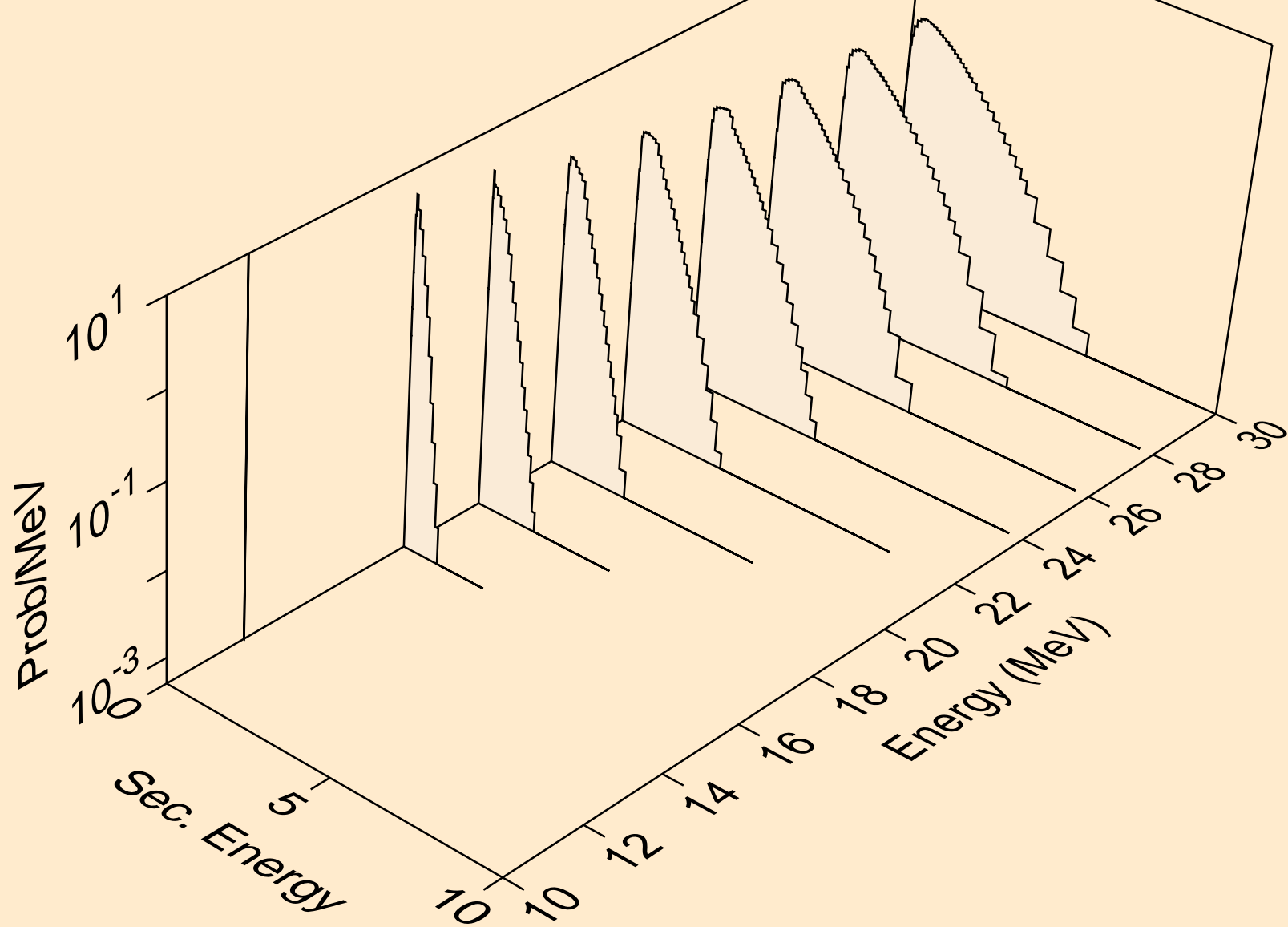

ZN078 ALPHA ACER TENDL-2023 LIBRARY; T=0.K
neutrons from (a,3n)a

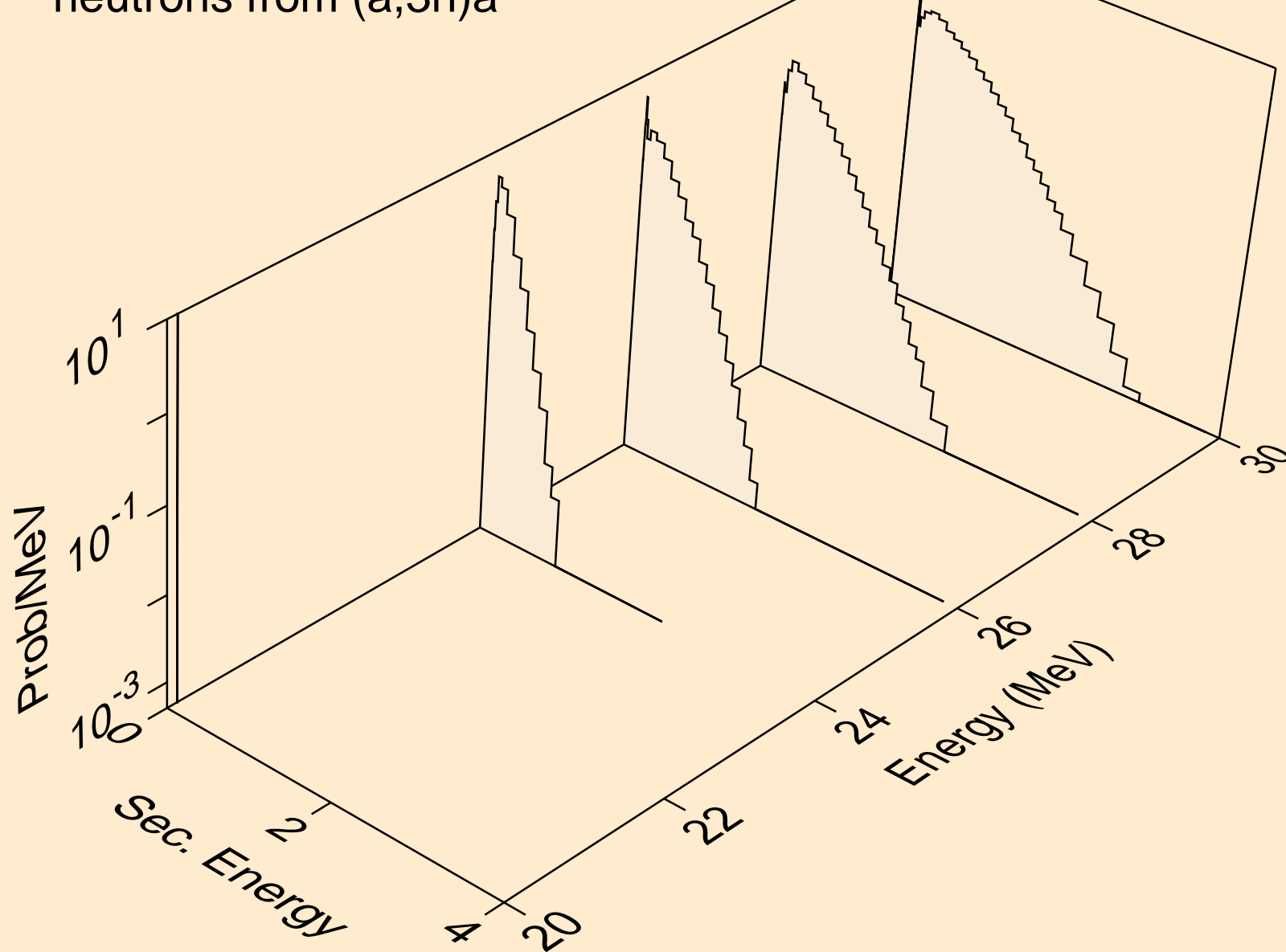

ZN078 ALPHA ACER TENDL-2023 LIBRARY; T=0.K
neutrons from (a,n*)p

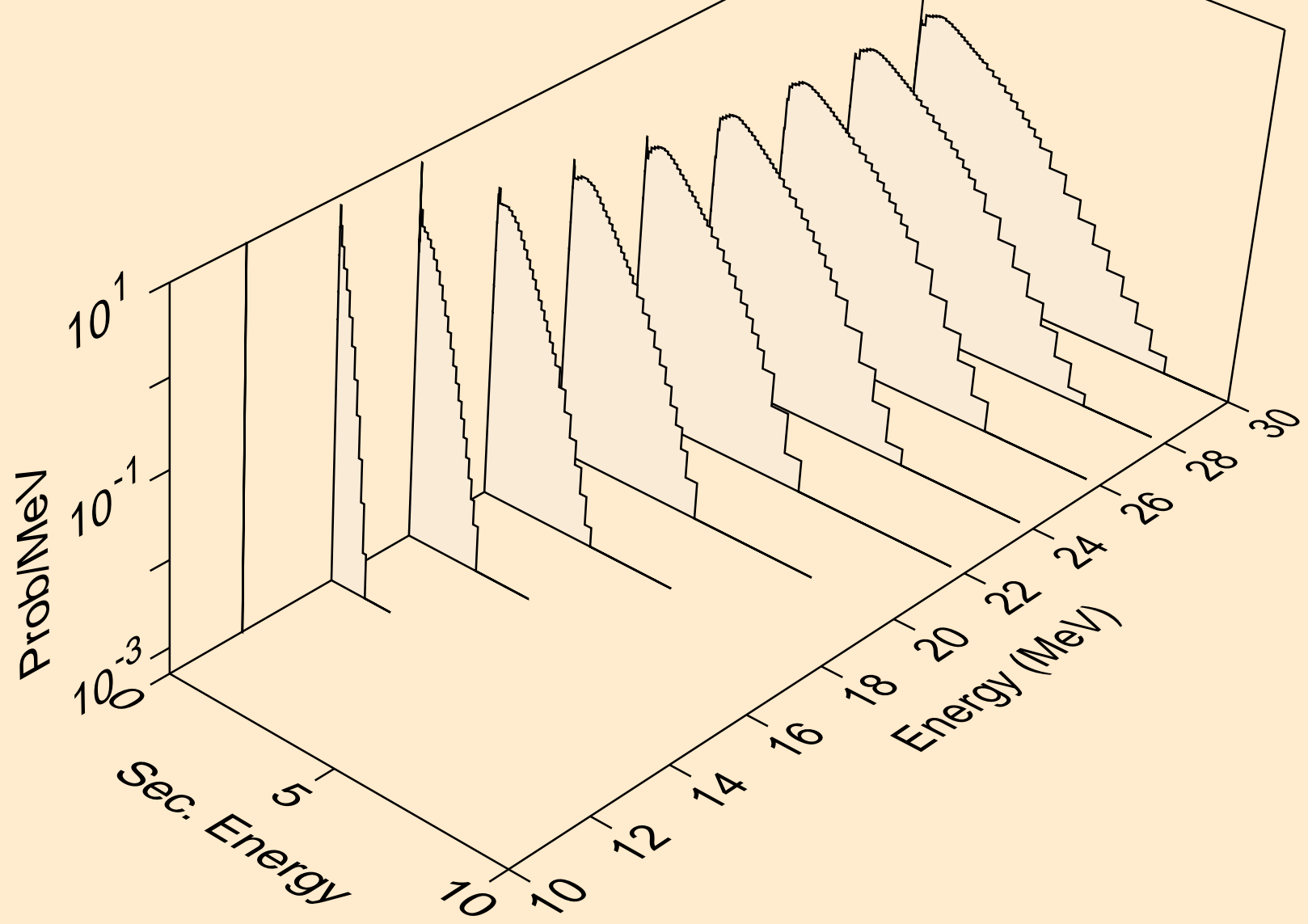

ZN078 ALPHA ACER TENDL-2023 LIBRARY; T=0.K
neutrons from (a,n*)d

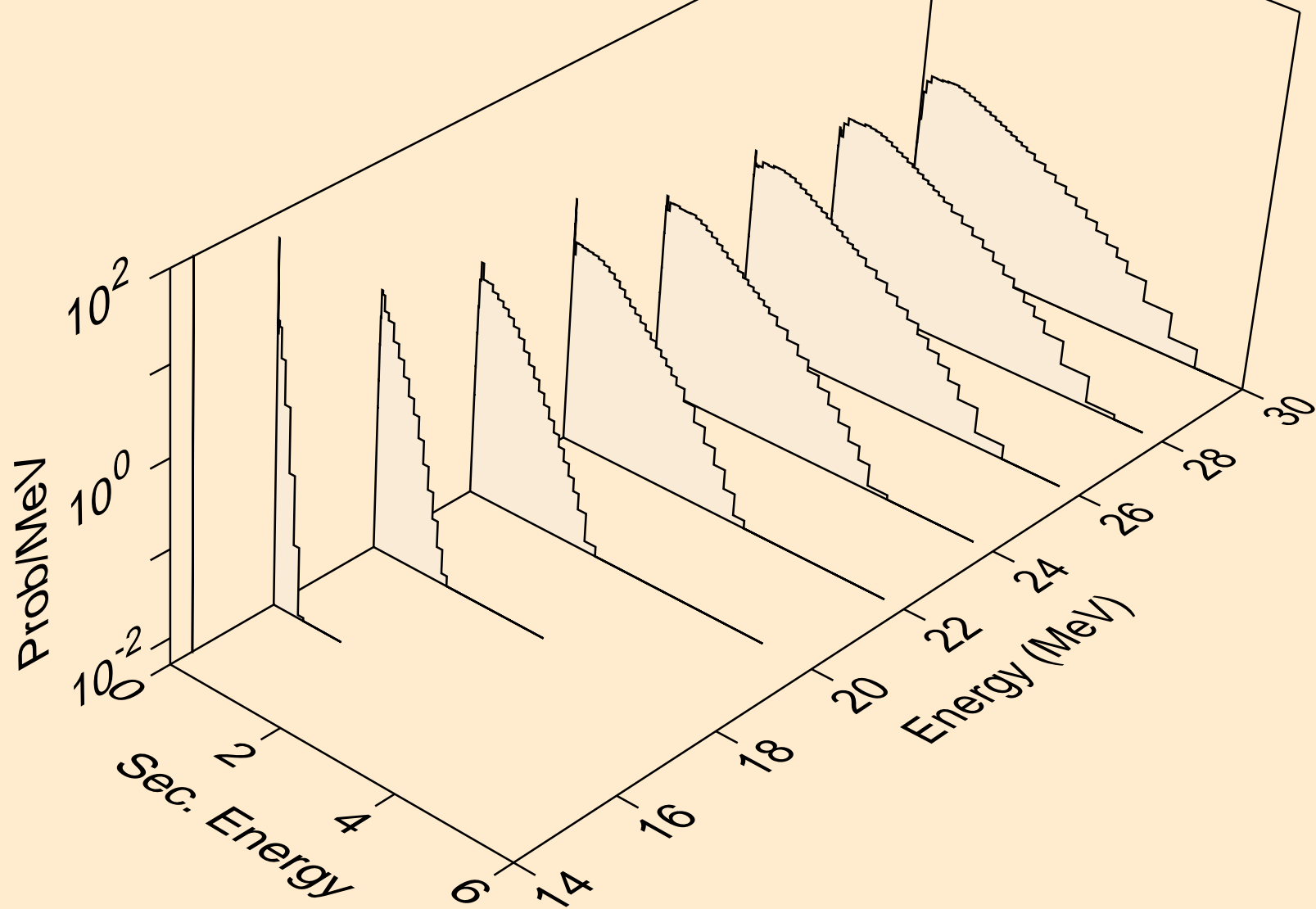

ZN078 ALPHA ACER TENDL-2023 LIBRARY; T=0.K
neutrons from (a,n*)t

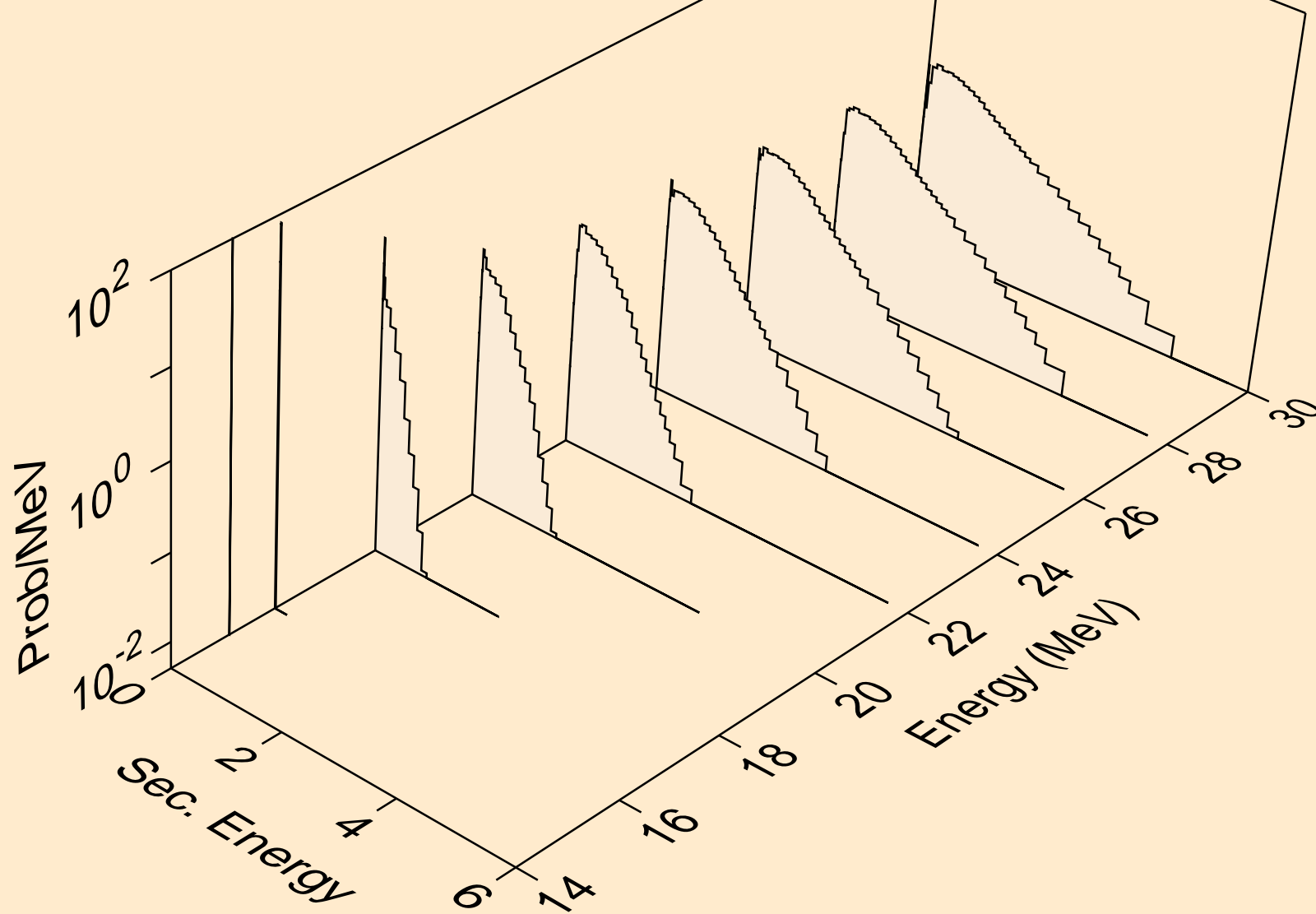

ZN078 ALPHA ACER TENDL-2023 LIBRARY; T=0.K
neutrons from (a,n*)he3

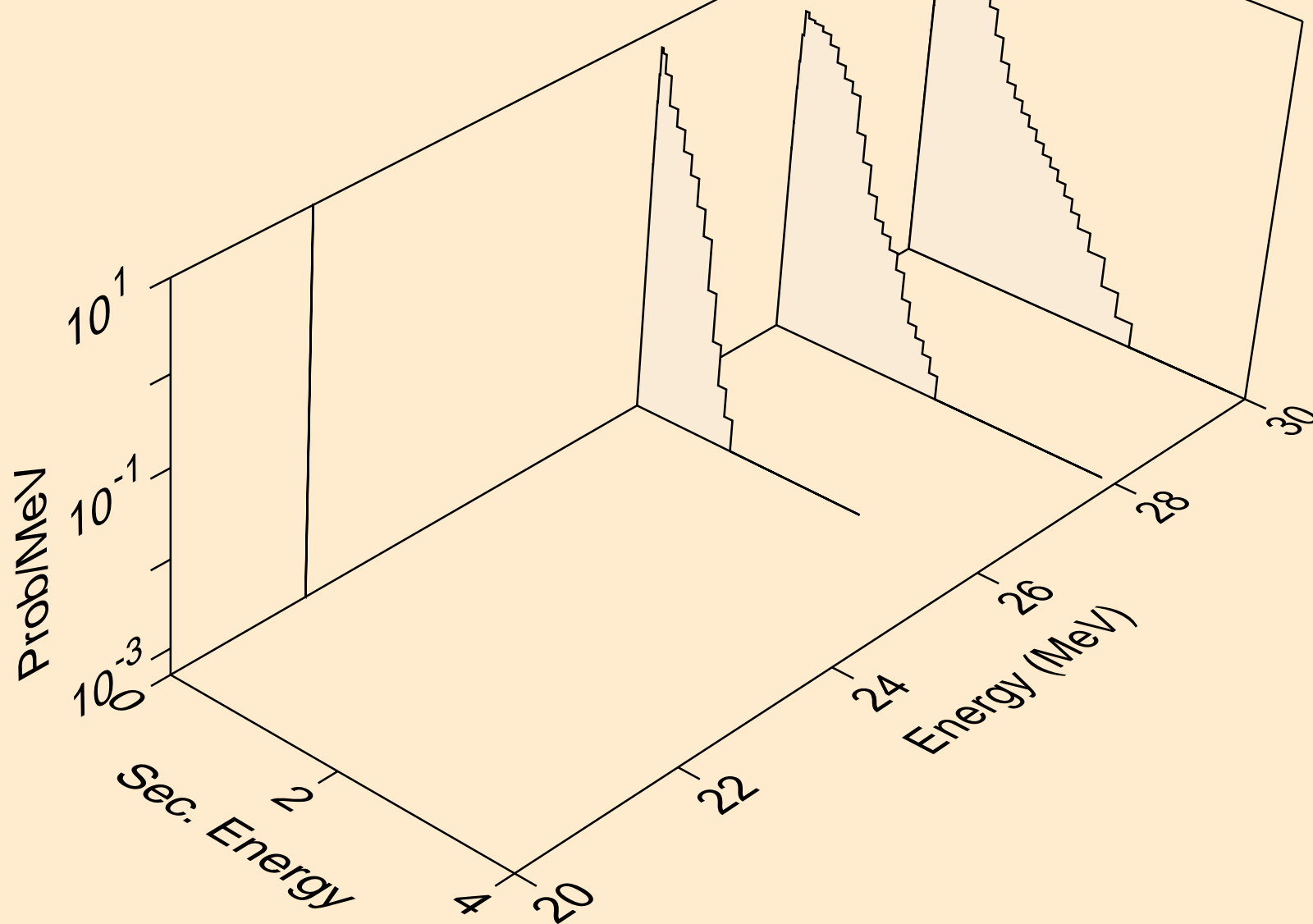

ZN078 ALPHA ACER TENDL-2023 LIBRARY; T=0.K
neutrons from (a,4n)

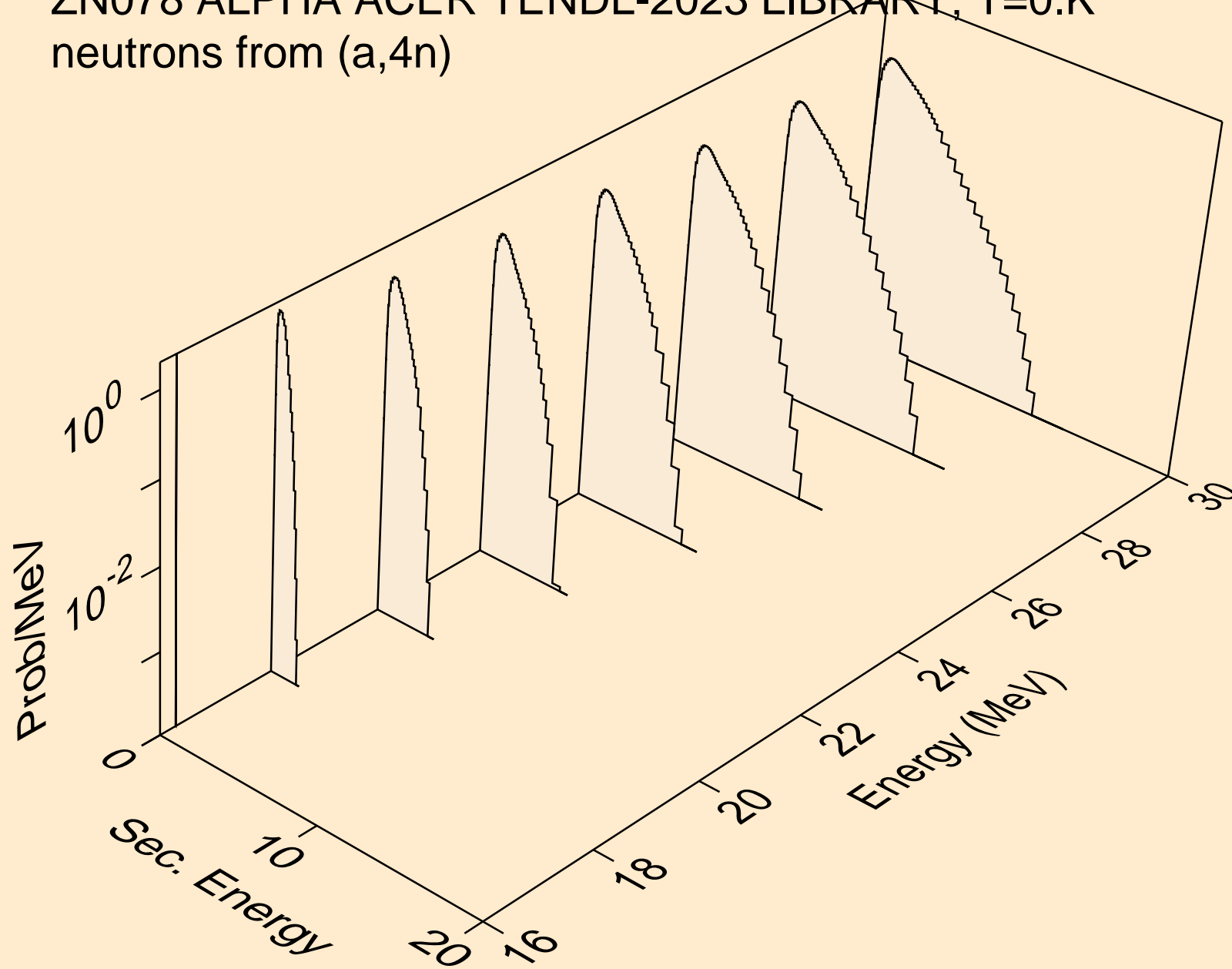

ZN078 ALPHA ACER TENDL-2023 LIBRARY; T=0.K
neutrons from (a,2np)

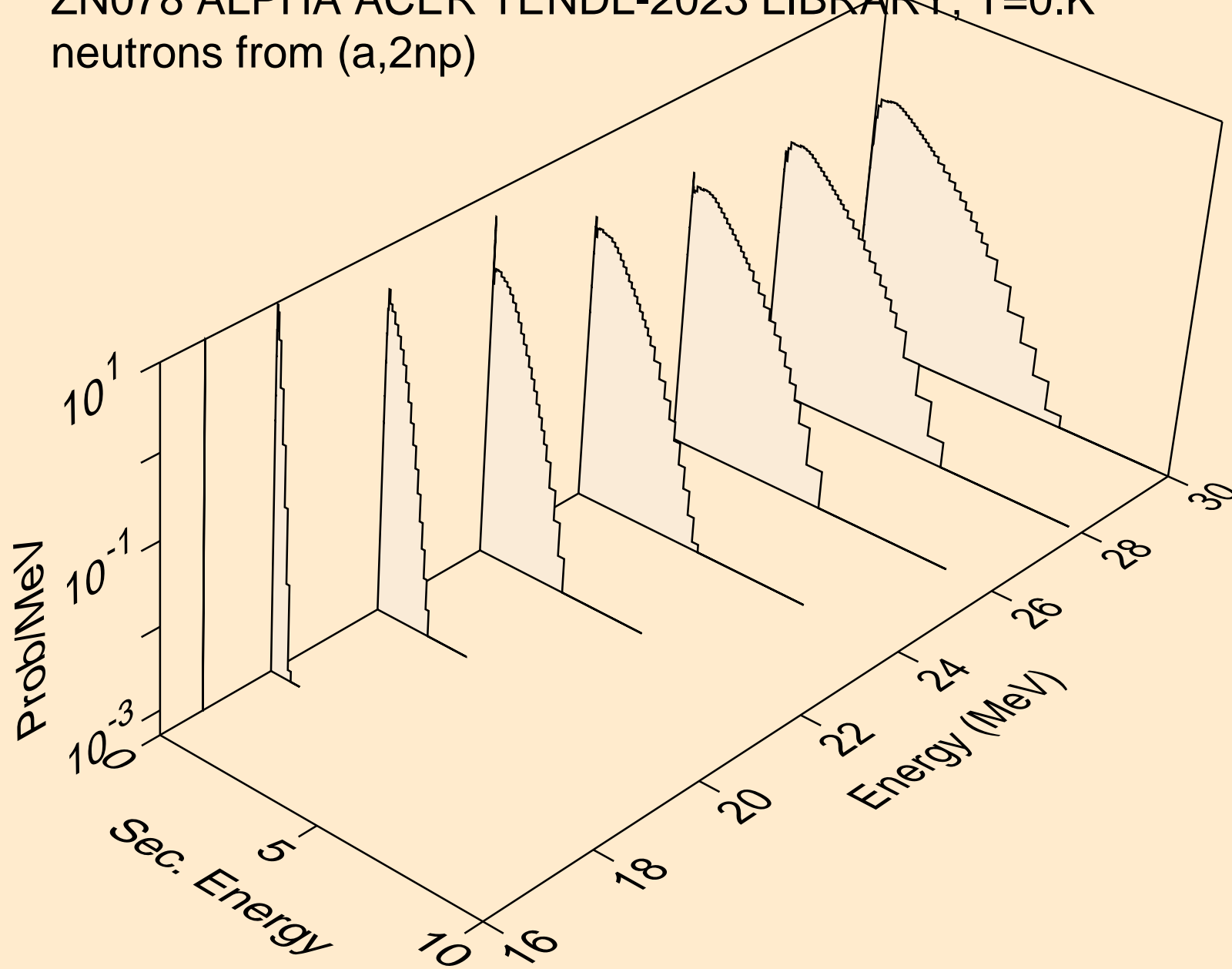

ZN078 ALPHA ACER TENDL-2023 LIBRARY; T=0.K
neutrons from (a,3np)

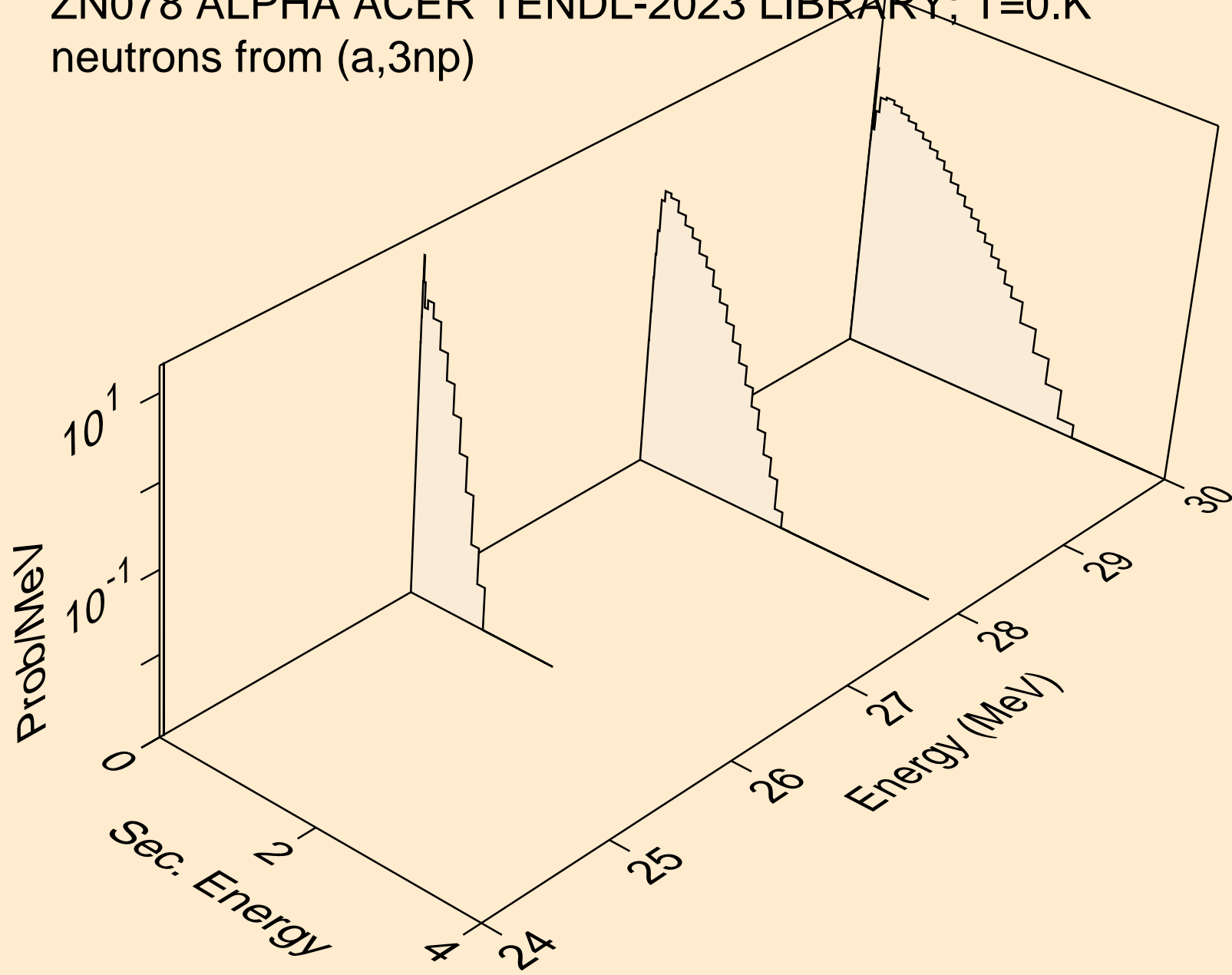

ZN078 ALPHA ACER TENDL-2023 LIBRARY; T=0.K
protons from (a,x)

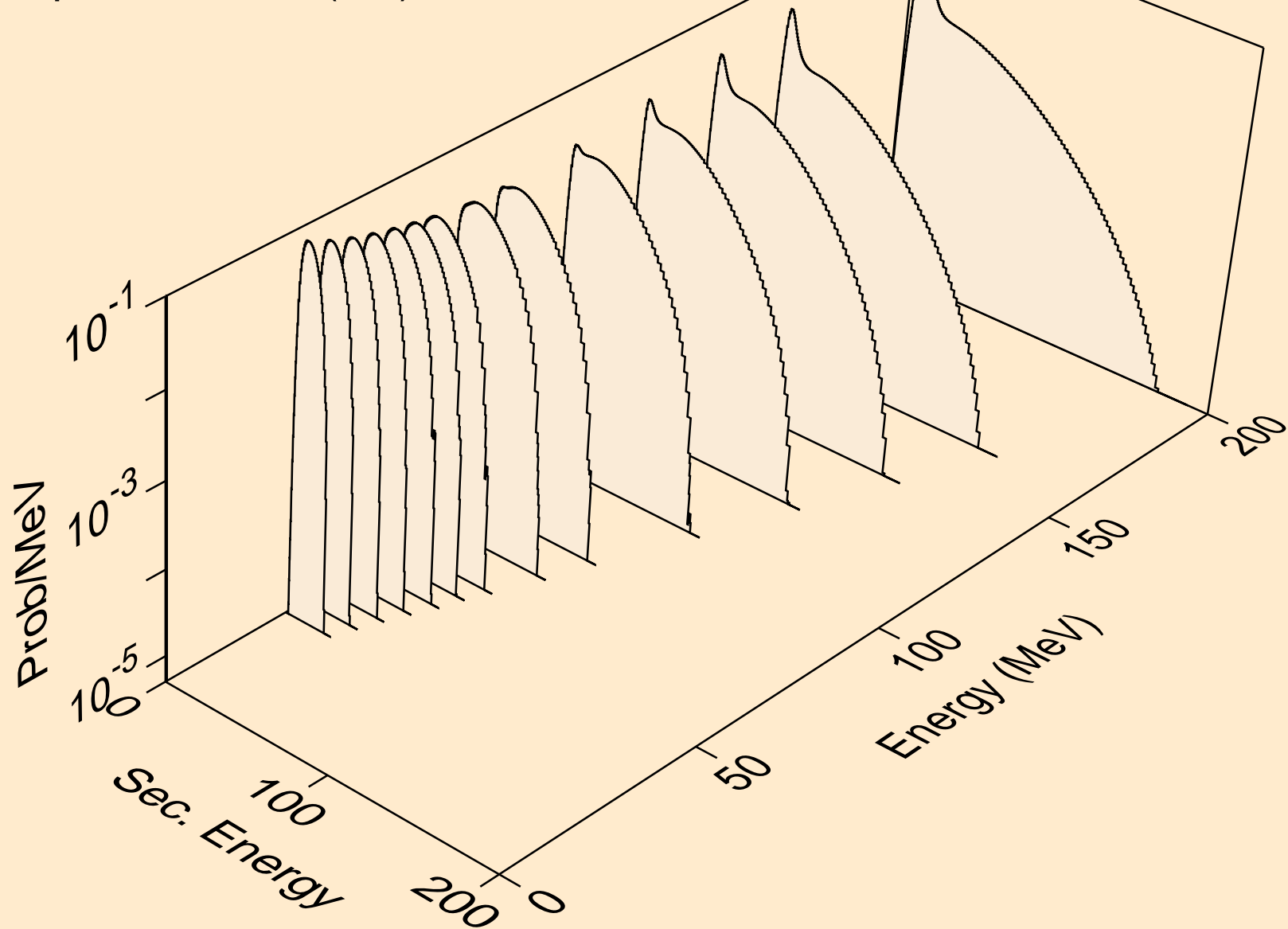

ZN078 ALPHA ACER TENDL-2023 LIBRARY; T=0.K
protons from (a,n*)p

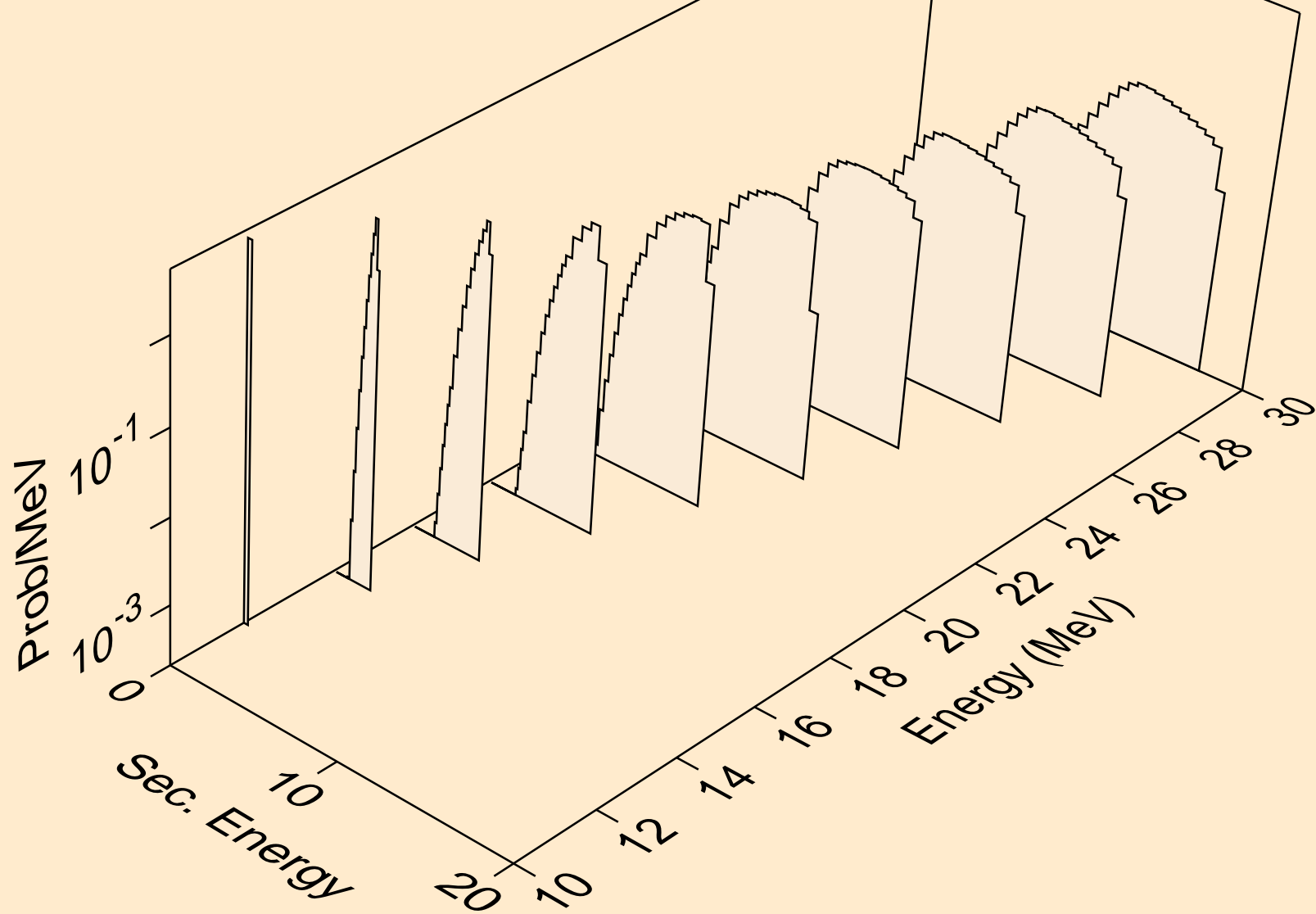

ZN078 ALPHA ACER TENDL-2023 LIBRARY; T=0.K
protons from (a,2np)

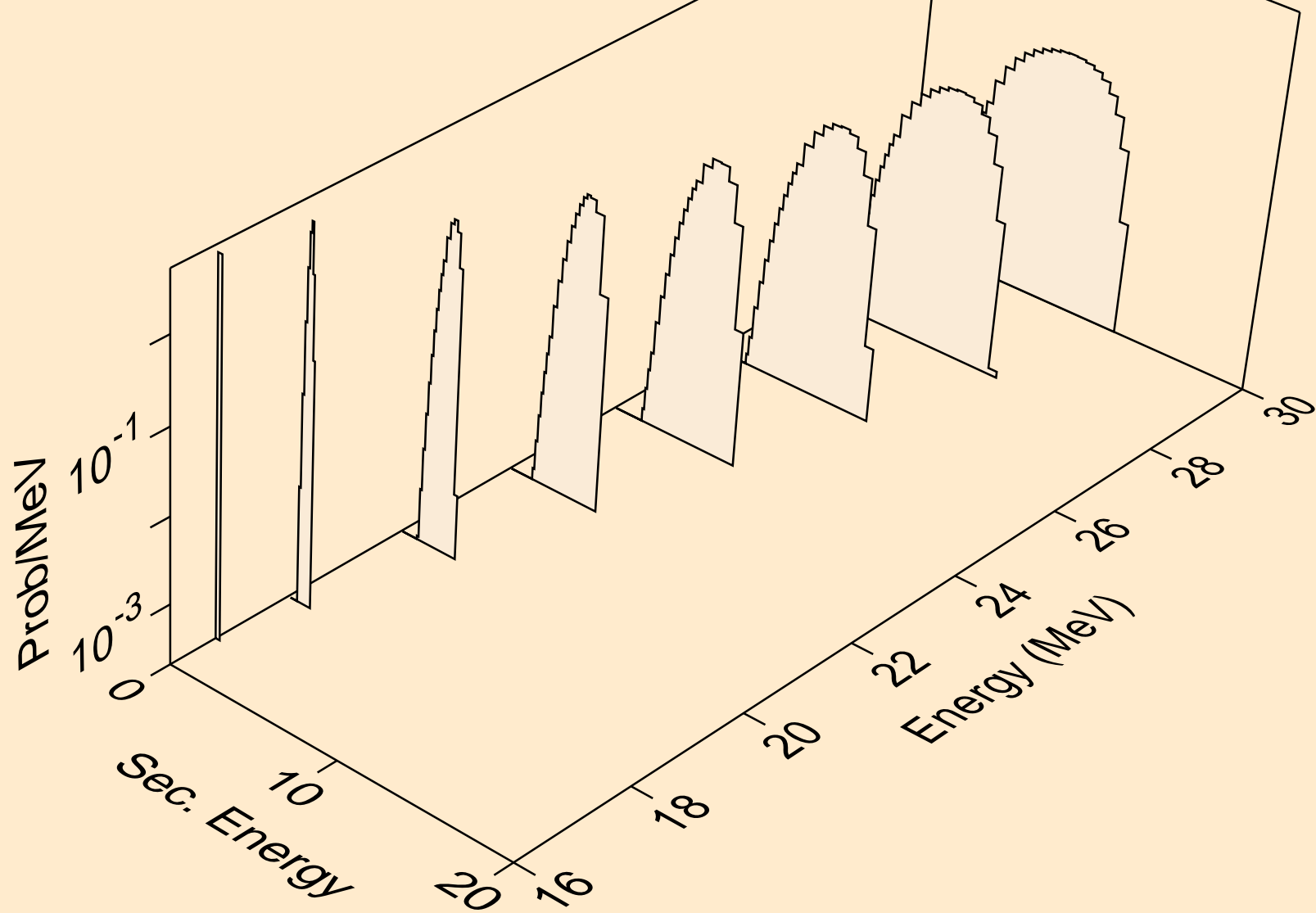

ZN078 ALPHA ACER TENDL-2023 LIBRARY; T=0.K
protons from (a,3np)

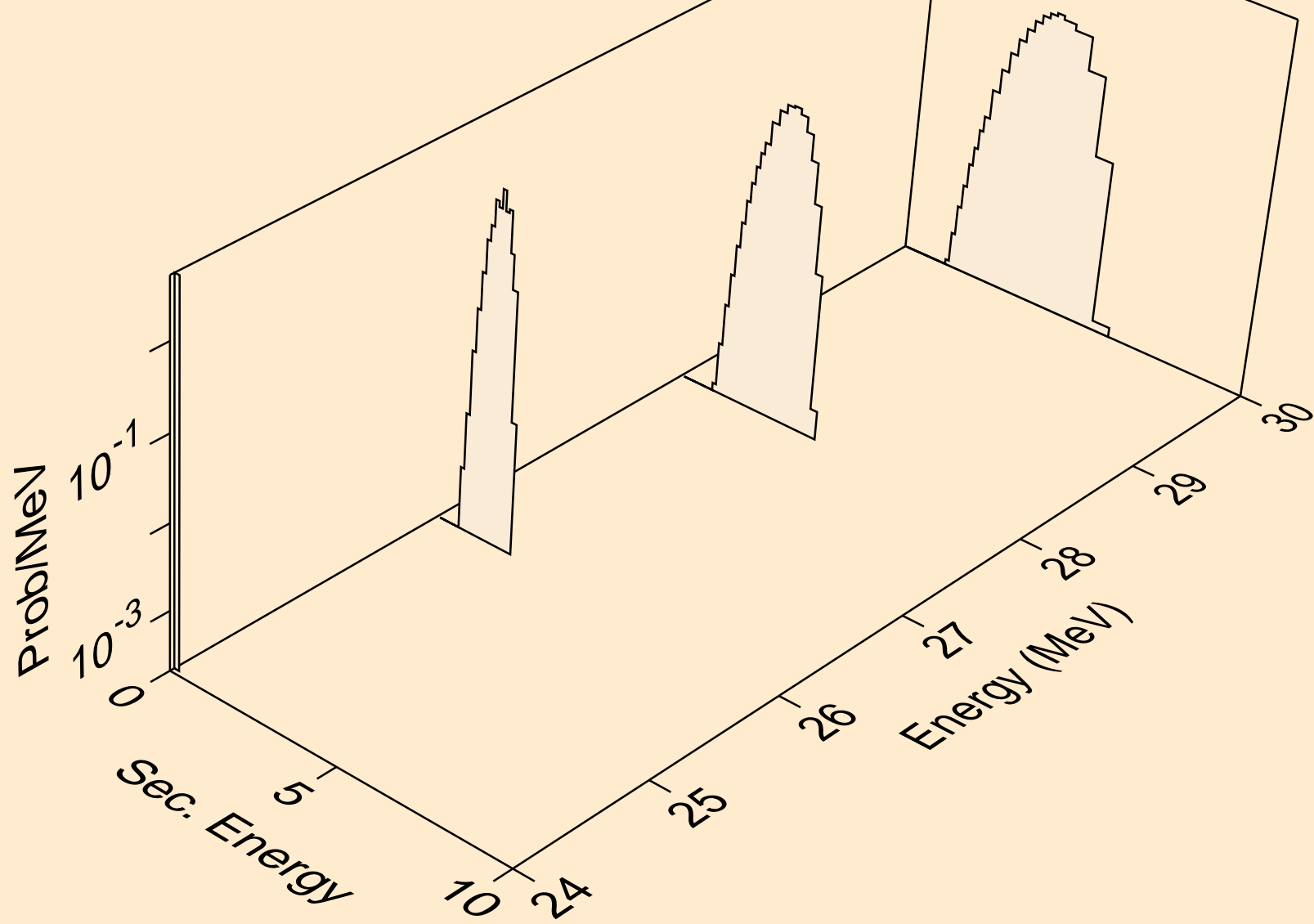

ZN078 ALPHA ACER TENDL-2023 LIBRARY; T=0.K
protons from (a,p)

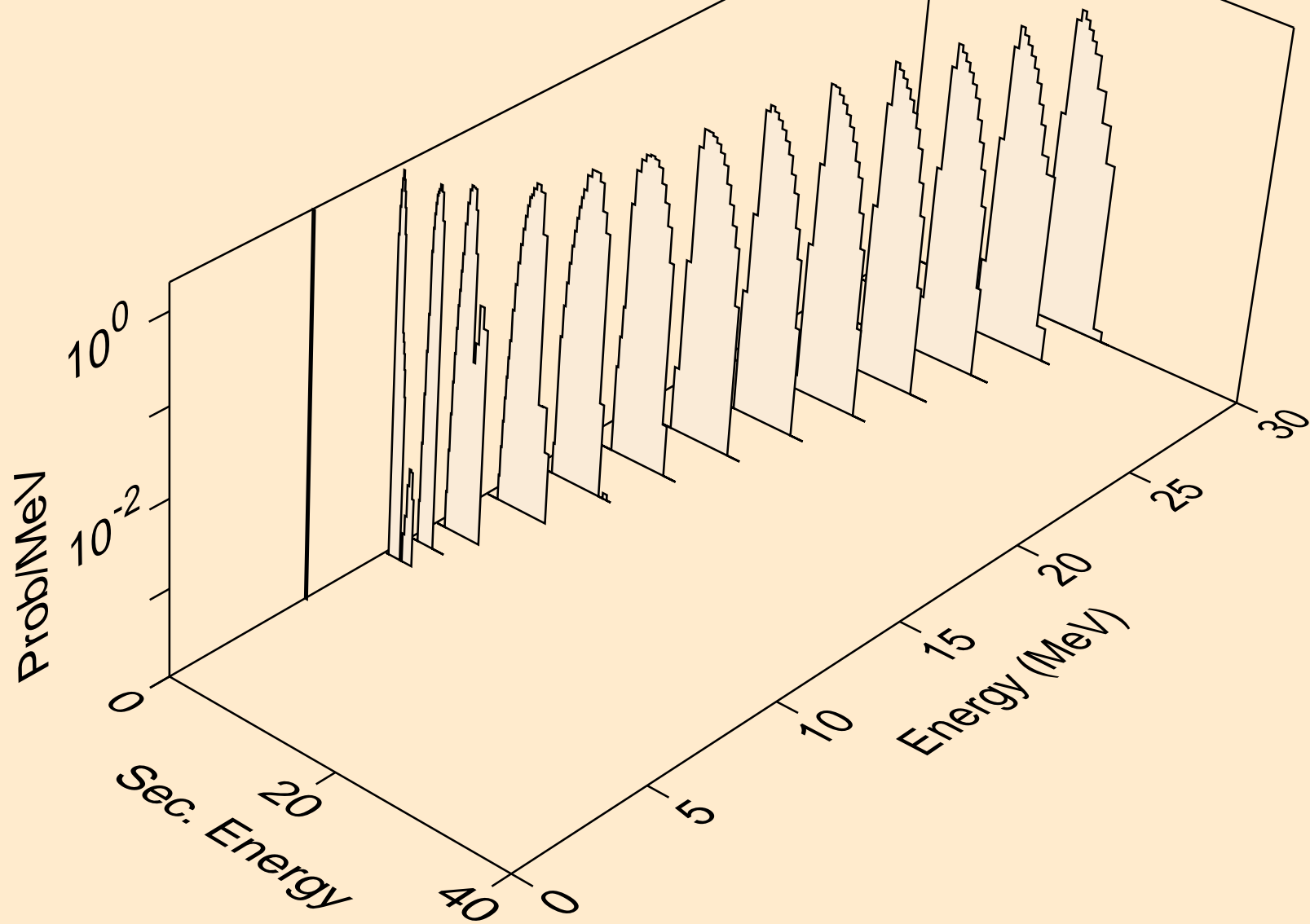

ZN078 ALPHA ACER TENDL-2023 LIBRARY; T=0.K
protons from (a,2p)

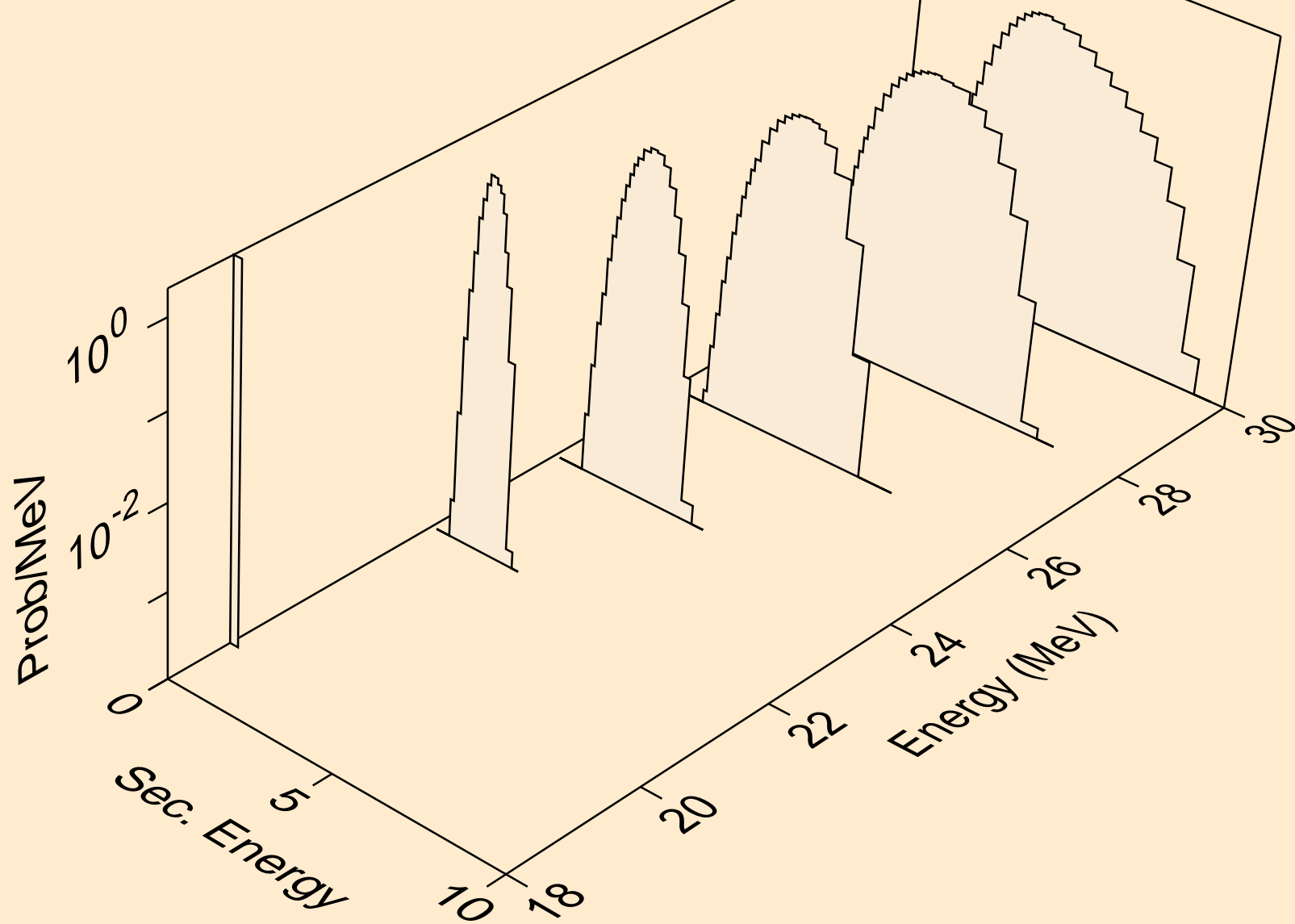

ZN078 ALPHA ACER TENDL-2023 LIBRARY; T=0.K
deuterons from (a,x)

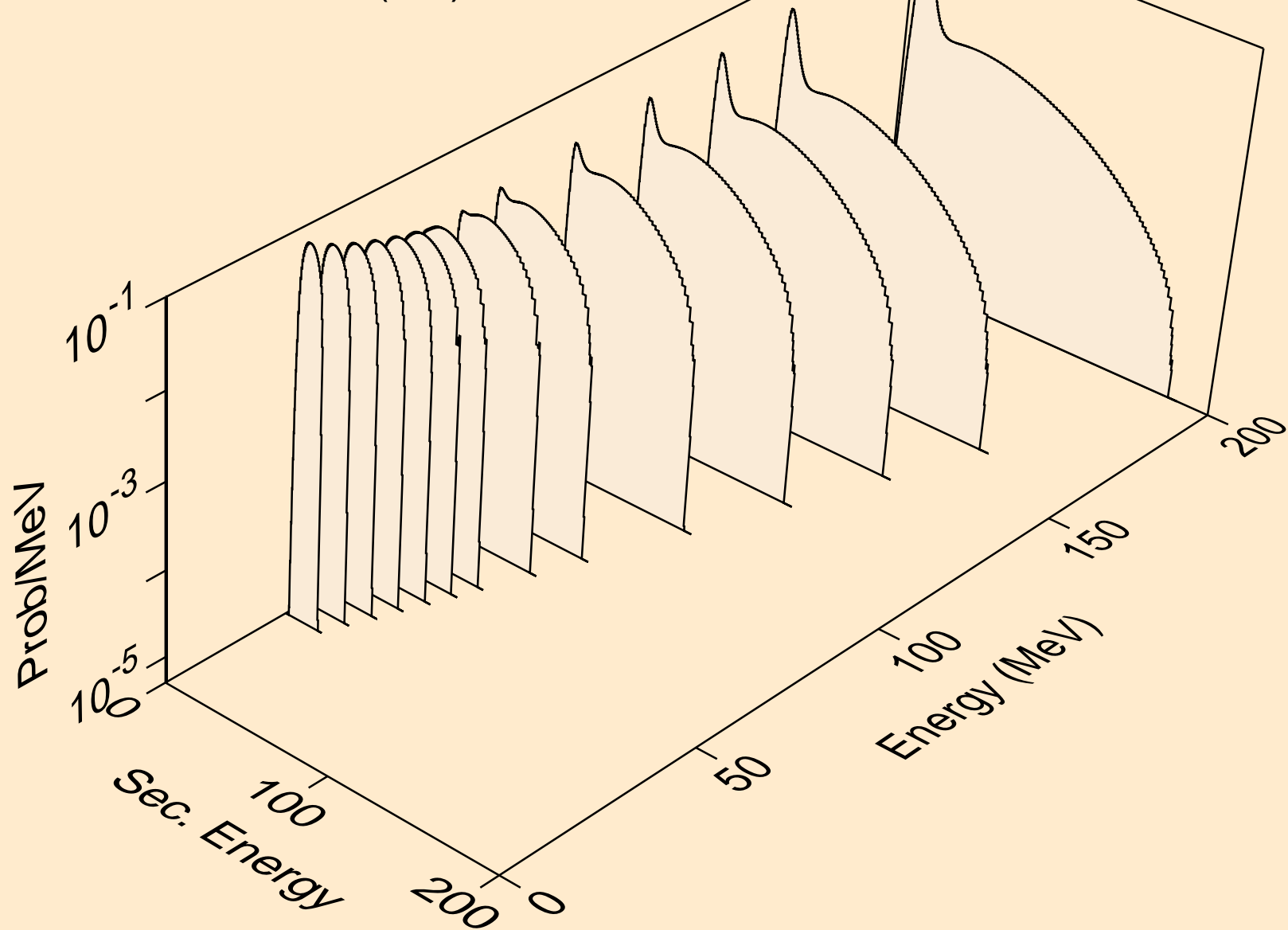

ZN078 ALPHA ACER TENDL-2023 LIBRARY; T=0.K
deuterons from (a,2nd)

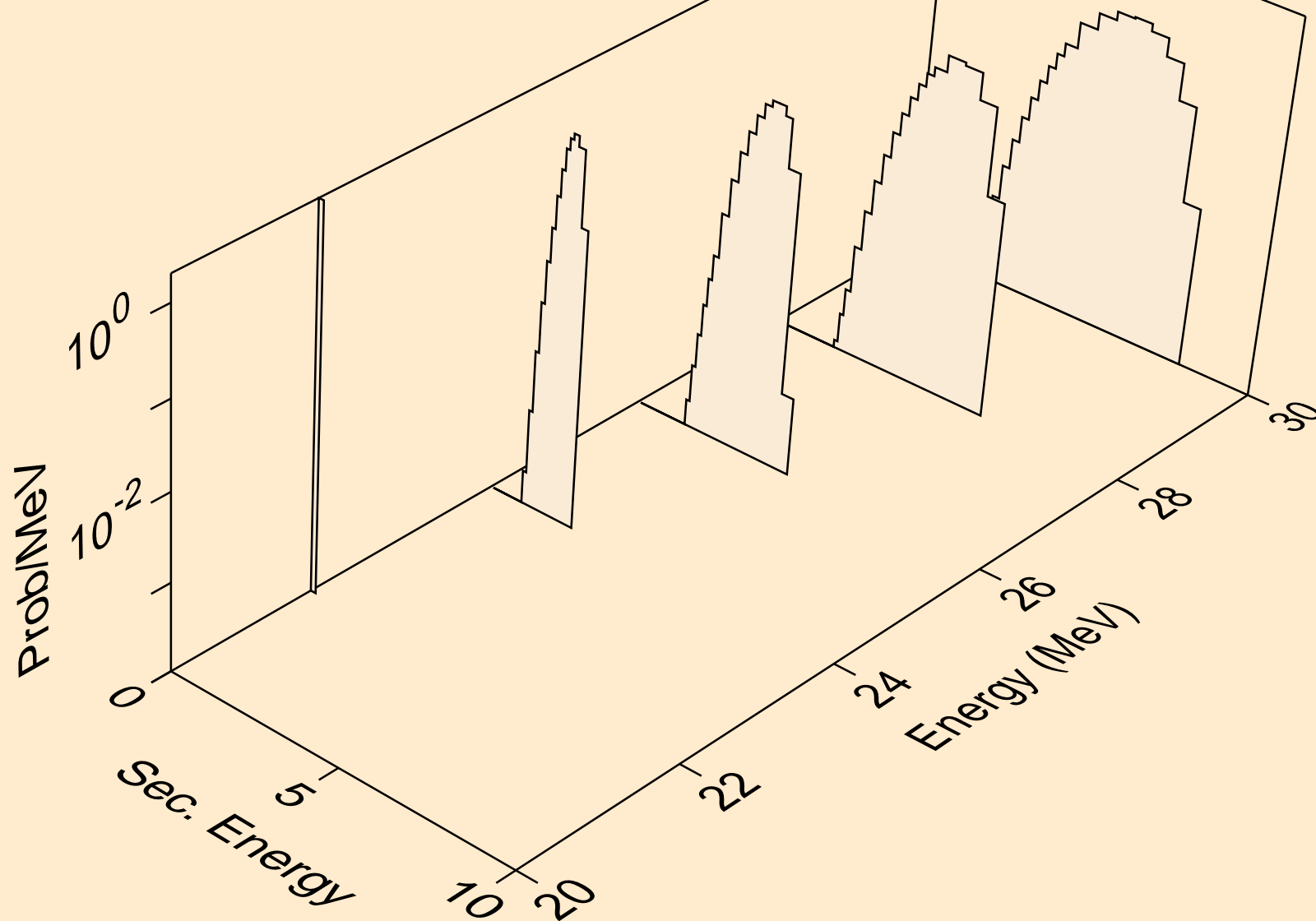

ZN078 ALPHA ACER TENDL-2023 LIBRARY; T=0.K
deuterons from (a,n*)d

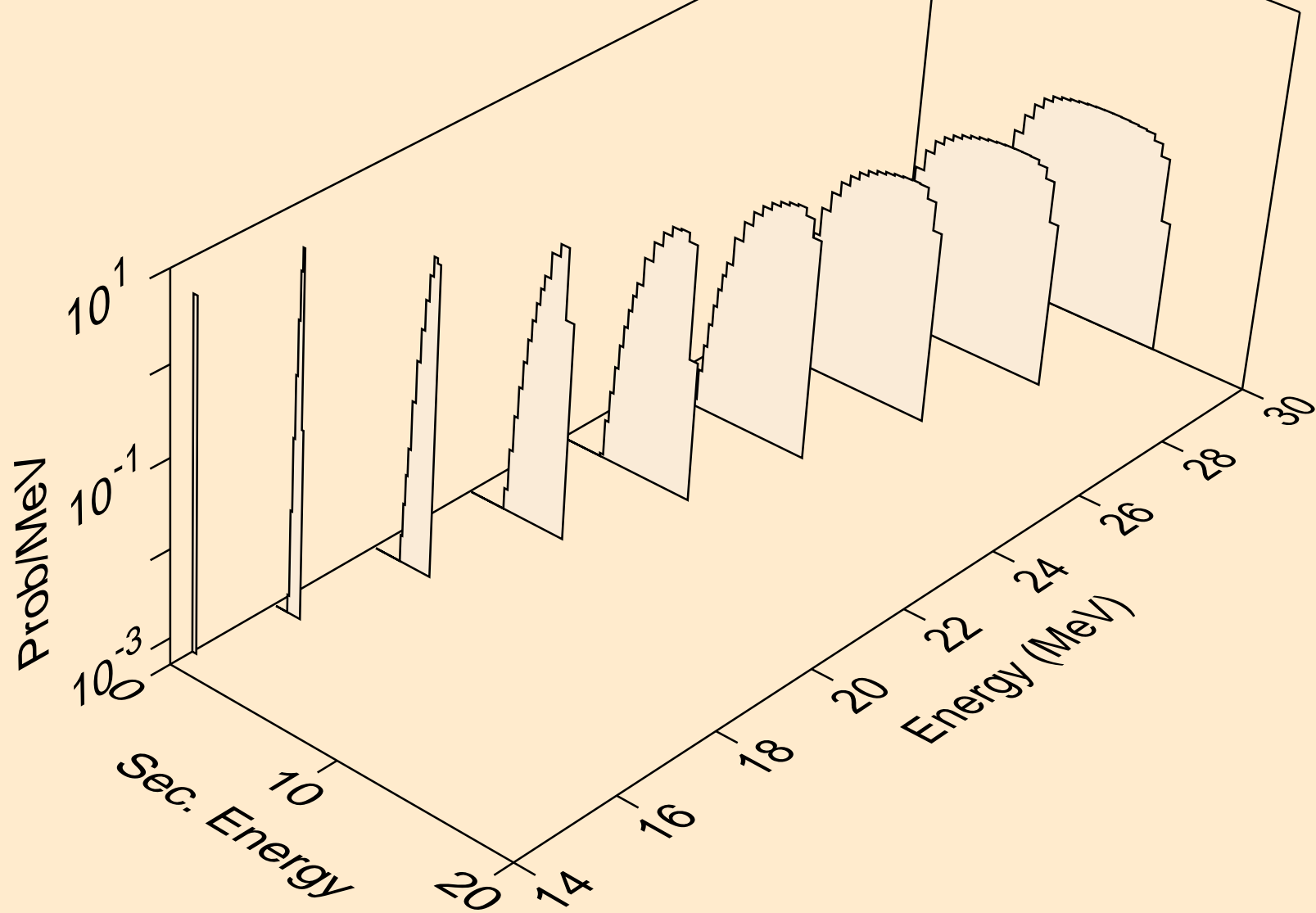

ZN078 ALPHA ACER TENDL-2023 LIBRARY; T=0.K
deuterons from (a,d)

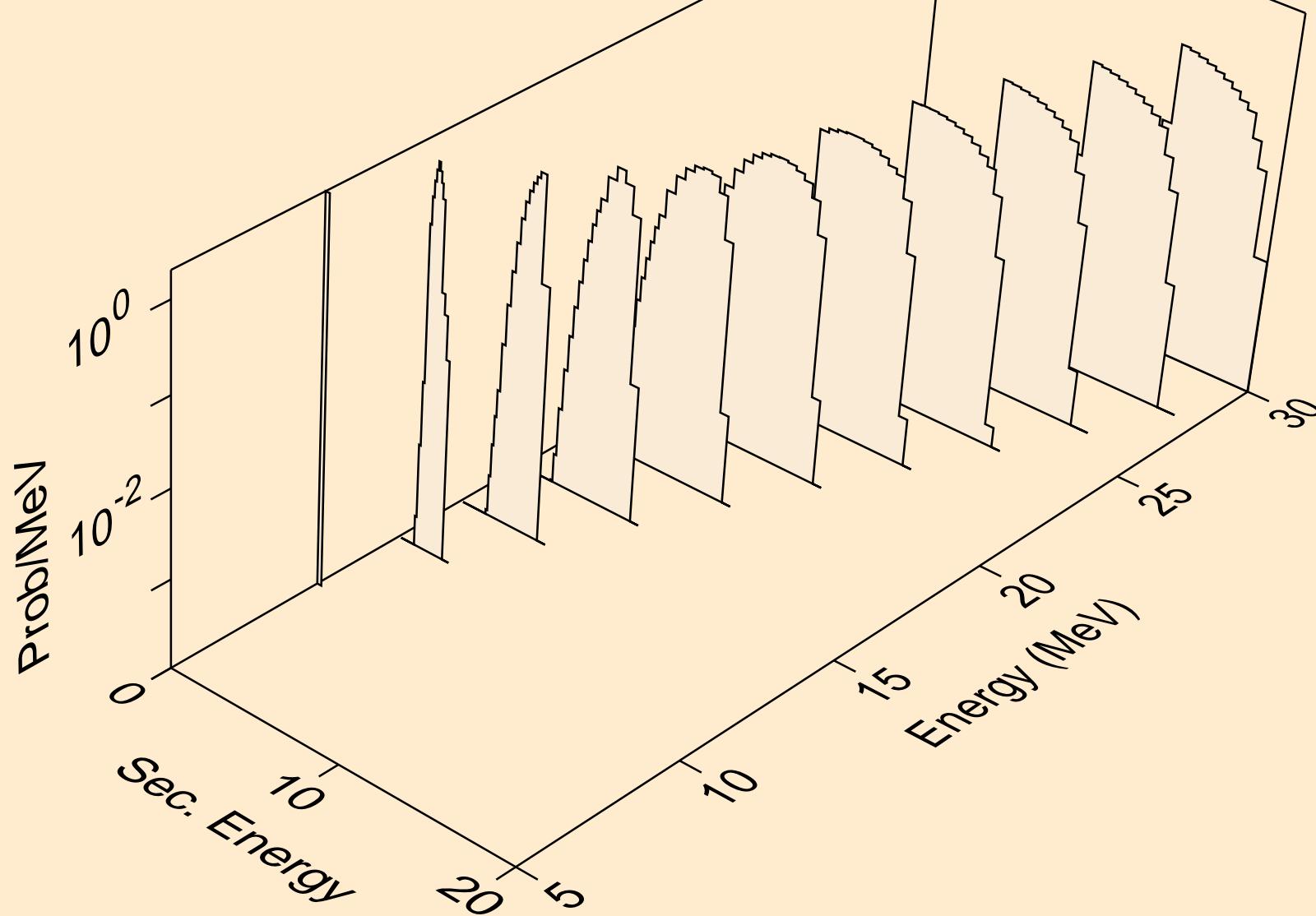

ZN078 ALPHA ACER TENDL-2023 LIBRARY; T=0.K
tritons from (a,x)

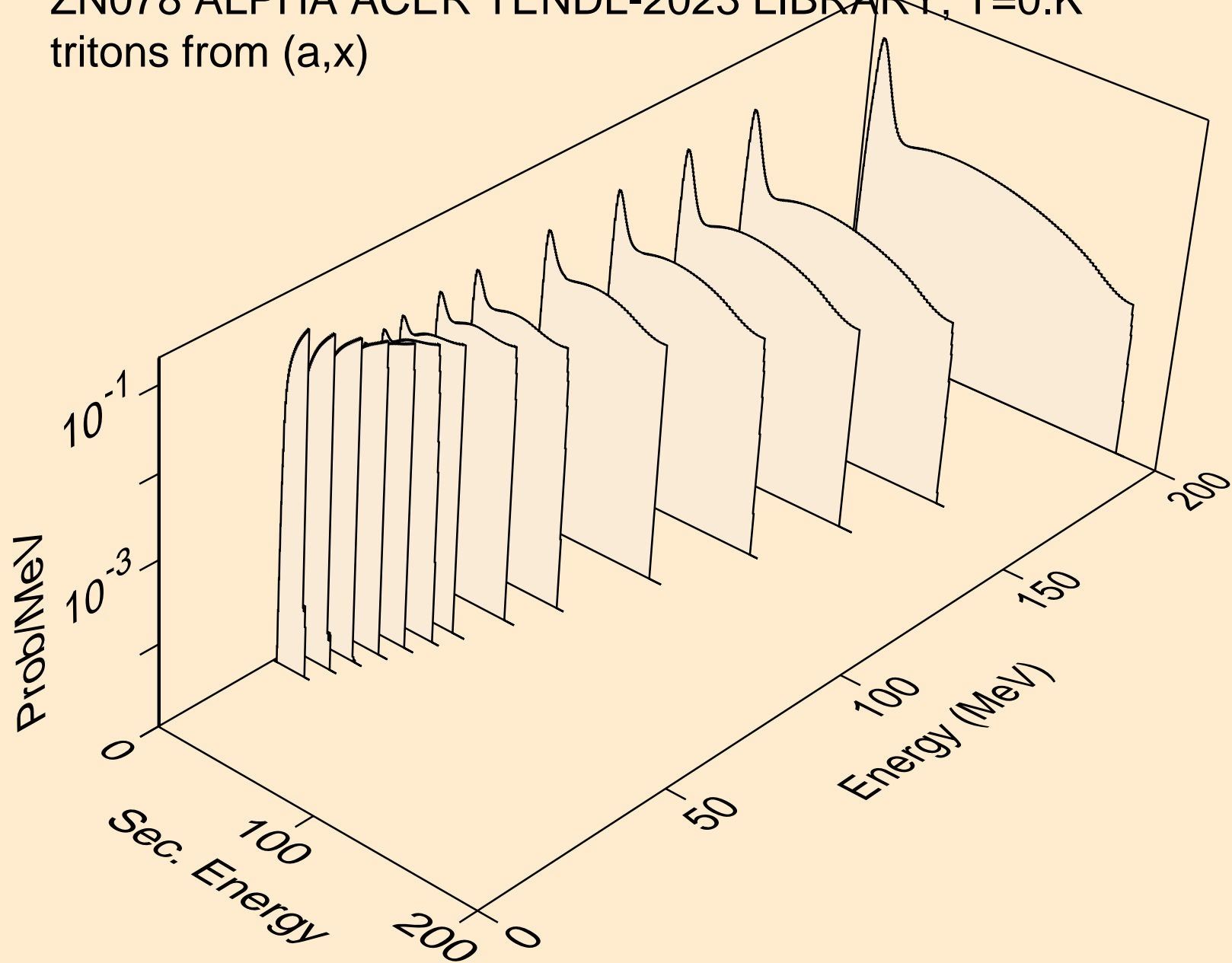

ZN078 ALPHA ACER TENDL-2023 LIBRARY; T=0.K
tritons from (a,n*)t

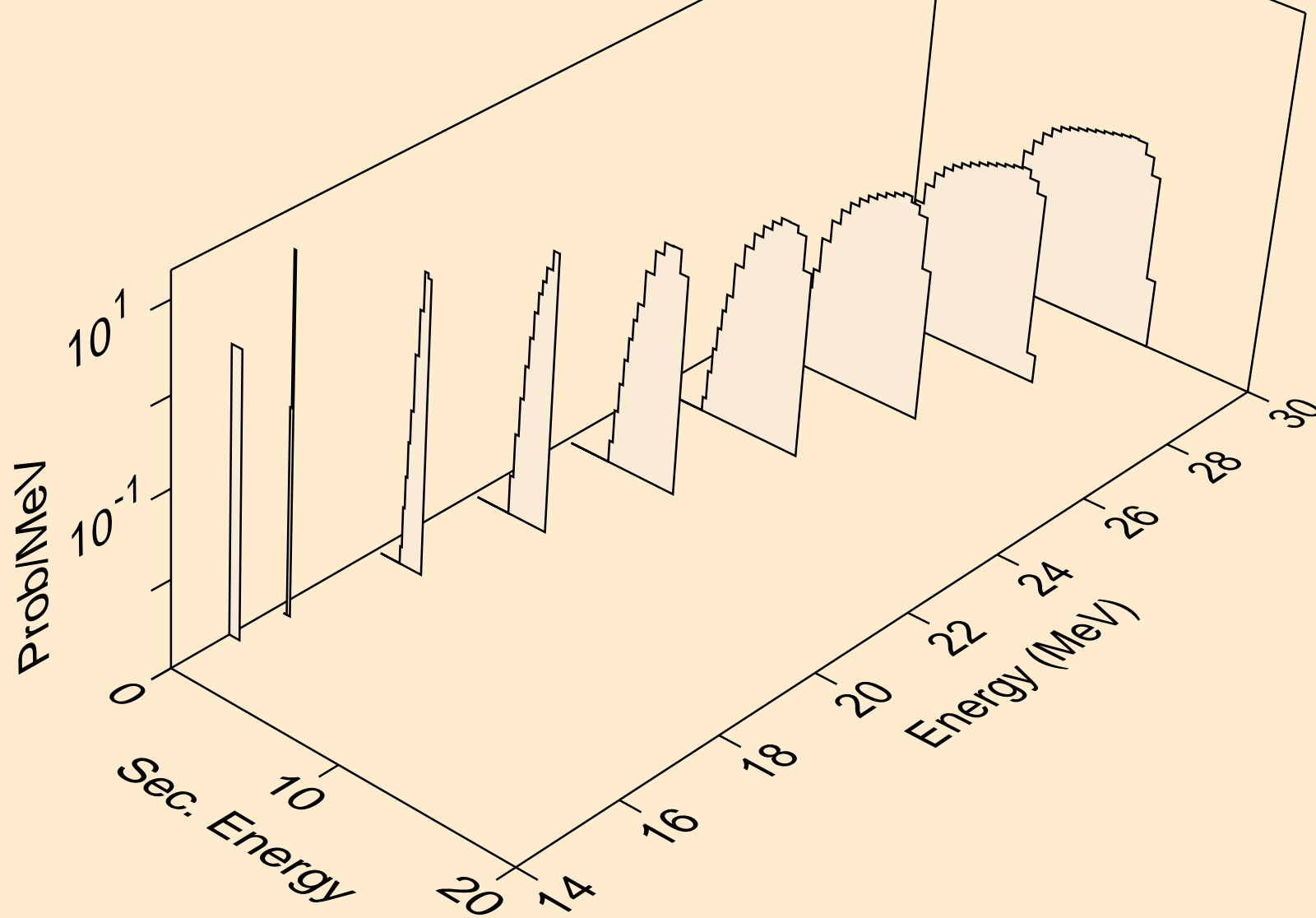

ZN078 ALPHA ACER TENDL-2023 LIBRARY; T=0.K
tritons from (a,t)

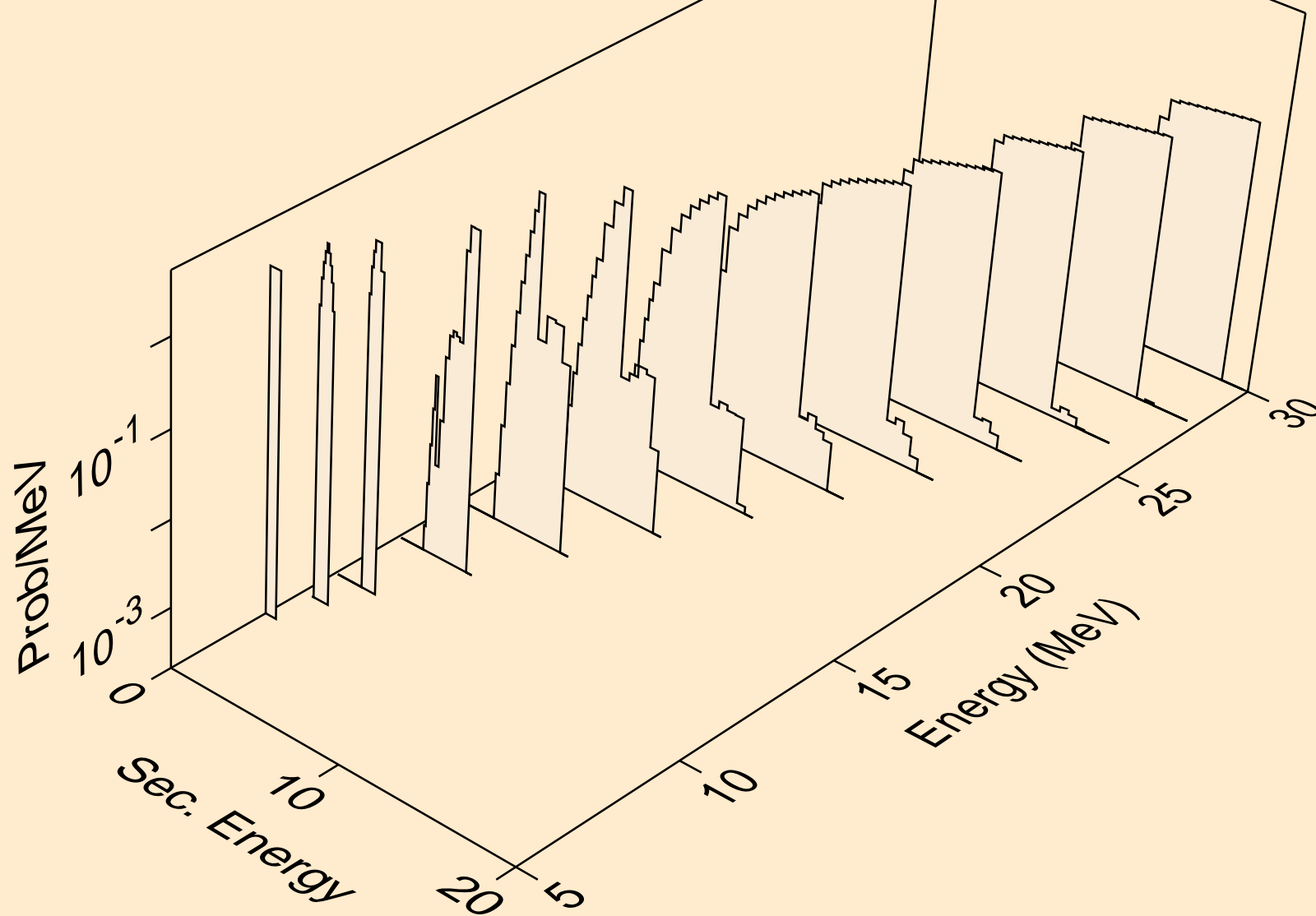

ZN078 ALPHA ACER TENDL-2023 LIBRARY; T=0.K
he3s from (a,x)

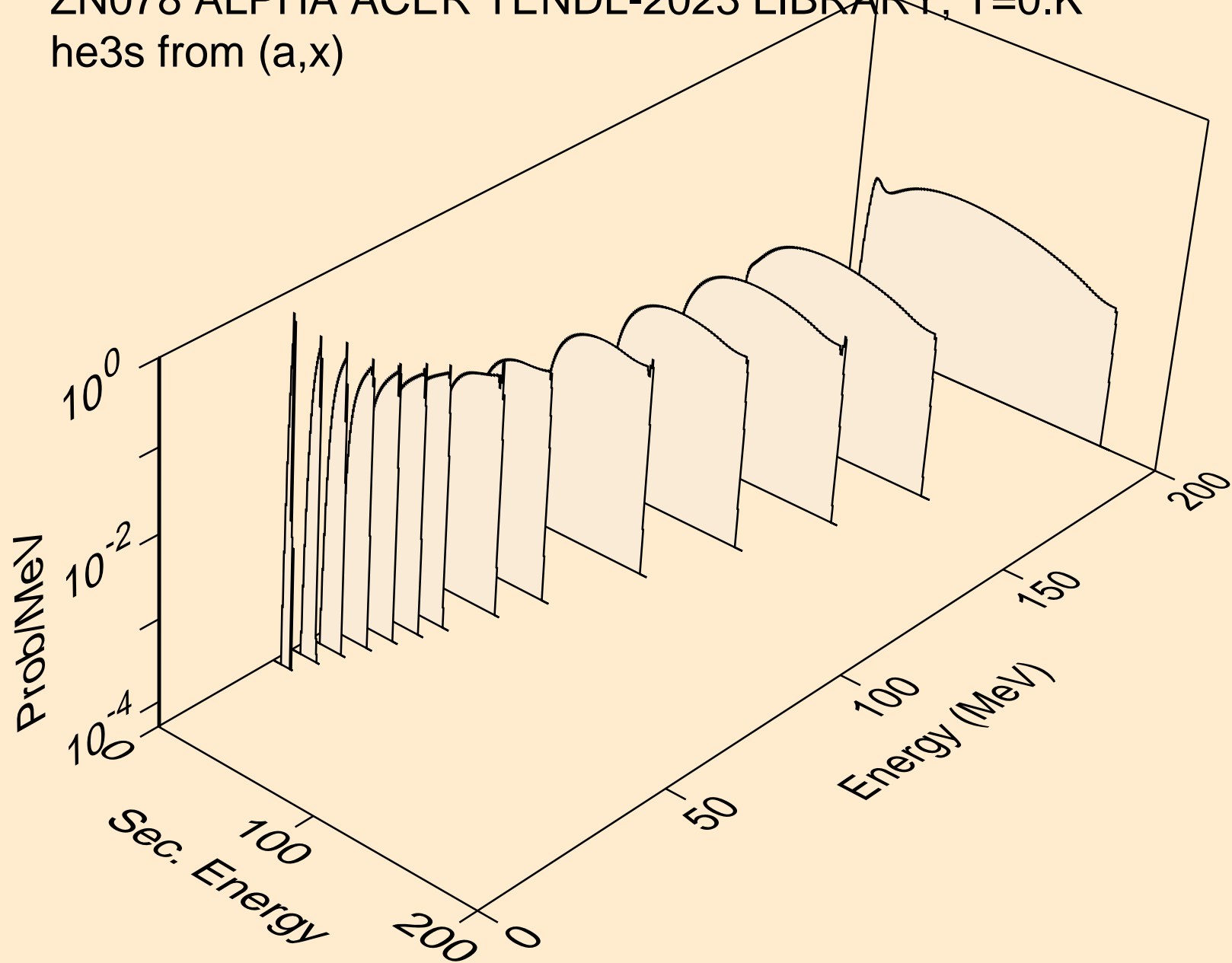

ZN078 ALPHA ACER TENDL-2023 LIBRARY; T=0.K
he3s from (a,n*)he3

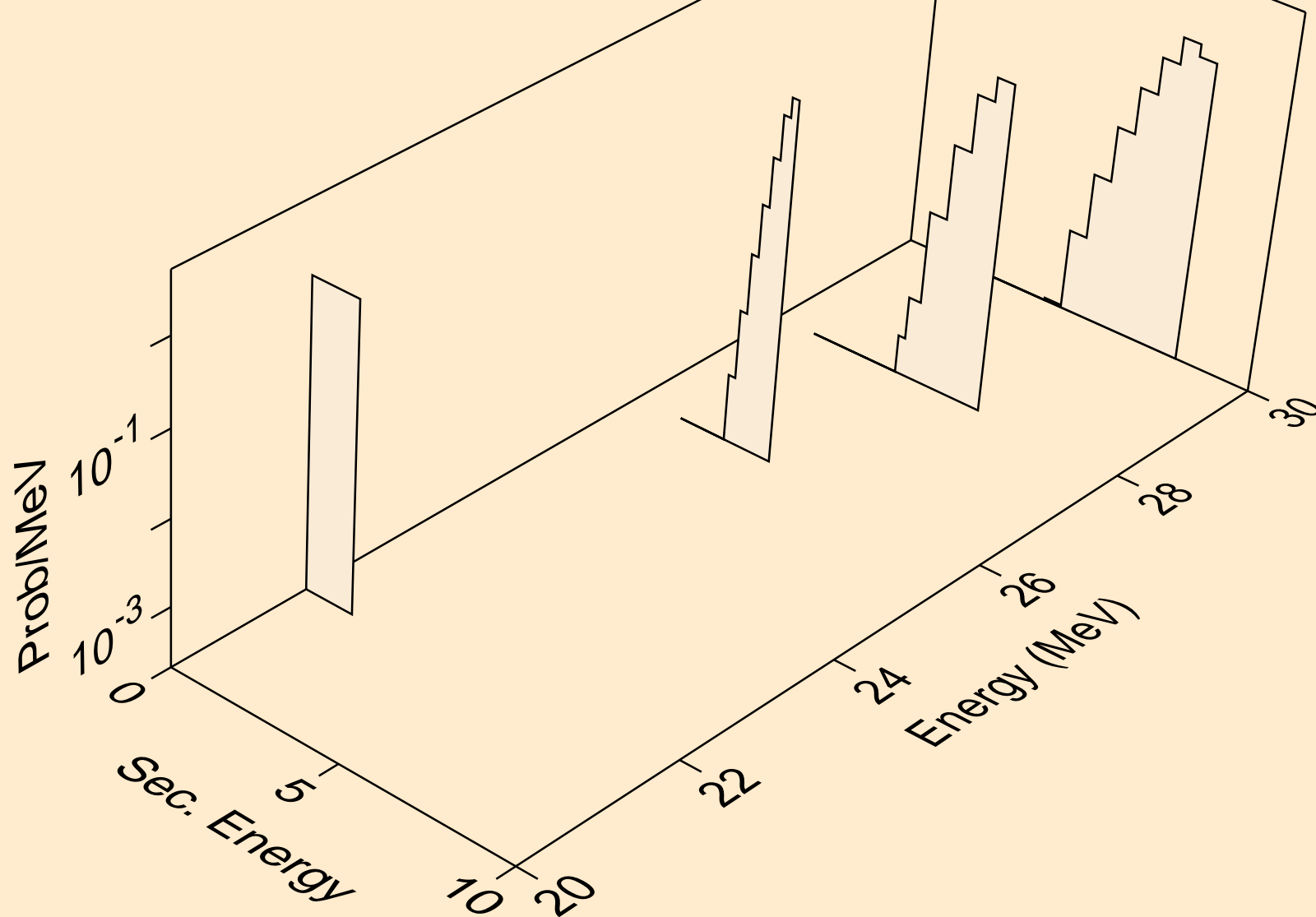

ZN078 ALPHA ACER TENDL-2023 LIBRARY; T=0.K
he3s from (a,he3)

