

# AS080 DEUTERON ACER TENDL-2023 LIBRARY; T=0.K

## Principal cross sections

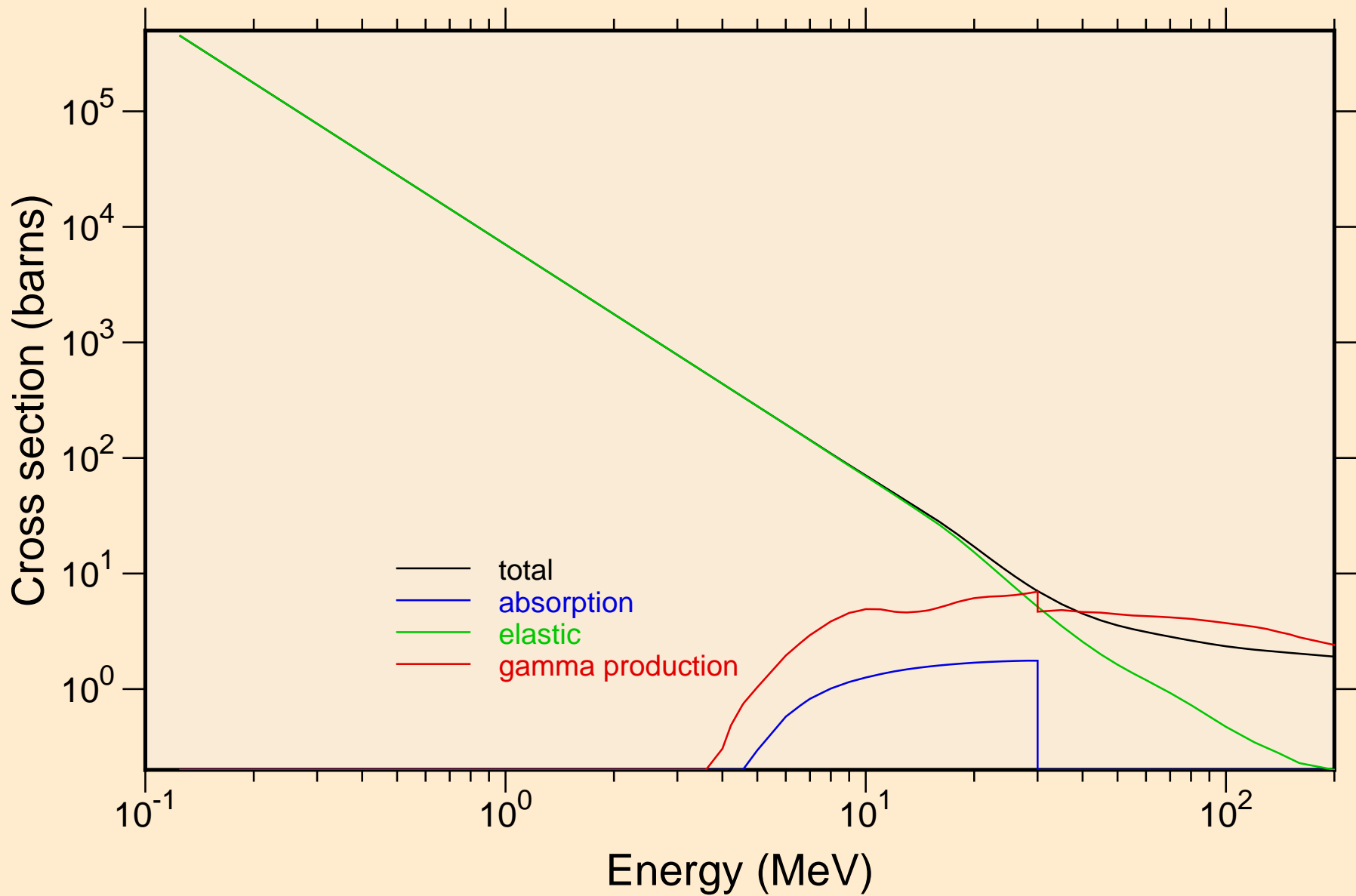

# AS080 DEUTERON ACER TENDL-2023 LIBRARY; T=0.K

## Heating

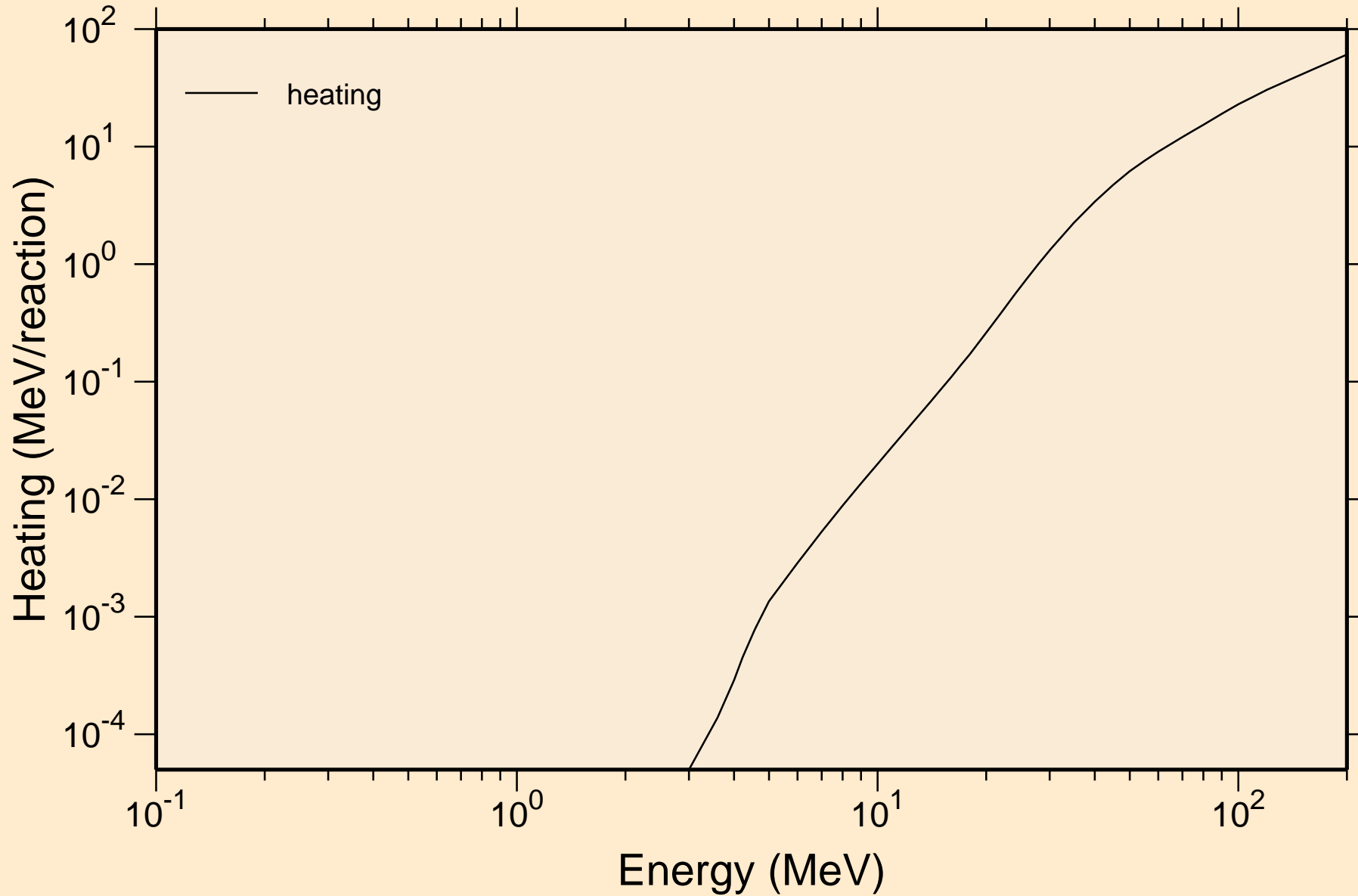

AS080 DEUTERON ACER TENDL-2023 LIBRARY; T=0.K  
Principal cross sections

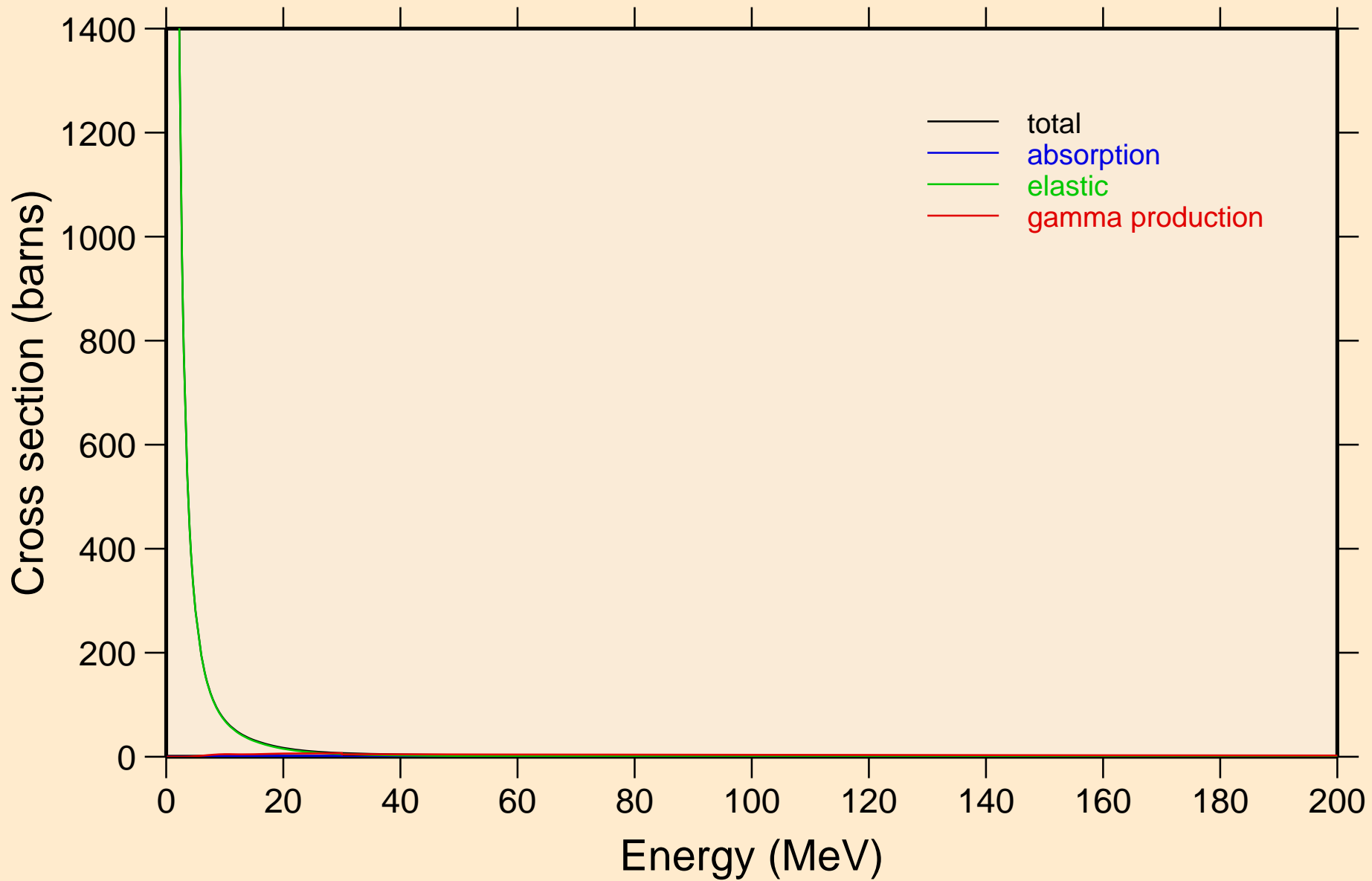

AS080 DEUTERON ACER TENDL-2023 LIBRARY; T=0.K  
Heating

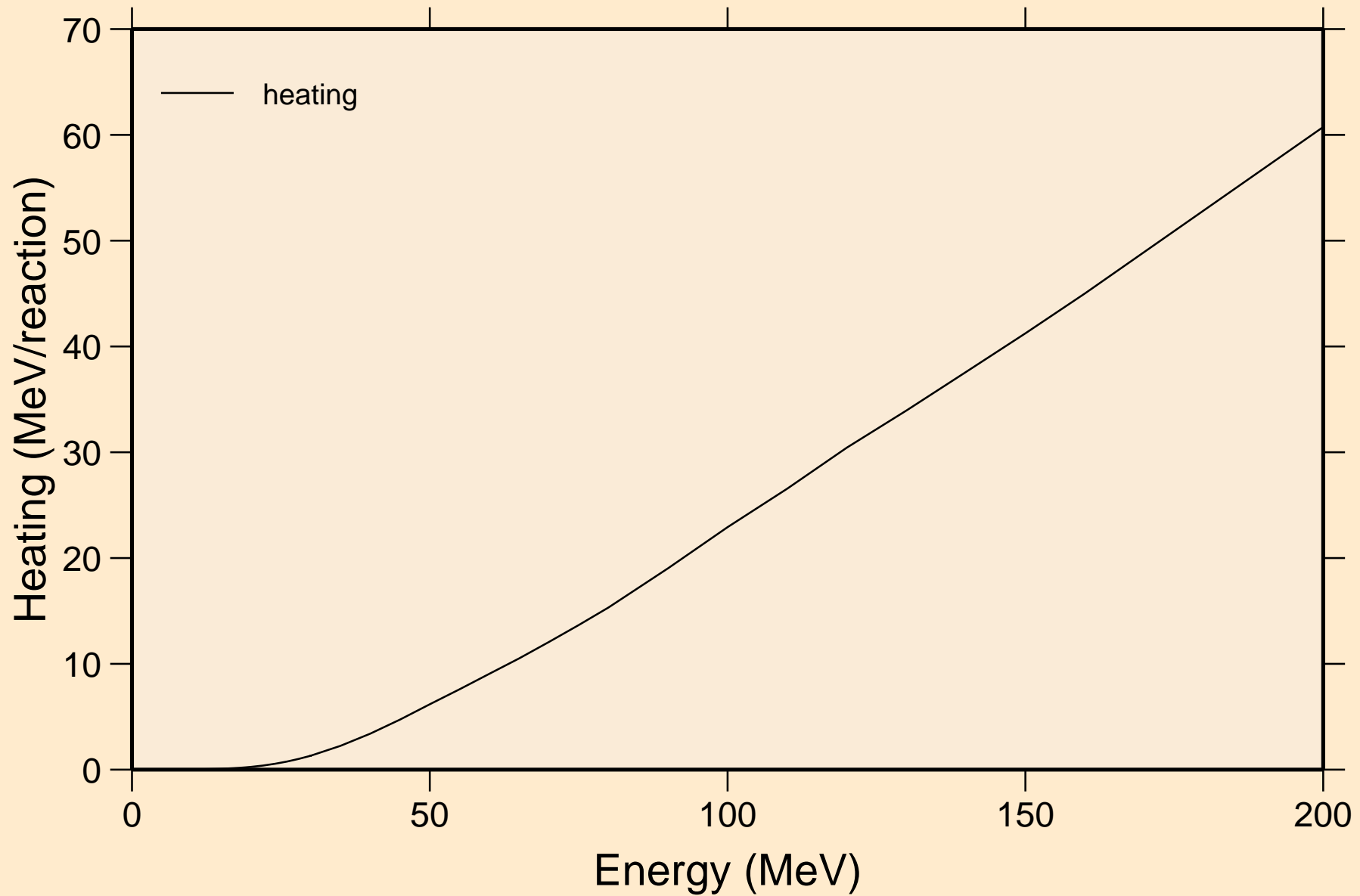

# AS080 DEUTERON ACER TENDL-2023 LIBRARY; T=0.K

## Threshold reactions

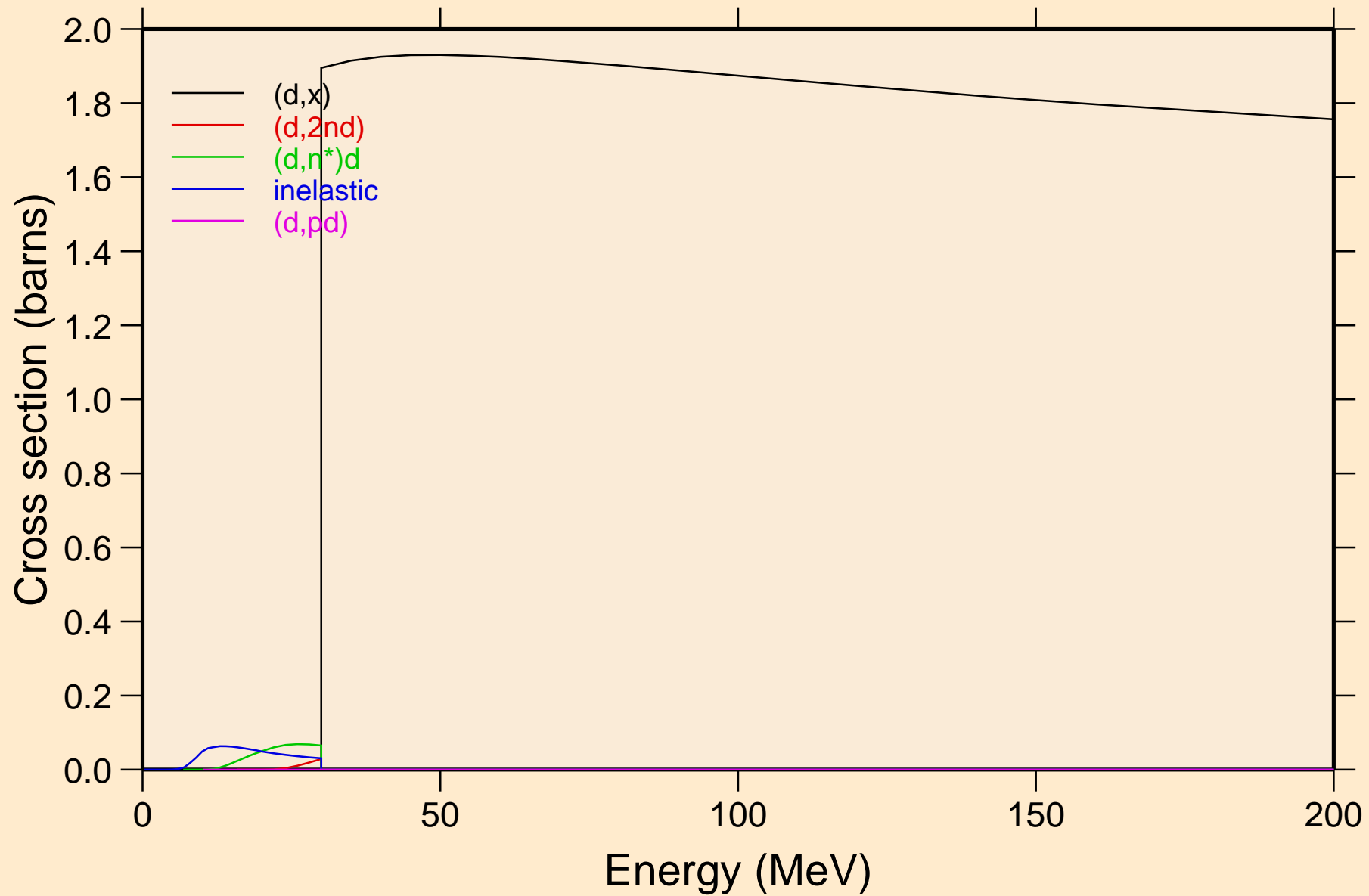

AS080 DEUTERON ACER TENDL-2023 LIBRARY; T=0.K  
Threshold reactions

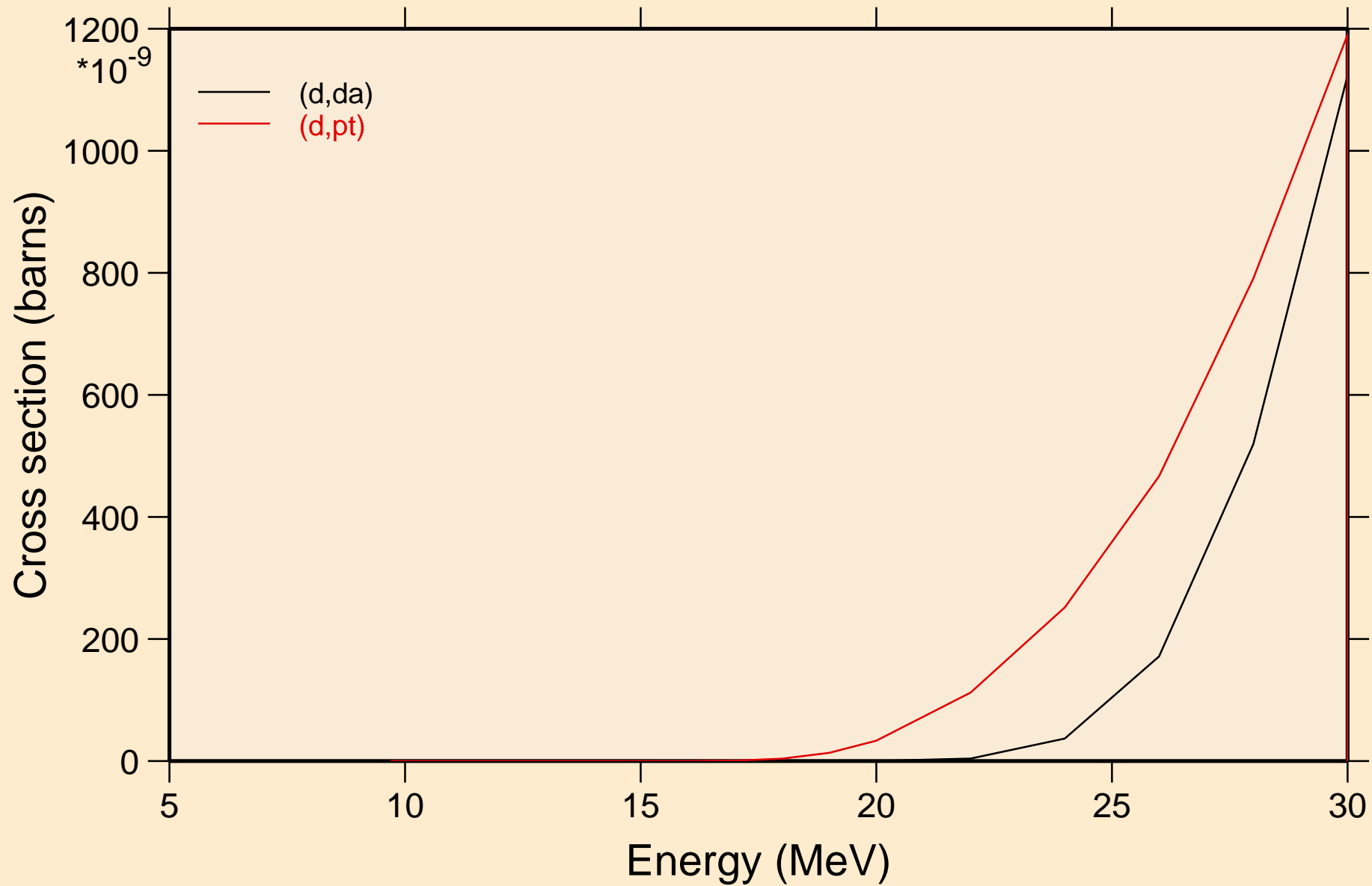

AS080 DEUTERON ACER TENDL-2023 LIBRARY; T=0.K  
Threshold reactions

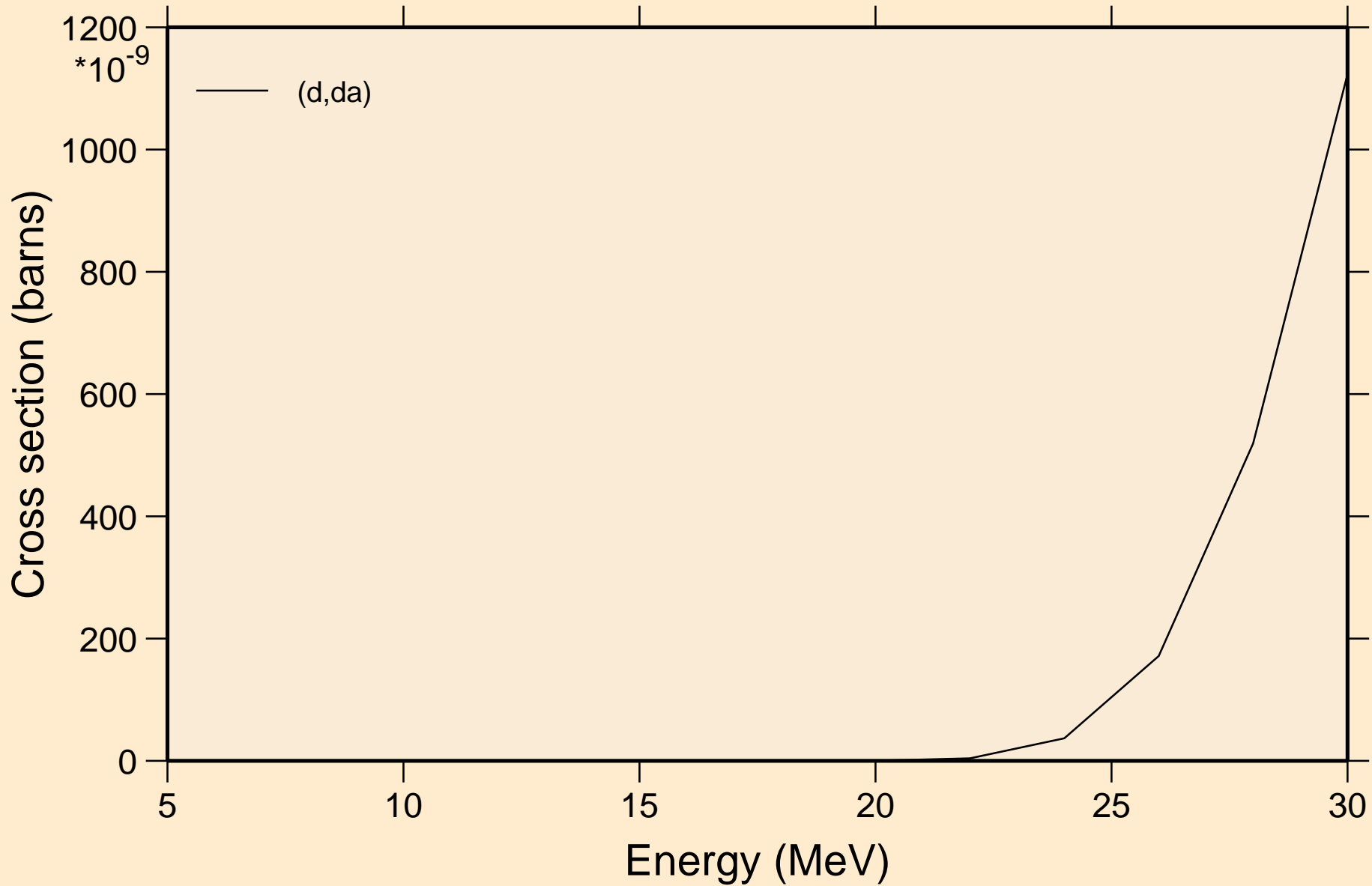

AS080 DEUTERON ACER TENDL-2023 LIBRARY; T=0.K  
angular distribution for elastic

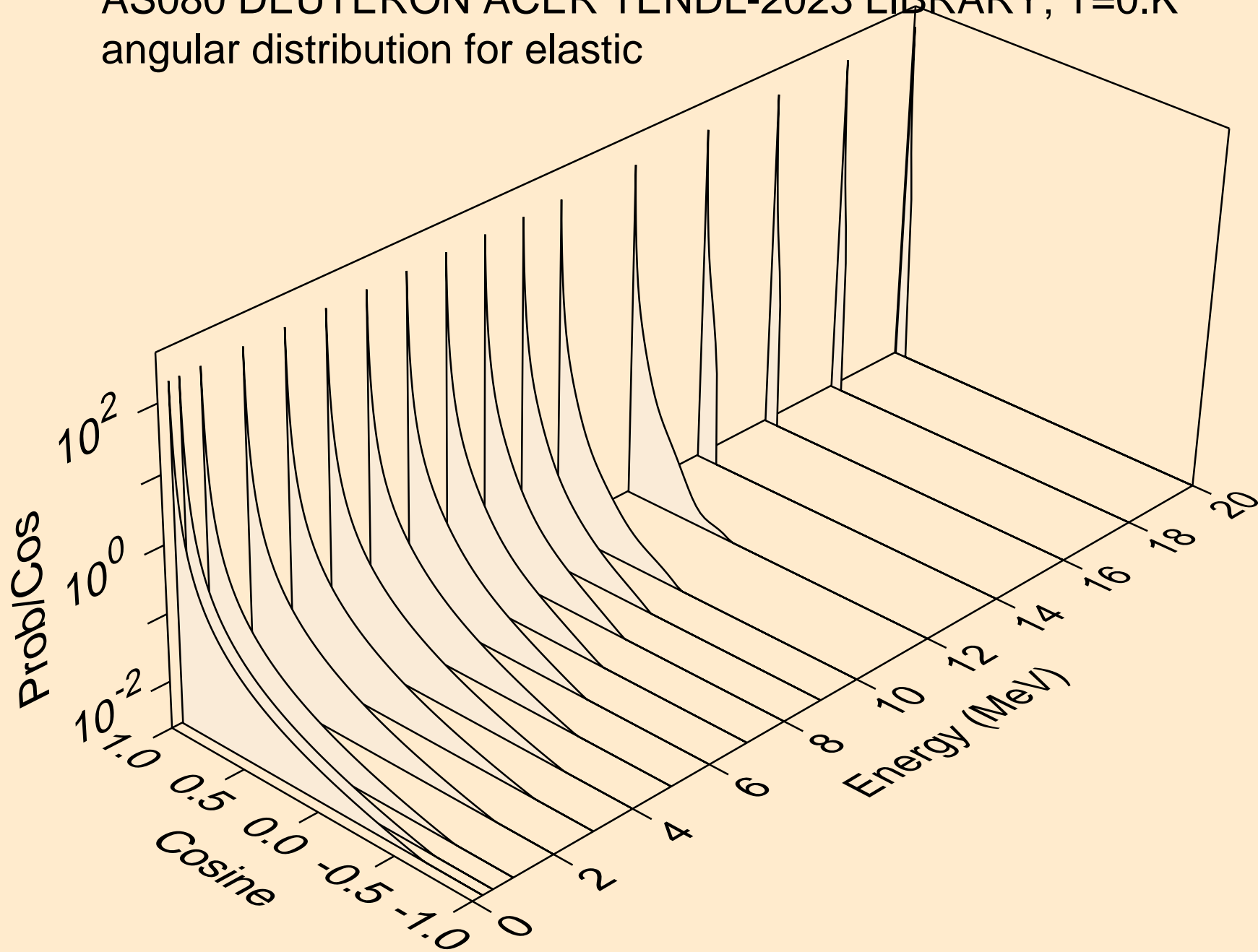



AS080 DEUTERON ACER TENDL-2023 LIBRARY; T=0.K  
angular distribution for elastic

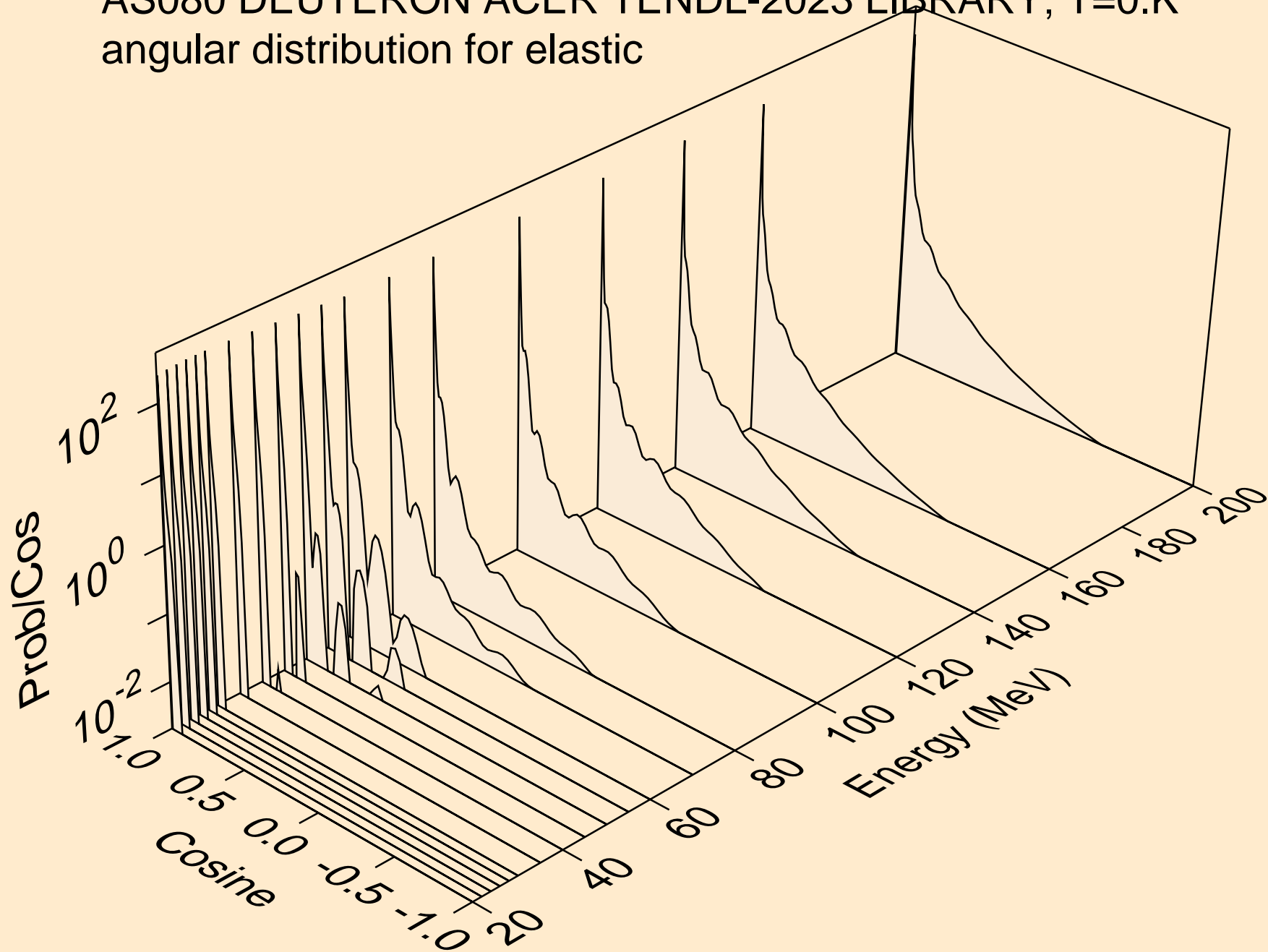

AS080 DEUTERON ACER TENDL-2023 LIBRARY; T=0.K  
Deuteron emission for (d,x)

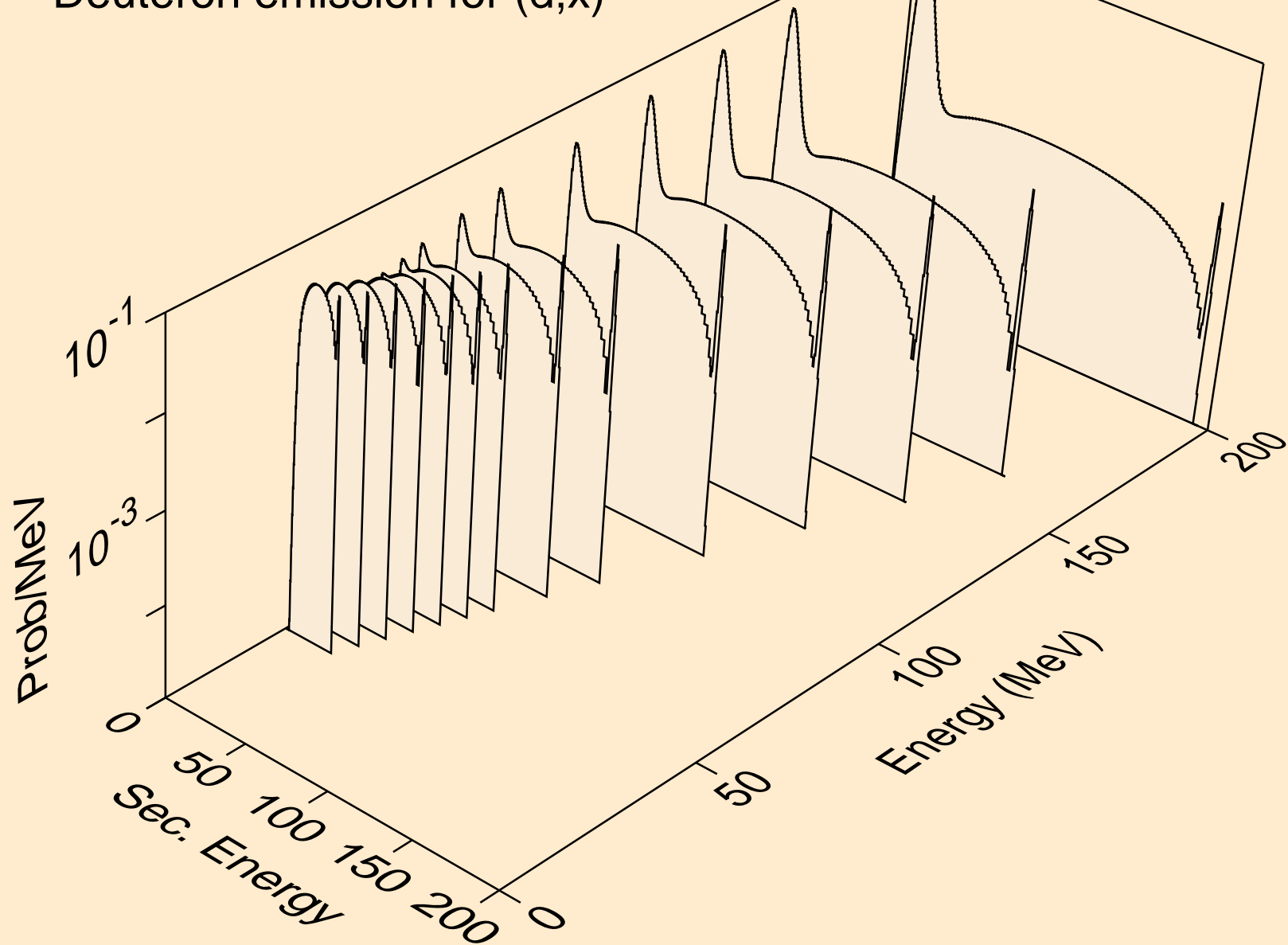

AS080 DEUTERON ACER TENDL-2023 LIBRARY; T=0.K  
Deuteron emission for (d,2nd)

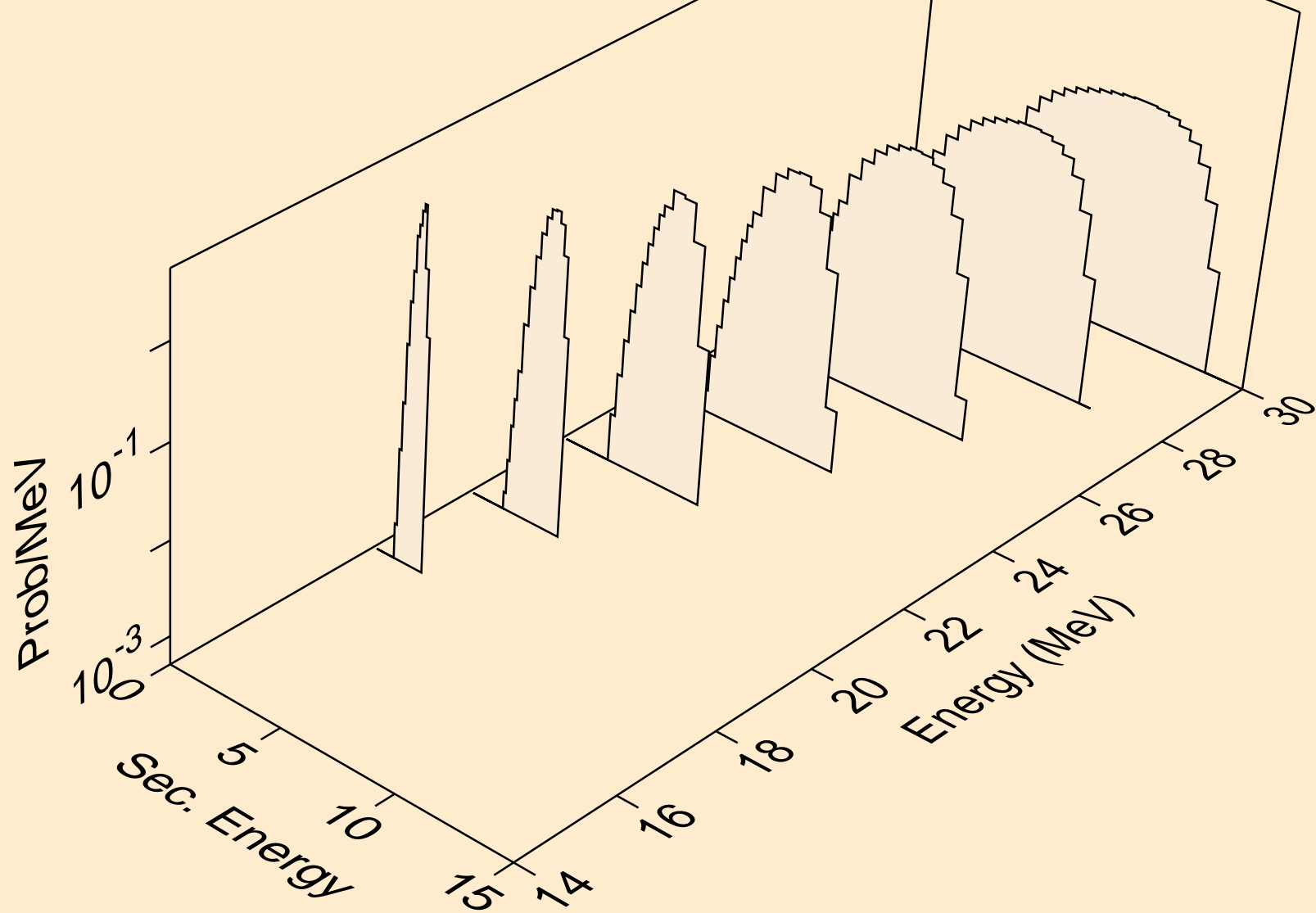

AS080 DEUTERON ACER TENDL-2023 LIBRARY; T=0.K  
Deuteron emission for (d,n\*)d

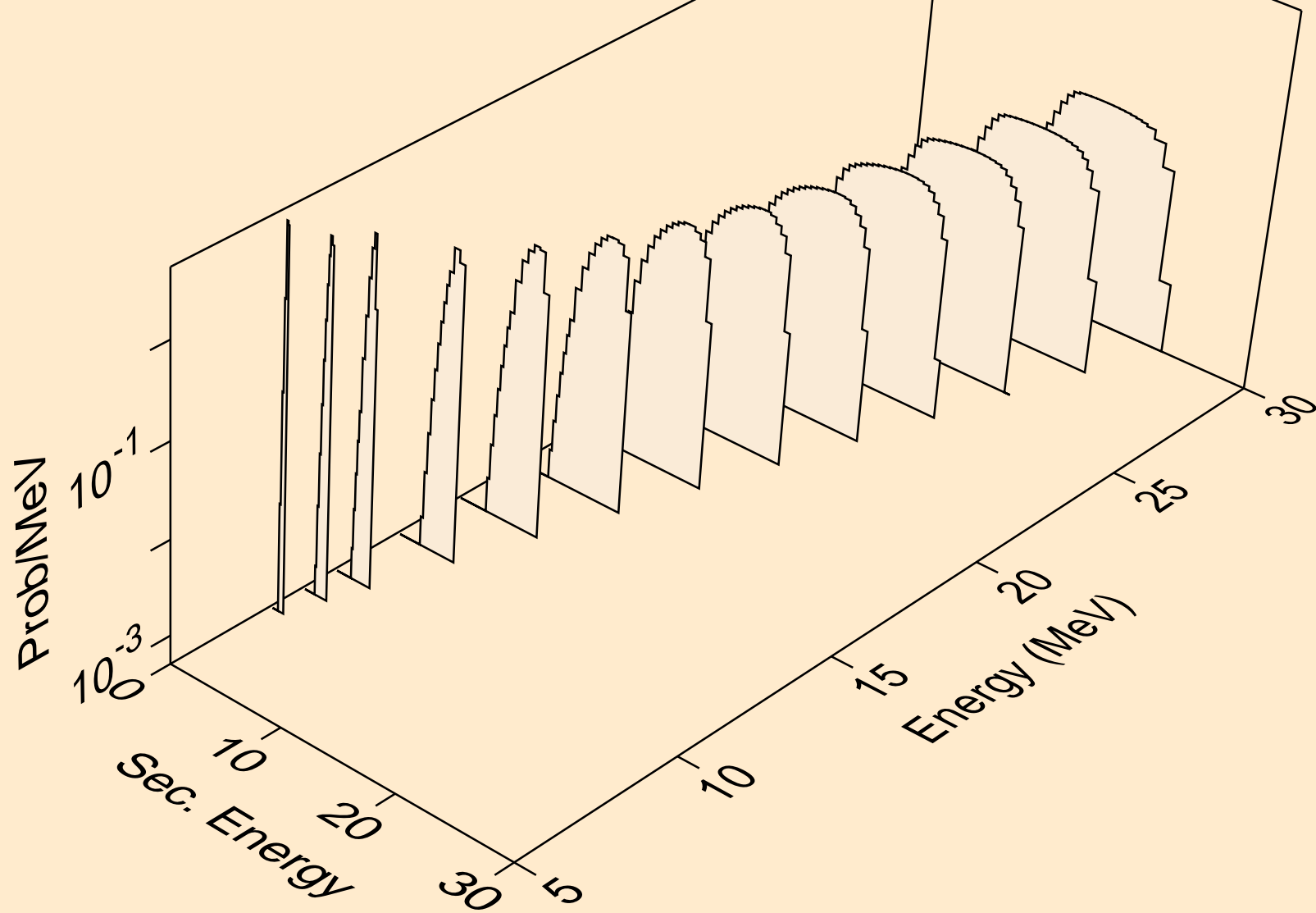

AS080 DEUTERON ACER TENDL-2023 LIBRARY; T=0.K  
Deuteron emission for inelastic

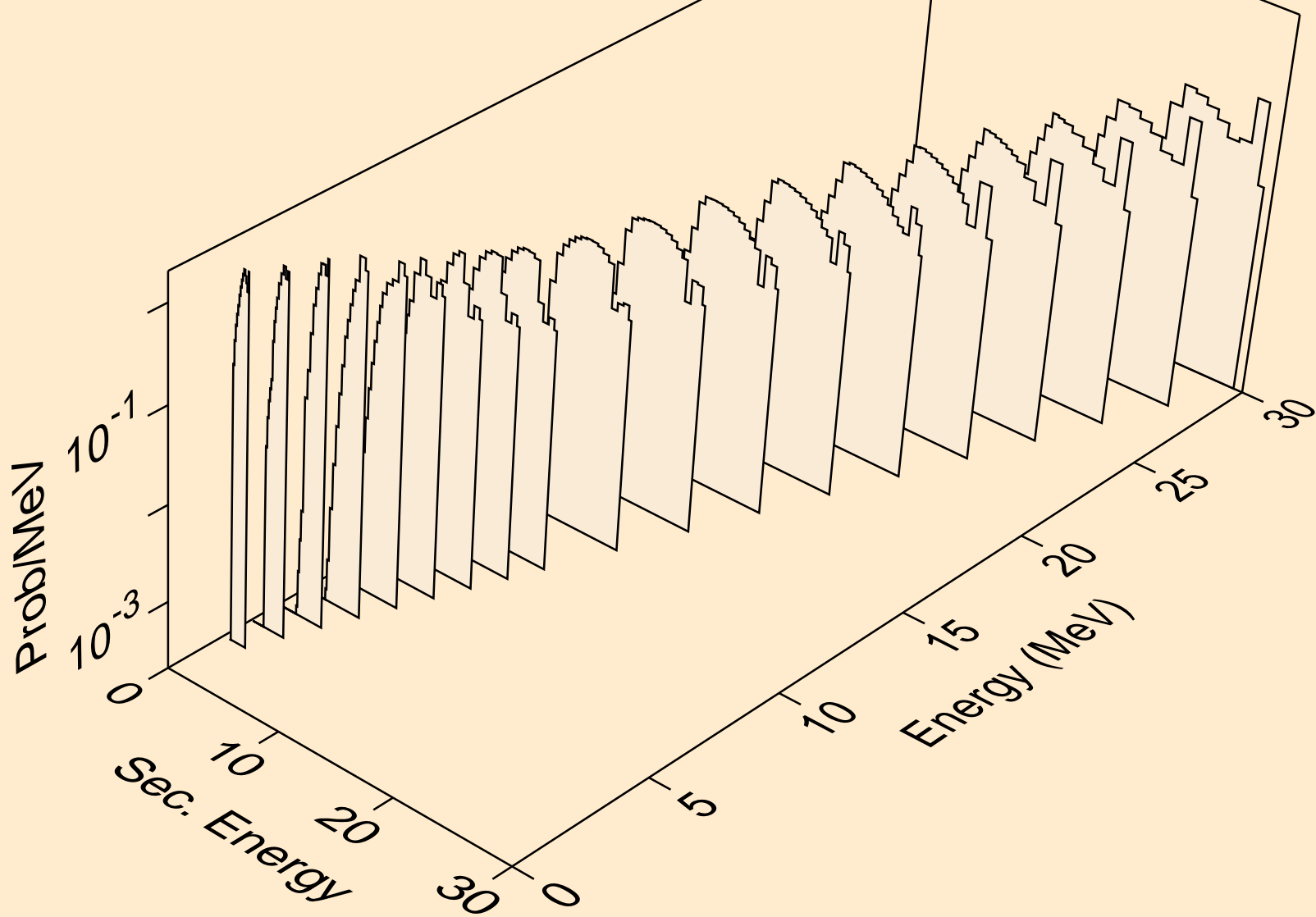

AS080 DEUTERON ACER TENDL-2023 LIBRARY; T=0.K  
Deuteron emission for (d,pd)

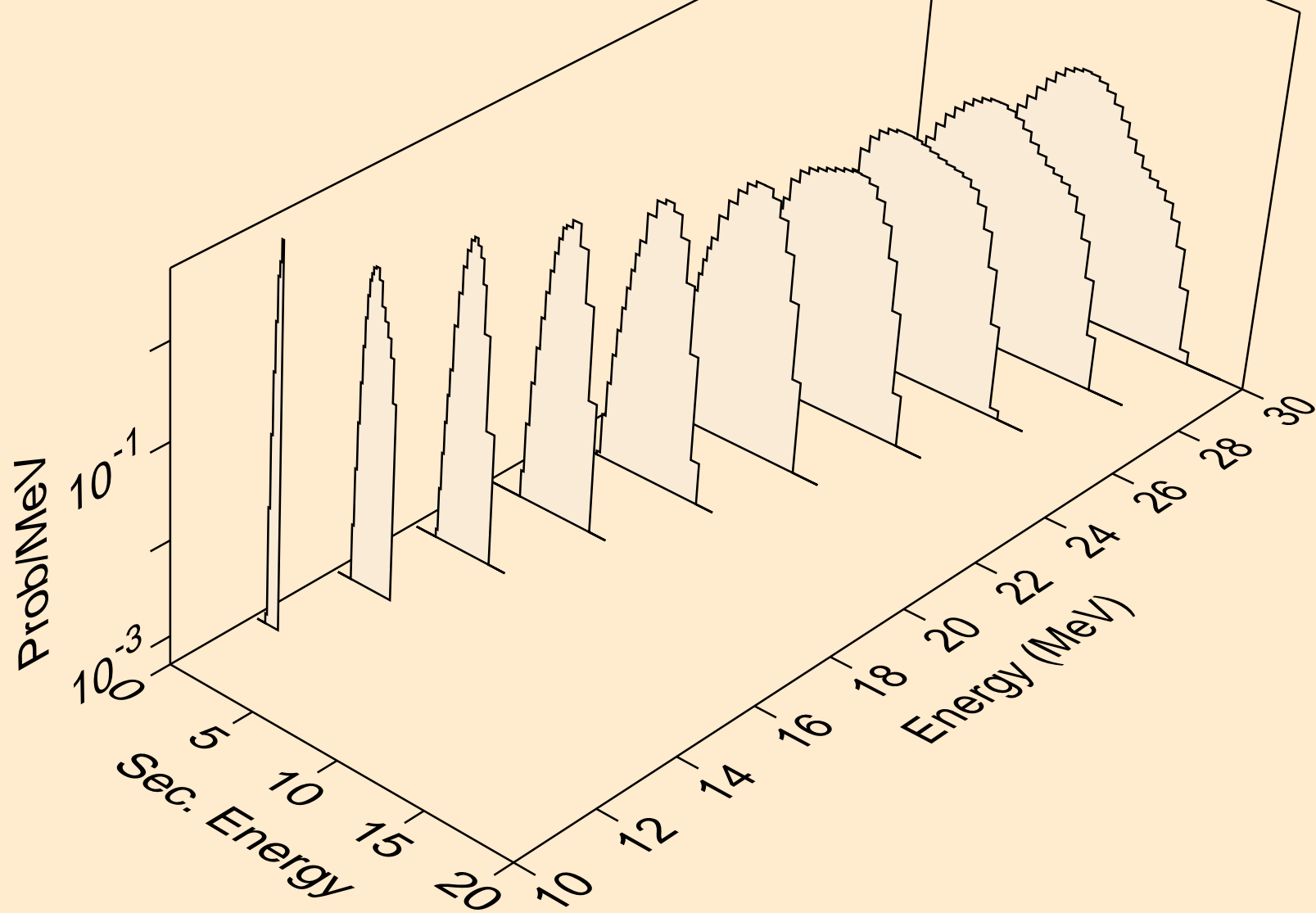

AS080 DEUTERON ACER TENDL-2023 LIBRARY; T=0.K  
Deuteron emission for (d,da)

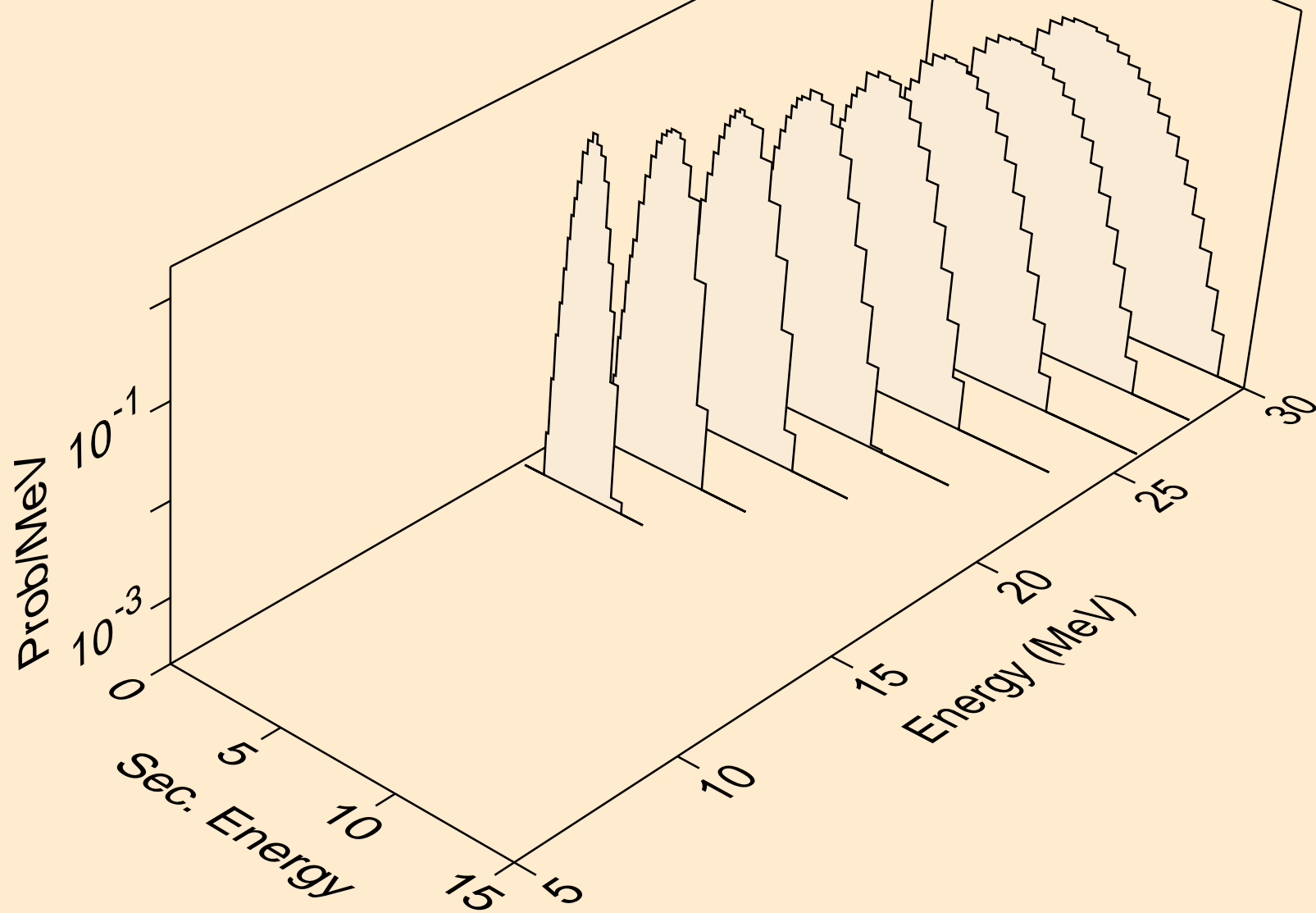

AS080 DEUTERON ACER TENDL-2023 LIBRARY; T=0.K  
Photon emission for (z,n)

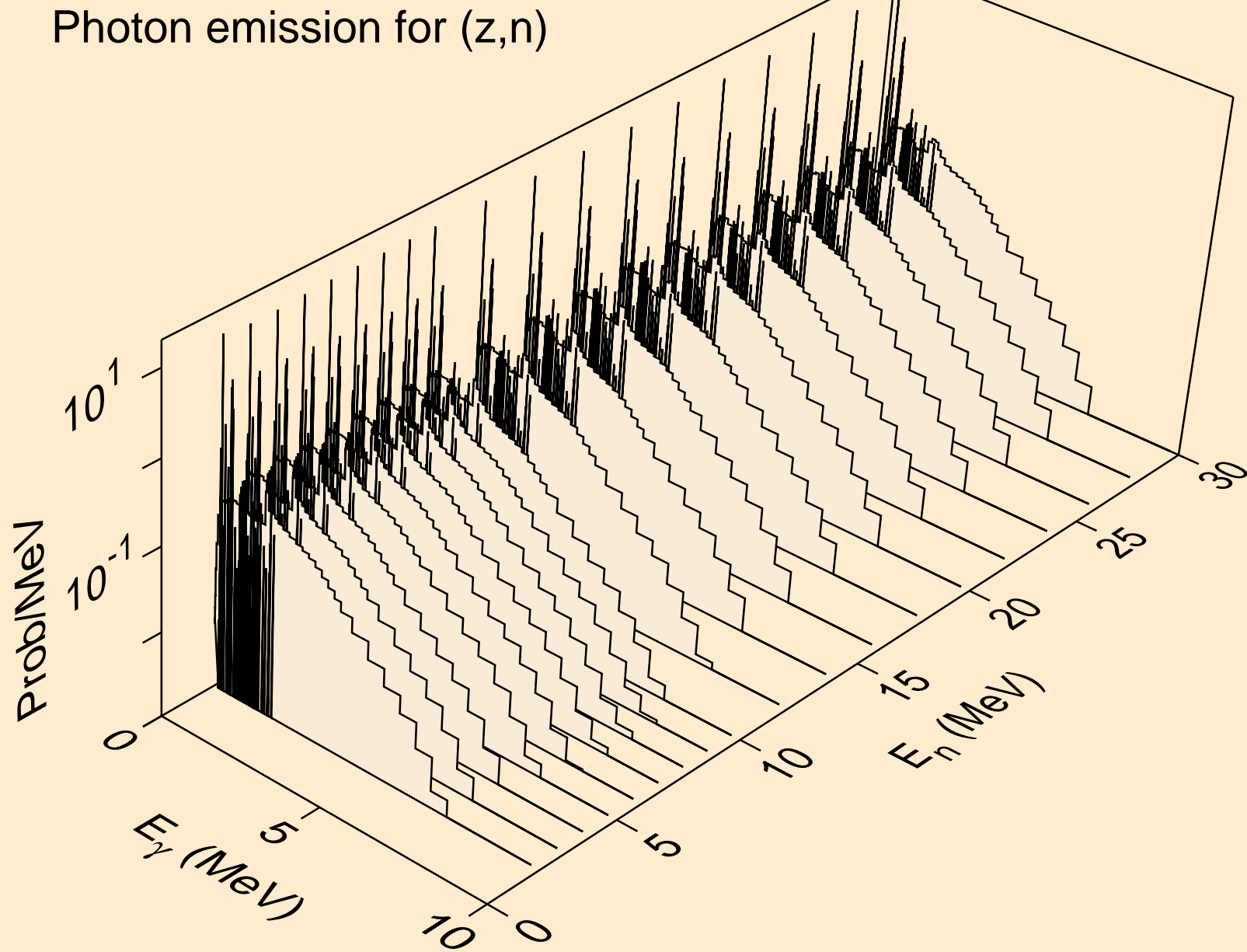



AS080 DEUTERON ACER TENDL-2023 LIBRARY; T=0.K  
Photon emission for (z,x)

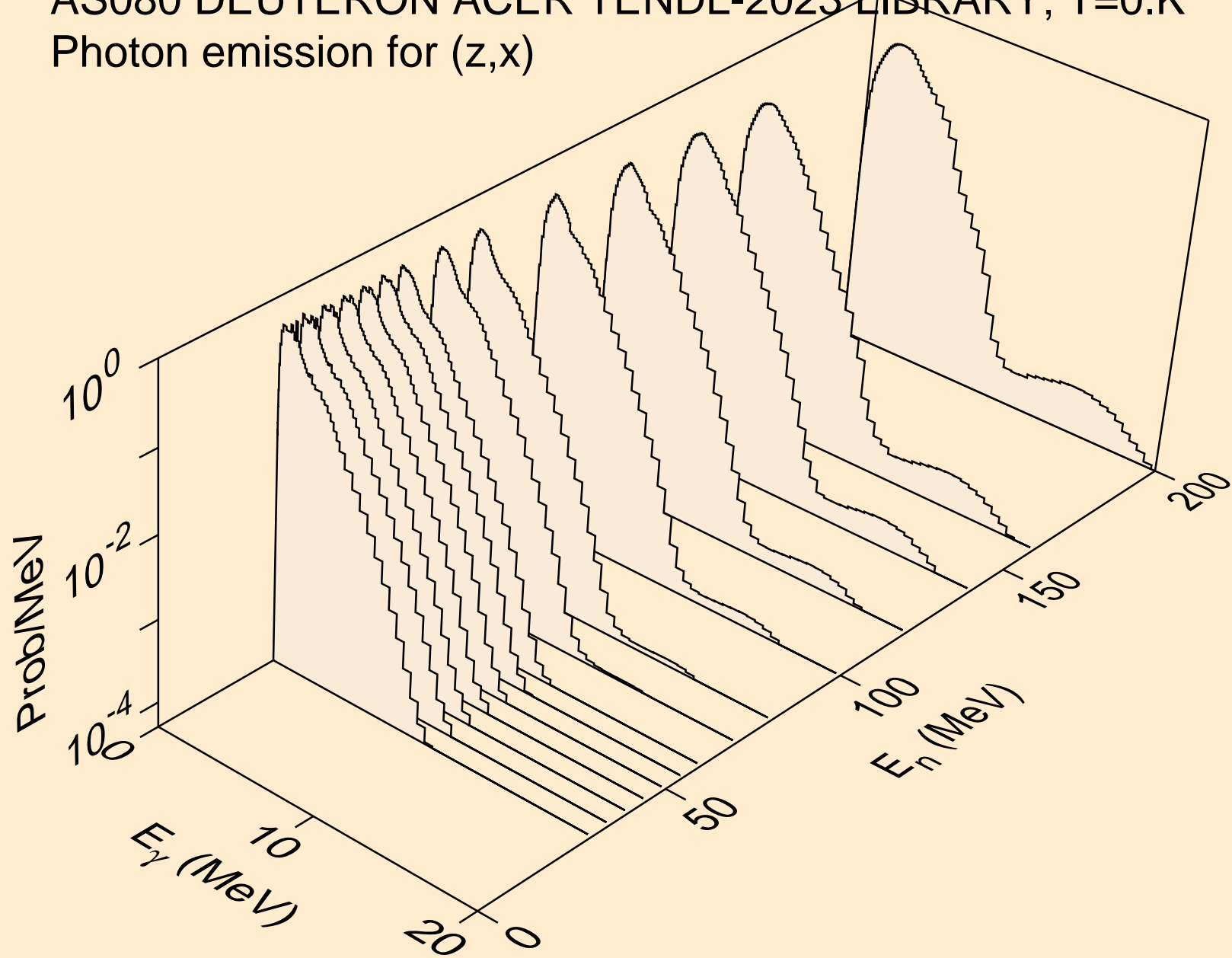

AS080 DEUTERON ACER TENDL-2023 LIBRARY; T=0.K  
Photon emission for (n,2nd)

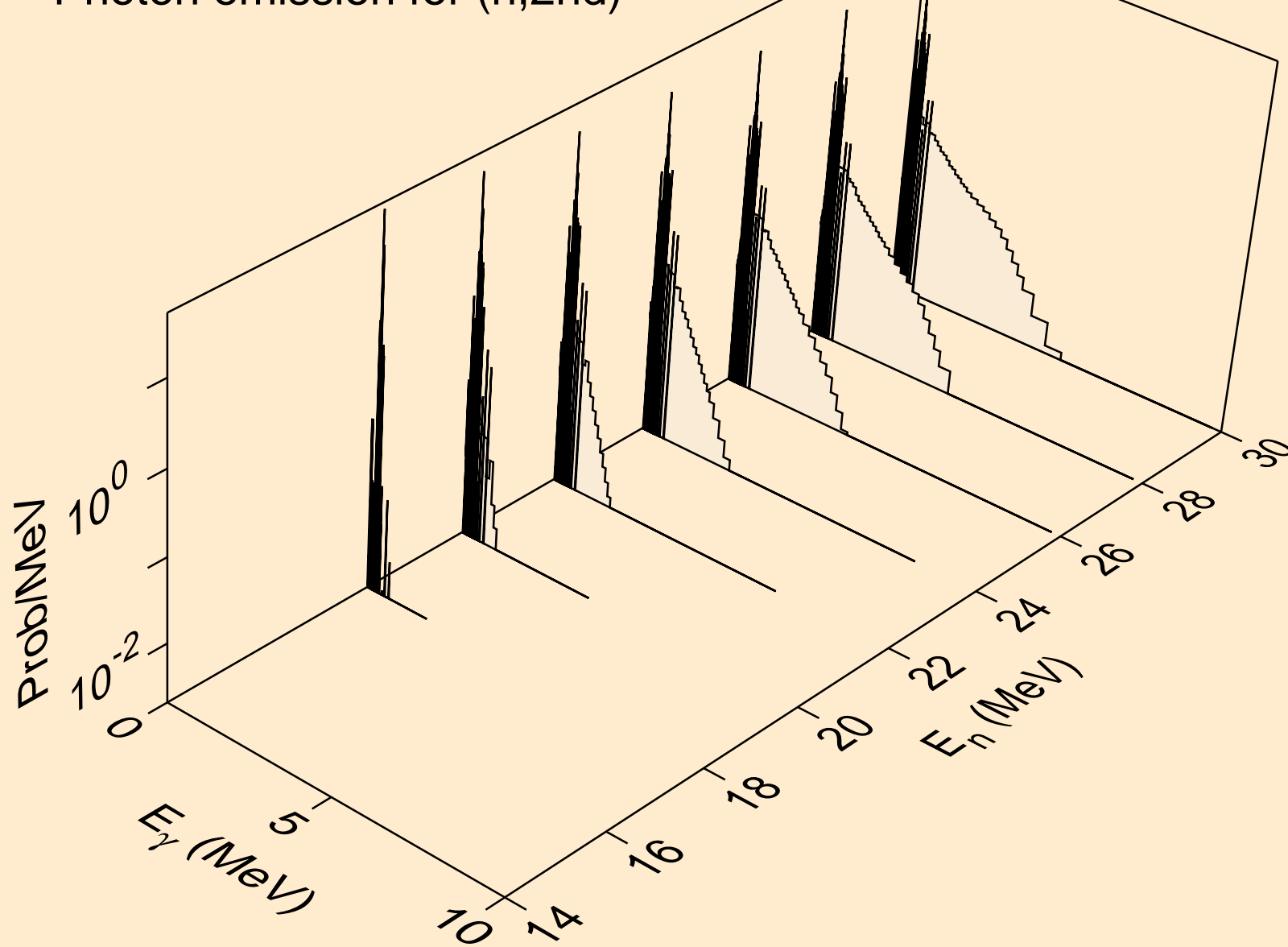

AS080 DEUTERON ACER TENDL-2023 LIBRARY; T=0.K  
Photon emission for (n,2n)

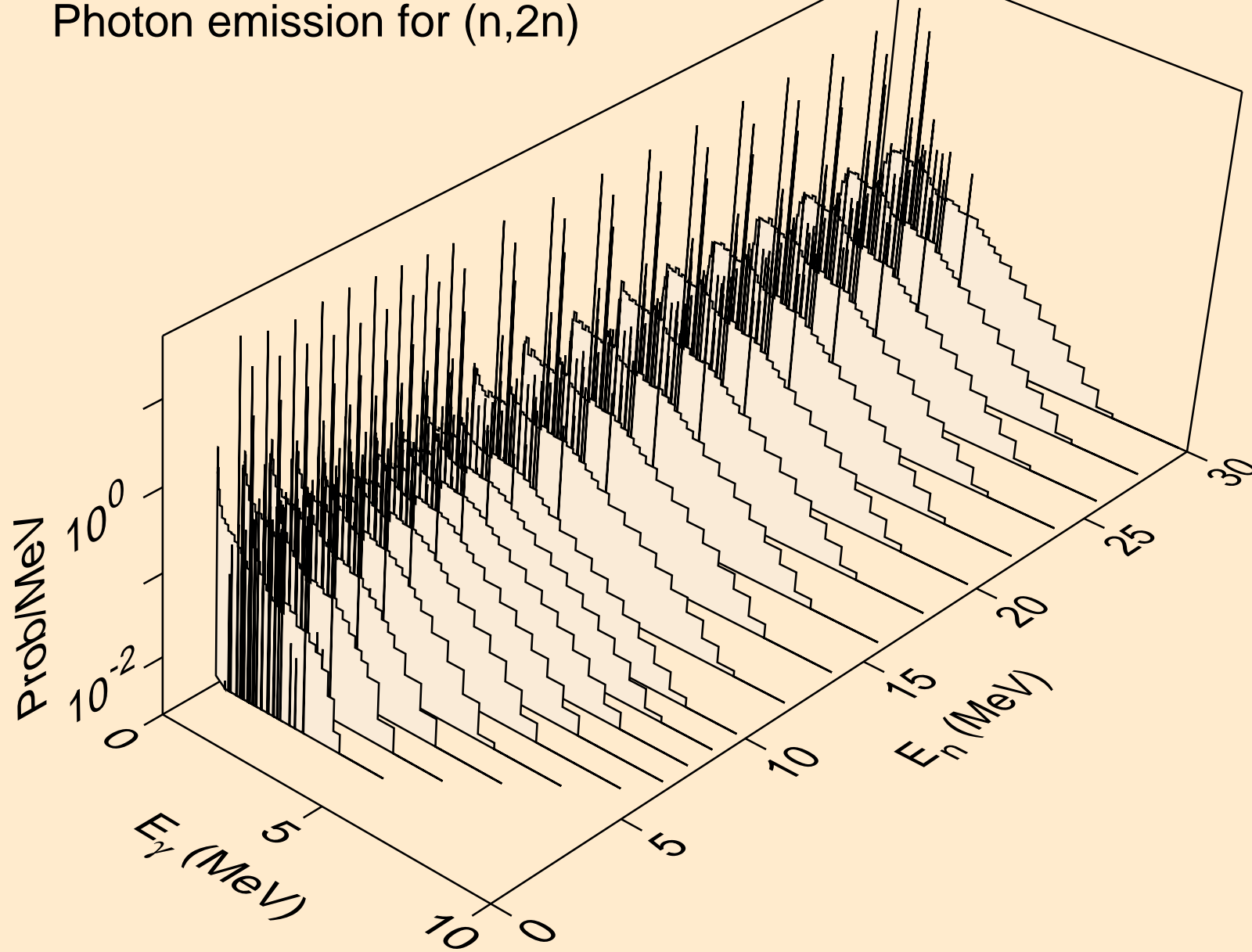

AS080 DEUTERON ACER TENDL-2023 LIBRARY; T=0.K  
Photon emission for (n,3n)

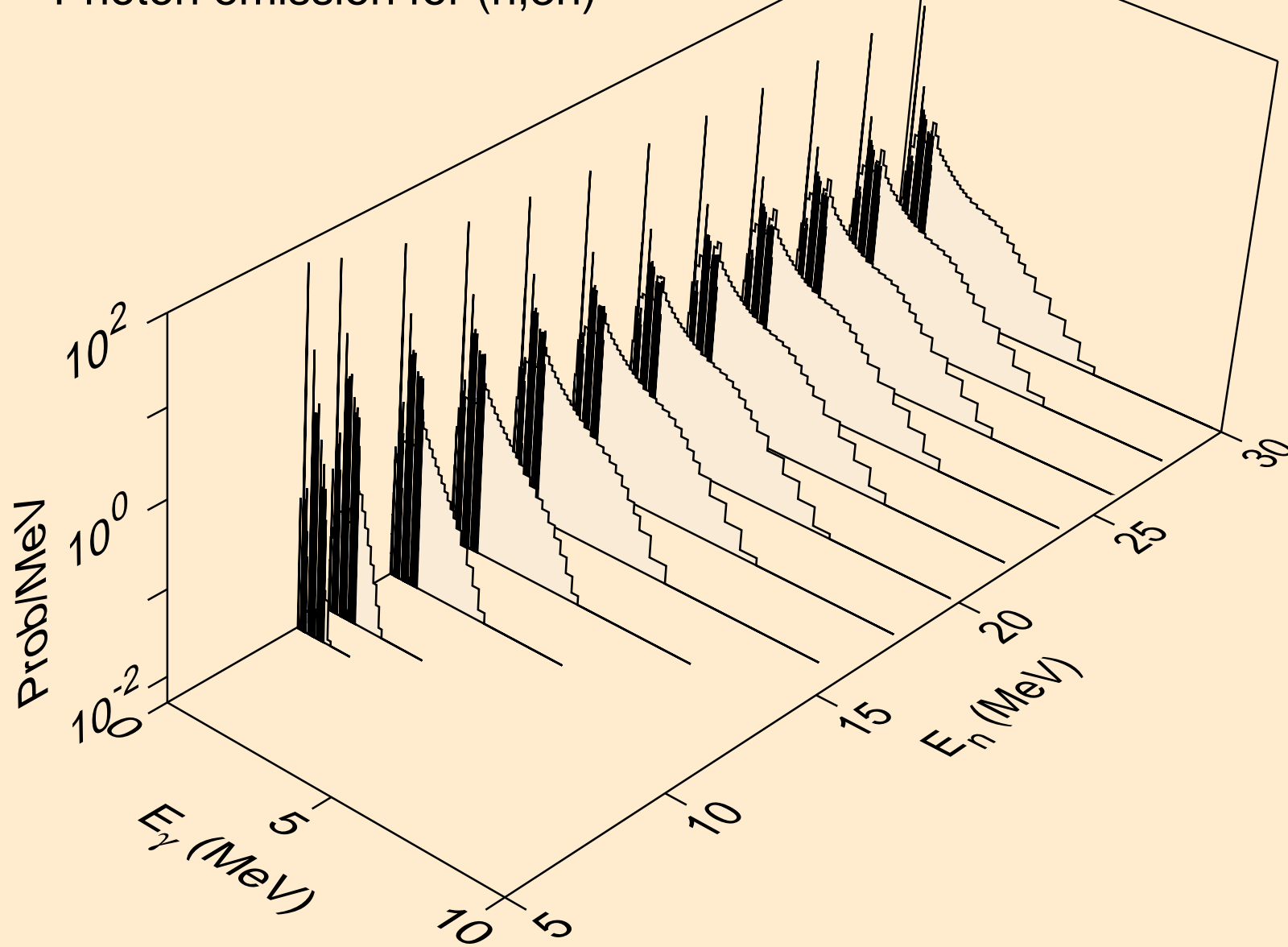

AS080 DEUTERON ACER TENDL-2023 LIBRARY; T=0.K  
Photon emission for (n,n\*)a

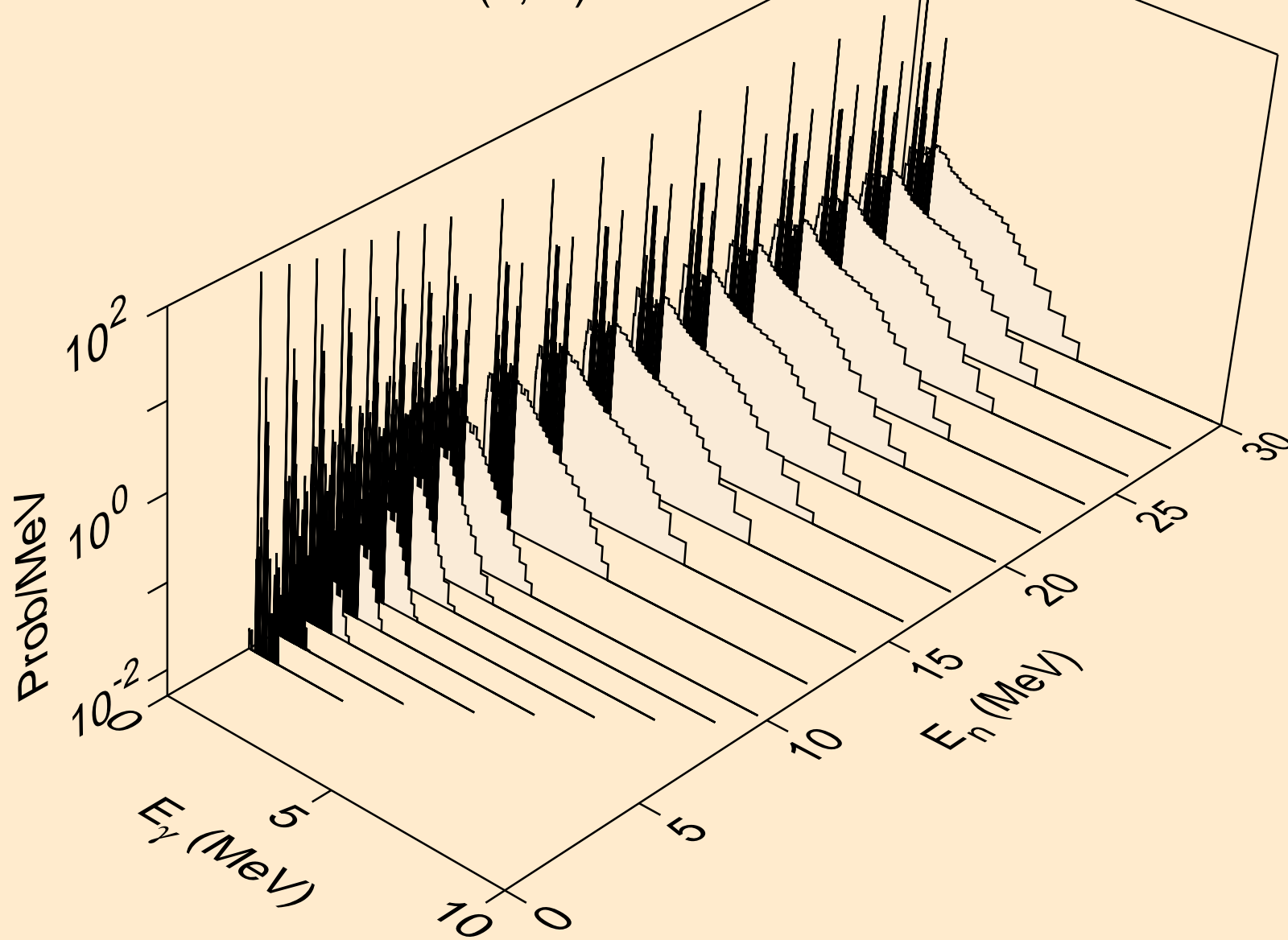

AS080 DEUTERON ACER TENDL-2023 LIBRARY; T=0.K  
Photon emission for (n,2n)a

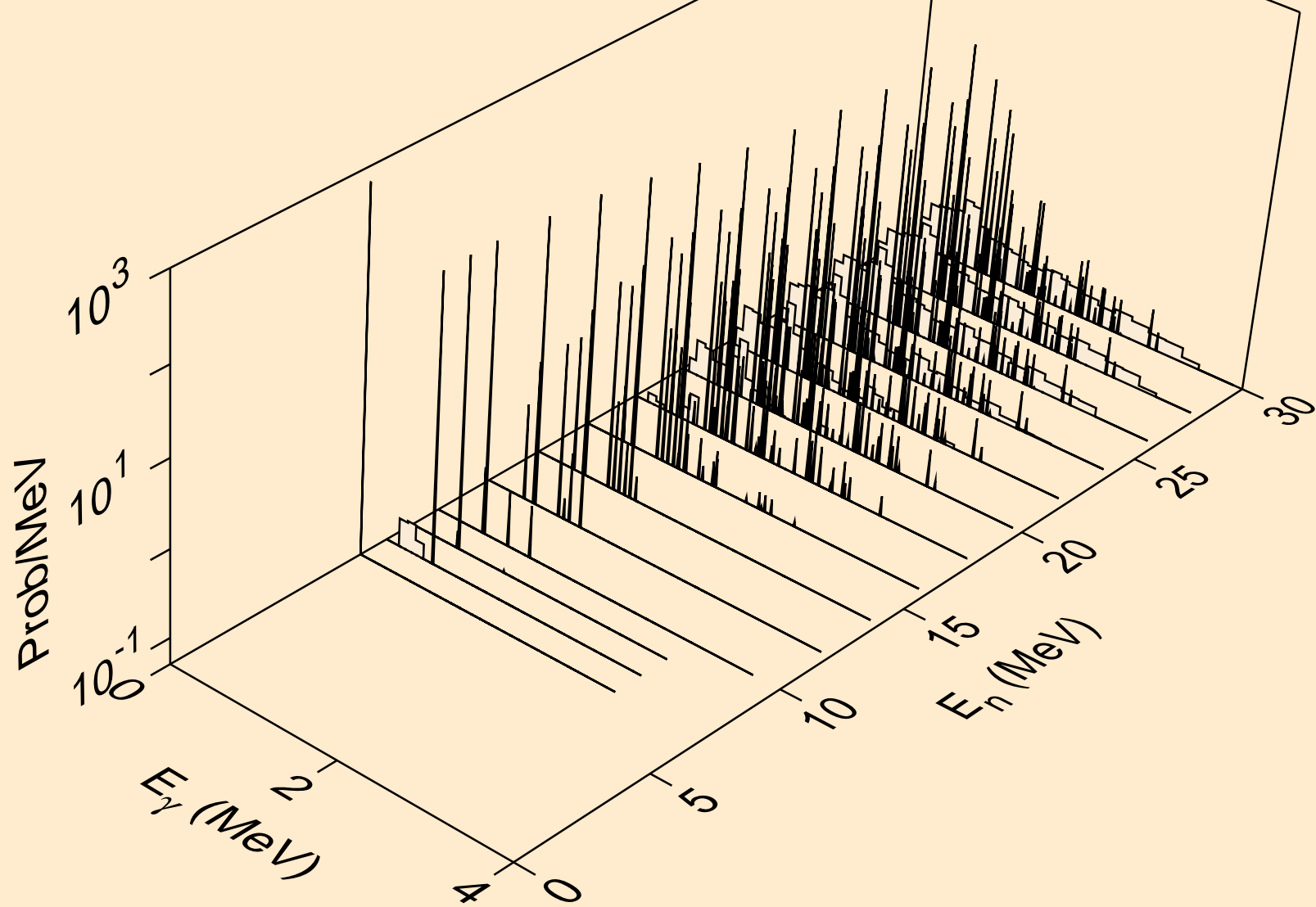

AS080 DEUTERON ACER TENDL-2023 LIBRARY; T=0.K  
Photon emission for (n,3n)a

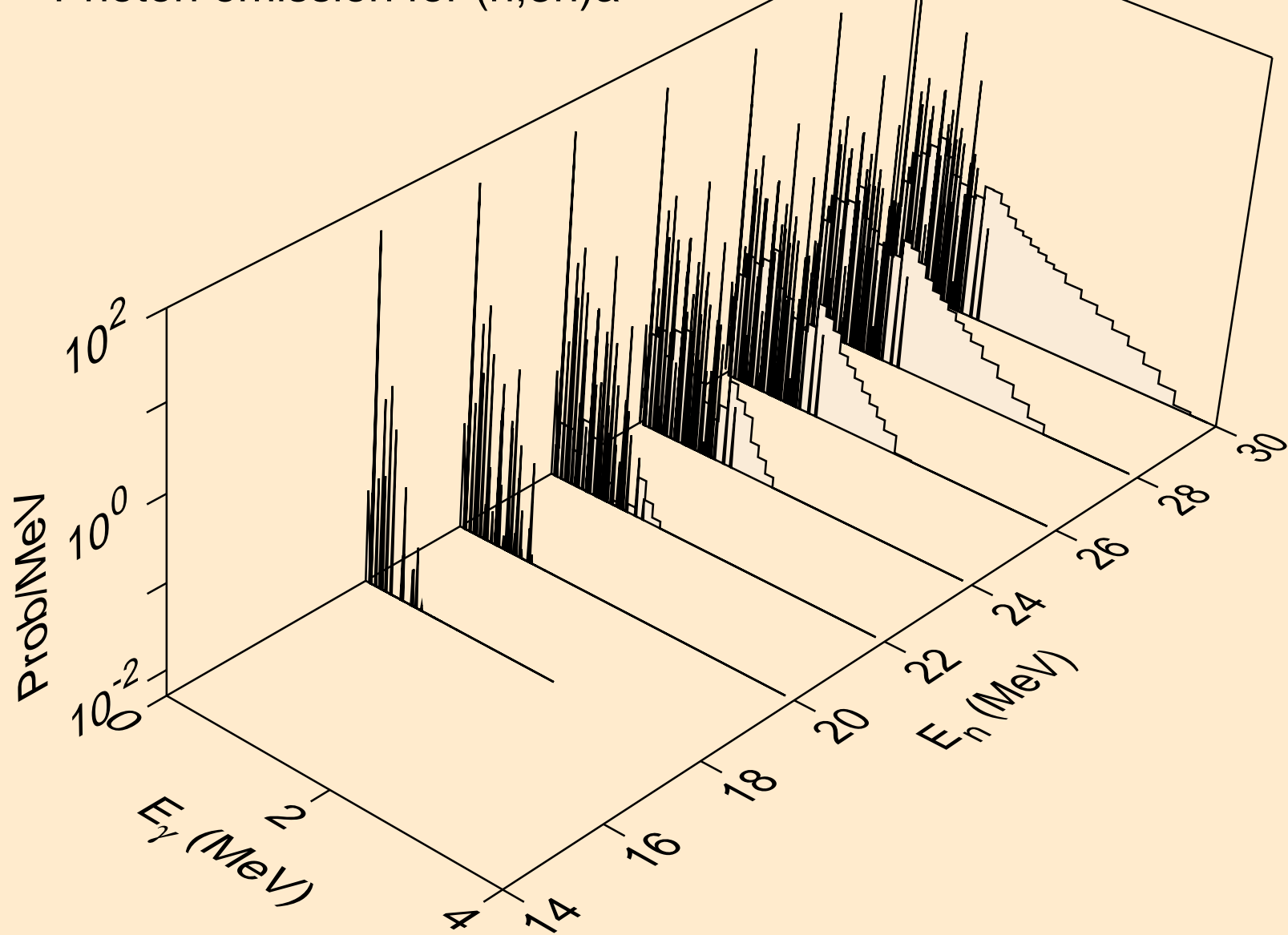

AS080 DEUTERON ACER TENDL-2023 LIBRARY; T=0.K  
Photon emission for (n,n\*)p

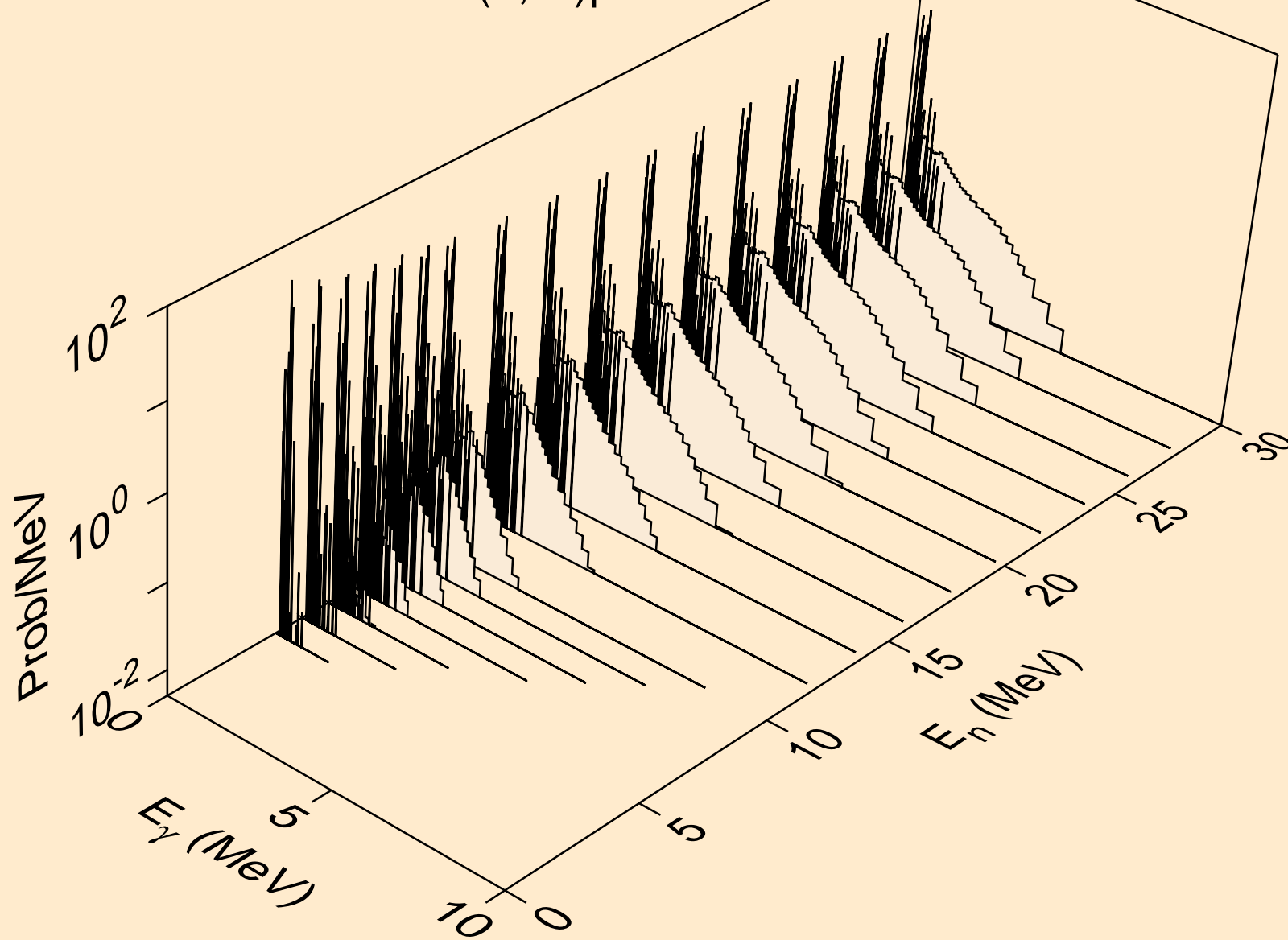



AS080 DEUTERON ACER TENDL-2023 LIBRARY; T=0.K  
Photon emission for (n,n\*)2a

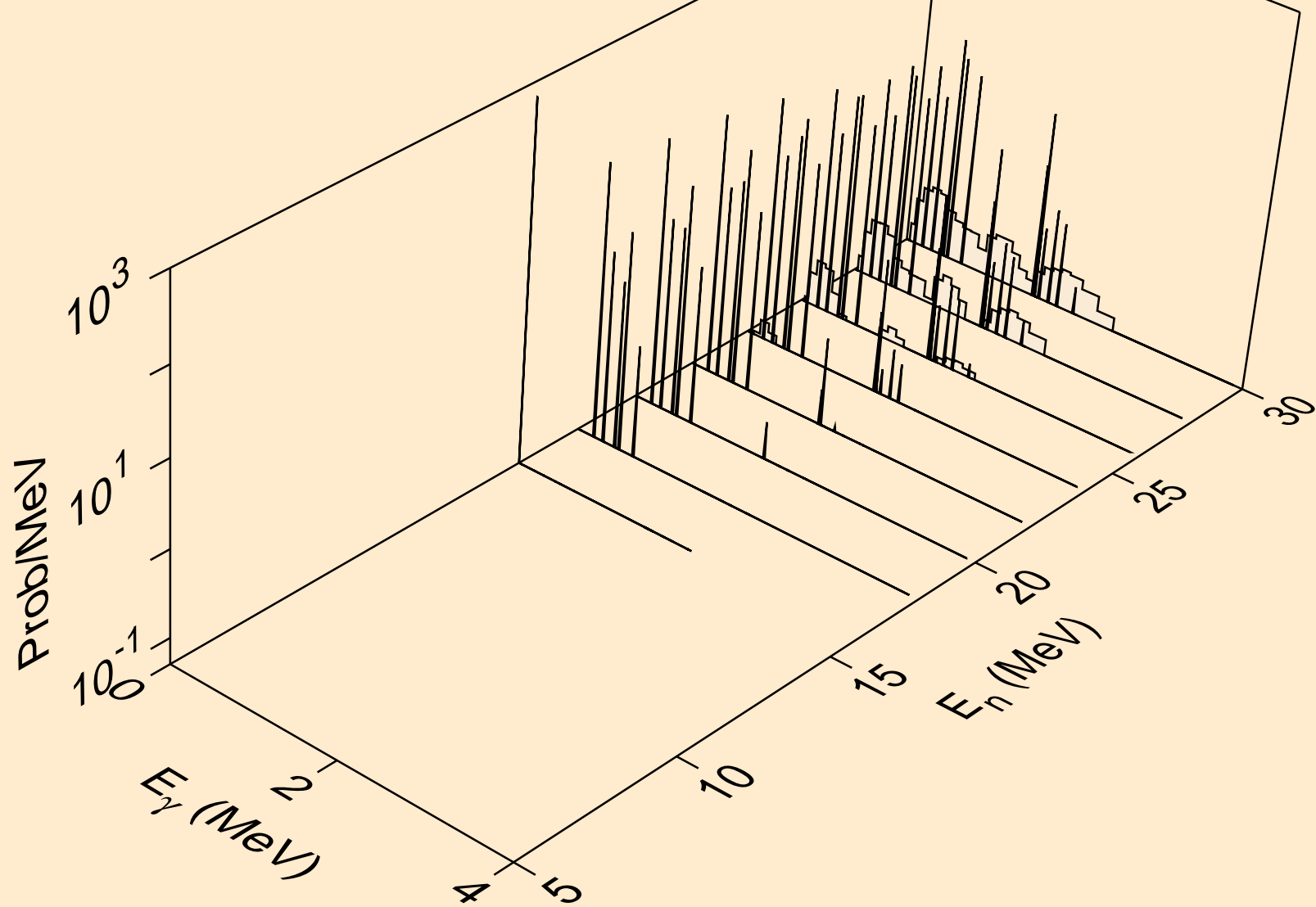

AS080 DEUTERON ACER TENDL-2023 LIBRARY; T=0.K  
Photon emission for (n,2n)2a

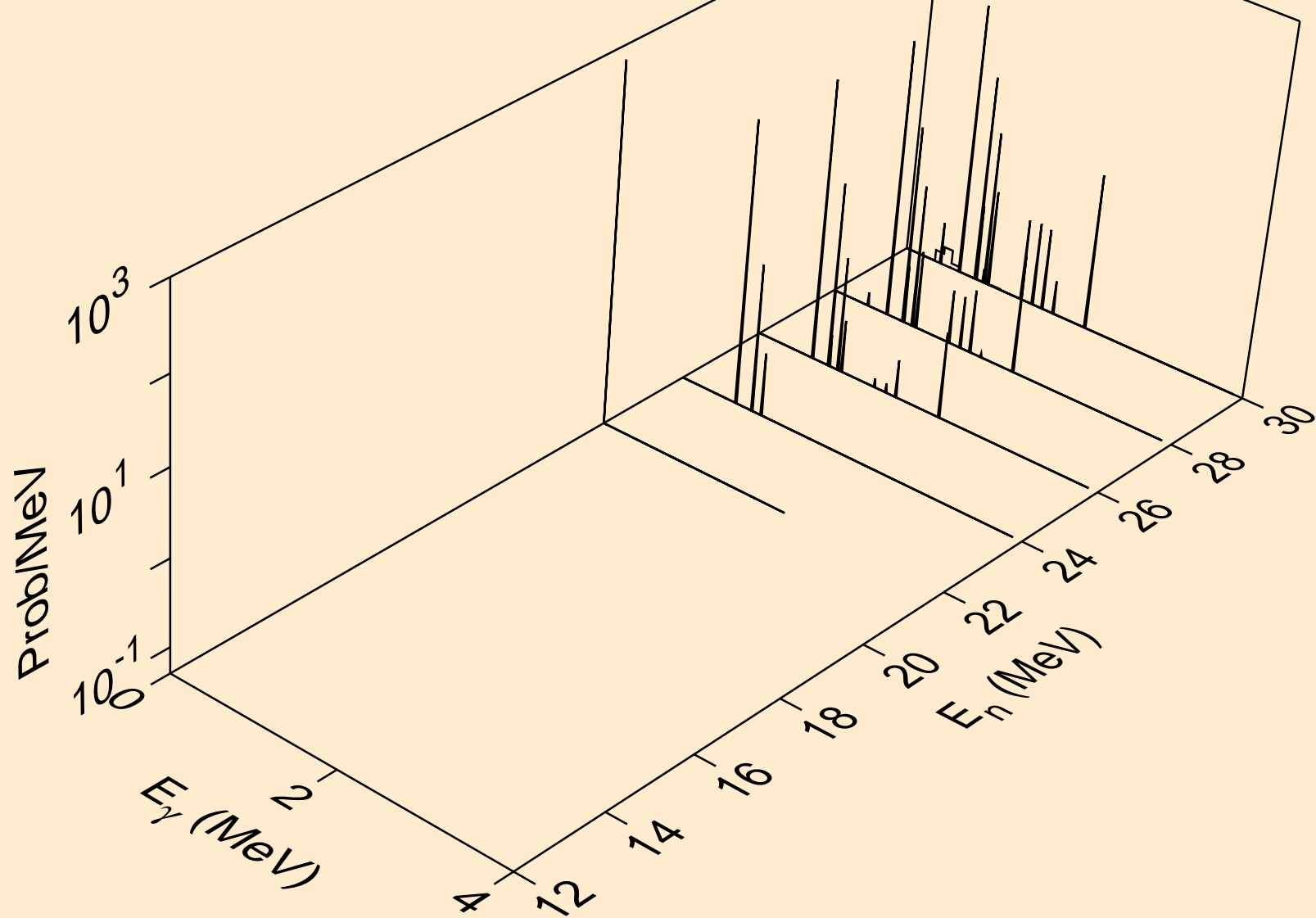

AS080 DEUTERON ACER TENDL-2023 LIBRARY; T=0.K  
Photon emission for (n,n\*)d

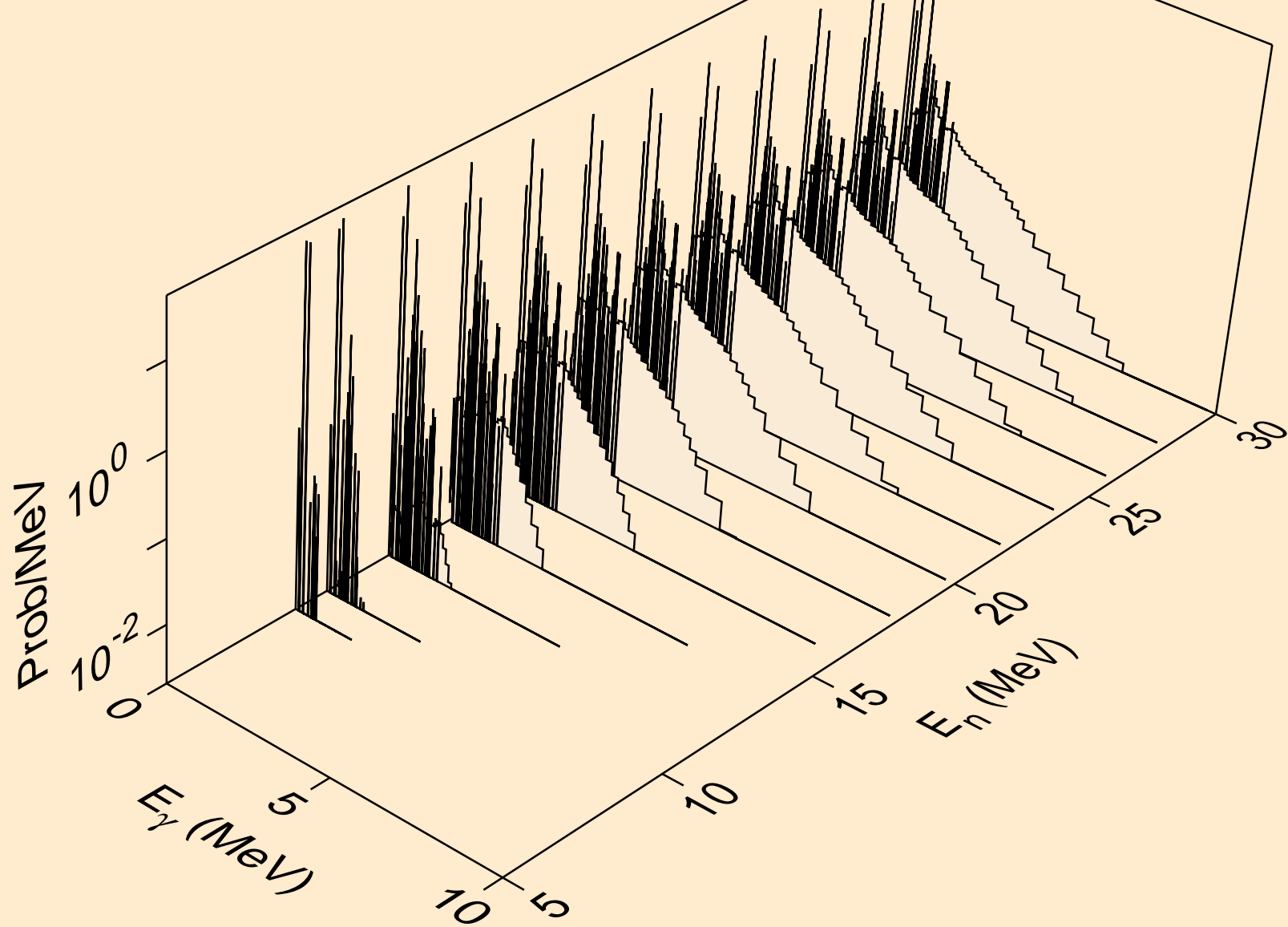

AS080 DEUTERON ACER TENDL-2023 LIBRARY; T=0.K  
Photon emission for (n,n\*)t

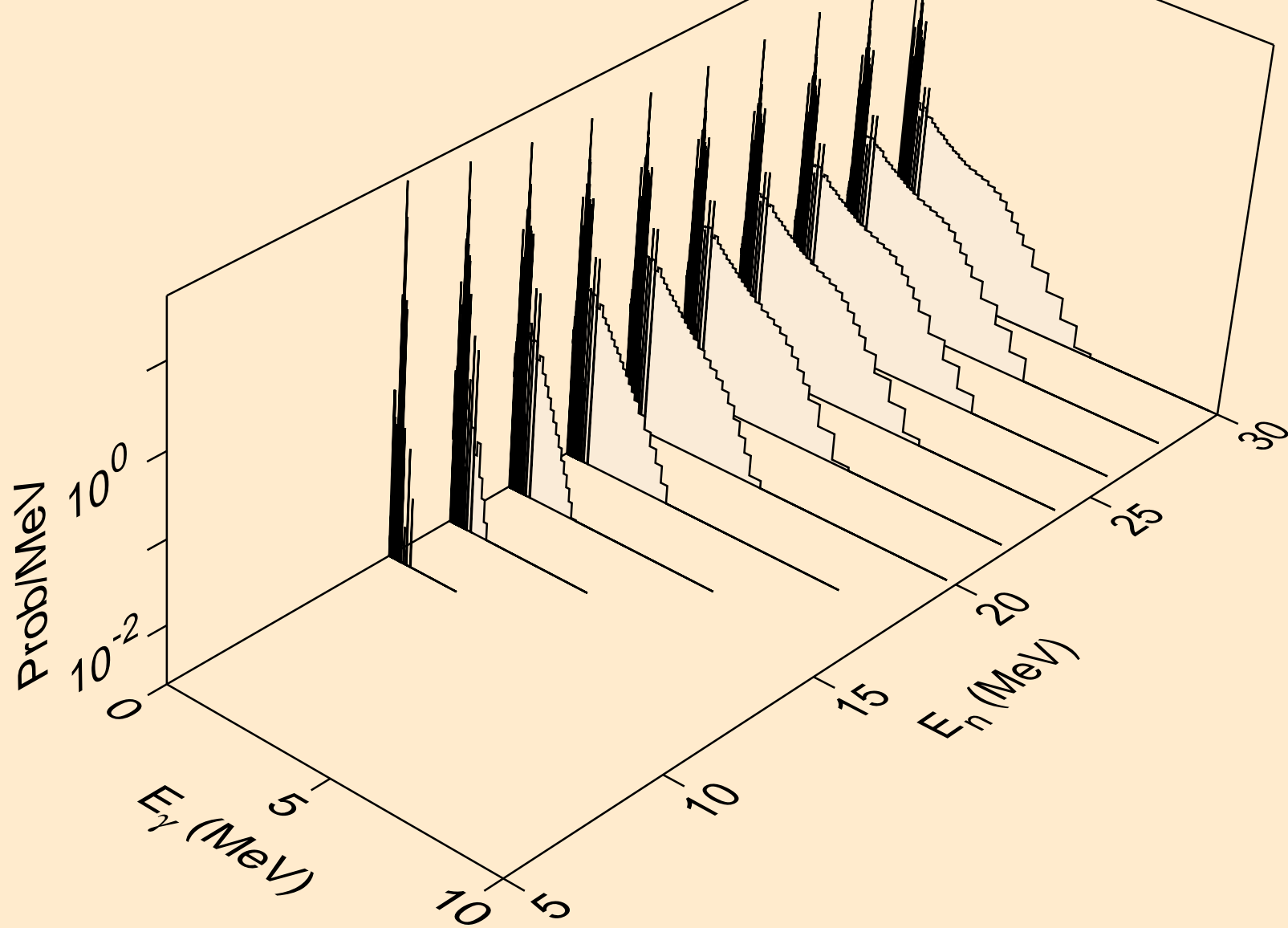

AS080 DEUTERON ACER TENDL-2023 LIBRARY; T=0.K  
Photon emission for (n,n\*)he3

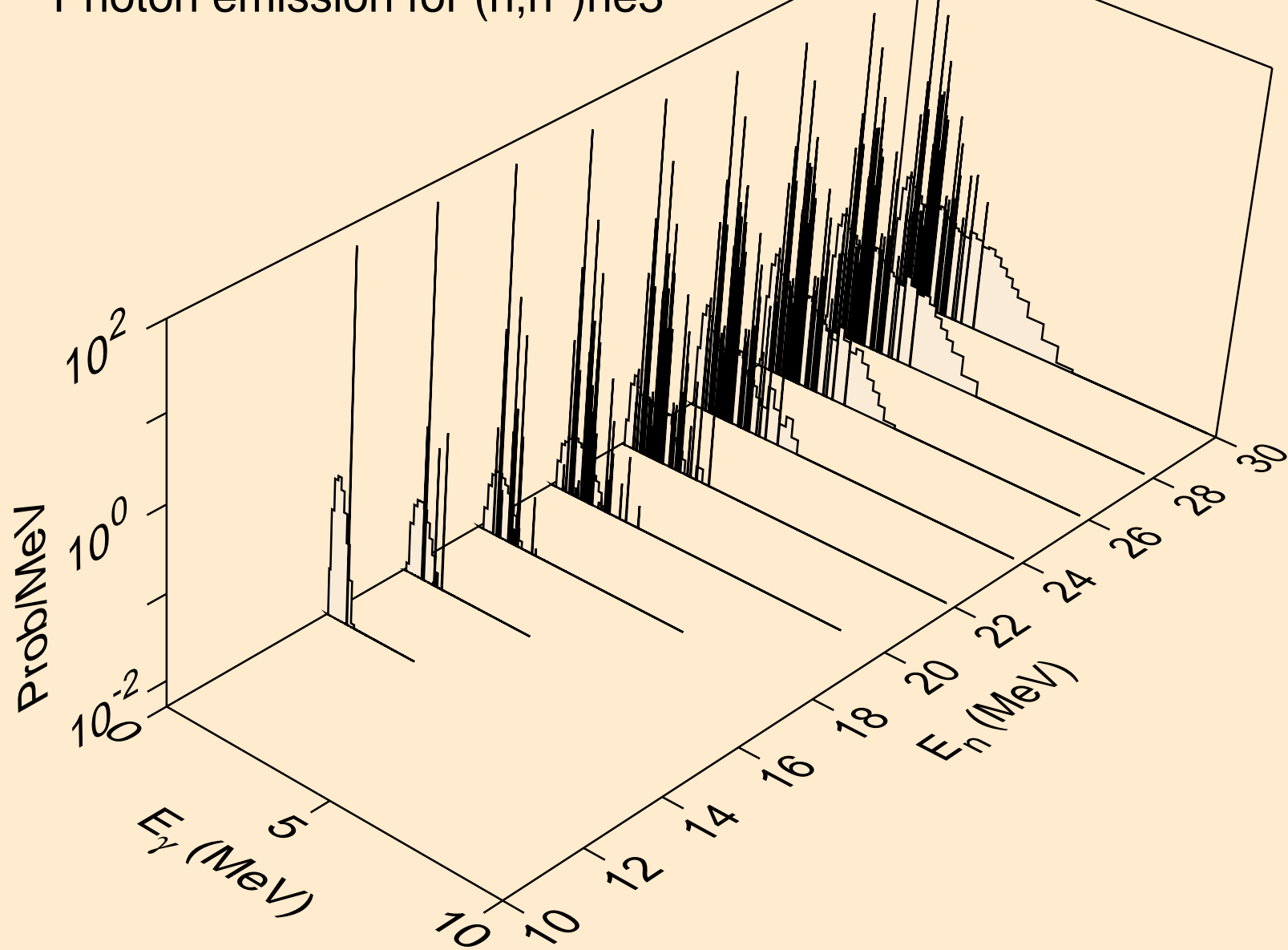

AS080 DEUTERON ACER TENDL-2023 LIBRARY; T=0.K  
Photon emission for (n,4n)

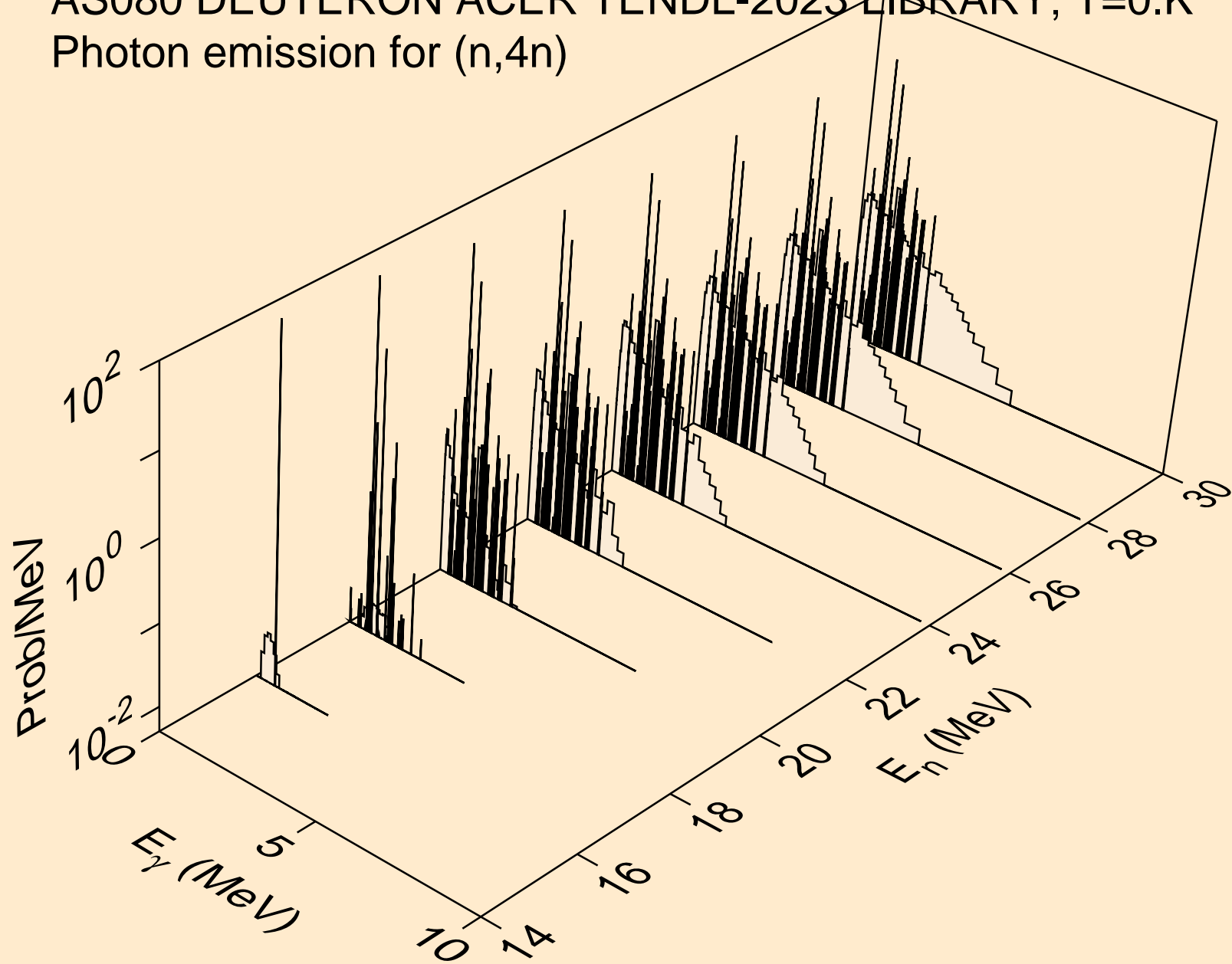

AS080 DEUTERON ACER TENDL-2023 LIBRARY; T=0.K  
Photon emission for (n,2np)

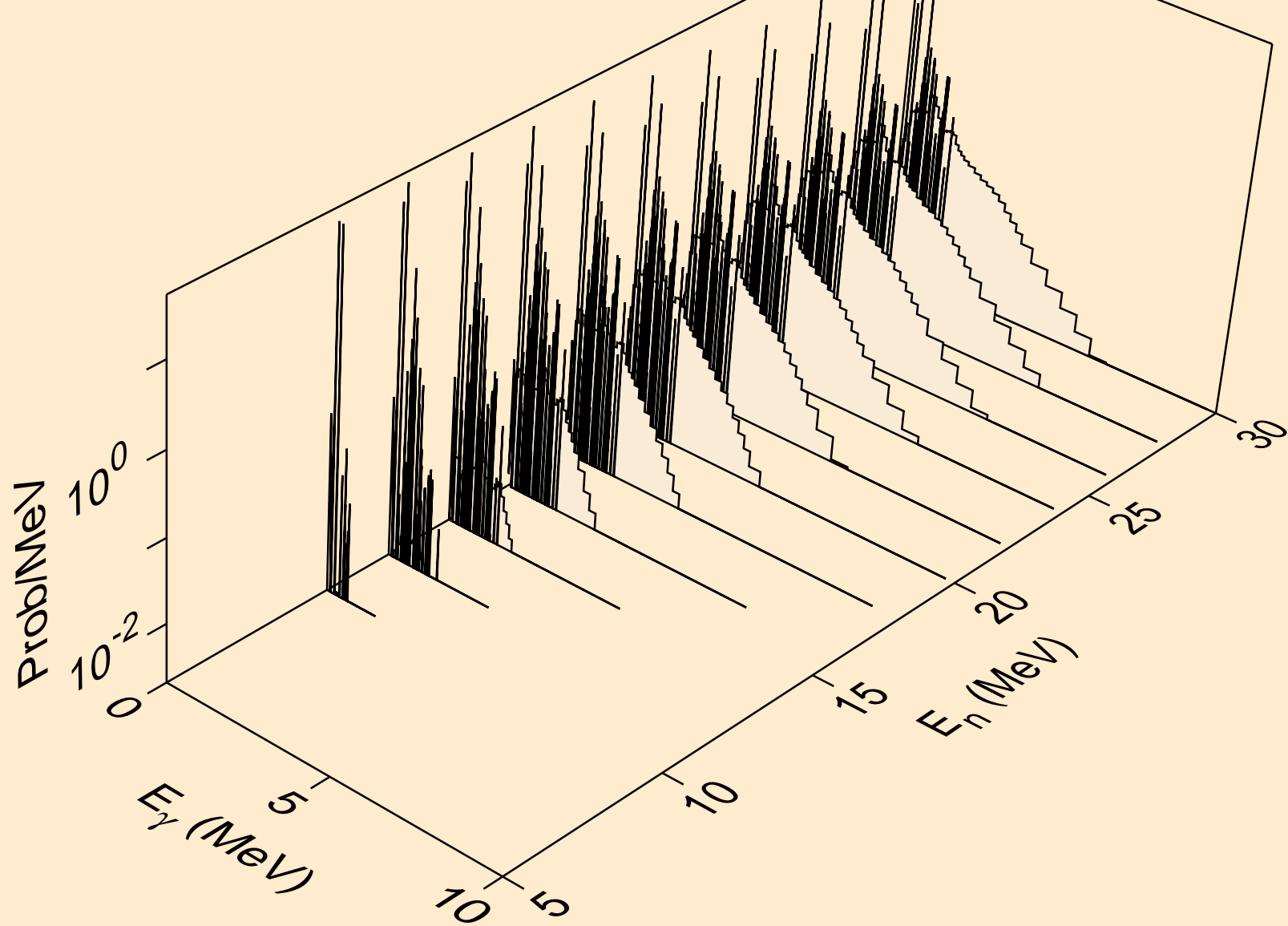

AS080 DEUTERON ACER TENDL-2023 LIBRARY; T=0.K  
Photon emission for (n,3np)

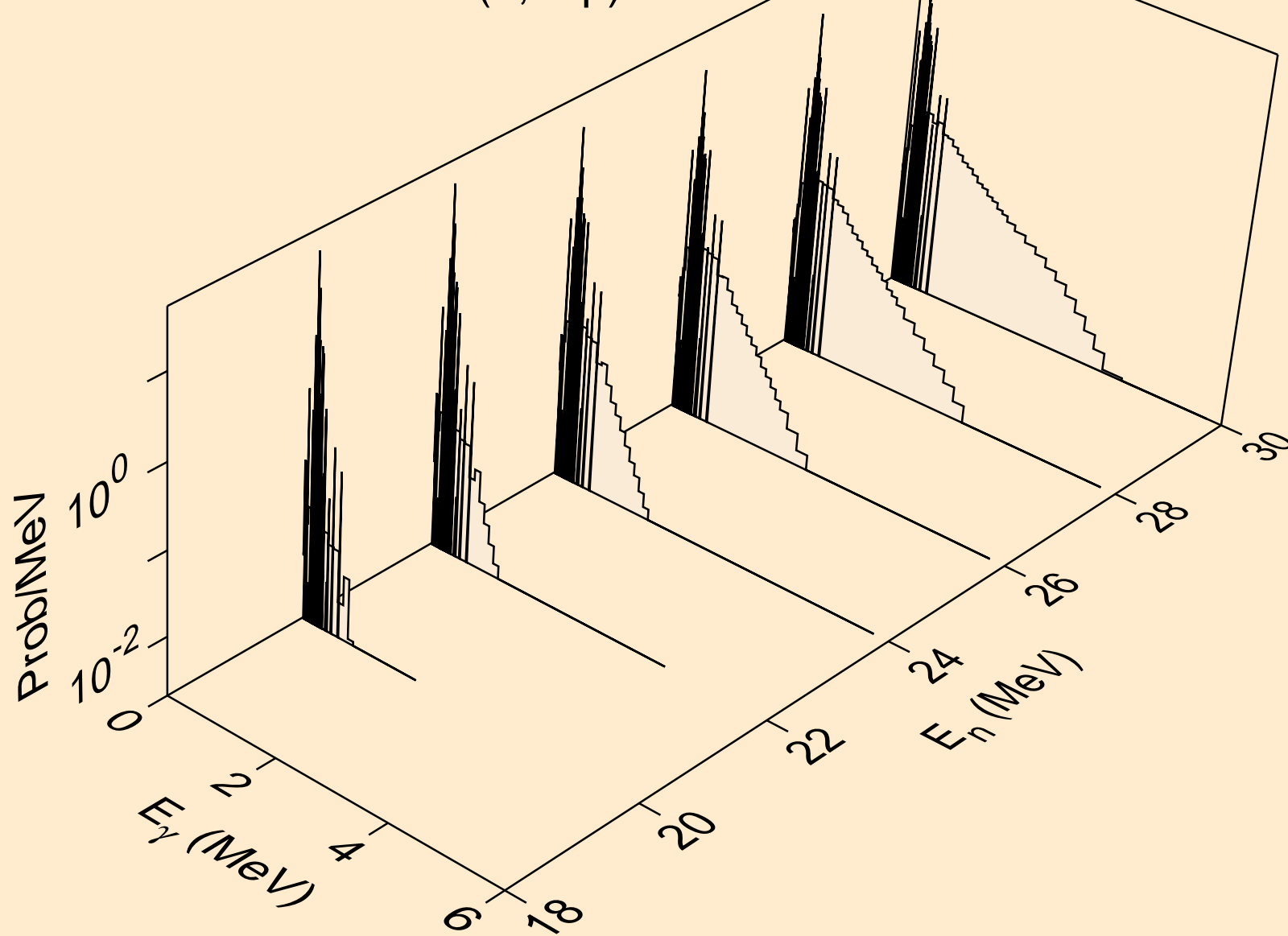



AS080 DEUTERON ACER TENDL-2023 LIBRARY; T=0.K  
Photon emission for (n,n2p)

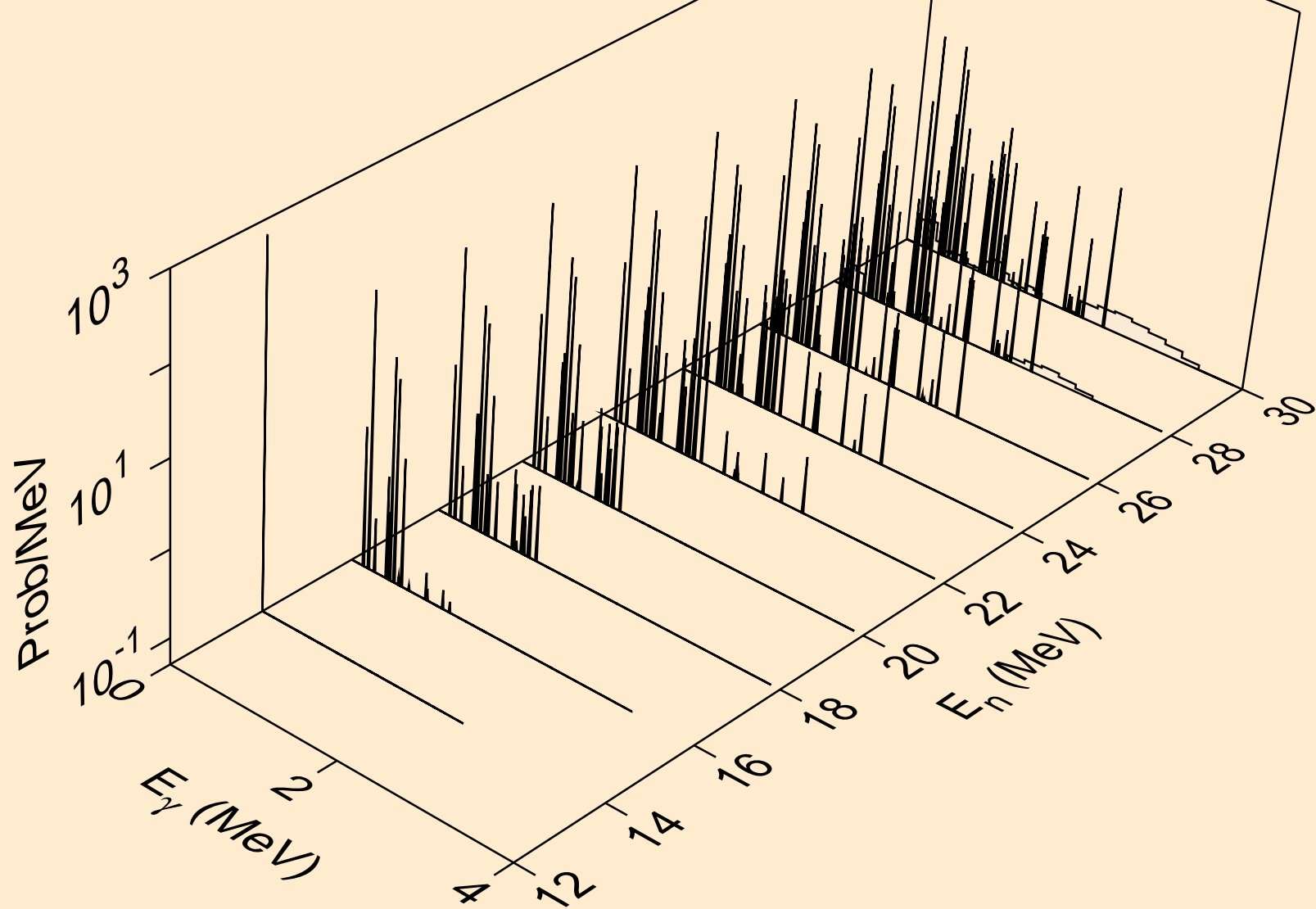

AS080 DEUTERON ACER TENDL-2023 LIBRARY; T=0.K  
Photon emission for (n,npa)

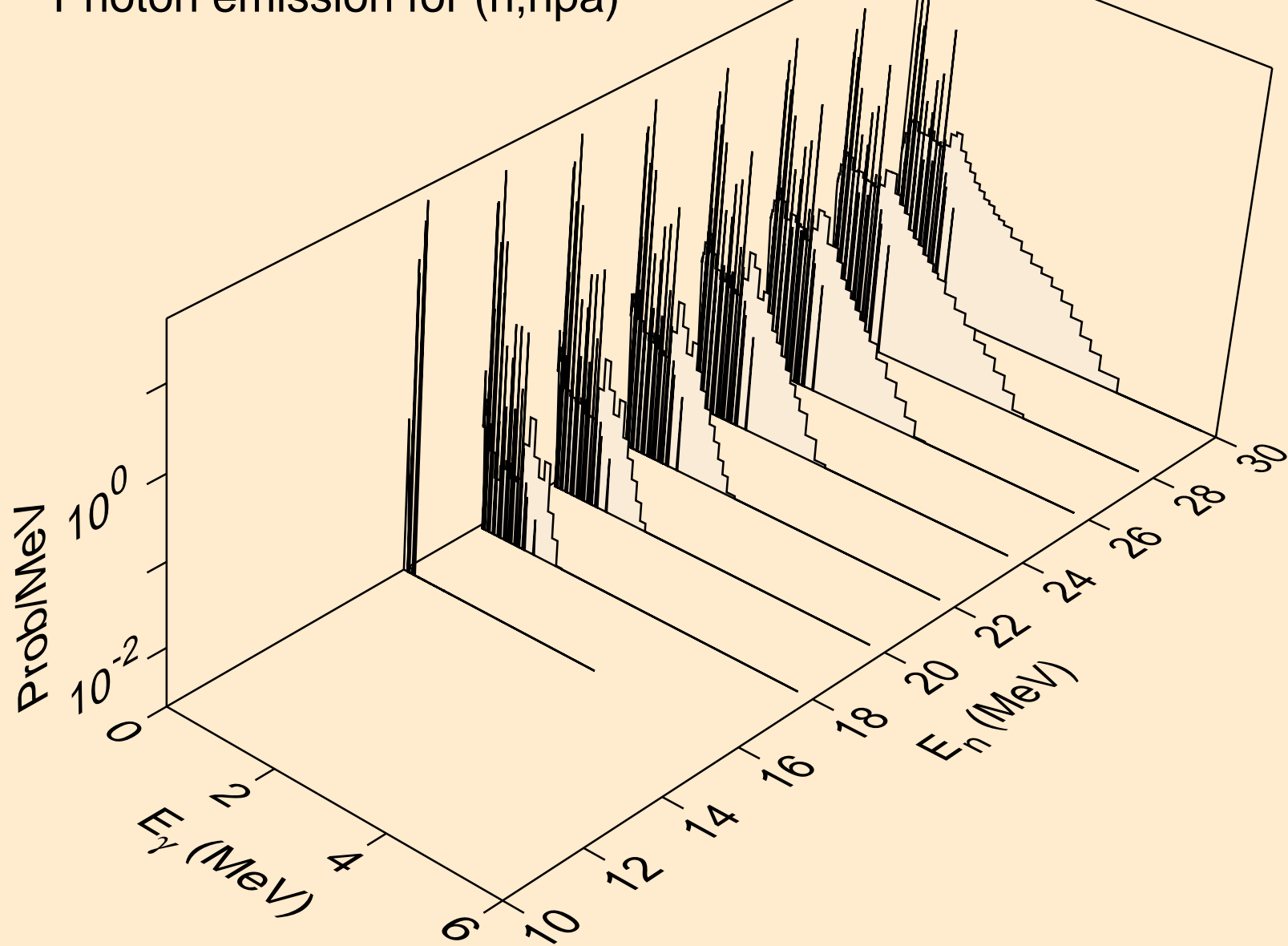

AS080 DEUTERON ACER TENDL-2023 LIBRARY; T=0.K  
Photon emission for (n,gma)

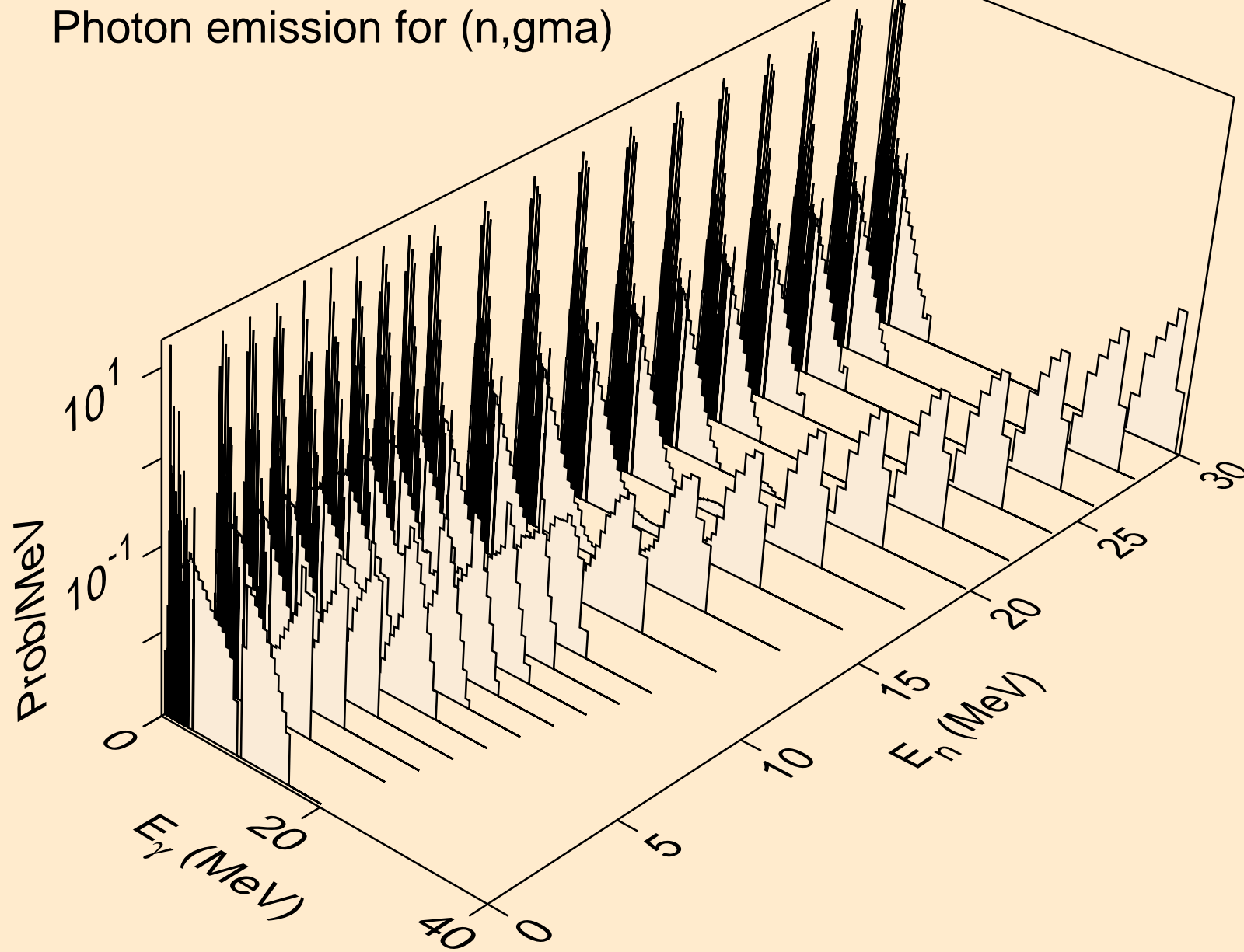

AS080 DEUTERON ACER TENDL-2023 LIBRARY; T=0.K  
Photon emission for (n,p)

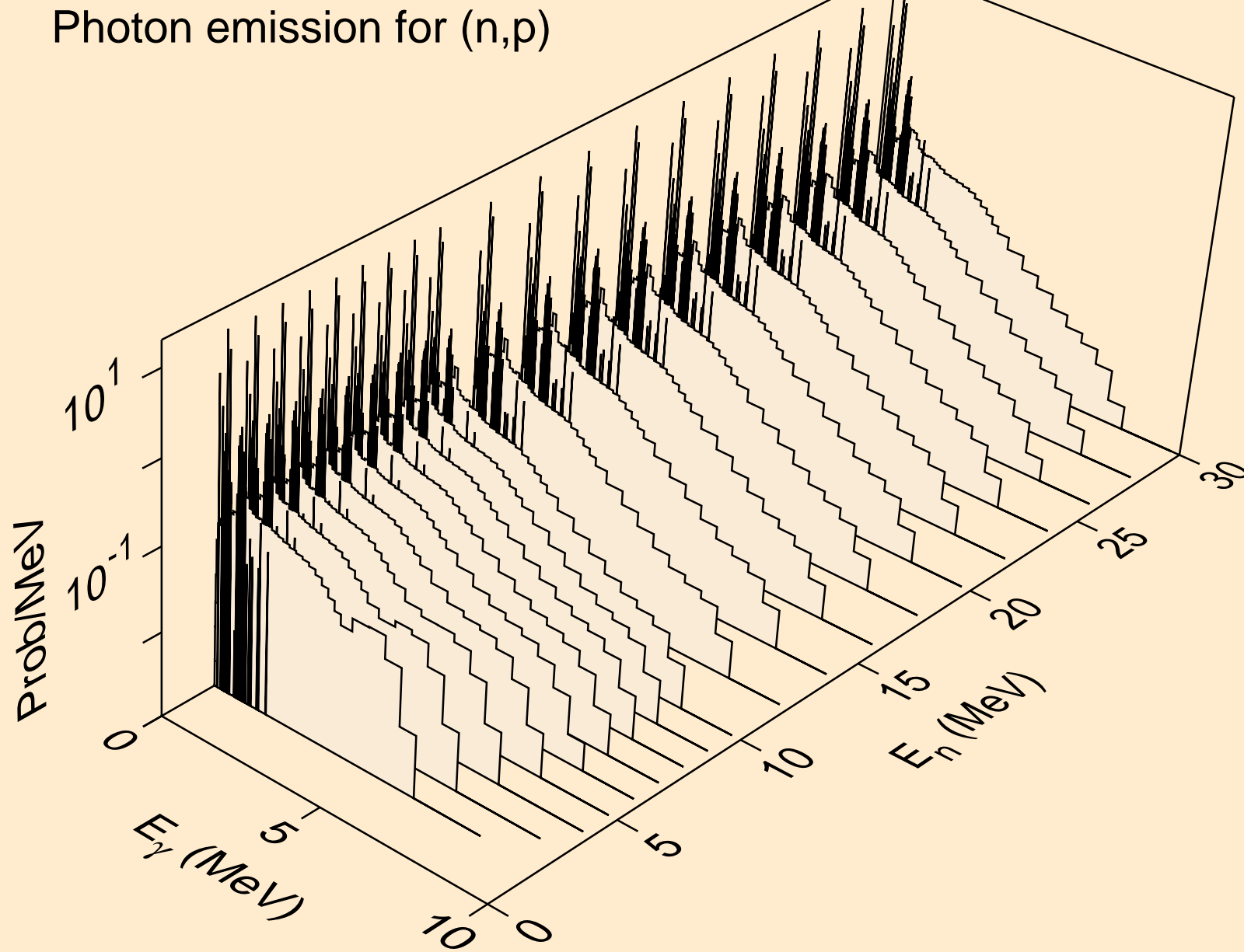

AS080 DEUTERON ACER TENDL-2023 LIBRARY; T=0.K  
Photon emission for inelastic

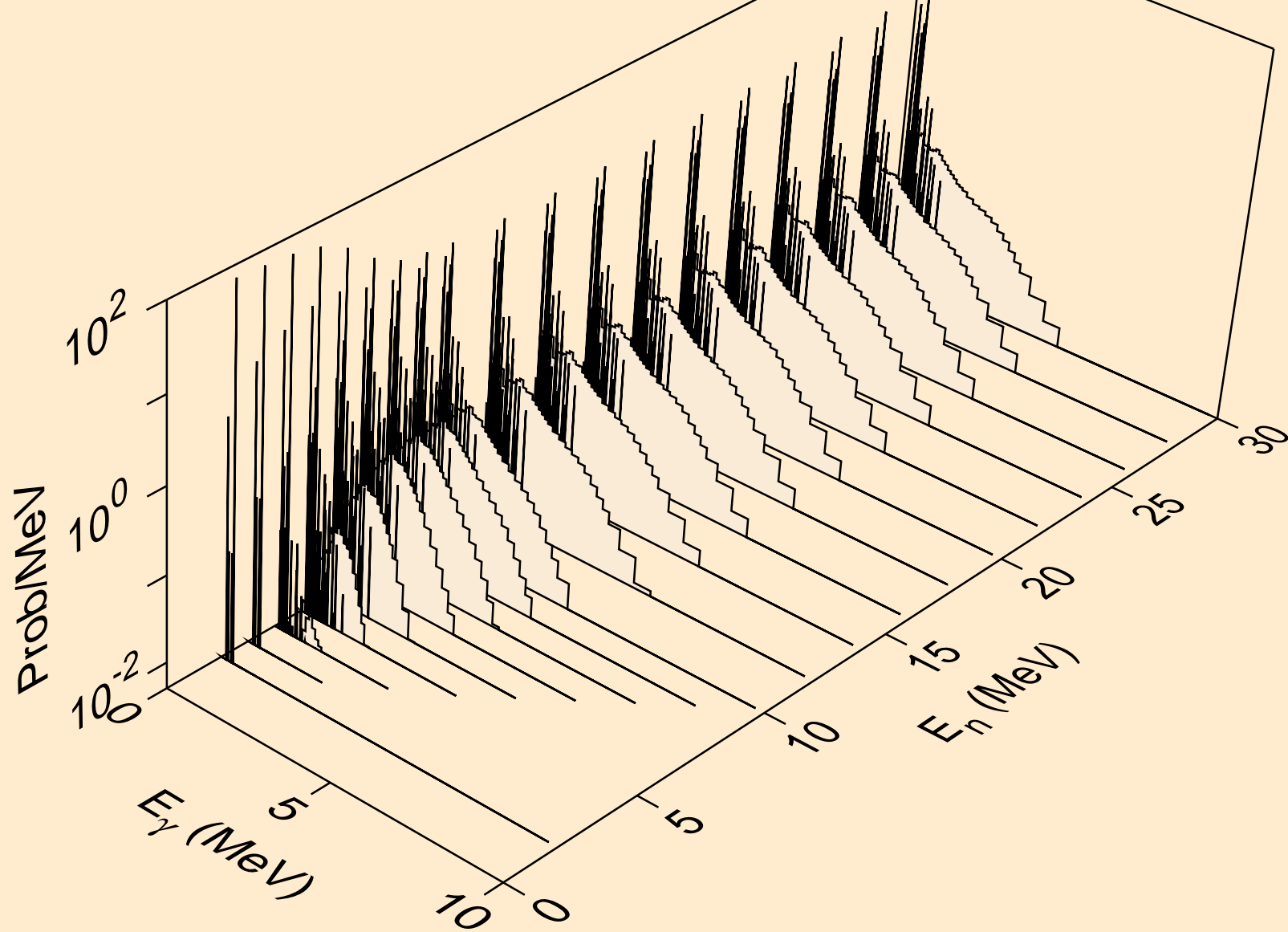

AS080 DEUTERON ACER TENDL-2023 LIBRARY; T=0.K  
Photon emission for (n,t)

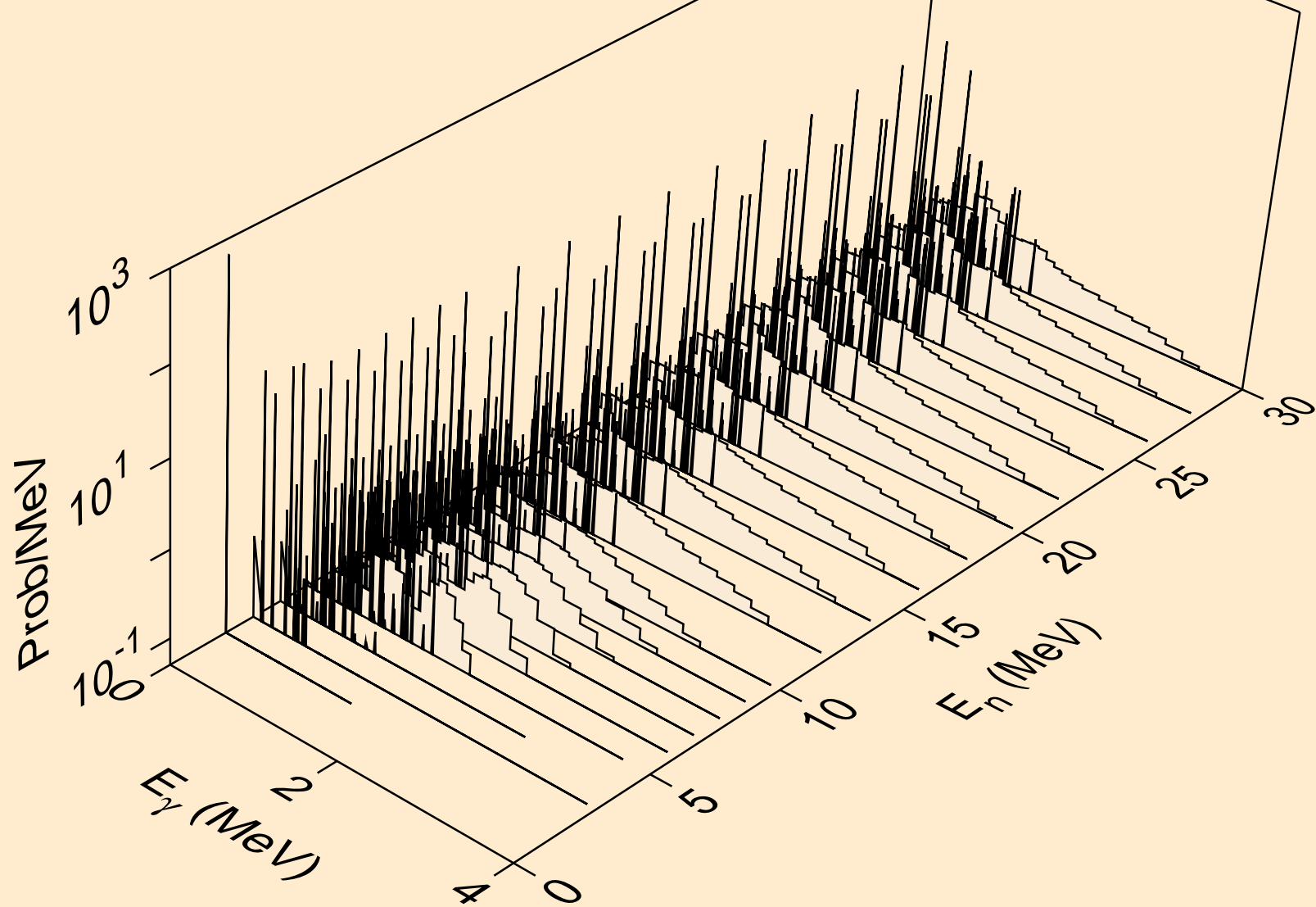

AS080 DEUTERON ACER TENDL-2023 LIBRARY; T=0.K  
Photon emission for (n,he3)

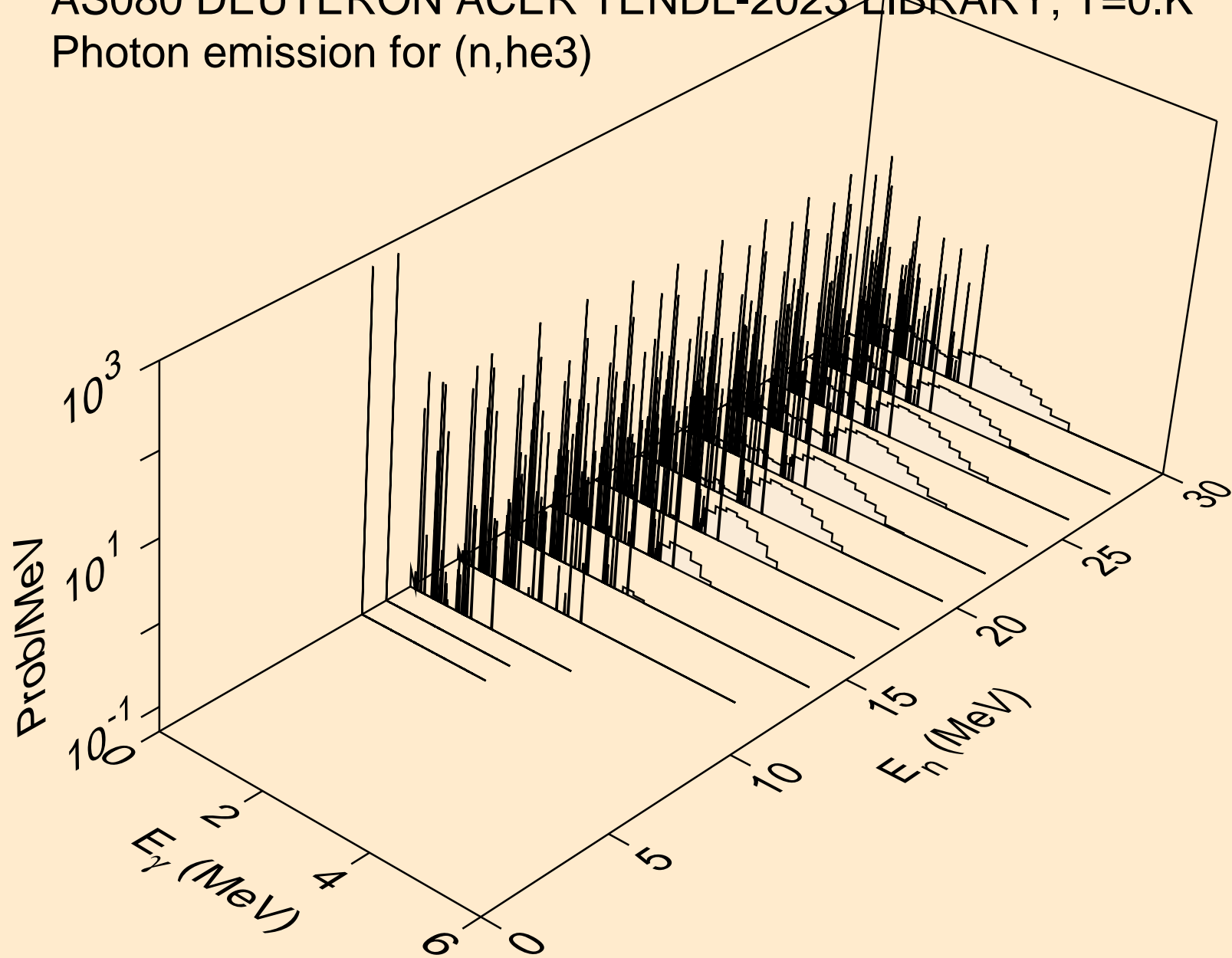

AS080 DEUTERON ACER TENDL-2023 LIBRARY; T=0.K  
Photon emission for (n,a)

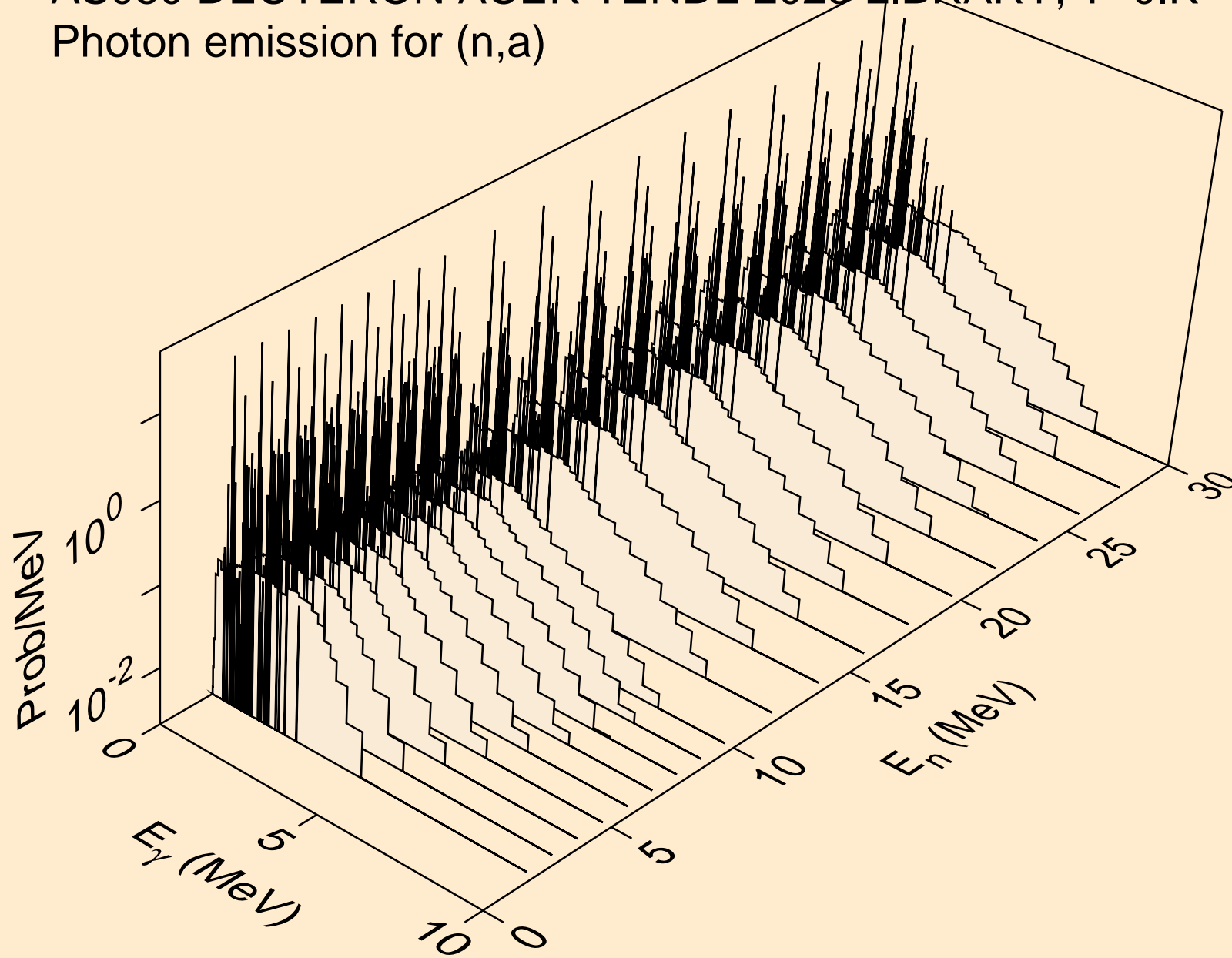



AS080 DEUTERON ACER TENDL-2023 LIBRARY; T=0.K  
Photon emission for (n,2a)

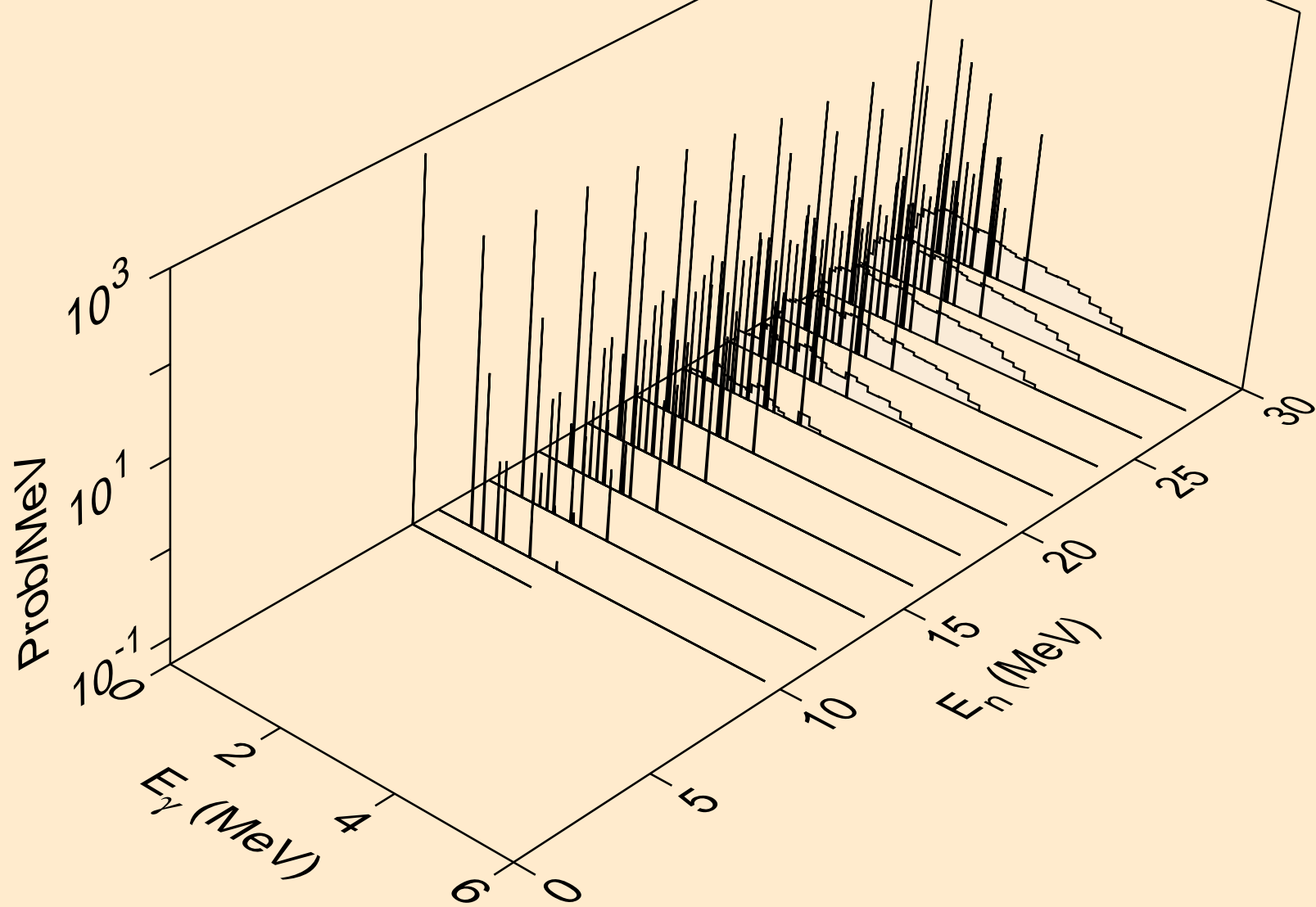

AS080 DEUTERON ACER TENDL-2023 LIBRARY; T=0.K  
Photon emission for (n,2p)

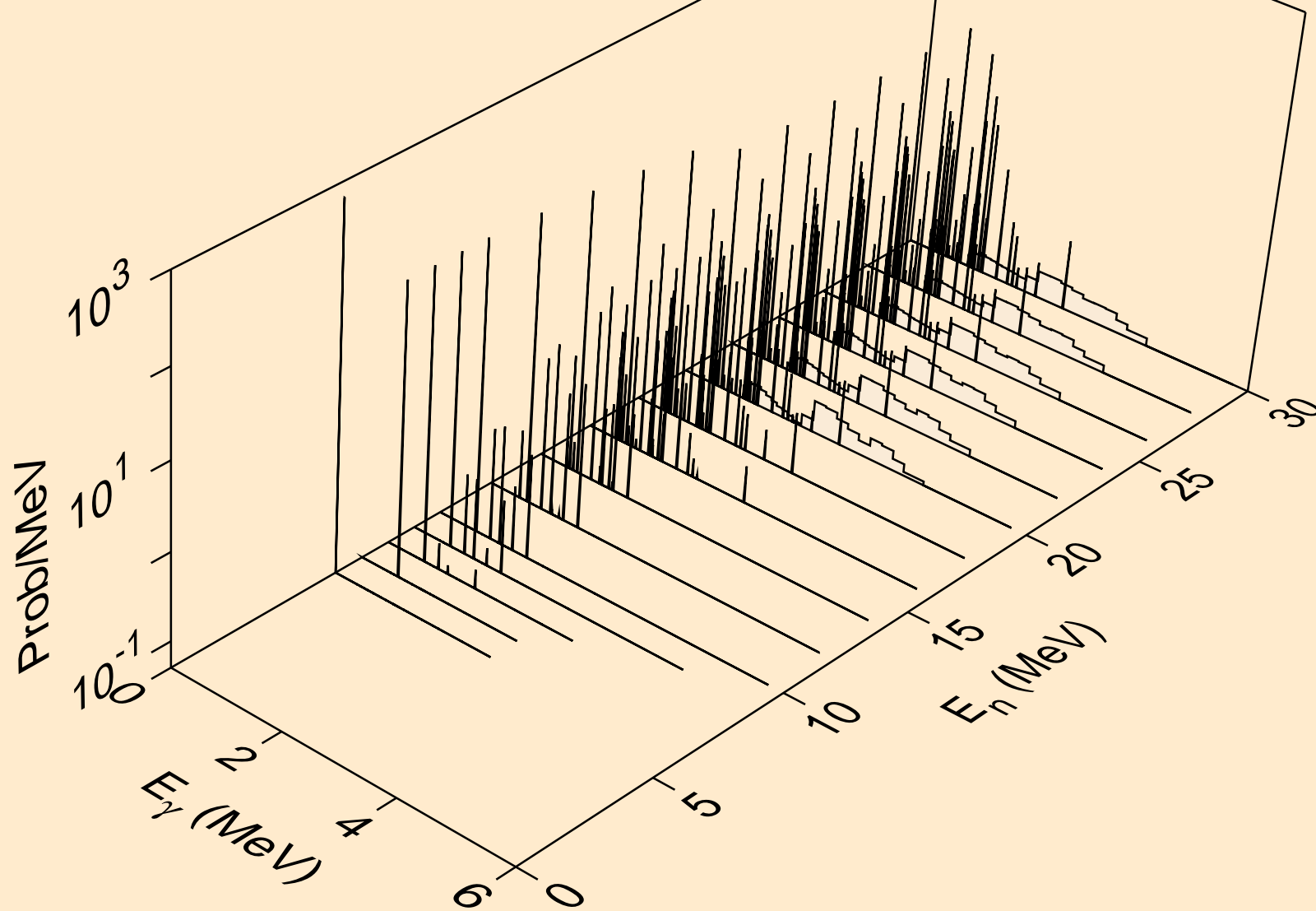

AS080 DEUTERON ACER TENDL-2023 LIBRARY; T=0.K  
Photon emission for (n,p)

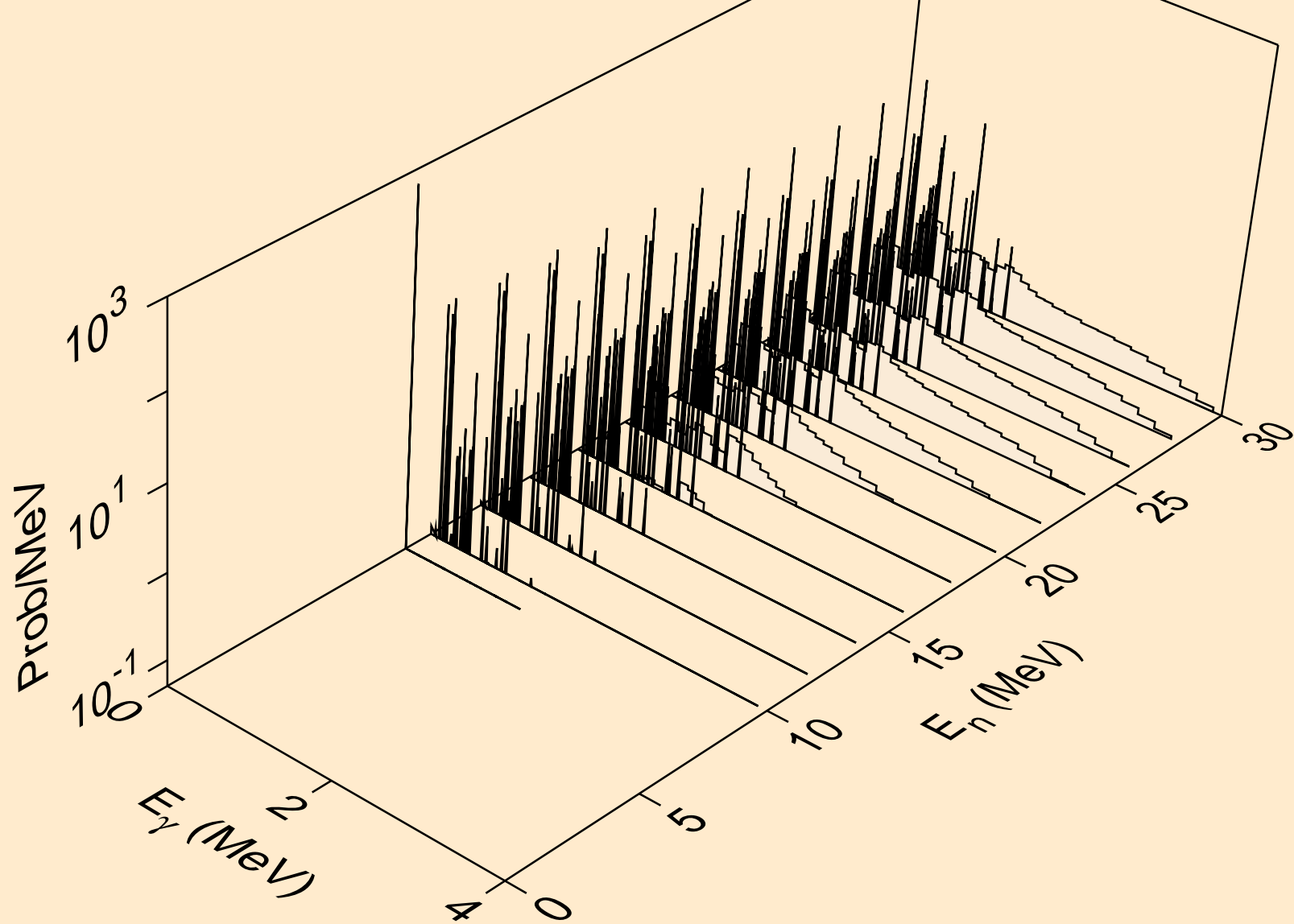

AS080 DEUTERON ACER TENDL-2023 LIBRARY; T=0.K  
Photon emission for (n,pd)

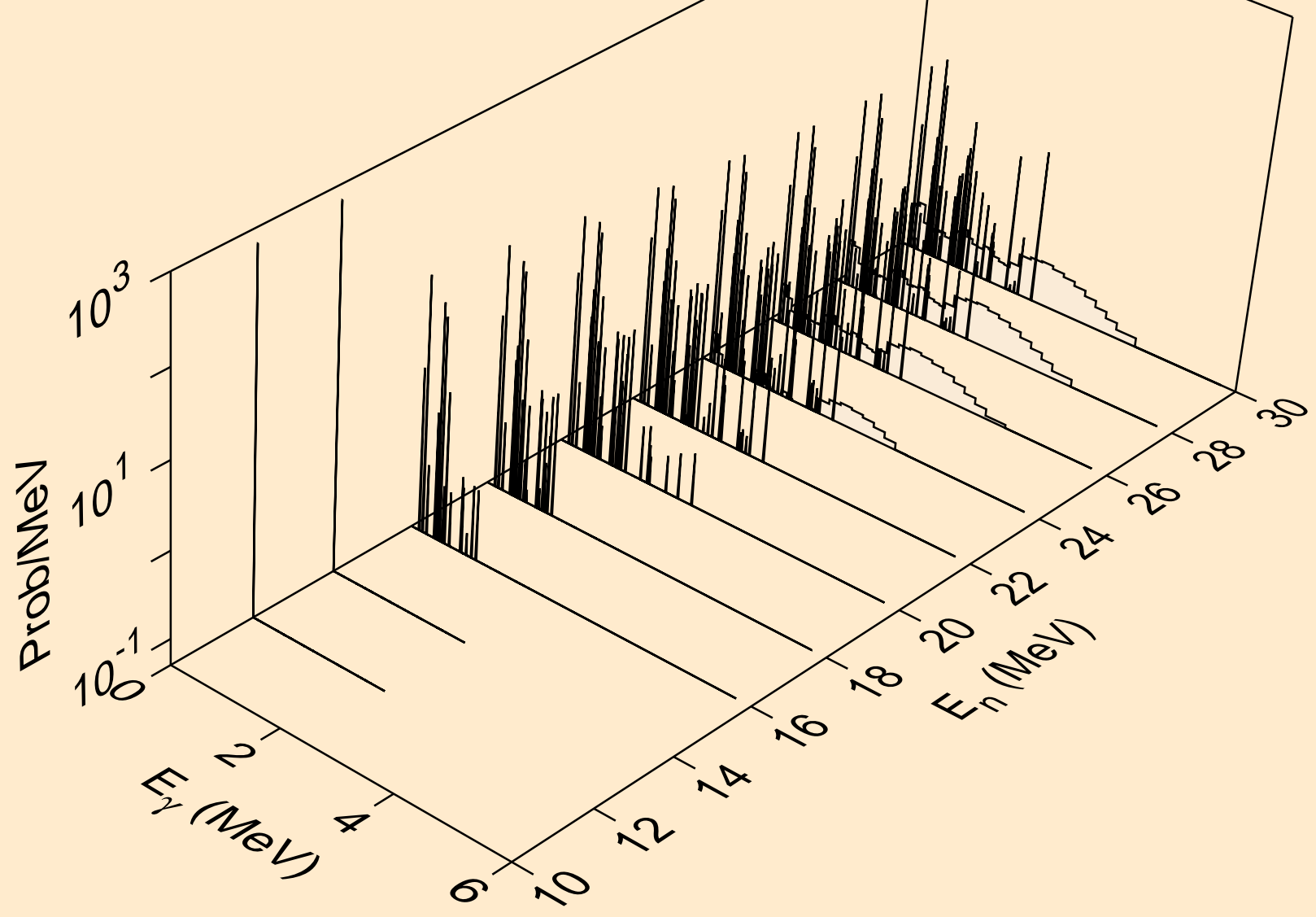

AS080 DEUTERON ACER TENDL-2023 LIBRARY; T=0.K  
Photon emission for (n,pt)

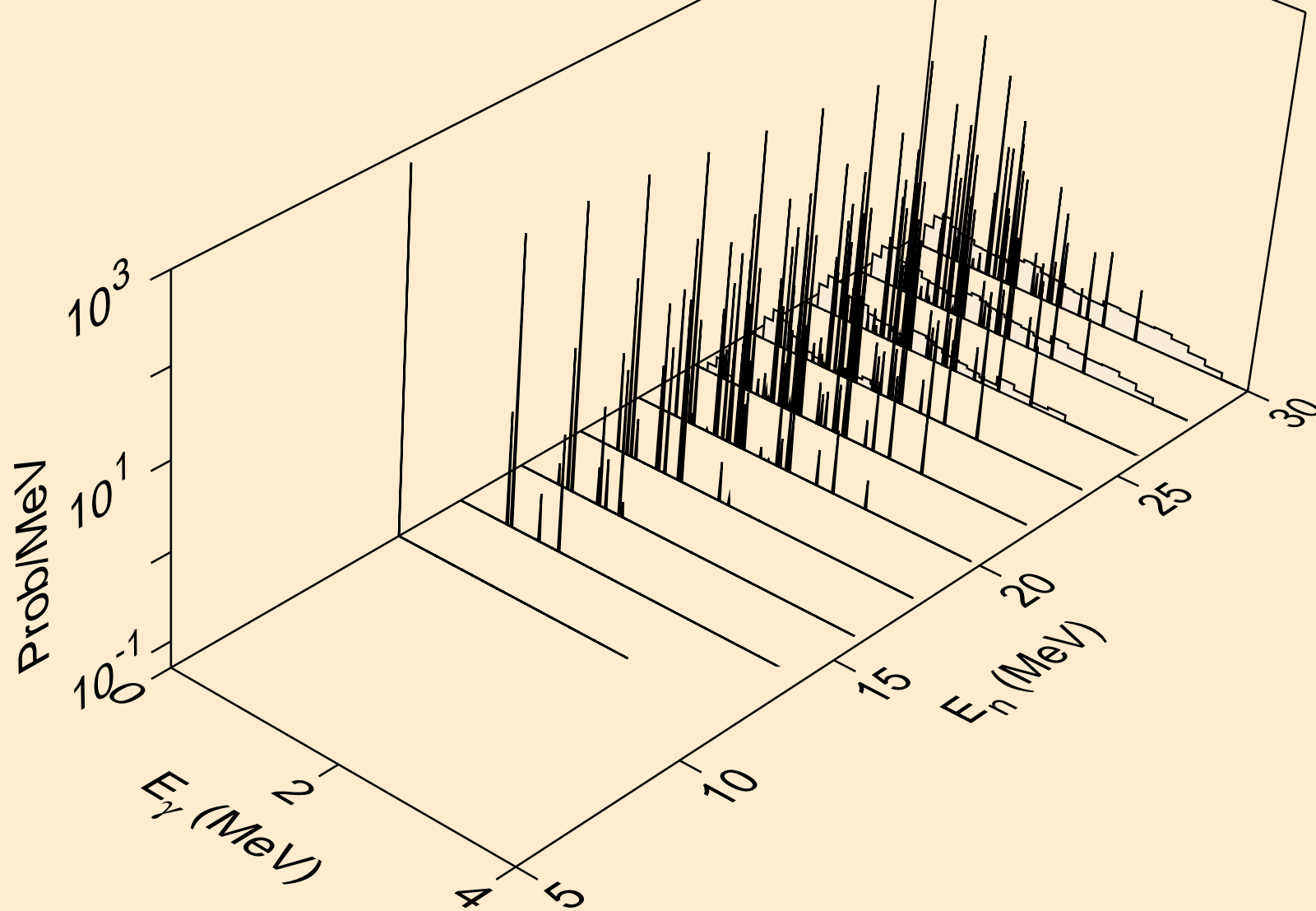

AS080 DEUTERON ACER TENDL-2023 LIBRARY; T=0.K  
Photon emission for (n,da)

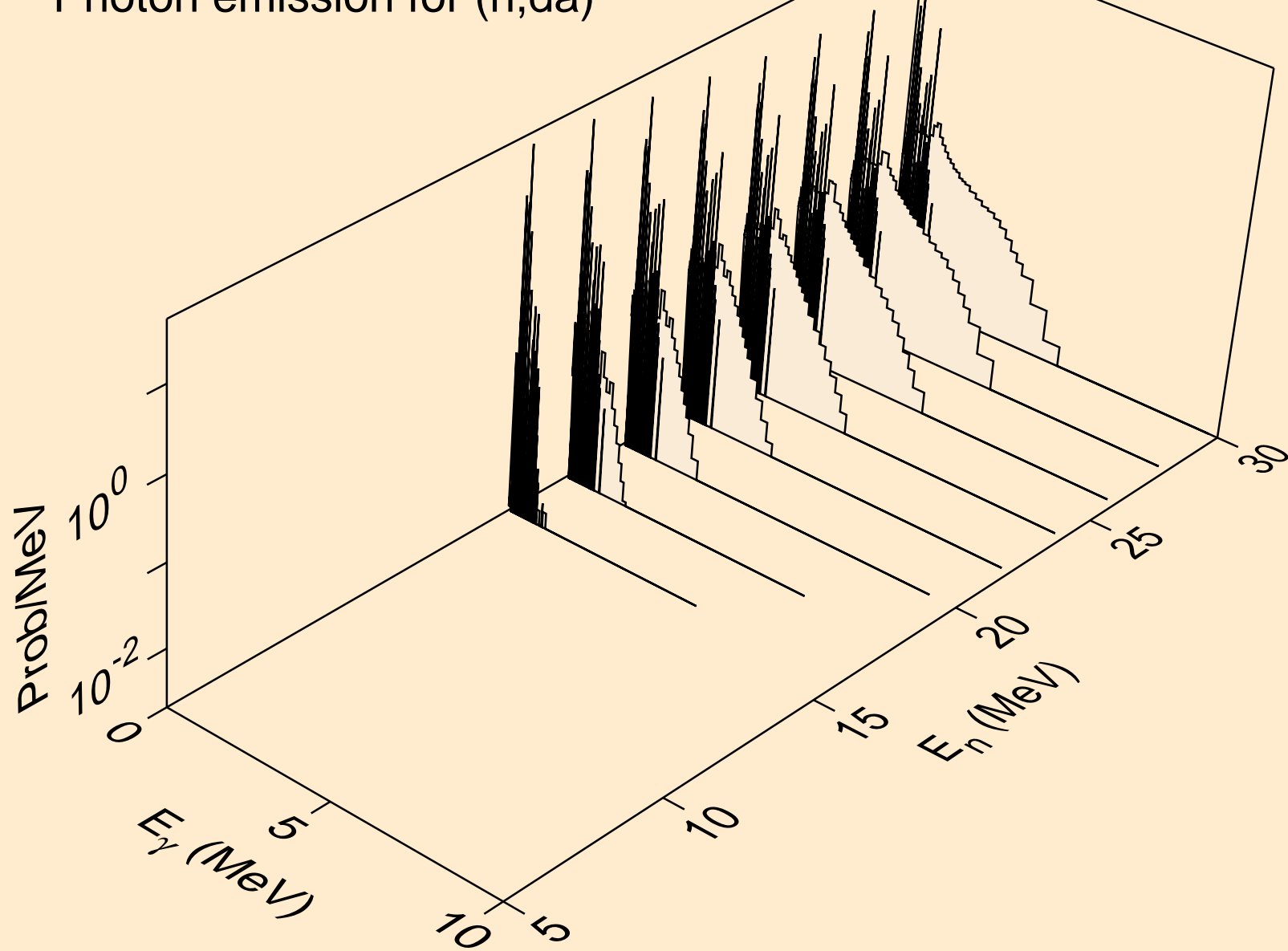

# AS080 DEUTERON ACER TENDL-2023 LIBRARY; T=0.K

## Particle heating contributions

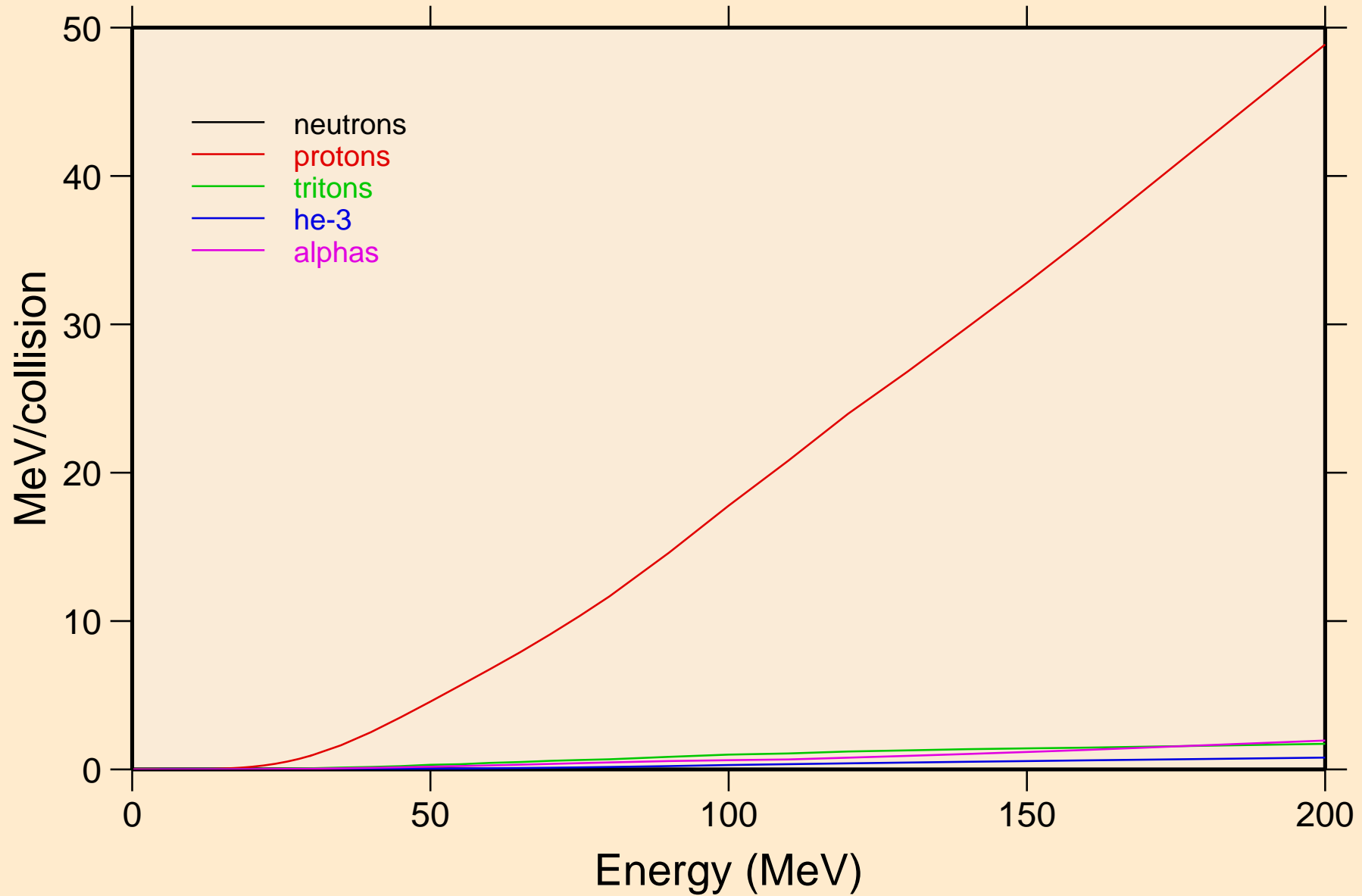

AS080 DEUTERON ACER TENDL-2023 LIBRARY; T=0.K  
Recoil Heating

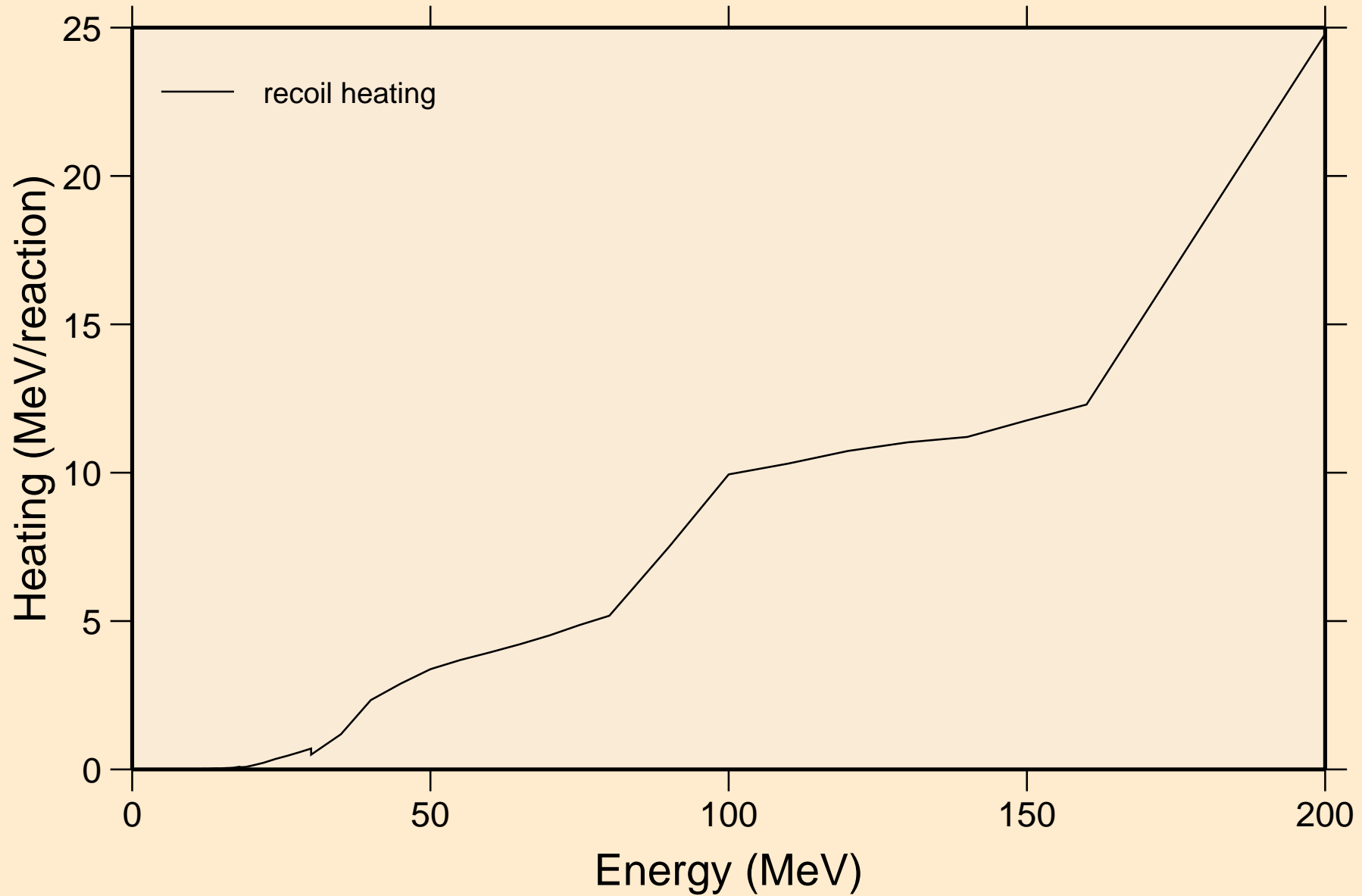



AS080 DEUTERON ACER TENDL-2023 LIBRARY; T=0.K  
Particle production cross sections

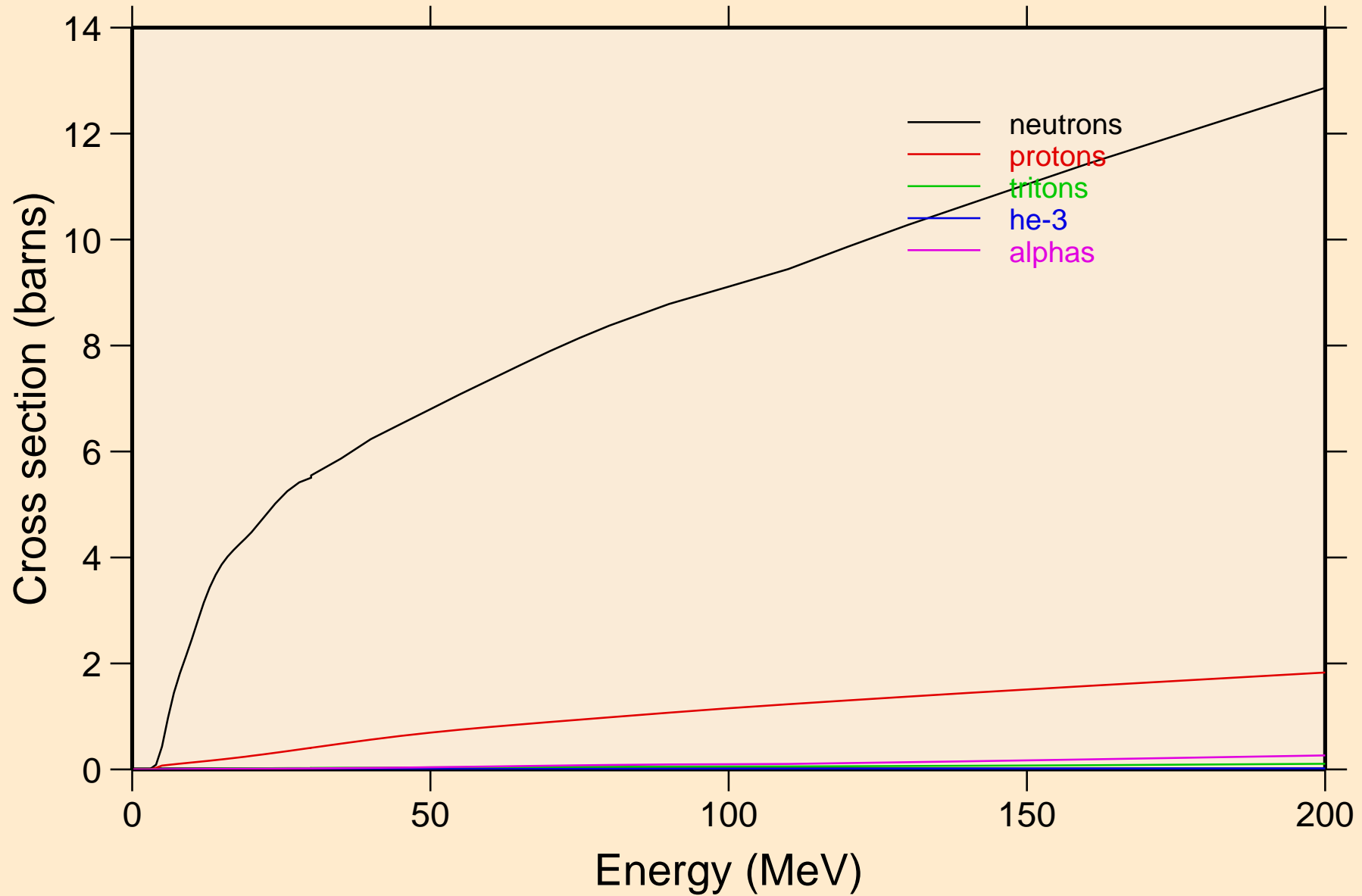

AS080 DEUTERON ACER TENDL-2023 LIBRARY; T=0.K  
neutrons from (d,n)

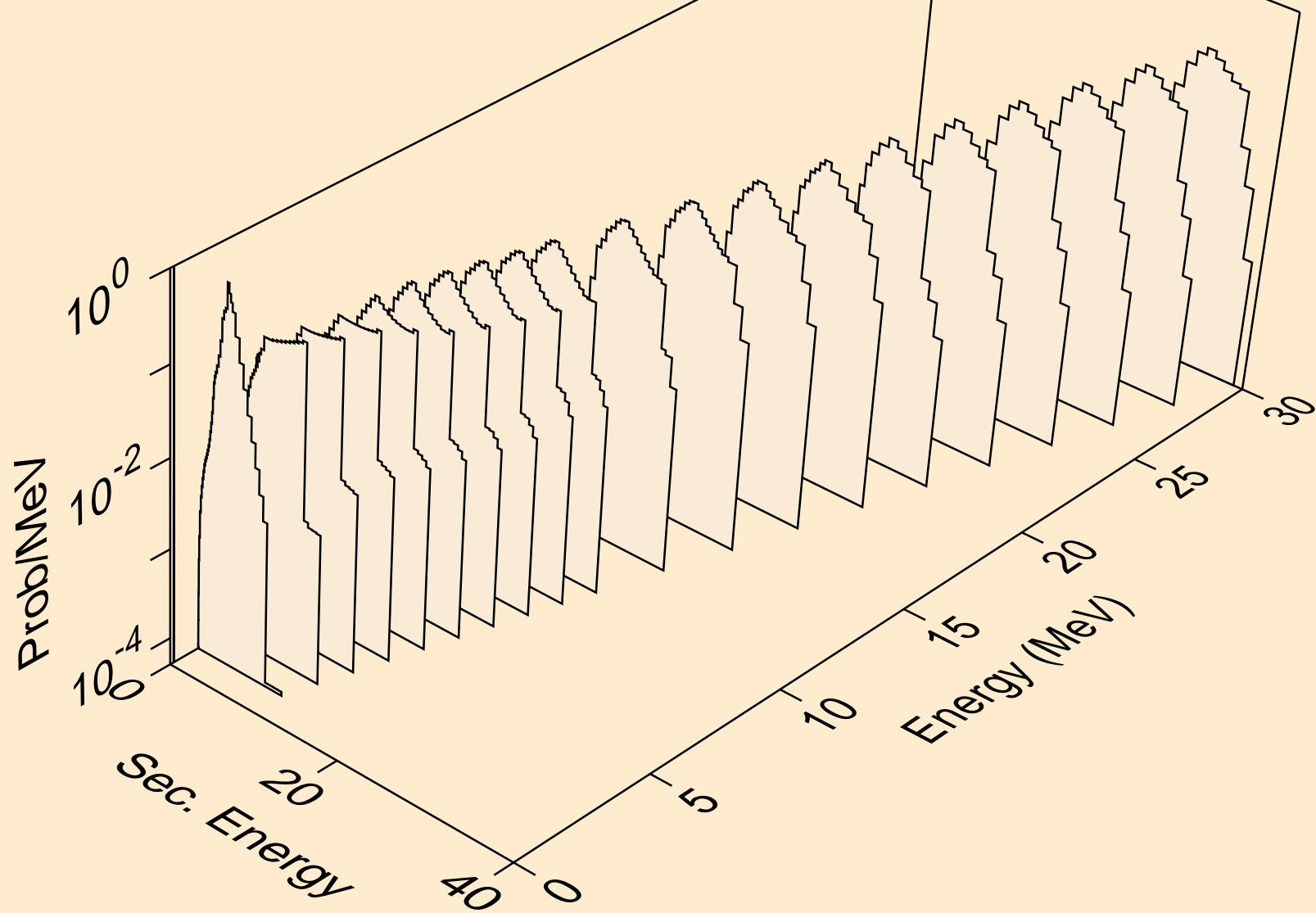

AS080 DEUTERON ACER TENDL-2023 LIBRARY; T=0.K  
neutrons from (d,x)

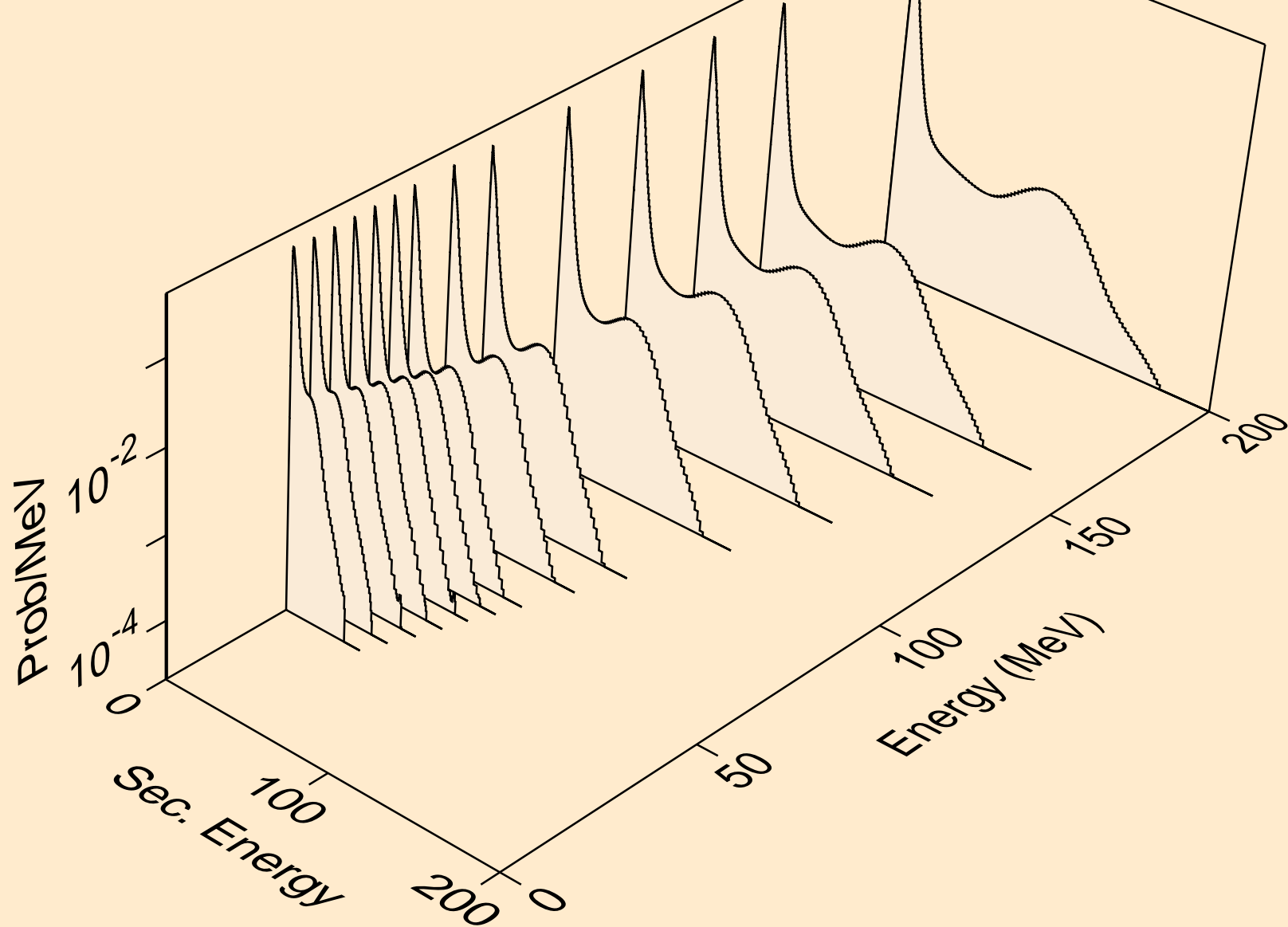

AS080 DEUTERON ACER TENDL-2023 LIBRARY; T=0.K  
neutrons from (d,2nd)

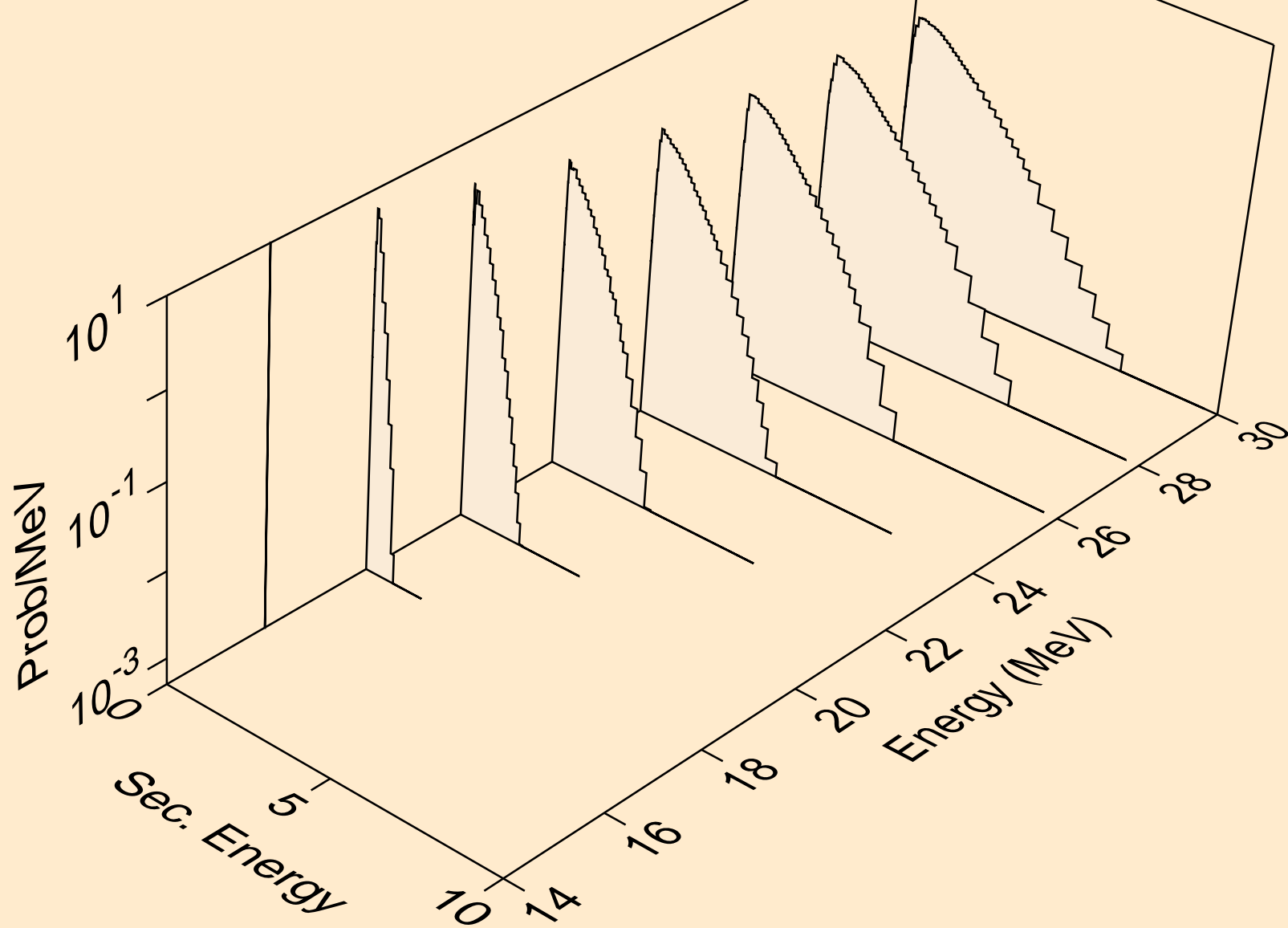

AS080 DEUTERON ACER TENDL-2023 LIBRARY; T=0.K  
neutrons from (d,2n)

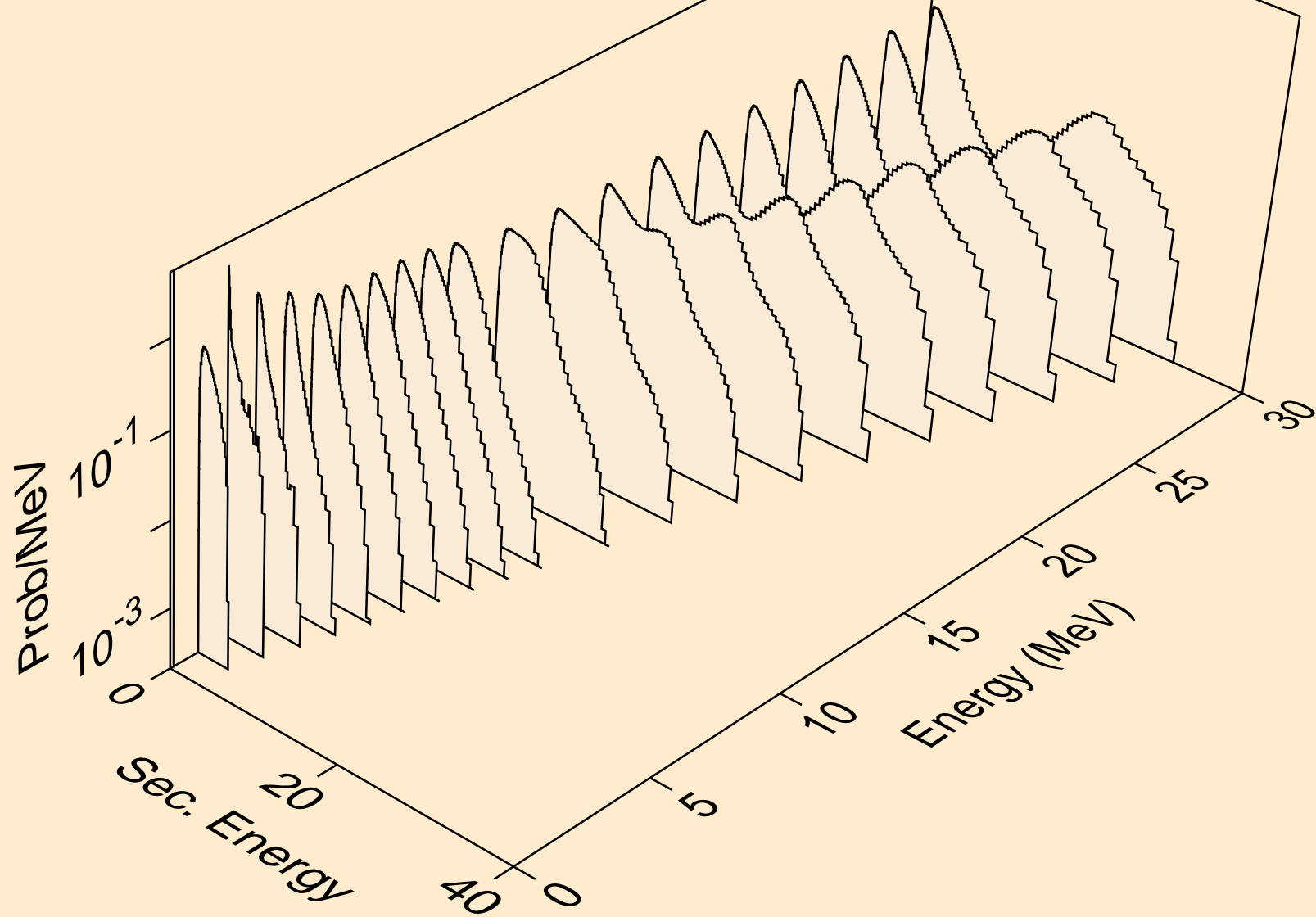

AS080 DEUTERON ACER TENDL-2023 LIBRARY; T=0.K  
neutrons from (d,3n)

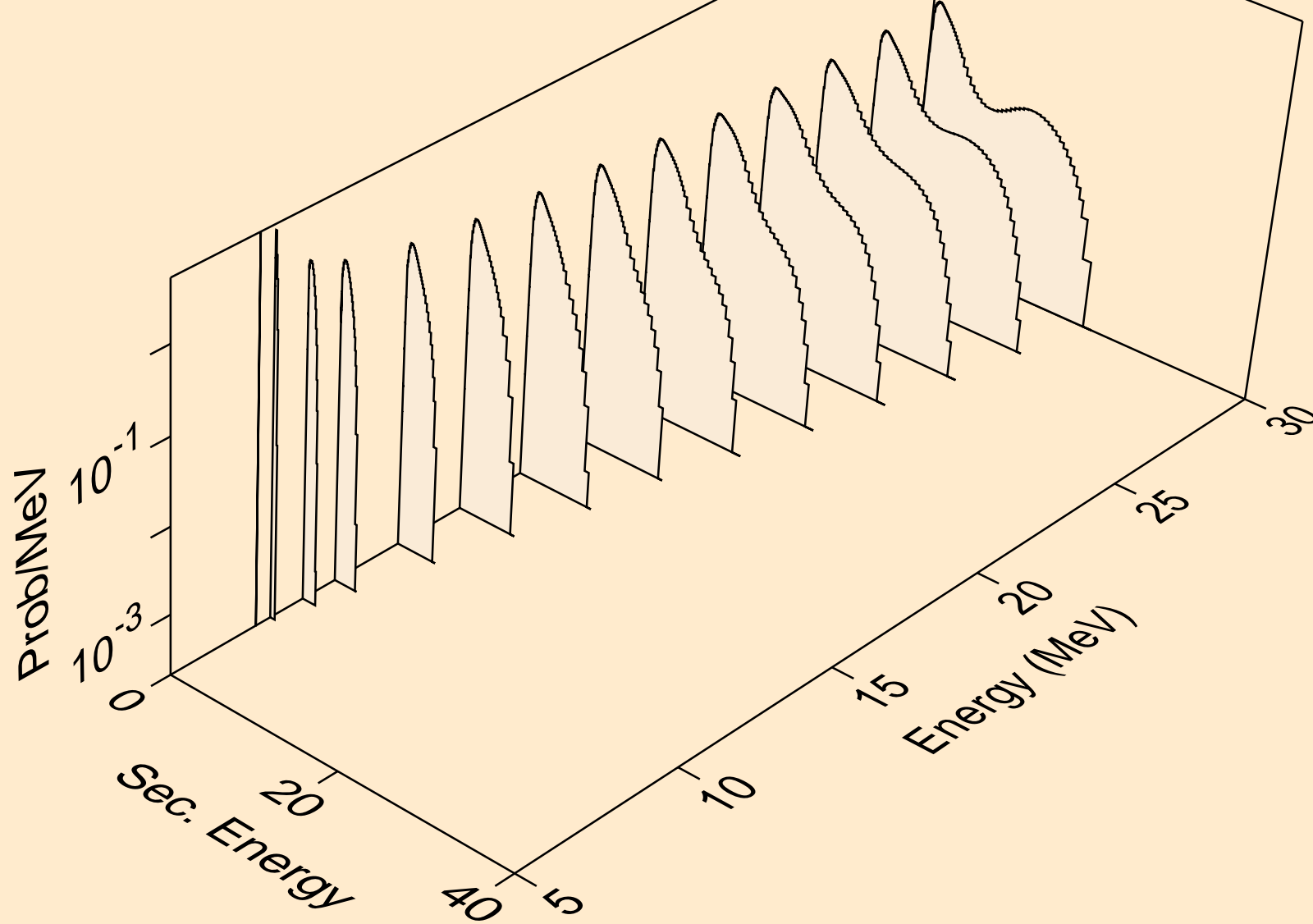

AS080 DEUTERON ACER TENDL-2023 LIBRARY; T=0.K  
neutrons from (d,n\*)a

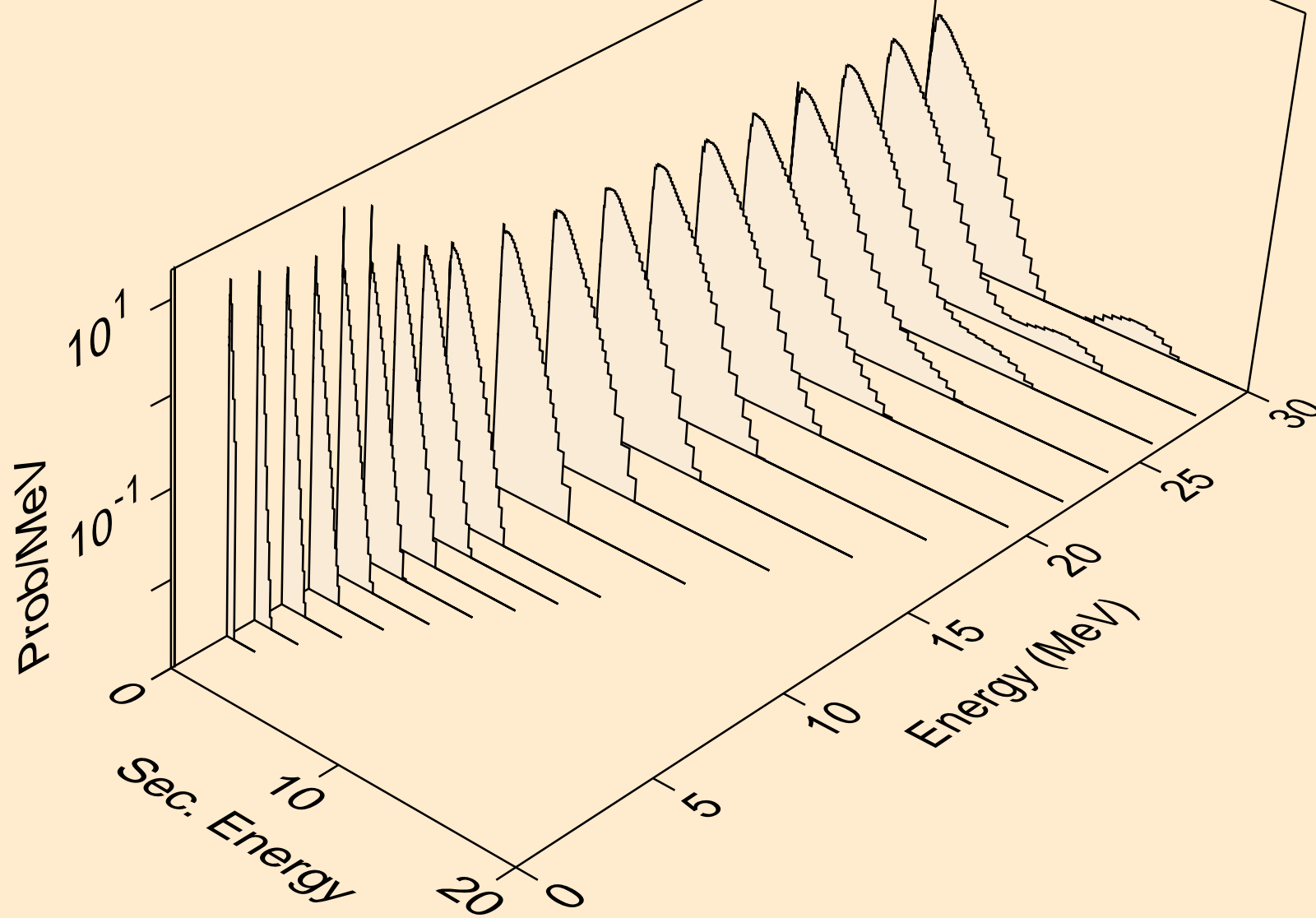

AS080 DEUTERON ACER TENDL-2023 LIBRARY; T=0.K  
neutrons from (d,2n)a

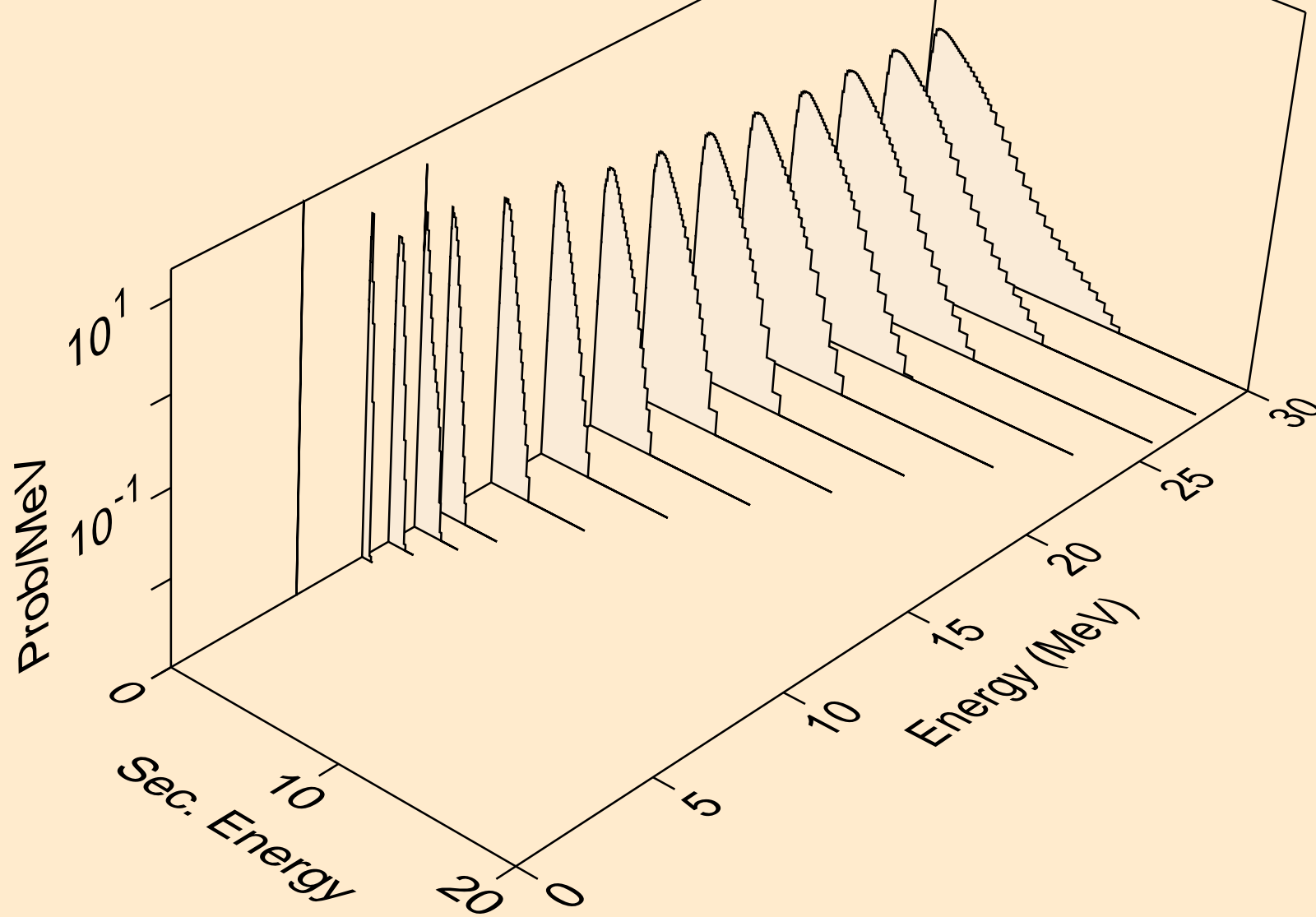



AS080 DEUTERON ACER TENDL-2023 LIBRARY; T=0.K  
neutrons from (d,3n)a

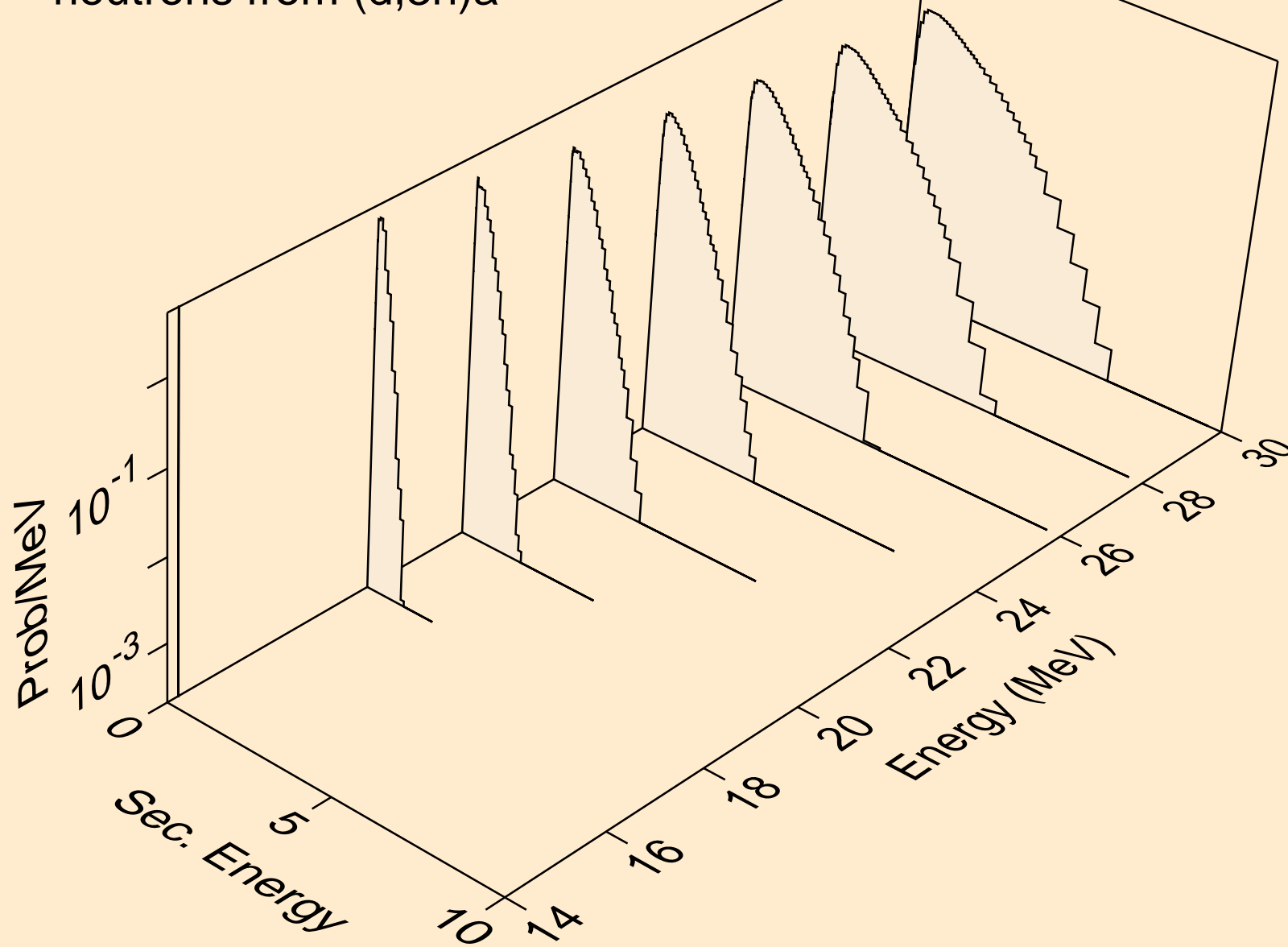

AS080 DEUTERON ACER TENDL-2023 LIBRARY; T=0.K  
neutrons from (d,n\*)p

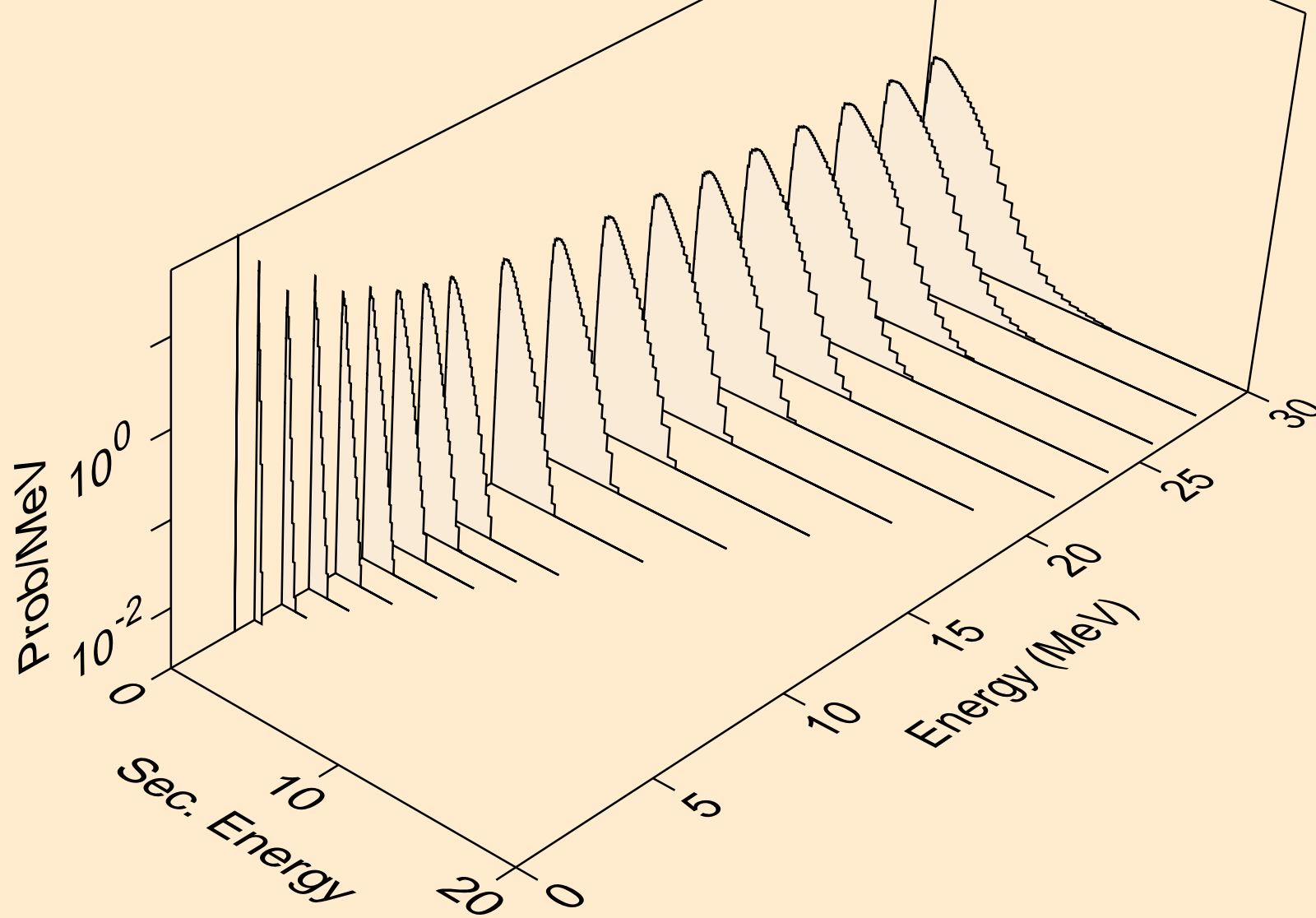

AS080 DEUTERON ACER TENDL-2023 LIBRARY; T=0.K  
neutrons from (d,n\*)2a

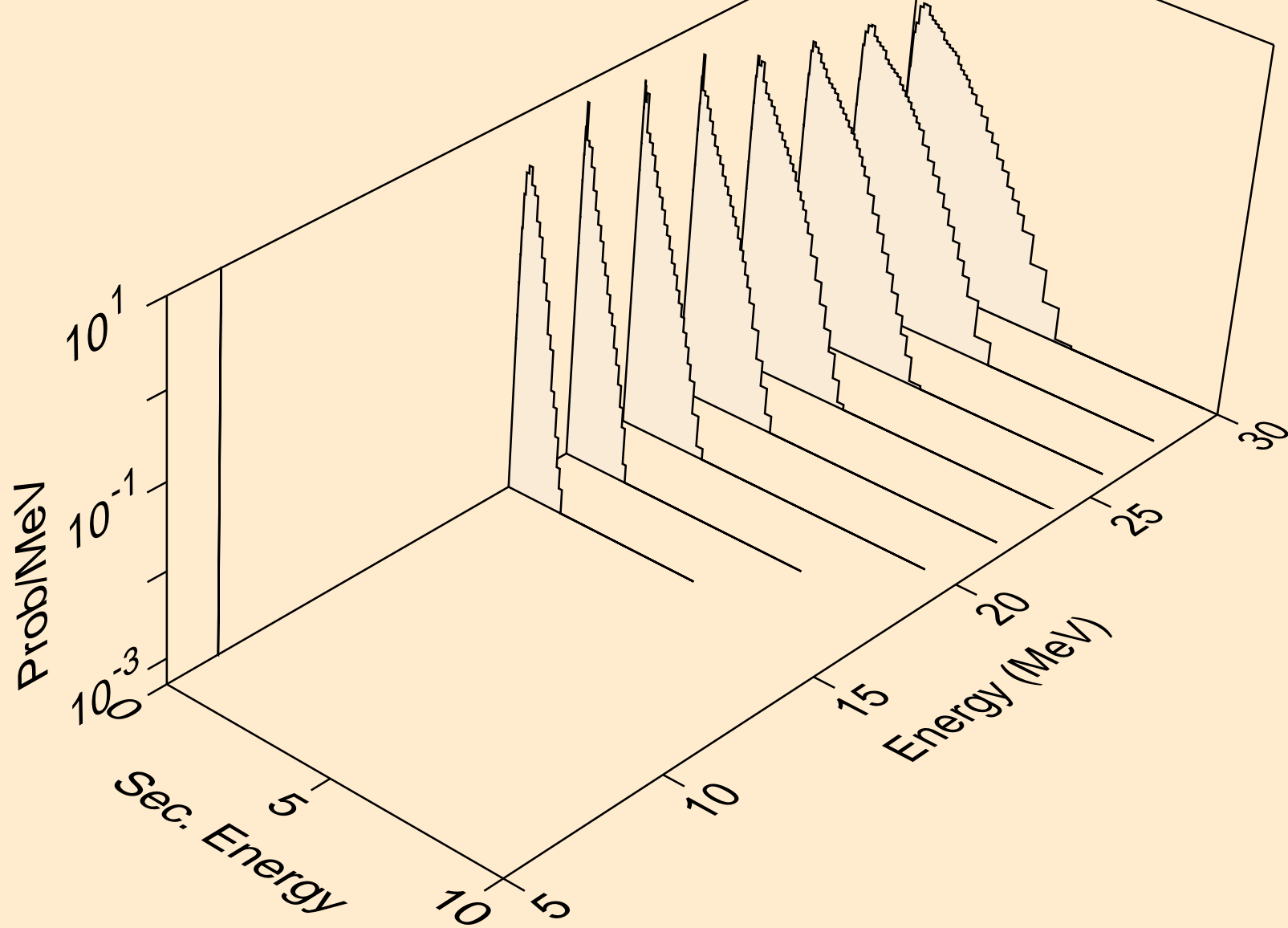

AS080 DEUTERON ACER TENDL-2023 LIBRARY; T=0.K  
neutrons from (d,2n)2a

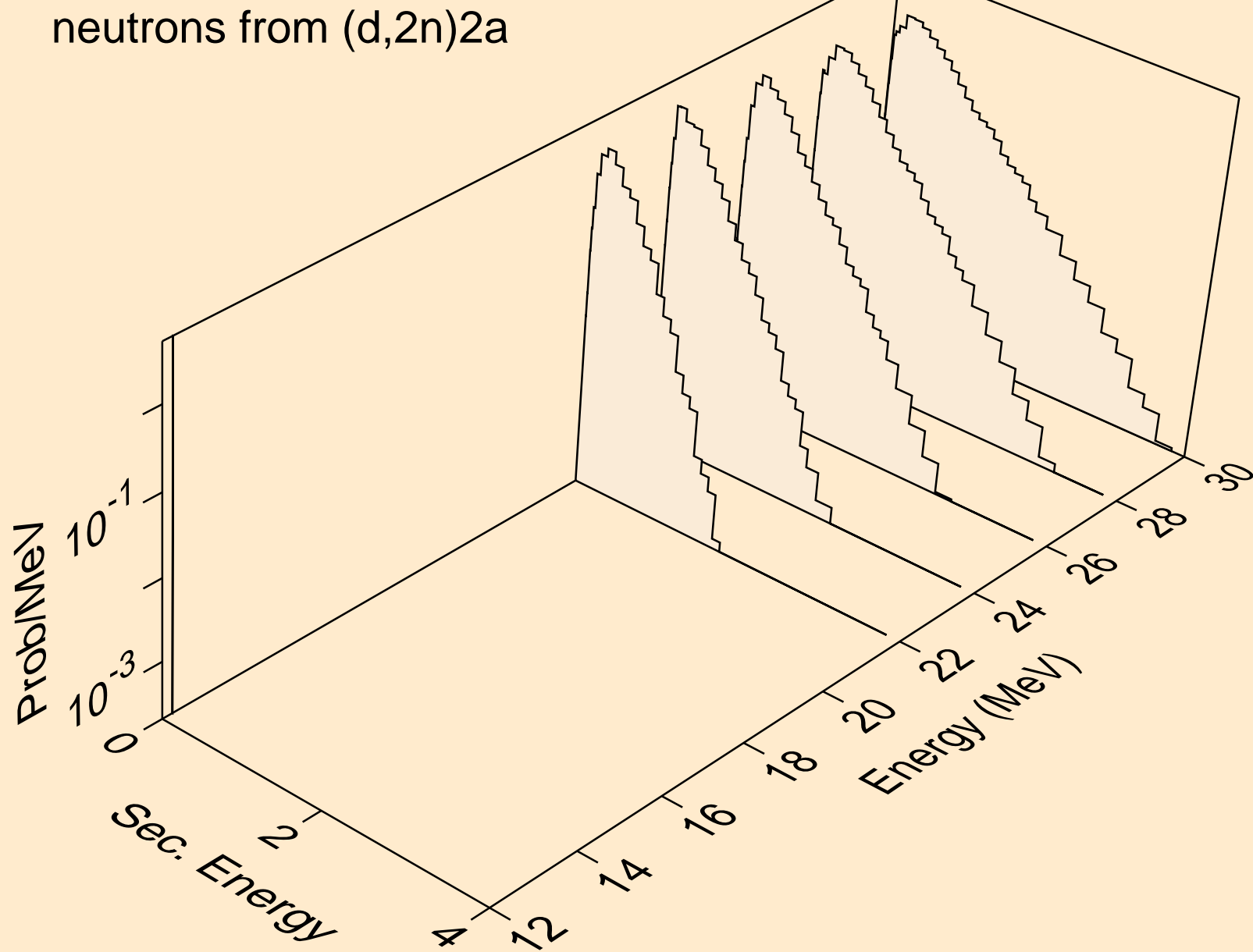

AS080 DEUTERON ACER TENDL-2023 LIBRARY; T=0.K  
neutrons from (d,n\*)d

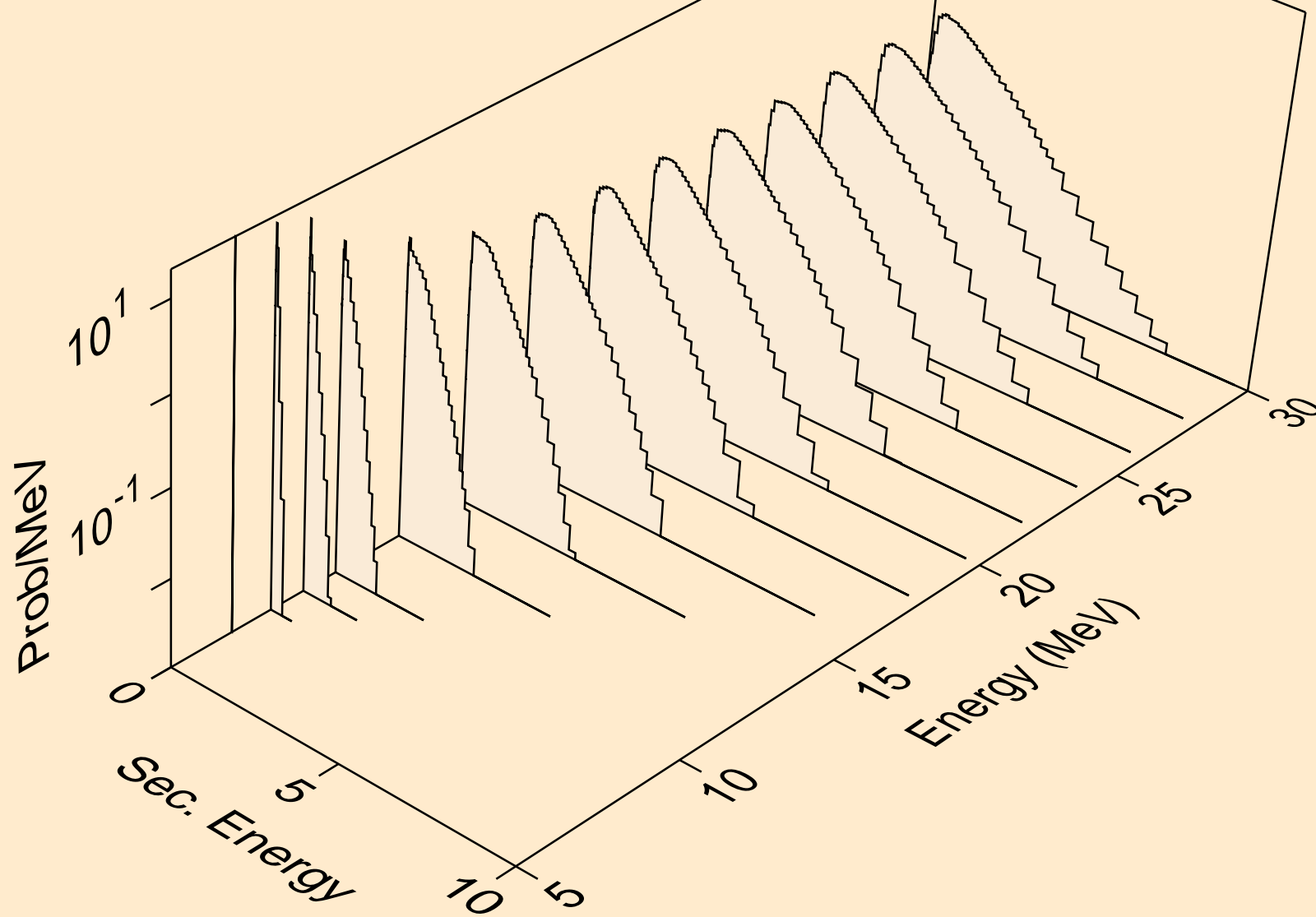

AS080 DEUTERON ACER TENDL-2023 LIBRARY; T=0.K  
neutrons from (d,n\*)t

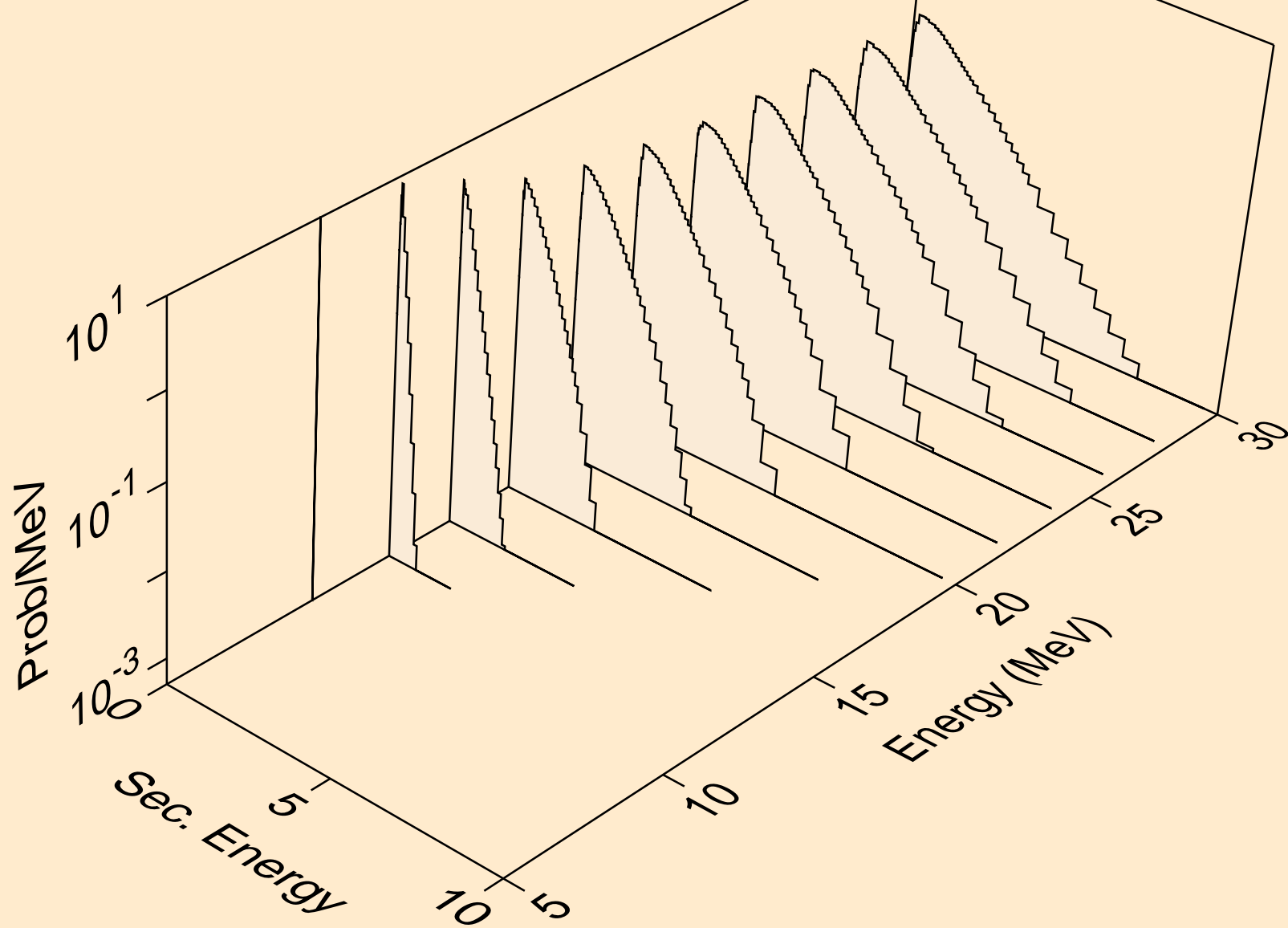

AS080 DEUTERON ACER TENDL-2023 LIBRARY; T=0.K  
neutrons from (d,n\*)he3

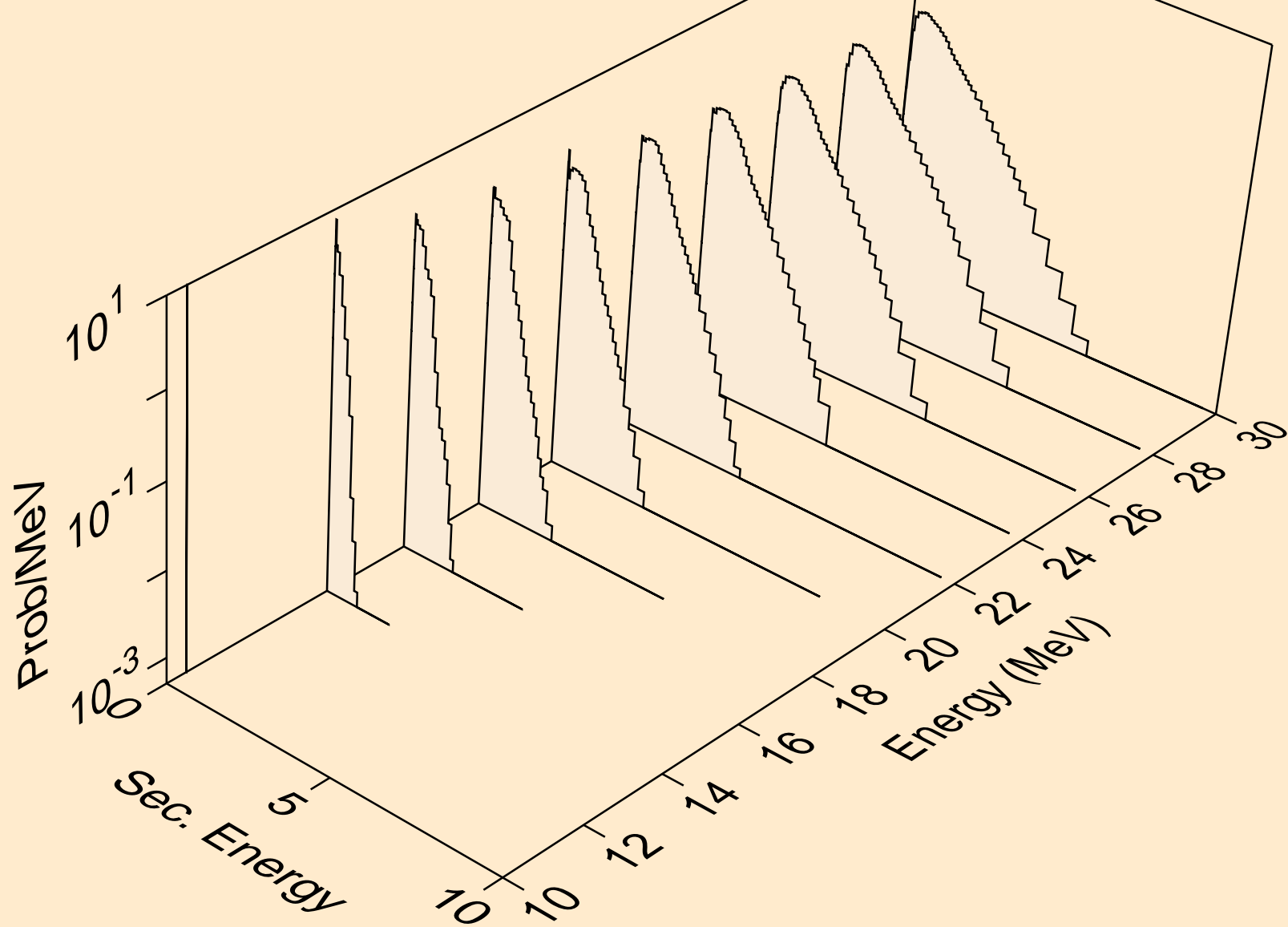

AS080 DEUTERON ACER TENDL-2023 LIBRARY; T=0.K  
neutrons from (d,4n)

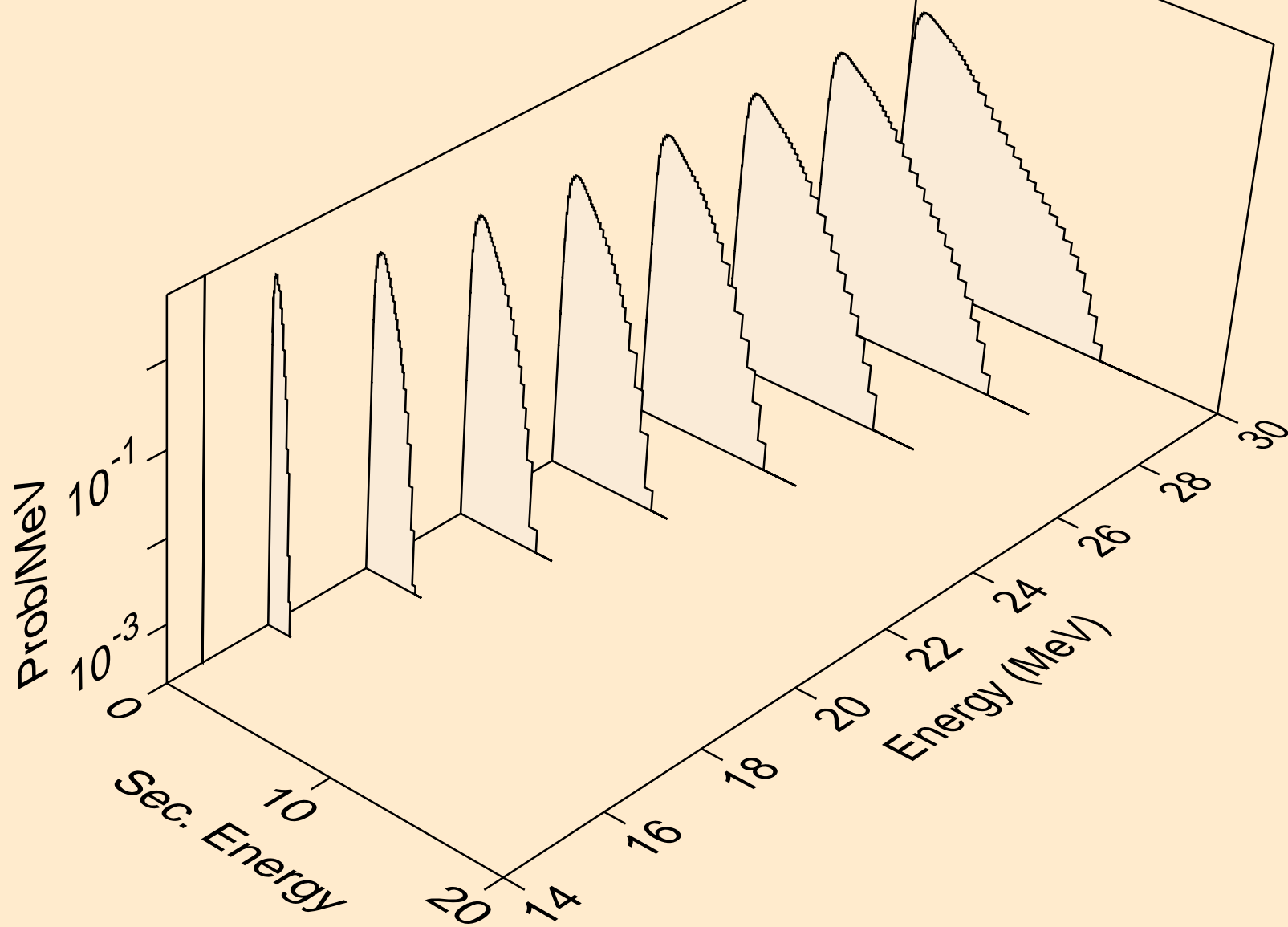



AS080 DEUTERON ACER TENDL-2023 LIBRARY; T=0.K  
neutrons from (d,2np)

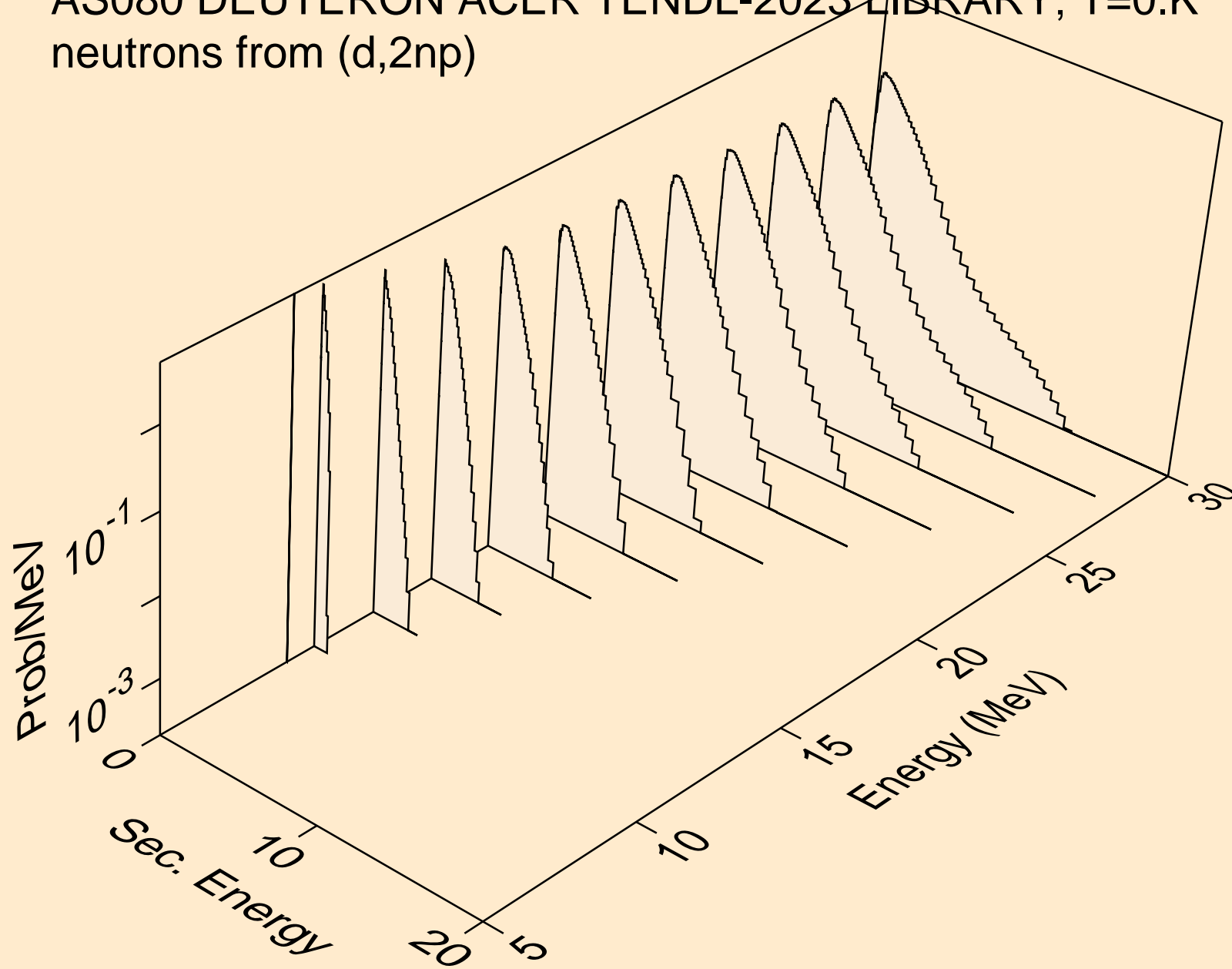

AS080 DEUTERON ACER TENDL-2023 LIBRARY; T=0.K  
neutrons from (d,3np)

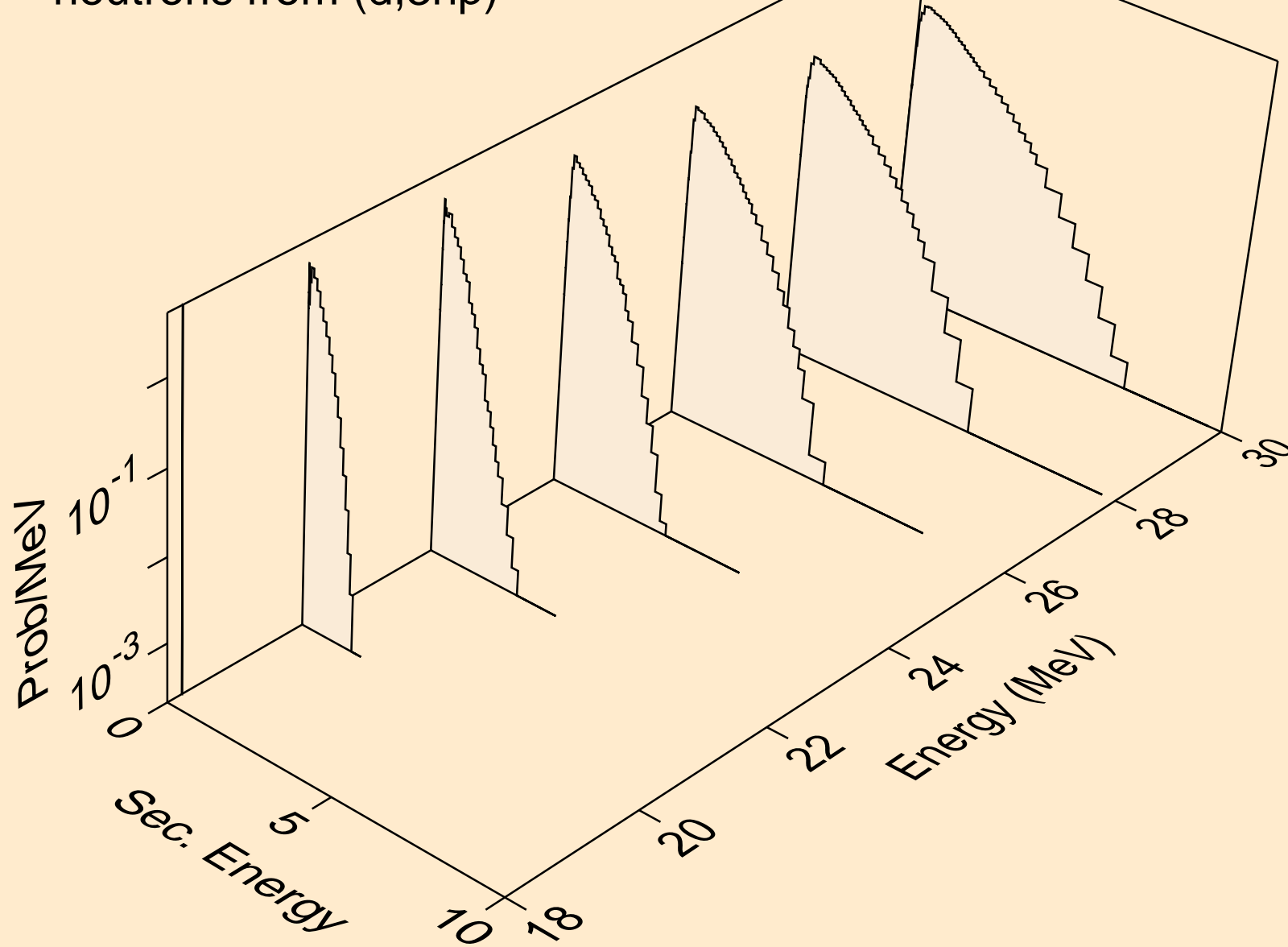

AS080 DEUTERON ACER TENDL-2023 LIBRARY; T=0.K  
neutrons from (d,n2p)

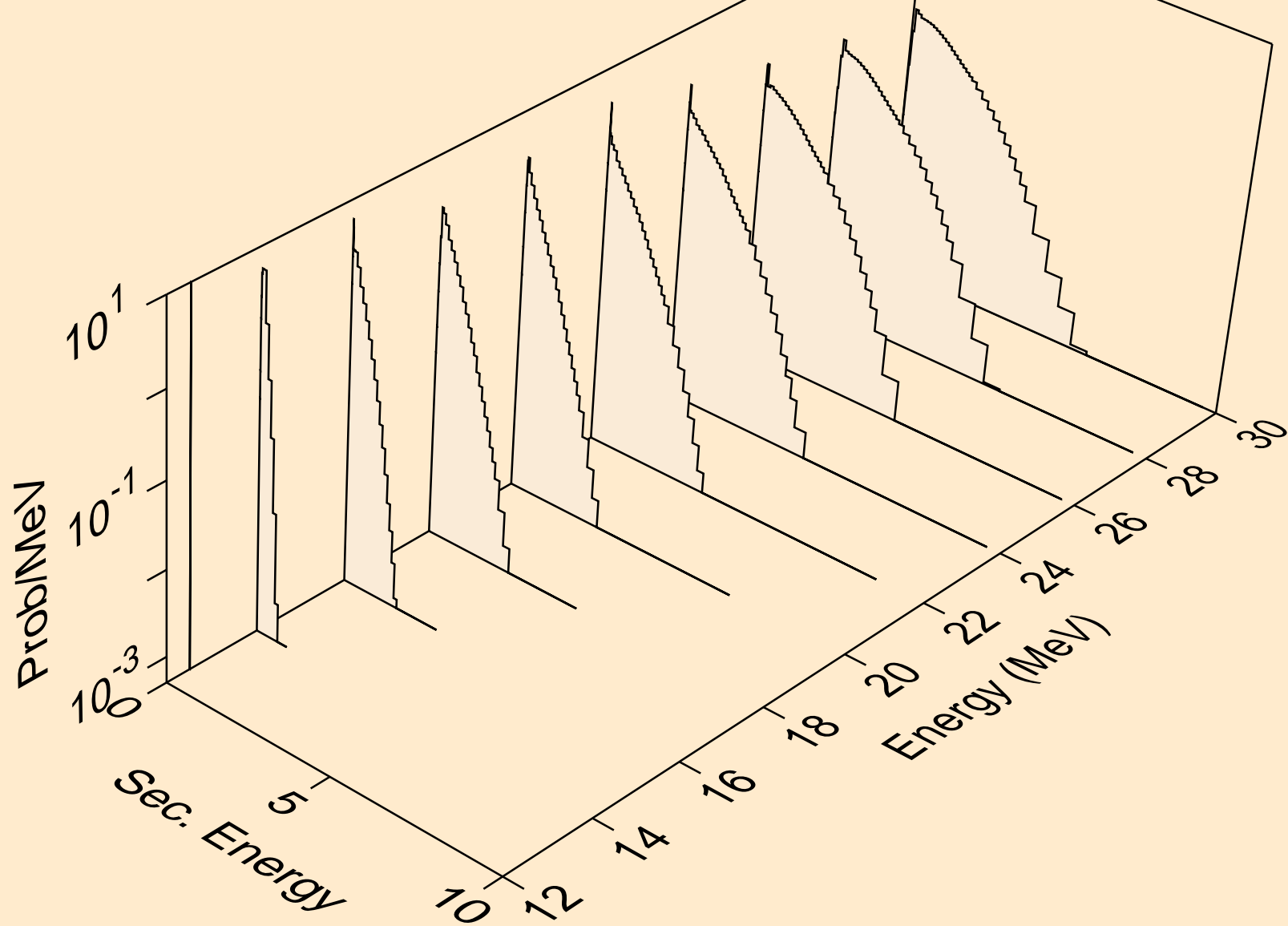

AS080 DEUTERON ACER TENDL-2023 LIBRARY; T=0.K  
neutrons from (d,npa)

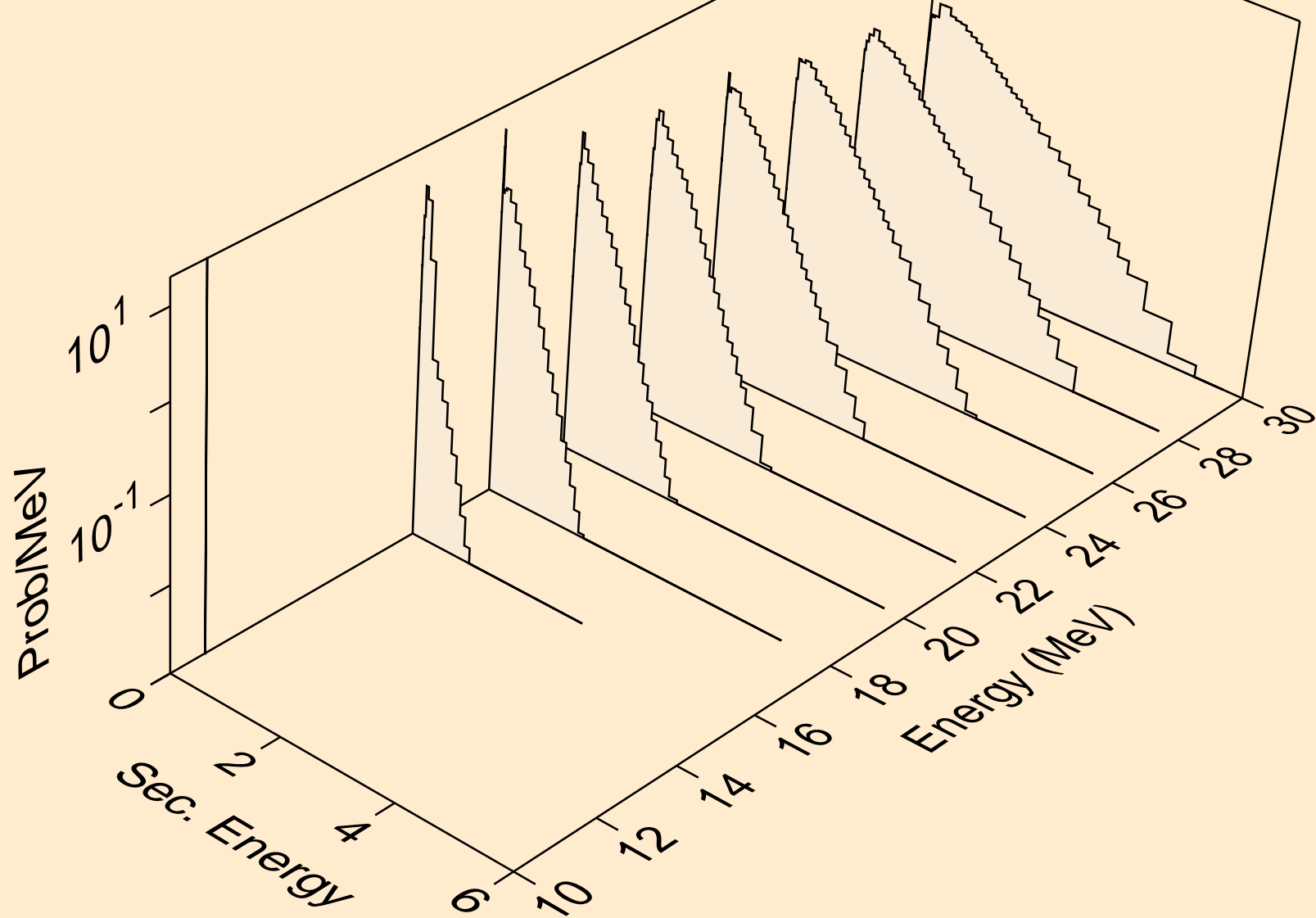

AS080 DEUTERON ACER TENDL-2023 LIBRARY; T=0.K  
protons from (d,x)

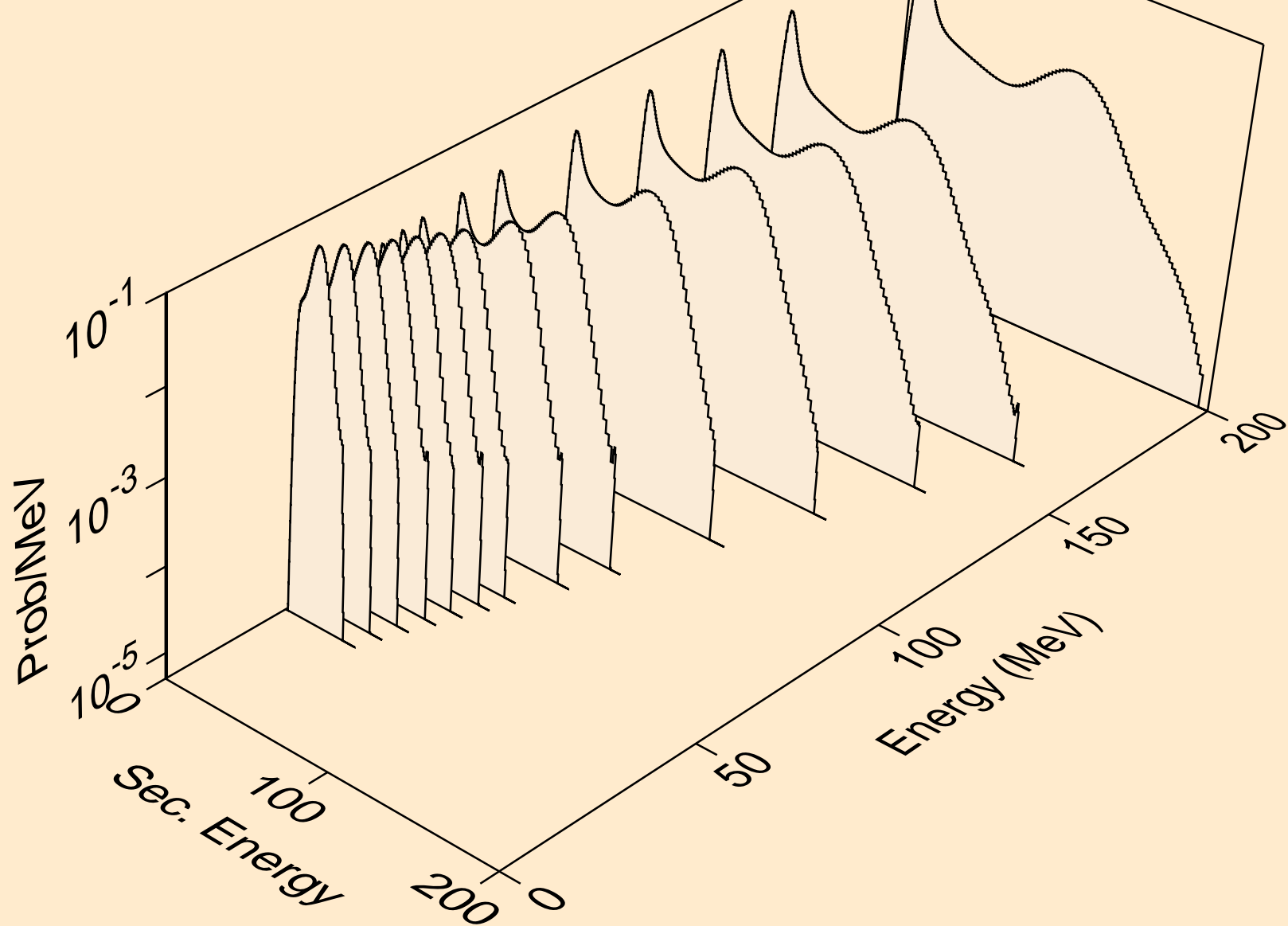

AS080 DEUTERON ACER TENDL-2023 LIBRARY; T=0.K  
protons from (d,n\*)p

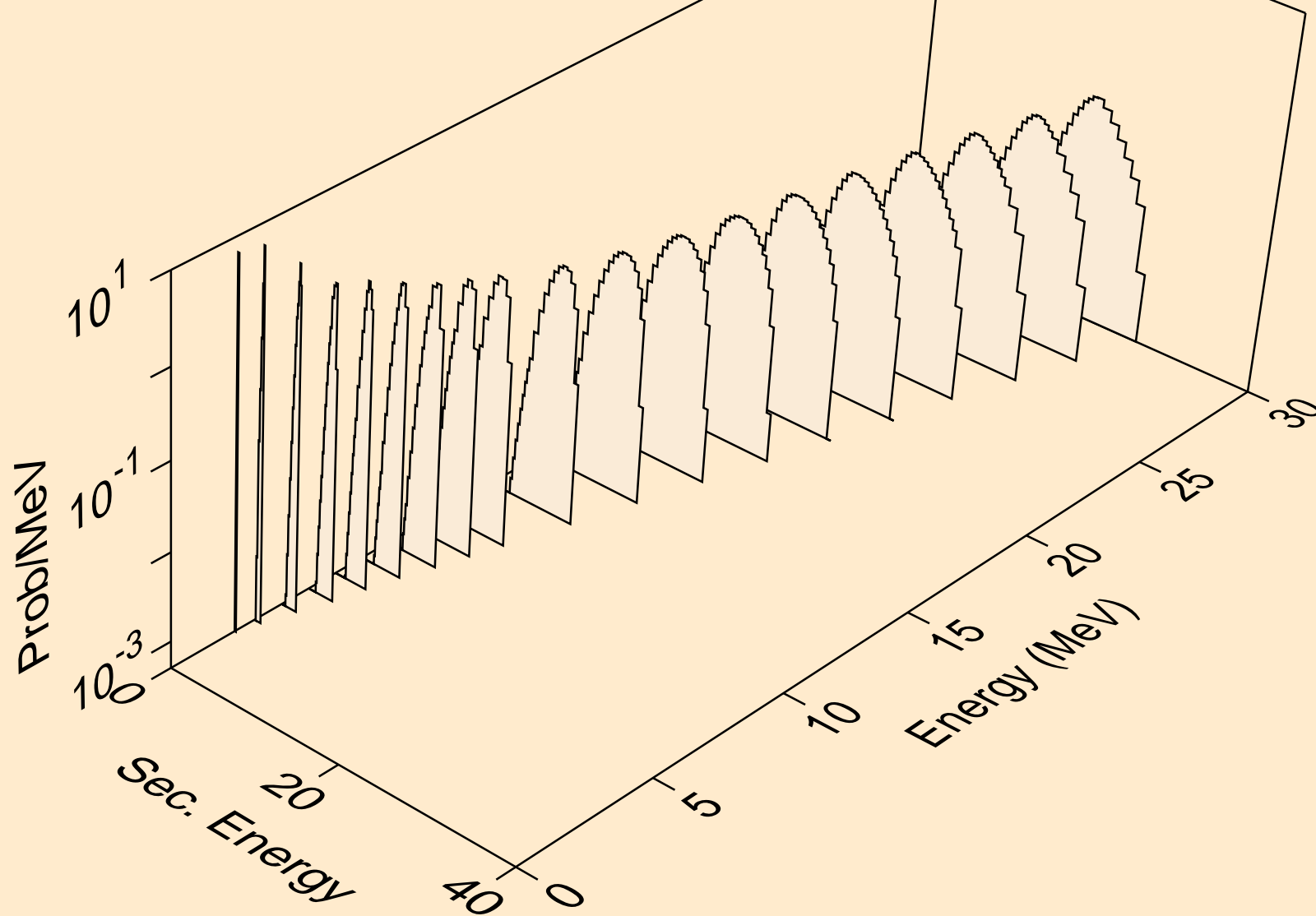

AS080 DEUTERON ACER TENDL-2023 LIBRARY; T=0.K  
protons from (d,2np)

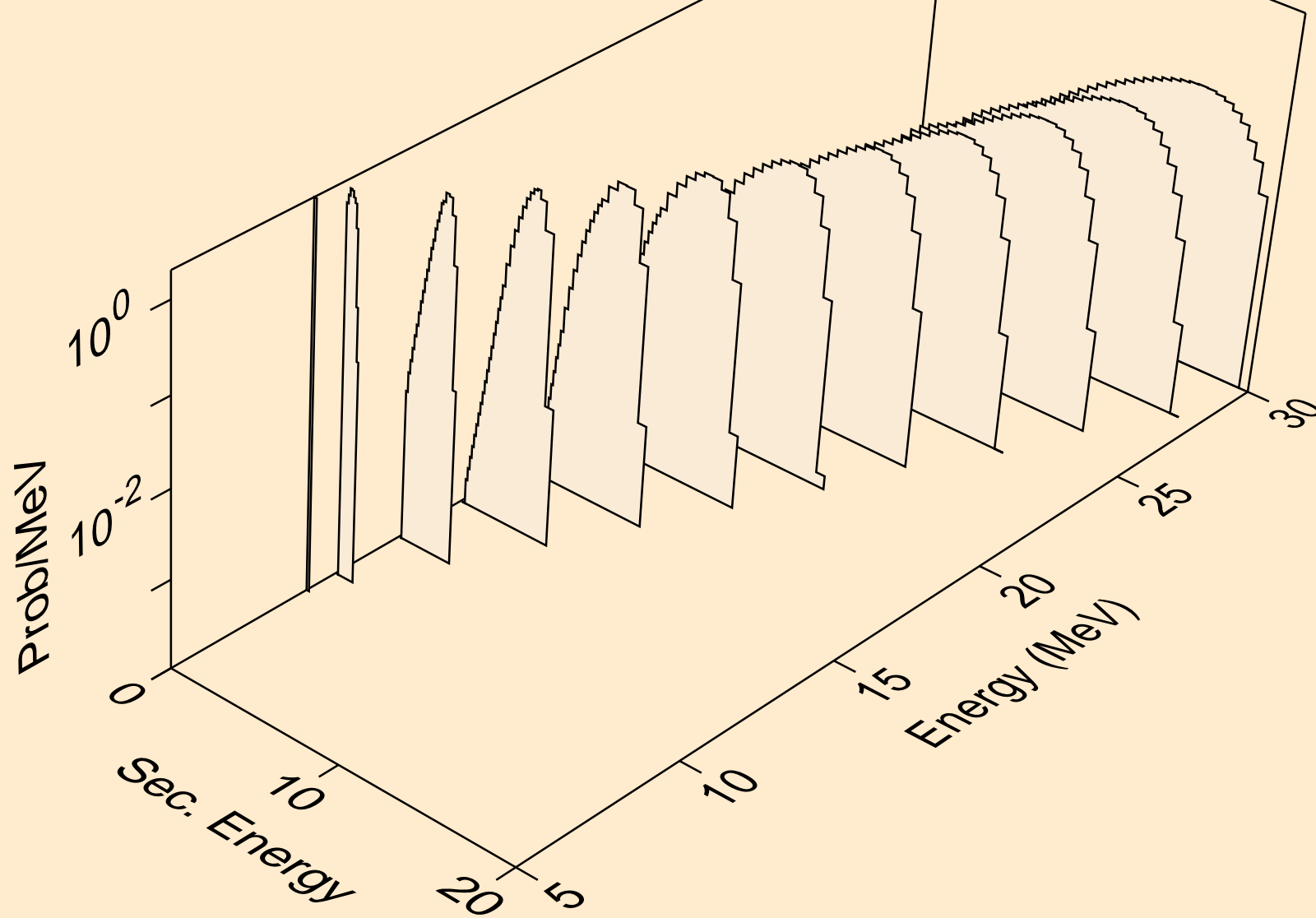

AS080 DEUTERON ACER TENDL-2023 LIBRARY; T=0.K  
protons from (d,3np)

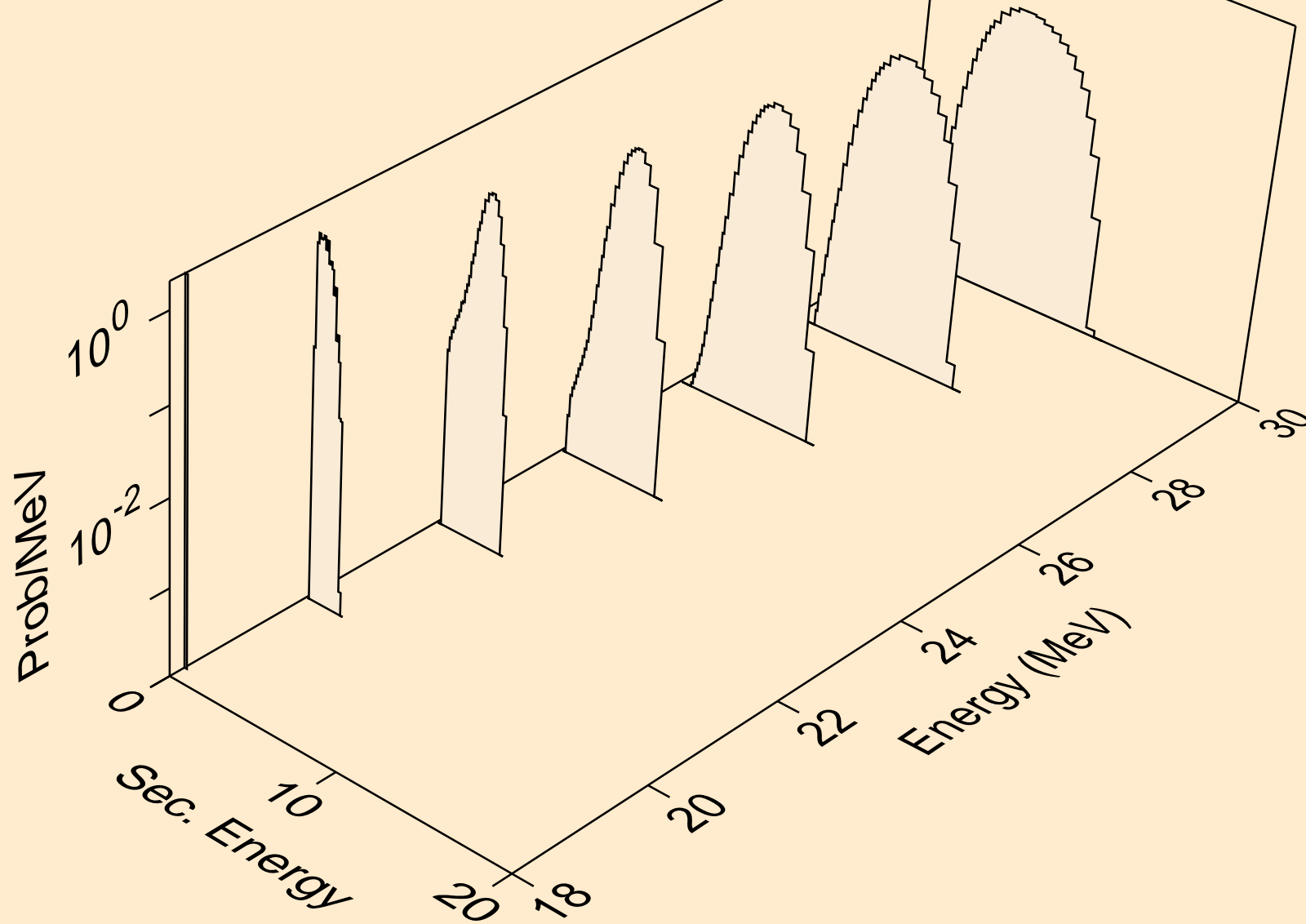



AS080 DEUTERON ACER TENDL-2023 LIBRARY; T=0.K  
protons from (d,n2p)

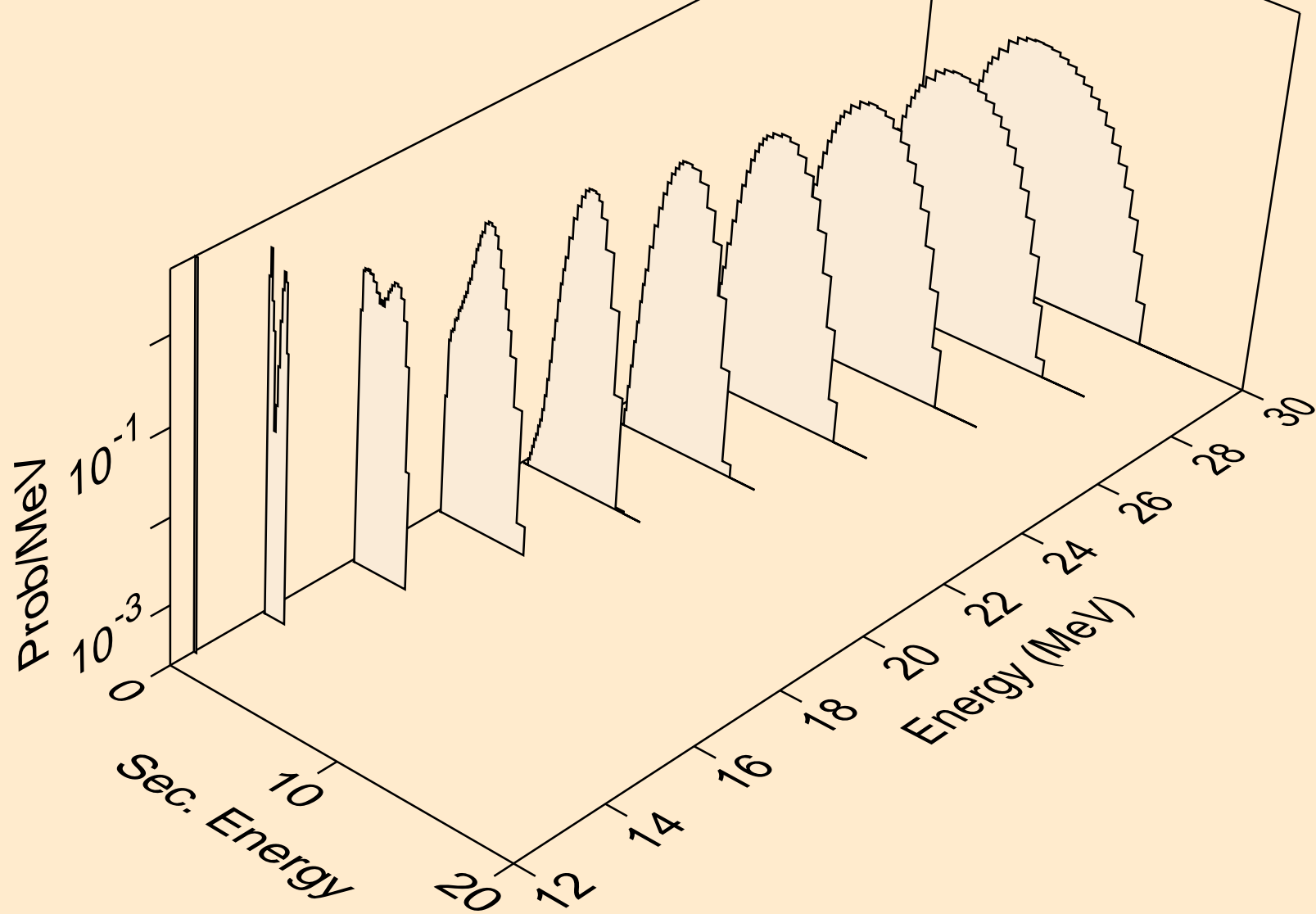

AS080 DEUTERON ACER TENDL-2023 LIBRARY; T=0.K  
protons from (d,npa)

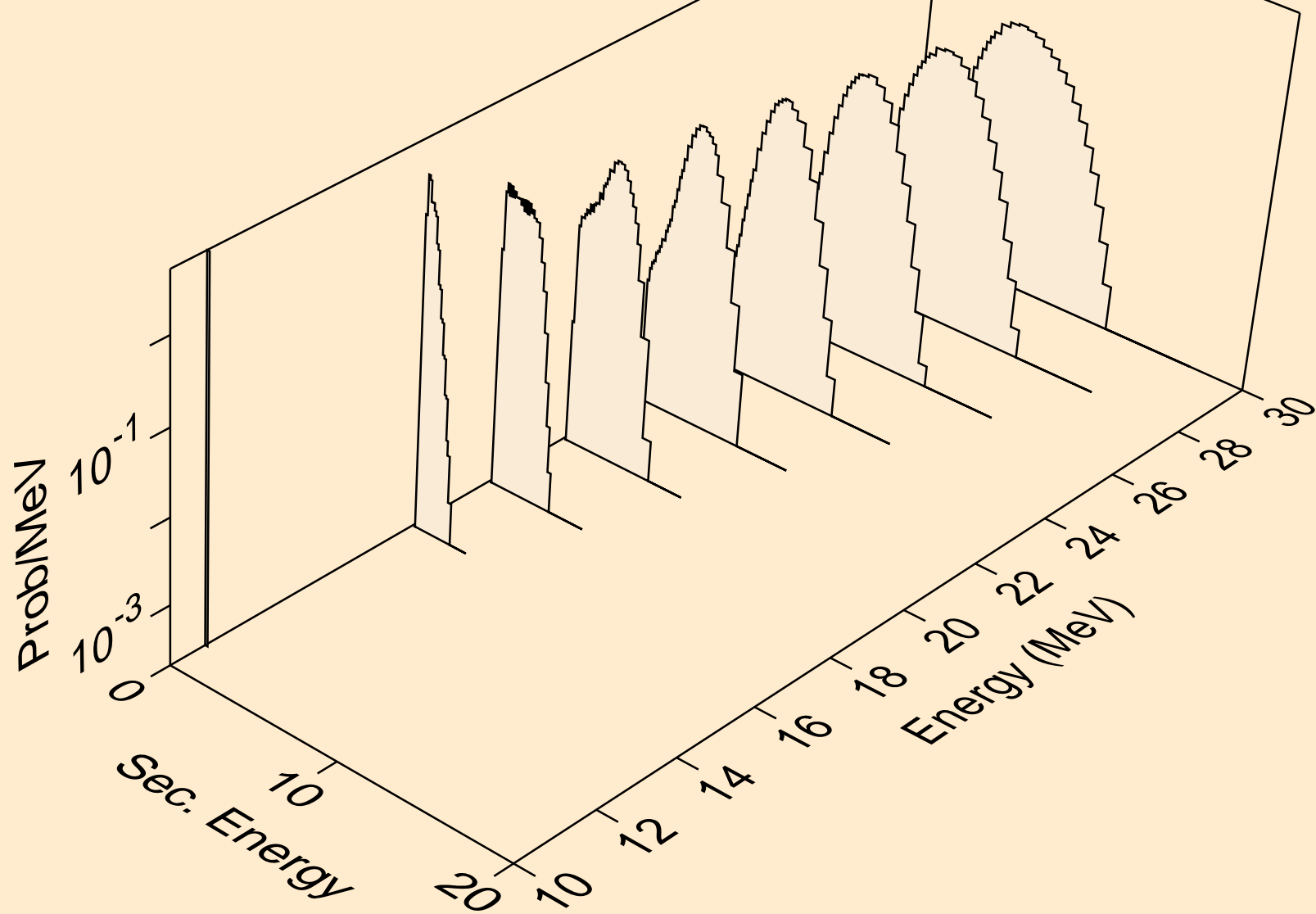

AS080 DEUTERON ACER TENDL-2023 LIBRARY; T=0.K  
protons from (d,p)

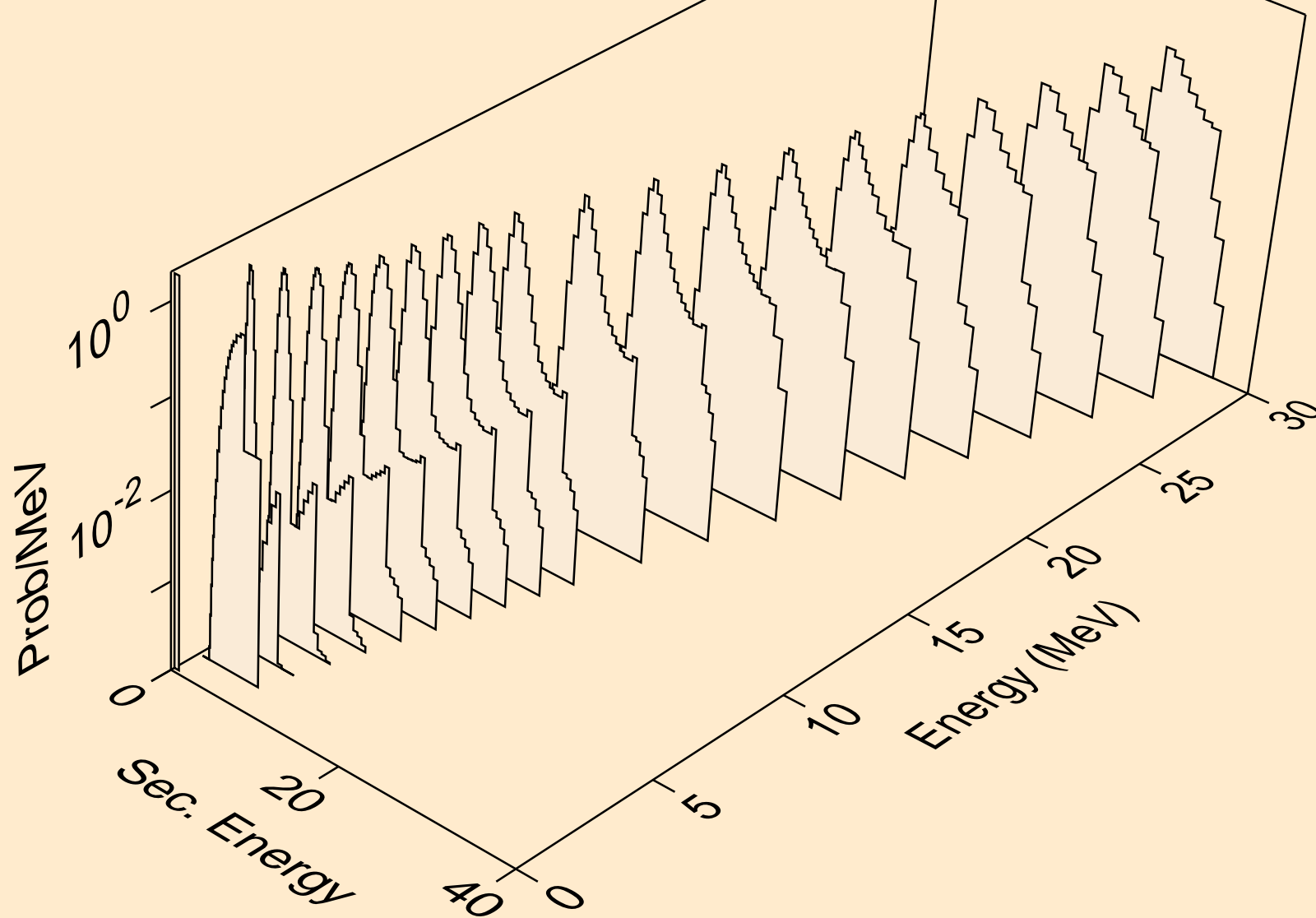

AS080 DEUTERON ACER TENDL-2023 LIBRARY; T=0.K  
protons from (d,2p)

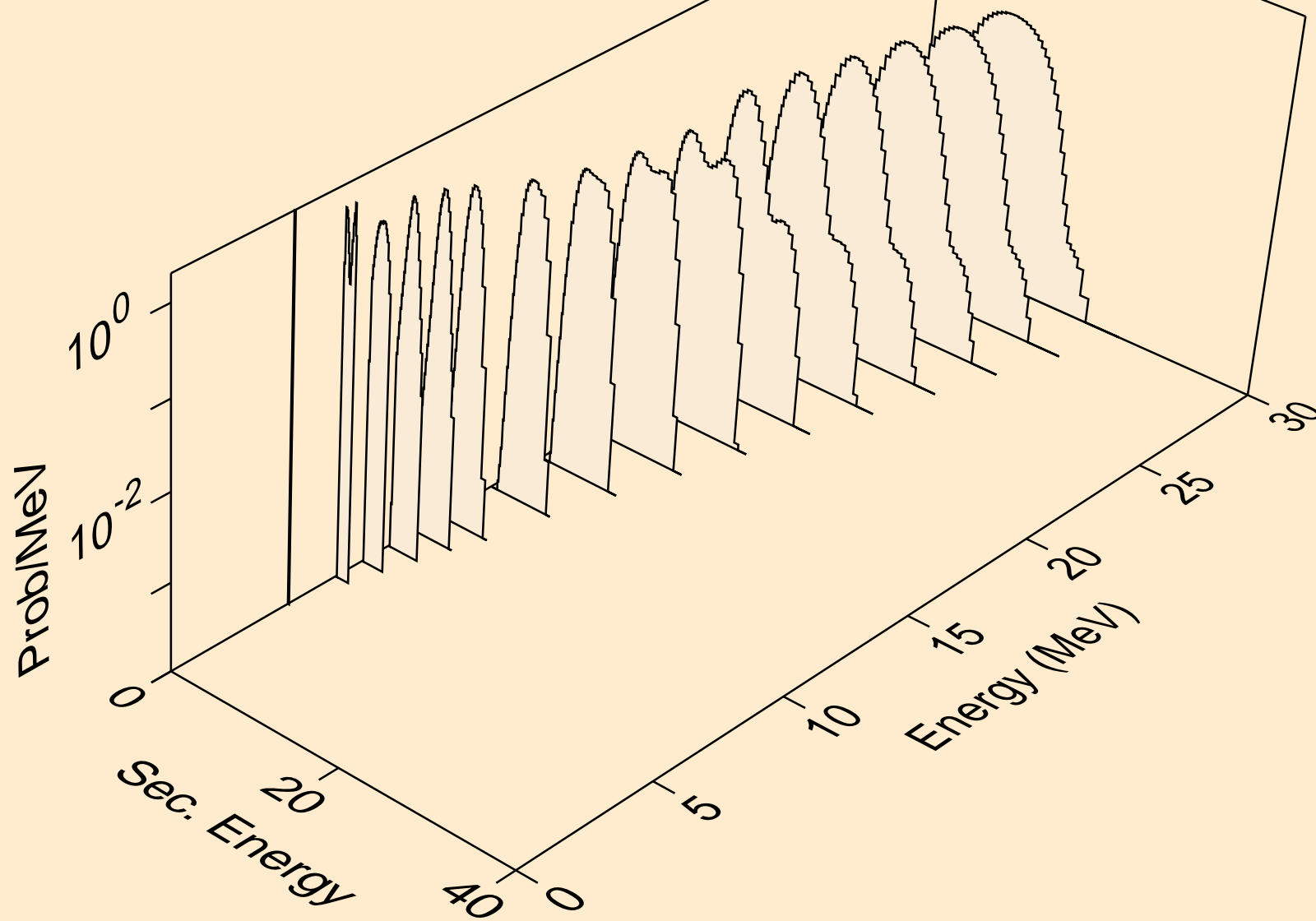

AS080 DEUTERON ACER TENDL-2023 LIBRARY; T=0.K  
protons from (d,pa)

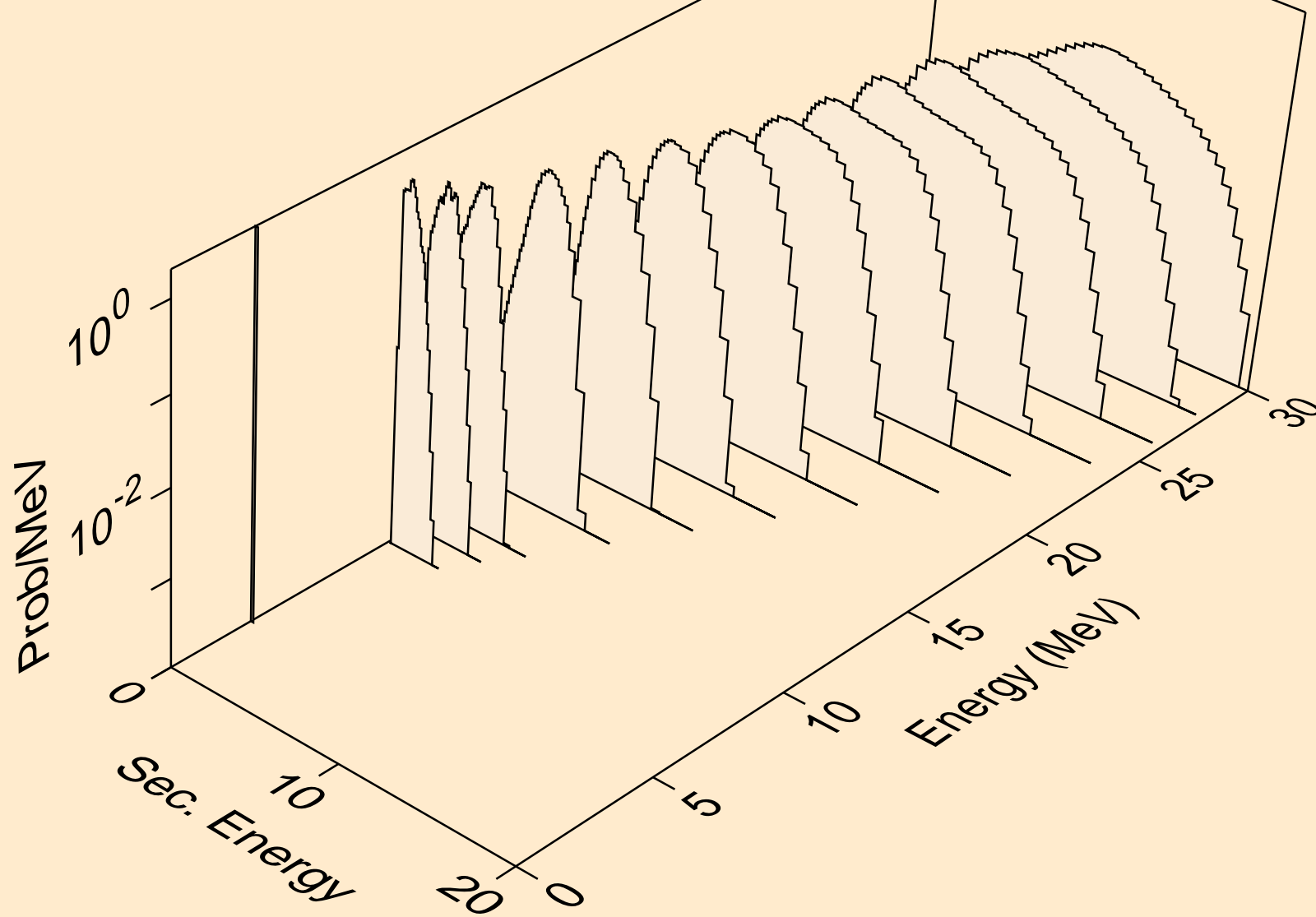

AS080 DEUTERON ACER TENDL-2023 LIBRARY; T=0.K  
protons from (d,pd)

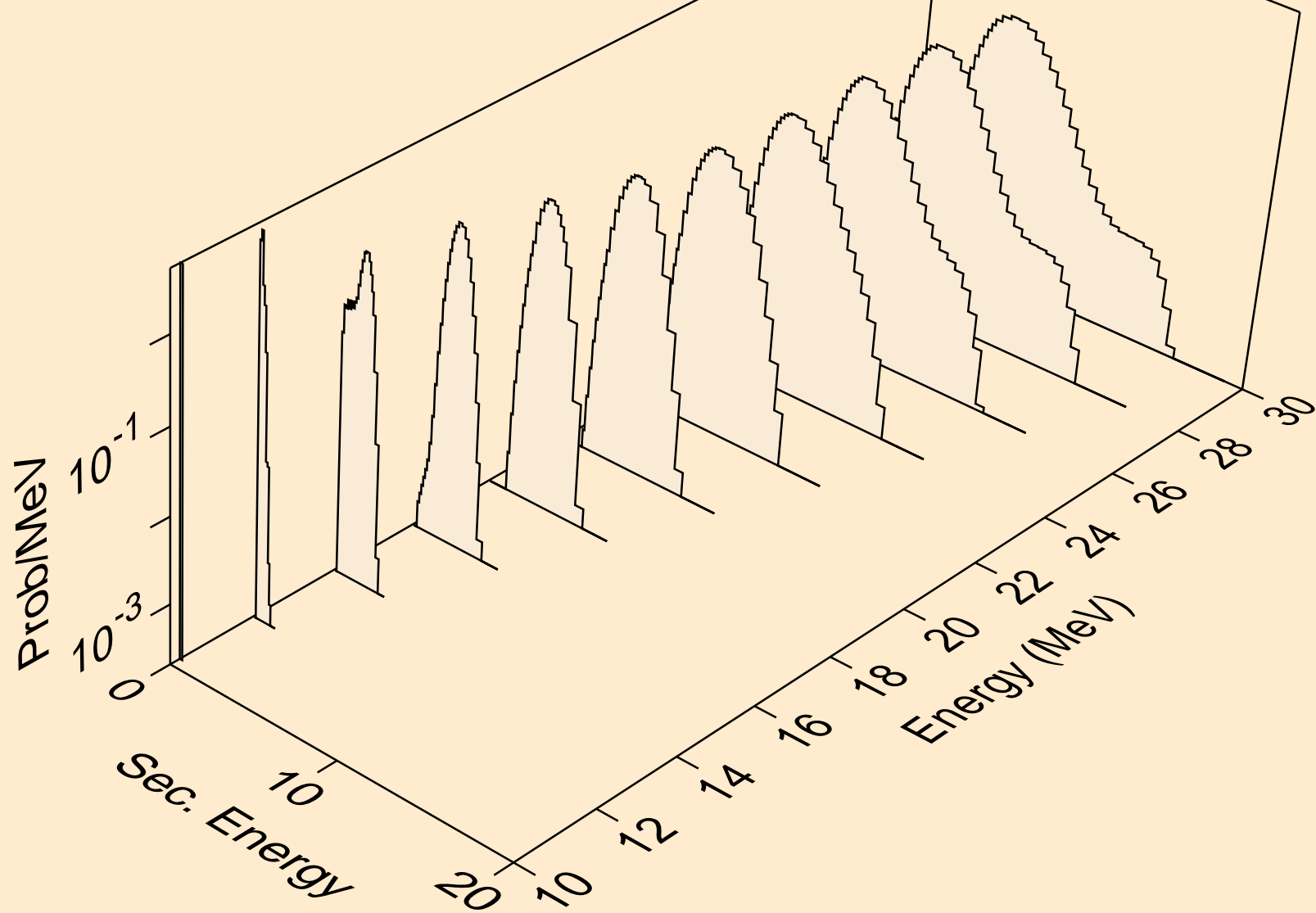

AS080 DEUTERON ACER TENDL-2023 LIBRARY; T=0.K  
protons from (d,pt)

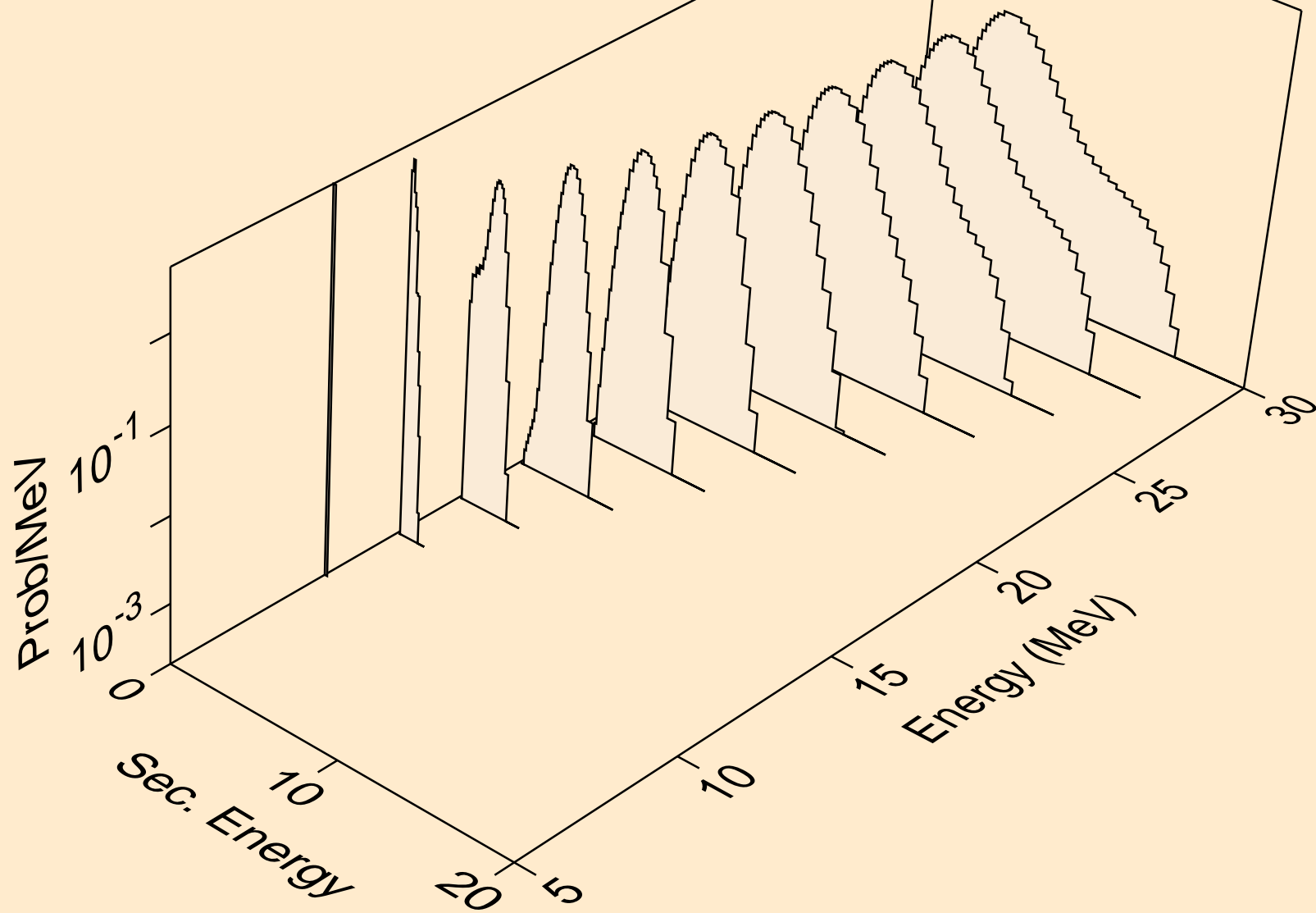

AS080 DEUTERON ACER TENDL-2023 LIBRARY; T=0.K  
tritons from (d,x)

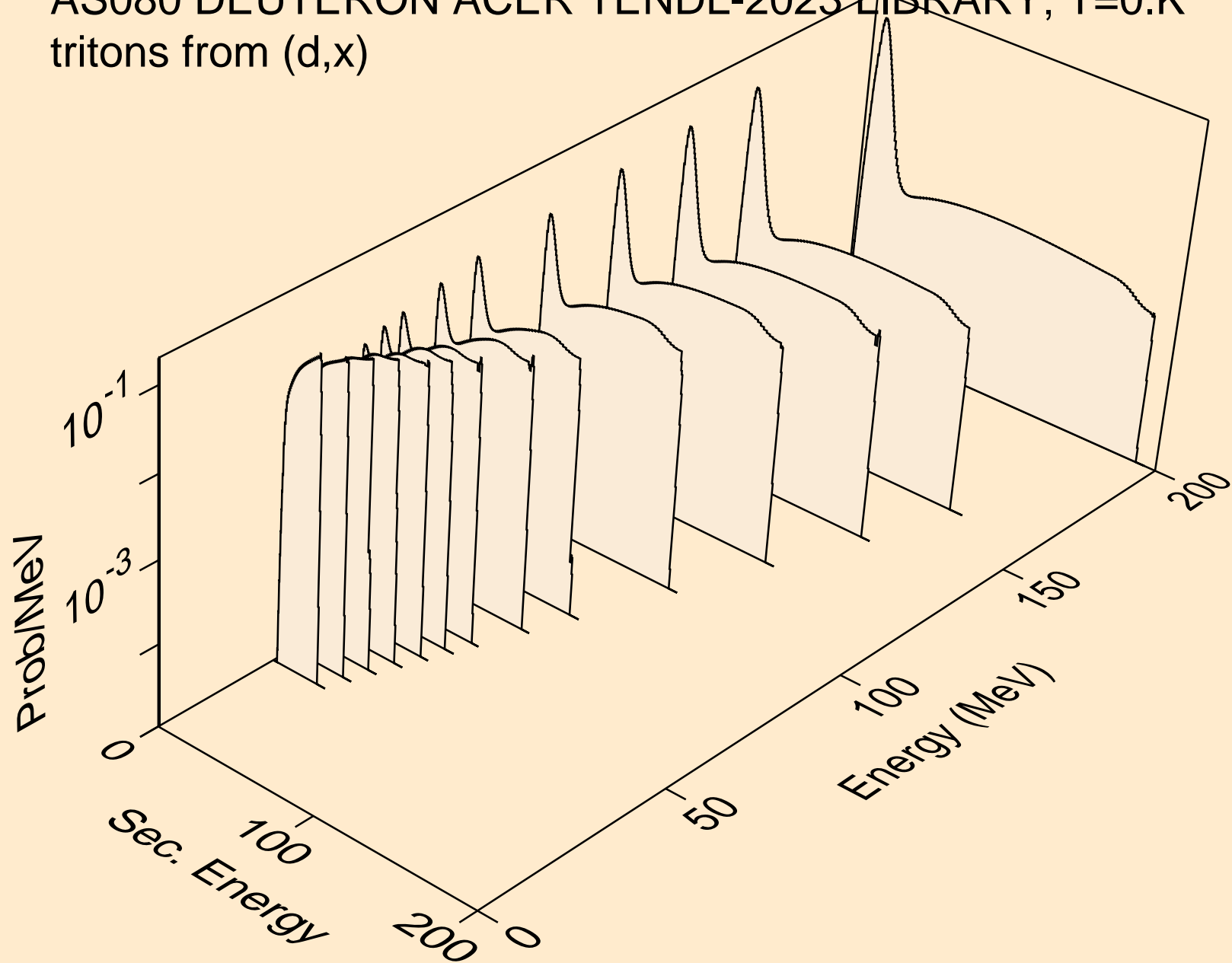



AS080 DEUTERON ACER TENDL-2023 LIBRARY; T=0.K  
tritons from (d,n\*)t

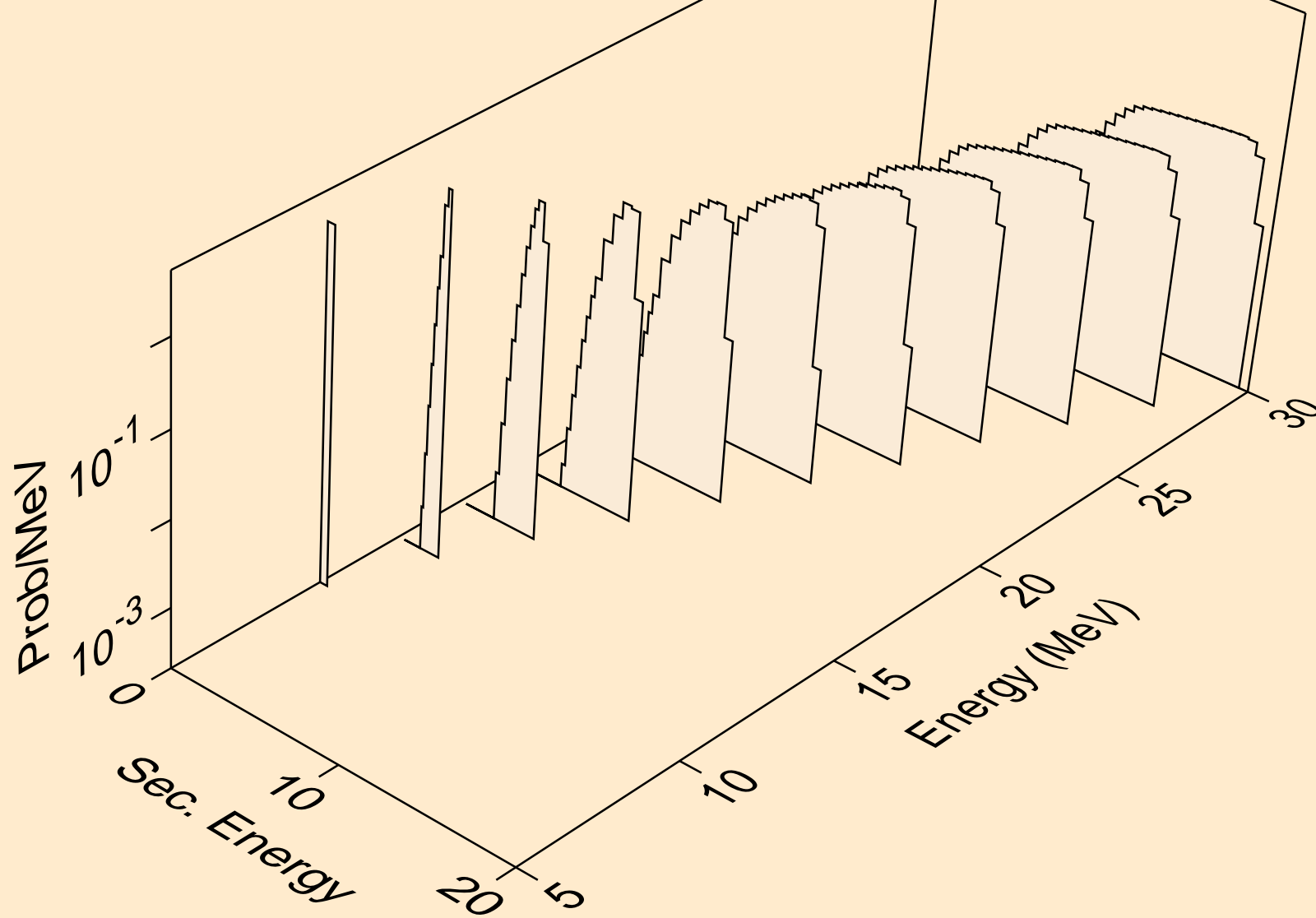

AS080 DEUTERON ACER TENDL-2023 LIBRARY; T=0.K  
tritons from (d,t)

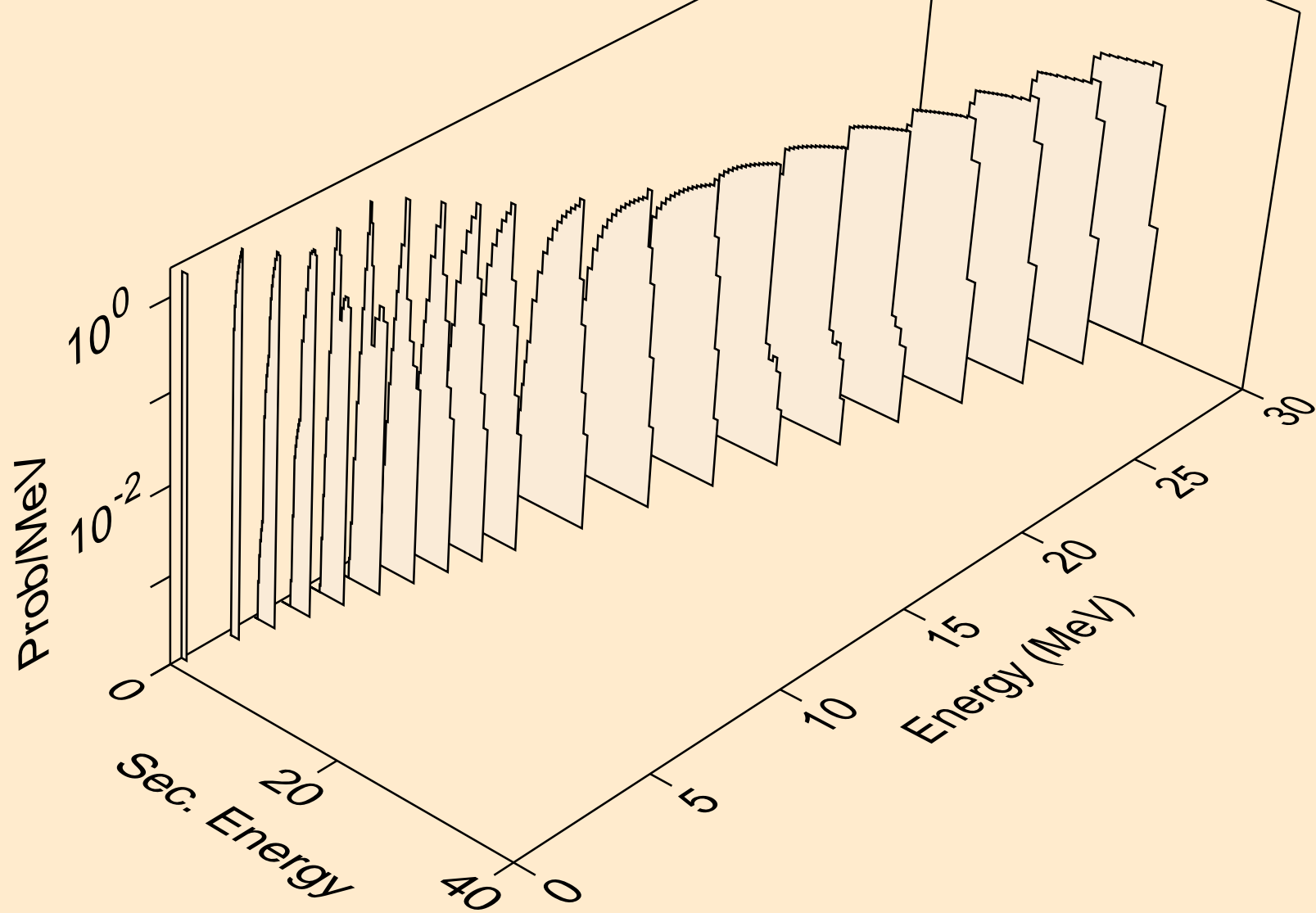

AS080 DEUTERON ACER TENDL-2023 LIBRARY; T=0.K  
tritons from (d,pt)

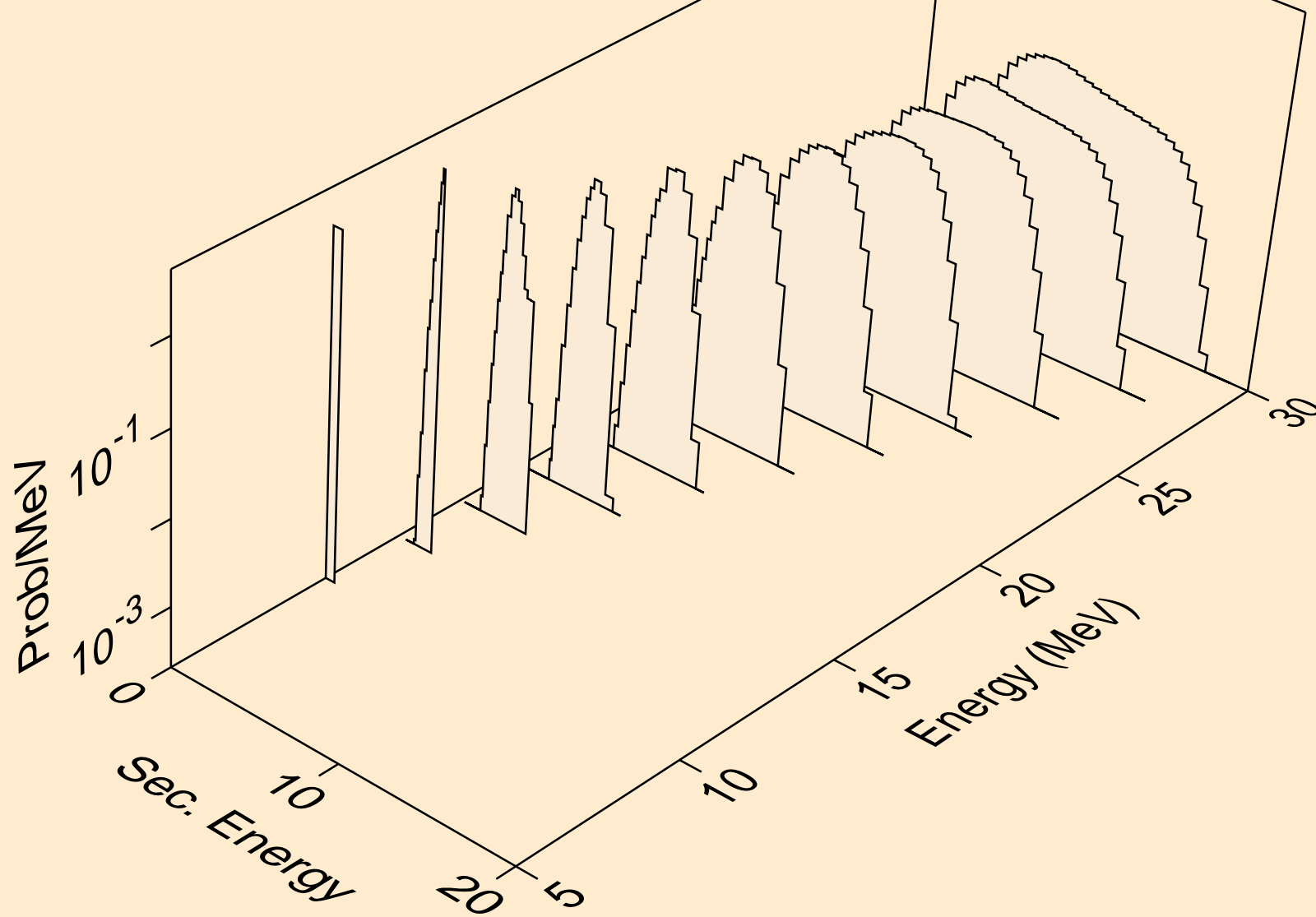

AS080 DEUTERON ACER TENDL-2023 LIBRARY; T=0.K  
he3s from (d,x)

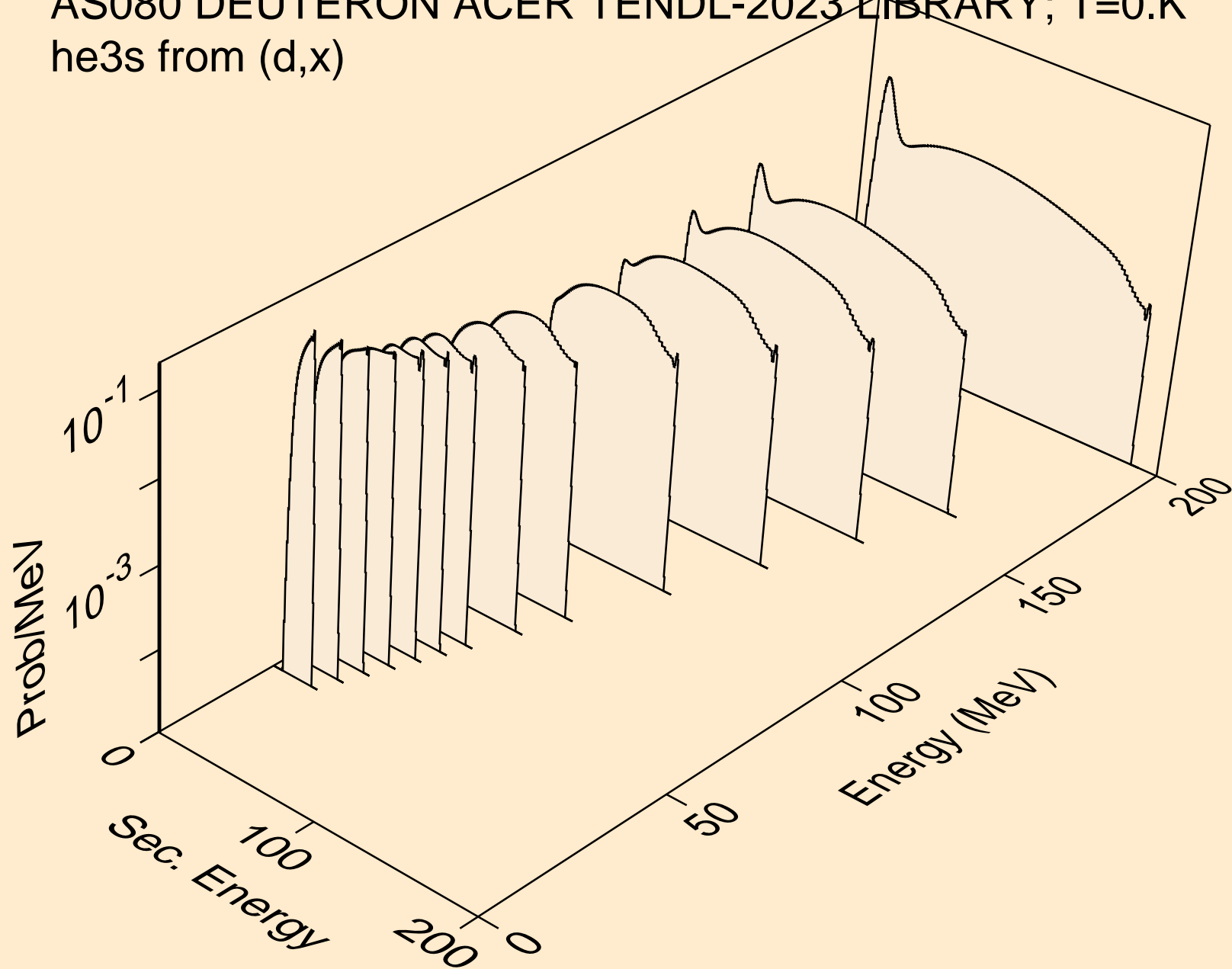

AS080 DEUTERON ACER TENDL-2023 LIBRARY; T=0.K  
he3s from (d,n\*)he3

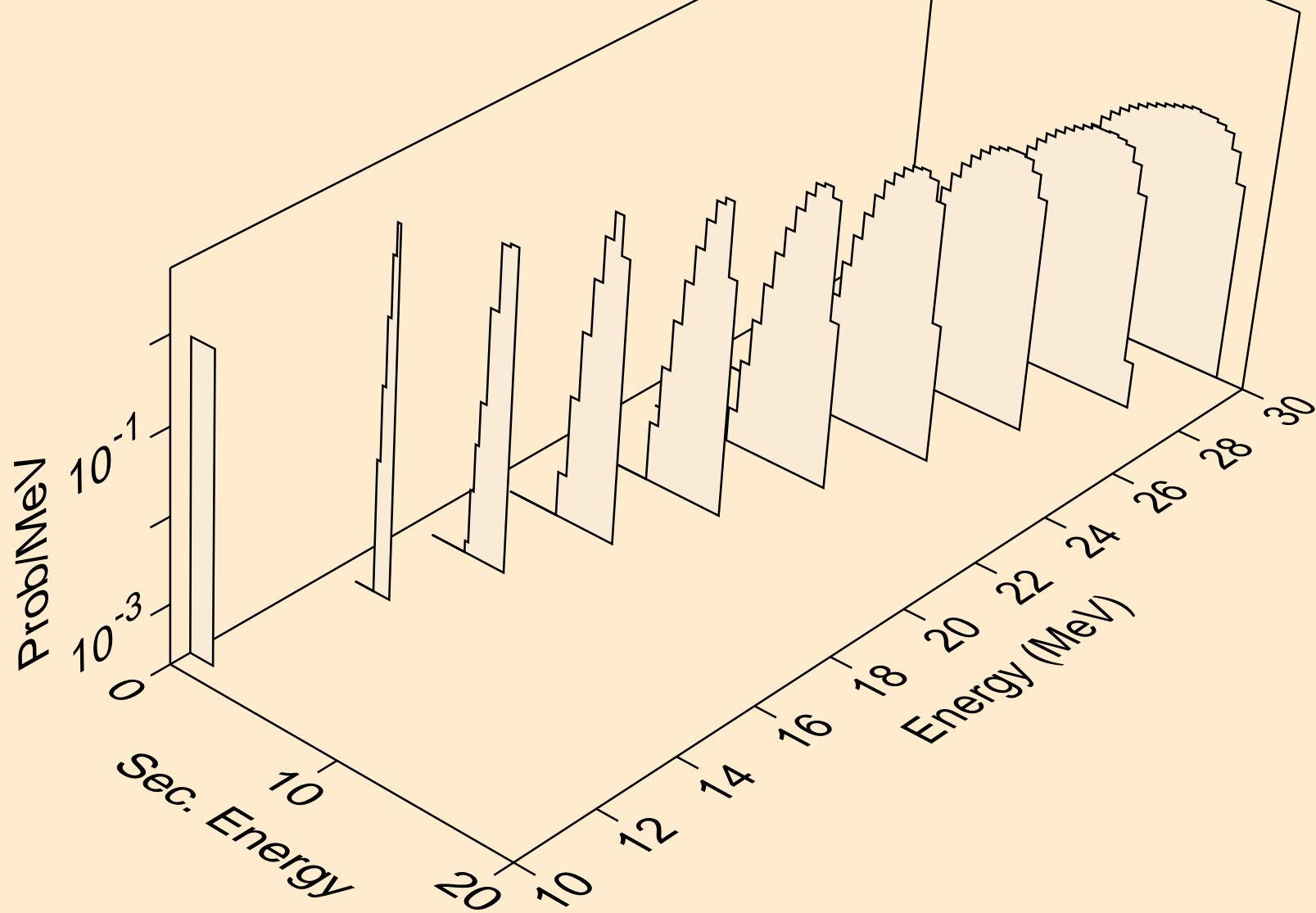

AS080 DEUTERON ACER TENDL-2023 LIBRARY; T=0.K  
he3s from (d,he3)

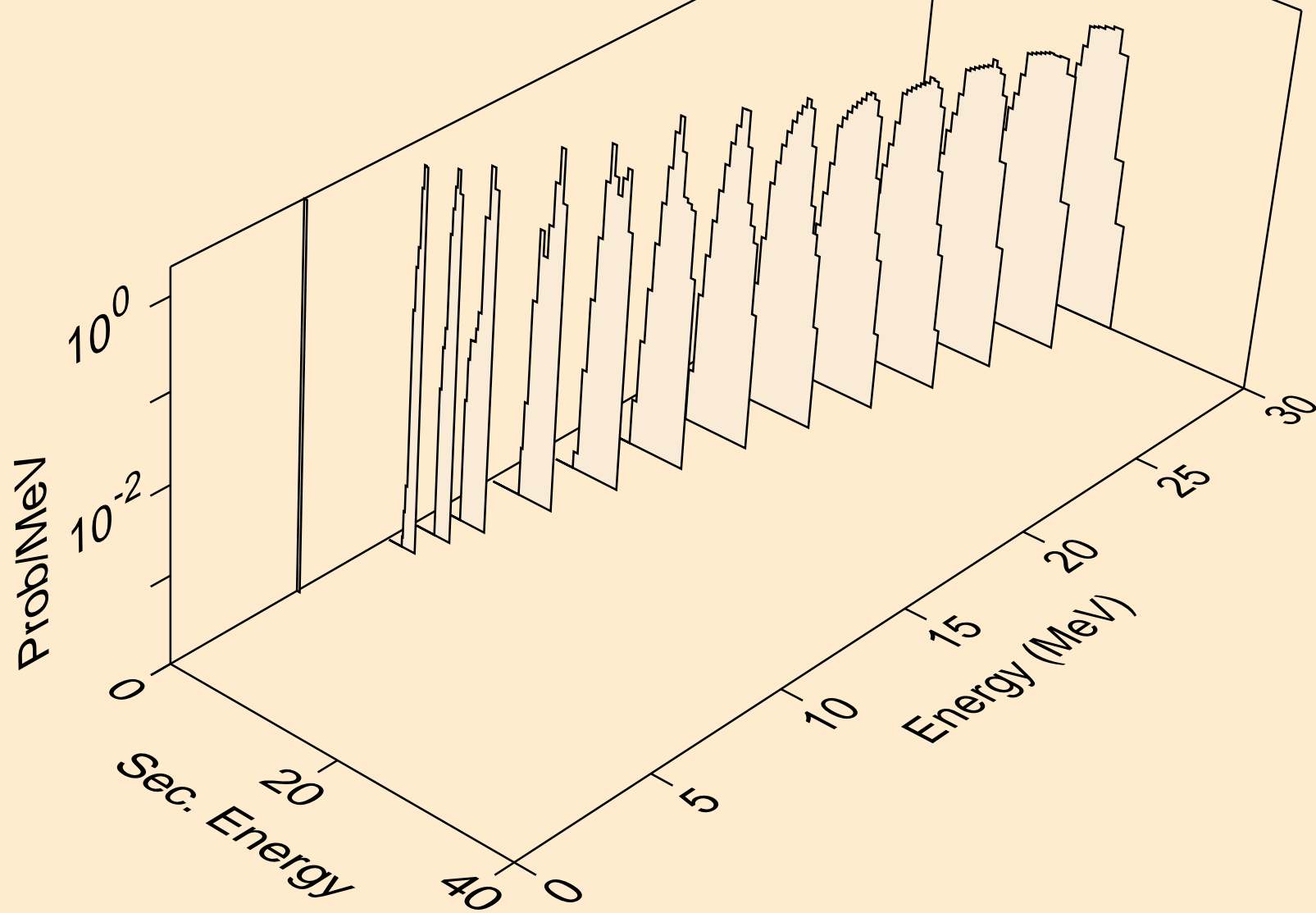

AS080 DEUTERON ACER TENDL-2023 LIBRARY; T=0.K  
alphas from (d,x)

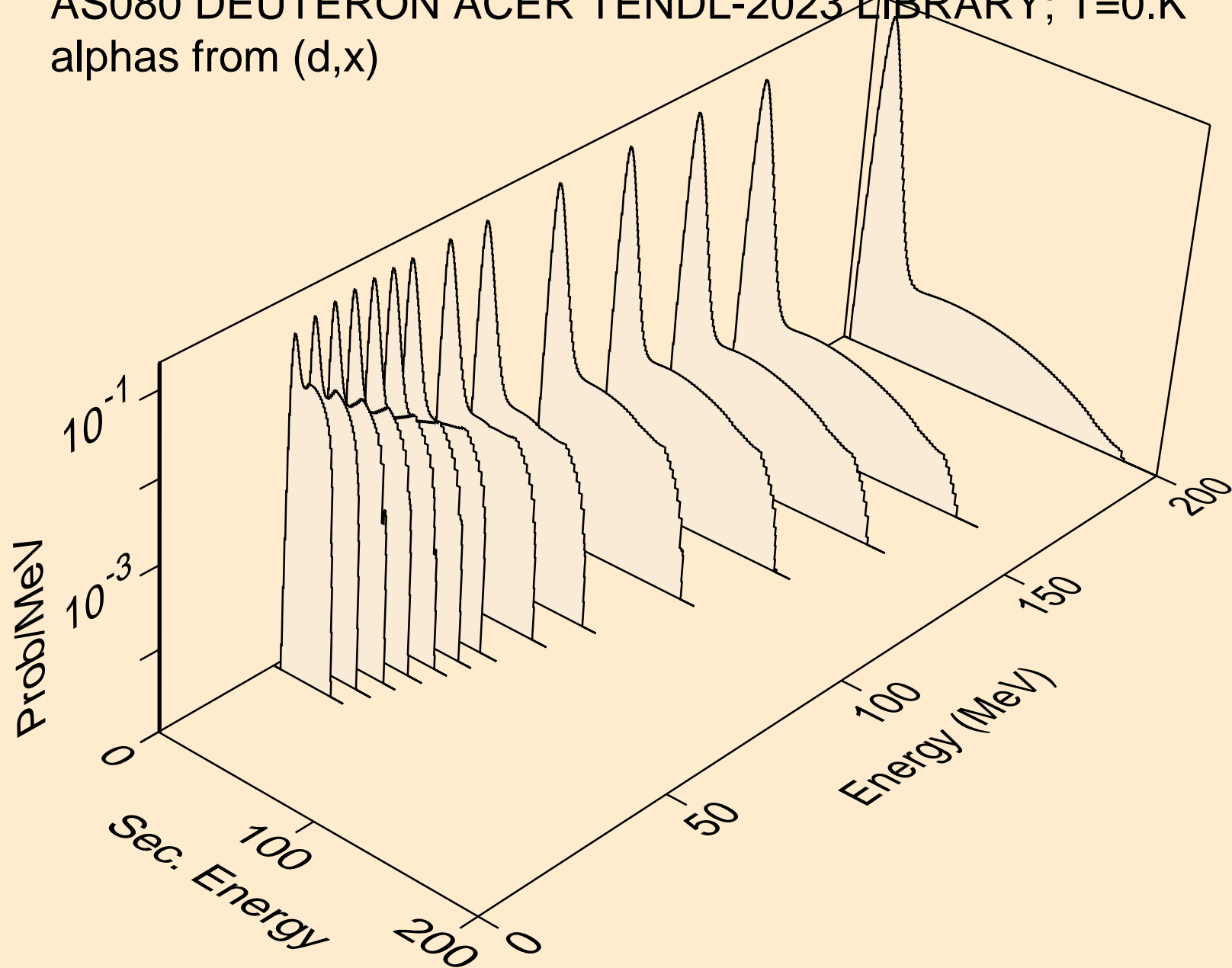

AS080 DEUTERON ACER TENDL-2023 LIBRARY; T=0.K  
alphas from (d,n\*)a

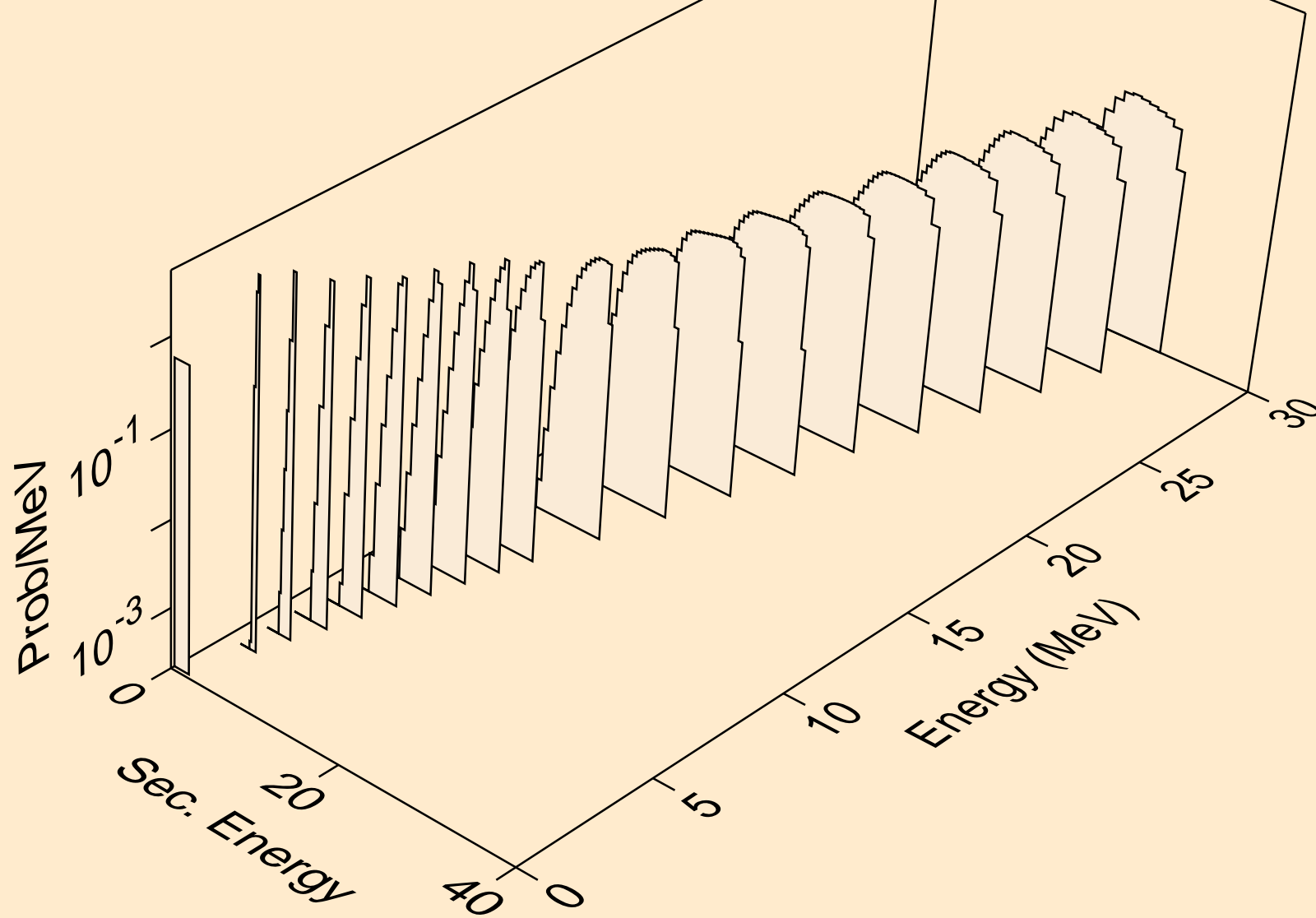



AS080 DEUTERON ACER TENDL-2023 LIBRARY; T=0.K  
alphas from (d,2n)a

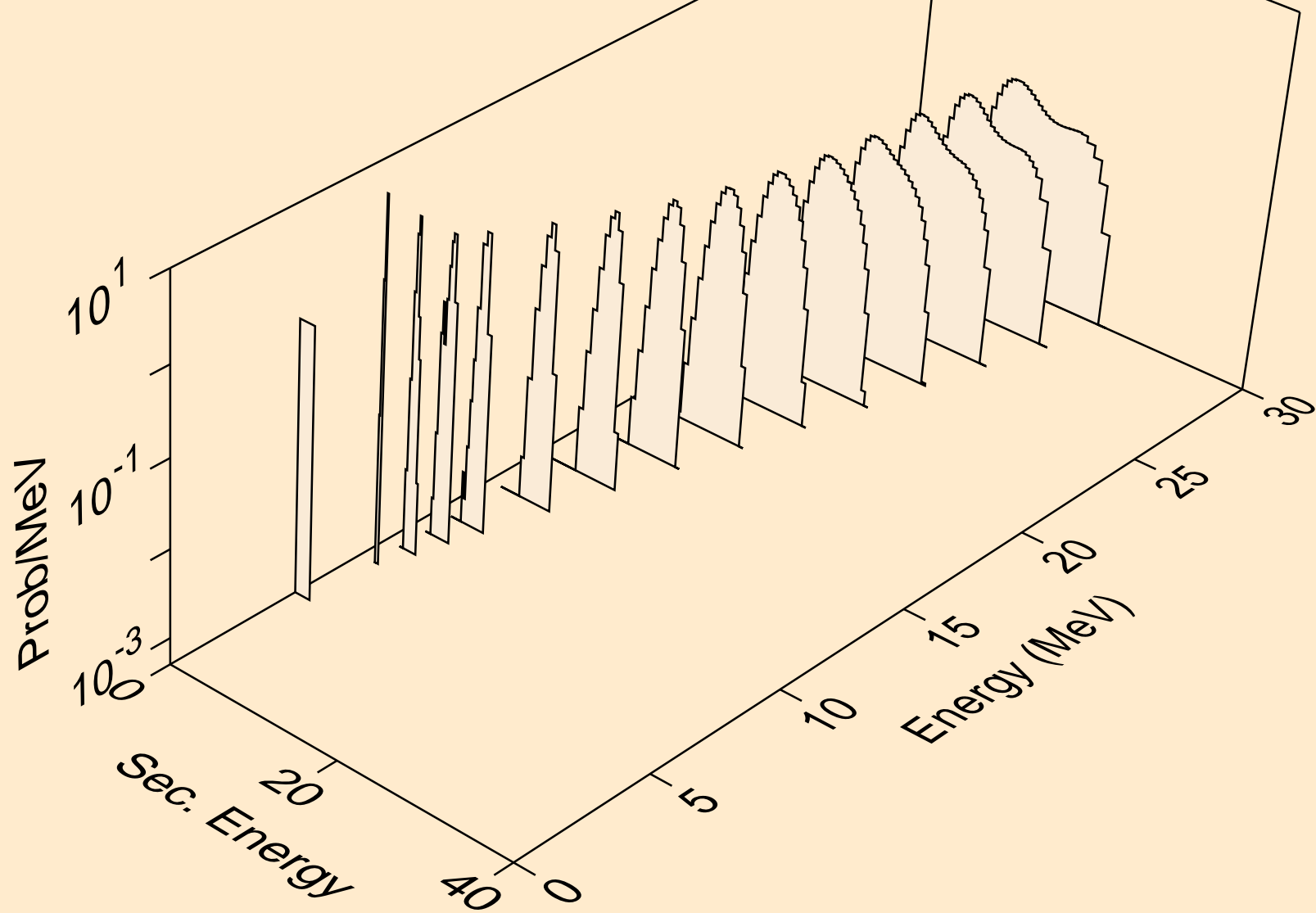

AS080 DEUTERON ACER TENDL-2023 LIBRARY; T=0.K  
alphas from (d,3n)a

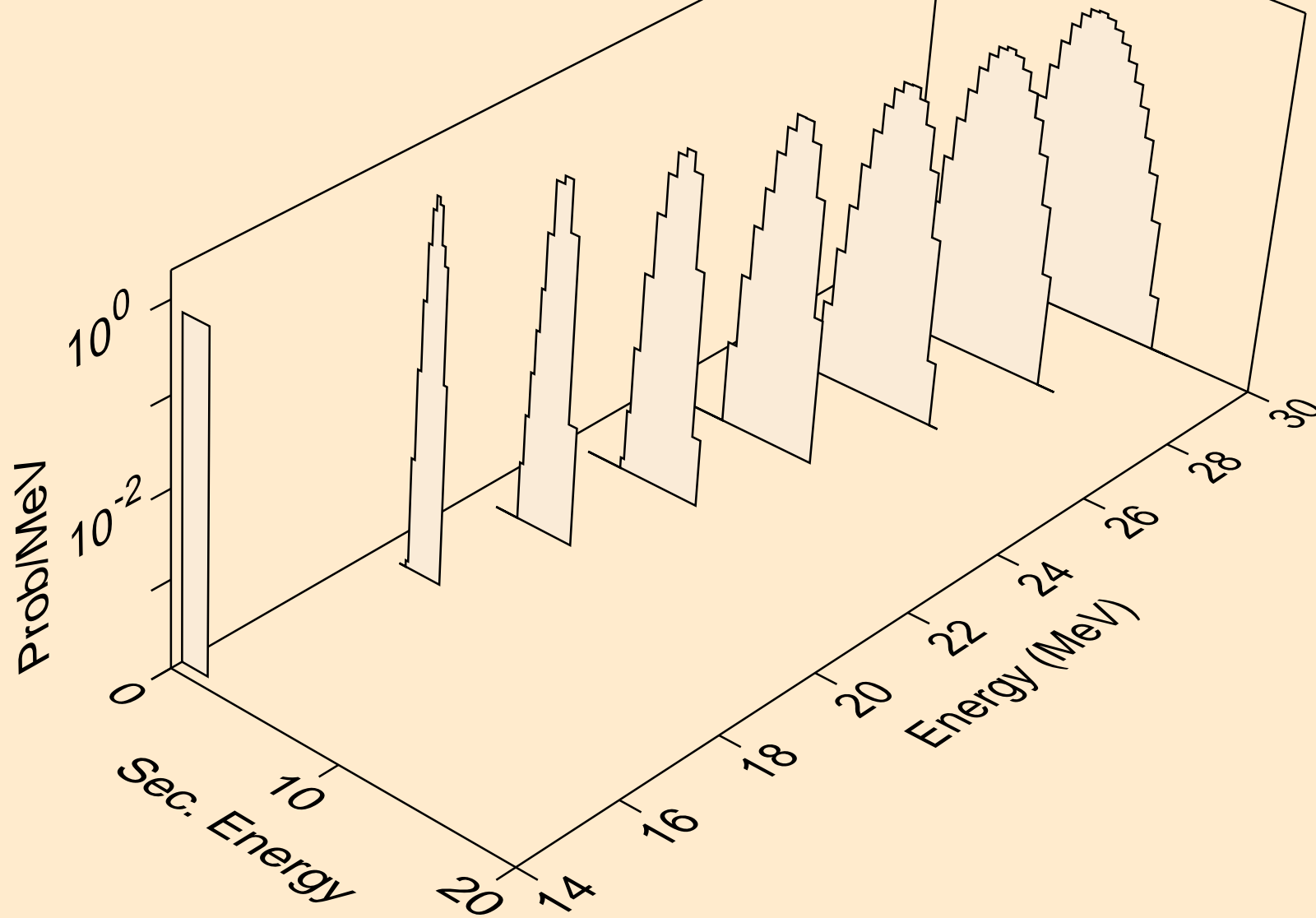

AS080 DEUTERON ACER TENDL-2023 LIBRARY; T=0.K  
alphas from (d,n\*)2a

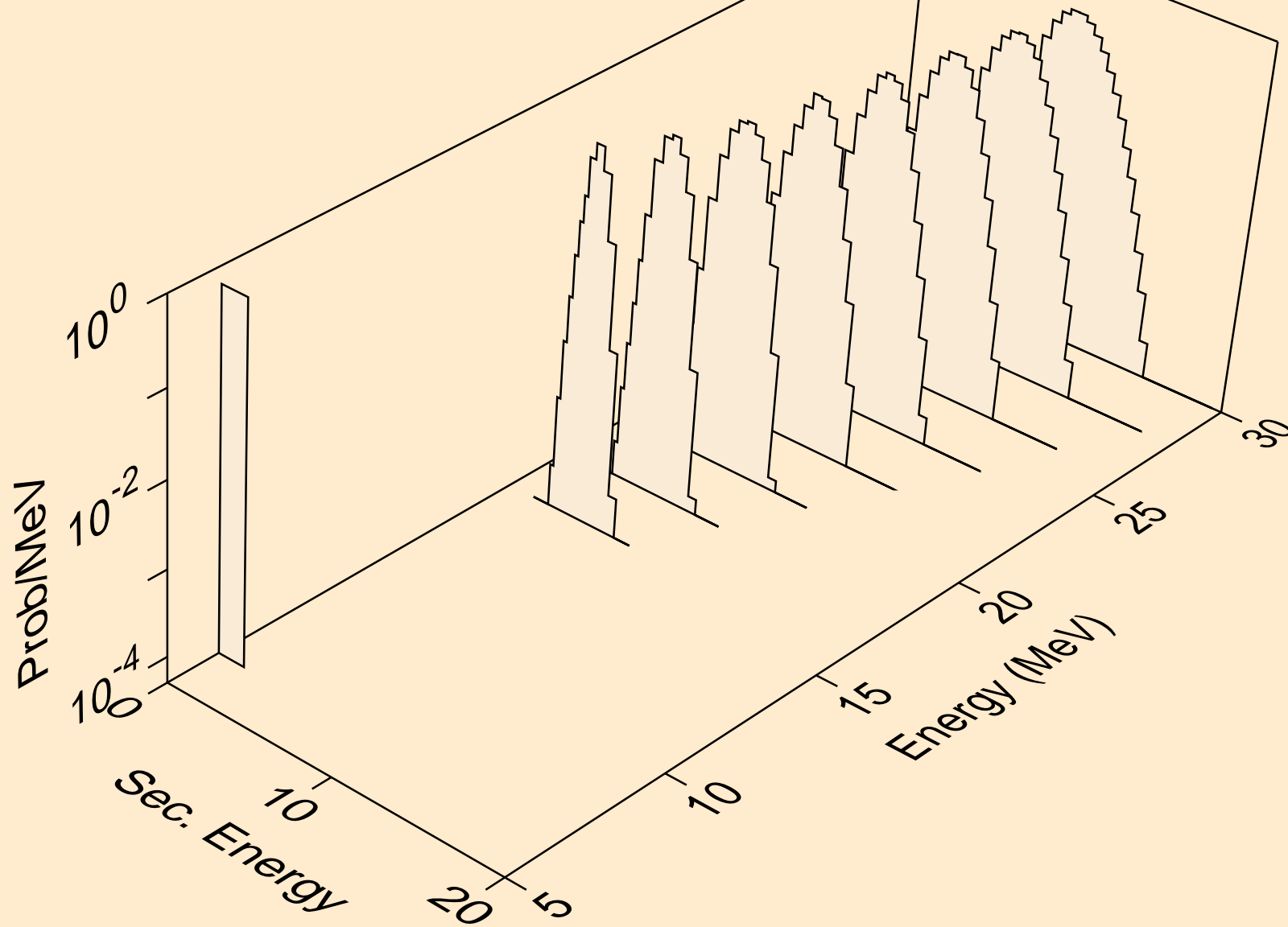

AS080 DEUTERON ACER TENDL-2023 LIBRARY; T=0.K  
alphas from (d,2n)2a

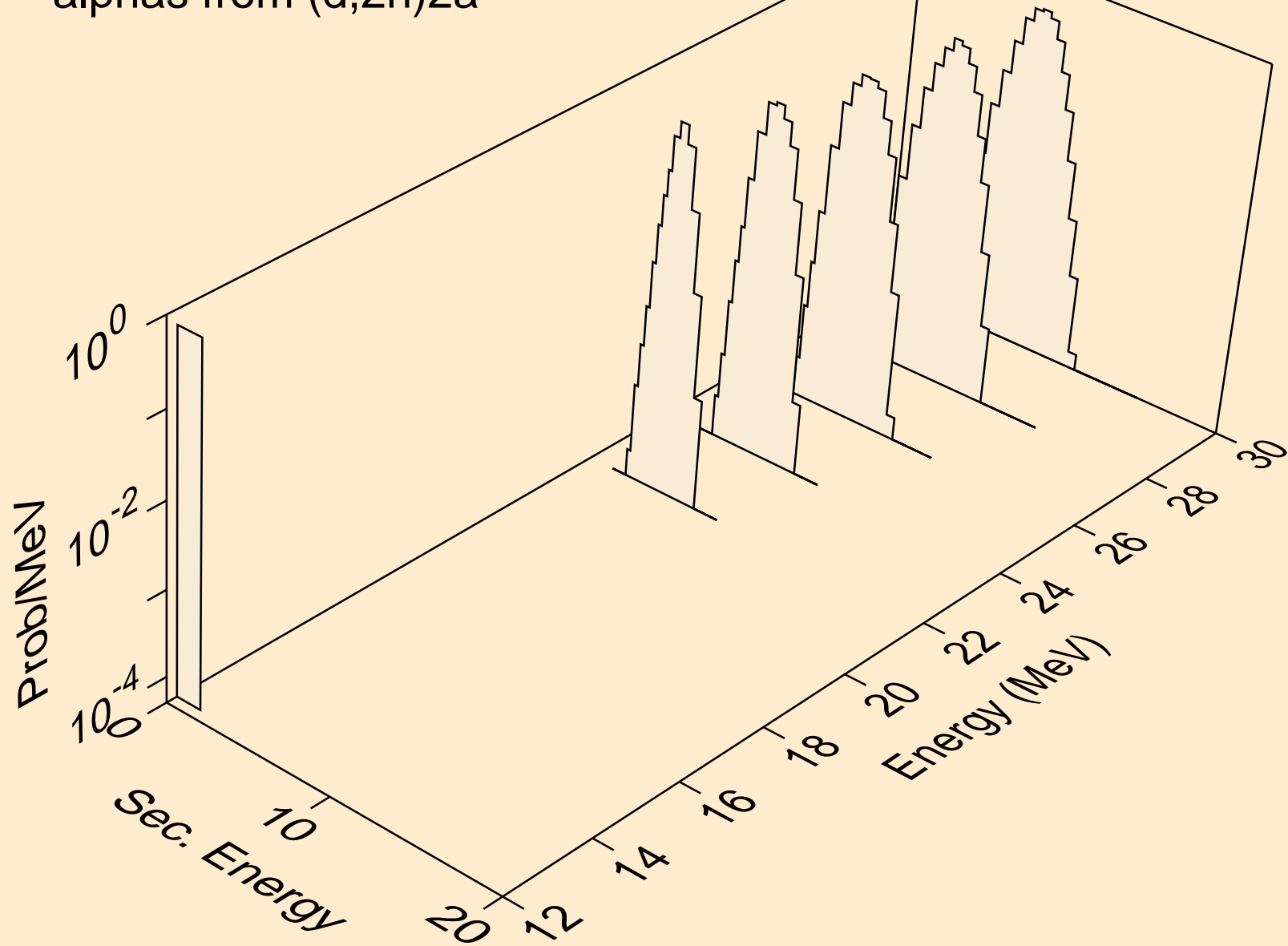

AS080 DEUTERON ACER TENDL-2023 LIBRARY; T=0.K  
alphas from (d,npa)

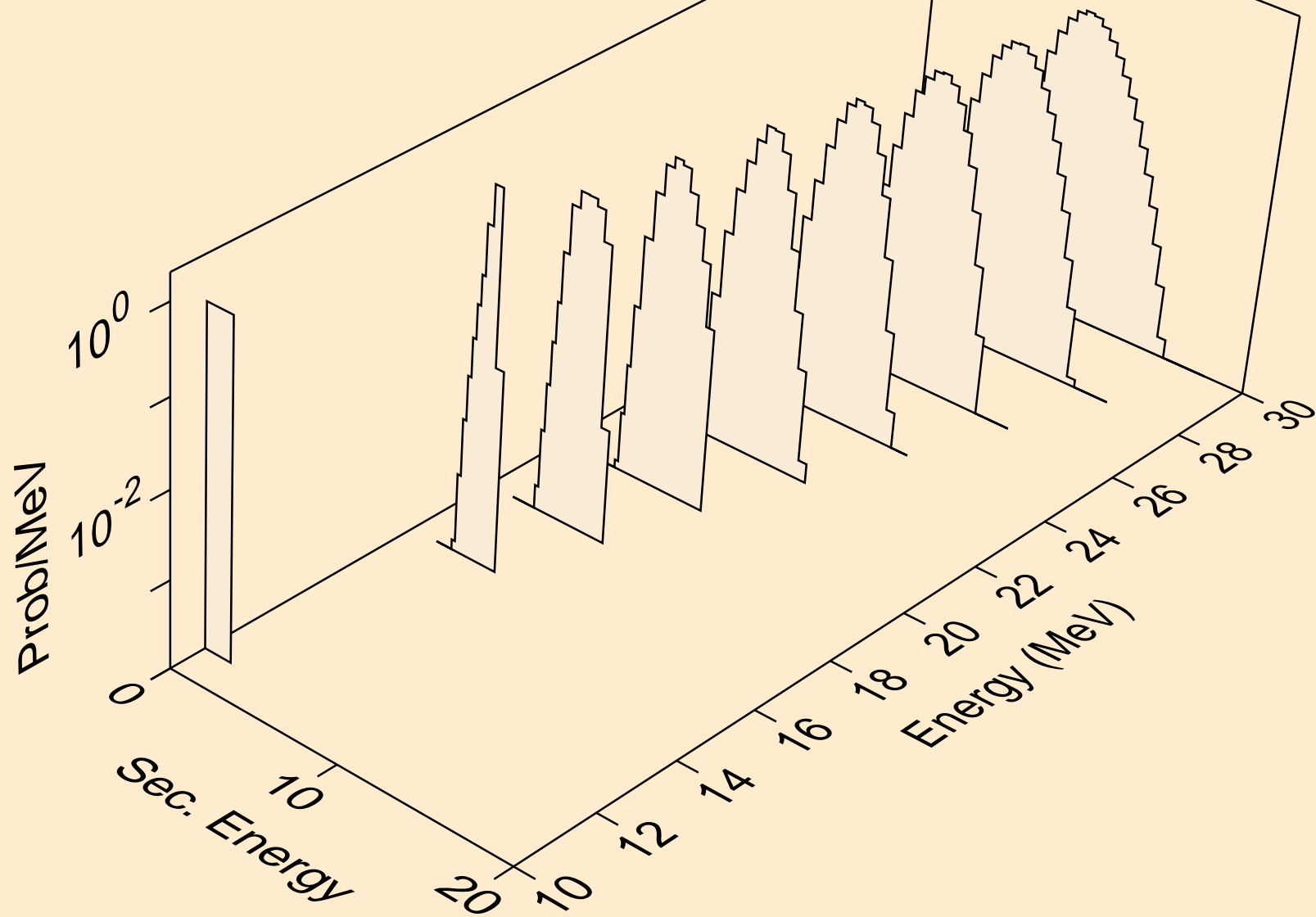

AS080 DEUTERON ACER TENDL-2023 LIBRARY; T=0.K  
alphas from (d,a)

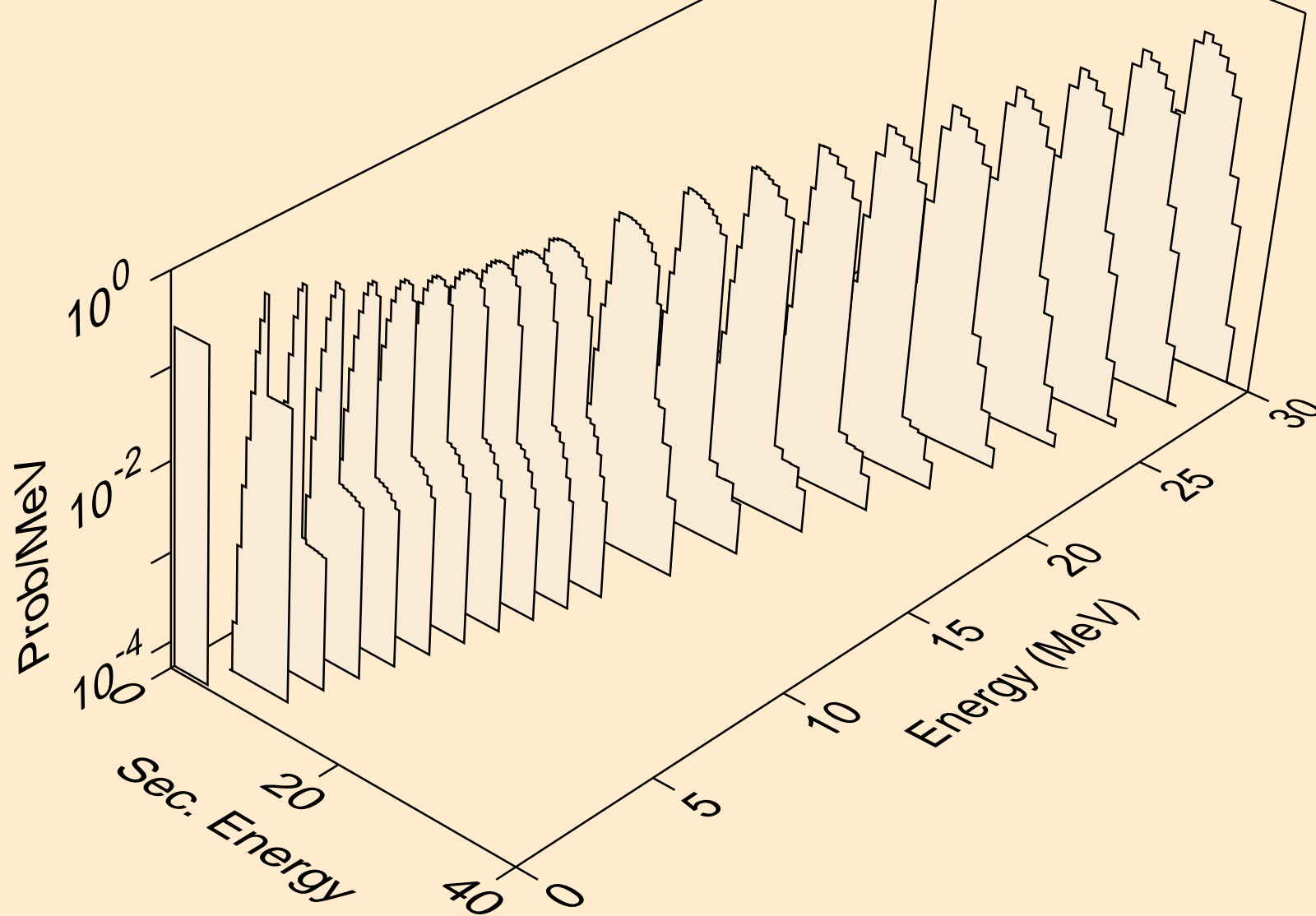

AS080 DEUTERON ACER TENDL-2023 LIBRARY; T=0.K  
alphas from (d,2a)

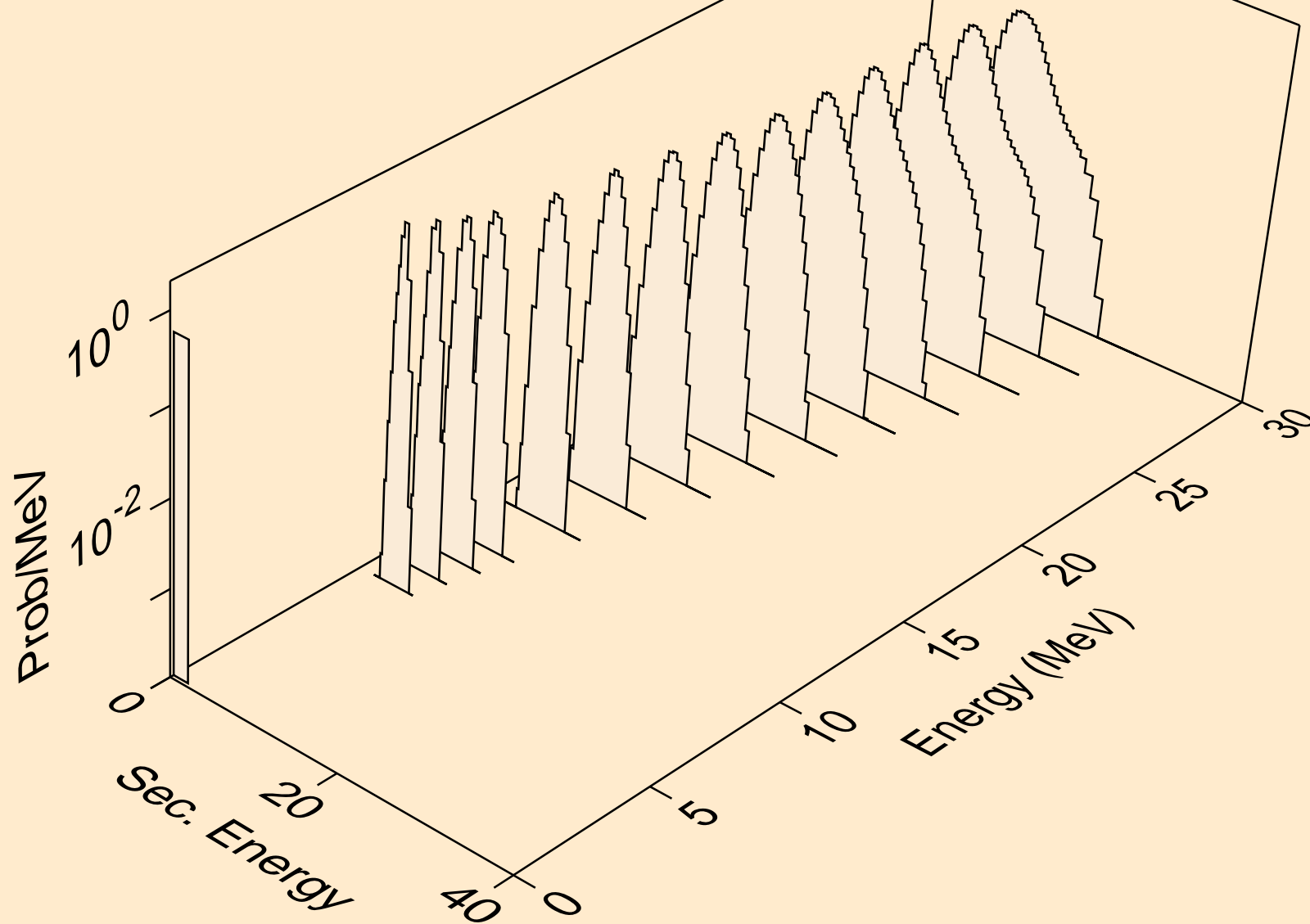

AS080 DEUTERON ACER TENDL-2023 LIBRARY; T=0.K  
alphas from (d,pa)

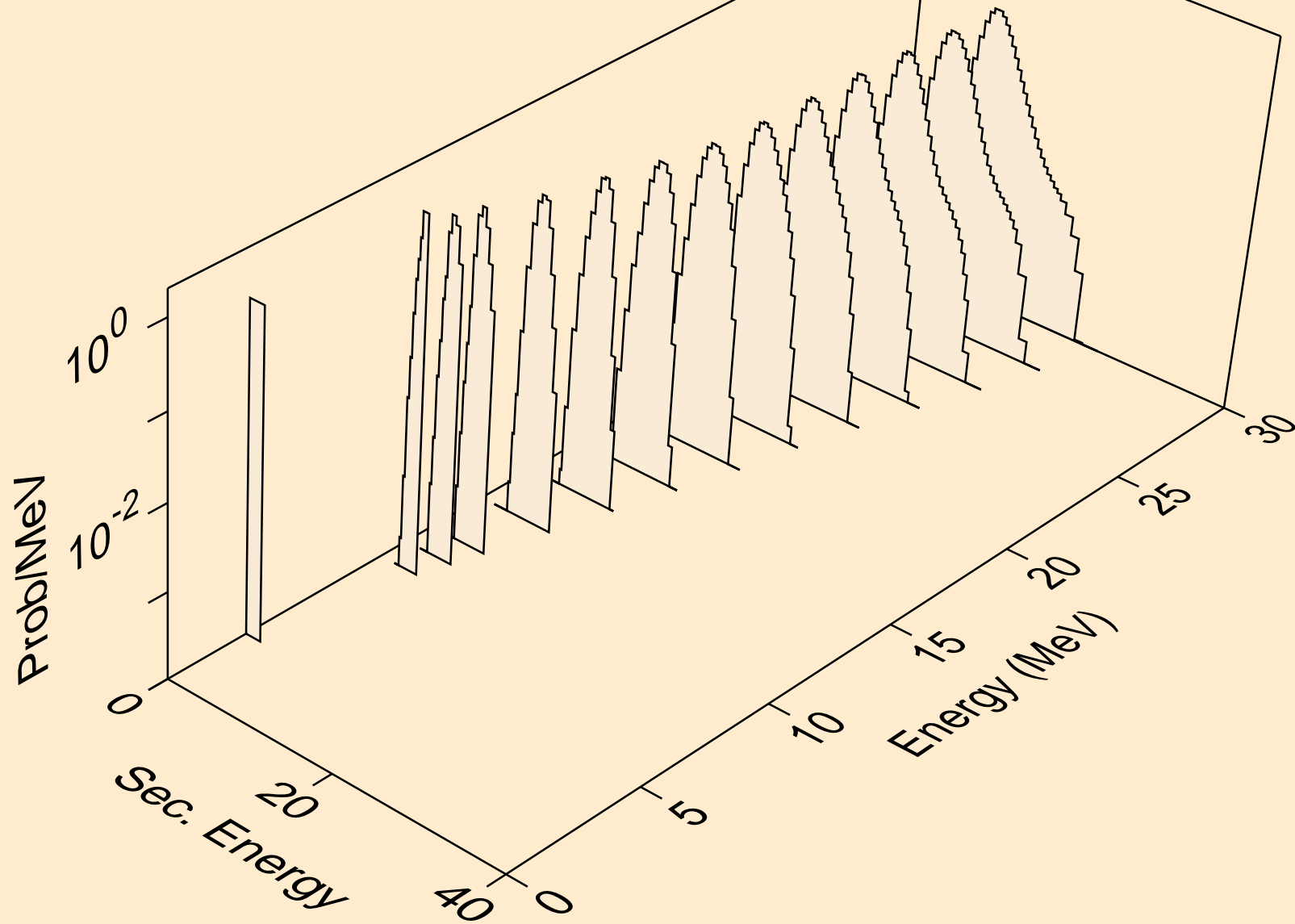



AS080 DEUTERON ACER TENDL-2023 LIBRARY; T=0.K  
alphas from (d,da)

