

AS081 DEUTERON ACER TENDL-2023 LIBRARY; T=0.K  
Principal cross sections

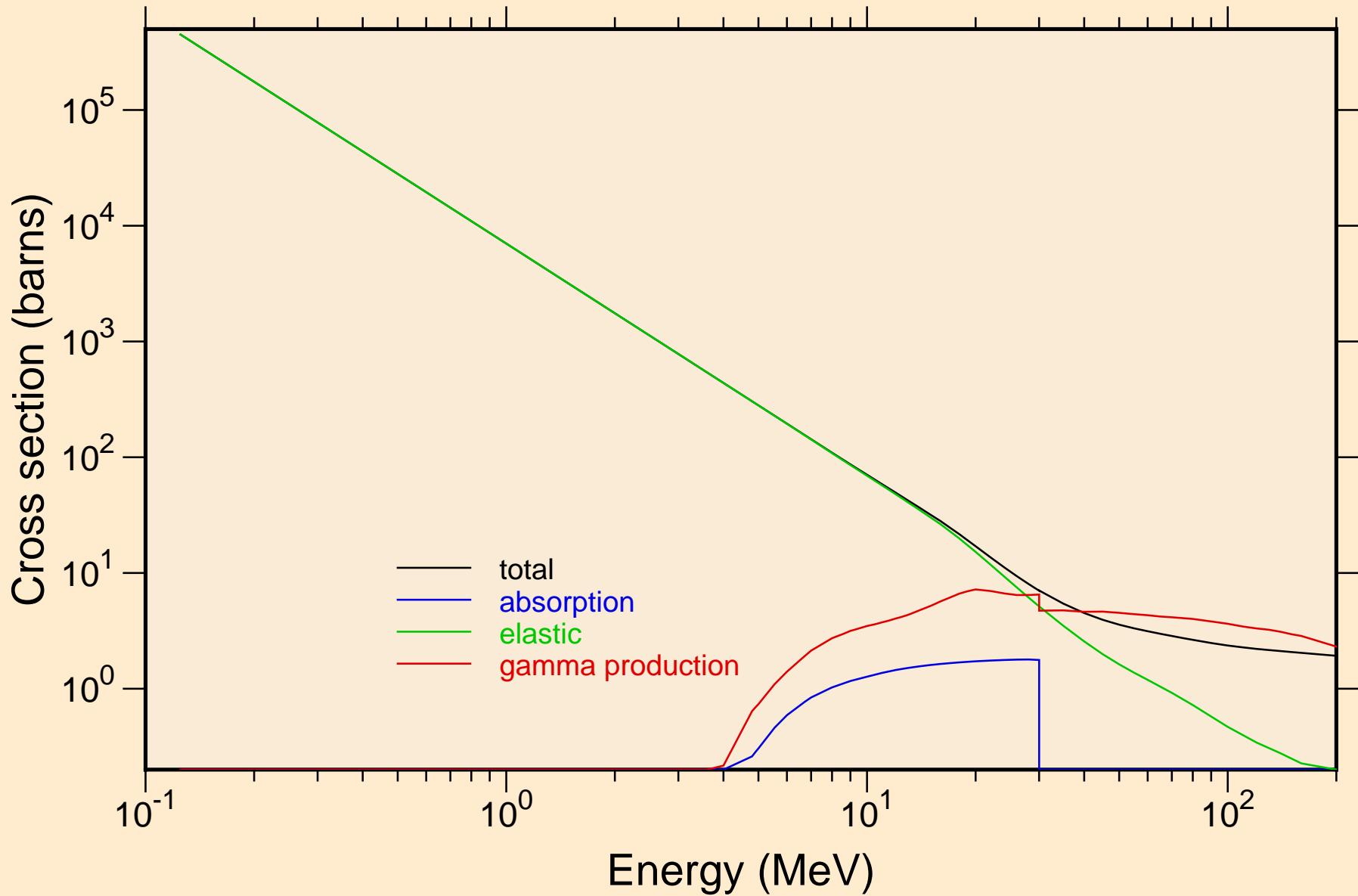

# AS081 DEUTERON ACER TENDL-2023 LIBRARY; T=0.K

## Heating

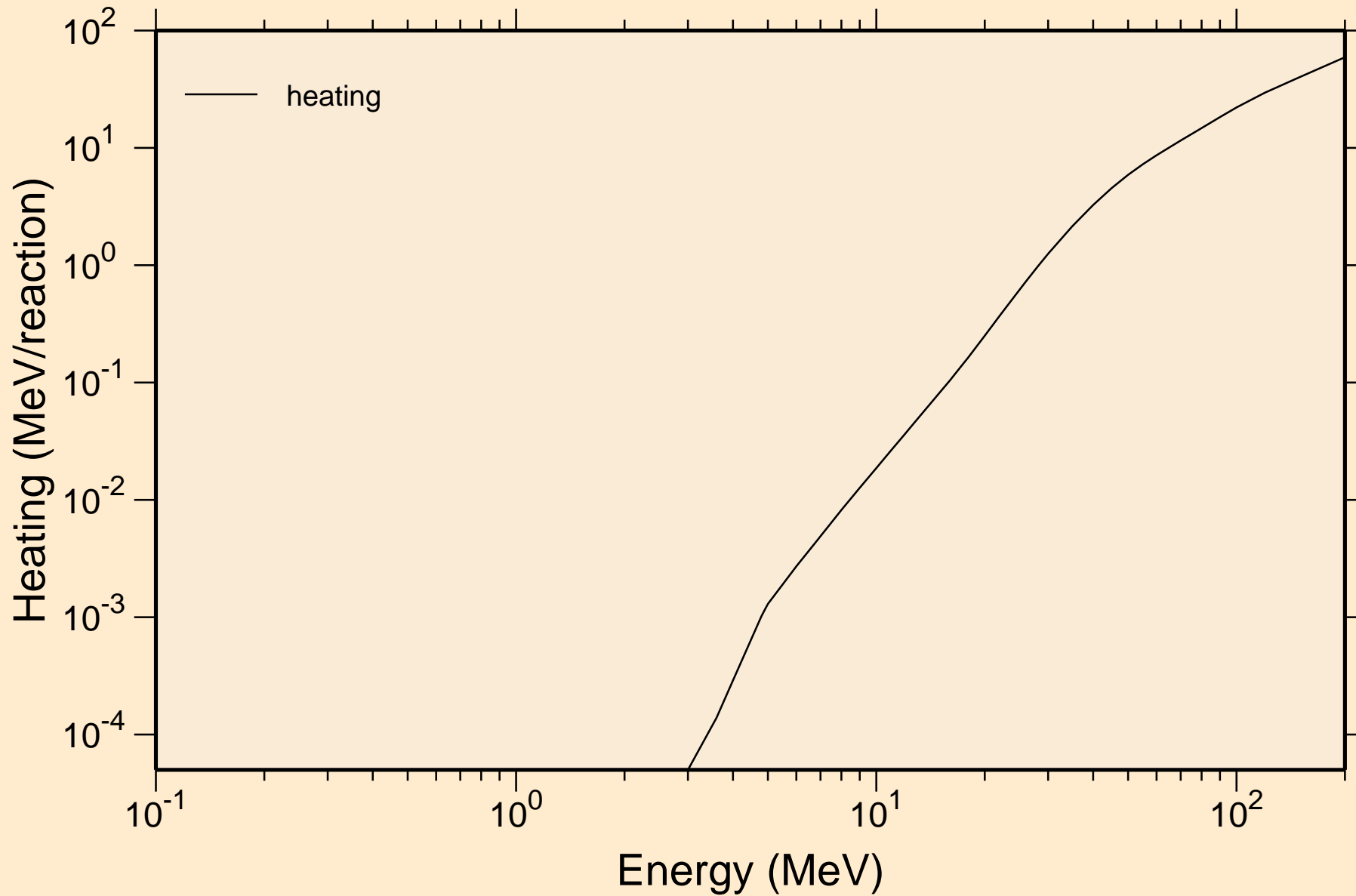

AS081 DEUTERON ACER TENDL-2023 LIBRARY; T=0.K  
Principal cross sections

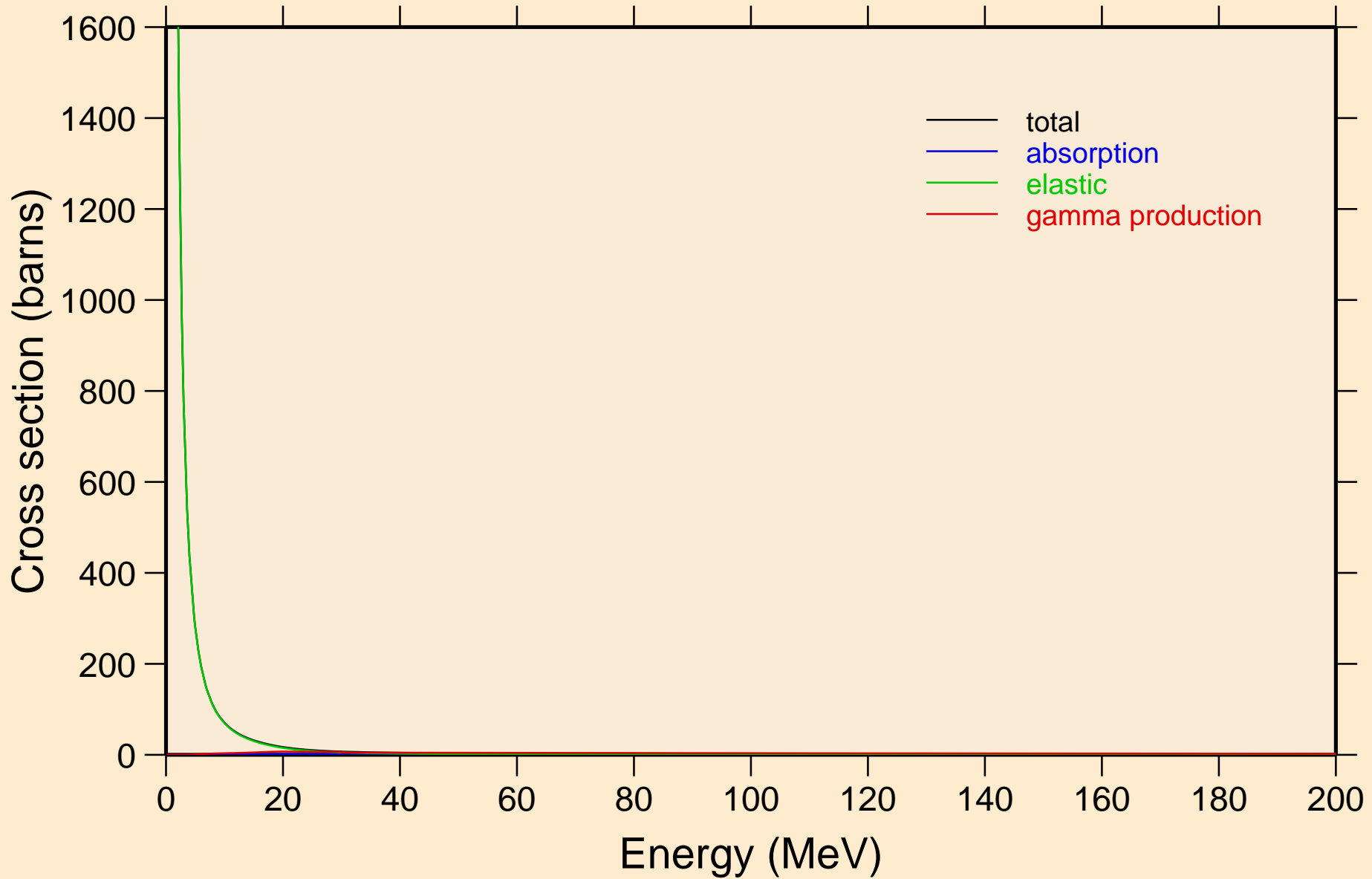

# AS081 DEUTERON ACER TENDL-2023 LIBRARY; T=0.K

## Heating

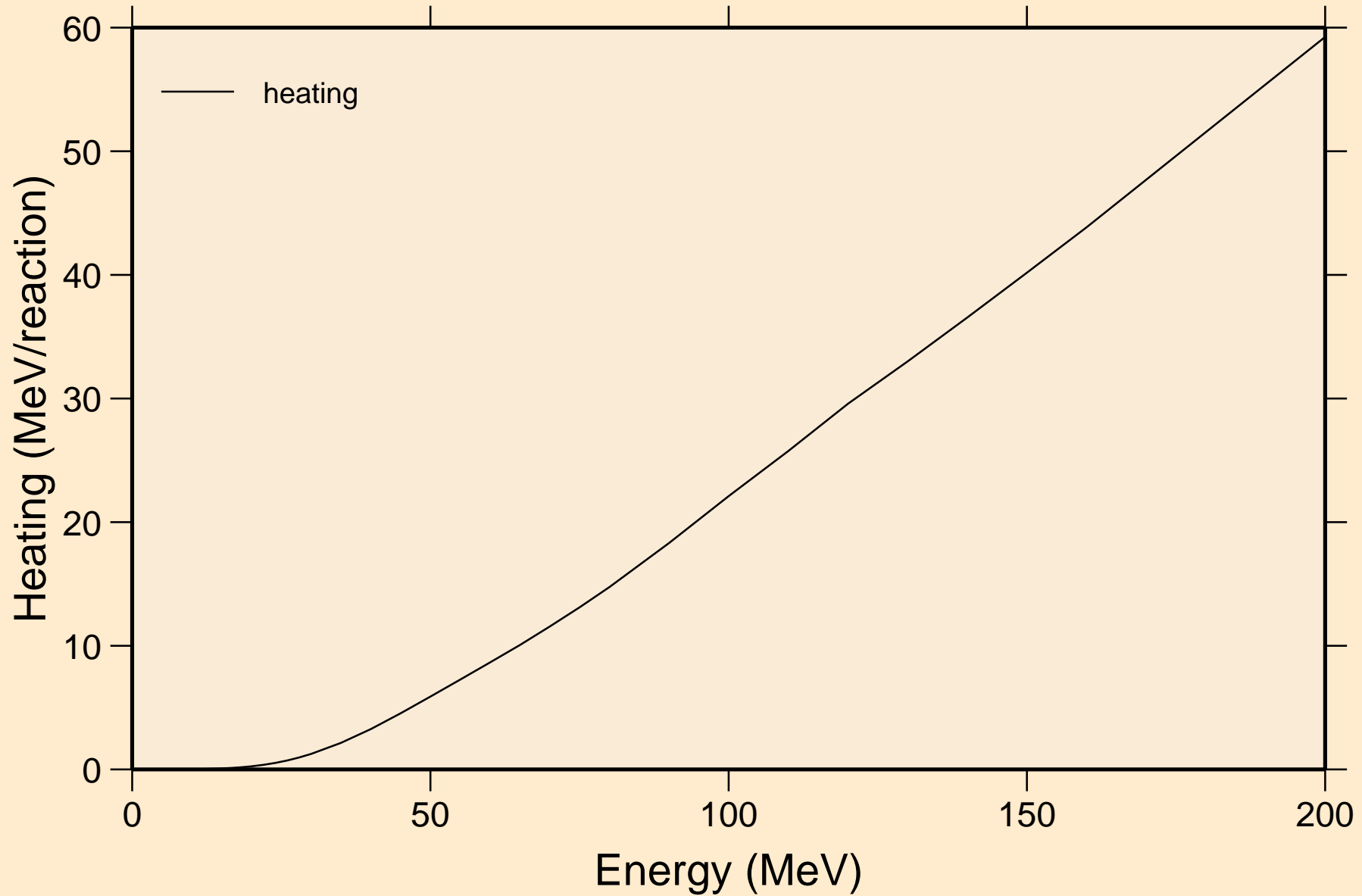

# AS081 DEUTERON ACER TENDL-2023 LIBRARY; T=0.K

## Threshold reactions

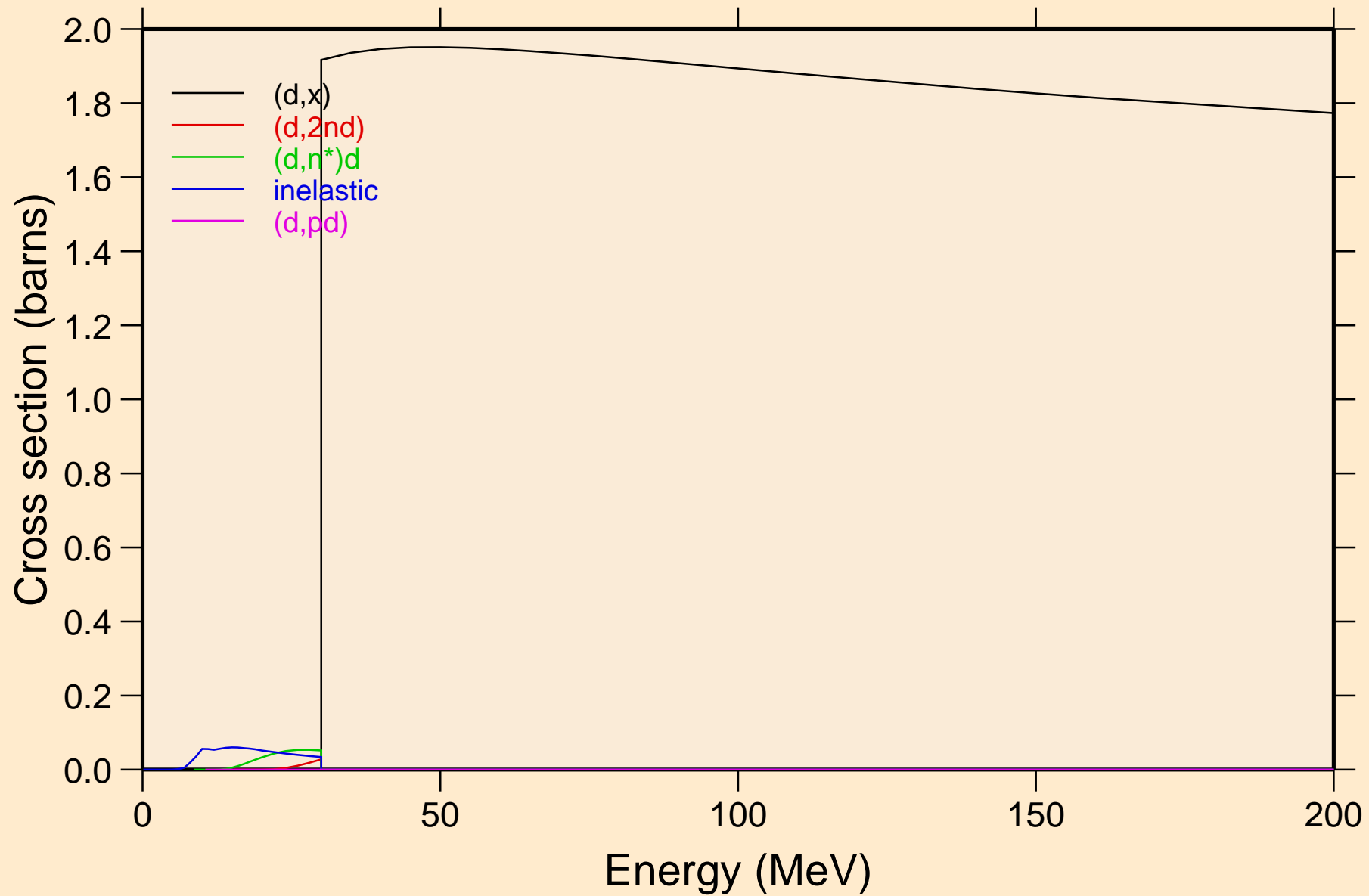

AS081 DEUTERON ACER TENDL-2023 LIBRARY; T=0.K  
Threshold reactions

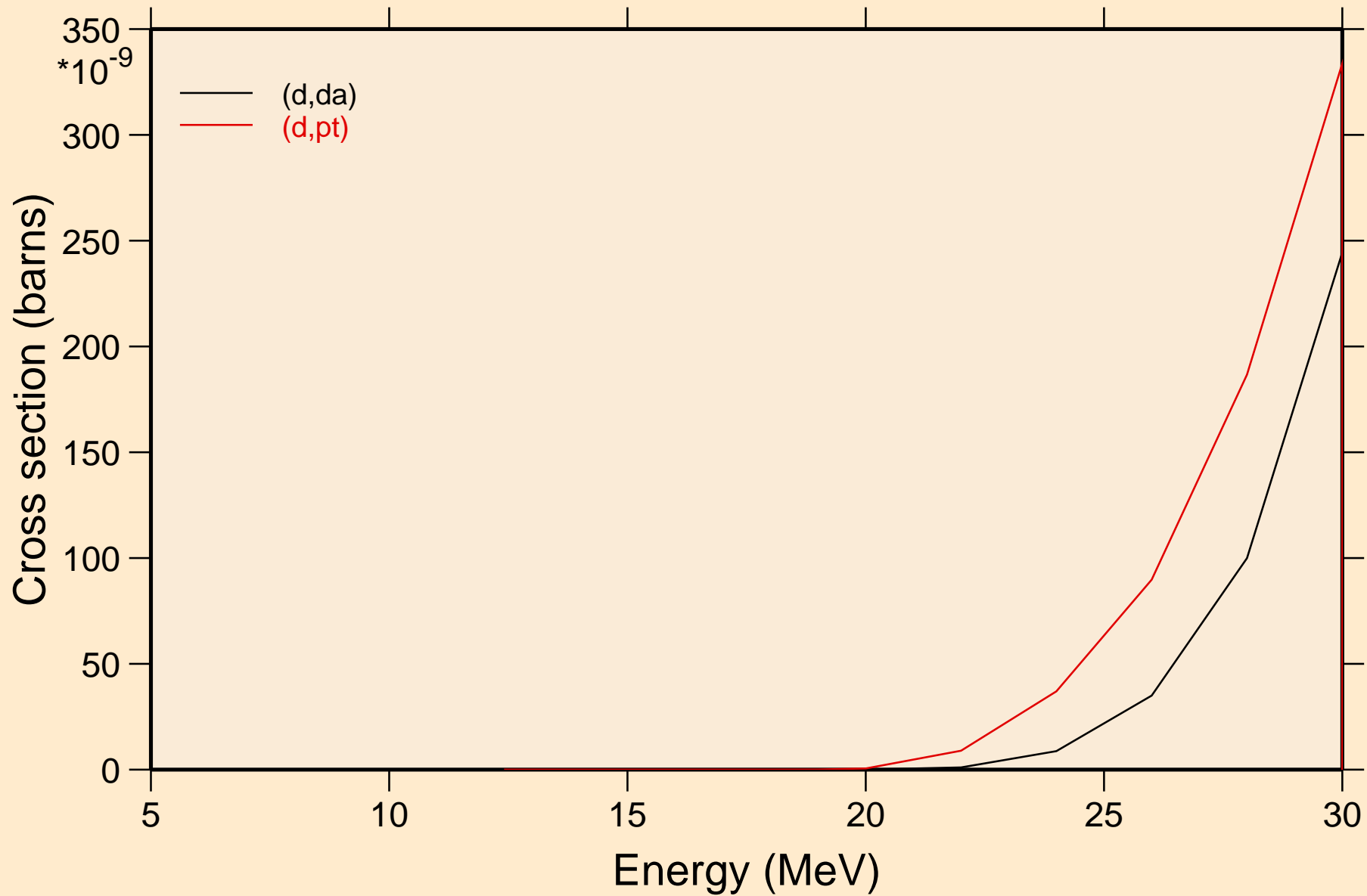

AS081 DEUTERON ACER TENDL-2023 LIBRARY; T=0.K  
Threshold reactions

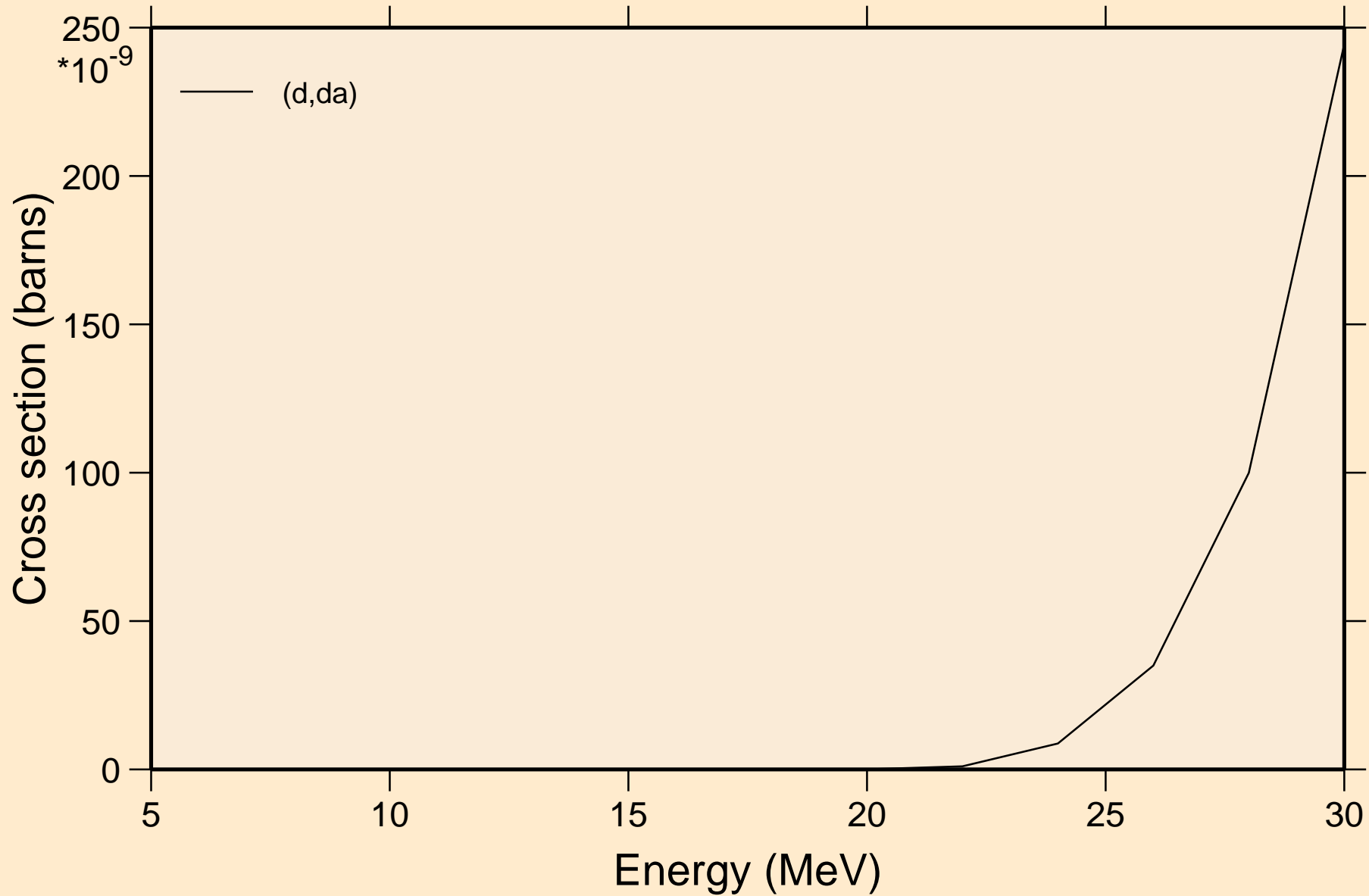

AS081 DEUTERON ACER TENDL-2023 LIBRARY; T=0.K  
angular distribution for elastic

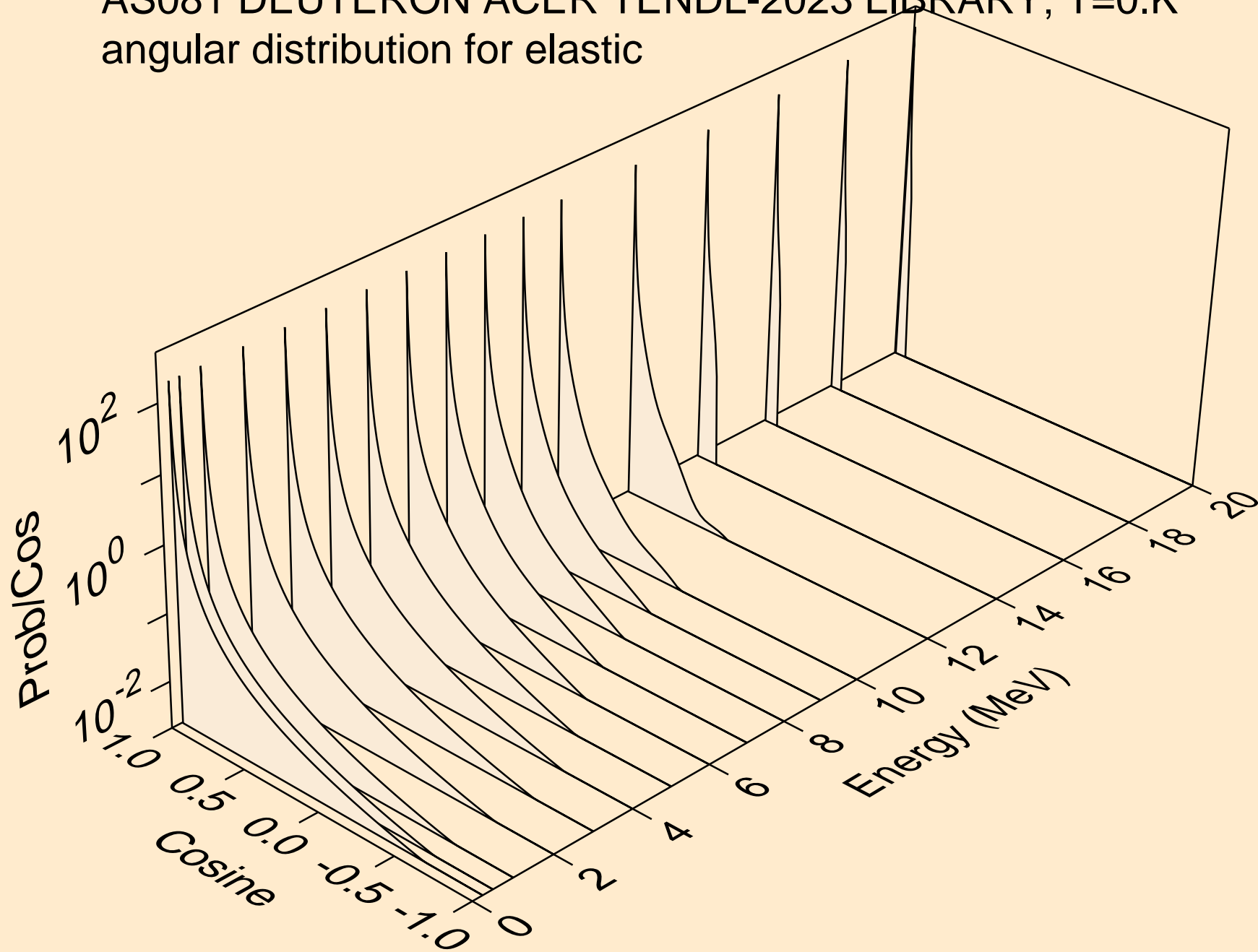



AS081 DEUTERON ACER TENDL-2023 LIBRARY; T=0.K  
angular distribution for elastic

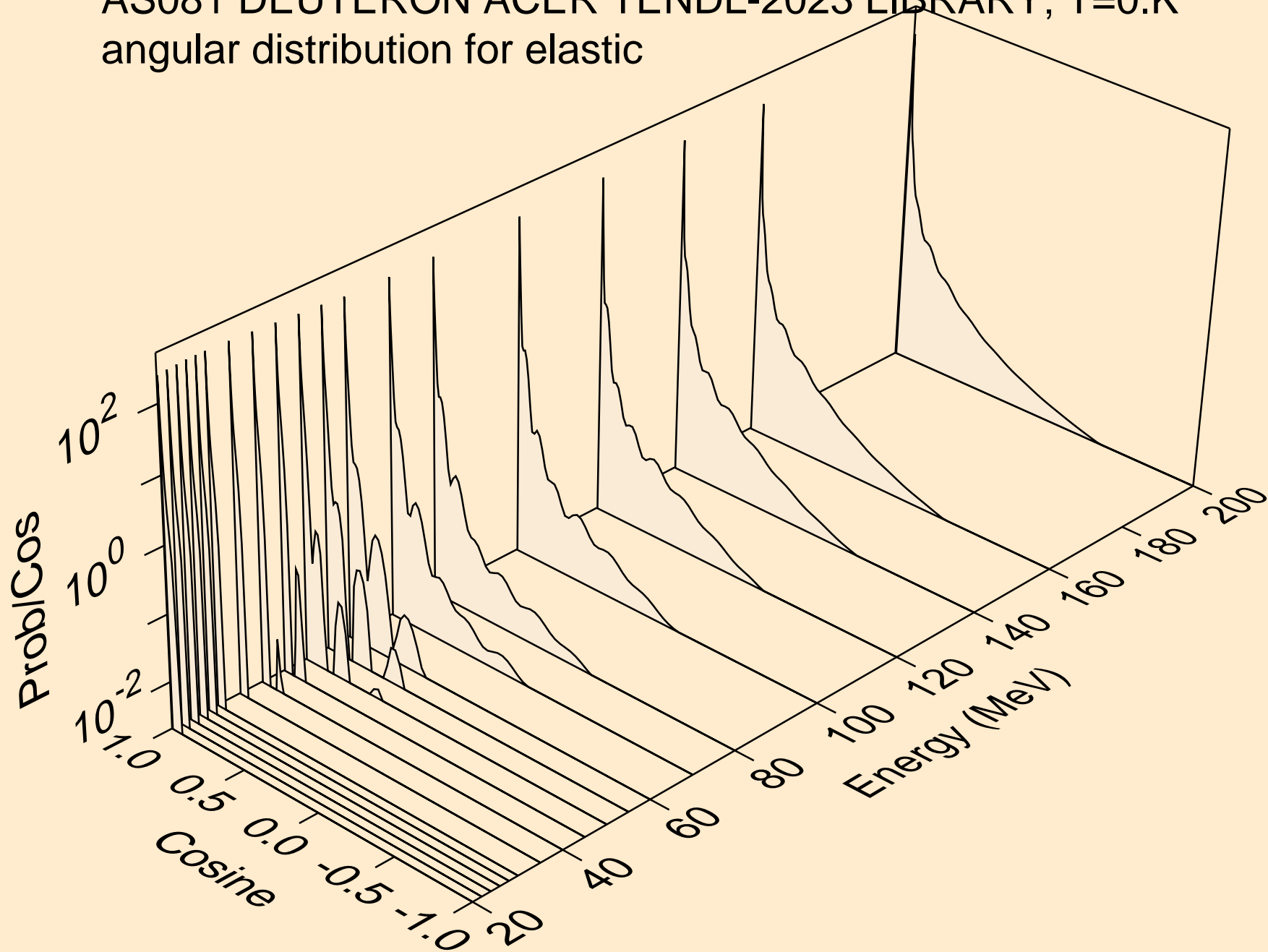

AS081 DEUTERON ACER TENDL-2023 LIBRARY; T=0.K  
Deuteron emission for (d,x)

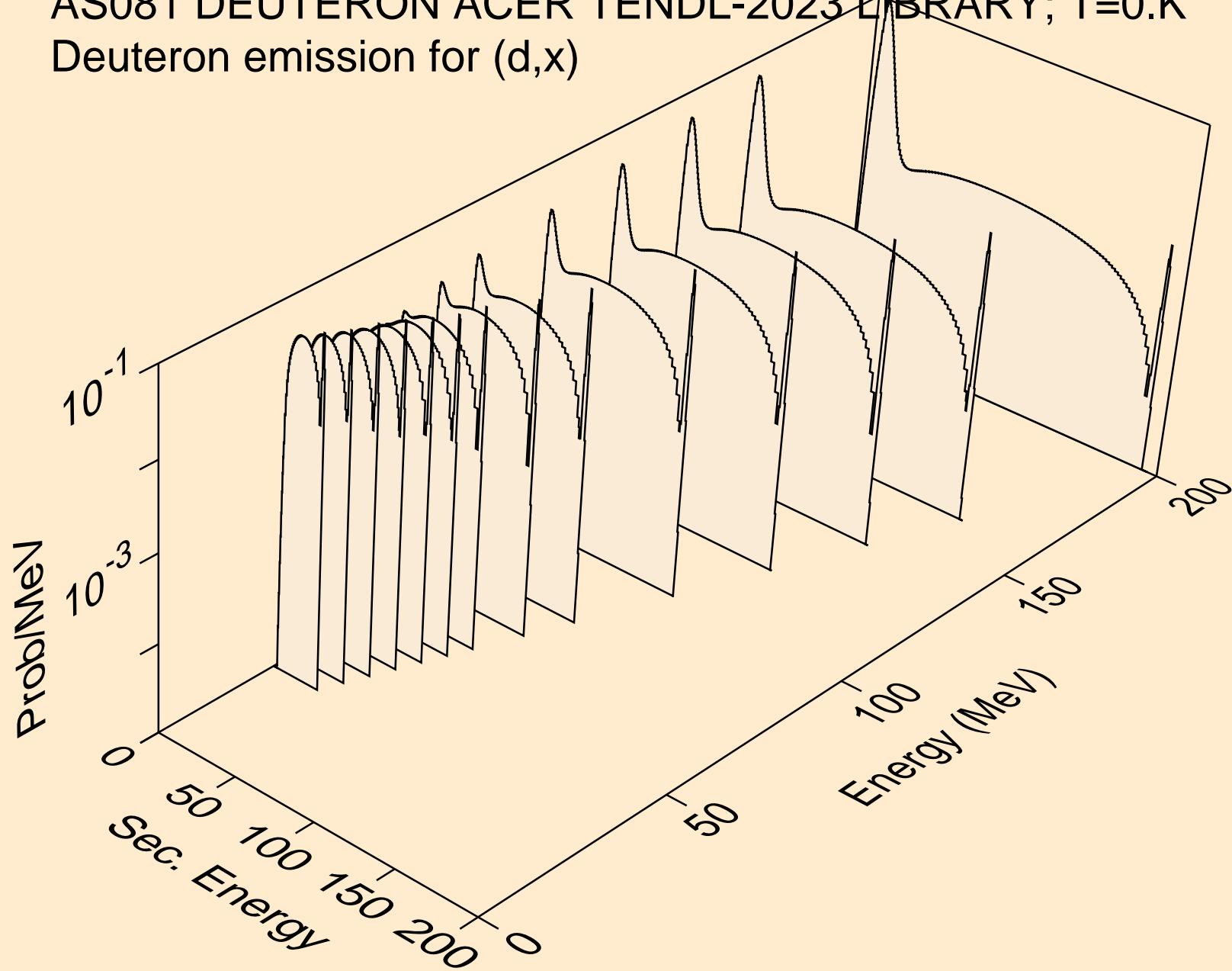

AS081 DEUTERON ACER TENDL-2023 LIBRARY; T=0.K  
Deuteron emission for (d,2nd)

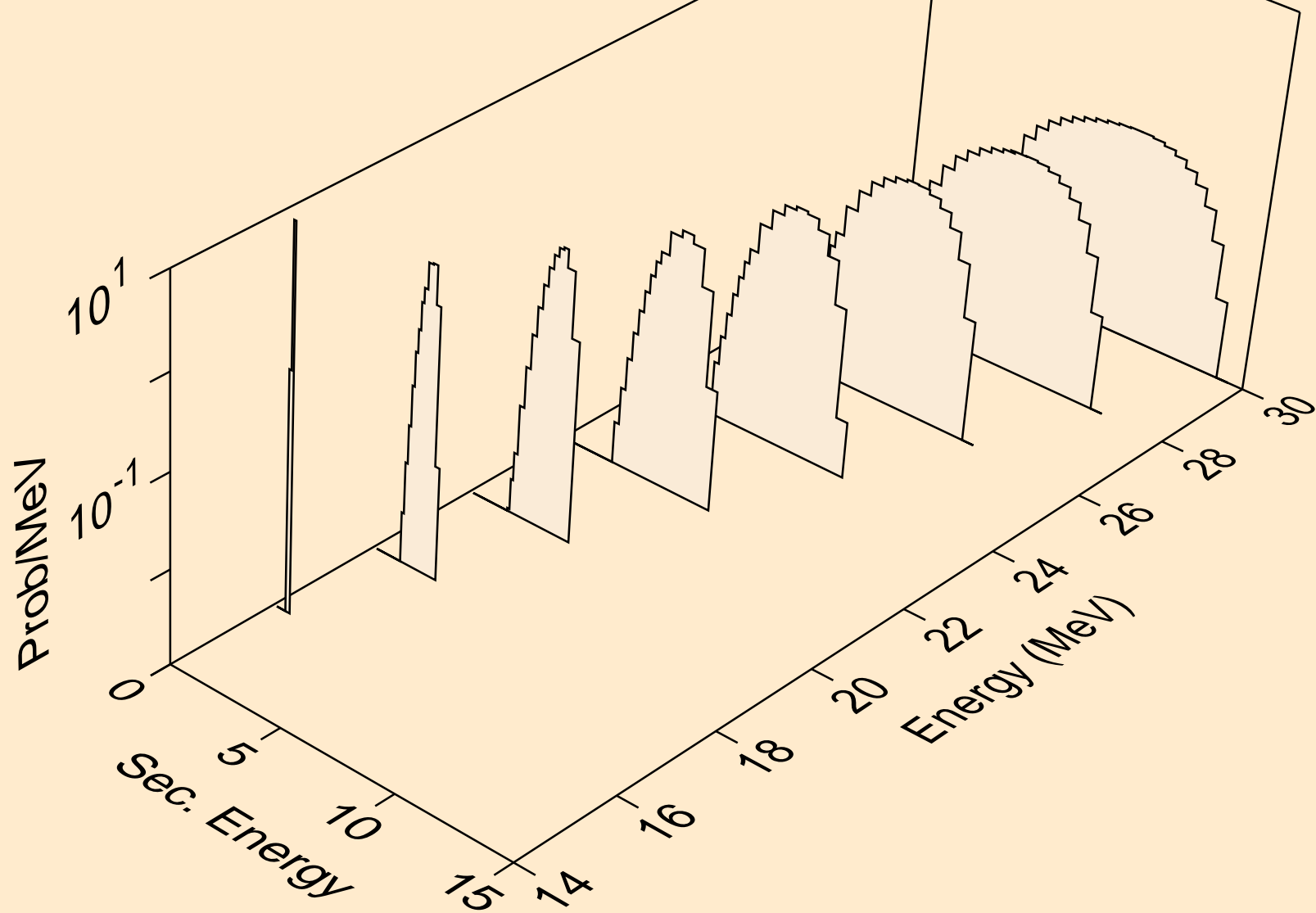

AS081 DEUTERON ACER TENDL-2023 LIBRARY; T=0.K  
Deuteron emission for (d,n\*)d

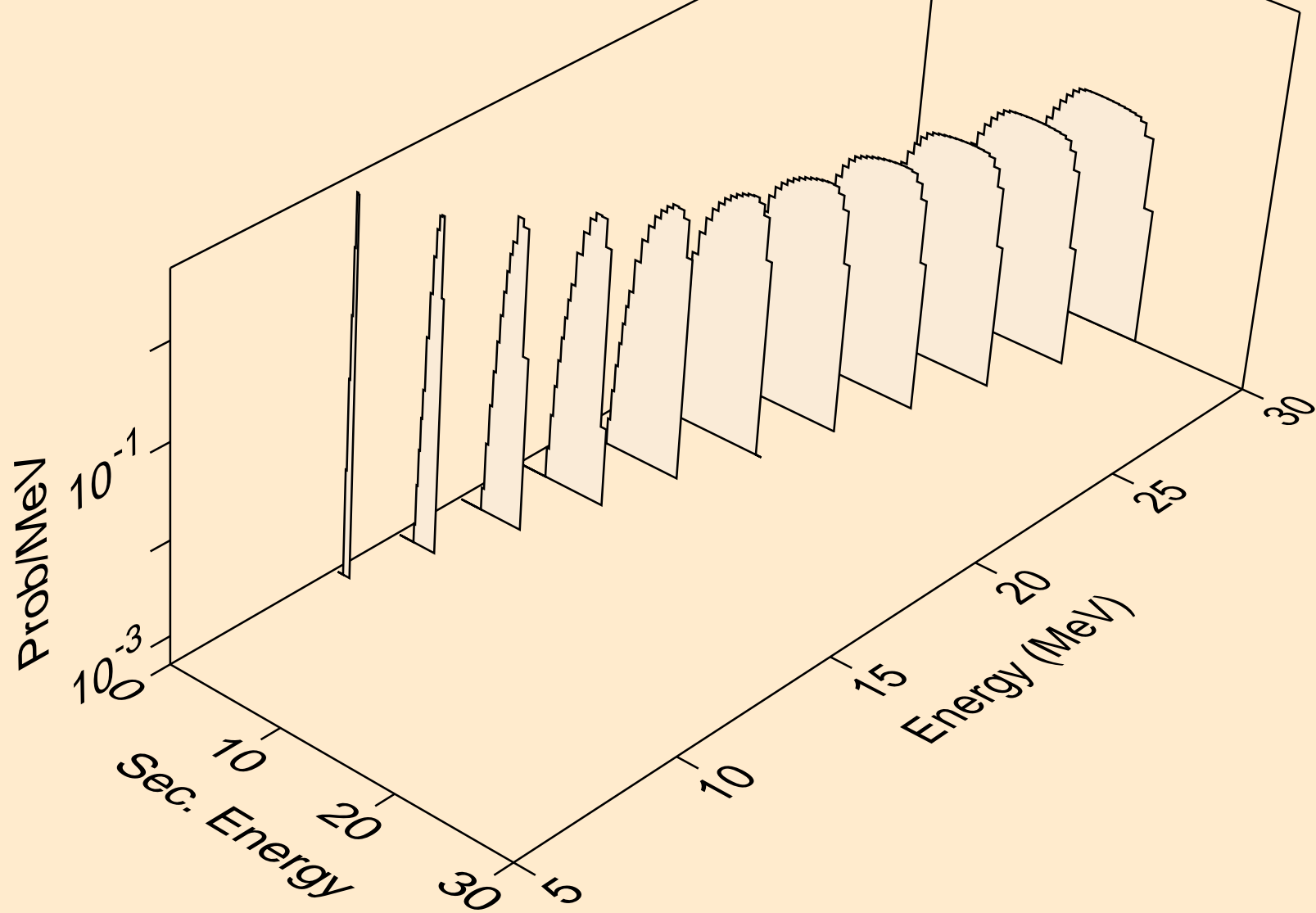

AS081 DEUTERON ACER TENDL-2023 LIBRARY; T=0.K  
Deuteron emission for inelastic

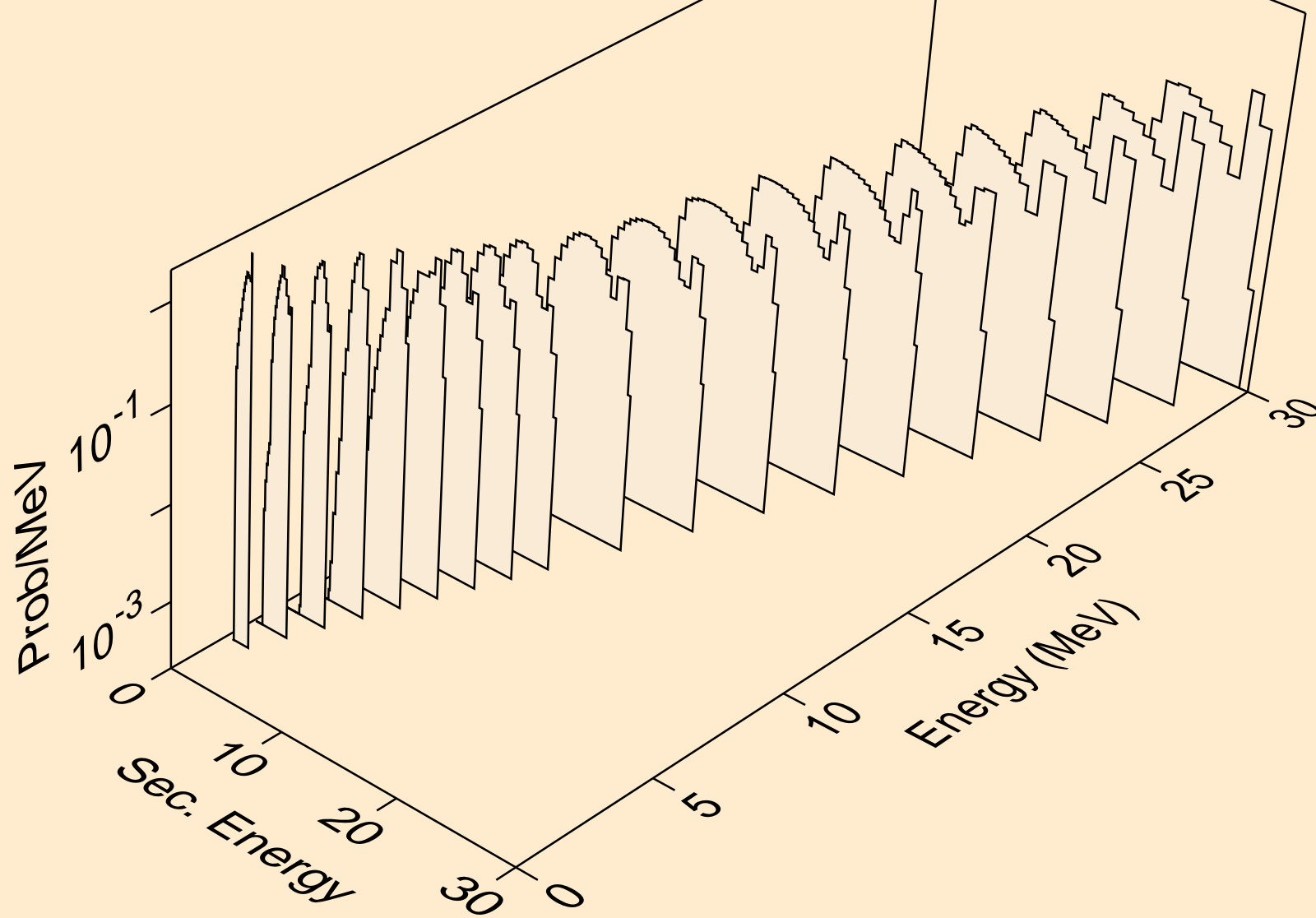

AS081 DEUTERON ACER TENDL-2023 LIBRARY; T=0.K  
Deuteron emission for (d,pd)

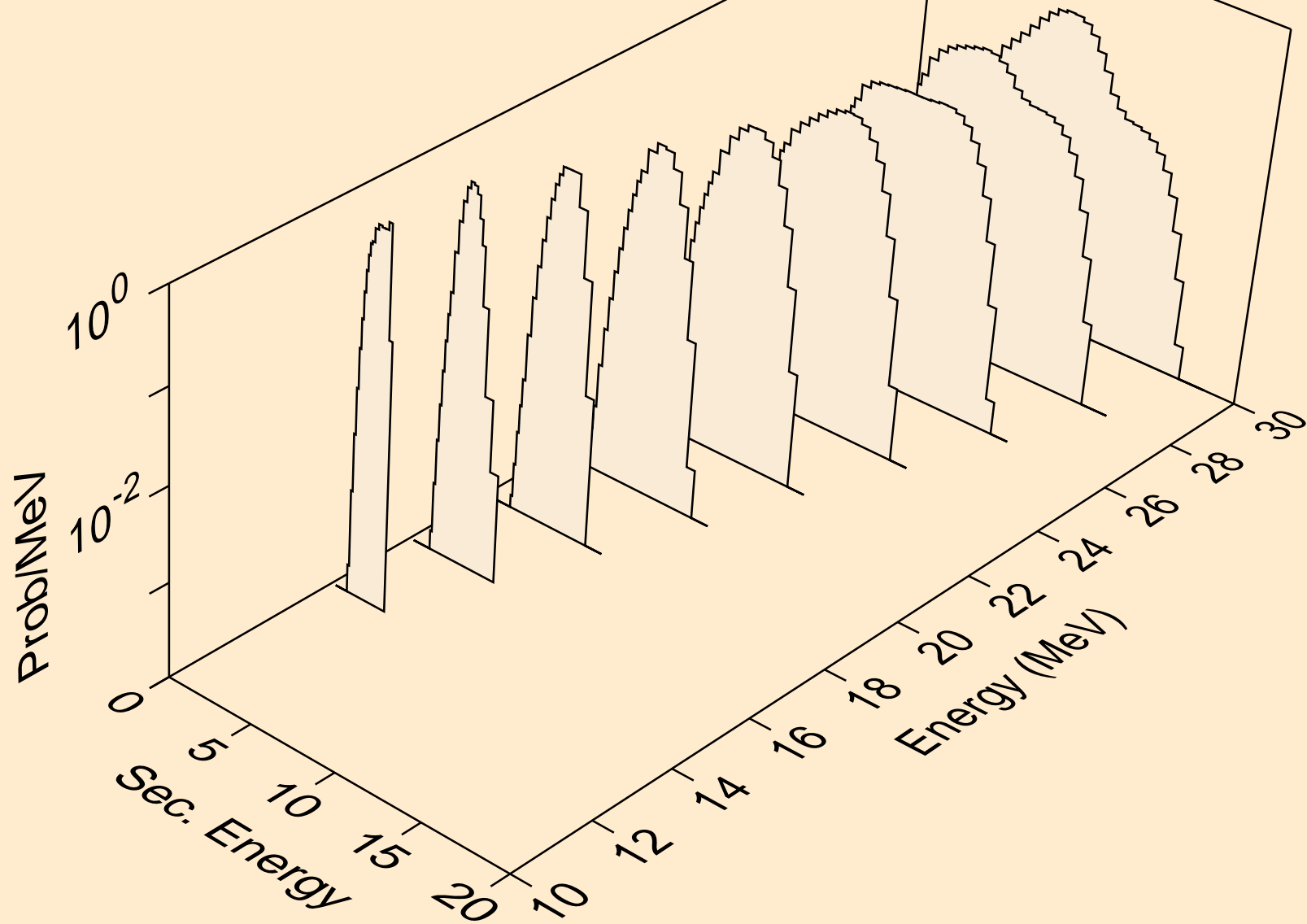

AS081 DEUTERON ACER TENDL-2023 LIBRARY; T=0.K  
Deuteron emission for (d,da)

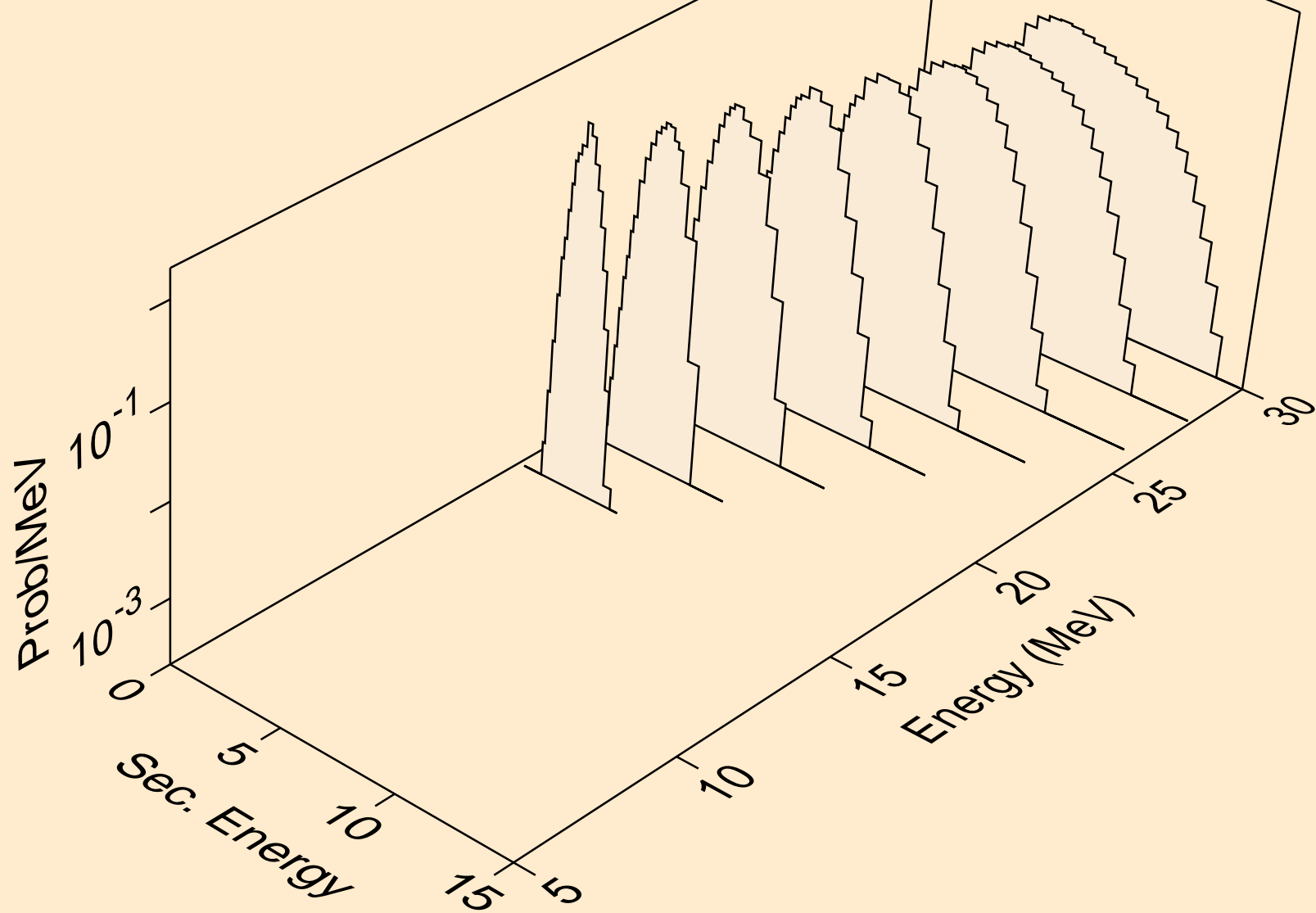

AS081 DEUTERON ACER TENDL-2023 LIBRARY; T=0.K  
Photon emission for (z,n)

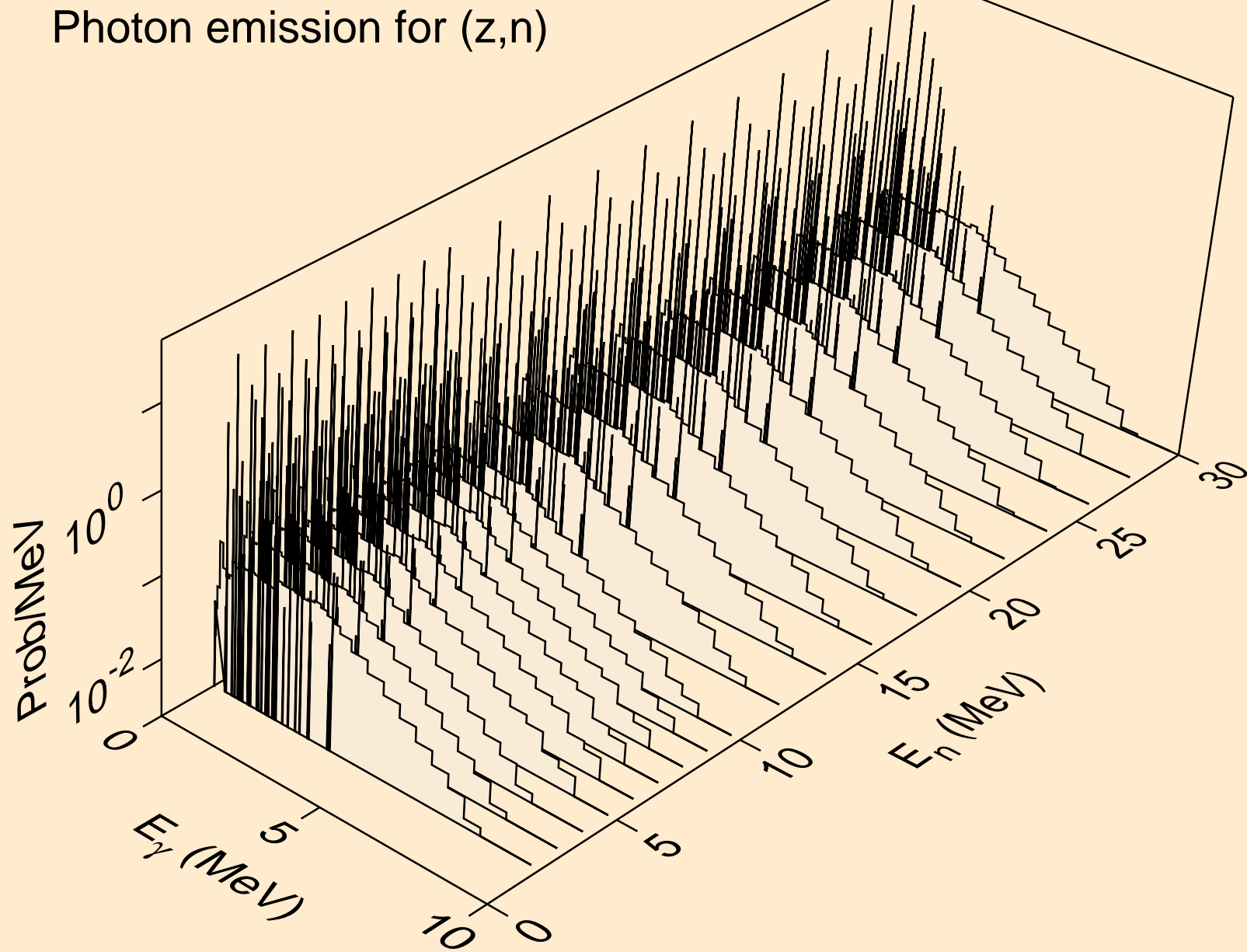



AS081 DEUTERON ACER TENDL-2023 LIBRARY; T=0.K  
Photon emission for (z,x)

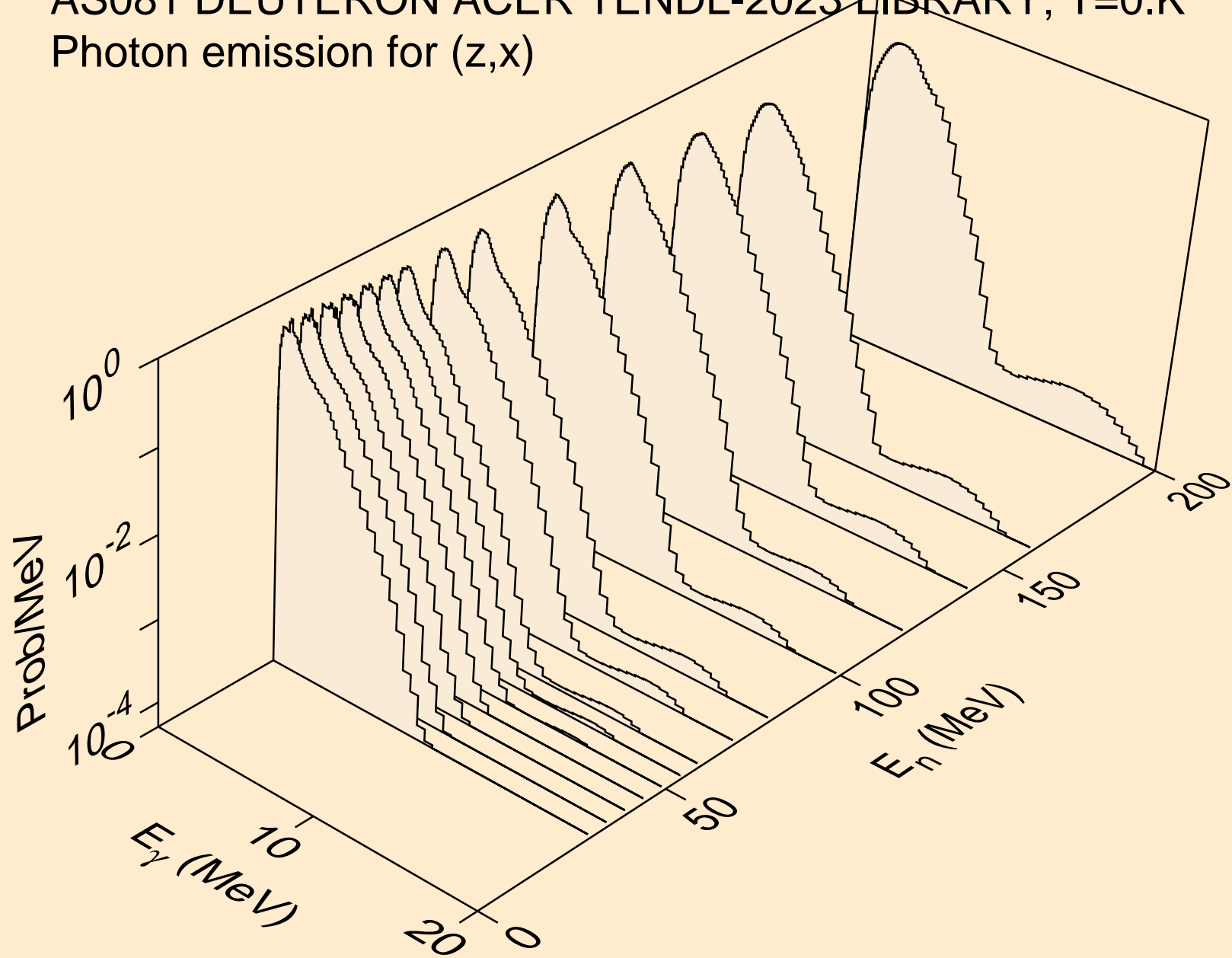

AS081 DEUTERON ACER TENDL-2023 LIBRARY; T=0.K  
Photon emission for (n,2nd)

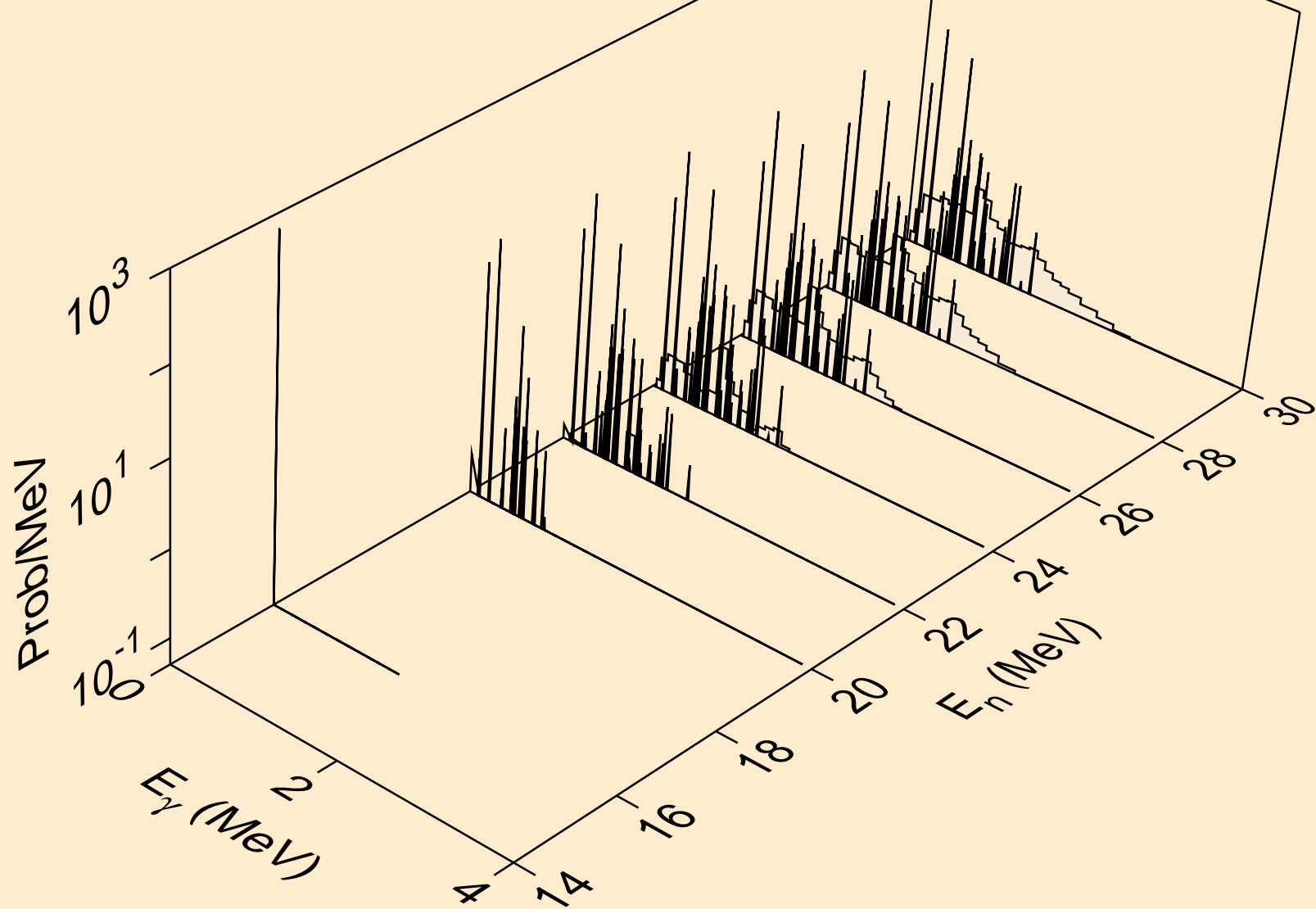

AS081 DEUTERON ACER TENDL-2023 LIBRARY; T=0.K  
Photon emission for (n,2n)

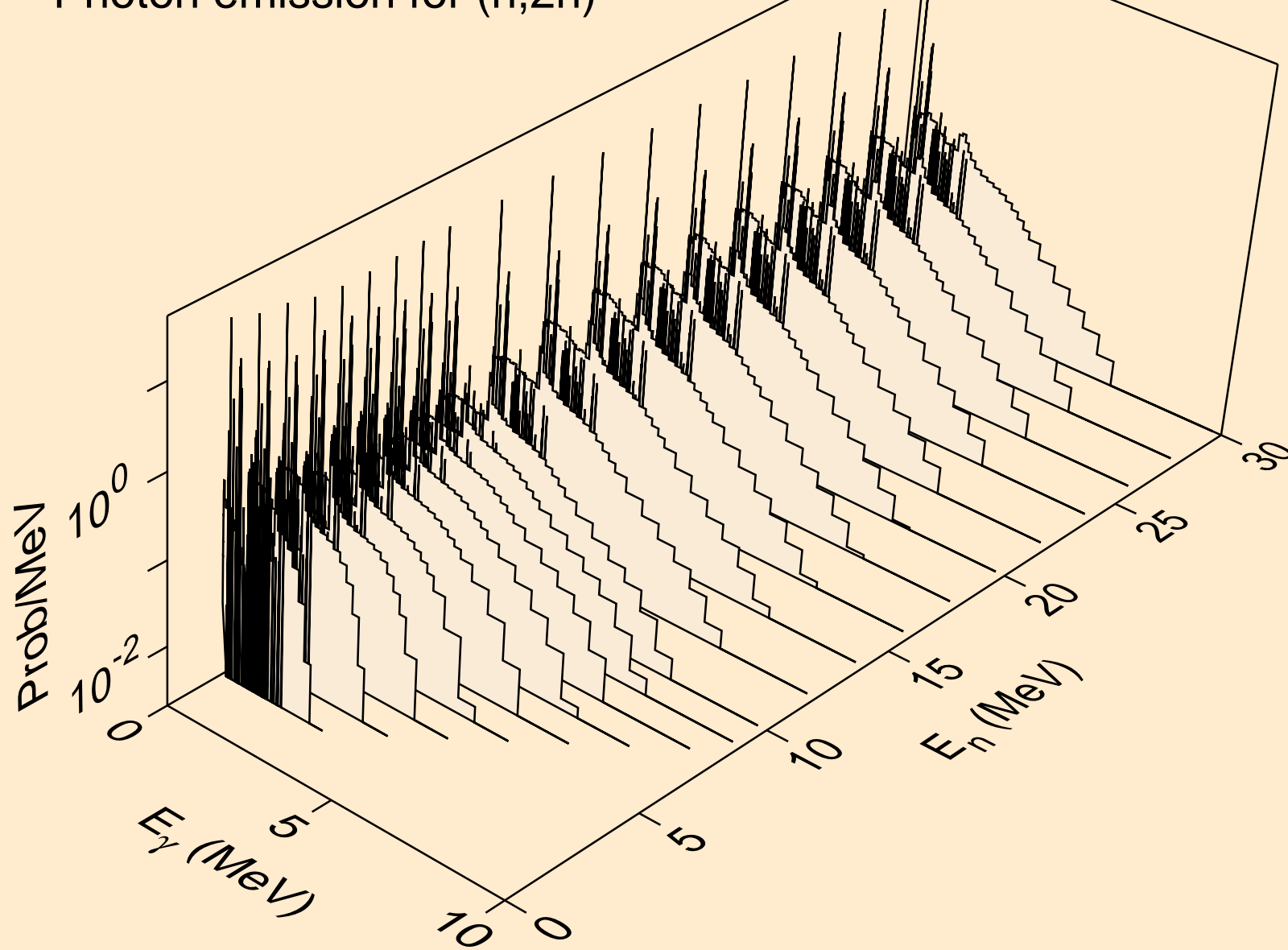

AS081 DEUTERON ACER TENDL-2023 LIBRARY; T=0.K  
Photon emission for (n,3n)

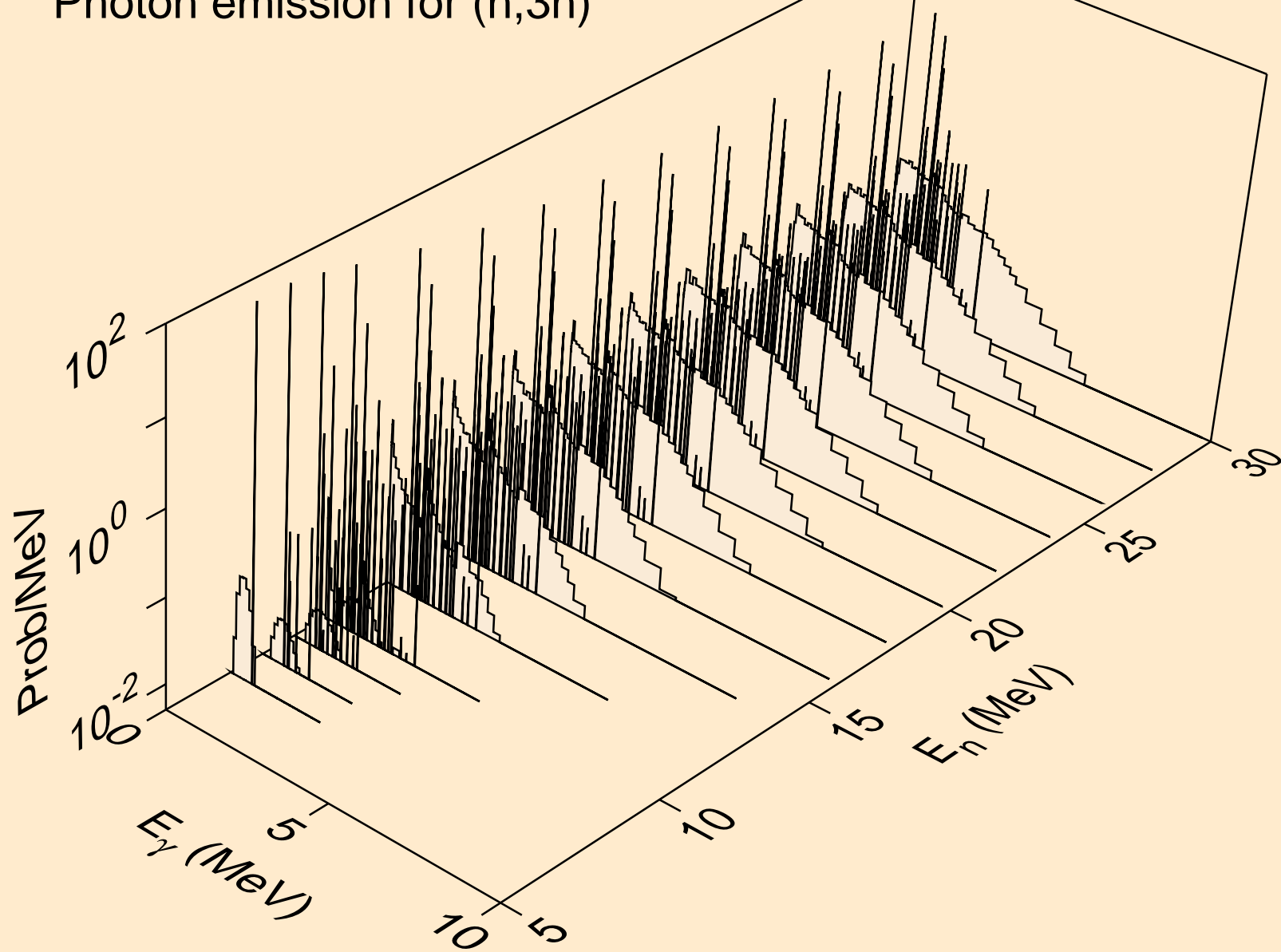

AS081 DEUTERON ACER TENDL-2023 LIBRARY; T=0.K  
Photon emission for (n,n\*)a

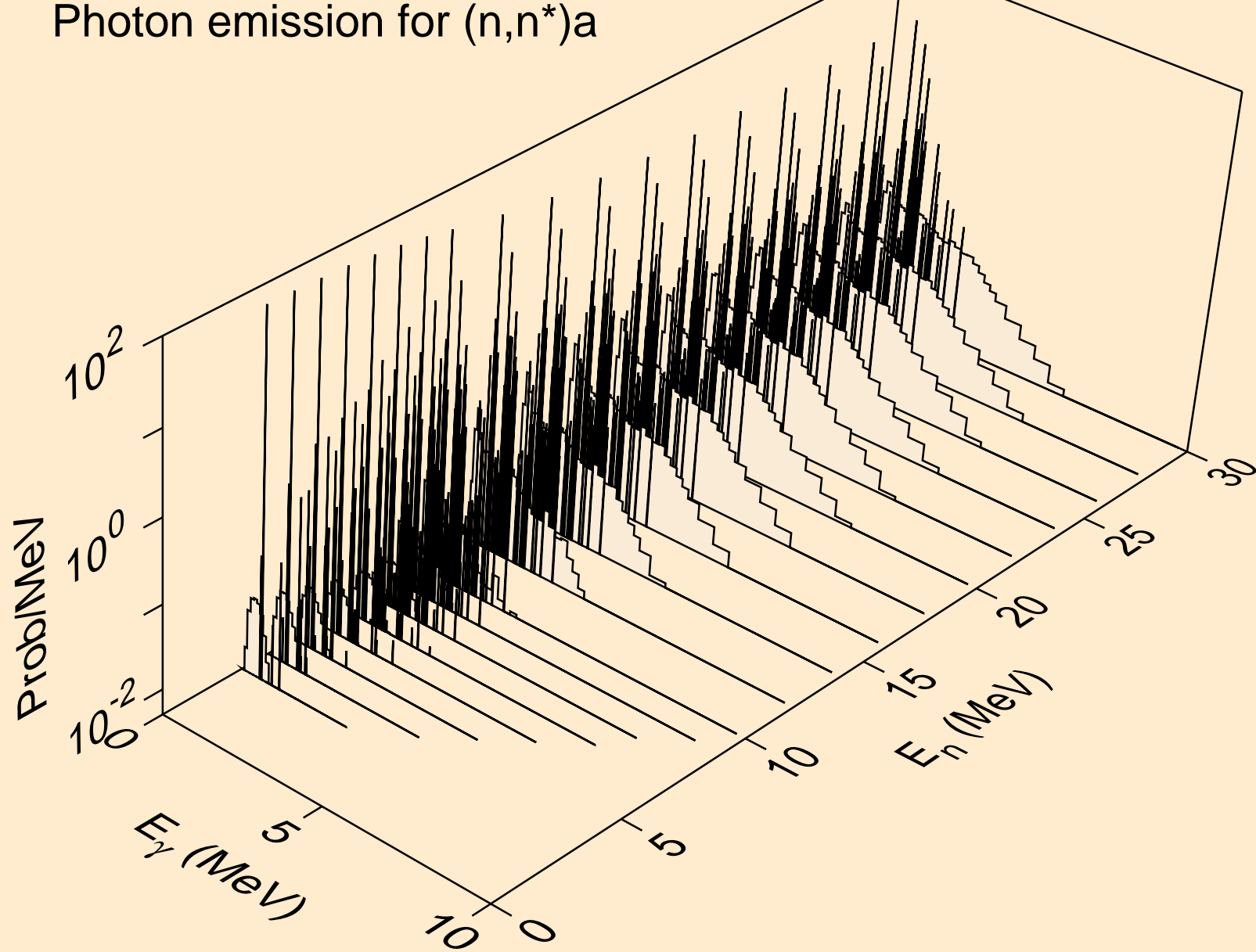

AS081 DEUTERON ACER TENDL-2023 LIBRARY; T=0.K  
Photon emission for (n,2n)a

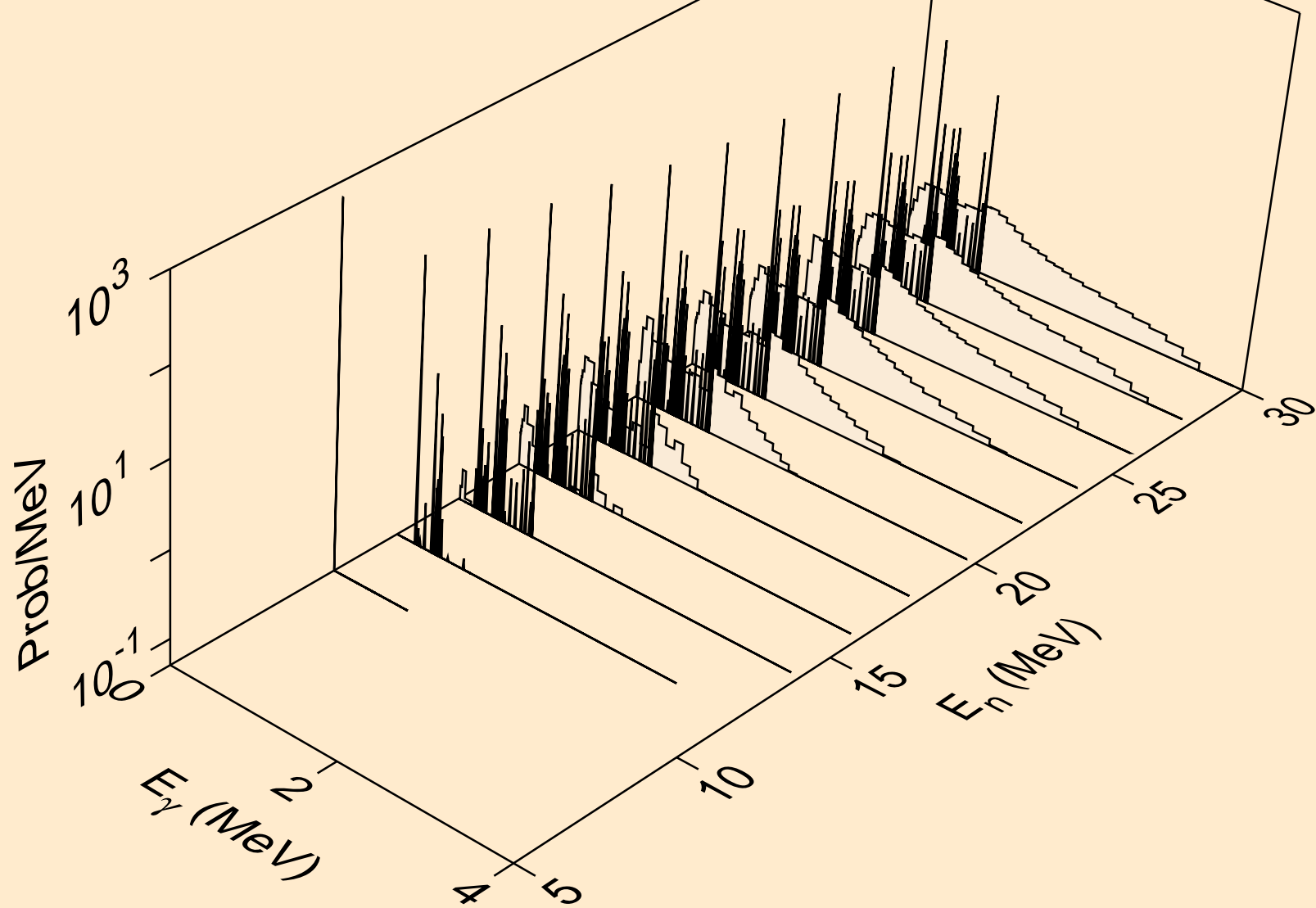

AS081 DEUTERON ACER TENDL-2023 LIBRARY; T=0.K  
Photon emission for (n,3n)a

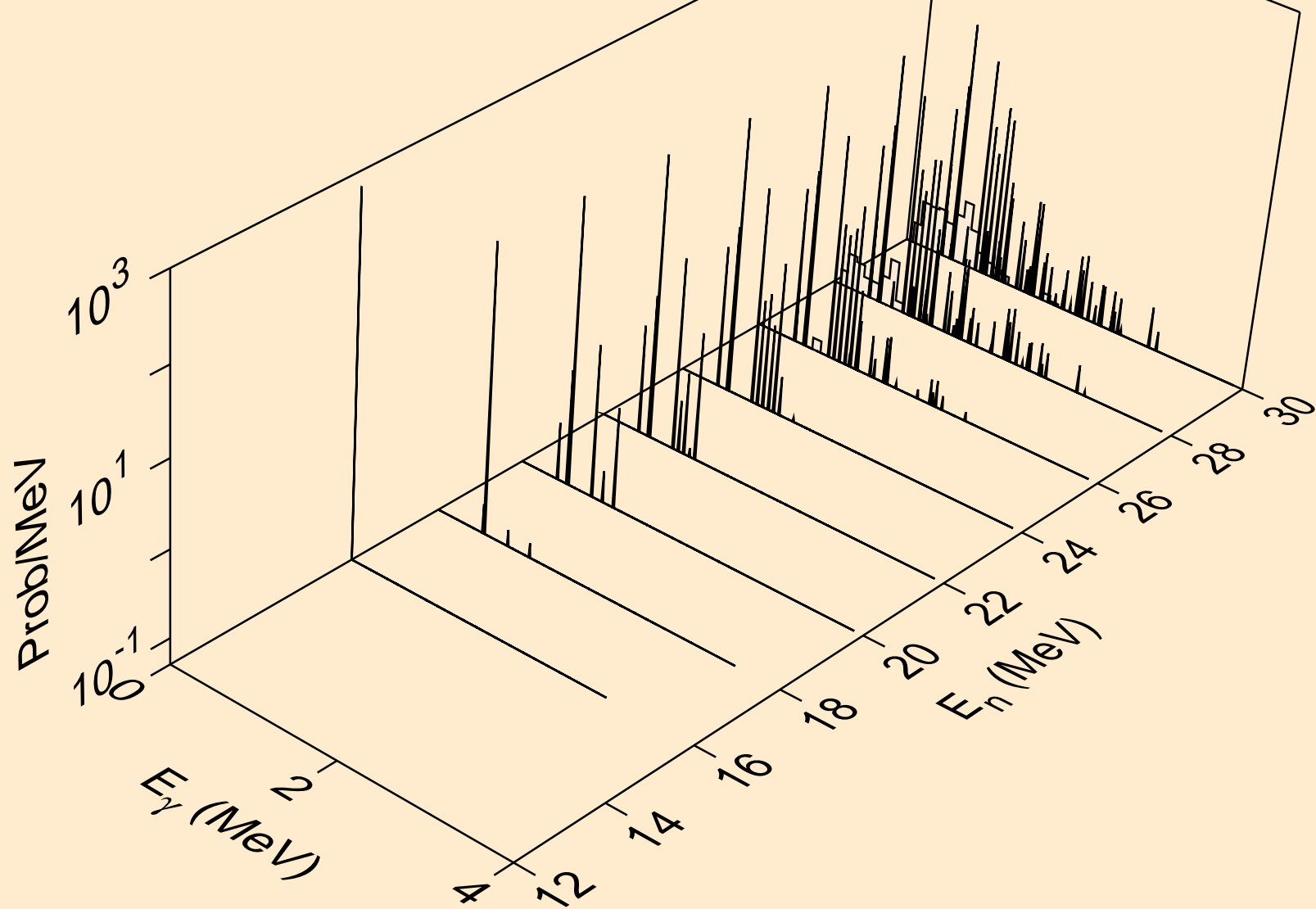

AS081 DEUTERON ACER TENDL-2023 LIBRARY; T=0.K  
Photon emission for (n,n\*)p

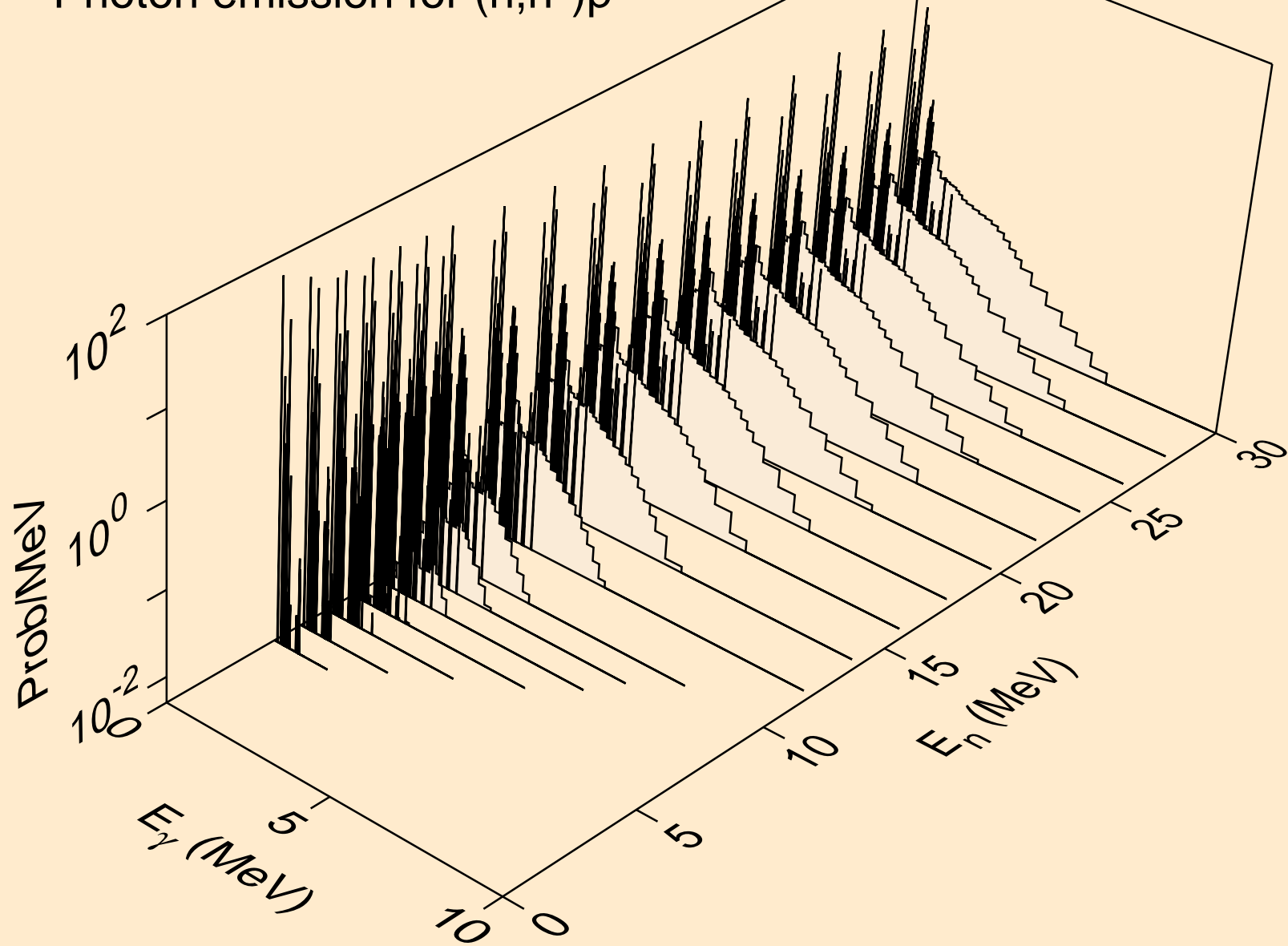



AS081 DEUTERON ACER TENDL-2023 LIBRARY; T=0.K  
Photon emission for (n,n\*)2a

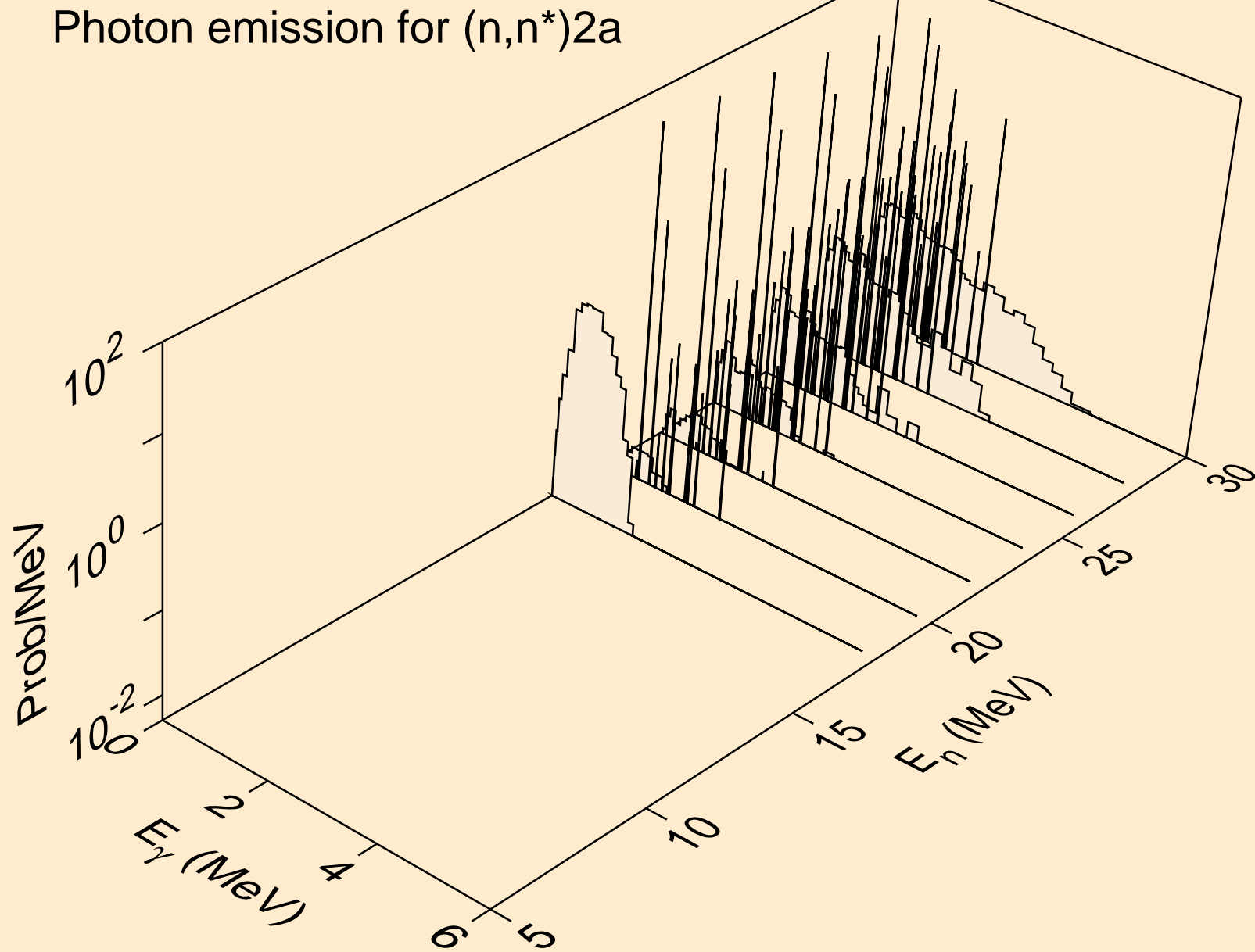

AS081 DEUTERON ACER TENDL-2023 LIBRARY; T=0.K  
Photon emission for (n,n\*)d

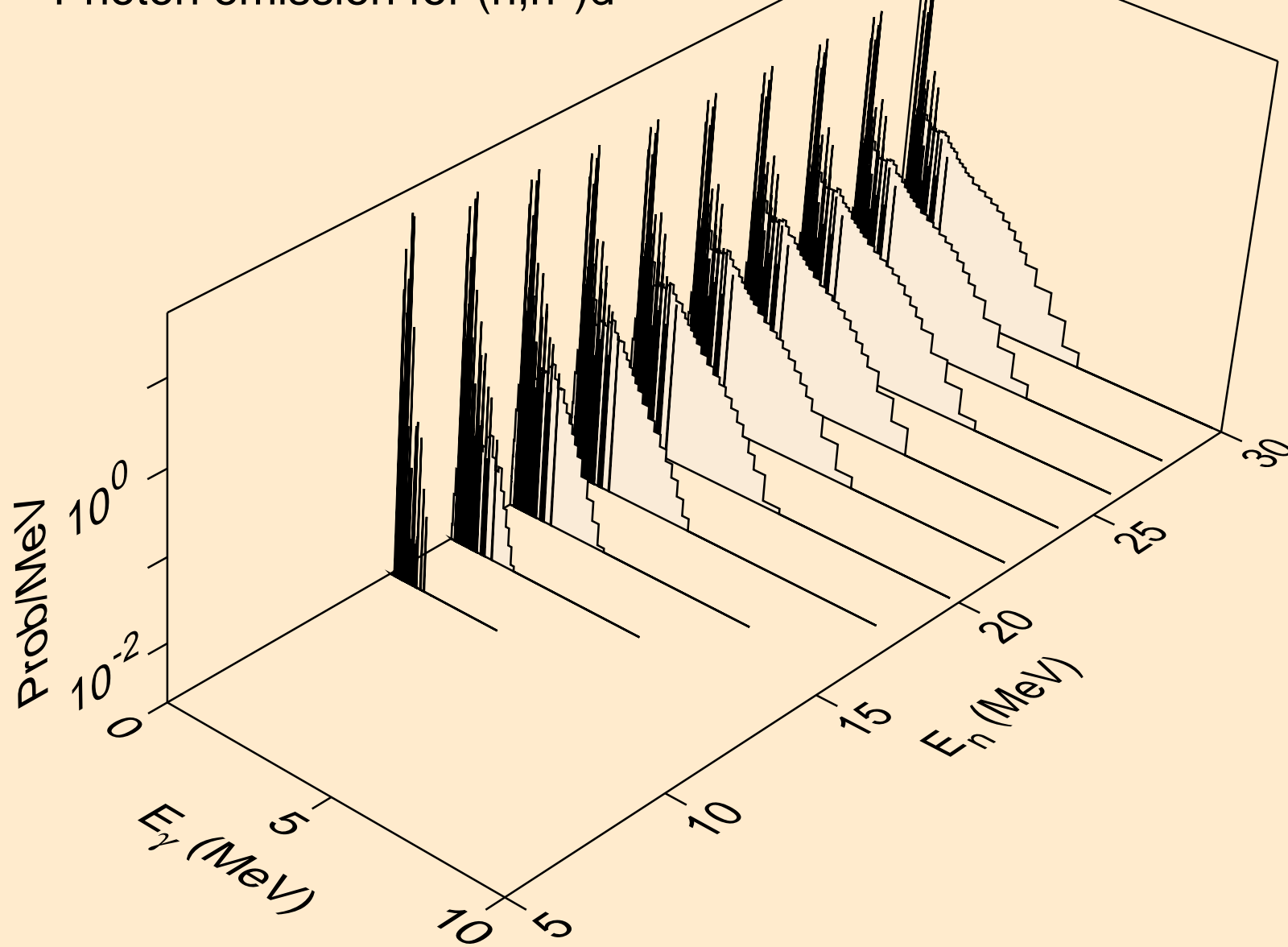

AS081 DEUTERON ACER TENDL-2023 LIBRARY; T=0.K  
Photon emission for (n,n\*)t

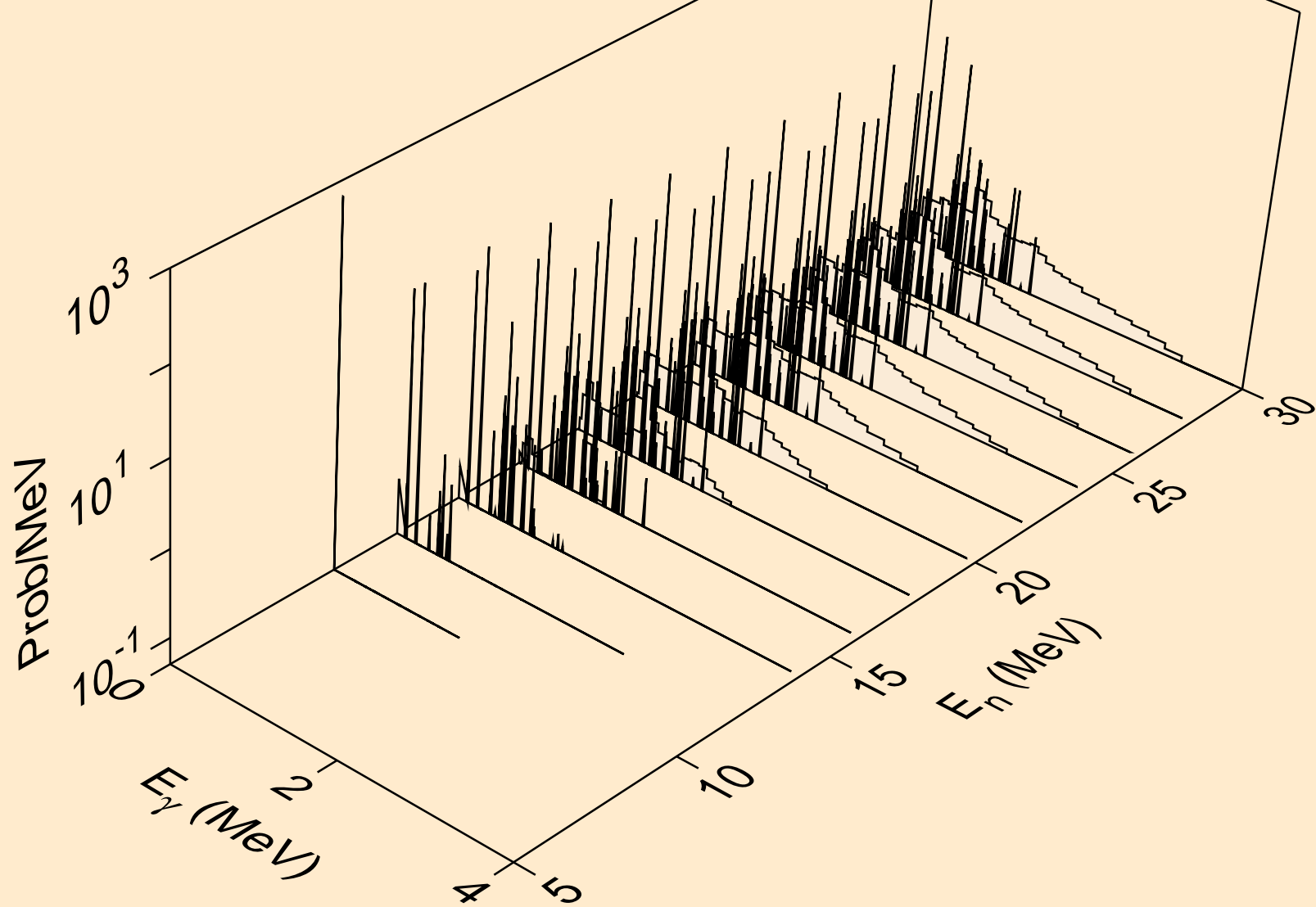

AS081 DEUTERON ACER TENDL-2023 LIBRARY; T=0.K  
Photon emission for (n,n\*)he3

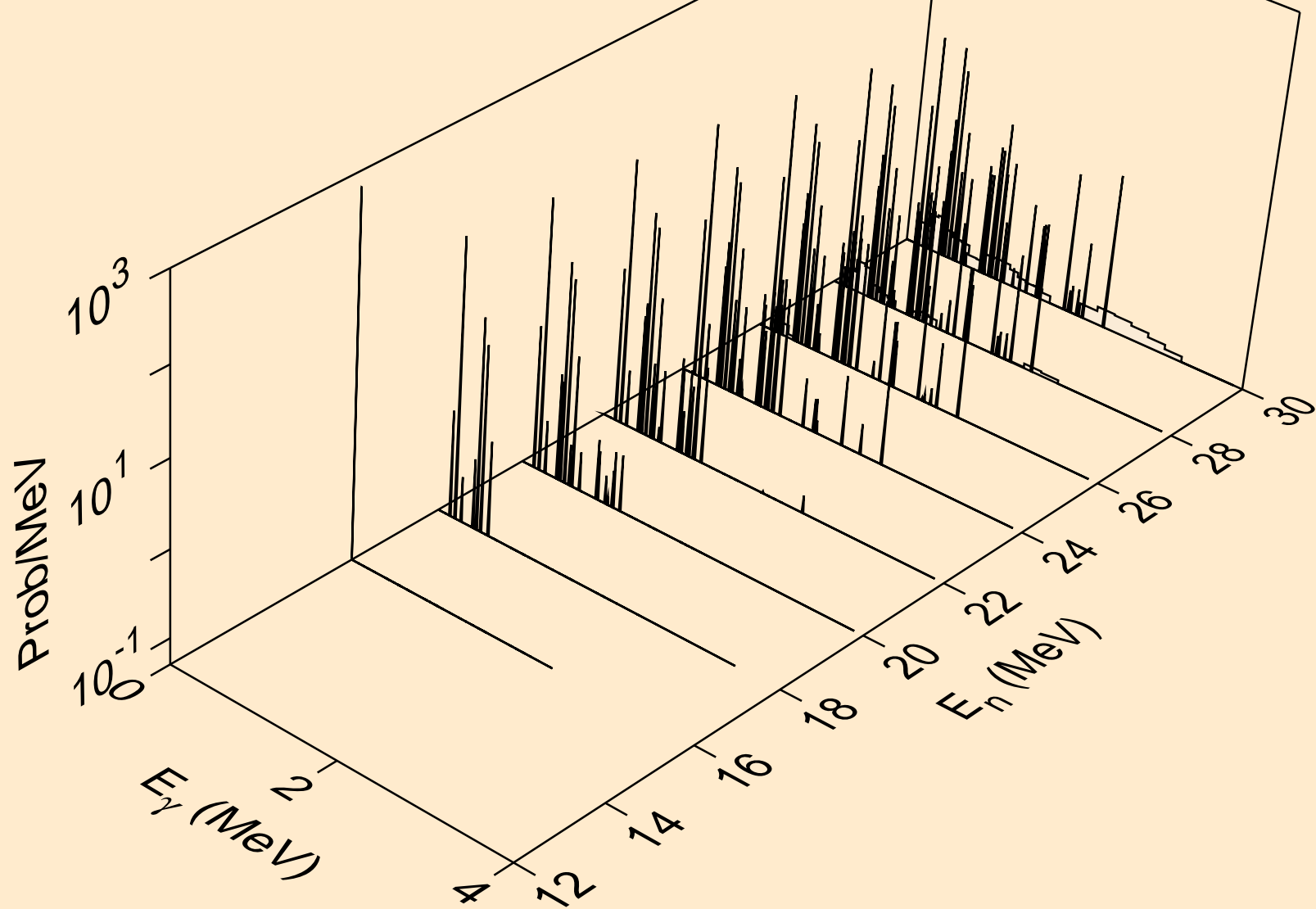

AS081 DEUTERON ACER TENDL-2023 LIBRARY; T=0.K  
Photon emission for (n,4n)

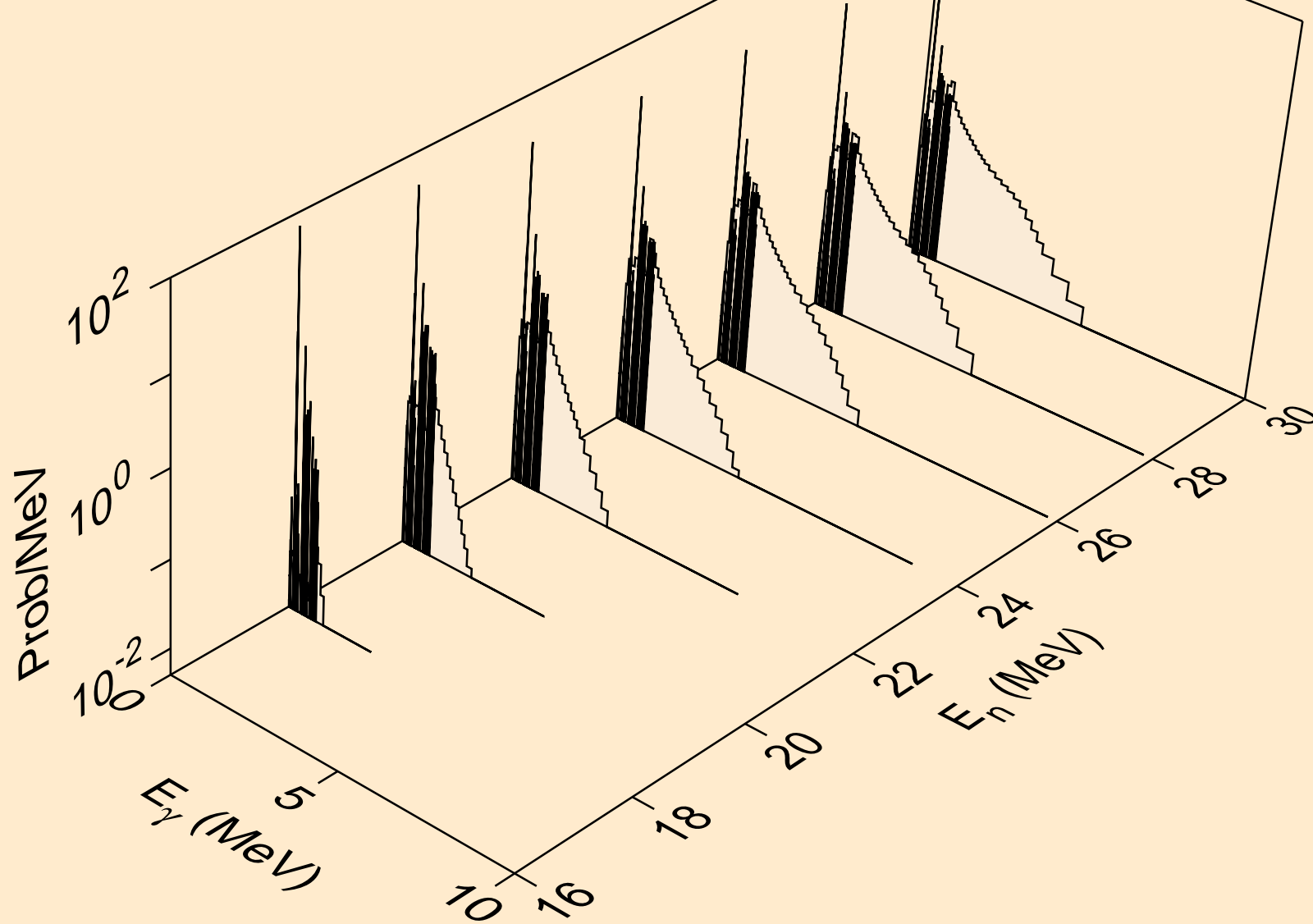

AS081 DEUTERON ACER TENDL-2023 LIBRARY; T=0.K  
Photon emission for (n,2np)

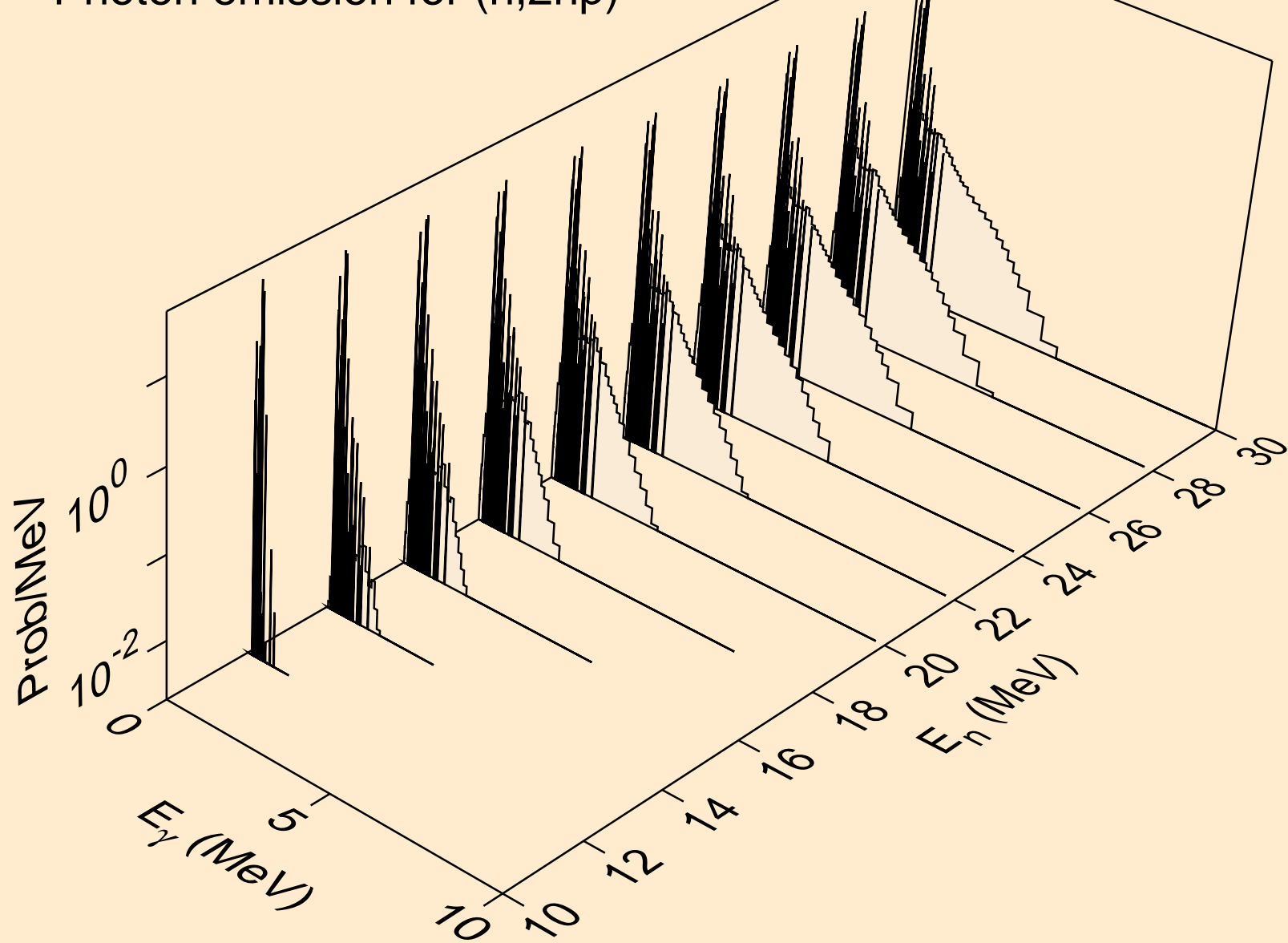

AS081 DEUTERON ACER TENDL-2023 LIBRARY; T=0.K  
Photon emission for (n,3np)

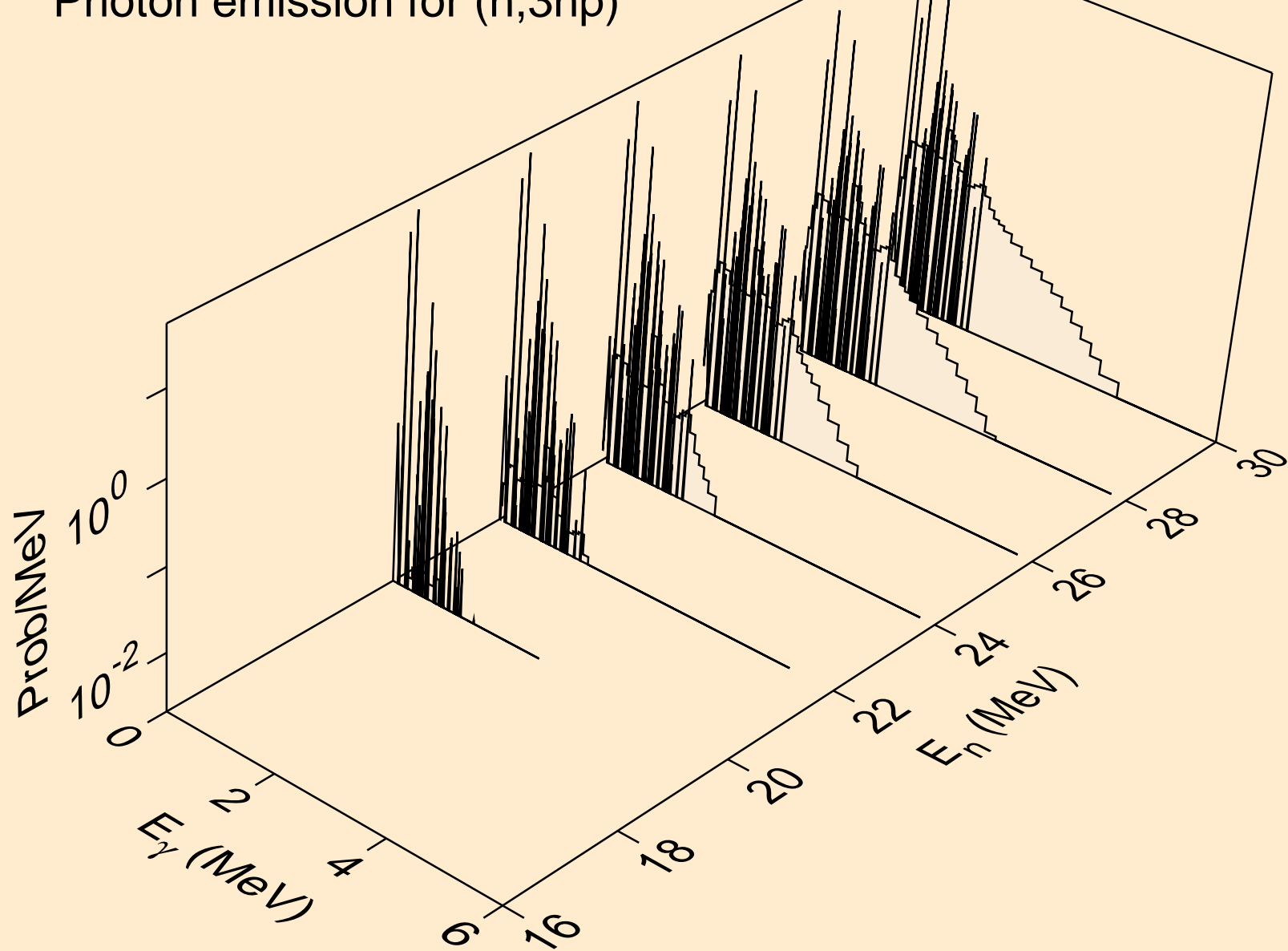

AS081 DEUTERON ACER TENDL-2023 LIBRARY; T=0.K  
Photon emission for (n,n2p)

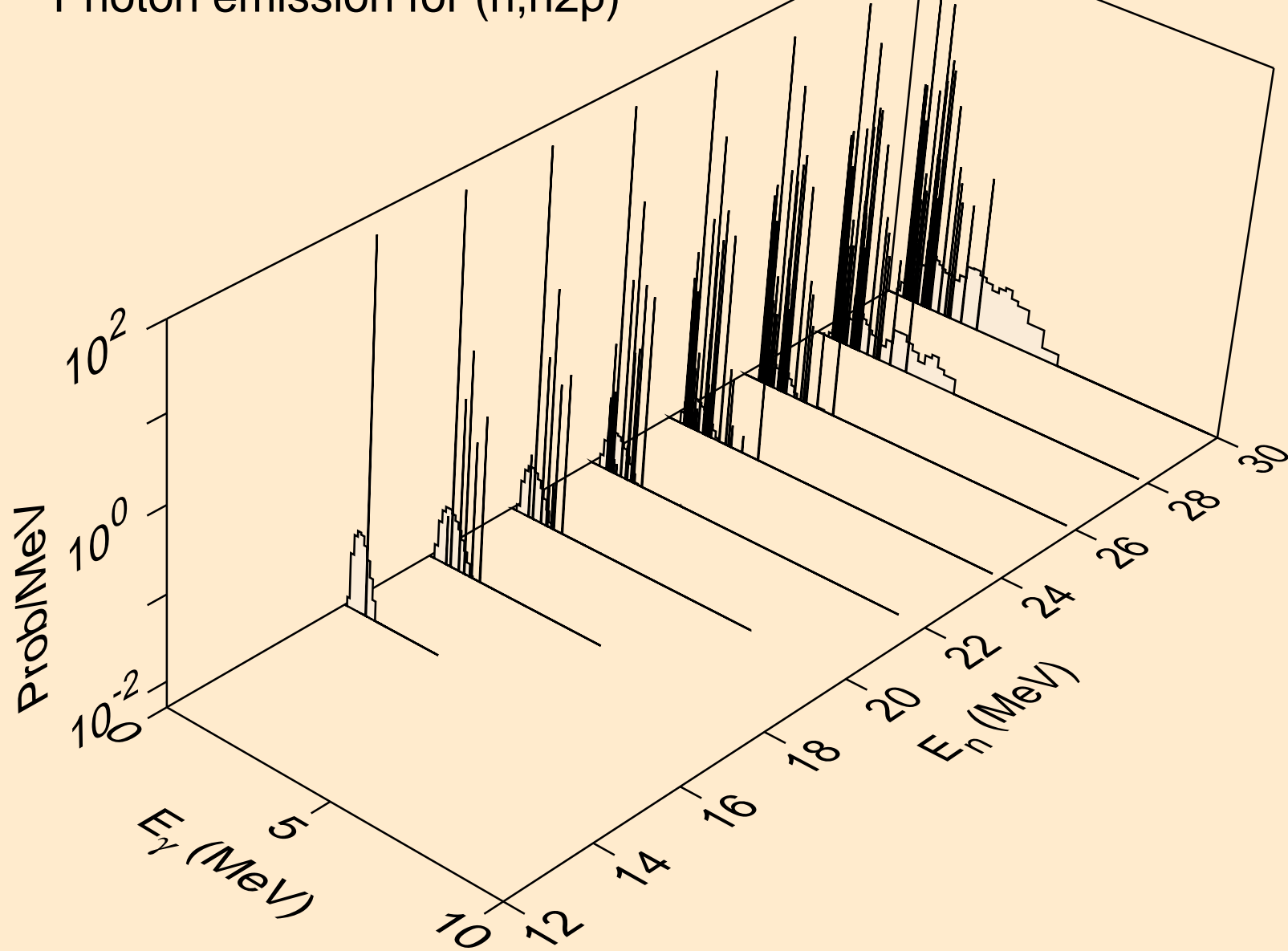



AS081 DEUTERON ACER TENDL-2023 LIBRARY; T=0.K  
Photon emission for (n,npa)

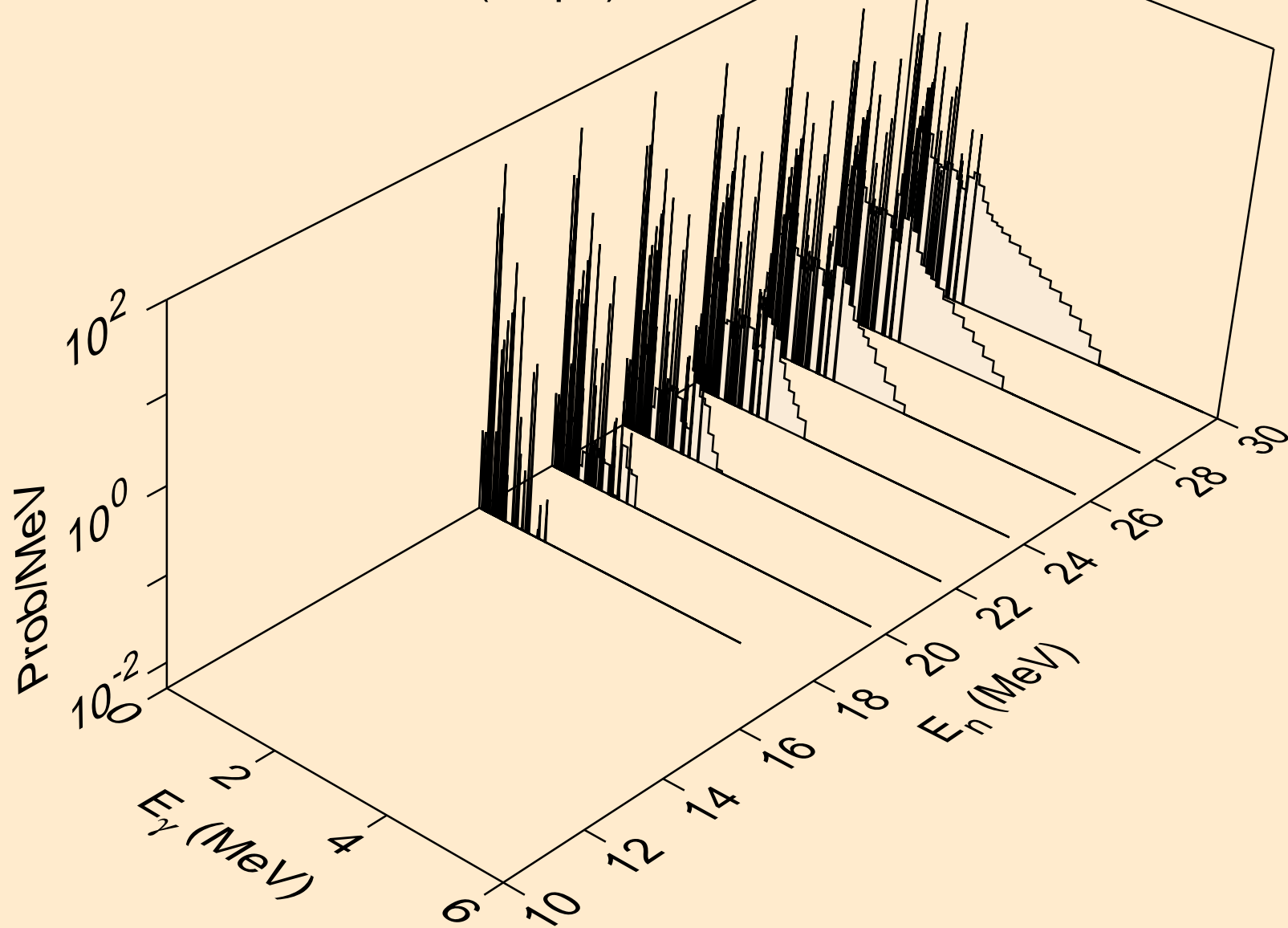

AS081 DEUTERON ACER TENDL-2023 LIBRARY; T=0.K  
Photon emission for (n,gma)

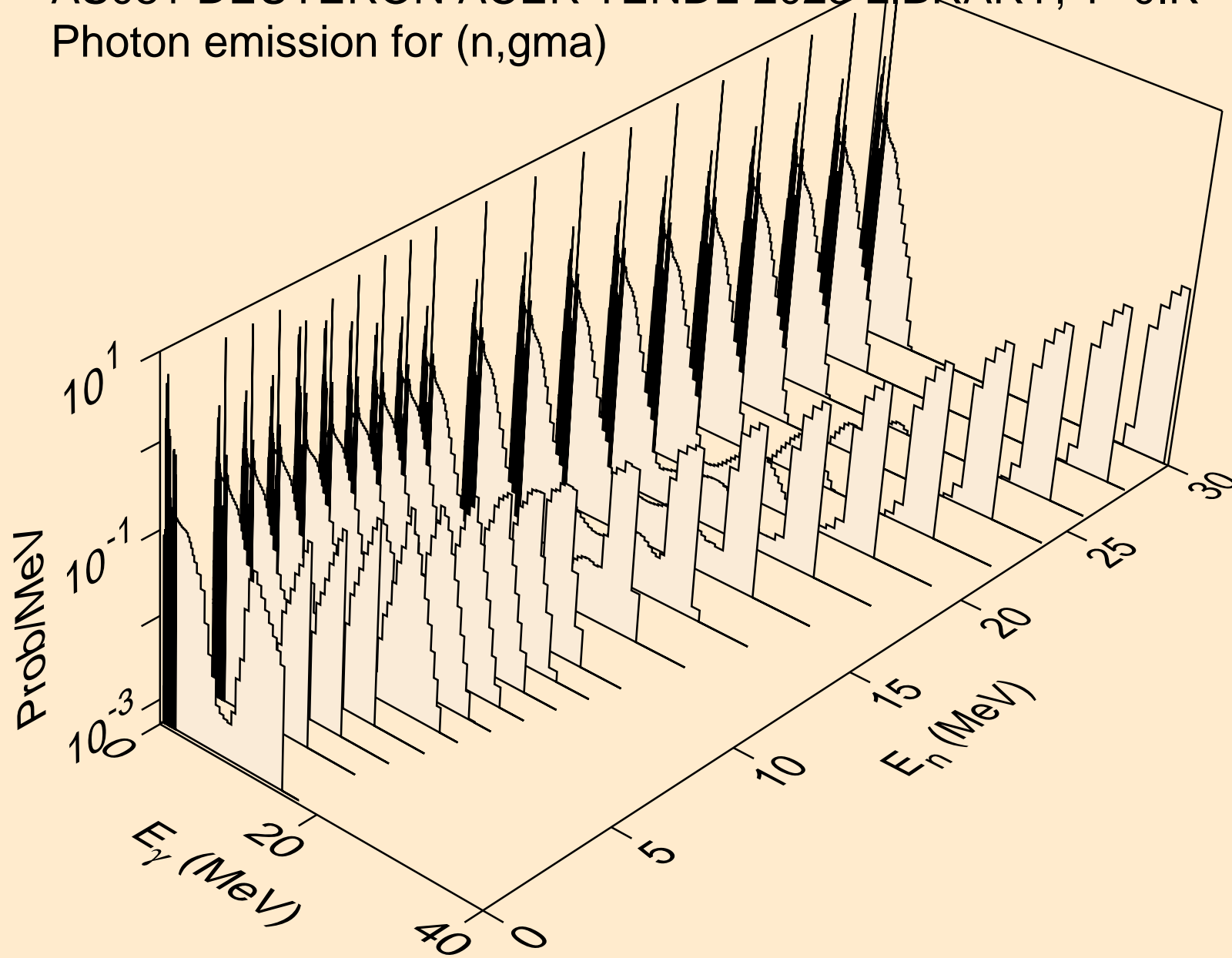

AS081 DEUTERON ACER TENDL-2023 LIBRARY; T=0.K  
Photon emission for (n,p)

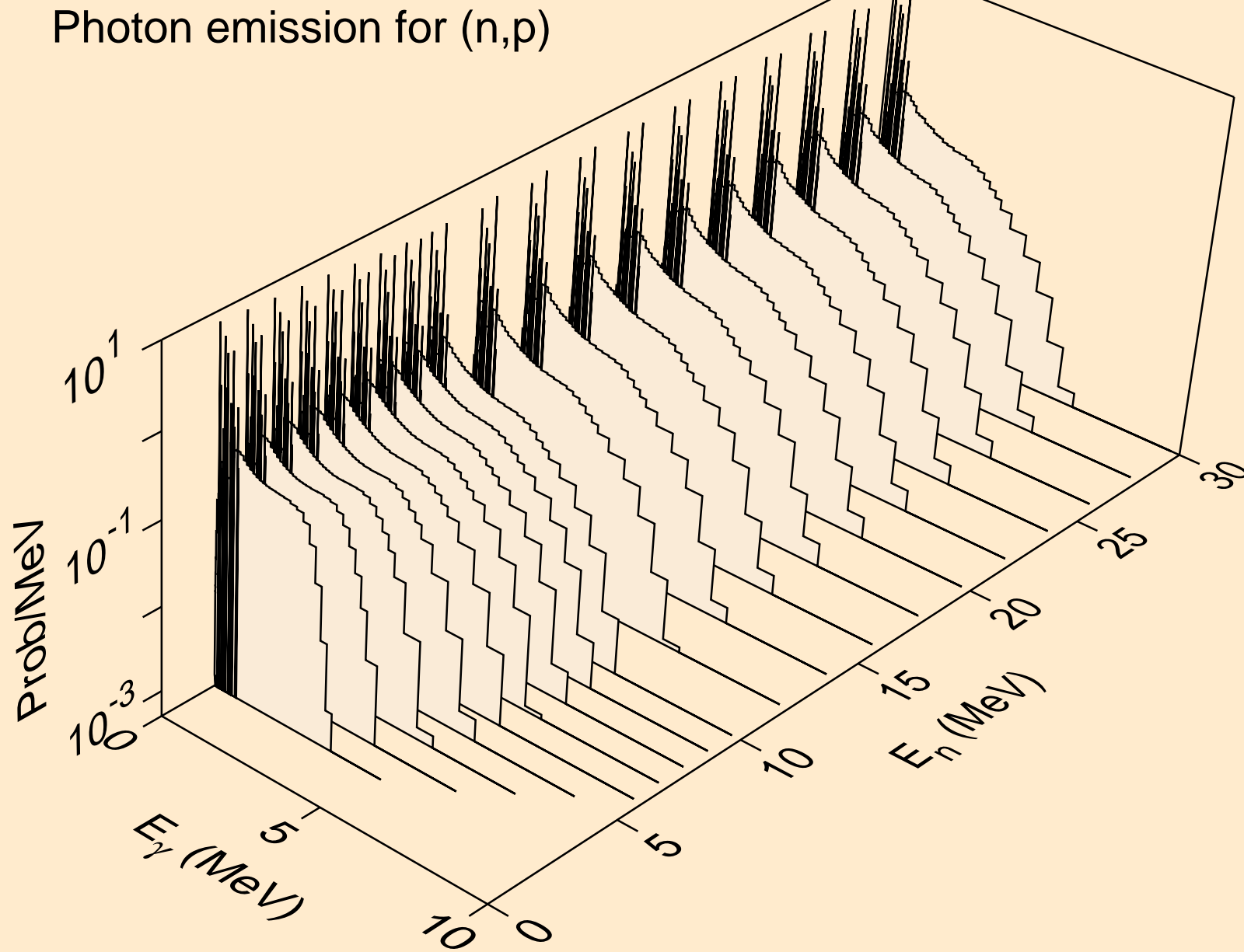

AS081 DEUTERON ACER TENDL-2023 LIBRARY; T=0.K  
Photon emission for inelastic

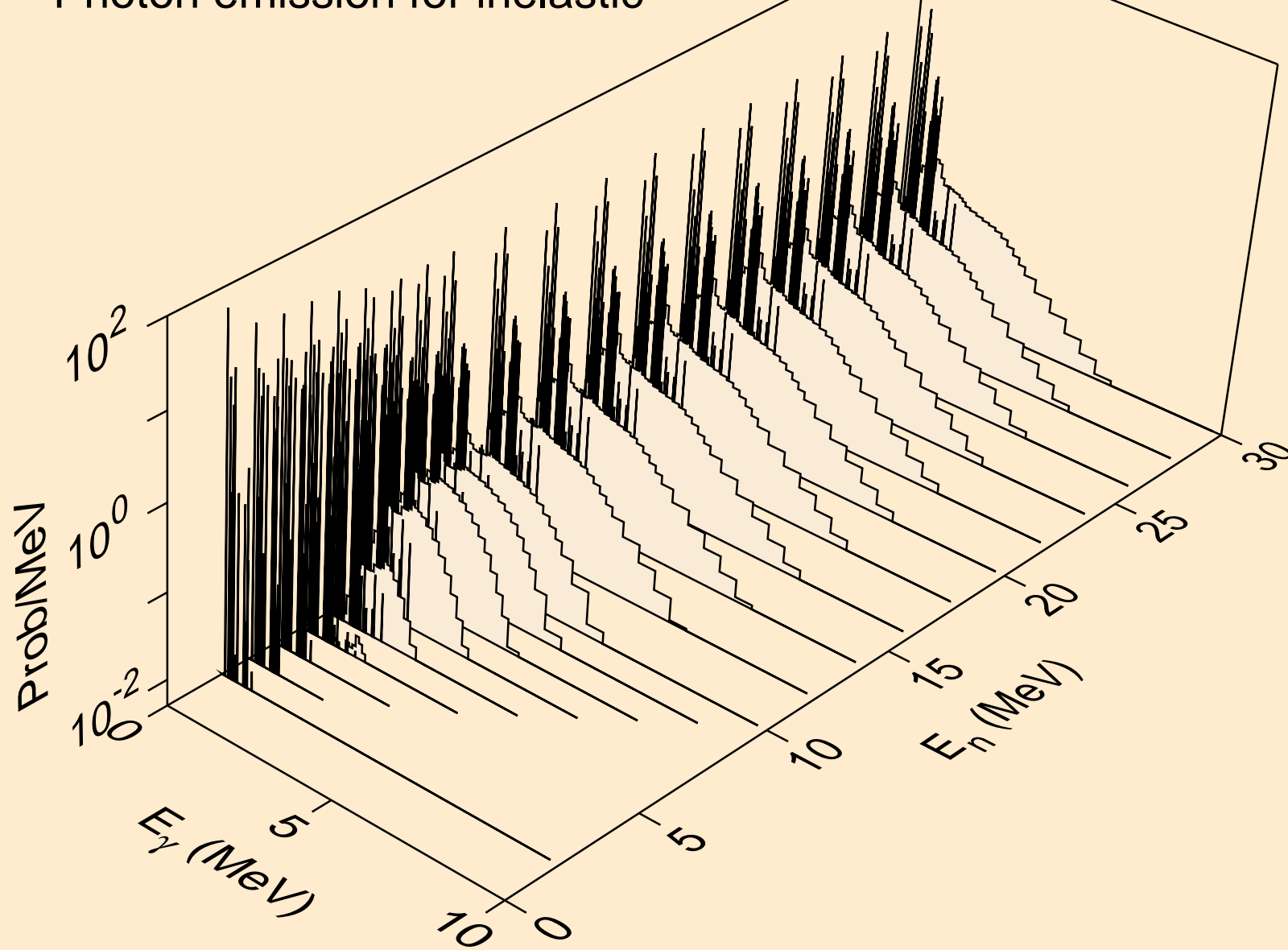

AS081 DEUTERON ACER TENDL-2023 LIBRARY; T=0.K  
Photon emission for (n,t)

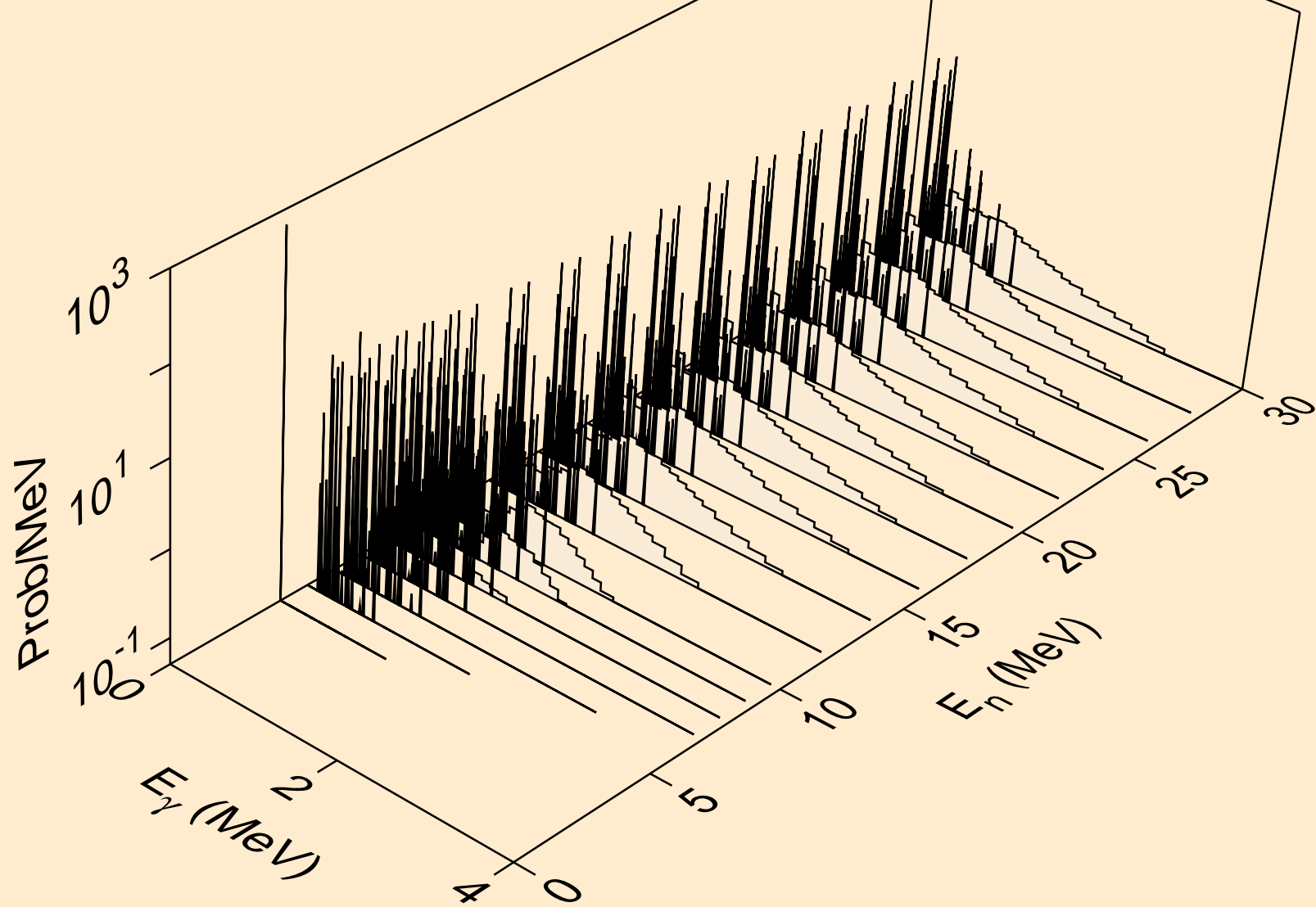

AS081 DEUTERON ACER TENDL-2023 LIBRARY; T=0.K  
Photon emission for (n,he3)

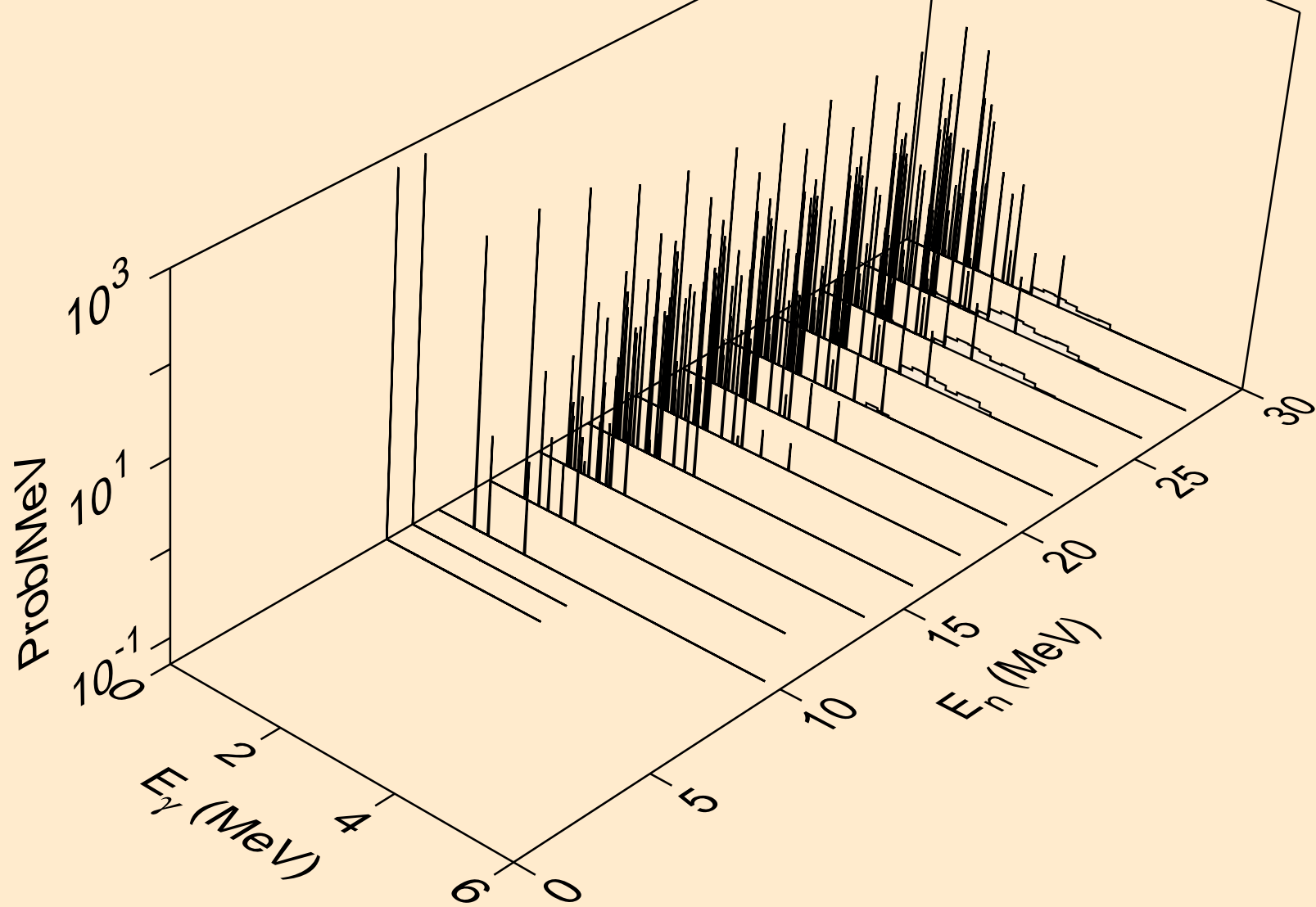

AS081 DEUTERON ACER TENDL-2023 LIBRARY; T=0.K  
Photon emission for (n,a)

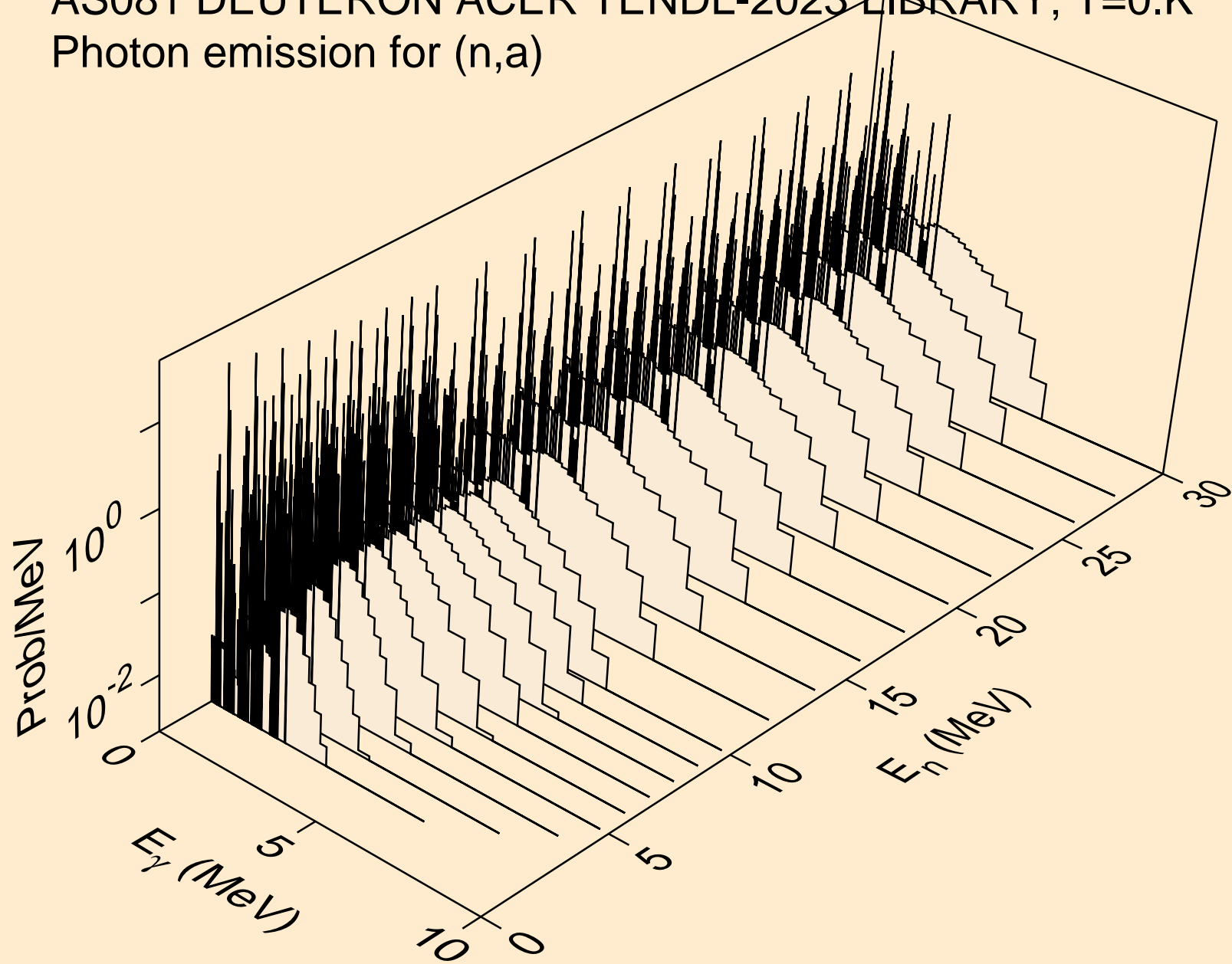

AS081 DEUTERON ACER TENDL-2023 LIBRARY; T=0.K  
Photon emission for (n,2a)

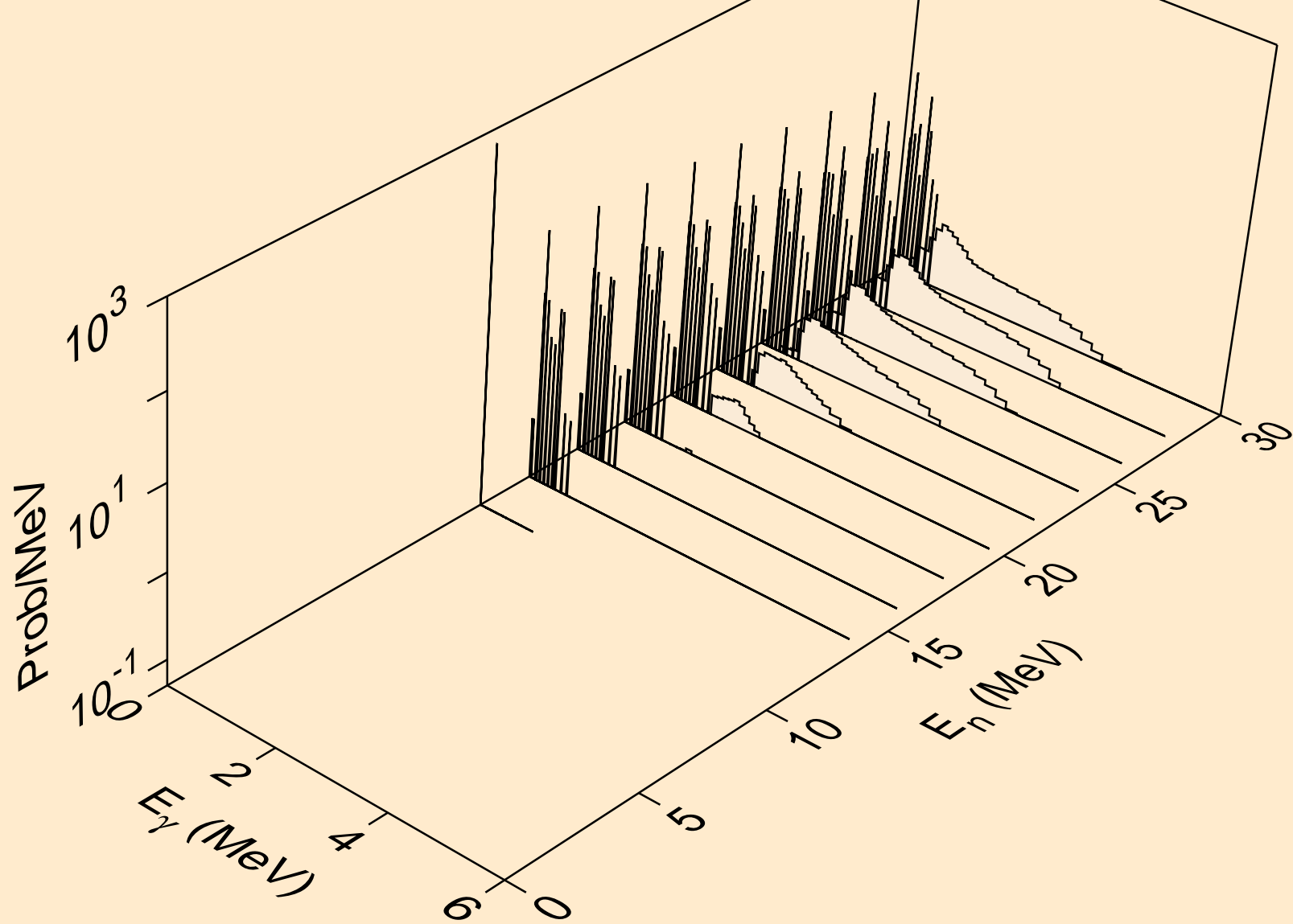



AS081 DEUTERON ACER TENDL-2023 LIBRARY; T=0.K  
Photon emission for (n,2p)

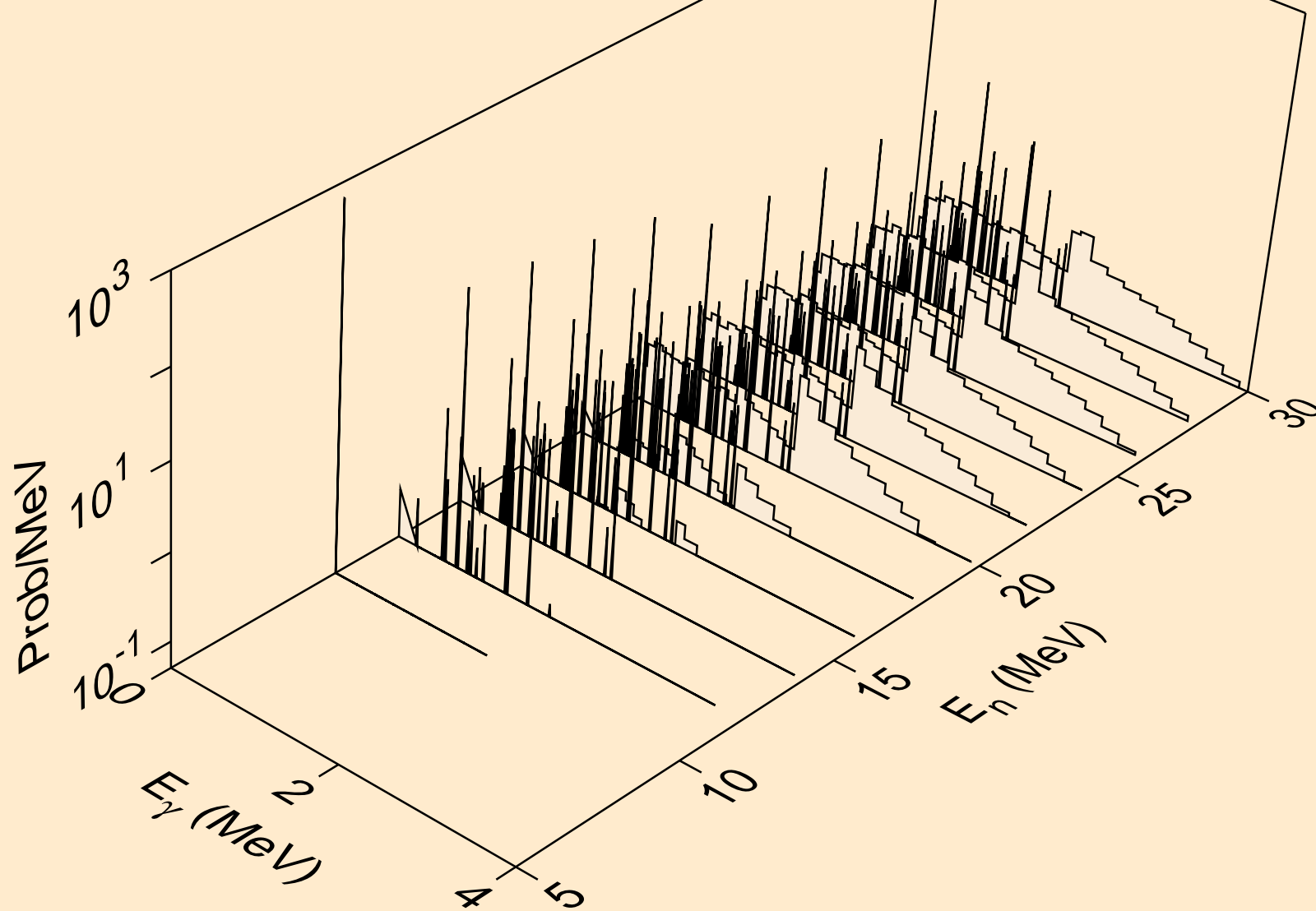

AS081 DEUTERON ACER TENDL-2023 LIBRARY; T=0.K  
Photon emission for (n,p)

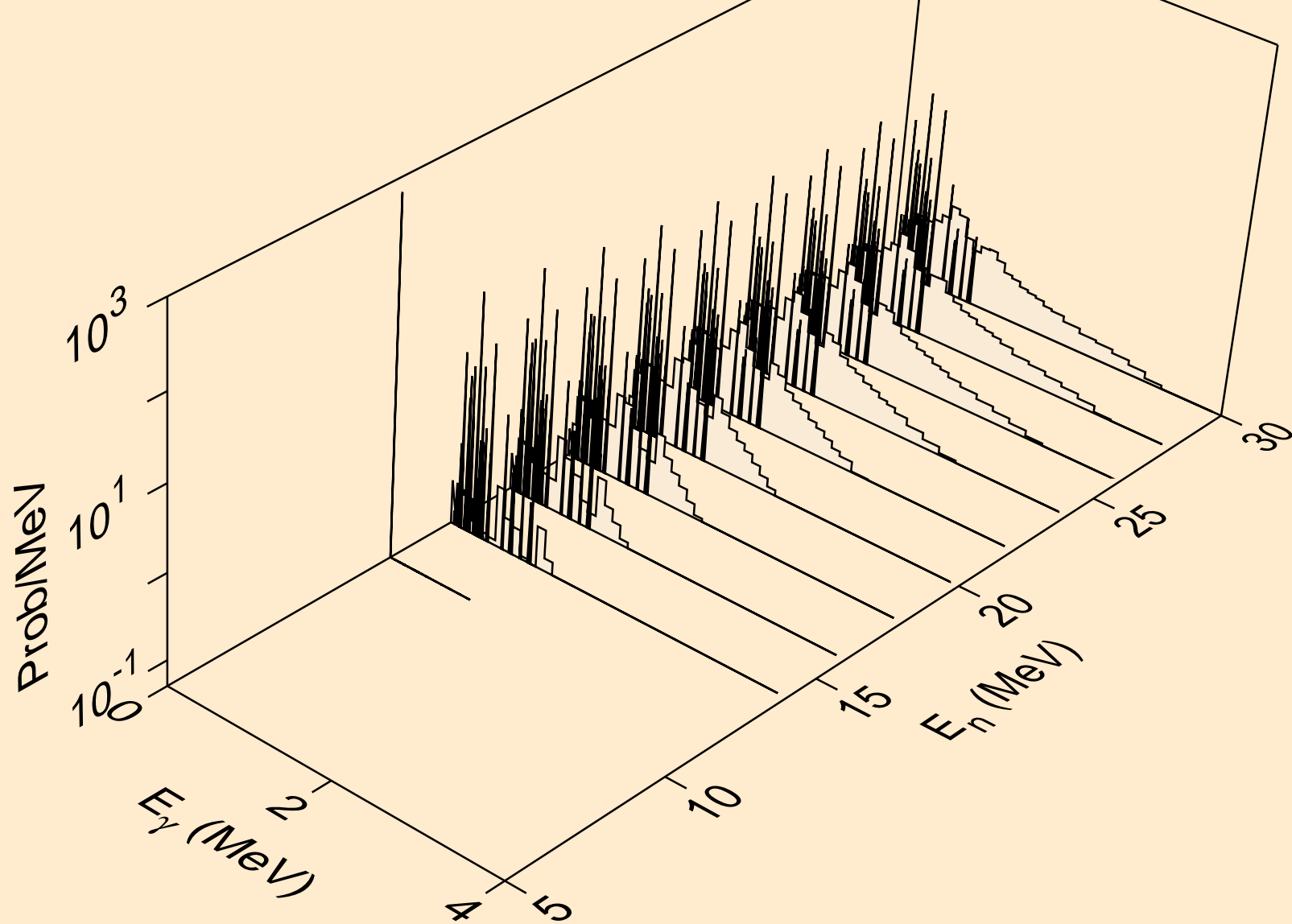

AS081 DEUTERON ACER TENDL-2023 LIBRARY; T=0.K  
Photon emission for (n,pd)

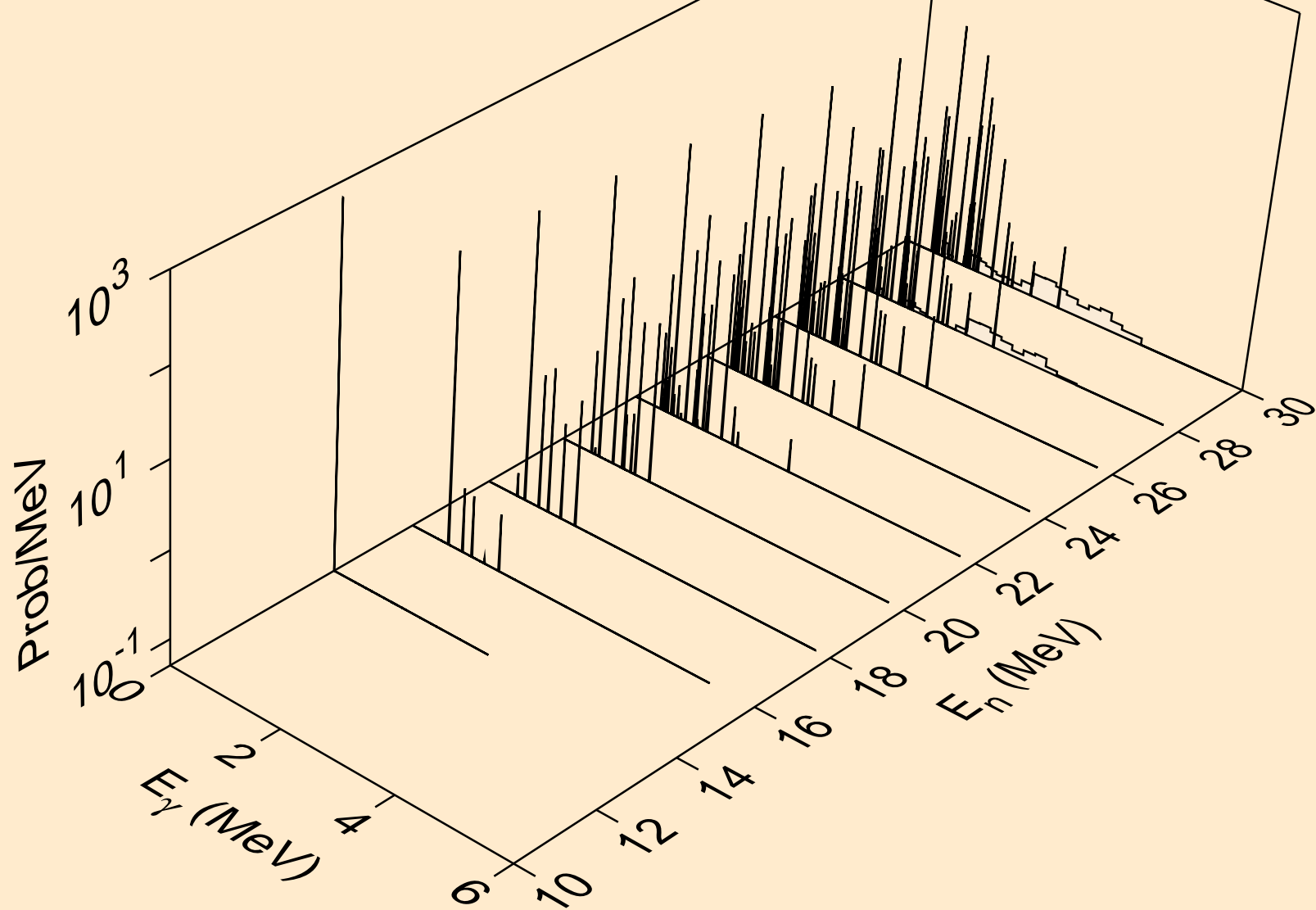

AS081 DEUTERON ACER TENDL-2023 LIBRARY; T=0.K  
Photon emission for (n,pt)

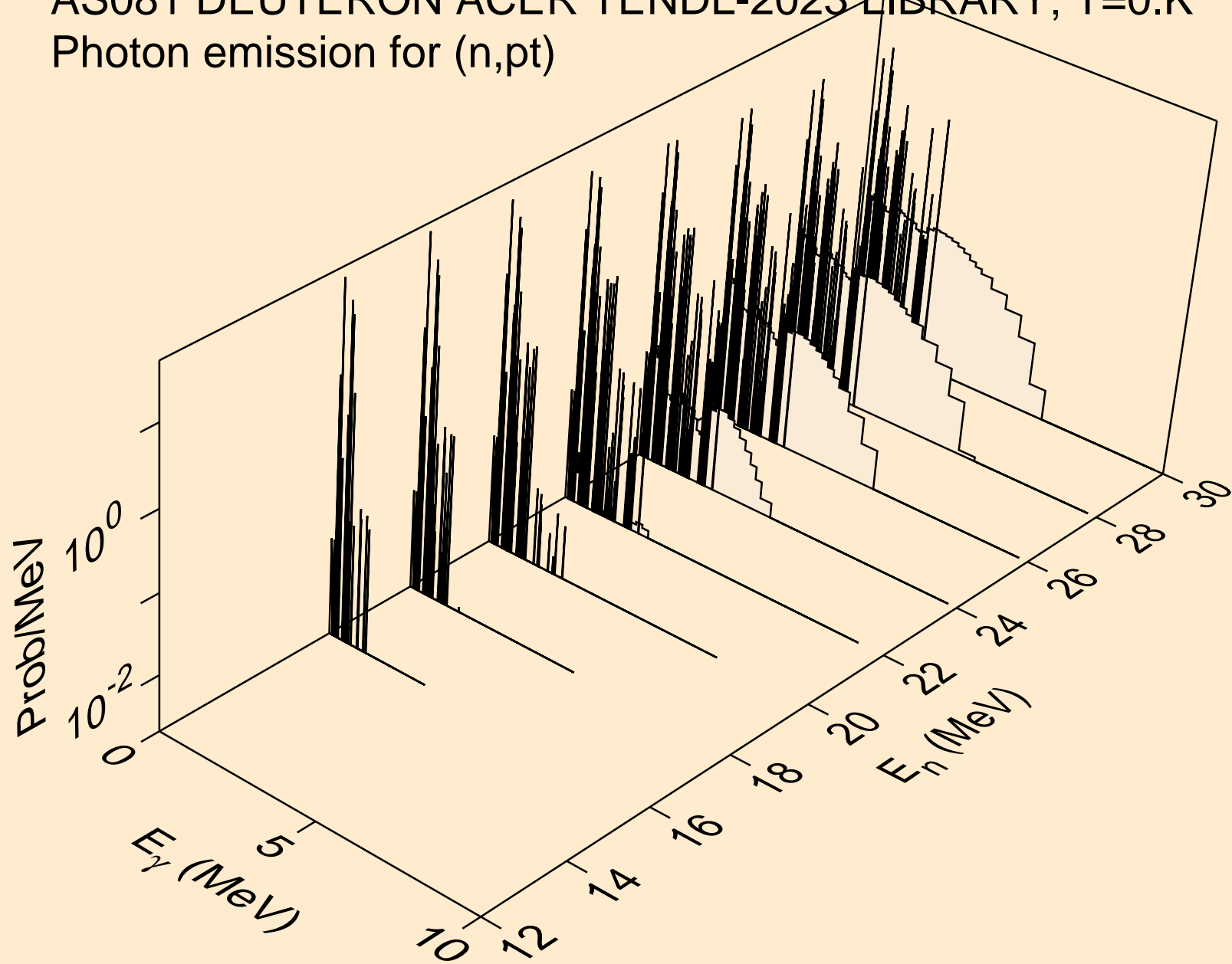

AS081 DEUTERON ACER TENDL-2023 LIBRARY; T=0.K  
Photon emission for (n,da)

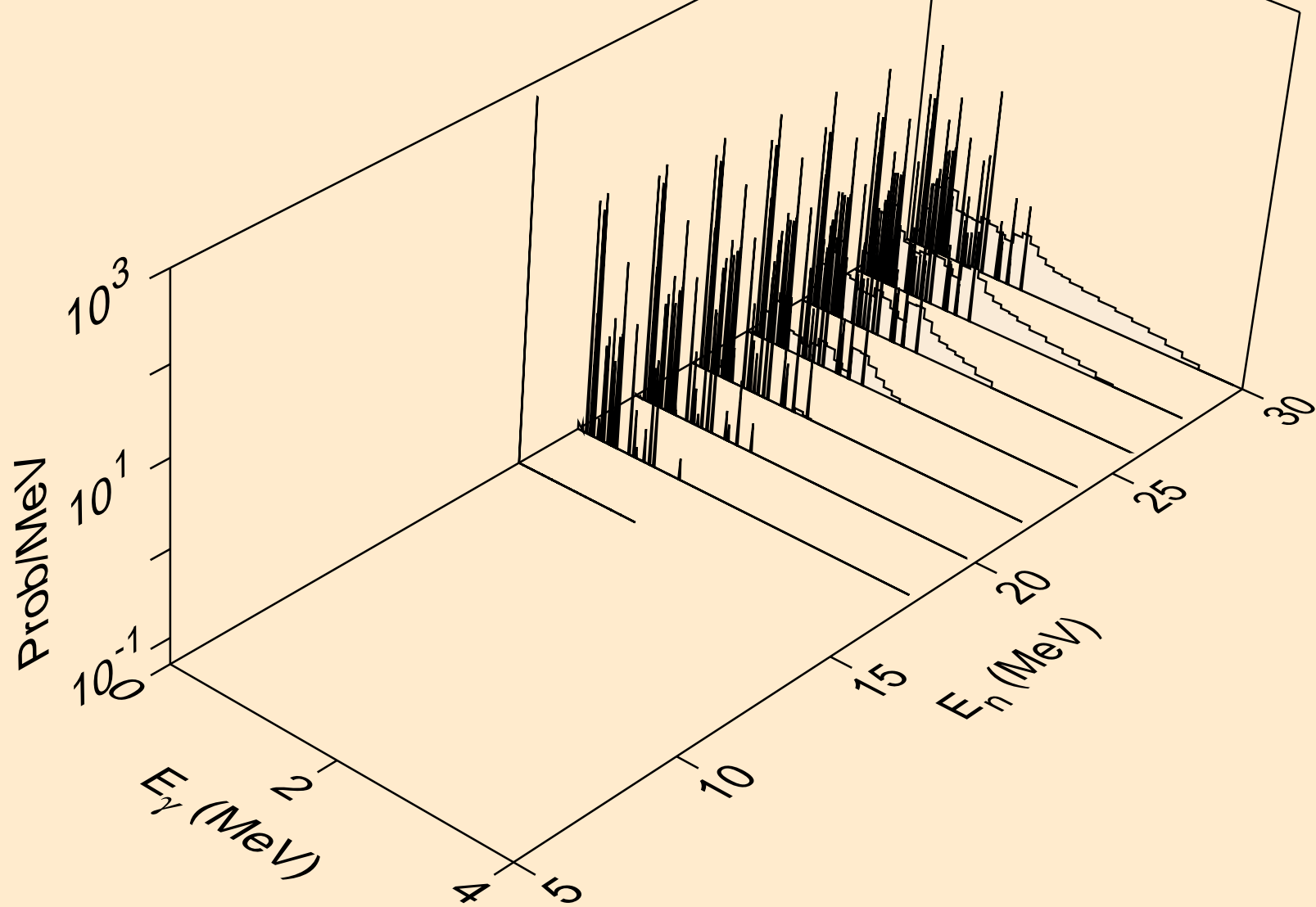

# AS081 DEUTERON ACER TENDL-2023 LIBRARY; T=0.K

## Particle heating contributions

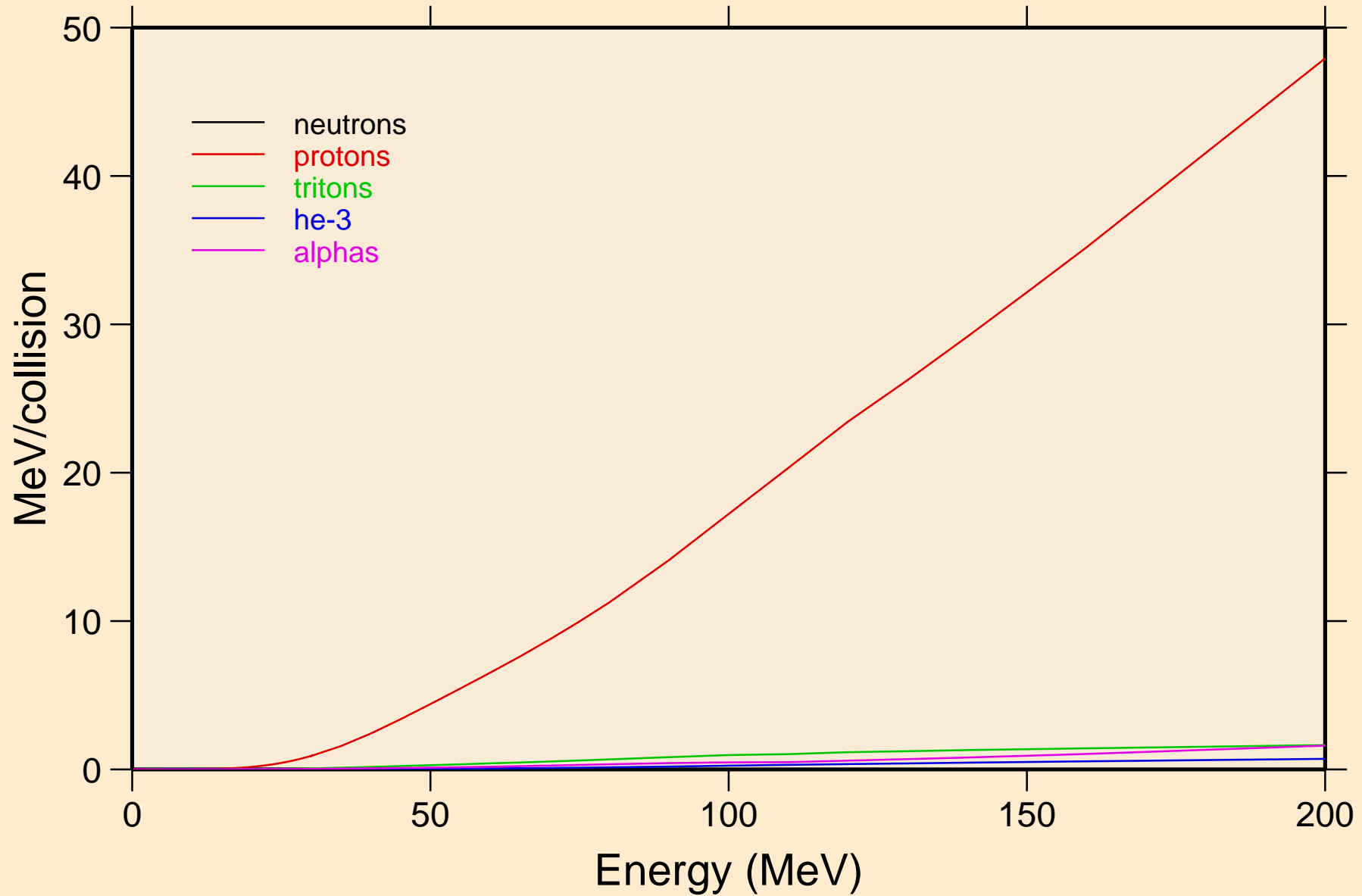

AS081 DEUTERON ACER TENDL-2023 LIBRARY; T=0.K  
Recoil Heating

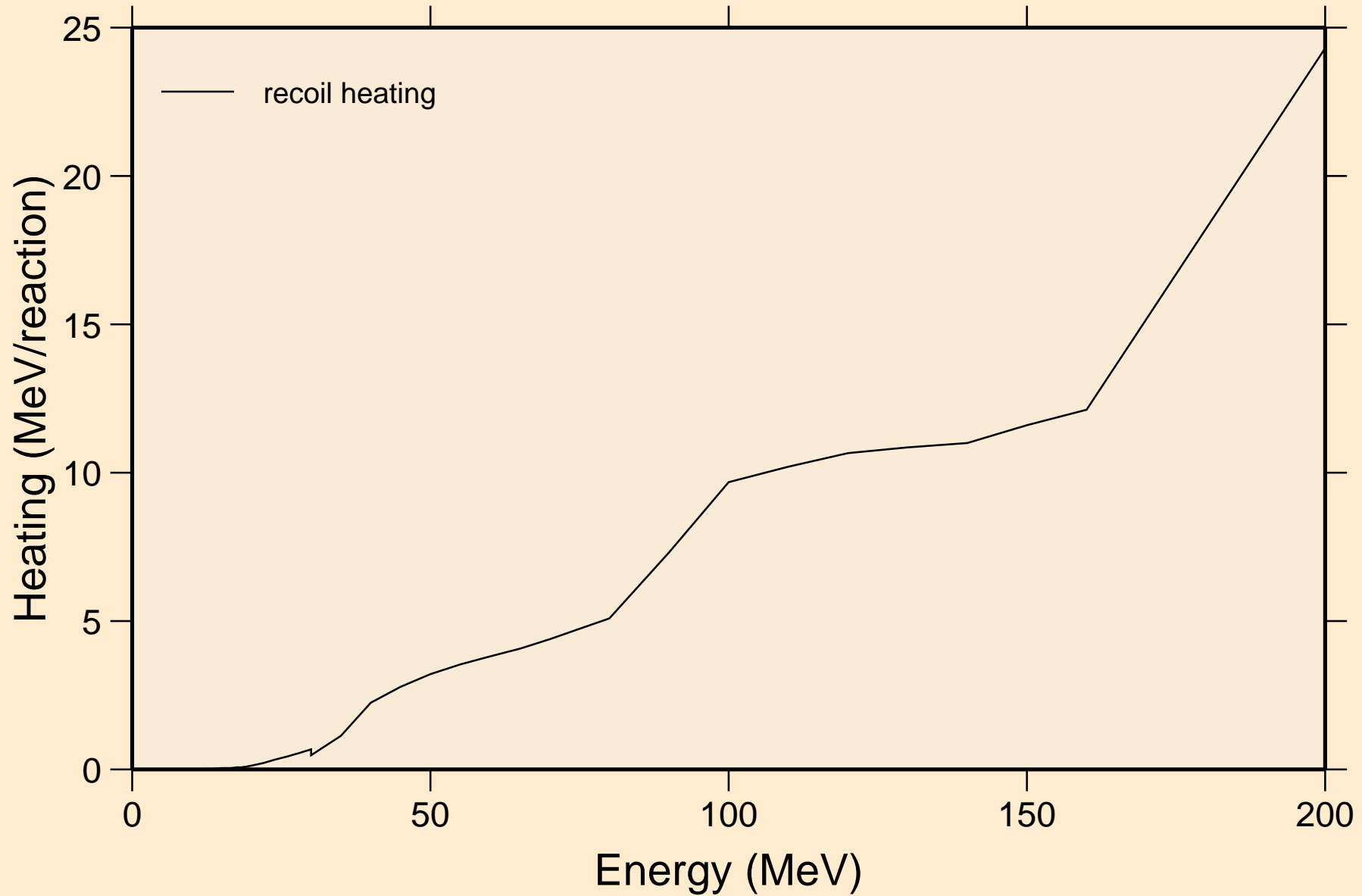

AS081 DEUTERON ACER TENDL-2023 LIBRARY; T=0.K  
Particle production cross sections

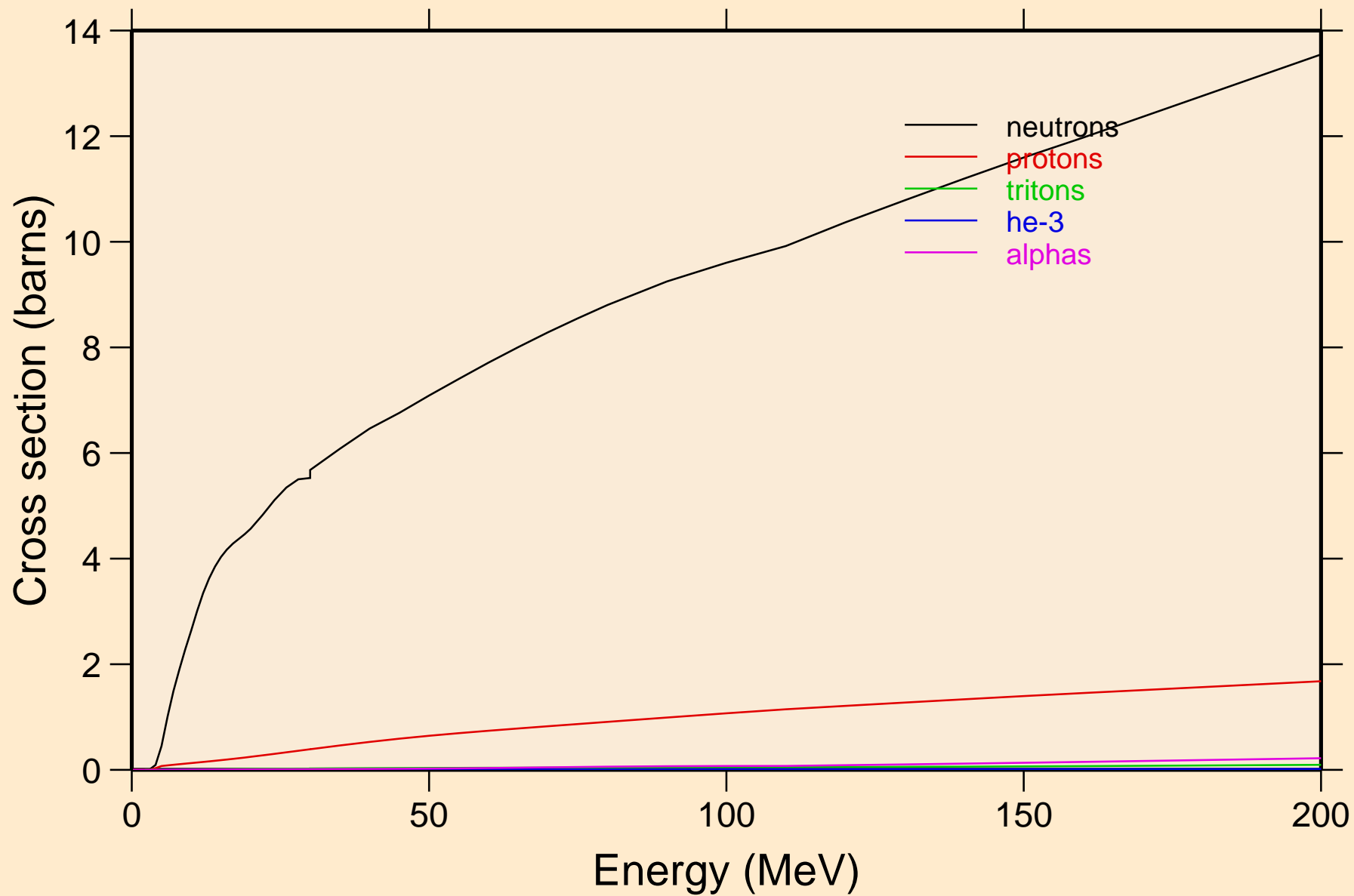



AS081 DEUTERON ACER TENDL-2023 LIBRARY; T=0.K  
neutrons from (d,n)

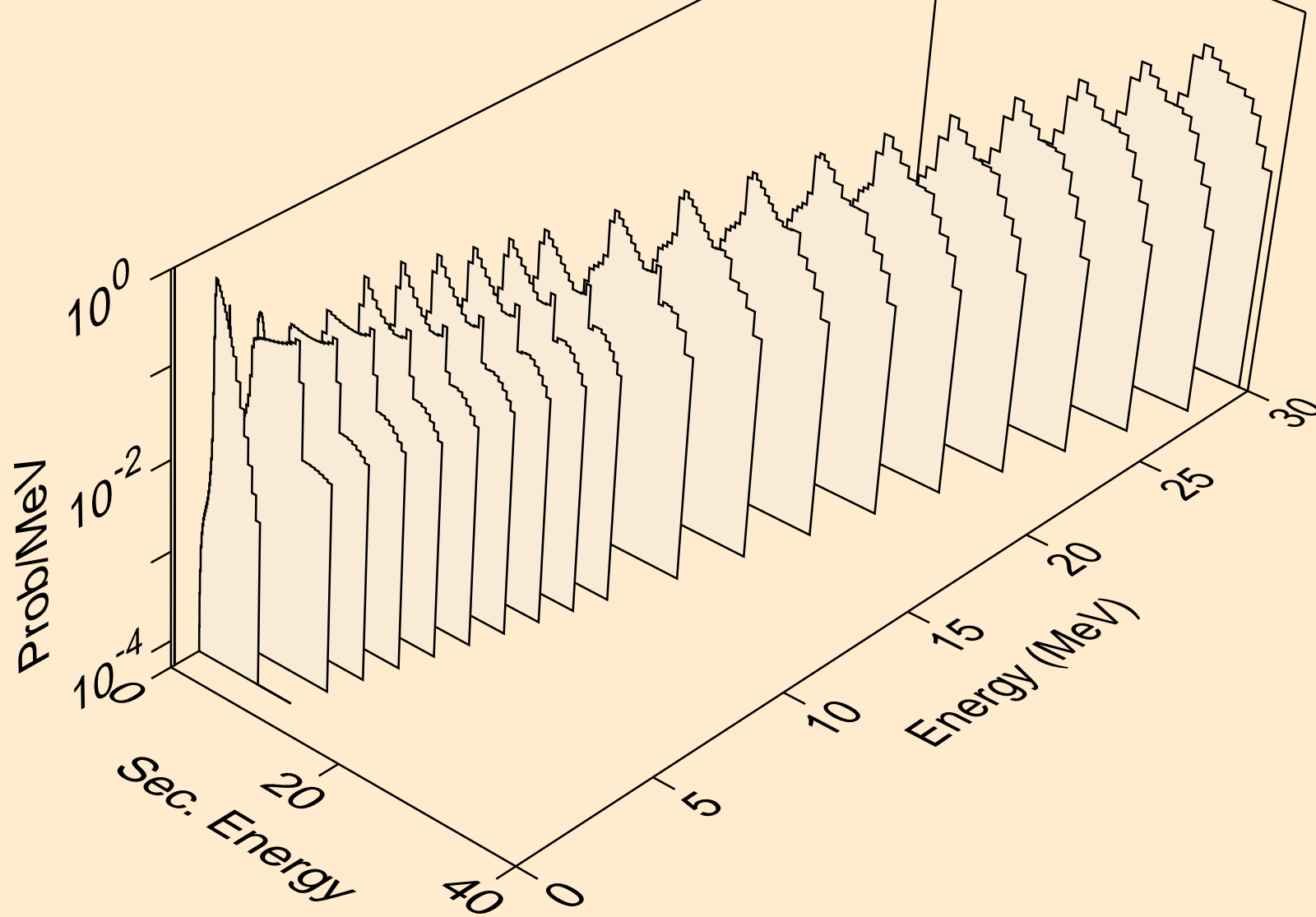

AS081 DEUTERON ACER TENDL-2023 LIBRARY; T=0.K  
neutrons from (d,x)

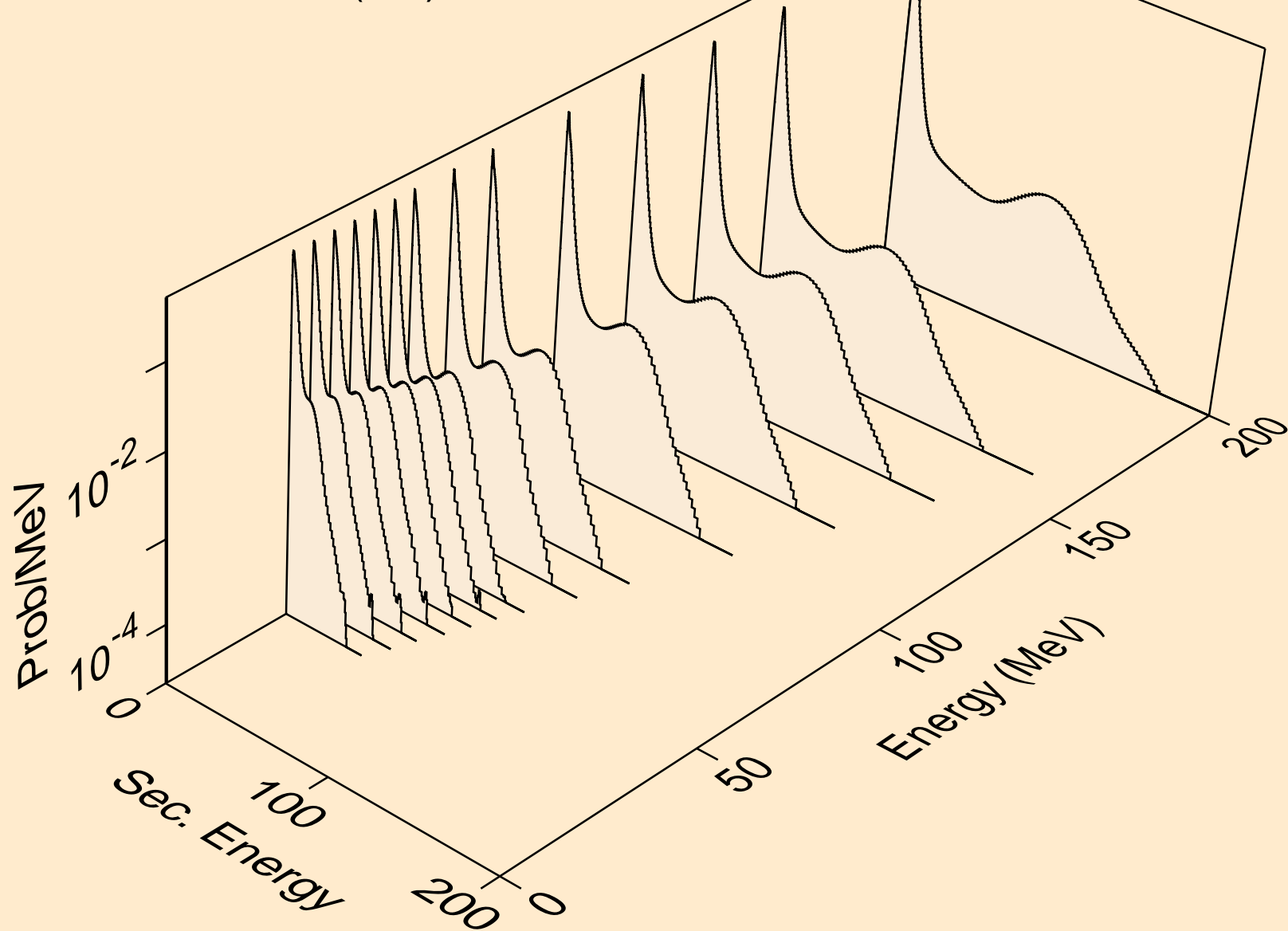

AS081 DEUTERON ACER TENDL-2023 LIBRARY; T=0.K  
neutrons from (d,2nd)

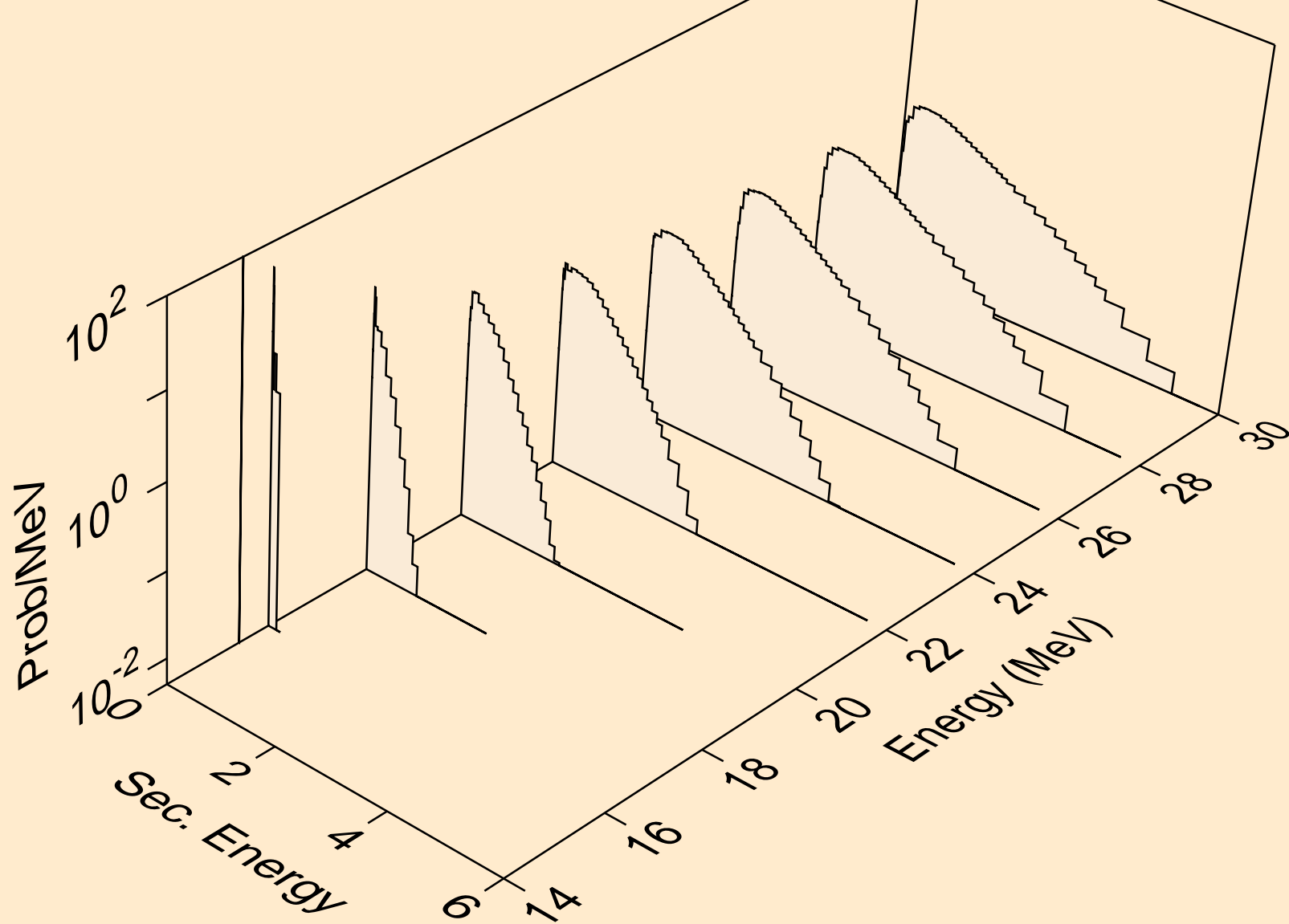

AS081 DEUTERON ACER TENDL-2023 LIBRARY; T=0.K  
neutrons from (d,2n)

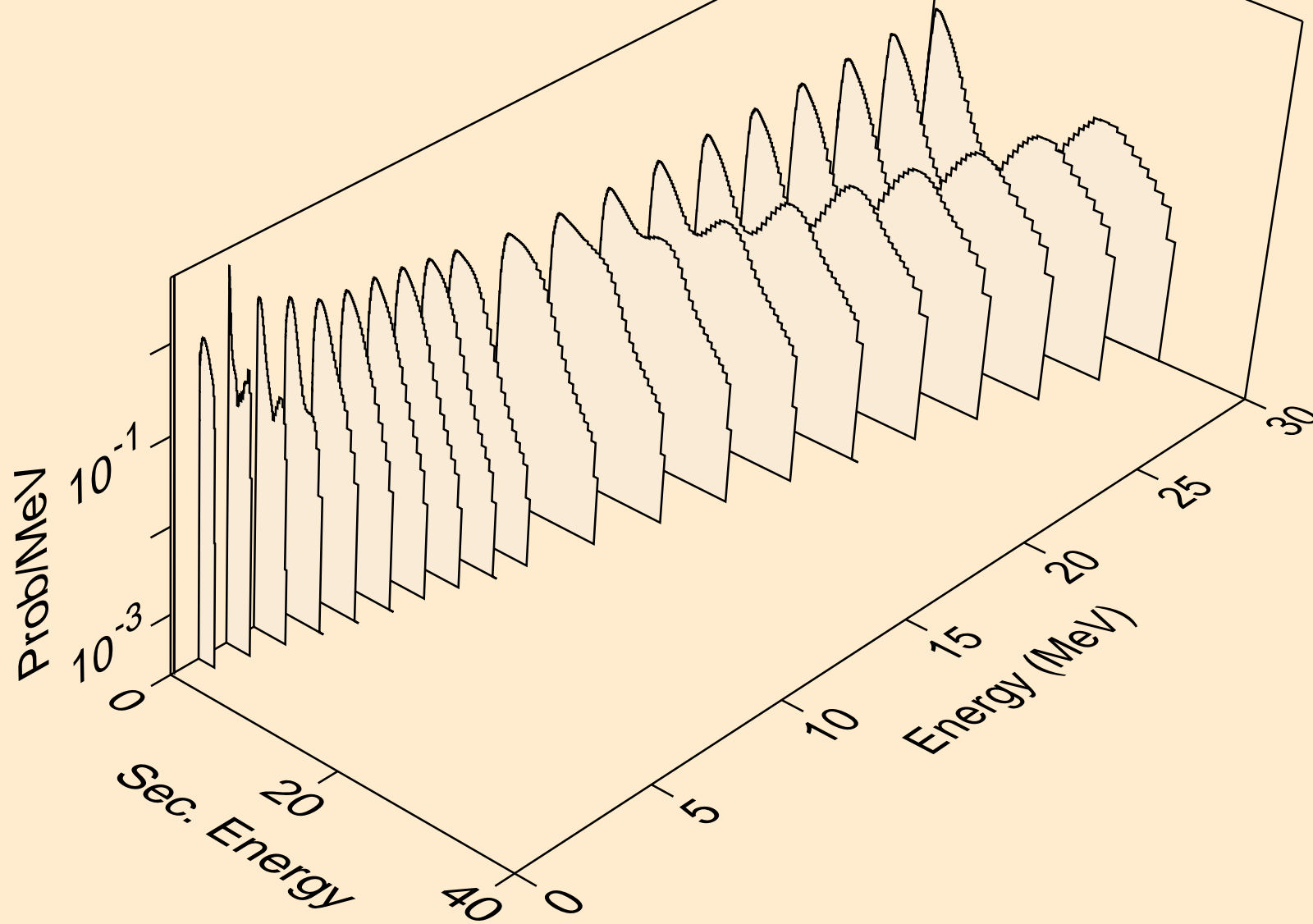

AS081 DEUTERON ACER TENDL-2023 LIBRARY; T=0.K  
neutrons from (d,3n)

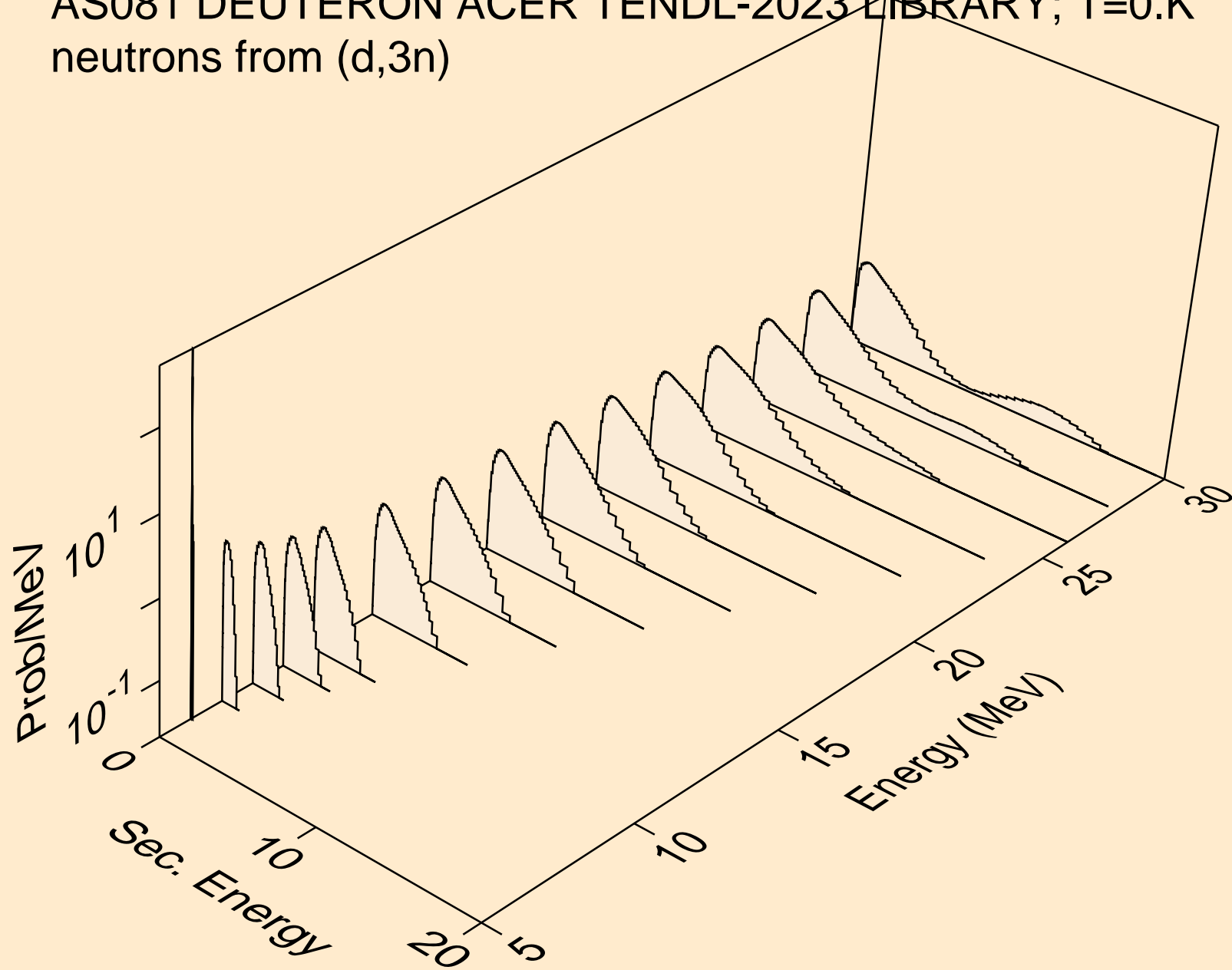

AS081 DEUTERON ACER TENDL-2023 LIBRARY; T=0.K  
neutrons from (d,n\*)a

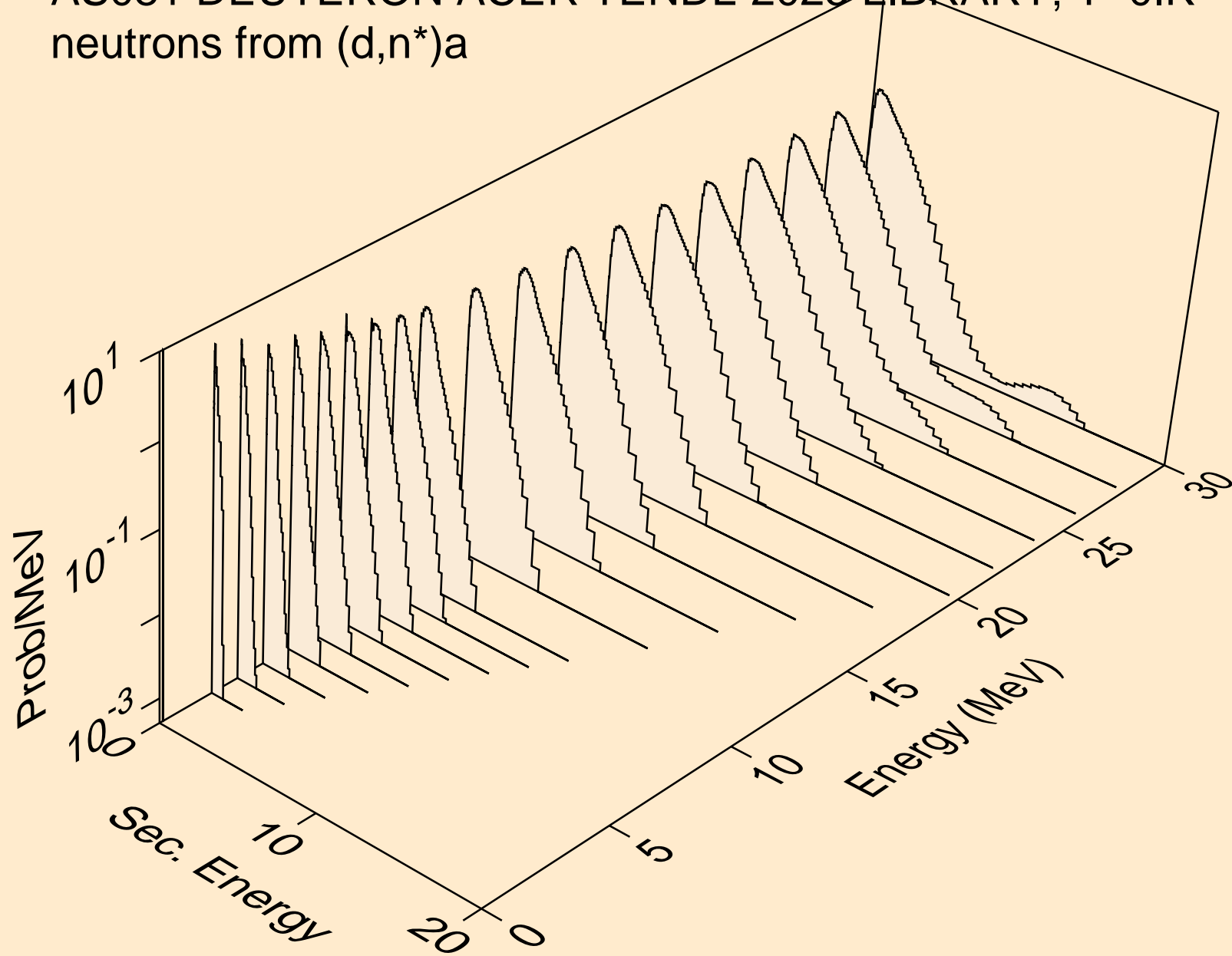

AS081 DEUTERON ACER TENDL-2023 LIBRARY; T=0.K  
neutrons from (d,2n)a

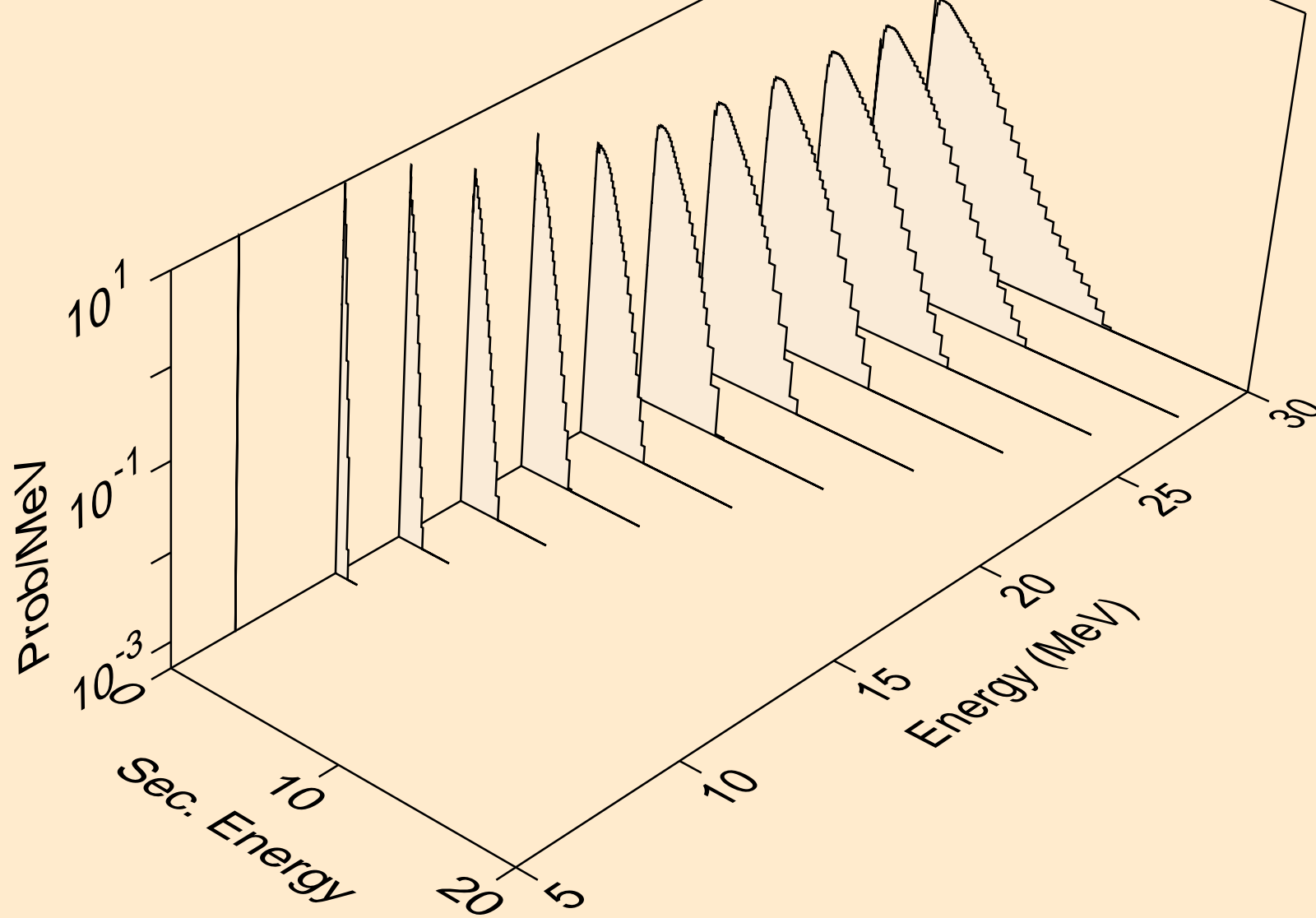

AS081 DEUTERON ACER TENDL-2023 LIBRARY; T=0.K  
neutrons from (d,3n)a

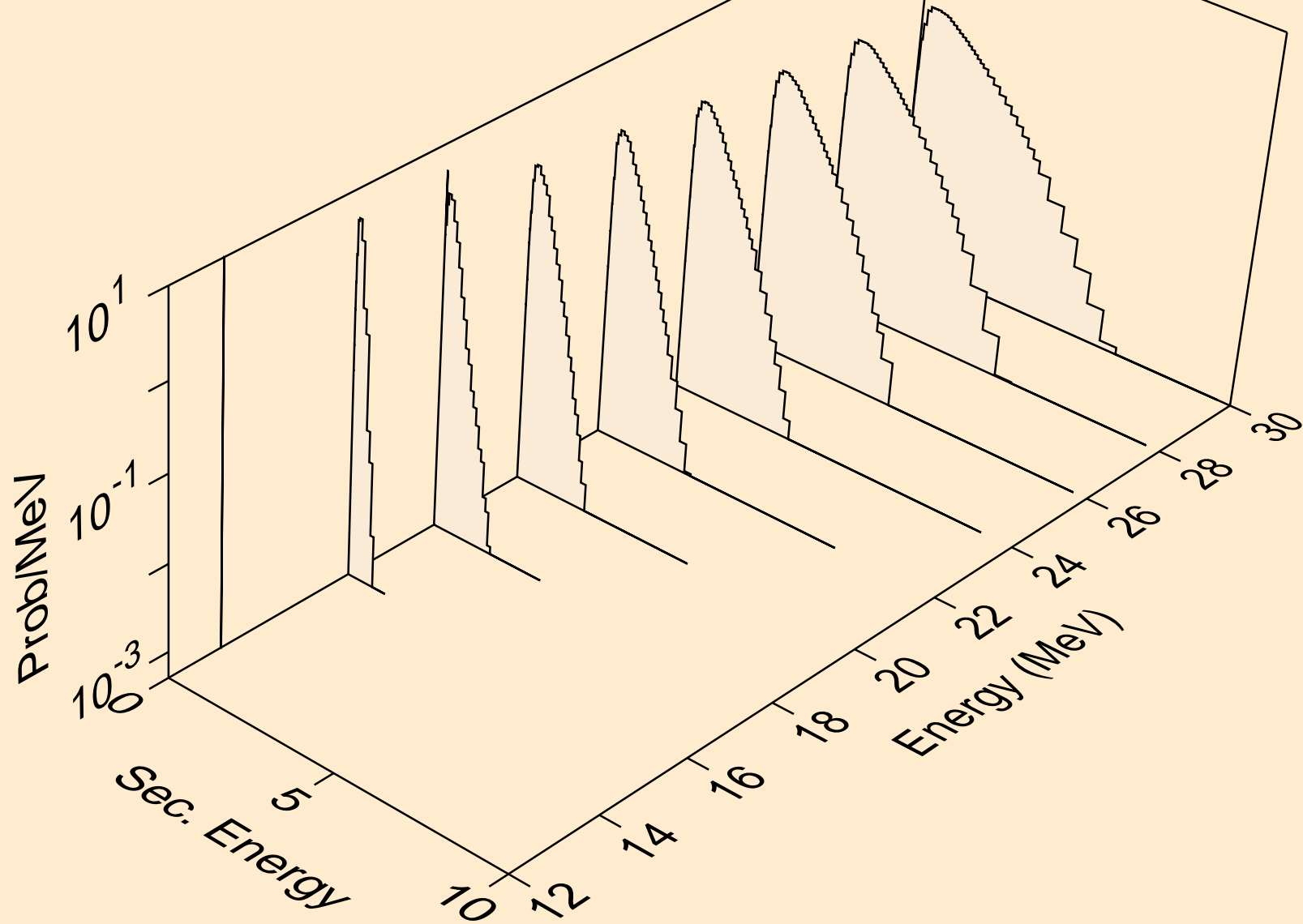



AS081 DEUTERON ACER TENDL-2023 LIBRARY; T=0.K  
neutrons from (d,n\*)p

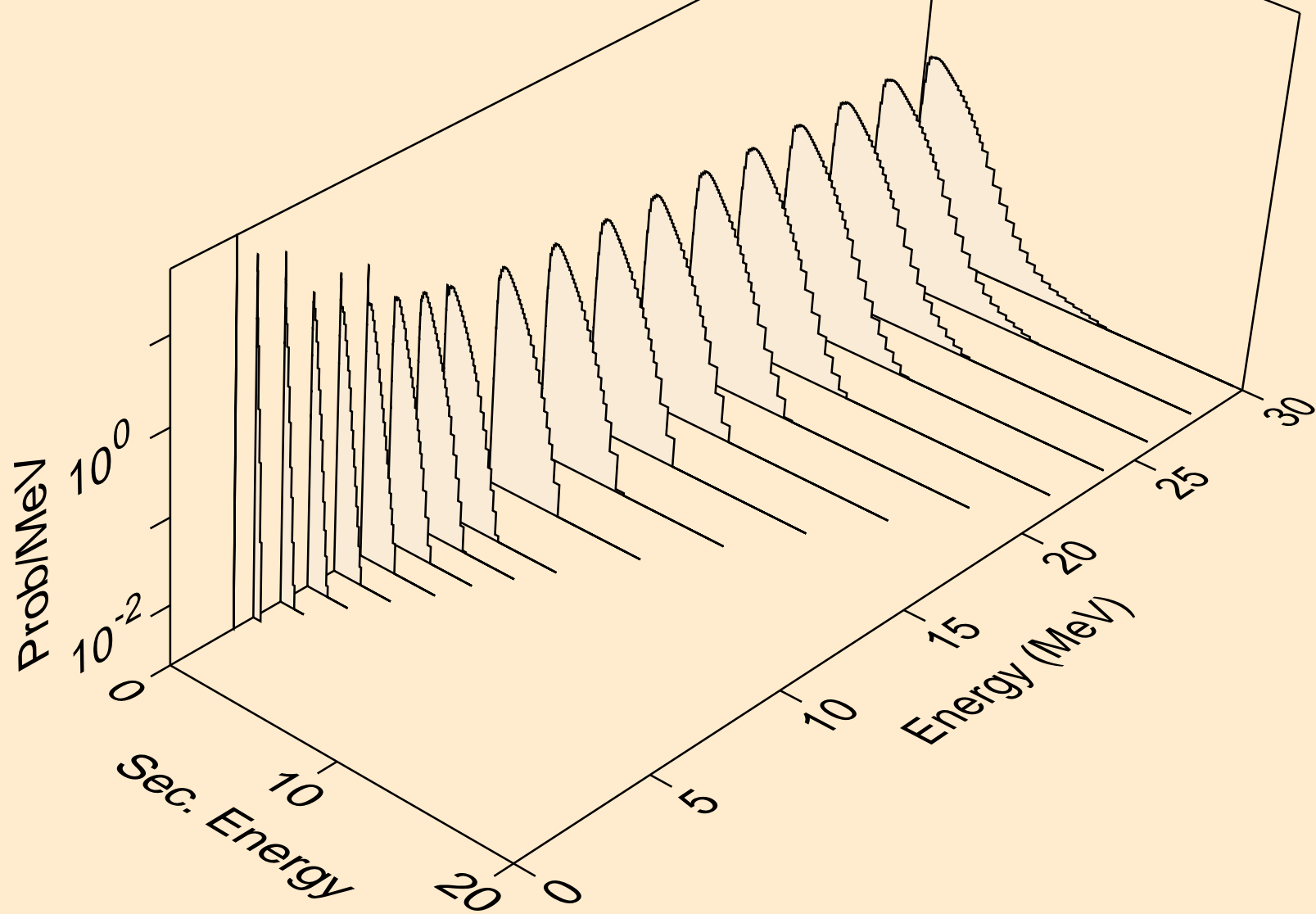

AS081 DEUTERON ACER TENDL-2023 LIBRARY; T=0.K  
neutrons from (d,n\*)2a

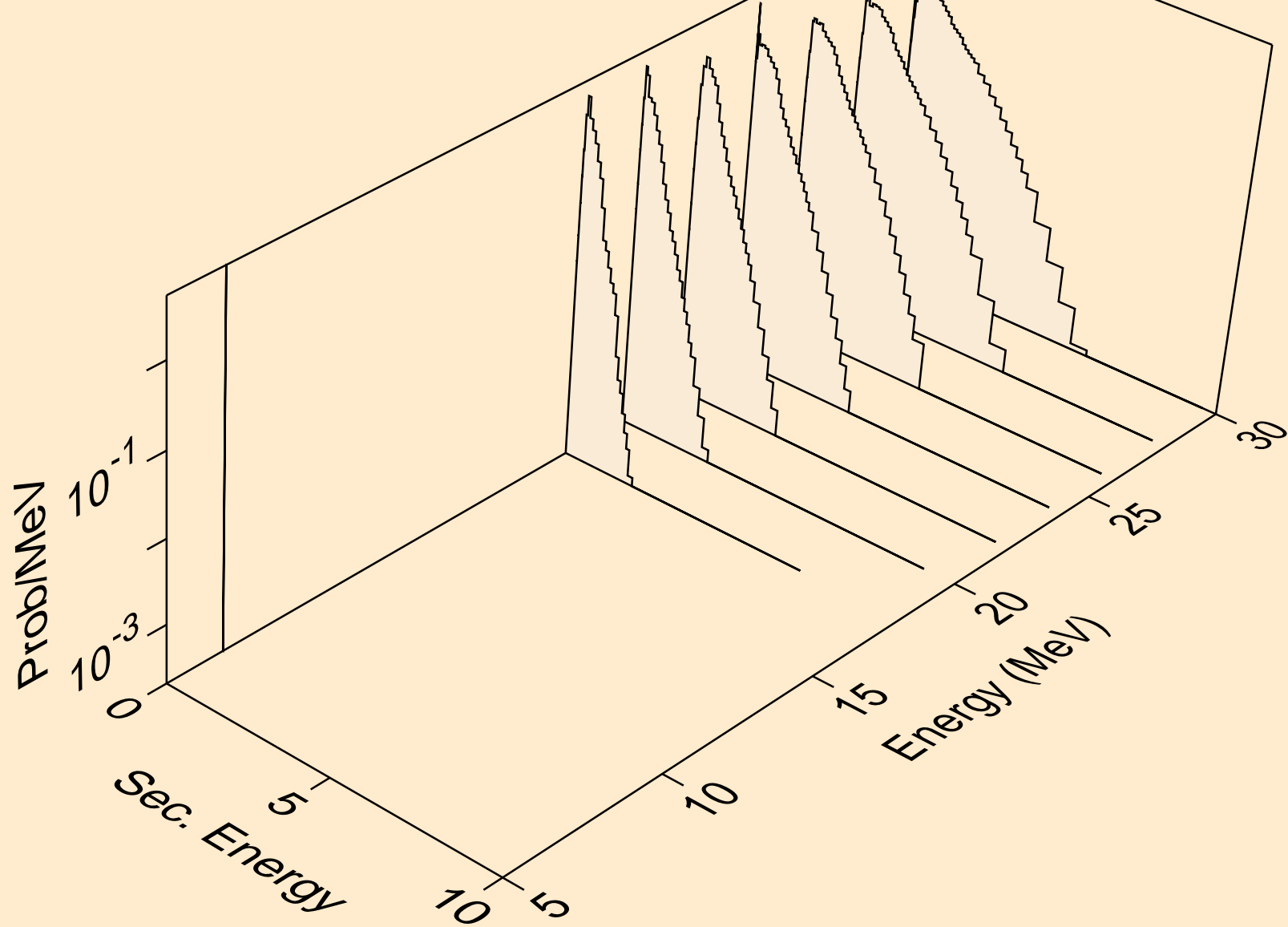

AS081 DEUTERON ACER TENDL-2023 LIBRARY; T=0.K  
neutrons from (d,n\*)d

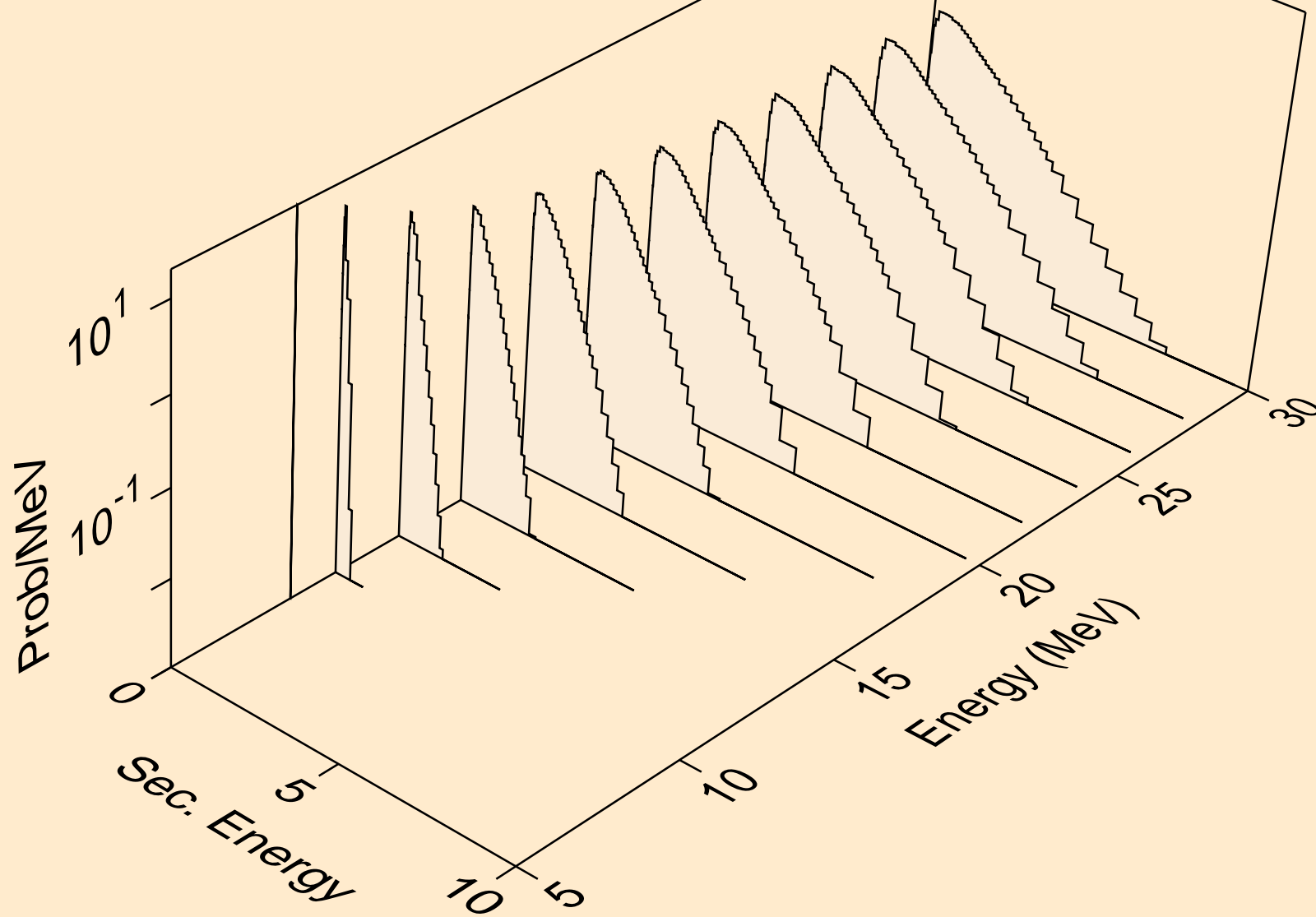

AS081 DEUTERON ACER TENDL-2023 LIBRARY; T=0.K  
neutrons from (d,n\*)t

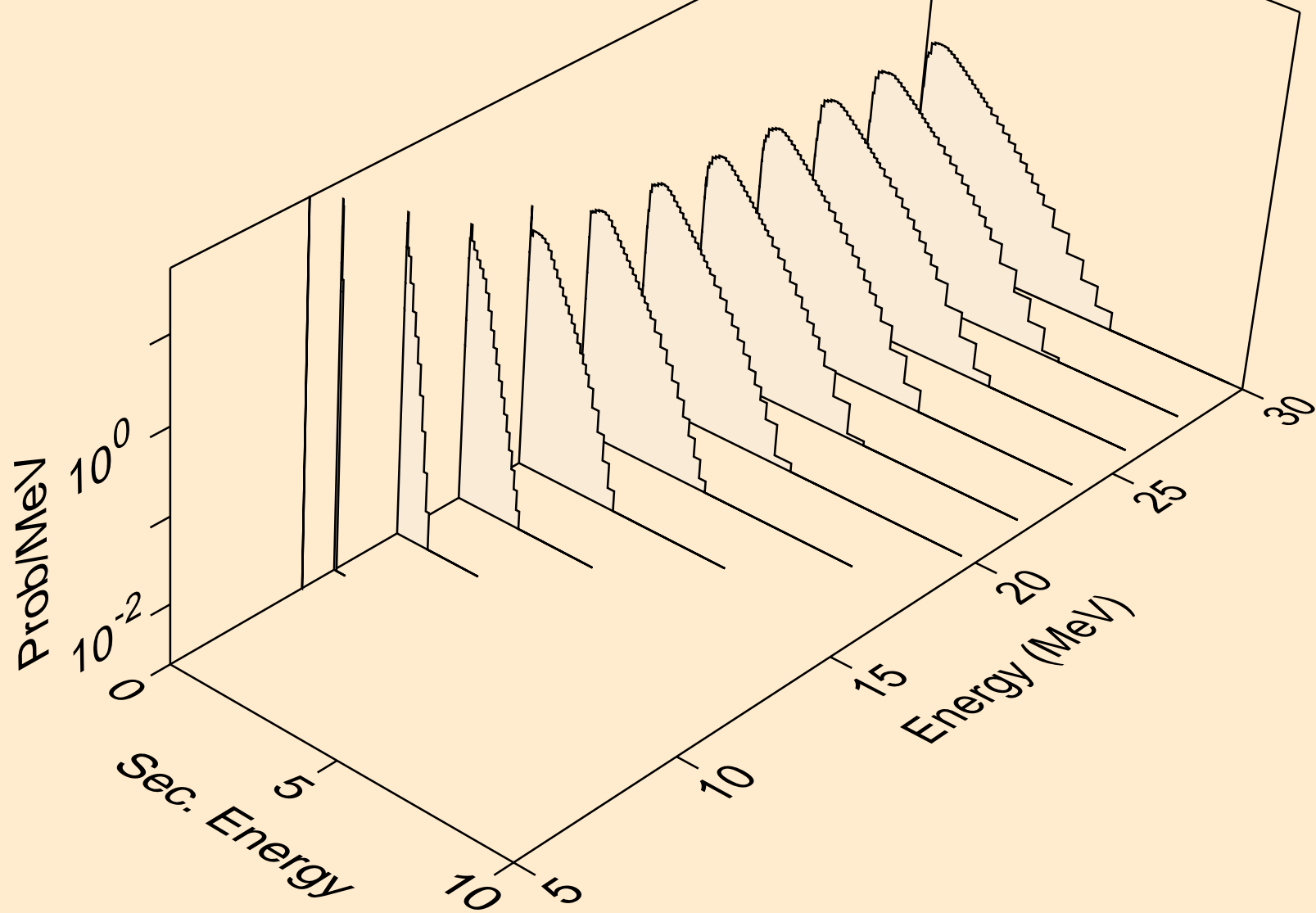

AS081 DEUTERON ACER TENDL-2023 LIBRARY; T=0.K  
neutrons from (d,n\*)he3

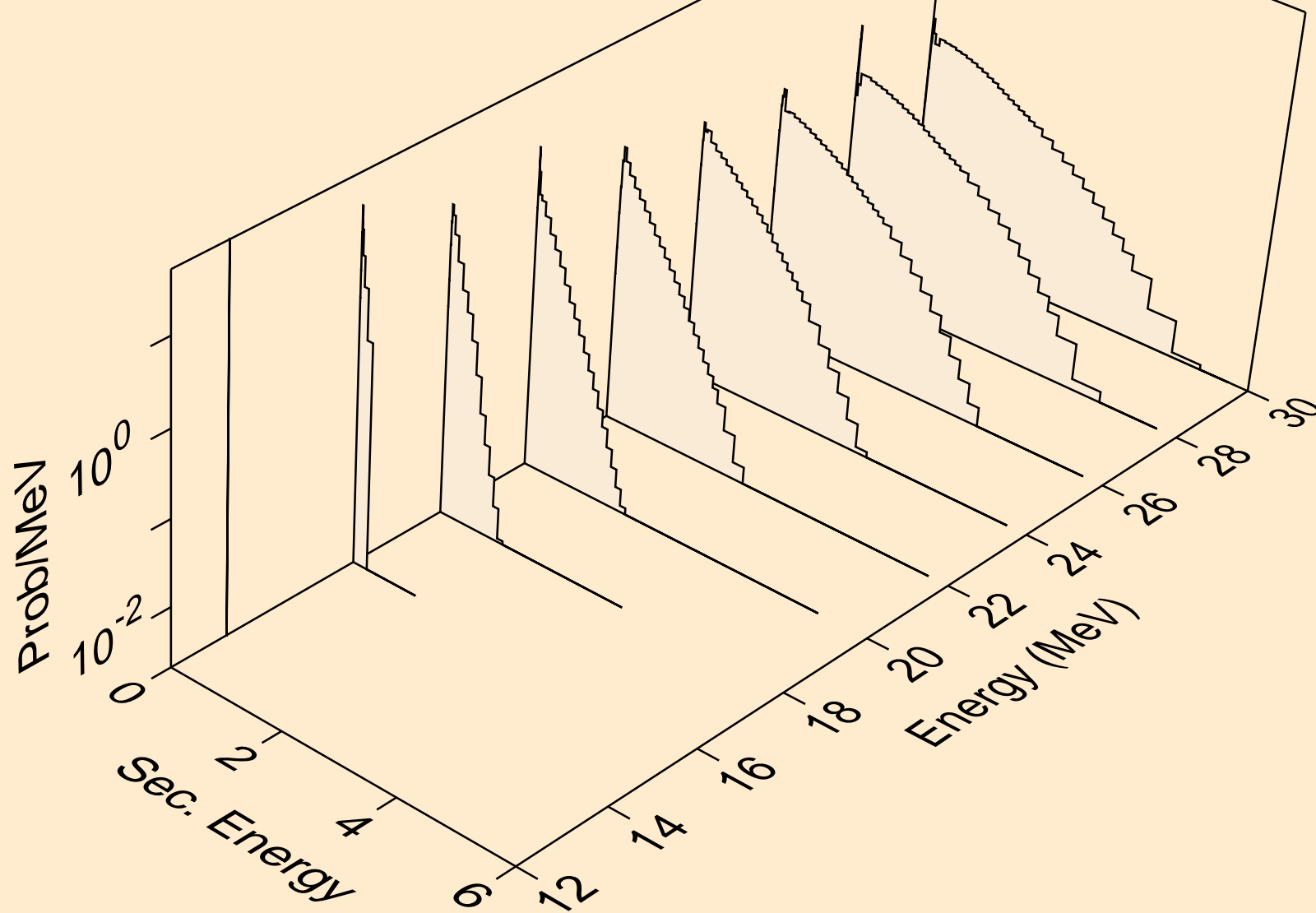

AS081 DEUTERON ACER TENDL-2023 LIBRARY; T=0.K  
neutrons from (d,4n)

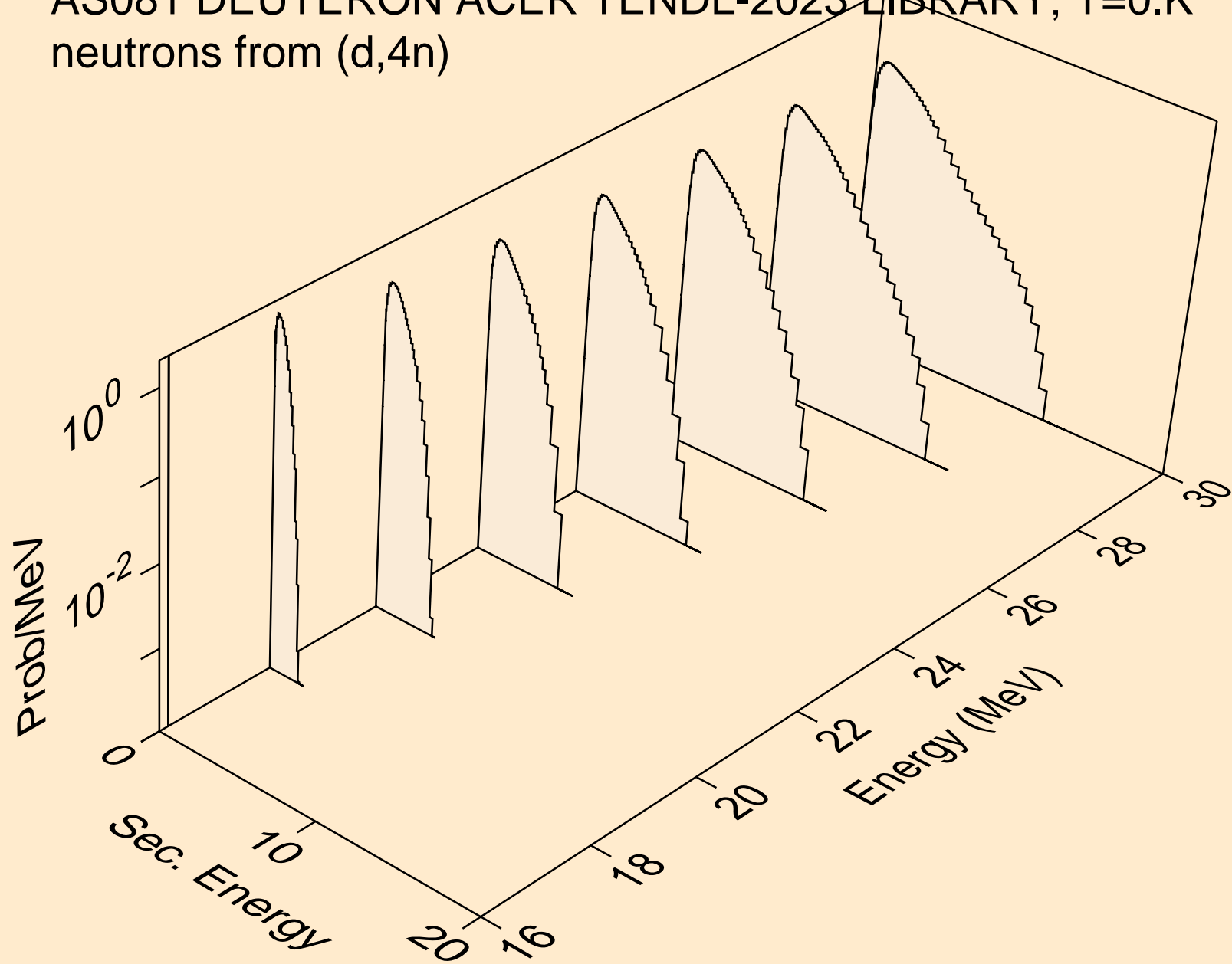

AS081 DEUTERON ACER TENDL-2023 LIBRARY; T=0.K  
neutrons from (d,2np)

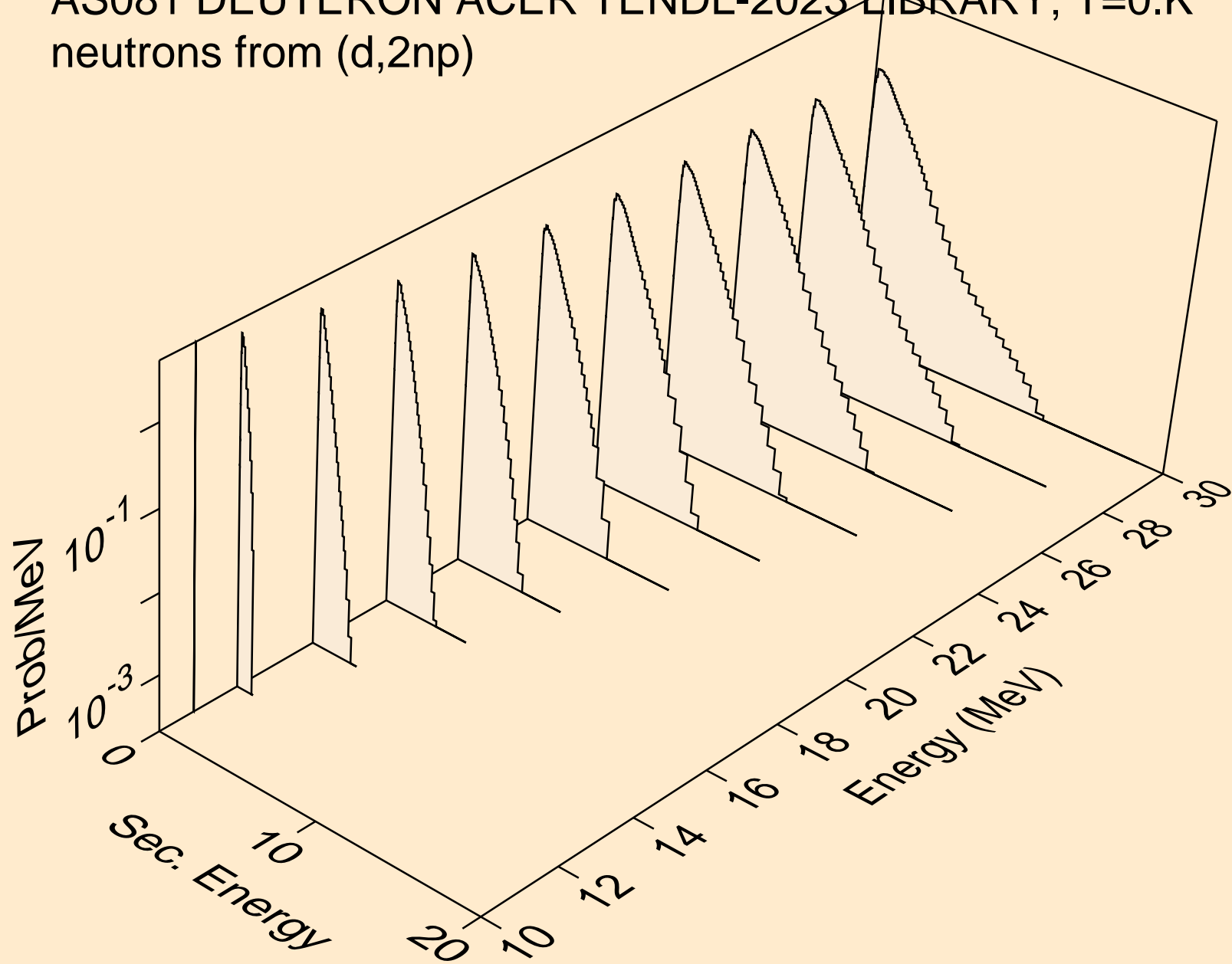

AS081 DEUTERON ACER TENDL-2023 LIBRARY; T=0.K  
neutrons from (d,3np)

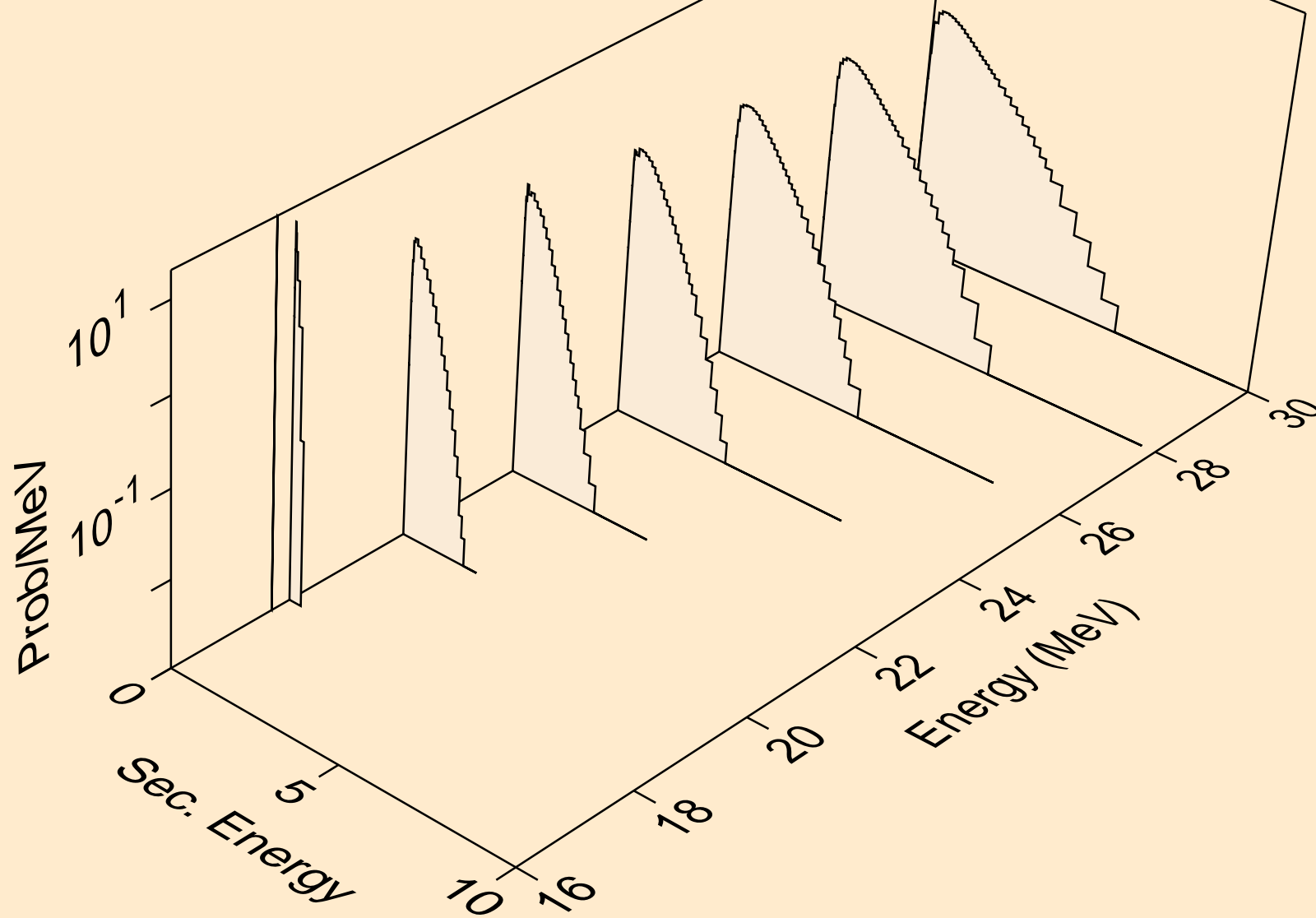



AS081 DEUTERON ACER TENDL-2023 LIBRARY; T=0.K  
neutrons from (d,n2p)

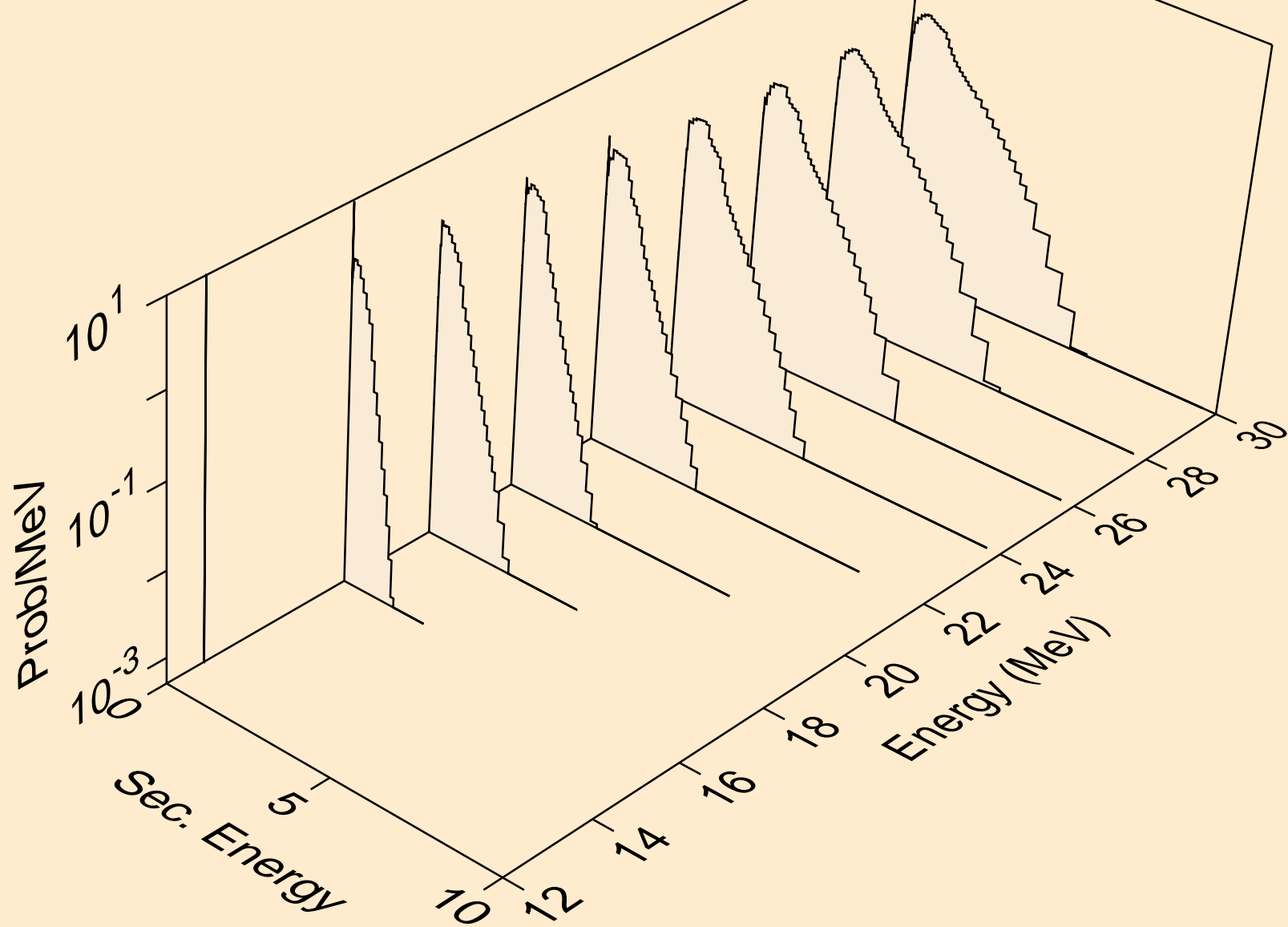

AS081 DEUTERON ACER TENDL-2023 LIBRARY; T=0.K  
neutrons from (d,npa)

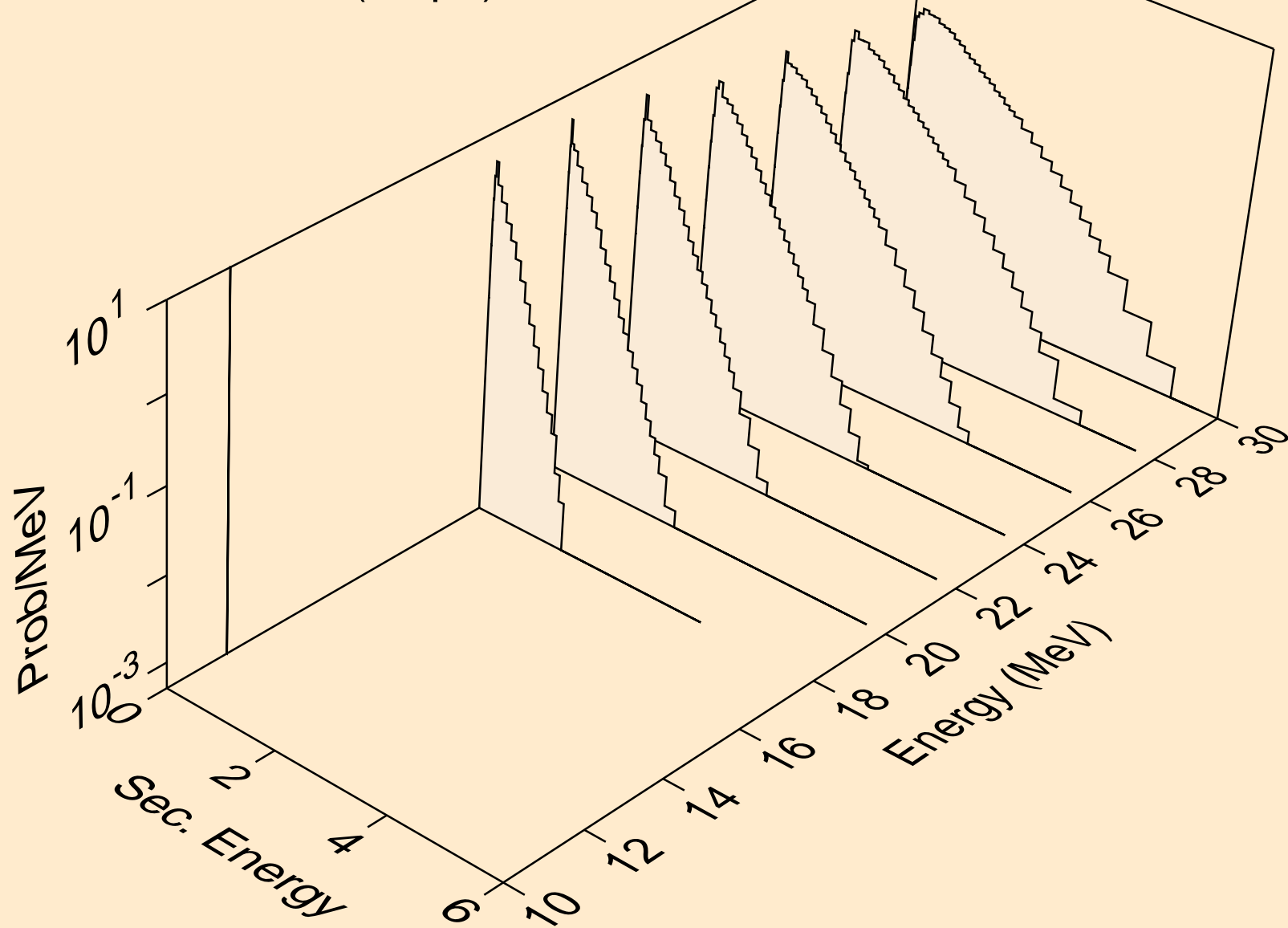

AS081 DEUTERON ACER TENDL-2023 LIBRARY; T=0.K  
protons from (d,x)

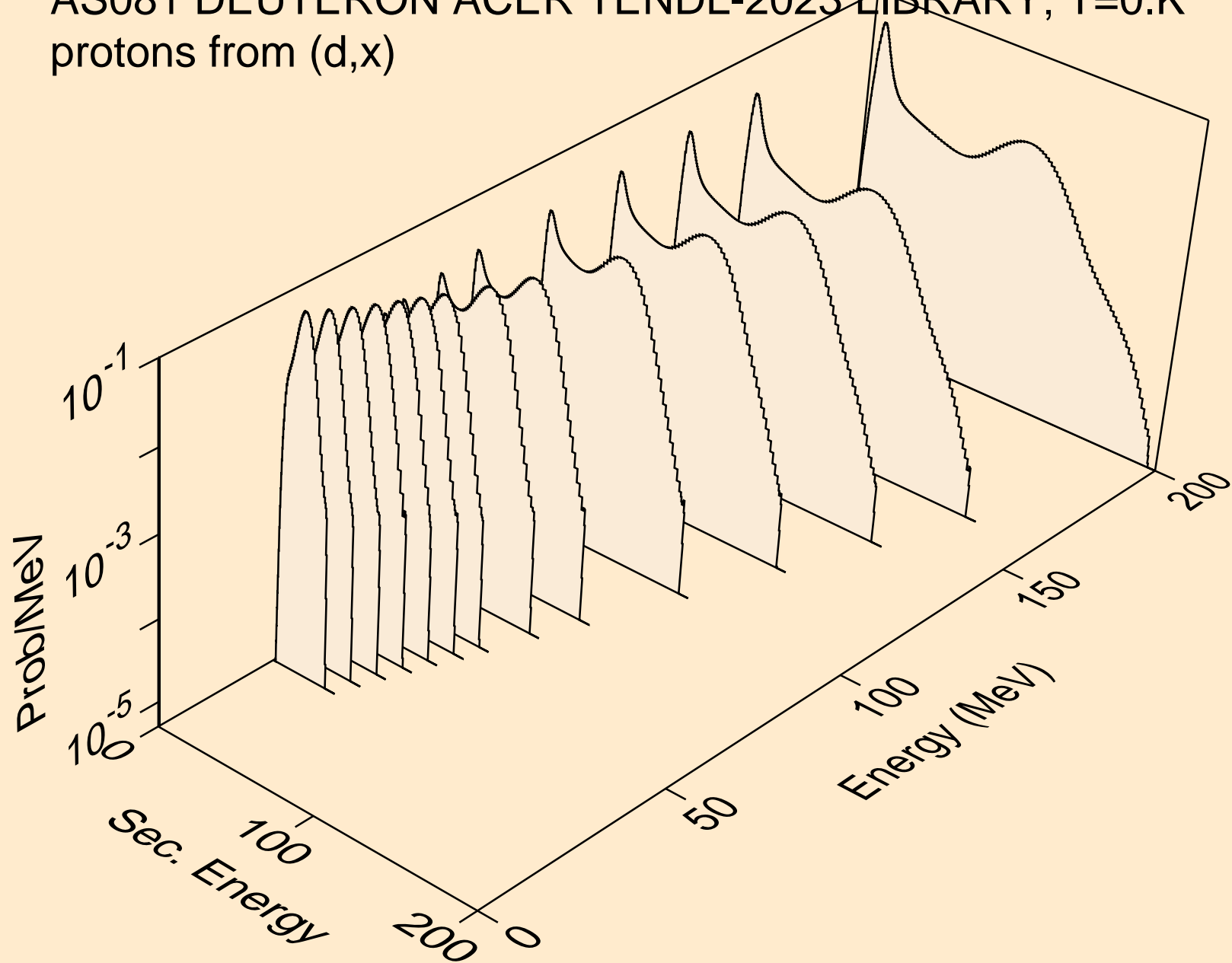

AS081 DEUTERON ACER TENDL-2023 LIBRARY; T=0.K  
protons from (d,n\*)p

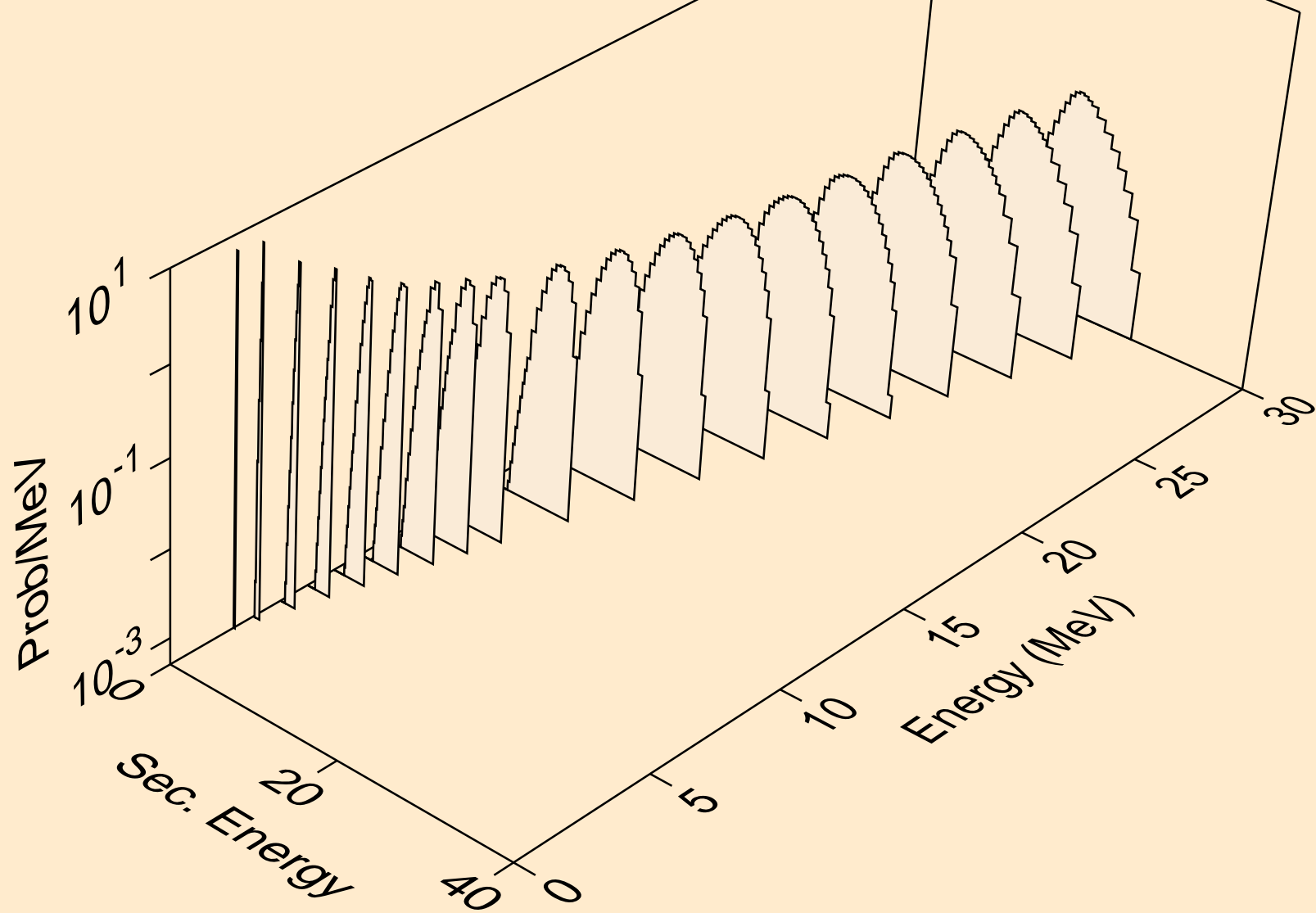

AS081 DEUTERON ACER TENDL-2023 LIBRARY; T=0.K  
protons from (d,2np)

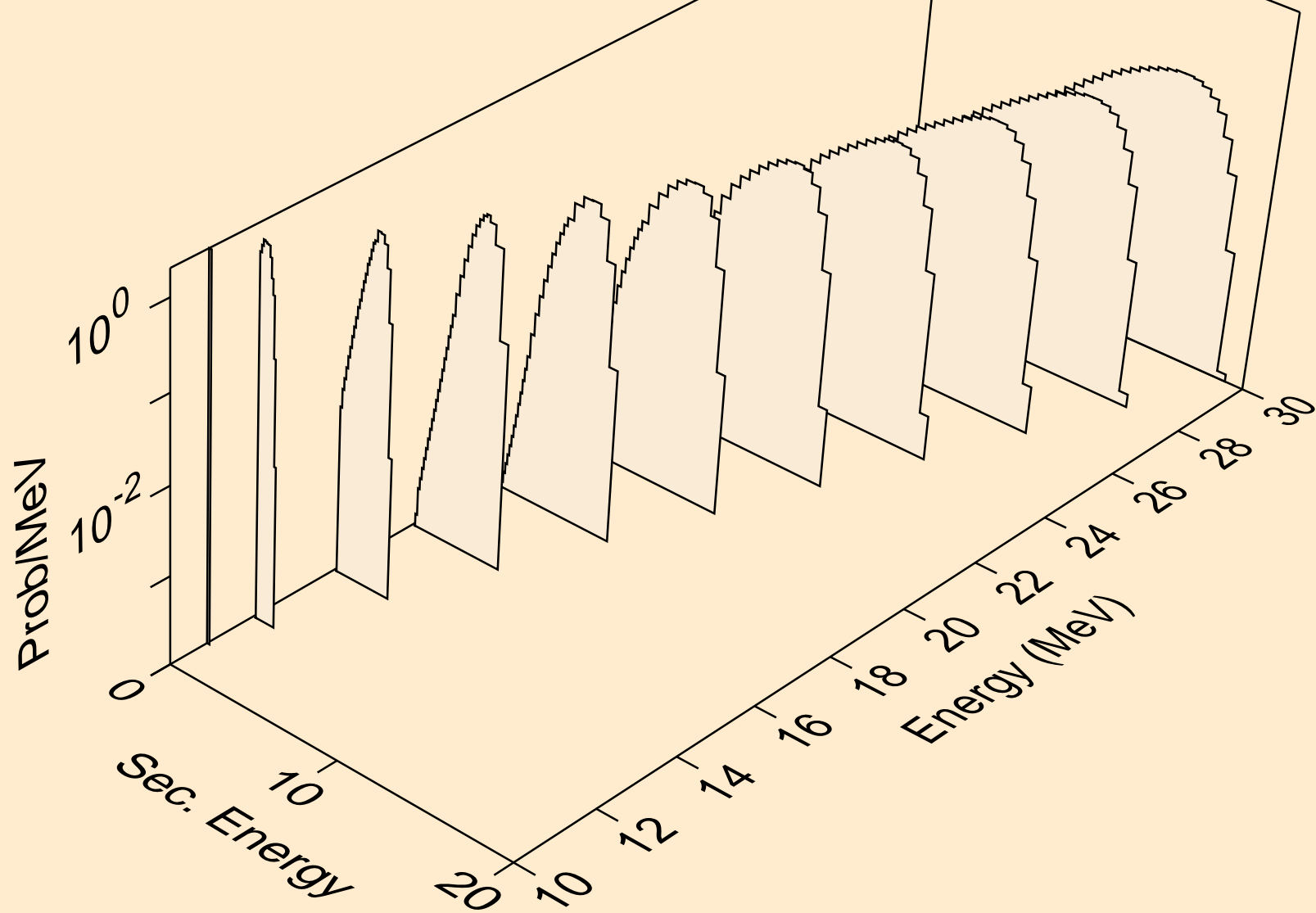

AS081 DEUTERON ACER TENDL-2023 LIBRARY; T=0.K  
protons from (d,3np)

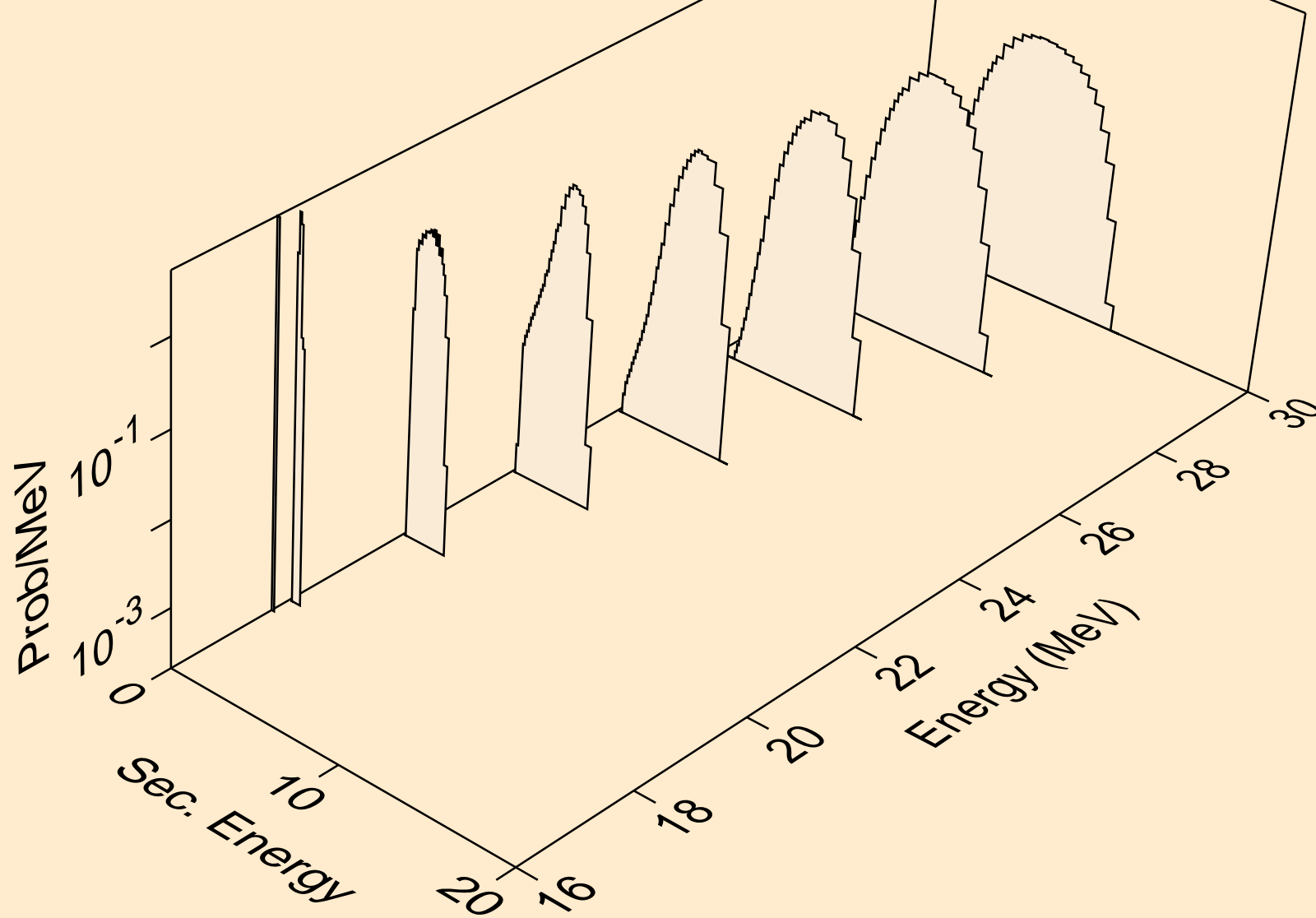

AS081 DEUTERON ACER TENDL-2023 LIBRARY; T=0.K  
protons from (d,n2p)

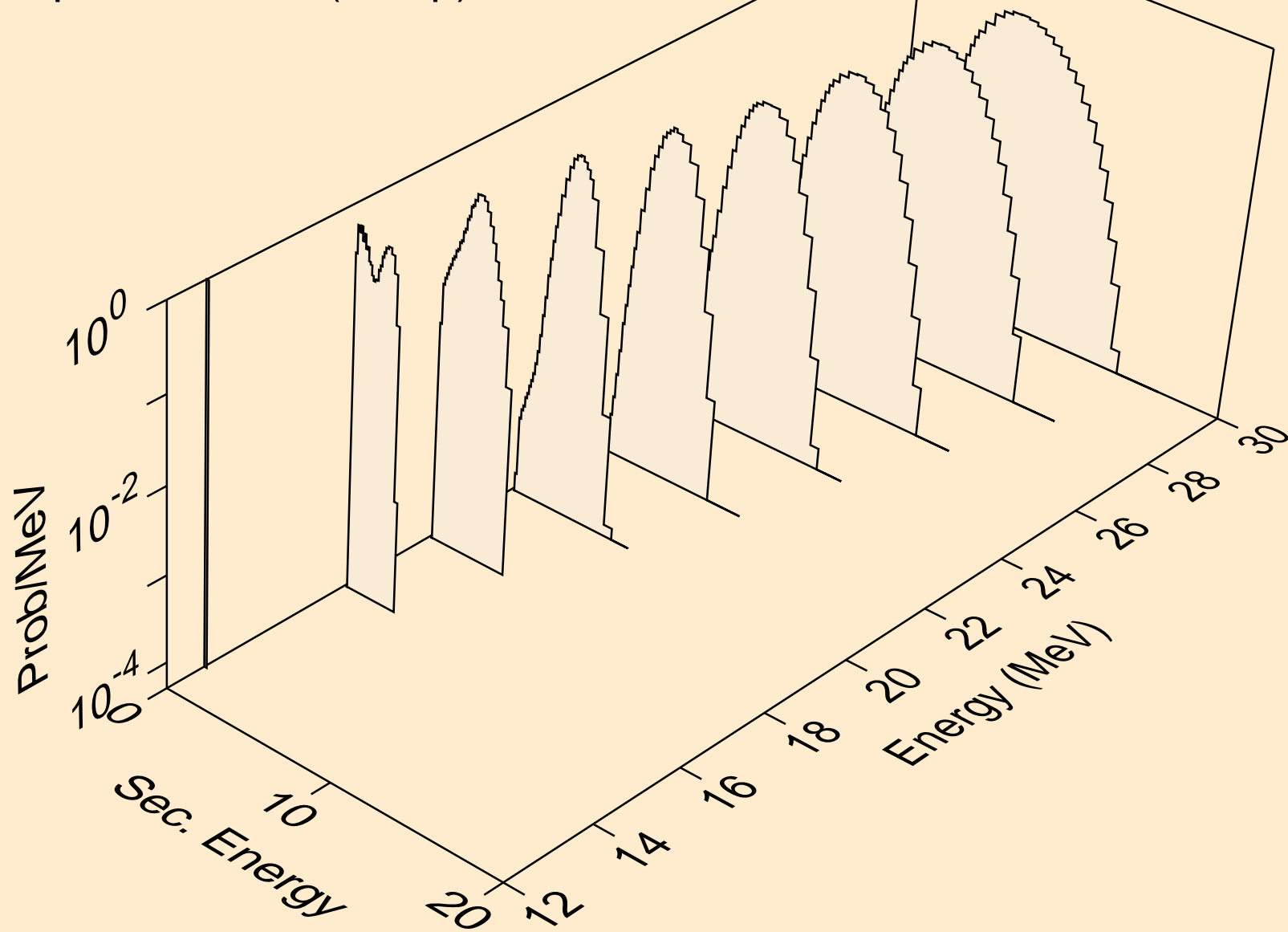

AS081 DEUTERON ACER TENDL-2023 LIBRARY; T=0.K  
protons from (d,npa)

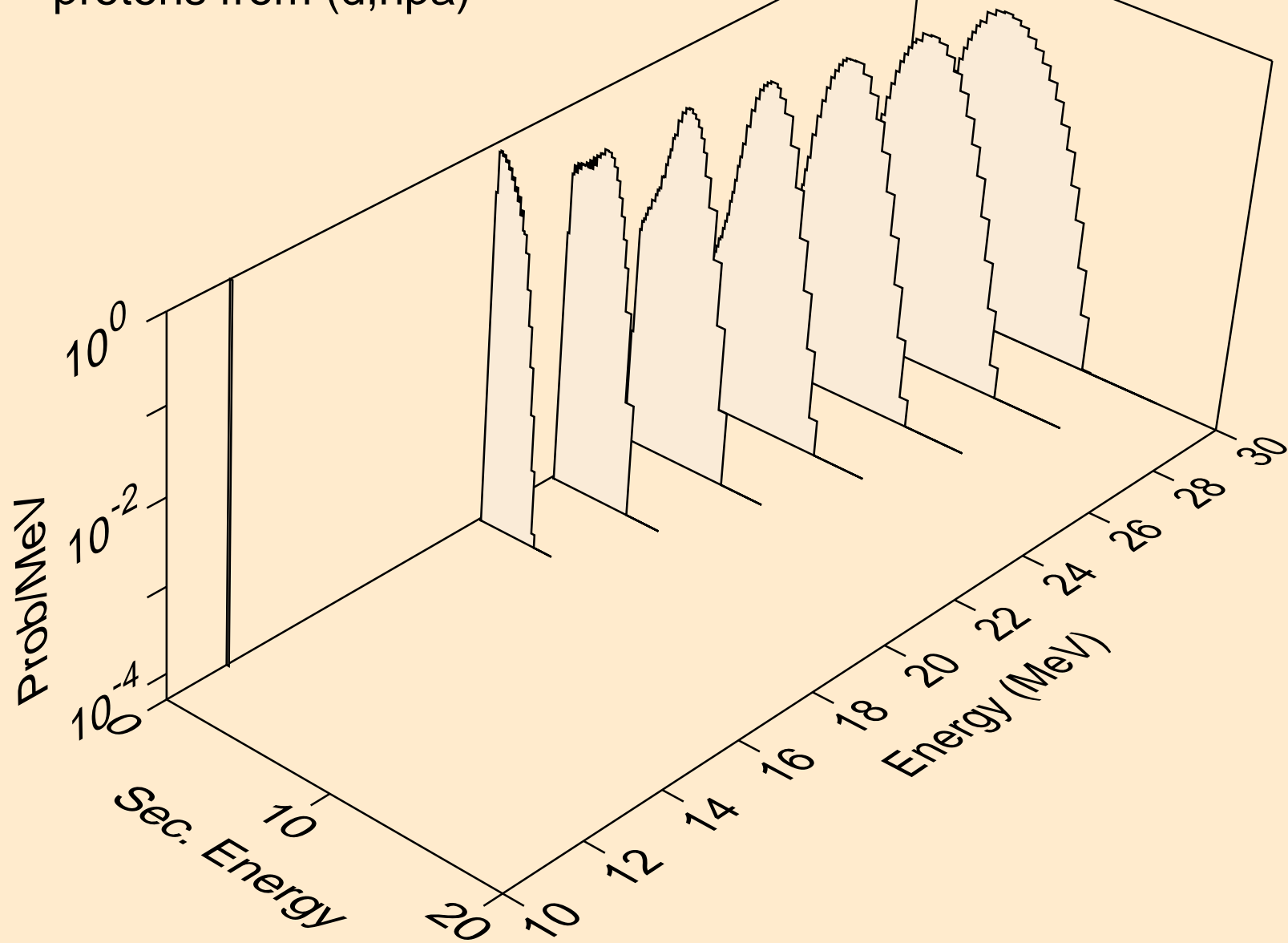



AS081 DEUTERON ACER TENDL-2023 LIBRARY; T=0.K  
protons from (d,p)

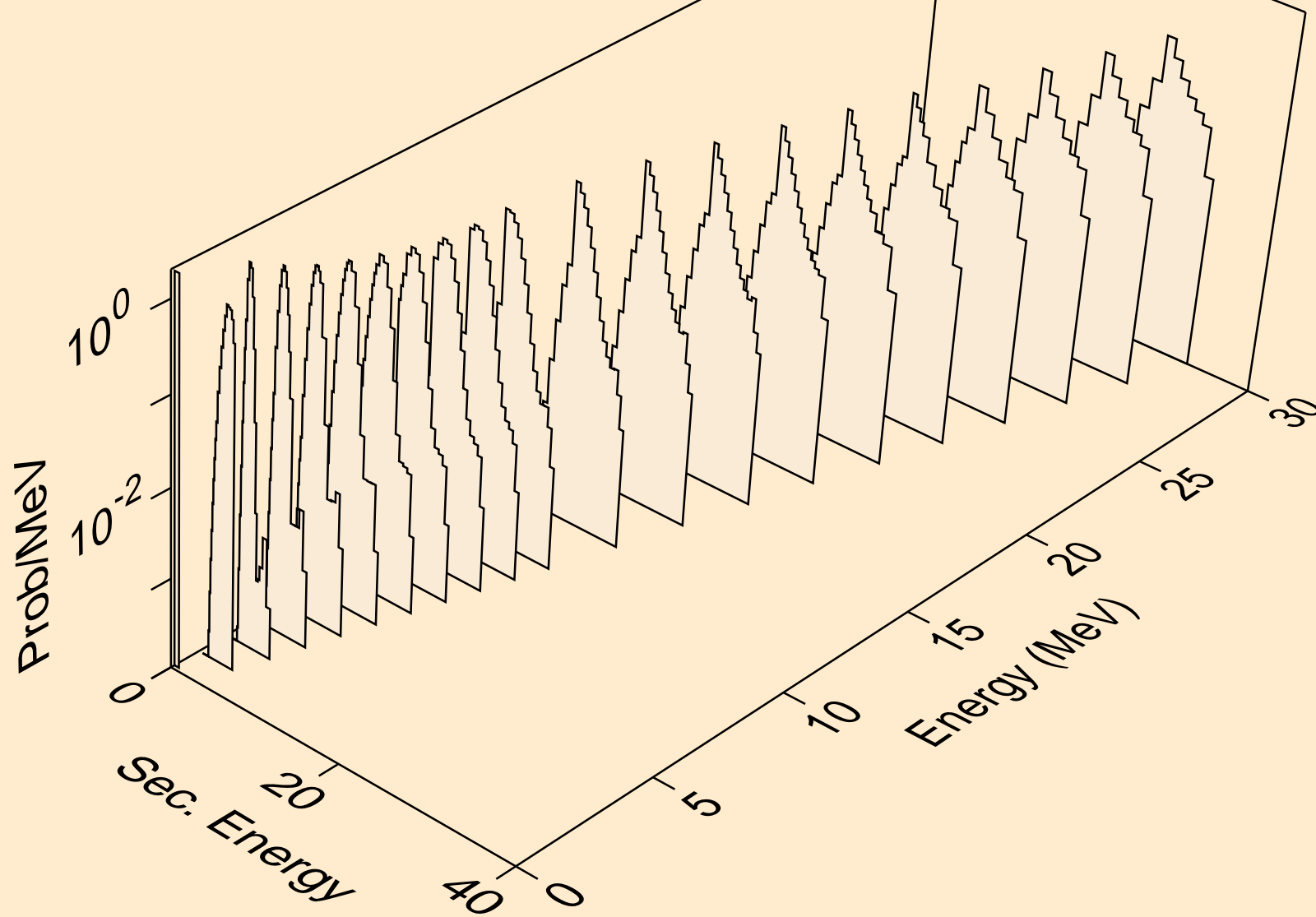

AS081 DEUTERON ACER TENDL-2023 LIBRARY; T=0.K  
protons from (d,2p)

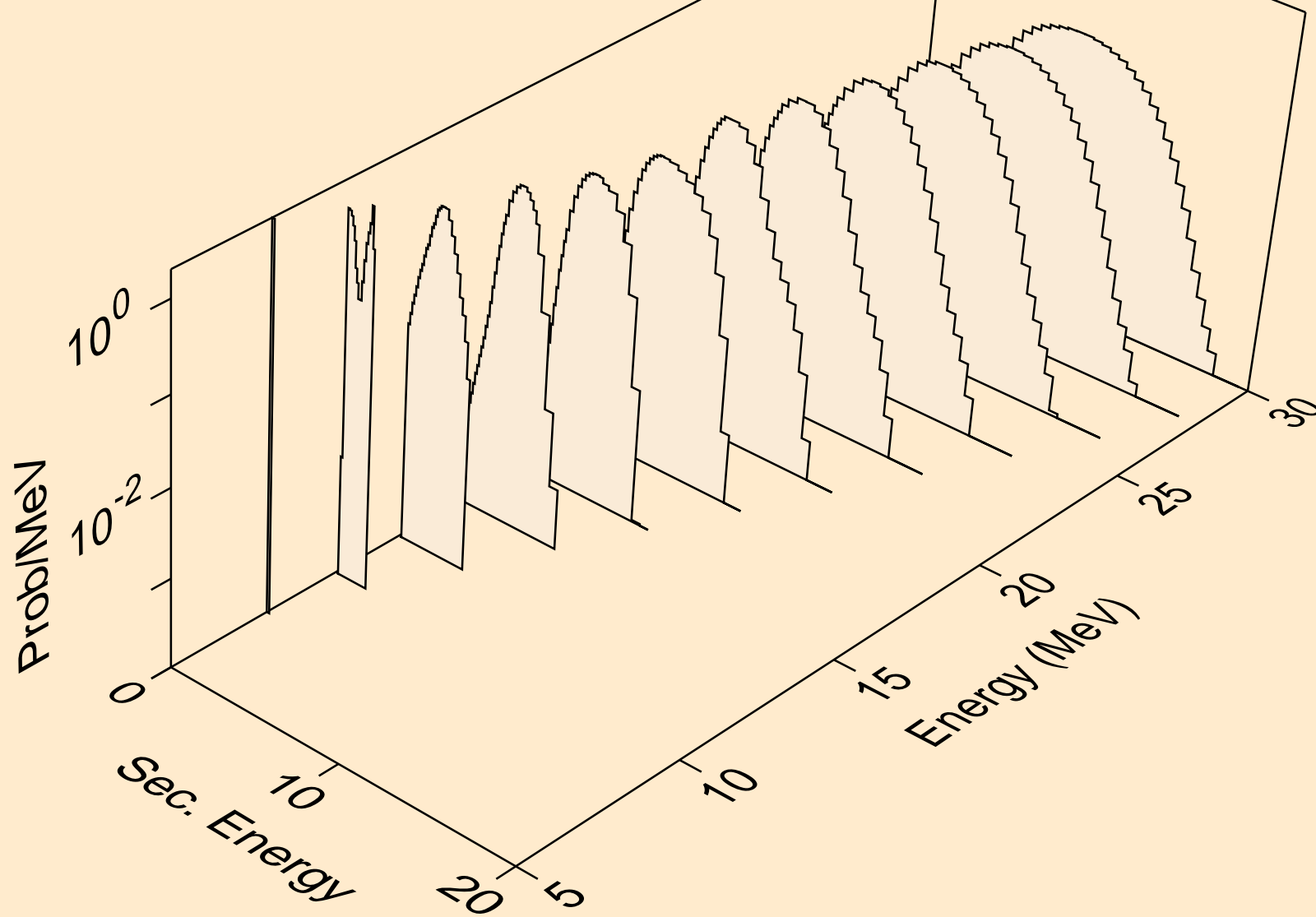

AS081 DEUTERON ACER TENDL-2023 LIBRARY; T=0.K  
protons from (d,pa)

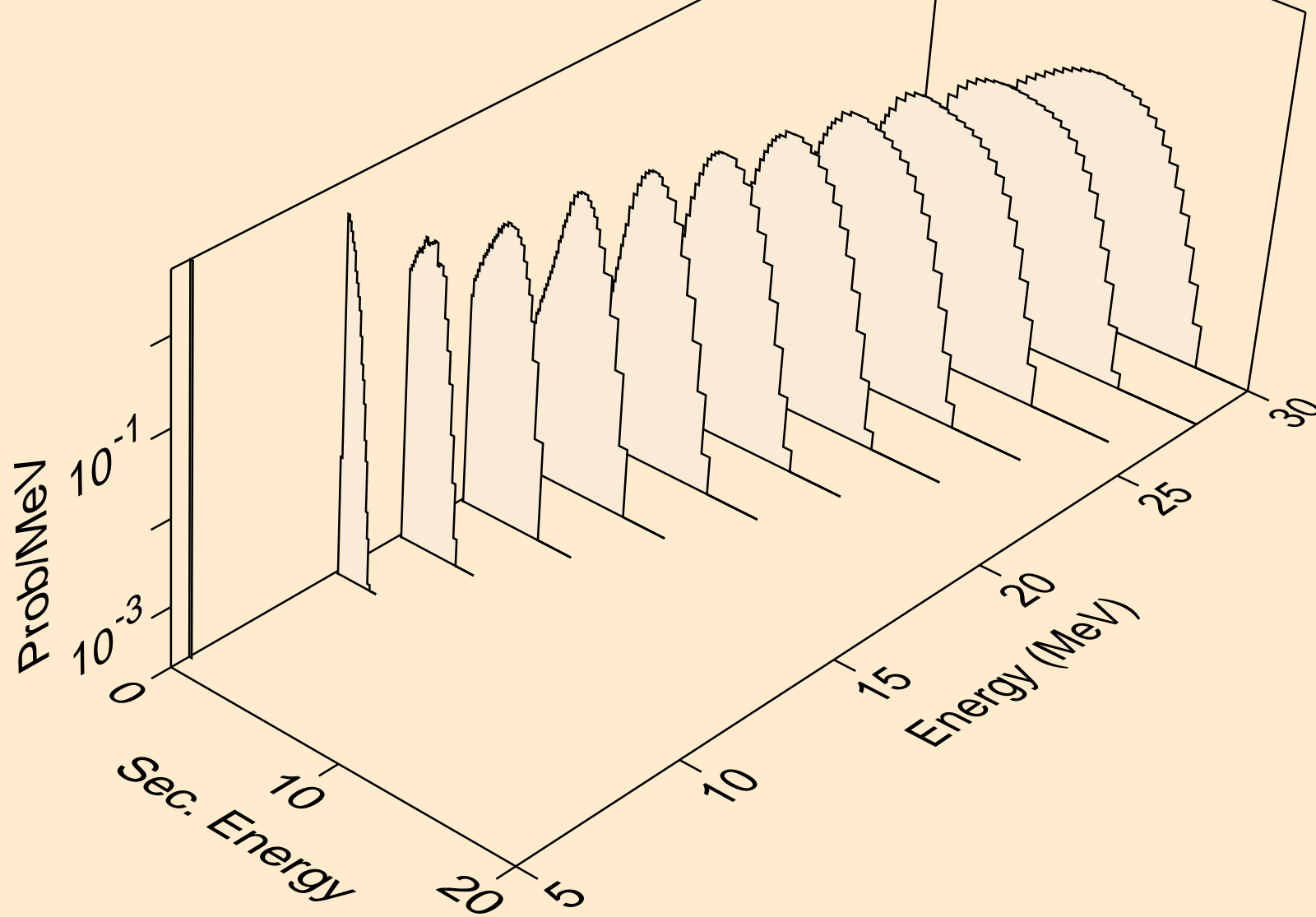

AS081 DEUTERON ACER TENDL-2023 LIBRARY; T=0.K  
protons from (d,pd)

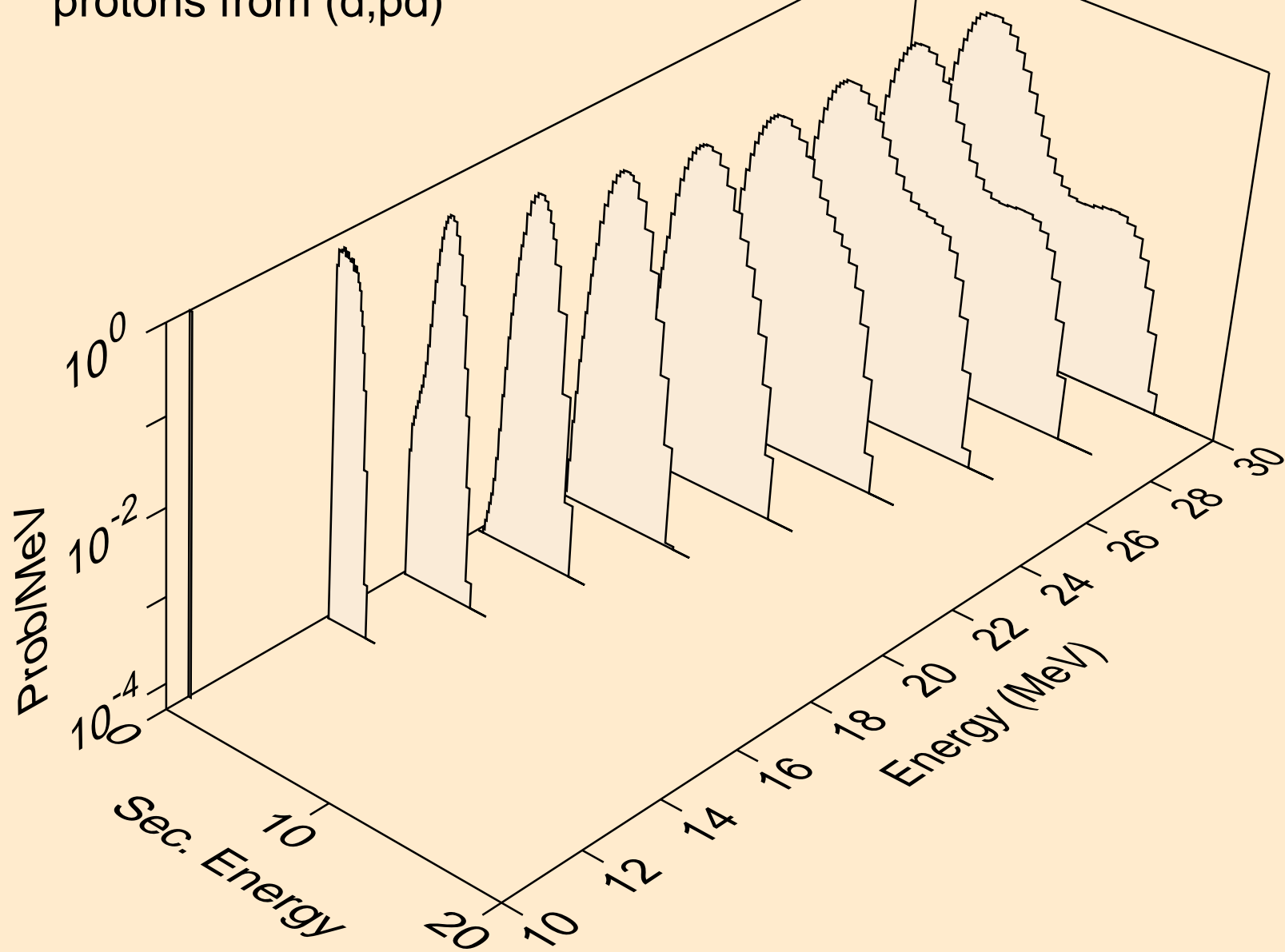

AS081 DEUTERON ACER TENDL-2023 LIBRARY; T=0.K  
protons from (d,pt)

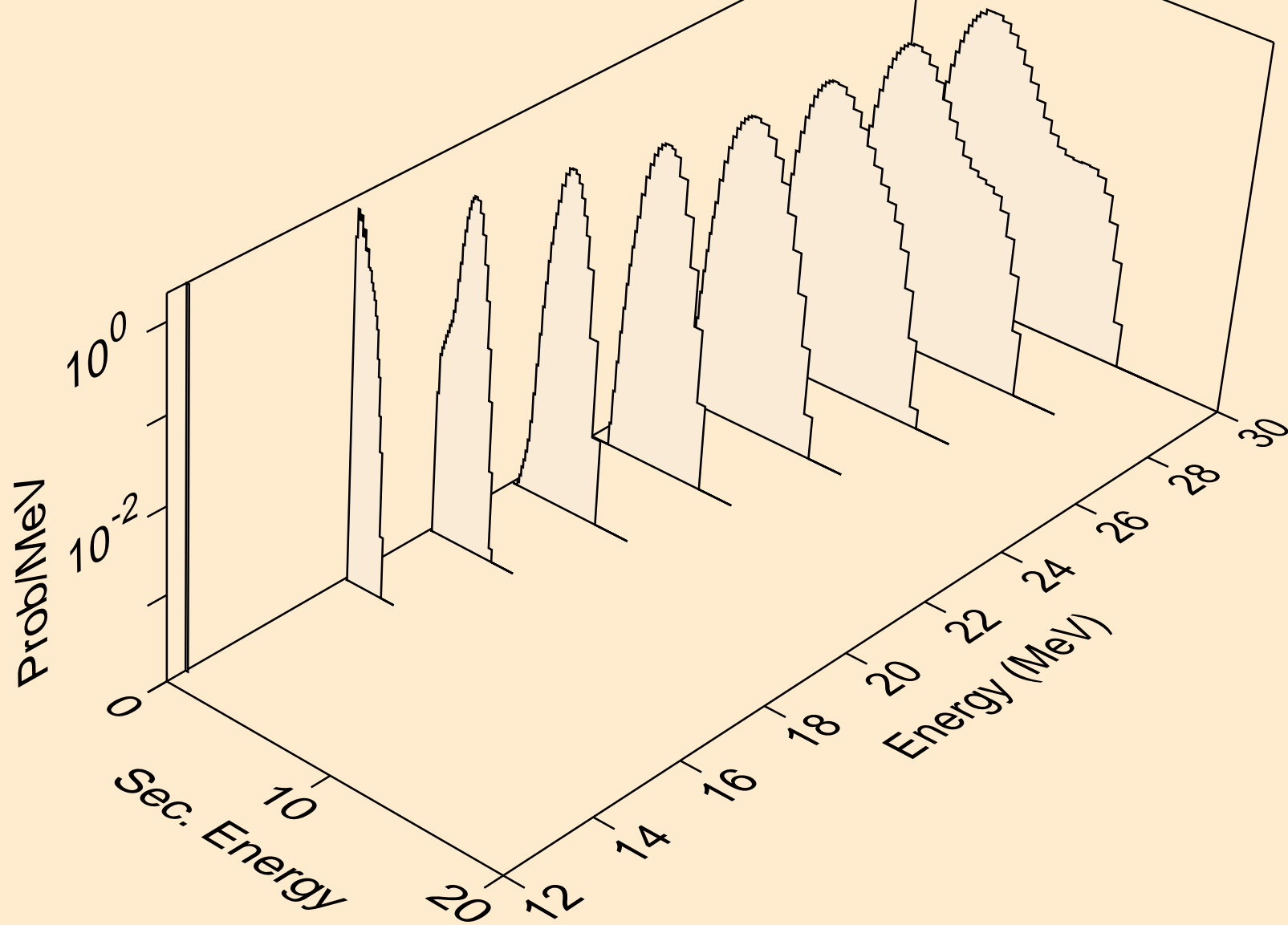

AS081 DEUTERON ACER TENDL-2023 LIBRARY; T=0.K  
tritons from (d,x)

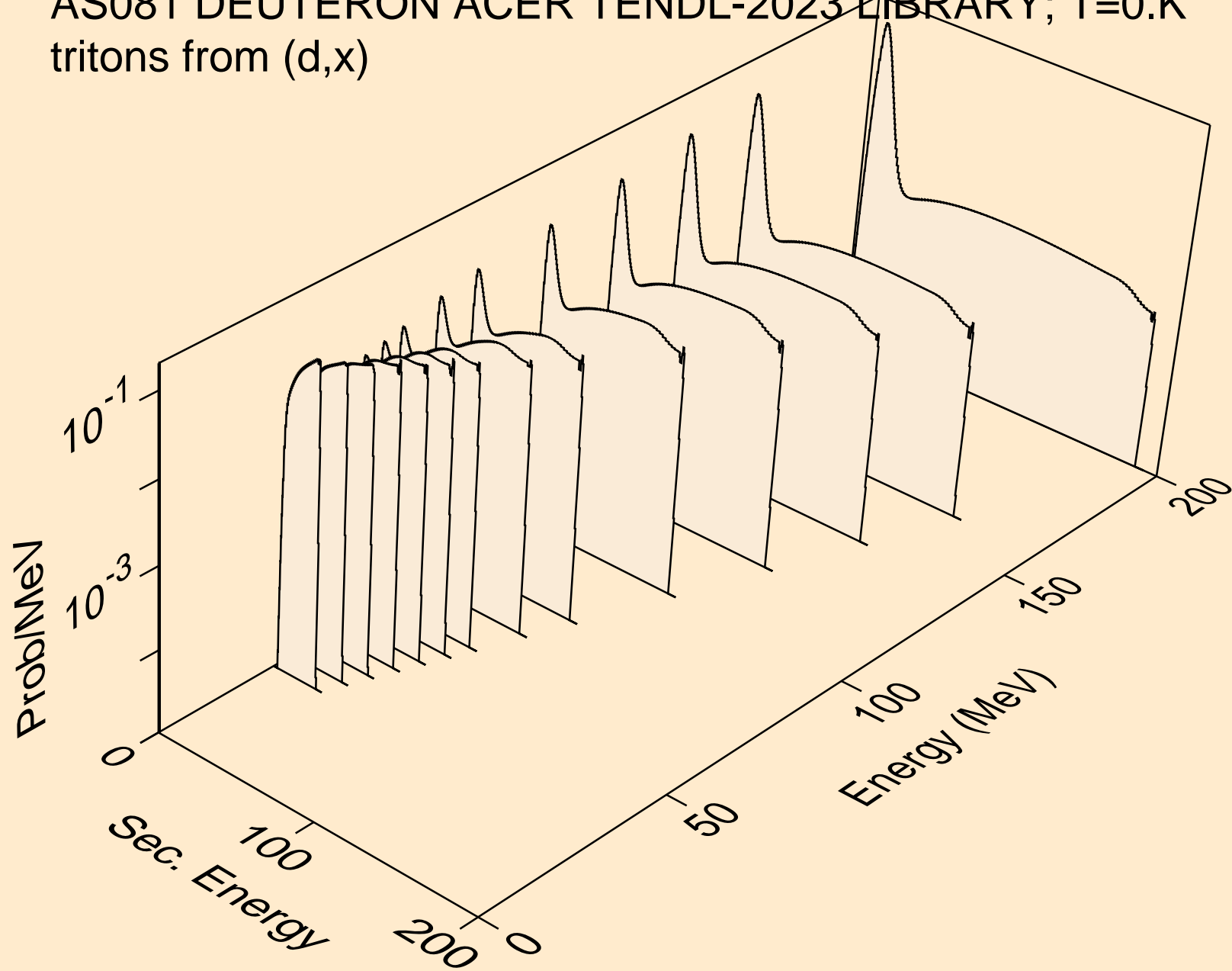

AS081 DEUTERON ACER TENDL-2023 LIBRARY; T=0.K  
tritons from (d,n\*)t

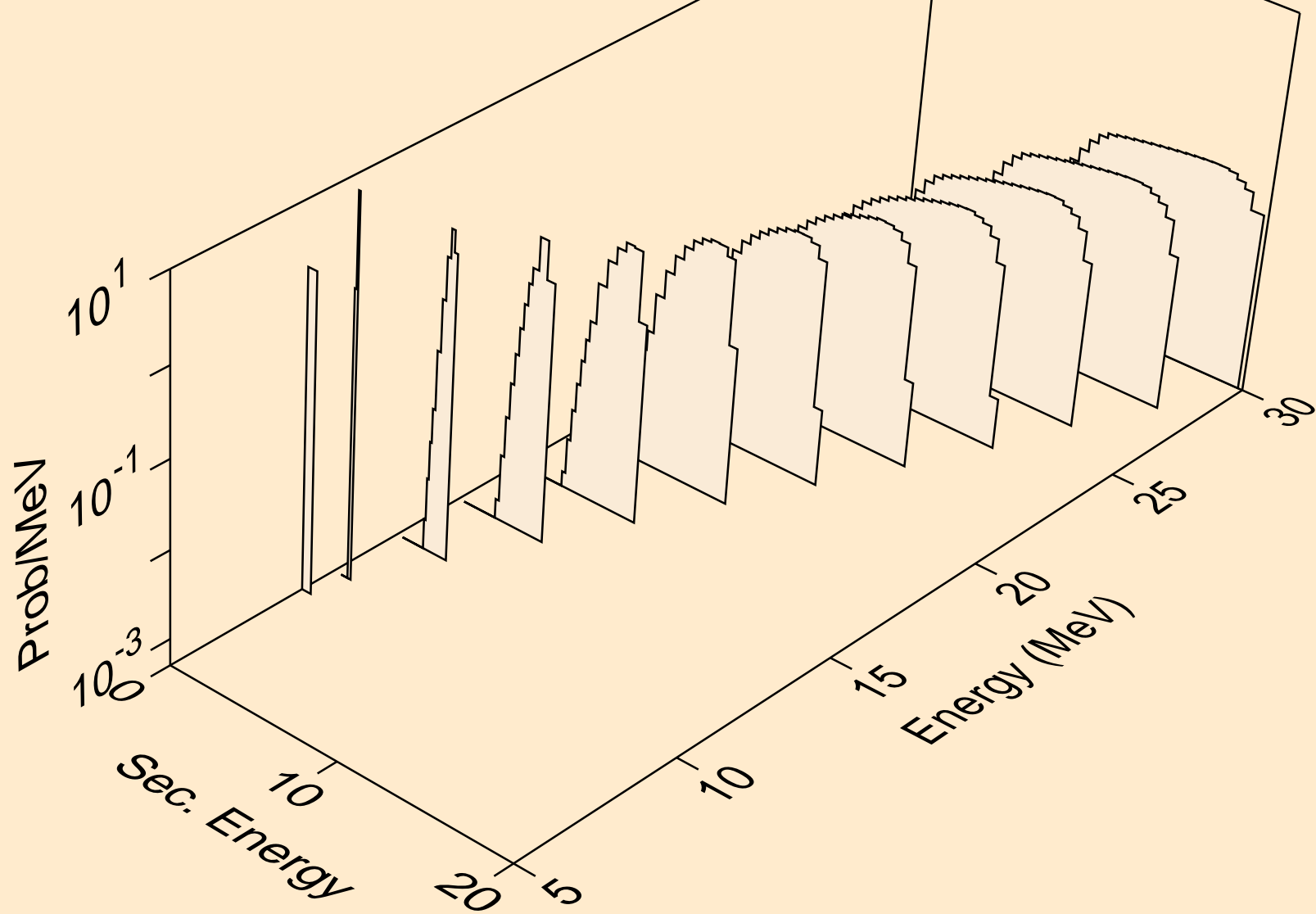

AS081 DEUTERON ACER TENDL-2023 LIBRARY; T=0.K  
tritons from (d,t)

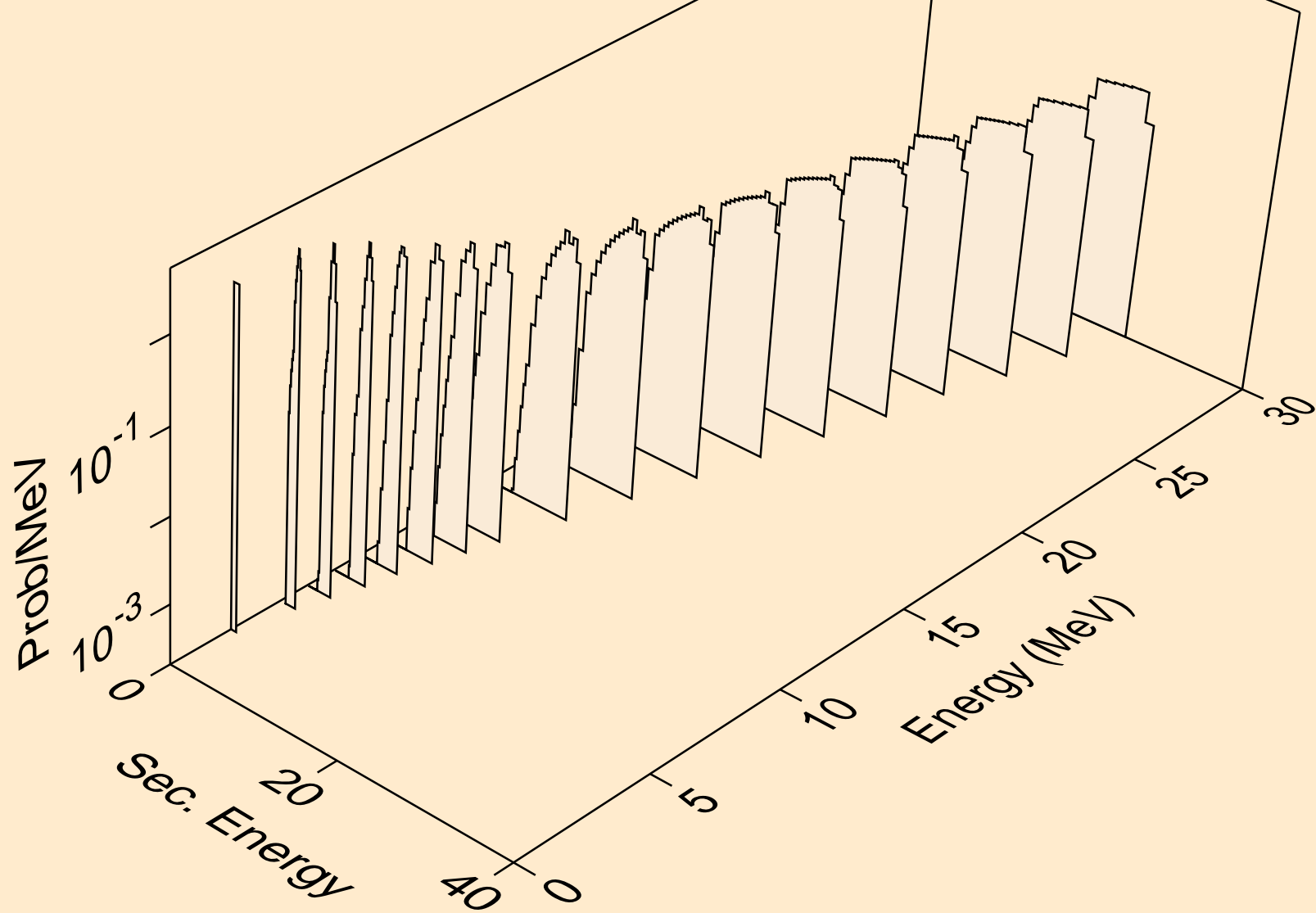



AS081 DEUTERON ACER TENDL-2023 LIBRARY; T=0.K  
tritons from (d,pt)

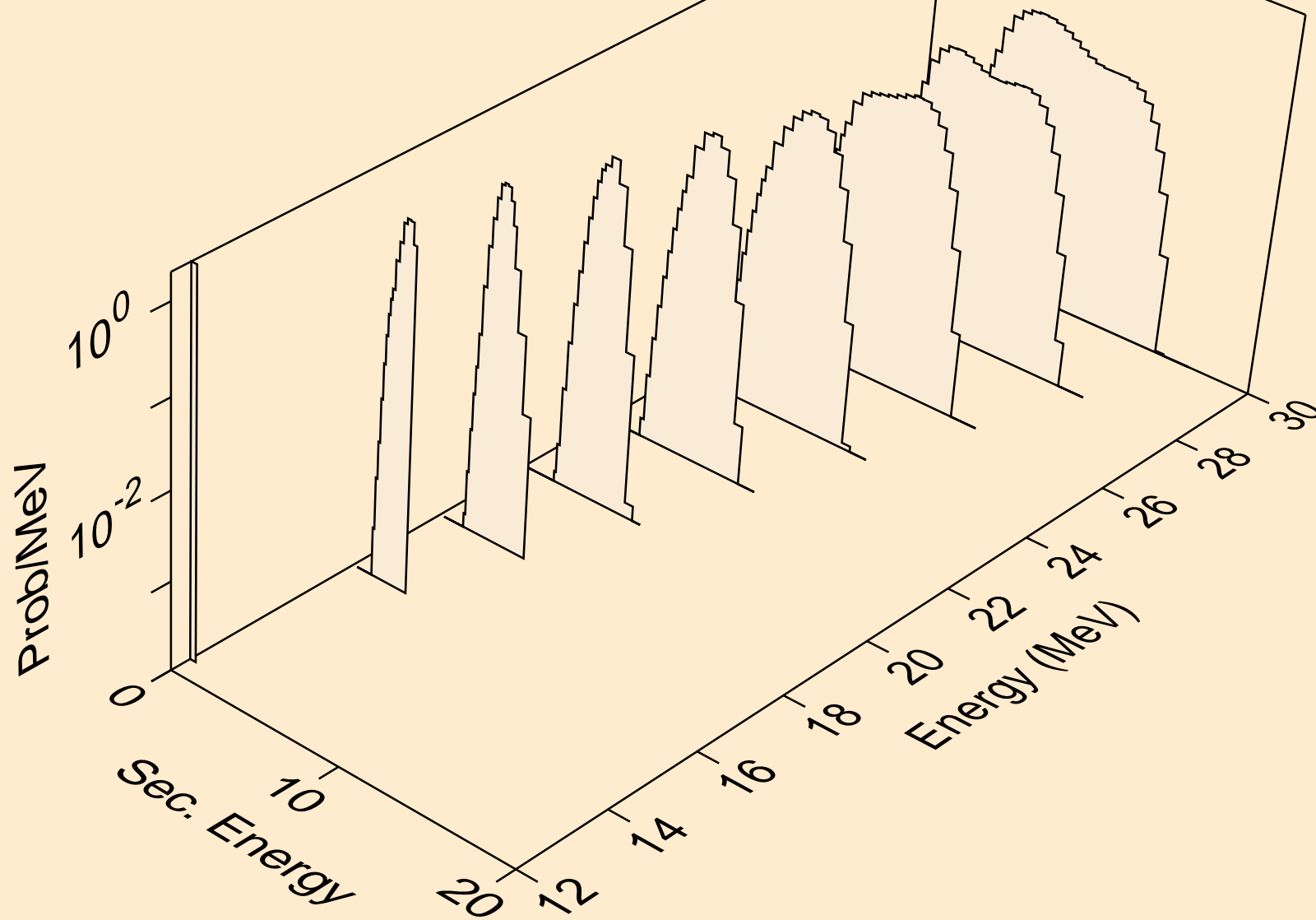

AS081 DEUTERON ACER TENDL-2023 LIBRARY; T=0.K  
he3s from (d,x)

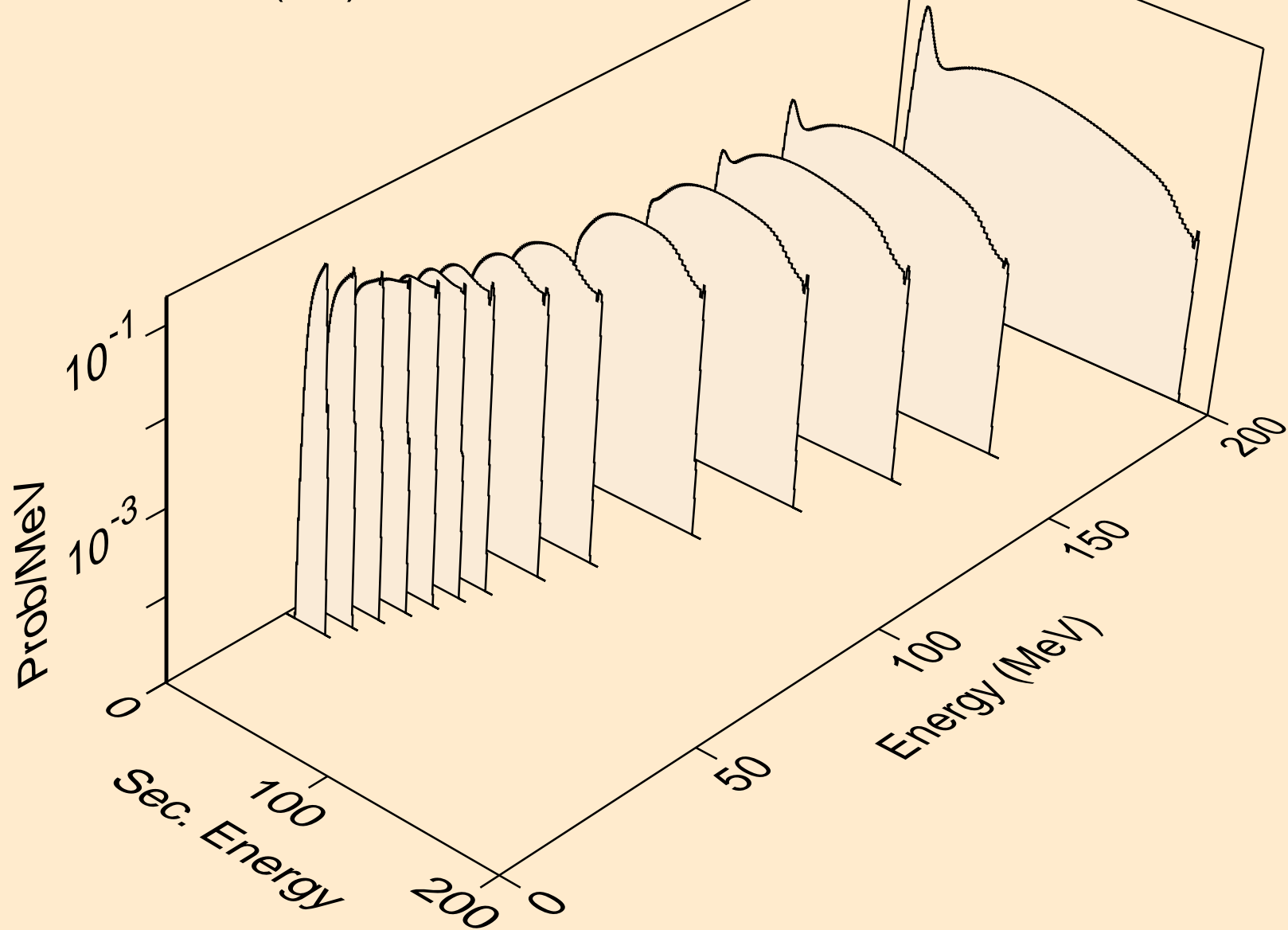

AS081 DEUTERON ACER TENDL-2023 LIBRARY; T=0.K  
he3s from (d,n\*)he3

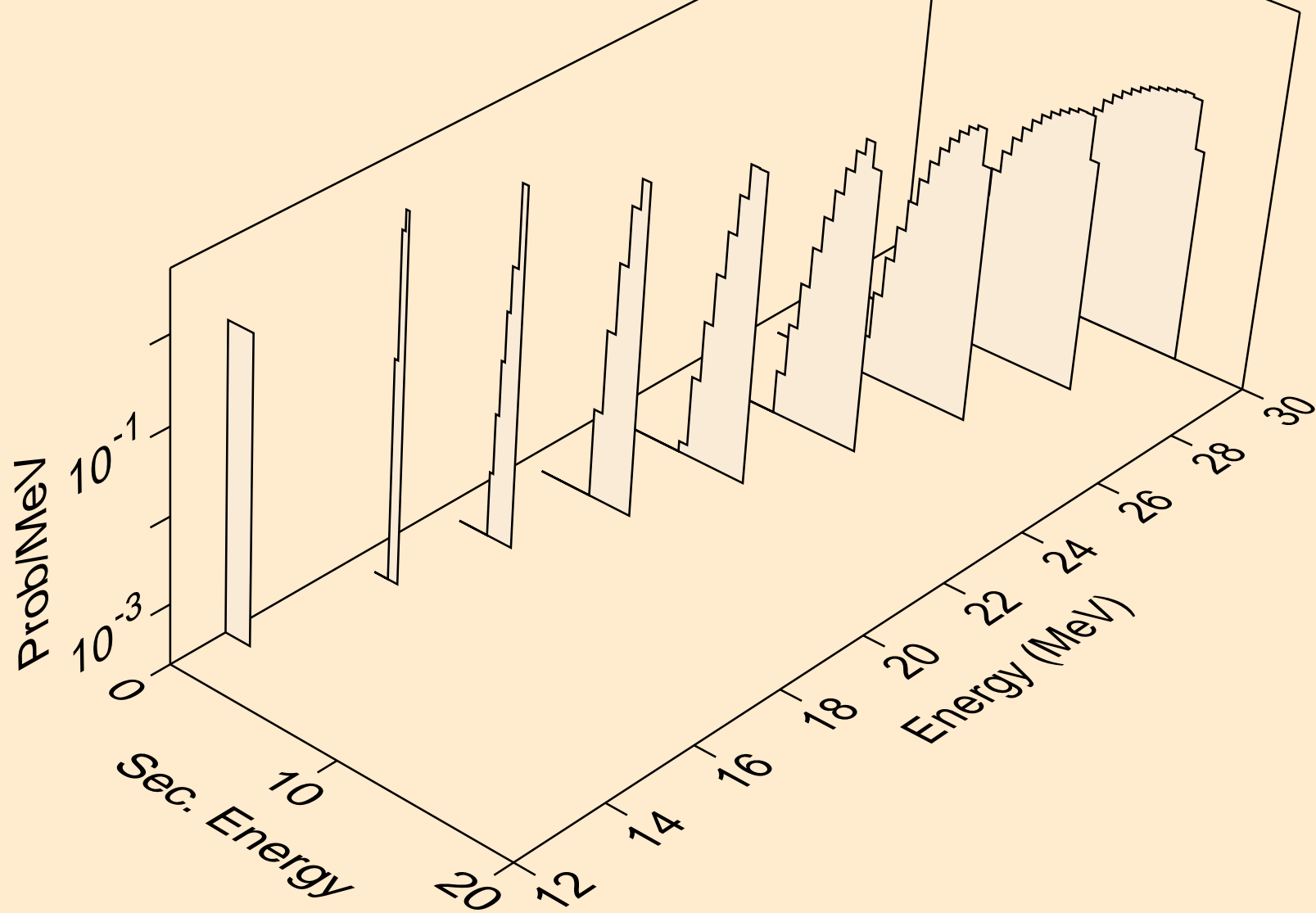

AS081 DEUTERON ACER TENDL-2023 LIBRARY; T=0.K  
he3s from (d,he3)

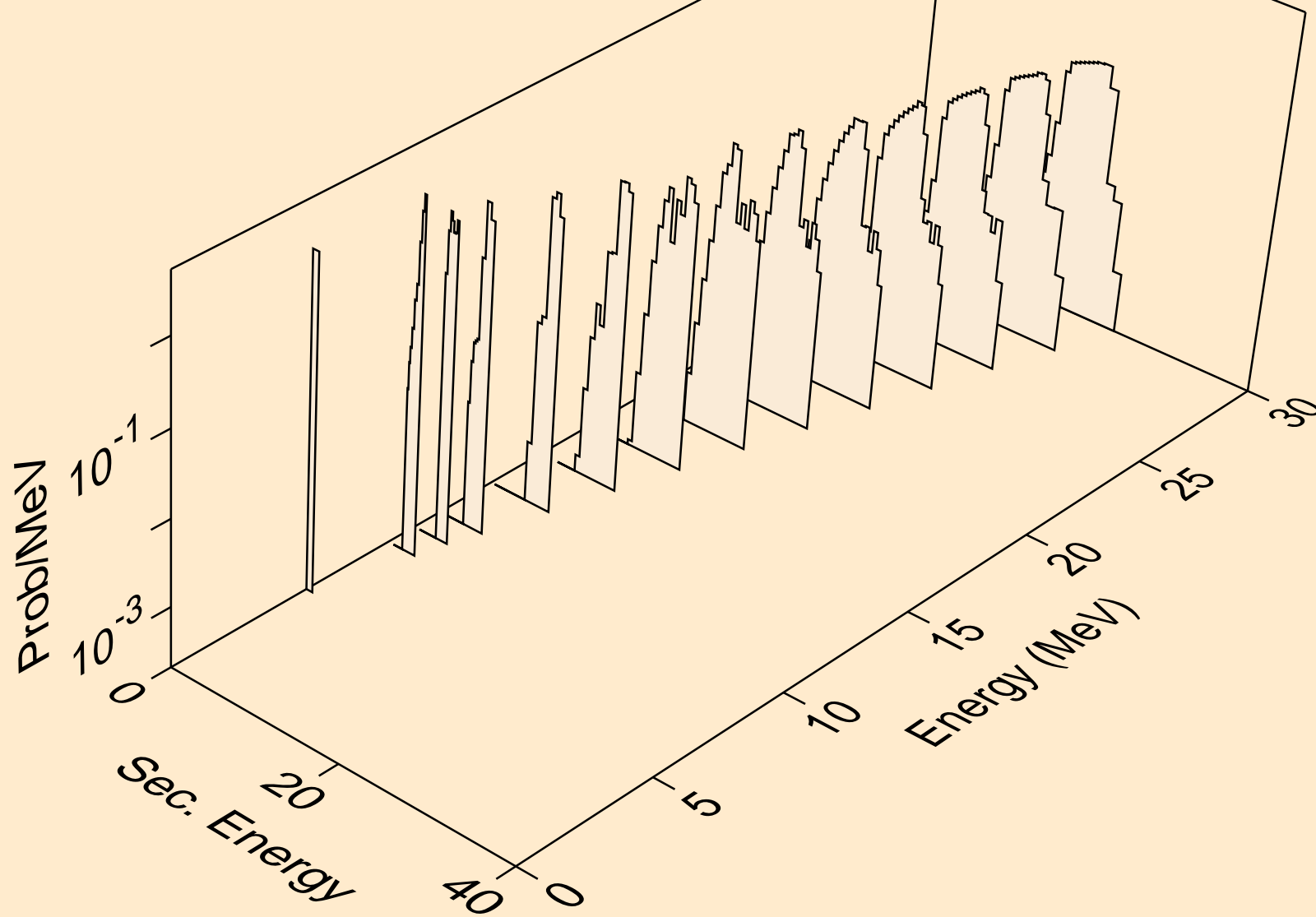

AS081 DEUTERON ACER TENDL-2023 LIBRARY; T=0.K  
alphas from (d,x)

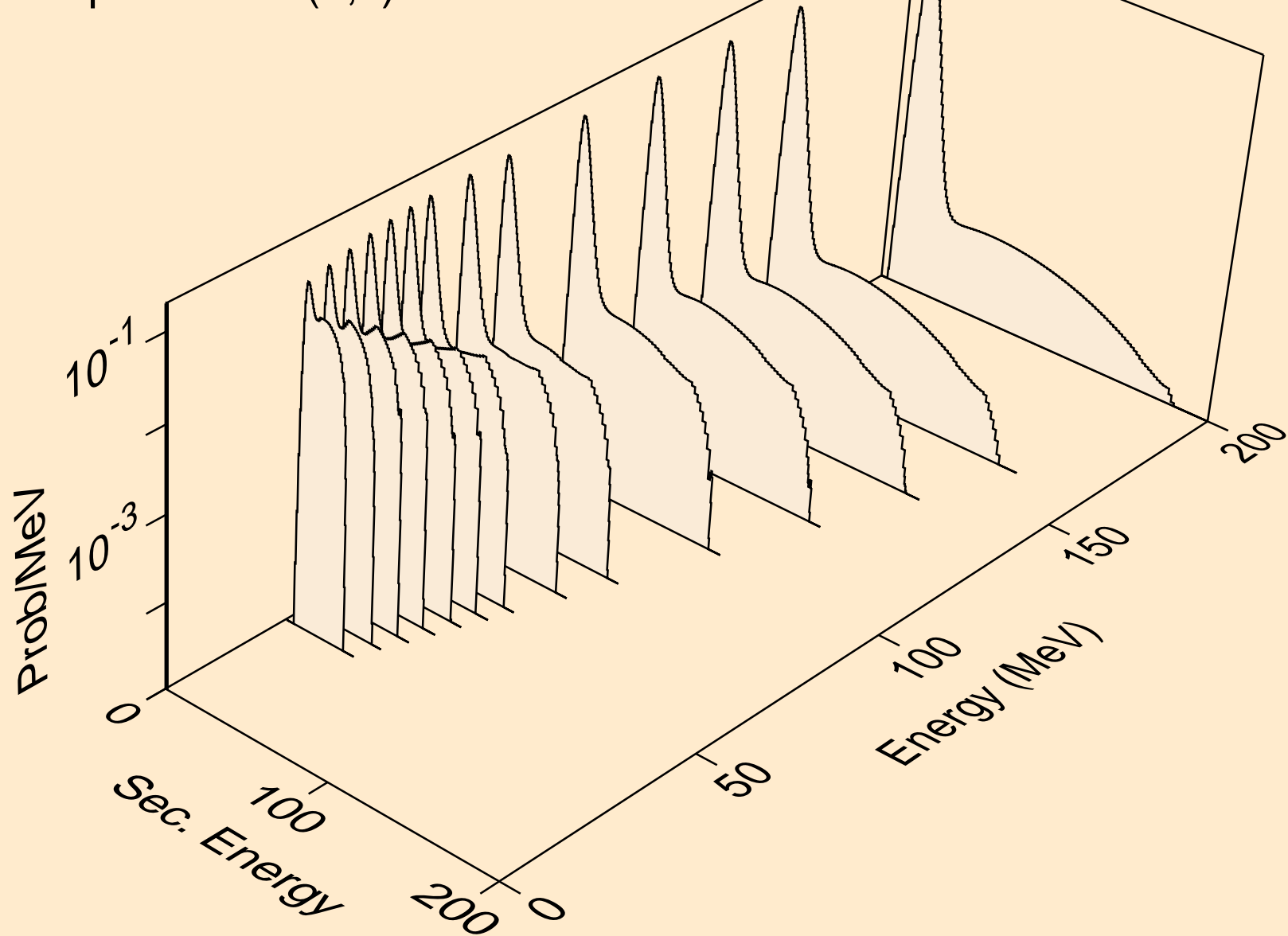

AS081 DEUTERON ACER TENDL-2023 LIBRARY; T=0.K  
alphas from (d,n\*)a

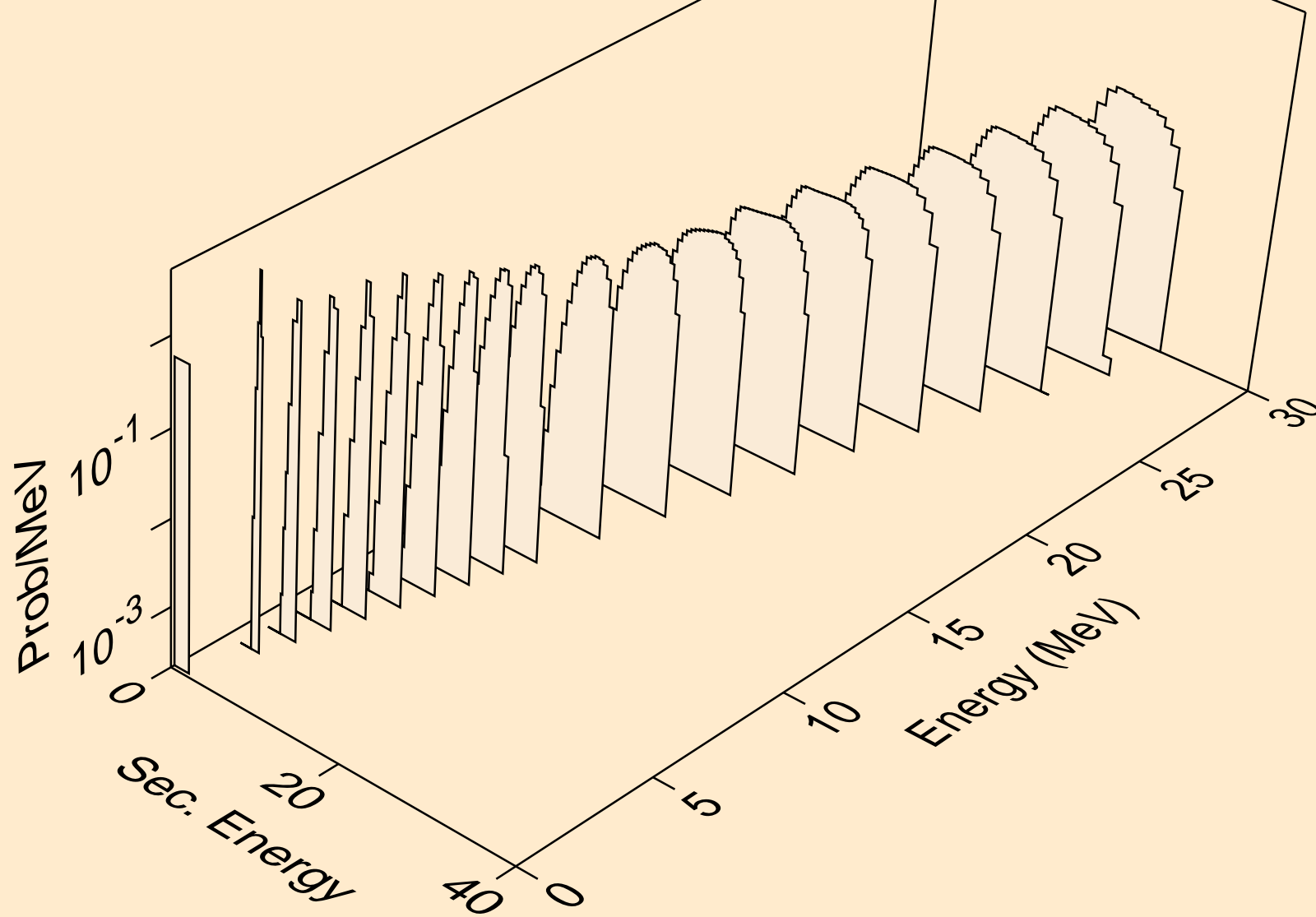

AS081 DEUTERON ACER TENDL-2023 LIBRARY; T=0.K  
alphas from (d,2n)a

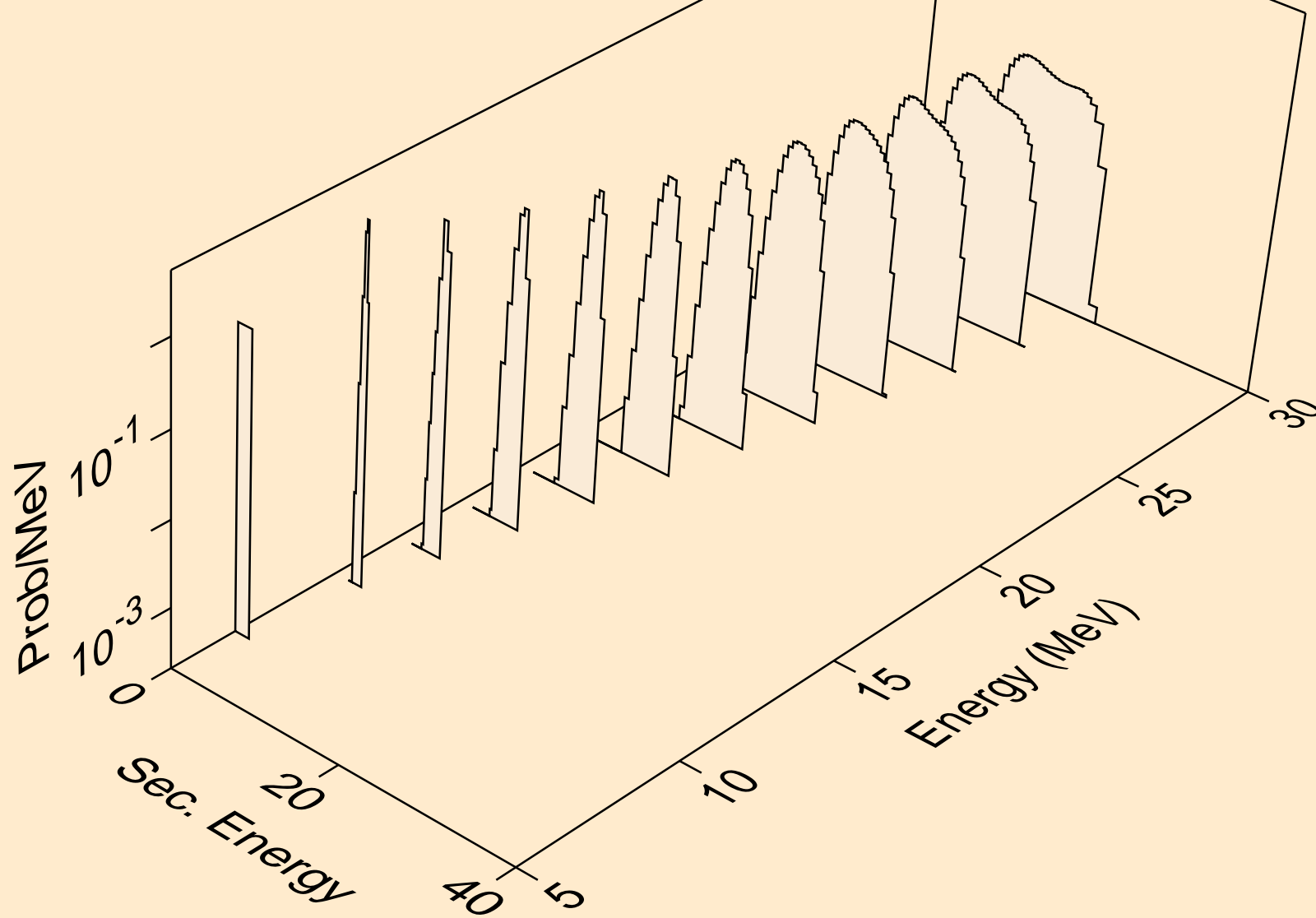

AS081 DEUTERON ACER TENDL-2023 LIBRARY; T=0.K  
alphas from (d,3n)a

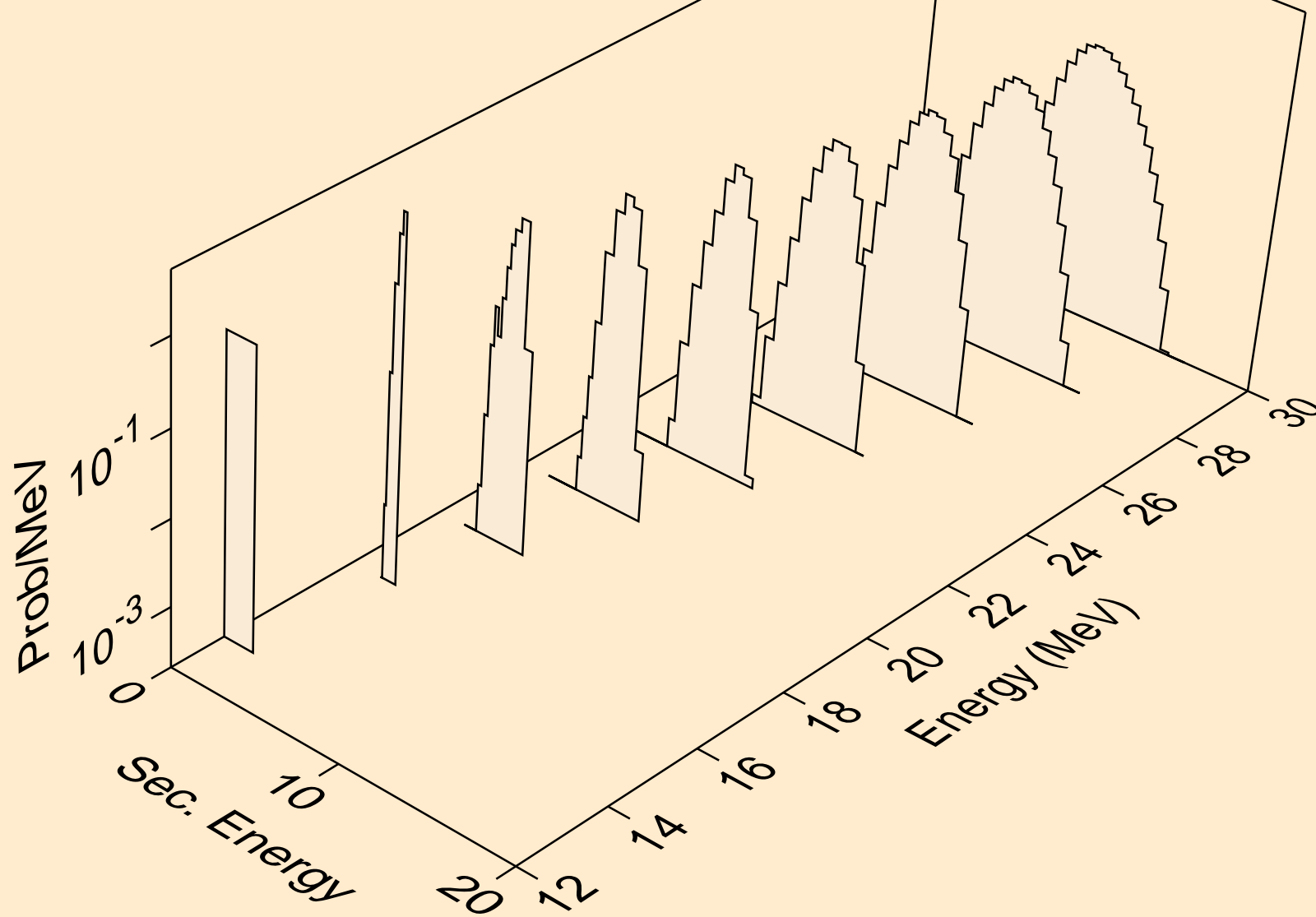



AS081 DEUTERON ACER TENDL-2023 LIBRARY; T=0.K  
alphas from (d,n\*)2a

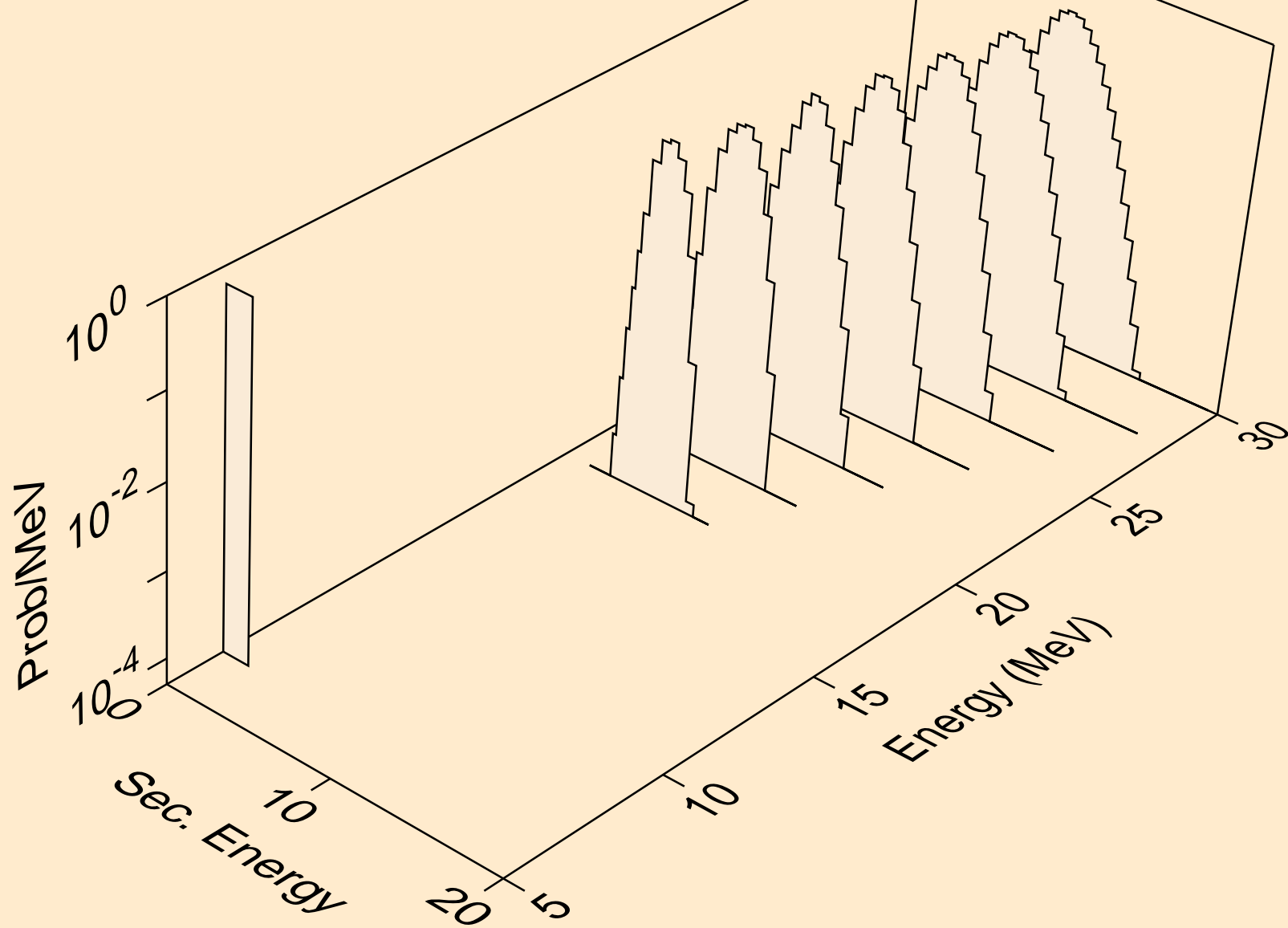

AS081 DEUTERON ACER TENDL-2023 LIBRARY; T=0.K  
alphas from (d,npa)

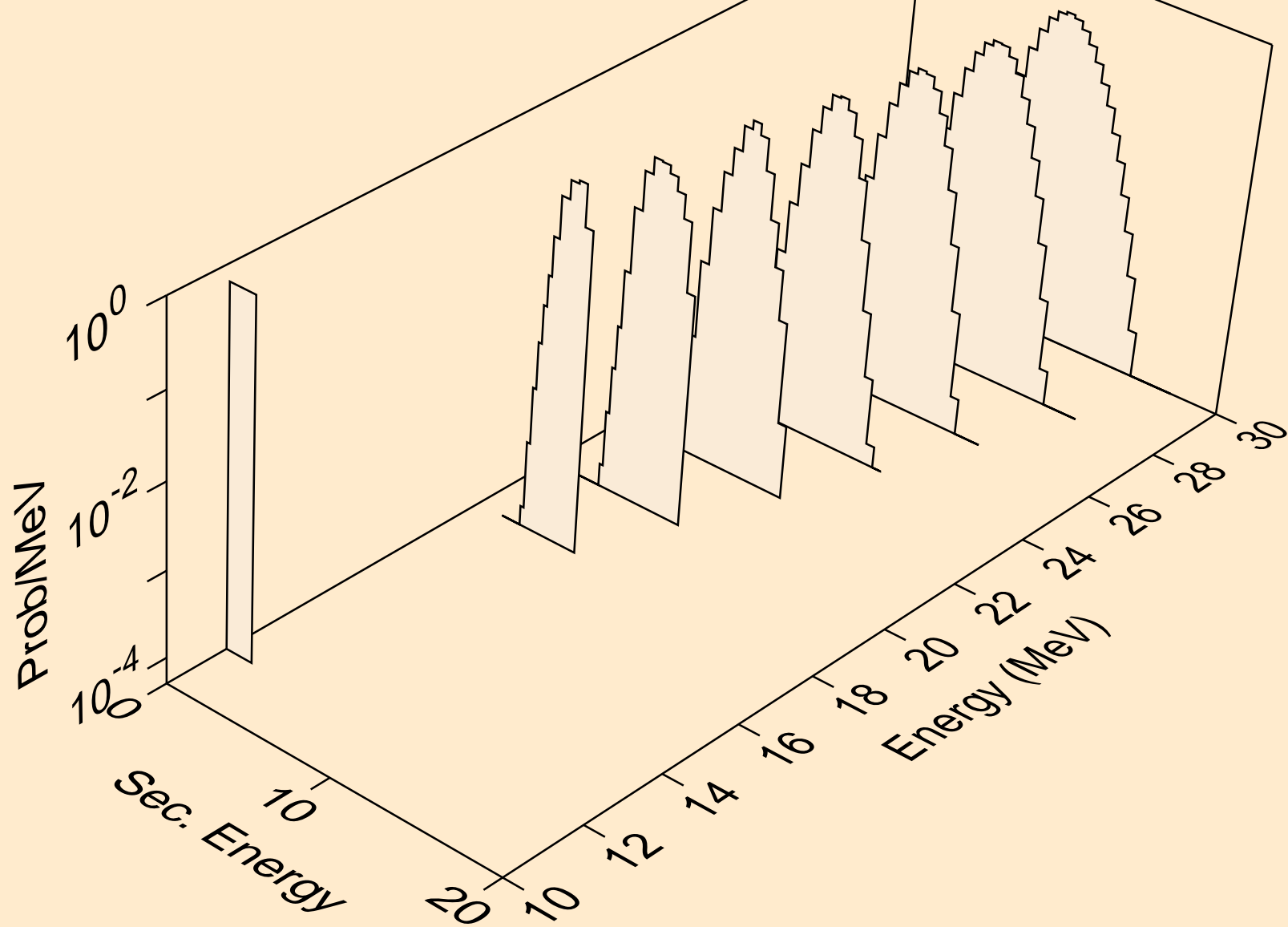

AS081 DEUTERON ACER TENDL-2023 LIBRARY; T=0.K  
alphas from (d,a)

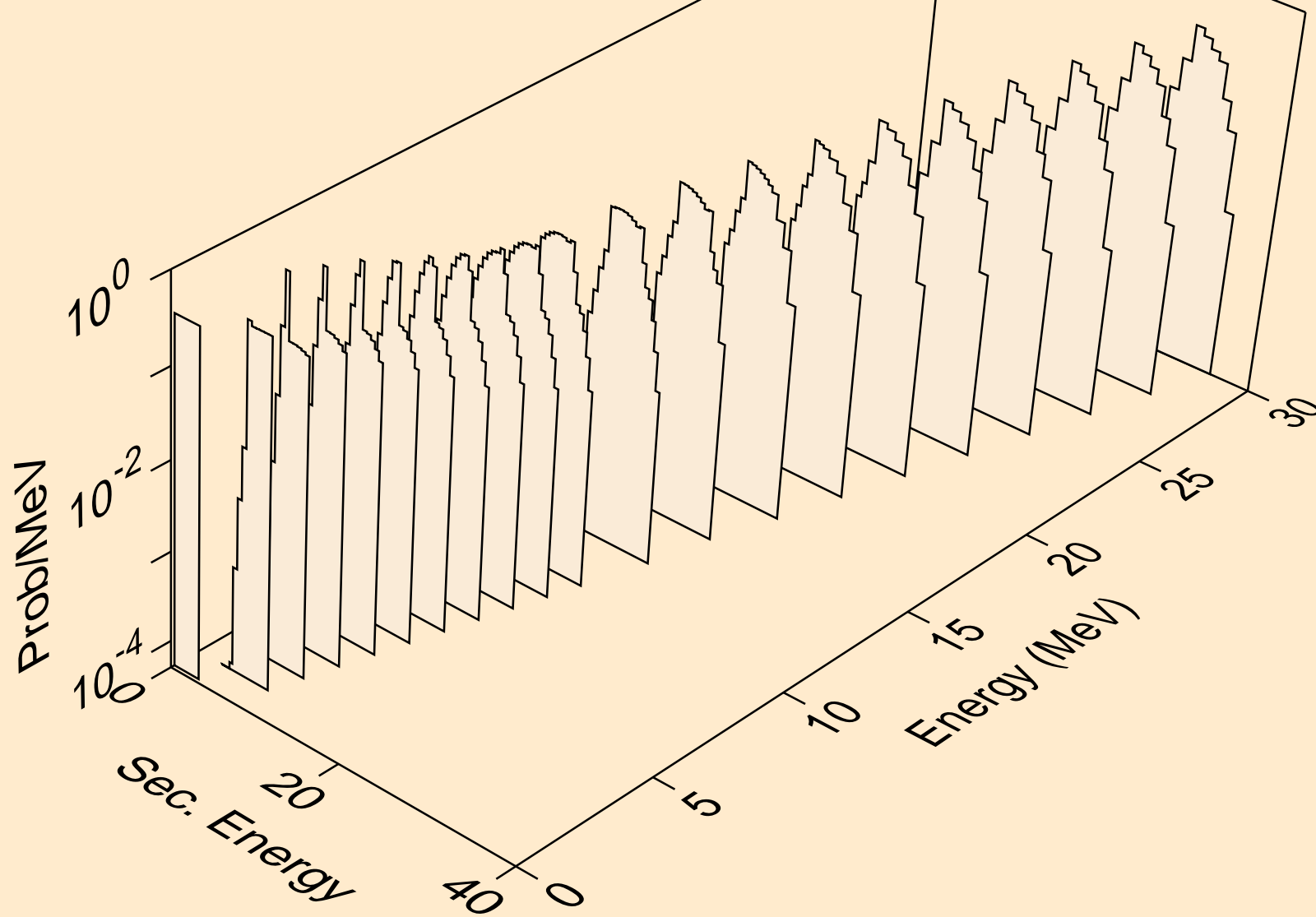

AS081 DEUTERON ACER TENDL-2023 LIBRARY; T=0.K  
alphas from (d,2a)

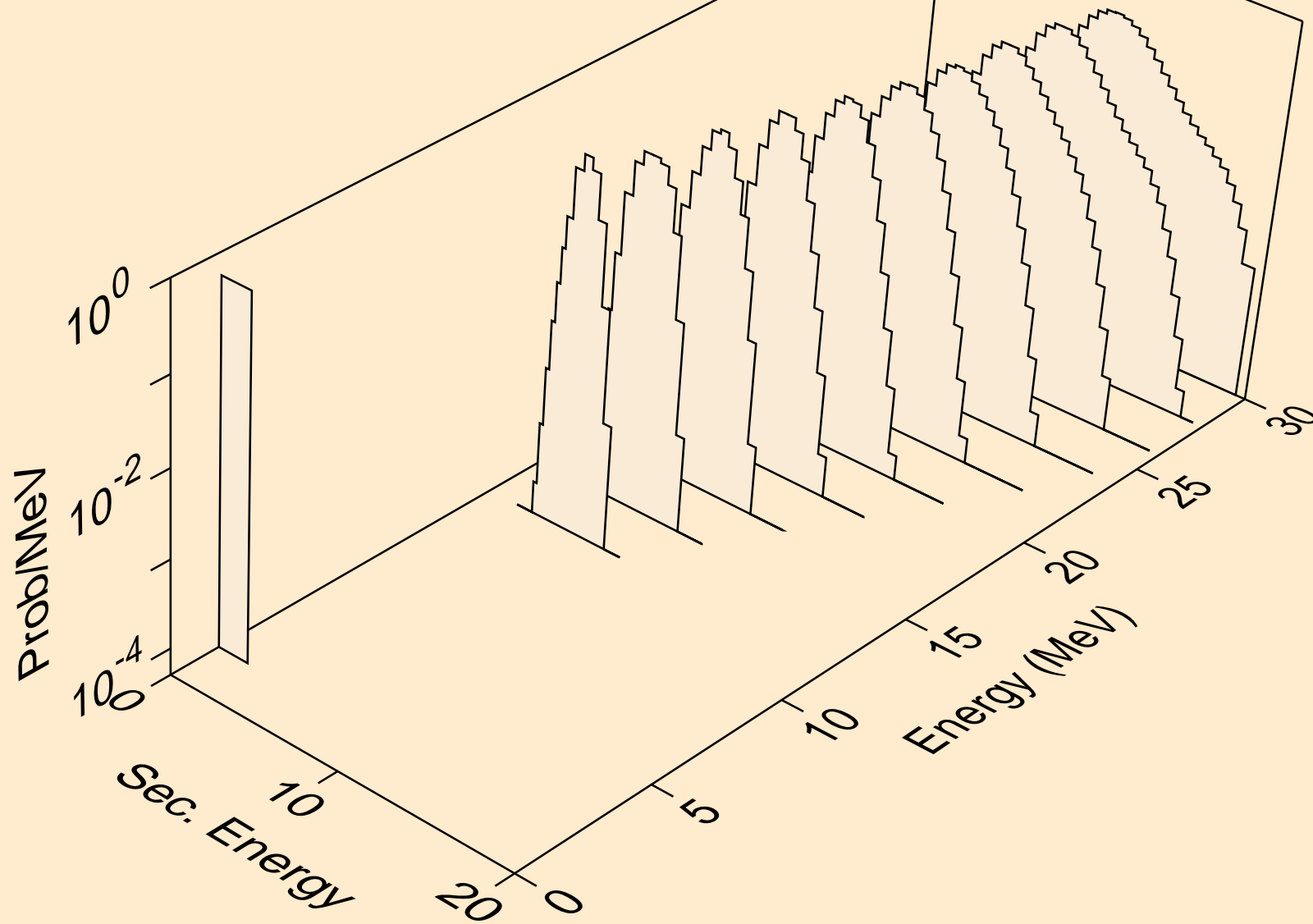

AS081 DEUTERON ACER TENDL-2023 LIBRARY; T=0.K  
alphas from (d,pa)

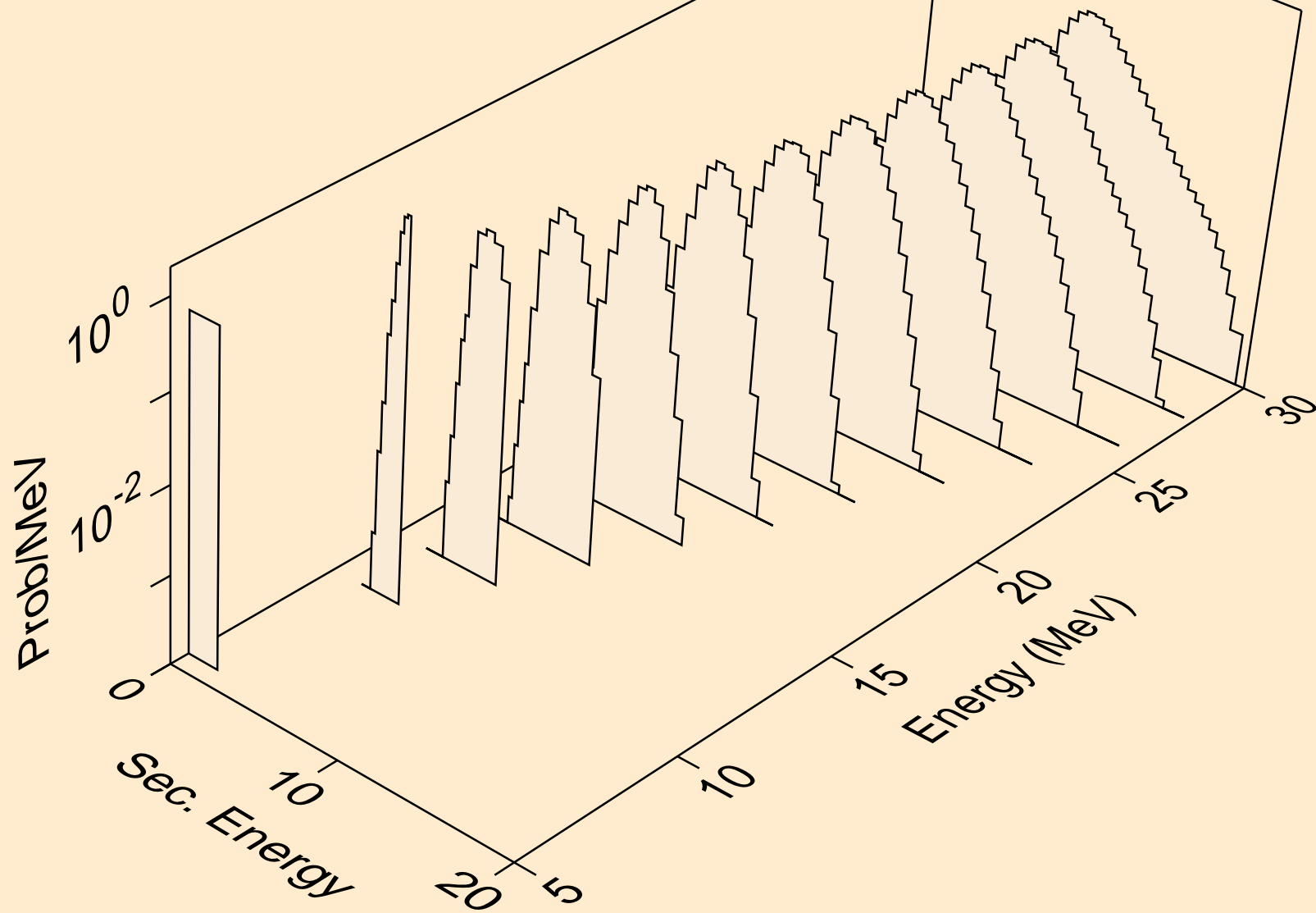

AS081 DEUTERON ACER TENDL-2023 LIBRARY; T=0.K  
alphas from (d,da)

