

AU185M DEUTERON ACER TENDL-2023 LIBRARY; T=0.K  
Principal cross sections

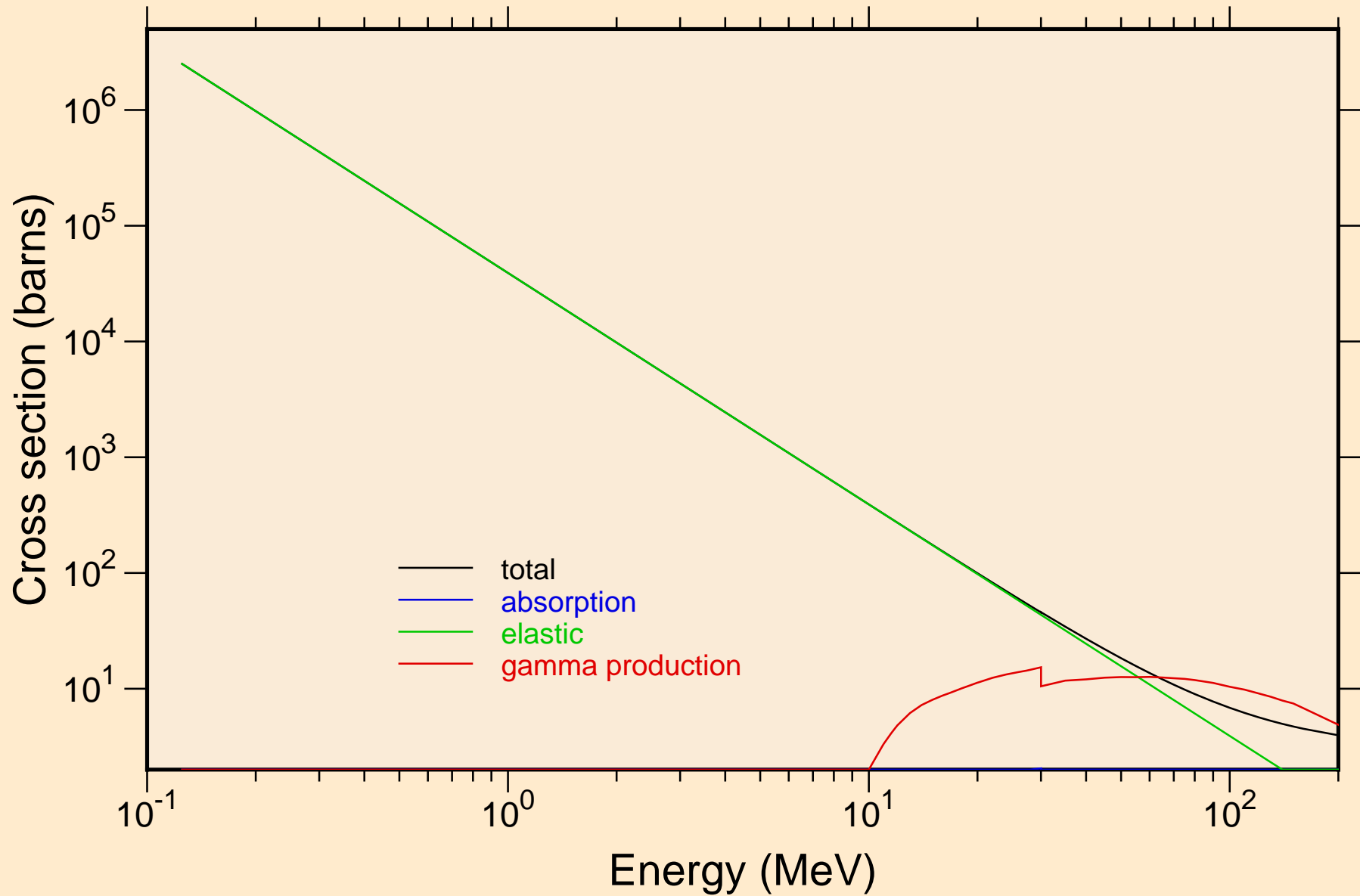

AU185M DEUTERON ACER TENDL-2023 LIBRARY; T=0.K  
Heating

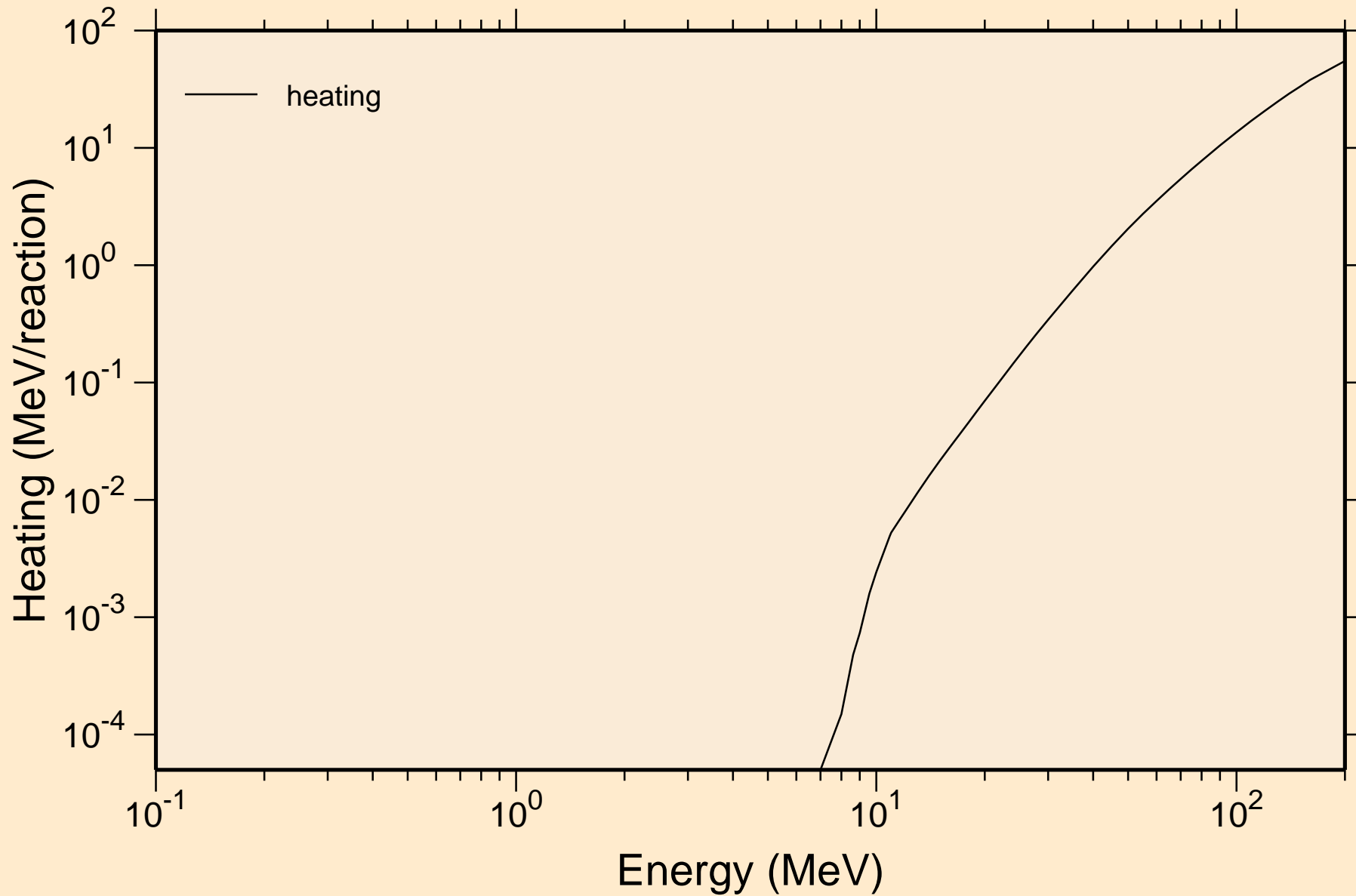

AU185M DEUTERON ACER TENDL-2023 LIBRARY; T=0.K  
Principal cross sections

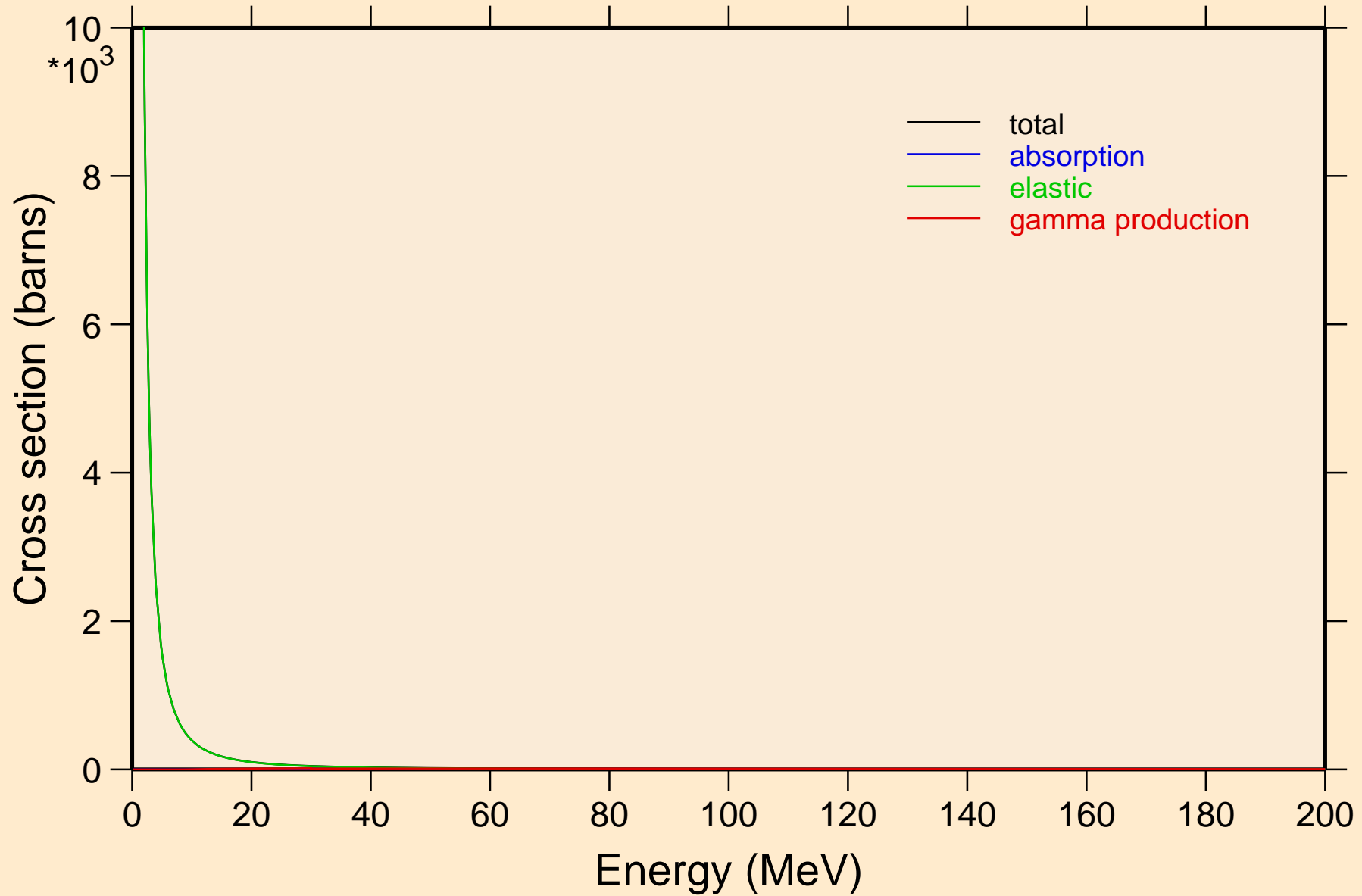

AU185M DEUTERON ACER TENDL-2023 LIBRARY; T=0.K  
Heating

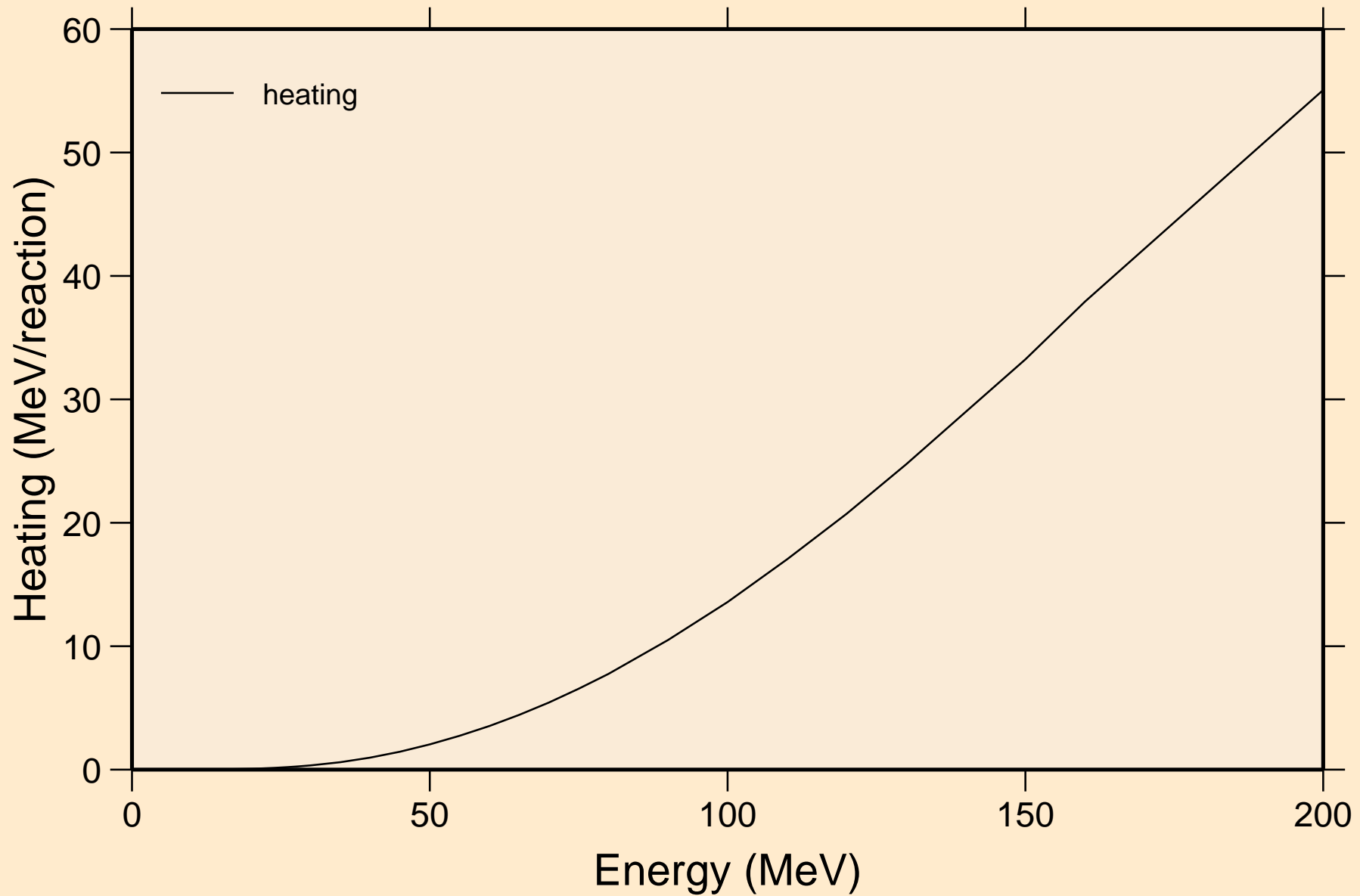

AU185M DEUTERON ACER TENDL-2023 LIBRARY; T=0.K  
Threshold reactions

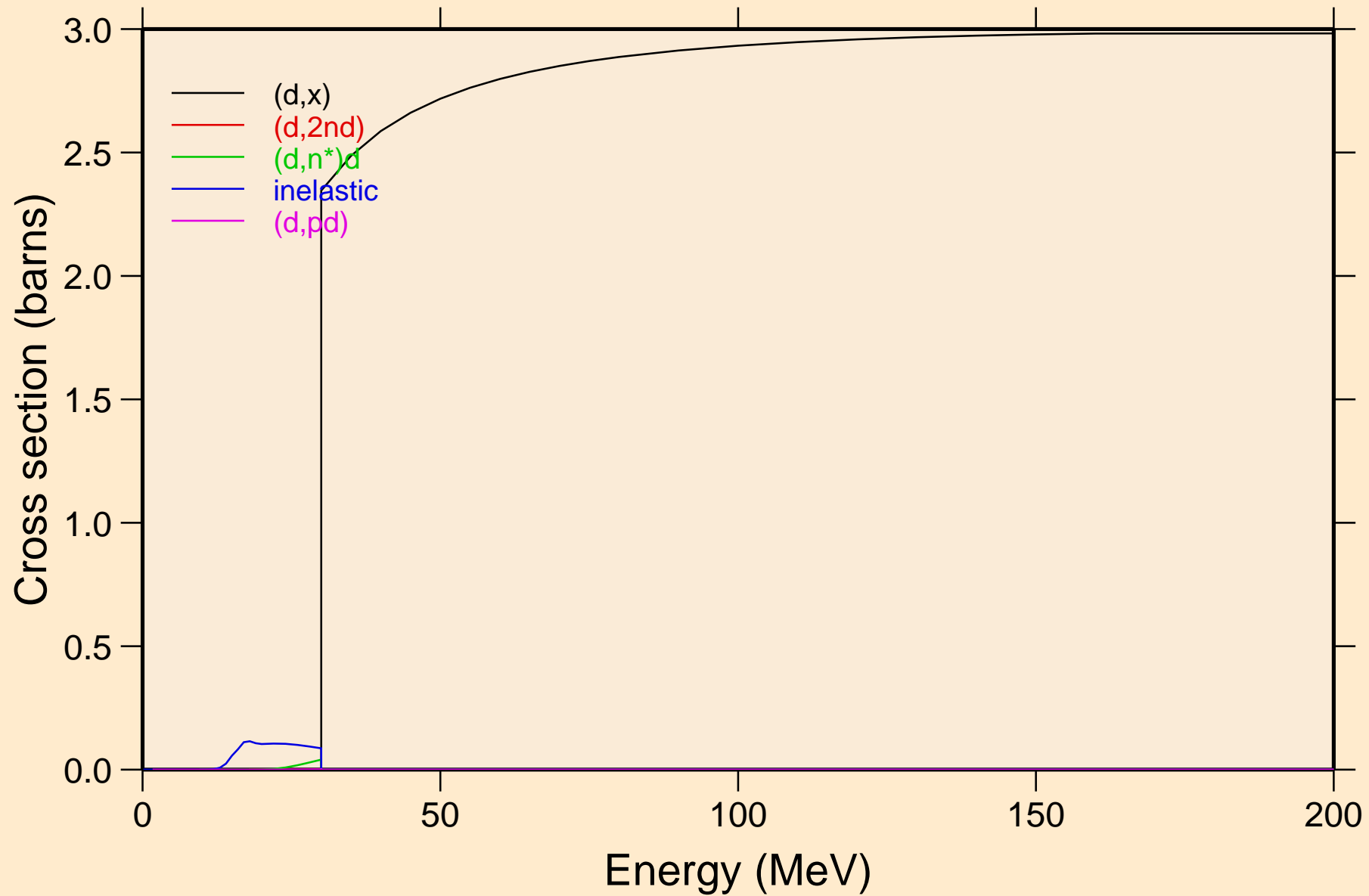

AU185M DEUTERON ACER TENDL-2023 LIBRARY; T=0.K  
Threshold reactions

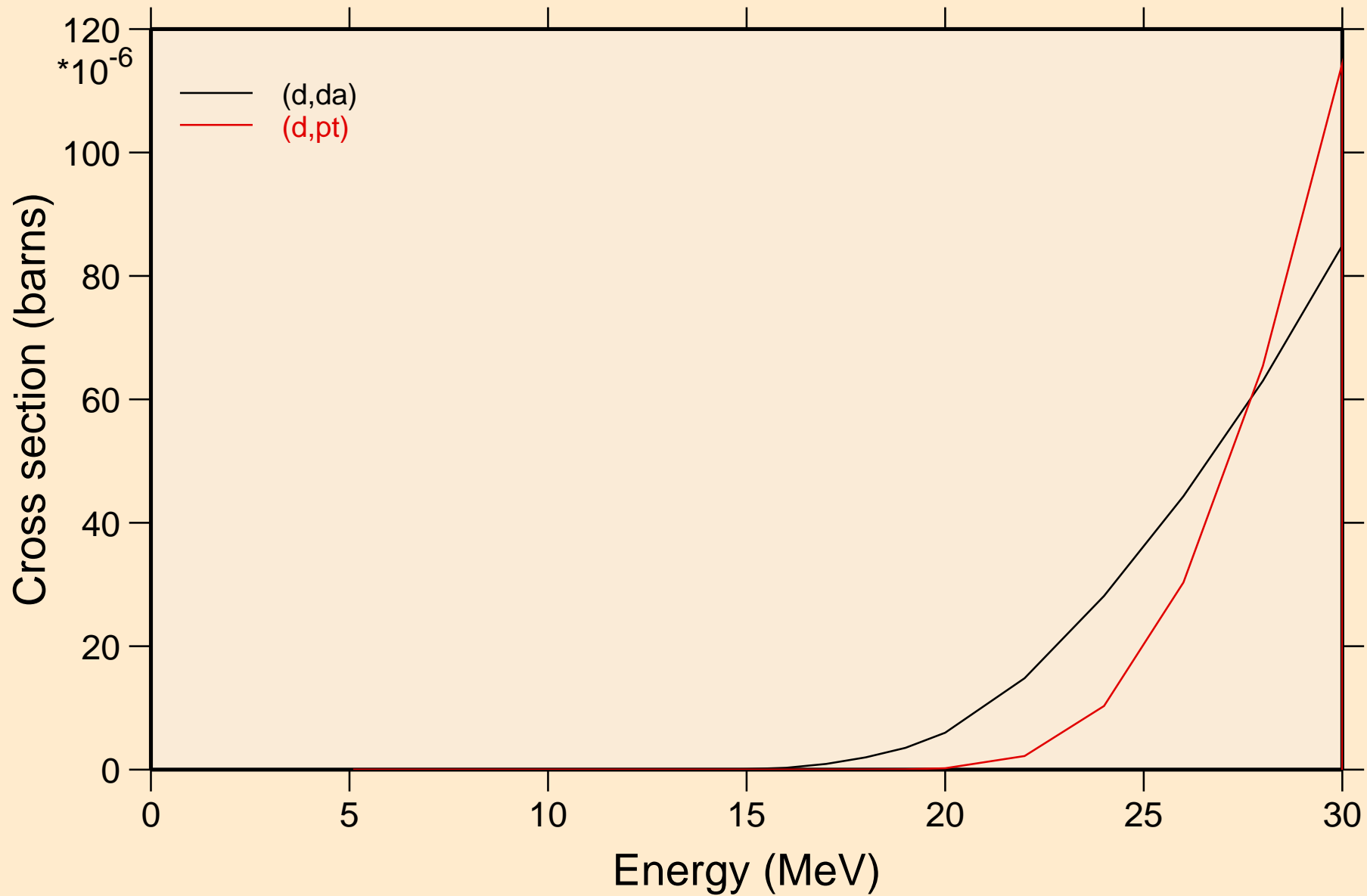

AU185M DEUTERON ACER TENDL-2023 LIBRARY; T=0.K  
Threshold reactions

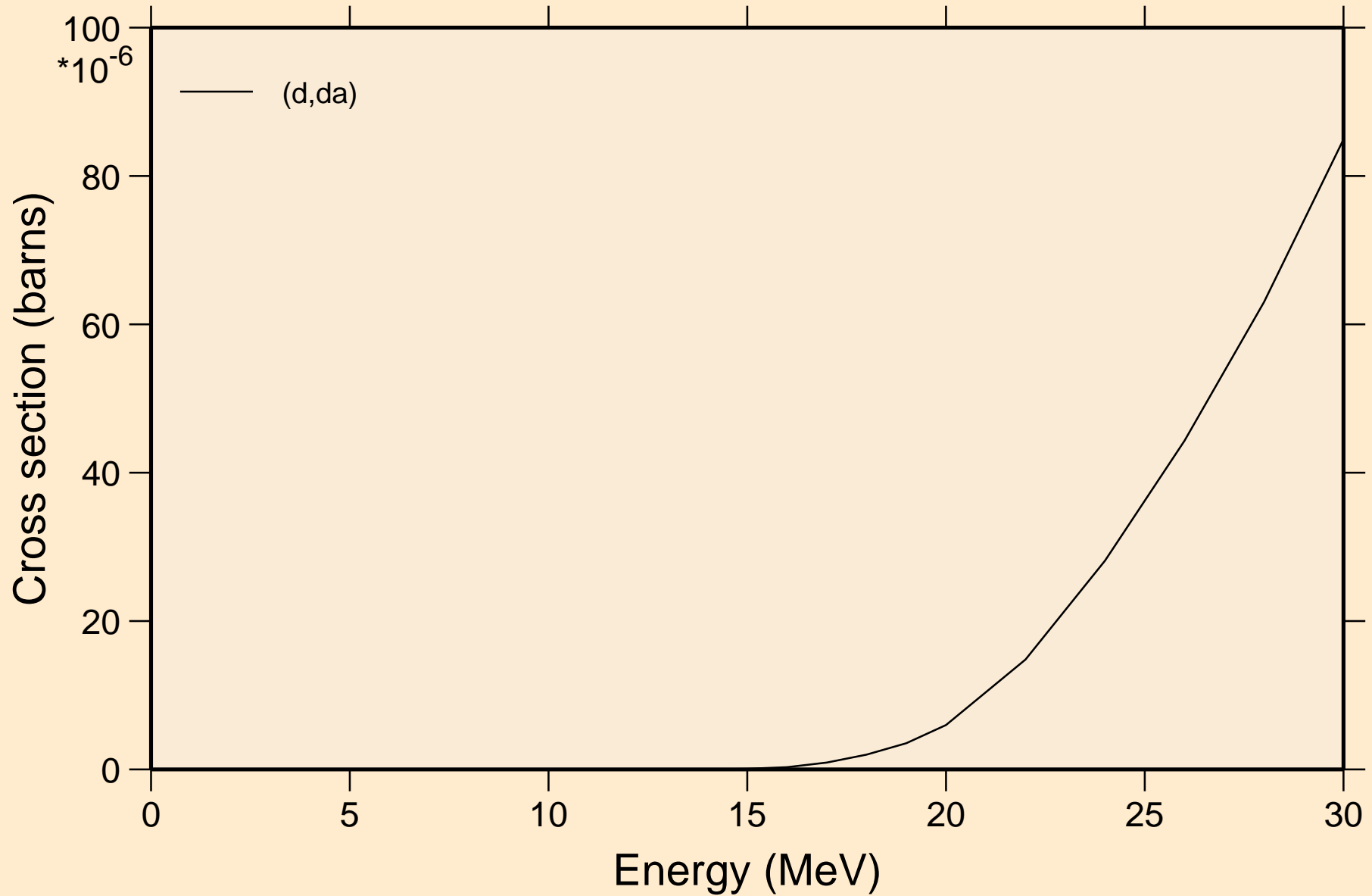

AU185M DEUTERON ACER TENDL-2023 LIBRARY; T=0.K  
angular distribution for elastic

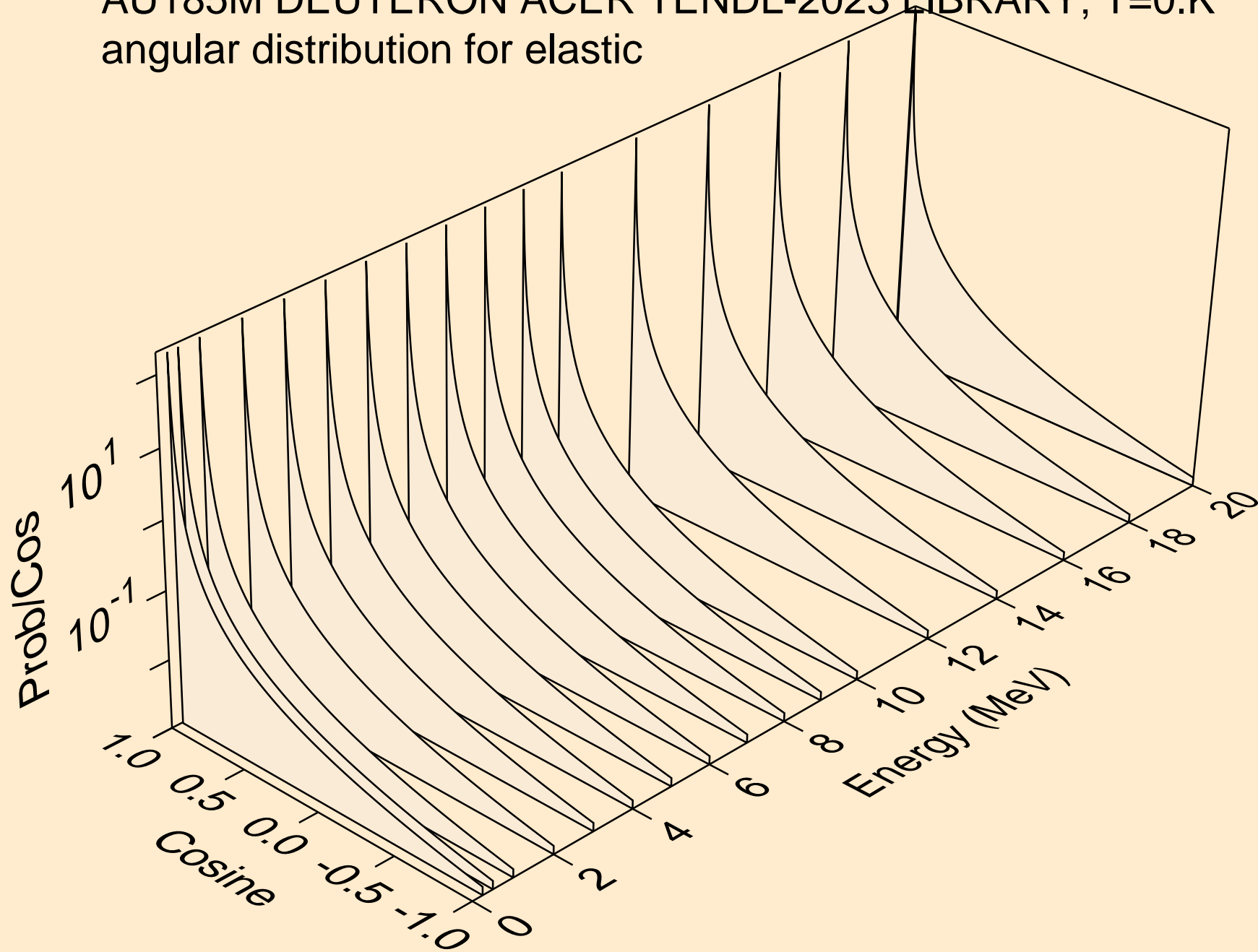



AU185M DEUTERON ACER TENDL-2023 LIBRARY; T=0.K  
angular distribution for elastic

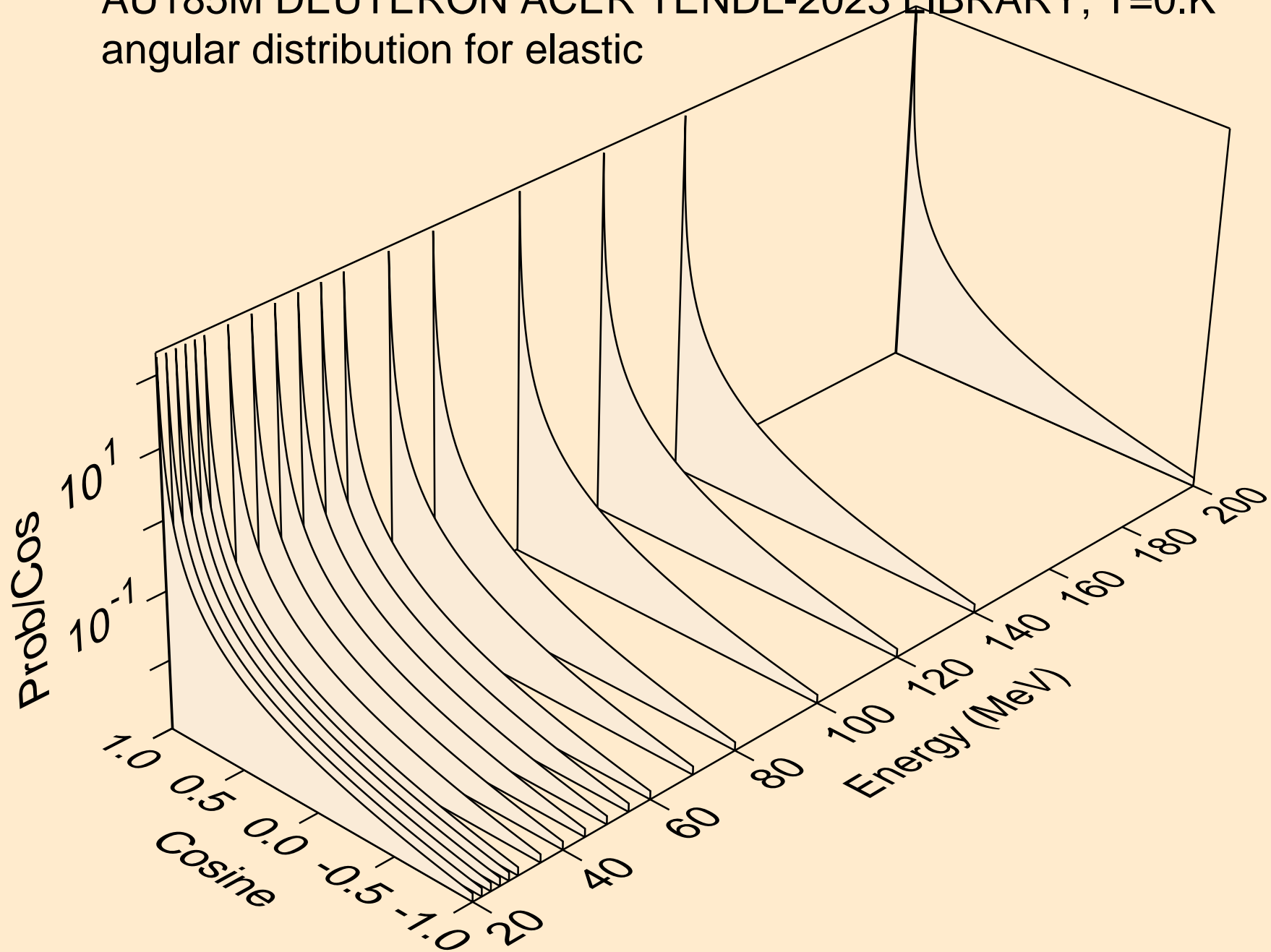

AU185M DEUTERON ACER TENDL-2023 LIBRARY; T=0.K  
Deuteron emission for (d,x)

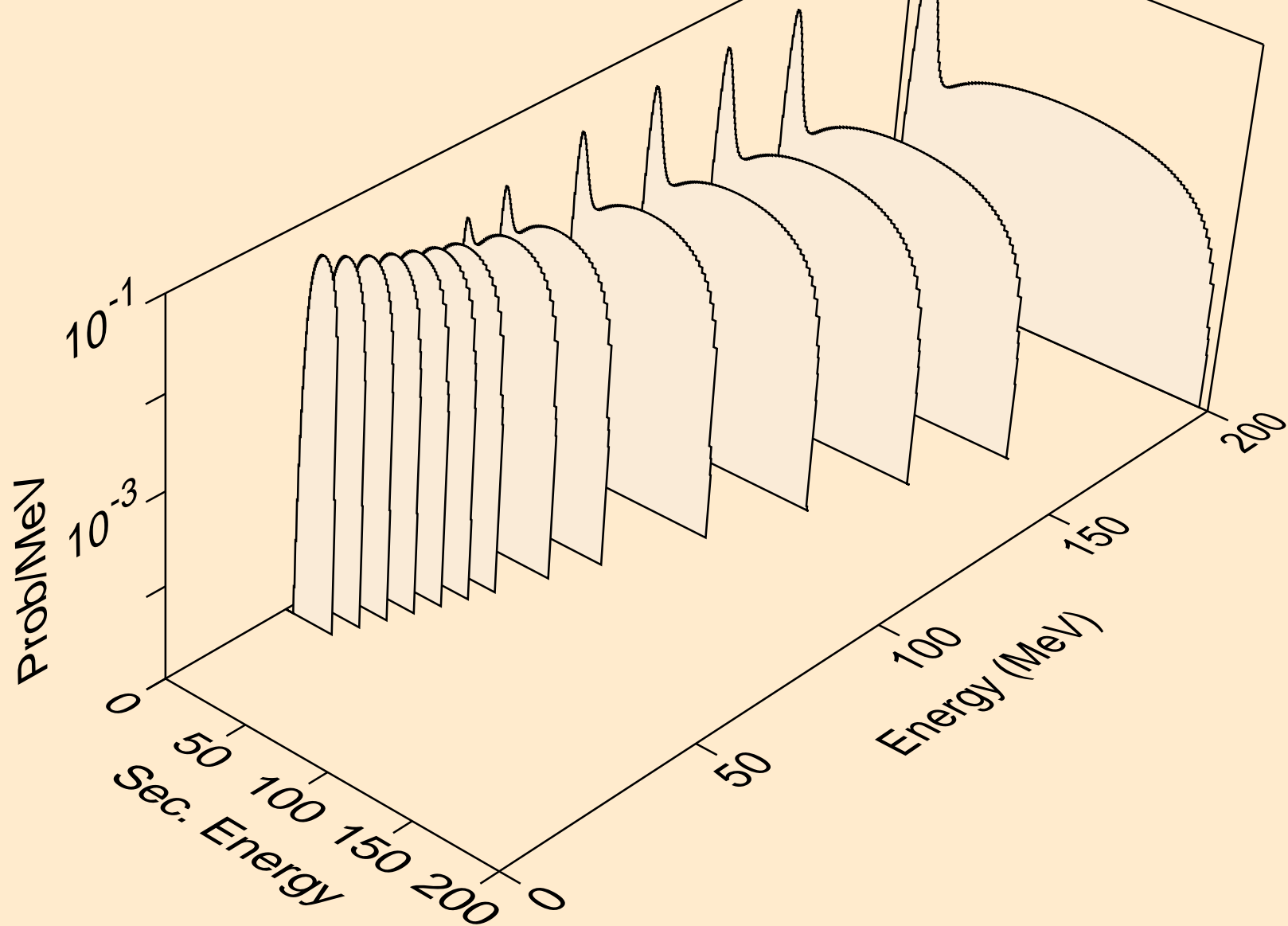

AU185M DEUTERON ACER TENDL-2023 LIBRARY; T=0.K  
Deuteron emission for (d,2nd)

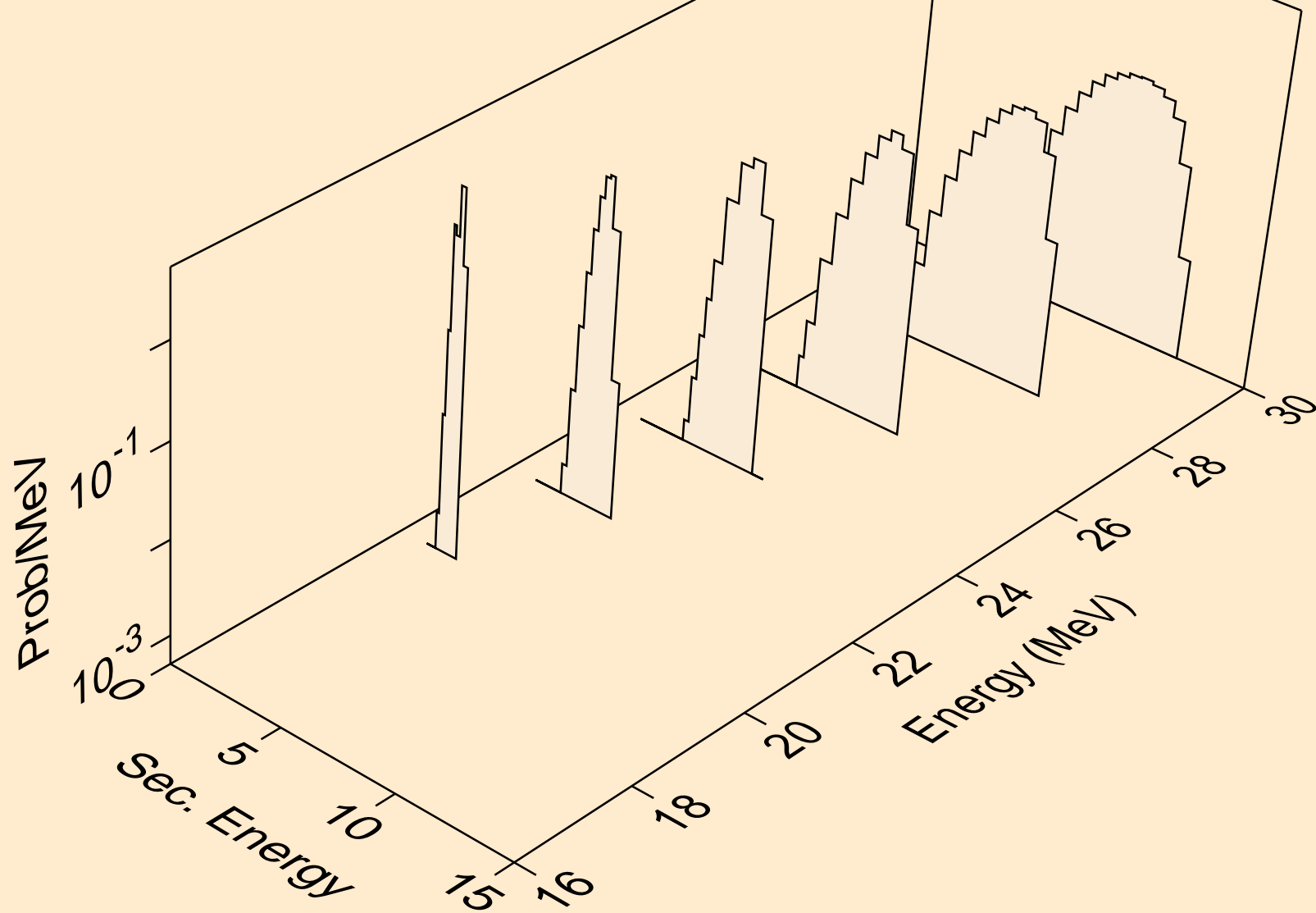

AU185M DEUTERON ACER TENDL-2023 LIBRARY; T=0.K  
Deuteron emission for (d,n\*)d

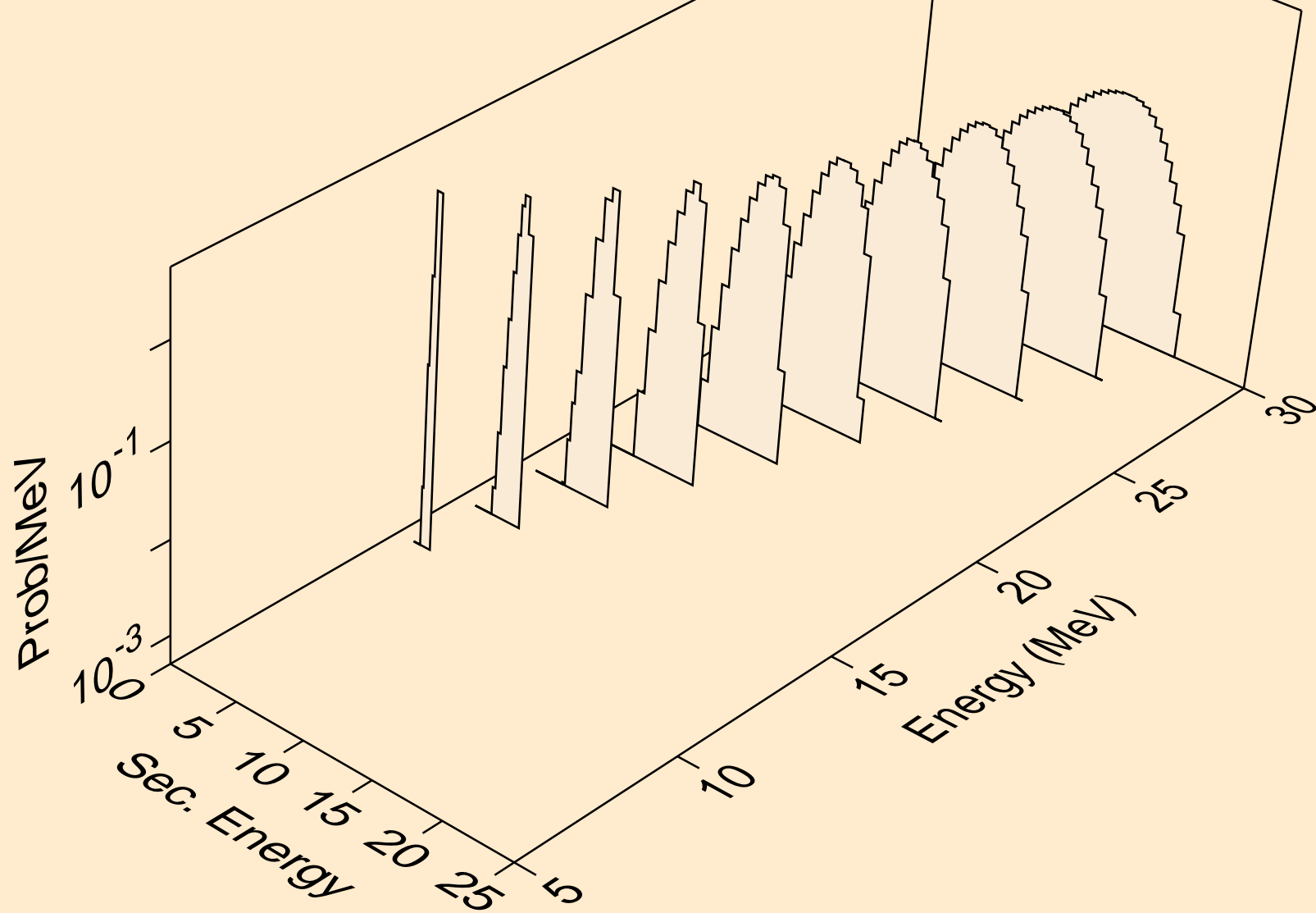

AU185M DEUTERON ACER TENDL-2023 LIBRARY; T=0.K  
Deuteron emission for inelastic

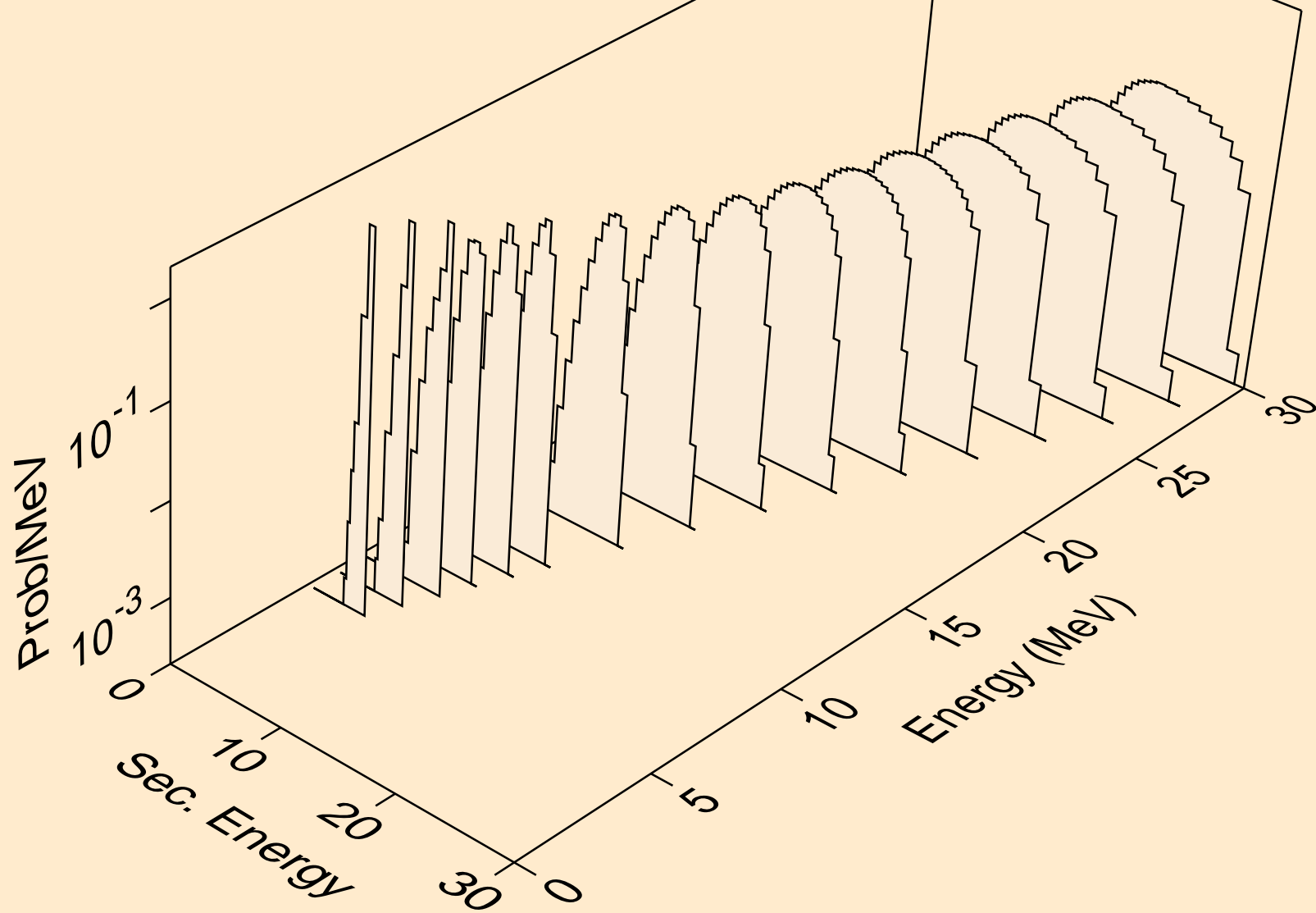

AU185M DEUTERON ACER TENDL-2023 LIBRARY; T=0.K  
Deuteron emission for (d,pd)

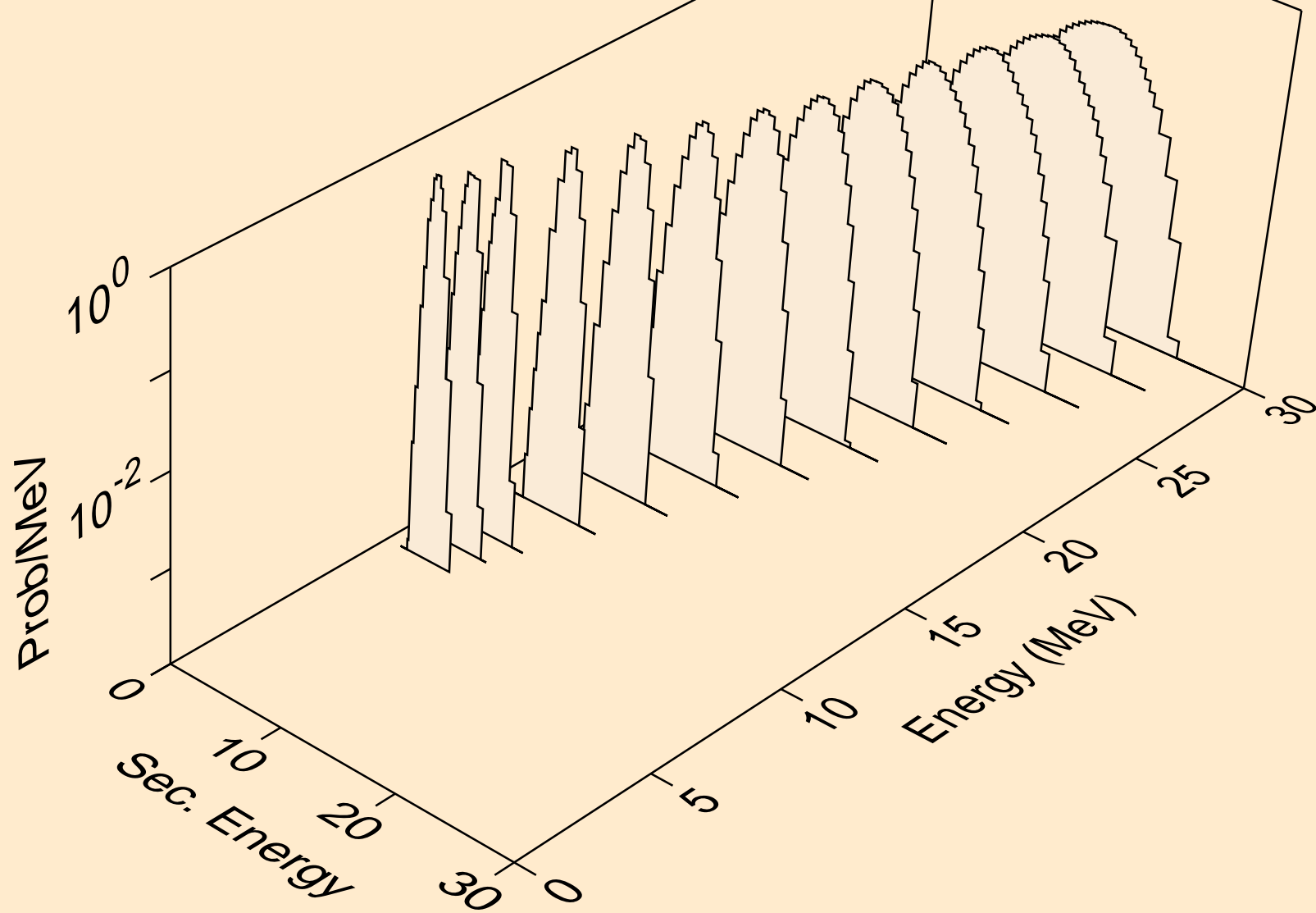

AU185M DEUTERON ACER TENDL-2023 LIBRARY; T=0.K  
Deuteron emission for (d,da)

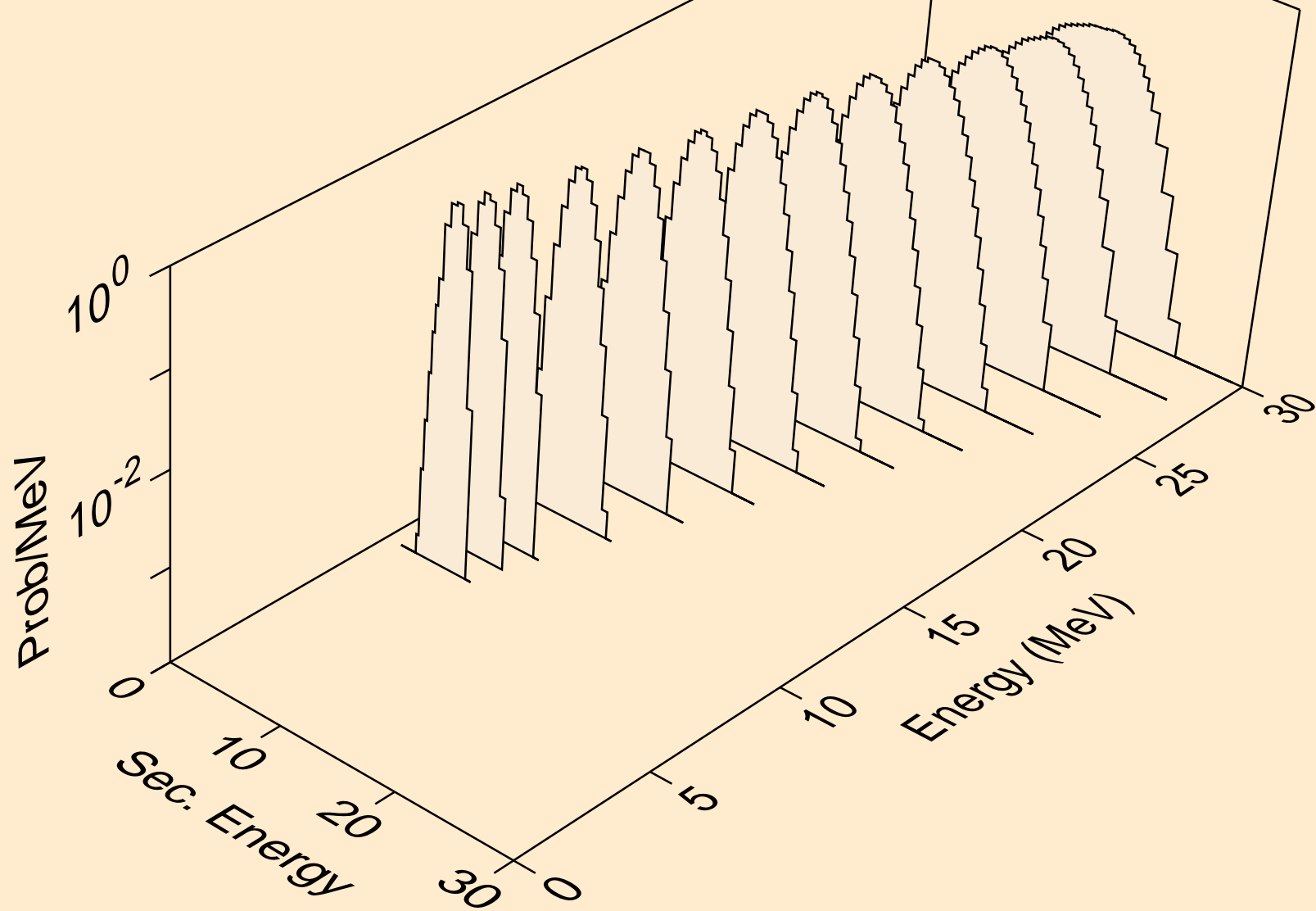

AU185M DEUTERON ACER TENDL-2023 LIBRARY; T=0.K  
Photon emission for (z,n)

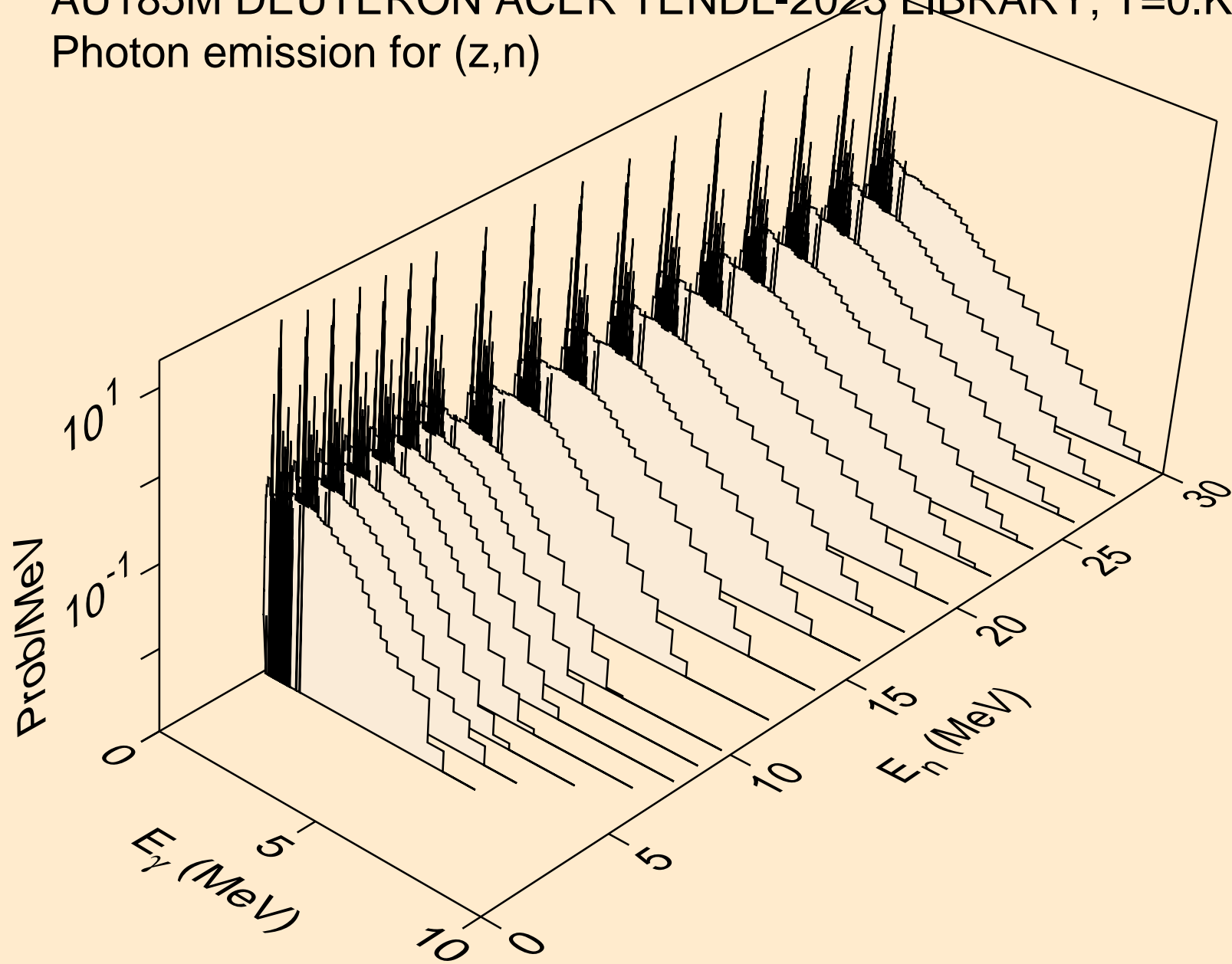



AU185M DEUTERON ACER TENDL-2023 LIBRARY; T=0.K  
Photon emission for (z,x)

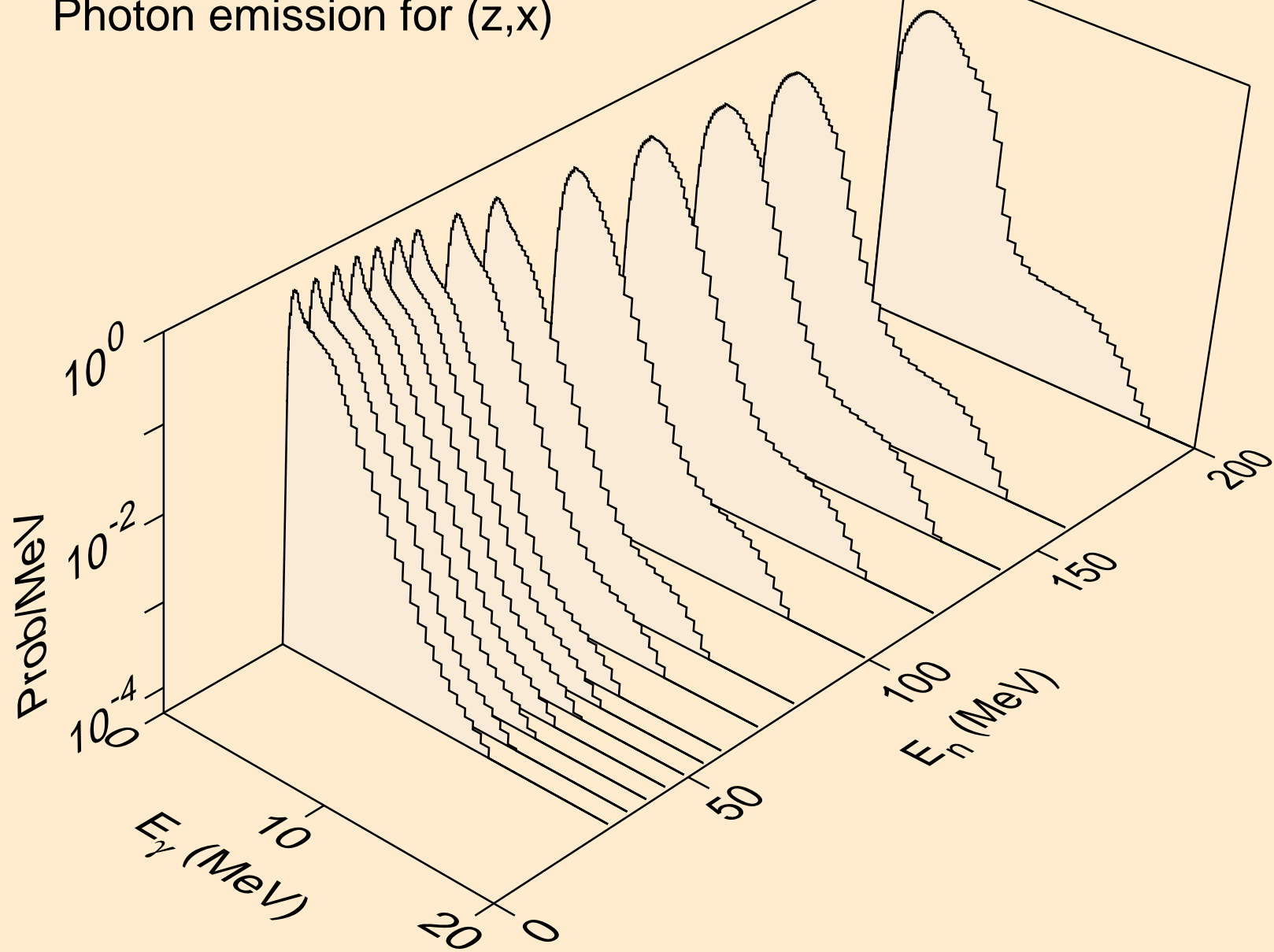

AU185M DEUTERON ACER TENDL-2023 LIBRARY; T=0.K  
Photon emission for (n,2nd)

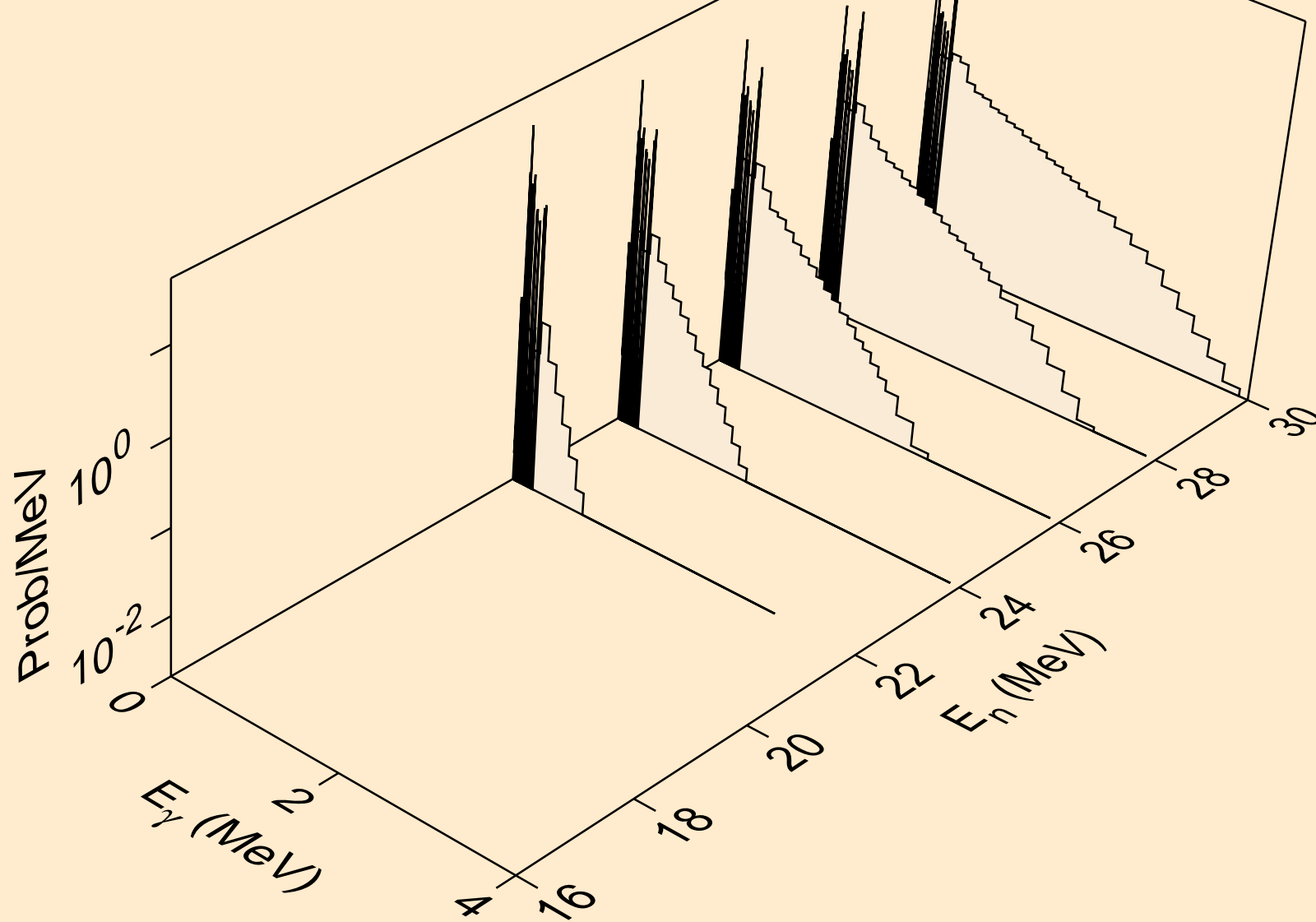

AU185M DEUTERON ACER TENDL-2023 LIBRARY; T=0.K  
Photon emission for (n,2n)

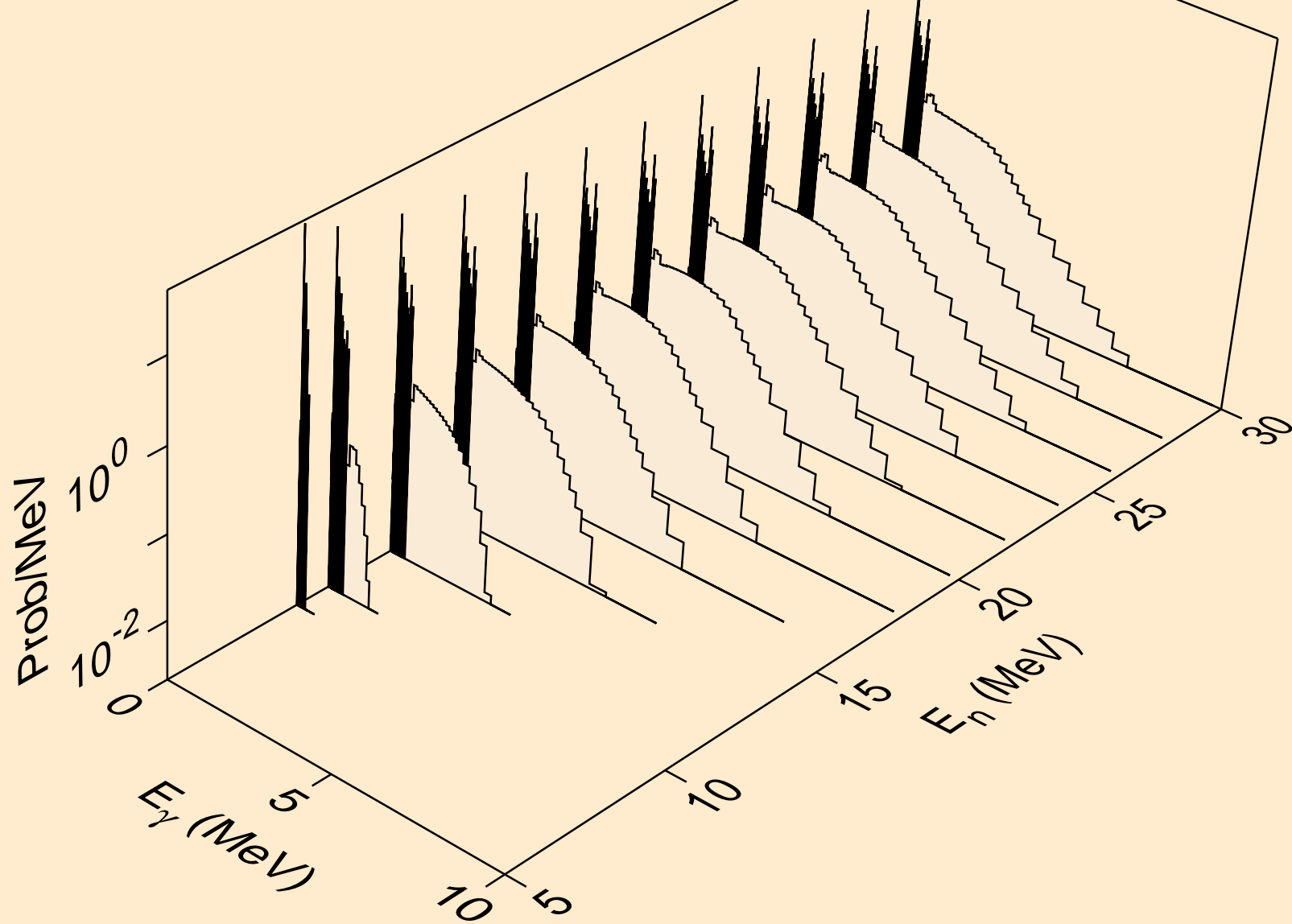

AU185M DEUTERON ACER TENDL-2023 LIBRARY; T=0.K  
Photon emission for (n,3n)

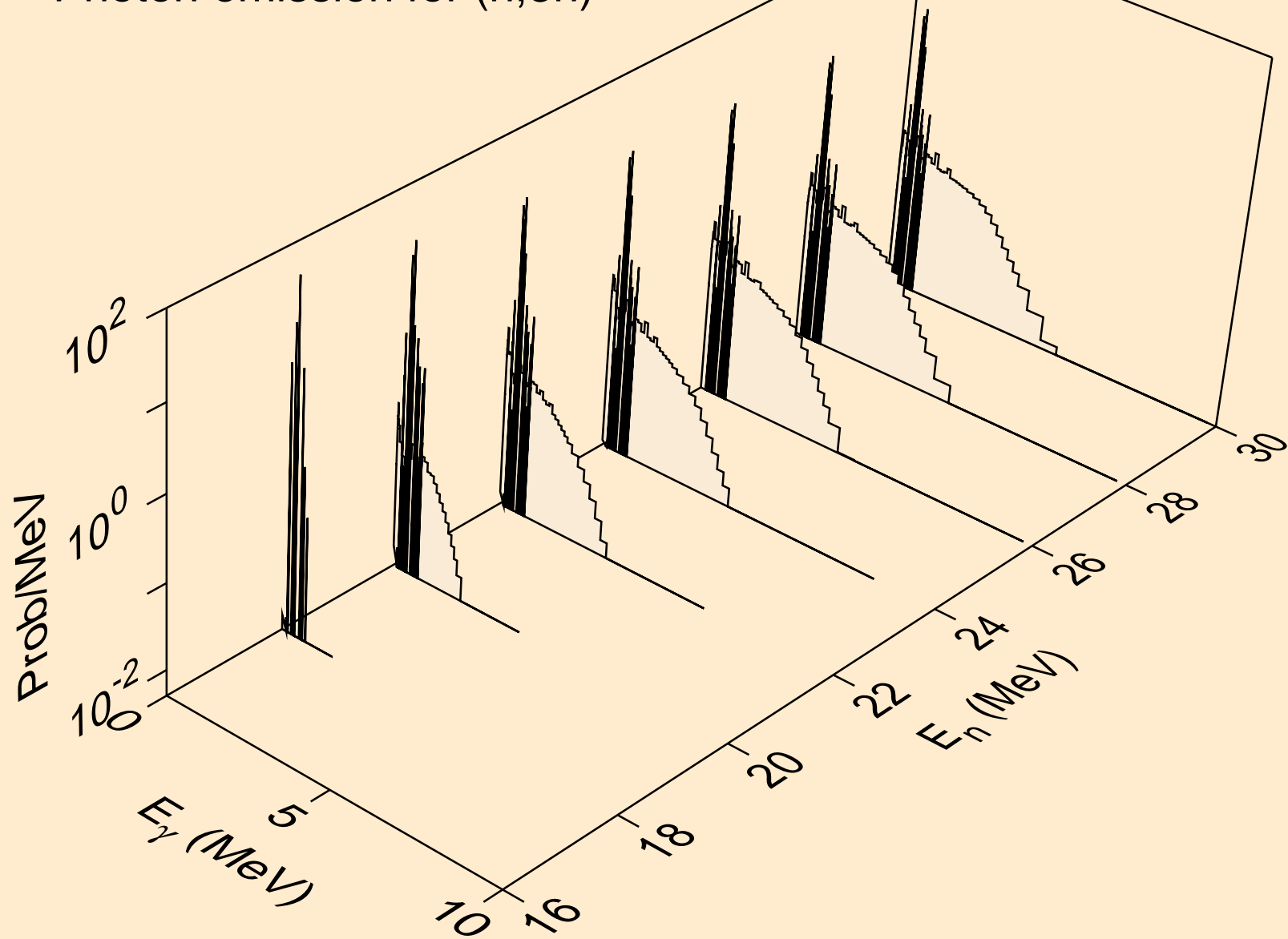

AU185M DEUTERON ACER TENDL-2023 LIBRARY; T=0.K  
Photon emission for (n,n\*)a

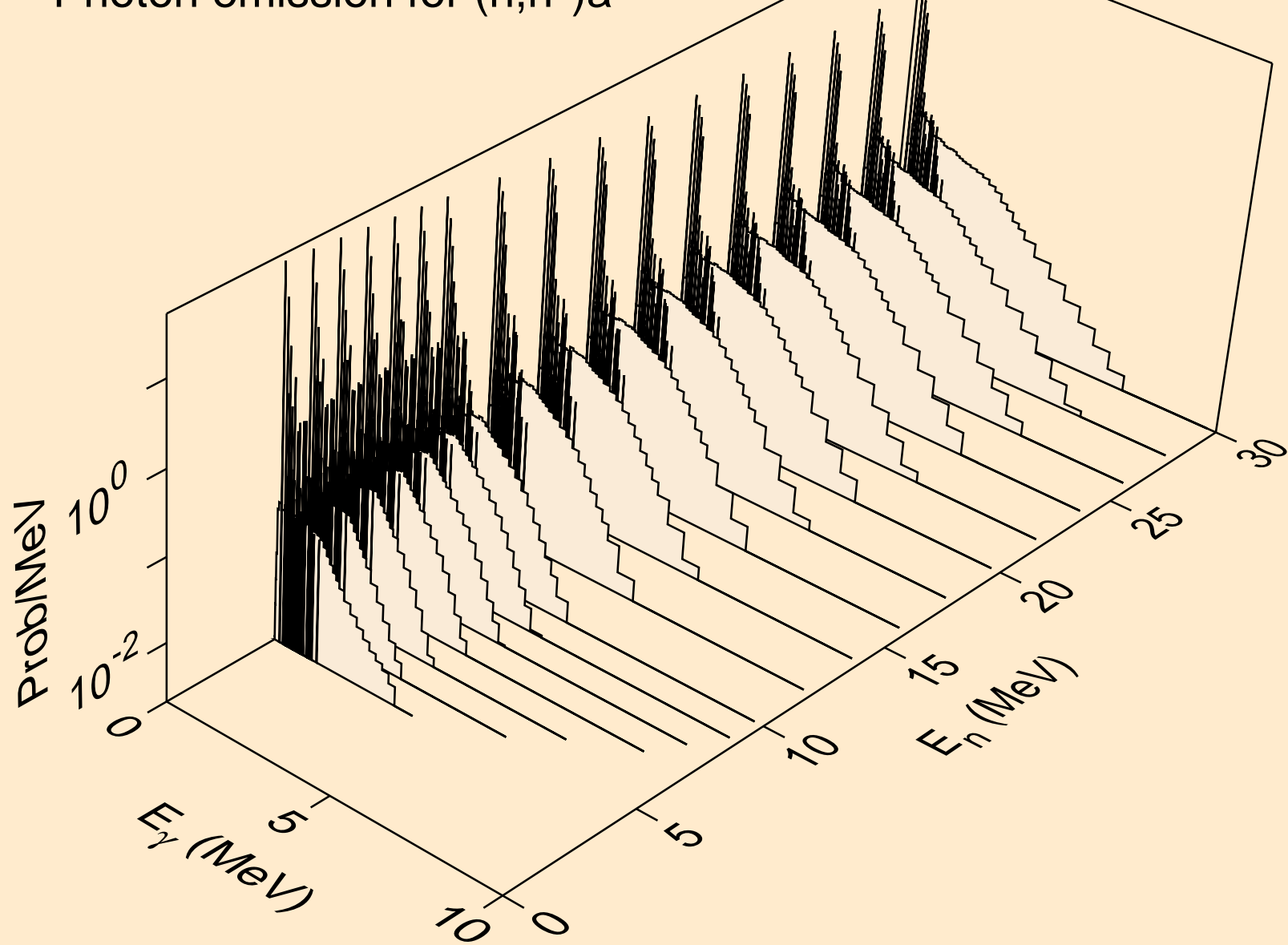

AU185M DEUTERON ACER TENDL-2023 LIBRARY; T=0.K  
Photon emission for (n,2n)a

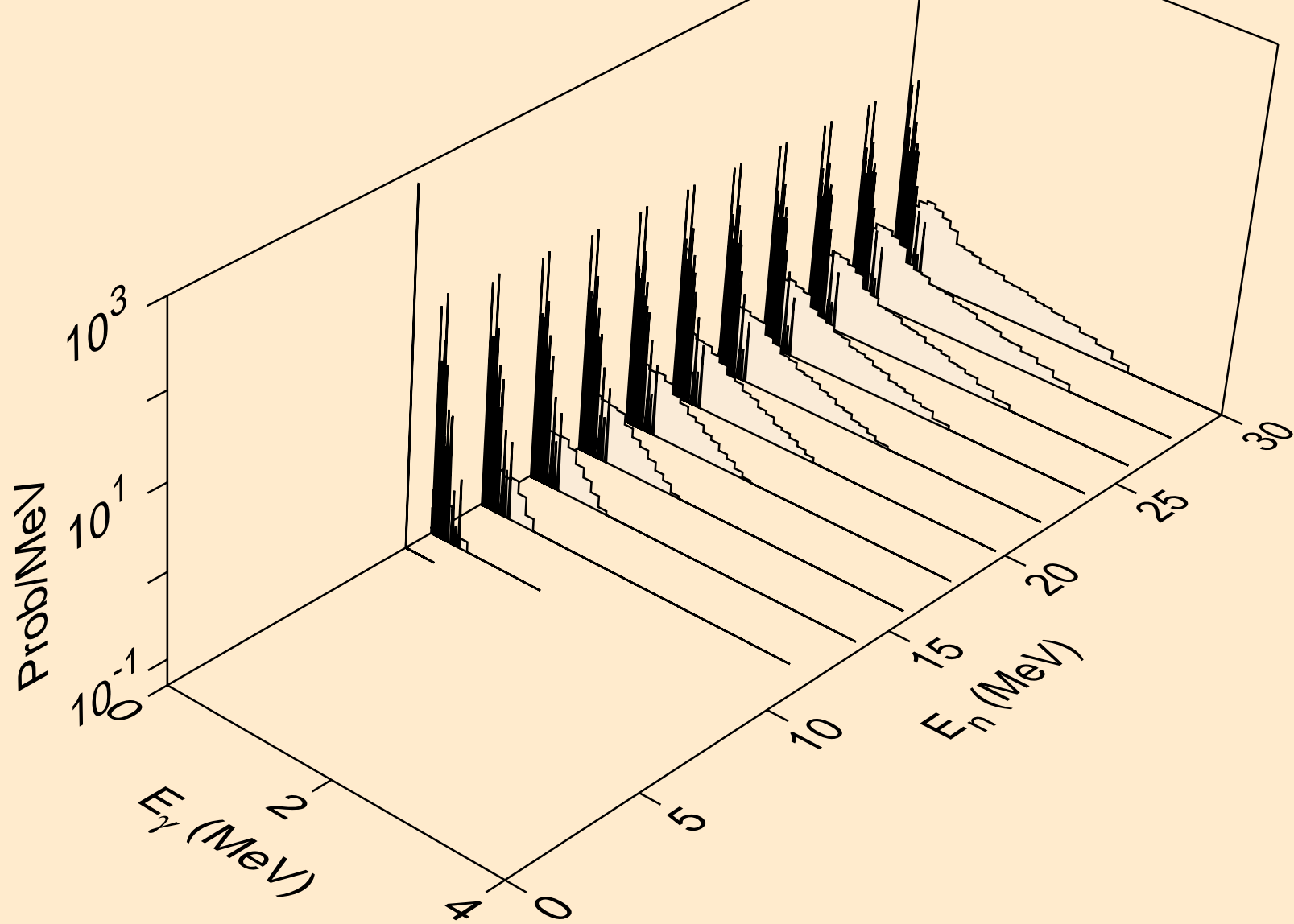

AU185M DEUTERON ACER TENDL-2023 LIBRARY; T=0.K  
Photon emission for (n,3n)a

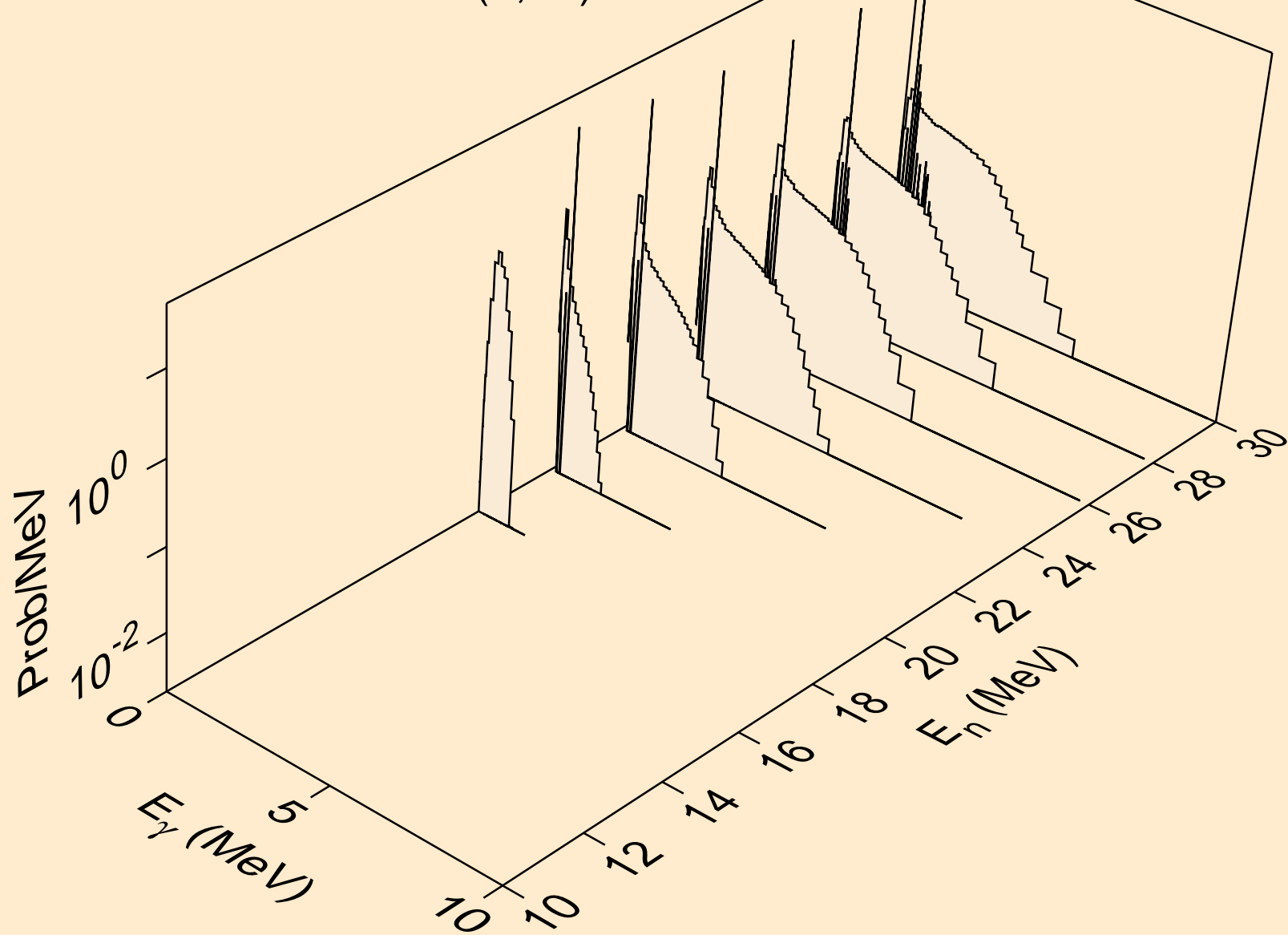

AU185M DEUTERON ACER TENDL-2023 LIBRARY; T=0.K  
Photon emission for (n,n\*)p

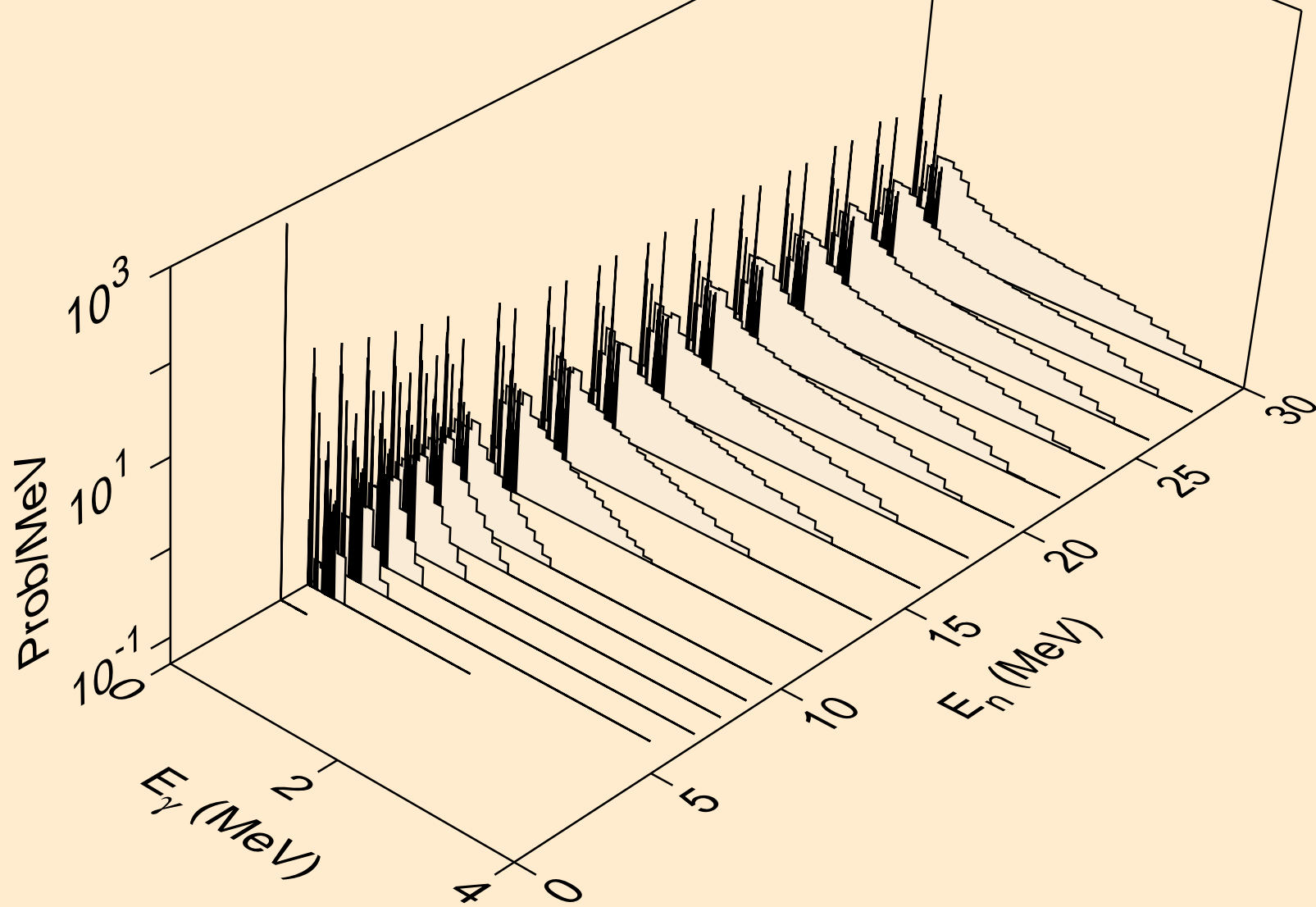



AU185M DEUTERON ACER TENDL-2023 LIBRARY; T=0.K  
Photon emission for (n,n\*)2a

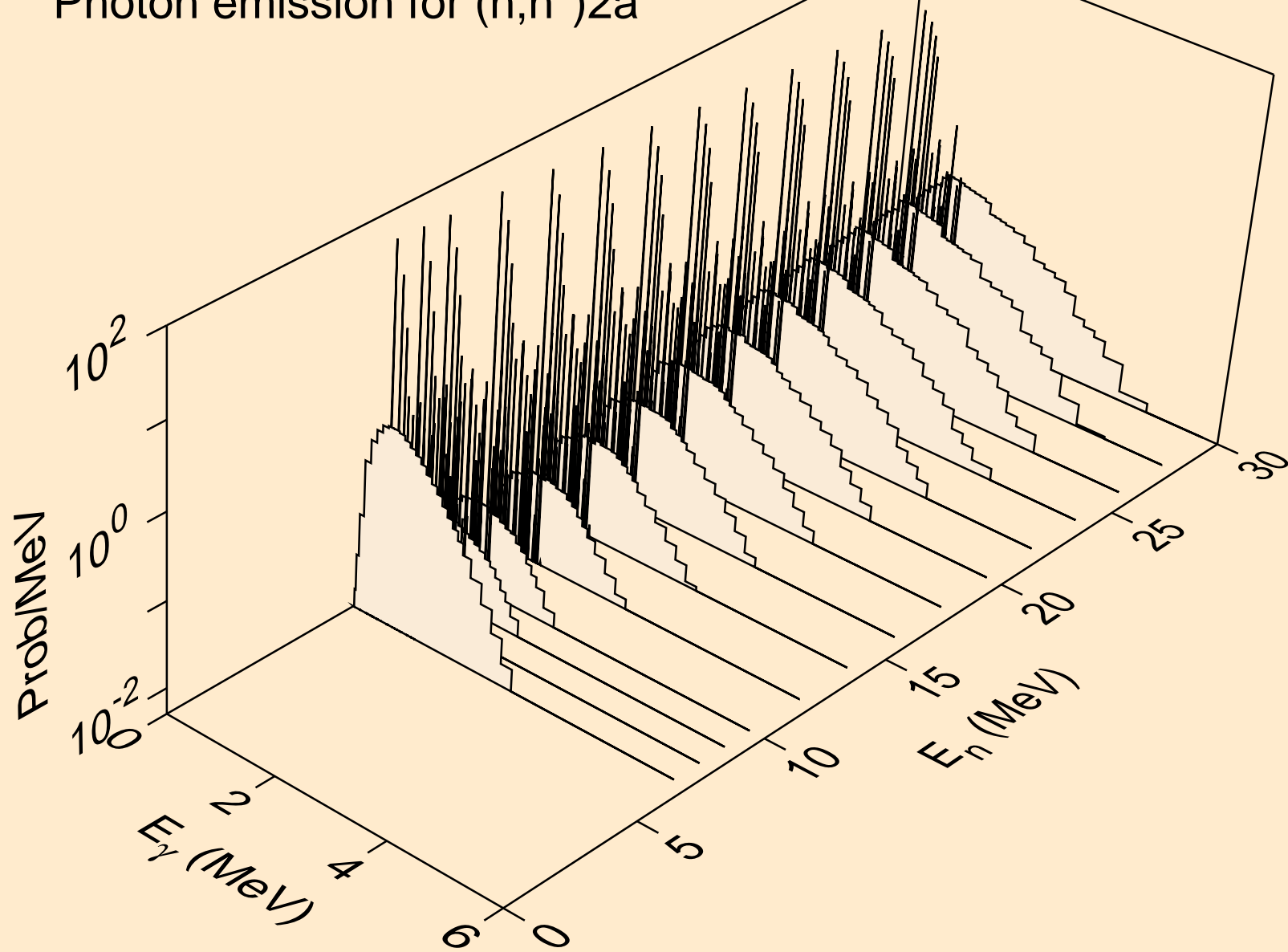

AU185M DEUTERON ACER TENDL-2023 LIBRARY; T=0.K  
Photon emission for (n,2n)2a

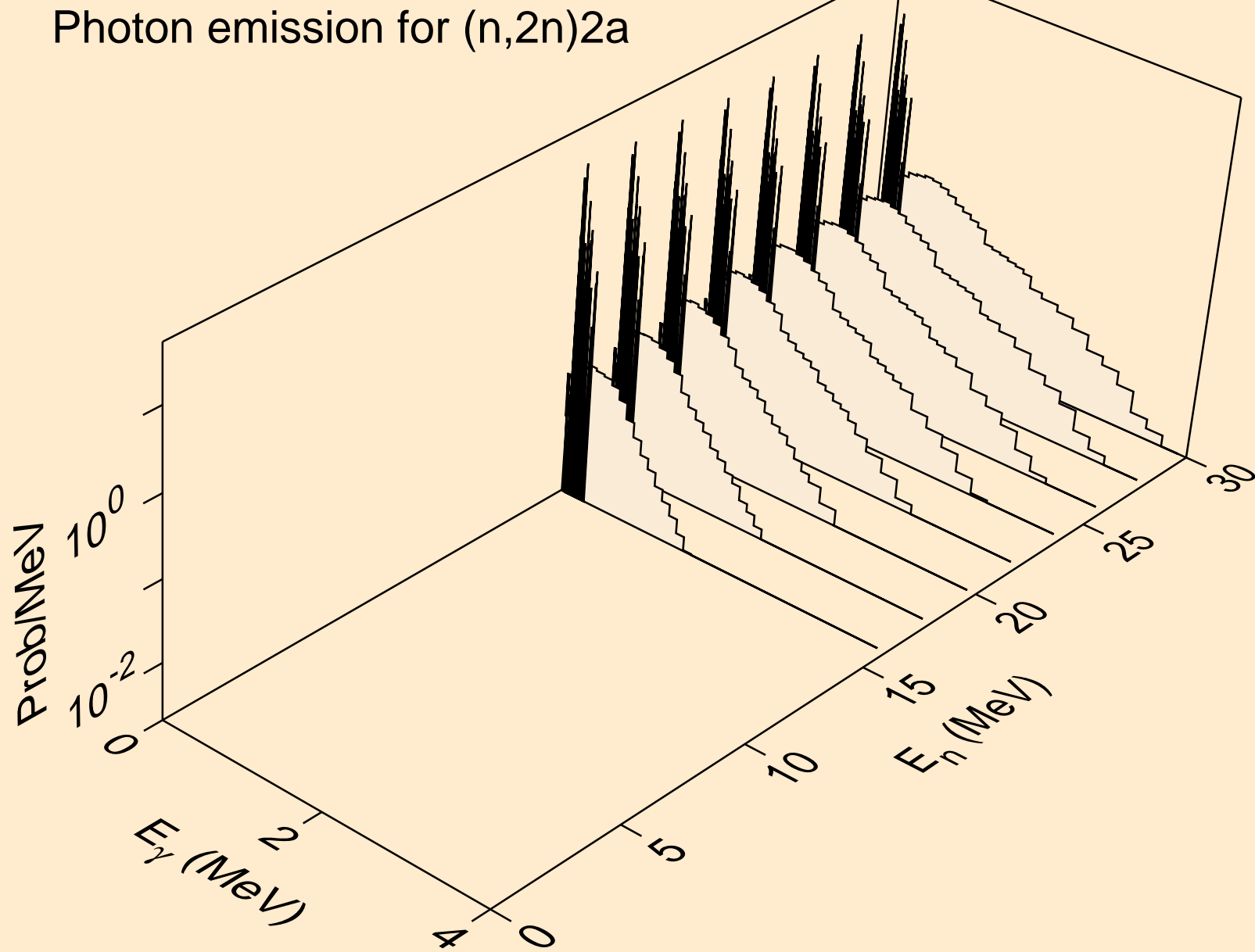

AU185M DEUTERON ACER TENDL-2023 LIBRARY; T=0.K  
Photon emission for (n,n\*)d

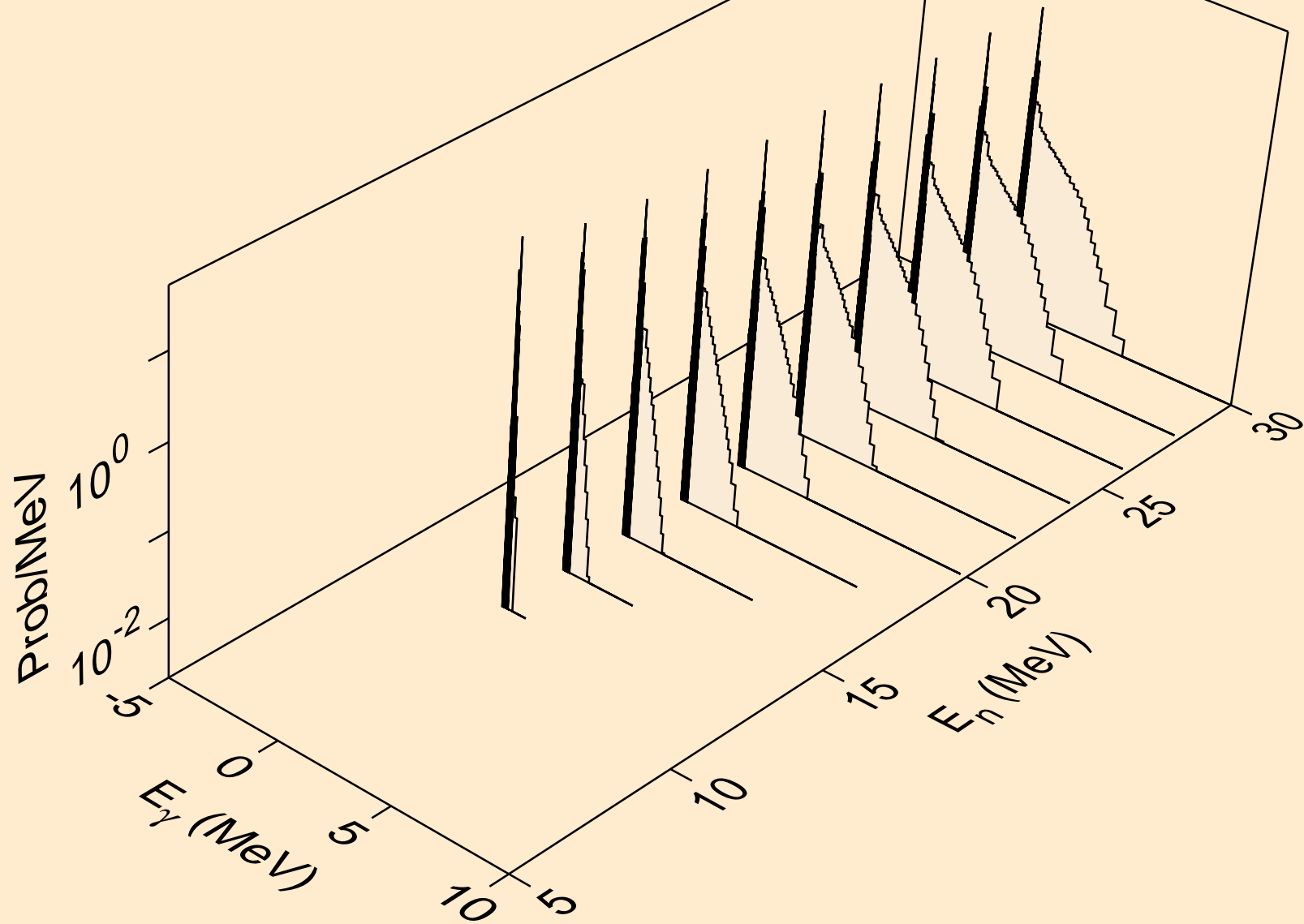

AU185M DEUTERON ACER TENDL-2023 LIBRARY; T=0.K  
Photon emission for (n,n\*)t

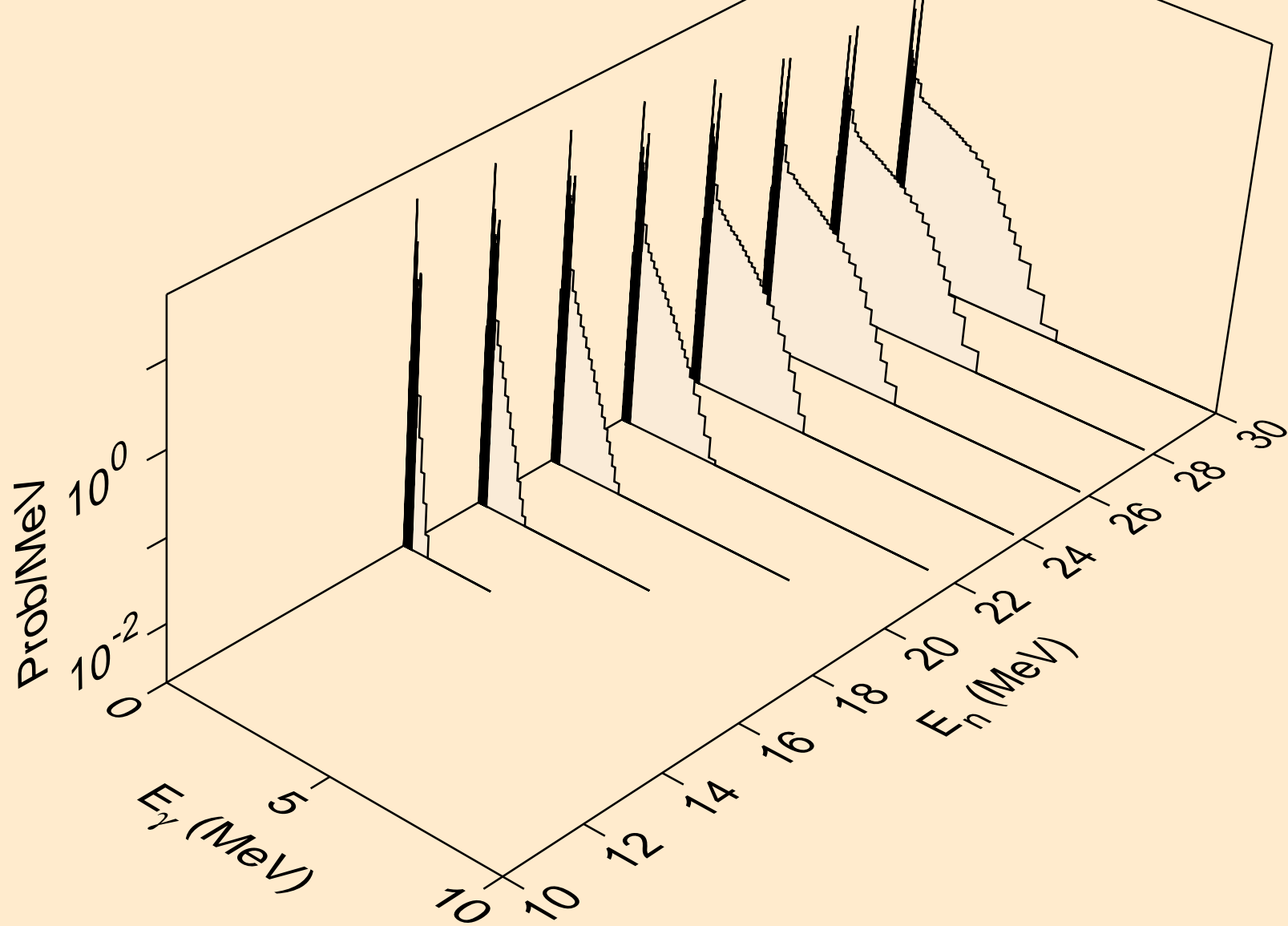

AU185M DEUTERON ACER TENDL-2023 LIBRARY; T=0.K  
Photon emission for (n,n\*)he3

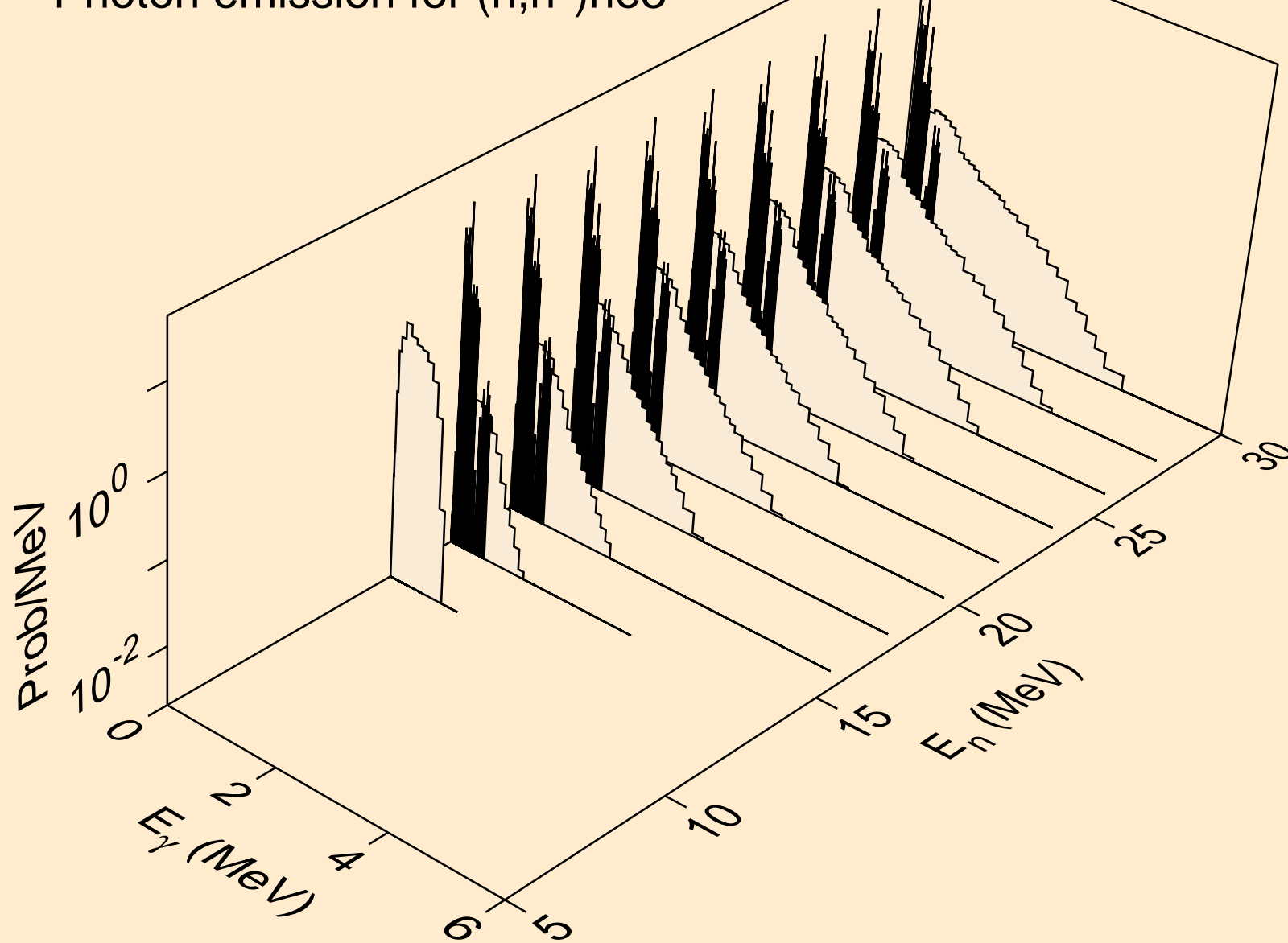

AU185M DEUTERON ACER TENDL-2023 LIBRARY; T=0.K  
Photon emission for (n,4n)

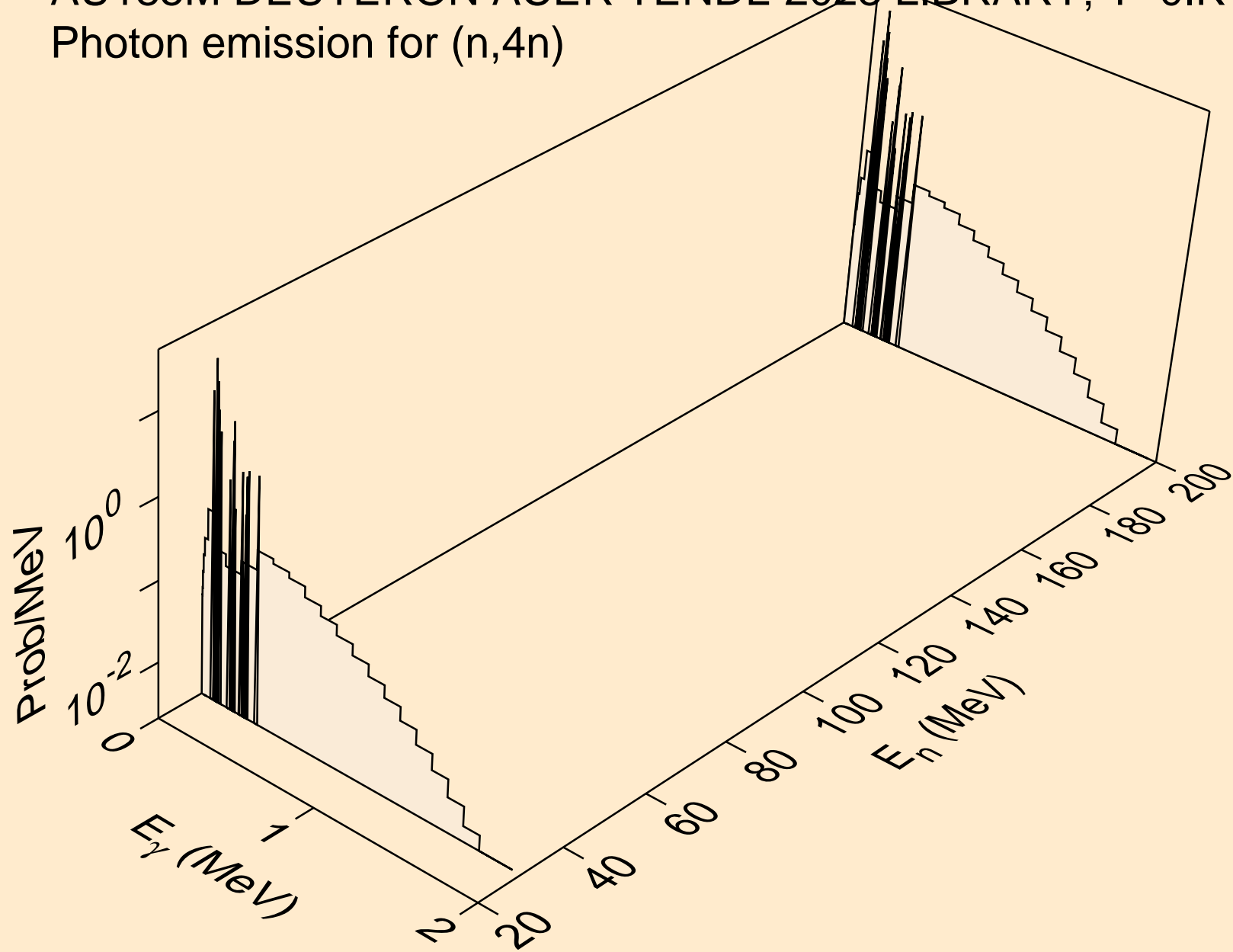

AU185M DEUTERON ACER TENDL-2023 LIBRARY; T=0.K  
Photon emission for (n,2np)

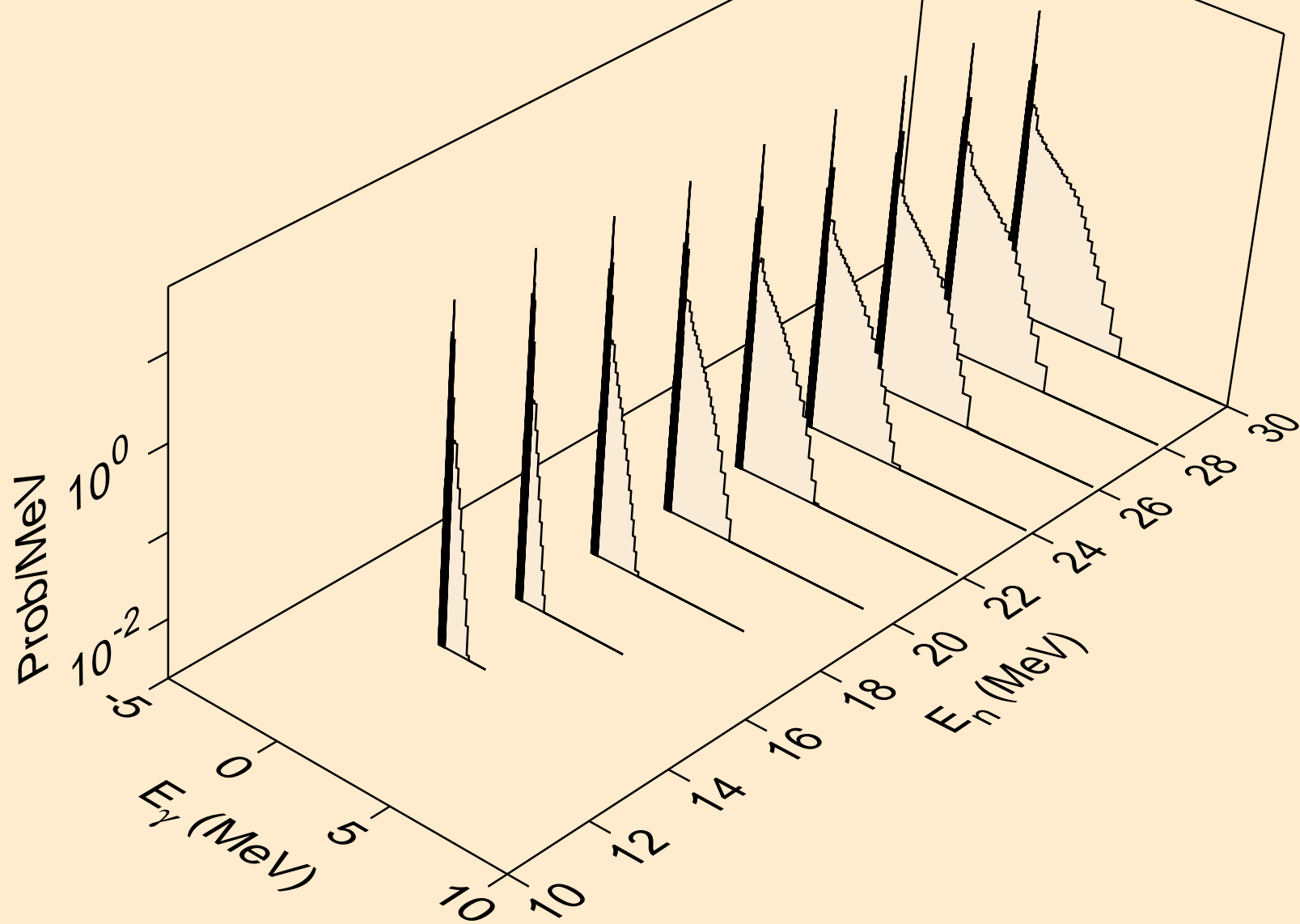

AU185M DEUTERON ACER TENDL-2023 LIBRARY; T=0.K  
Photon emission for (n,3np)

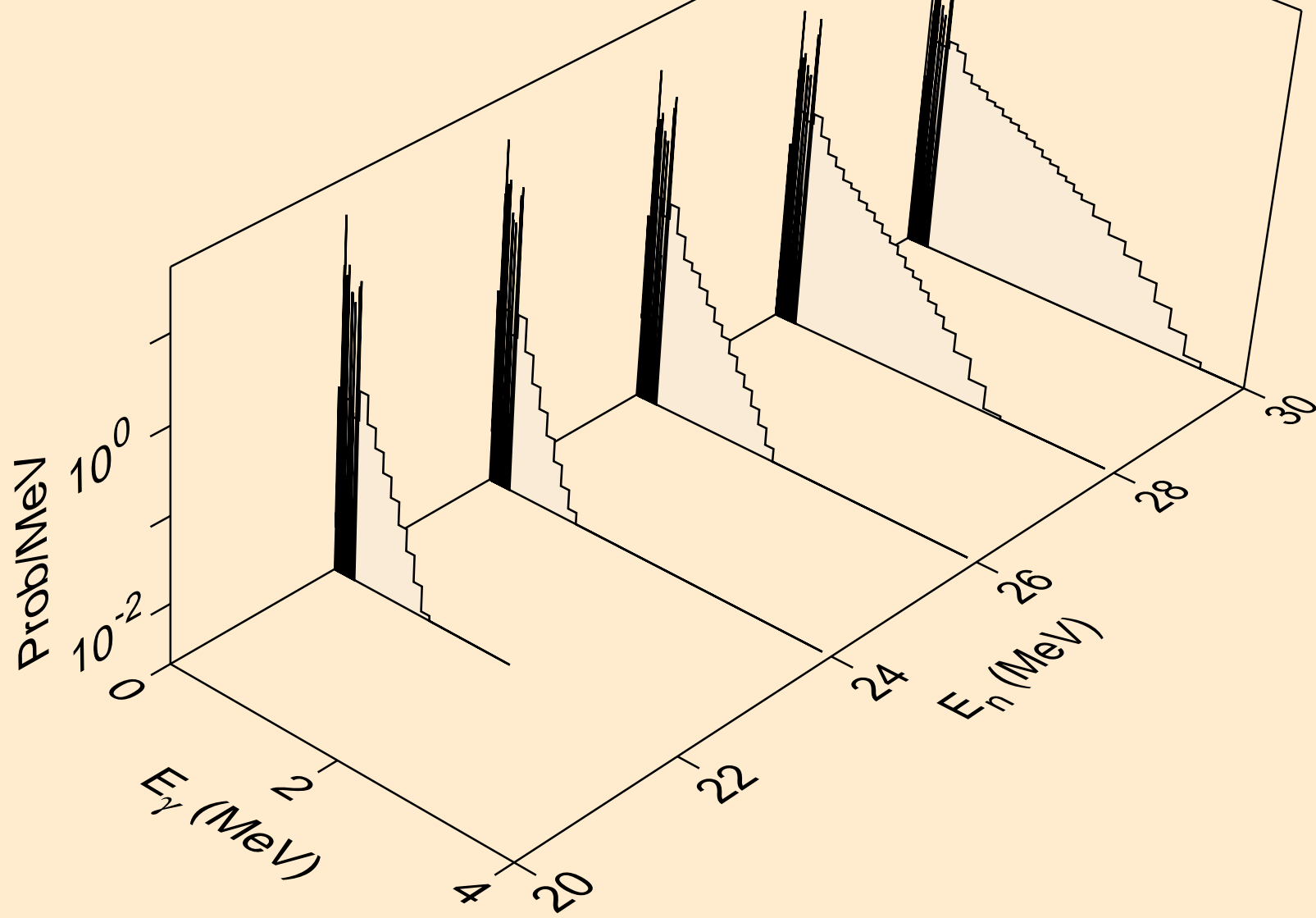



AU185M DEUTERON ACER TENDL-2023 LIBRARY; T=0.K  
Photon emission for (n,n2p)

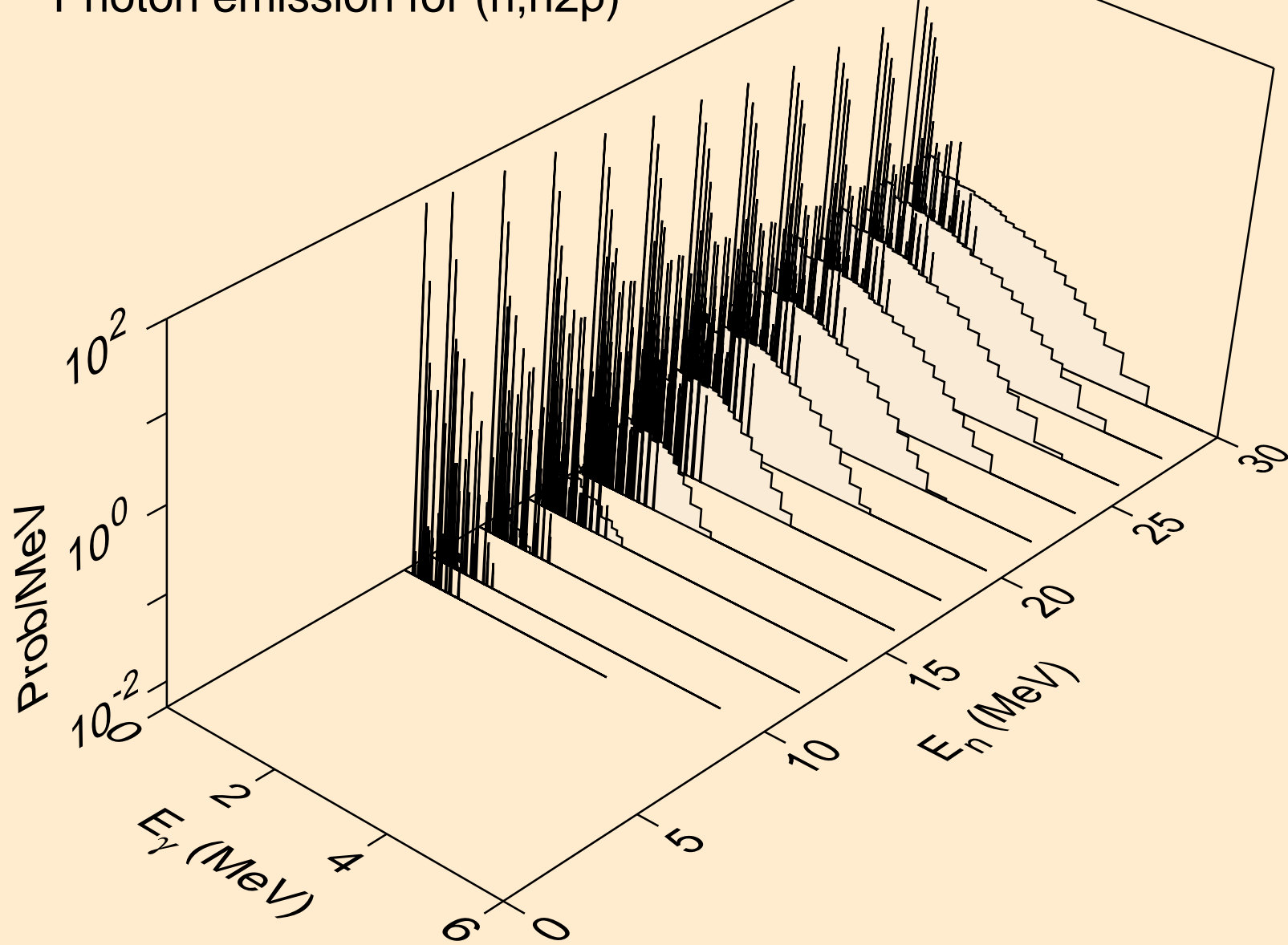

AU185M DEUTERON ACER TENDL-2023 LIBRARY; T=0.K  
Photon emission for (n,npa)

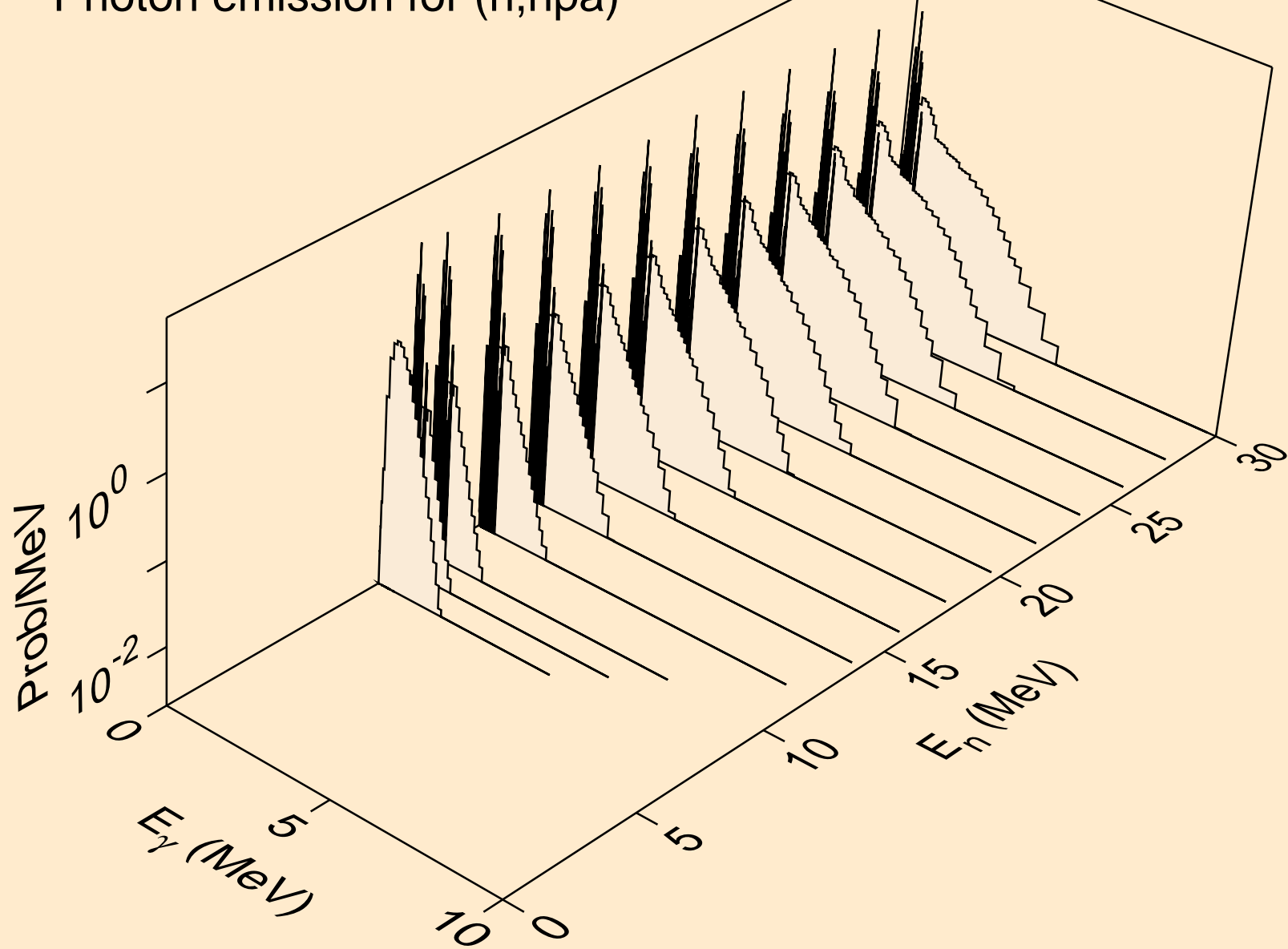

AU185M DEUTERON ACER TENDL-2023 LIBRARY; T=0.K  
Photon emission for (n,gma)

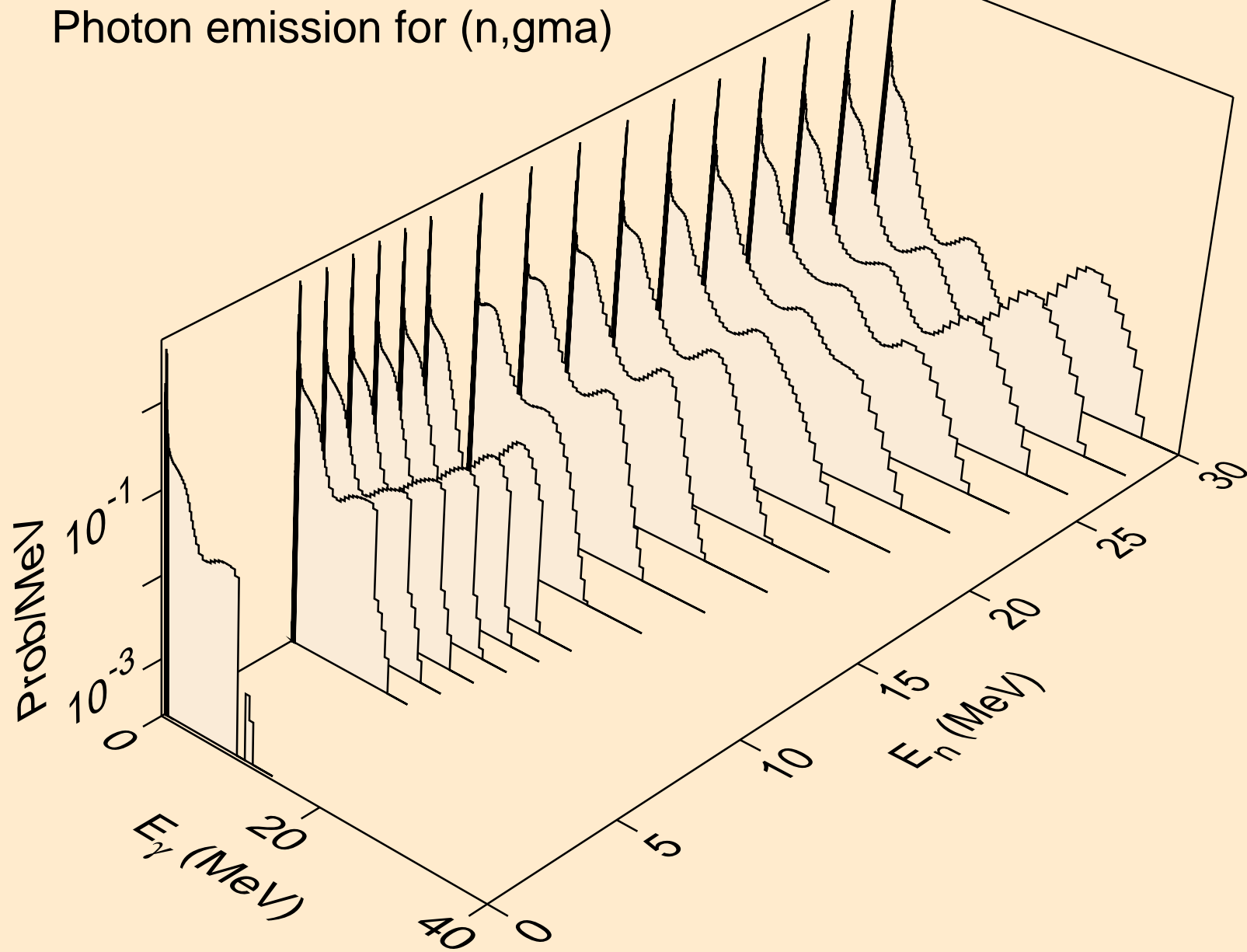

AU185M DEUTERON ACER TENDL-2023 LIBRARY; T=0.K  
Photon emission for (n,p)

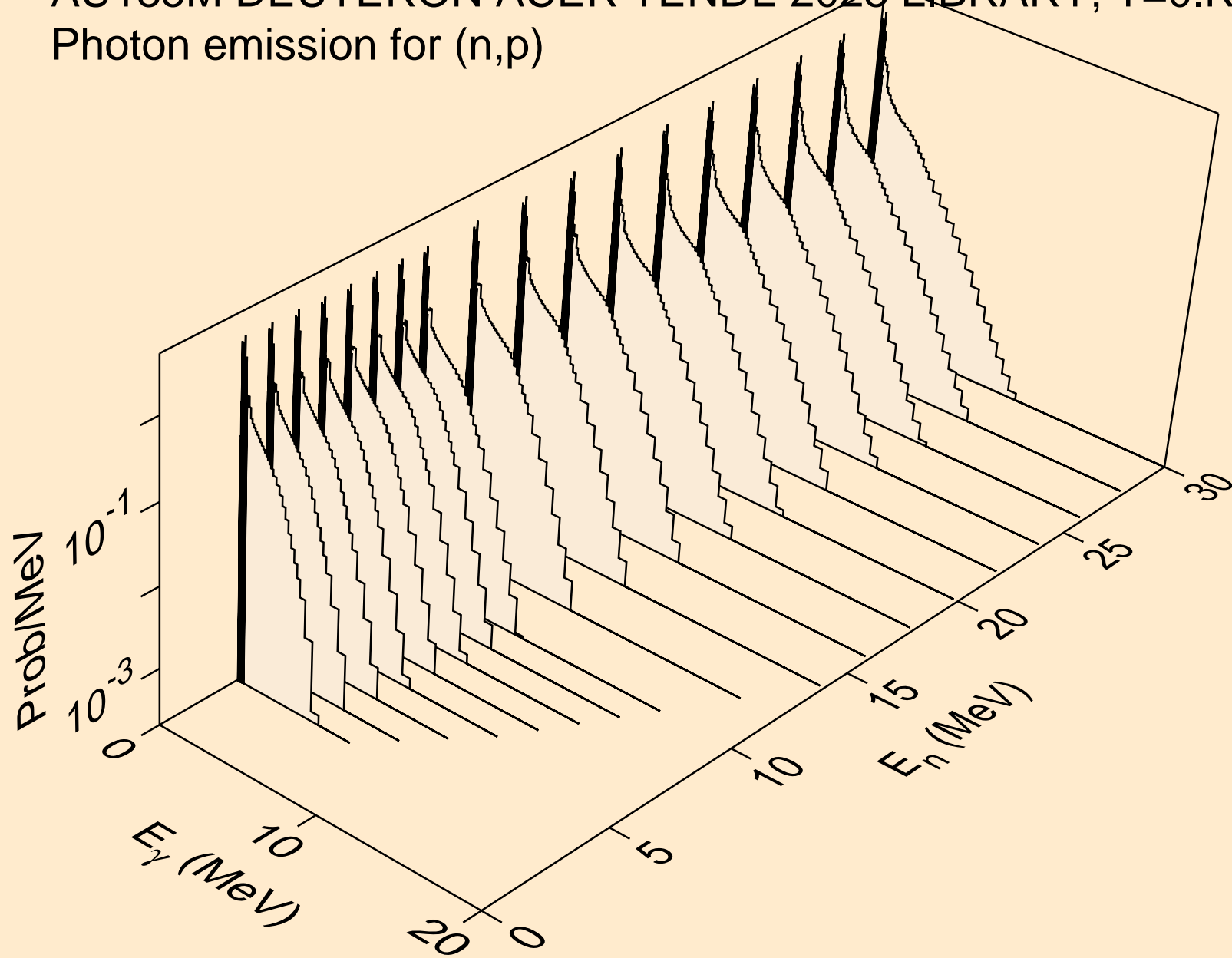

AU185M DEUTERON ACER TENDL-2023 LIBRARY; T=0.K  
Photon emission for inelastic

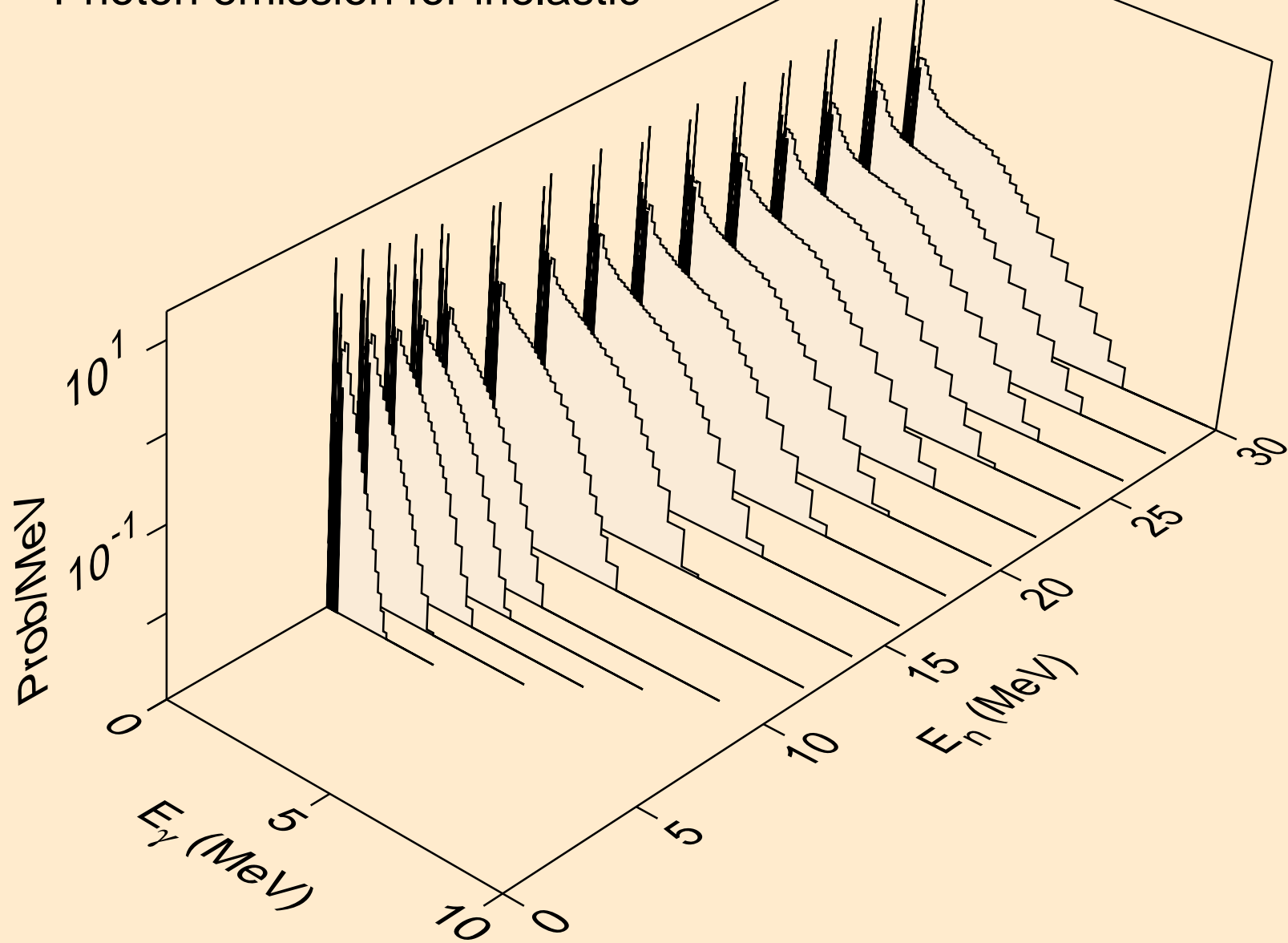

AU185M DEUTERON ACER TENDL-2023 LIBRARY; T=0.K  
Photon emission for (n,t)

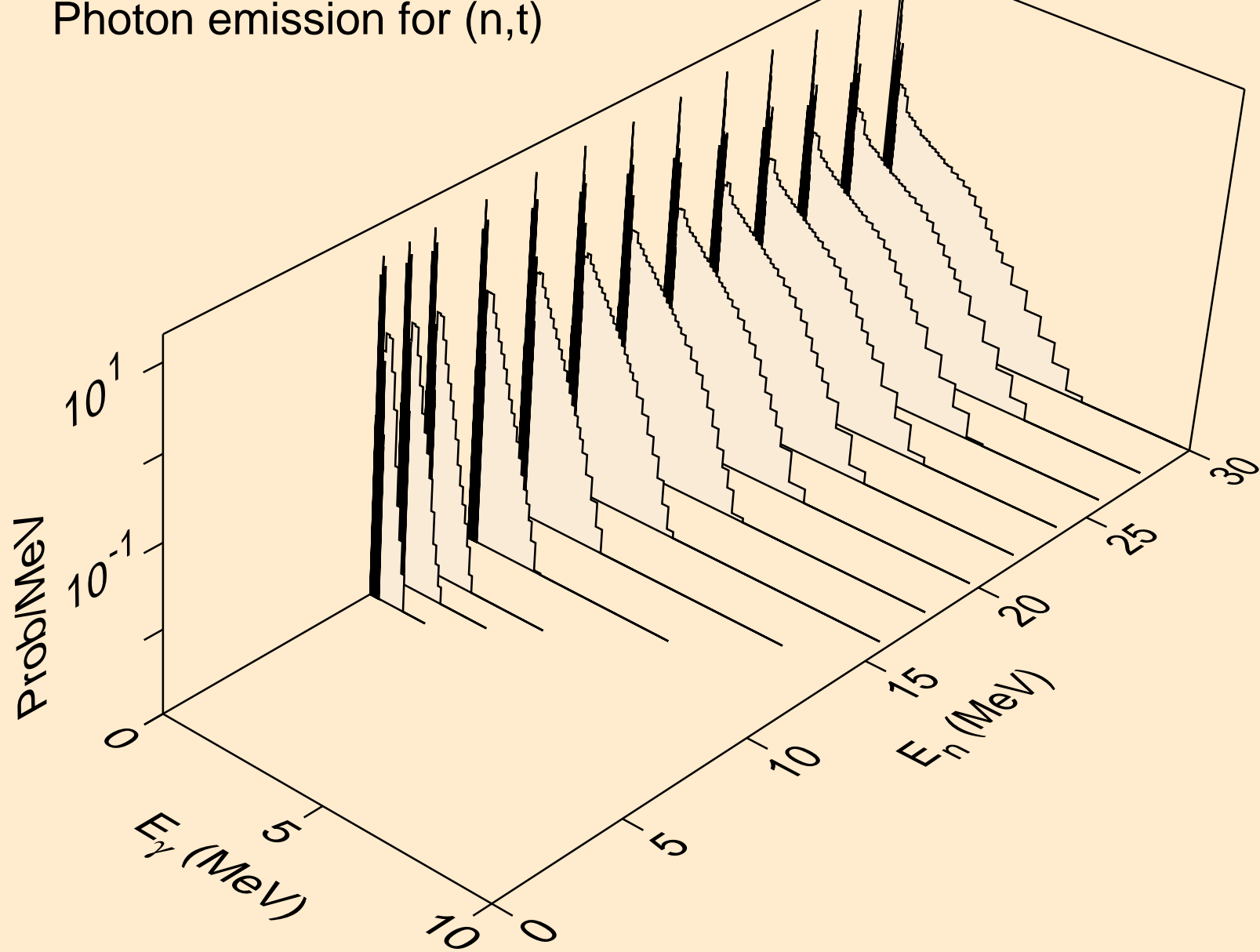

AU185M DEUTERON ACER TENDL-2023 LIBRARY; T=0.K  
Photon emission for (n,he3)

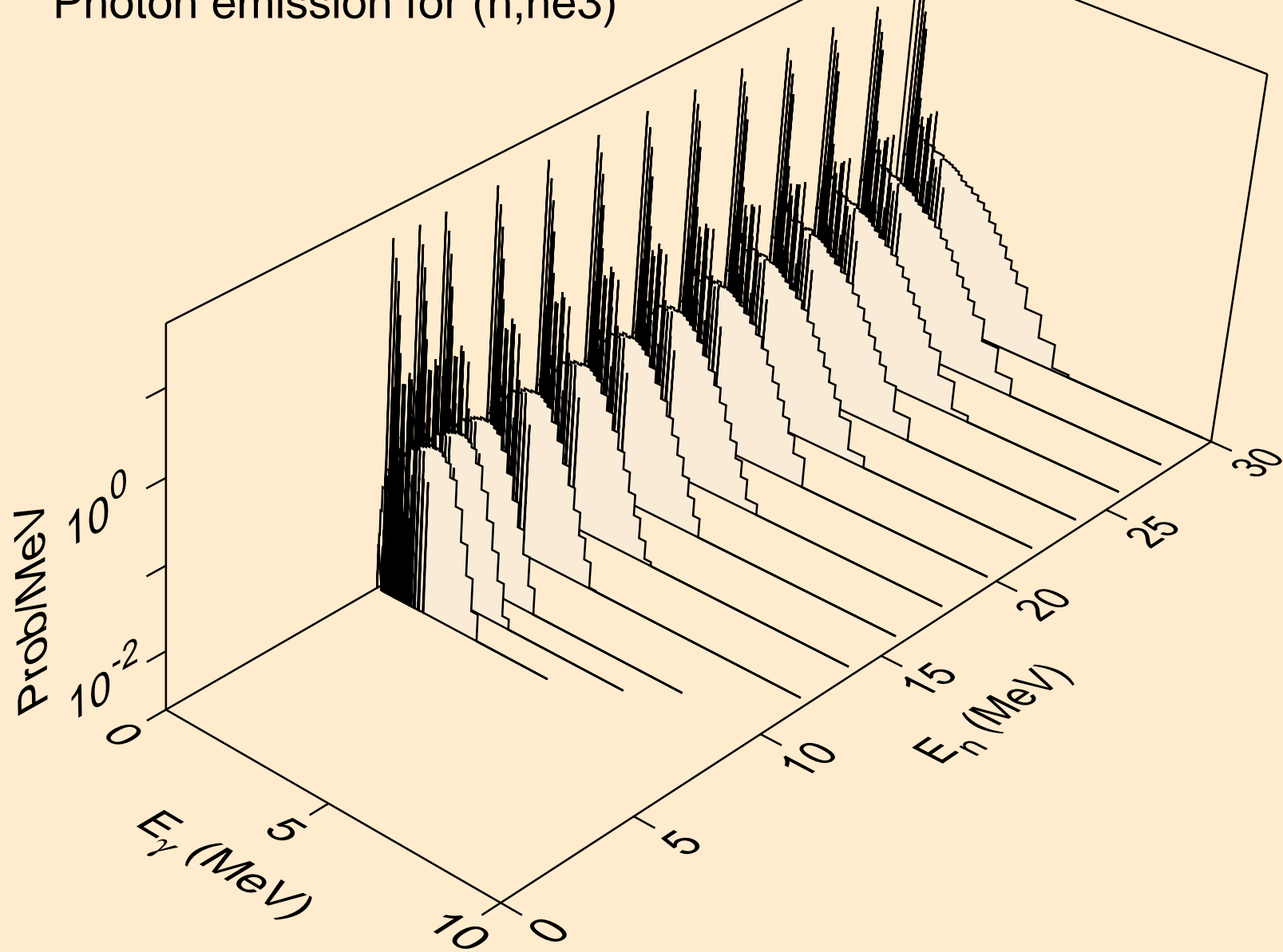

AU185M DEUTERON ACER TENDL-2023 LIBRARY; T=0.K  
Photon emission for (n,a)

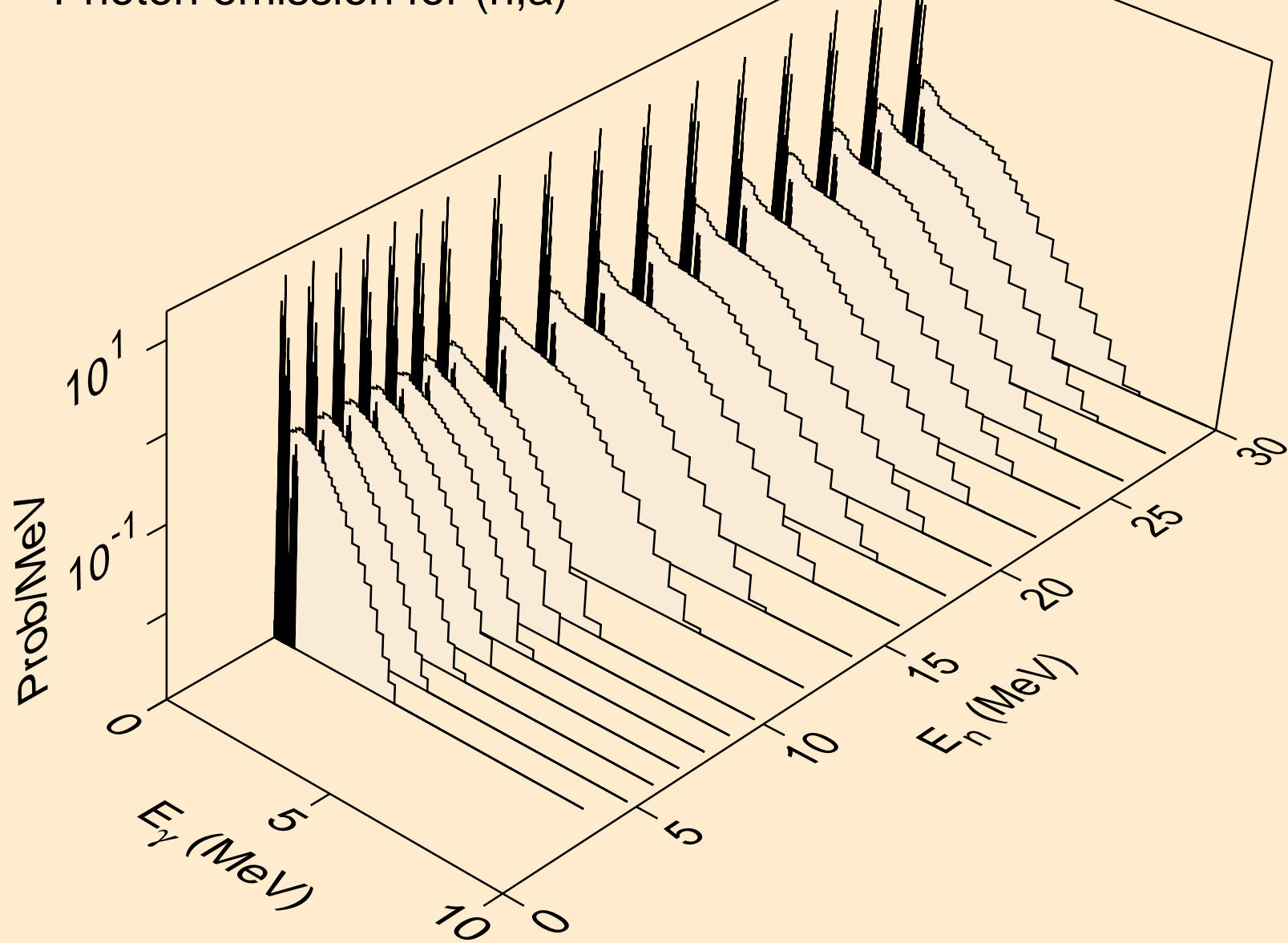



AU185M DEUTERON ACER TENDL-2023 LIBRARY; T=0.K  
Photon emission for (n,2a)

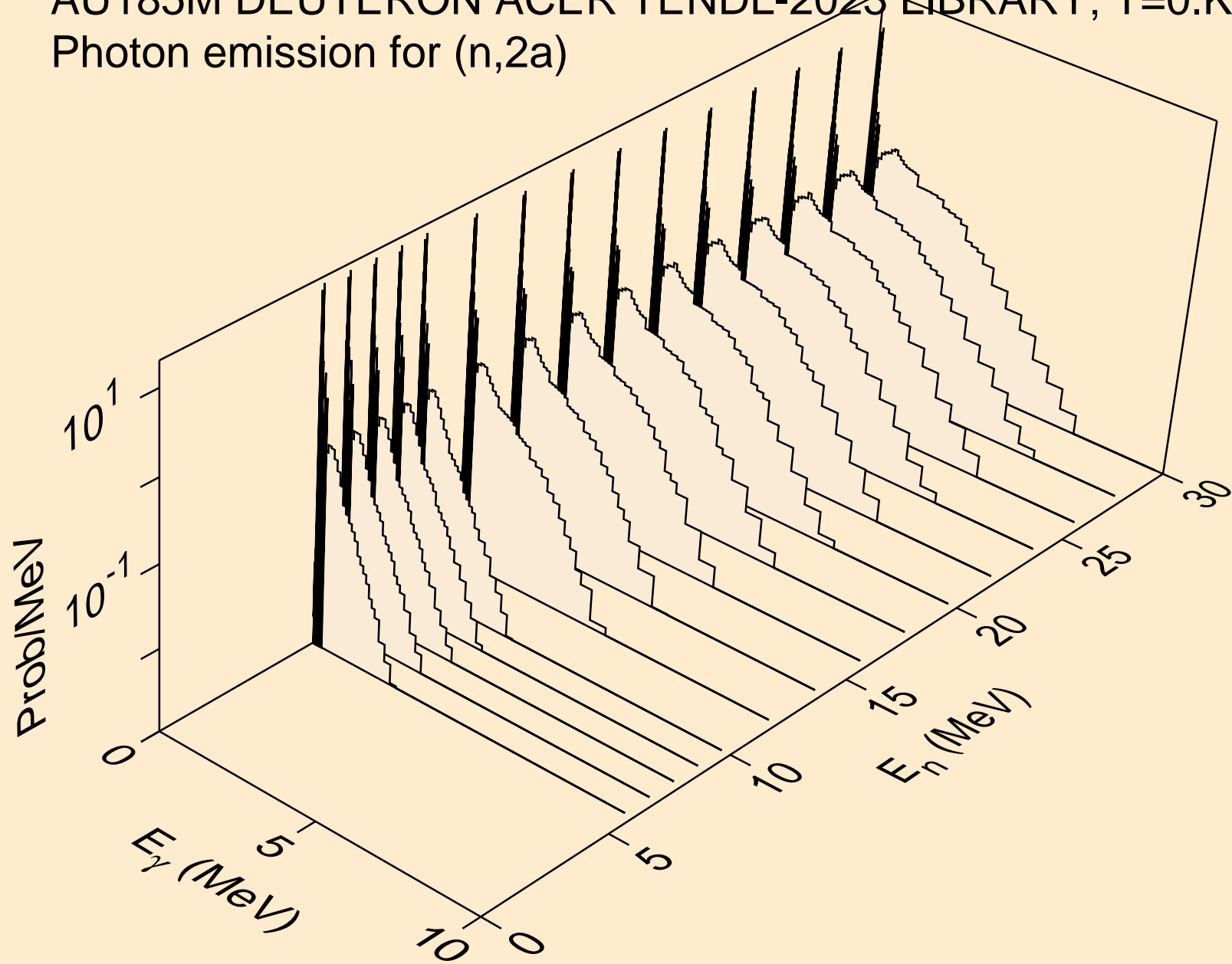

AU185M DEUTERON ACER TENDL-2023 LIBRARY; T=0.K  
Photon emission for (n,3a)

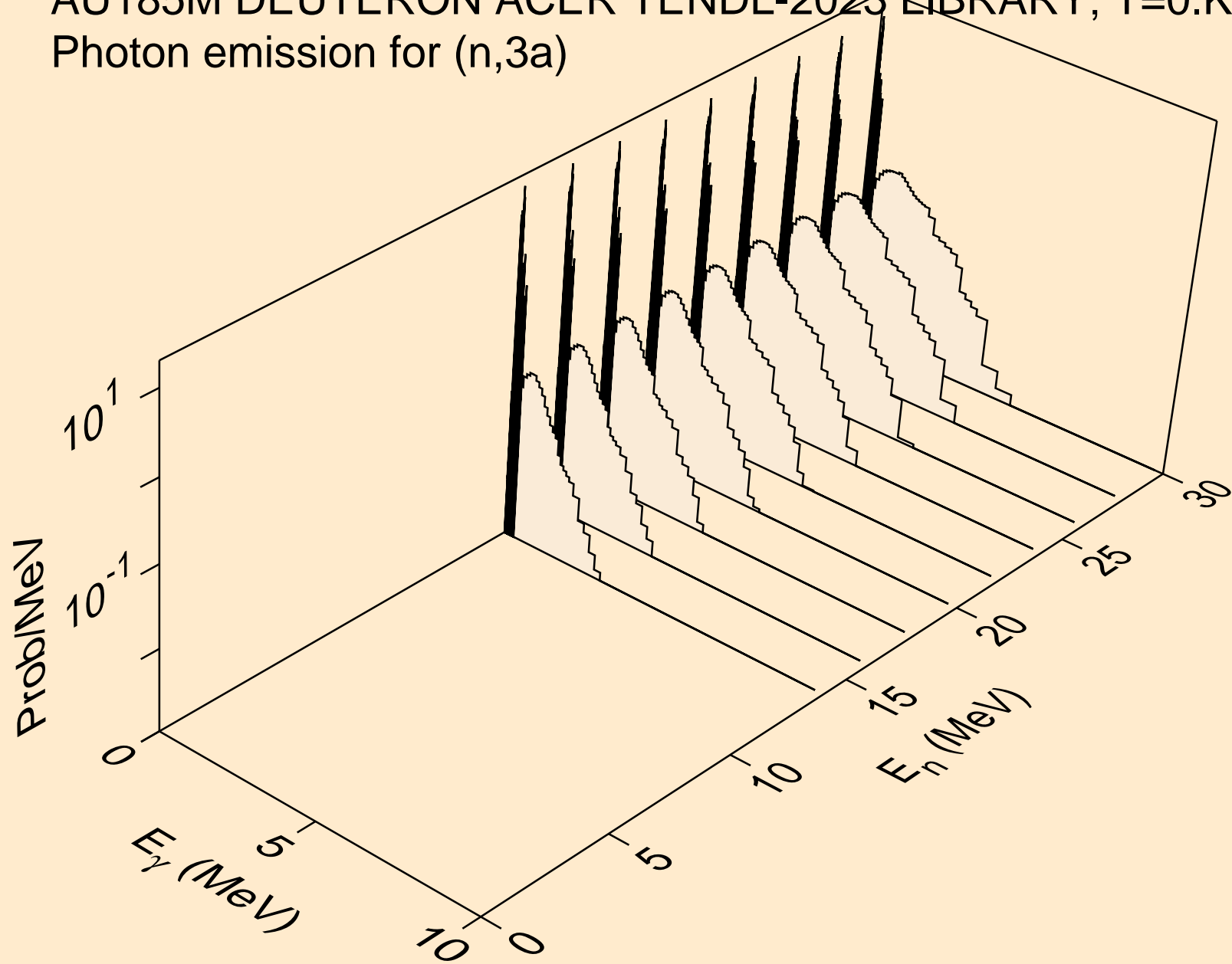

AU185M DEUTERON ACER TENDL-2023 LIBRARY; T=0.K  
Photon emission for (n,2p)

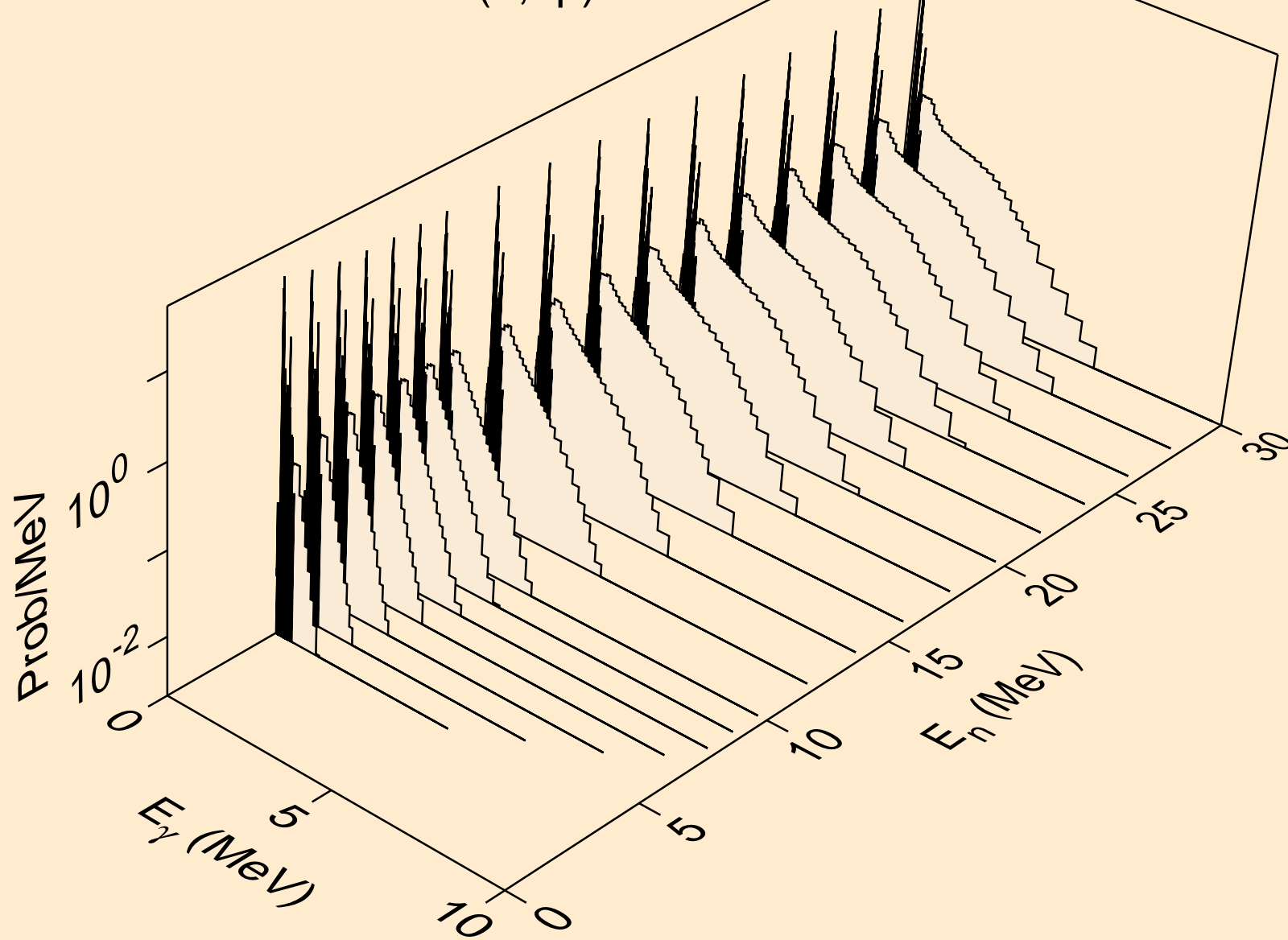

AU185M DEUTERON ACER TENDL-2023 LIBRARY; T=0.K  
Photon emission for (n,pa)

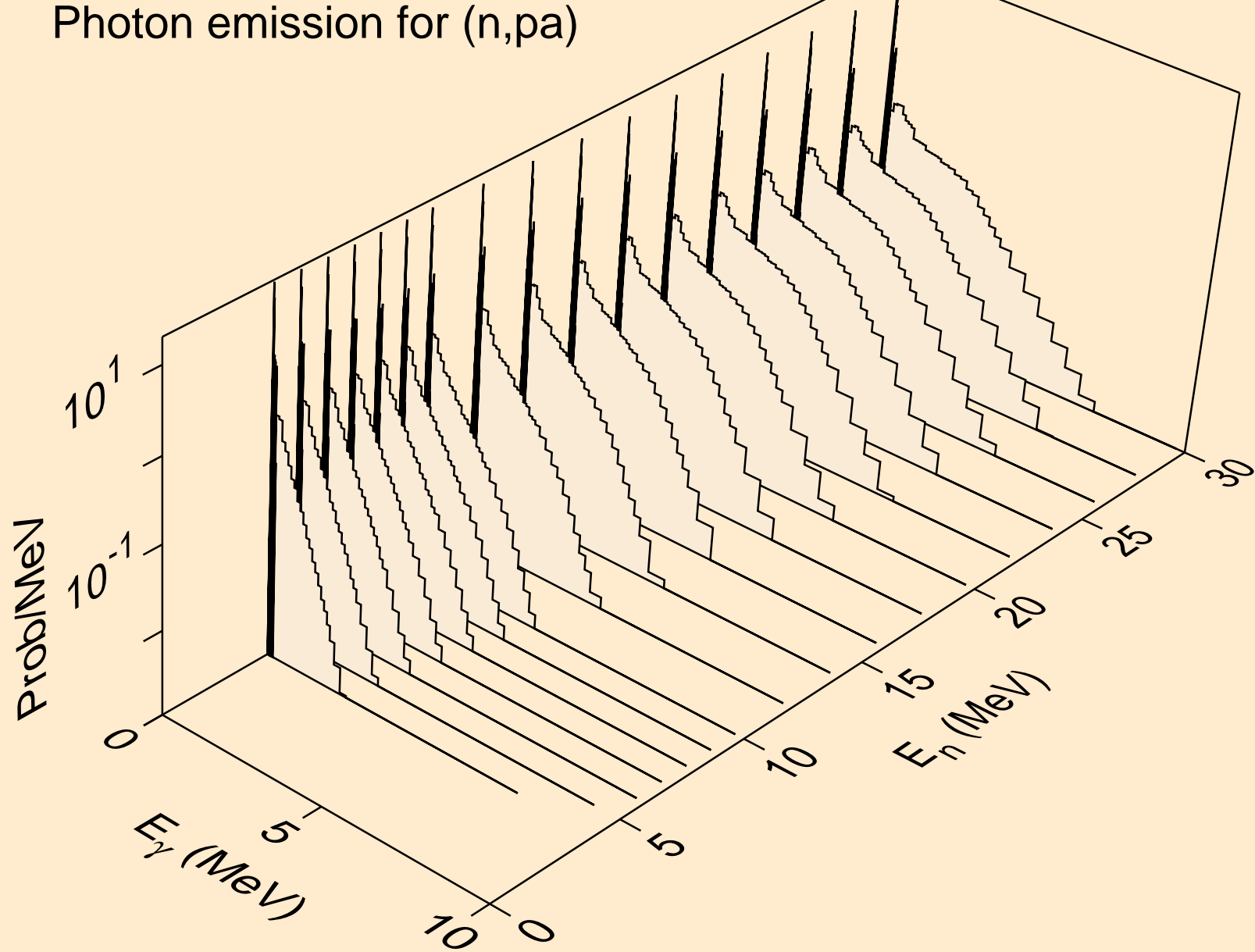

AU185M DEUTERON ACER TENDL-2023 LIBRARY; T=0.K  
Photon emission for (n,pd)

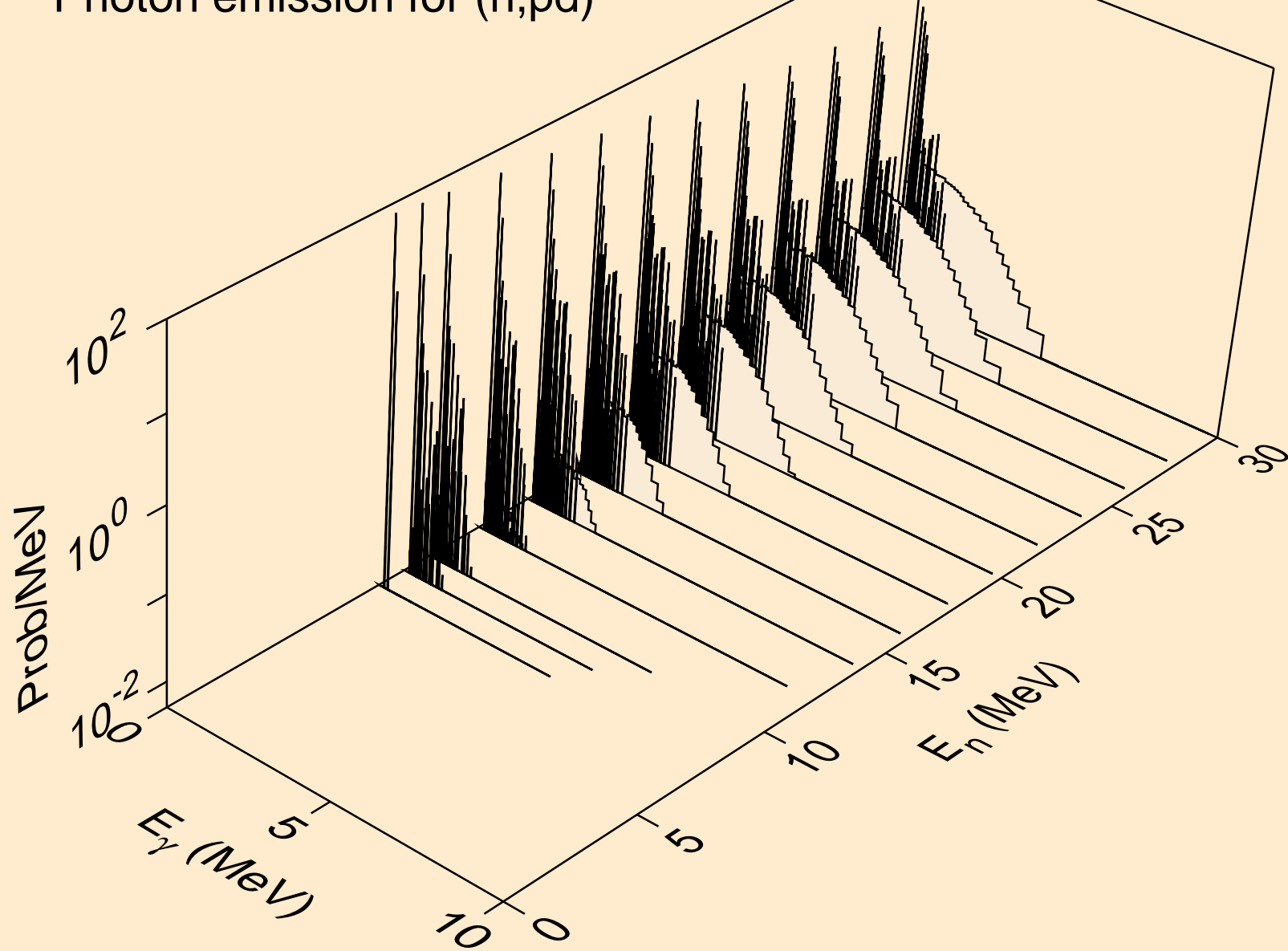

AU185M DEUTERON ACER TENDL-2023 LIBRARY; T=0.K  
Photon emission for (n,pt)

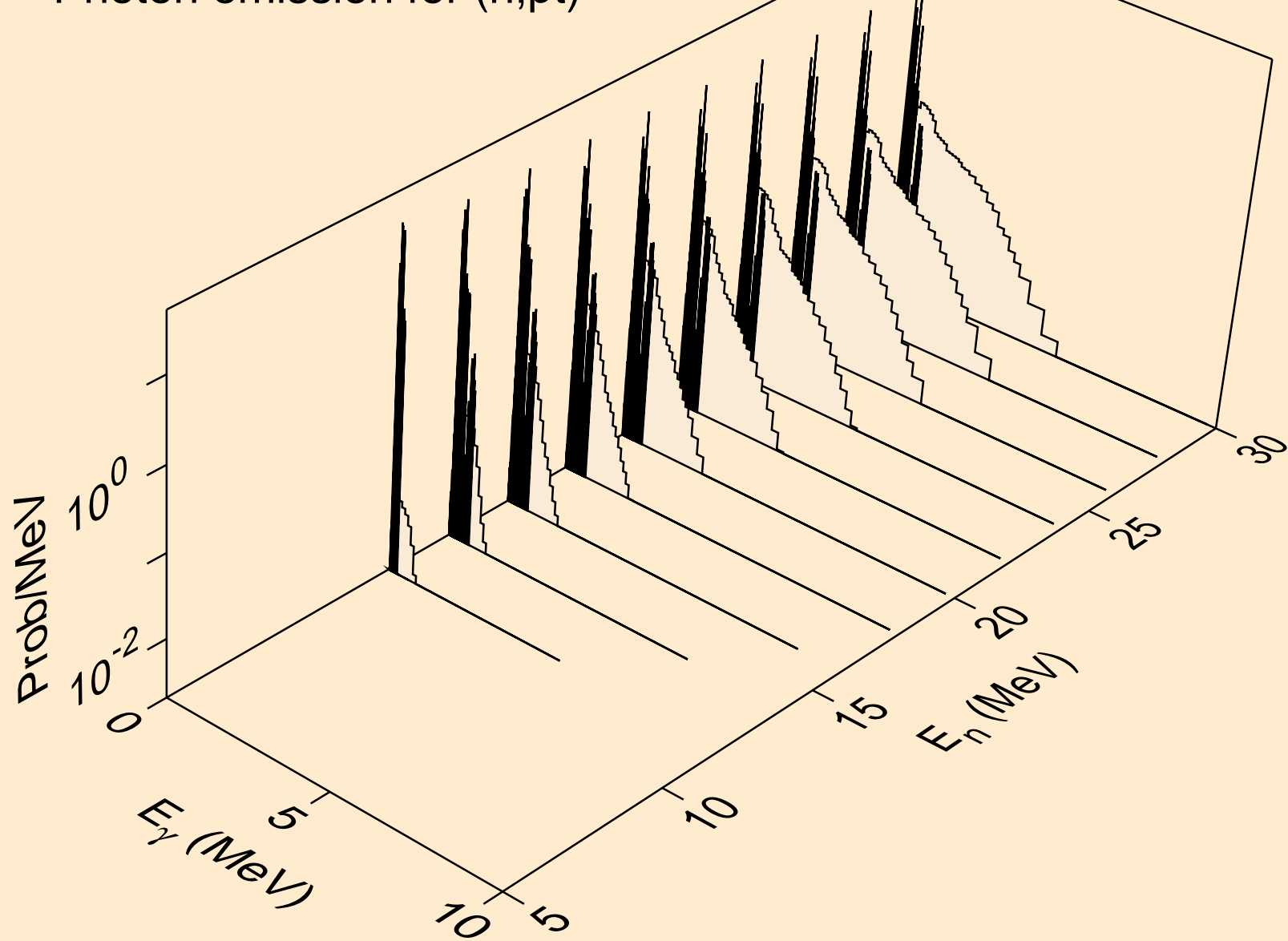

AU185M DEUTERON ACER TENDL-2023 LIBRARY; T=0.K  
Photon emission for (n,da)

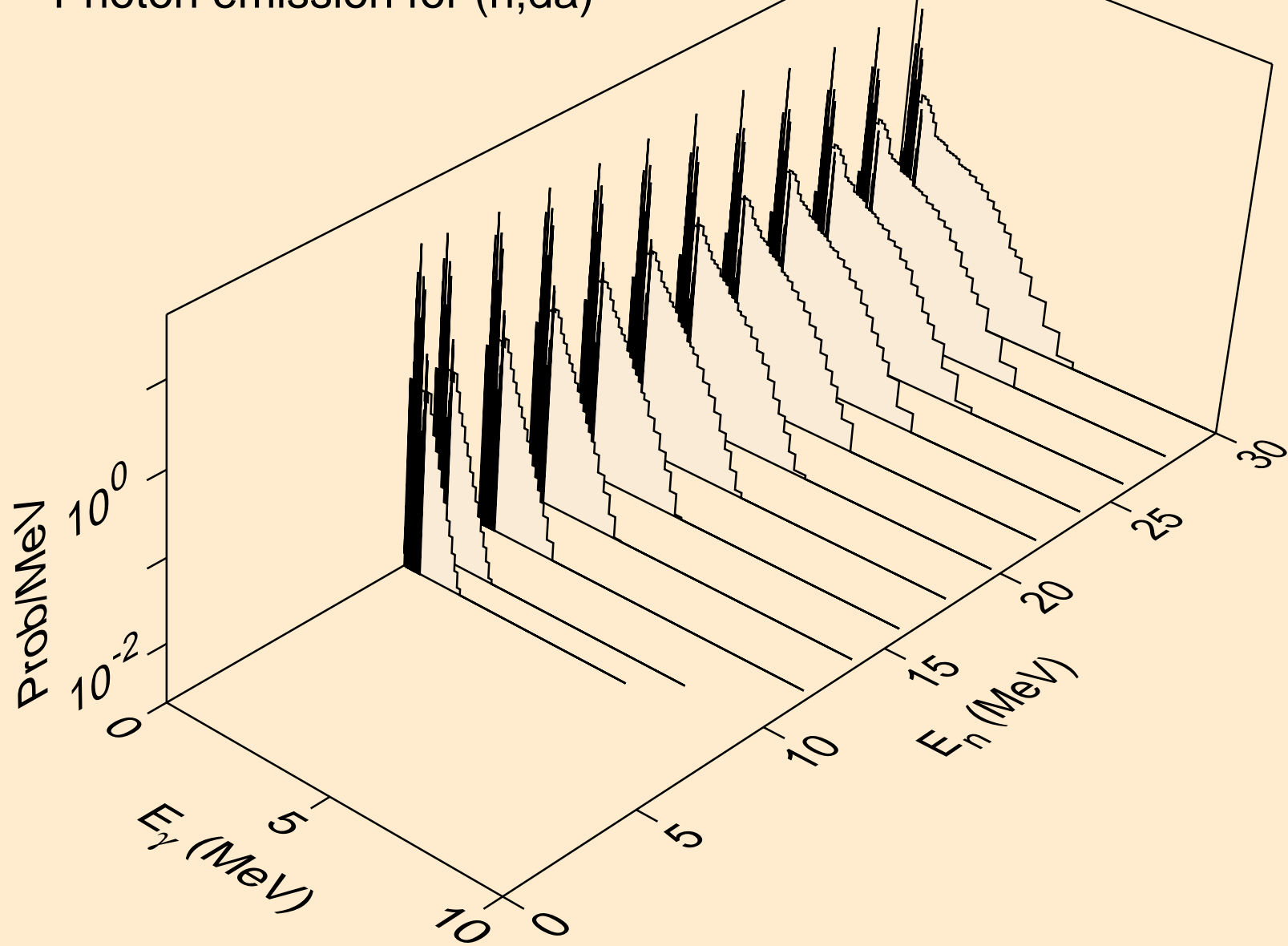

# AU185M DEUTERON ACER TENDL-2023 LIBRARY; T=0.K

## Particle heating contributions

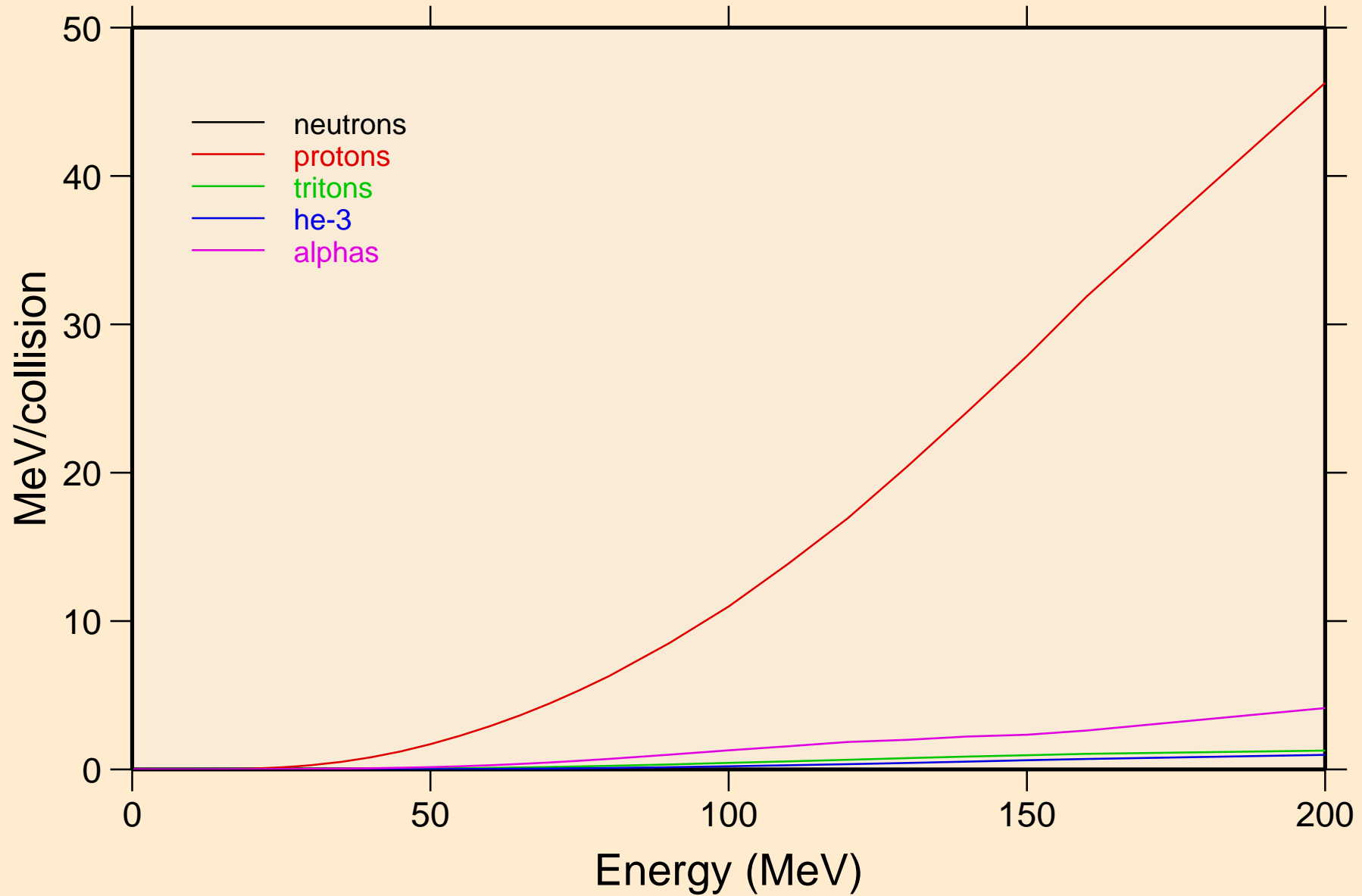



AU185M DEUTERON ACER TENDL-2023 LIBRARY; T=0.K  
Recoil Heating

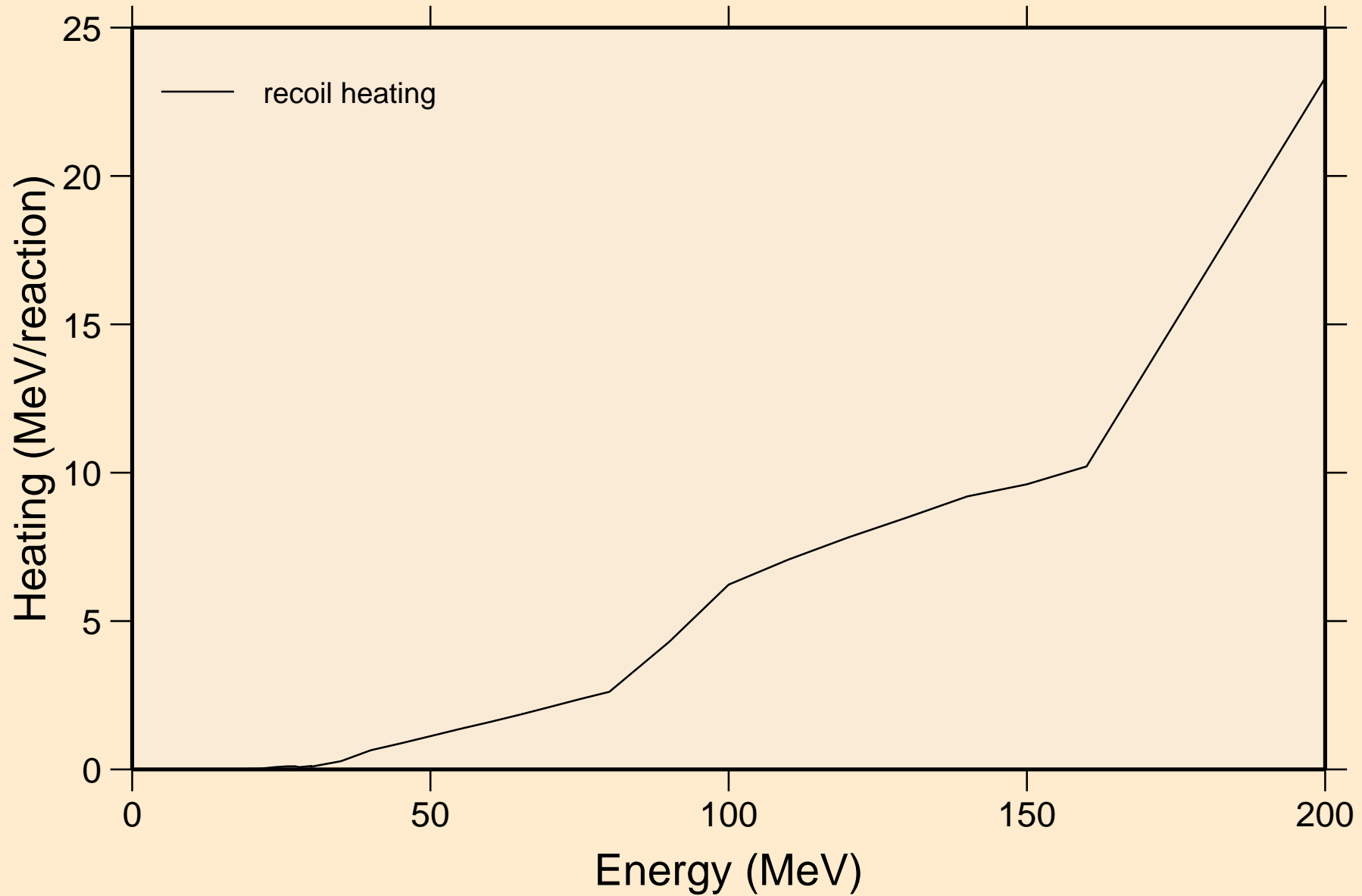

AU185M DEUTERON ACER TENDL-2023 LIBRARY; T=0.K  
Particle production cross sections

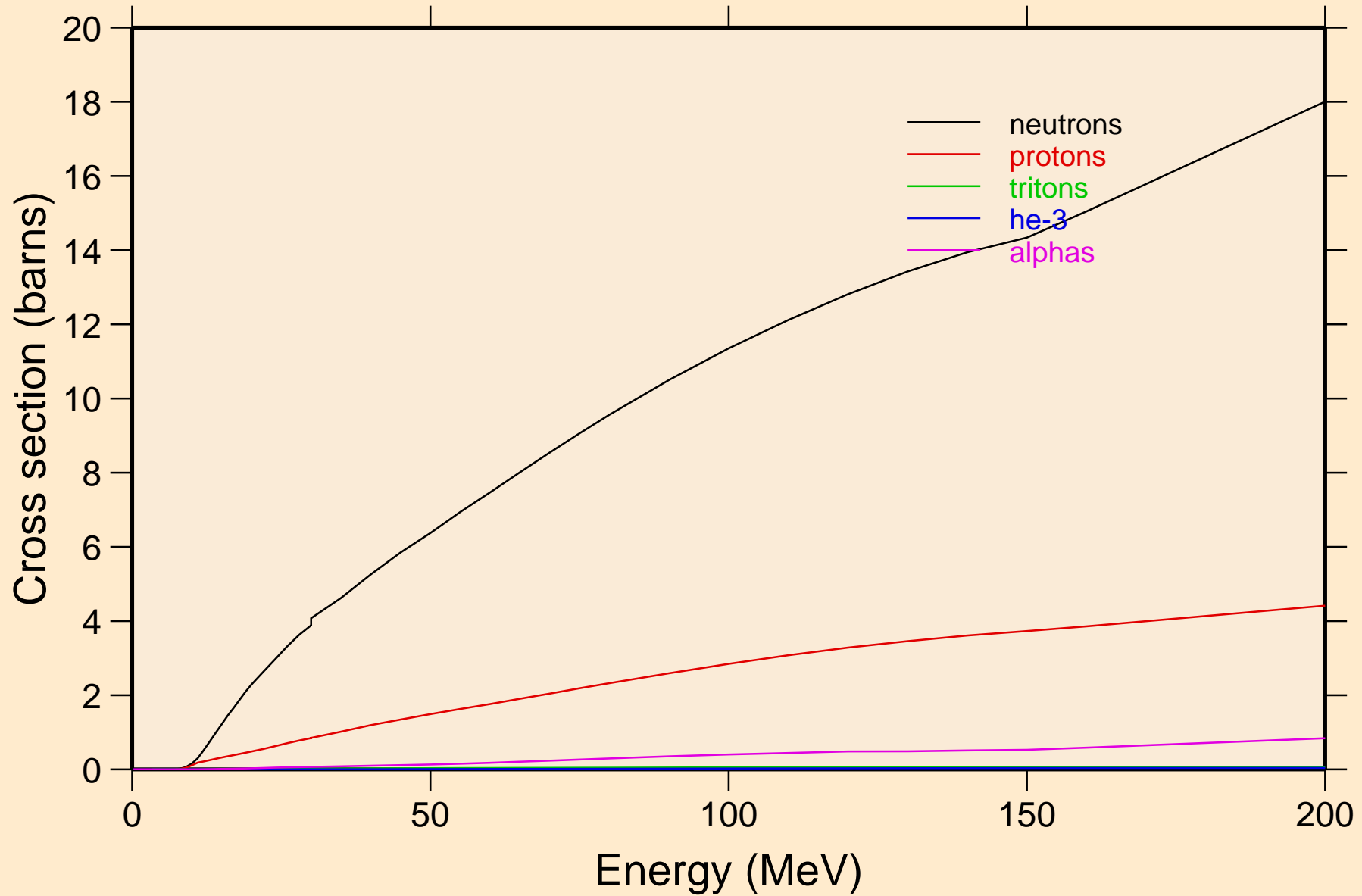

AU185M DEUTERON ACER TENDL-2023 LIBRARY; T=0.K  
neutrons from (d,n)

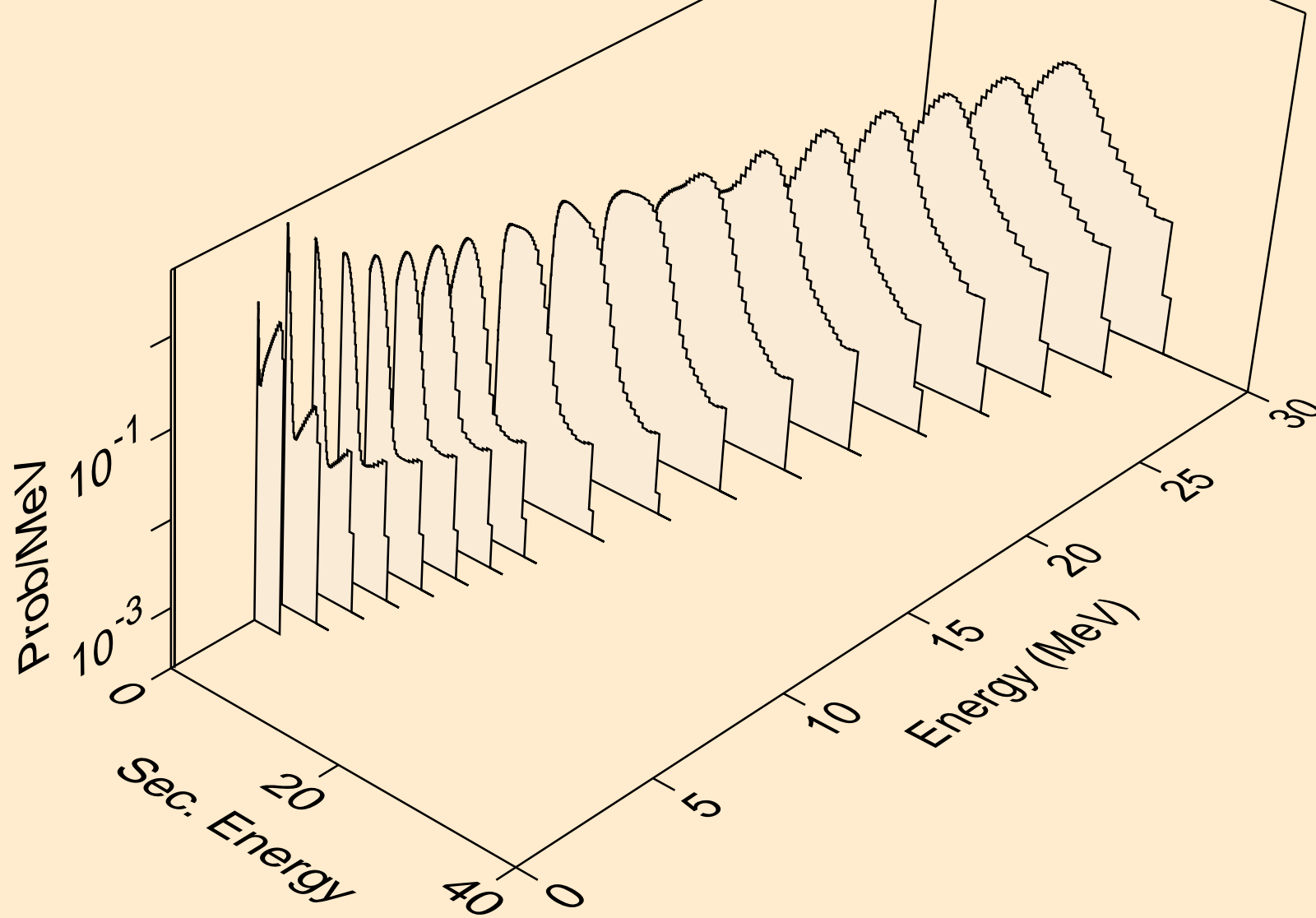

AU185M DEUTERON ACER TENDL-2023 LIBRARY; T=0.K  
neutrons from (d,x)

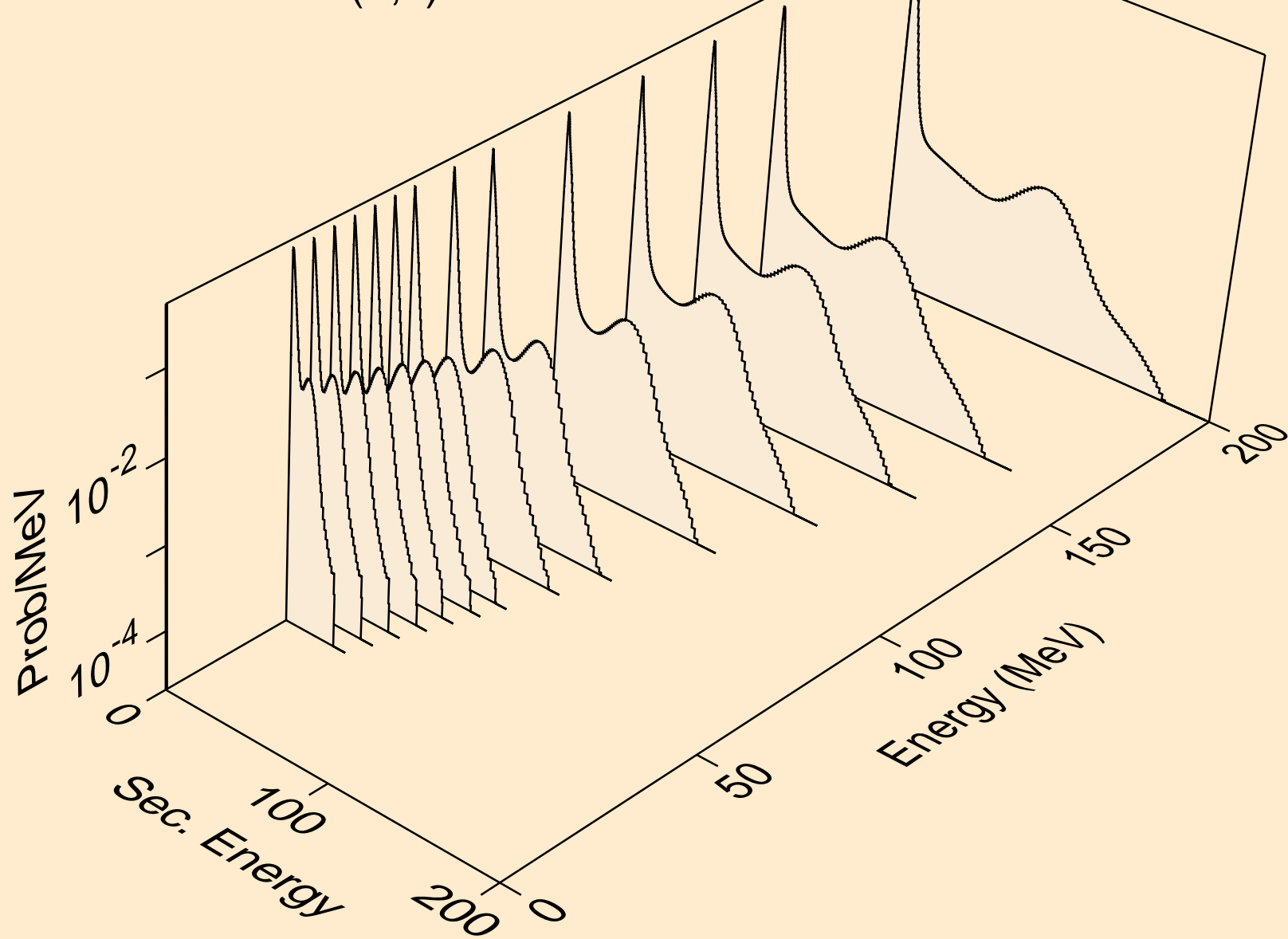

AU185M DEUTERON ACER TENDL-2023 LIBRARY; T=0.K  
neutrons from (d,2nd)

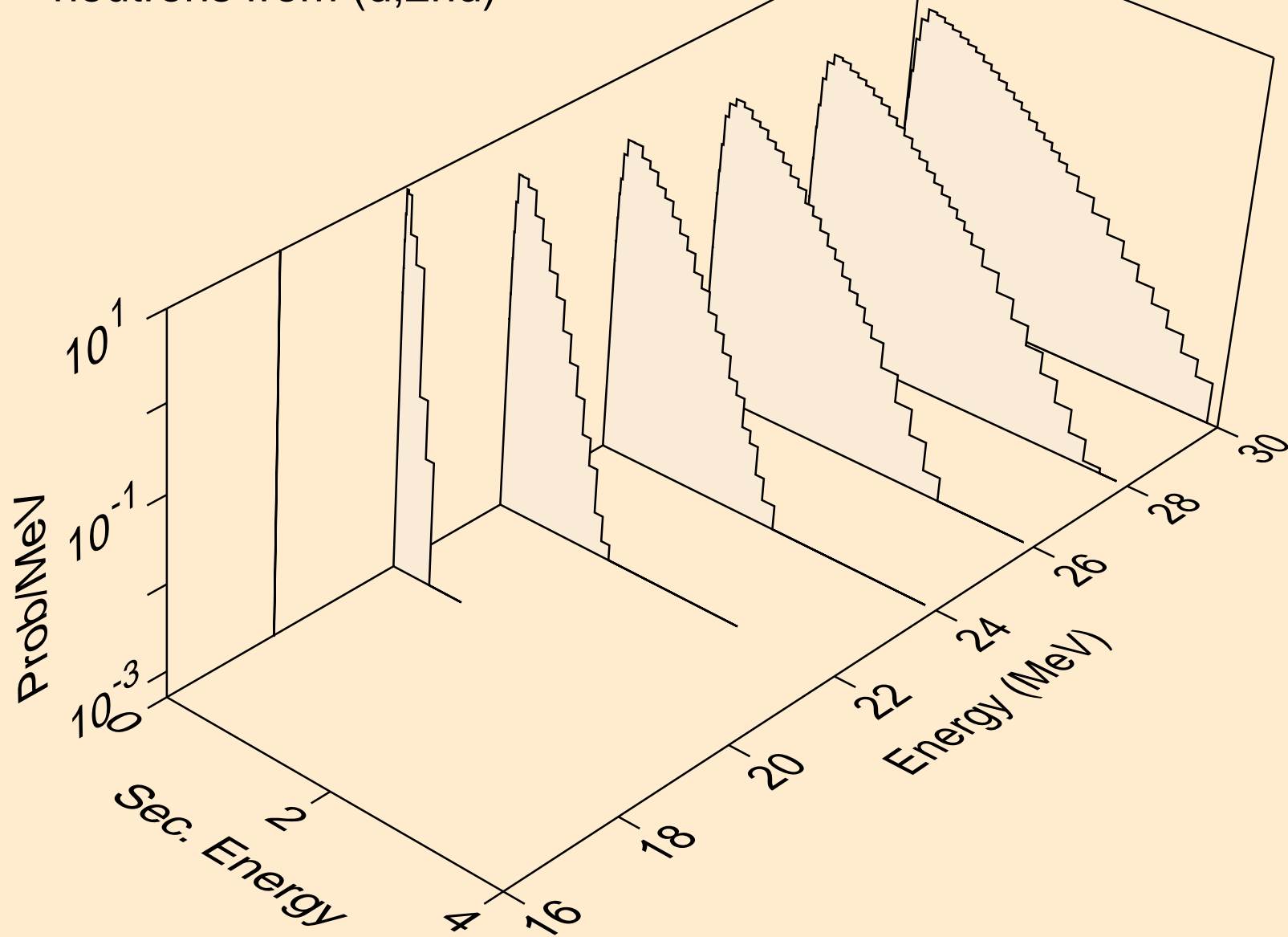

AU185M DEUTERON ACER TENDL-2023 LIBRARY; T=0.K  
neutrons from (d,2n)

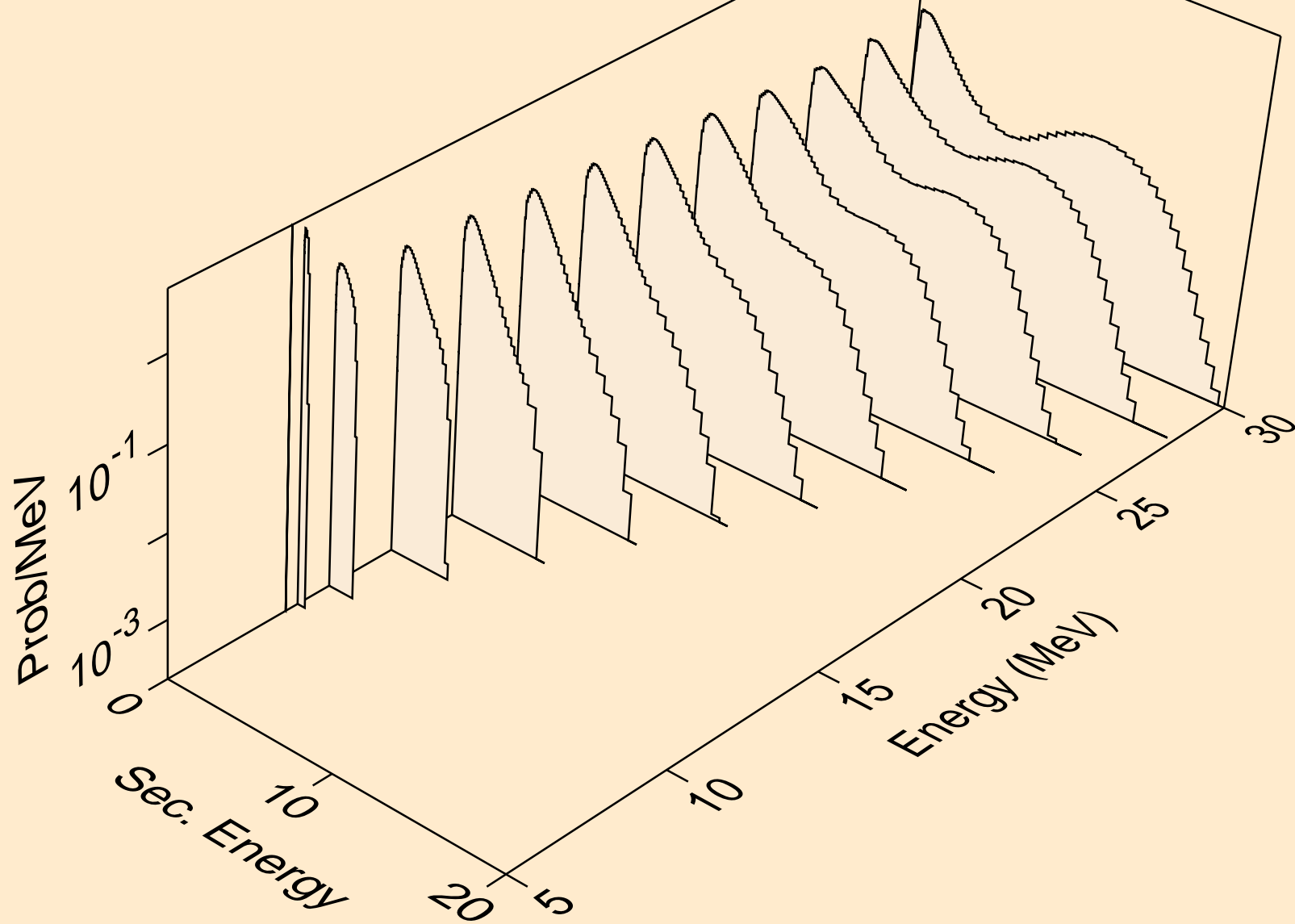

AU185M DEUTERON ACER TENDL-2023 LIBRARY; T=0.K  
neutrons from (d,3n)

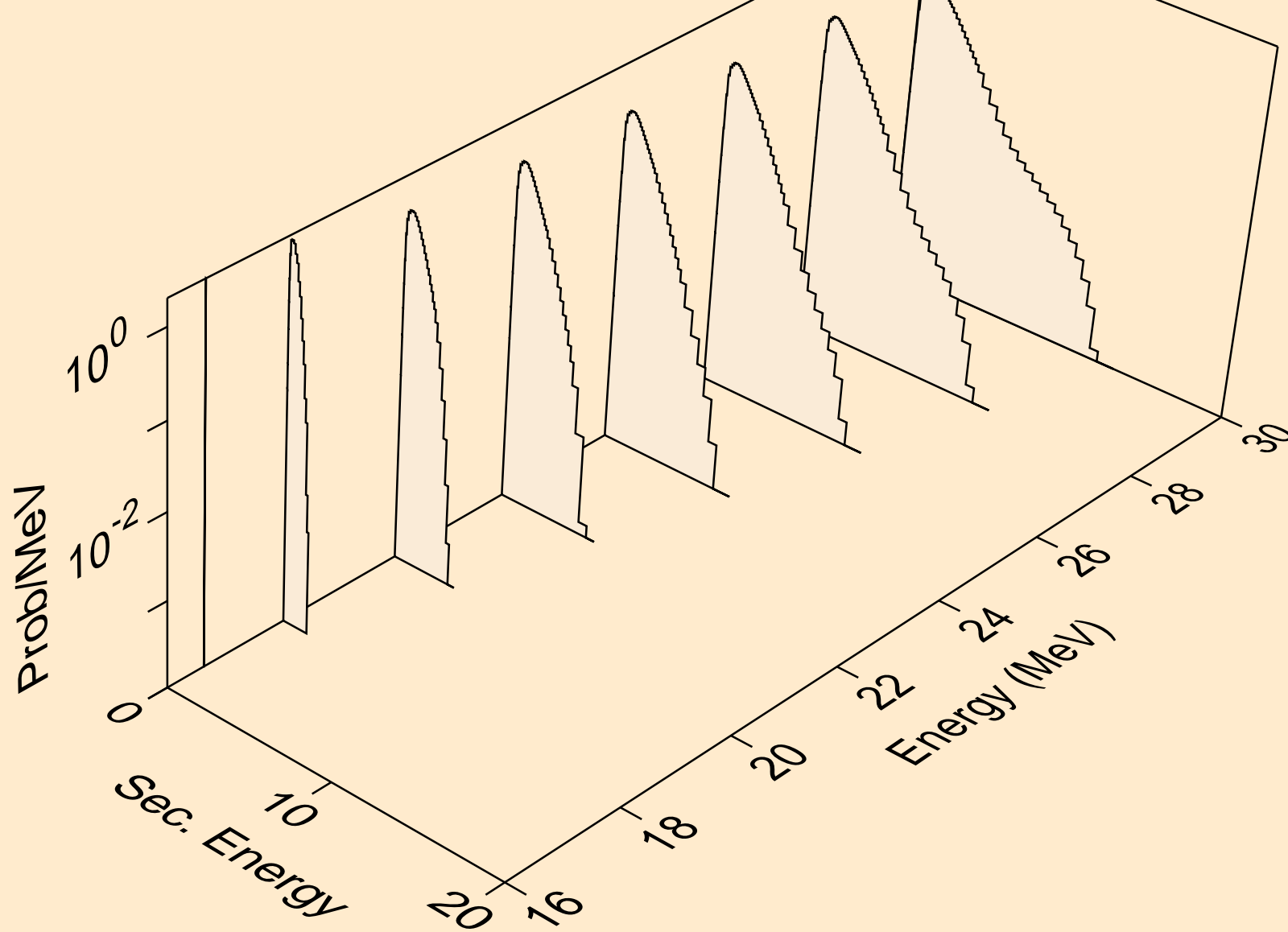

AU185M DEUTERON ACER TENDL-2023 LIBRARY; T=0.K  
neutrons from (d,n\*)a

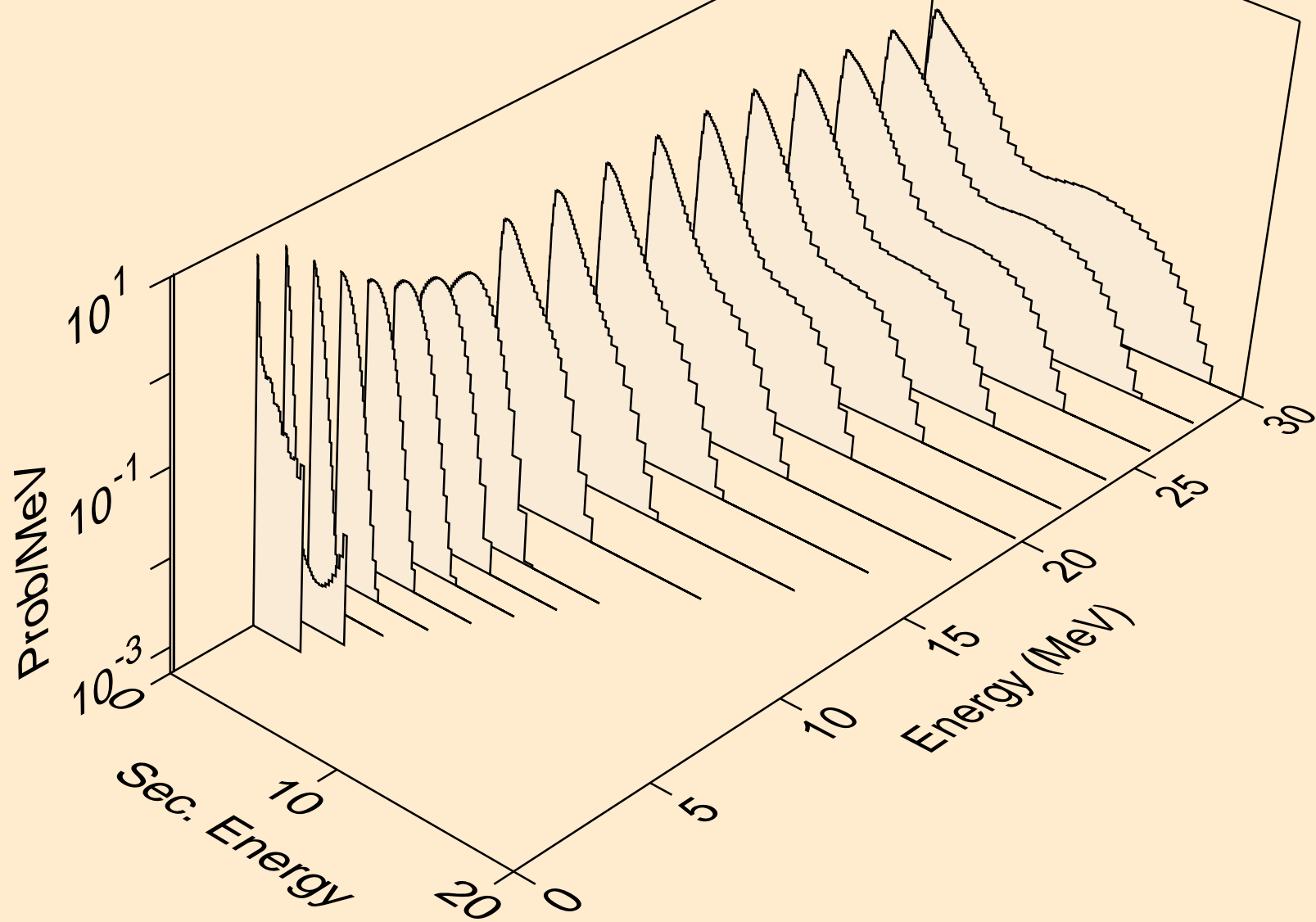



AU185M DEUTERON ACER TENDL-2023 LIBRARY; T=0.K  
neutrons from (d,2n)a

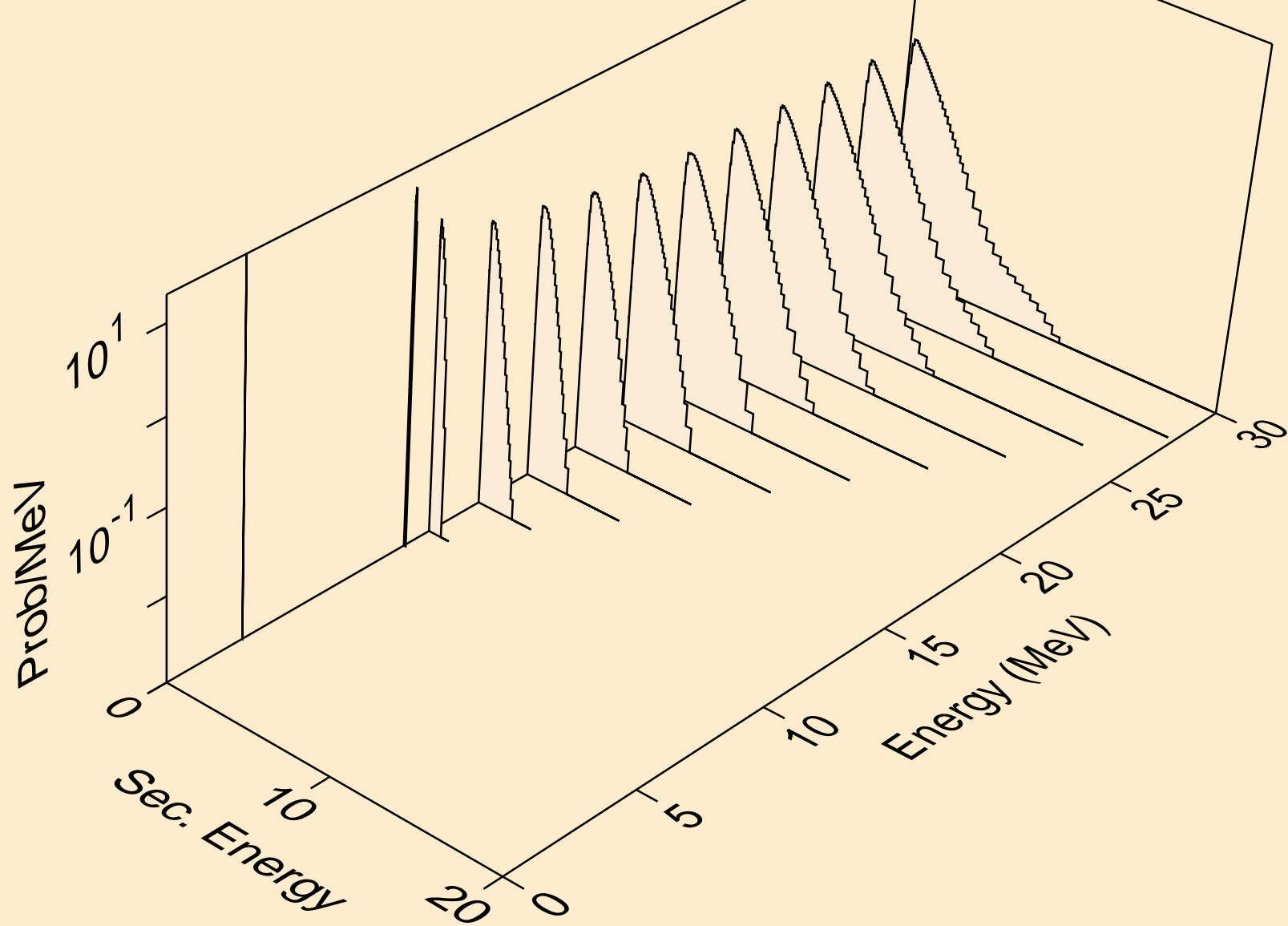

AU185M DEUTERON ACER TENDL-2023 LIBRARY; T=0.K  
neutrons from (d,3n)a

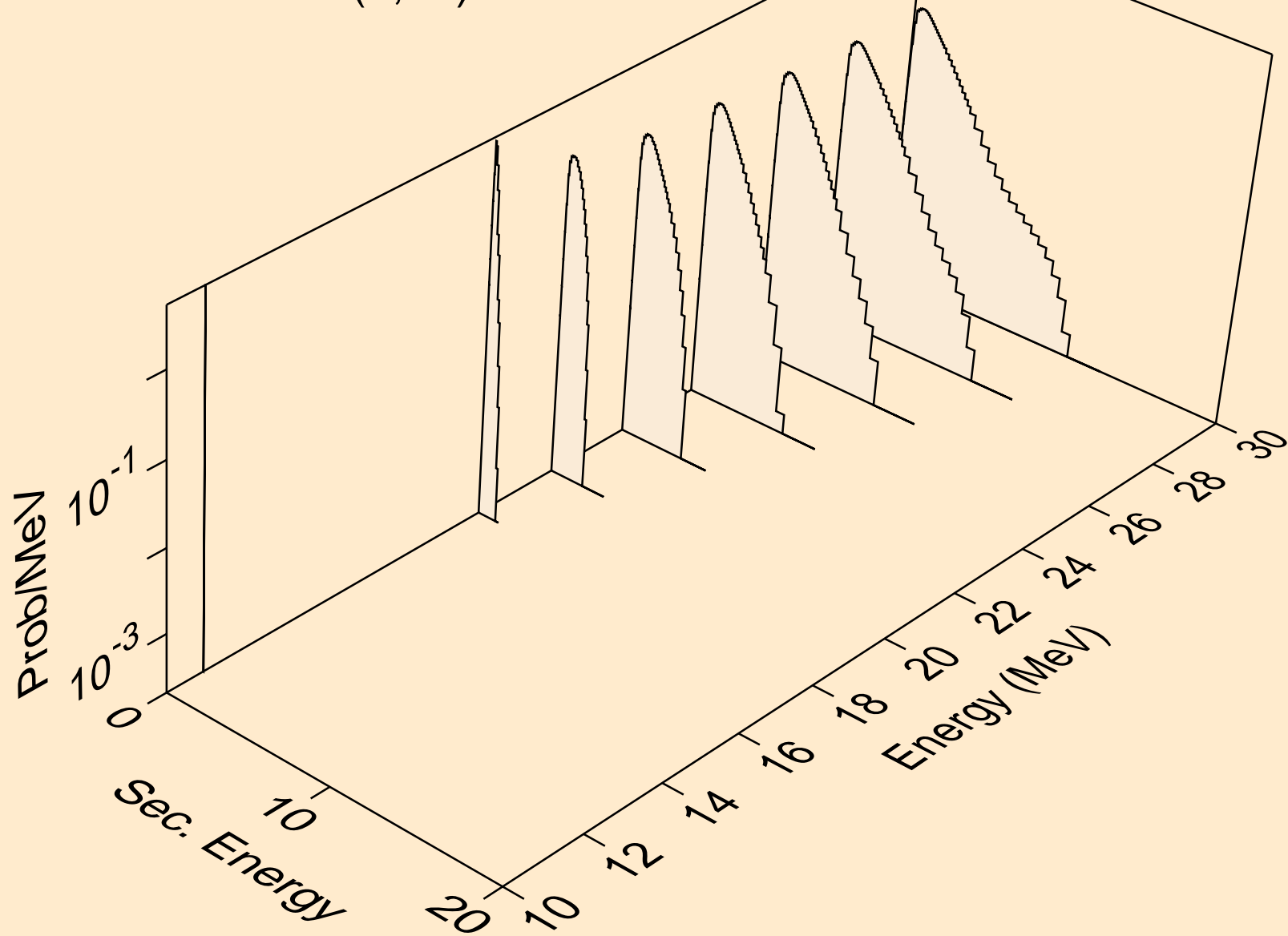

AU185M DEUTERON ACER TENDL-2023 LIBRARY; T=0.K  
neutrons from (d,n\*)p

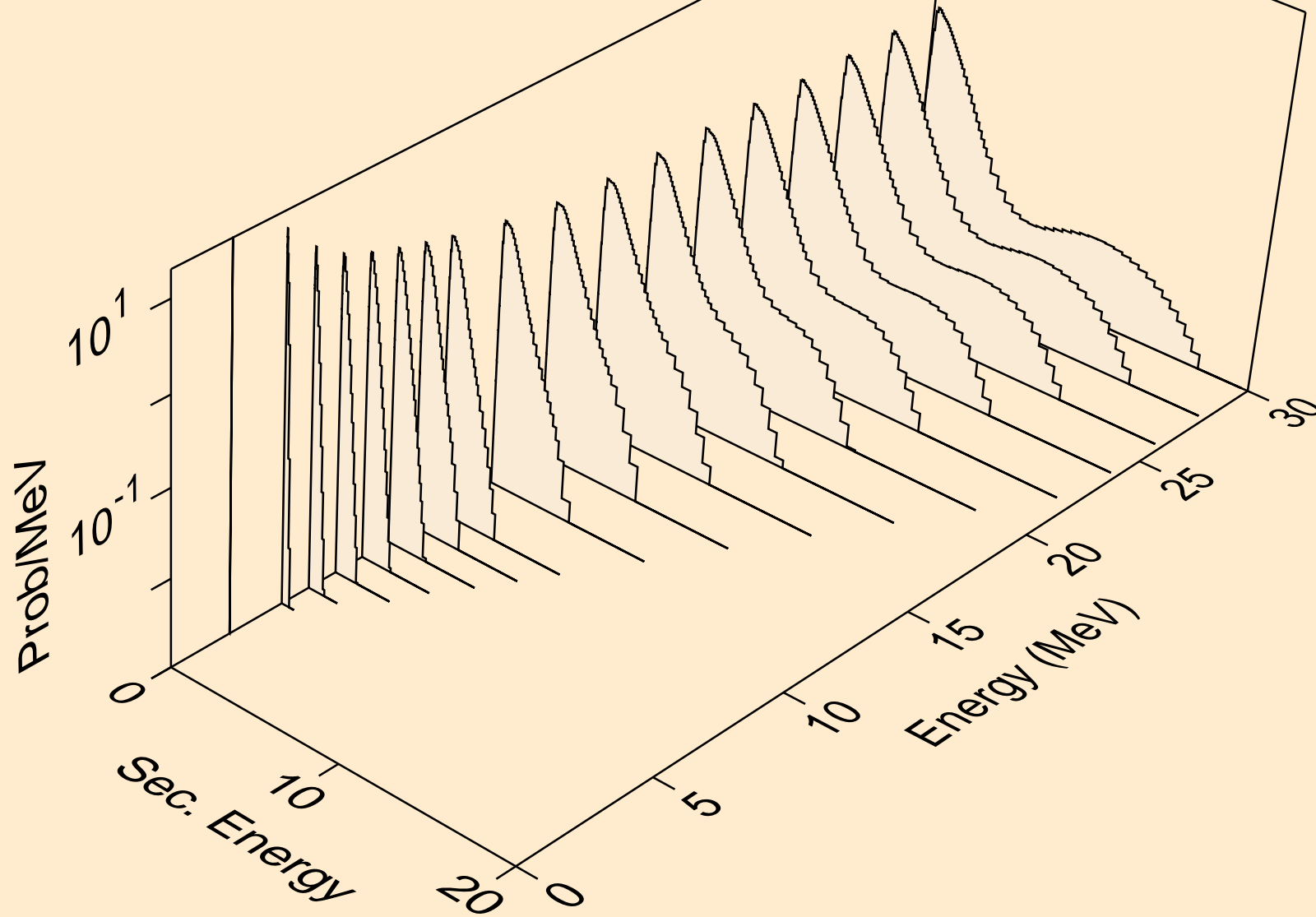

AU185M DEUTERON ACER TENDL-2023 LIBRARY; T=0.K  
neutrons from (d,n\*)2a

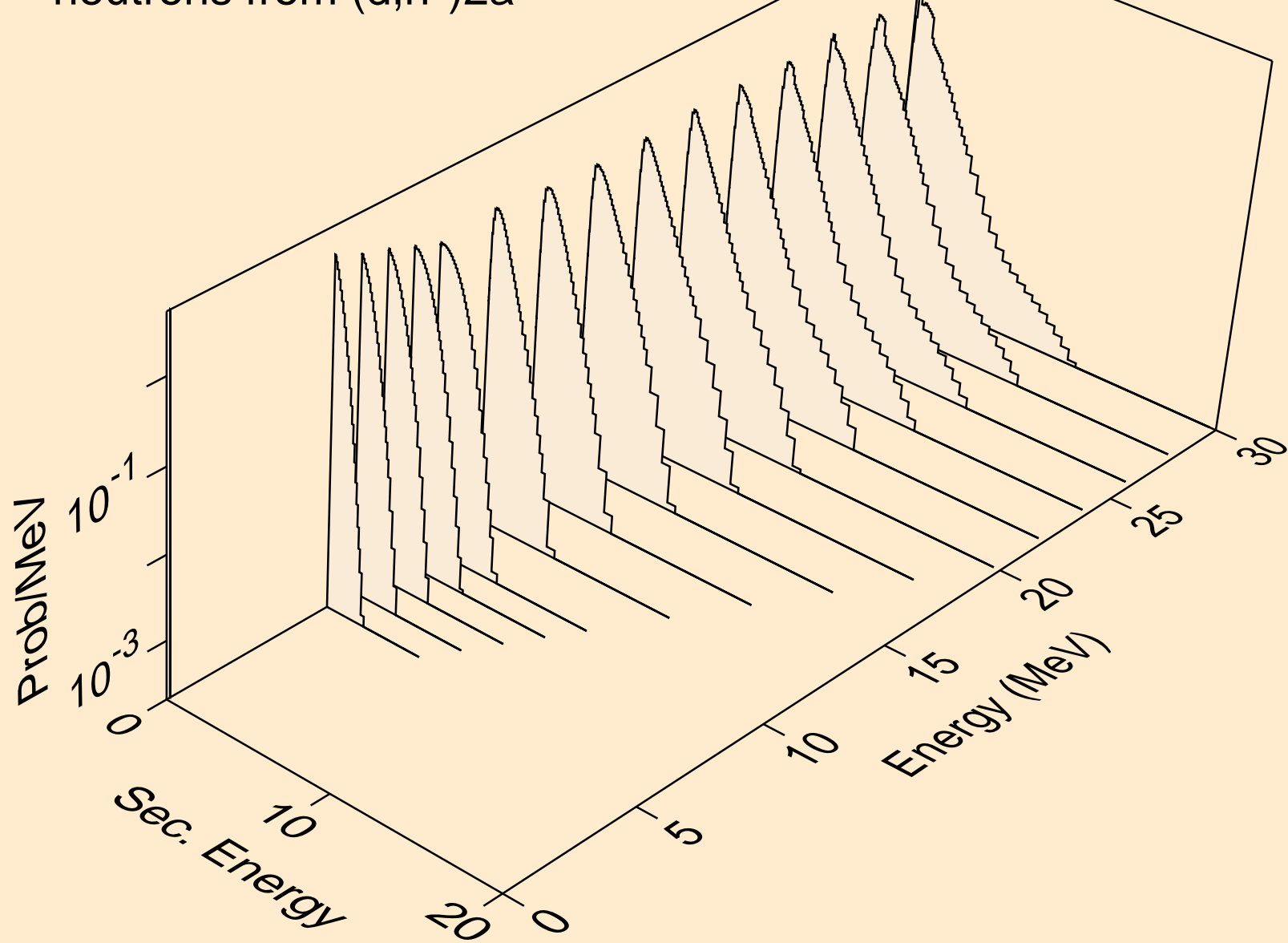

AU185M DEUTERON ACER TENDL-2023 LIBRARY; T=0.K  
neutrons from (d,2n)2a

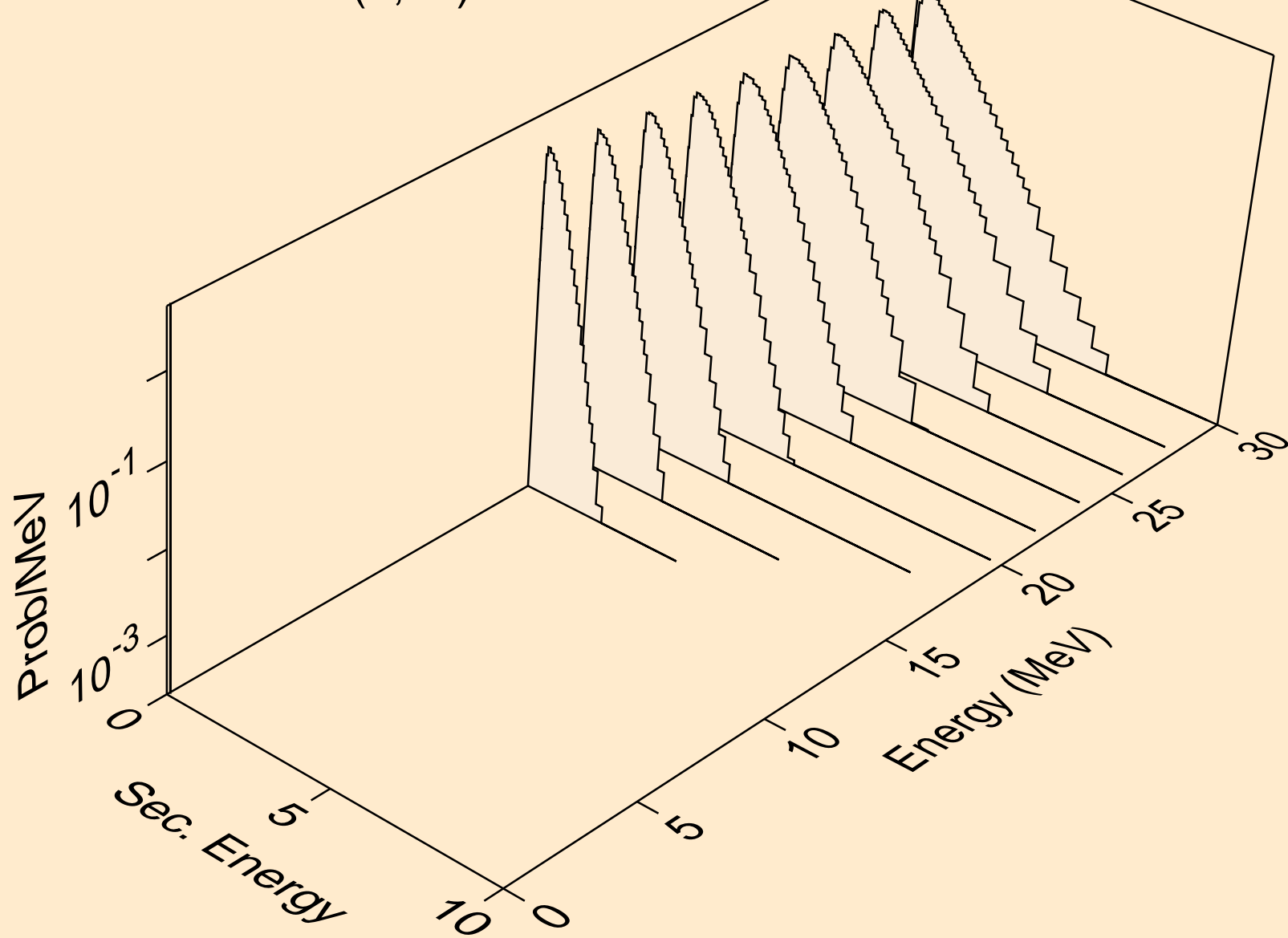

AU185M DEUTERON ACER TENDL-2023 LIBRARY; T=0.K  
neutrons from (d,n\*)d

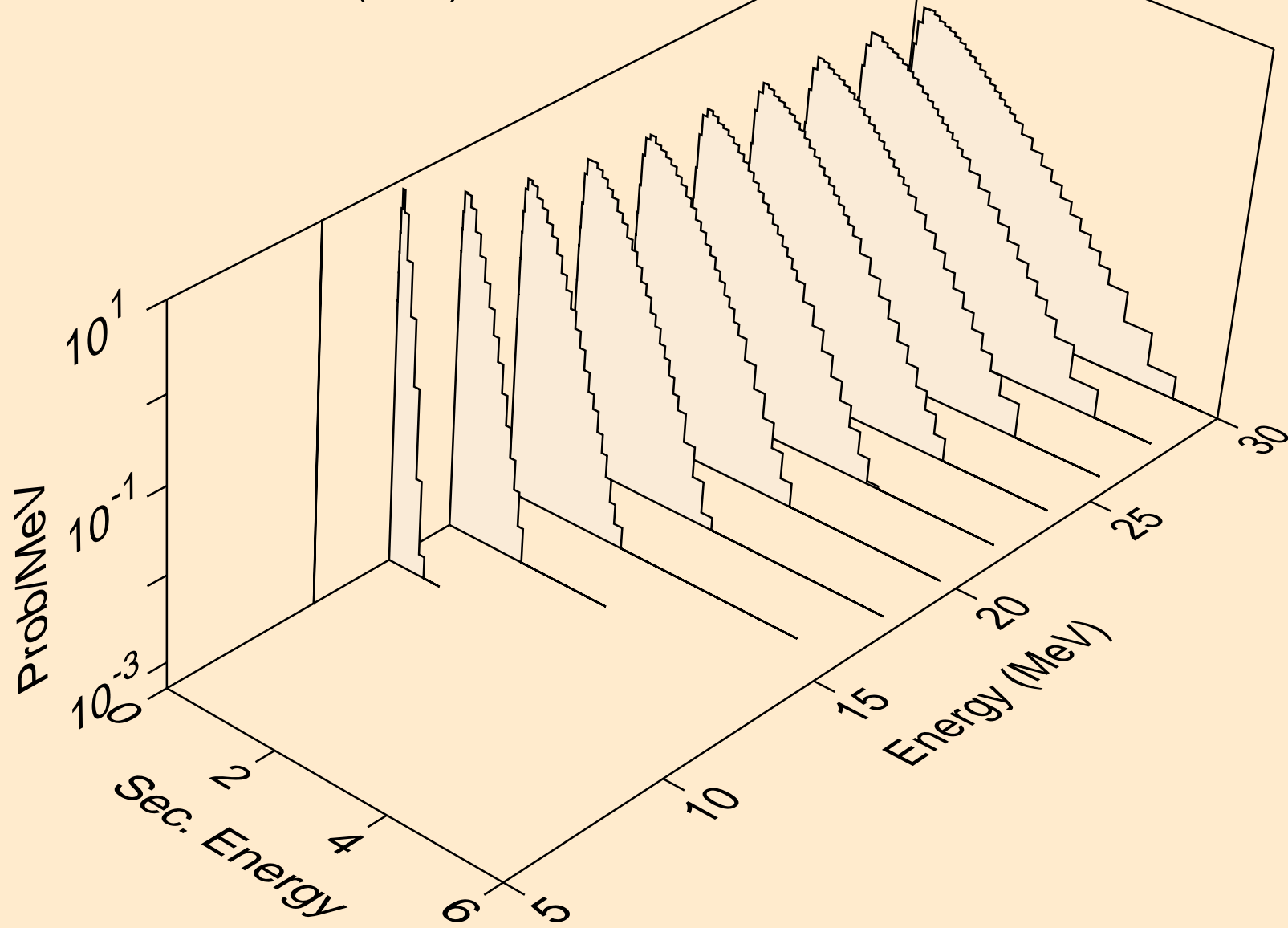

AU185M DEUTERON ACER TENDL-2023 LIBRARY; T=0.K  
neutrons from (d,n\*)t

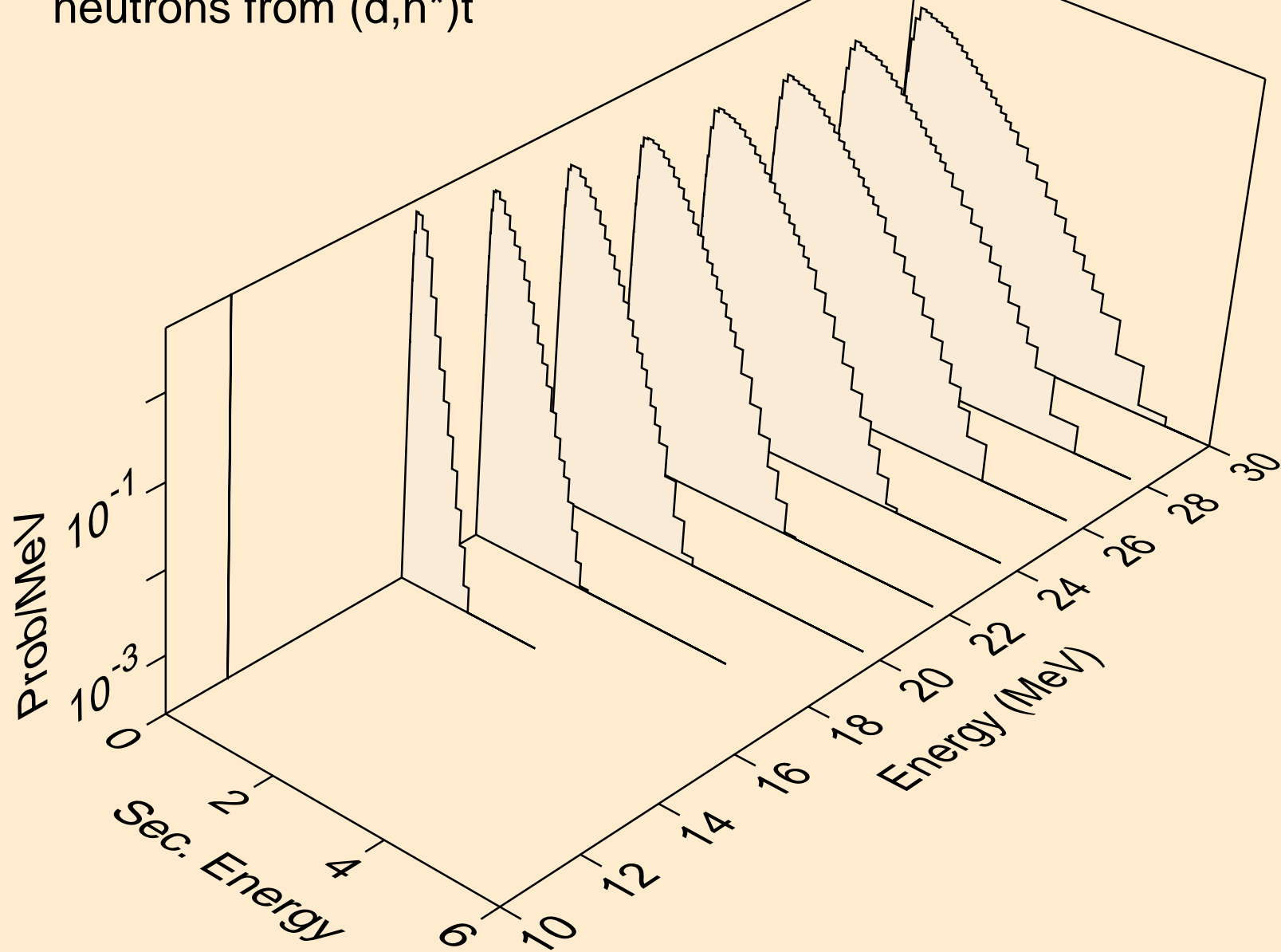

AU185M DEUTERON ACER TENDL-2023 LIBRARY; T=0.K  
neutrons from (d,n\*)he3

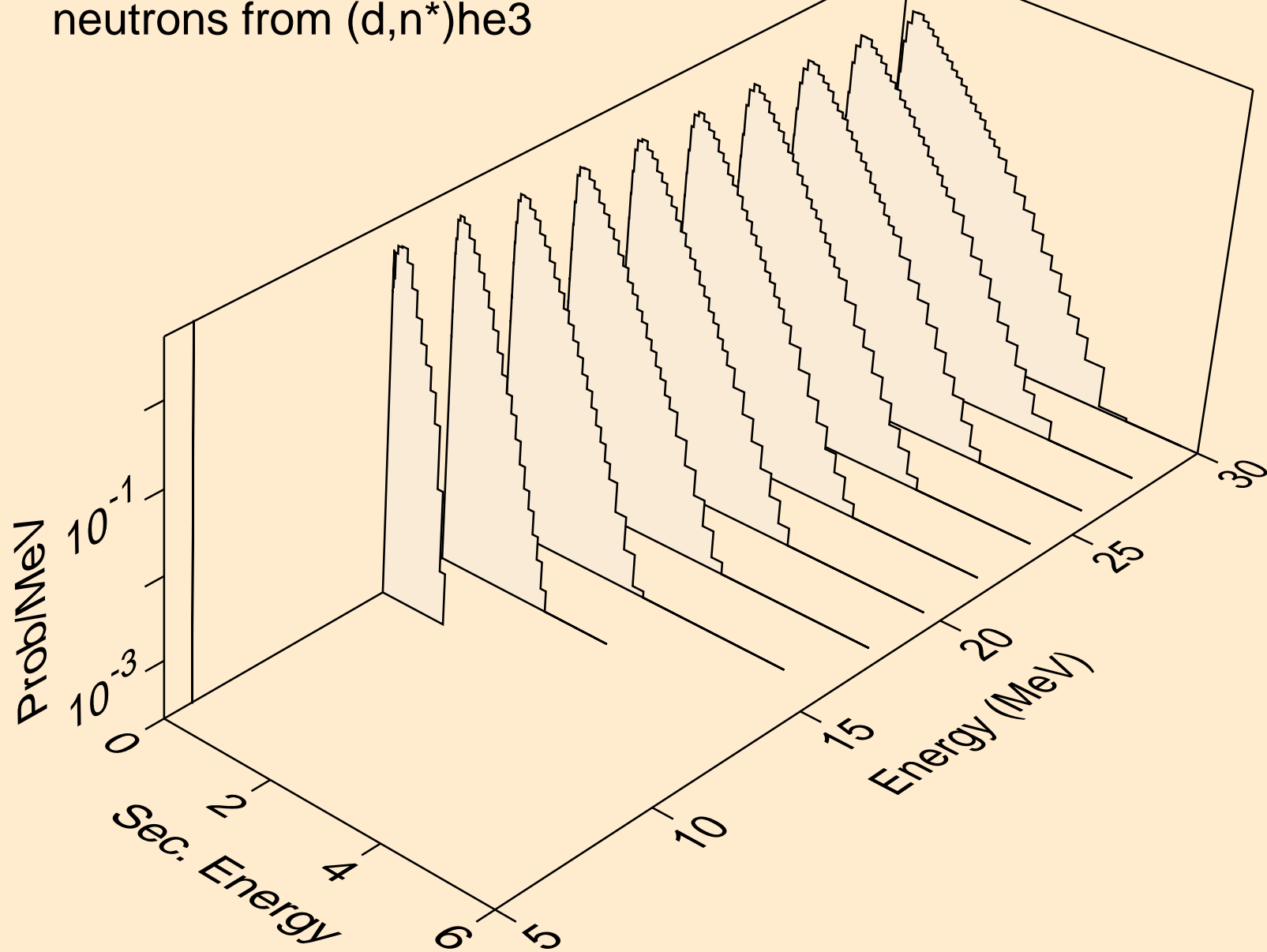



AU185M DEUTERON ACER TENDL-2023 LIBRARY; T=0.K  
neutrons from (d,4n)

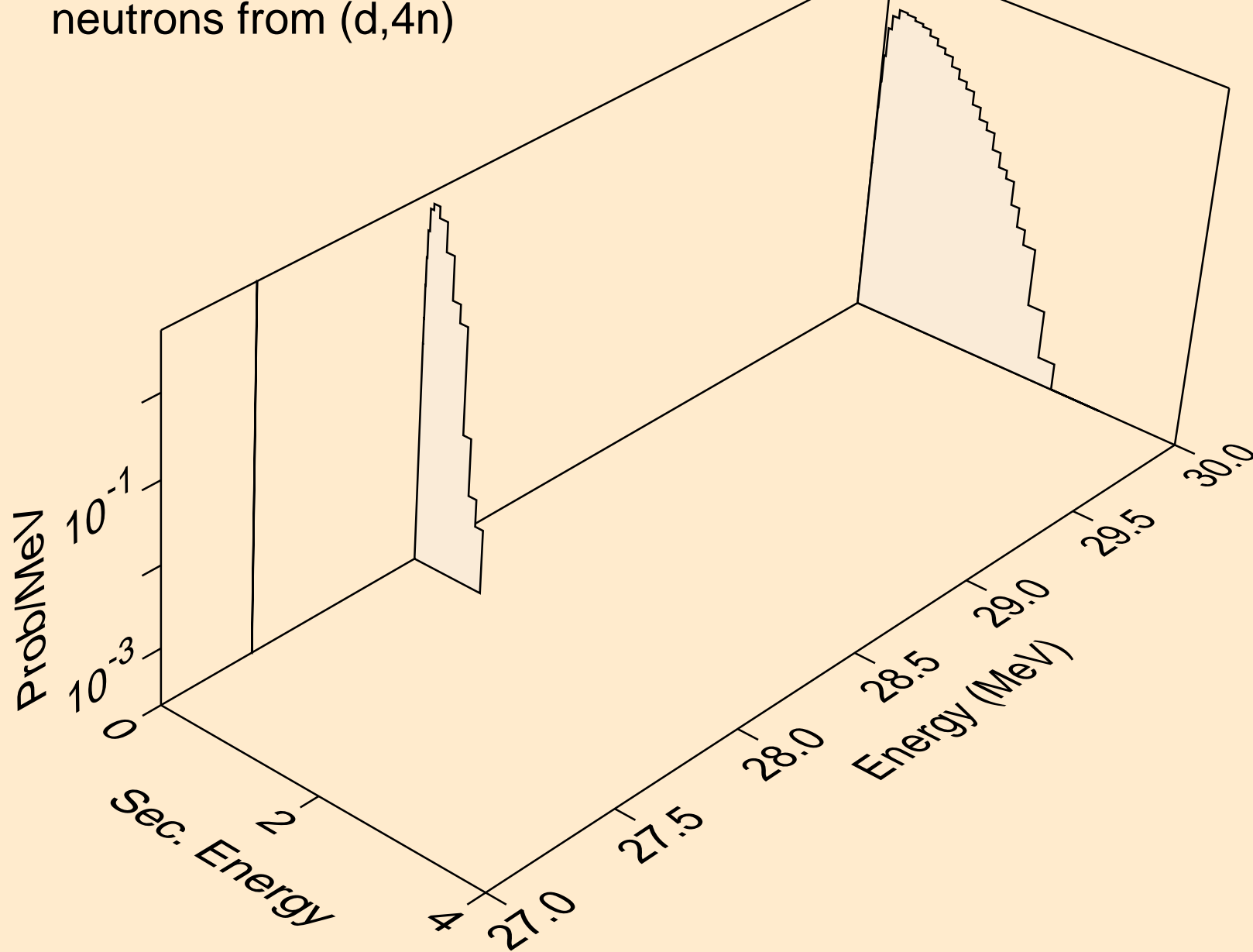

AU185M DEUTERON ACER TENDL-2023 LIBRARY; T=0.K  
neutrons from (d,2np)

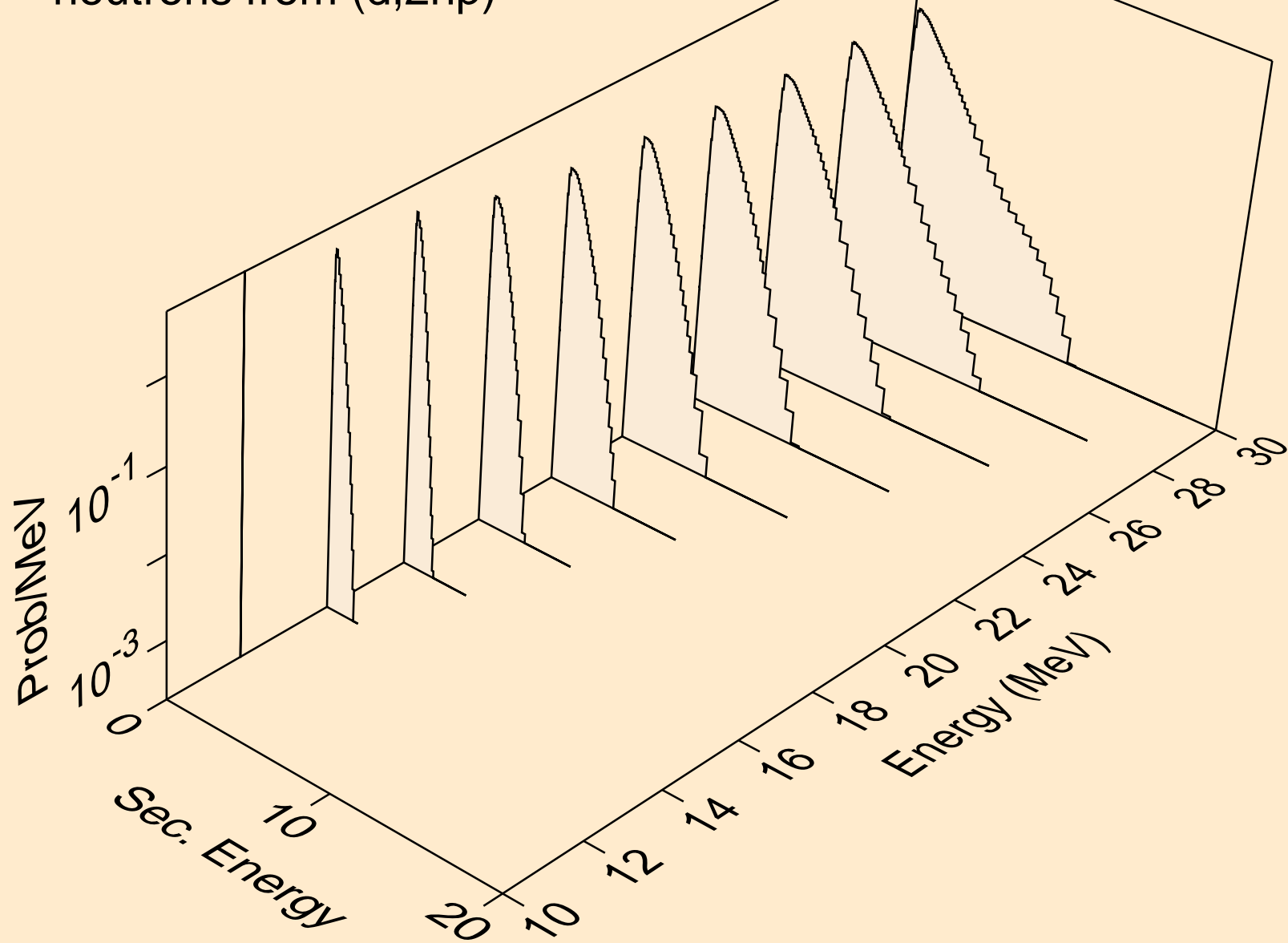

AU185M DEUTERON ACER TENDL-2023 LIBRARY; T=0.K  
neutrons from (d,3np)

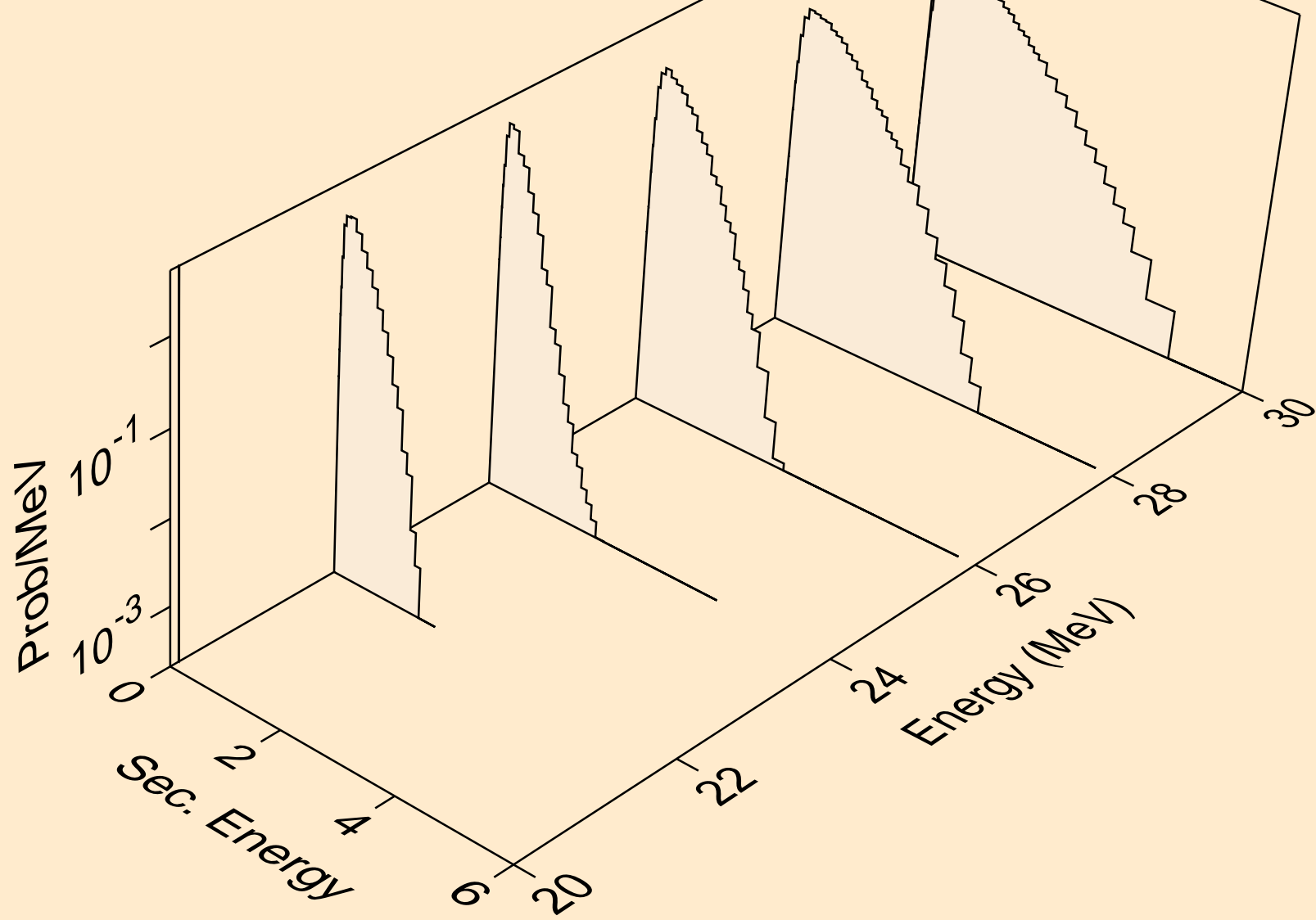

AU185M DEUTERON ACER TENDL-2023 LIBRARY; T=0.K  
neutrons from (d,n2p)

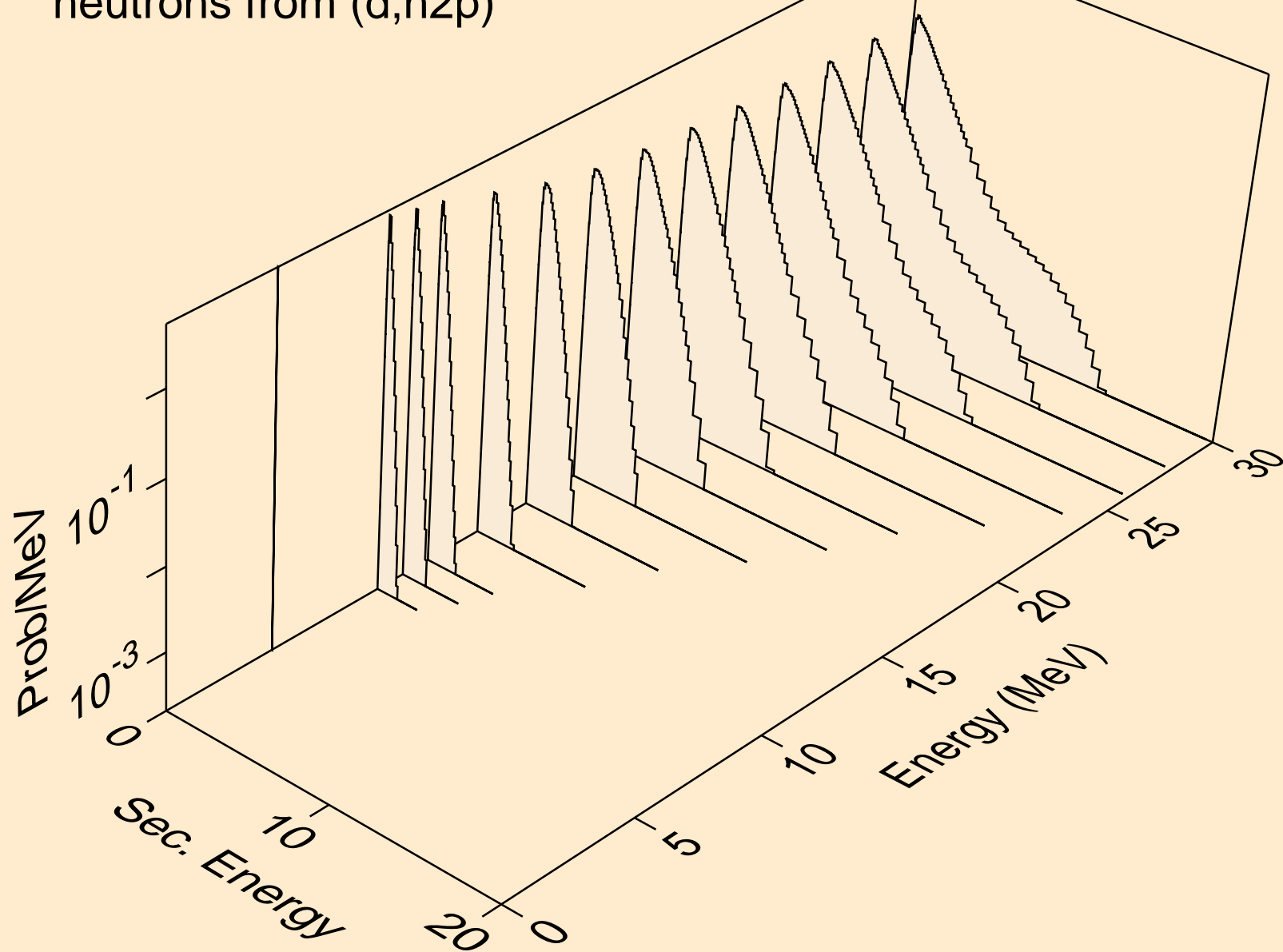

AU185M DEUTERON ACER TENDL-2023 LIBRARY; T=0.K  
neutrons from (d,npa)

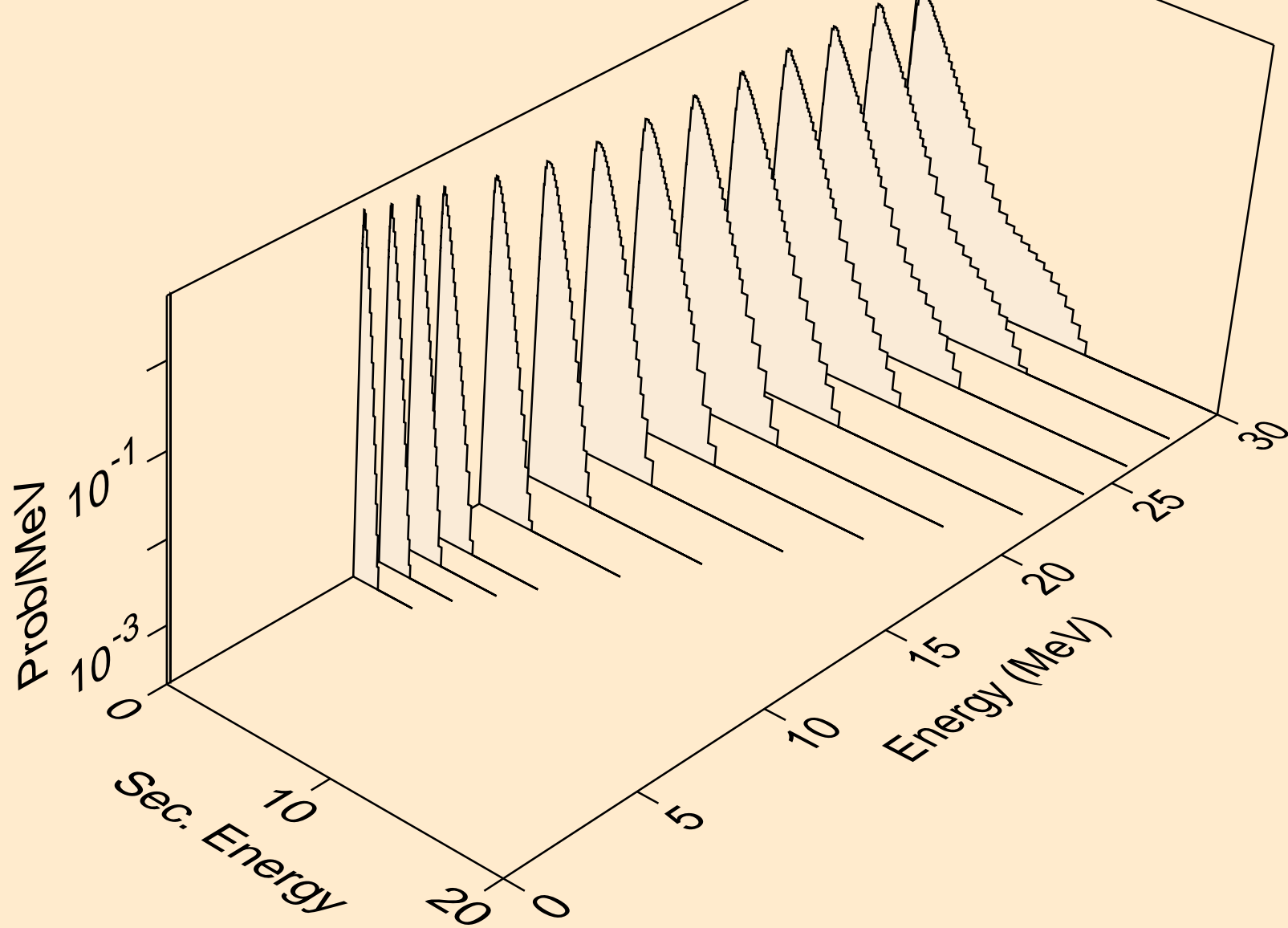

AU185M DEUTERON ACER TENDL-2023 LIBRARY; T=0.K  
protons from (d,x)

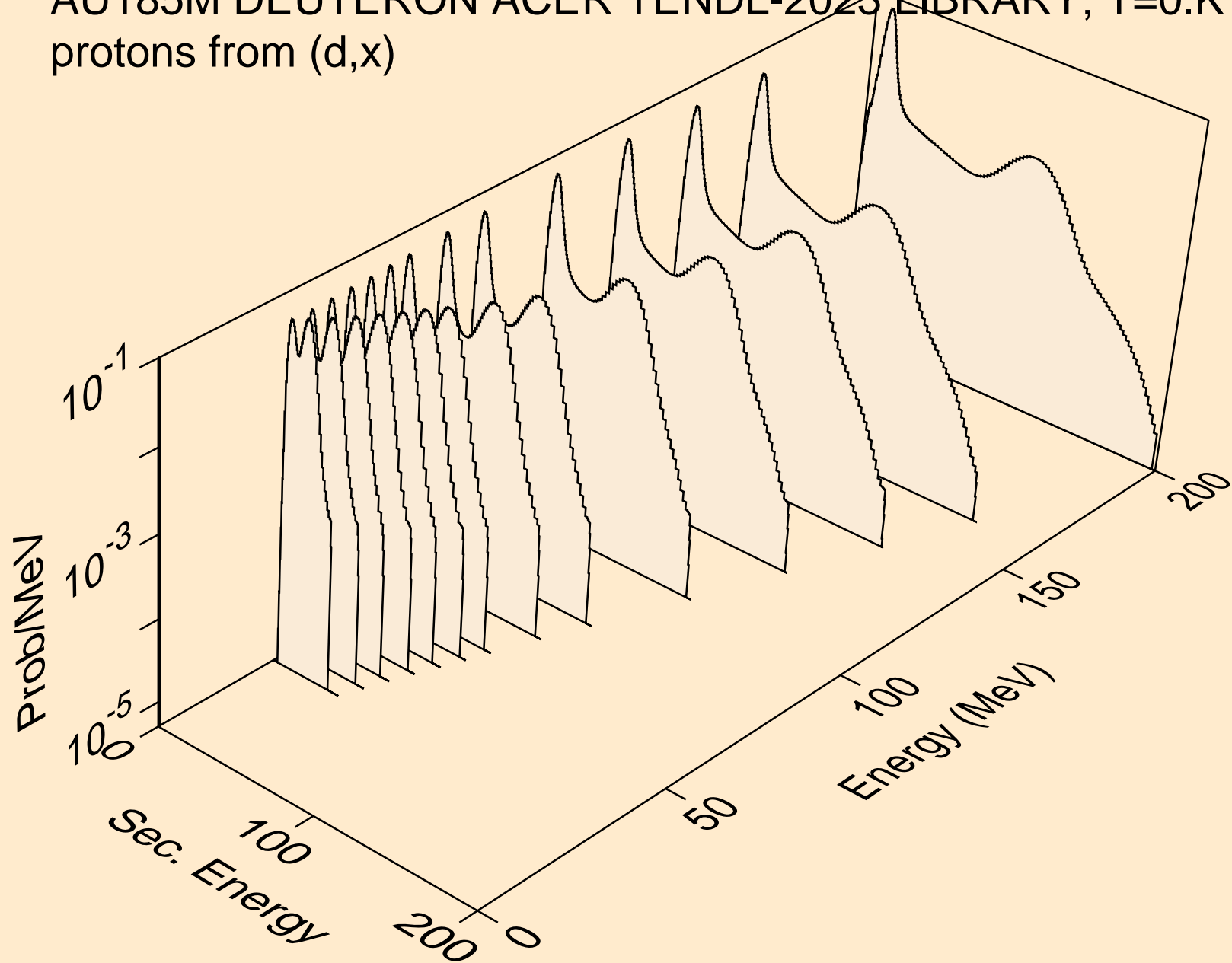

AU185M DEUTERON ACER TENDL-2023 LIBRARY; T=0.K  
protons from (d,n\*)p

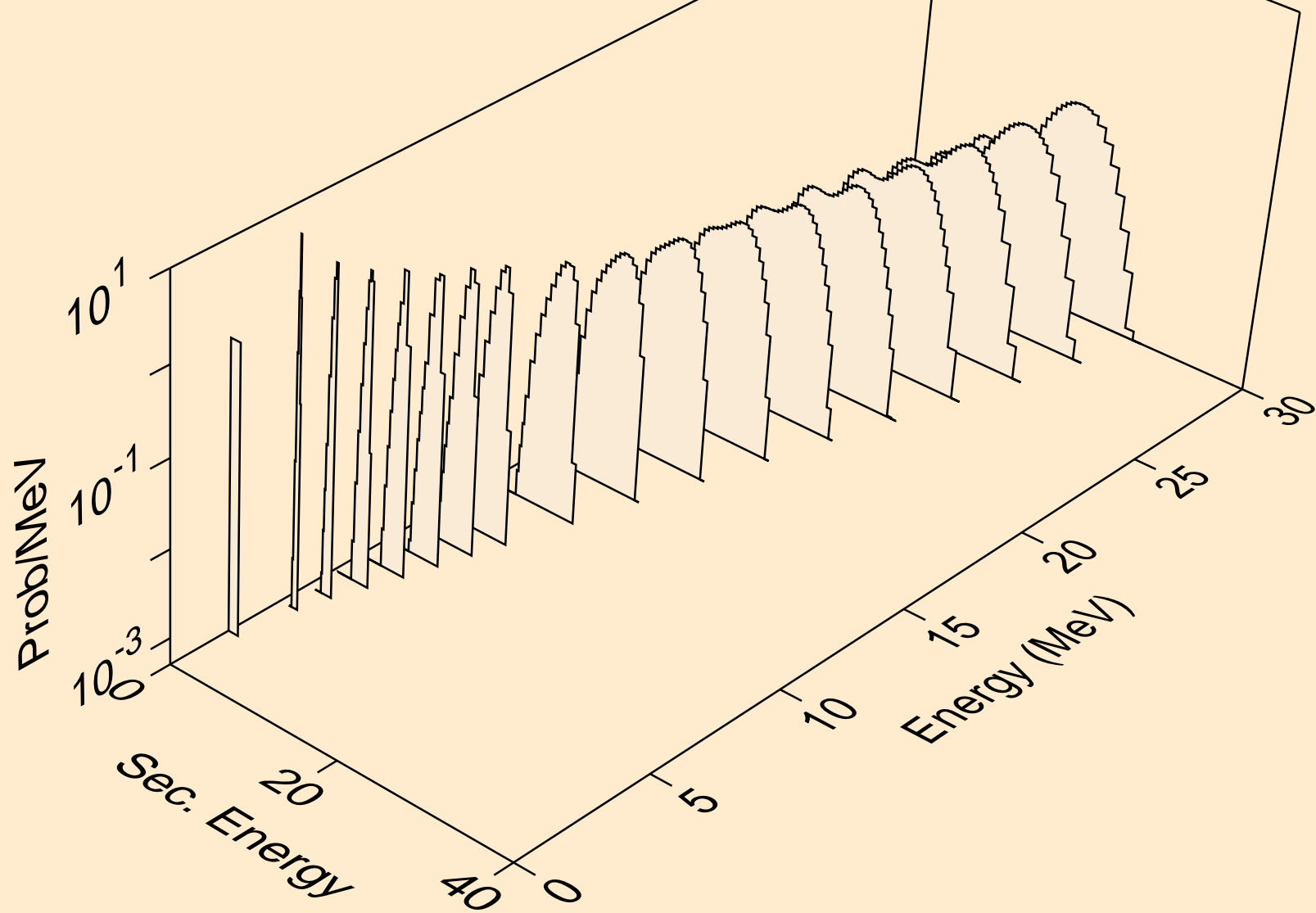

AU185M DEUTERON ACER TENDL-2023 LIBRARY; T=0.K  
protons from (d,2np)

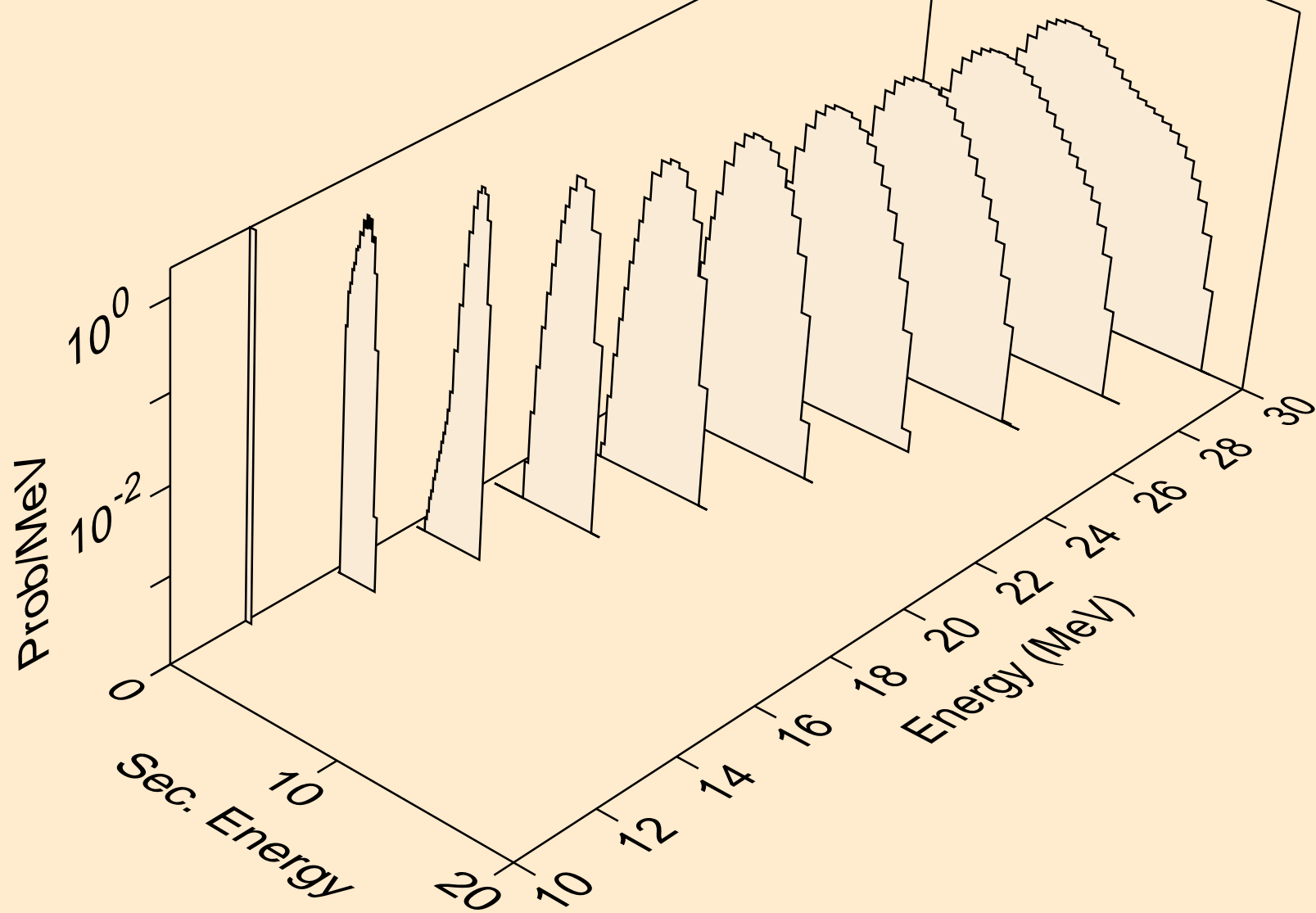



AU185M DEUTERON ACER TENDL-2023 LIBRARY; T=0.K  
protons from (d,3np)

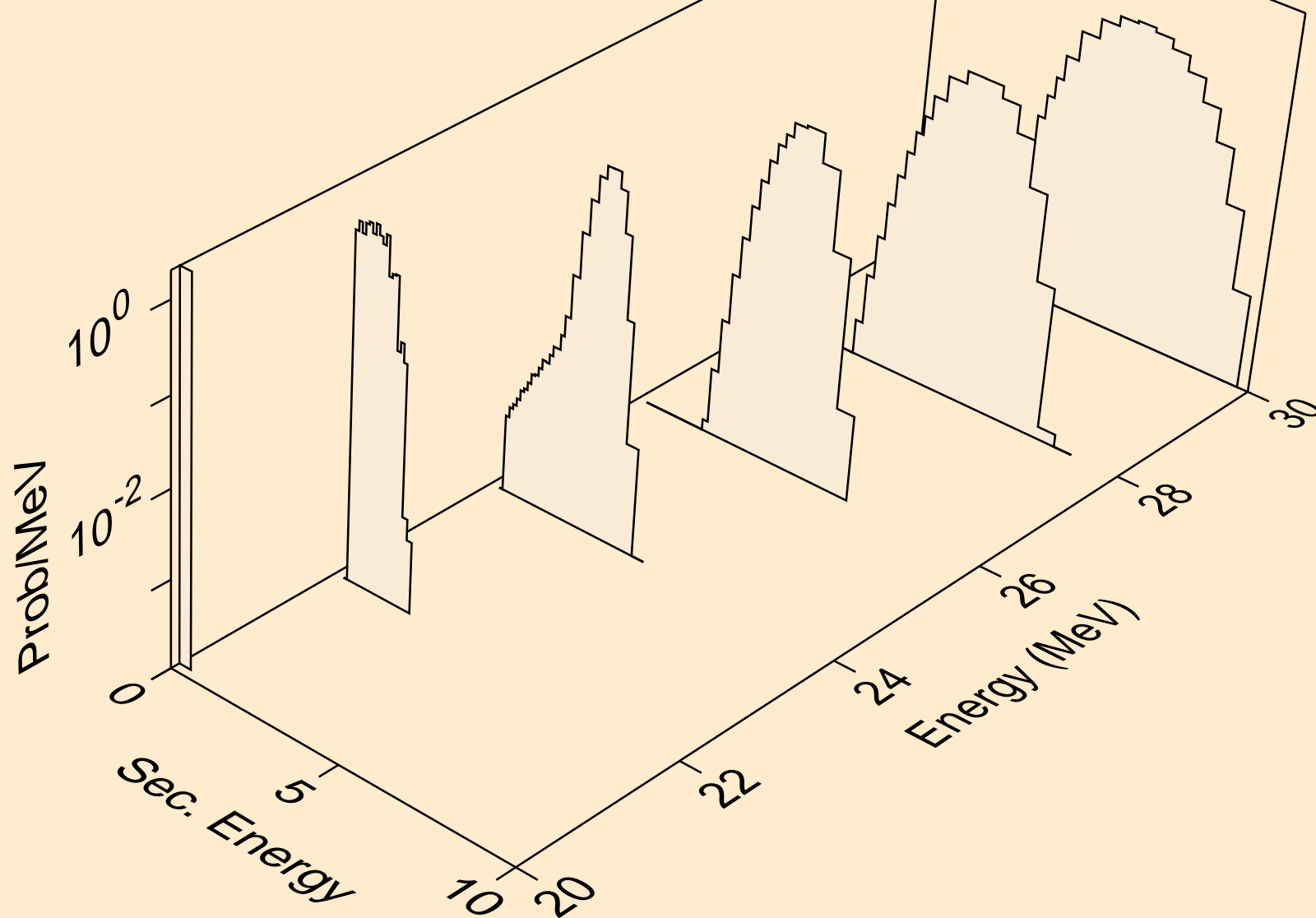

AU185M DEUTERON ACER TENDL-2023 LIBRARY; T=0.K  
protons from (d,n2p)

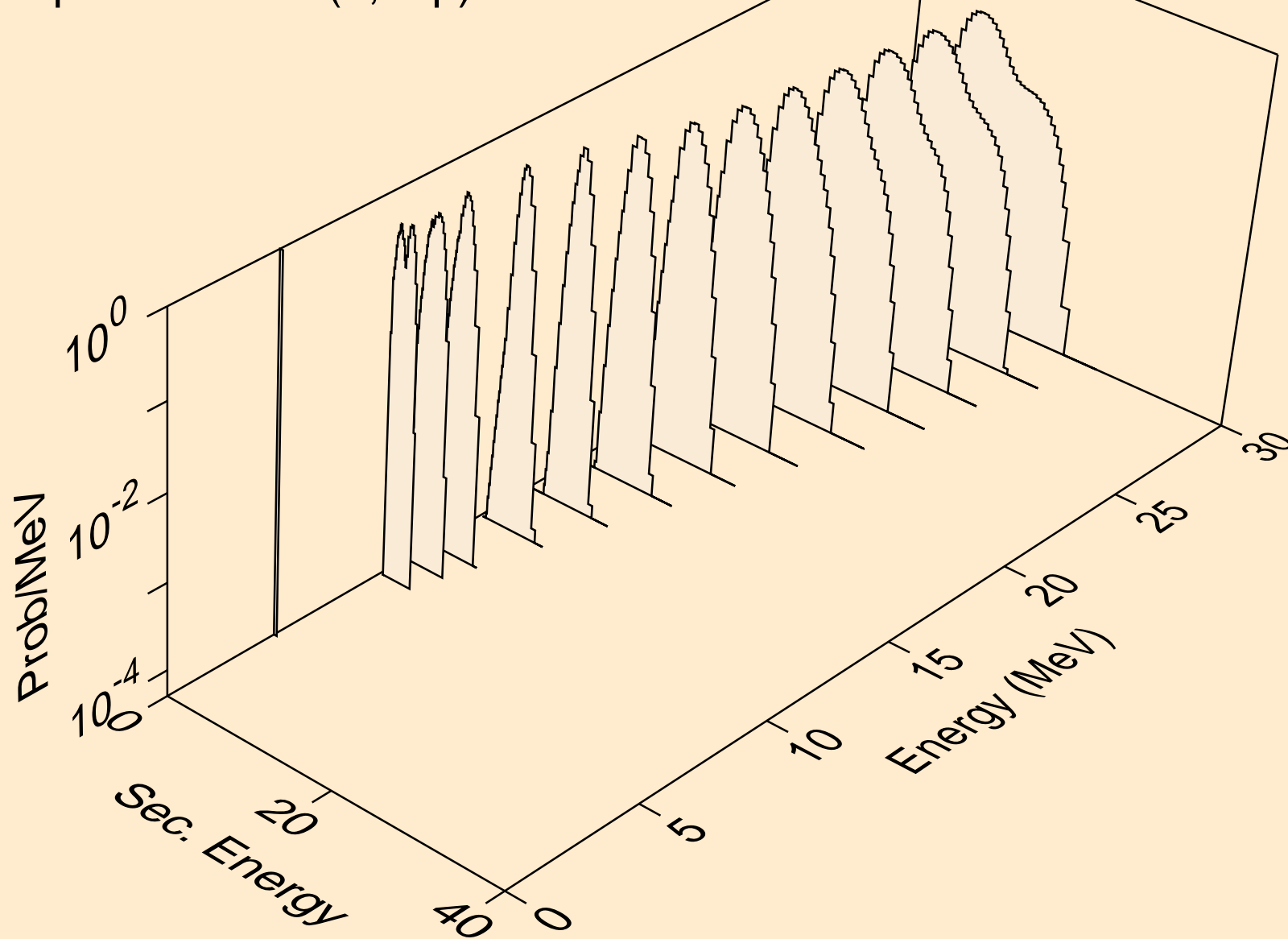

AU185M DEUTERON ACER TENDL-2023 LIBRARY; T=0.K  
protons from (d,npa)

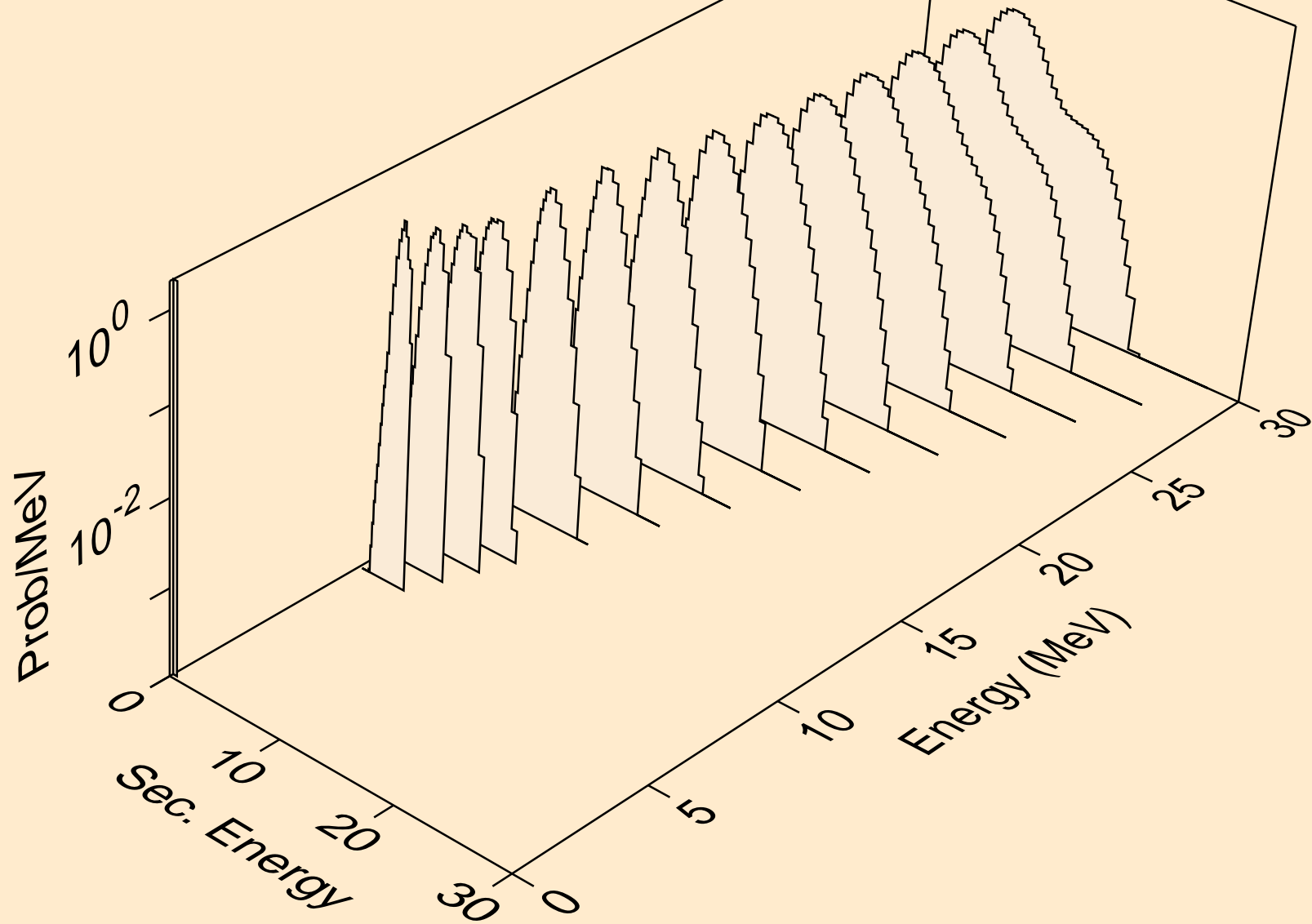

AU185M DEUTERON ACER TENDL-2023 LIBRARY; T=0.K  
protons from (d,p)

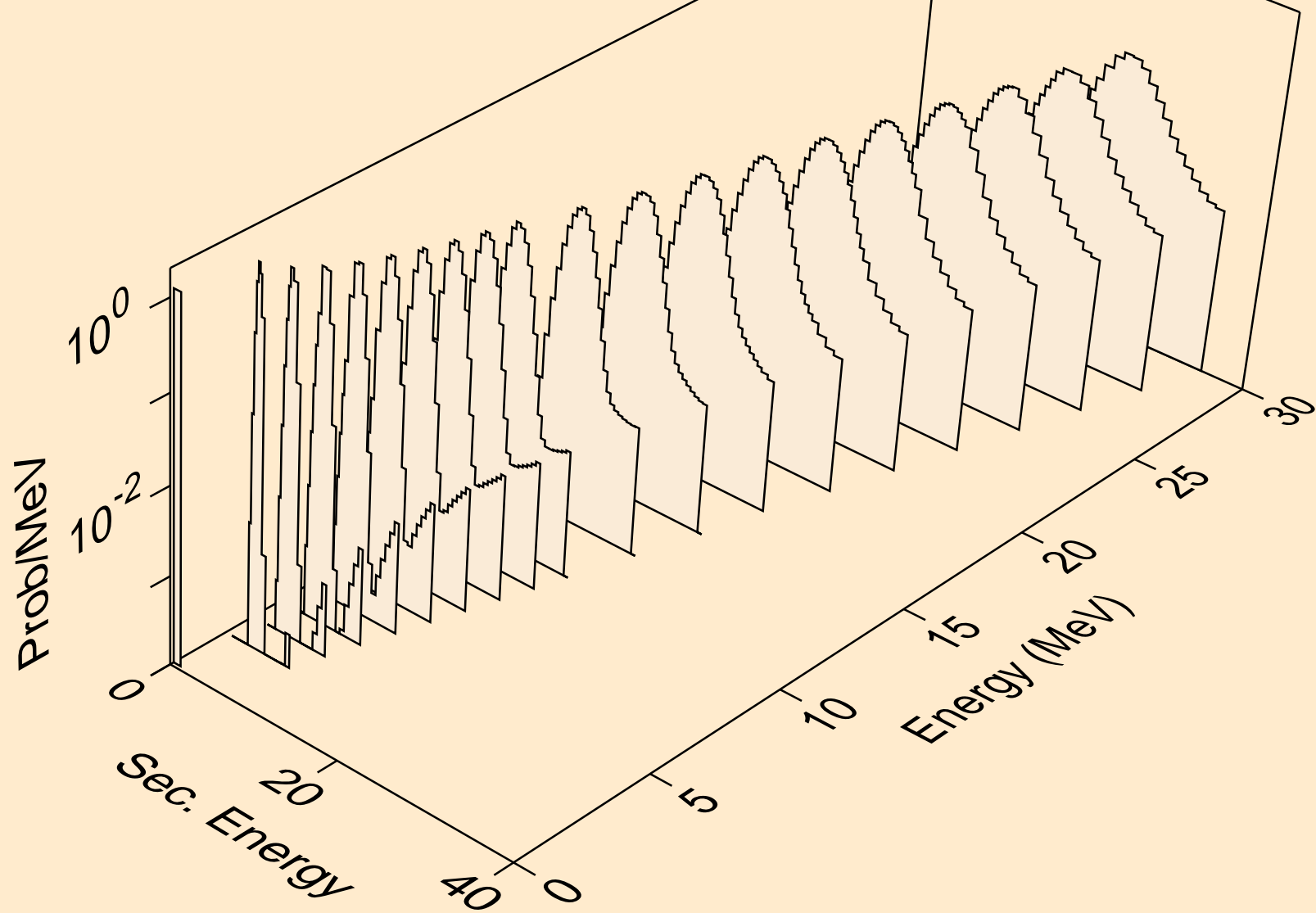

AU185M DEUTERON ACER TENDL-2023 LIBRARY; T=0.K  
protons from (d,2p)

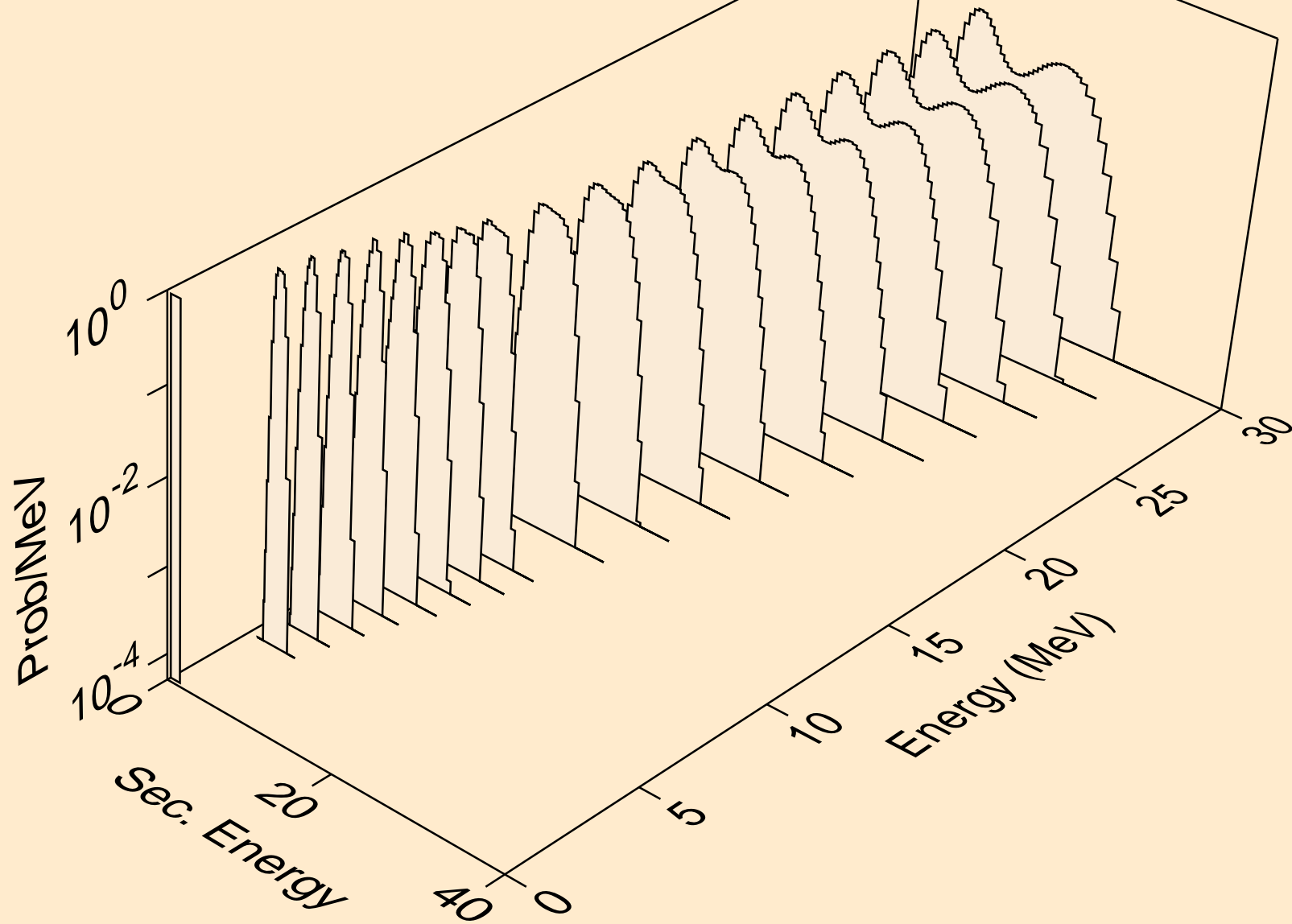

AU185M DEUTERON ACER TENDL-2023 LIBRARY; T=0.K  
protons from (d,pa)

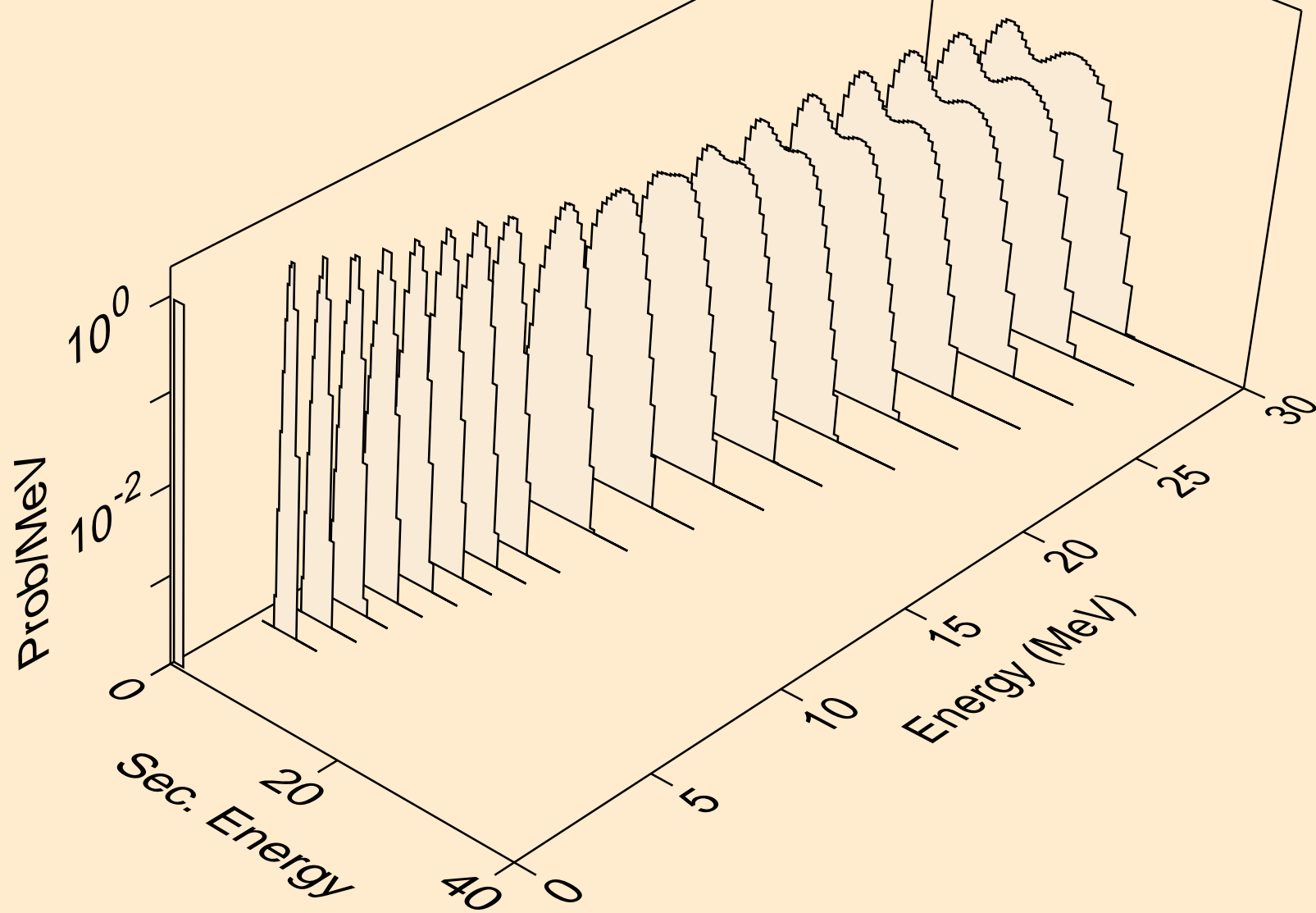

AU185M DEUTERON ACER TENDL-2023 LIBRARY; T=0.K  
protons from (d,pd)

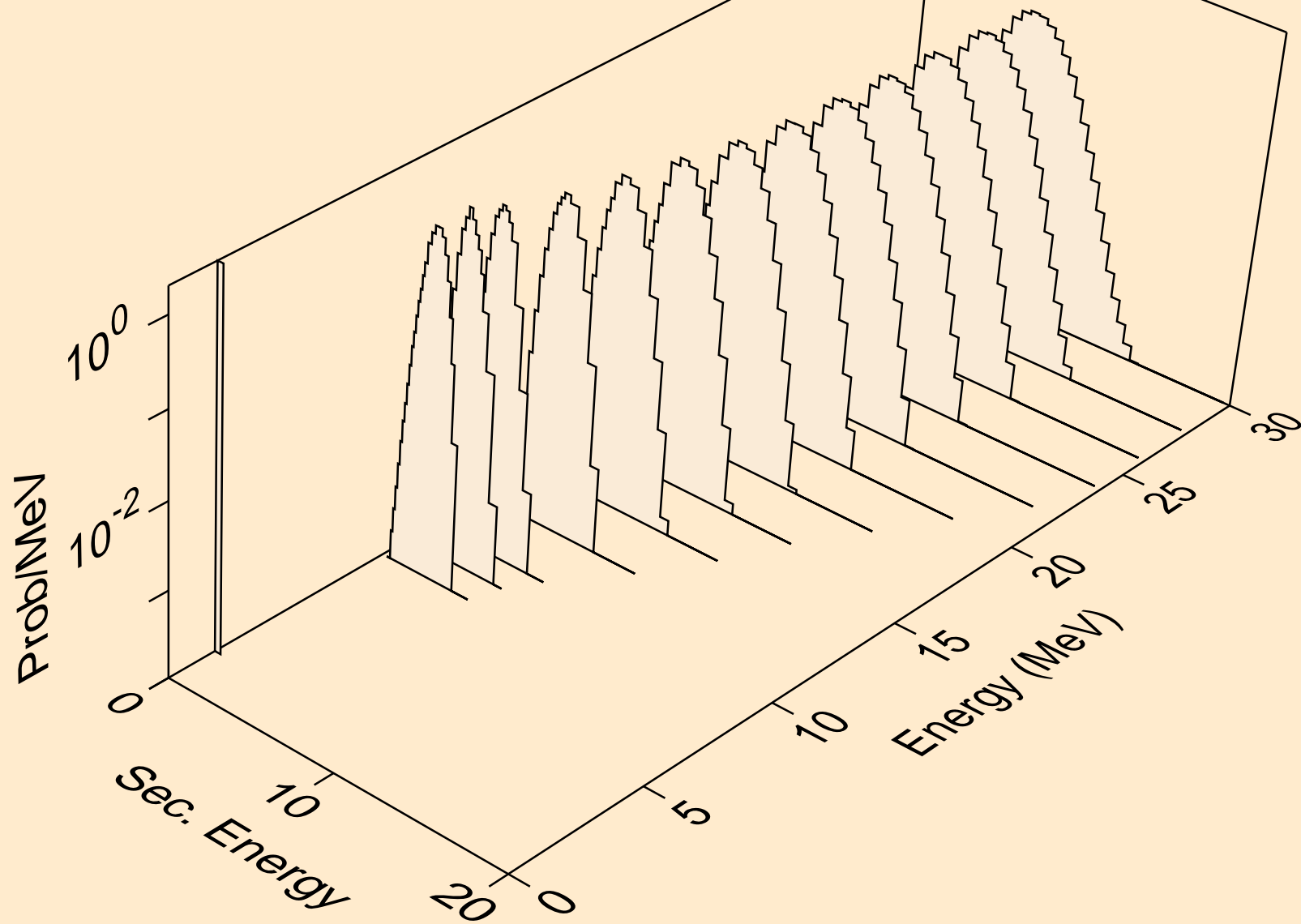

AU185M DEUTERON ACER TENDL-2023 LIBRARY; T=0.K  
protons from (d,pt)

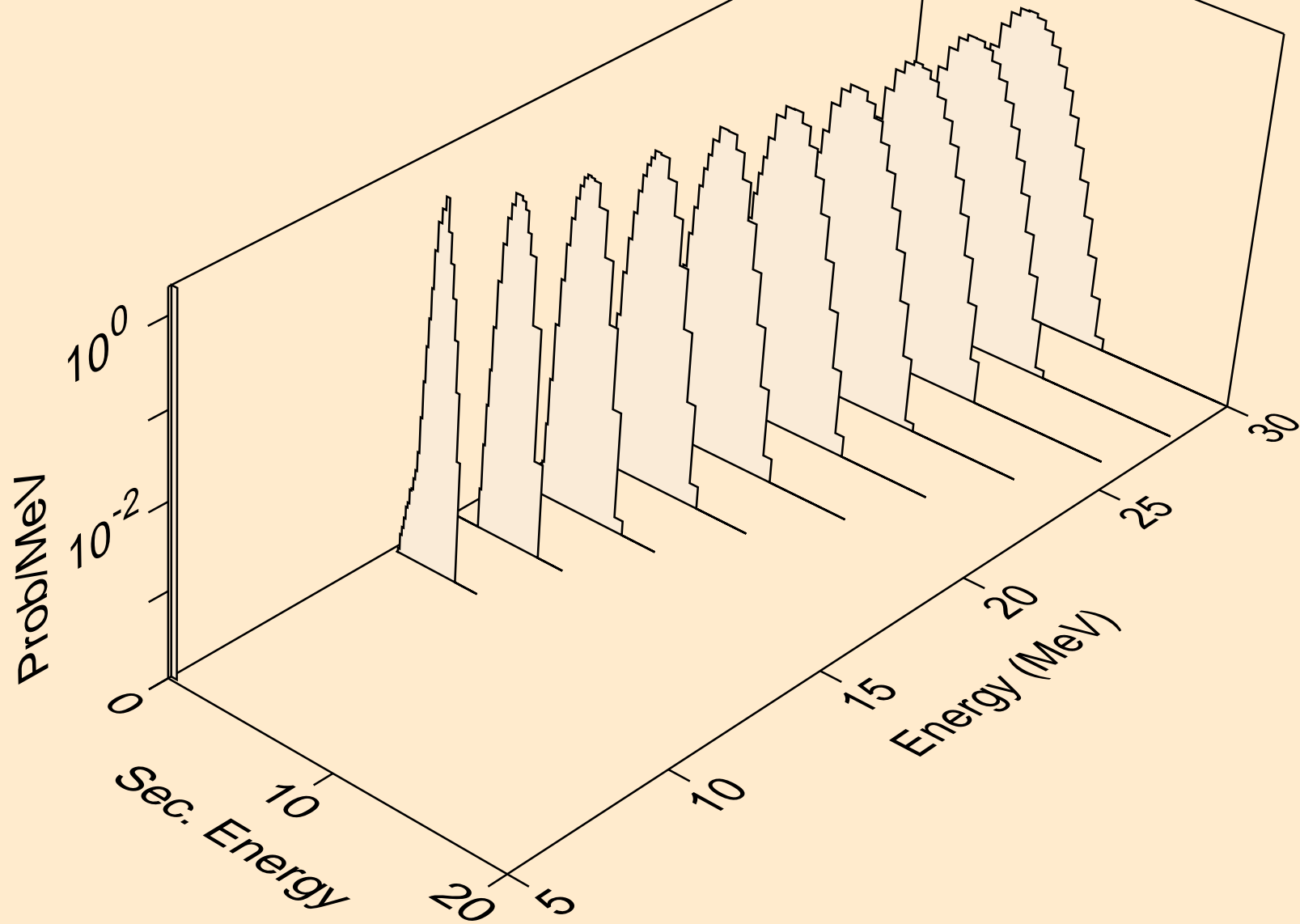



AU185M DEUTERON ACER TENDL-2023 LIBRARY; T=0.K  
tritons from (d,x)

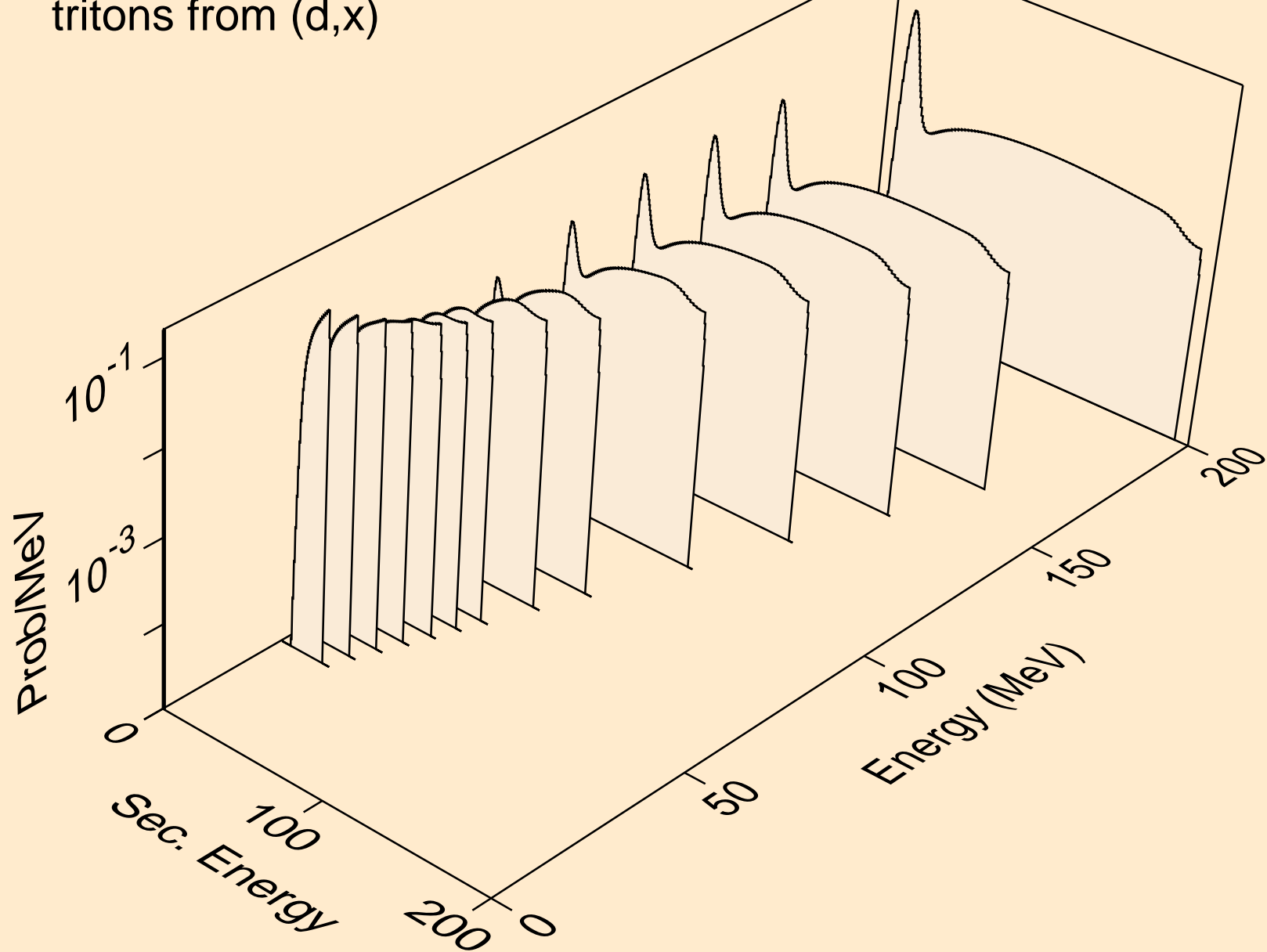

AU185M DEUTERON ACER TENDL-2023 LIBRARY; T=0.K  
tritons from (d,n\*)t

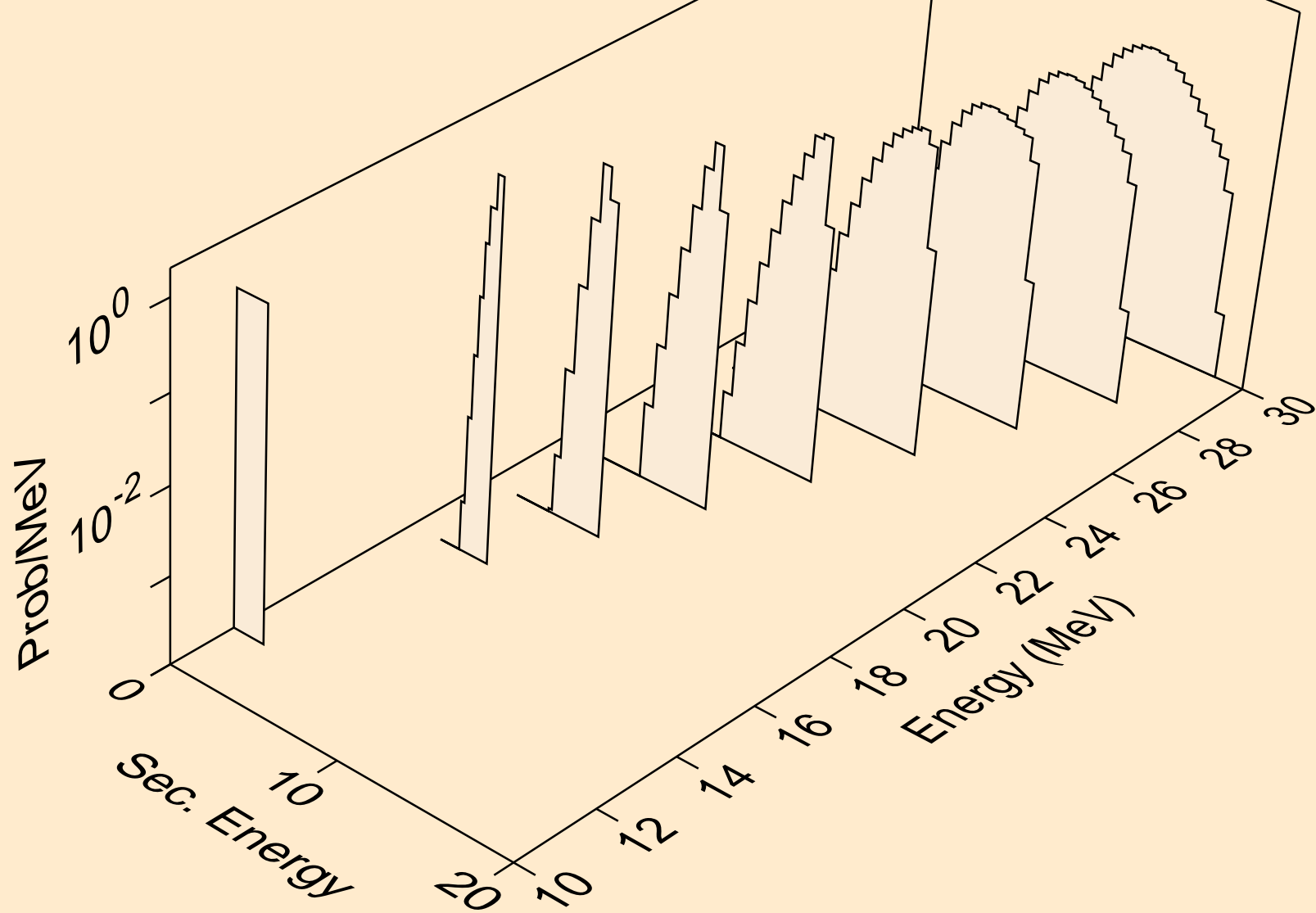

AU185M DEUTERON ACER TENDL-2023 LIBRARY; T=0.K  
tritons from (d,t)

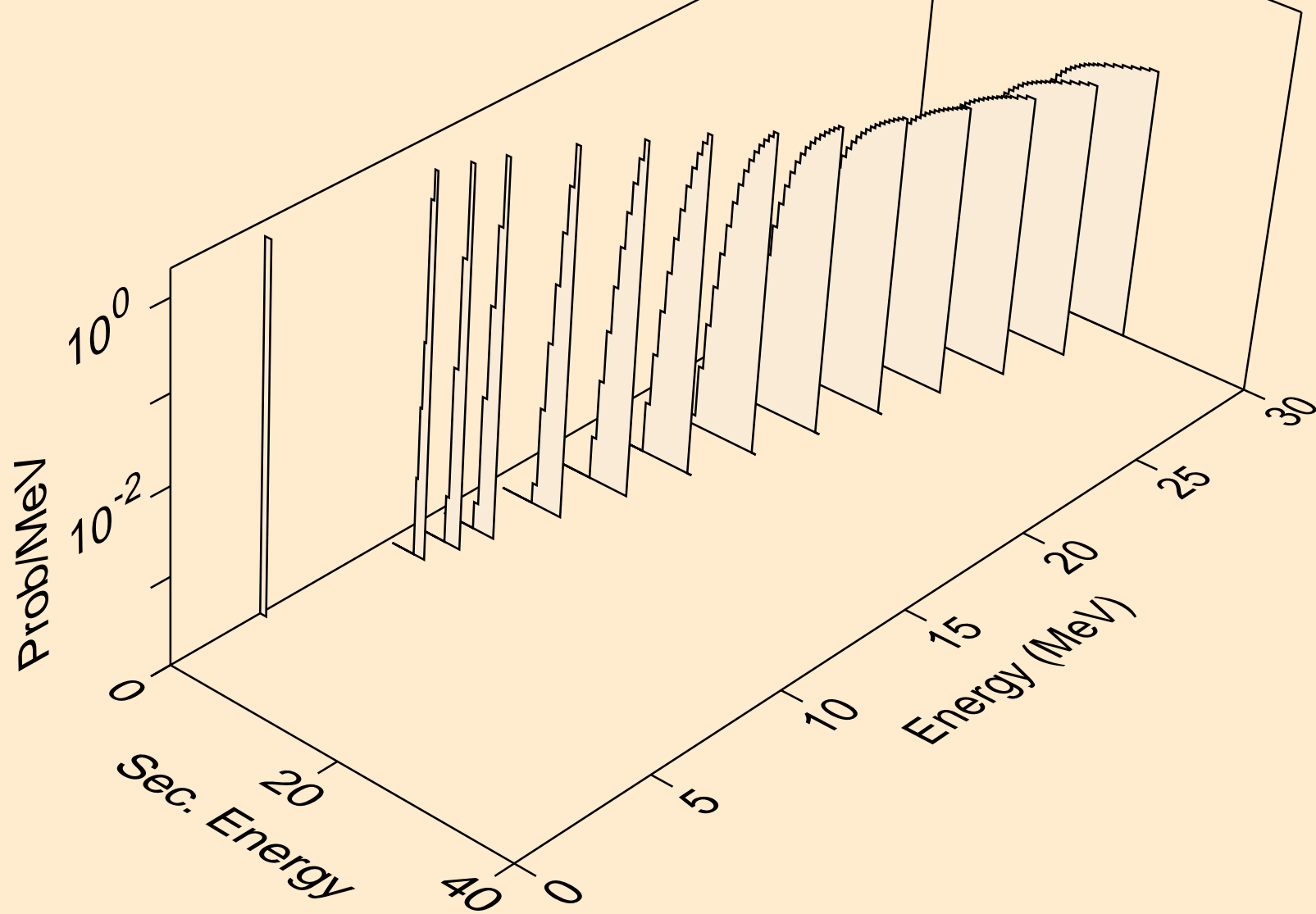

AU185M DEUTERON ACER TENDL-2023 LIBRARY; T=0.K  
tritons from (d,pt)

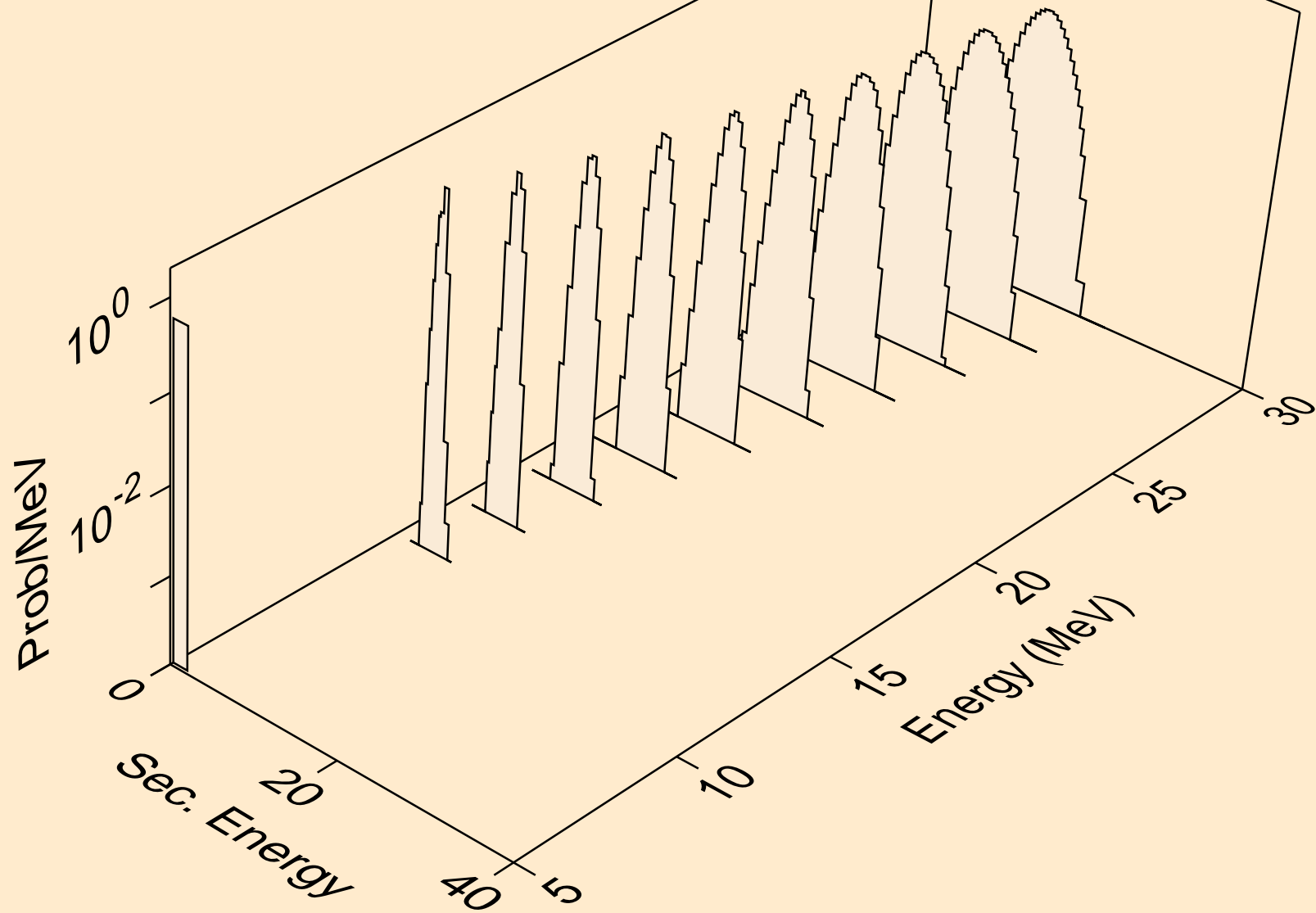

AU185M DEUTERON ACER TENDL-2023 LIBRARY; T=0.K  
he3s from (d,x)

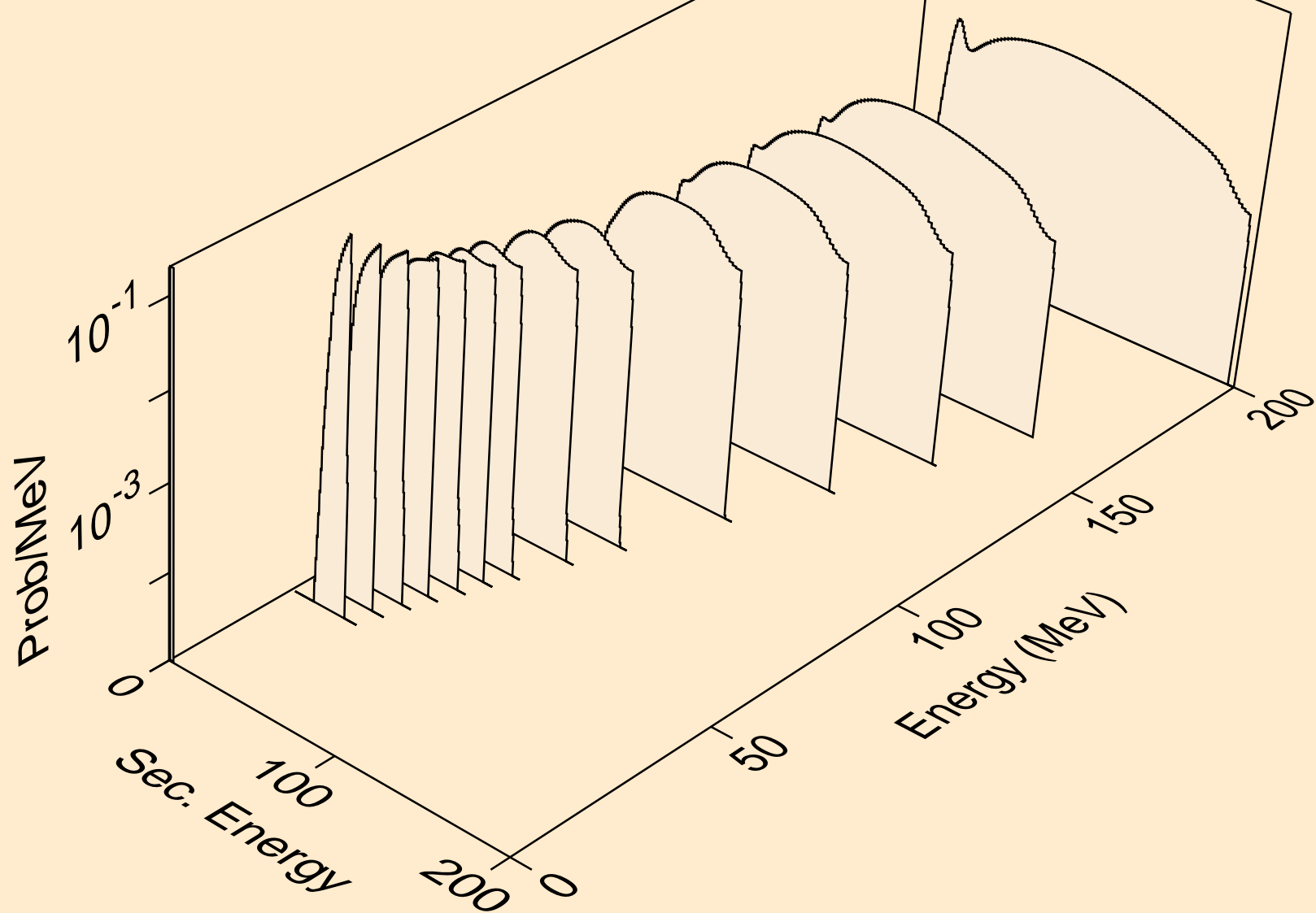

AU185M DEUTERON ACER TENDL-2023 LIBRARY; T=0.K  
he3s from (d,n\*)he3

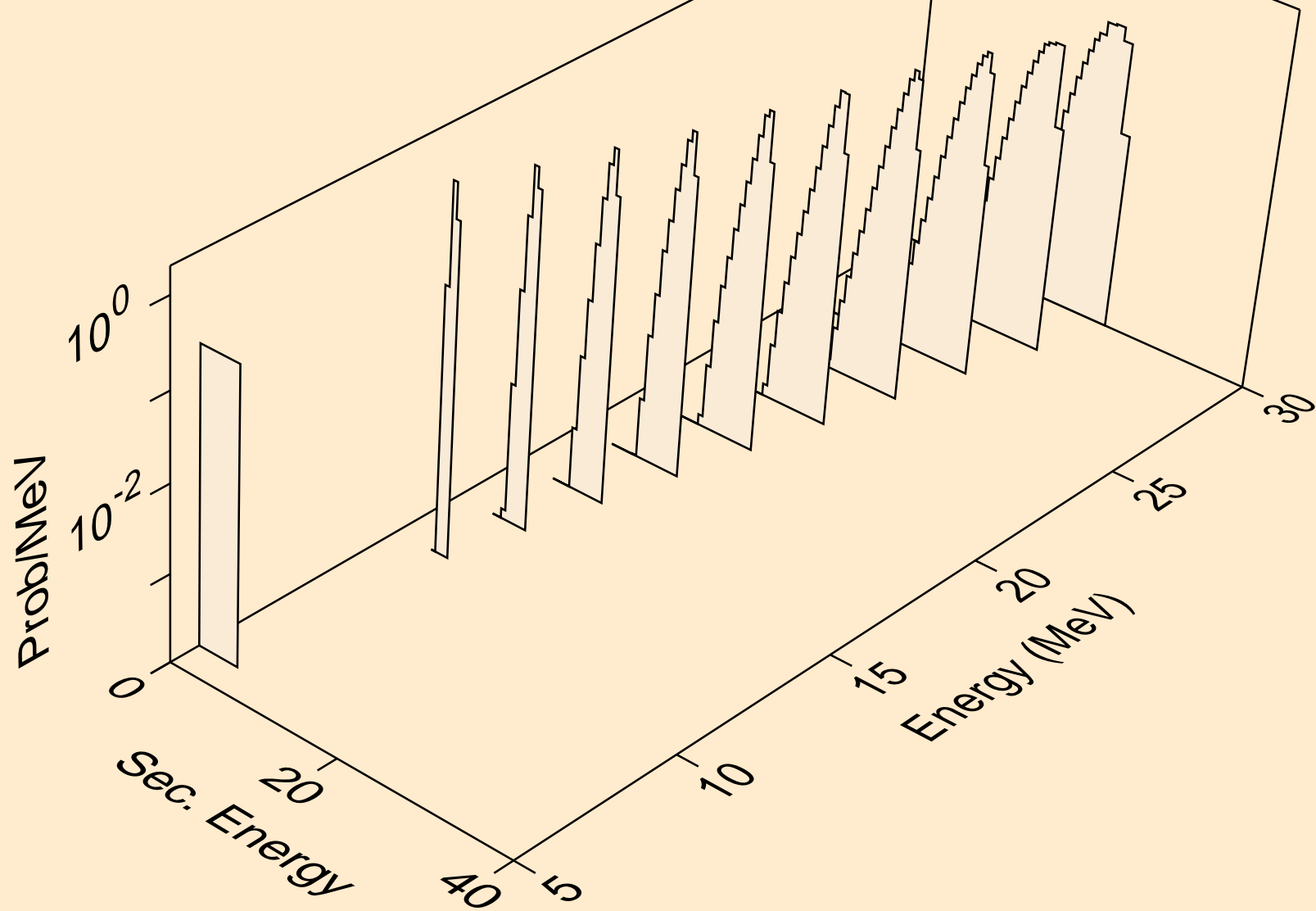

AU185M DEUTERON ACER TENDL-2023 LIBRARY; T=0.K  
he3s from (d,he3)

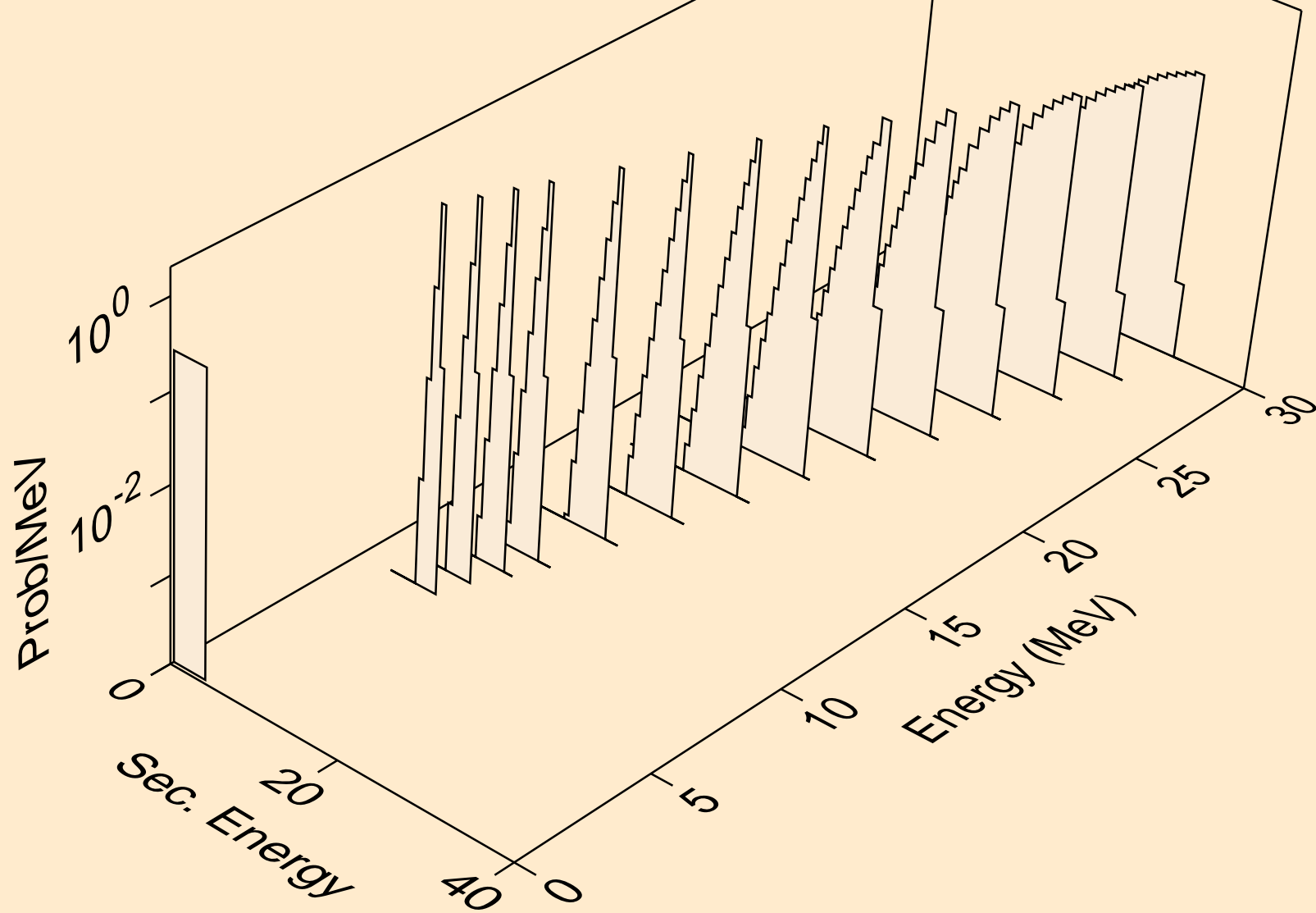

AU185M DEUTERON ACER TENDL-2023 LIBRARY; T=0.K  
alphas from (d,x)

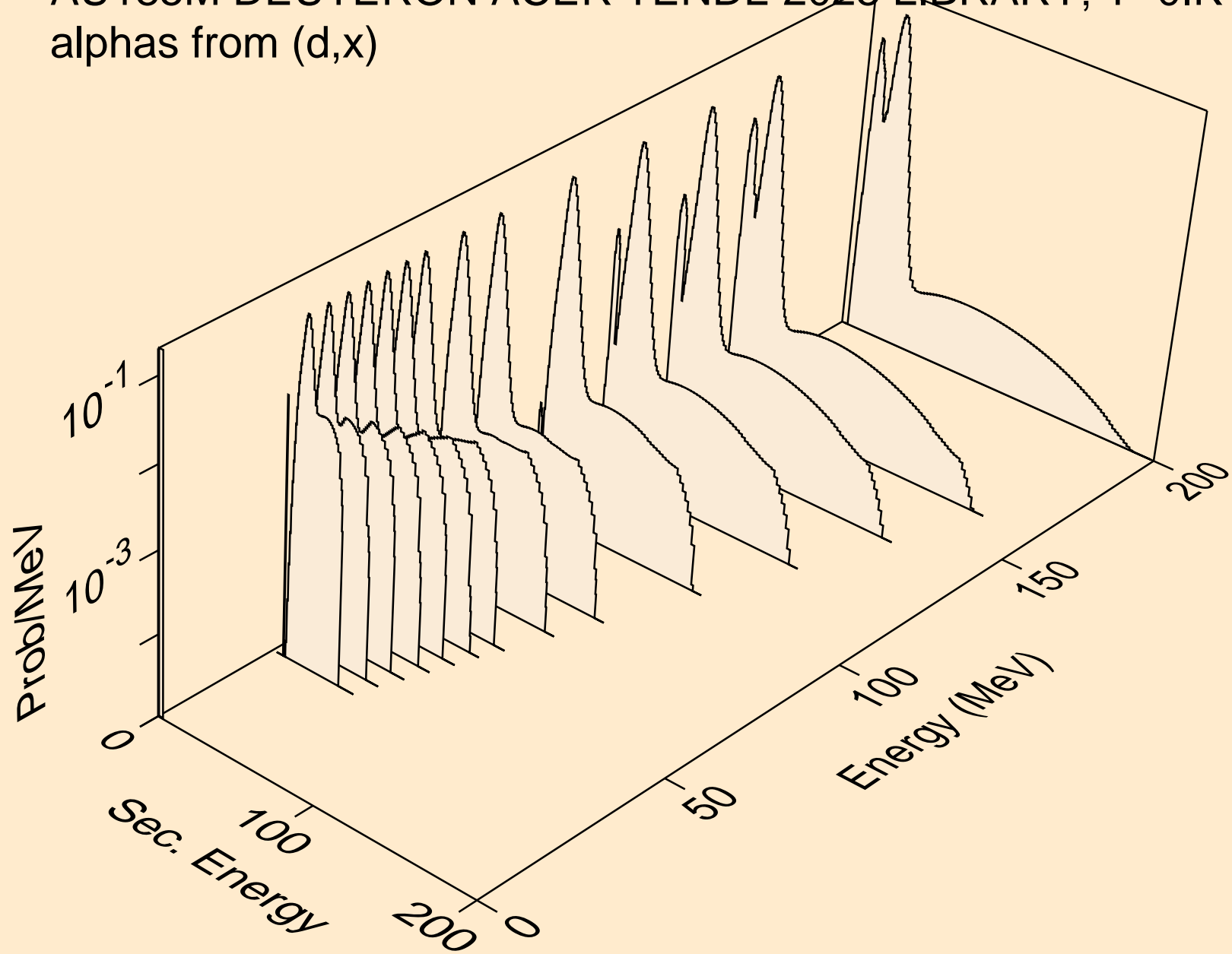



AU185M DEUTERON ACER TENDL-2023 LIBRARY; T=0.K  
alphas from (d,n\*)a

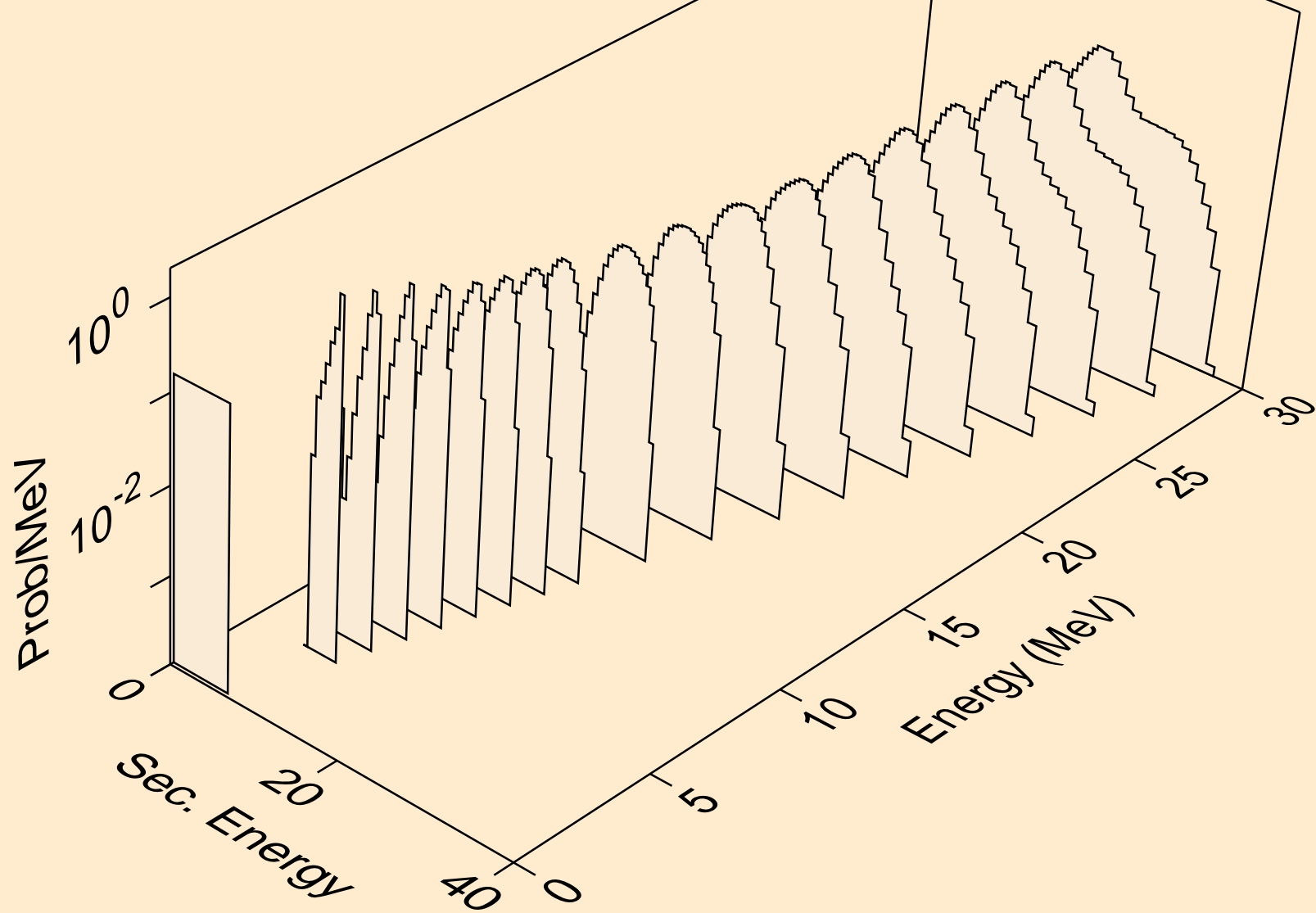

AU185M DEUTERON ACER TENDL-2023 LIBRARY; T=0.K  
alphas from (d,2n)a

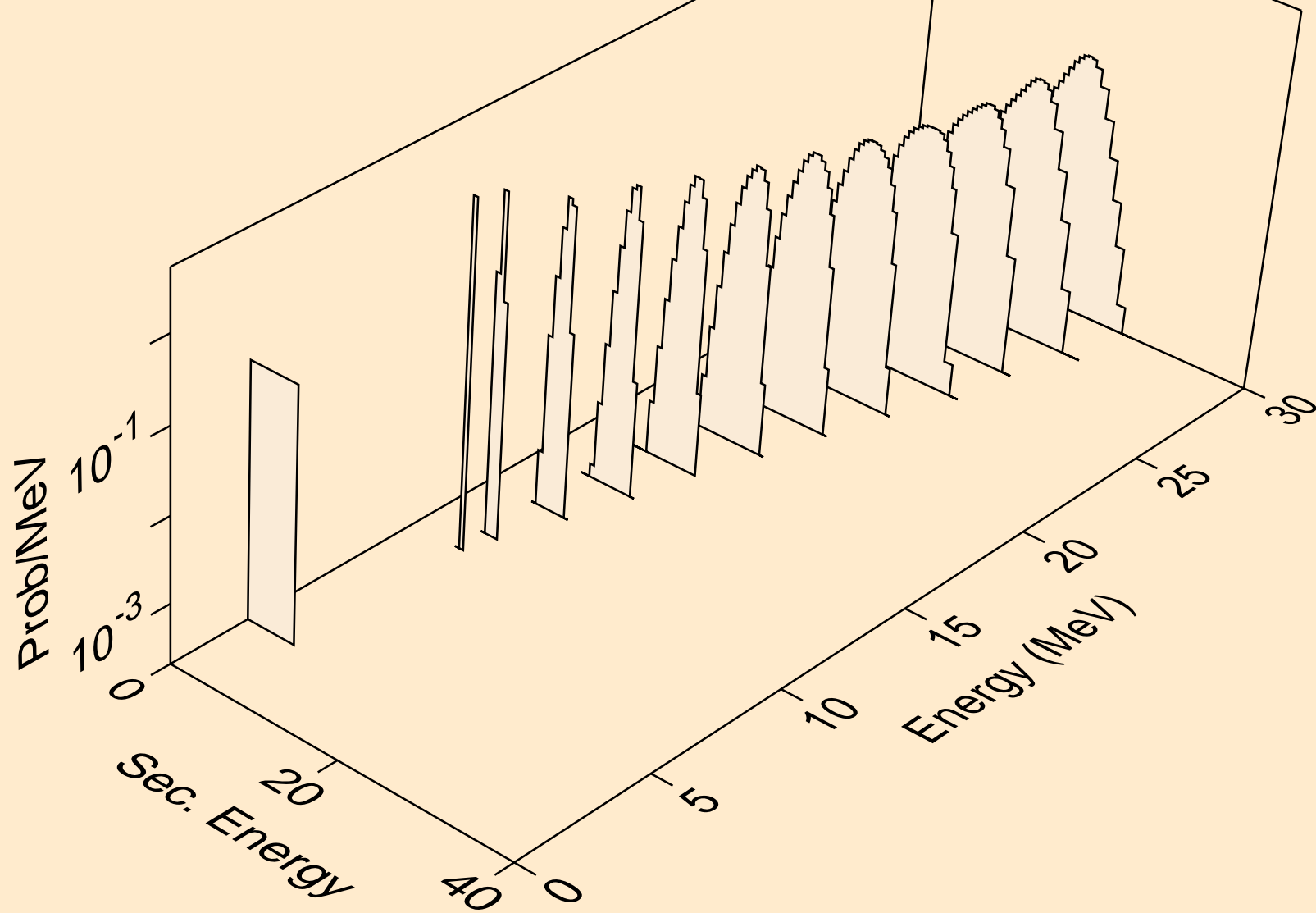

AU185M DEUTERON ACER TENDL-2023 LIBRARY; T=0.K  
alphas from (d,3n)a

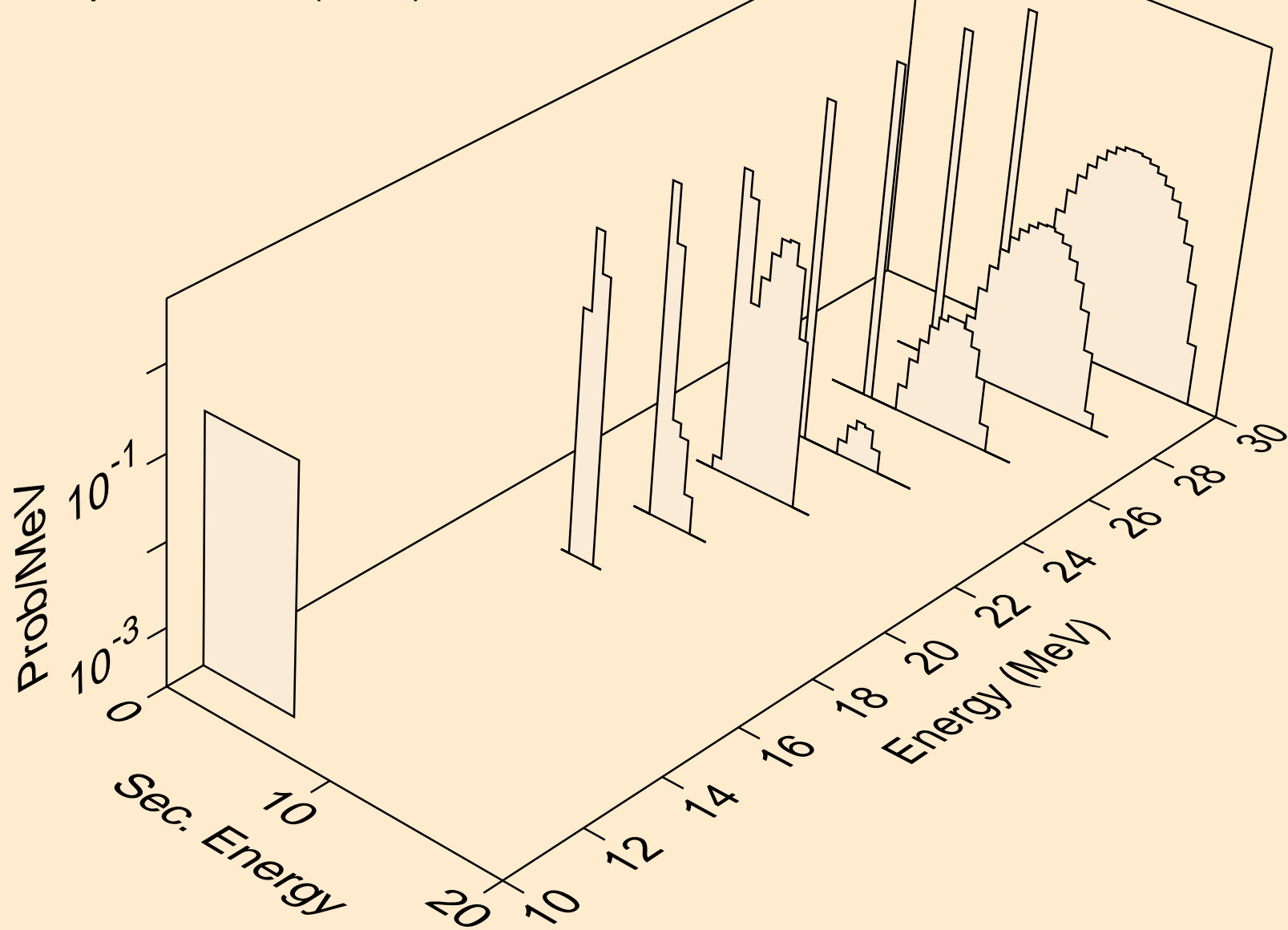

AU185M DEUTERON ACER TENDL-2023 LIBRARY; T=0.K  
alphas from (d,n\*)2a

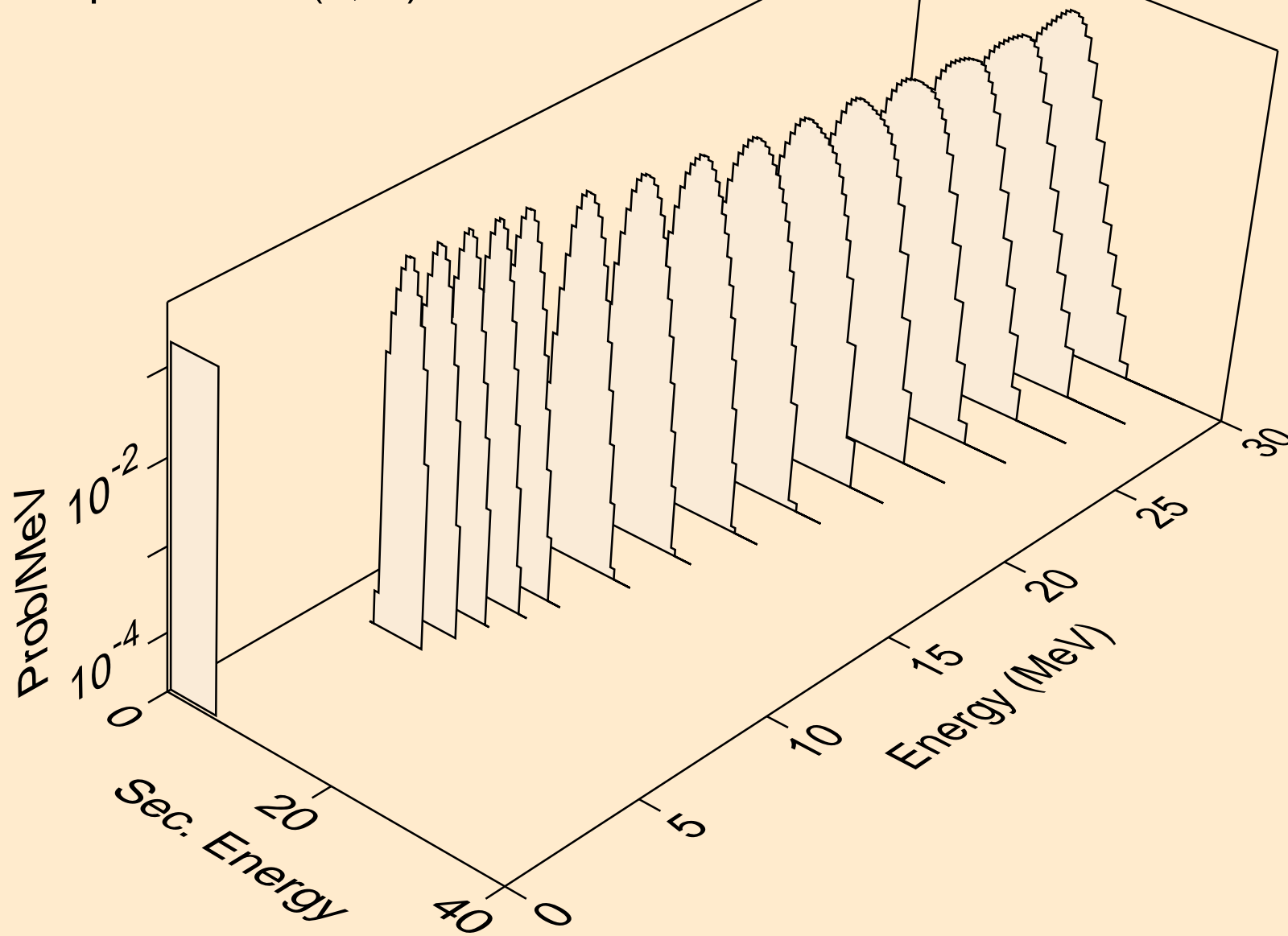

AU185M DEUTERON ACER TENDL-2023 LIBRARY; T=0.K  
alphas from (d,2n)2a

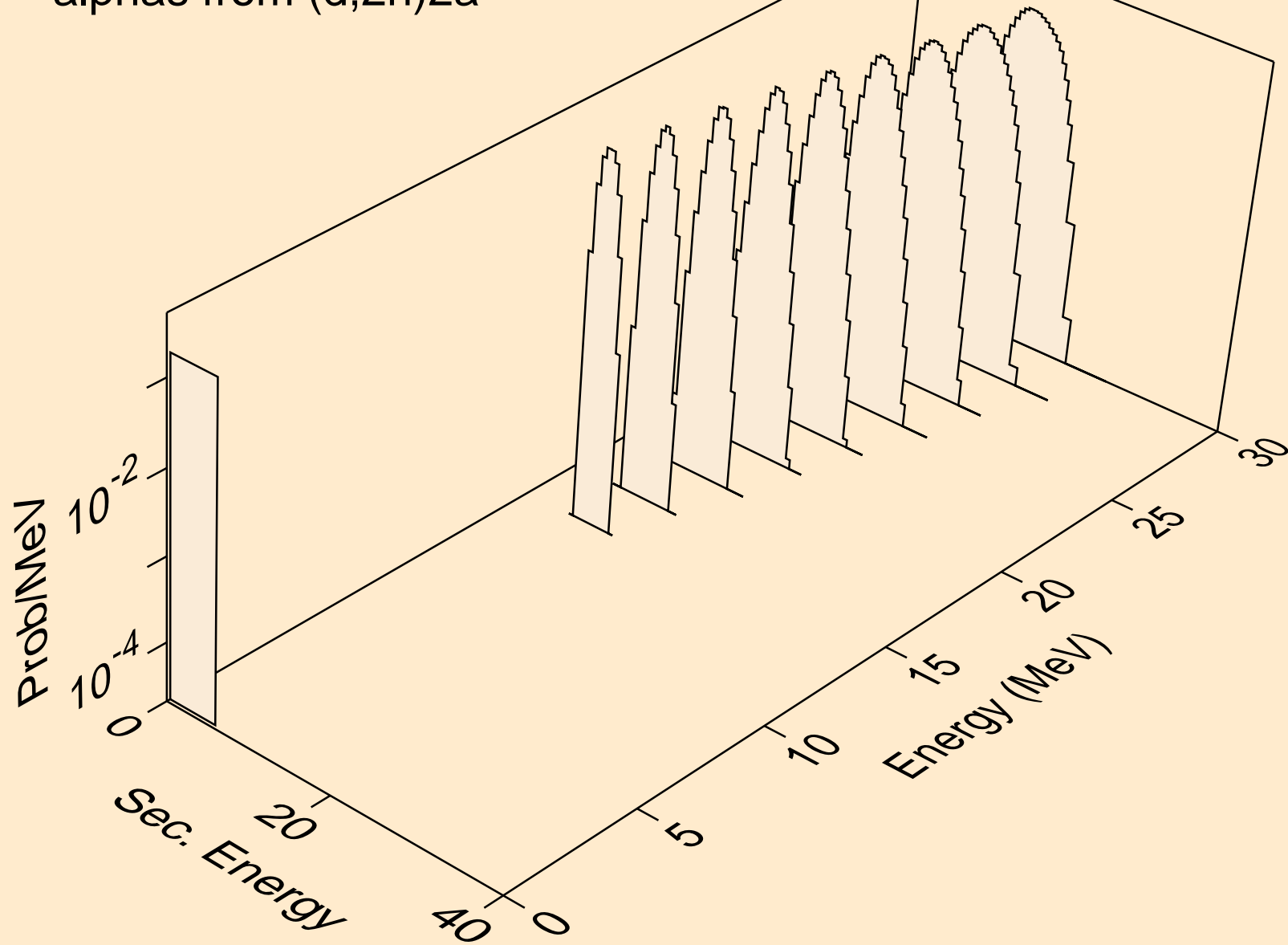

AU185M DEUTERON ACER TENDL-2023 LIBRARY; T=0.K  
alphas from (d,npa)

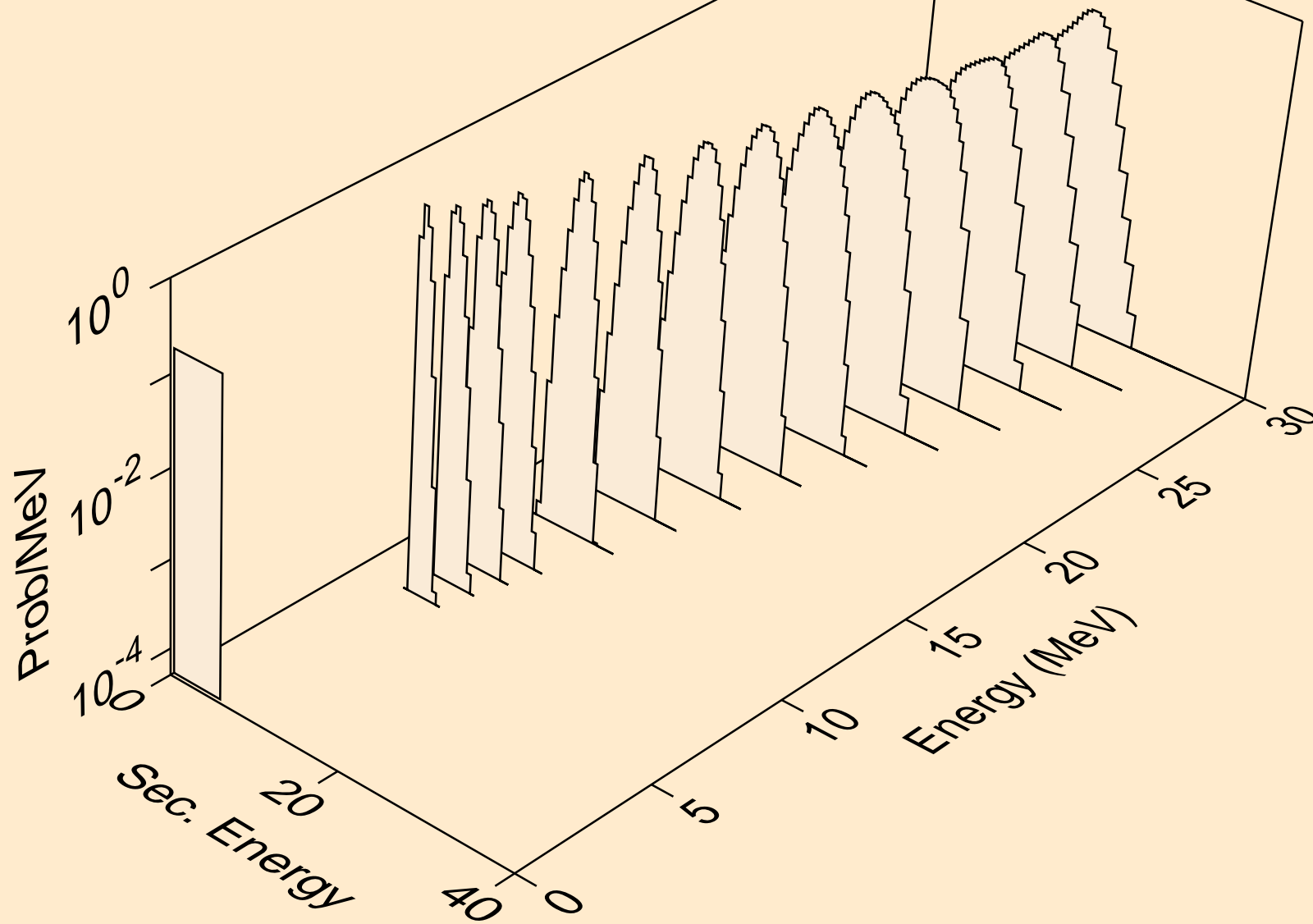

AU185M DEUTERON ACER TENDL-2023 LIBRARY; T=0.K  
alphas from (d,a)

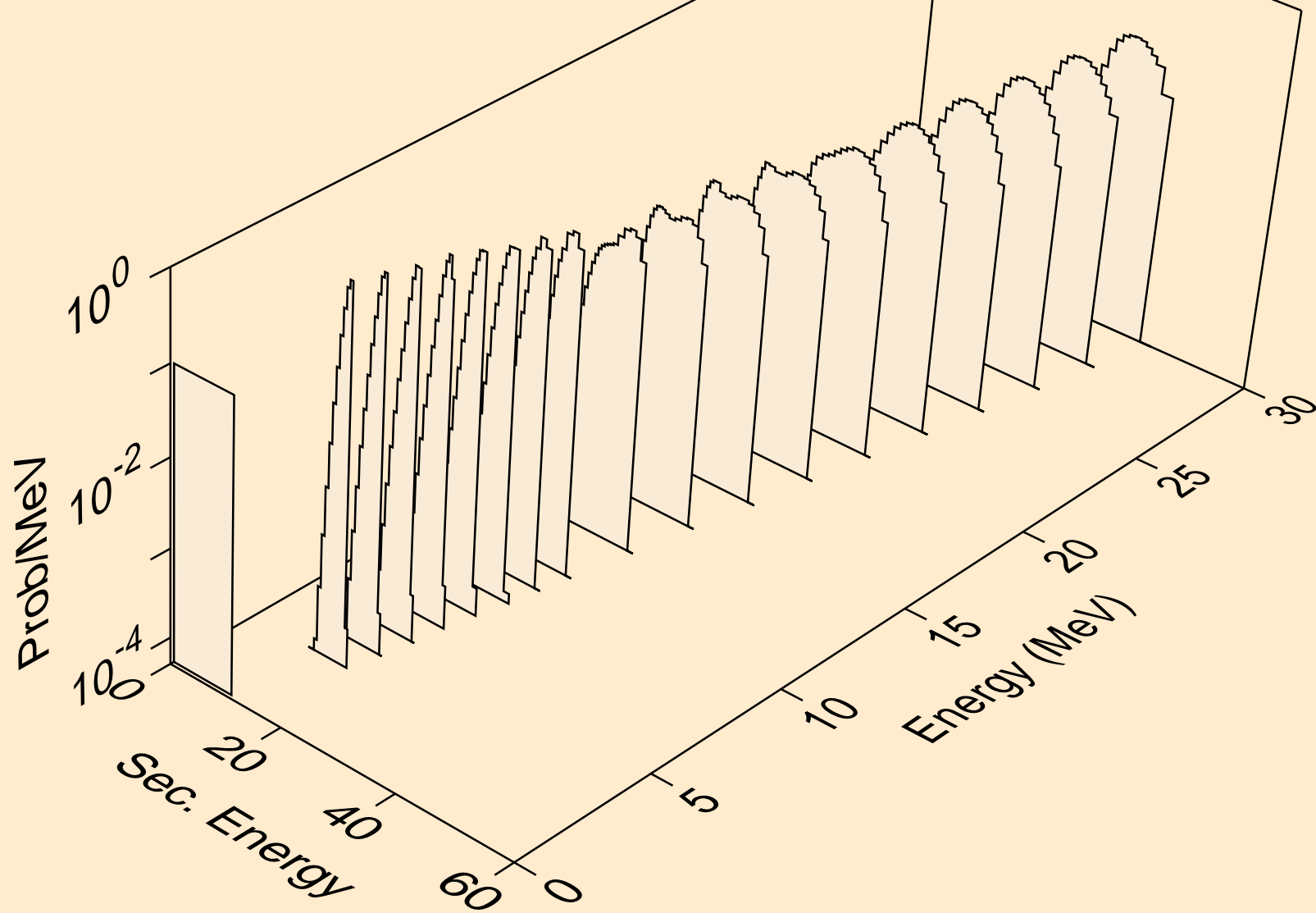

AU185M DEUTERON ACER TENDL-2023 LIBRARY; T=0.K  
alphas from (d,2a)

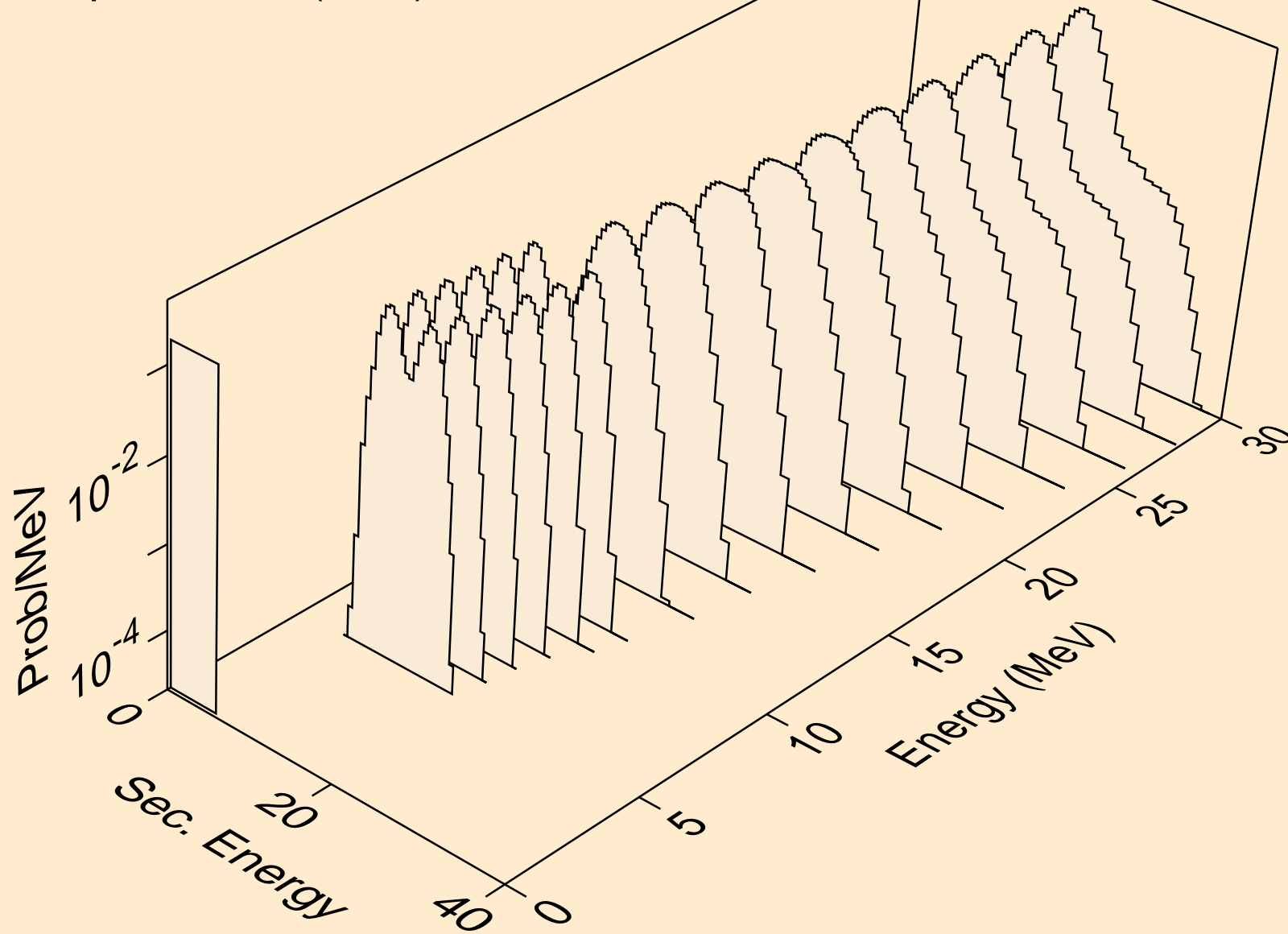



AU185M DEUTERON ACER TENDL-2023 LIBRARY; T=0.K  
alphas from (d,3a)

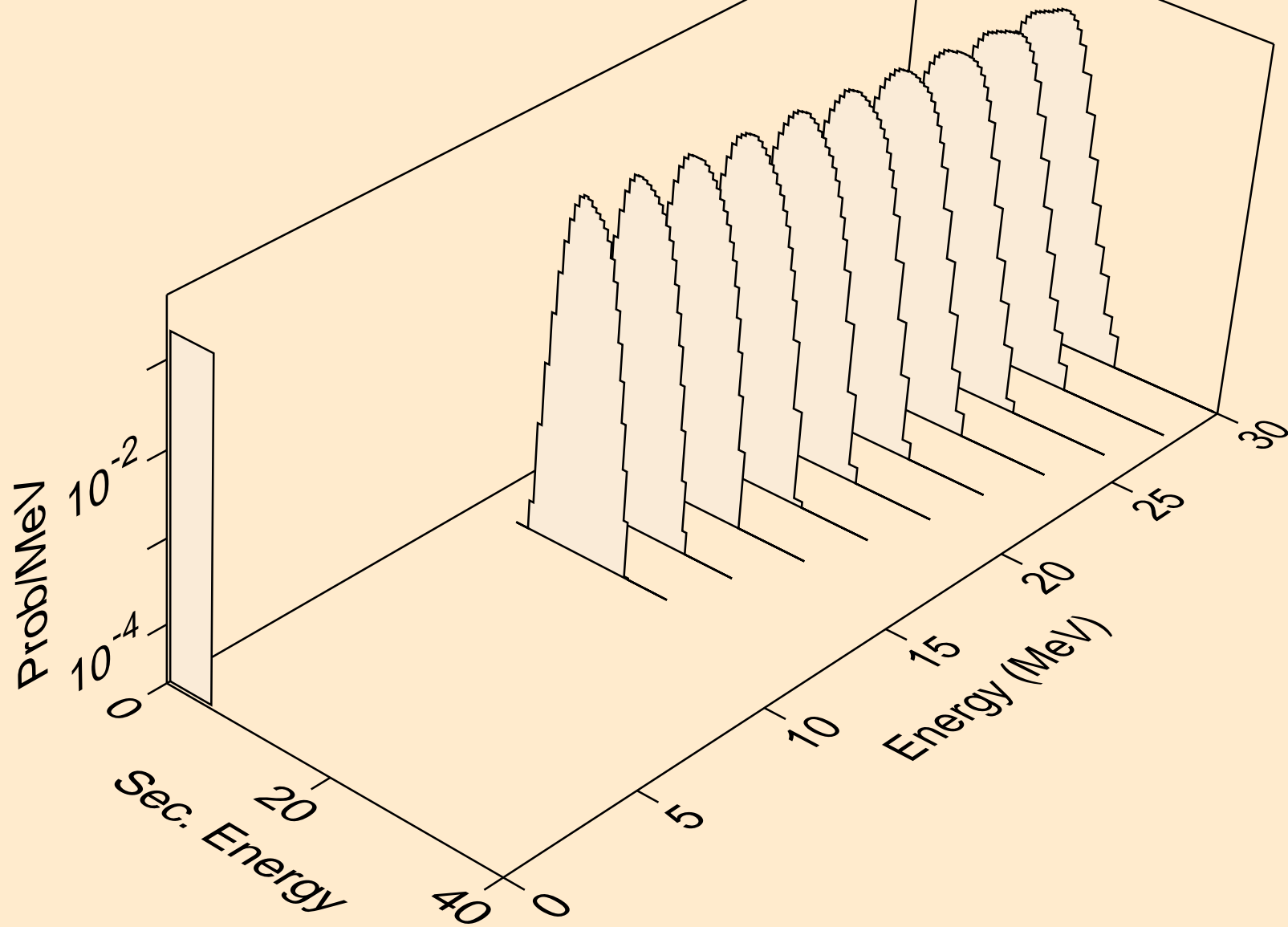

AU185M DEUTERON ACER TENDL-2023 LIBRARY; T=0.K  
alphas from (d,pa)

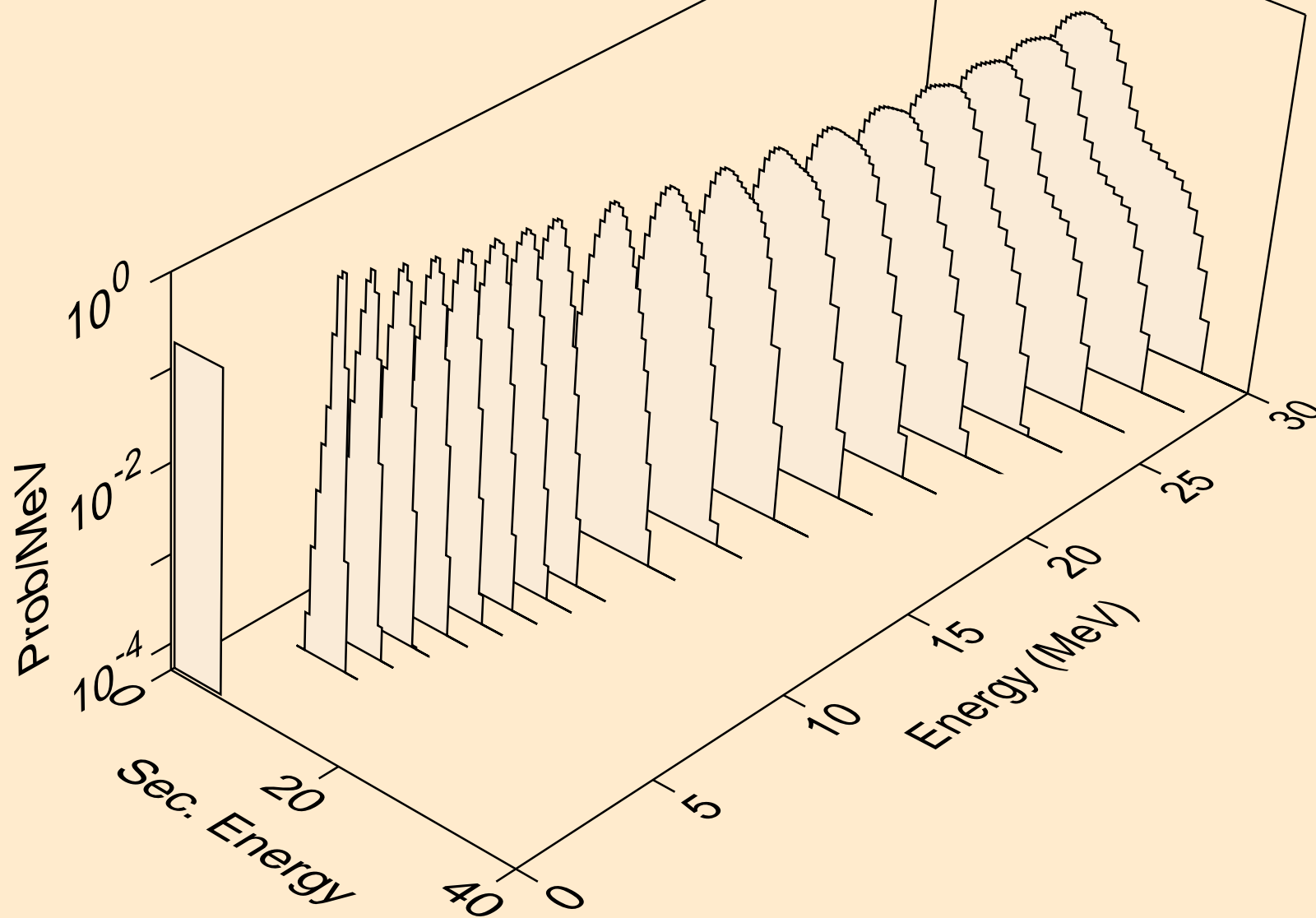

AU185M DEUTERON ACER TENDL-2023 LIBRARY; T=0.K  
alphas from (d,da)

