

AU189 DEUTERON ACER TENDL-2023 LIBRARY; T=0.K
Principal cross sections

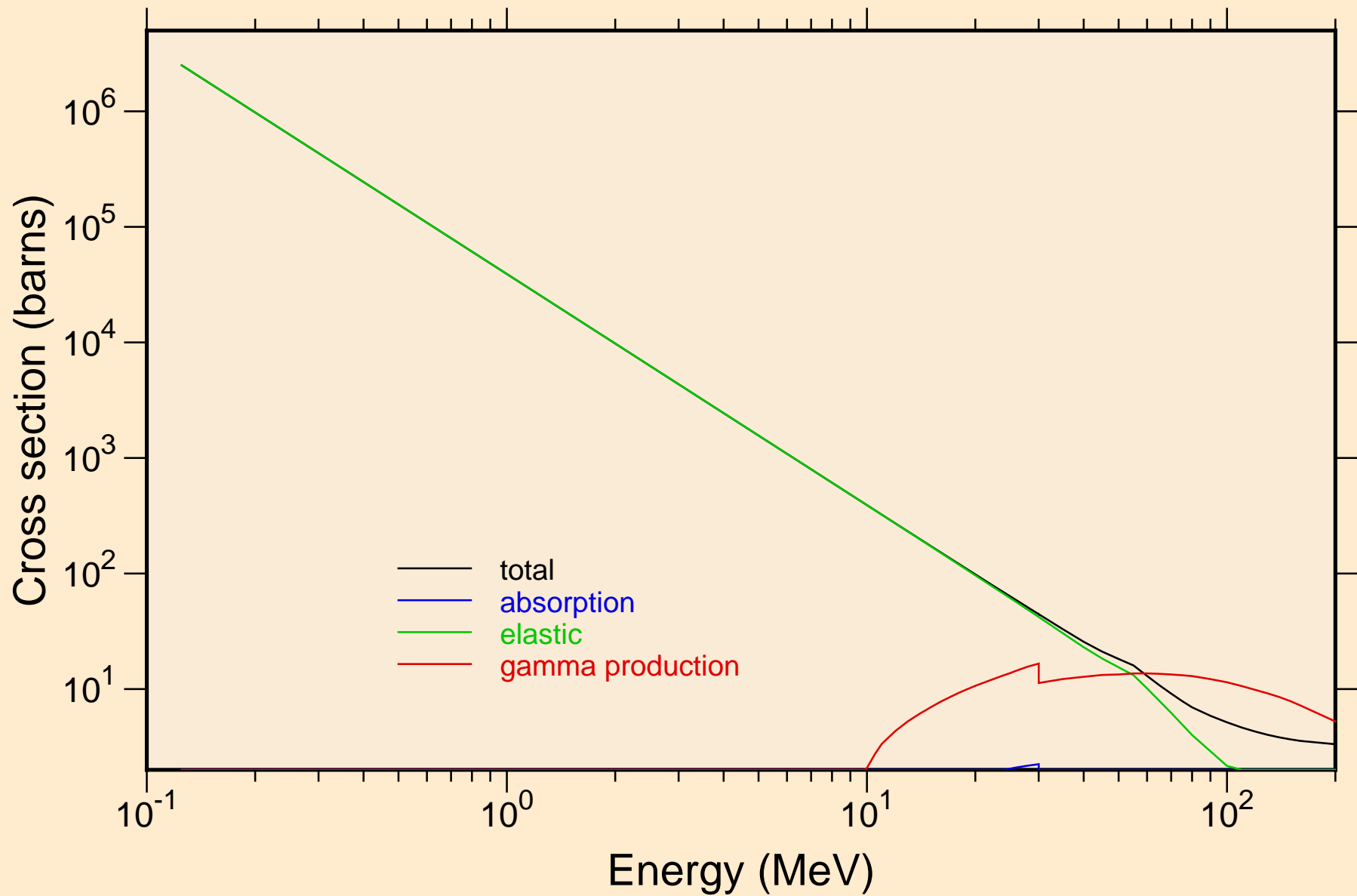

AU189 DEUTERON ACER TENDL-2023 LIBRARY; T=0.K
Heating

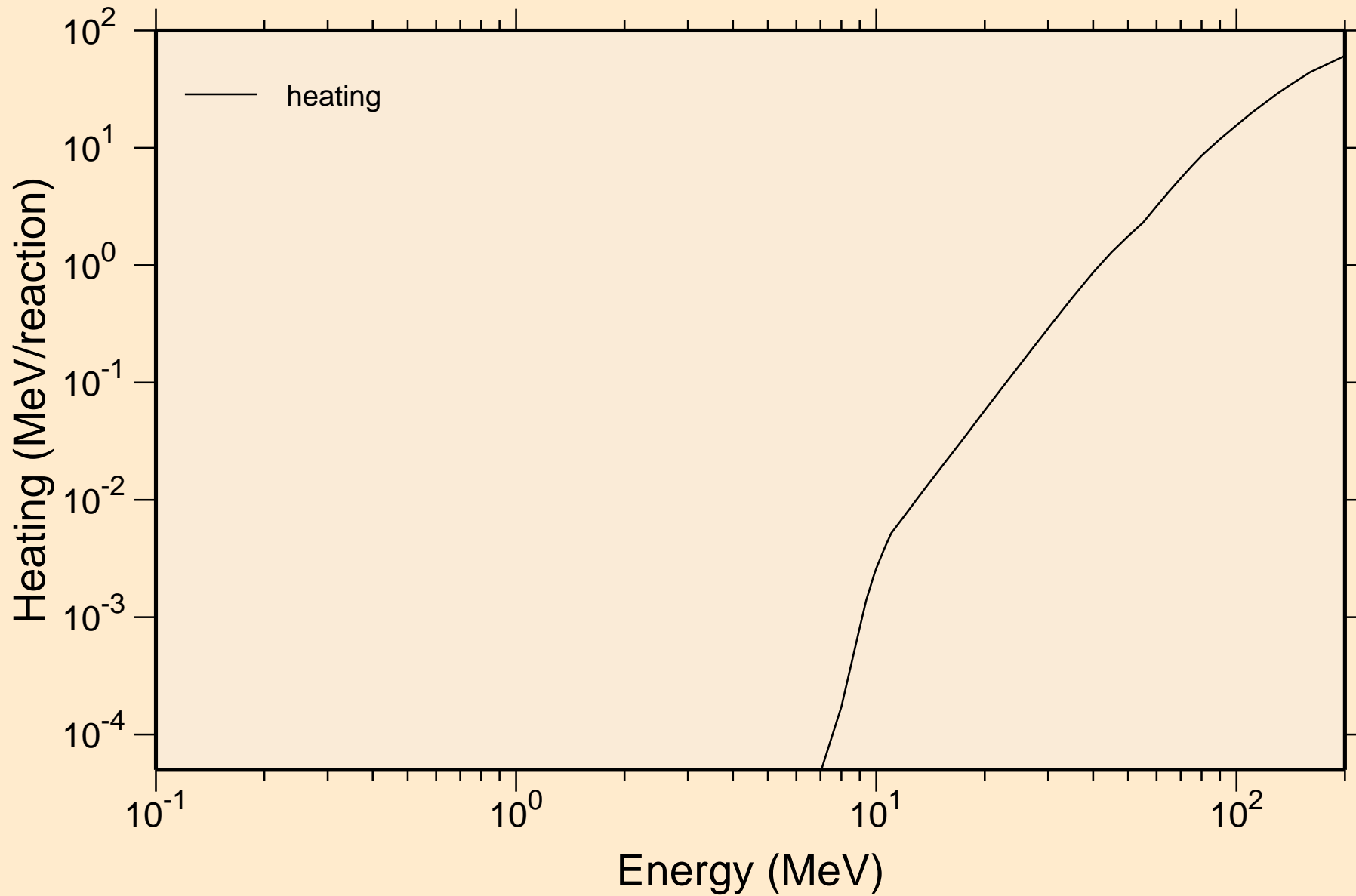

AU189 DEUTERON ACER TENDL-2023 LIBRARY; T=0.K
Principal cross sections

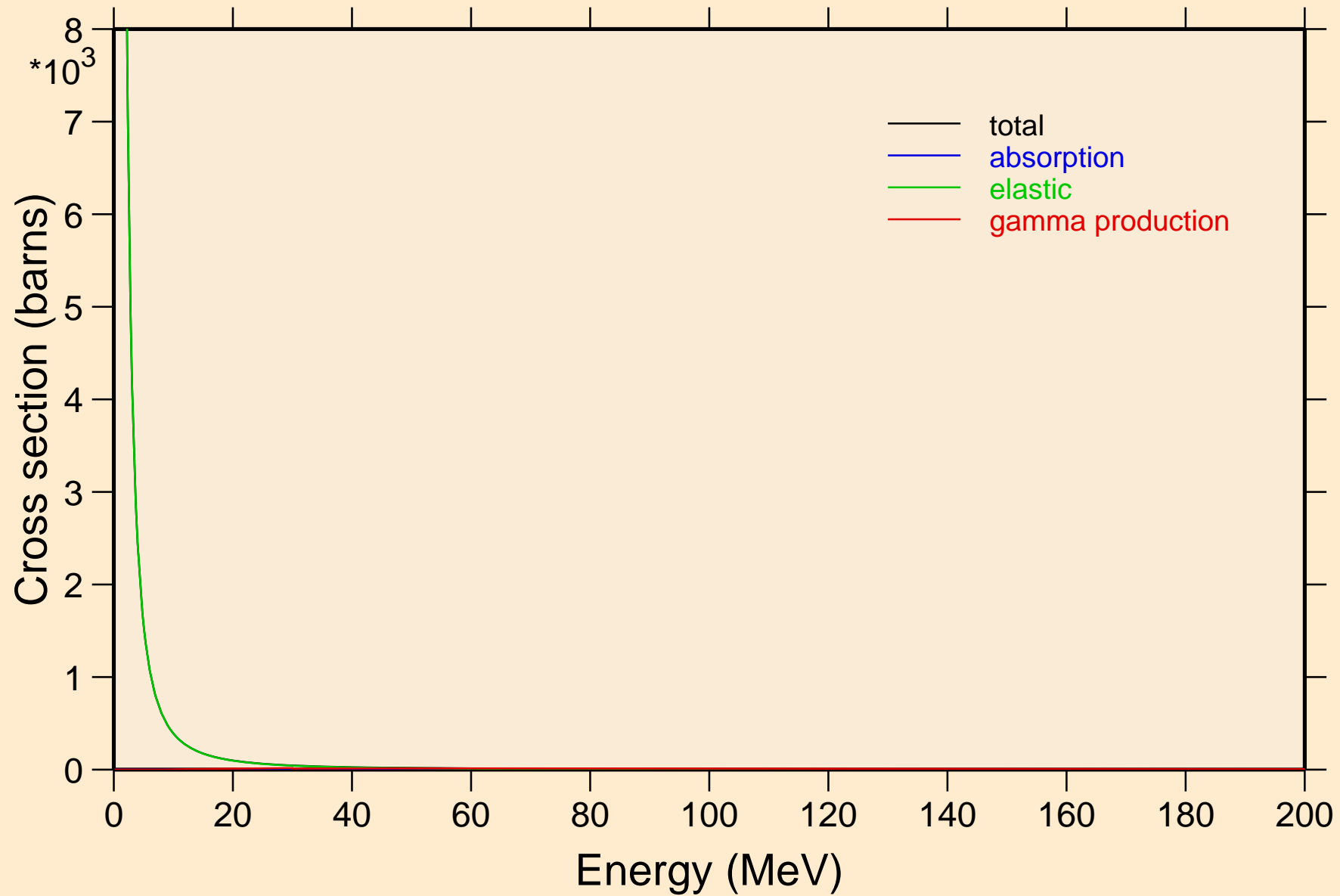

AU189 DEUTERON ACER TENDL-2023 LIBRARY; T=0.K
Heating

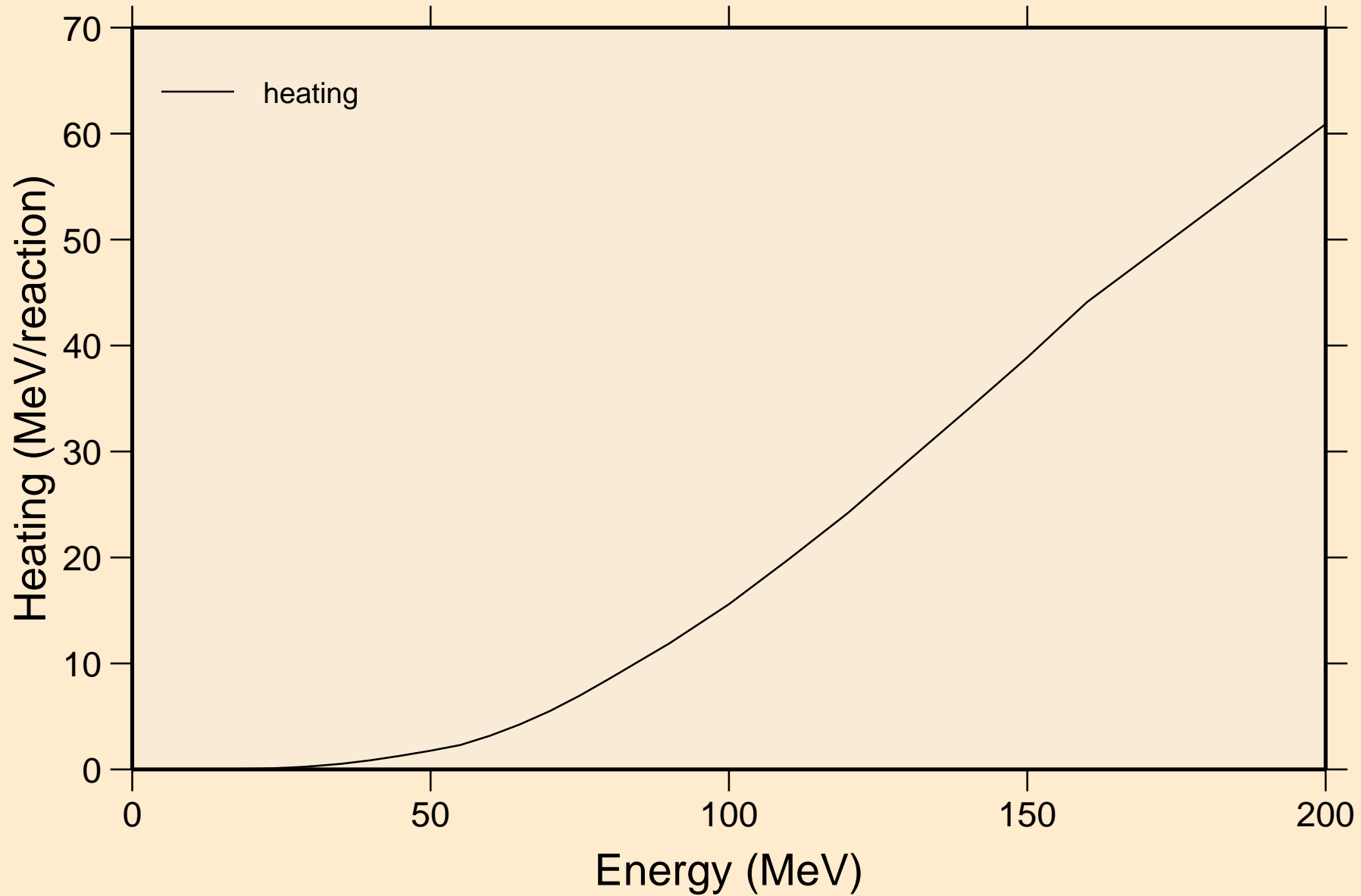

AU189 DEUTERON ACER TENDL-2023 LIBRARY; T=0.K

Threshold reactions

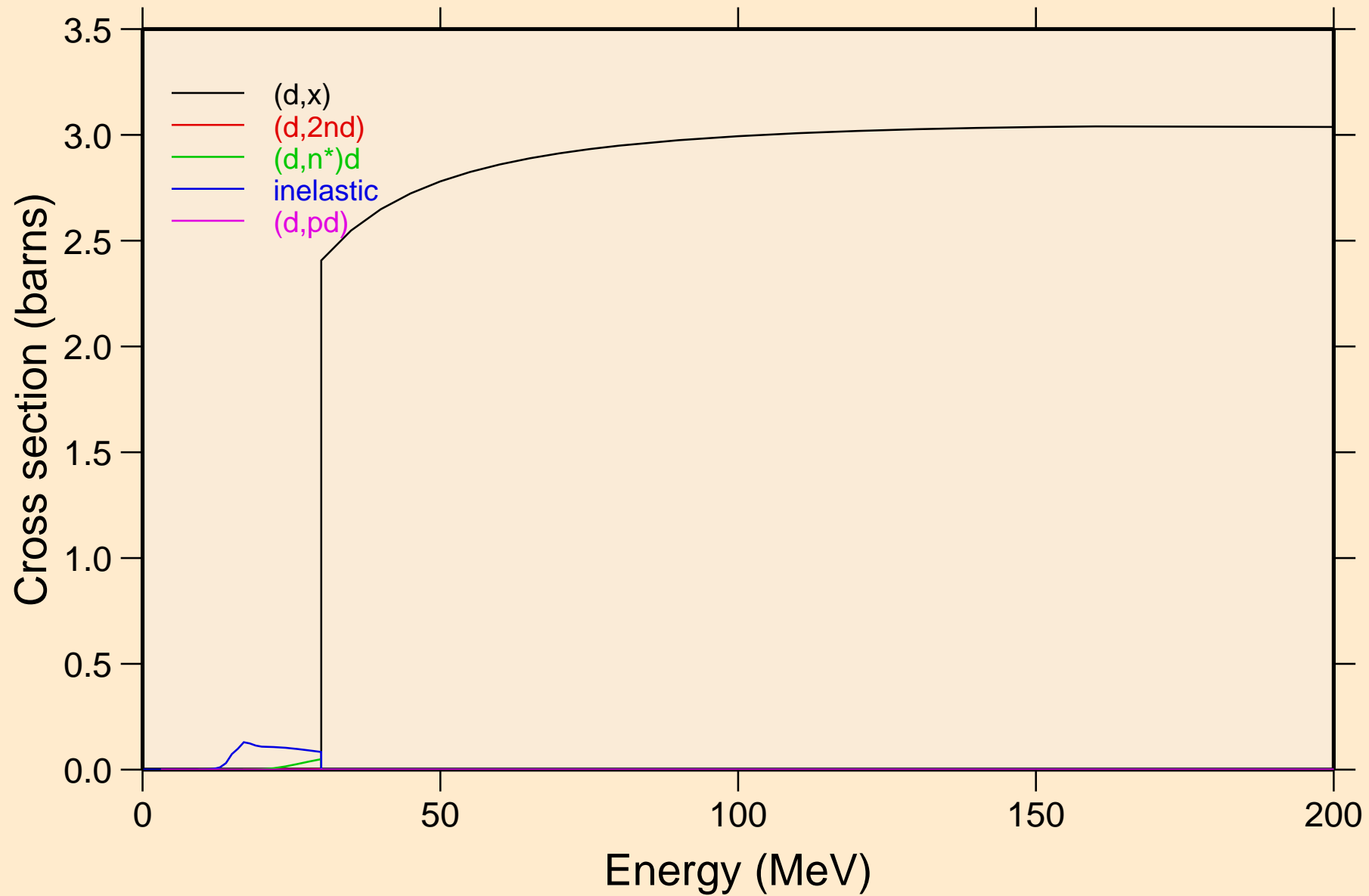

AU189 DEUTERON ACER TENDL-2023 LIBRARY; T=0.K
Threshold reactions

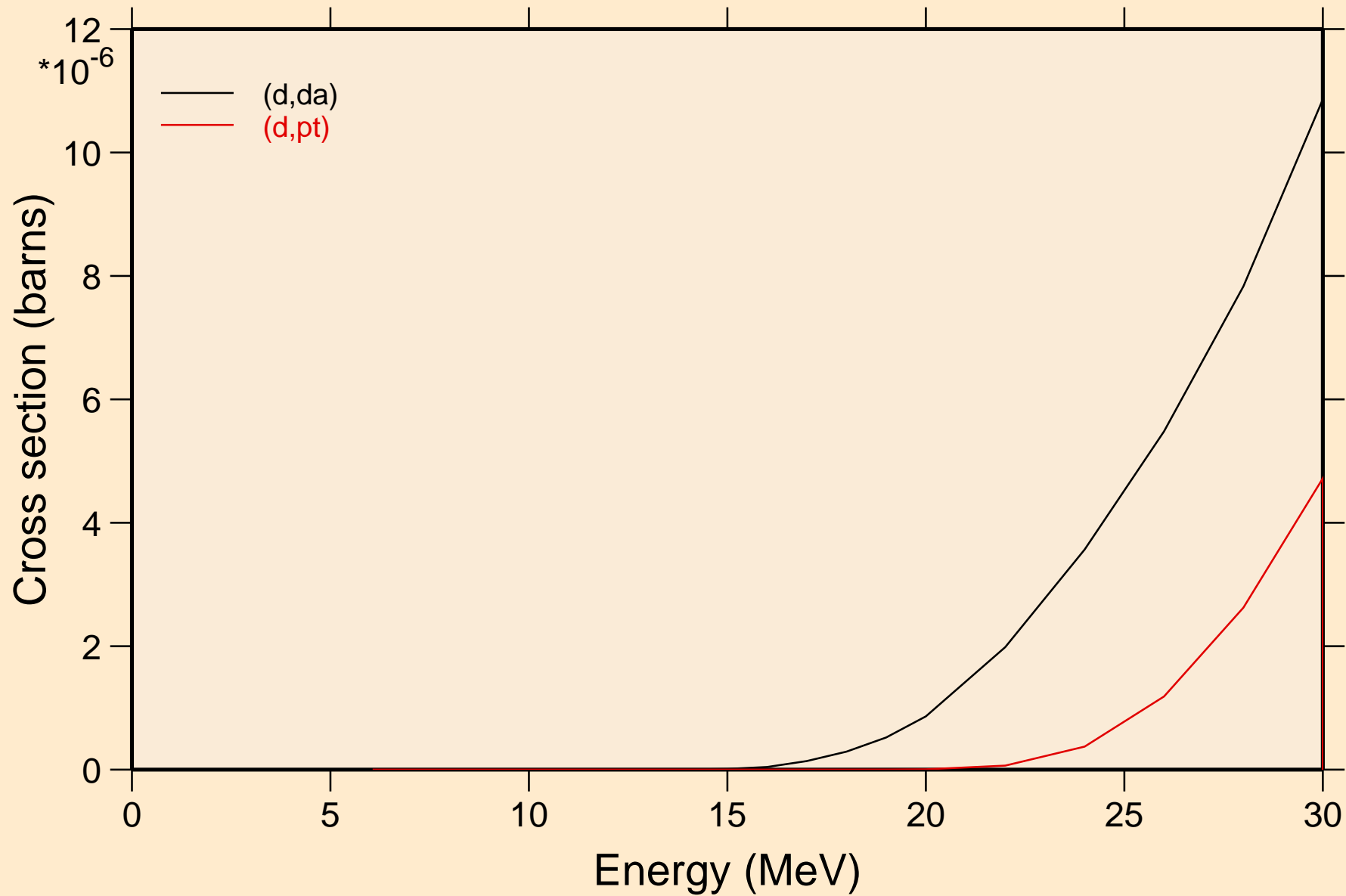

AU189 DEUTERON ACER TENDL-2023 LIBRARY; T=0.K
Threshold reactions

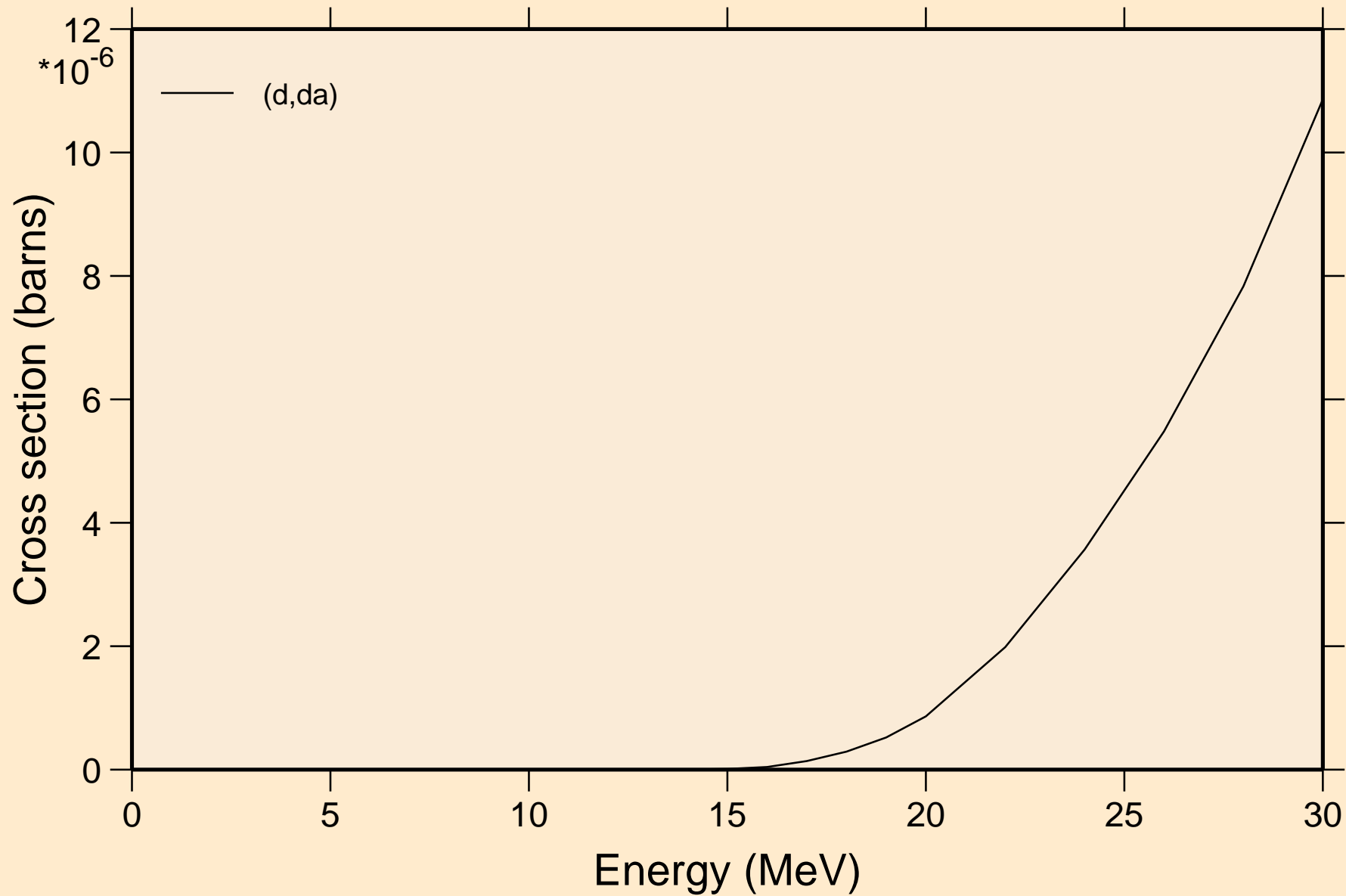

AU189 DEUTERON ACER TENDL-2023 LIBRARY; T=0.K
angular distribution for elastic

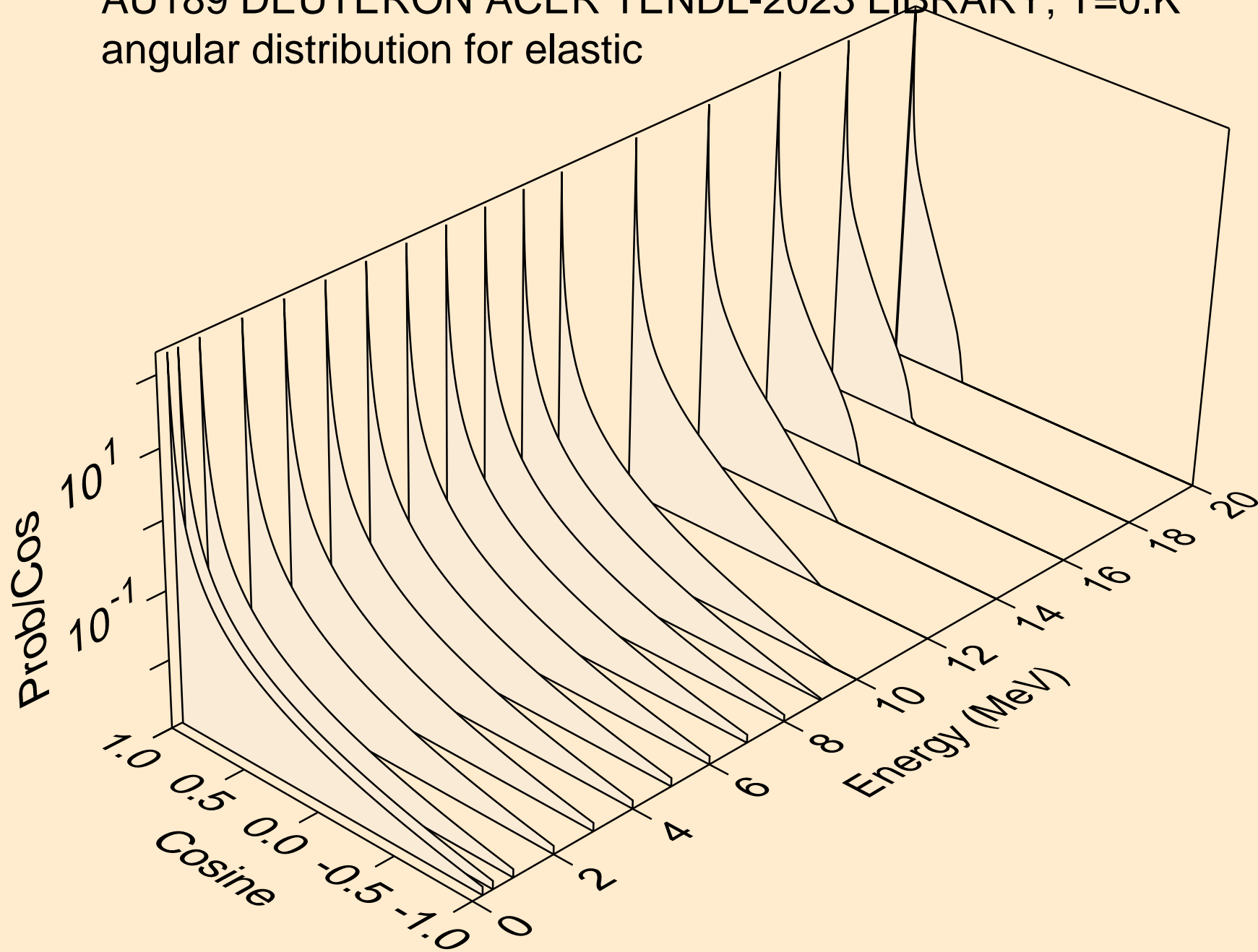

AU189 DEUTERON ACER TENDL-2023 LIBRARY; T=0.K
angular distribution for elastic

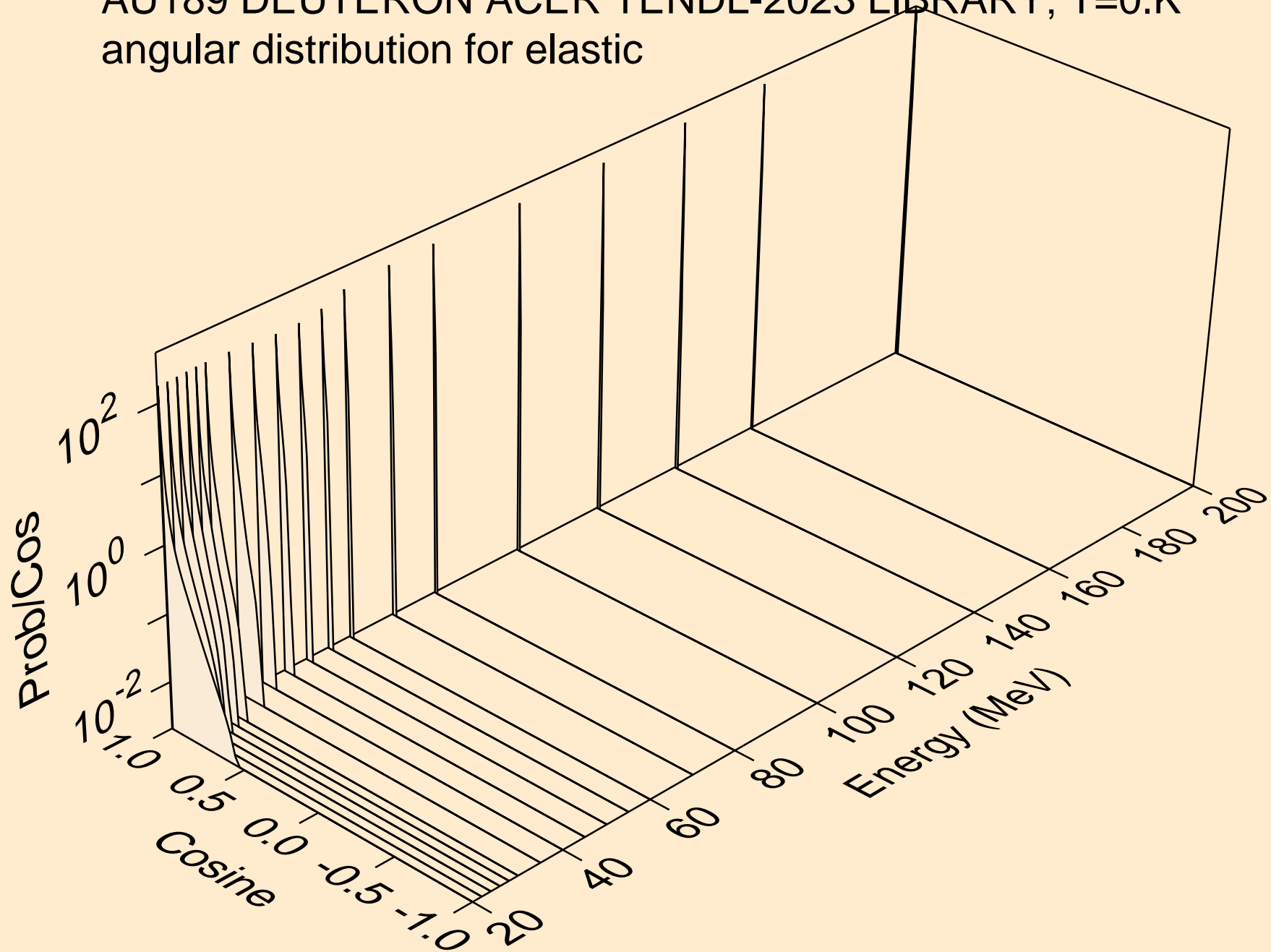

AU189 DEUTERON ACER TENDL-2023 LIBRARY; T=0.K
Deuteron emission for (d,x)

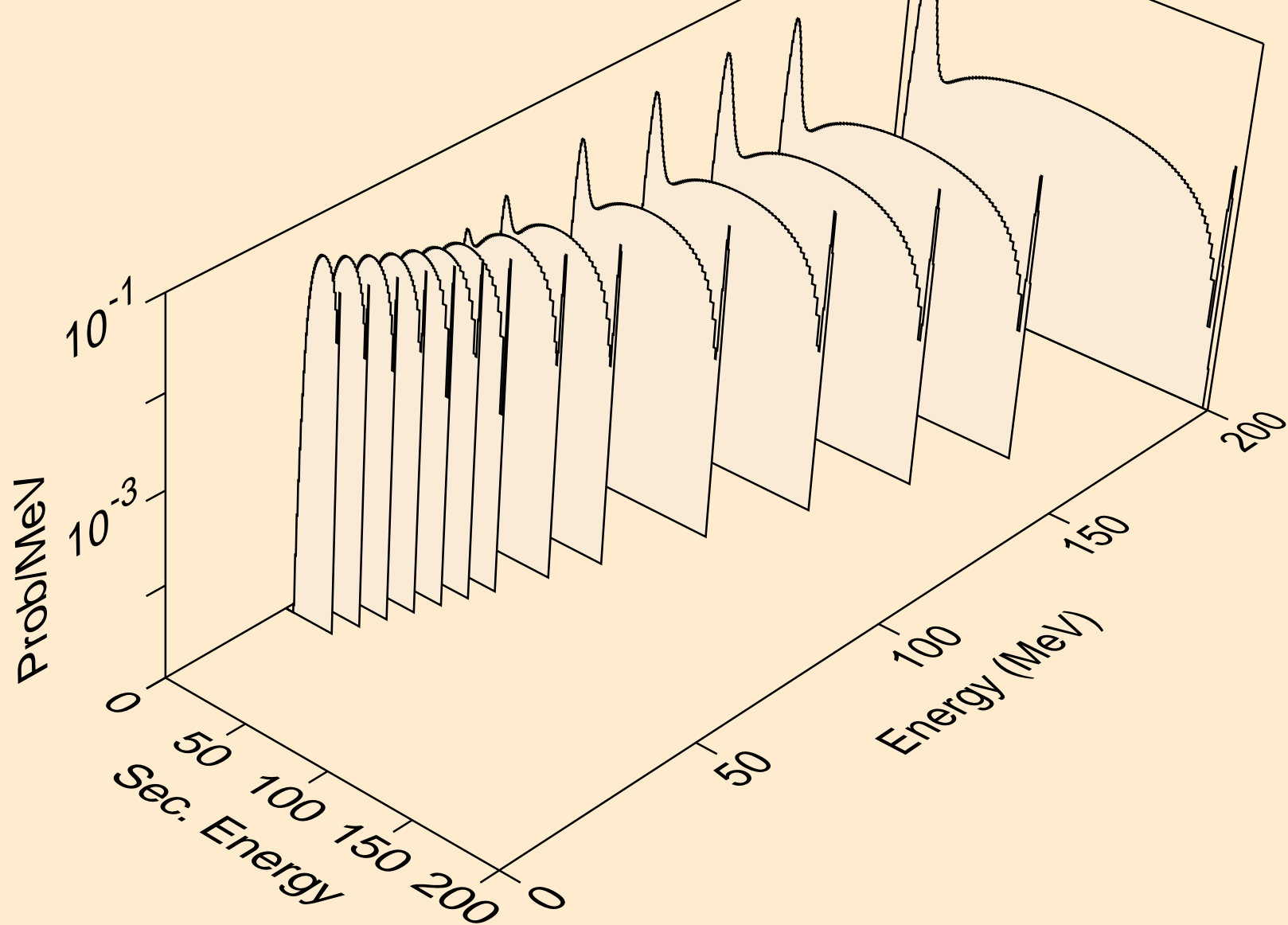

AU189 DEUTERON ACER TENDL-2023 LIBRARY; T=0.K
Deuteron emission for (d,2nd)

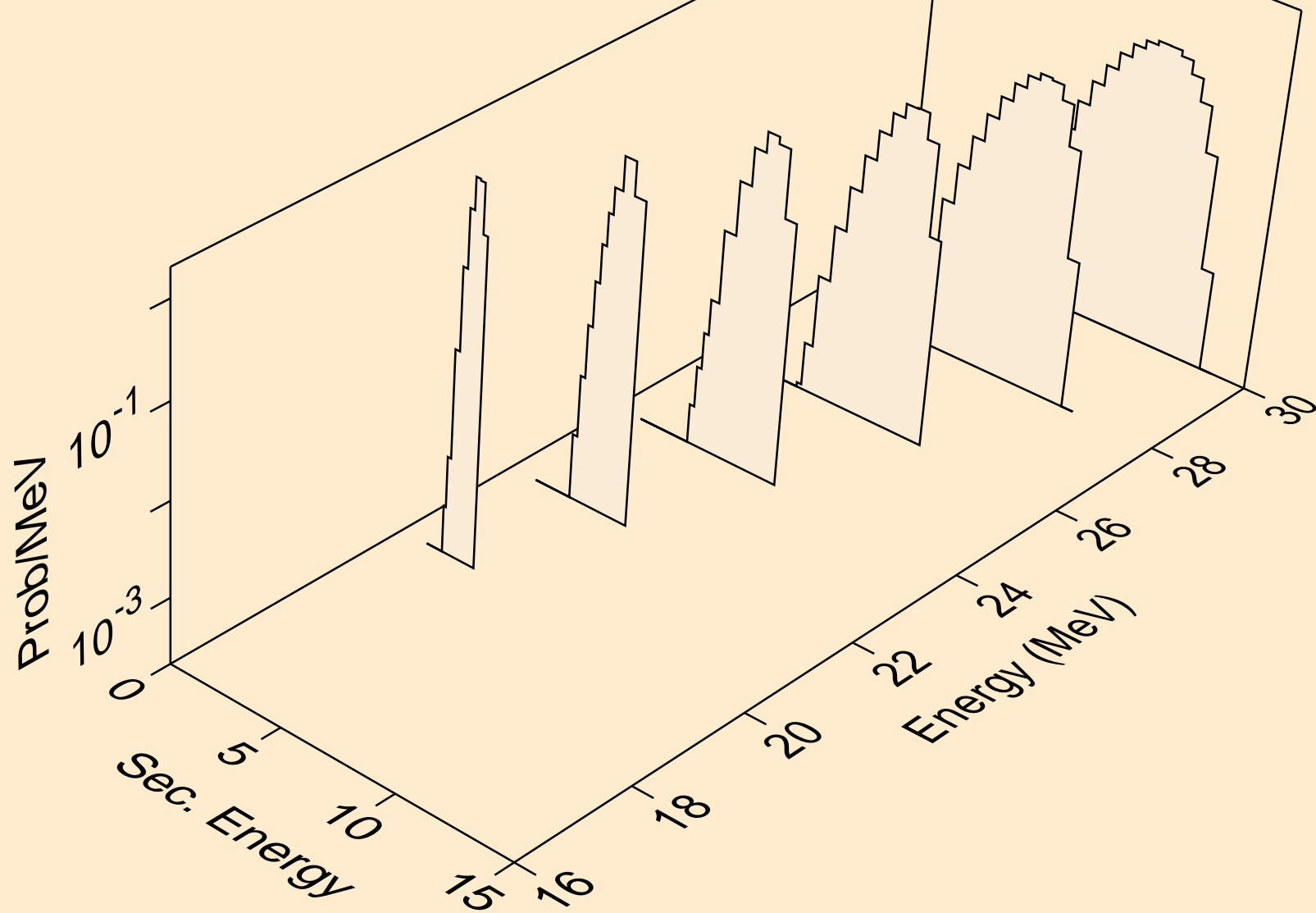

AU189 DEUTERON ACER TENDL-2023 LIBRARY; T=0.K
Deuteron emission for (d,n*)d

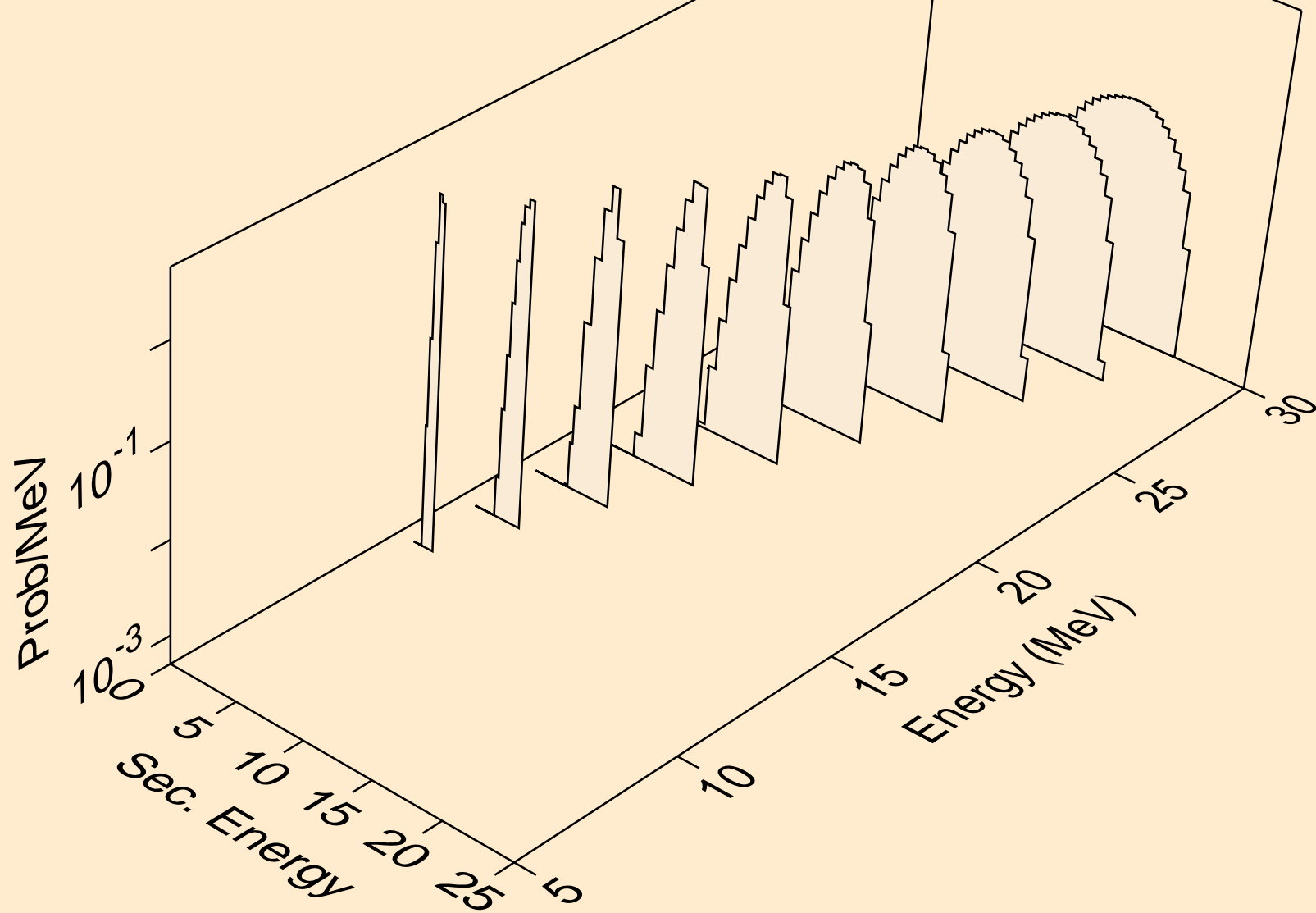

AU189 DEUTERON ACER TENDL-2023 LIBRARY; T=0.K
Deuteron emission for inelastic

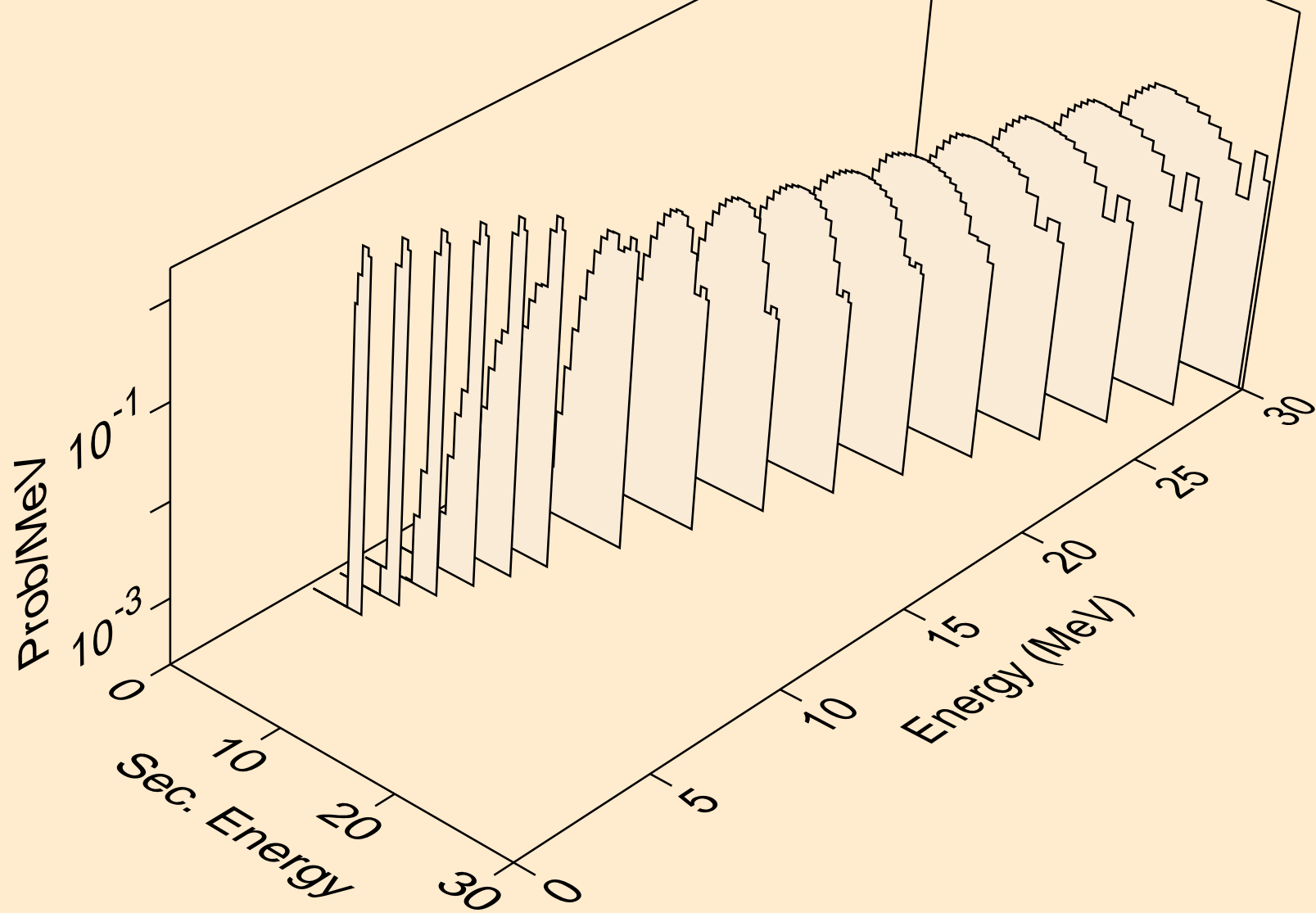

AU189 DEUTERON ACER TENDL-2023 LIBRARY; T=0.K
Deuteron emission for (d,pd)

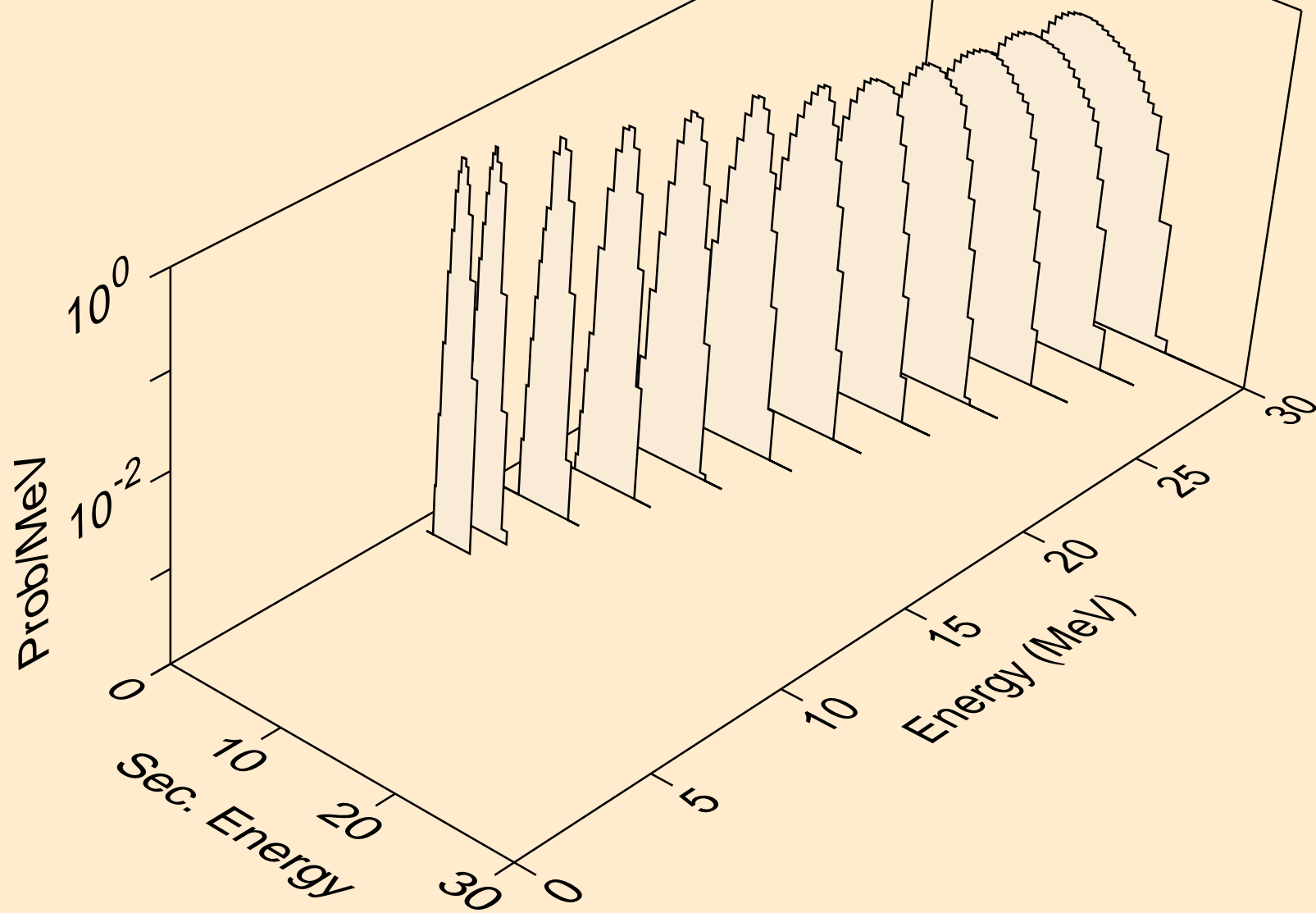

AU189 DEUTERON ACER TENDL-2023 LIBRARY; T=0.K
Deuteron emission for (d,da)

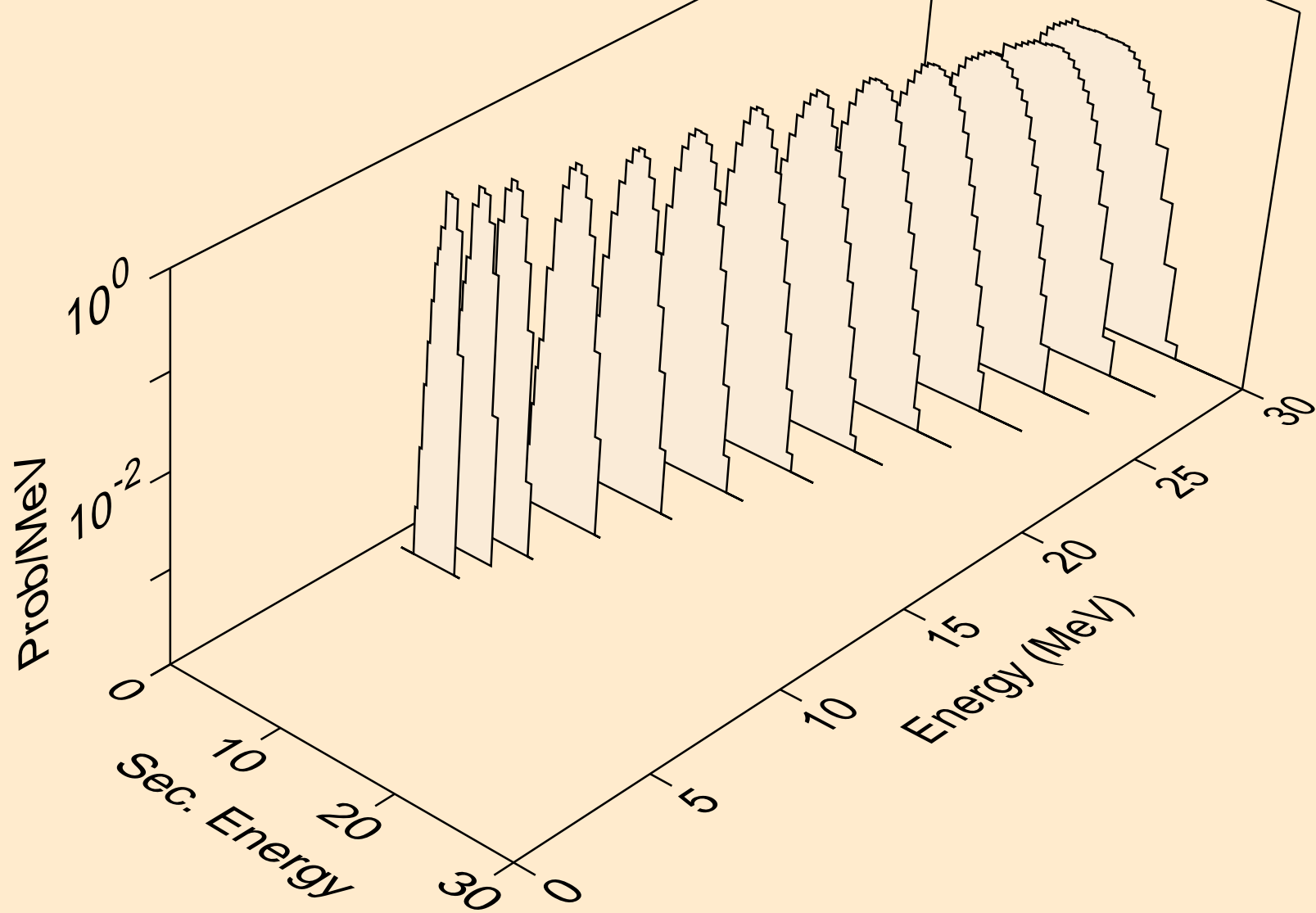

AU189 DEUTERON ACER TENDL-2023 LIBRARY; T=0.K
Photon emission for (z,n)

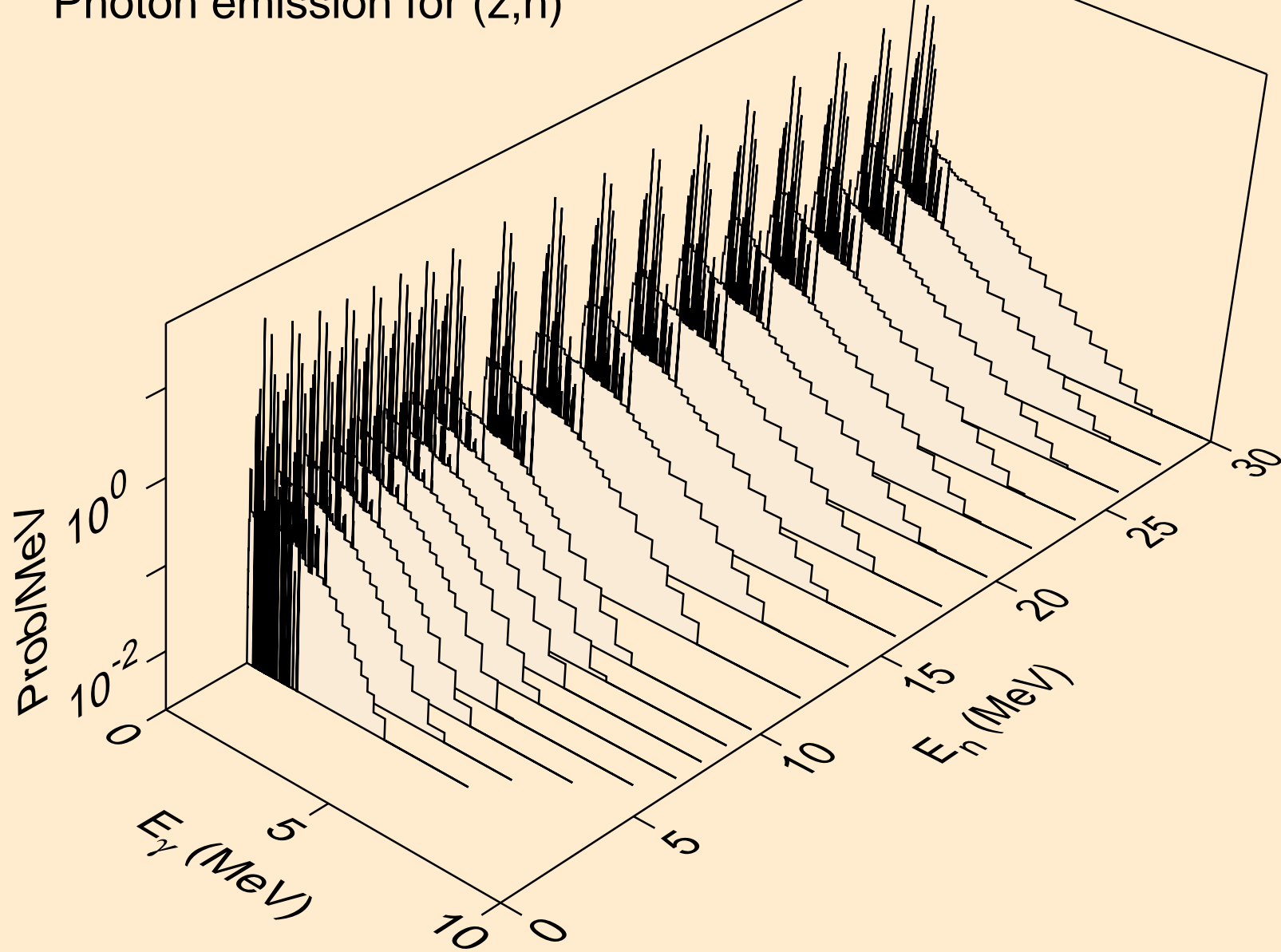

AU189 DEUTERON ACER TENDL-2023 LIBRARY; T=0.K
Photon emission for (z,x)

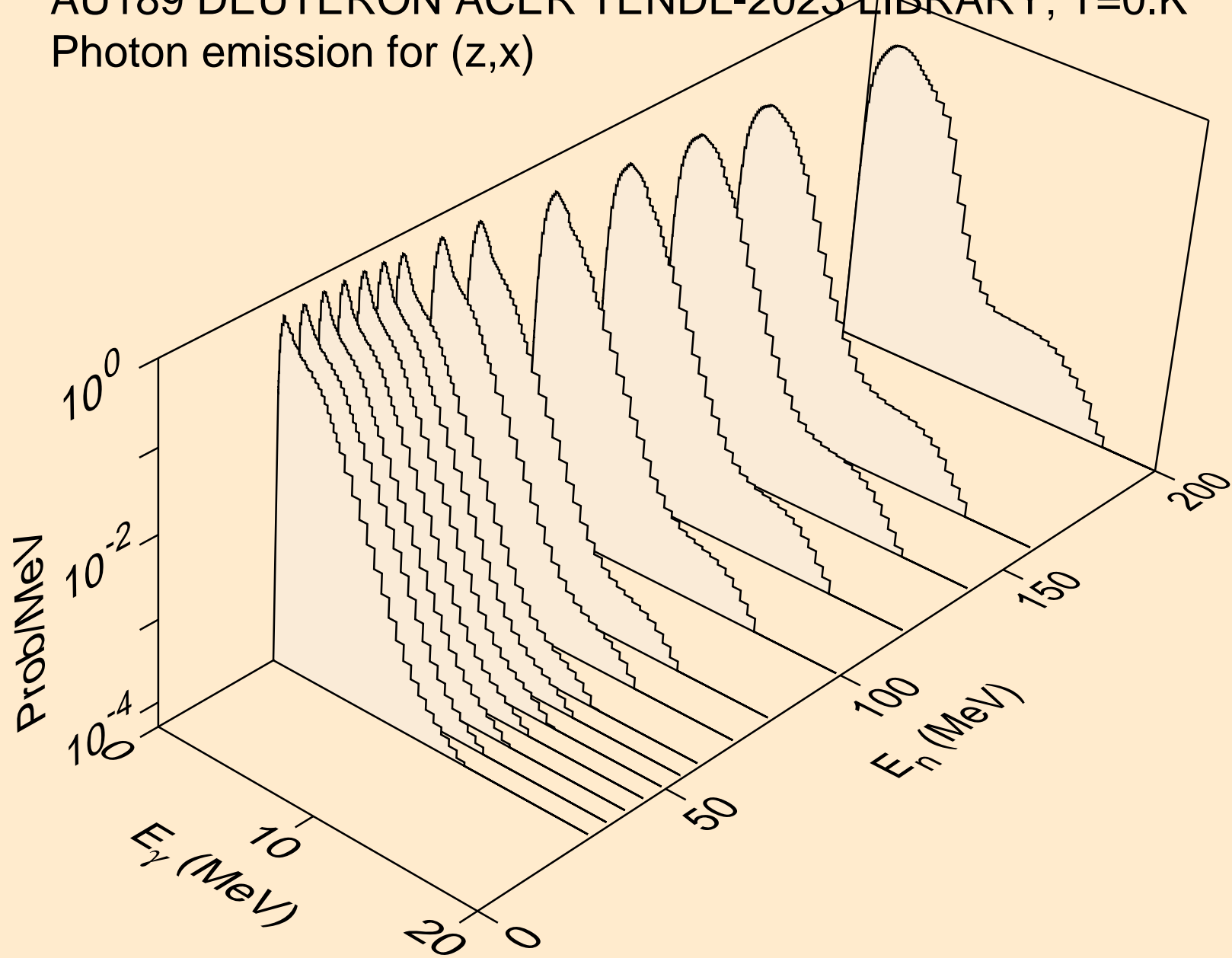

AU189 DEUTERON ACER TENDL-2023 LIBRARY; T=0.K
Photon emission for (n,2nd)

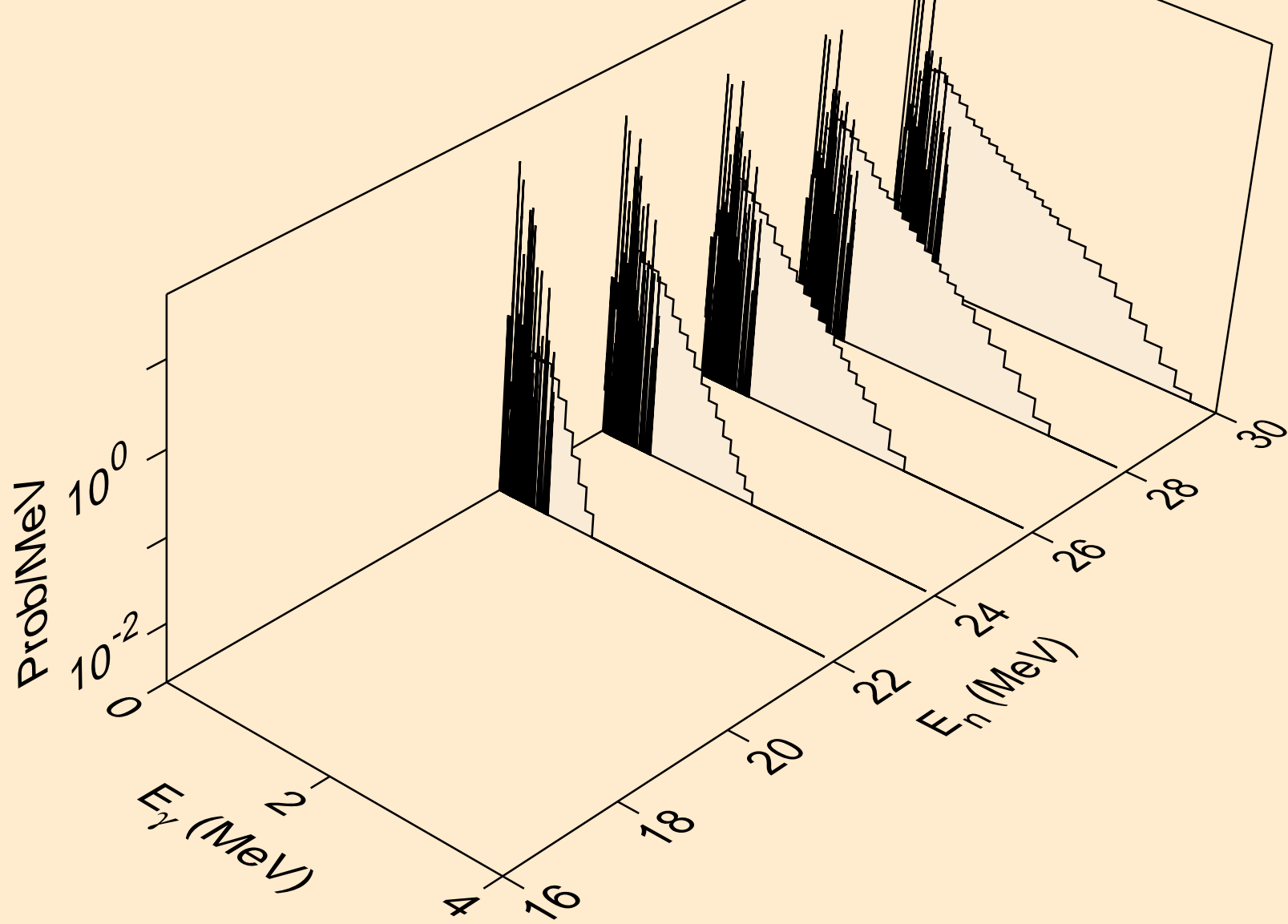

AU189 DEUTERON ACER TENDL-2023 LIBRARY; T=0.K
Photon emission for (n,2n)

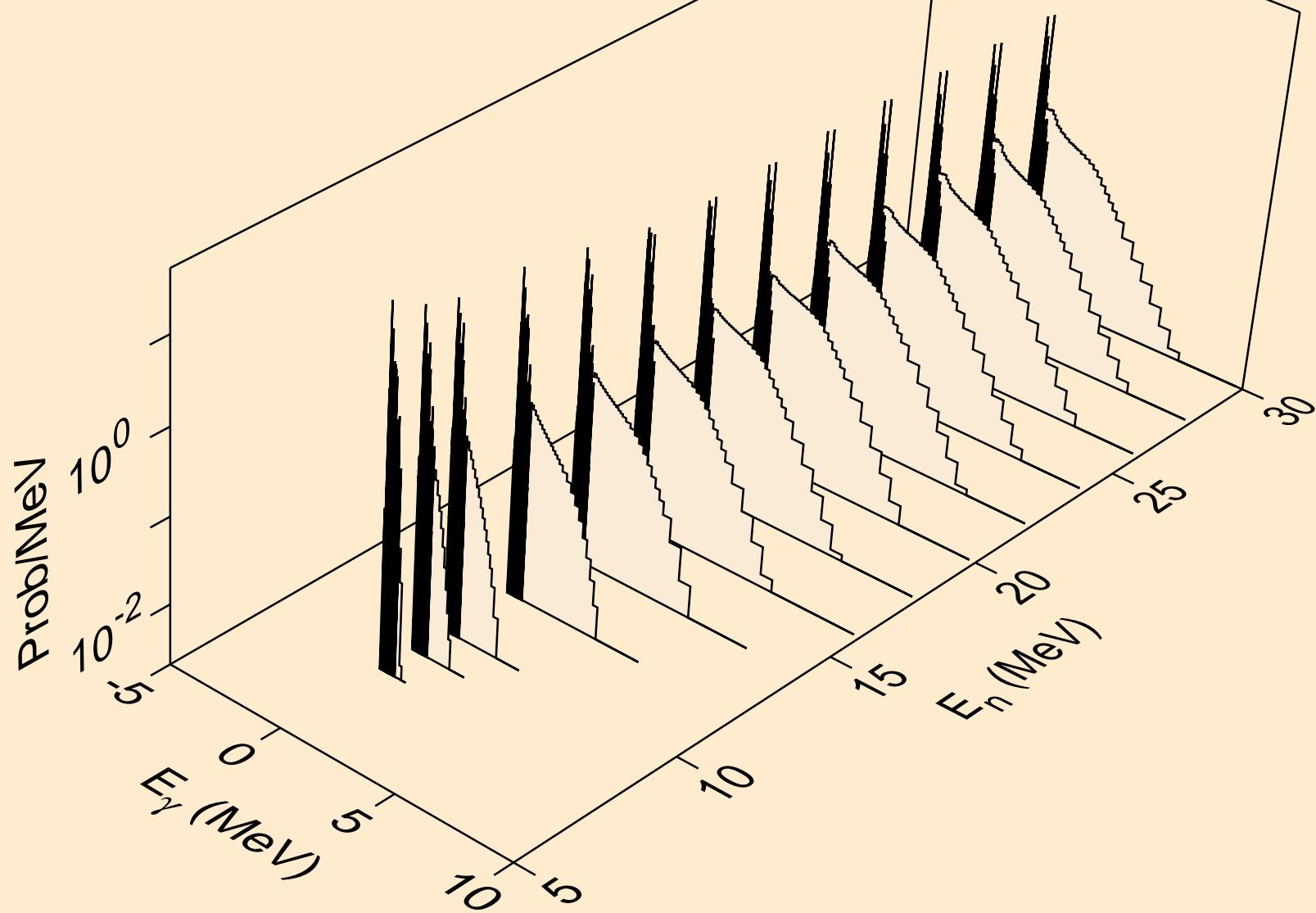

AU189 DEUTERON ACER TENDL-2023 LIBRARY; T=0.K
Photon emission for (n,3n)

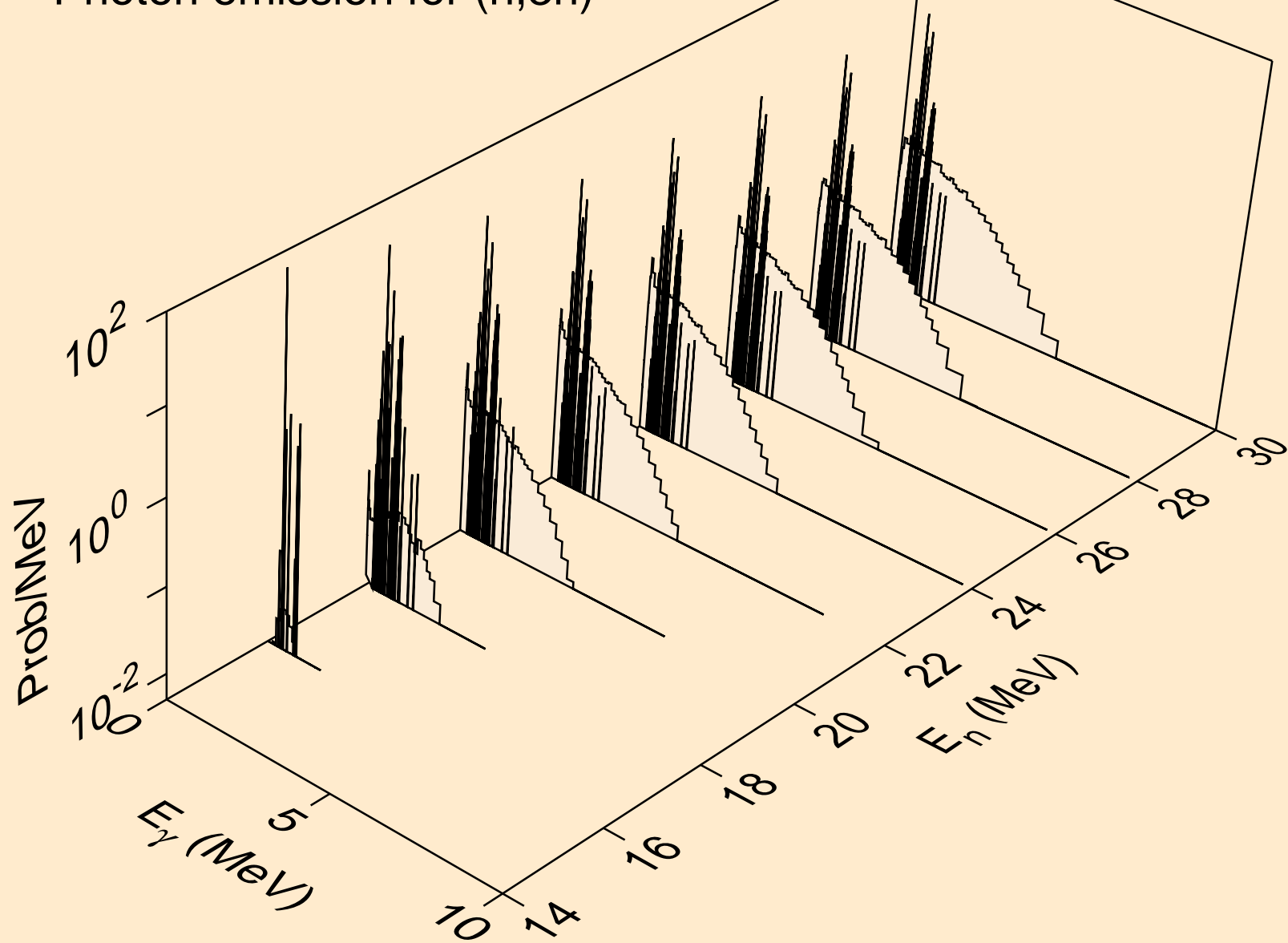

AU189 DEUTERON ACER TENDL-2023 LIBRARY; T=0.K
Photon emission for (n,n*)a

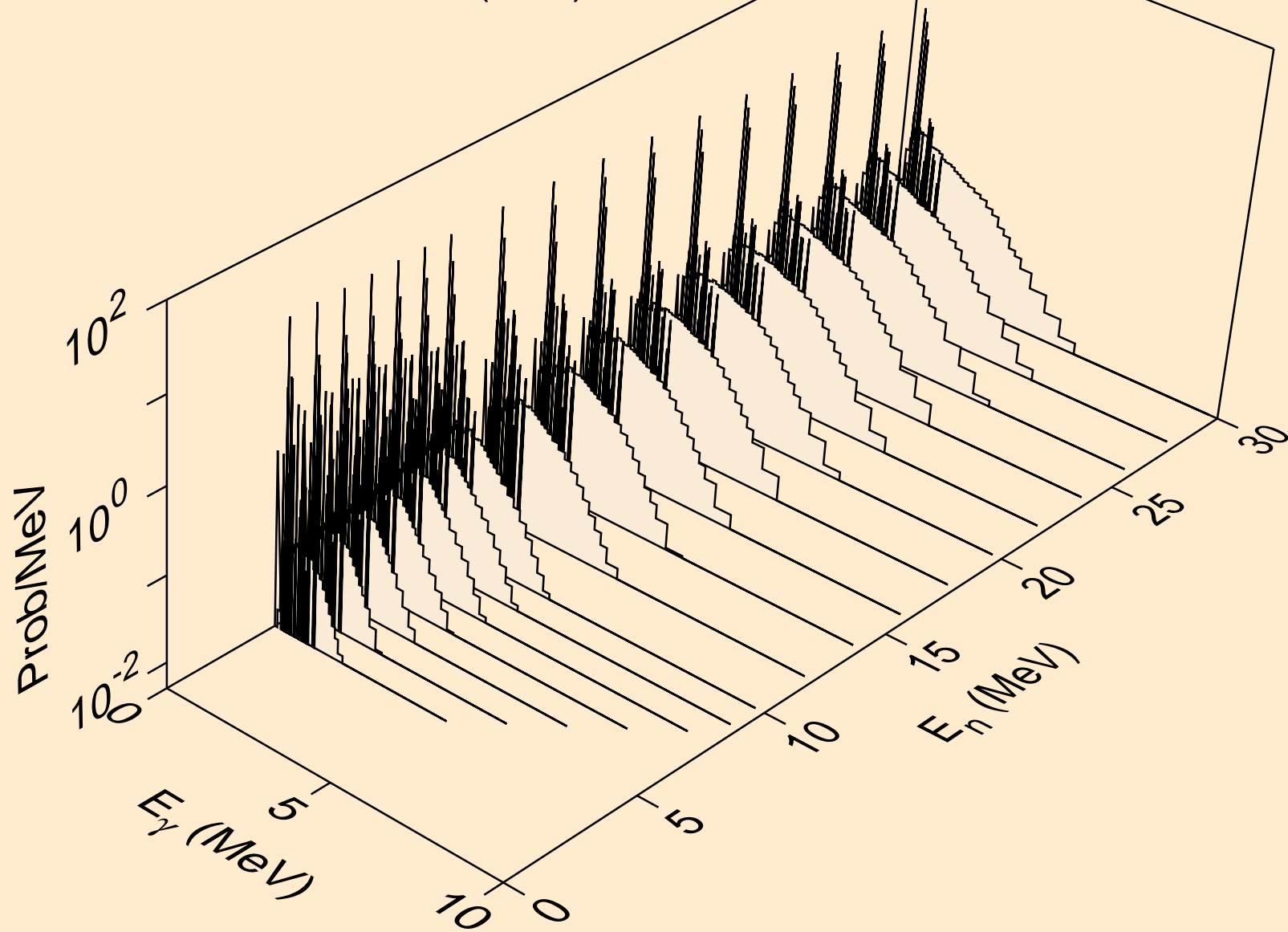

AU189 DEUTERON ACER TENDL-2023 LIBRARY; T=0.K
Photon emission for (n,2n) α

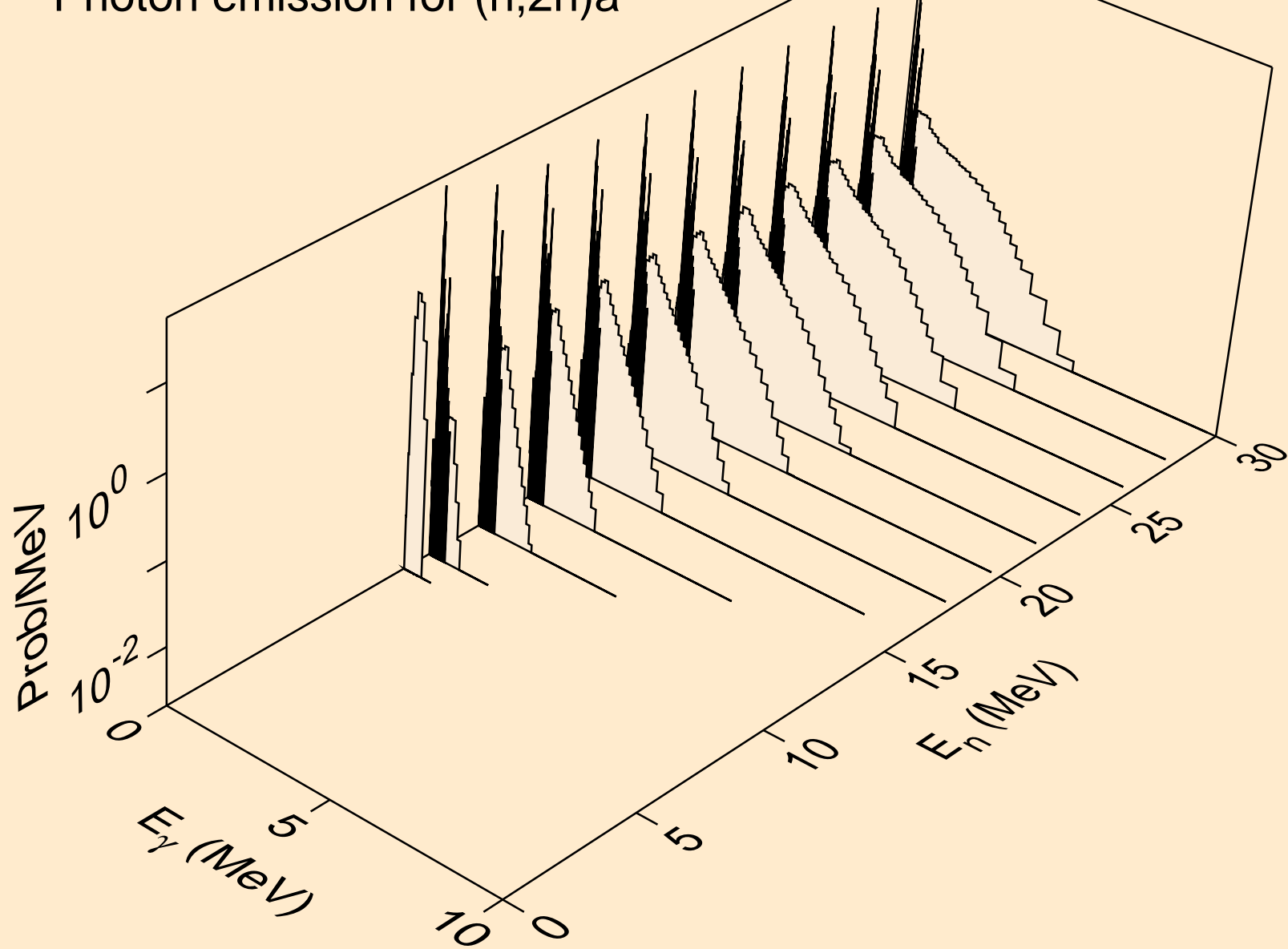

AU189 DEUTERON ACER TENDL-2023 LIBRARY; T=0.K
Photon emission for (n,3n)a

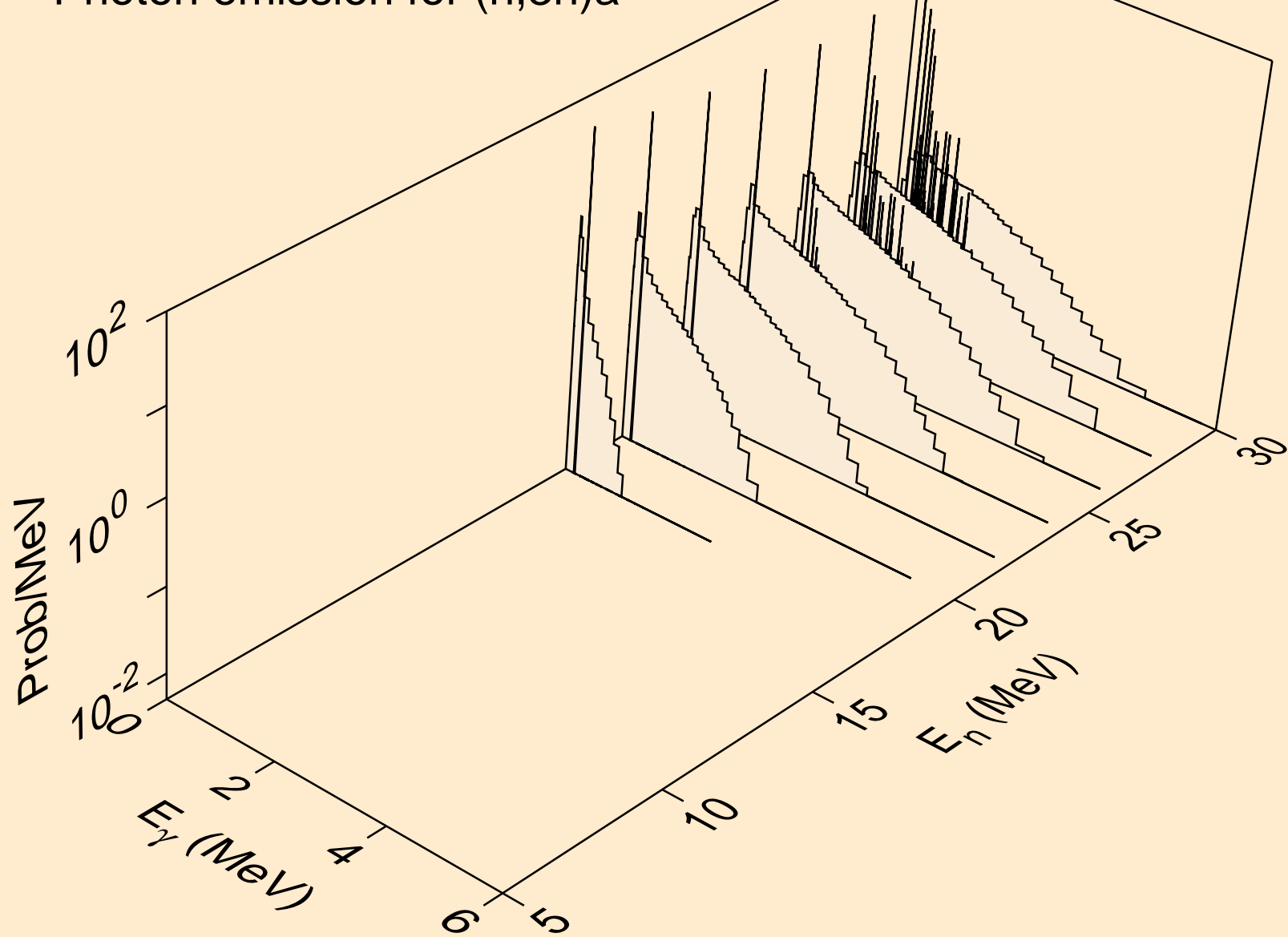

AU189 DEUTERON ACER TENDL-2023 LIBRARY; T=0.K
Photon emission for (n,n*)p

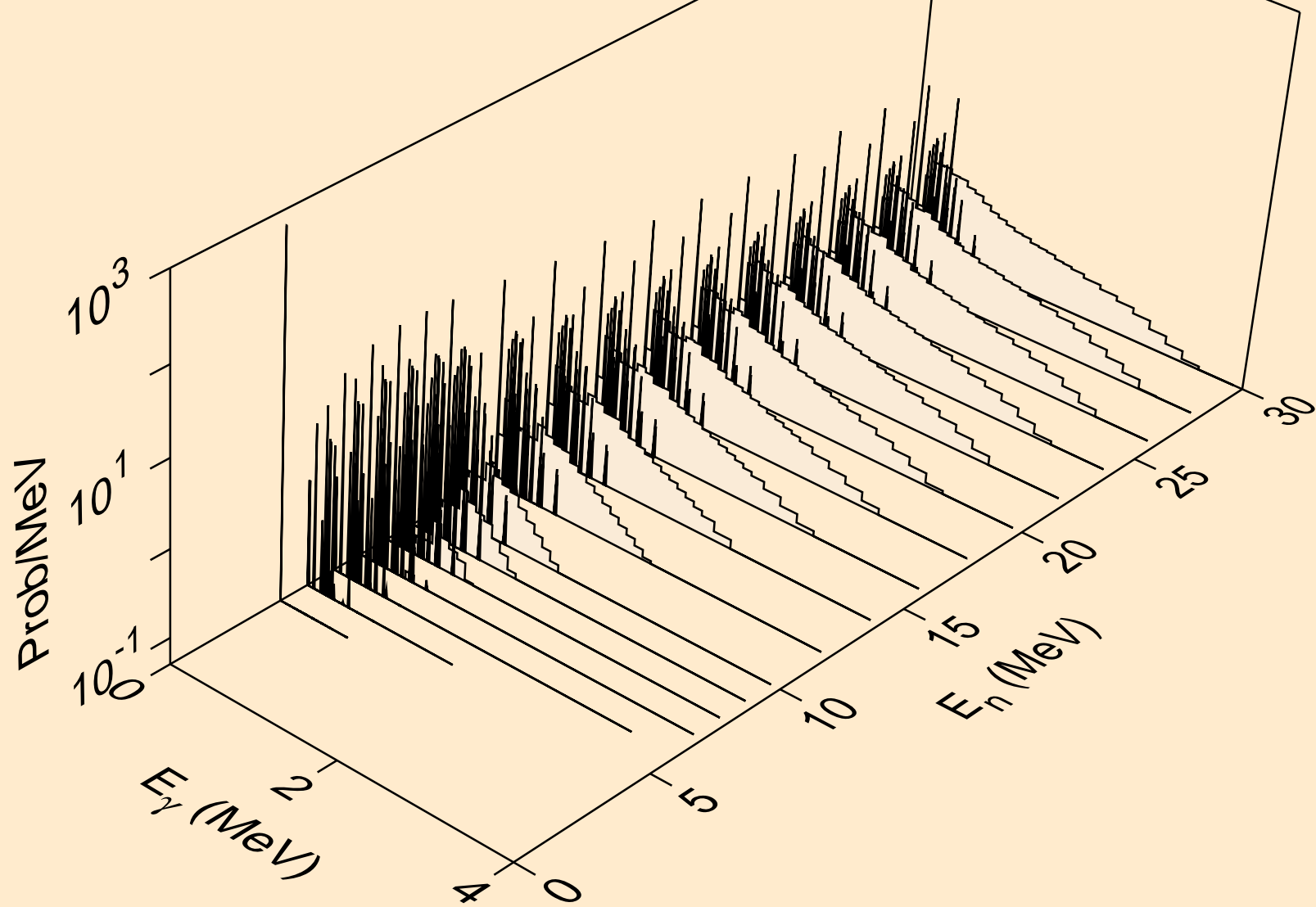

AU189 DEUTERON ACER TENDL-2023 LIBRARY; T=0.K
Photon emission for (n,n*)2a

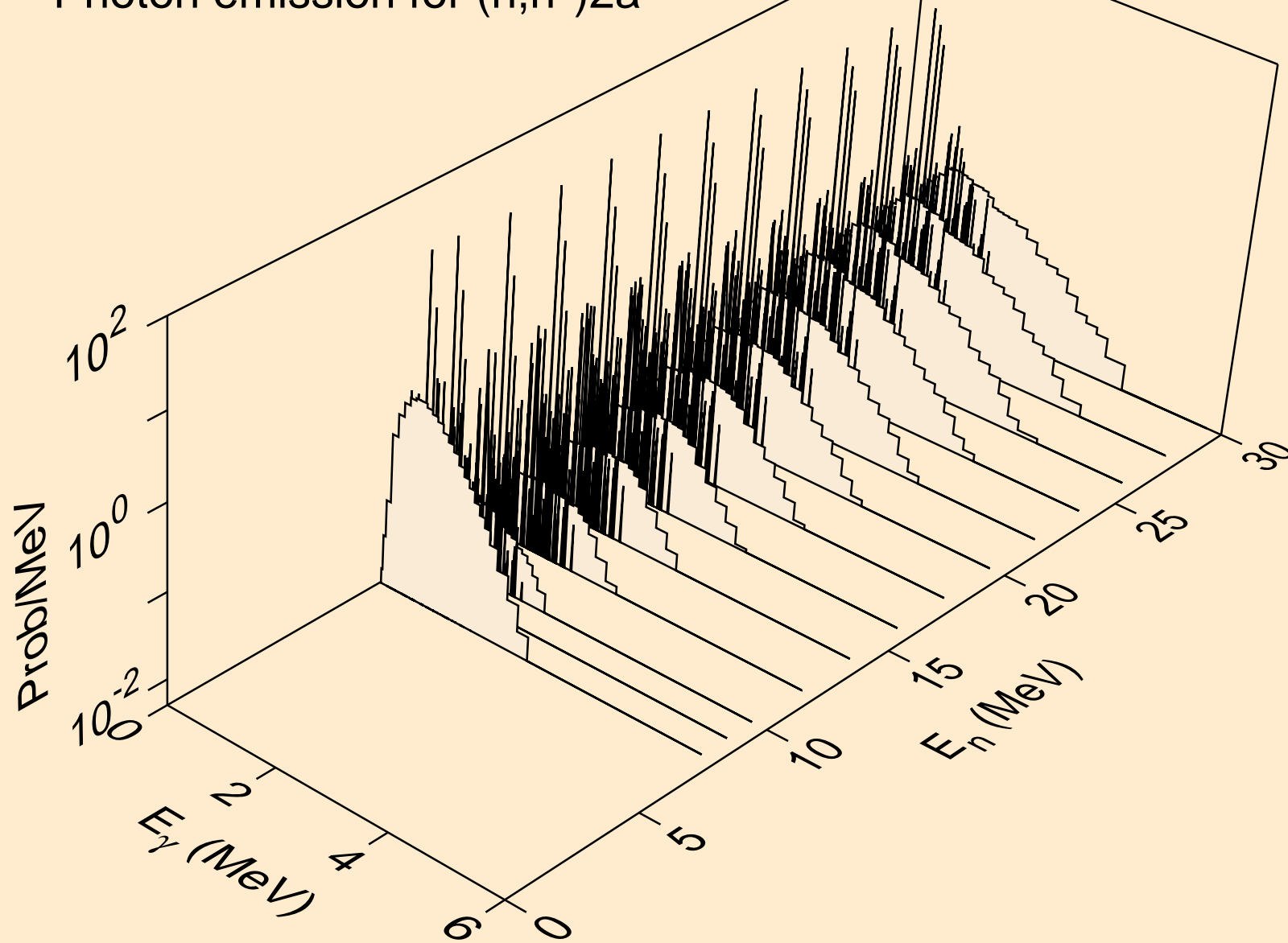

AU189 DEUTERON ACER TENDL-2023 LIBRARY; T=0.K
Photon emission for (n,2n)2a

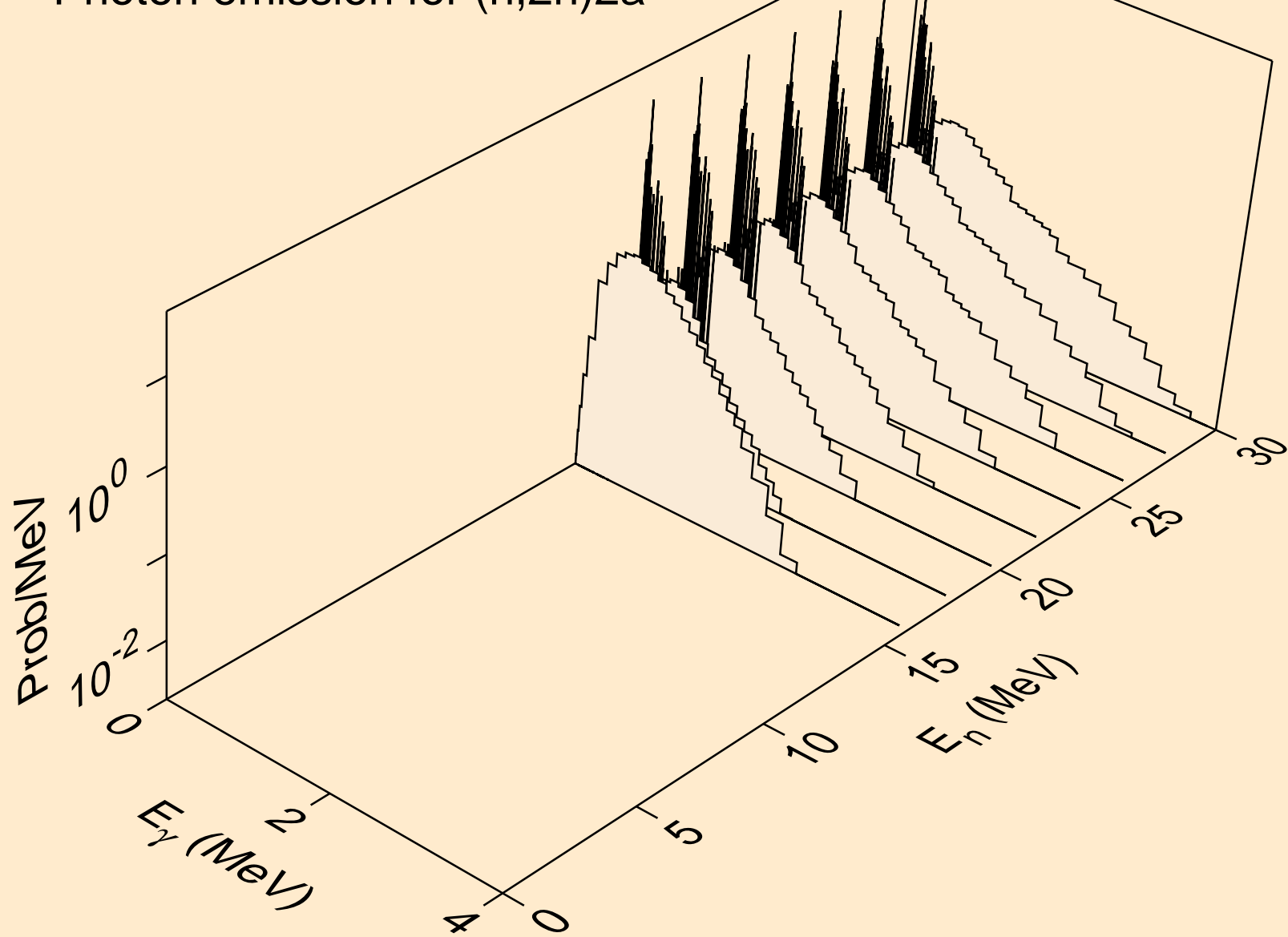

AU189 DEUTERON ACER TENDL-2023 LIBRARY; T=0.K
Photon emission for (n,n*)d

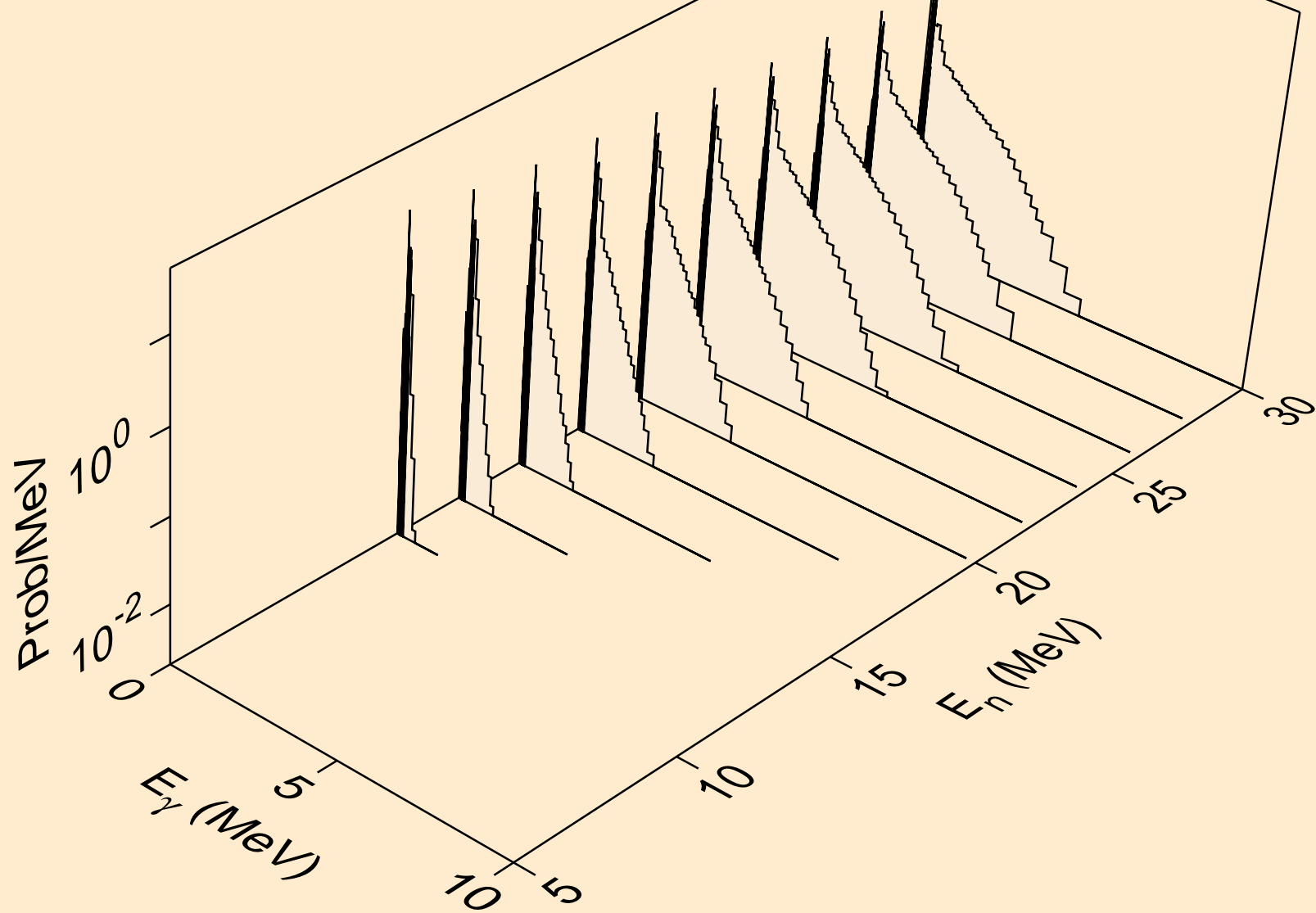

AU189 DEUTERON ACER TENDL-2023 LIBRARY; T=0.K
Photon emission for (n,n*)t

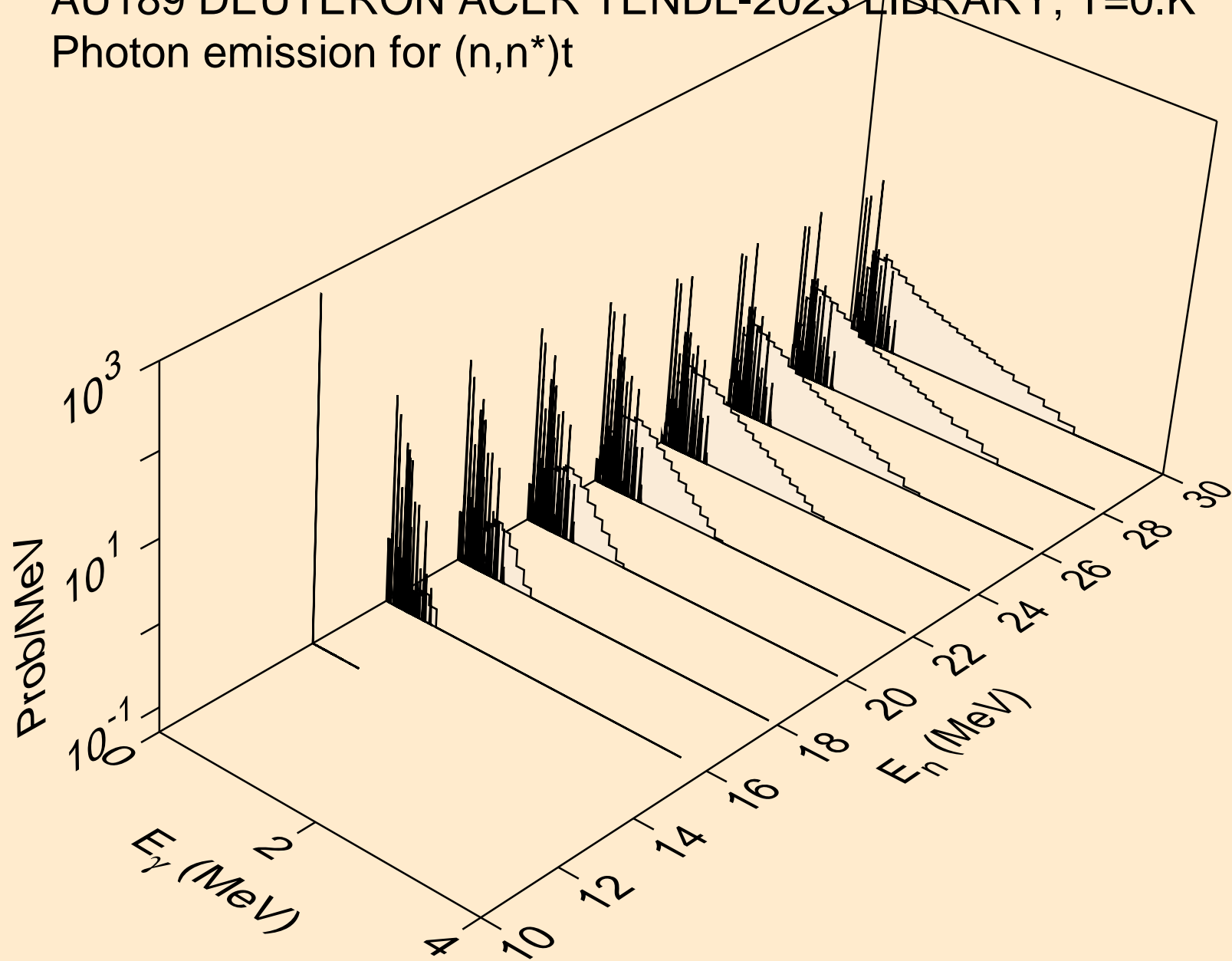

AU189 DEUTERON ACER TENDL-2023 LIBRARY; T=0.K
Photon emission for (n,n*)he3

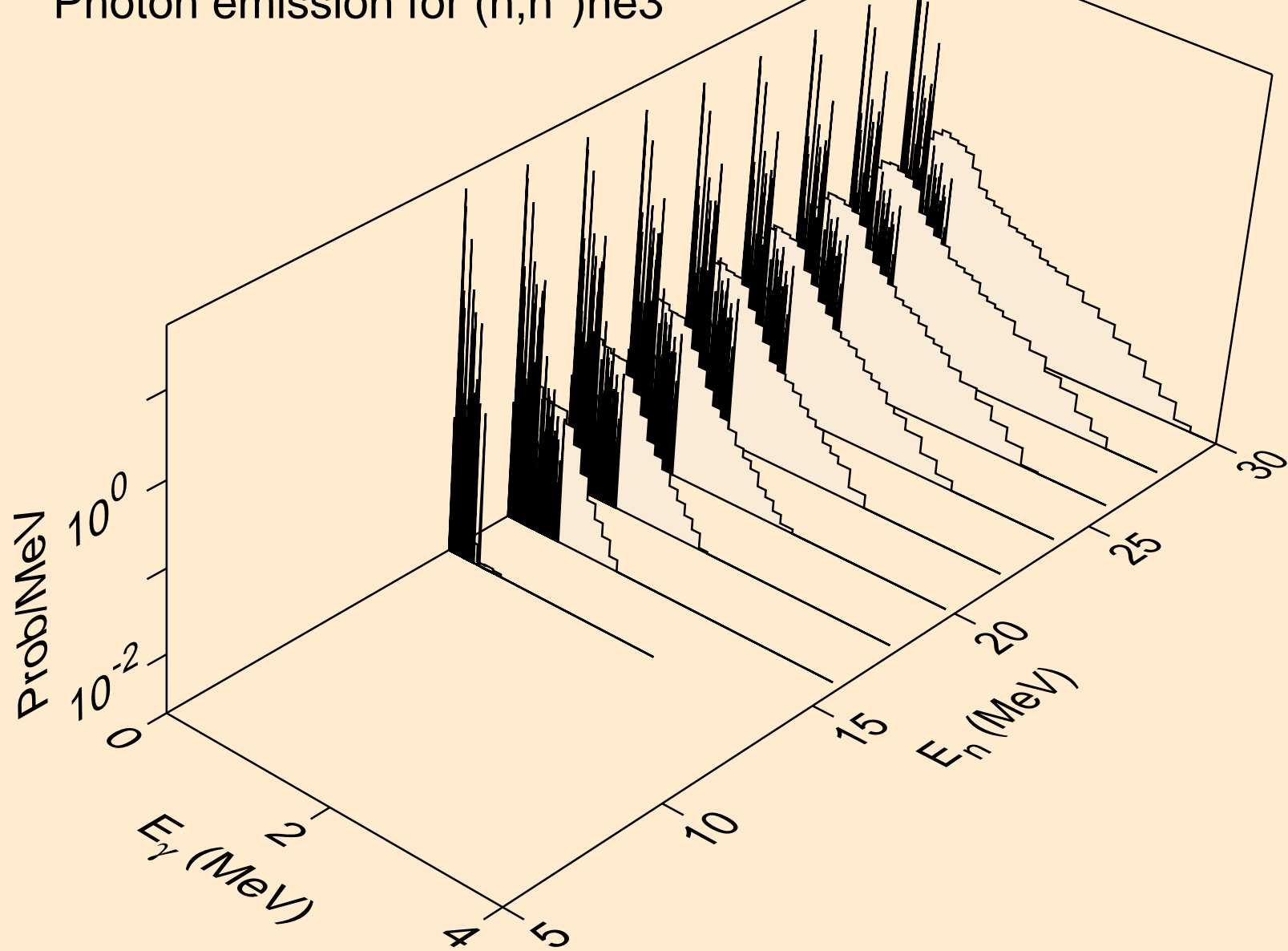

AU189 DEUTERON ACER TENDL-2023 LIBRARY; T=0.K
Photon emission for (n,4n)

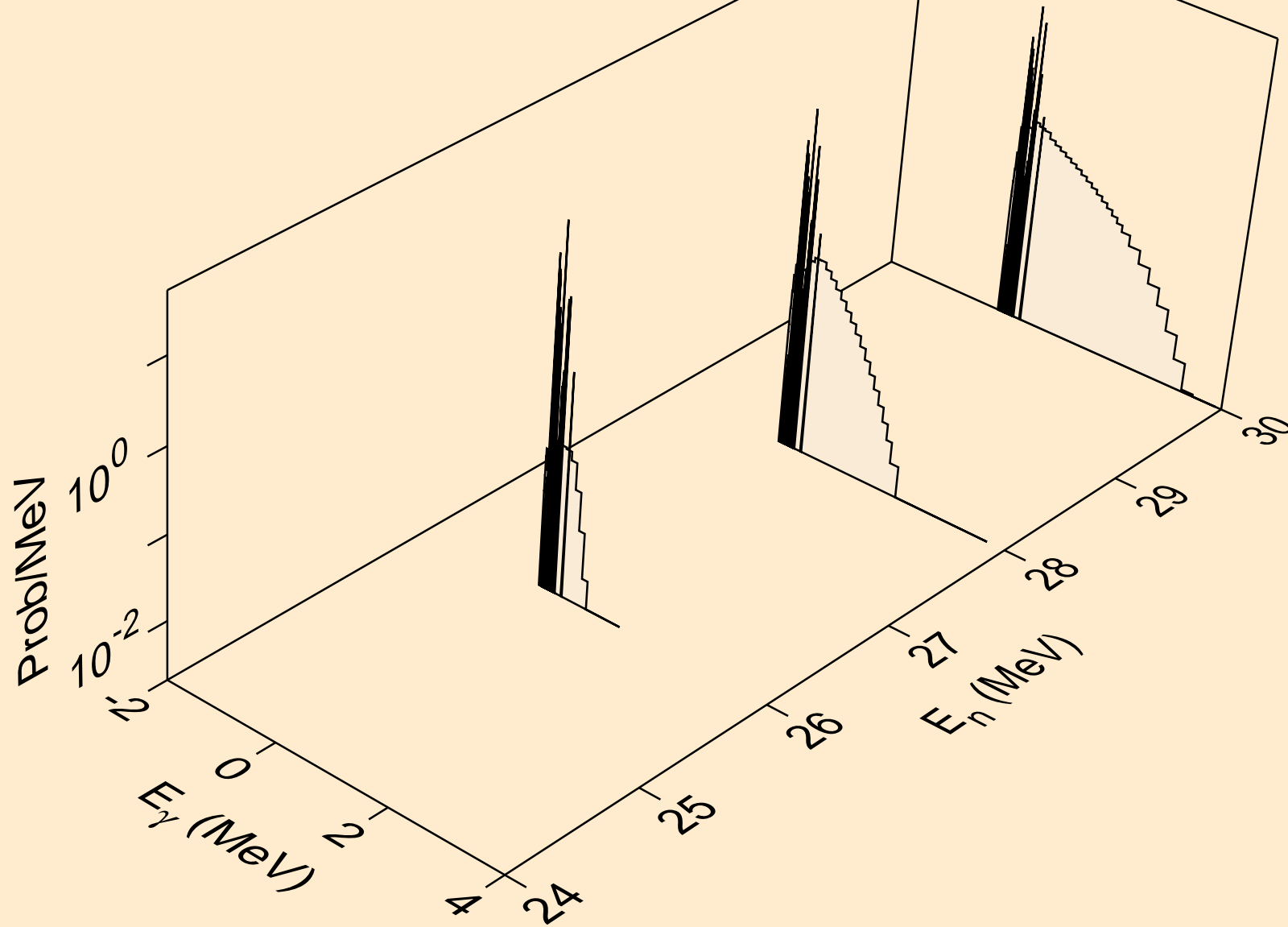

AU189 DEUTERON ACER TENDL-2023 LIBRARY; T=0.K
Photon emission for (n,2np)

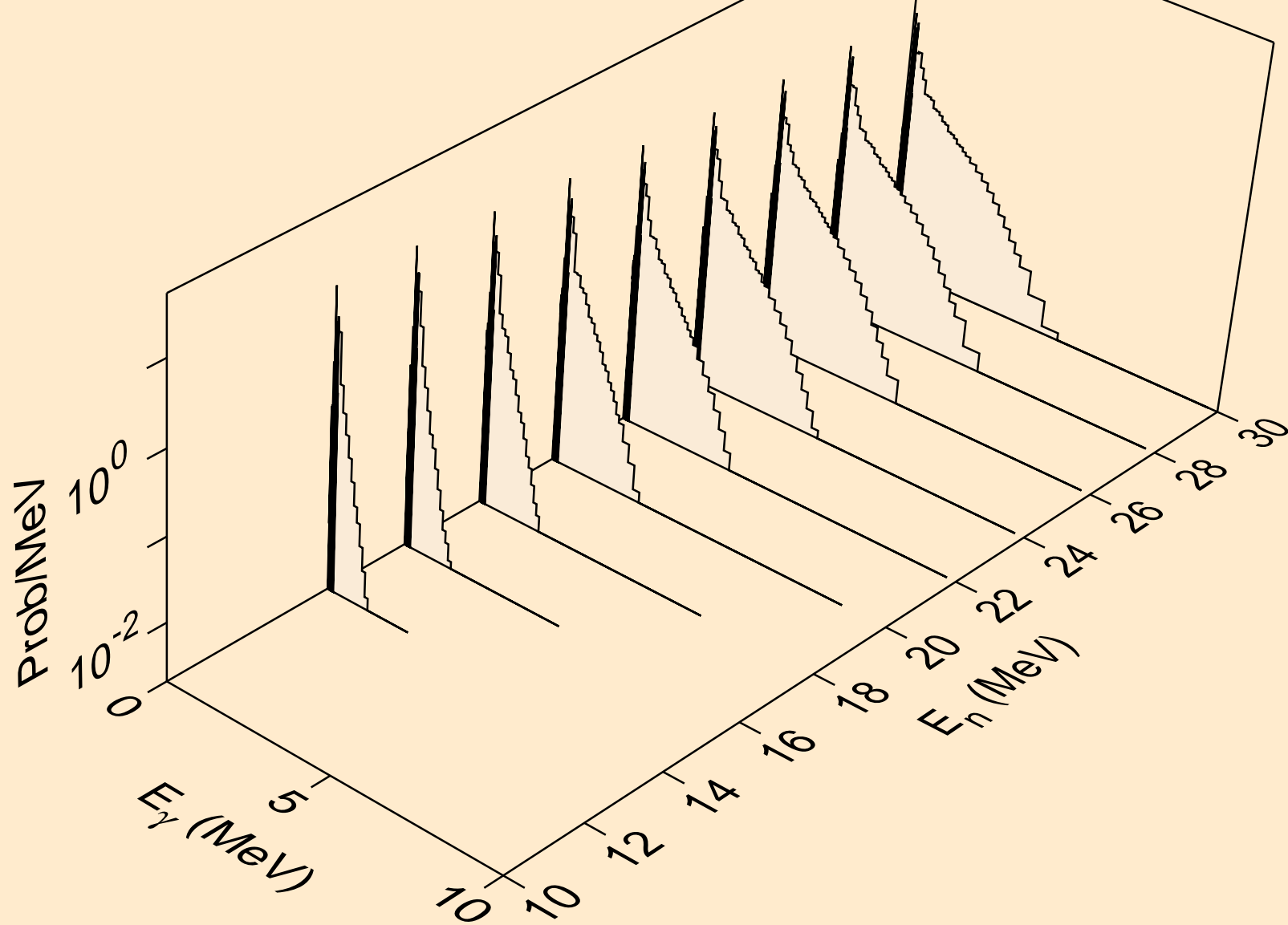

AU189 DEUTERON ACER TENDL-2023 LIBRARY; T=0.K
Photon emission for (n,3np)

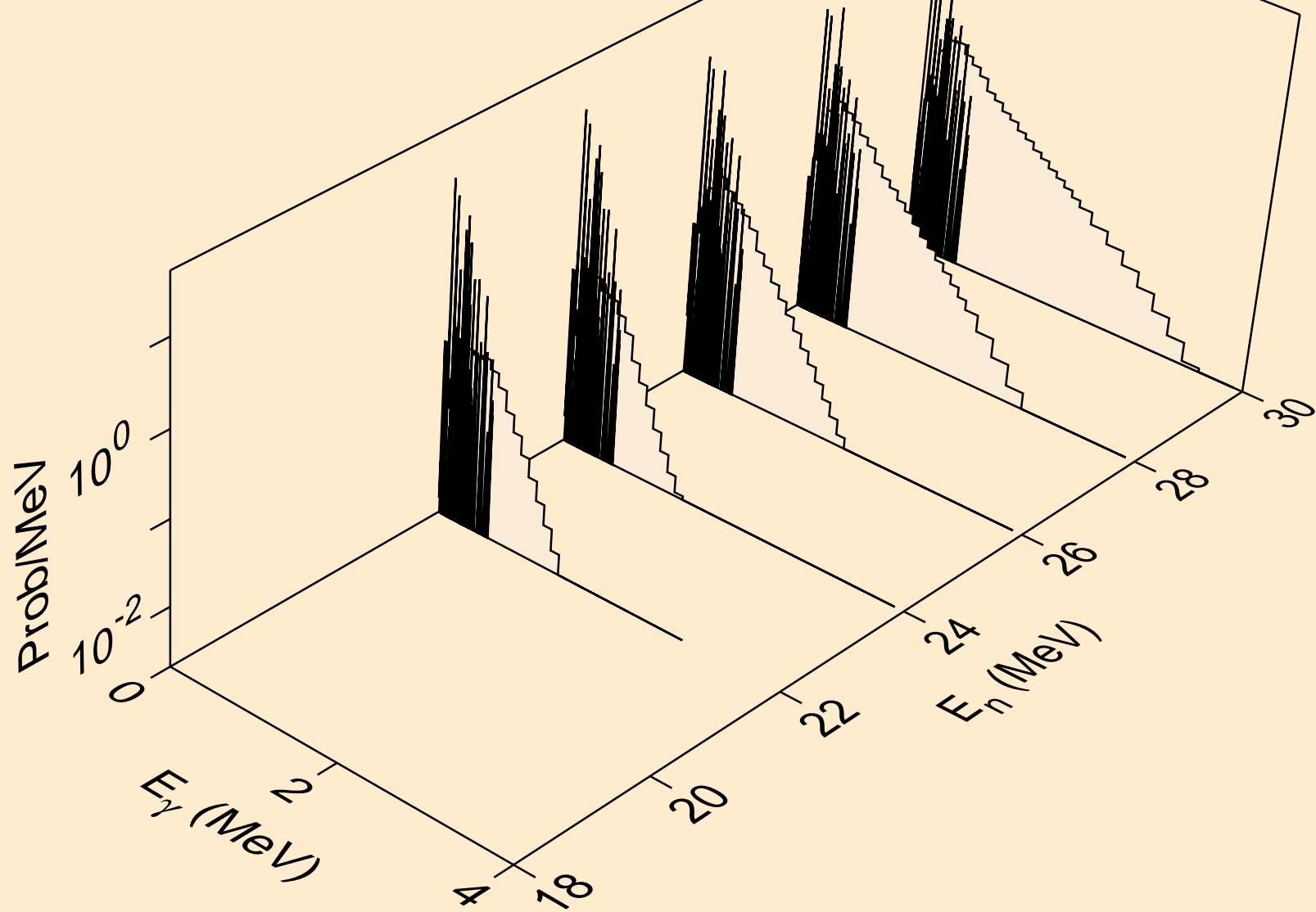

AU189 DEUTERON ACER TENDL-2023 LIBRARY; T=0.K
Photon emission for (n,n2p)

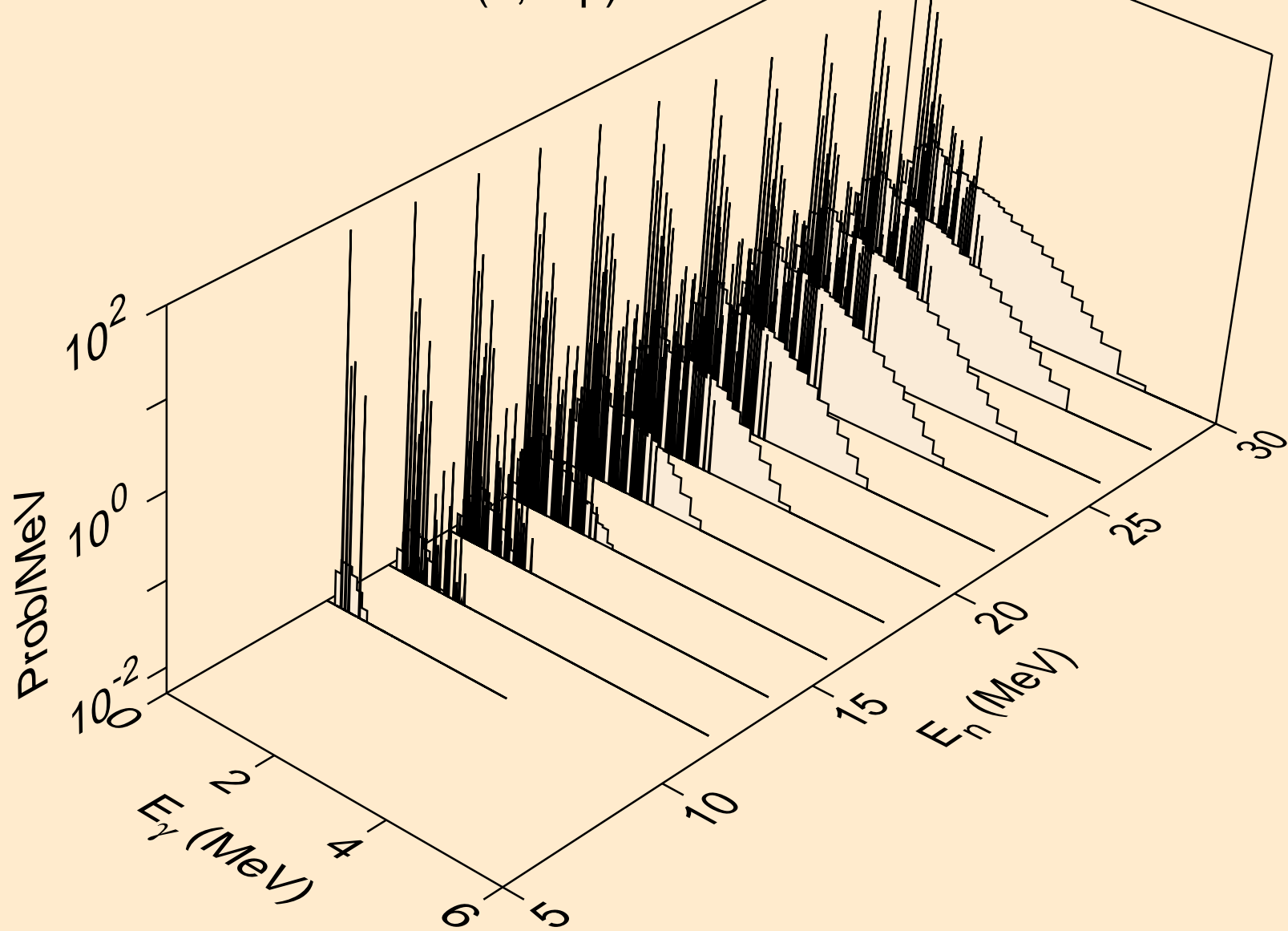

AU189 DEUTERON ACER TENDL-2023 LIBRARY; T=0.K
Photon emission for (n,npa)

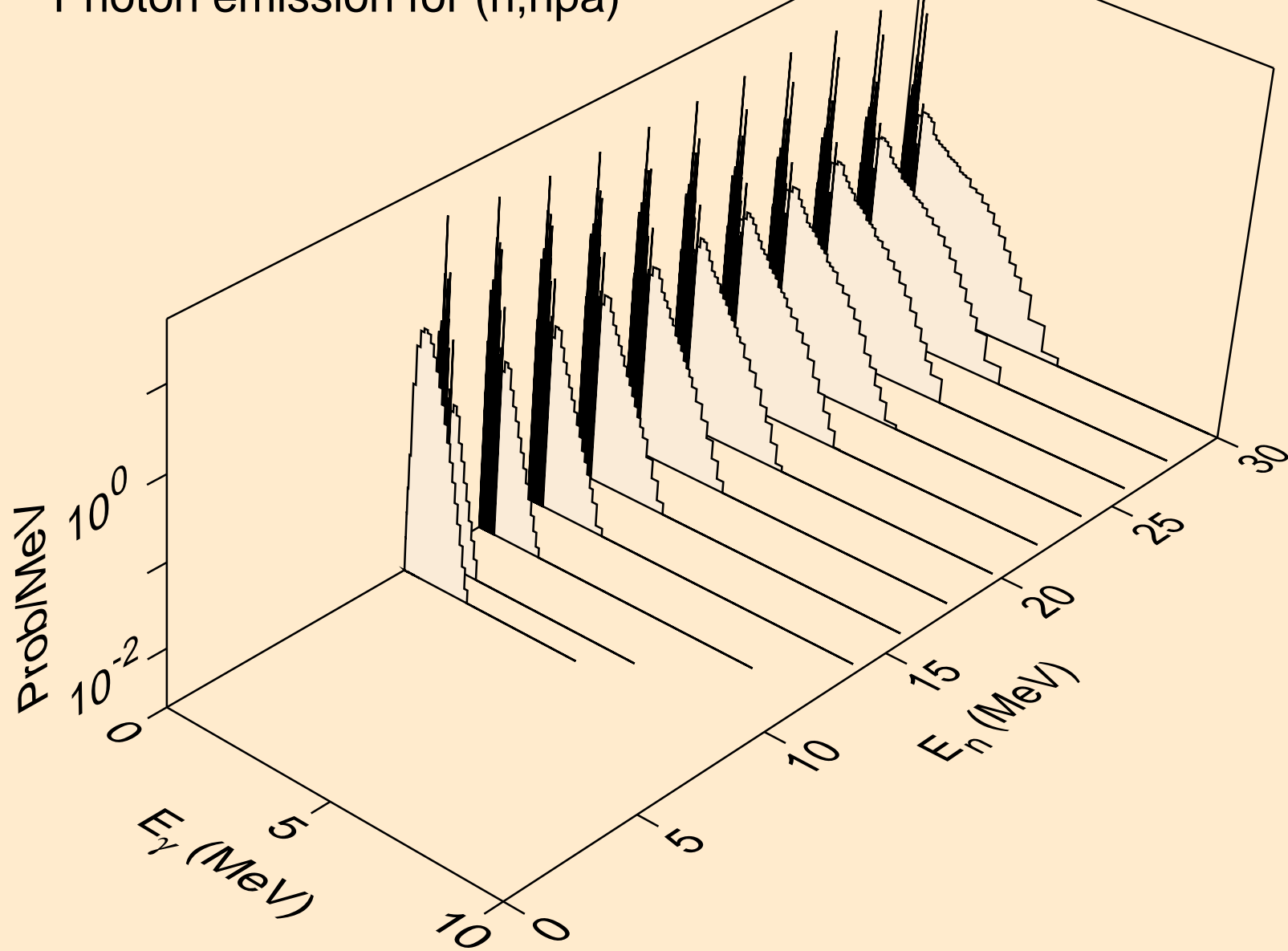

AU189 DEUTERON ACER TENDL-2023 LIBRARY; T=0.K
Photon emission for (n,gma)

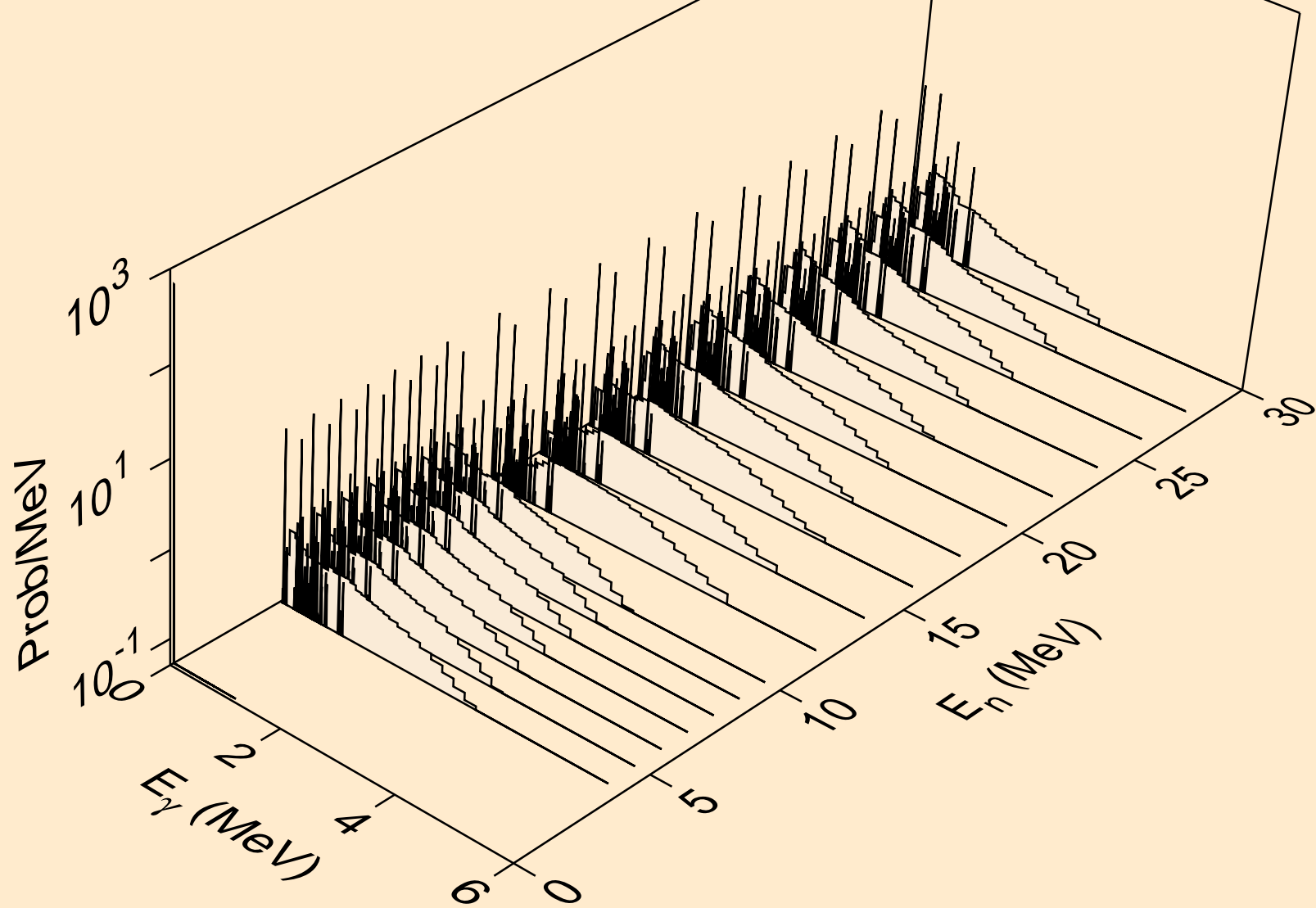

AU189 DEUTERON ACER TENDL-2023 LIBRARY; T=0.K
Photon emission for (n,p)

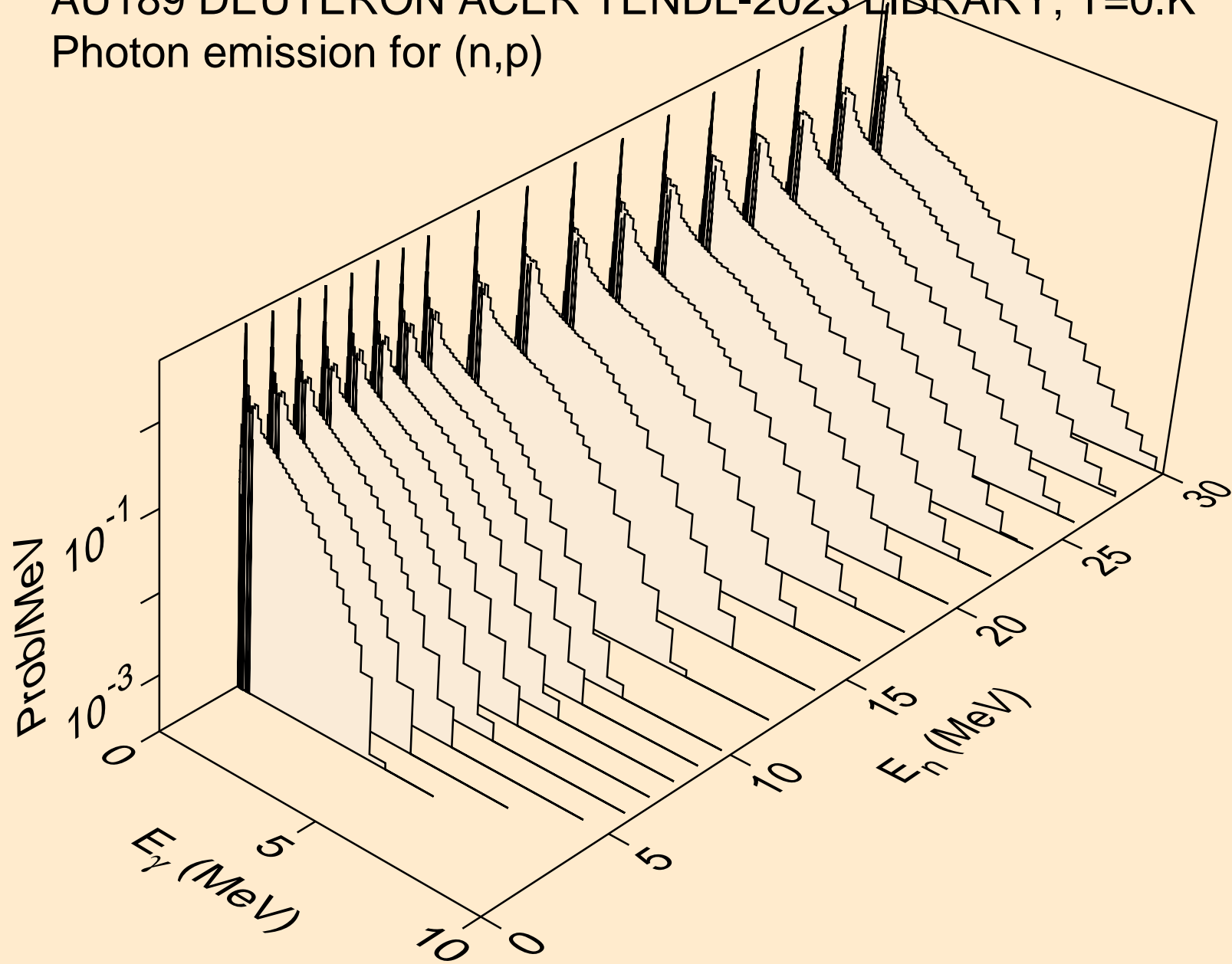

AU189 DEUTERON ACER TENDL-2023 LIBRARY; T=0.K
Photon emission for inelastic

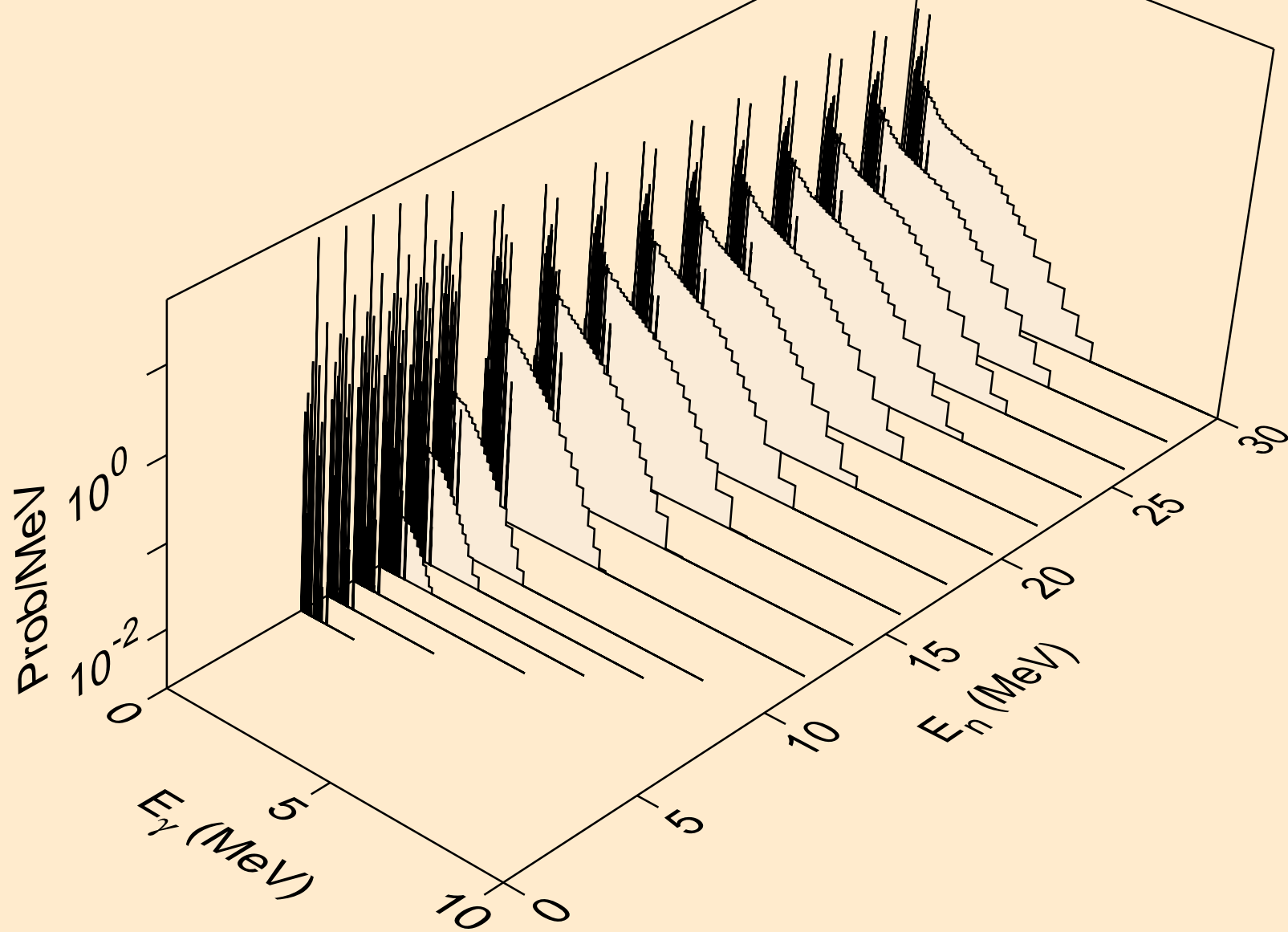

AU189 DEUTERON ACER TENDL-2023 LIBRARY; T=0.K
Photon emission for (n,t)

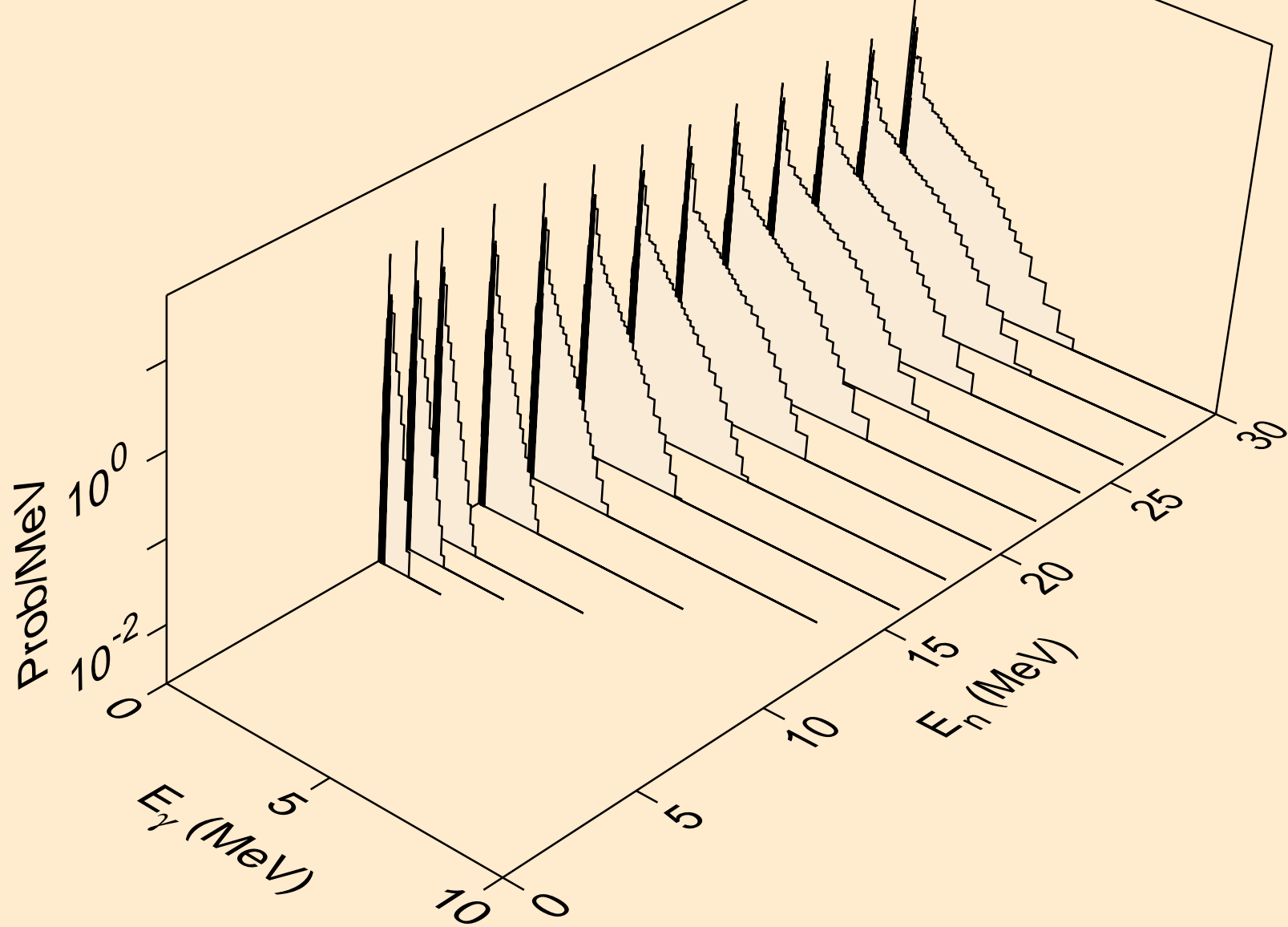

AU189 DEUTERON ACER TENDL-2023 LIBRARY; T=0.K
Photon emission for (n,he3)

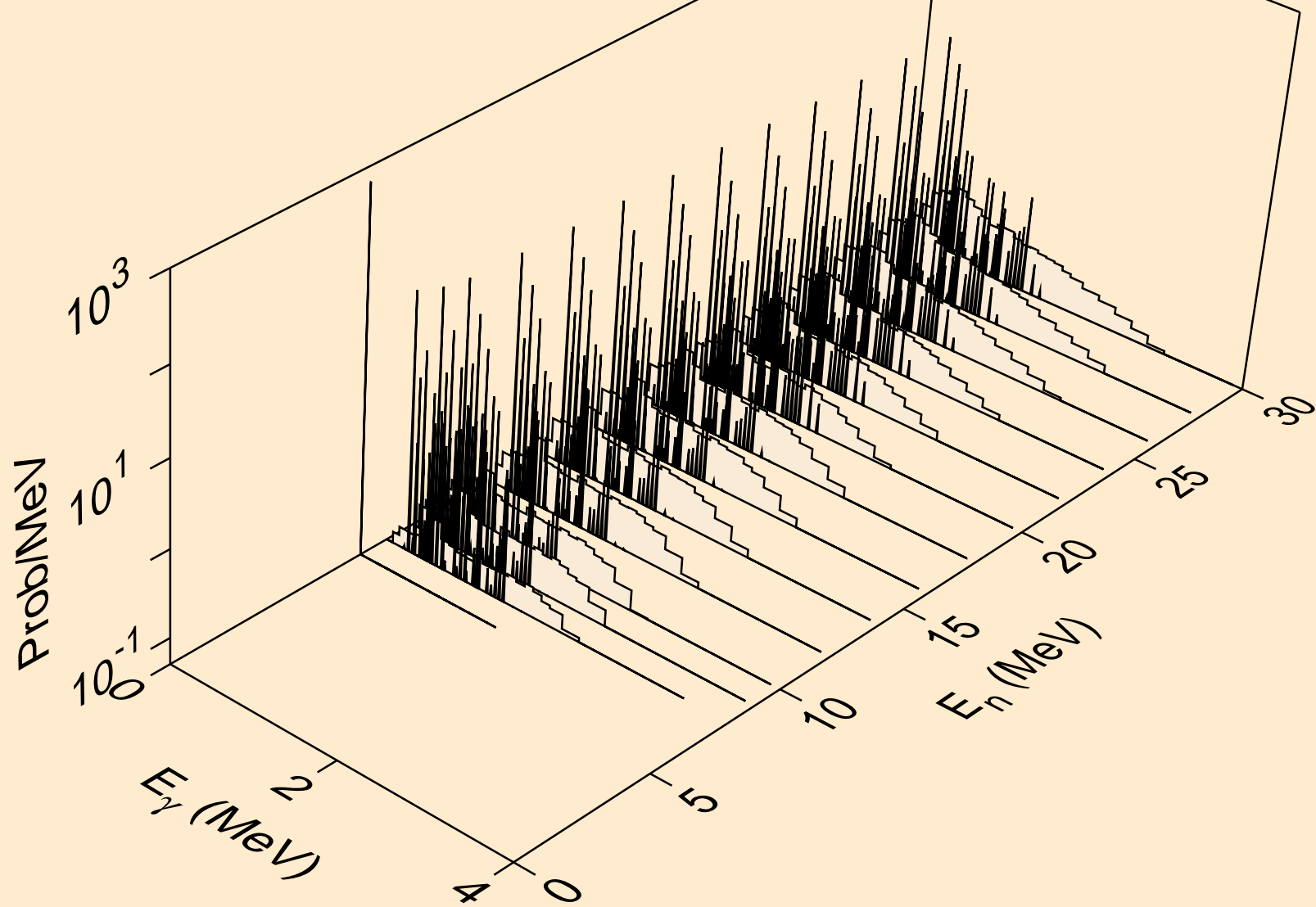

AU189 DEUTERON ACER TENDL-2023 LIBRARY; T=0.K
Photon emission for (n,a)

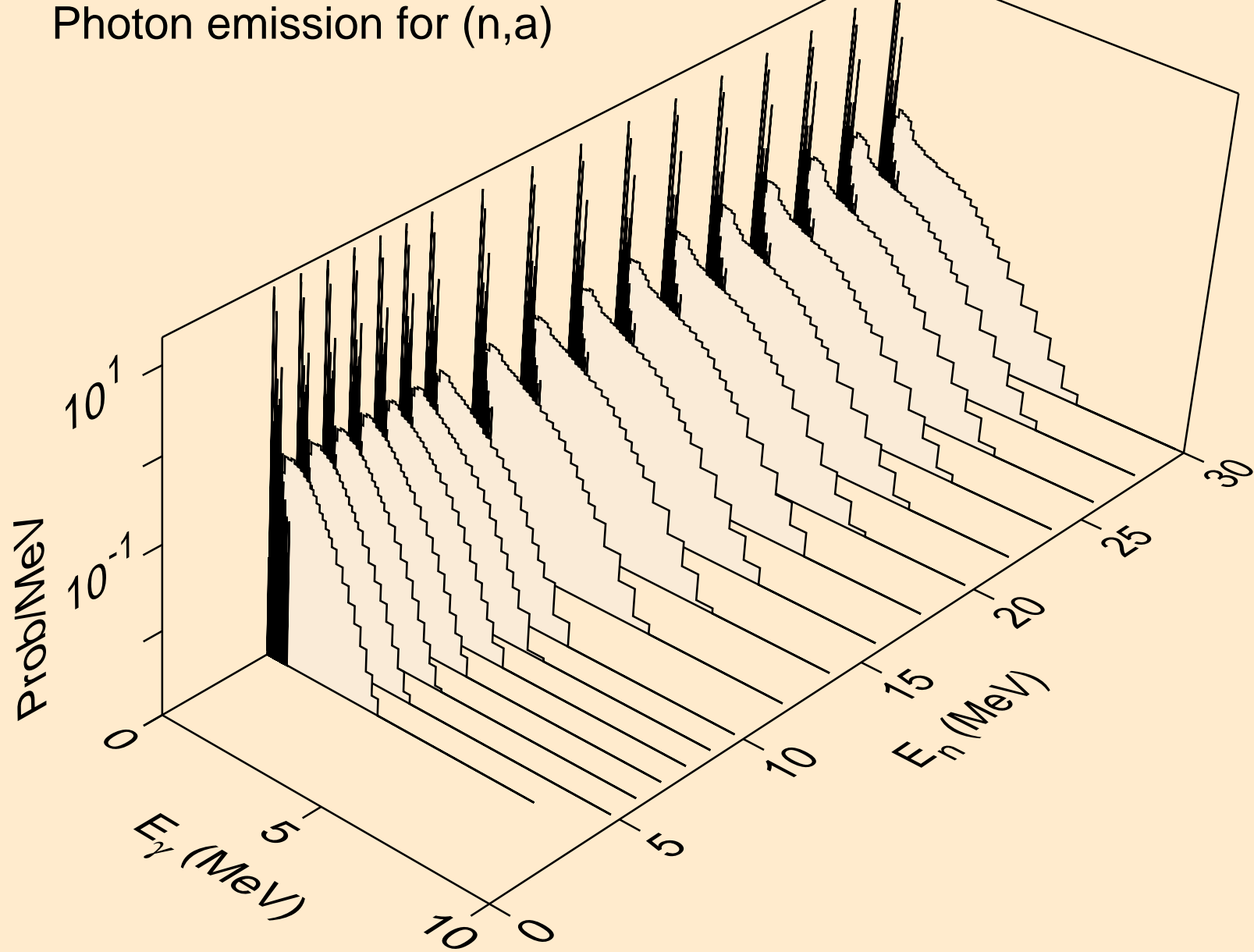

AU189 DEUTERON ACER TENDL-2023 LIBRARY; T=0.K
Photon emission for (n,2a)

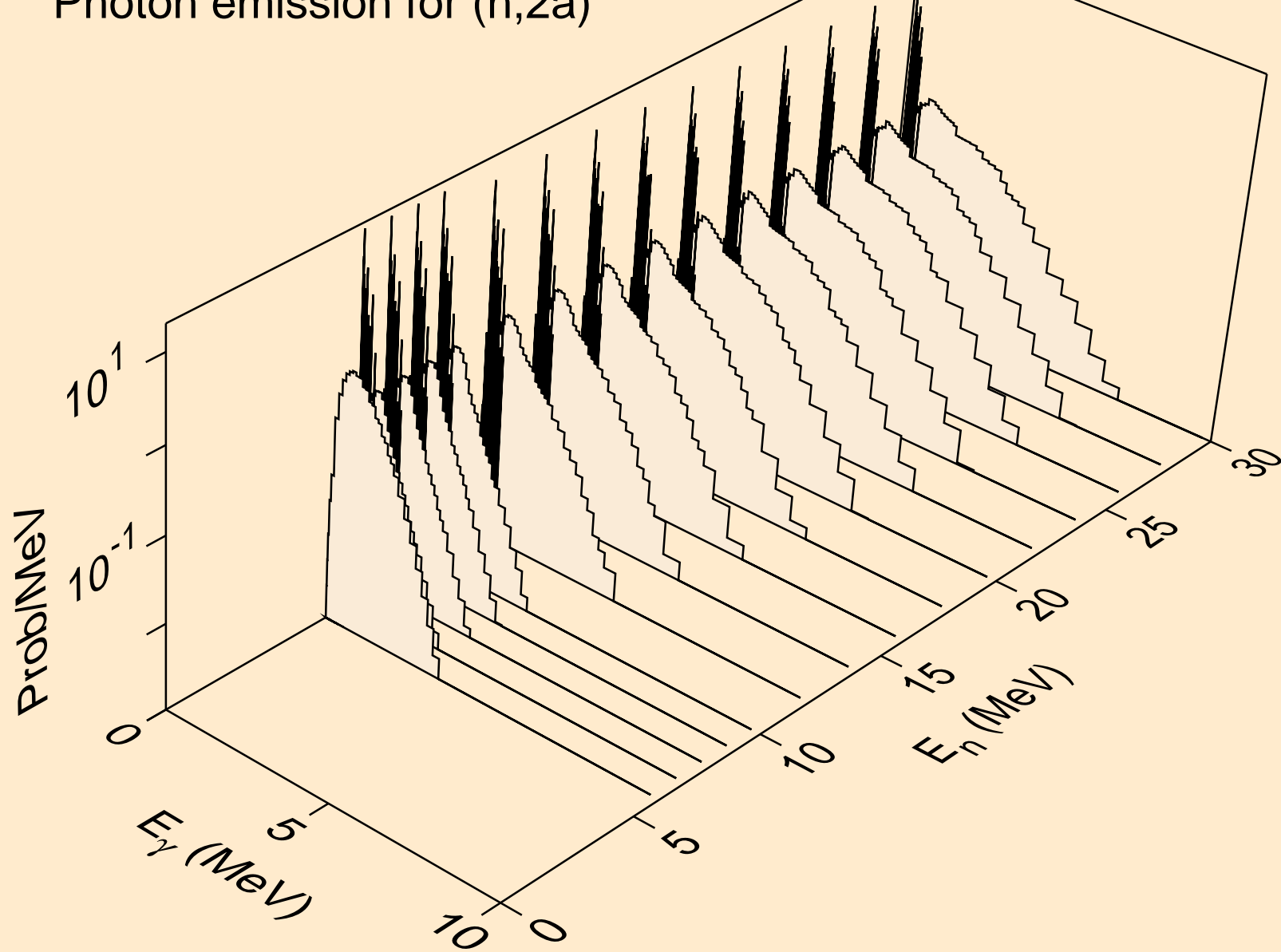

AU189 DEUTERON ACER TENDL-2023 LIBRARY; T=0.K
Photon emission for (n,2p)

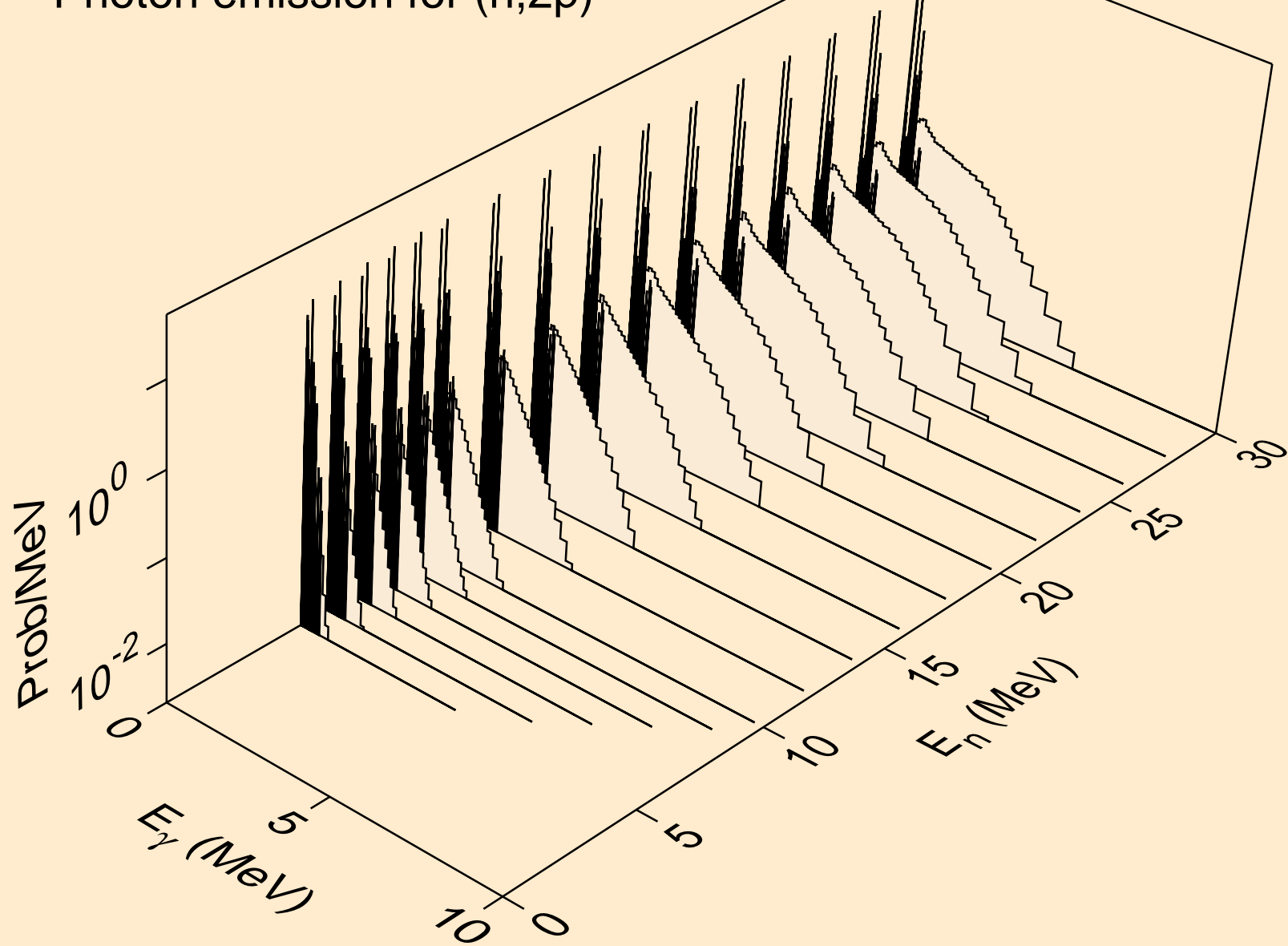

AU189 DEUTERON ACER TENDL-2023 LIBRARY; T=0.K
Photon emission for (n,p α)

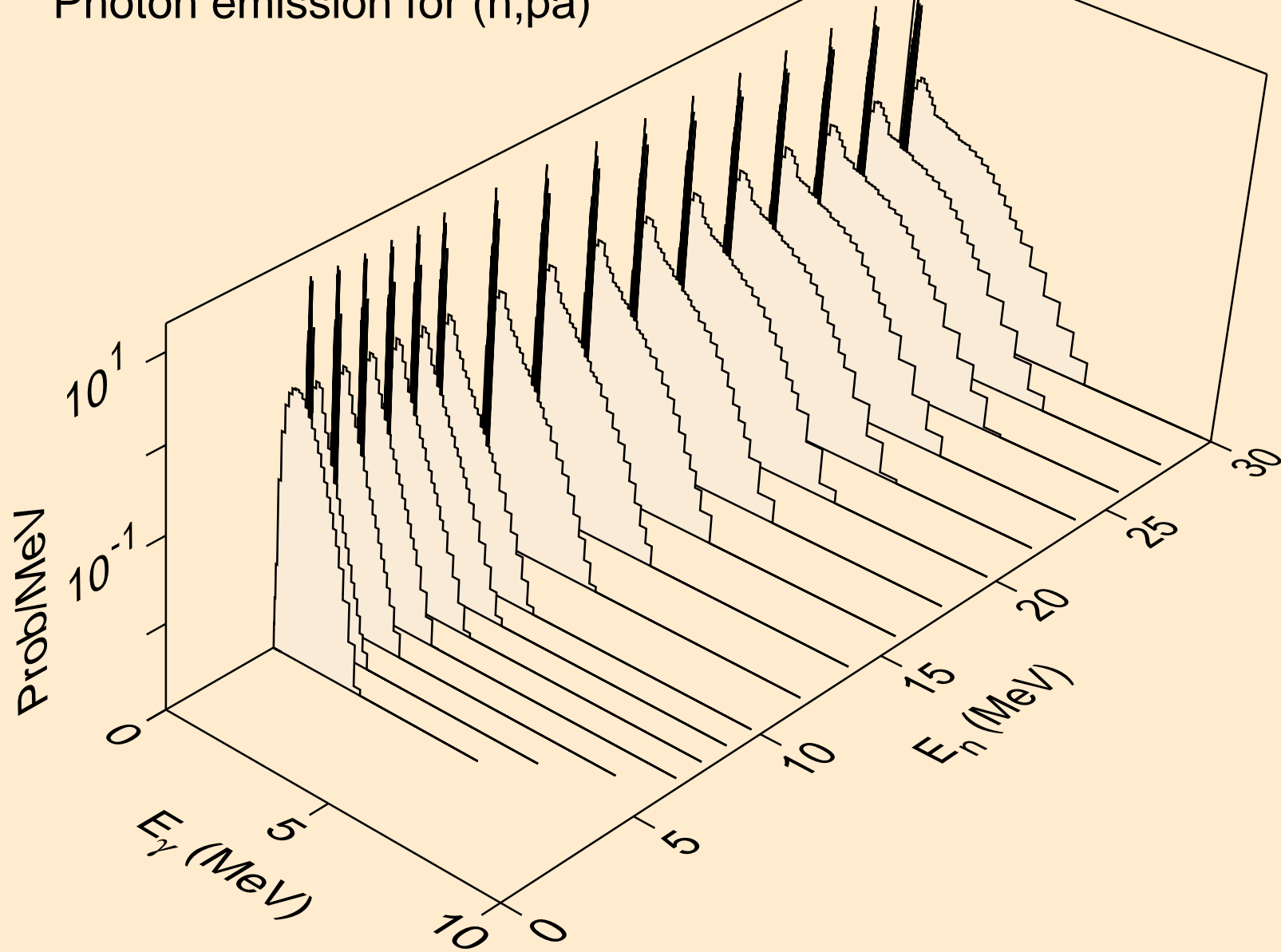

AU189 DEUTERON ACER TENDL-2023 LIBRARY; T=0.K
Photon emission for (n,pd)

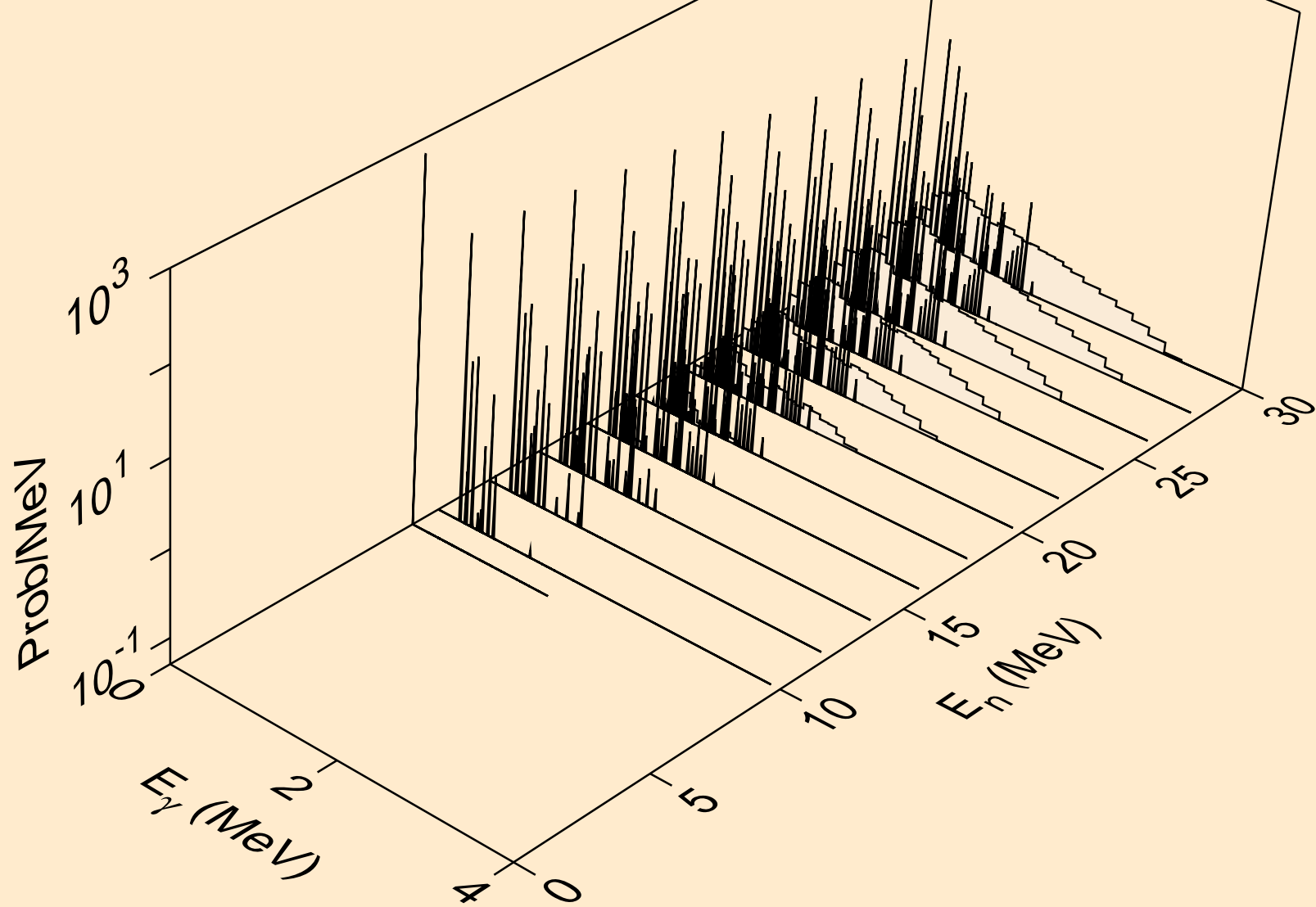

AU189 DEUTERON ACER TENDL-2023 LIBRARY; T=0.K
Photon emission for (n,pt)

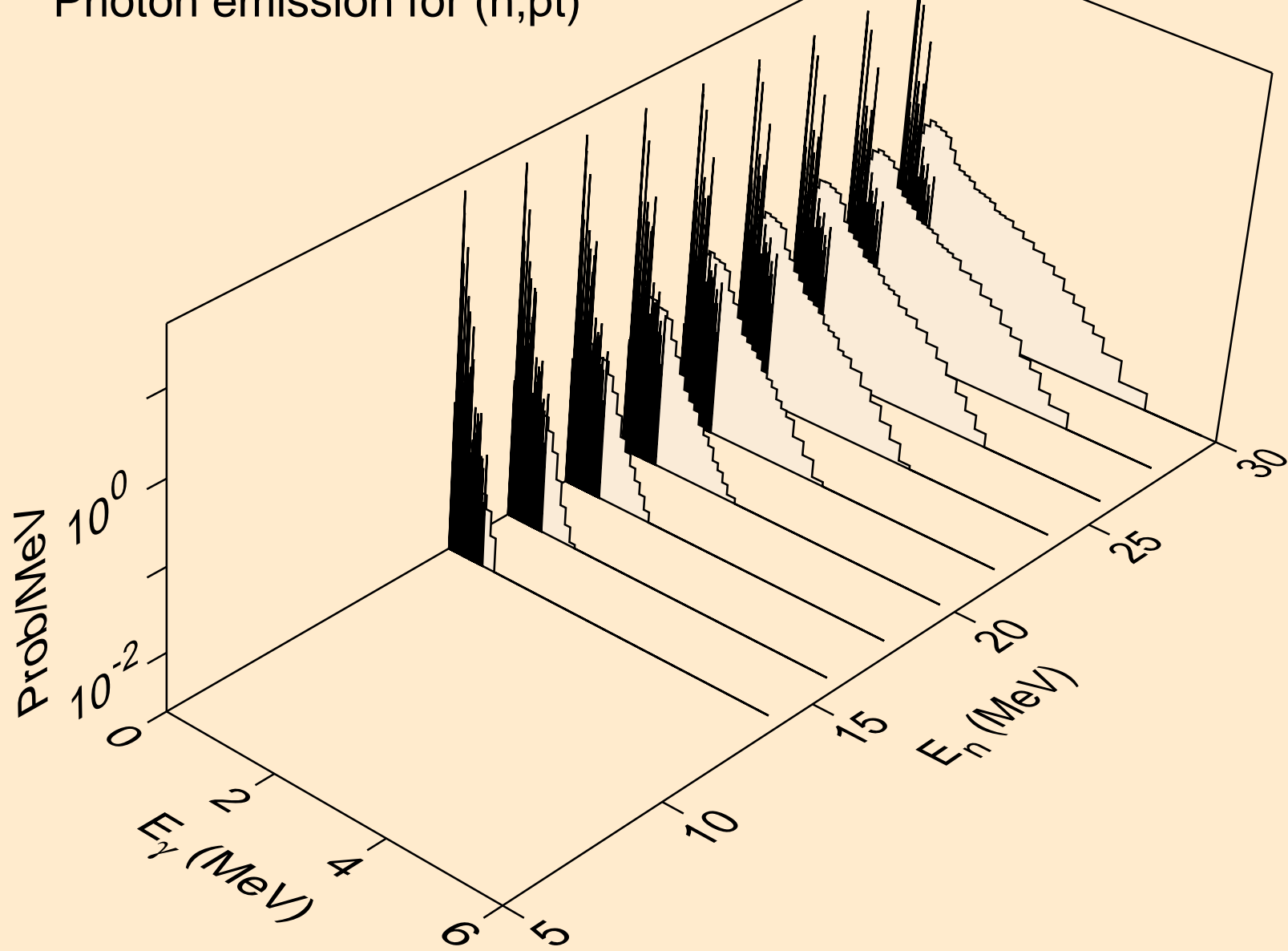

AU189 DEUTERON ACER TENDL-2023 LIBRARY; T=0.K
Photon emission for (n,da)

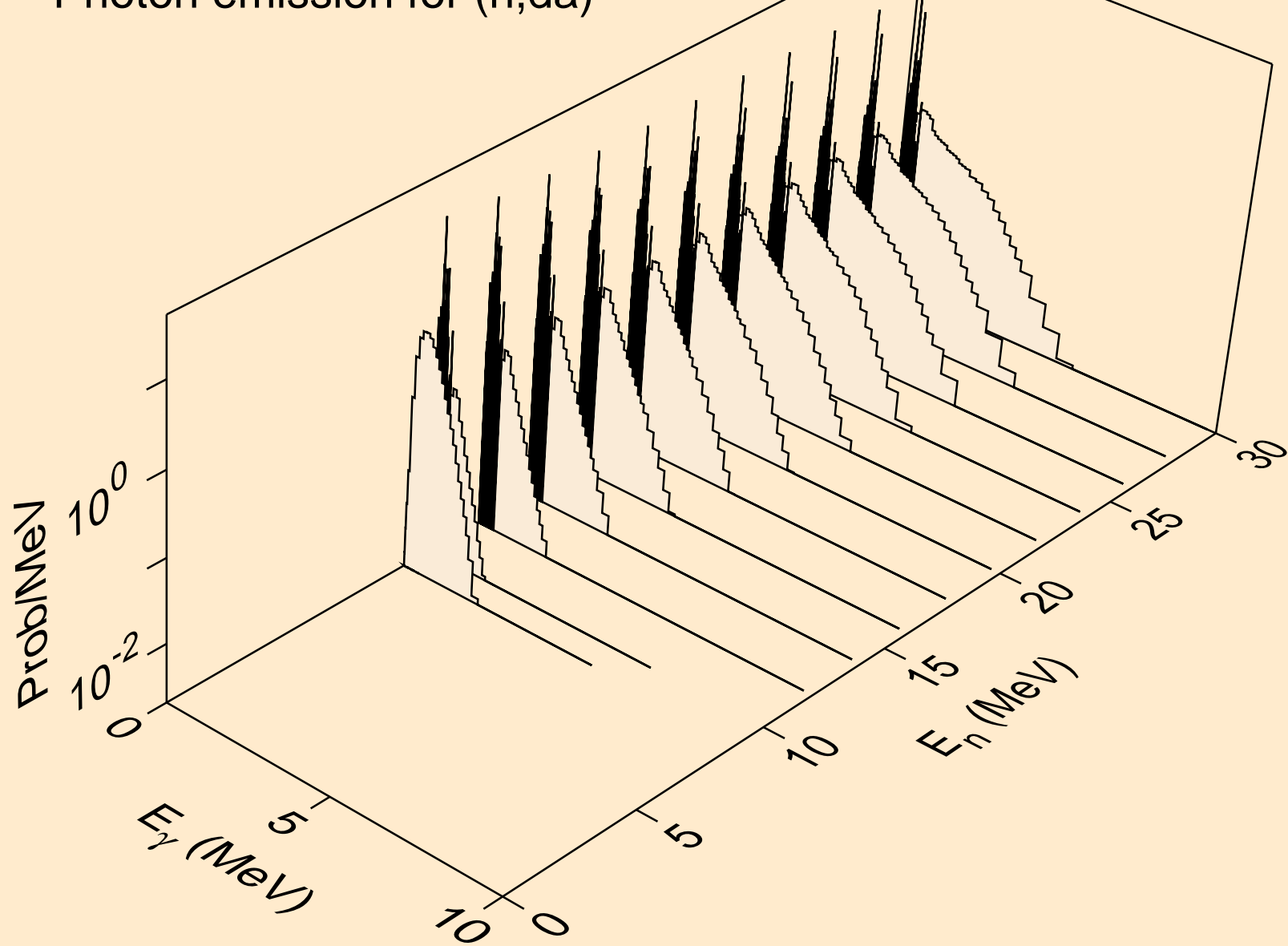

AU189 DEUTERON ACER TENDL-2023 LIBRARY; T=0.K

Particle heating contributions

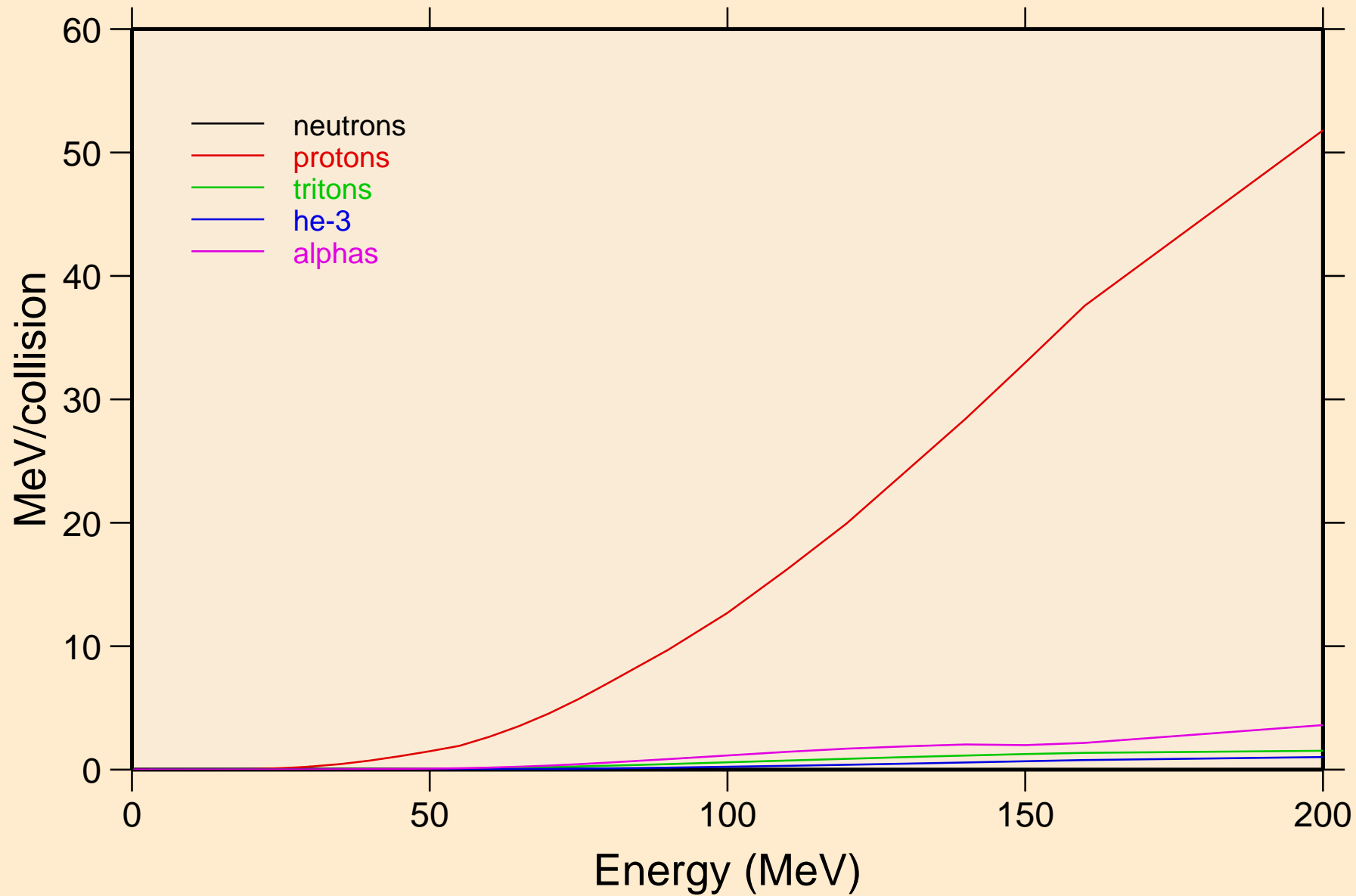

AU189 DEUTERON ACER TENDL-2023 LIBRARY; T=0.K
Recoil Heating

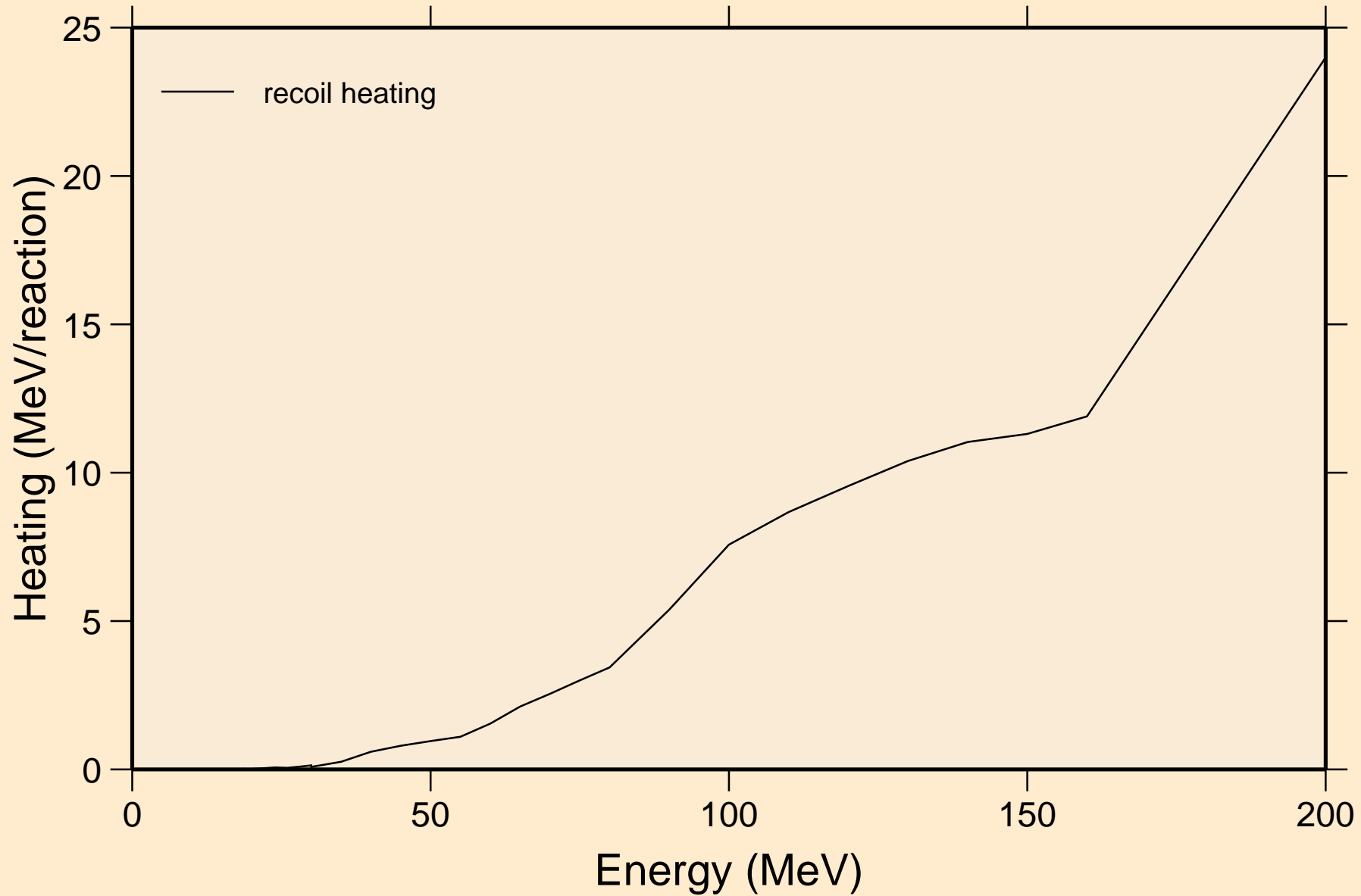

AU189 DEUTERON ACER TENDL-2023 LIBRARY; T=0.K
Particle production cross sections

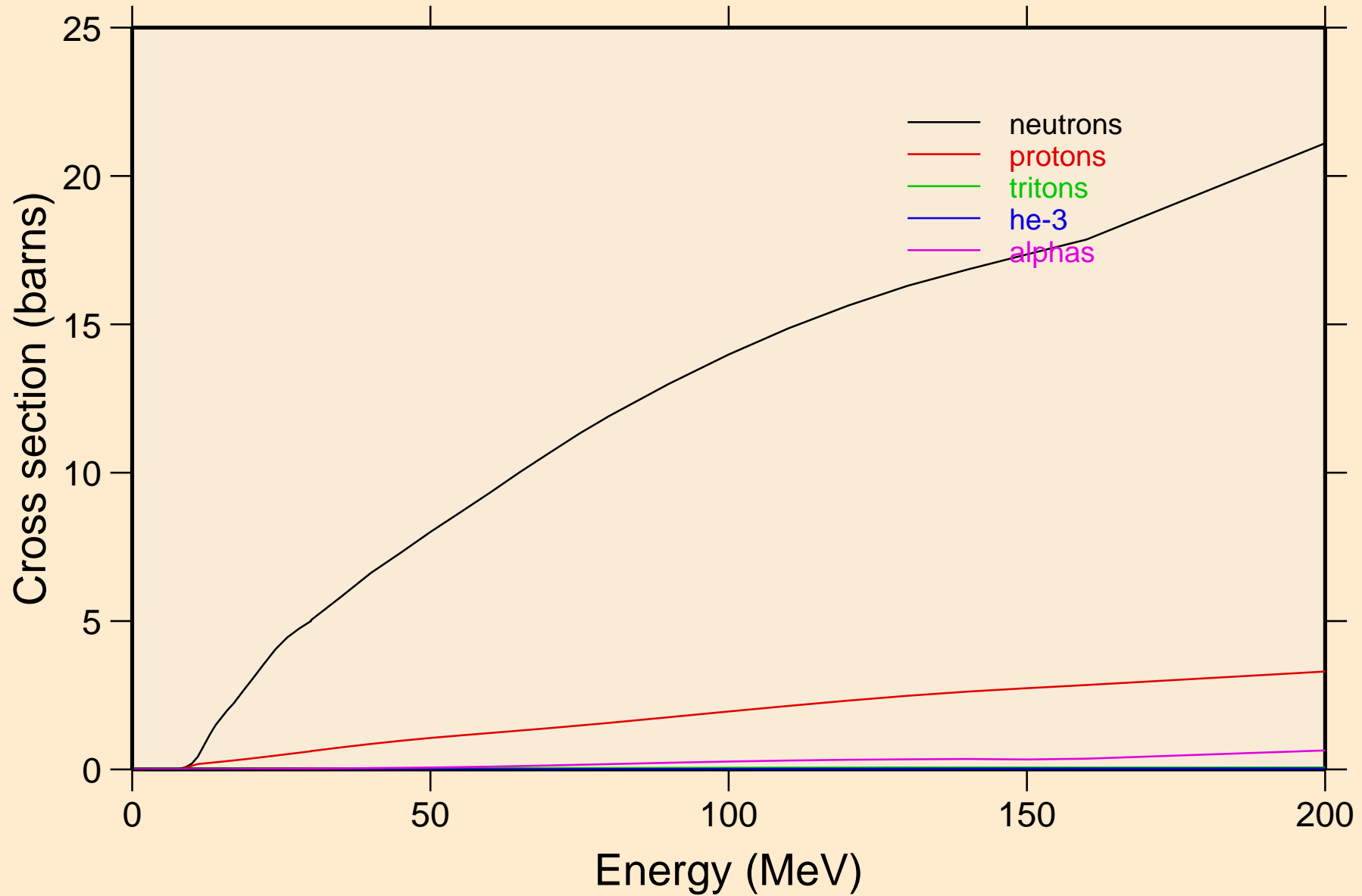

AU189 DEUTERON ACER TENDL-2023 LIBRARY; T=0.K
neutrons from (d,n)

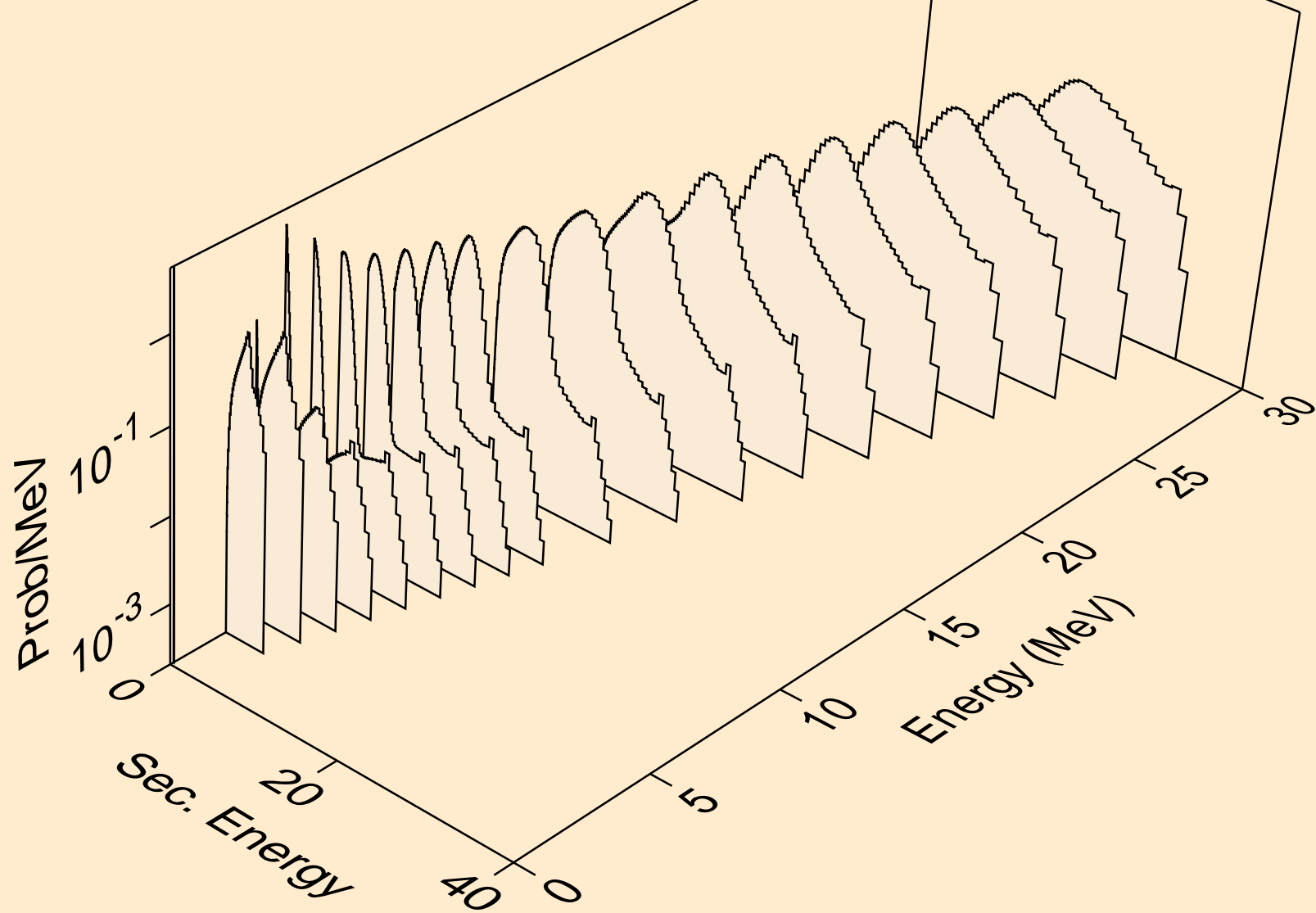

AU189 DEUTERON ACER TENDL-2023 LIBRARY; T=0.K
neutrons from (d,x)

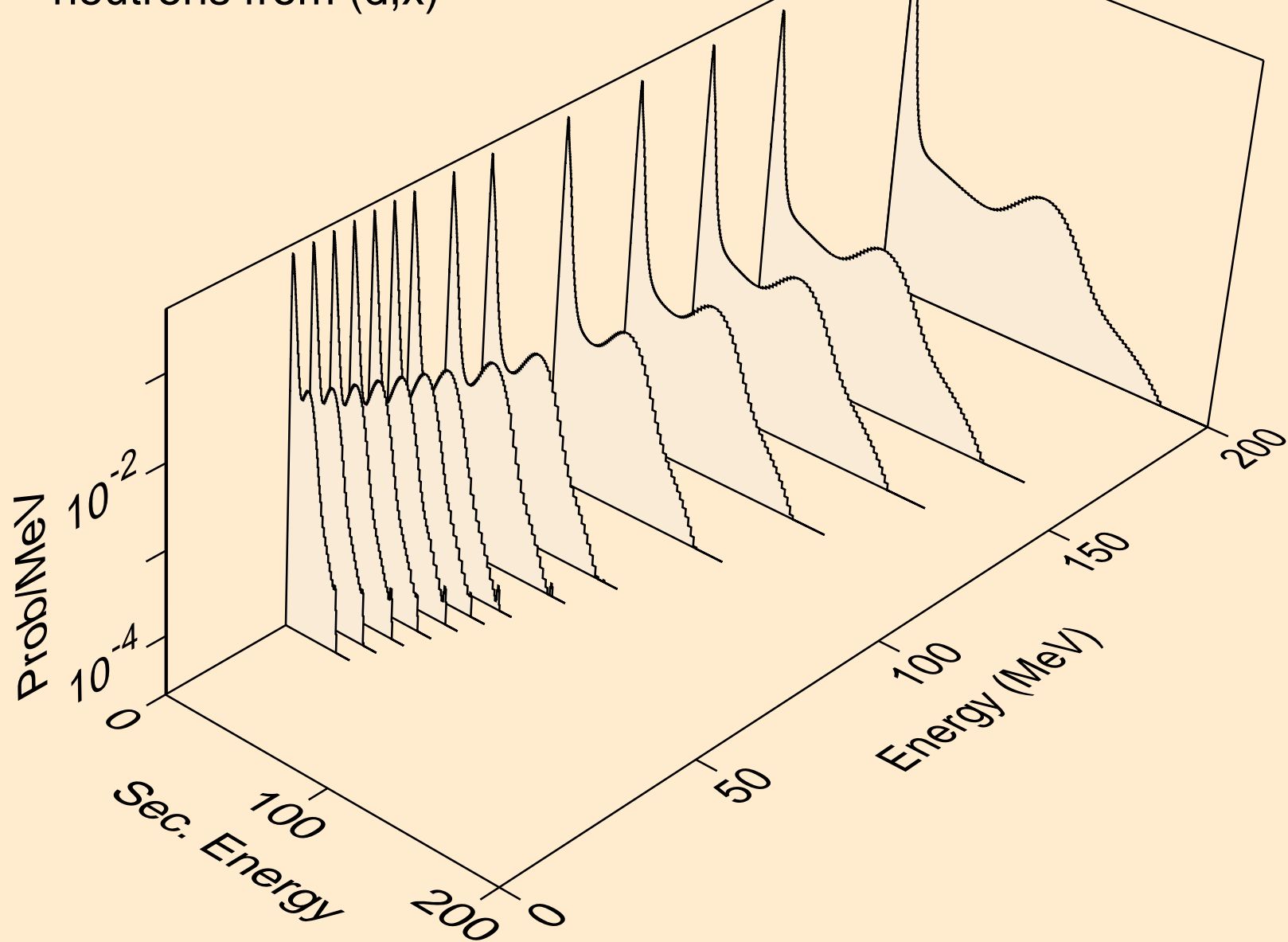

AU189 DEUTERON ACER TENDL-2023 LIBRARY; T=0.K
neutrons from (d,2nd)

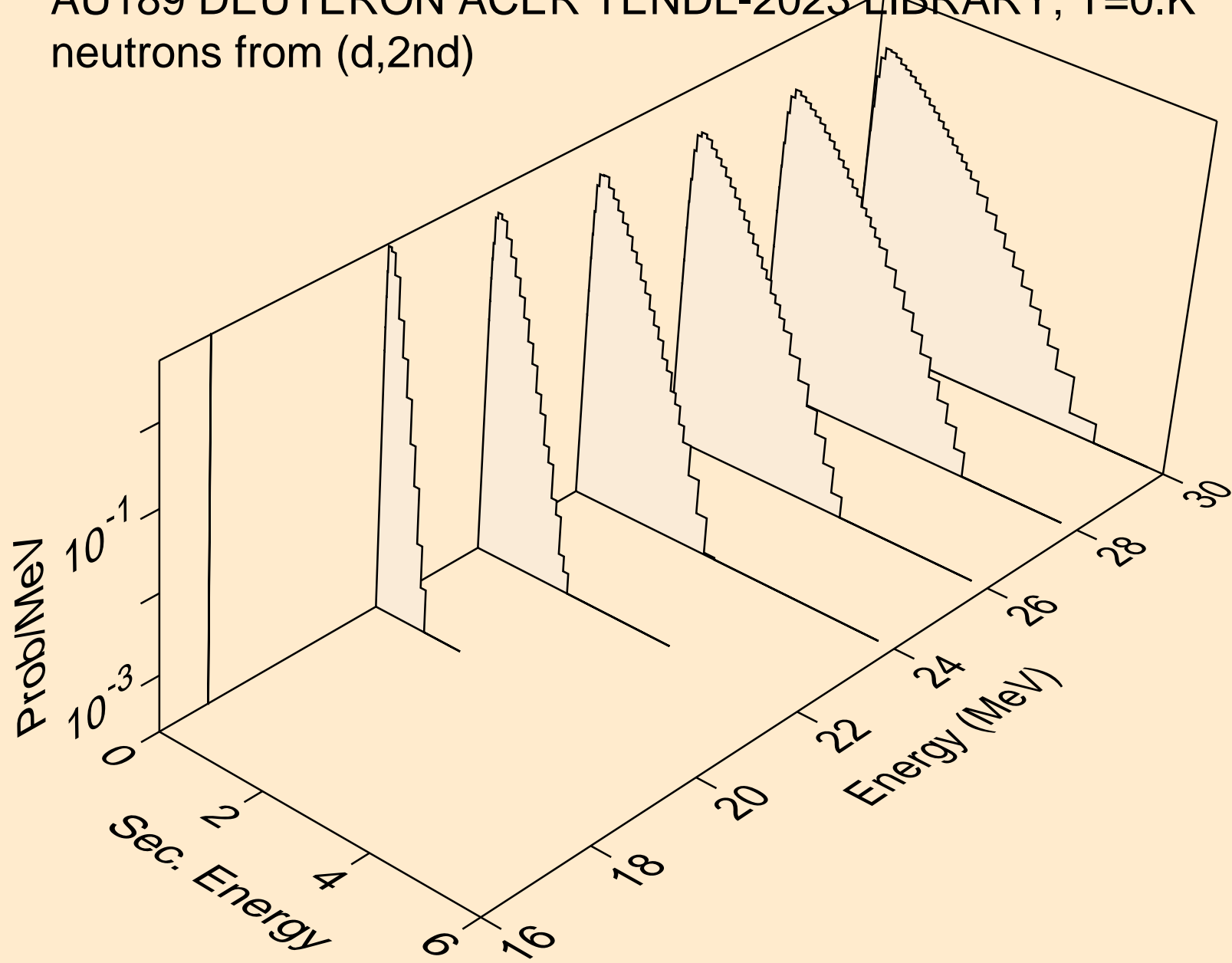

AU189 DEUTERON ACER TENDL-2023 LIBRARY; T=0.K
neutrons from (d,2n)

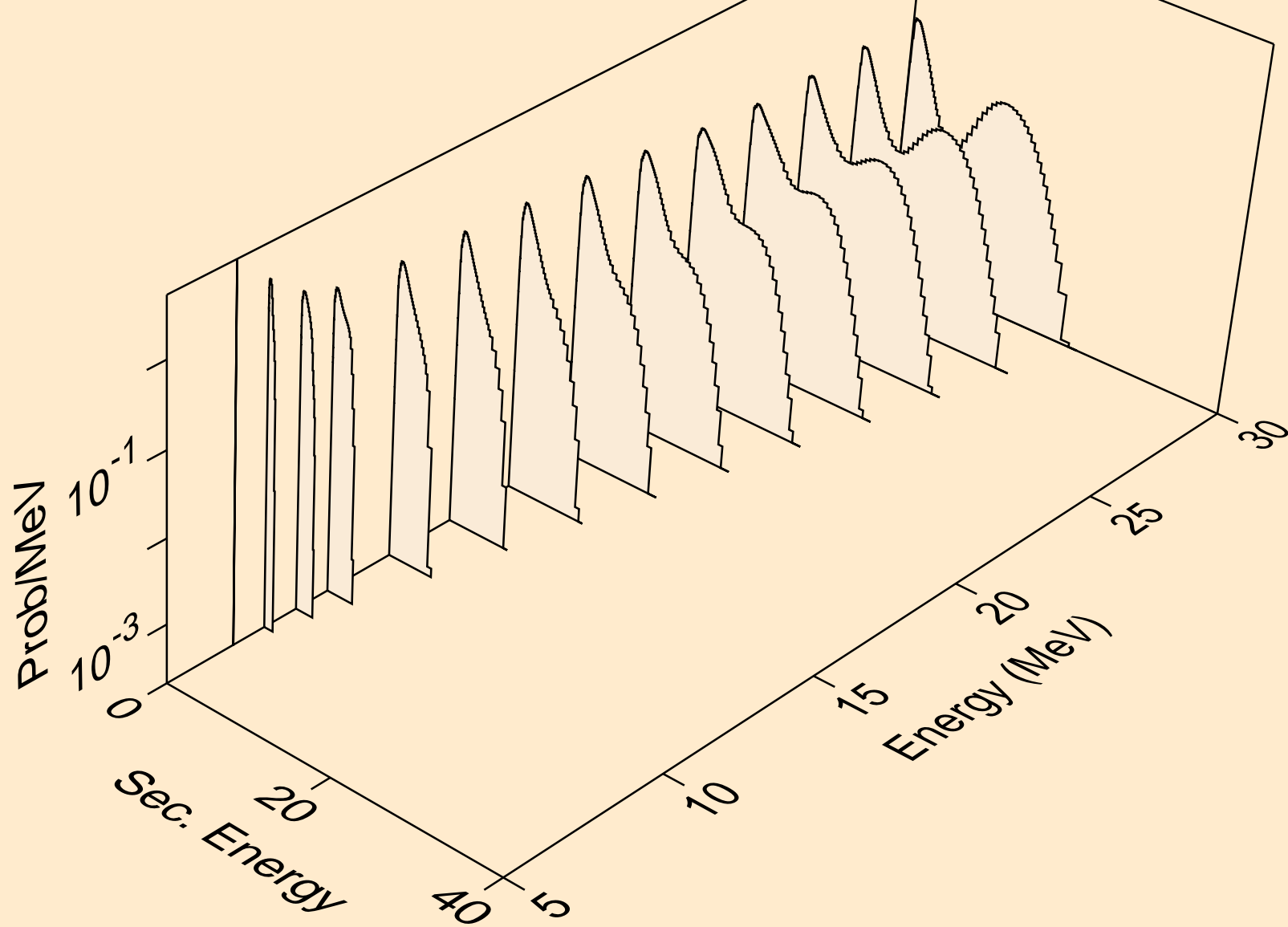

AU189 DEUTERON ACER TENDL-2023 LIBRARY; T=0.K
neutrons from (d,3n)

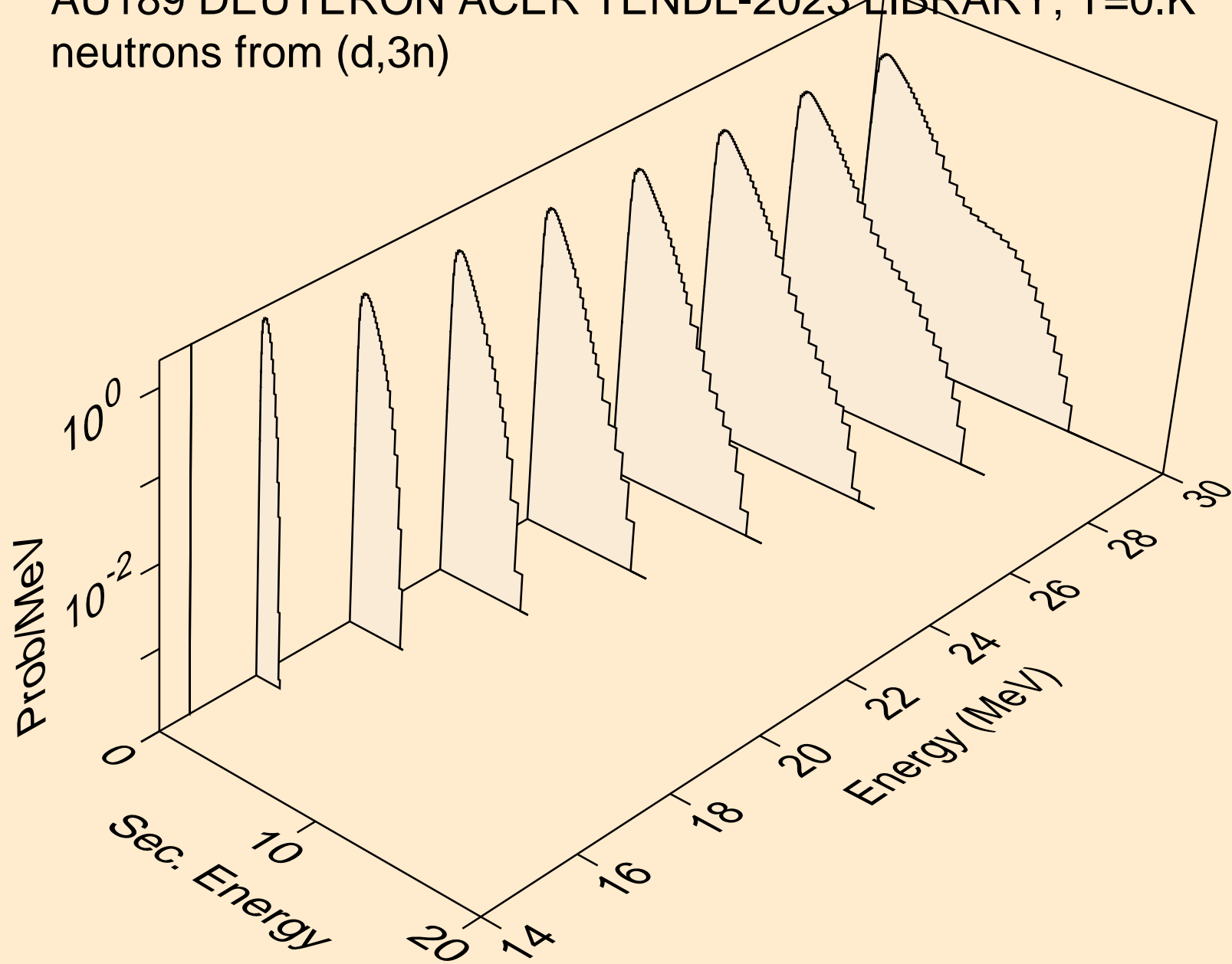

AU189 DEUTERON ACER TENDL-2023 LIBRARY; T=0.K
neutrons from (d,n*)a

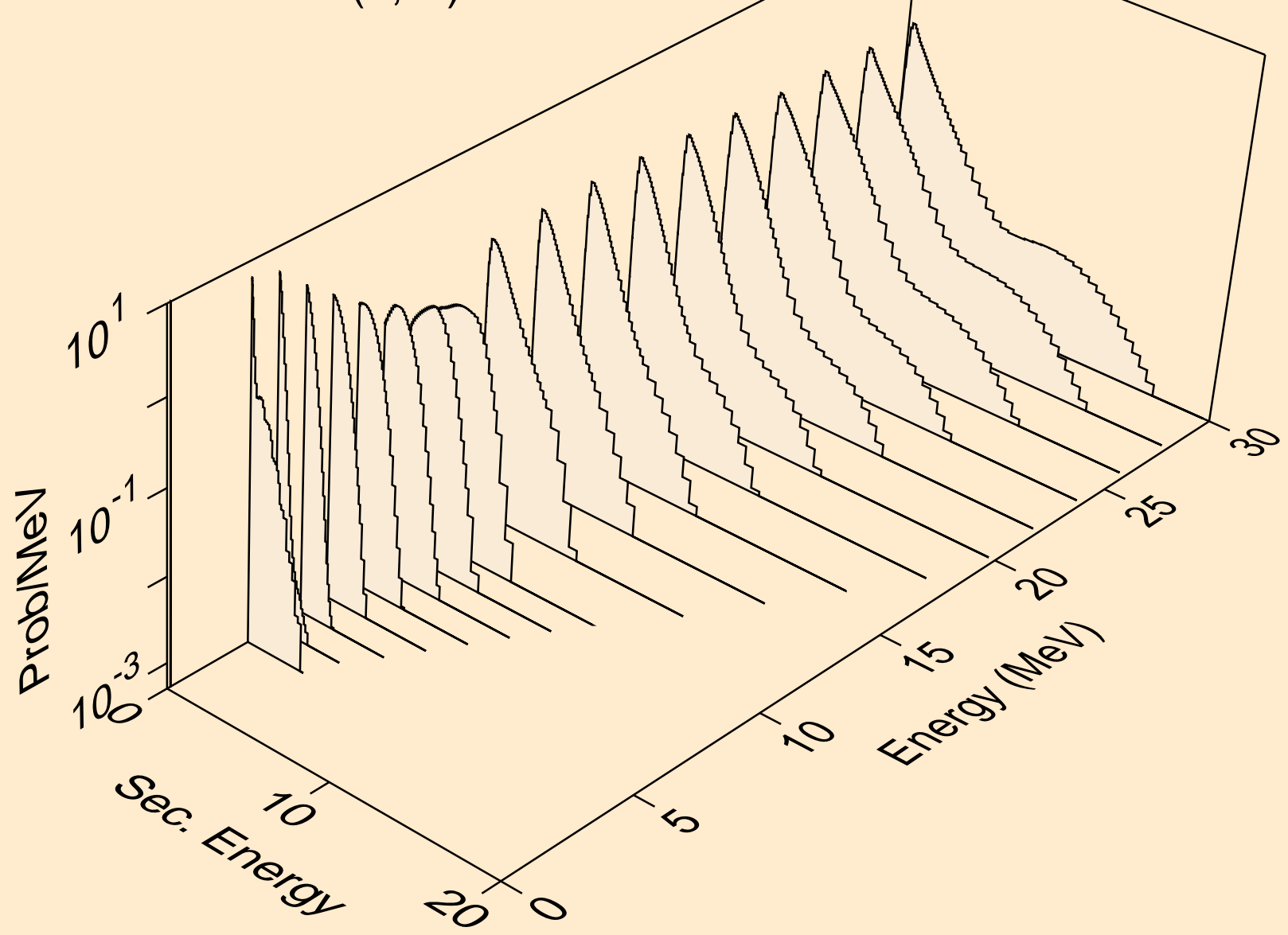

AU189 DEUTERON ACER TENDL-2023 LIBRARY; T=0.K
neutrons from (d,2n)a

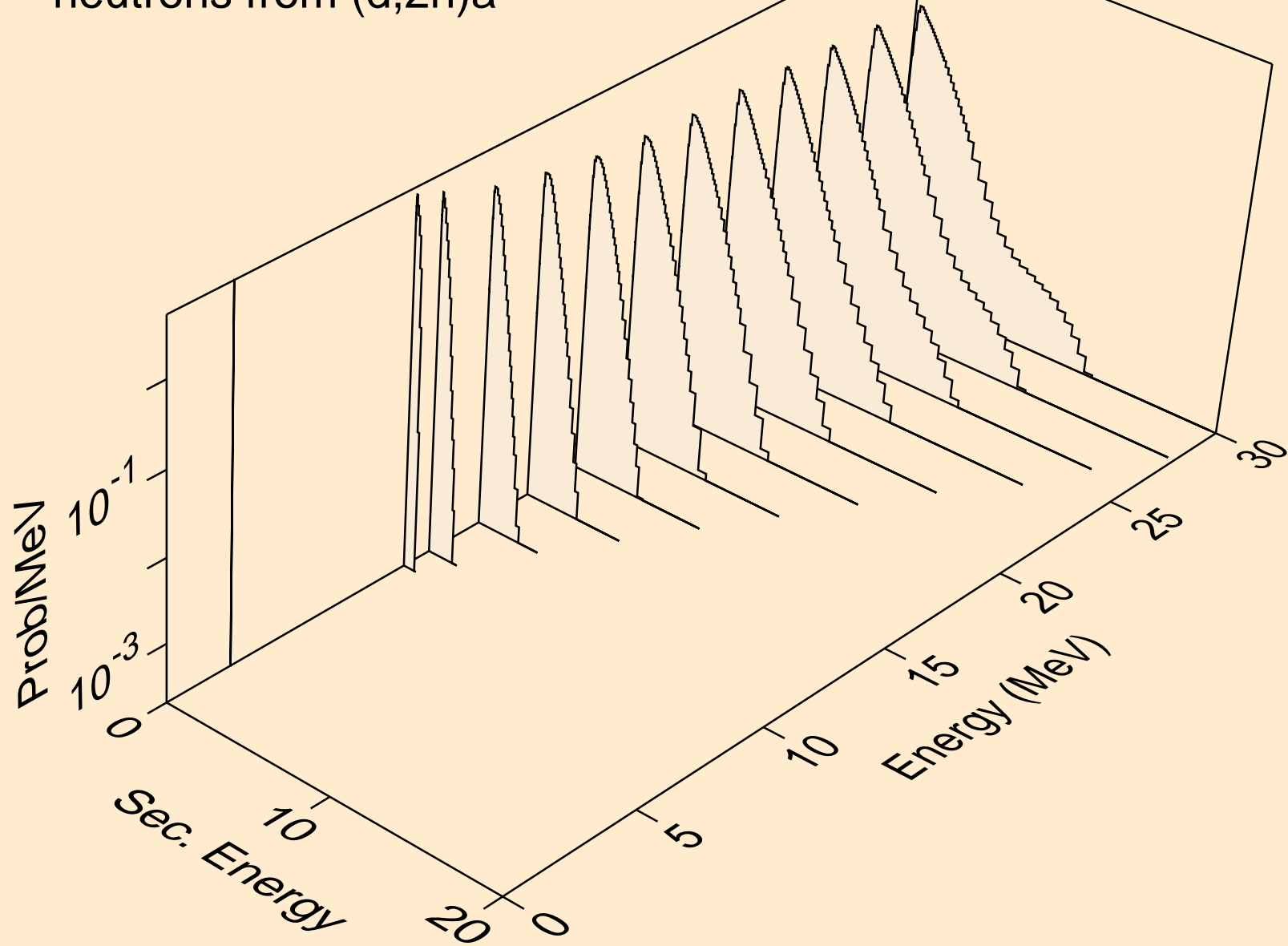

AU189 DEUTERON ACER TENDL-2023 LIBRARY; T=0.K
neutrons from (d,3n)a

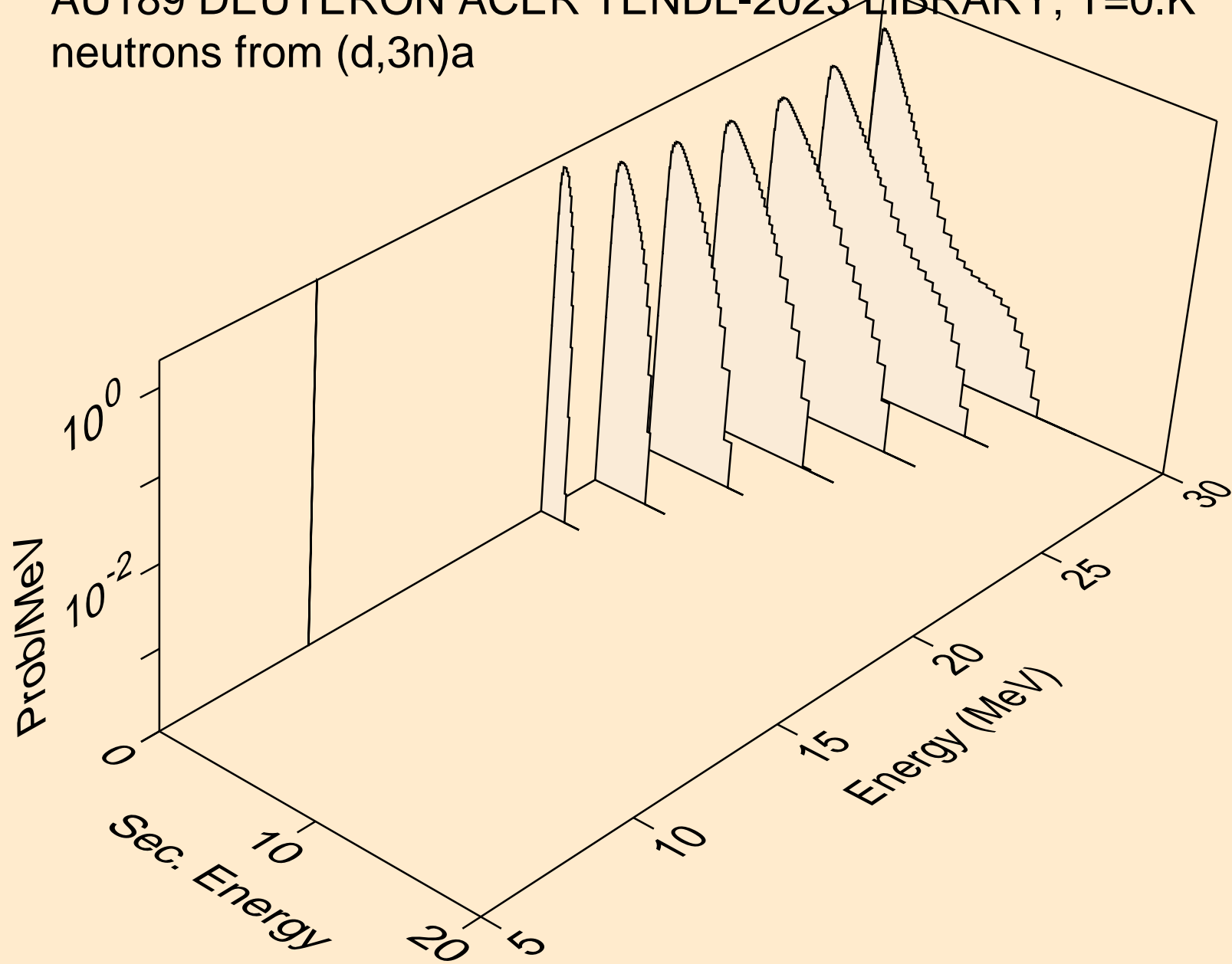

AU189 DEUTERON ACER TENDL-2023 LIBRARY; T=0.K
neutrons from (d,n*)p

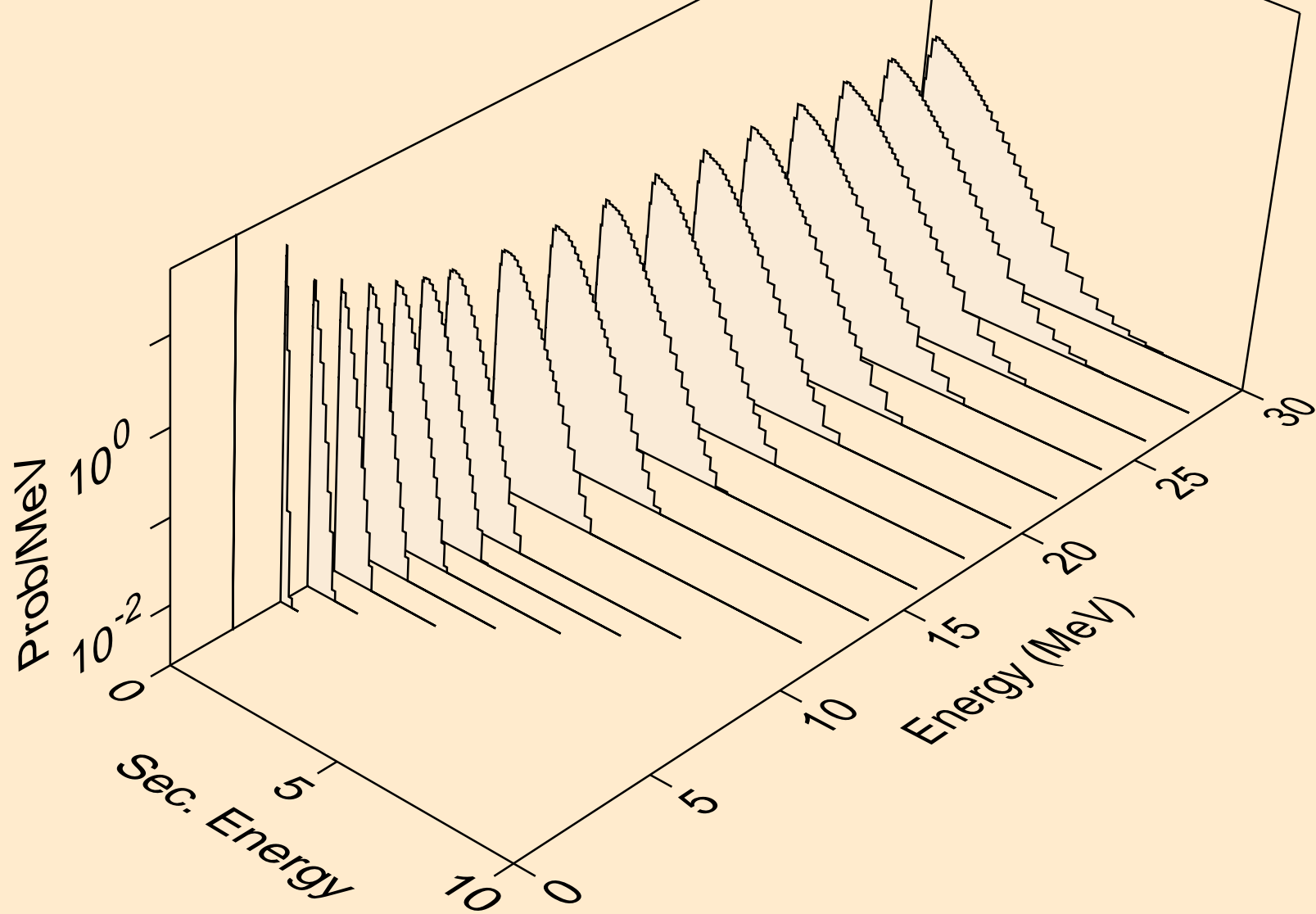

AU189 DEUTERON ACER TENDL-2023 LIBRARY; T=0.K
neutrons from (d,n*)2a

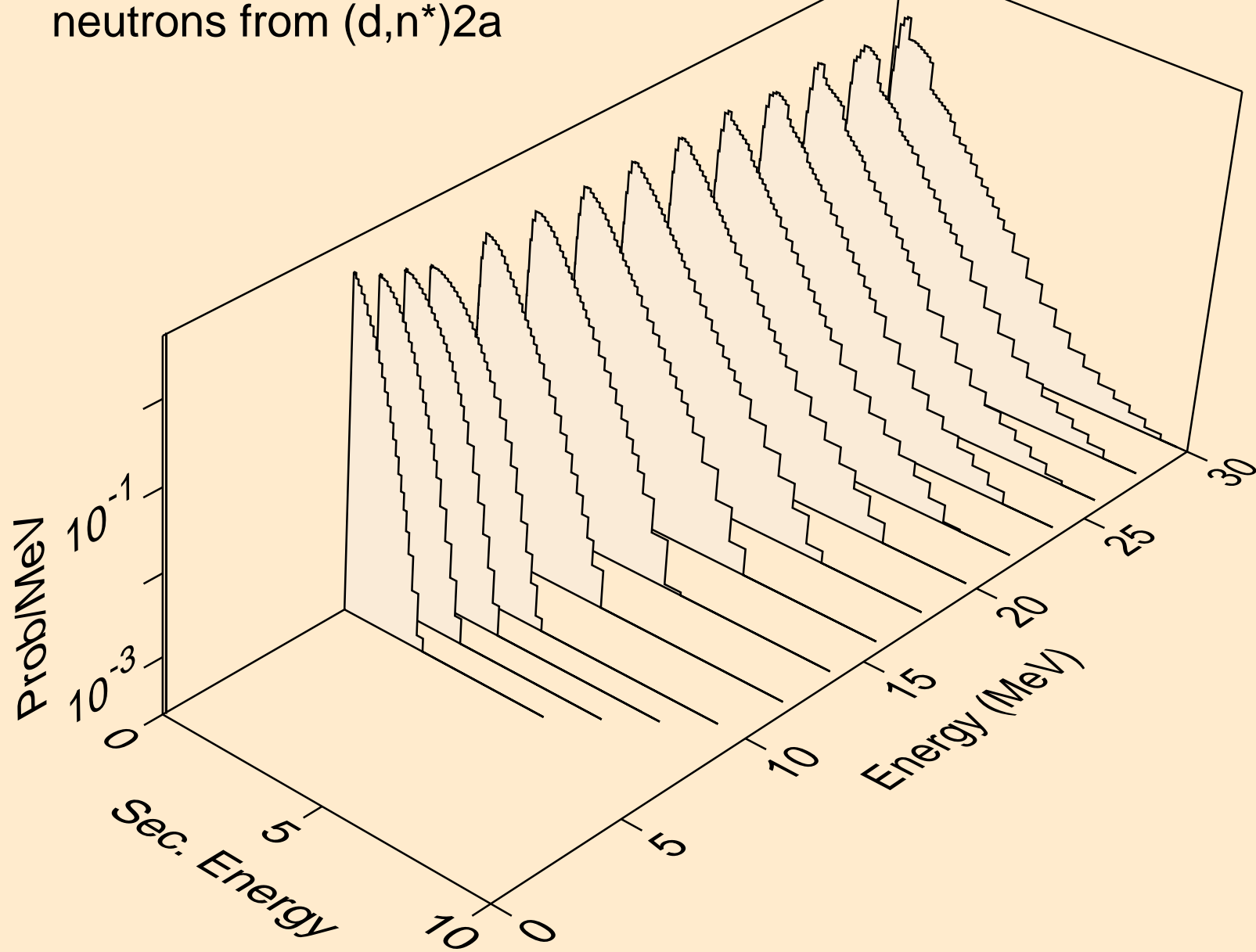

AU189 DEUTERON ACER TENDL-2023 LIBRARY; T=0.K
neutrons from (d,2n)2a

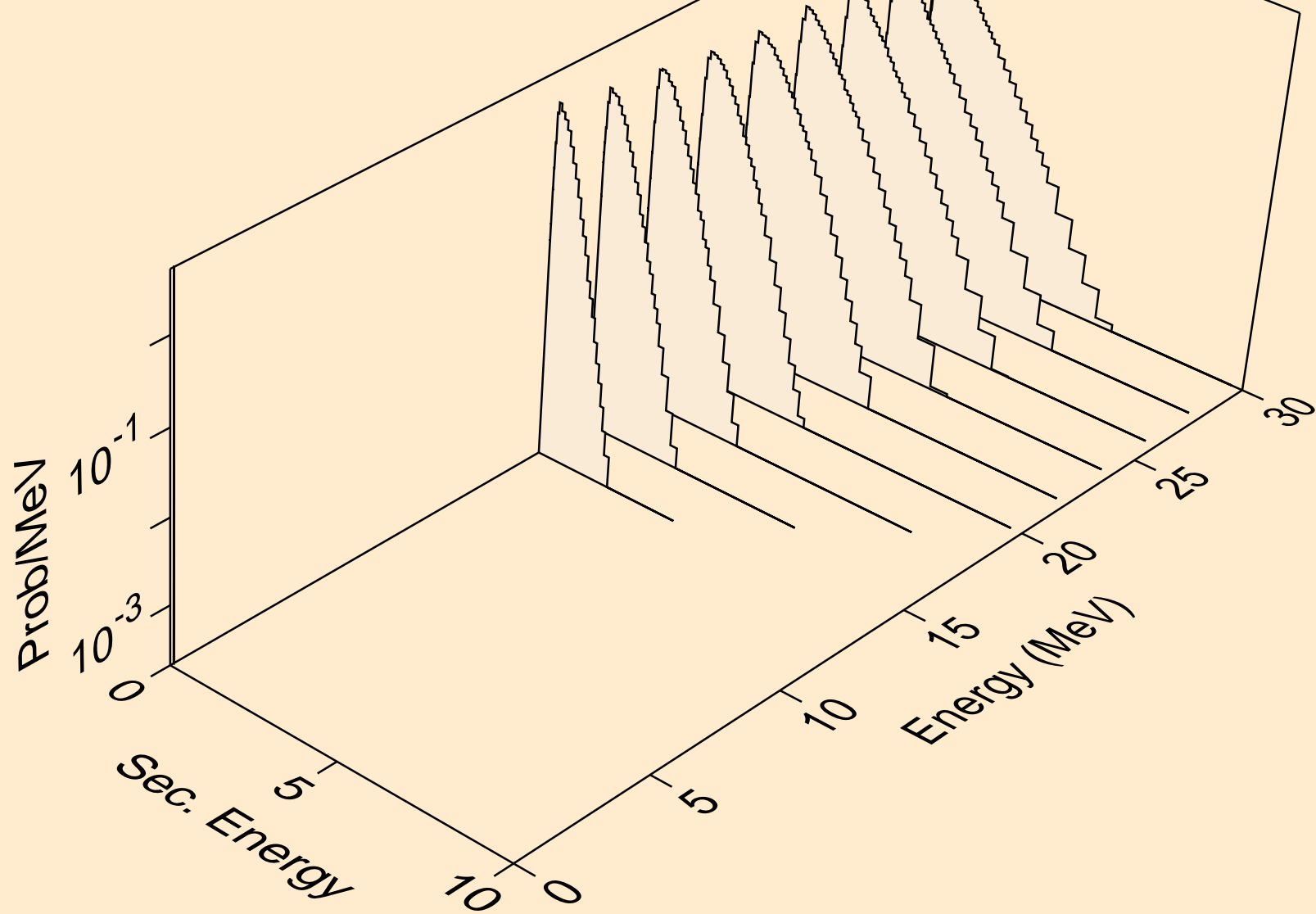

AU189 DEUTERON ACER TENDL-2023 LIBRARY; T=0.K
neutrons from (d,n*)d

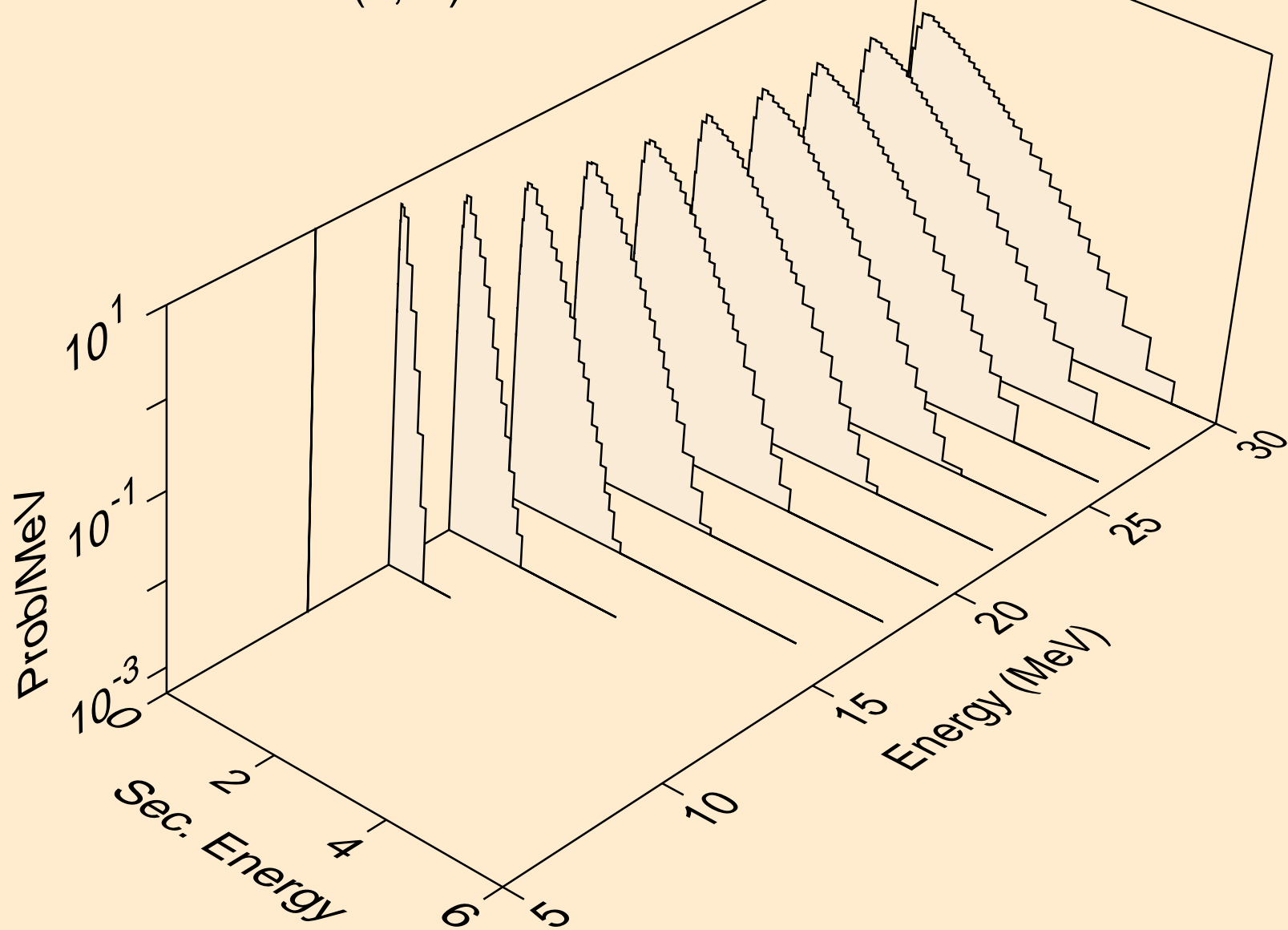

AU189 DEUTERON ACER TENDL-2023 LIBRARY; T=0.K
neutrons from (d,n*)t

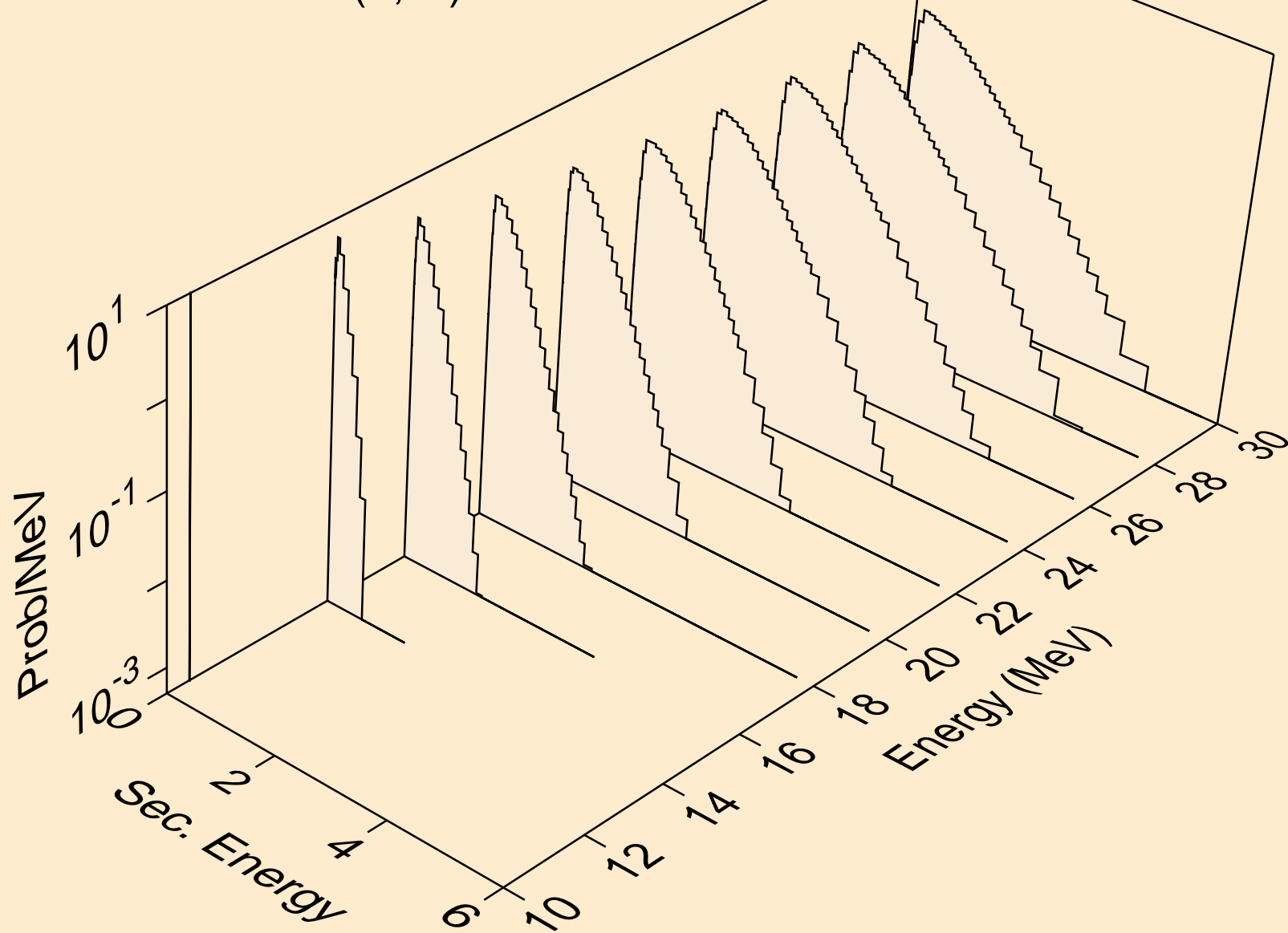

AU189 DEUTERON ACER TENDL-2023 LIBRARY; T=0.K
neutrons from (d,n*)he3

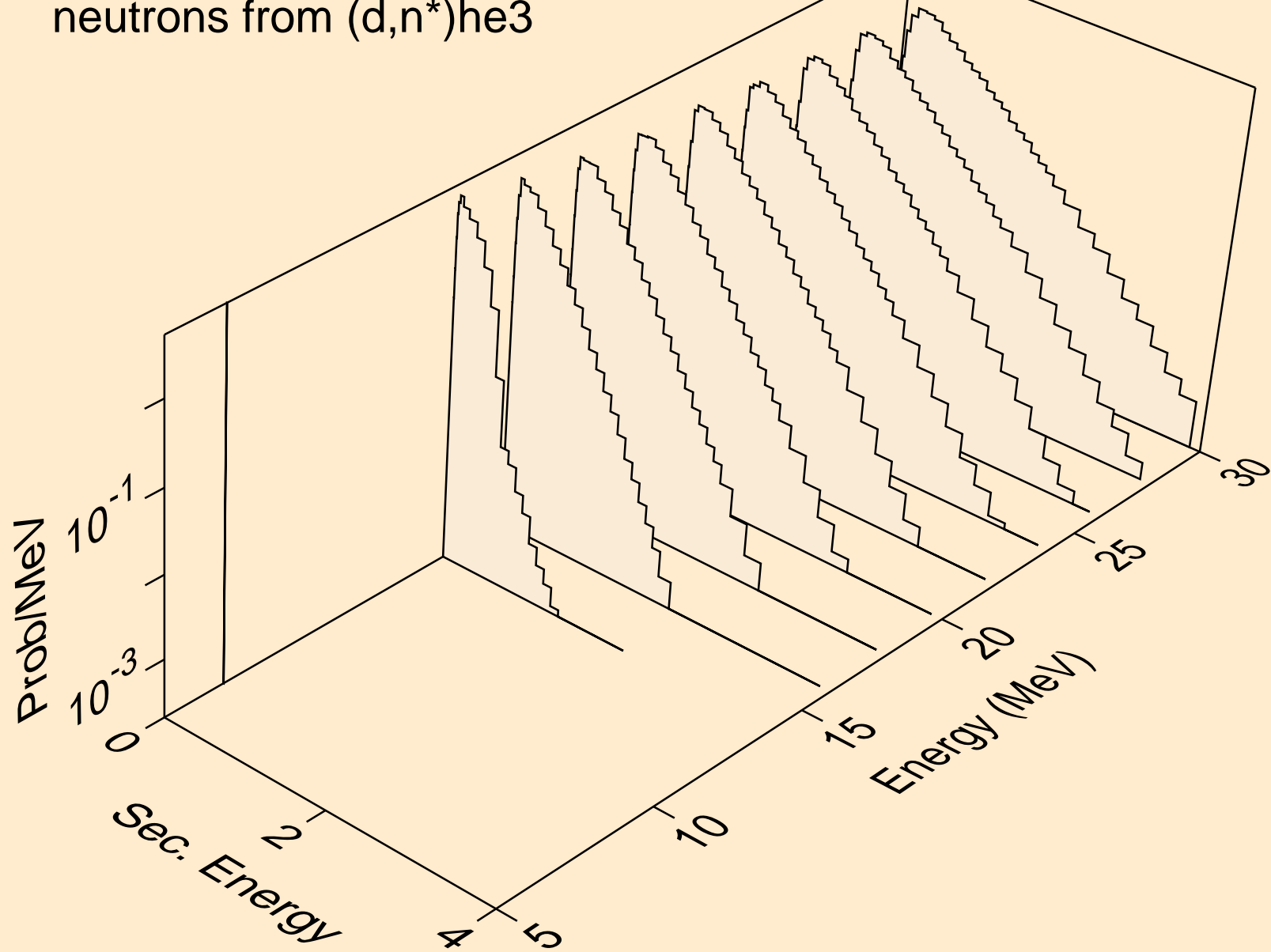

AU189 DEUTERON ACER TENDL-2023 LIBRARY; T=0.K
neutrons from (d,4n)

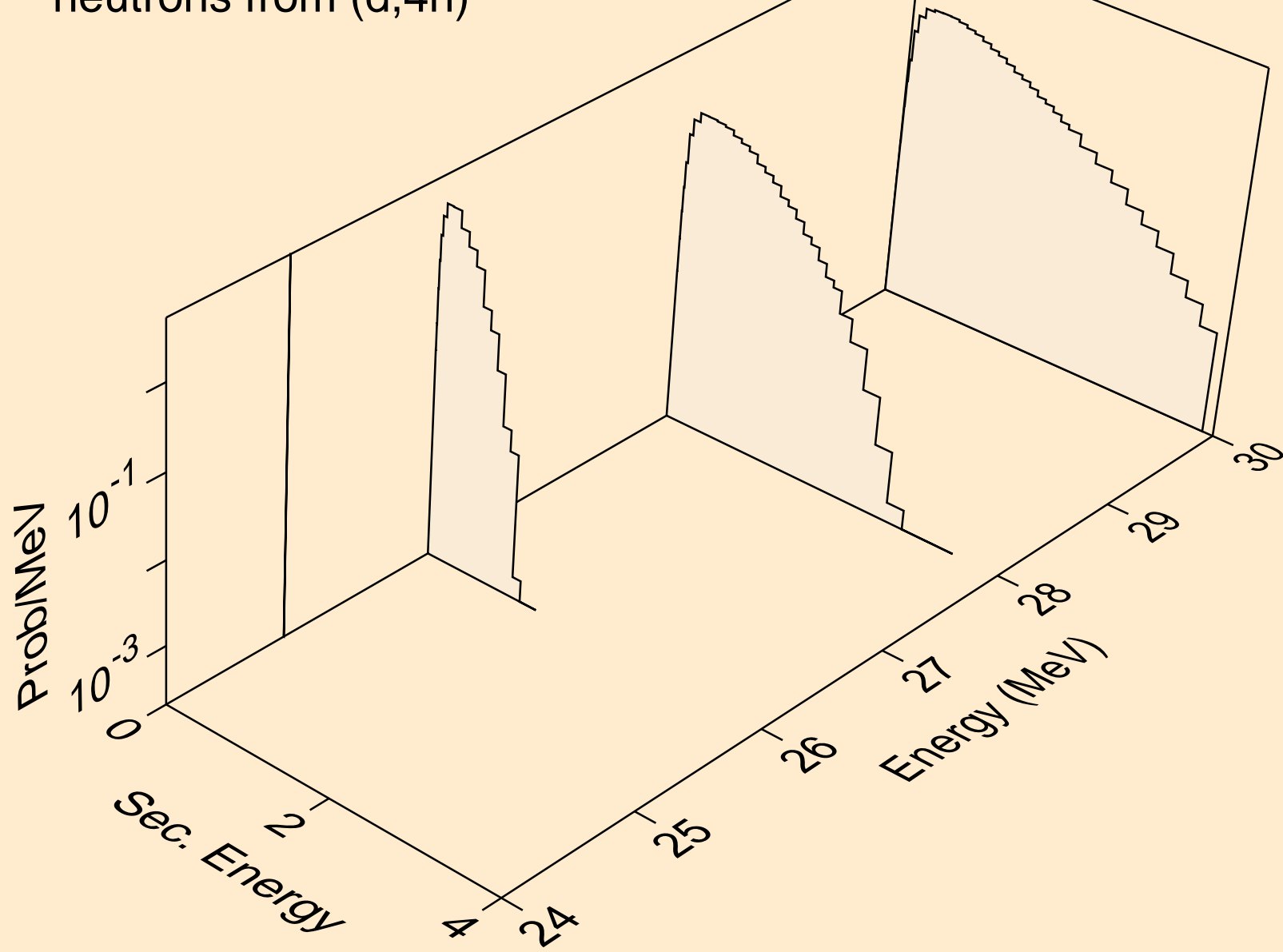

AU189 DEUTERON ACER TENDL-2023 LIBRARY; T=0.K
neutrons from (d,2np)

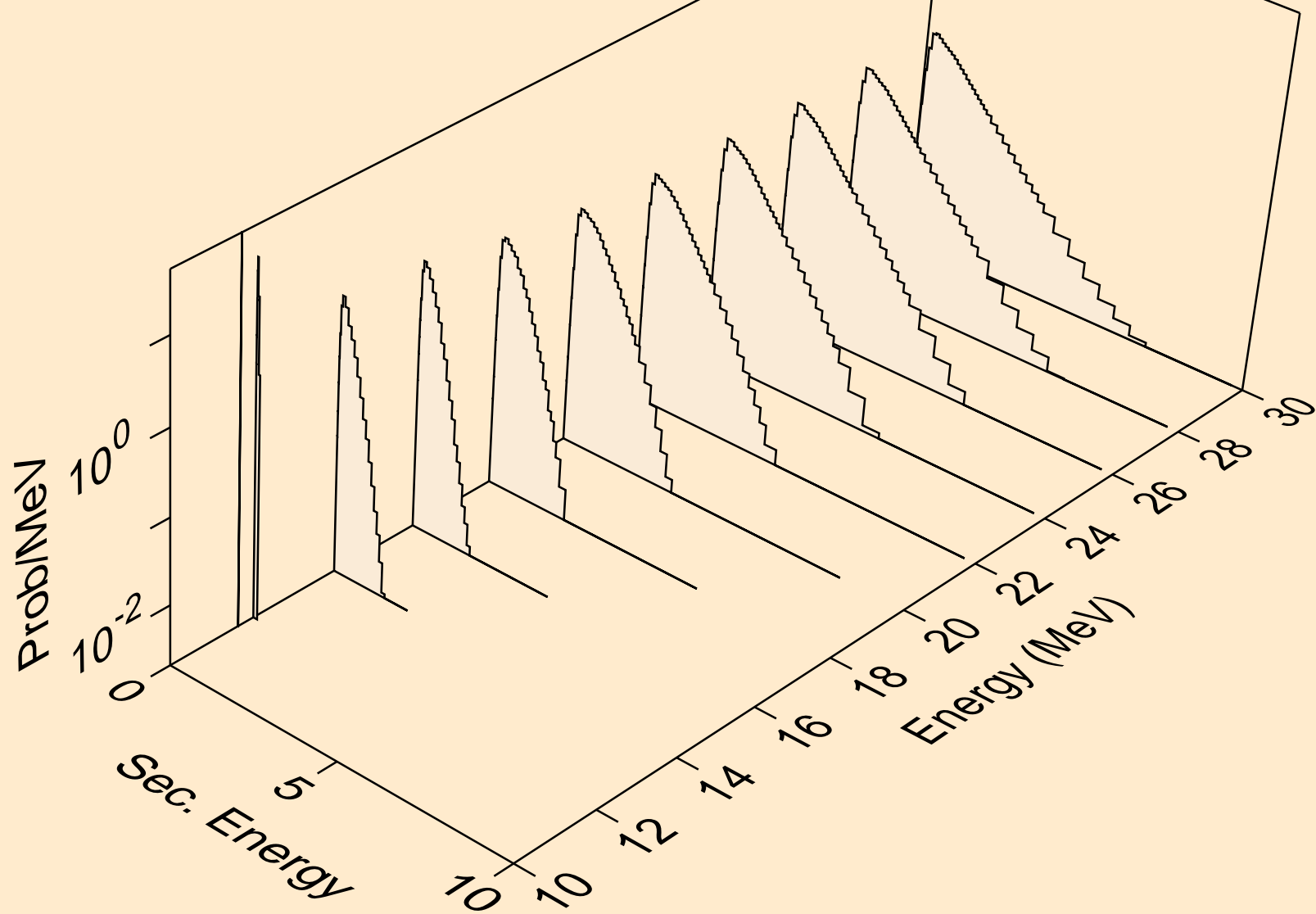

AU189 DEUTERON ACER TENDL-2023 LIBRARY; T=0.K
neutrons from (d,3np)

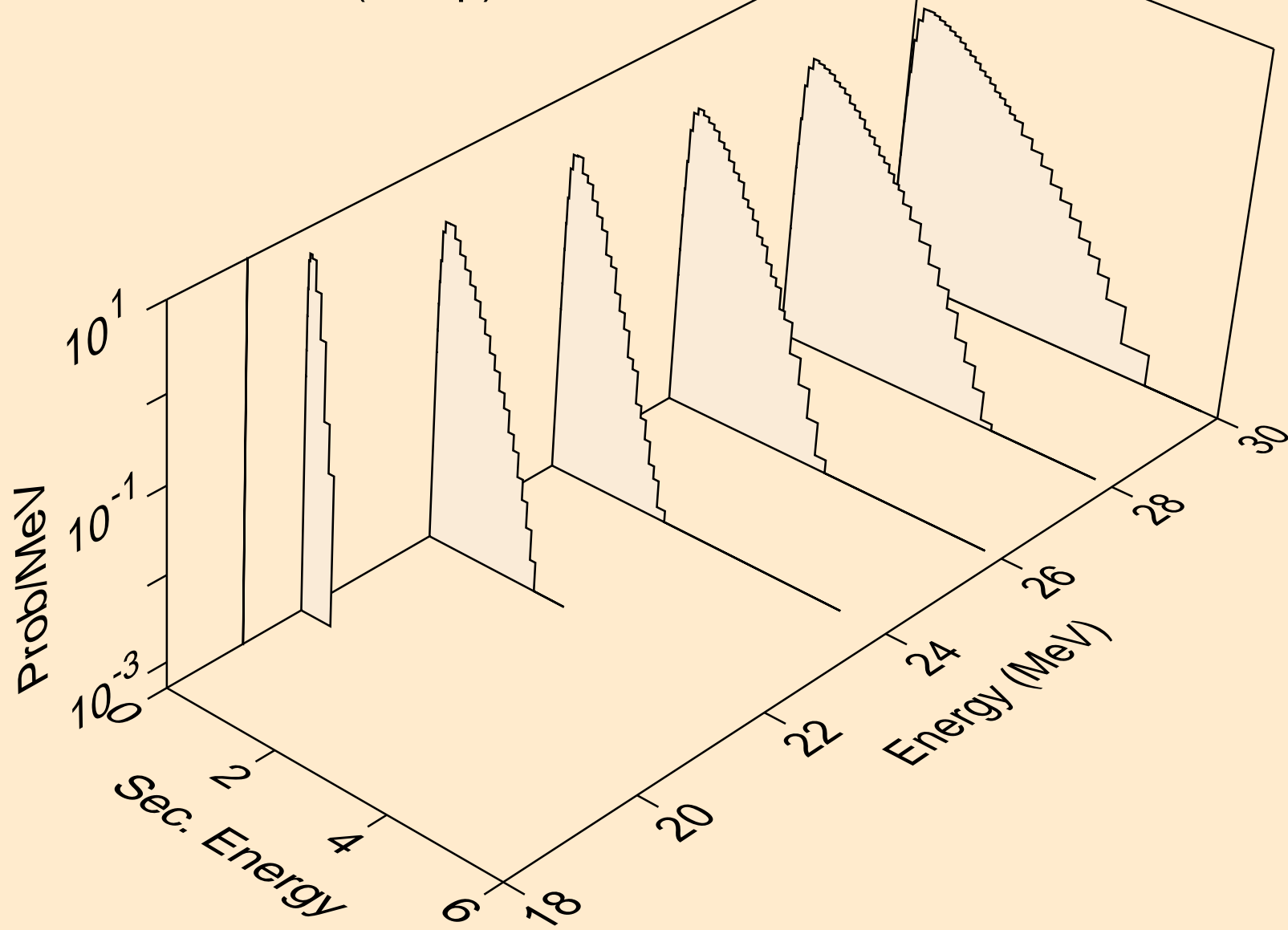

AU189 DEUTERON ACER TENDL-2023 LIBRARY; T=0.K
neutrons from (d,n2p)

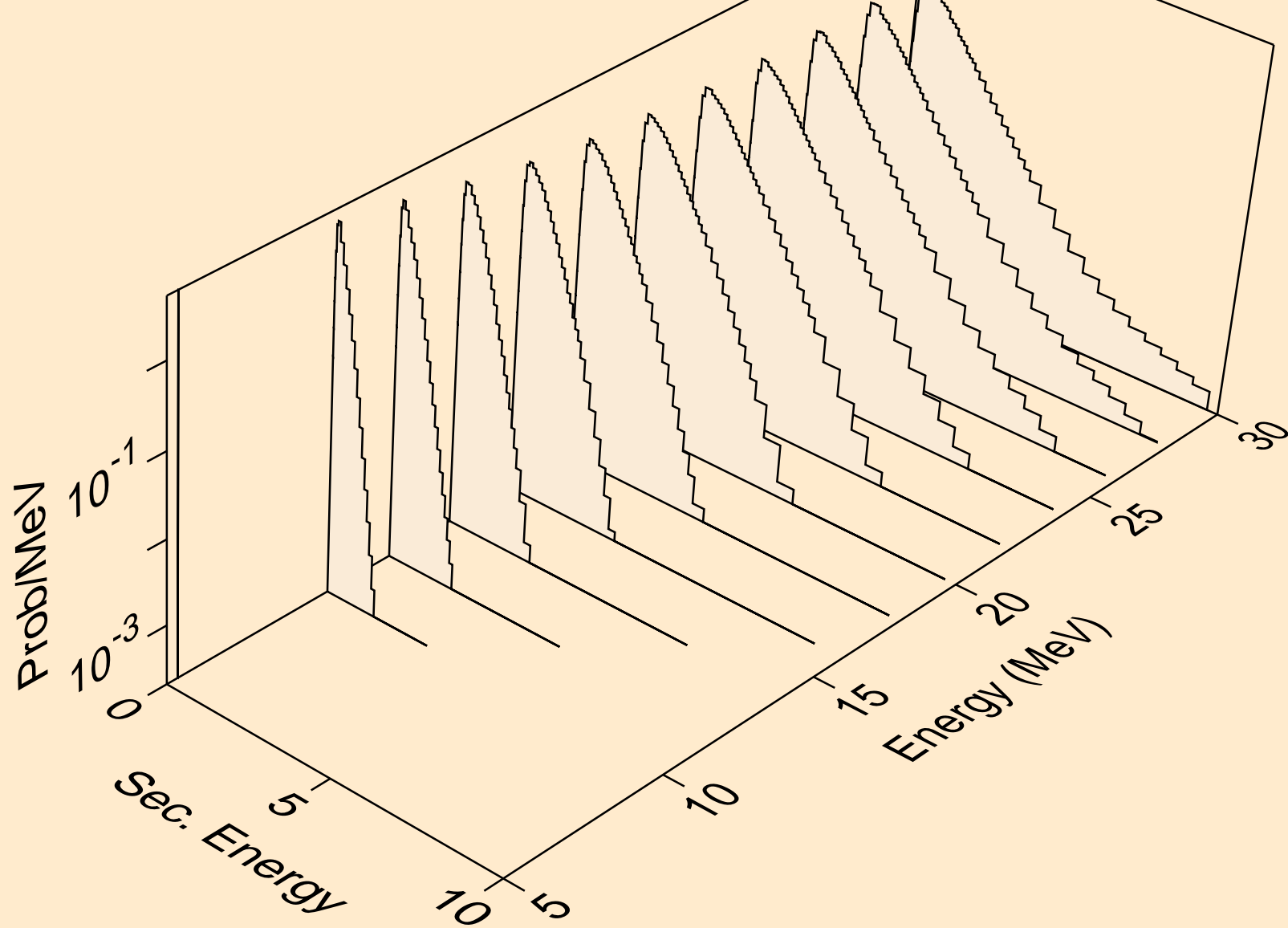

AU189 DEUTERON ACER TENDL-2023 LIBRARY; T=0.K
neutrons from (d,npa)

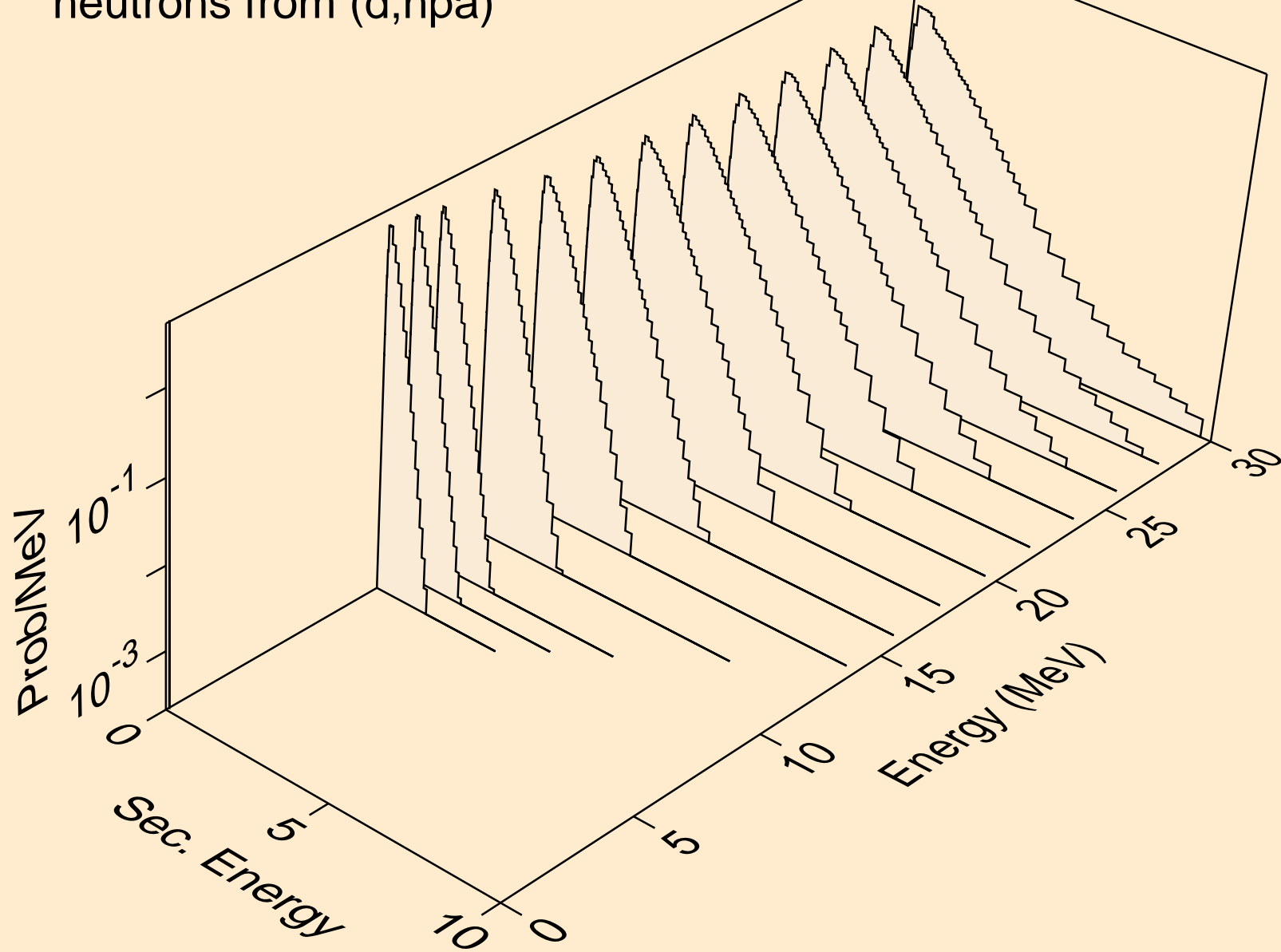

AU189 DEUTERON ACER TENDL-2023 LIBRARY; T=0.K
protons from (d,x)

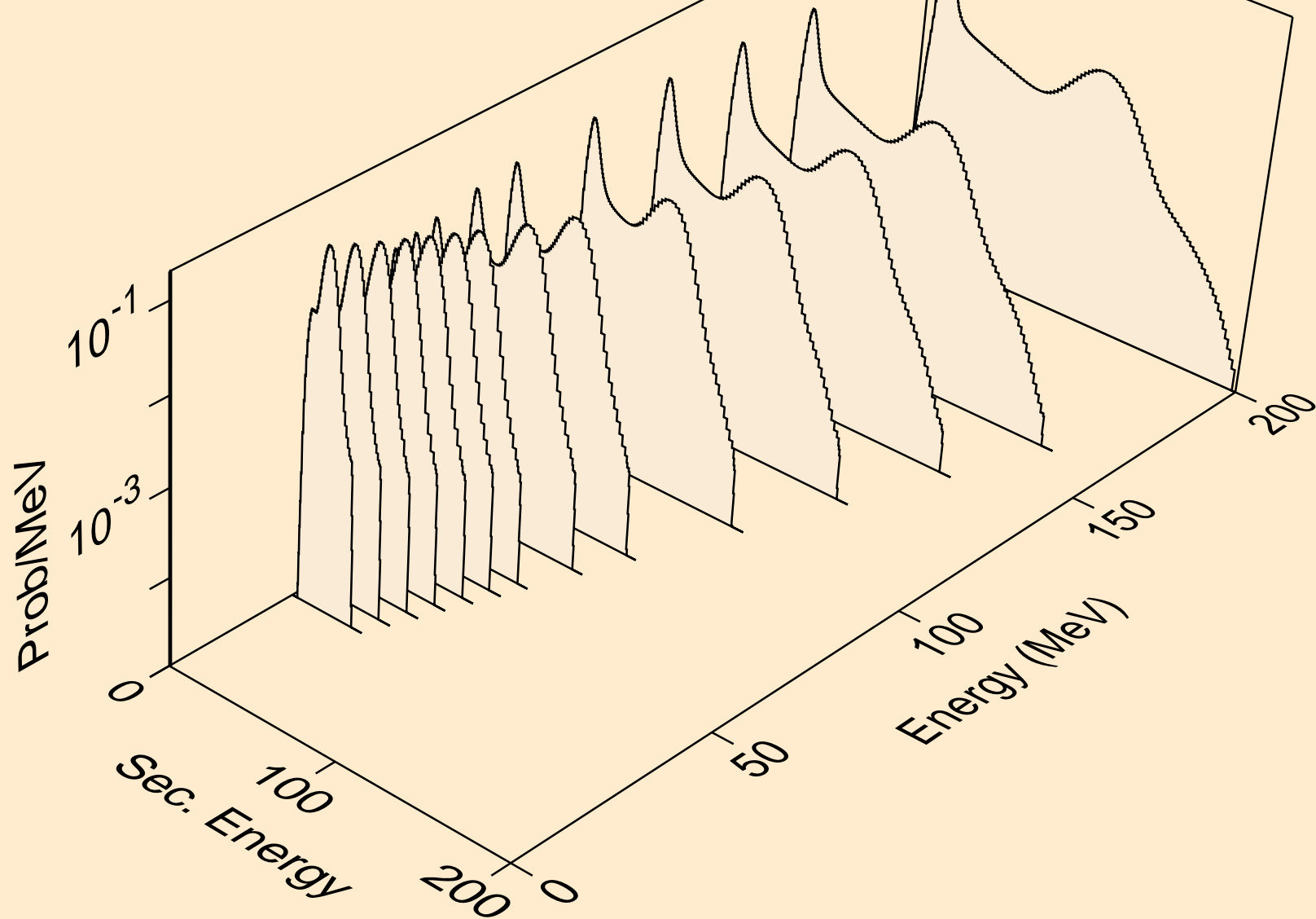

AU189 DEUTERON ACER TENDL-2023 LIBRARY; T=0.K
protons from (d,n*)p

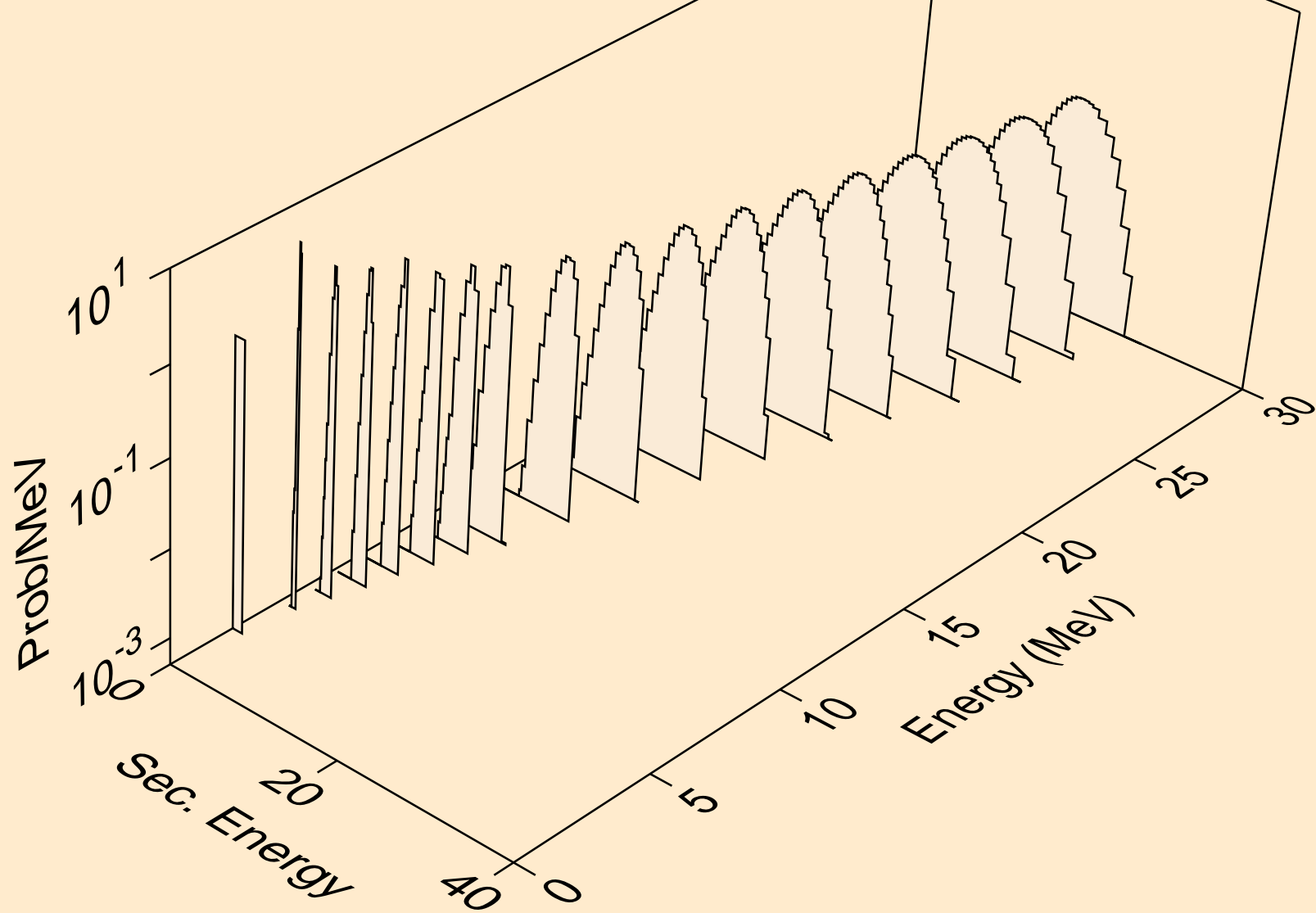

AU189 DEUTERON ACER TENDL-2023 LIBRARY; T=0.K
protons from (d,2np)

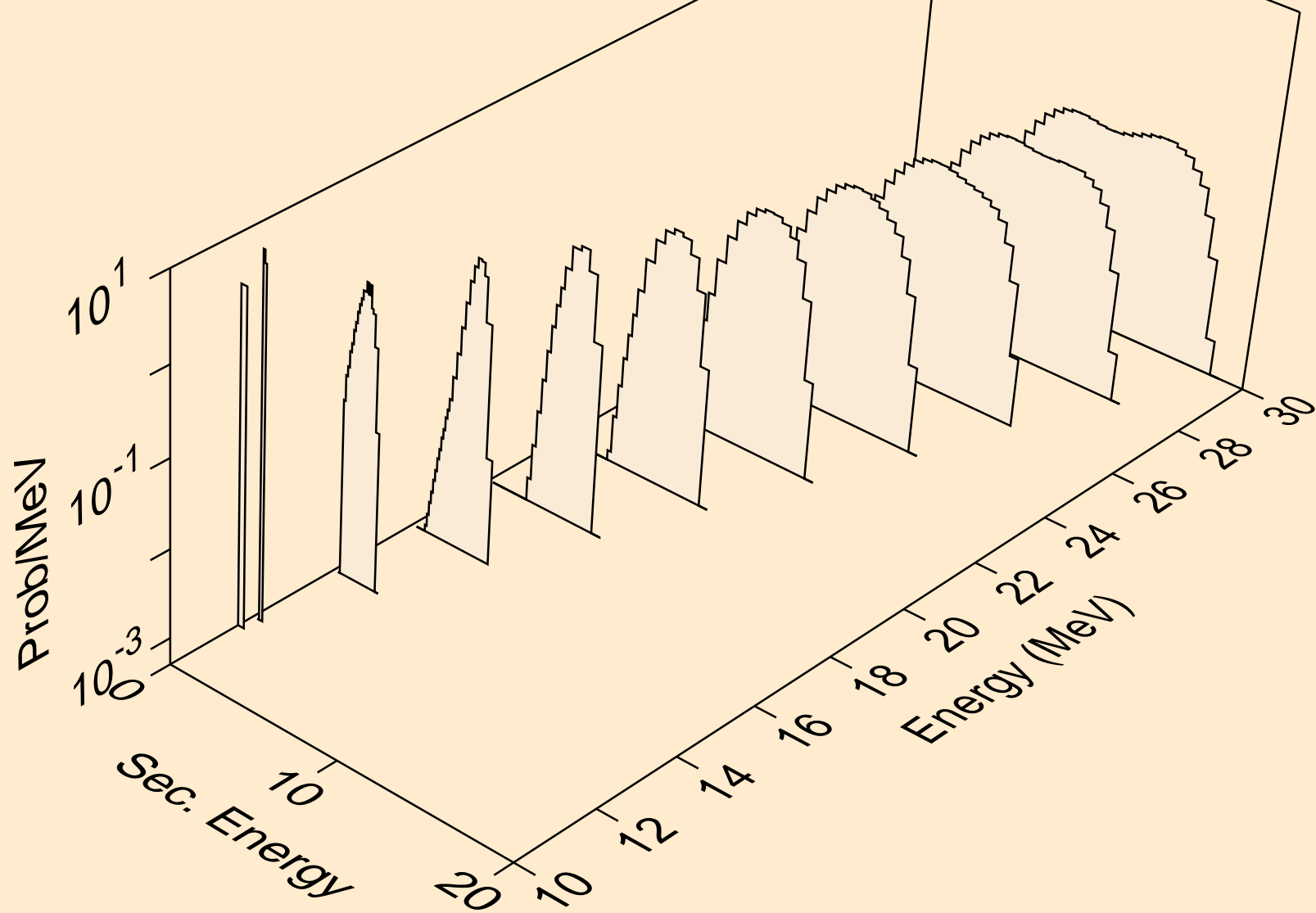

AU189 DEUTERON ACER TENDL-2023 LIBRARY; T=0.K
protons from (d,3np)

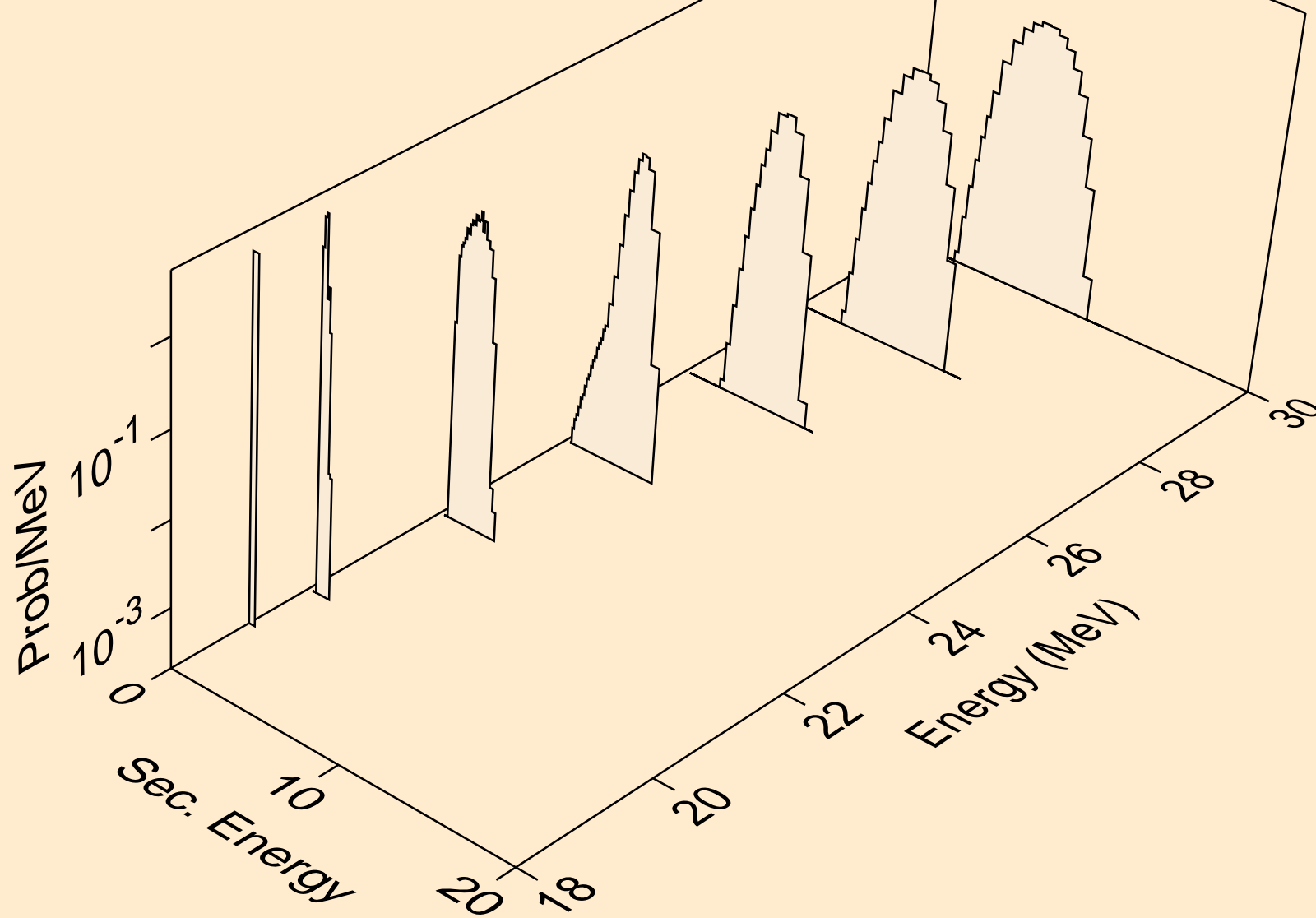

AU189 DEUTERON ACER TENDL-2023 LIBRARY; T=0.K
protons from (d,n2p)

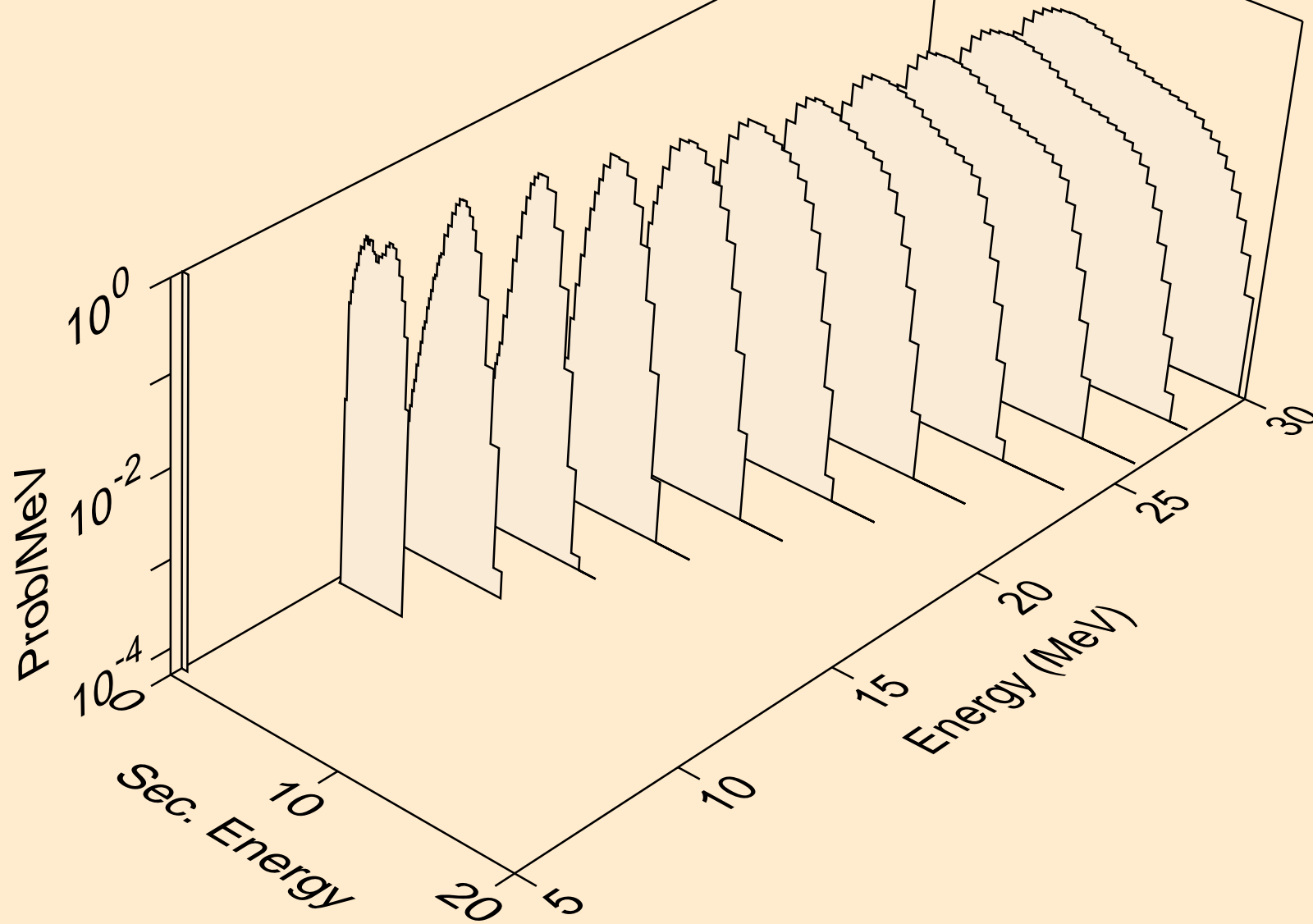

AU189 DEUTERON ACER TENDL-2023 LIBRARY; T=0.K
protons from (d,npa)

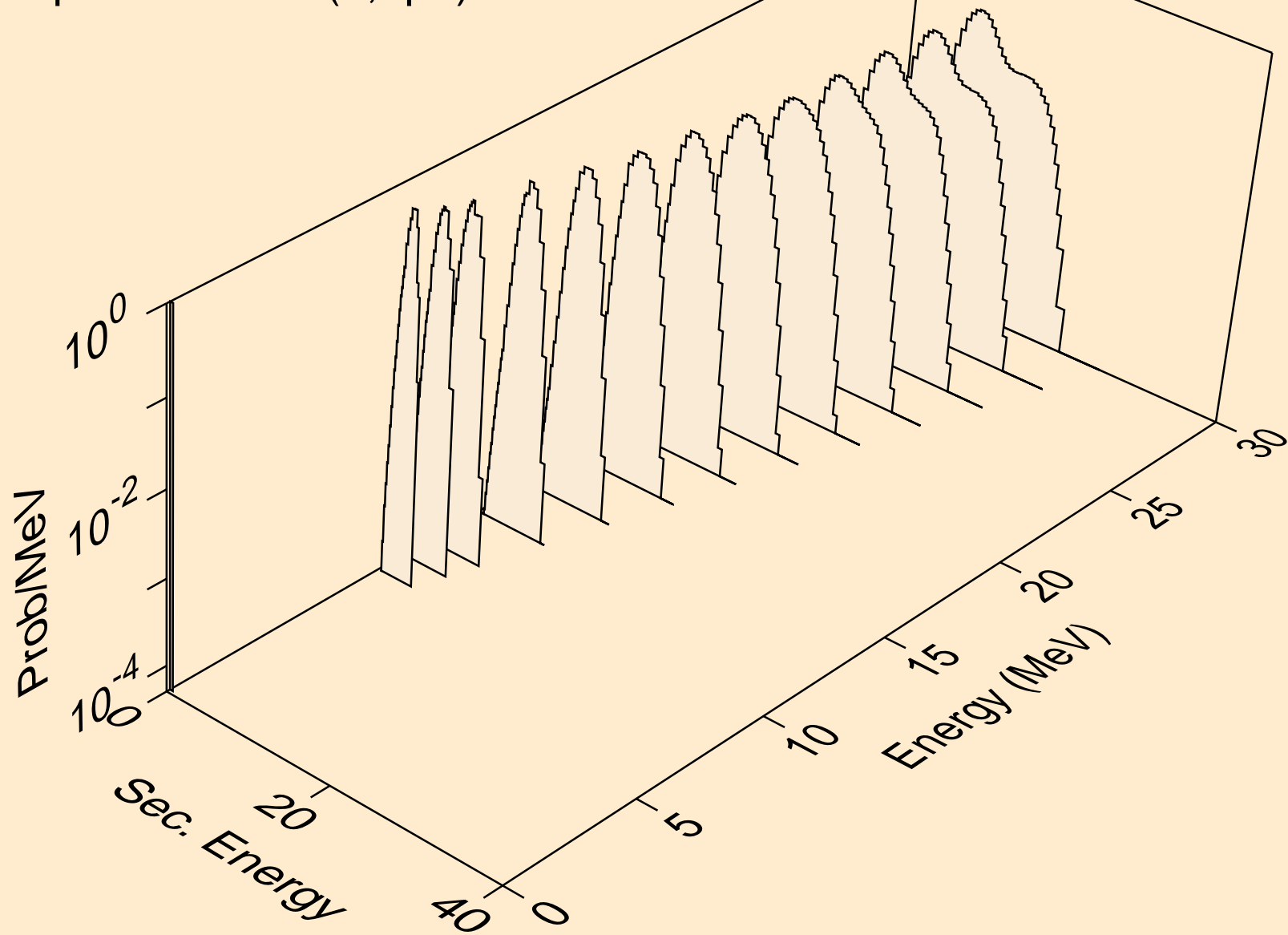

AU189 DEUTERON ACER TENDL-2023 LIBRARY; T=0.K
protons from (d,p)

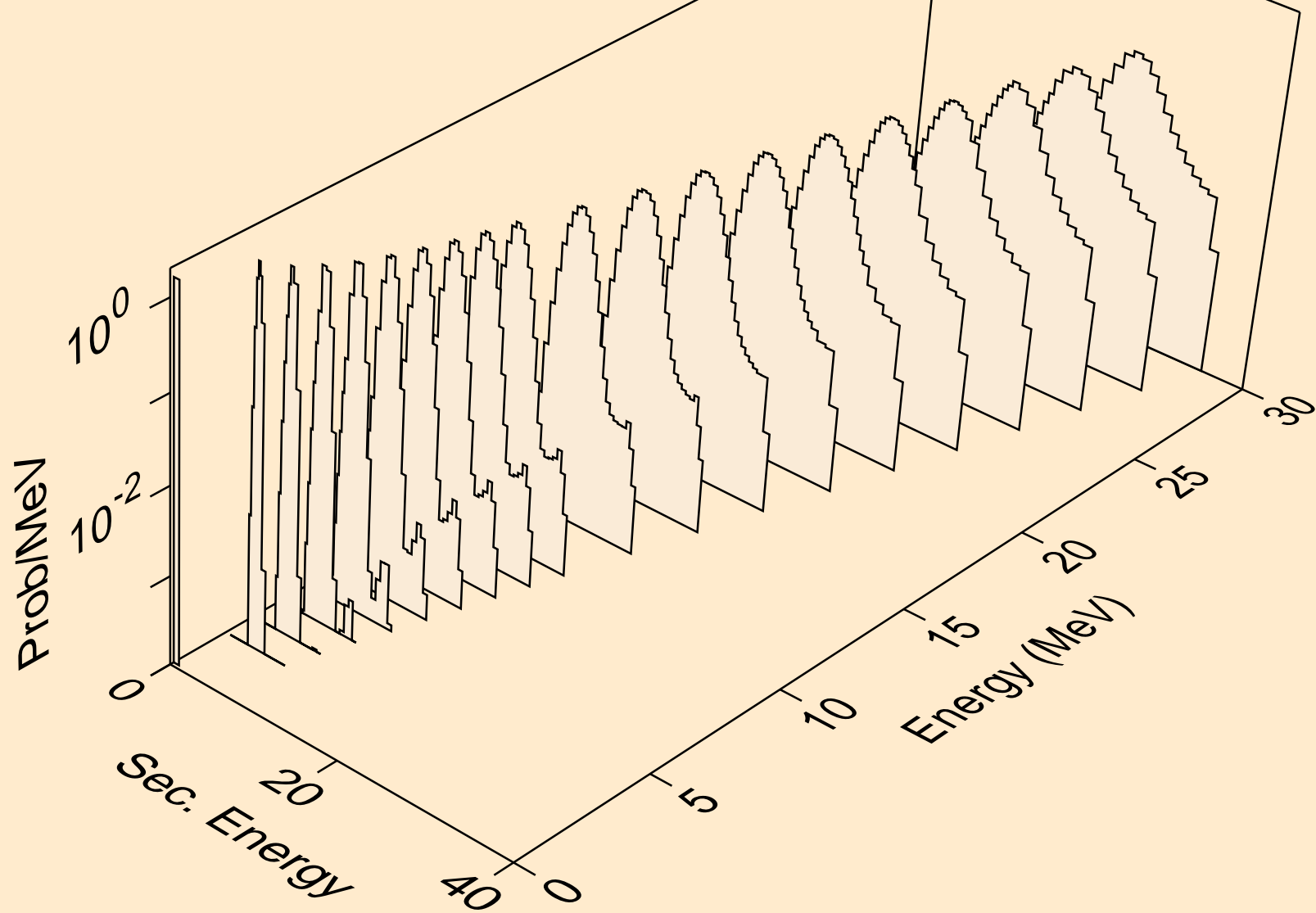

AU189 DEUTERON ACER TENDL-2023 LIBRARY; T=0.K
protons from (d,2p)

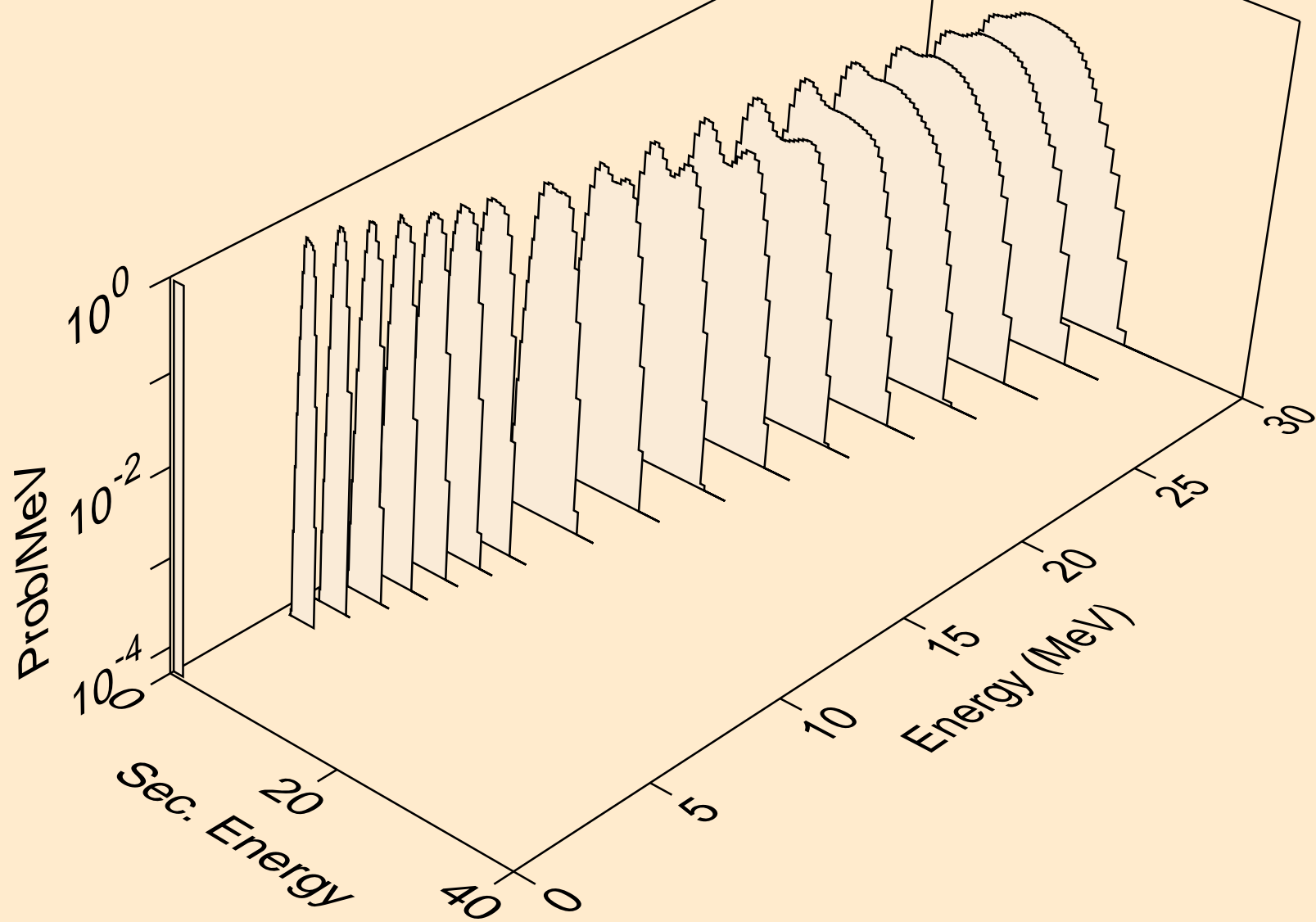

AU189 DEUTERON ACER TENDL-2023 LIBRARY; T=0.K
protons from (d,pa)

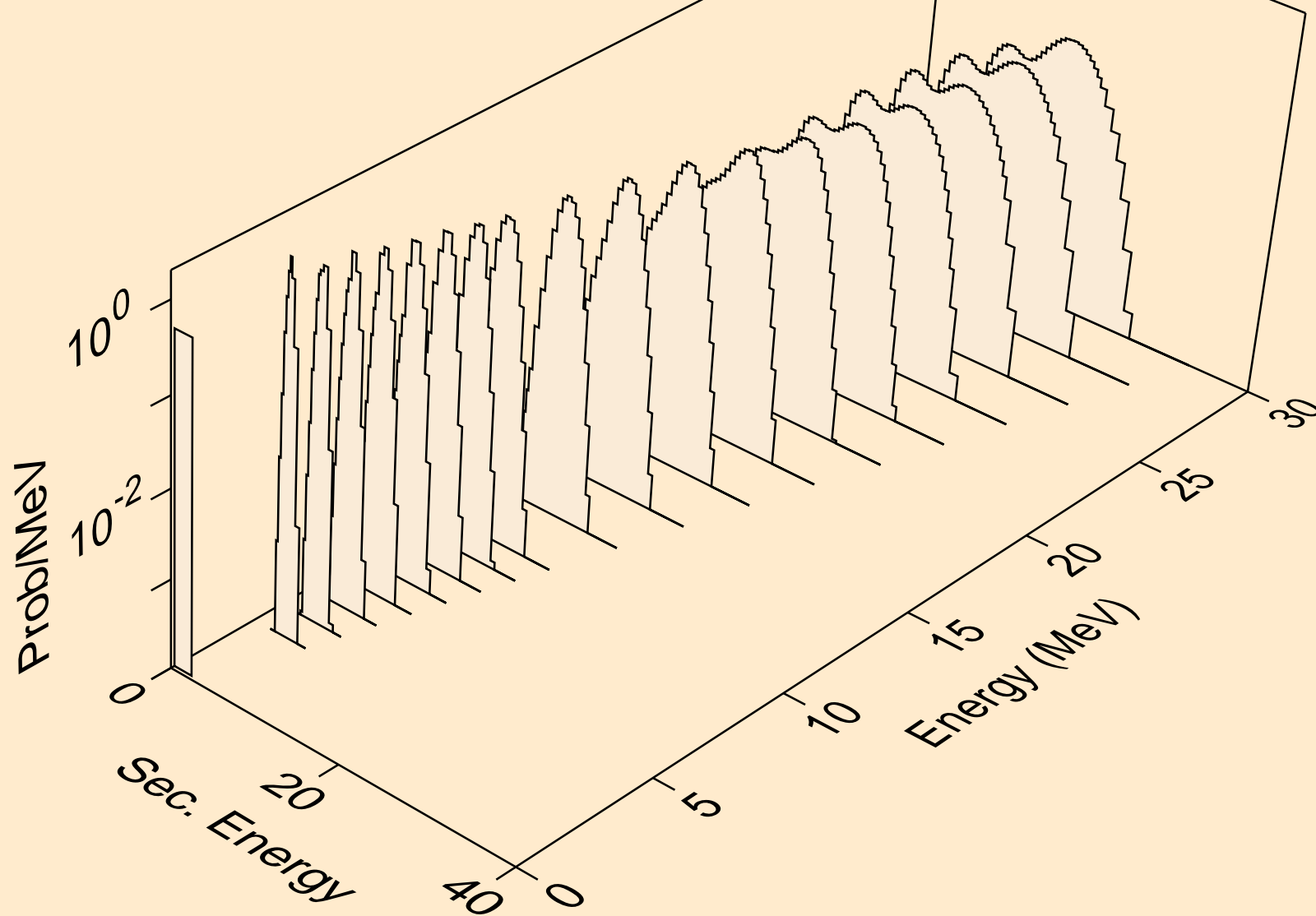

AU189 DEUTERON ACER TENDL-2023 LIBRARY; T=0.K
protons from (d,pd)

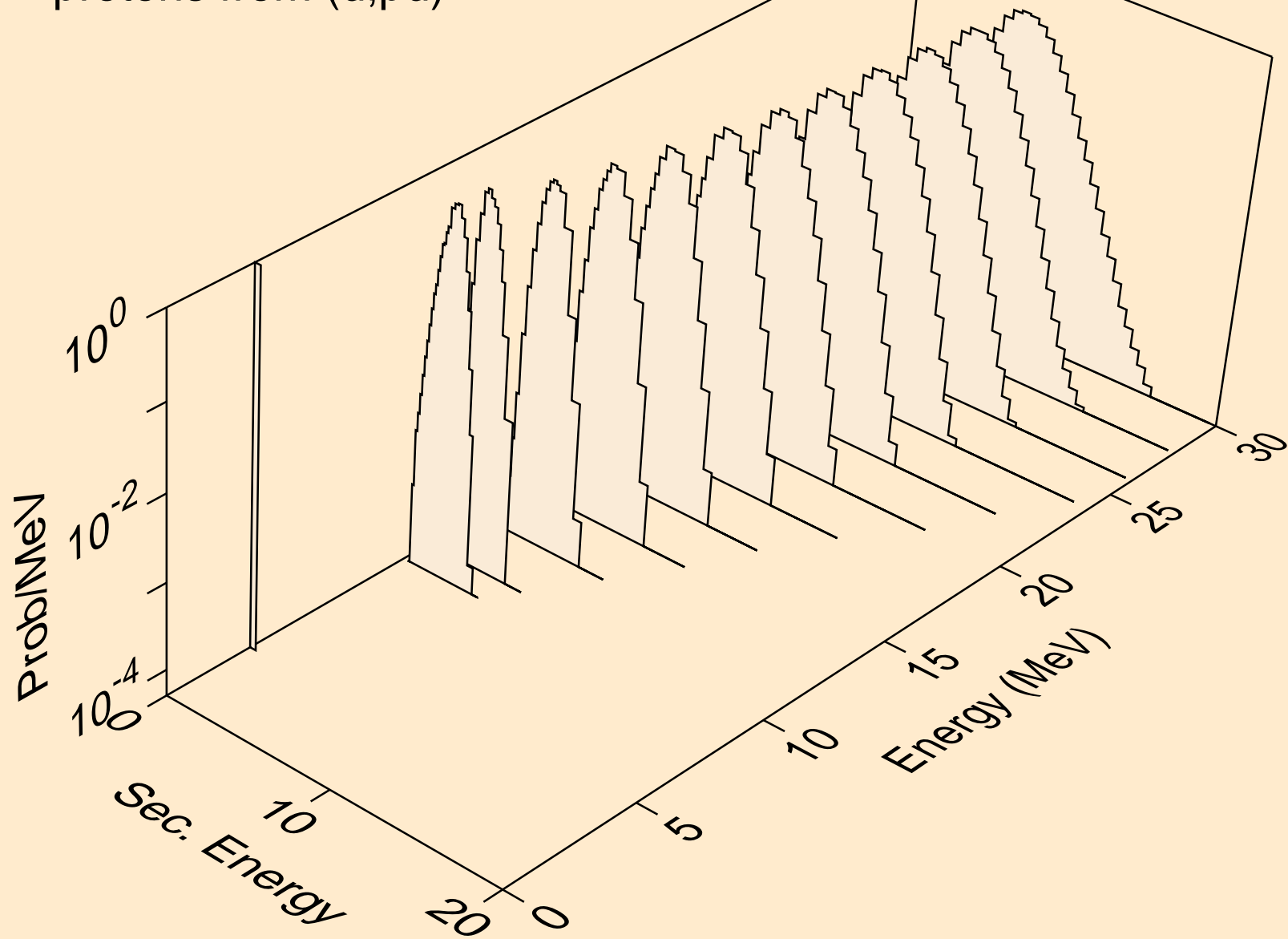

AU189 DEUTERON ACER TENDL-2023 LIBRARY; T=0.K
protons from (d,pt)

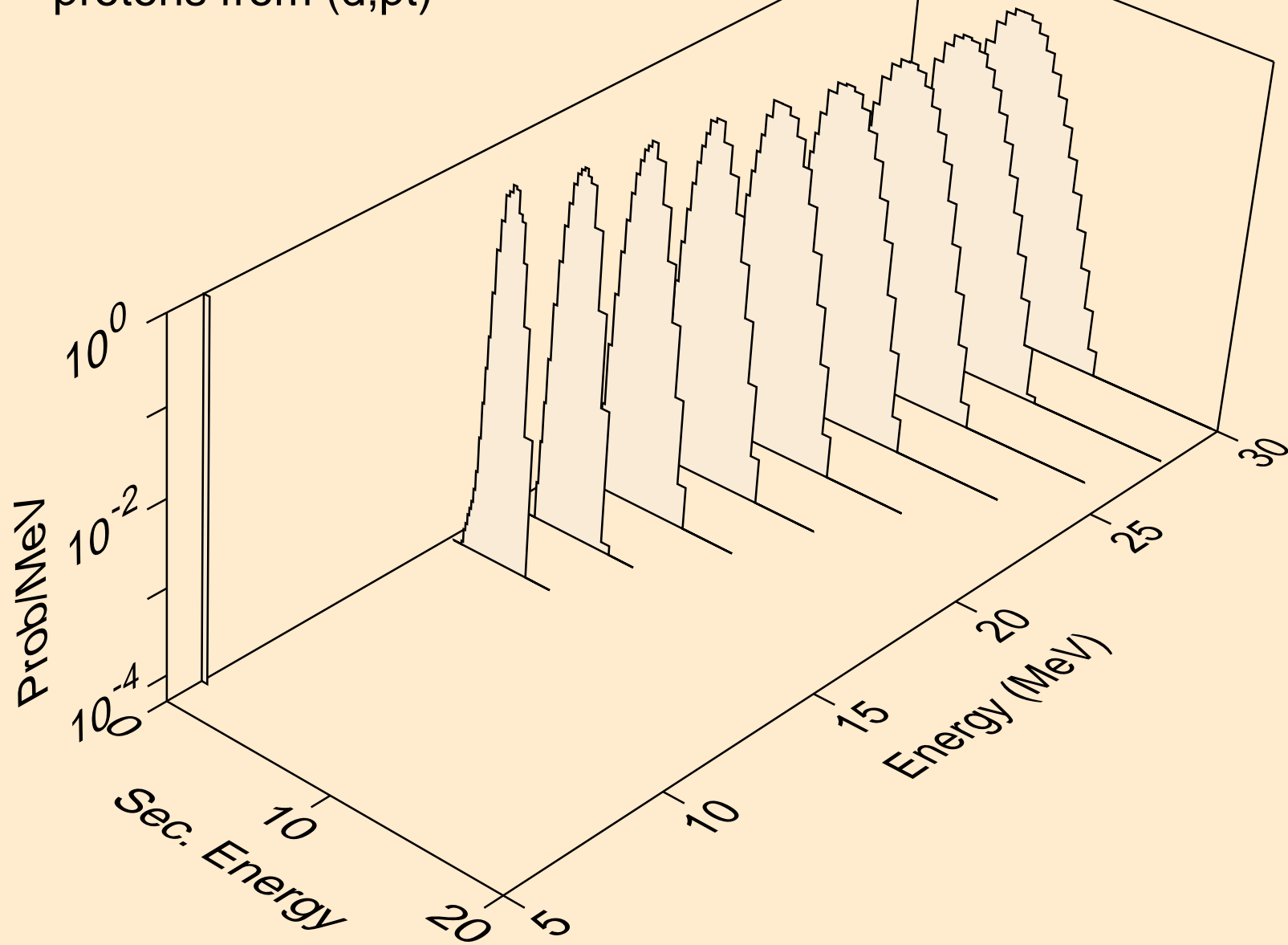

AU189 DEUTERON ACER TENDL-2023 LIBRARY; T=0.K
tritons from (d,x)

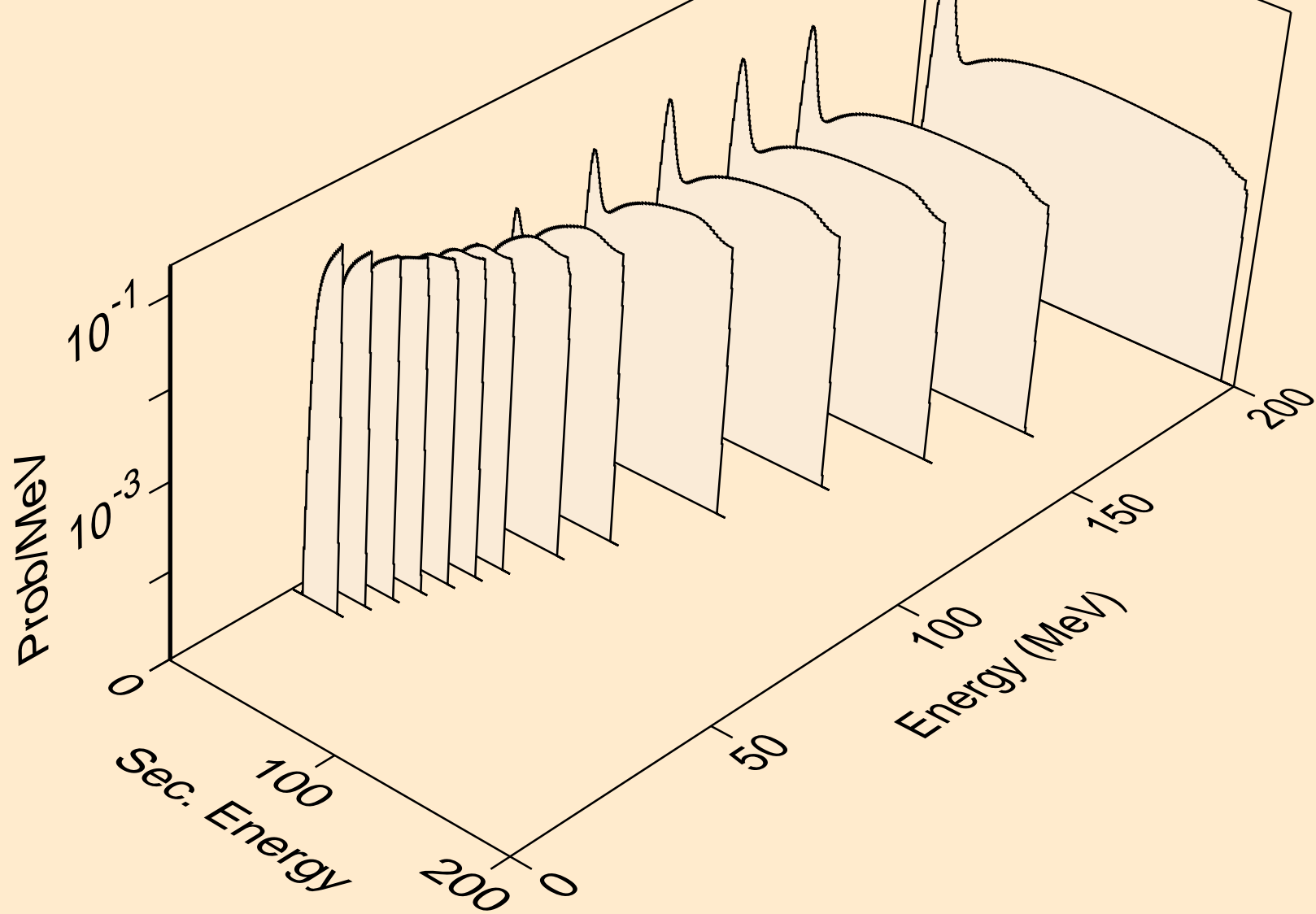

AU189 DEUTERON ACER TENDL-2023 LIBRARY; T=0.K
tritons from (d,n*)t

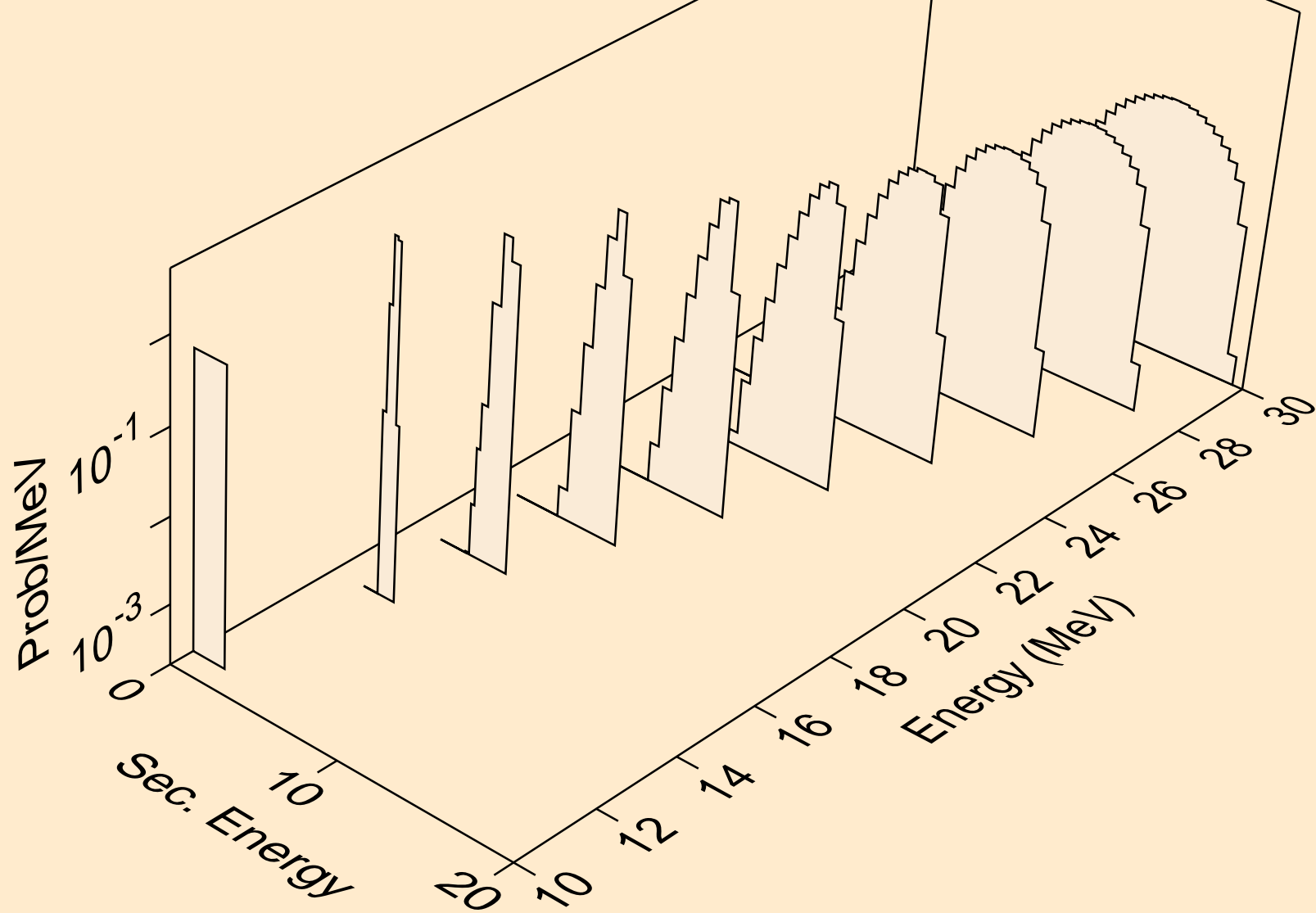

AU189 DEUTERON ACER TENDL-2023 LIBRARY; T=0.K
tritons from (d,t)

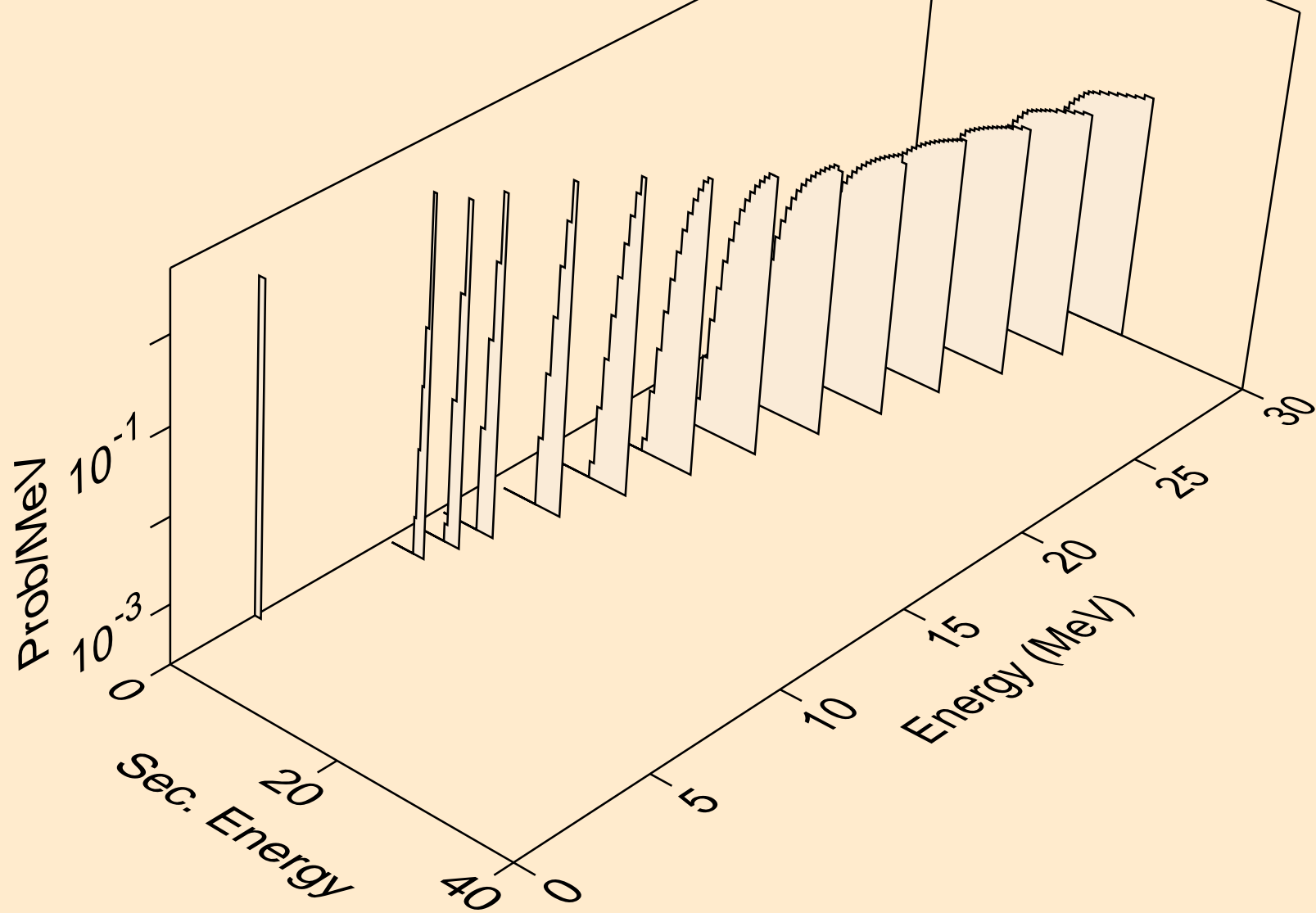

AU189 DEUTERON ACER TENDL-2023 LIBRARY; T=0.K
tritons from (d,pt)

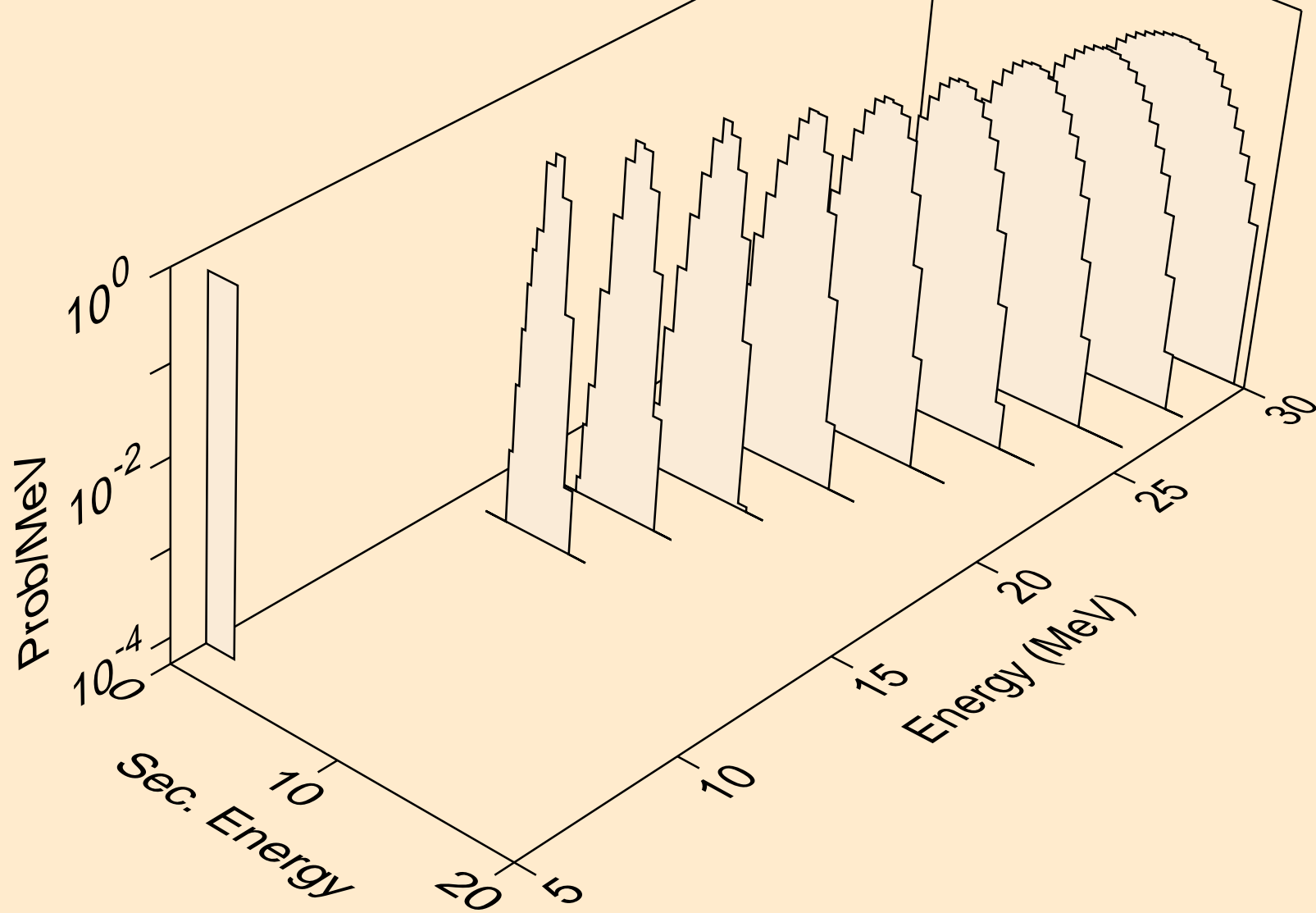

AU189 DEUTERON ACER TENDL-2023 LIBRARY; T=0.K
he3s from (d,x)

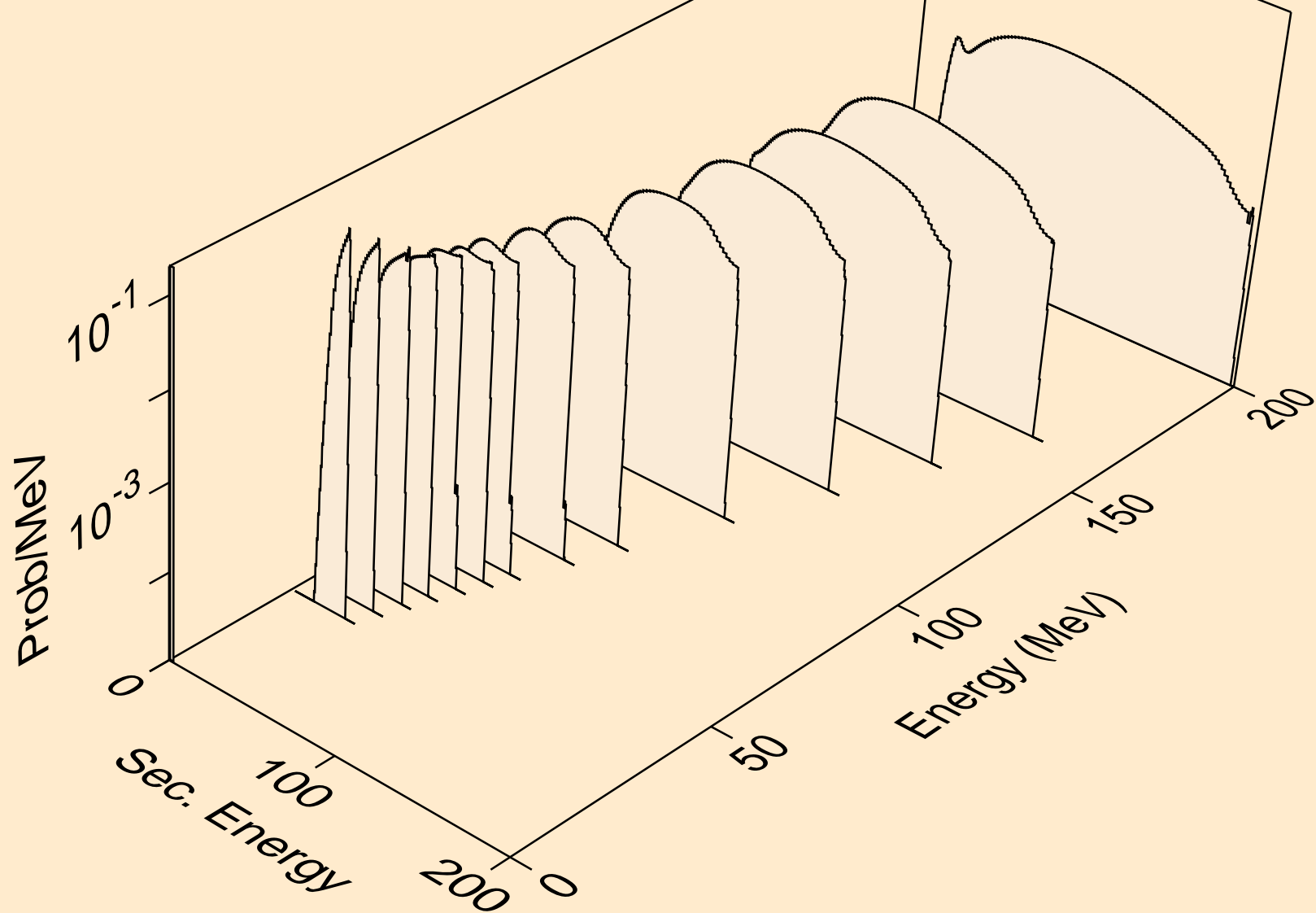

AU189 DEUTERON ACER TENDL-2023 LIBRARY; T=0.K
he3s from (d,n*)he3

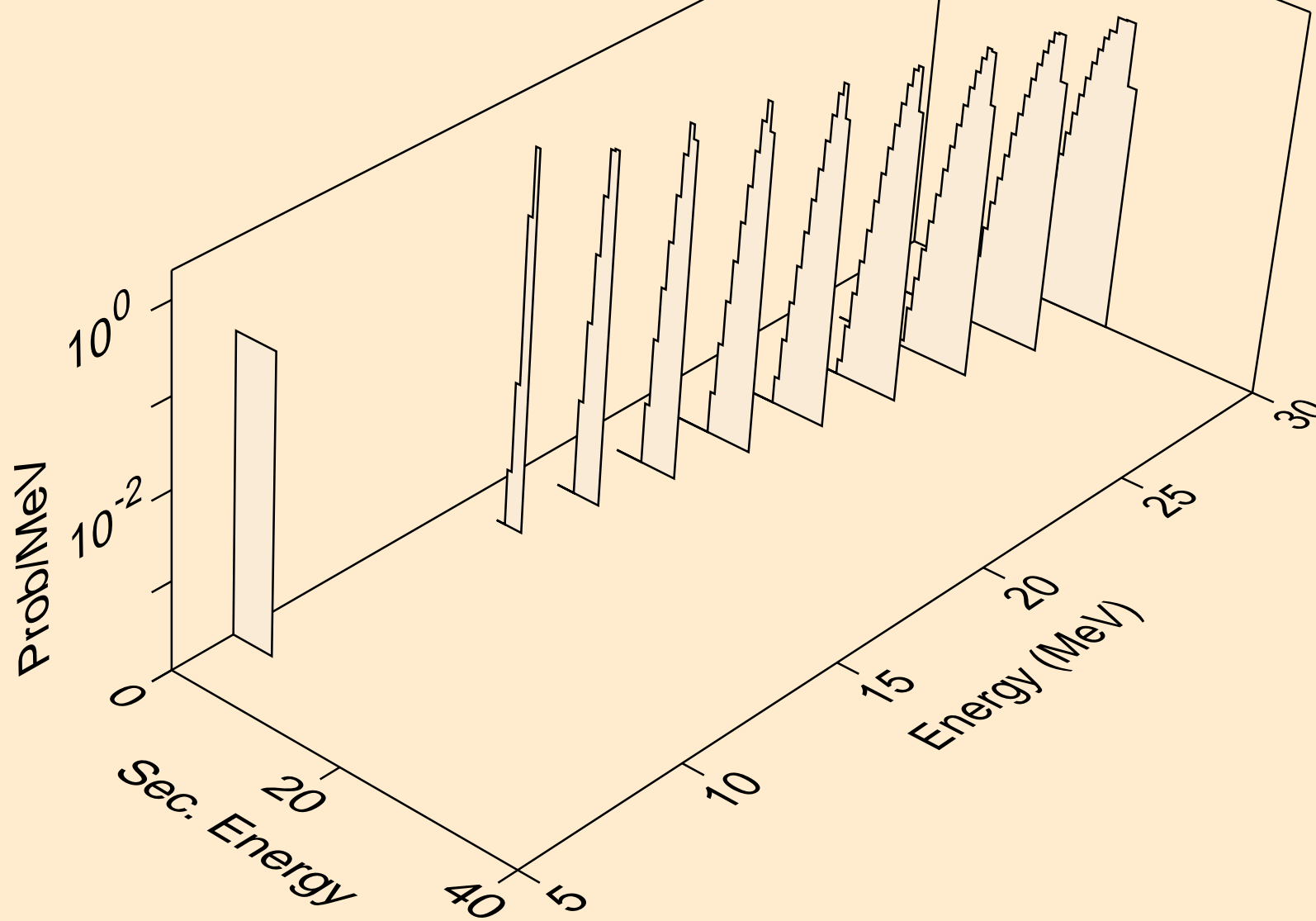

AU189 DEUTERON ACER TENDL-2023 LIBRARY; T=0.K
he3s from (d,he3)

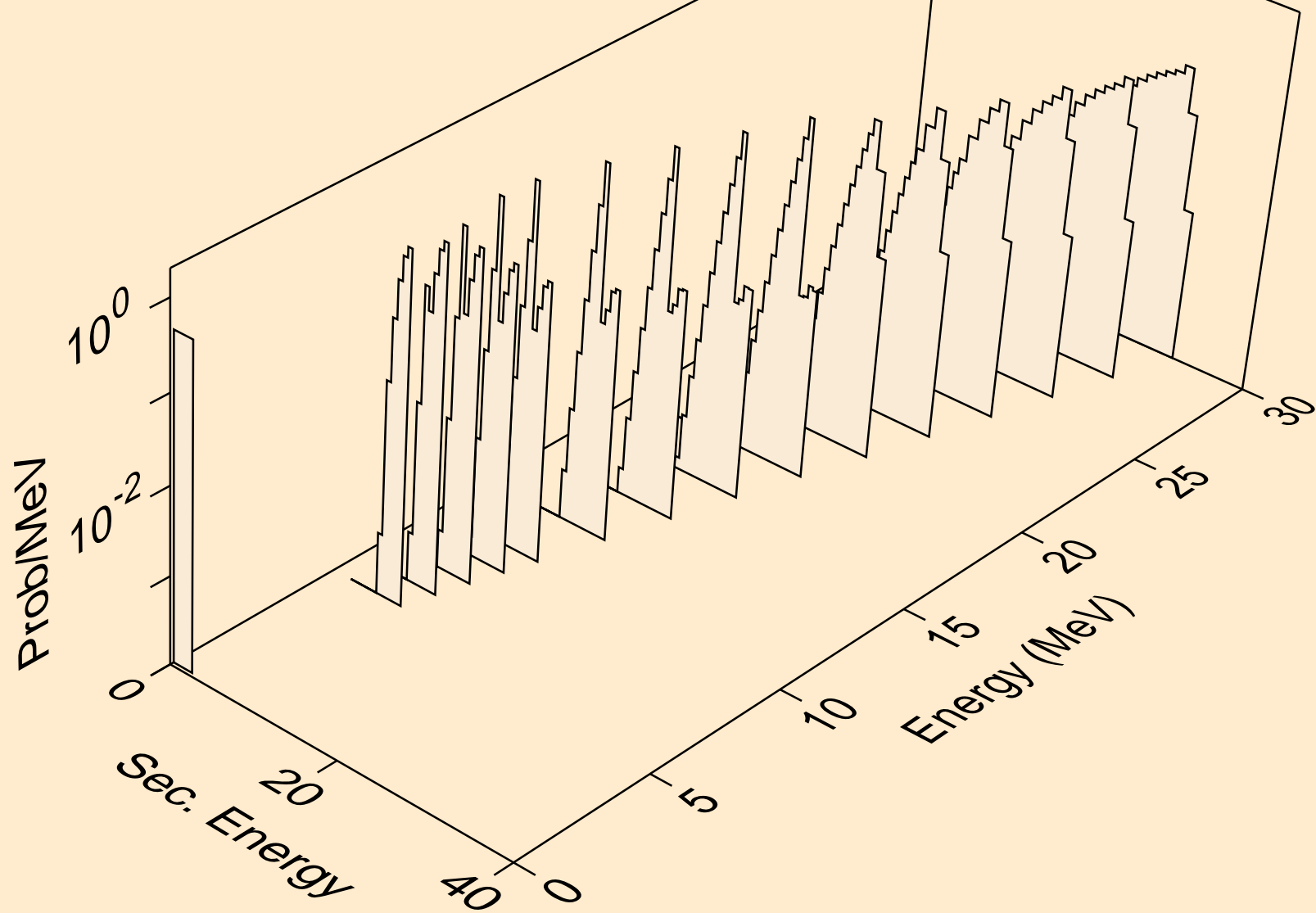

AU189 DEUTERON ACER TENDL-2023 LIBRARY; T=0.K
alphas from (d,x)

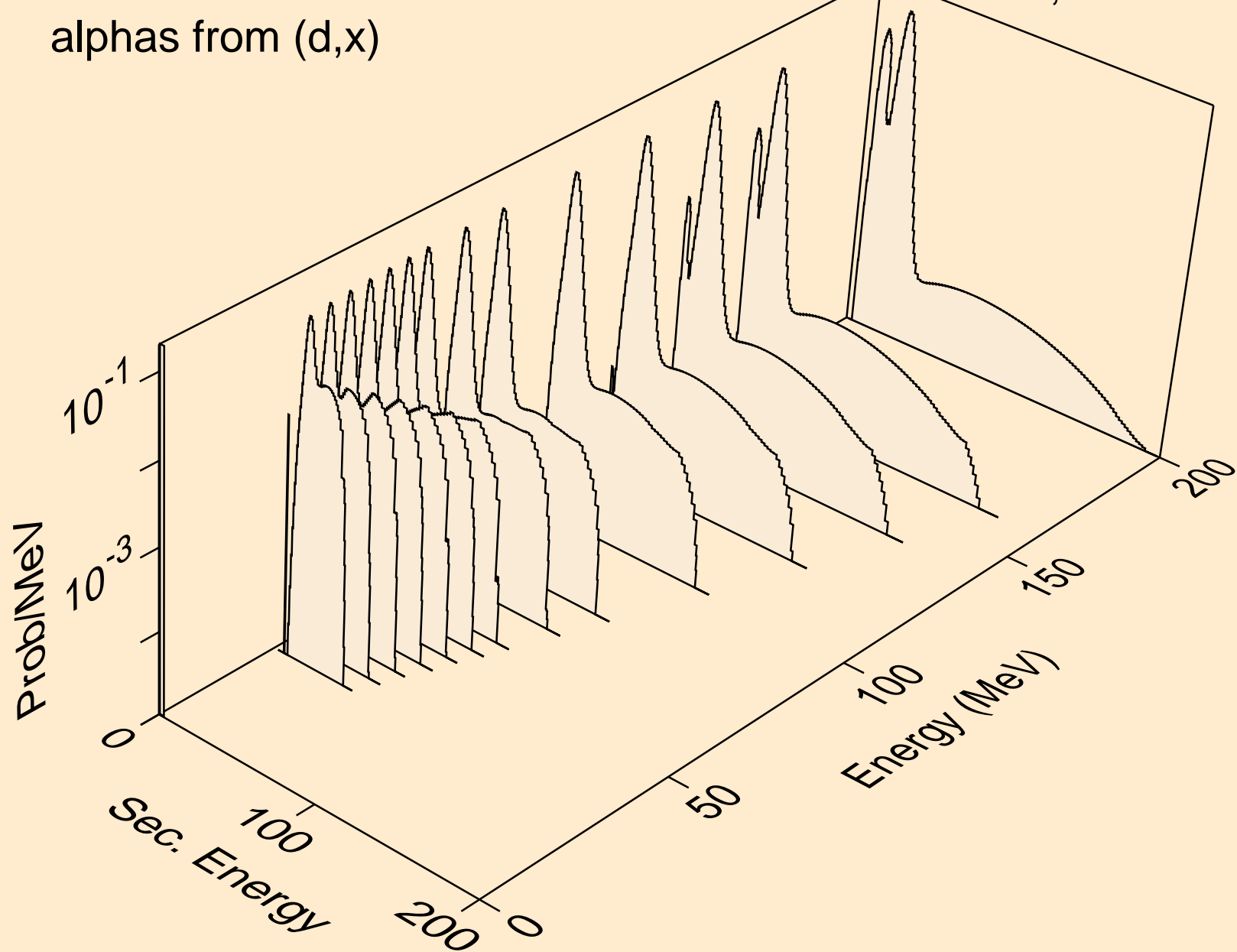

AU189 DEUTERON ACER TENDL-2023 LIBRARY; T=0.K
alphas from (d,n*)a

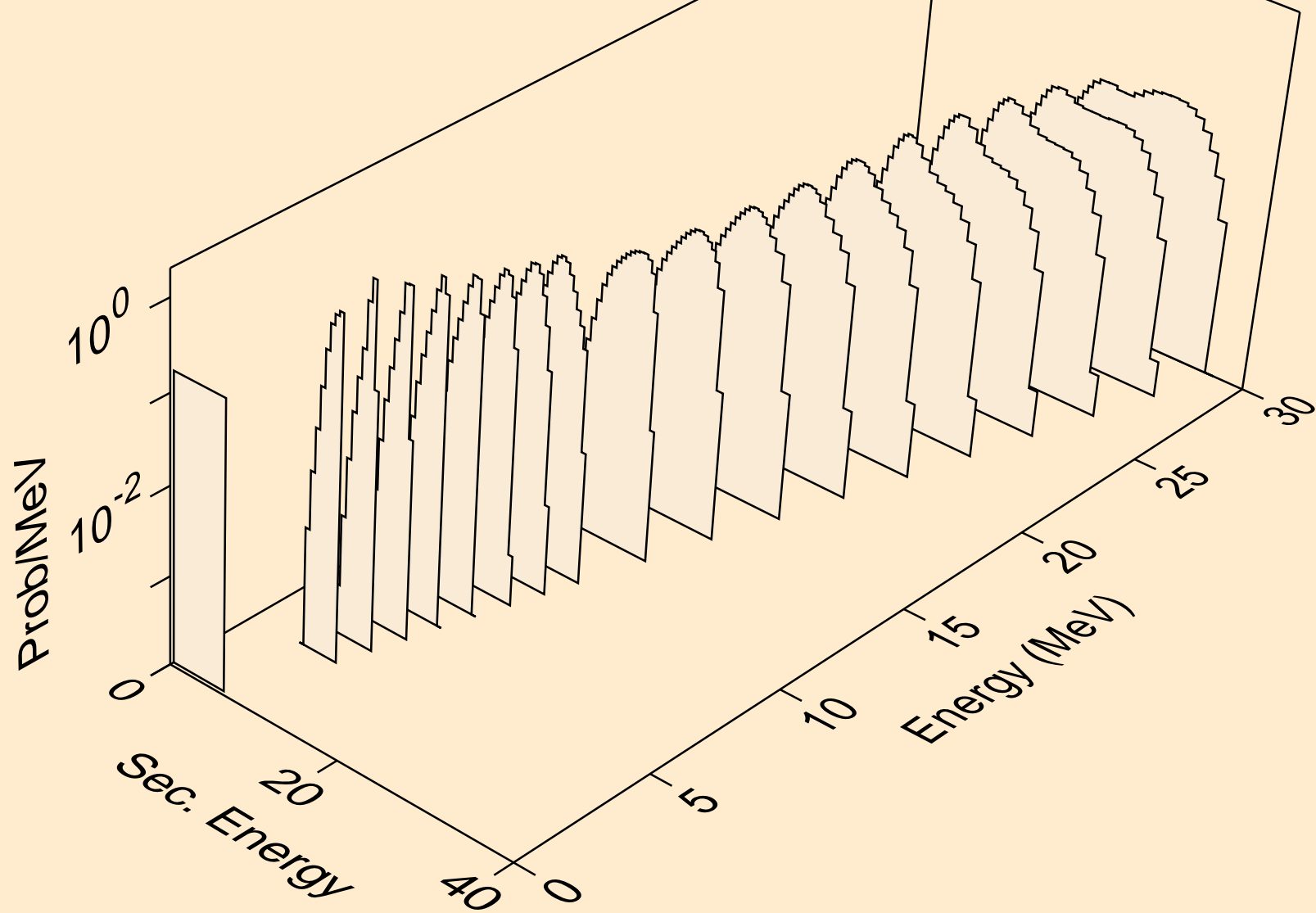

AU189 DEUTERON ACER TENDL-2023 LIBRARY; T=0.K
alphas from (d,2n)a

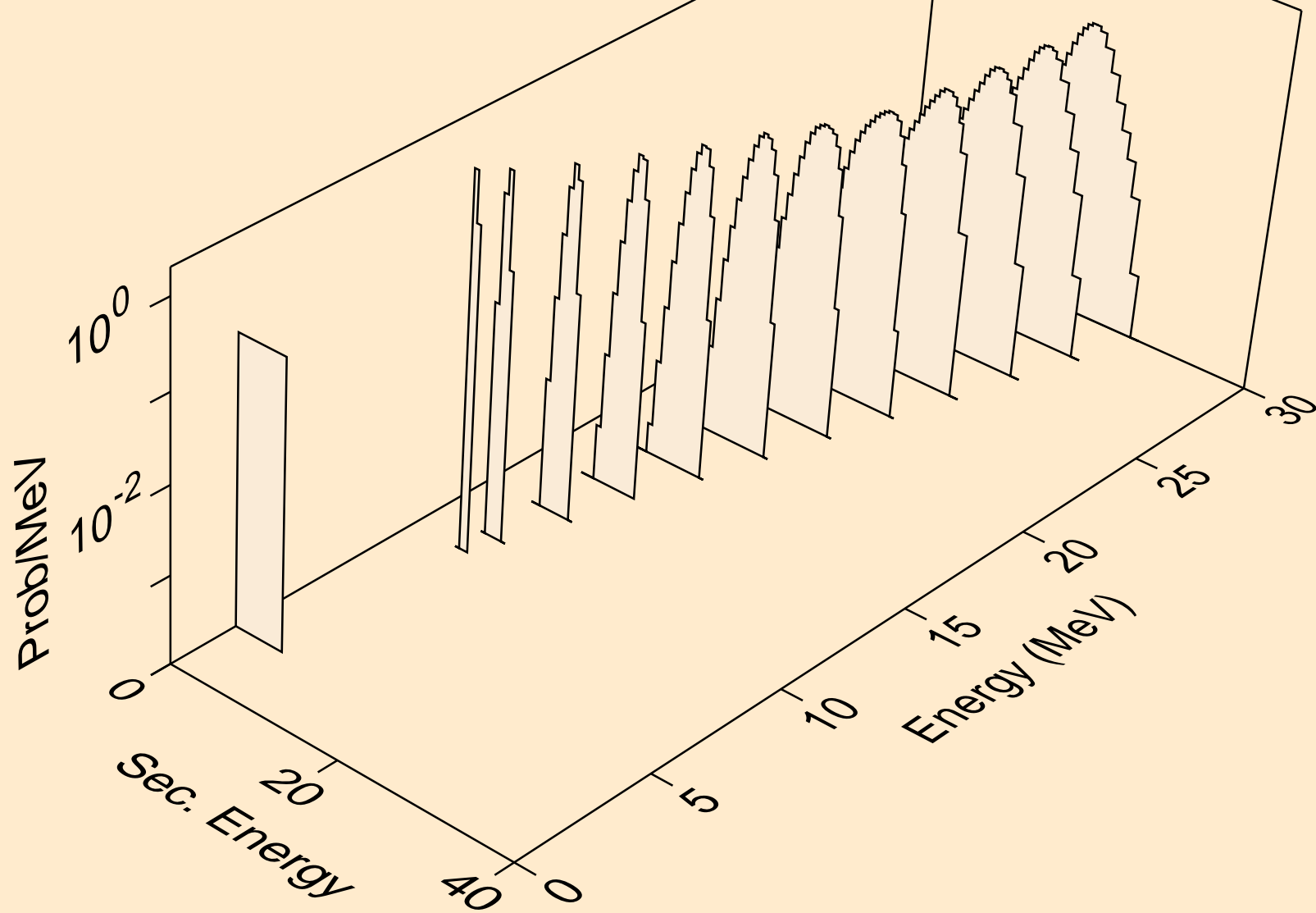

AU189 DEUTERON ACER TENDL-2023 LIBRARY; T=0.K
alphas from (d,3n)a

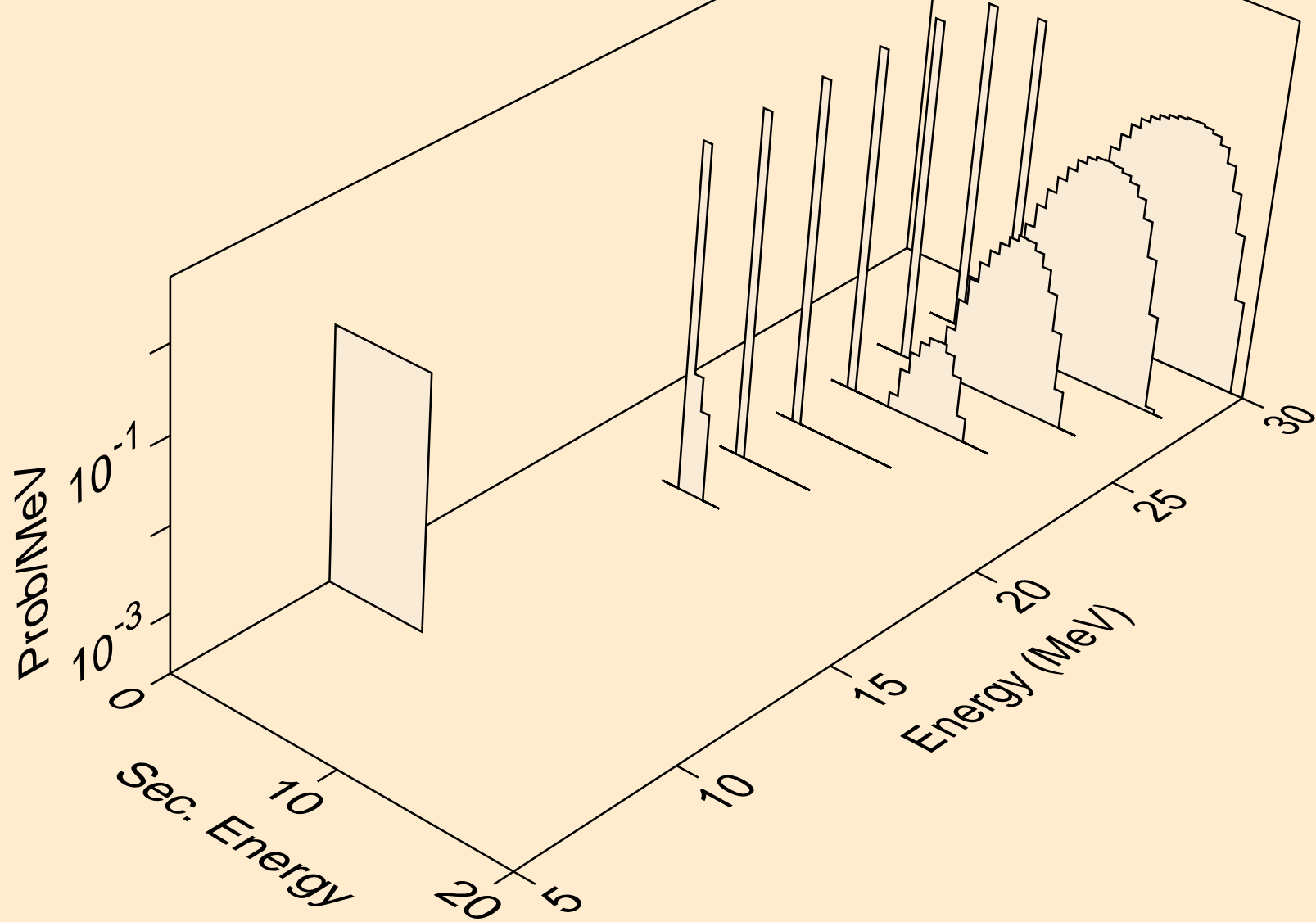

AU189 DEUTERON ACER TENDL-2023 LIBRARY; T=0.K
alphas from (d,n*)2a

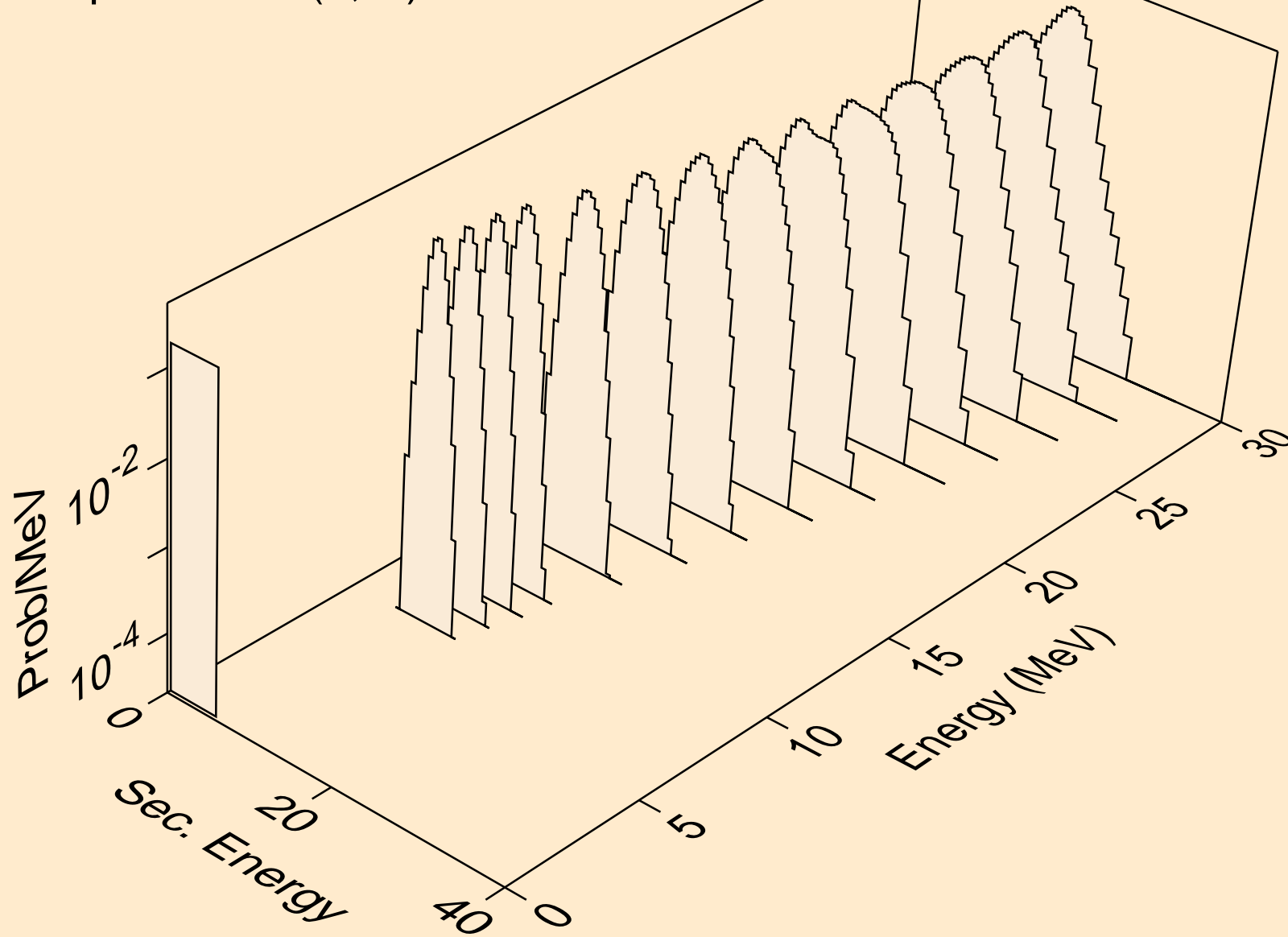

AU189 DEUTERON ACER TENDL-2023 LIBRARY; T=0.K
alphas from (d,2n)2a

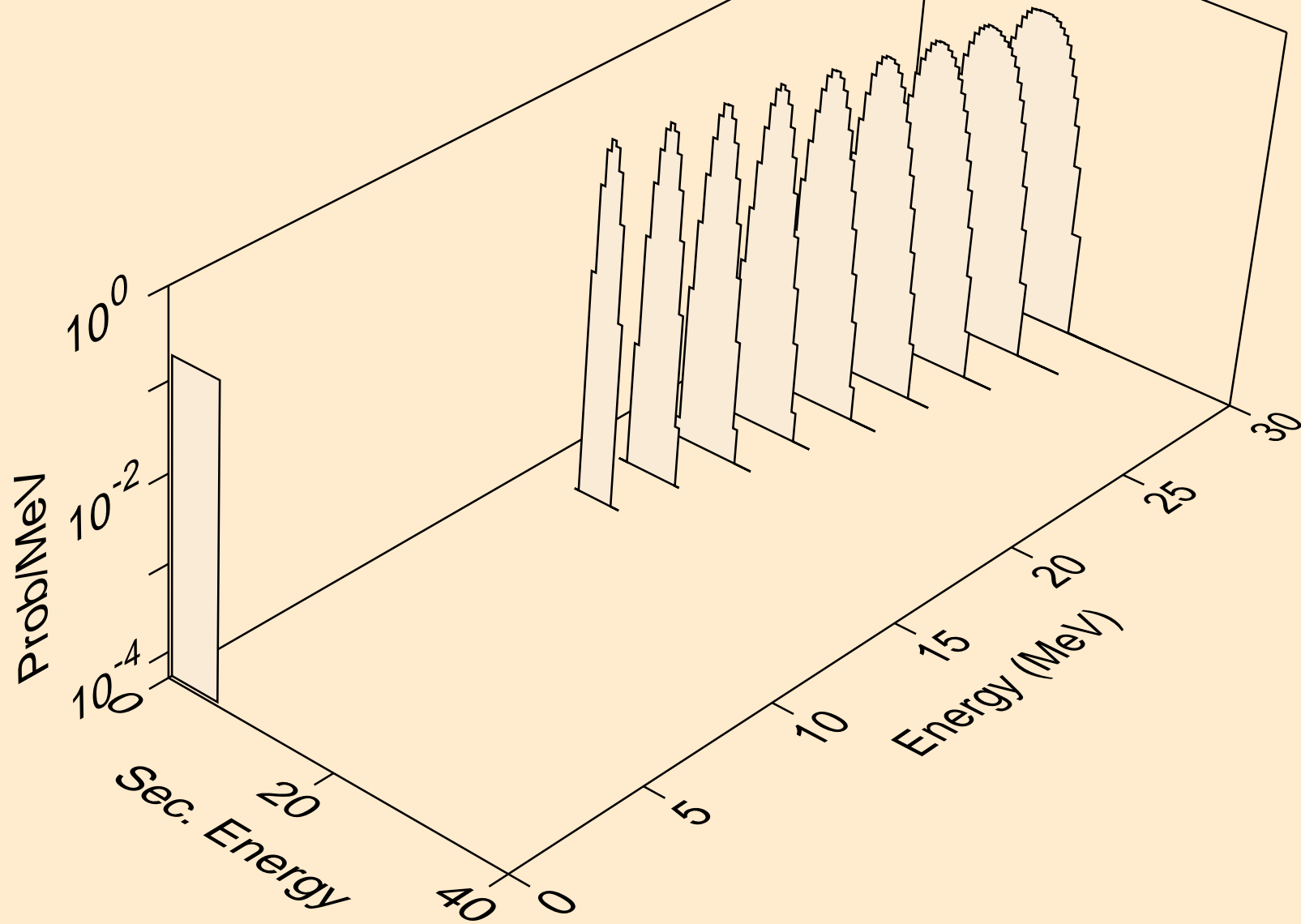

AU189 DEUTERON ACER TENDL-2023 LIBRARY; T=0.K
alphas from (d,npa)

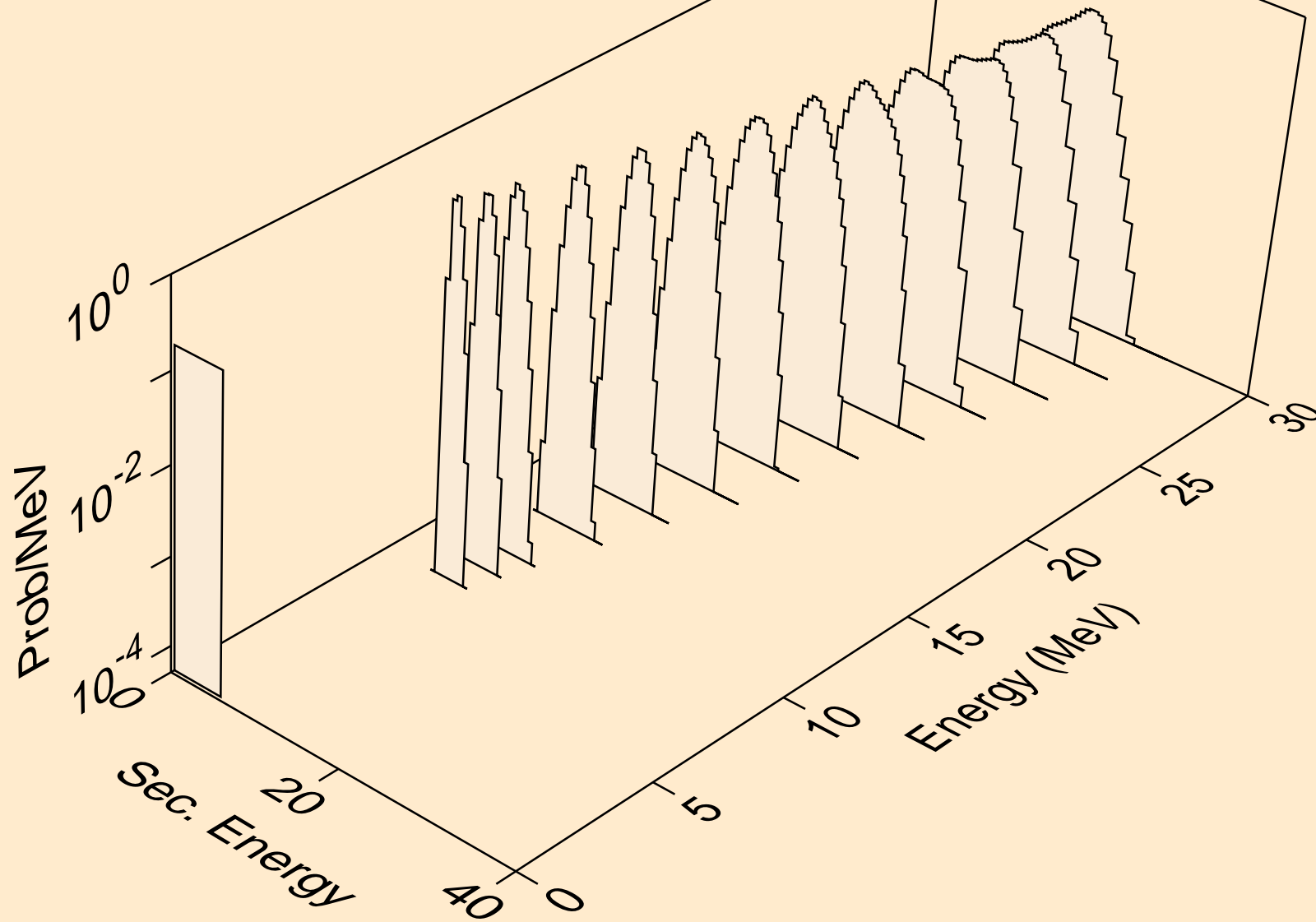

AU189 DEUTERON ACER TENDL-2023 LIBRARY; T=0.K
alphas from (d,a)

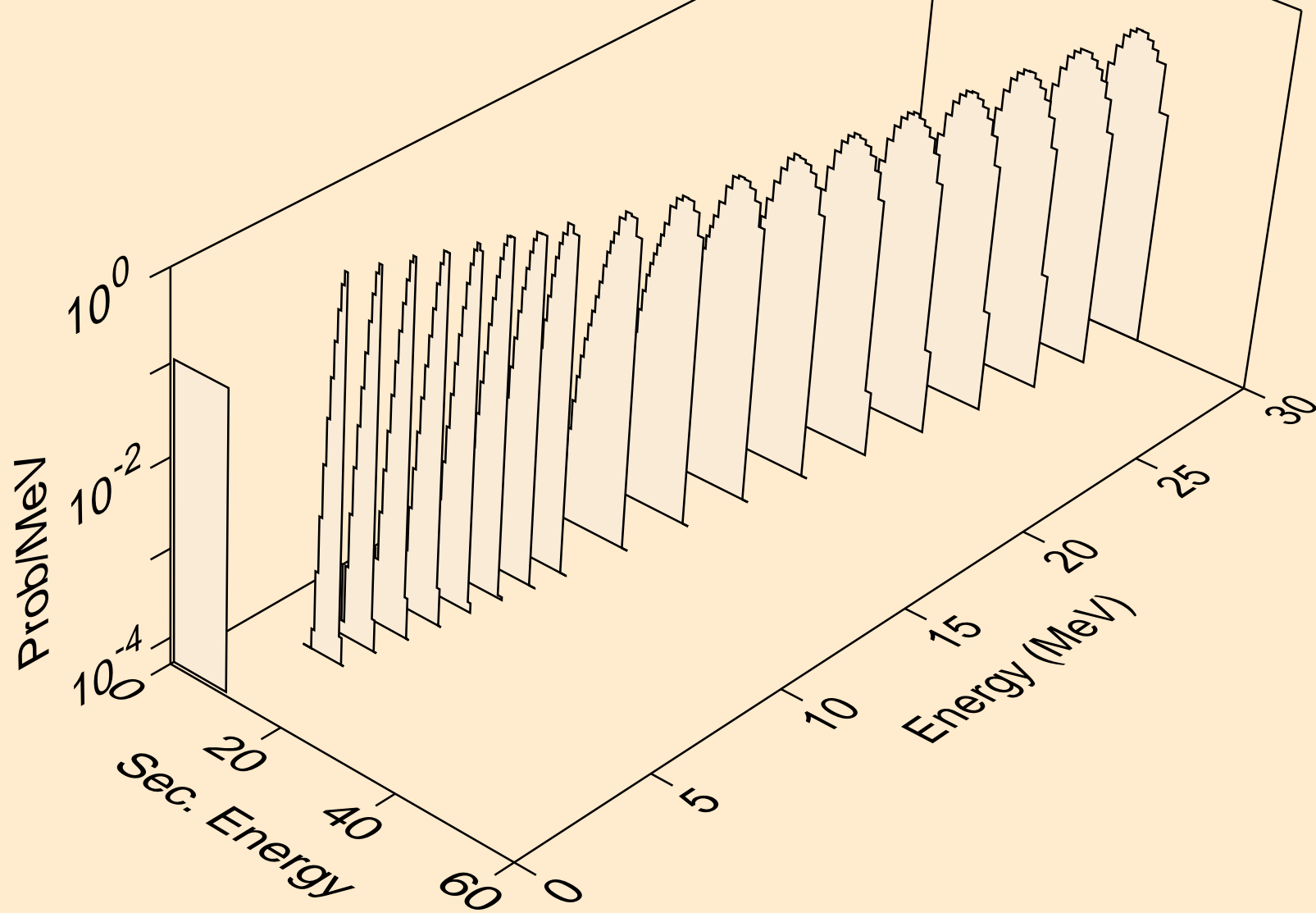

AU189 DEUTERON ACER TENDL-2023 LIBRARY; T=0.K
alphas from (d,2a)

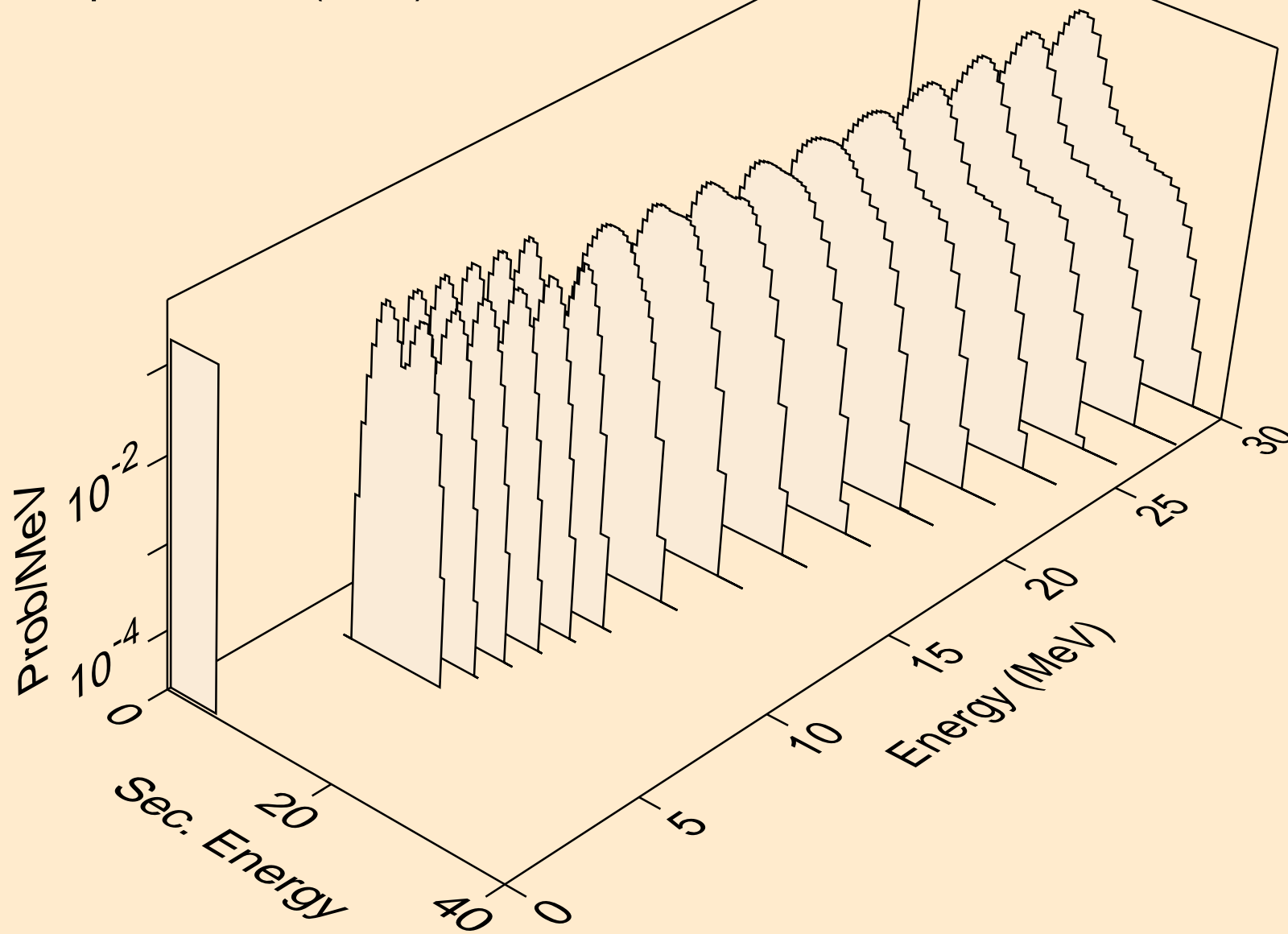

AU189 DEUTERON ACER TENDL-2023 LIBRARY; T=0.K
alphas from (d,pa)

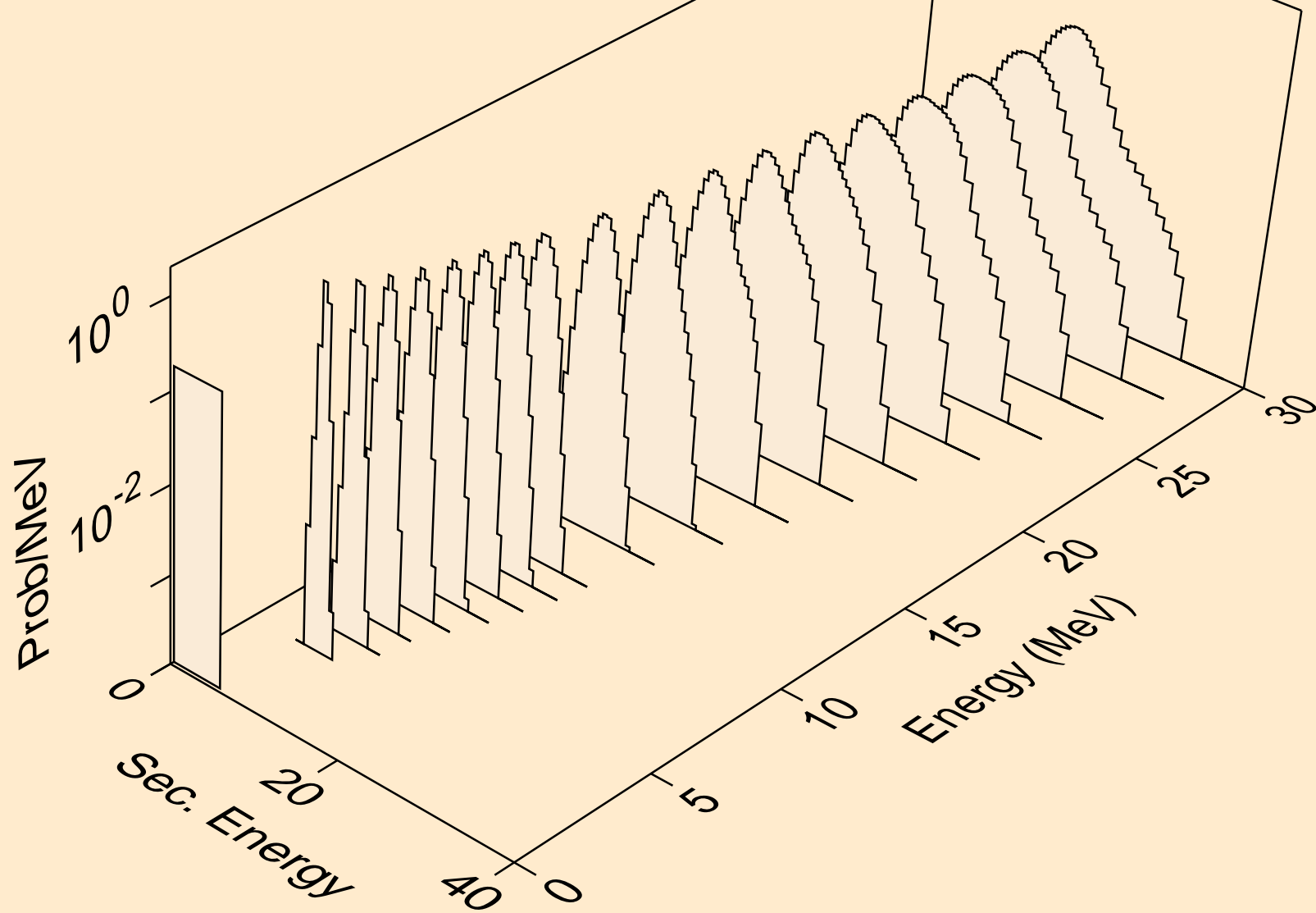

AU189 DEUTERON ACER TENDL-2023 LIBRARY; T=0.K
alphas from (d,da)

