

BA135 DEUTERON ACER TENDL-2023 LIBRARY; T=0.K

Principal cross sections

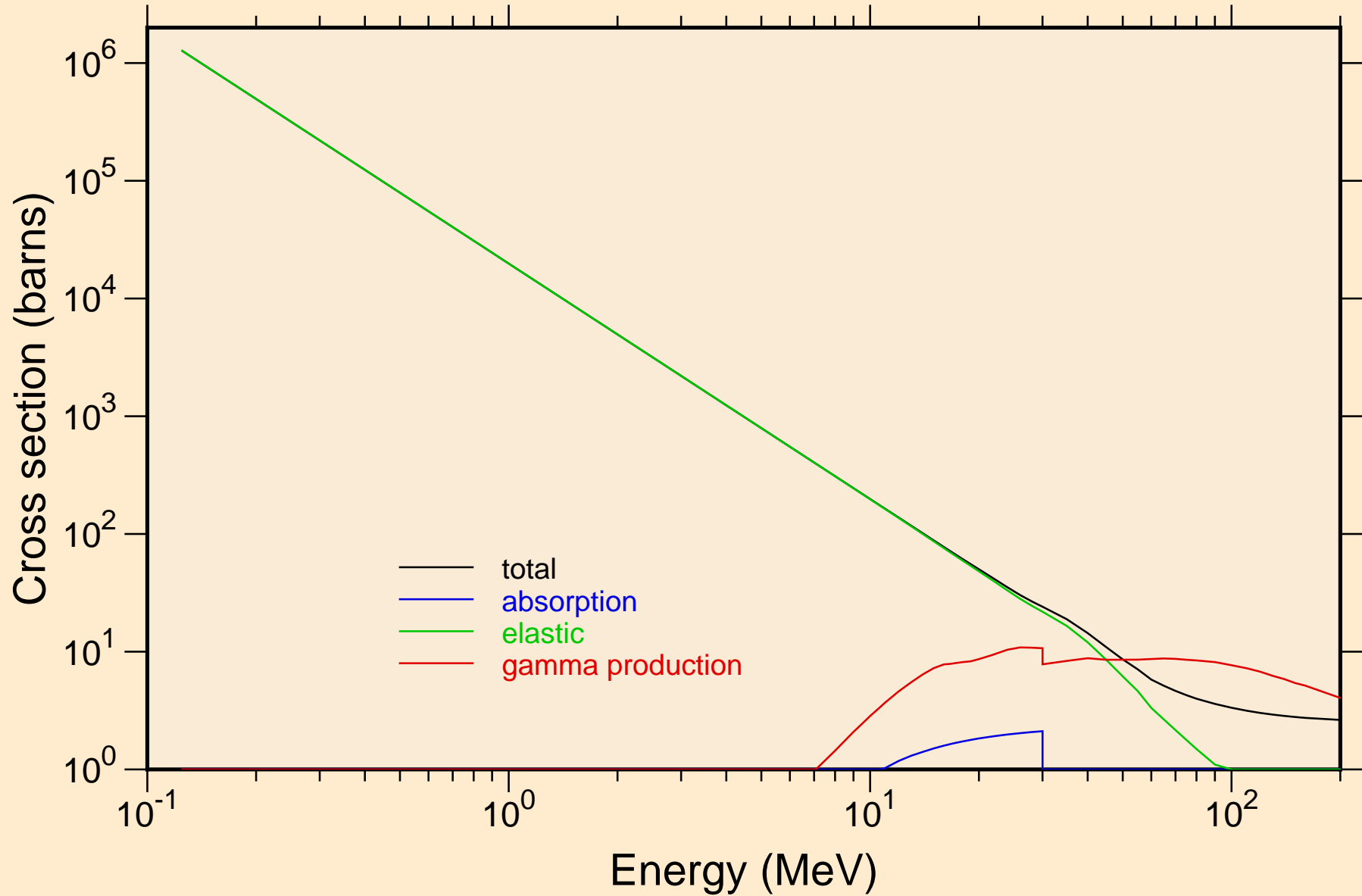

BA135 DEUTERON ACER TENDL-2023 LIBRARY; T=0.K
Heating

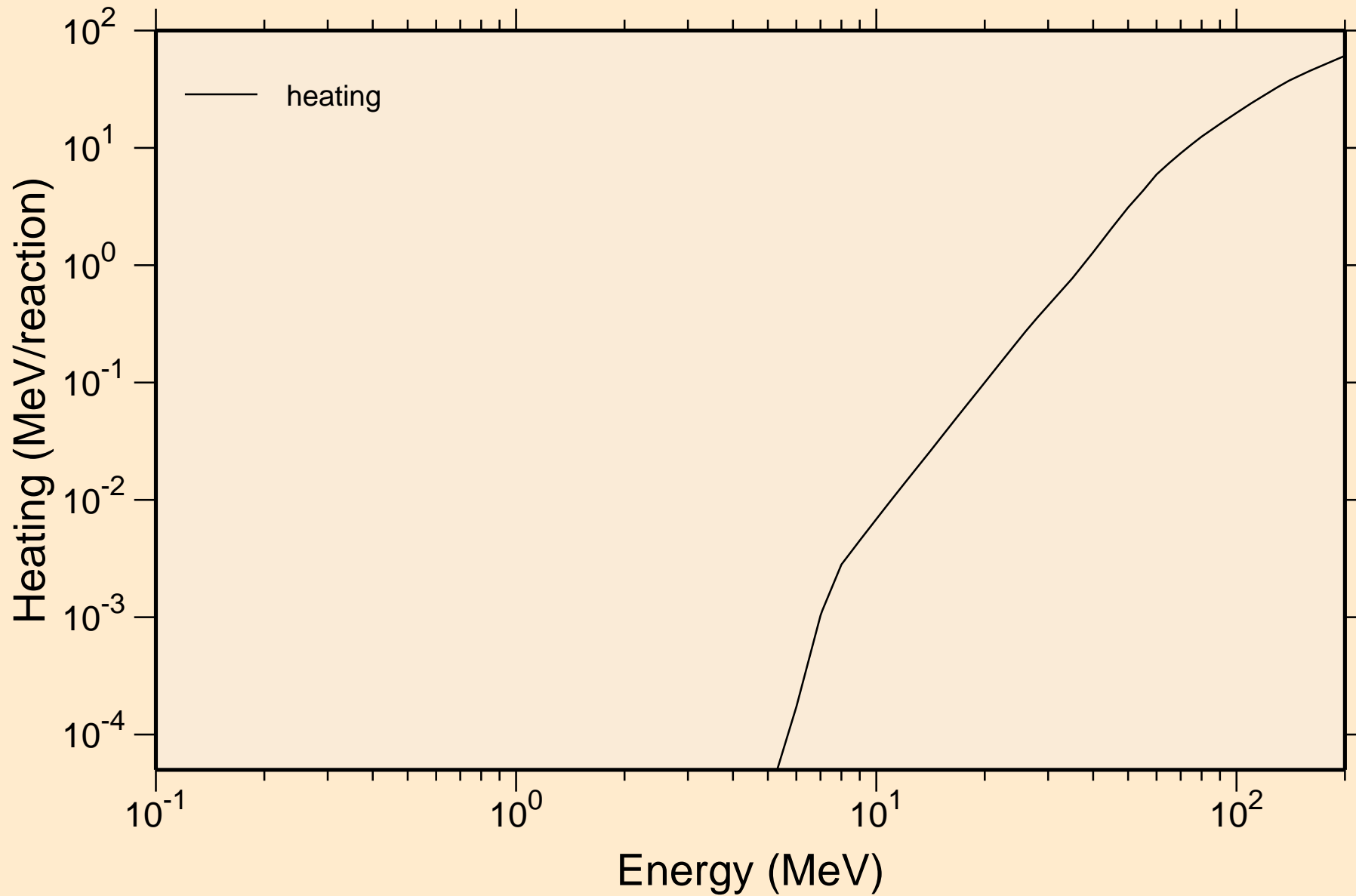

BA135 DEUTERON ACER TENDL-2023 LIBRARY; T=0.K

Principal cross sections

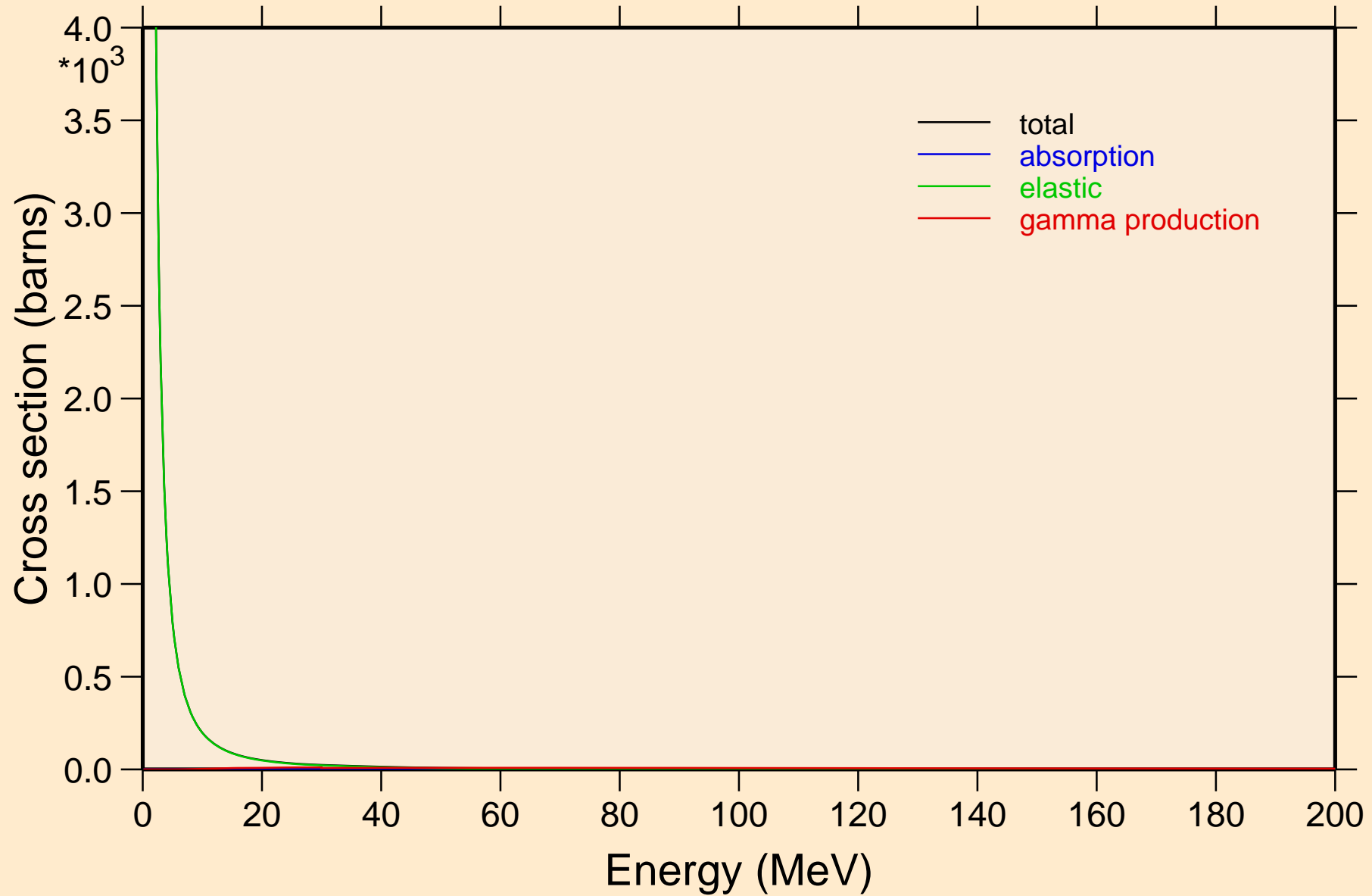

BA135 DEUTERON ACER TENDL-2023 LIBRARY; T=0.K

Heating

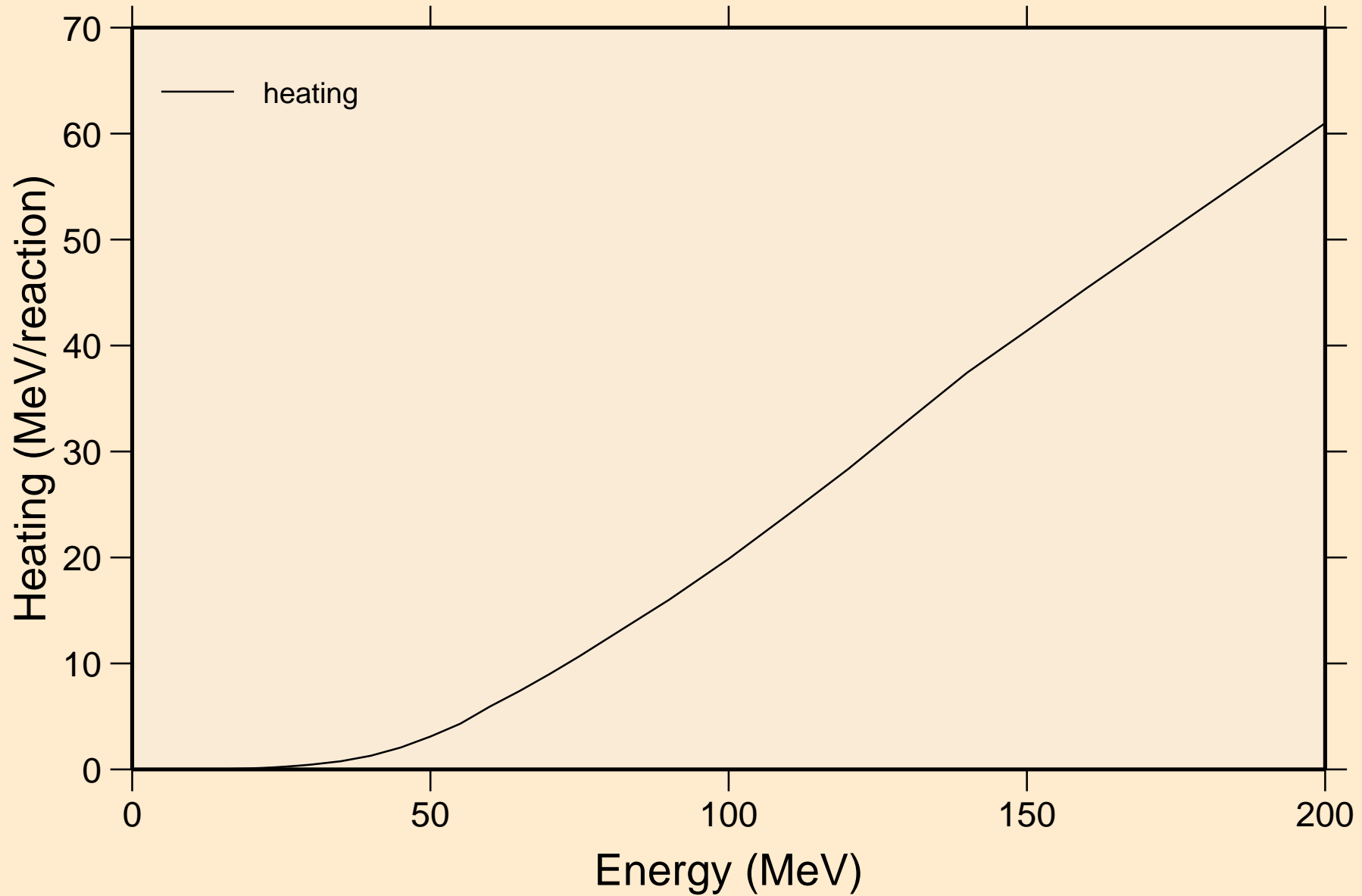

BA135 DEUTERON ACER TENDL-2023 LIBRARY; T=0.K
Threshold reactions

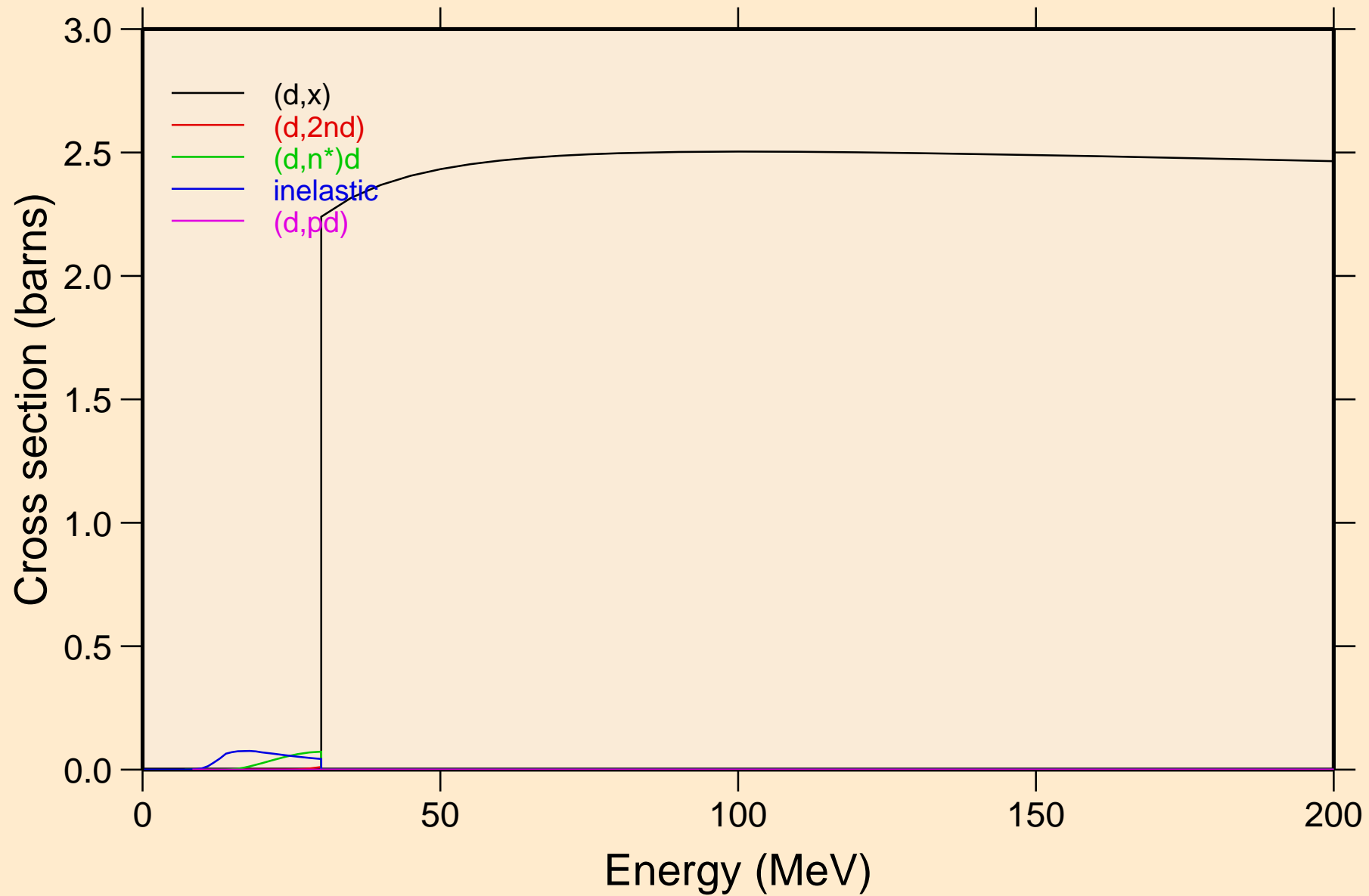

BA135 DEUTERON ACER TENDL-2023 LIBRARY; T=0.K
Threshold reactions

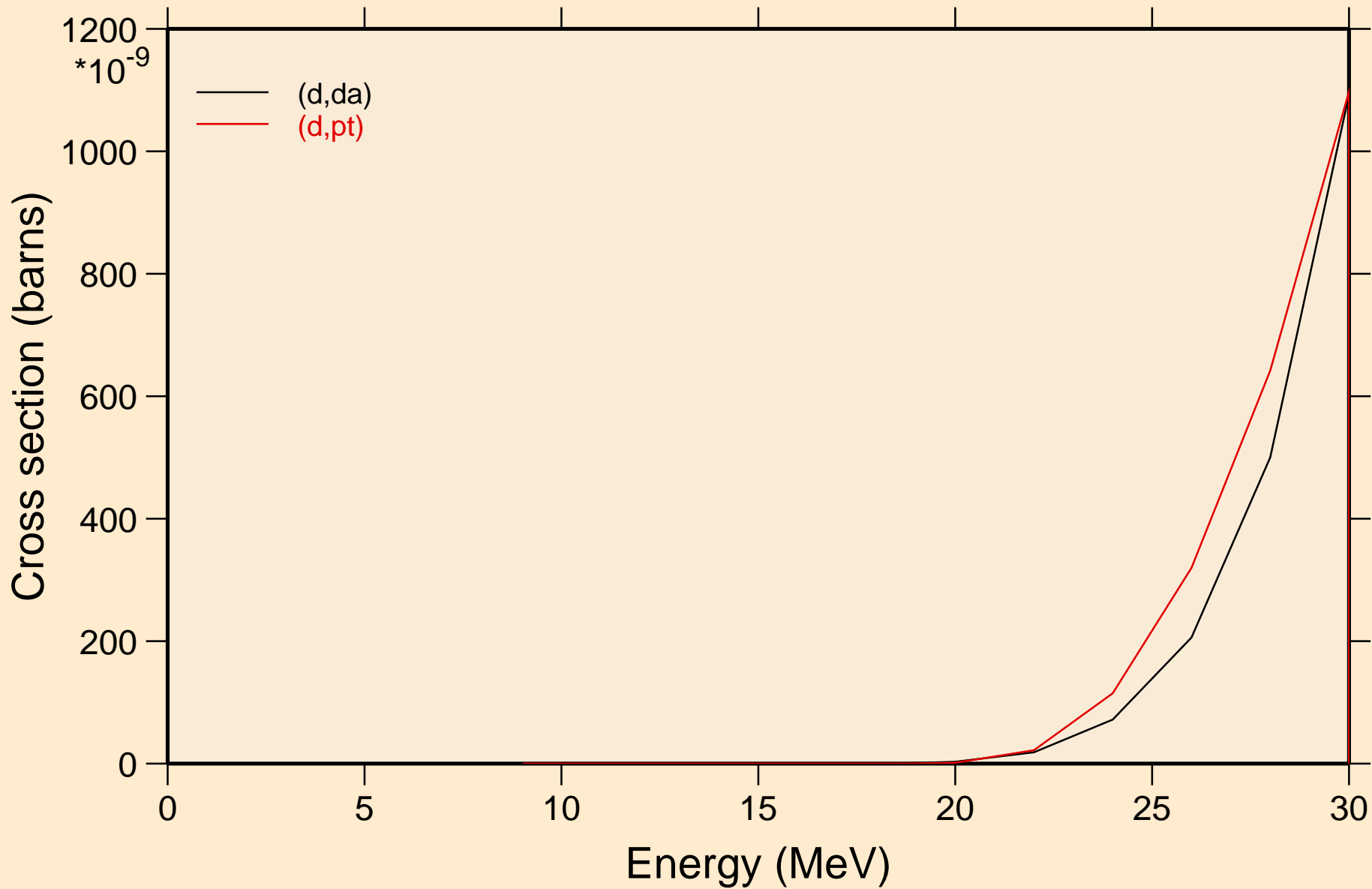

BA135 DEUTERON ACER TENDL-2023 LIBRARY; T=0.K
Threshold reactions

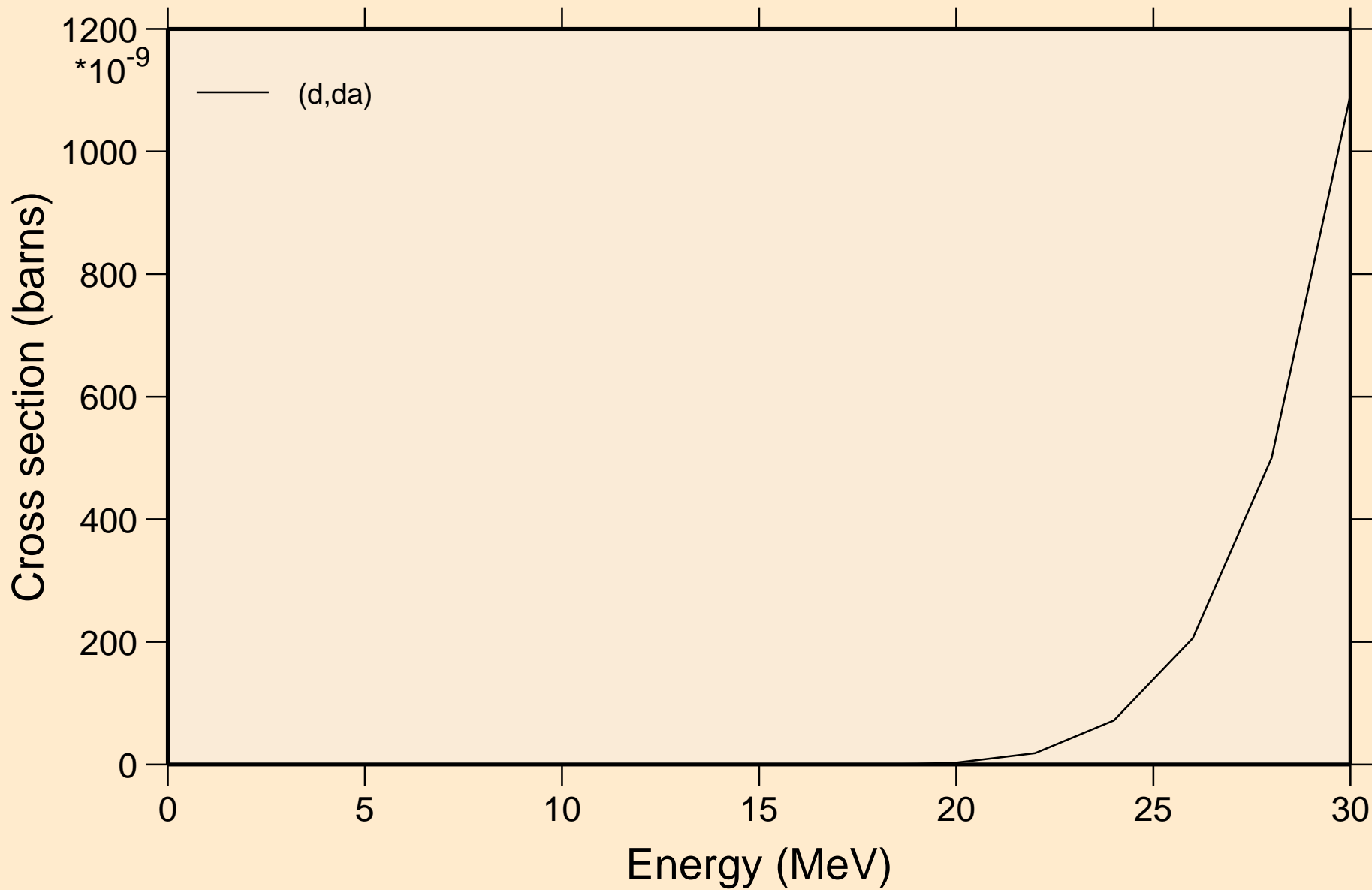

BA135 DEUTERON ACER TENDL-2023 LIBRARY; T=0.K
angular distribution for elastic

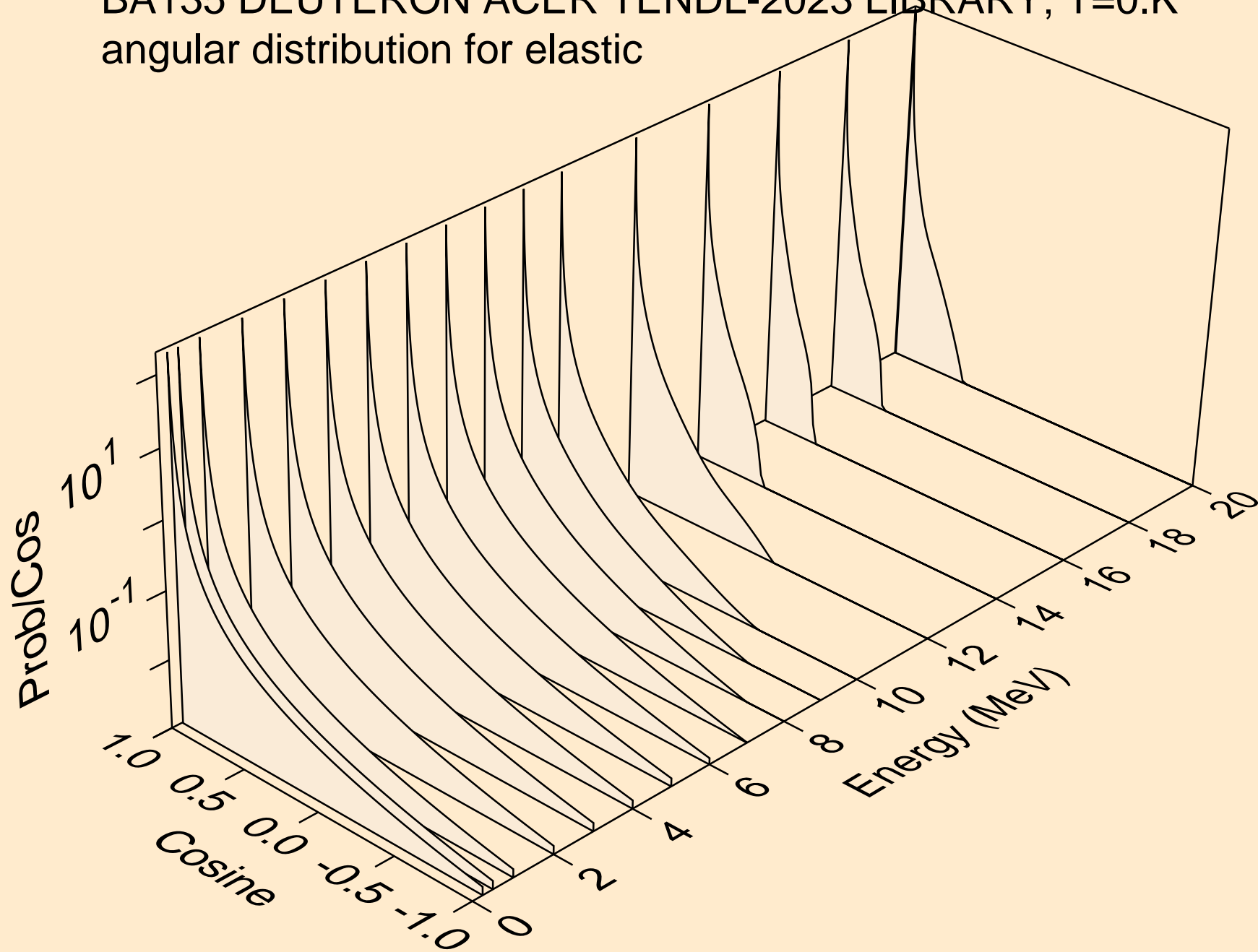

BA135 DEUTERON ACER TENDL-2023 LIBRARY; T=0.K
angular distribution for elastic

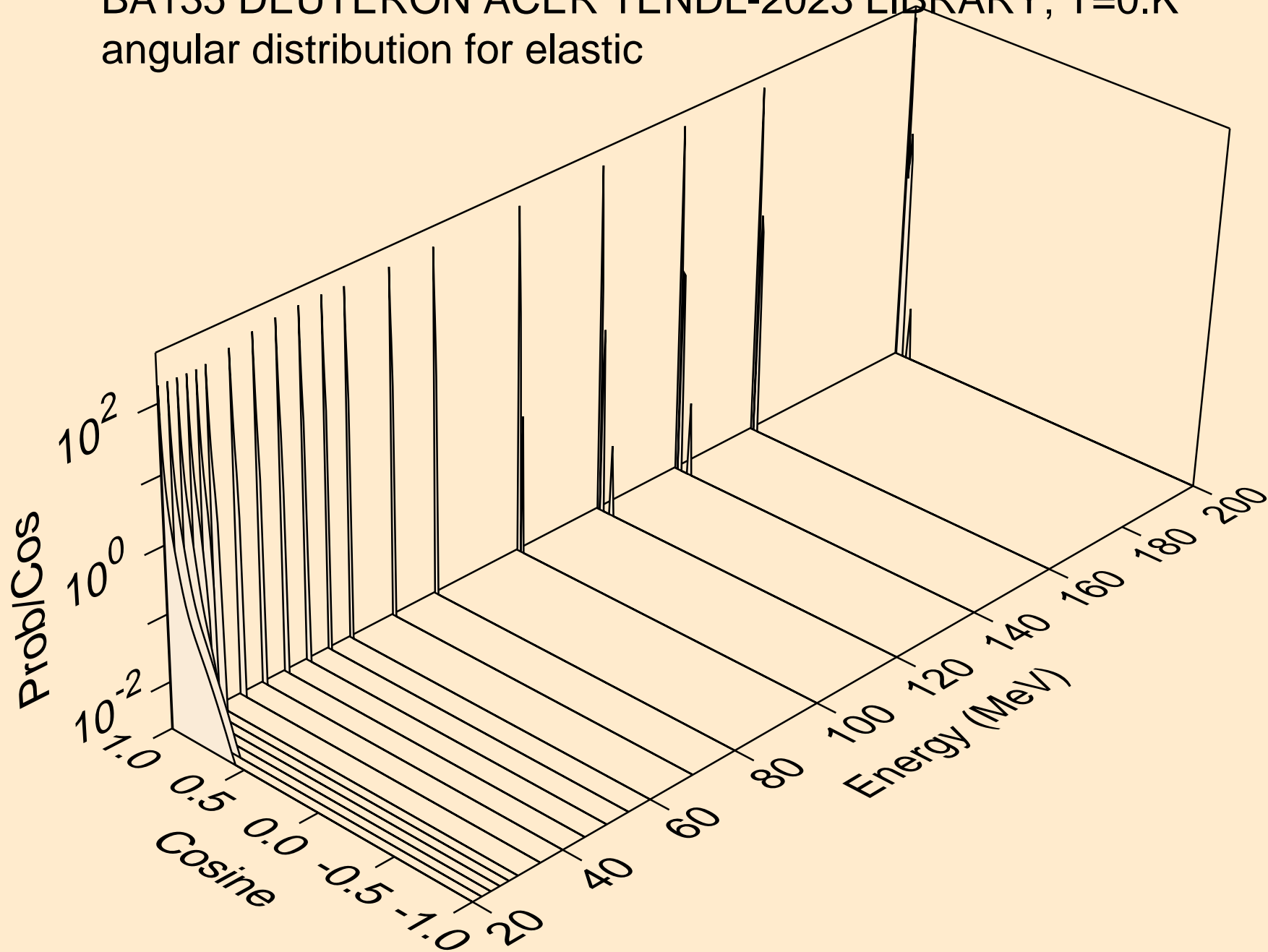

BA135 DEUTERON ACER TENDL-2023 LIBRARY; T=0.K
Deuteron emission for (d,x)

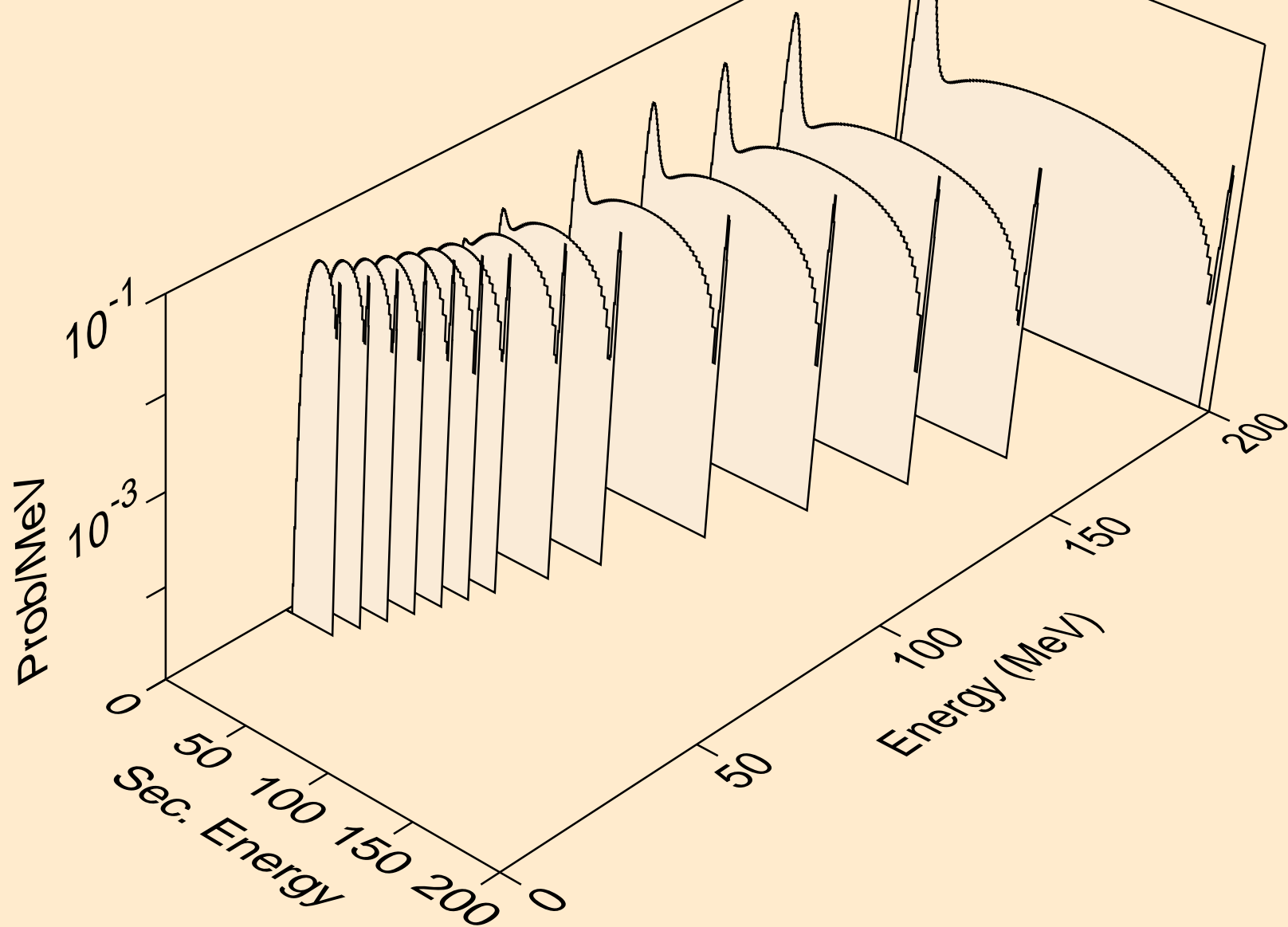

BA135 DEUTERON ACER TENDL-2023 LIBRARY; T=0.K
Deuteron emission for (d,2nd)

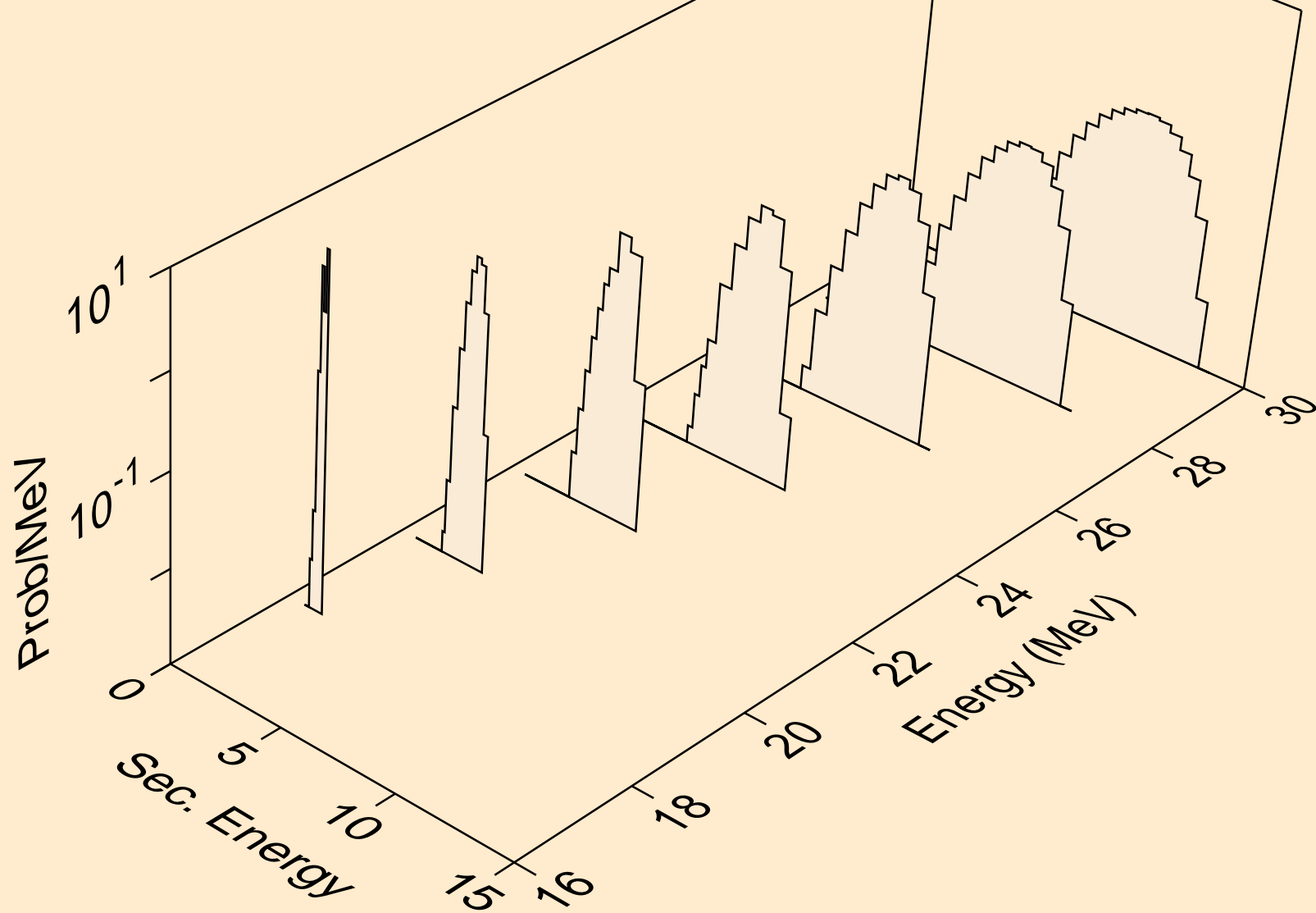

BA135 DEUTERON ACER TENDL-2023 LIBRARY; T=0.K
Deuteron emission for (d,n*)d

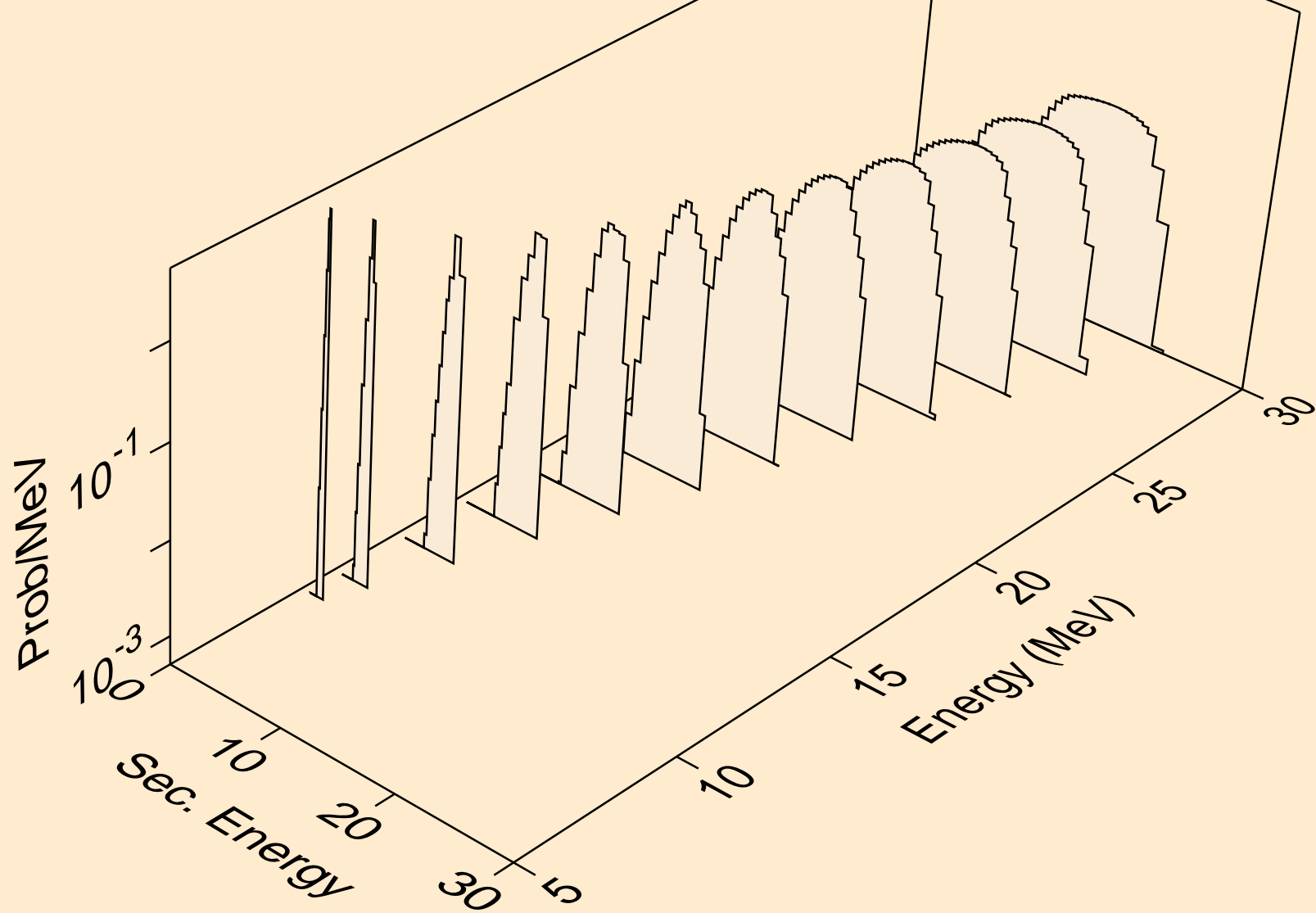

BA135 DEUTERON ACER TENDL-2023 LIBRARY; T=0.K
Deuteron emission for inelastic

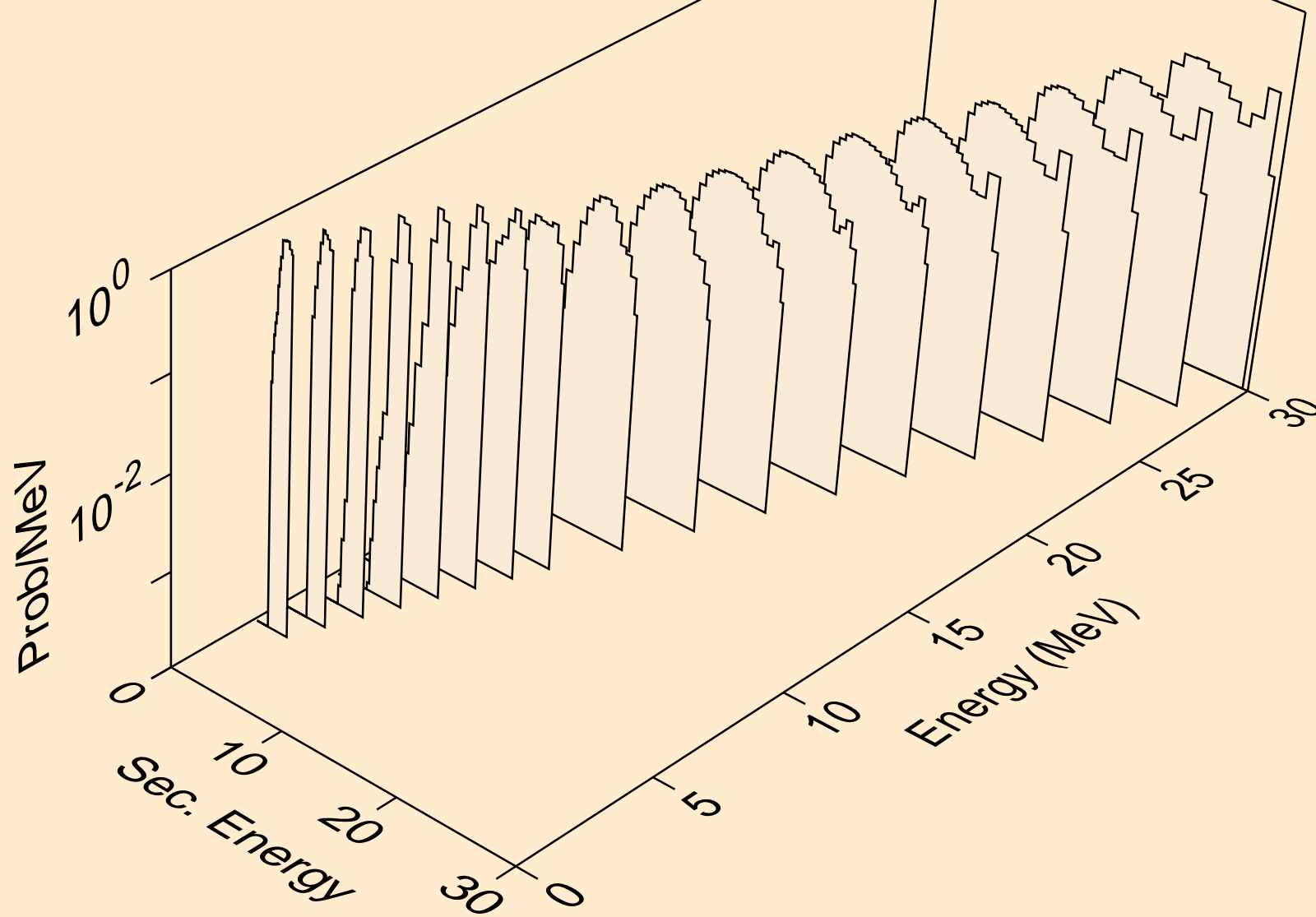

BA135 DEUTERON ACER TENDL-2023 LIBRARY; T=0.K
Deuteron emission for (d,pd)

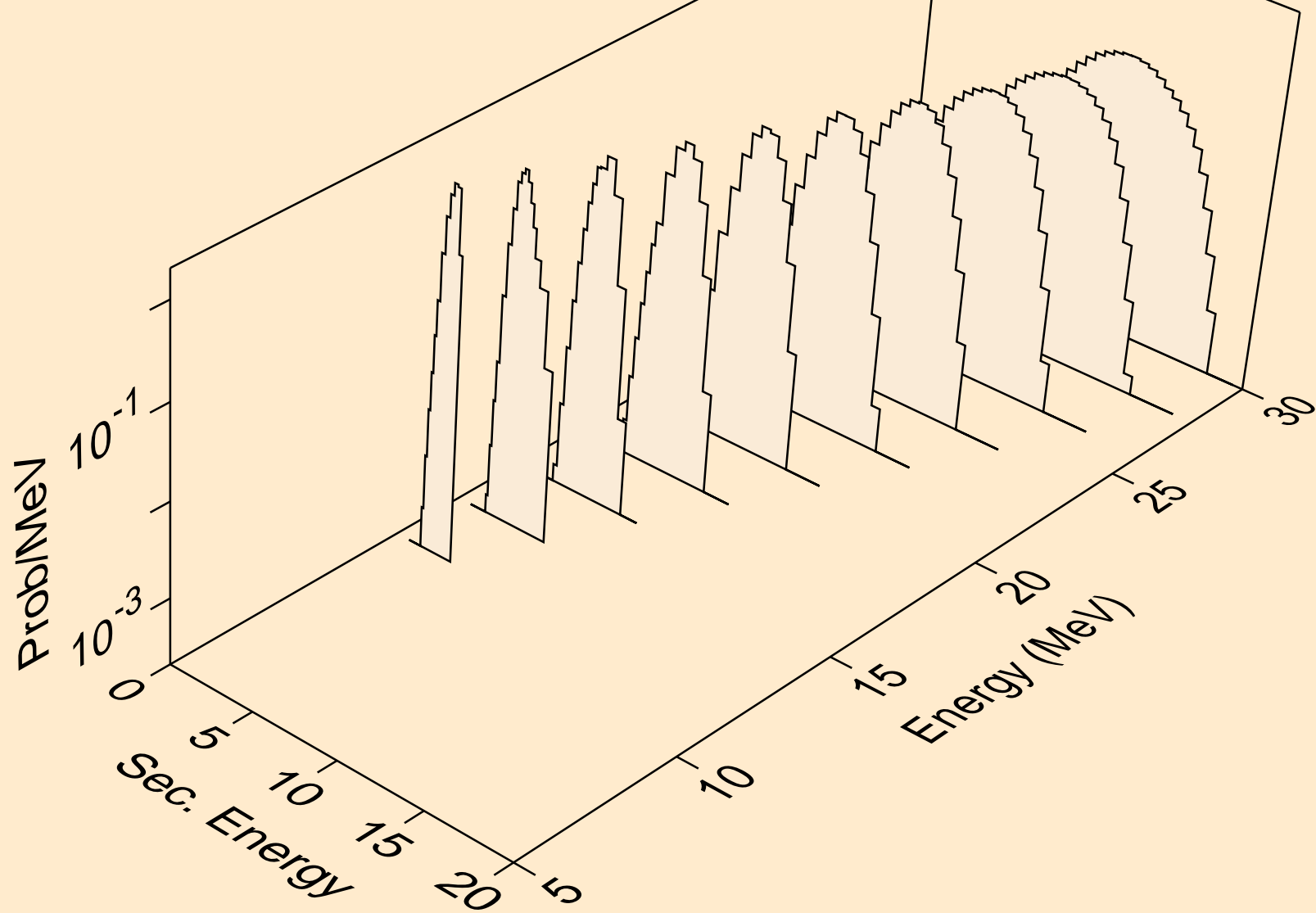

BA135 DEUTERON ACER TENDL-2023 LIBRARY; T=0.K
Deuteron emission for (d,da)

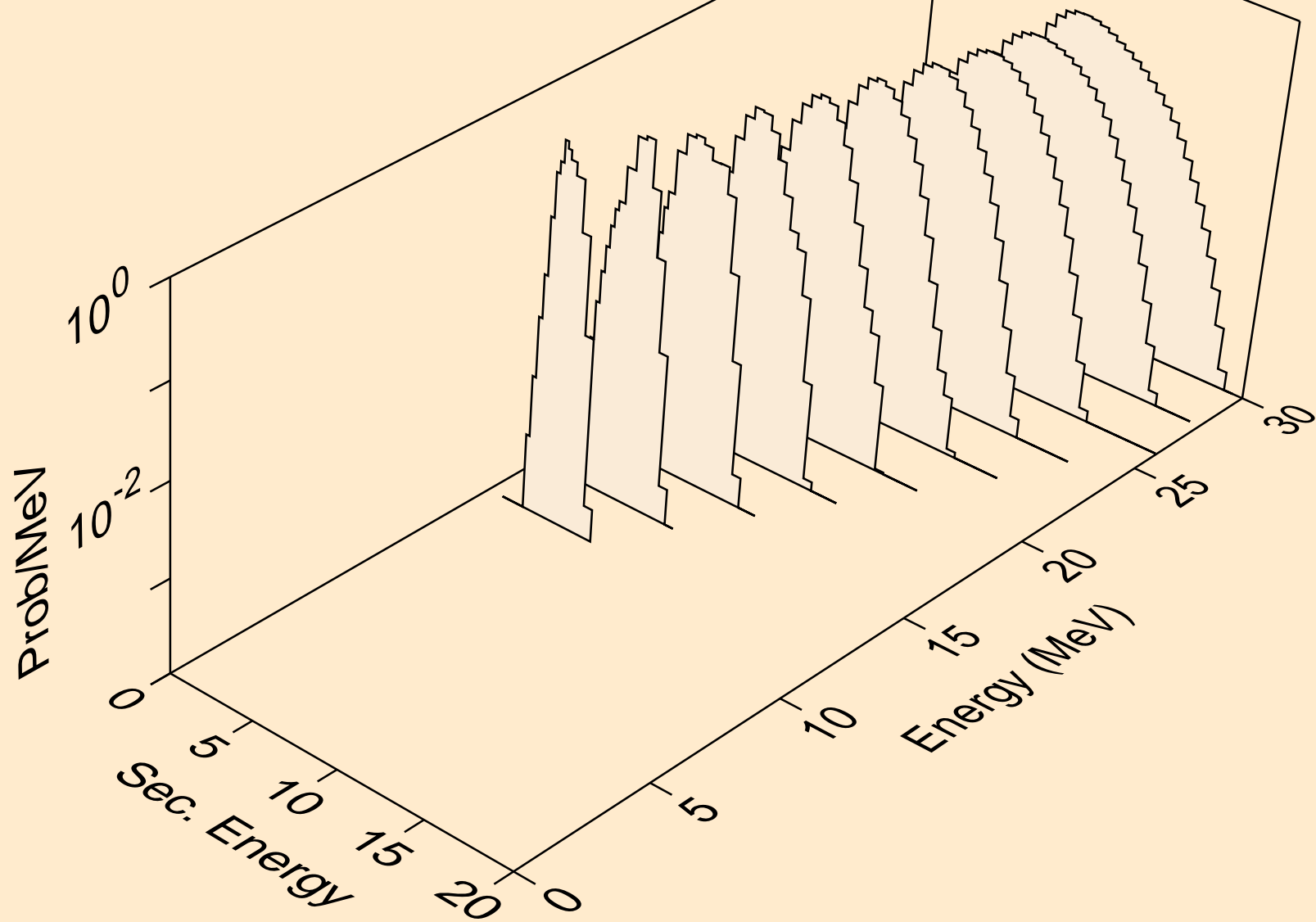

BA135 DEUTERON ACER TENDL-2023 LIBRARY; T=0.K
Photon emission for (z,n)

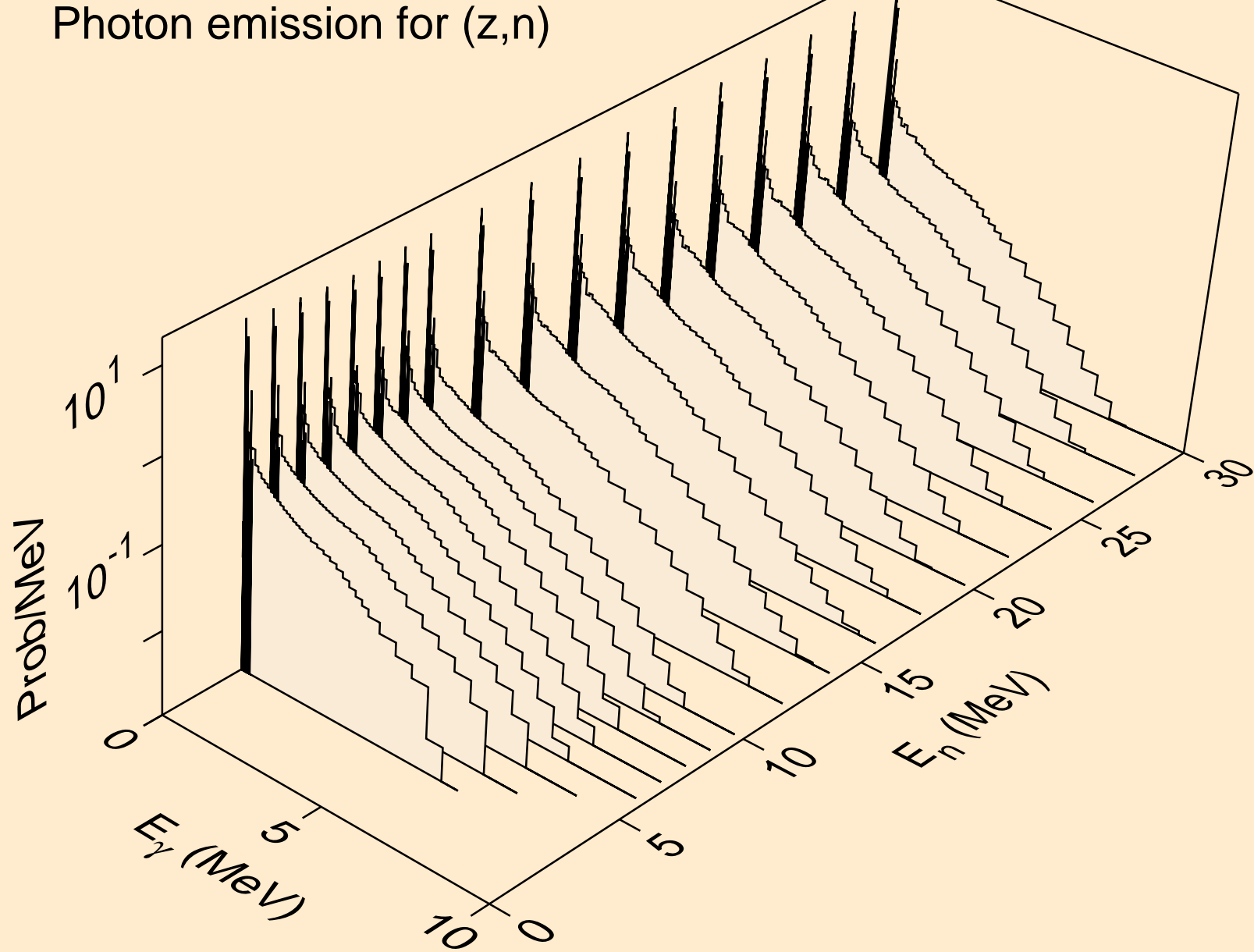

BA135 DEUTERON ACER TENDL-2023 LIBRARY; T=0.K
Photon emission for (z,x)

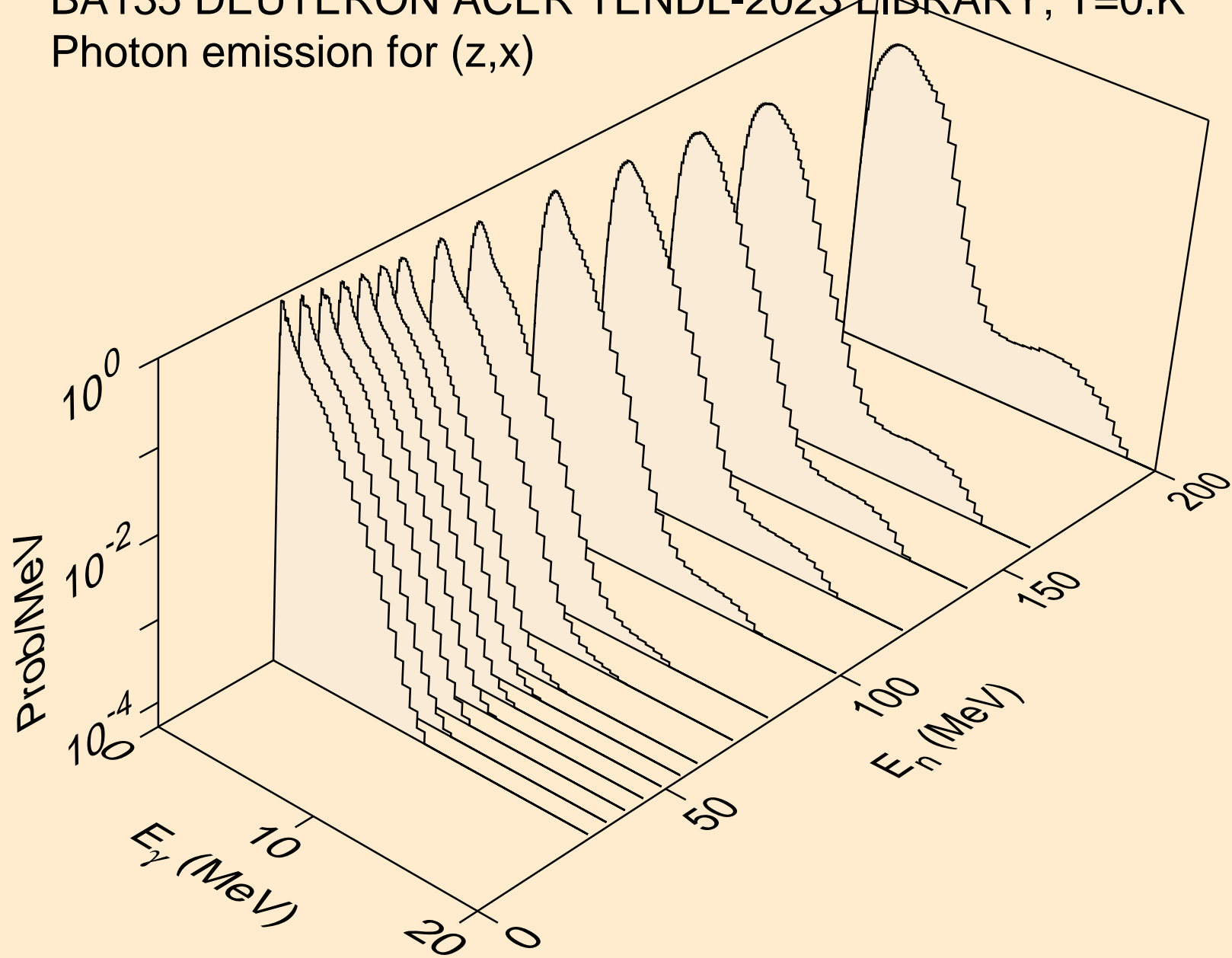

BA135 DEUTERON ACER TENDL-2023 LIBRARY; T=0.K
Photon emission for (n,2nd)

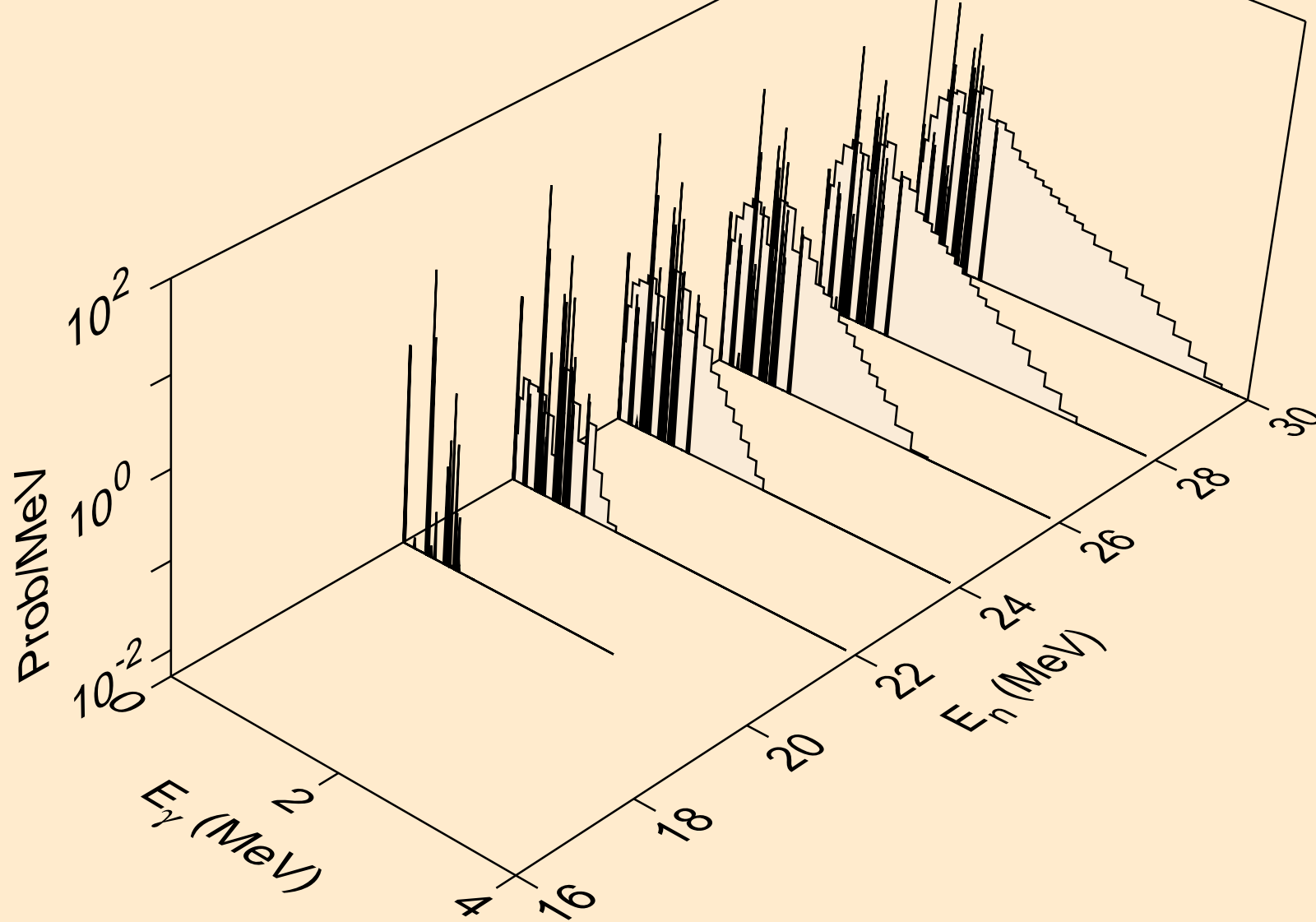

BA135 DEUTERON ACER TENDL-2023 LIBRARY; T=0.K
Photon emission for (n,2n)

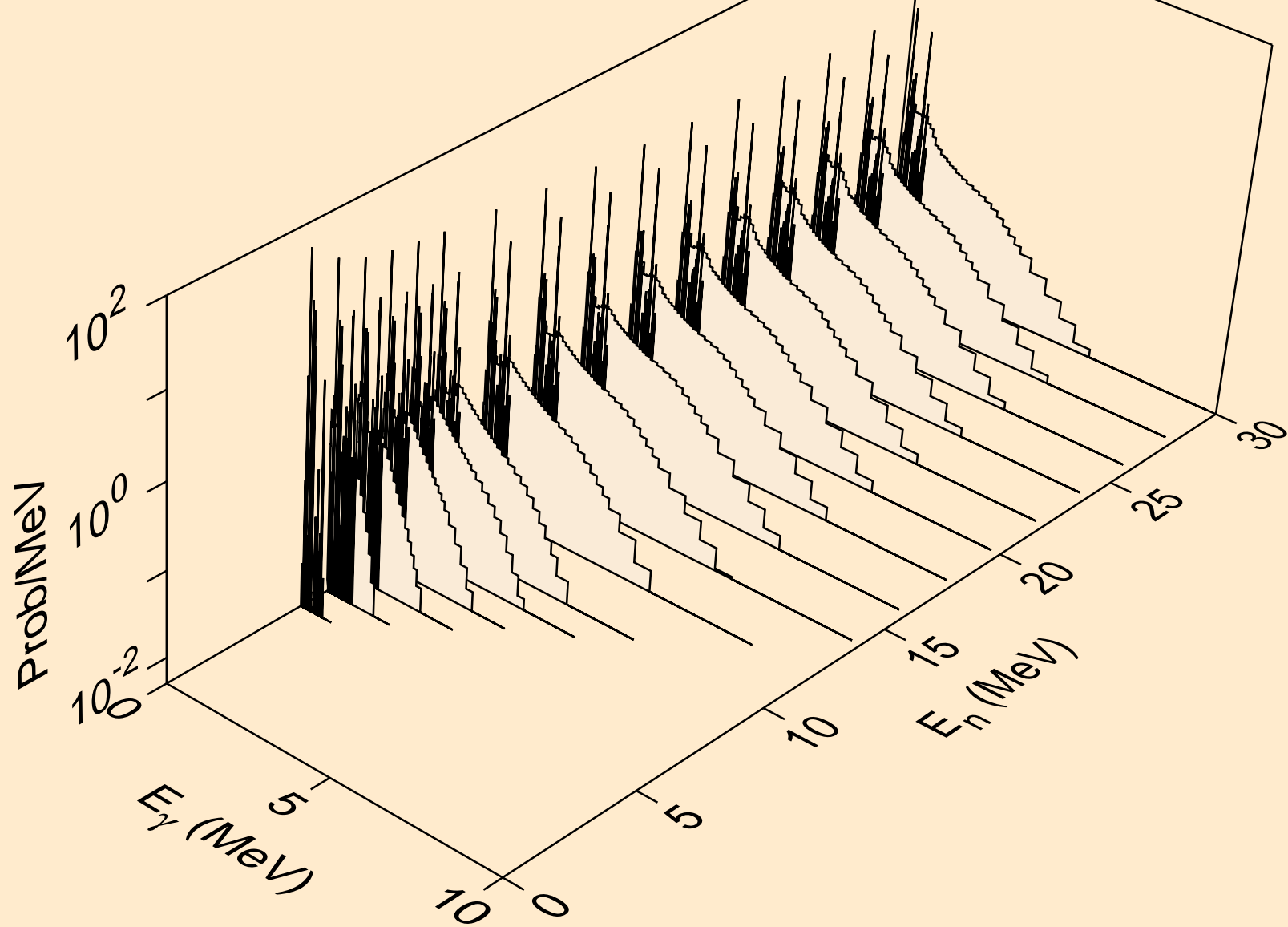

BA135 DEUTERON ACER TENDL-2023 LIBRARY; T=0.K
Photon emission for (n,3n)

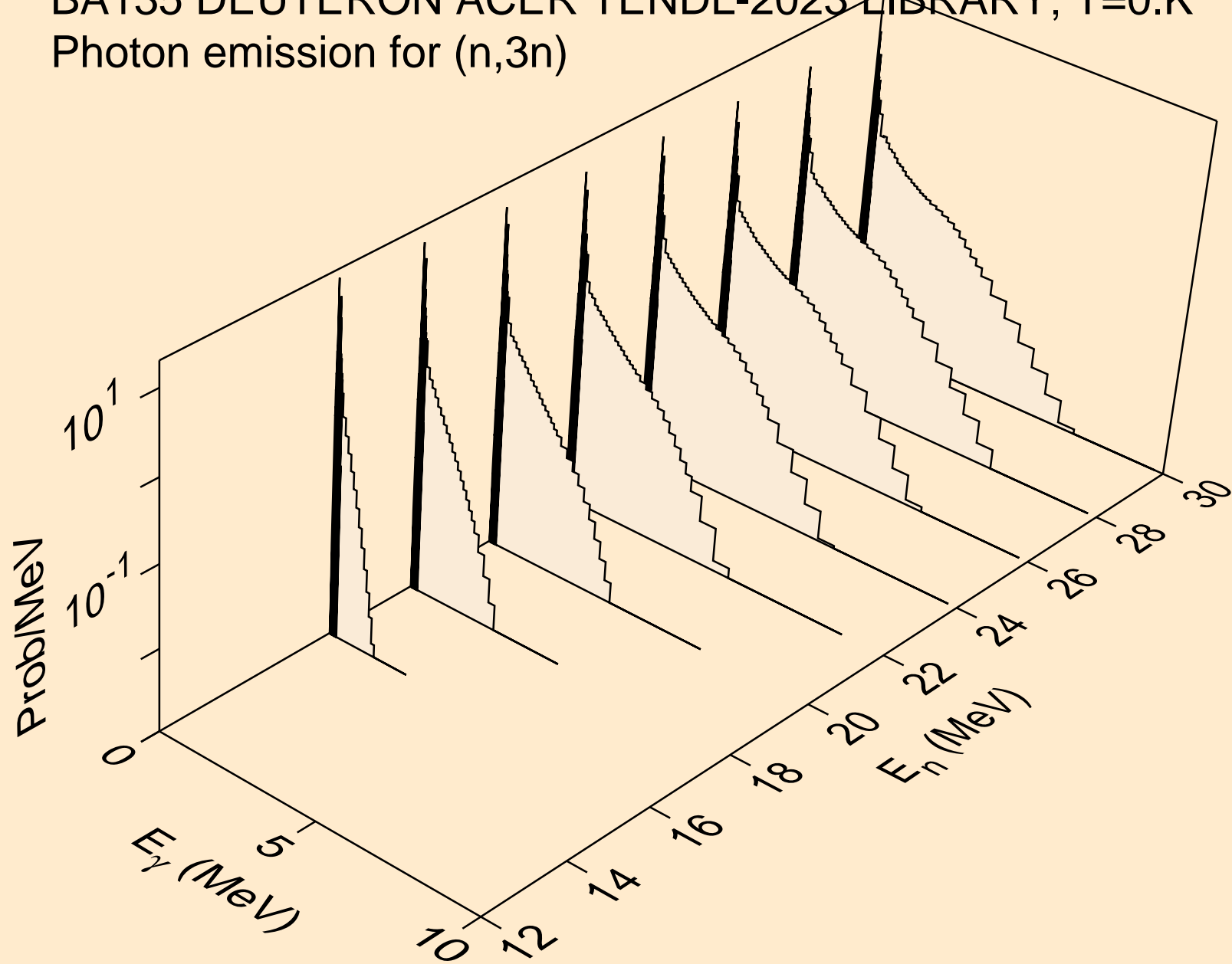

BA135 DEUTERON ACER TENDL-2023 LIBRARY; T=0.K
Photon emission for (n,n*)a

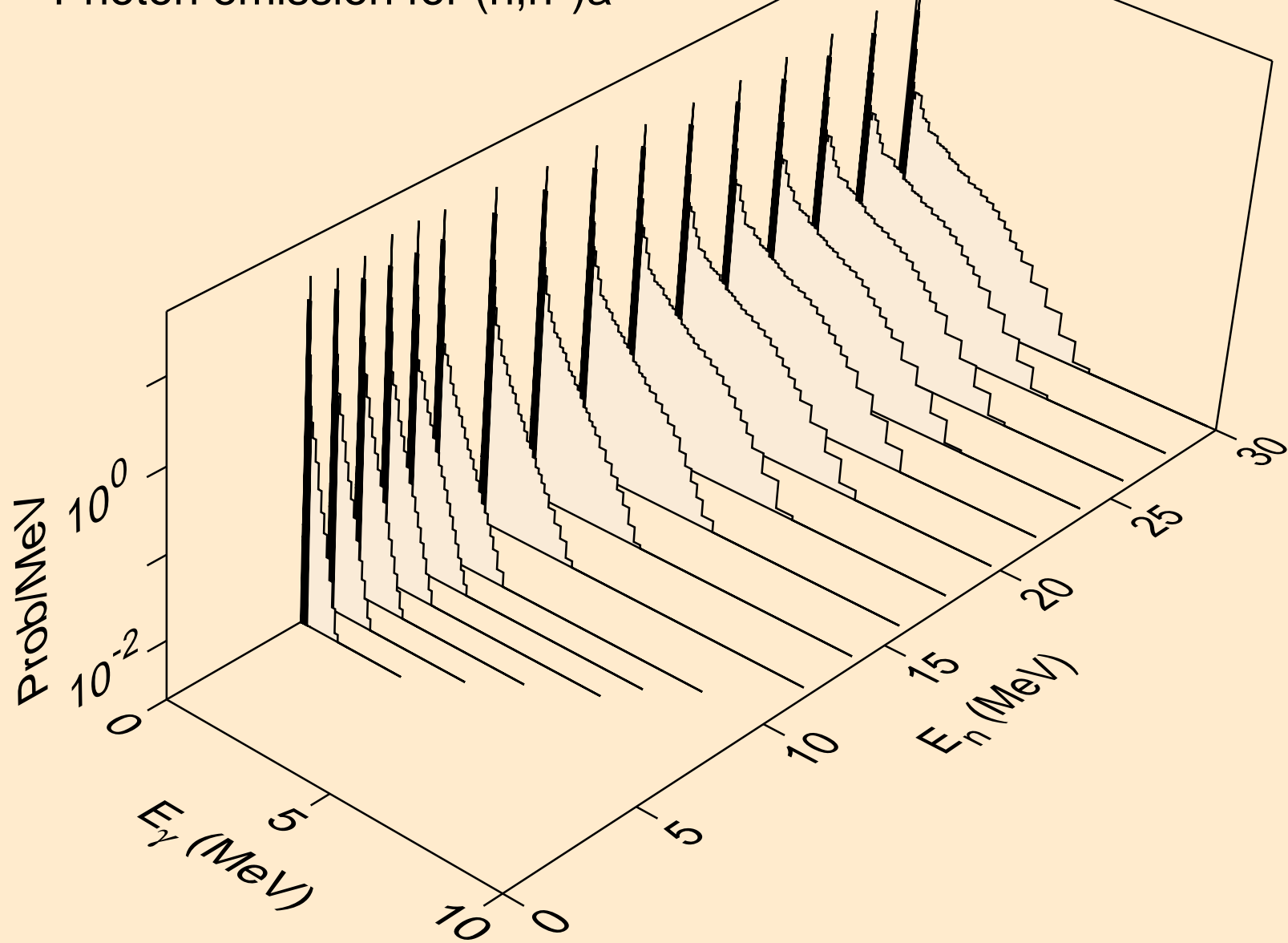

BA135 DEUTERON ACER TENDL-2023 LIBRARY; T=0.K
Photon emission for (n,2n)a

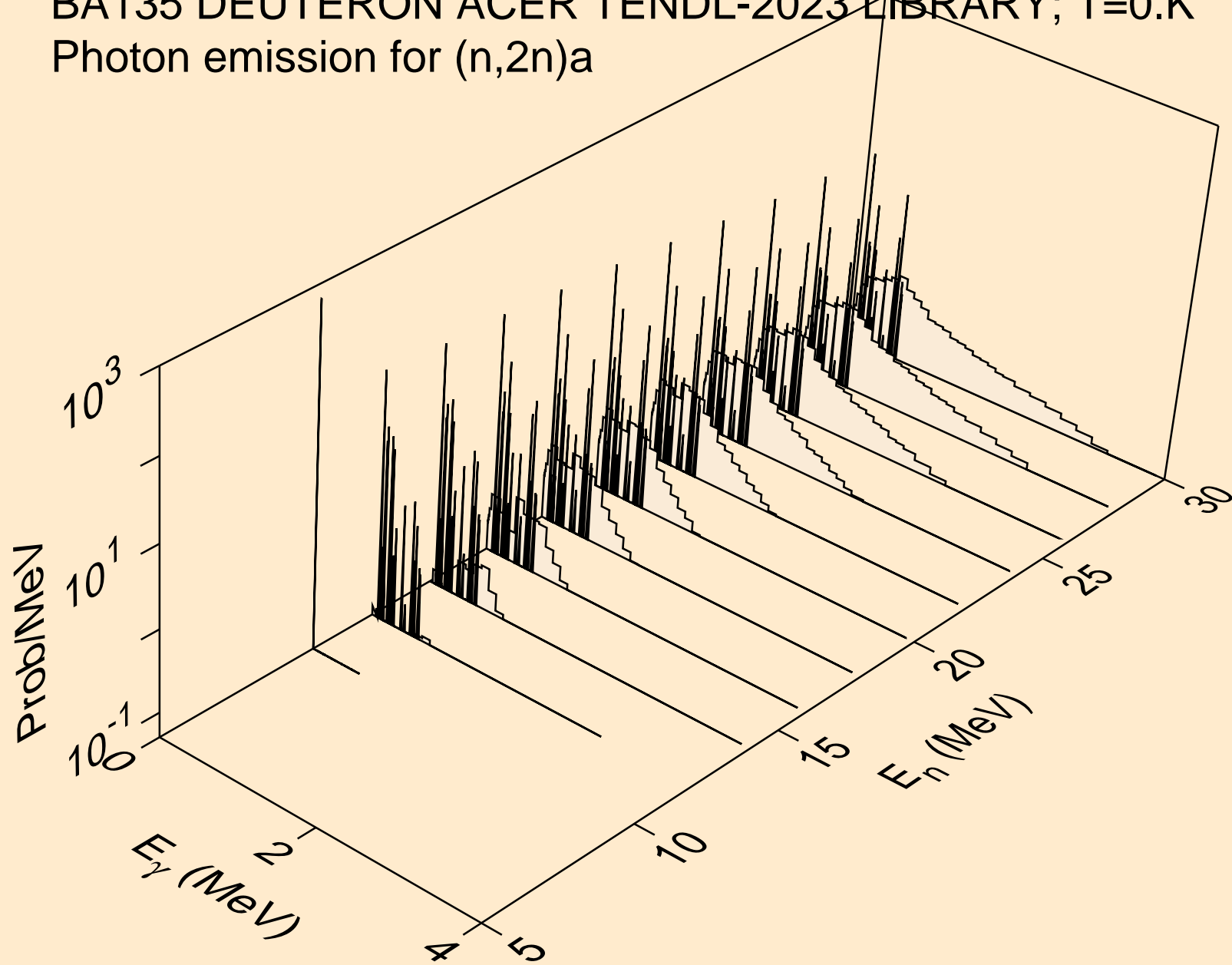

BA135 DEUTERON ACER TENDL-2023 LIBRARY; T=0.K
Photon emission for (n,3n)a

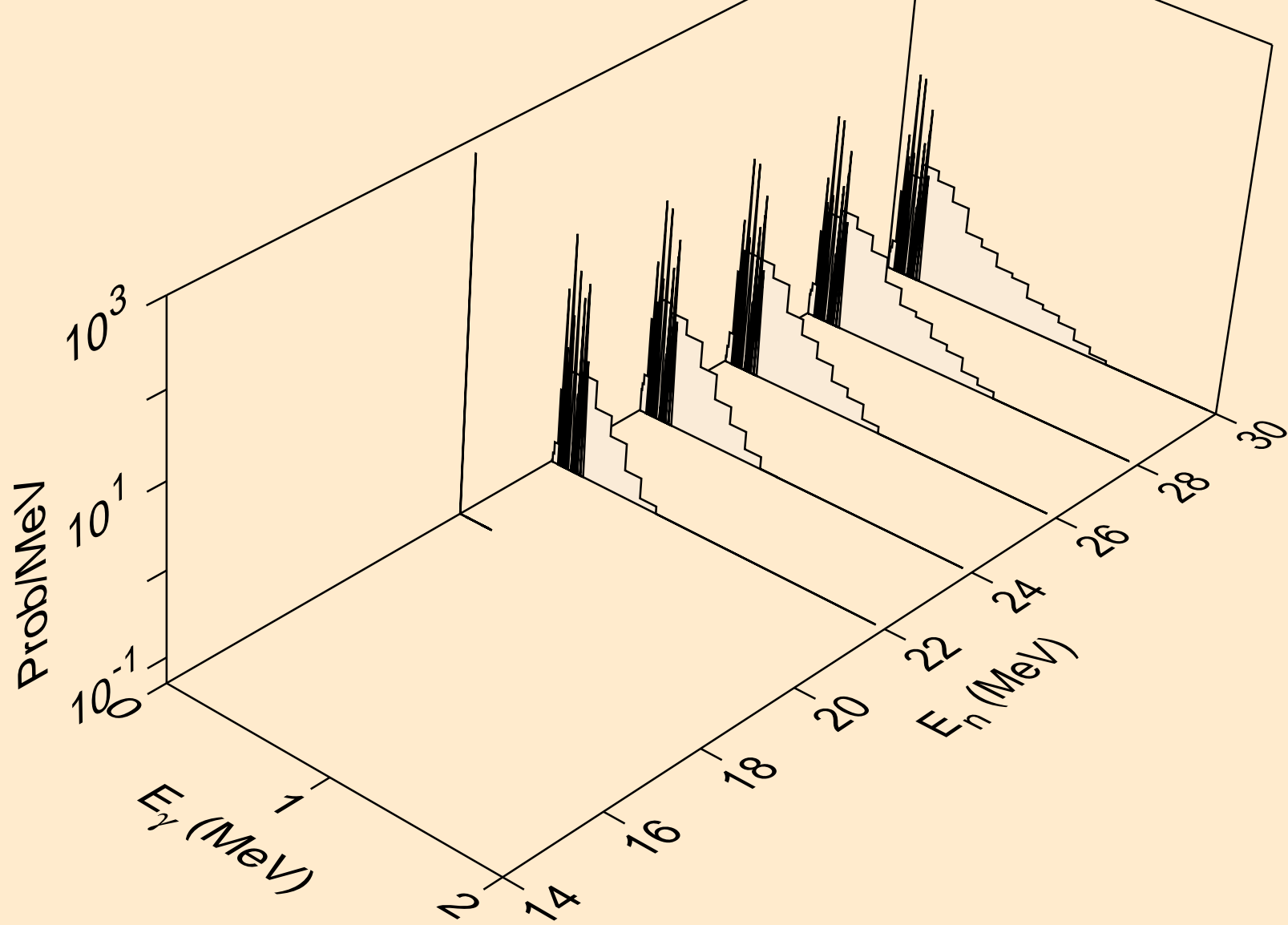

BA135 DEUTERON ACER TENDL-2023 LIBRARY; T=0.K
Photon emission for (n,n*)p

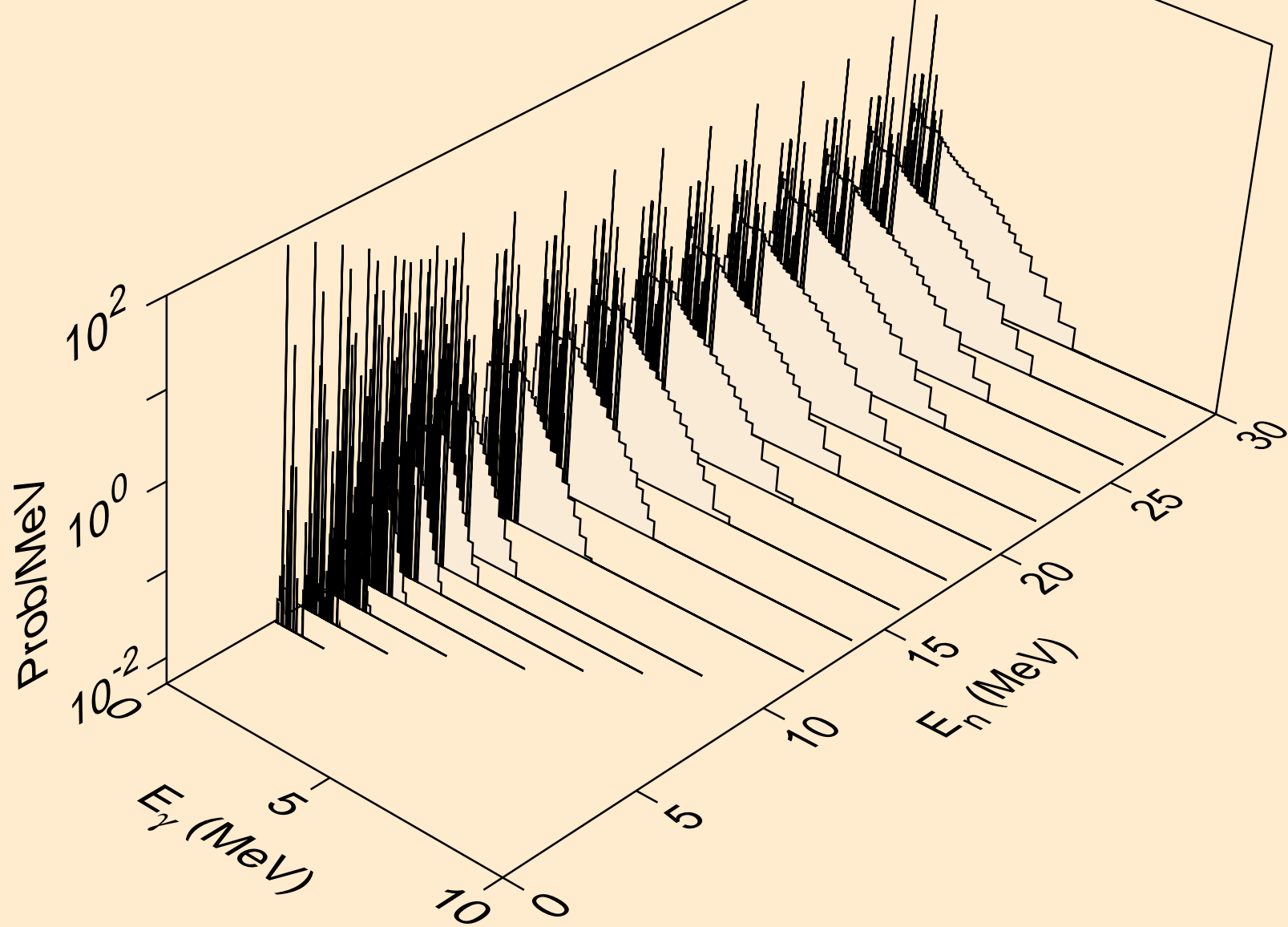

BA135 DEUTERON ACER TENDL-2023 LIBRARY; T=0.K
Photon emission for (n,n*)2a

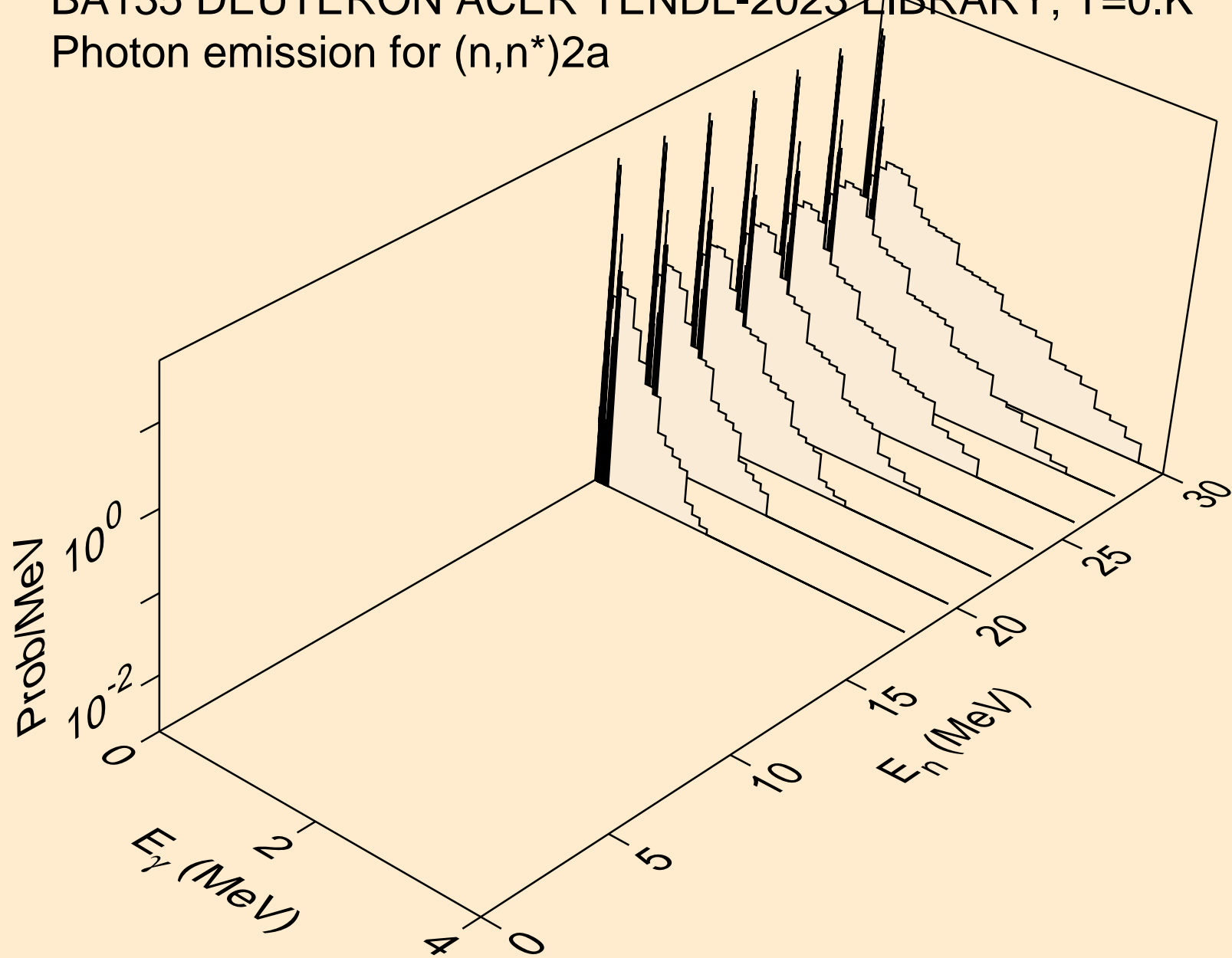

BA135 DEUTERON ACER TENDL-2023 LIBRARY; T=0.K
Photon emission for (n,n*)d

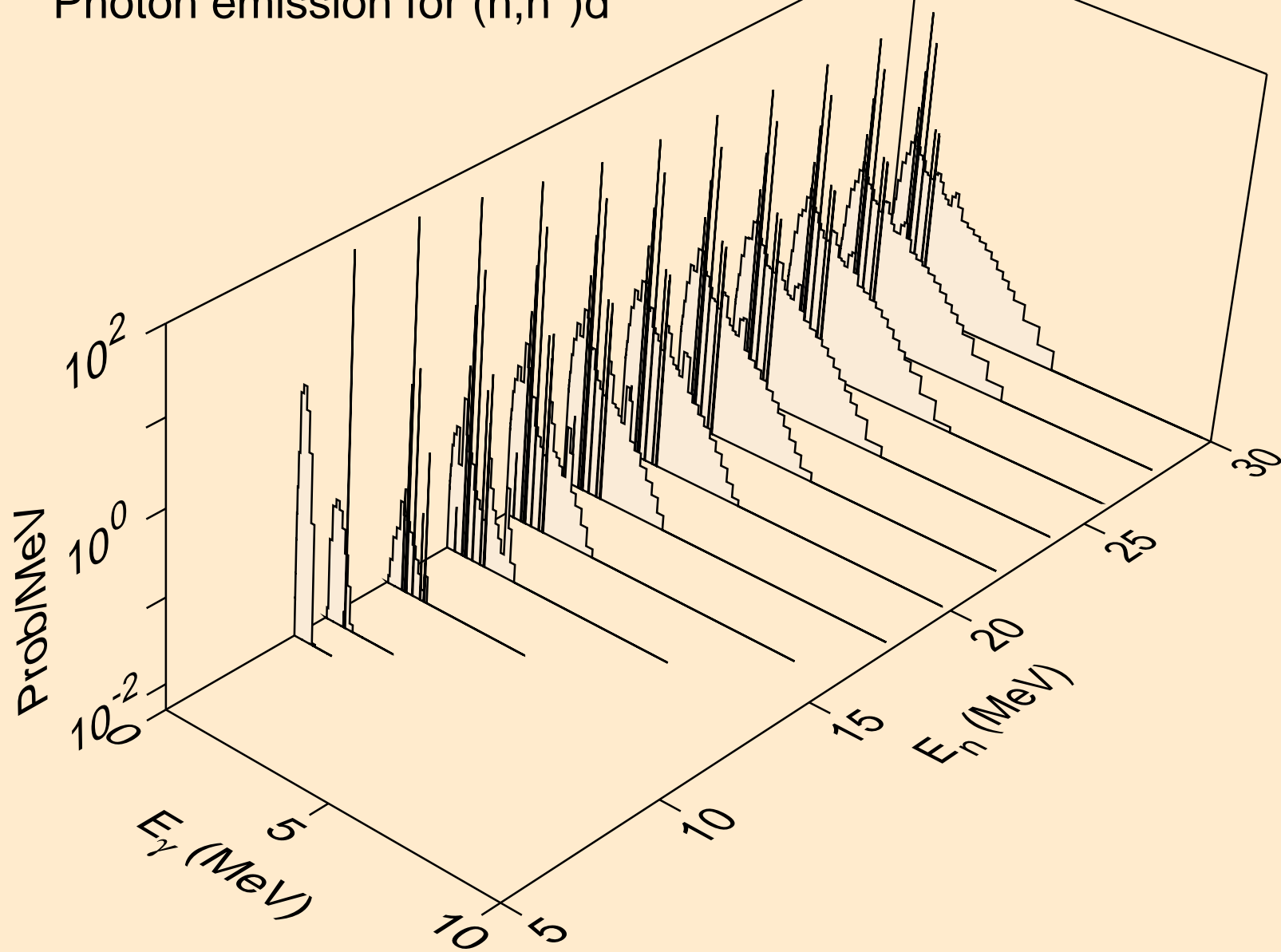

BA135 DEUTERON ACER TENDL-2023 LIBRARY; T=0.K
Photon emission for (n,n*)t

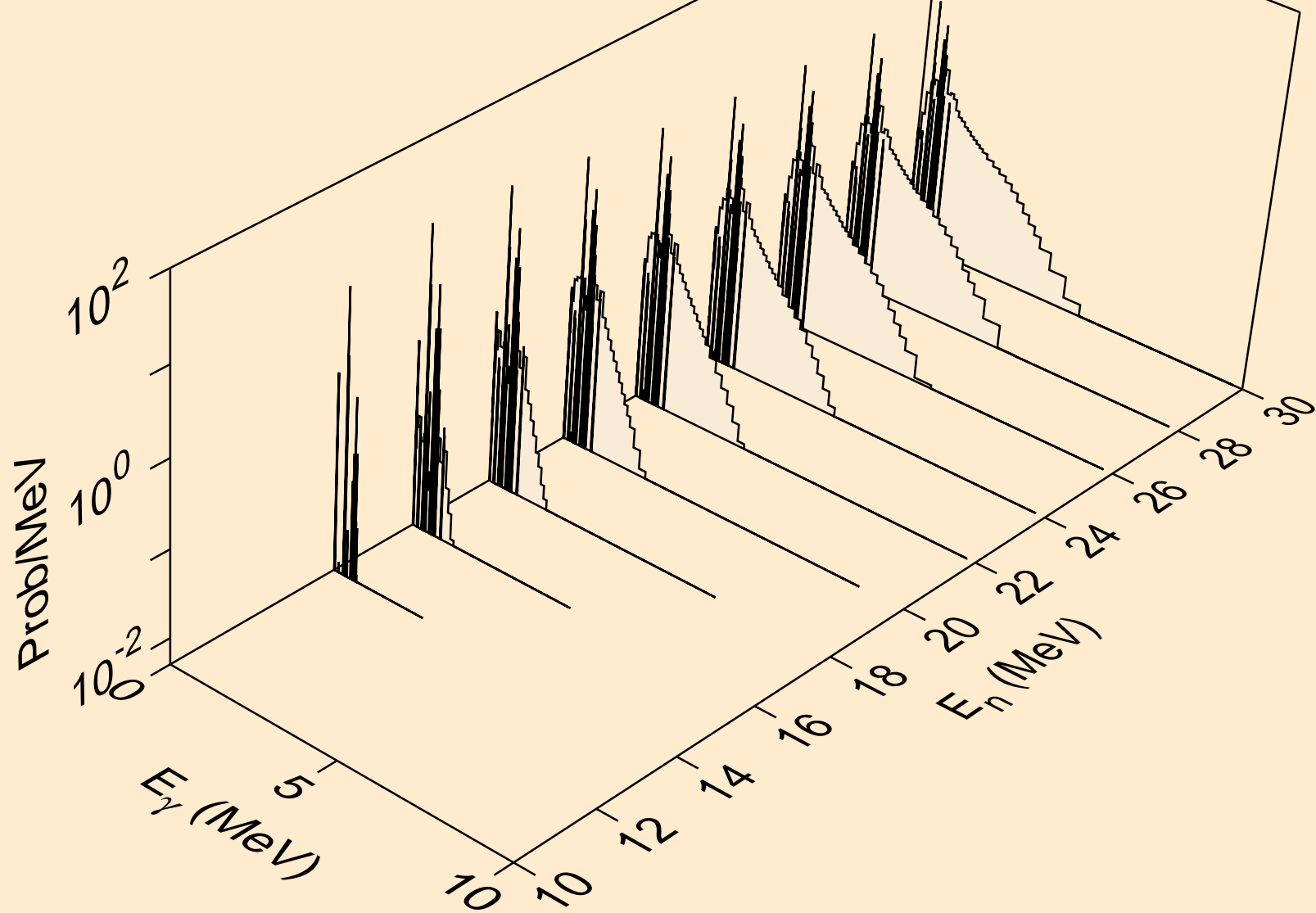

BA135 DEUTERON ACER TENDL-2023 LIBRARY; T=0.K
Photon emission for (n,n*)he3

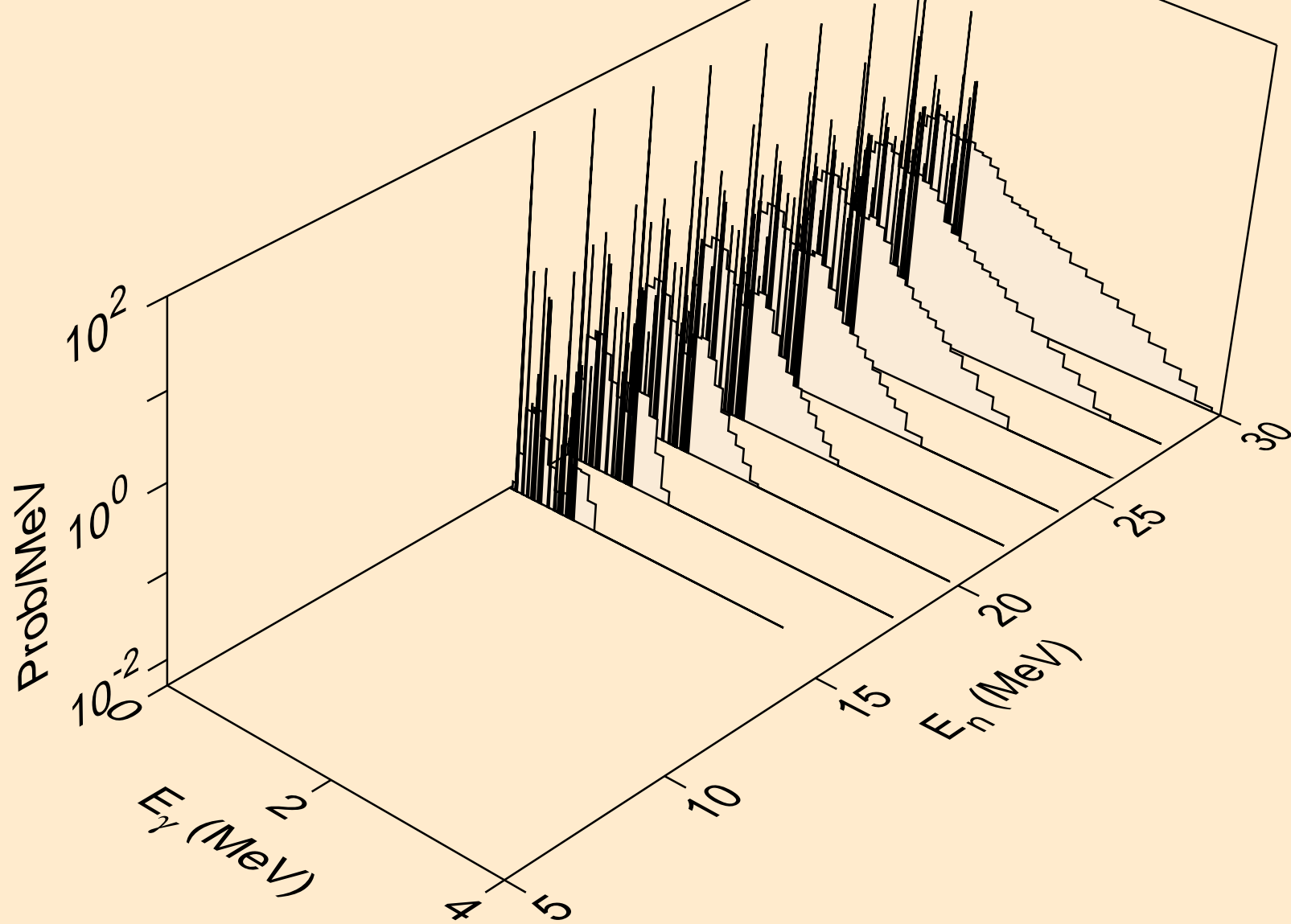

BA135 DEUTERON ACER TENDL-2023 LIBRARY; T=0.K
Photon emission for (n,4n)

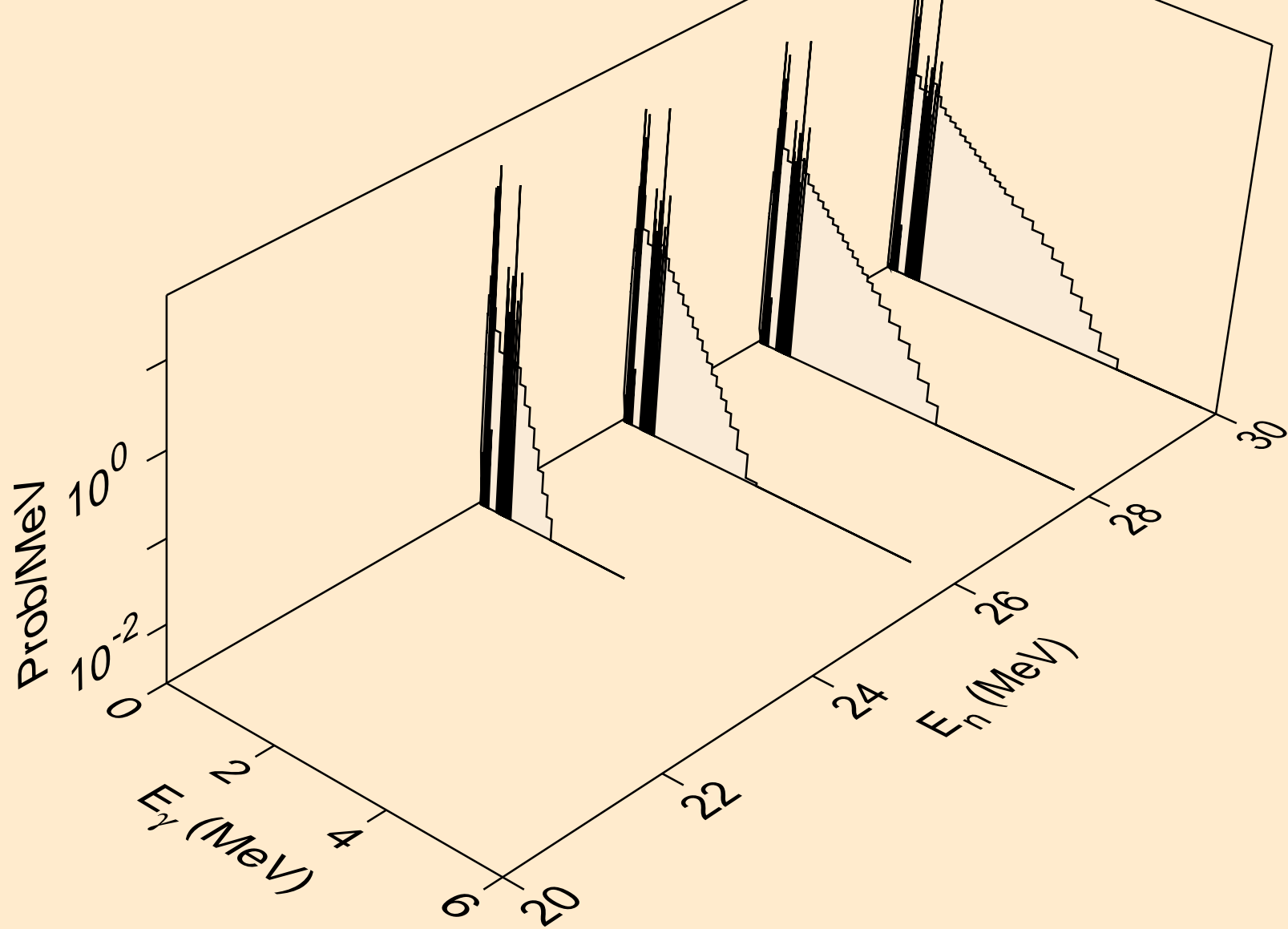

BA135 DEUTERON ACER TENDL-2023 LIBRARY; T=0.K
Photon emission for (n,2np)

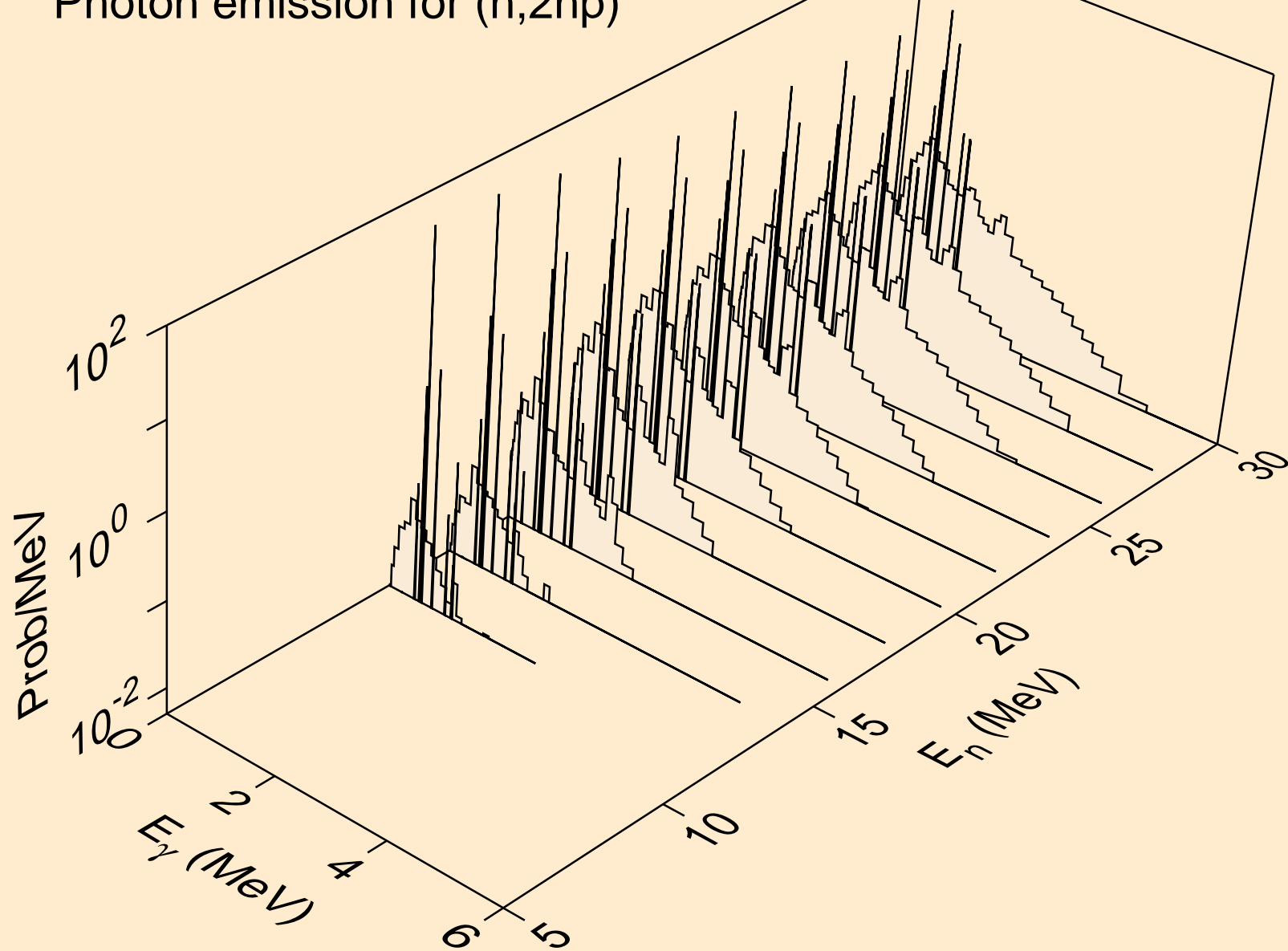

BA135 DEUTERON ACER TENDL-2023 LIBRARY; T=0.K
Photon emission for (n,3np)

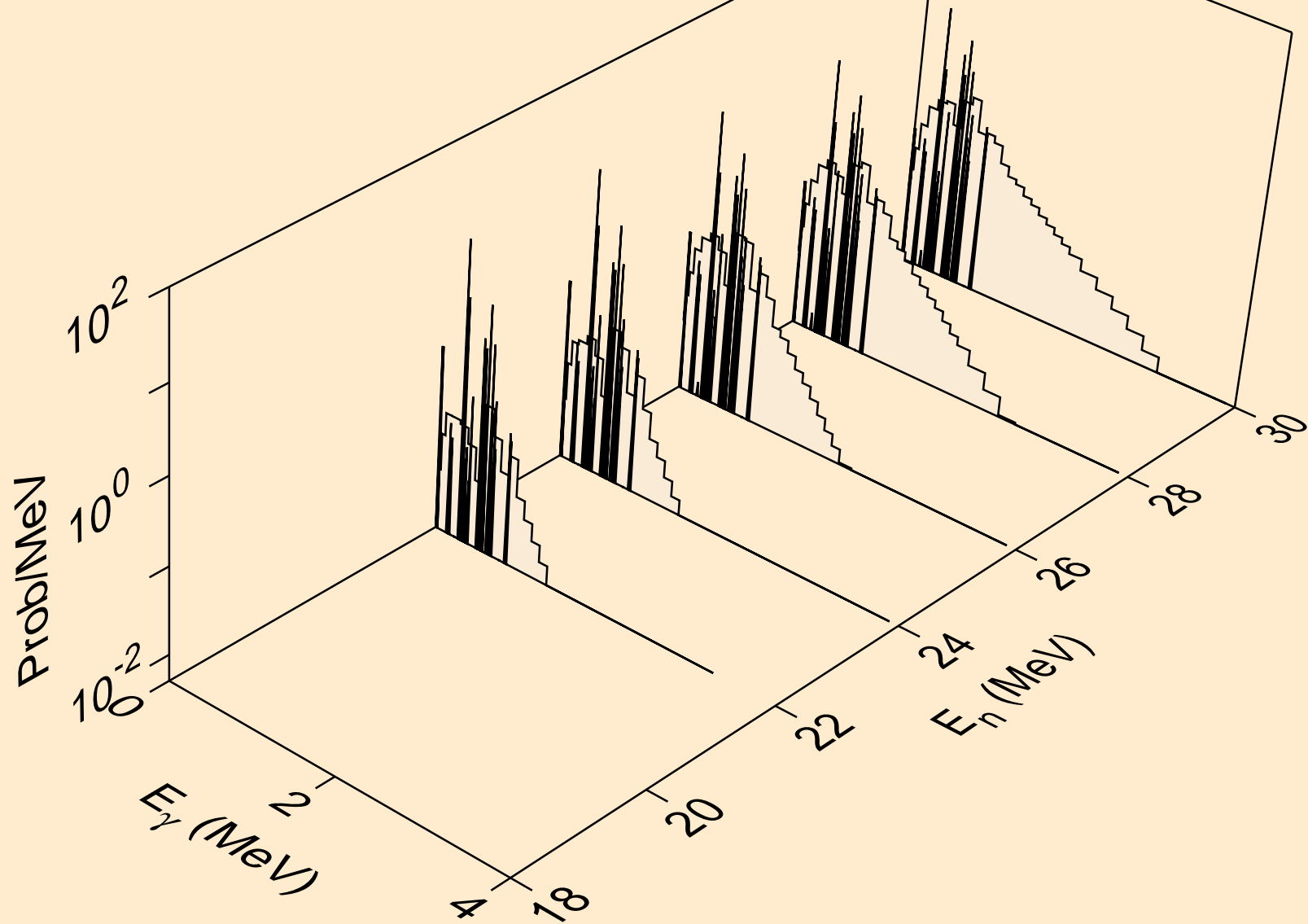

BA135 DEUTERON ACER TENDL-2023 LIBRARY; T=0.K
Photon emission for (n,n2p)

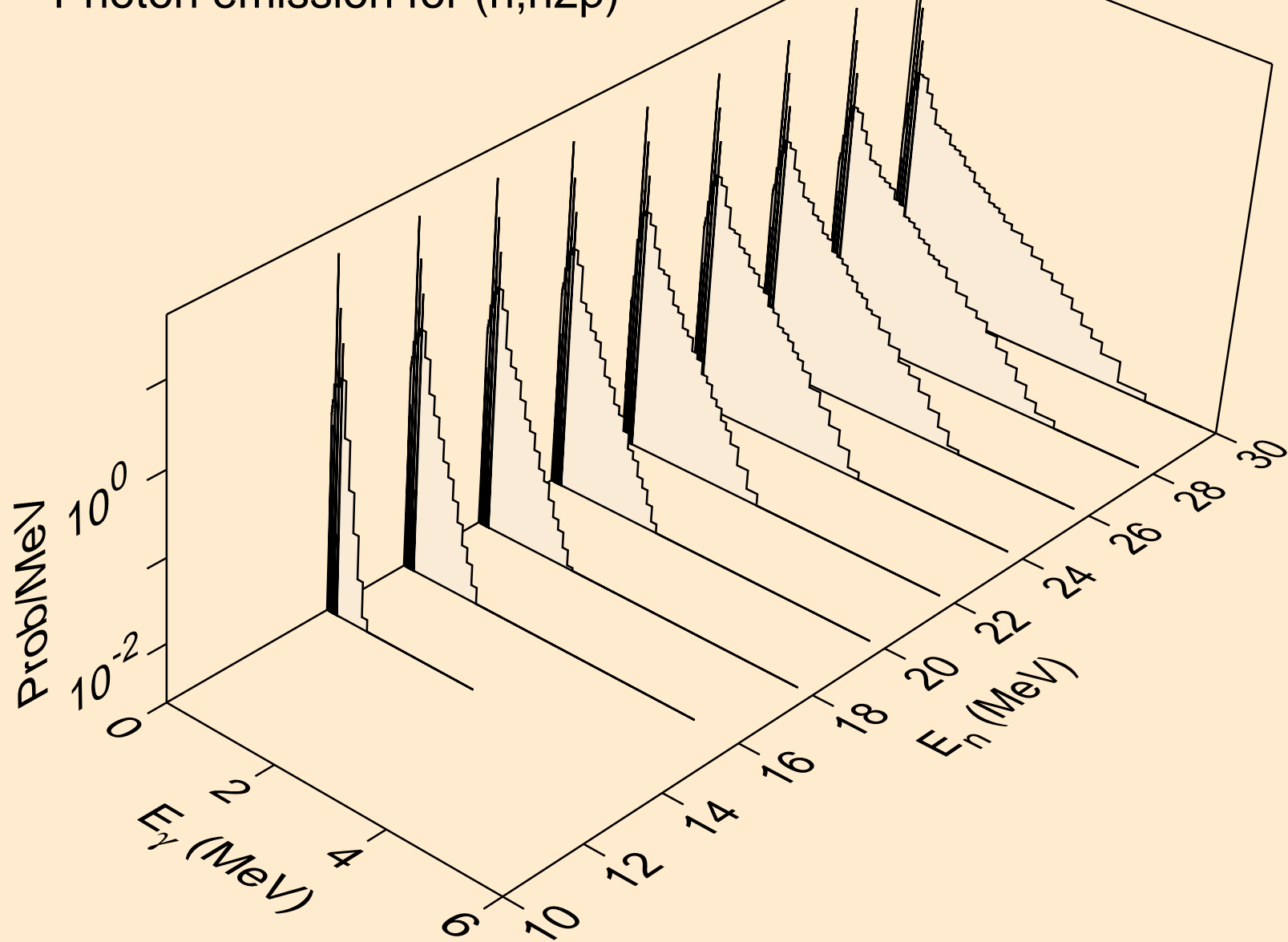

BA135 DEUTERON ACER TENDL-2023 LIBRARY; T=0.K
Photon emission for (n,npa)

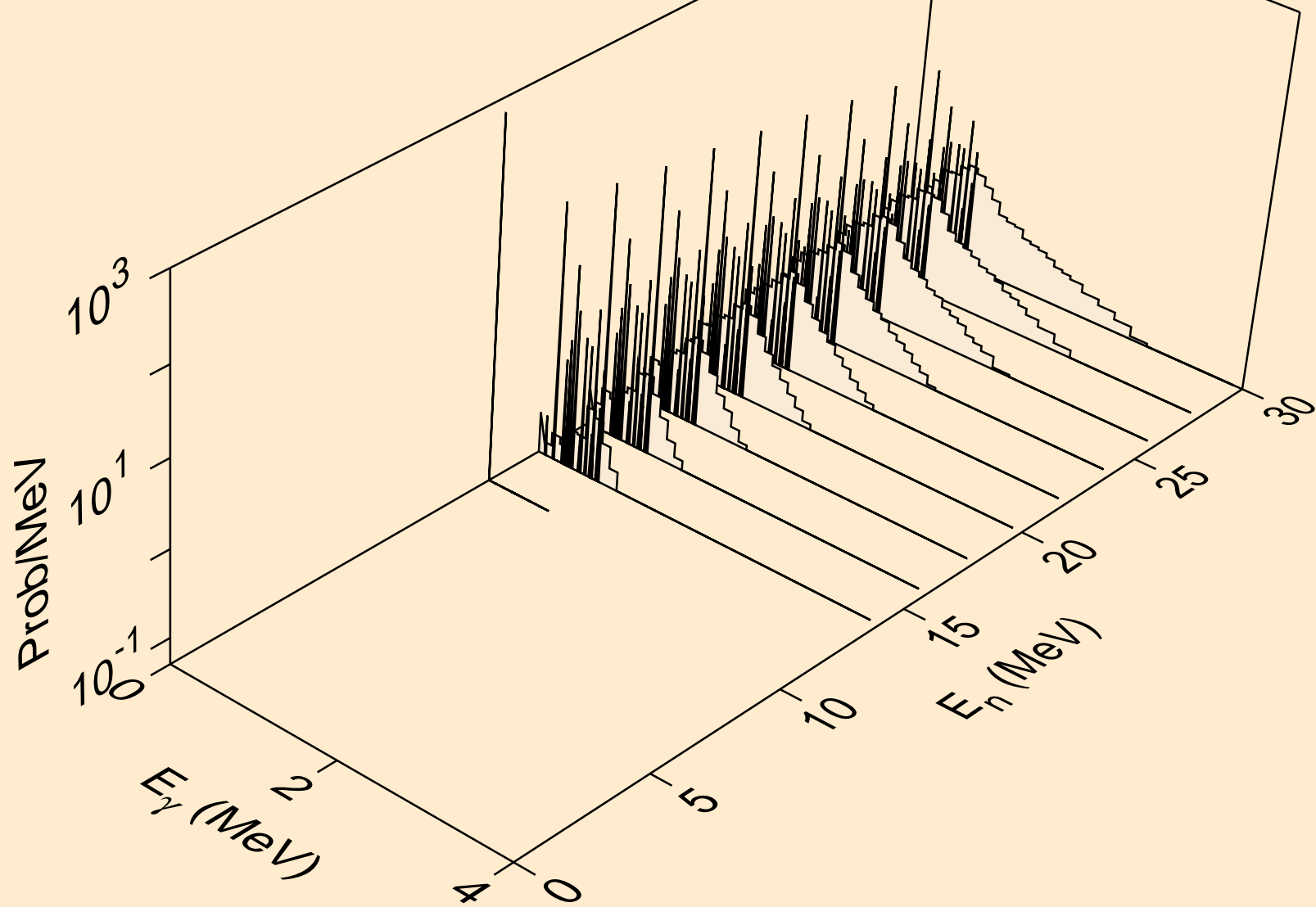

BA135 DEUTERON ACER TENDL-2023 LIBRARY; T=0.K
Photon emission for (n,gma)

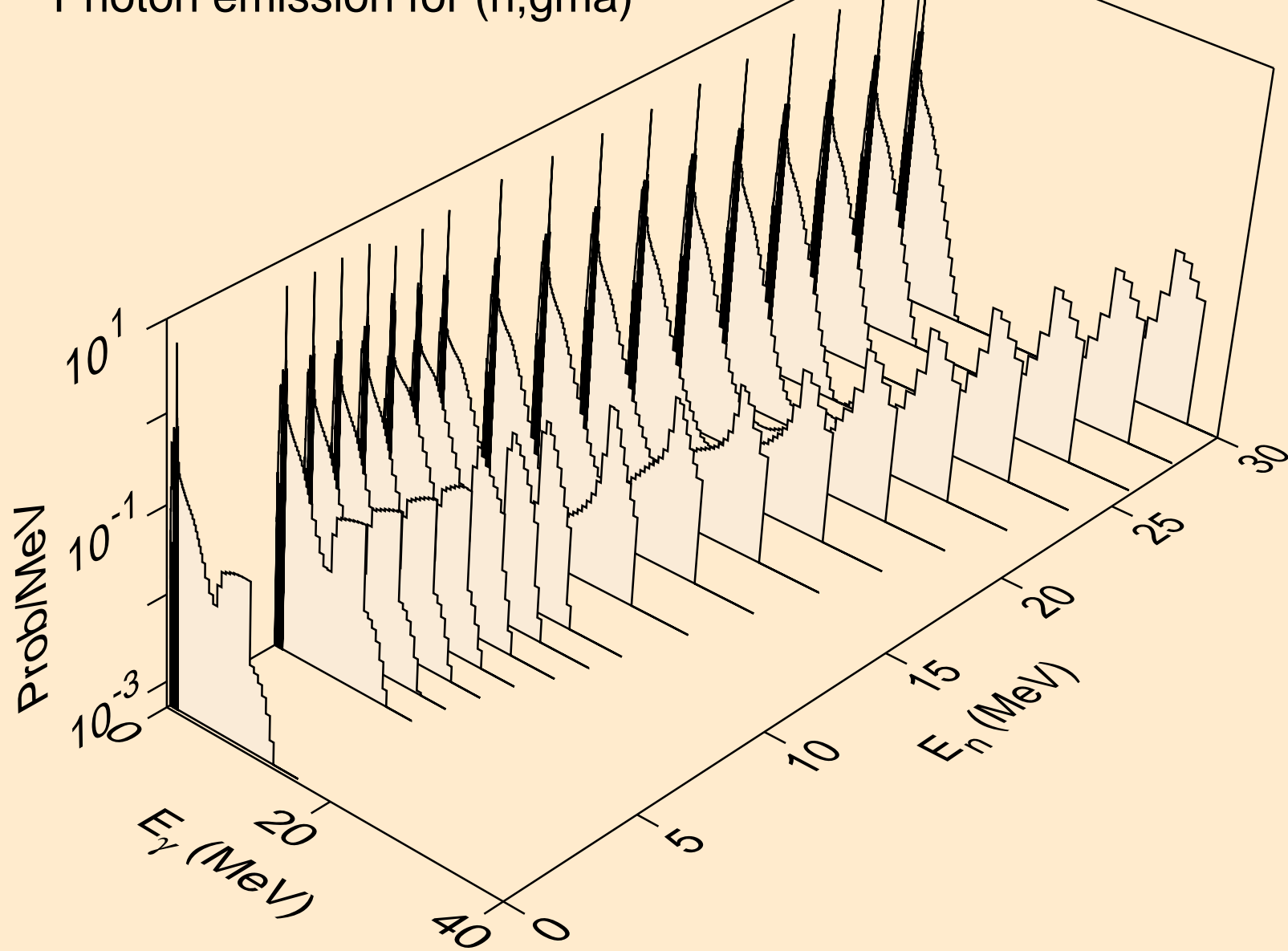

BA135 DEUTERON ACER TENDL-2023 LIBRARY; T=0.K
Photon emission for (n,p)

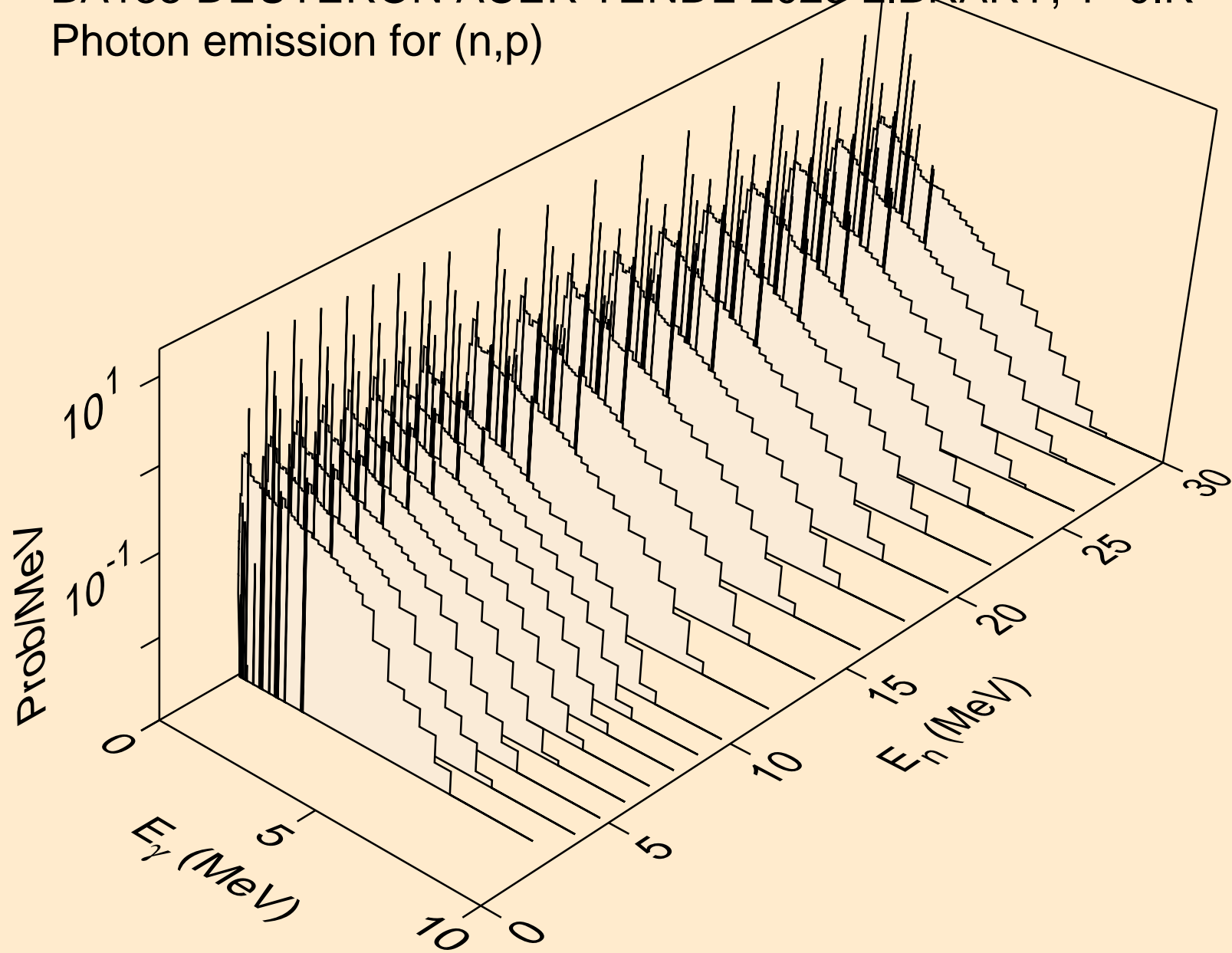

BA135 DEUTERON ACER TENDL-2023 LIBRARY; T=0.K
Photon emission for inelastic

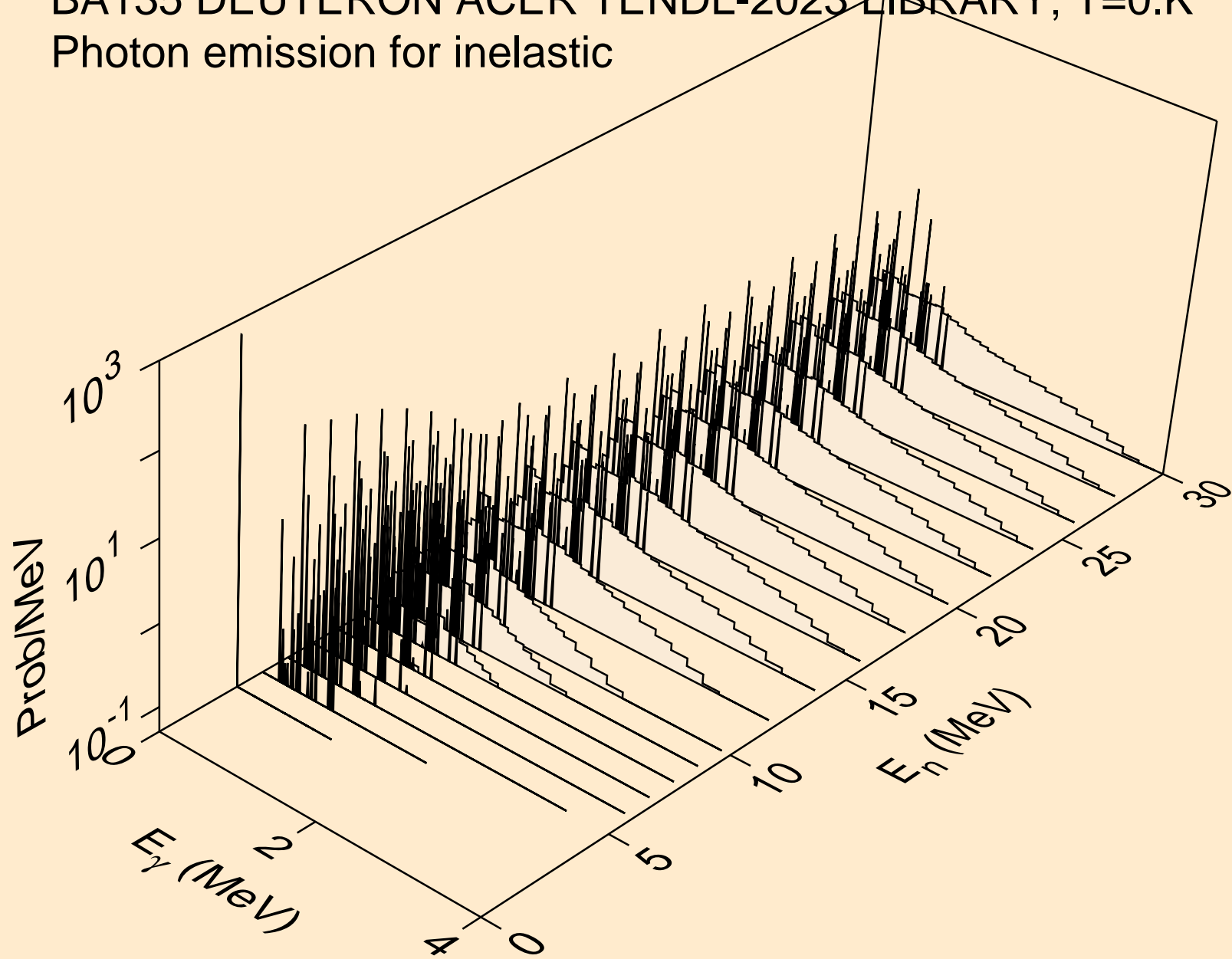

BA135 DEUTERON ACER TENDL-2023 LIBRARY; T=0.K
Photon emission for (n,t)

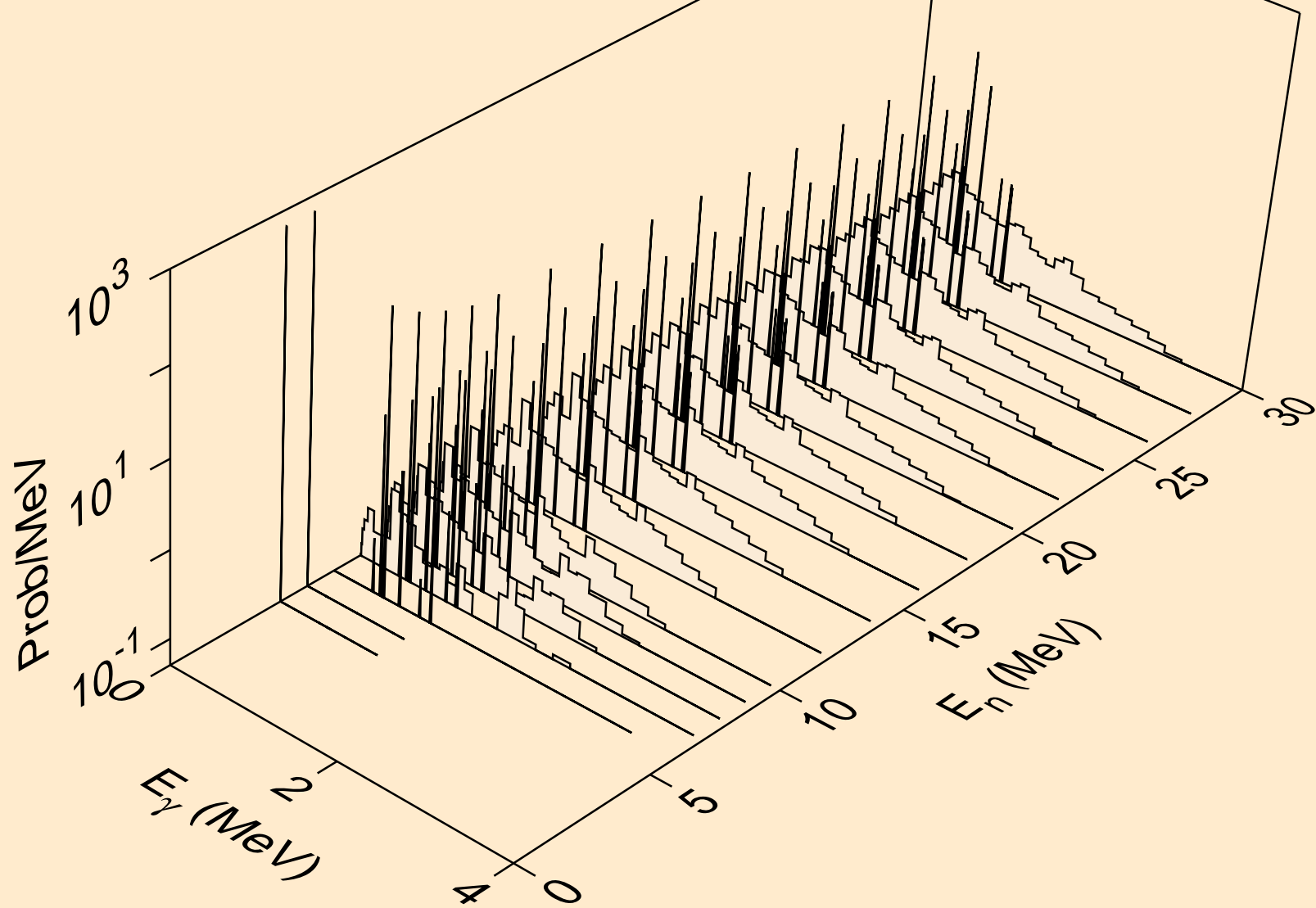

BA135 DEUTERON ACER TENDL-2023 LIBRARY; T=0.K
Photon emission for (n,he3)

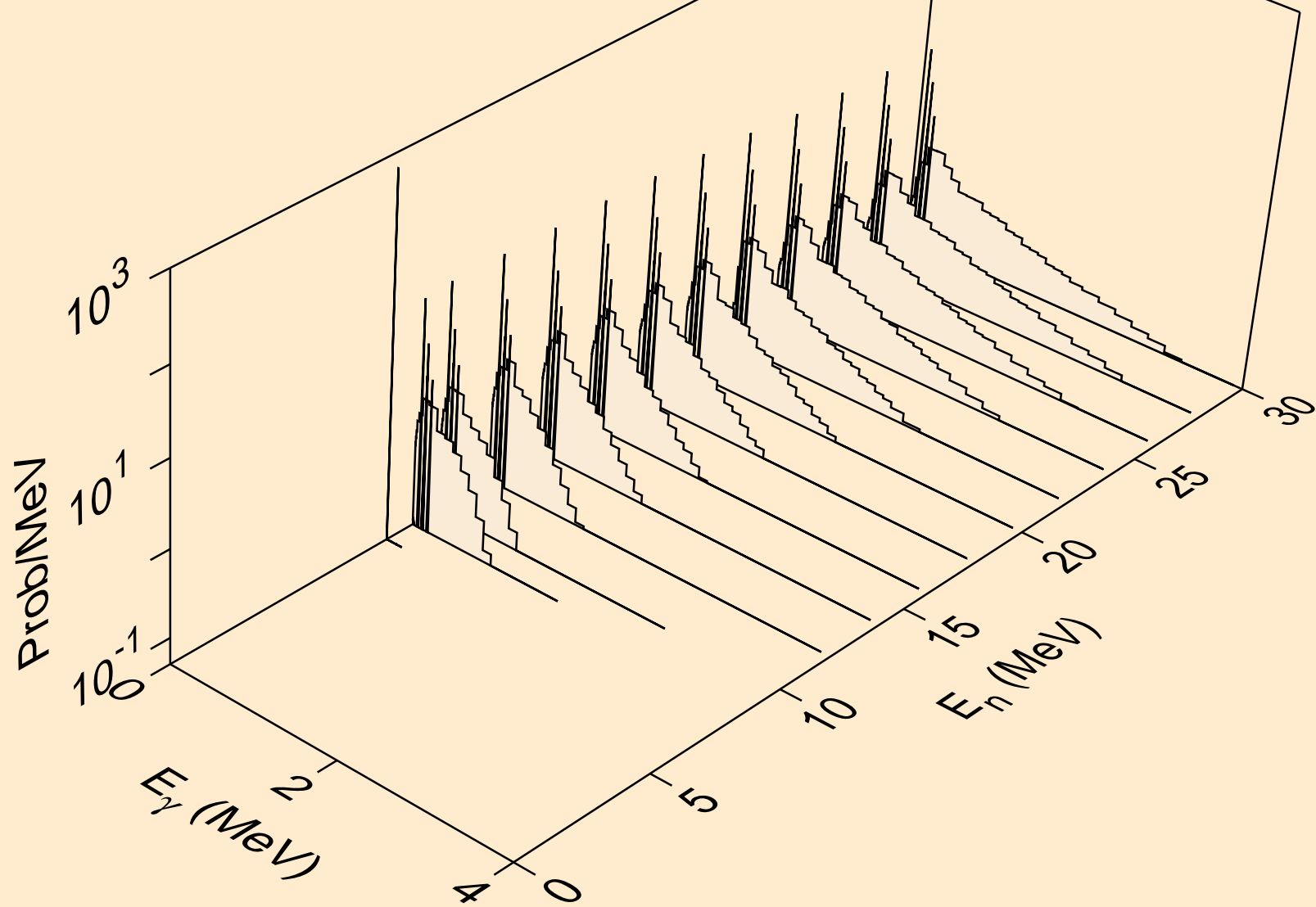

BA135 DEUTERON ACER TENDL-2023 LIBRARY; T=0.K
Photon emission for (n,a)

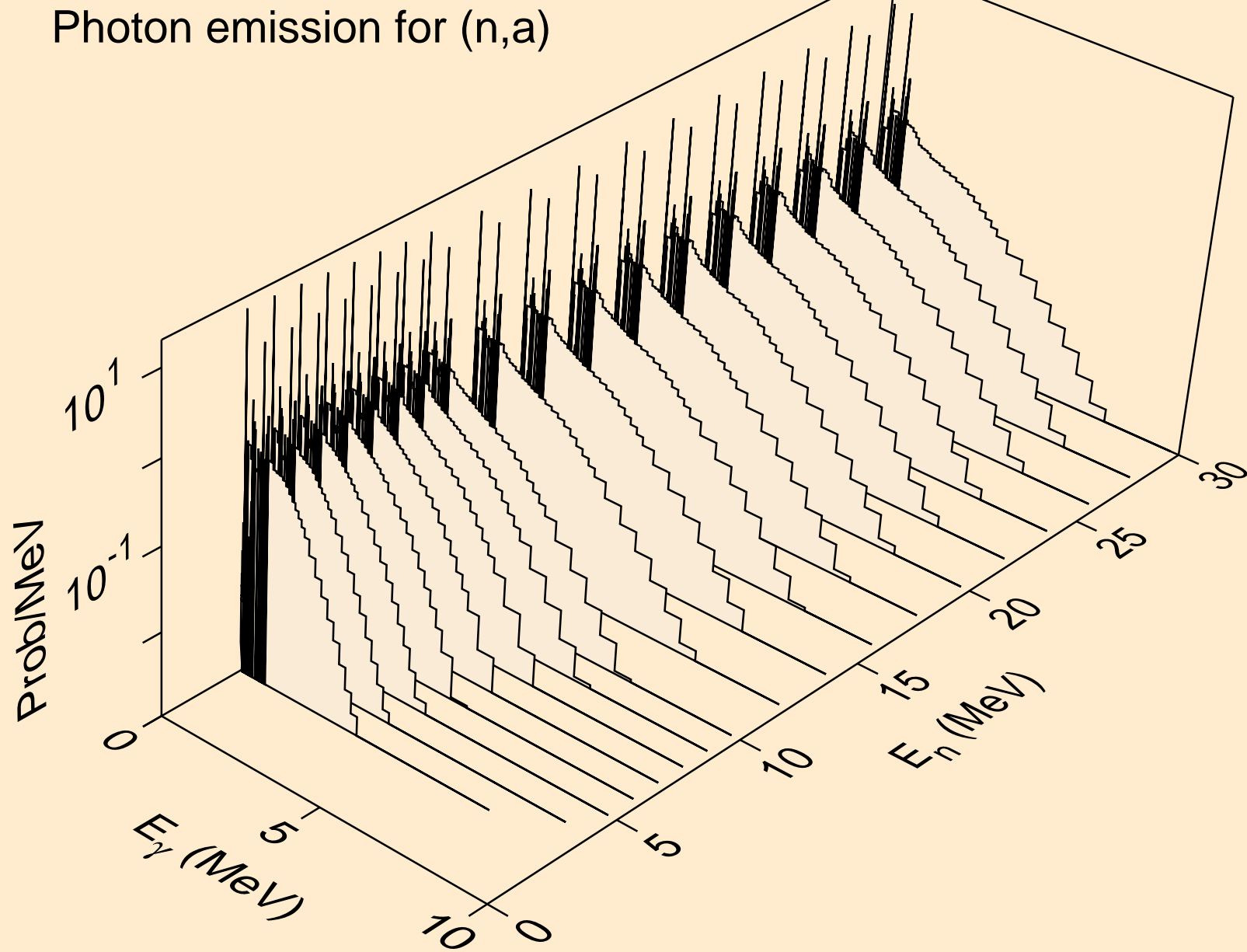

BA135 DEUTERON ACER TENDL-2023 LIBRARY; T=0.K
Photon emission for (n,2a)

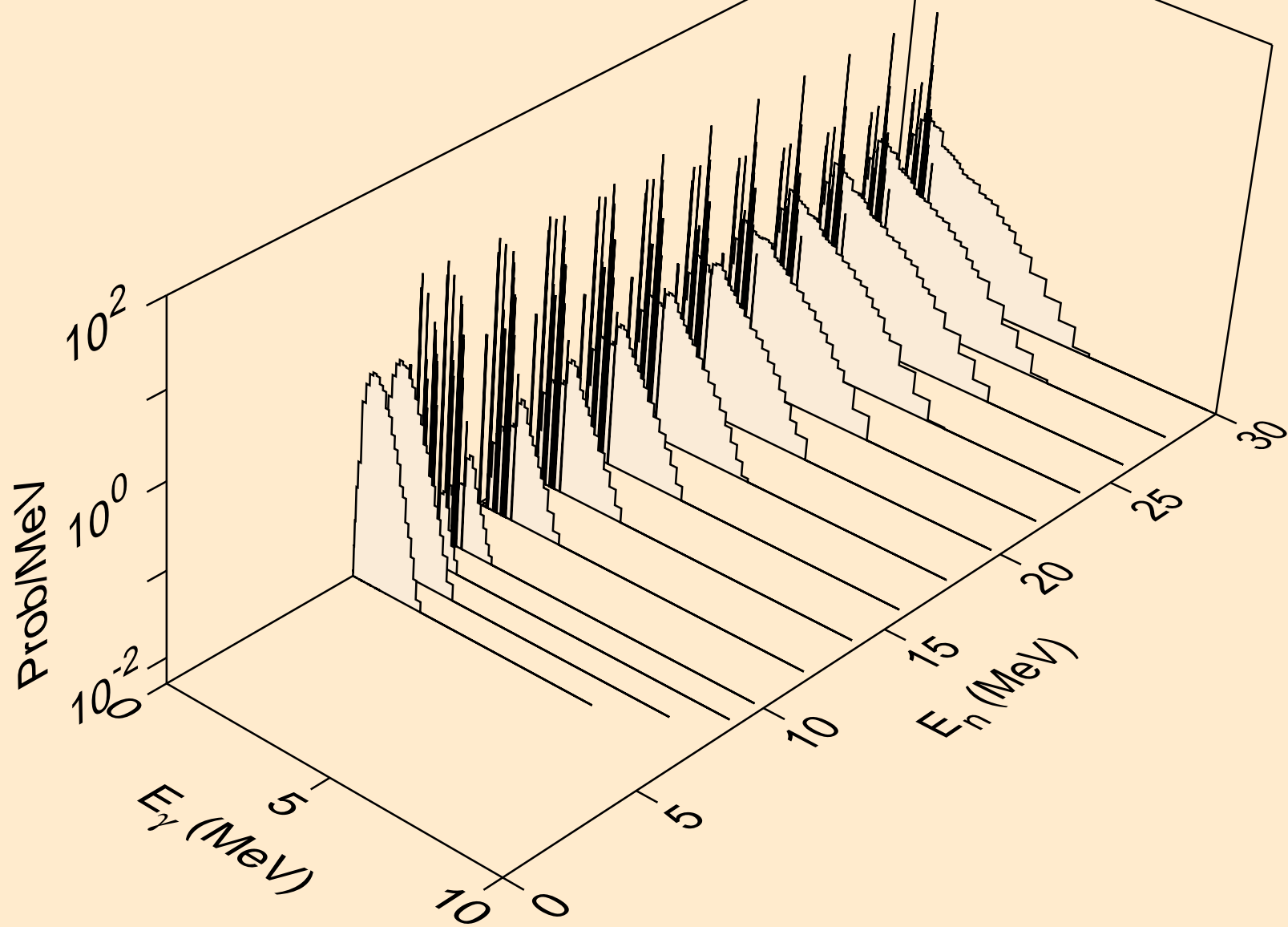

BA135 DEUTERON ACER TENDL-2023 LIBRARY; T=0.K
Photon emission for (n,2p)

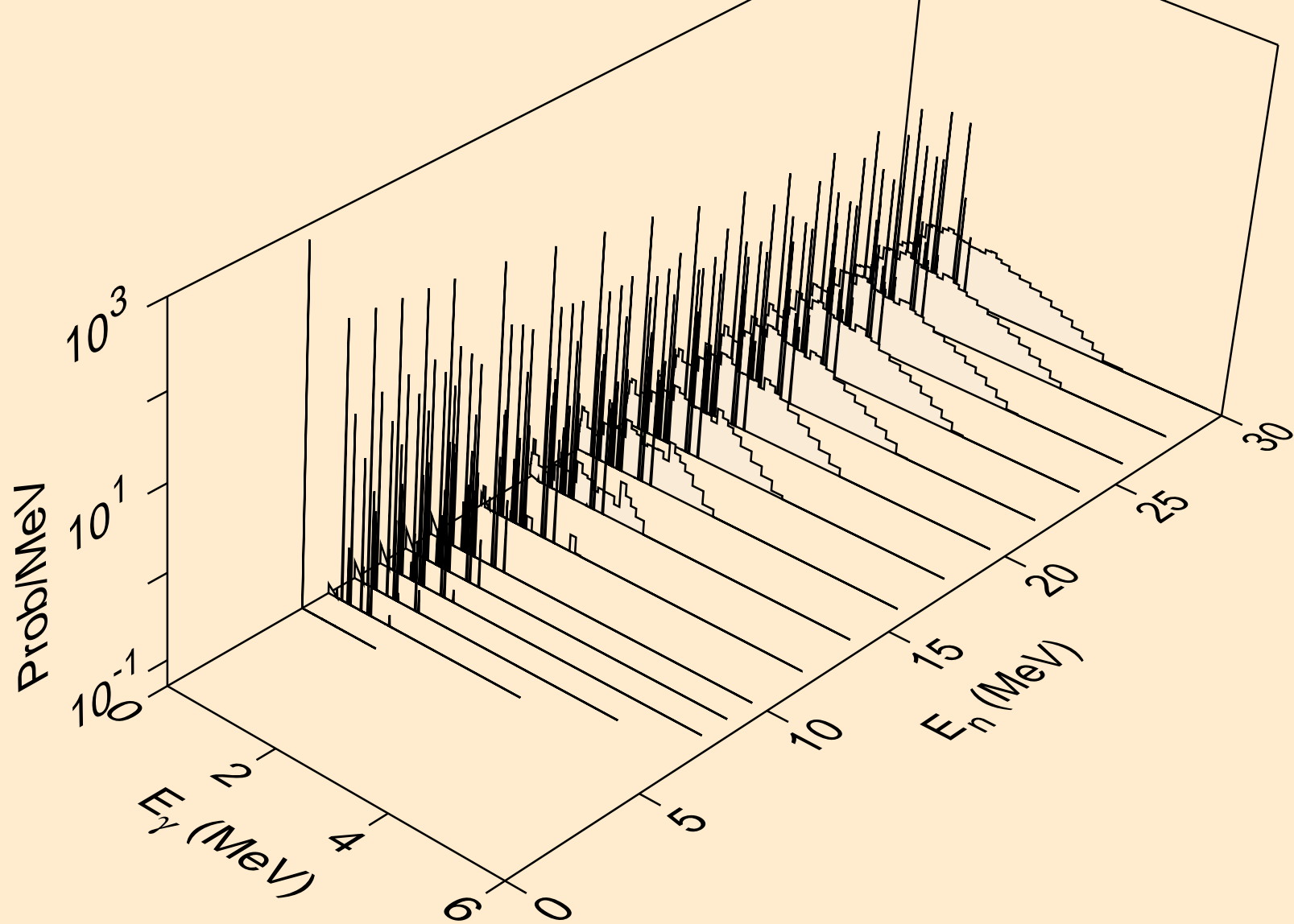

BA135 DEUTERON ACER TENDL-2023 LIBRARY; T=0.K
Photon emission for (n,p)

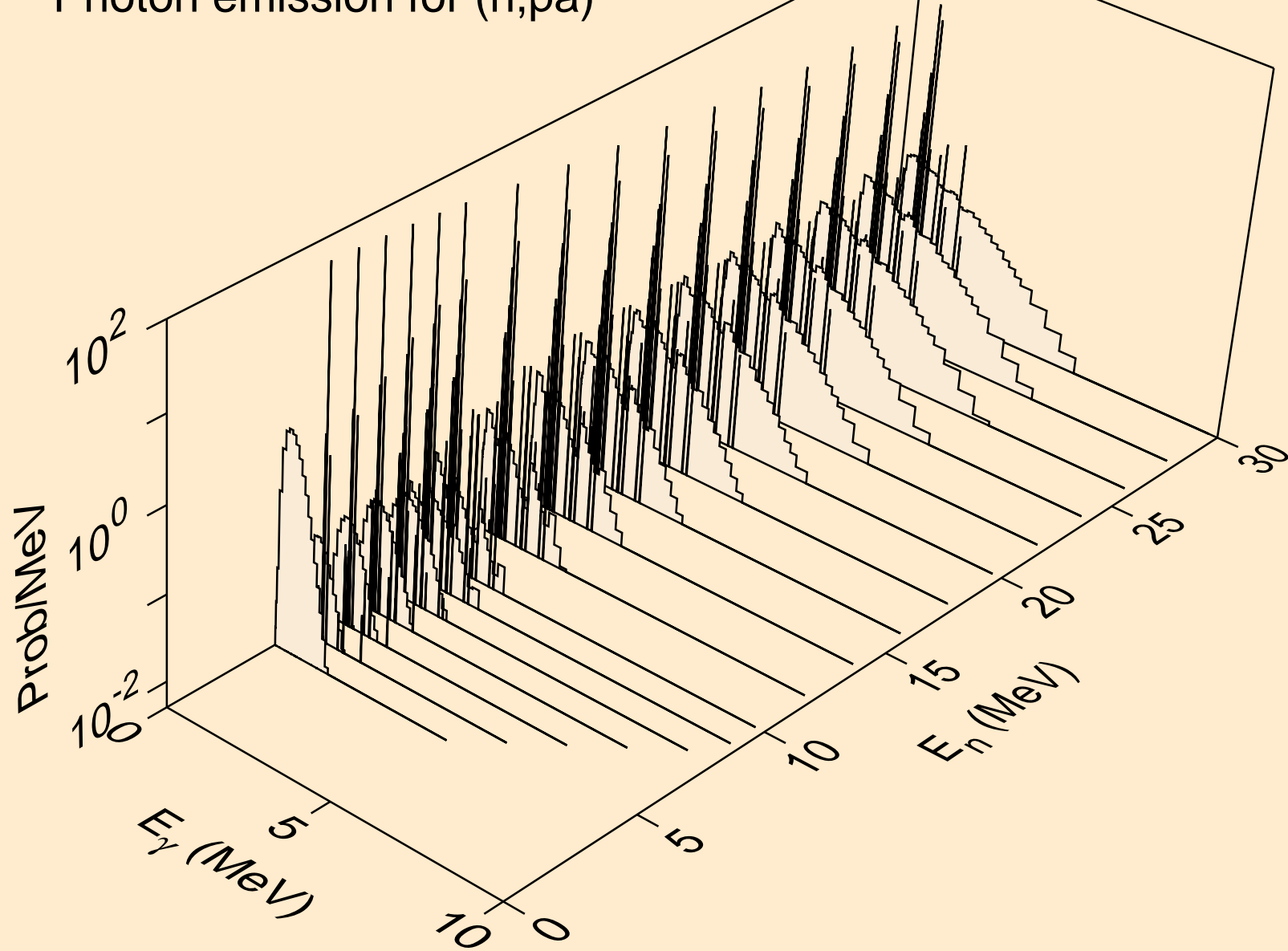

BA135 DEUTERON ACER TENDL-2023 LIBRARY; T=0.K
Photon emission for (n,pd)

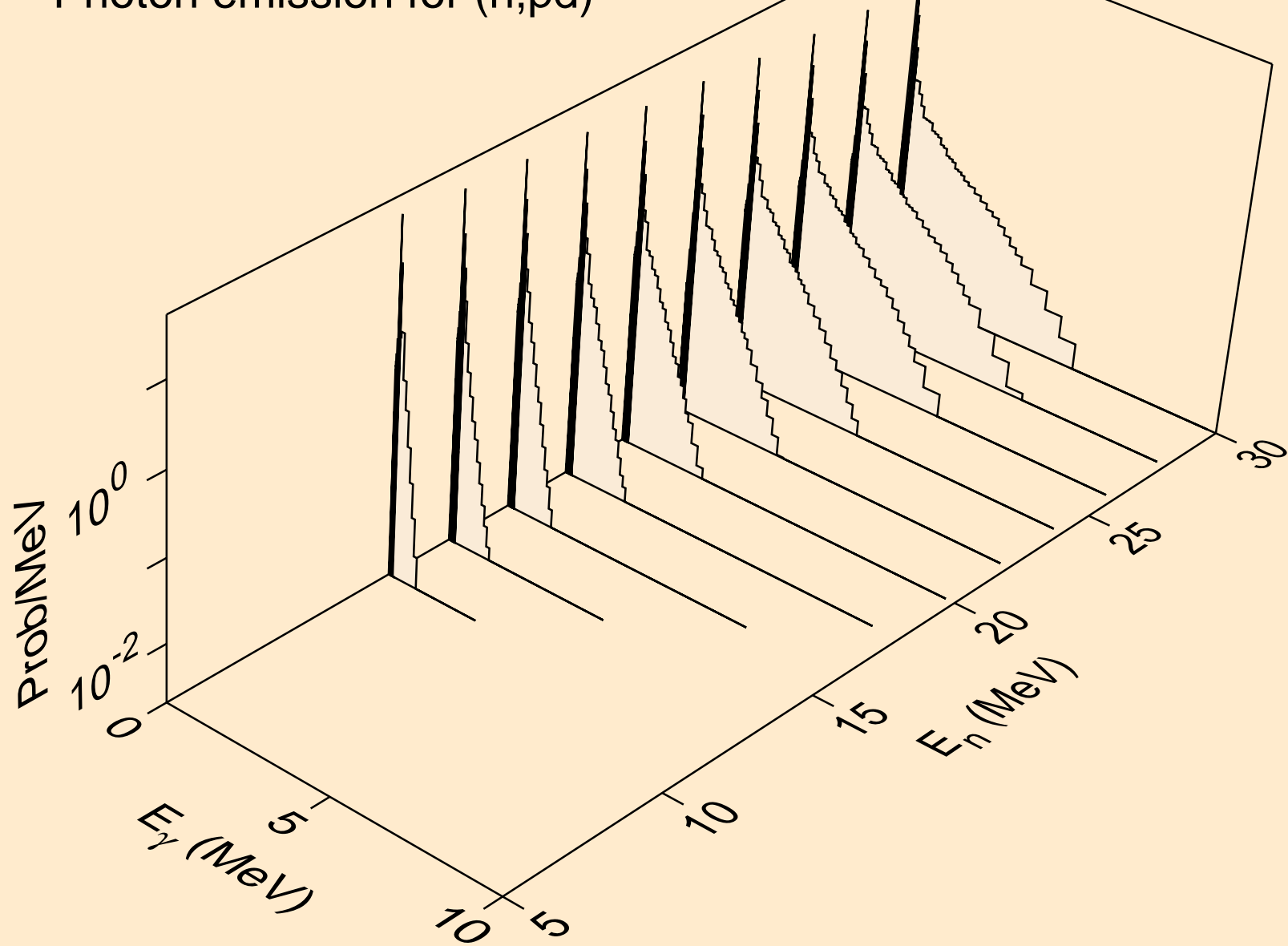

BA135 DEUTERON ACER TENDL-2023 LIBRARY; T=0.K
Photon emission for (n,pt)

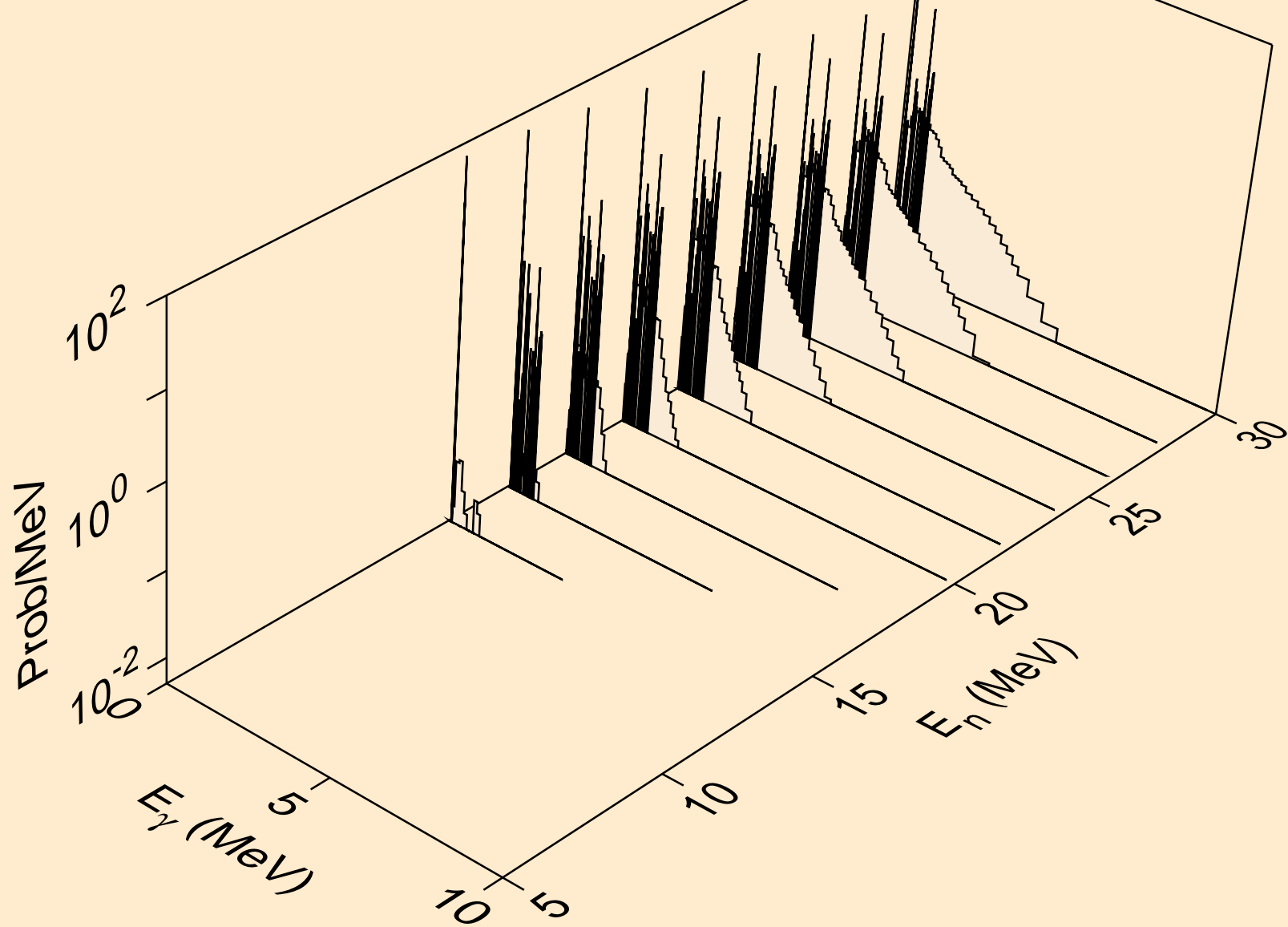

BA135 DEUTERON ACER TENDL-2023 LIBRARY; T=0.K
Photon emission for (n,da)

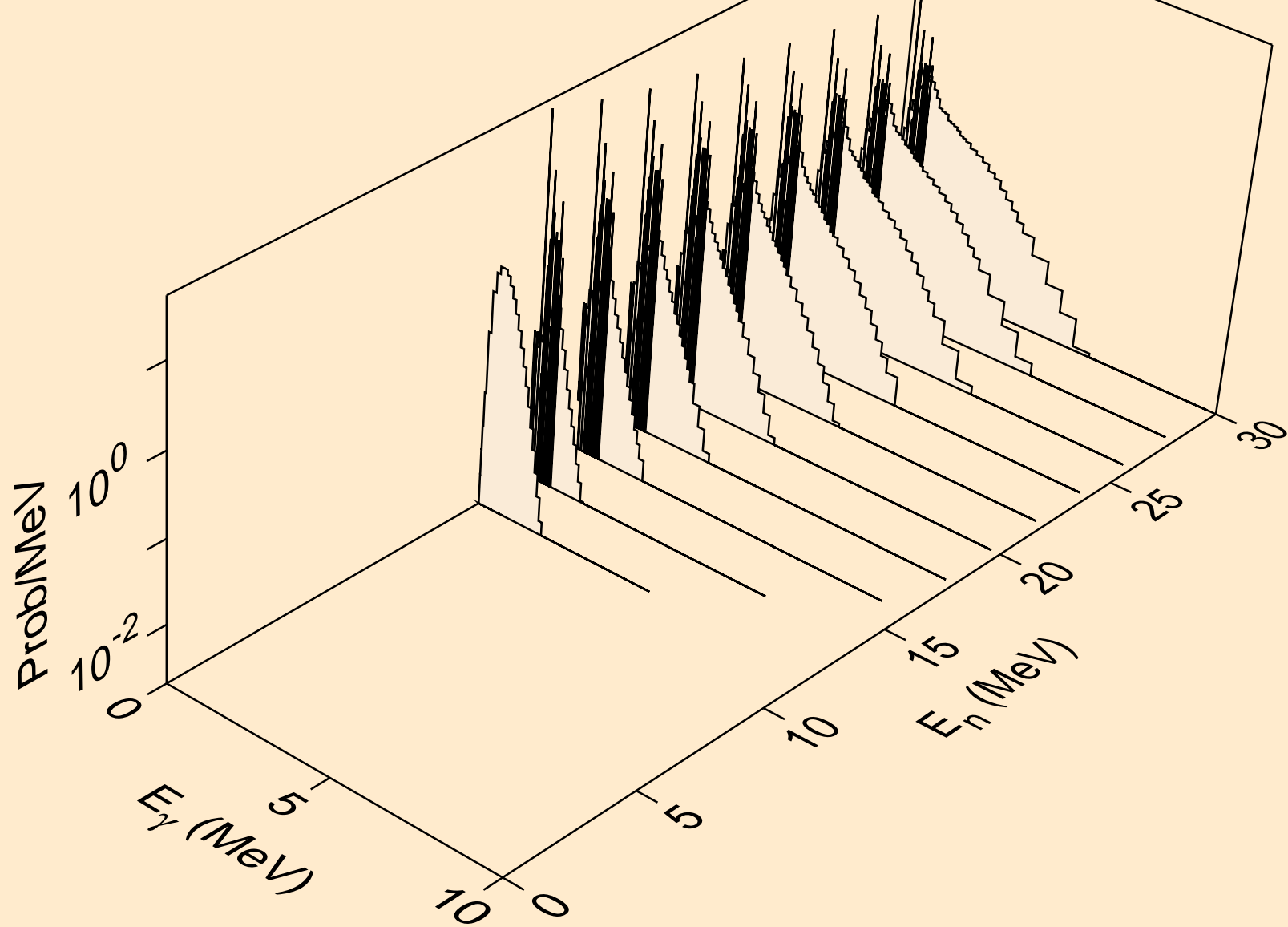

BA135 DEUTERON ACER TENDL-2023 LIBRARY; T=0.K

Particle heating contributions

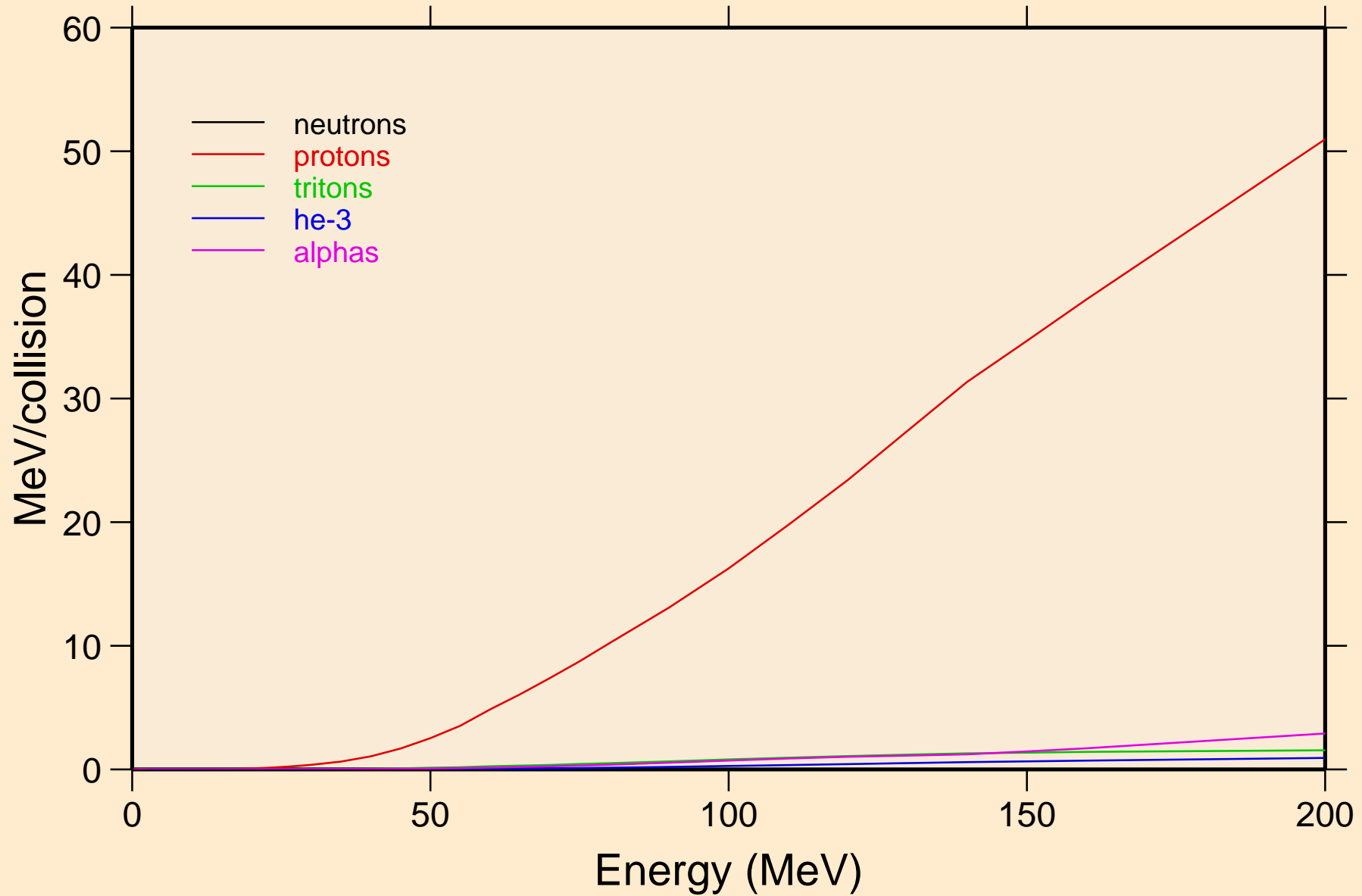

BA135 DEUTERON ACER TENDL-2023 LIBRARY; T=0.K
Recoil Heating

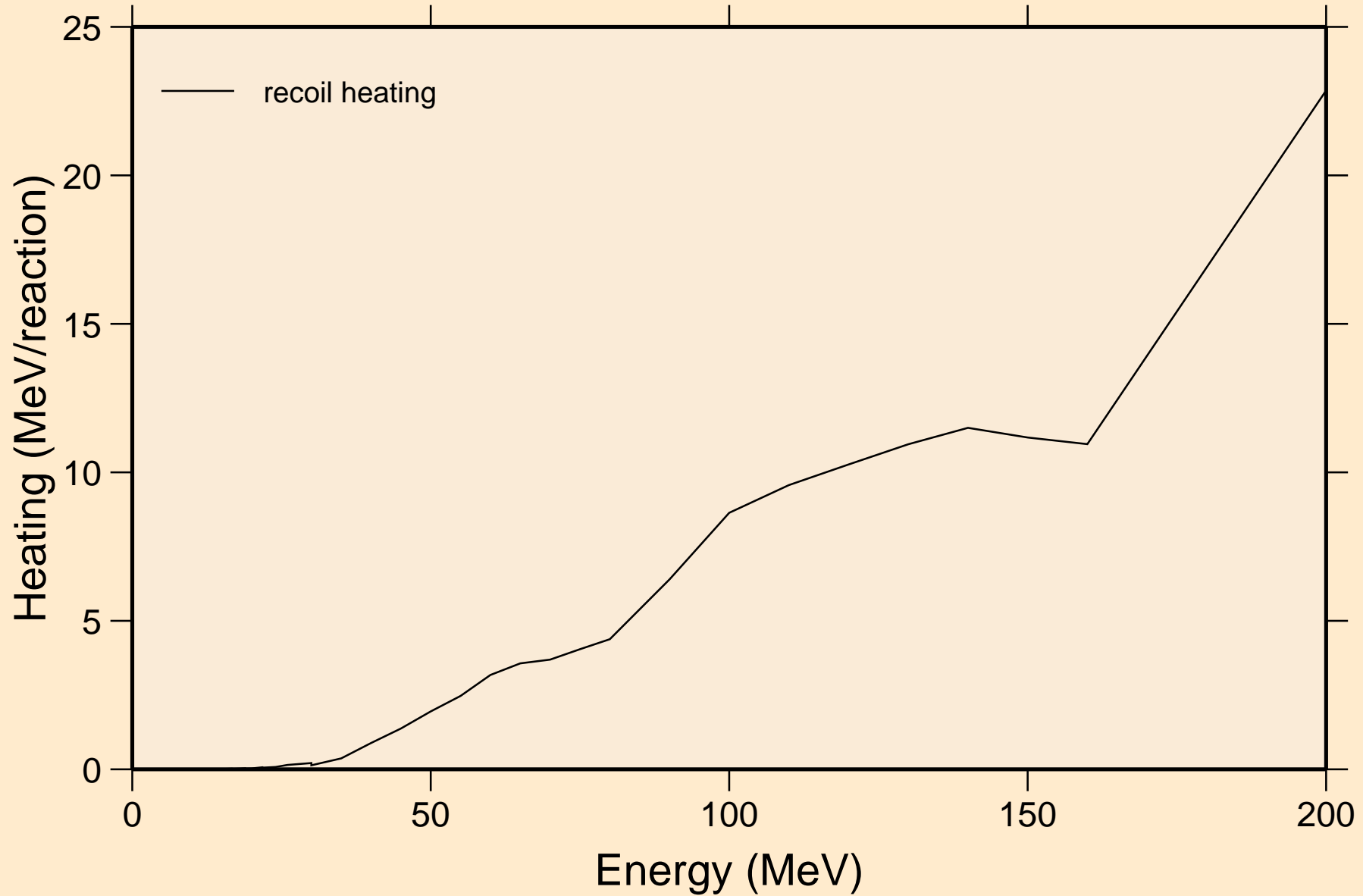

BA135 DEUTERON ACER TENDL-2023 LIBRARY; T=0.K
Particle production cross sections

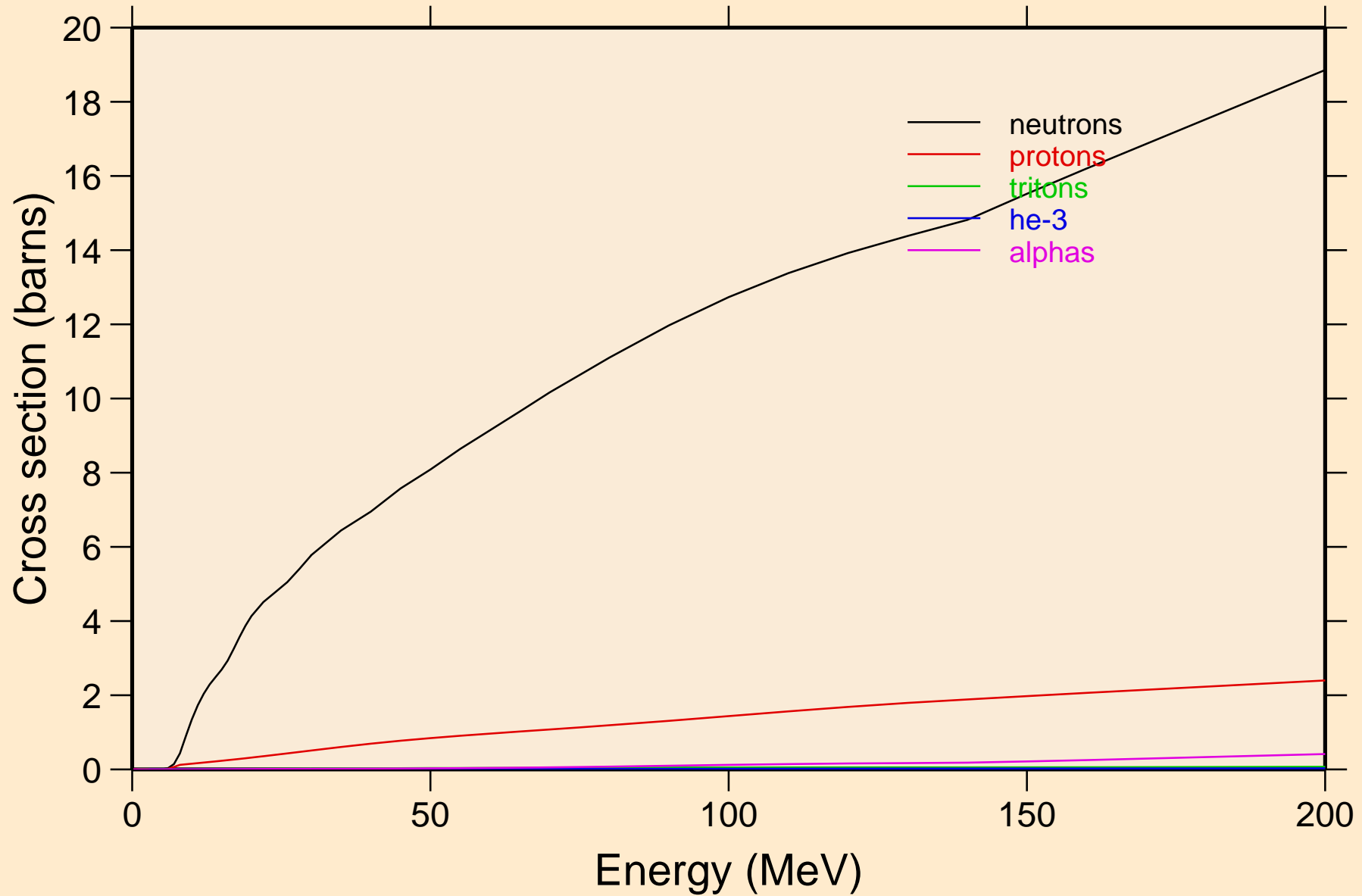

BA135 DEUTERON ACER TENDL-2023 LIBRARY; T=0.K
neutrons from (d,n)

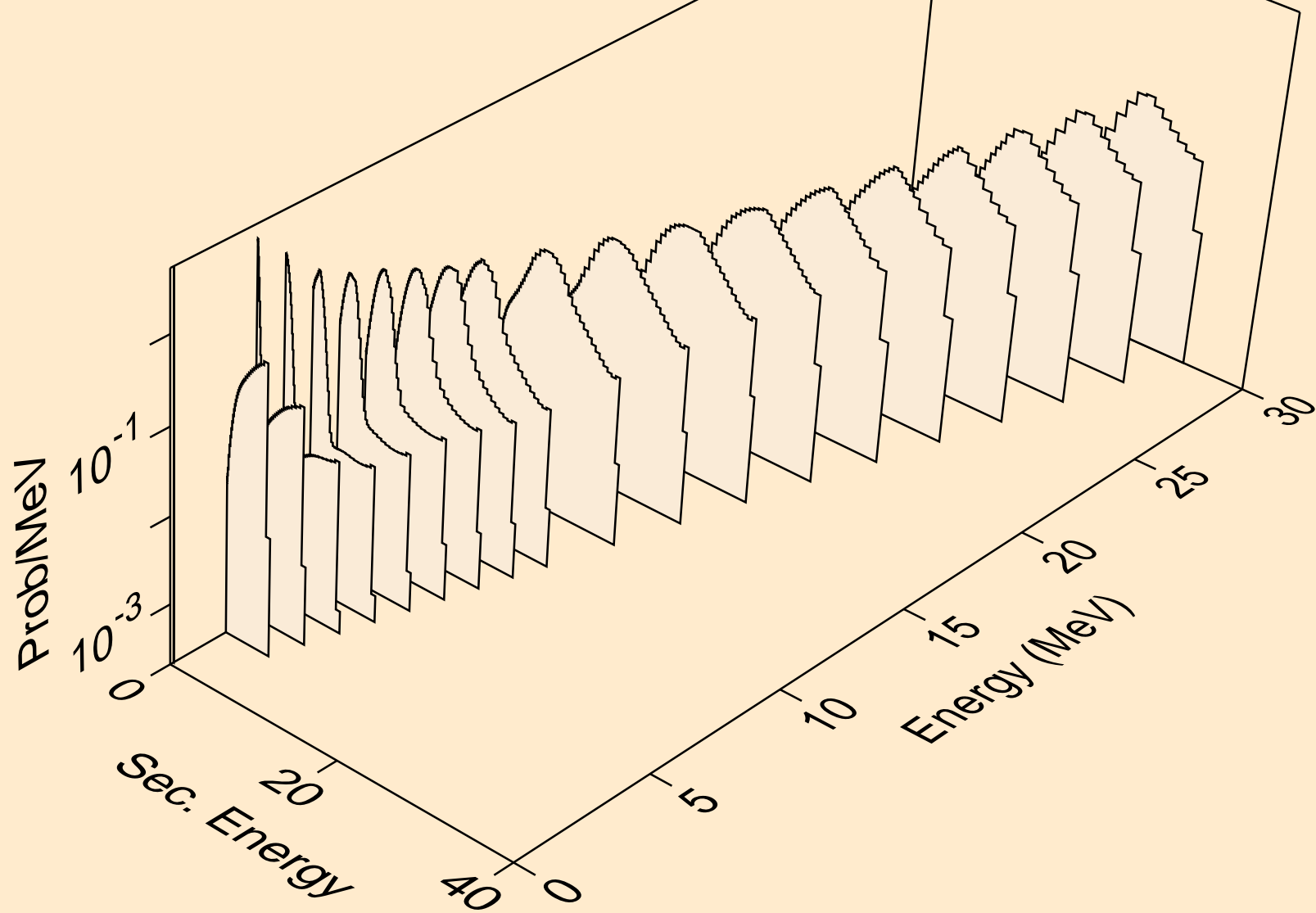

BA135 DEUTERON ACER TENDL-2023 LIBRARY; T=0.K
neutrons from (d,x)

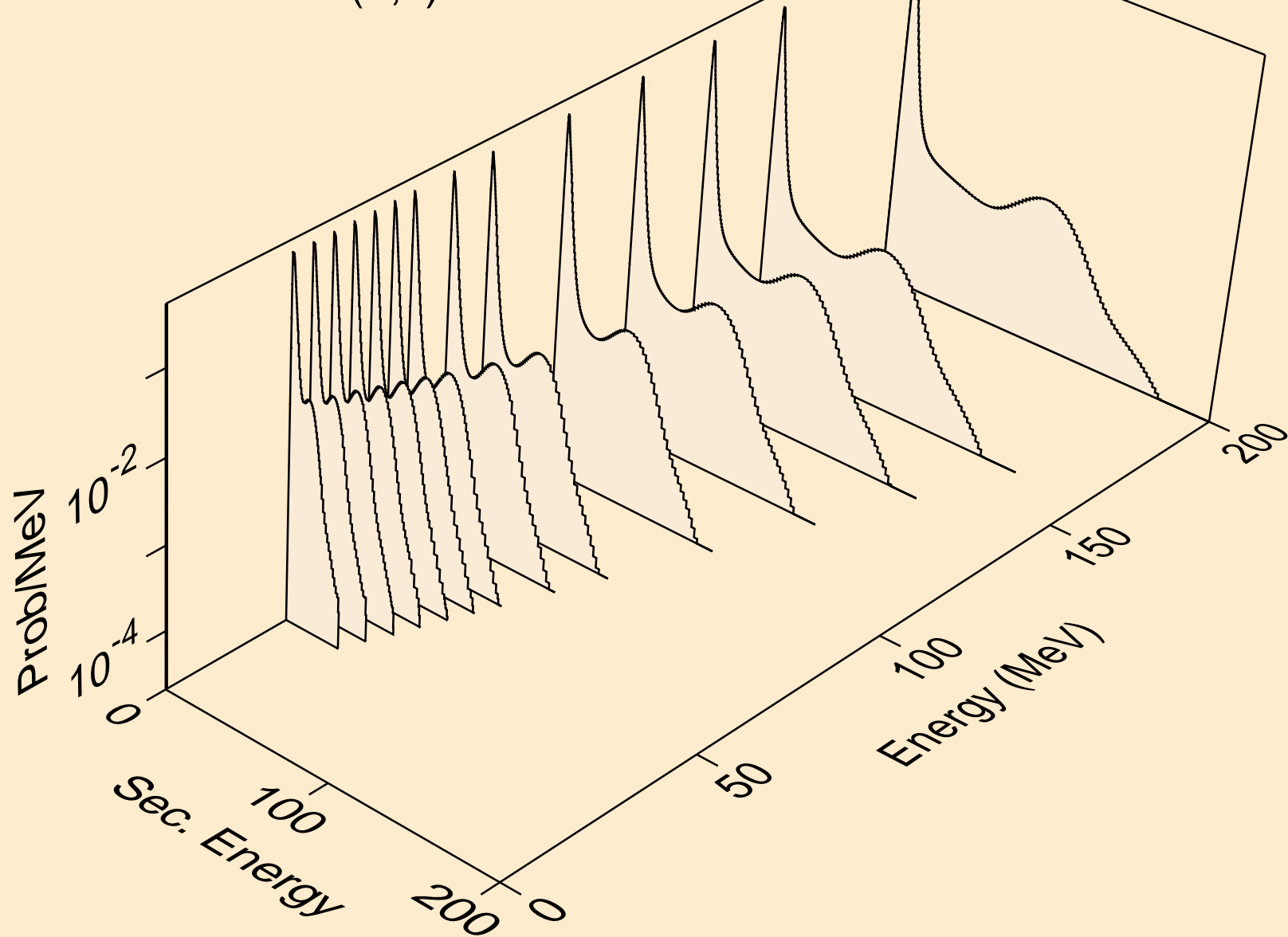

BA135 DEUTERON ACER TENDL-2023 LIBRARY; T=0.K
neutrons from (d,2nd)

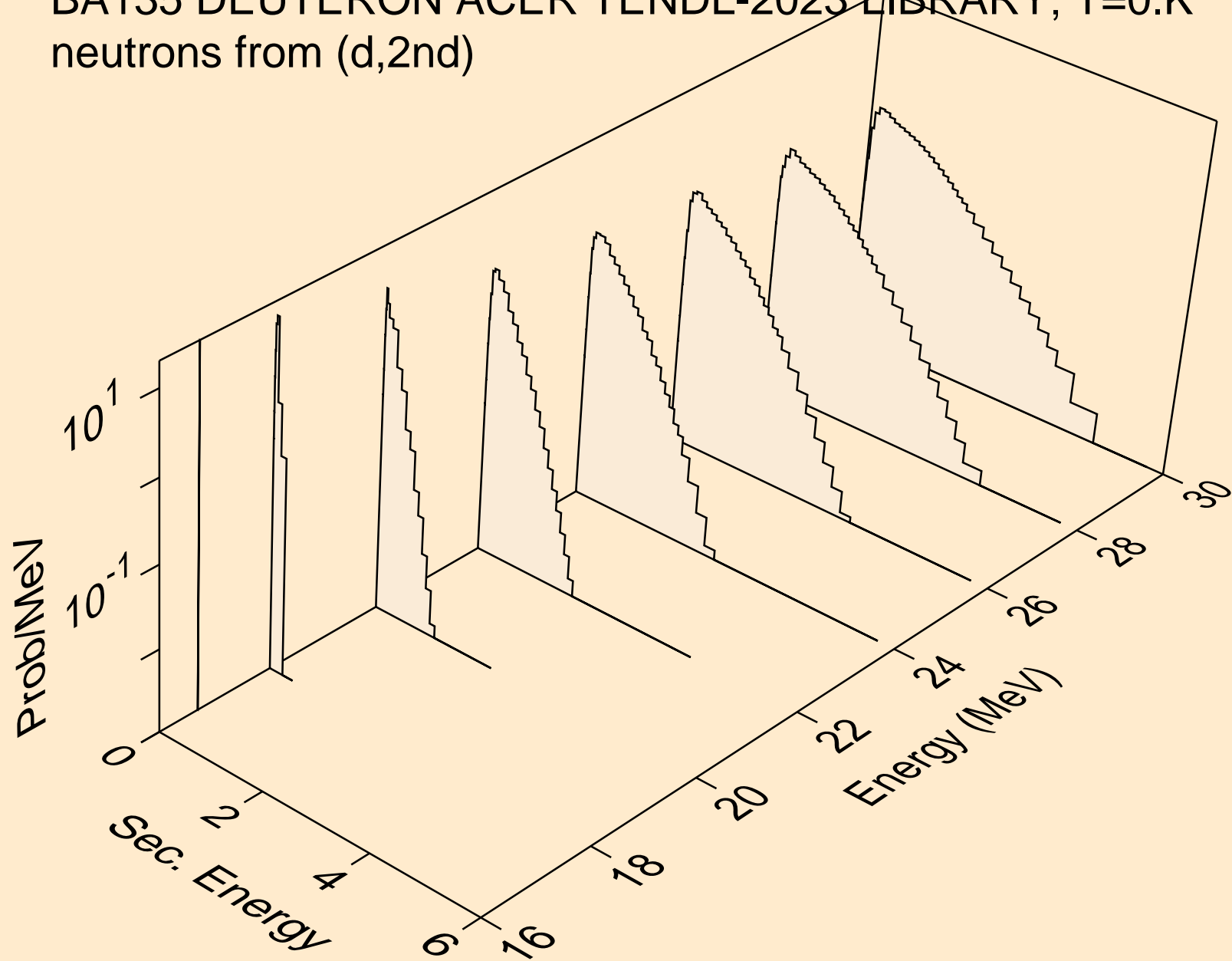

BA135 DEUTERON ACER TENDL-2023 LIBRARY; T=0.K
neutrons from (d,2n)

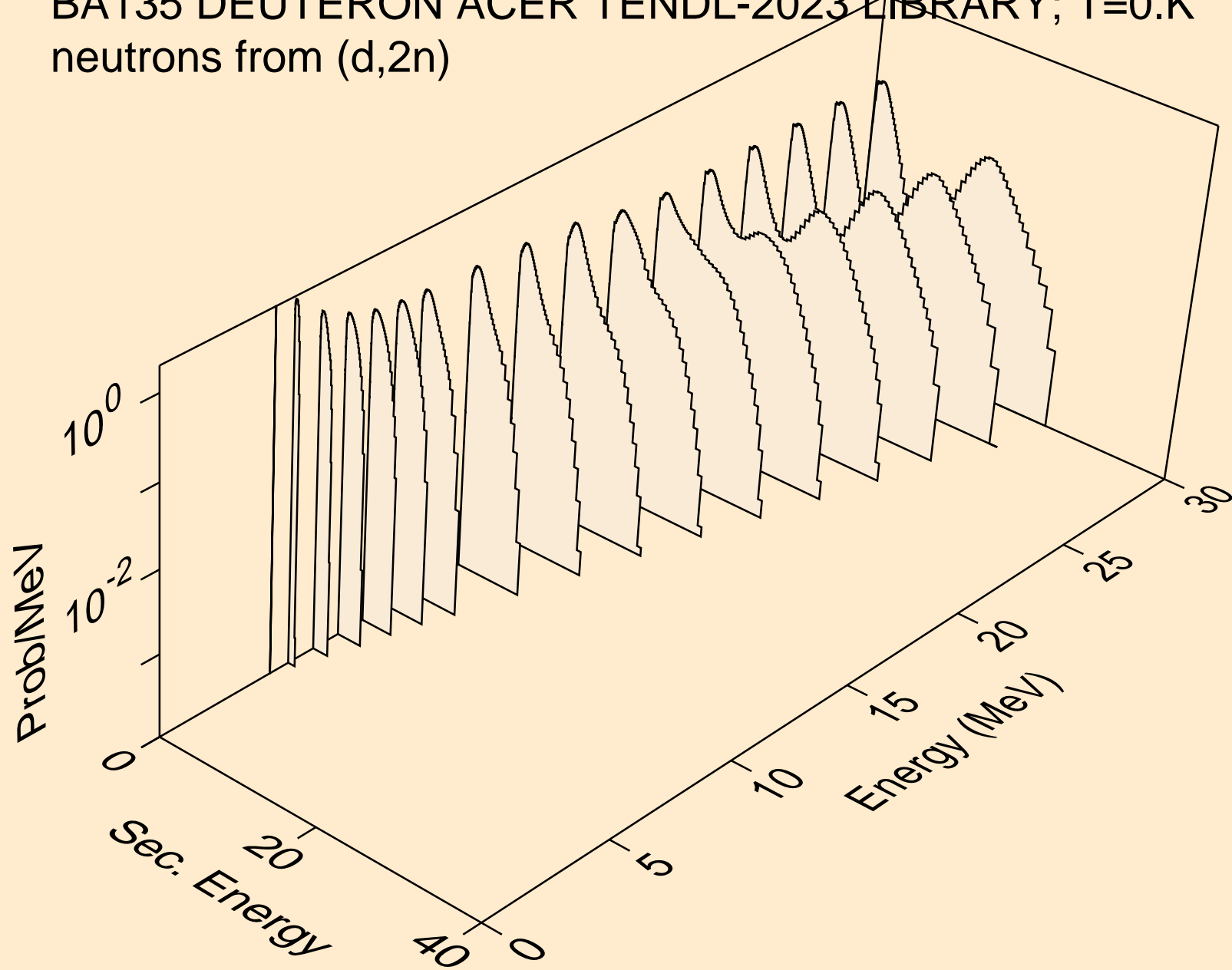

BA135 DEUTERON ACER TENDL-2023 LIBRARY; T=0.K
neutrons from (d,3n)

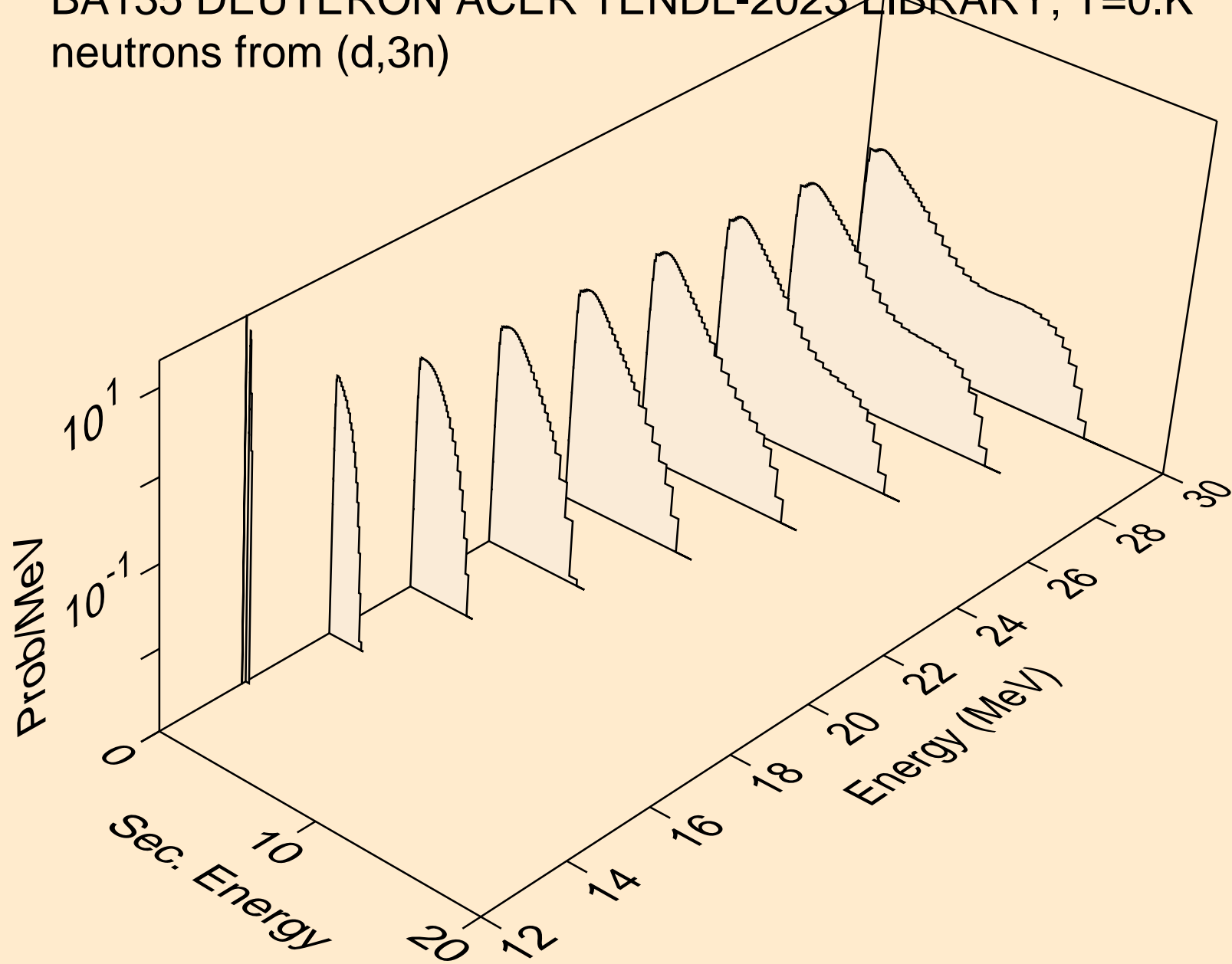

BA135 DEUTERON ACER TENDL-2023 LIBRARY; T=0.K
neutrons from (d,n*)a

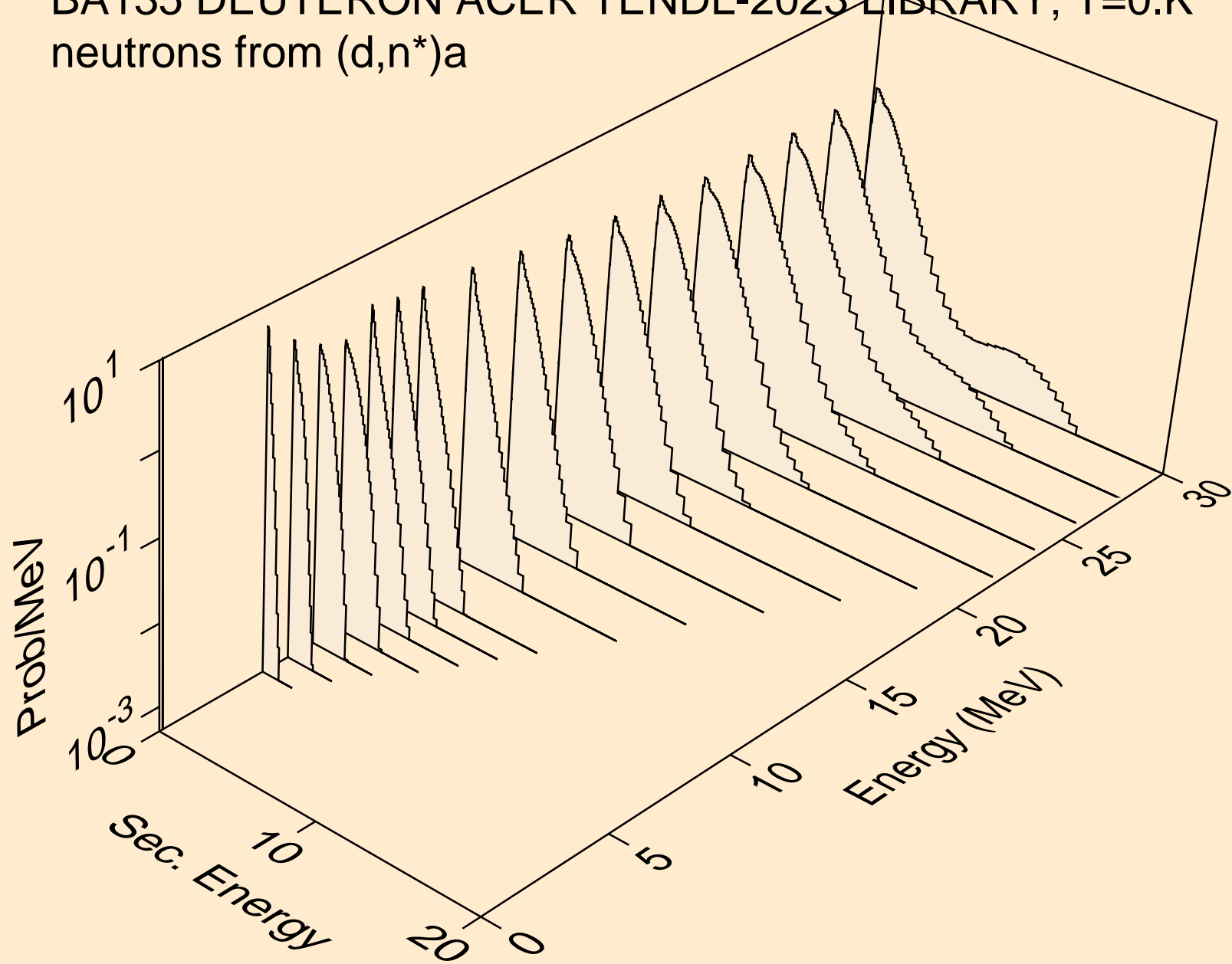

BA135 DEUTERON ACER TENDL-2023 LIBRARY; T=0.K
neutrons from (d,2n)a

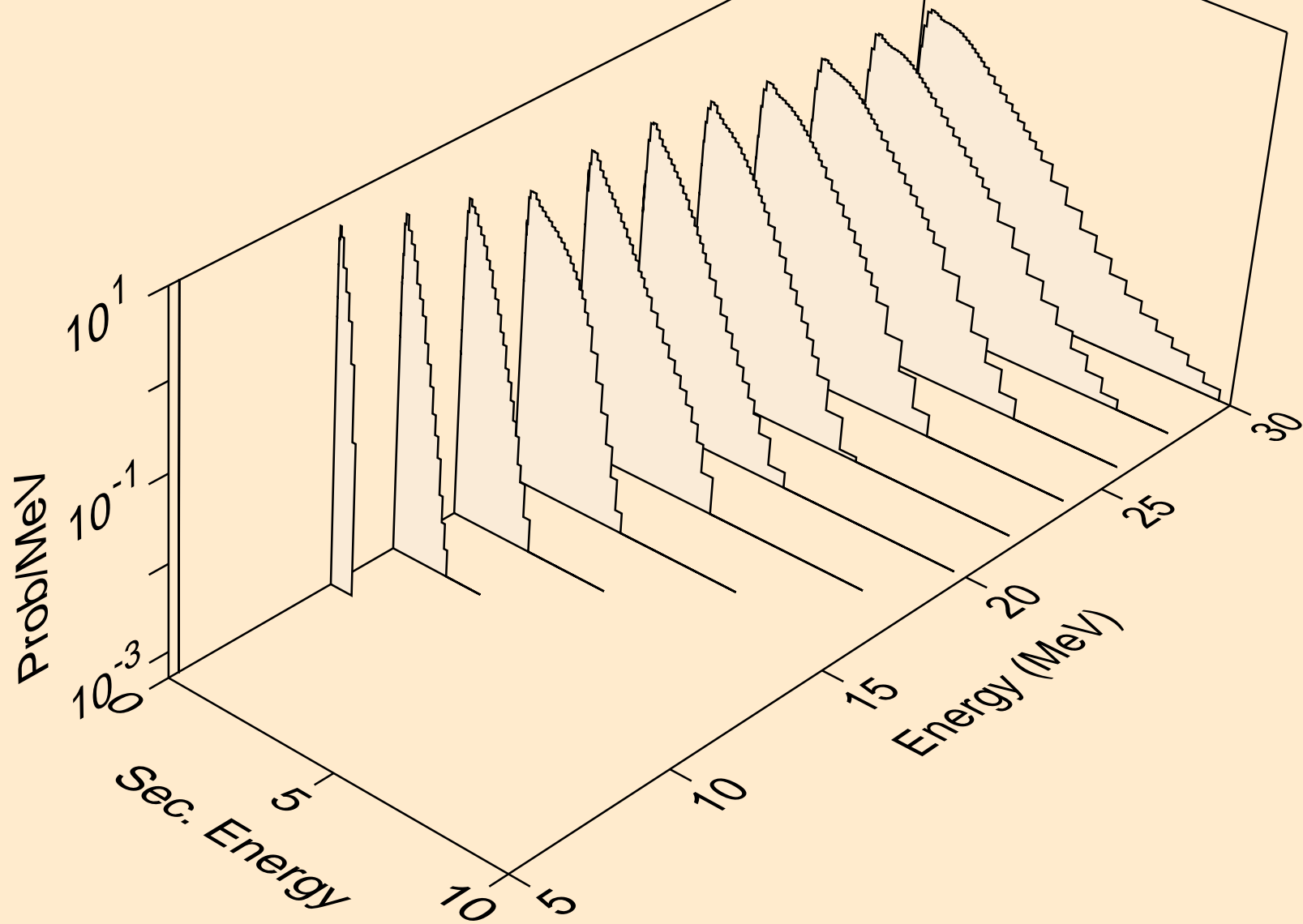

BA135 DEUTERON ACER TENDL-2023 LIBRARY; T=0.K
neutrons from (d,3n)a

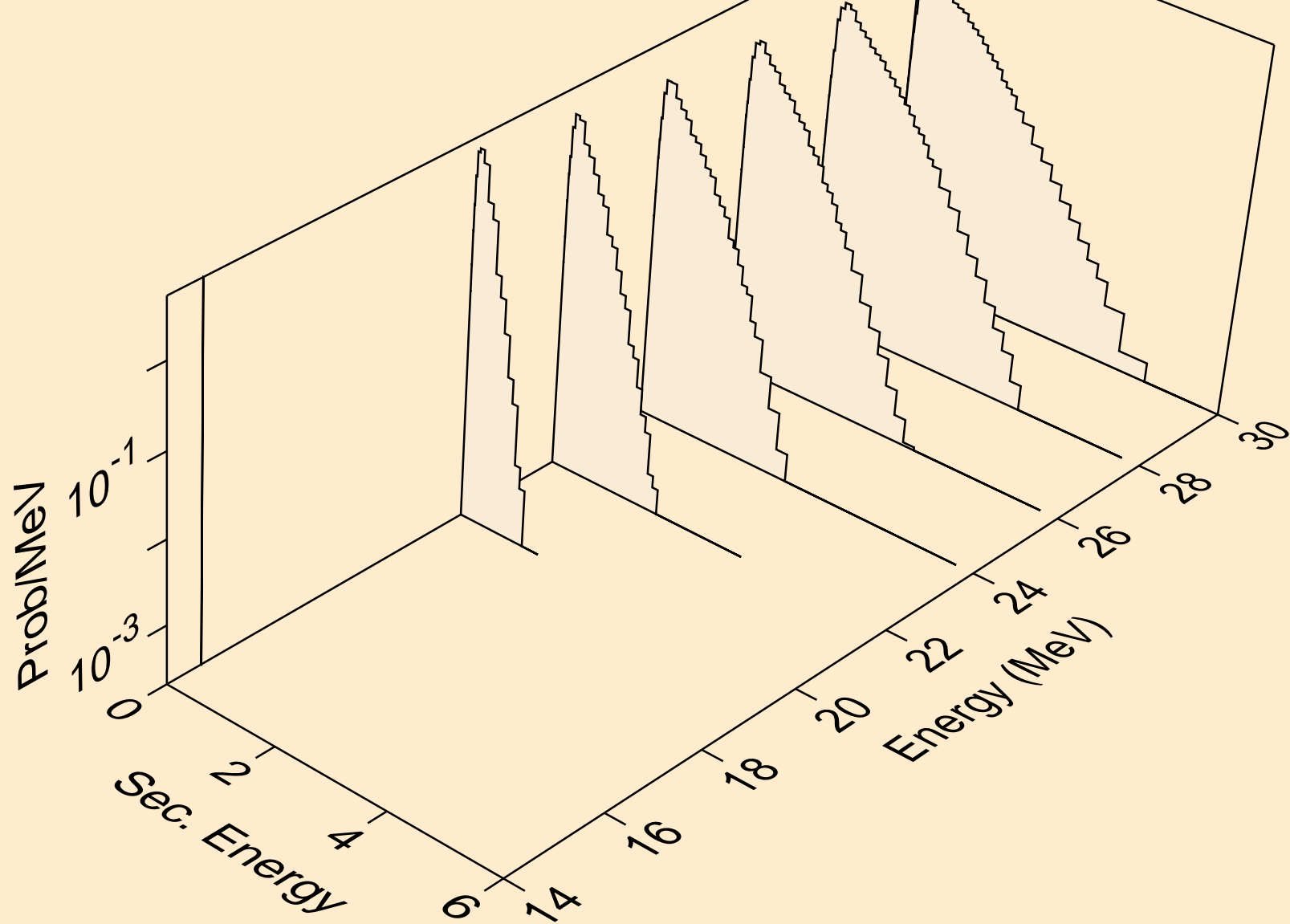

BA135 DEUTERON ACER TENDL-2023 LIBRARY; T=0.K
neutrons from (d,n*)p

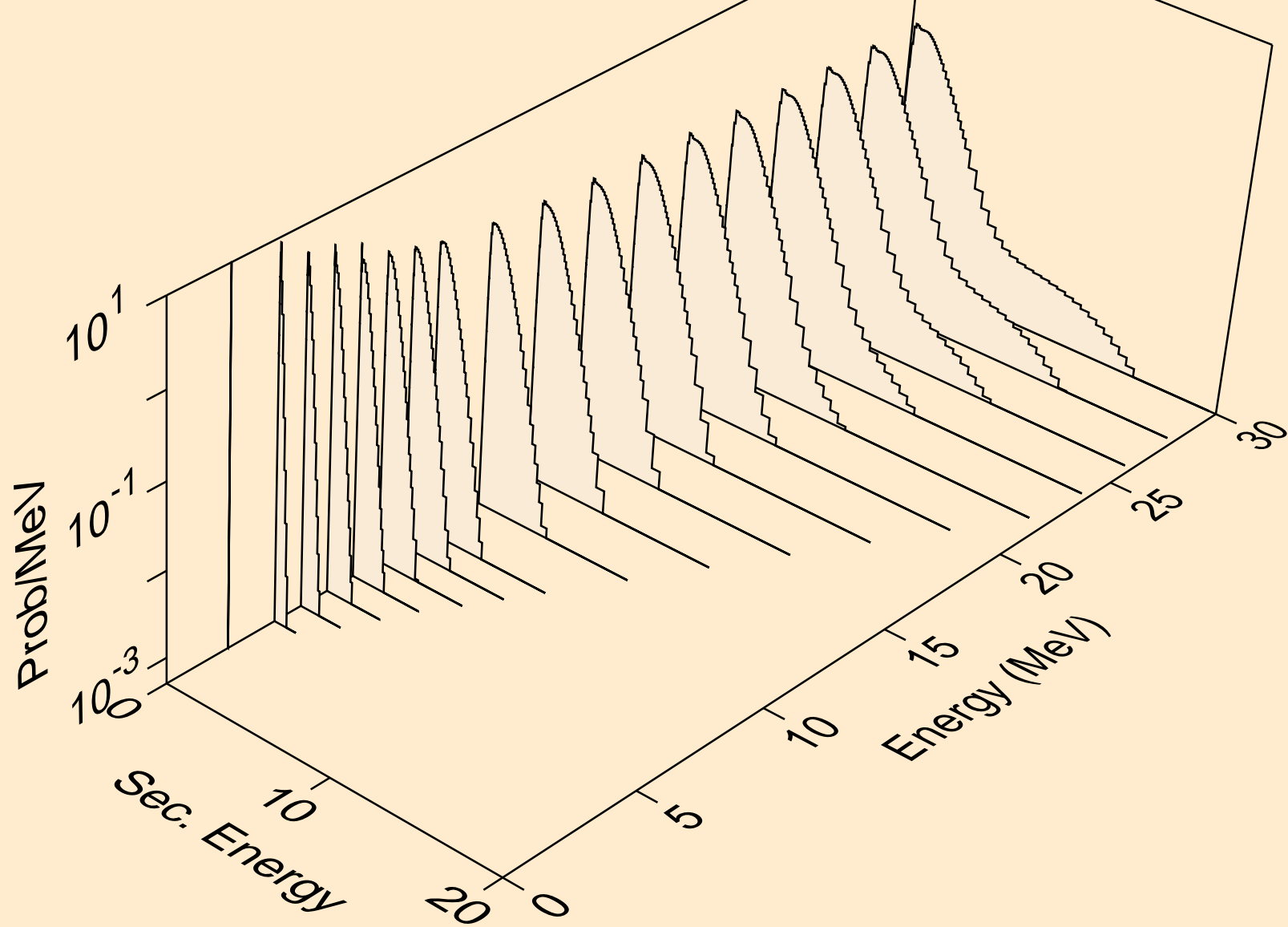

BA135 DEUTERON ACER TENDL-2023 LIBRARY; T=0.K
neutrons from (d,n*)2a

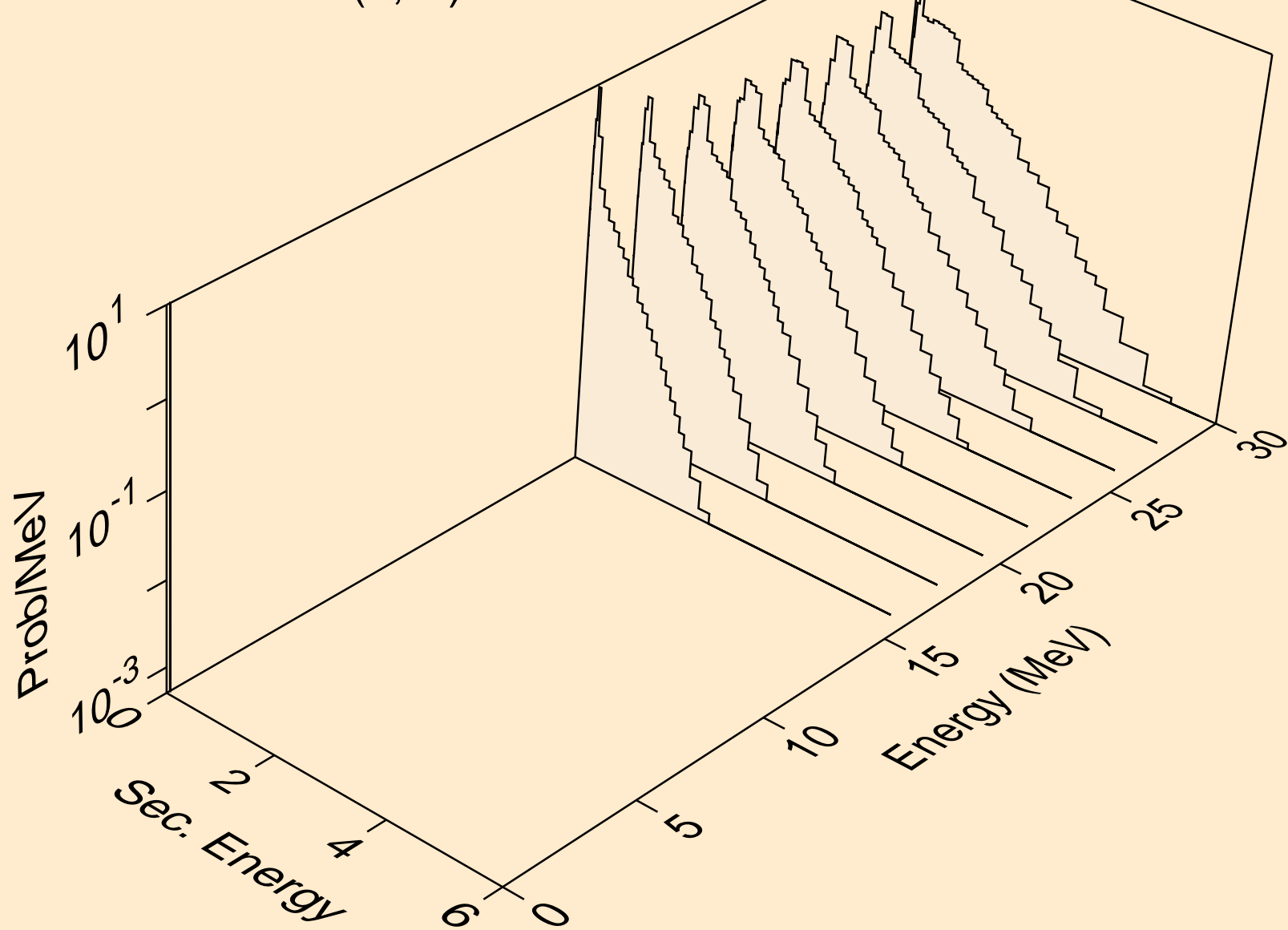

BA135 DEUTERON ACER TENDL-2023 LIBRARY; T=0.K
neutrons from (d,n*)d

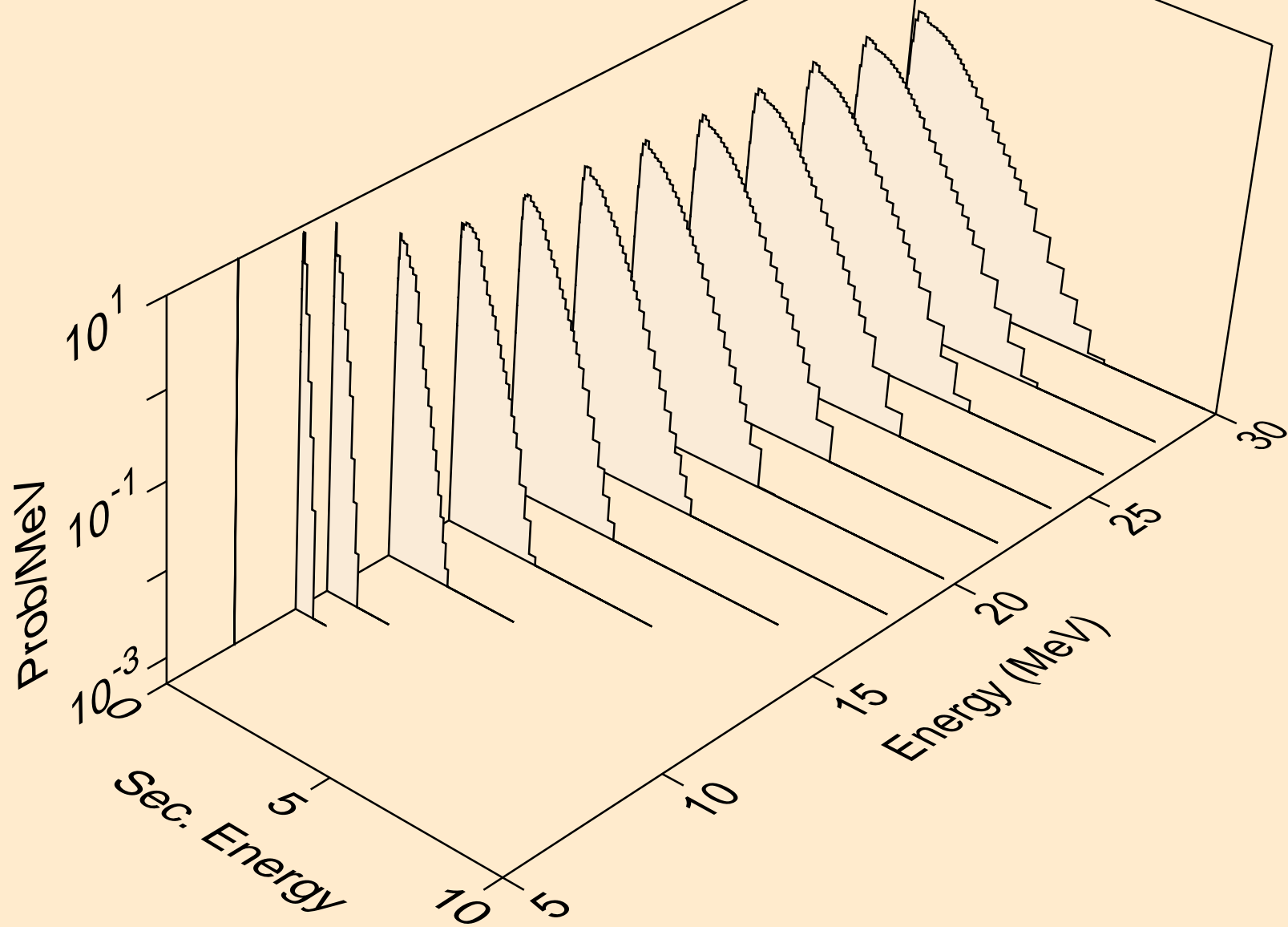

BA135 DEUTERON ACER TENDL-2023 LIBRARY; T=0.K
neutrons from (d,n*)t

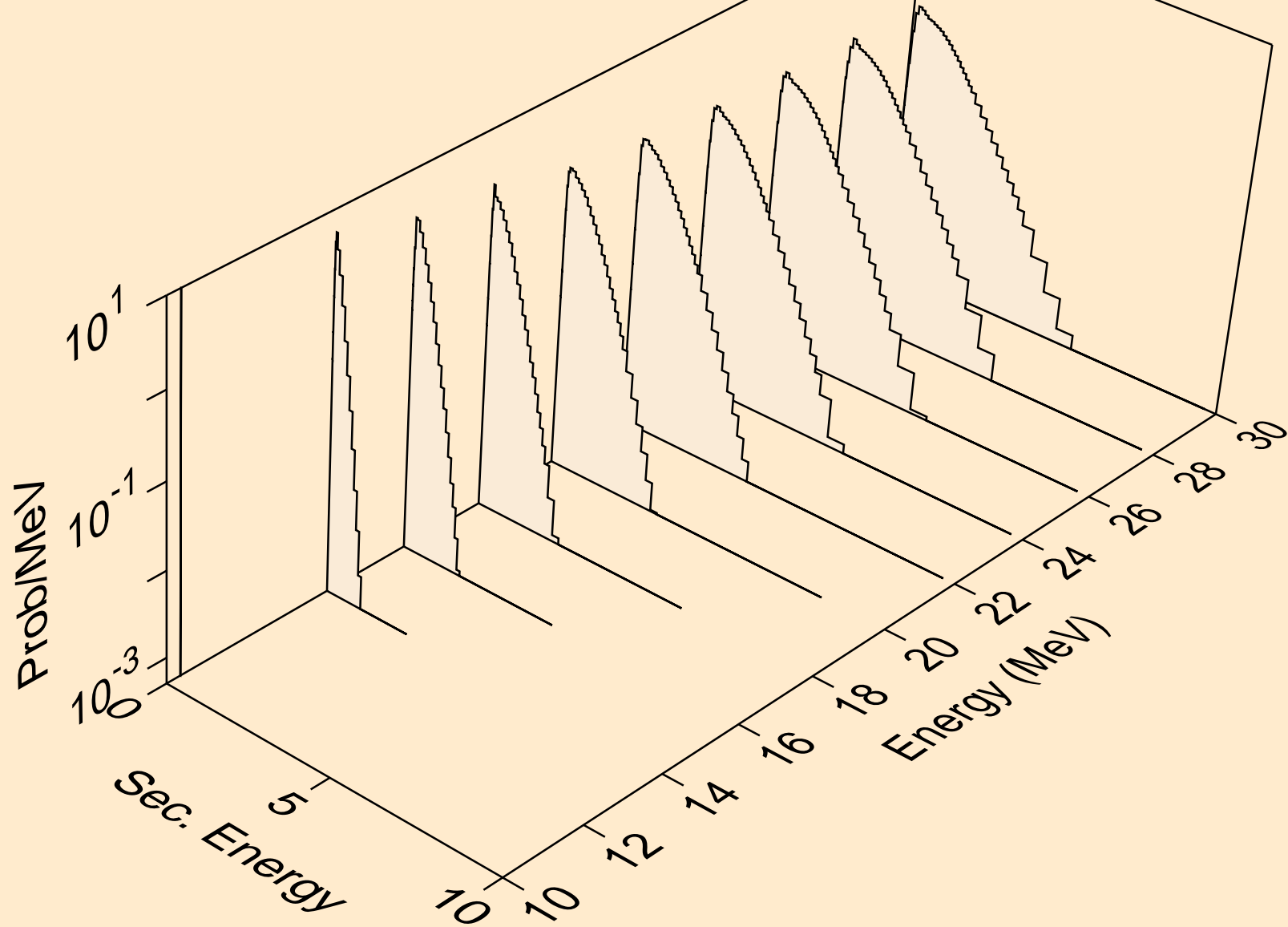

BA135 DEUTERON ACER TENDL-2023 LIBRARY; T=0.K
neutrons from (d,n*)he3

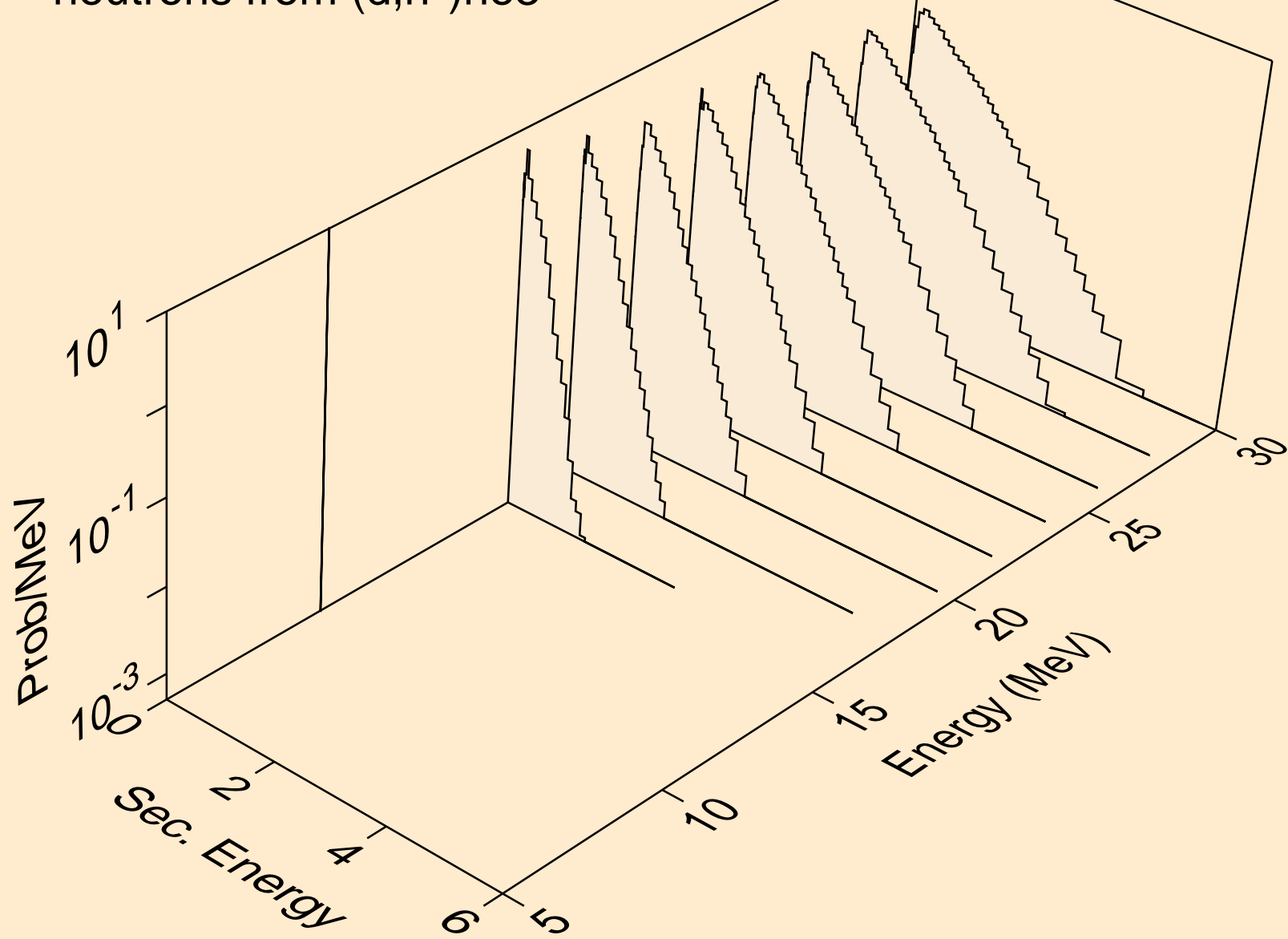

BA135 DEUTERON ACER TENDL-2023 LIBRARY; T=0.K
neutrons from (d,4n)

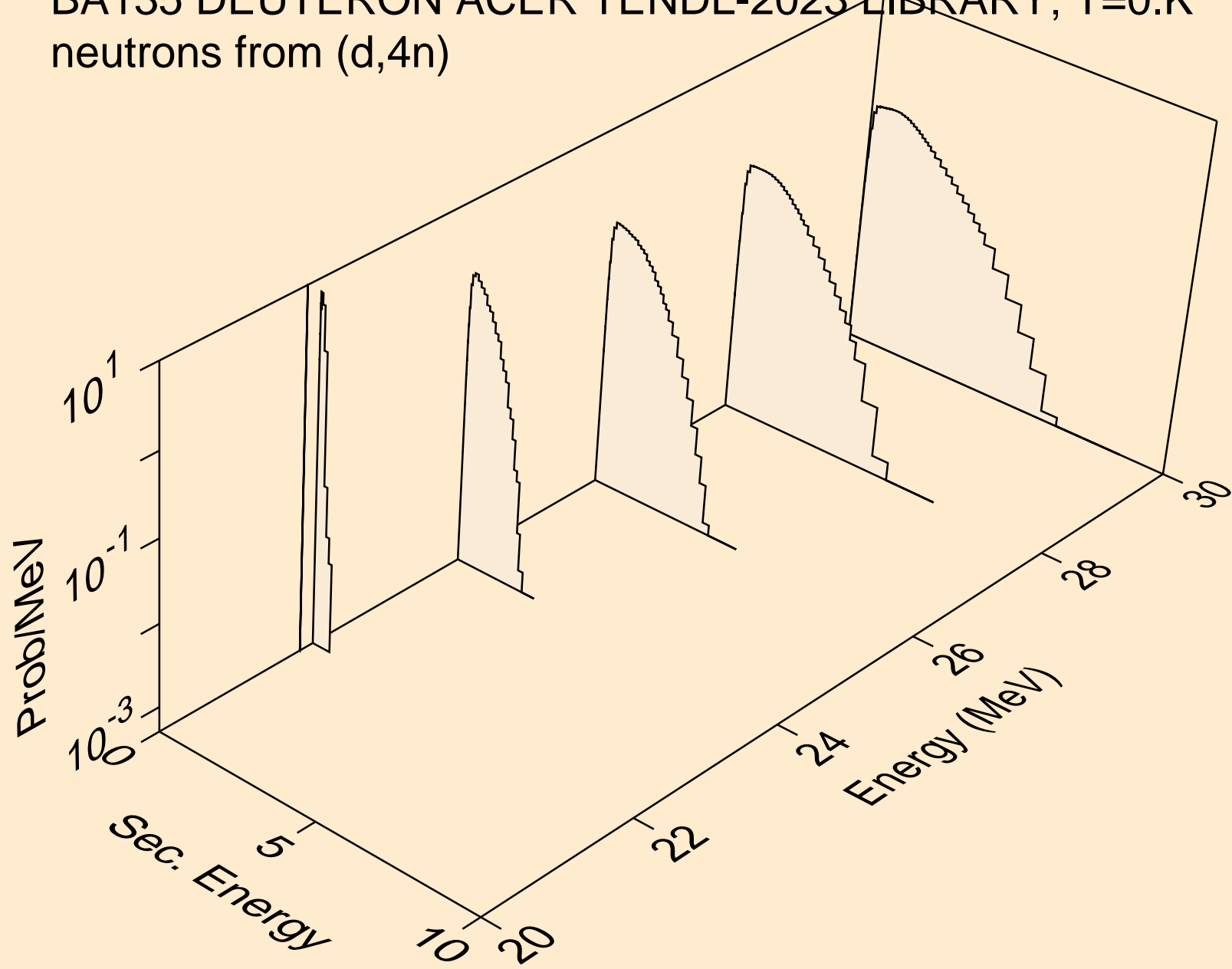

BA135 DEUTERON ACER TENDL-2023 LIBRARY; T=0.K
neutrons from (d,2np)

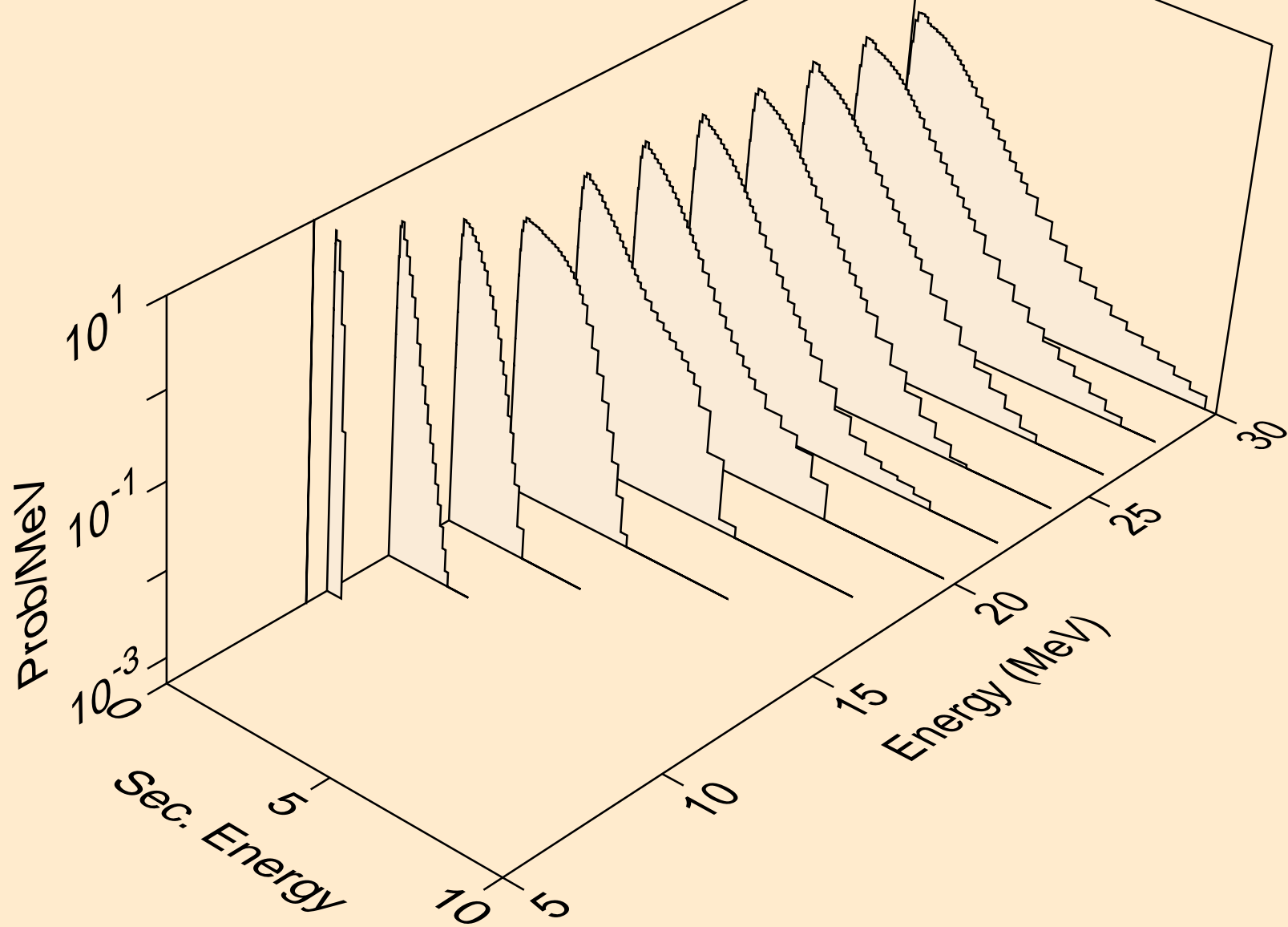

BA135 DEUTERON ACER TENDL-2023 LIBRARY; T=0.K
neutrons from (d,3np)

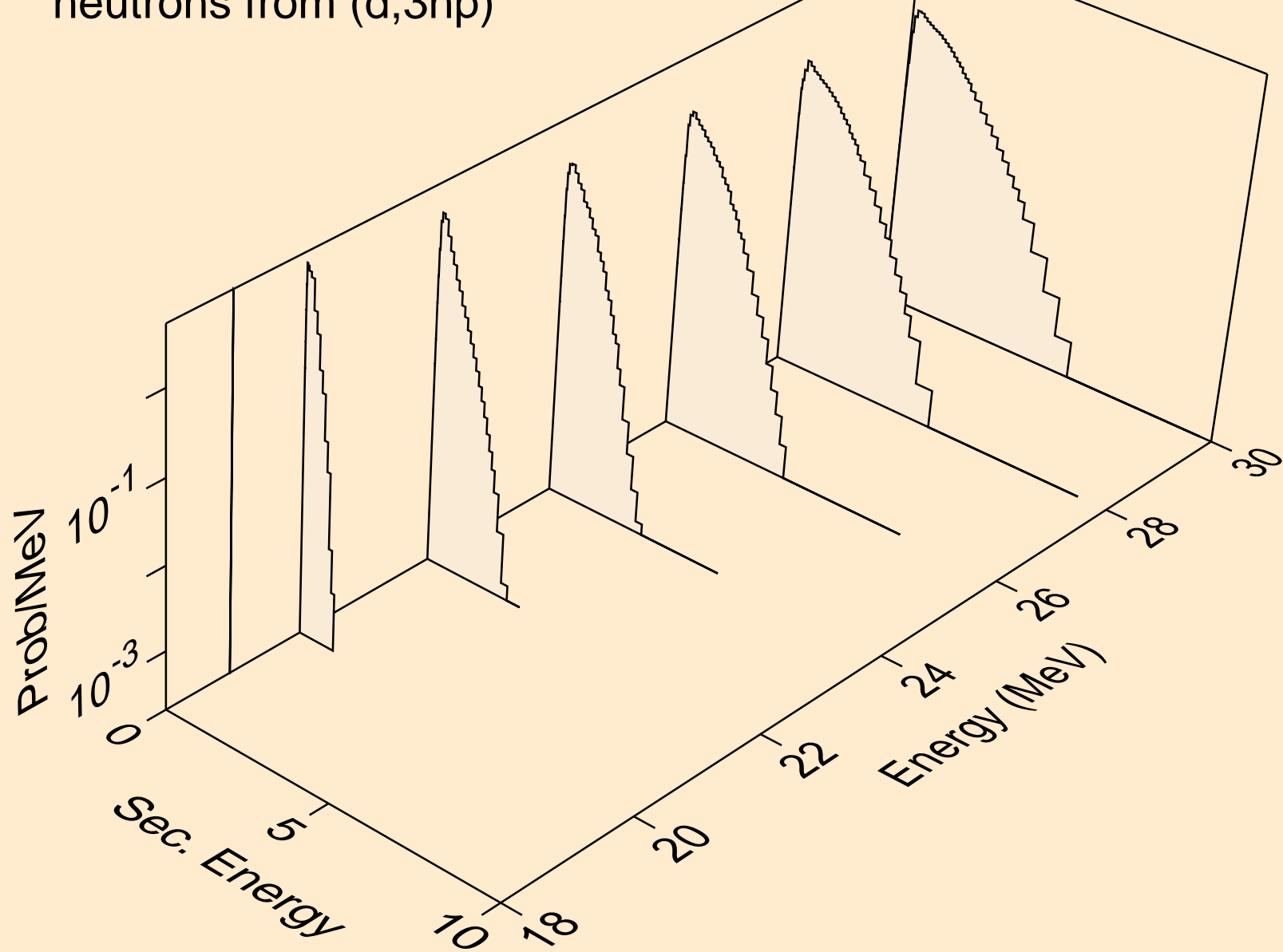

BA135 DEUTERON ACER TENDL-2023 LIBRARY; T=0.K
neutrons from (d,n2p)

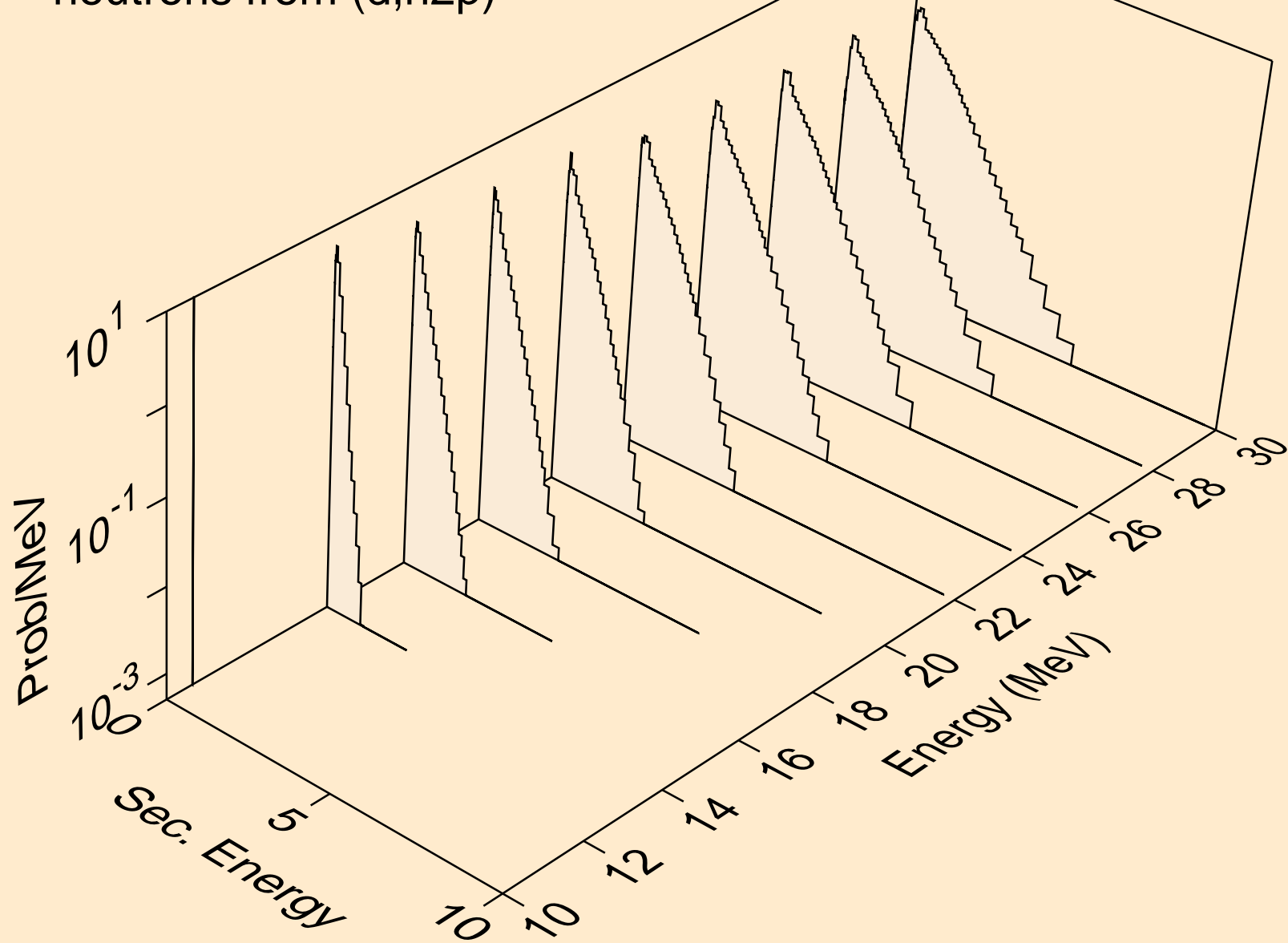

BA135 DEUTERON ACER TENDL-2023 LIBRARY; T=0.K
neutrons from (d,npa)

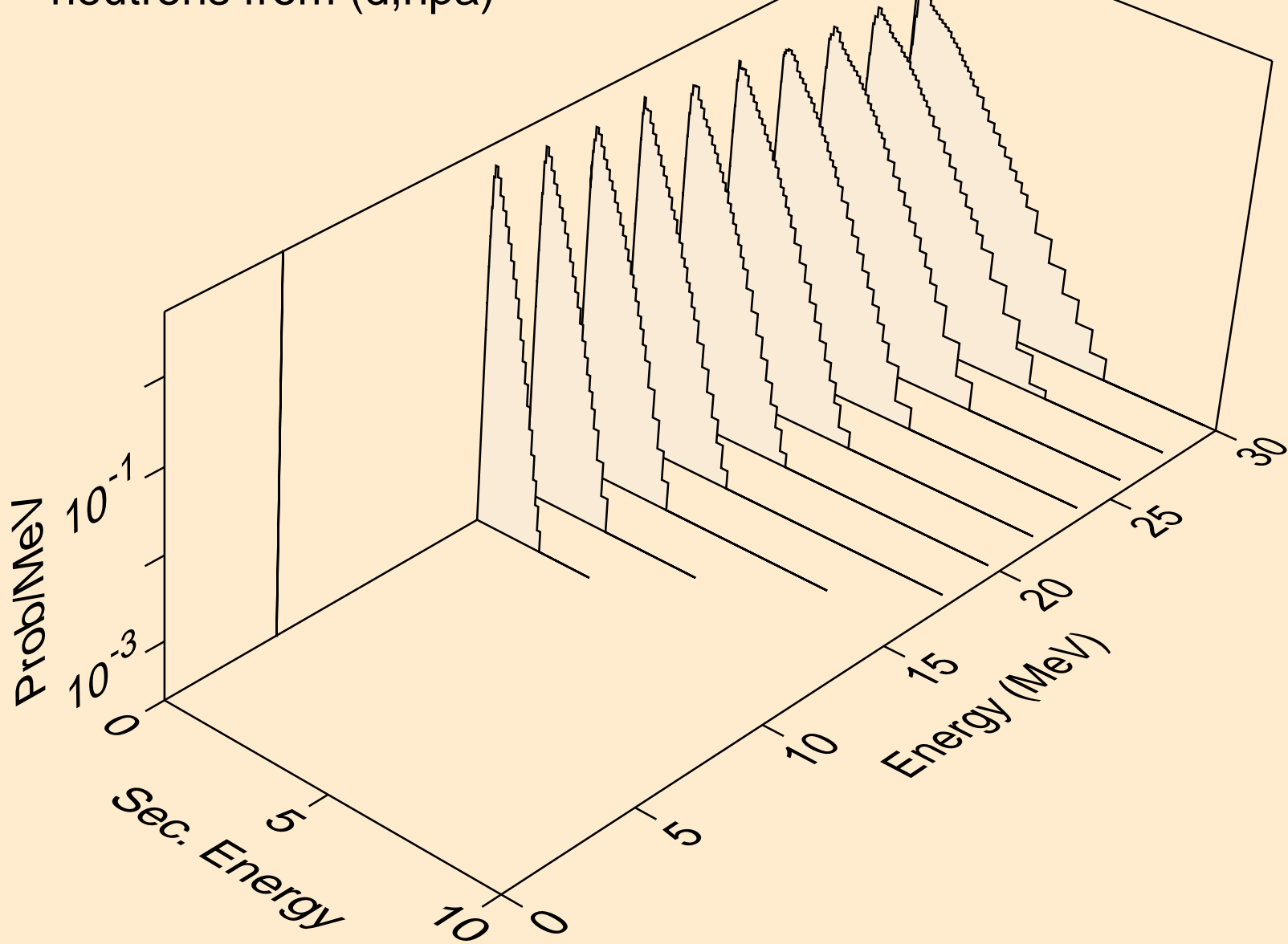

BA135 DEUTERON ACER TENDL-2023 LIBRARY; T=0.K
protons from (d,x)

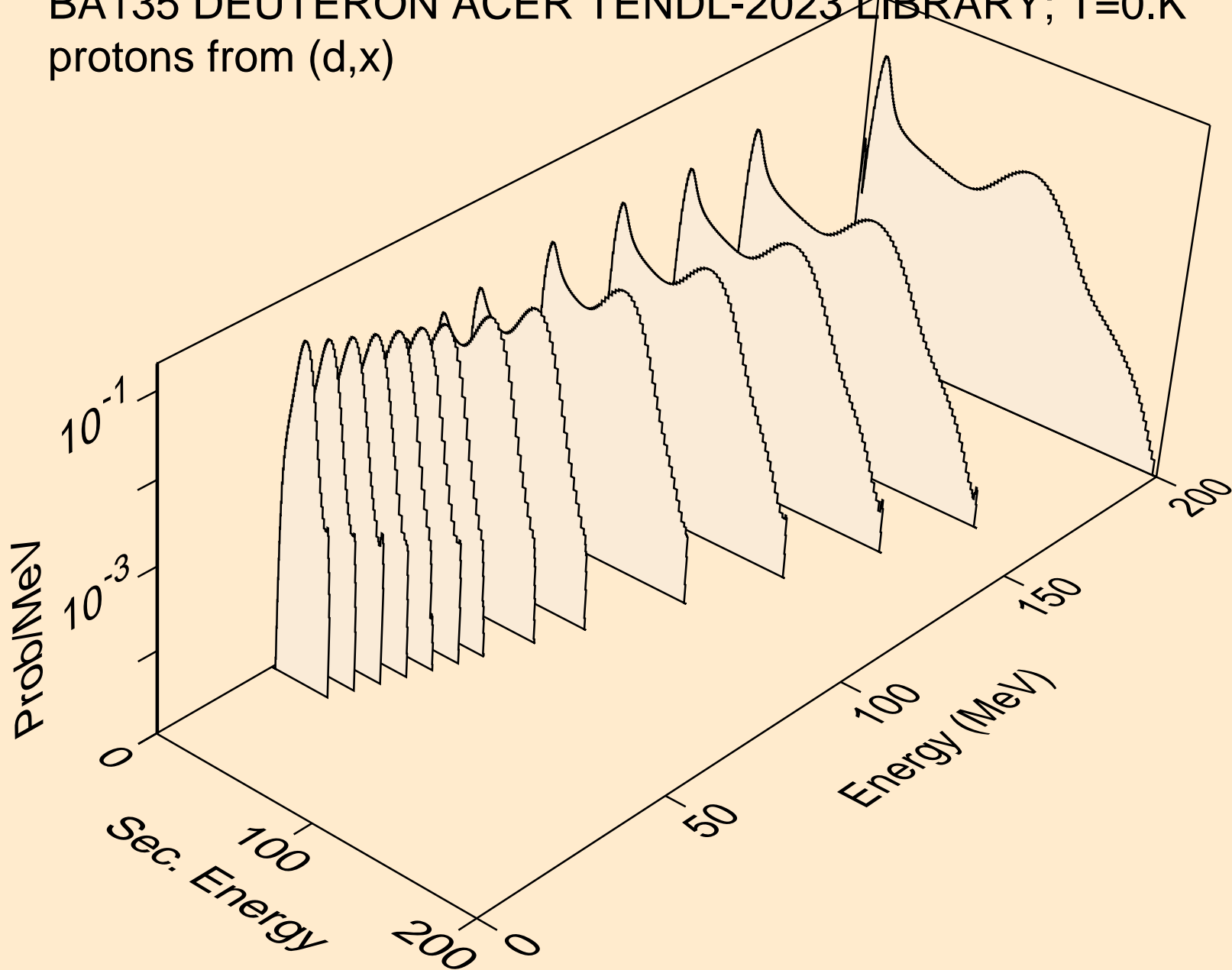

BA135 DEUTERON ACER TENDL-2023 LIBRARY; T=0.K
protons from (d,n*)p

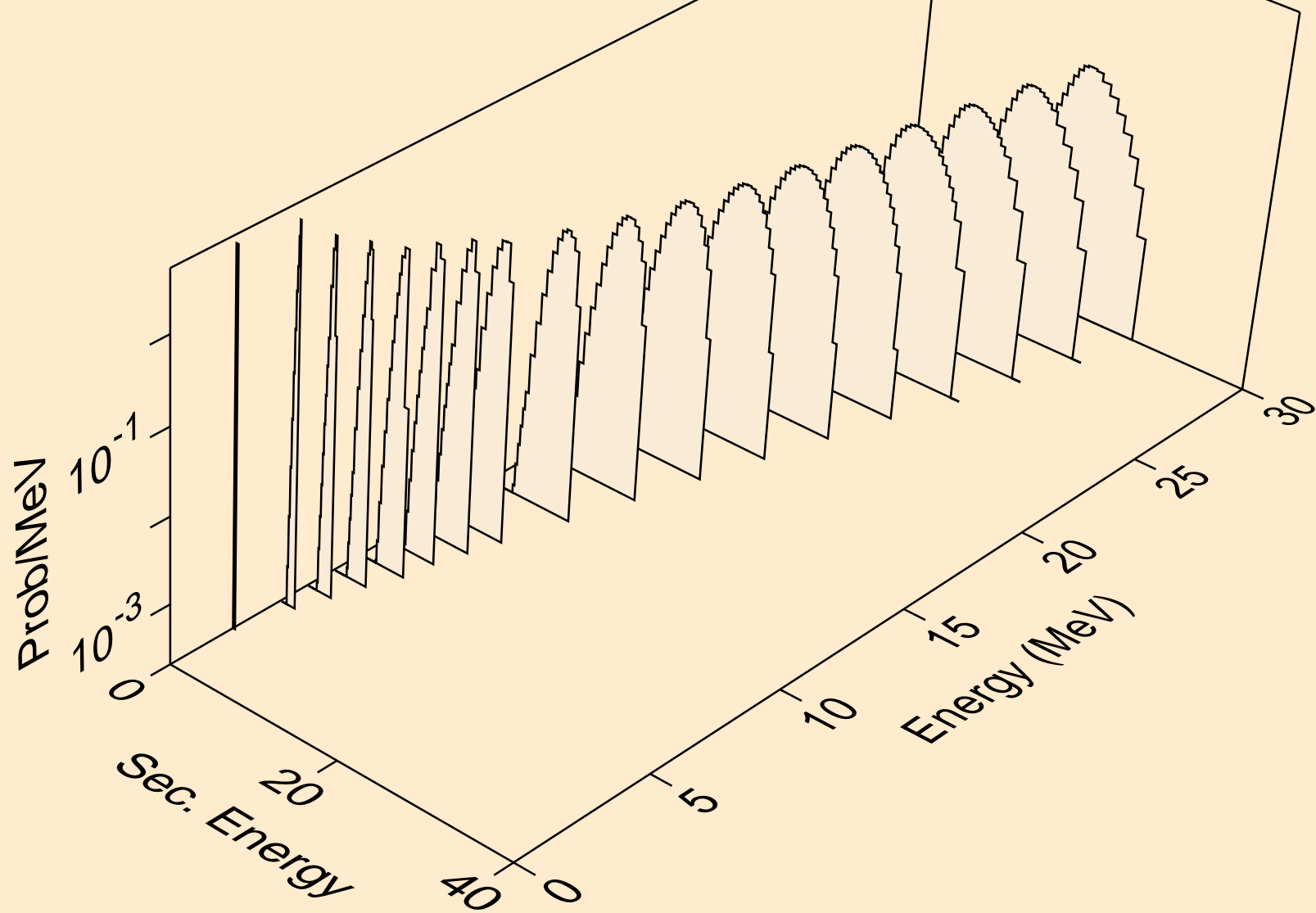

BA135 DEUTERON ACER TENDL-2023 LIBRARY; T=0.K
protons from (d,2np)

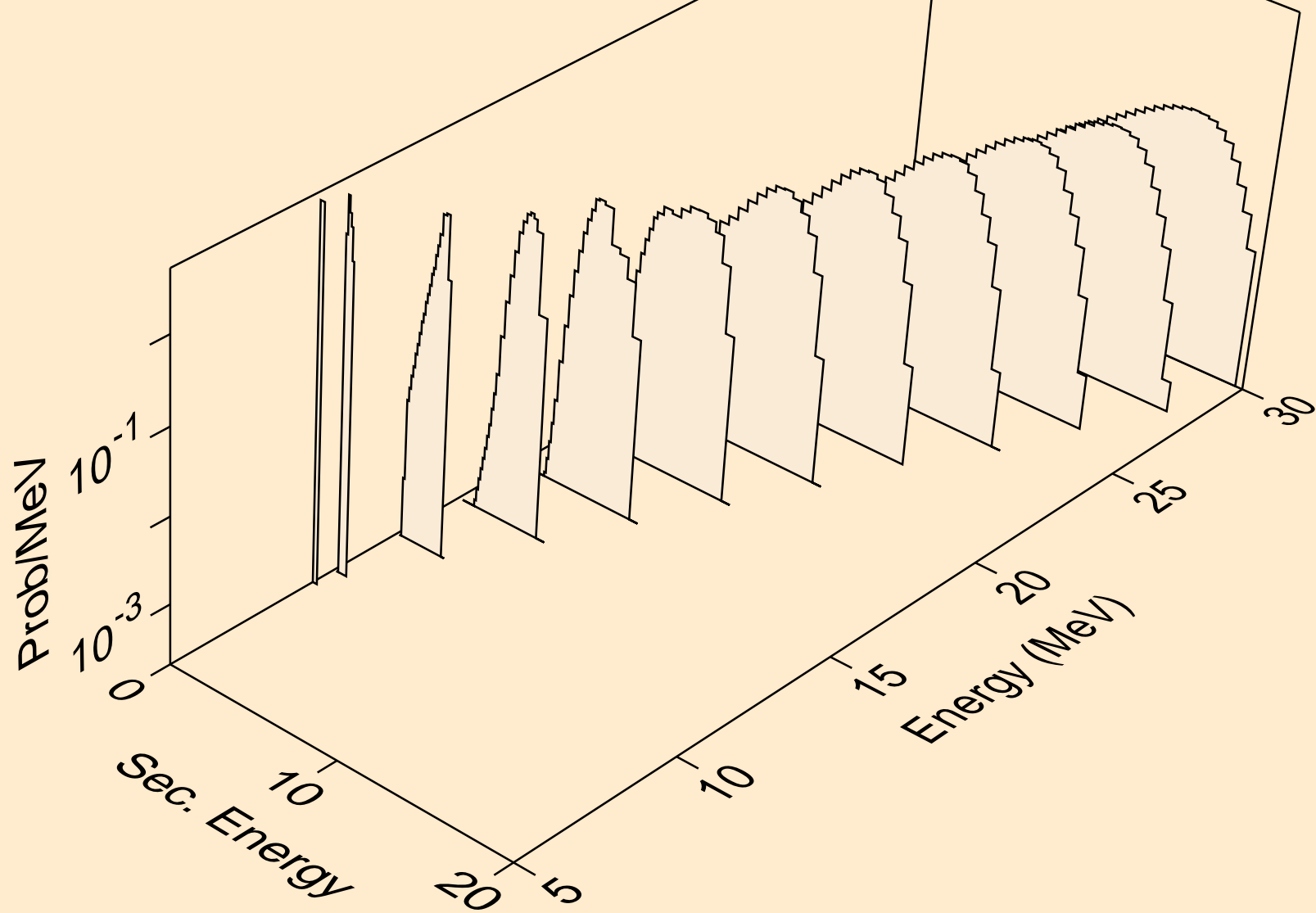

BA135 DEUTERON ACER TENDL-2023 LIBRARY; T=0.K
protons from (d,3np)

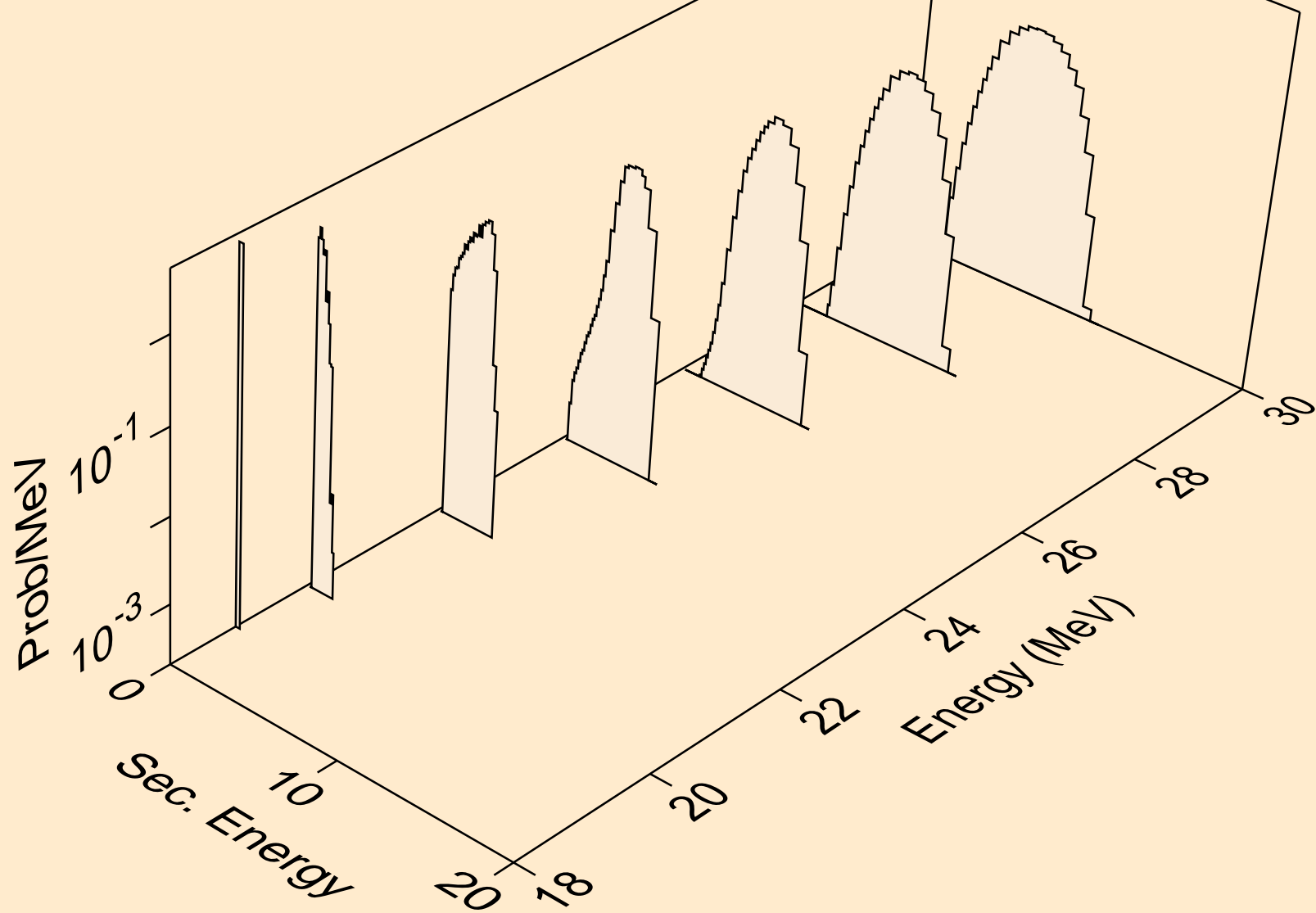

BA135 DEUTERON ACER TENDL-2023 LIBRARY; T=0.K
protons from (d,n2p)

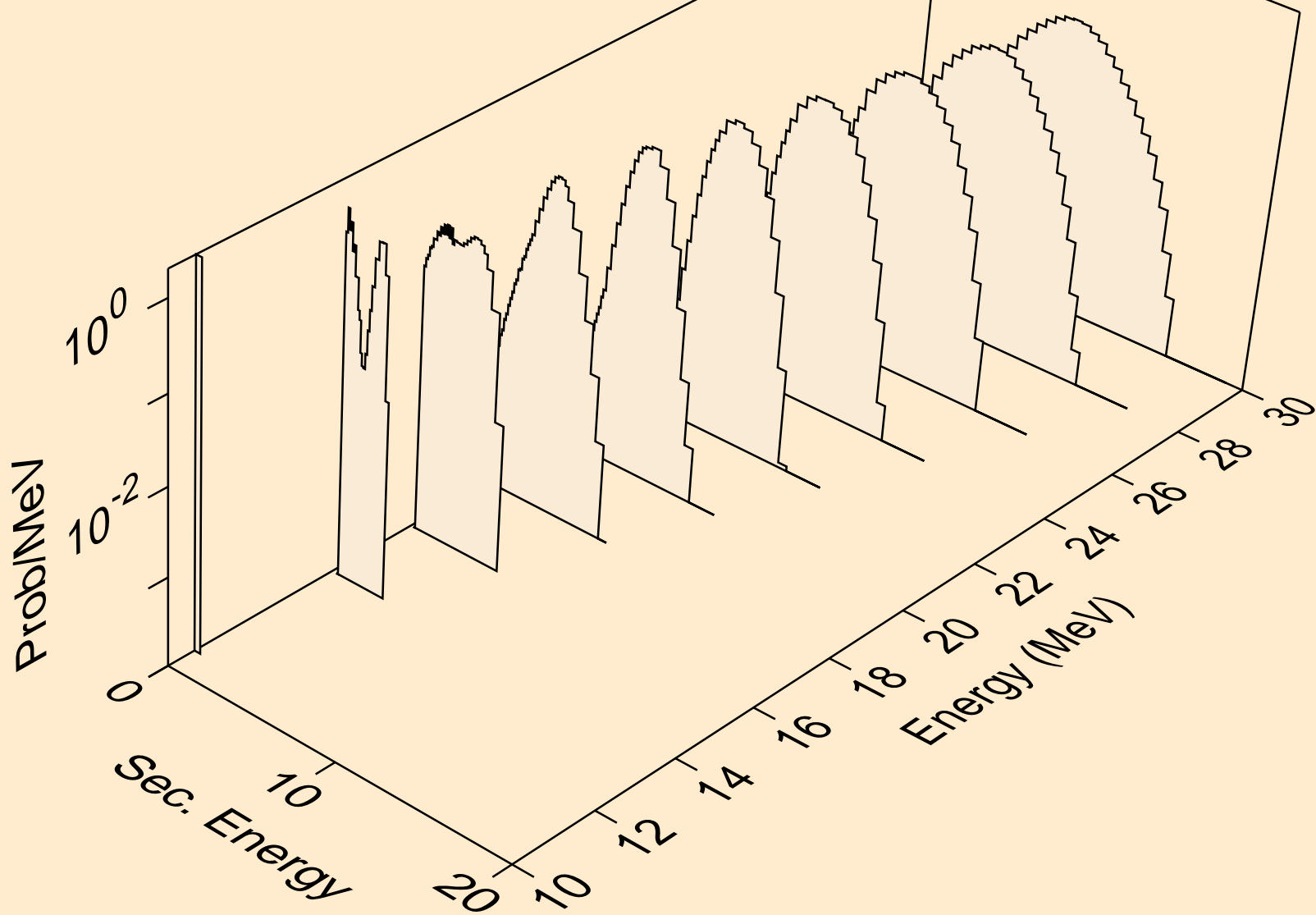

BA135 DEUTERON ACER TENDL-2023 LIBRARY; T=0.K
protons from (d,npa)

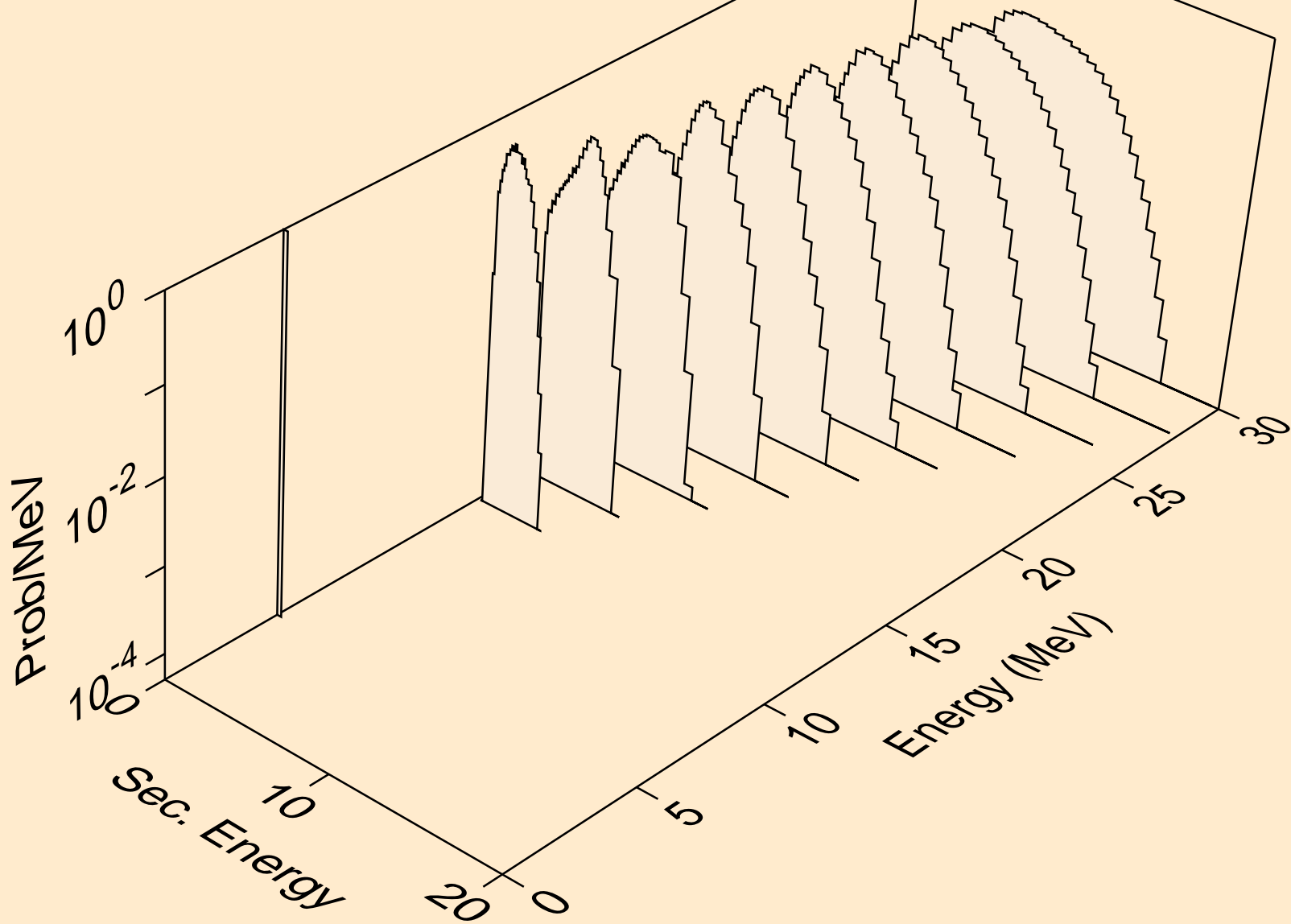

BA135 DEUTERON ACER TENDL-2023 LIBRARY; T=0.K
protons from (d,p)

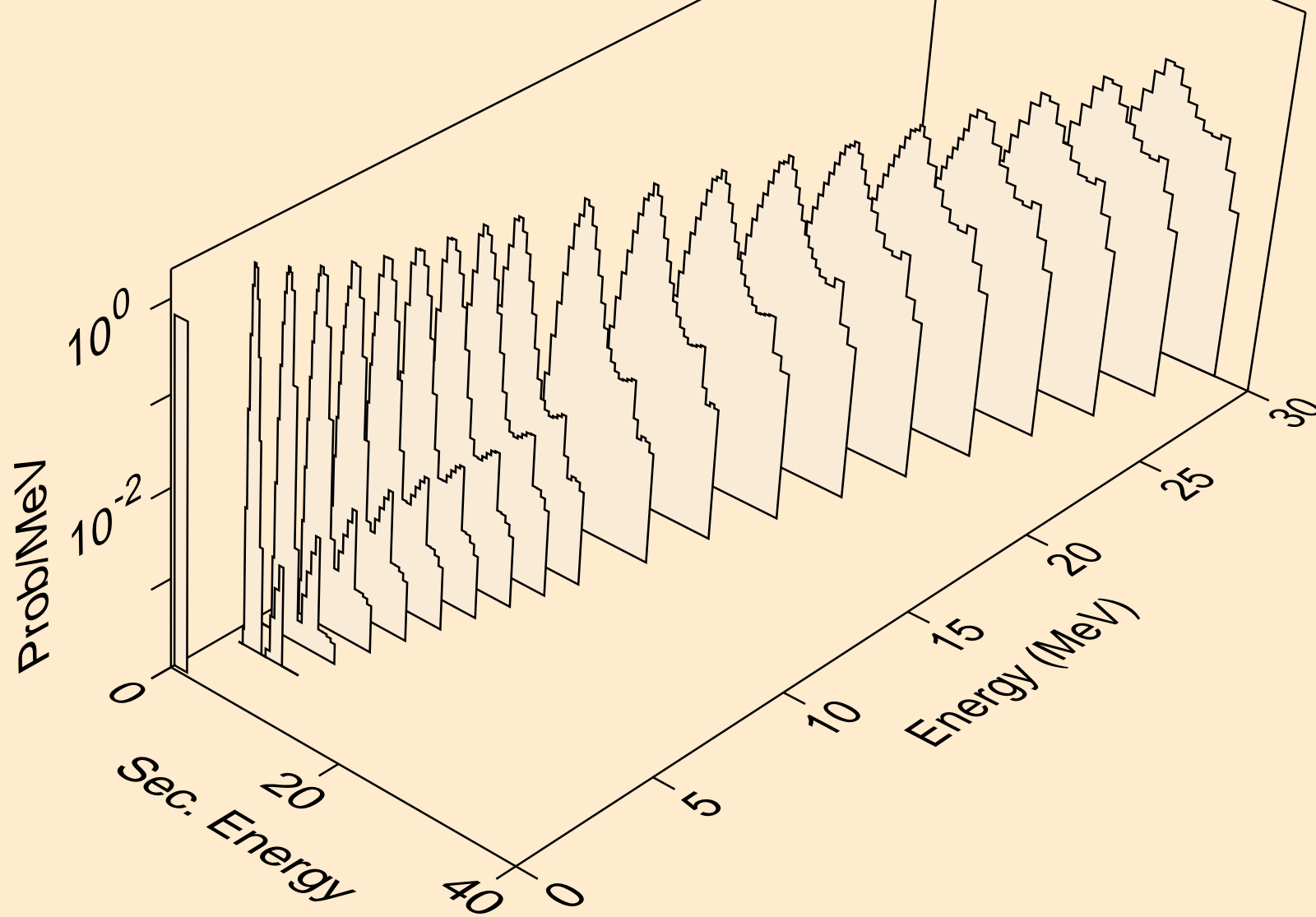

BA135 DEUTERON ACER TENDL-2023 LIBRARY; T=0.K
protons from (d,2p)

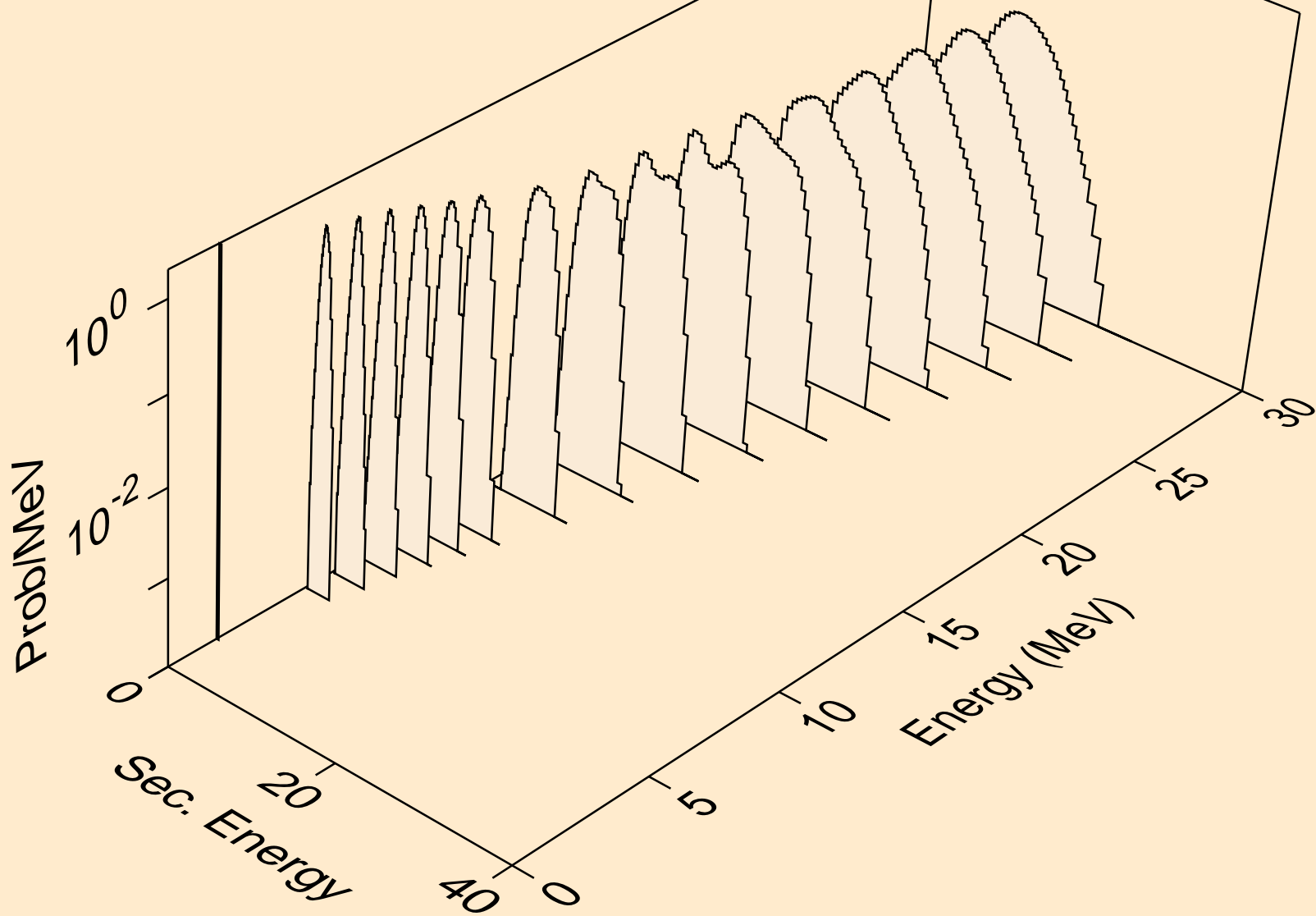

BA135 DEUTERON ACER TENDL-2023 LIBRARY; T=0.K
protons from (d,pa)

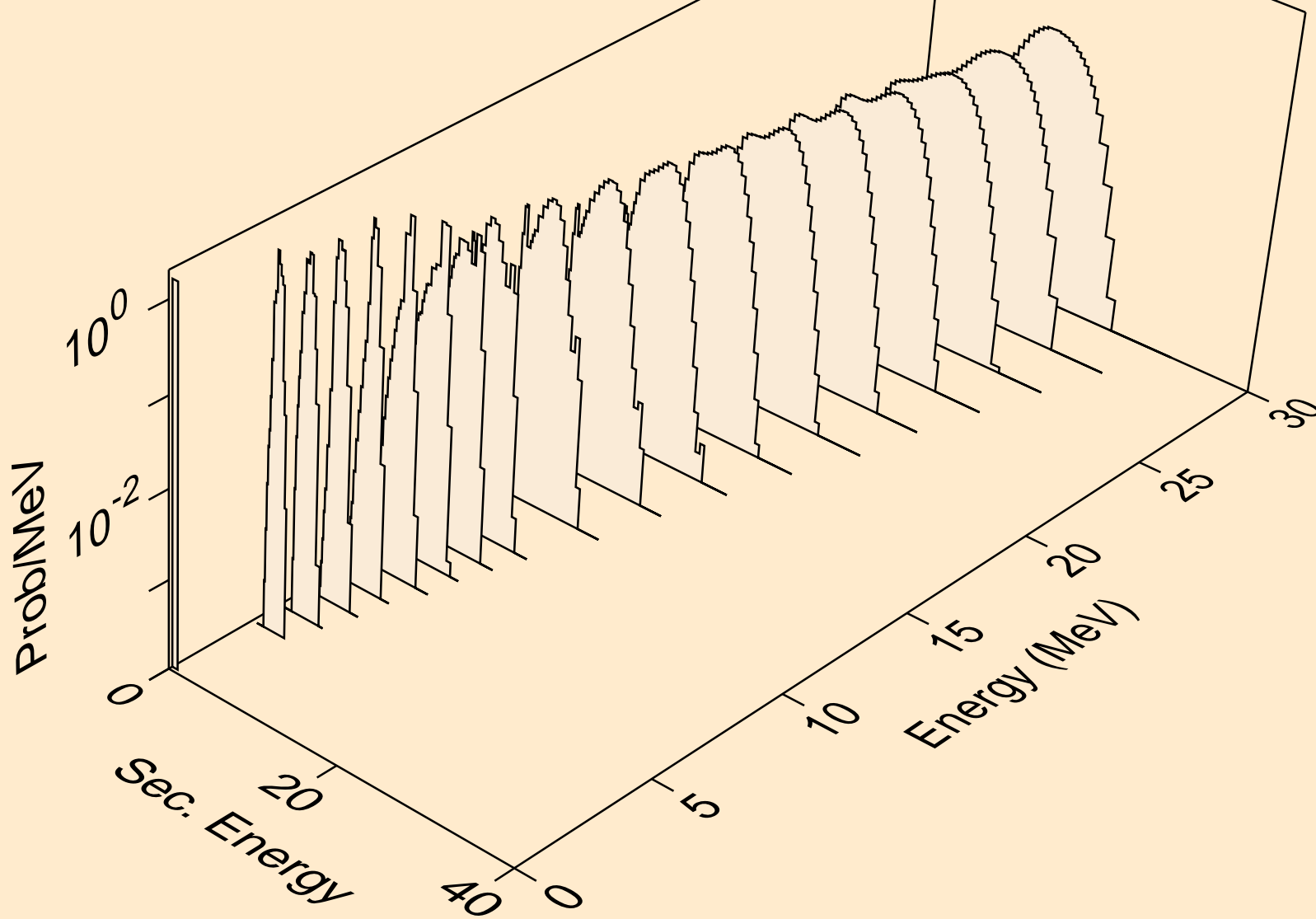

BA135 DEUTERON ACER TENDL-2023 LIBRARY; T=0.K
protons from (d,pd)

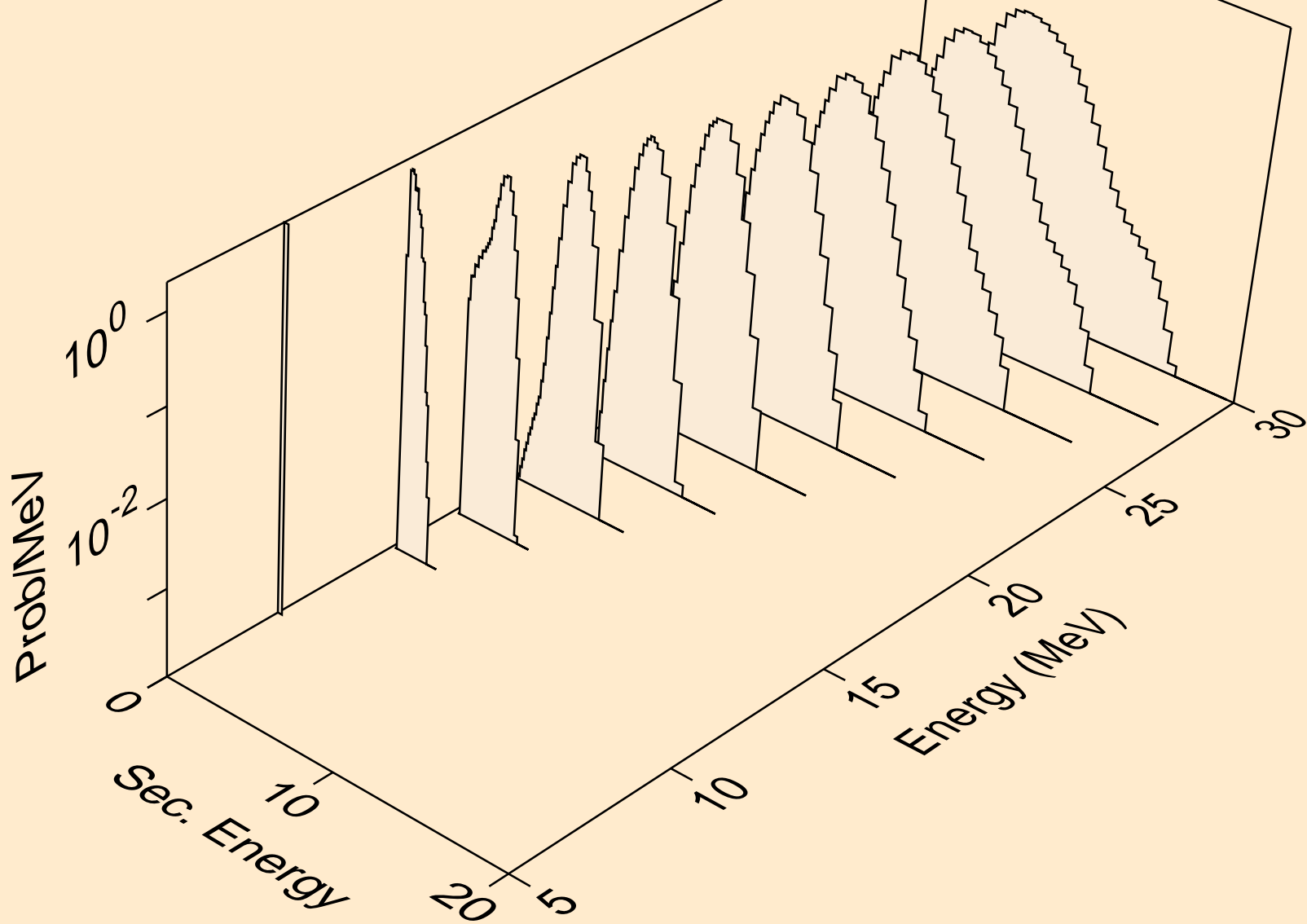

BA135 DEUTERON ACER TENDL-2023 LIBRARY; T=0.K
protons from (d,pt)

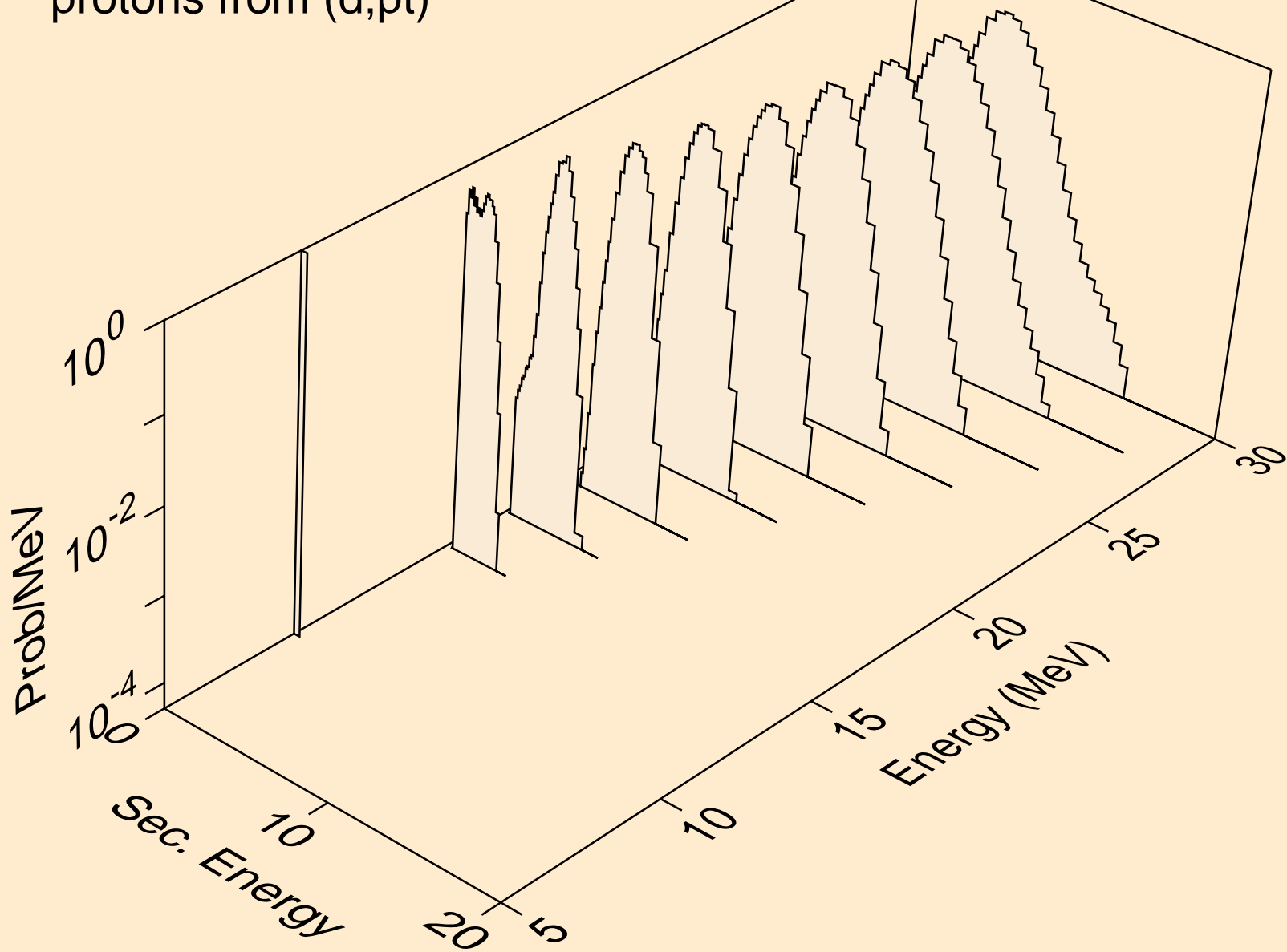

BA135 DEUTERON ACER TENDL-2023 LIBRARY; T=0.K
tritons from (d,x)

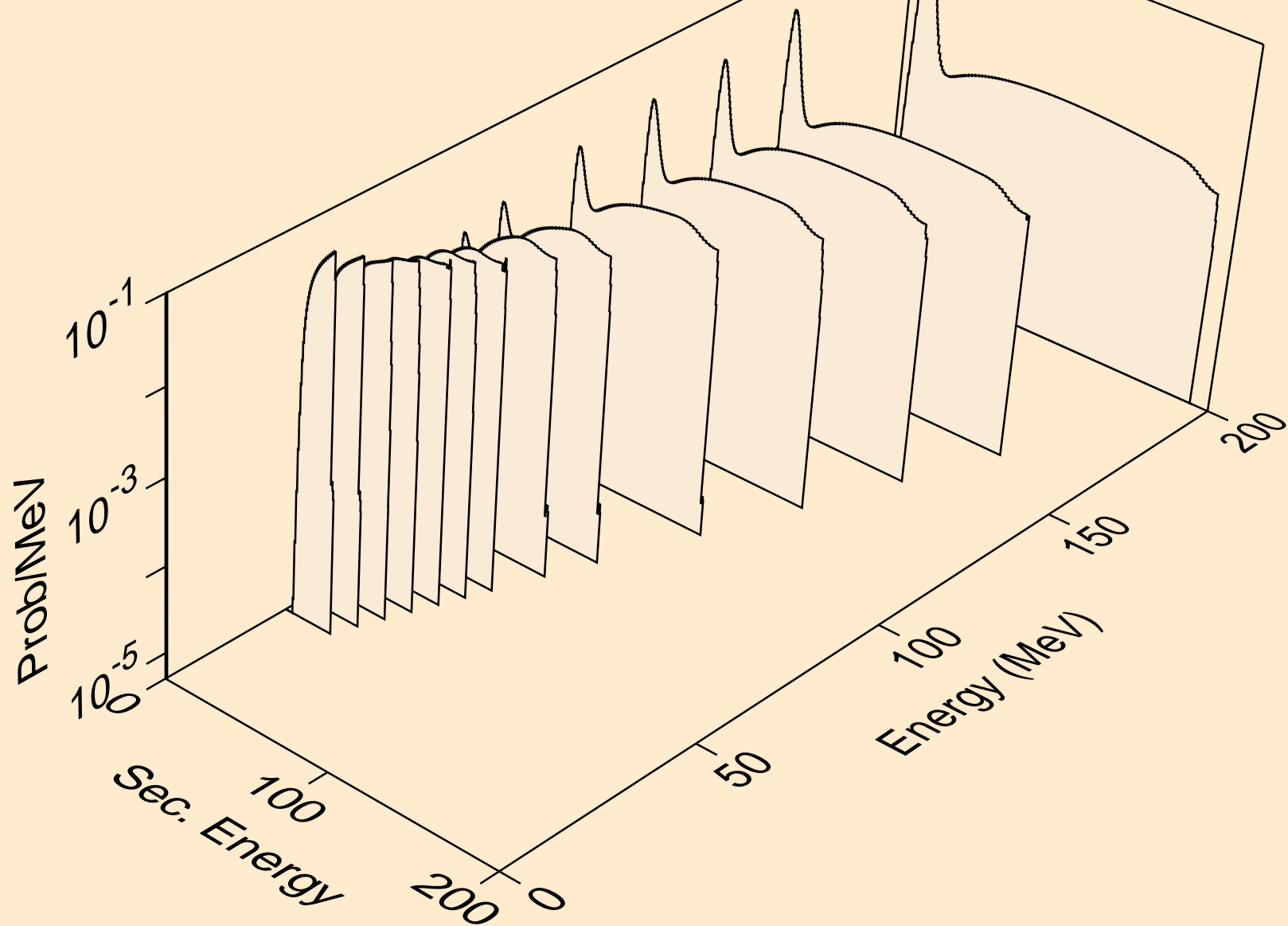

BA135 DEUTERON ACER TENDL-2023 LIBRARY; T=0.K
tritons from (d,n*)t

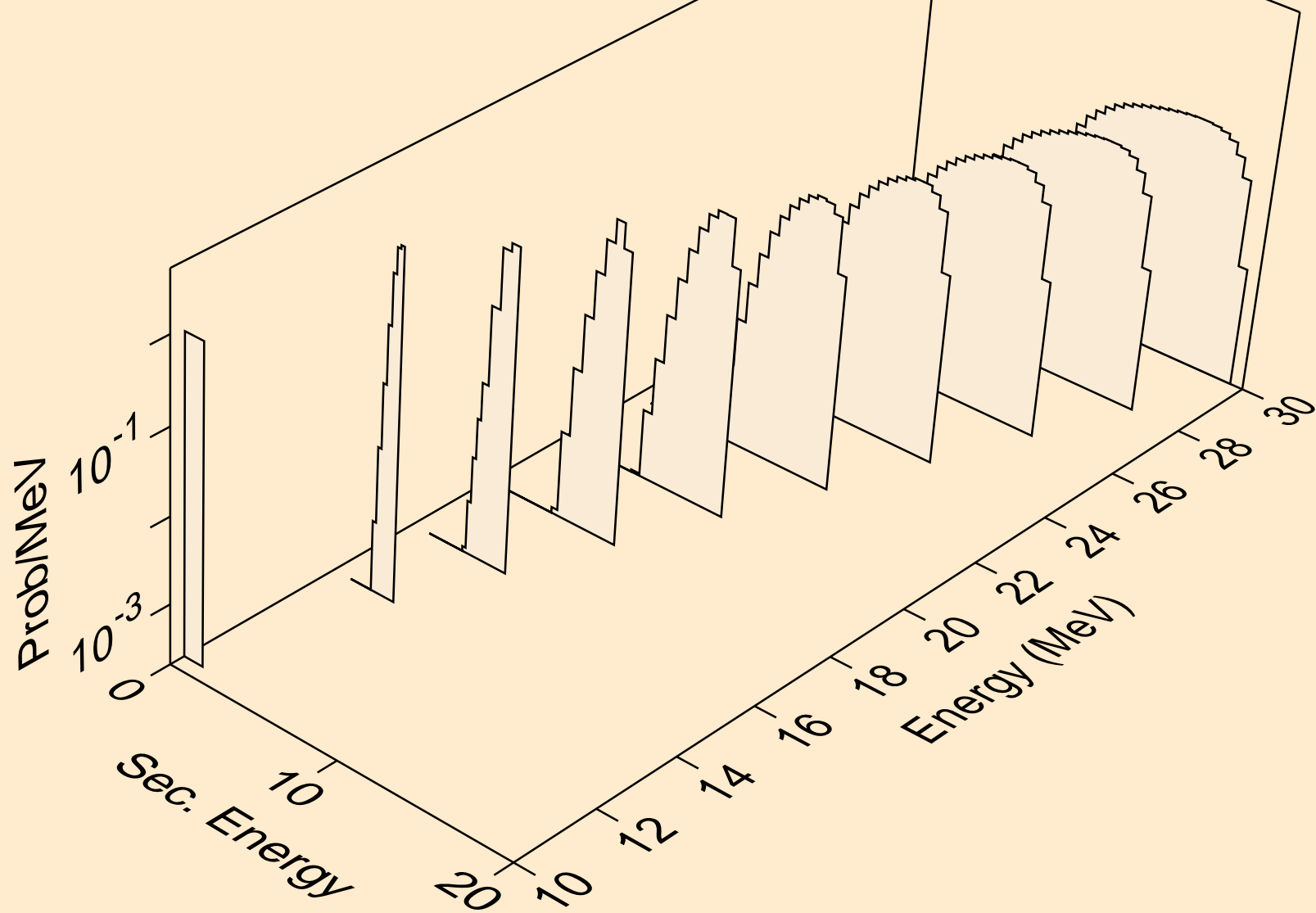

BA135 DEUTERON ACER TENDL-2023 LIBRARY; T=0.K
tritons from (d,t)

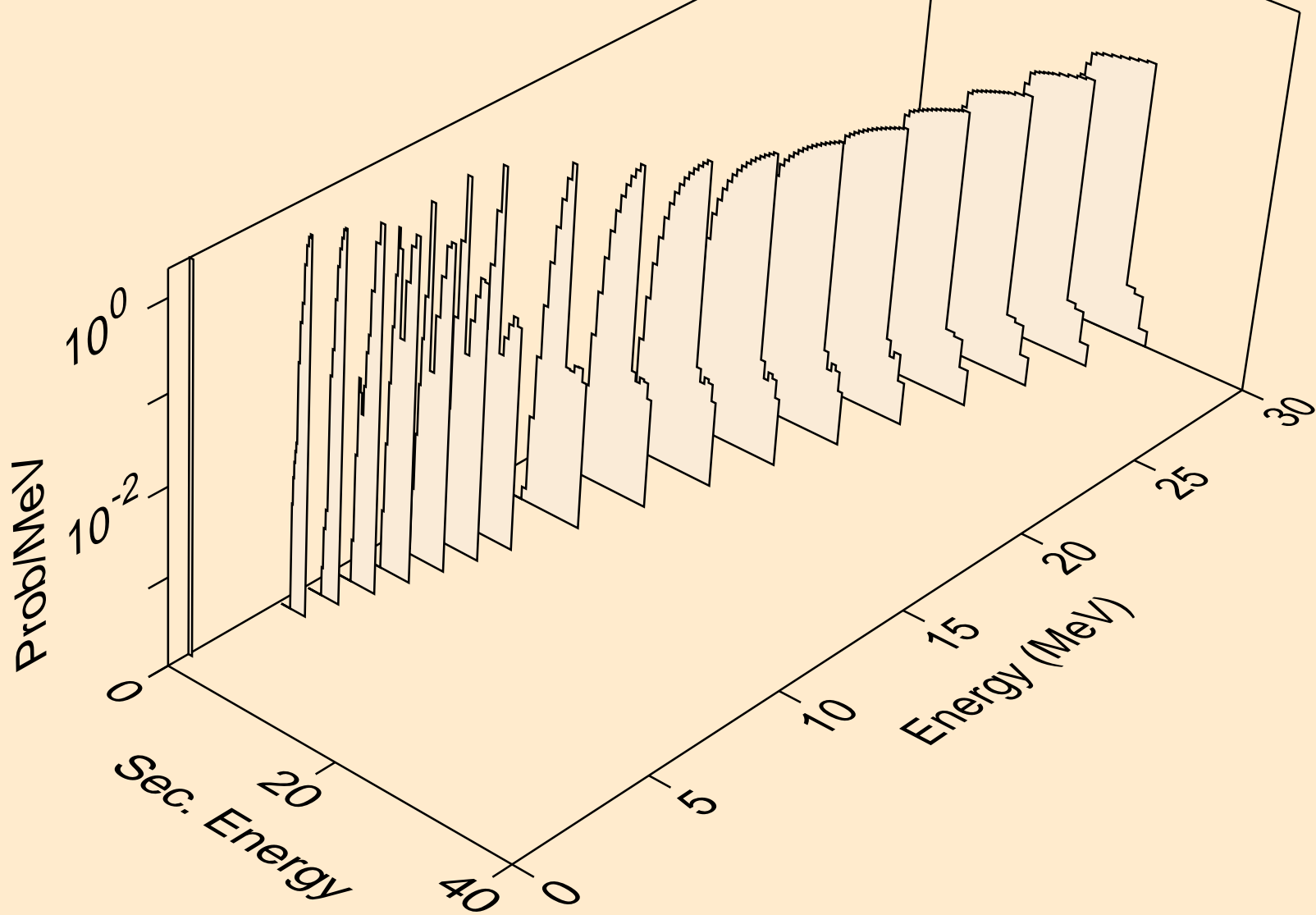

BA135 DEUTERON ACER TENDL-2023 LIBRARY; T=0.K
tritons from (d,pt)

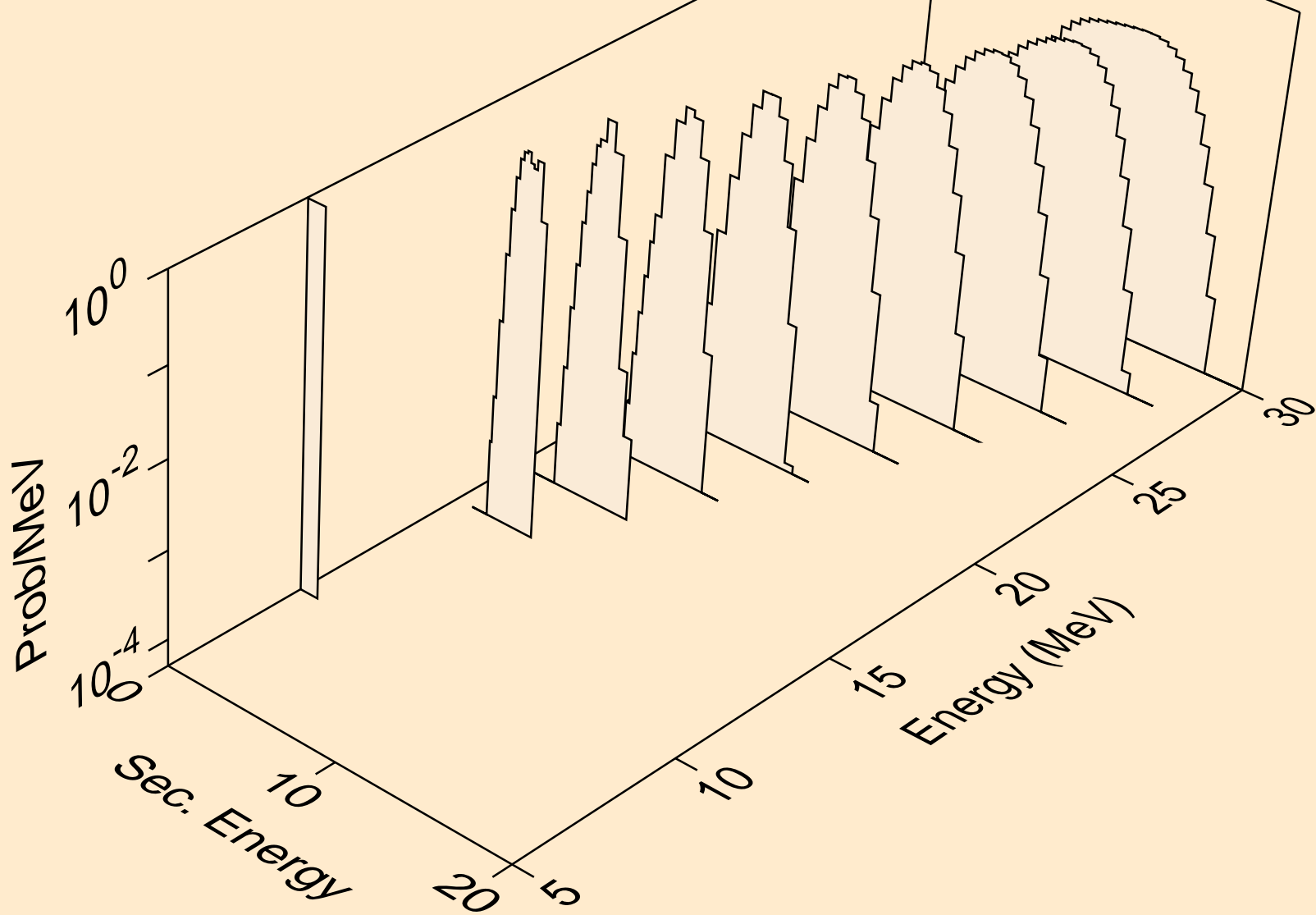

BA135 DEUTERON ACER TENDL-2023 LIBRARY; T=0.K
he3s from (d,x)

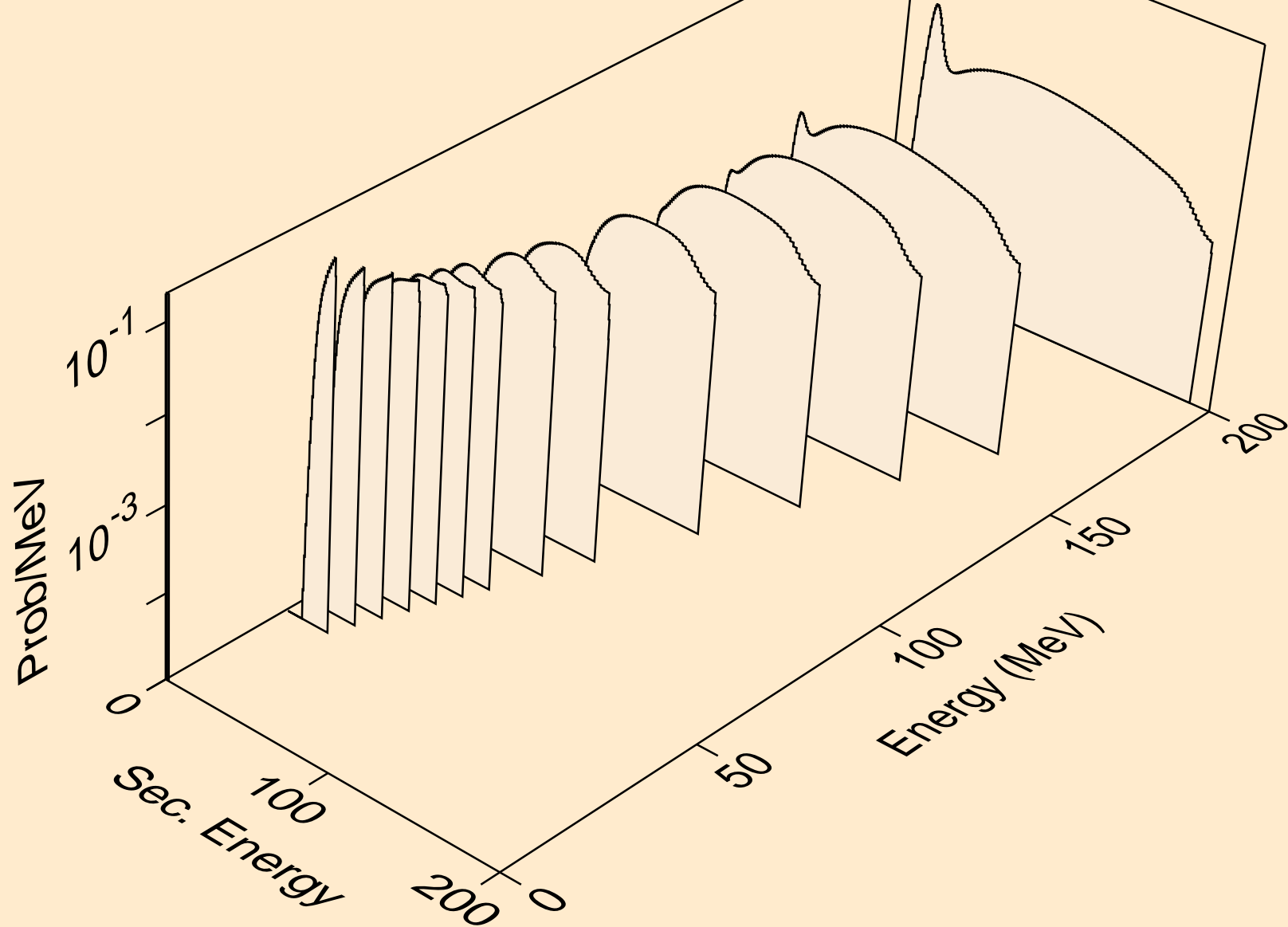

BA135 DEUTERON ACER TENDL-2023 LIBRARY; T=0.K
he3s from (d,n*)he3

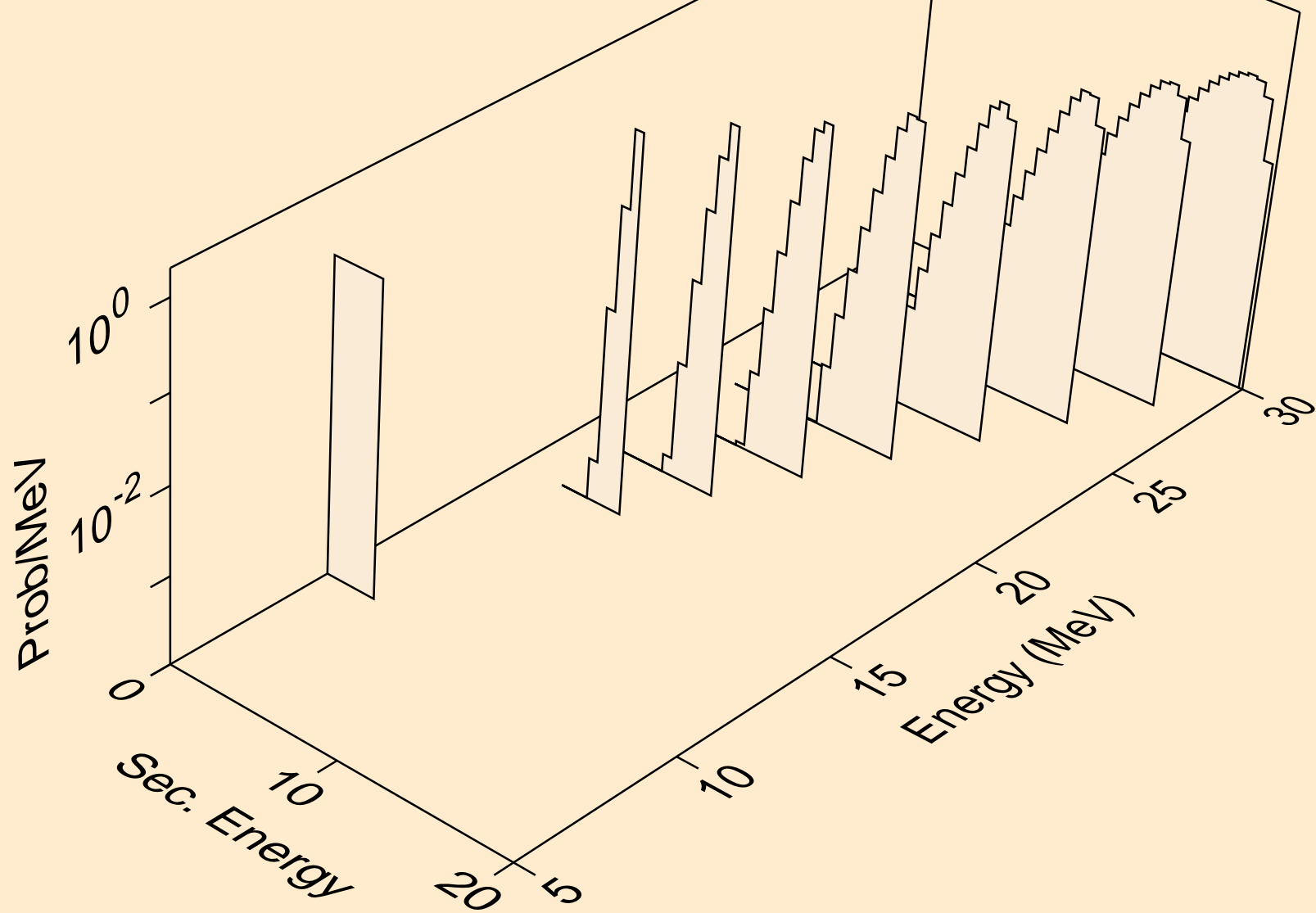

BA135 DEUTERON ACER TENDL-2023 LIBRARY; T=0.K
he3s from (d,he3)

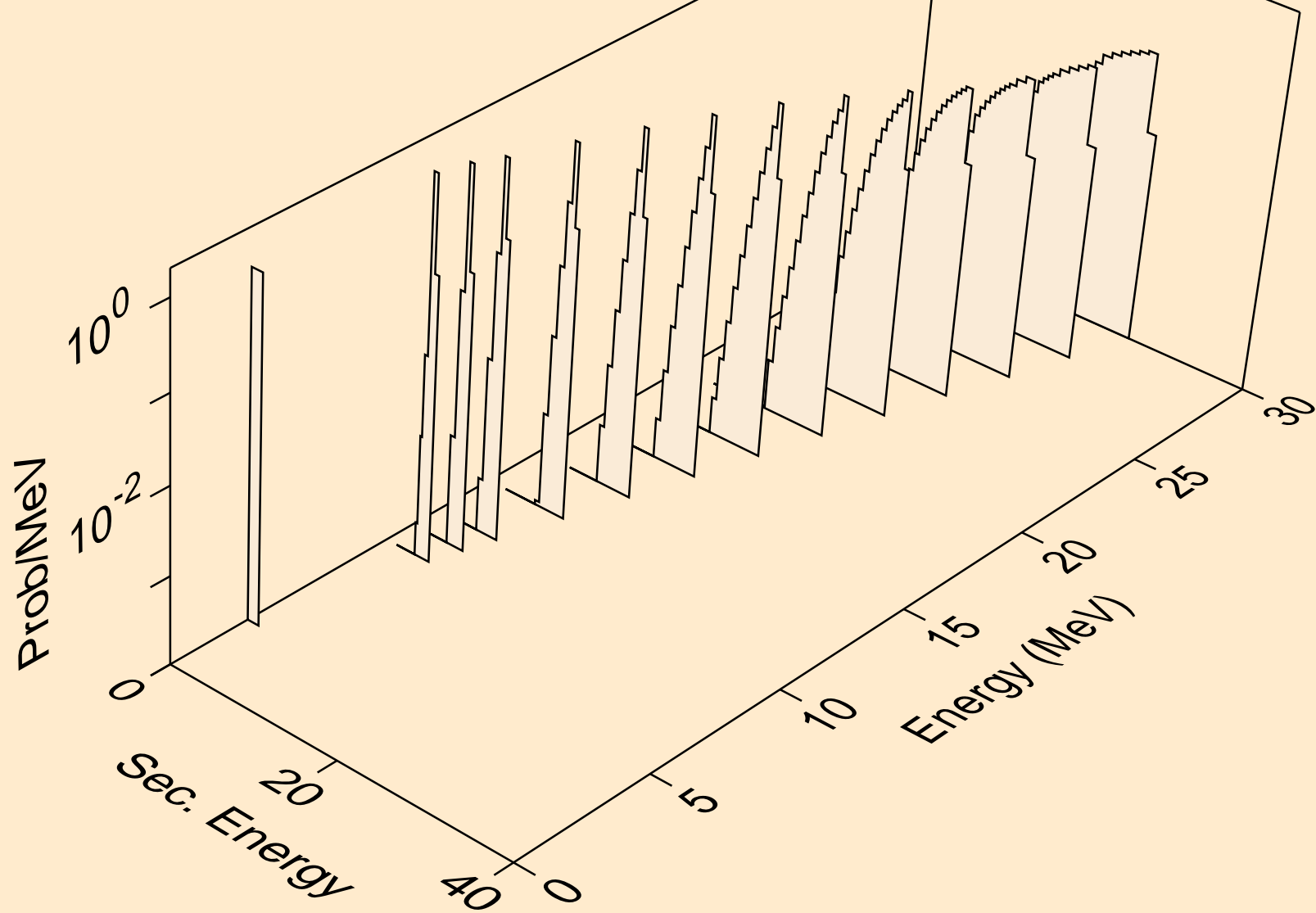

BA135 DEUTERON ACER TENDL-2023 LIBRARY; T=0.K
alphas from (d,x)

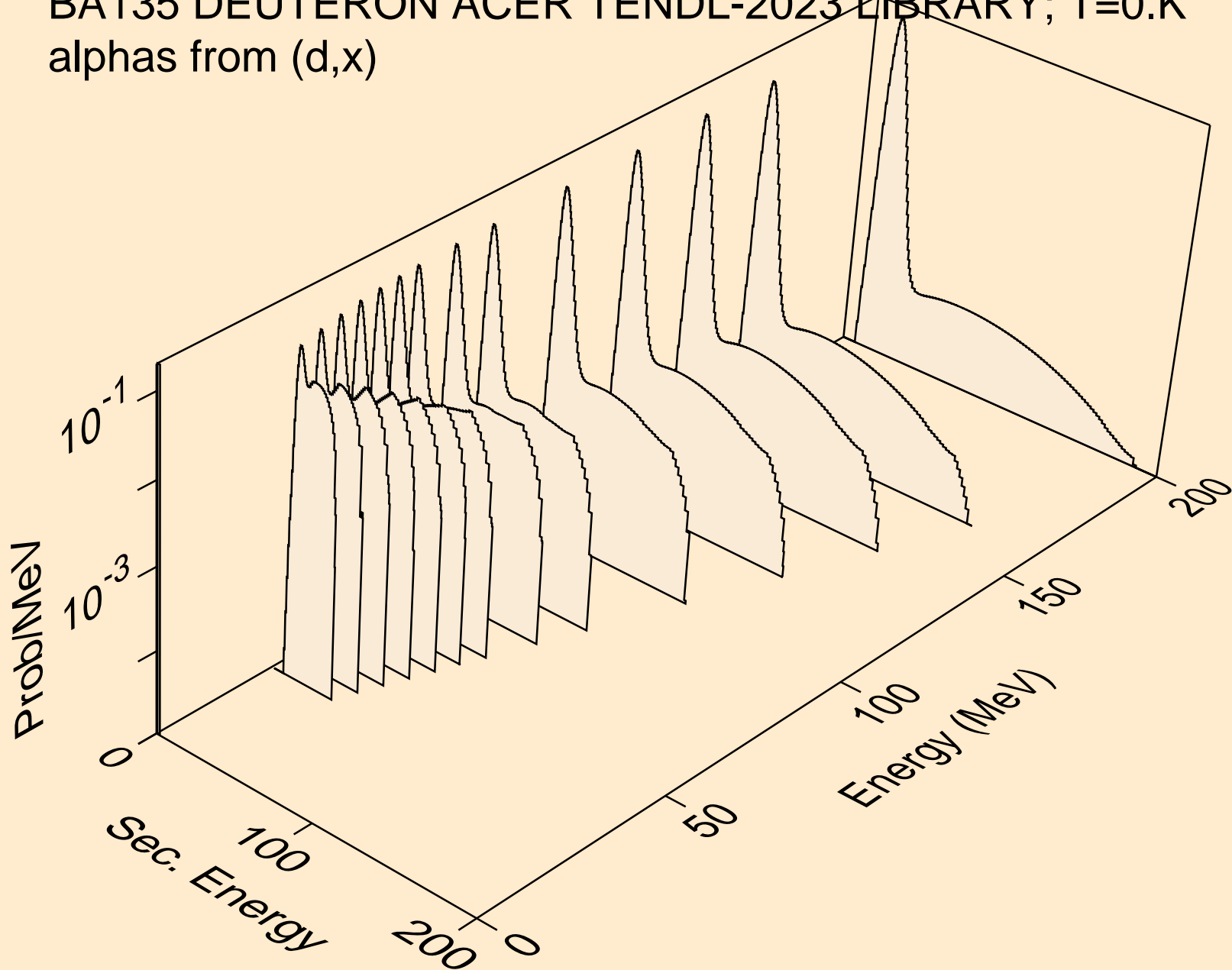

BA135 DEUTERON ACER TENDL-2023 LIBRARY; T=0.K
alphas from (d,n*)a

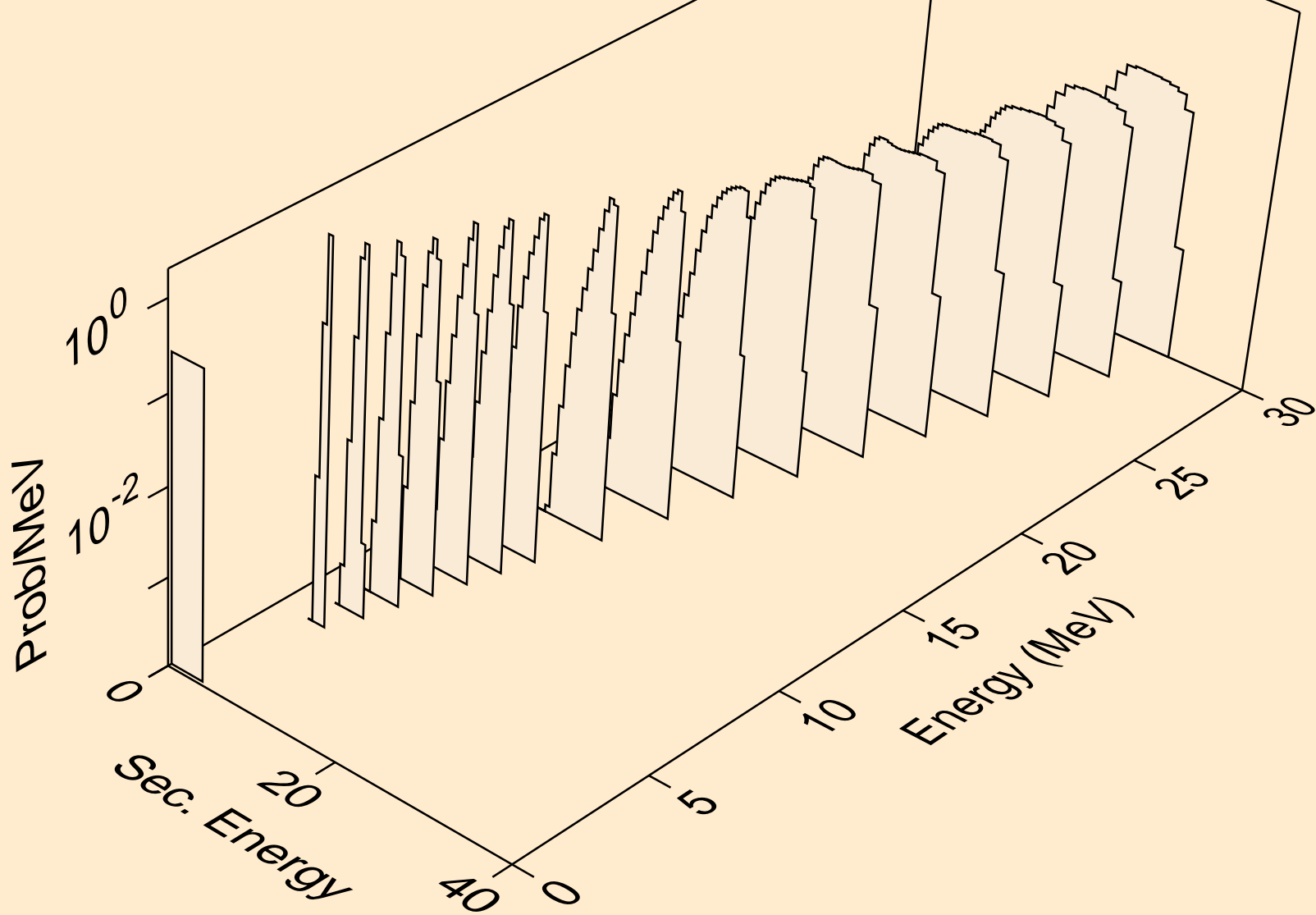

BA135 DEUTERON ACER TENDL-2023 LIBRARY; T=0.K
alphas from (d,2n)a

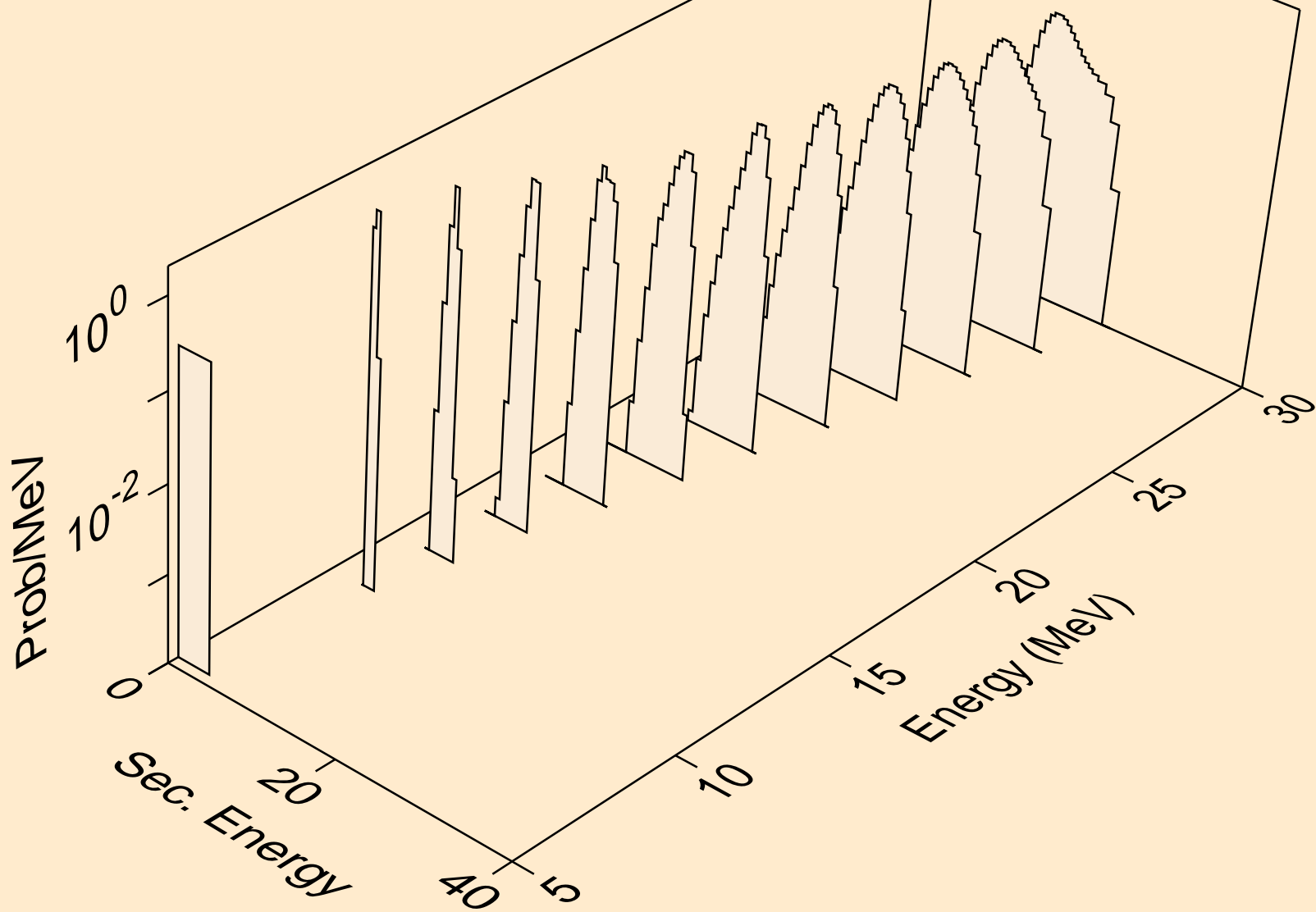

BA135 DEUTERON ACER TENDL-2023 LIBRARY; T=0.K
alphas from (d,3n)a

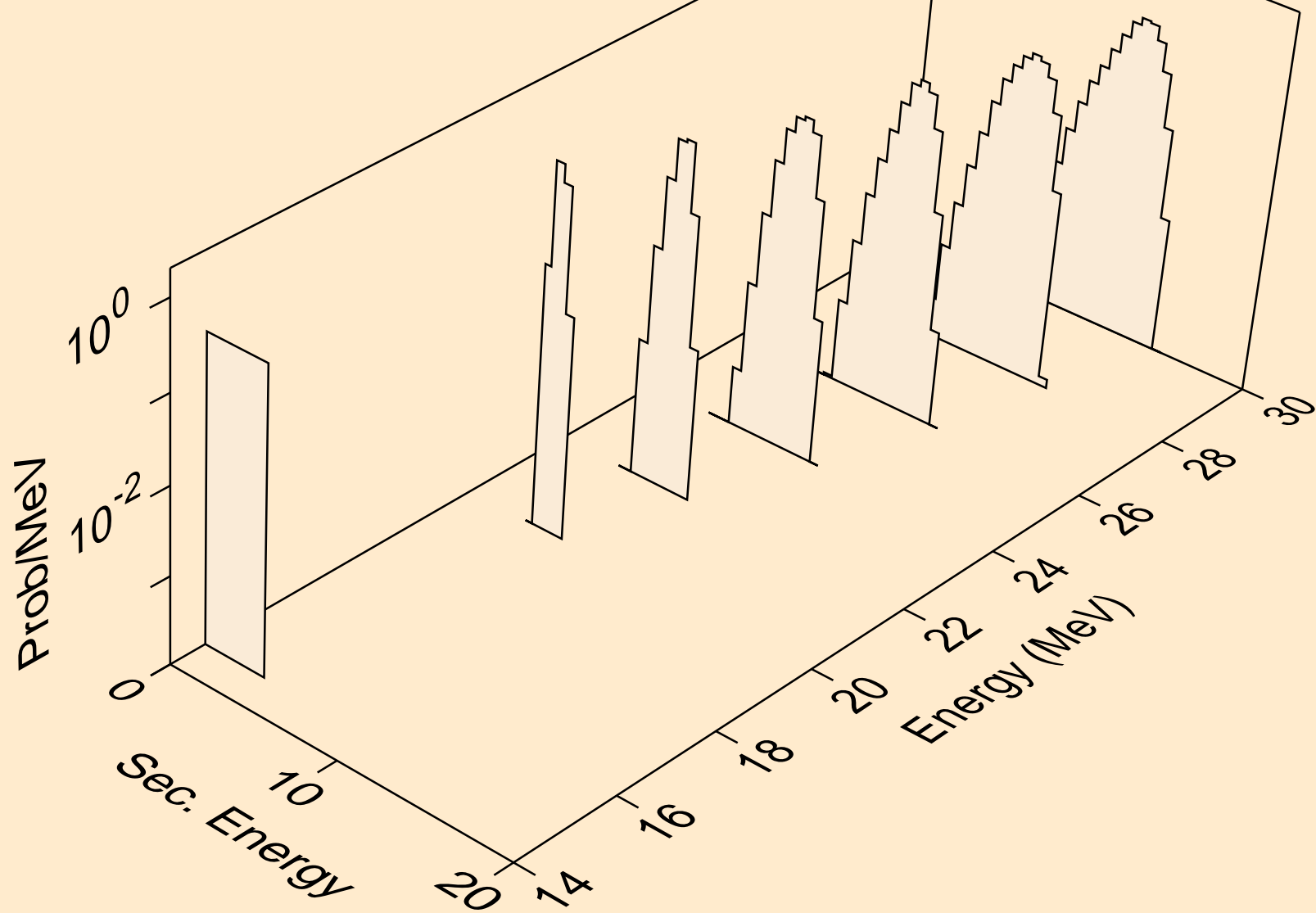

BA135 DEUTERON ACER TENDL-2023 LIBRARY; T=0.K
alphas from (d,n*)2a

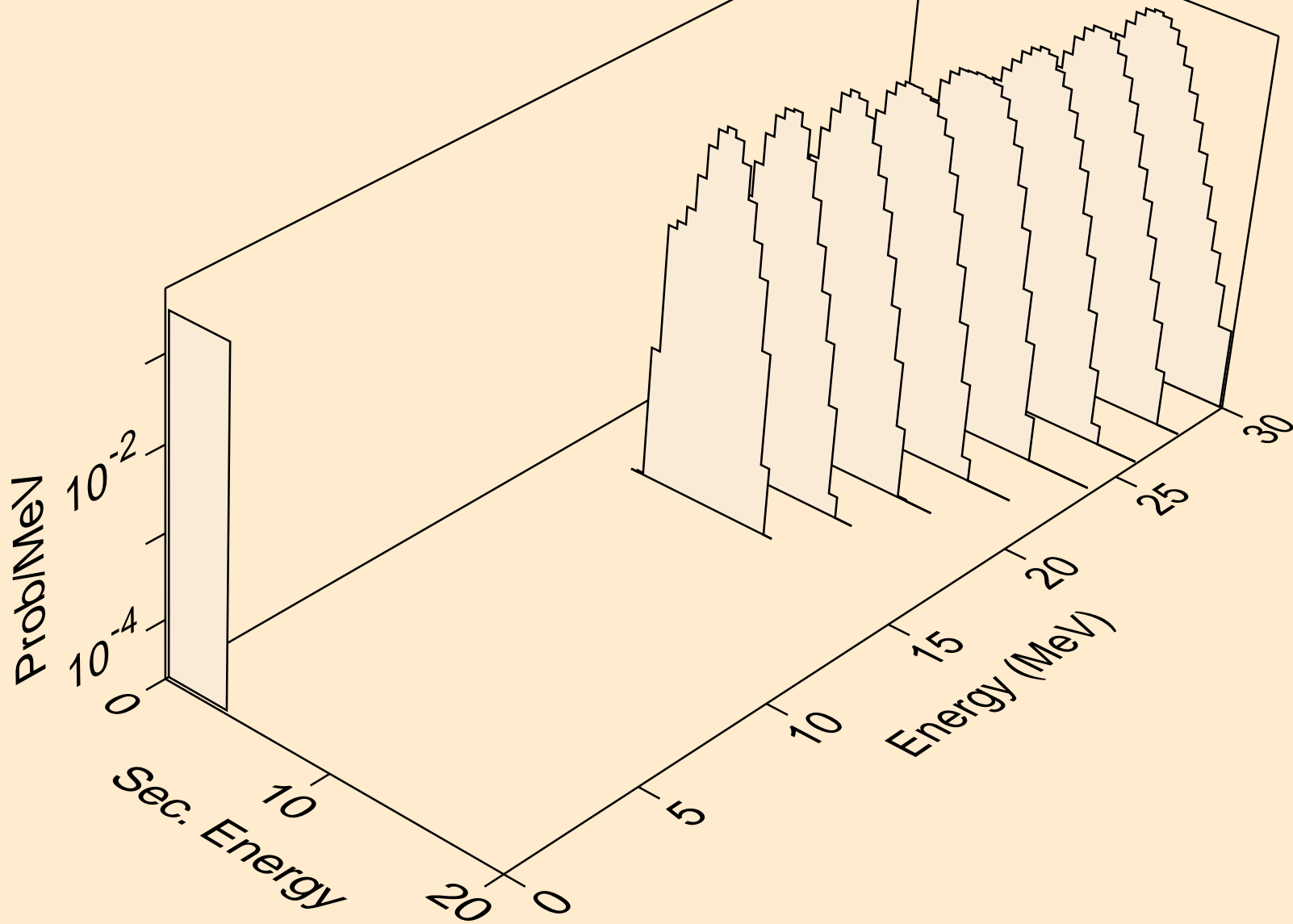

BA135 DEUTERON ACER TENDL-2023 LIBRARY; T=0.K
alphas from (d,npa)

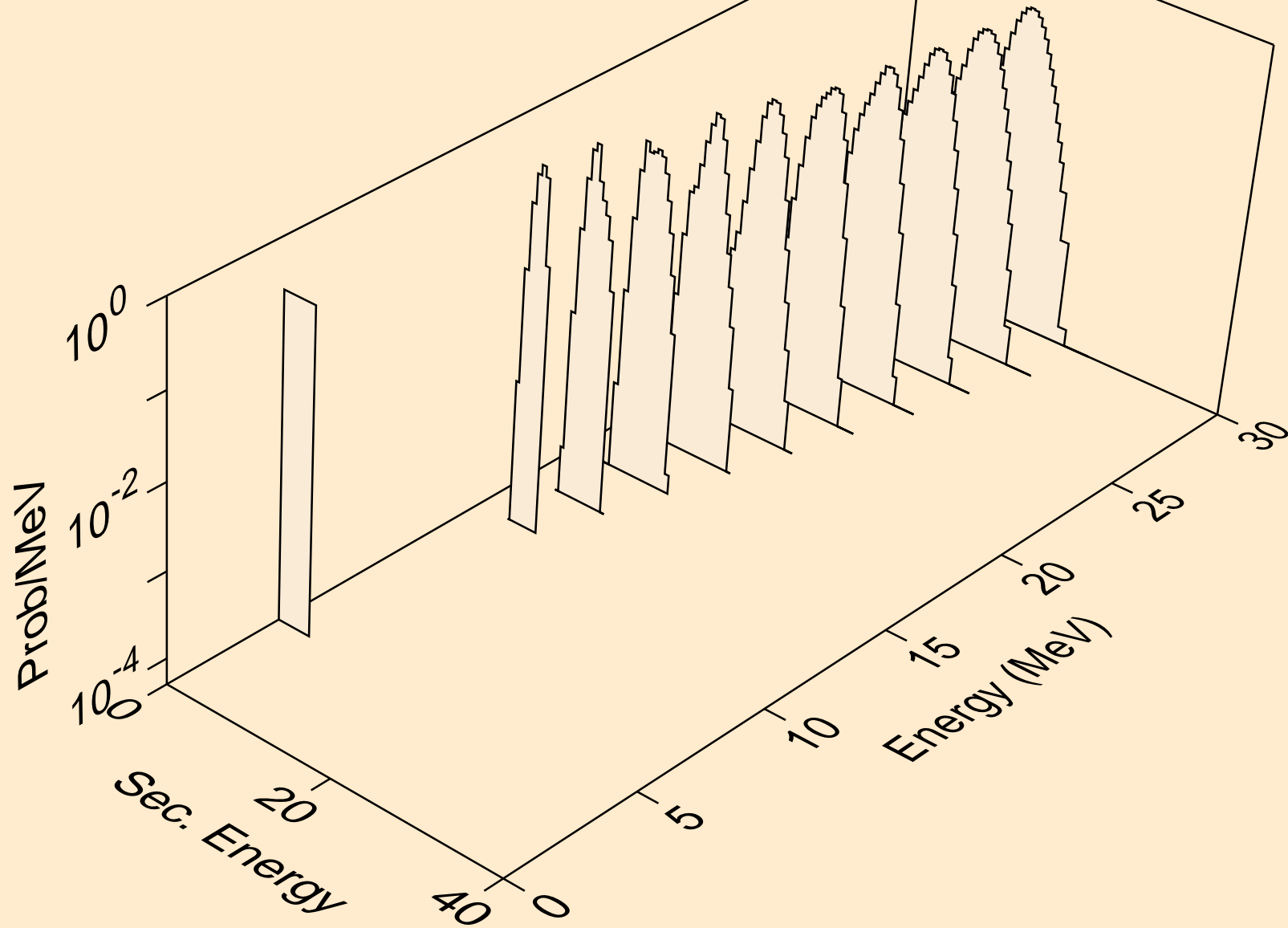

BA135 DEUTERON ACER TENDL-2023 LIBRARY; T=0.K
alphas from (d,a)

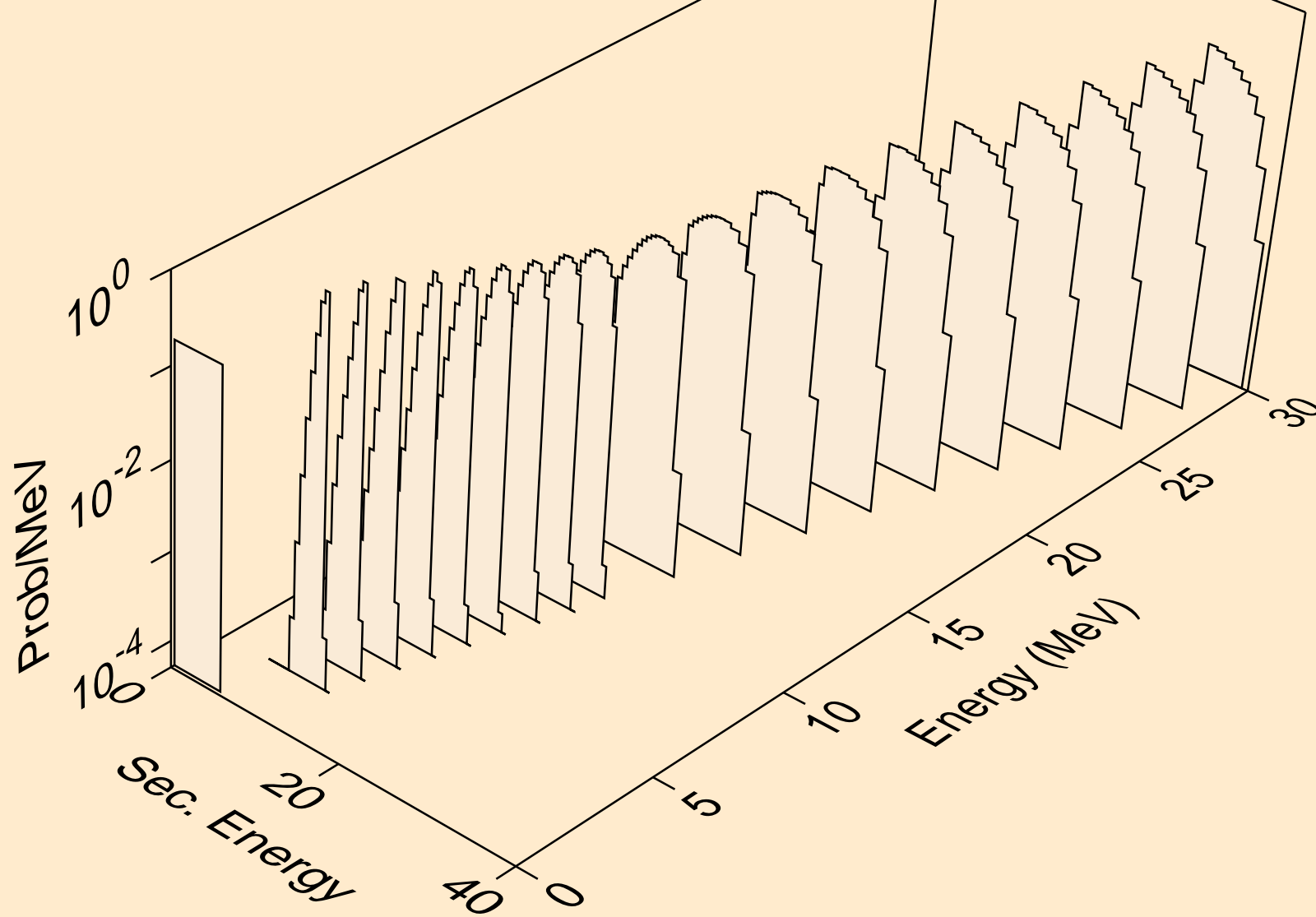

BA135 DEUTERON ACER TENDL-2023 LIBRARY; T=0.K
alphas from (d,2a)

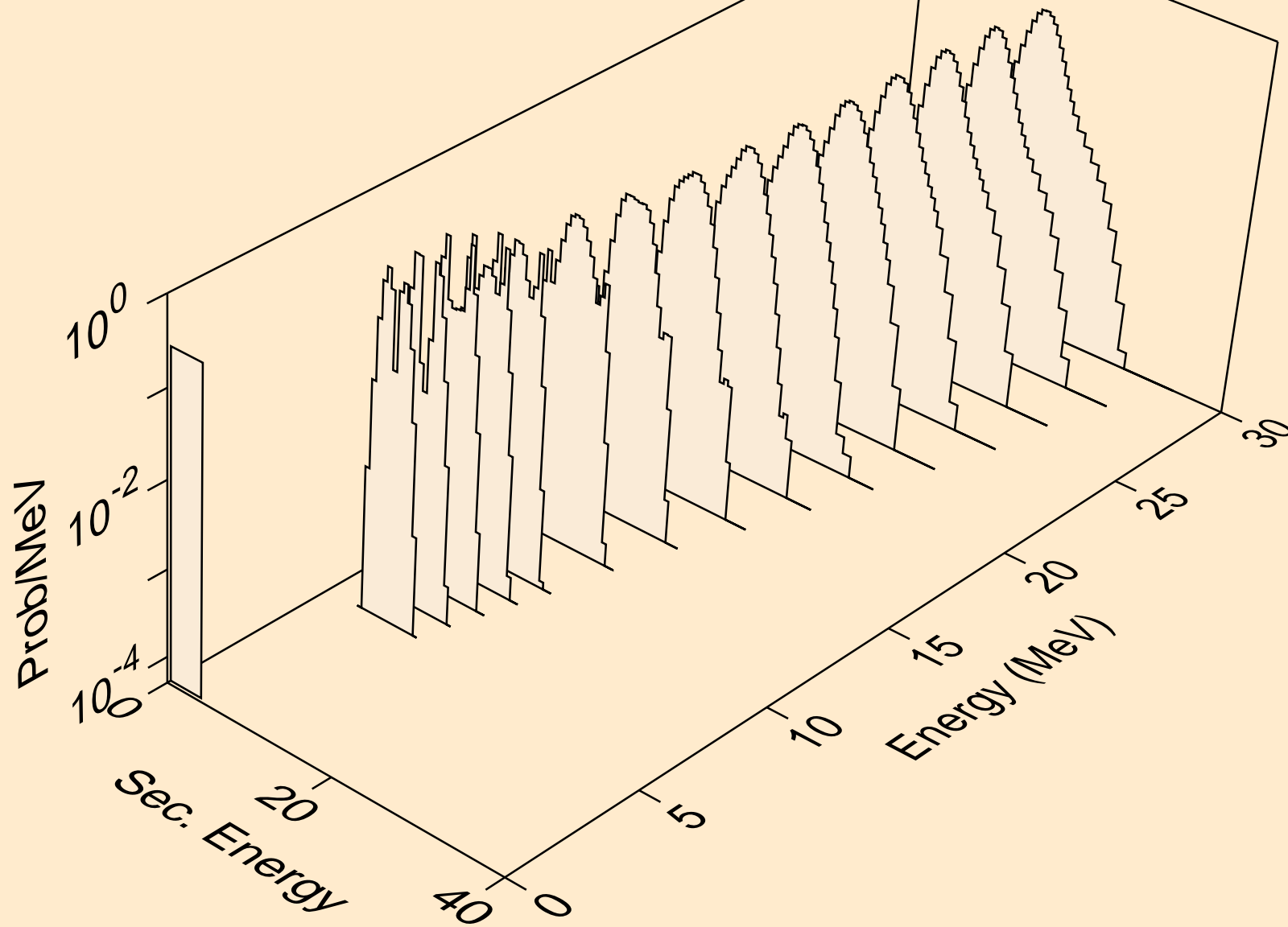

BA135 DEUTERON ACER TENDL-2023 LIBRARY; T=0.K
alphas from (d,pa)

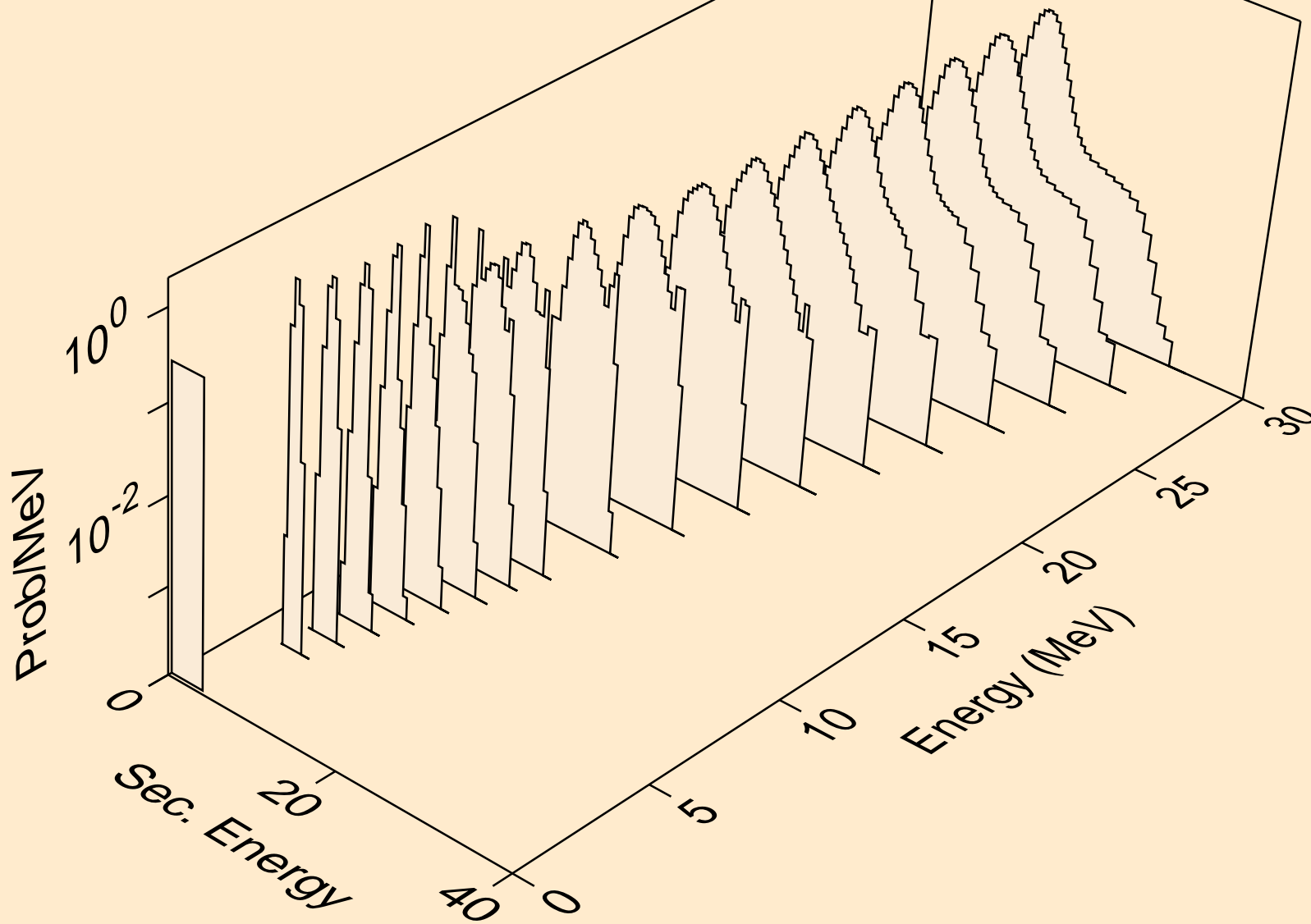

BA135 DEUTERON ACER TENDL-2023 LIBRARY; T=0.K
alphas from (d,da)

