

# BE010 DEUTERON ACER TENDL-2023 LIBRARY; T=0.K

## Principal cross sections

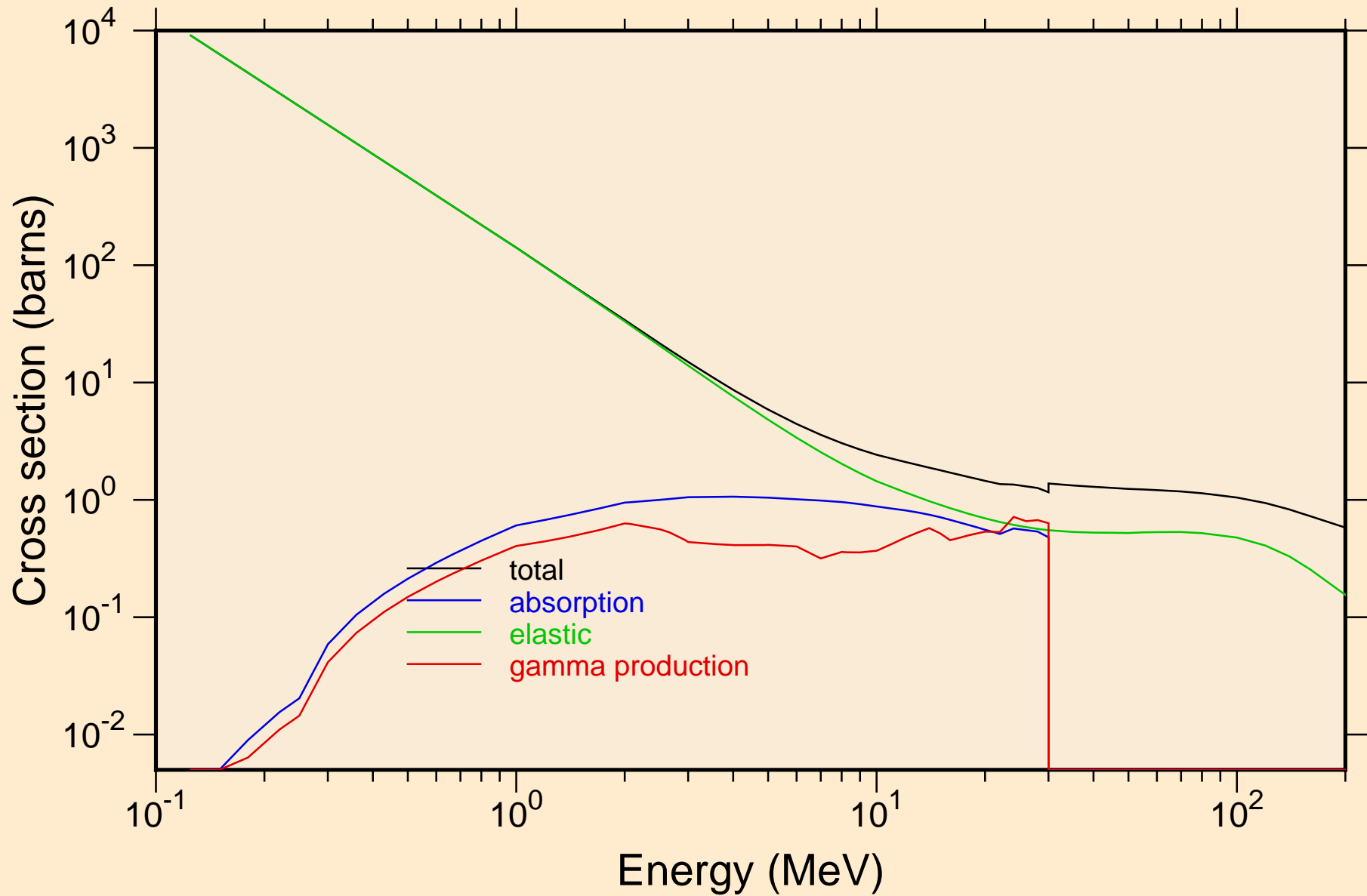

# BE010 DEUTERON ACER TENDL-2023 LIBRARY; T=0.K

## Heating

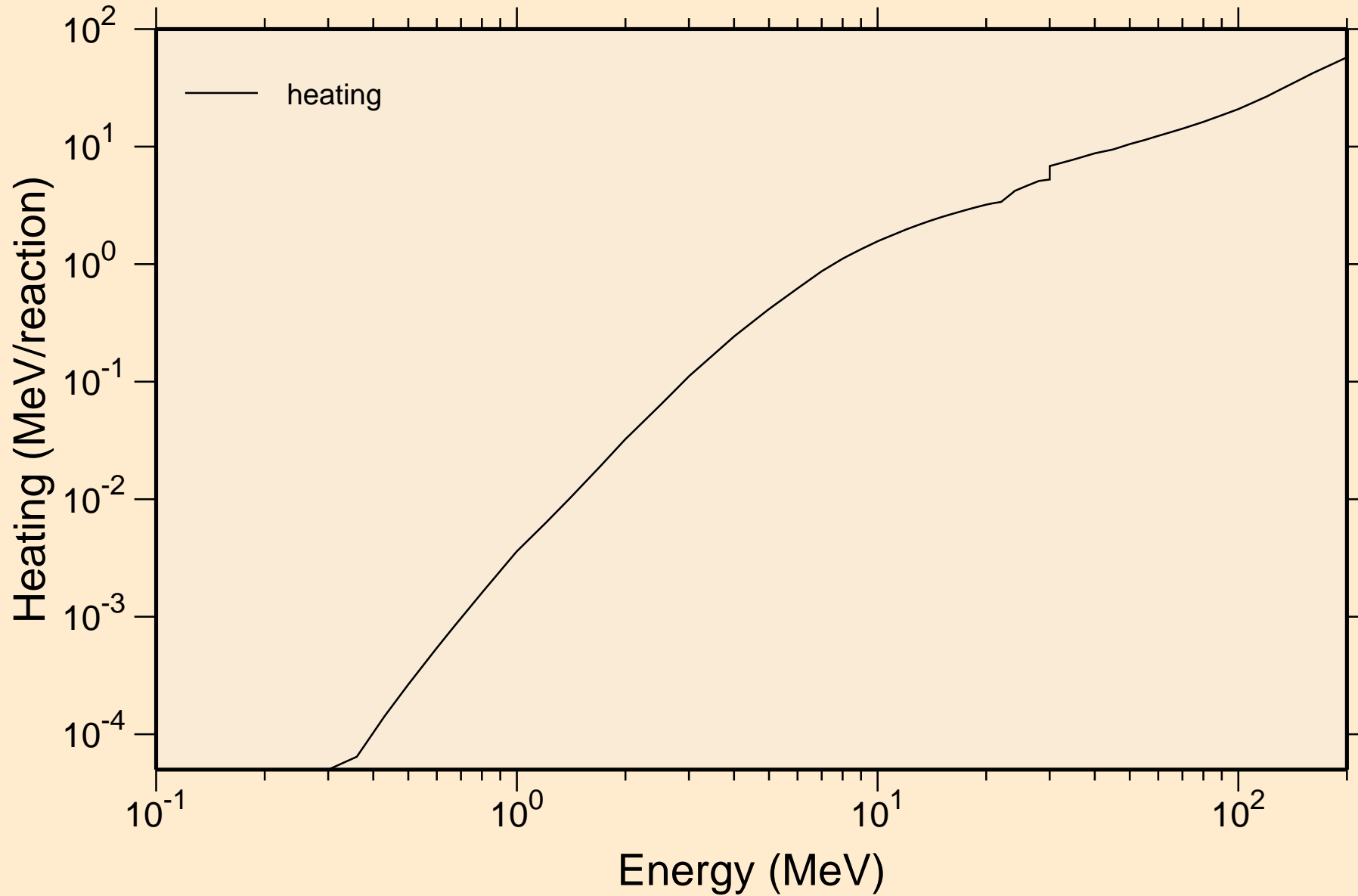

BE010 DEUTERON ACER TENDL-2023 LIBRARY; T=0.K  
Principal cross sections

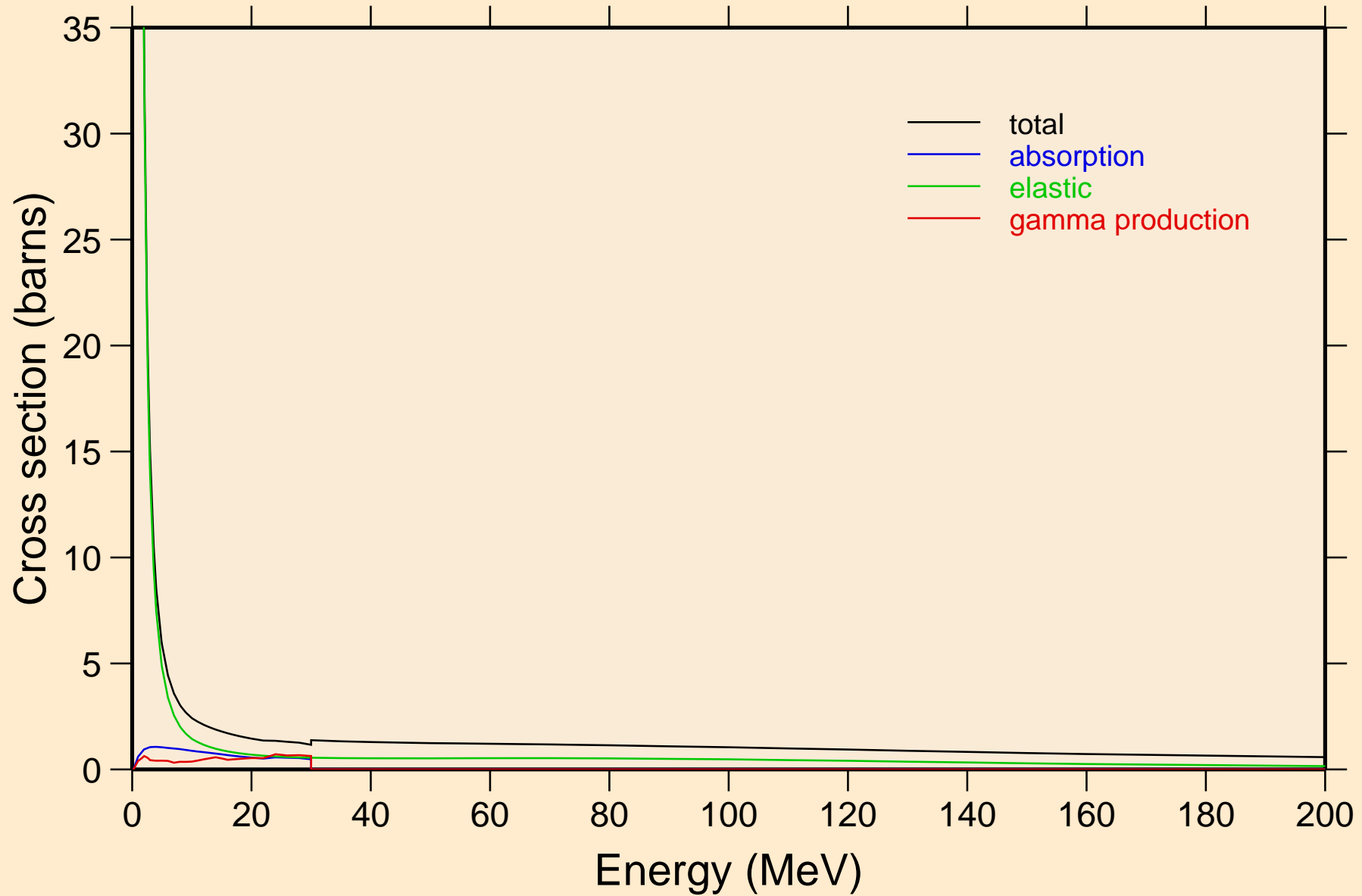

# BE010 DEUTERON ACER TENDL-2023 LIBRARY; T=0.K

## Heating

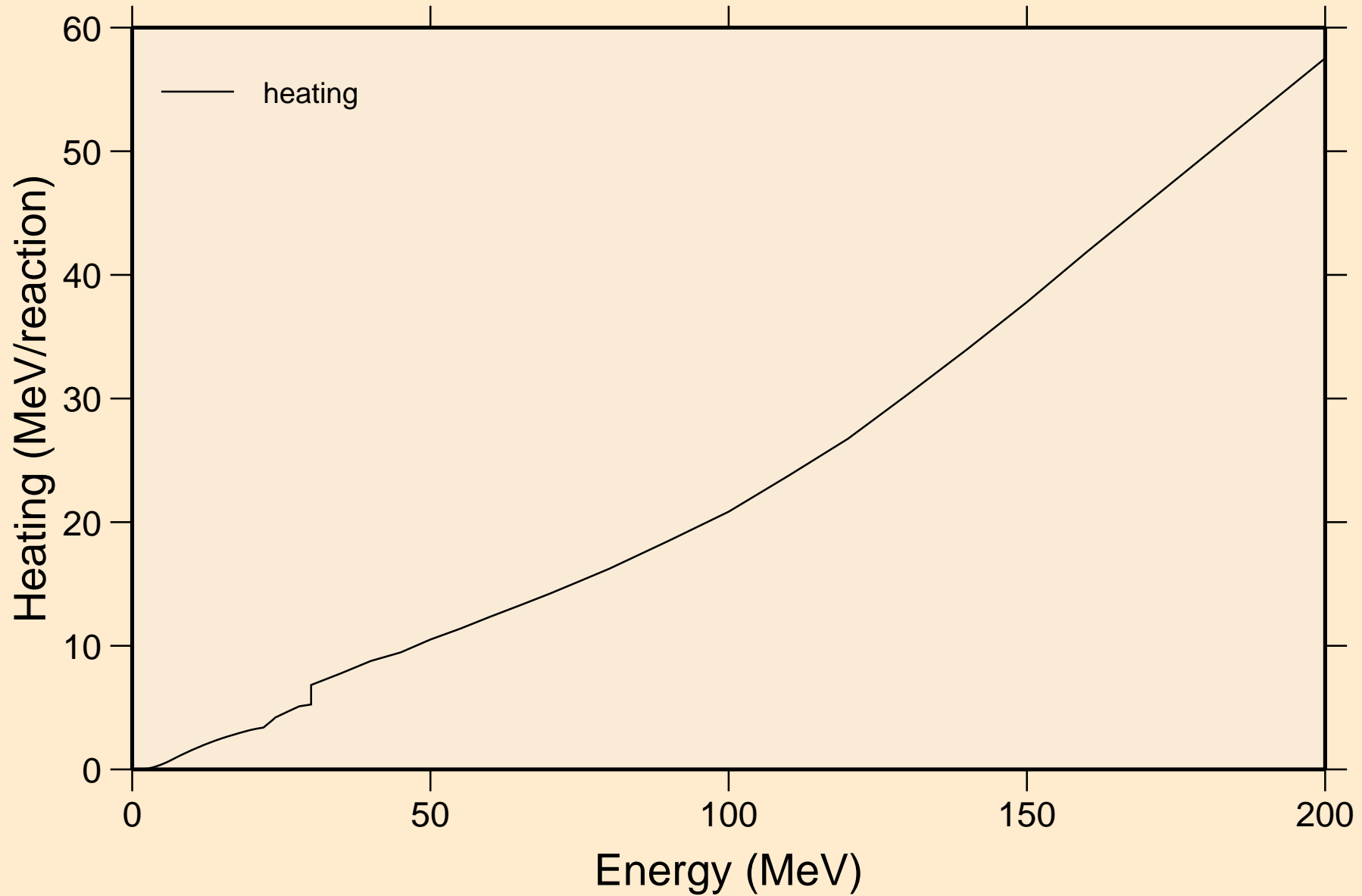

BE010 DEUTERON ACER TENDL-2023 LIBRARY; T=0.K  
Threshold reactions

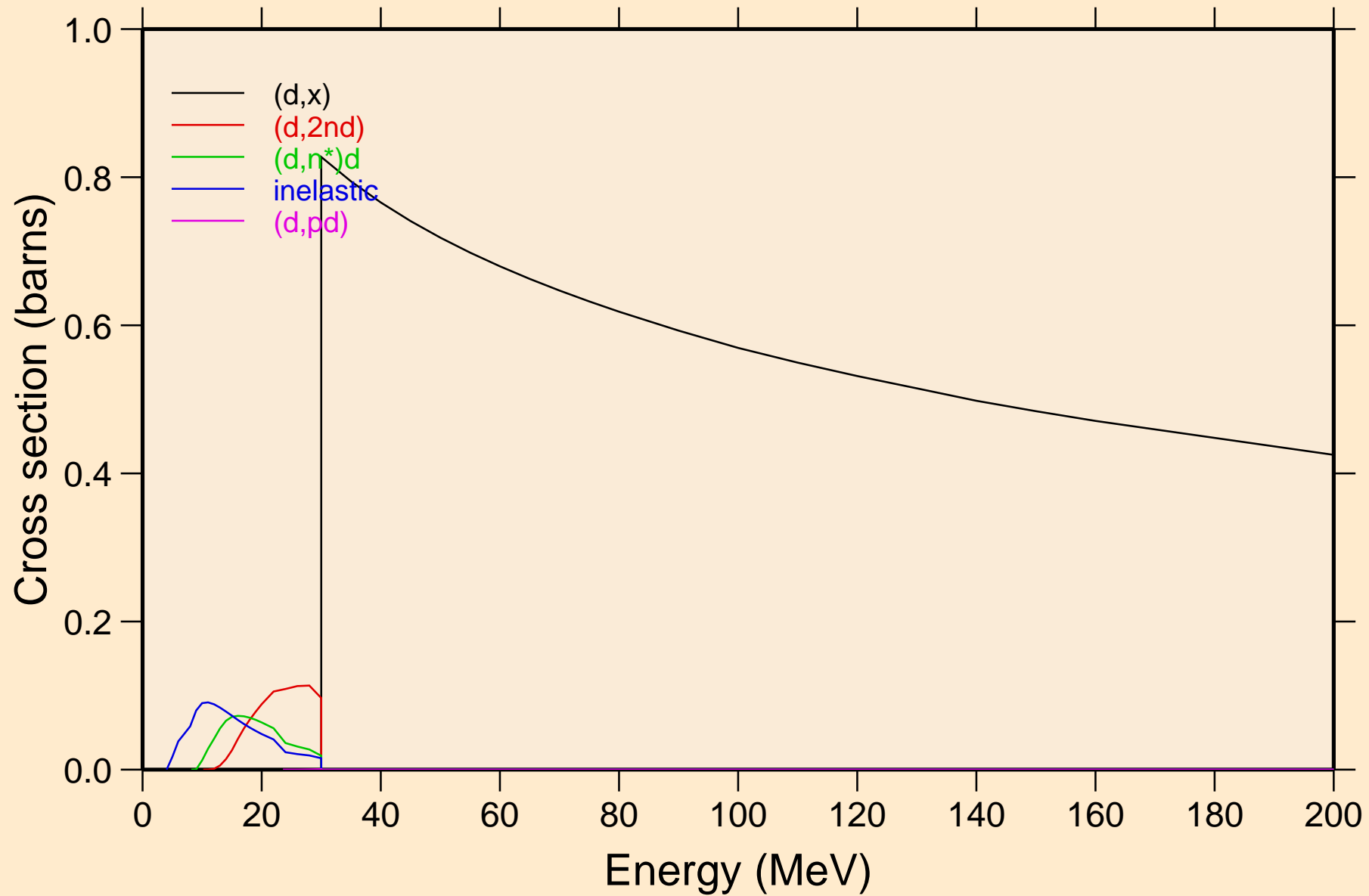

BE010 DEUTERON ACER TENDL-2023 LIBRARY; T=0.K  
Threshold reactions

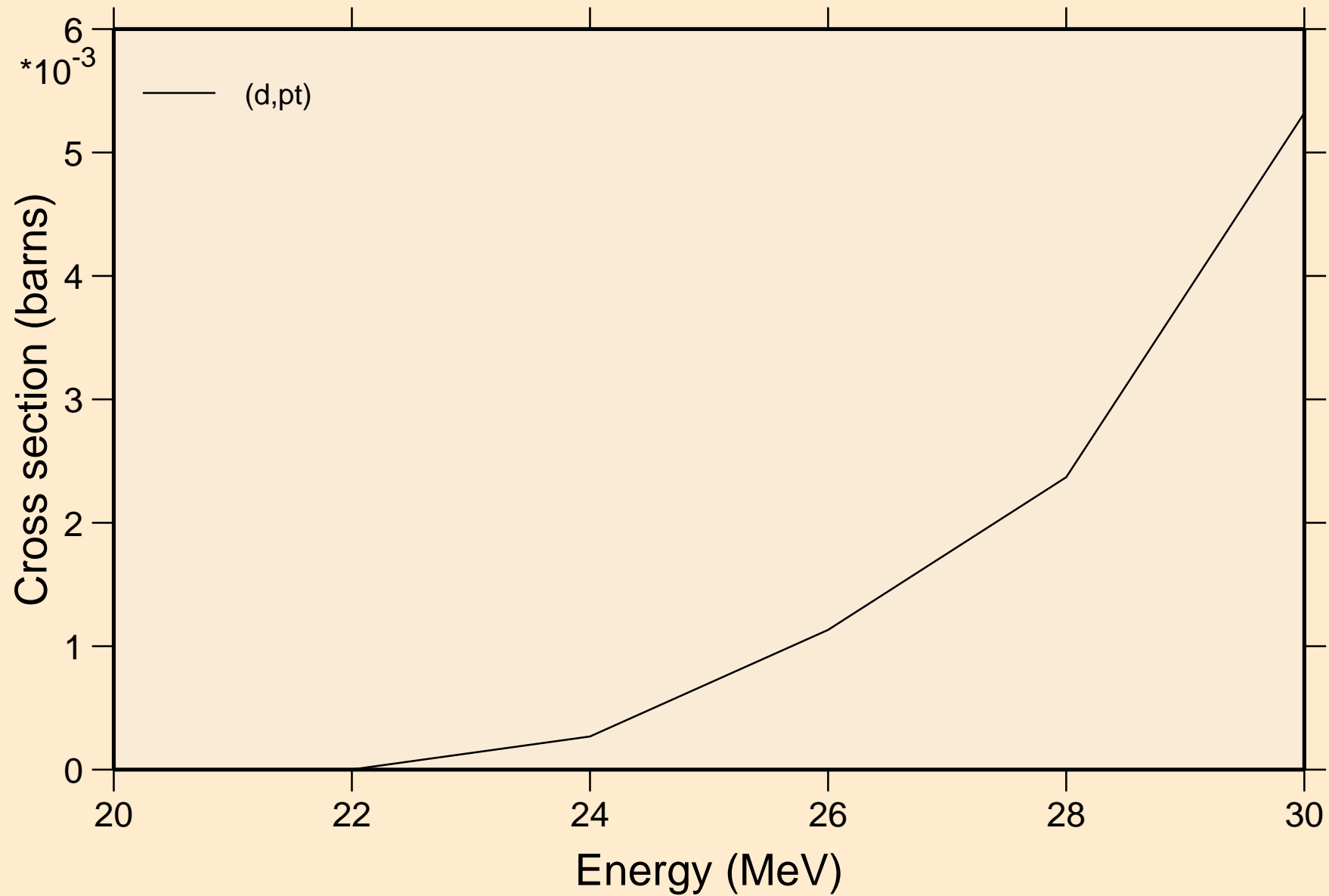

BE010 DEUTERON ACER TENDL-2023 LIBRARY; T=0.K  
angular distribution for elastic

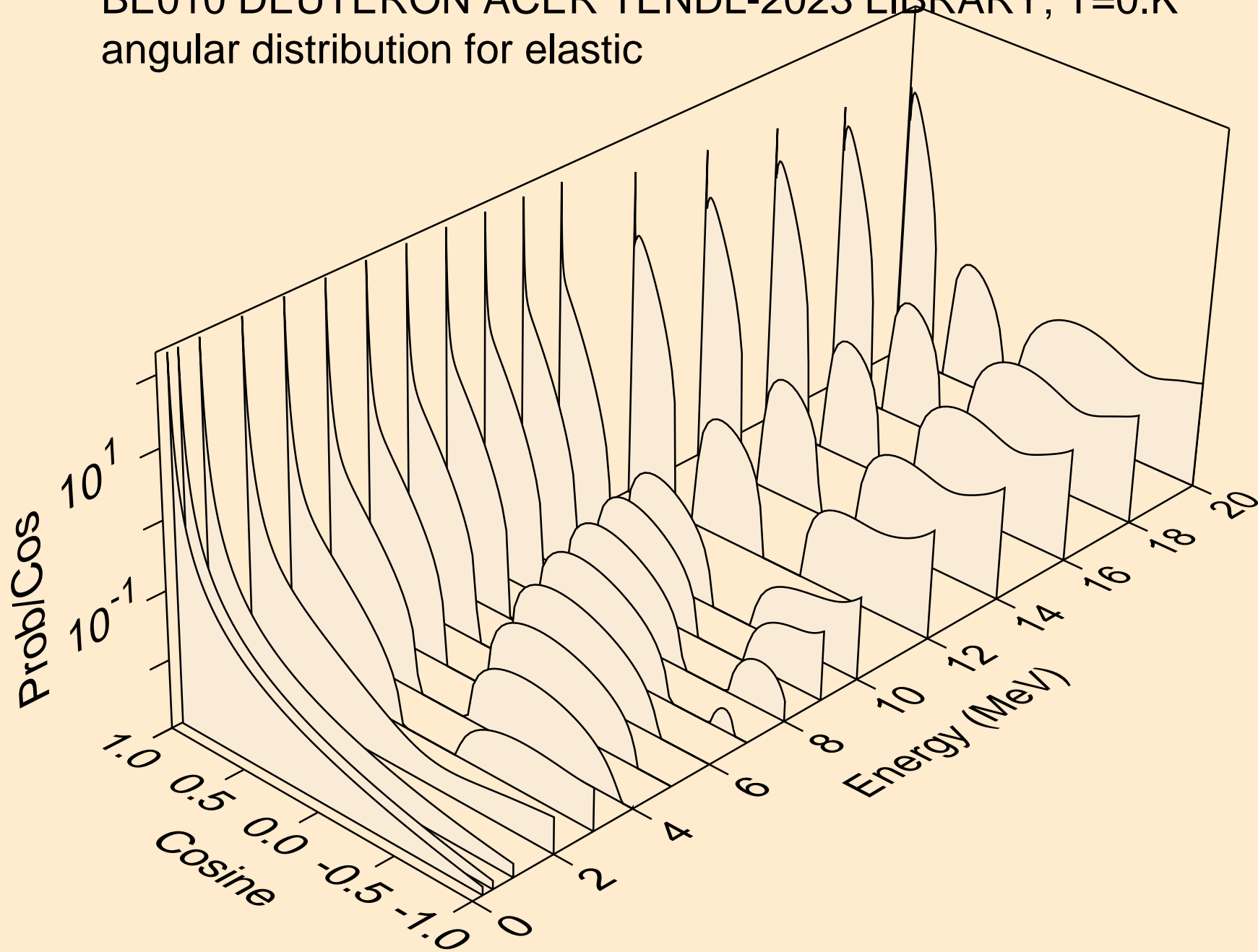

BE010 DEUTERON ACER TENDL-2023 LIBRARY; T=0.K  
angular distribution for elastic

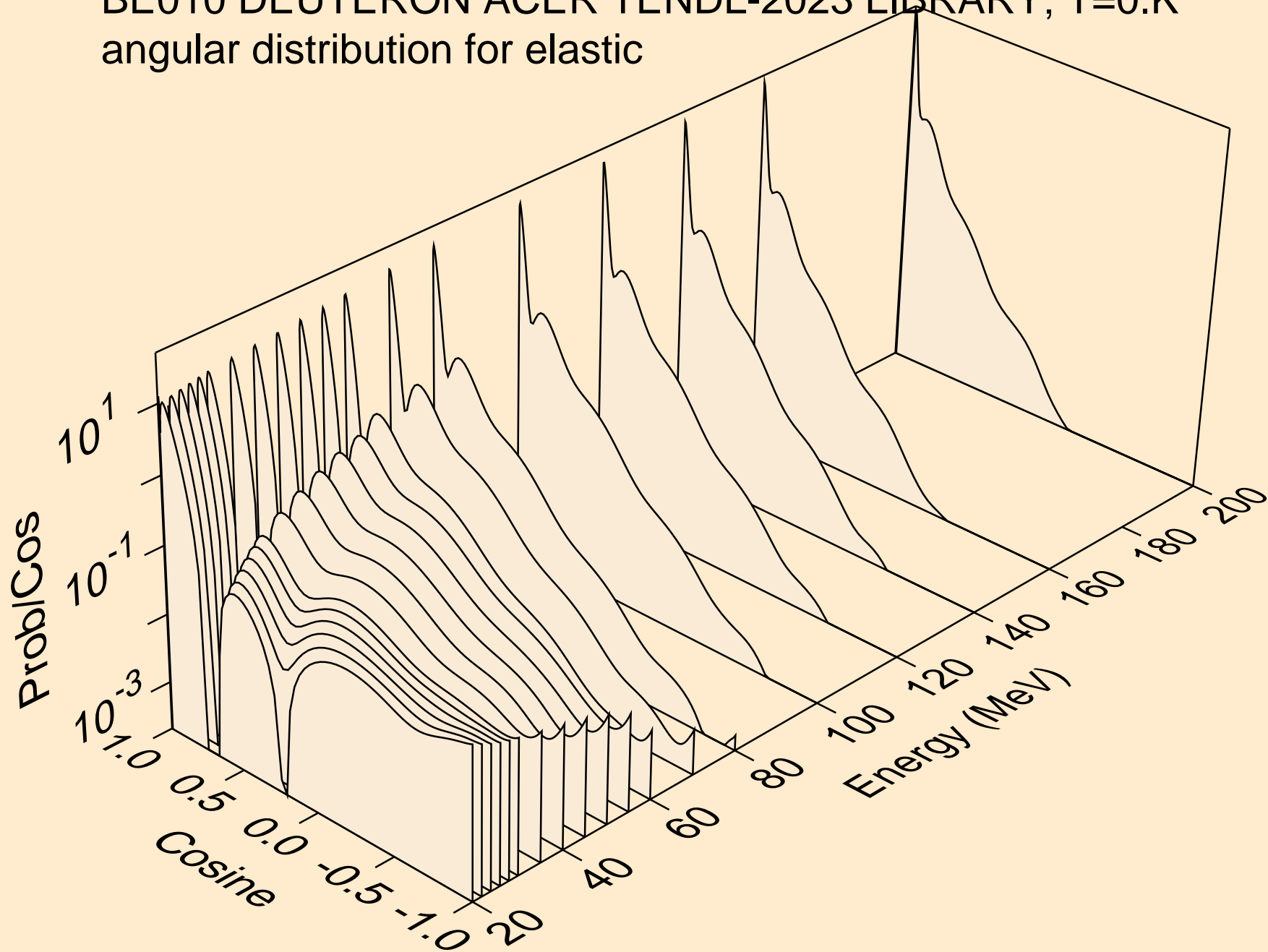



BE010 DEUTERON ACER TENDL-2023 LIBRARY; T=0.K  
Deuteron emission for (d,x)

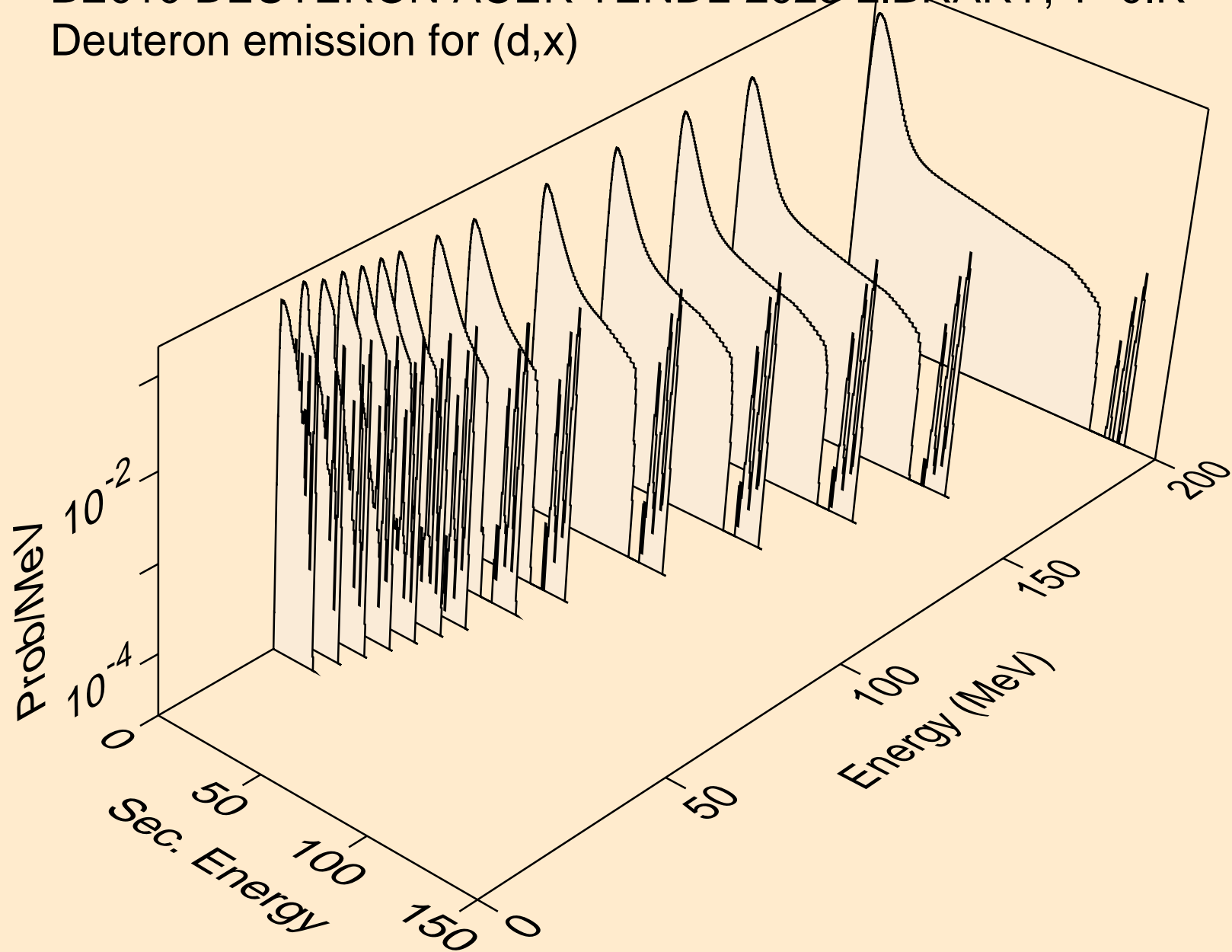

BE010 DEUTERON ACER TENDL-2023 LIBRARY; T=0.K  
Deuteron emission for (d,2nd)

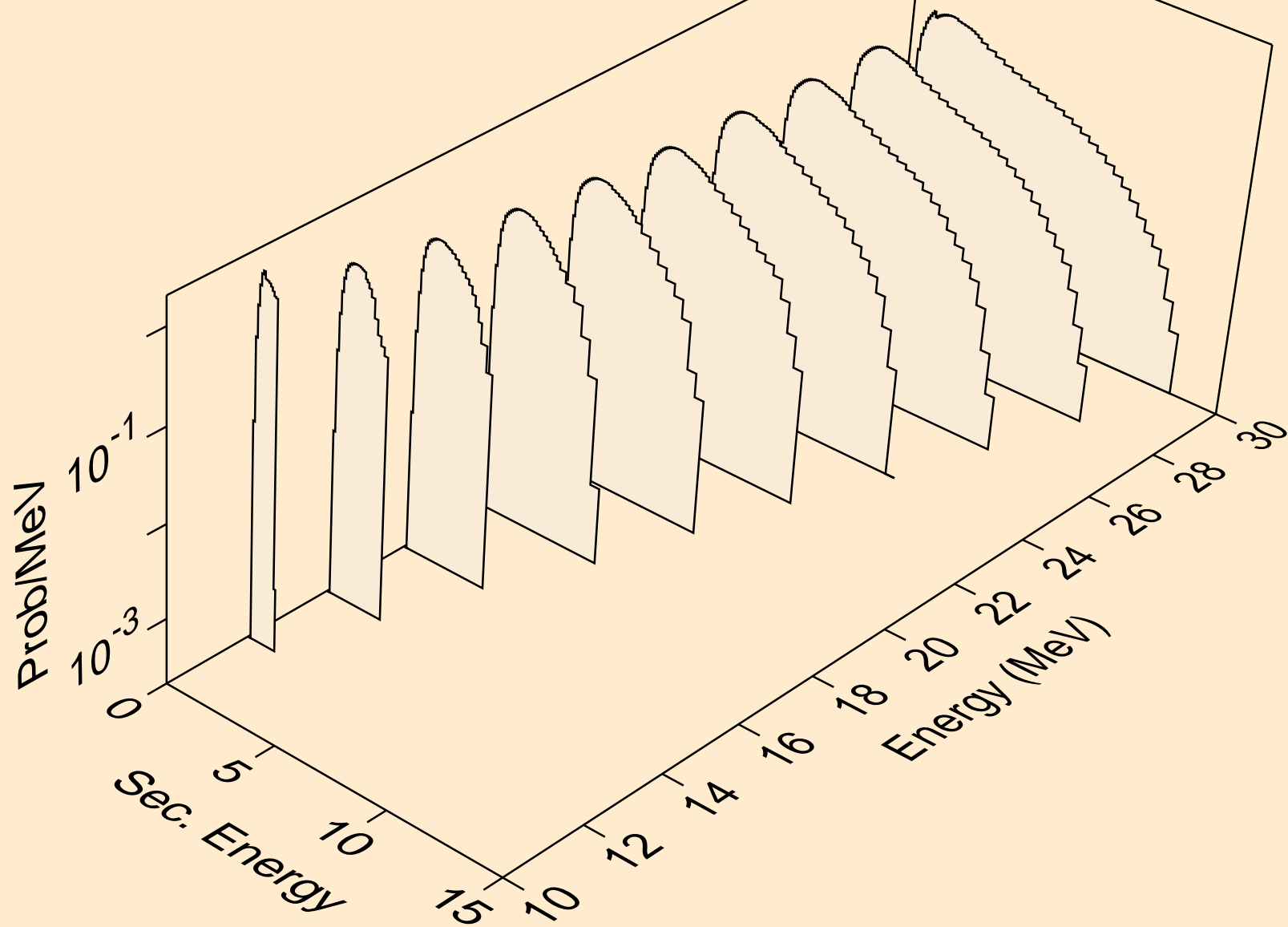

BE010 DEUTERON ACER TENDL-2023 LIBRARY; T=0.K  
Deuteron emission for (d,n\*)d

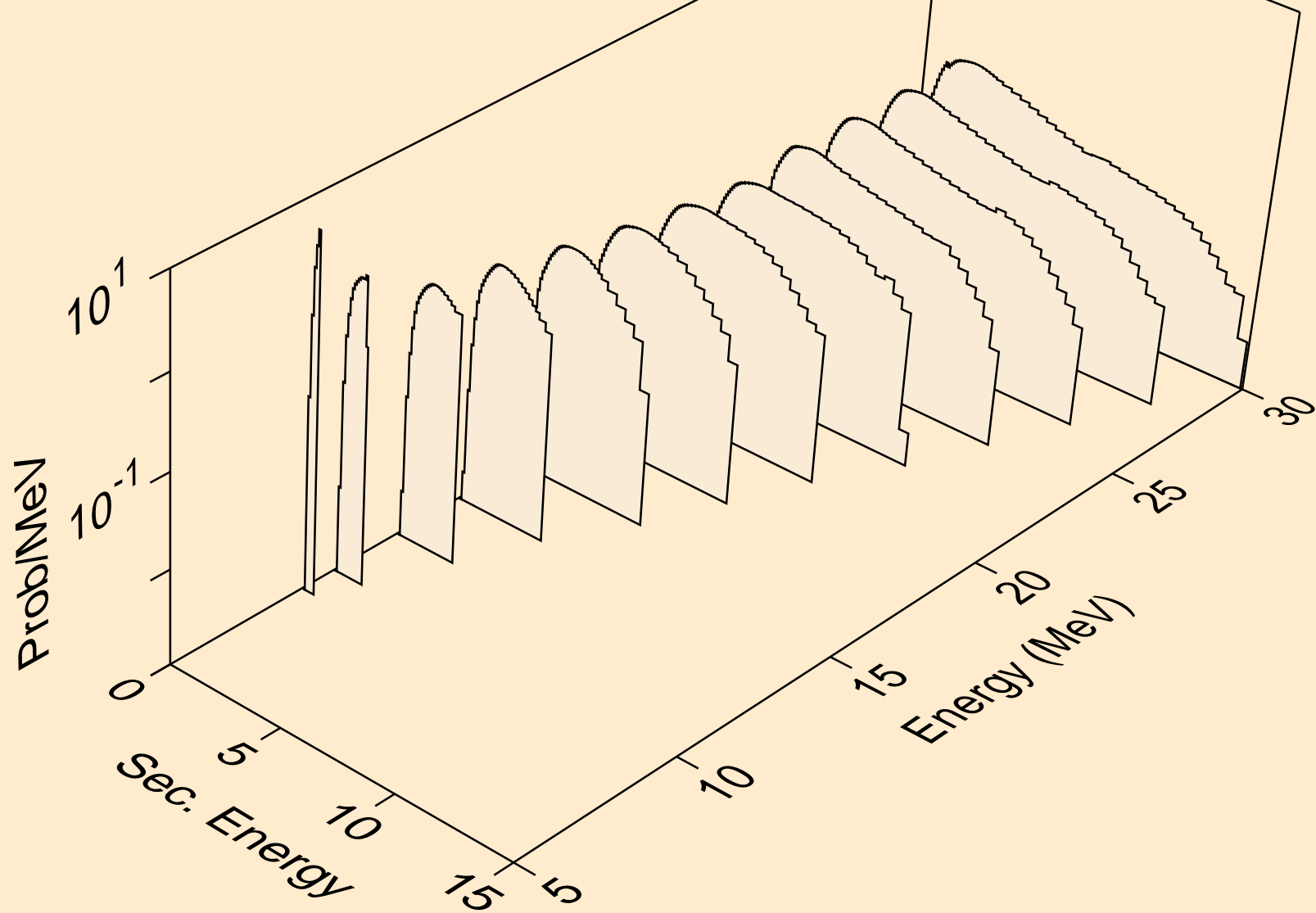

BE010 DEUTERON ACER TENDL-2023 LIBRARY; T=0.K  
Deuteron emission for inelastic

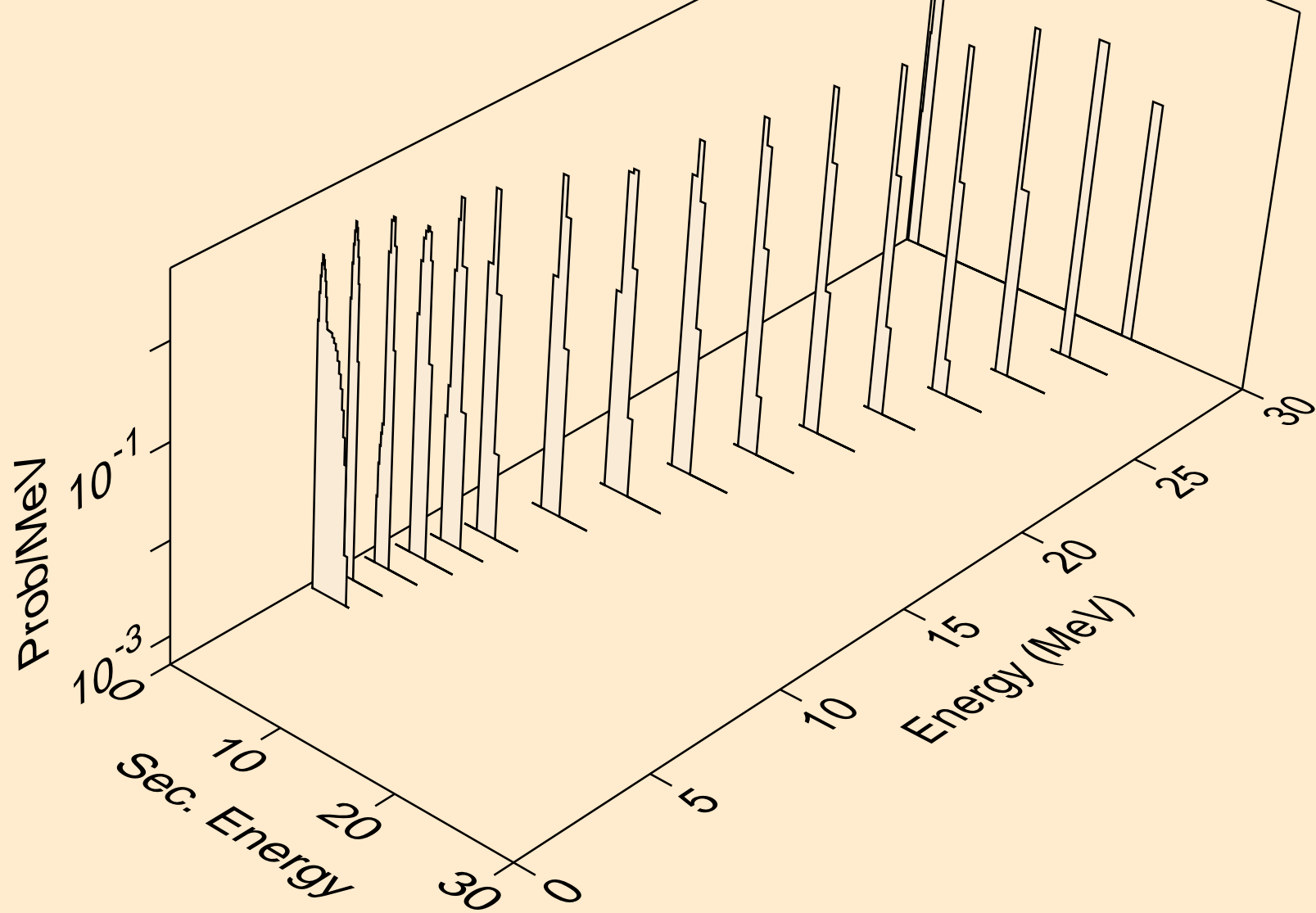

BE010 DEUTERON ACER TENDL-2023 LIBRARY; T=0.K  
Deuteron emission for (d,pd)

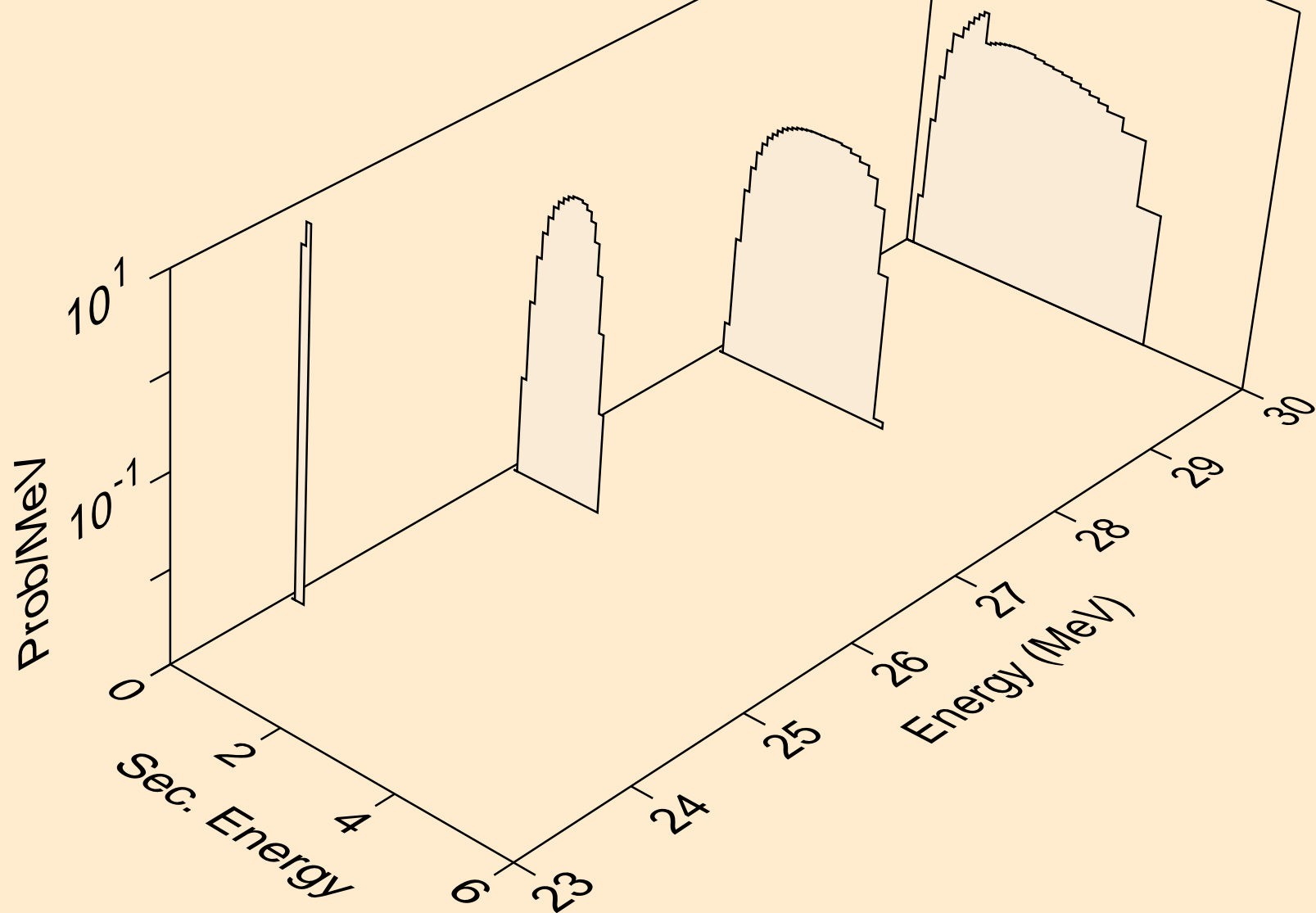

BE010 DEUTERON ACER TENDL-2023 LIBRARY; T=0.K  
Photon emission for (z,n)

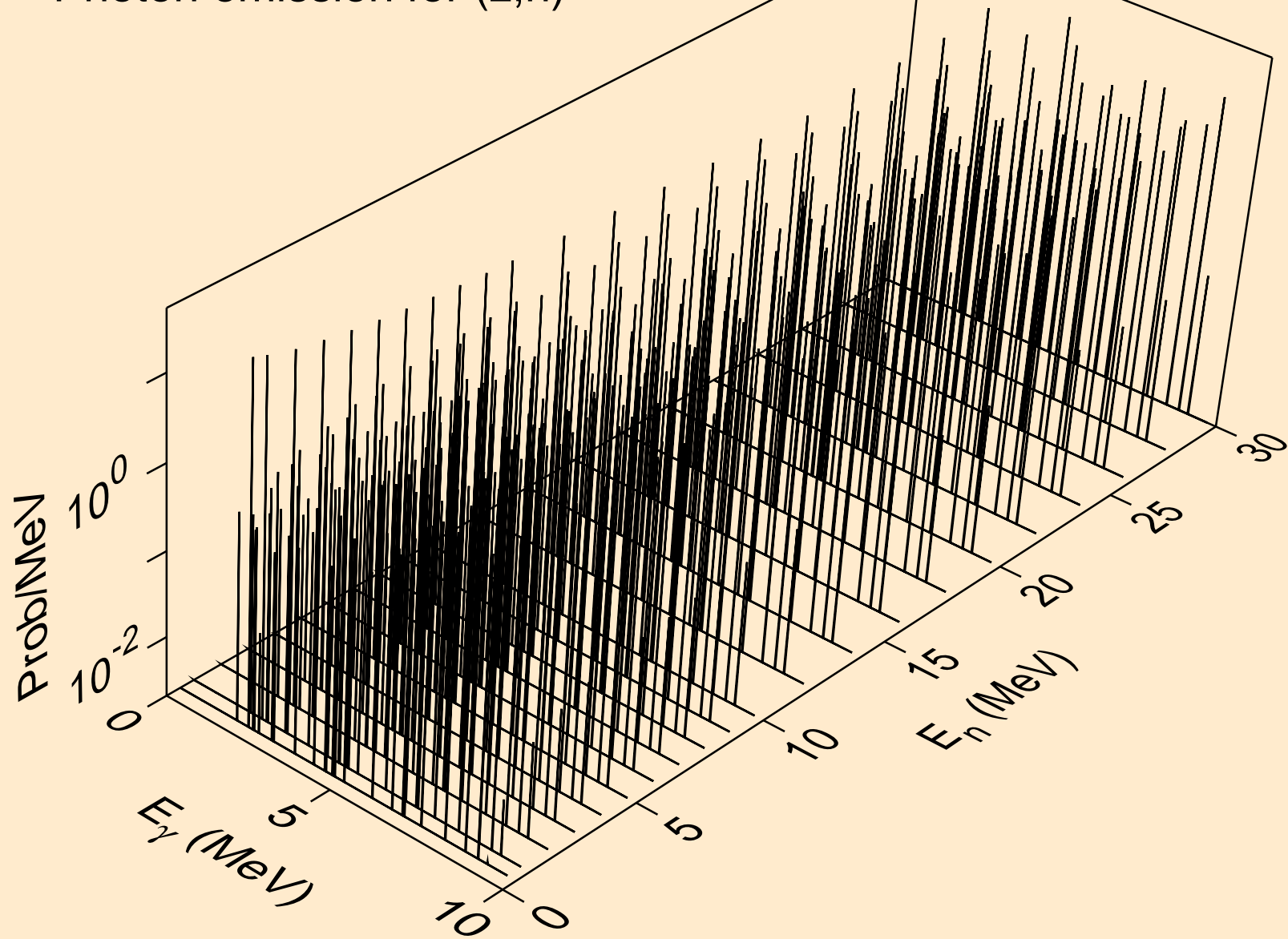

BE010 DEUTERON ACER TENDL-2023 LIBRARY; T=0.K  
Photon emission for (z,x)

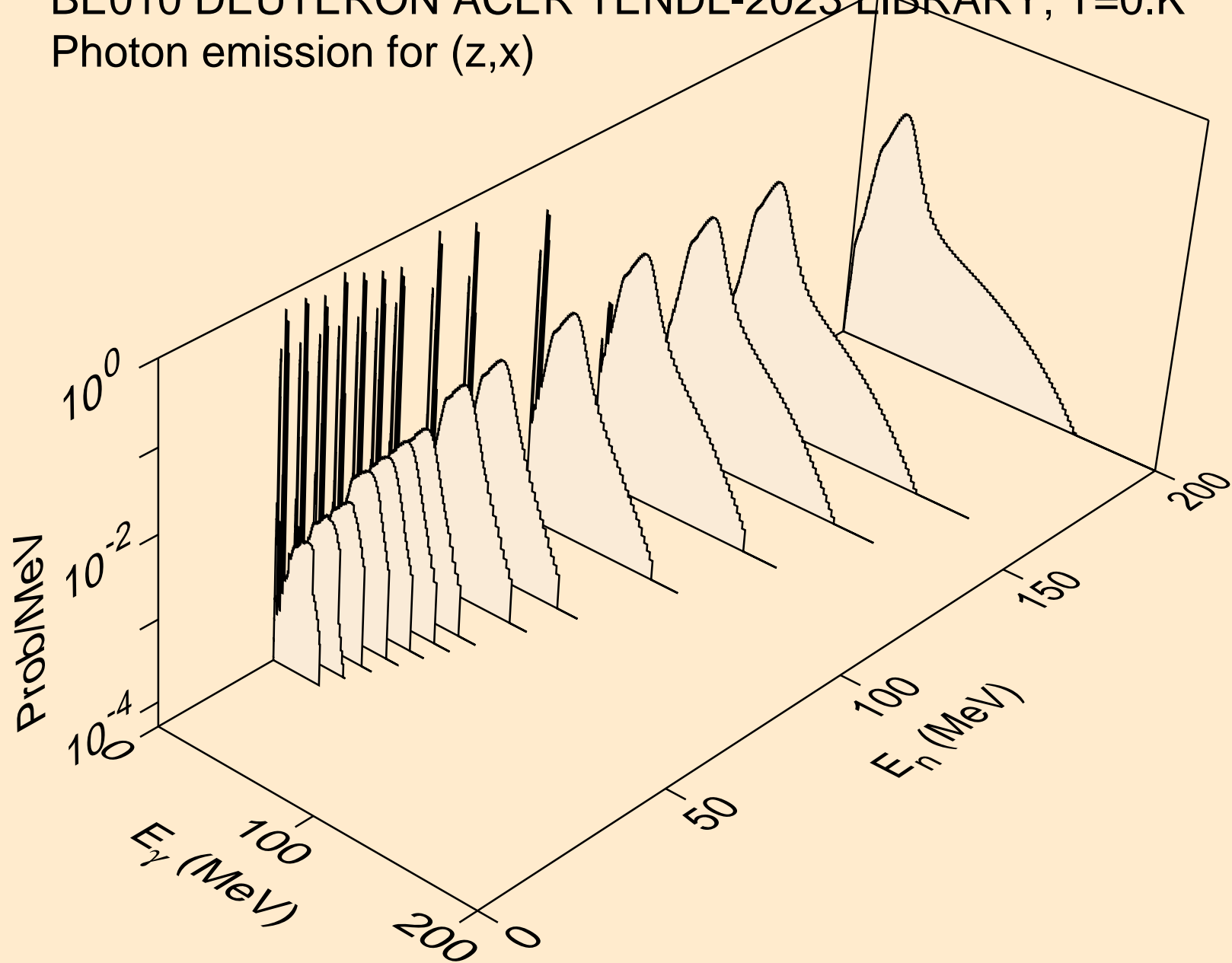

BE010 DEUTERON ACER TENDL-2023 LIBRARY; T=0.K  
Photon emission for (n,2nd)

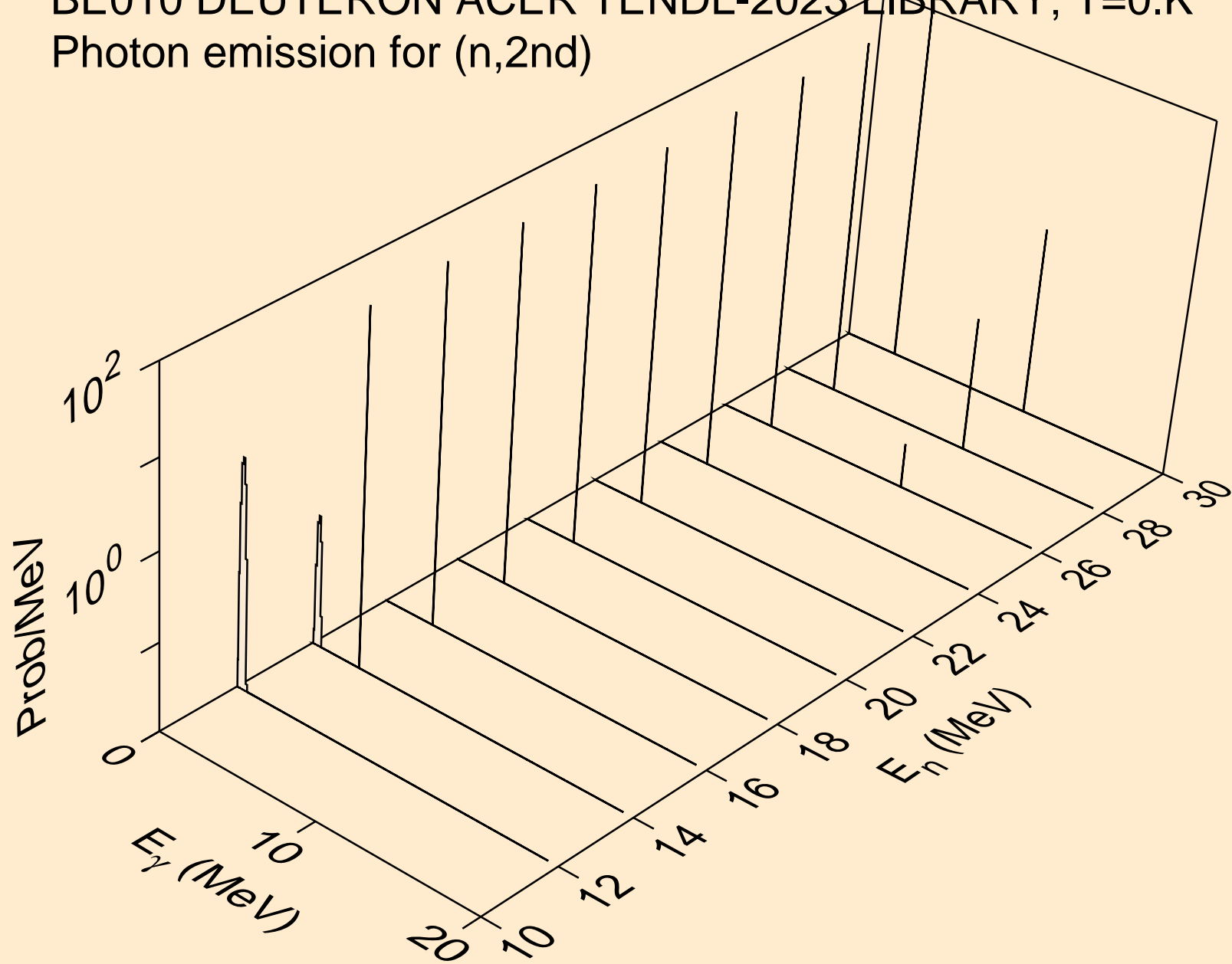



BE010 DEUTERON ACER TENDL-2023 LIBRARY; T=0.K  
Photon emission for (n,2n)

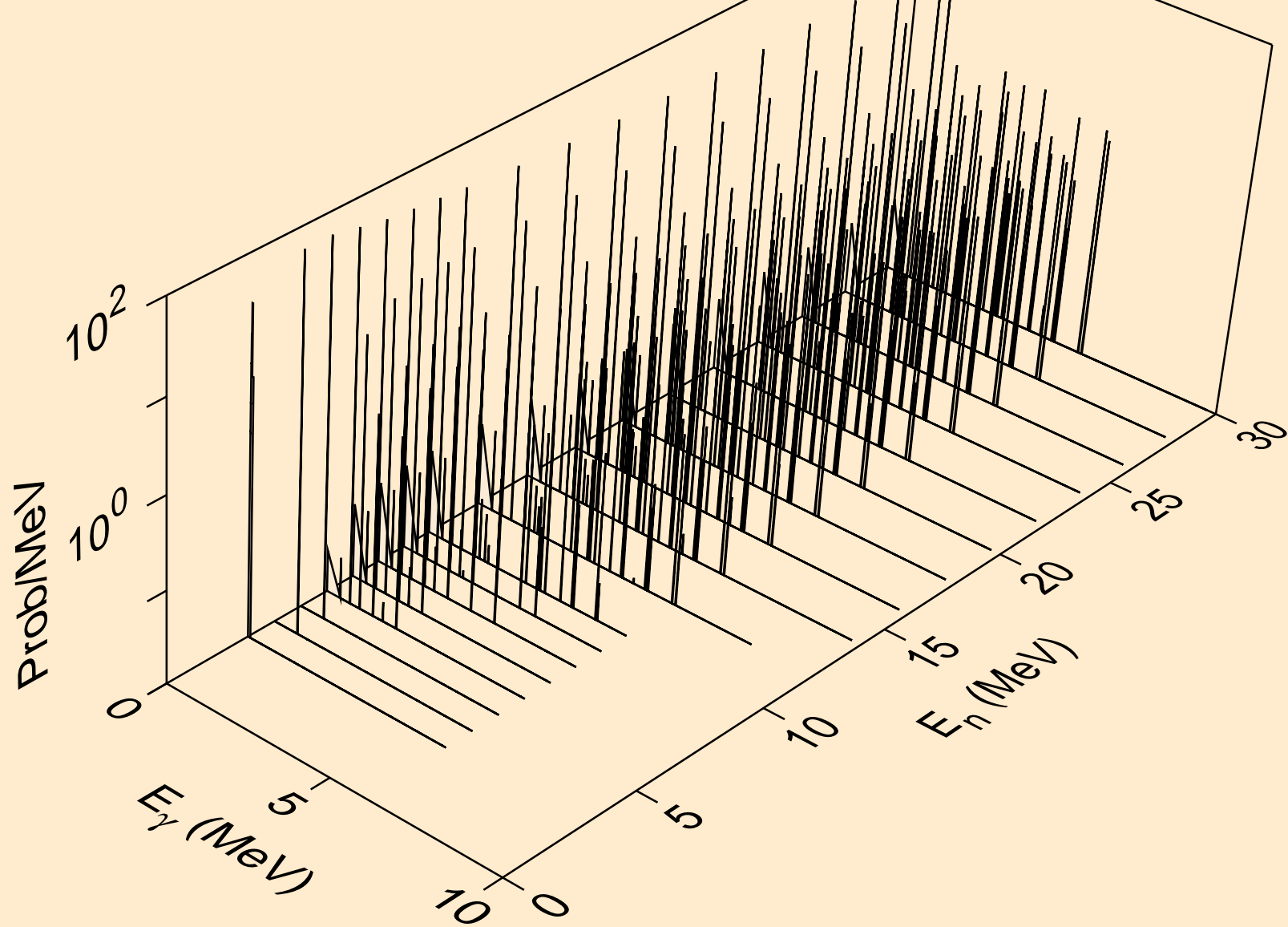

BE010 DEUTERON ACER TENDL-2023 LIBRARY; T=0.K  
Photon emission for (n,3n)

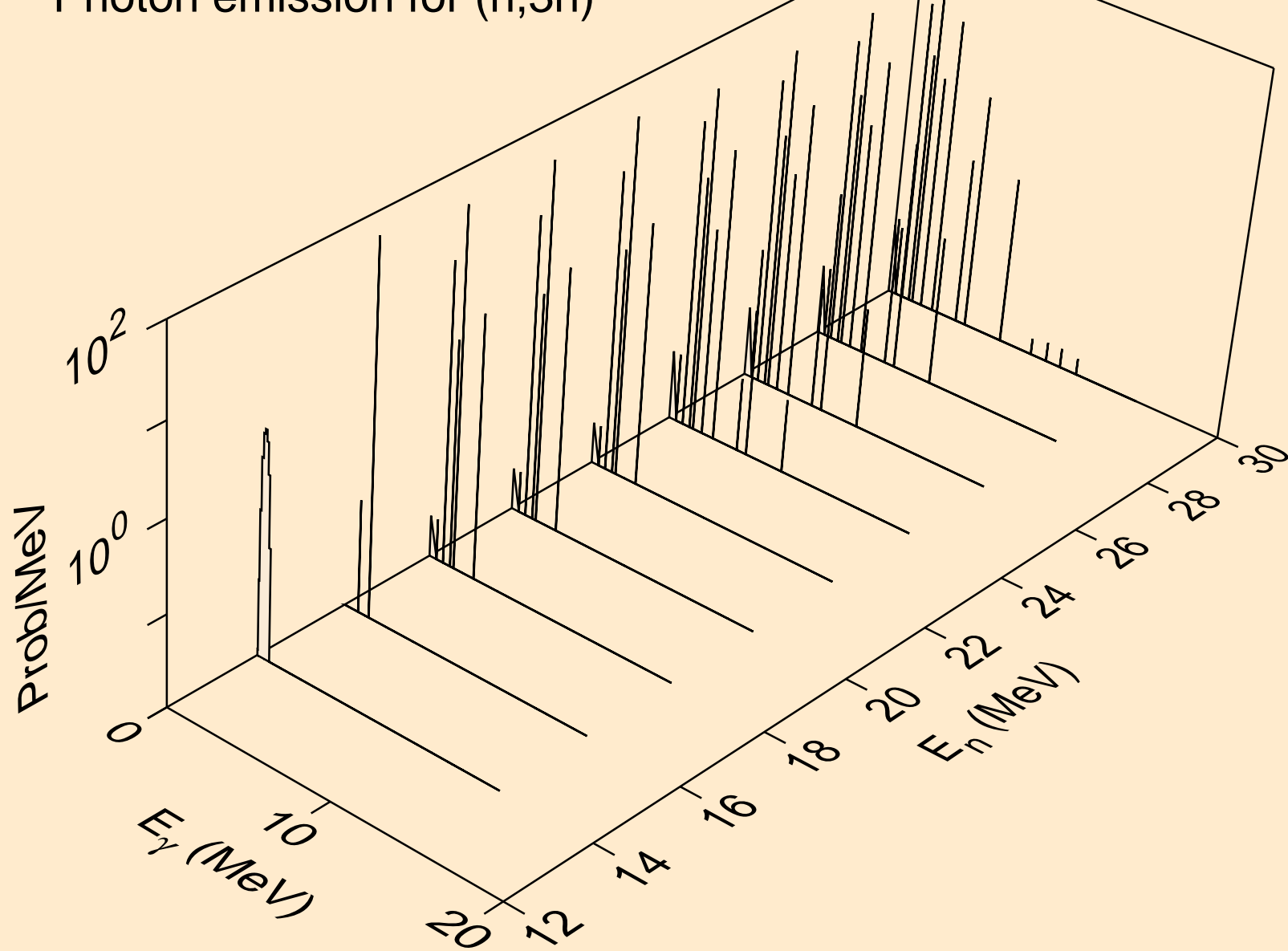

BE010 DEUTERON ACER TENDL-2023 LIBRARY; T=0.K  
Photon emission for (n,n\*)a

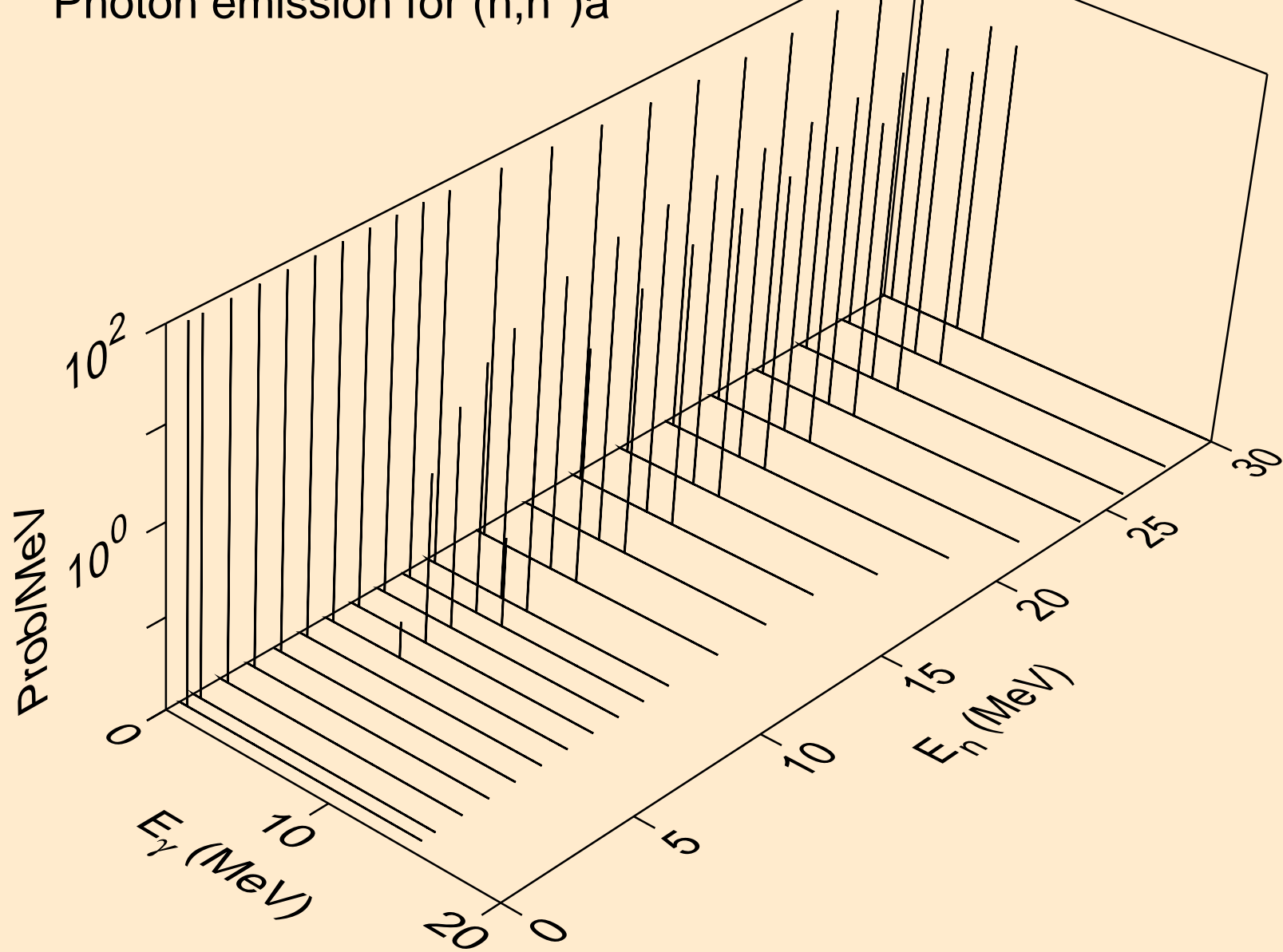

BE010 DEUTERON ACER TENDL-2023 LIBRARY; T=0.K  
Photon emission for (n,2n)a

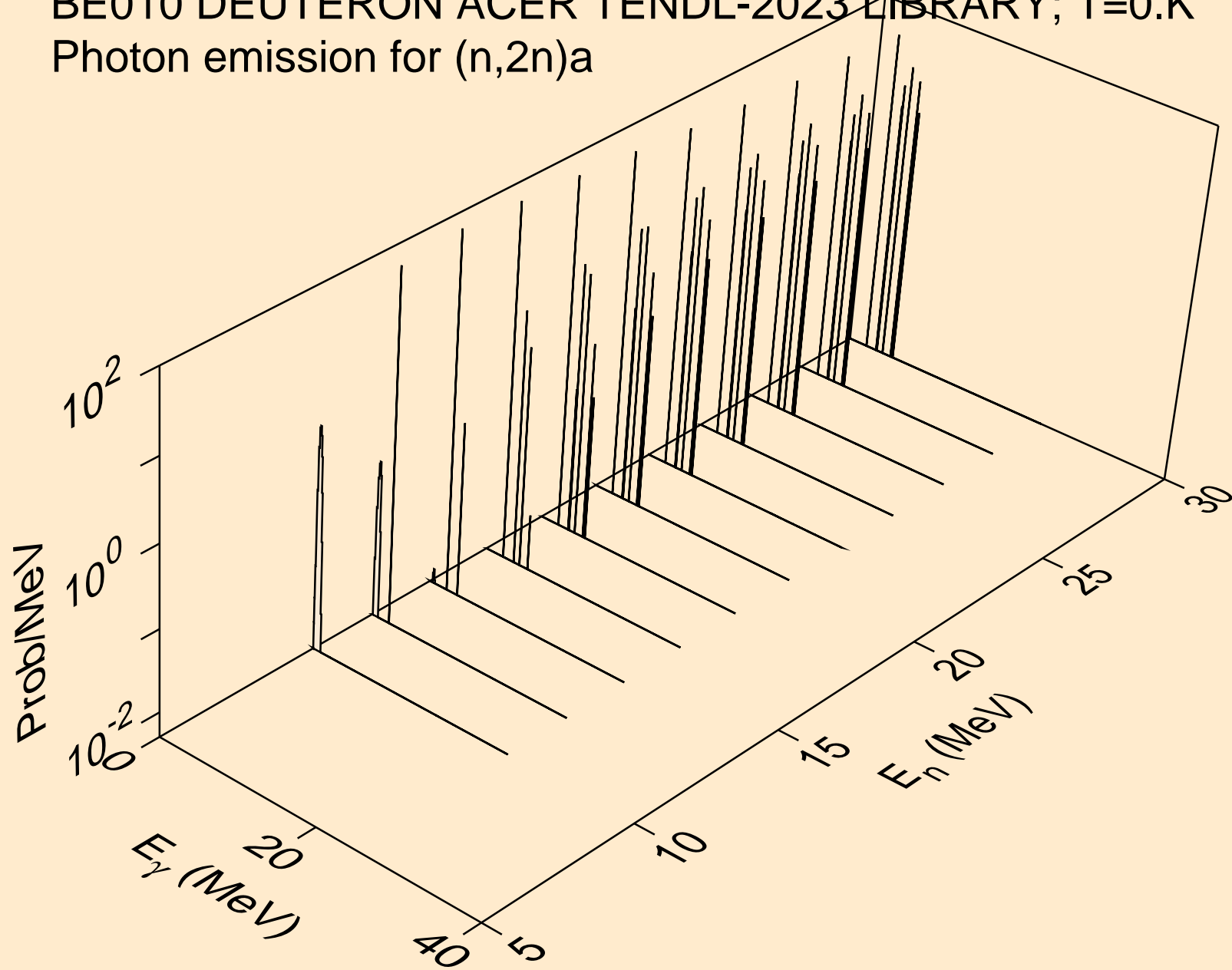

BE010 DEUTERON ACER TENDL-2023 LIBRARY; T=0.K  
Photon emission for (n,n\*)p

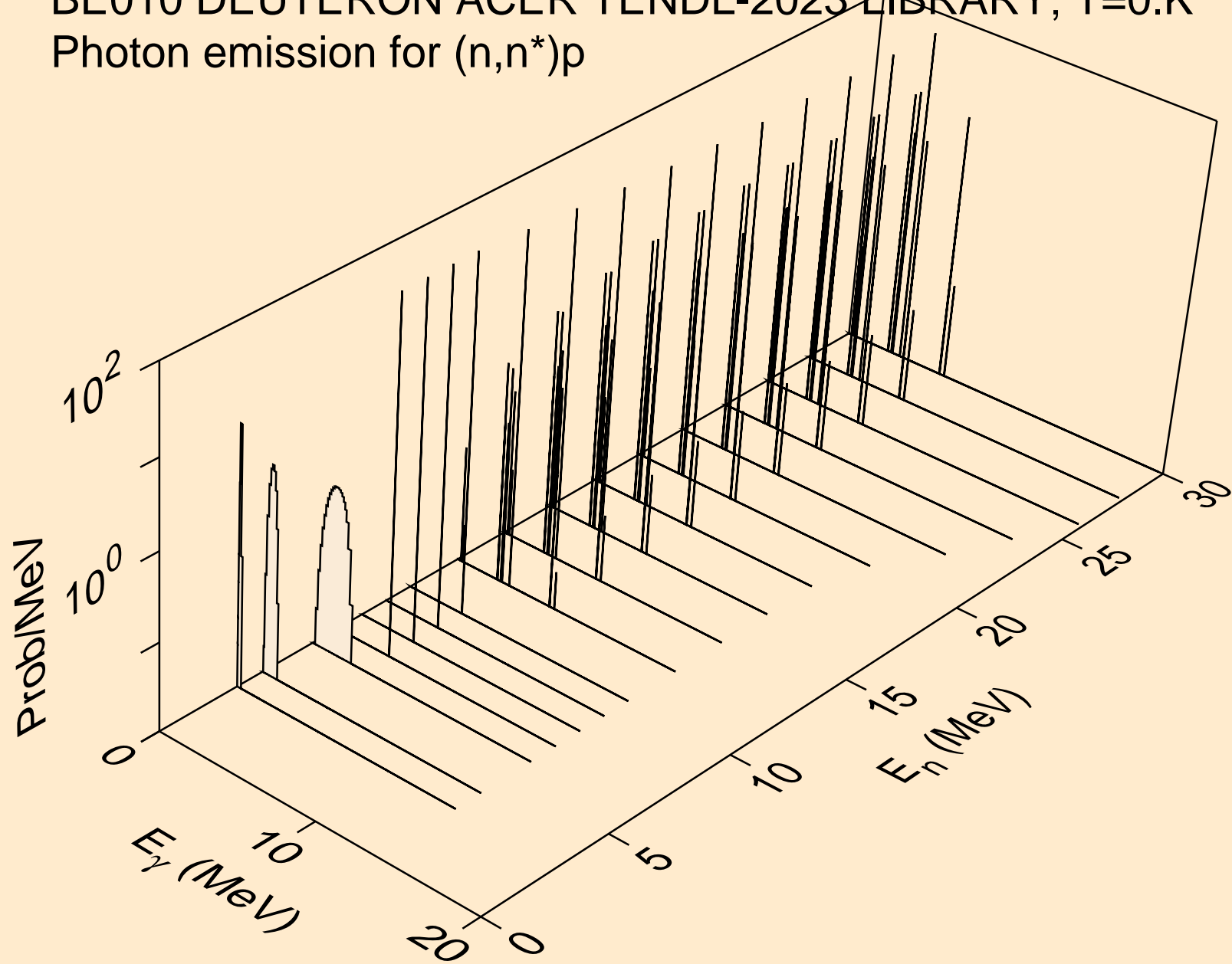

BE010 DEUTERON ACER TENDL-2023 LIBRARY; T=0.K  
Photon emission for (n,n\*)d

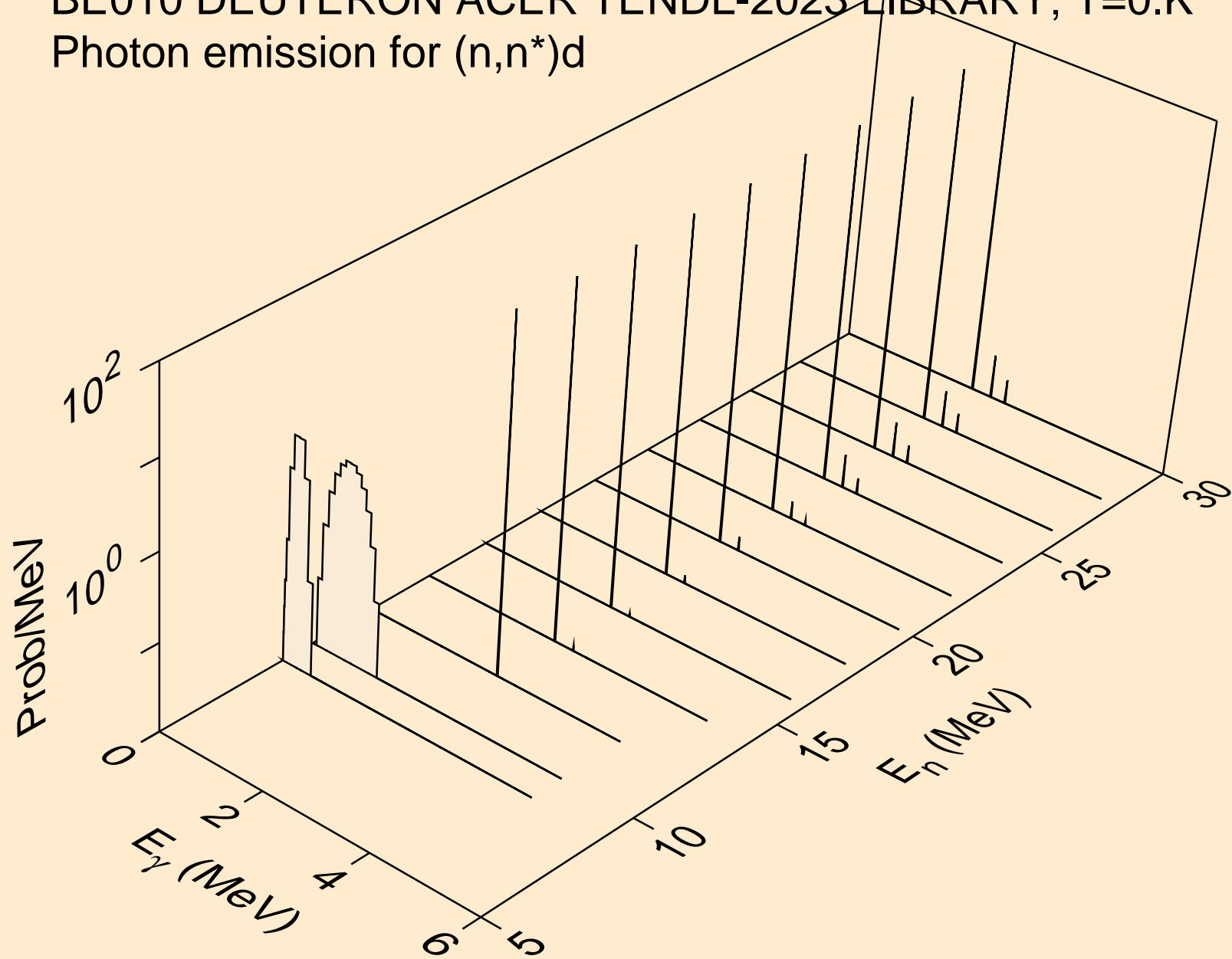

BE010 DEUTERON ACER TENDL-2023 LIBRARY; T=0.K  
Photon emission for (n,n\*)t

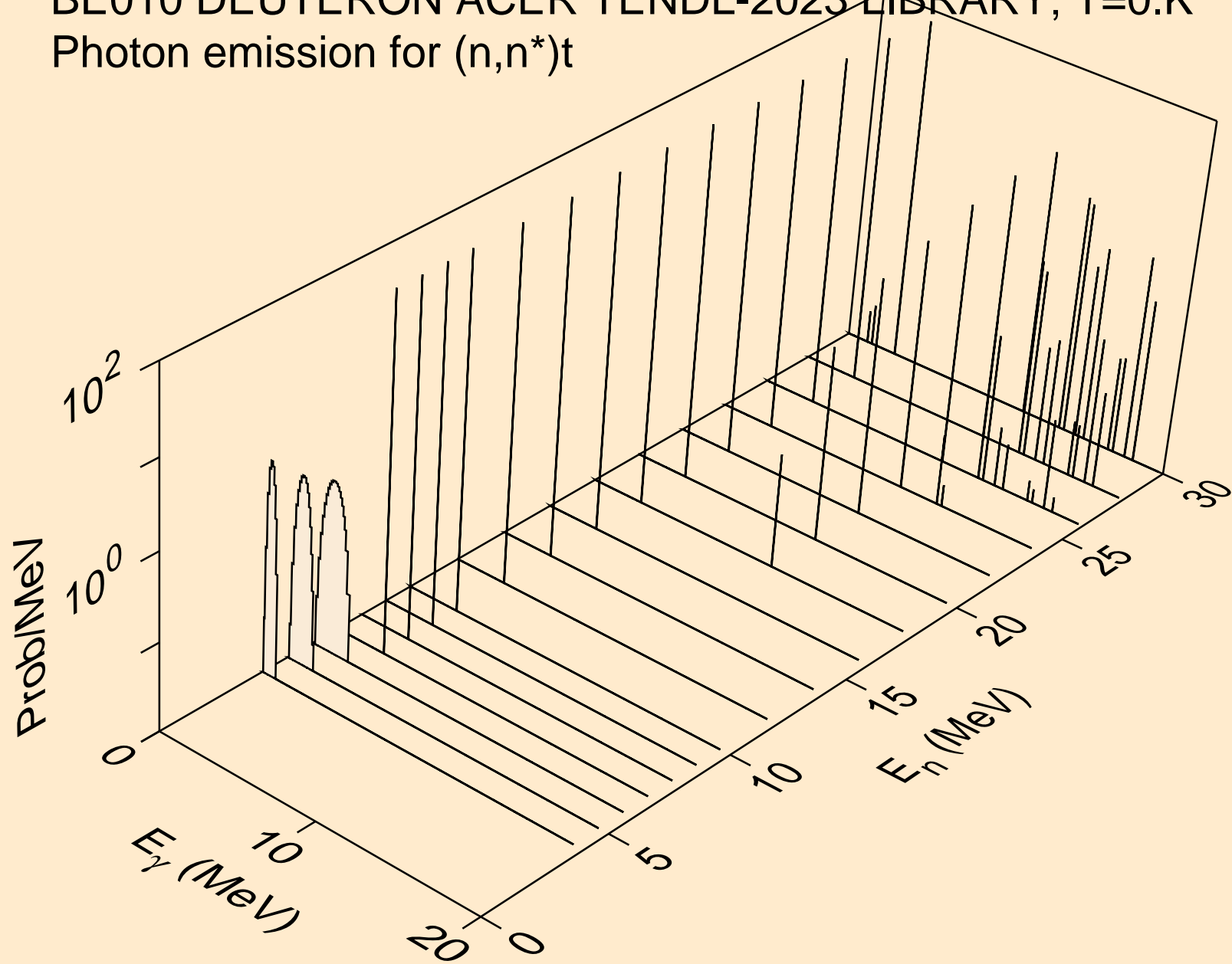

BE010 DEUTERON ACER TENDL-2023 LIBRARY; T=0.K  
Photon emission for (n,n\*)he3

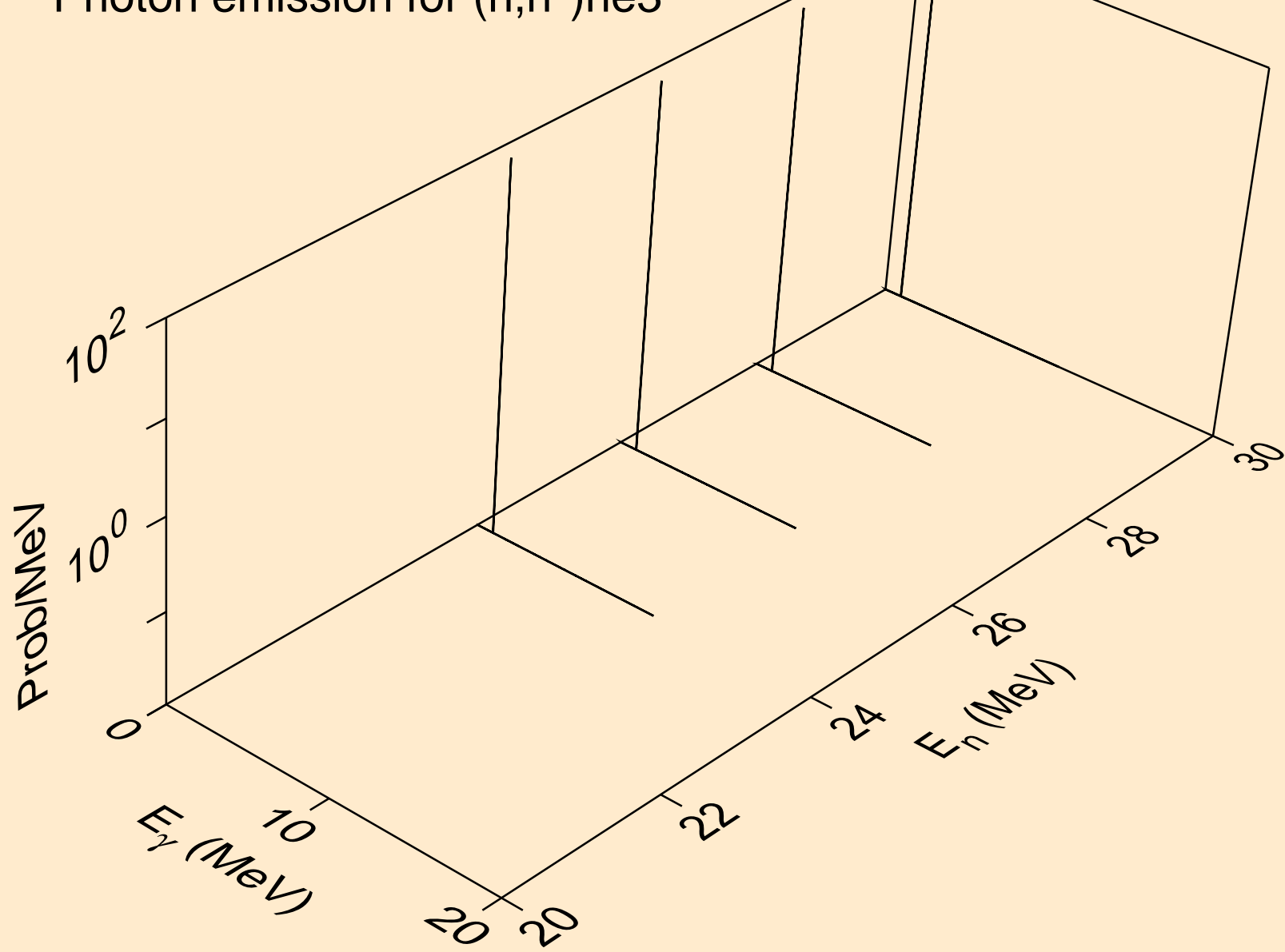



BE010 DEUTERON ACER TENDL-2023 LIBRARY; T=0.K  
Photon emission for (n,2np)

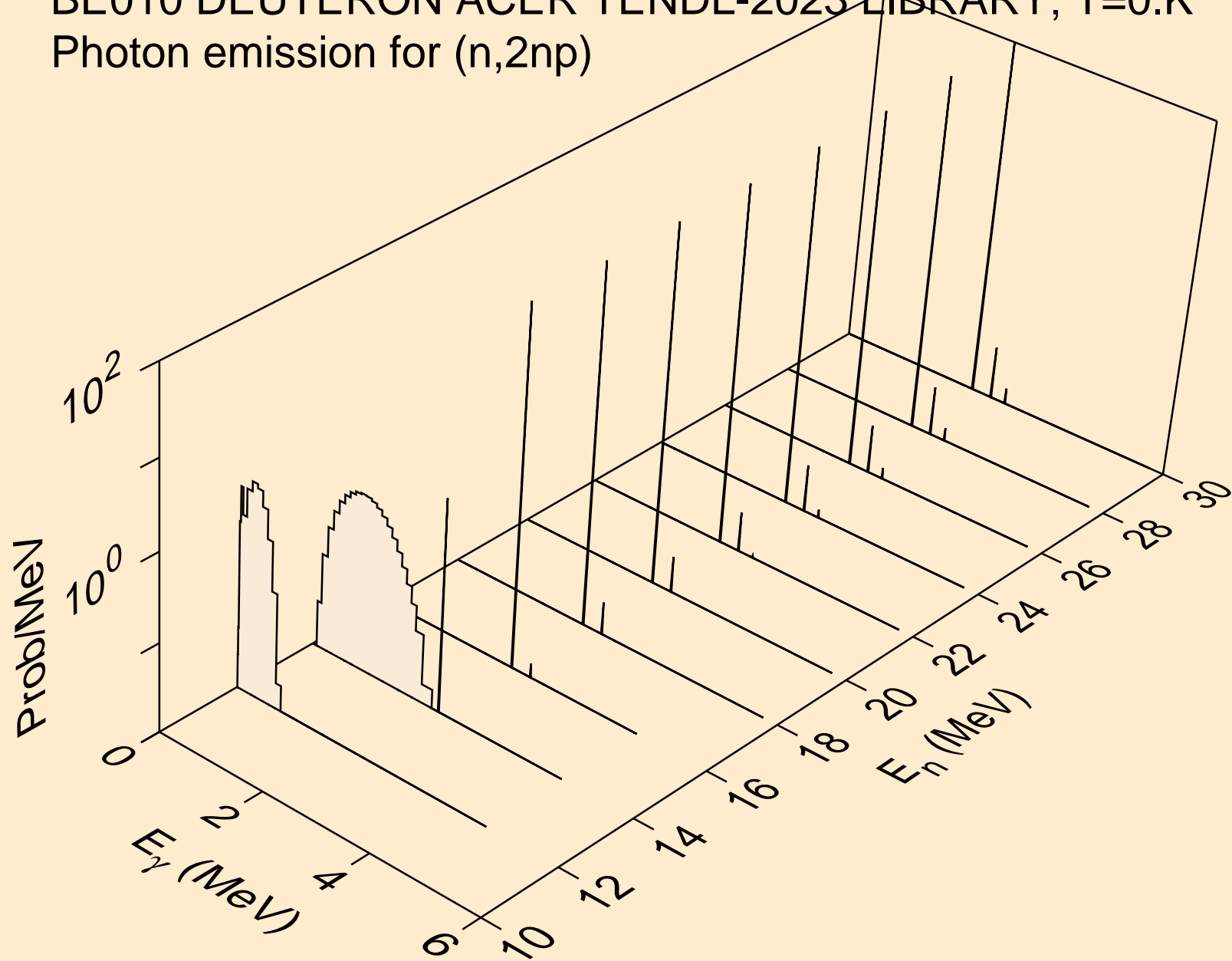

BE010 DEUTERON ACER TENDL-2023 LIBRARY; T=0.K  
Photon emission for (n,3np)

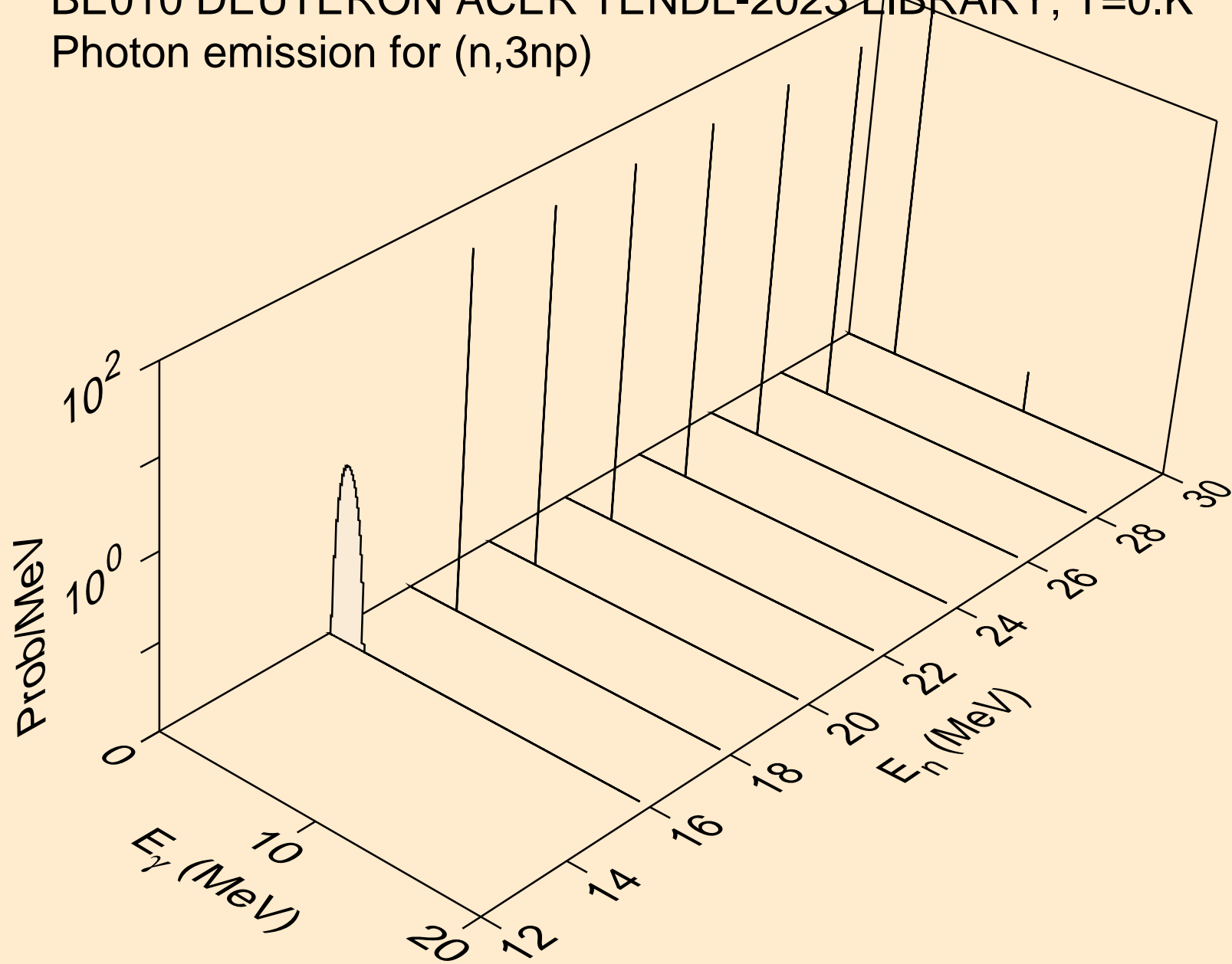

BE010 DEUTERON ACER TENDL-2023 LIBRARY; T=0.K  
Photon emission for (n,n2p)

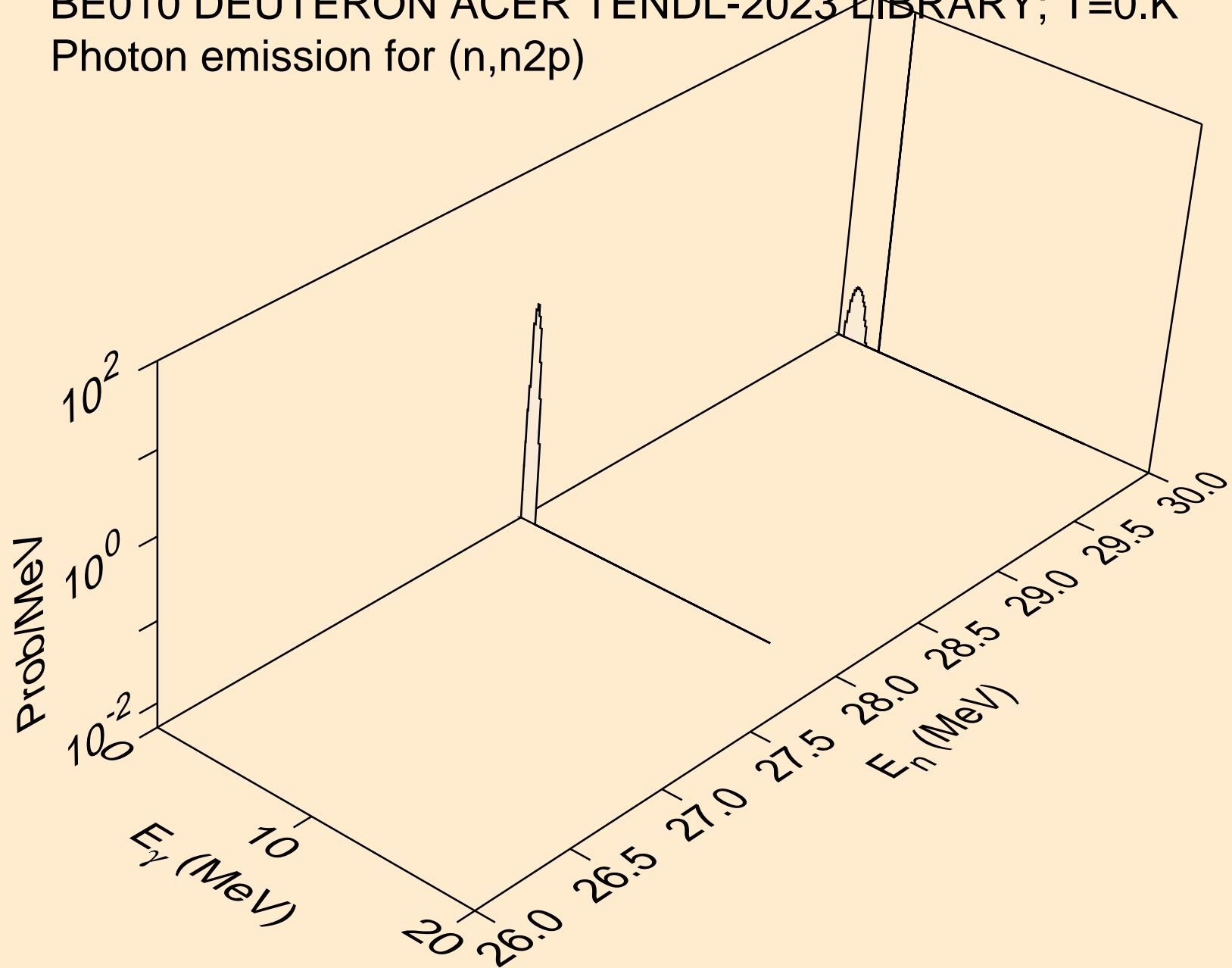

BE010 DEUTERON ACER TENDL-2023 LIBRARY; T=0.K  
Photon emission for (n,gma)

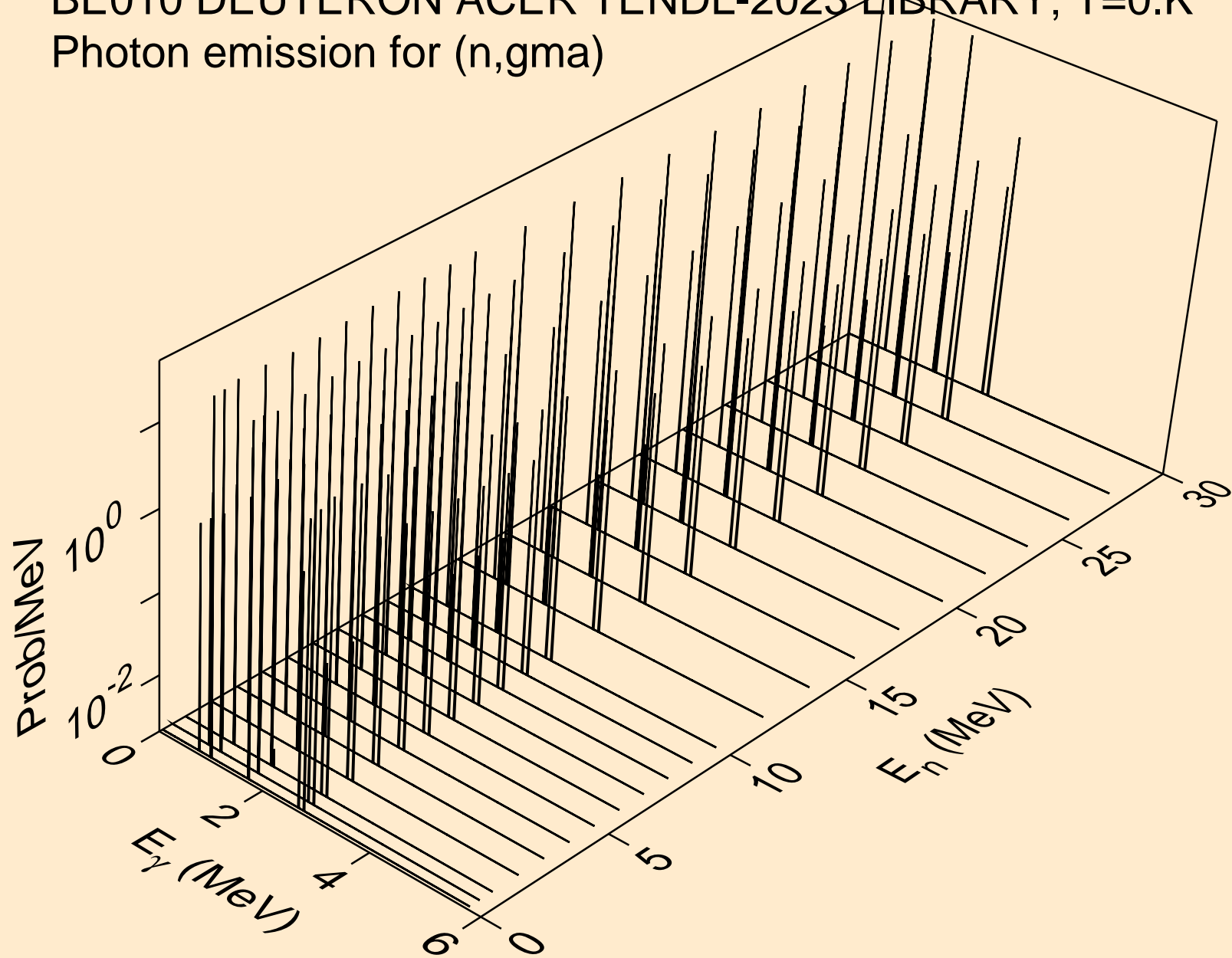

BE010 DEUTERON ACER TENDL-2023 LIBRARY; T=0.K  
Photon emission for (n,p)

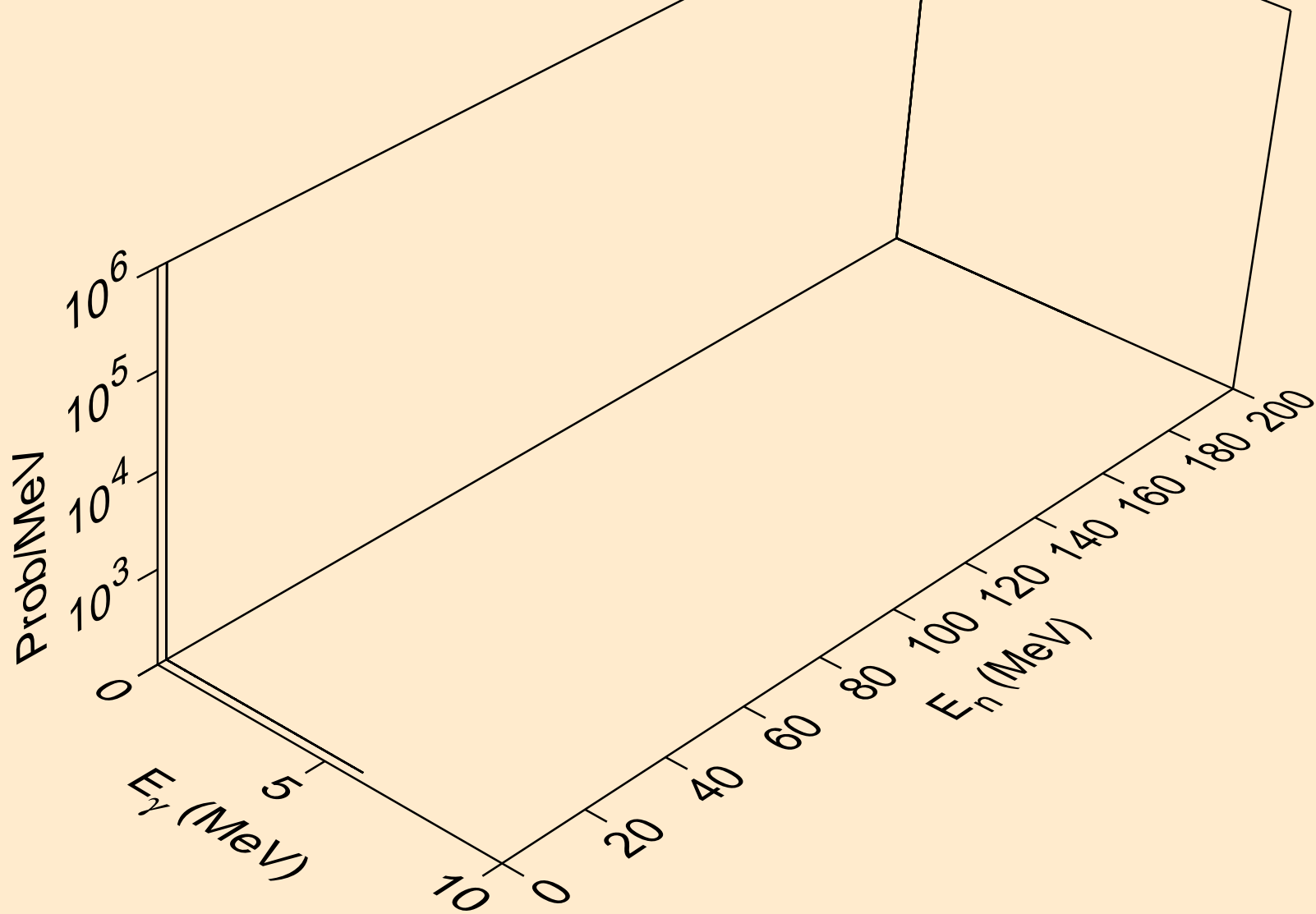

BE010 DEUTERON ACER TENDL-2023 LIBRARY; T=0.K  
Photon emission for inelastic

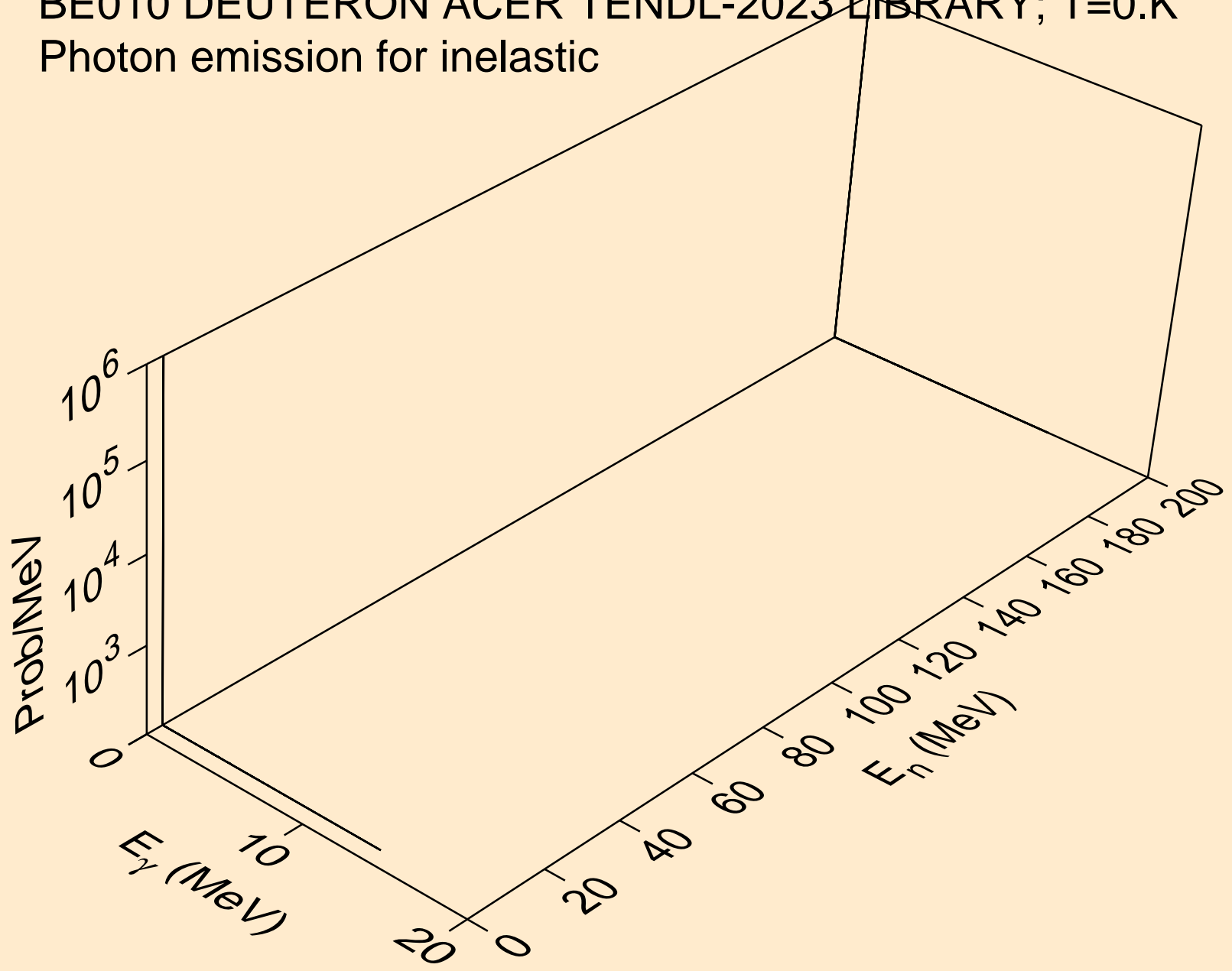

BE010 DEUTERON ACER TENDL-2023 LIBRARY; T=0.K  
Photon emission for (n,t)

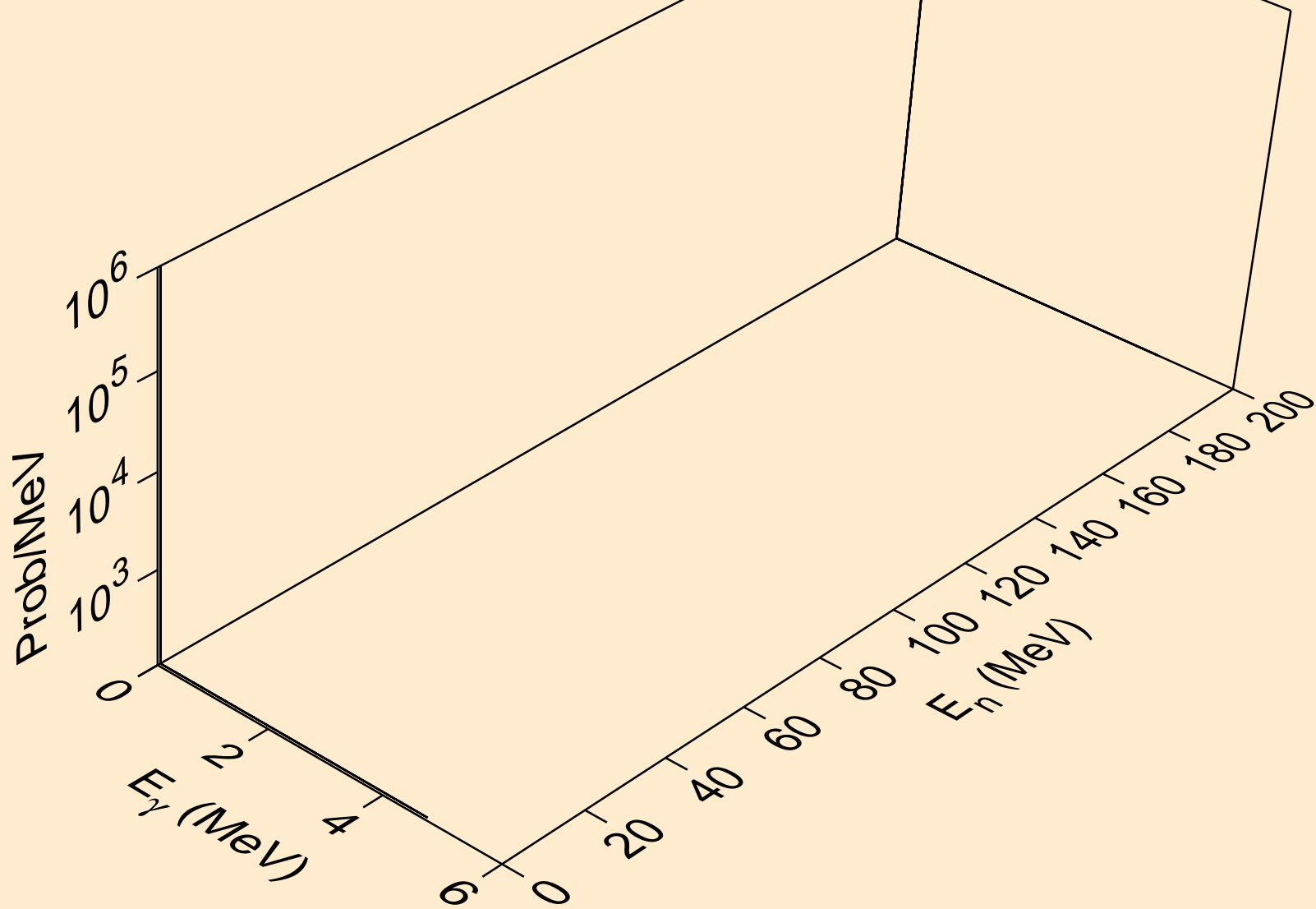

BE010 DEUTERON ACER TENDL-2023 LIBRARY; T=0.K  
Photon emission for (n,he3)

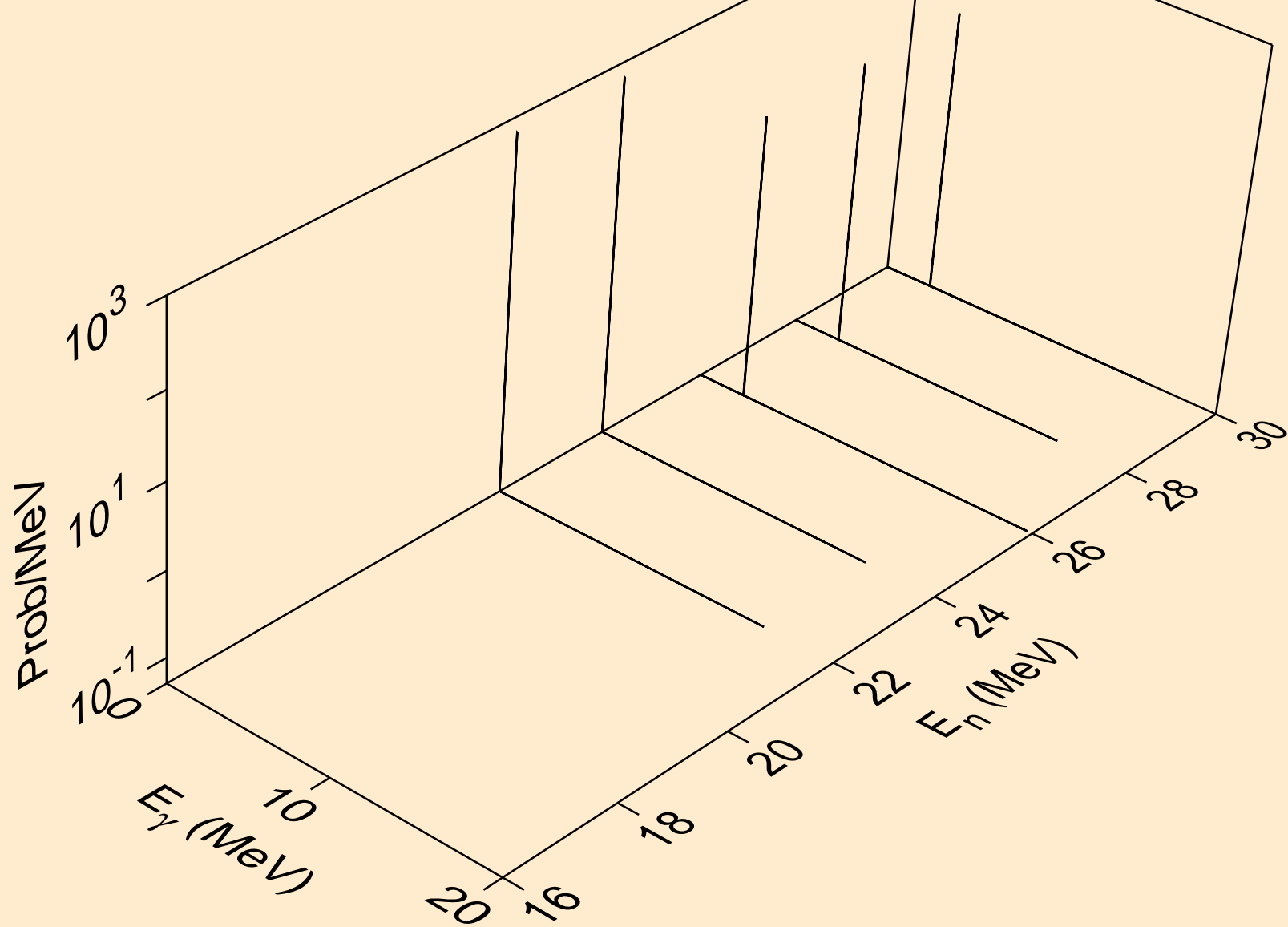



BE010 DEUTERON ACER TENDL-2023 LIBRARY; T=0.K  
Photon emission for (n,a)

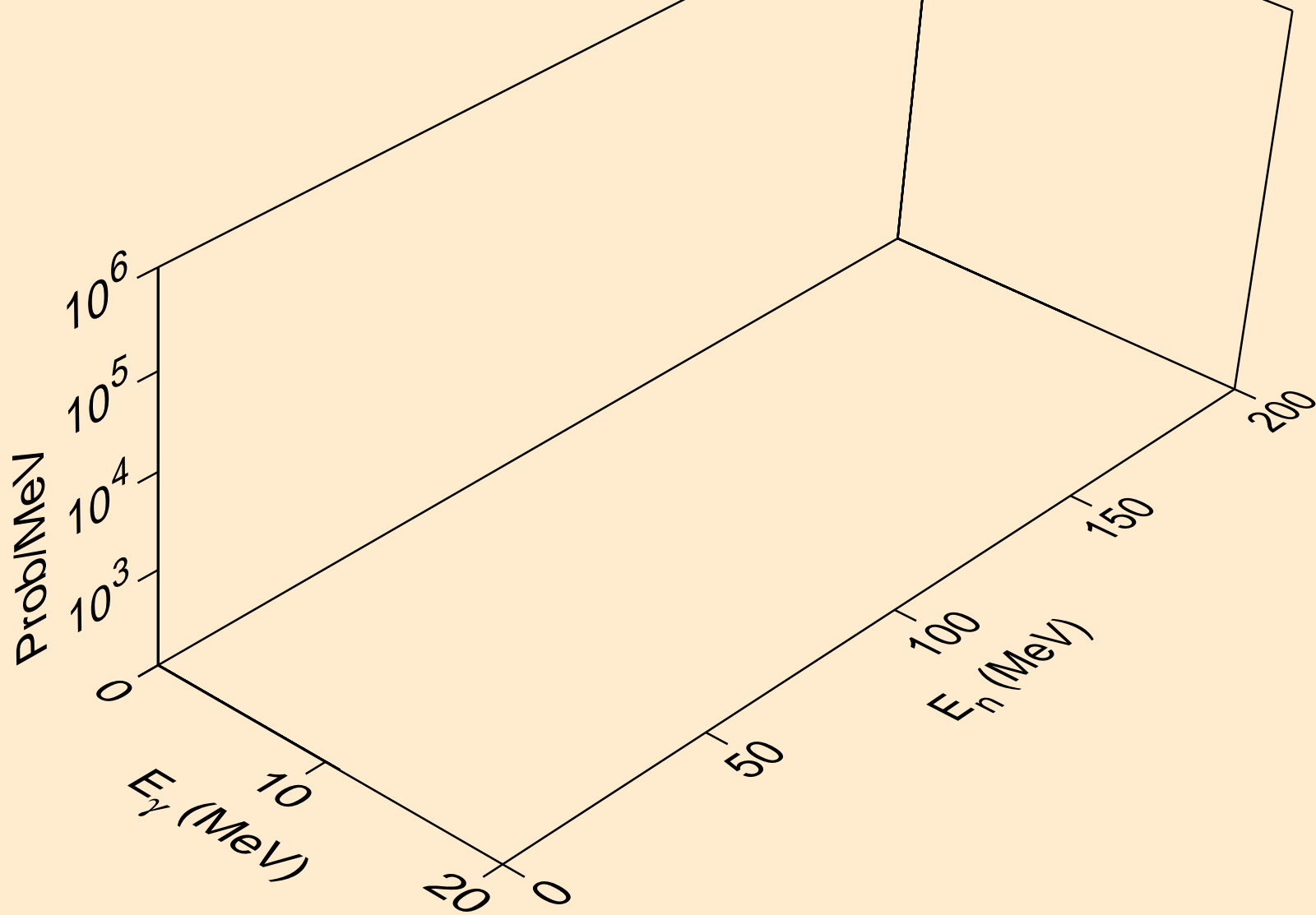

BE010 DEUTERON ACER TENDL-2023 LIBRARY; T=0.K  
Photon emission for (n,2p)

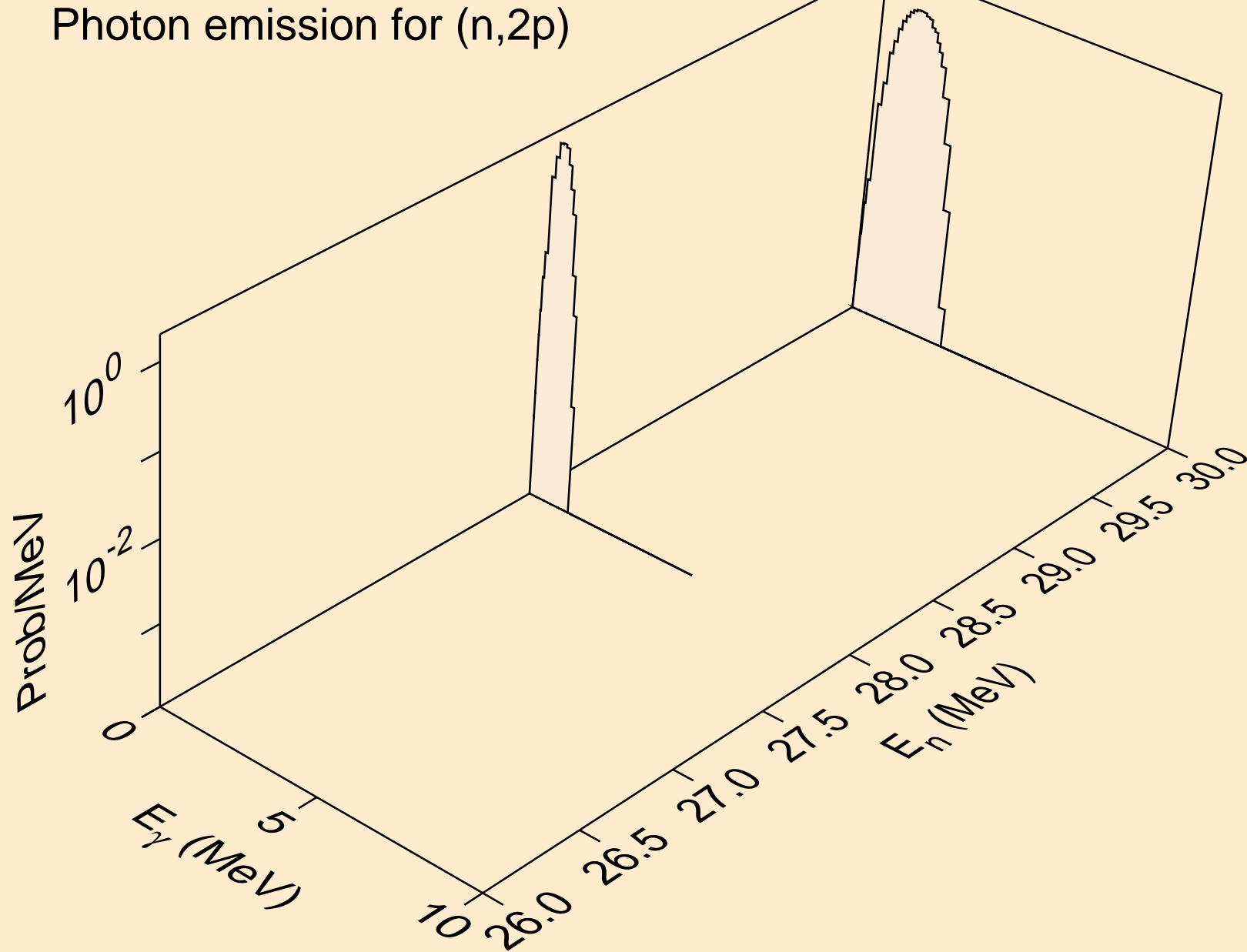

BE010 DEUTERON ACER TENDL-2023 LIBRARY; T=0.K  
Photon emission for (n,pd)

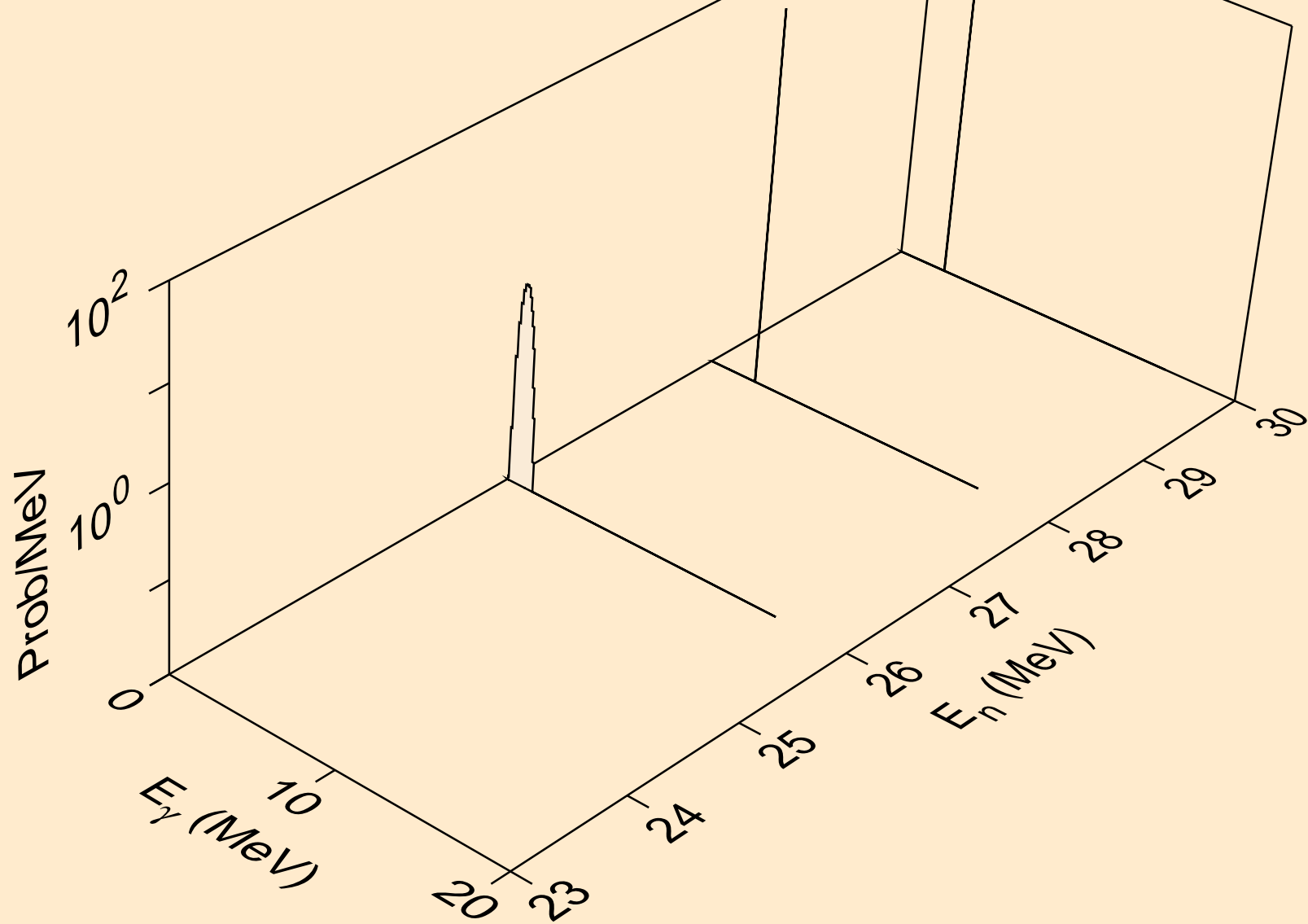

BE010 DEUTERON ACER TENDL-2023 LIBRARY; T=0.K  
Photon emission for (n,pt)

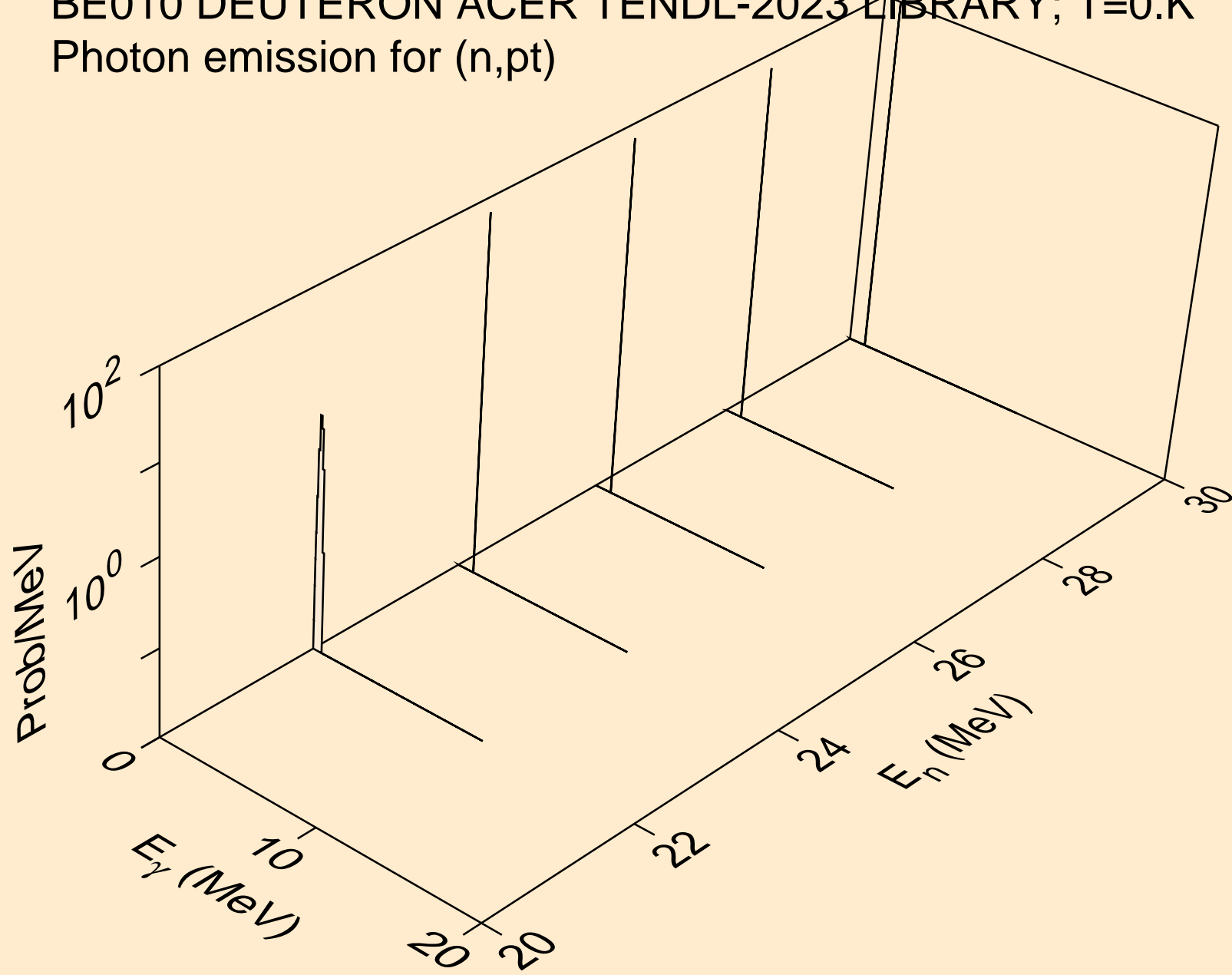

# BE010 DEUTERON ACER TENDL-2023 LIBRARY; T=0.K

## Particle heating contributions

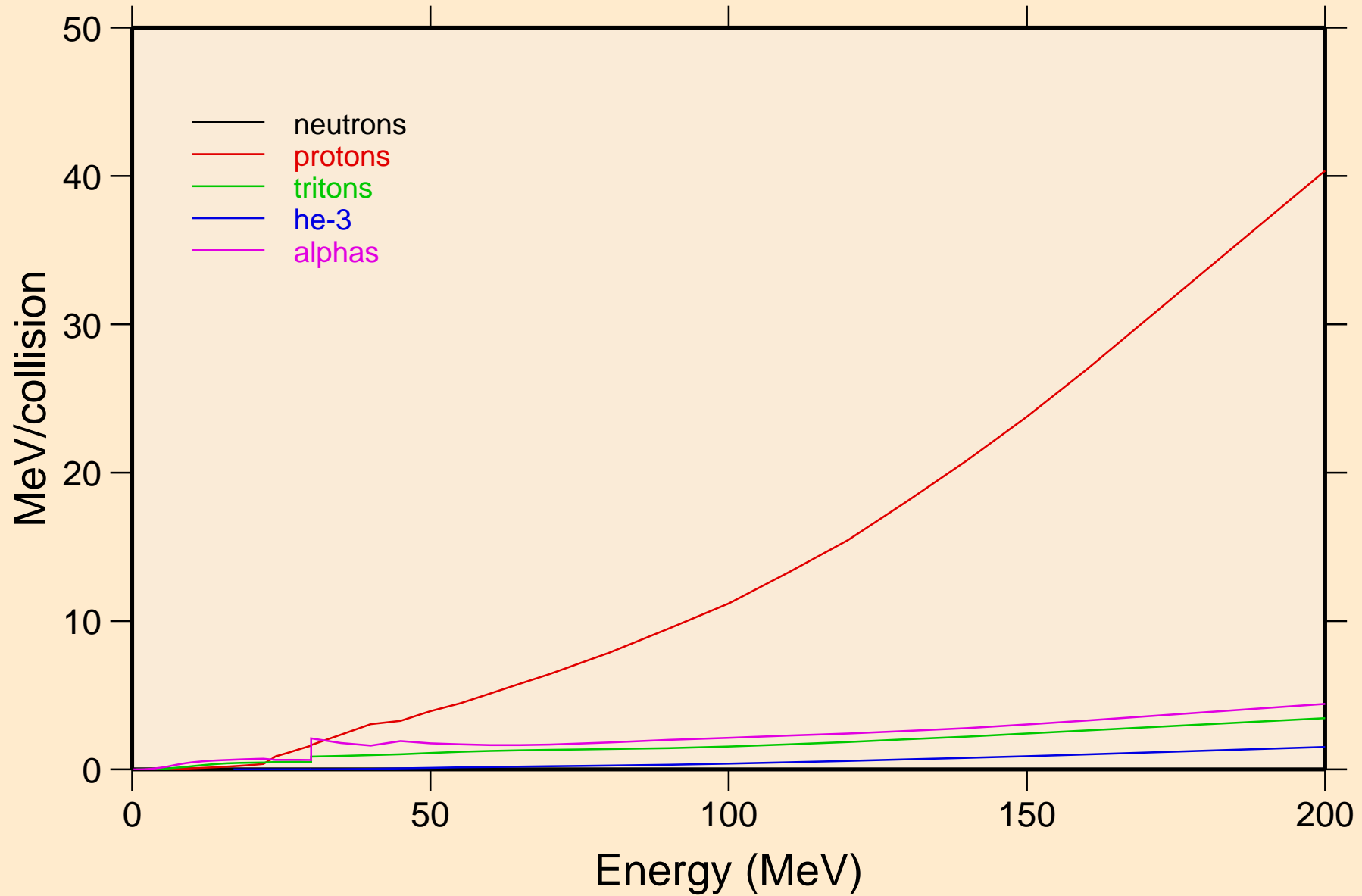

BE010 DEUTERON ACER TENDL-2023 LIBRARY; T=0.K  
Recoil Heating

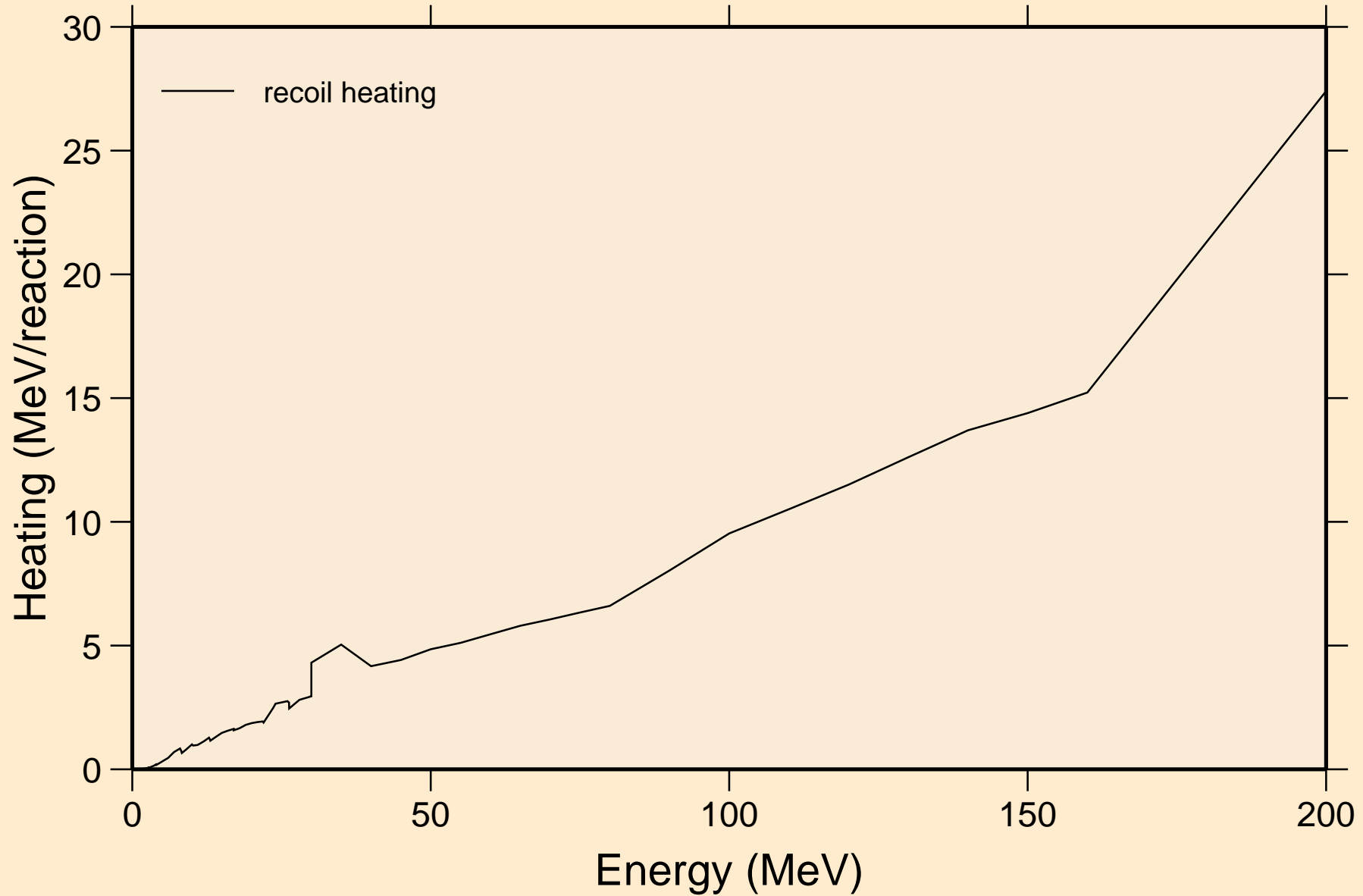

BE010 DEUTERON ACER TENDL-2023 LIBRARY; T=0.K  
Particle production cross sections

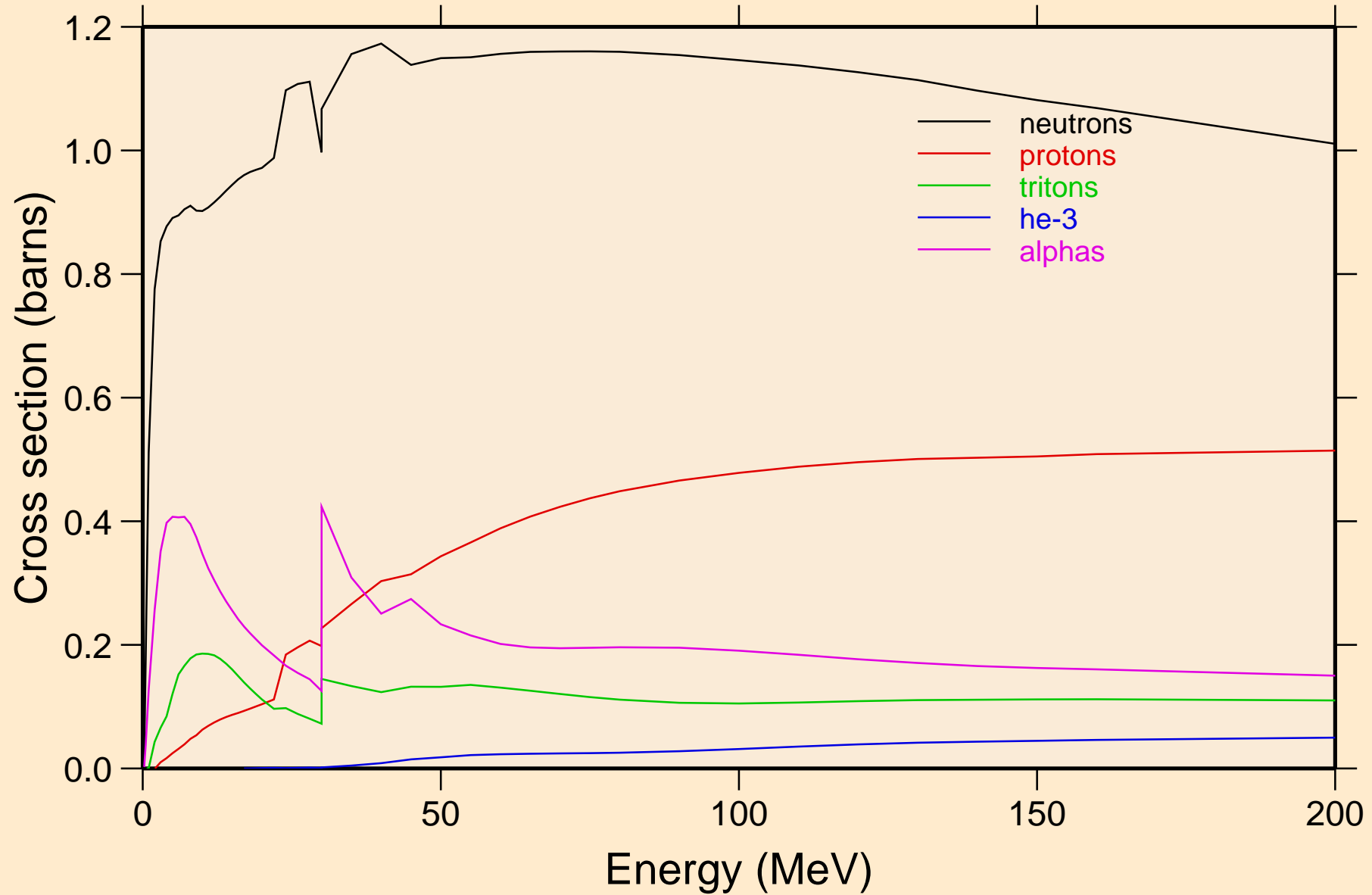

BE010 DEUTERON ACER TENDL-2023 LIBRARY; T=0.K  
neutrons from (d,n)

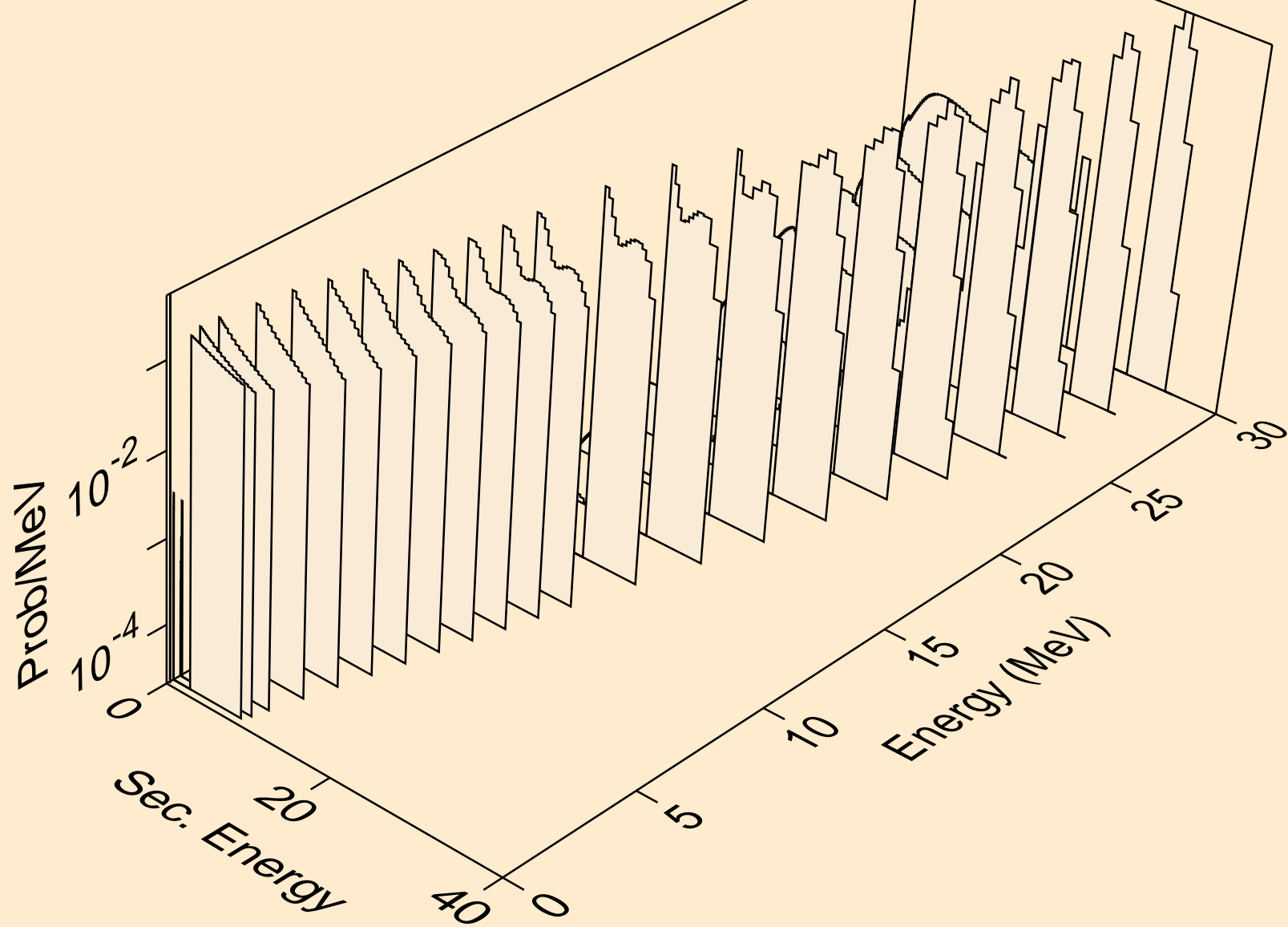



BE010 DEUTERON ACER TENDL-2023 LIBRARY; T=0.K  
neutrons from (d,x)

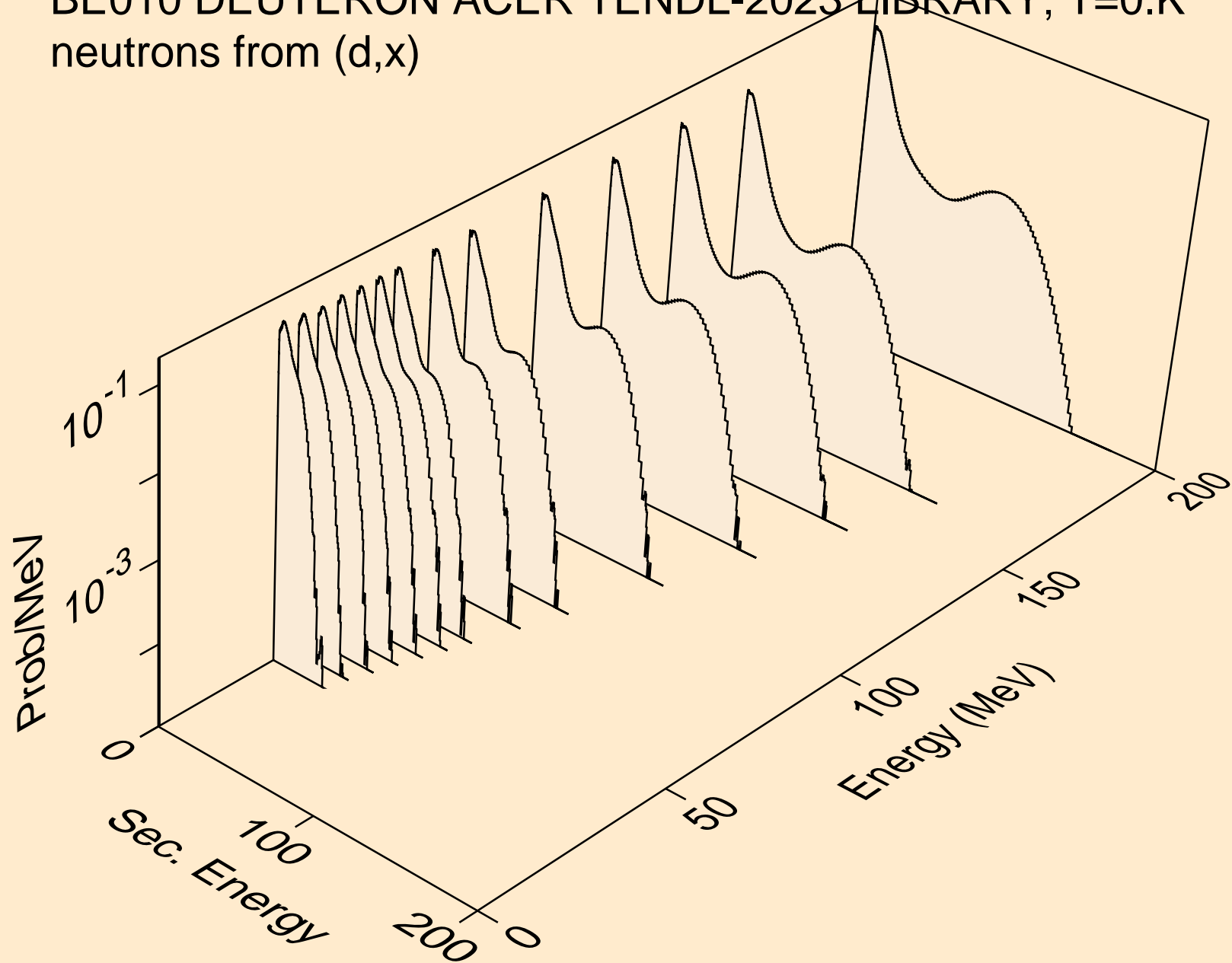

BE010 DEUTERON ACER TENDL-2023 LIBRARY; T=0.K  
neutrons from (d,2nd)

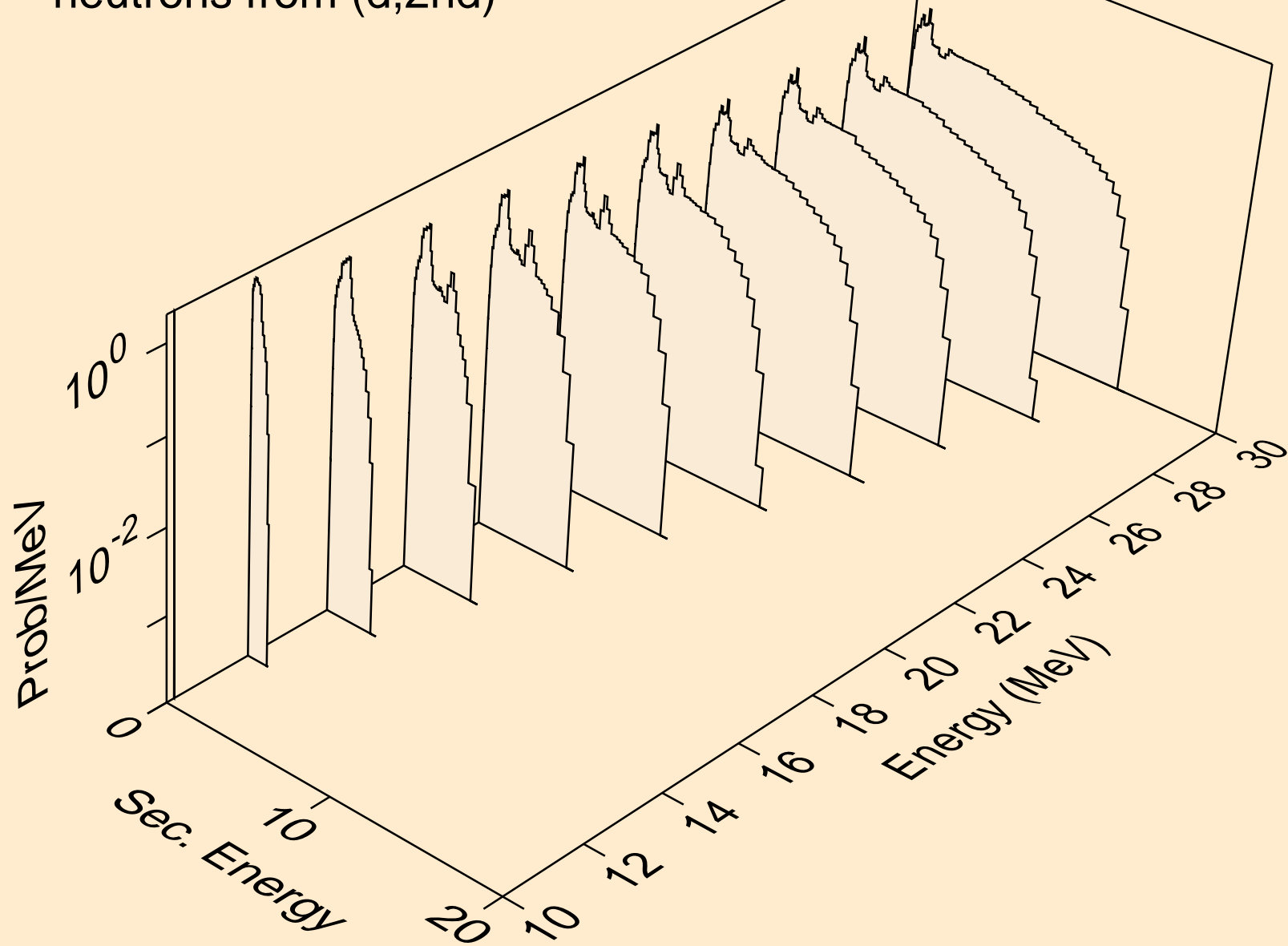

BE010 DEUTERON ACER TENDL-2023 LIBRARY; T=0.K  
neutrons from (d,2n)

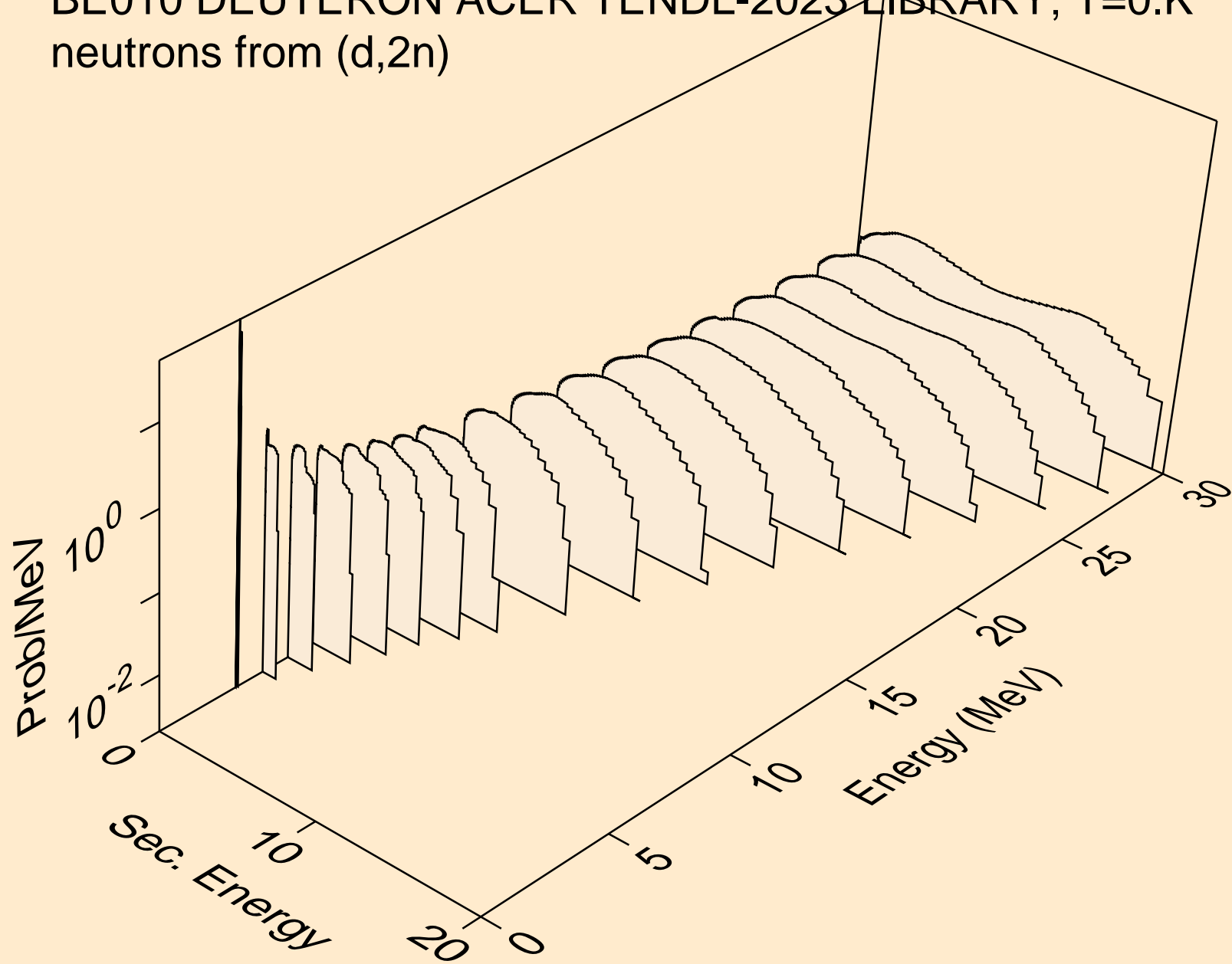

BE010 DEUTERON ACER TENDL-2023 LIBRARY; T=0.K  
neutrons from (d,3n)

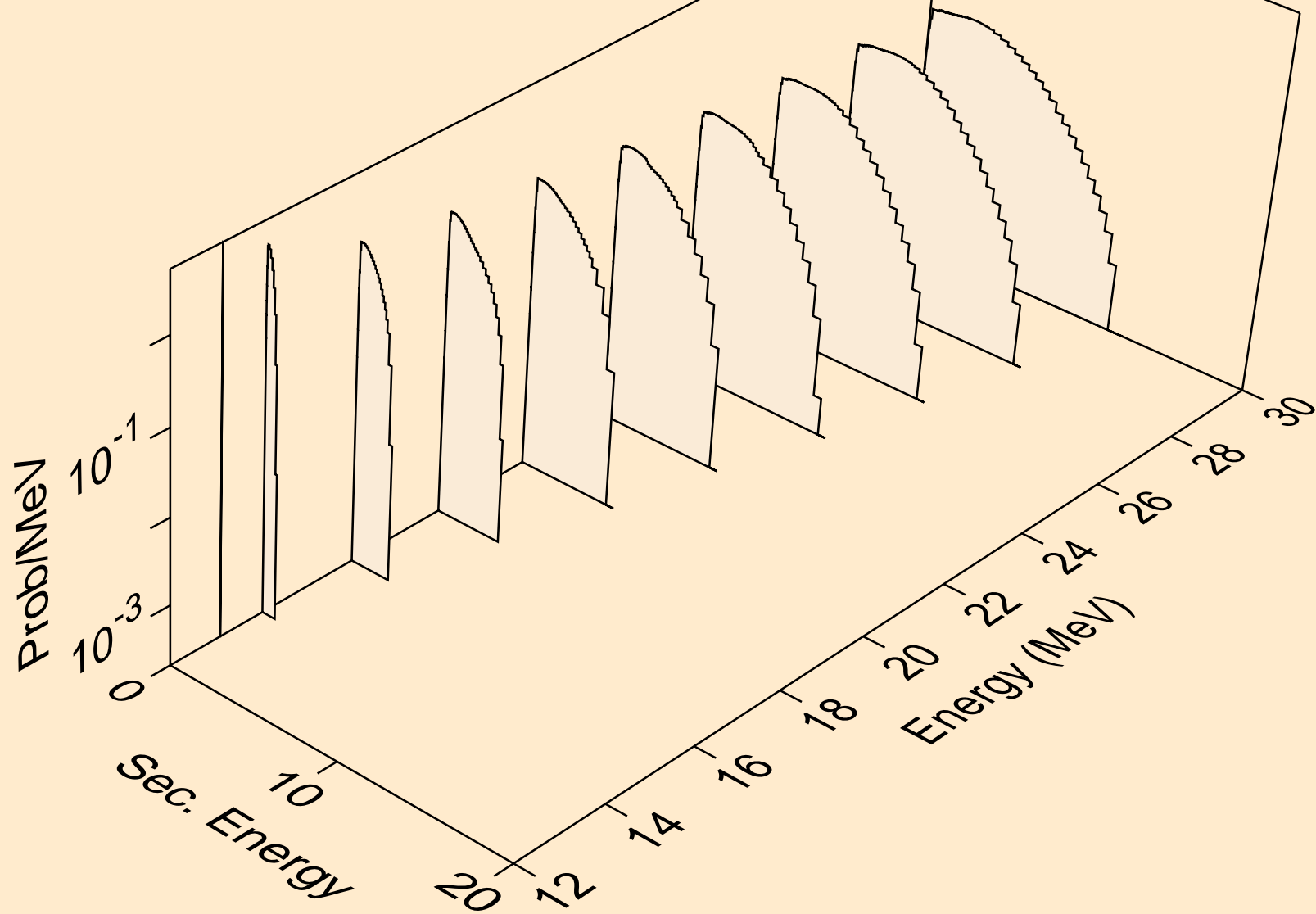

BE010 DEUTERON ACER TENDL-2023 LIBRARY; T=0.K  
neutrons from (d,n\*)a

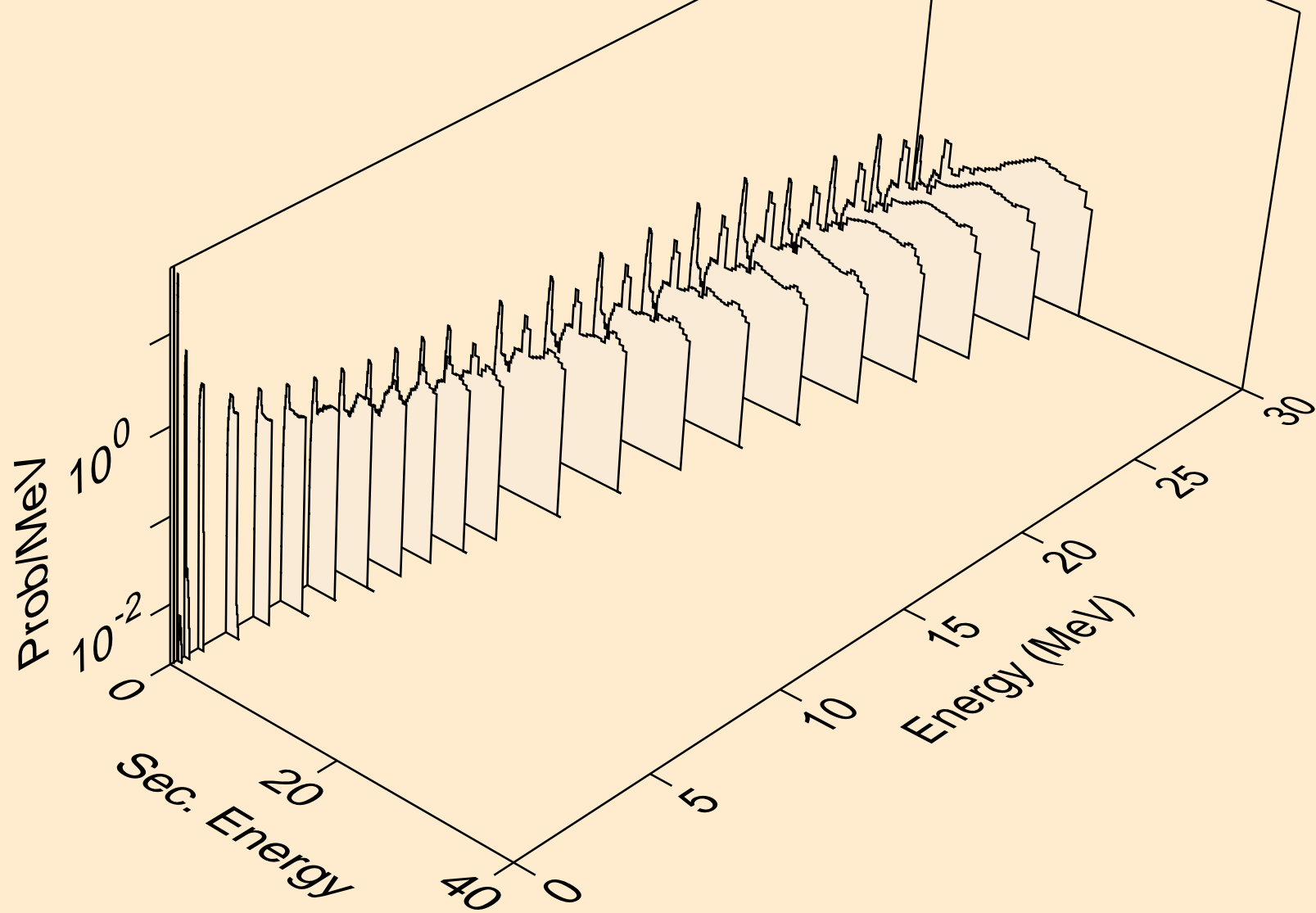

BE010 DEUTERON ACER TENDL-2023 LIBRARY; T=0.K  
neutrons from (d,2n)a

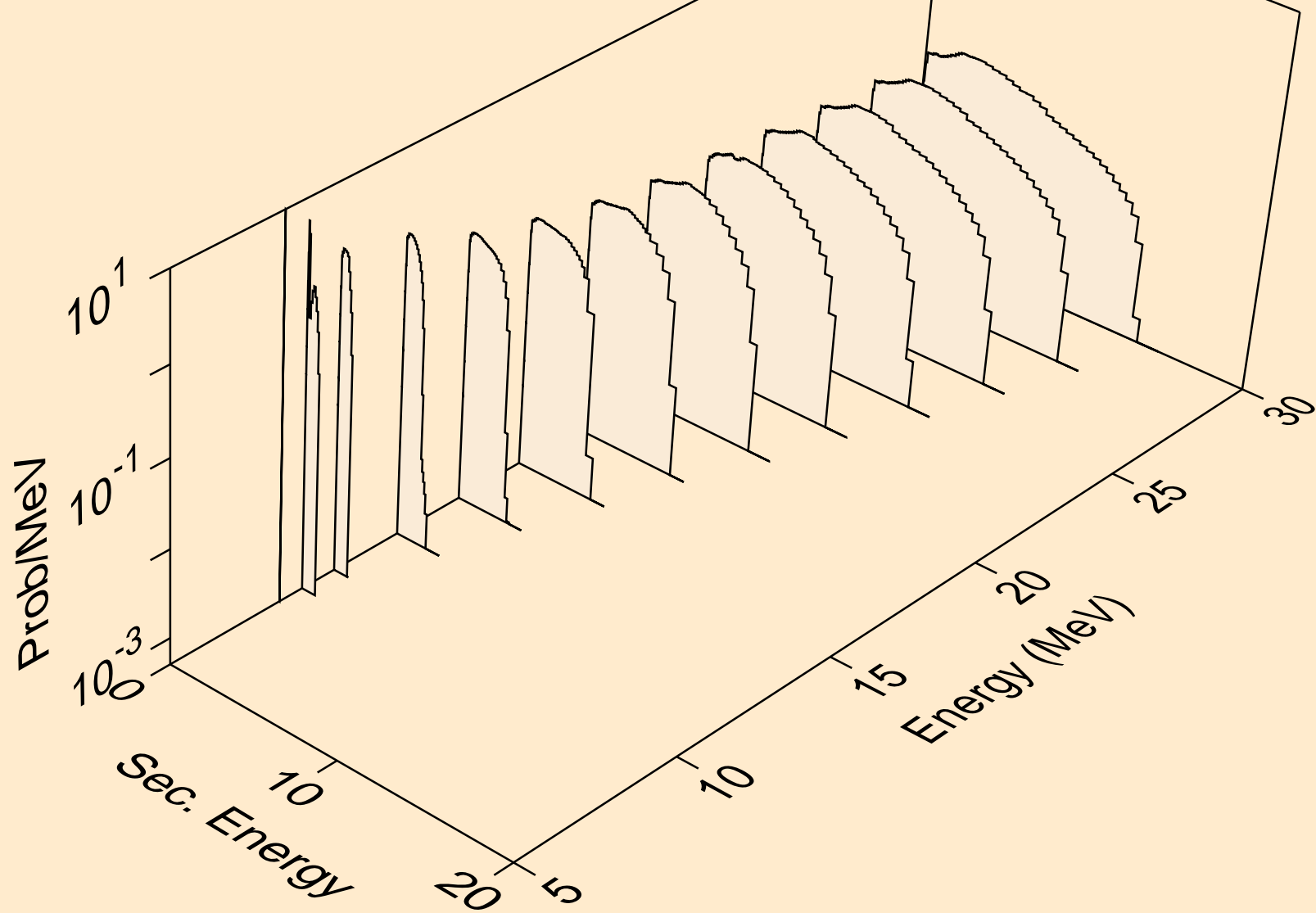

BE010 DEUTERON ACER TENDL-2023 LIBRARY; T=0.K  
neutrons from (d,n\*)p

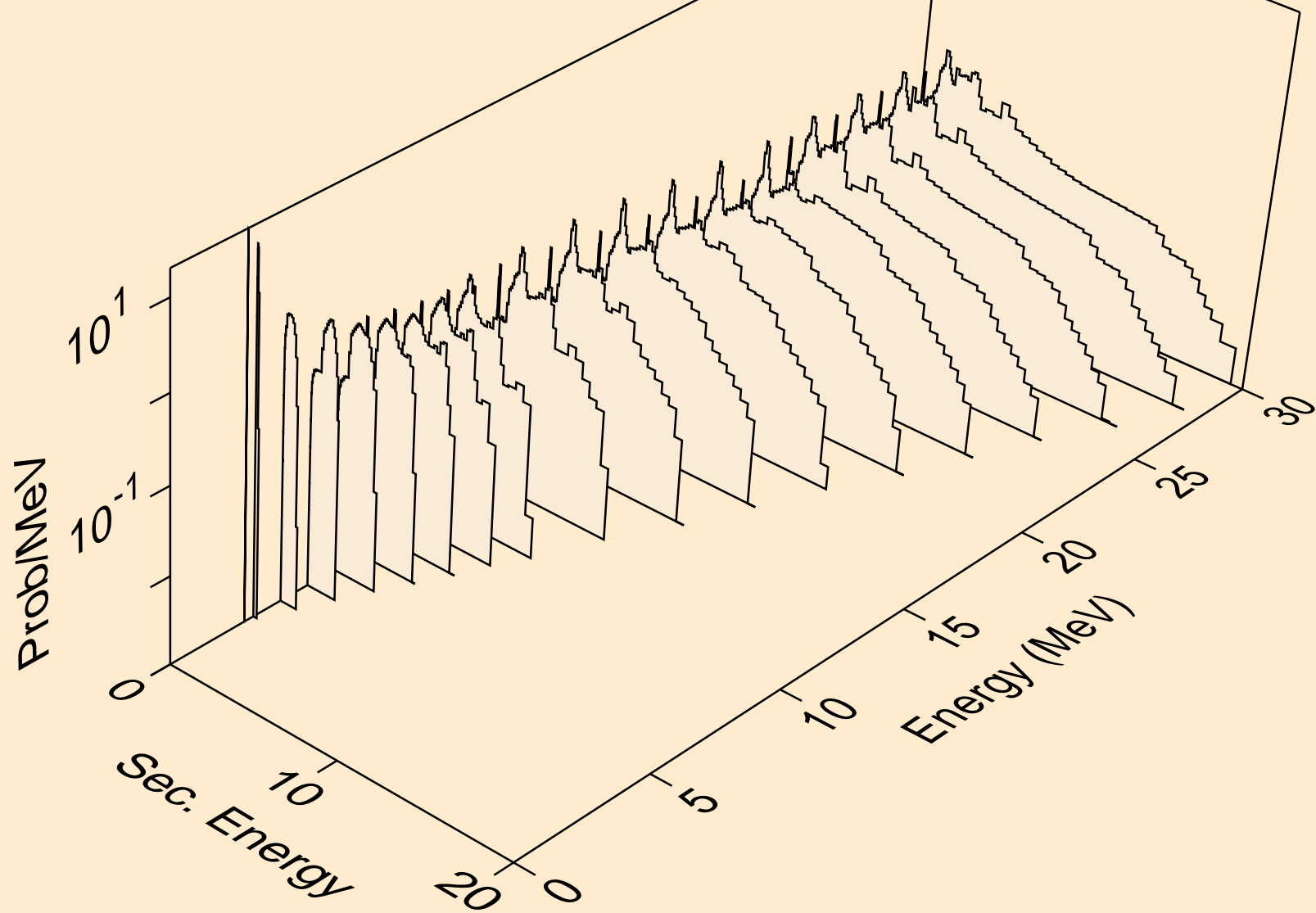

BE010 DEUTERON ACER TENDL-2023 LIBRARY; T=0.K  
neutrons from (d,n\*)d

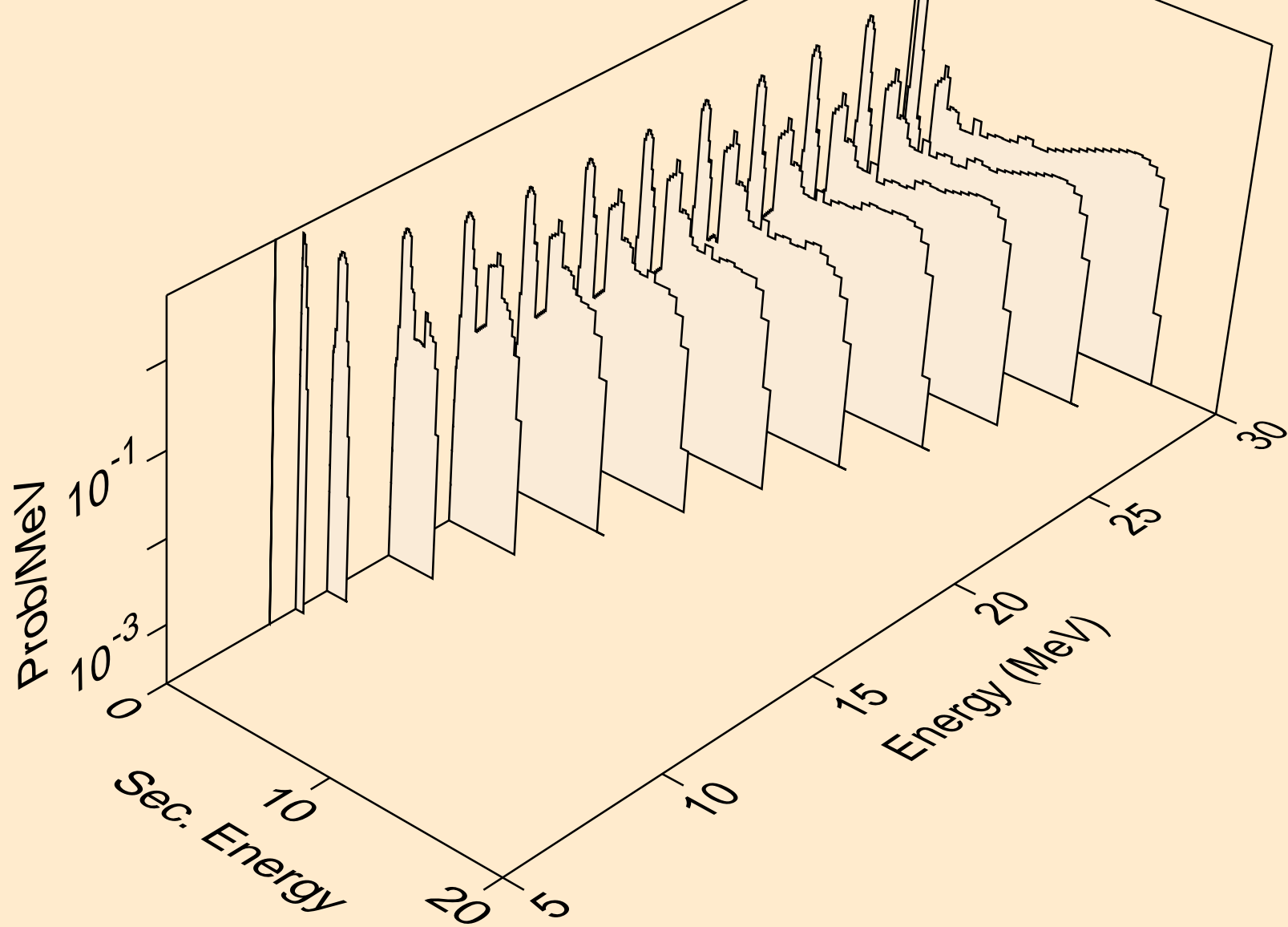



BE010 DEUTERON ACER TENDL-2023 LIBRARY; T=0.K  
neutrons from (d,n\*)t

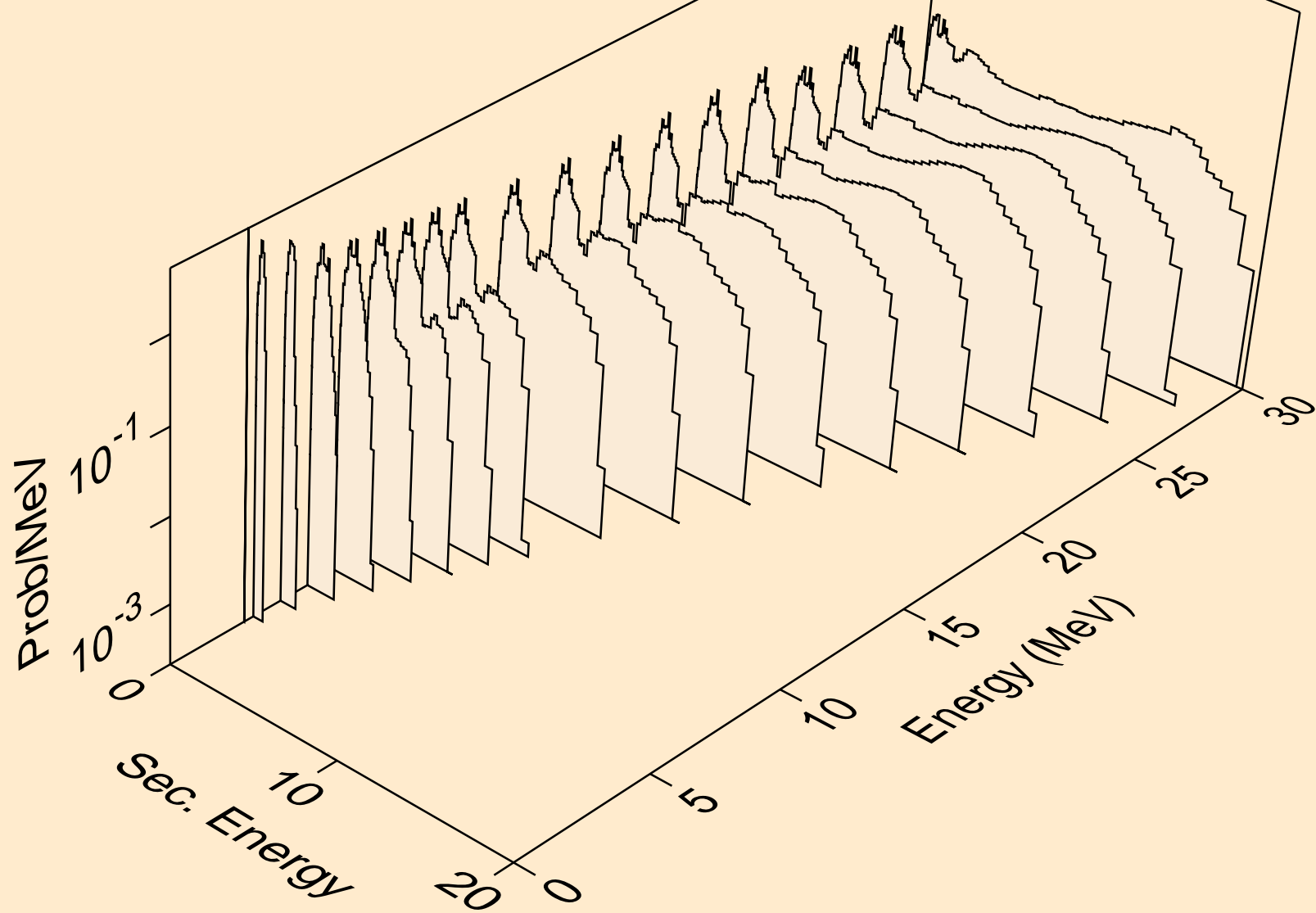

BE010 DEUTERON ACER TENDL-2023 LIBRARY; T=0.K  
neutrons from (d,n\*)he3

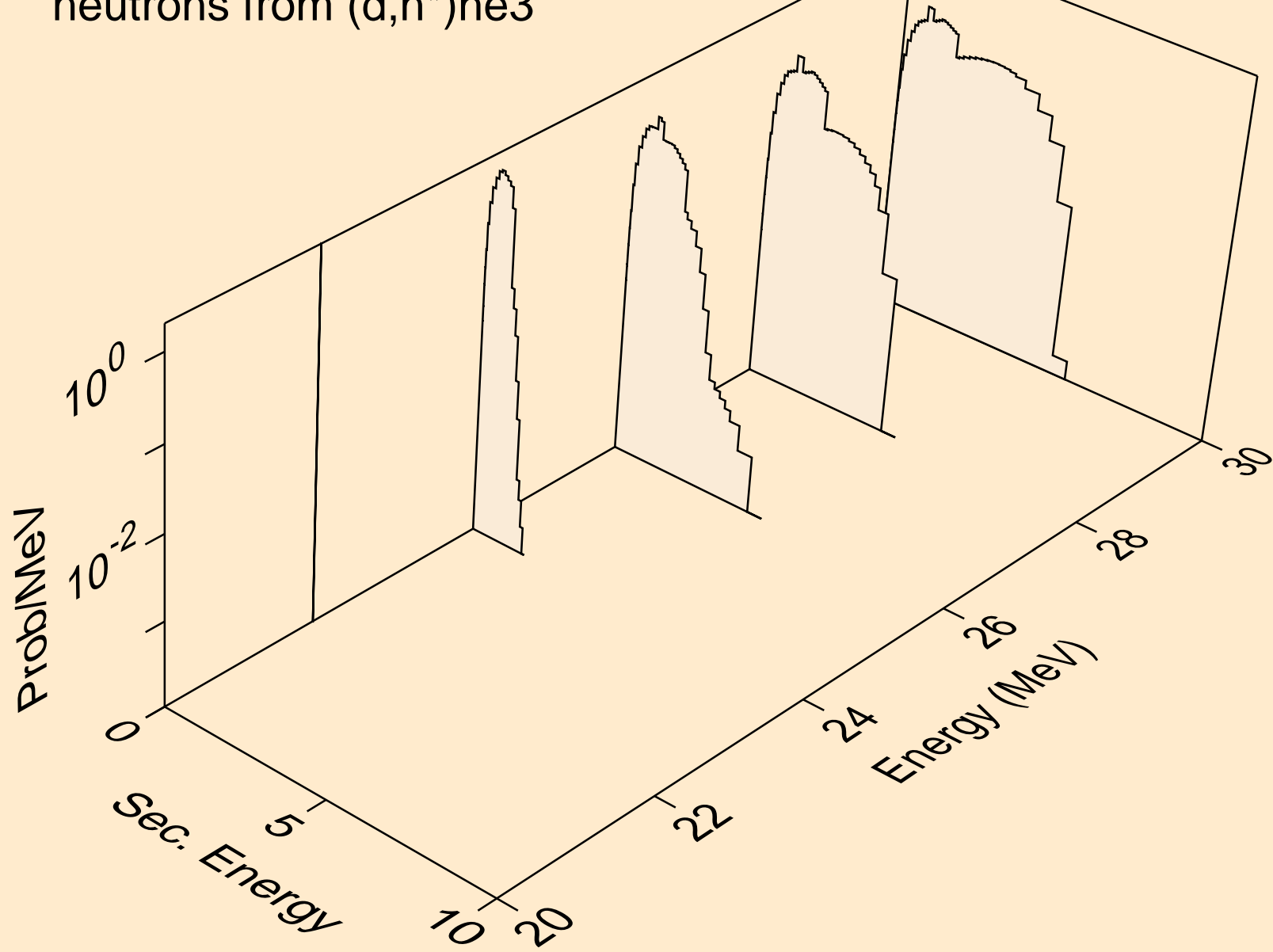

BE010 DEUTERON ACER TENDL-2023 LIBRARY; T=0.K  
neutrons from (d,2np)

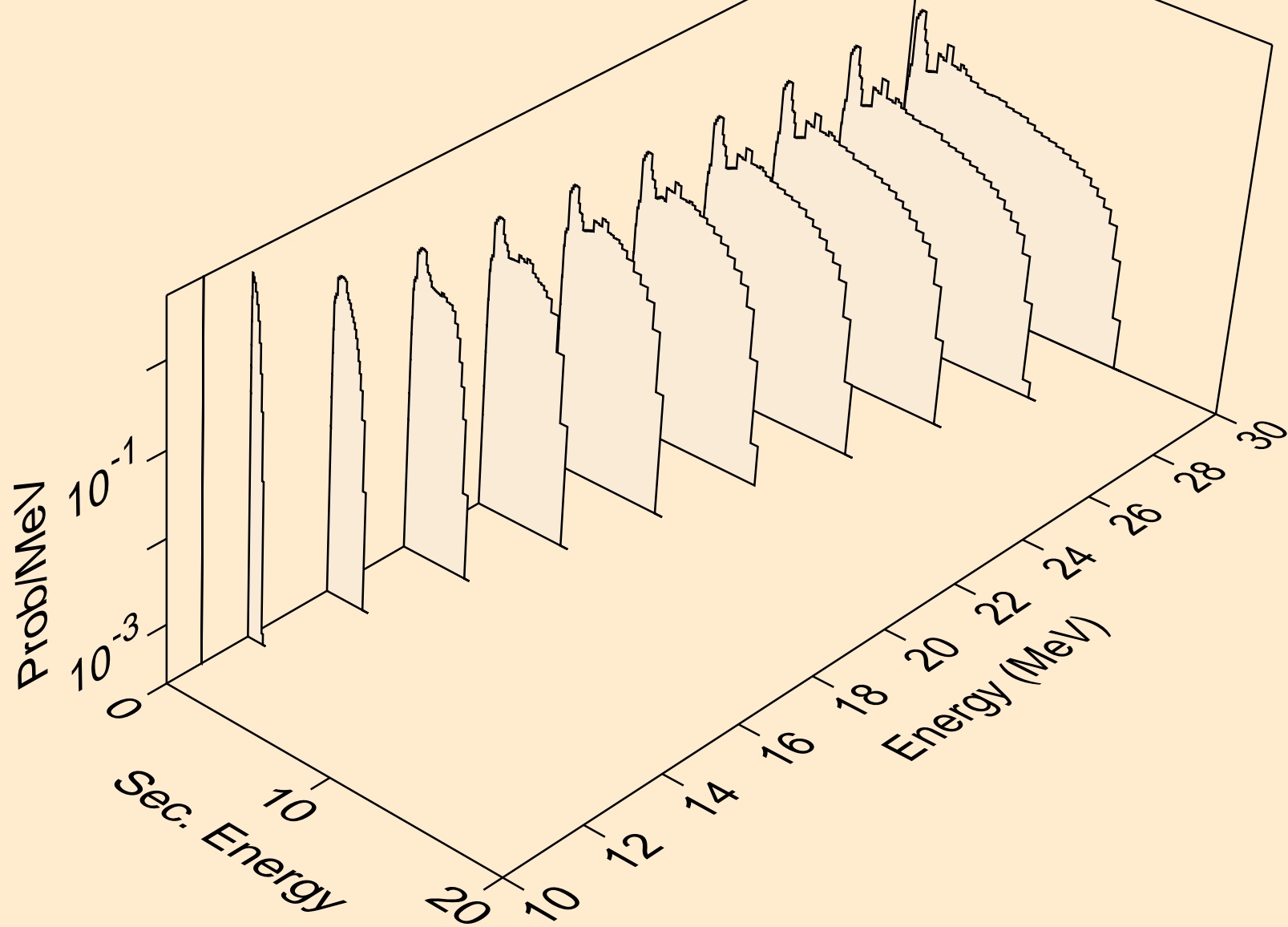

BE010 DEUTERON ACER TENDL-2023 LIBRARY; T=0.K  
neutrons from (d,3np)

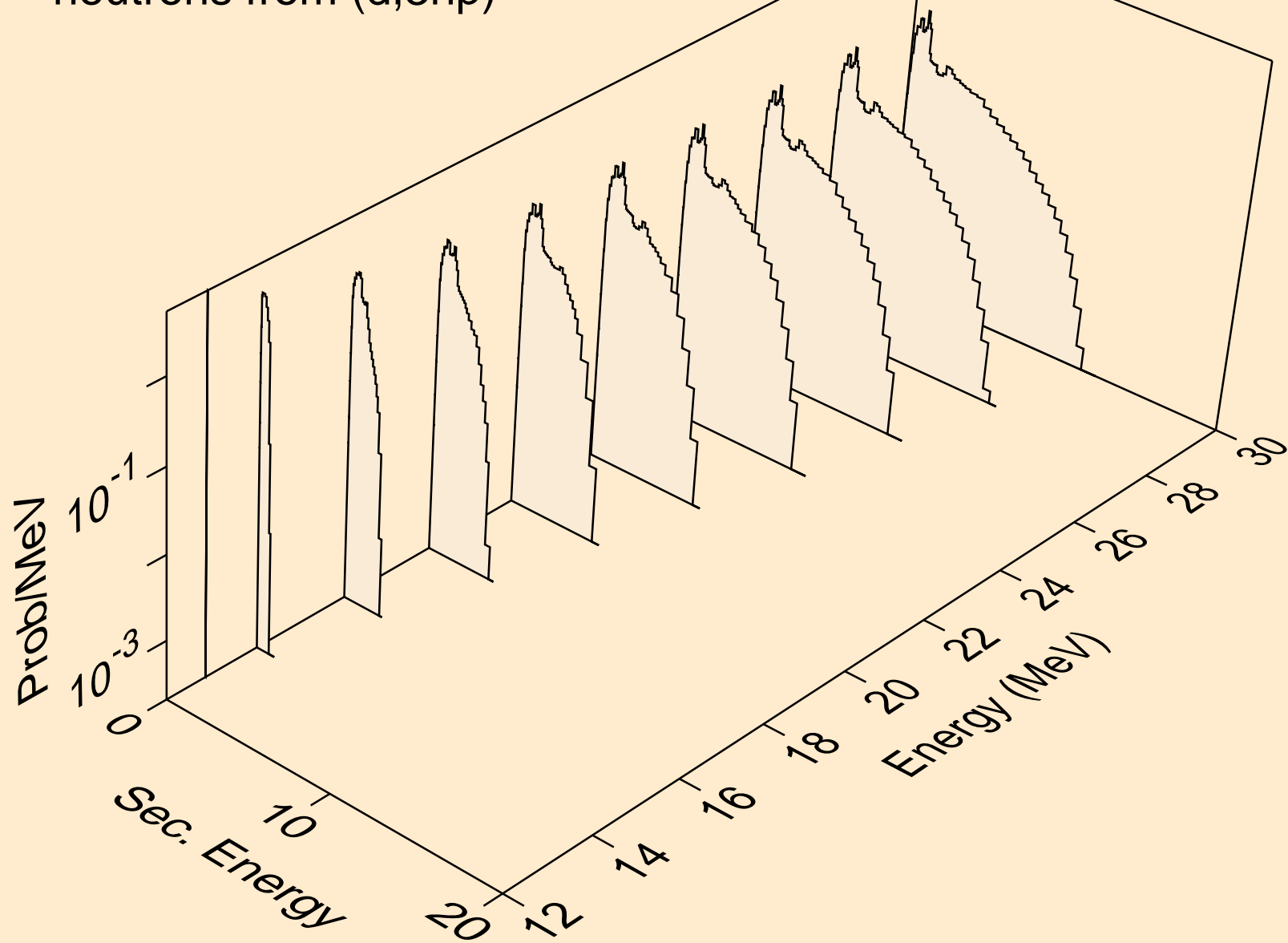

BE010 DEUTERON ACER TENDL-2023 LIBRARY; T=0.K  
neutrons from (d,n2p)

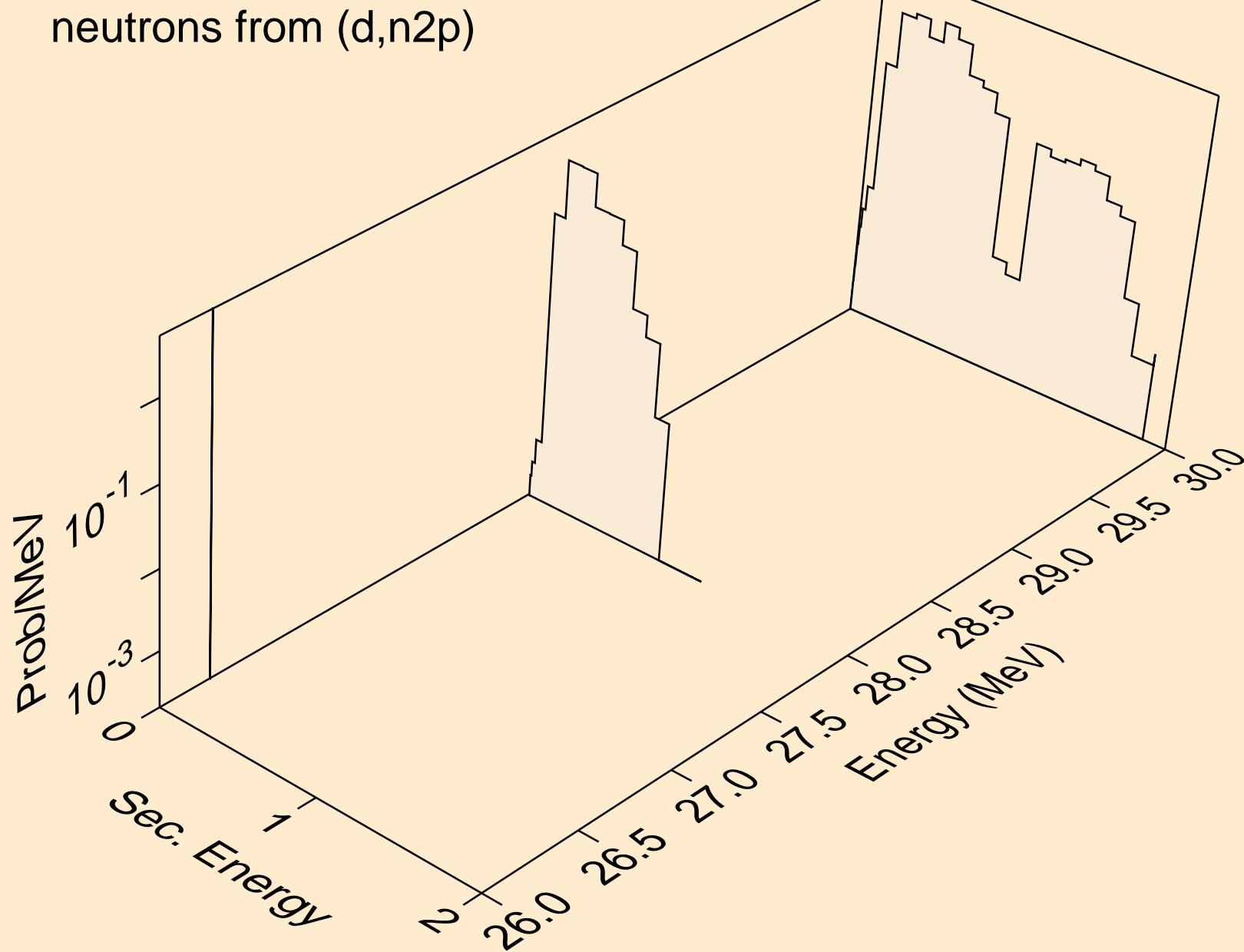

BE010 DEUTERON ACER TENDL-2023 LIBRARY; T=0.K  
protons from (d,x)

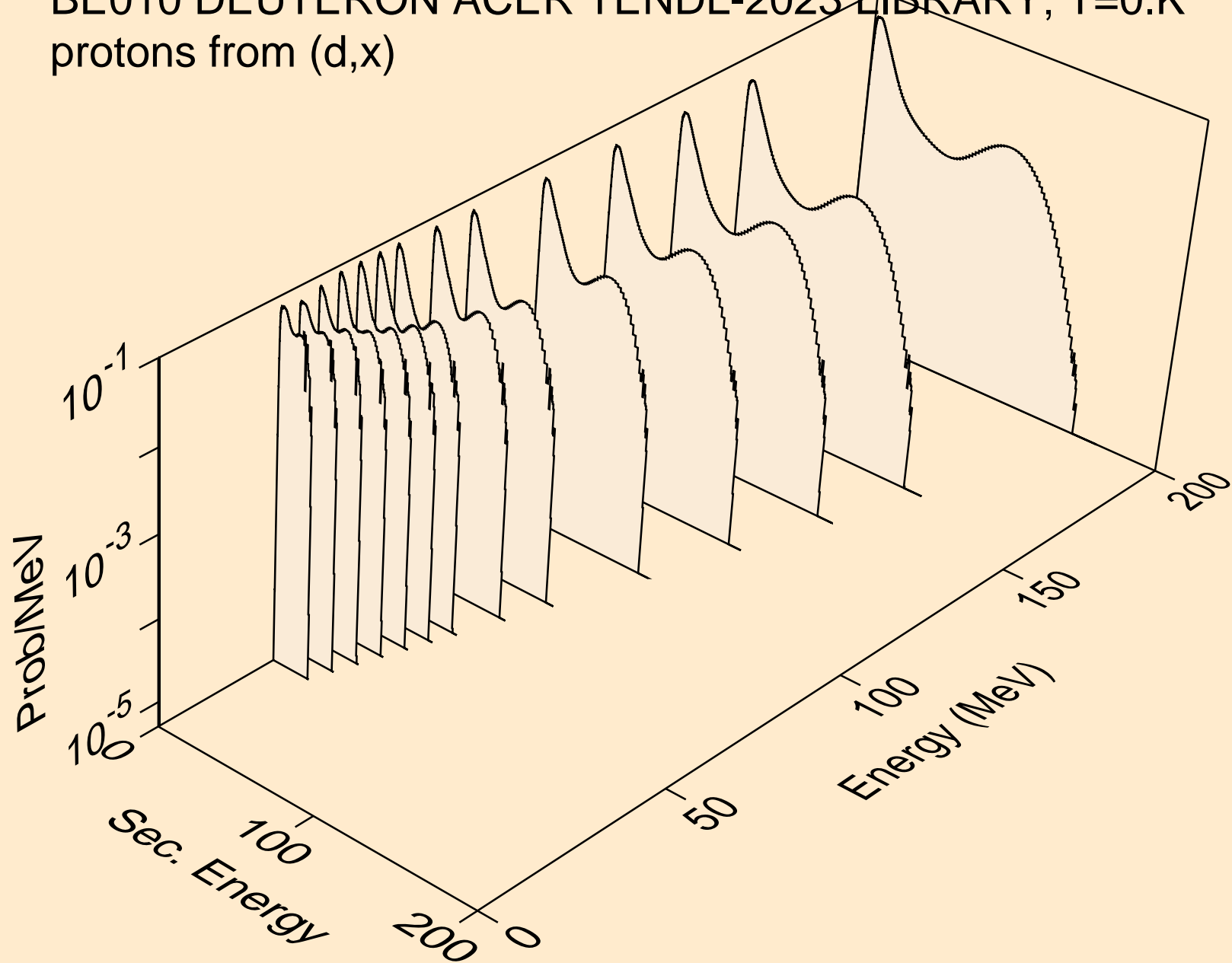

BE010 DEUTERON ACER TENDL-2023 LIBRARY; T=0.K  
protons from (d,n\*)p

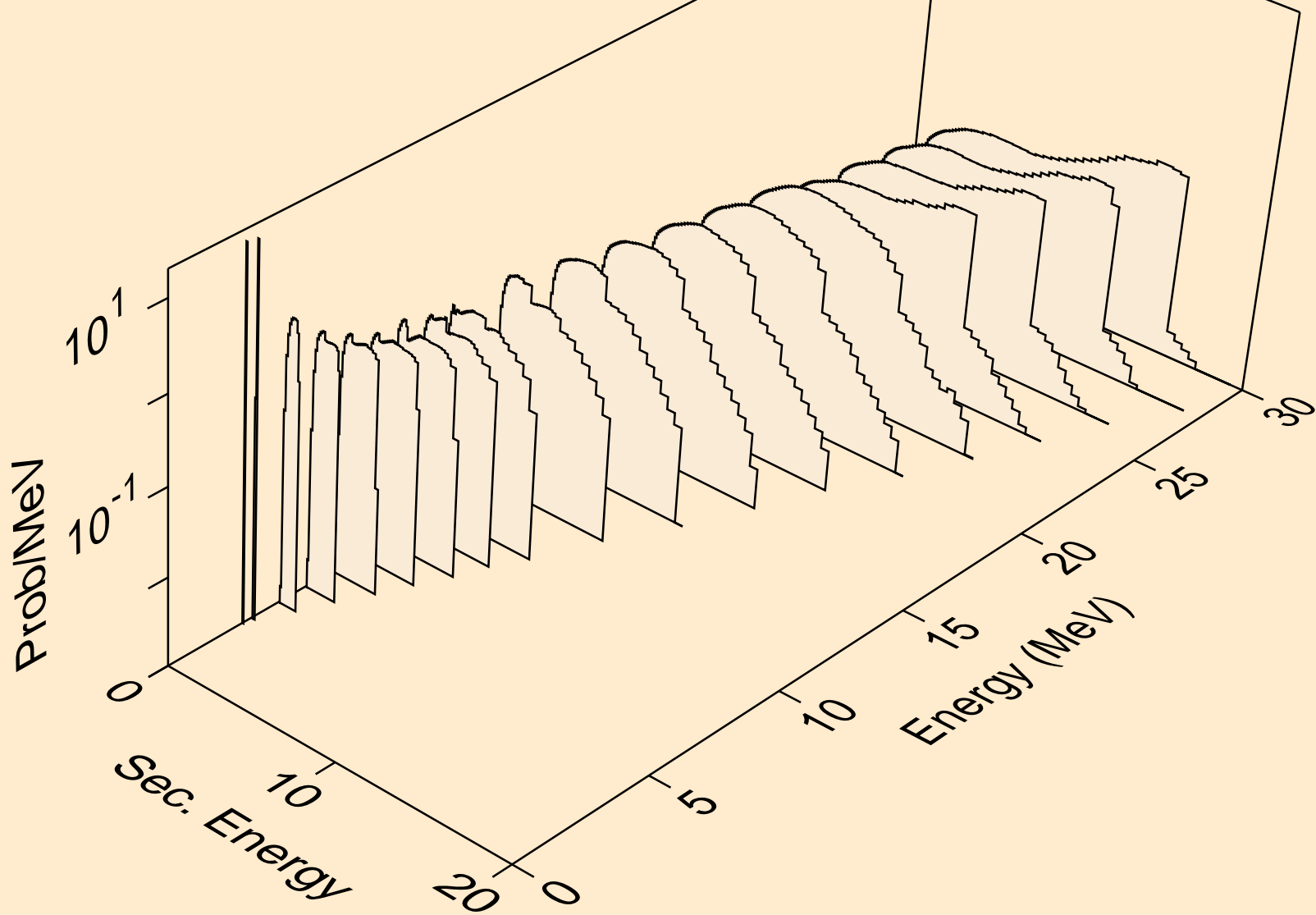

BE010 DEUTERON ACER TENDL-2023 LIBRARY; T=0.K  
protons from (d,2np)

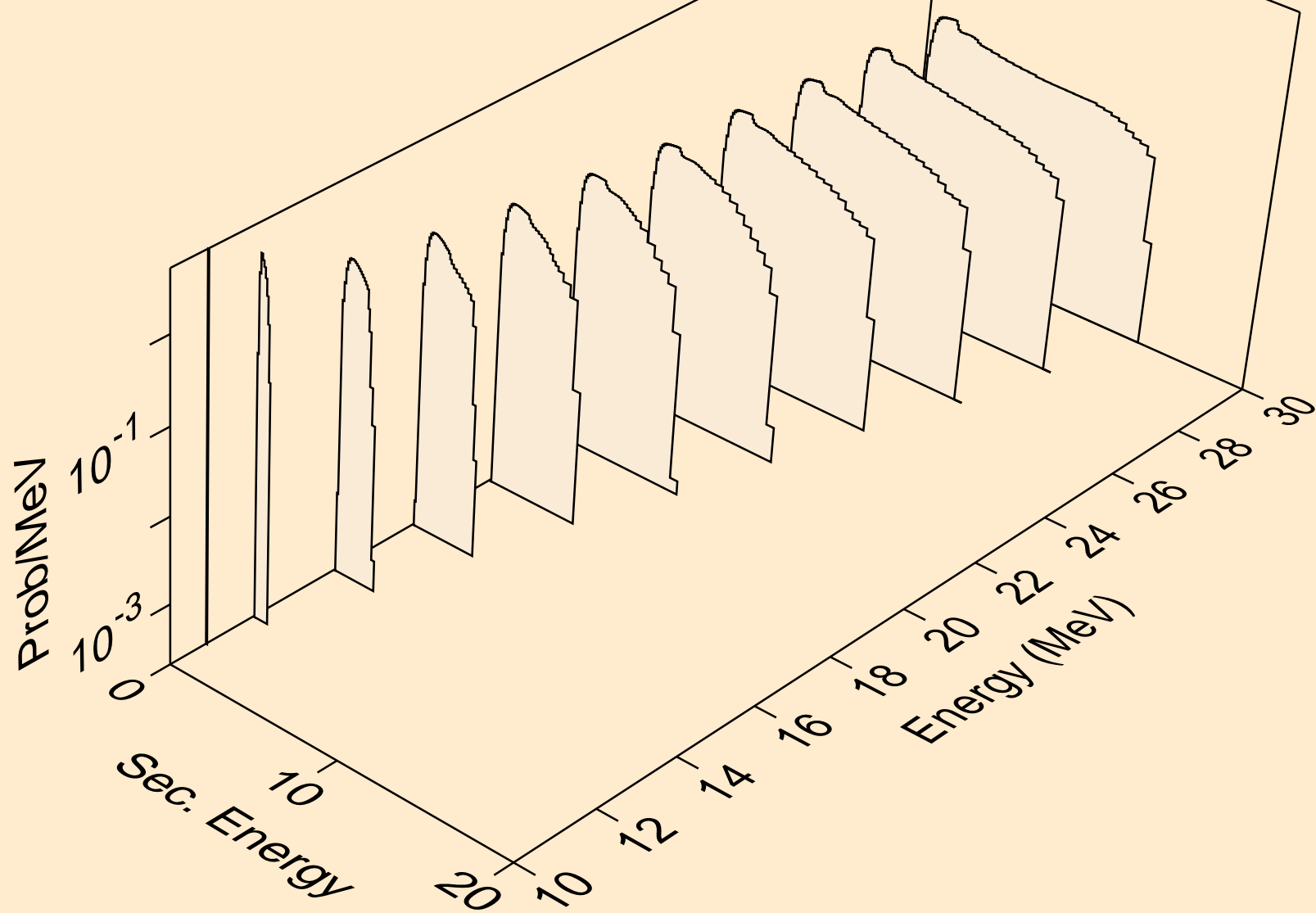



BE010 DEUTERON ACER TENDL-2023 LIBRARY; T=0.K  
protons from (d,3np)

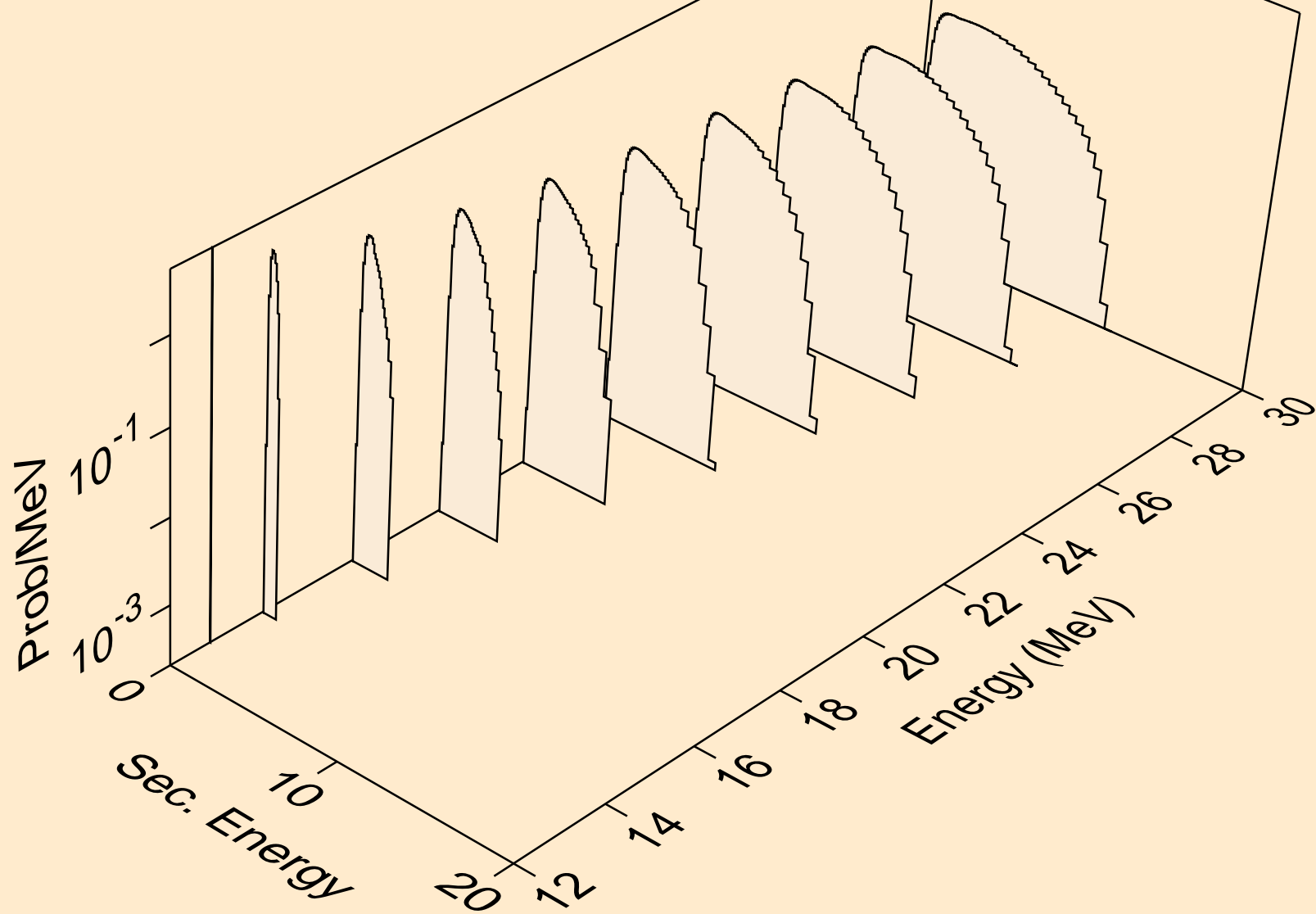

BE010 DEUTERON ACER TENDL-2023 LIBRARY; T=0.K  
protons from (d,n2p)

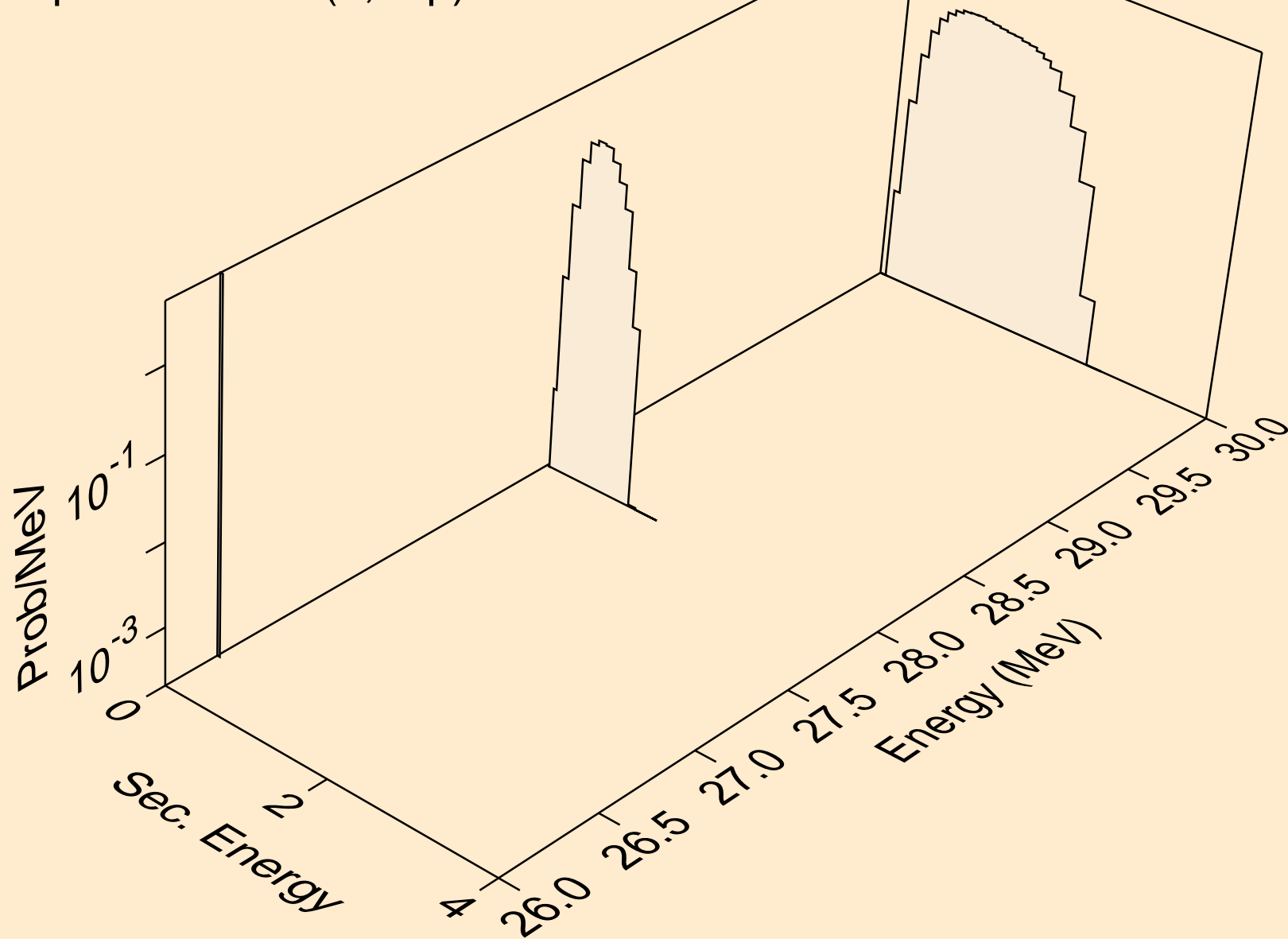

BE010 DEUTERON ACER TENDL-2023 LIBRARY; T=0.K  
protons from (d,p)

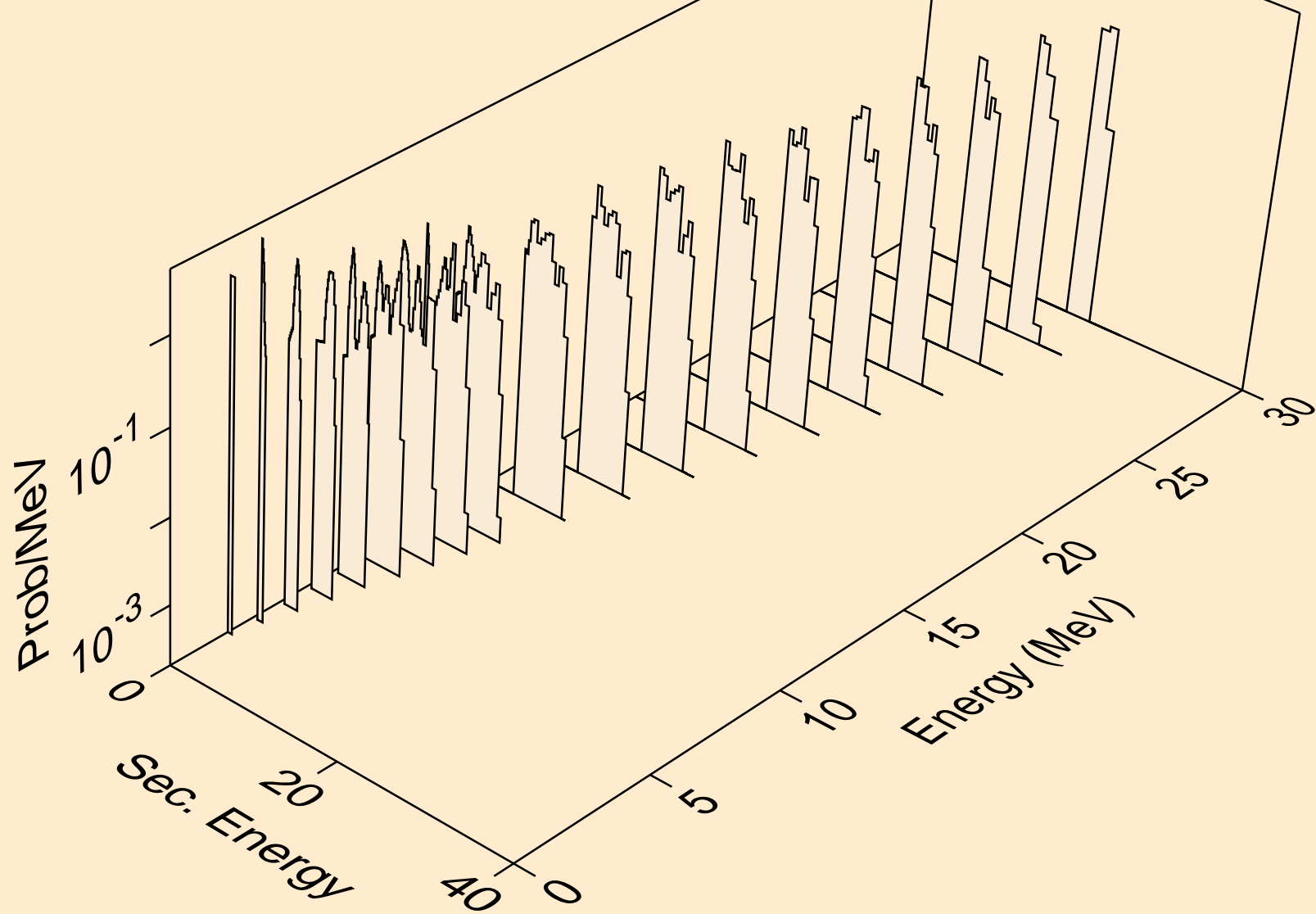

BE010 DEUTERON ACER TENDL-2023 LIBRARY; T=0.K  
protons from (d,2p)

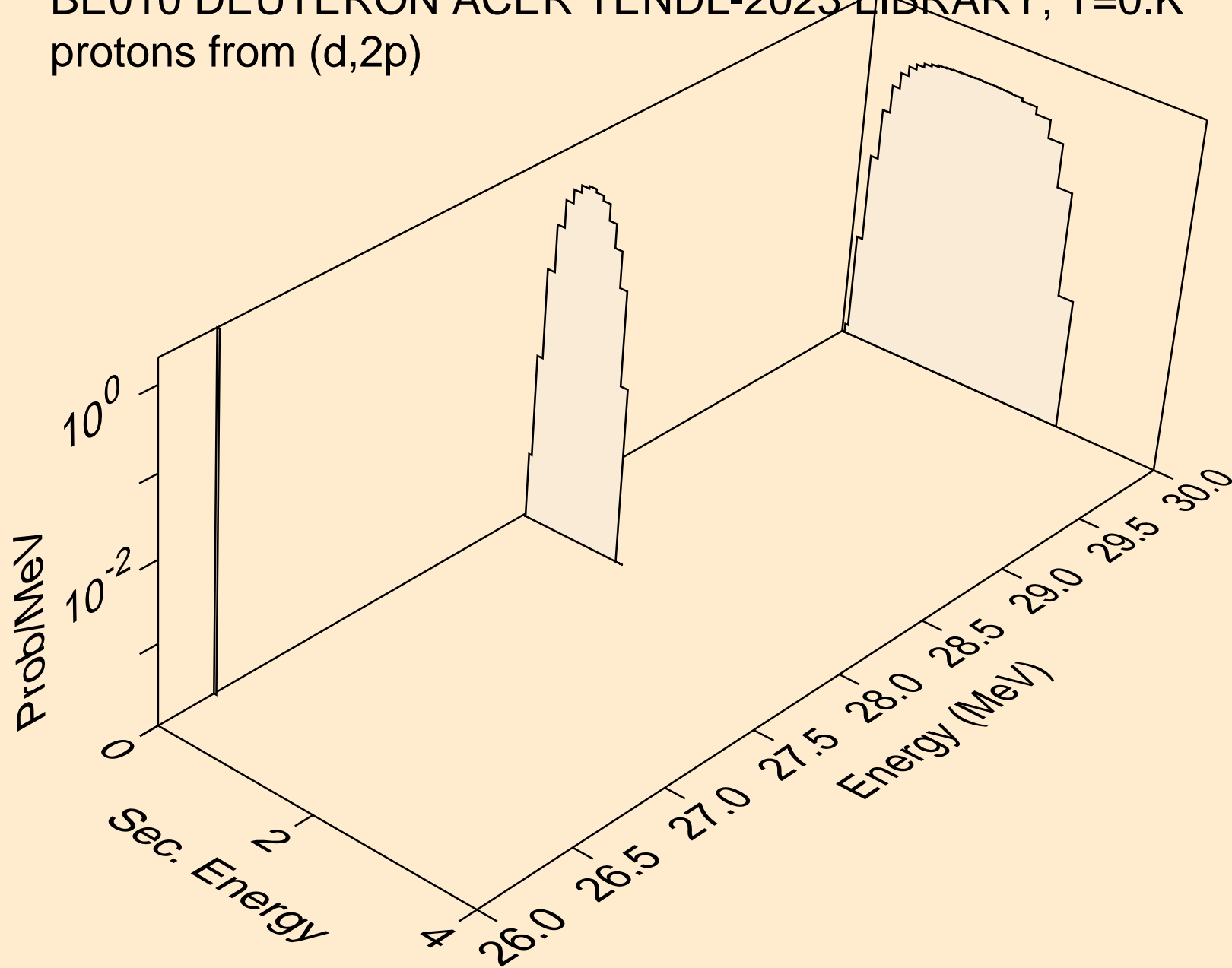

BE010 DEUTERON ACER TENDL-2023 LIBRARY; T=0.K  
protons from (d,pd)

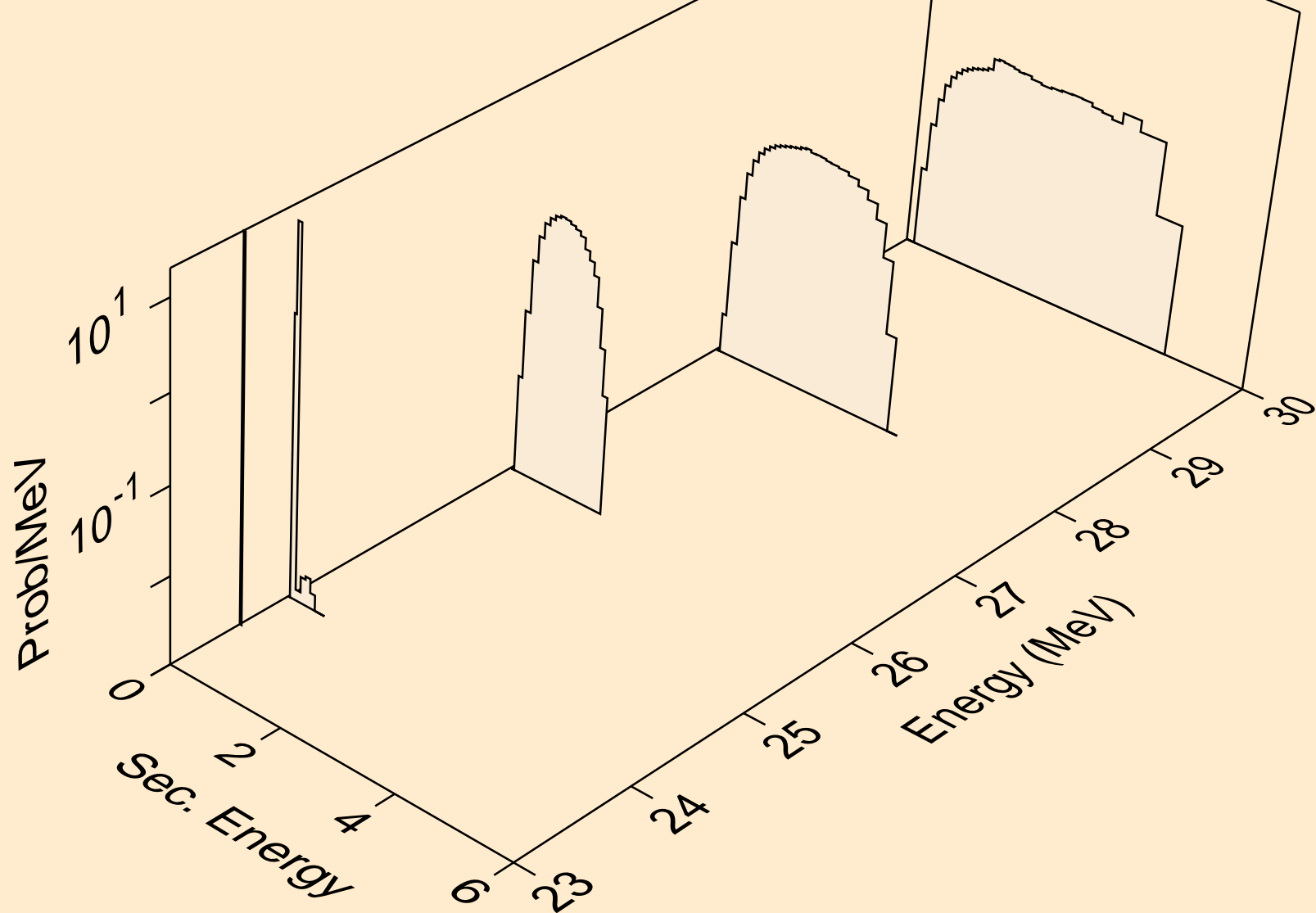

BE010 DEUTERON ACER TENDL-2023 LIBRARY; T=0.K  
protons from (d,pt)

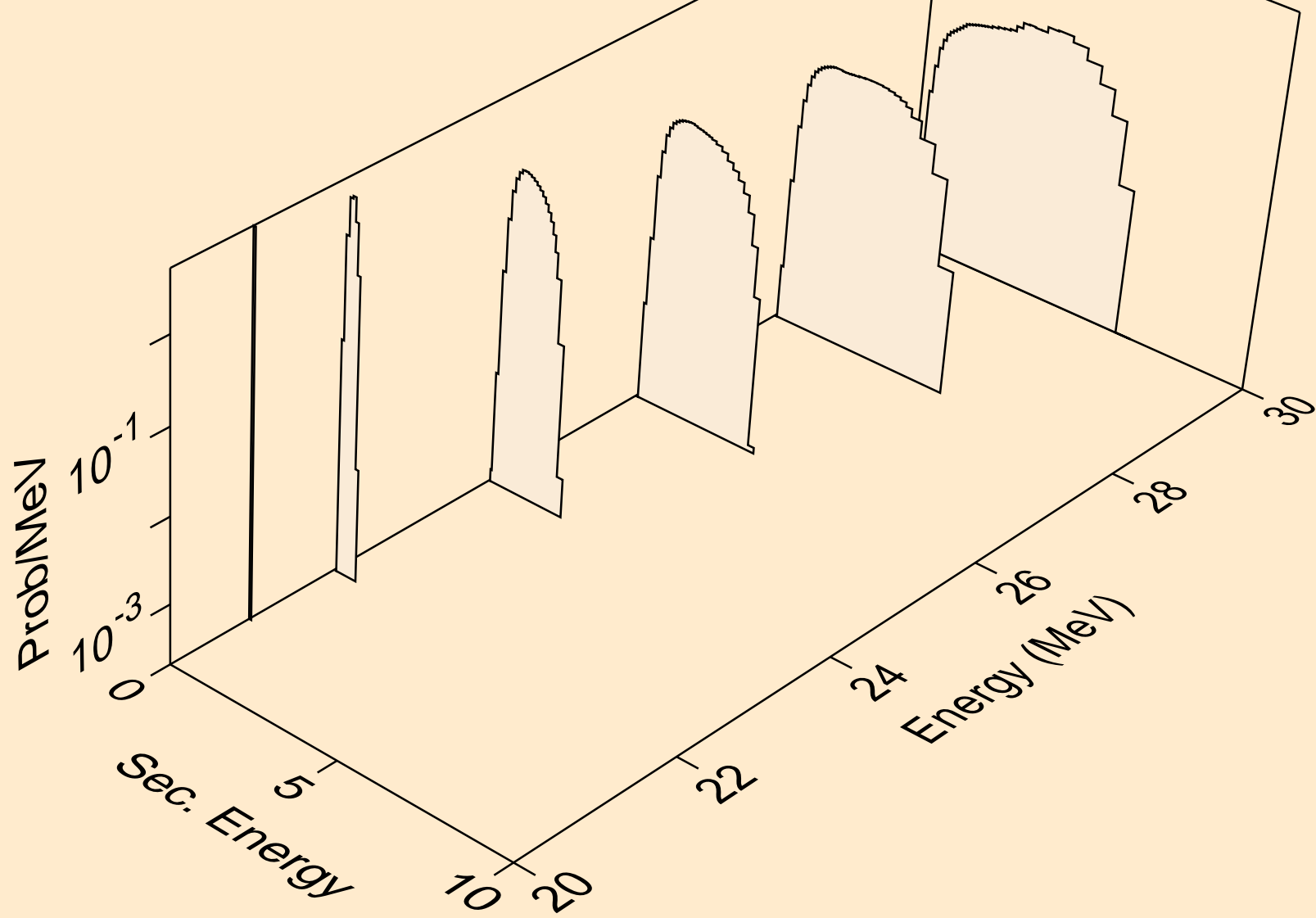

BE010 DEUTERON ACER TENDL-2023 LIBRARY; T=0.K  
tritons from (d,x)

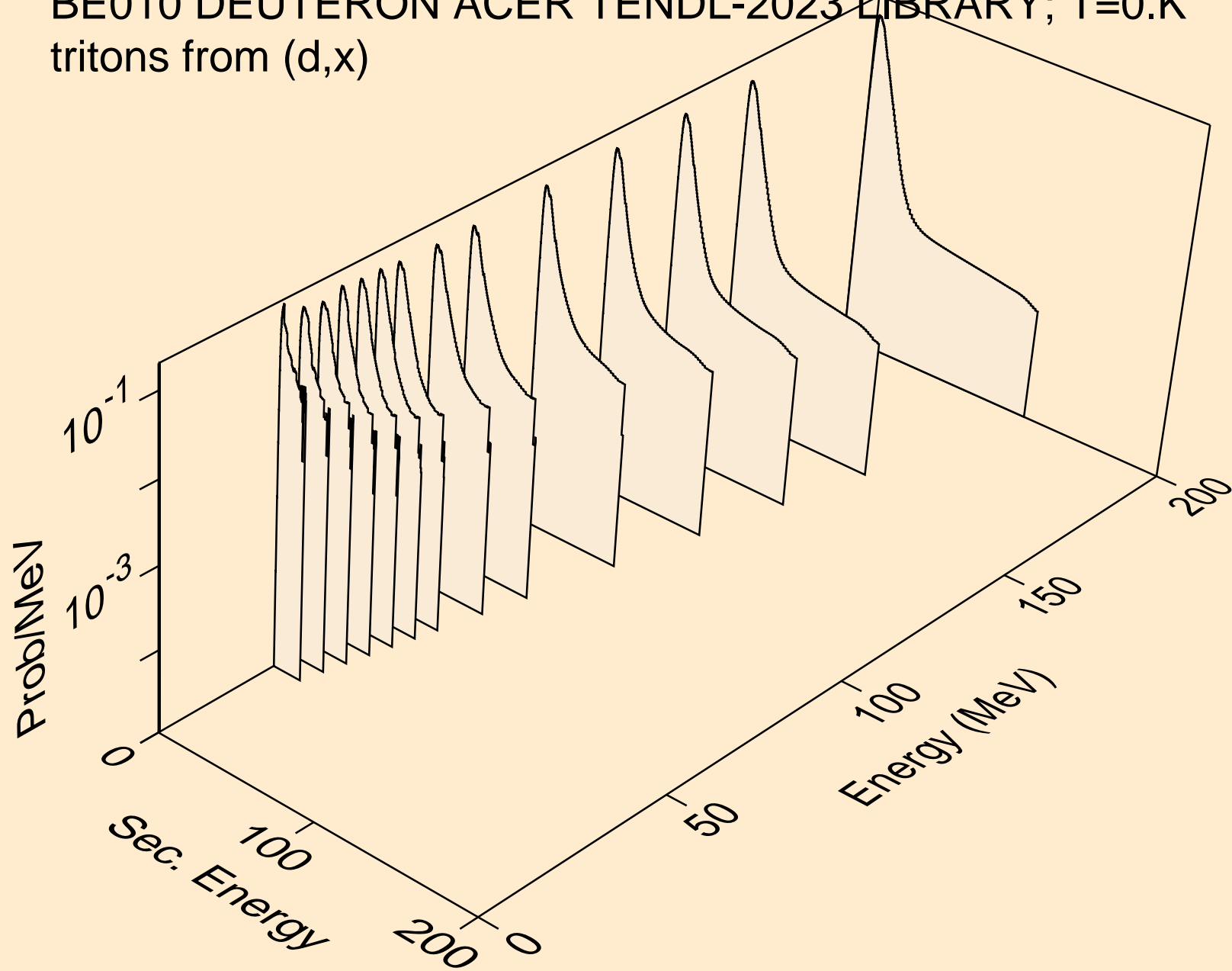

BE010 DEUTERON ACER TENDL-2023 LIBRARY; T=0.K  
tritons from (d,n\*)t

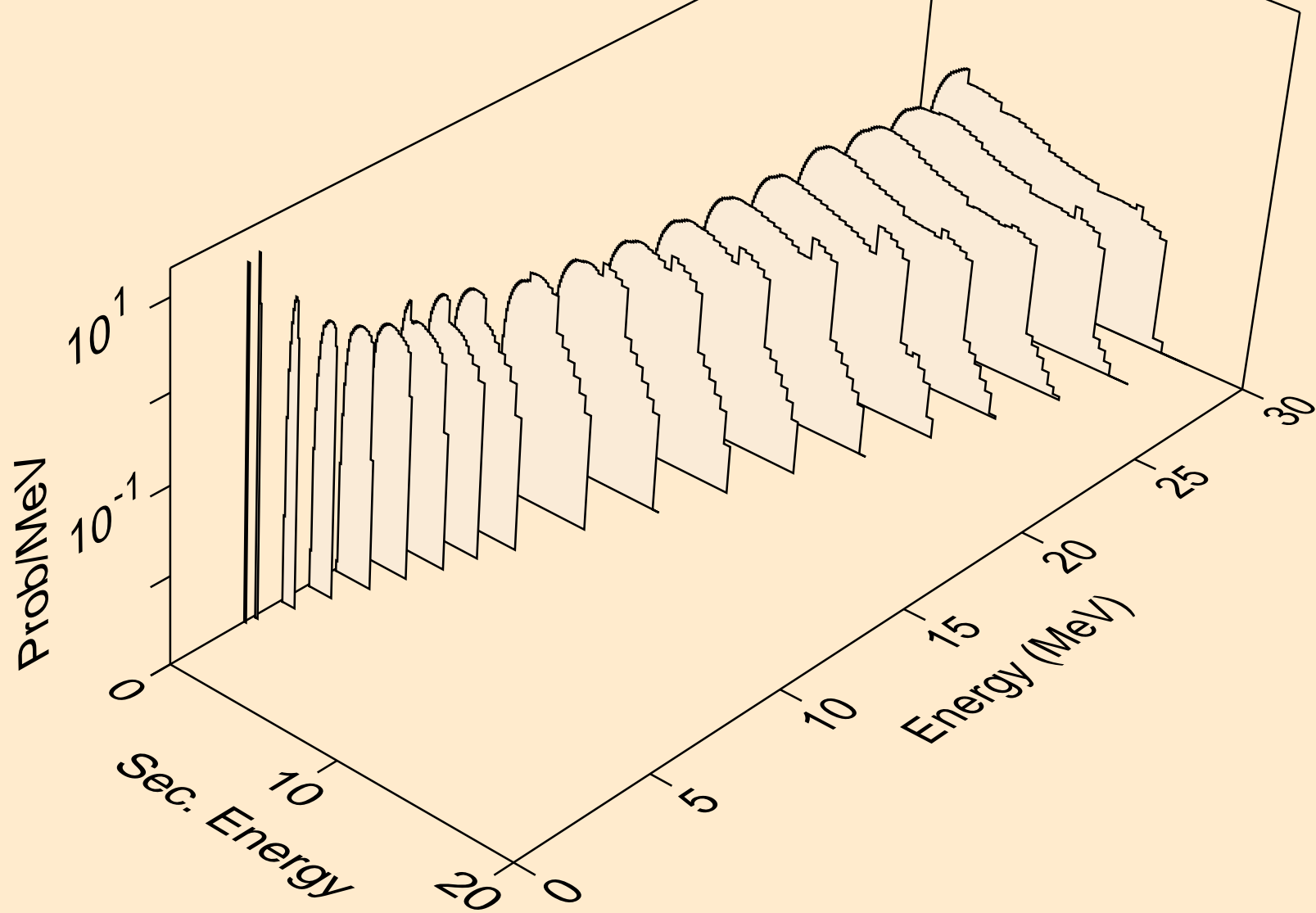



BE010 DEUTERON ACER TENDL-2023 LIBRARY; T=0.K  
tritons from (d,t)

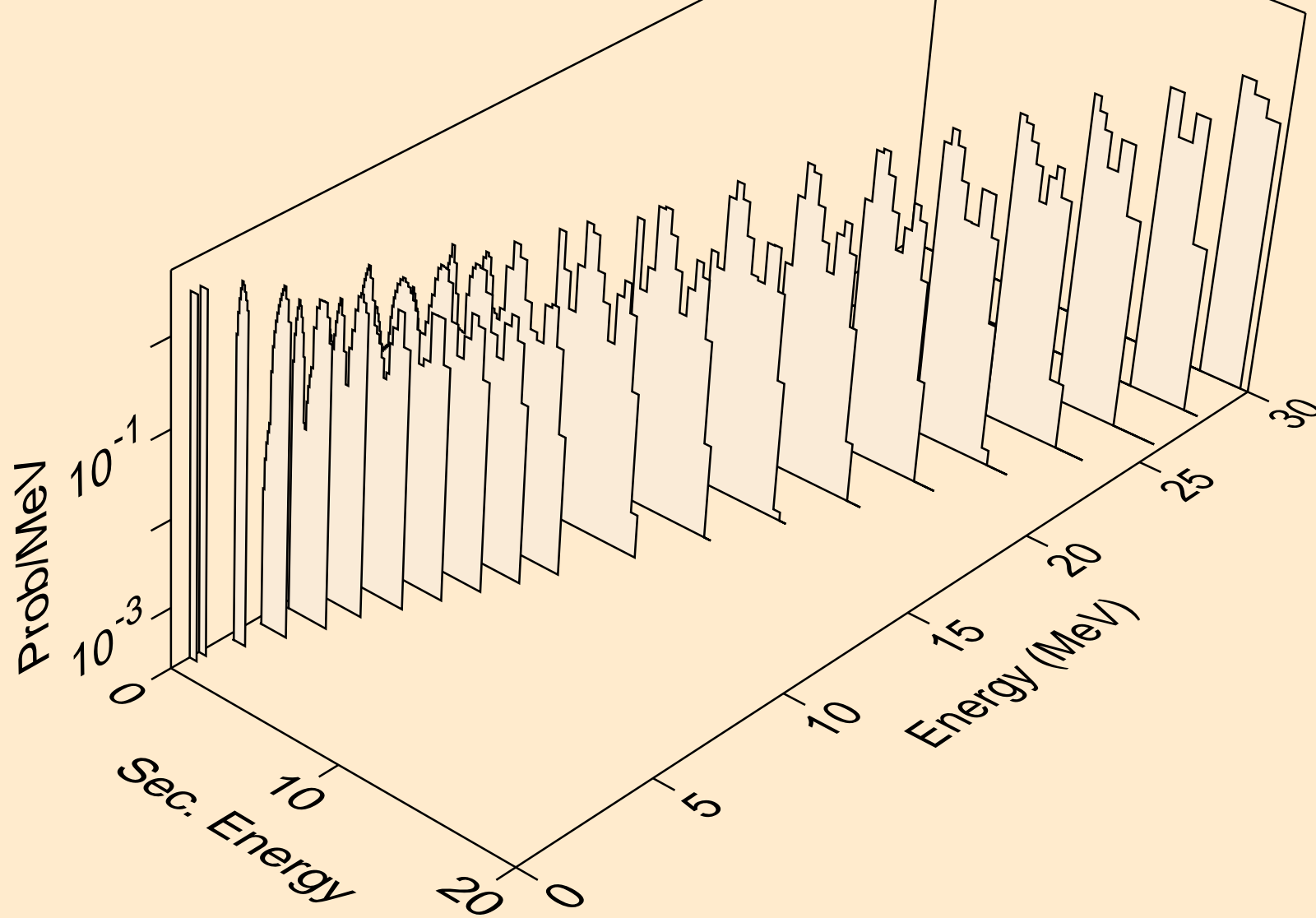

BE010 DEUTERON ACER TENDL-2023 LIBRARY; T=0.K  
tritons from (d,pt)

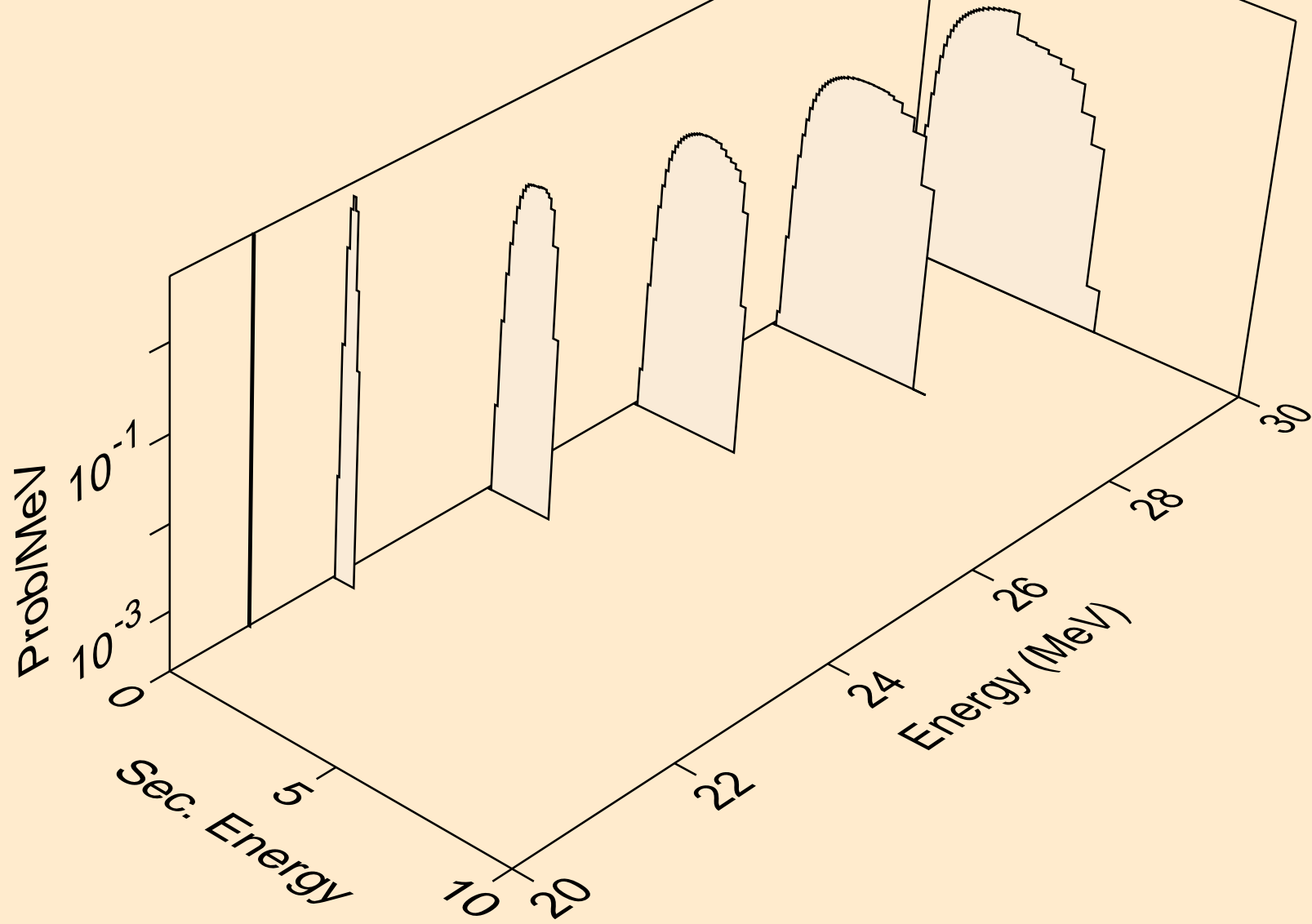

BE010 DEUTERON ACER TENDL-2023 LIBRARY; T=0.K  
he3s from (d,x)

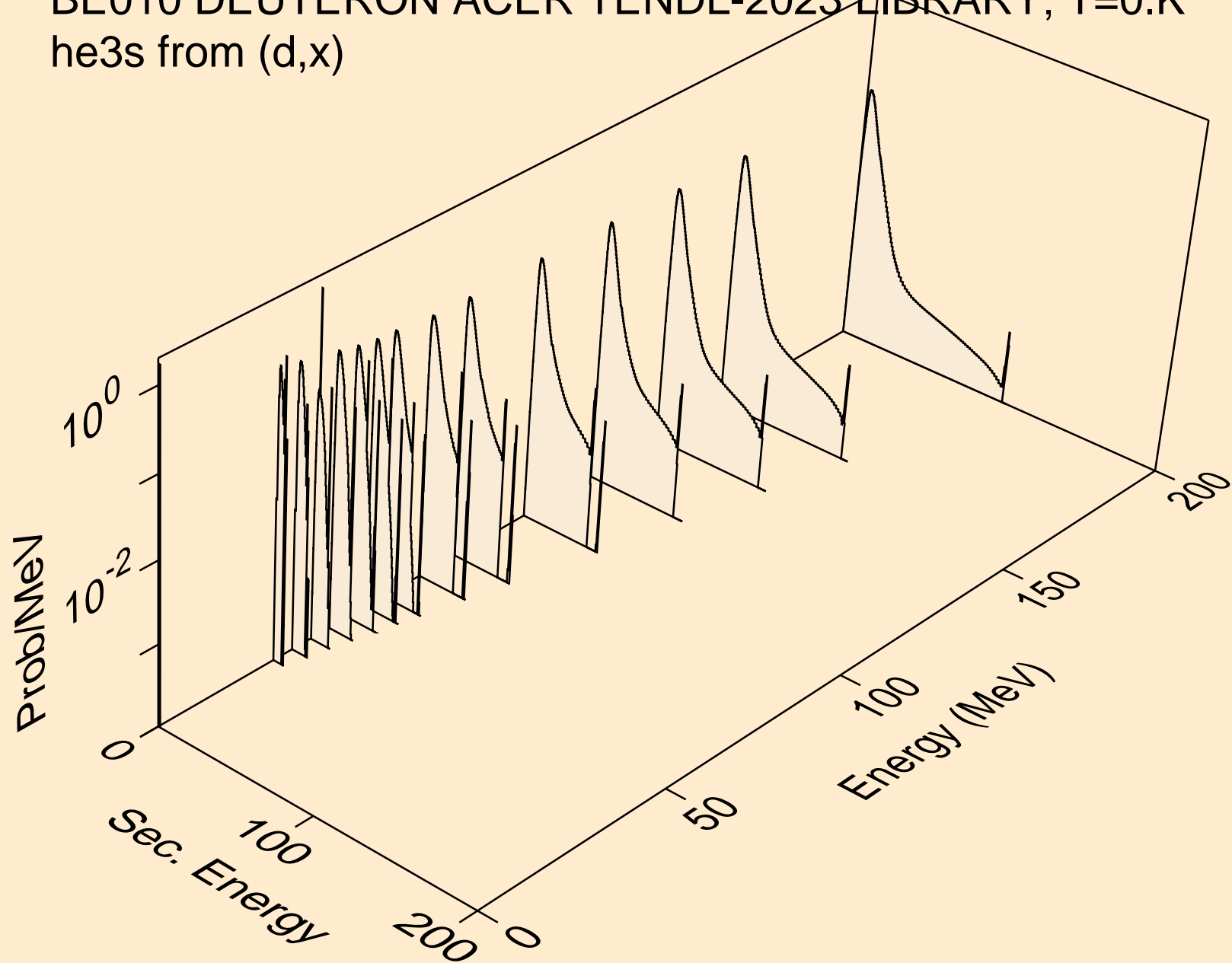

BE010 DEUTERON ACER TENDL-2023 LIBRARY; T=0.K  
he3s from (d,n\*)he3

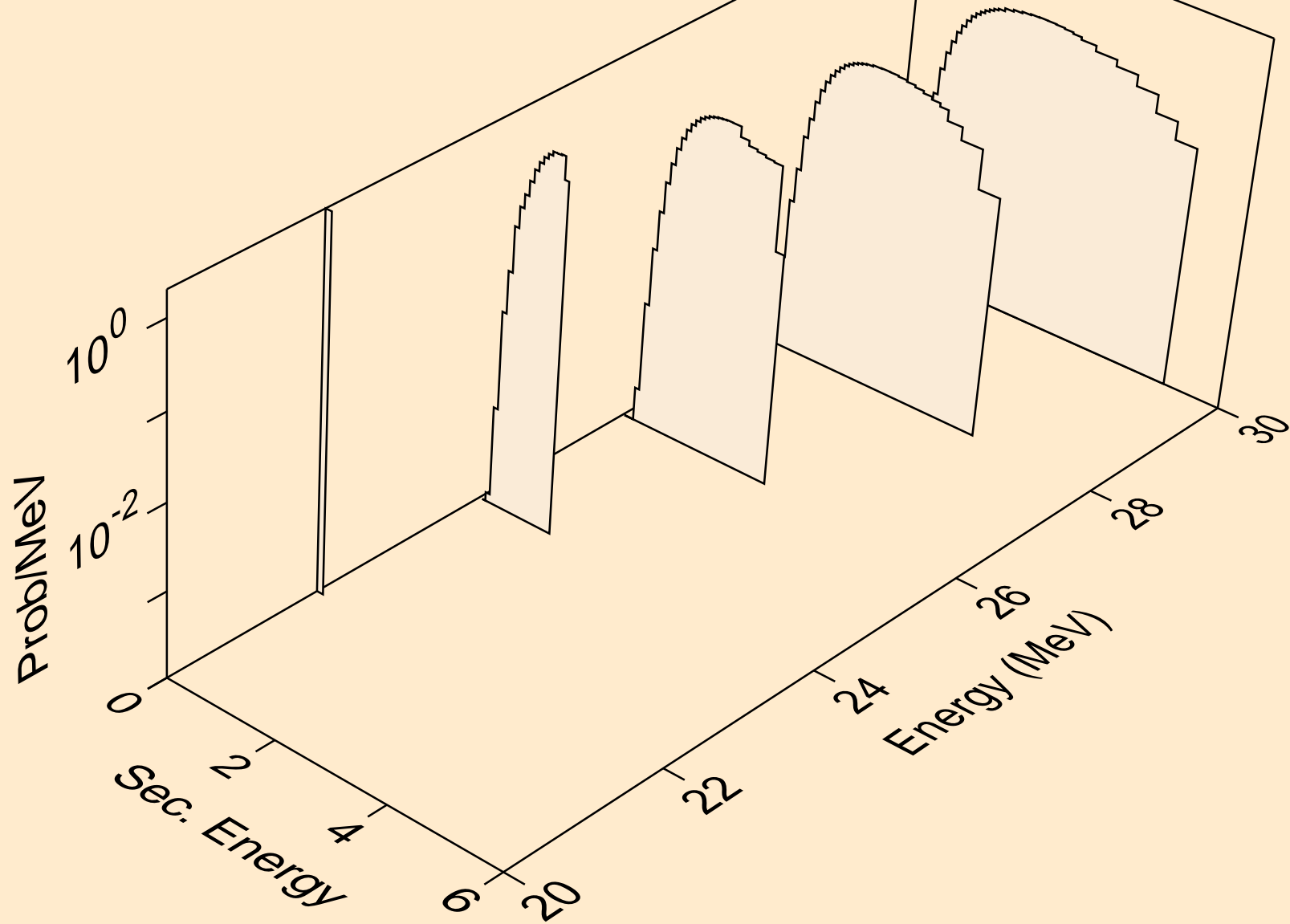

BE010 DEUTERON ACER TENDL-2023 LIBRARY; T=0.K  
he3s from (d,he3)

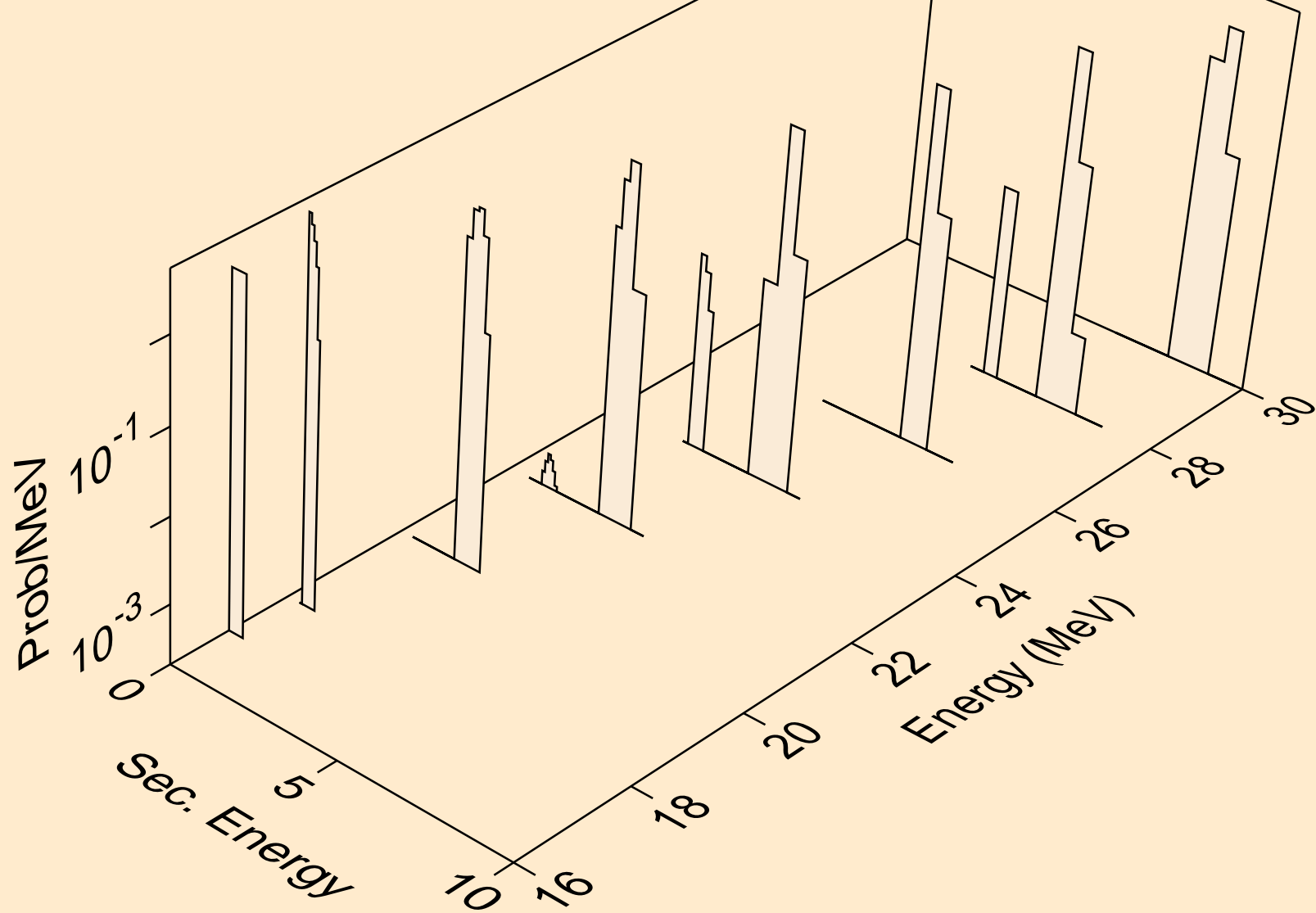

BE010 DEUTERON ACER TENDL-2023 LIBRARY; T=0.K  
alphas from (d,x)

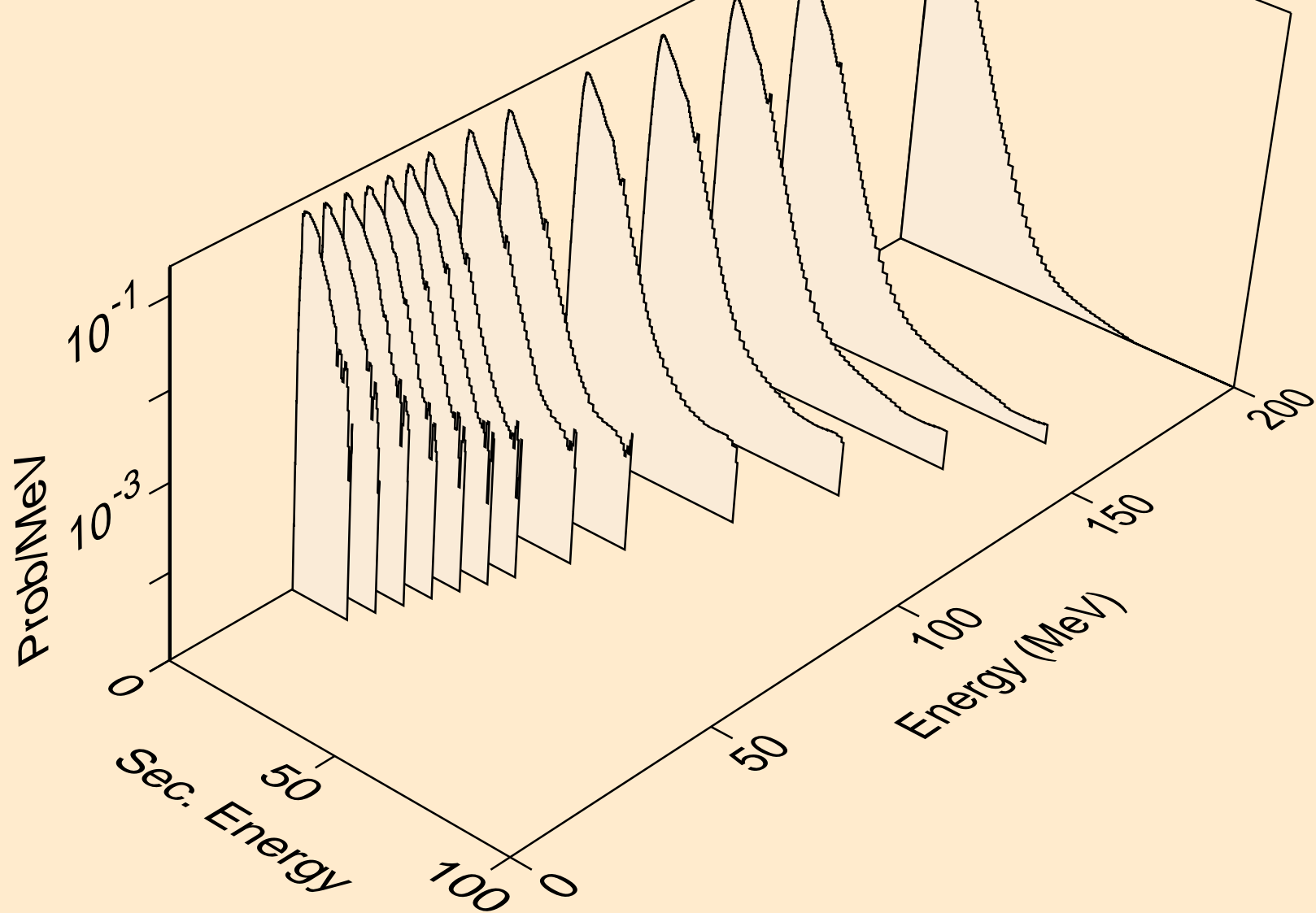

BE010 DEUTERON ACER TENDL-2023 LIBRARY; T=0.K  
alphas from (d,n\*)a

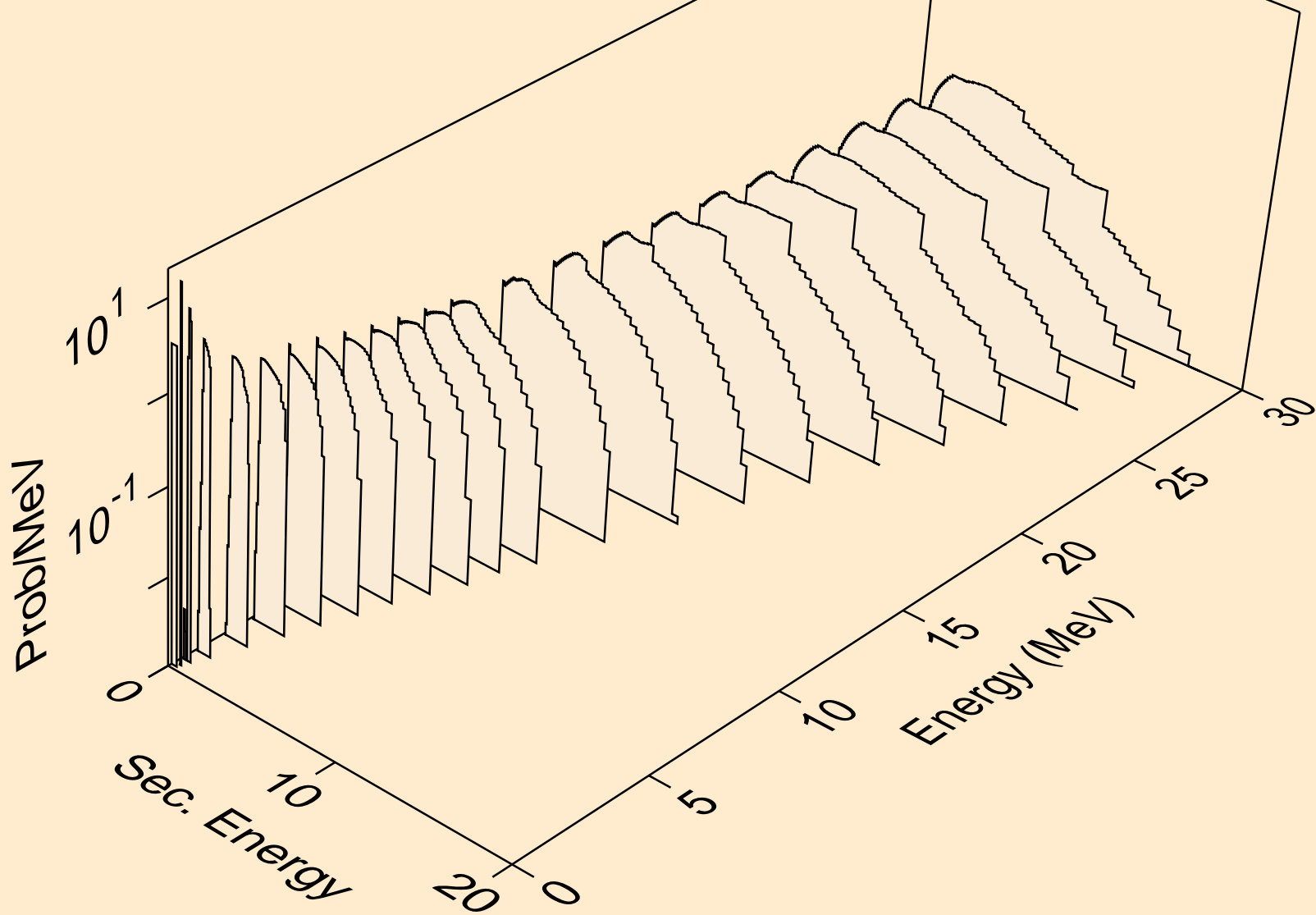

BE010 DEUTERON ACER TENDL-2023 LIBRARY; T=0.K  
alphas from (d,2n)a

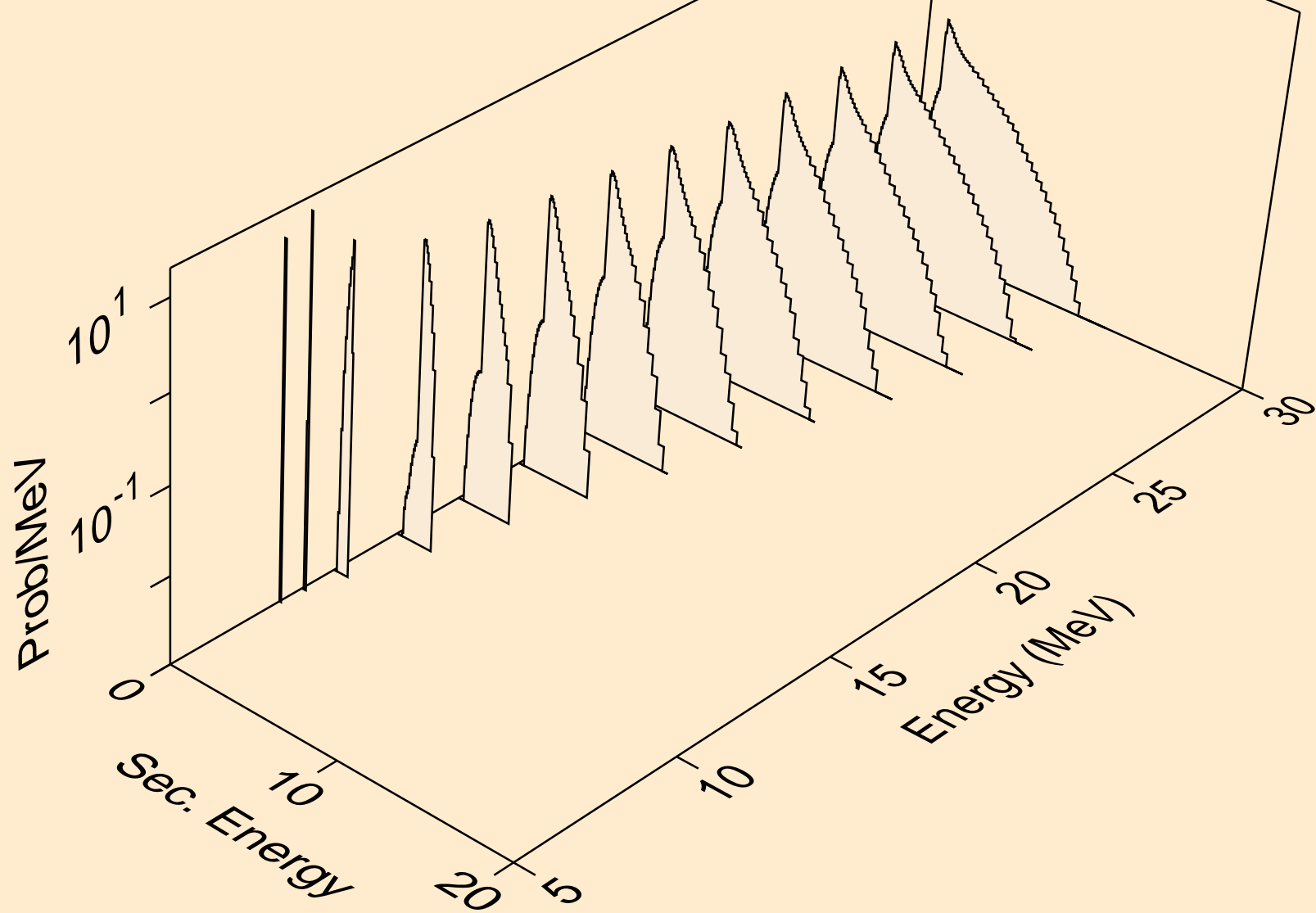



BE010 DEUTERON ACER TENDL-2023 LIBRARY; T=0.K  
alphas from (d,a)

