

BK234 DEUTERON ACER TENDL-2023 LIBRARY; T=0.K
Principal cross sections

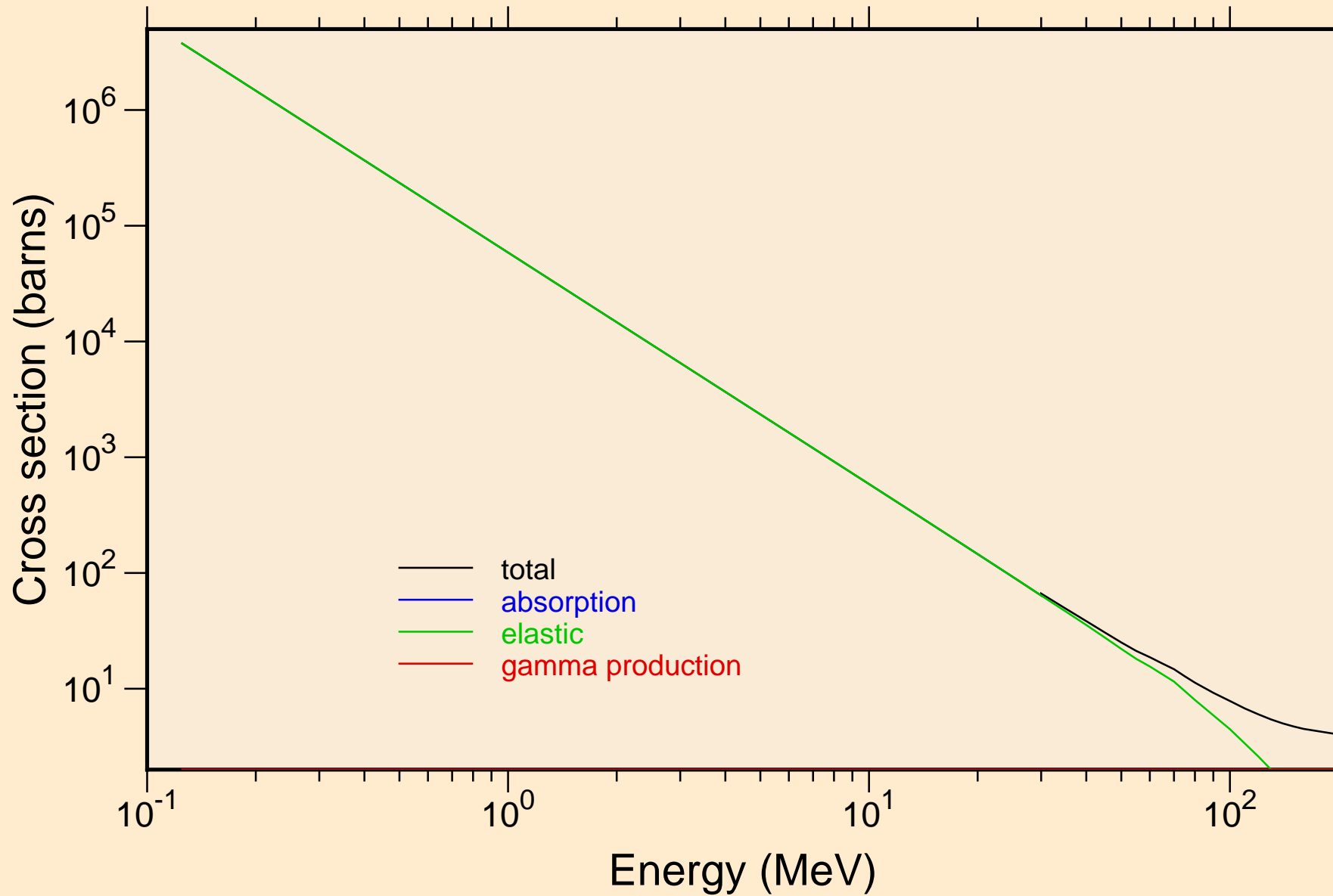

BK234 DEUTERON ACER TENDL-2023 LIBRARY; T=0.K
Heating

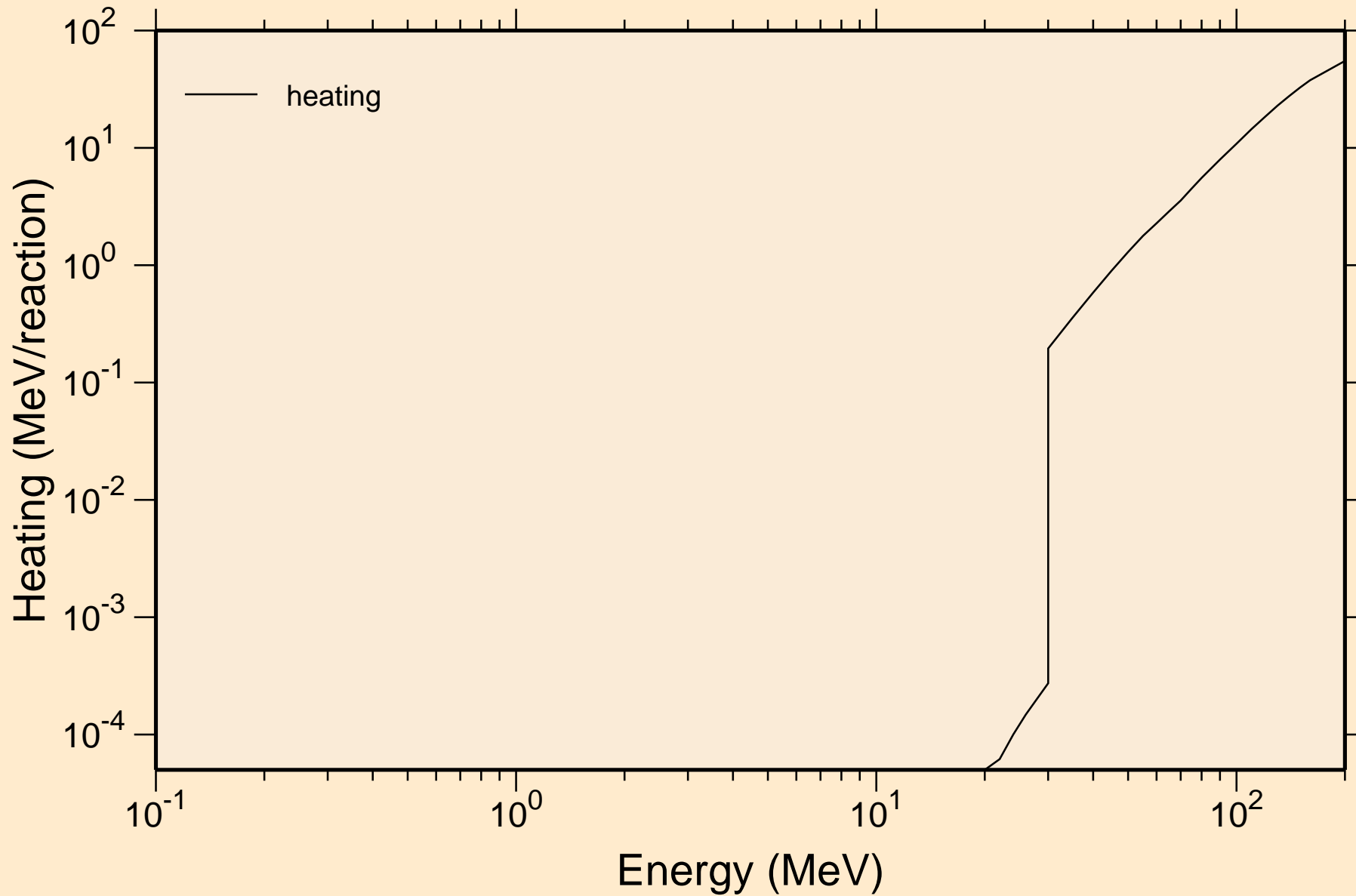

BK234 DEUTERON ACER TENDL-2023 LIBRARY; T=0.K
Principal cross sections

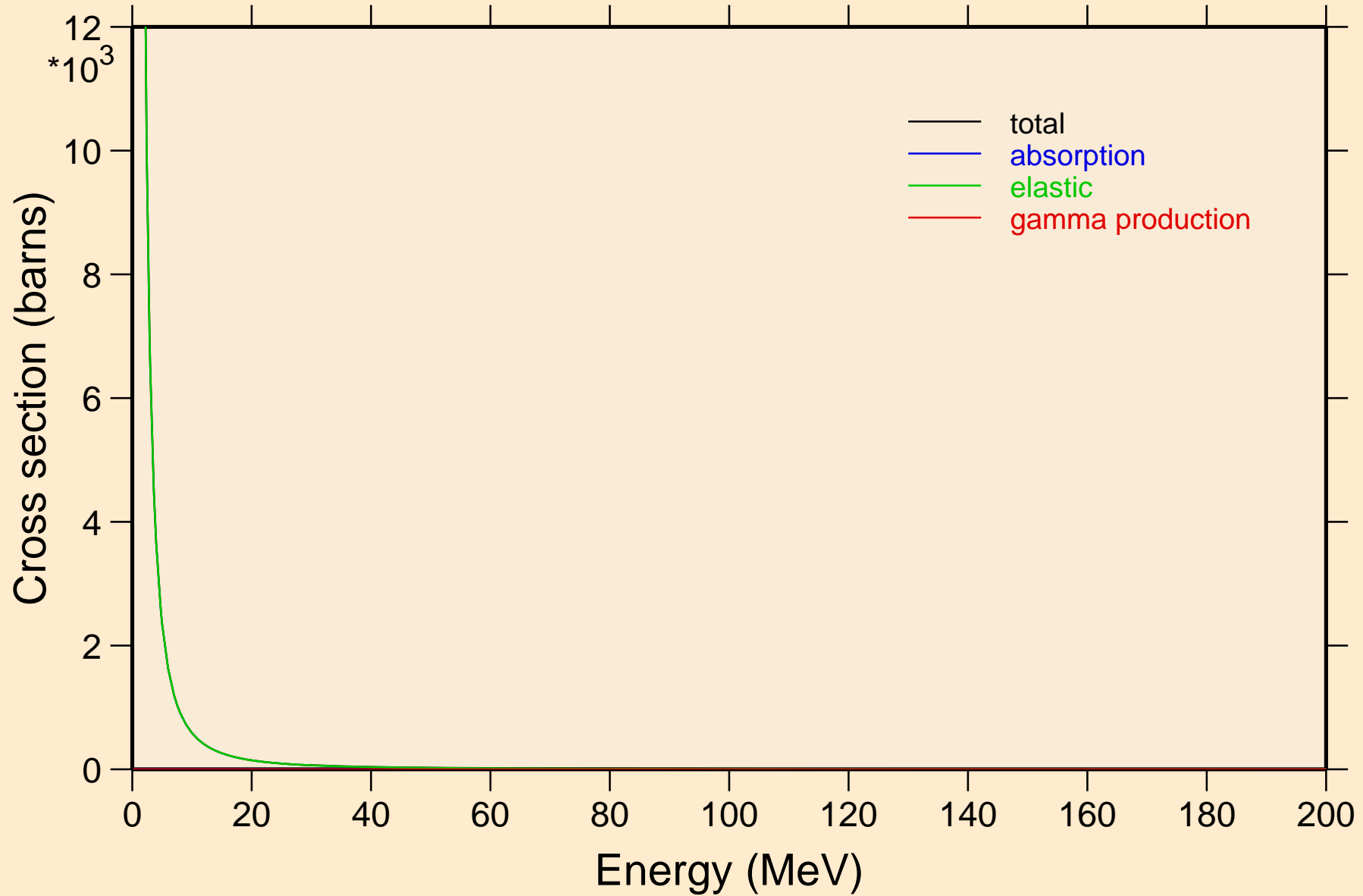

BK234 DEUTERON ACER TENDL-2023 LIBRARY; T=0.K

Heating

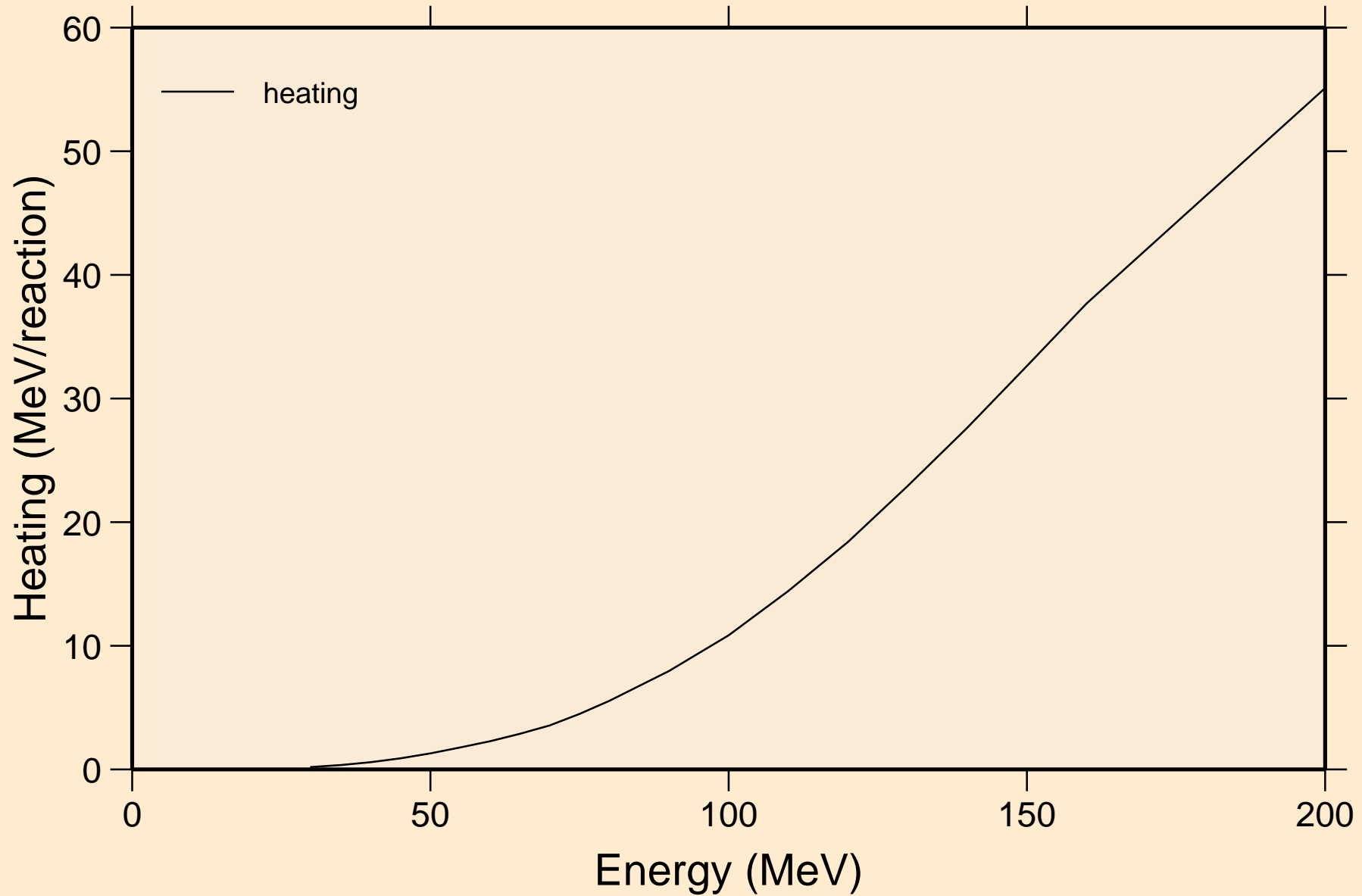

BK234 DEUTERON ACER TENDL-2023 LIBRARY; T=0.K
Threshold reactions

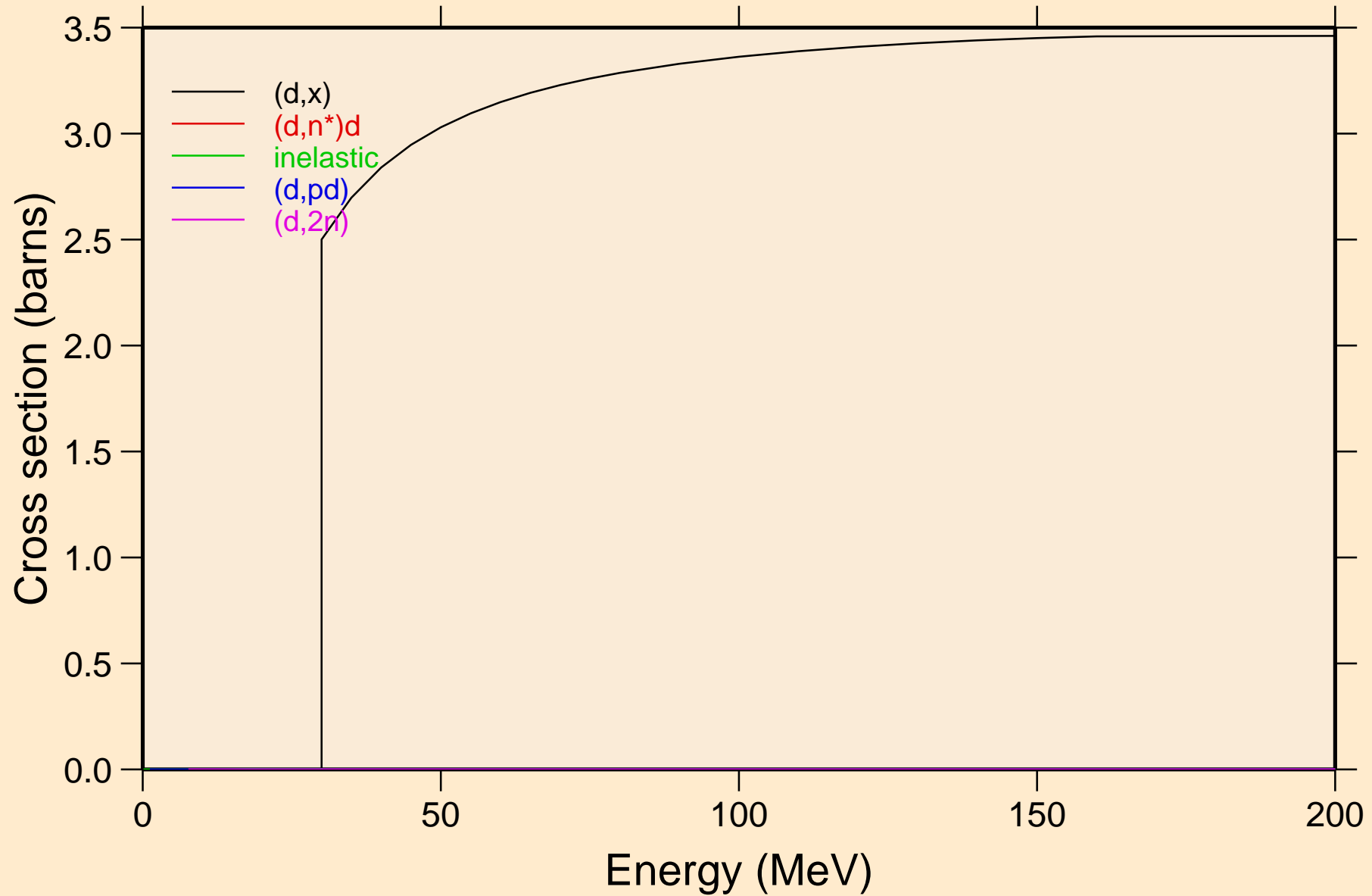

BK234 DEUTERON ACER TENDL-2023 LIBRARY; T=0.K
Threshold reactions

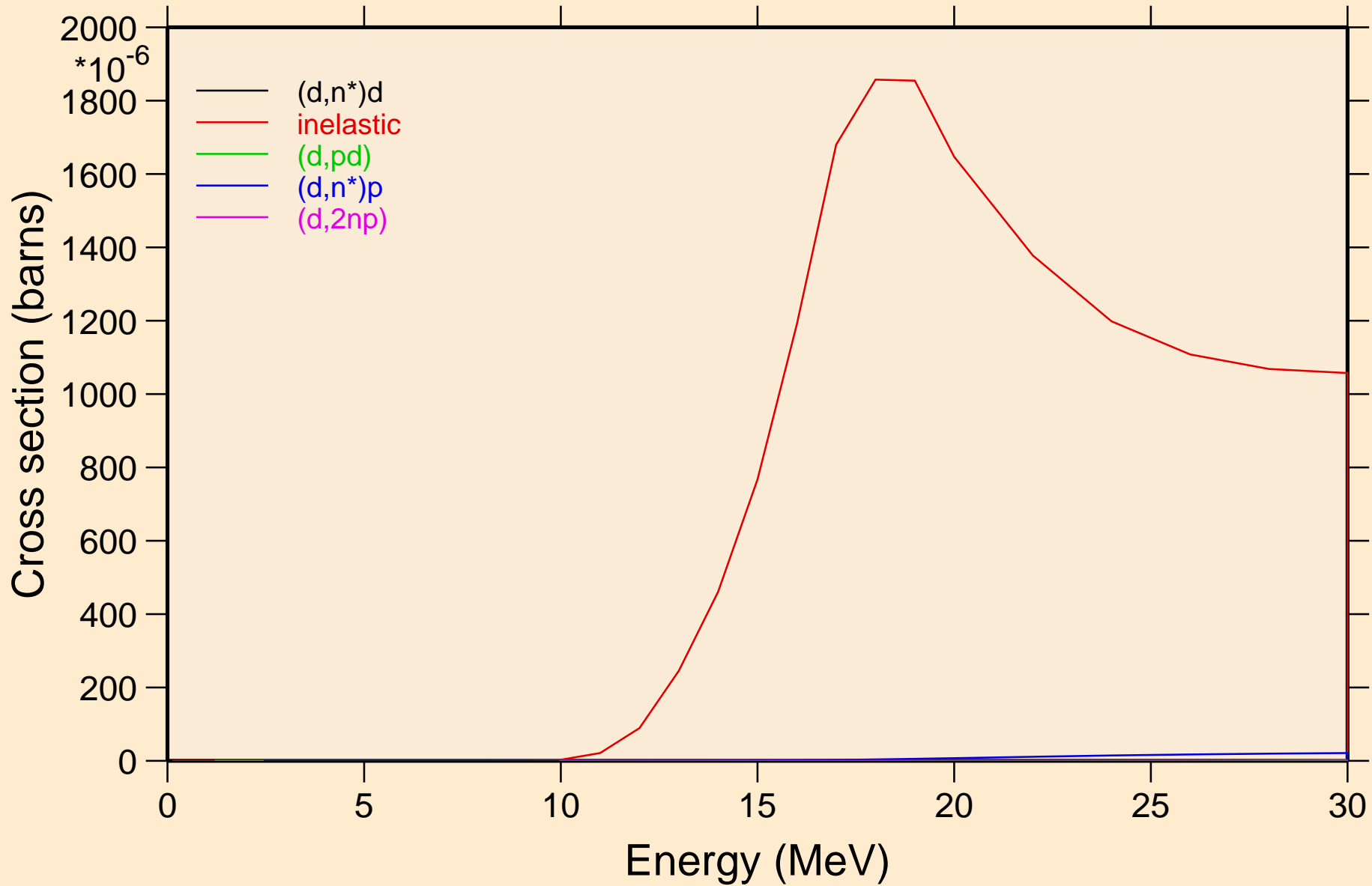

BK234 DEUTERON ACER TENDL-2023 LIBRARY; T=0.K

Threshold reactions

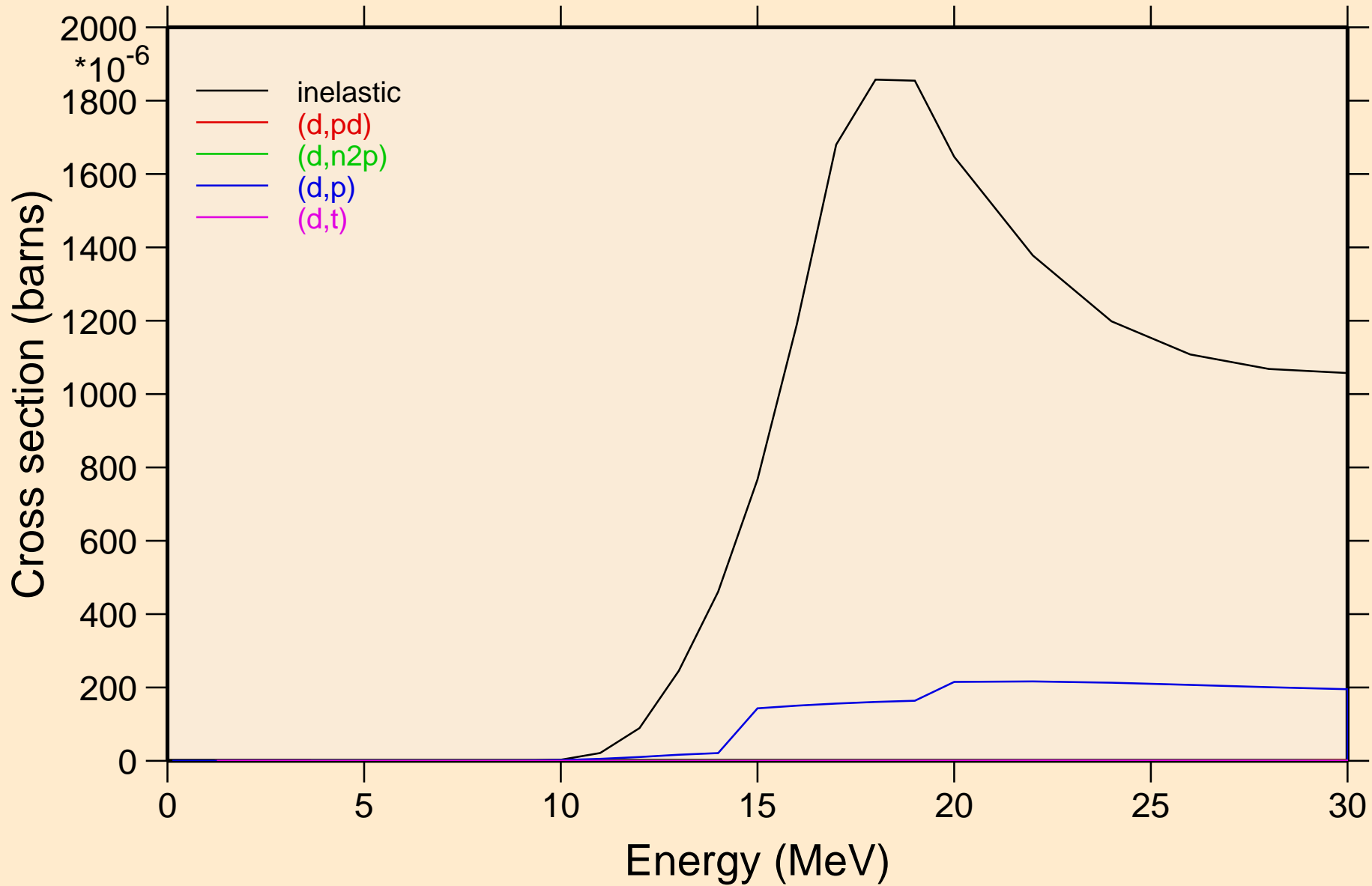

BK234 DEUTERON ACER TENDL-2023 LIBRARY; T=0.K
Threshold reactions

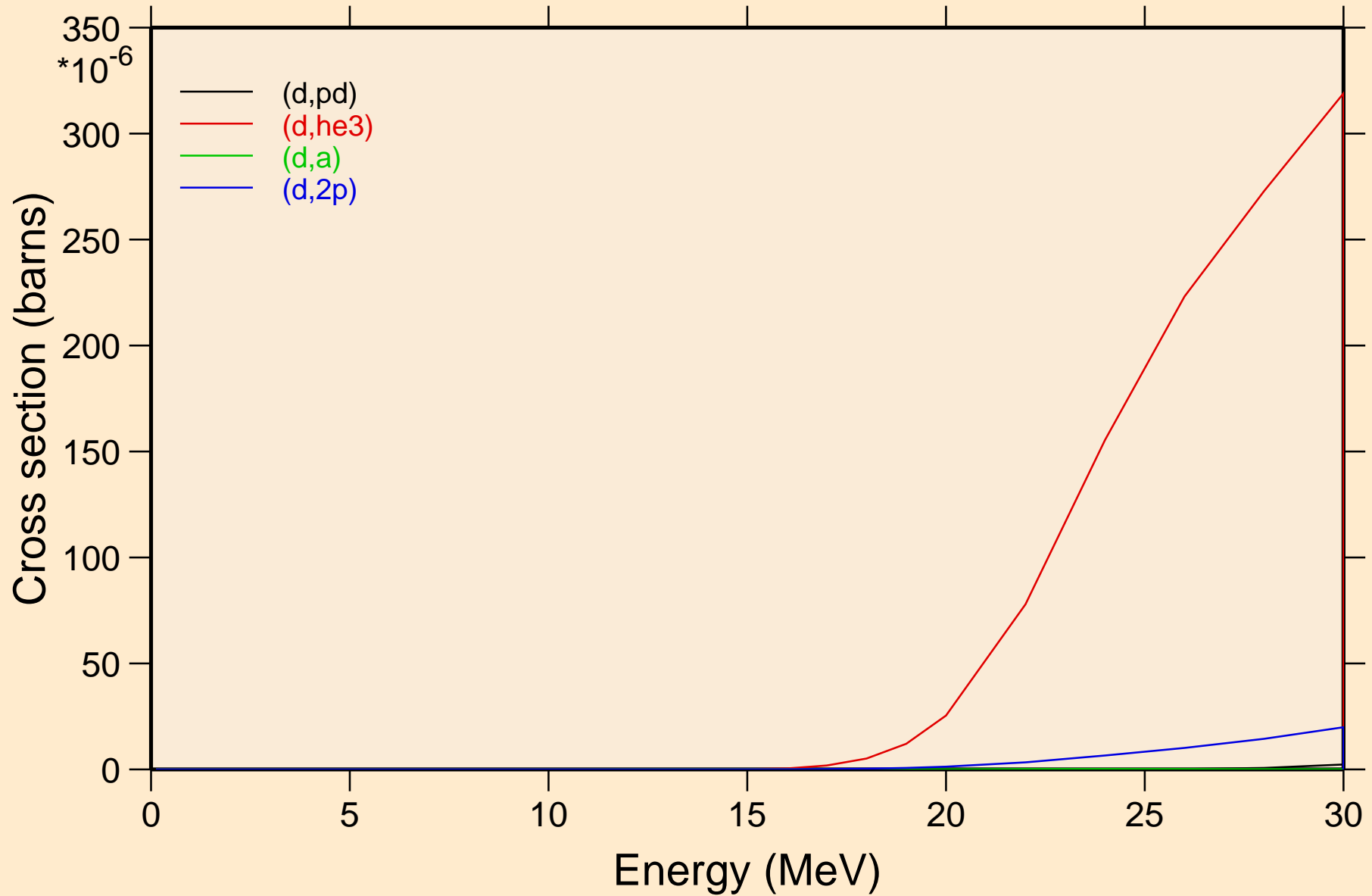

BK234 DEUTERON ACER TENDL-2023 LIBRARY; T=0.K
Threshold reactions

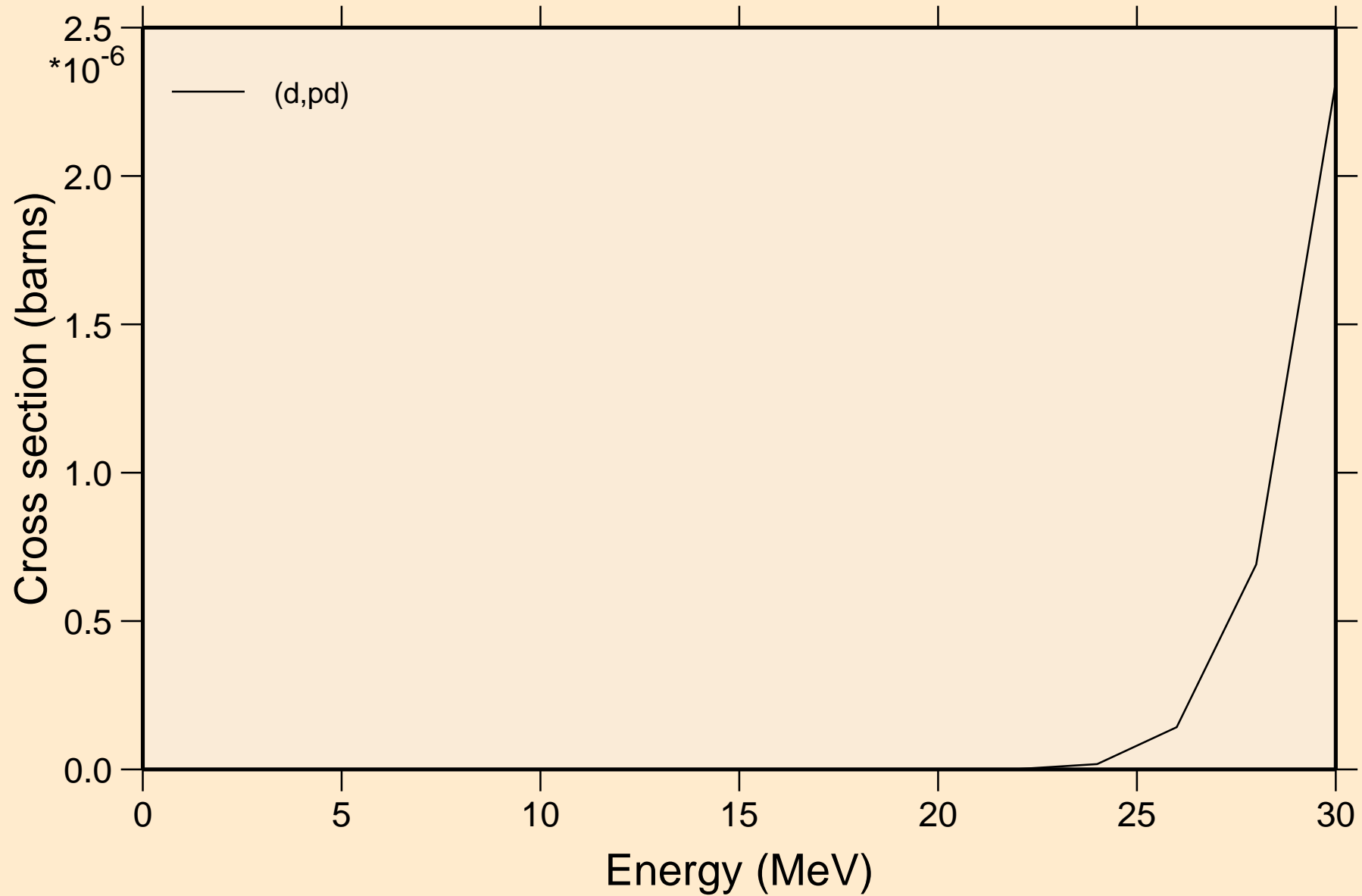

BK234 DEUTERON ACER TENDL-2023 LIBRARY; T=0.K
angular distribution for elastic

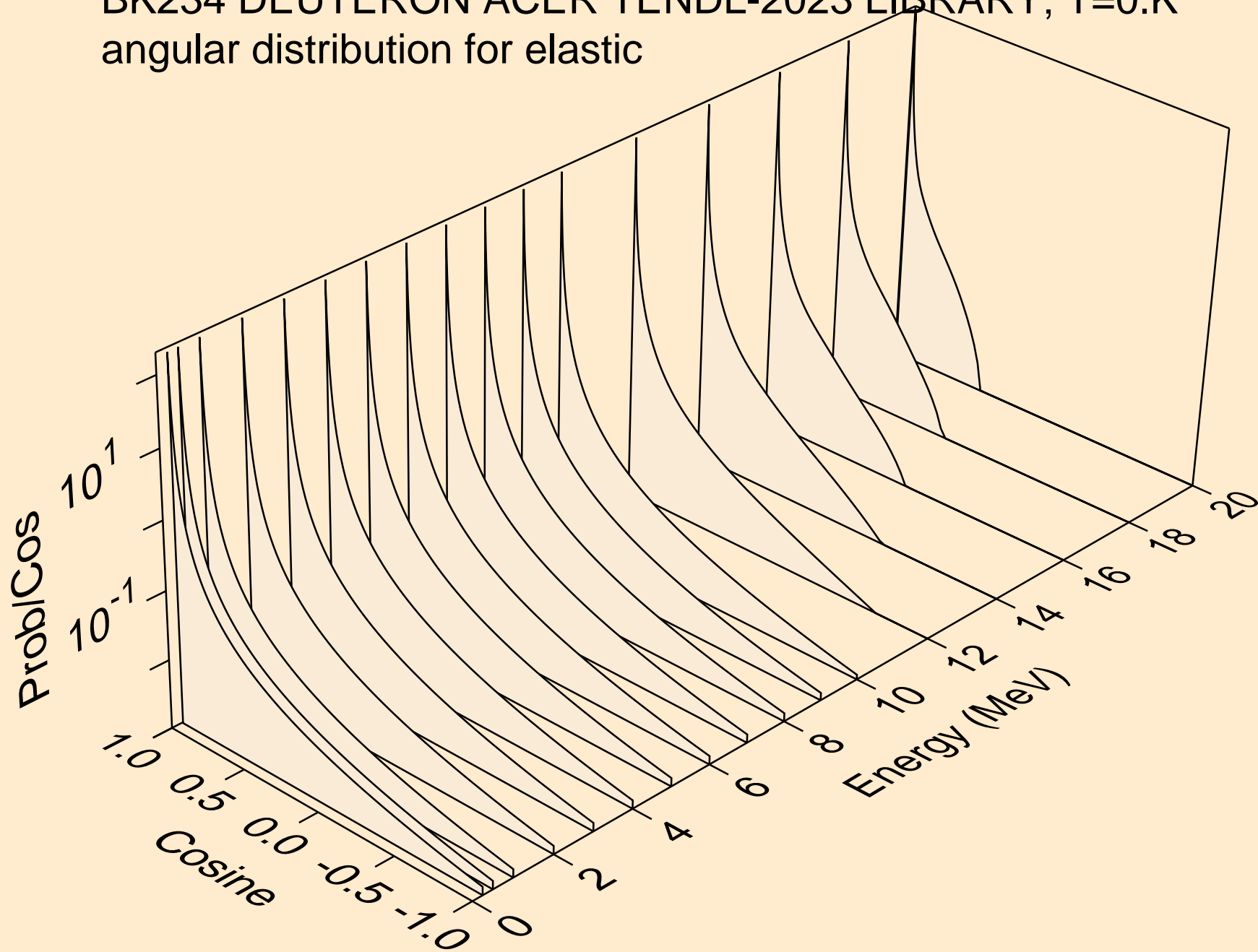

BK234 DEUTERON ACER TENDL-2023 LIBRARY; T=0.K
angular distribution for elastic

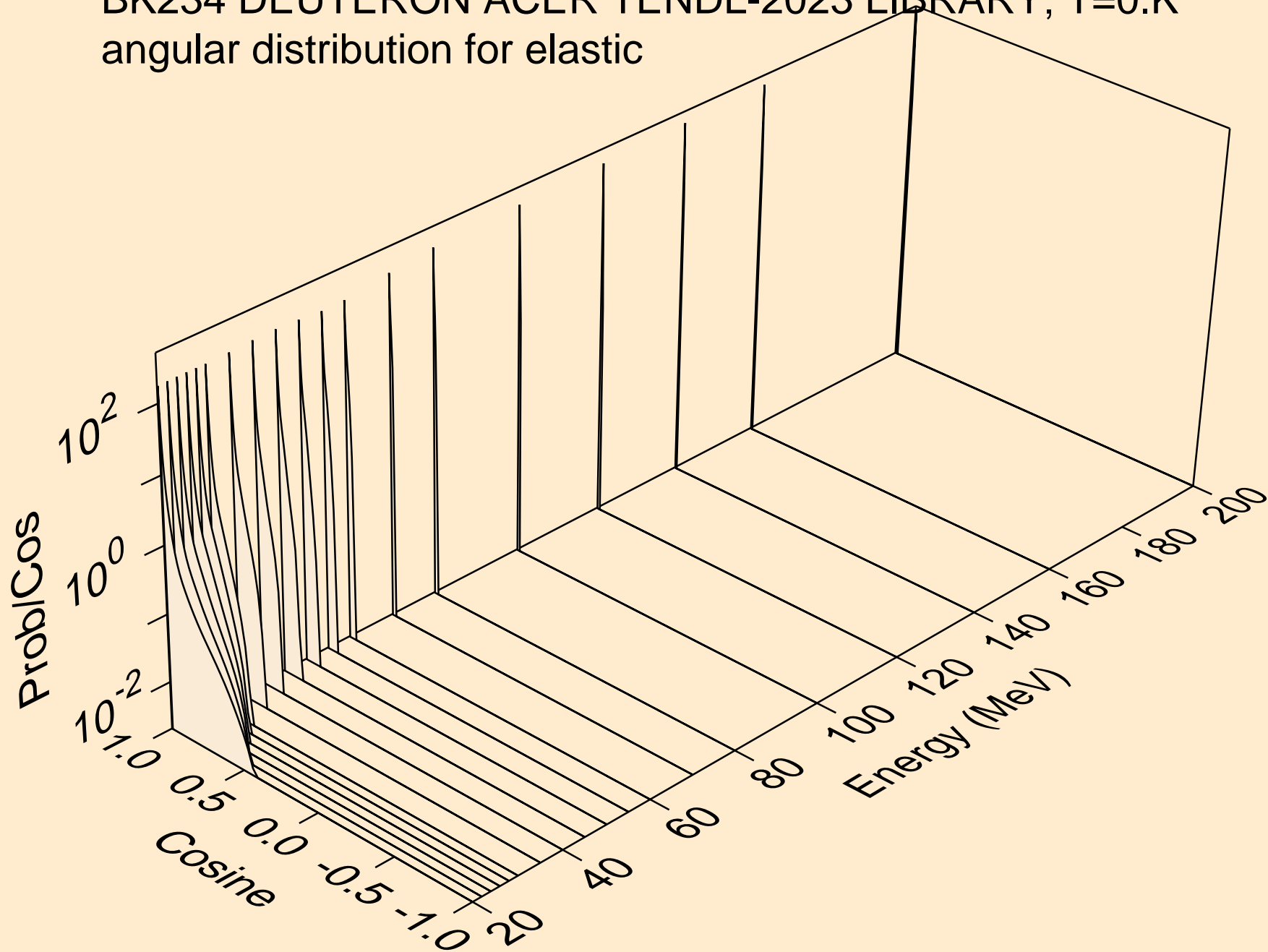

BK234 DEUTERON ACER TENDL-2023 LIBRARY; T=0.K
Deuteron emission for (d,x)

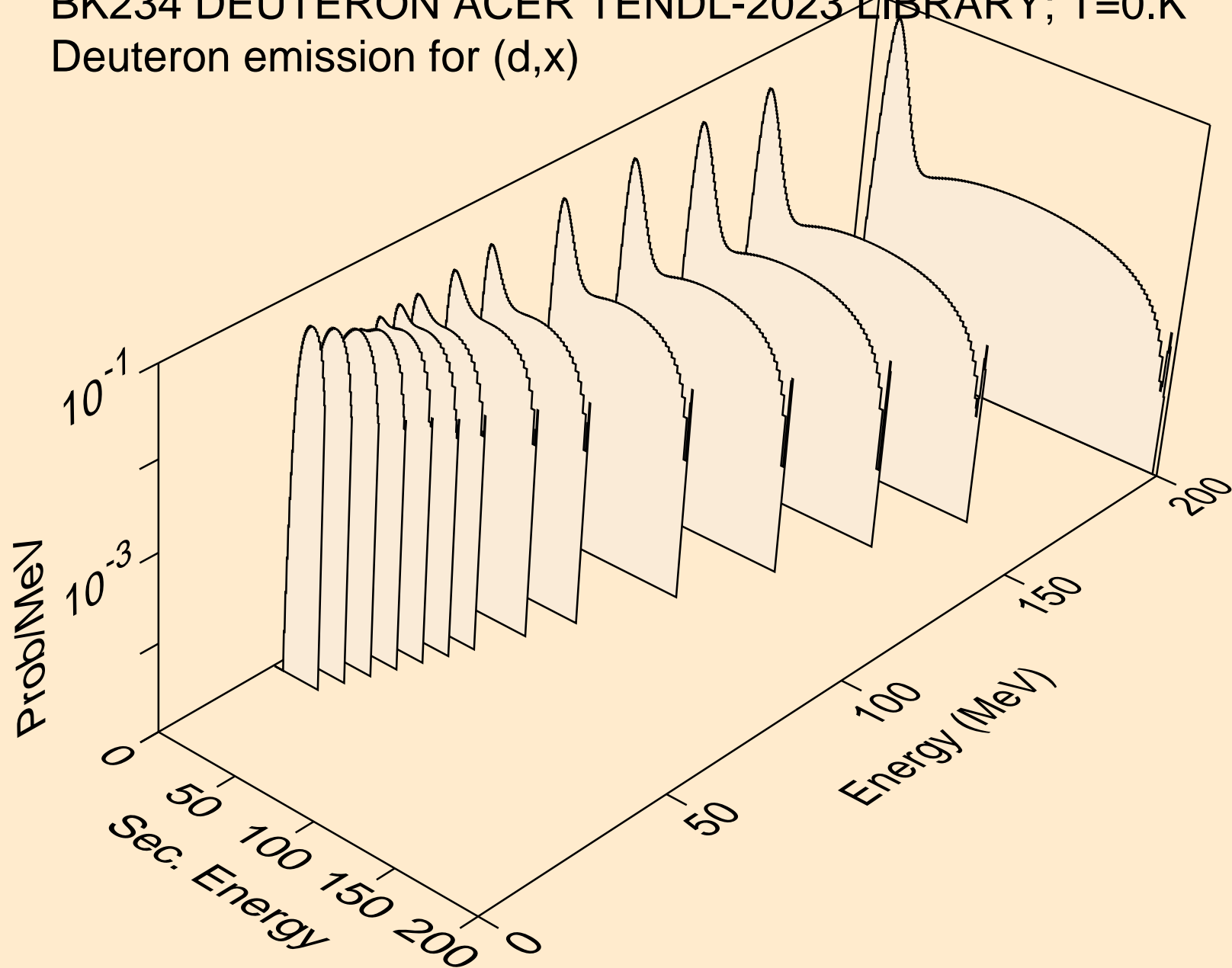

BK234 DEUTERON ACER TENDL-2023 LIBRARY; T=0.K
Deuteron emission for (d,n*)d

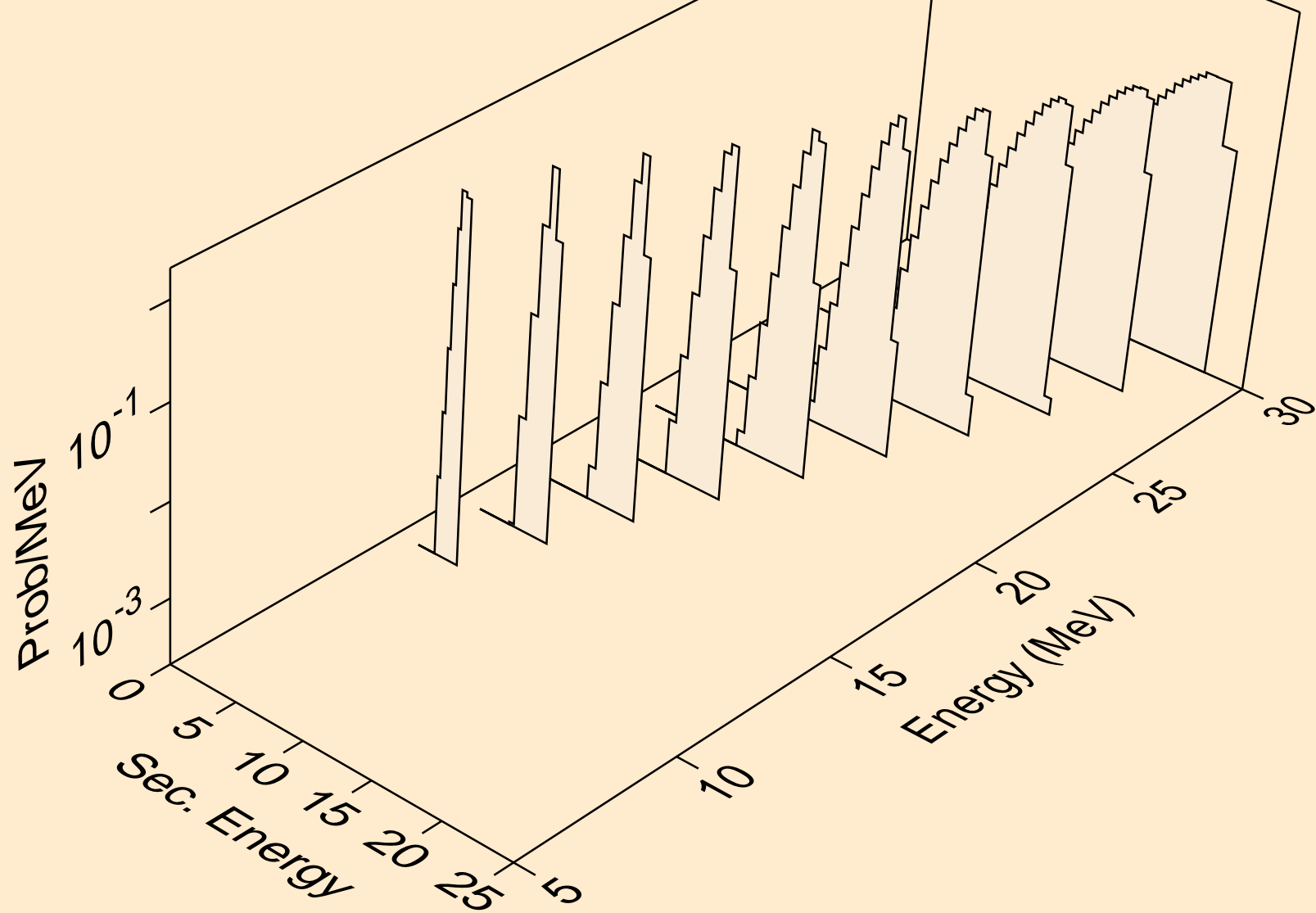

BK234 DEUTERON ACER TENDL-2023 LIBRARY; T=0.K
Deuteron emission for inelastic

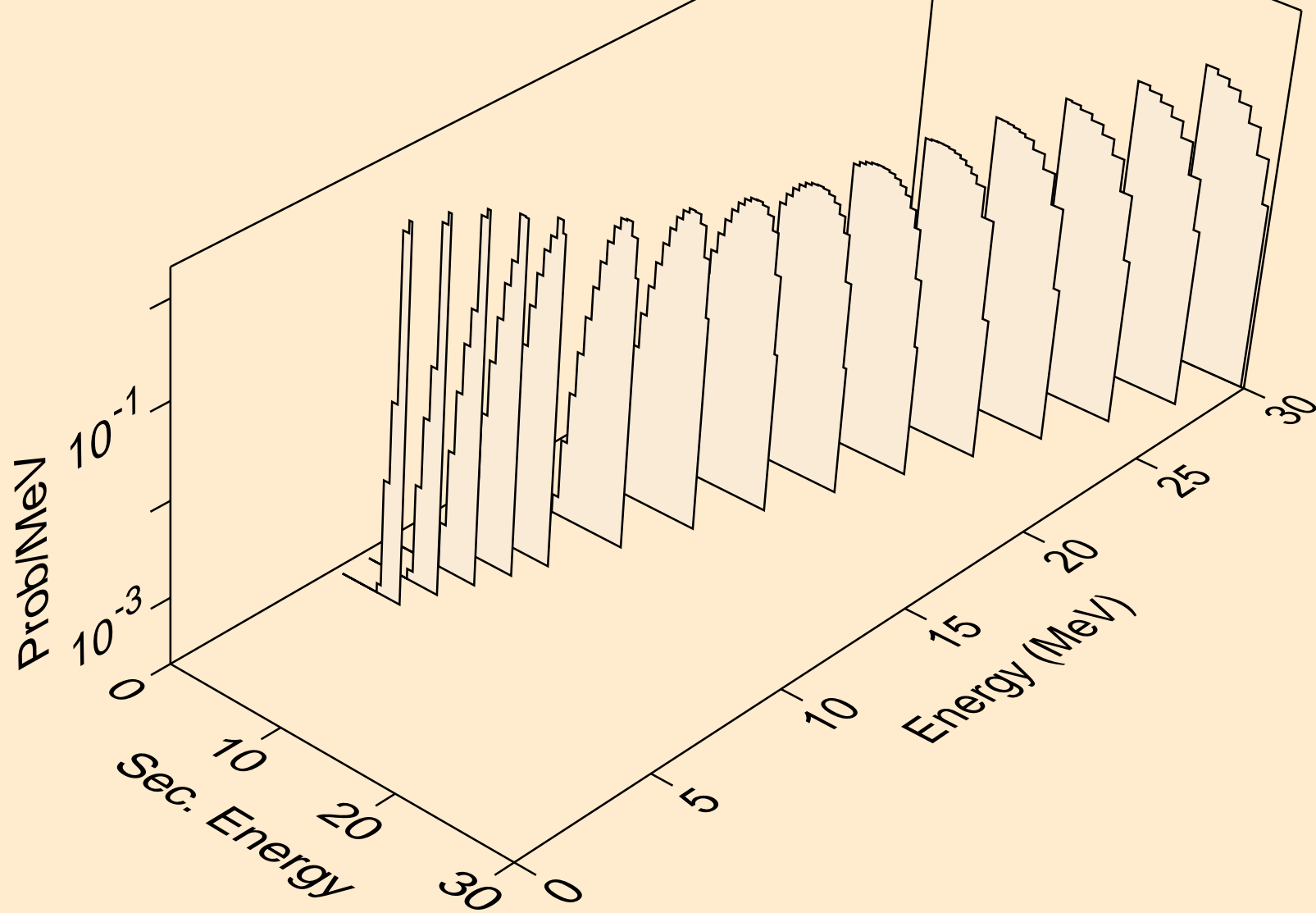

BK234 DEUTERON ACER TENDL-2023 LIBRARY; T=0.K
Deuteron emission for (d,pd)

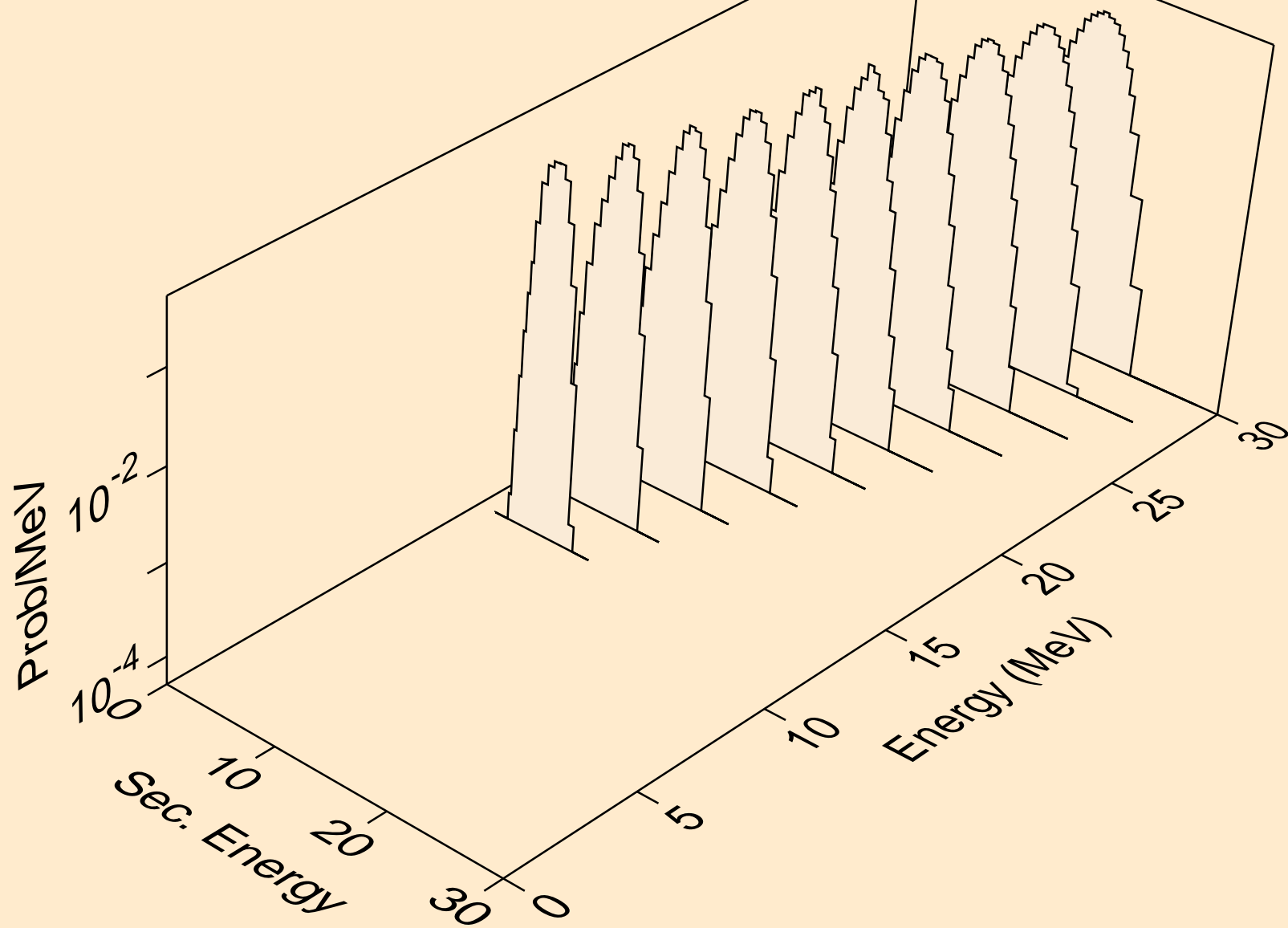

BK234 DEUTERON ACER TENDL-2023 LIBRARY; T=0.K
Photon emission for (z,n)

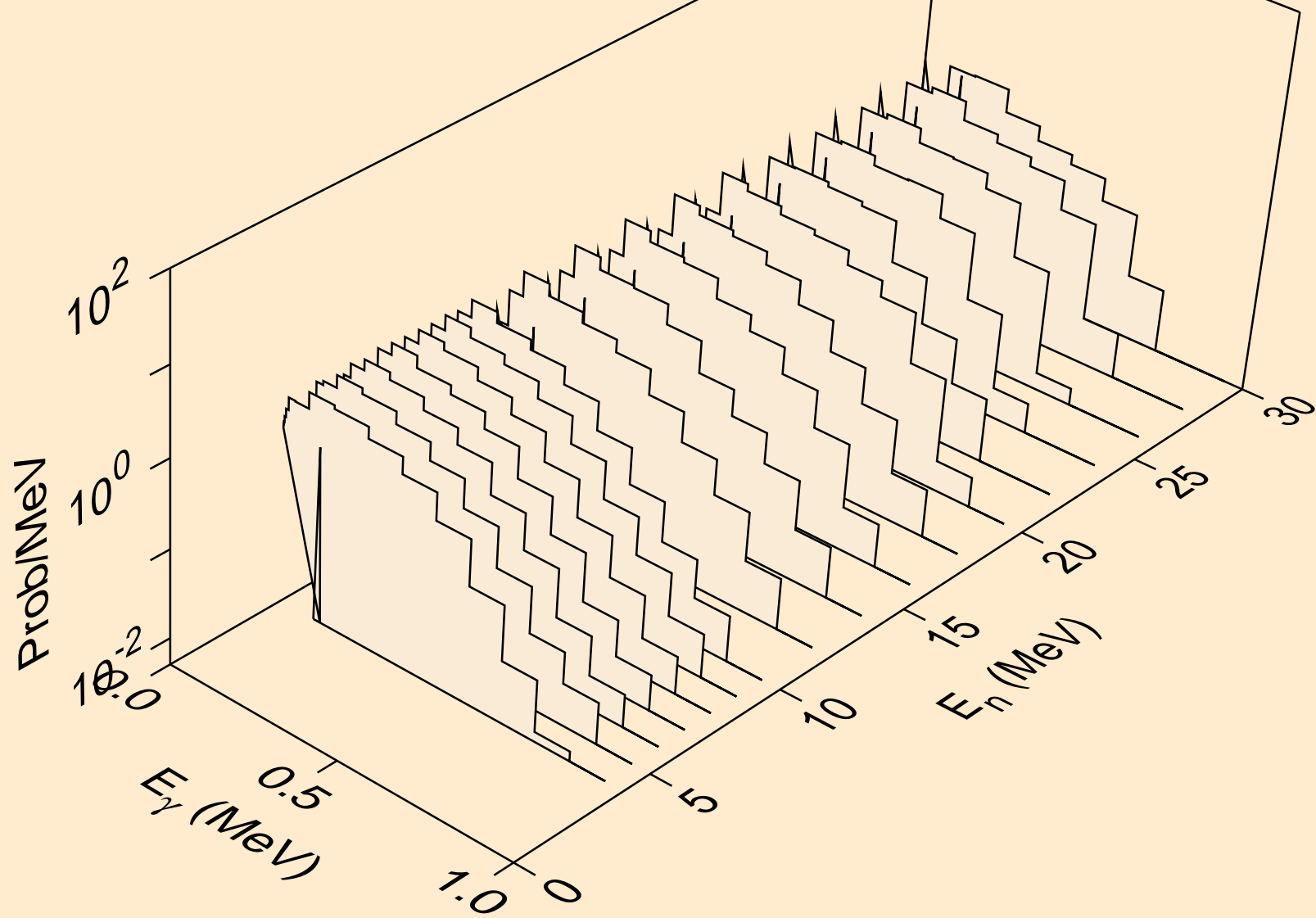

BK234 DEUTERON ACER TENDL-2023 LIBRARY; T=0.K
Photon emission for (z,x)

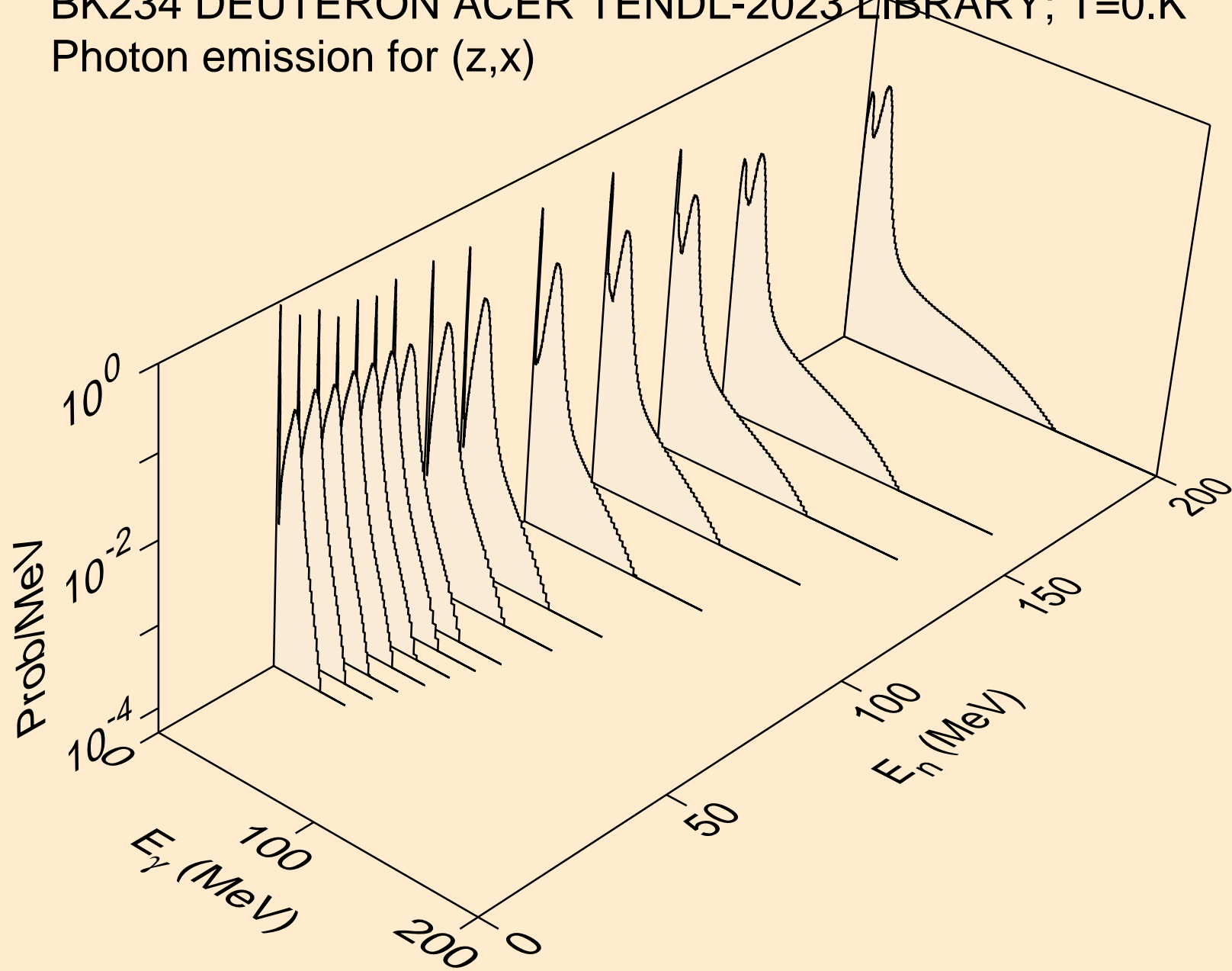

BK234 DEUTERON ACER TENDL-2023 LIBRARY; T=0.K
Photon emission for (n,2n)

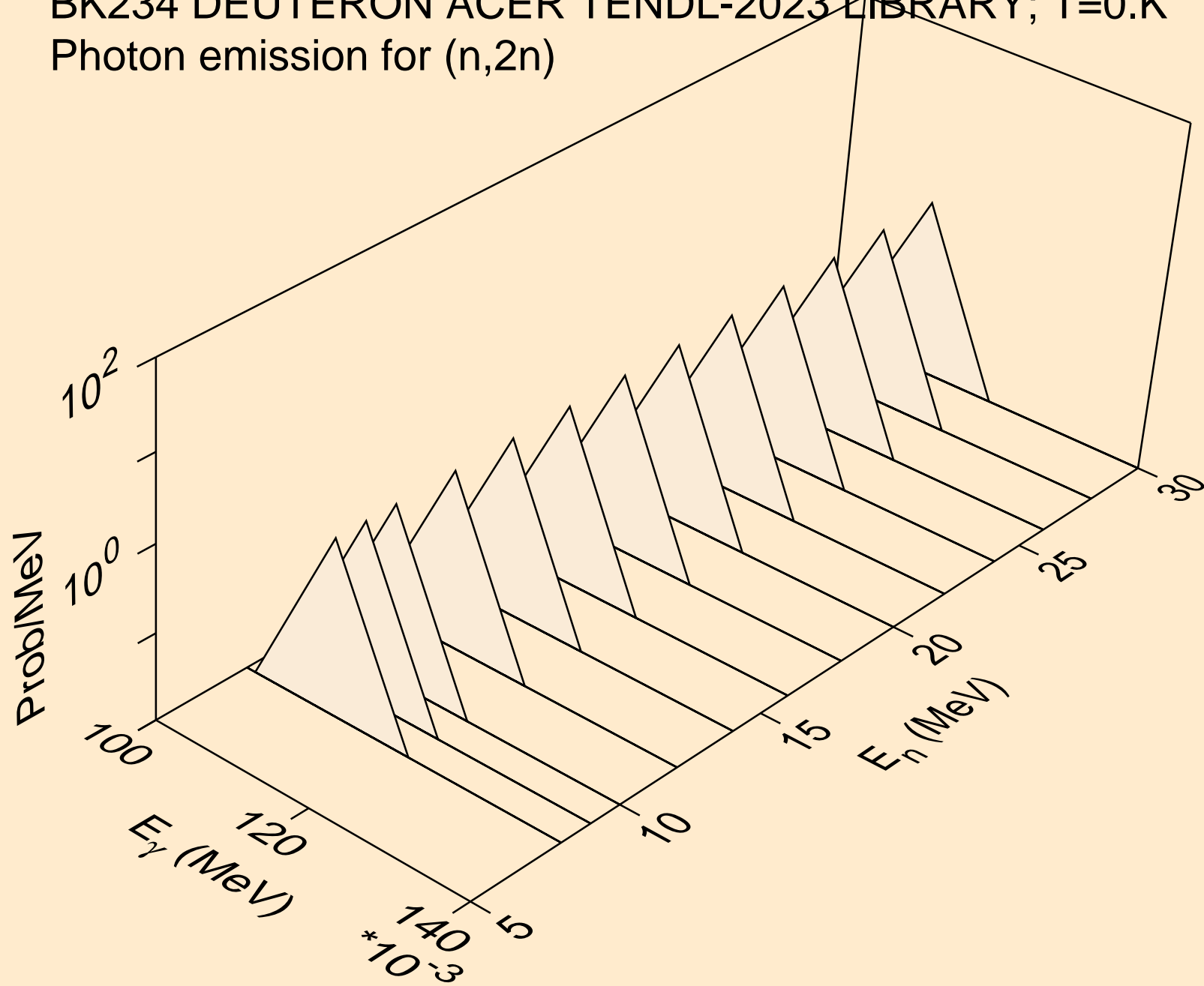

BK234 DEUTERON ACER TENDL-2023 LIBRARY; T=0.K
Photon emission for (n,n*)p

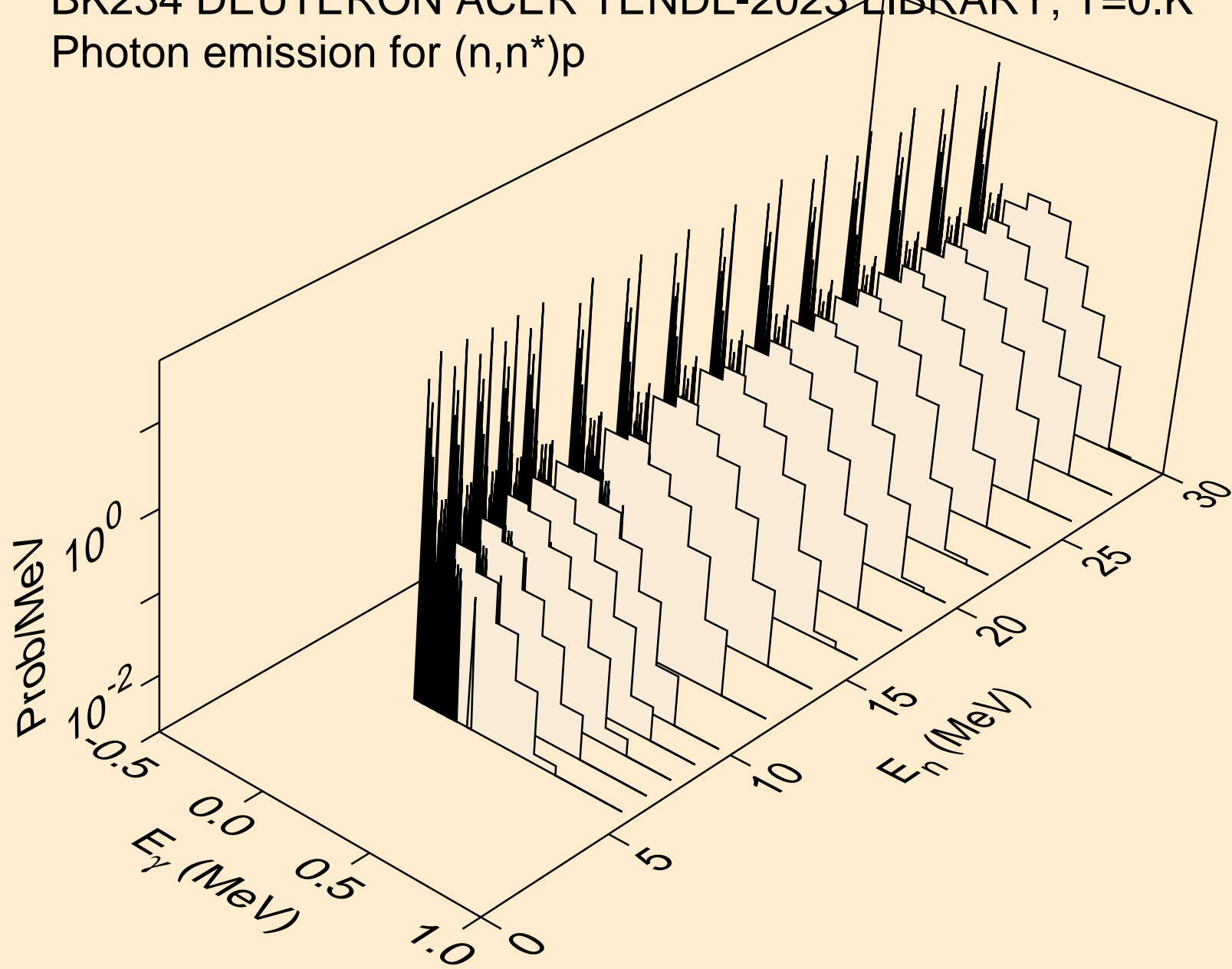

BK234 DEUTERON ACER TENDL-2023 LIBRARY; T=0.K
Photon emission for (n,n*)d

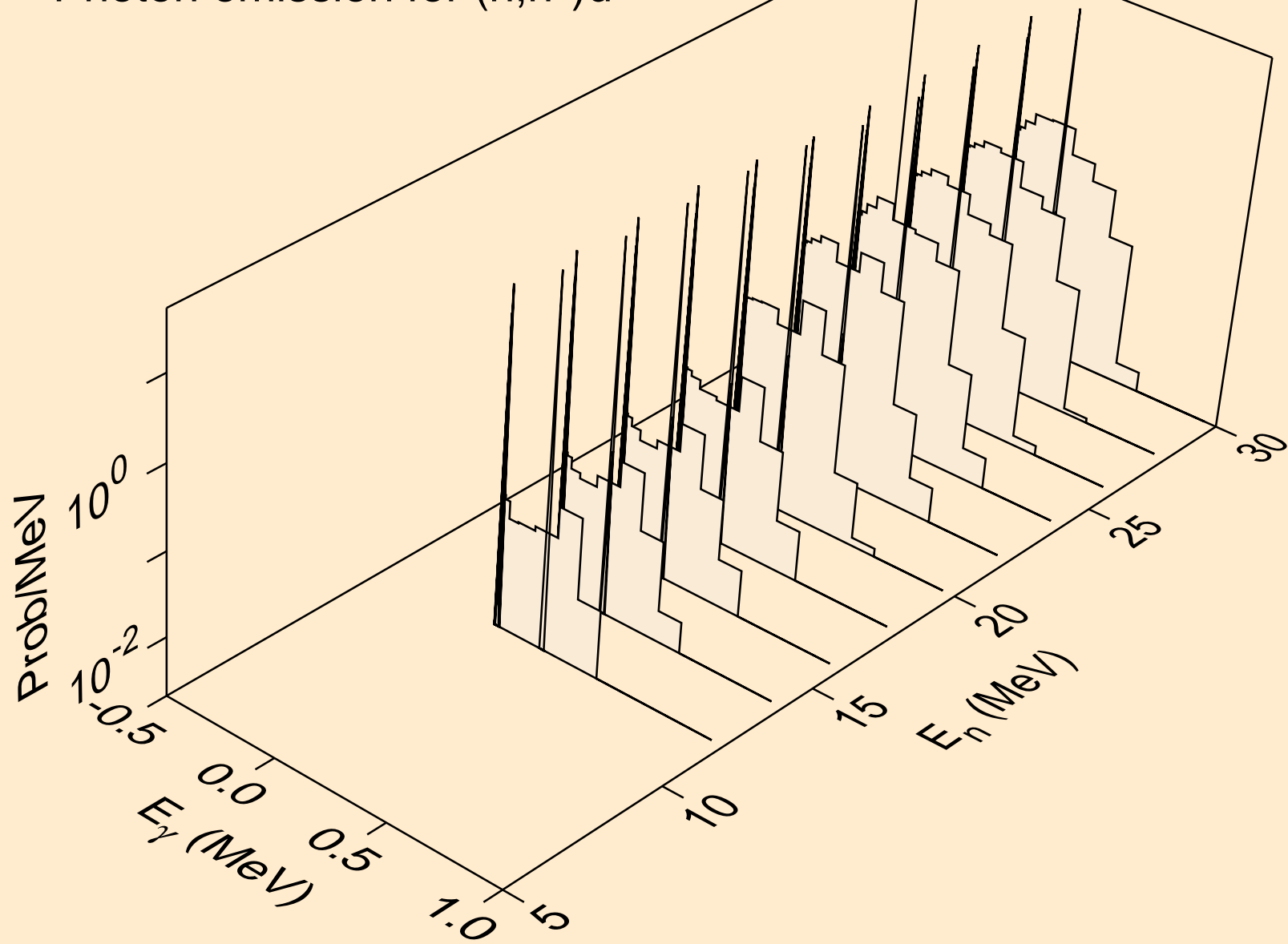

BK234 DEUTERON ACER TENDL-2023 LIBRARY; T=0.K
Photon emission for (n,2np)

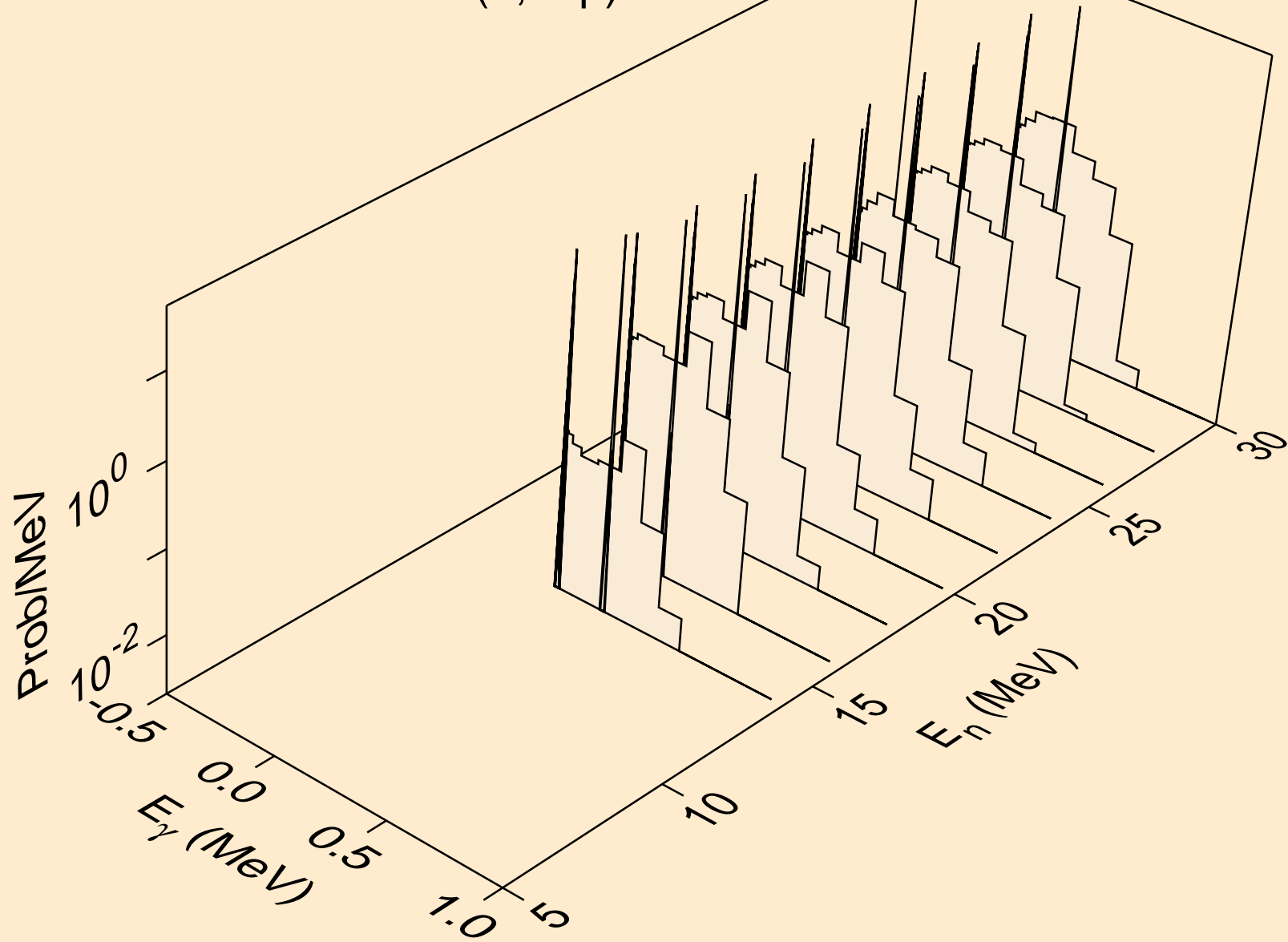

BK234 DEUTERON ACER TENDL-2023 LIBRARY; T=0.K
Photon emission for (n,n2p)

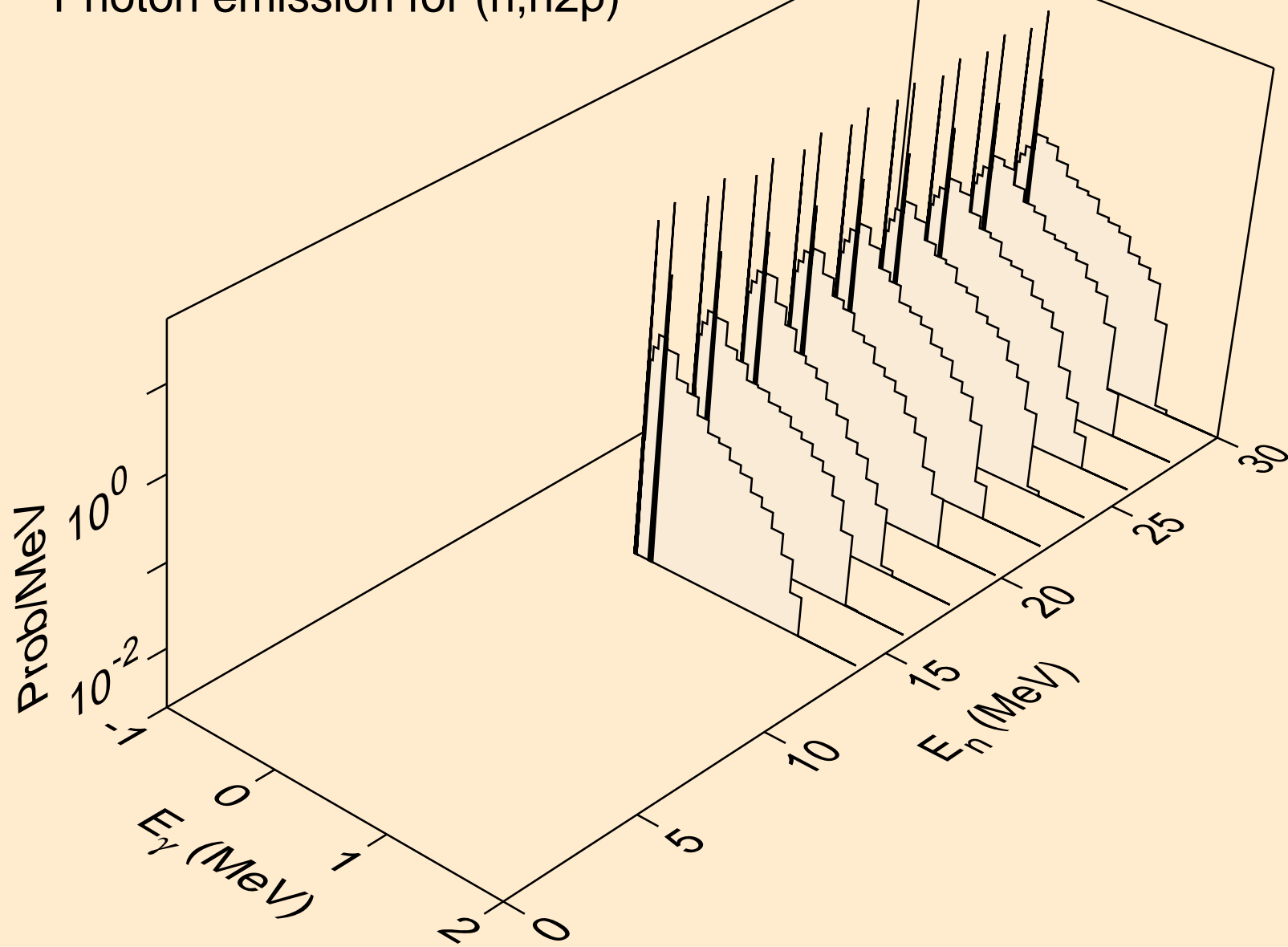

BK234 DEUTERON ACER TENDL-2023 LIBRARY; T=0.K
Photon emission for (n,p)

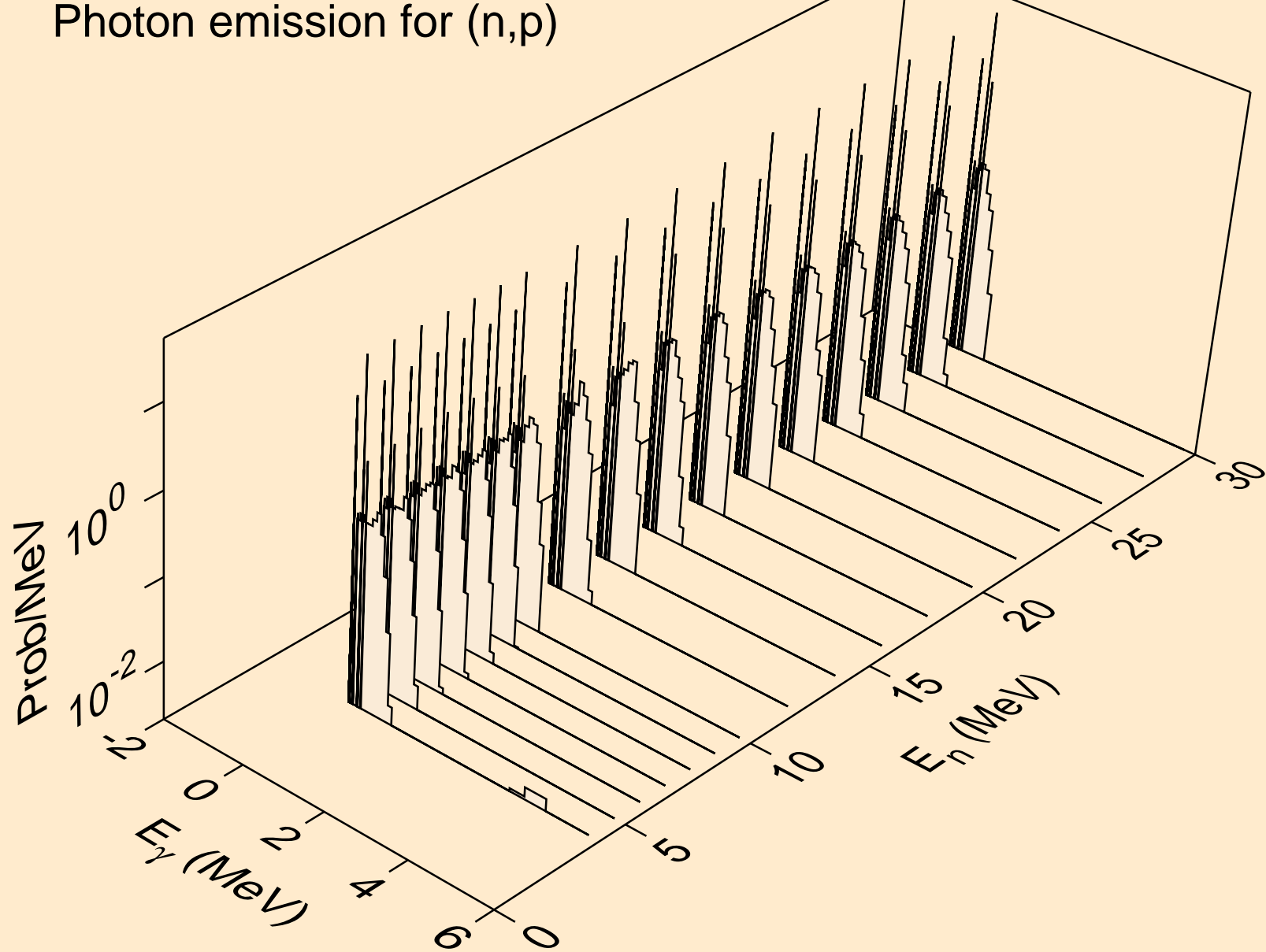

BK234 DEUTERON ACER TENDL-2023 LIBRARY; T=0.K
Photon emission for inelastic

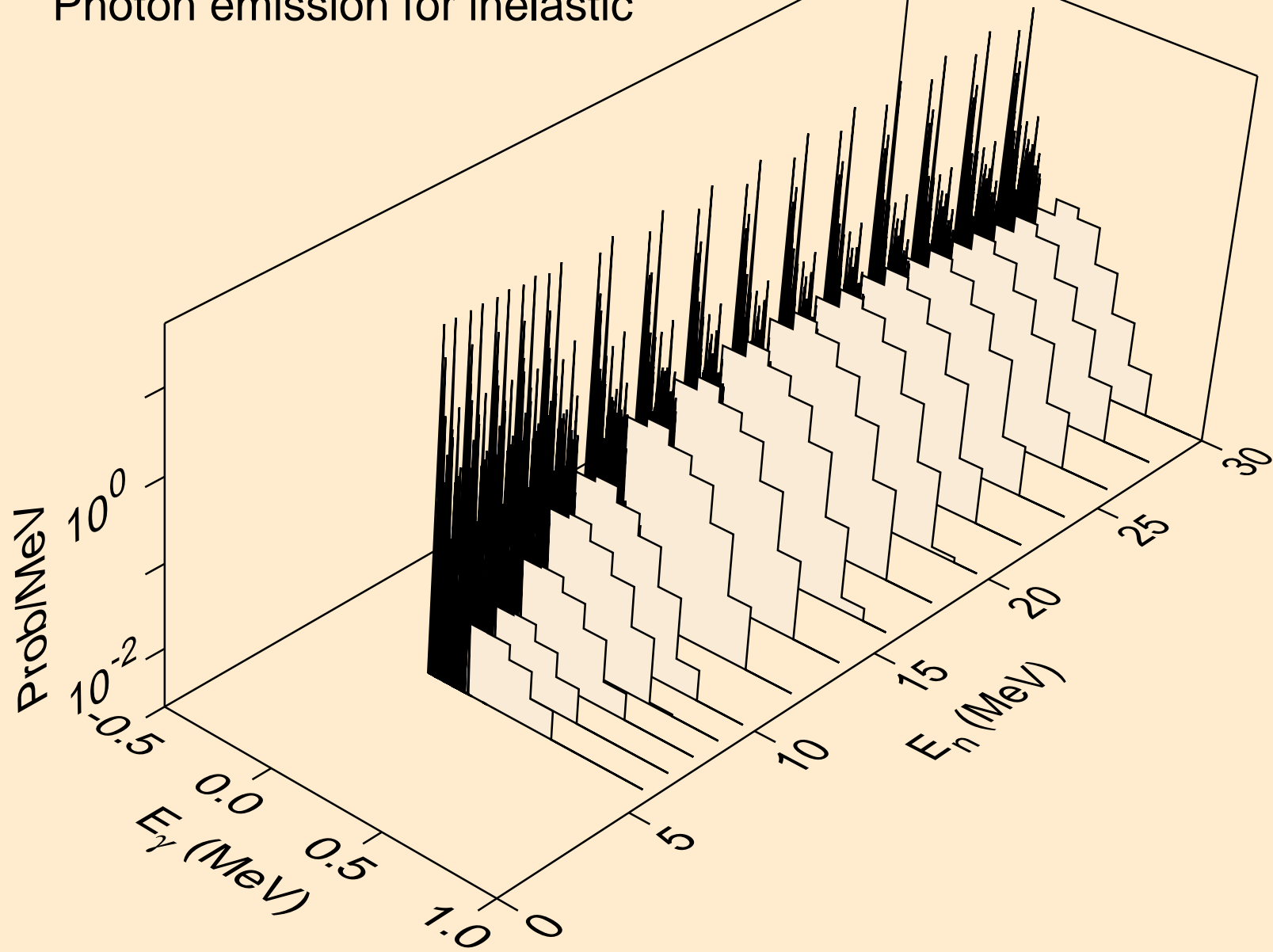

BK234 DEUTERON ACER TENDL-2023 LIBRARY; T=0.K
Photon emission for (n,t)

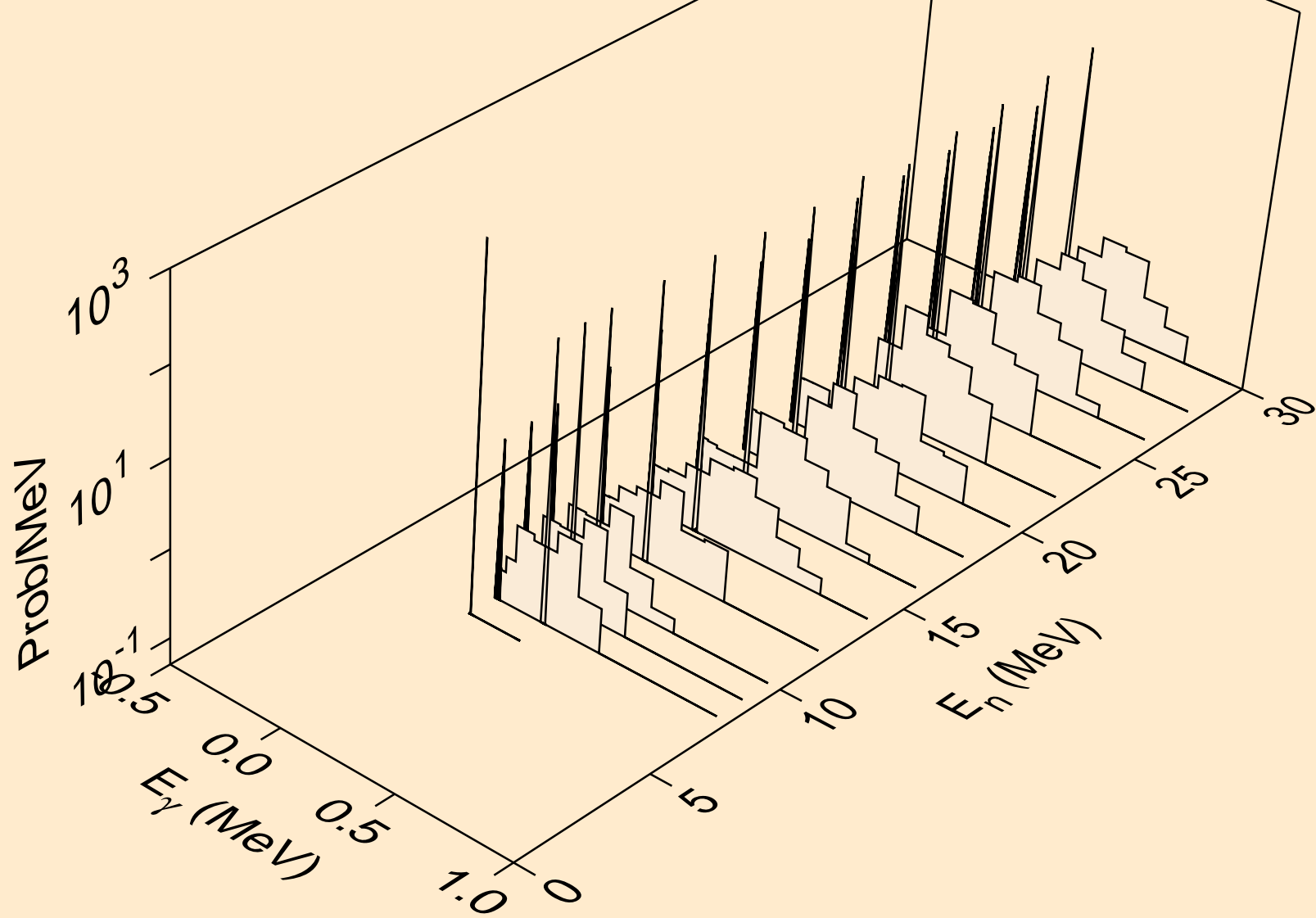

BK234 DEUTERON ACER TENDL-2023 LIBRARY; T=0.K
Photon emission for (n,he3)

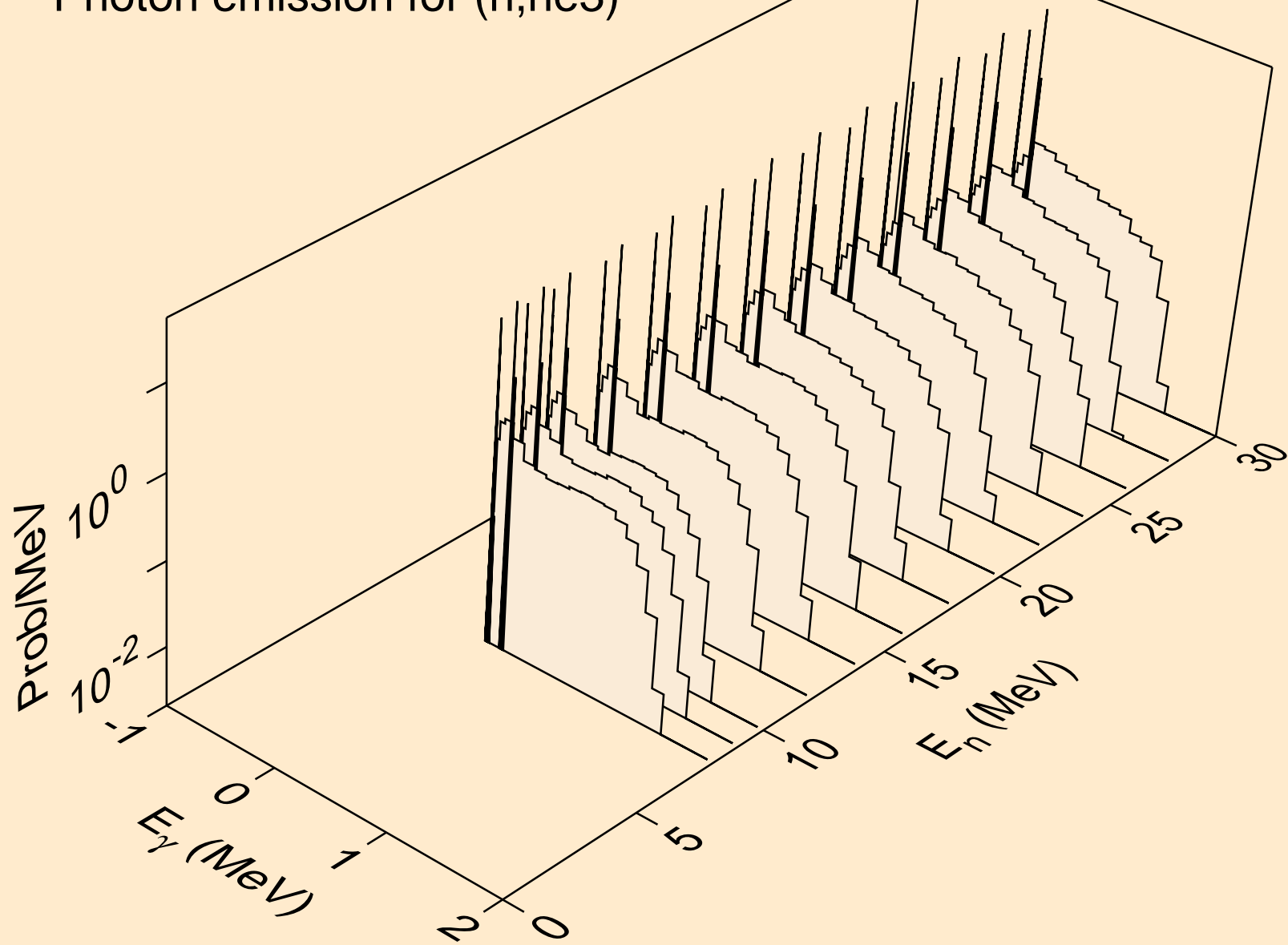

BK234 DEUTERON ACER TENDL-2023 LIBRARY; T=0.K
Photon emission for (n,a)

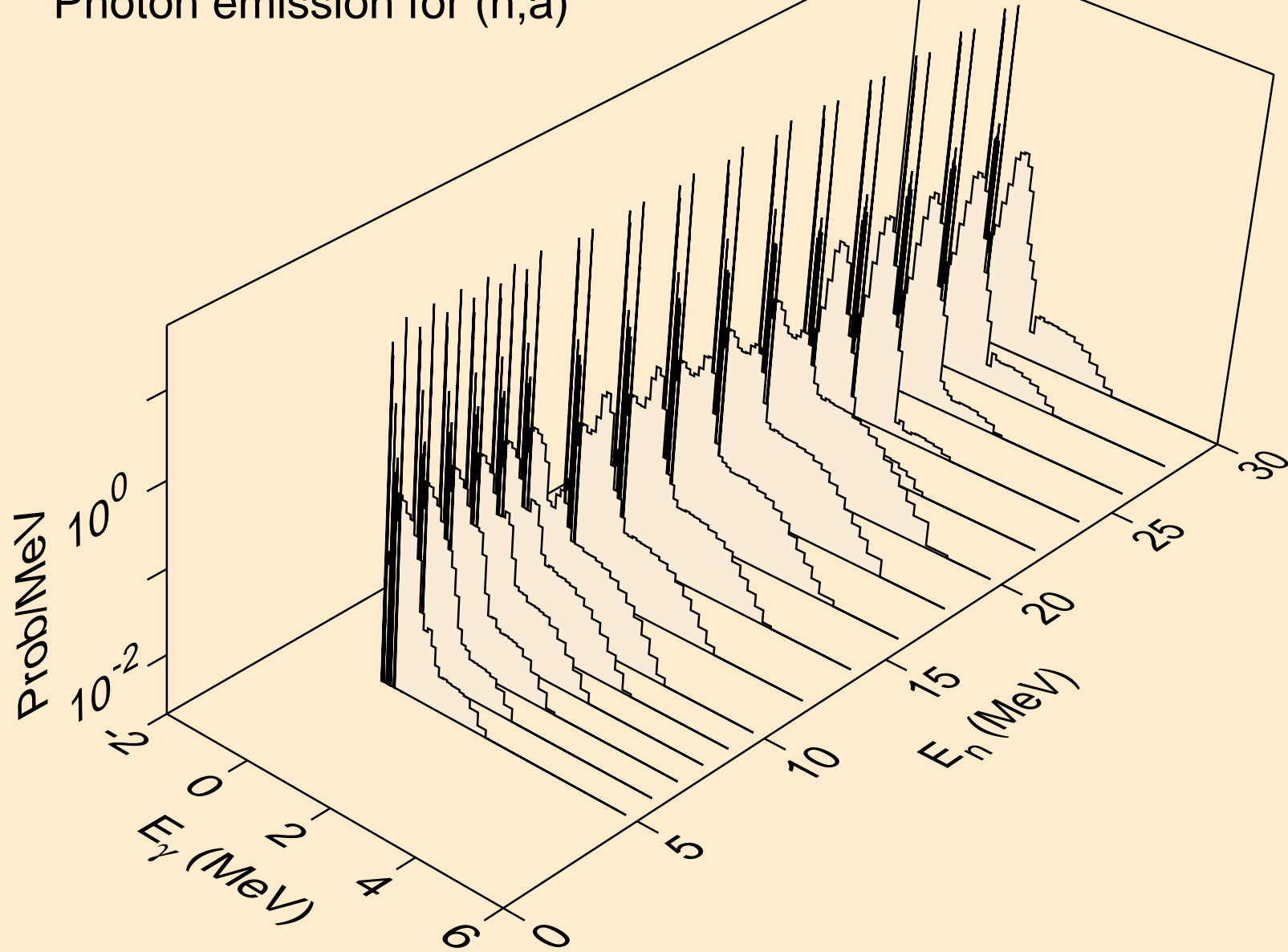

BK234 DEUTERON ACER TENDL-2023 LIBRARY; T=0.K
Photon emission for (n,2p)

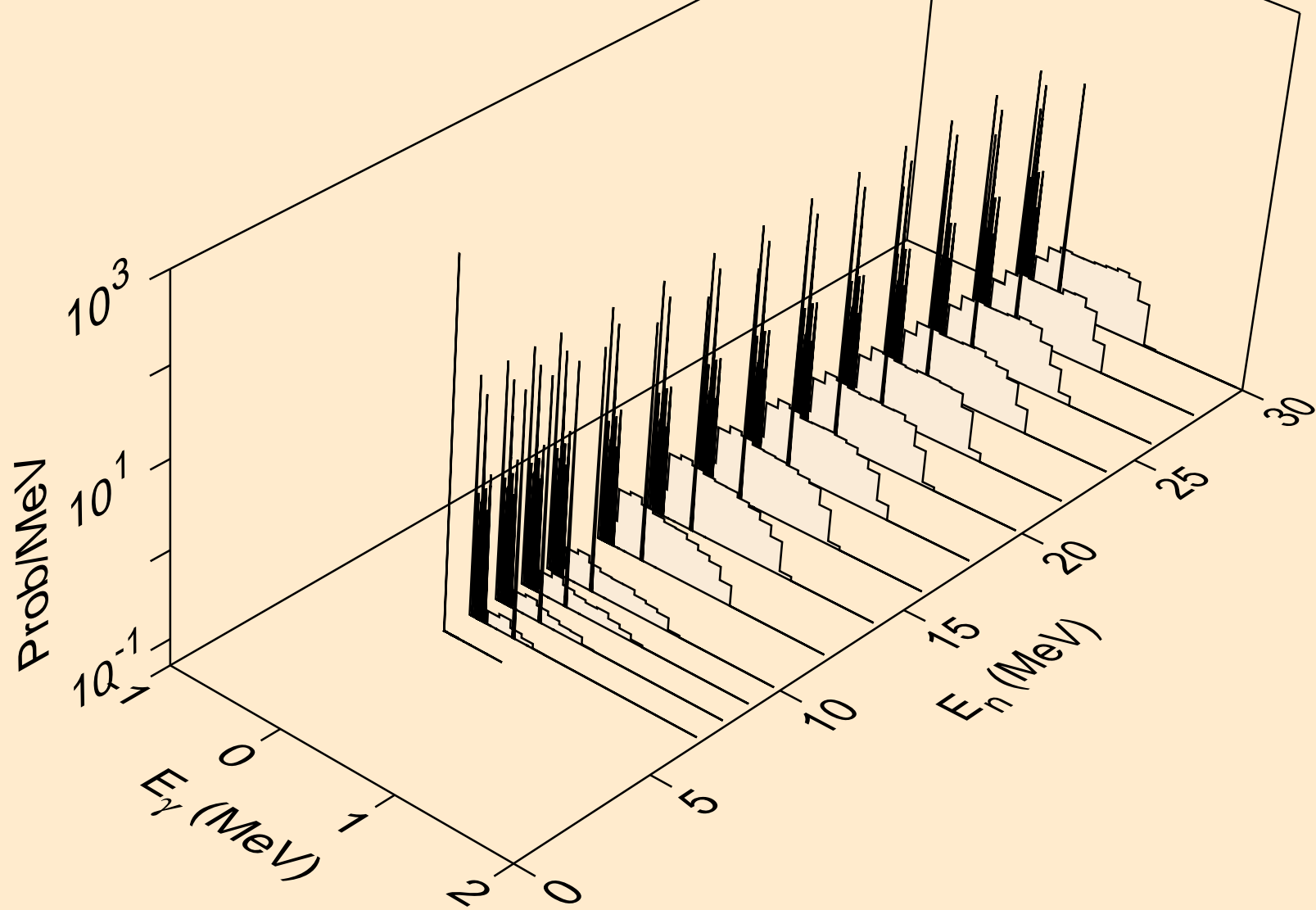

BK234 DEUTERON ACER TENDL-2023 LIBRARY; T=0.K
Photon emission for (n,pd)

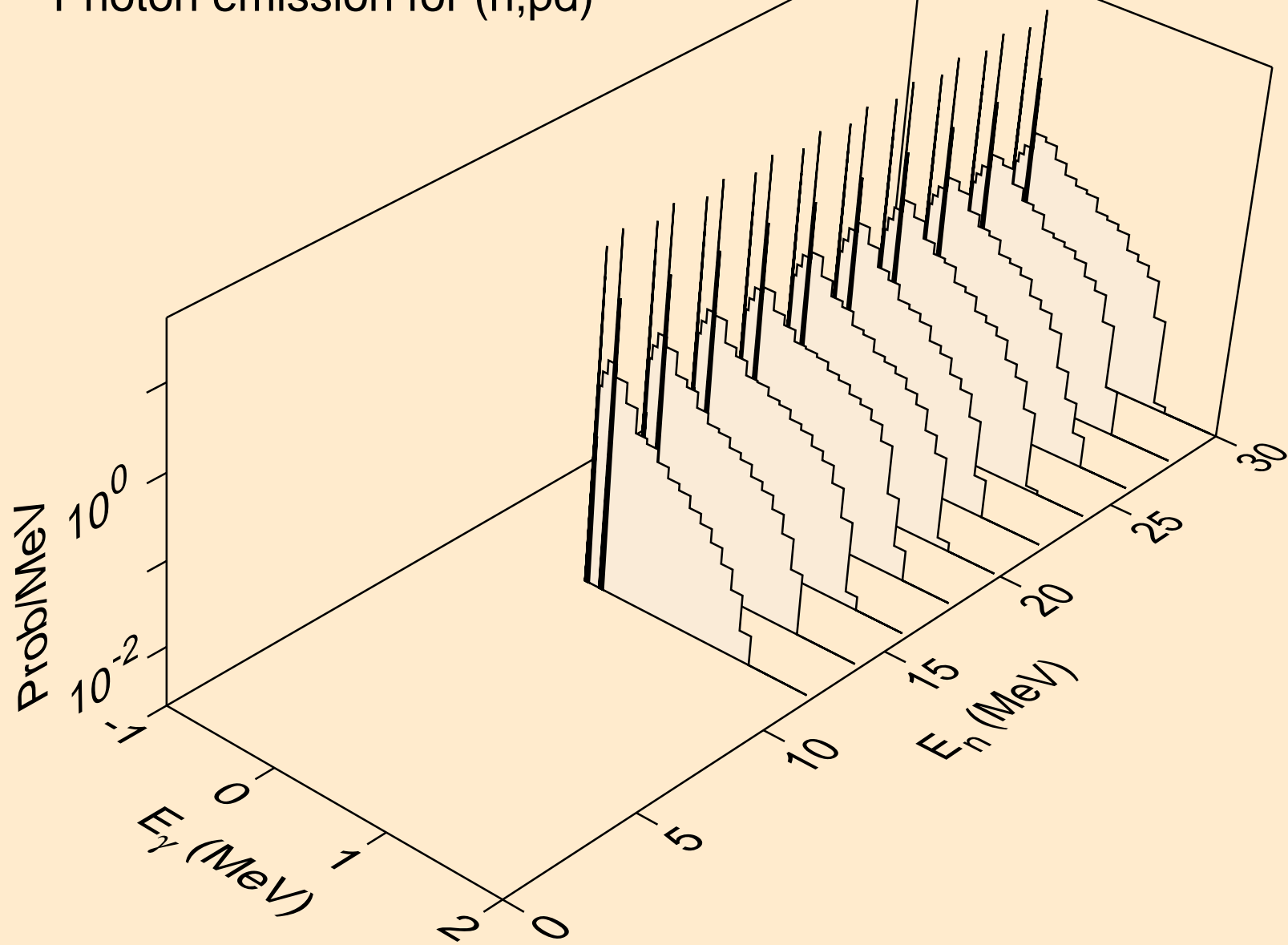

BK234 DEUTERON ACER TENDL-2023 LIBRARY; T=0.K

Particle heating contributions

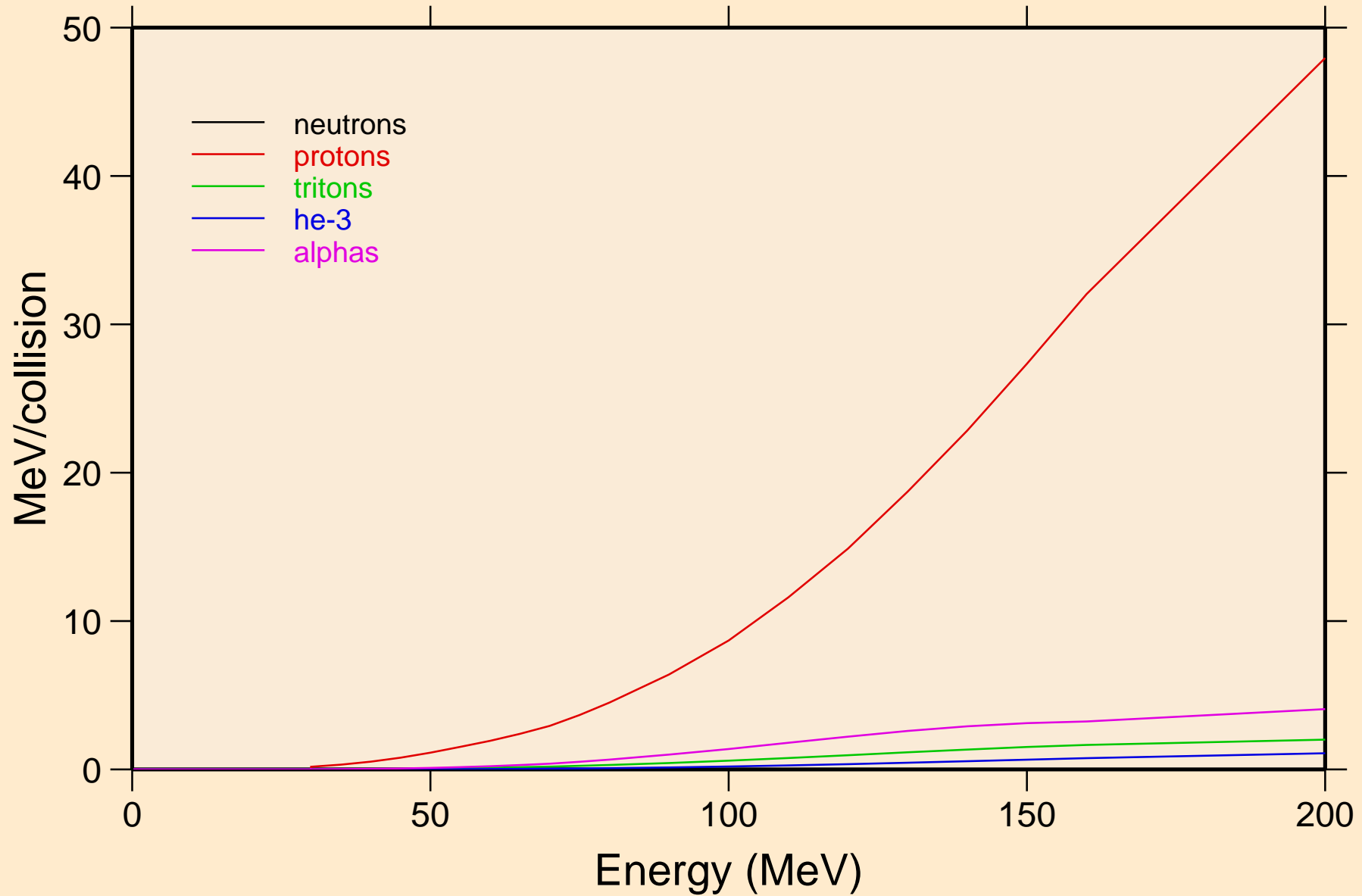

BK234 DEUTERON ACER TENDL-2023 LIBRARY; T=0.K
Recoil Heating

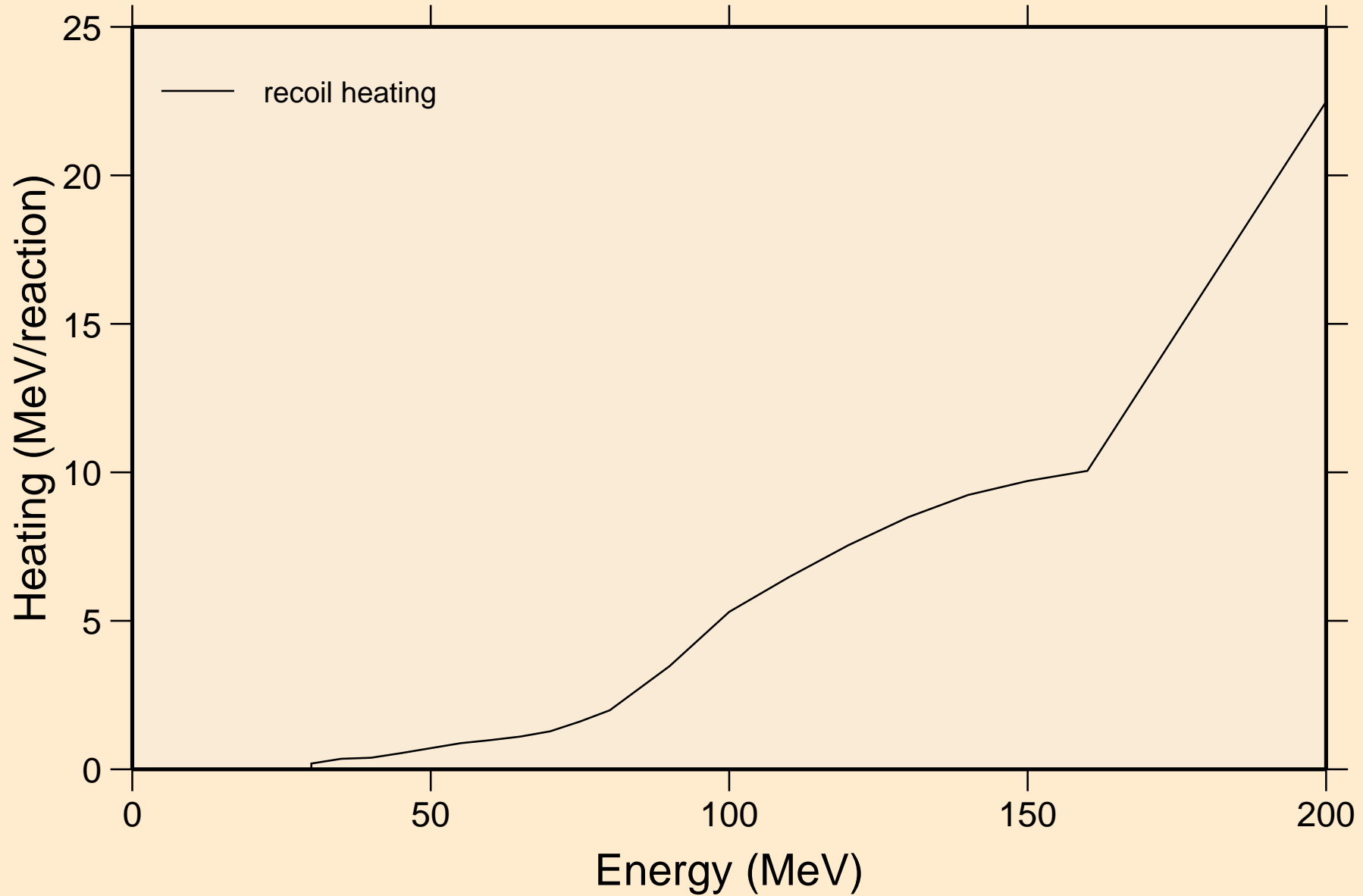

BK234 DEUTERON ACER TENDL-2023 LIBRARY; T=0.K
Particle production cross sections

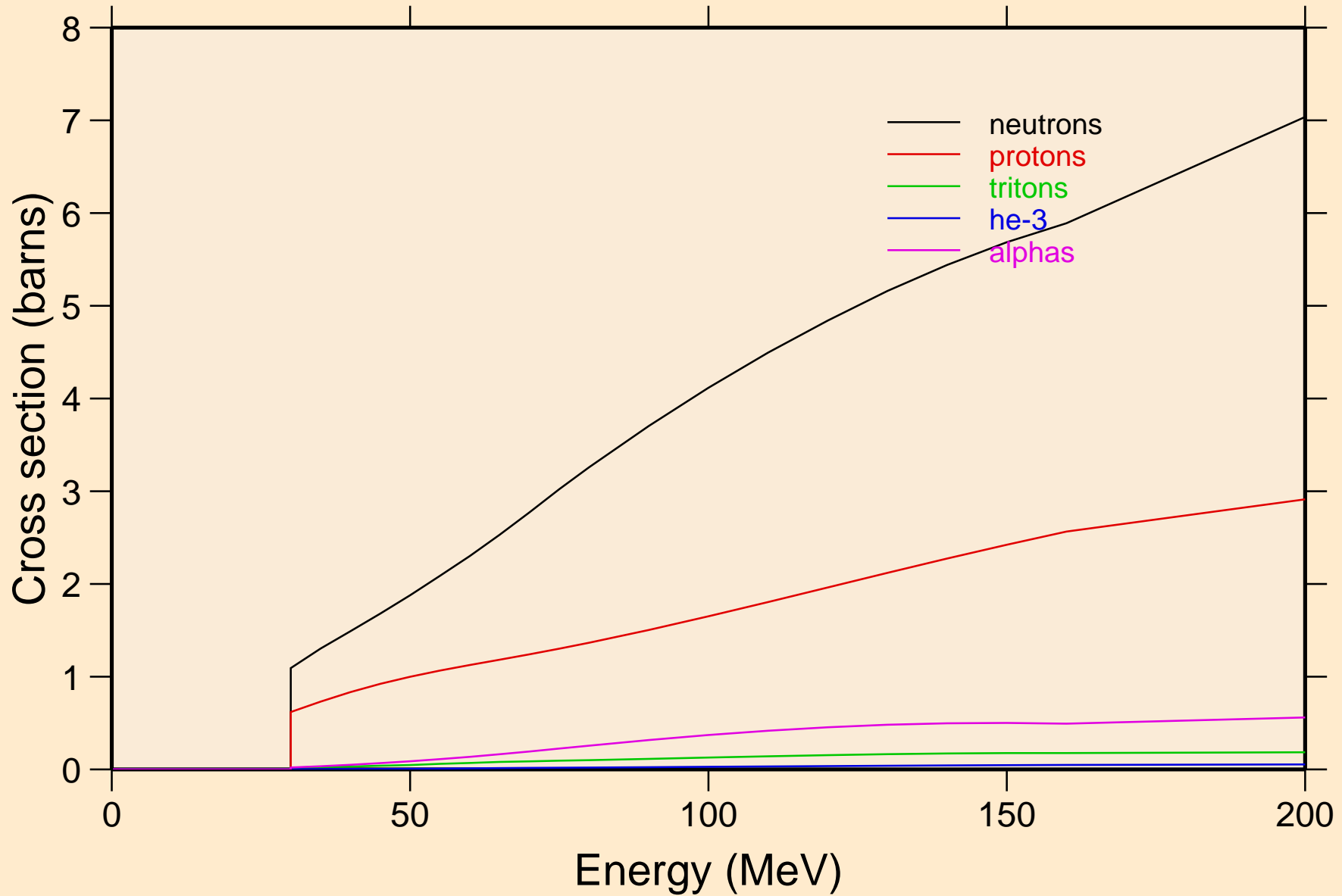

BK234 DEUTERON ACER TENDL-2023 LIBRARY; T=0.K
neutrons from (d,n)

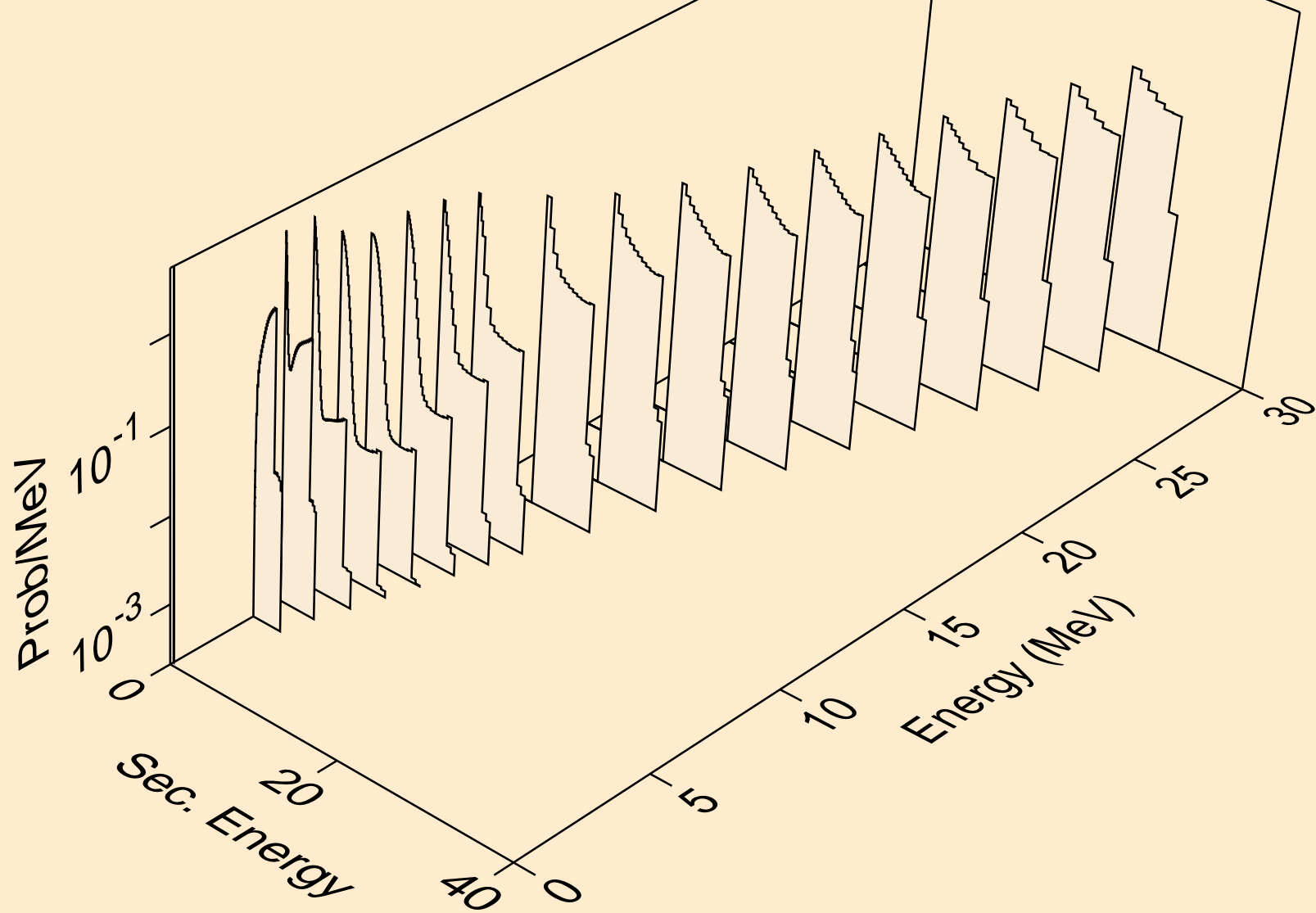

BK234 DEUTERON ACER TENDL-2023 LIBRARY; T=0.K
neutrons from (d,x)

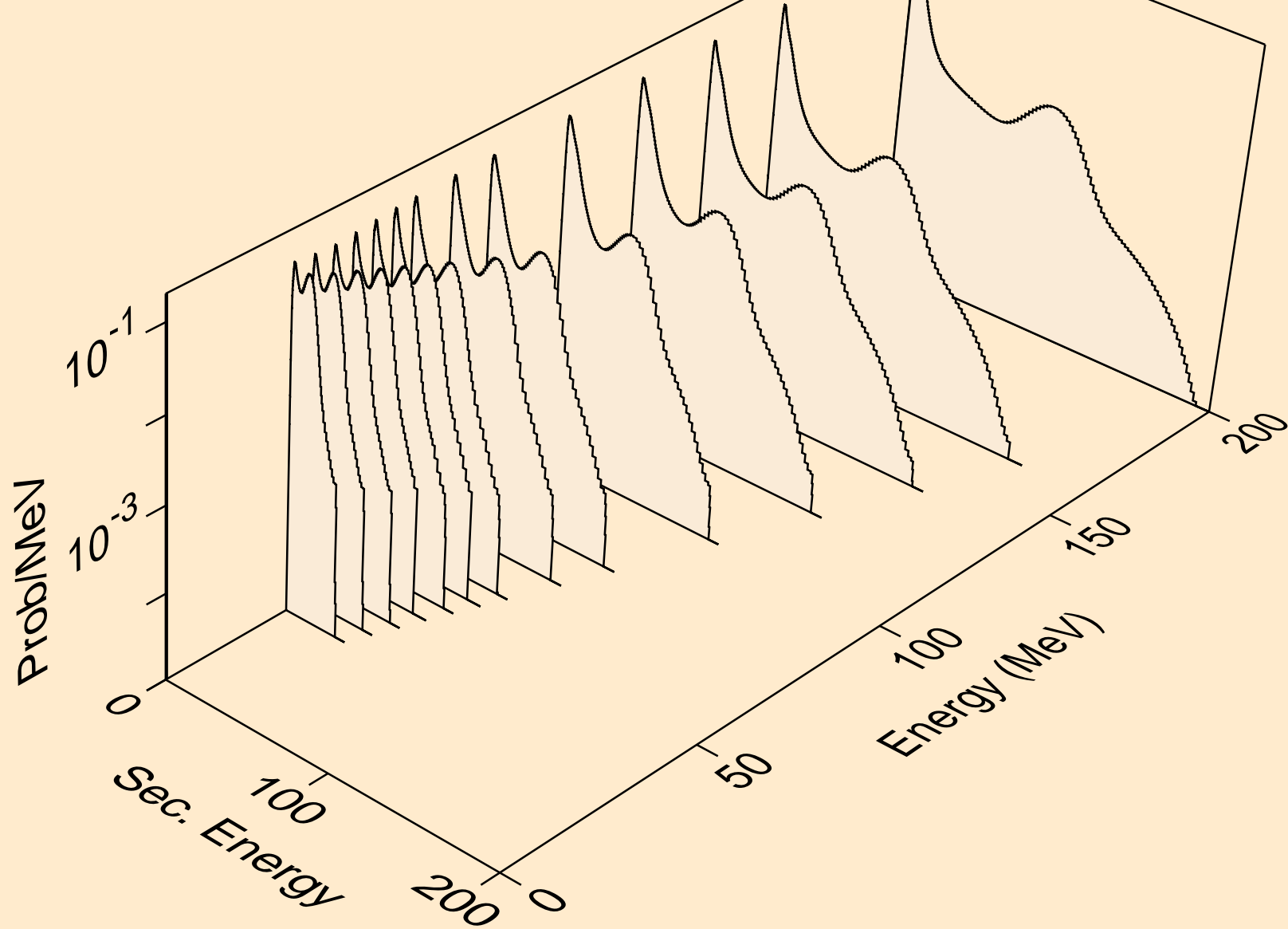

BK234 DEUTERON ACER TENDL-2023 LIBRARY; T=0.K
neutrons from (d,2n)

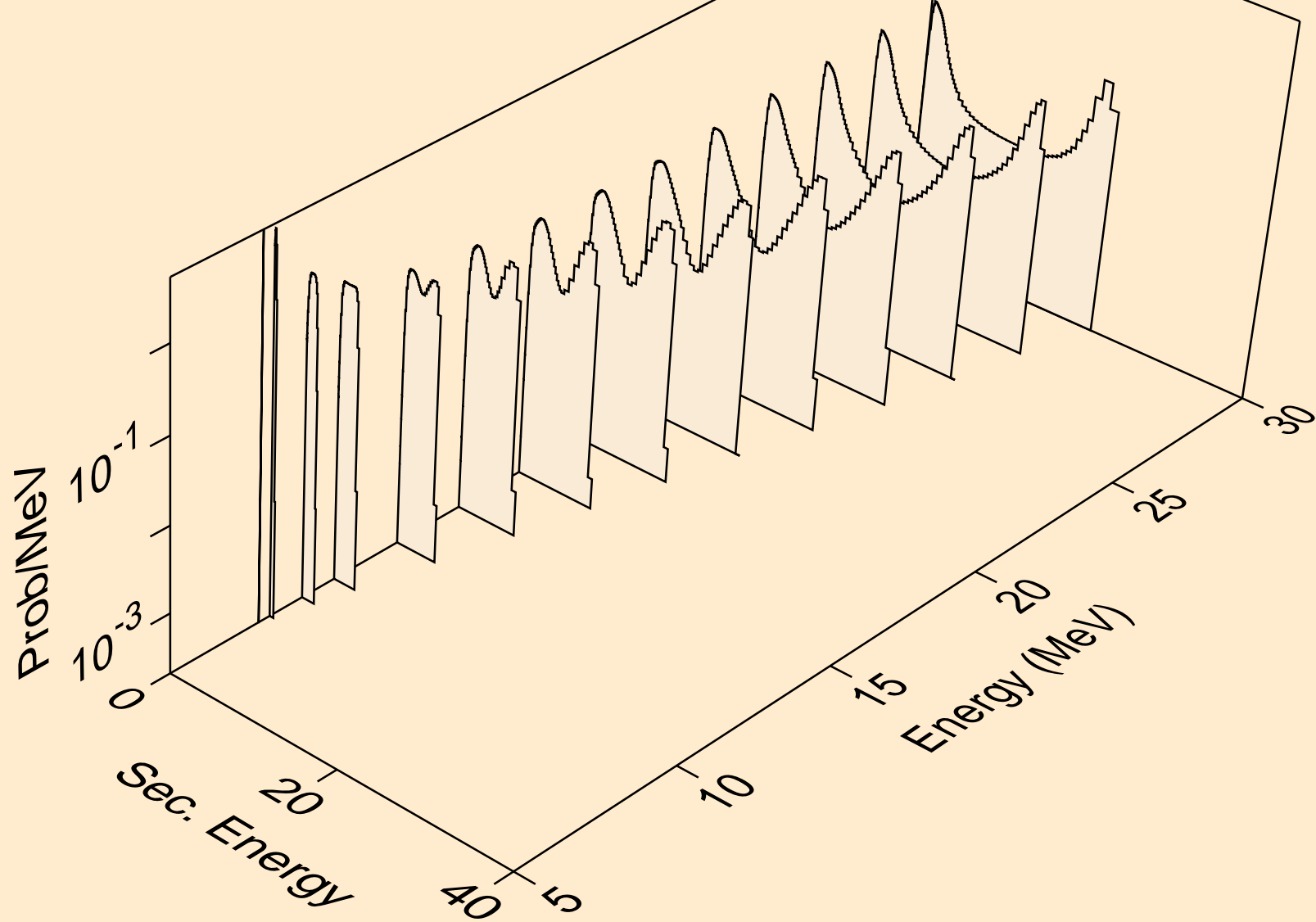

BK234 DEUTERON ACER TENDL-2023 LIBRARY; T=0.K
neutrons from (d,n*)p

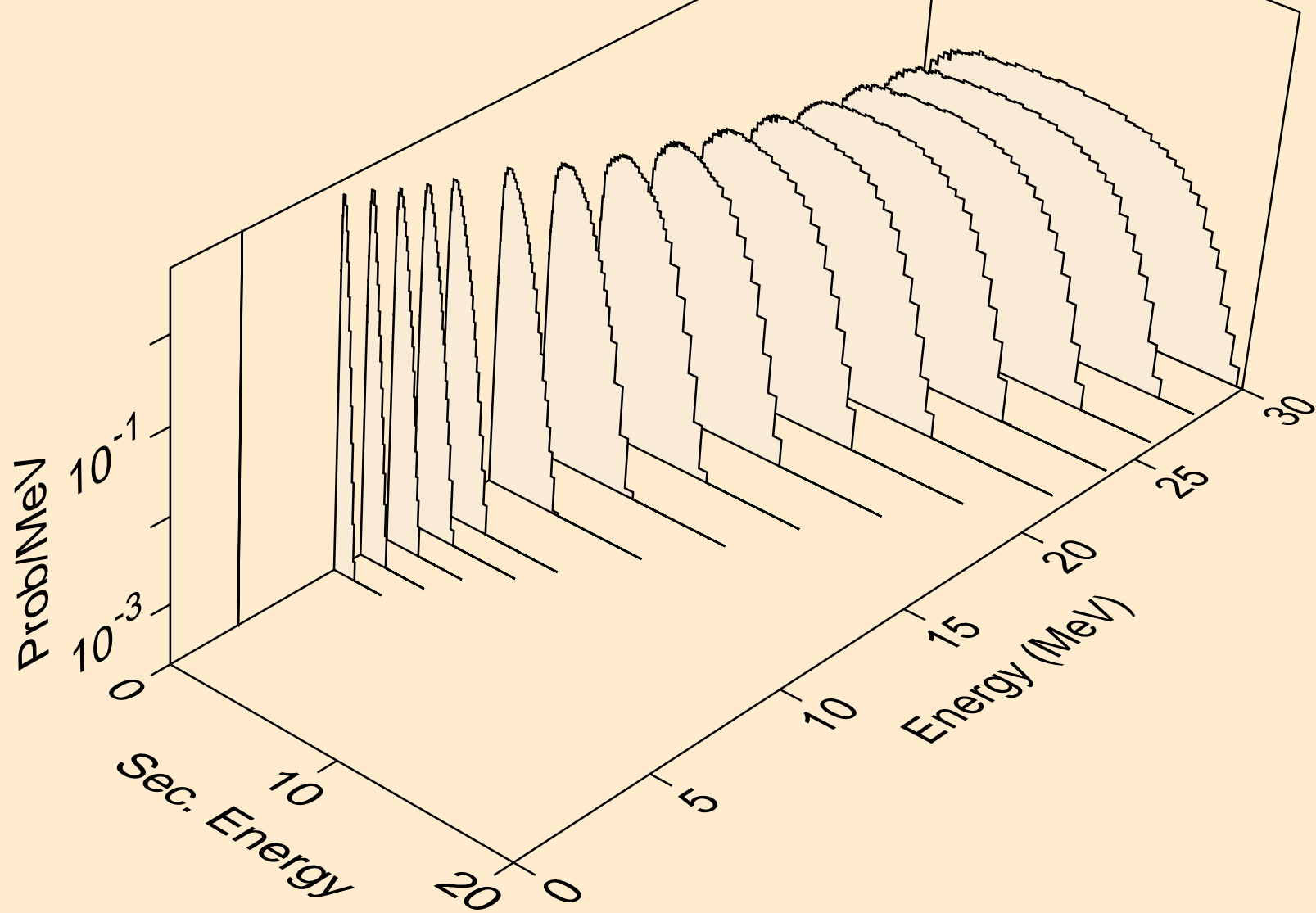

BK234 DEUTERON ACER TENDL-2023 LIBRARY; T=0.K
neutrons from (d,n*)d

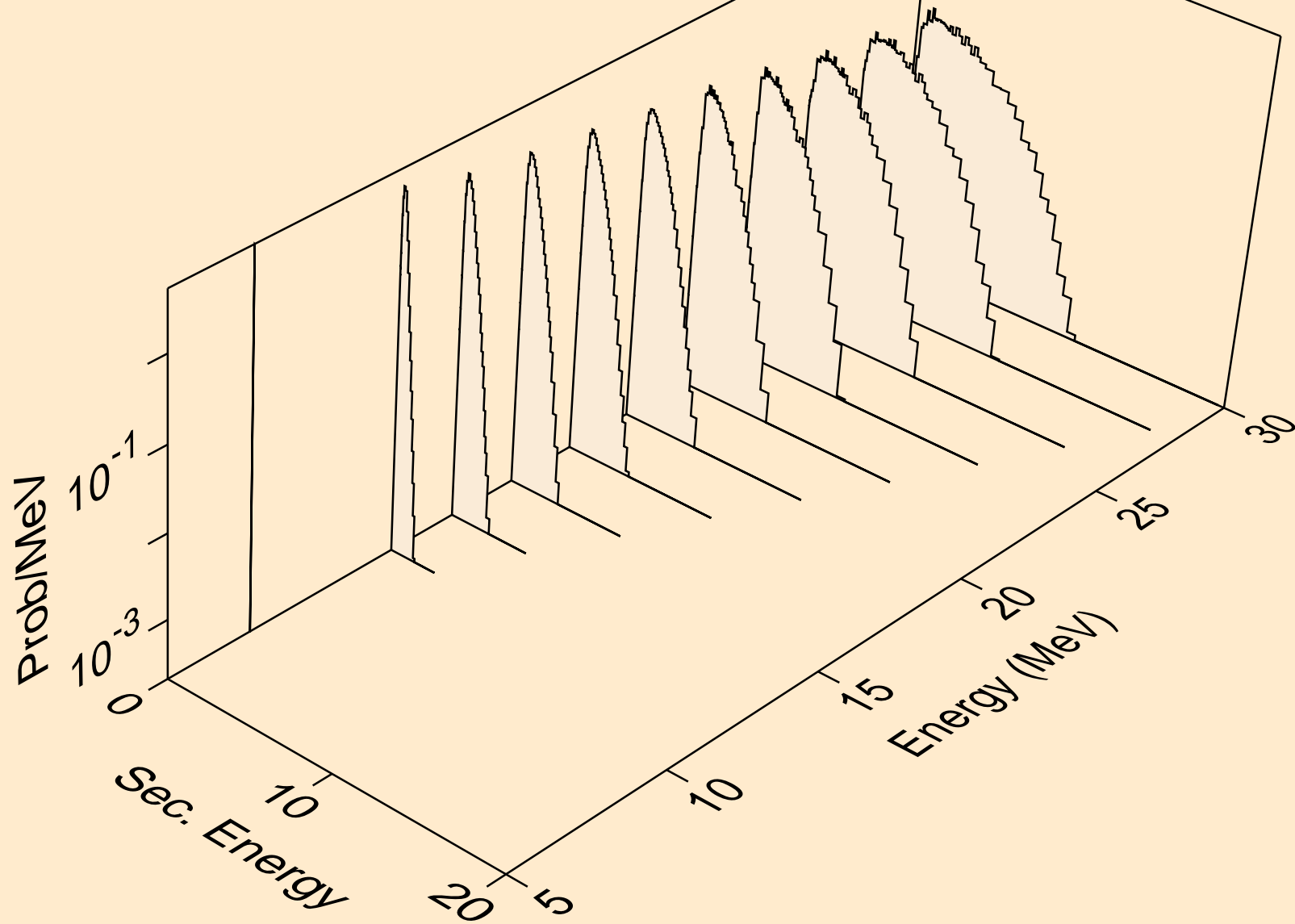

BK234 DEUTERON ACER TENDL-2023 LIBRARY; T=0.K
neutrons from (d,2np)

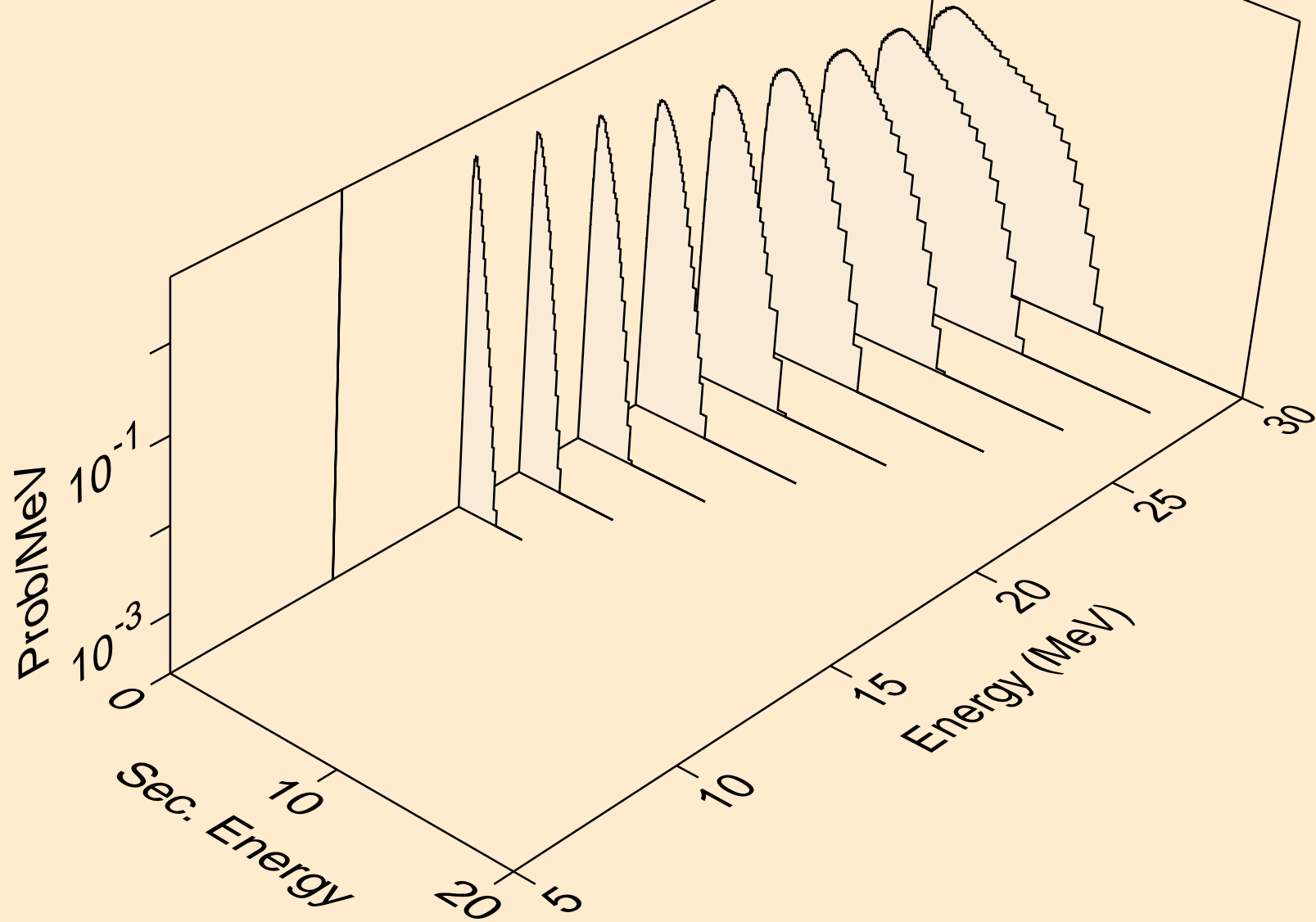

BK234 DEUTERON ACER TENDL-2023 LIBRARY; T=0.K
neutrons from (d,n2p)

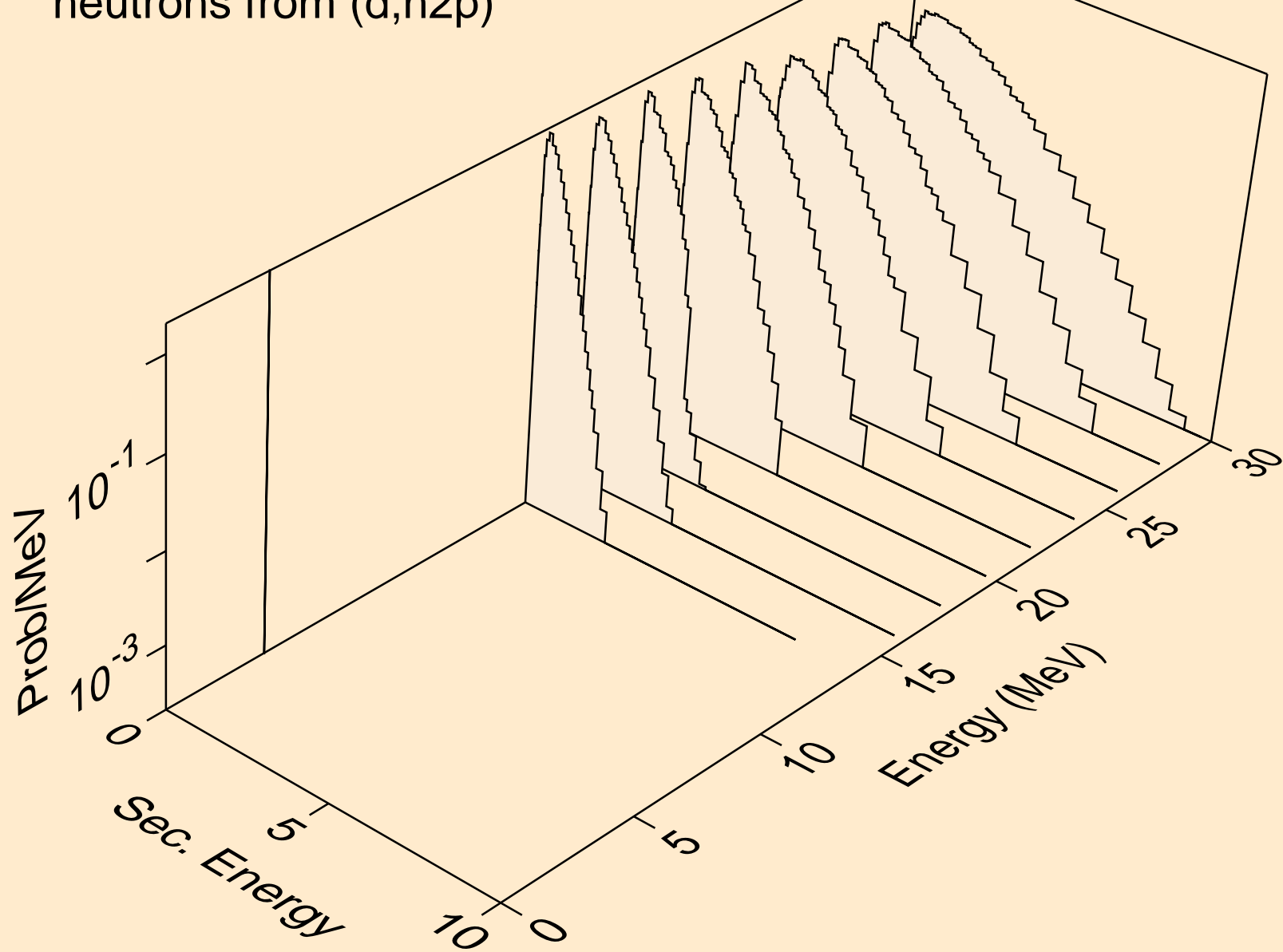

BK234 DEUTERON ACER TENDL-2023 LIBRARY; T=0.K
protons from (d,x)

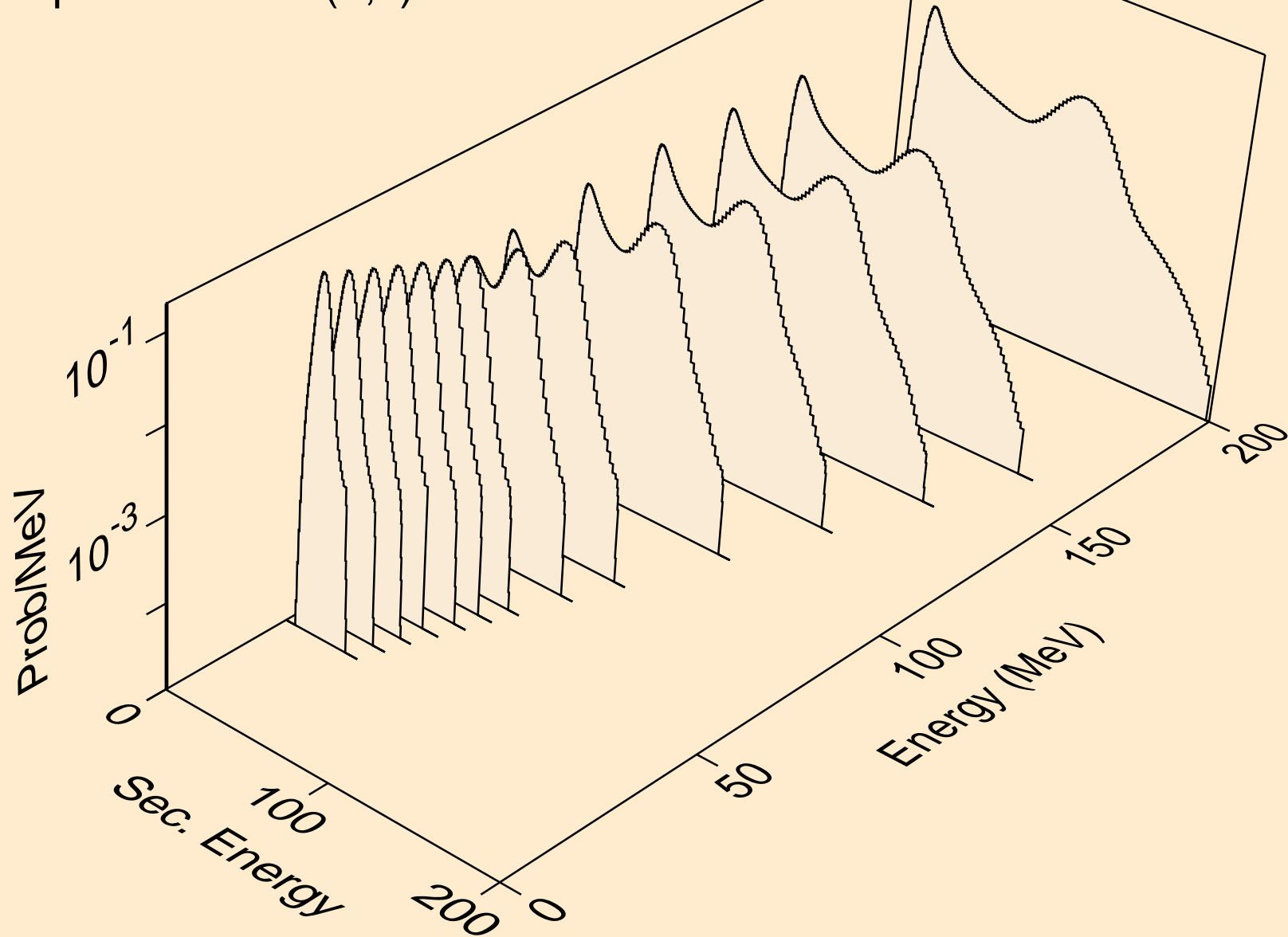

BK234 DEUTERON ACER TENDL-2023 LIBRARY; T=0.K
protons from (d,n*)p

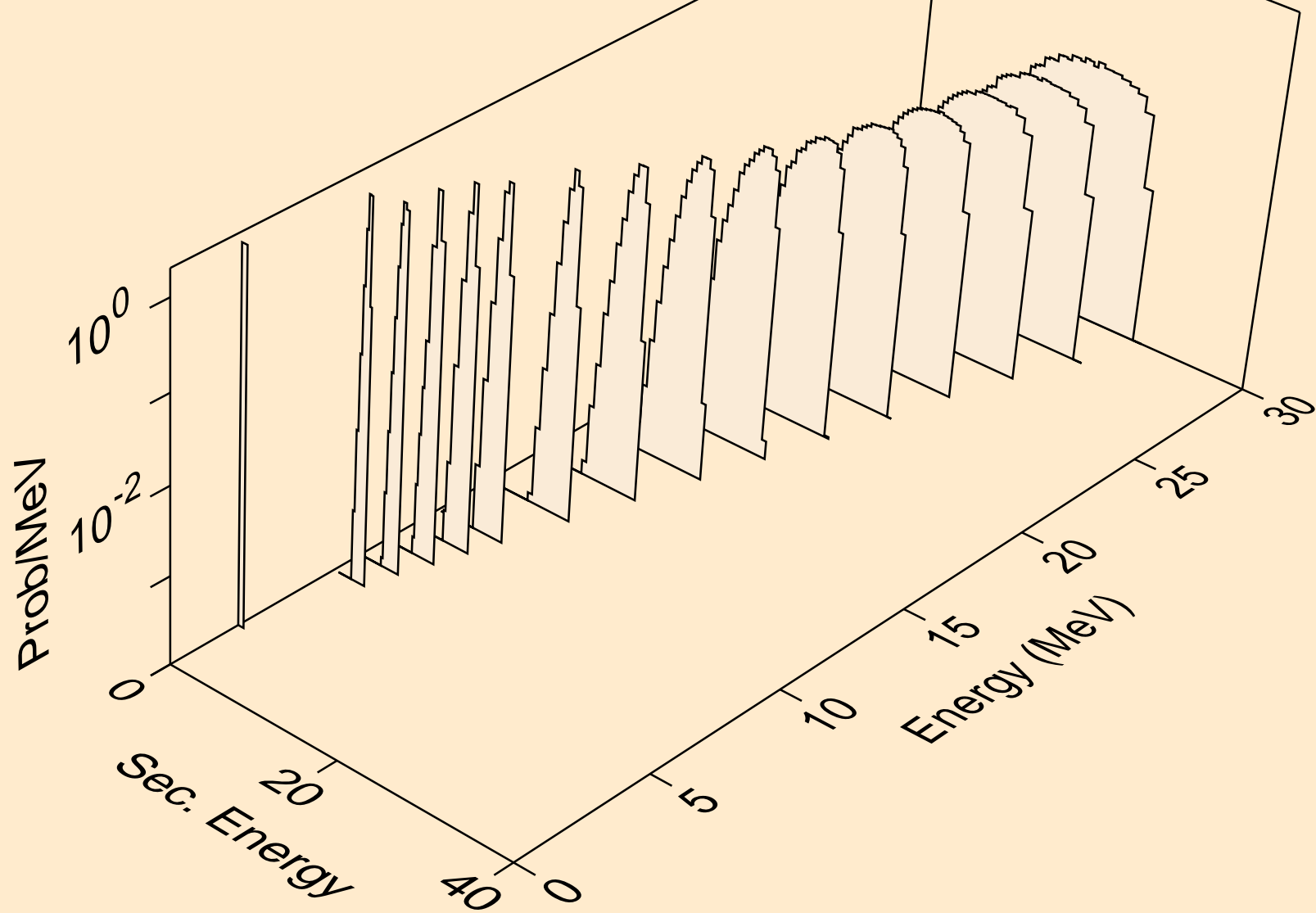

BK234 DEUTERON ACER TENDL-2023 LIBRARY; T=0.K
protons from (d,2np)

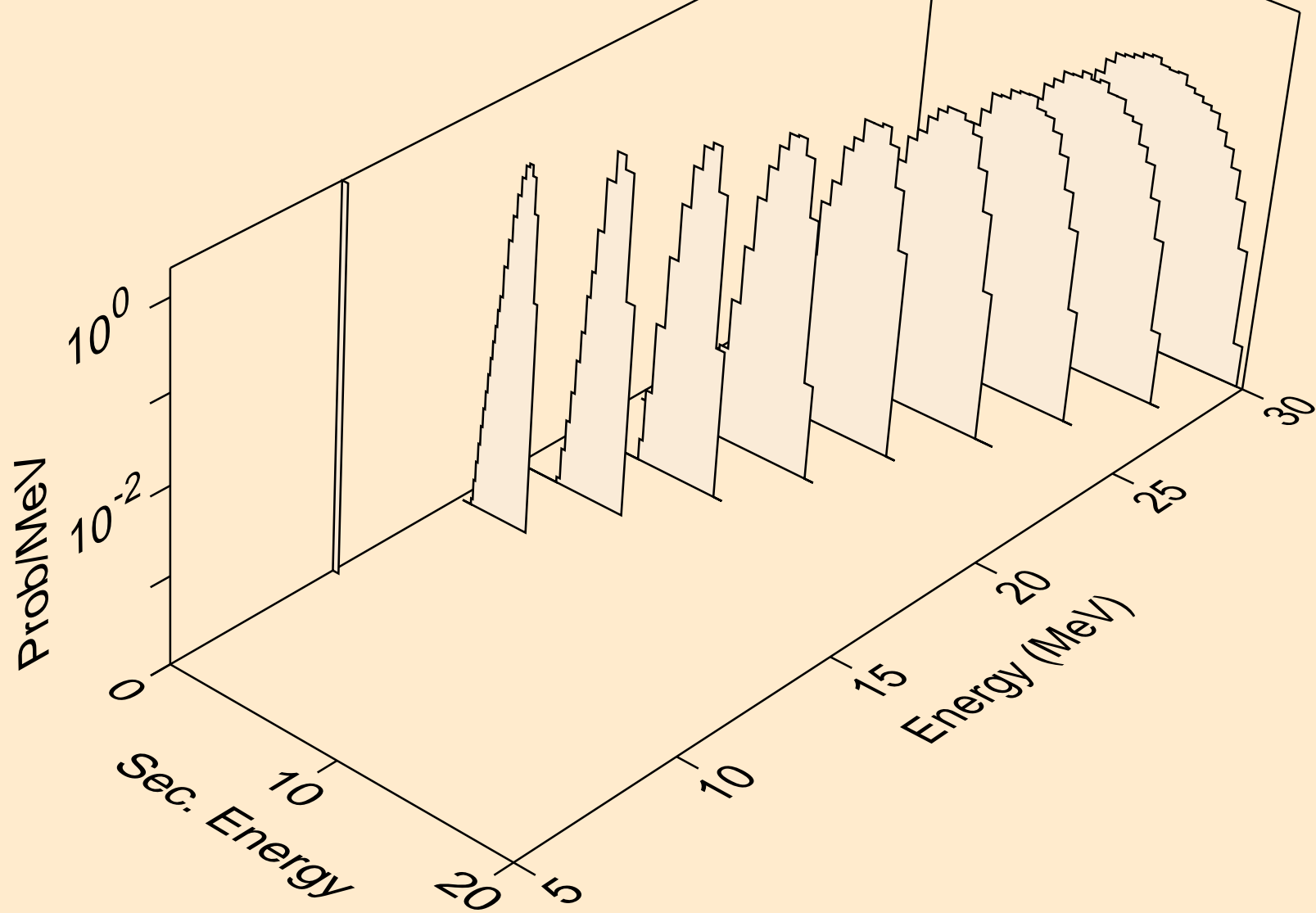

BK234 DEUTERON ACER TENDL-2023 LIBRARY; T=0.K
protons from (d,n2p)

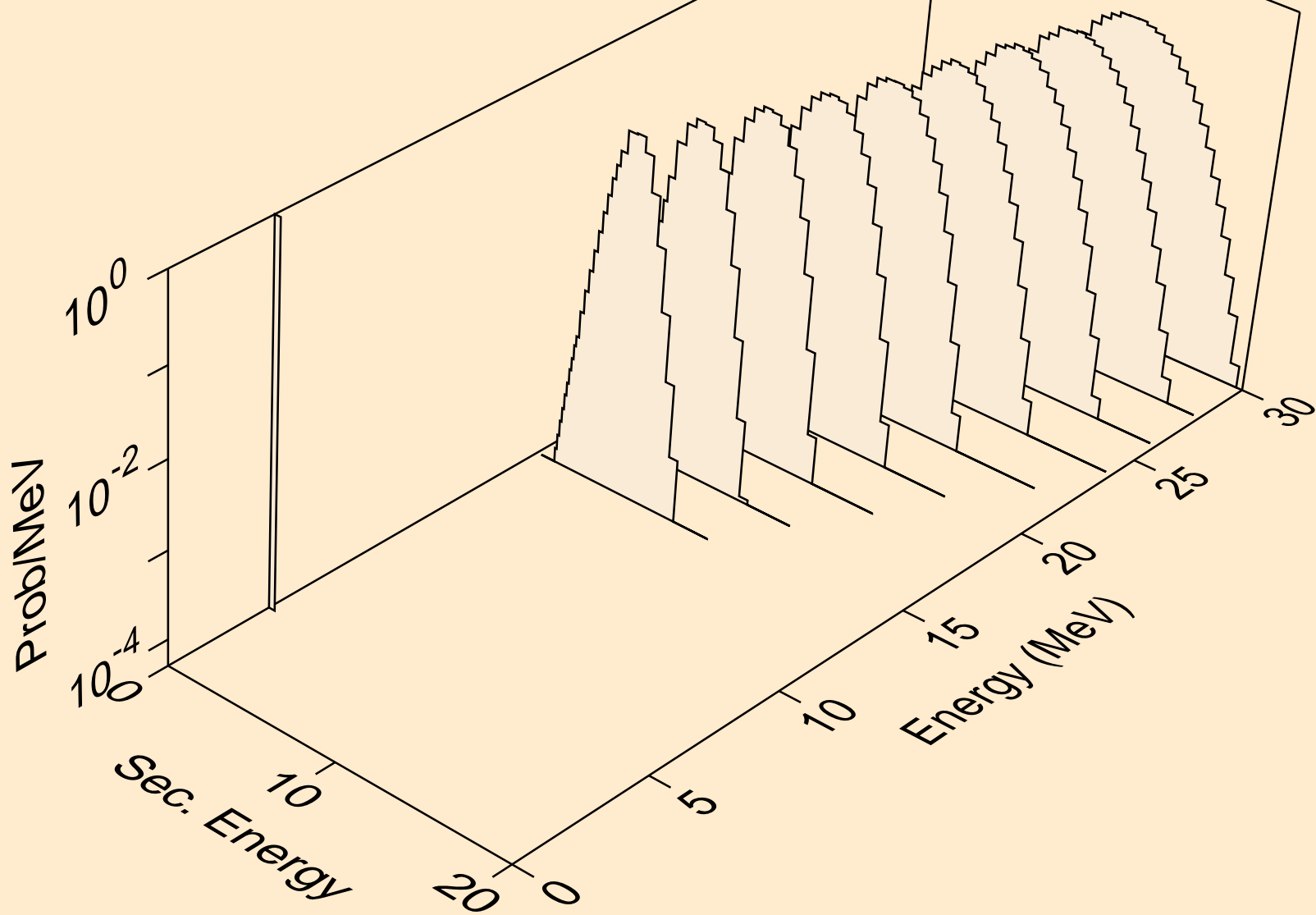

BK234 DEUTERON ACER TENDL-2023 LIBRARY; T=0.K
protons from (d,p)

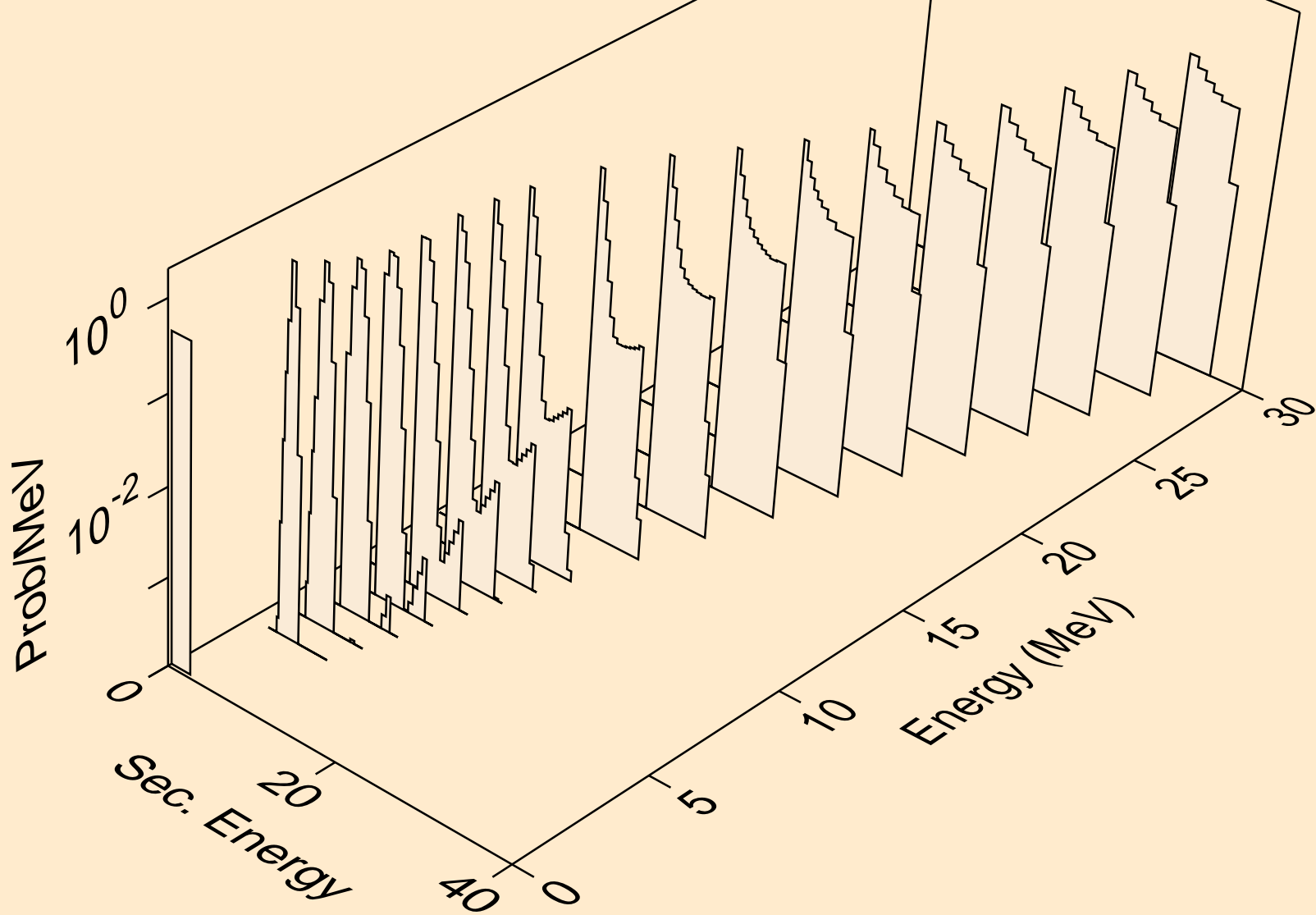

BK234 DEUTERON ACER TENDL-2023 LIBRARY; T=0.K
protons from (d,2p)

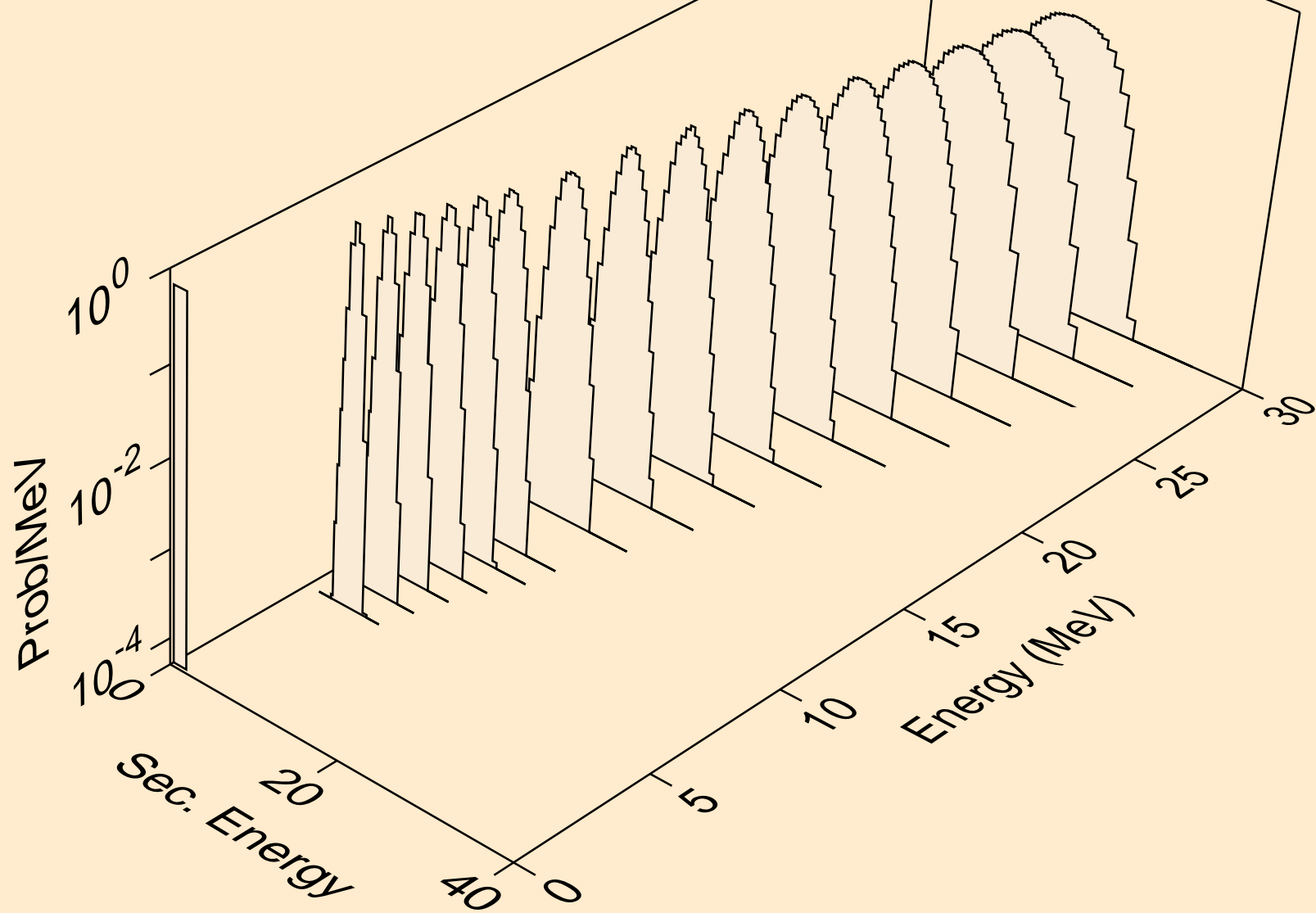

BK234 DEUTERON ACER TENDL-2023 LIBRARY; T=0.K
protons from (d,pd)

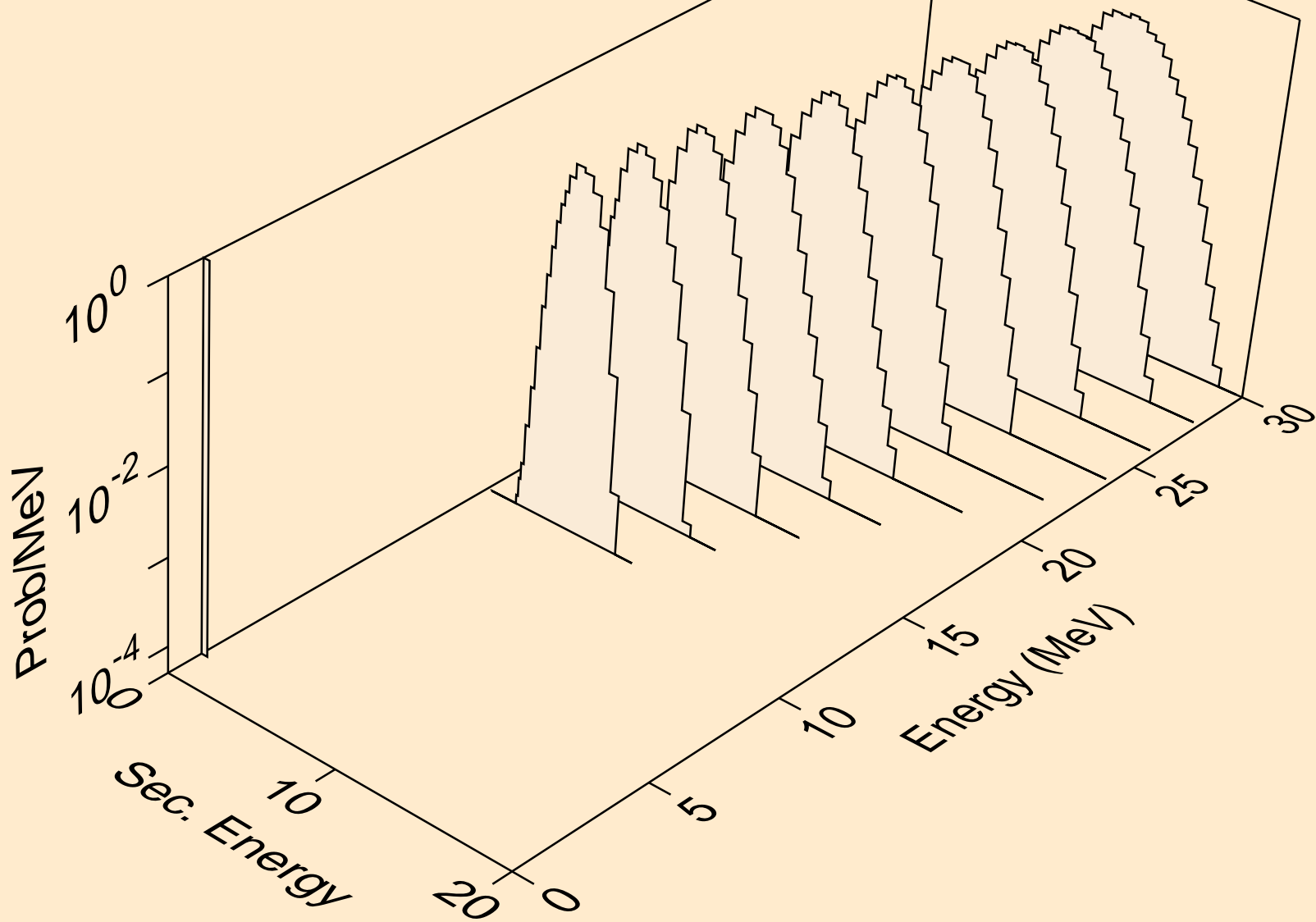

BK234 DEUTERON ACER TENDL-2023 LIBRARY; T=0.K
tritons from (d,x)

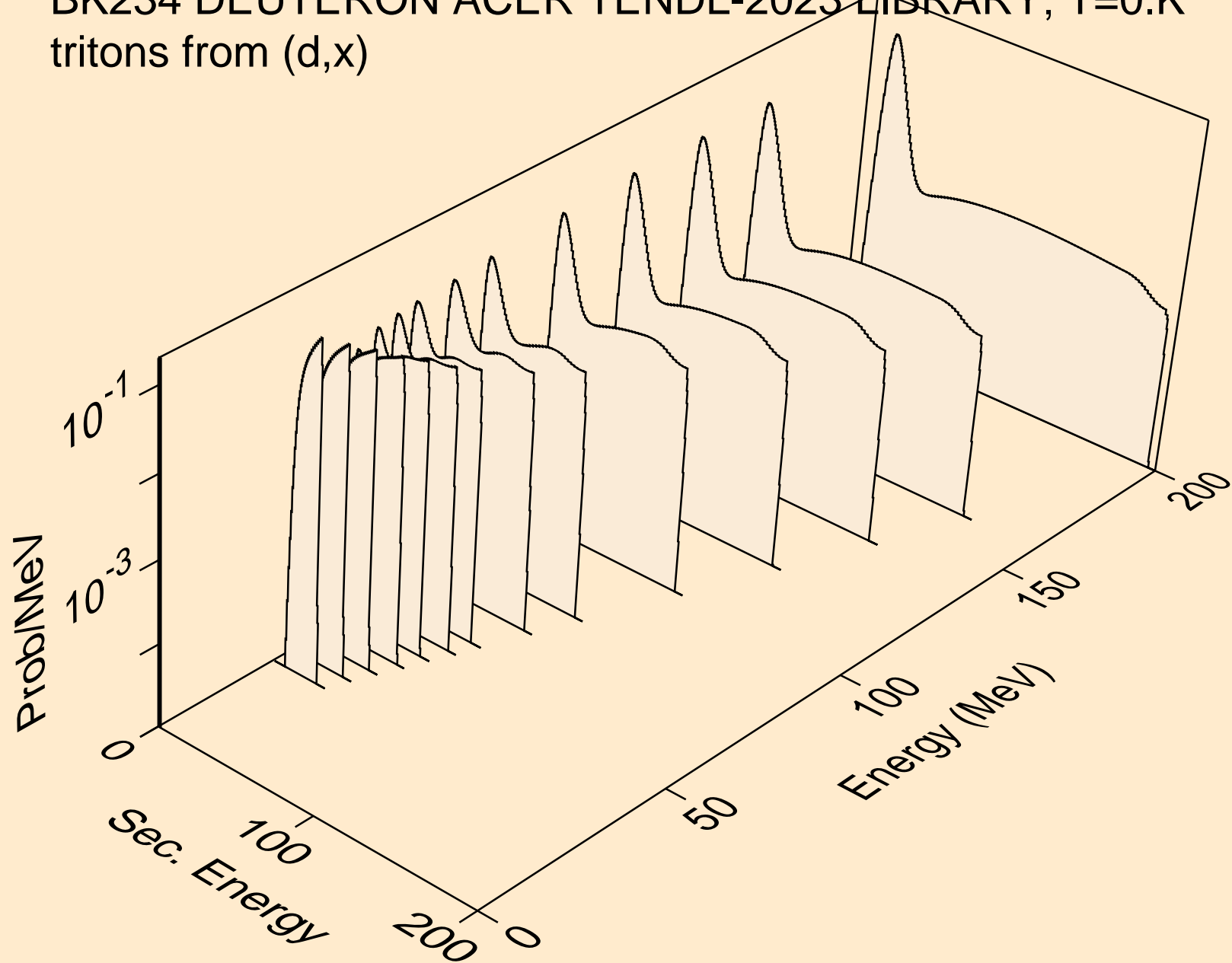

BK234 DEUTERON ACER TENDL-2023 LIBRARY; T=0.K
tritons from (d,t)

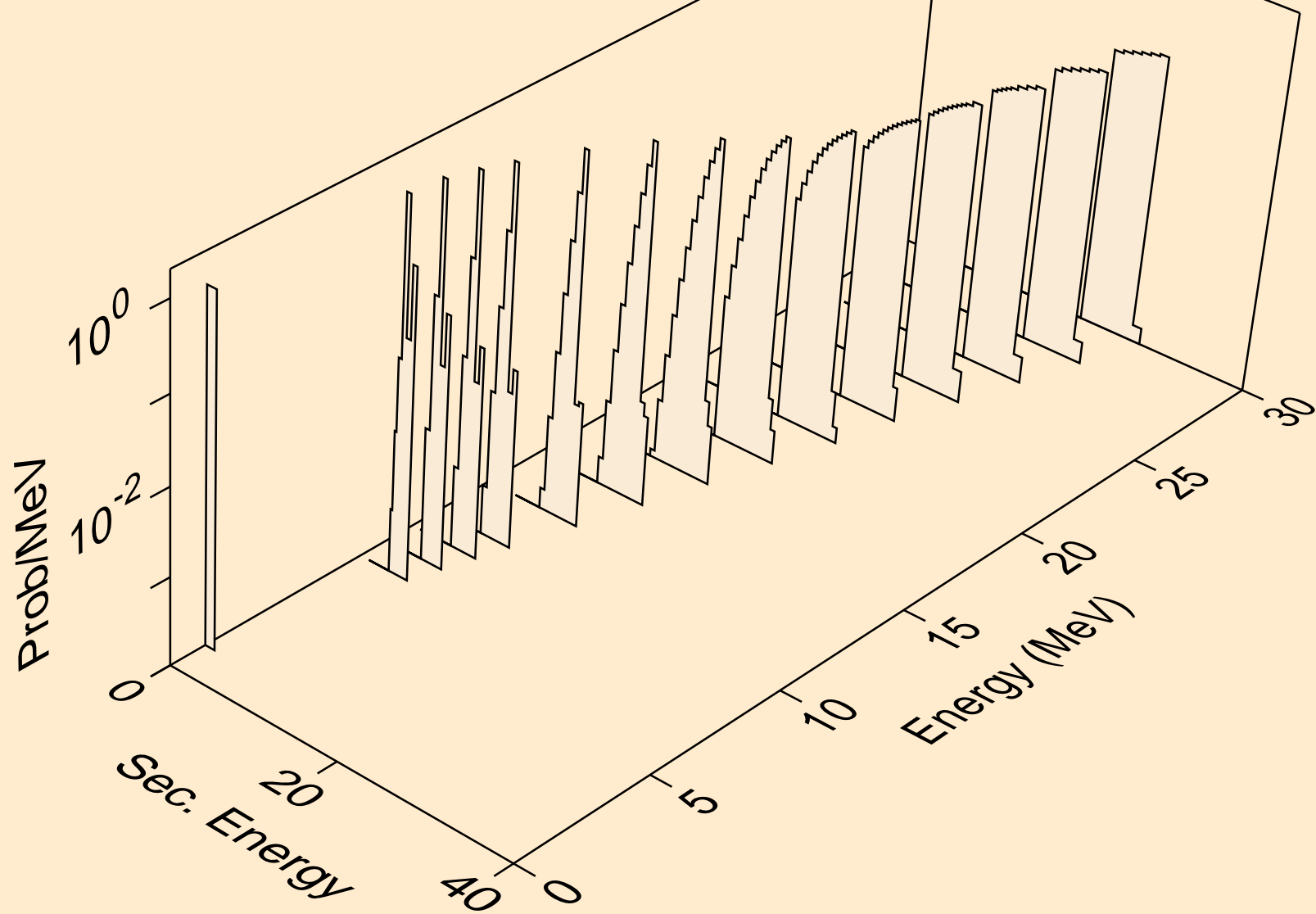

BK234 DEUTERON ACER TENDL-2023 LIBRARY; T=0.K
he3s from (d,x)

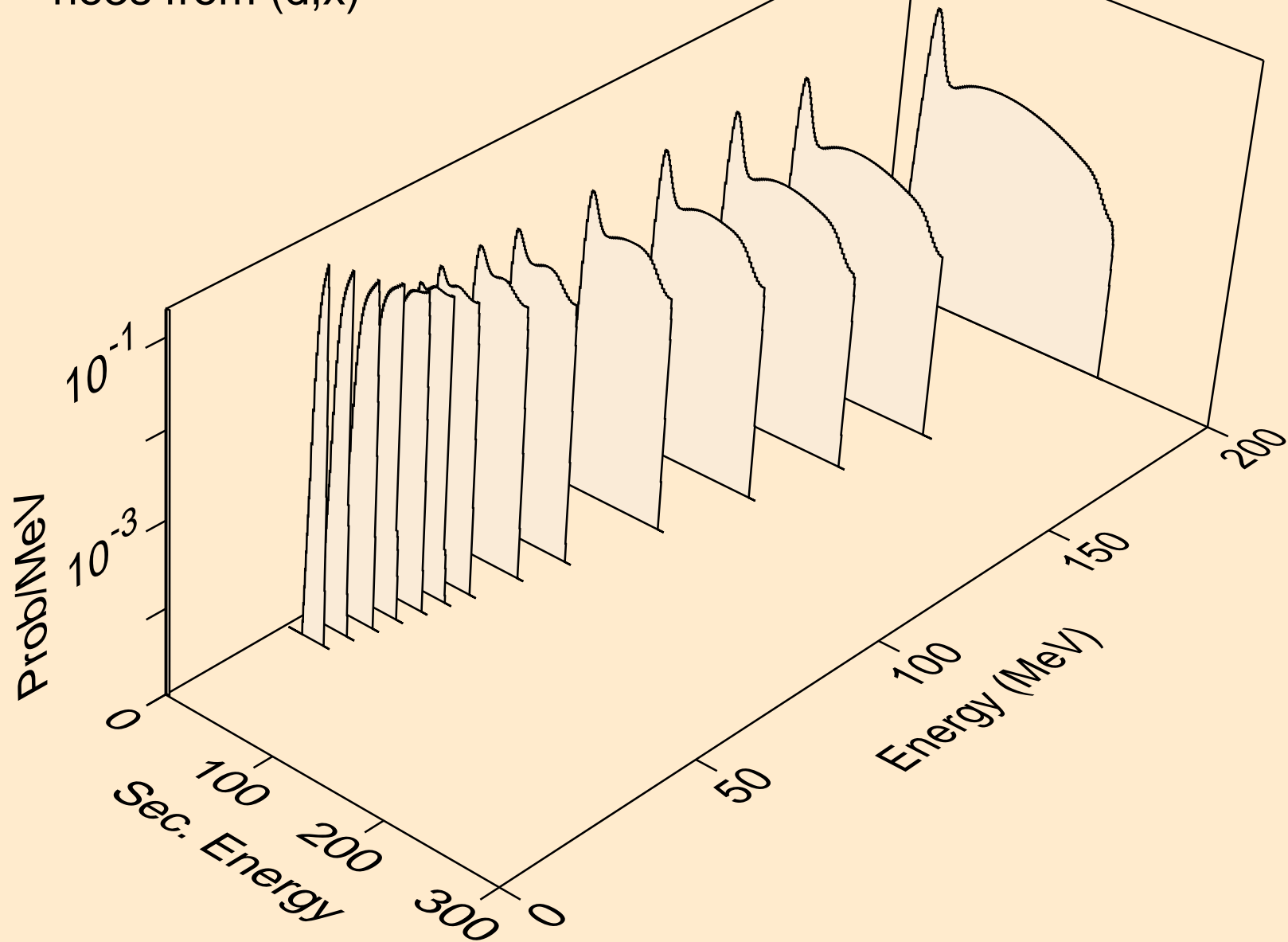

BK234 DEUTERON ACER TENDL-2023 LIBRARY; T=0.K
he3s from (d,he3)

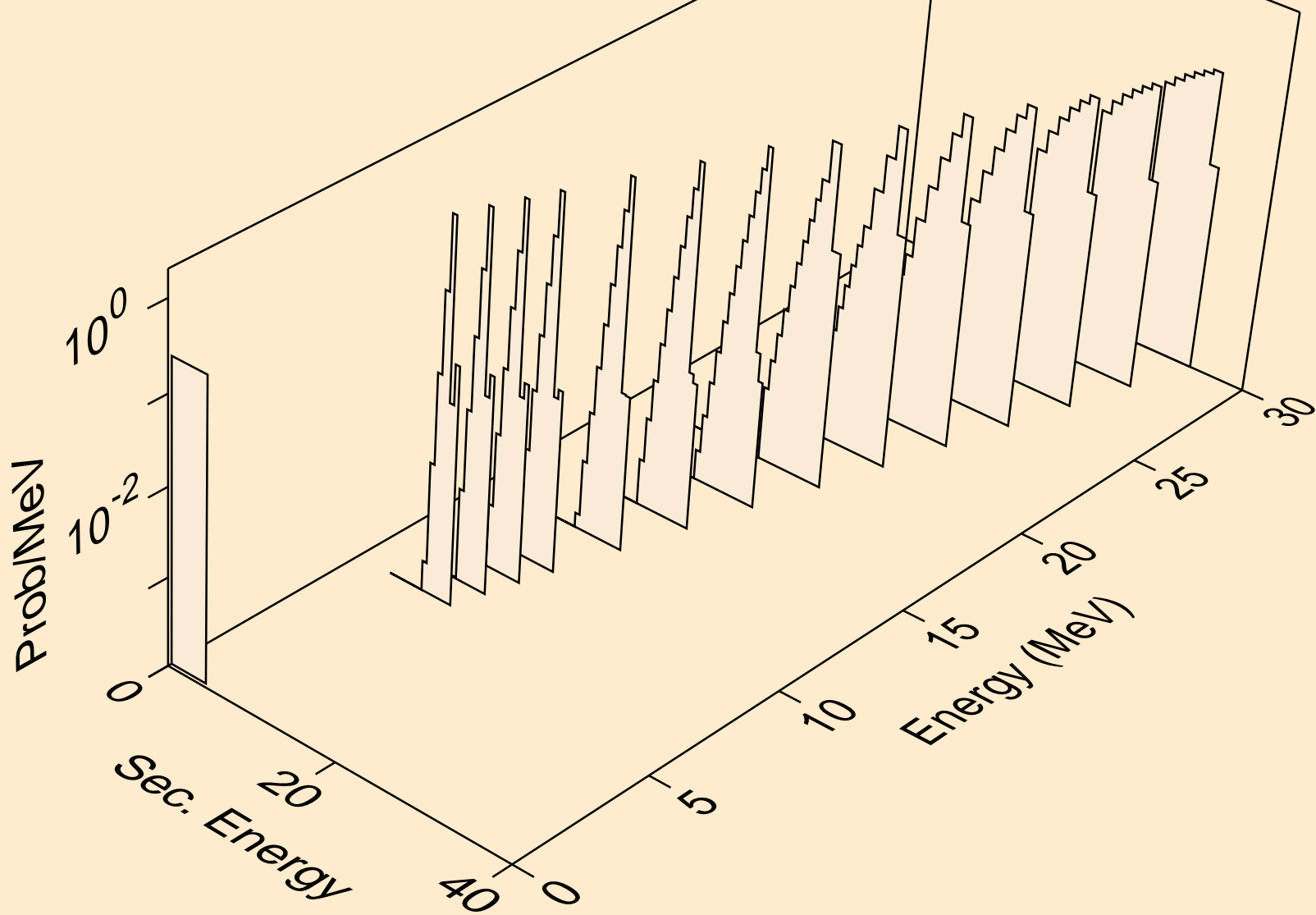

BK234 DEUTERON ACER TENDL-2023 LIBRARY; T=0.K
alphas from (d,x)

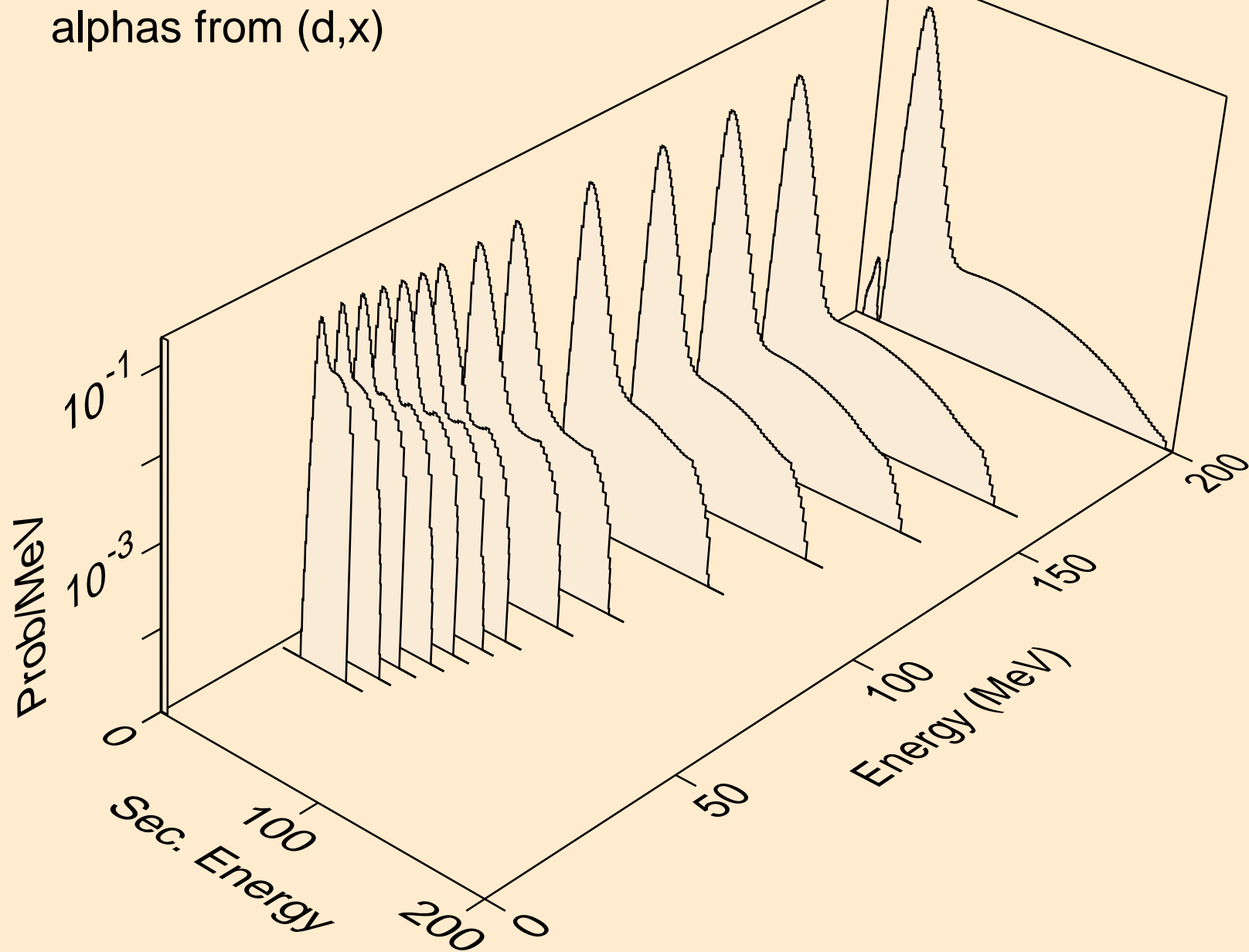

BK234 DEUTERON ACER TENDL-2023 LIBRARY; T=0.K
alphas from (d,a)

