

CM237 DEUTERON ACER TENDL-2023 LIBRARY; T=0.K
Principal cross sections

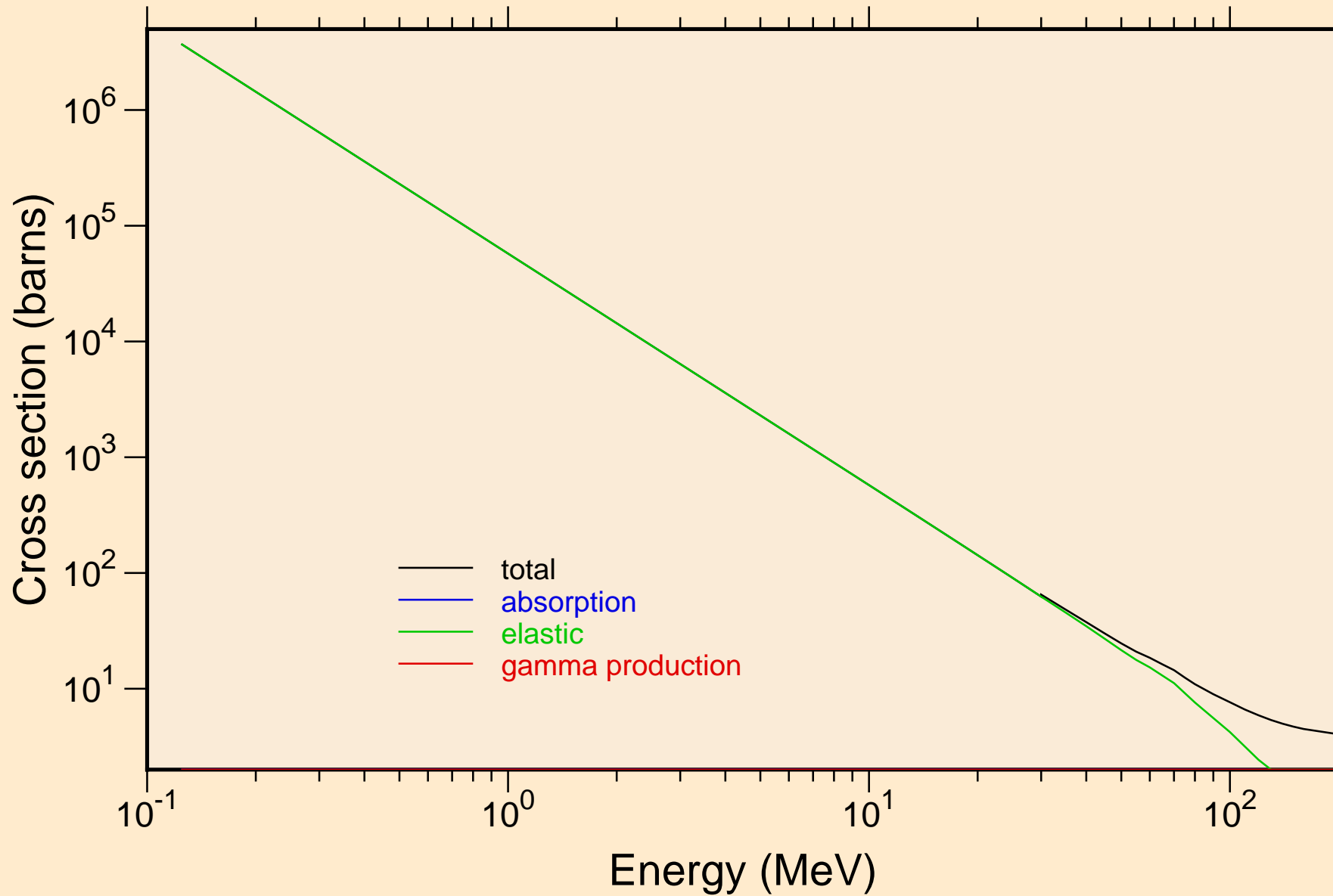

CM237 DEUTERON ACER TENDL-2023 LIBRARY; T=0.K

Heating

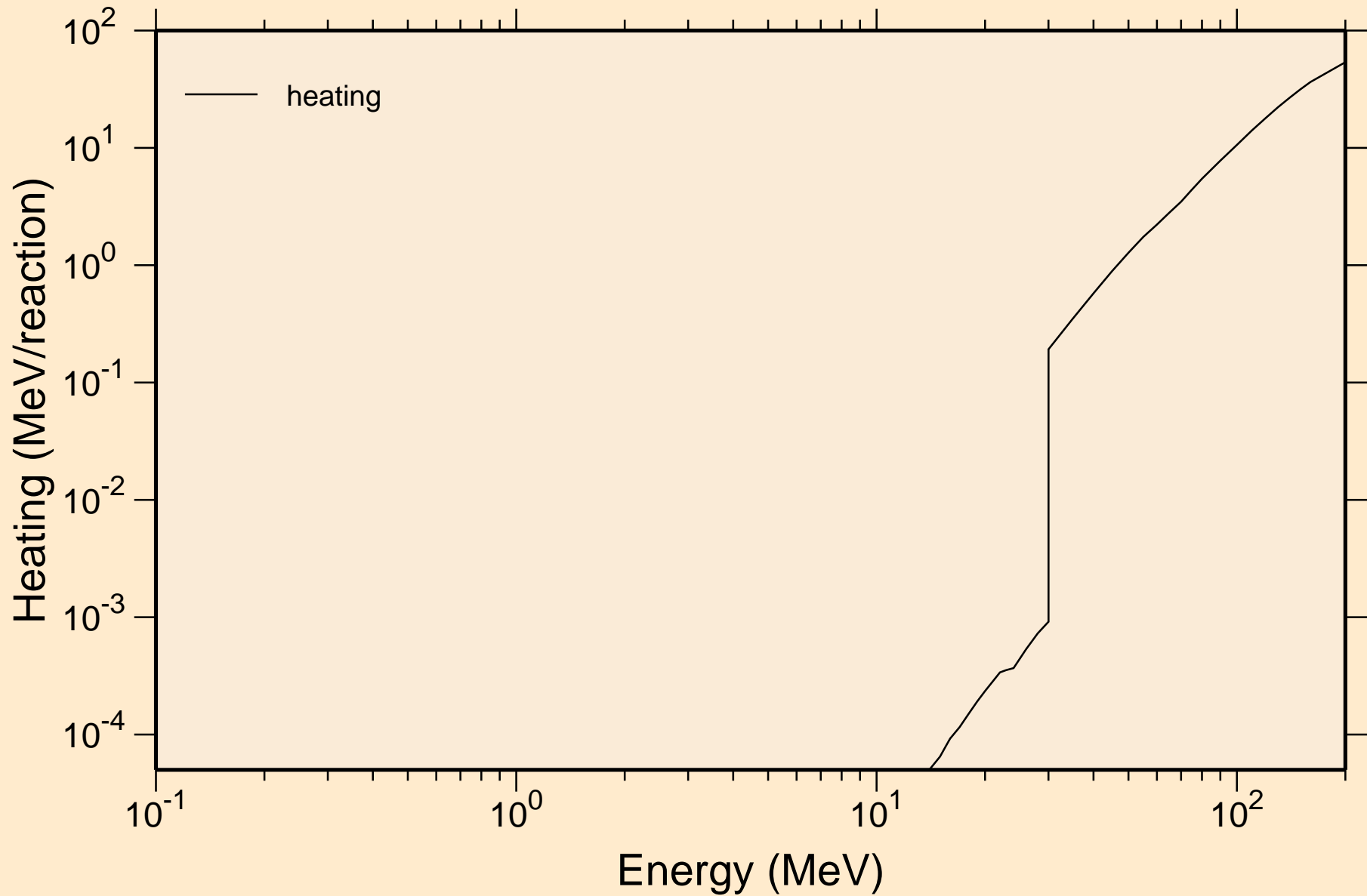

CM237 DEUTERON ACER TENDL-2023 LIBRARY; T=0.K
Principal cross sections

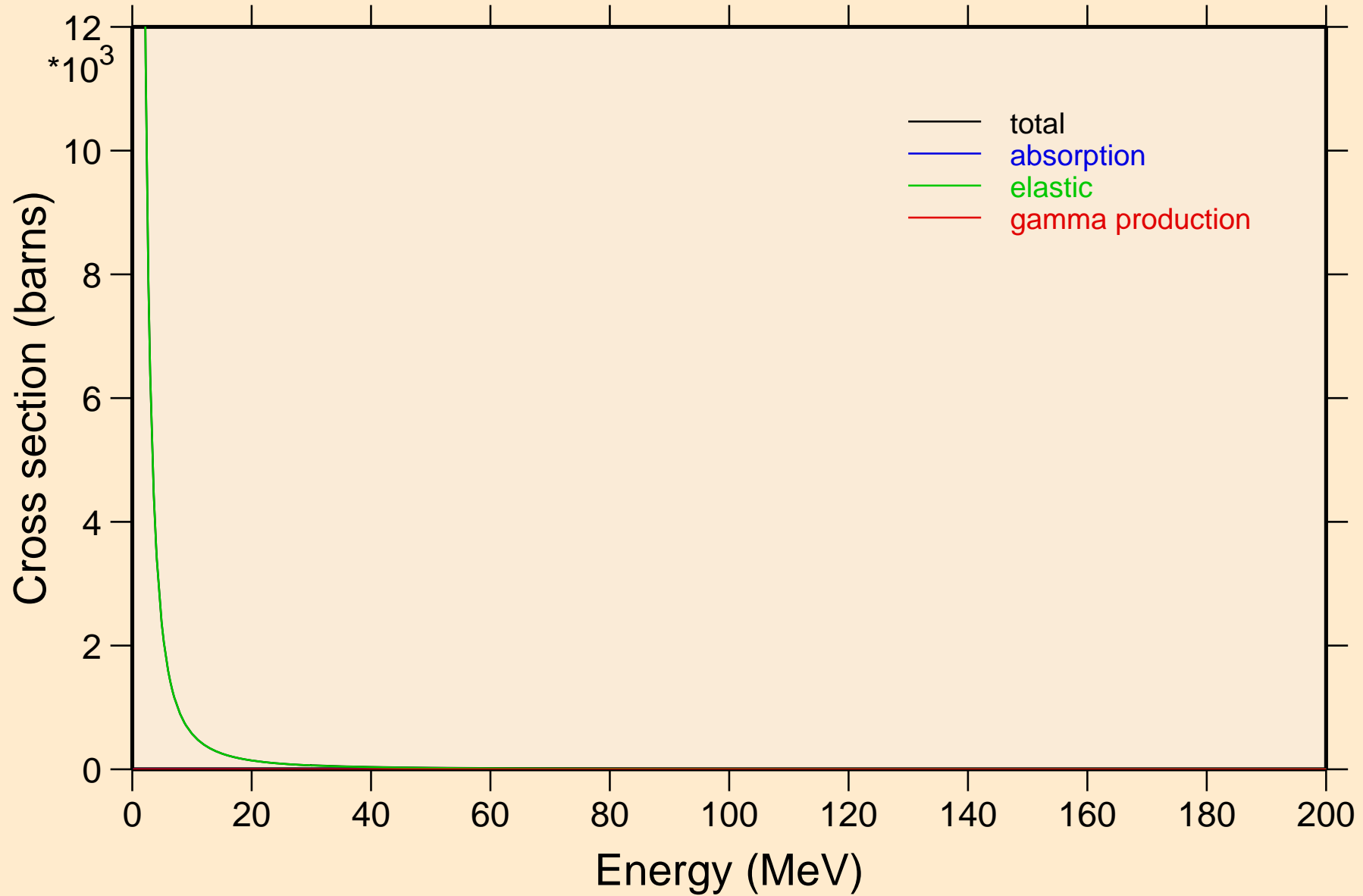

CM237 DEUTERON ACER TENDL-2023 LIBRARY; T=0.K

Heating

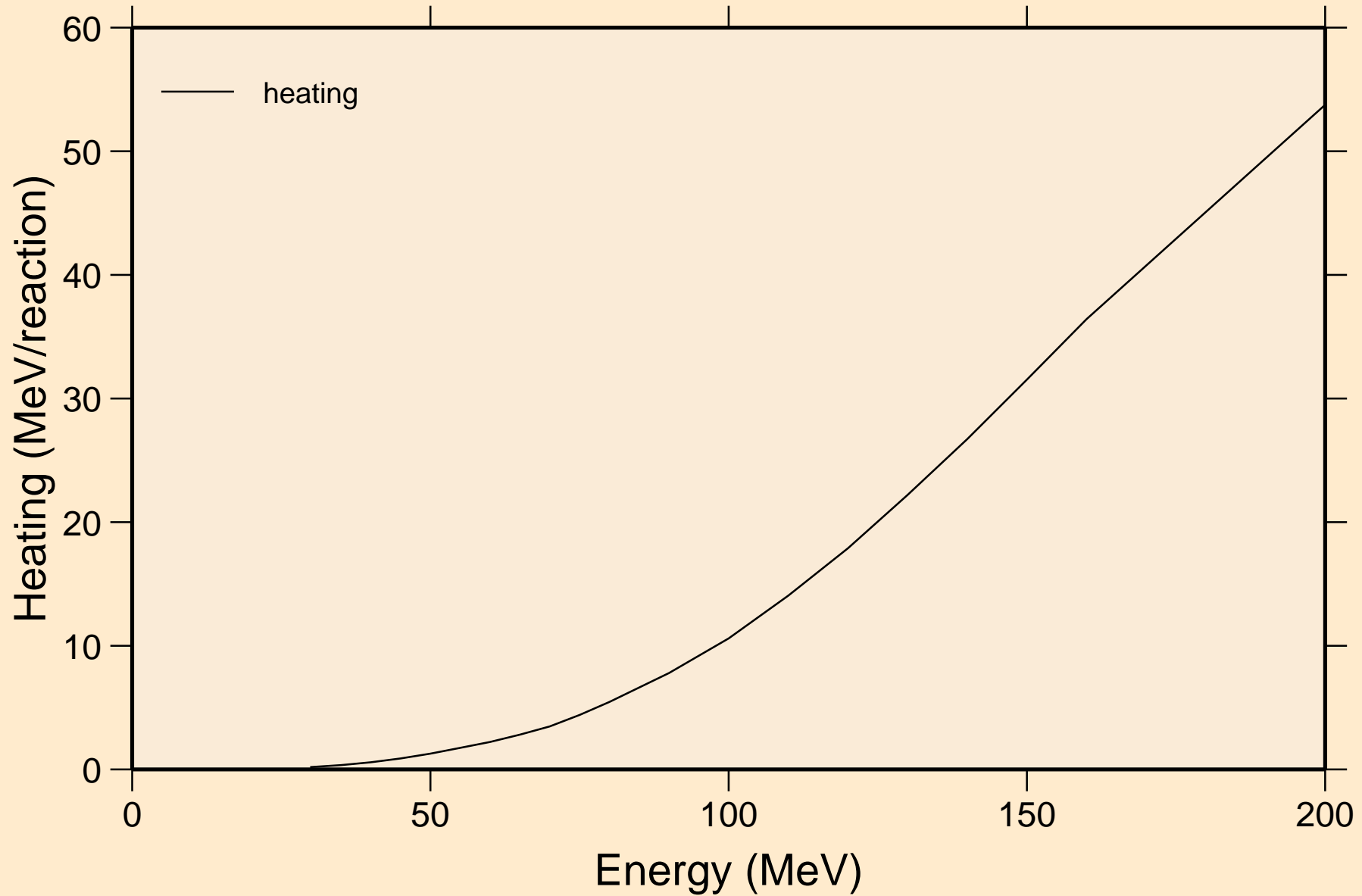

CM237 DEUTERON ACER TENDL-2023 LIBRARY; T=0.K

Threshold reactions

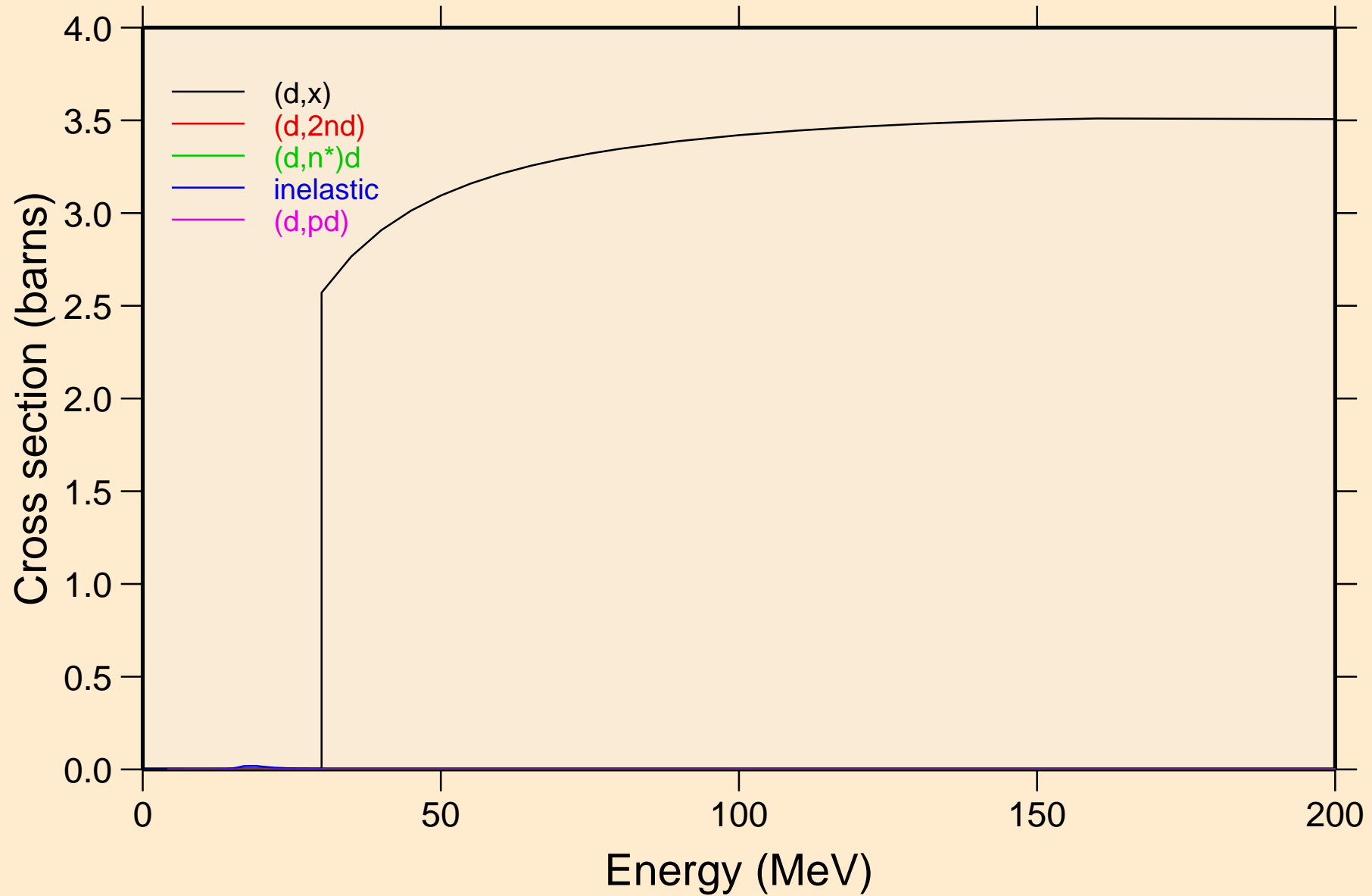

CM237 DEUTERON ACER TENDL-2023 LIBRARY; T=0.K
angular distribution for elastic

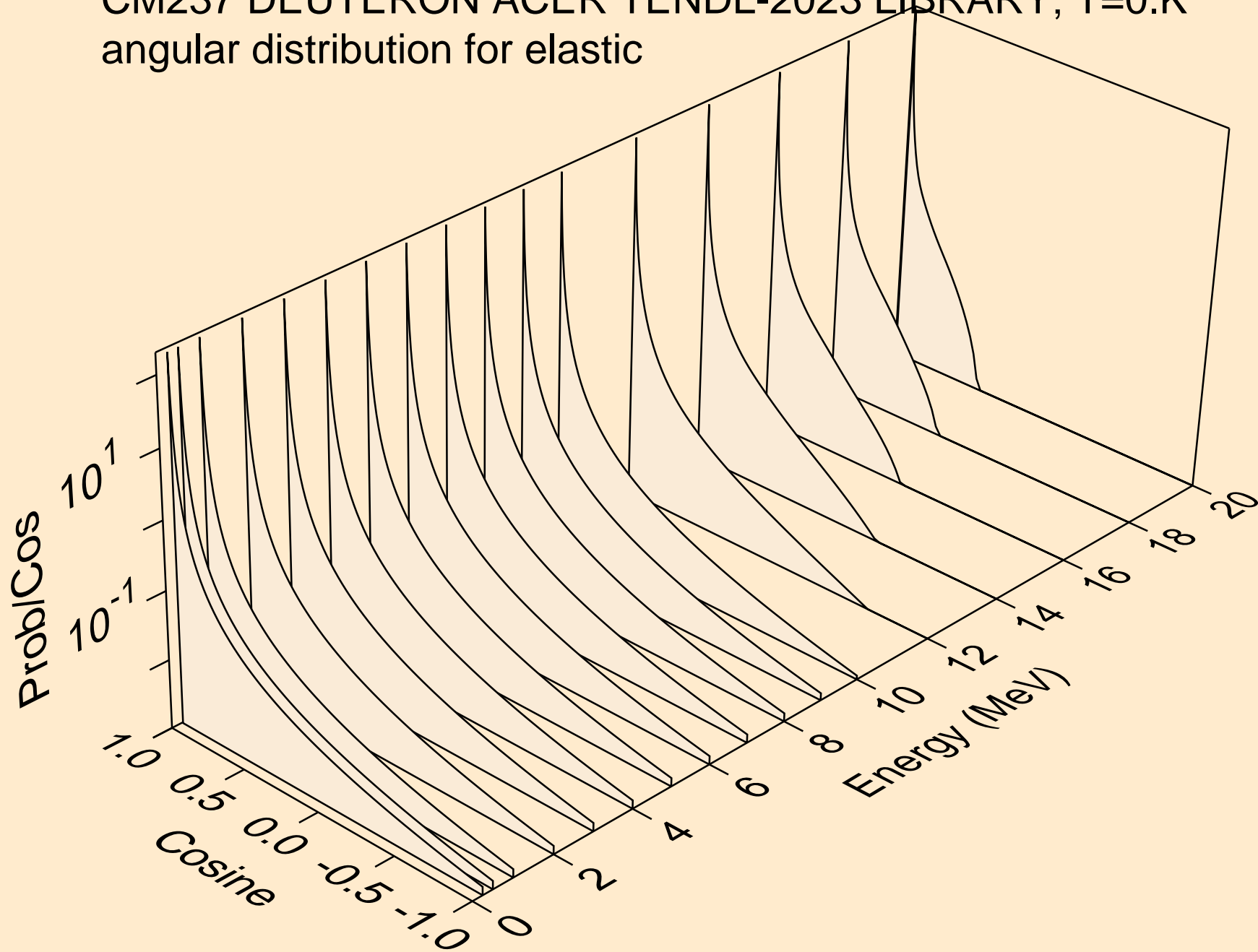

CM237 DEUTERON ACER TENDL-2023 LIBRARY; T=0.K
angular distribution for elastic

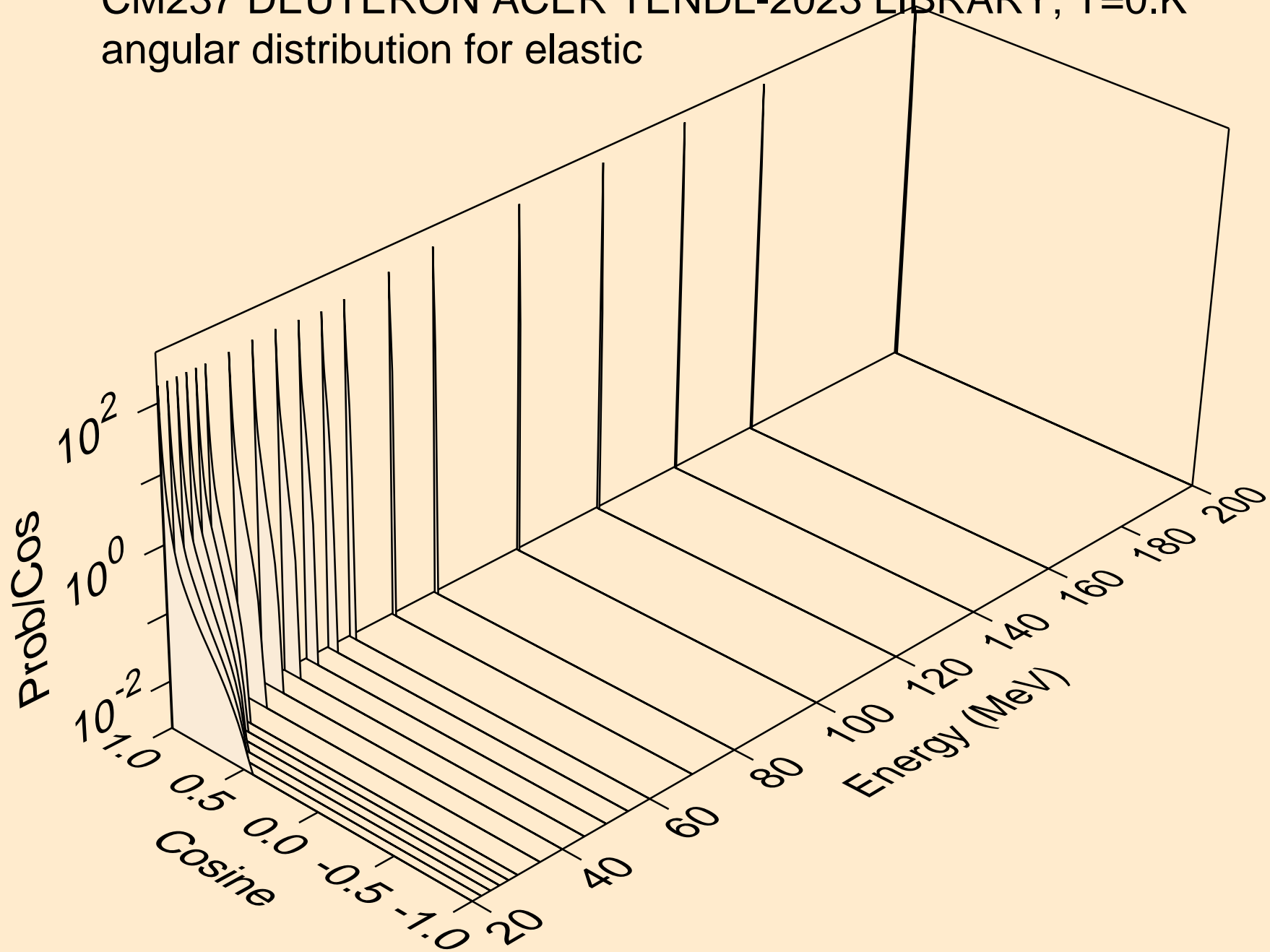

CM237 DEUTERON ACER TENDL-2023 LIBRARY; T=0.K
Deuteron emission for (d,x)

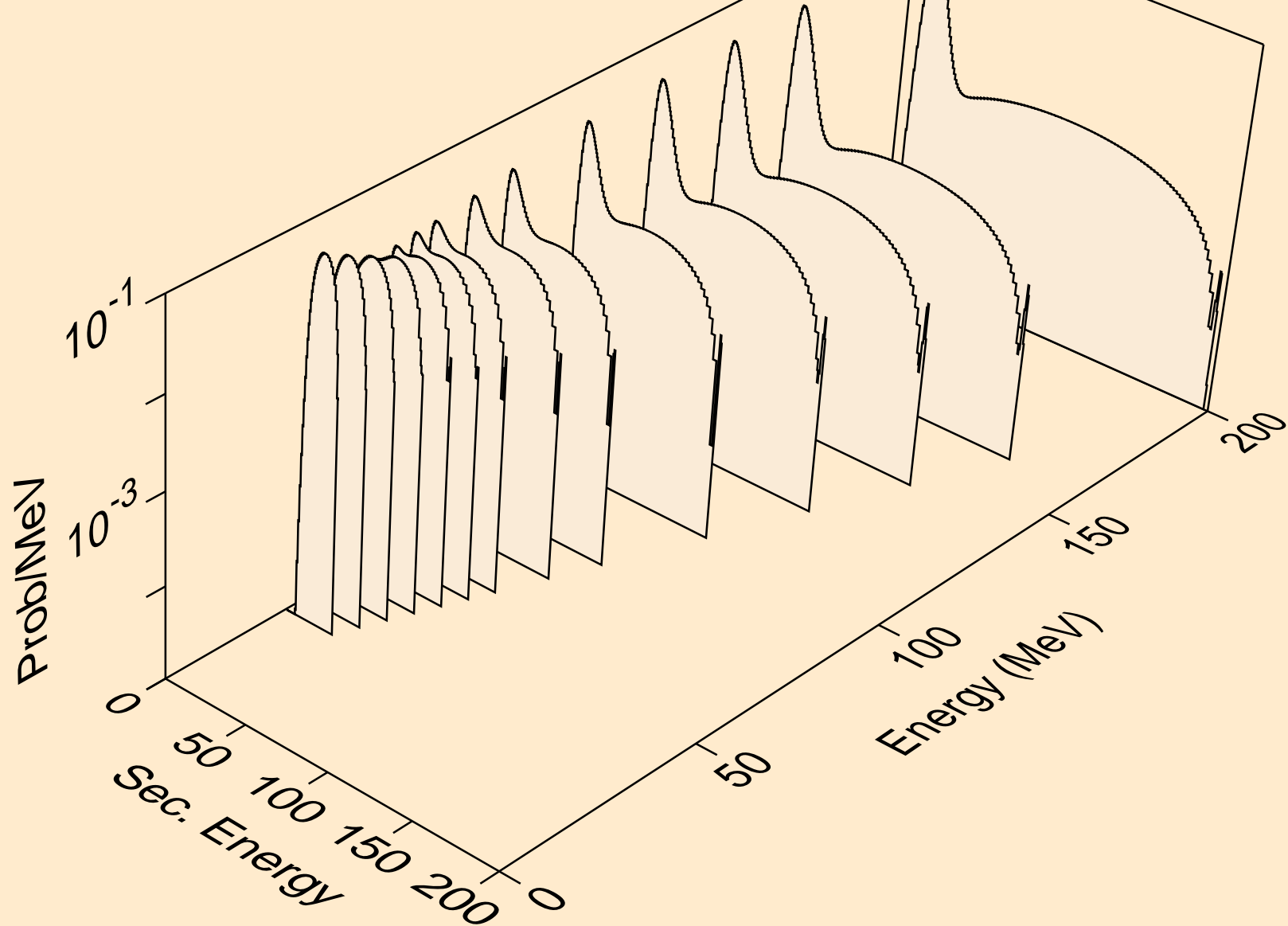

CM237 DEUTERON ACER TENDL-2023 LIBRARY; T=0.K
Deuteron emission for (d,2nd)

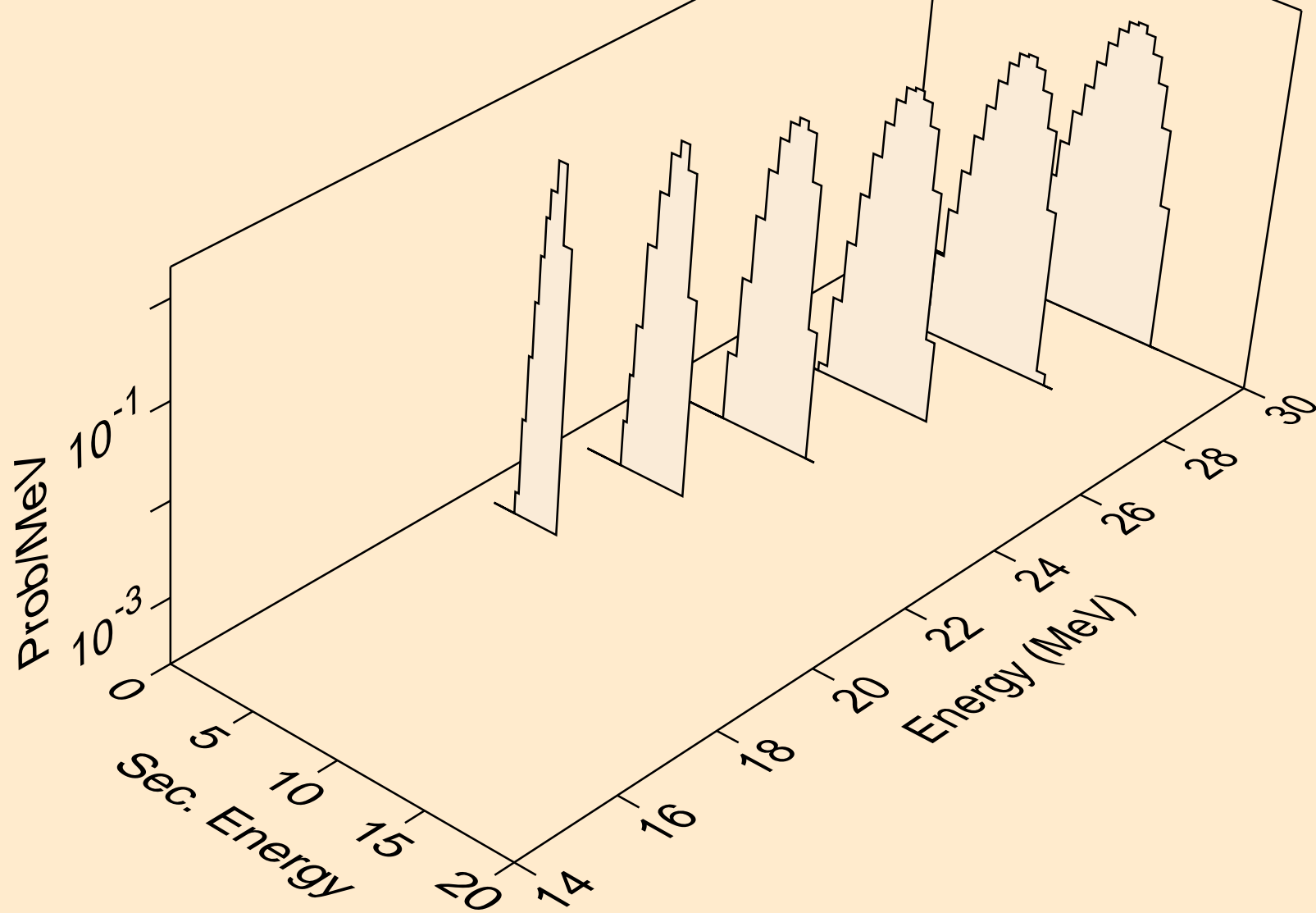

CM237 DEUTERON ACER TENDL-2023 LIBRARY; T=0.K
Deuteron emission for (d,n*)d

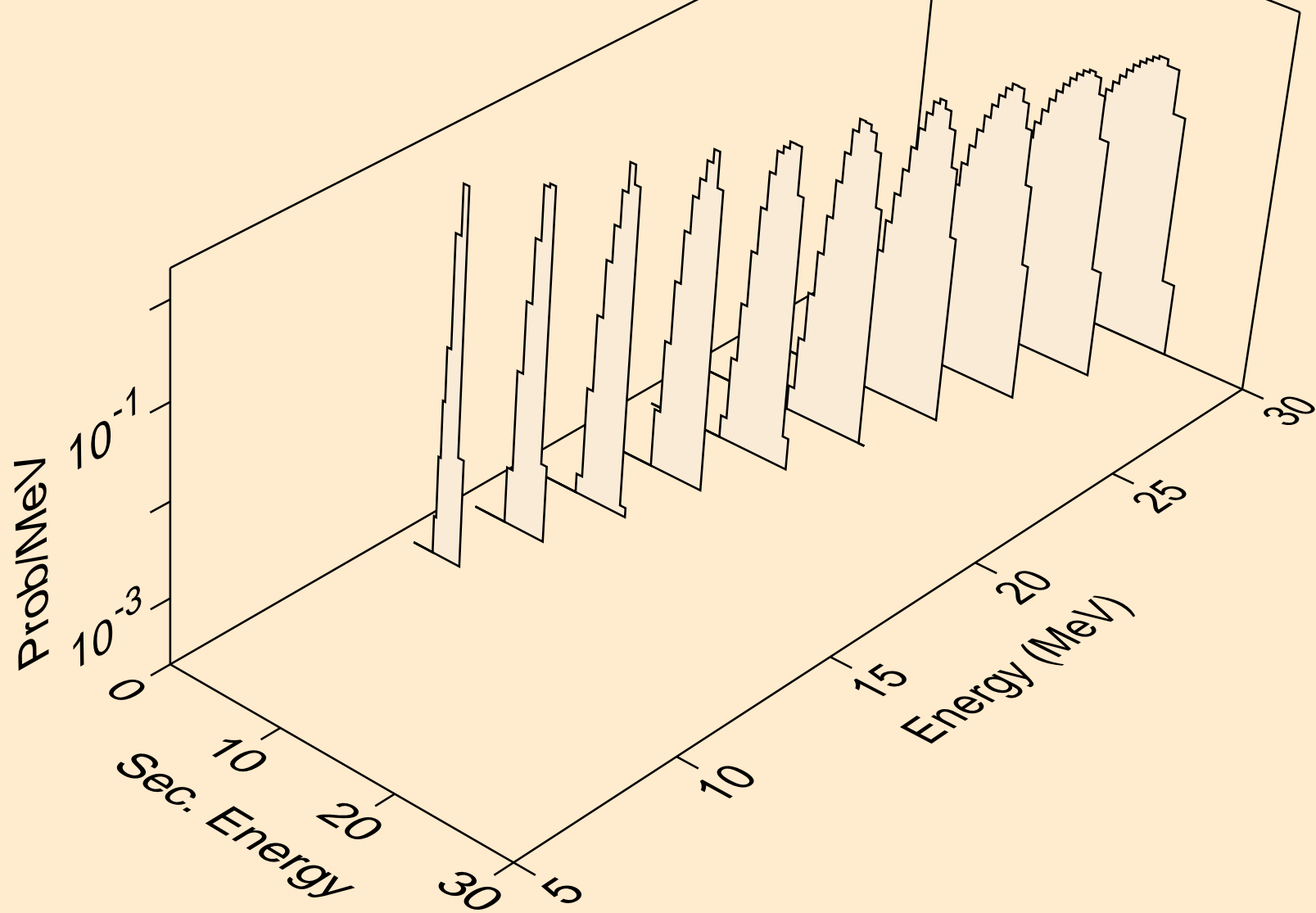

CM237 DEUTERON ACER TENDL-2023 LIBRARY; T=0.K
Deuteron emission for inelastic

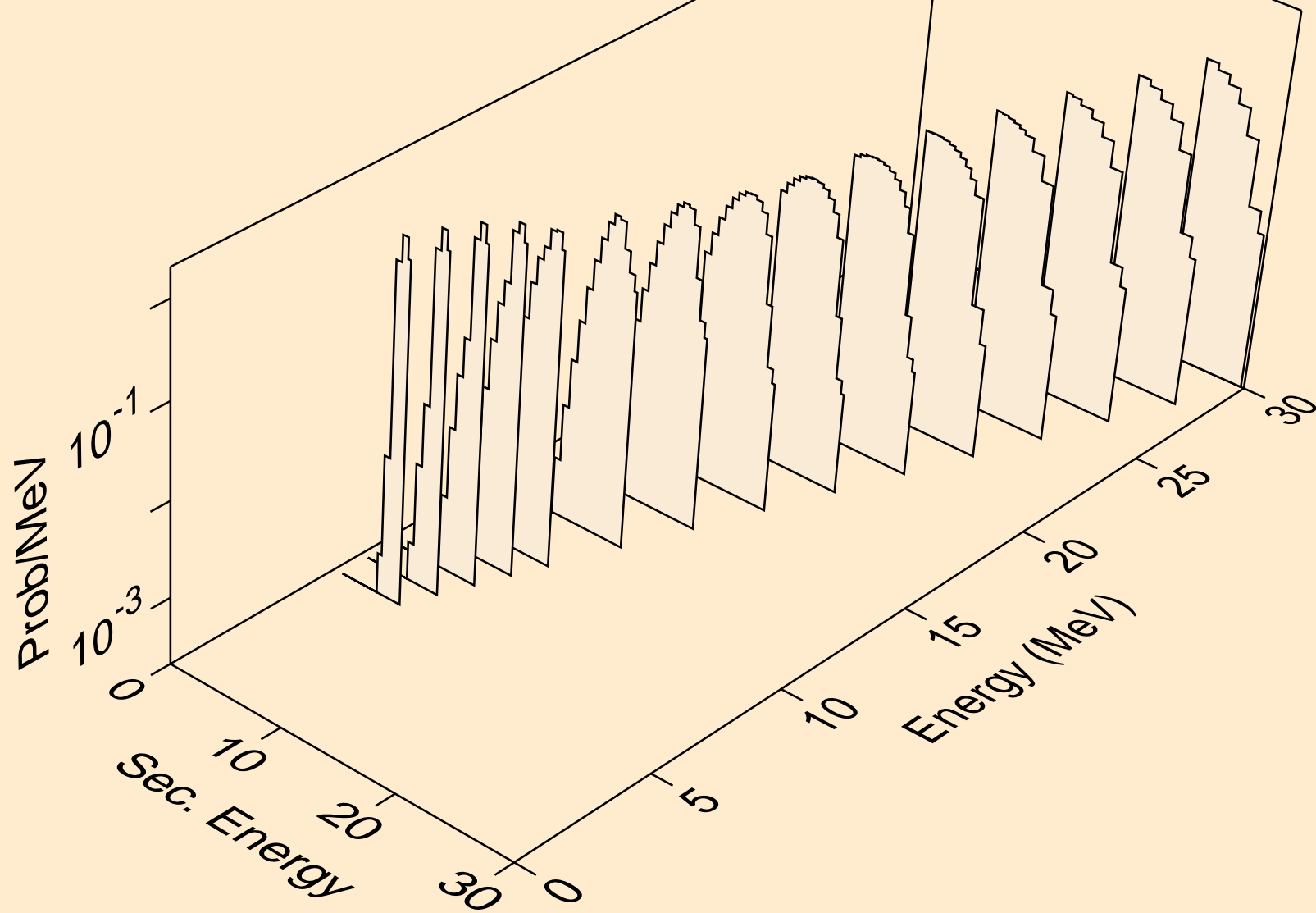

CM237 DEUTERON ACER TENDL-2023 LIBRARY; T=0.K
Deuteron emission for (d,pd)

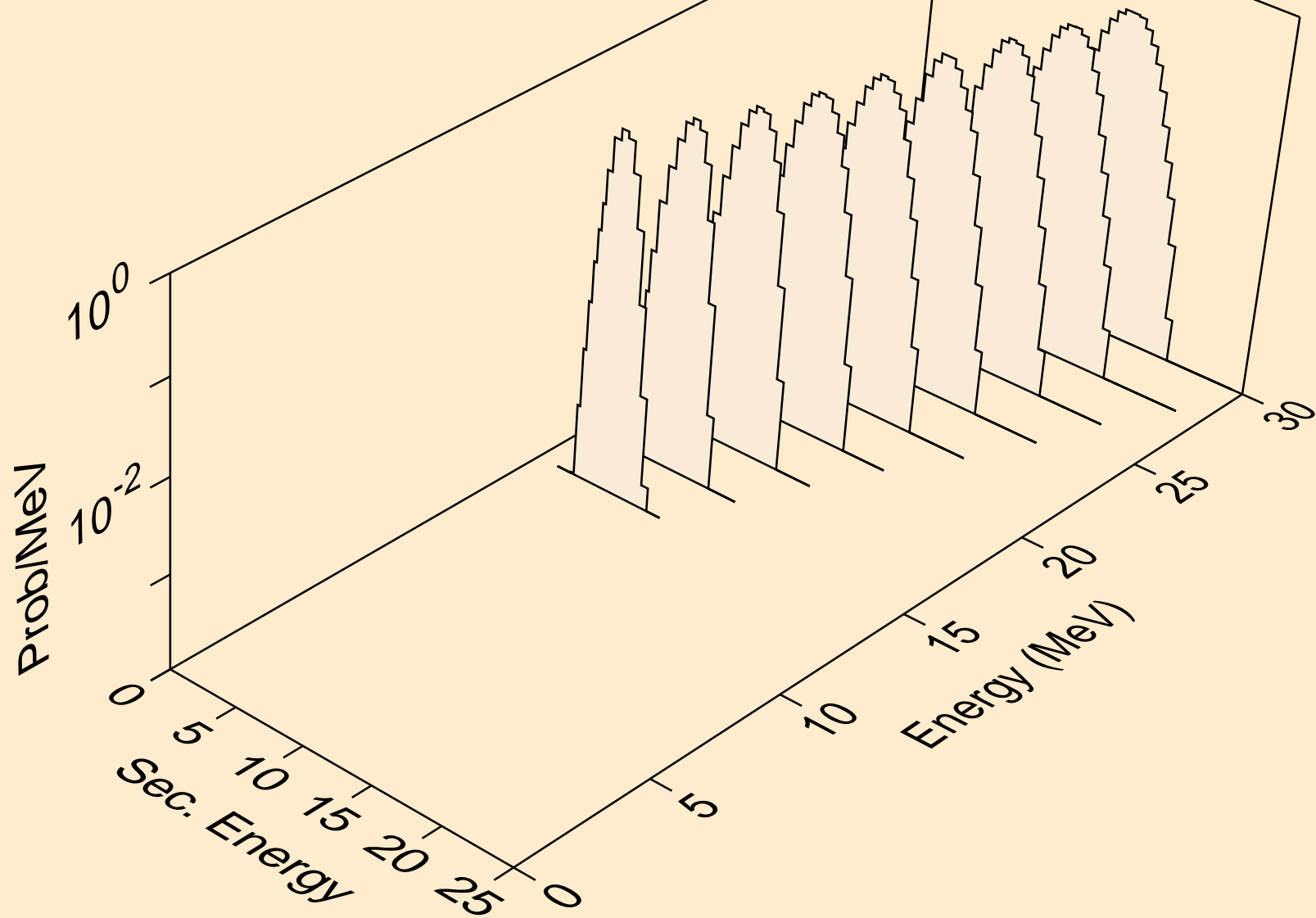

CM237 DEUTERON ACER TENDL-2023 LIBRARY; T=0.K
Photon emission for (z,n)

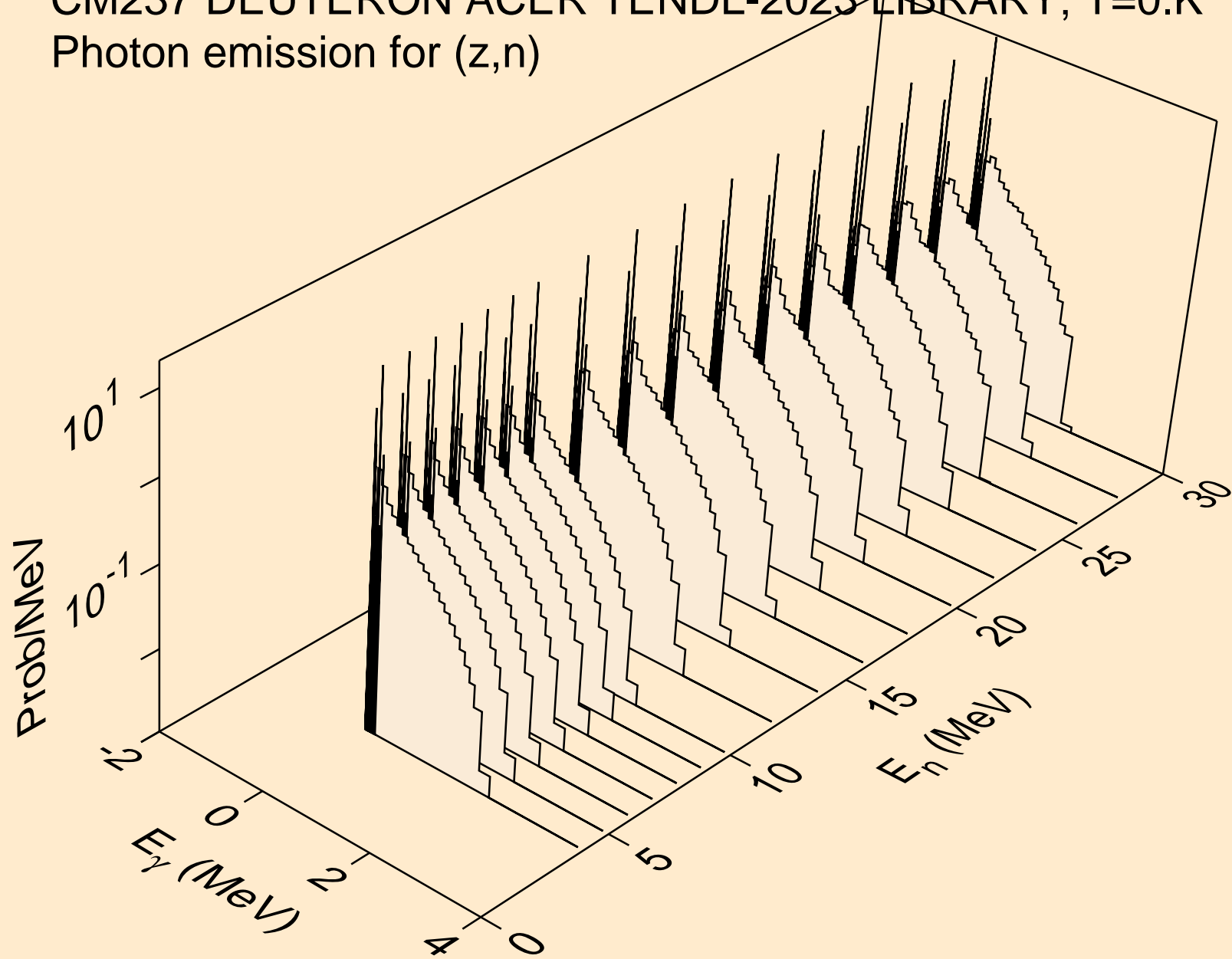

CM237 DEUTERON ACER TENDL-2023 LIBRARY; T=0.K
Photon emission for (z,x)

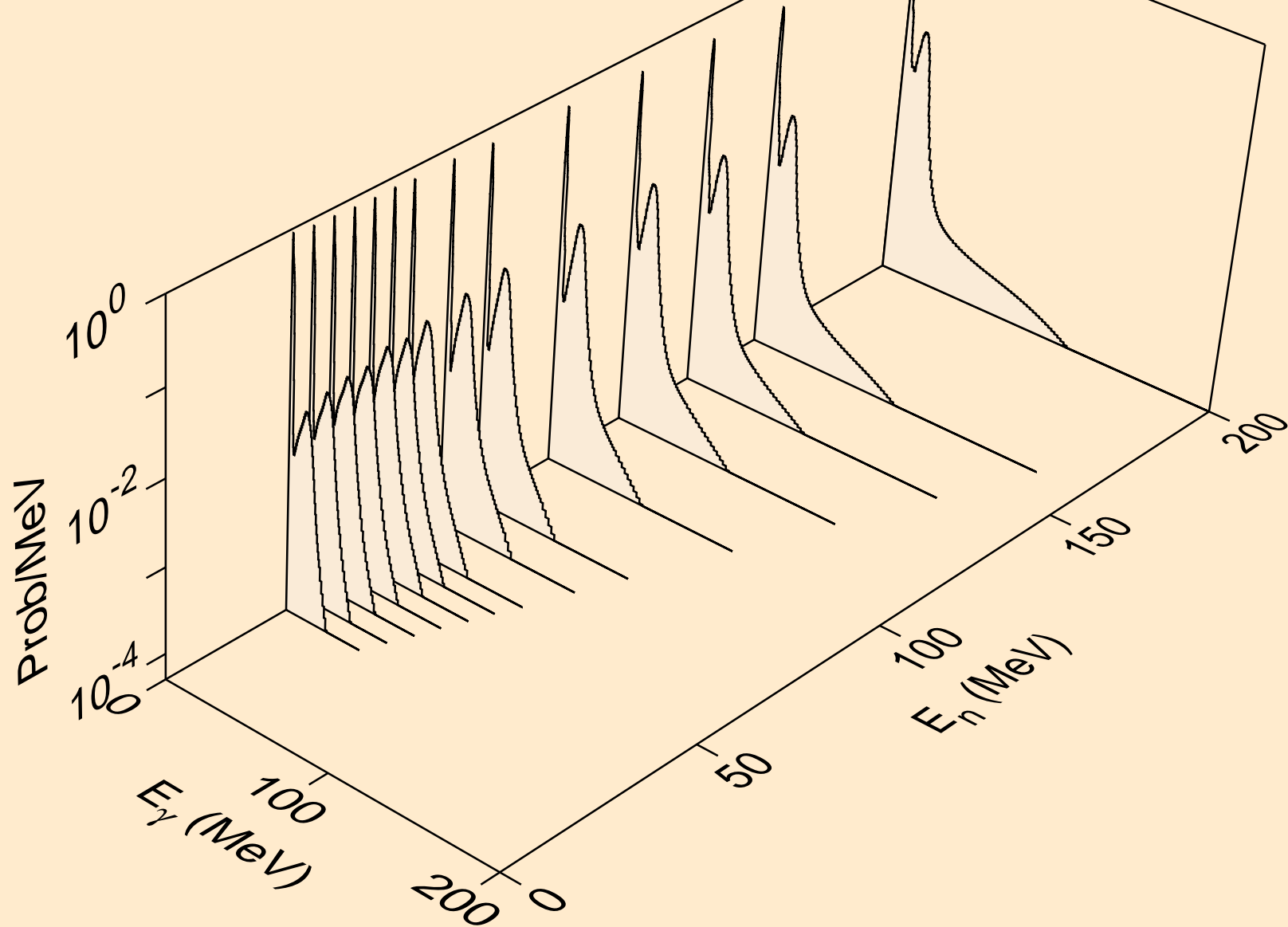

CM237 DEUTERON ACER TENDL-2023 LIBRARY; T=0.K
Photon emission for (n,2nd)

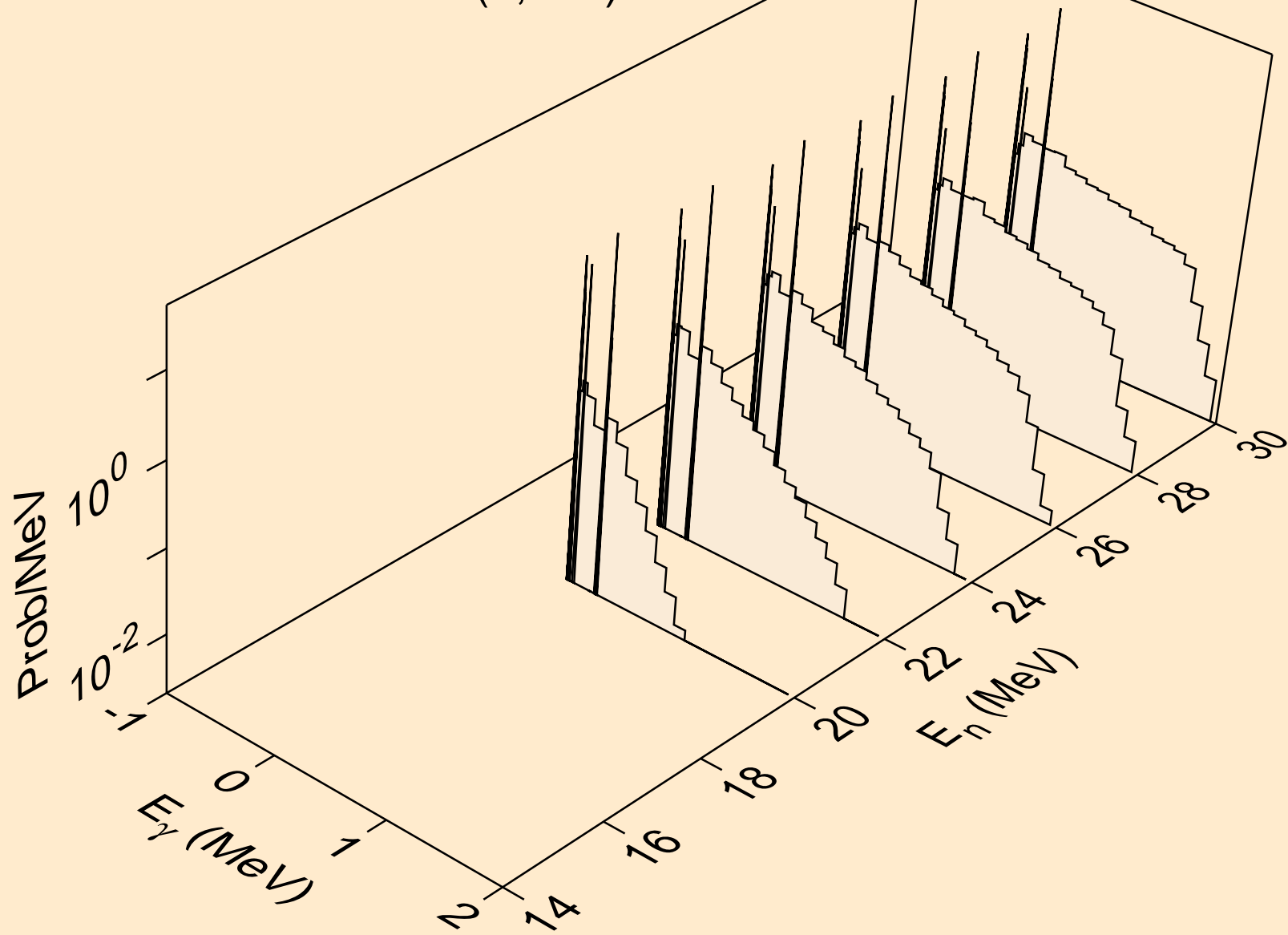

CM237 DEUTERON ACER TENDL-2023 LIBRARY; T=0.K
Photon emission for (n,2n)

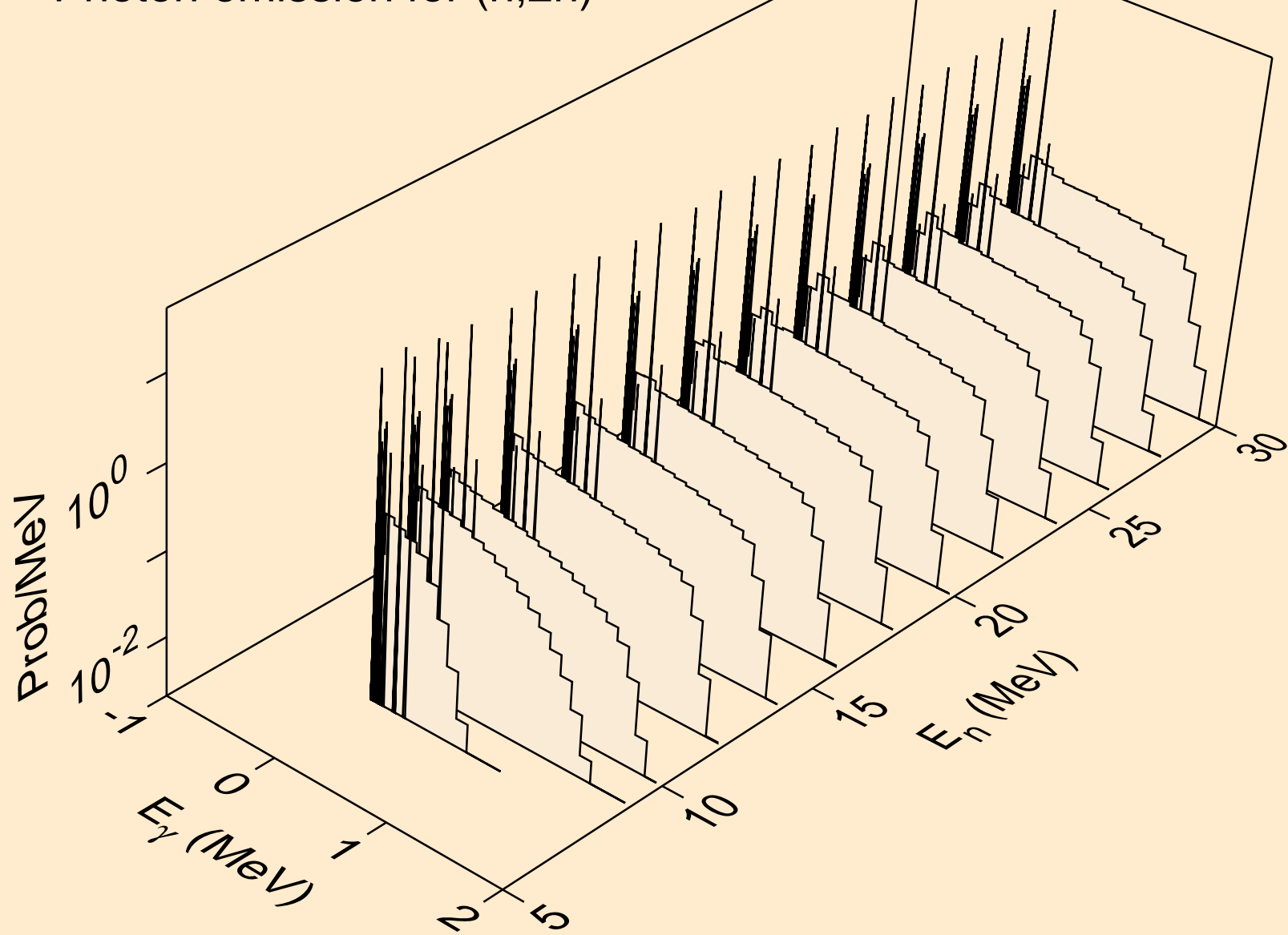

CM237 DEUTERON ACER TENDL-2023 LIBRARY; T=0.K
Photon emission for (n,3n)

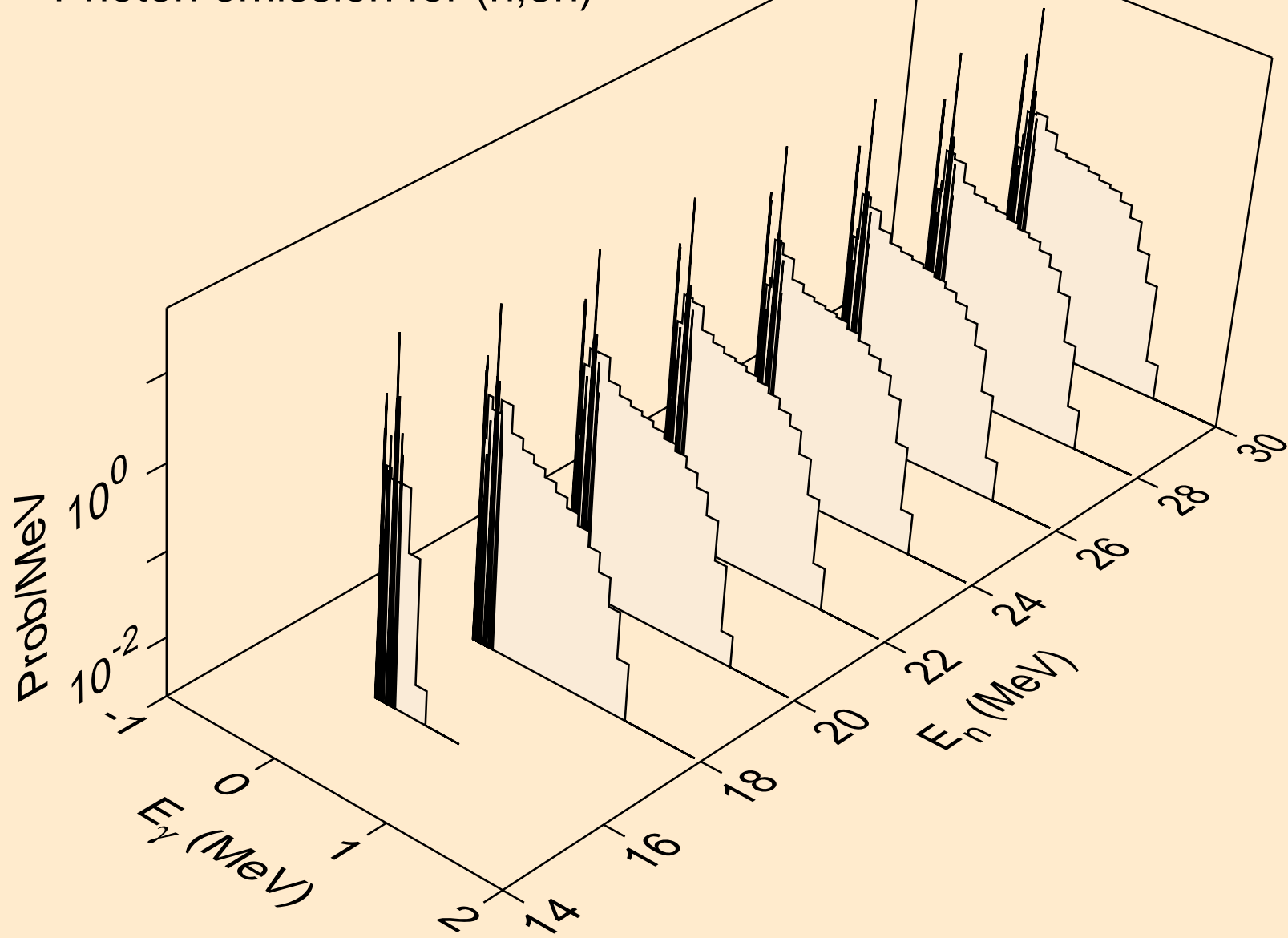

CM237 DEUTERON ACER TENDL-2023 LIBRARY; T=0.K
Photon emission for (n,n*)a

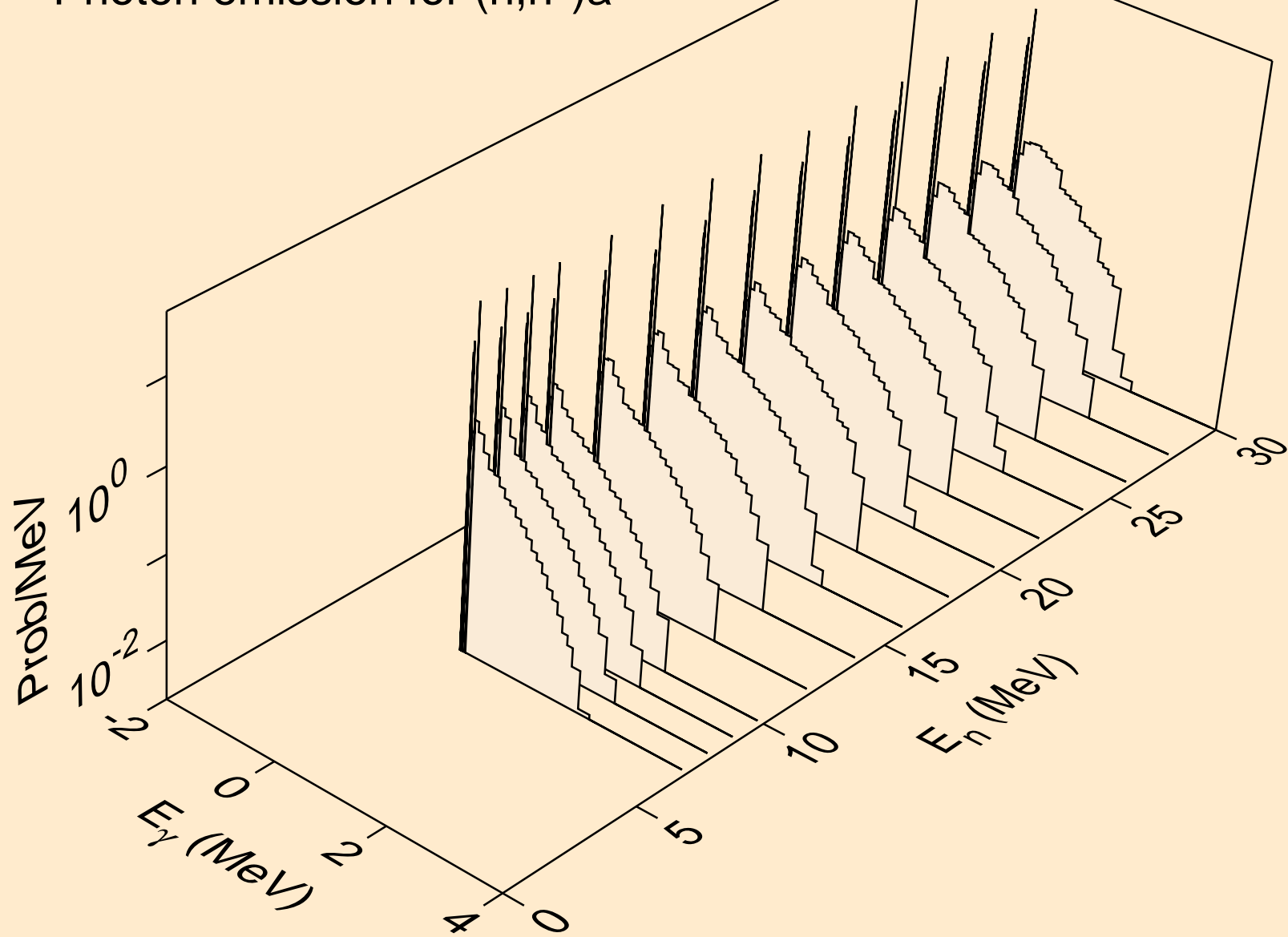

CM237 DEUTERON ACER TENDL-2023 LIBRARY; T=0.K
Photon emission for (n,2n) α

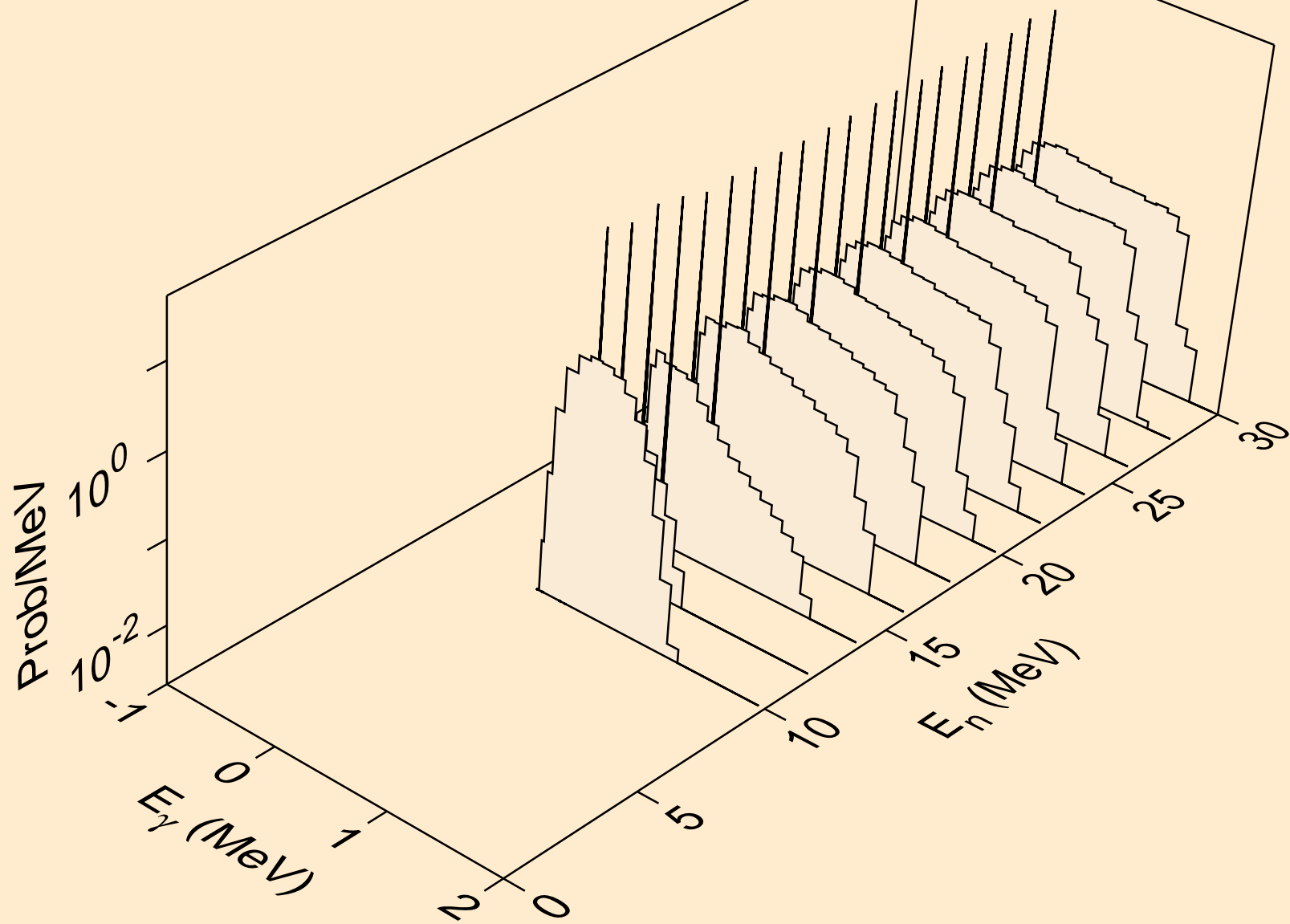

CM237 DEUTERON ACER TENDL-2023 LIBRARY; T=0.K
Photon emission for (n,n*)p

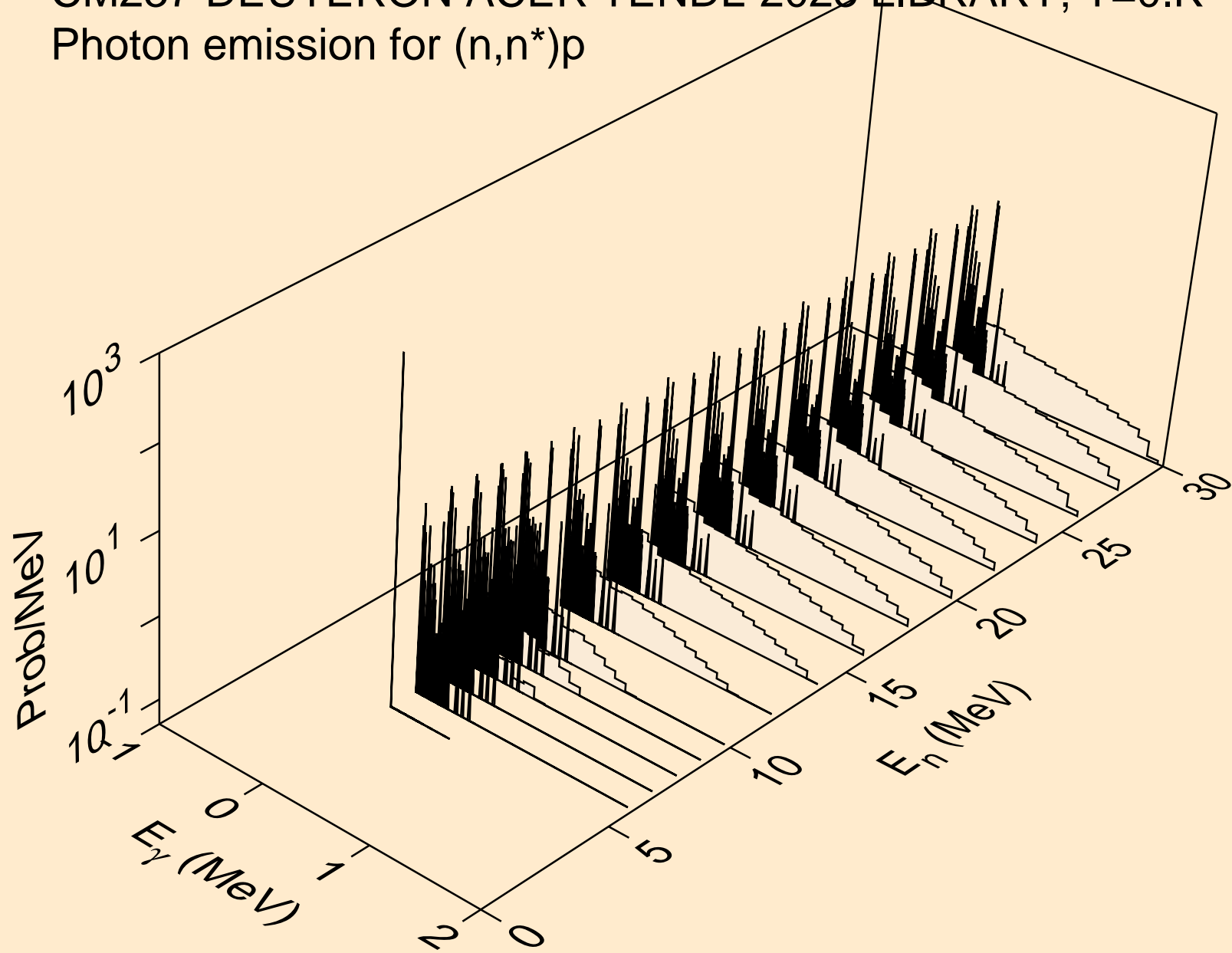

CM237 DEUTERON ACER TENDL-2023 LIBRARY; T=0.K
Photon emission for (n,n*)d

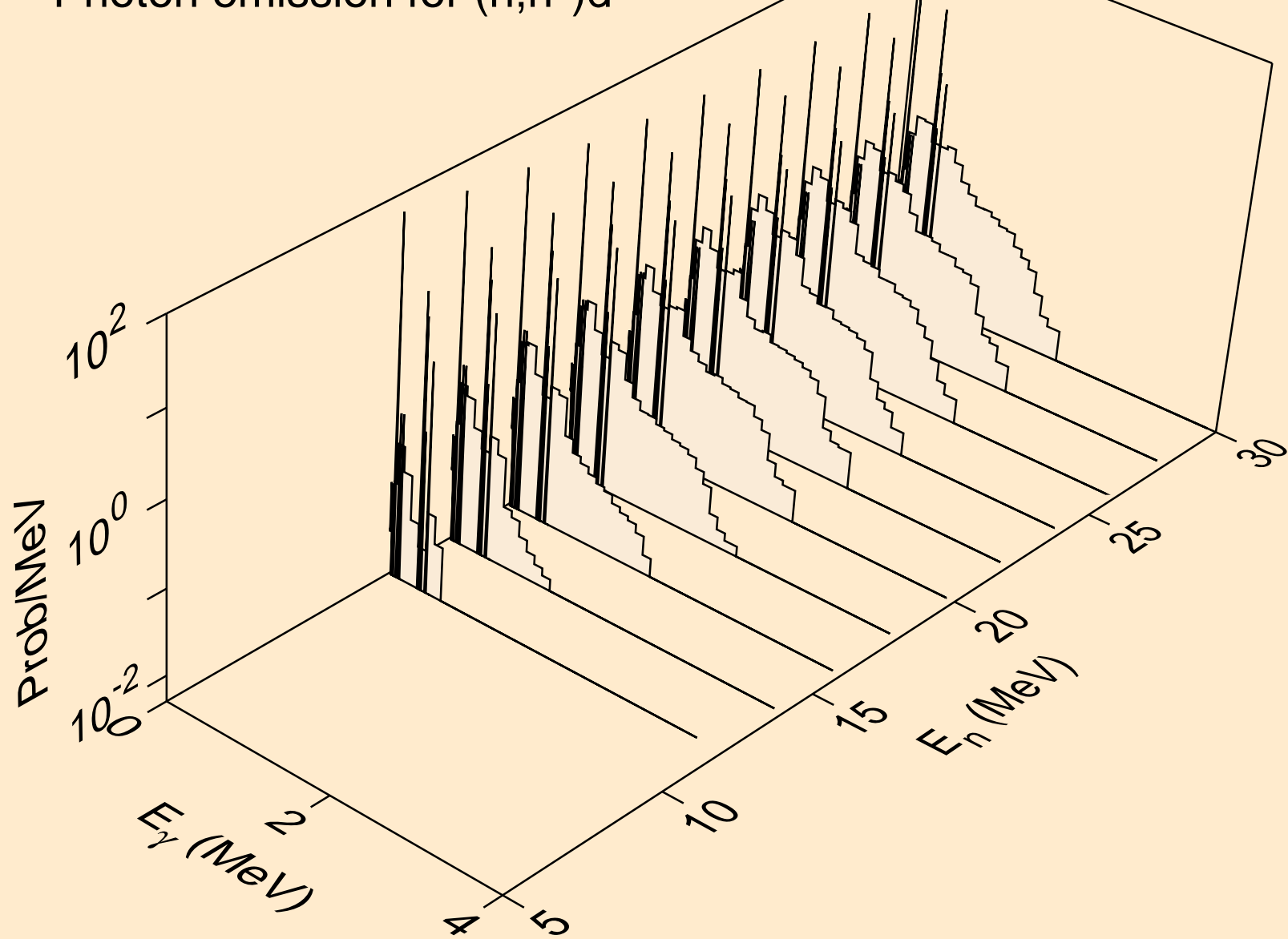

CM237 DEUTERON ACER TENDL-2023 LIBRARY; T=0.K
Photon emission for (n,n*)t

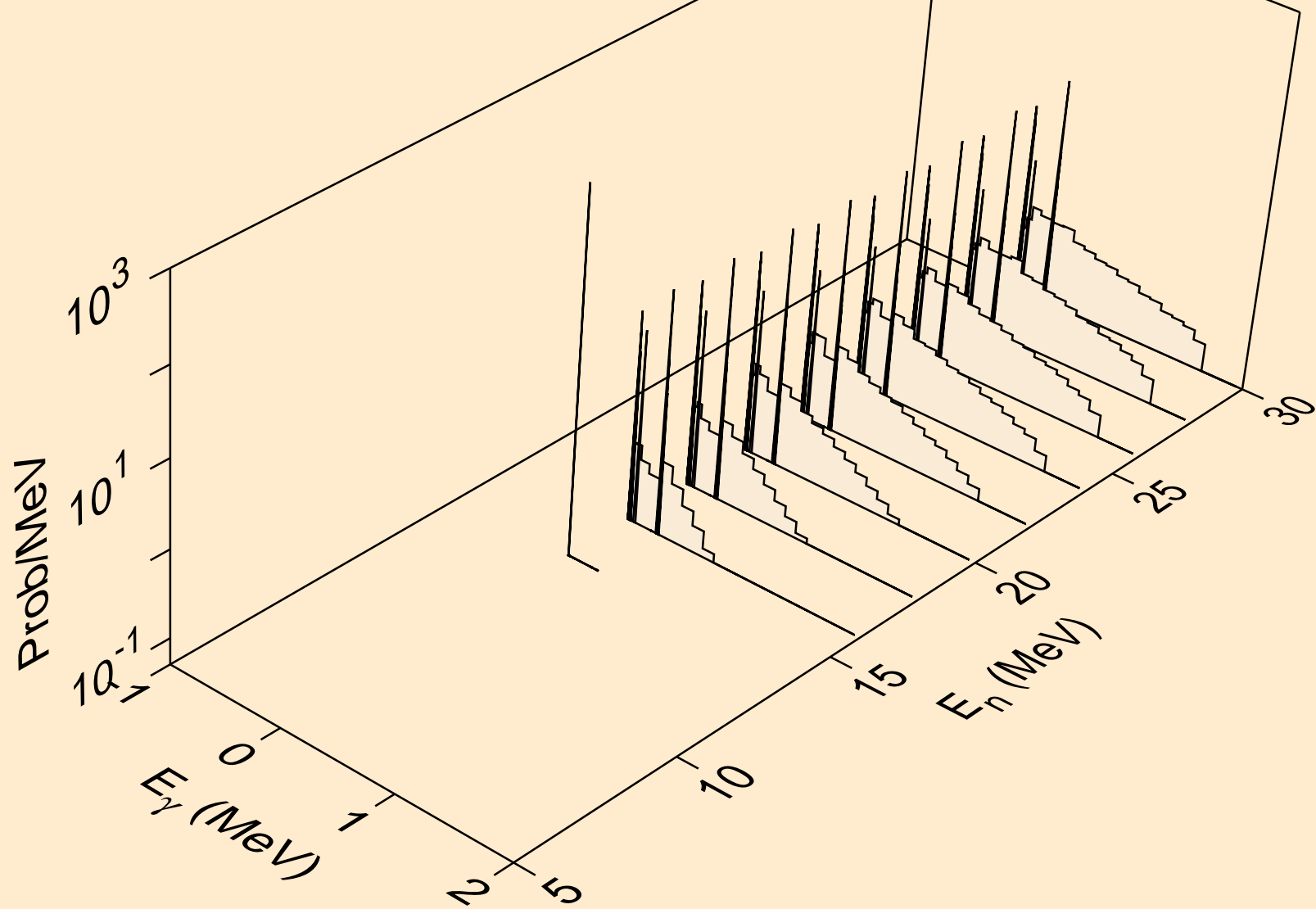

CM237 DEUTERON ACER TENDL-2023 LIBRARY; T=0.K
Photon emission for (n,n*)he3

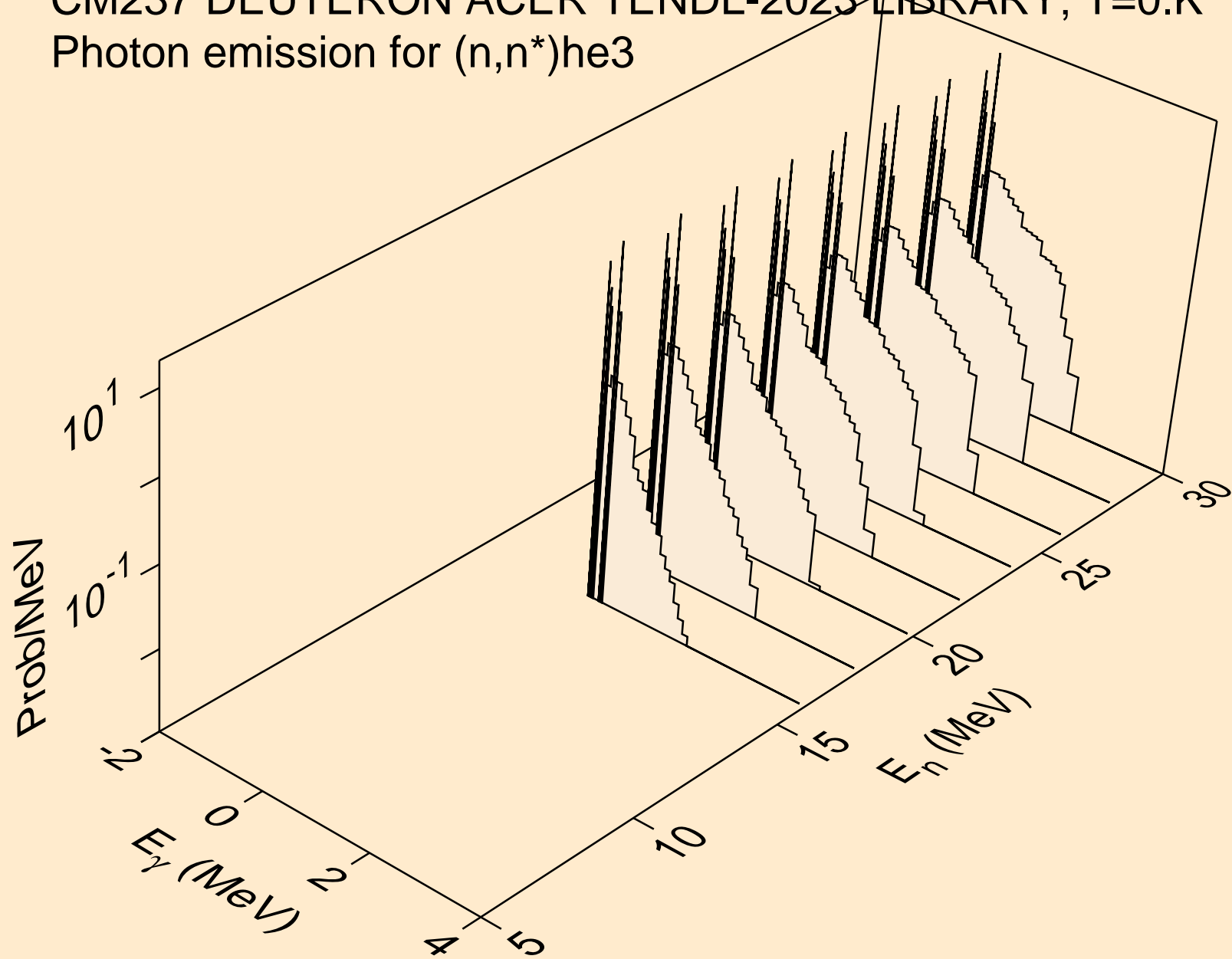

CM237 DEUTERON ACER TENDL-2023 LIBRARY; T=0.K
Photon emission for (n,4n)

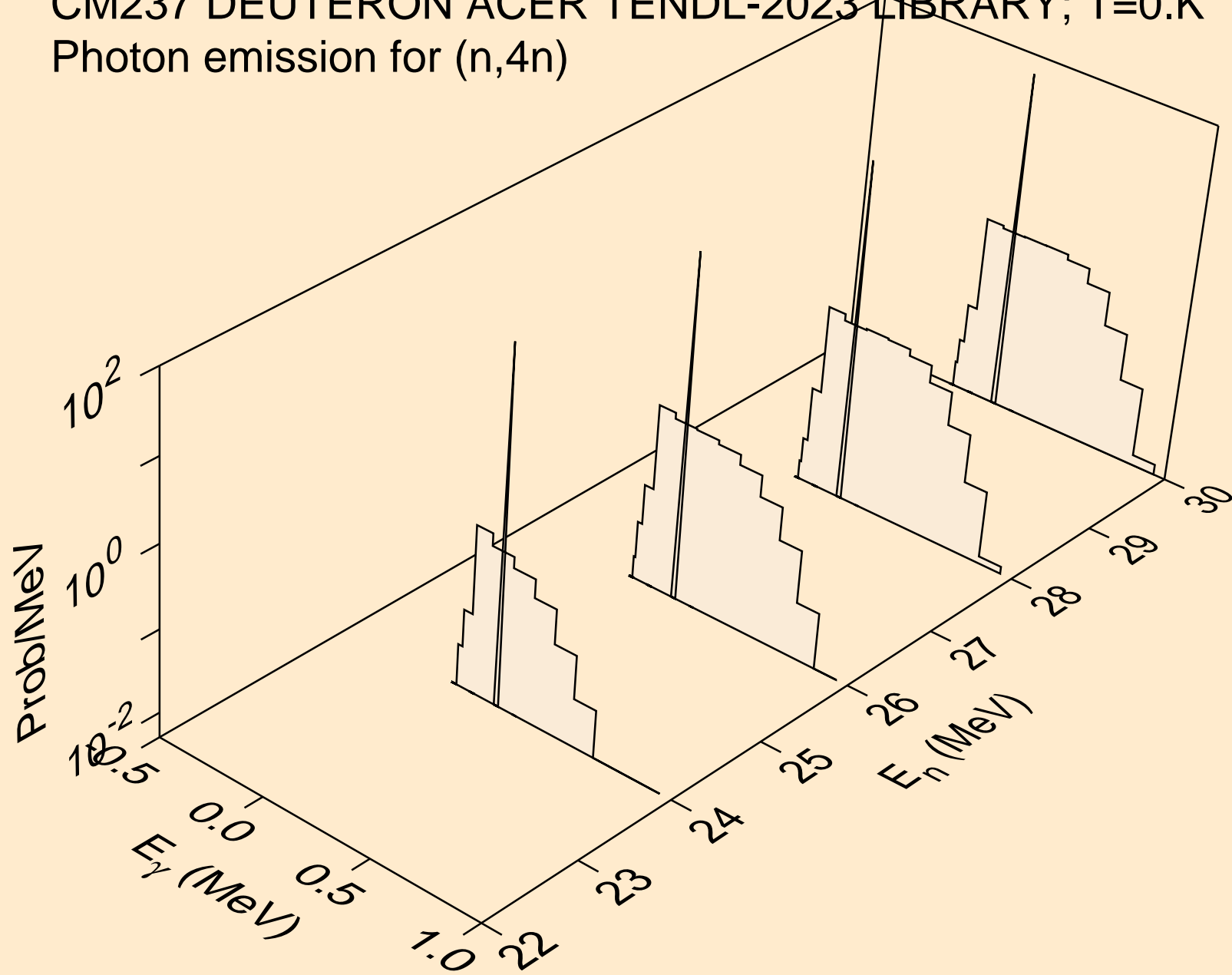

CM237 DEUTERON ACER TENDL-2023 LIBRARY; T=0.K
Photon emission for (n,2np)

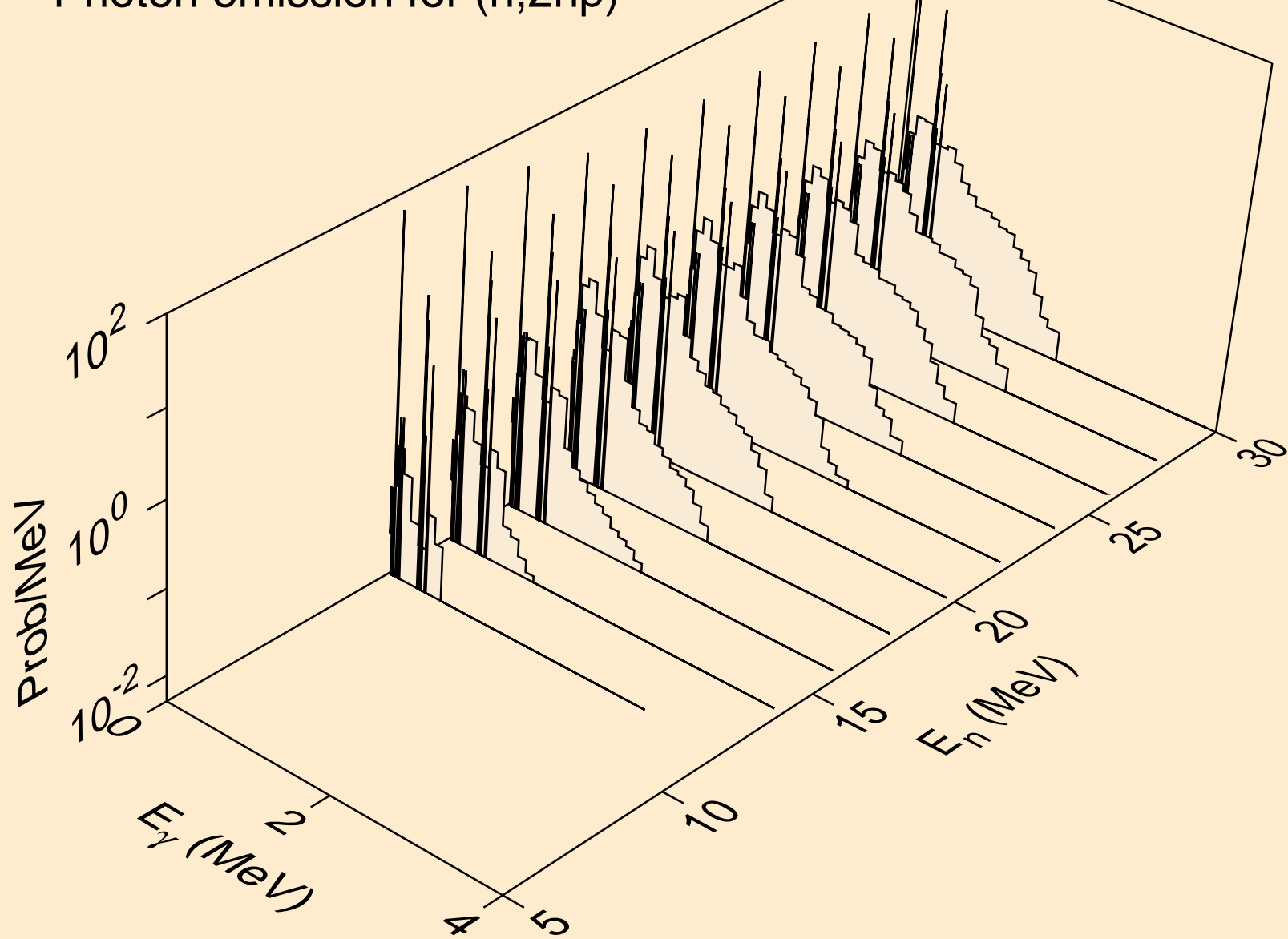

CM237 DEUTERON ACER TENDL-2023 LIBRARY; T=0.K
Photon emission for (n,n2p)

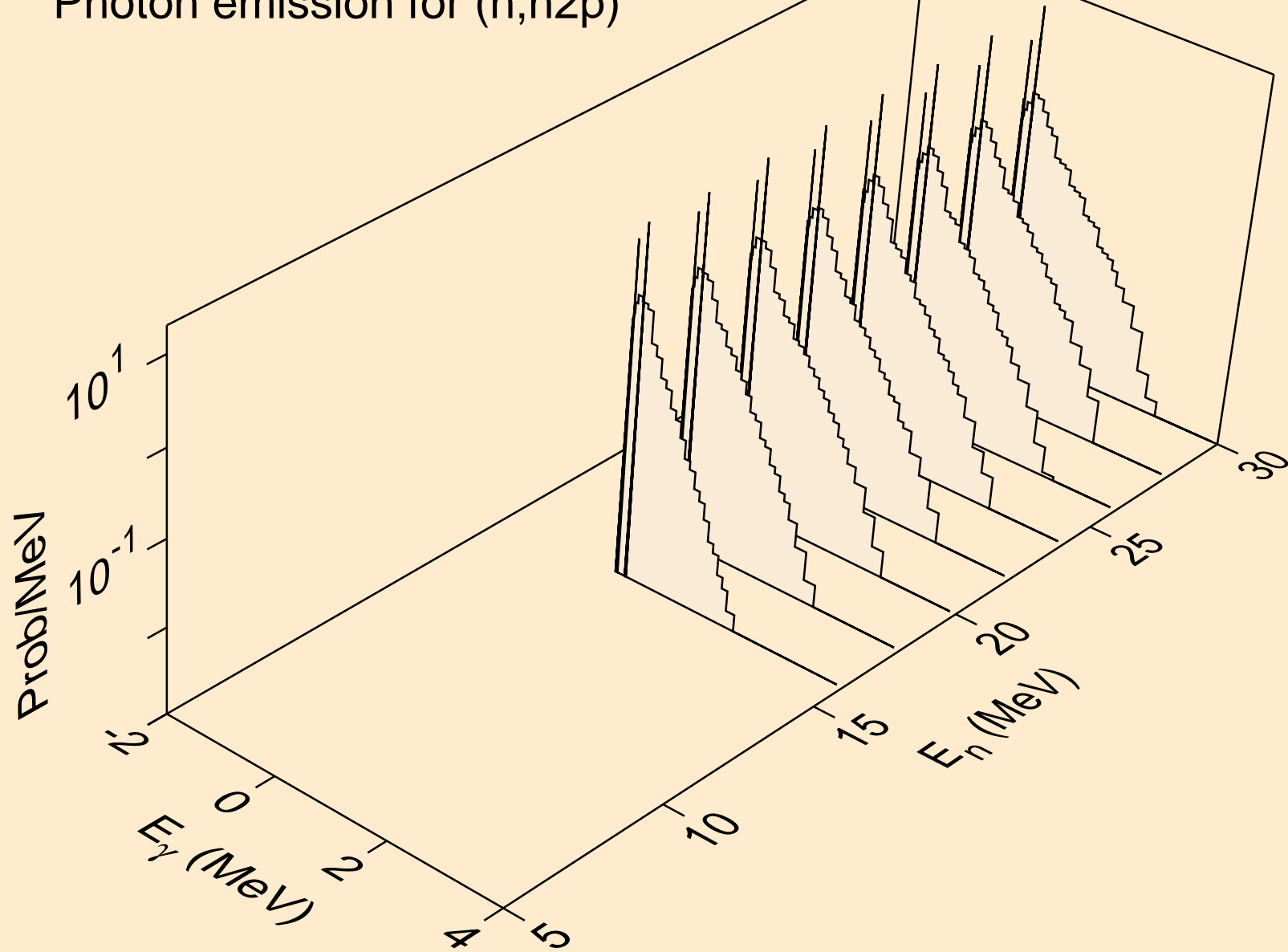

CM237 DEUTERON ACER TENDL-2023 LIBRARY; T=0.K
Photon emission for (n,npa)

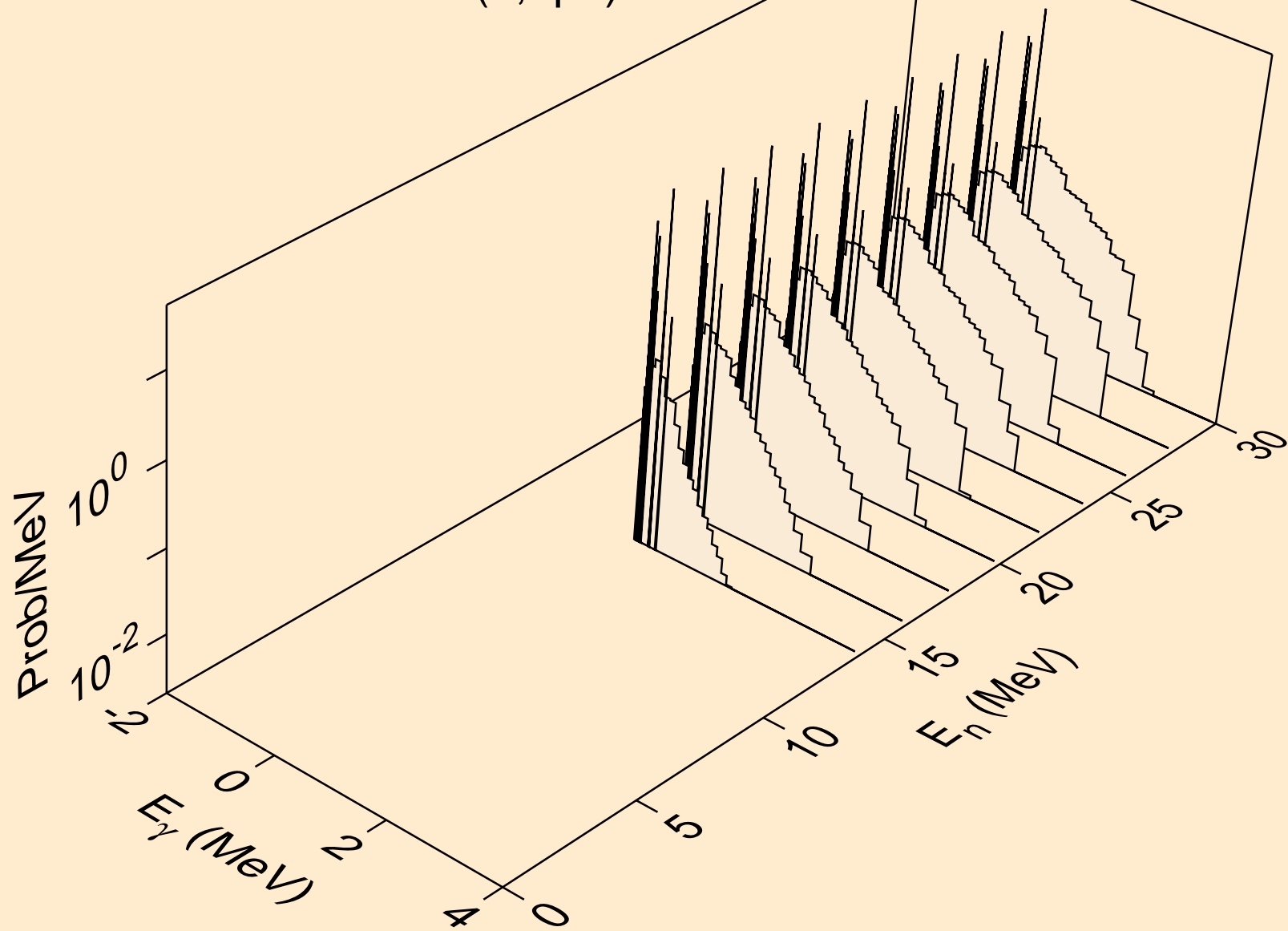

CM237 DEUTERON ACER TENDL-2023 LIBRARY; T=0.K
Photon emission for (n,gma)

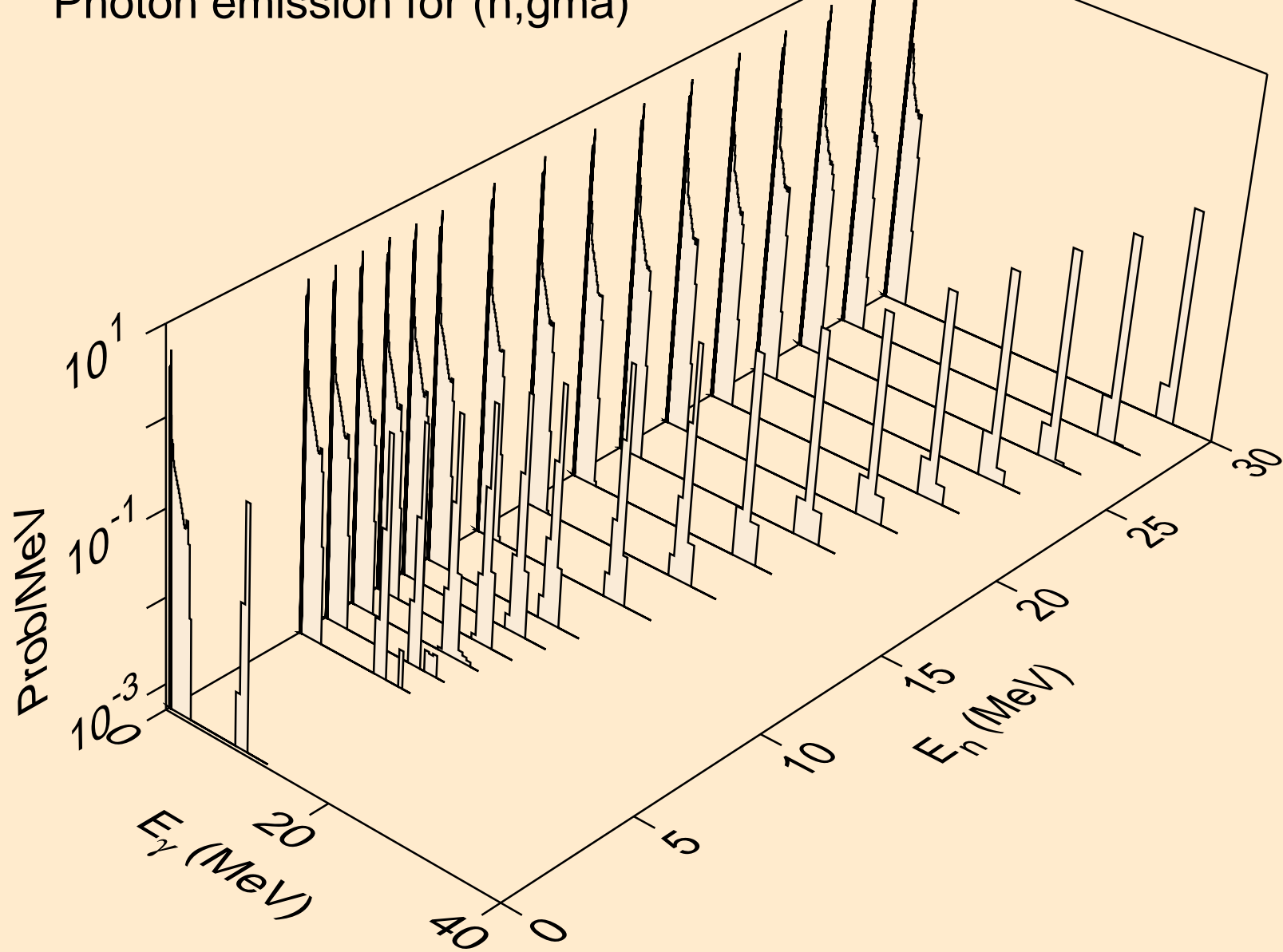

CM237 DEUTERON ACER TENDL-2023 LIBRARY; T=0.K
Photon emission for (n,p)

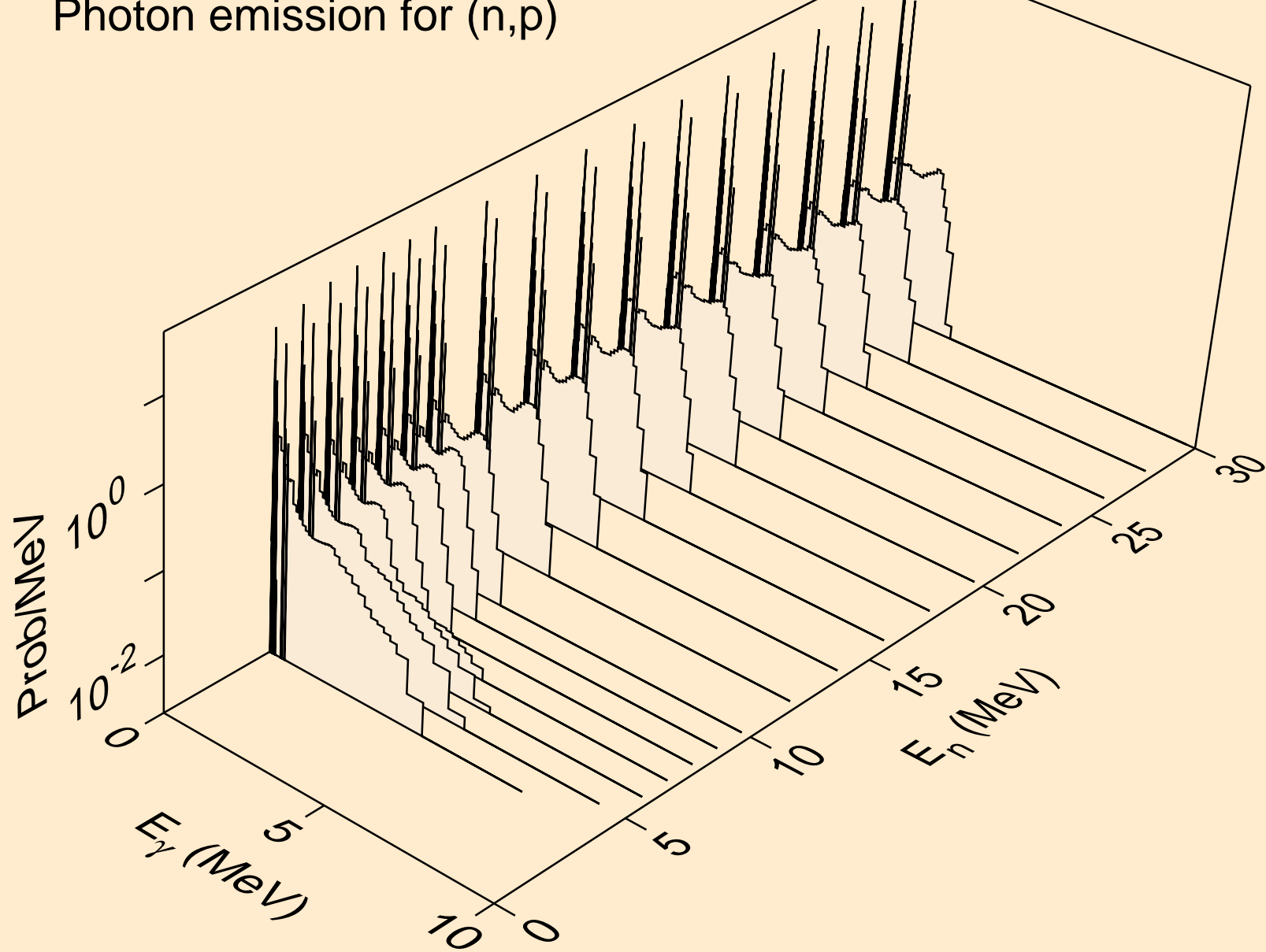

CM237 DEUTERON ACER TENDL-2023 LIBRARY; T=0.K
Photon emission for inelastic

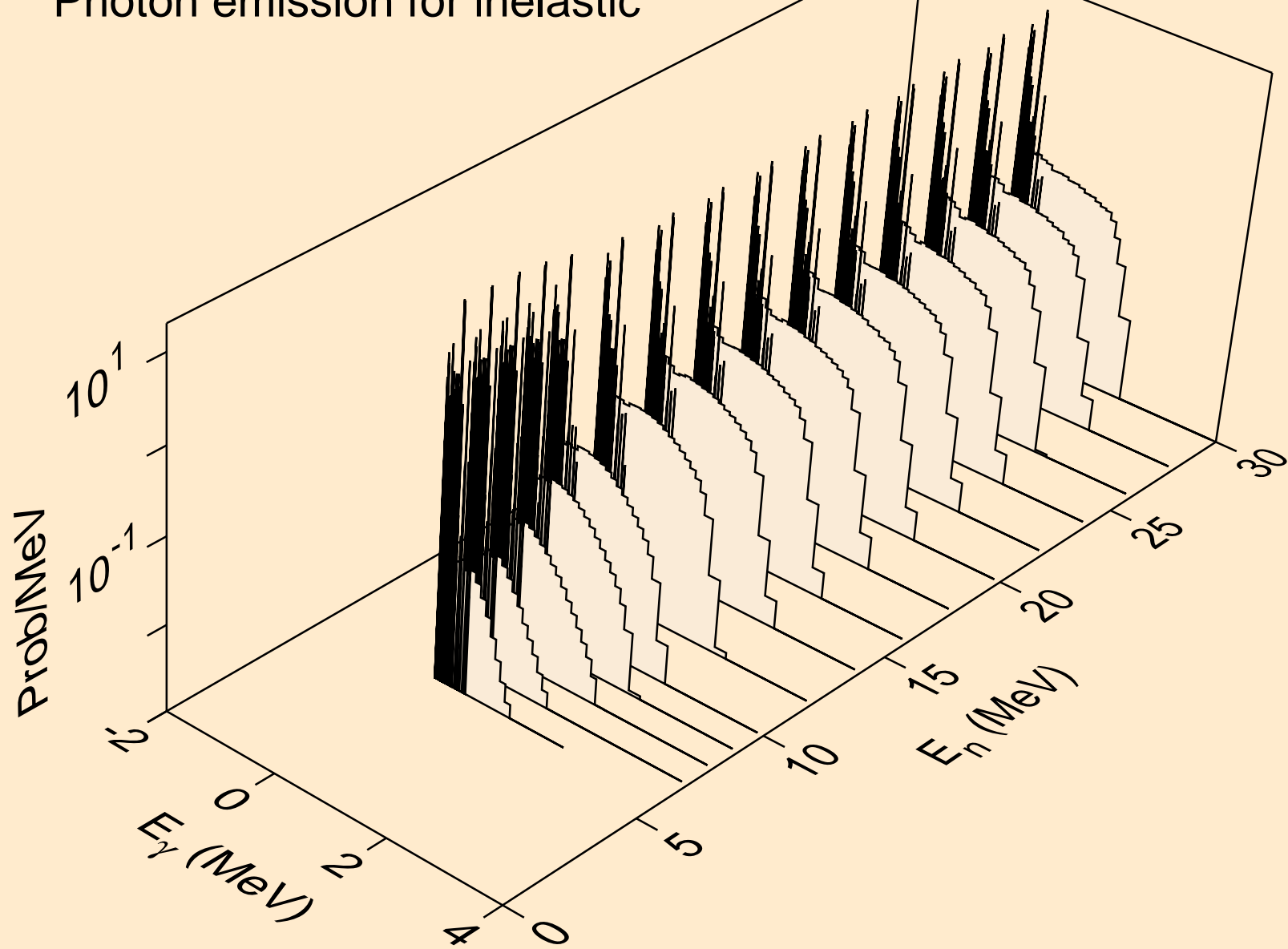

CM237 DEUTERON ACER TENDL-2023 LIBRARY; T=0.K
Photon emission for (n,t)

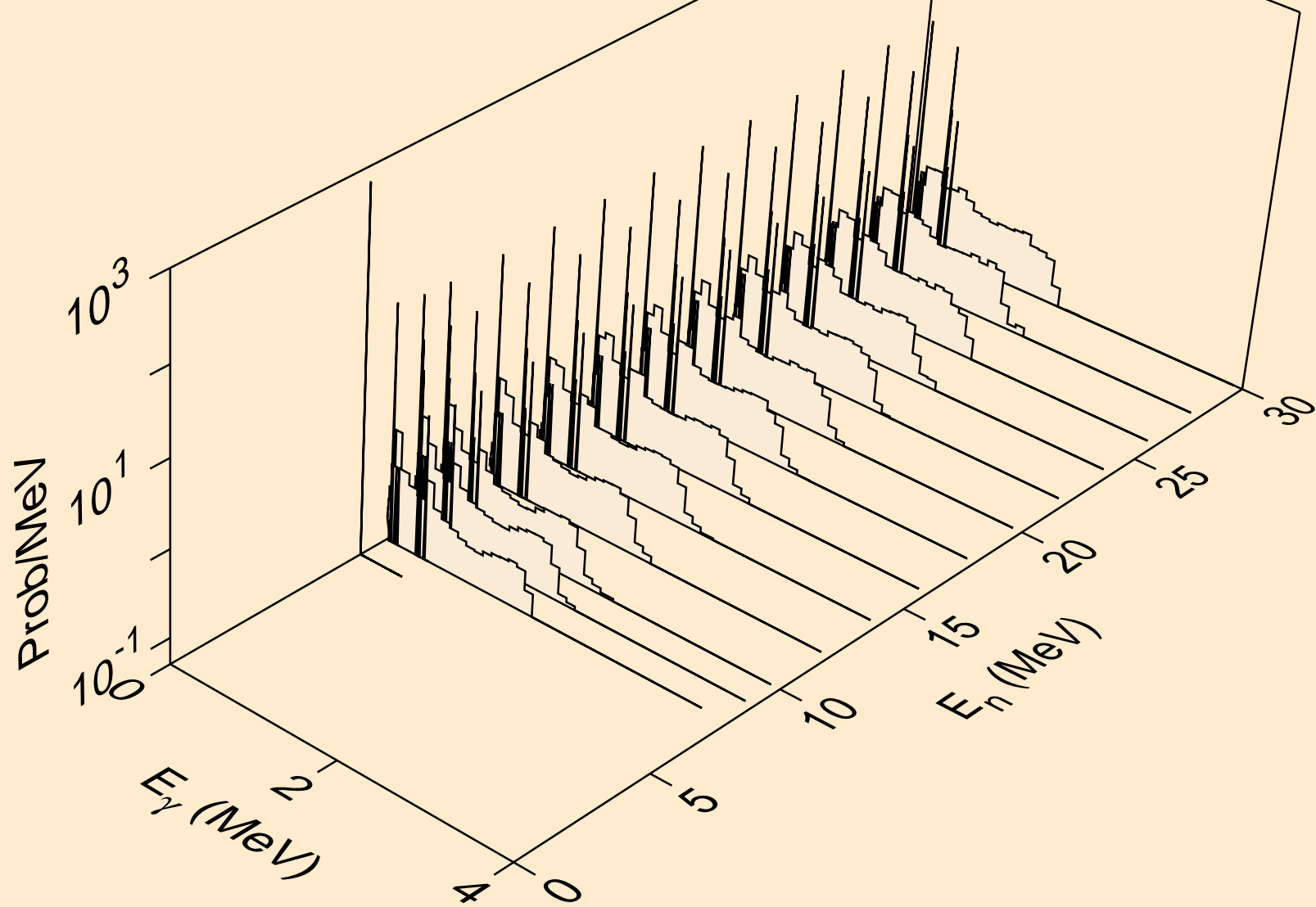

CM237 DEUTERON ACER TENDL-2023 LIBRARY; T=0.K
Photon emission for (n,he3)

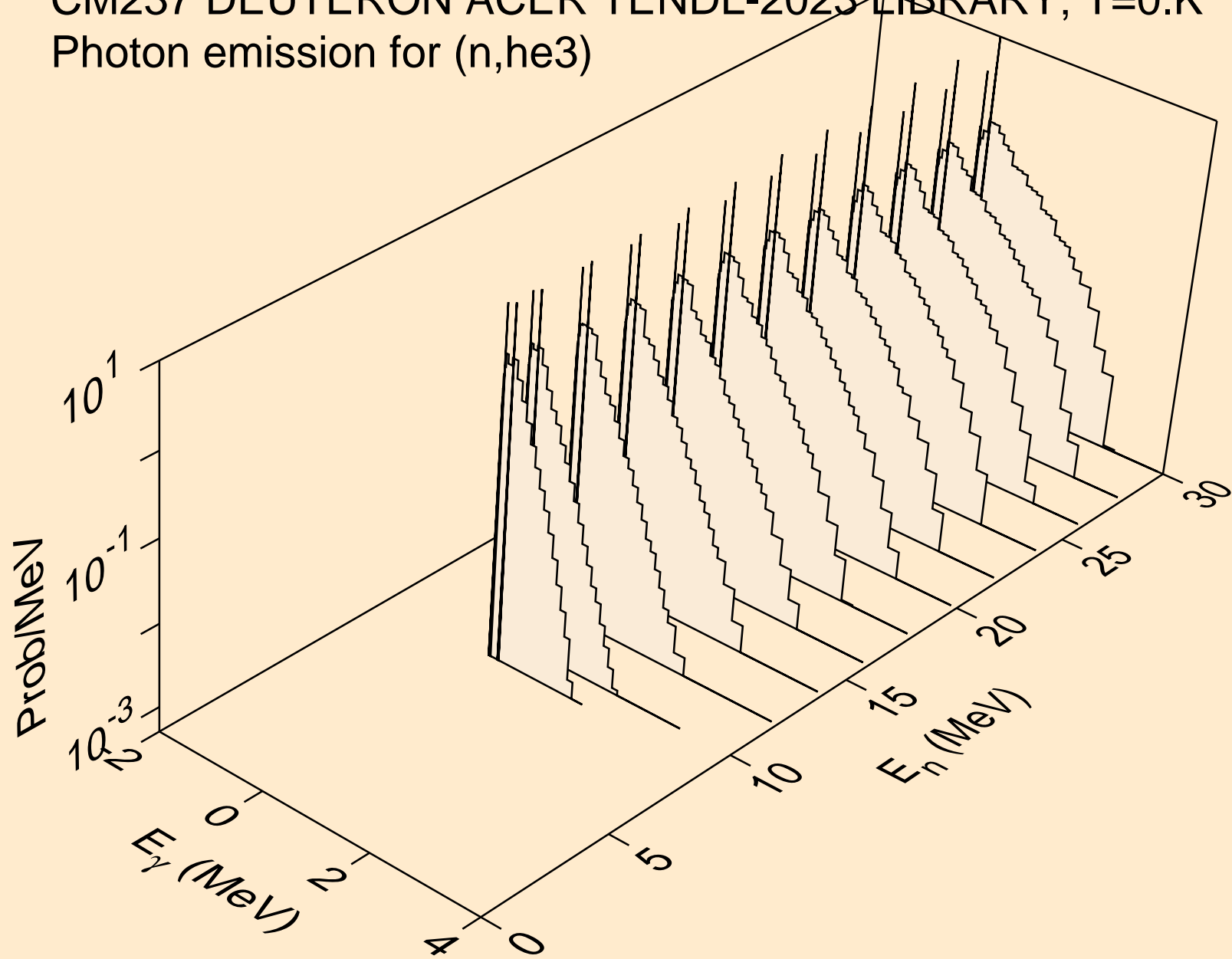

CM237 DEUTERON ACER TENDL-2023 LIBRARY; T=0.K
Photon emission for (n,a)

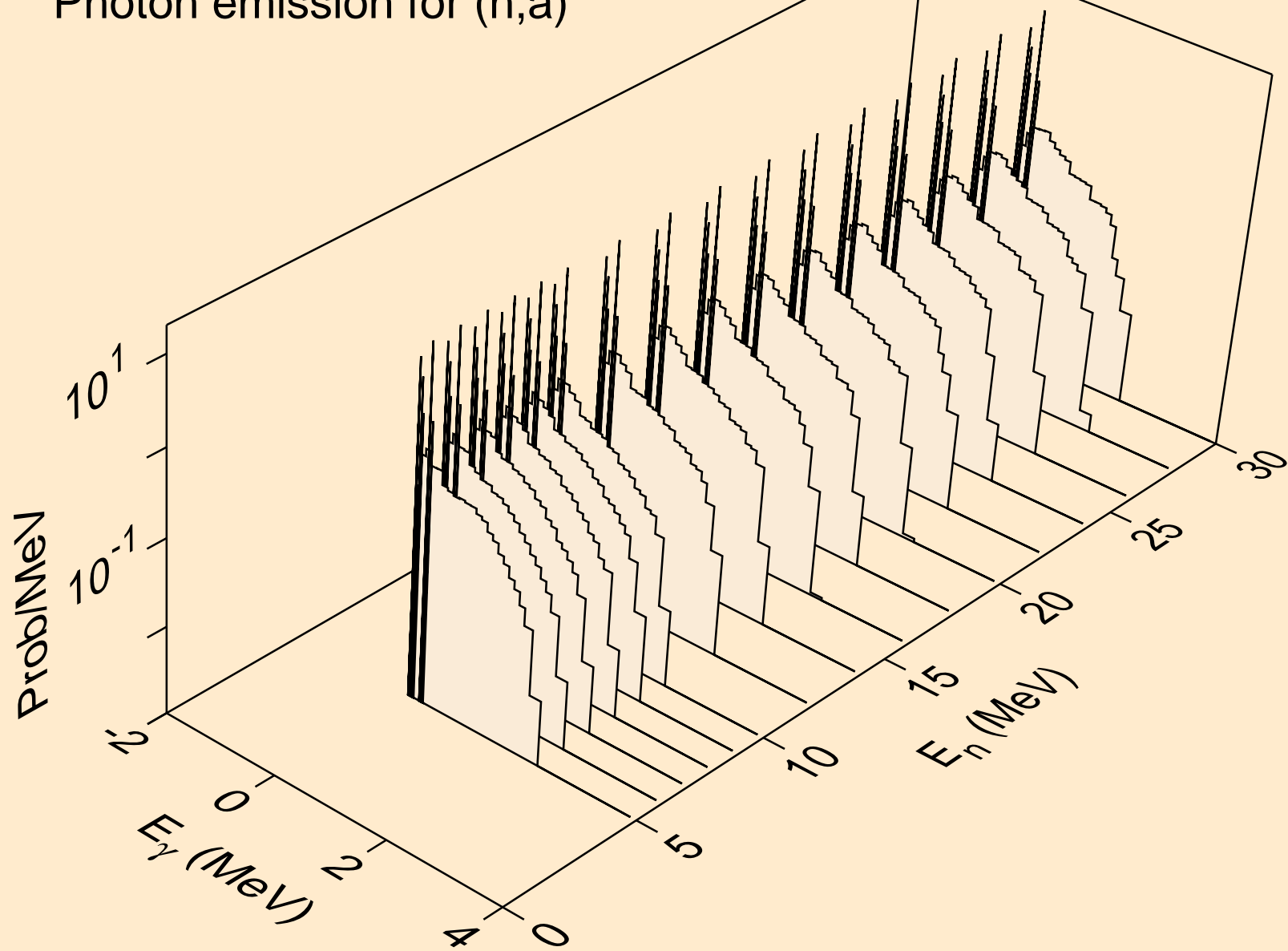

CM237 DEUTERON ACER TENDL-2023 LIBRARY; T=0.K
Photon emission for (n,2p)

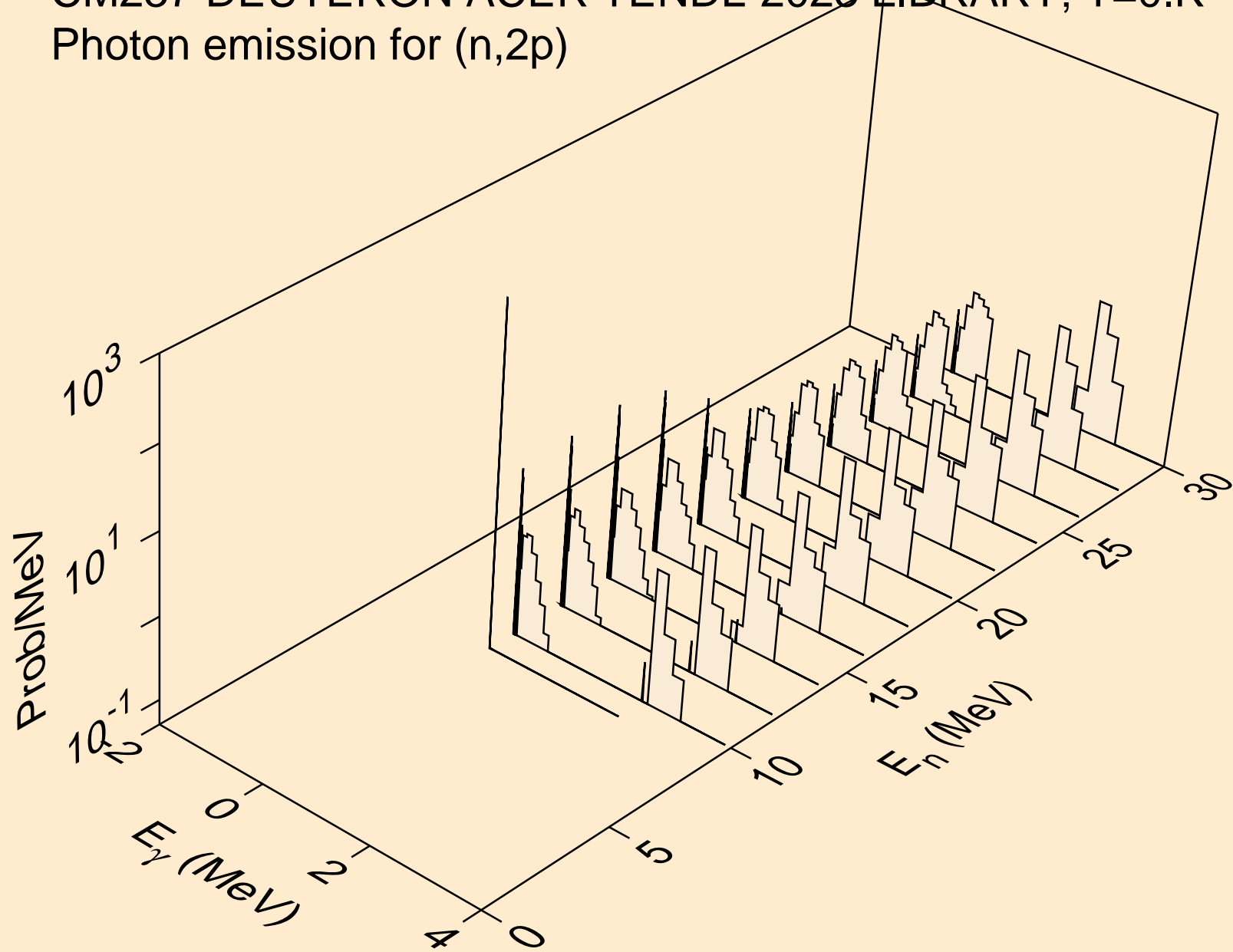

CM237 DEUTERON ACER TENDL-2023 LIBRARY; T=0.K
Photon emission for (n,pd)

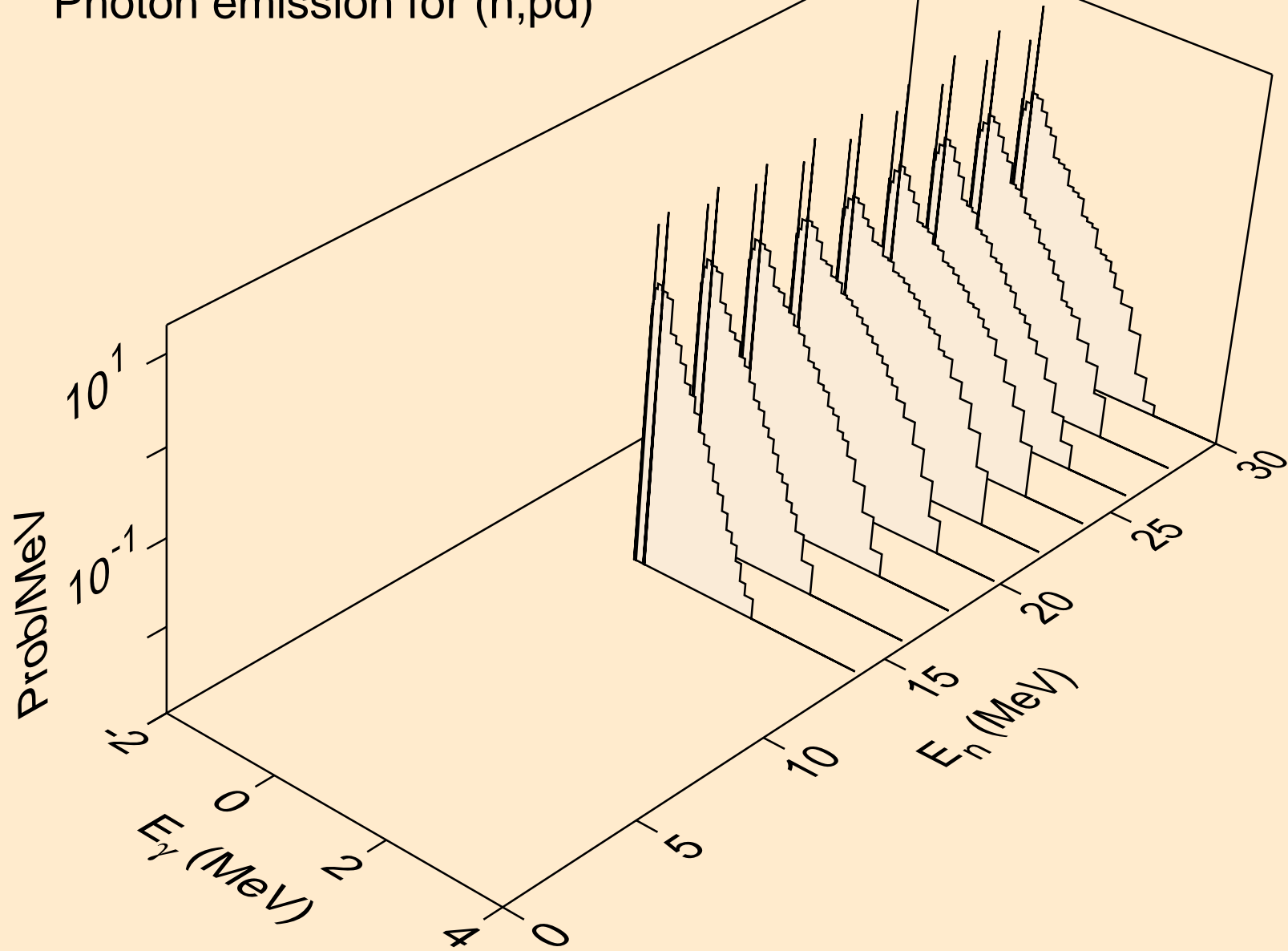

CM237 DEUTERON ACER TENDL-2023 LIBRARY; T=0.K
Particle heating contributions

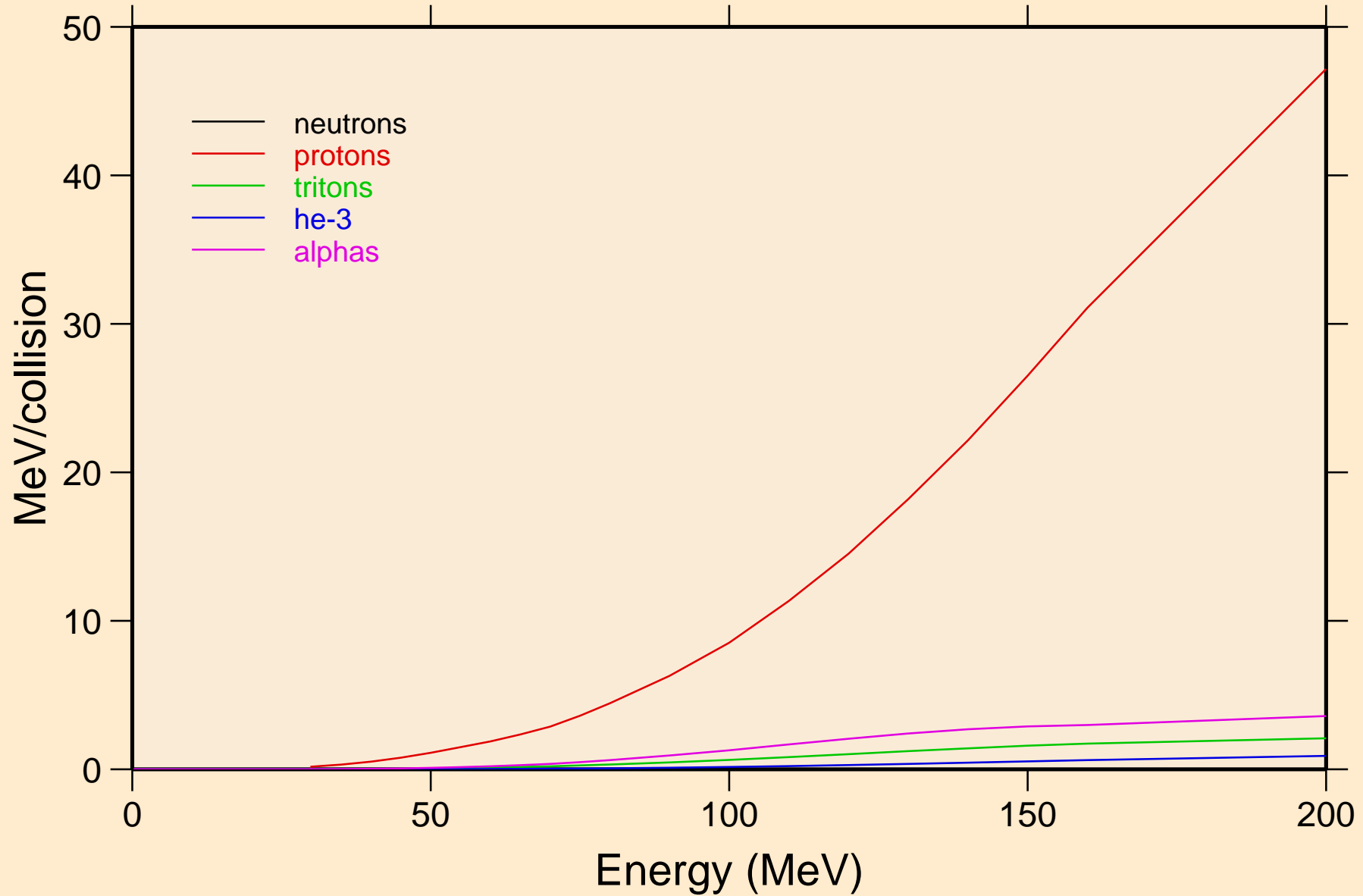

CM237 DEUTERON ACER TENDL-2023 LIBRARY; T=0.K
Recoil Heating

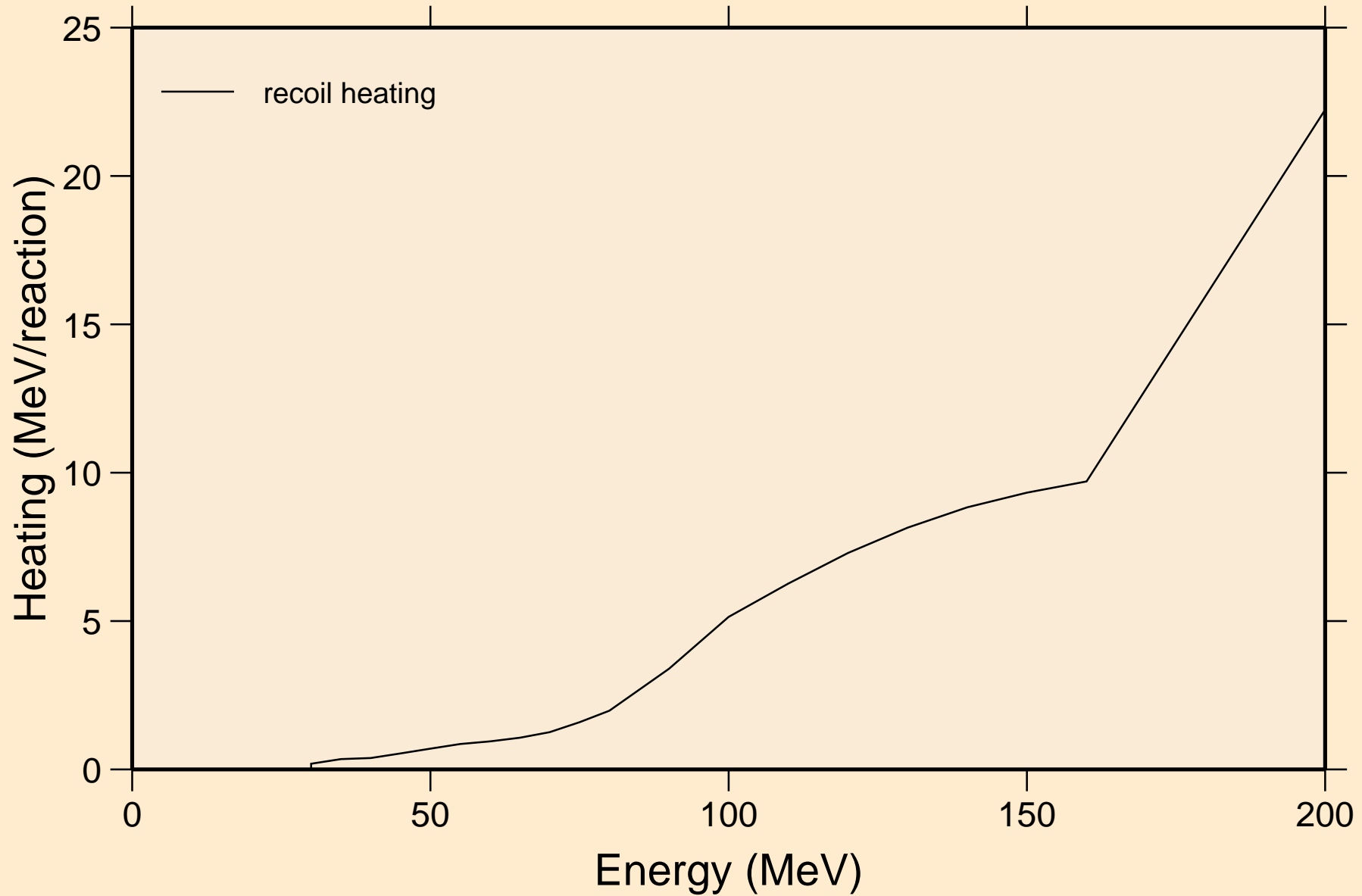

CM237 DEUTERON ACER TENDL-2023 LIBRARY; T=0.K
Particle production cross sections

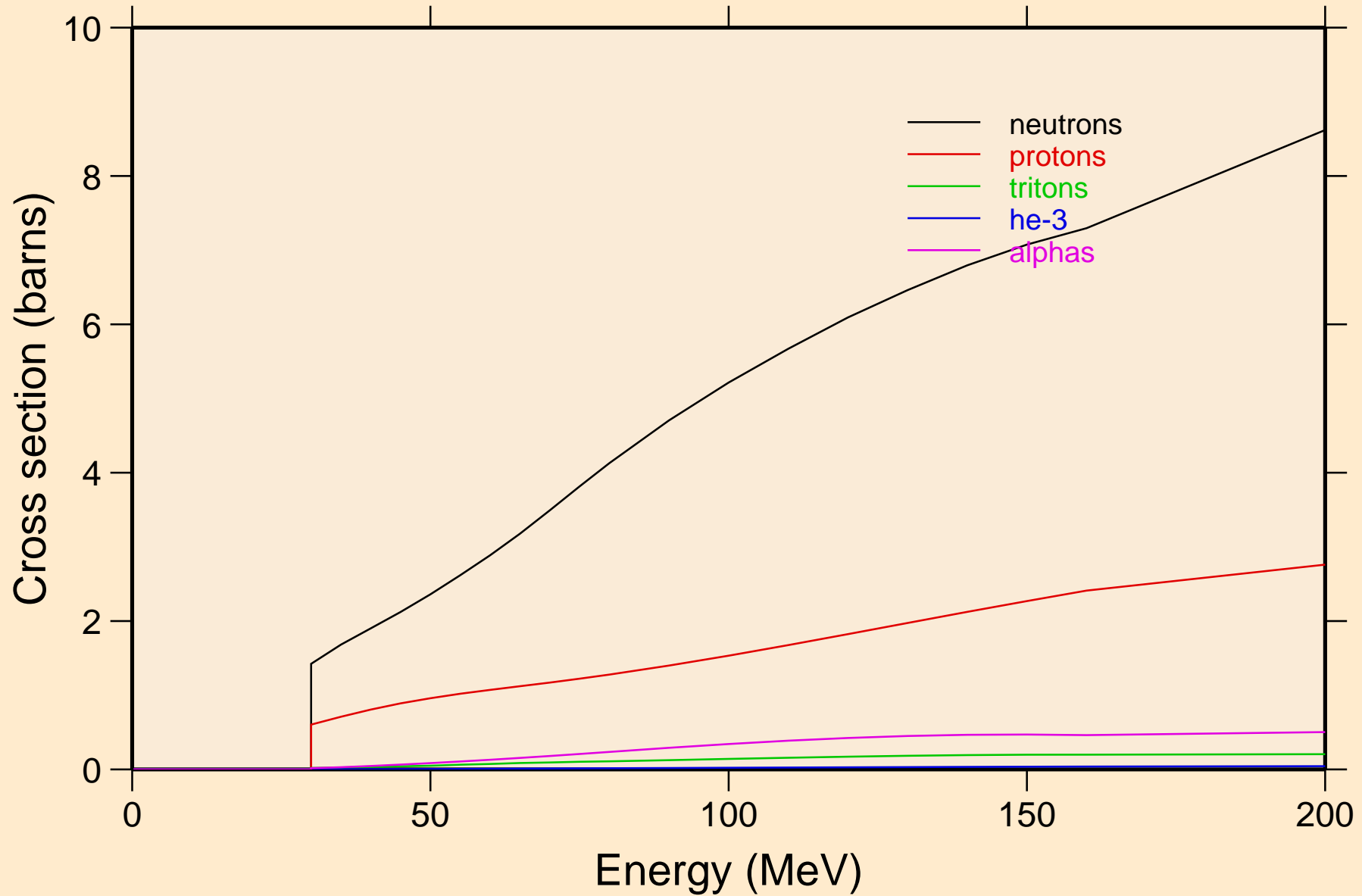

CM237 DEUTERON ACER TENDL-2023 LIBRARY; T=0.K
neutrons from (d,n)

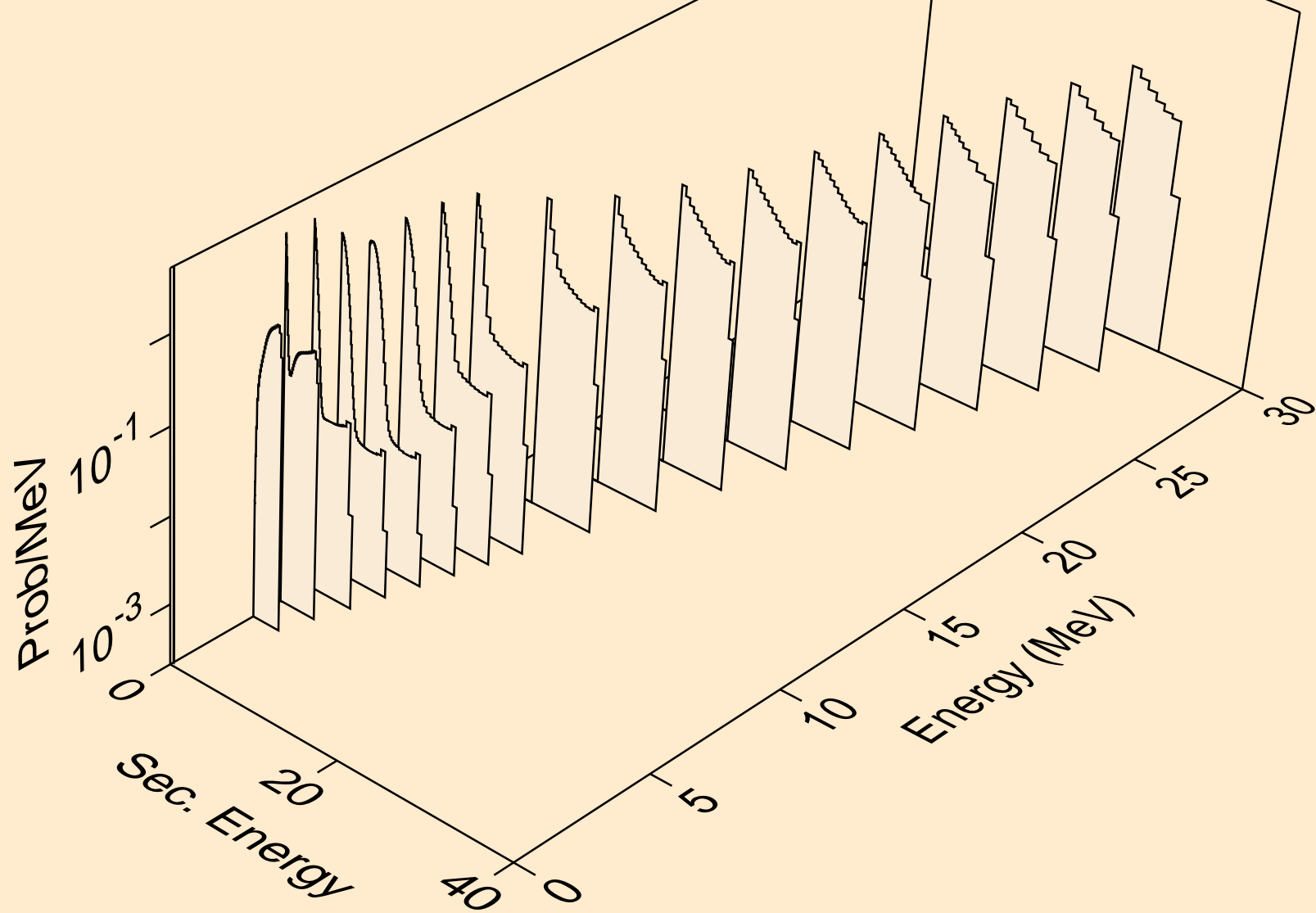

CM237 DEUTERON ACER TENDL-2023 LIBRARY; T=0.K
neutrons from (d,x)

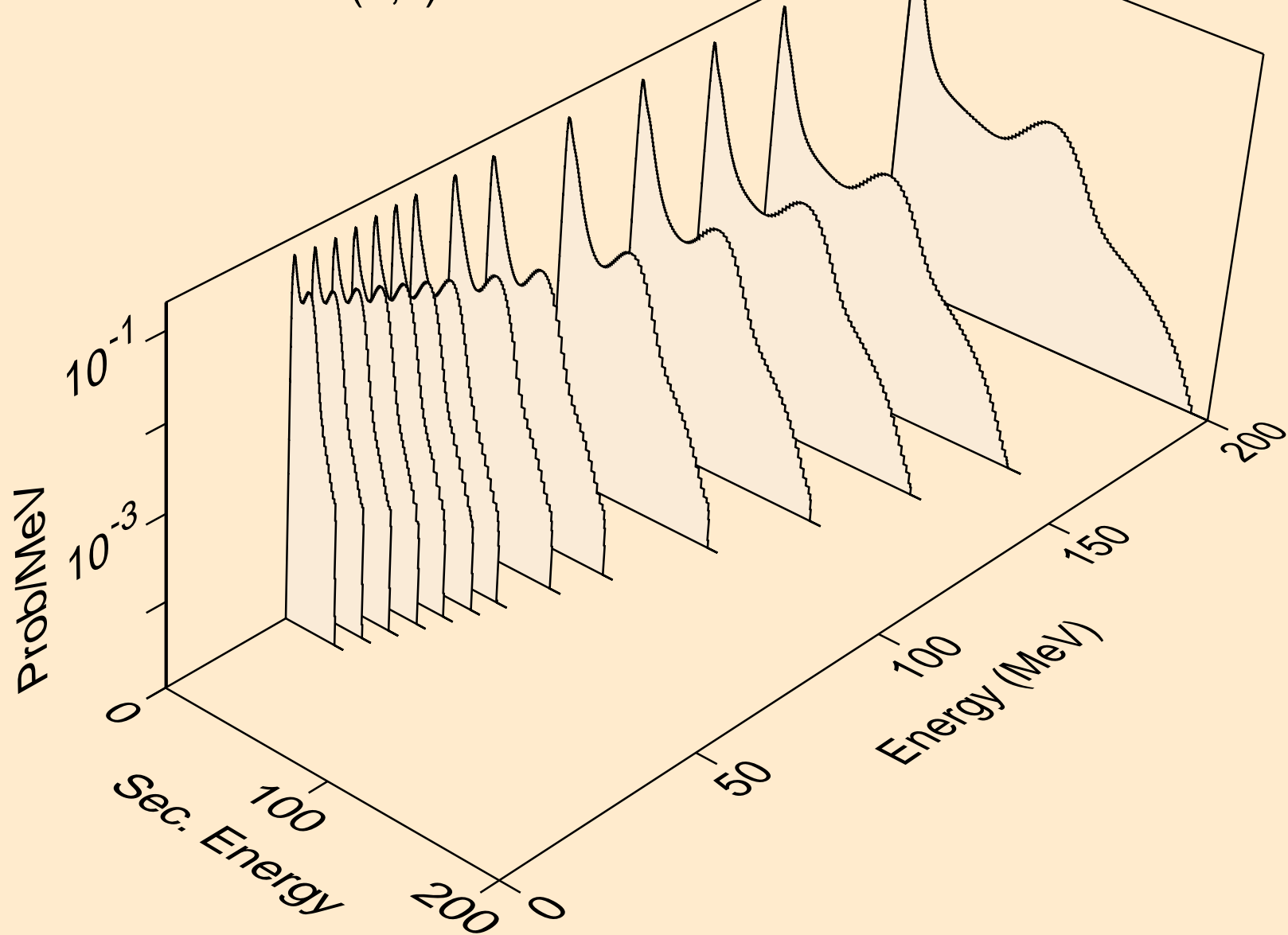

CM237 DEUTERON ACER TENDL-2023 LIBRARY; T=0.K
neutrons from (d,2nd)

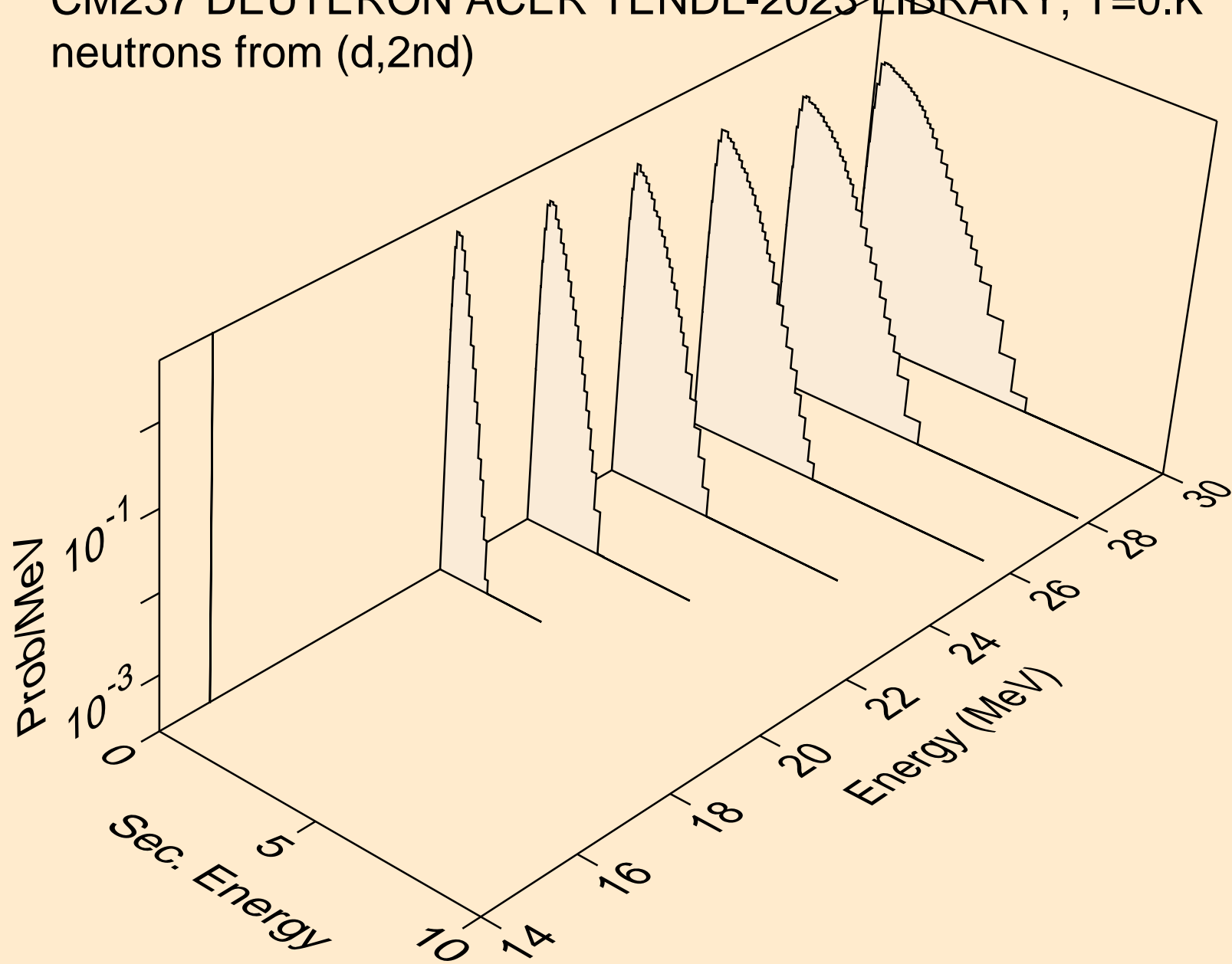

CM237 DEUTERON ACER TENDL-2023 LIBRARY; T=0.K
neutrons from (d,2n)

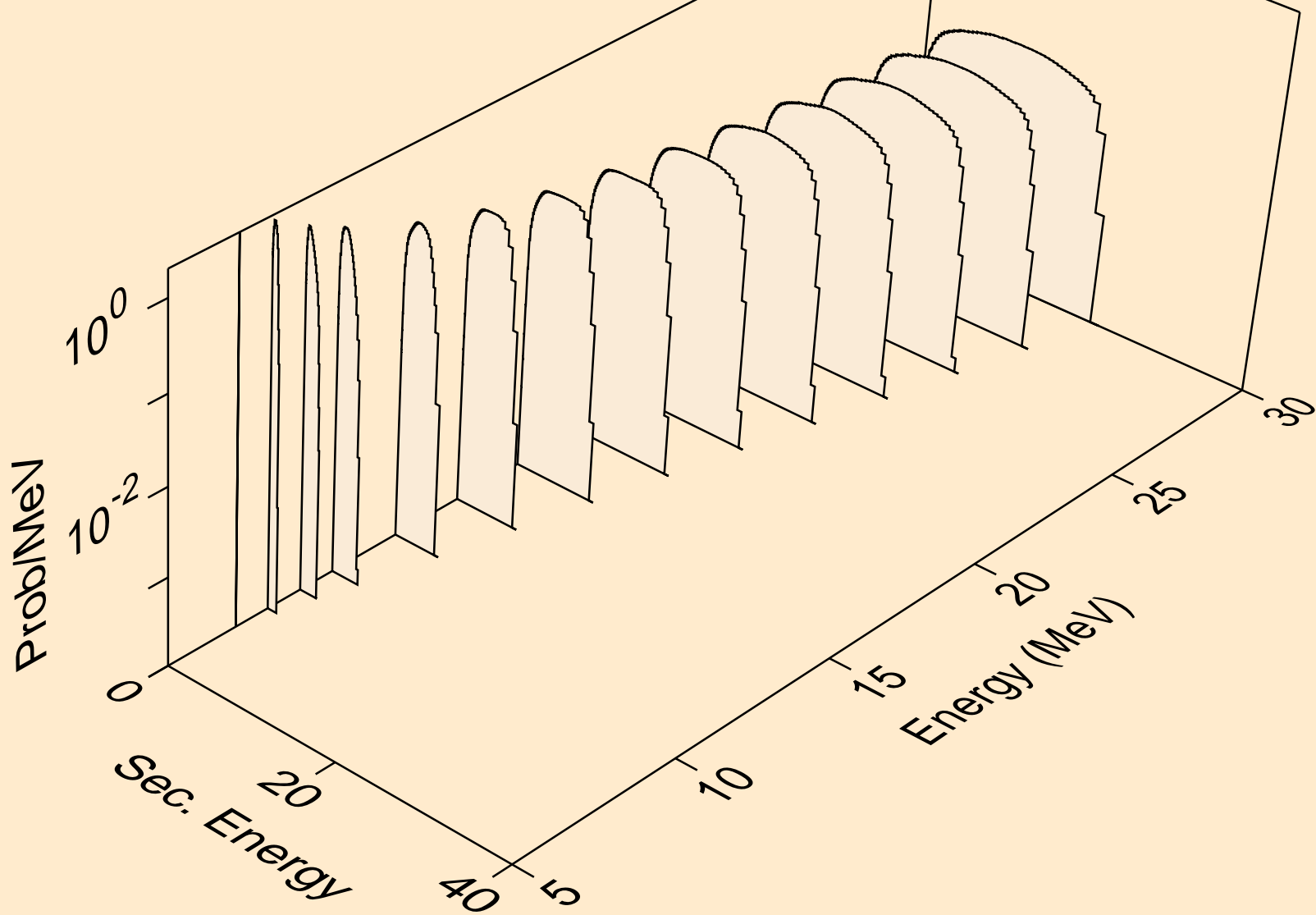

CM237 DEUTERON ACER TENDL-2023 LIBRARY; T=0.K
neutrons from (d,3n)

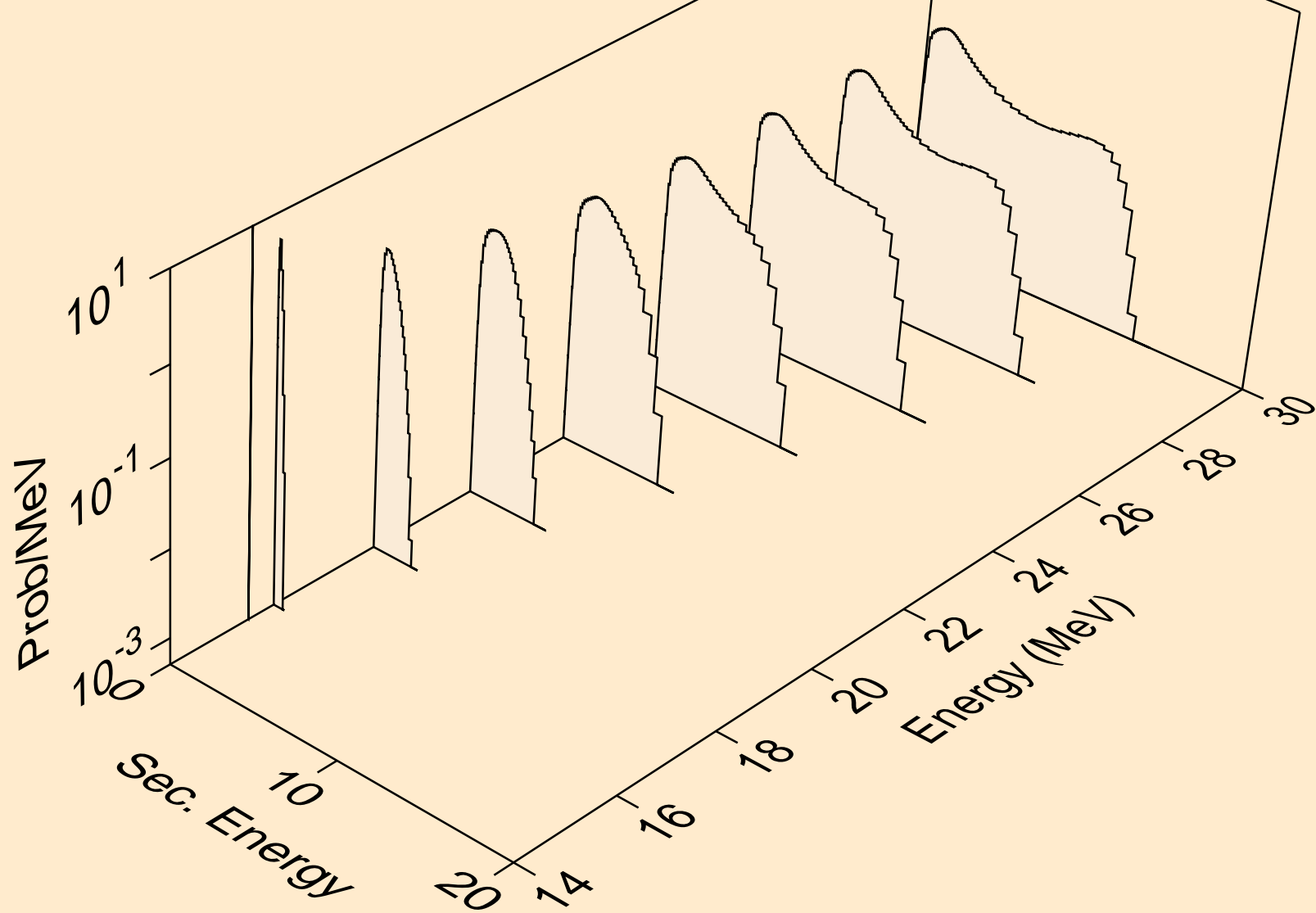

CM237 DEUTERON ACER TENDL-2023 LIBRARY; T=0.K
neutrons from (d,n*)a

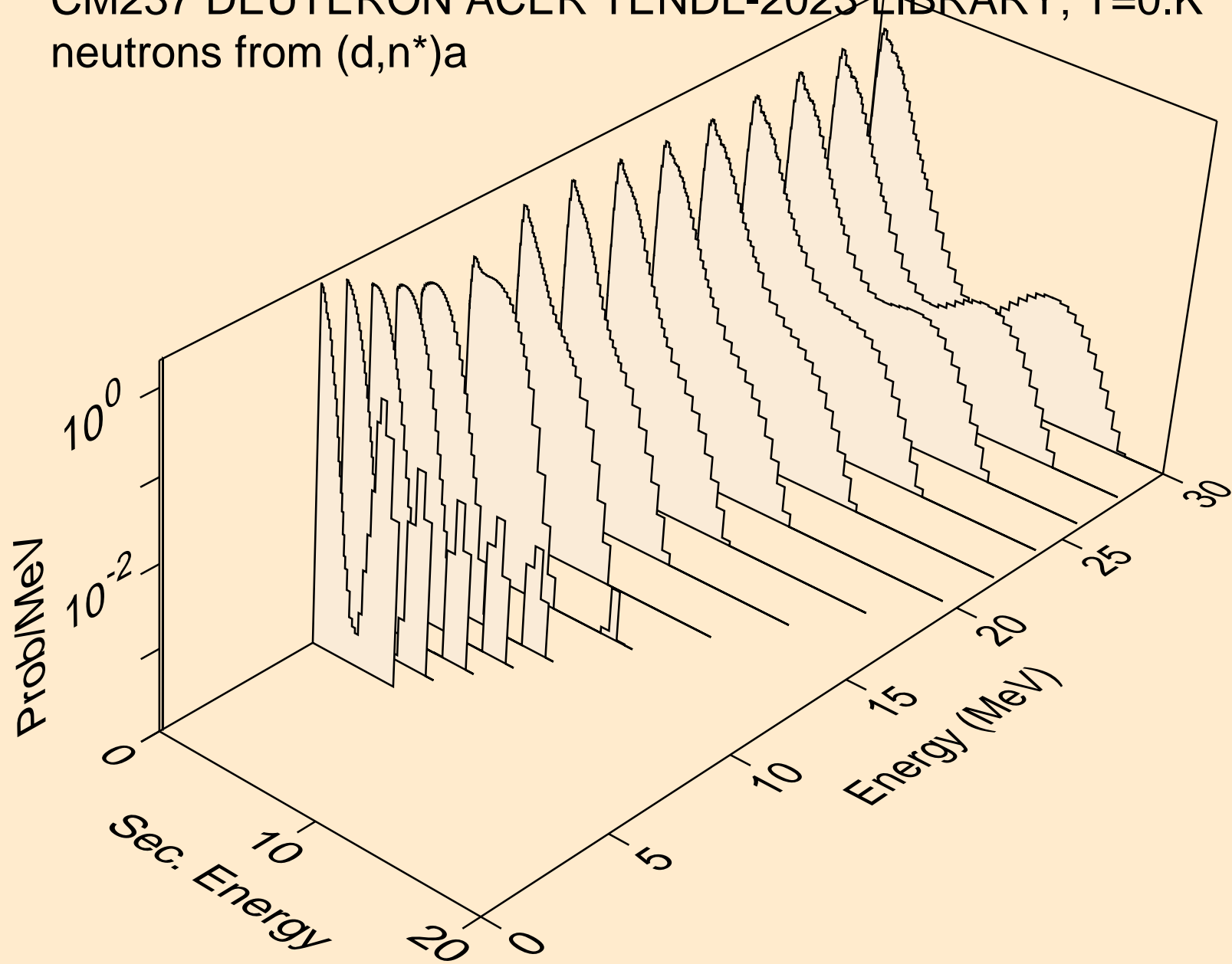

CM237 DEUTERON ACER TENDL-2023 LIBRARY; T=0.K
neutrons from (d,2n)a

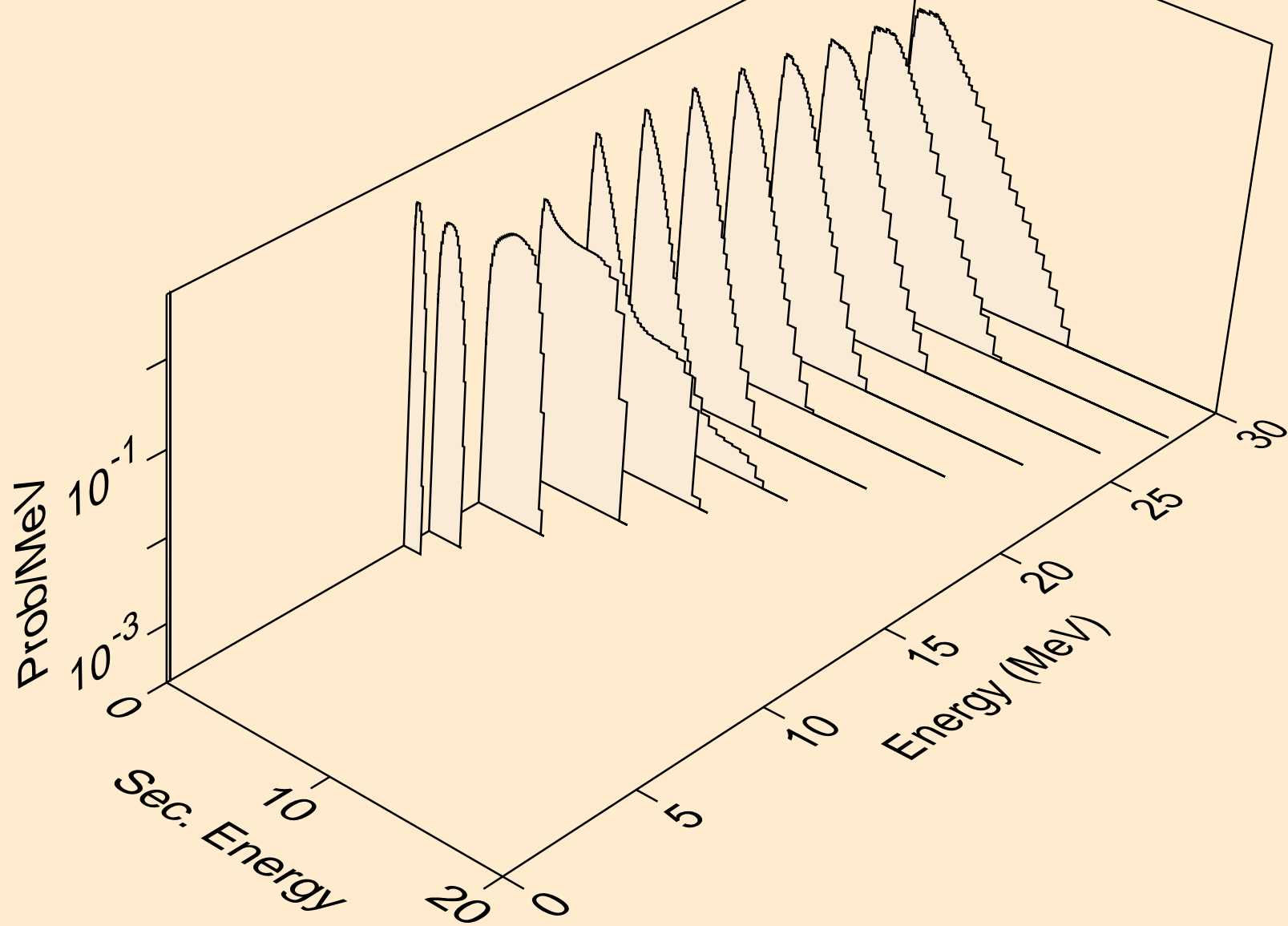

CM237 DEUTERON ACER TENDL-2023 LIBRARY; T=0.K
neutrons from (d,n*)p

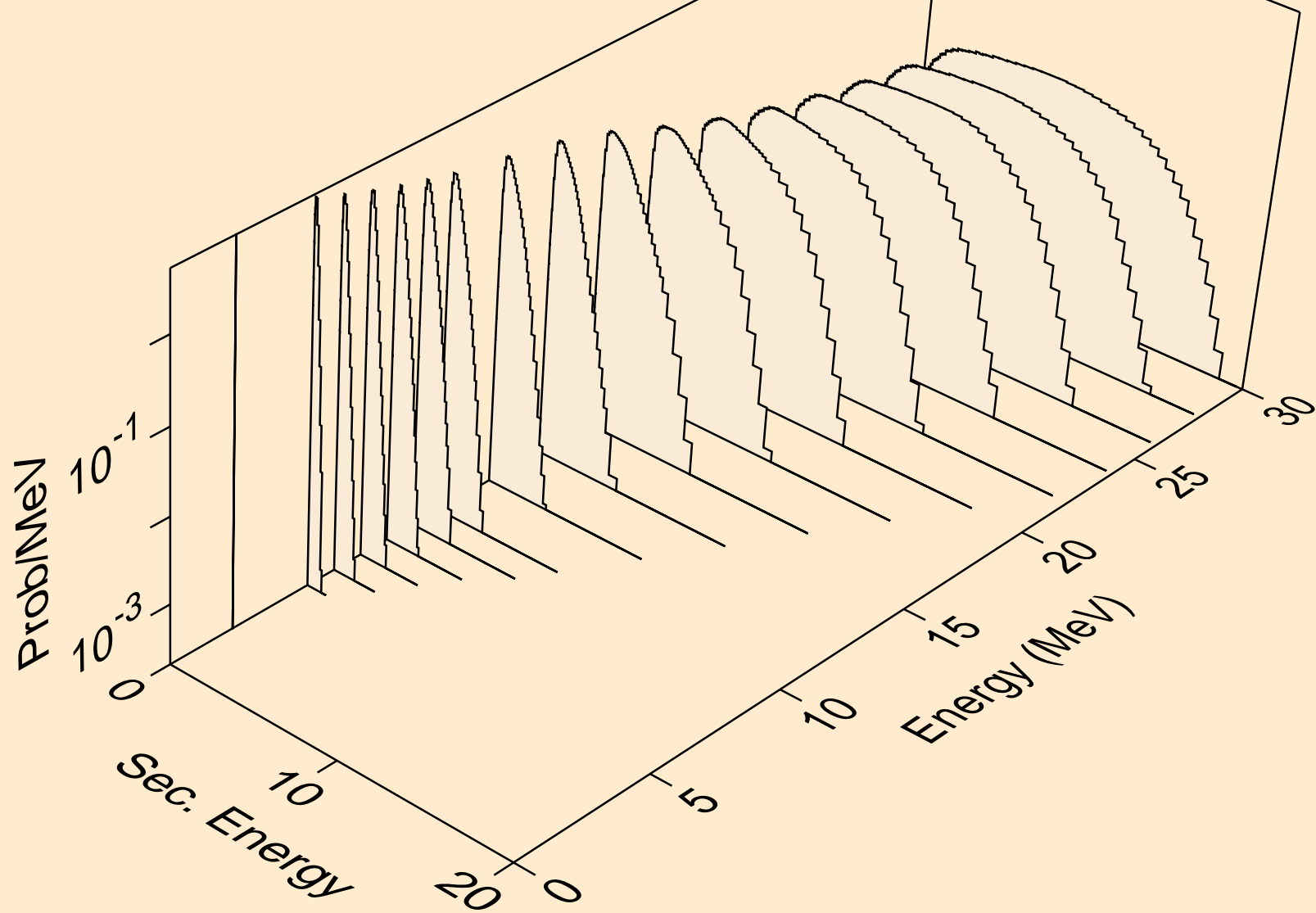

CM237 DEUTERON ACER TENDL-2023 LIBRARY; T=0.K
neutrons from (d,n*)d

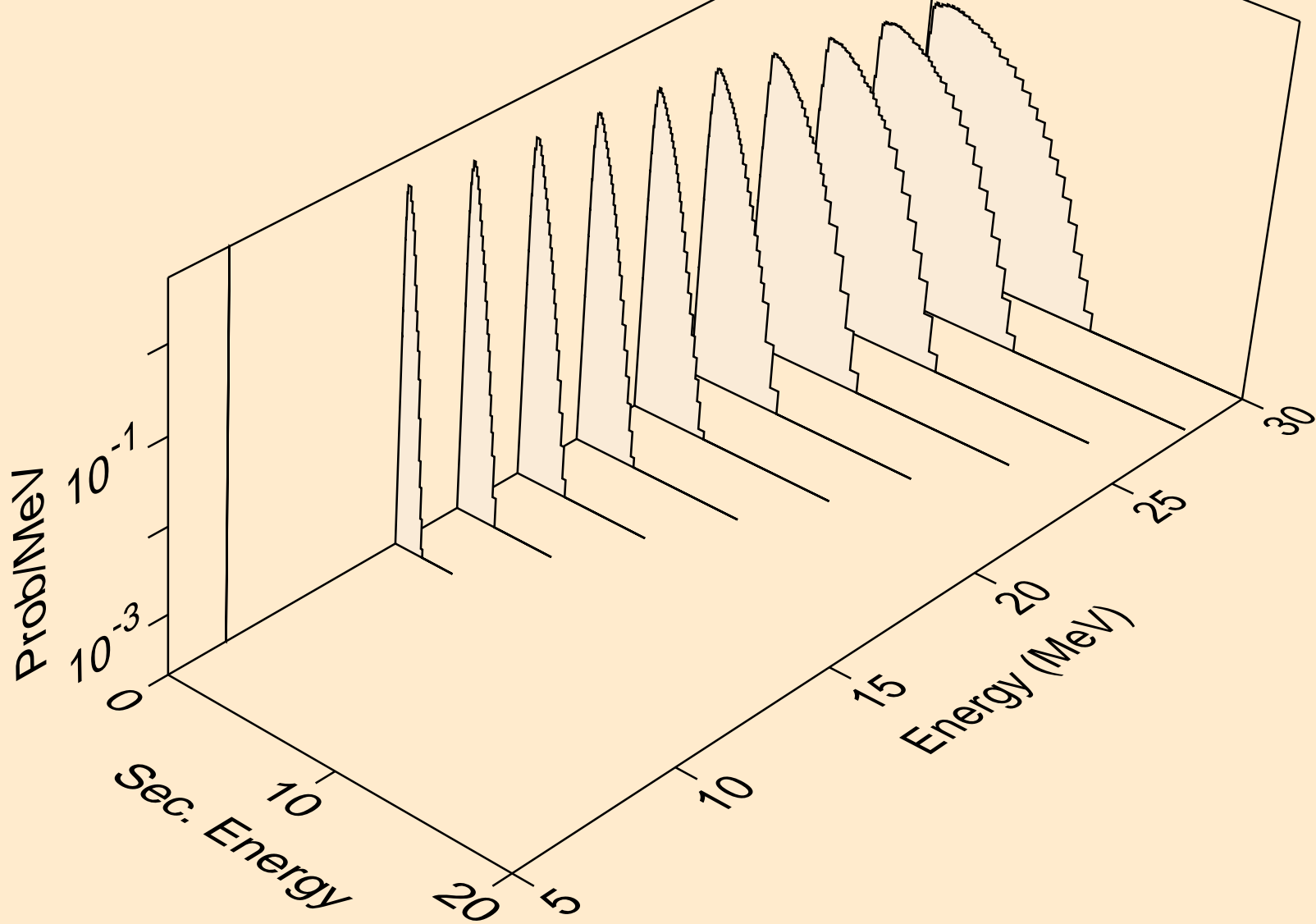

CM237 DEUTERON ACER TENDL-2023 LIBRARY; T=0.K
neutrons from (d,n*)t

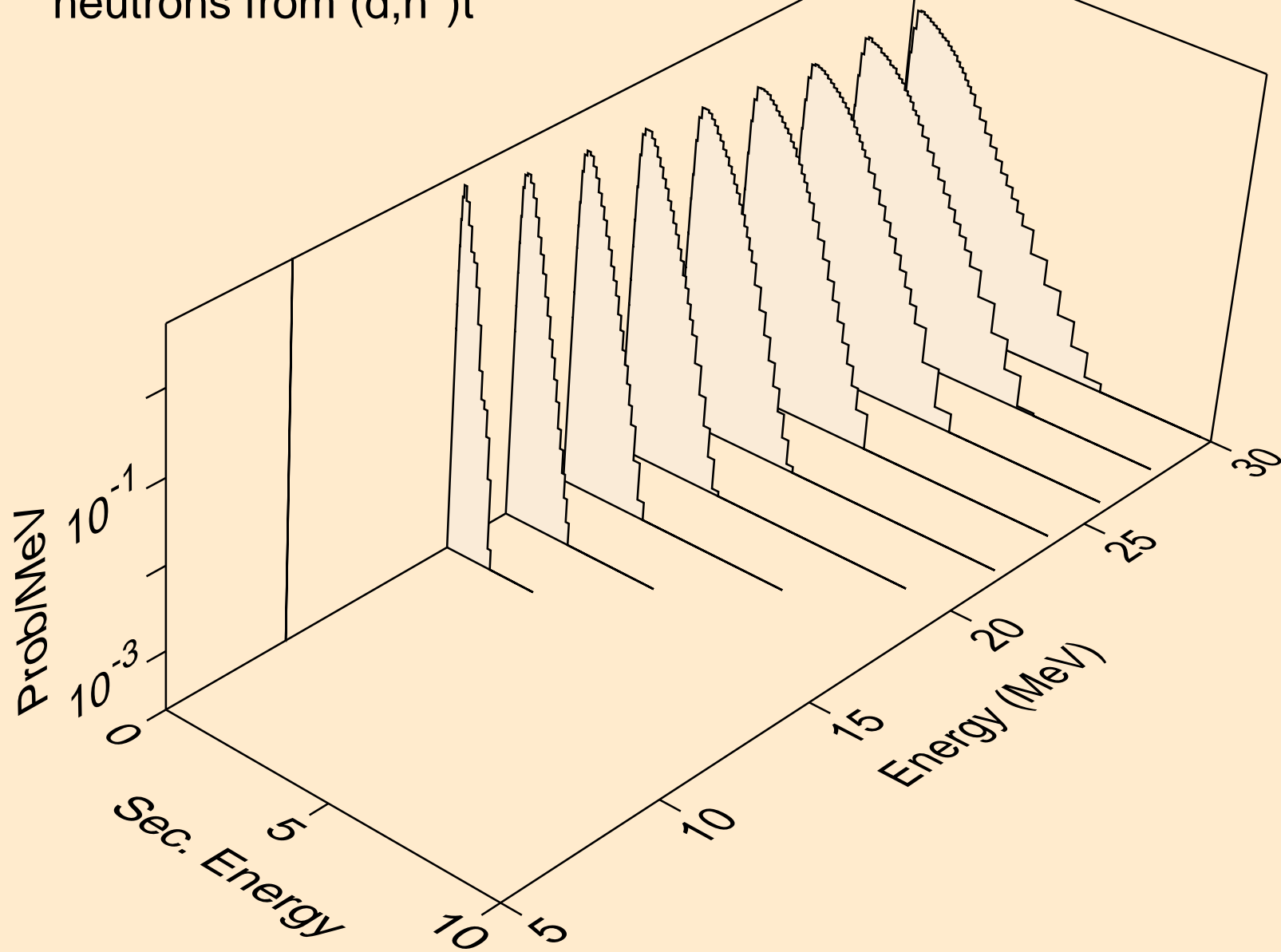

CM237 DEUTERON ACER TENDL-2023 LIBRARY; T=0.K
neutrons from (d,n*)he3

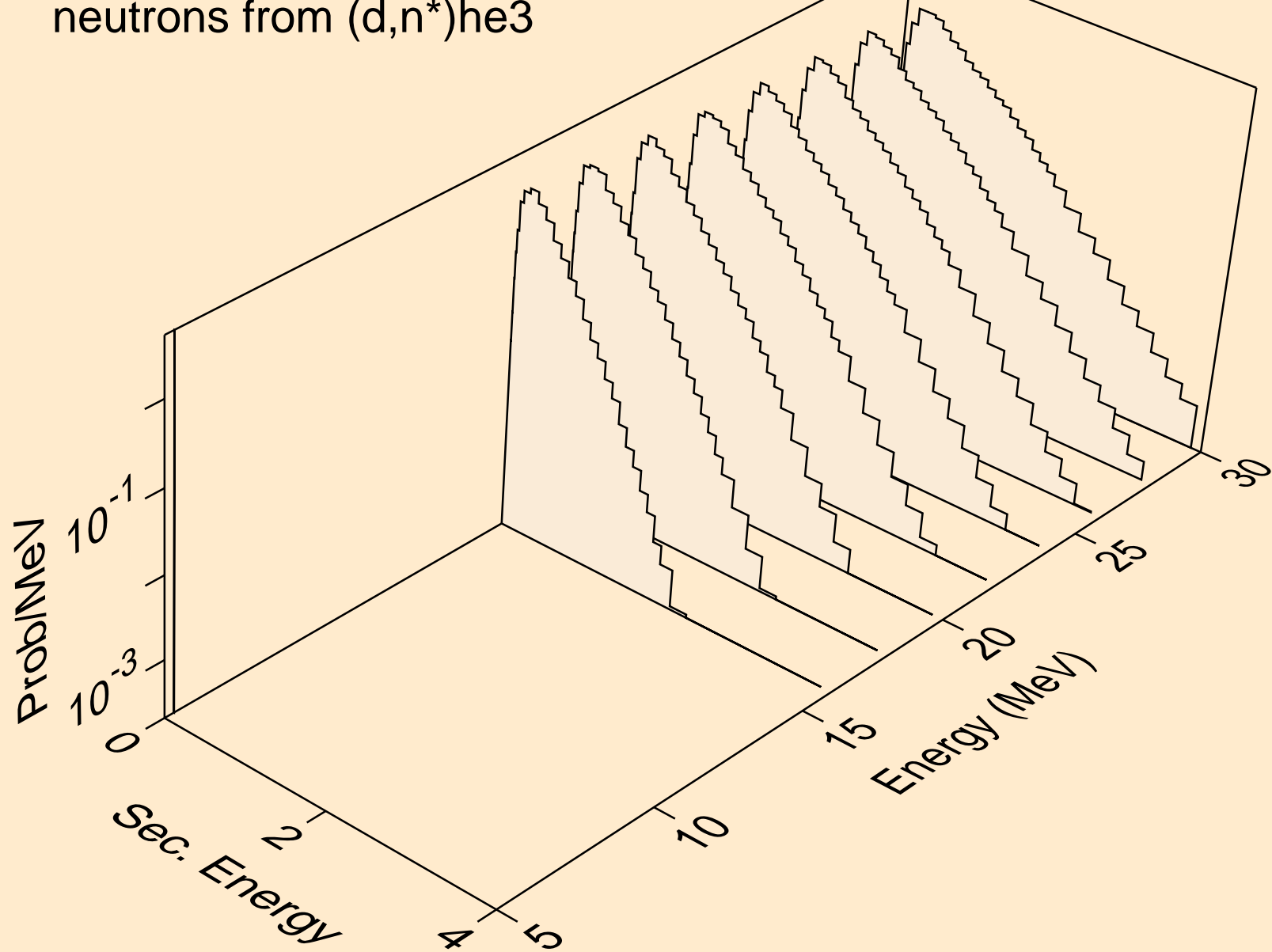

CM237 DEUTERON ACER TENDL-2023 LIBRARY; T=0.K
neutrons from (d,4n)

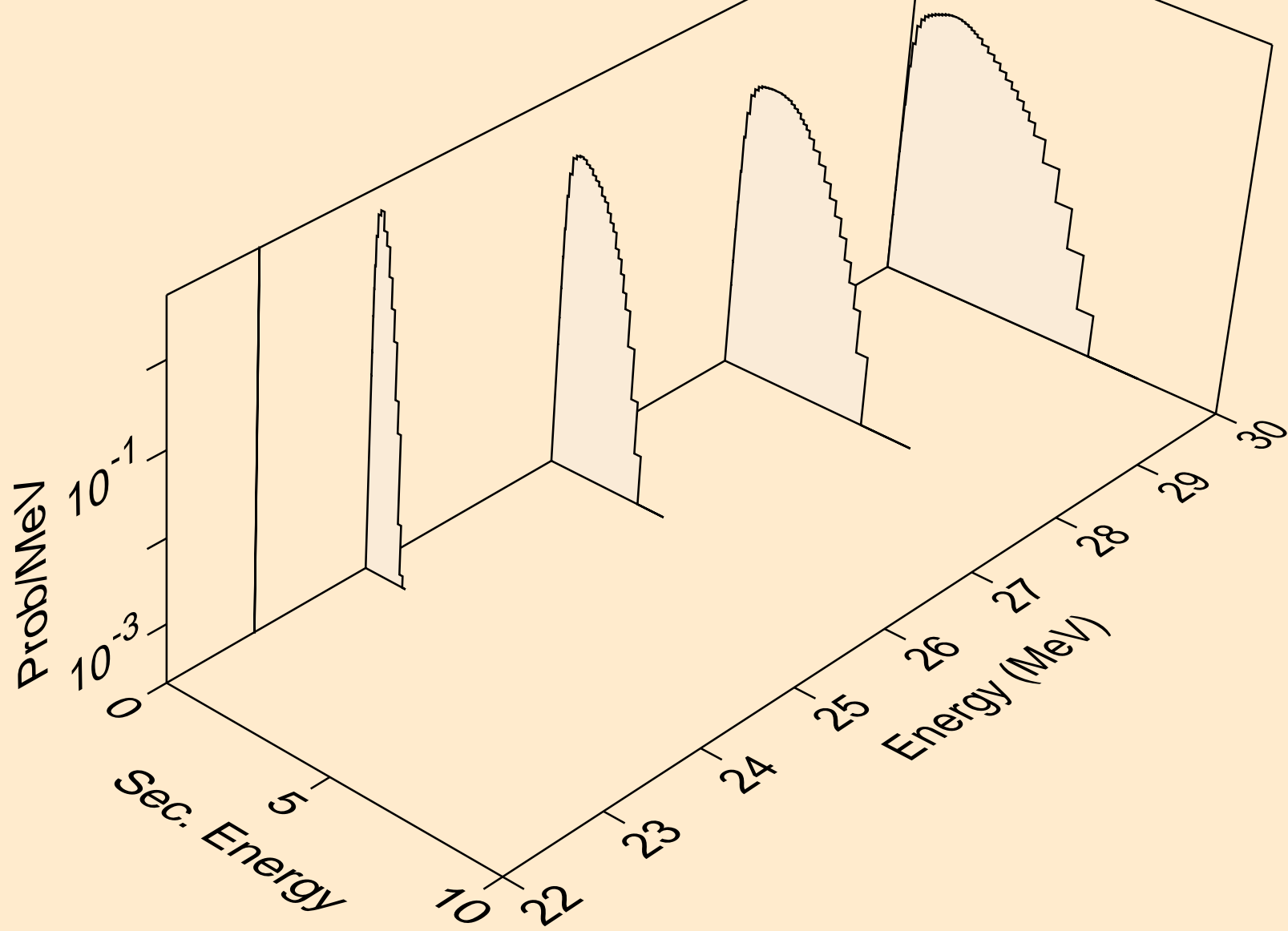

CM237 DEUTERON ACER TENDL-2023 LIBRARY; T=0.K
neutrons from (d,2np)

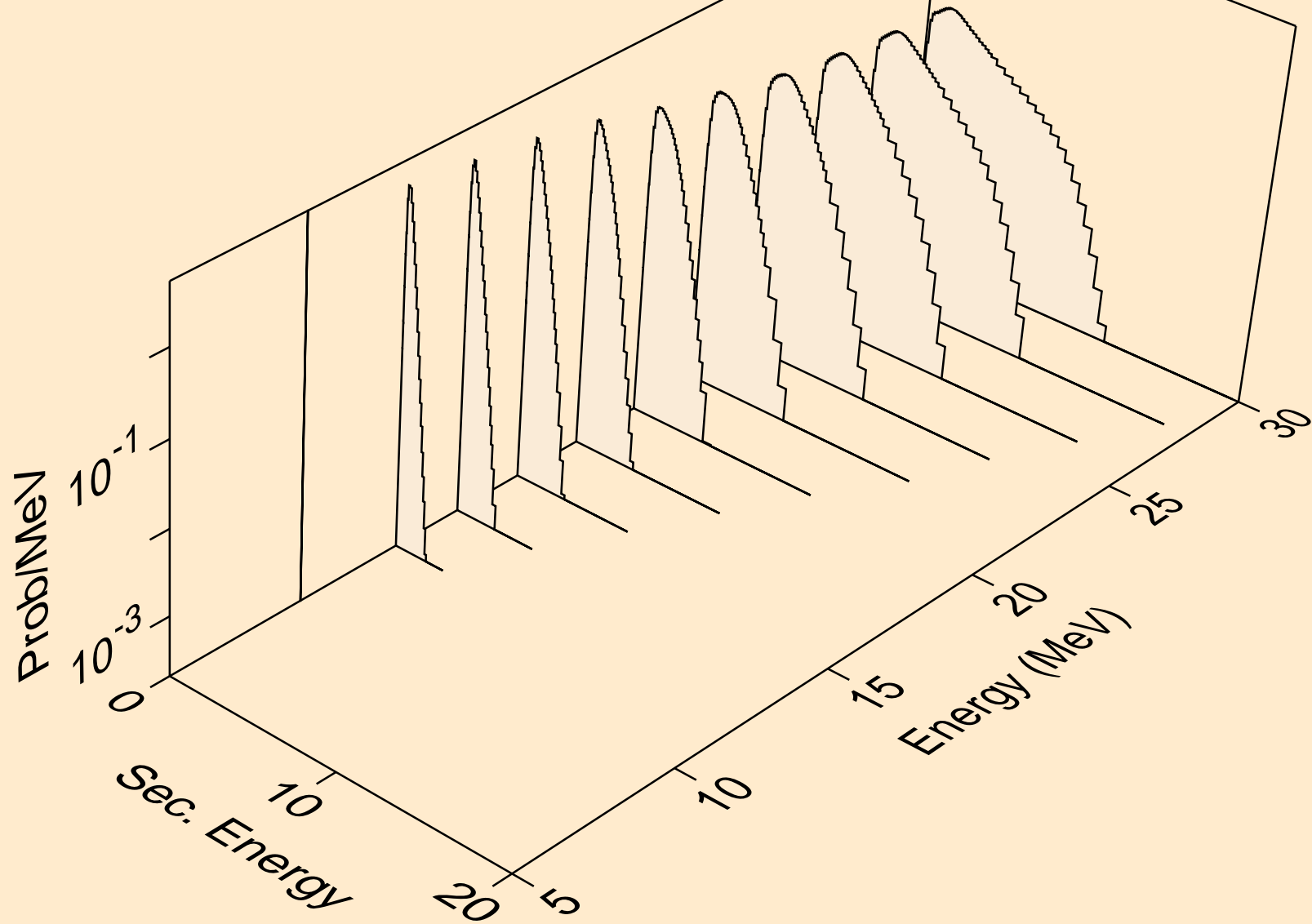

CM237 DEUTERON ACER TENDL-2023 LIBRARY; T=0.K
neutrons from (d,n2p)

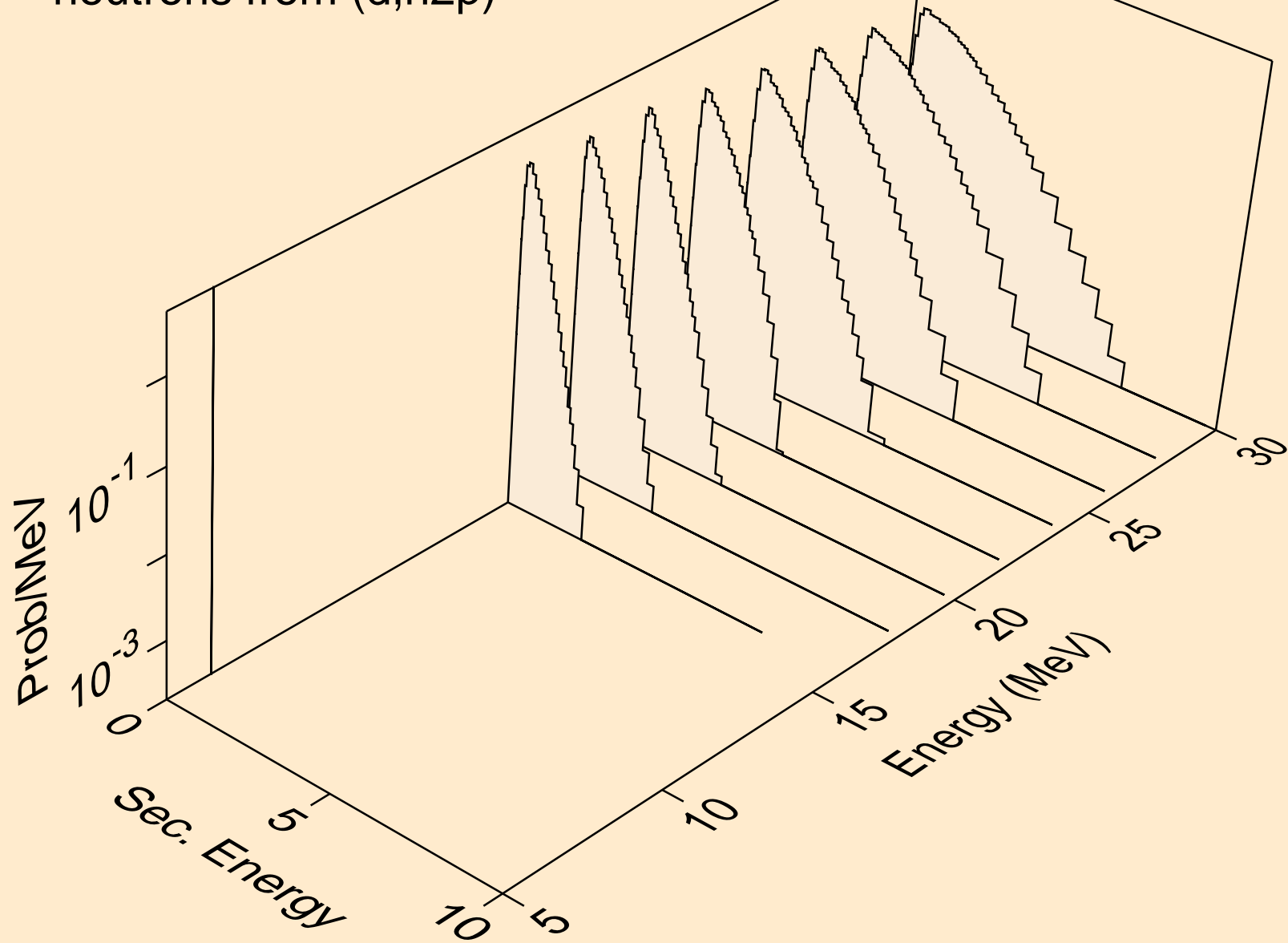

CM237 DEUTERON ACER TENDL-2023 LIBRARY; T=0.K
neutrons from (d,npa)

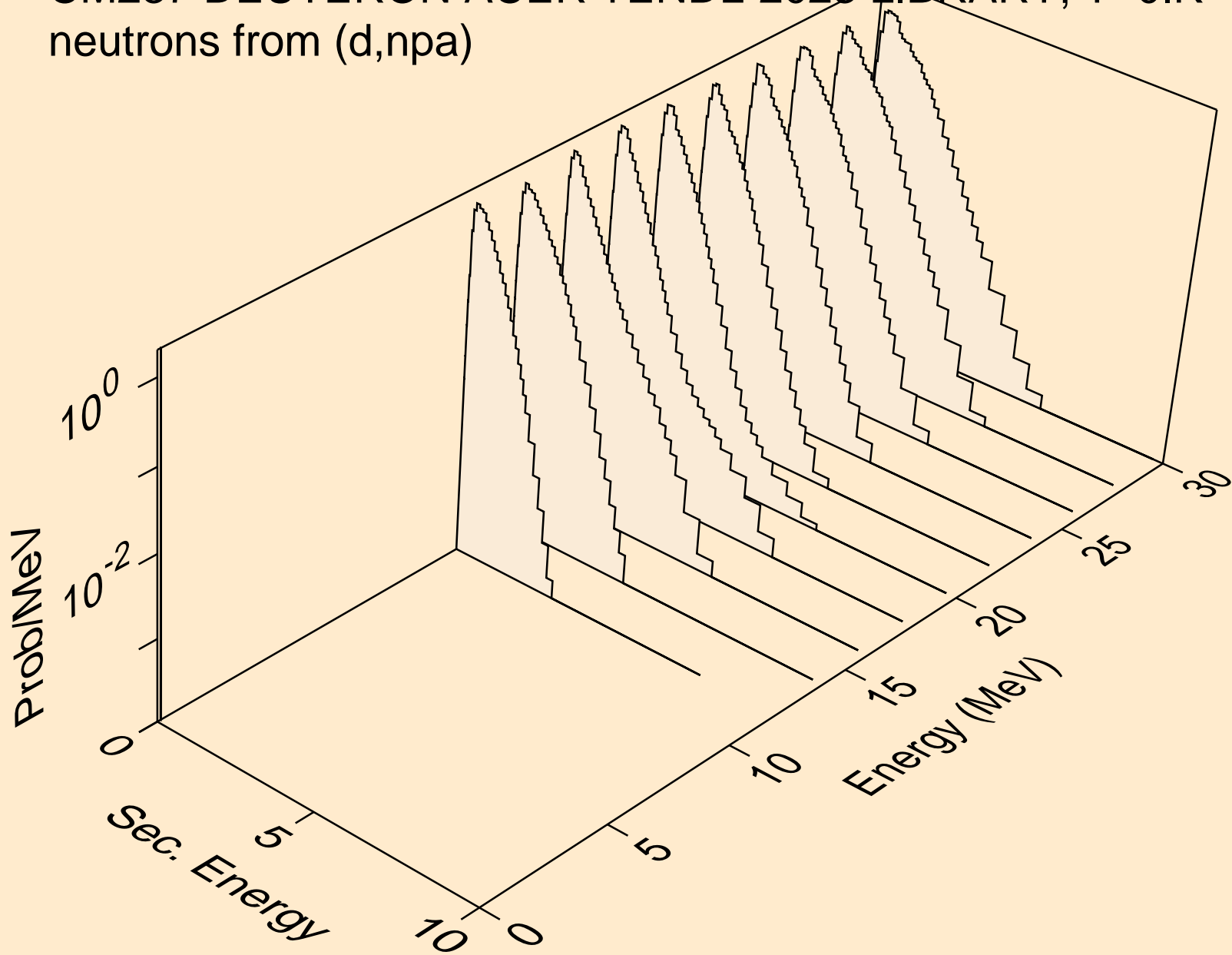

CM237 DEUTERON ACER TENDL-2023 LIBRARY; T=0.K
protons from (d,x)

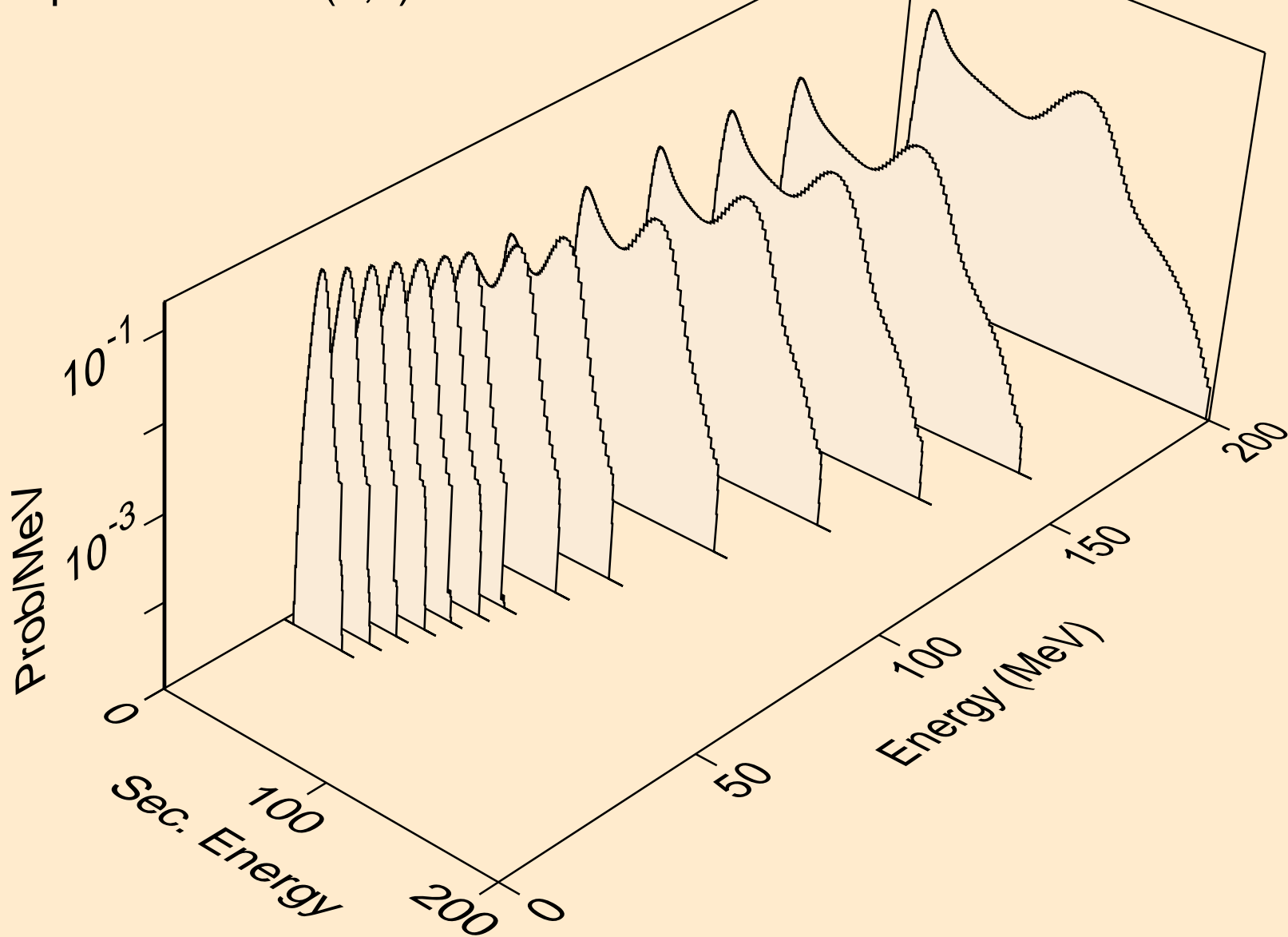

CM237 DEUTERON ACER TENDL-2023 LIBRARY; T=0.K
protons from (d,n*)p

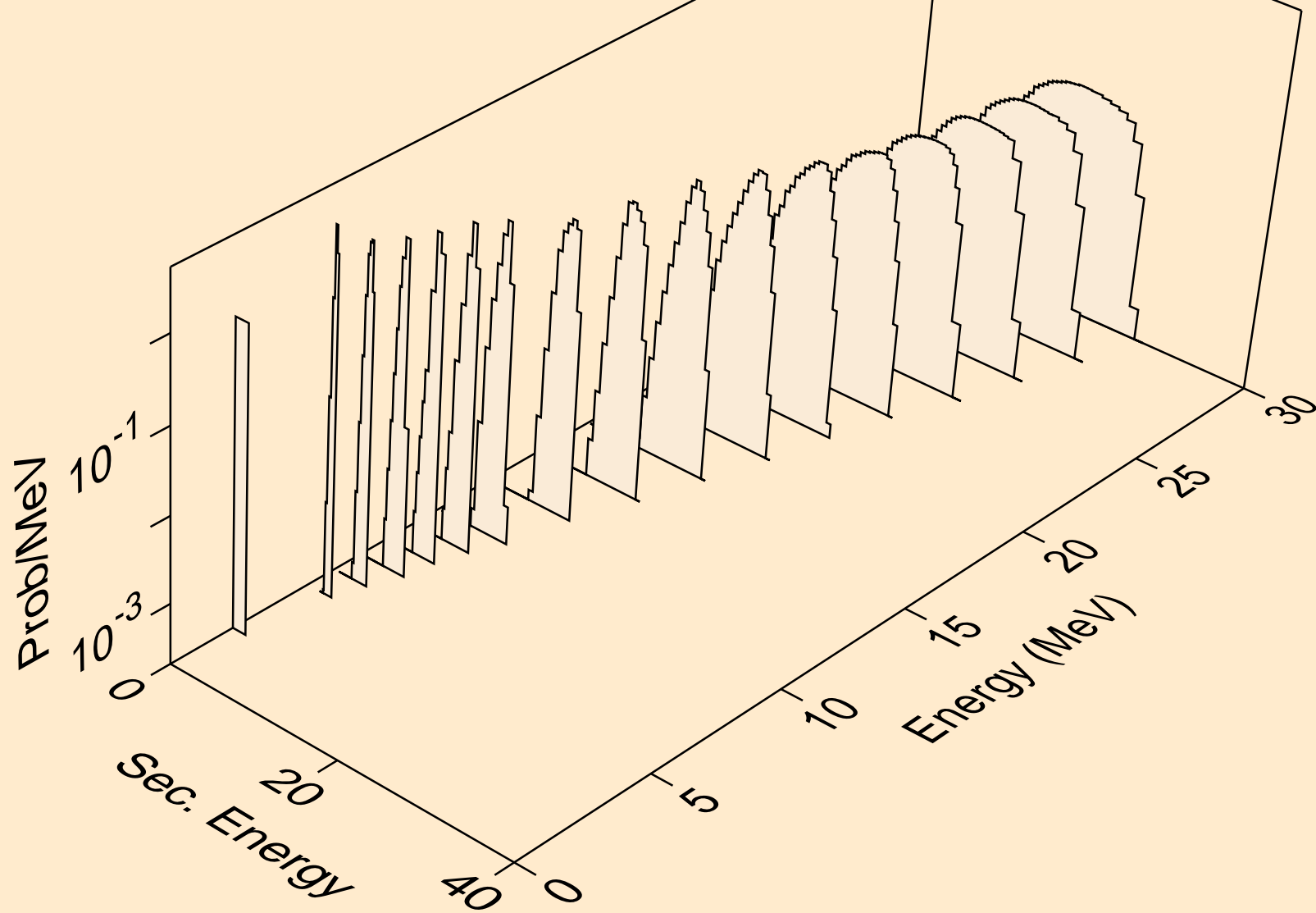

CM237 DEUTERON ACER TENDL-2023 LIBRARY; T=0.K
protons from (d,2np)

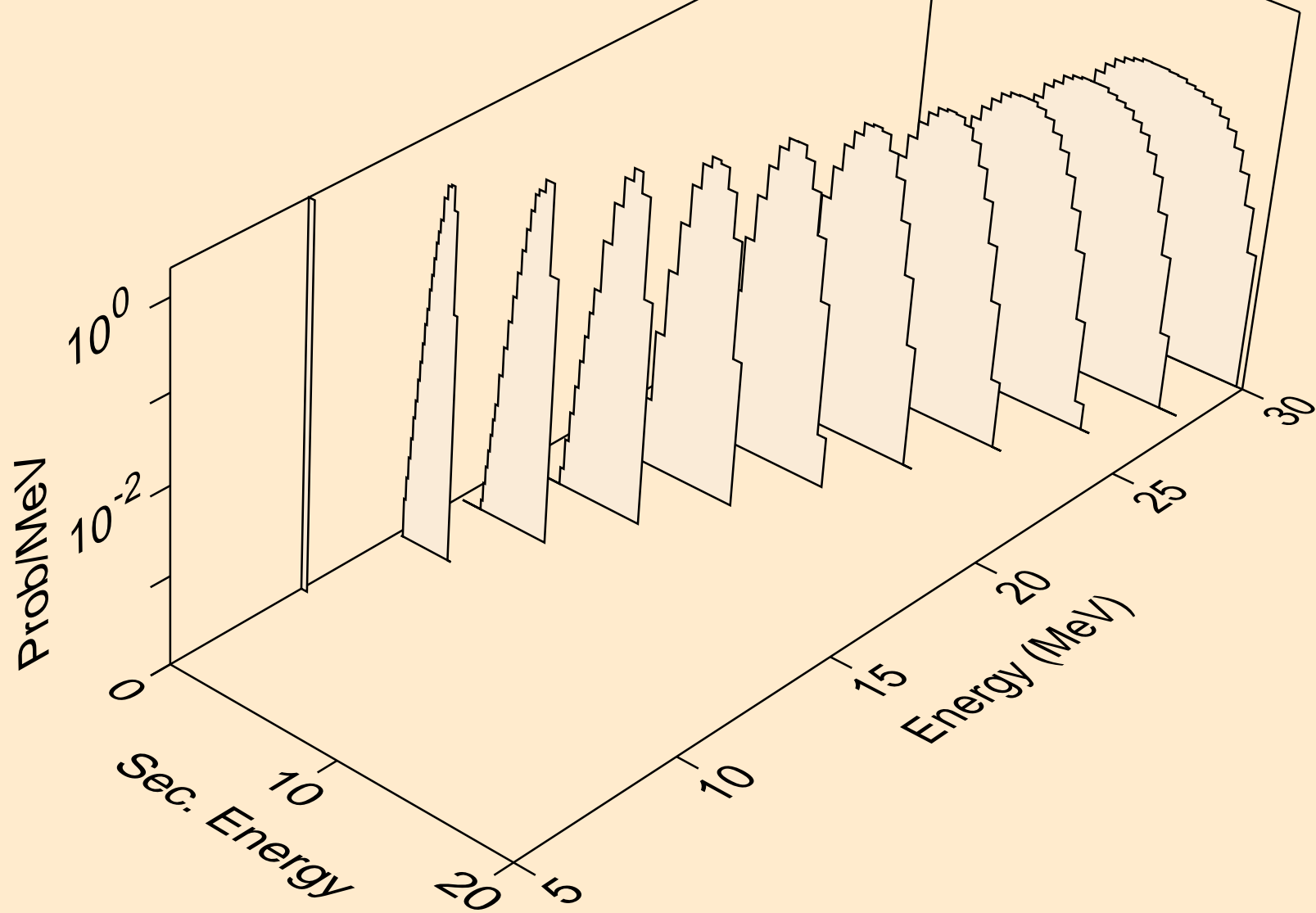

CM237 DEUTERON ACER TENDL-2023 LIBRARY; T=0.K
protons from (d,n2p)

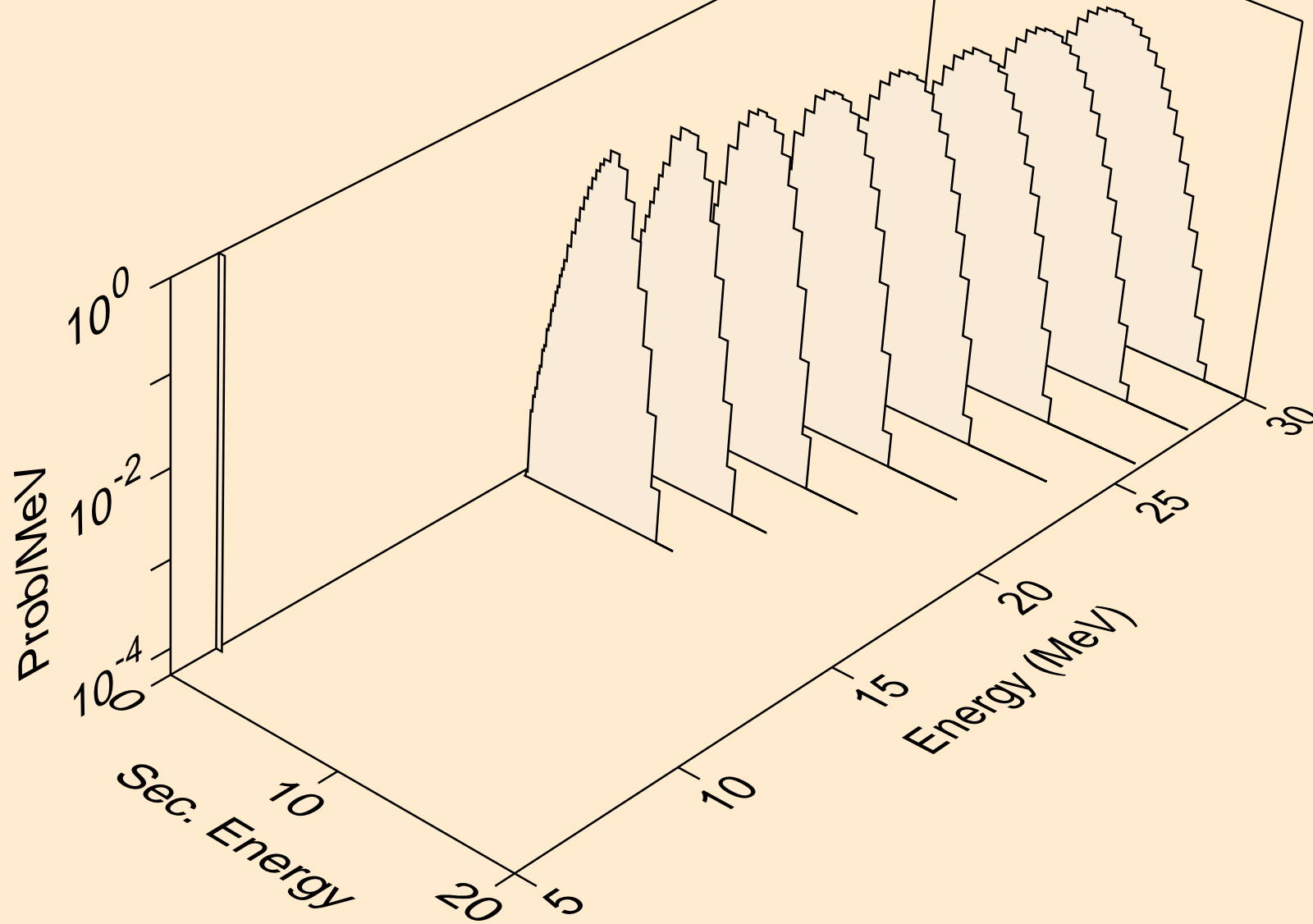

CM237 DEUTERON ACER TENDL-2023 LIBRARY; T=0.K
protons from (d,npa)

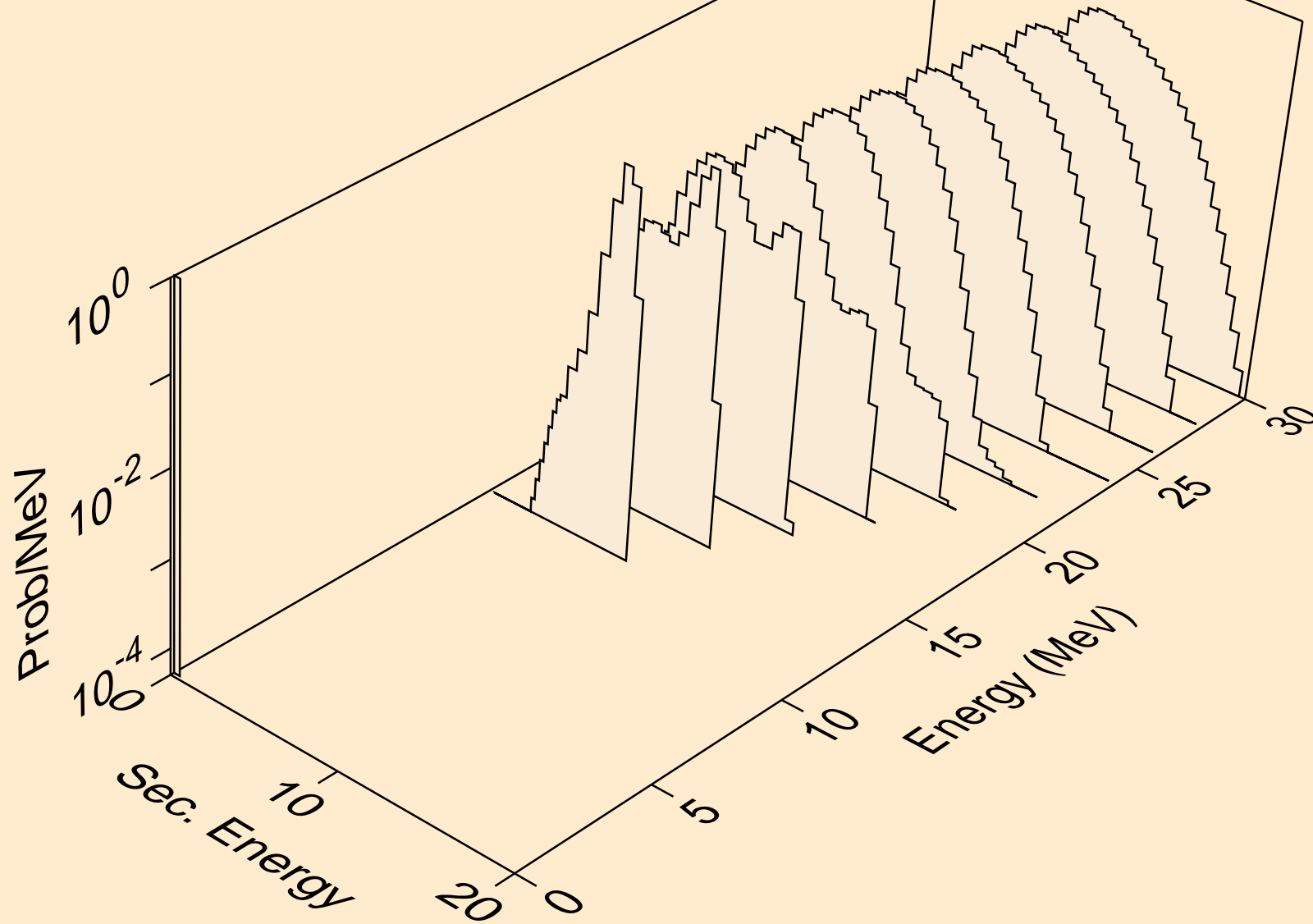

CM237 DEUTERON ACER TENDL-2023 LIBRARY; T=0.K
protons from (d,p)

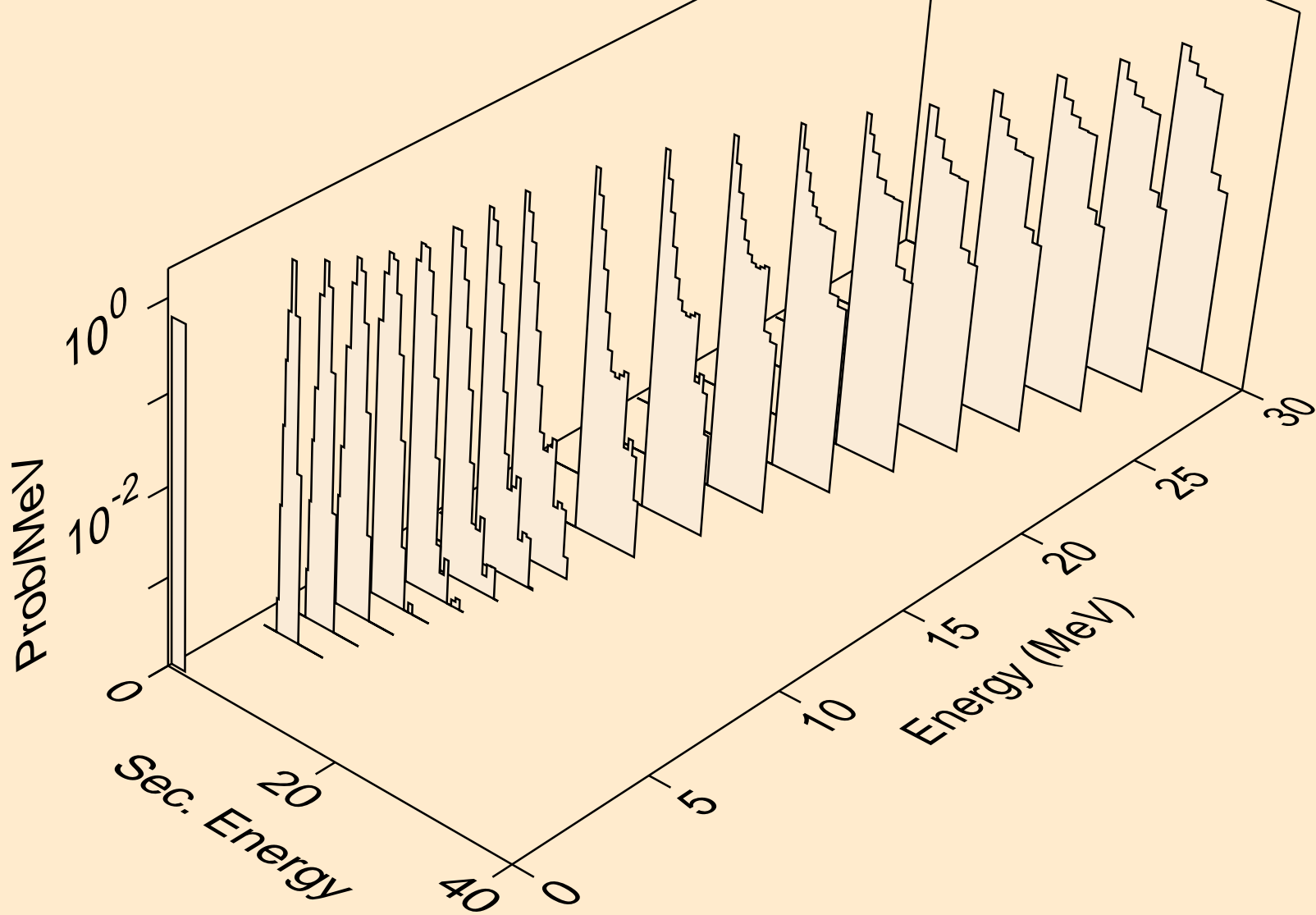

CM237 DEUTERON ACER TENDL-2023 LIBRARY; T=0.K
protons from (d,2p)

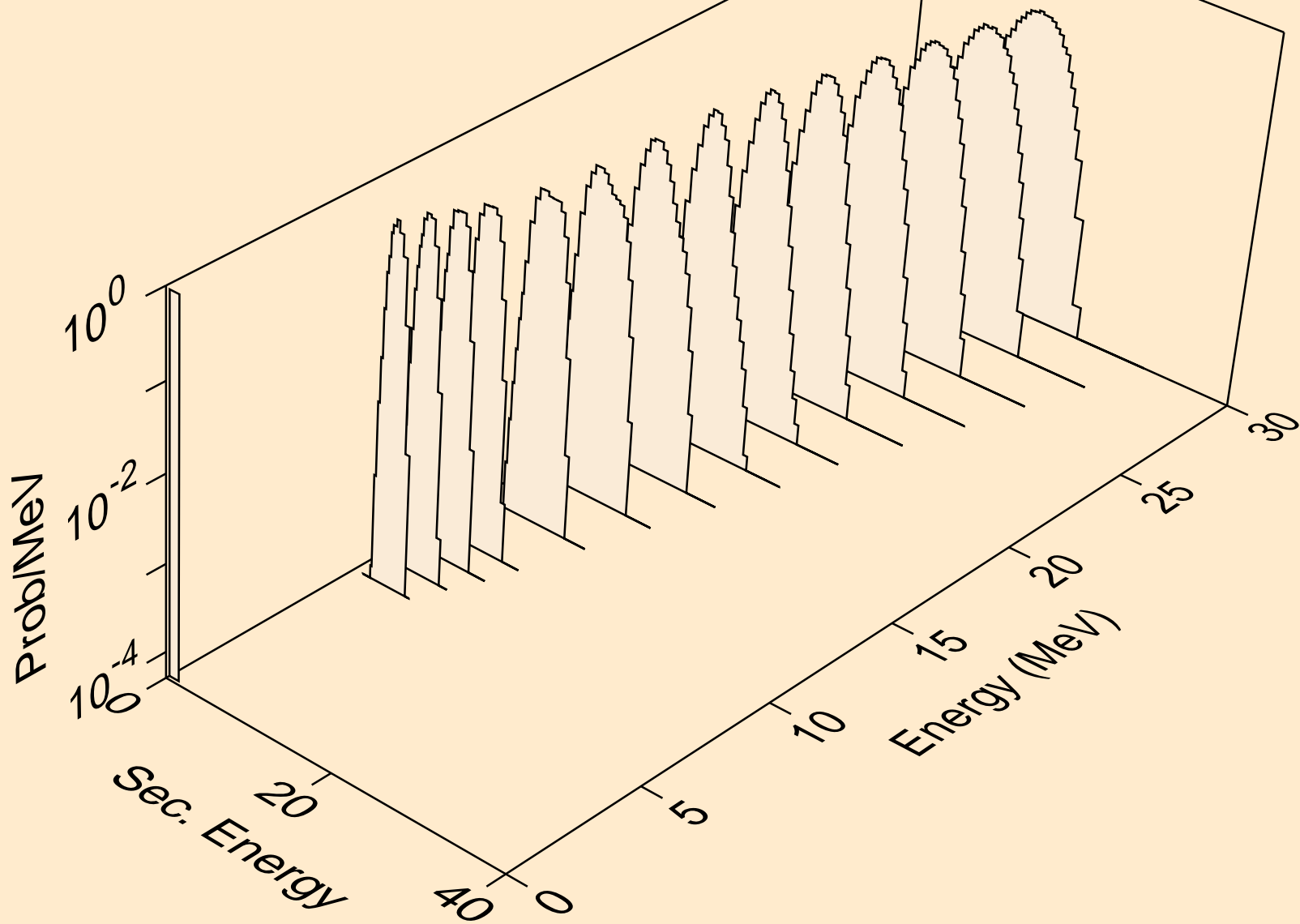

CM237 DEUTERON ACER TENDL-2023 LIBRARY; T=0.K
protons from (d,pd)

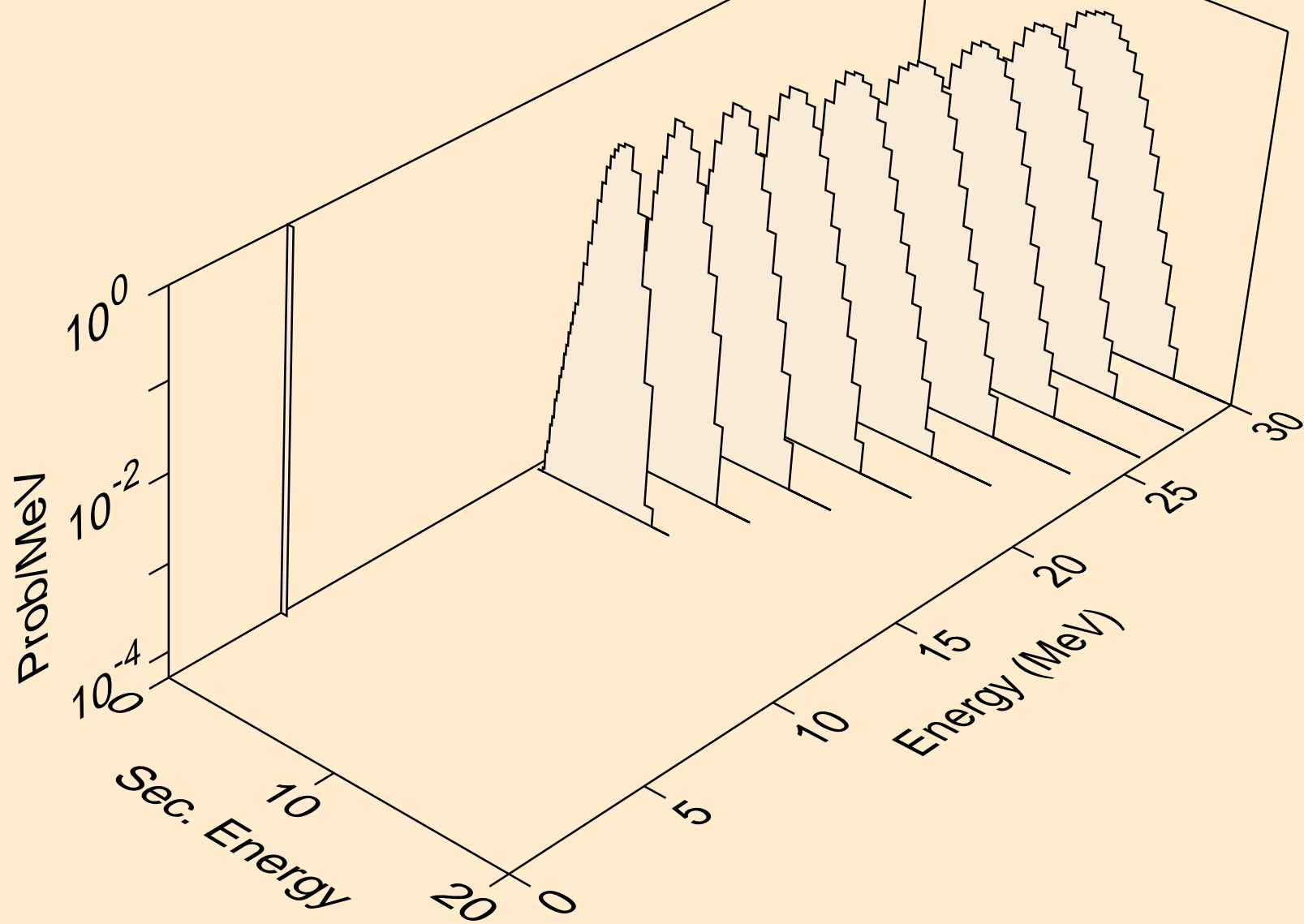

CM237 DEUTERON ACER TENDL-2023 LIBRARY; T=0.K
tritons from (d,x)

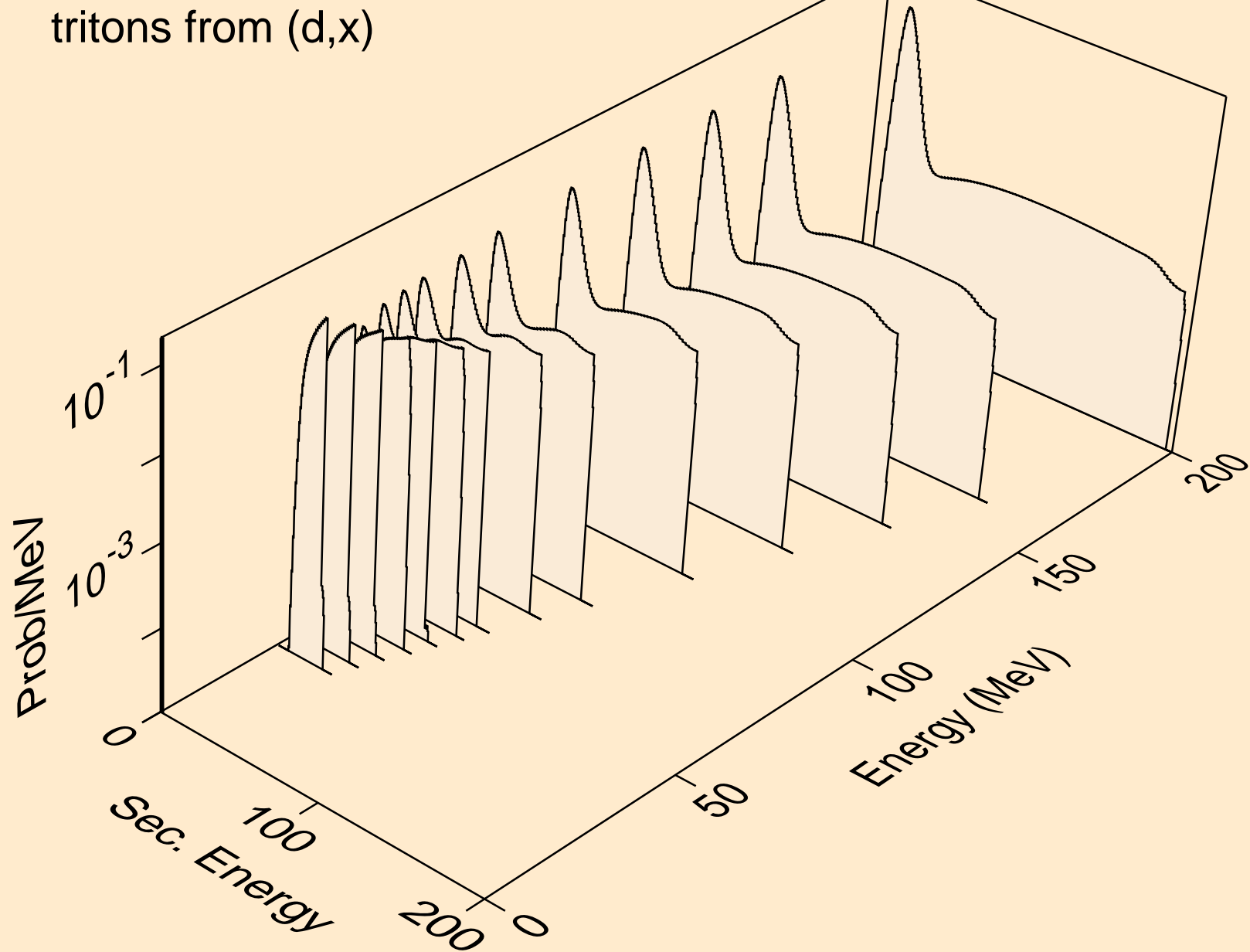

CM237 DEUTERON ACER TENDL-2023 LIBRARY; T=0.K
tritons from (d,n*)t

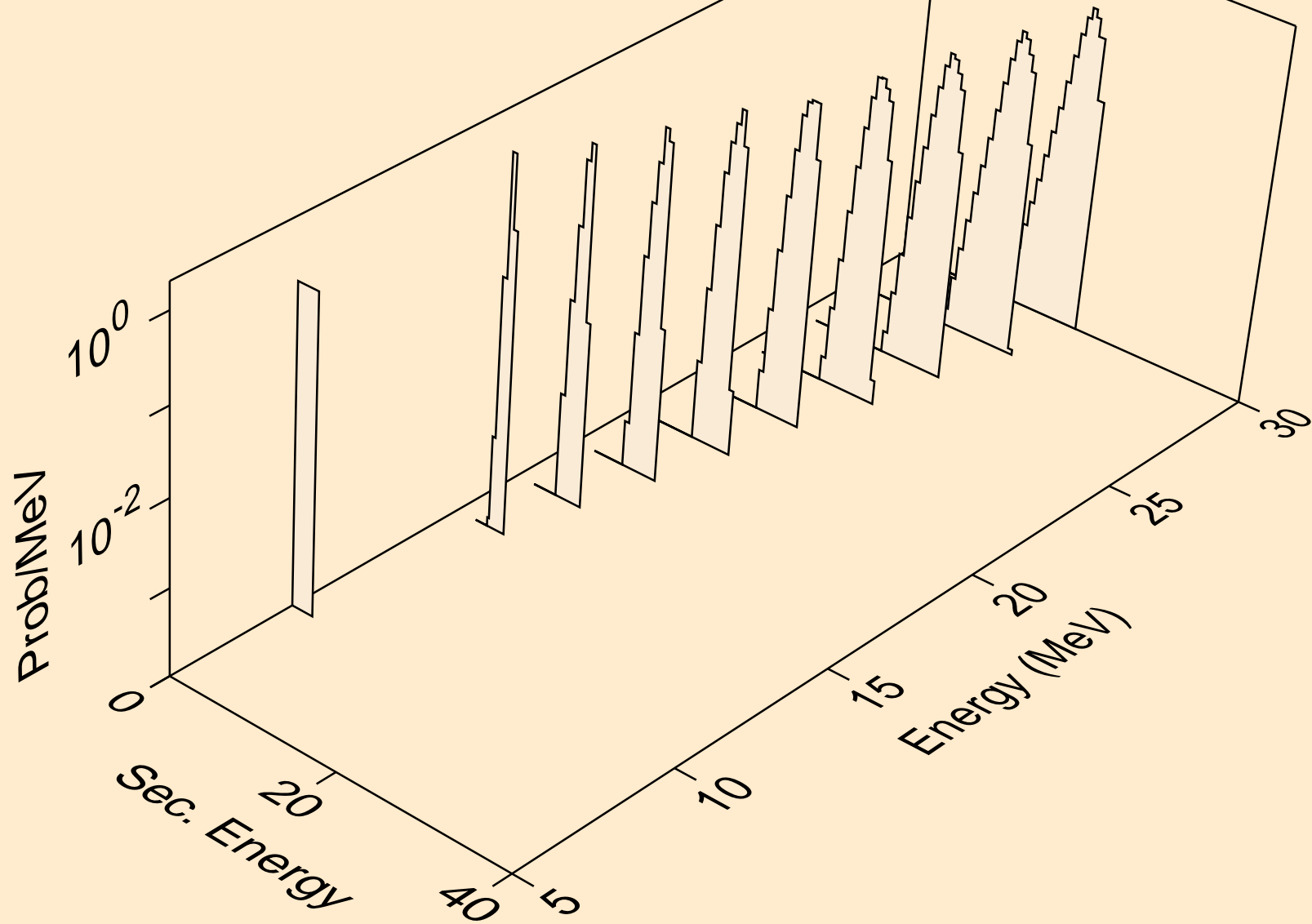

CM237 DEUTERON ACER TENDL-2023 LIBRARY; T=0.K
tritons from (d,t)

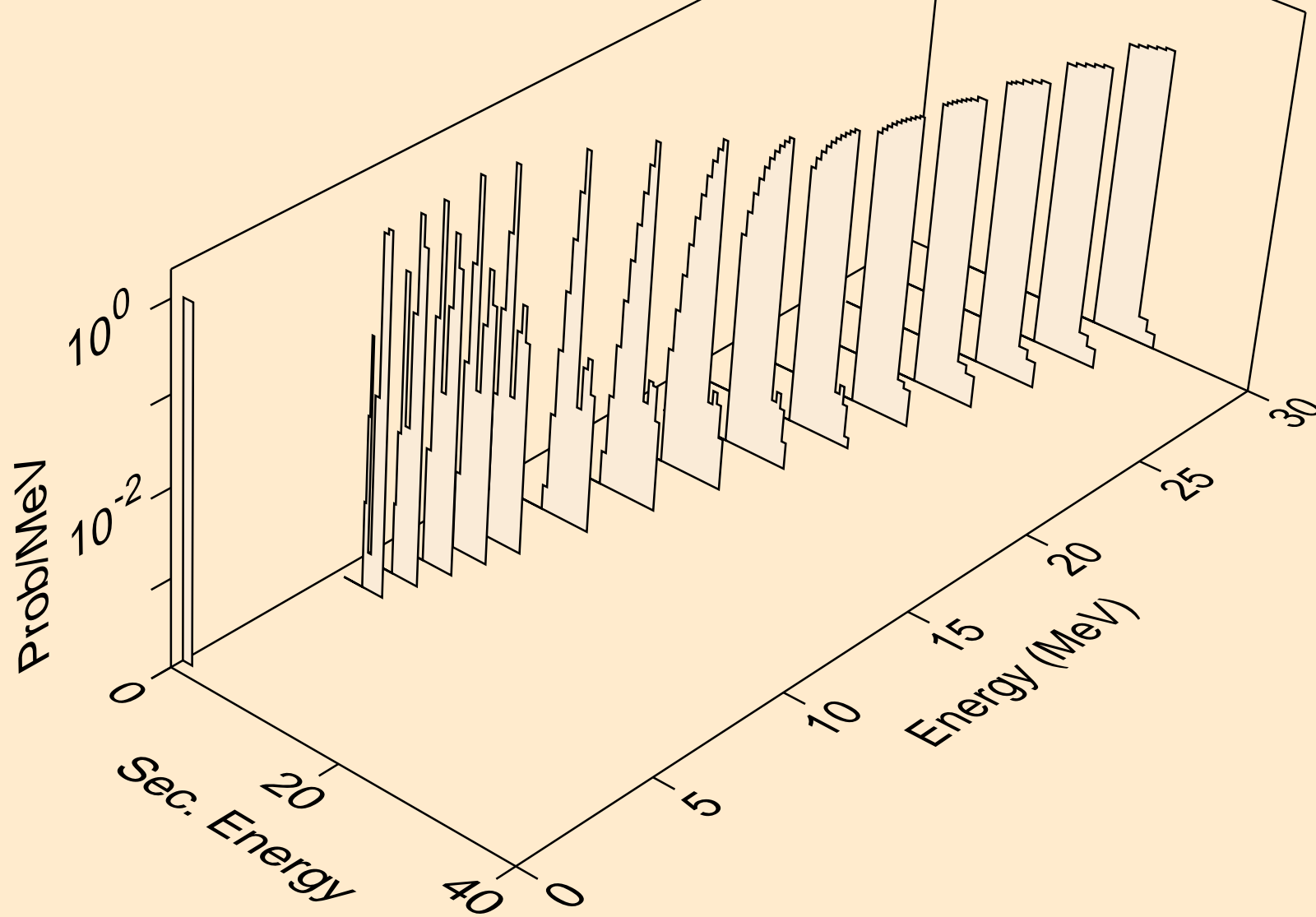

CM237 DEUTERON ACER TENDL-2023 LIBRARY; T=0.K
he3s from (d,x)

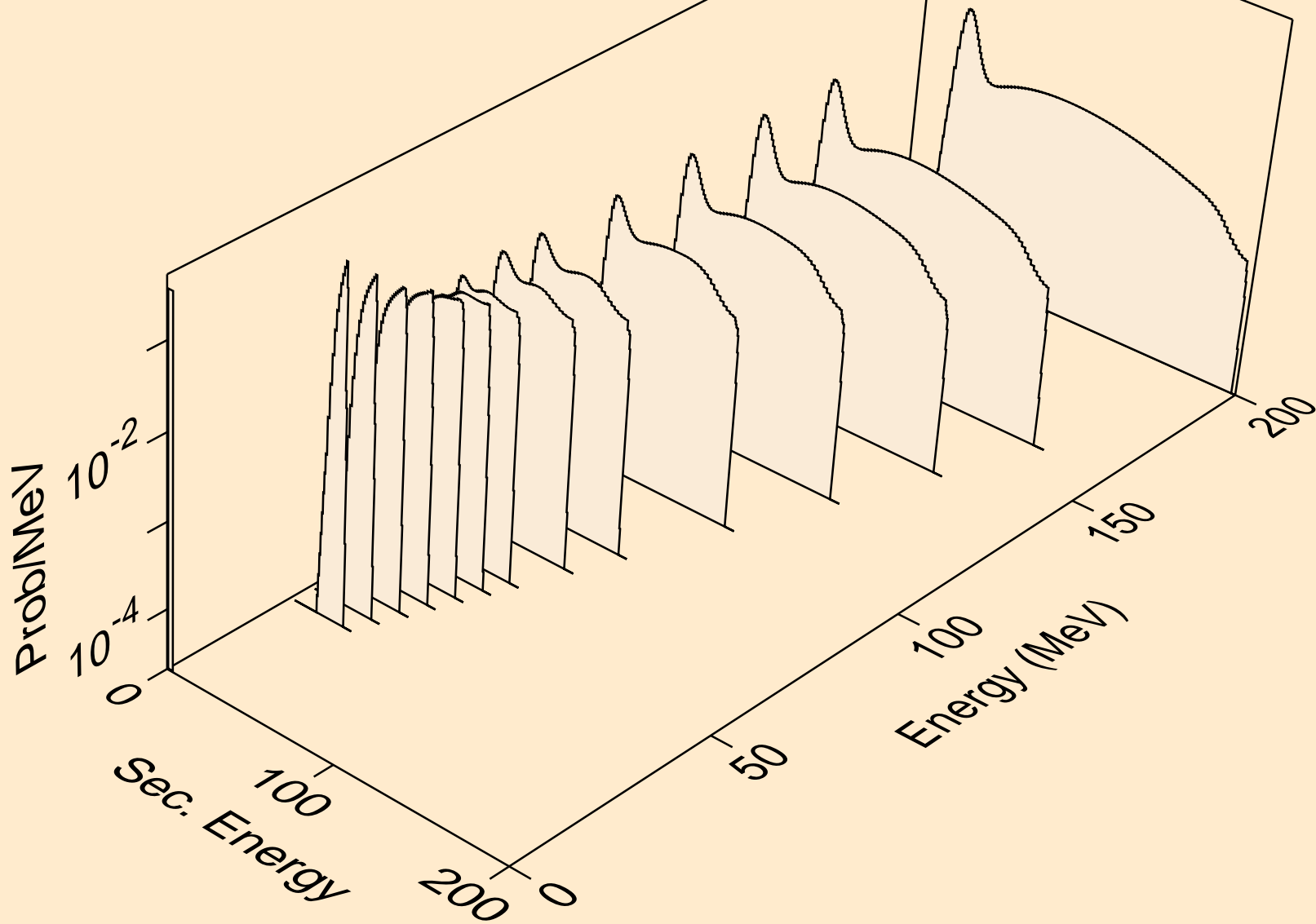

CM237 DEUTERON ACER TENDL-2023 LIBRARY; T=0.K
he3s from (d,n*)he3

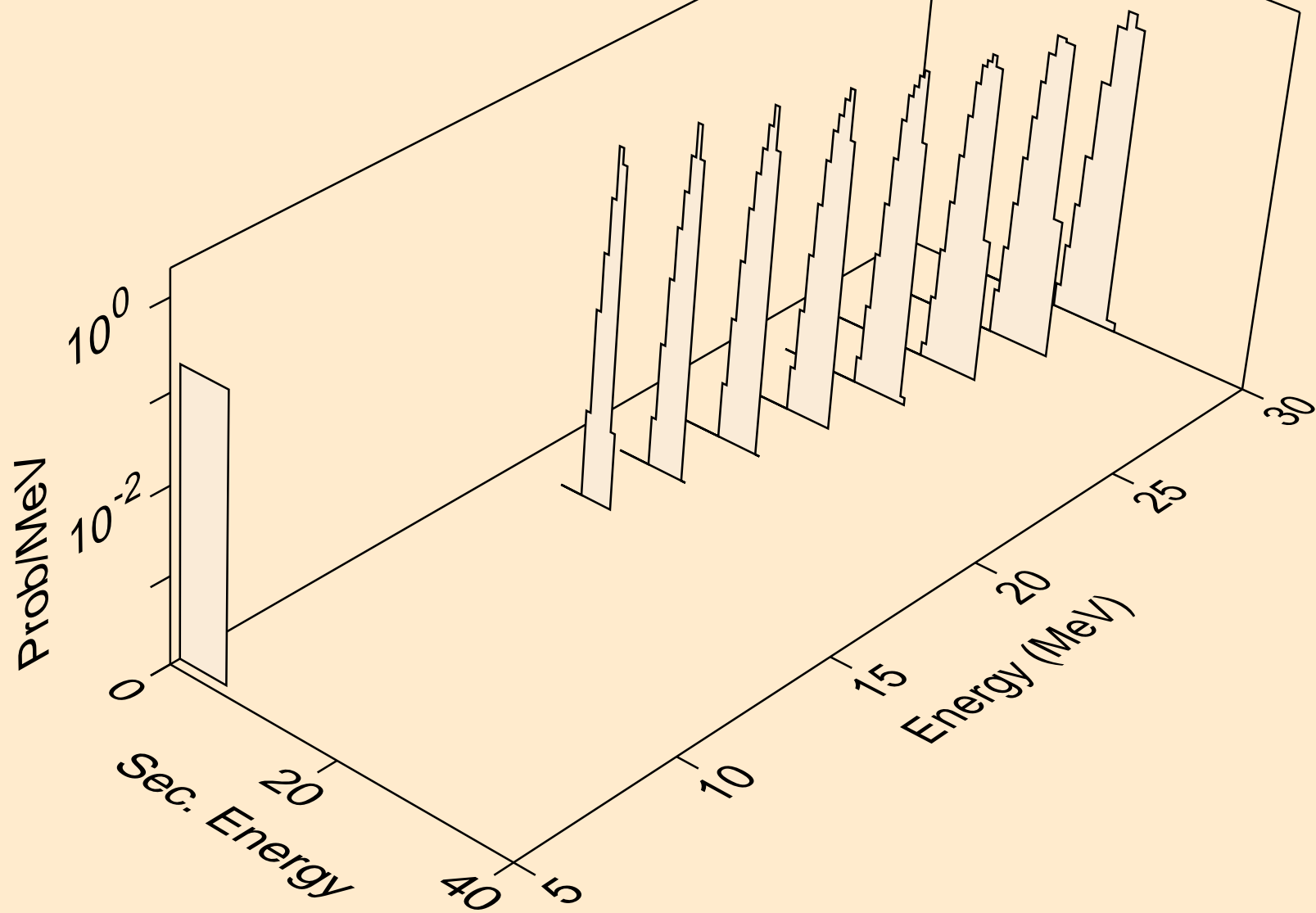

CM237 DEUTERON ACER TENDL-2023 LIBRARY; T=0.K
he3s from (d,he3)

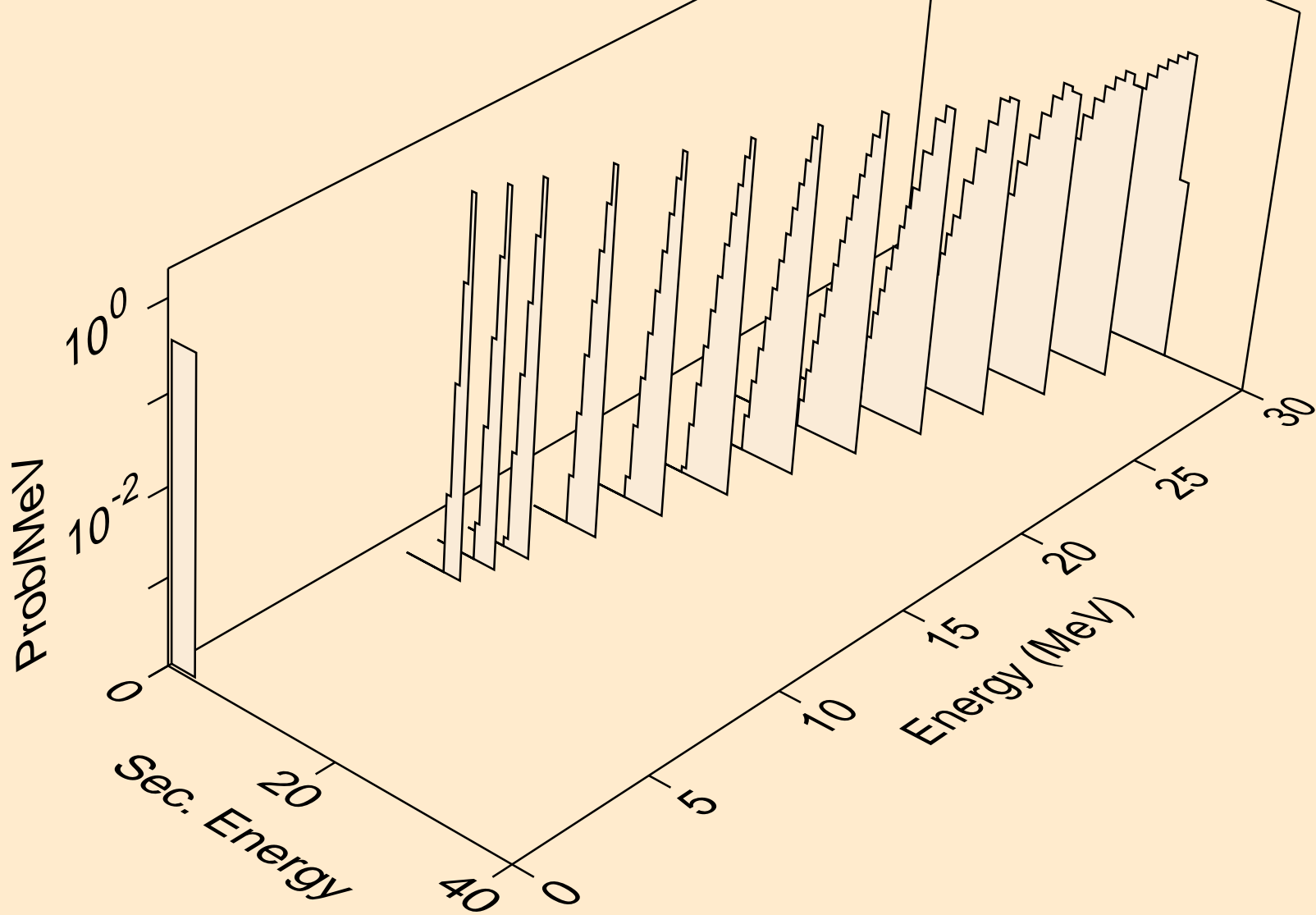

CM237 DEUTERON ACER TENDL-2023 LIBRARY; T=0.K
alphas from (d,x)

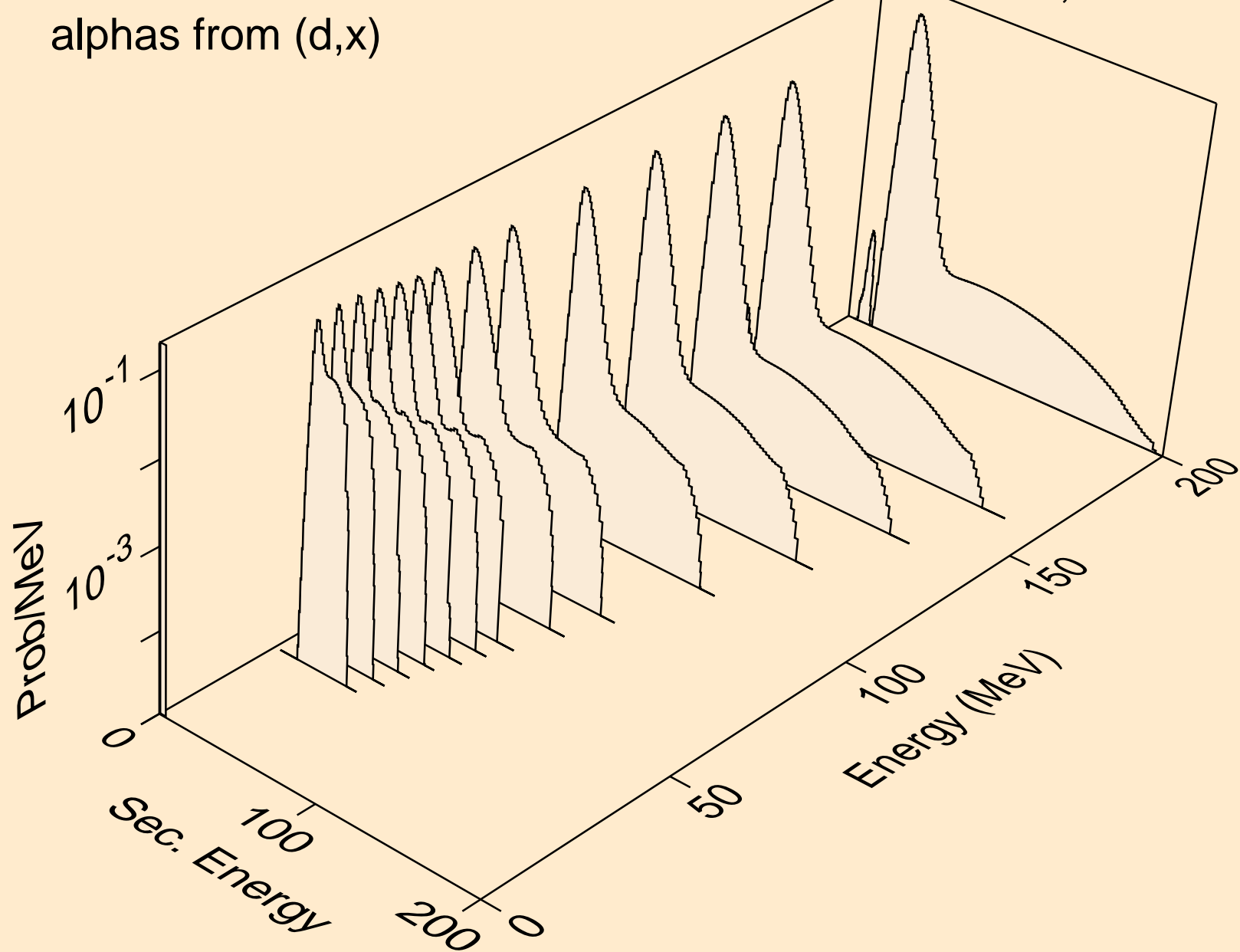

CM237 DEUTERON ACER TENDL-2023 LIBRARY; T=0.K
alphas from (d,n*)a

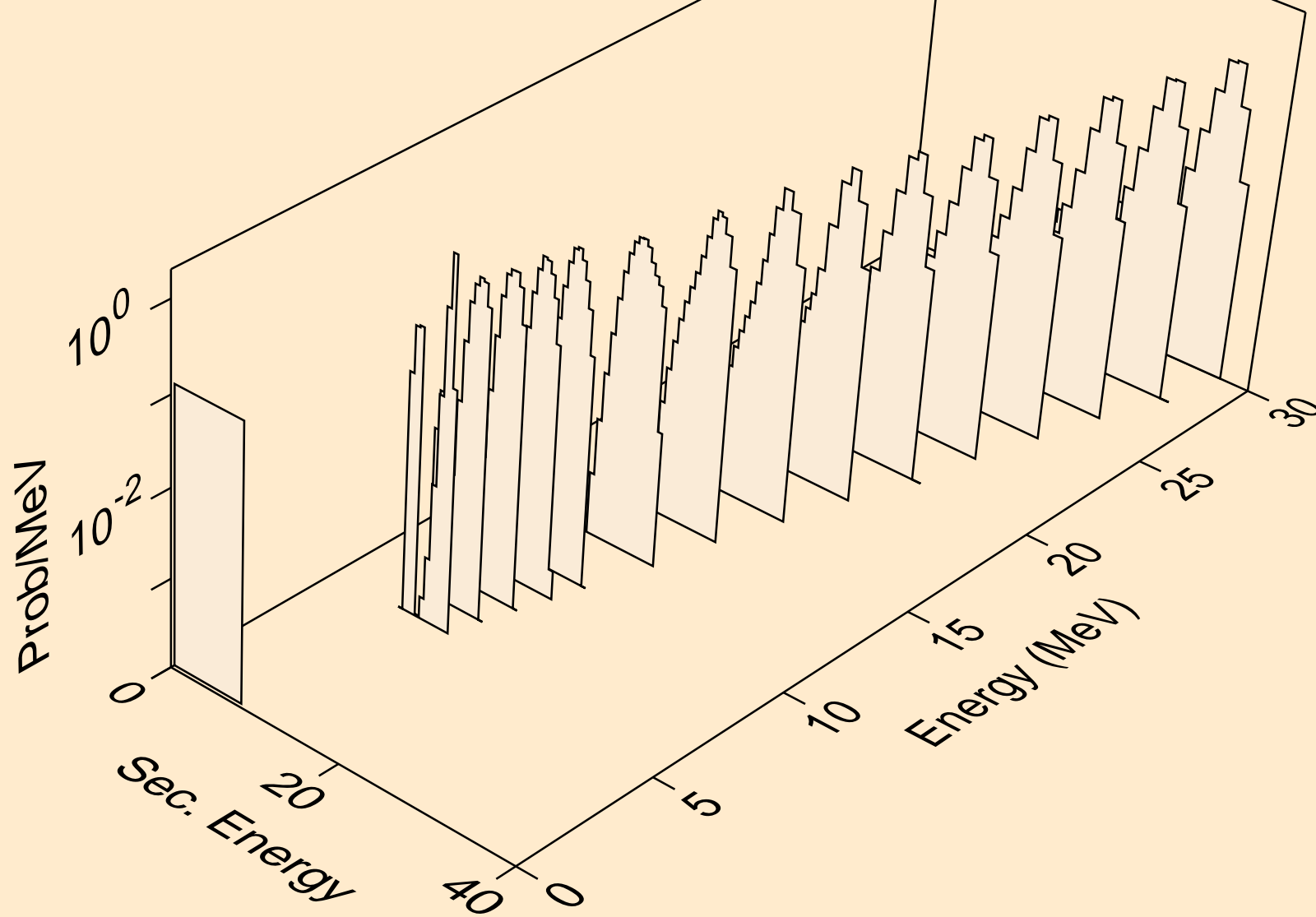

CM237 DEUTERON ACER TENDL-2023 LIBRARY; T=0.K
alphas from (d,2n)a

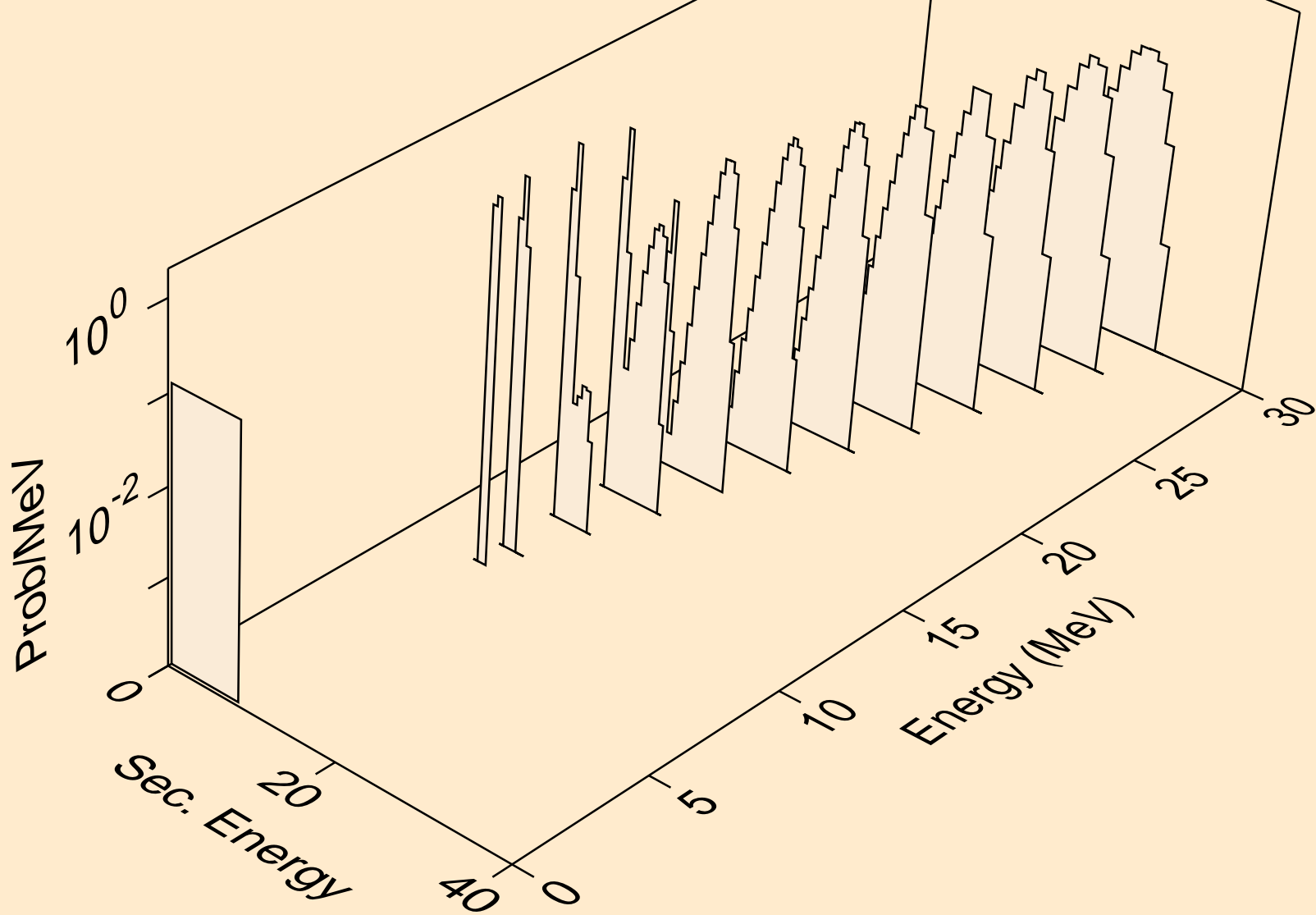

CM237 DEUTERON ACER TENDL-2023 LIBRARY; T=0.K
alphas from (d,npa)

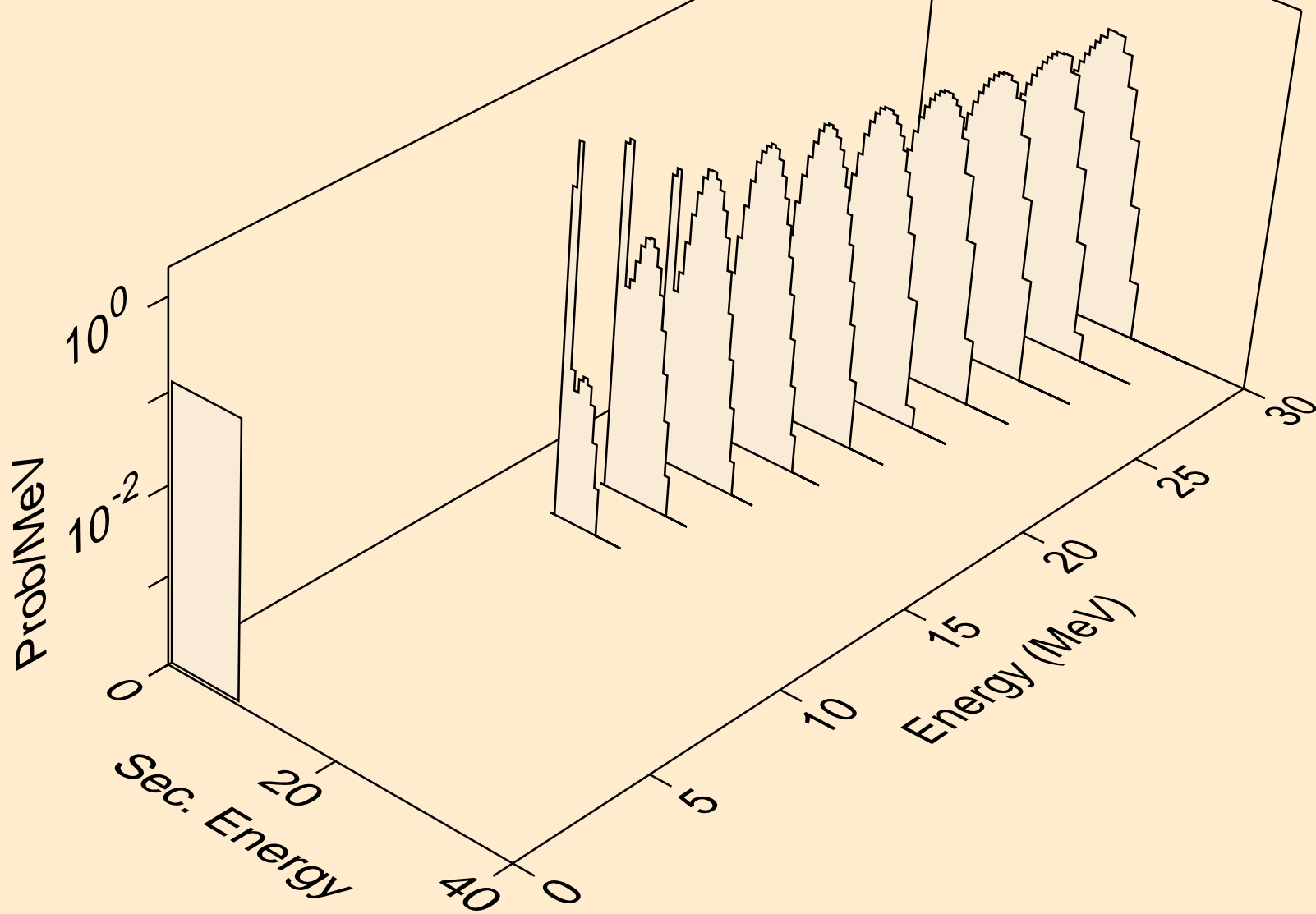

CM237 DEUTERON ACER TENDL-2023 LIBRARY; T=0.K
alphas from (d,a)

