

DB257 DEUTERON ACER TENDL-2023 LIBRARY; T=0.K  
Principal cross sections

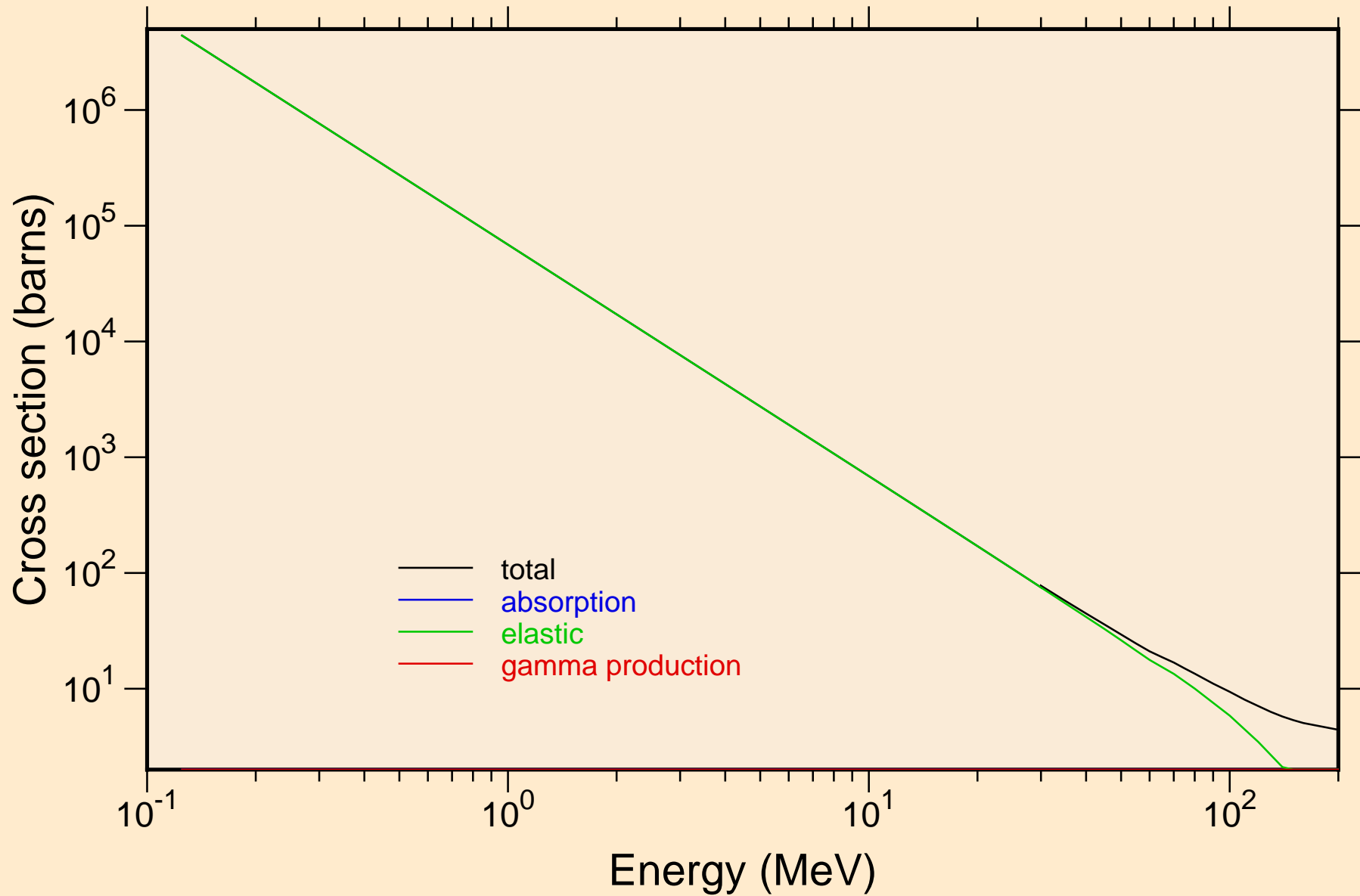

DB257 DEUTERON ACER TENDL-2023 LIBRARY; T=0.K  
Heating

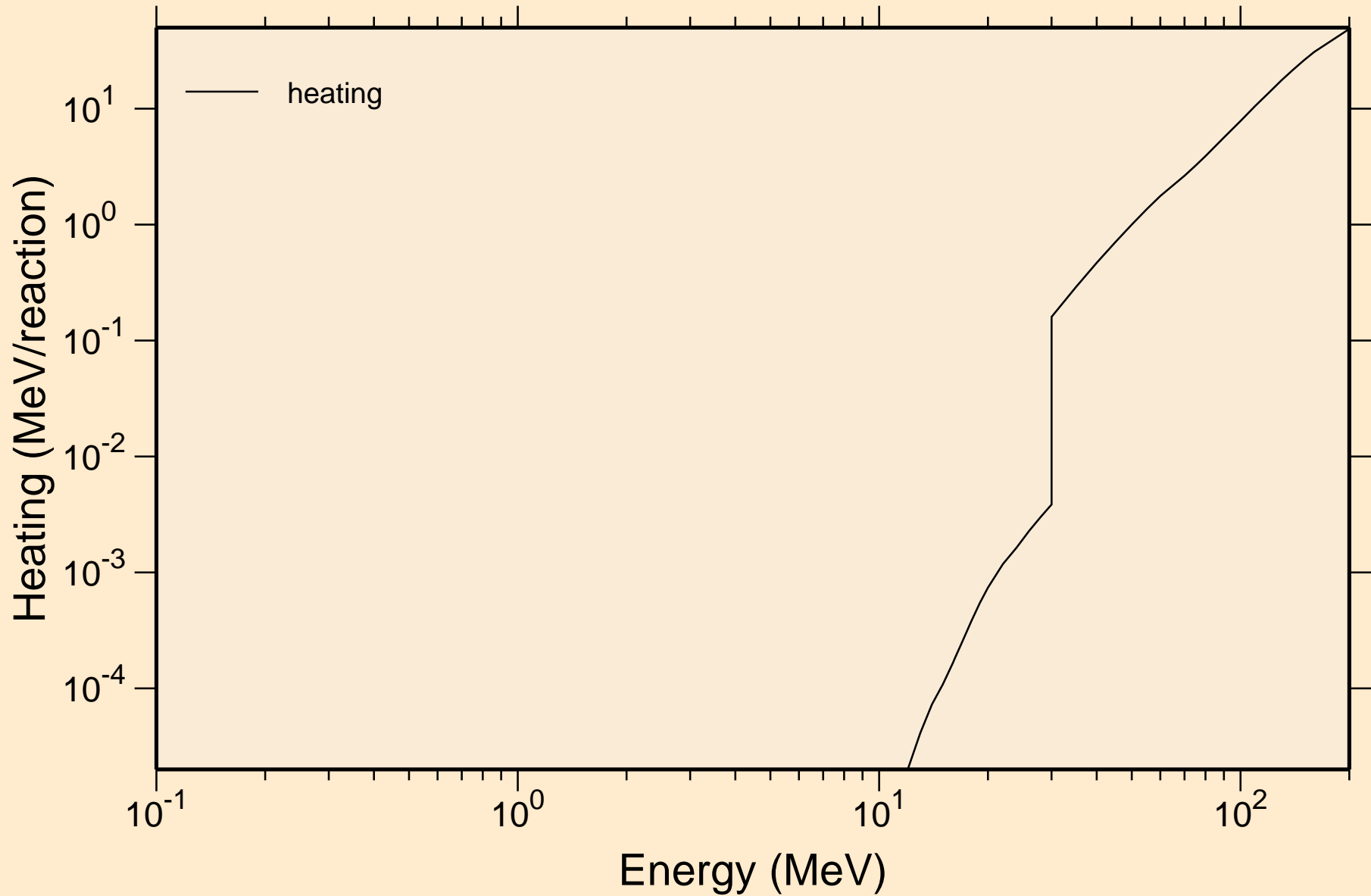

DB257 DEUTERON ACER TENDL-2023 LIBRARY; T=0.K  
Principal cross sections

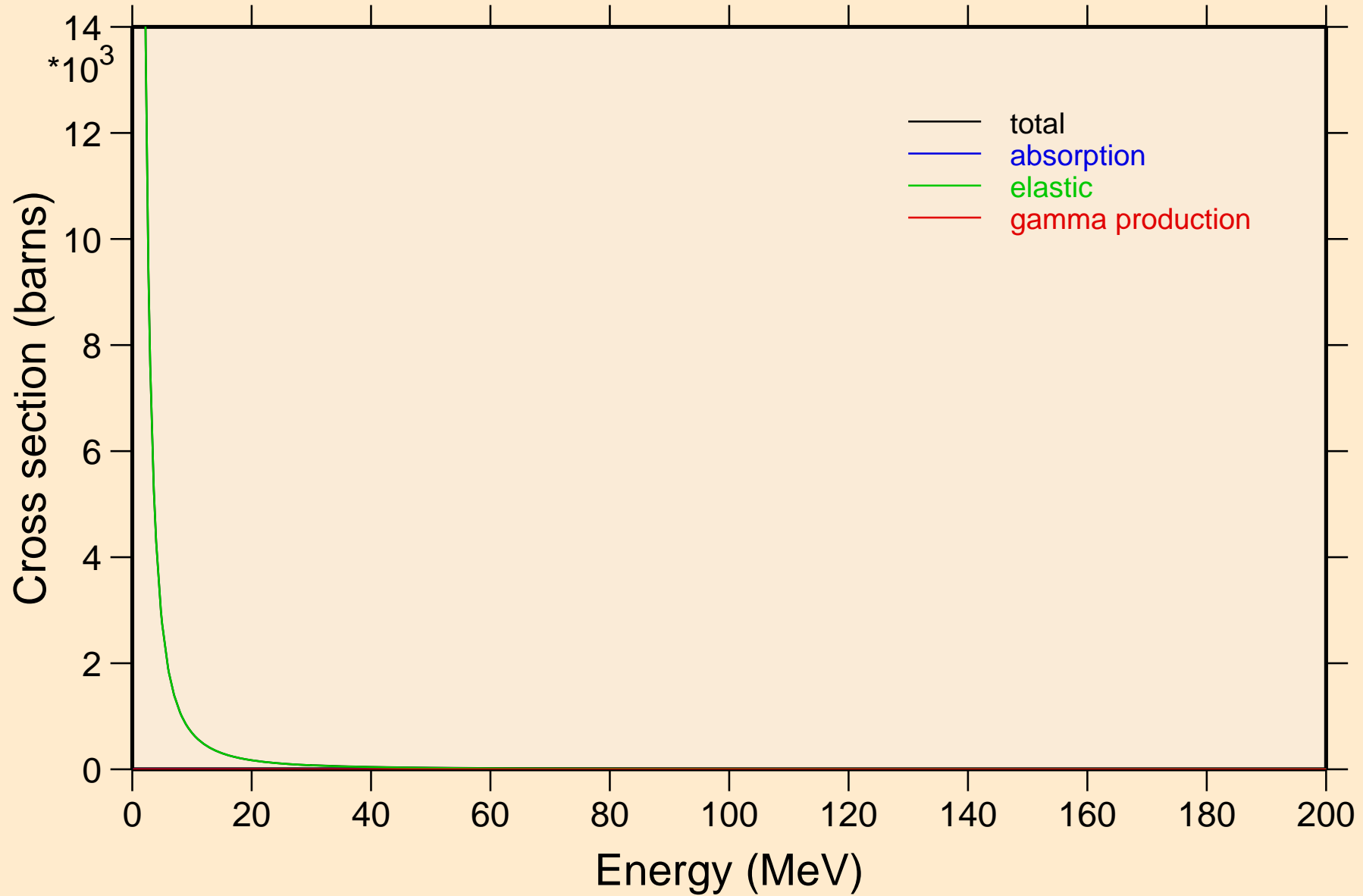

DB257 DEUTERON ACER TENDL-2023 LIBRARY; T=0.K

Heating

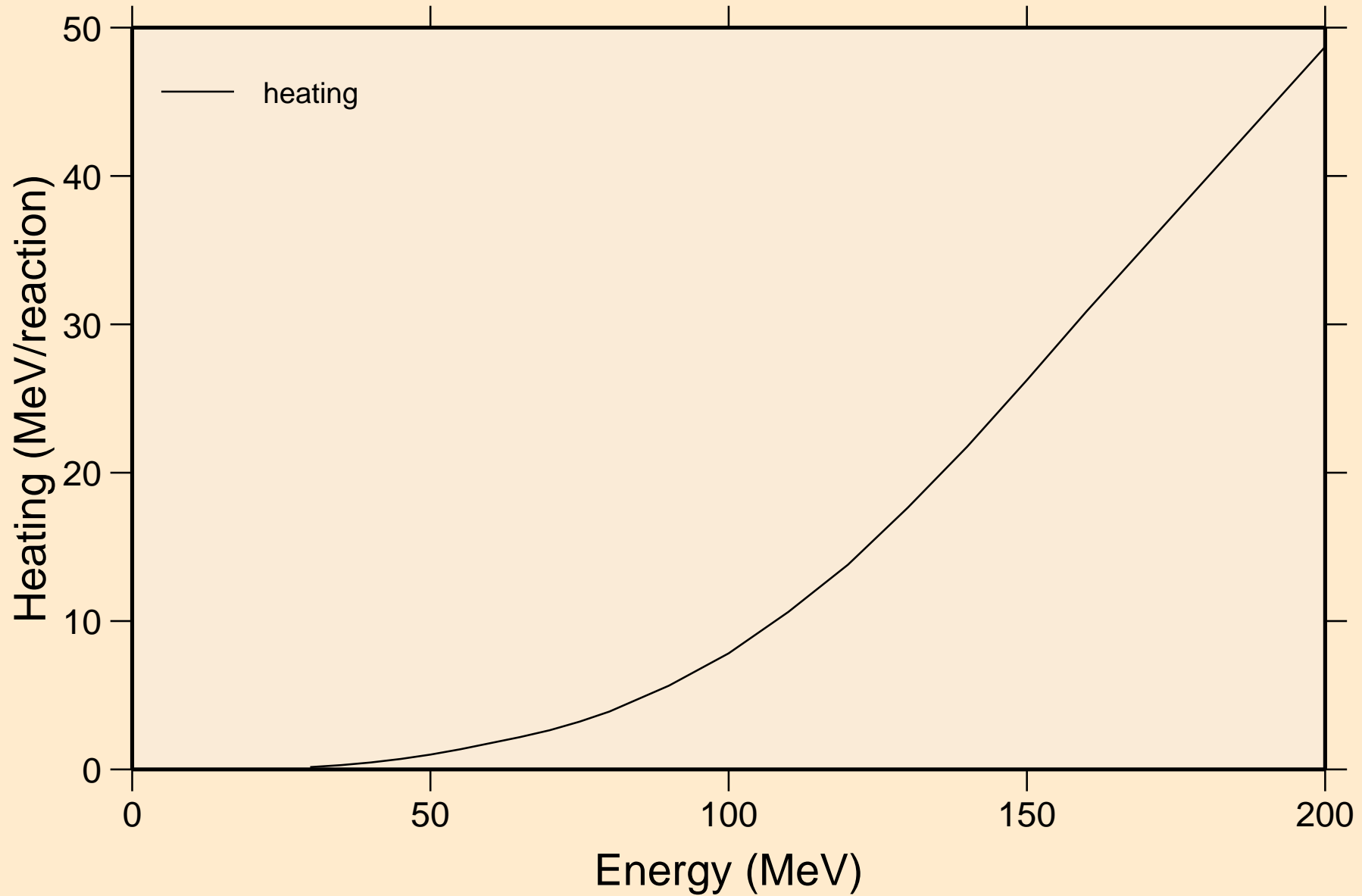

DB257 DEUTERON ACER TENDL-2023 LIBRARY; T=0.K  
Threshold reactions

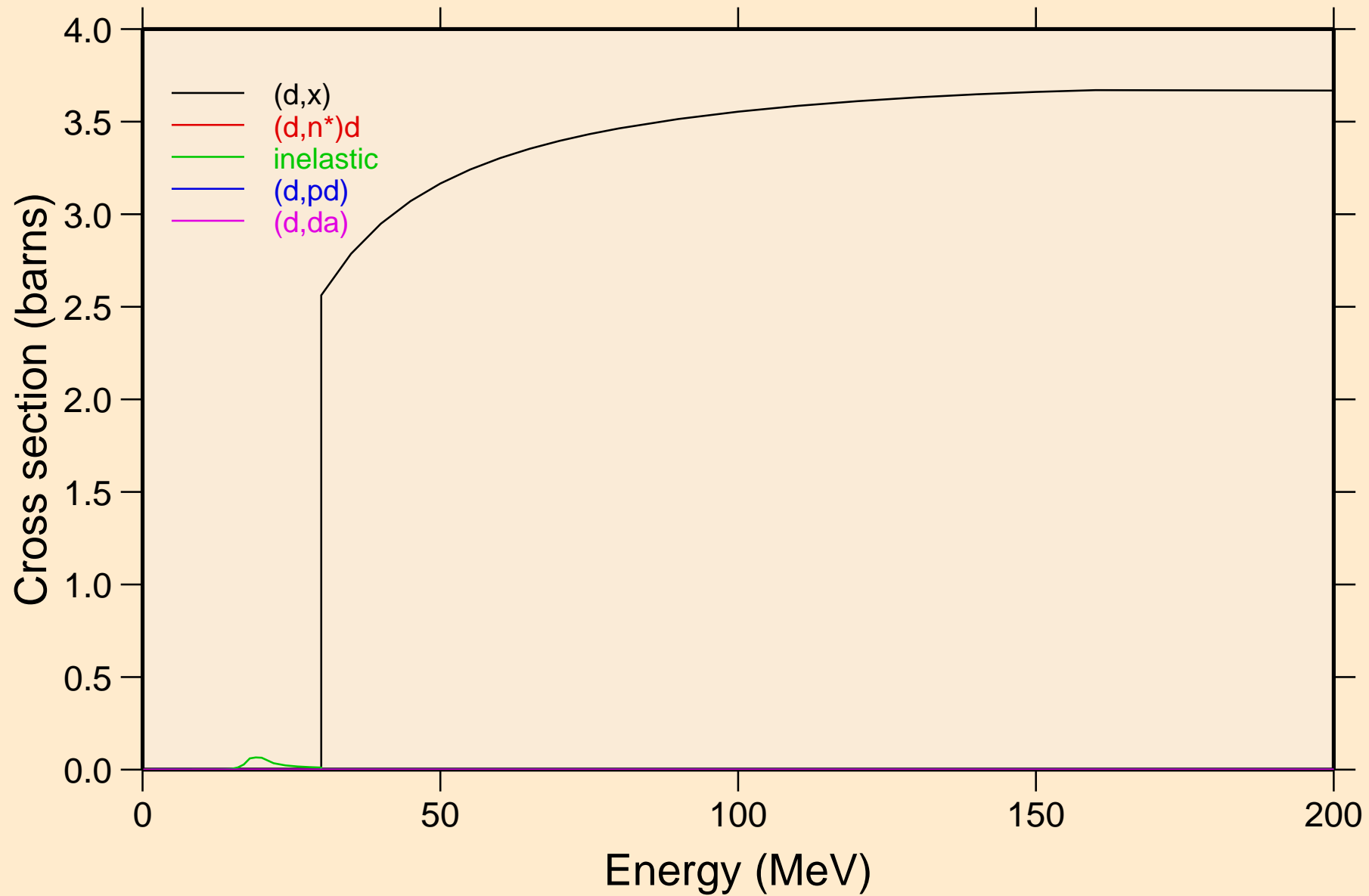

DB257 DEUTERON ACER TENDL-2023 LIBRARY; T=0.K  
angular distribution for elastic

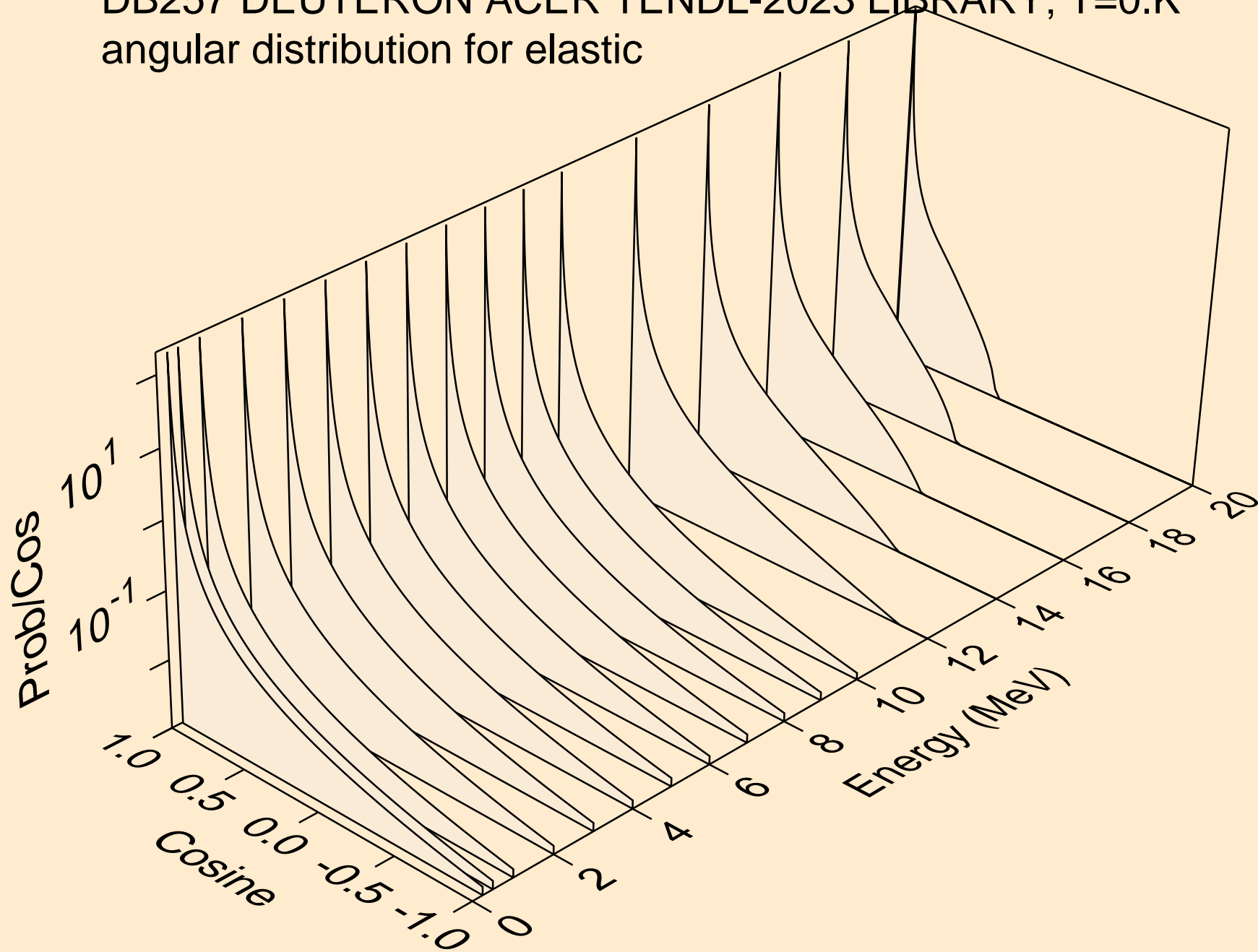

DB257 DEUTERON ACER TENDL-2023 LIBRARY; T=0.K  
angular distribution for elastic

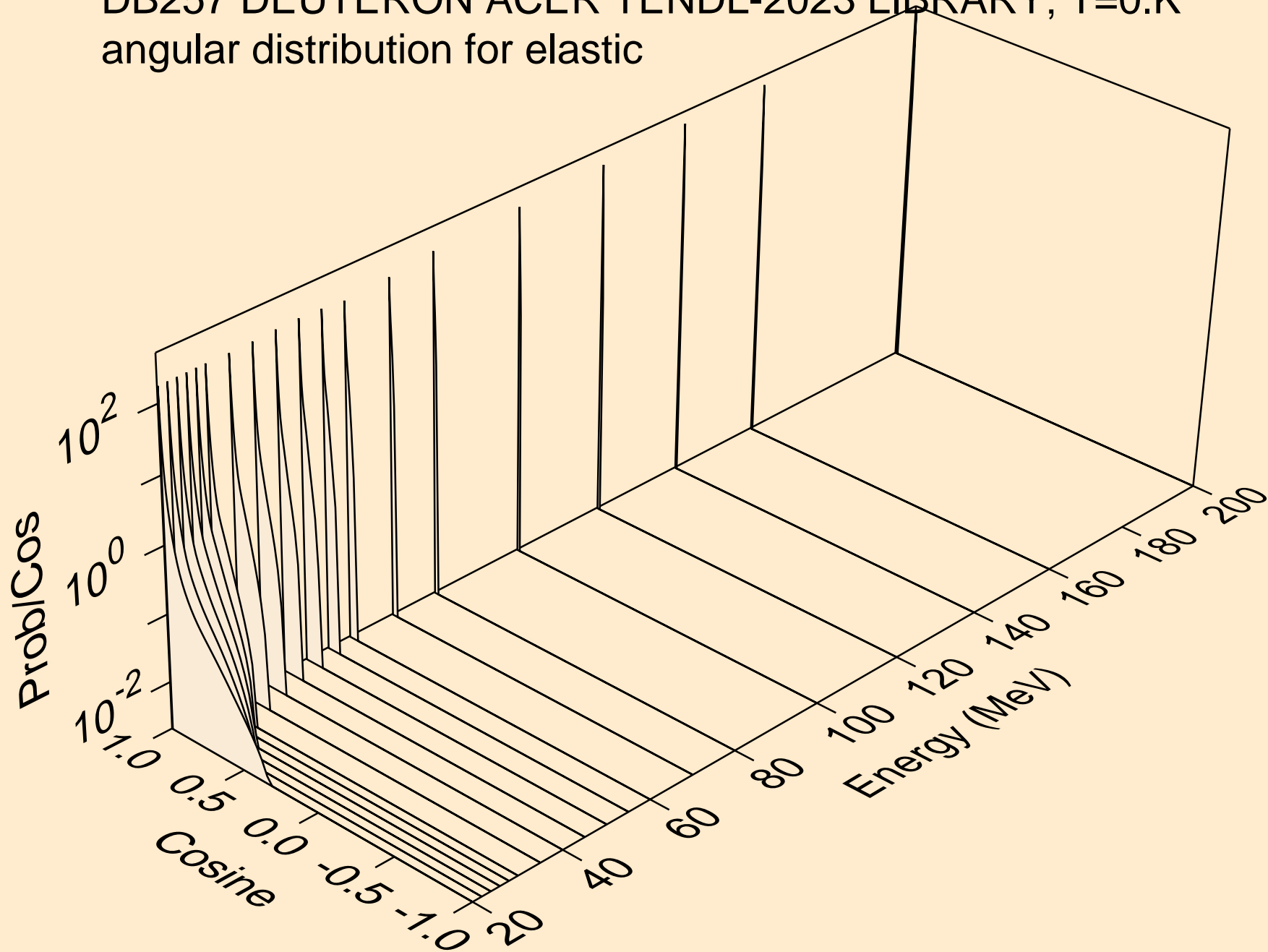

DB257 DEUTERON ACER TENDL-2023 LIBRARY; T=0.K  
Deuteron emission for (d,x)

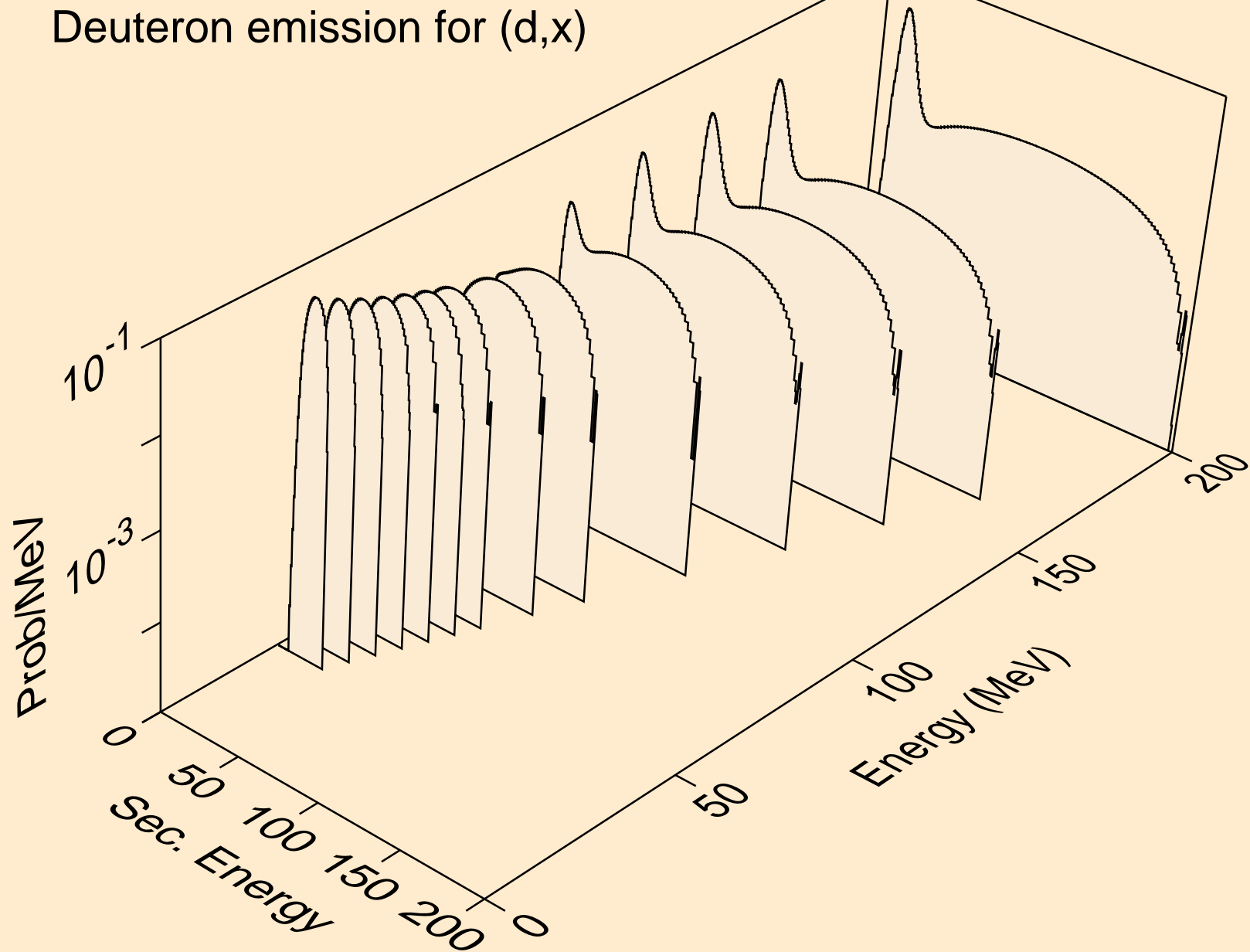



DB257 DEUTERON ACER TENDL-2023 LIBRARY; T=0.K  
Deuteron emission for (d,n\*)d

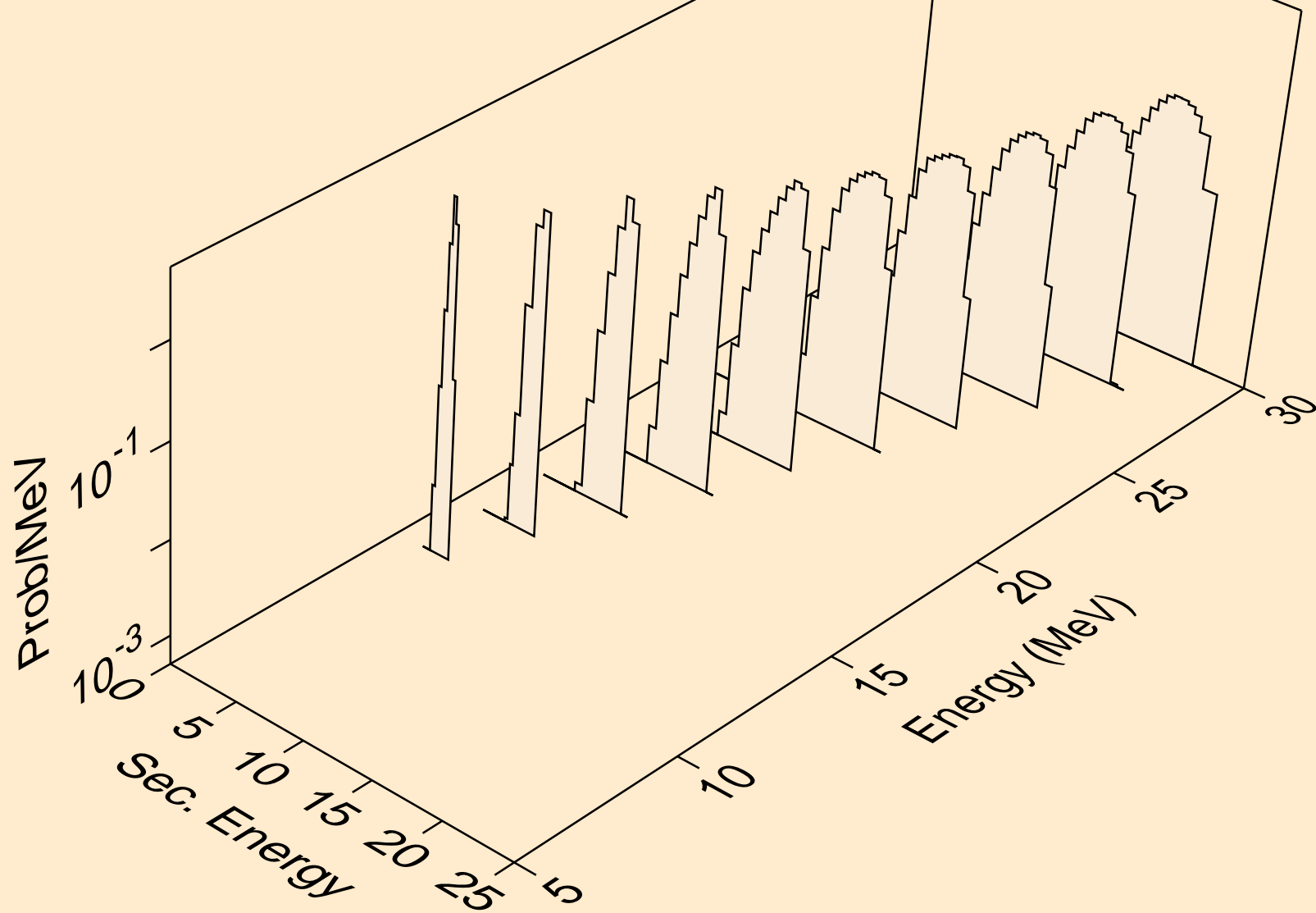

DB257 DEUTERON ACER TENDL-2023 LIBRARY; T=0.K  
Deuteron emission for inelastic

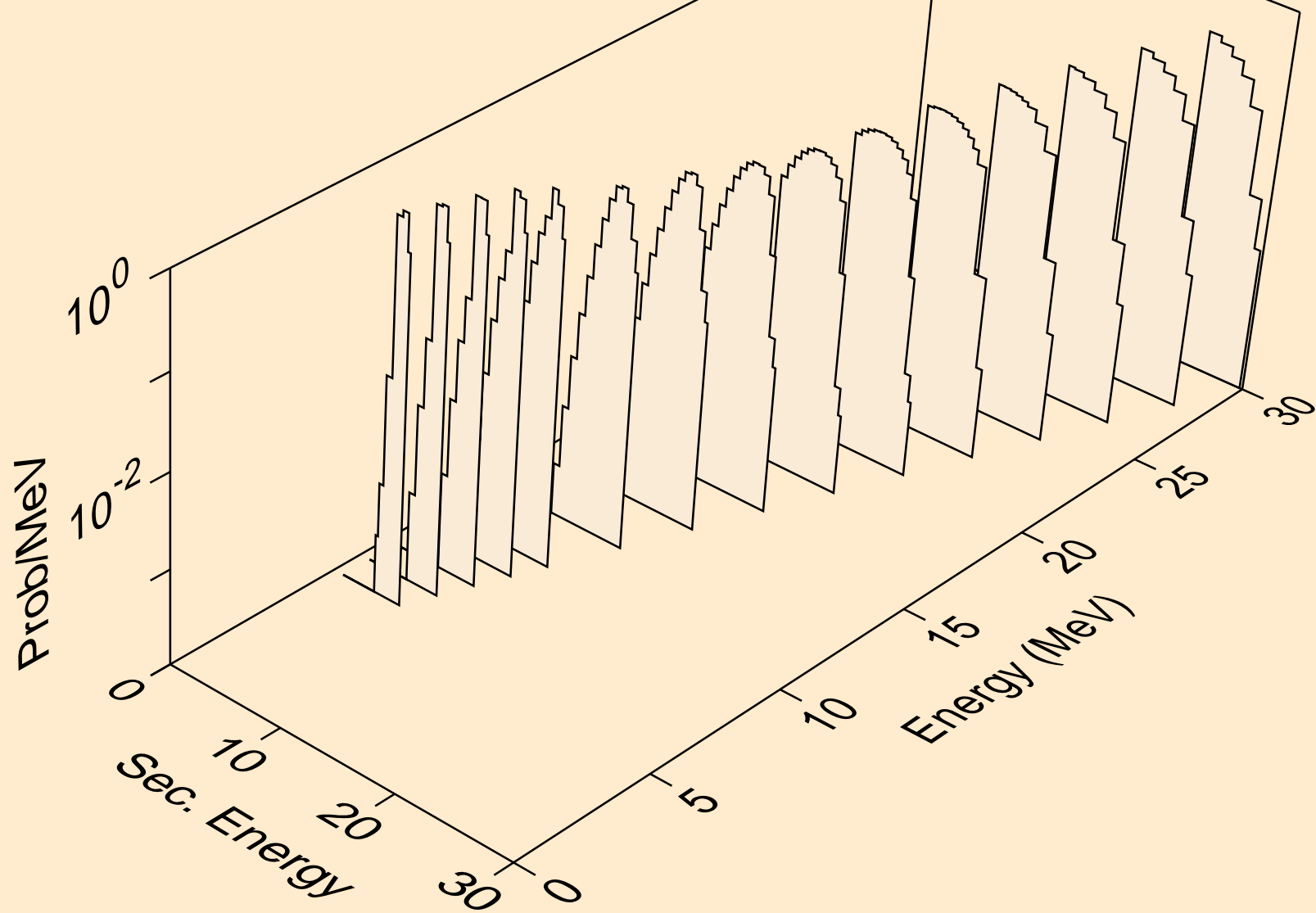

DB257 DEUTERON ACER TENDL-2023 LIBRARY; T=0.K  
Deuteron emission for (d,pd)

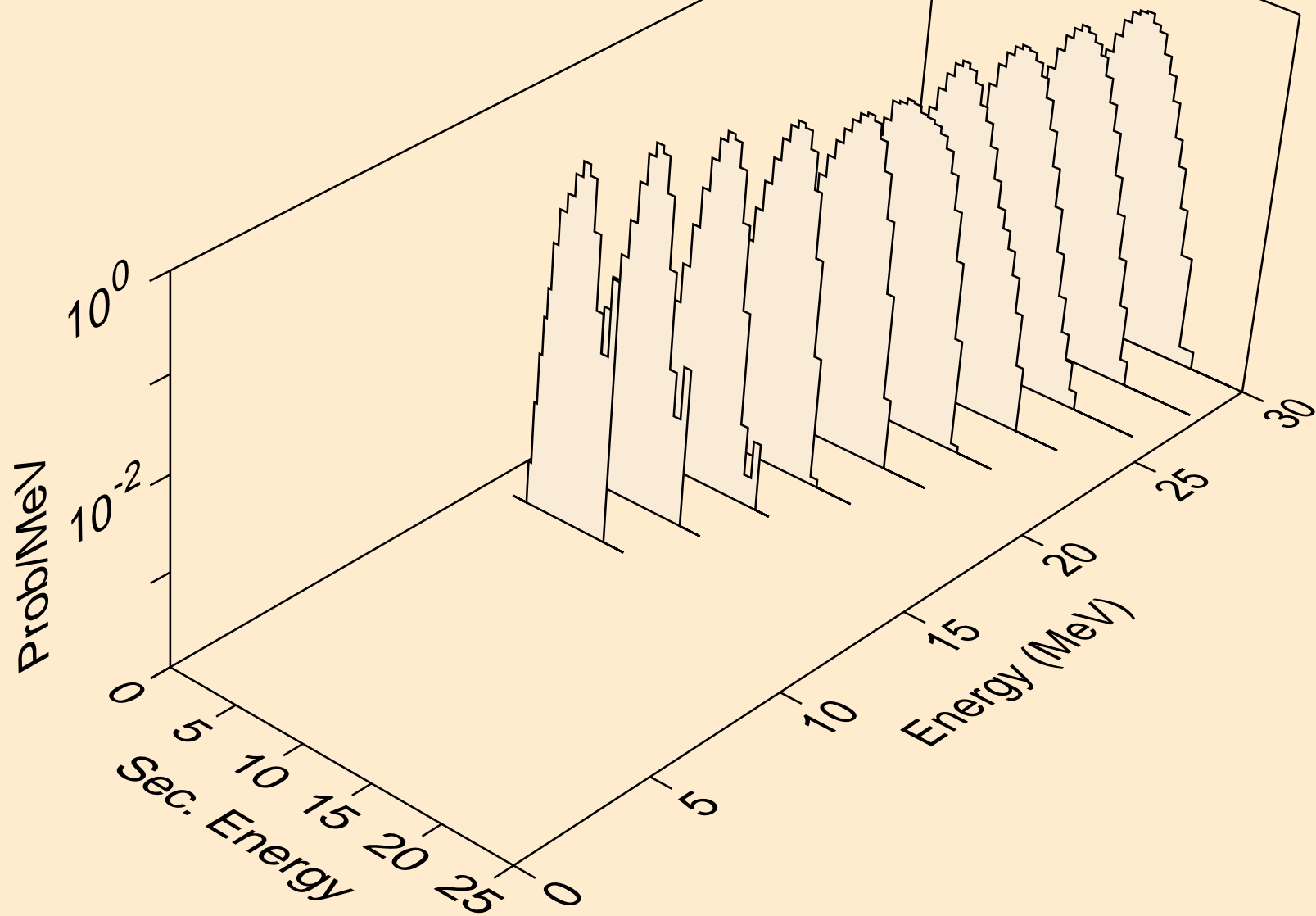

DB257 DEUTERON ACER TENDL-2023 LIBRARY; T=0.K  
Deuteron emission for (d,da)

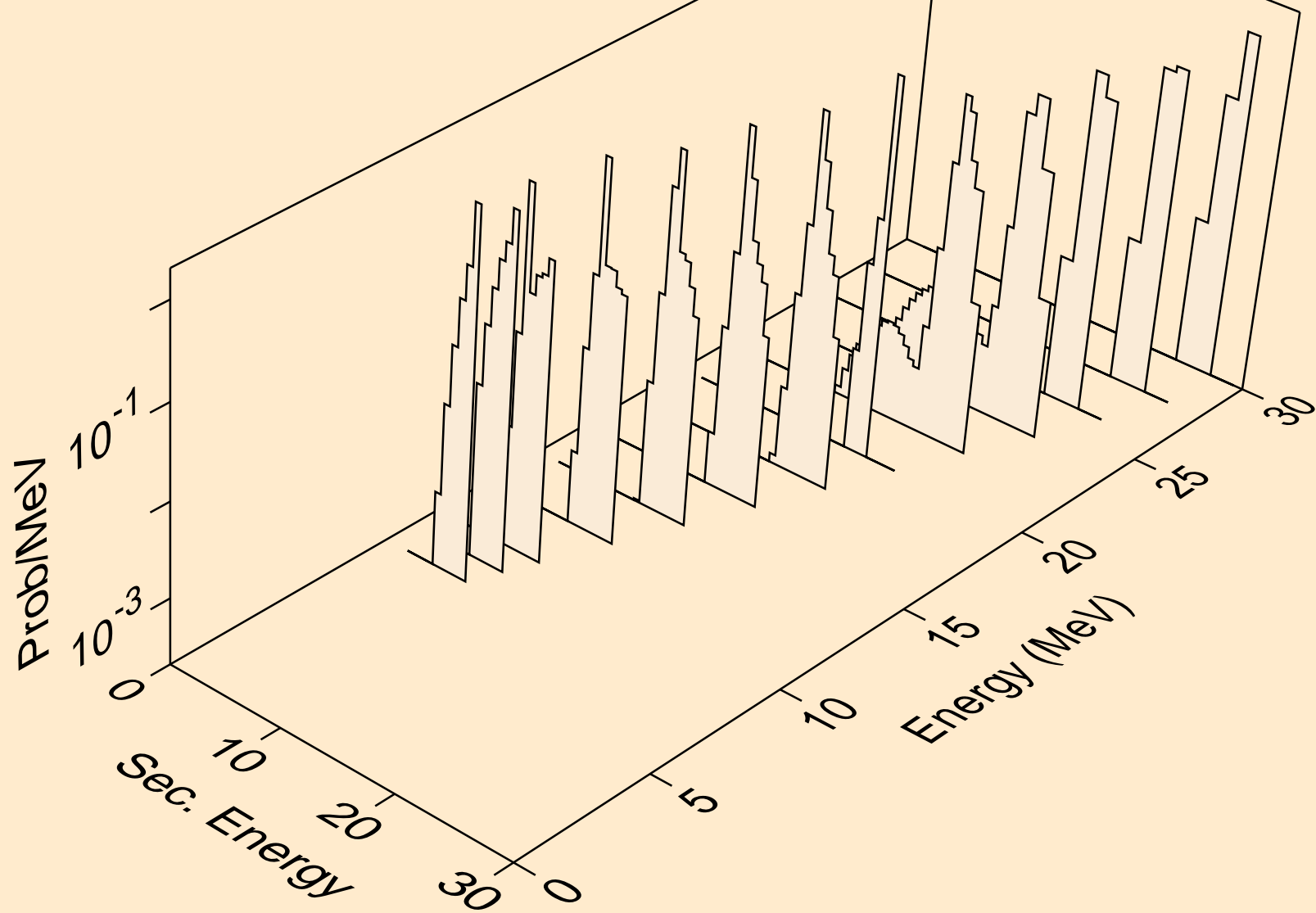

DB257 DEUTERON ACER TENDL-2023 LIBRARY; T=0.K  
Photon emission for (z,n)

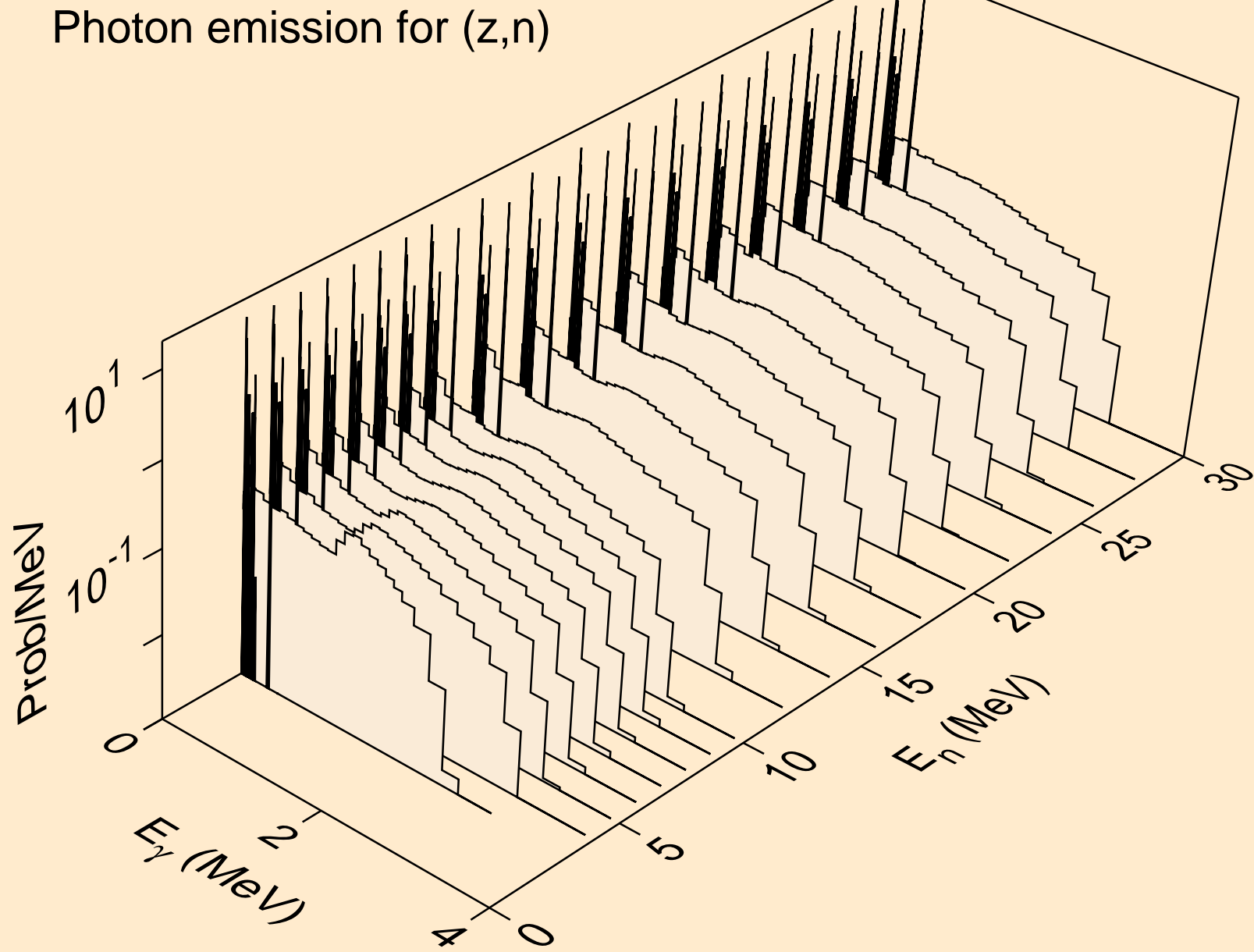

DB257 DEUTERON ACER TENDL-2023 LIBRARY; T=0.K  
Photon emission for (z,x)

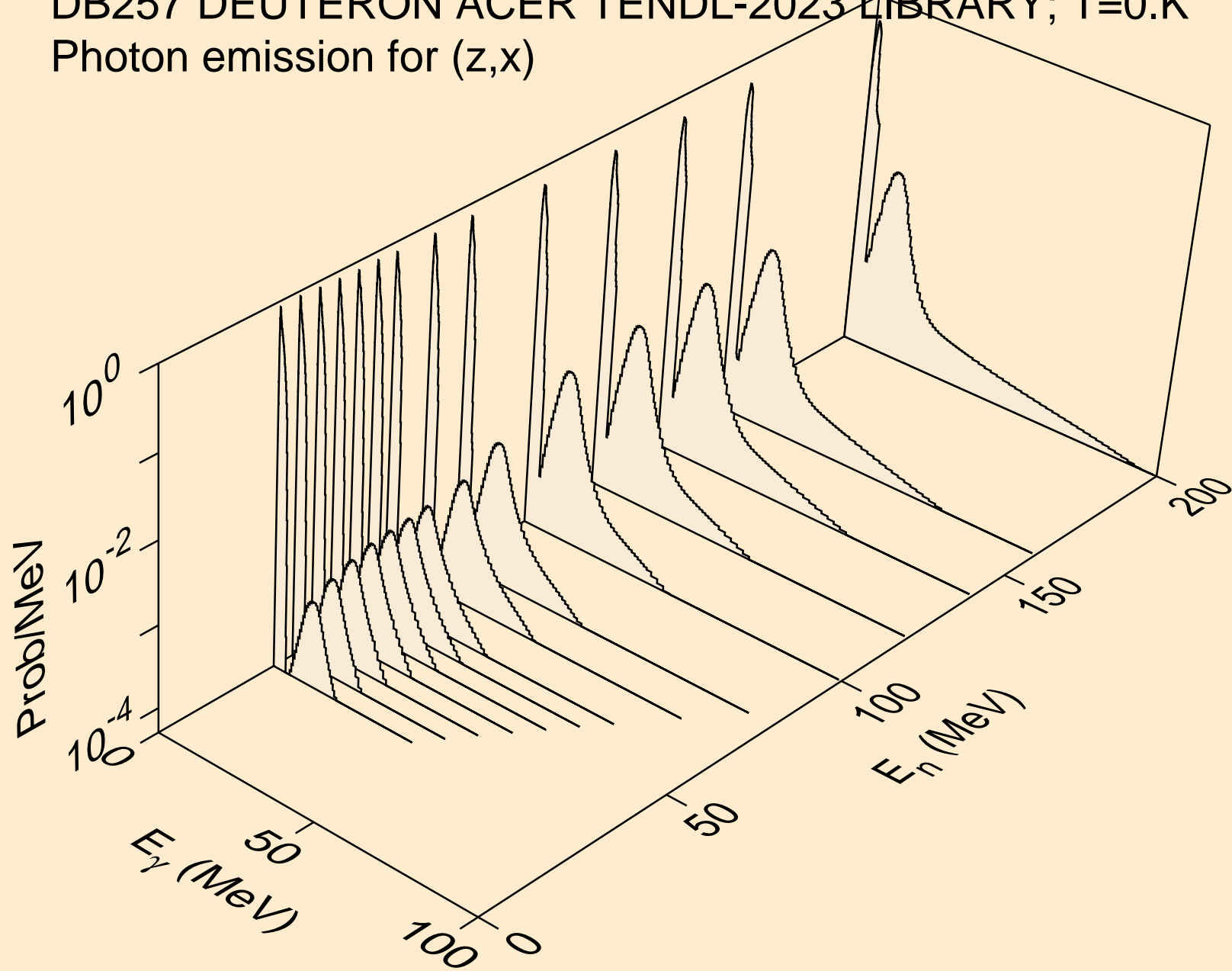

DB257 DEUTERON ACER TENDL-2023 LIBRARY; T=0.K  
Photon emission for (n,2n)

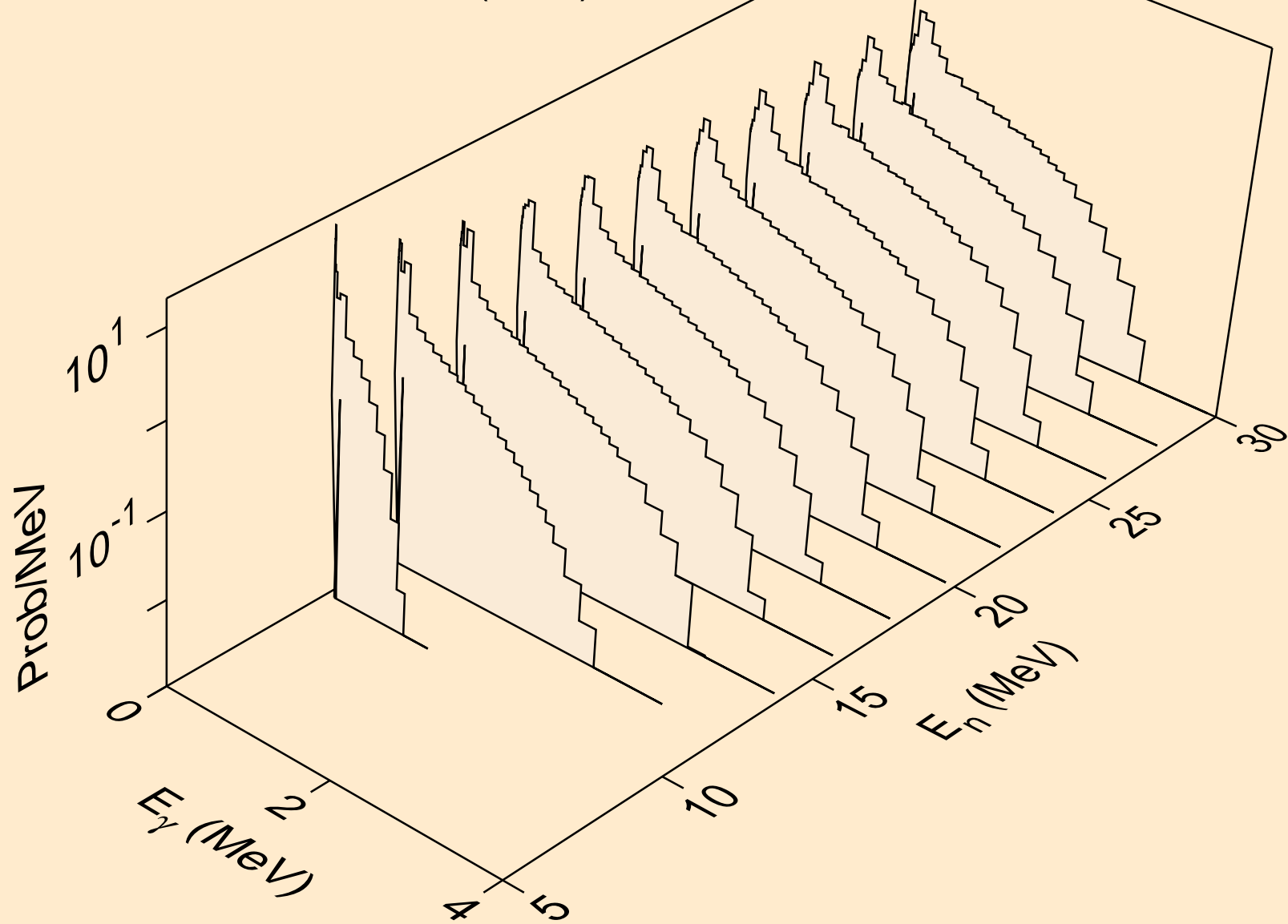

DB257 DEUTERON ACER TENDL-2023 LIBRARY; T=0.K  
Photon emission for (n,3n)

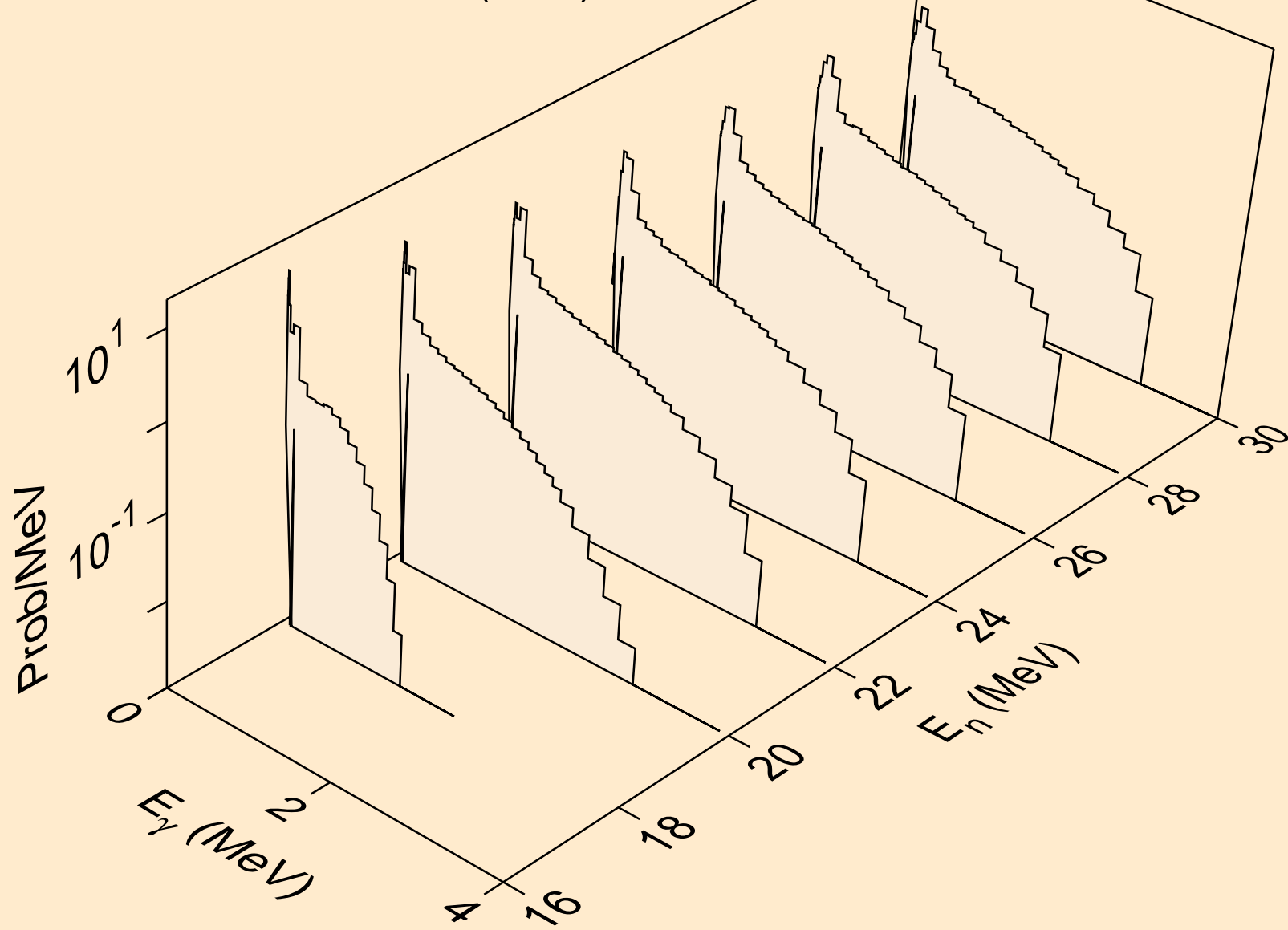



DB257 DEUTERON ACER TENDL-2023 LIBRARY; T=0.K  
Photon emission for (n,n\*)a

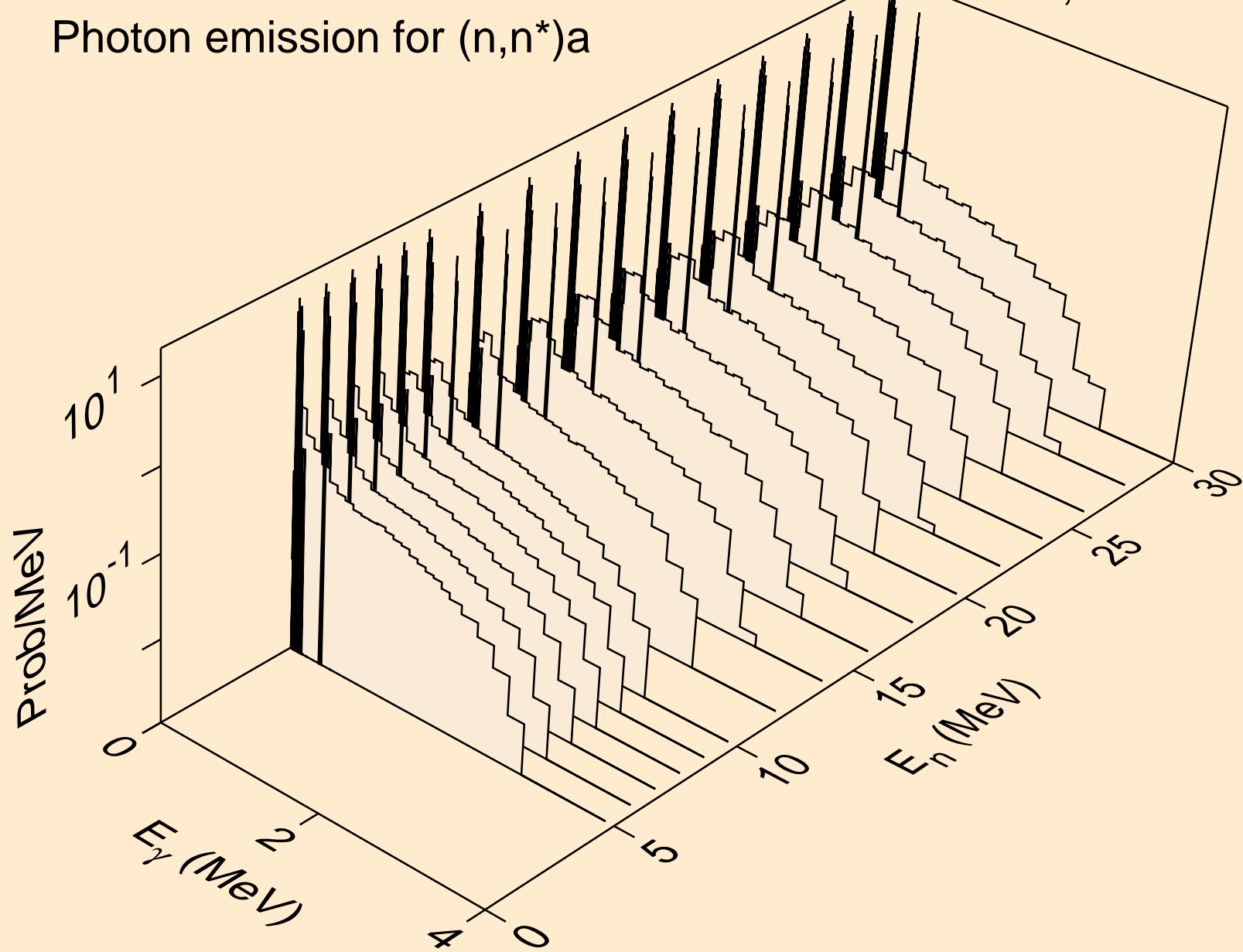

DB257 DEUTERON ACER TENDL-2023 LIBRARY; T=0.K  
Photon emission for (n,2n)a

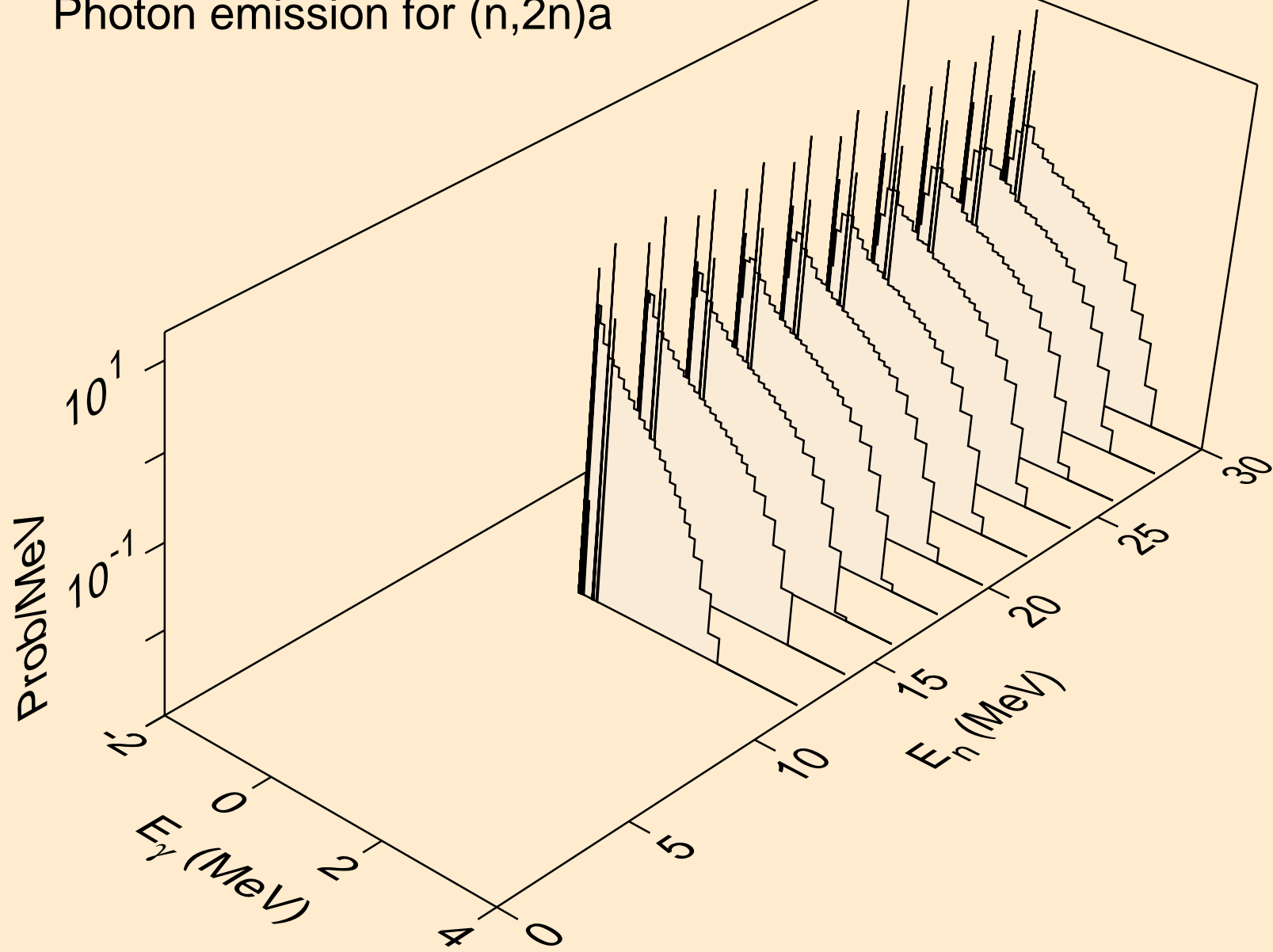

DB257 DEUTERON ACER TENDL-2023 LIBRARY; T=0.K  
Photon emission for (n,3n)a

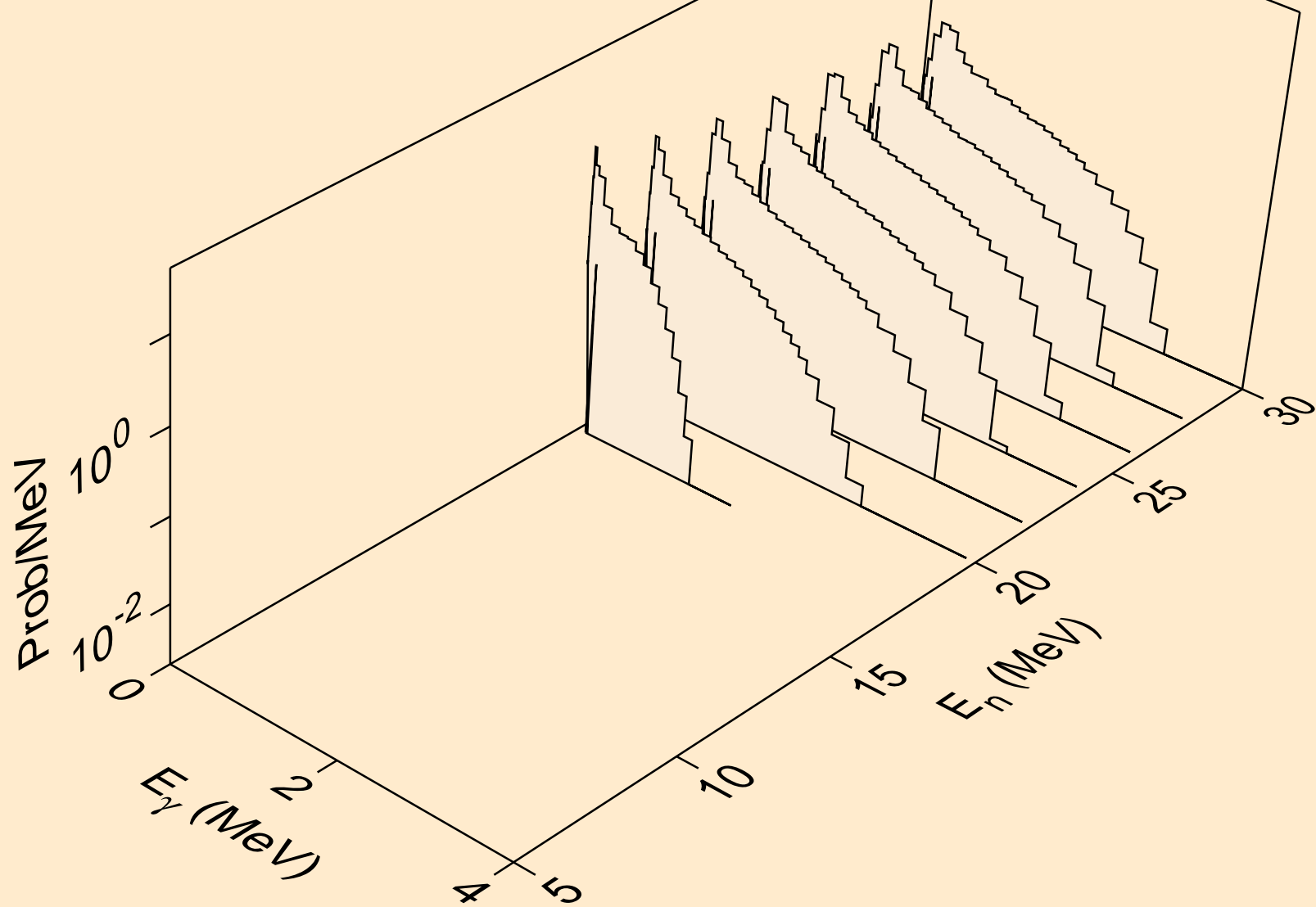

DB257 DEUTERON ACER TENDL-2023 LIBRARY; T=0.K  
Photon emission for (n,n\*)p

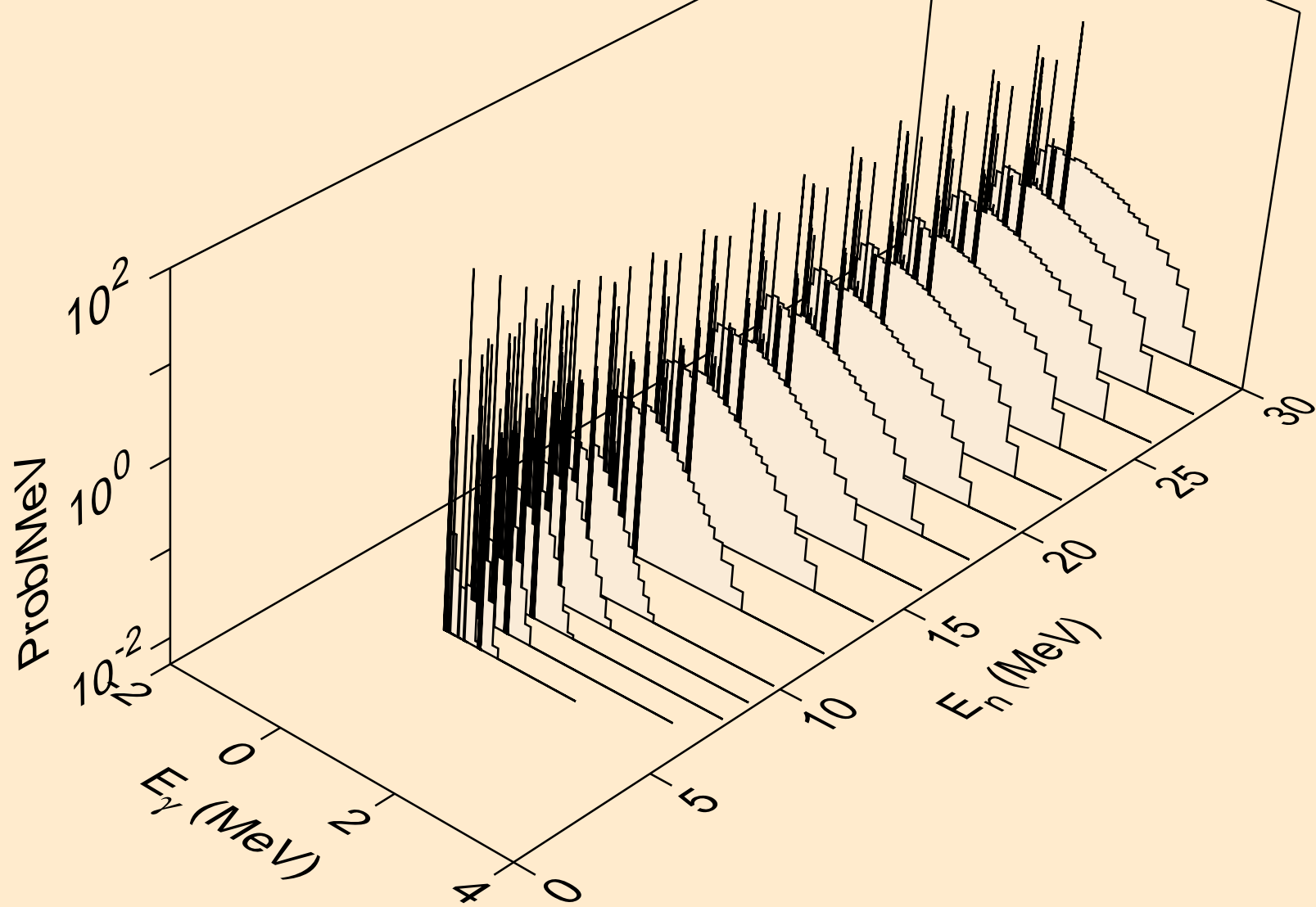

DB257 DEUTERON ACER TENDL-2023 LIBRARY; T=0.K  
Photon emission for (n,n\*)d

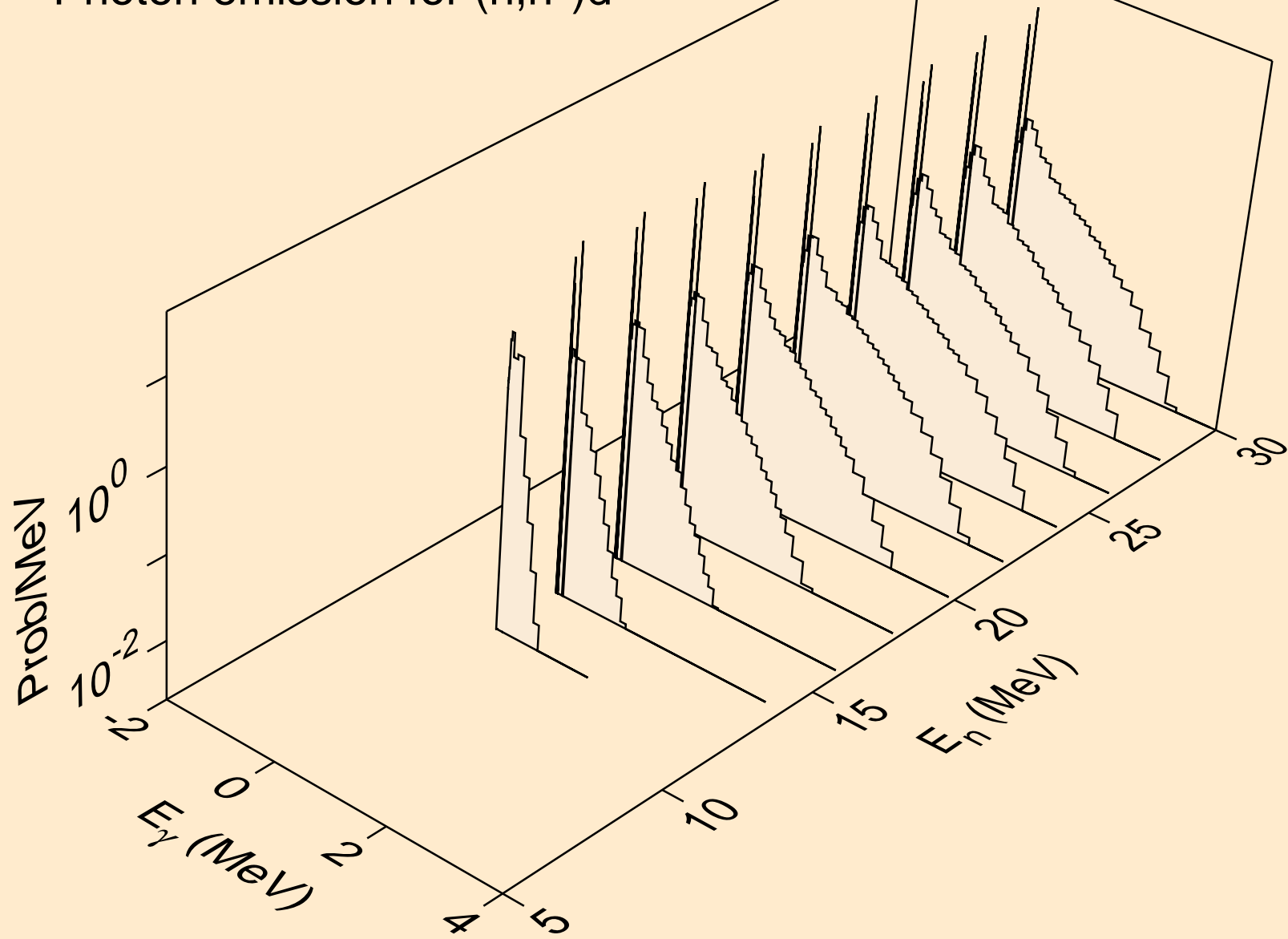

DB257 DEUTERON ACER TENDL-2023 LIBRARY; T=0.K  
Photon emission for (n,n\*)t

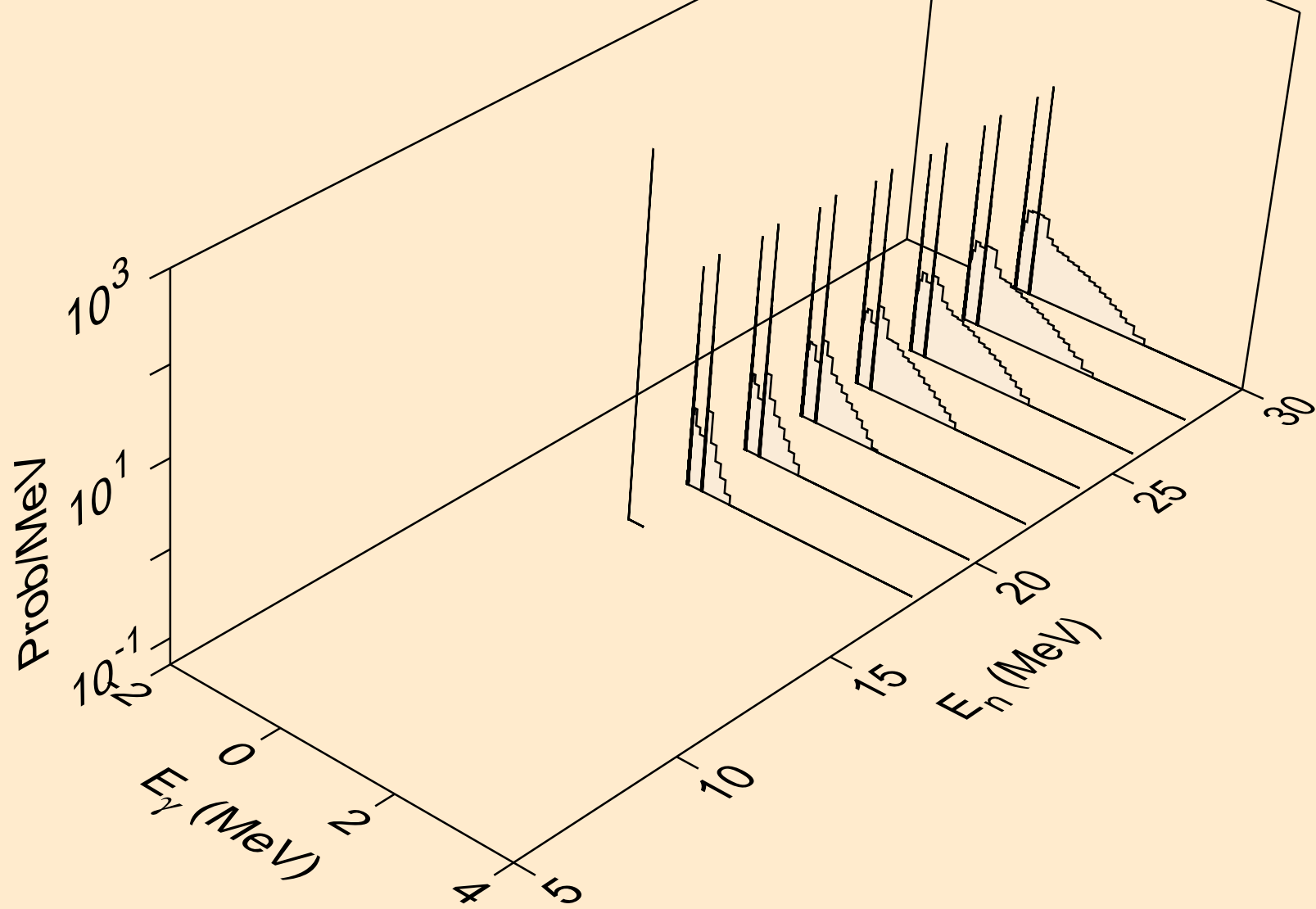

DB257 DEUTERON ACER TENDL-2023 LIBRARY; T=0.K  
Photon emission for (n,2np)

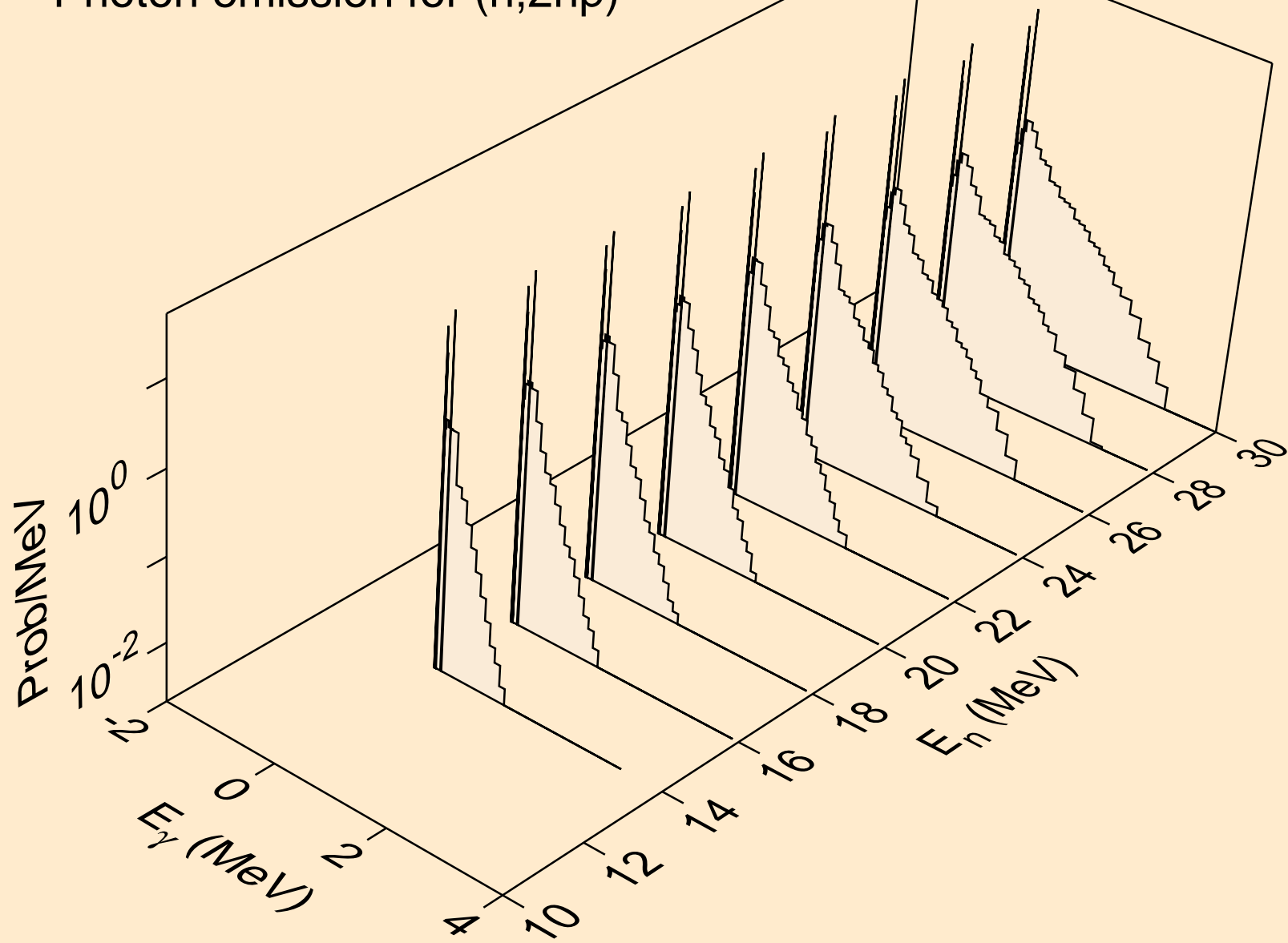

DB257 DEUTERON ACER TENDL-2023 LIBRARY; T=0.K  
Photon emission for (n,n2p)

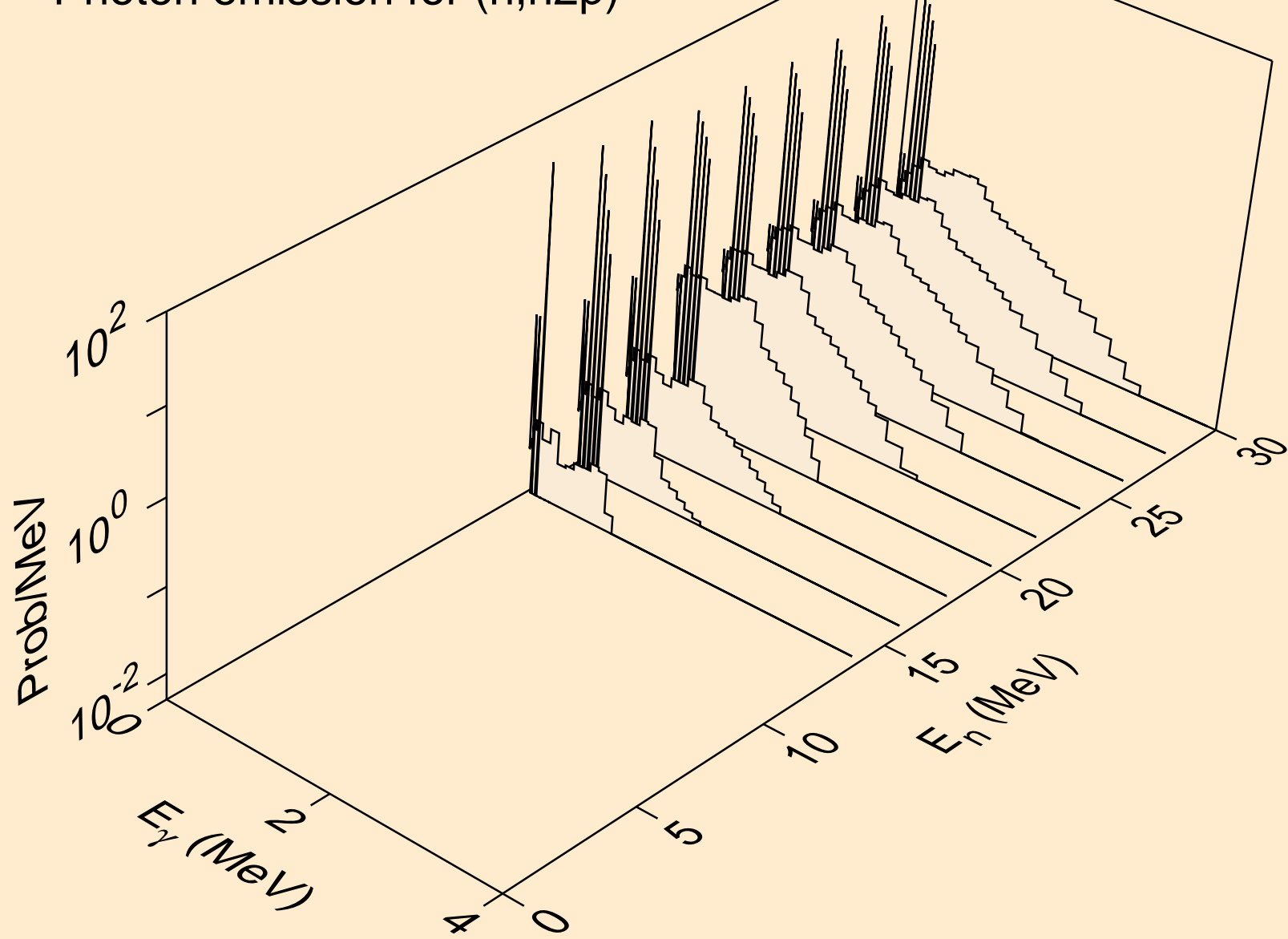



DB257 DEUTERON ACER TENDL-2023 LIBRARY; T=0.K  
Photon emission for (n,npa)

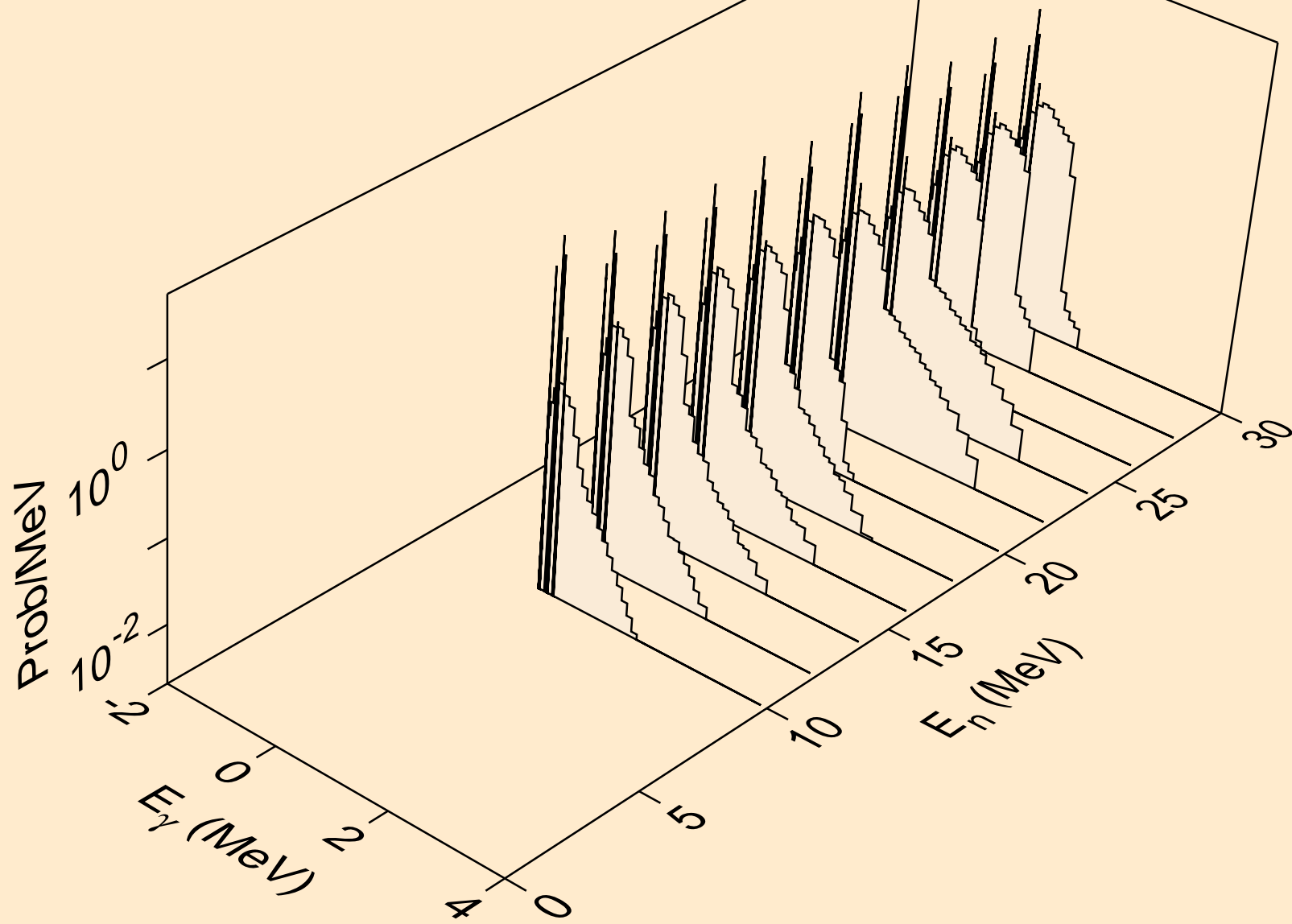

DB257 DEUTERON ACER TENDL-2023 LIBRARY; T=0.K  
Photon emission for (n,gma)

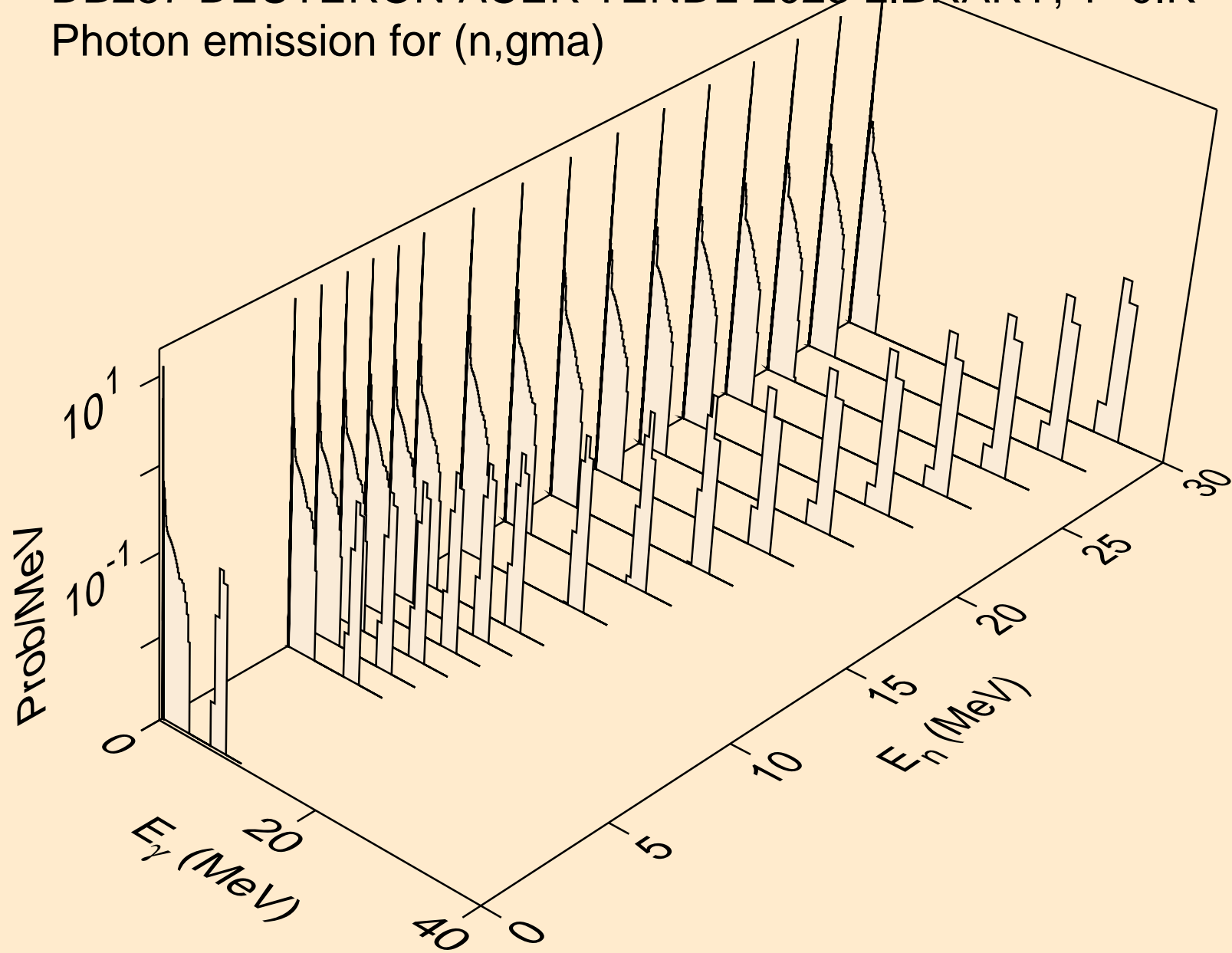

DB257 DEUTERON ACER TENDL-2023 LIBRARY; T=0.K  
Photon emission for (n,p)

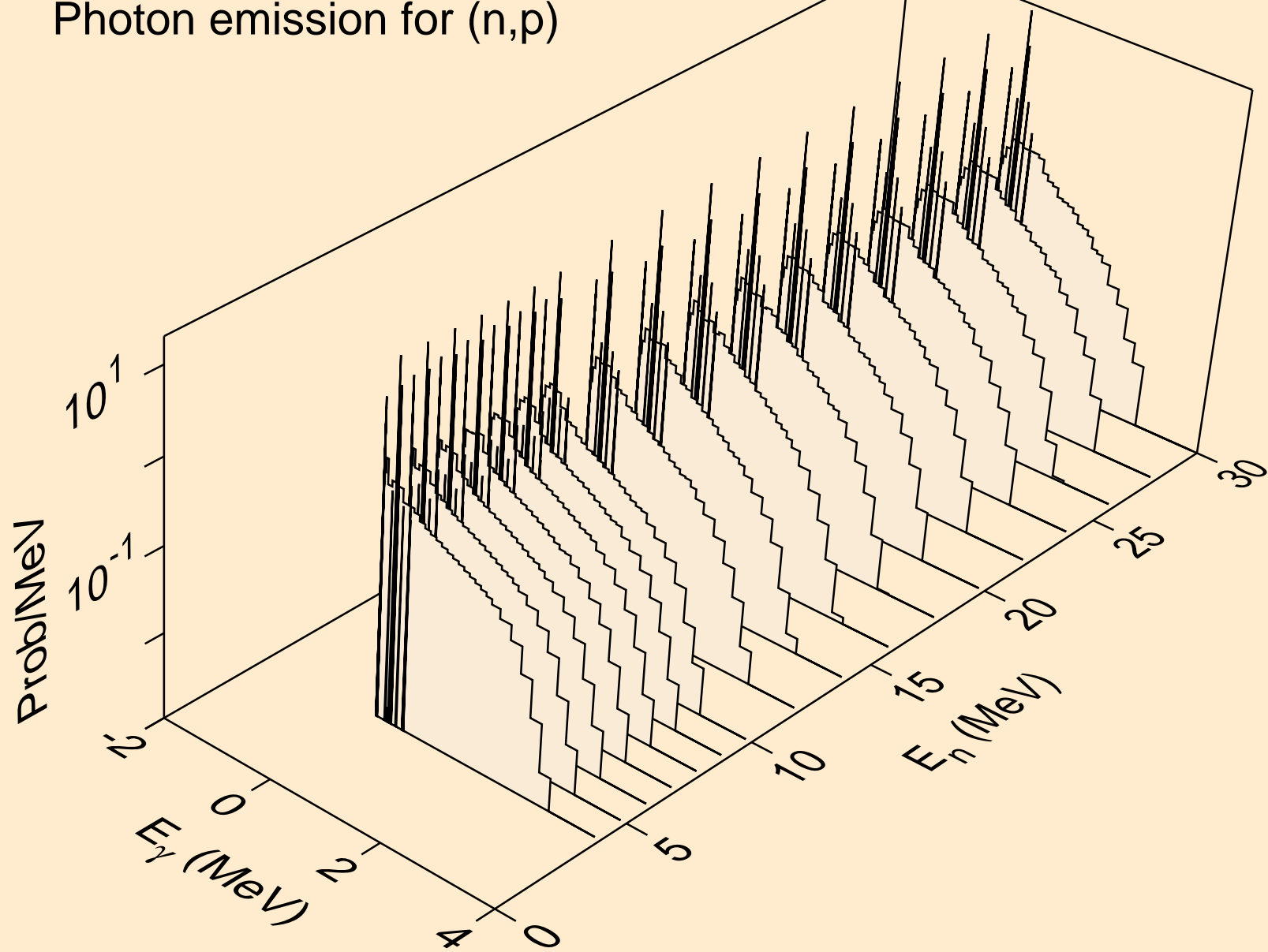

DB257 DEUTERON ACER TENDL-2023 LIBRARY; T=0.K  
Photon emission for inelastic

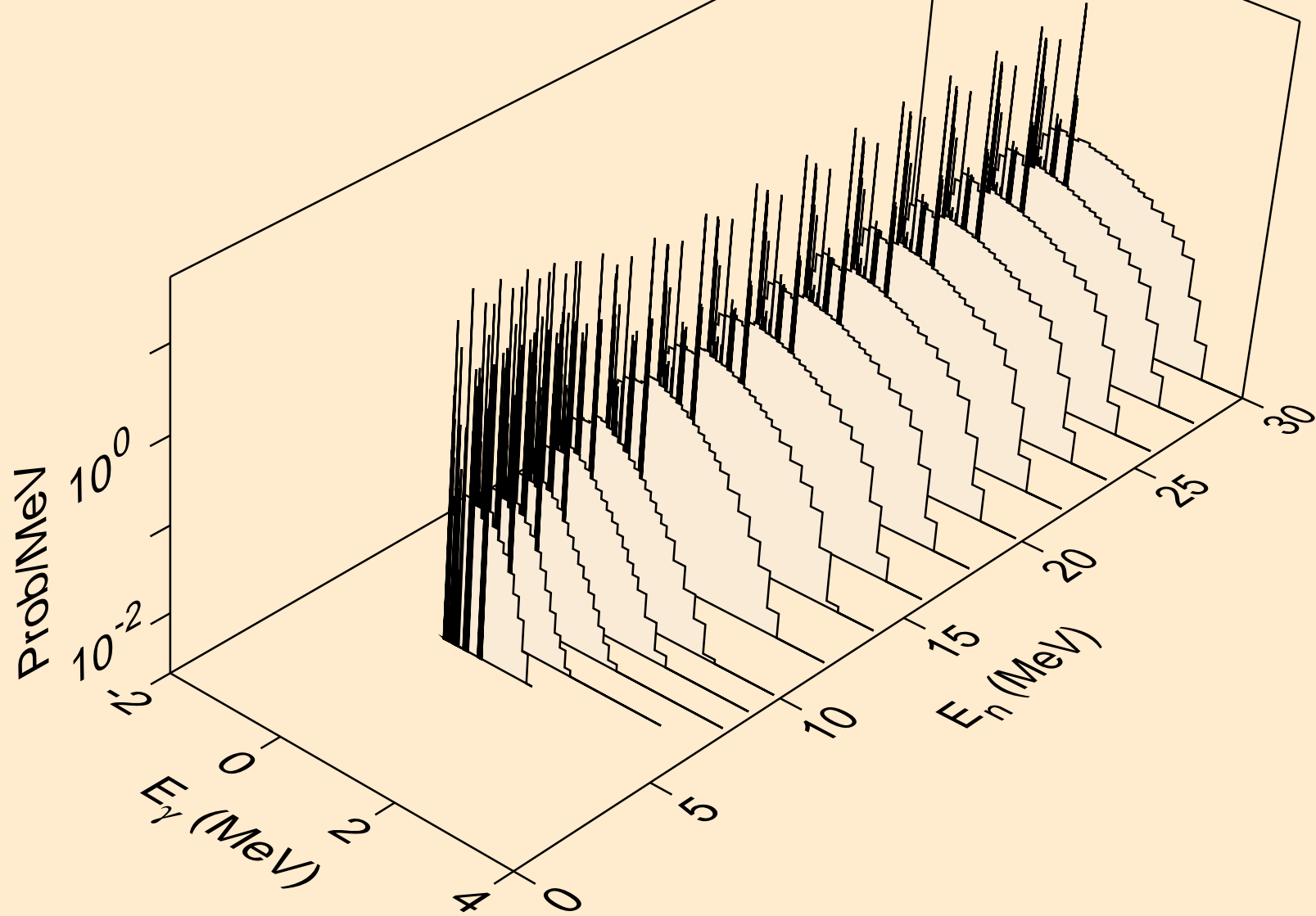

DB257 DEUTERON ACER TENDL-2023 LIBRARY; T=0.K  
Photon emission for (n,t)

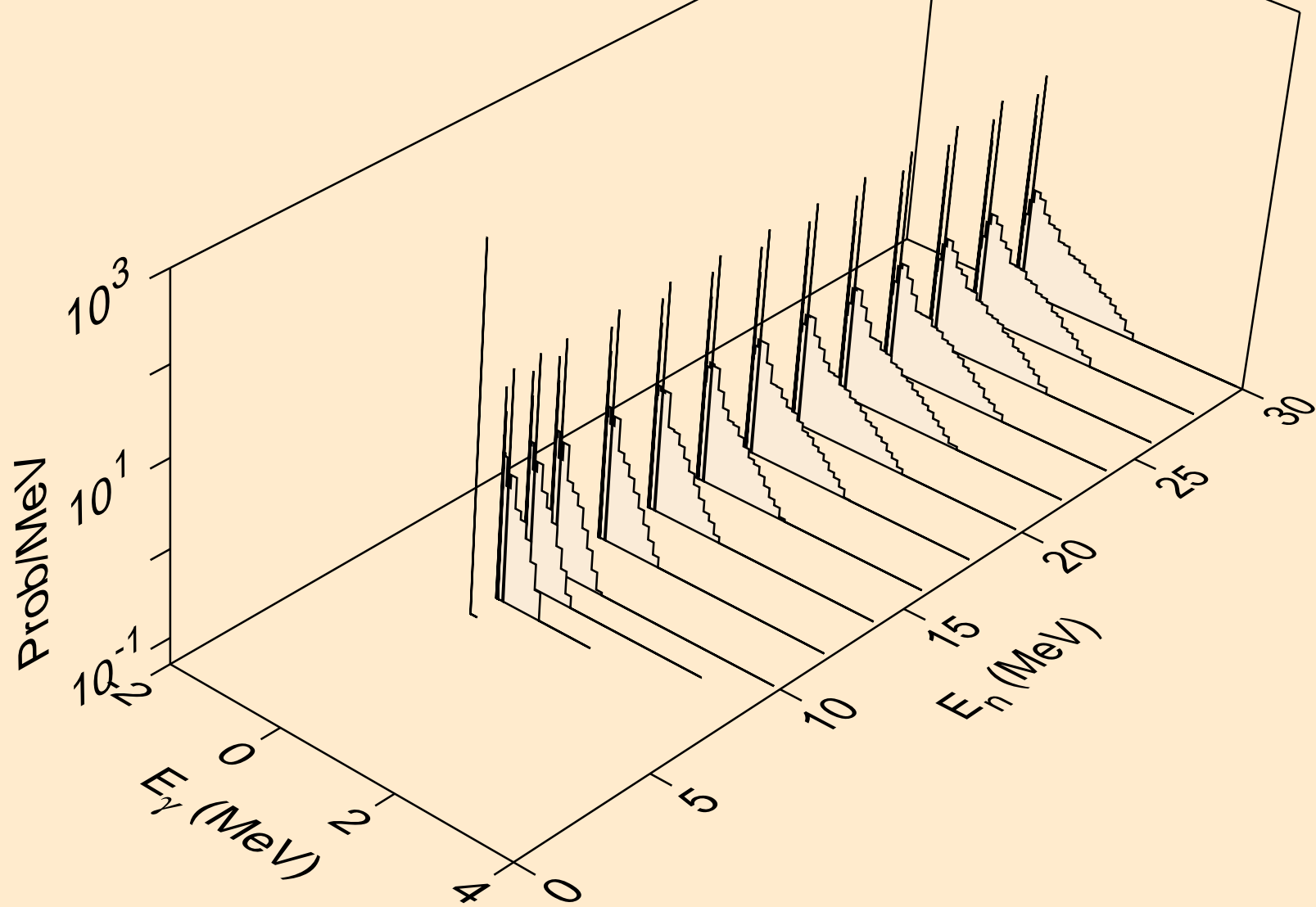

DB257 DEUTERON ACER TENDL-2023 LIBRARY; T=0.K  
Photon emission for (n,he3)

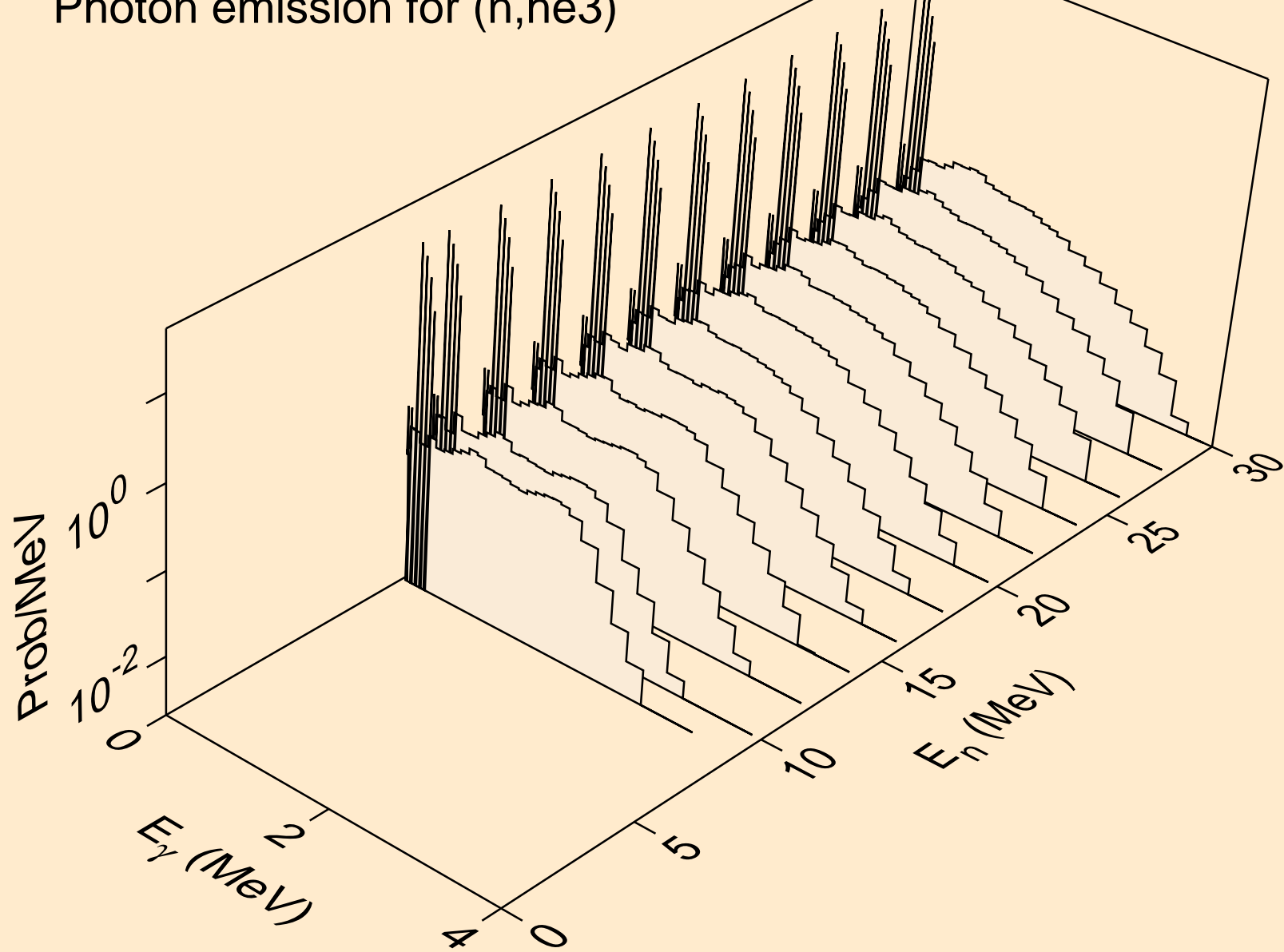

DB257 DEUTERON ACER TENDL-2023 LIBRARY; T=0.K  
Photon emission for (n,a)

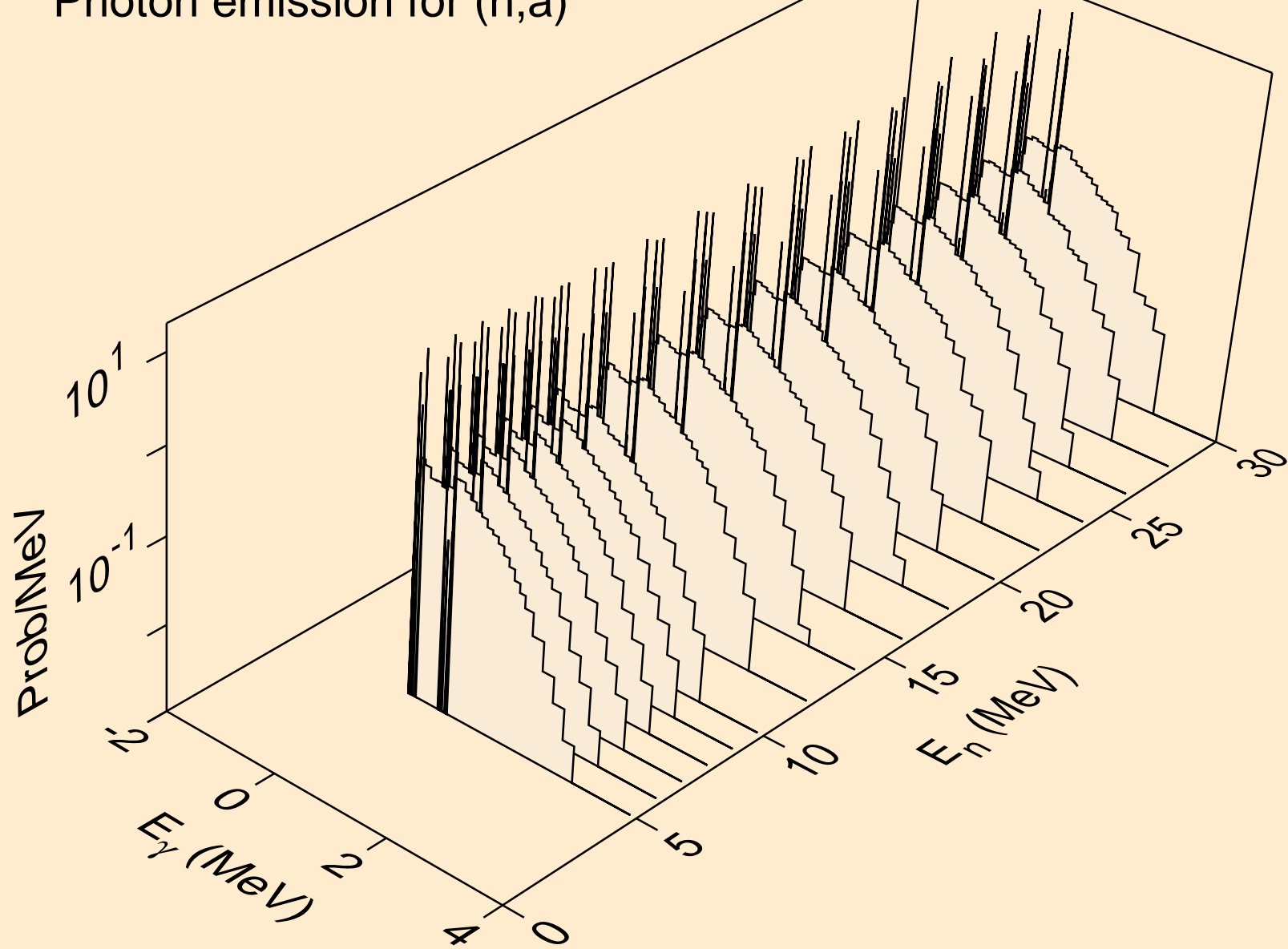

DB257 DEUTERON ACER TENDL-2023 LIBRARY; T=0.K  
Photon emission for (n,2a)

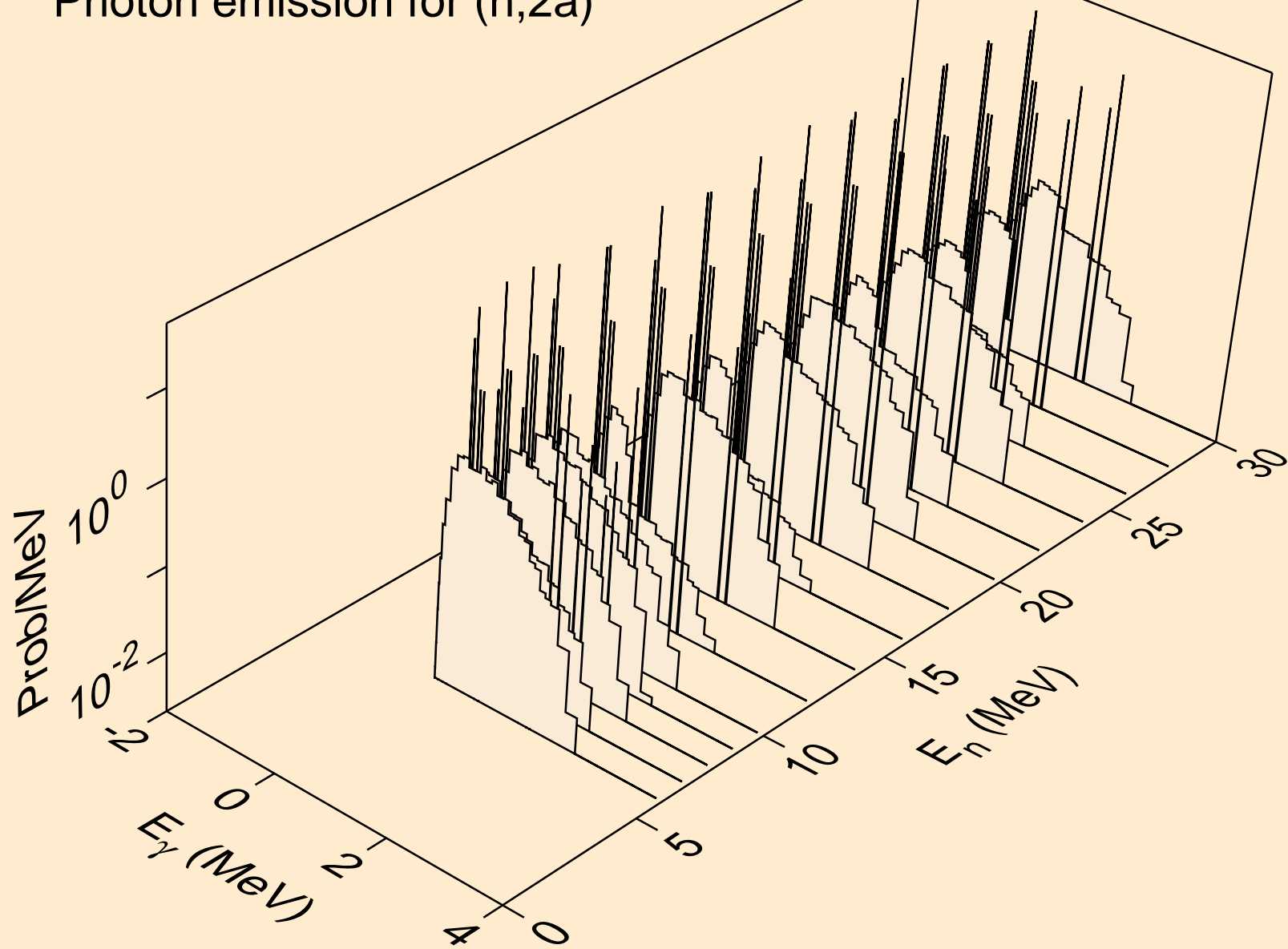



DB257 DEUTERON ACER TENDL-2023 LIBRARY; T=0.K  
Photon emission for (n,2p)

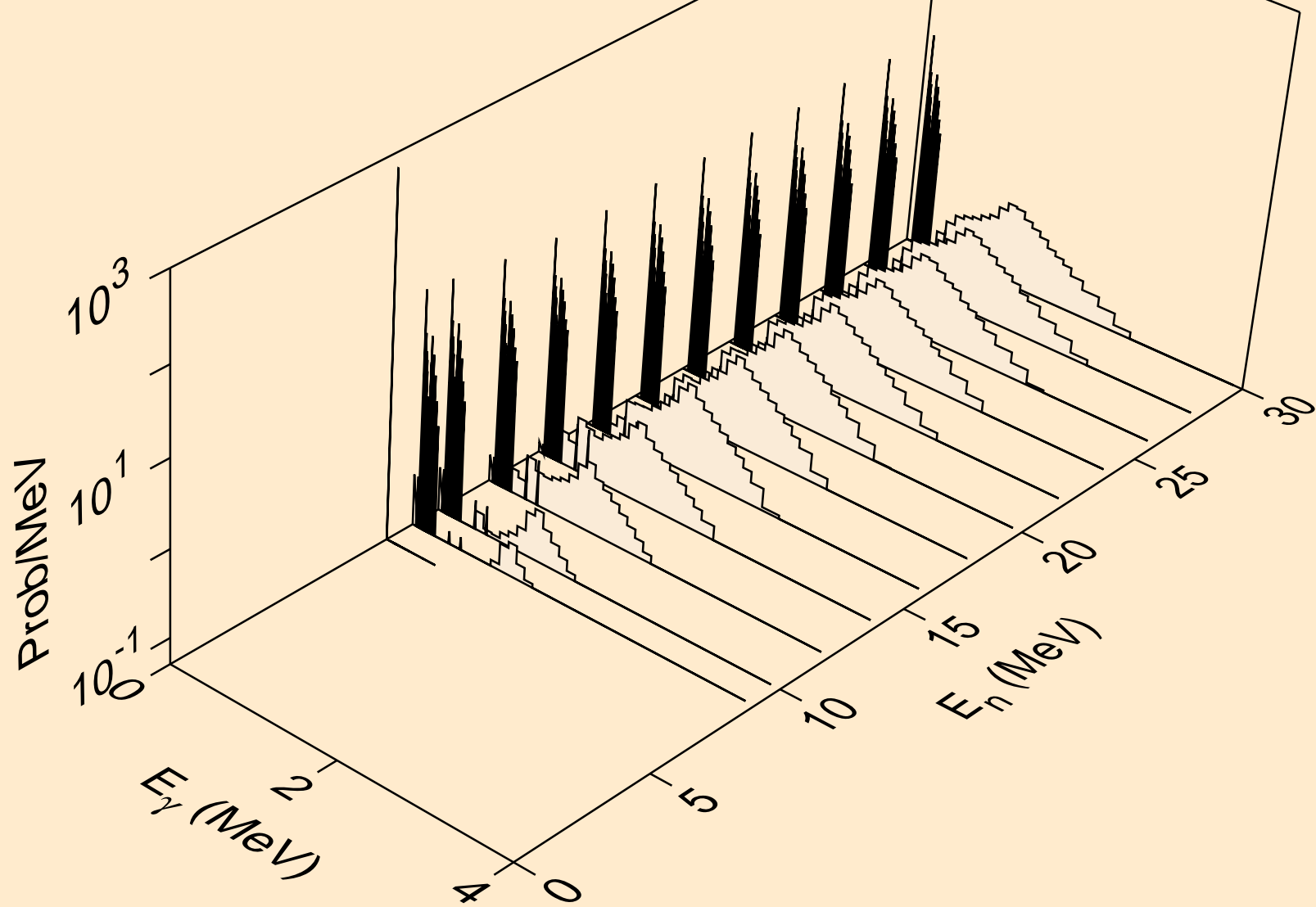

DB257 DEUTERON ACER TENDL-2023 LIBRARY; T=0.K  
Photon emission for (n,p)

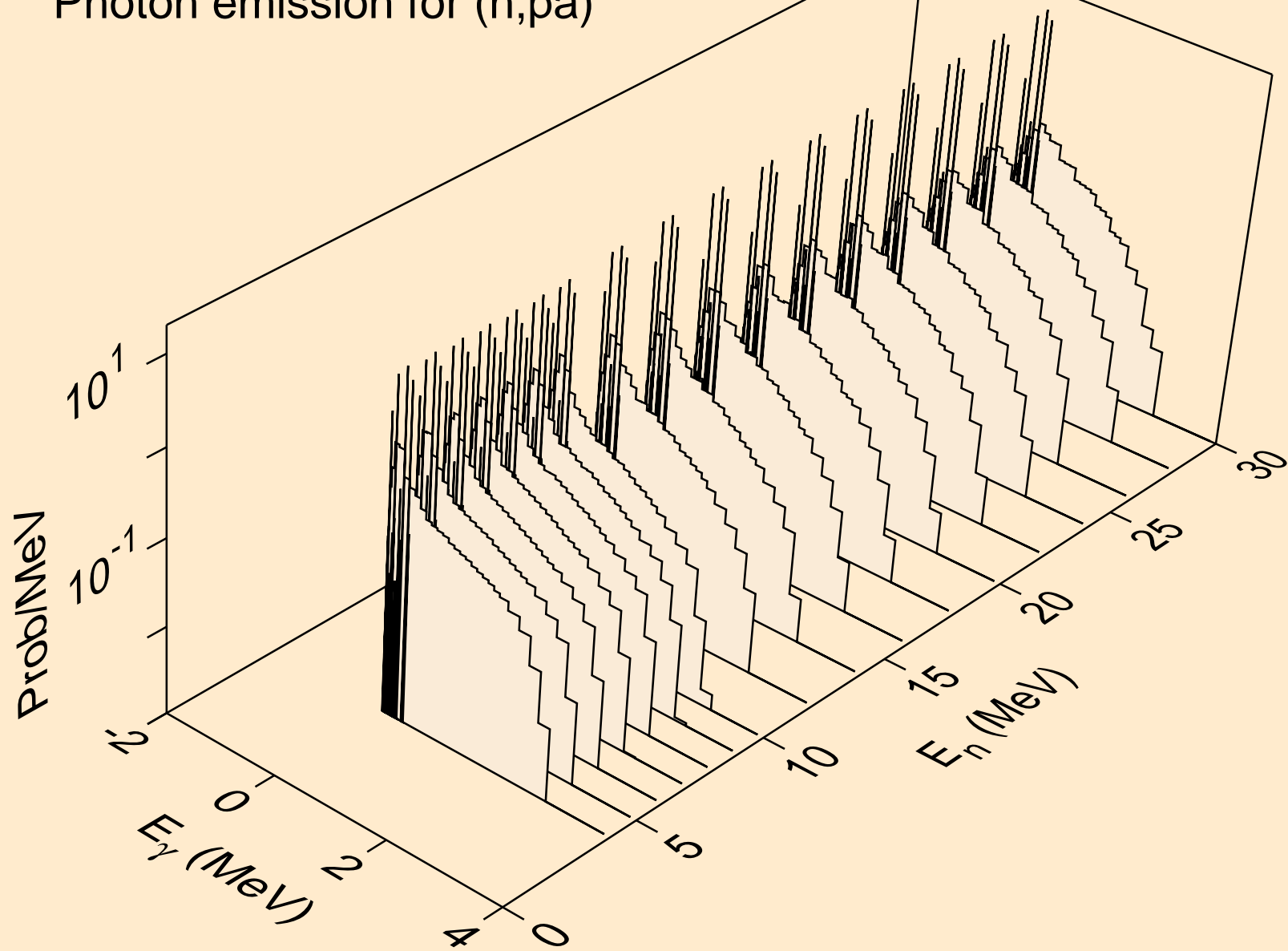

DB257 DEUTERON ACER TENDL-2023 LIBRARY; T=0.K  
Photon emission for (n,pd)

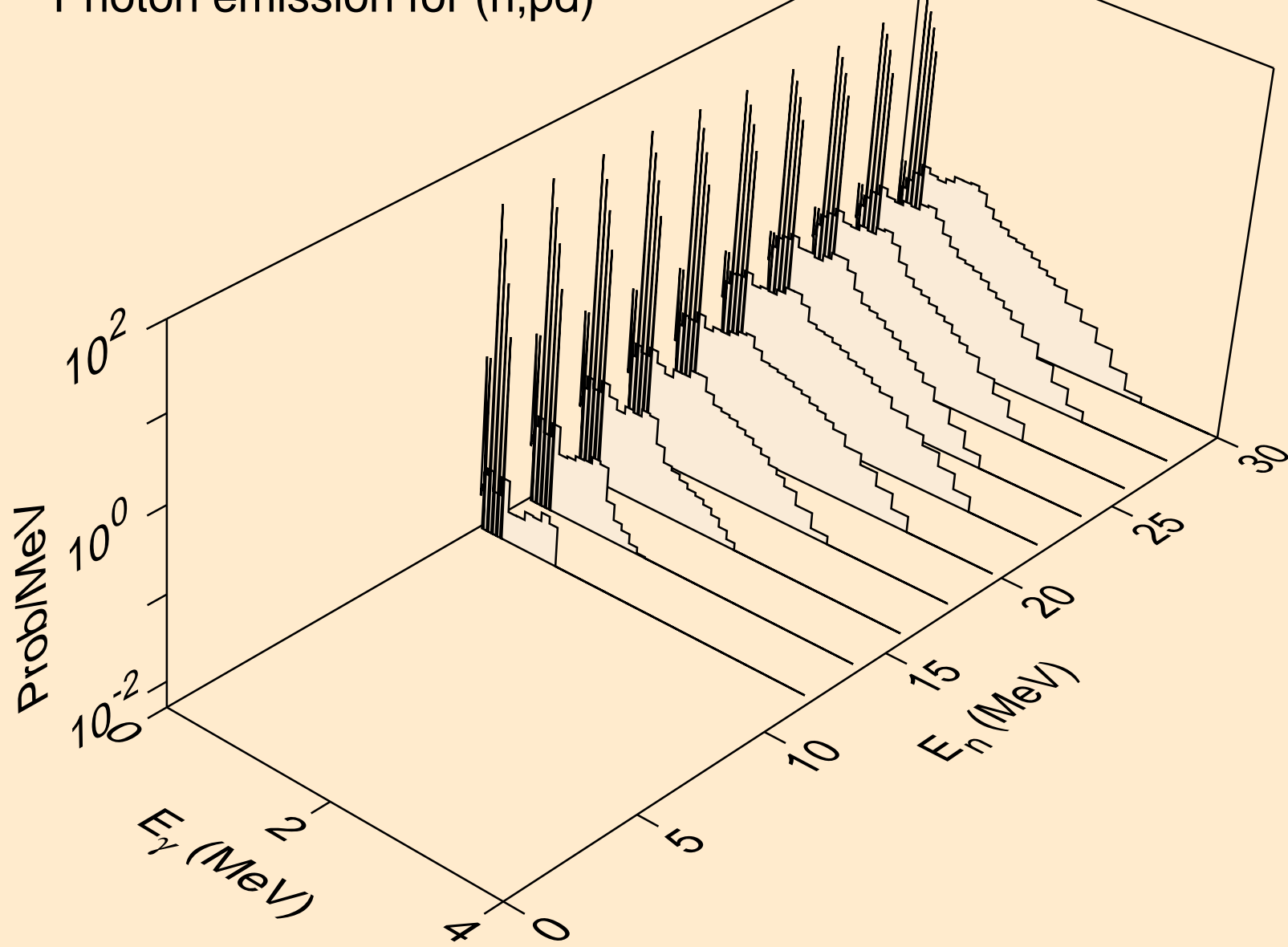

DB257 DEUTERON ACER TENDL-2023 LIBRARY; T=0.K  
Photon emission for (n,da)

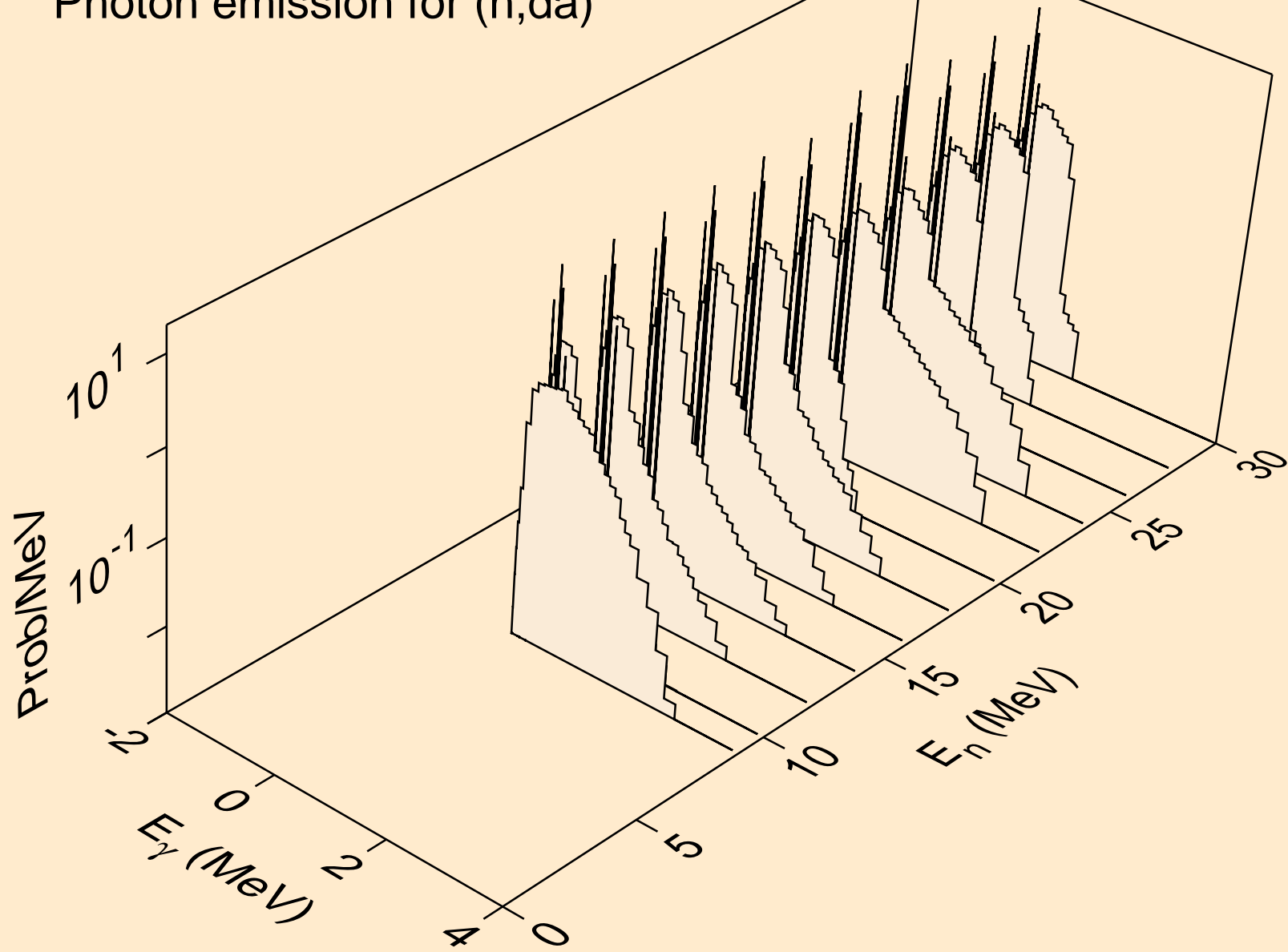

# DB257 DEUTERON ACER TENDL-2023 LIBRARY; T=0.K

## Particle heating contributions

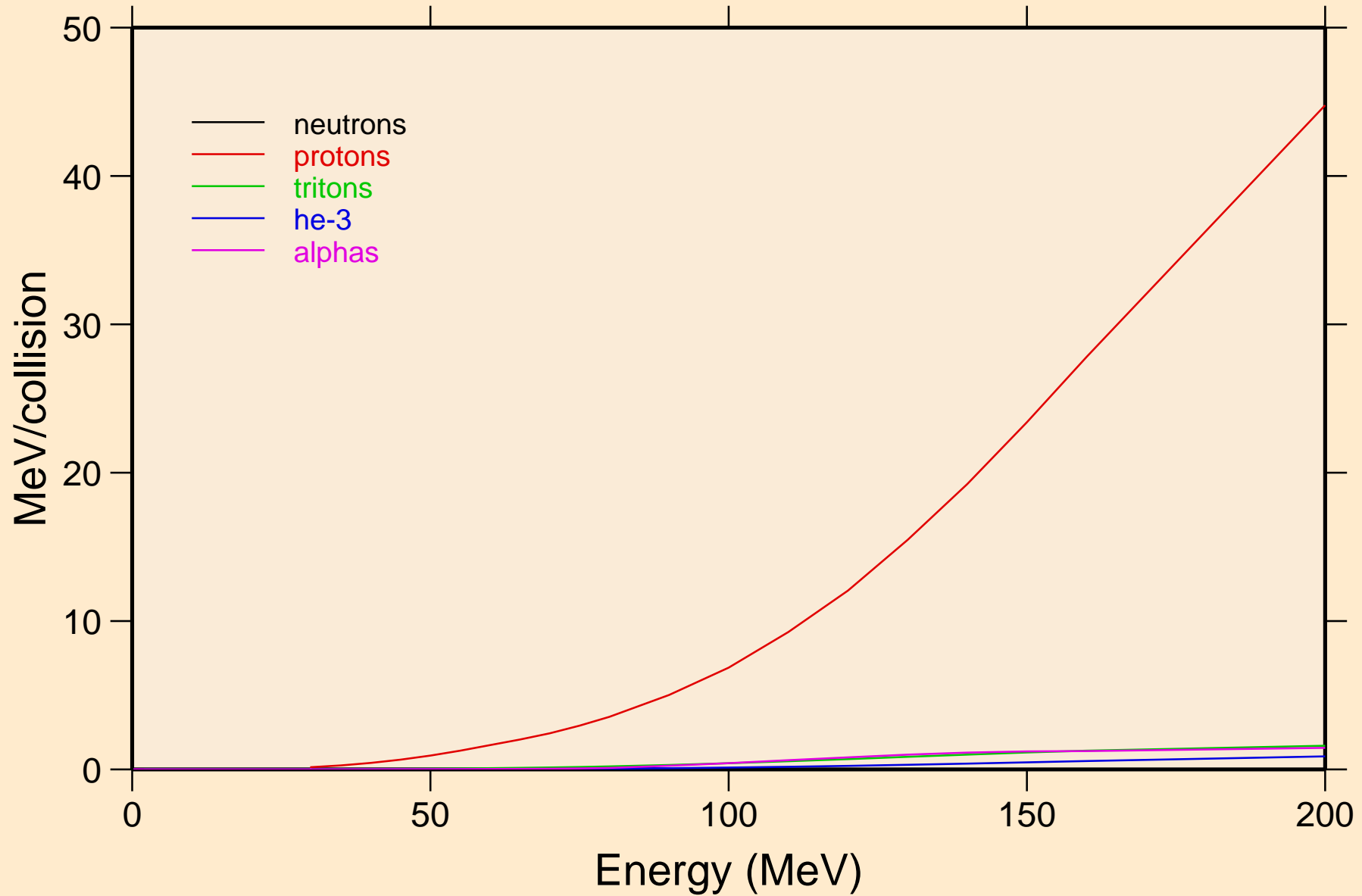

DB257 DEUTERON ACER TENDL-2023 LIBRARY; T=0.K  
Recoil Heating

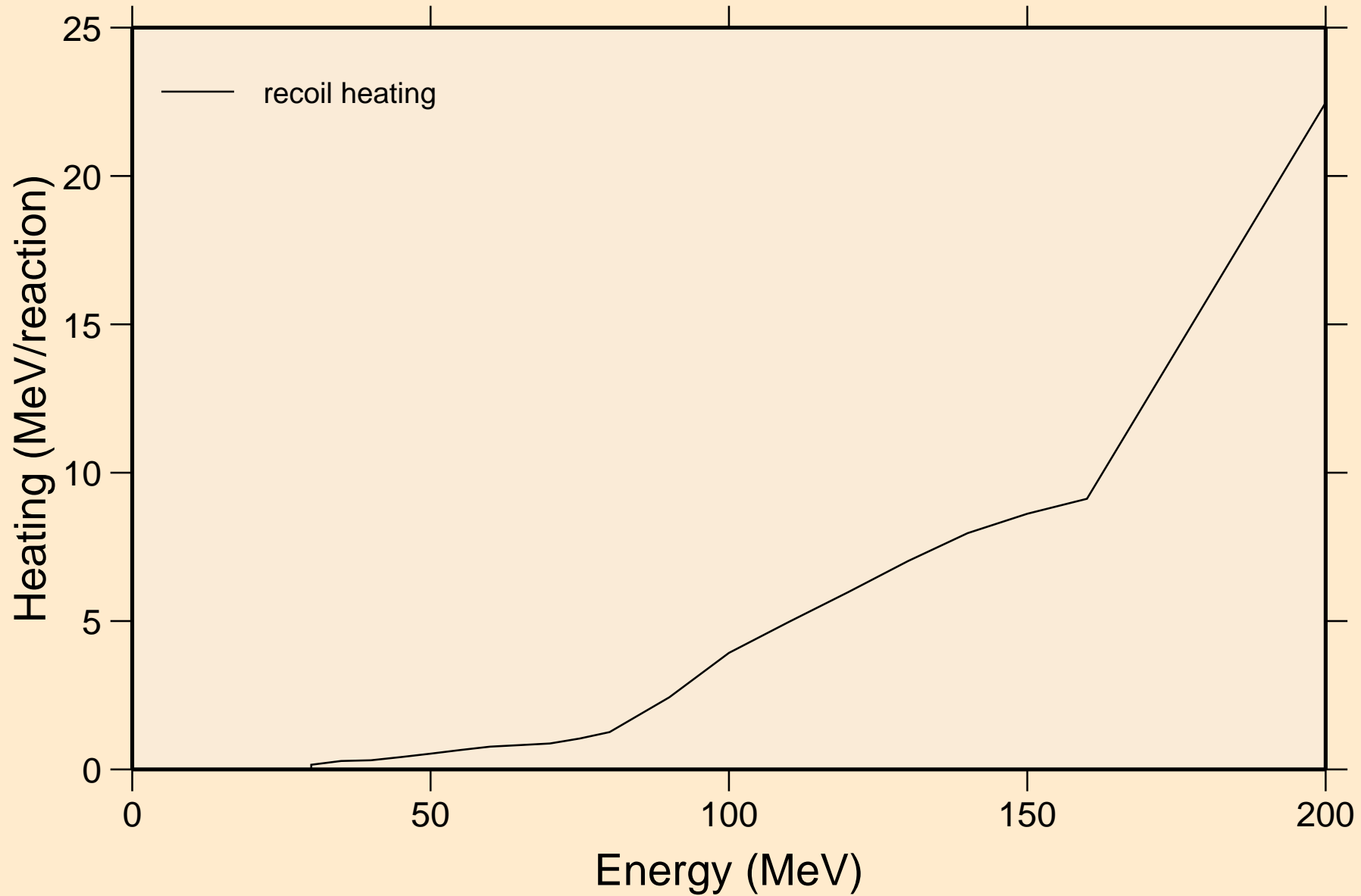

DB257 DEUTERON ACER TENDL-2023 LIBRARY; T=0.K  
Particle production cross sections

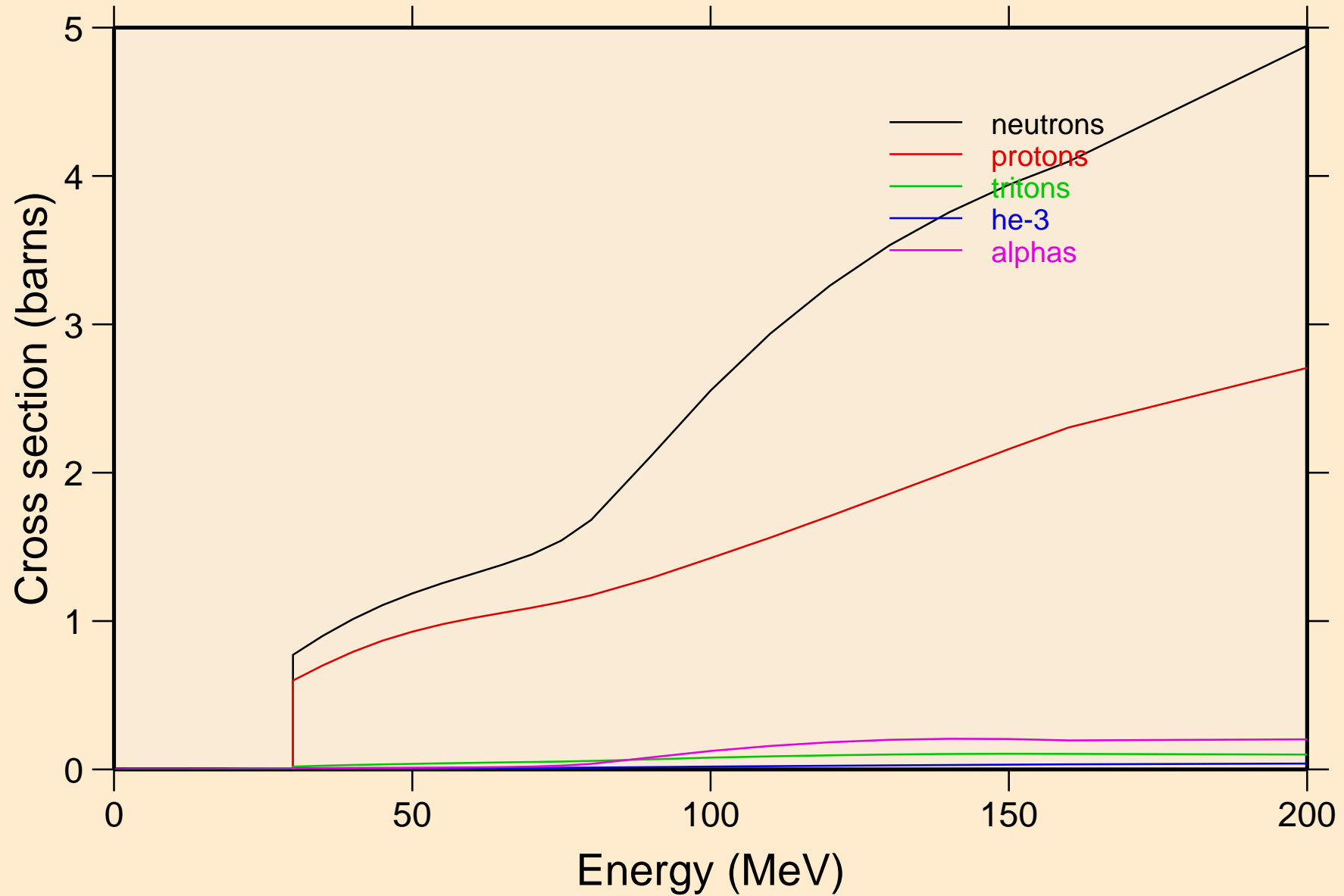

DB257 DEUTERON ACER TENDL-2023 LIBRARY; T=0.K  
neutrons from (d,n)

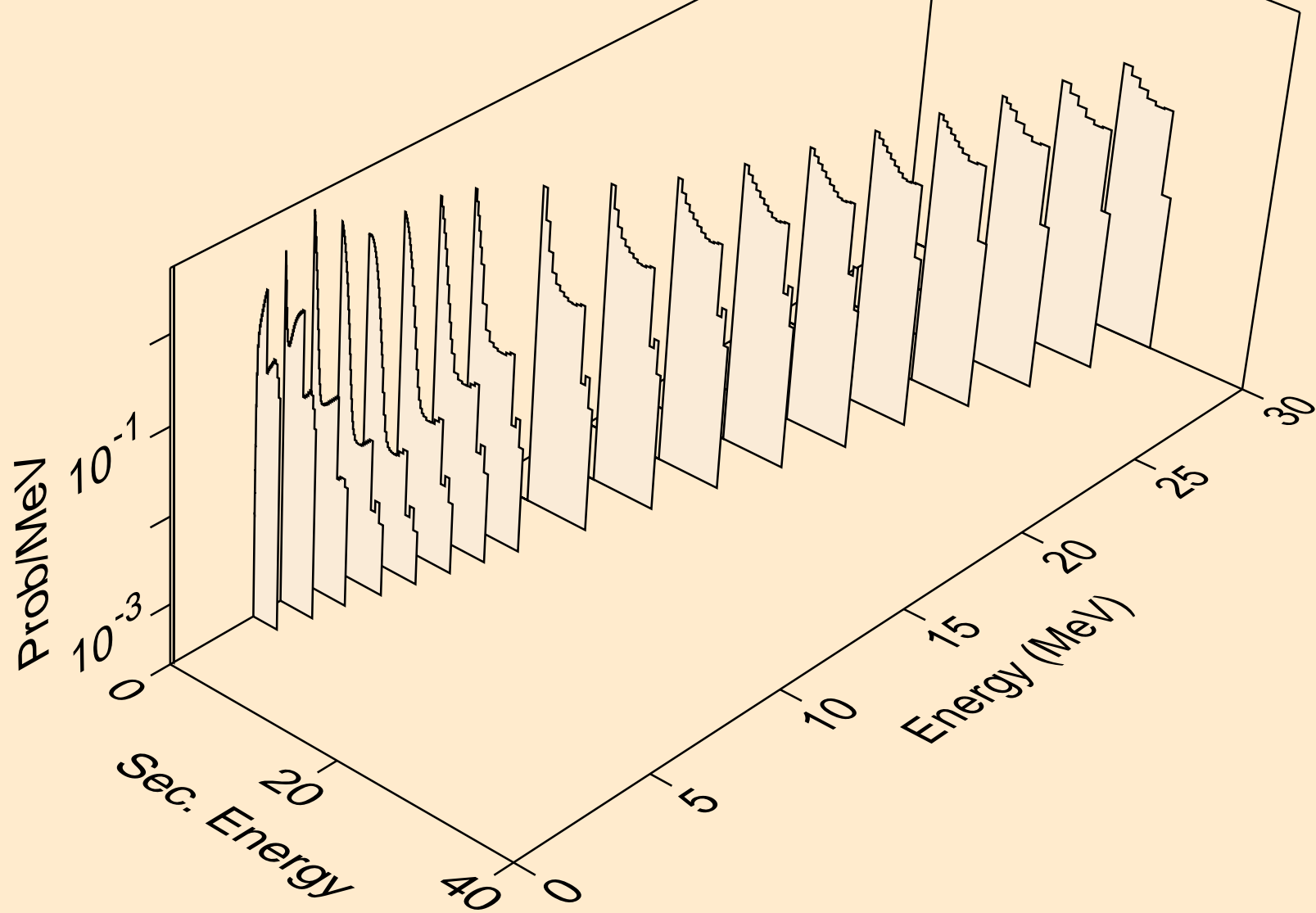



DB257 DEUTERON ACER TENDL-2023 LIBRARY; T=0.K  
neutrons from (d,x)

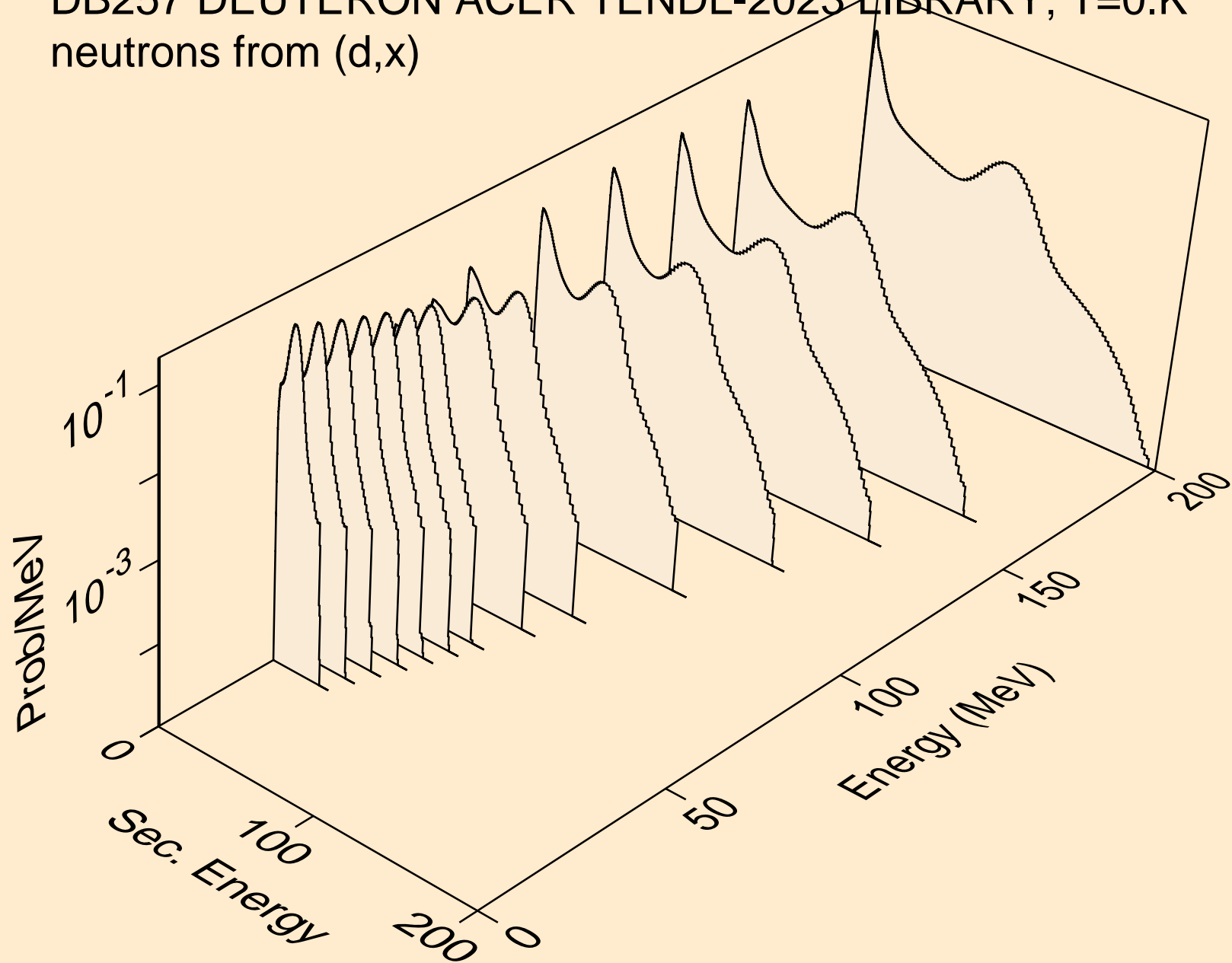

DB257 DEUTERON ACER TENDL-2023 LIBRARY; T=0.K  
neutrons from (d,2n)

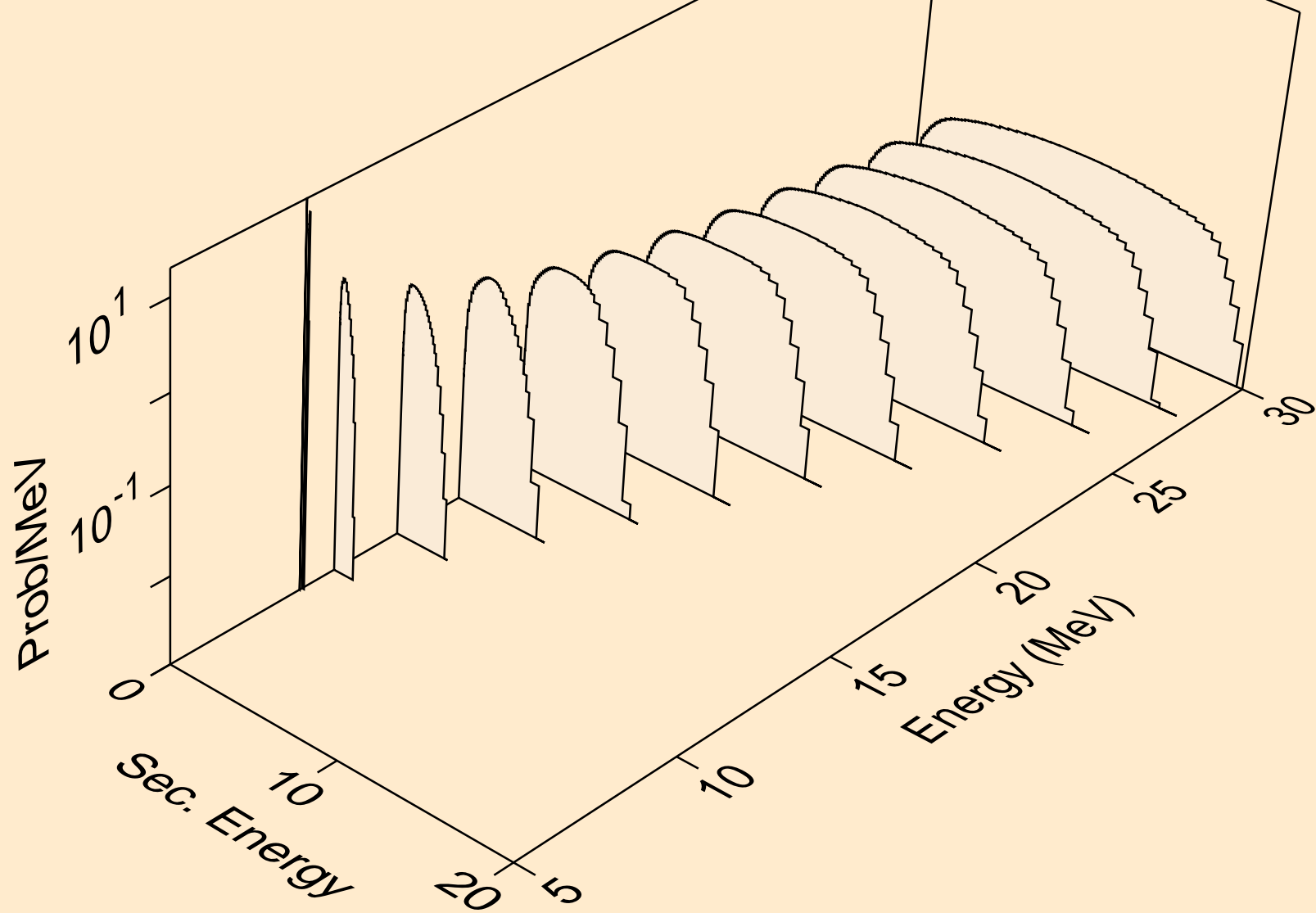

DB257 DEUTERON ACER TENDL-2023 LIBRARY; T=0.K  
neutrons from (d,3n)

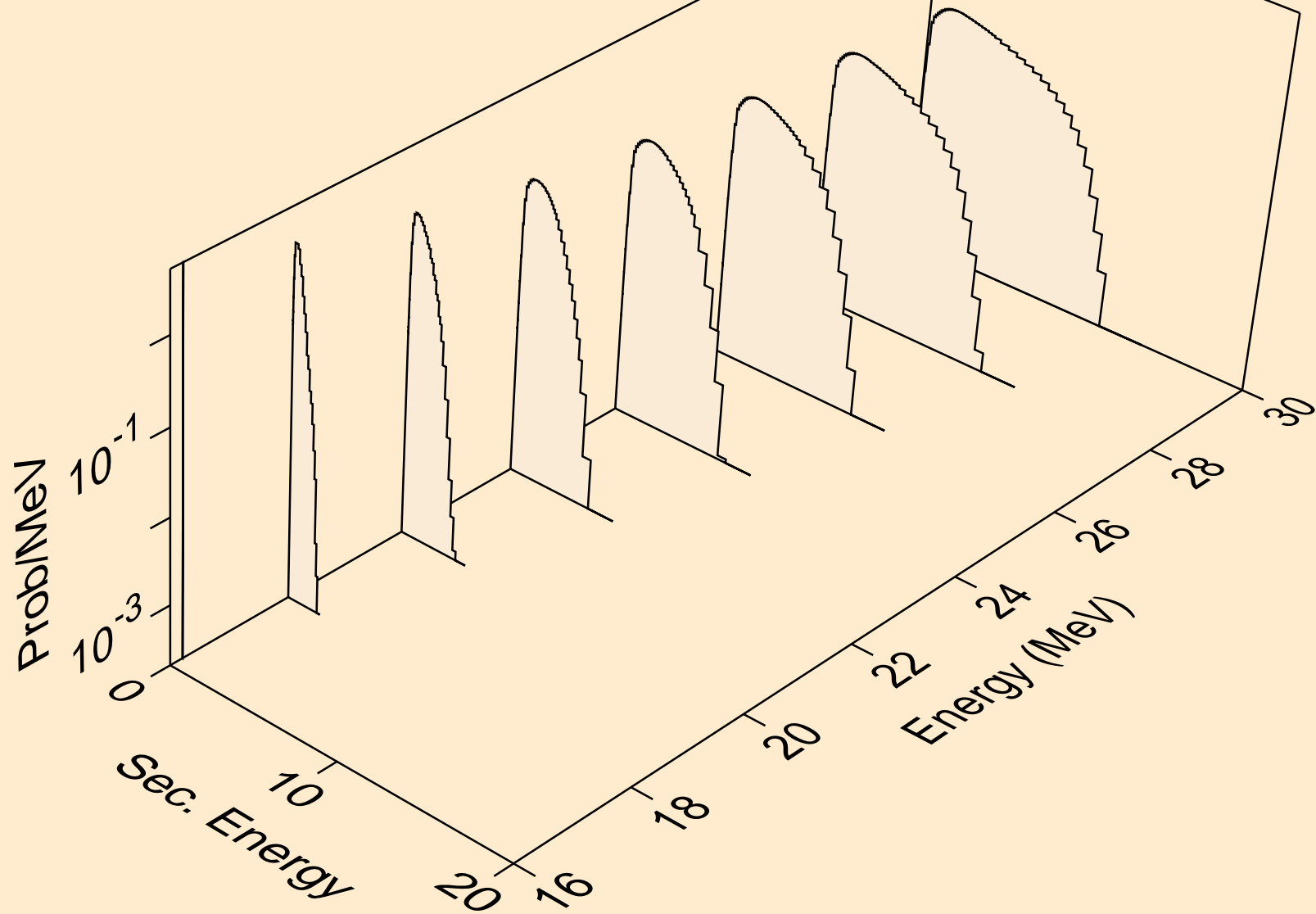

DB257 DEUTERON ACER TENDL-2023 LIBRARY; T=0.K  
neutrons from (d,n\*)a

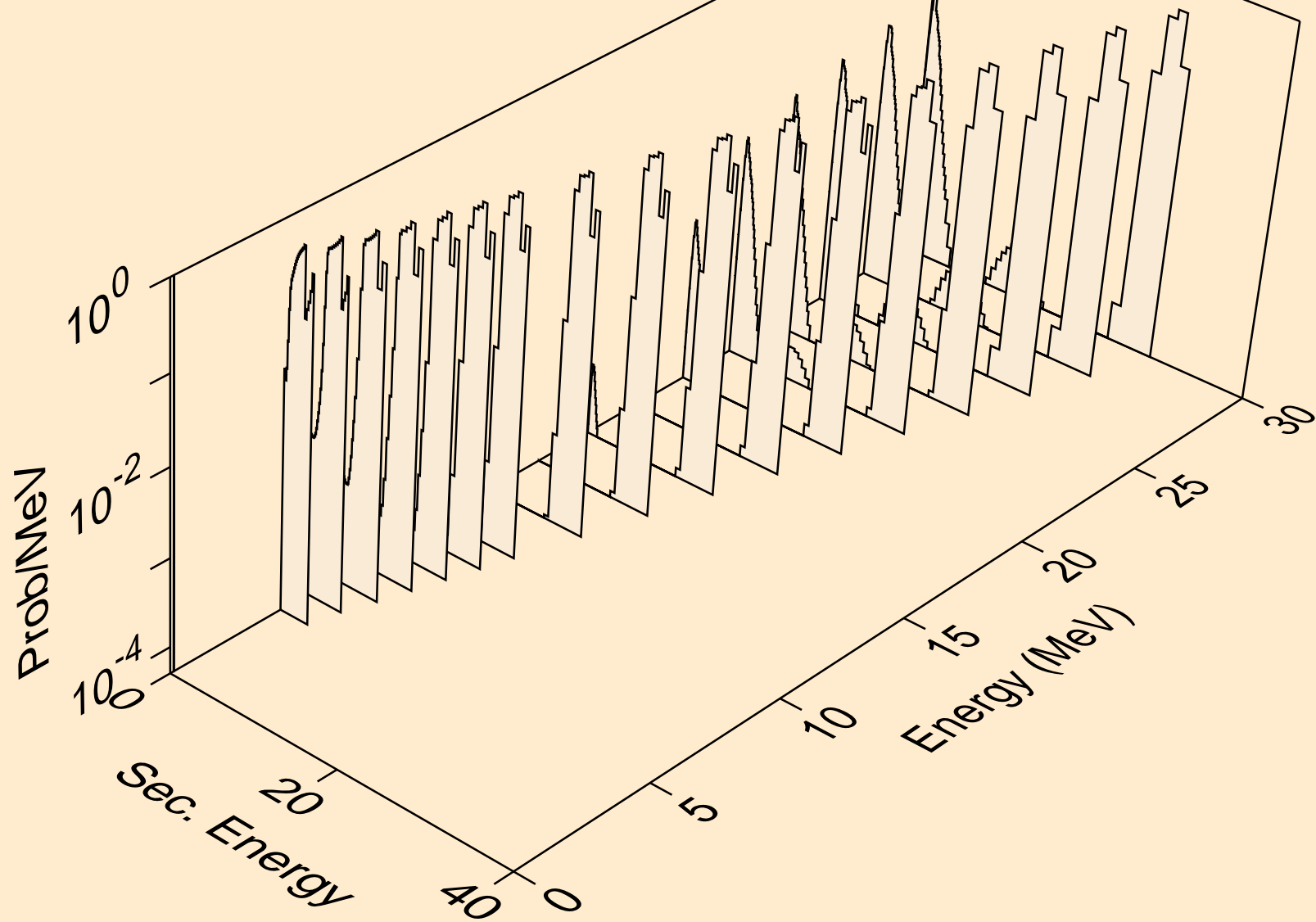

DB257 DEUTERON ACER TENDL-2023 LIBRARY; T=0.K  
neutrons from (d,2n)a

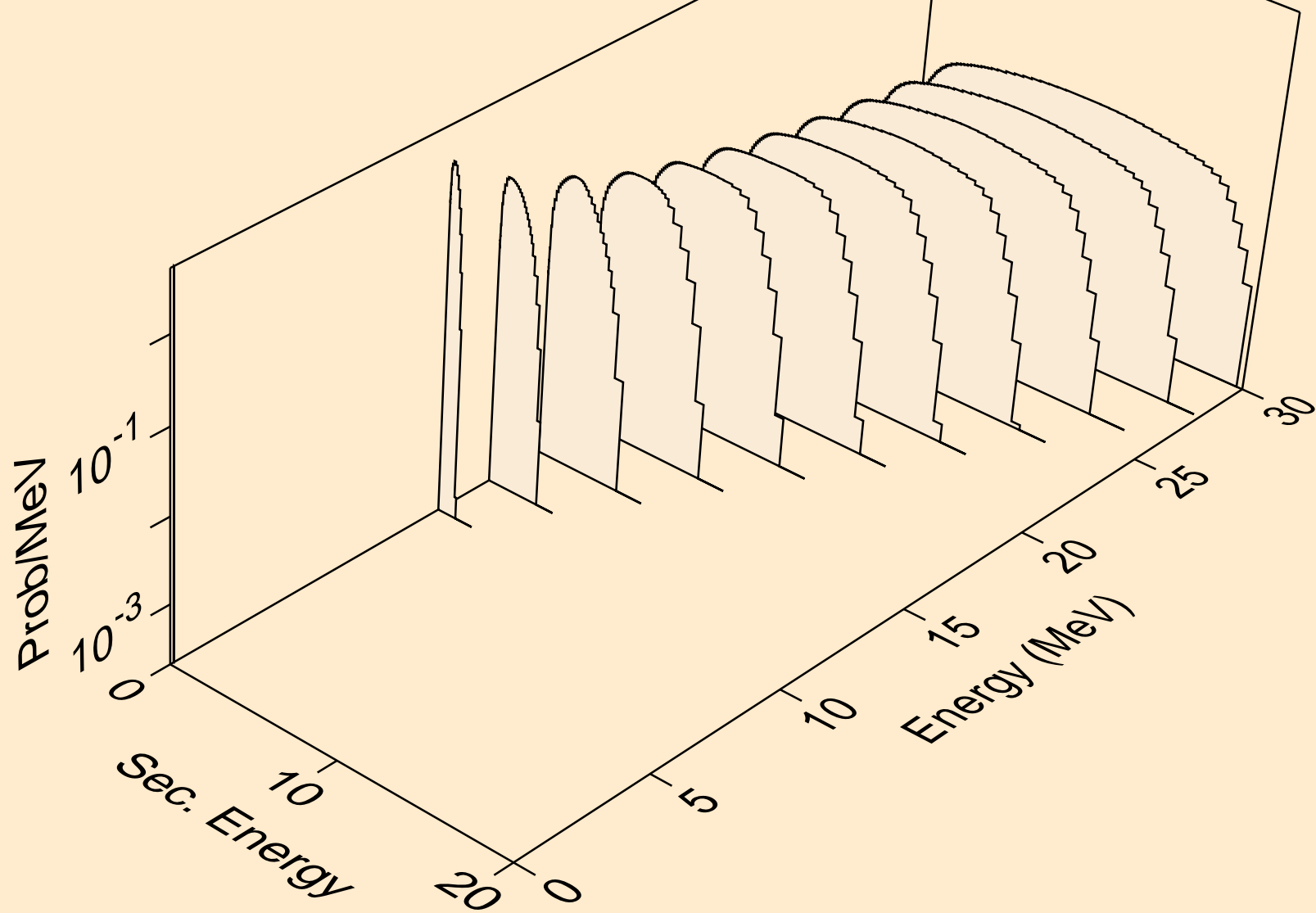

DB257 DEUTERON ACER TENDL-2023 LIBRARY; T=0.K  
neutrons from (d,3n)a

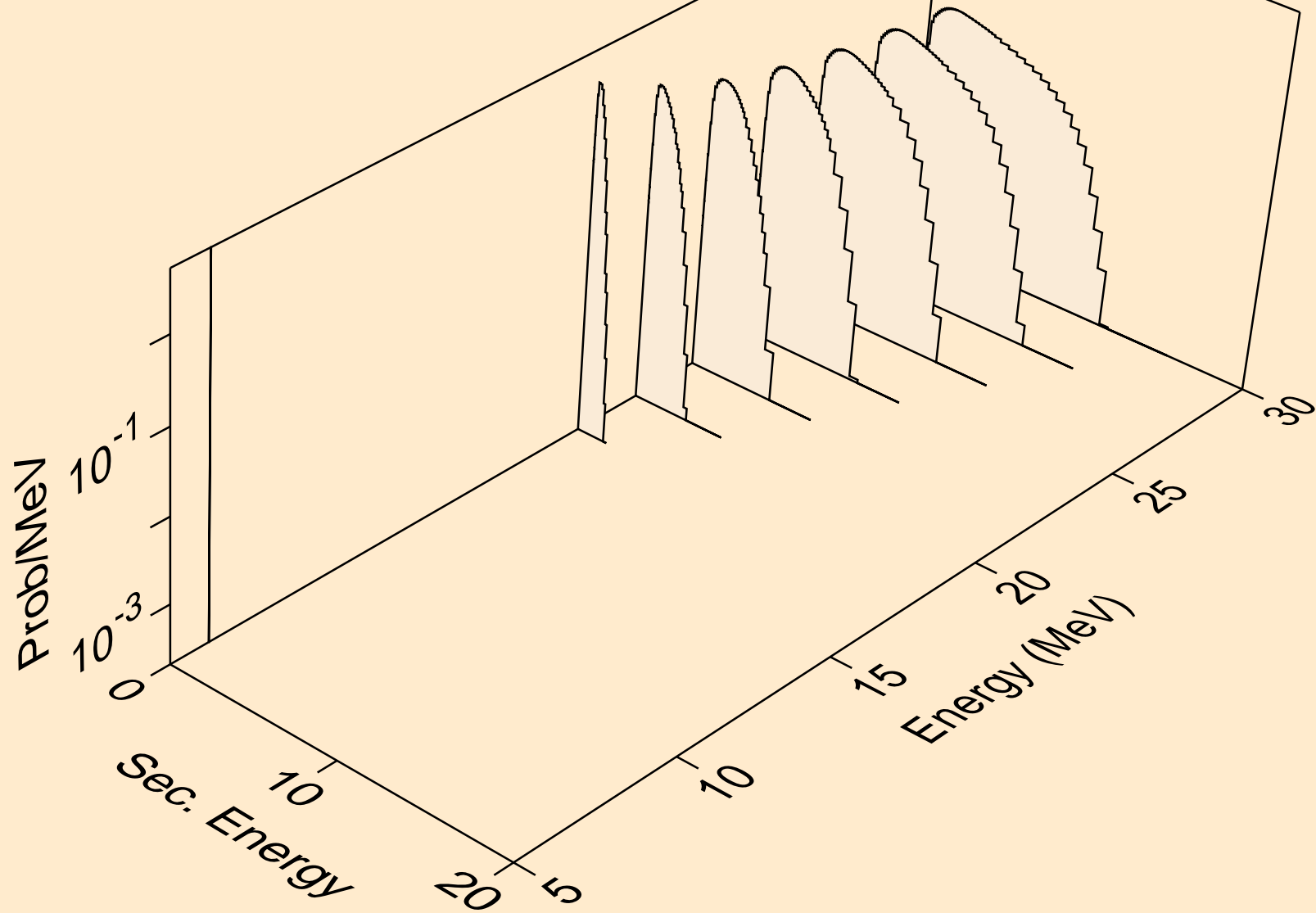

DB257 DEUTERON ACER TENDL-2023 LIBRARY; T=0.K  
neutrons from (d,n\*)p

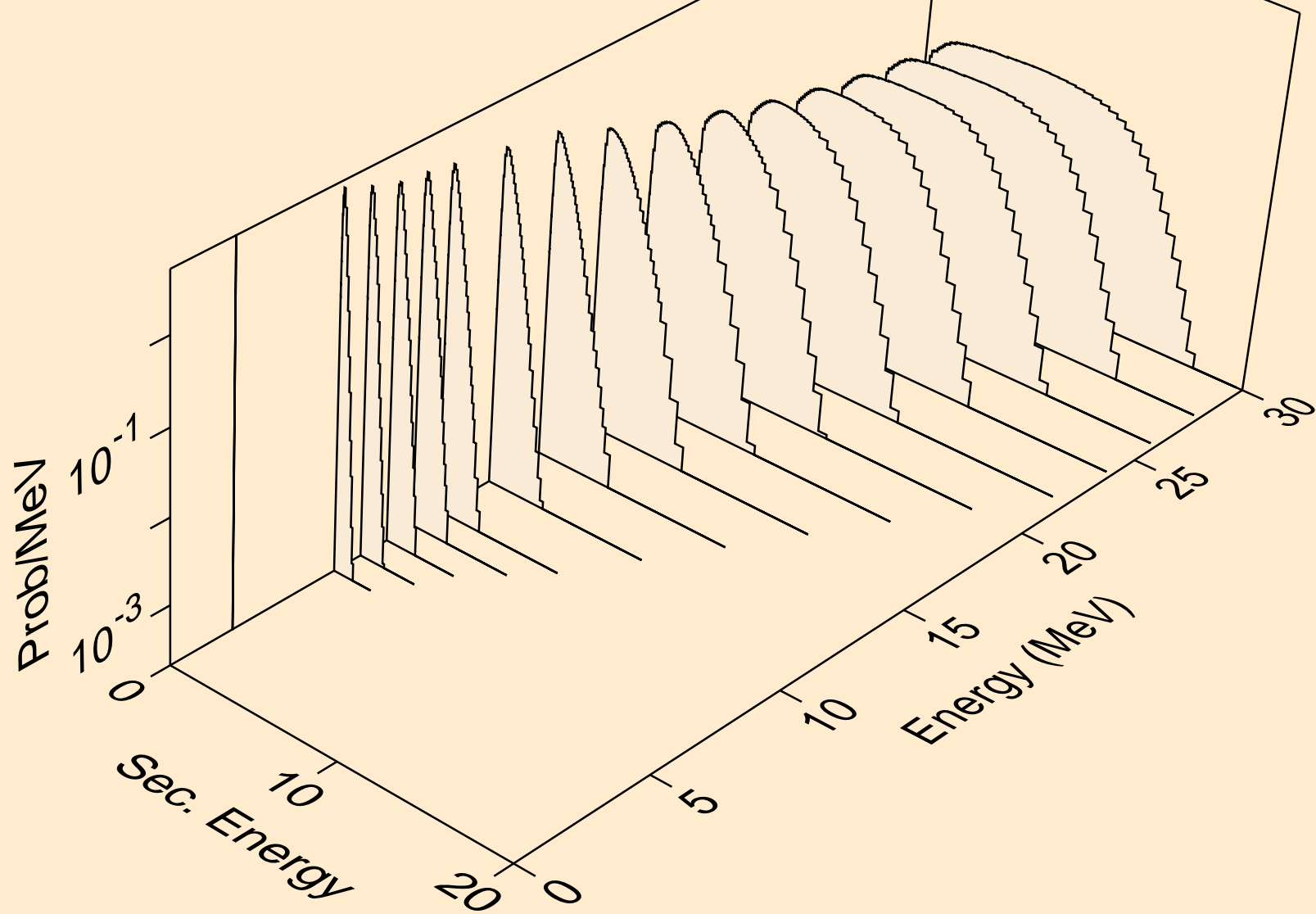

DB257 DEUTERON ACER TENDL-2023 LIBRARY; T=0.K  
neutrons from (d,n\*)d

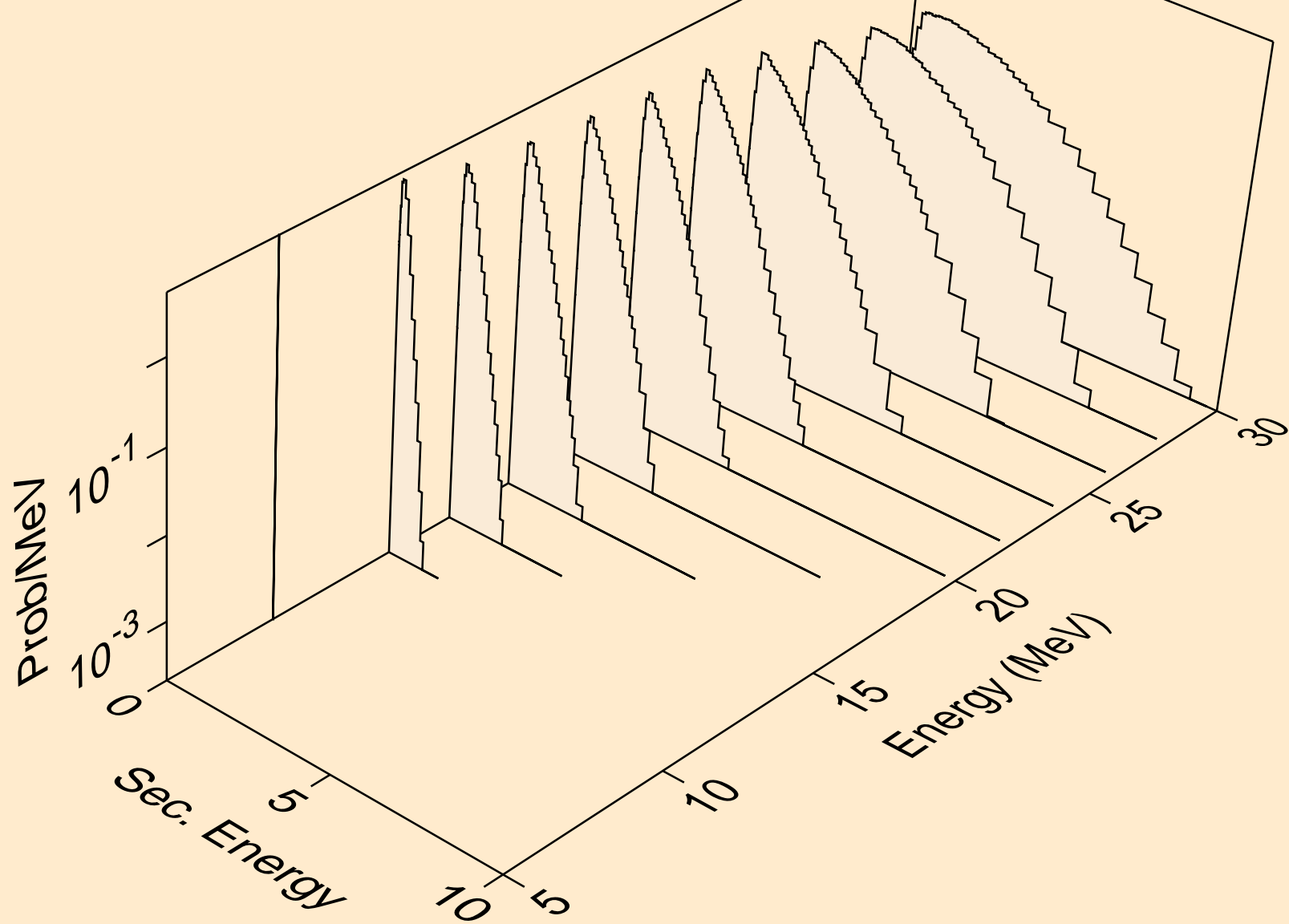



DB257 DEUTERON ACER TENDL-2023 LIBRARY; T=0.K  
neutrons from (d,n\*)t

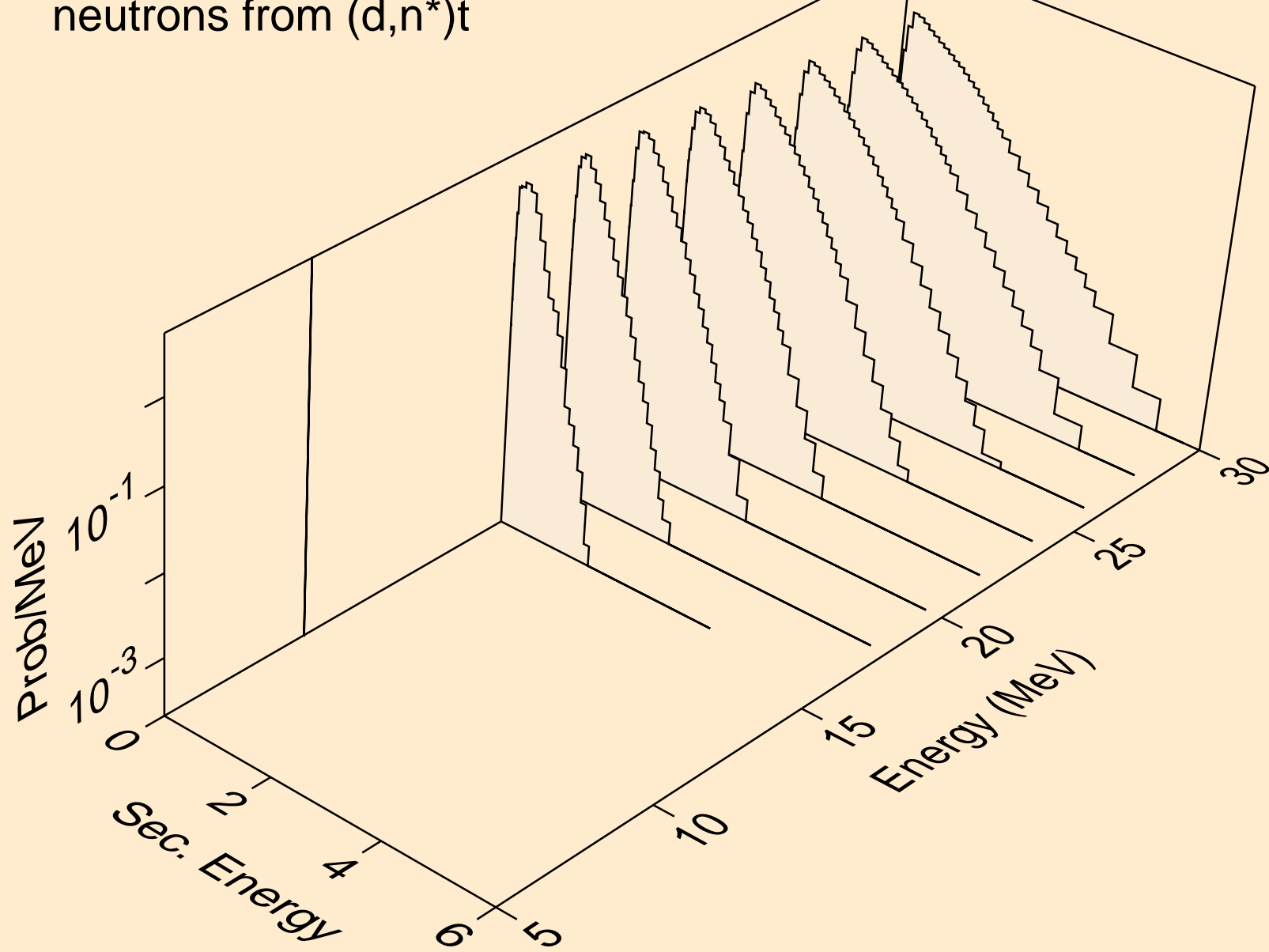

DB257 DEUTERON ACER TENDL-2023 LIBRARY; T=0.K  
neutrons from (d,2np)

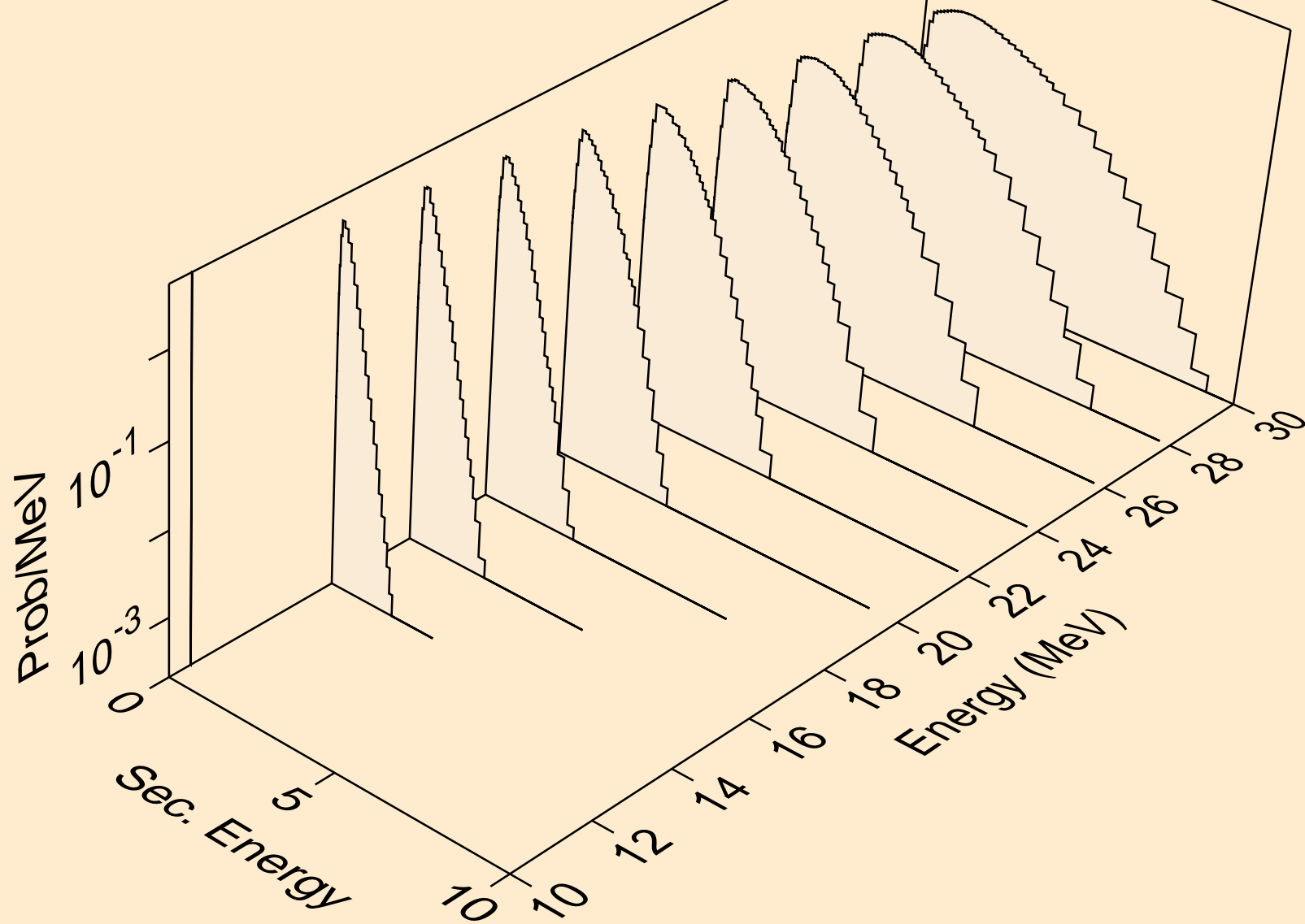

DB257 DEUTERON ACER TENDL-2023 LIBRARY; T=0.K  
neutrons from (d,n2p)

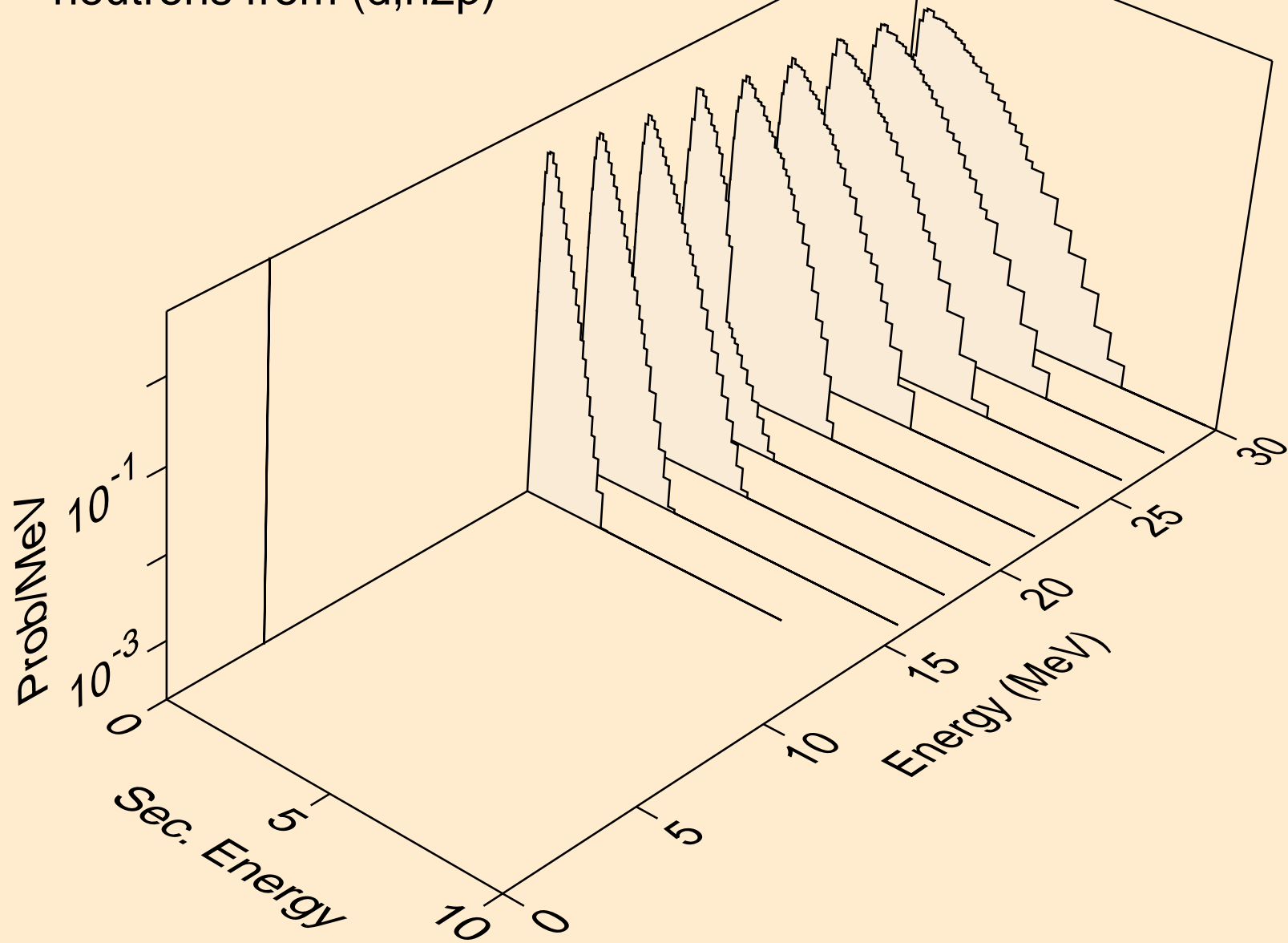

DB257 DEUTERON ACER TENDL-2023 LIBRARY; T=0.K  
neutrons from (d,npa)

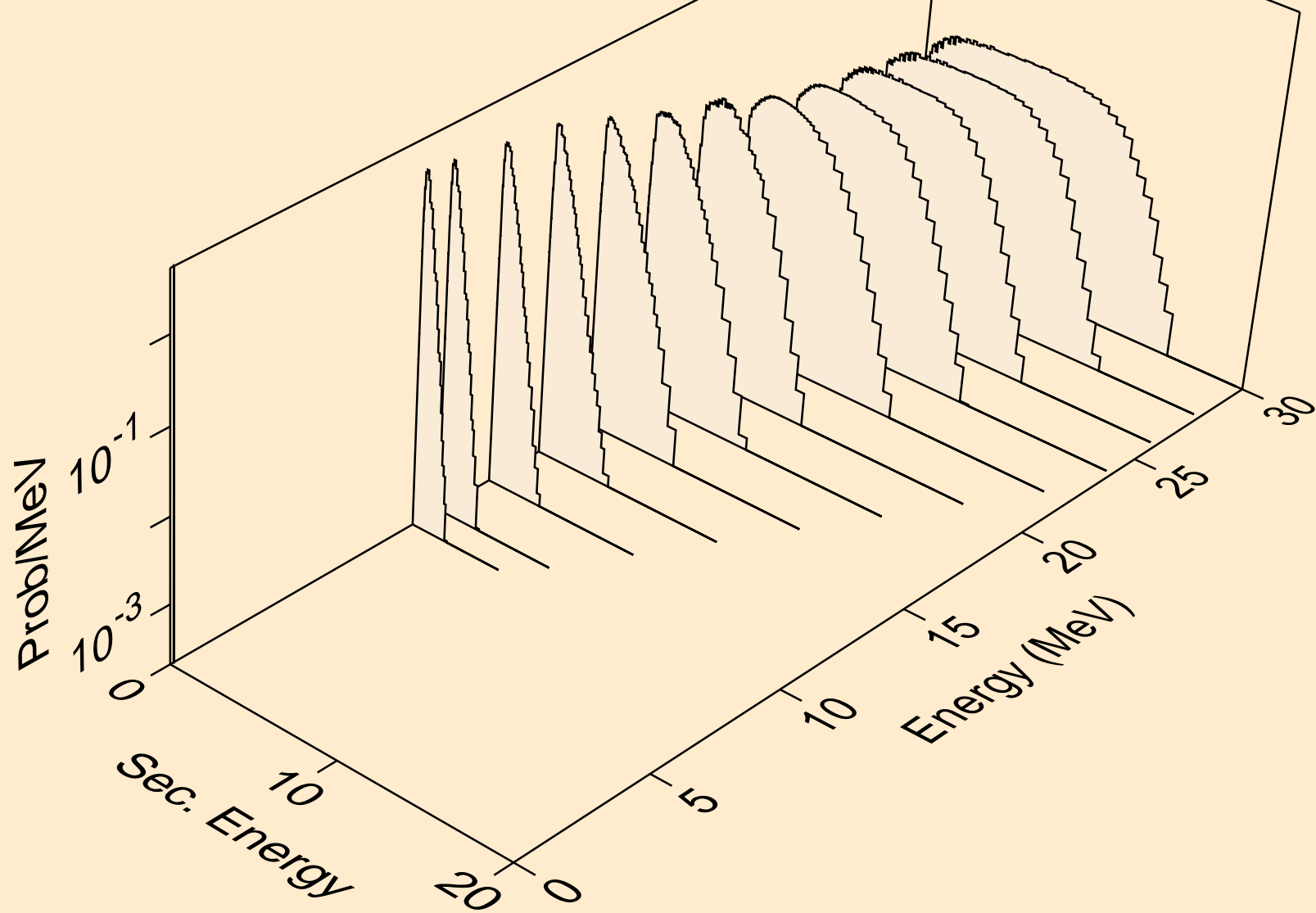

DB257 DEUTERON ACER TENDL-2023 LIBRARY; T=0.K  
protons from (d,x)

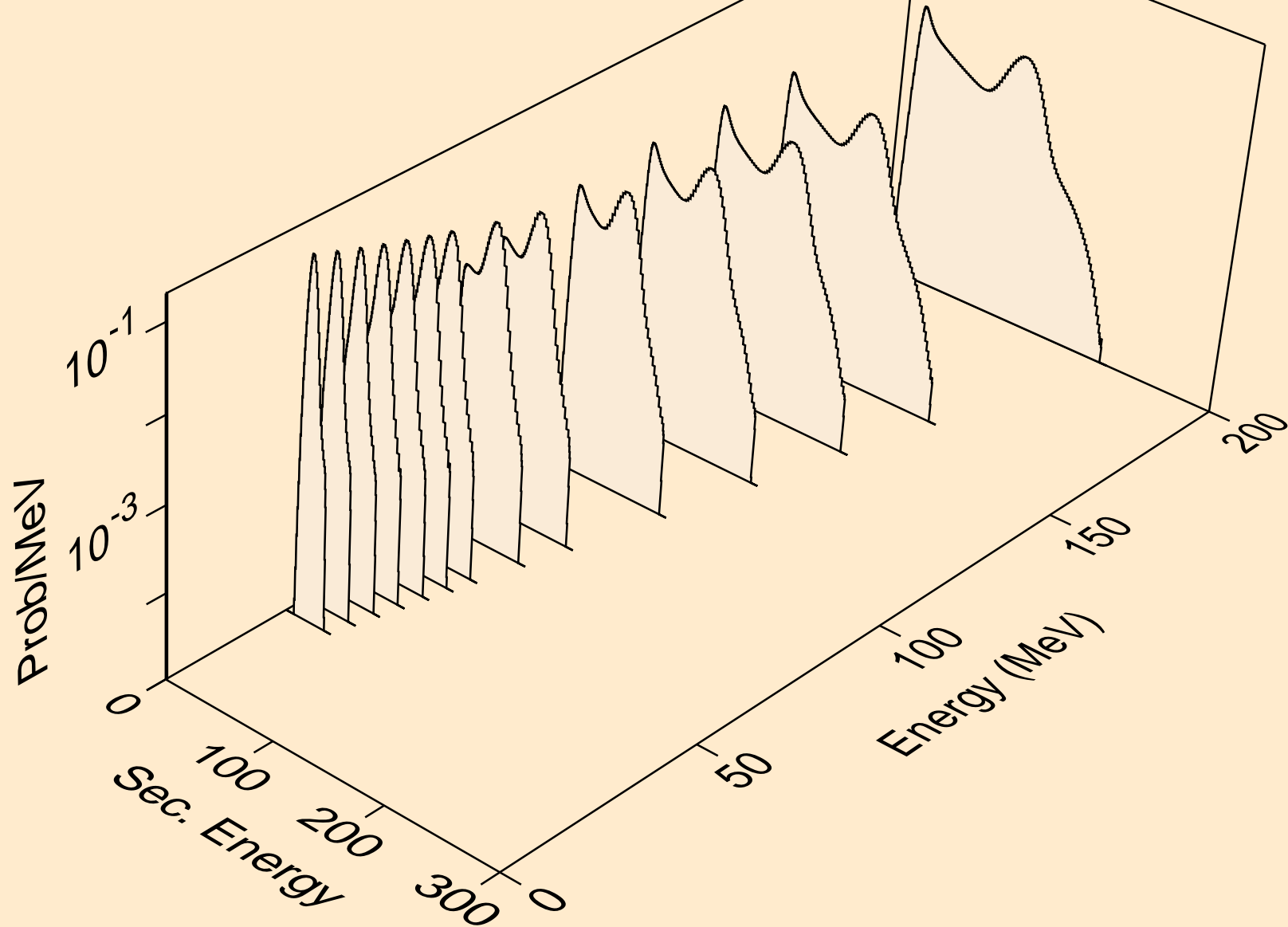

DB257 DEUTERON ACER TENDL-2023 LIBRARY; T=0.K  
protons from (d,n\*)p

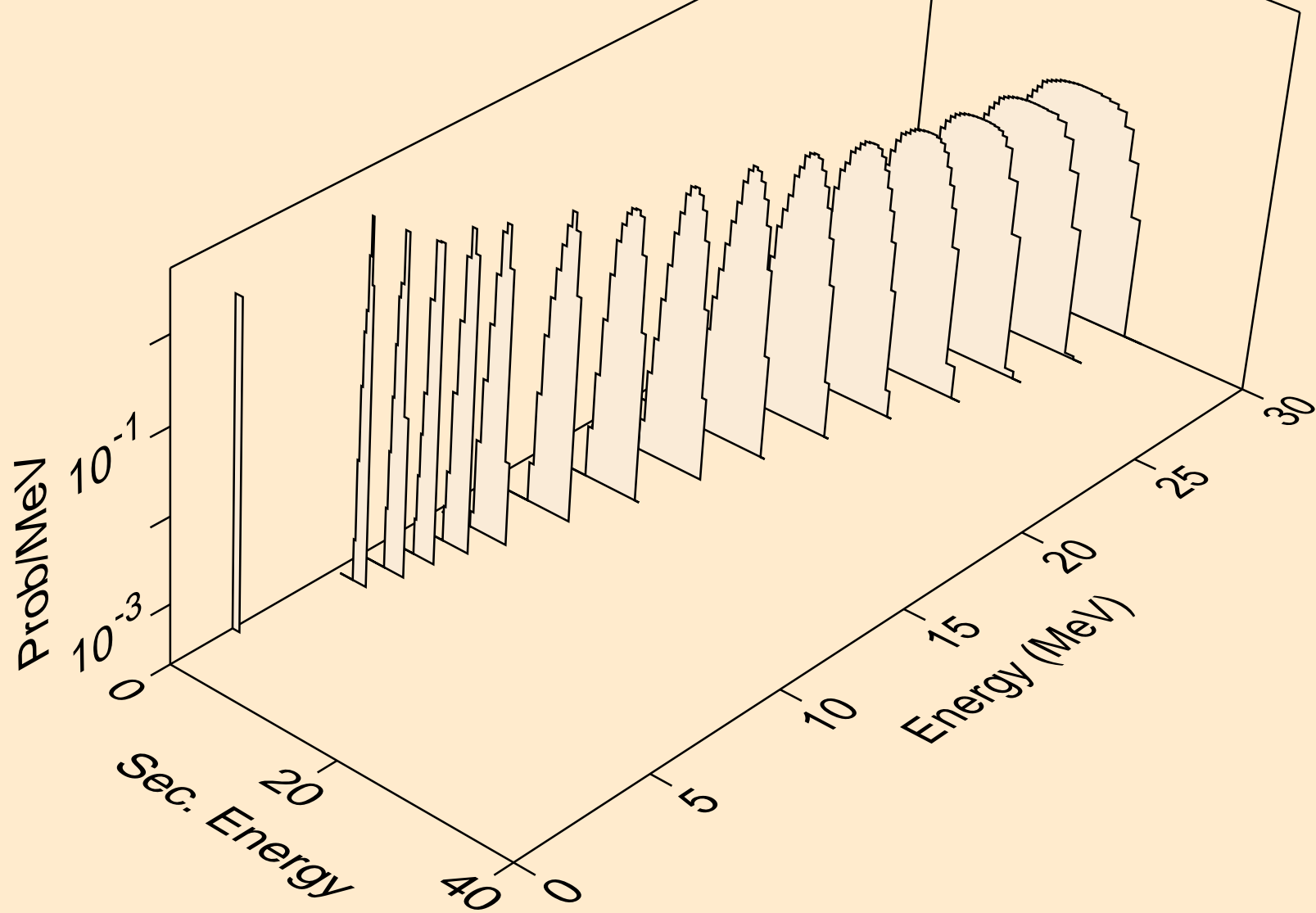

DB257 DEUTERON ACER TENDL-2023 LIBRARY; T=0.K  
protons from (d,2np)

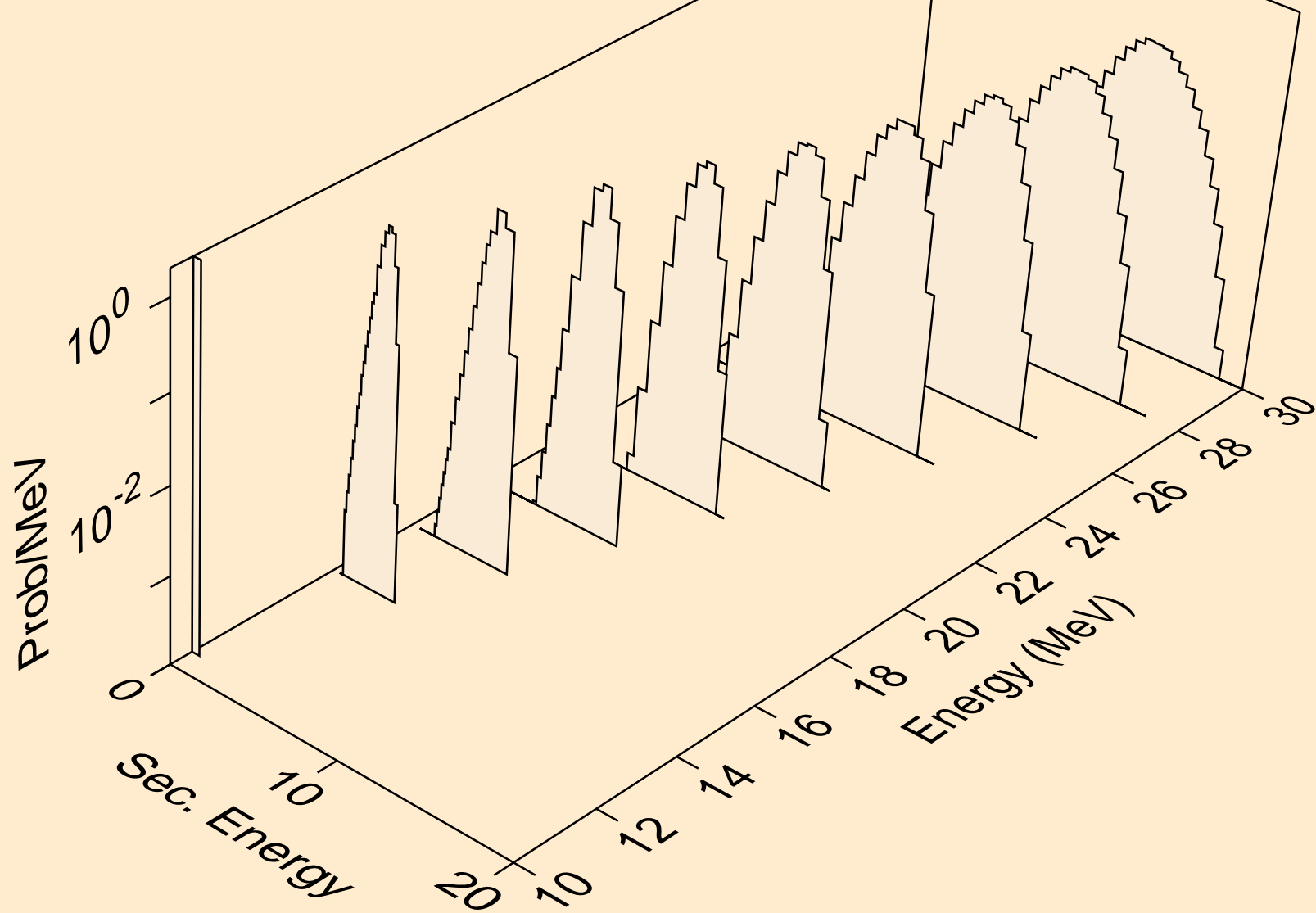

DB257 DEUTERON ACER TENDL-2023 LIBRARY; T=0.K  
protons from (d,n2p)

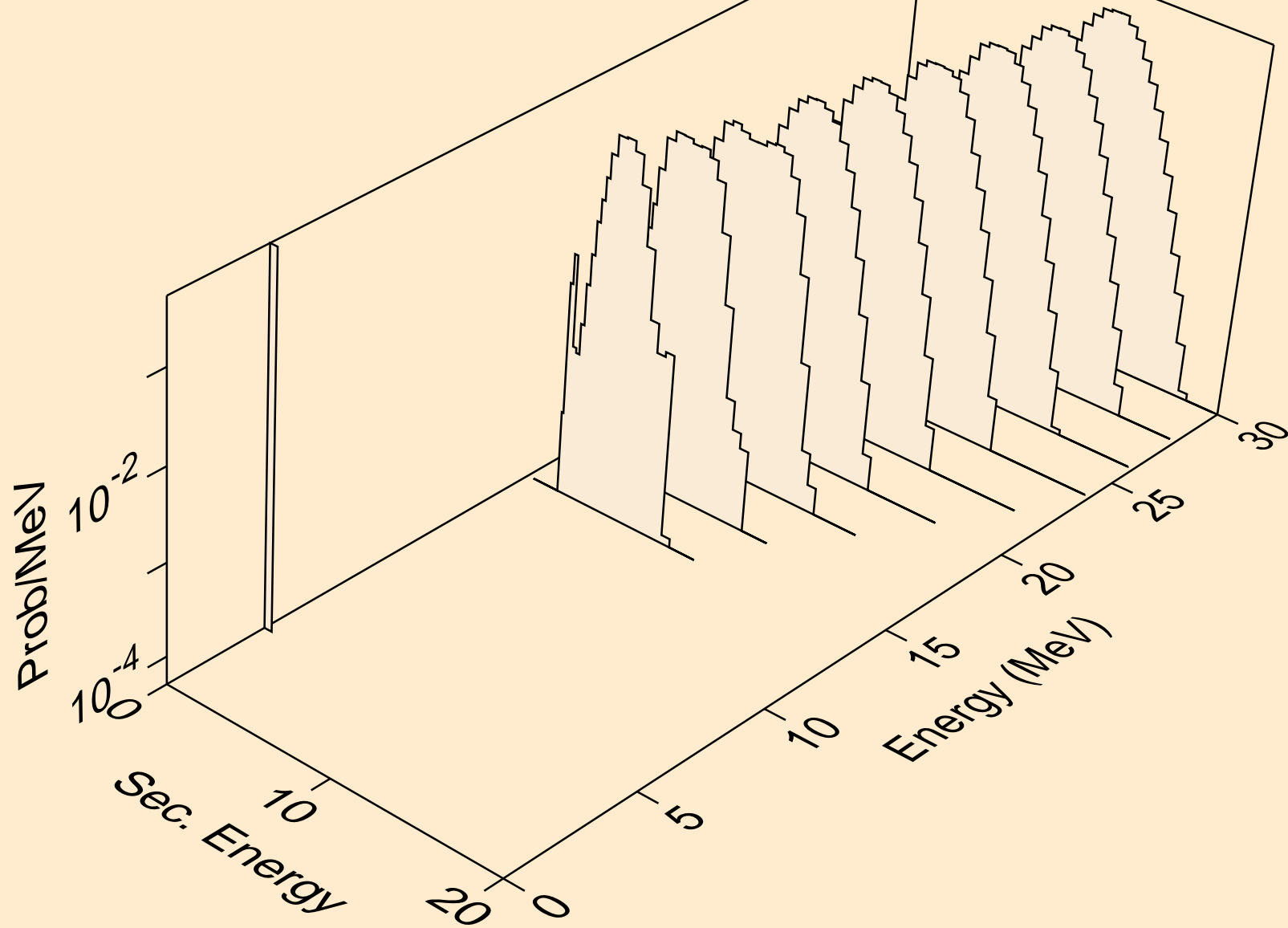



DB257 DEUTERON ACER TENDL-2023 LIBRARY; T=0.K  
protons from (d,npa)

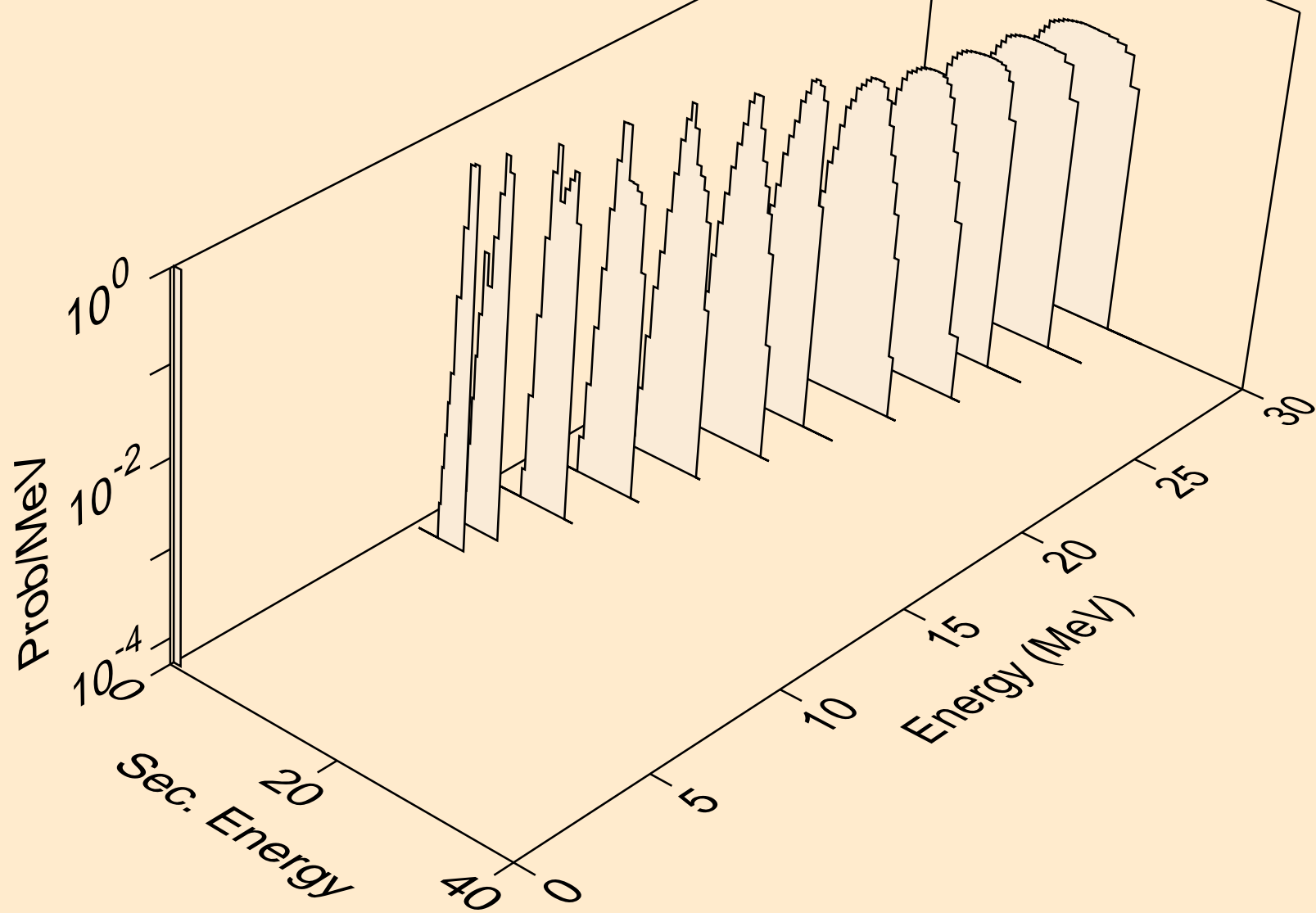

DB257 DEUTERON ACER TENDL-2023 LIBRARY; T=0.K  
protons from (d,p)

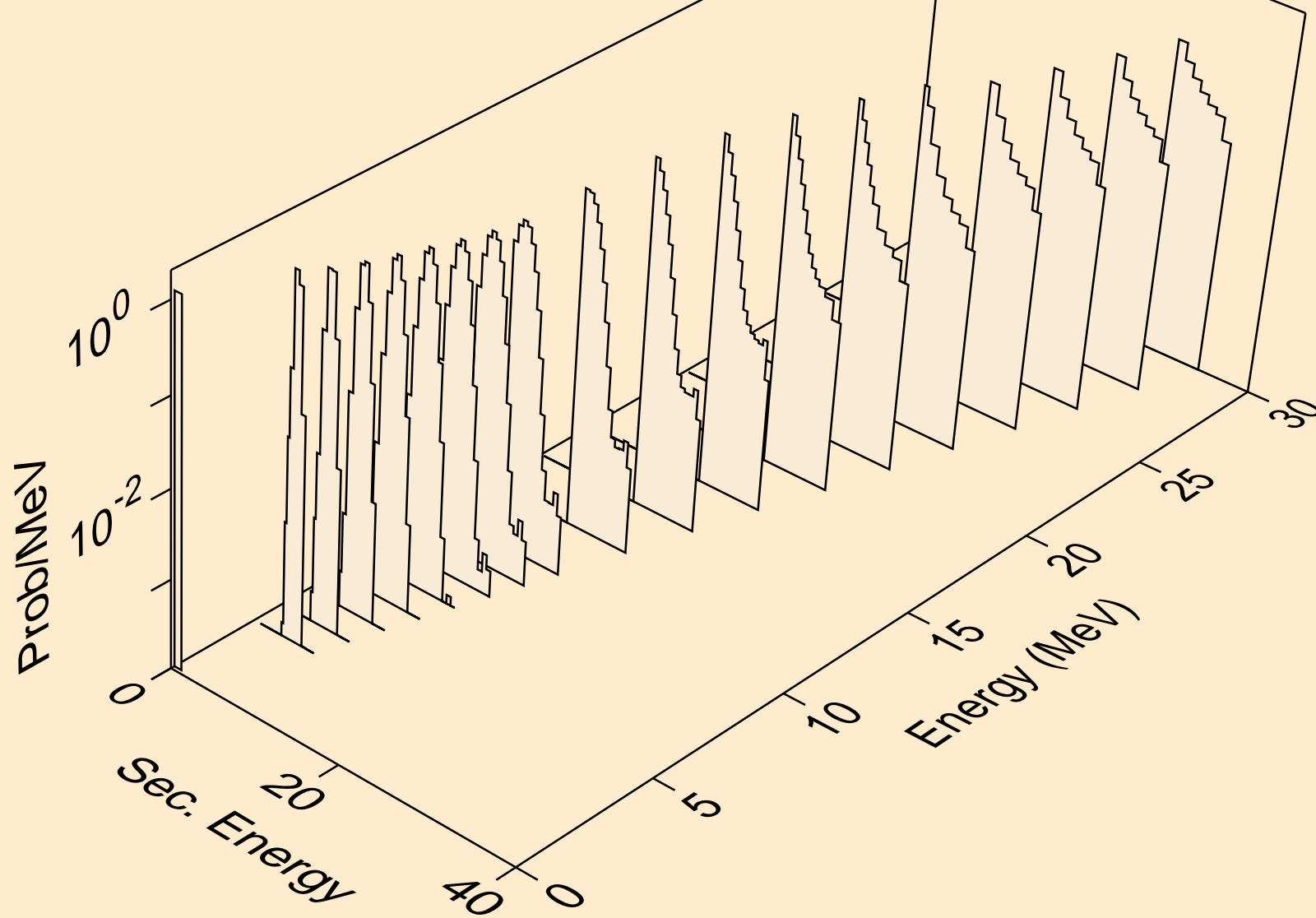

DB257 DEUTERON ACER TENDL-2023 LIBRARY; T=0.K  
protons from (d,2p)

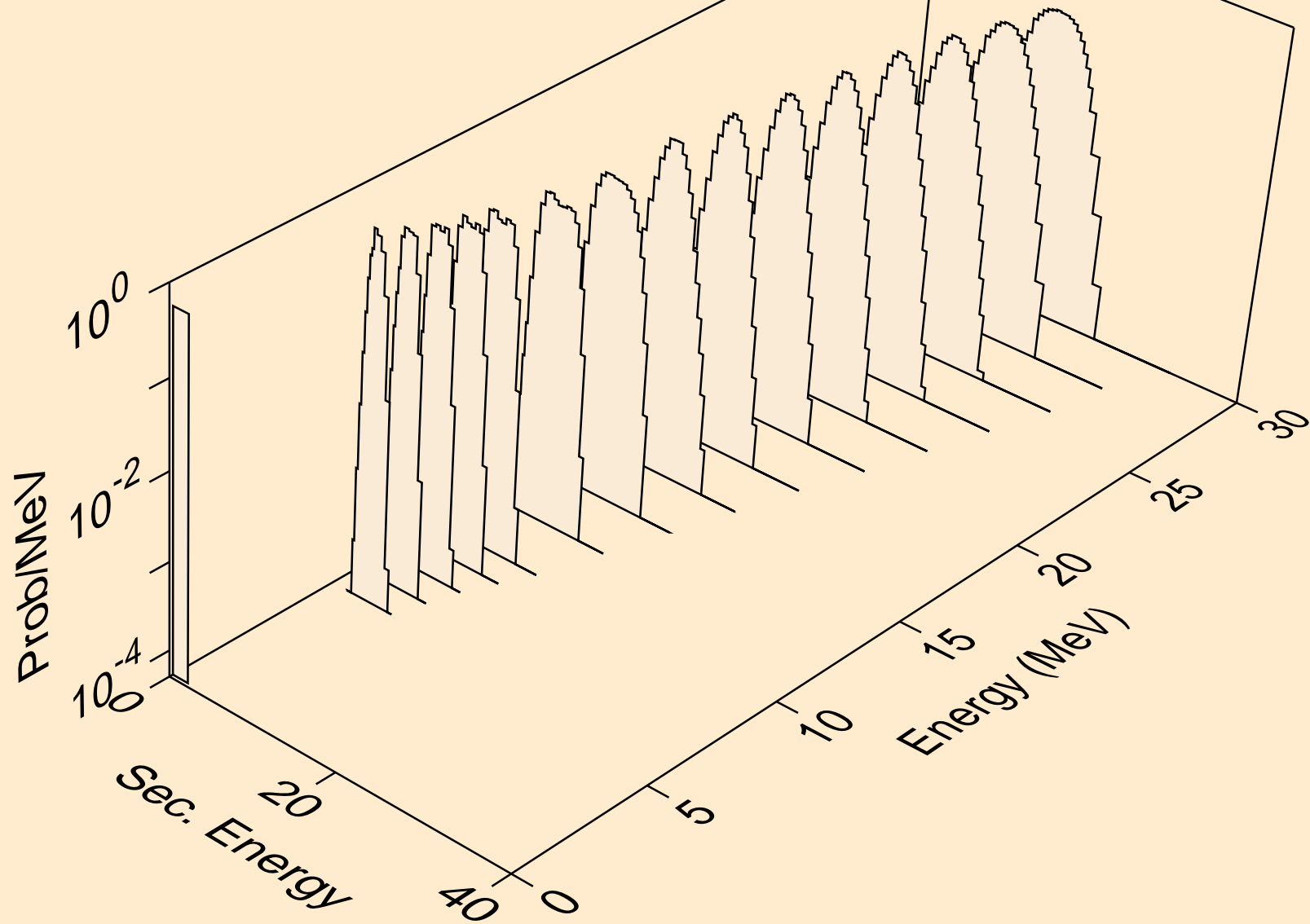

DB257 DEUTERON ACER TENDL-2023 LIBRARY; T=0.K  
protons from (d,pa)

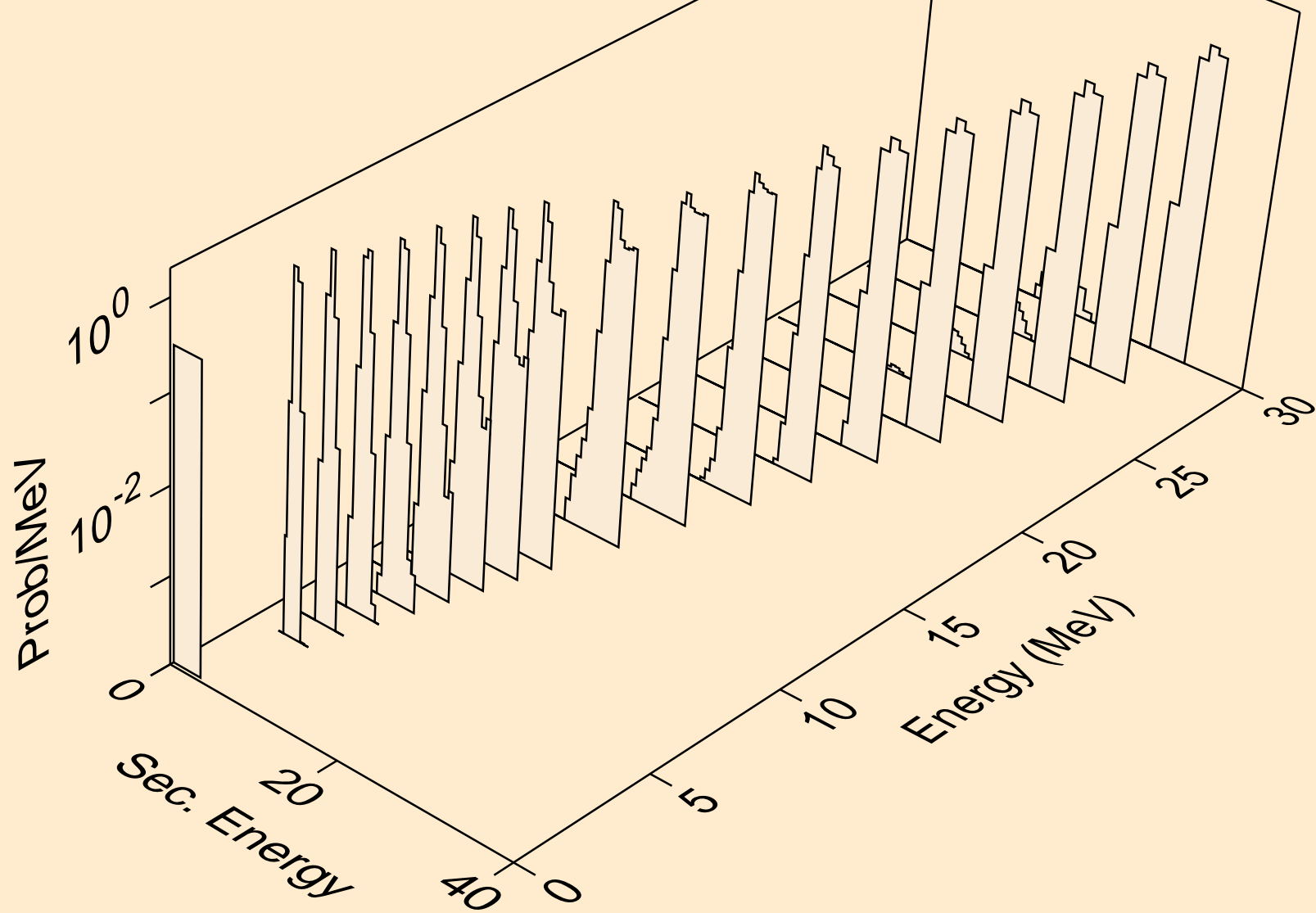

DB257 DEUTERON ACER TENDL-2023 LIBRARY; T=0.K  
protons from (d,pd)

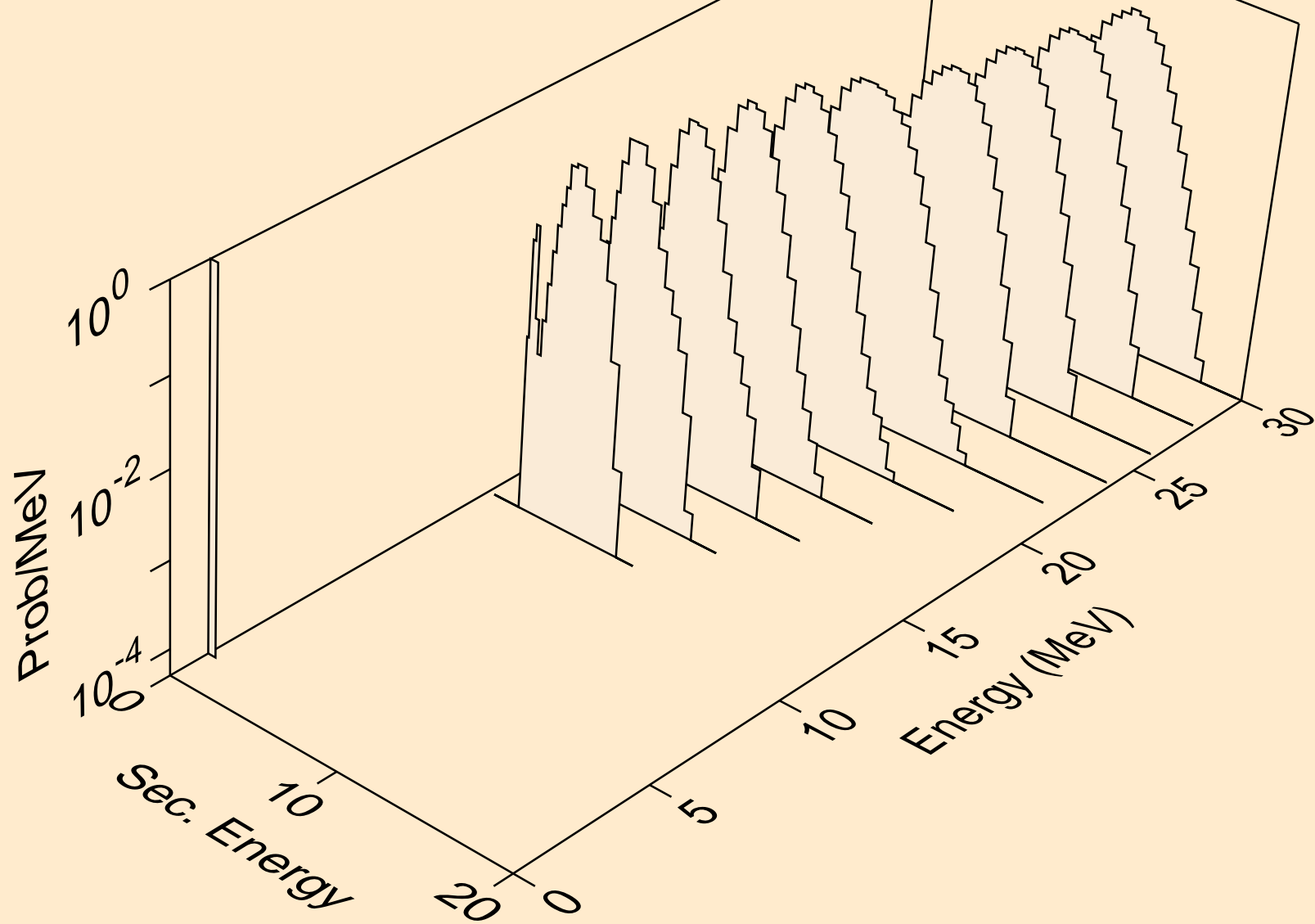

DB257 DEUTERON ACER TENDL-2023 LIBRARY; T=0.K  
tritons from (d,x)

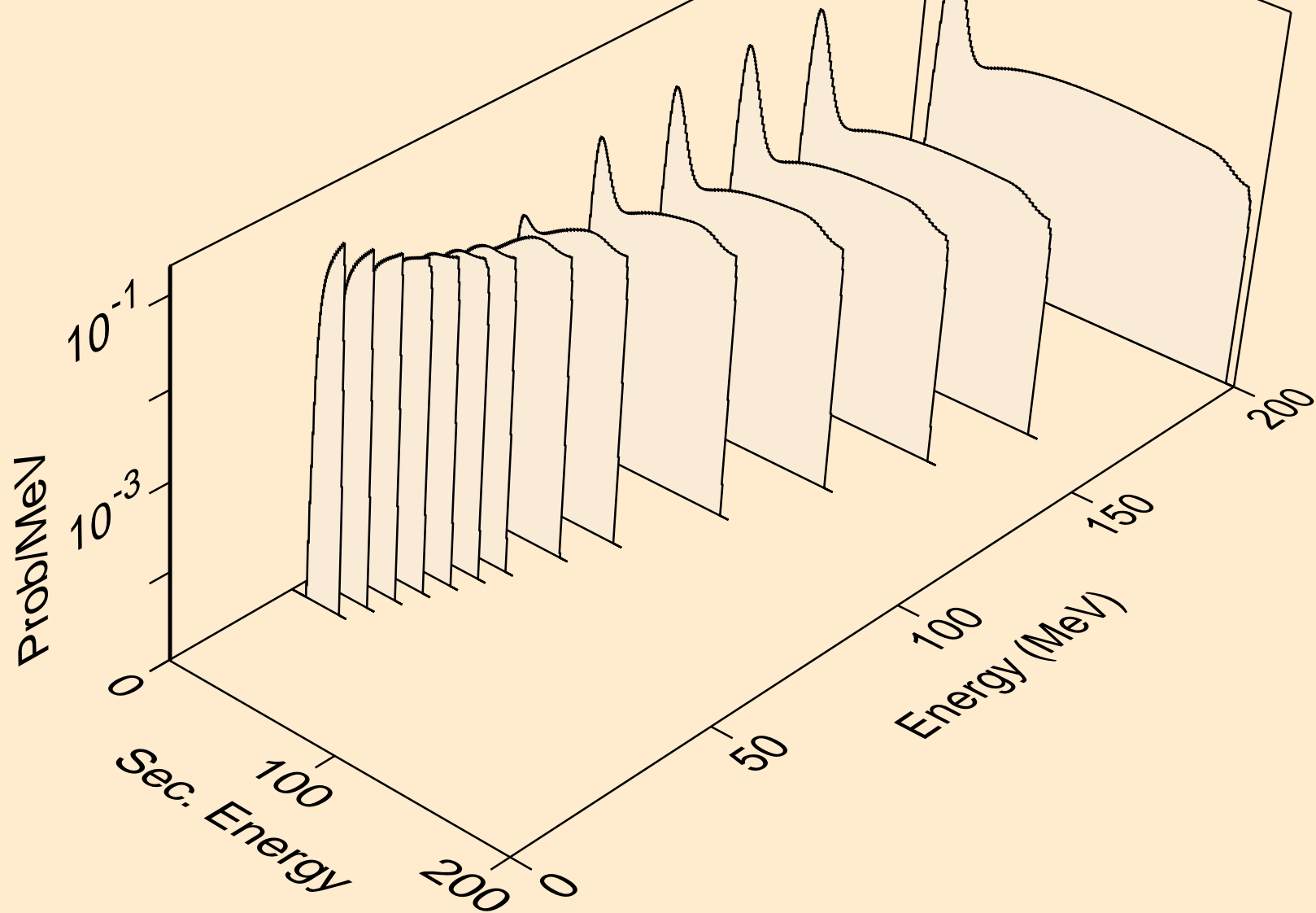

DB257 DEUTERON ACER TENDL-2023 LIBRARY; T=0.K  
tritons from (d,n\*)t

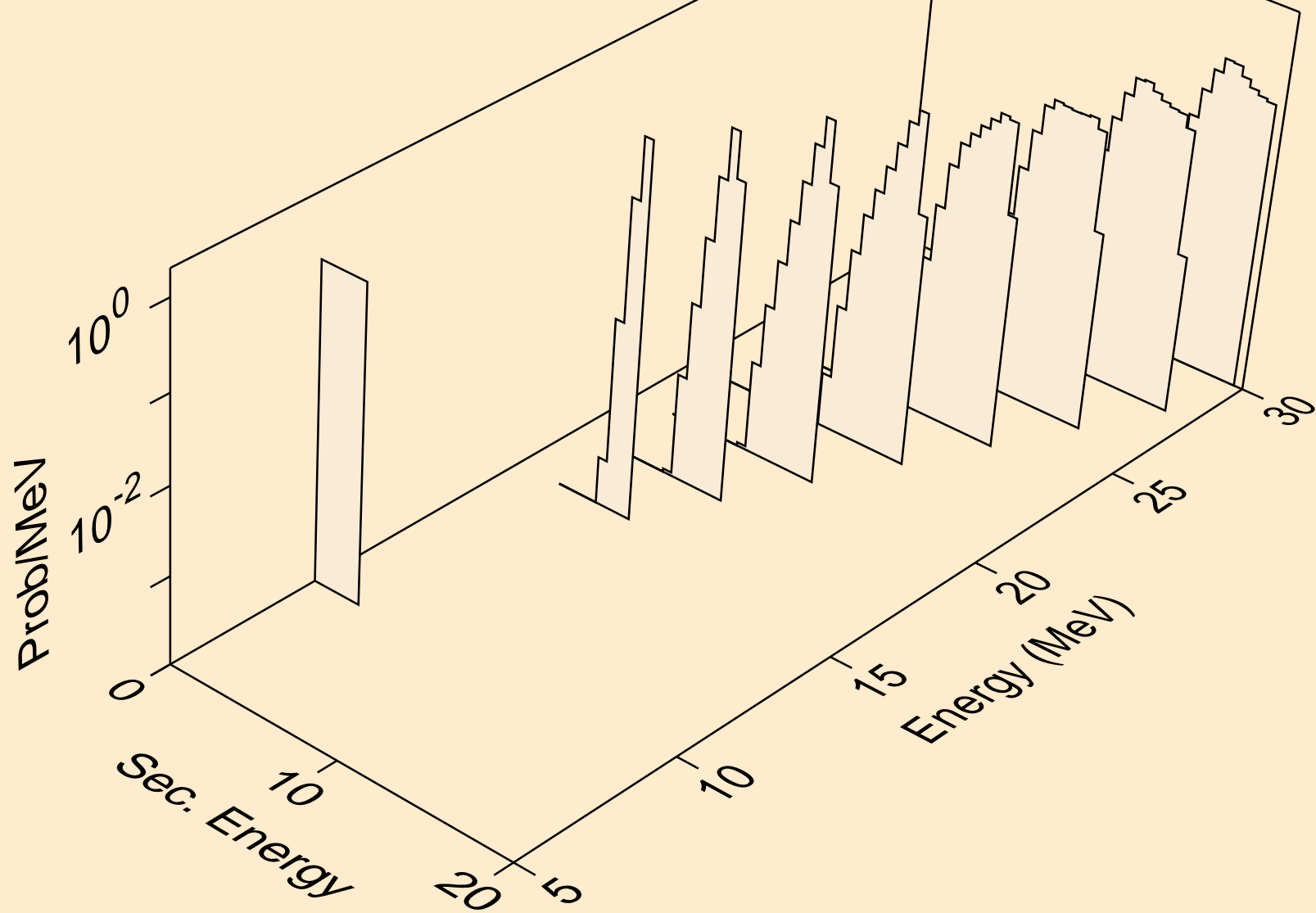

DB257 DEUTERON ACER TENDL-2023 LIBRARY; T=0.K  
tritons from (d,t)

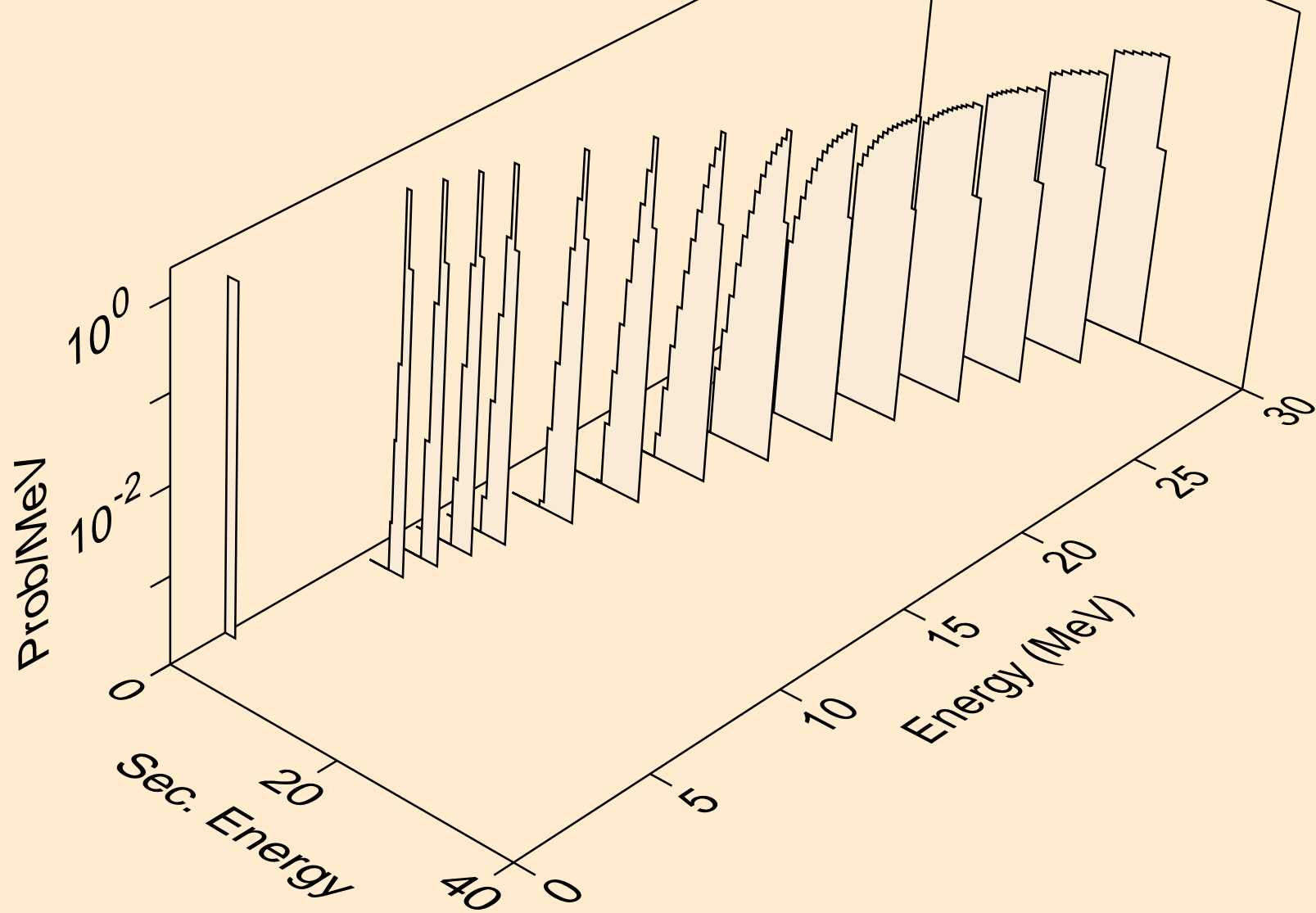



DB257 DEUTERON ACER TENDL-2023 LIBRARY; T=0.K  
he3s from (d,x)

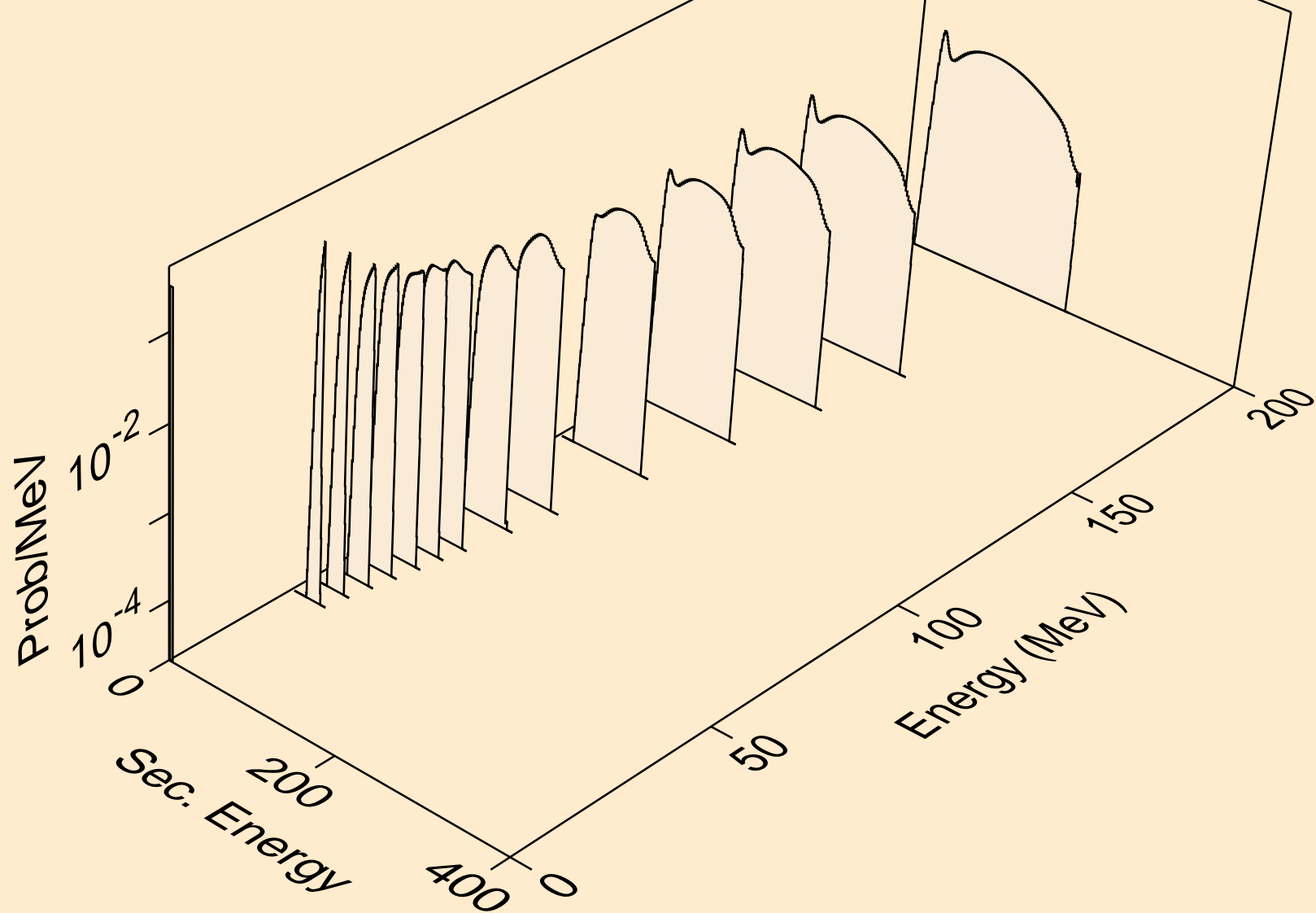

DB257 DEUTERON ACER TENDL-2023 LIBRARY; T=0.K  
he3s from (d,he3)

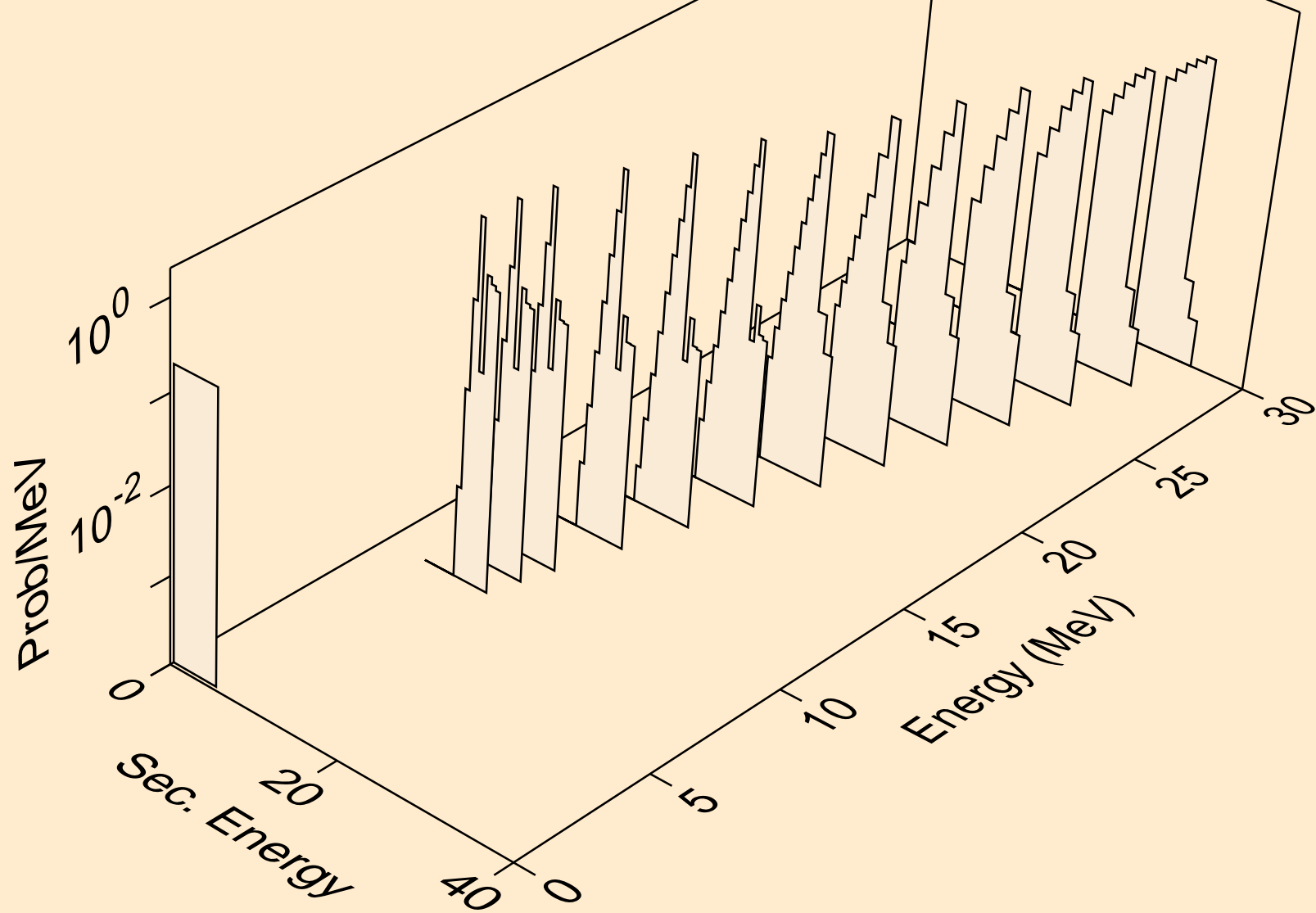

DB257 DEUTERON ACER TENDL-2023 LIBRARY; T=0.K  
alphas from (d,x)

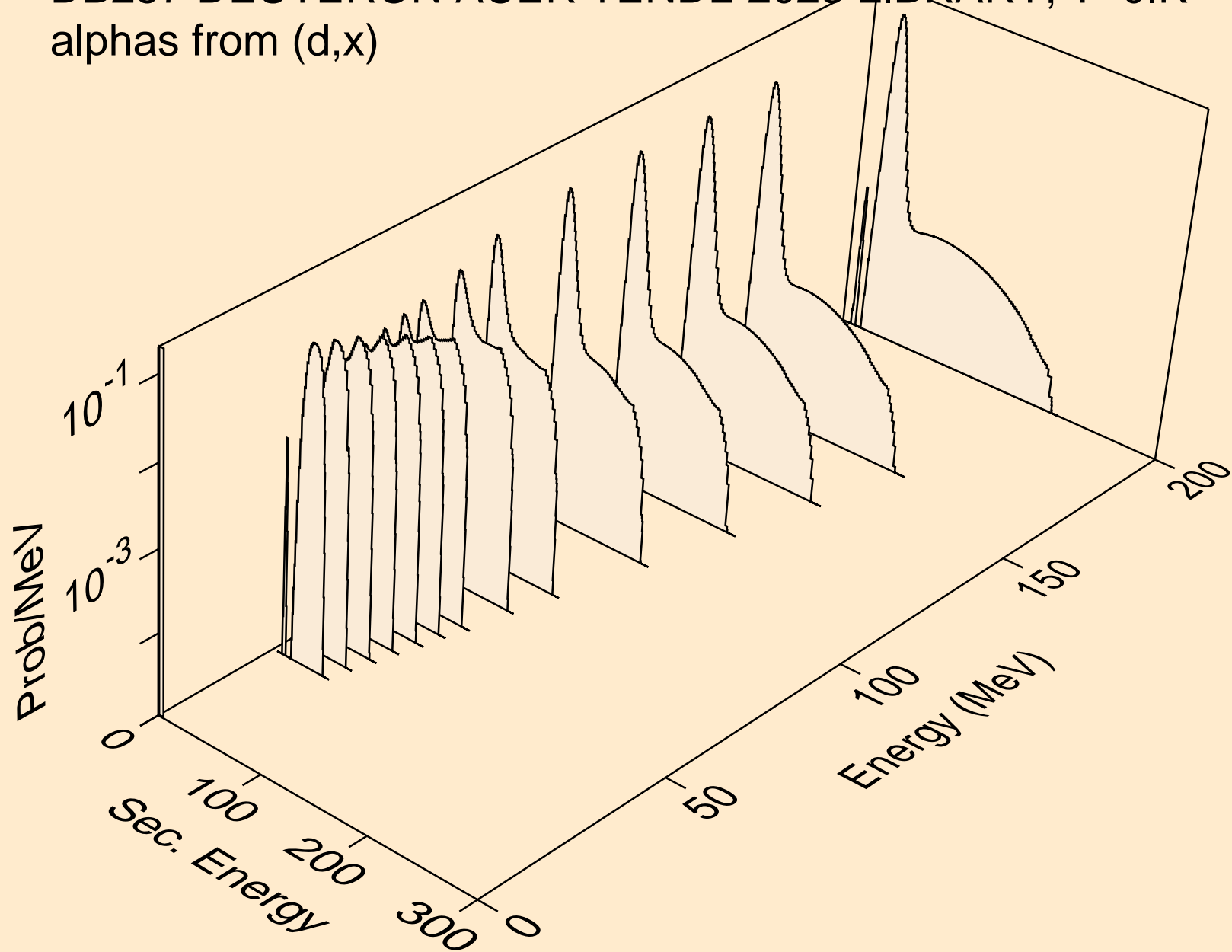

DB257 DEUTERON ACER TENDL-2023 LIBRARY; T=0.K  
alphas from (d,n\*)a

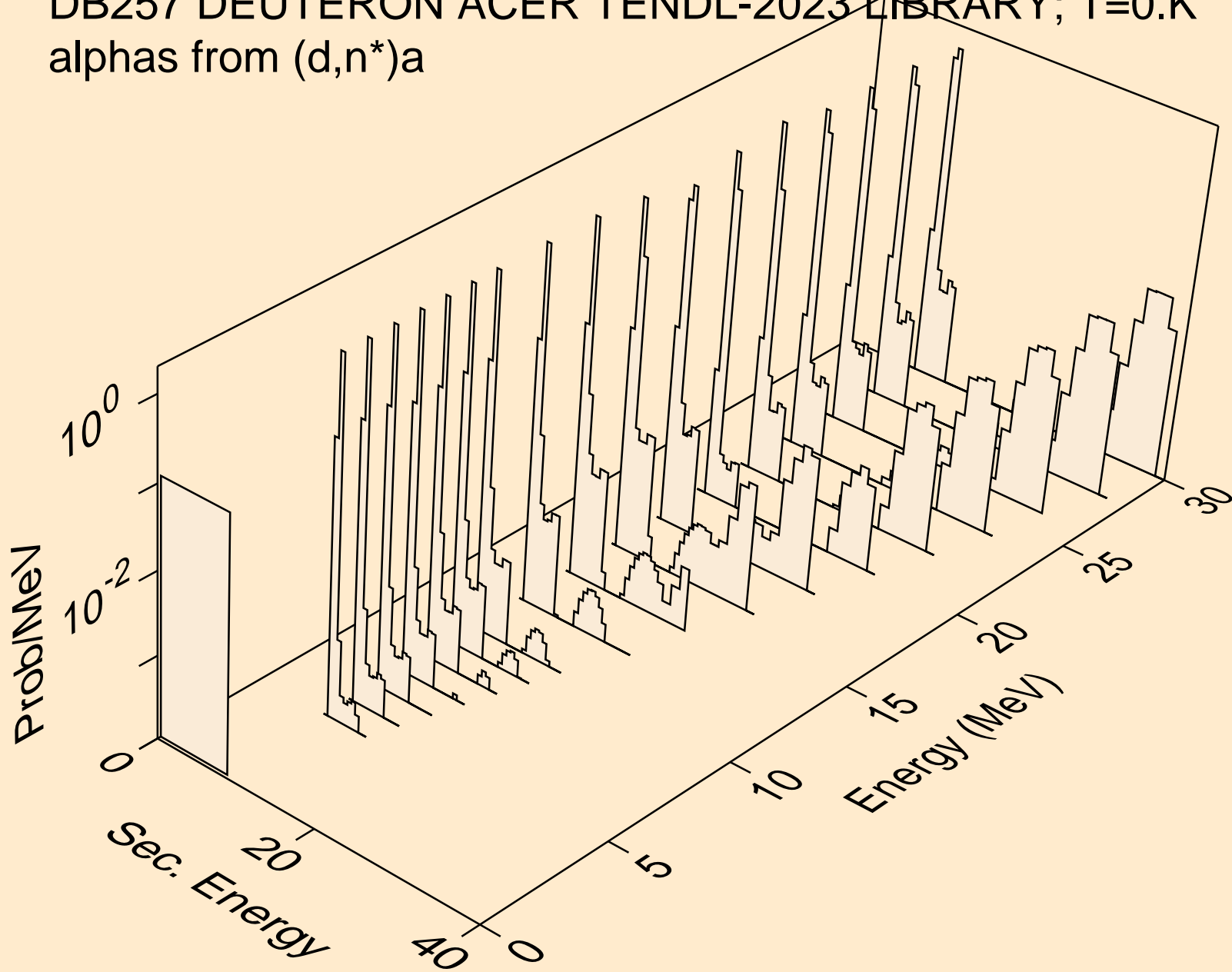

DB257 DEUTERON ACER TENDL-2023 LIBRARY; T=0.K  
alphas from (d,2n)a

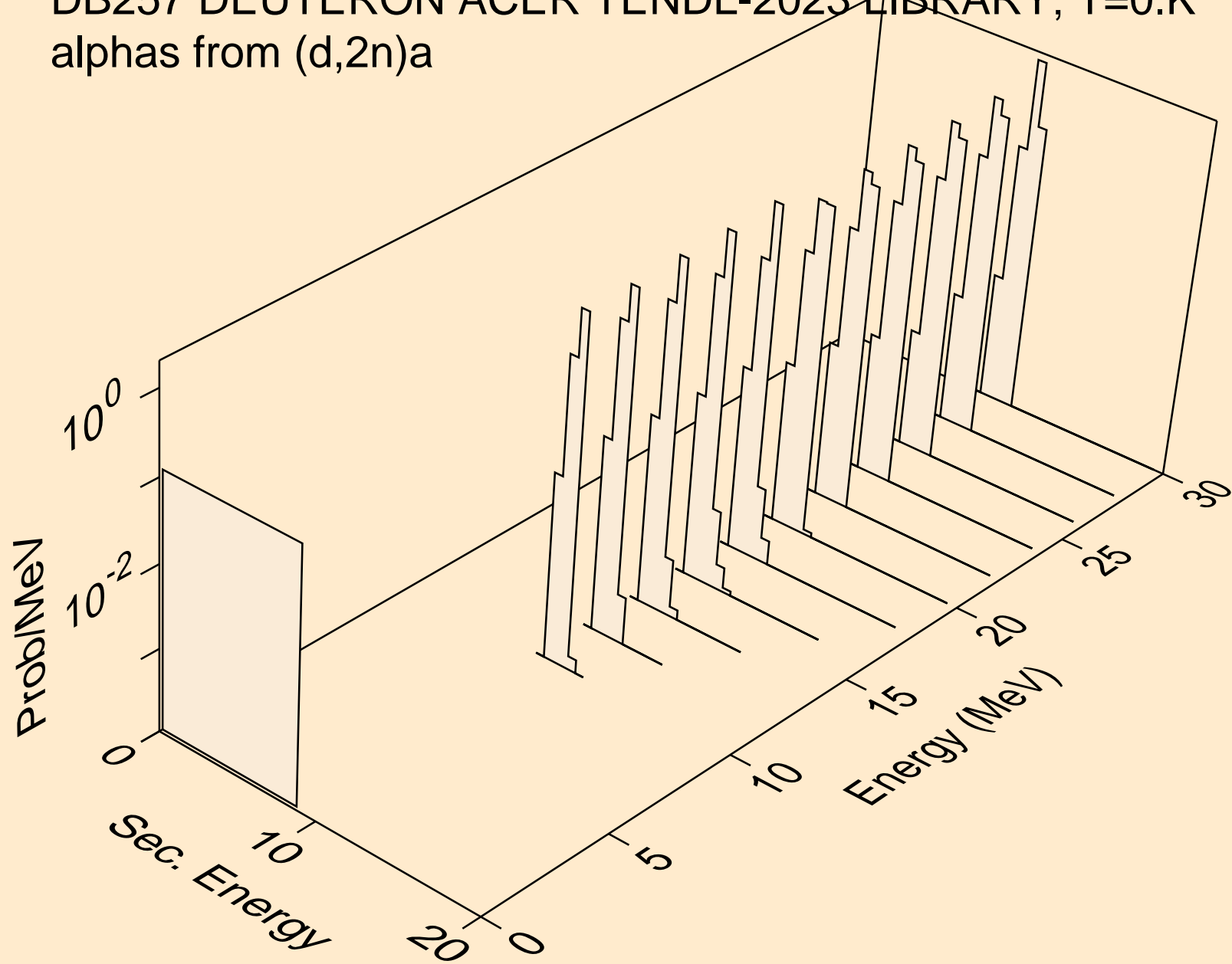

DB257 DEUTERON ACER TENDL-2023 LIBRARY; T=0.K  
alphas from (d,3n)a

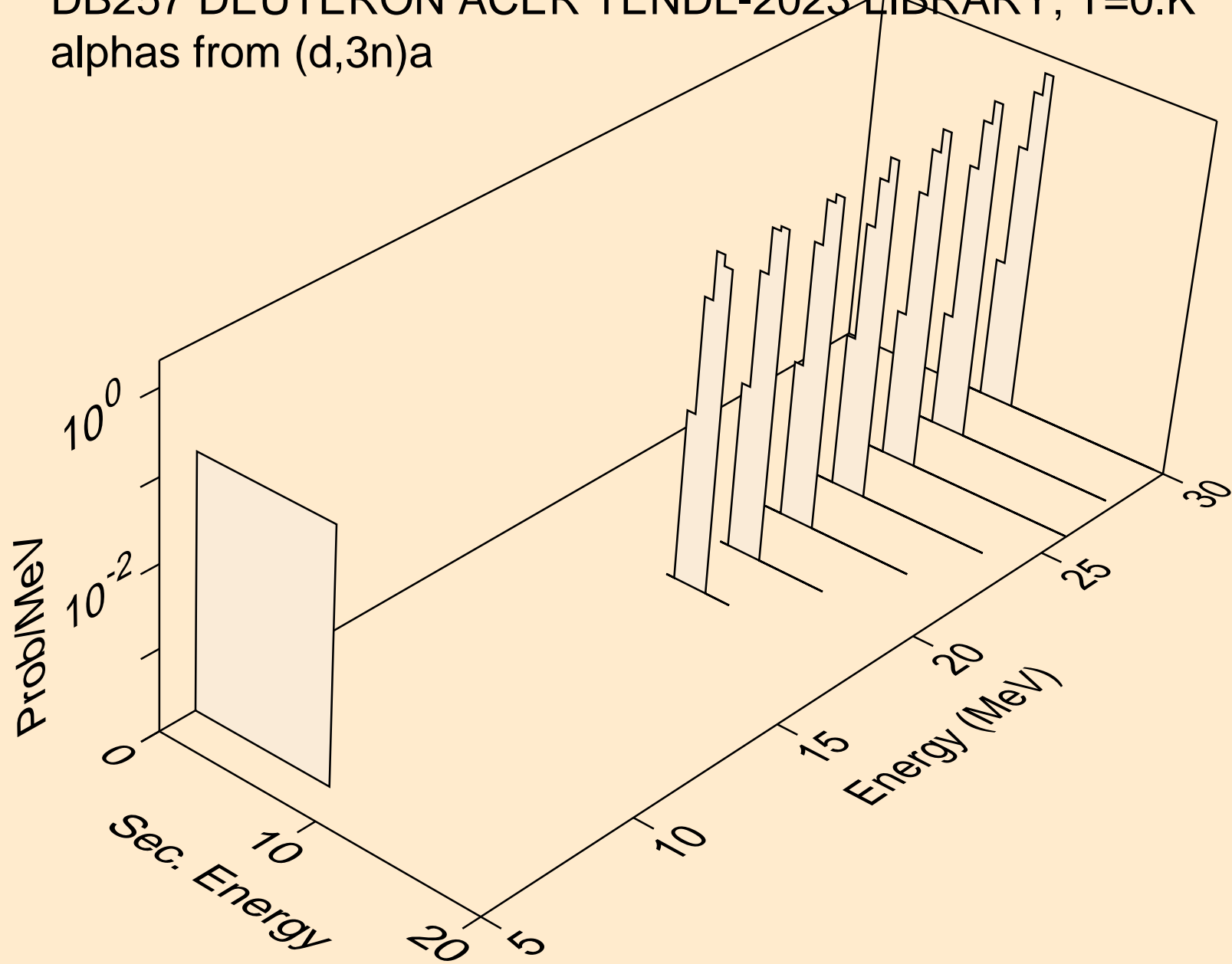

DB257 DEUTERON ACER TENDL-2023 LIBRARY; T=0.K  
alphas from (d,npa)

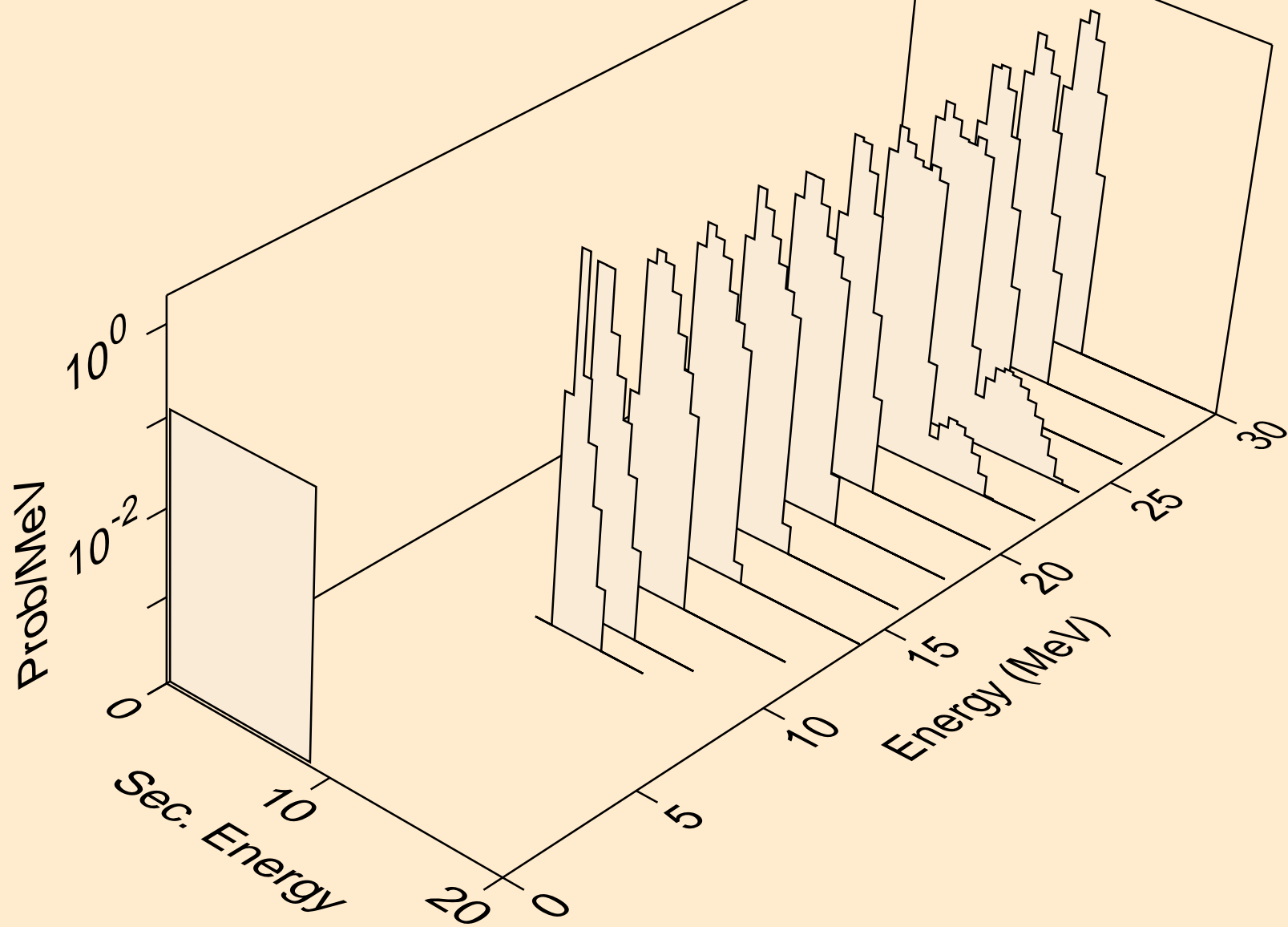

DB257 DEUTERON ACER TENDL-2023 LIBRARY; T=0.K  
alphas from (d,a)

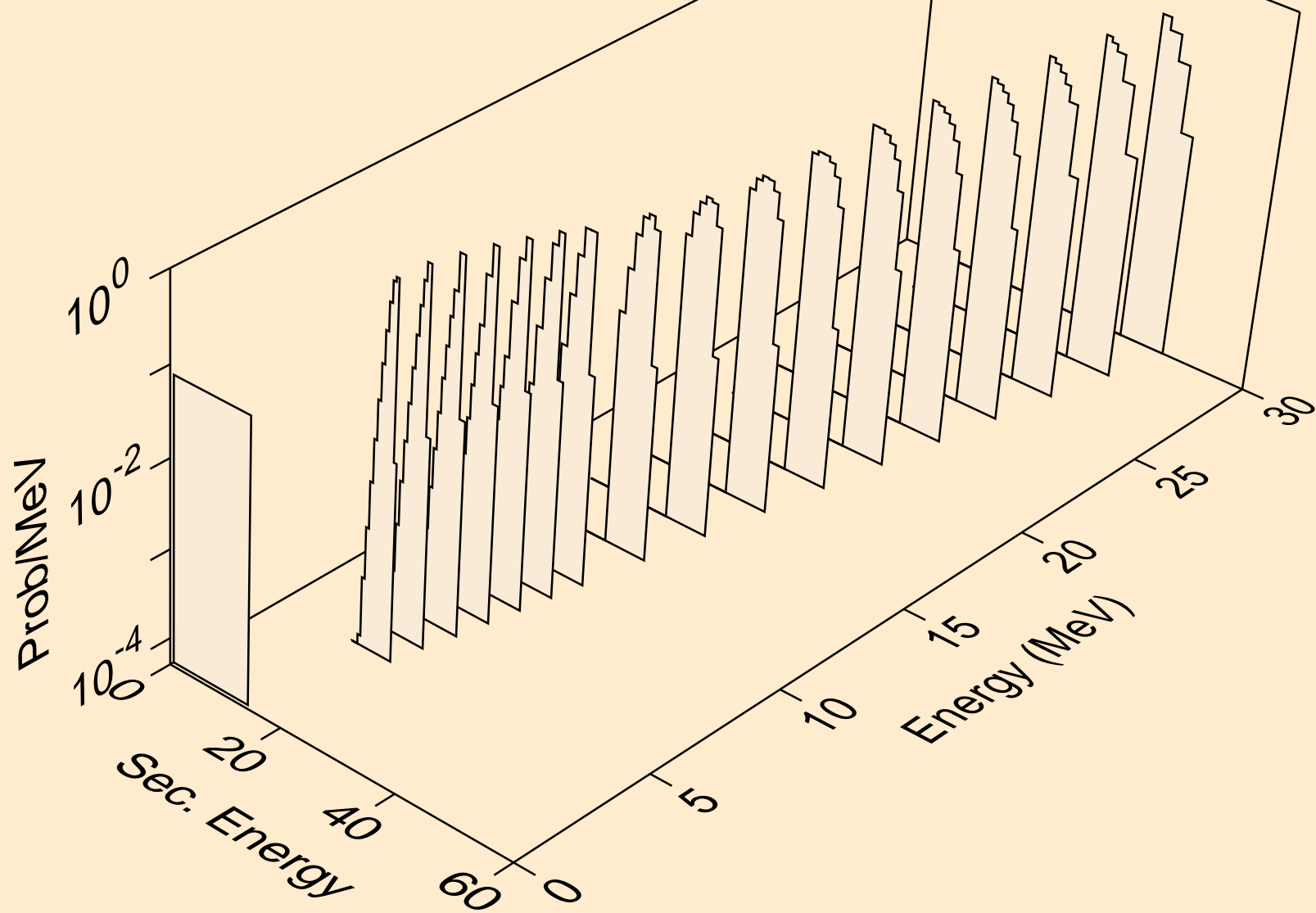



DB257 DEUTERON ACER TENDL-2023 LIBRARY; T=0.K  
alphas from (d,2a)

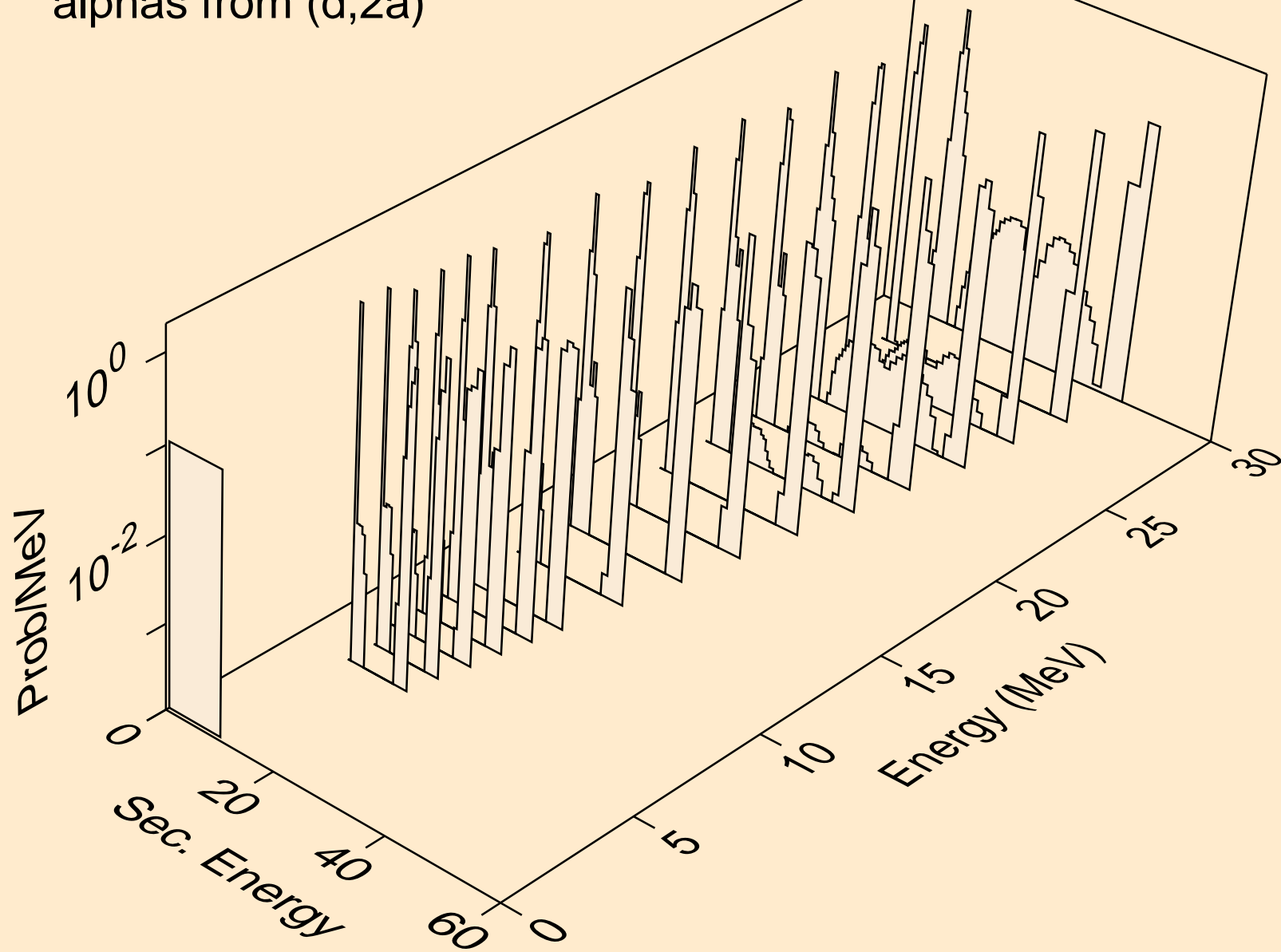

DB257 DEUTERON ACER TENDL-2023 LIBRARY; T=0.K  
alphas from (d,pa)

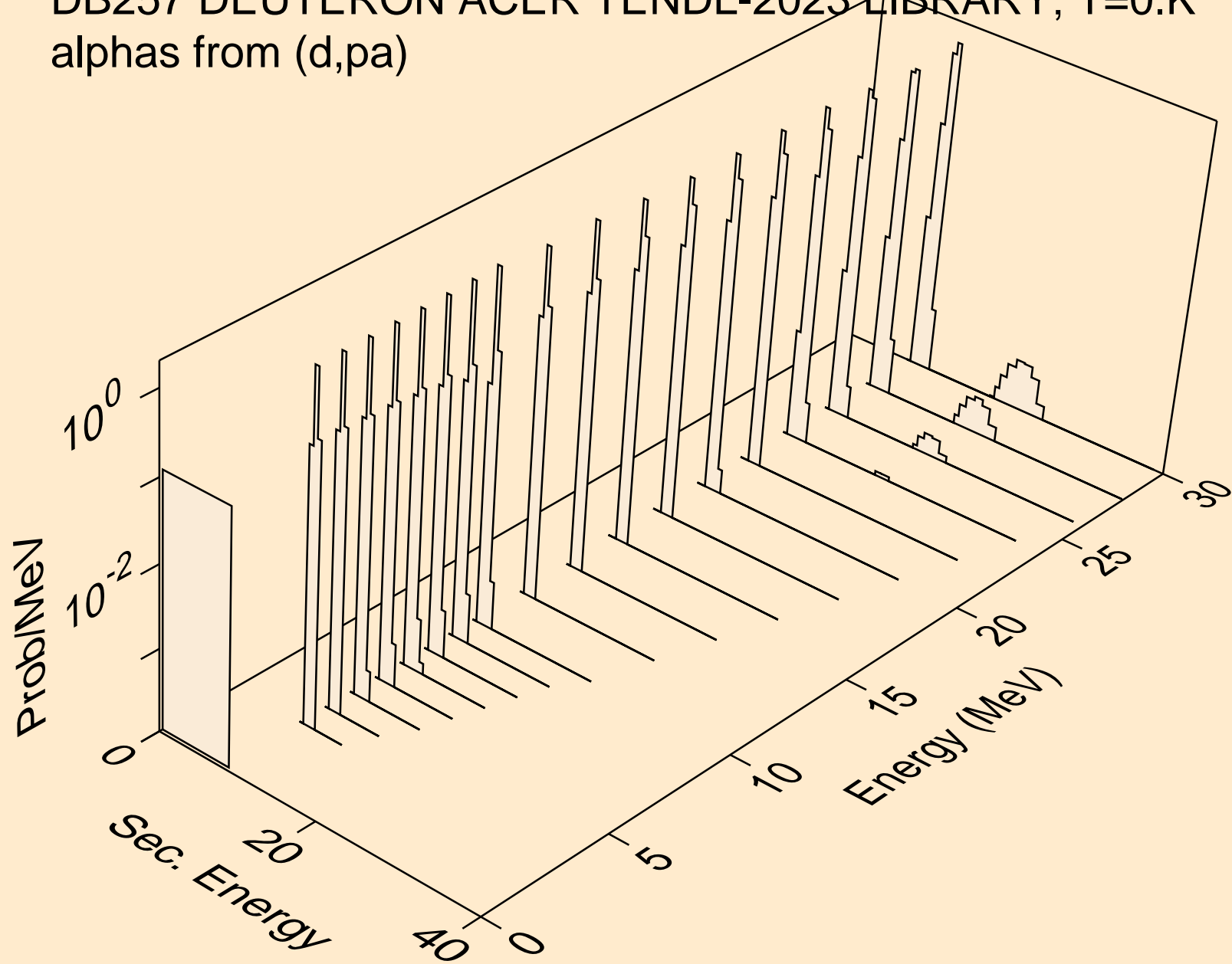

DB257 DEUTERON ACER TENDL-2023 LIBRARY; T=0.K  
alphas from (d,da)

