

DY149 DEUTERON ACER TENDL-2023 LIBRARY; T=0.K  
Principal cross sections

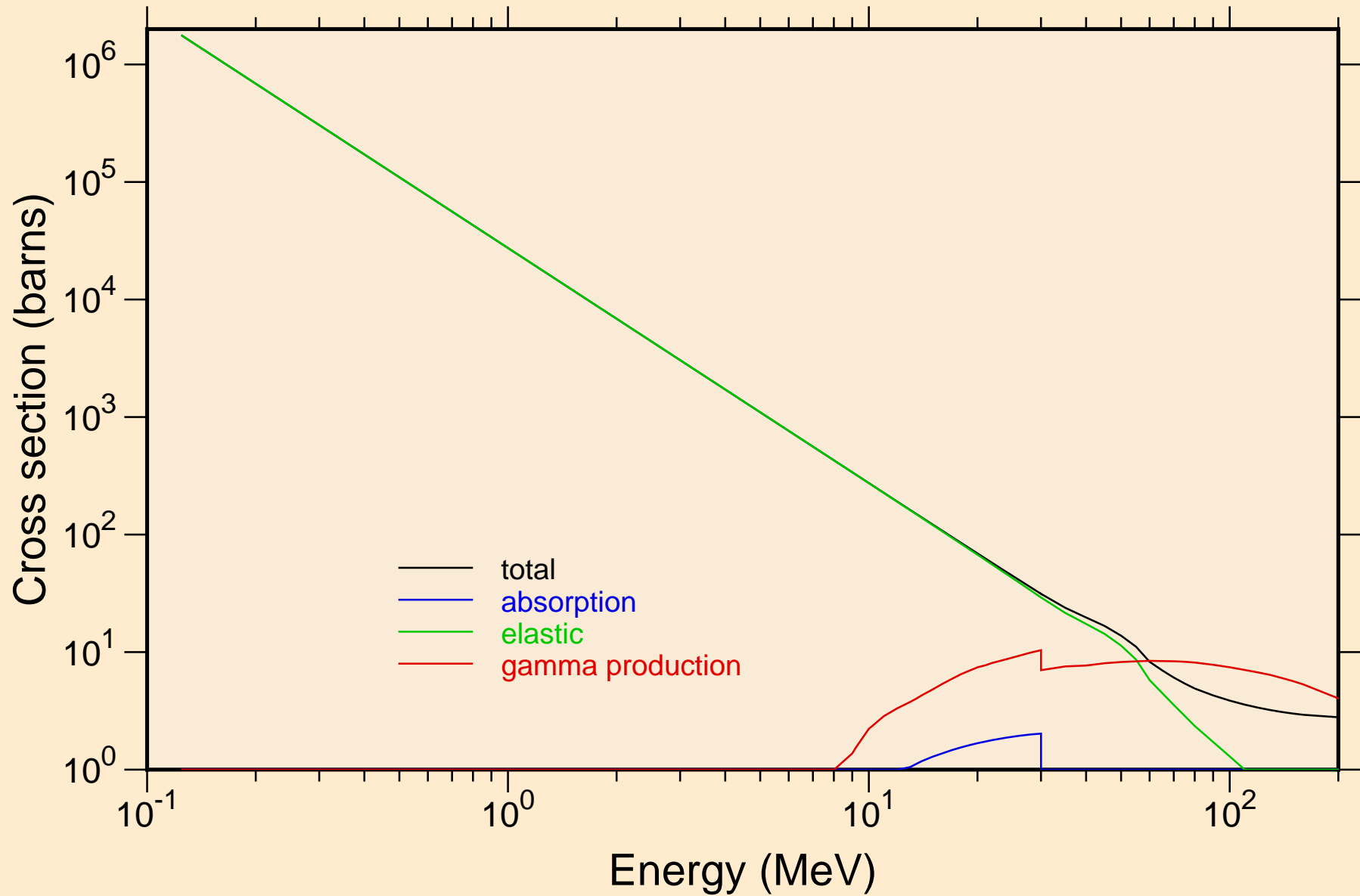

DY149 DEUTERON ACER TENDL-2023 LIBRARY; T=0.K  
Heating

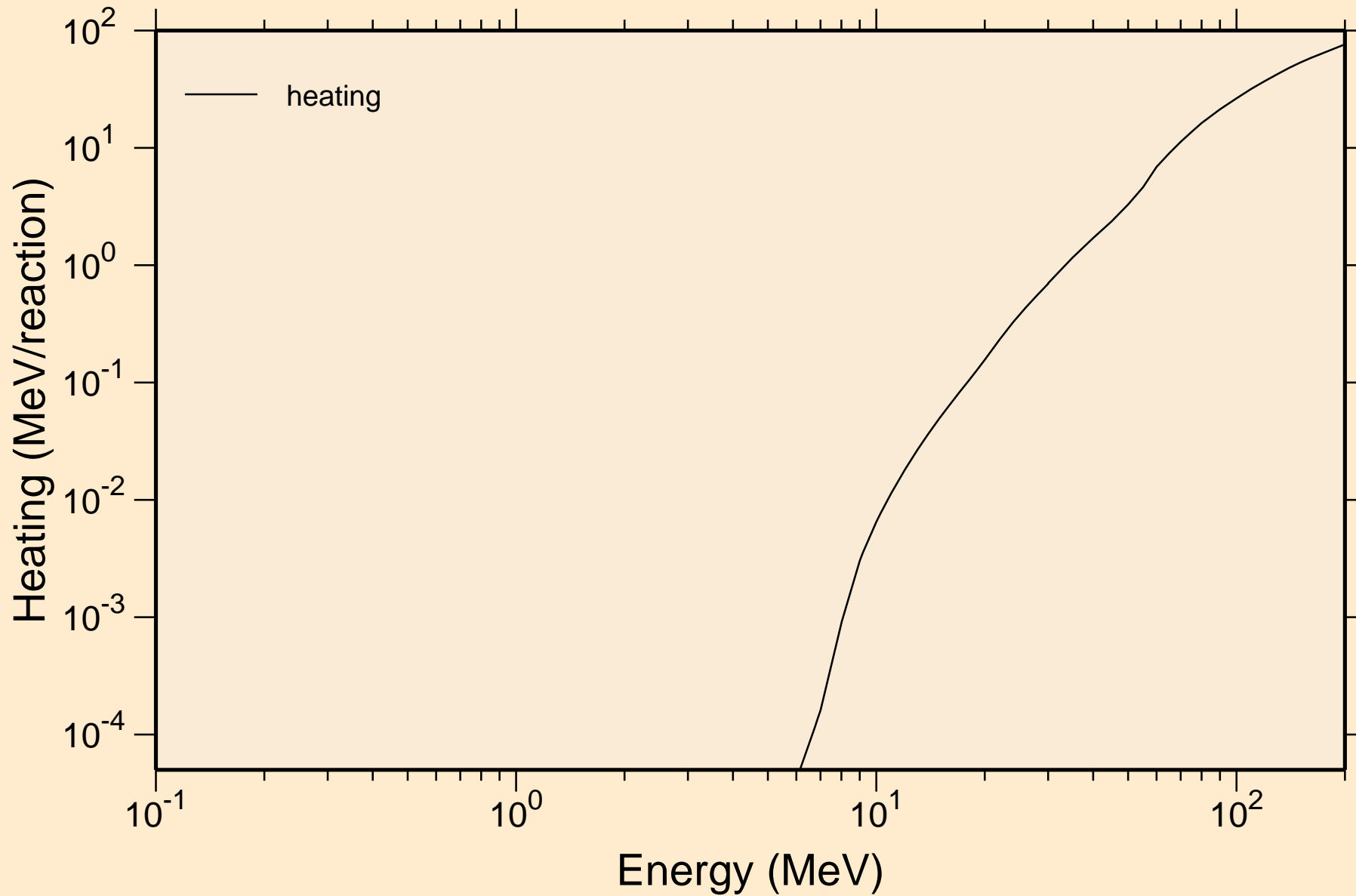

DY149 DEUTERON ACER TENDL-2023 LIBRARY; T=0.K  
Principal cross sections

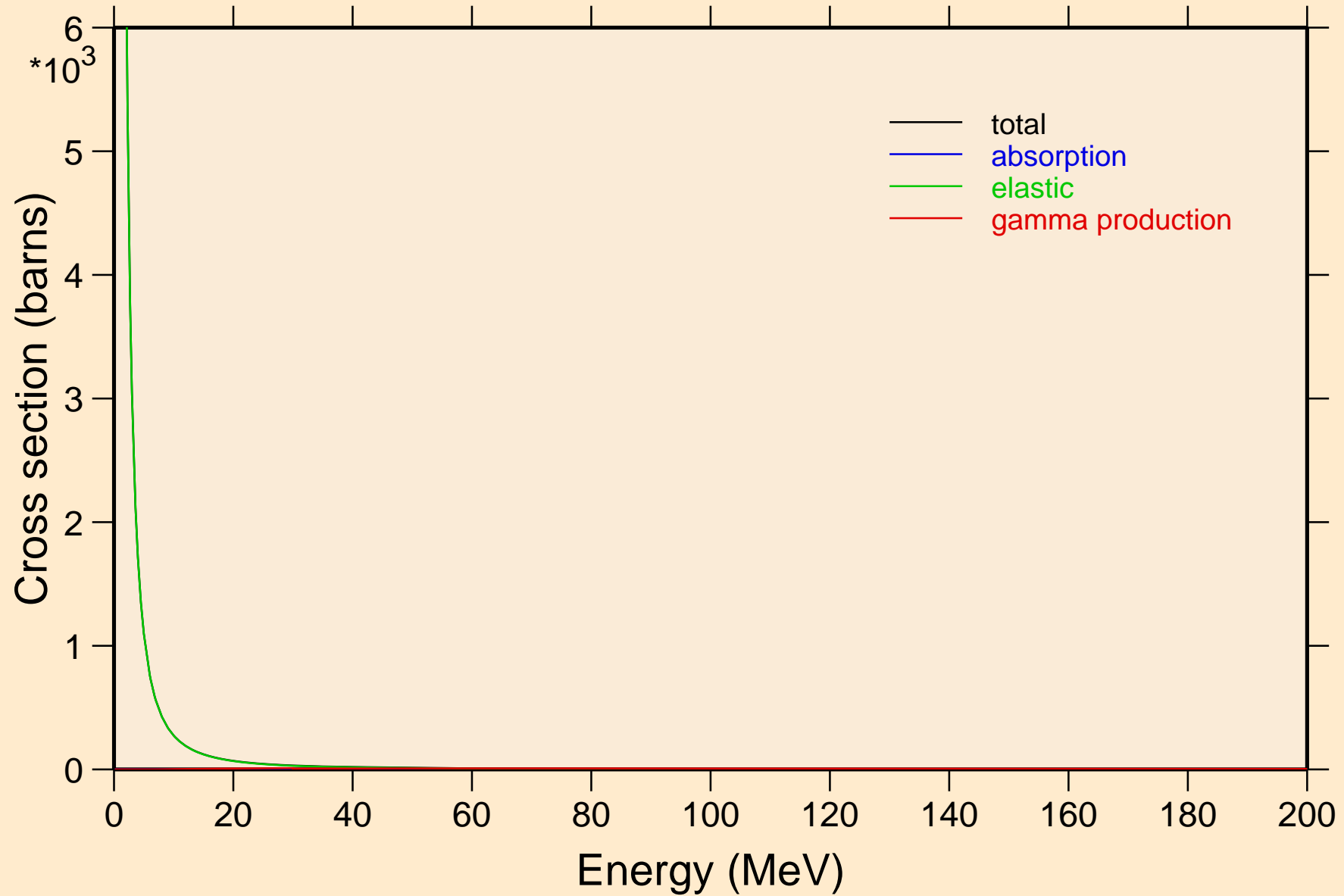

# DY149 DEUTERON ACER TENDL-2023 LIBRARY; T=0.K

## Heating

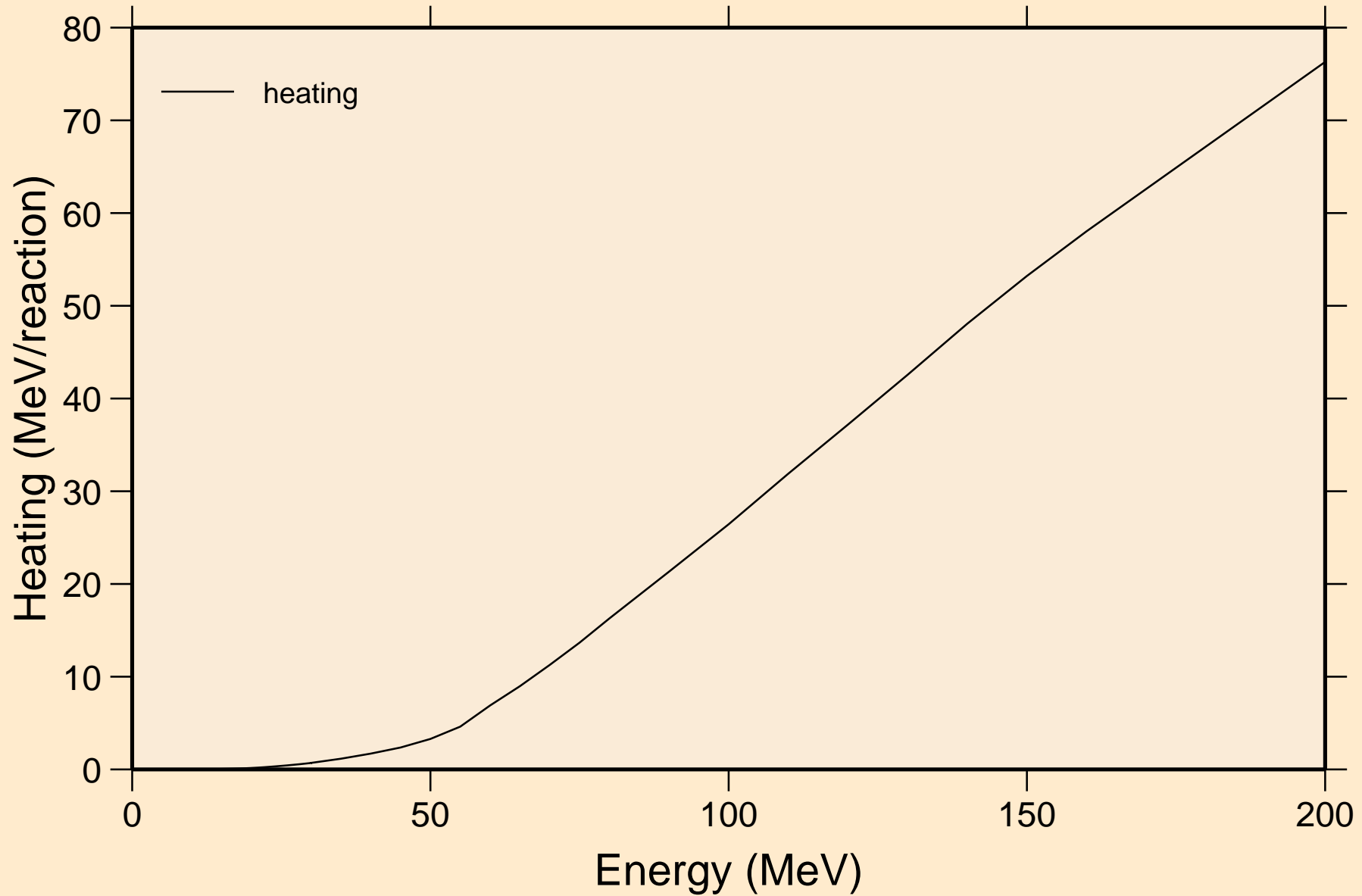

# DY149 DEUTERON ACER TENDL-2023 LIBRARY; T=0.K

## Threshold reactions

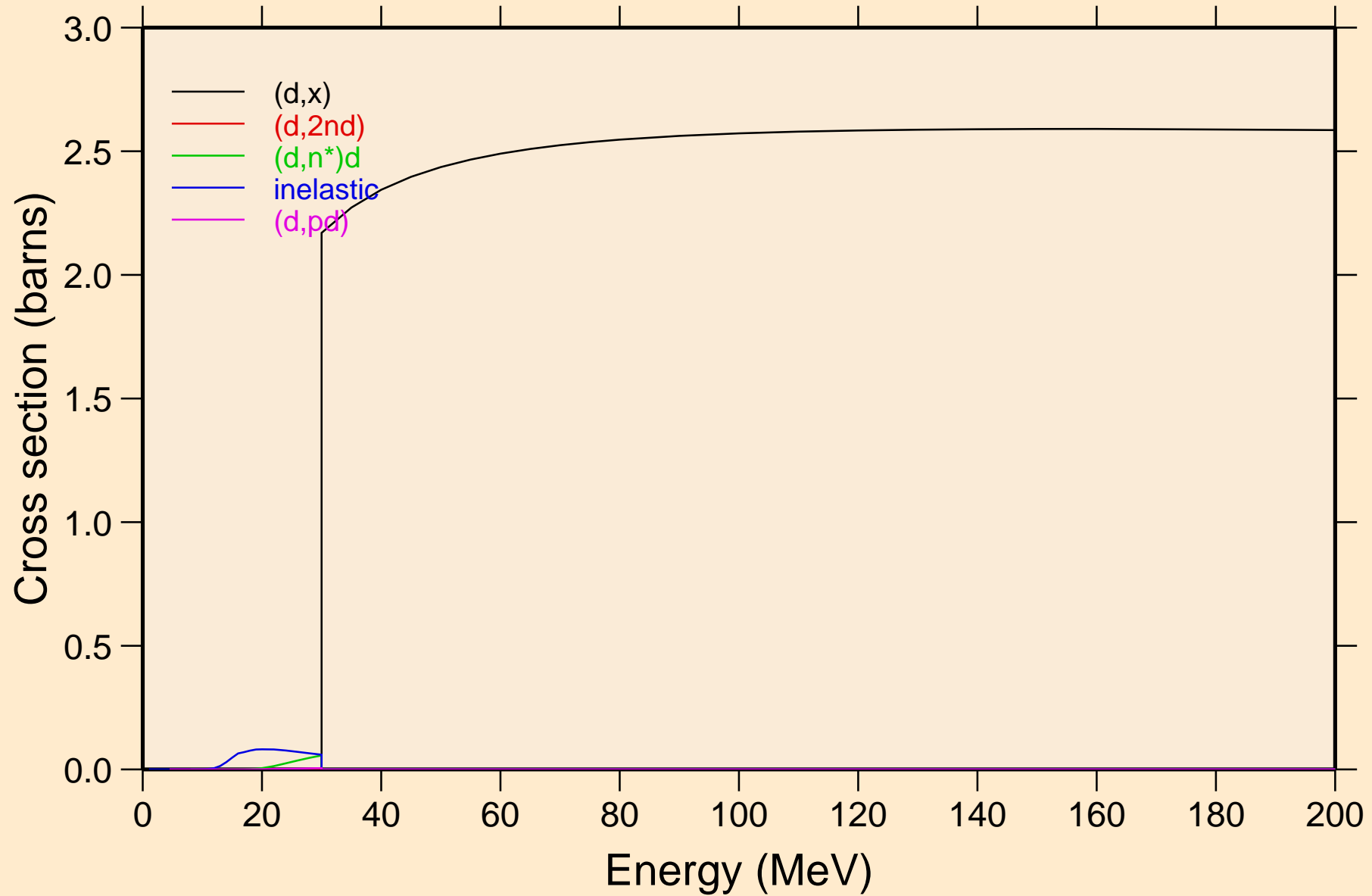

DY149 DEUTERON ACER TENDL-2023 LIBRARY; T=0.K  
Threshold reactions

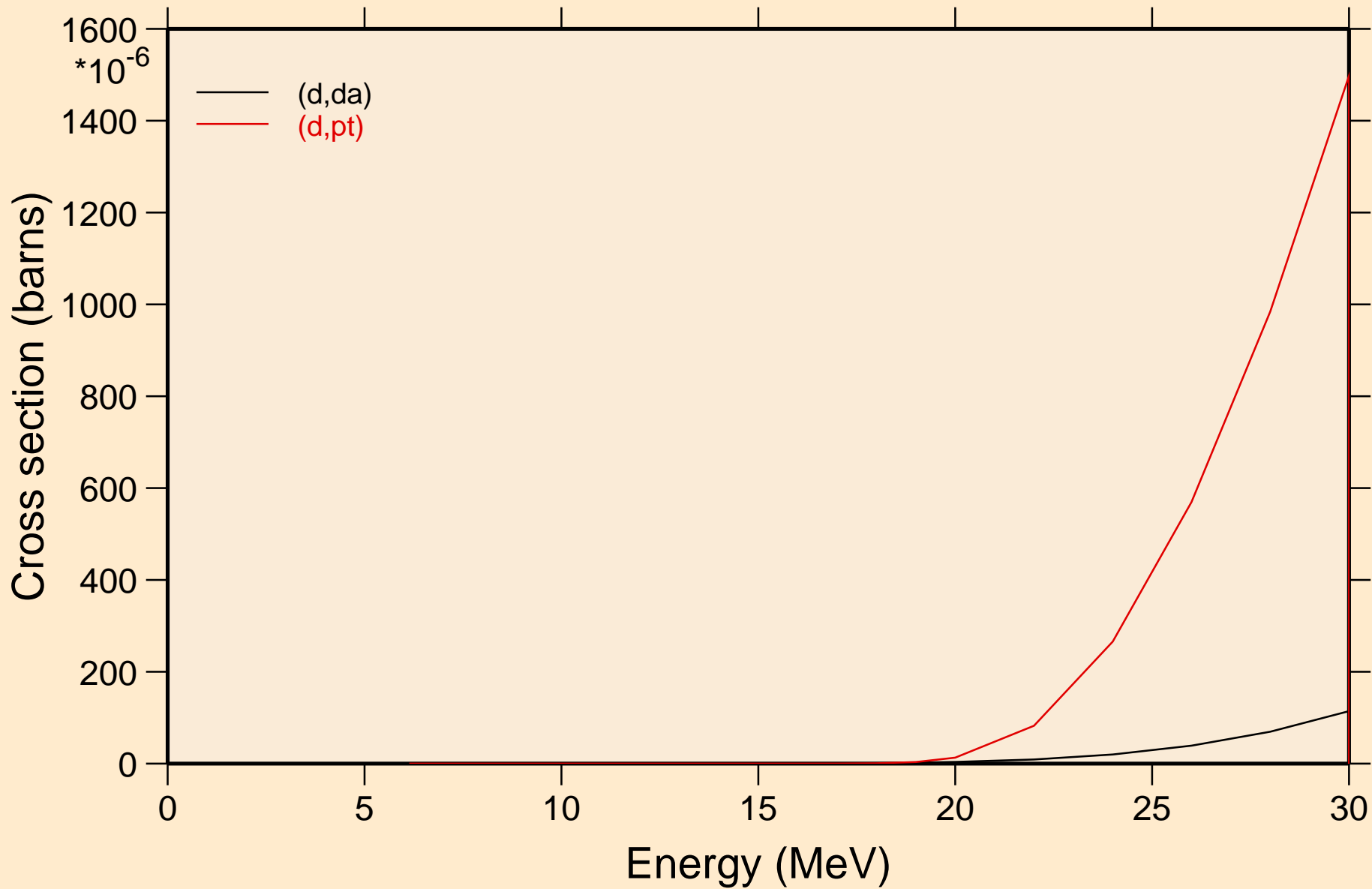

DY149 DEUTERON ACER TENDL-2023 LIBRARY; T=0.K  
Threshold reactions

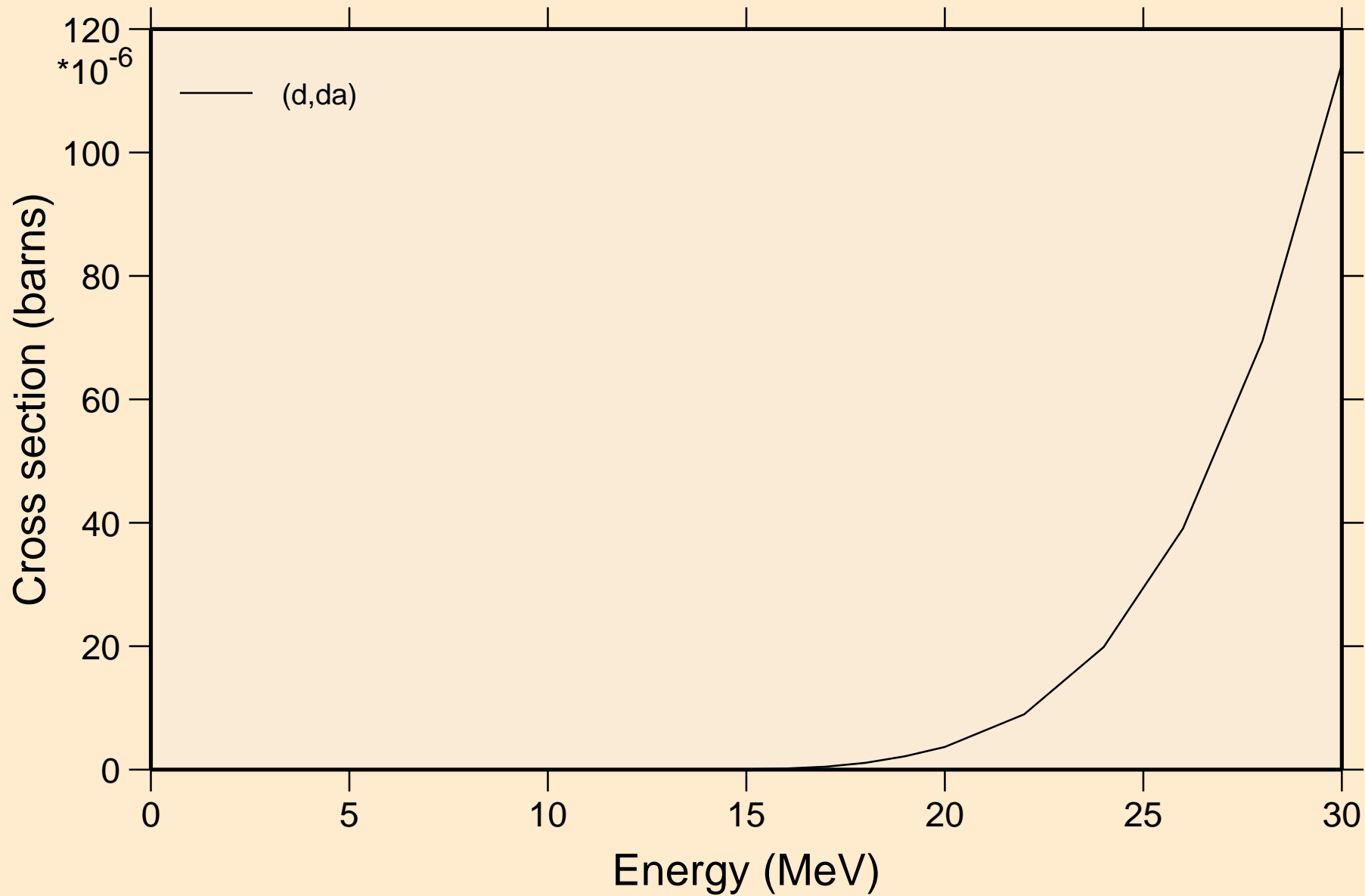

DY149 DEUTERON ACER TENDL-2023 LIBRARY; T=0.K  
angular distribution for elastic

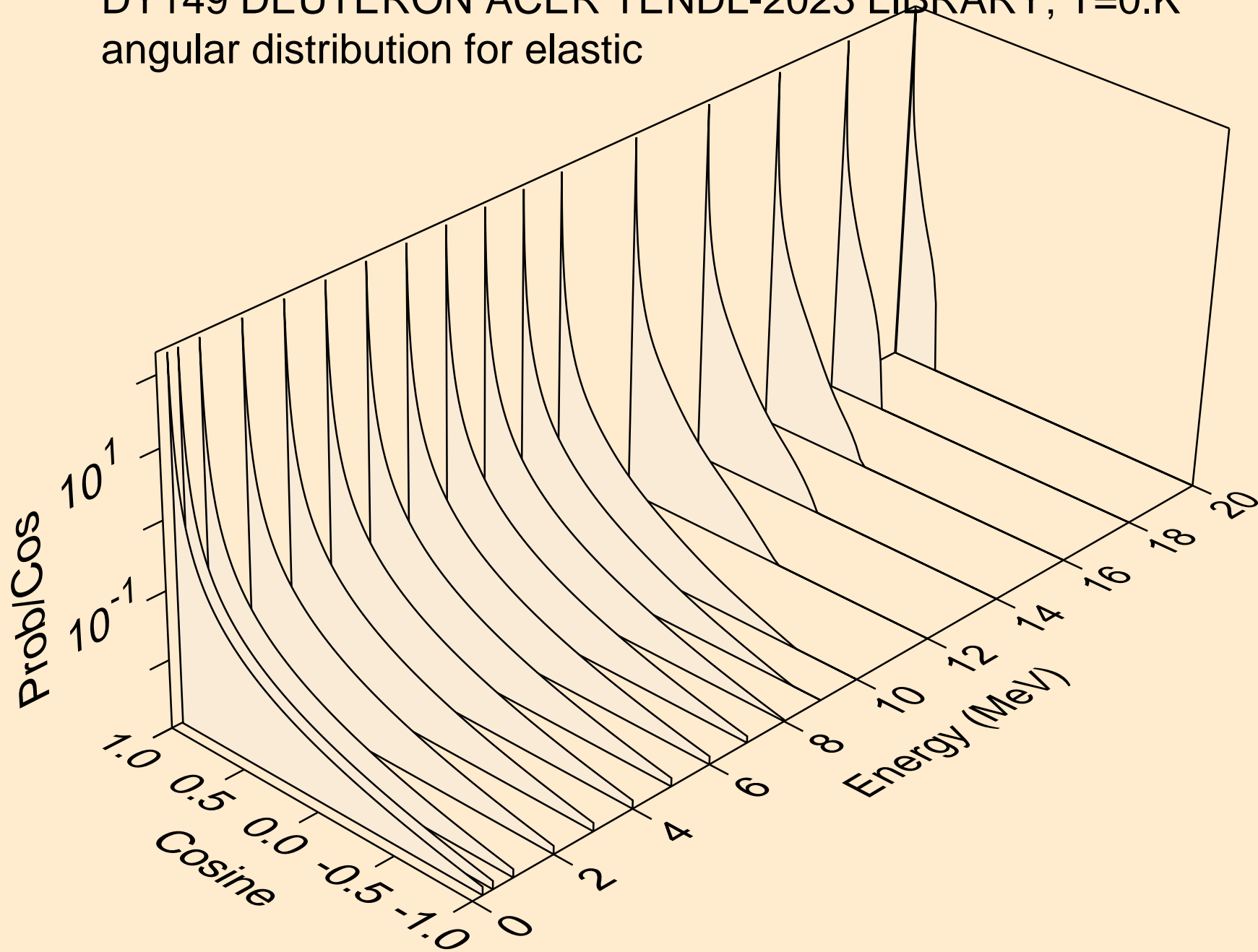



DY149 DEUTERON ACER TENDL-2023 LIBRARY; T=0.K  
angular distribution for elastic

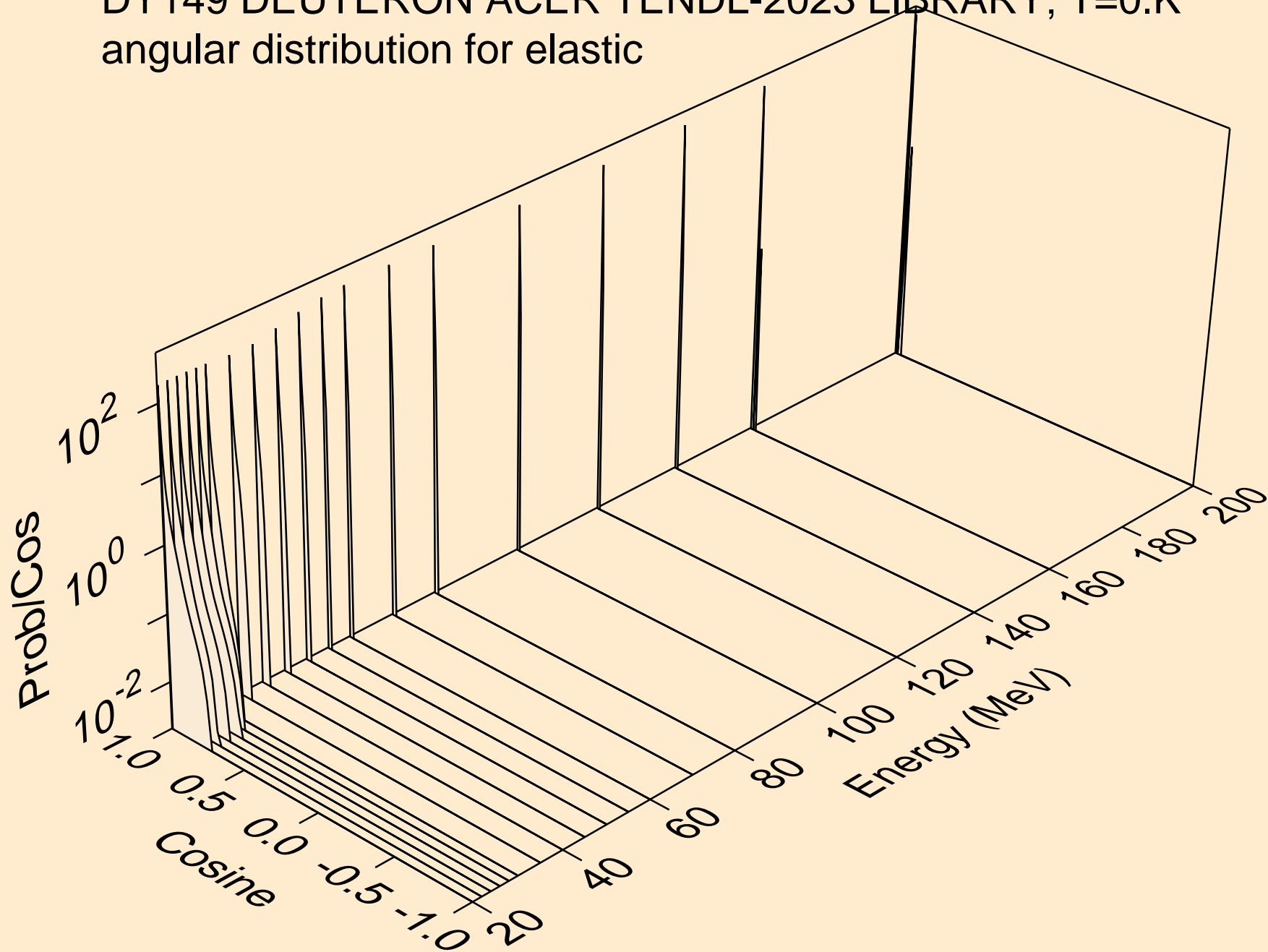

DY149 DEUTERON ACER TENDL-2023 LIBRARY; T=0.K  
Deuteron emission for (d,x)

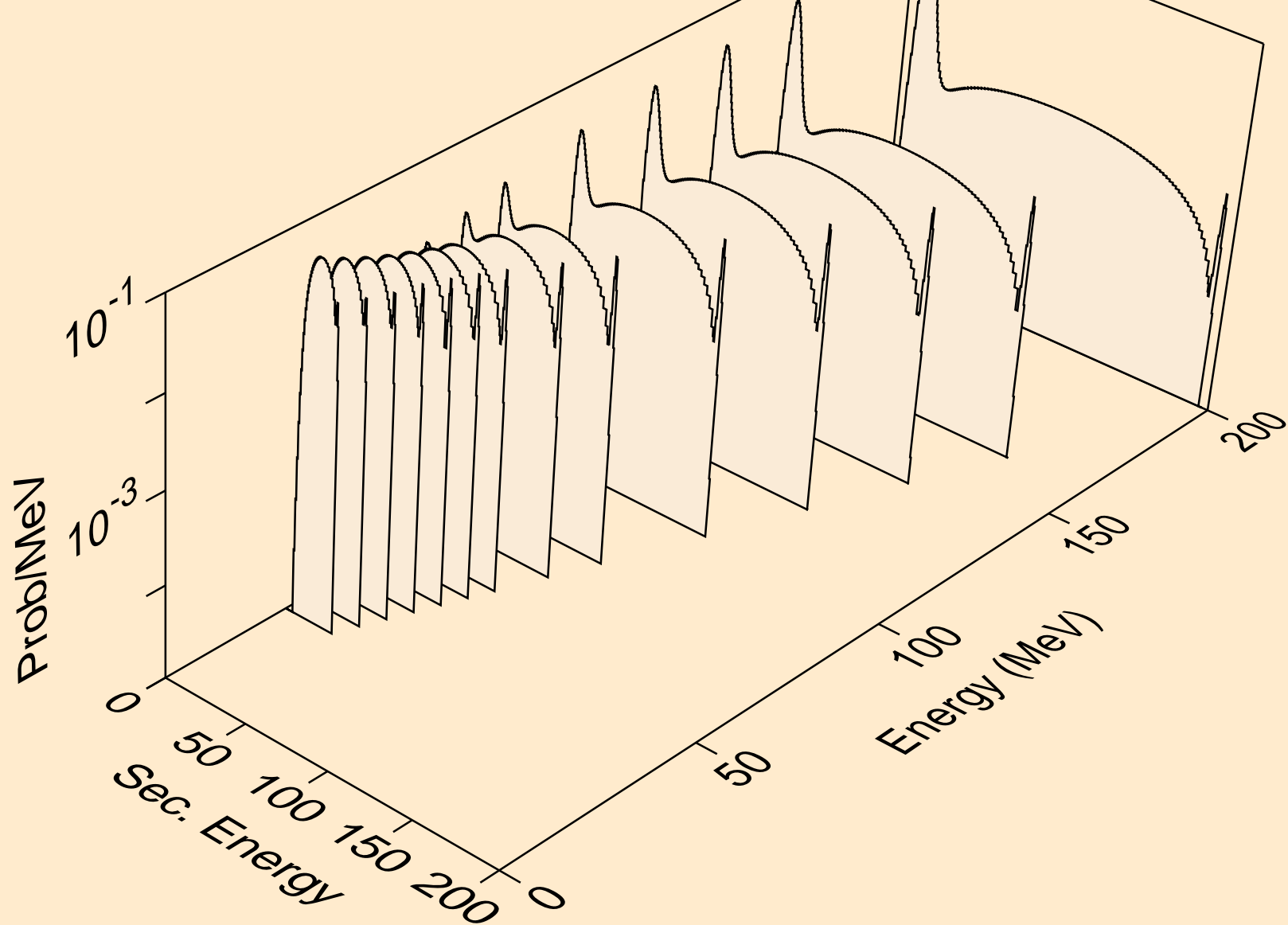

DY149 DEUTERON ACER TENDL-2023 LIBRARY; T=0.K  
Deuteron emission for (d,2nd)

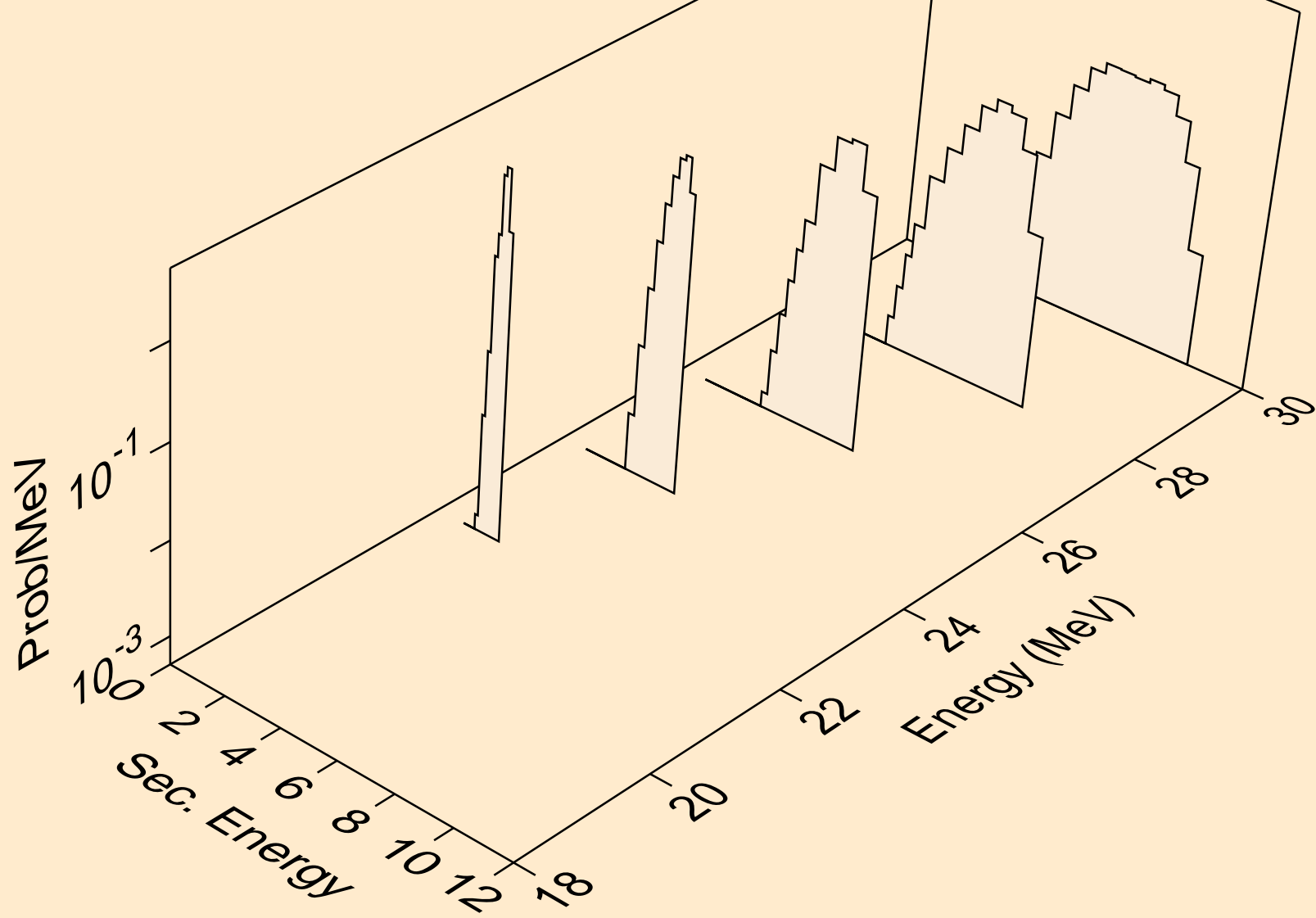

DY149 DEUTERON ACER TENDL-2023 LIBRARY; T=0.K  
Deuteron emission for (d,n\*)d

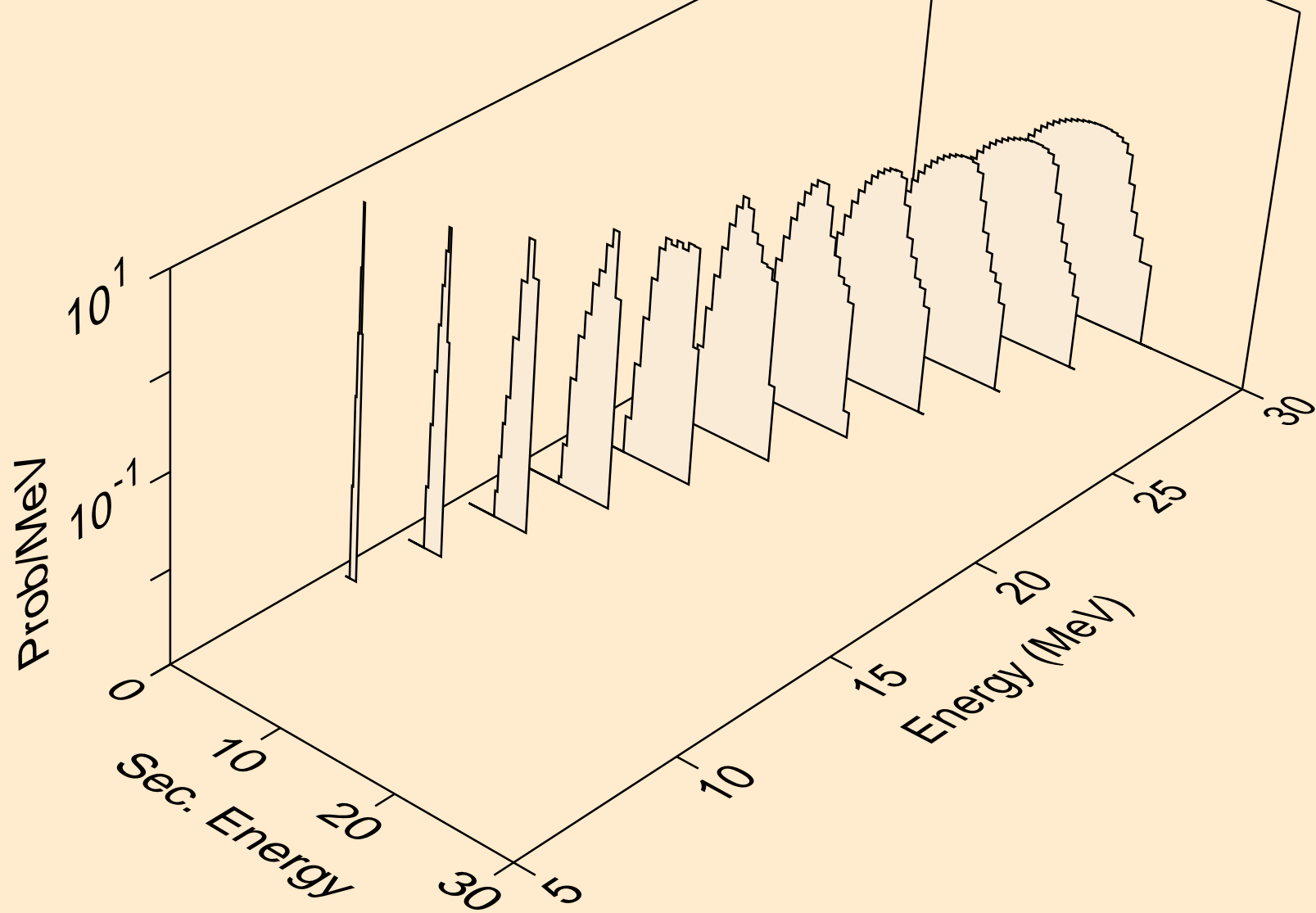

DY149 DEUTERON ACER TENDL-2023 LIBRARY; T=0.K  
Deuteron emission for inelastic

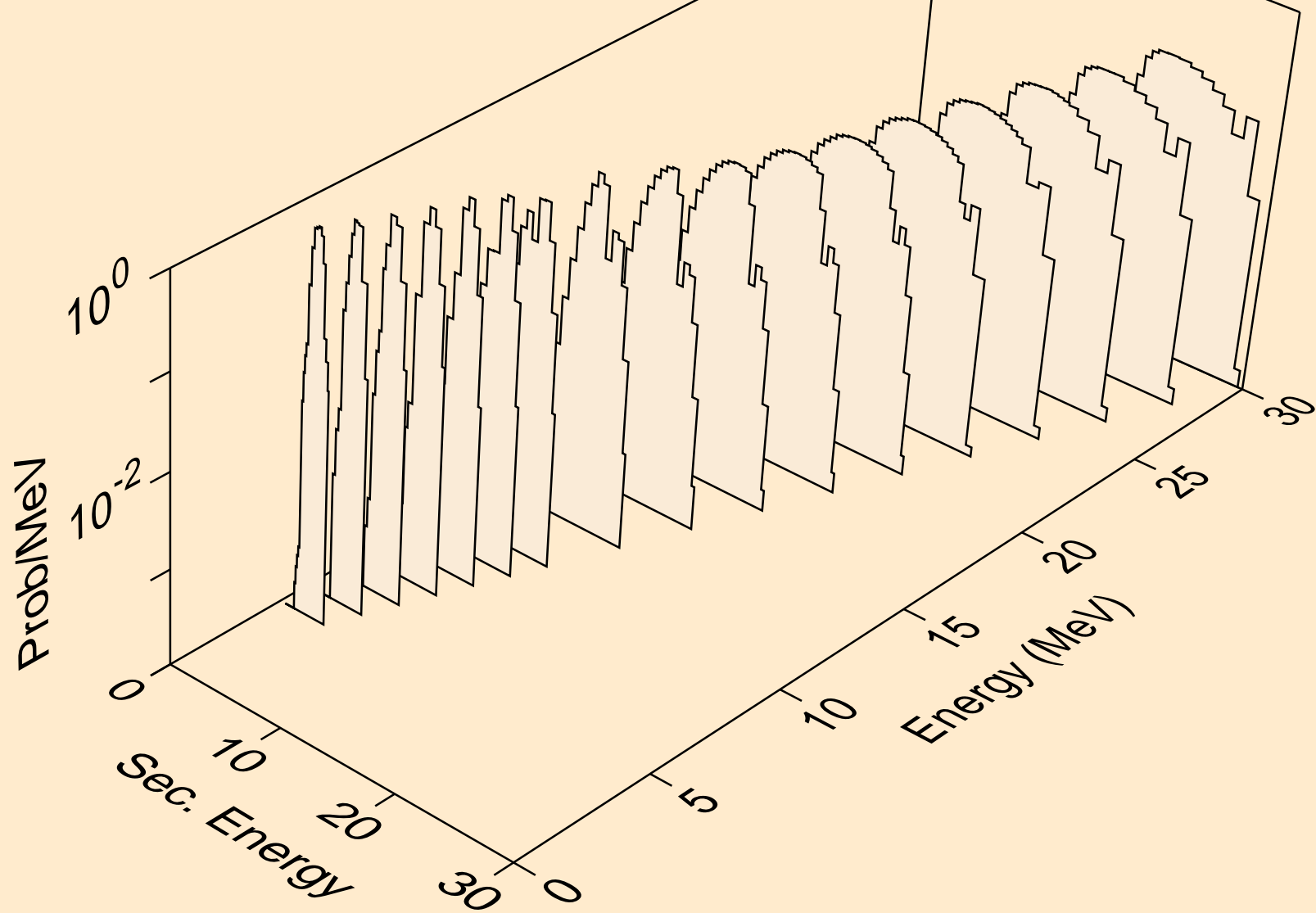

DY149 DEUTERON ACER TENDL-2023 LIBRARY; T=0.K  
Deuteron emission for (d,pd)

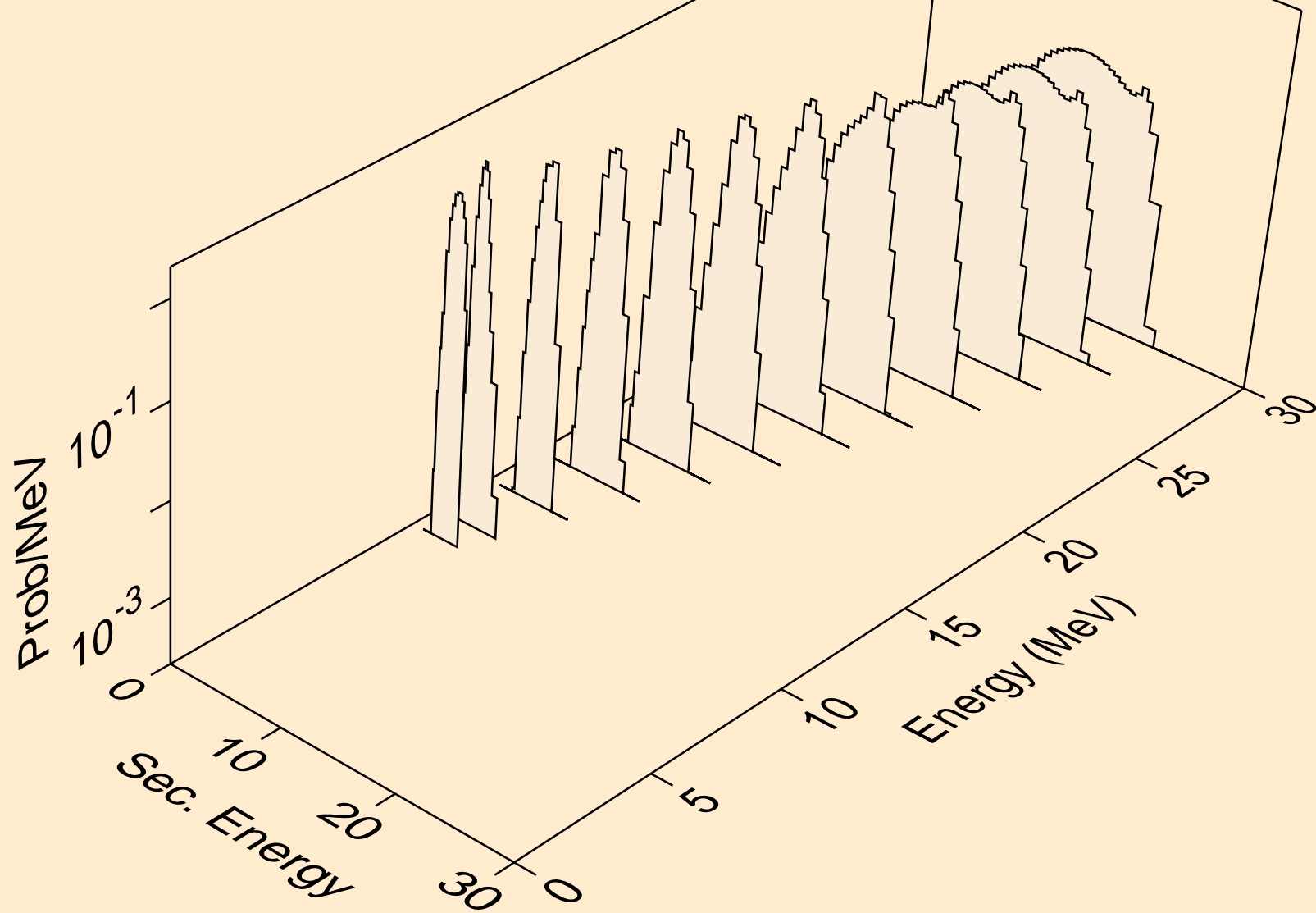

DY149 DEUTERON ACER TENDL-2023 LIBRARY; T=0.K  
Deuteron emission for (d,da)

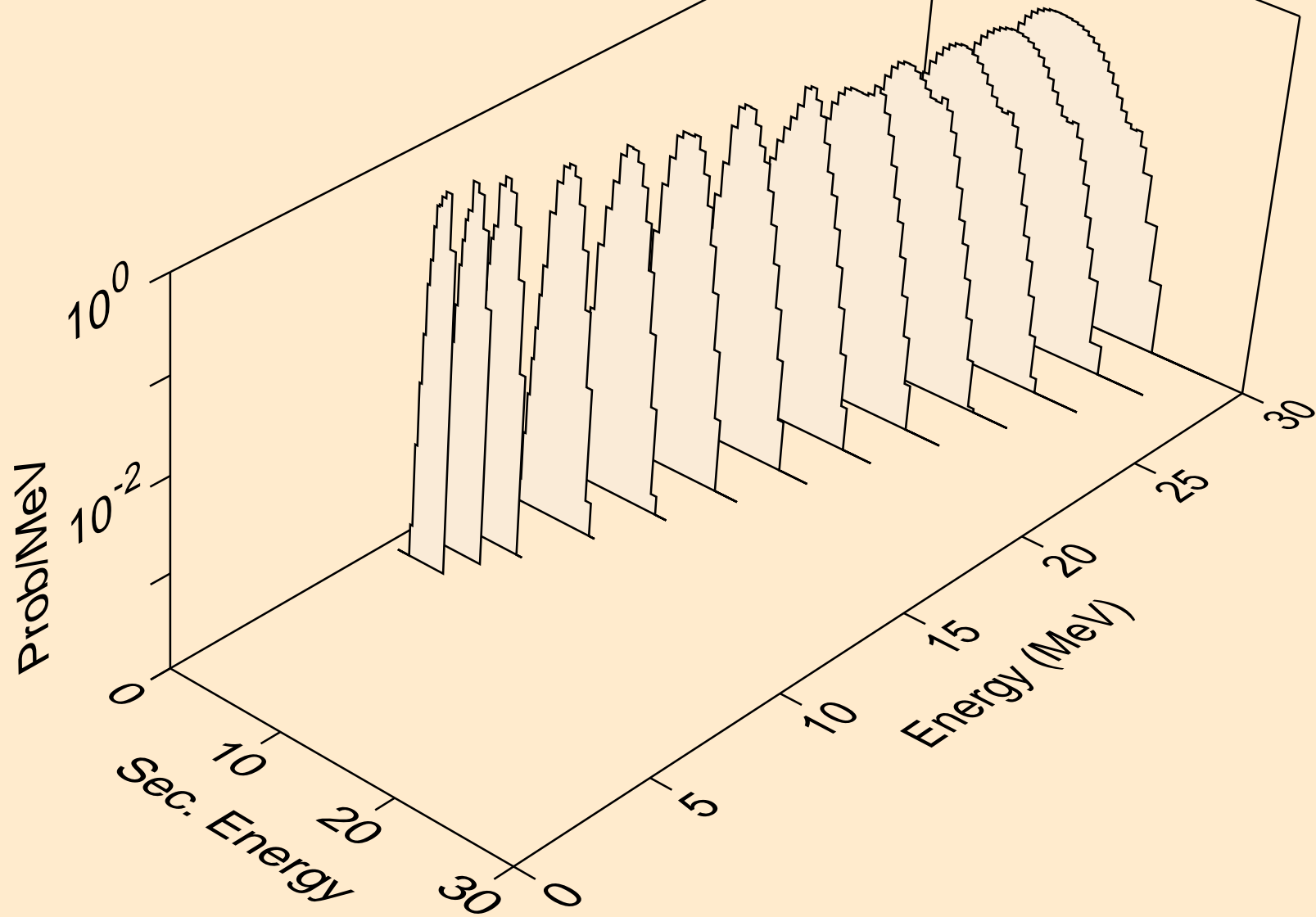

DY149 DEUTERON ACER TENDL-2023 LIBRARY; T=0.K  
Photon emission for (z,n)

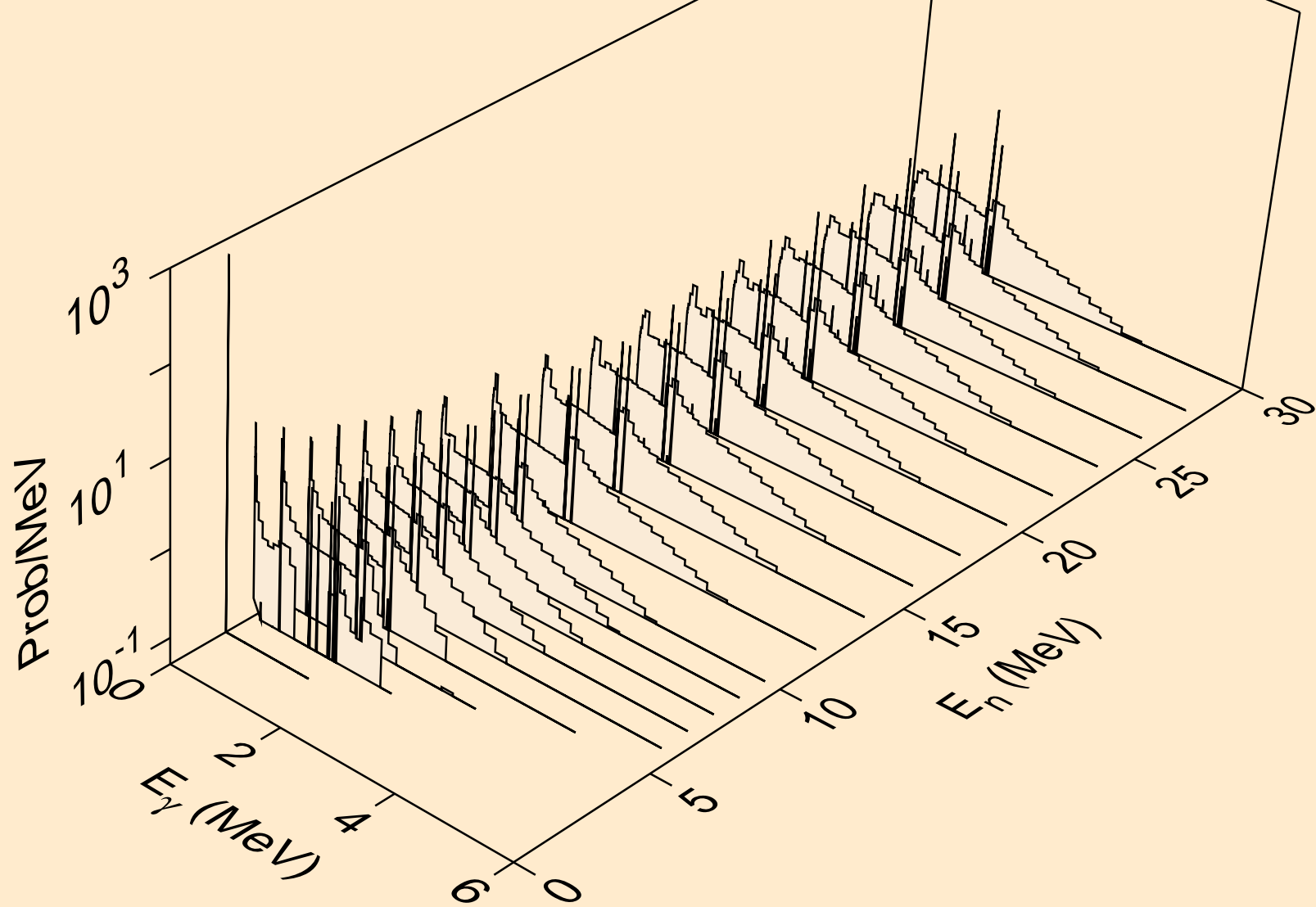



DY149 DEUTERON ACER TENDL-2023 LIBRARY; T=0.K  
Photon emission for (z,x)

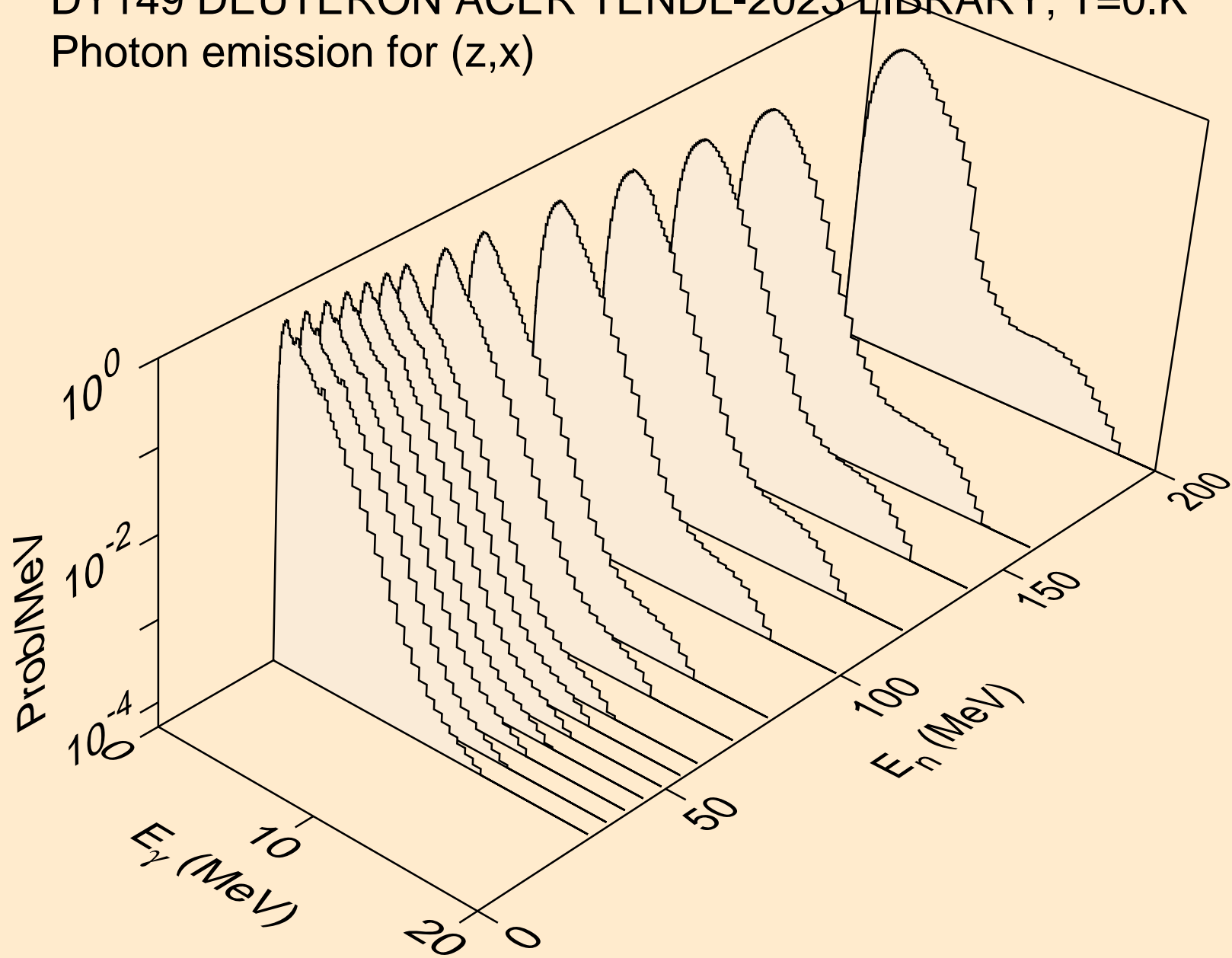

DY149 DEUTERON ACER TENDL-2023 LIBRARY; T=0.K  
Photon emission for (n,2nd)

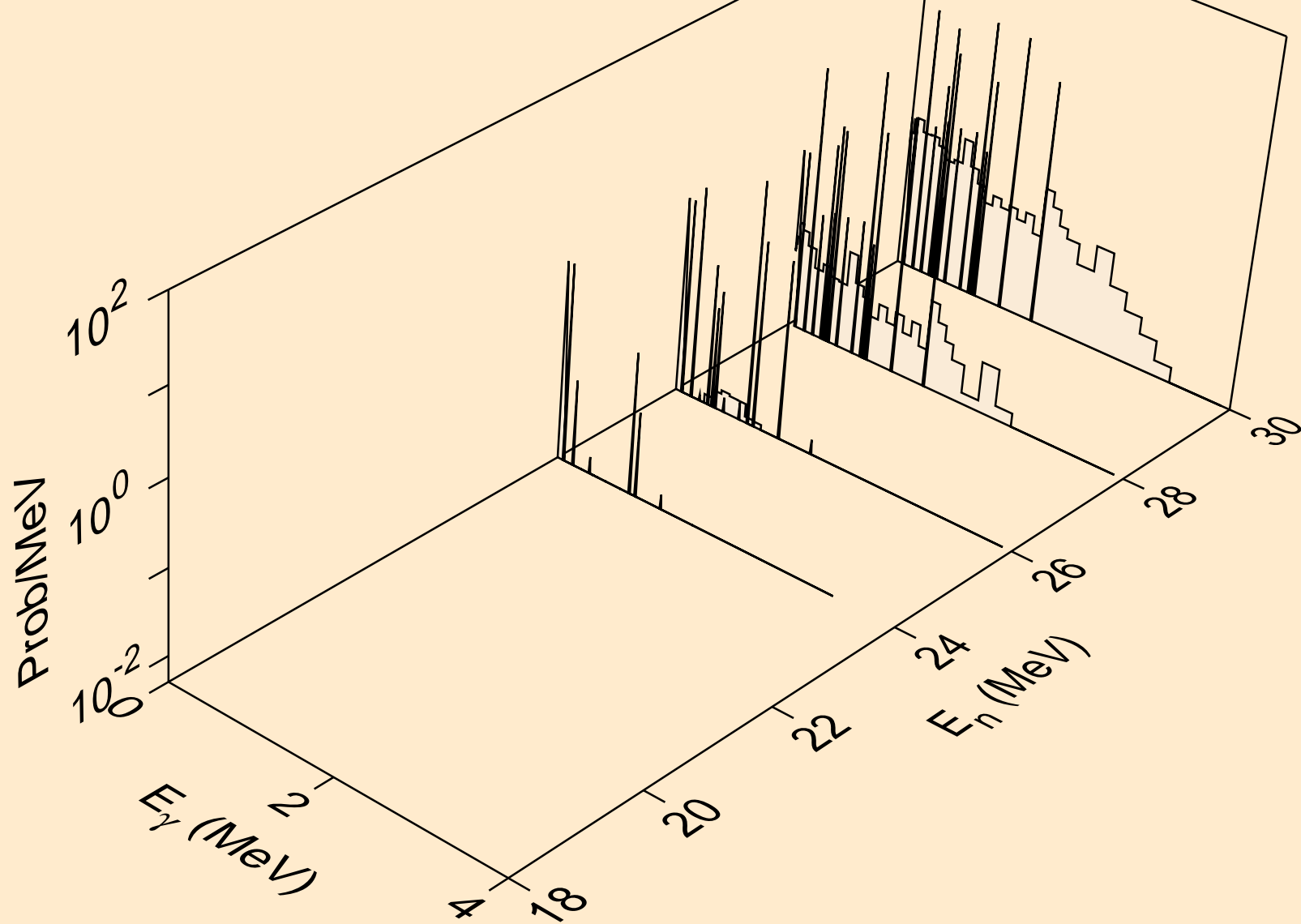

DY149 DEUTERON ACER TENDL-2023 LIBRARY; T=0.K  
Photon emission for (n,2n)

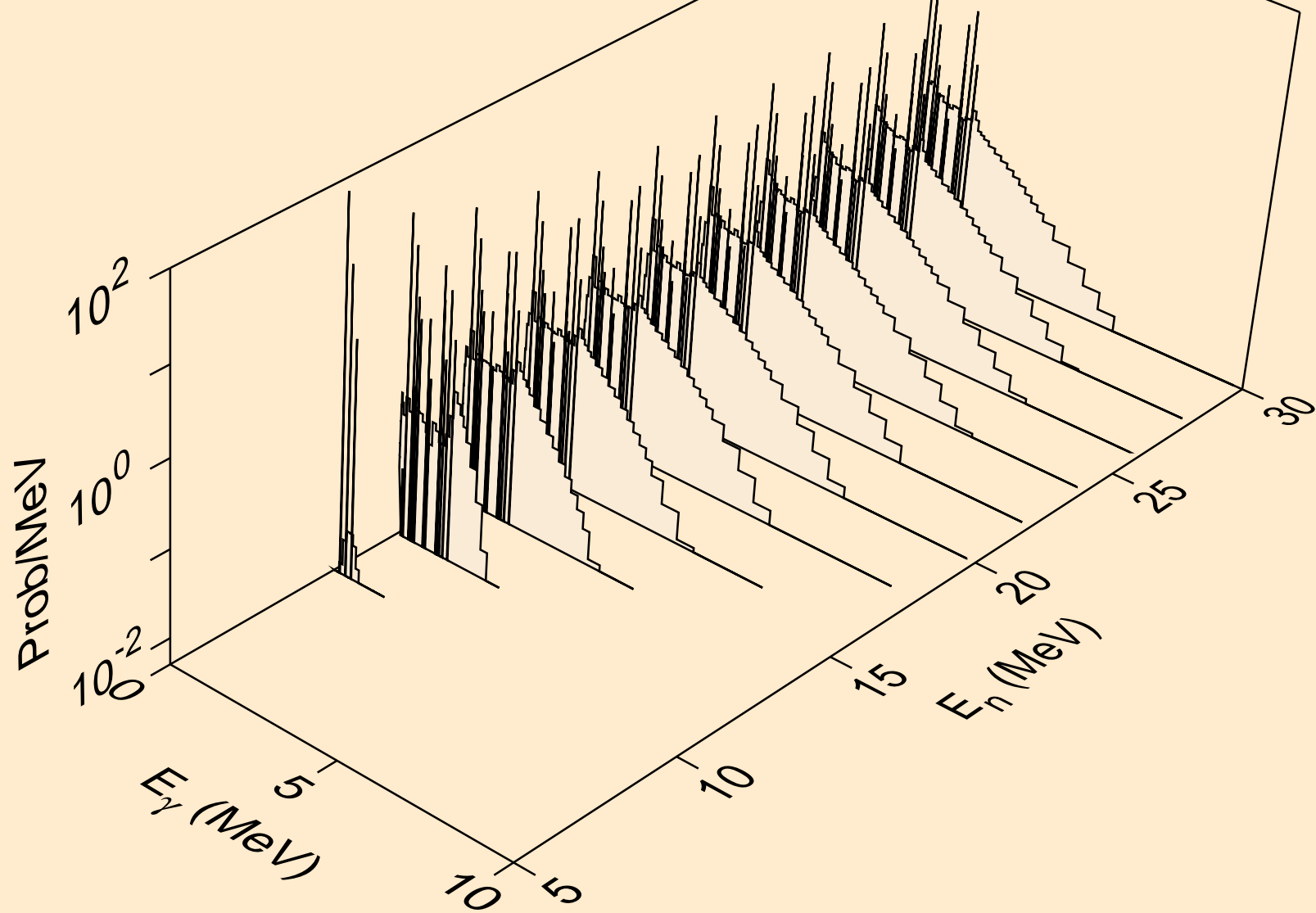

DY149 DEUTERON ACER TENDL-2023 LIBRARY; T=0.K  
Photon emission for (n,3n)

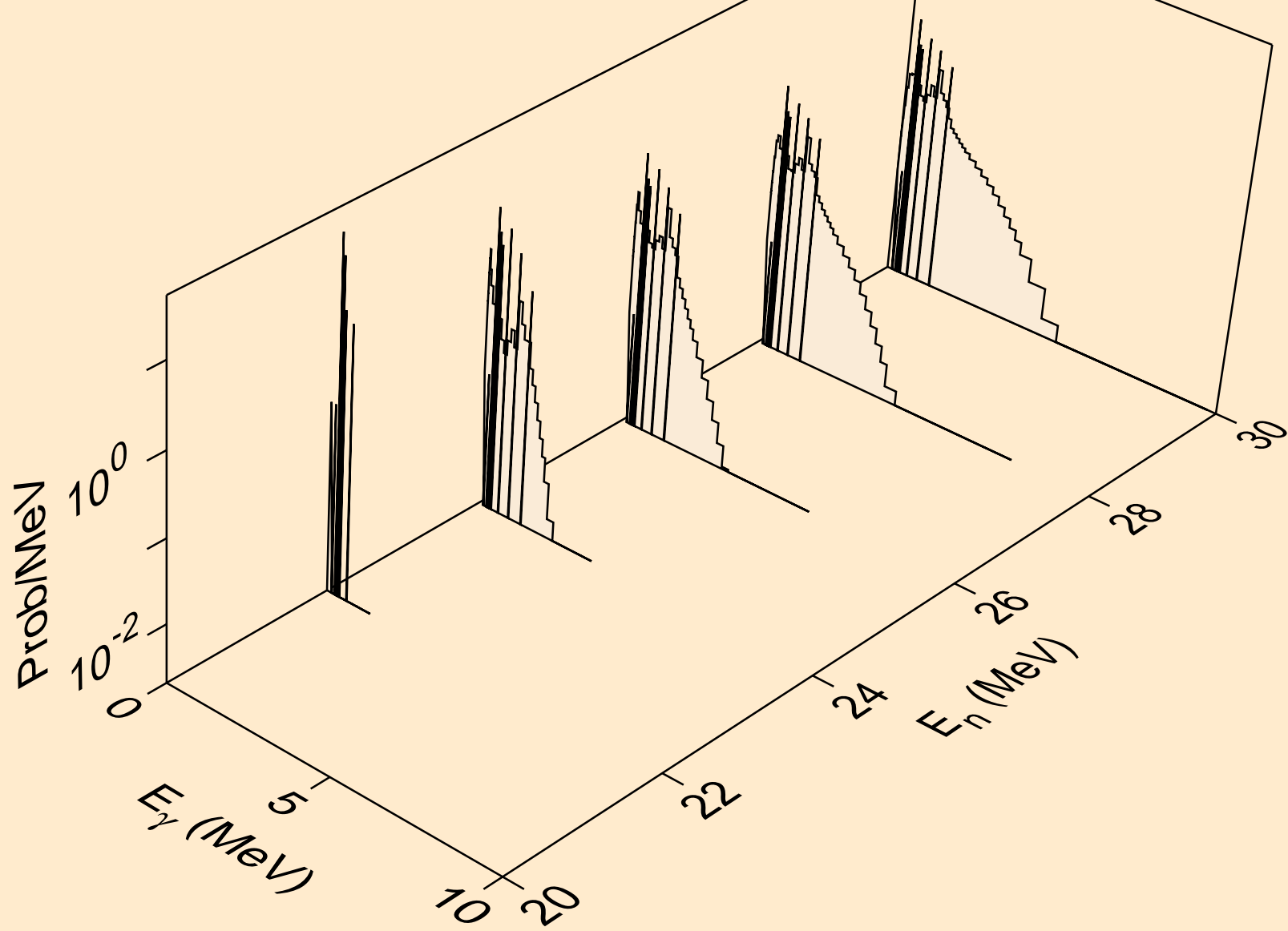

DY149 DEUTERON ACER TENDL-2023 LIBRARY; T=0.K  
Photon emission for (n,n\*)a

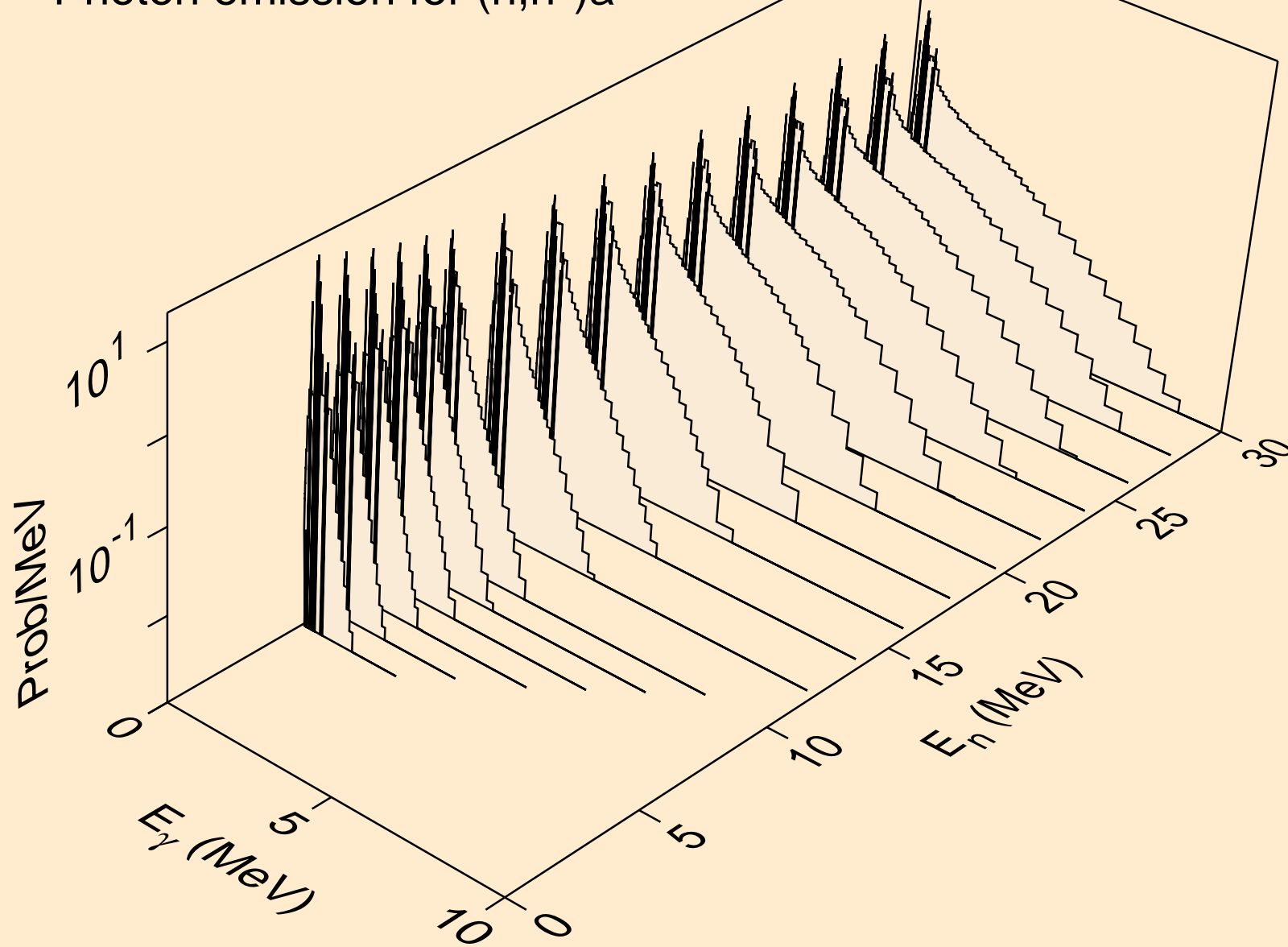

DY149 DEUTERON ACER TENDL-2023 LIBRARY; T=0.K  
Photon emission for (n,2n)a

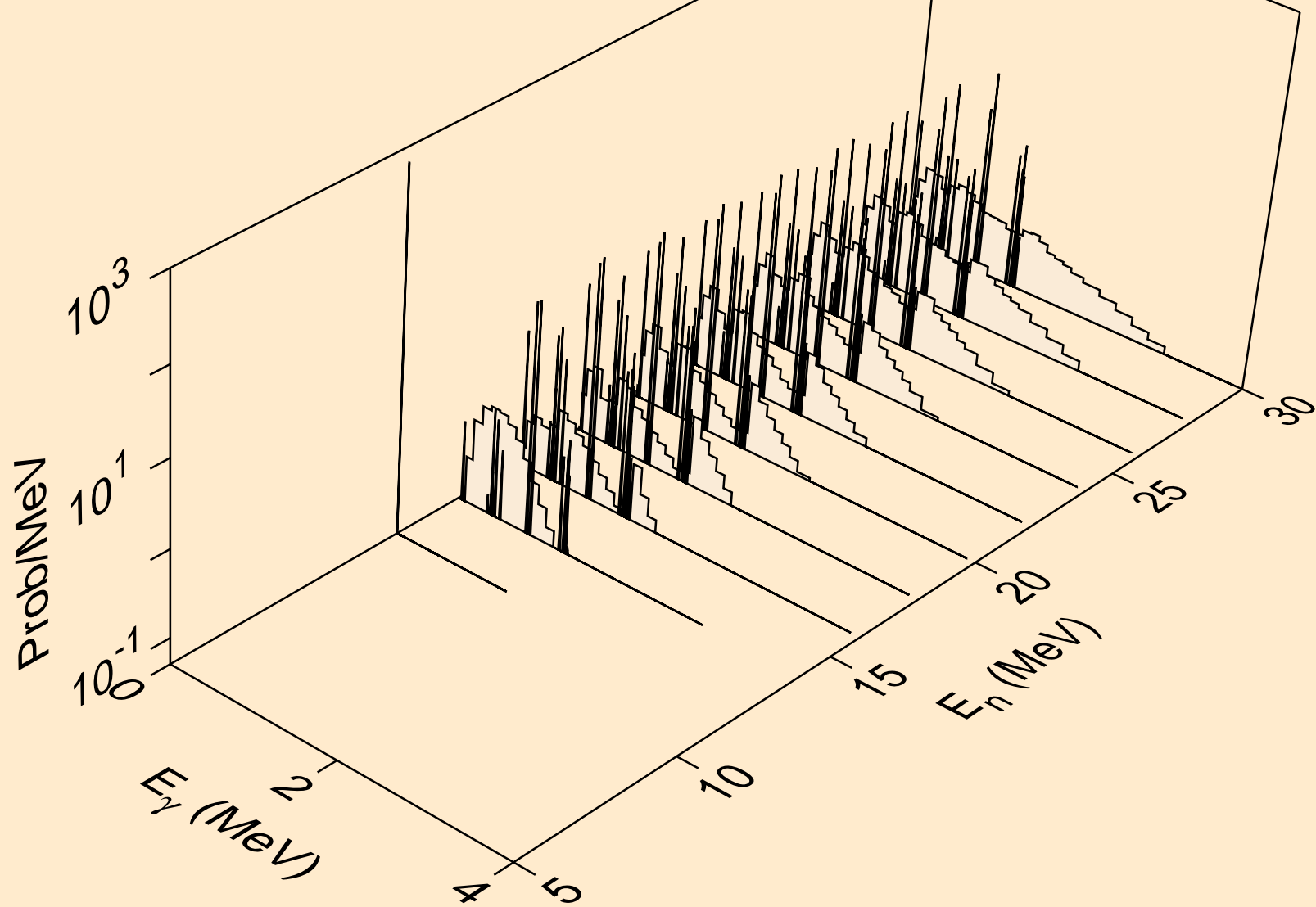

DY149 DEUTERON ACER TENDL-2023 LIBRARY; T=0.K  
Photon emission for (n,3n)a

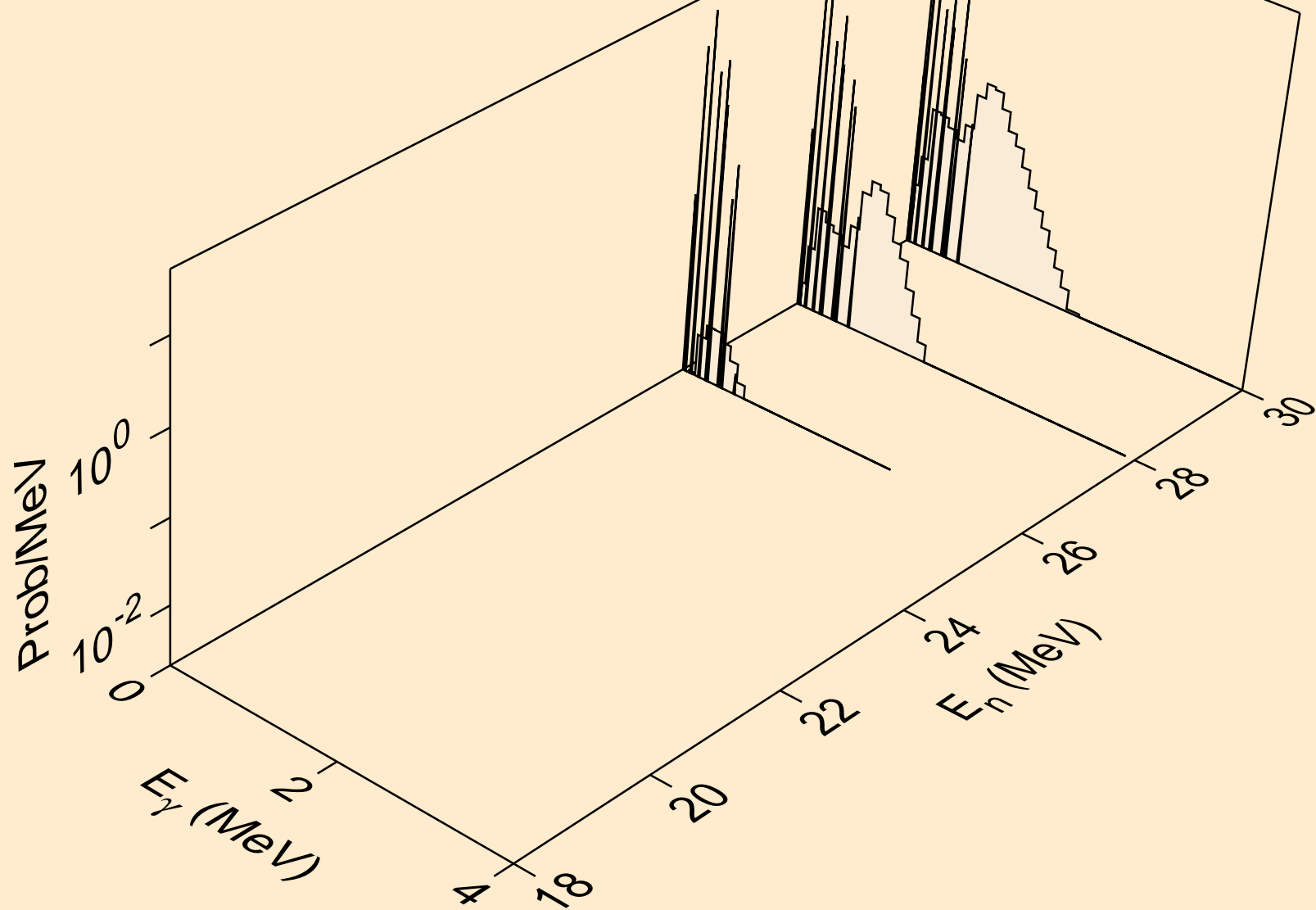

DY149 DEUTERON ACER TENDL-2023 LIBRARY; T=0.K  
Photon emission for (n,n\*)p

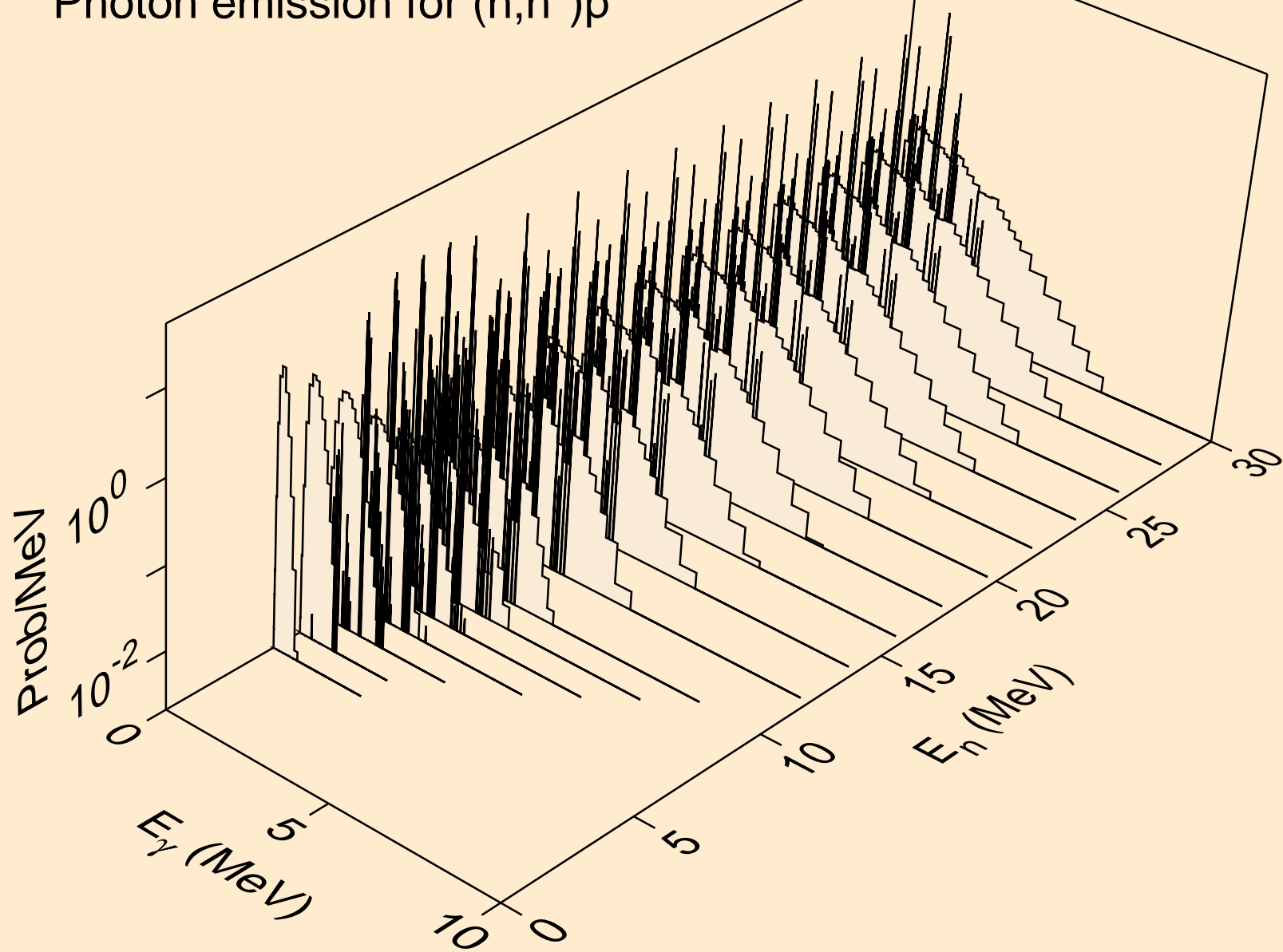



DY149 DEUTERON ACER TENDL-2023 LIBRARY; T=0.K  
Photon emission for (n,n\*)2a

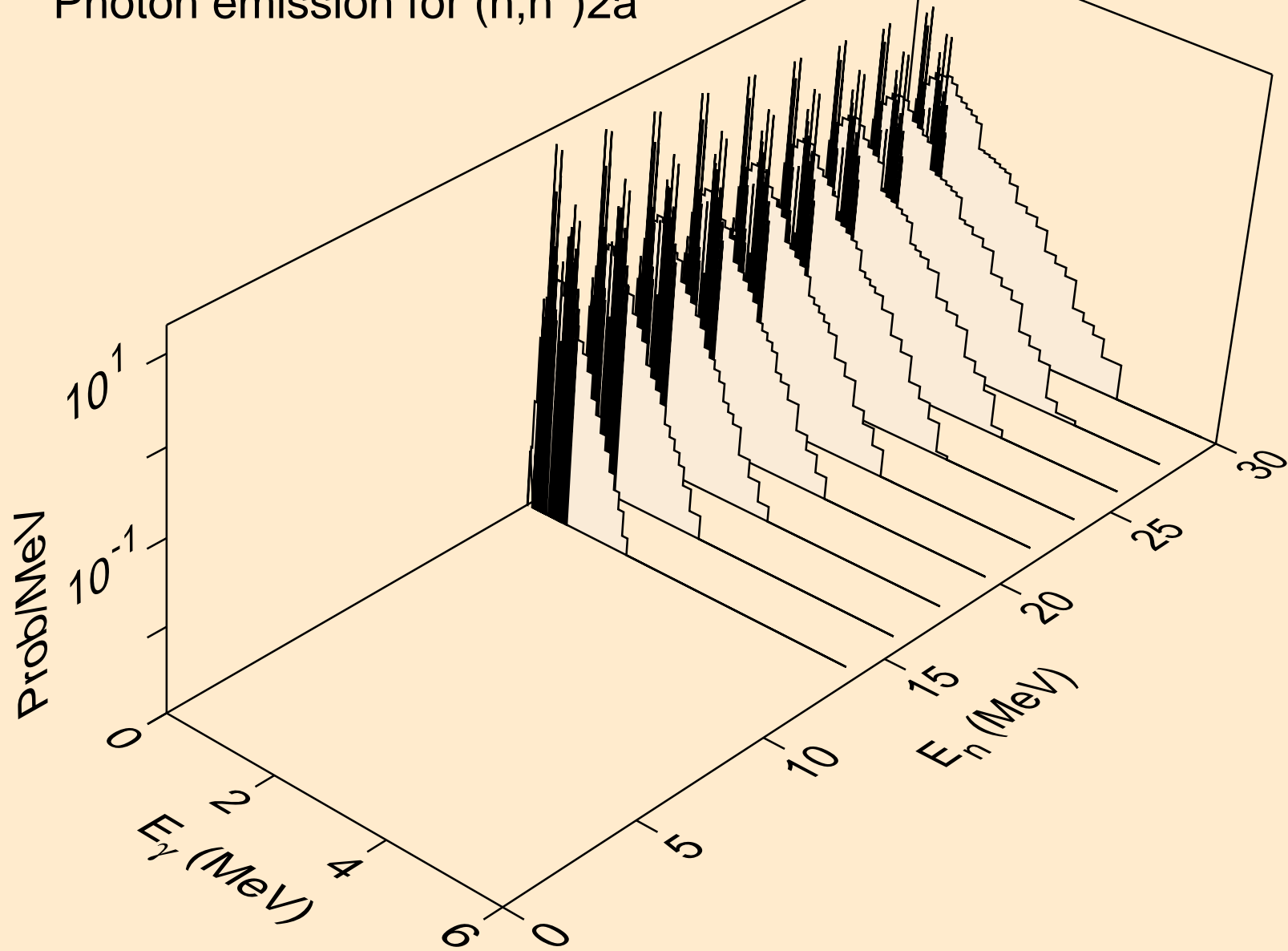

DY149 DEUTERON ACER TENDL-2023 LIBRARY; T=0.K  
Photon emission for (n,n\*)d

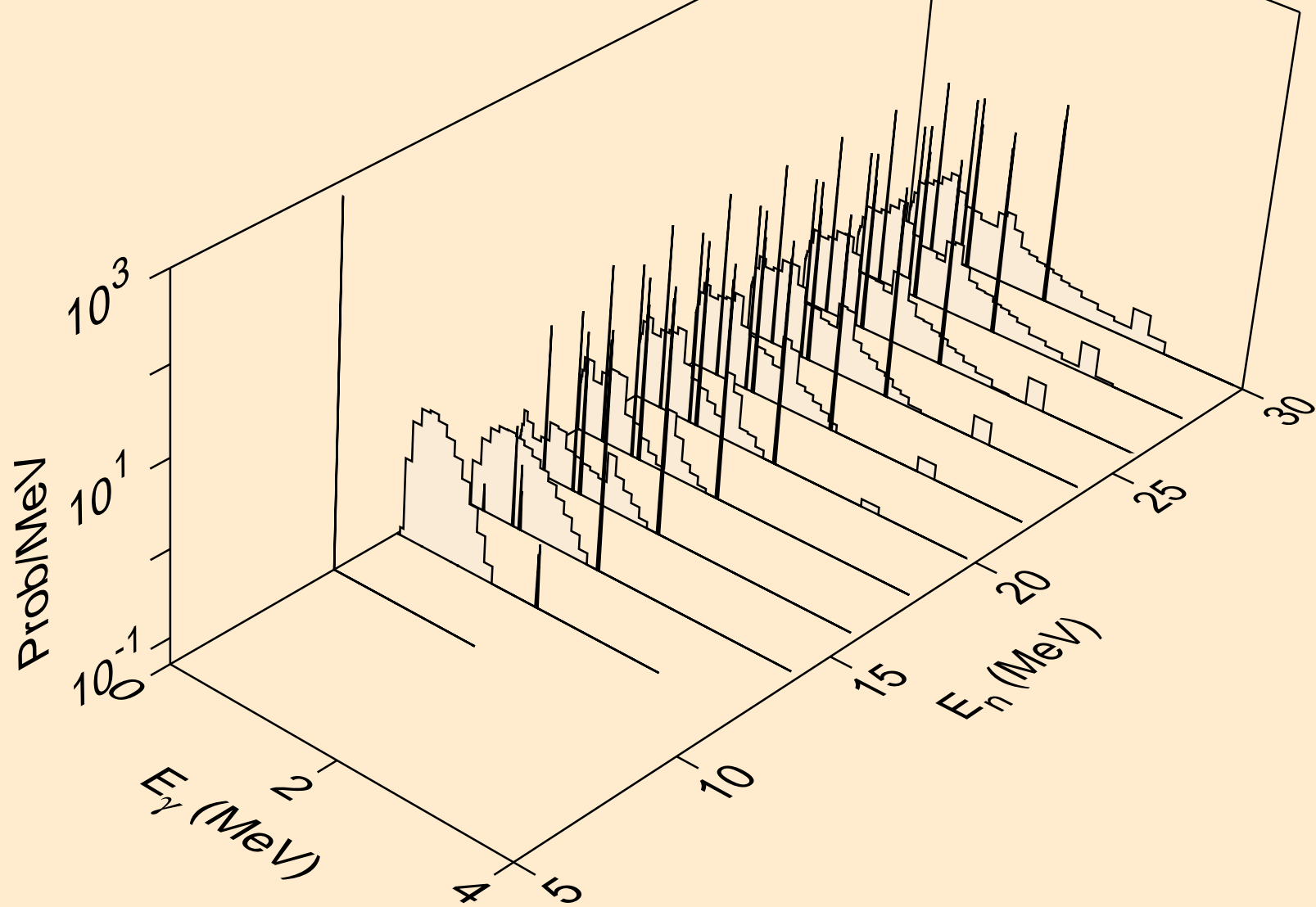

DY149 DEUTERON ACER TENDL-2023 LIBRARY; T=0.K  
Photon emission for (n,n\*)t

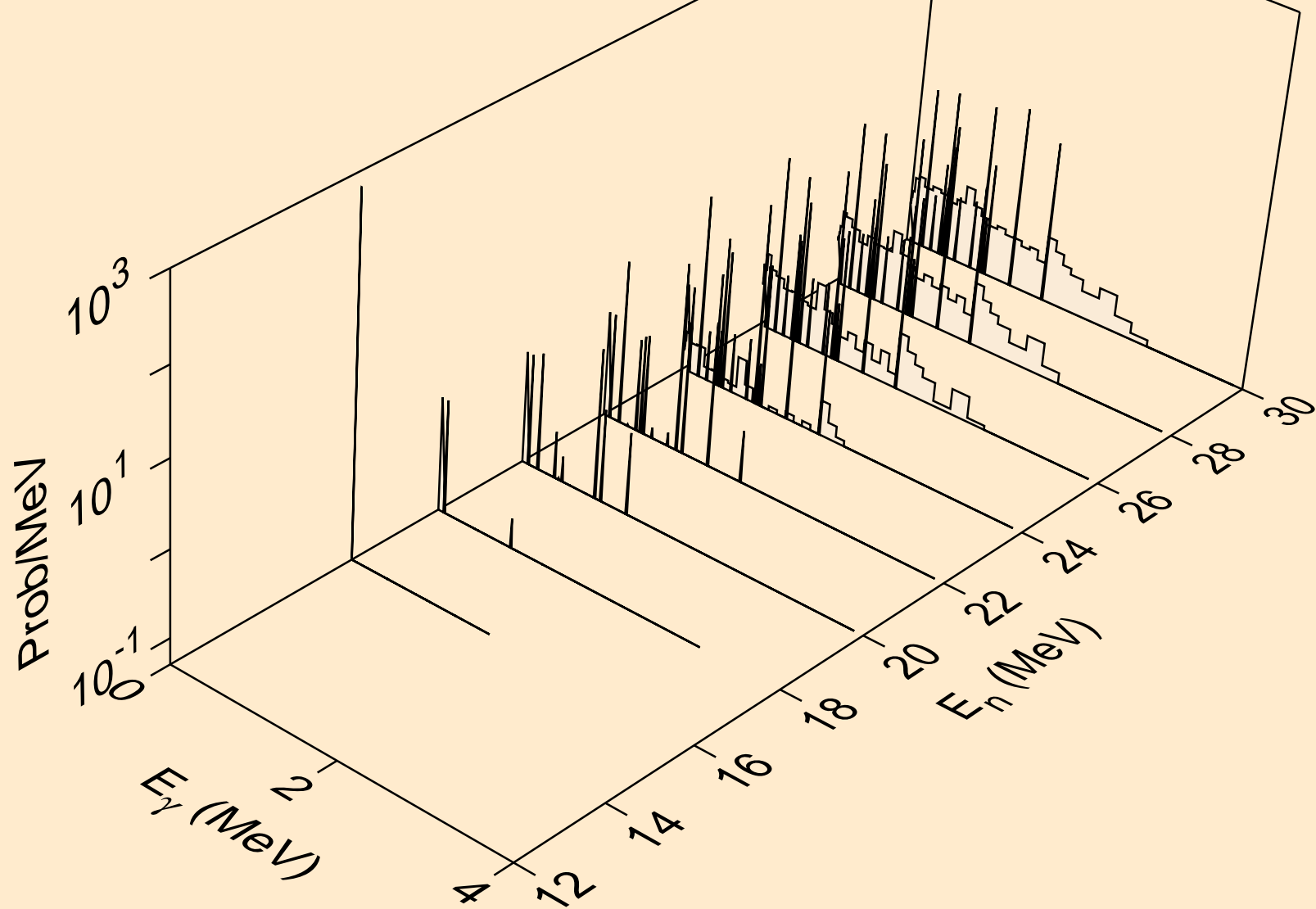

DY149 DEUTERON ACER TENDL-2023 LIBRARY; T=0.K  
Photon emission for (n,n\*)he3

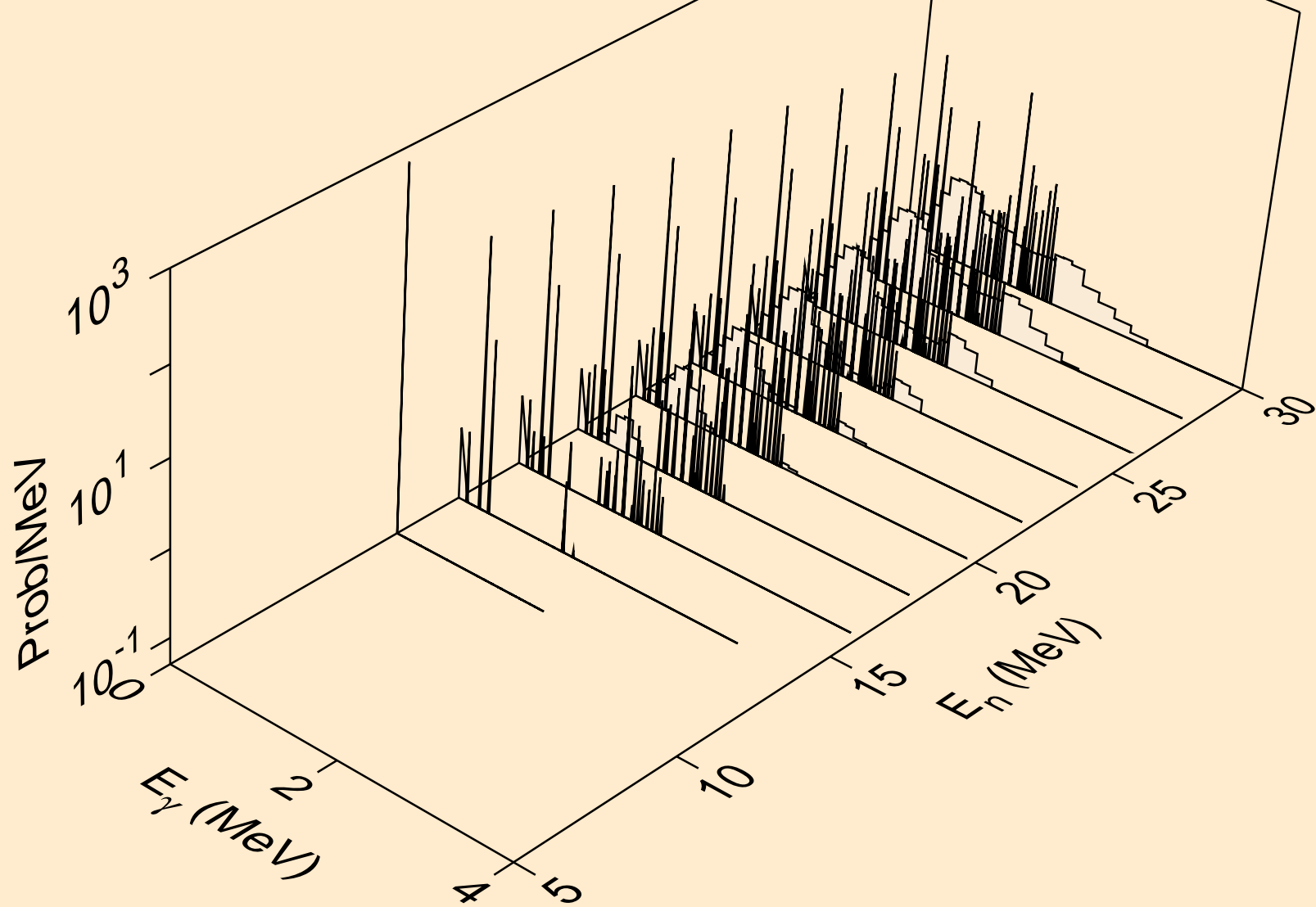

DY149 DEUTERON ACER TENDL-2023 LIBRARY; T=0.K  
Photon emission for (n,2np)

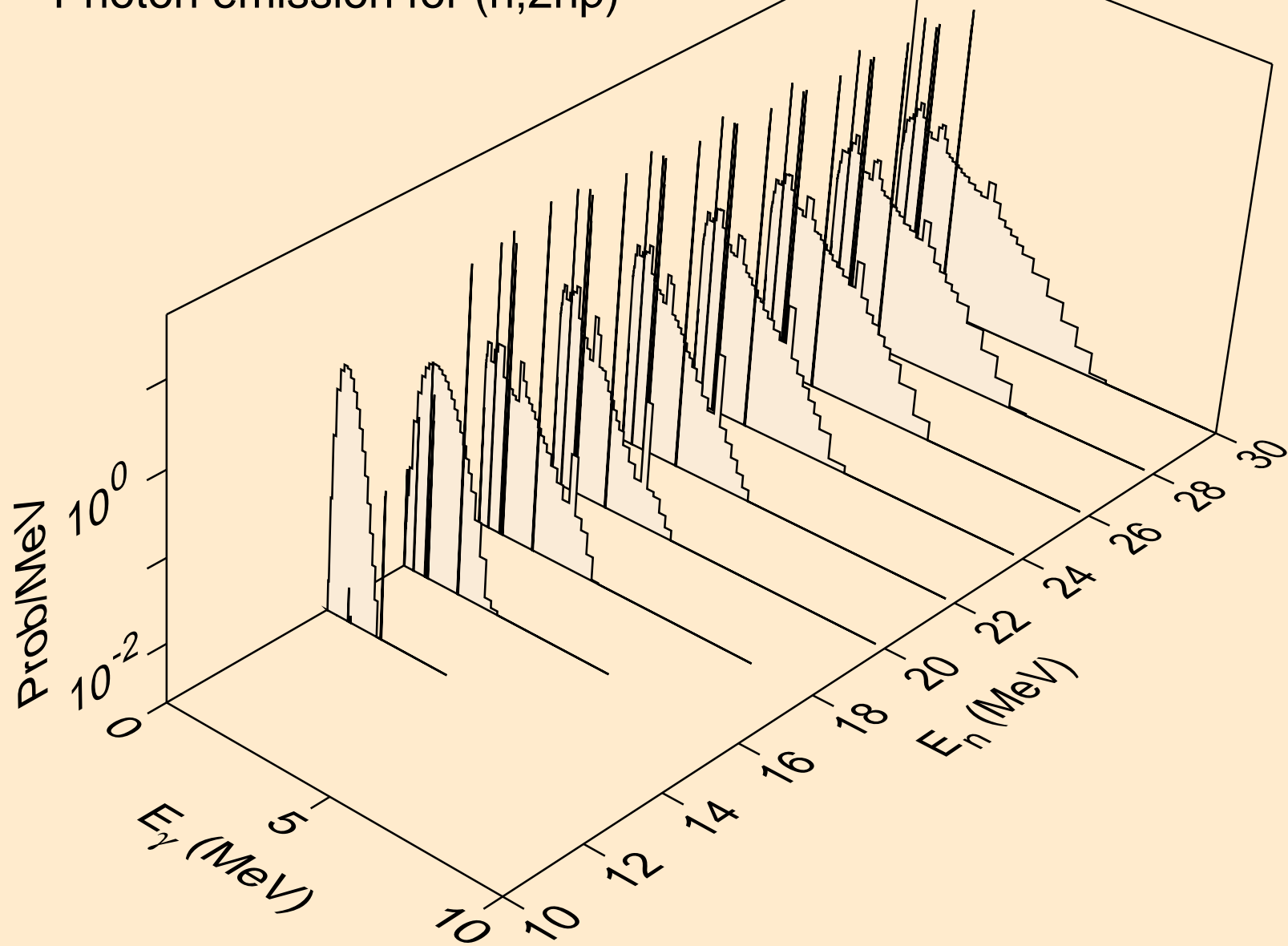

DY149 DEUTERON ACER TENDL-2023 LIBRARY; T=0.K  
Photon emission for (n,3np)

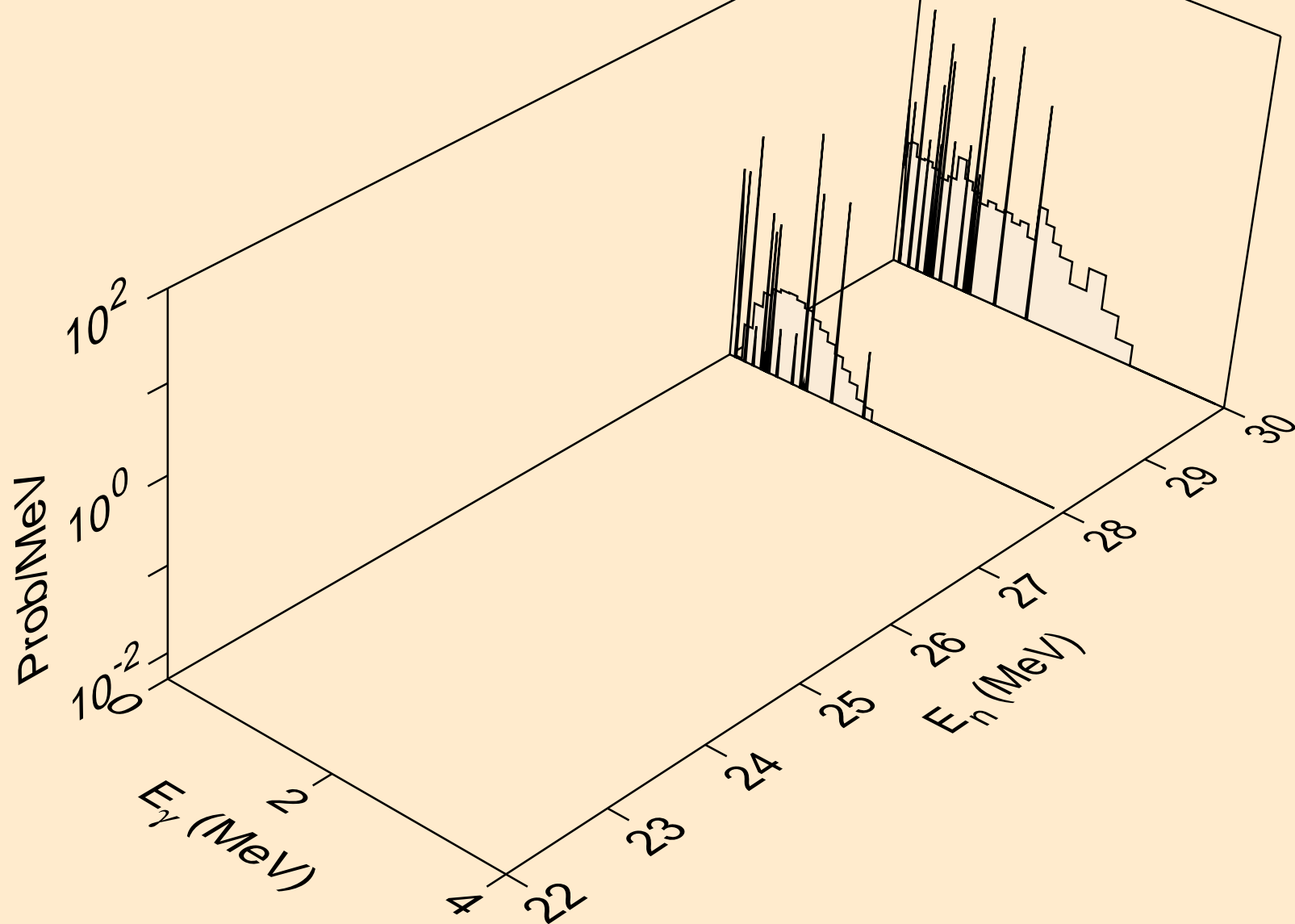

DY149 DEUTERON ACER TENDL-2023 LIBRARY; T=0.K  
Photon emission for (n,n2p)

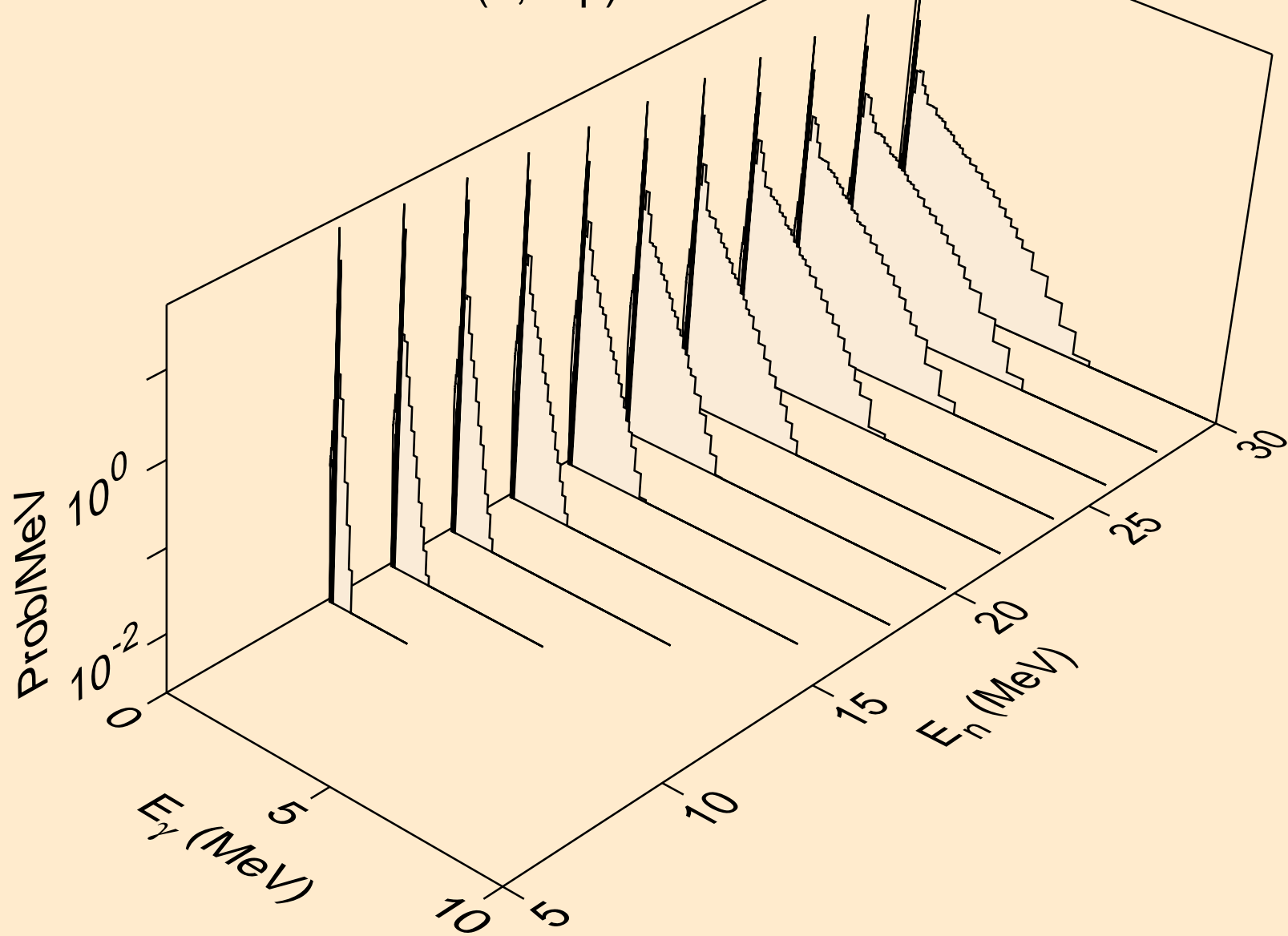

DY149 DEUTERON ACER TENDL-2023 LIBRARY; T=0.K  
Photon emission for (n,npa)

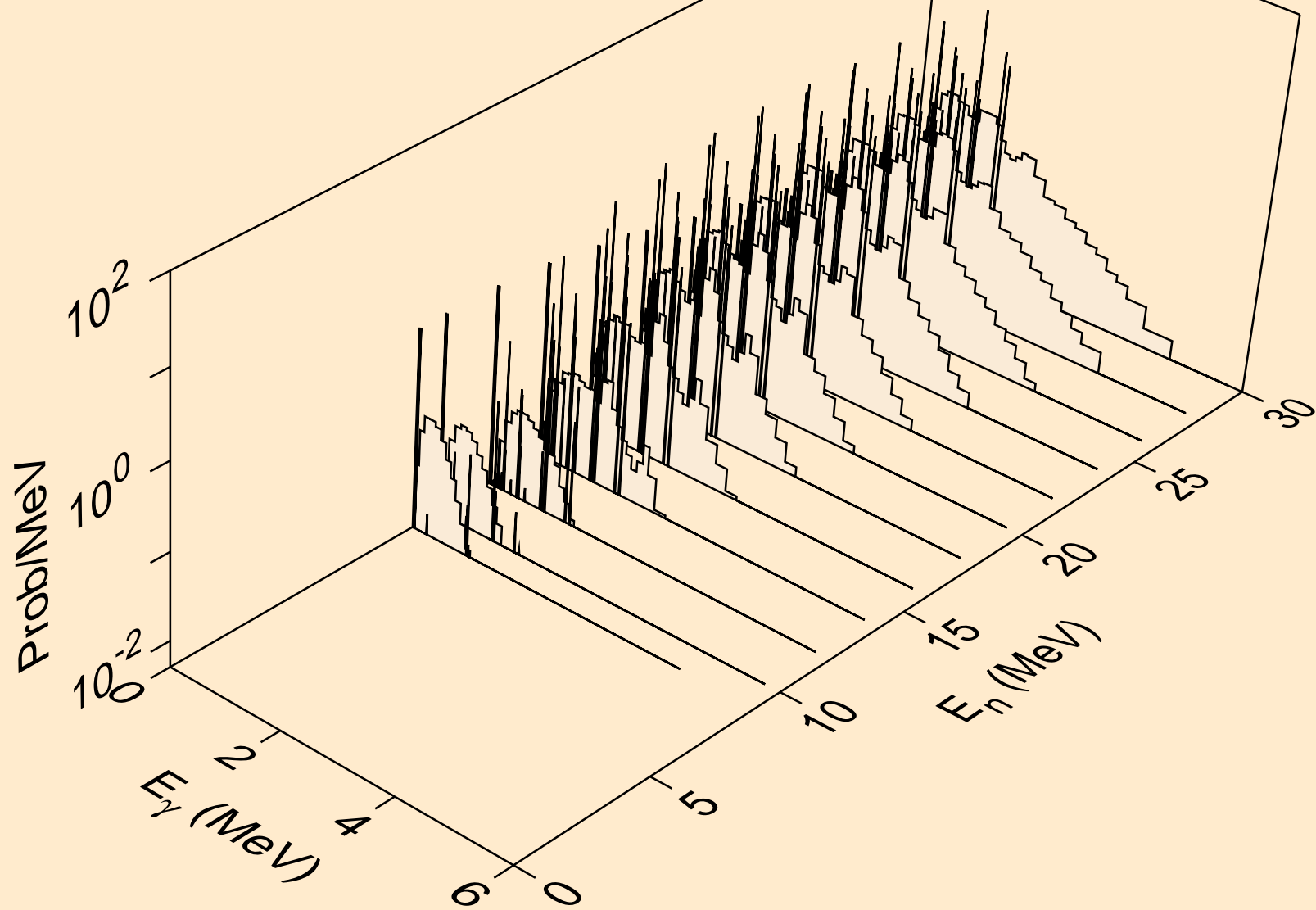



DY149 DEUTERON ACER TENDL-2023 LIBRARY; T=0.K  
Photon emission for (n,gma)

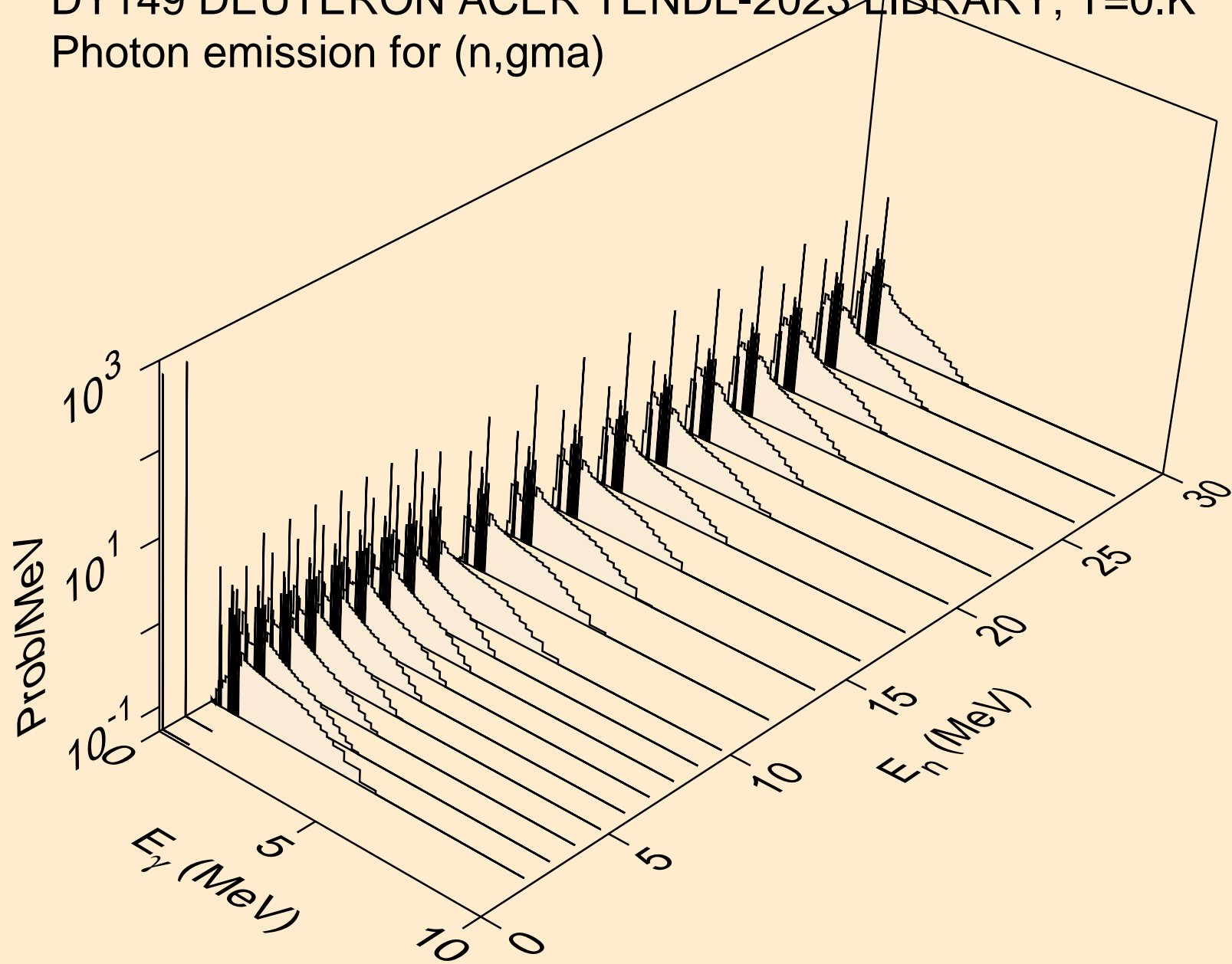

DY149 DEUTERON ACER TENDL-2023 LIBRARY; T=0.K  
Photon emission for (n,p)

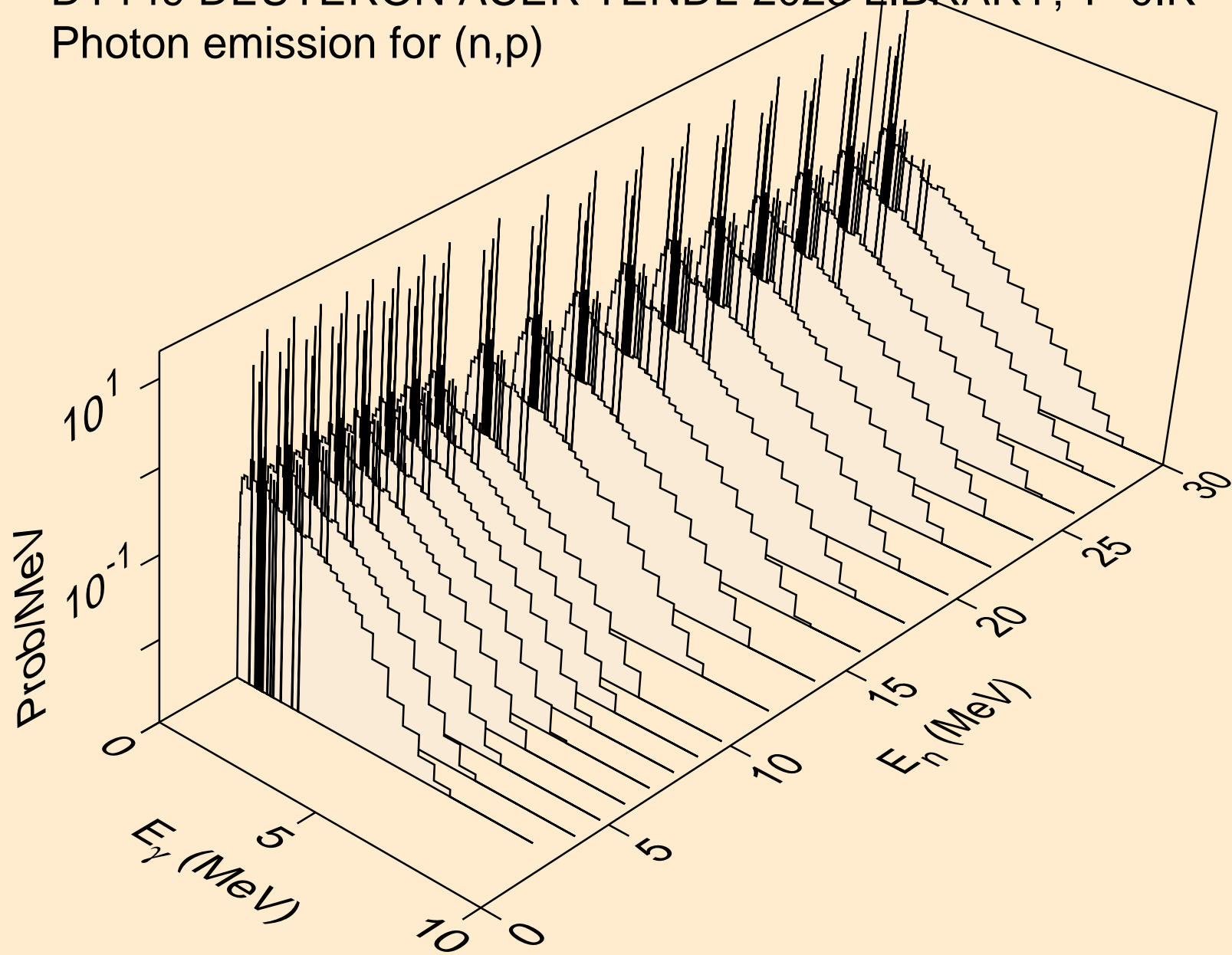

DY149 DEUTERON ACER TENDL-2023 LIBRARY; T=0.K  
Photon emission for inelastic

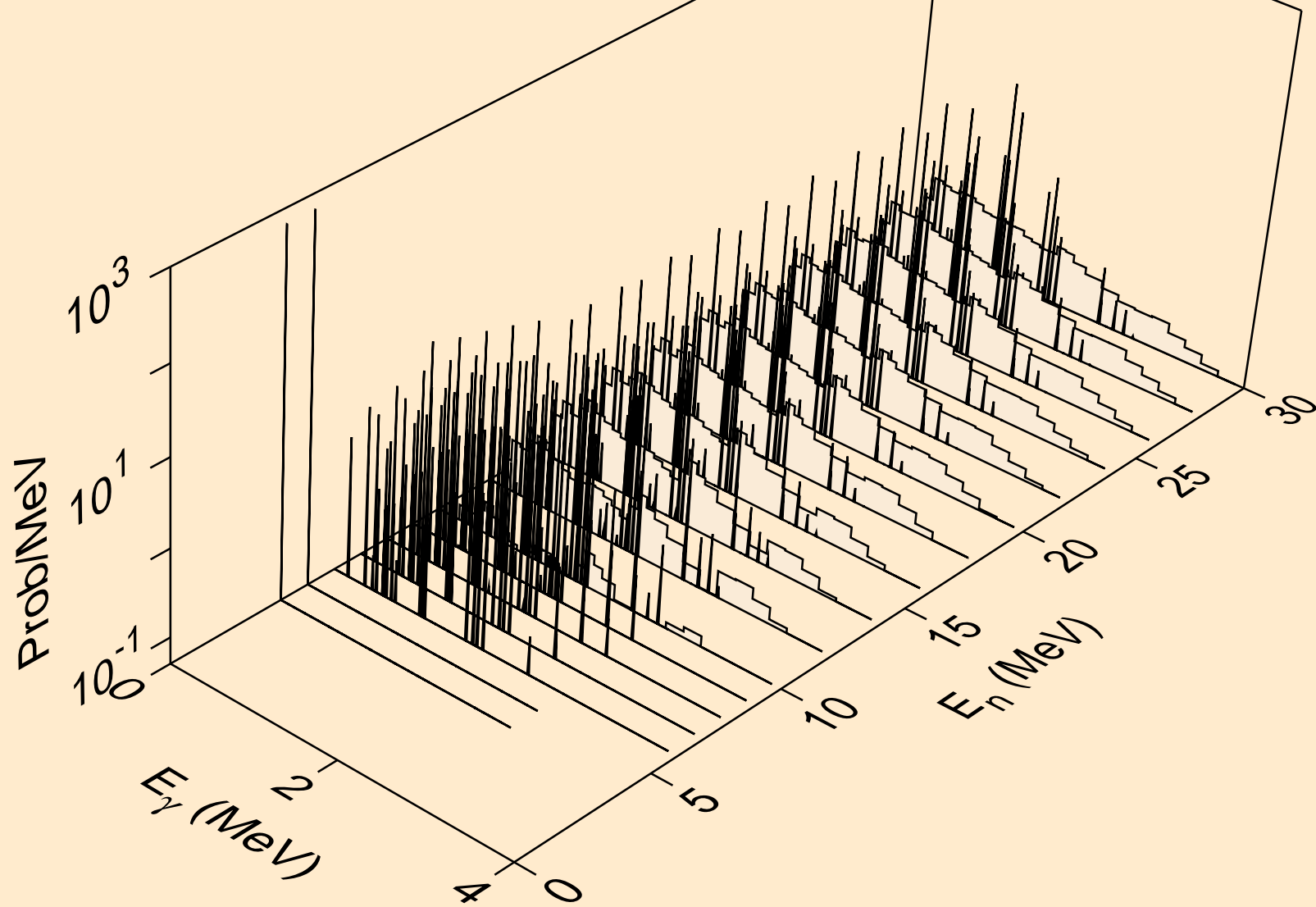

DY149 DEUTERON ACER TENDL-2023 LIBRARY; T=0.K  
Photon emission for (n,t)

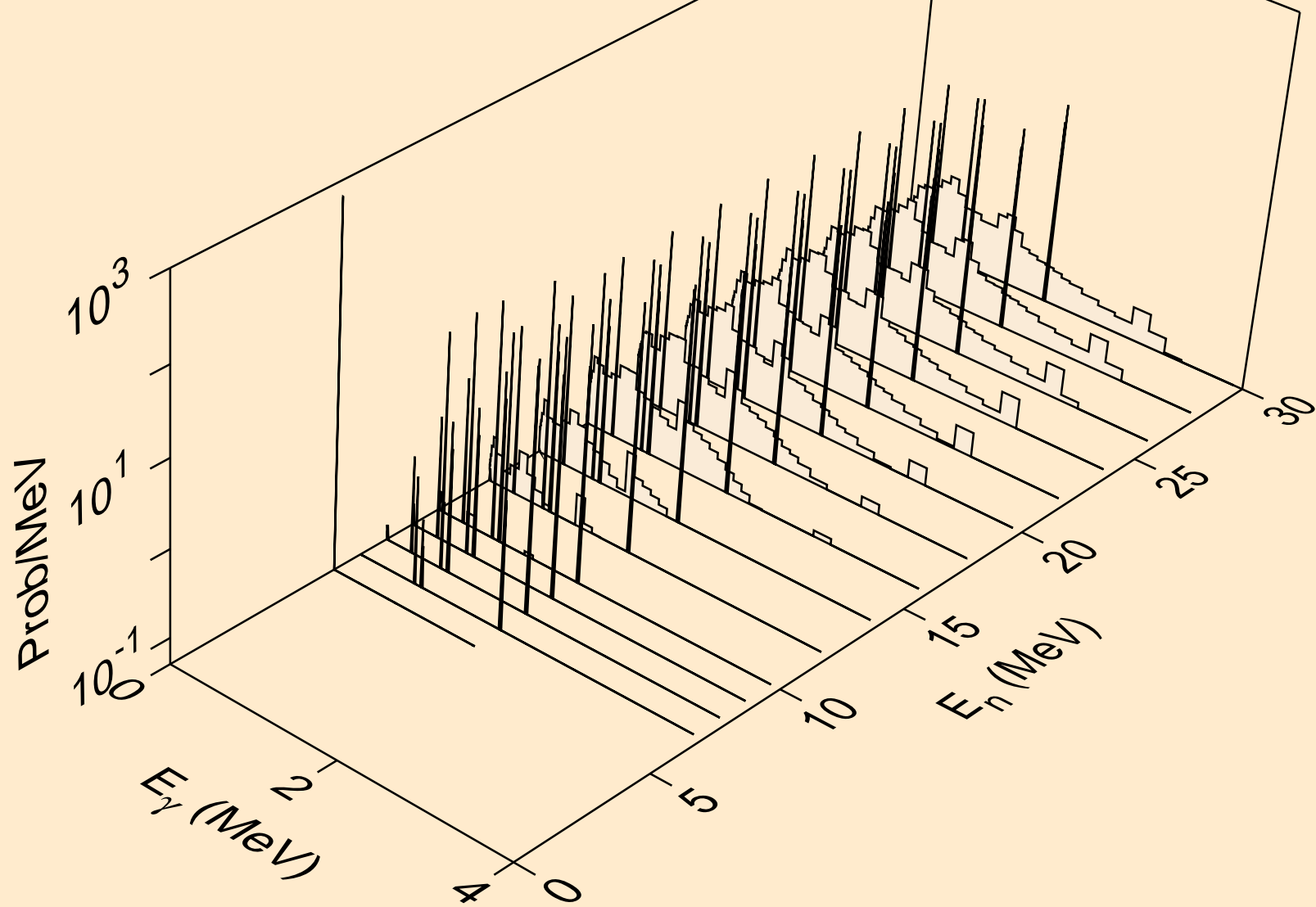

DY149 DEUTERON ACER TENDL-2023 LIBRARY; T=0.K  
Photon emission for (n,he3)

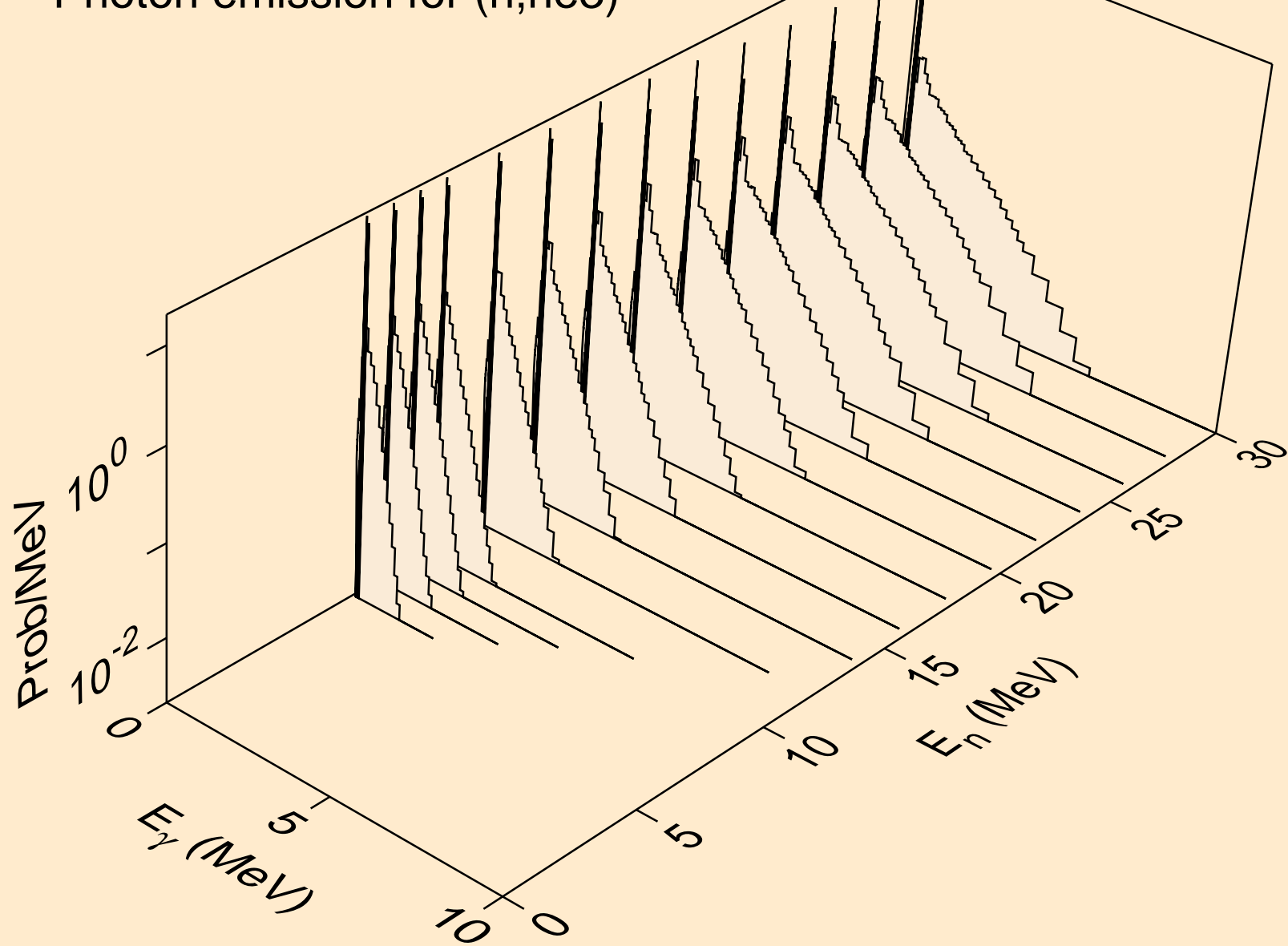

DY149 DEUTERON ACER TENDL-2023 LIBRARY; T=0.K  
Photon emission for (n,a)

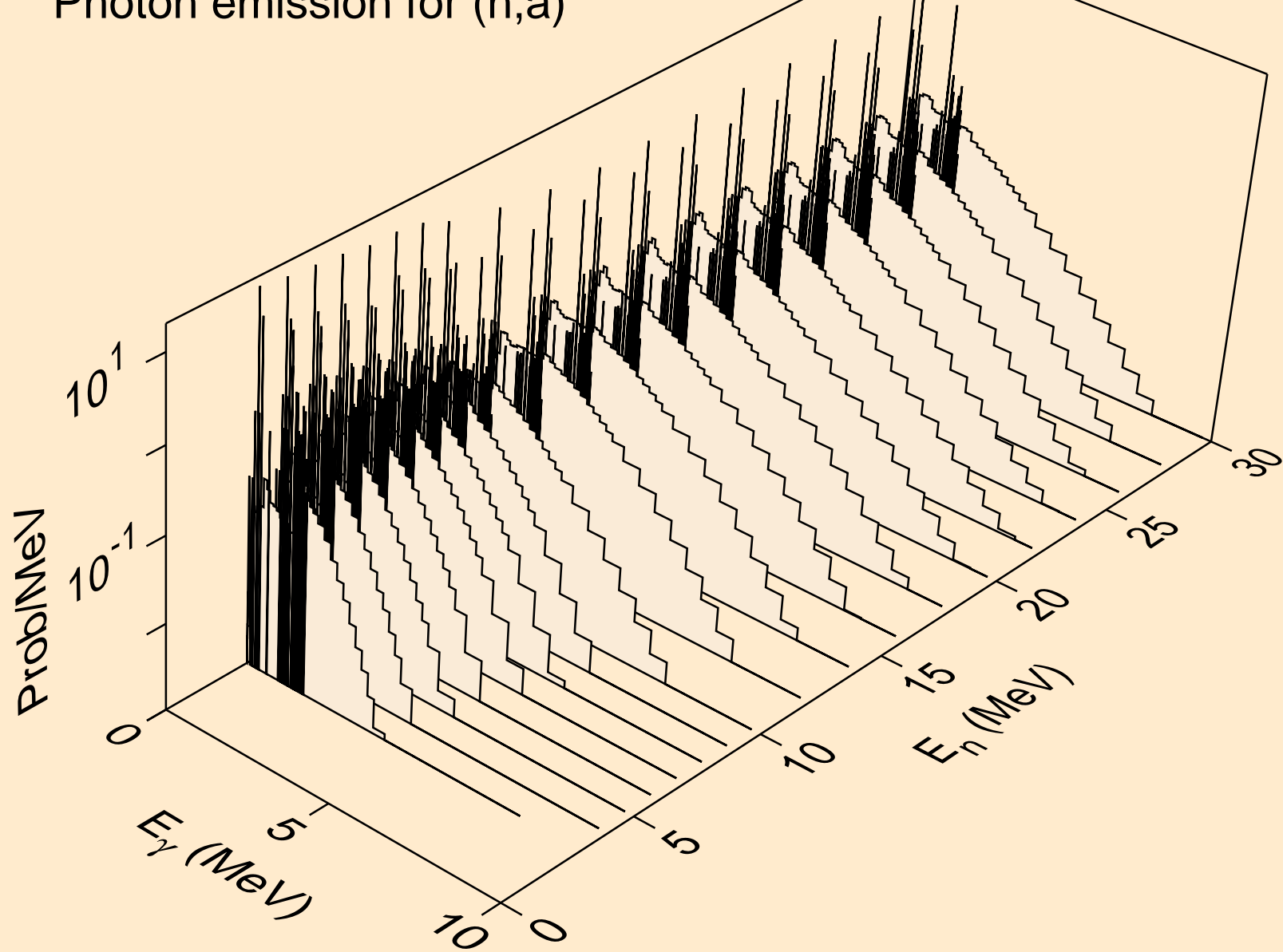

DY149 DEUTERON ACER TENDL-2023 LIBRARY; T=0.K  
Photon emission for (n,2a)

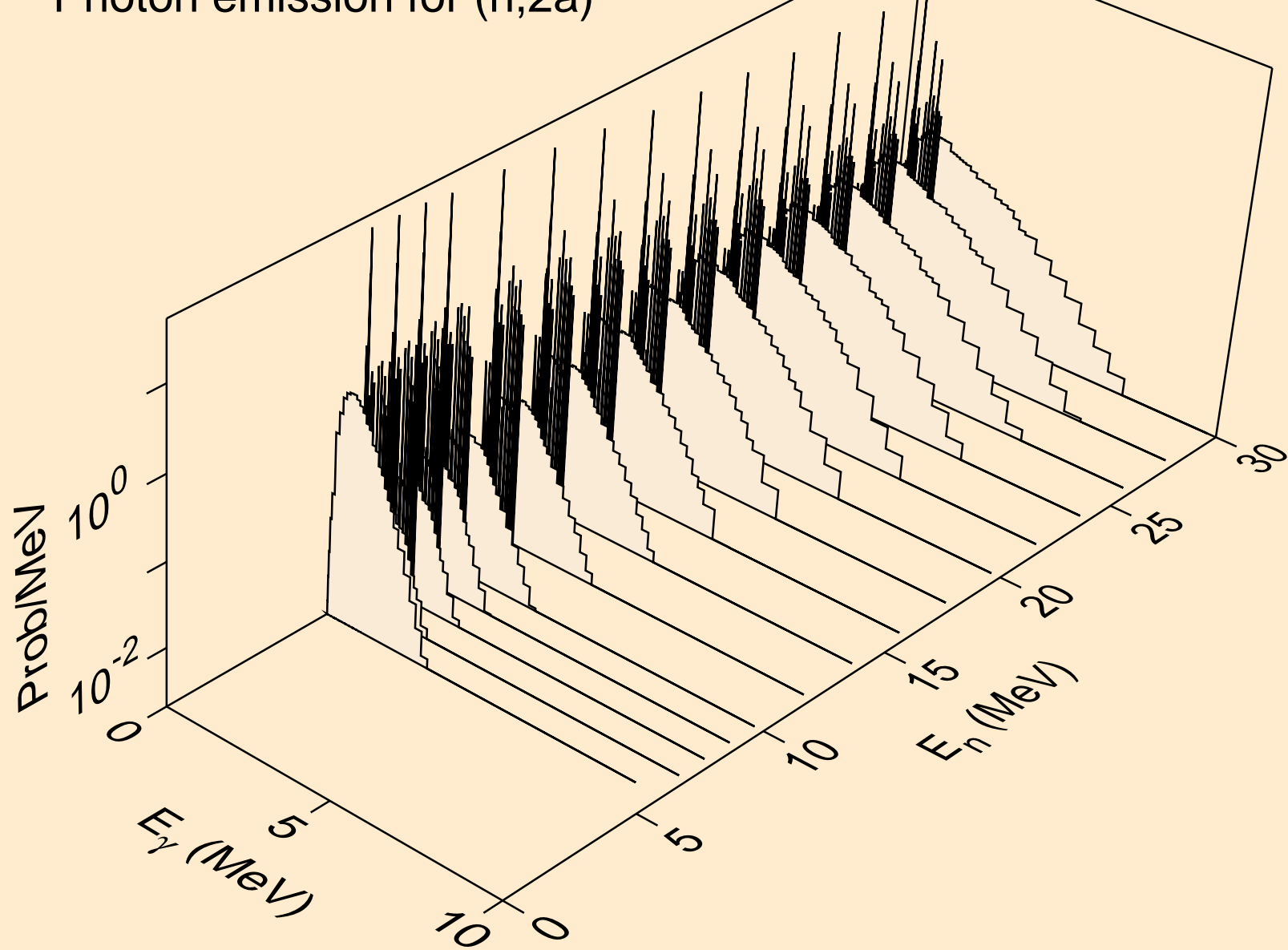

DY149 DEUTERON ACER TENDL-2023 LIBRARY; T=0.K  
Photon emission for (n,3a)

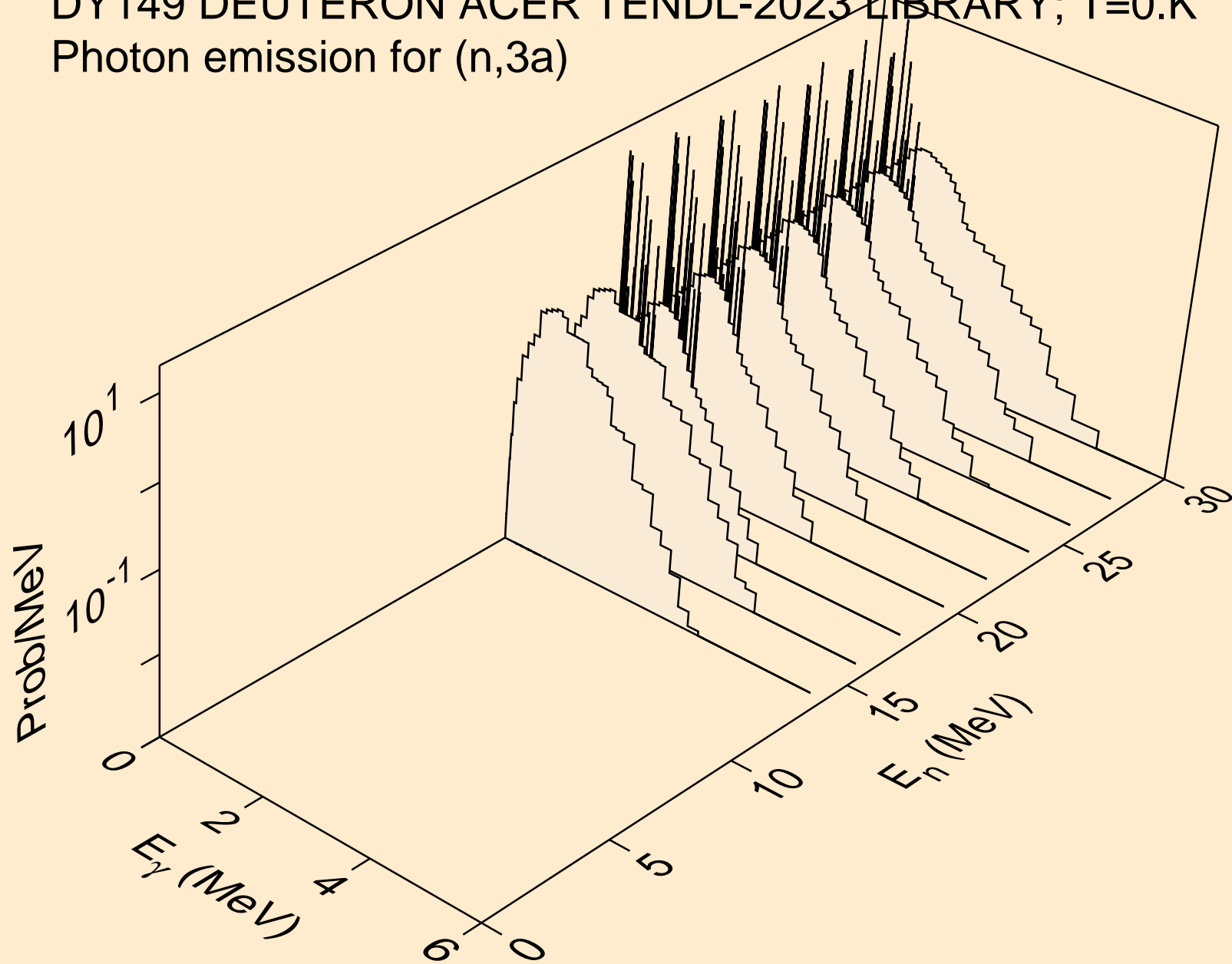



DY149 DEUTERON ACER TENDL-2023 LIBRARY; T=0.K  
Photon emission for (n,2p)

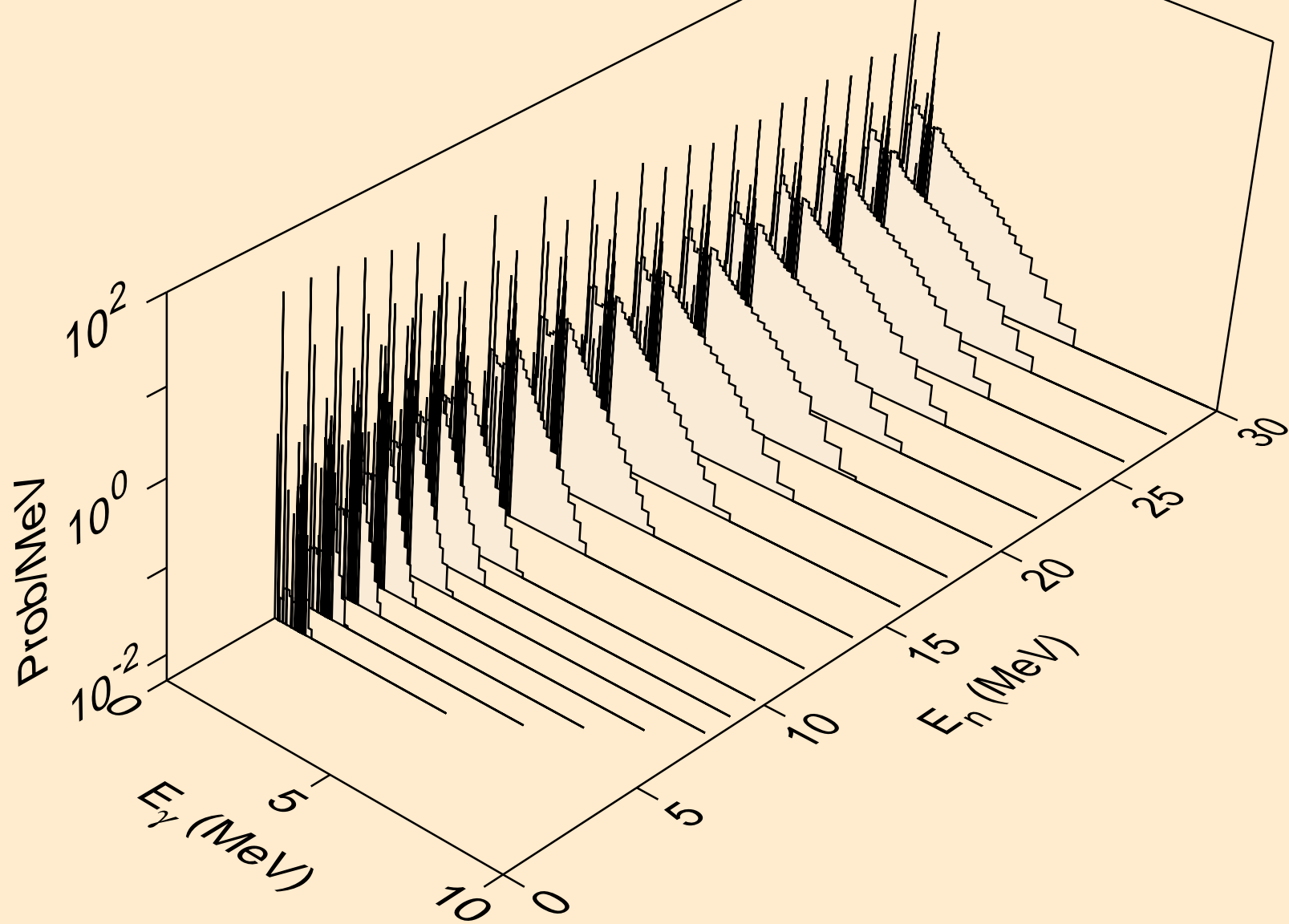

DY149 DEUTERON ACER TENDL-2023 LIBRARY; T=0.K  
Photon emission for (n,p)

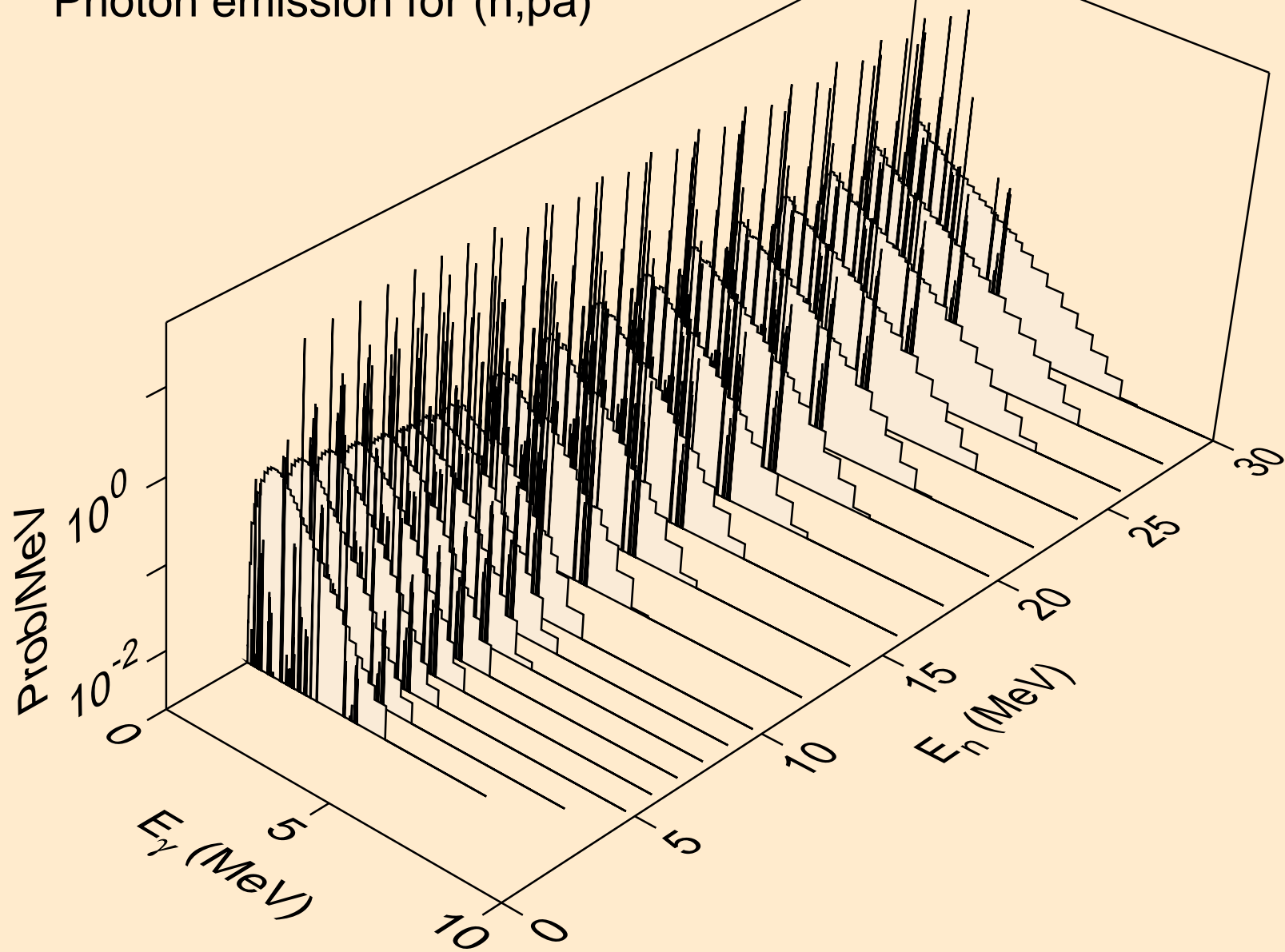

DY149 DEUTERON ACER TENDL-2023 LIBRARY; T=0.K  
Photon emission for (n,pd)

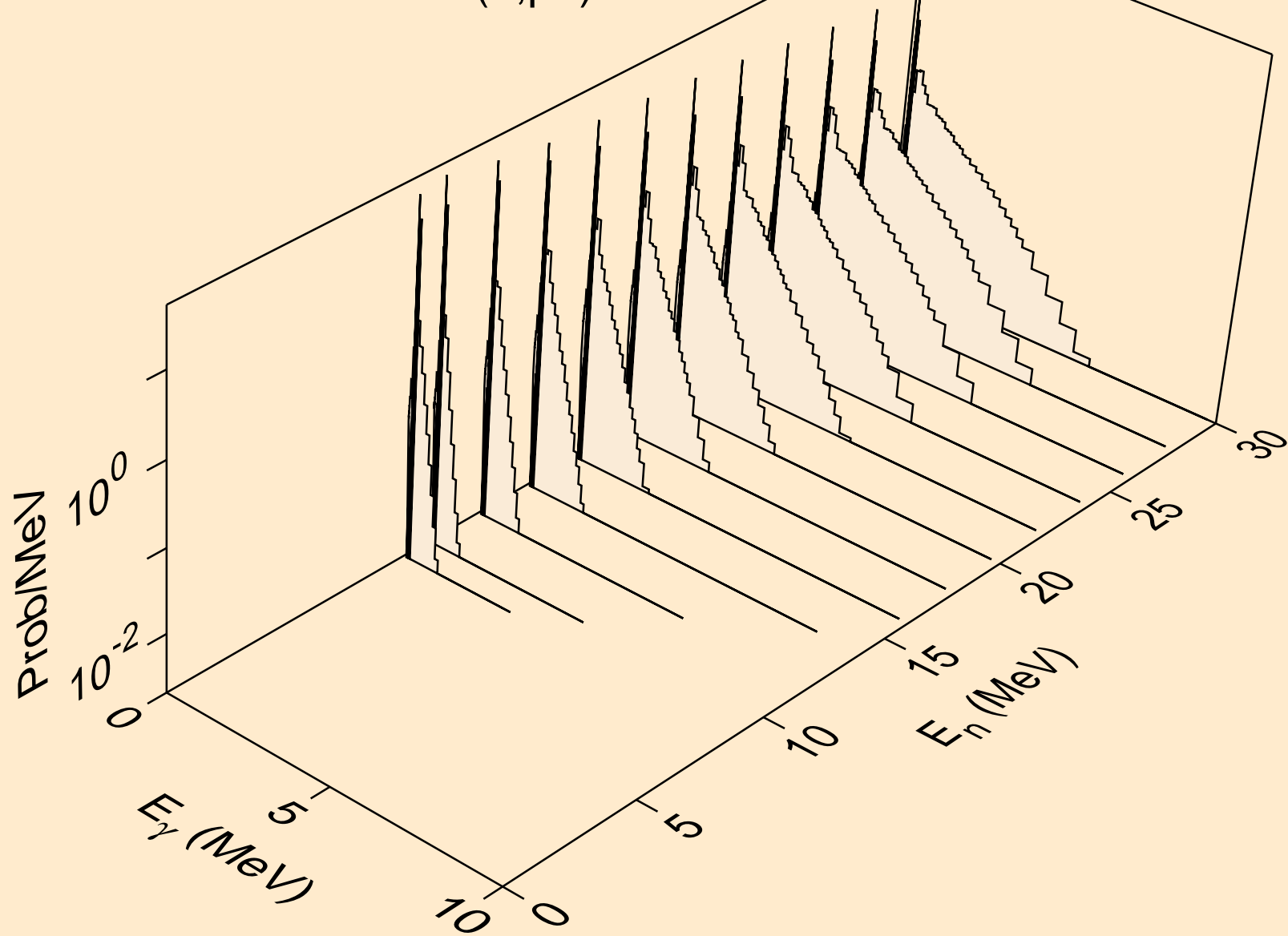

DY149 DEUTERON ACER TENDL-2023 LIBRARY; T=0.K  
Photon emission for (n,pt)

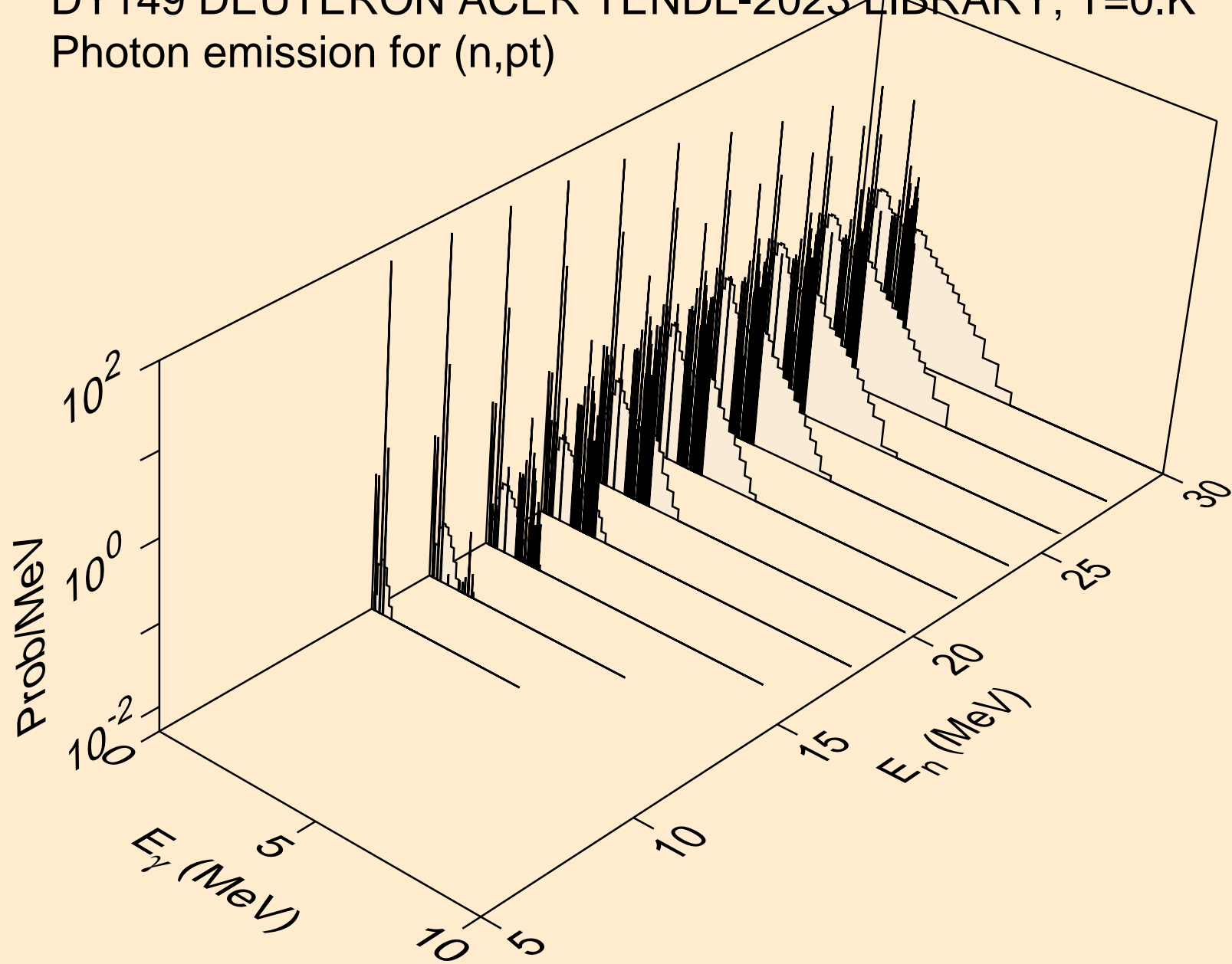

DY149 DEUTERON ACER TENDL-2023 LIBRARY; T=0.K  
Photon emission for (n,da)

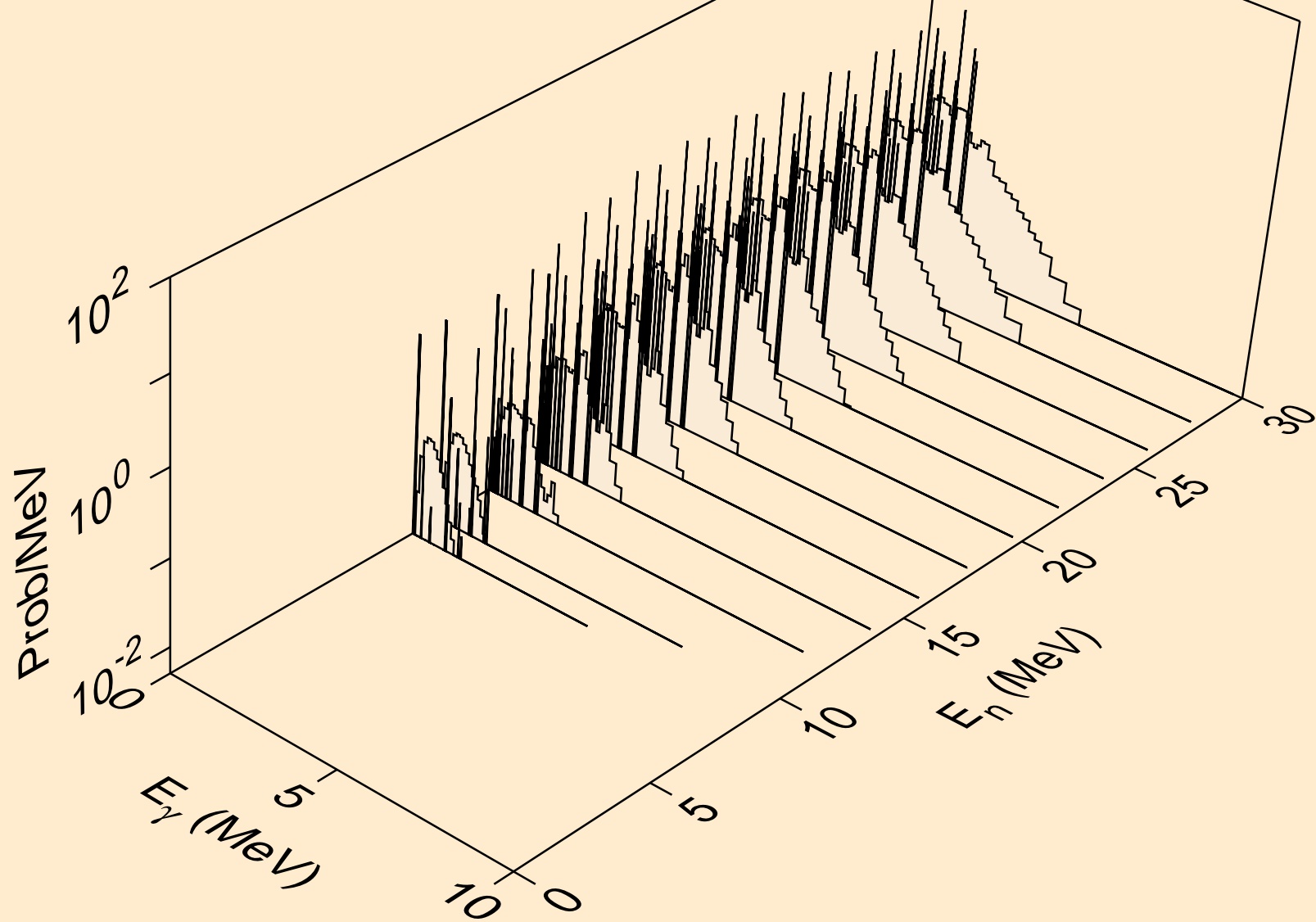

# DY149 DEUTERON ACER TENDL-2023 LIBRARY; T=0.K

## Particle heating contributions

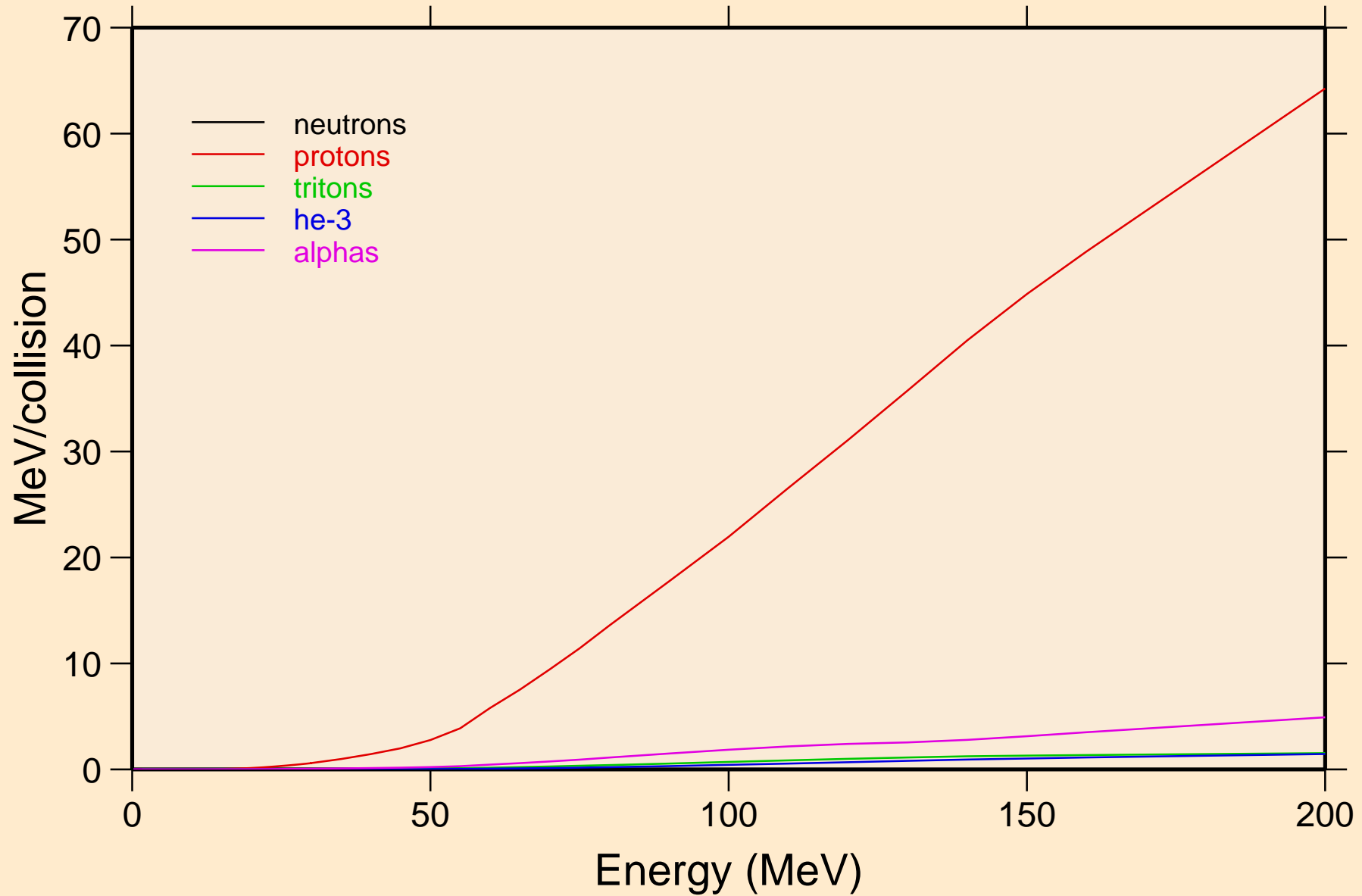

DY149 DEUTERON ACER TENDL-2023 LIBRARY; T=0.K  
Recoil Heating

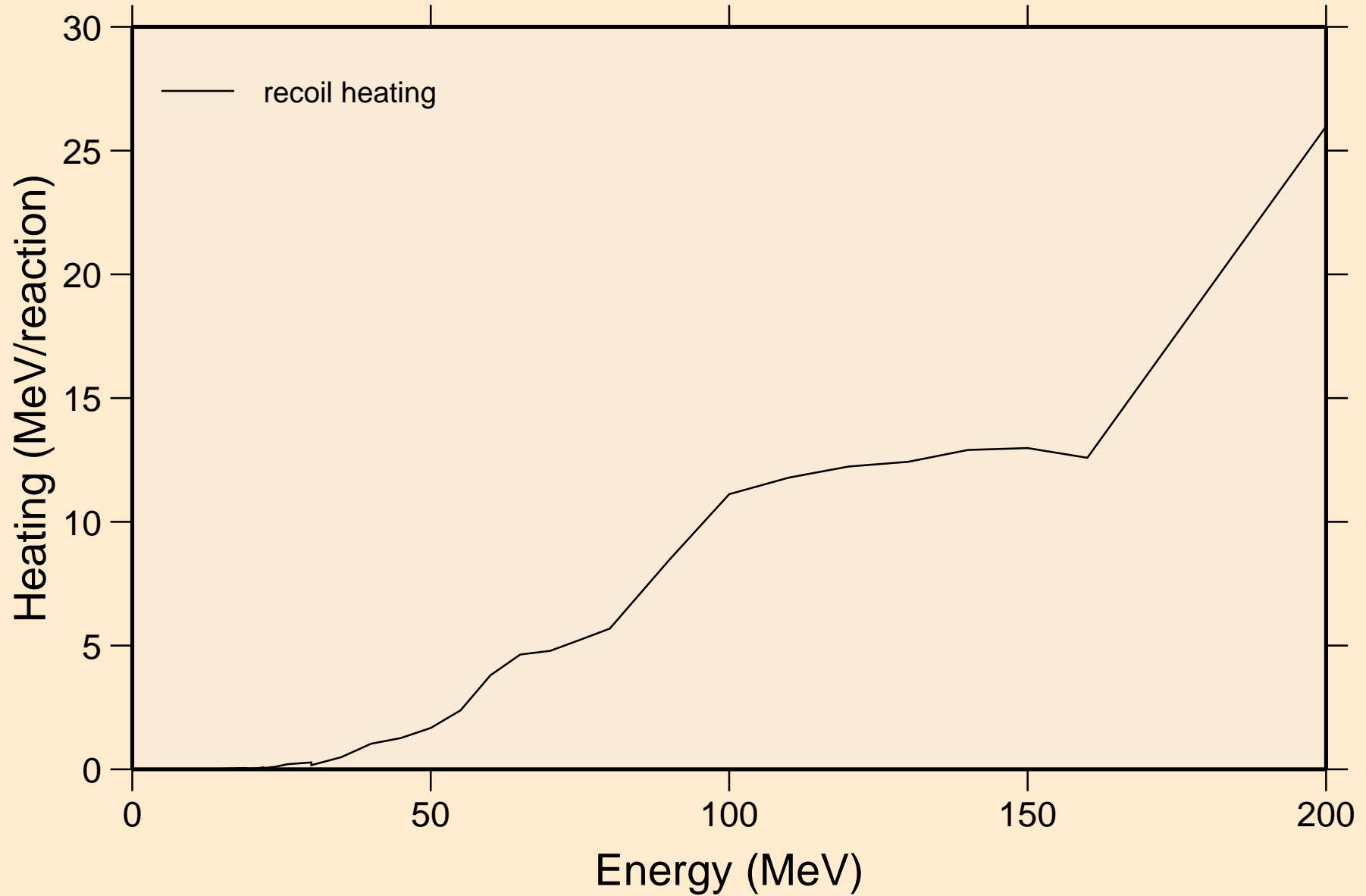

DY149 DEUTERON ACER TENDL-2023 LIBRARY; T=0.K  
Particle production cross sections

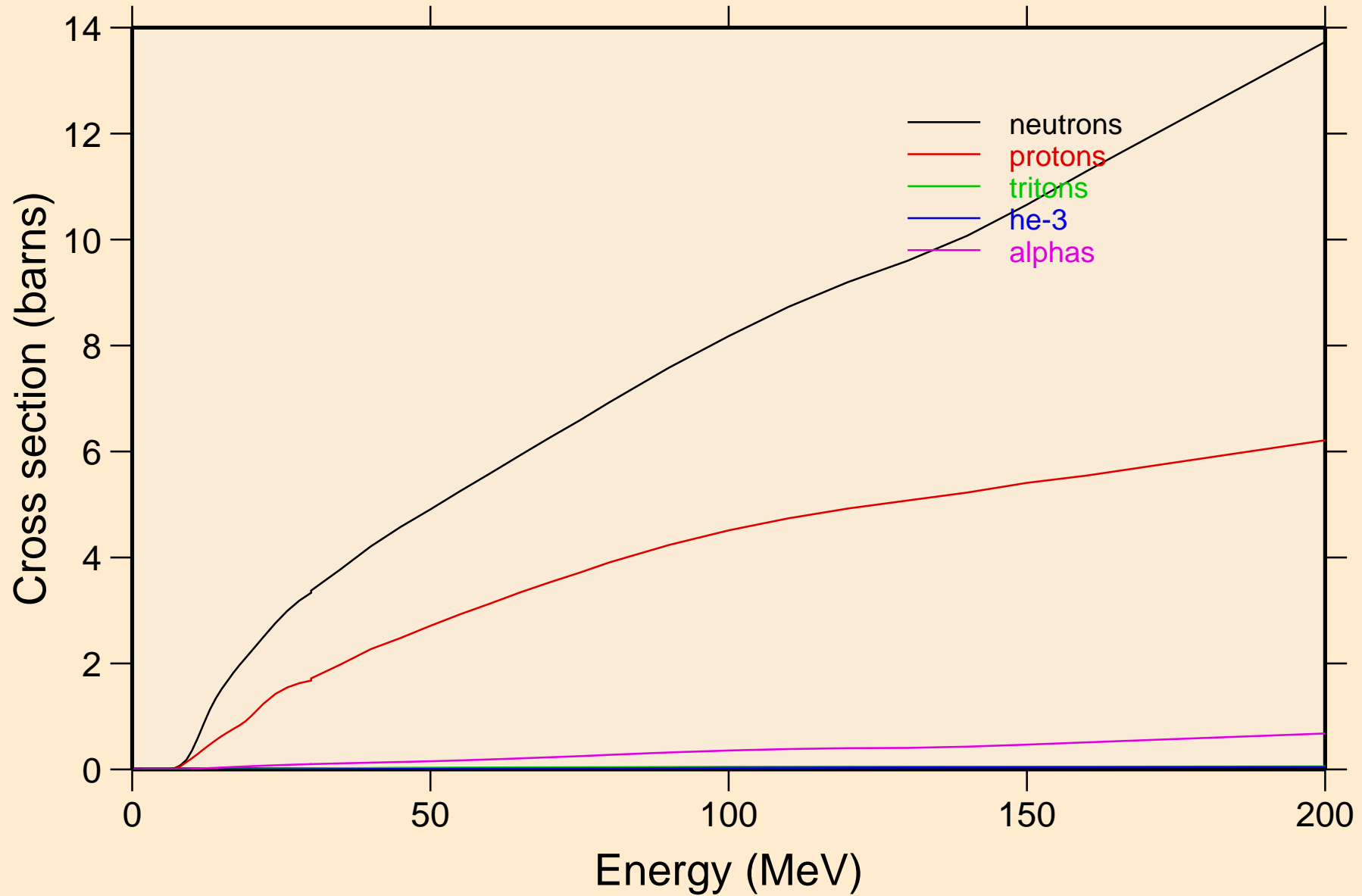



DY149 DEUTERON ACER TENDL-2023 LIBRARY; T=0.K  
neutrons from (d,n)

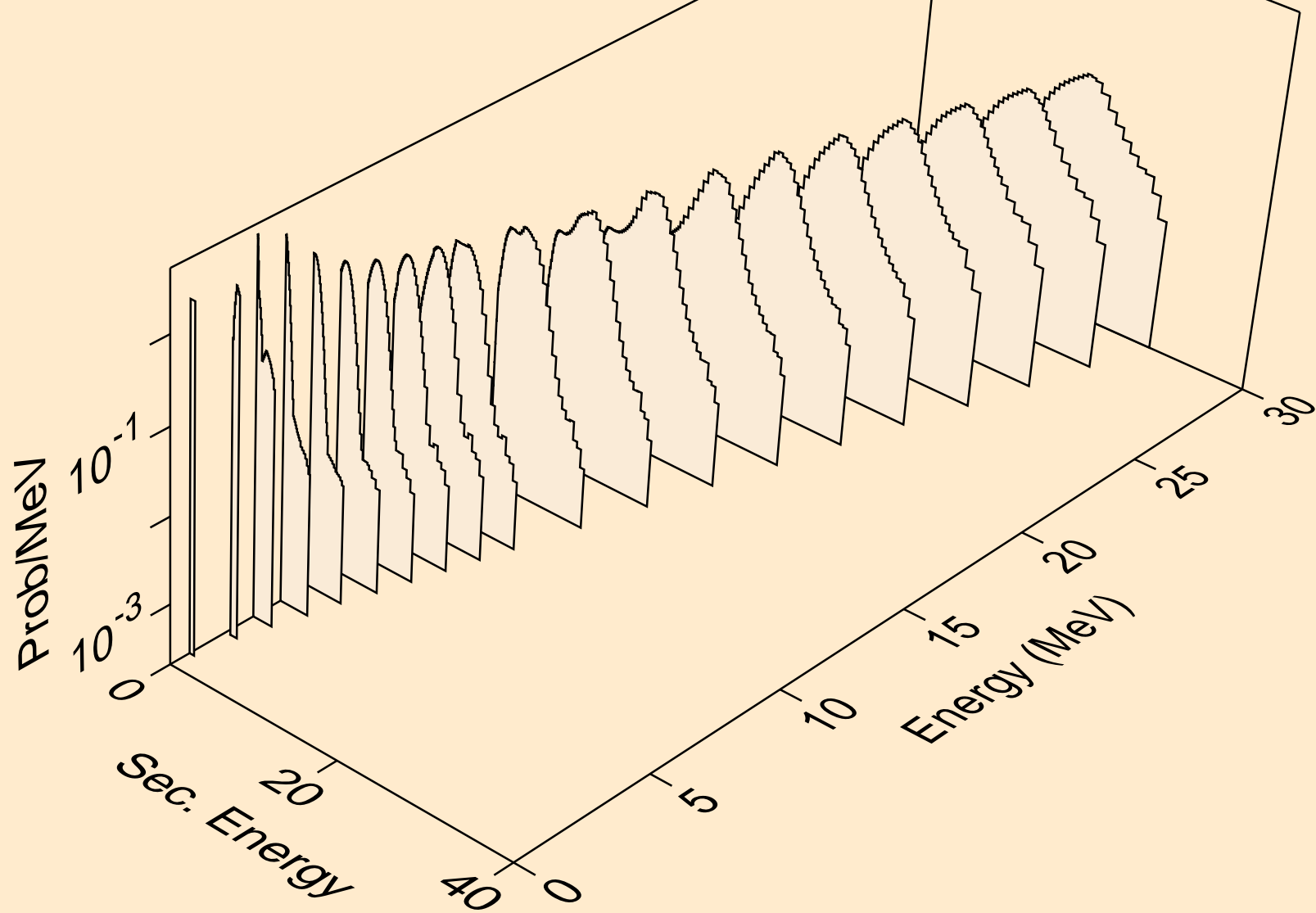

DY149 DEUTERON ACER TENDL-2023 LIBRARY; T=0.K  
neutrons from (d,x)

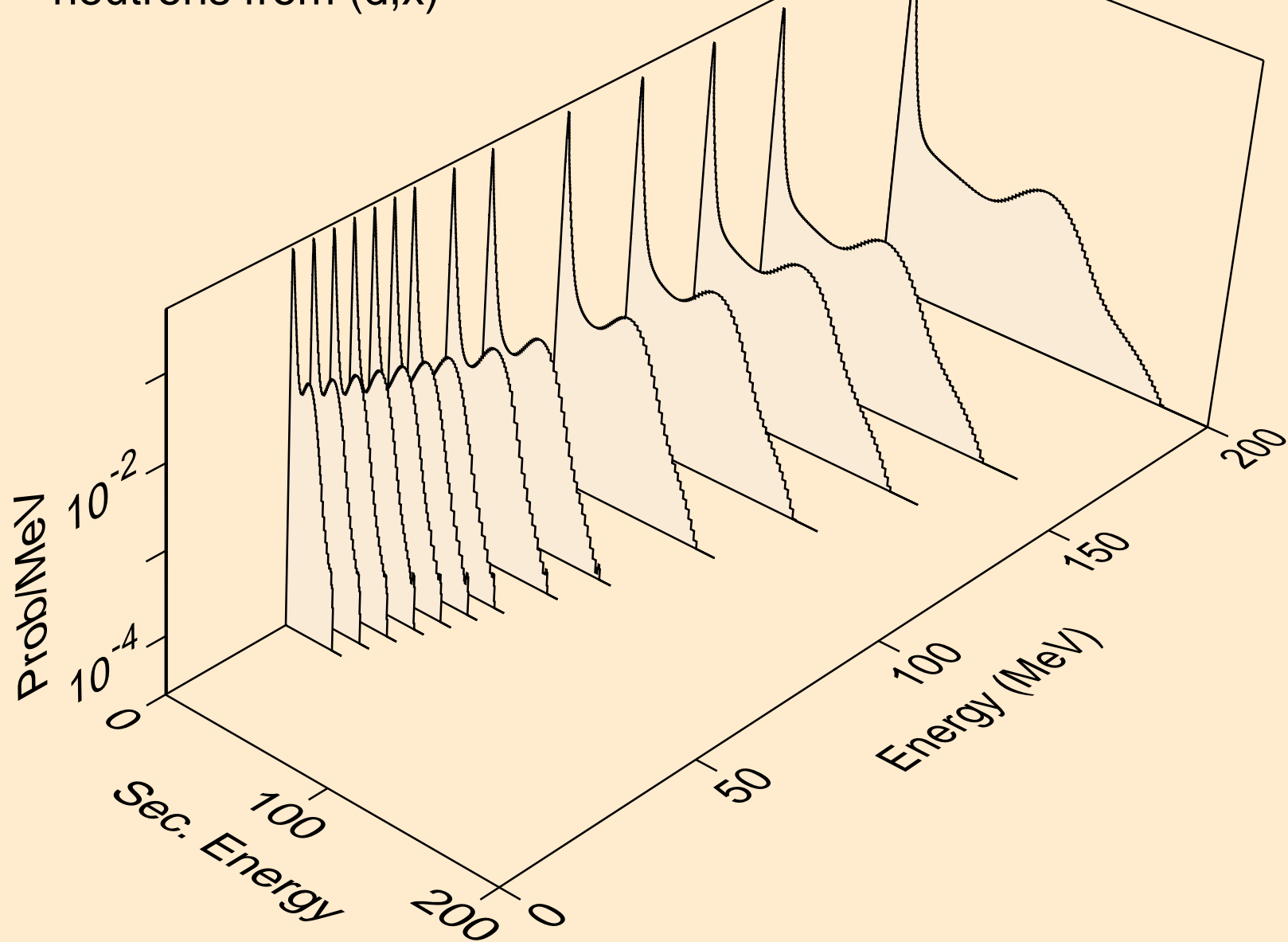

DY149 DEUTERON ACER TENDL-2023 LIBRARY; T=0.K  
neutrons from (d,2nd)

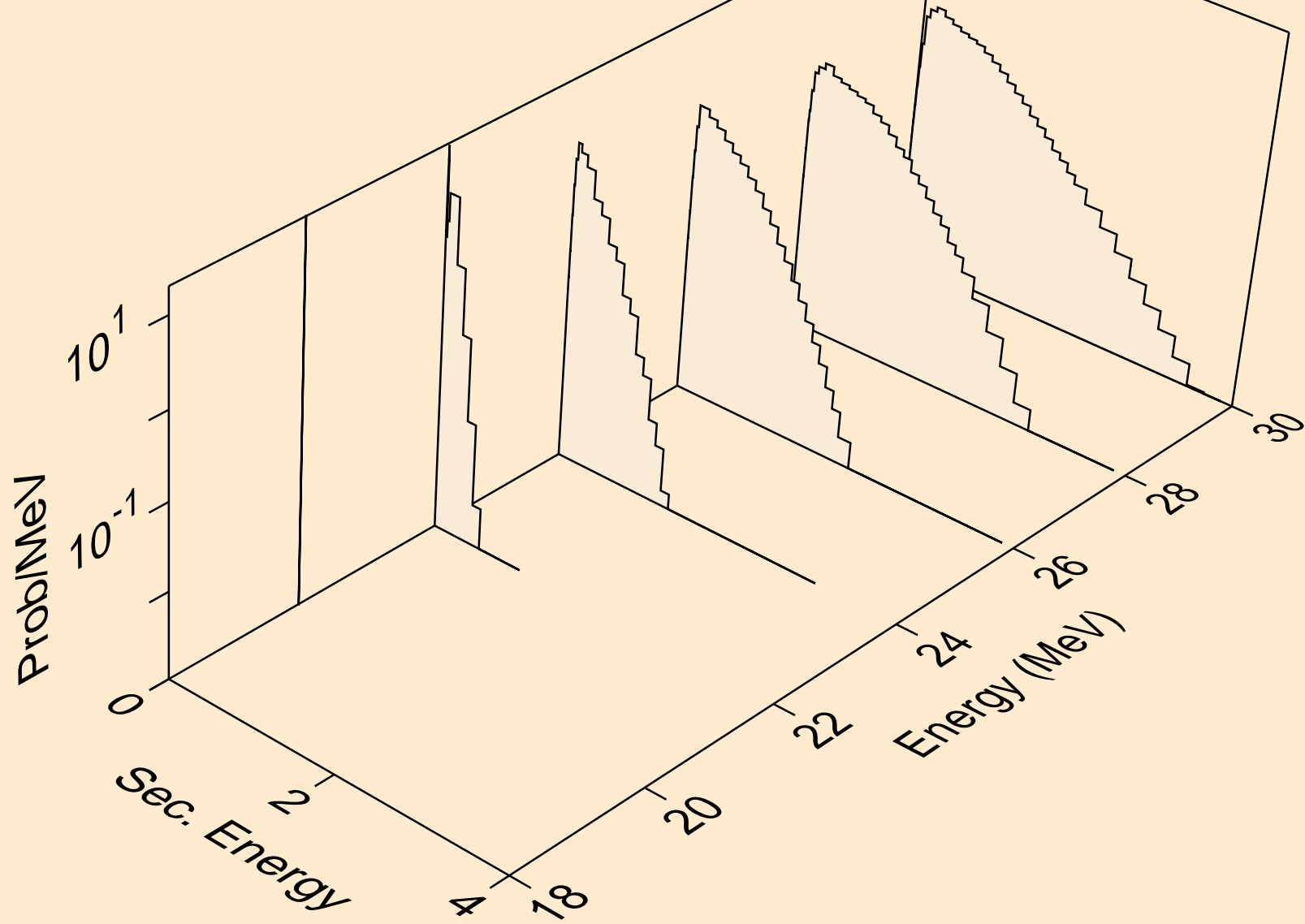

DY149 DEUTERON ACER TENDL-2023 LIBRARY; T=0.K  
neutrons from (d,2n)

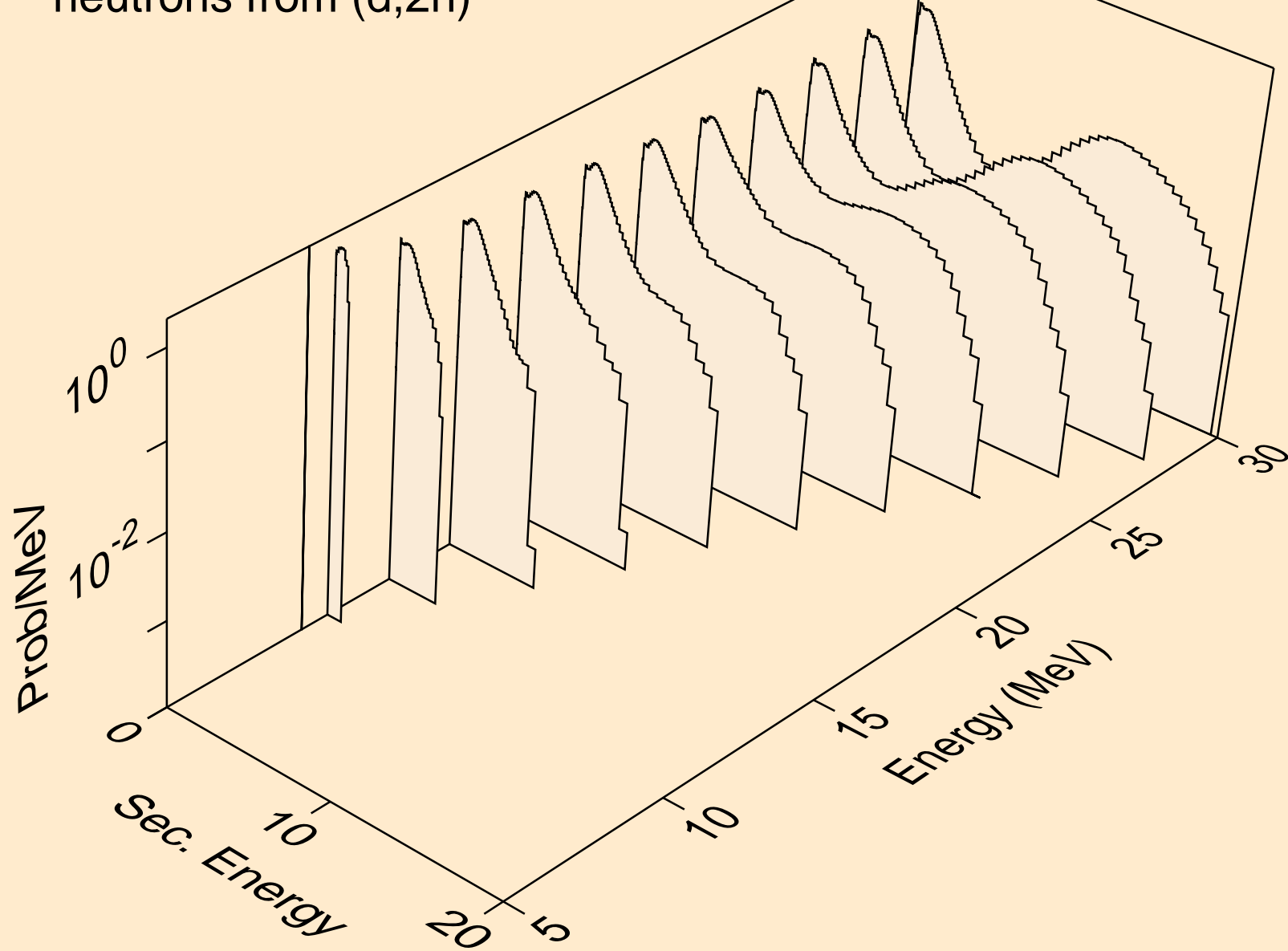

DY149 DEUTERON ACER TENDL-2023 LIBRARY; T=0.K  
neutrons from (d,3n)

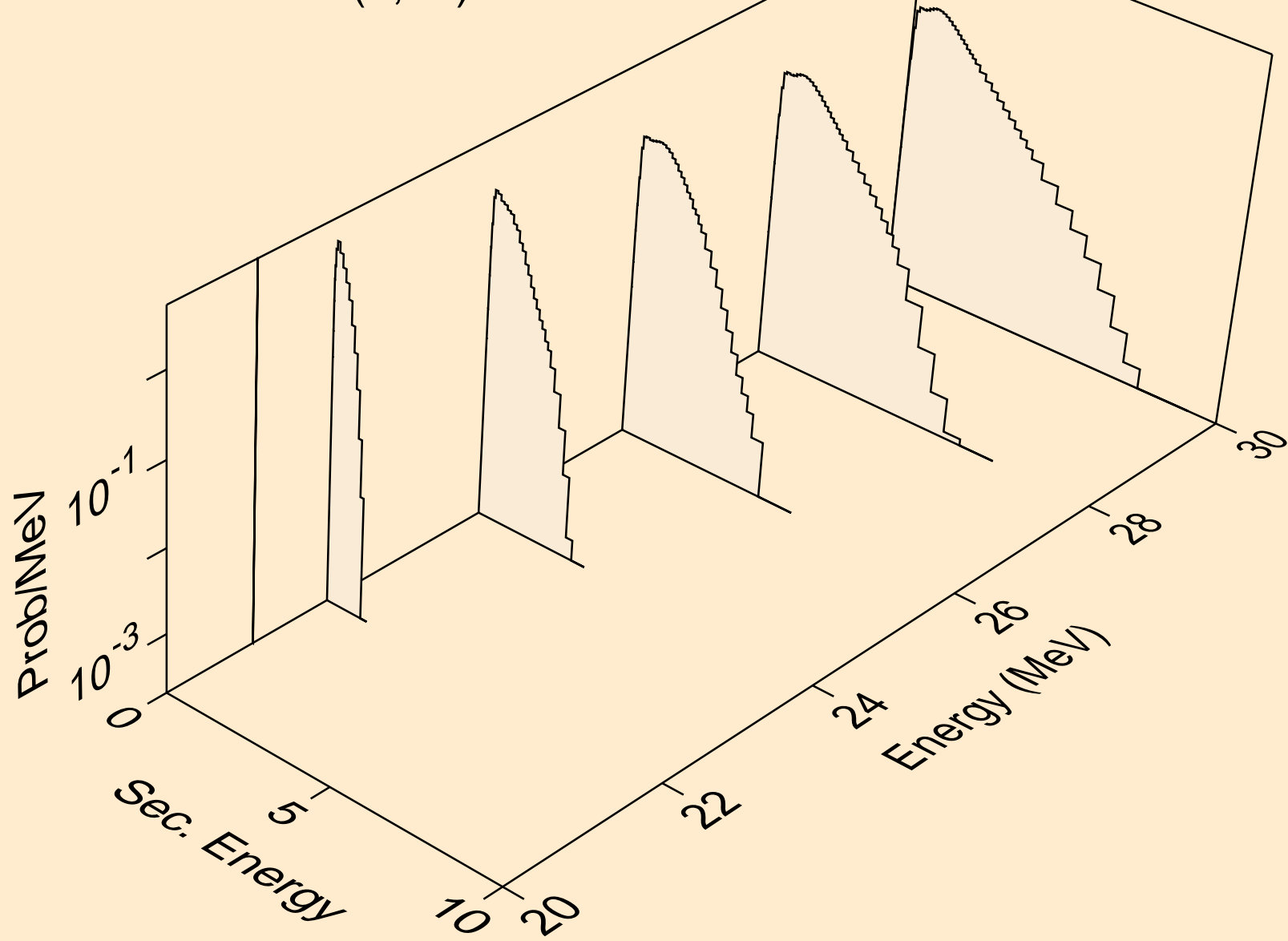

DY149 DEUTERON ACER TENDL-2023 LIBRARY; T=0.K  
neutrons from (d,n\*)a

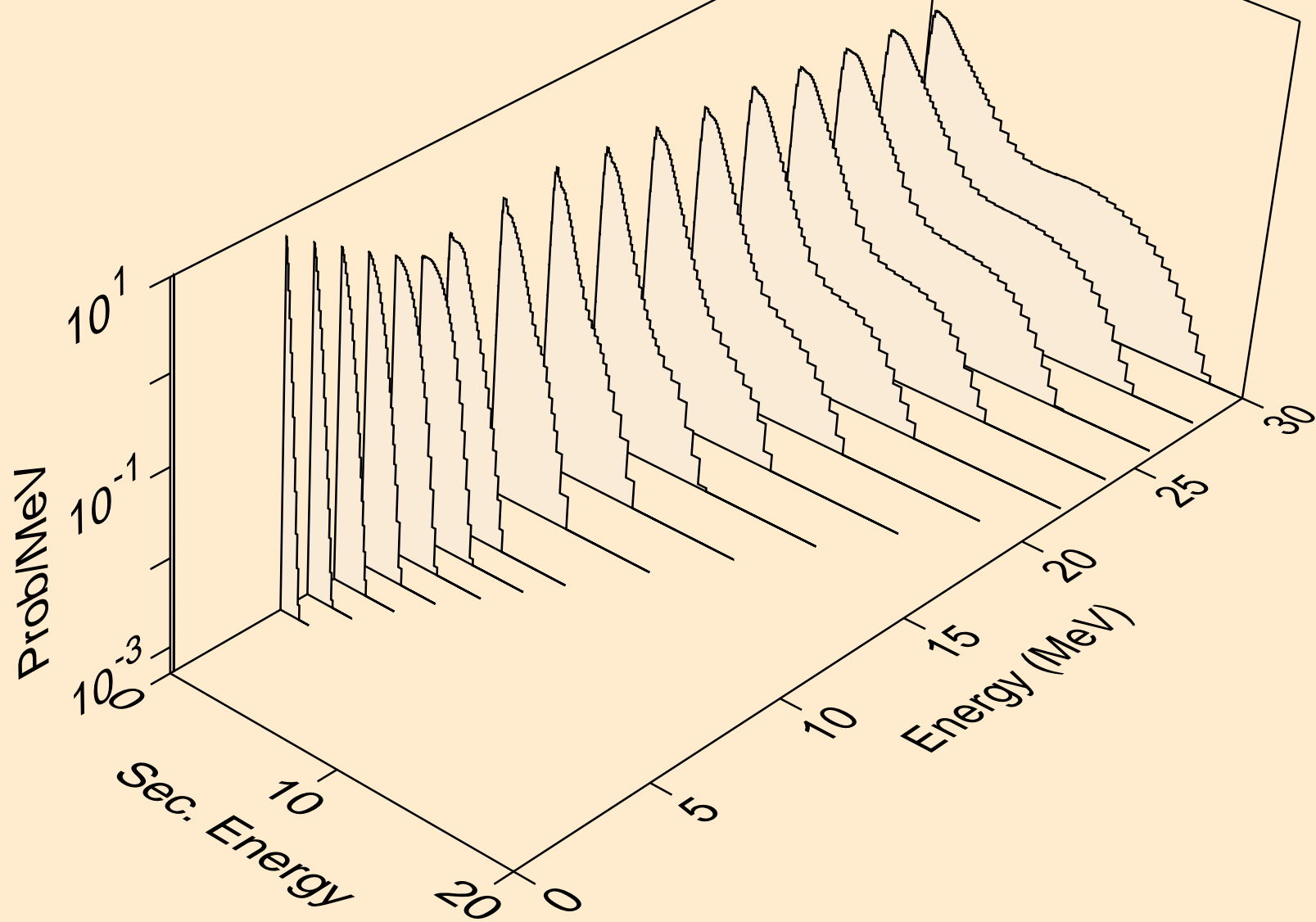

DY149 DEUTERON ACER TENDL-2023 LIBRARY; T=0.K  
neutrons from (d,2n)a

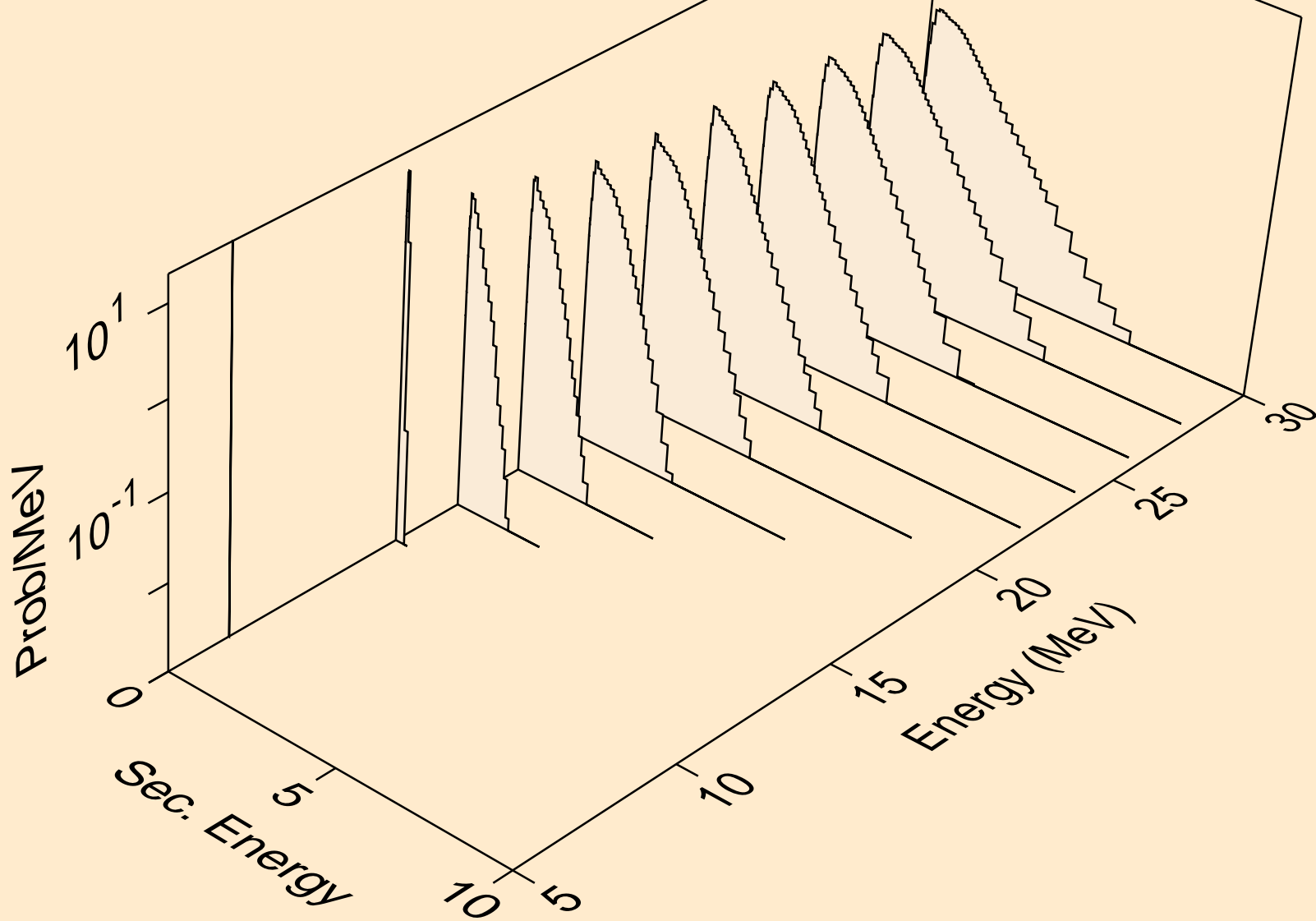

DY149 DEUTERON ACER TENDL-2023 LIBRARY; T=0.K  
neutrons from (d,3n)a

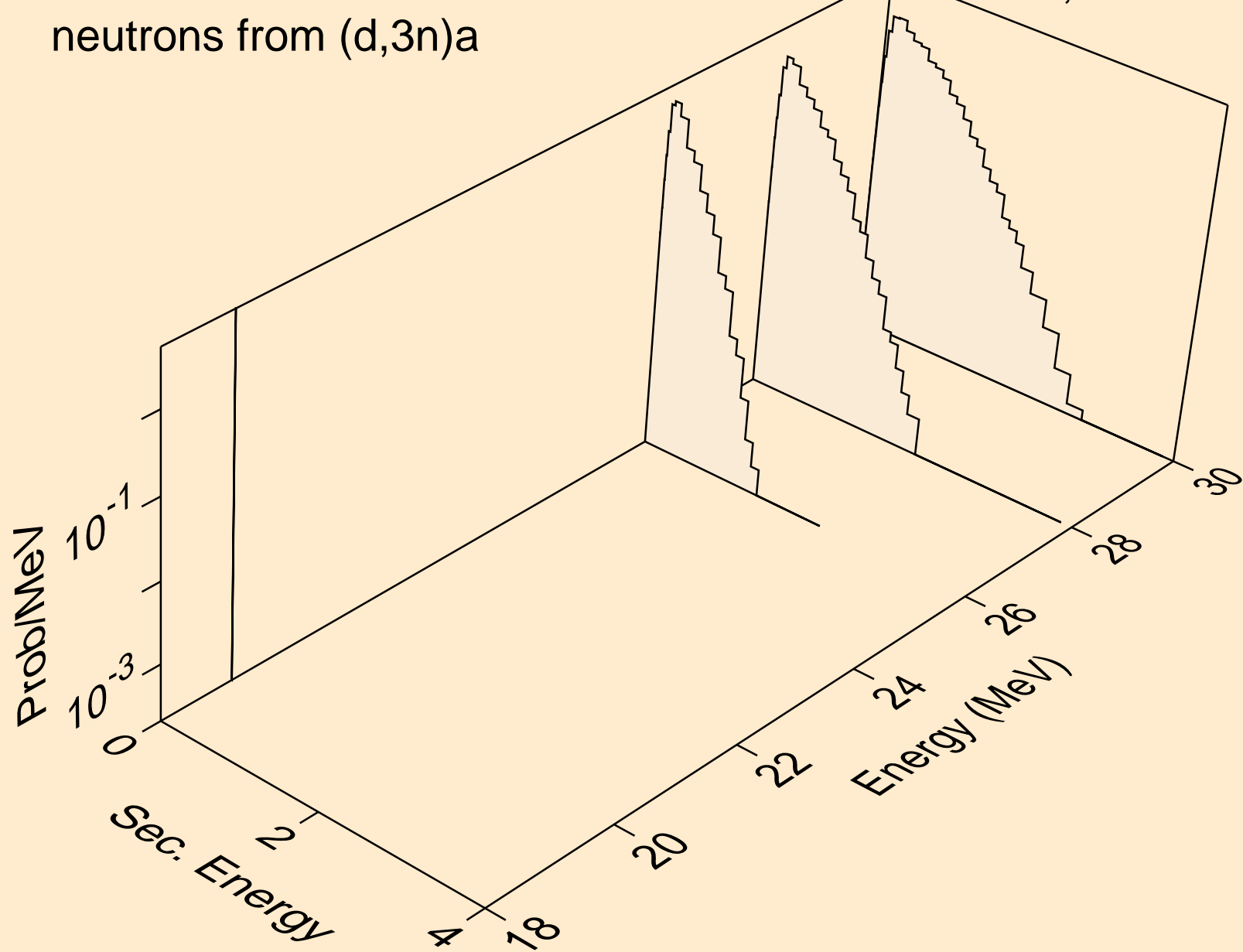



DY149 DEUTERON ACER TENDL-2023 LIBRARY; T=0.K  
neutrons from (d,n\*)p

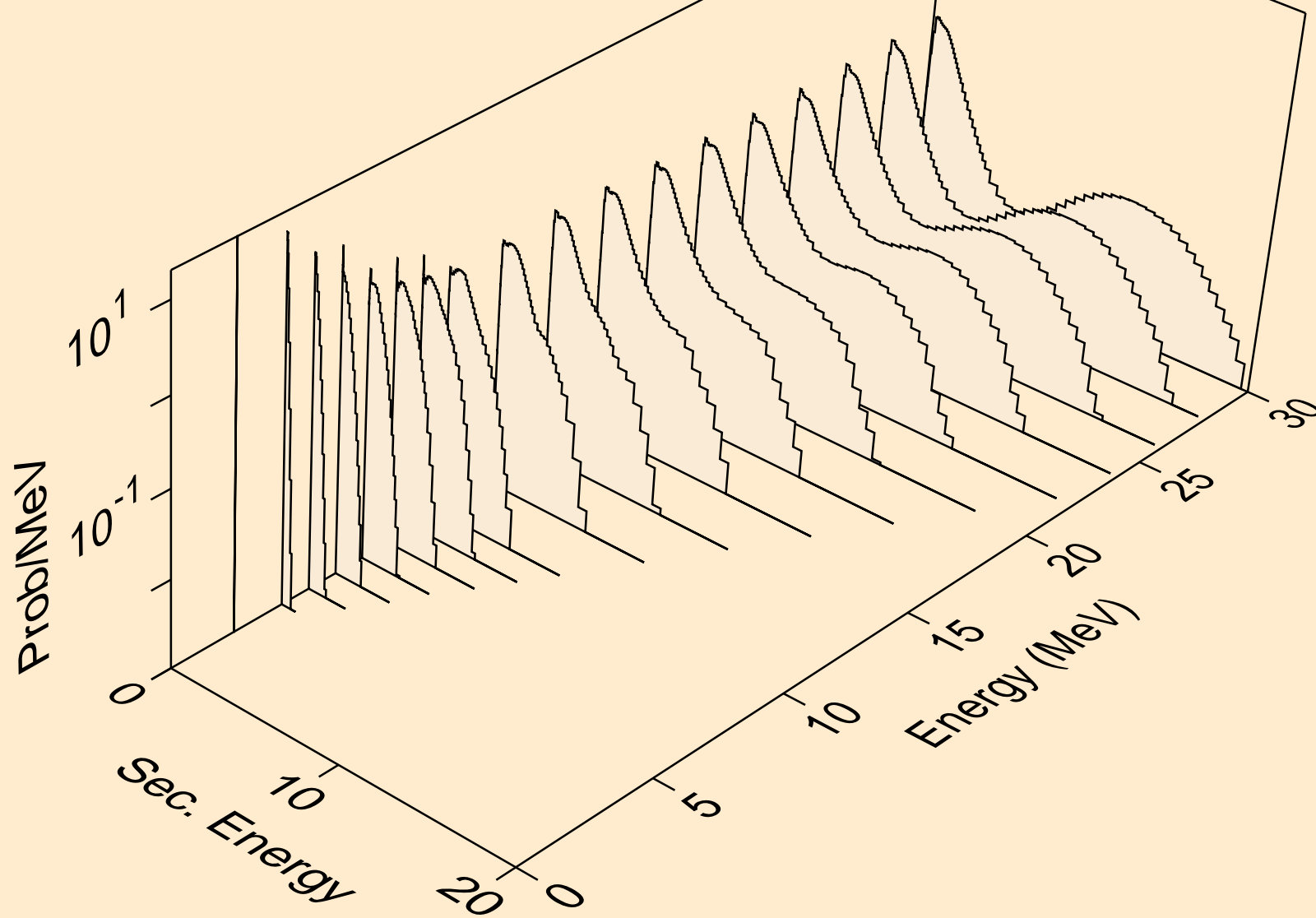

DY149 DEUTERON ACER TENDL-2023 LIBRARY; T=0.K  
neutrons from (d,n\*)2a

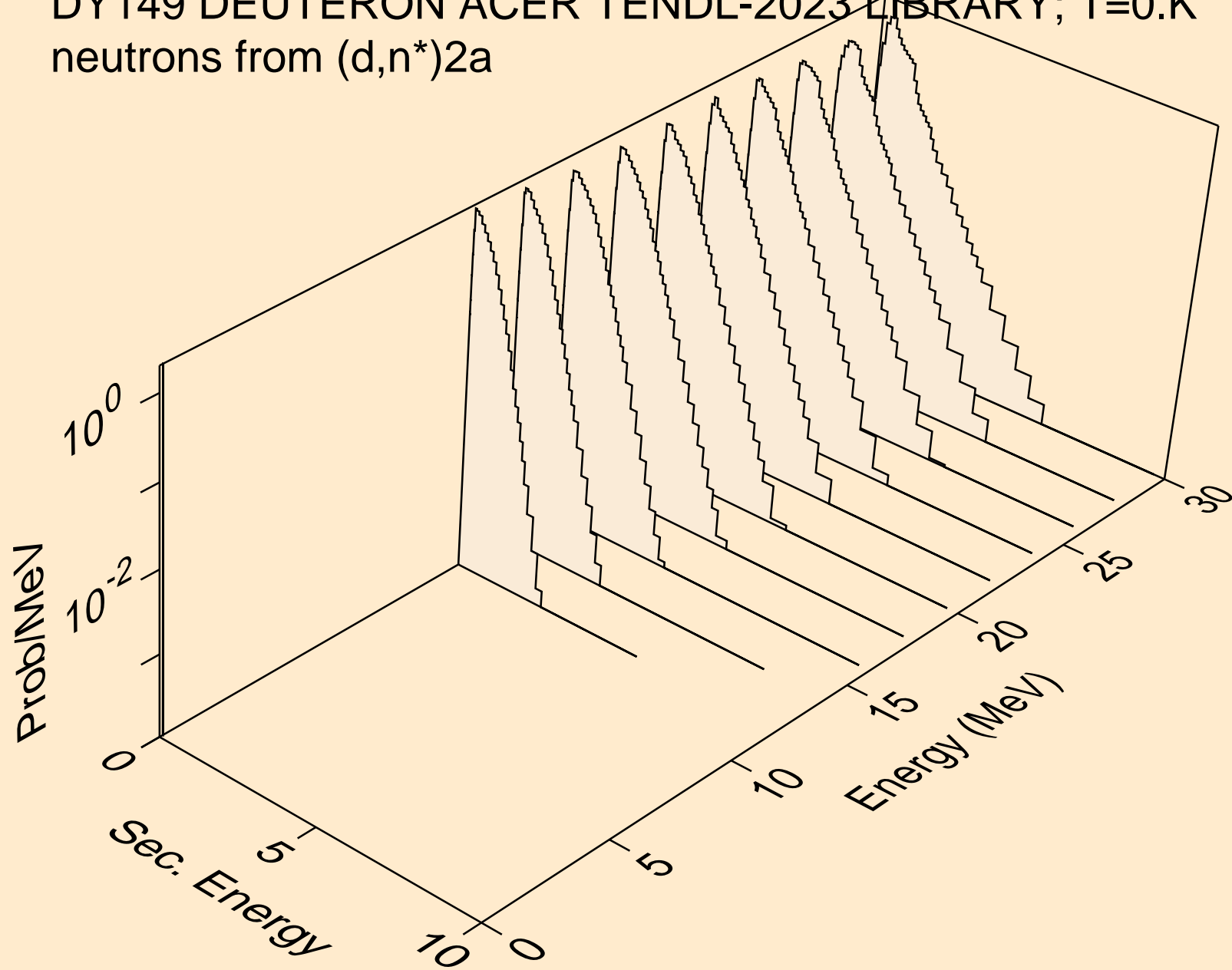

DY149 DEUTERON ACER TENDL-2023 LIBRARY; T=0.K  
neutrons from (d,n\*)d

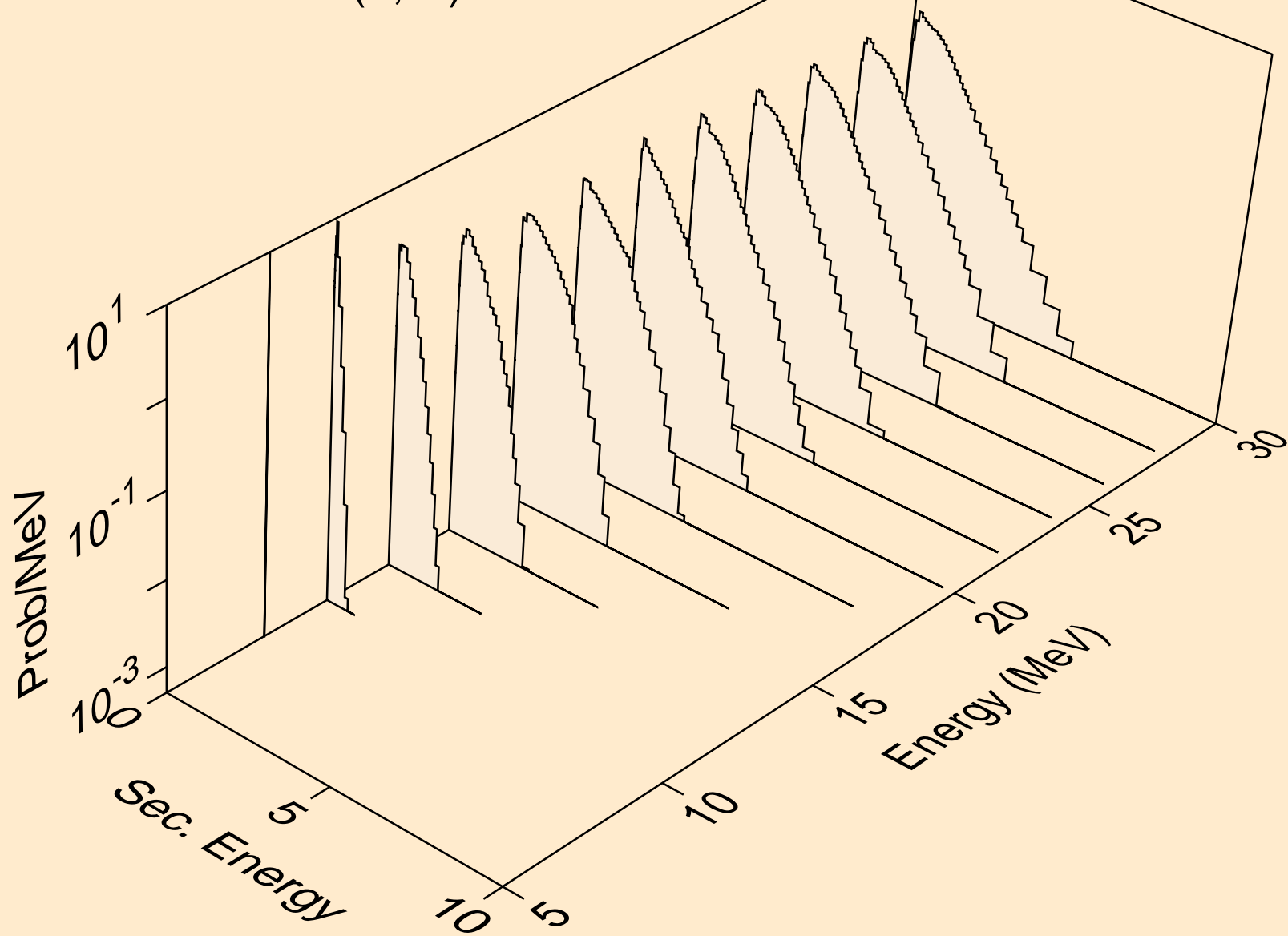

DY149 DEUTERON ACER TENDL-2023 LIBRARY; T=0.K  
neutrons from (d,n\*)t

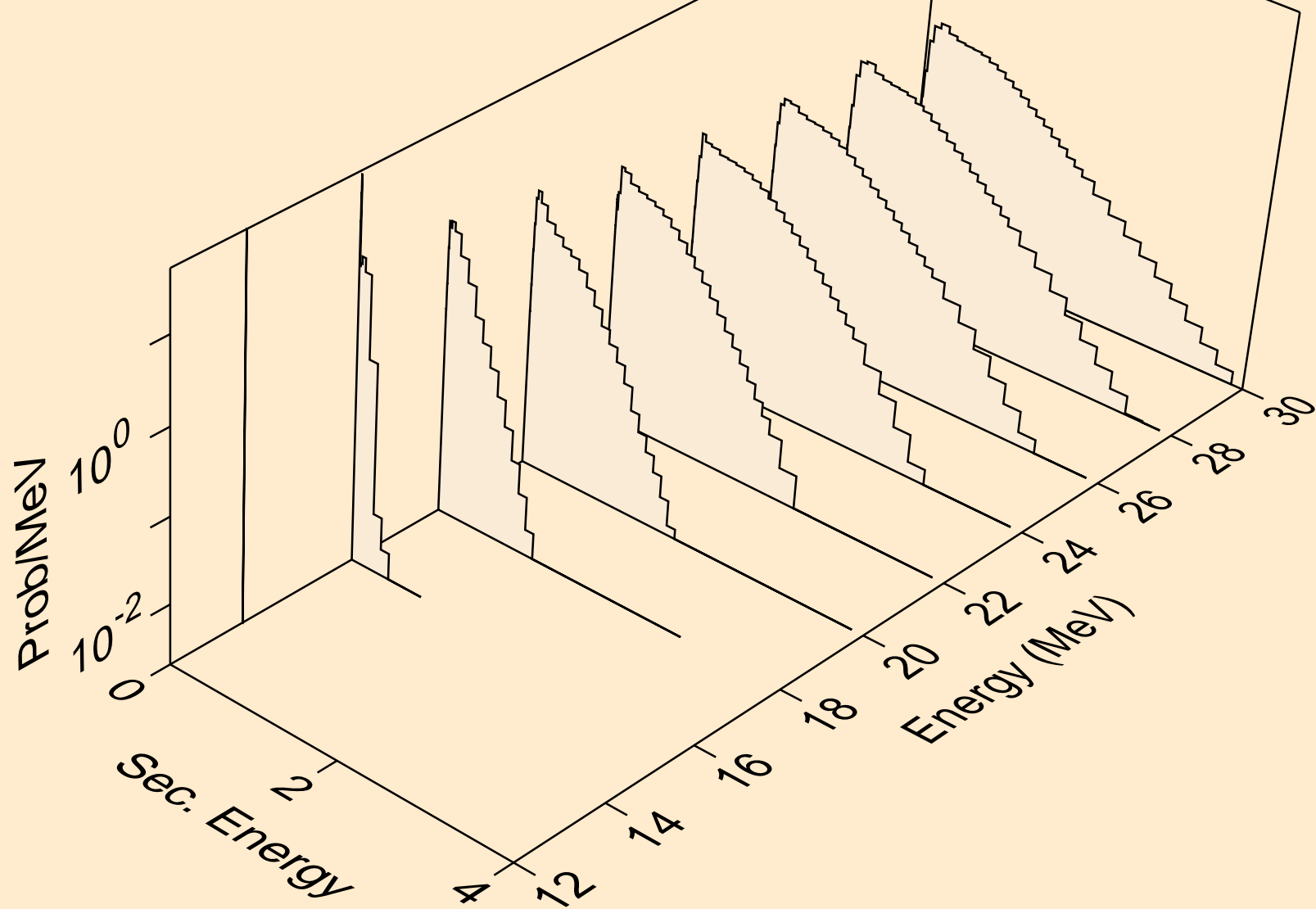

DY149 DEUTERON ACER TENDL-2023 LIBRARY; T=0.K  
neutrons from (d,n\*)he3

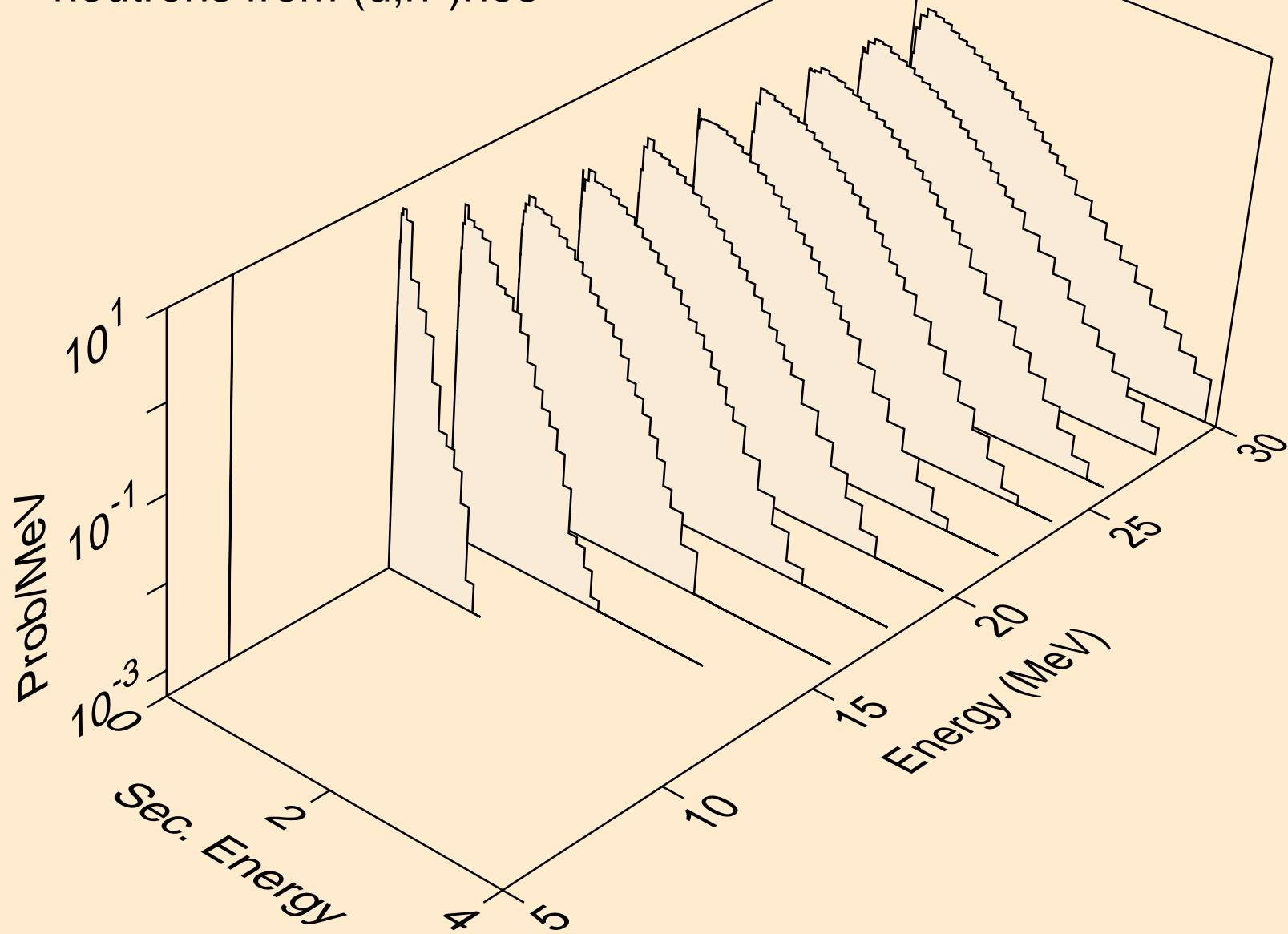

DY149 DEUTERON ACER TENDL-2023 LIBRARY; T=0.K  
neutrons from (d,2np)

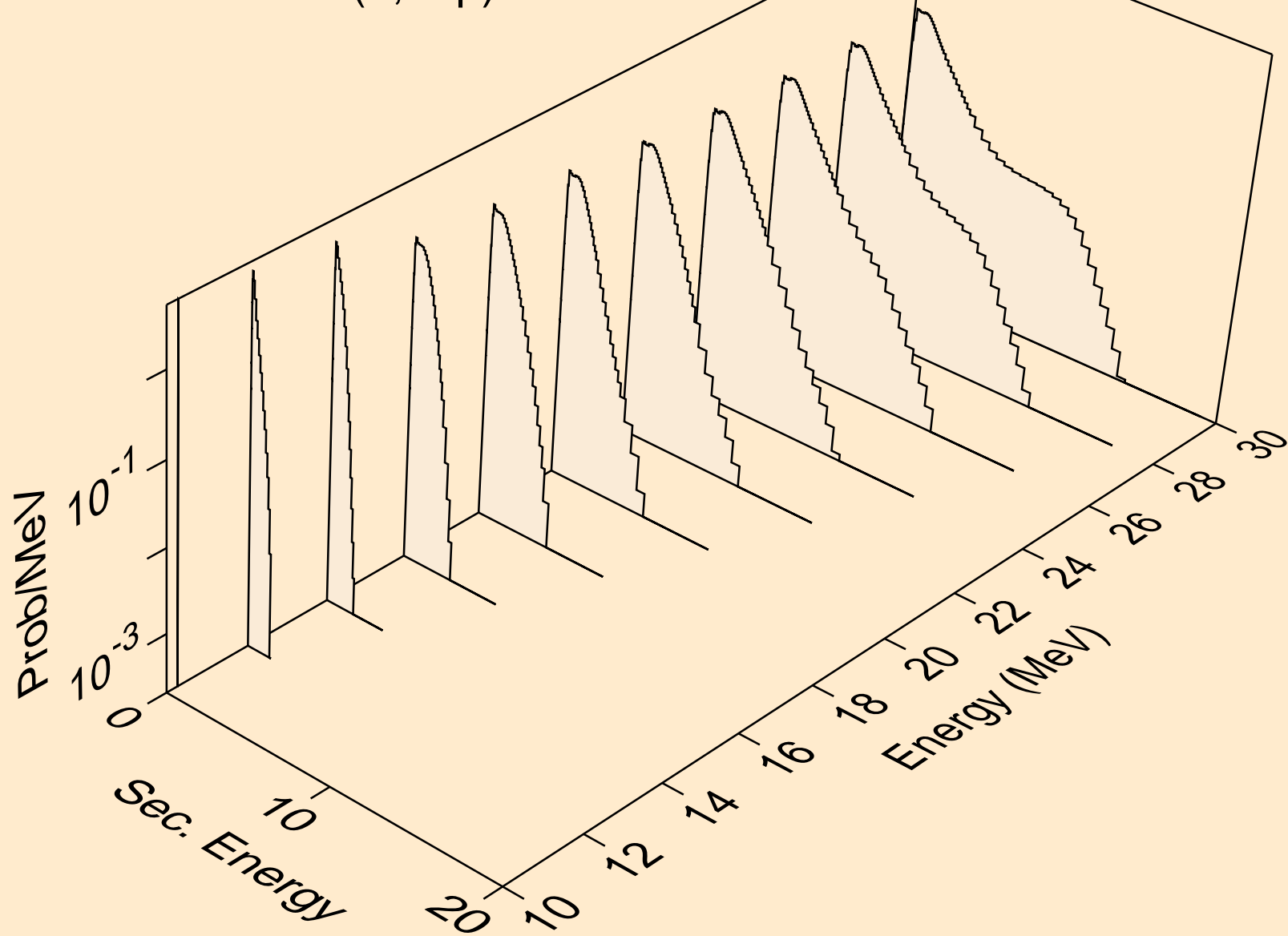

DY149 DEUTERON ACER TENDL-2023 LIBRARY; T=0.K  
neutrons from (d,3np)

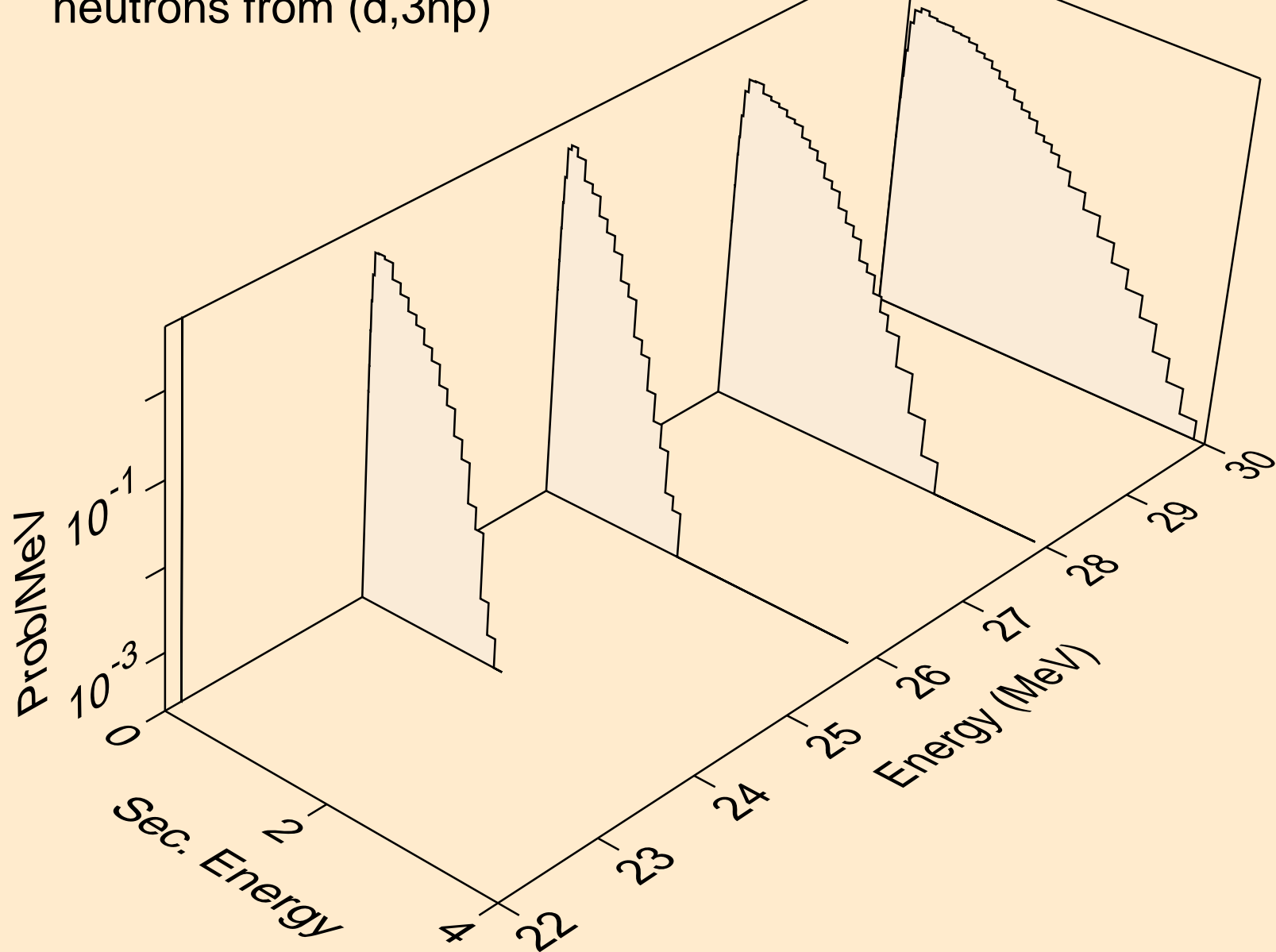

DY149 DEUTERON ACER TENDL-2023 LIBRARY; T=0.K  
neutrons from (d,n2p)

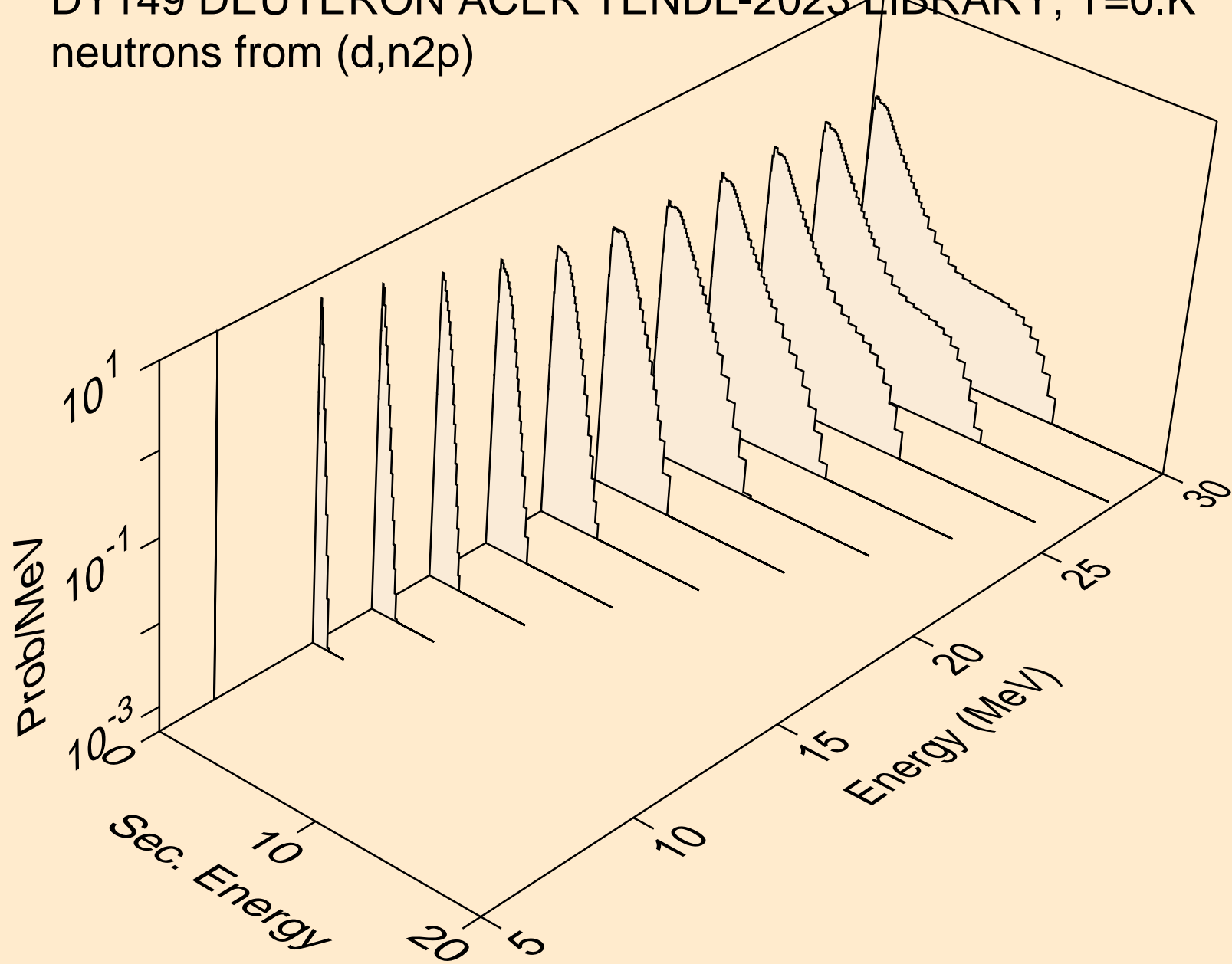



DY149 DEUTERON ACER TENDL-2023 LIBRARY; T=0.K  
neutrons from (d,npa)

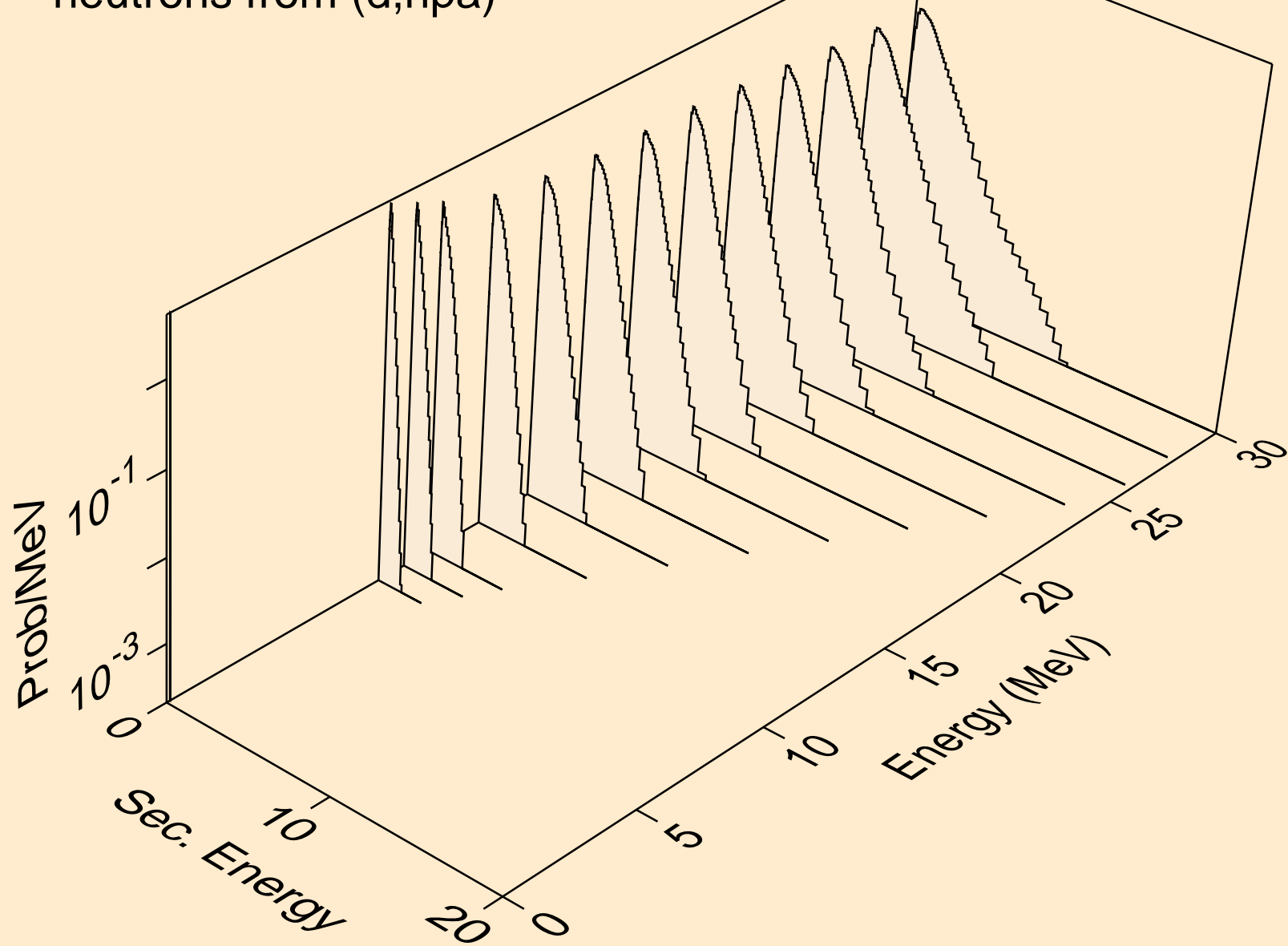

DY149 DEUTERON ACER TENDL-2023 LIBRARY; T=0.K  
protons from (d,x)

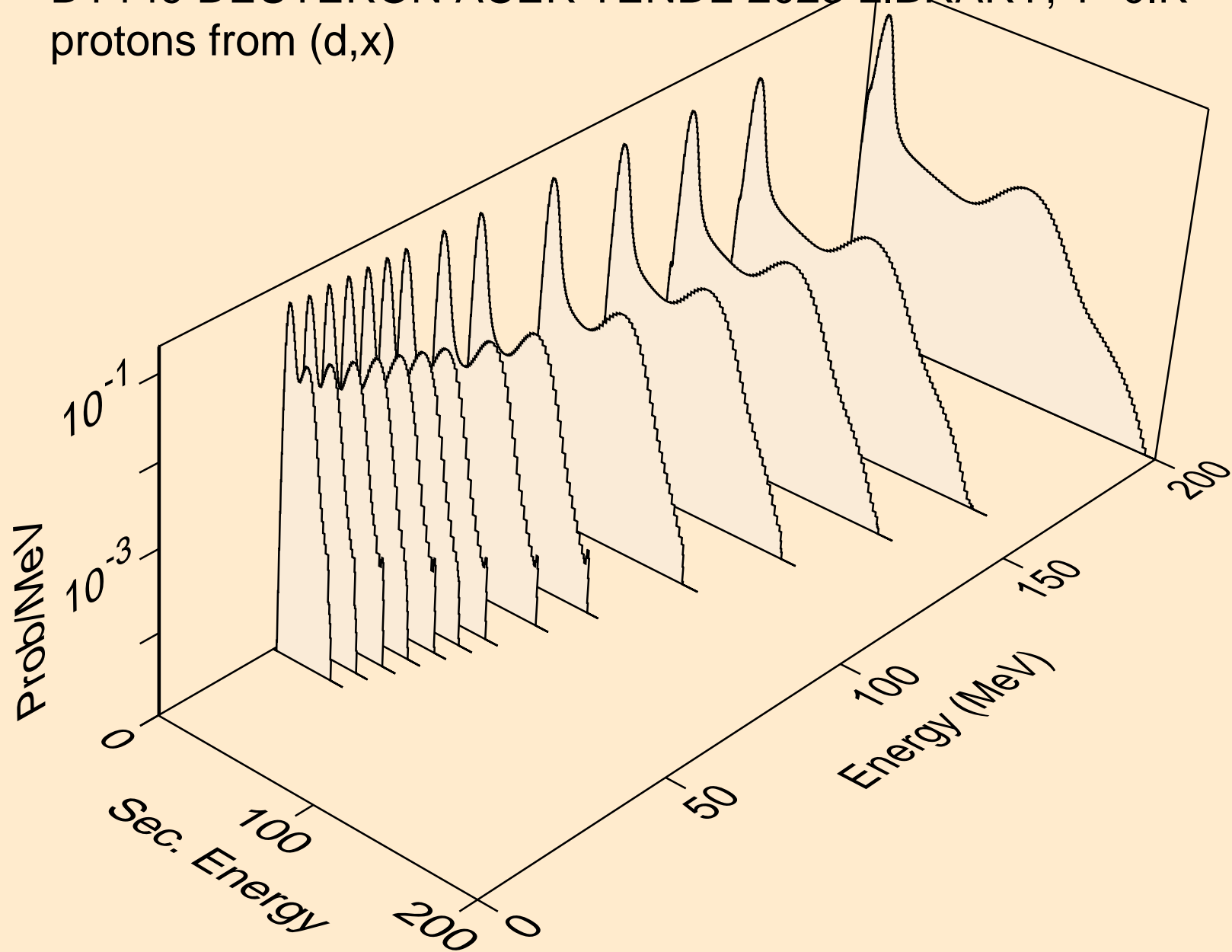

DY149 DEUTERON ACER TENDL-2023 LIBRARY; T=0.K  
protons from (d,n\*)p

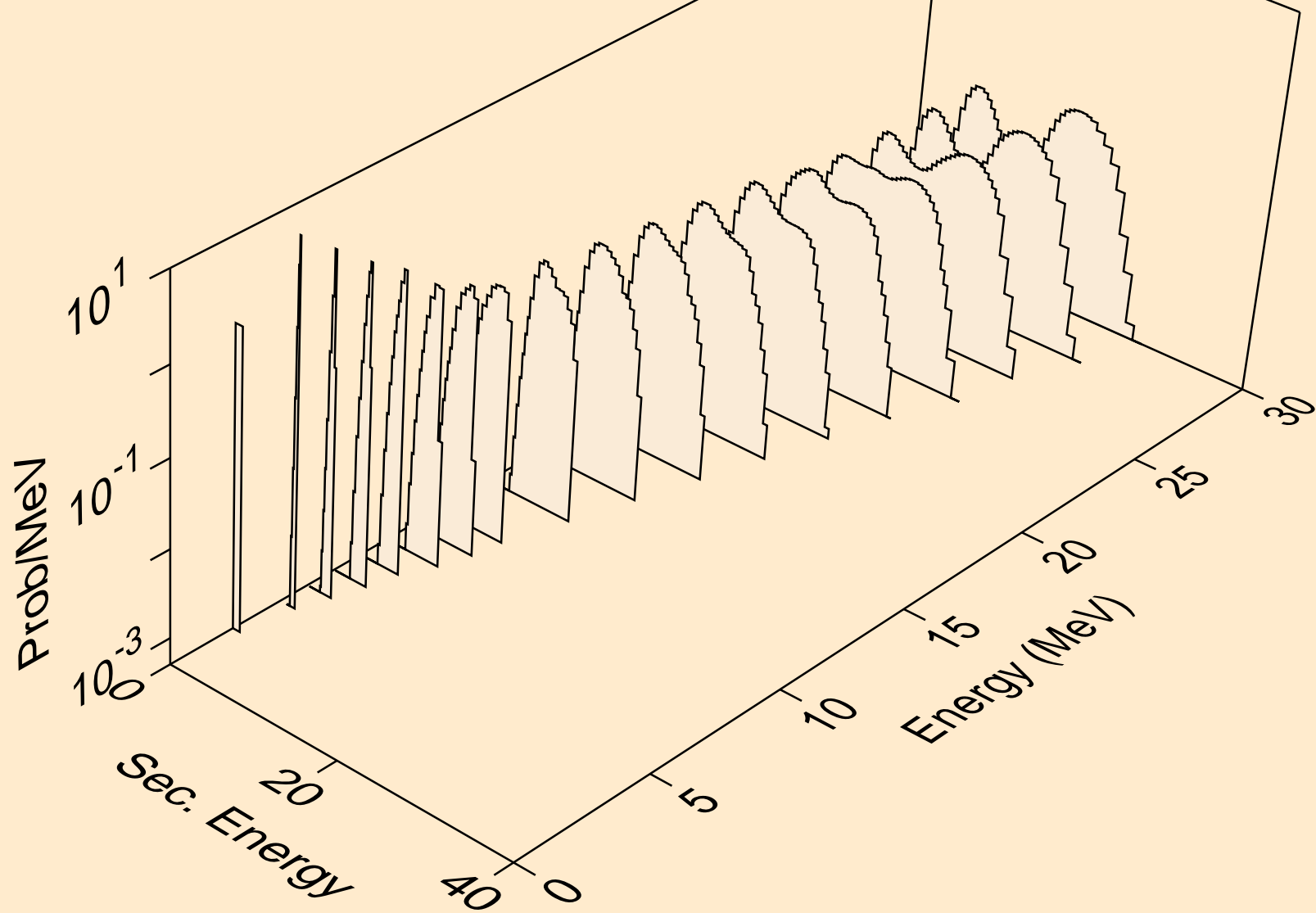

DY149 DEUTERON ACER TENDL-2023 LIBRARY; T=0.K  
protons from (d,2np)

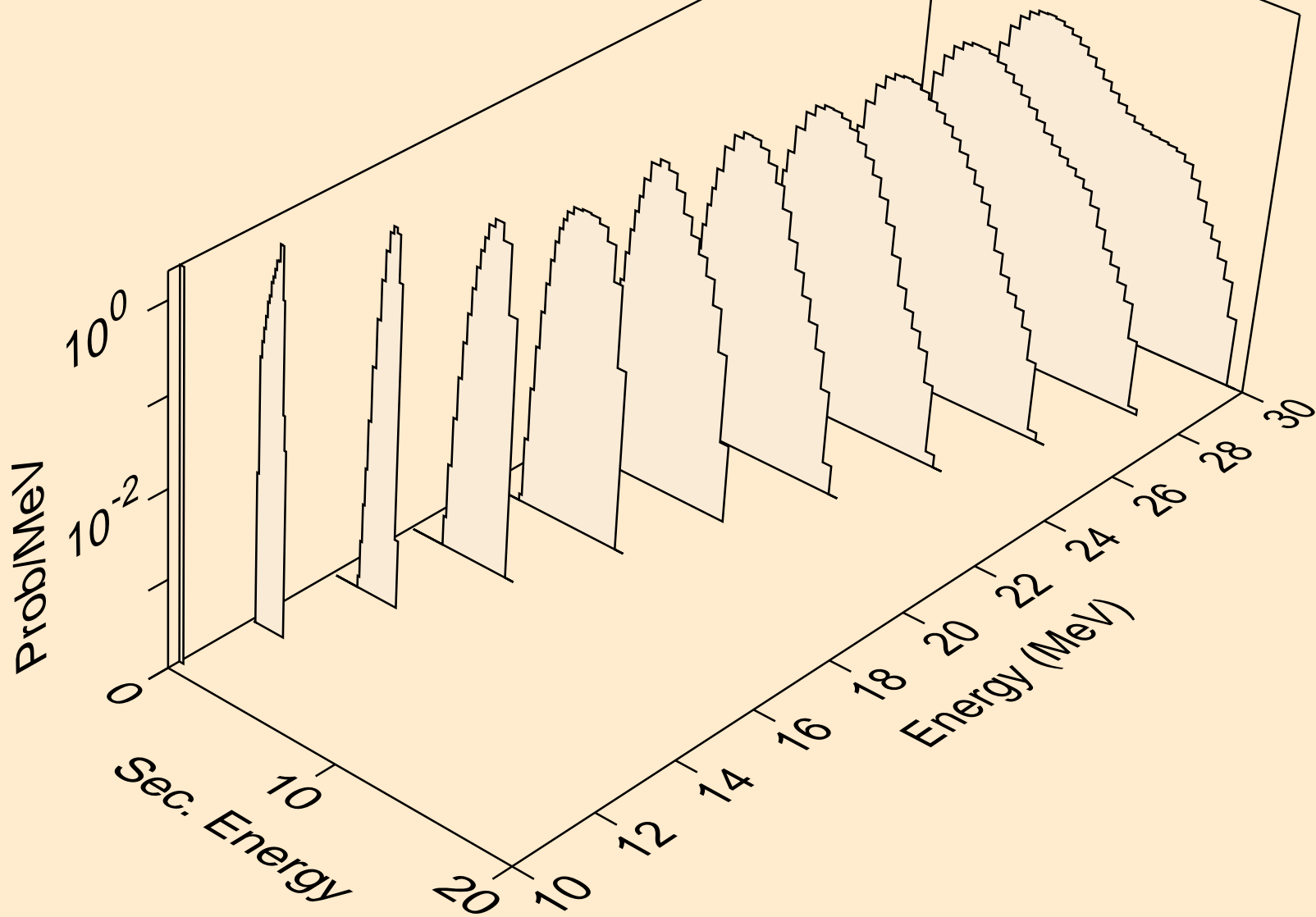

DY149 DEUTERON ACER TENDL-2023 LIBRARY; T=0.K  
protons from (d,3np)

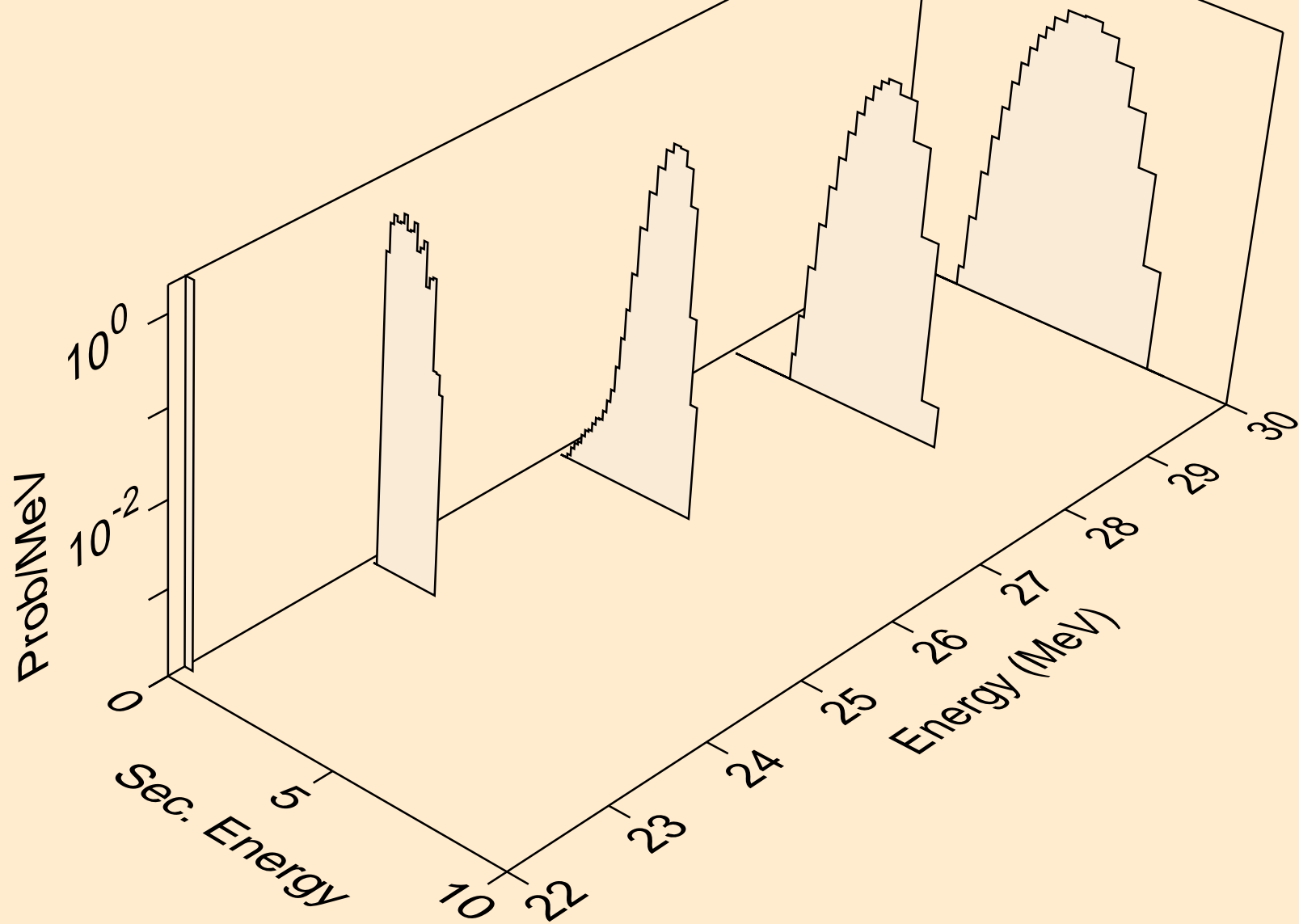

DY149 DEUTERON ACER TENDL-2023 LIBRARY; T=0.K  
protons from (d,n2p)

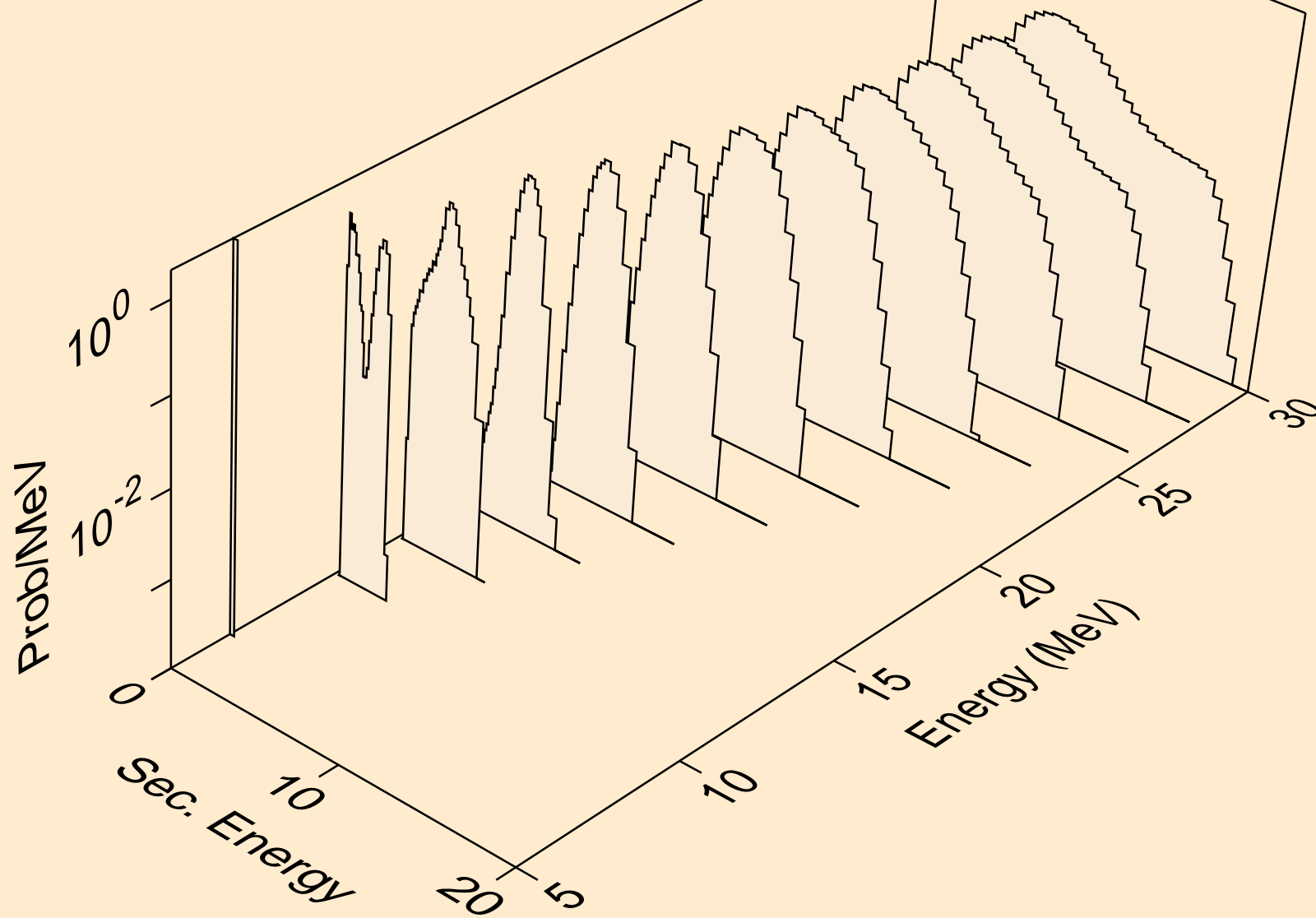

DY149 DEUTERON ACER TENDL-2023 LIBRARY; T=0.K  
protons from (d,npa)

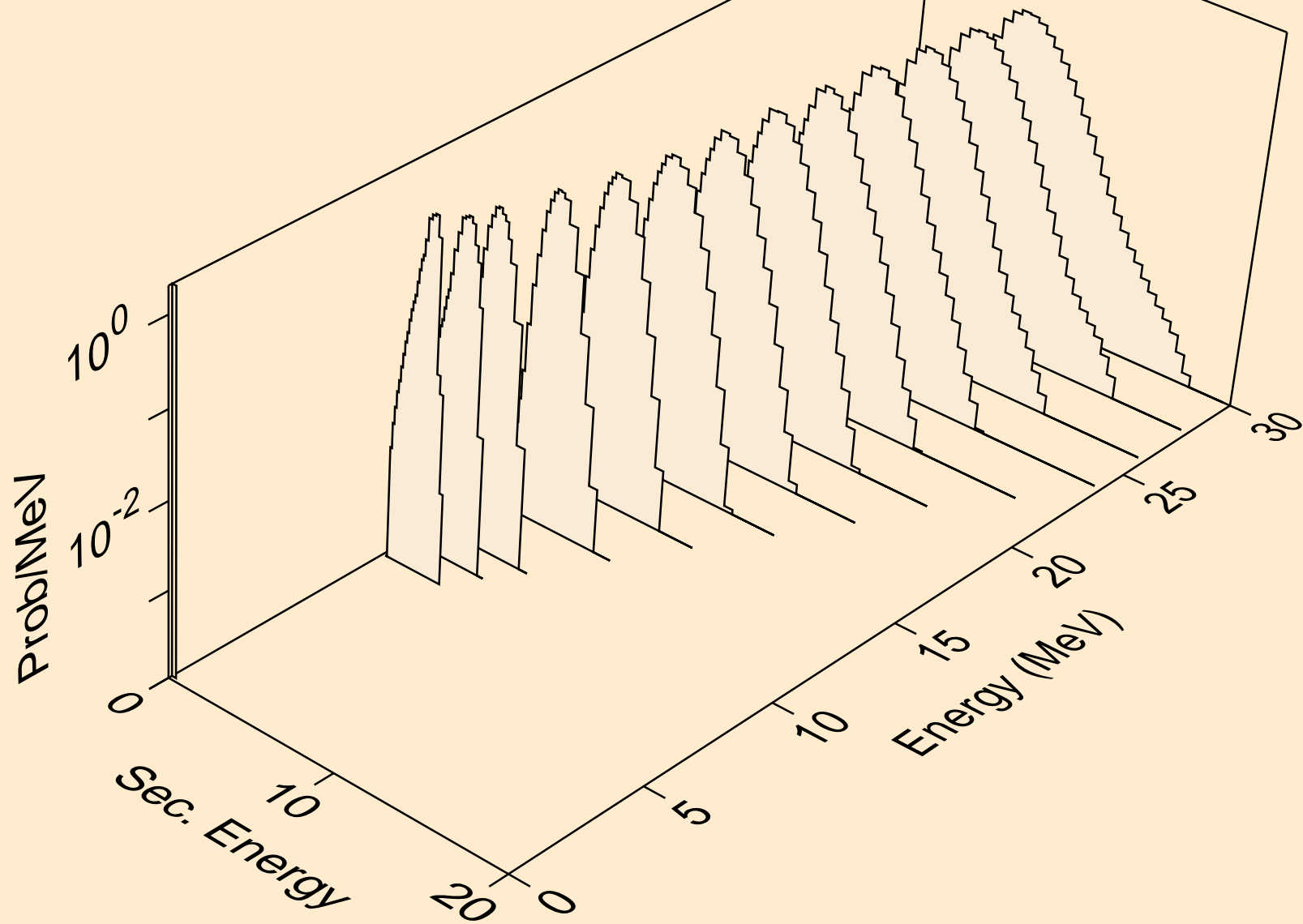

DY149 DEUTERON ACER TENDL-2023 LIBRARY; T=0.K  
protons from (d,p)

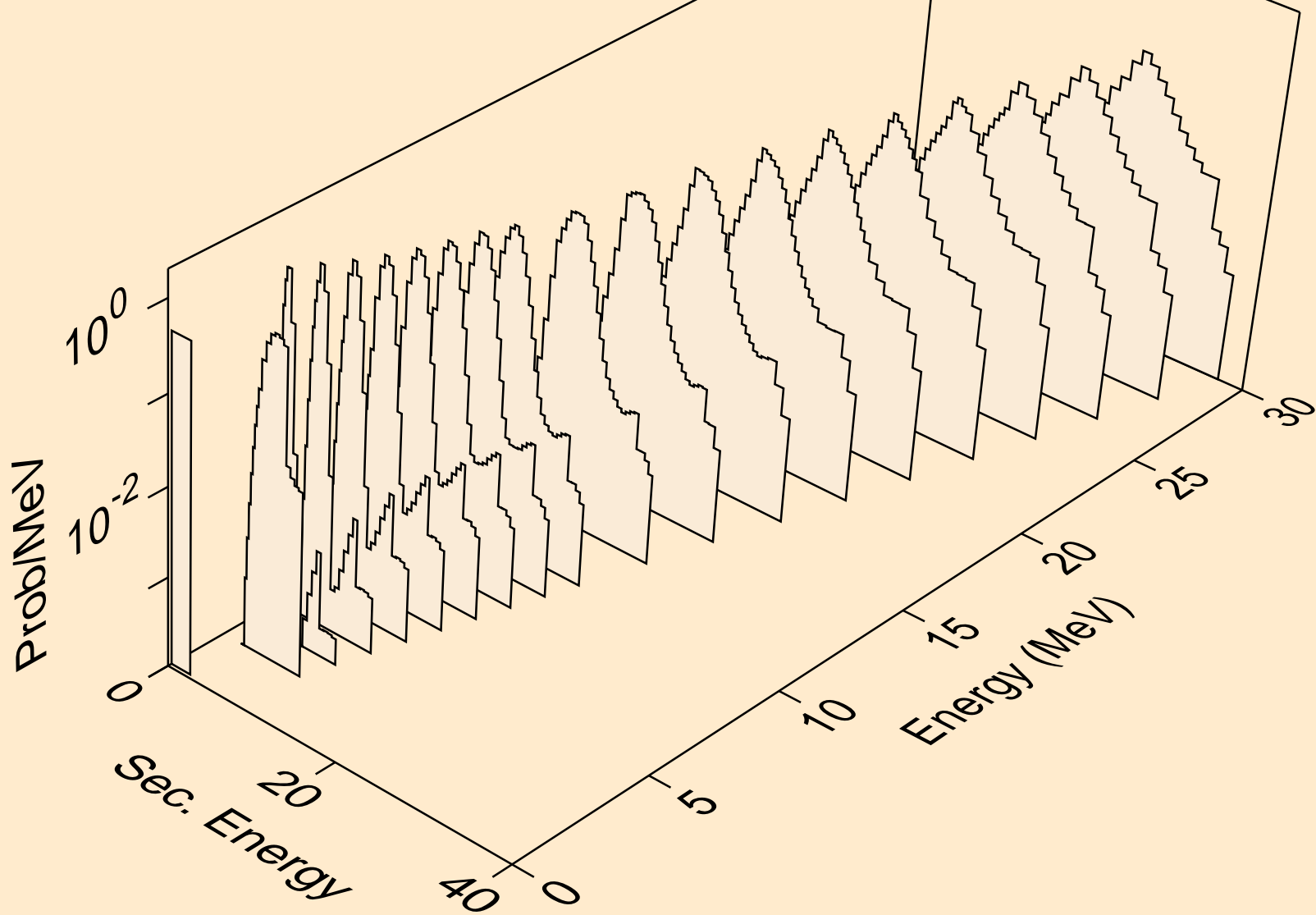



DY149 DEUTERON ACER TENDL-2023 LIBRARY; T=0.K  
protons from (d,2p)

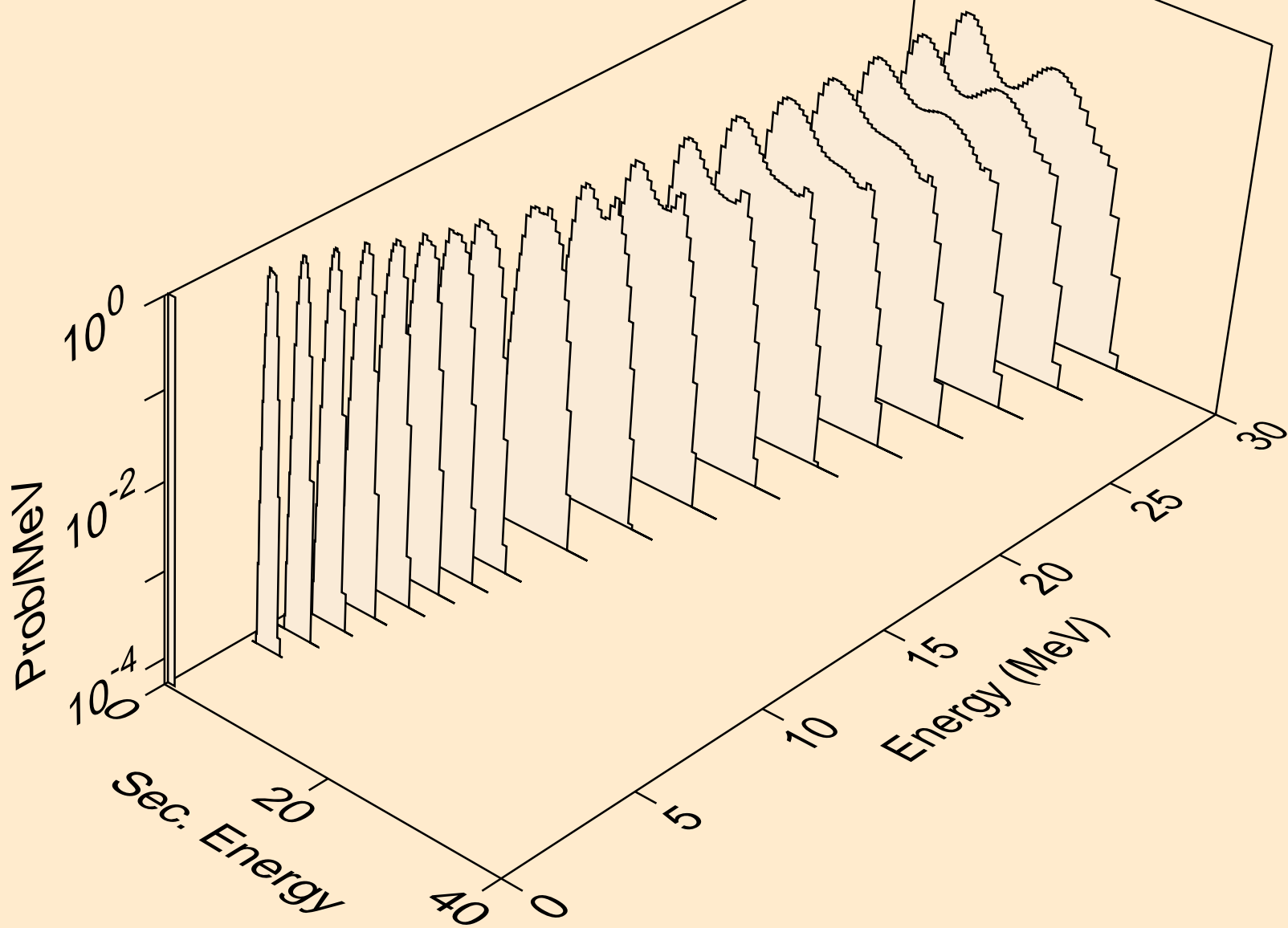

DY149 DEUTERON ACER TENDL-2023 LIBRARY; T=0.K  
protons from (d,pa)

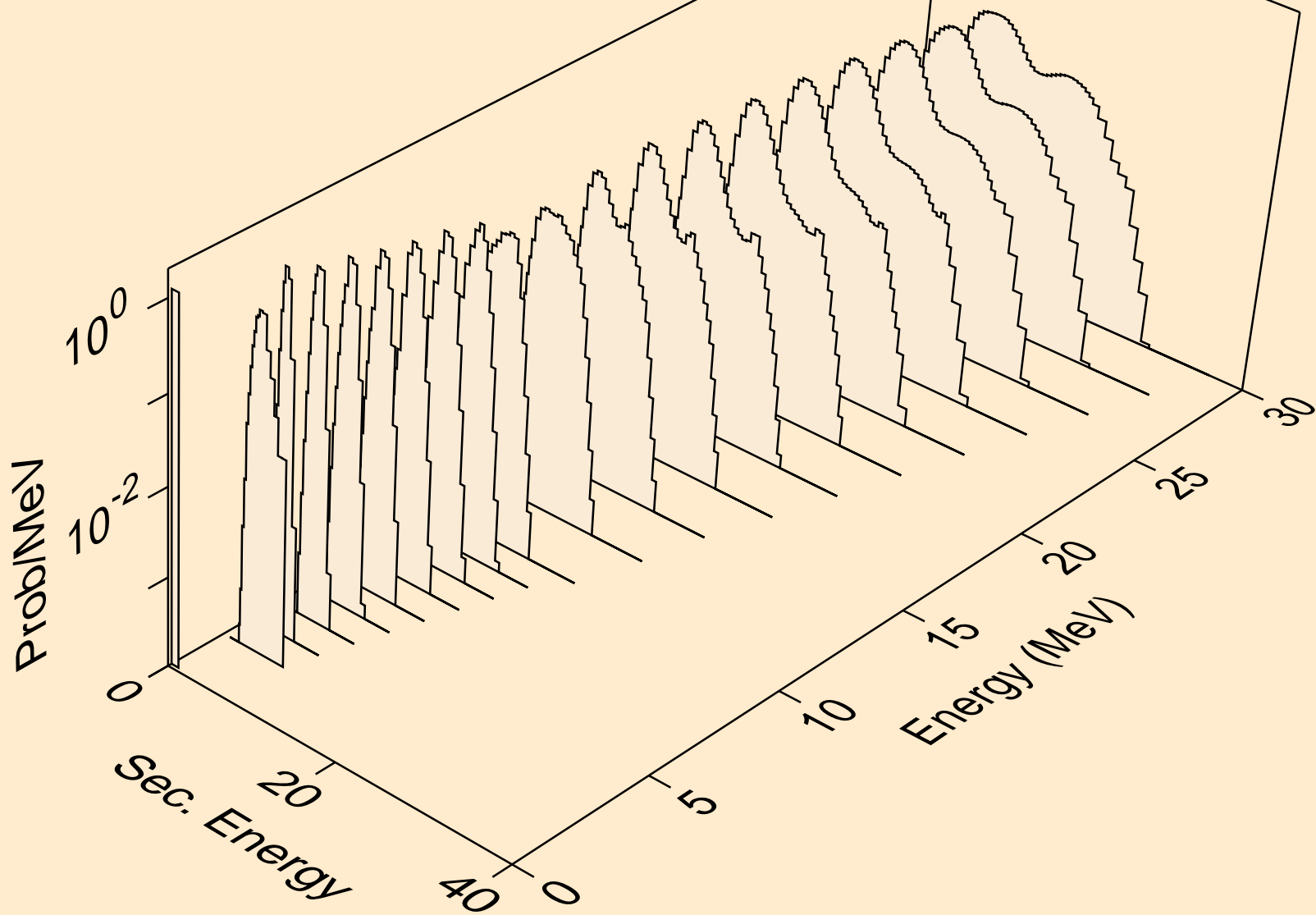

DY149 DEUTERON ACER TENDL-2023 LIBRARY; T=0.K  
protons from (d,pd)

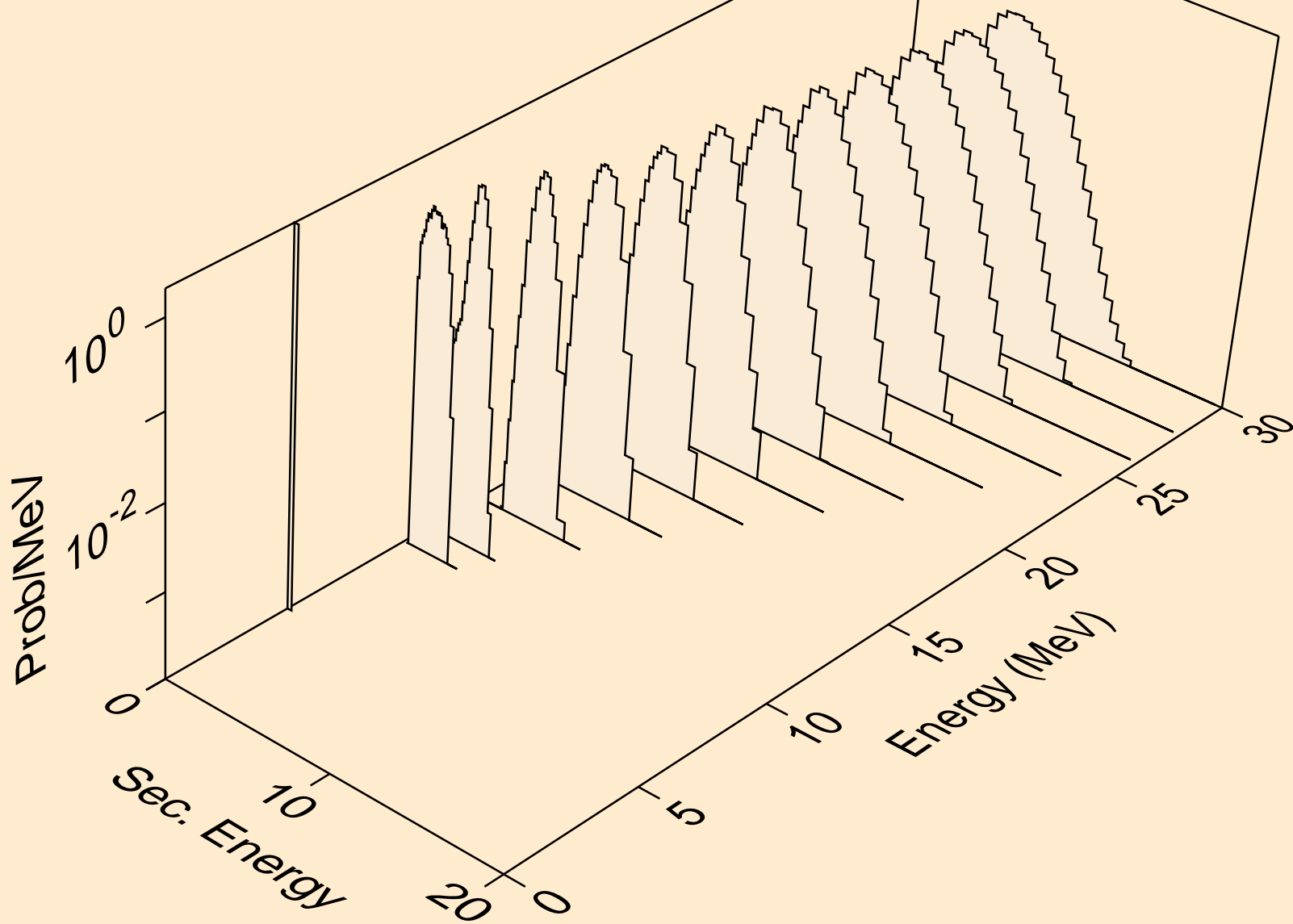

DY149 DEUTERON ACER TENDL-2023 LIBRARY; T=0.K  
protons from (d,pt)

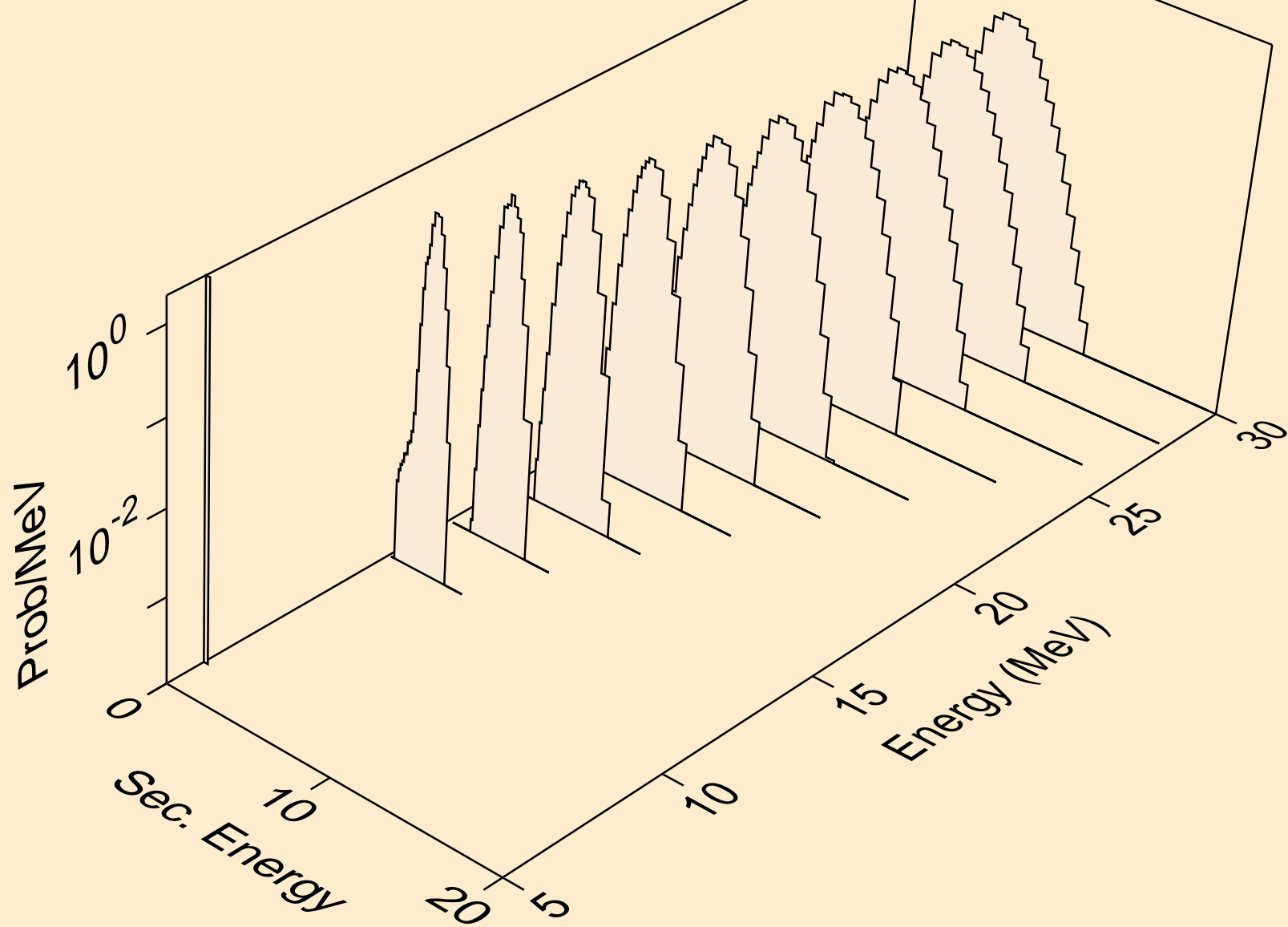

DY149 DEUTERON ACER TENDL-2023 LIBRARY; T=0.K  
tritons from (d,x)

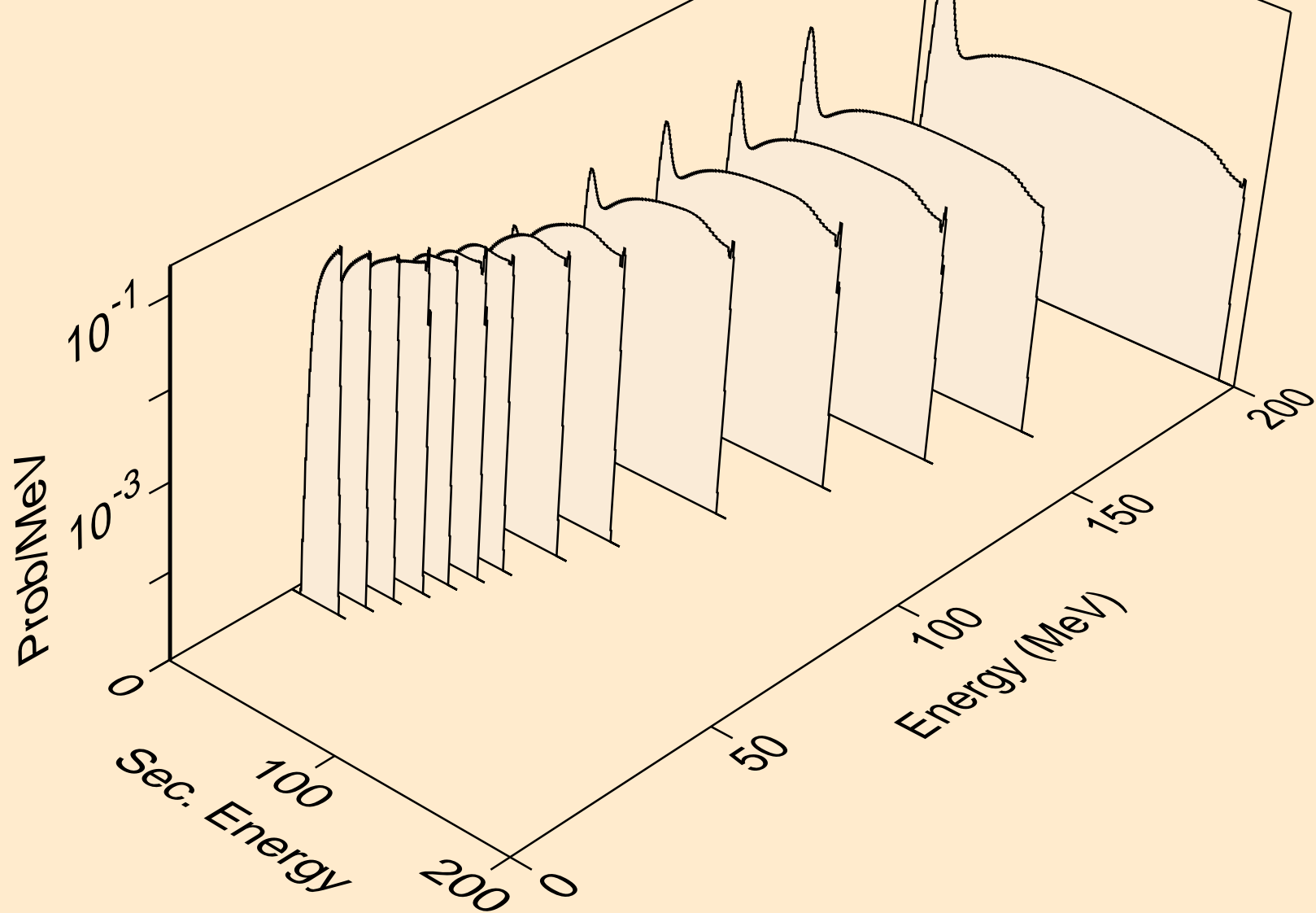

DY149 DEUTERON ACER TENDL-2023 LIBRARY; T=0.K  
tritons from (d,n\*)t

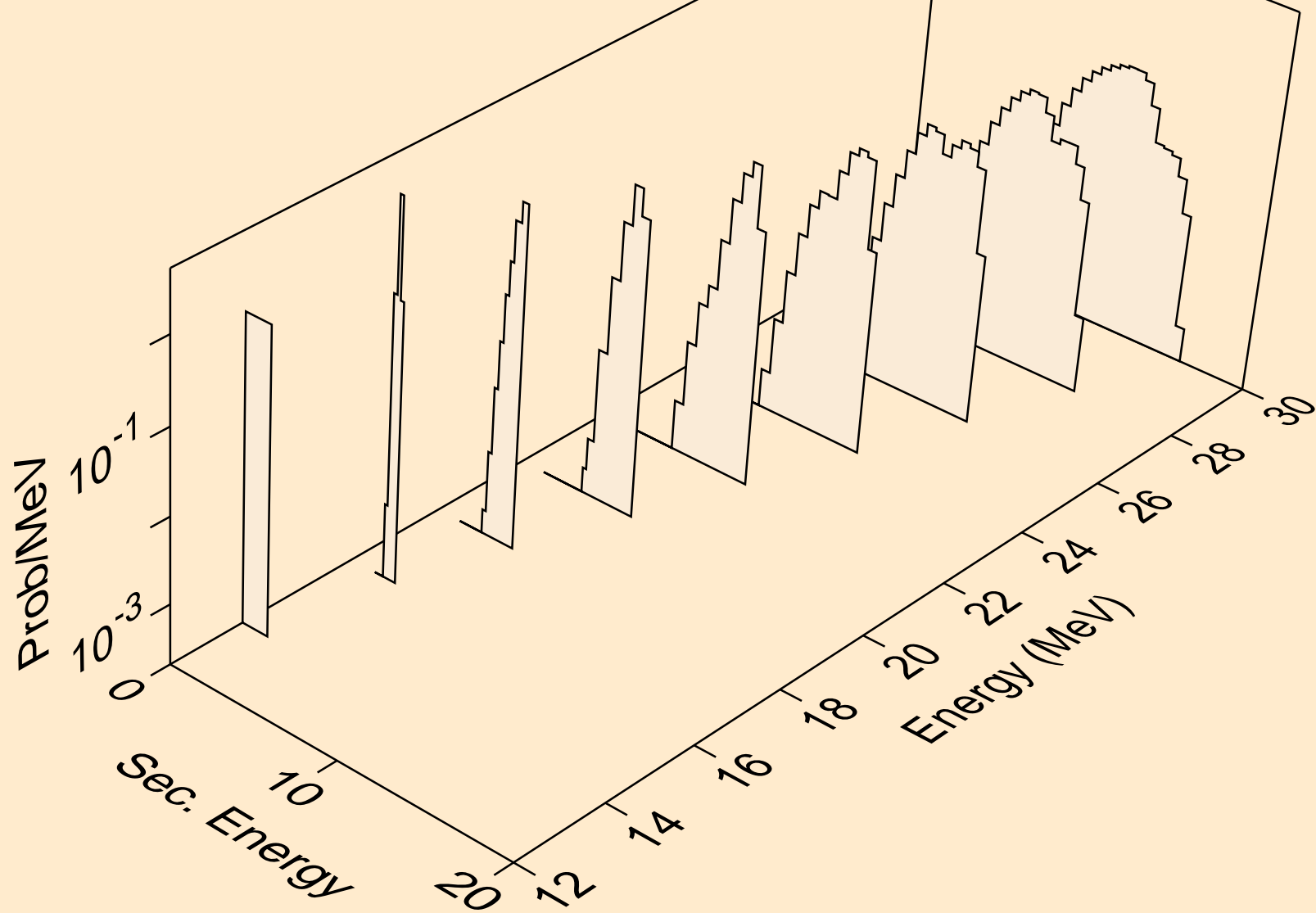

DY149 DEUTERON ACER TENDL-2023 LIBRARY; T=0.K  
tritons from (d,t)

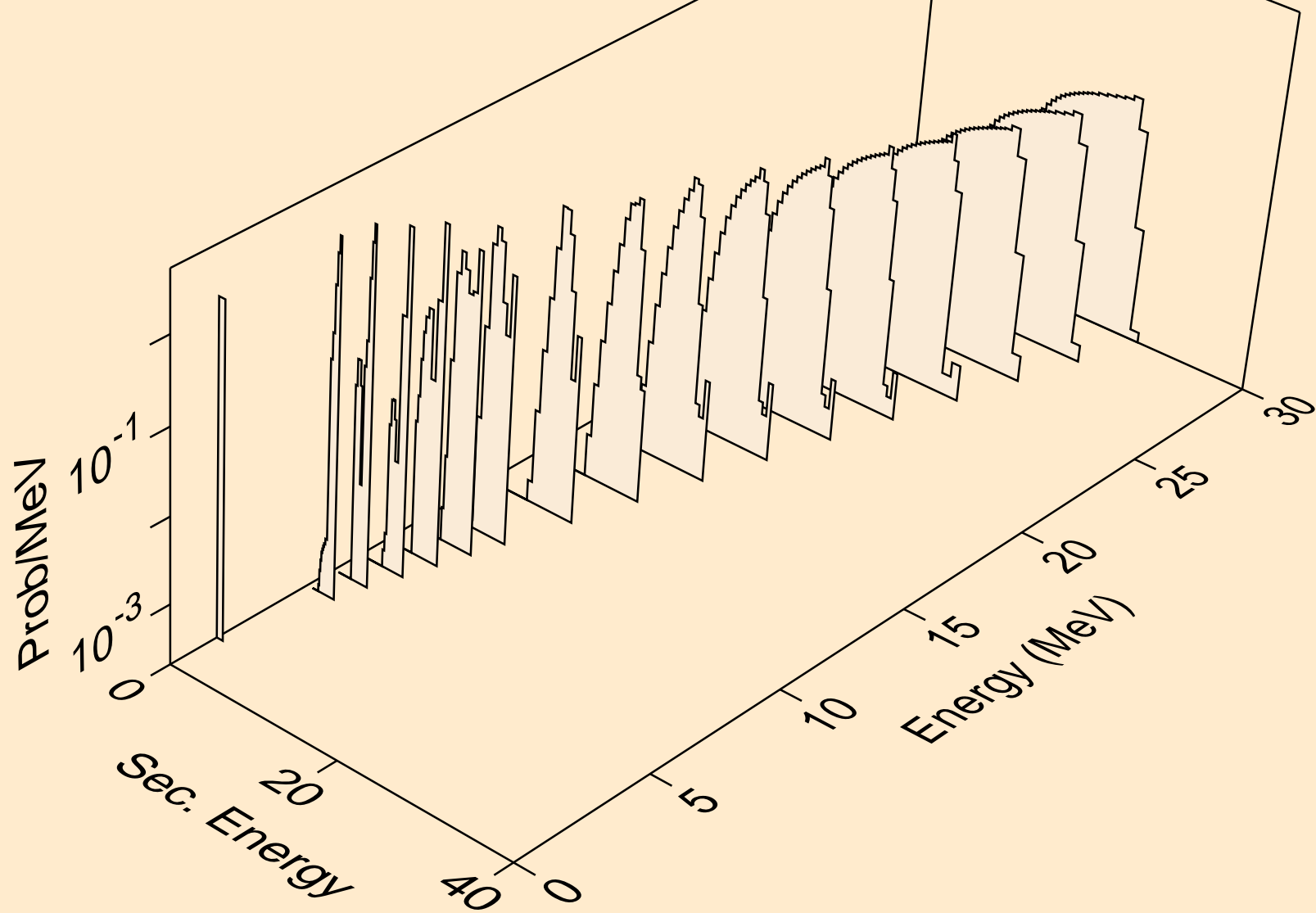

DY149 DEUTERON ACER TENDL-2023 LIBRARY; T=0.K  
tritons from (d,pt)

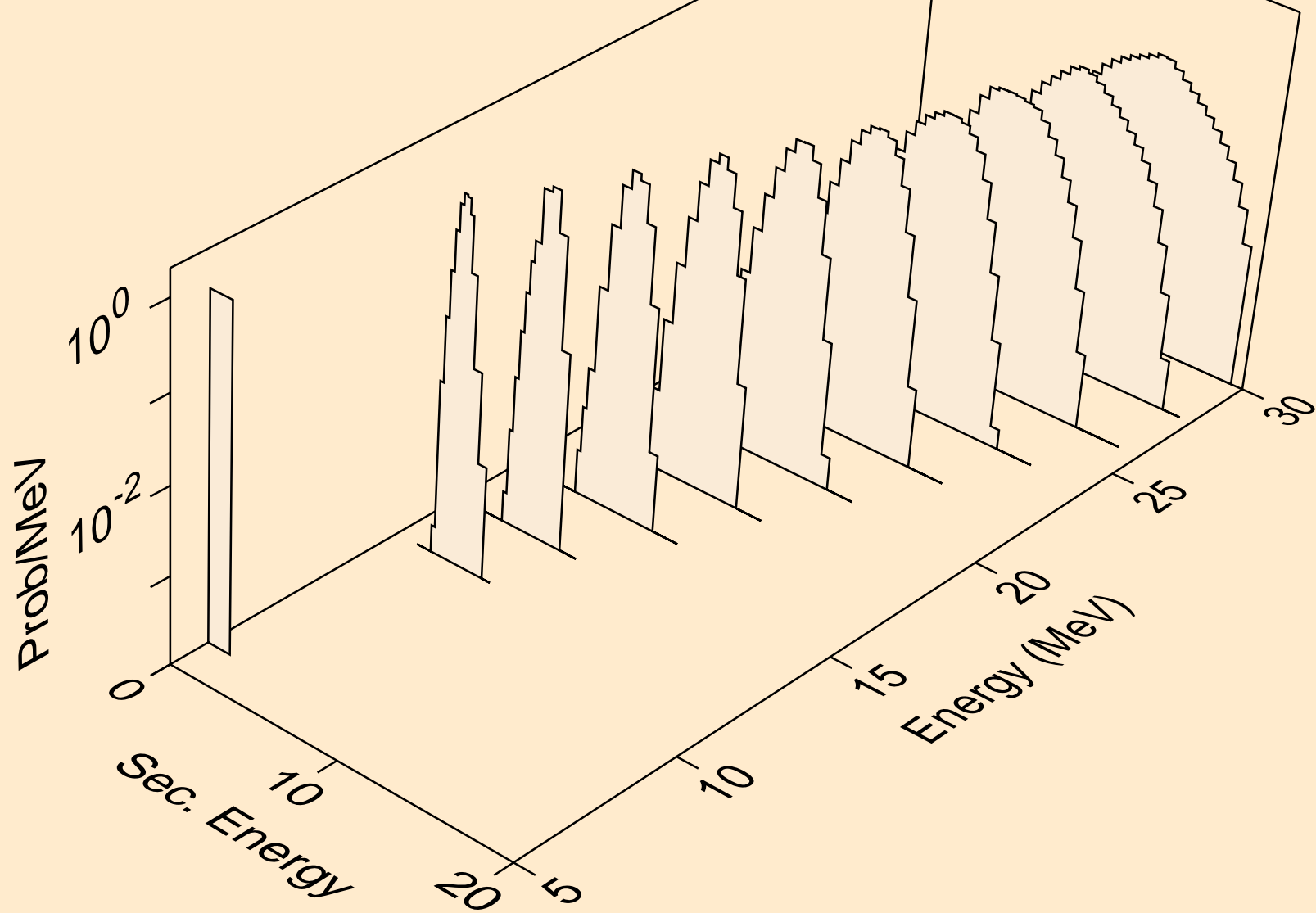



DY149 DEUTERON ACER TENDL-2023 LIBRARY; T=0.K  
he3s from (d,x)

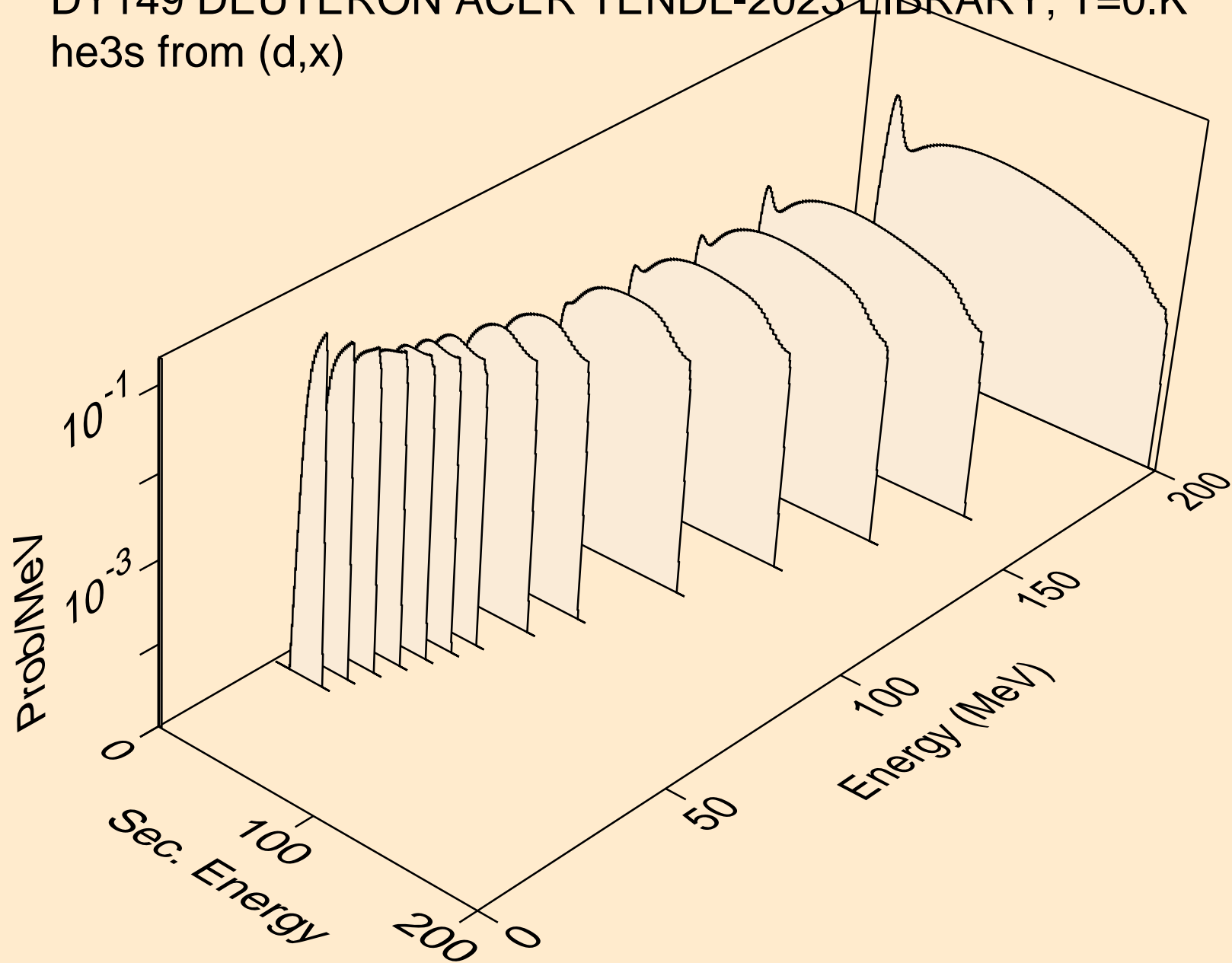

DY149 DEUTERON ACER TENDL-2023 LIBRARY; T=0.K  
he3s from (d,n\*)he3

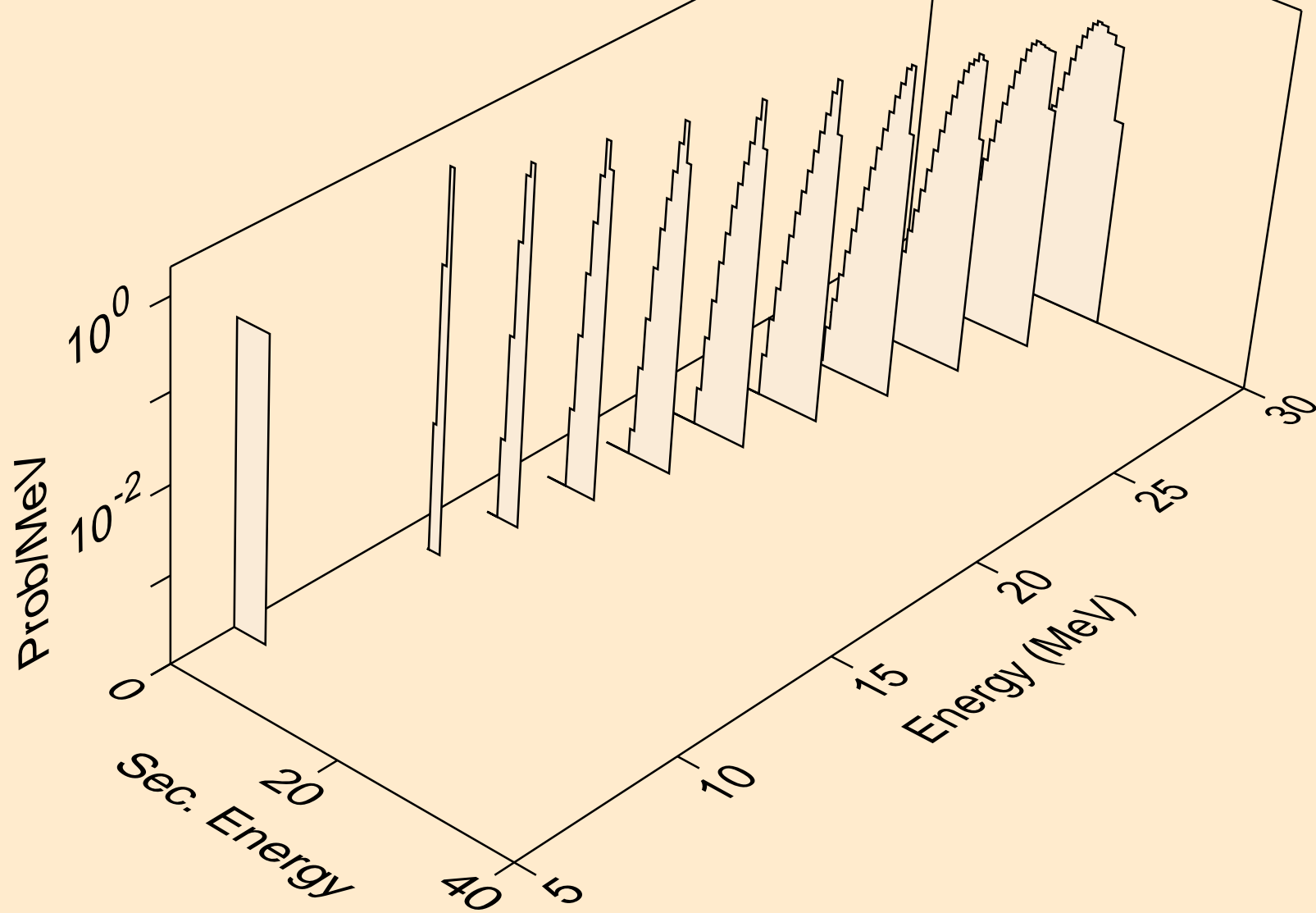

DY149 DEUTERON ACER TENDL-2023 LIBRARY; T=0.K  
he3s from (d,he3)

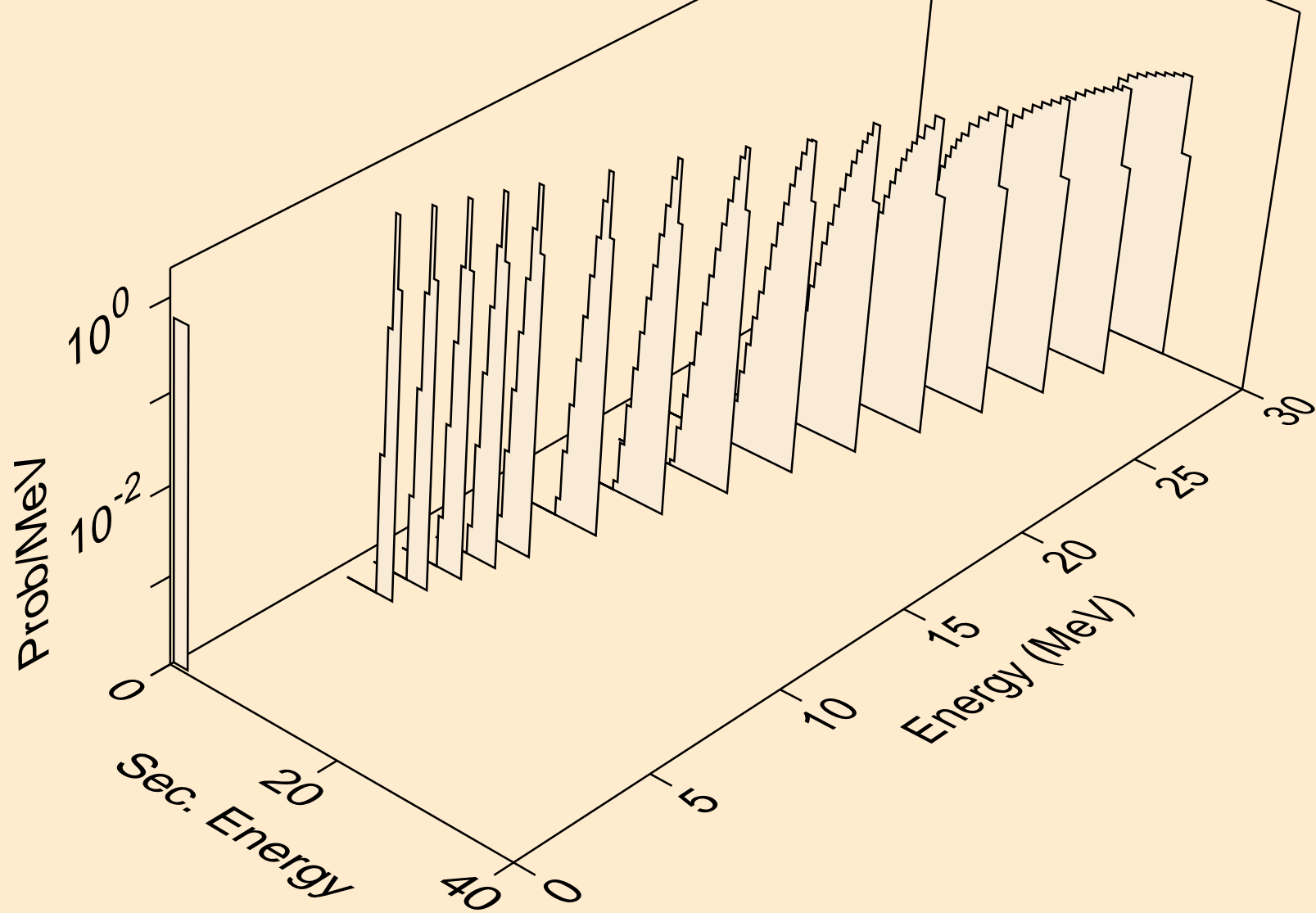

DY149 DEUTERON ACER TENDL-2023 LIBRARY; T=0.K  
alphas from (d,x)

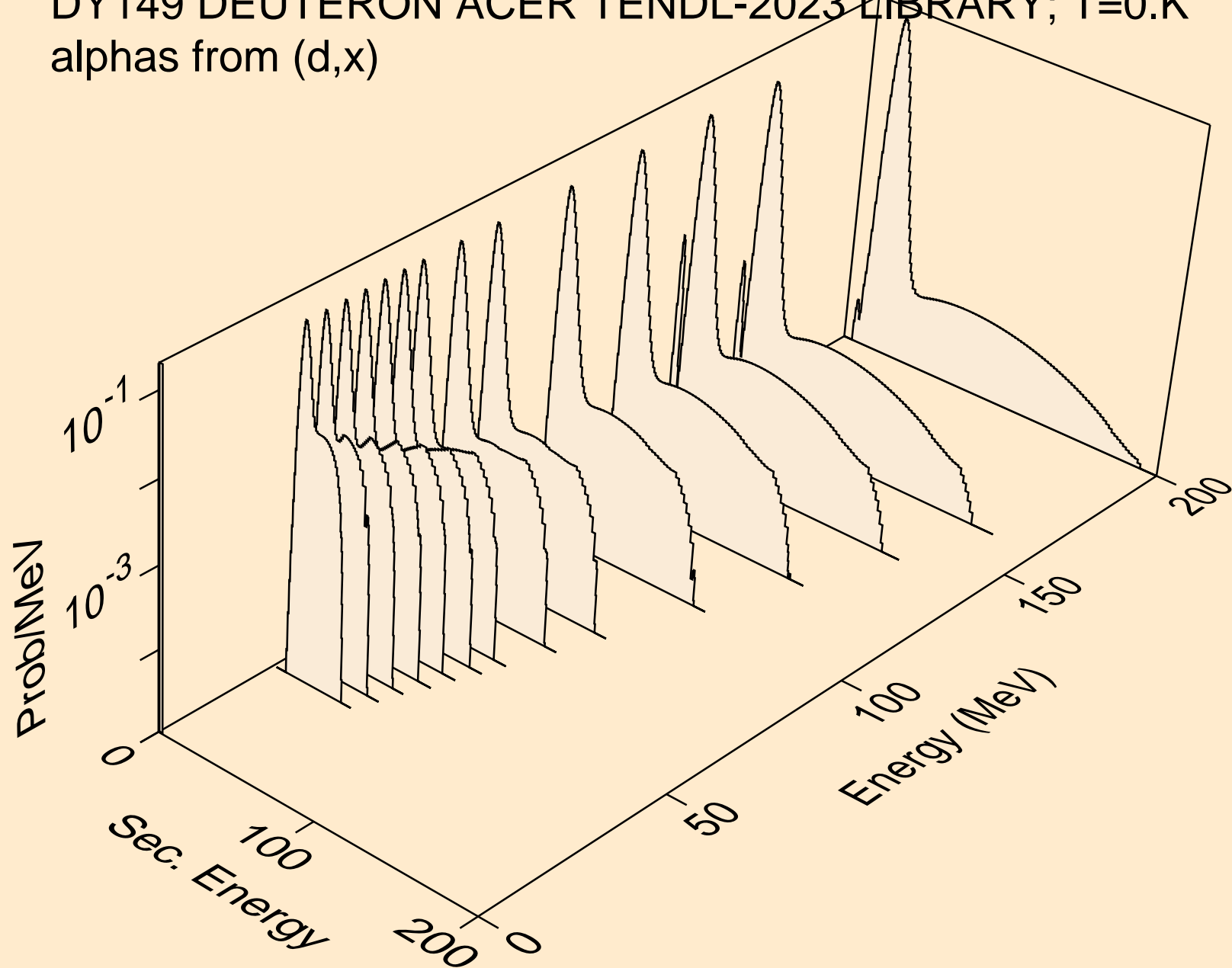

DY149 DEUTERON ACER TENDL-2023 LIBRARY; T=0.K  
alphas from (d,n\*)a

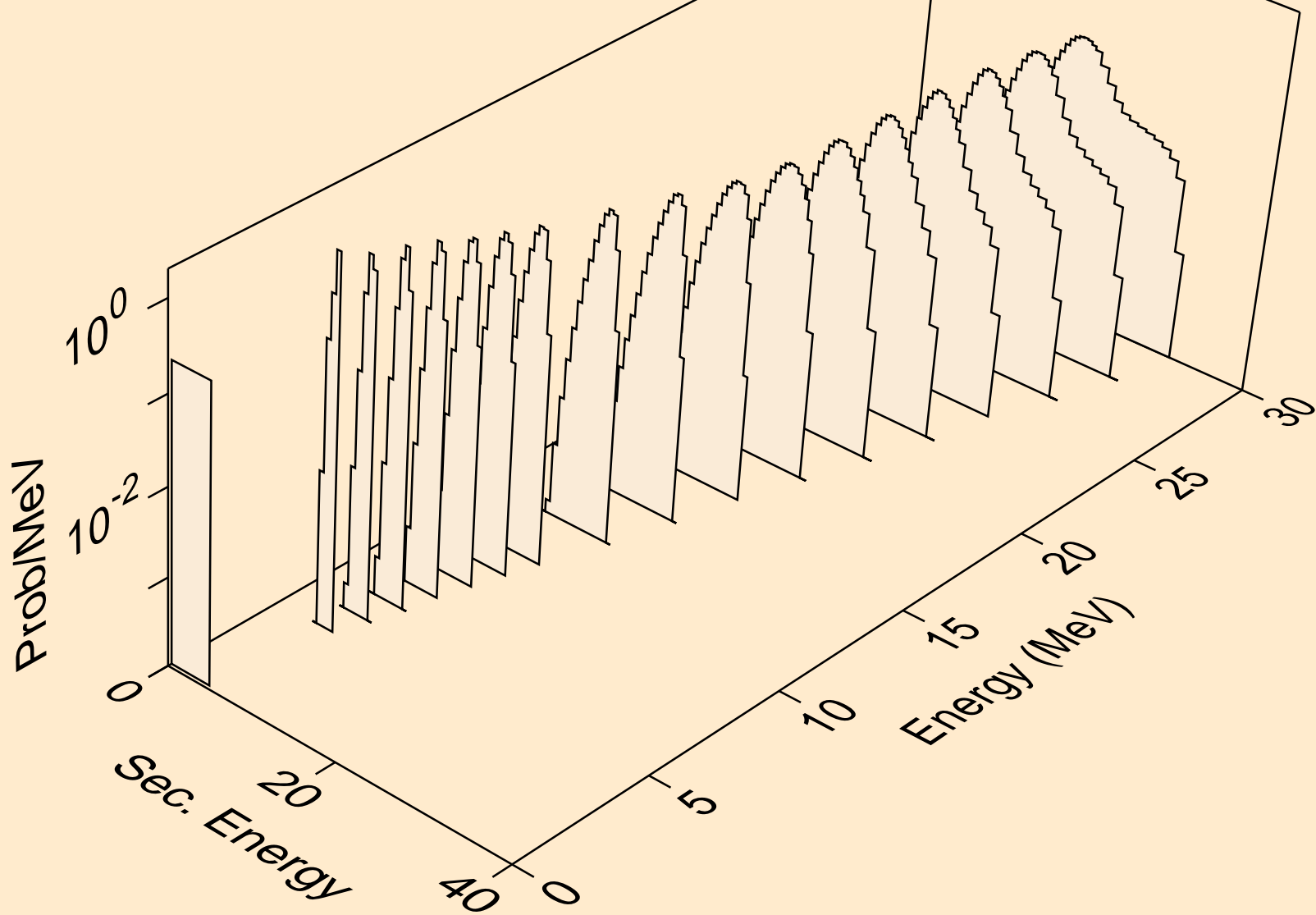

DY149 DEUTERON ACER TENDL-2023 LIBRARY; T=0.K  
alphas from (d,2n)a

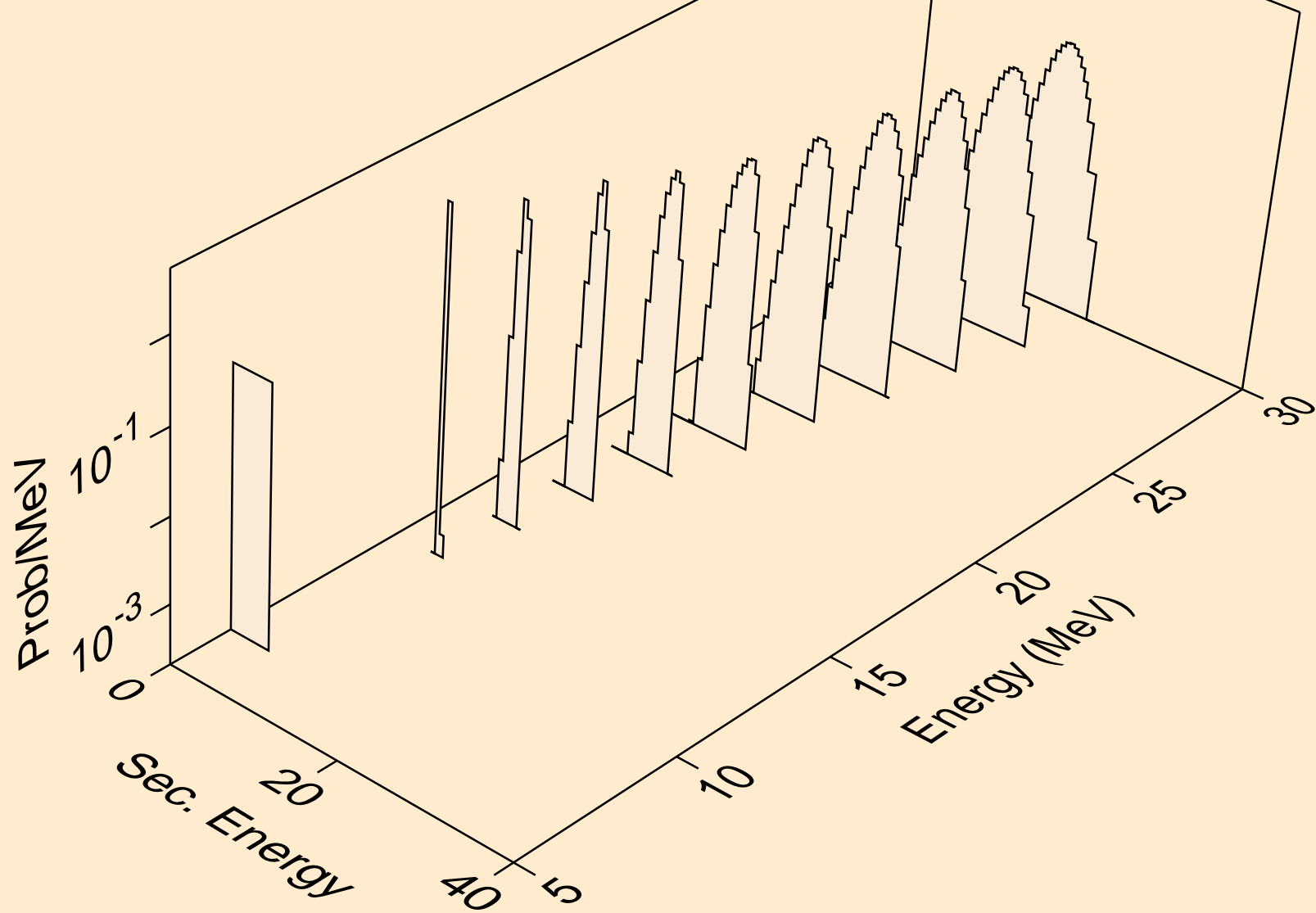

DY149 DEUTERON ACER TENDL-2023 LIBRARY; T=0.K  
alphas from (d,3n)a

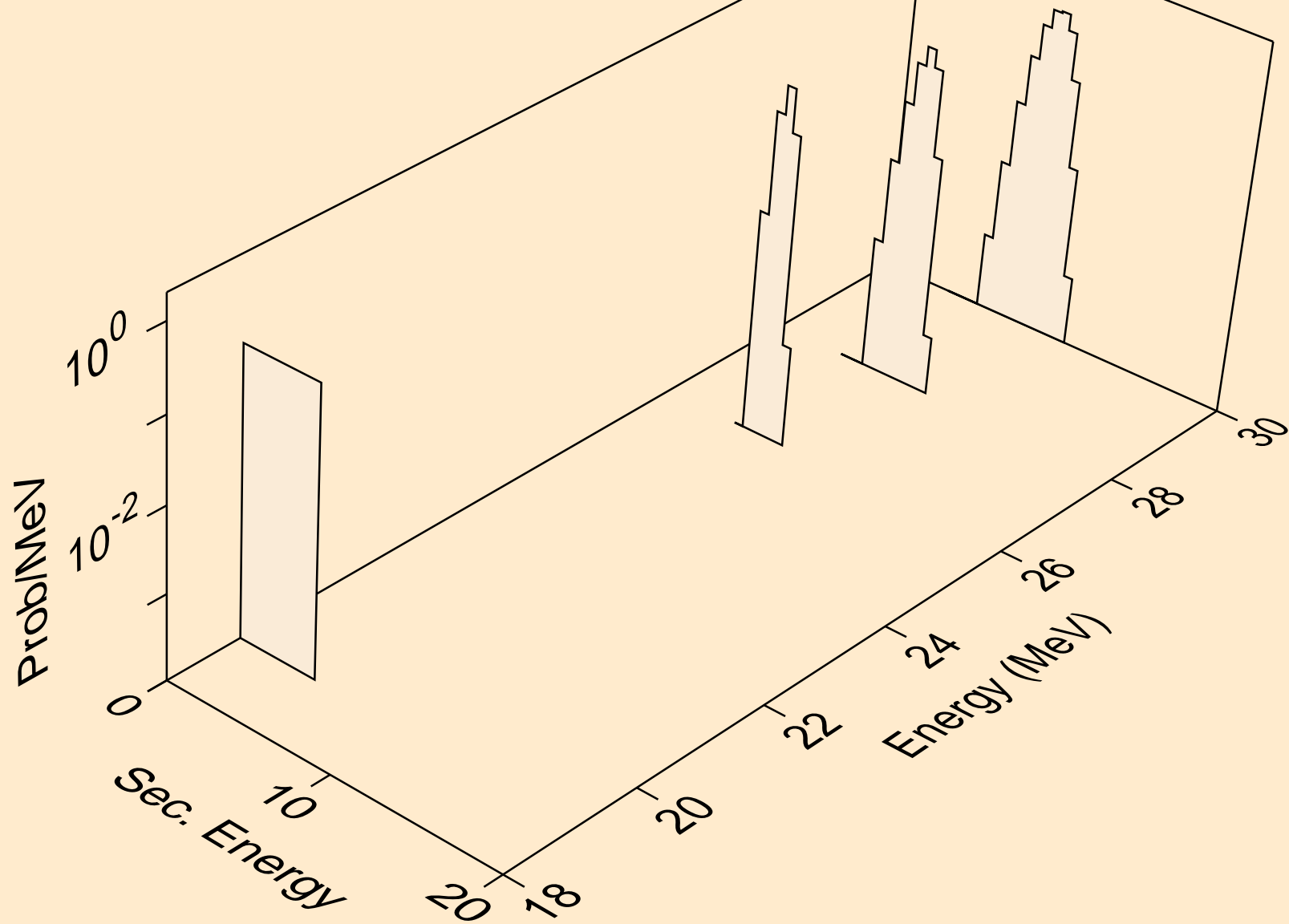

DY149 DEUTERON ACER TENDL-2023 LIBRARY; T=0.K  
alphas from (d,n\*)2a

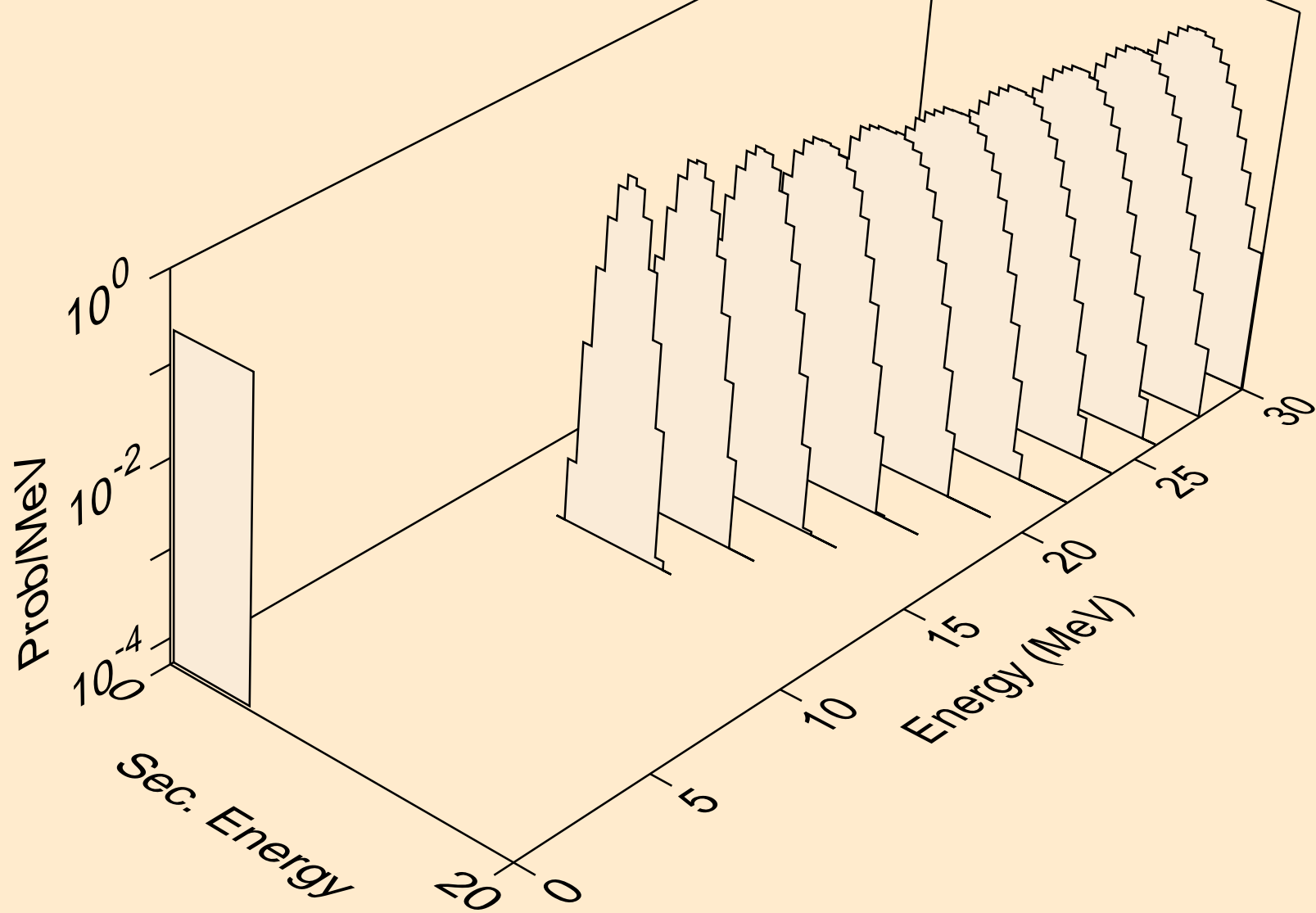



DY149 DEUTERON ACER TENDL-2023 LIBRARY; T=0.K  
alphas from (d,npa)

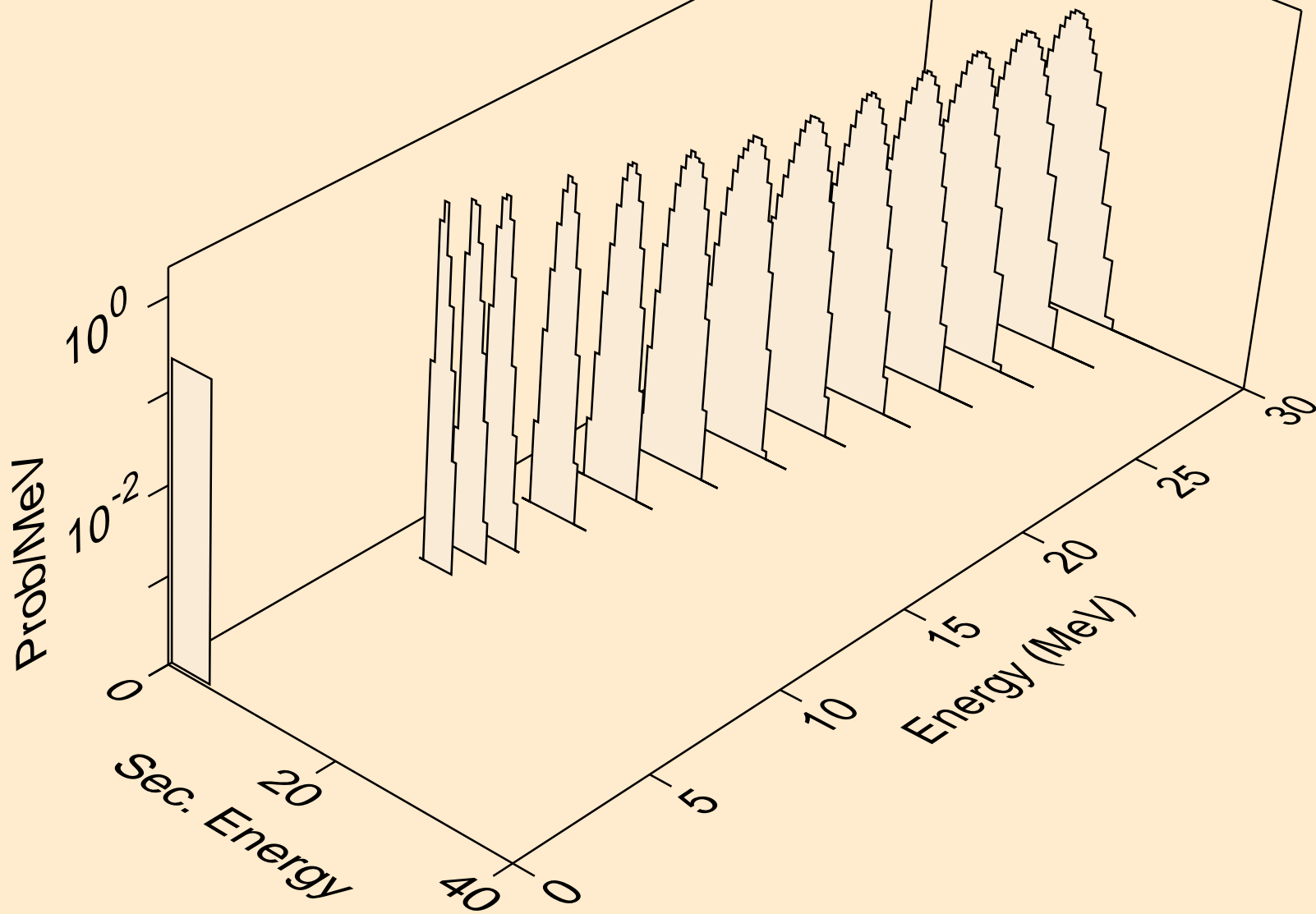

DY149 DEUTERON ACER TENDL-2023 LIBRARY; T=0.K  
alphas from (d,a)

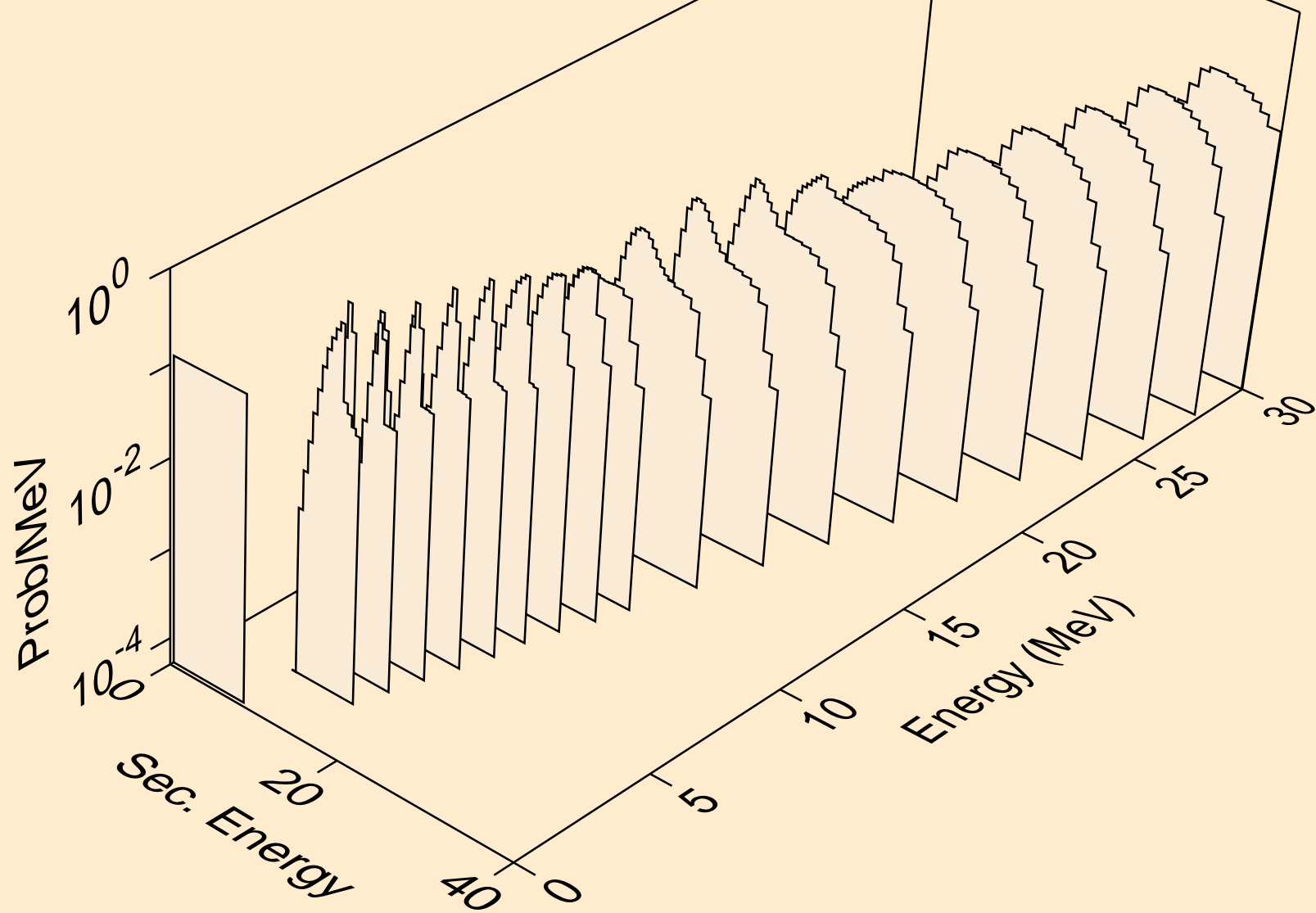

DY149 DEUTERON ACER TENDL-2023 LIBRARY; T=0.K  
alphas from (d,2a)

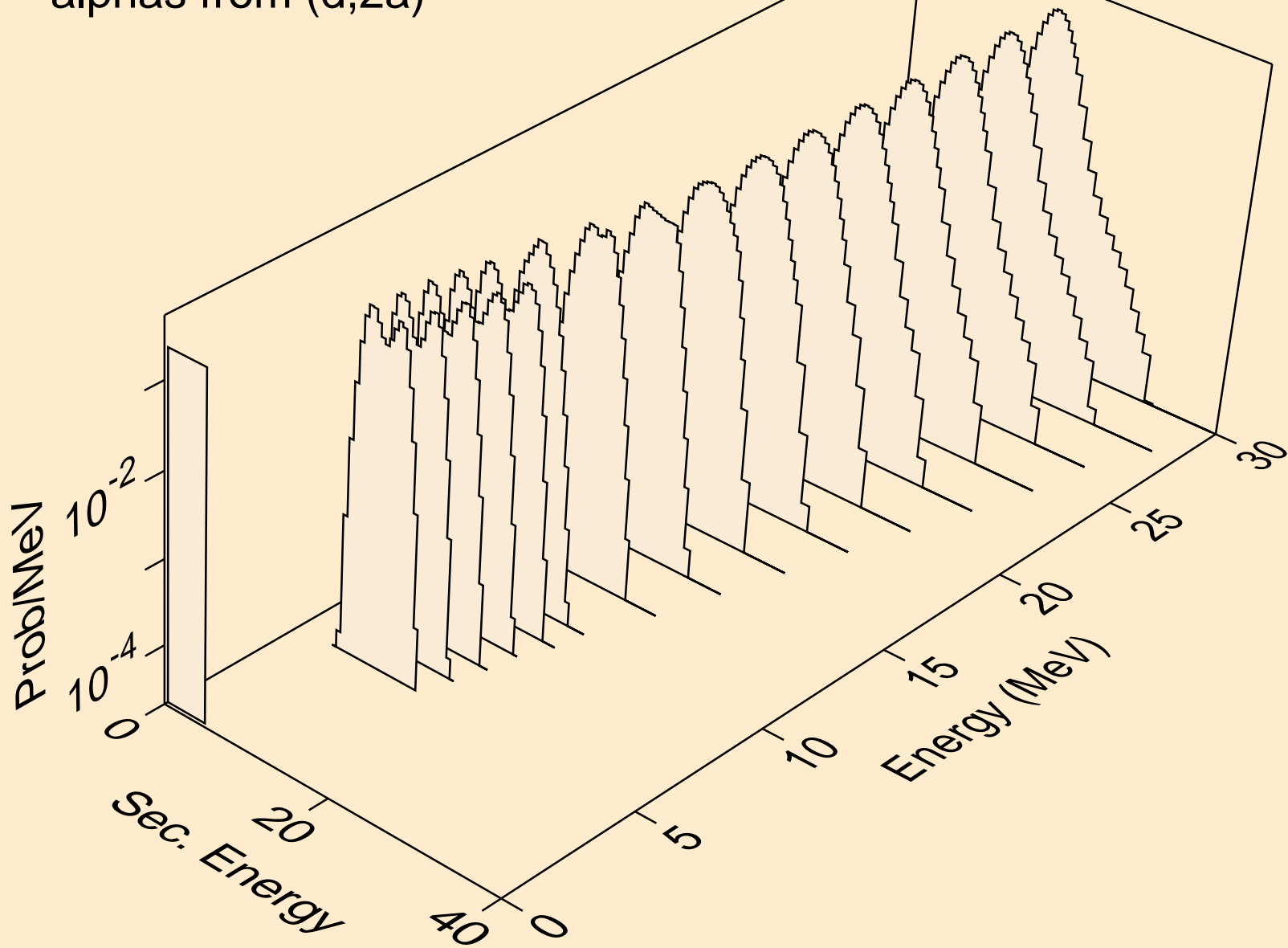

DY149 DEUTERON ACER TENDL-2023 LIBRARY; T=0.K  
alphas from (d,3a)

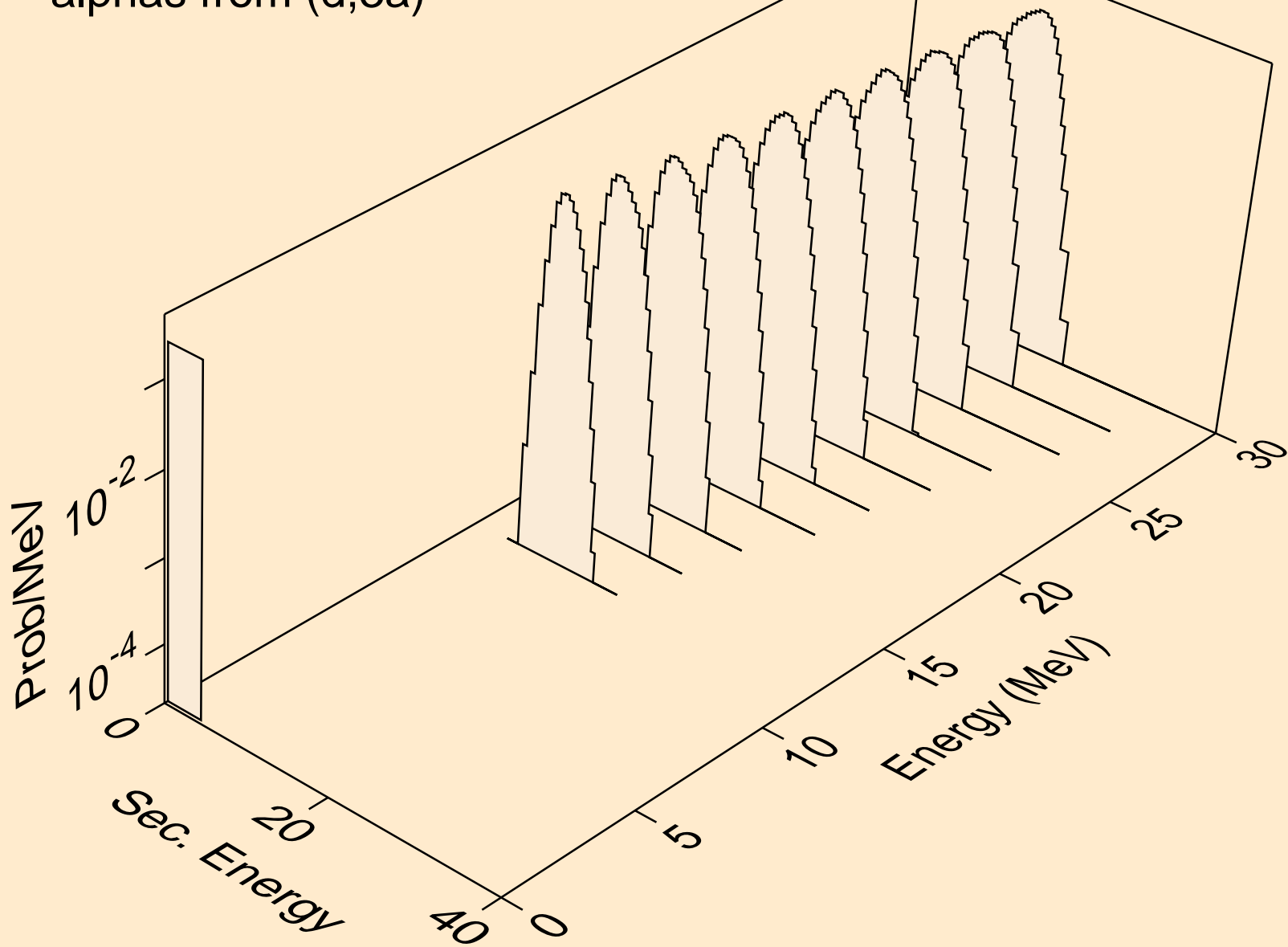

DY149 DEUTERON ACER TENDL-2023 LIBRARY; T=0.K  
alphas from (d,pa)

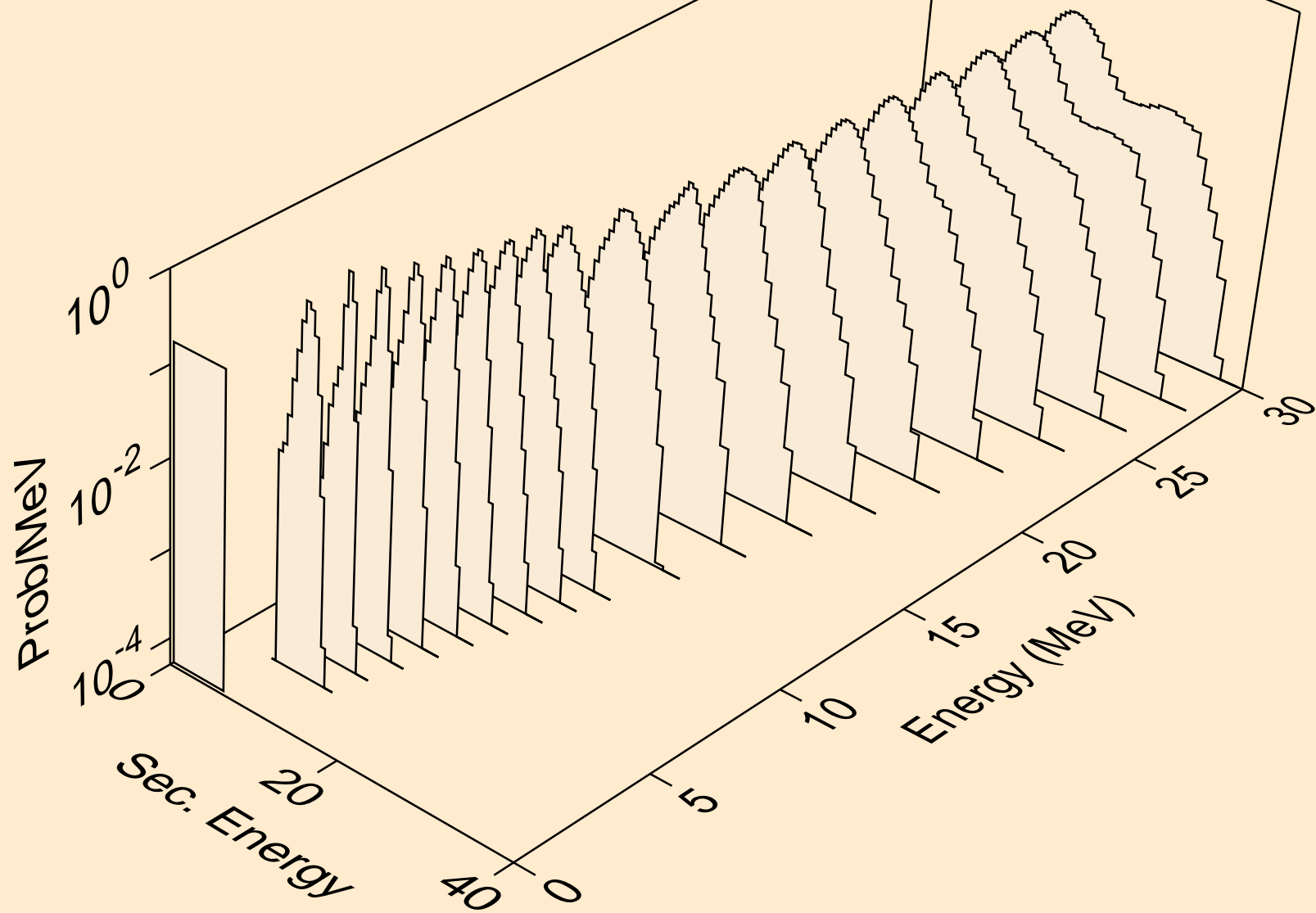

DY149 DEUTERON ACER TENDL-2023 LIBRARY; T=0.K  
alphas from (d,da)

