

IR205 DEUTERON ACER TENDL-2023 LIBRARY; T=0.K

Principal cross sections

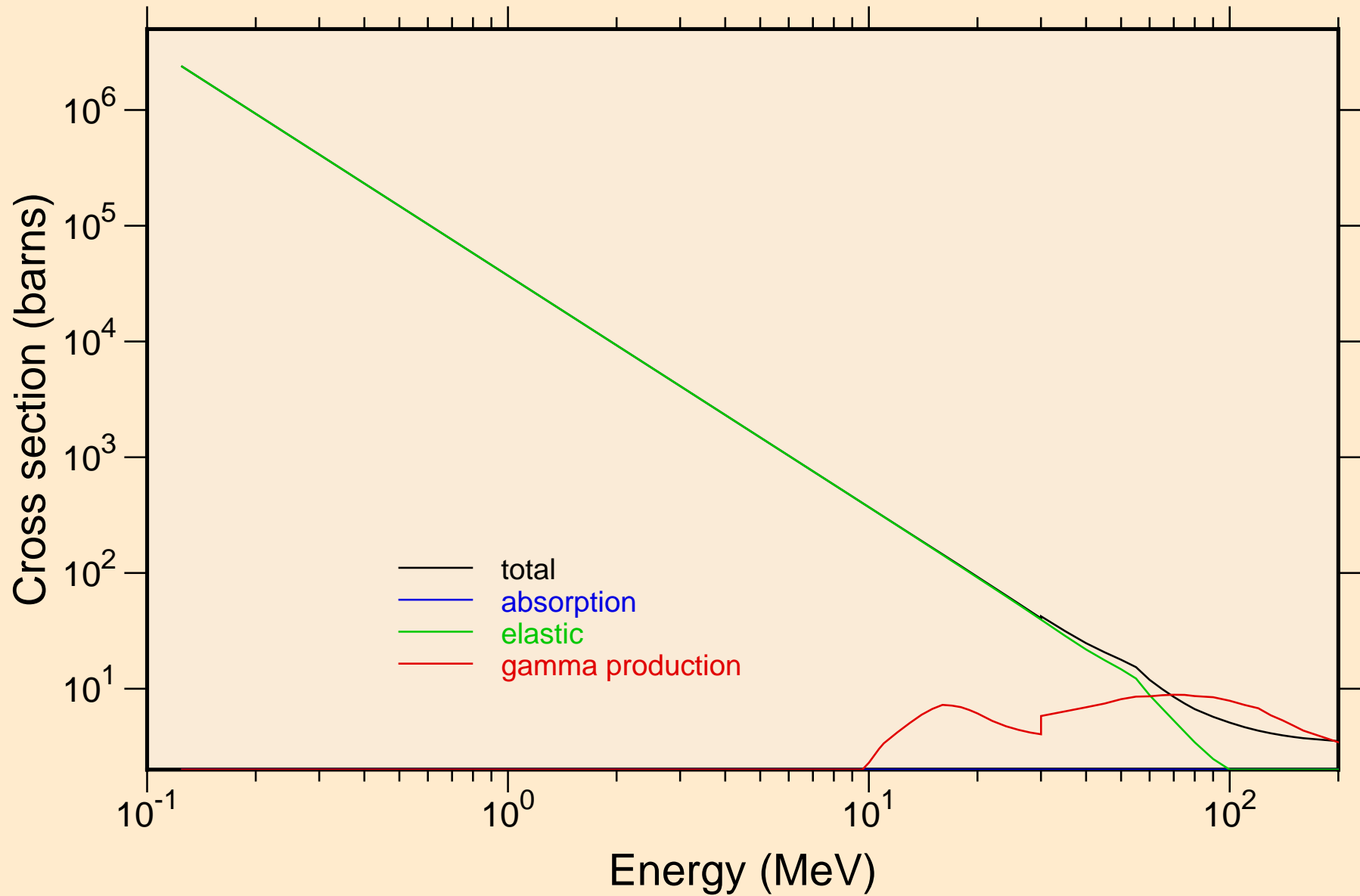

IR205 DEUTERON ACER TENDL-2023 LIBRARY; T=0.K

Heating

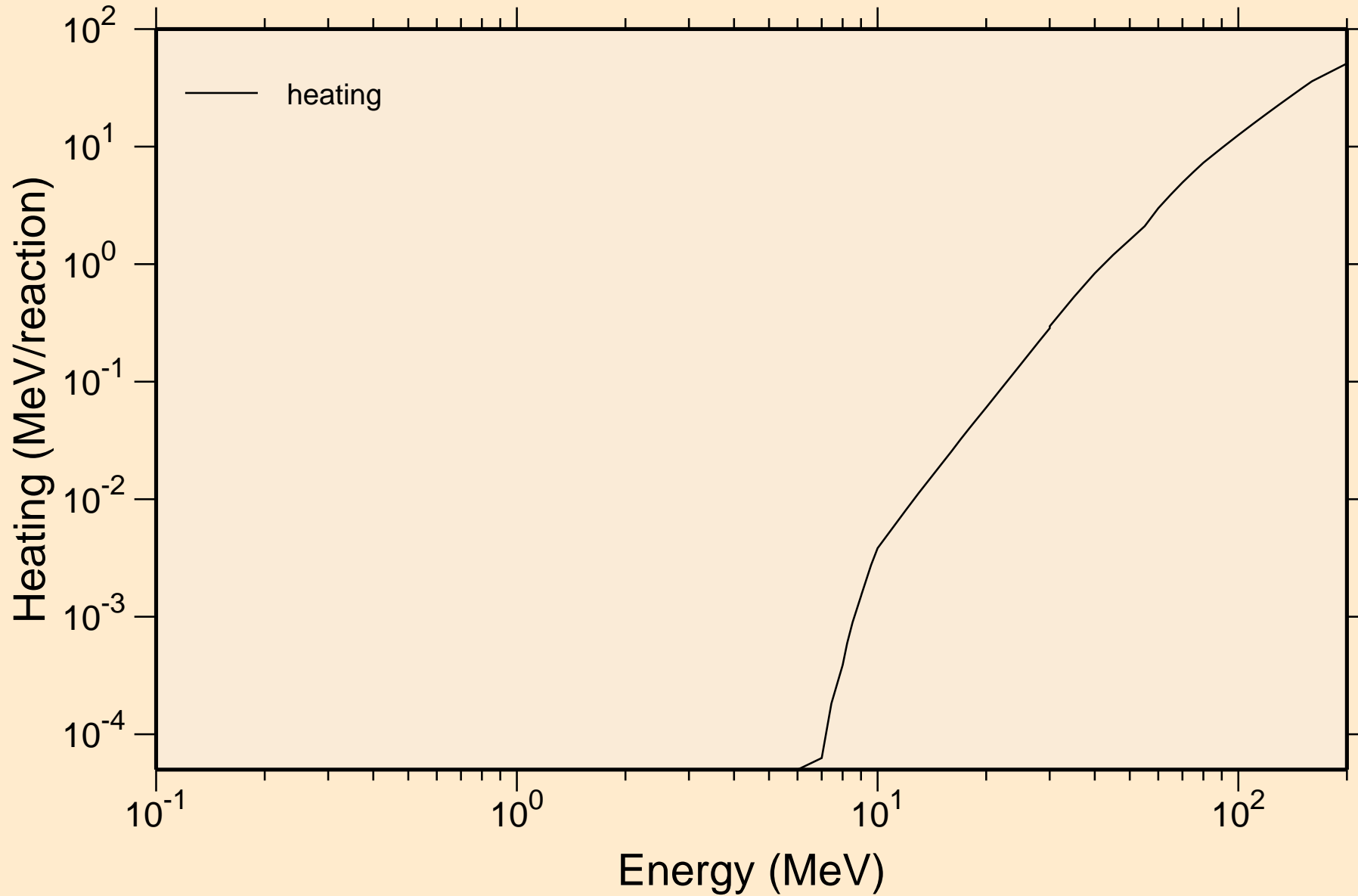

IR205 DEUTERON ACER TENDL-2023 LIBRARY; T=0.K
Principal cross sections

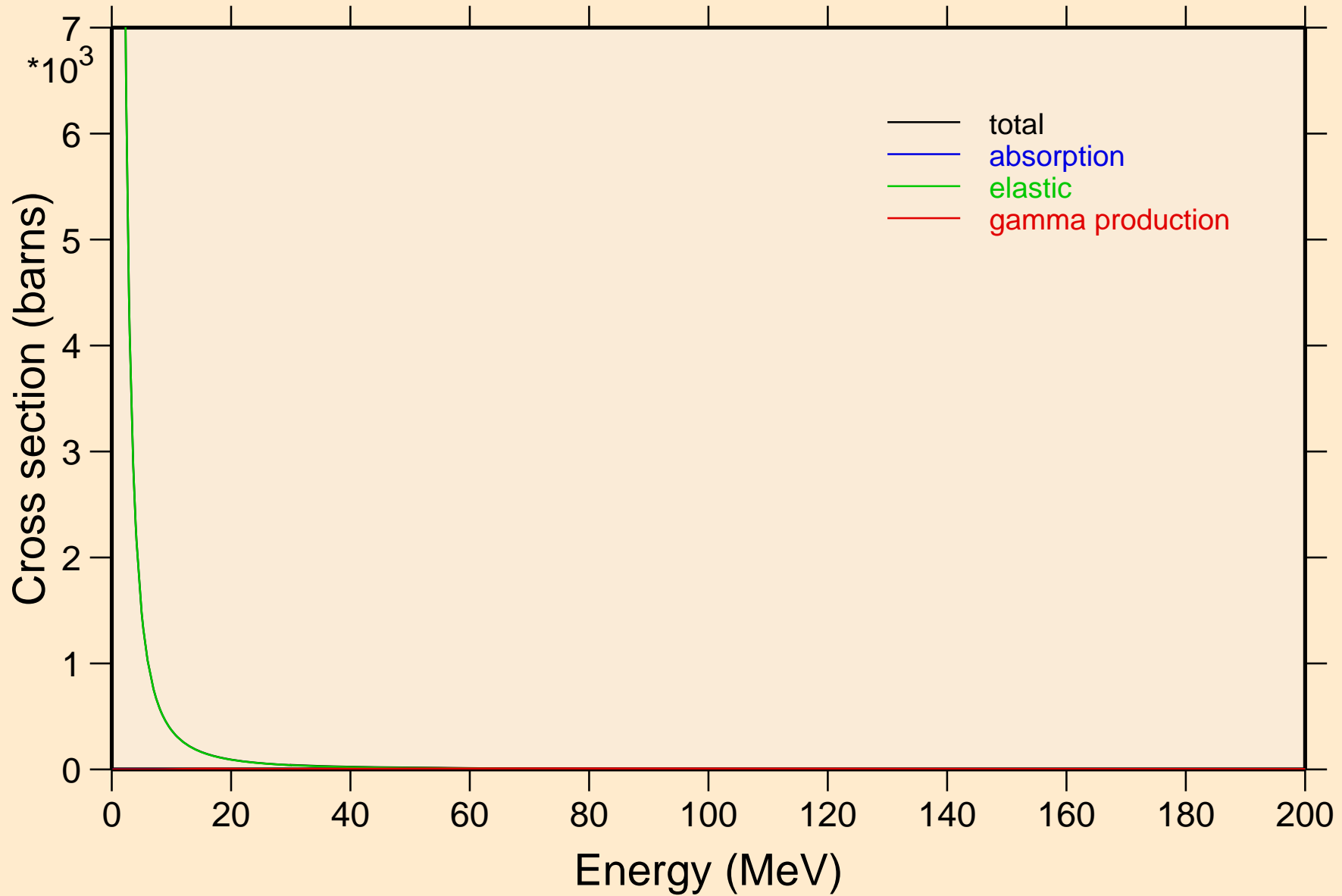

IR205 DEUTERON ACER TENDL-2023 LIBRARY; T=0.K

Heating

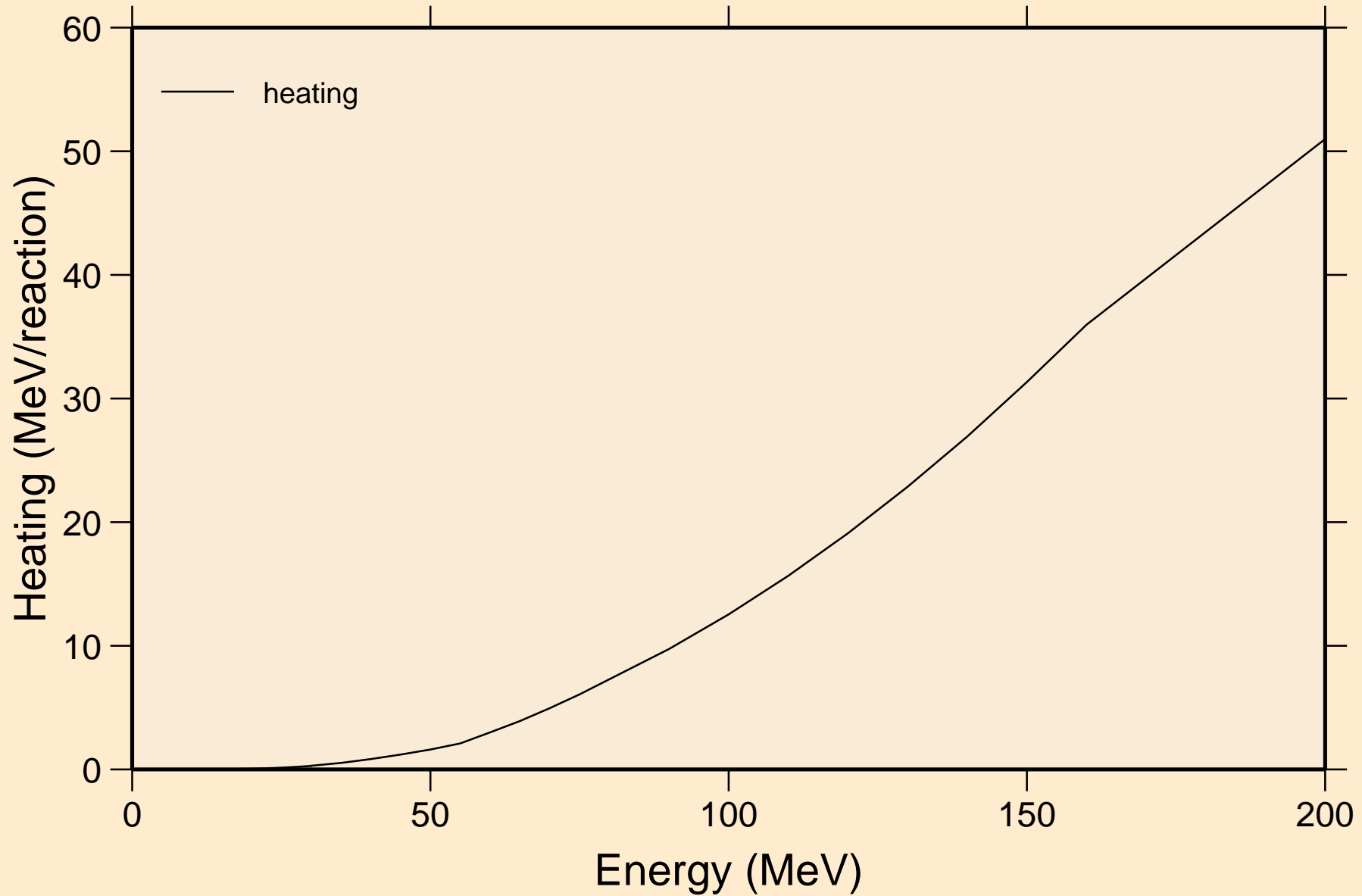

IR205 DEUTERON ACER TENDL-2023 LIBRARY; T=0.K
Threshold reactions

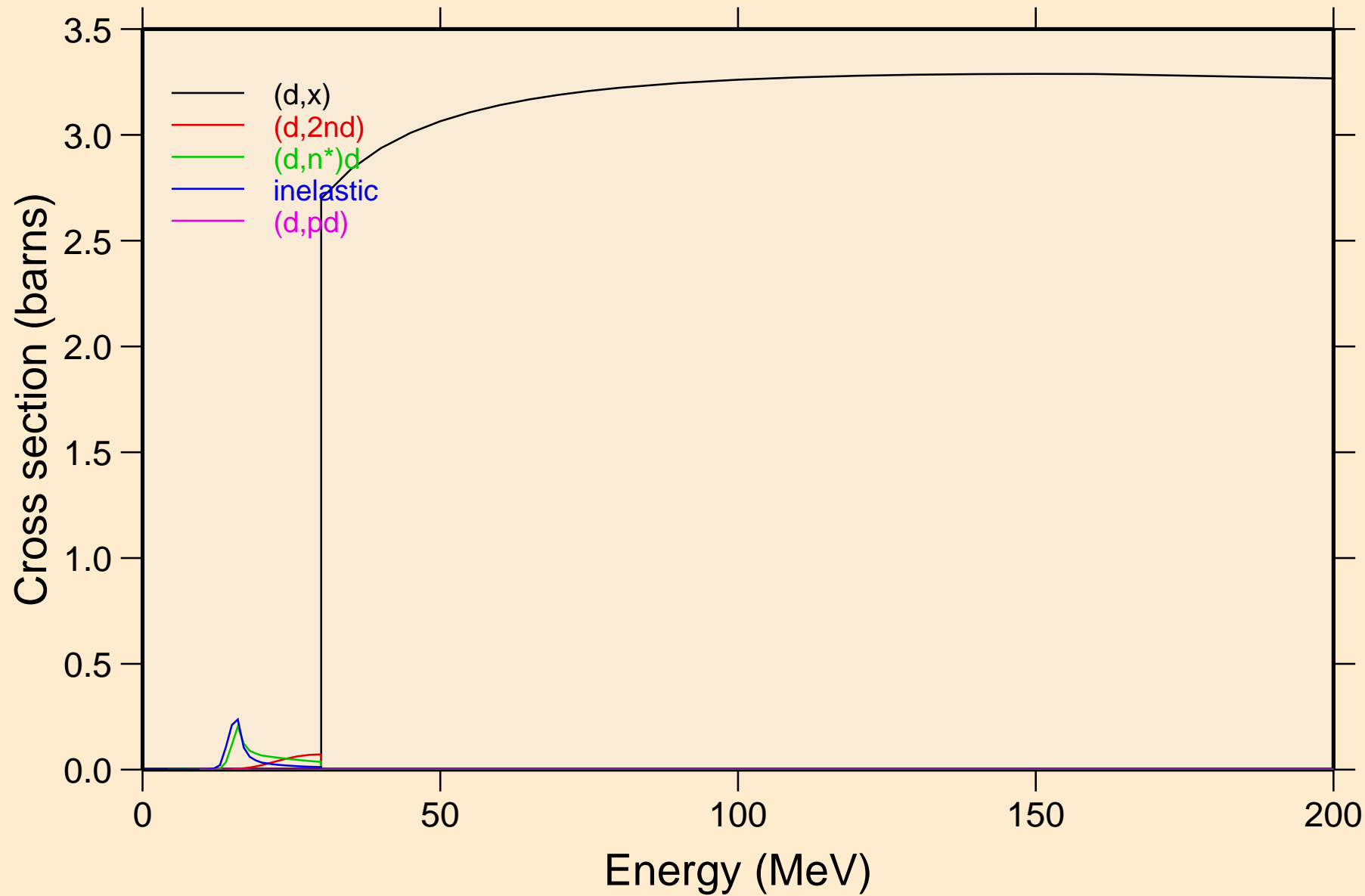

IR205 DEUTERON ACER TENDL-2023 LIBRARY; T=0.K
angular distribution for elastic

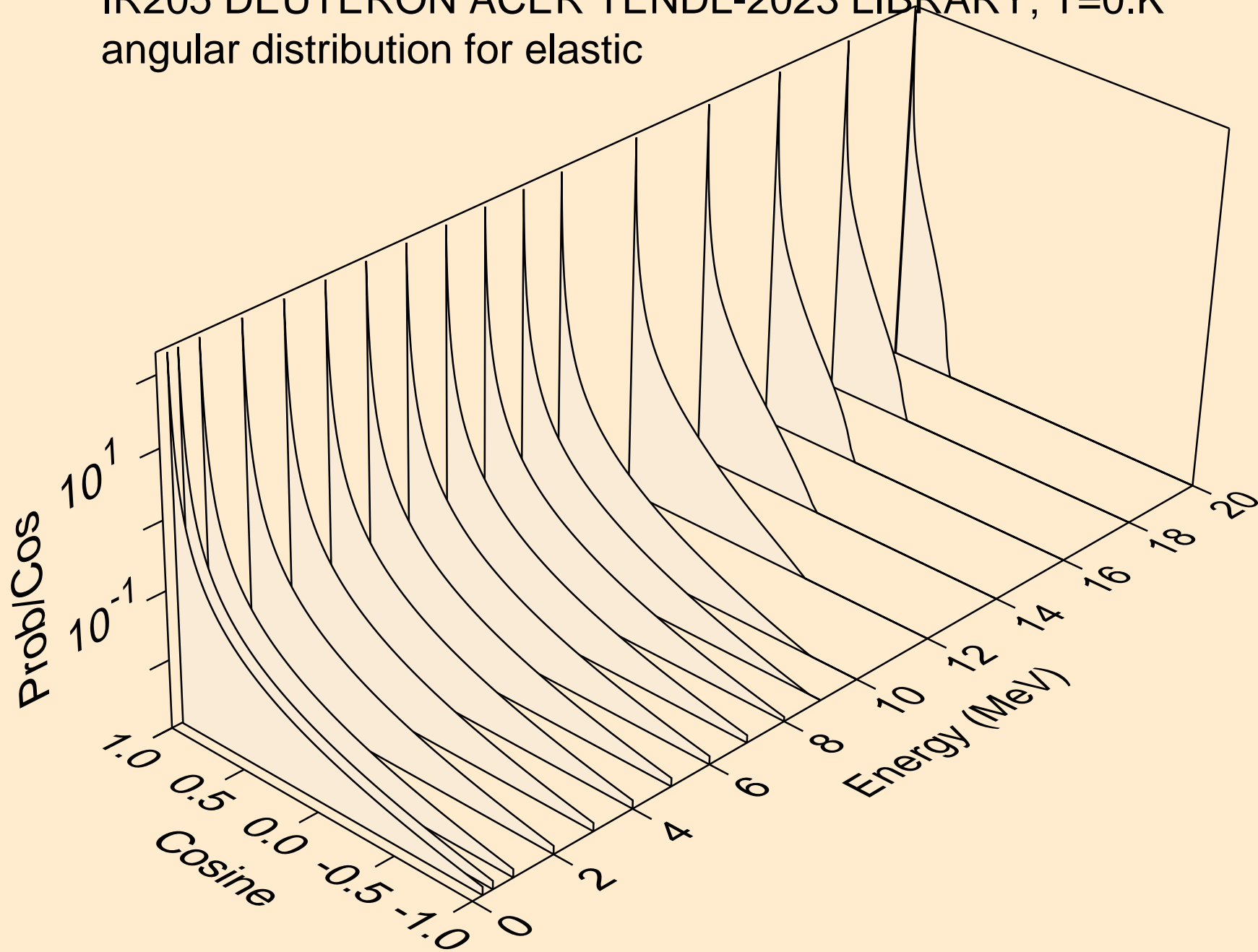

IR205 DEUTERON ACER TENDL-2023 LIBRARY; T=0.K
angular distribution for elastic

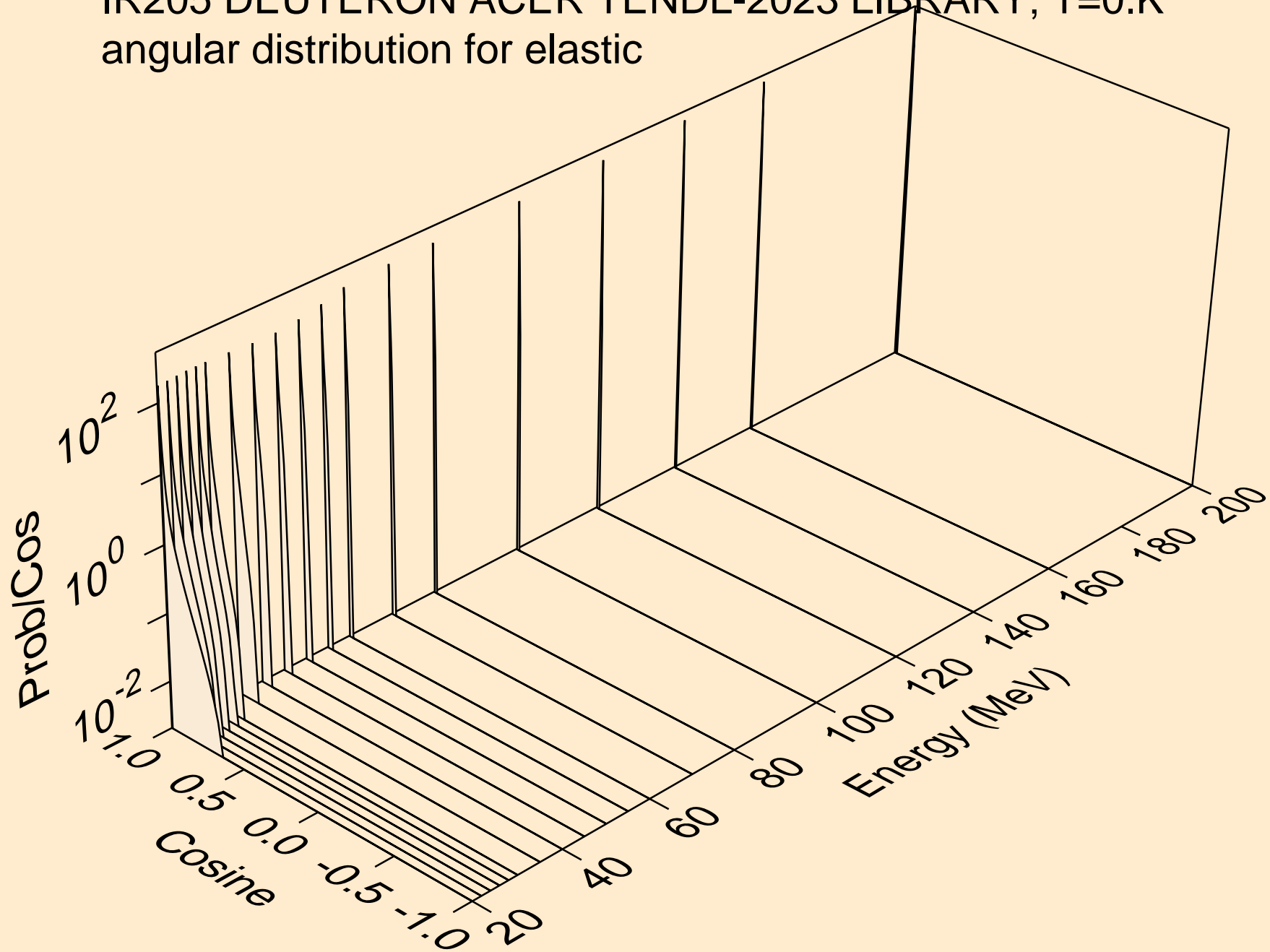

IR205 DEUTERON ACER TENDL-2023 LIBRARY; T=0.K
Deuteron emission for (d,x)

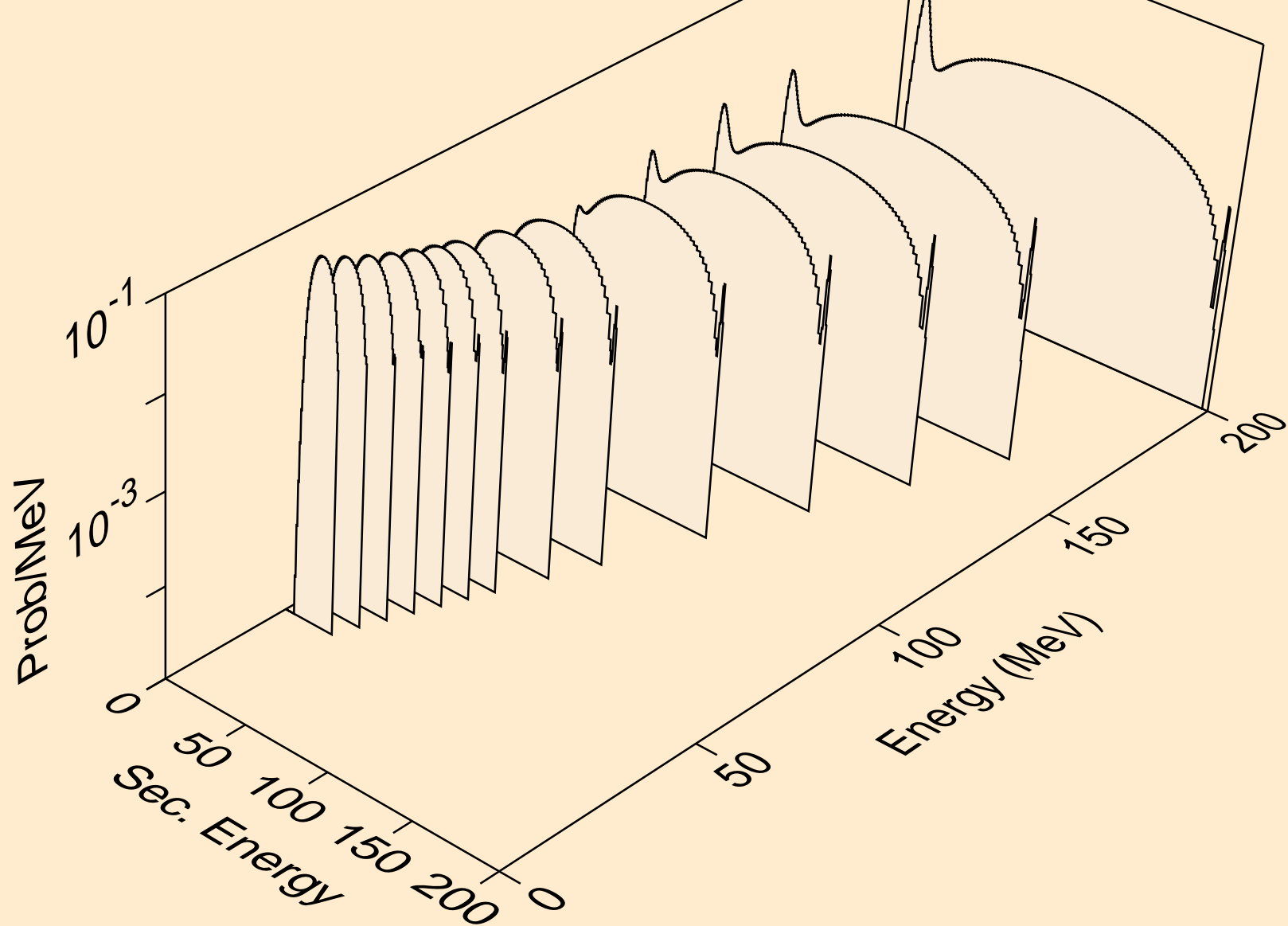

IR205 DEUTERON ACER TENDL-2023 LIBRARY; T=0.K
Deuteron emission for (d,2nd)

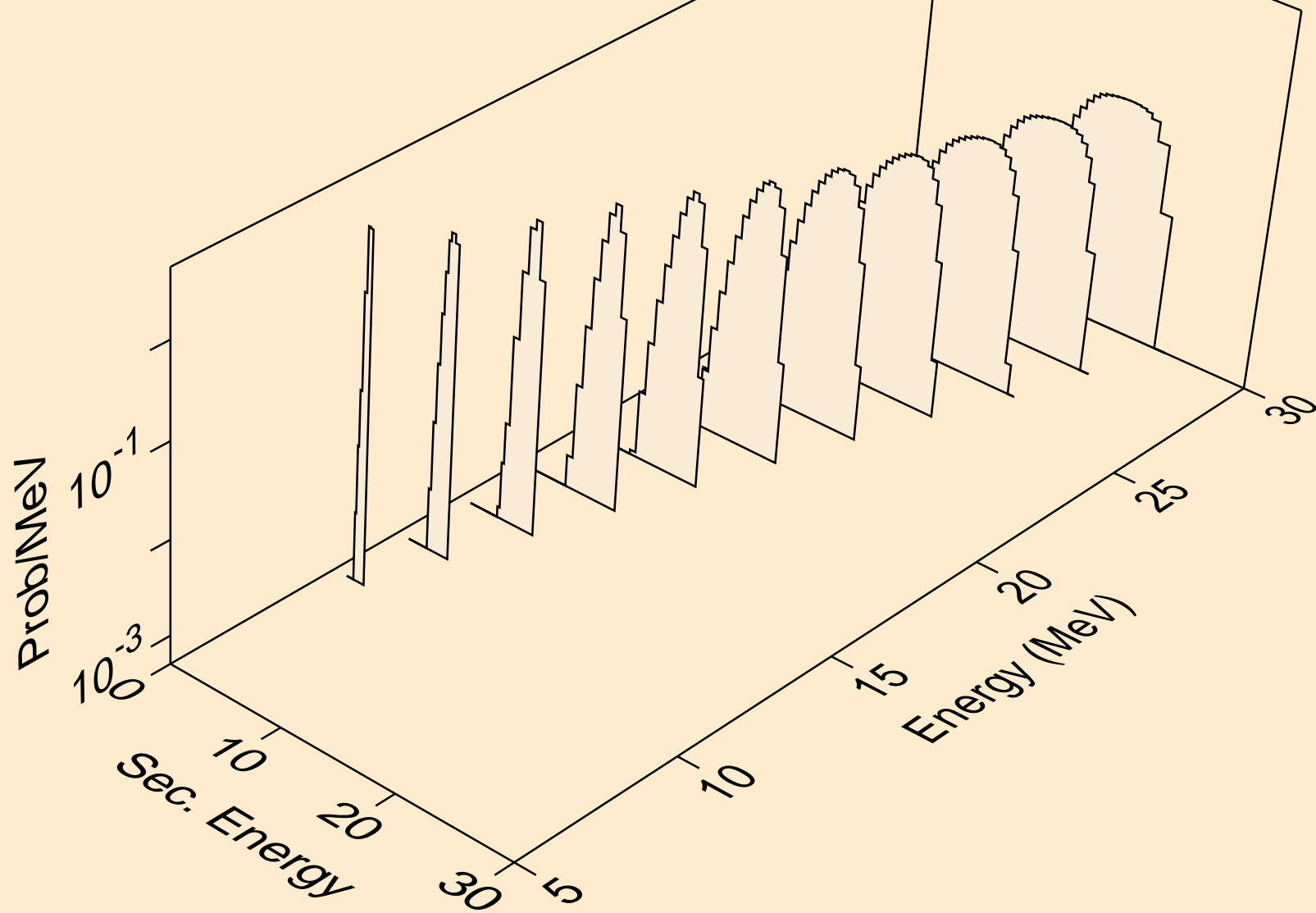

IR205 DEUTERON ACER TENDL-2023 LIBRARY; T=0.K
Deuteron emission for (d,n*)d

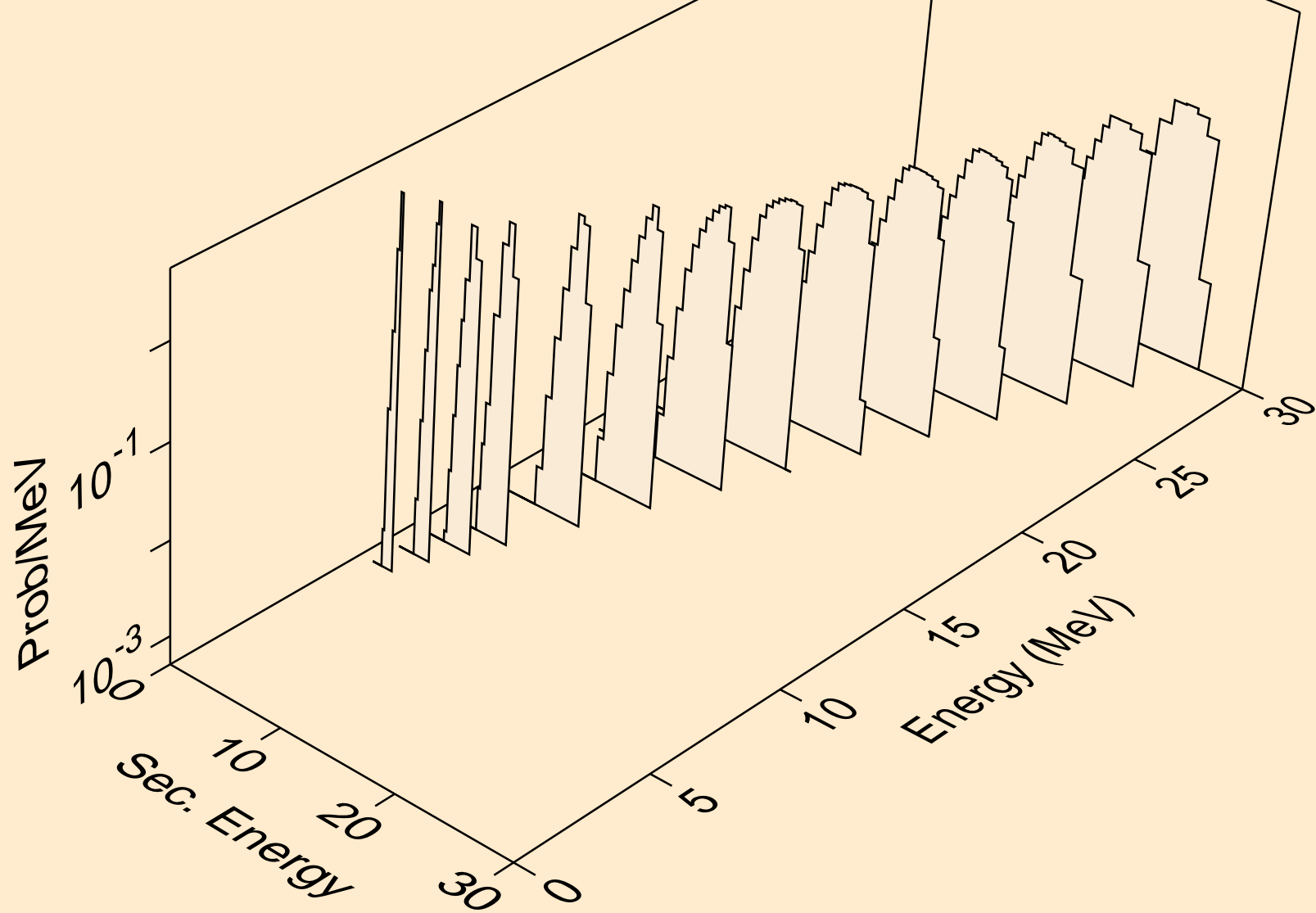

IR205 DEUTERON ACER TENDL-2023 LIBRARY; T=0.K
Deuteron emission for inelastic

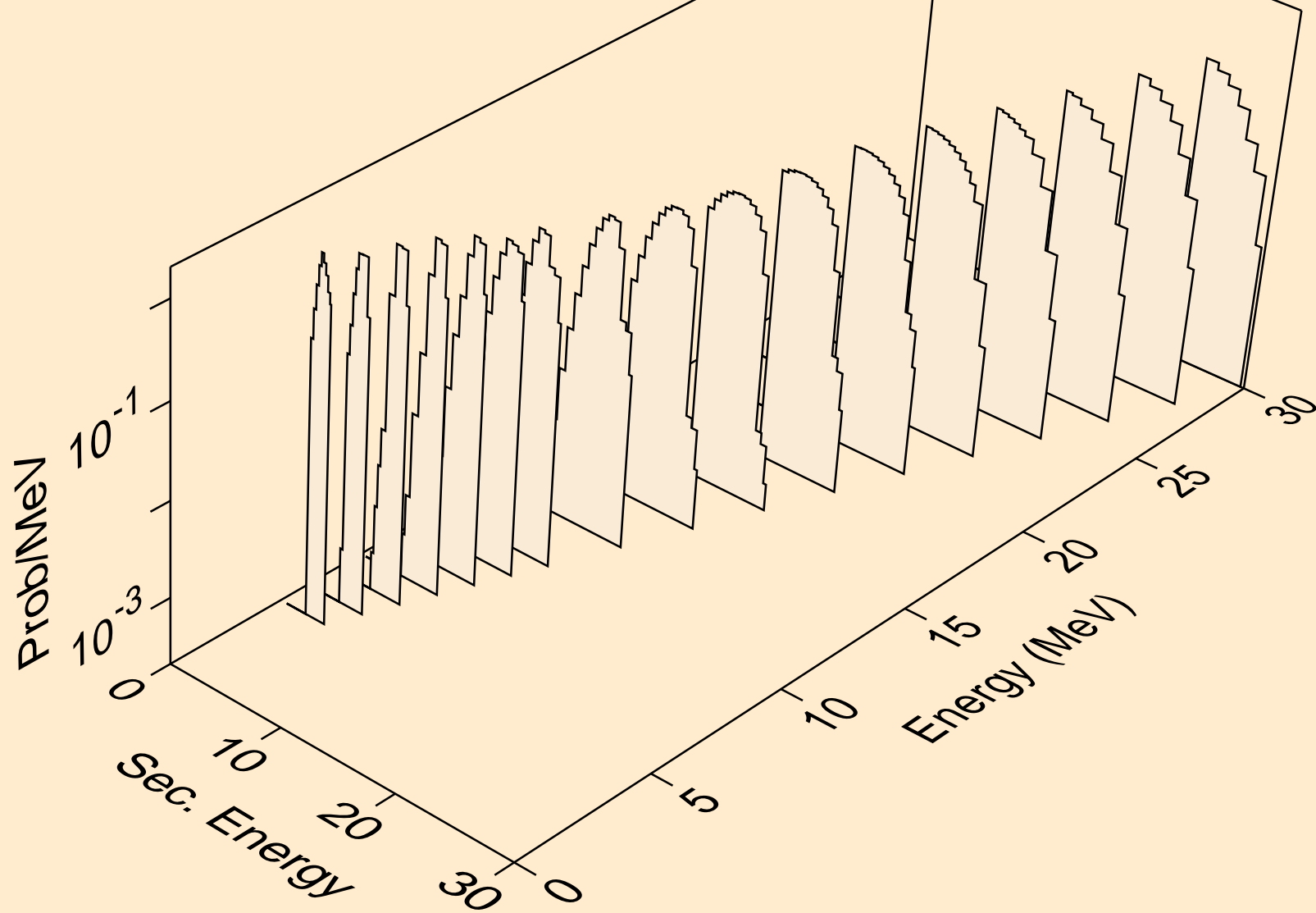

IR205 DEUTERON ACER TENDL-2023 LIBRARY; T=0.K
Deuteron emission for (d,pd)

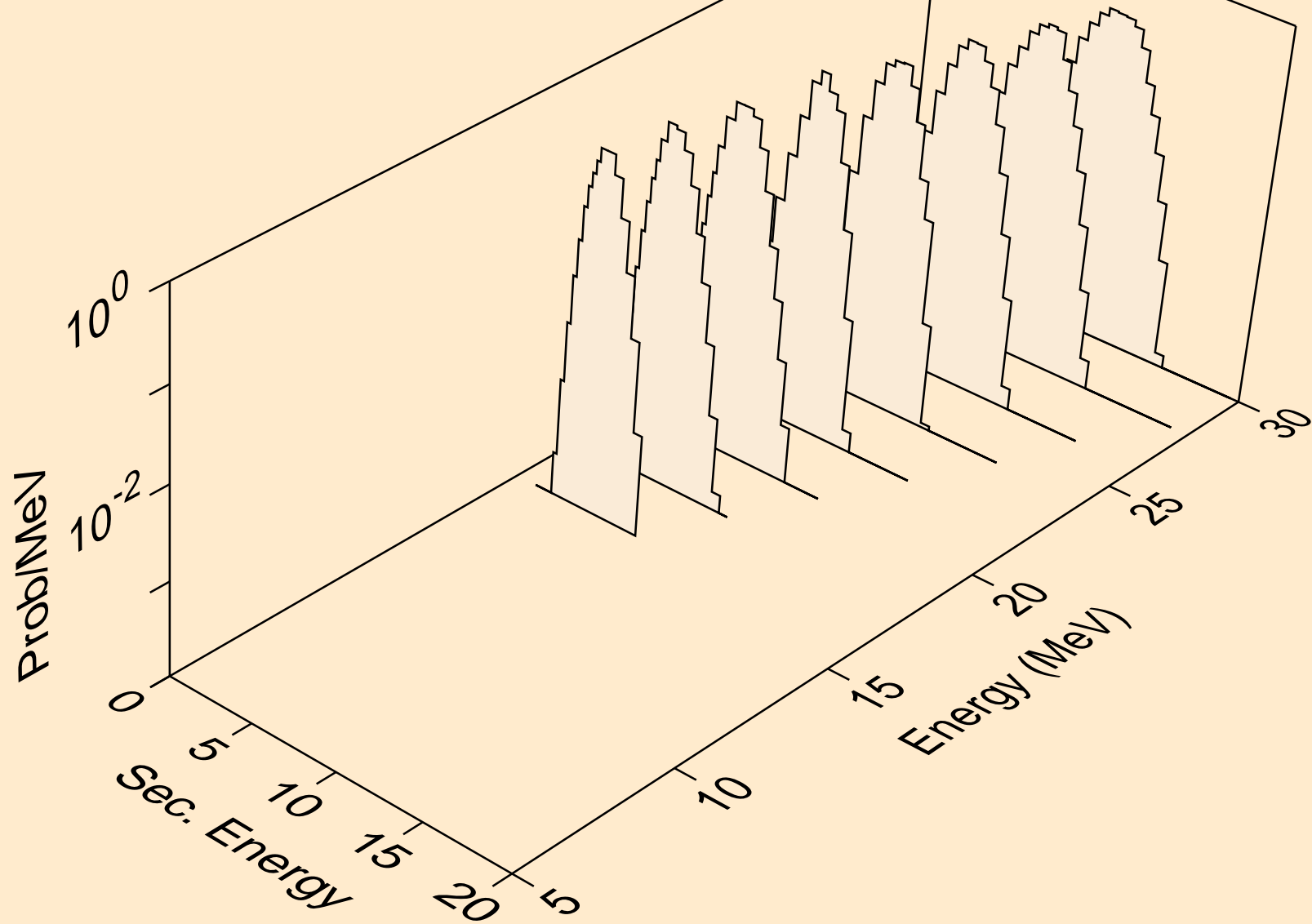

IR205 DEUTERON ACER TENDL-2023 LIBRARY; T=0.K
Photon emission for (z,n)

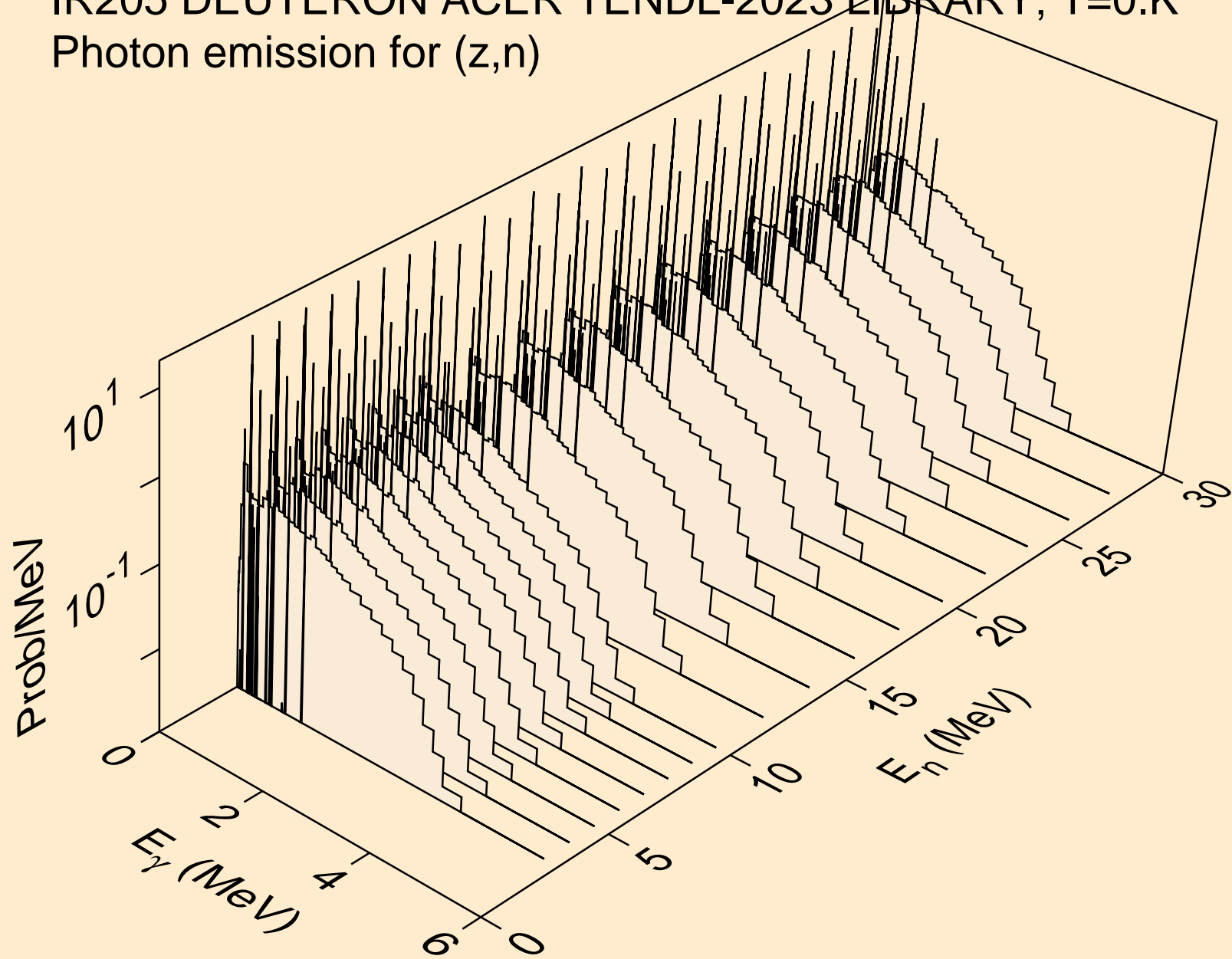

IR205 DEUTERON ACER TENDL-2023 LIBRARY; T=0.K
Photon emission for (z,x)

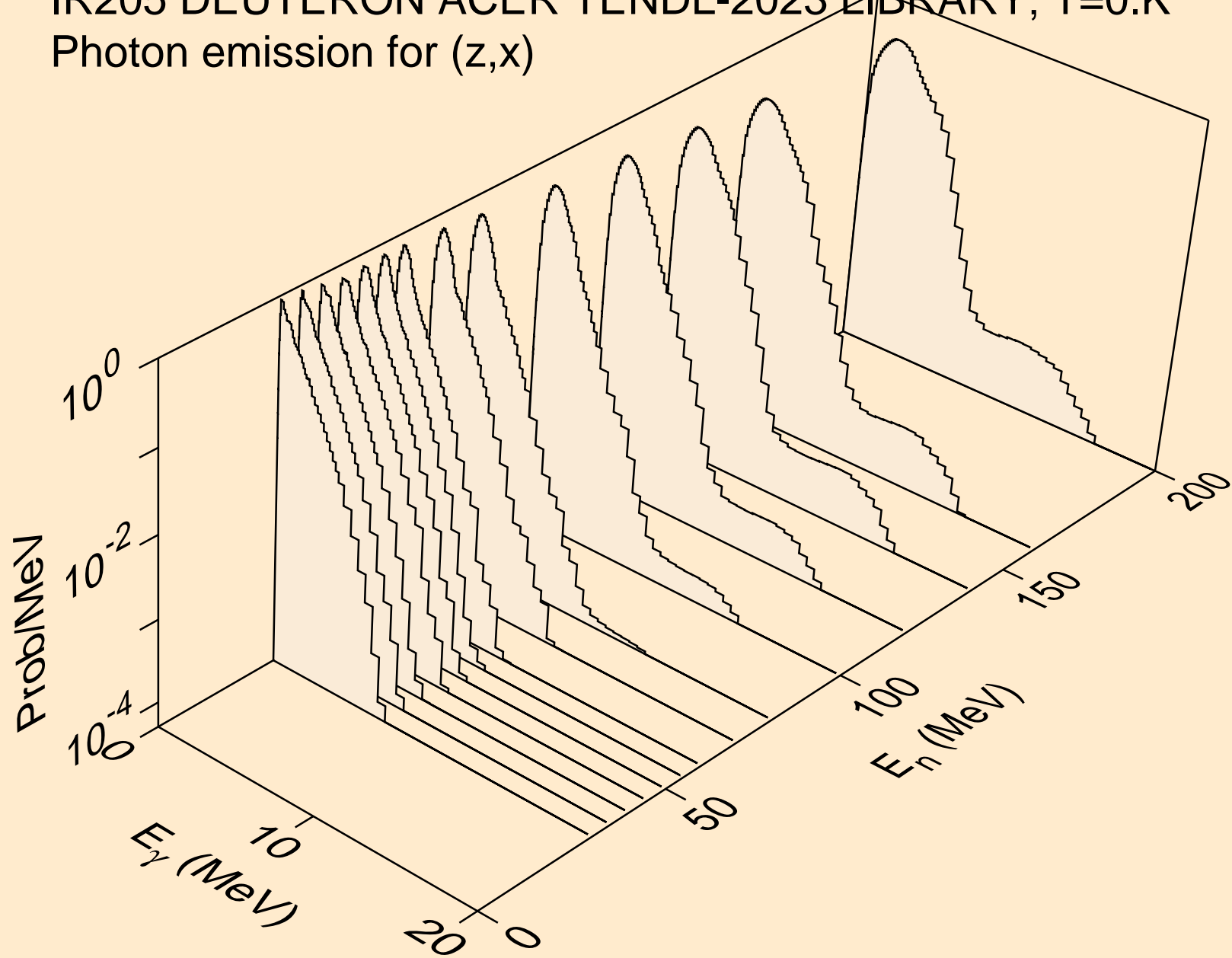

IR205 DEUTERON ACER TENDL-2023 LIBRARY; T=0.K
Photon emission for (n,2nd)

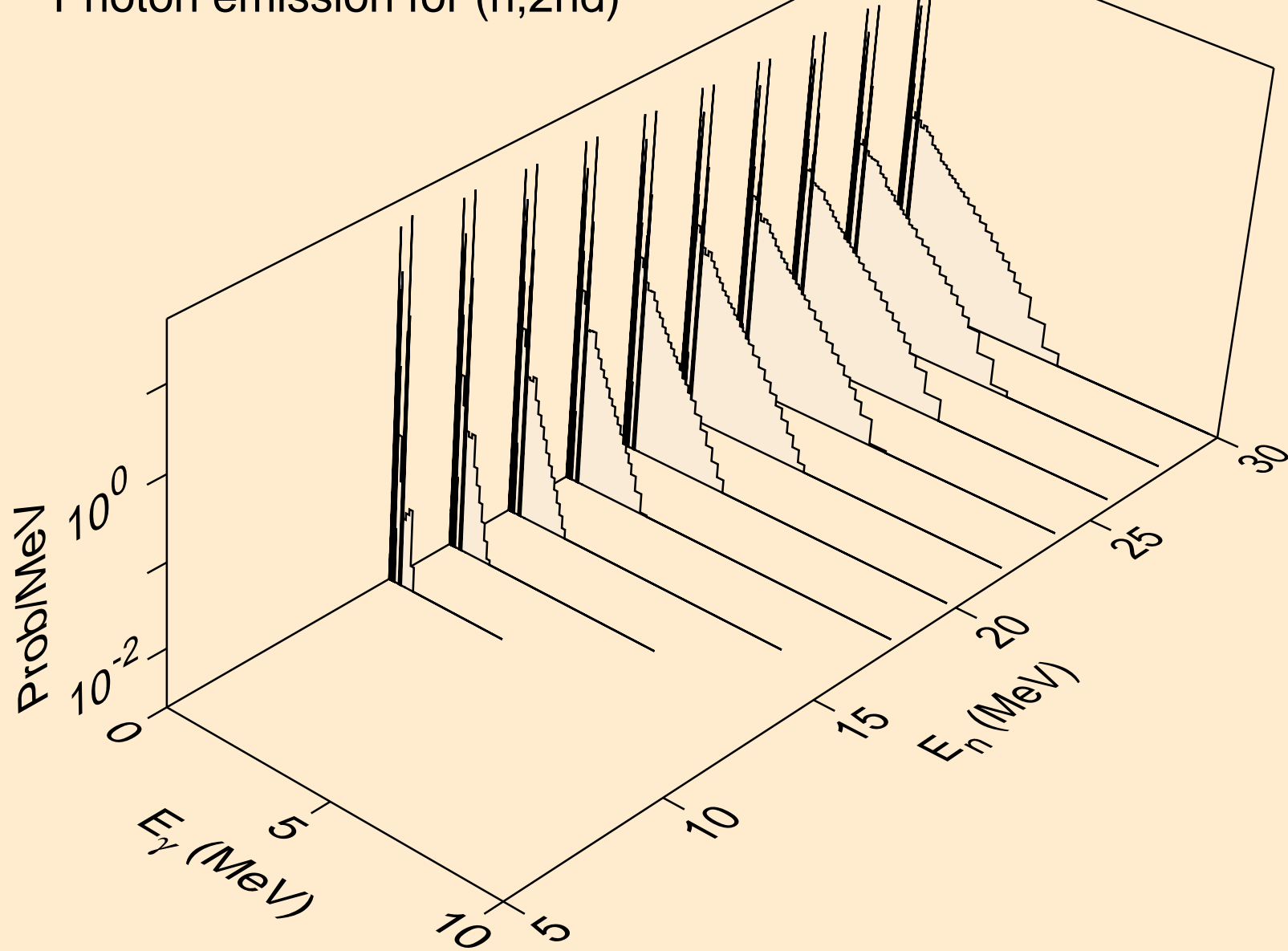

IR205 DEUTERON ACER TENDL-2023 LIBRARY; T=0.K
Photon emission for (n,2n)

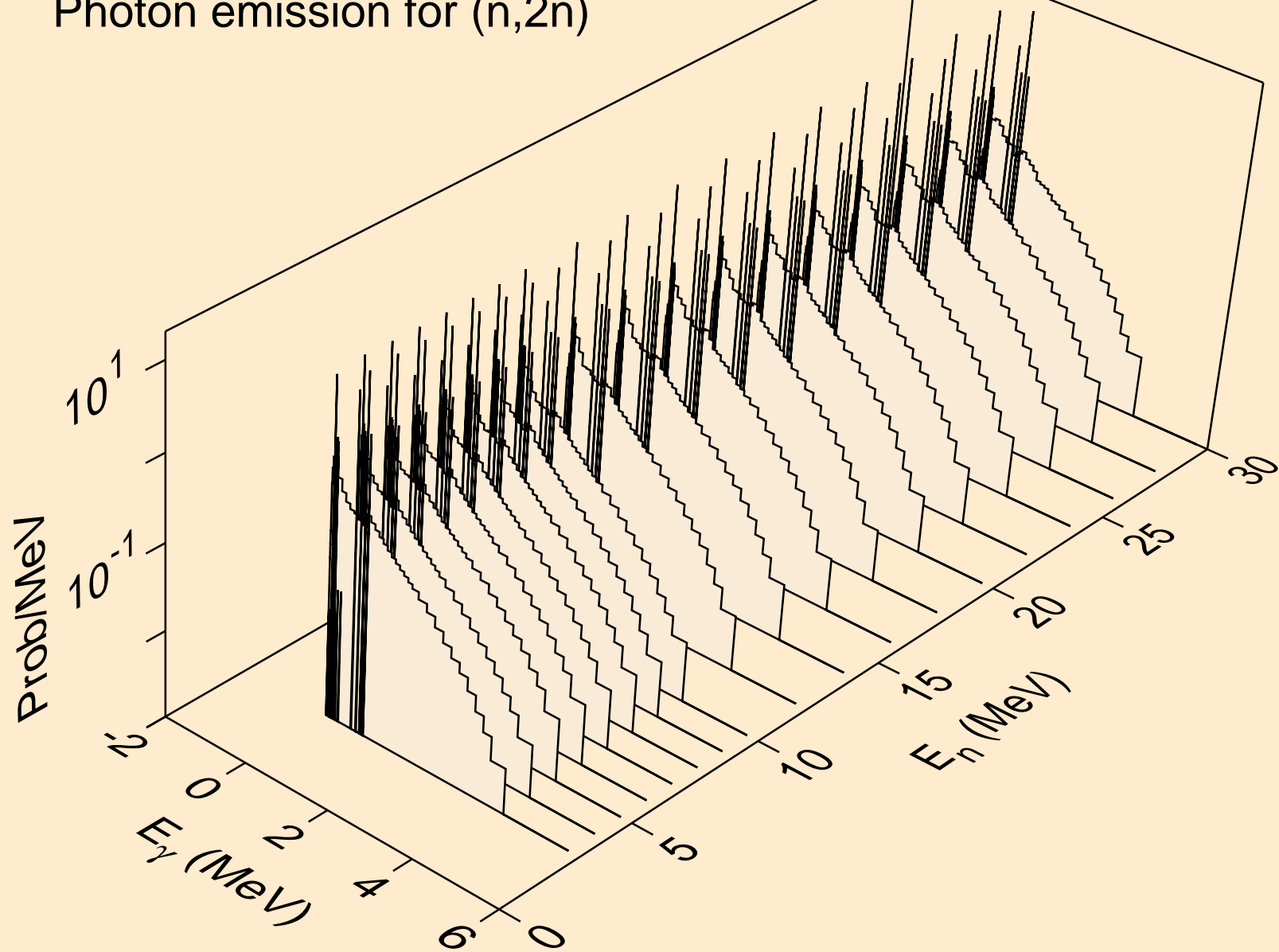

IR205 DEUTERON ACER TENDL-2023 LIBRARY; T=0.K
Photon emission for (n,3n)

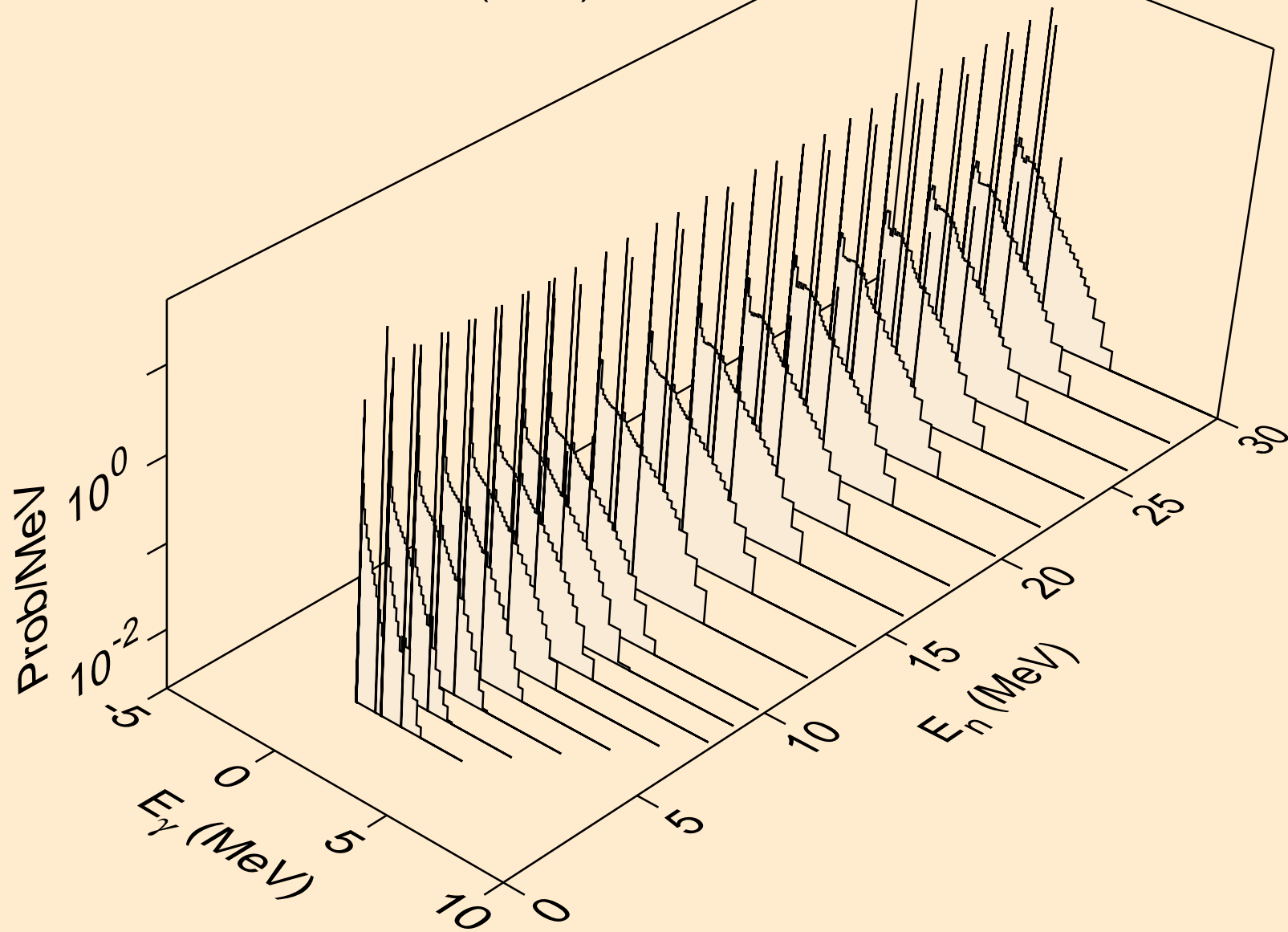

IR205 DEUTERON ACER TENDL-2023 LIBRARY; T=0.K
Photon emission for (n,n*)a

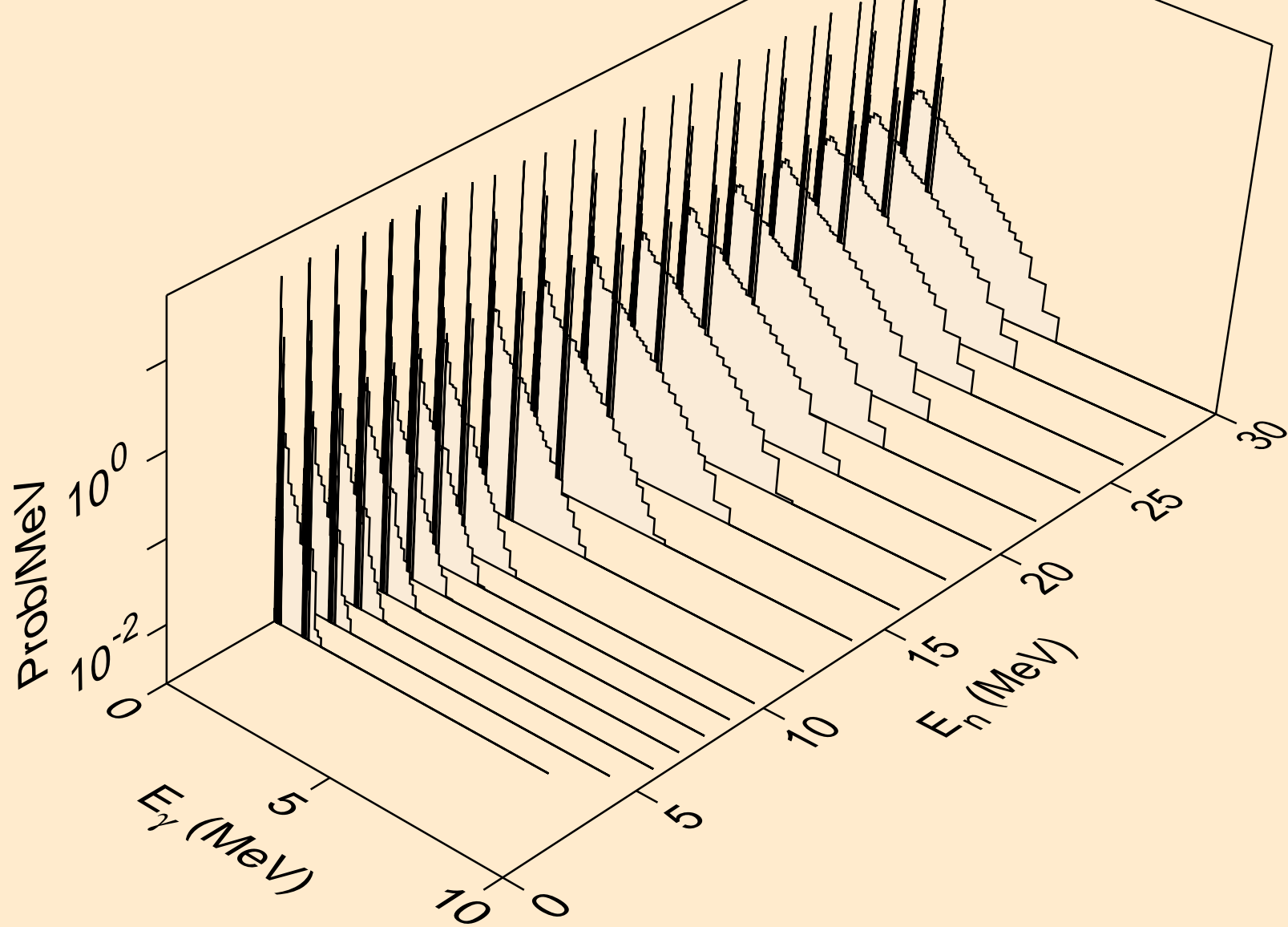

IR205 DEUTERON ACER TENDL-2023 LIBRARY; T=0.K
Photon emission for (n,2n)a

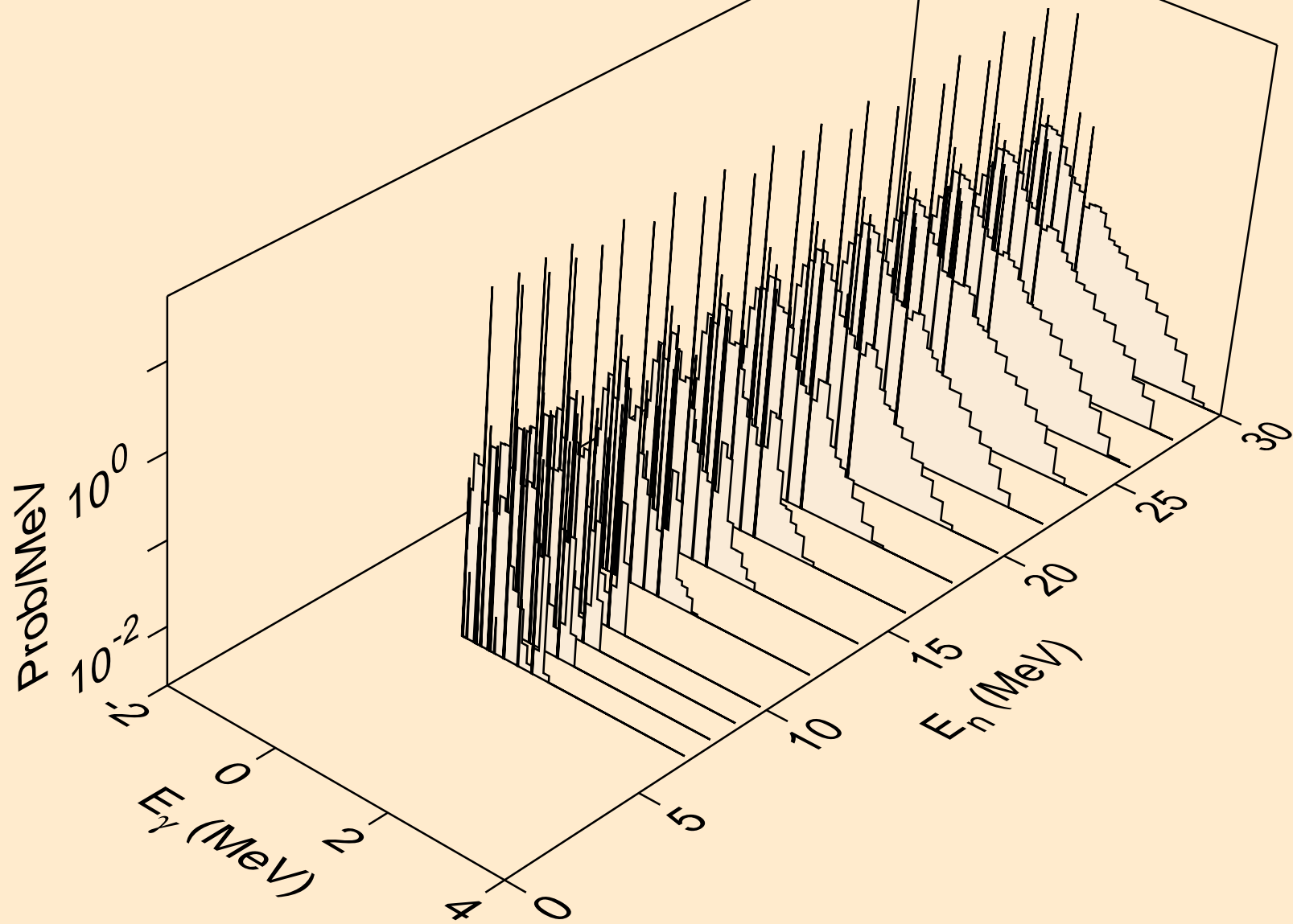

IR205 DEUTERON ACER TENDL-2023 LIBRARY; T=0.K
Photon emission for (n,3n)a

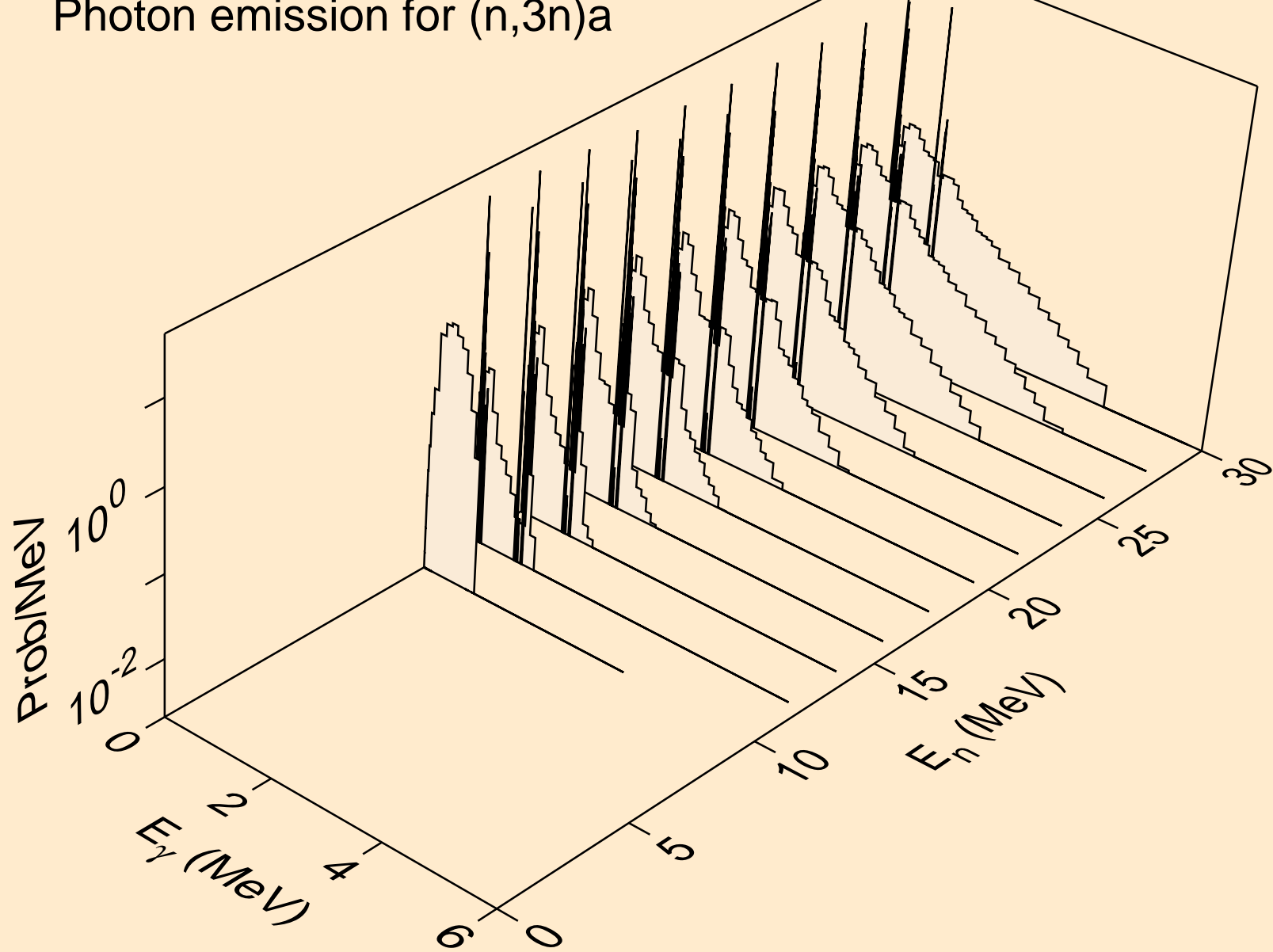

IR205 DEUTERON ACER TENDL-2023 LIBRARY; T=0.K
Photon emission for (n,n*)p

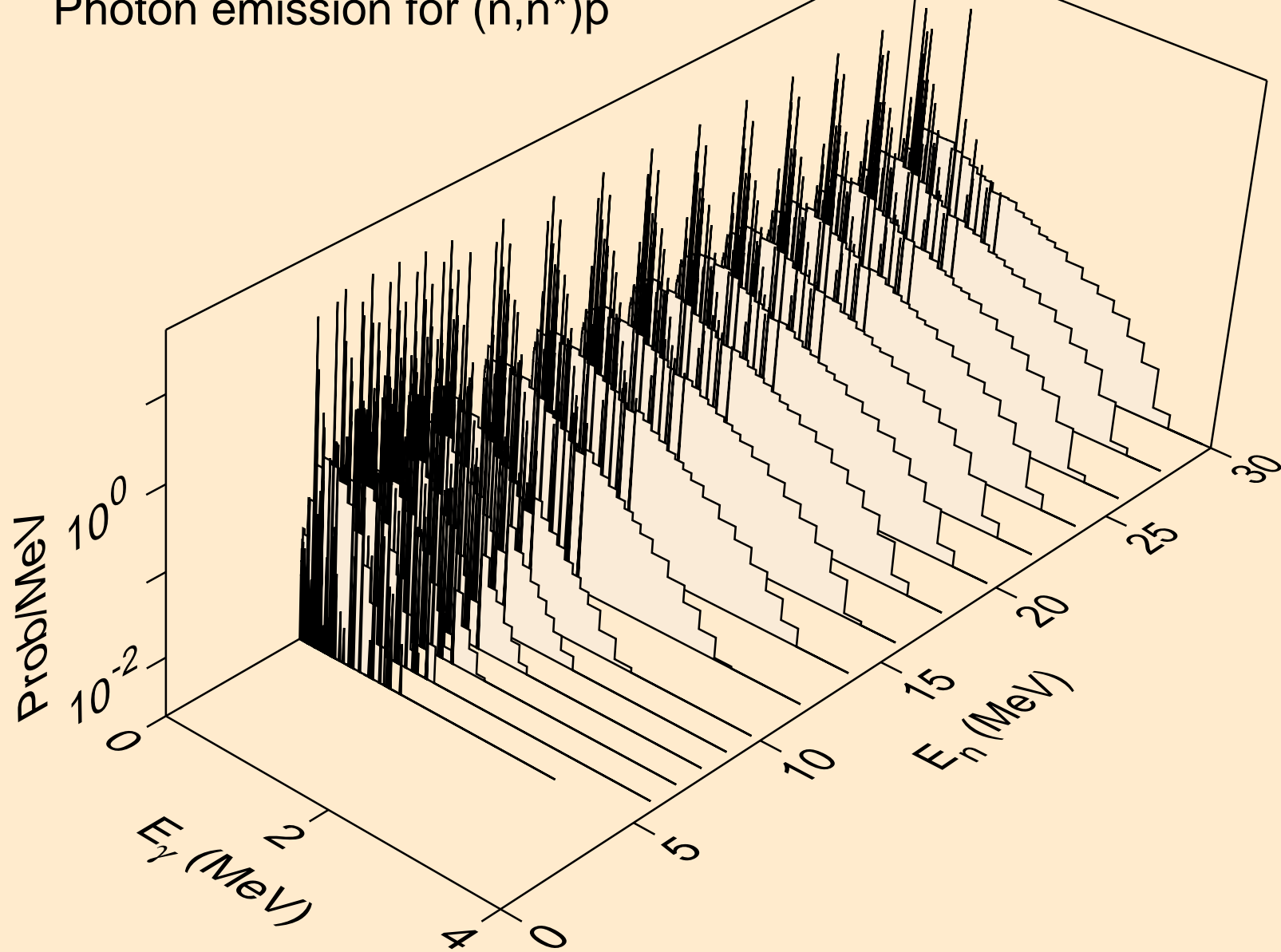

IR205 DEUTERON ACER TENDL-2023 LIBRARY; T=0.K
Photon emission for (n,n*)d

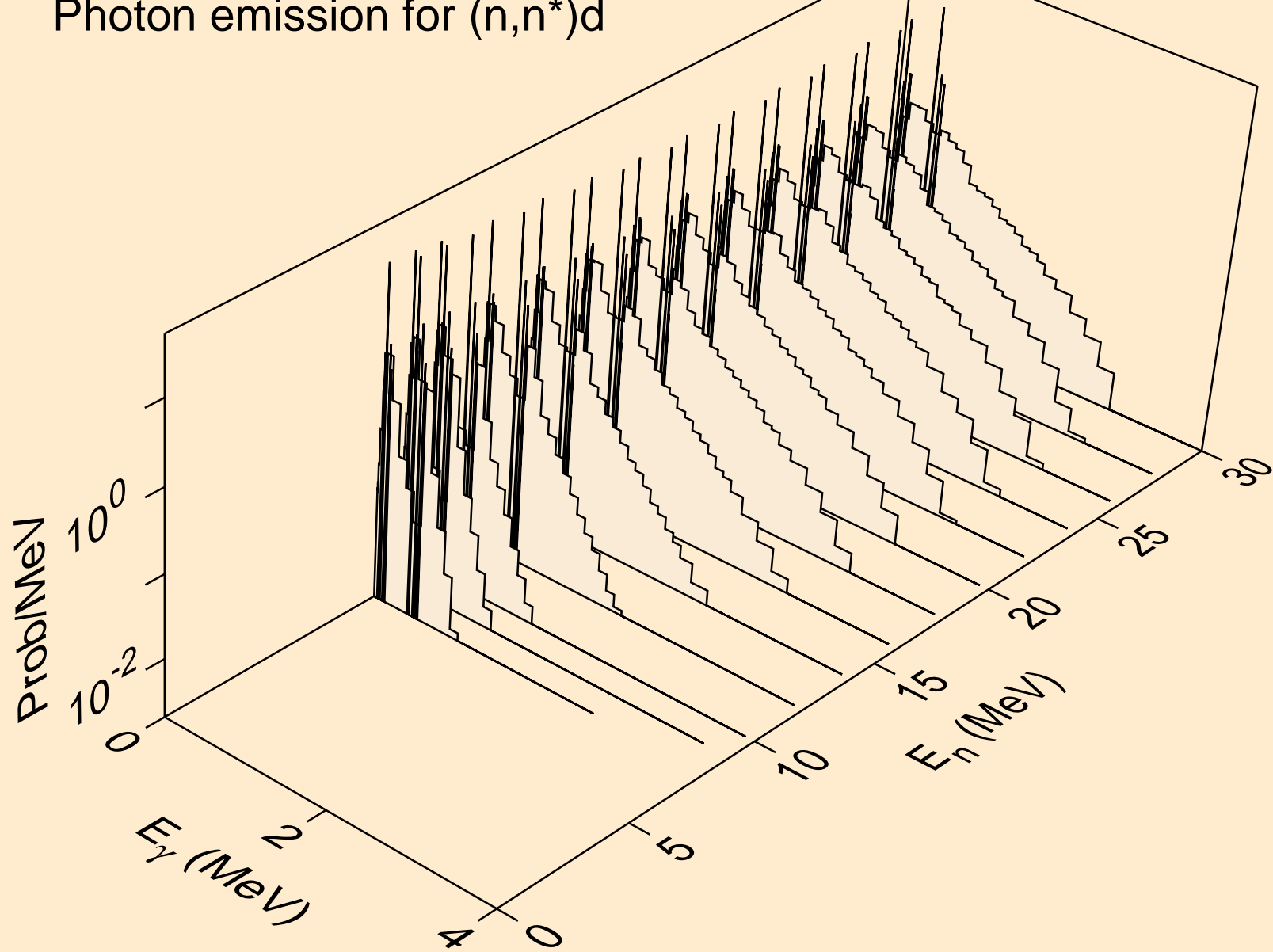

IR205 DEUTERON ACER TENDL-2023 LIBRARY; T=0.K
Photon emission for (n,n*)t

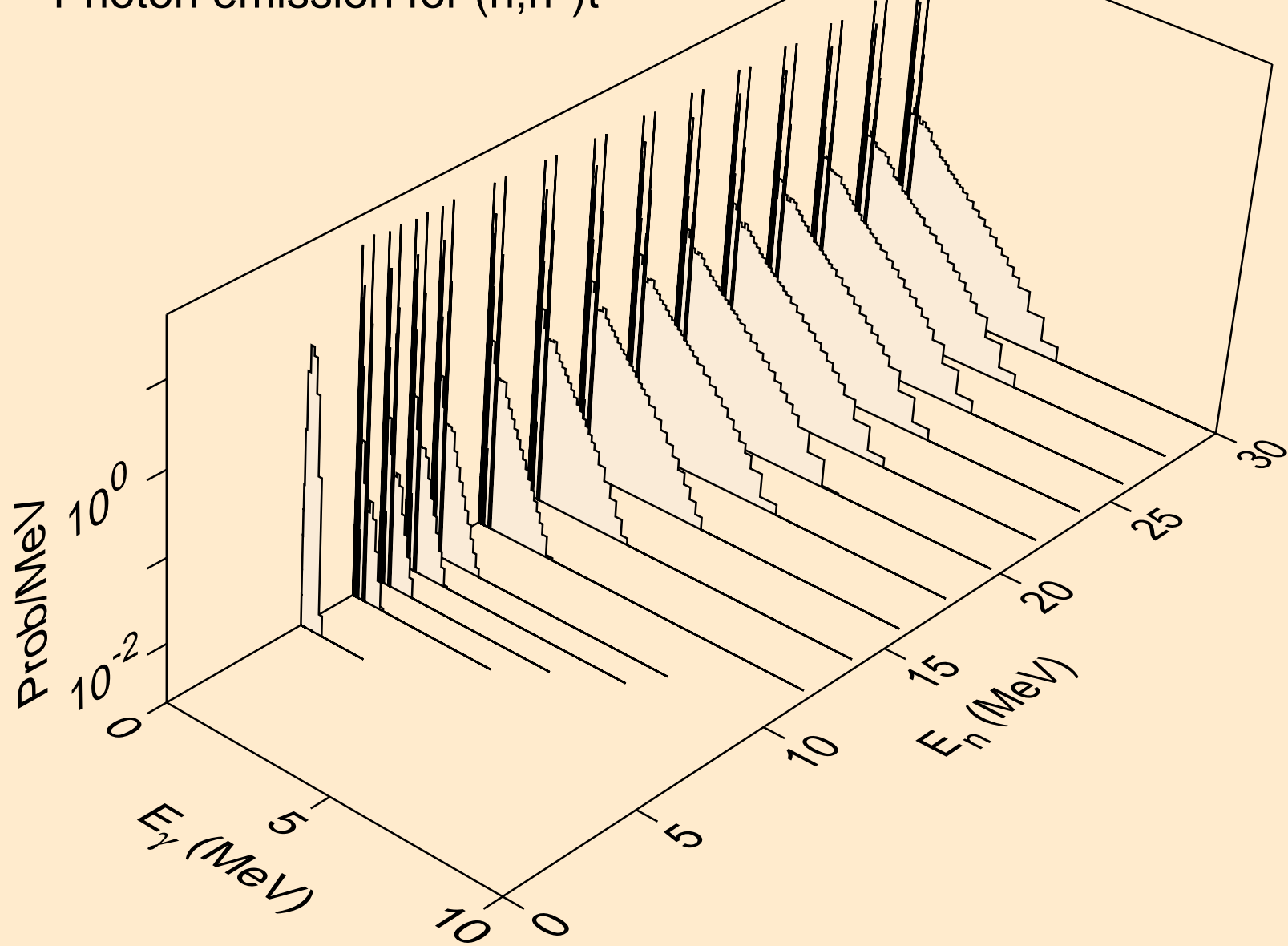

IR205 DEUTERON ACER TENDL-2023 LIBRARY; T=0.K
Photon emission for (n,n*)he3

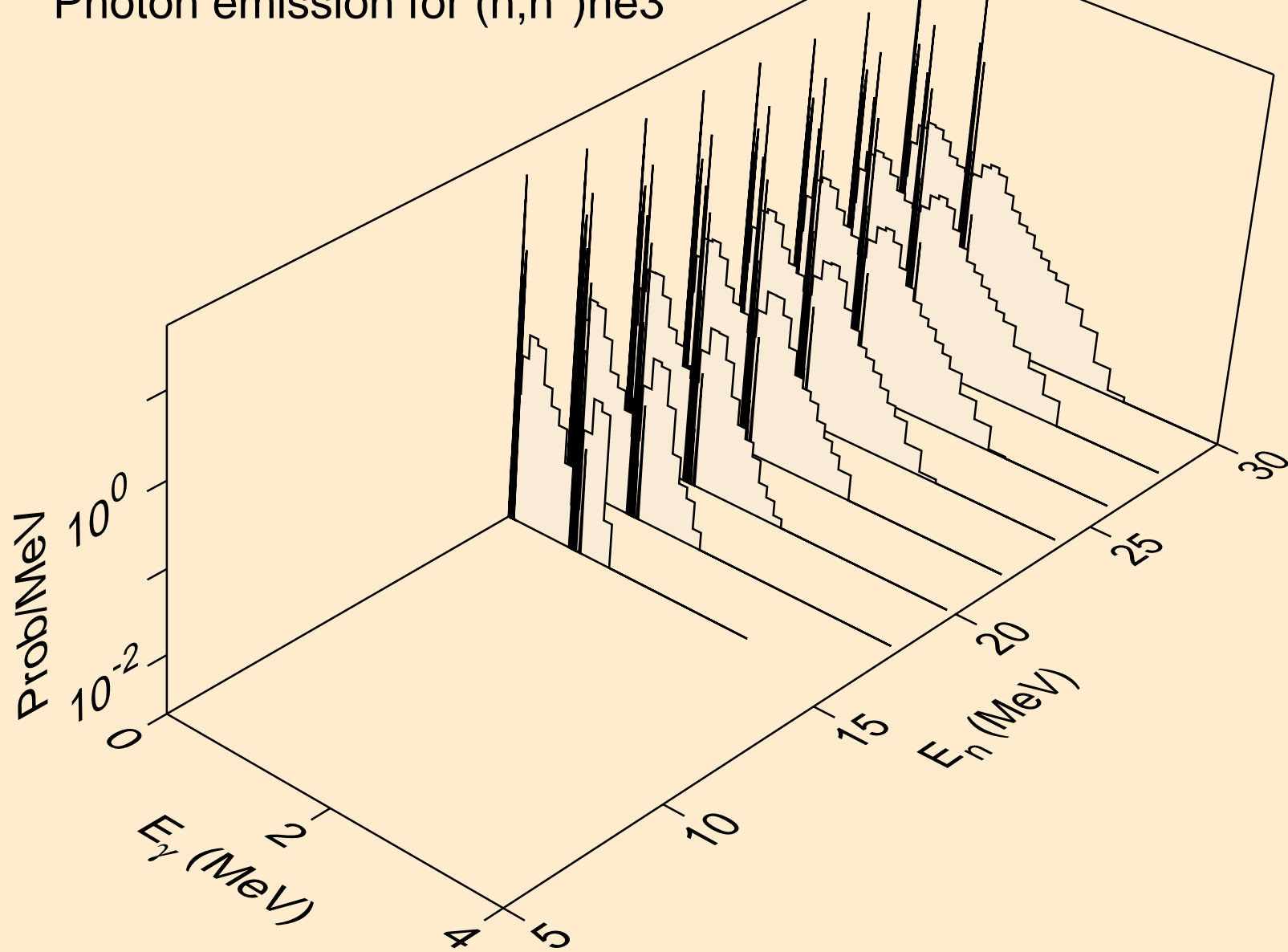

IR205 DEUTERON ACER TENDL-2023 LIBRARY; T=0.K
Photon emission for (n,4n)

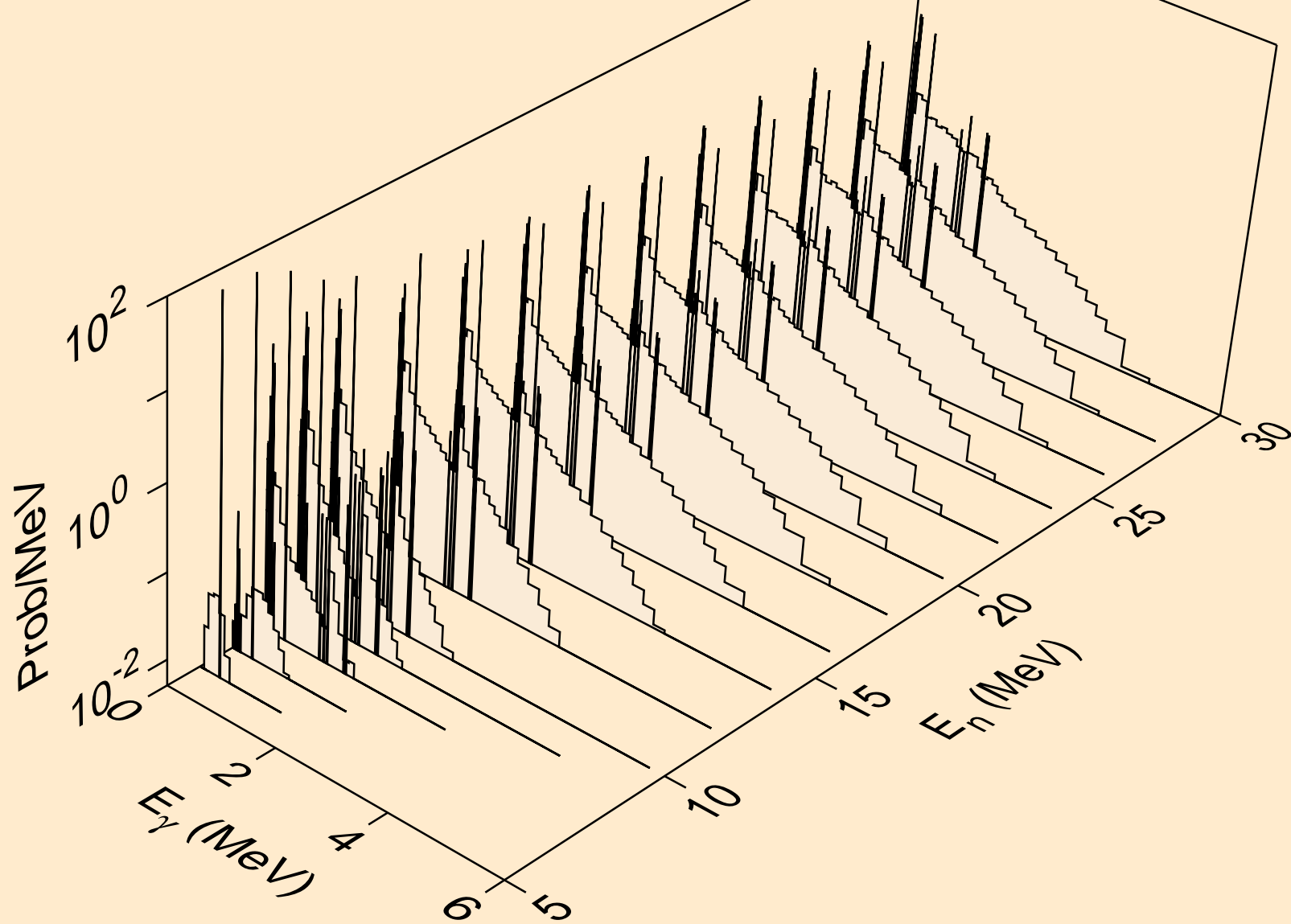

IR205 DEUTERON ACER TENDL-2023 LIBRARY; T=0.K
Photon emission for (n,2np)

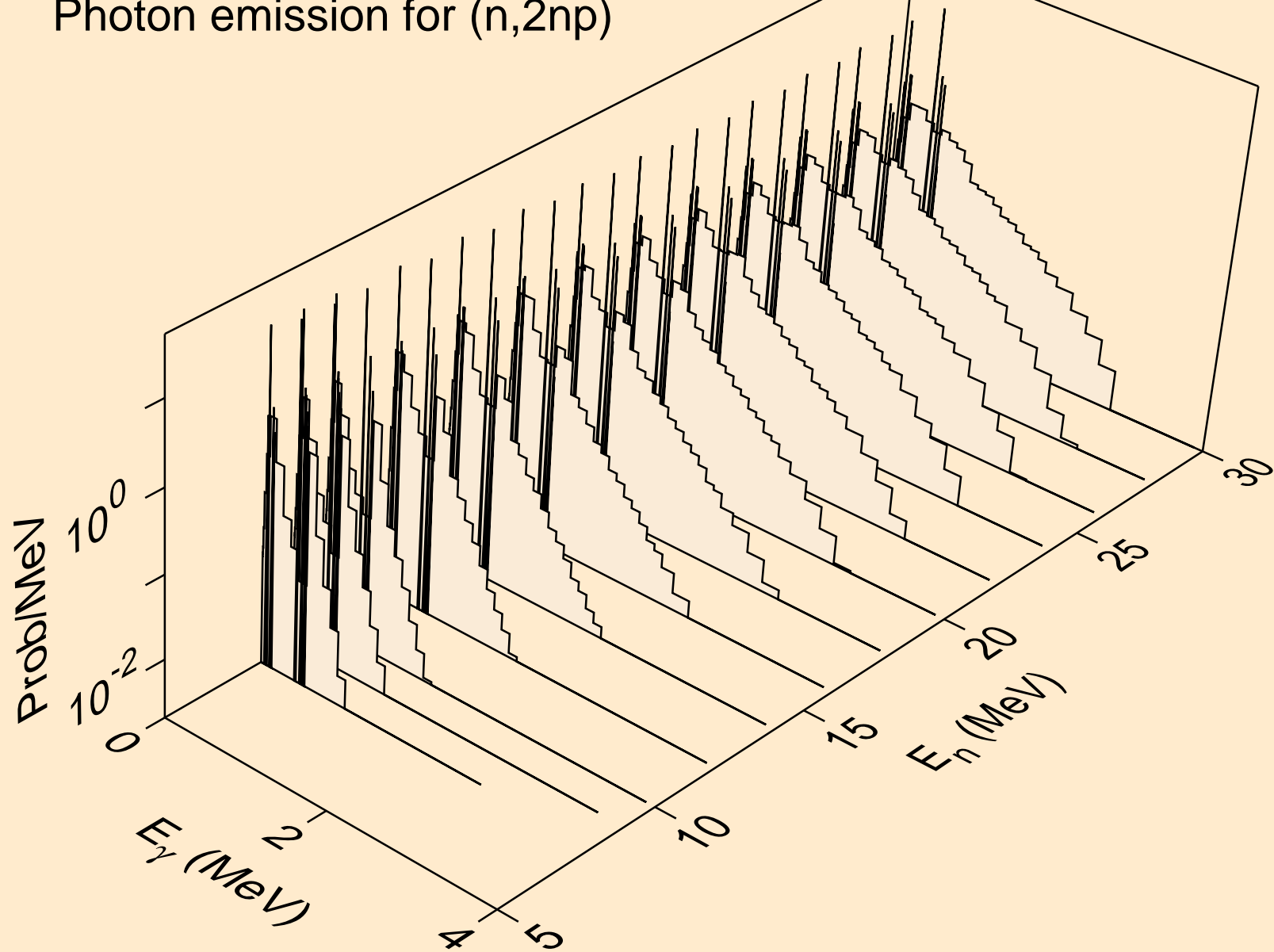

IR205 DEUTERON ACER TENDL-2023 LIBRARY; T=0.K
Photon emission for (n,3np)

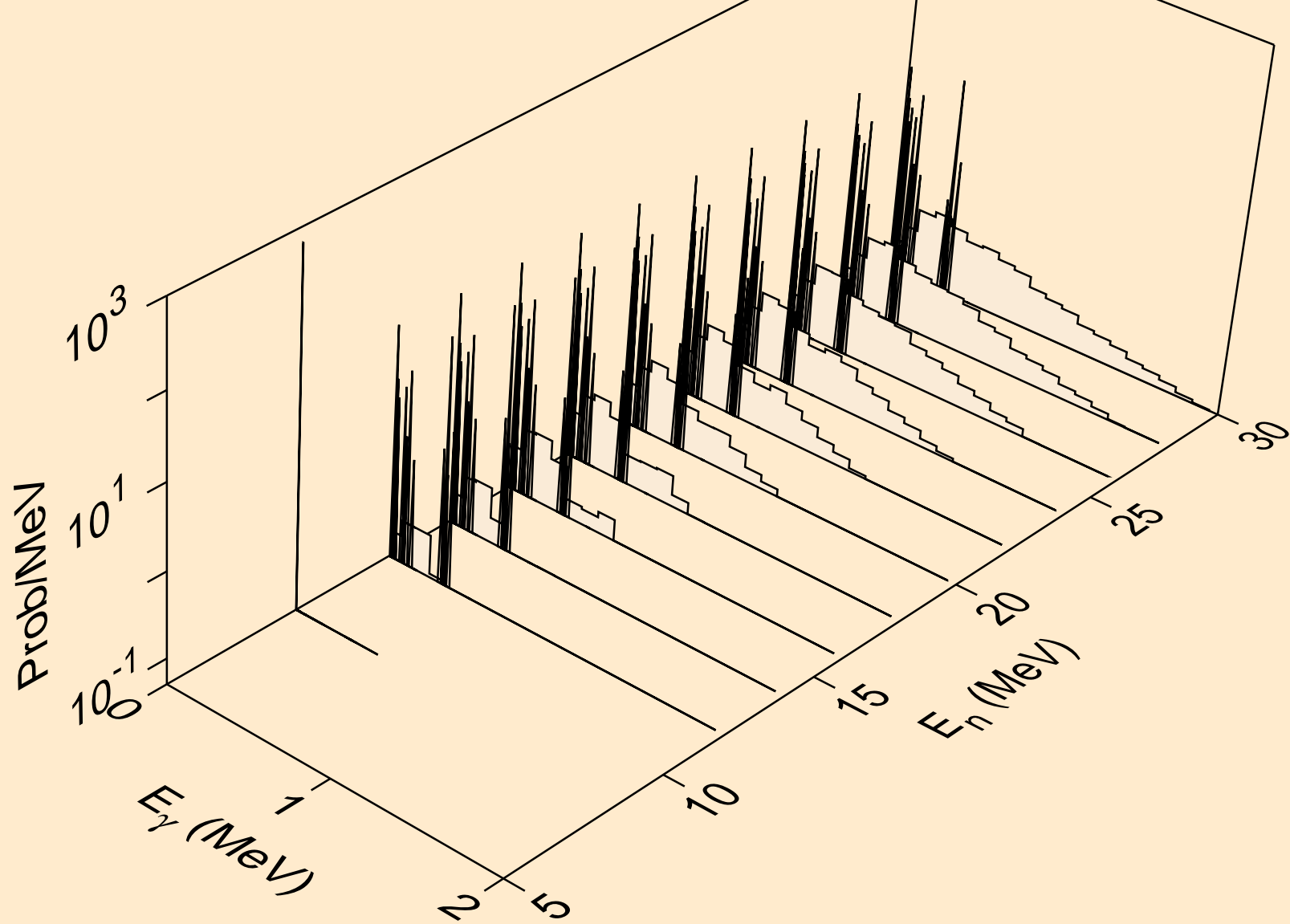

IR205 DEUTERON ACER TENDL-2023 LIBRARY; T=0.K
Photon emission for (n,n2p)

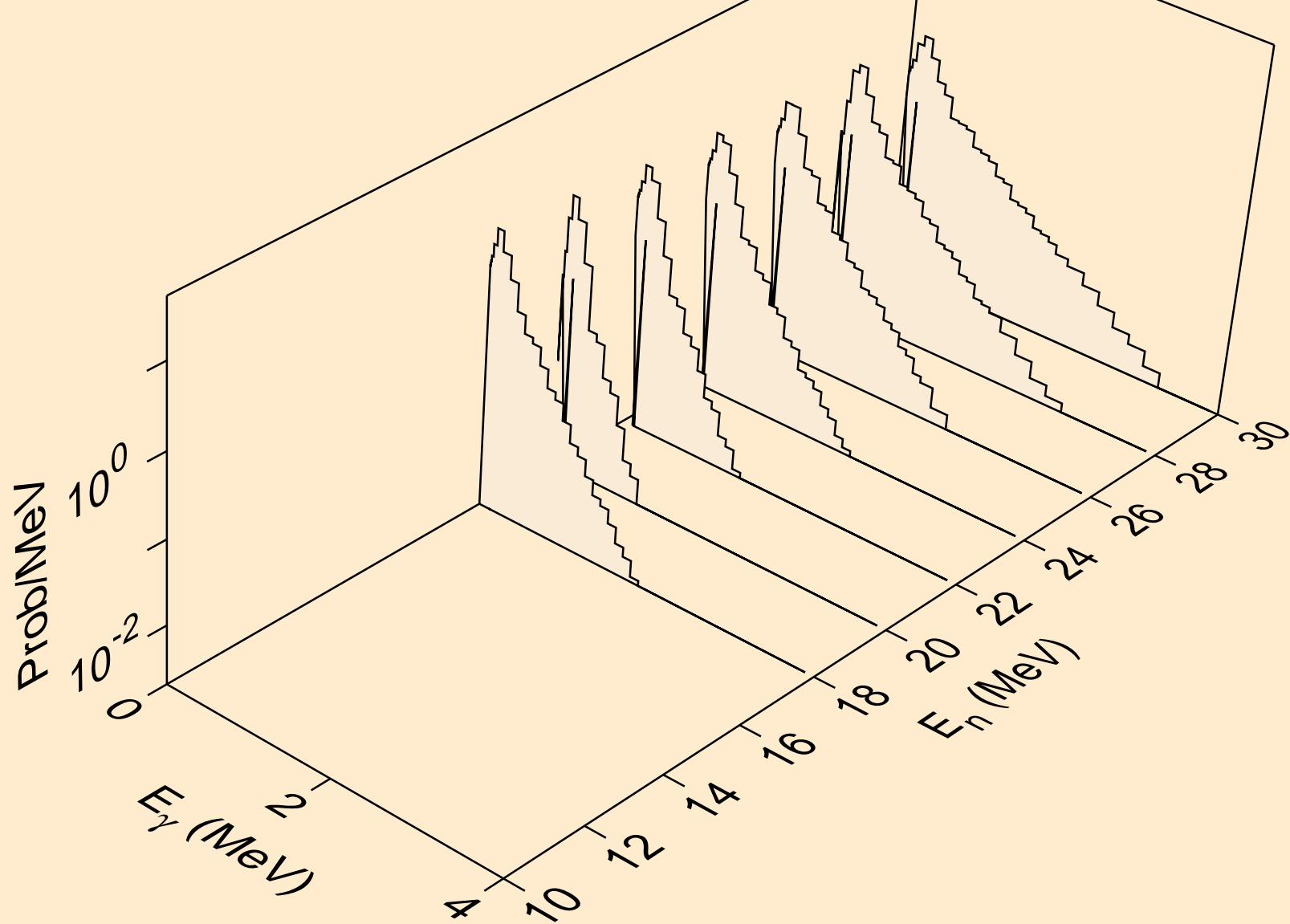

IR205 DEUTERON ACER TENDL-2023 LIBRARY; T=0.K
Photon emission for (n,gma)

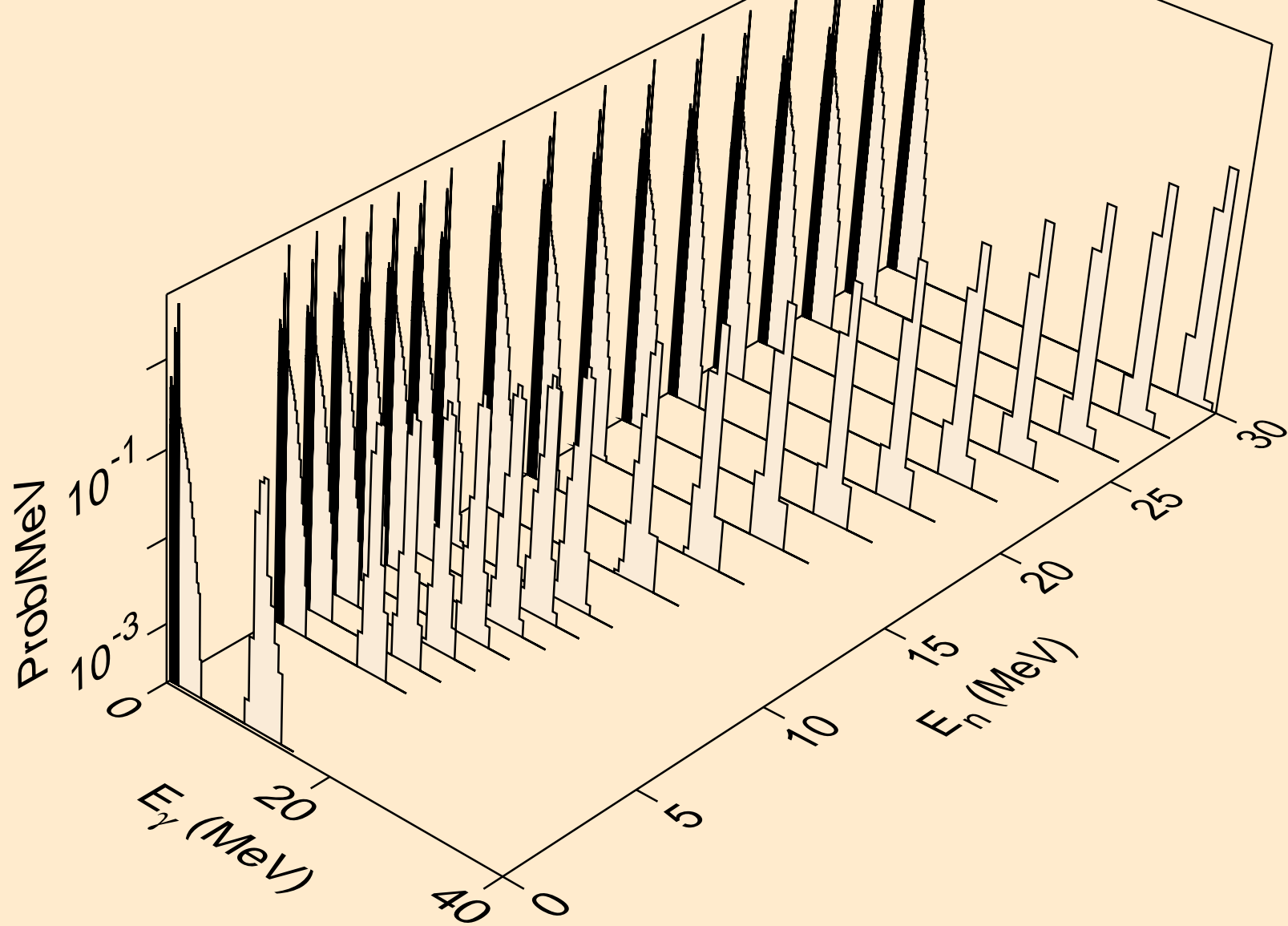

IR205 DEUTERON ACER TENDL-2023 LIBRARY; T=0.K
Photon emission for (n,p)

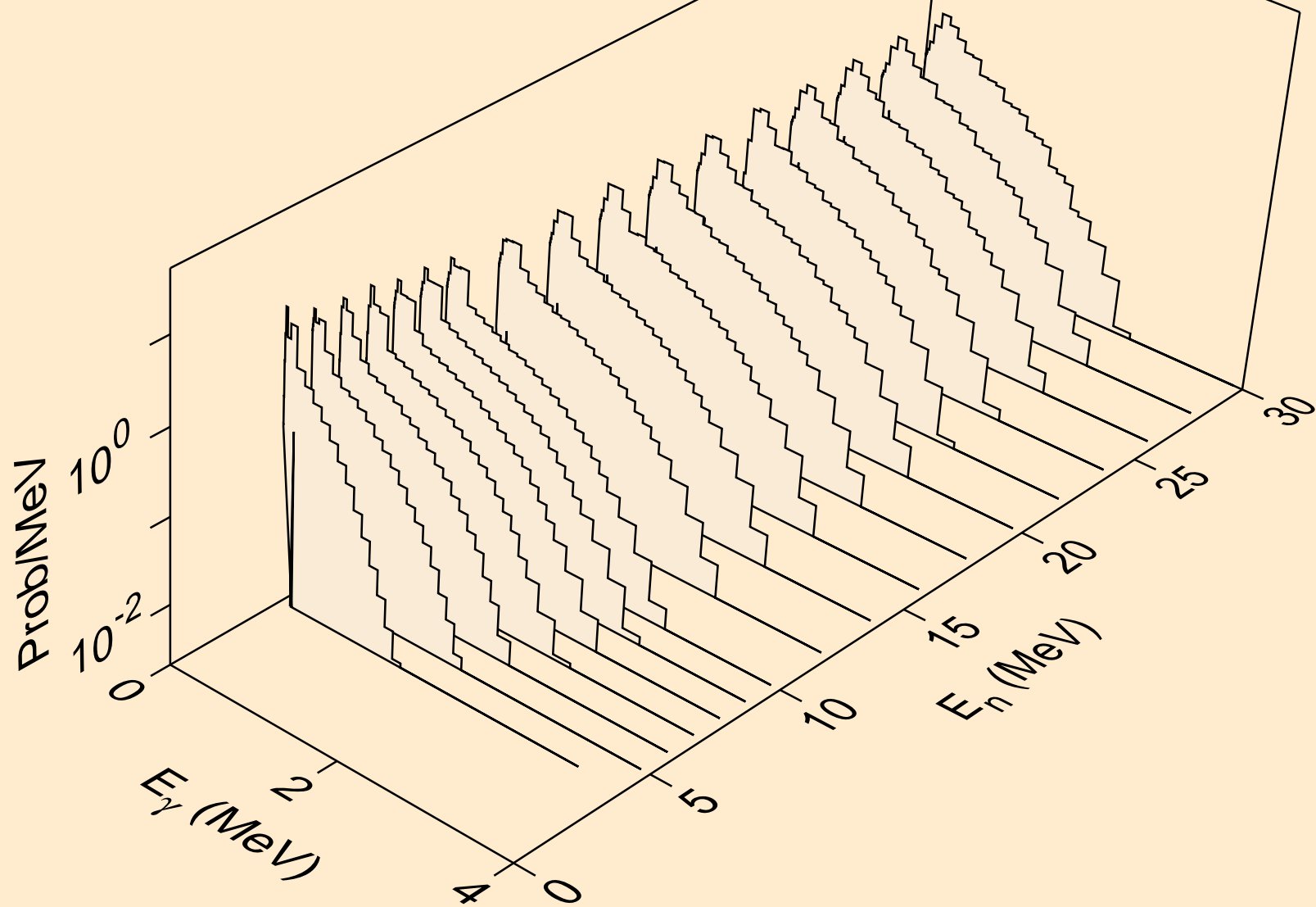

IR205 DEUTERON ACER TENDL-2023 LIBRARY; T=0.K
Photon emission for inelastic

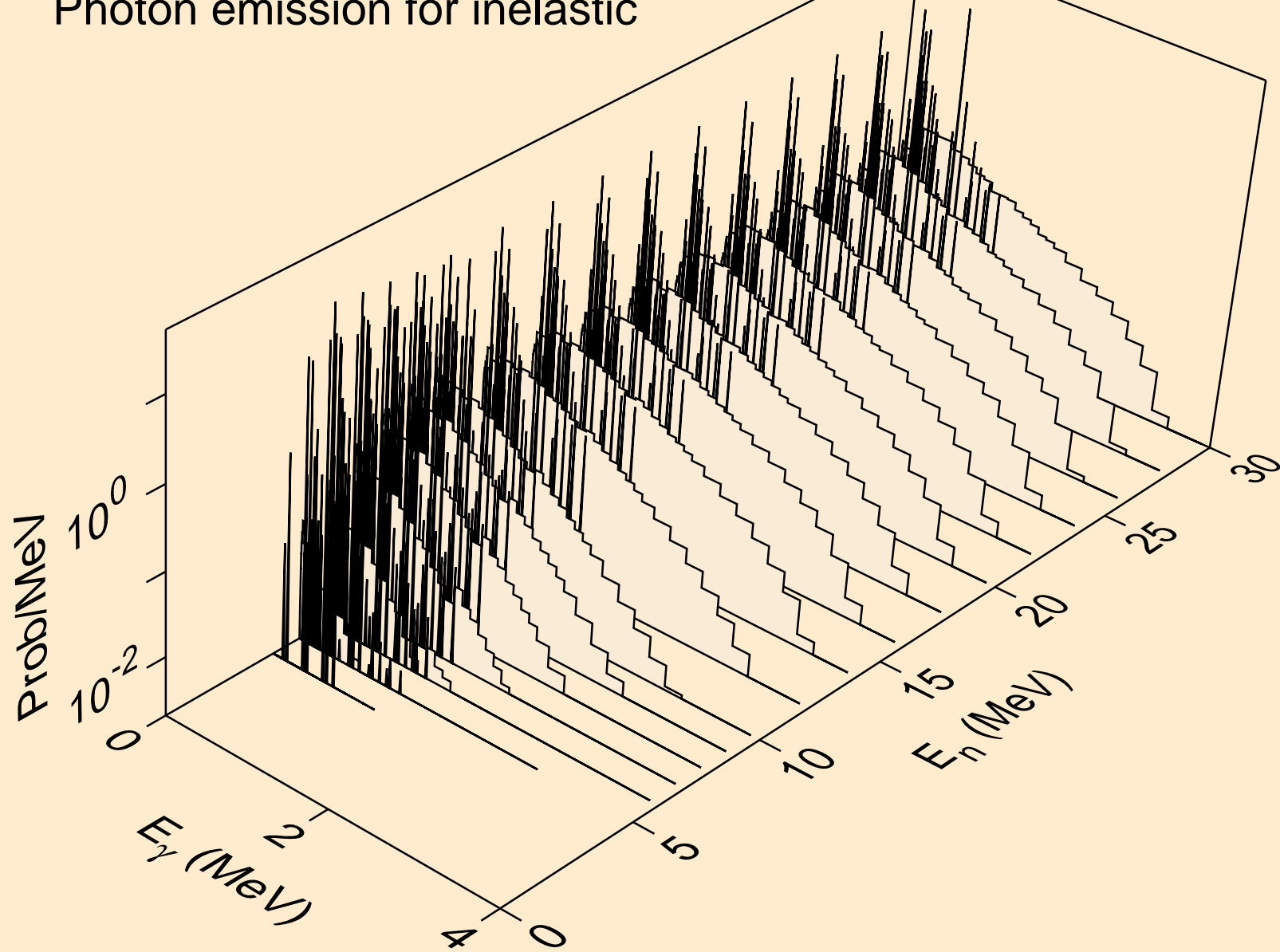

IR205 DEUTERON ACER TENDL-2023 LIBRARY; T=0.K
Photon emission for (n,t)

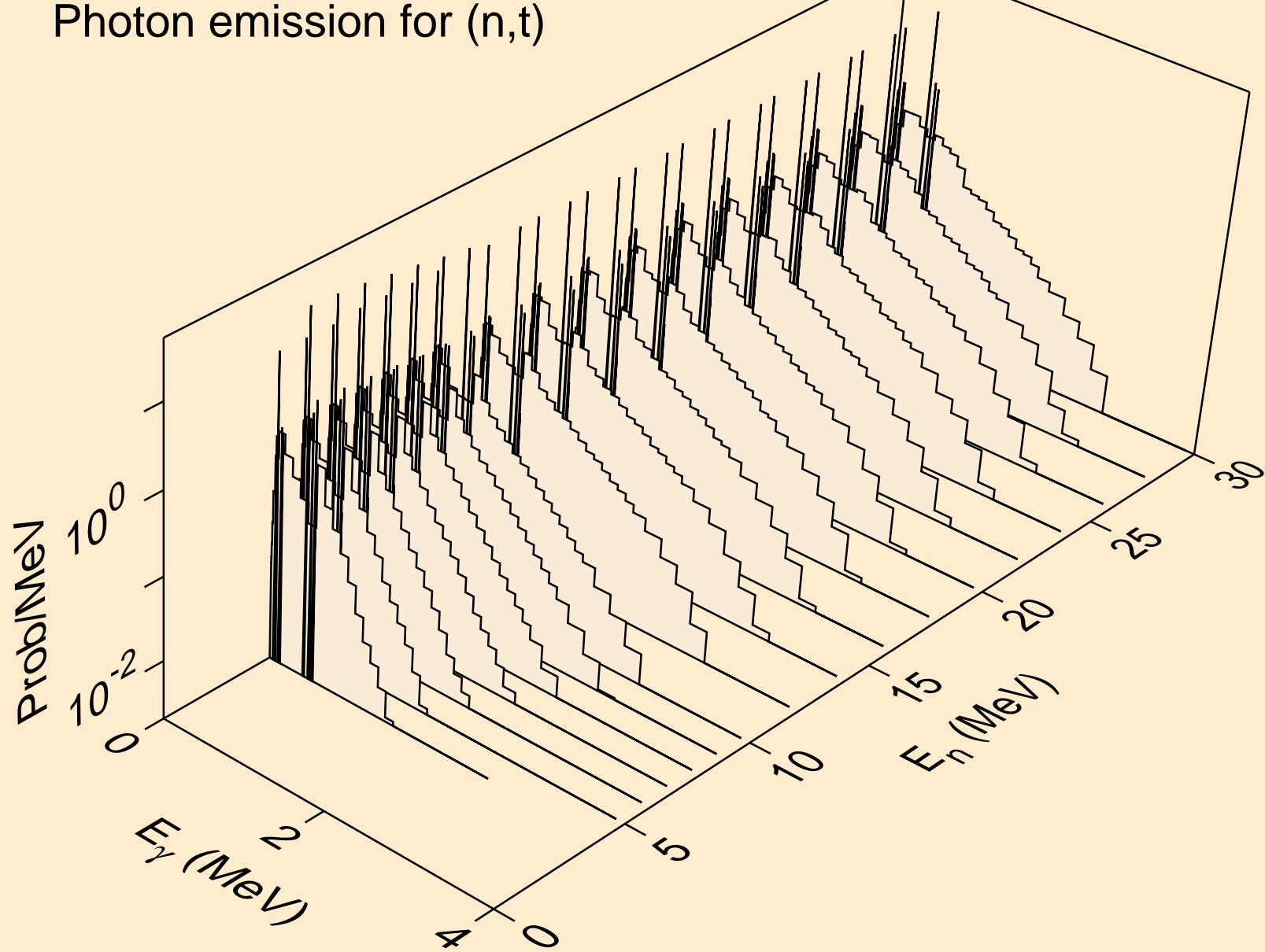

IR205 DEUTERON ACER TENDL-2023 LIBRARY; T=0.K
Photon emission for (n,he3)

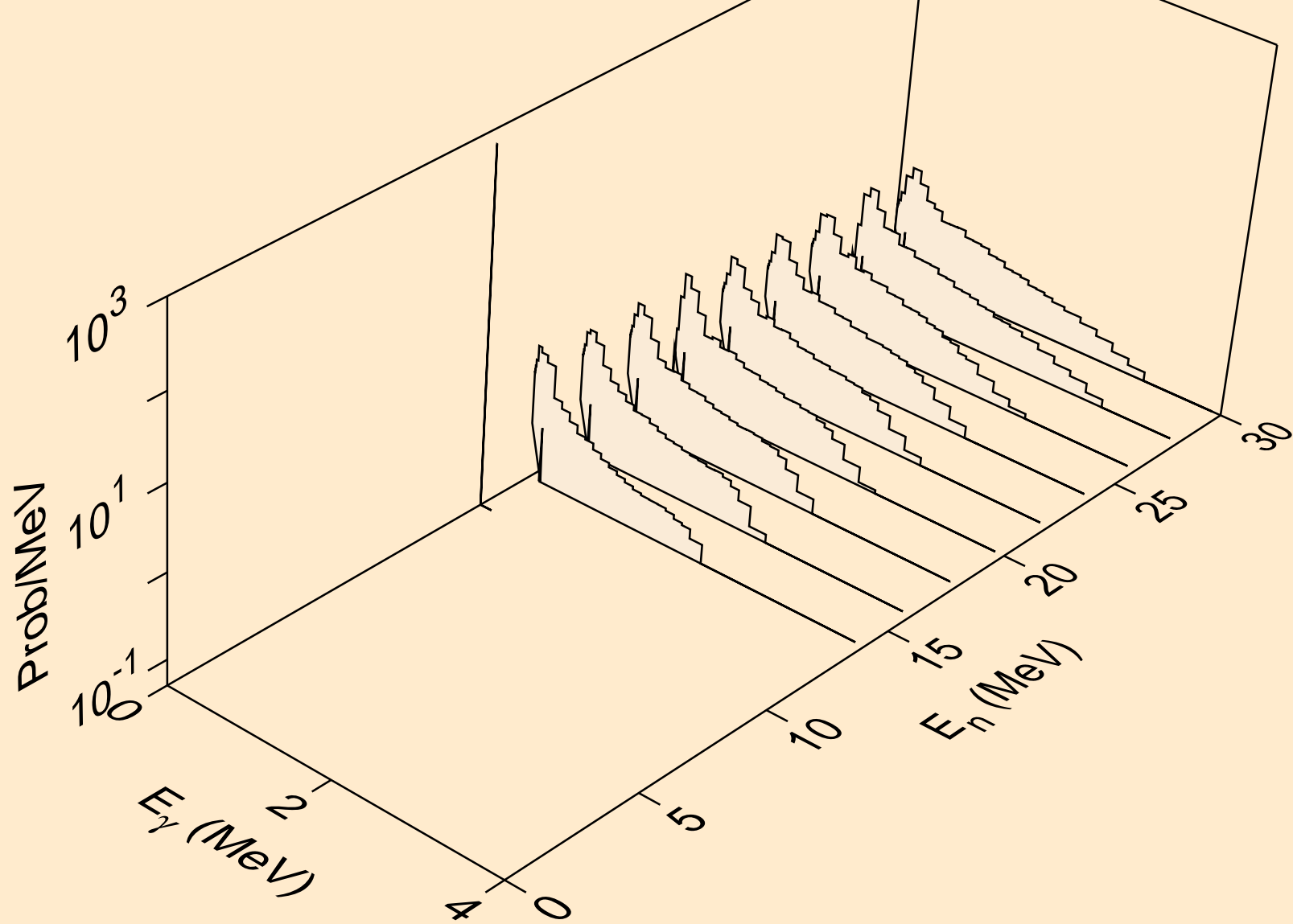

IR205 DEUTERON ACER TENDL-2023 LIBRARY; T=0.K
Photon emission for (n,a)

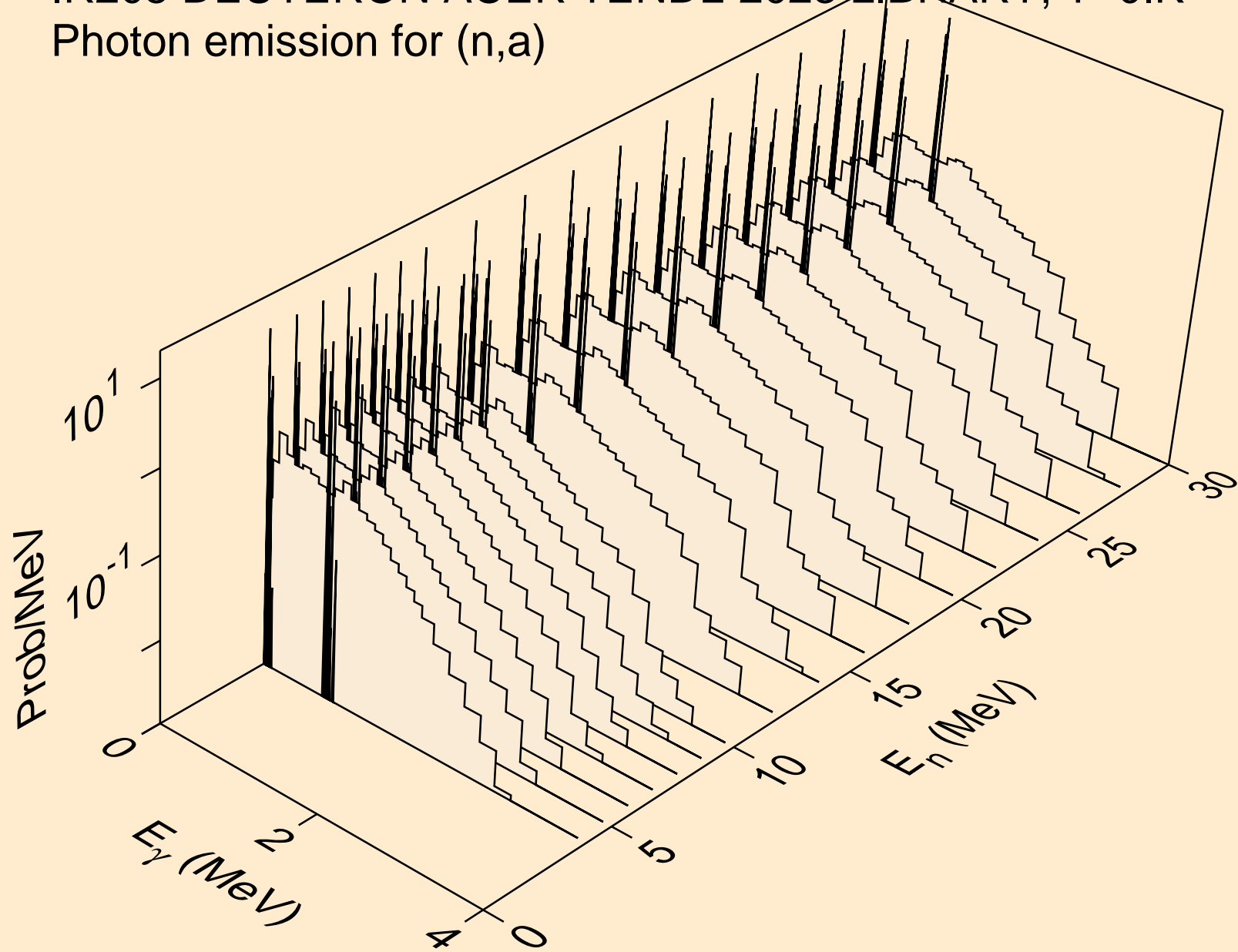

IR205 DEUTERON ACER TENDL-2023 LIBRARY; T=0.K
Photon emission for (n,2p)

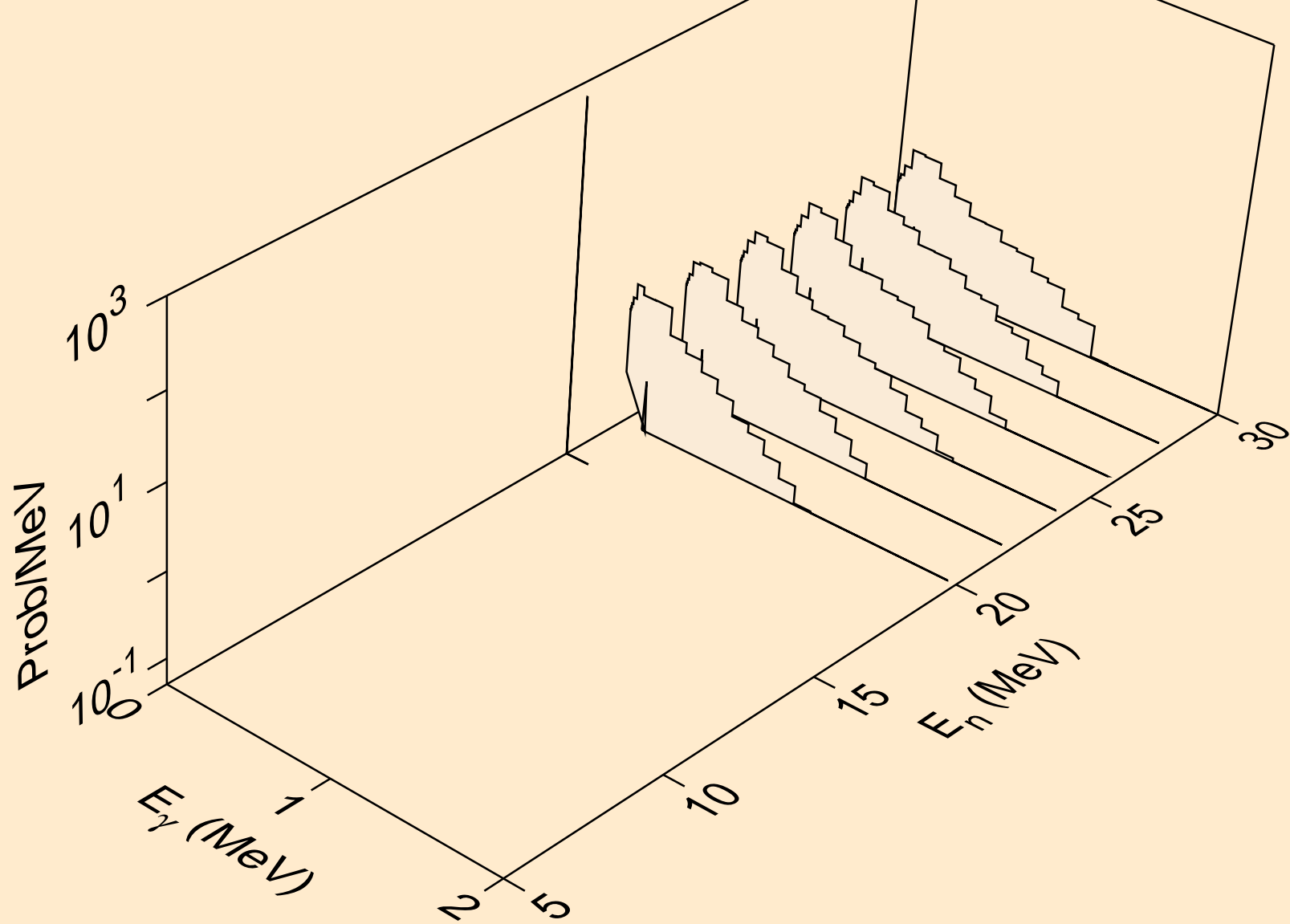

IR205 DEUTERON ACER TENDL-2023 LIBRARY; T=0.K
Photon emission for (n,pd)

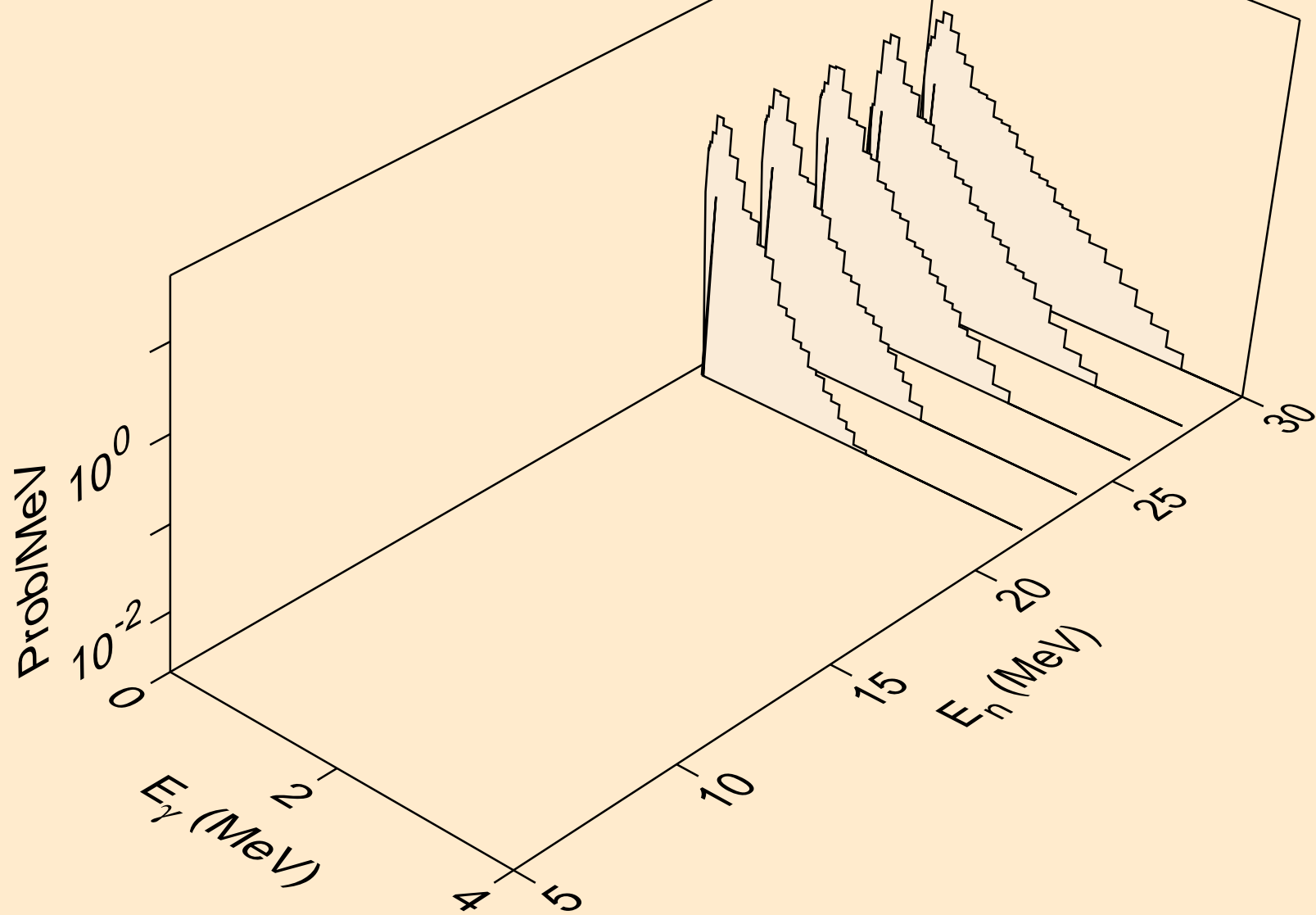

IR205 DEUTERON ACER TENDL-2023 LIBRARY; T=0.K
Particle heating contributions

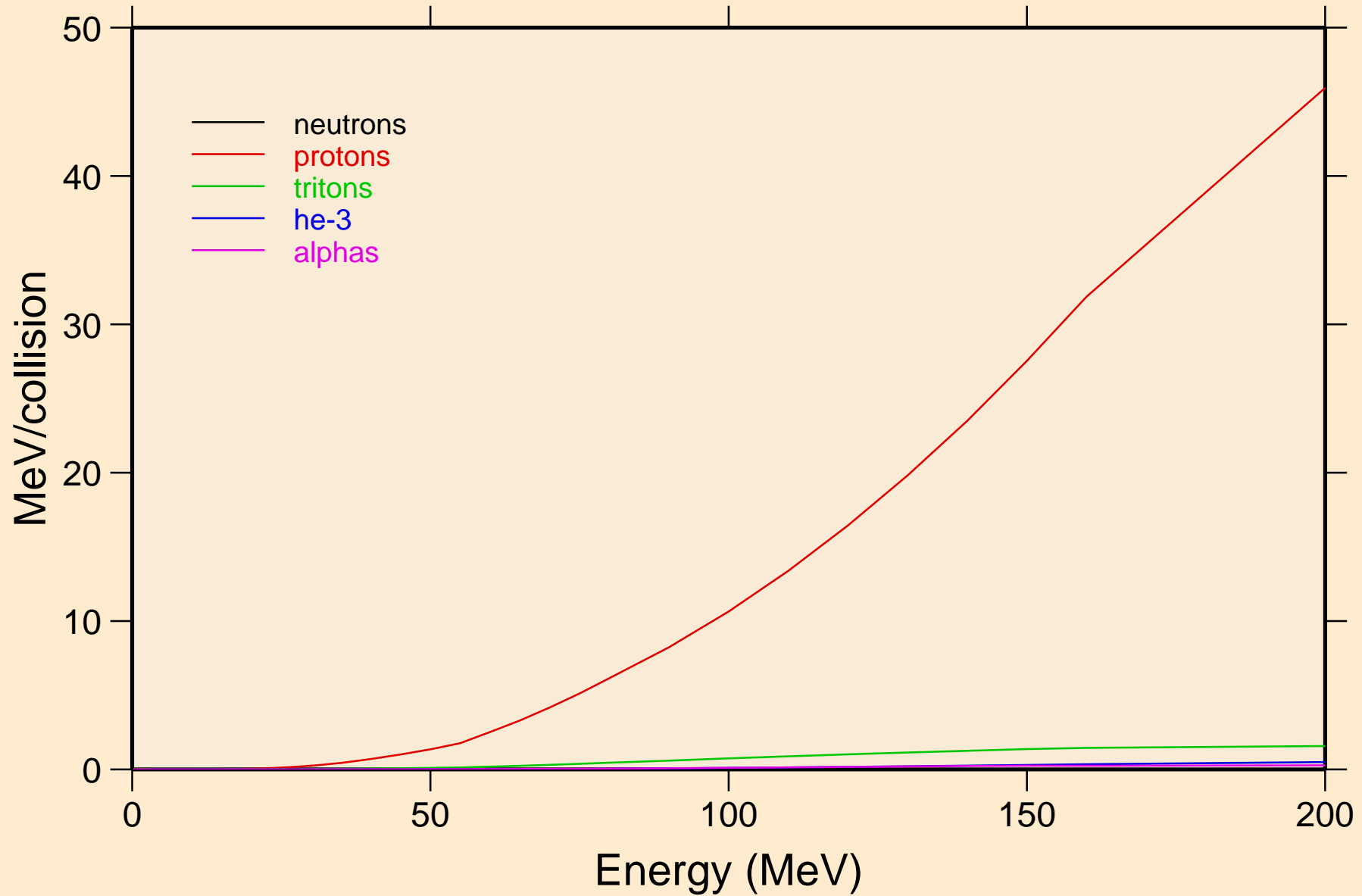

IR205 DEUTERON ACER TENDL-2023 LIBRARY; T=0.K
Recoil Heating

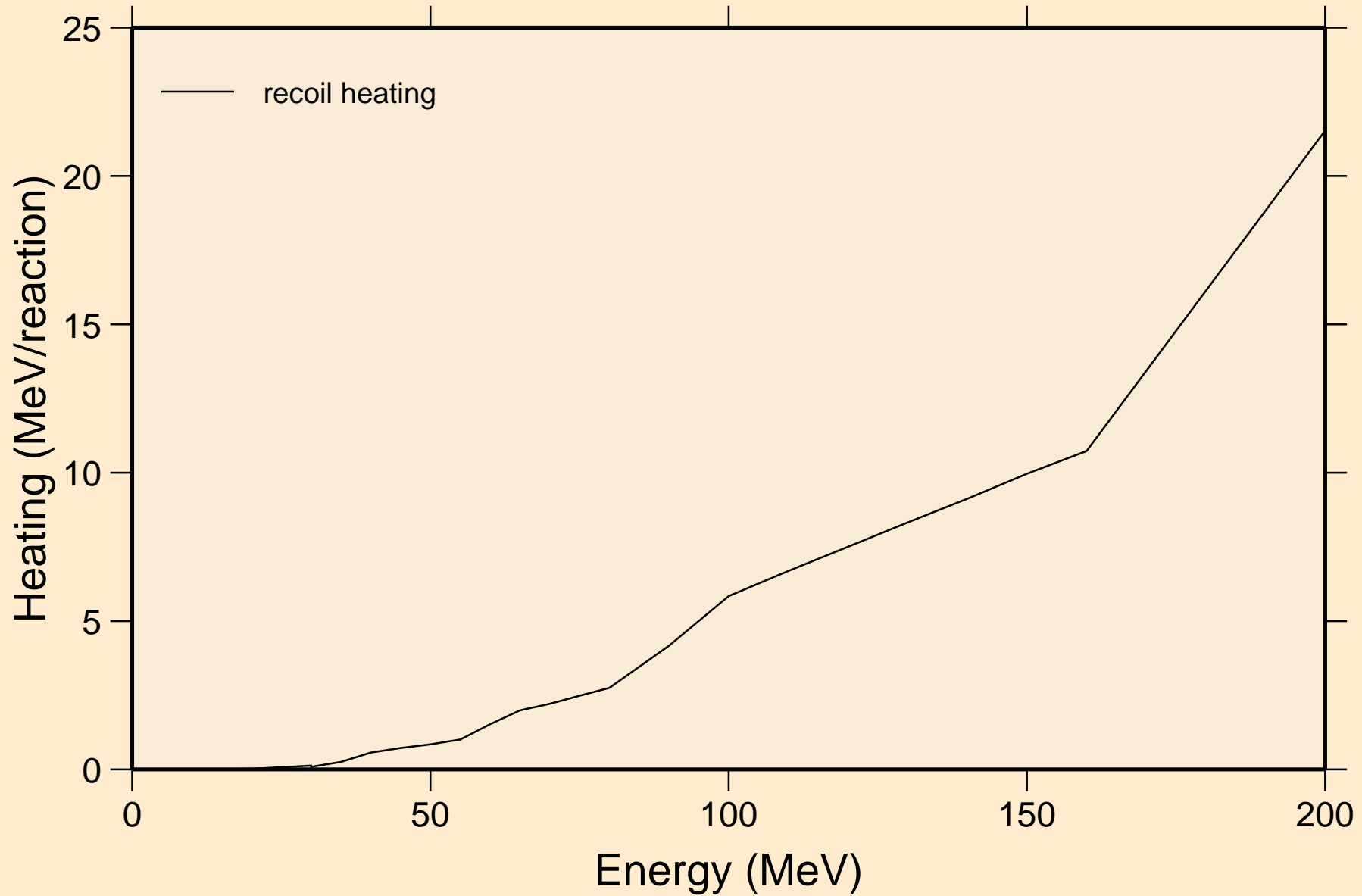

IR205 DEUTERON ACER TENDL-2023 LIBRARY; T=0.K
Particle production cross sections

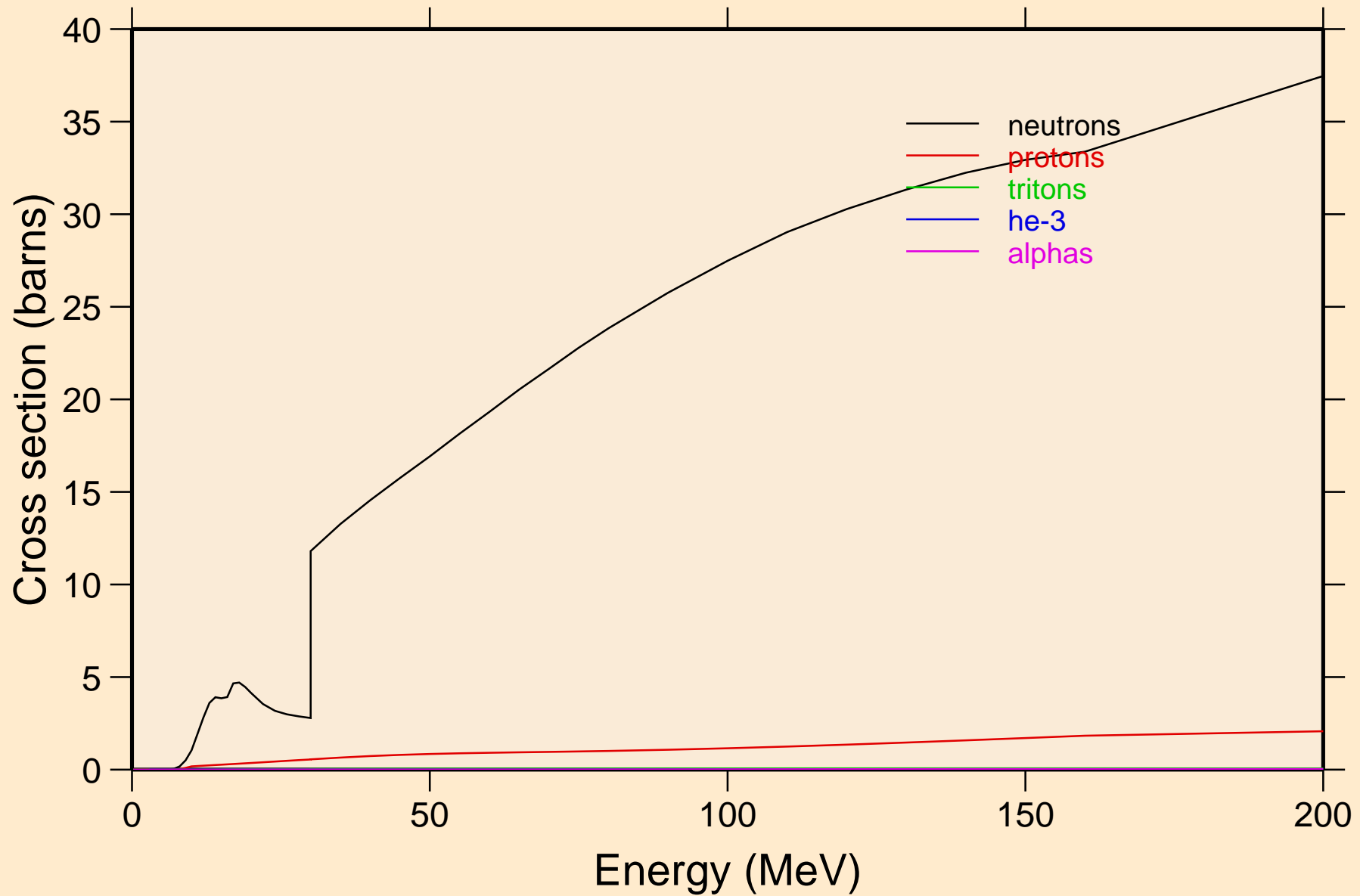

IR205 DEUTERON ACER TENDL-2023 LIBRARY; T=0.K
neutrons from (d,n)

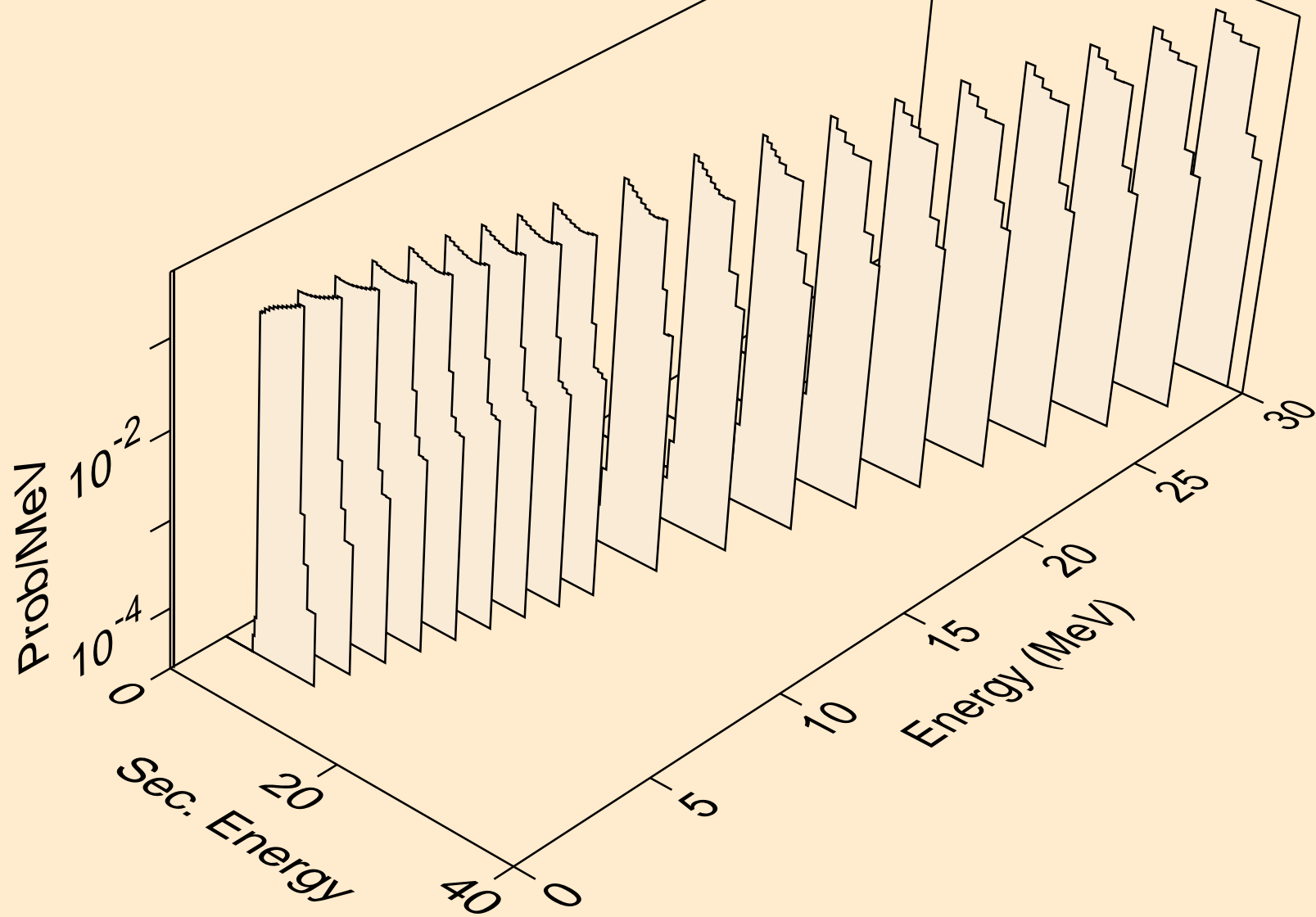

IR205 DEUTERON ACER TENDL-2023 LIBRARY; T=0.K
neutrons from (d,x)

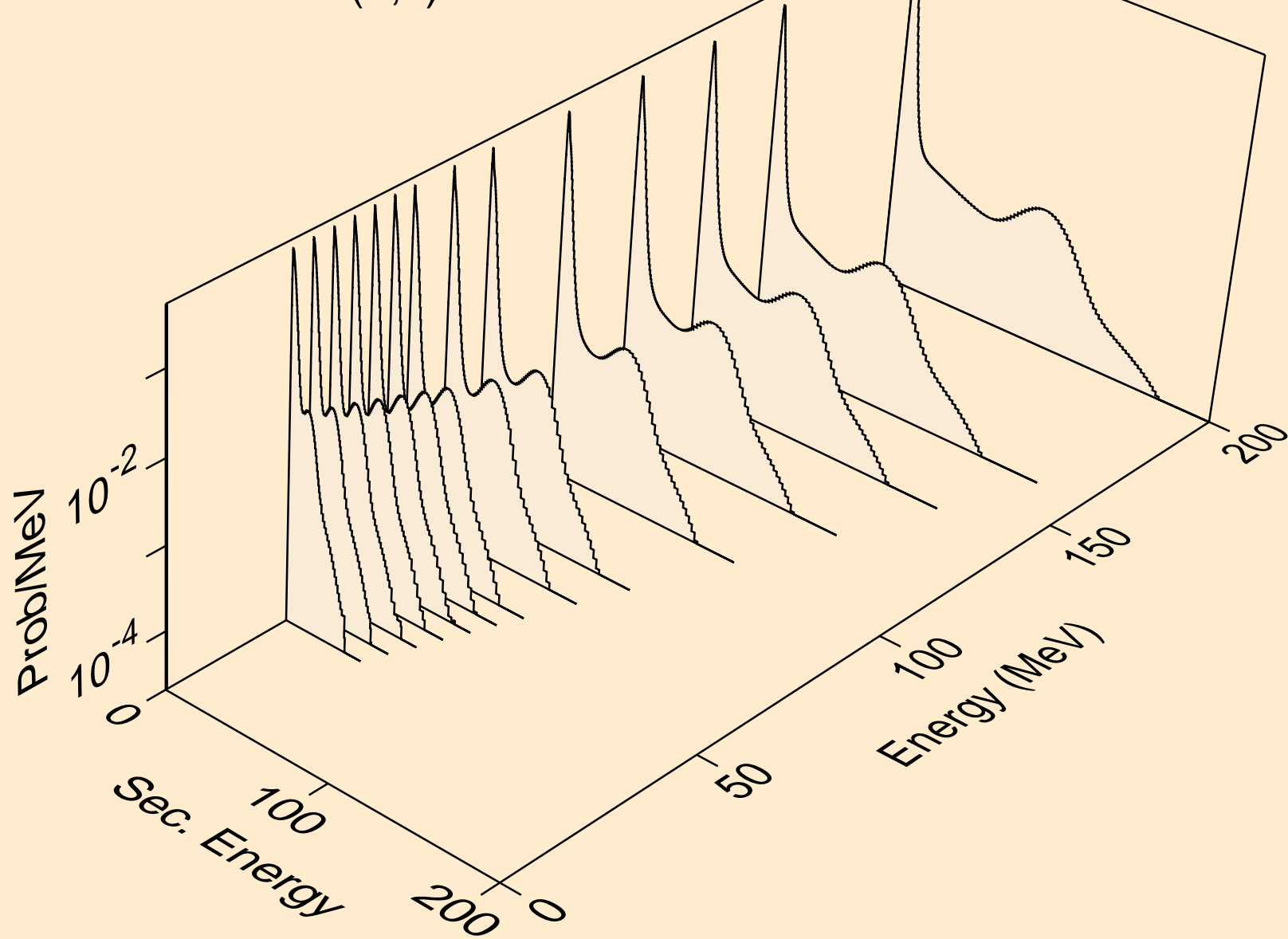

IR205 DEUTERON ACER TENDL-2023 LIBRARY; T=0.K
neutrons from (d,2nd)

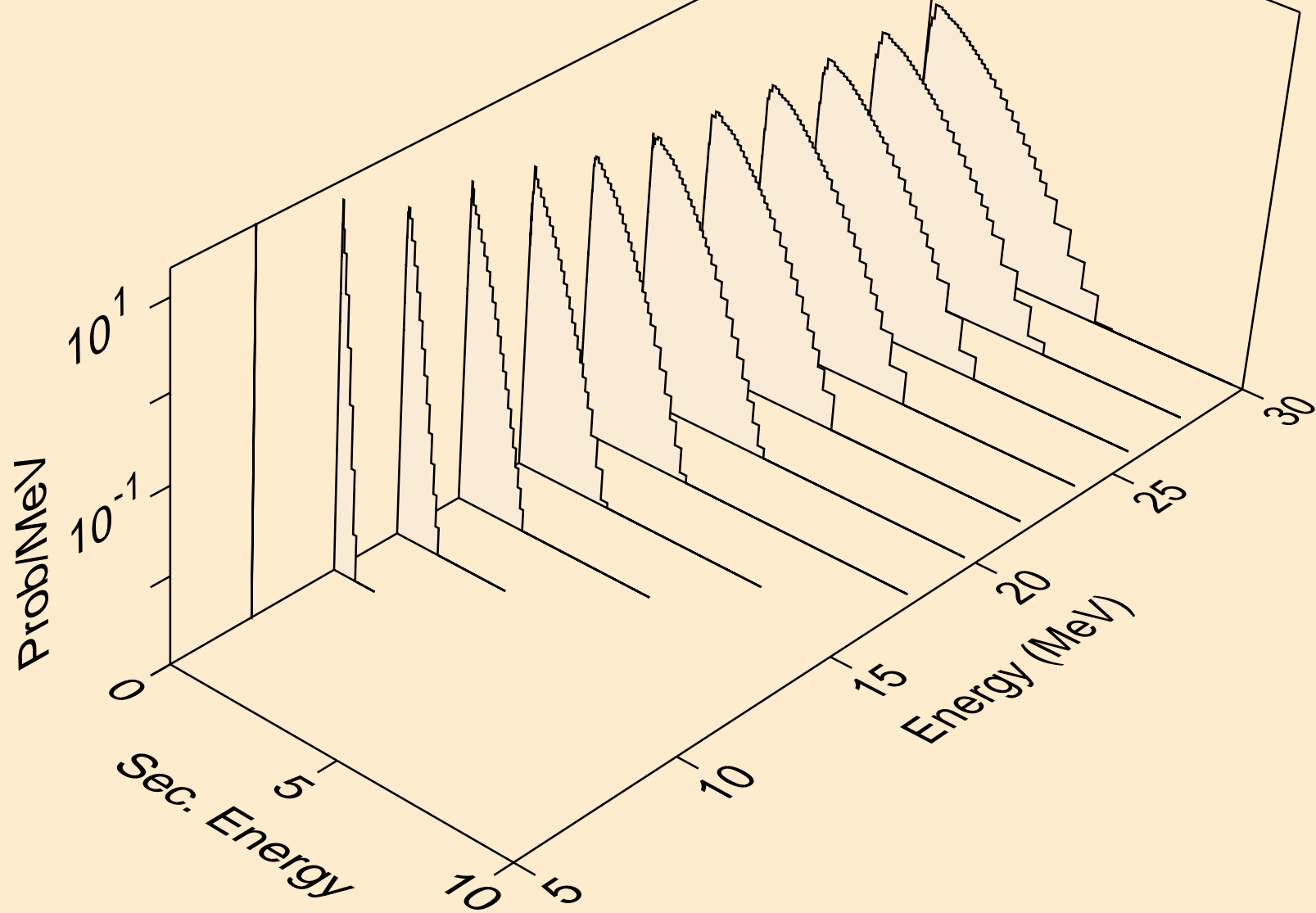

IR205 DEUTERON ACER TENDL-2023 LIBRARY; T=0.K
neutrons from (d,2n)

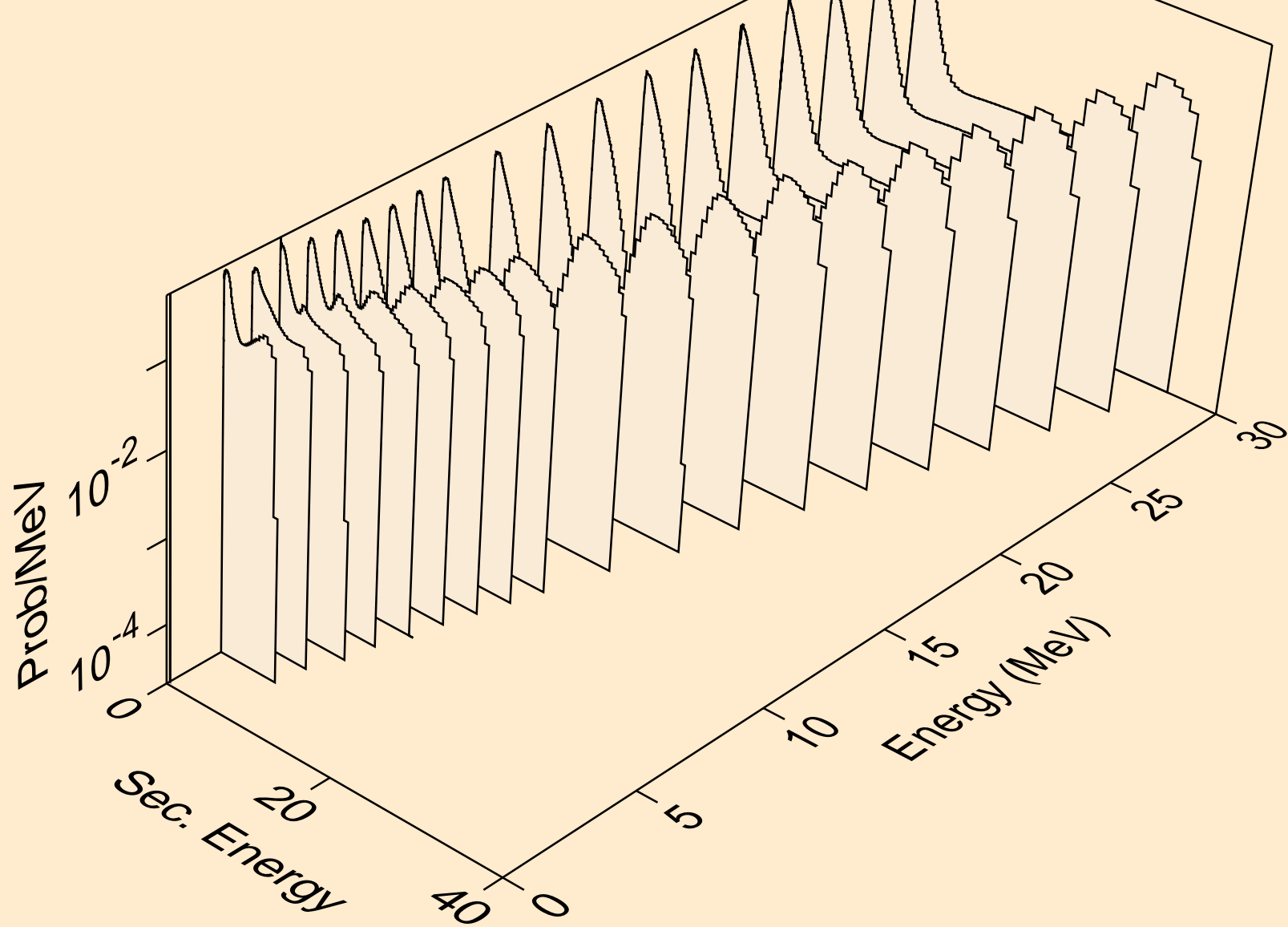

IR205 DEUTERON ACER TENDL-2023 LIBRARY; T=0.K
neutrons from (d,3n)

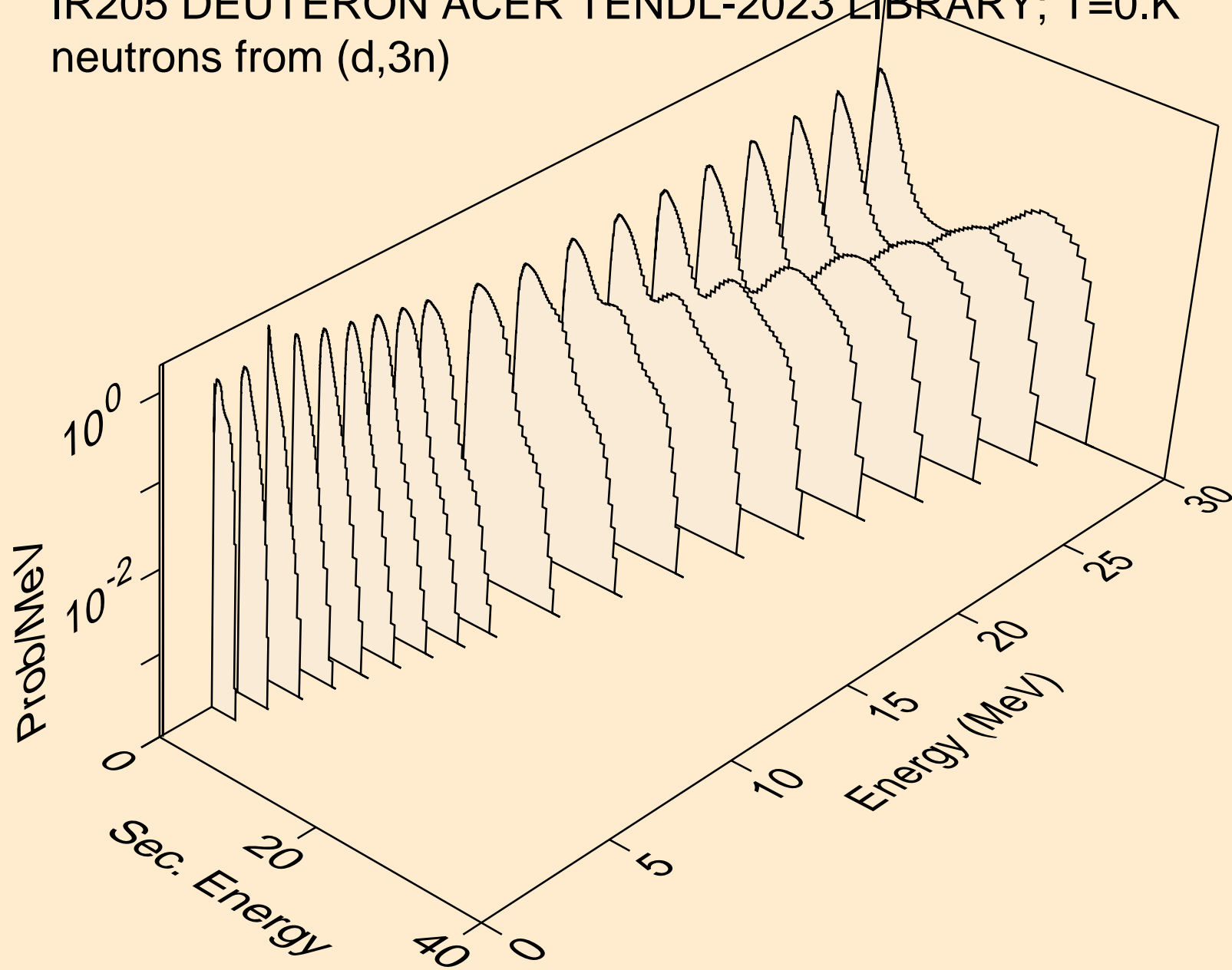

IR205 DEUTERON ACER TENDL-2023 LIBRARY; T=0.K
neutrons from (d,n*)a

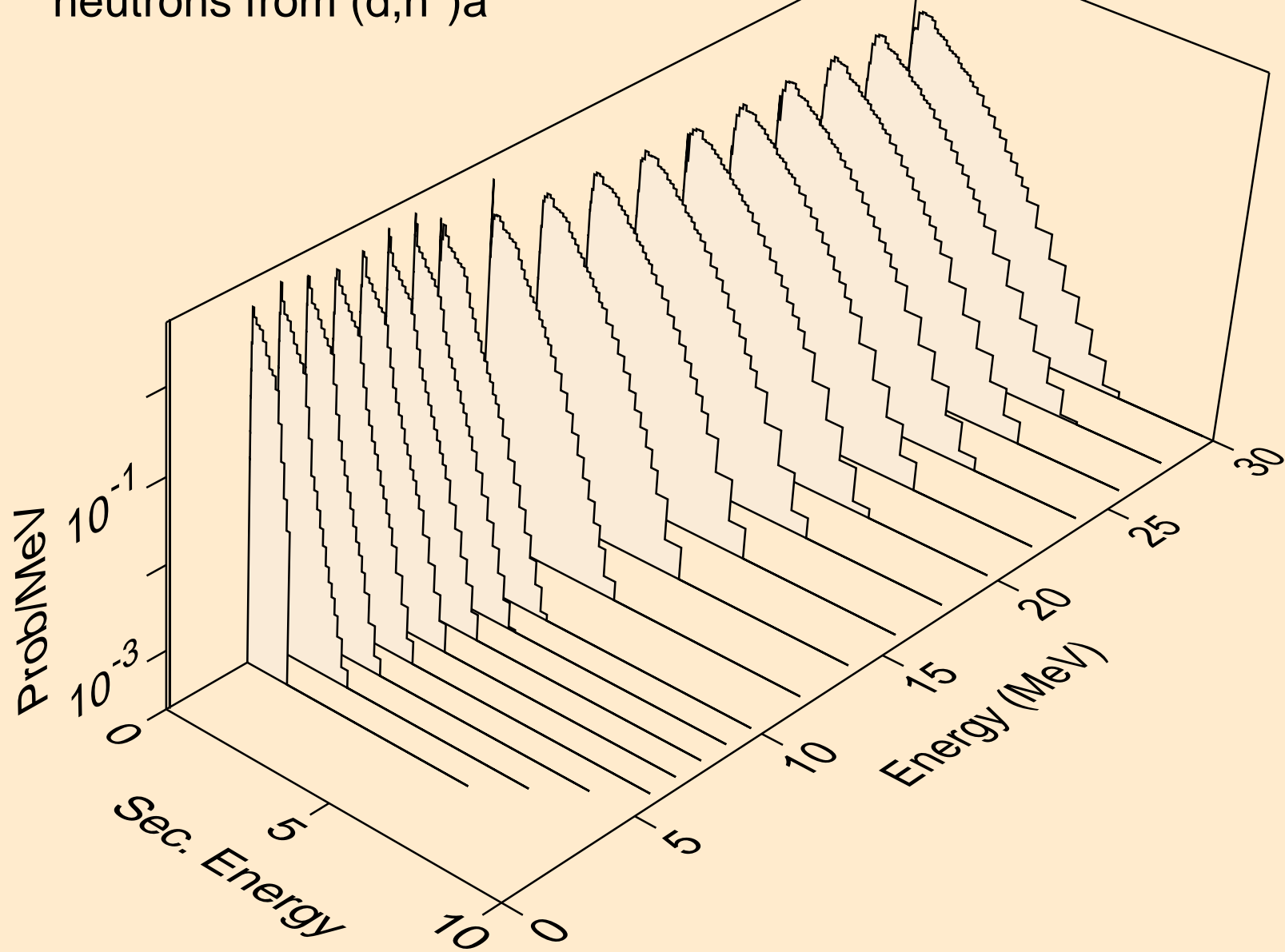

IR205 DEUTERON ACER TENDL-2023 LIBRARY; T=0.K
neutrons from (d,2n)a

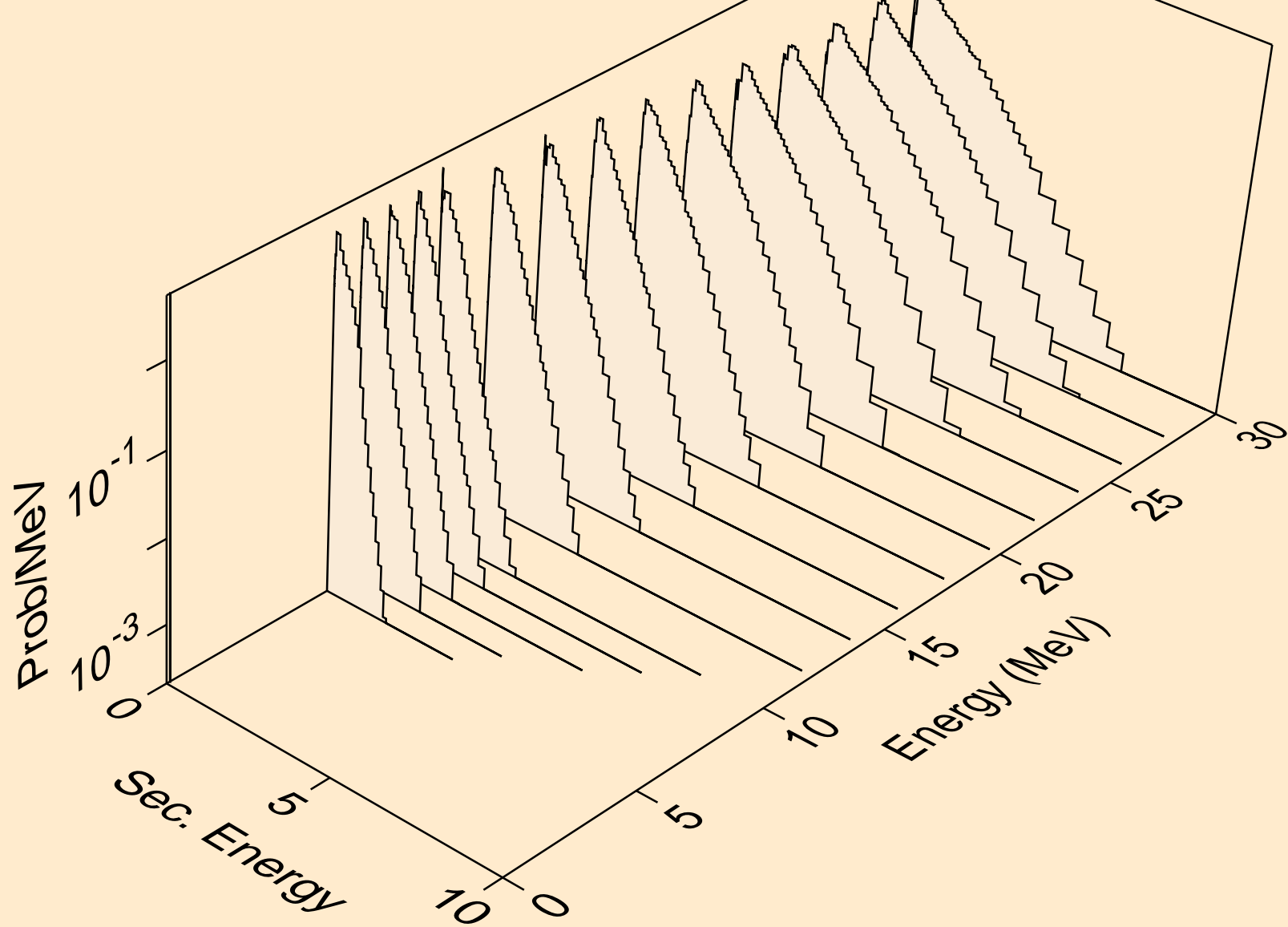

IR205 DEUTERON ACER TENDL-2023 LIBRARY; T=0.K
neutrons from (d,3n)a

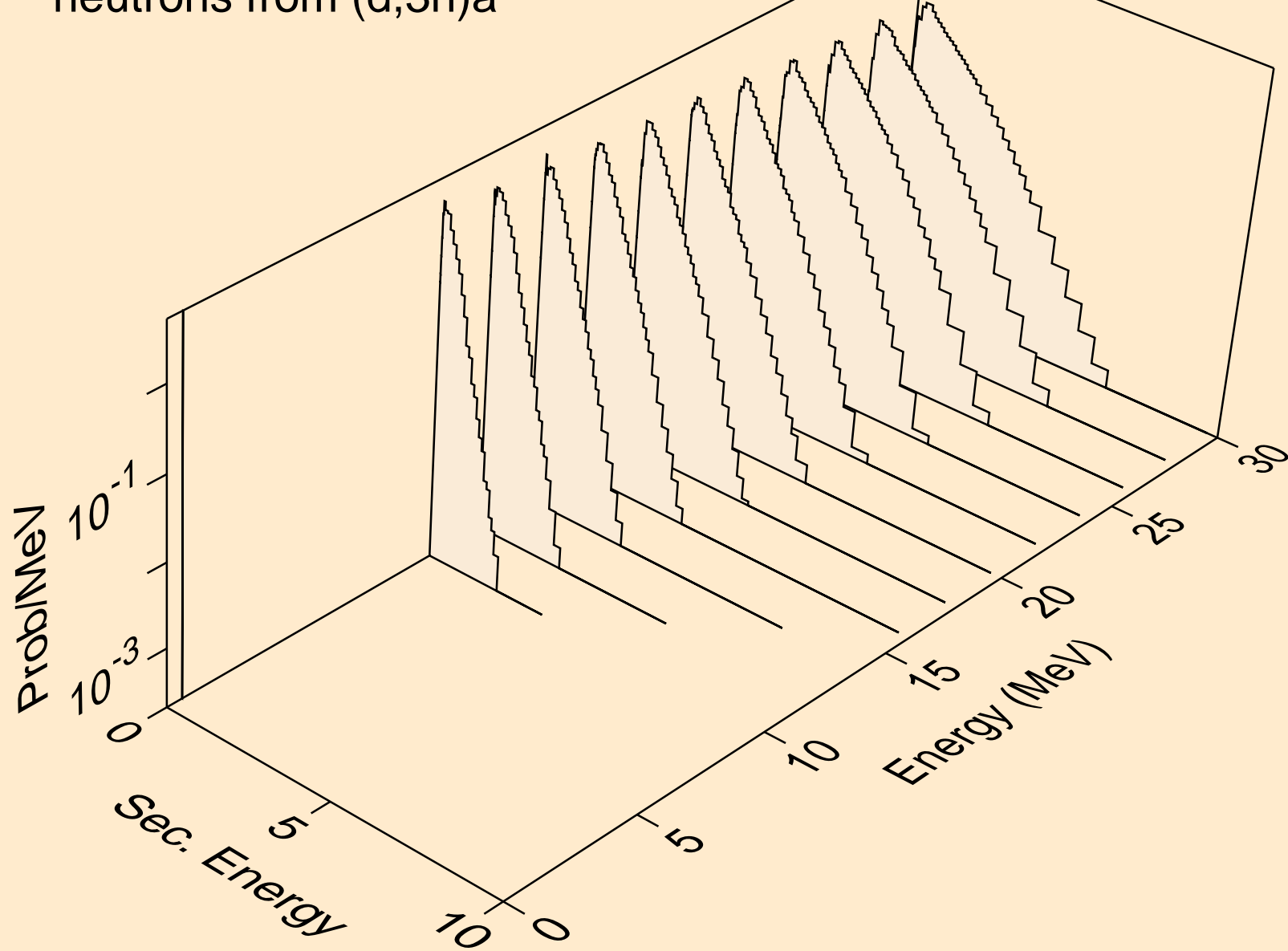

IR205 DEUTERON ACER TENDL-2023 LIBRARY; T=0.K
neutrons from (d,n*)p

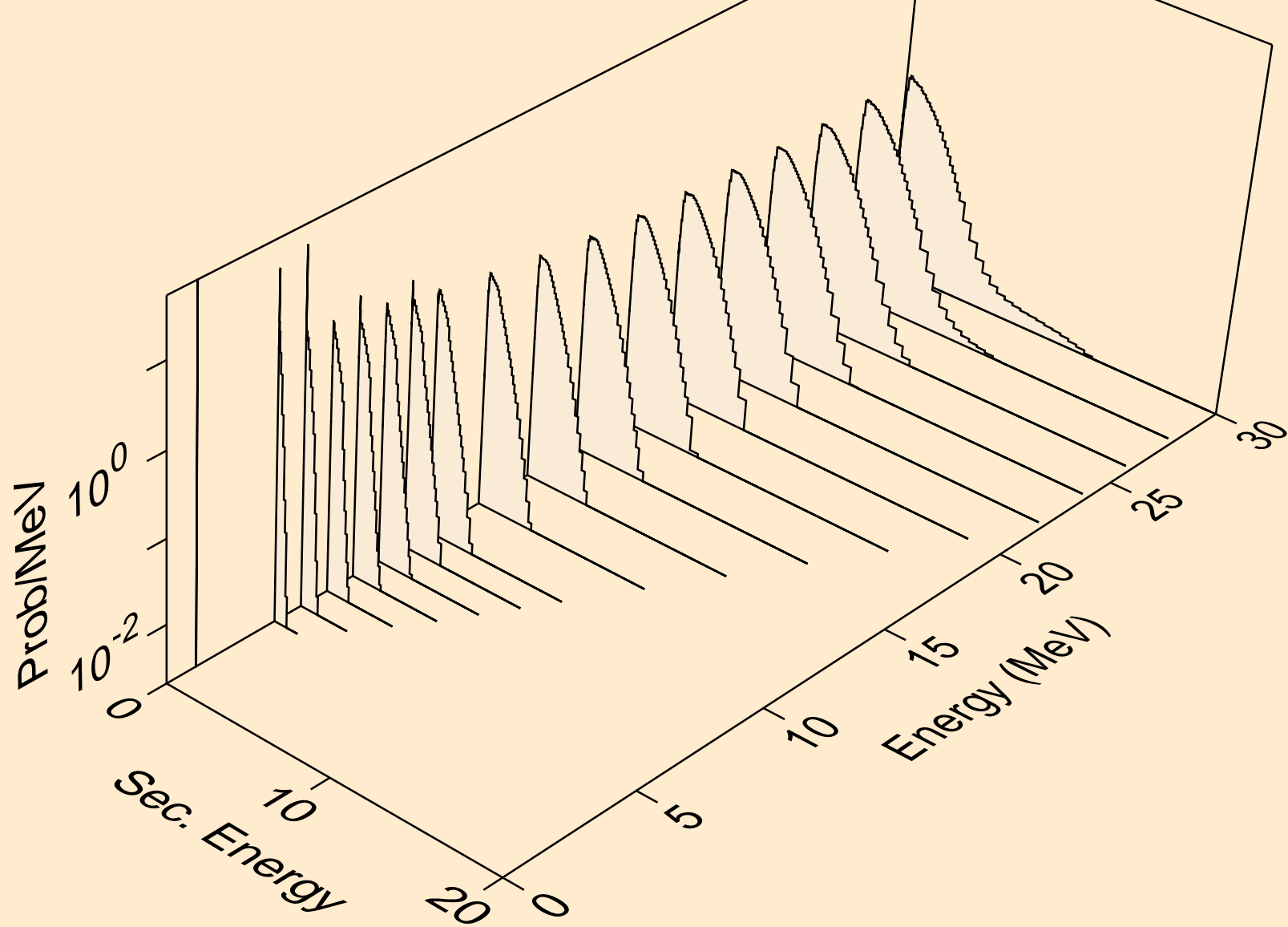

IR205 DEUTERON ACER TENDL-2023 LIBRARY; T=0.K
neutrons from (d,n*)d

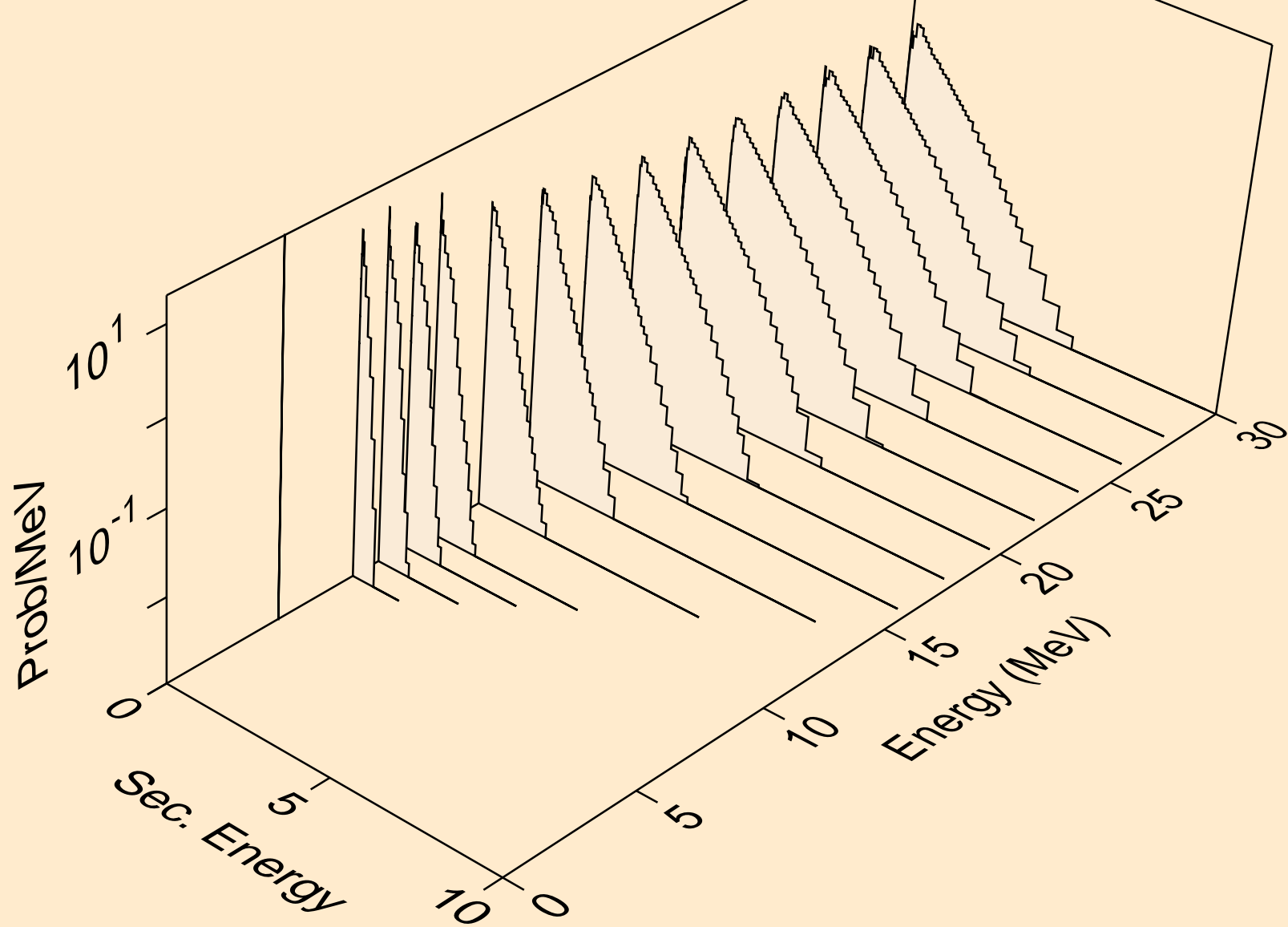

IR205 DEUTERON ACER TENDL-2023 LIBRARY; T=0.K
neutrons from (d,n*)t

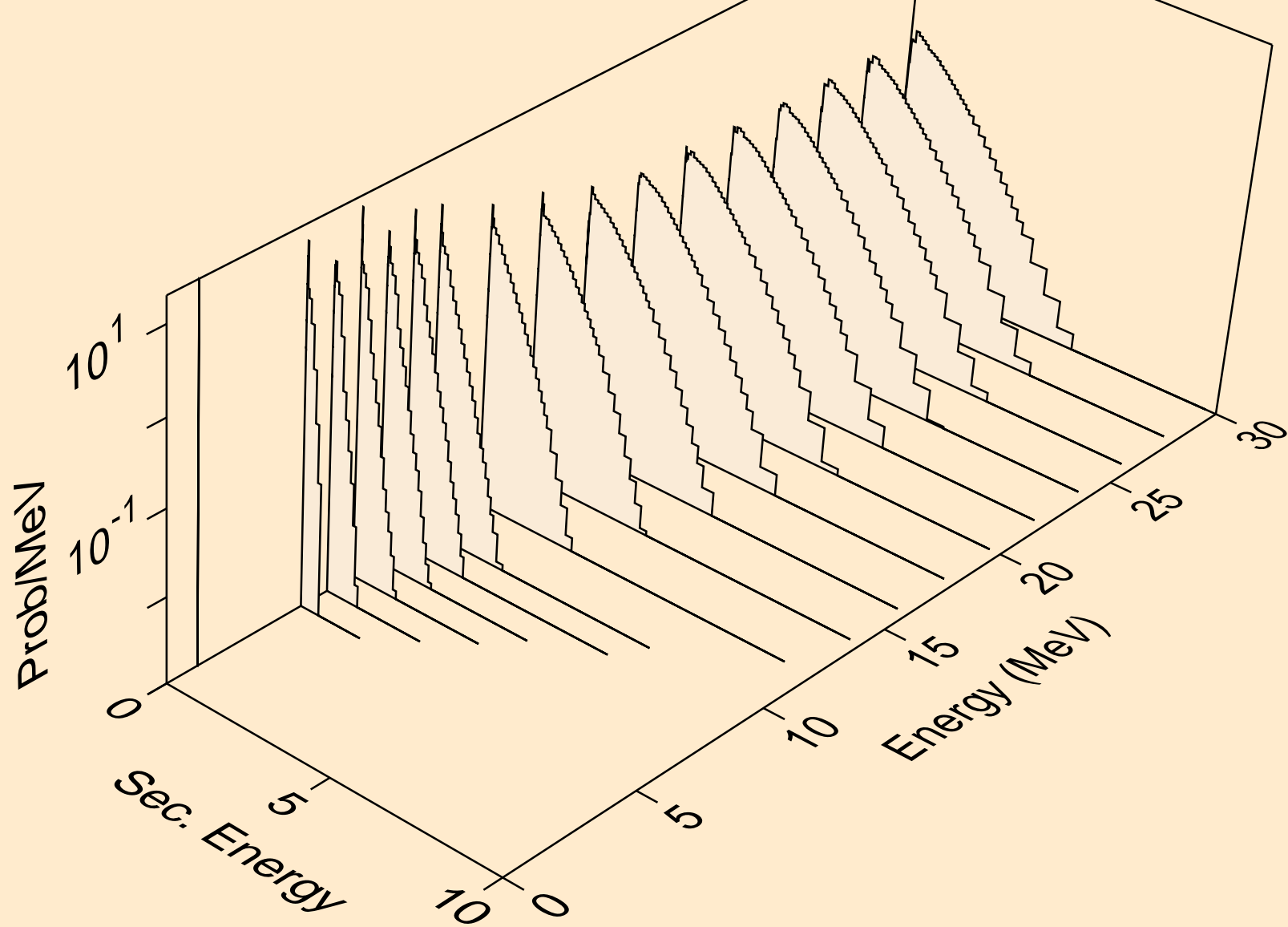

IR205 DEUTERON ACER TENDL-2023 LIBRARY; T=0.K
neutrons from (d,n*)he3

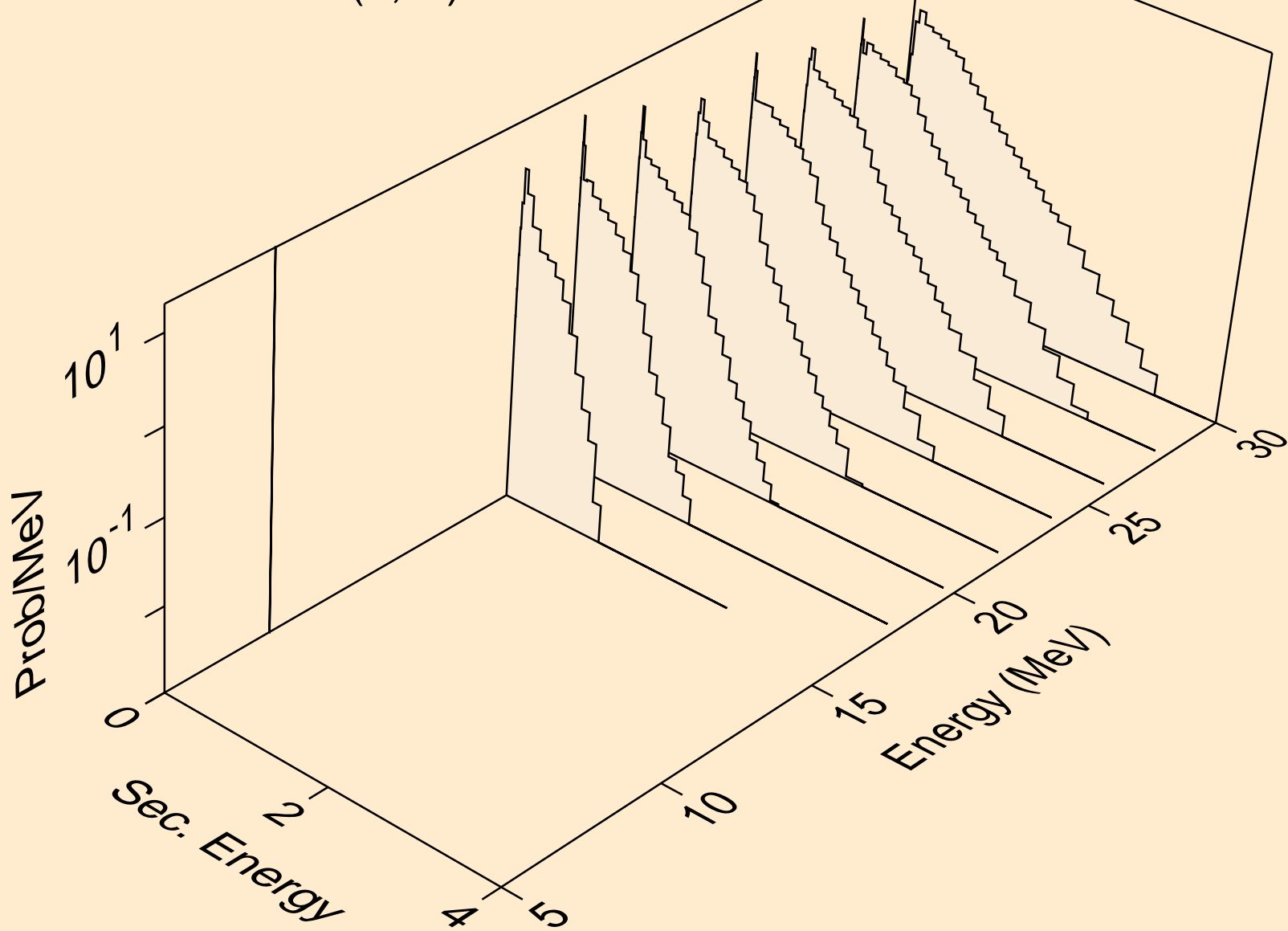

IR205 DEUTERON ACER TENDL-2023 LIBRARY; T=0.K
neutrons from (d,4n)

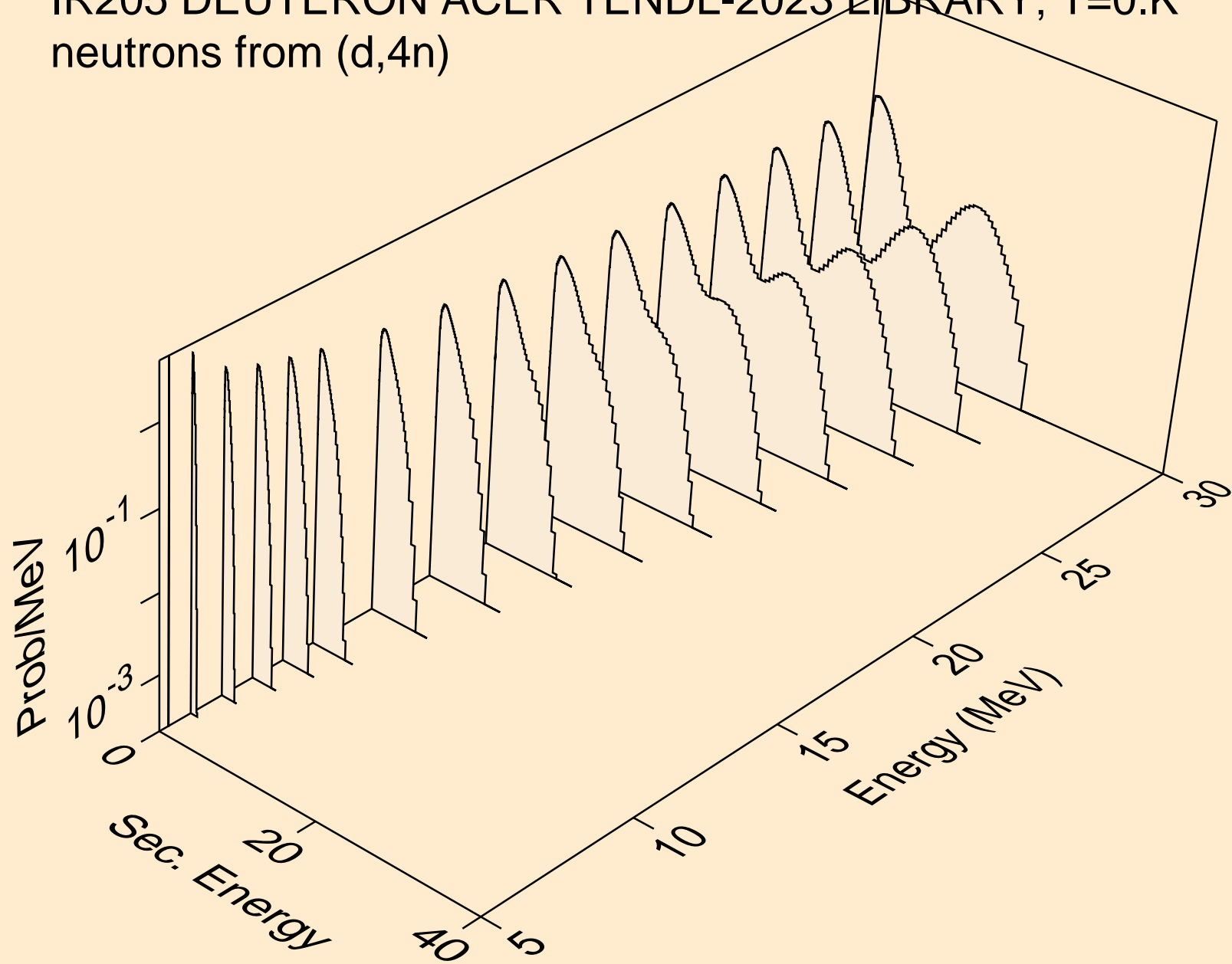

IR205 DEUTERON ACER TENDL-2023 LIBRARY; T=0.K
neutrons from (d,2np)

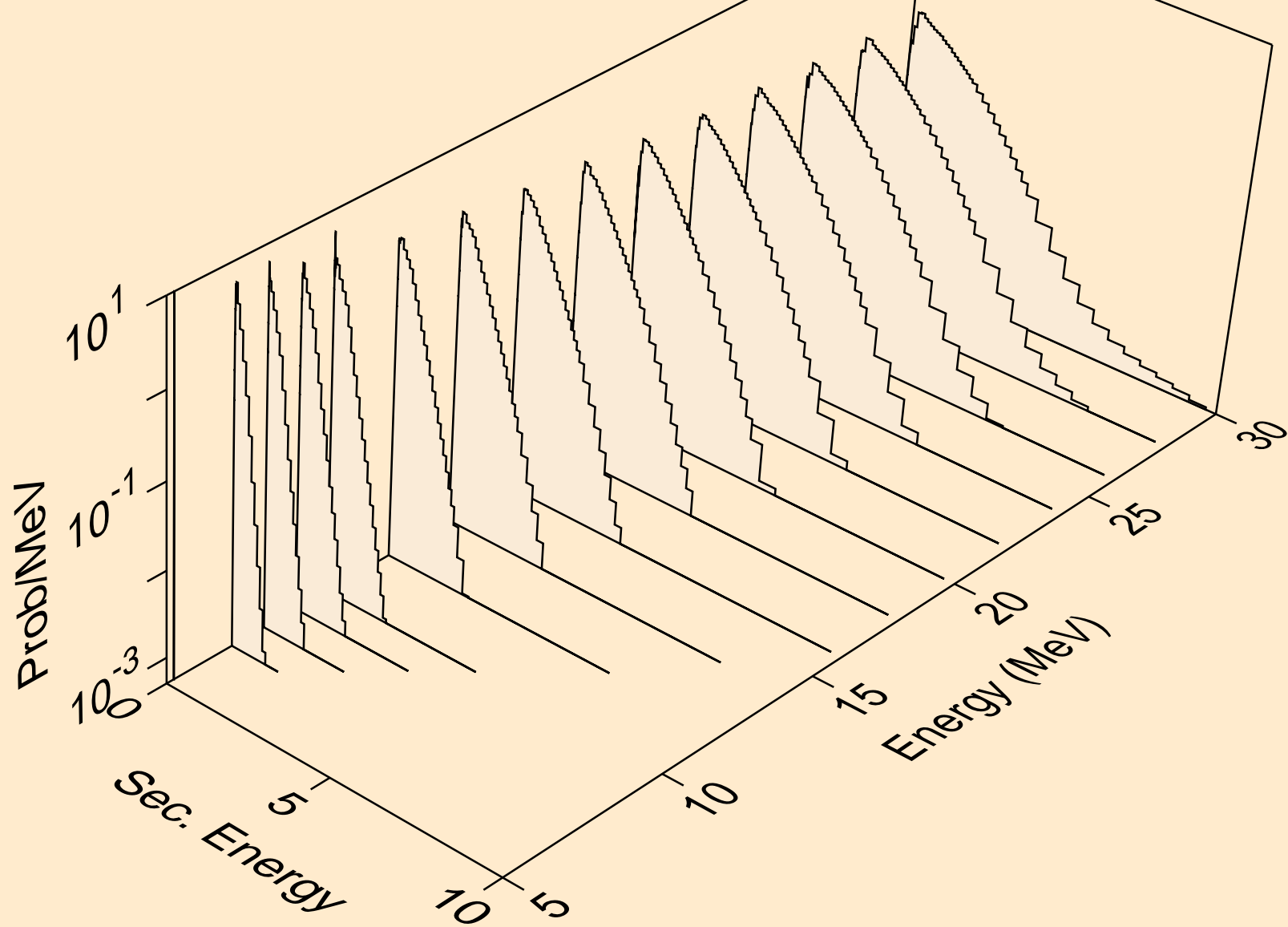

IR205 DEUTERON ACER TENDL-2023 LIBRARY; T=0.K
neutrons from (d,3np)

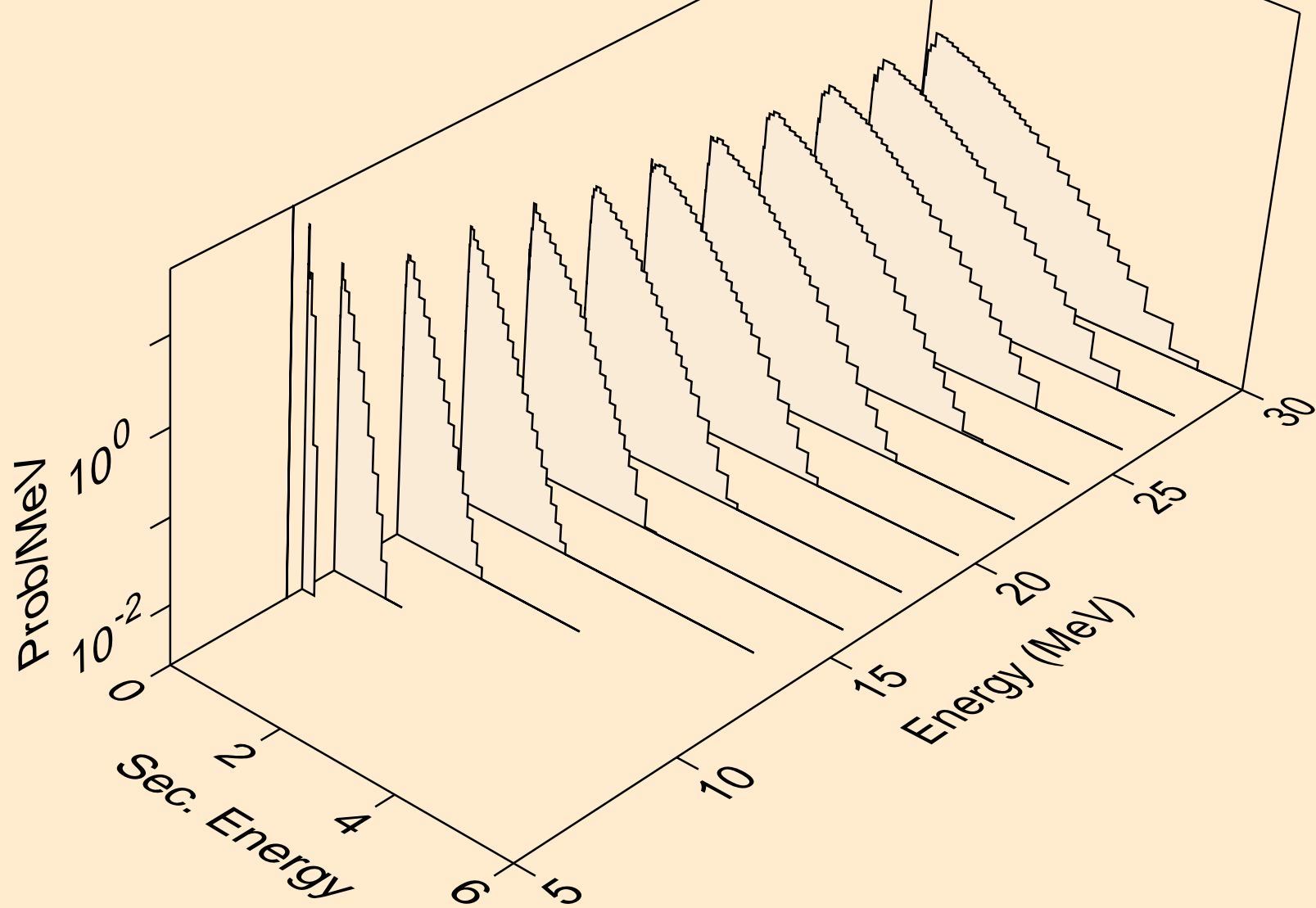

IR205 DEUTERON ACER TENDL-2023 LIBRARY; T=0.K
neutrons from (d,n2p)

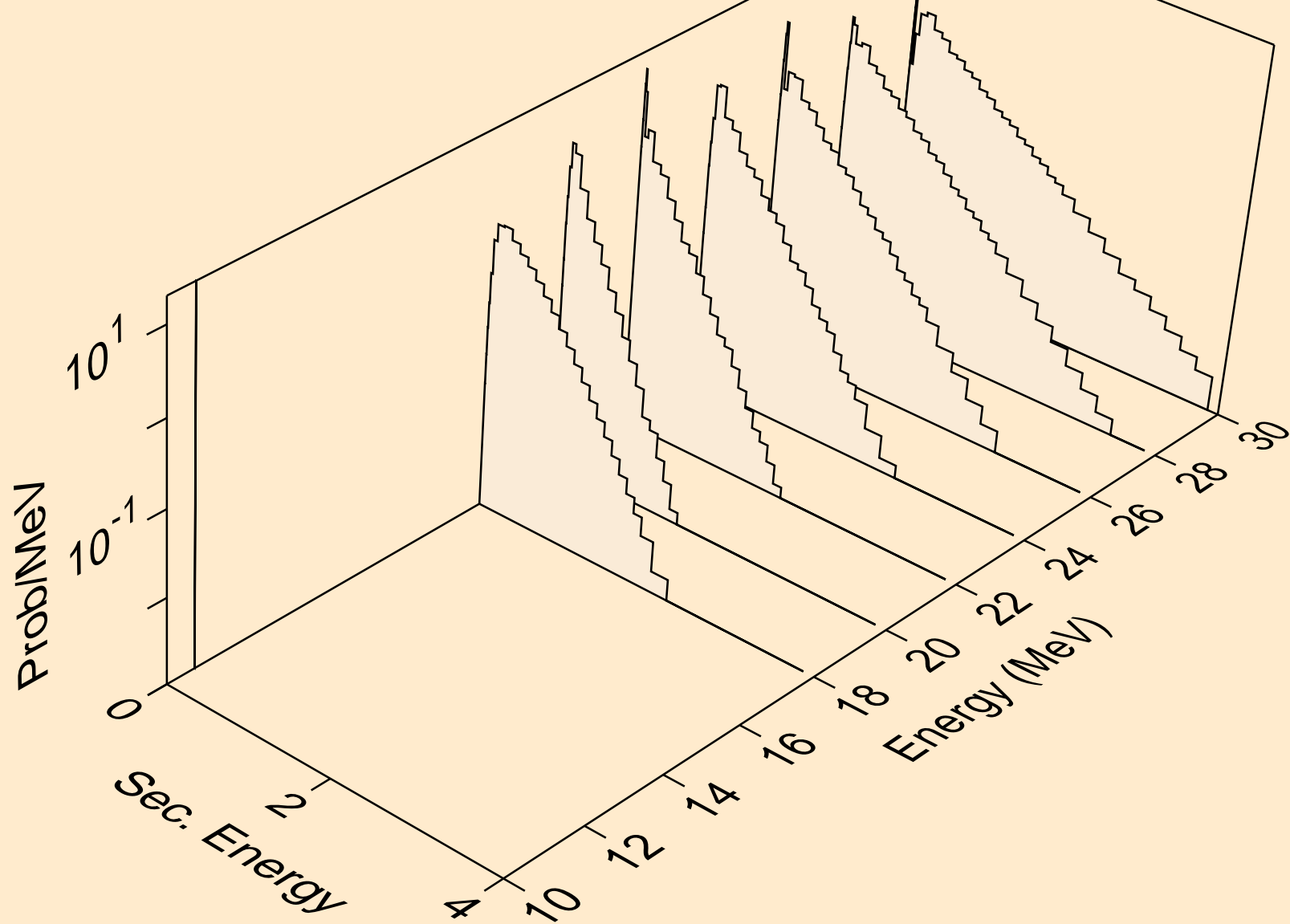

IR205 DEUTERON ACER TENDL-2023 LIBRARY; T=0.K
protons from (d,x)

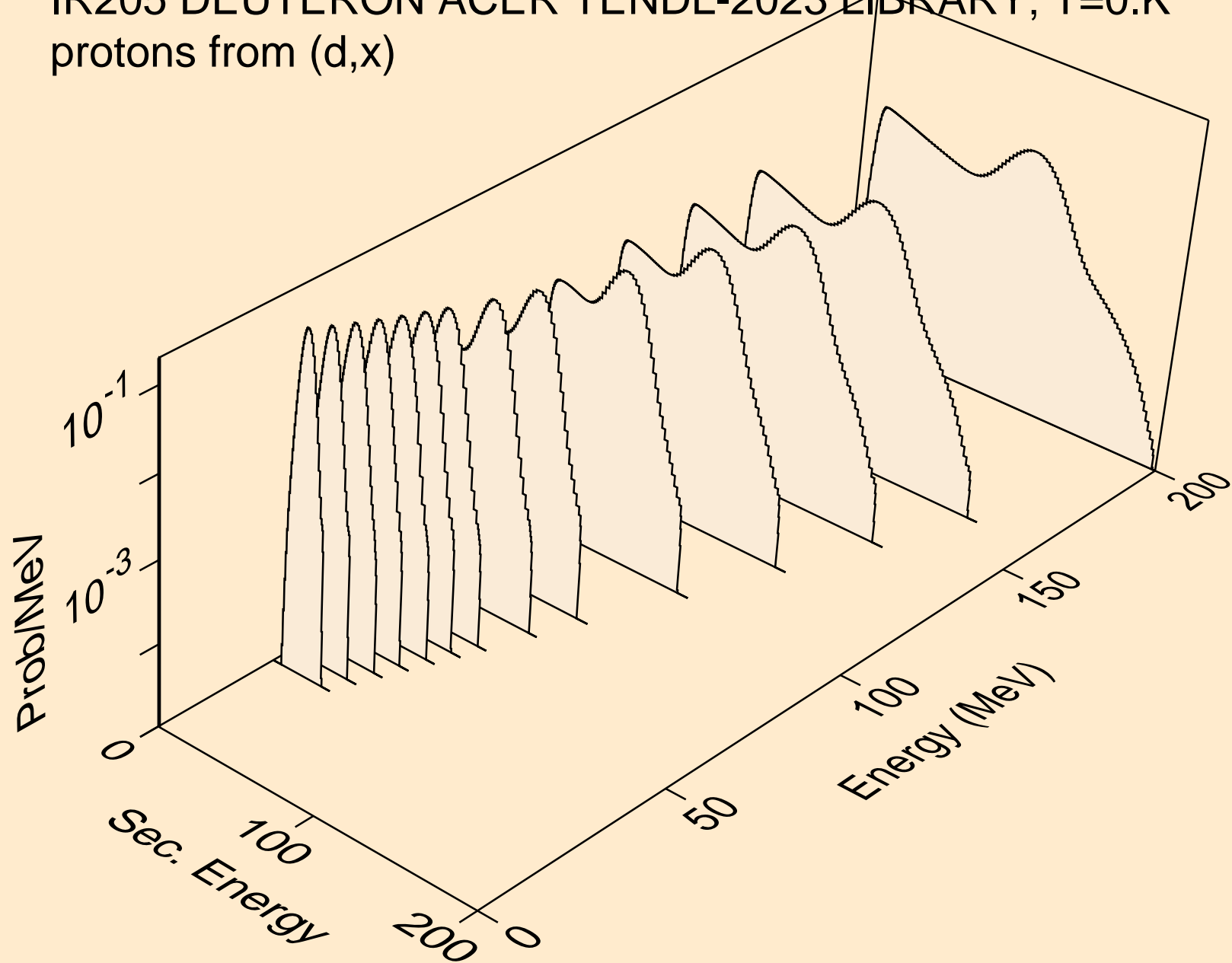

IR205 DEUTERON ACER TENDL-2023 LIBRARY; T=0.K
protons from (d,n*)p

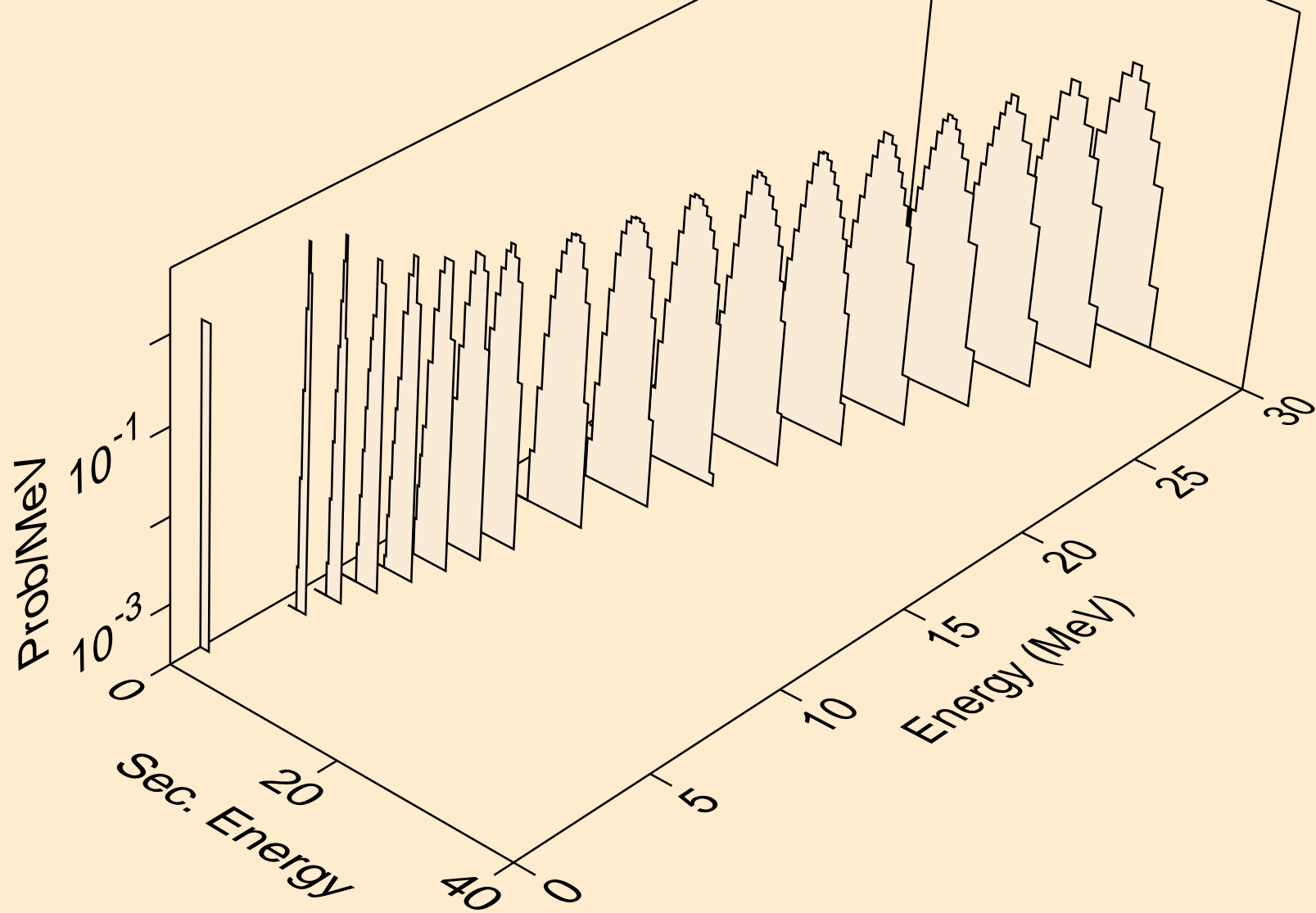

IR205 DEUTERON ACER TENDL-2023 LIBRARY; T=0.K
protons from (d,2np)

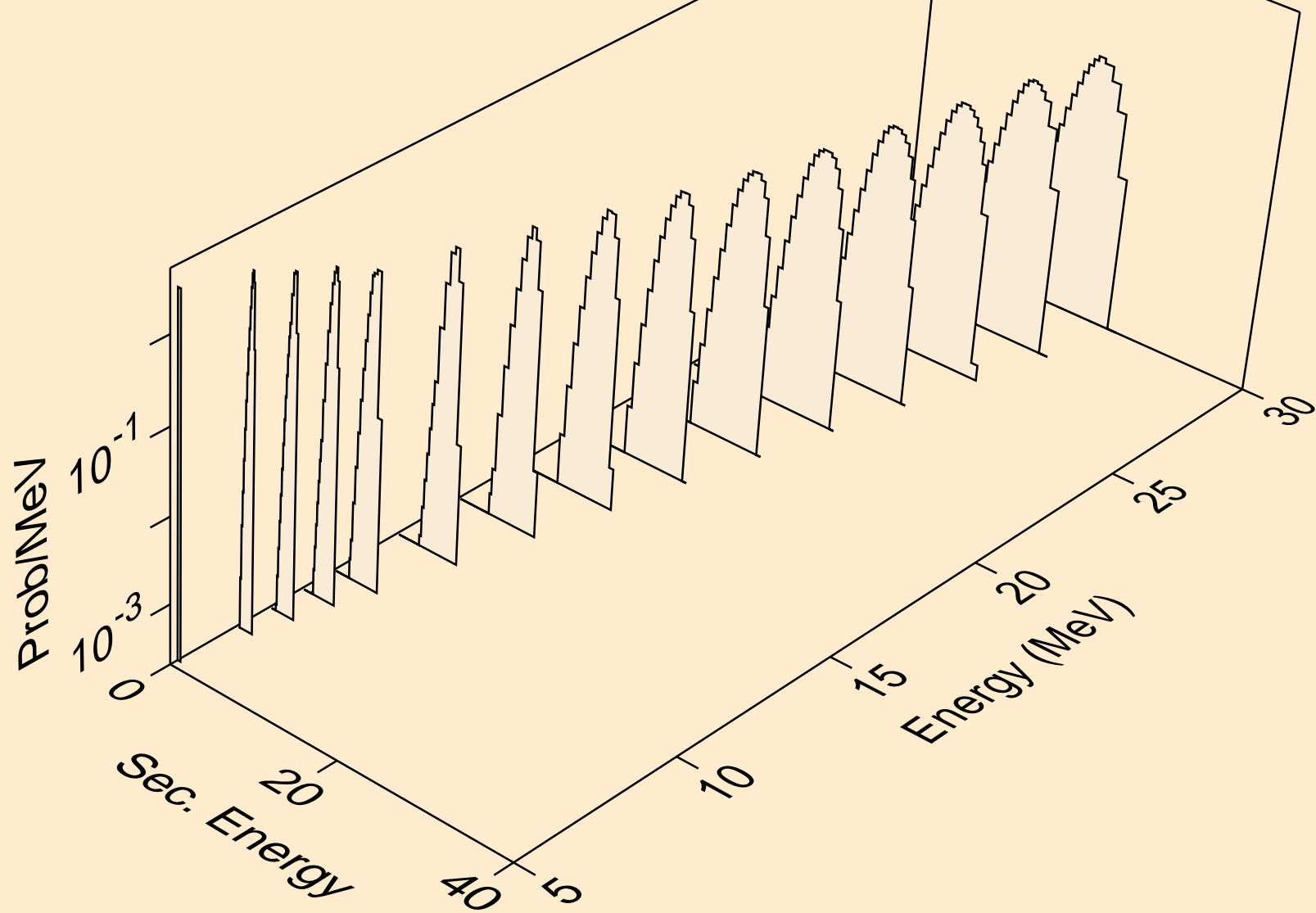

IR205 DEUTERON ACER TENDL-2023 LIBRARY; T=0.K
protons from (d,3np)

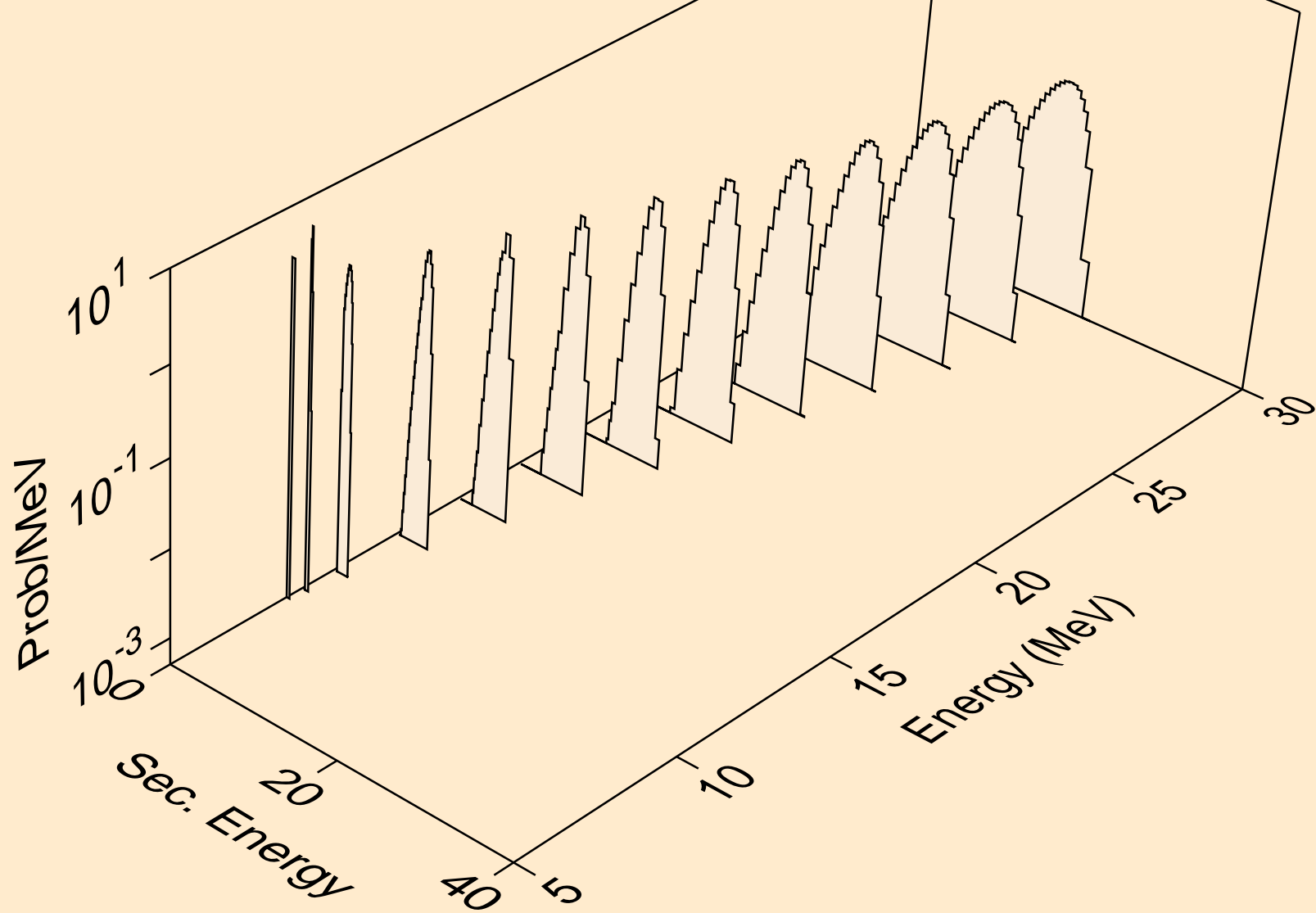

IR205 DEUTERON ACER TENDL-2023 LIBRARY; T=0.K
protons from (d,n2p)

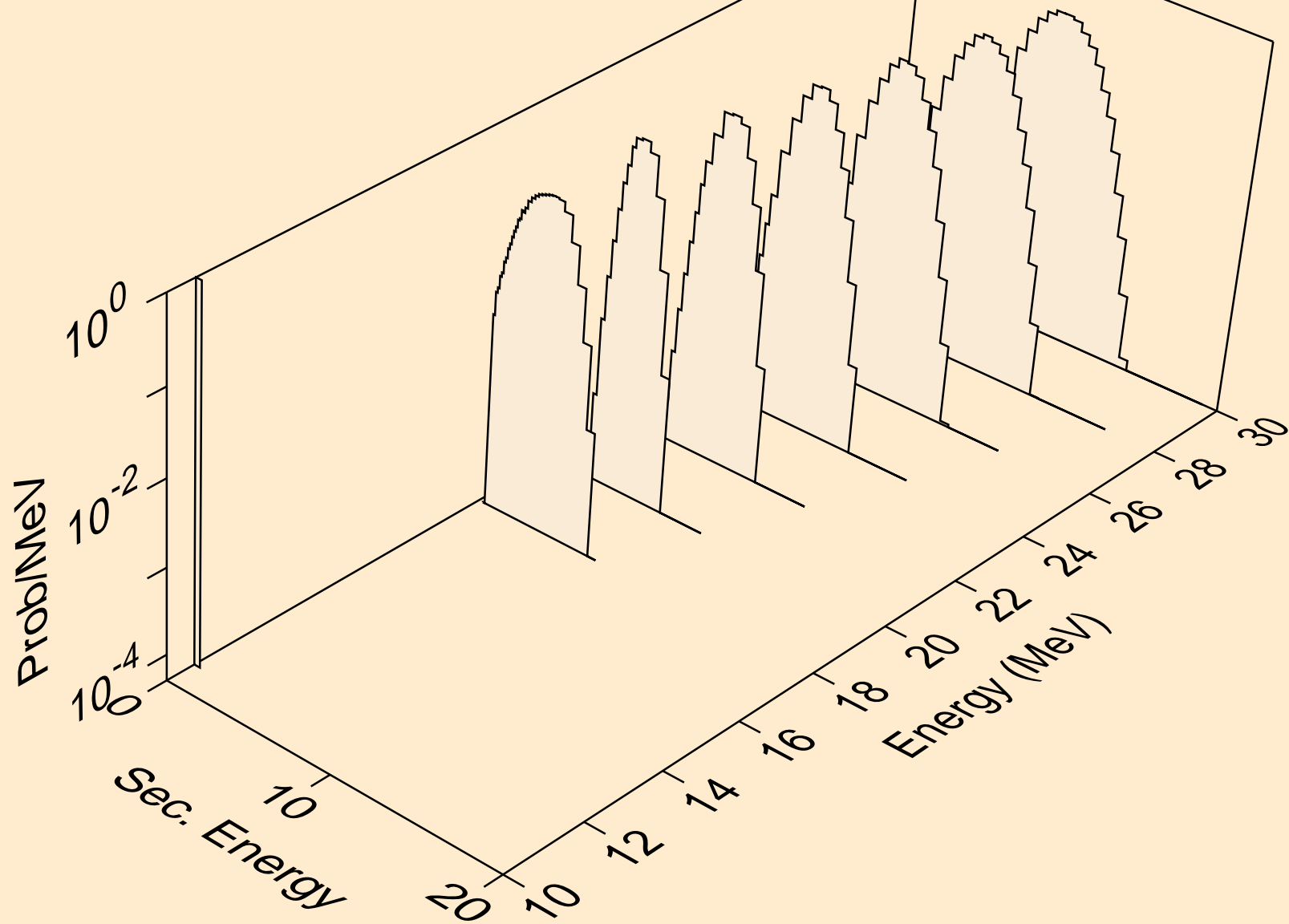

IR205 DEUTERON ACER TENDL-2023 LIBRARY; T=0.K
protons from (d,p)

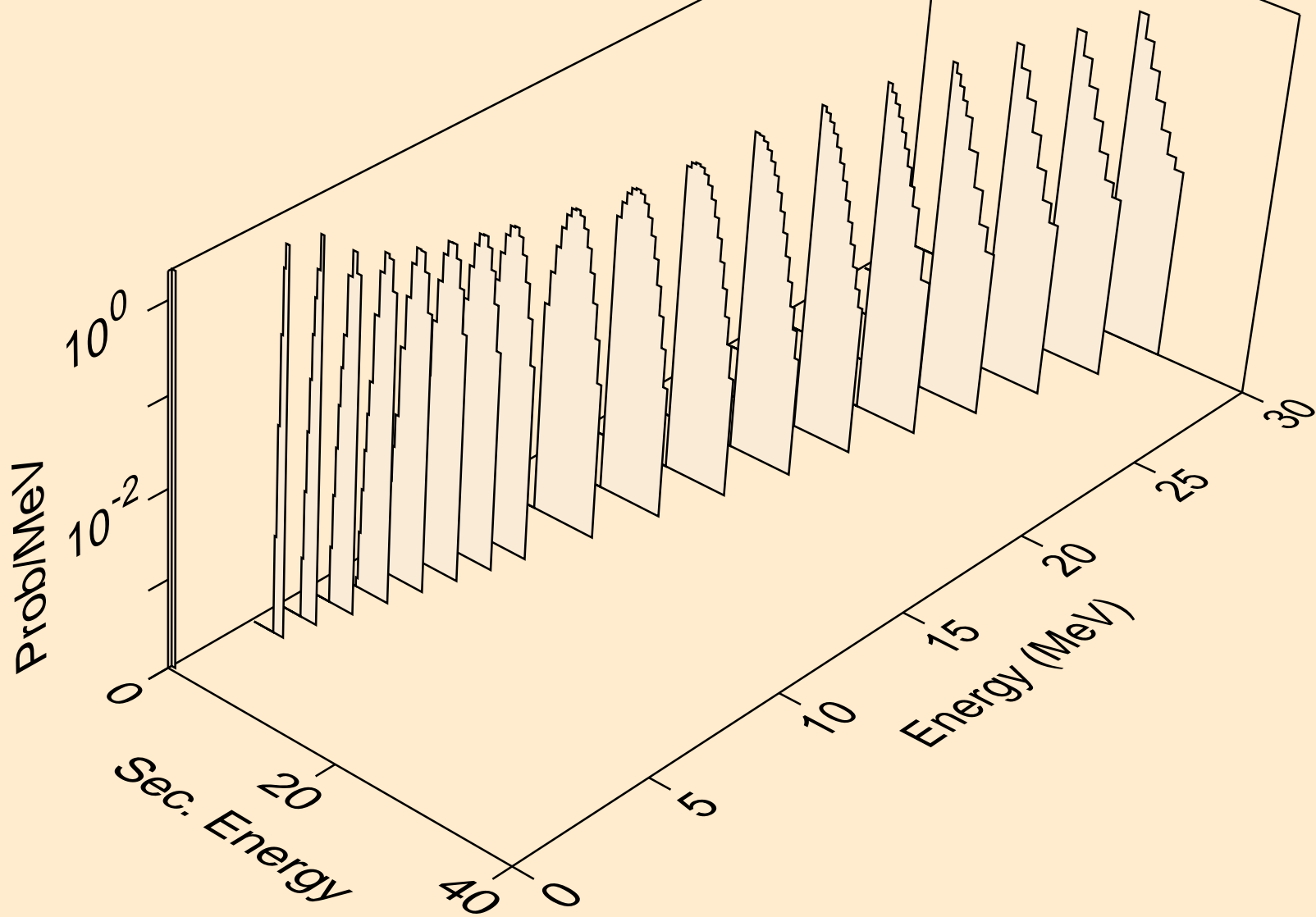

IR205 DEUTERON ACER TENDL-2023 LIBRARY; T=0.K
protons from (d,2p)

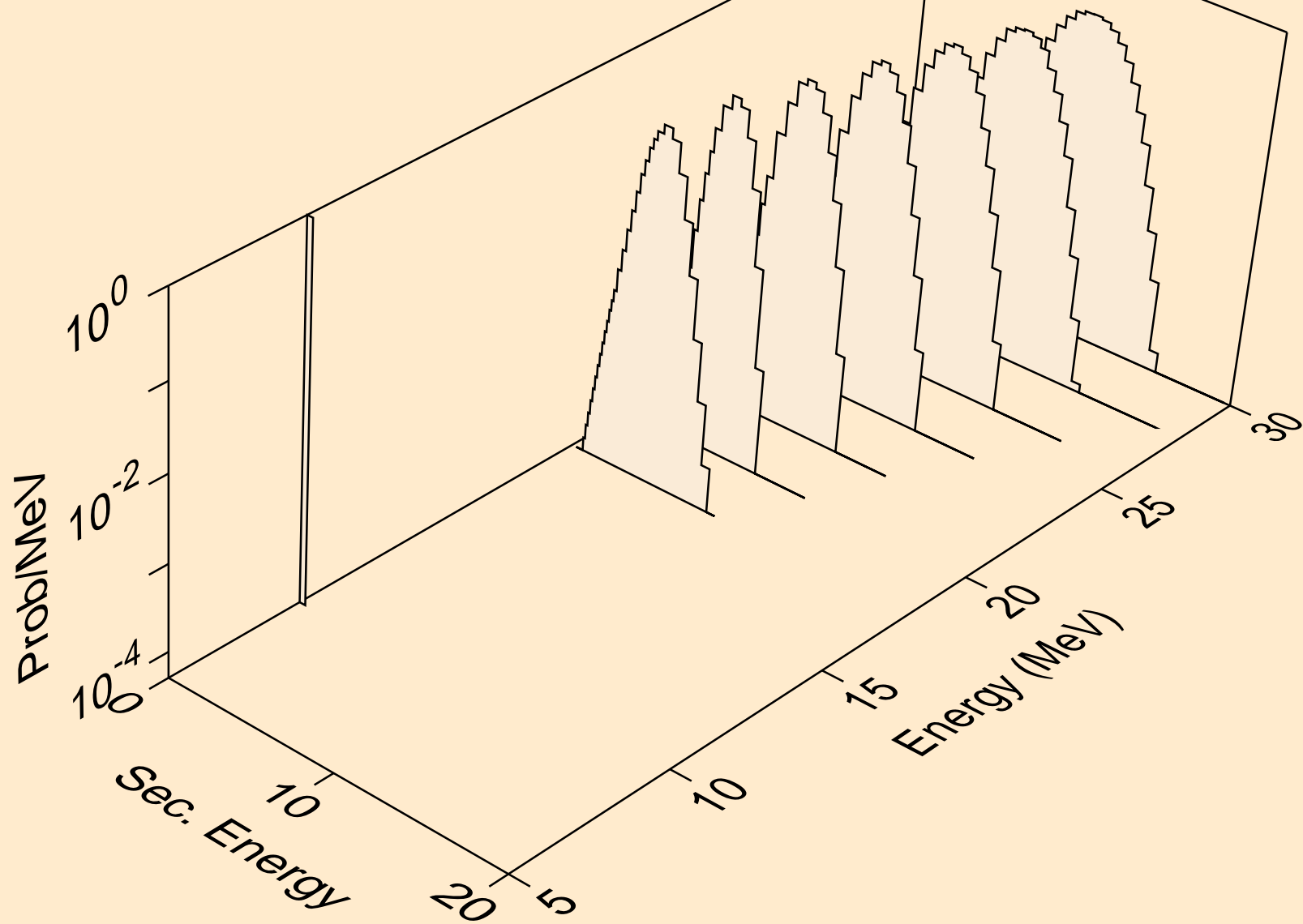

IR205 DEUTERON ACER TENDL-2023 LIBRARY; T=0.K
protons from (d,pd)

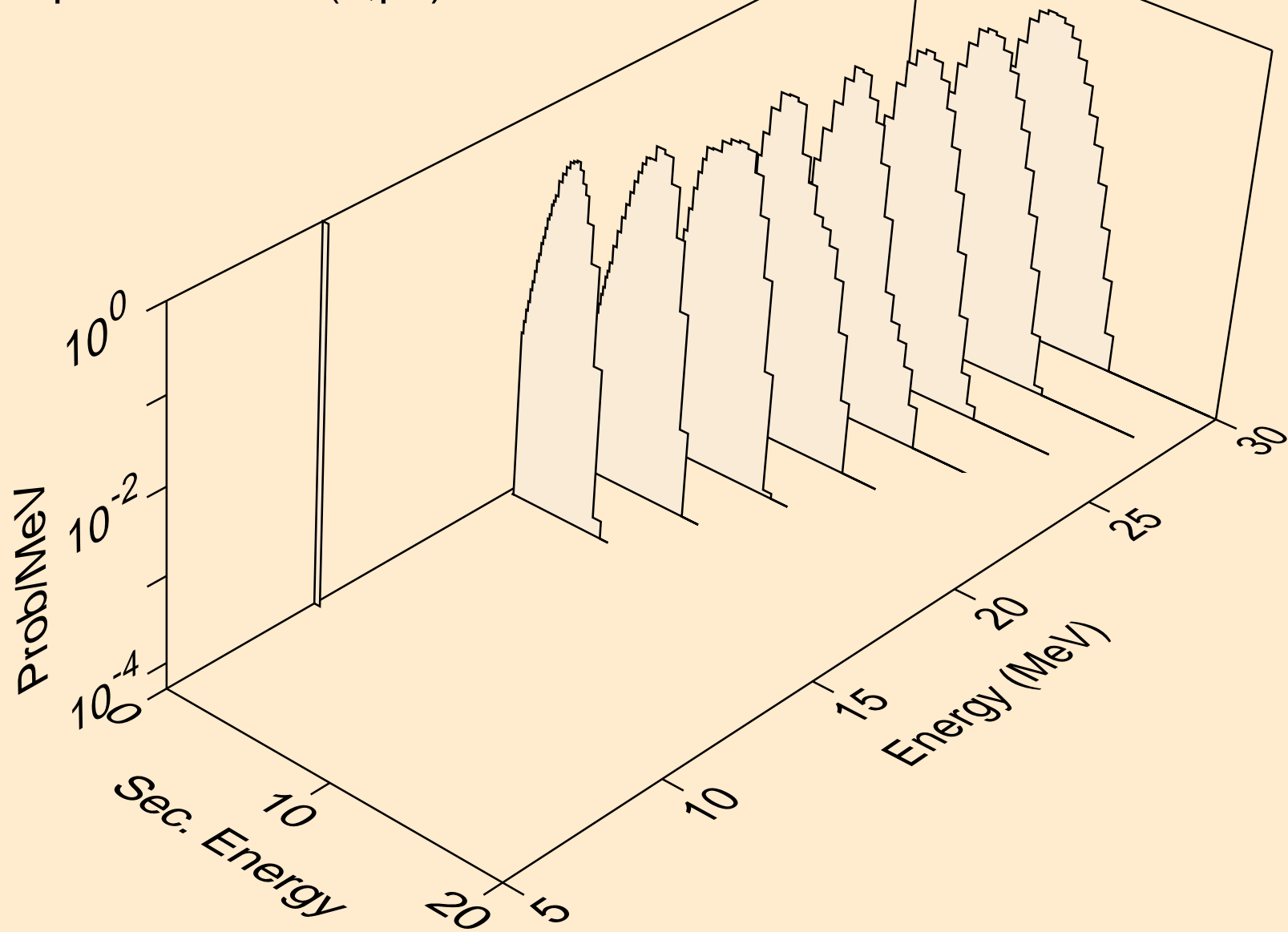

IR205 DEUTERON ACER TENDL-2023 LIBRARY; T=0.K
tritons from (d,x)

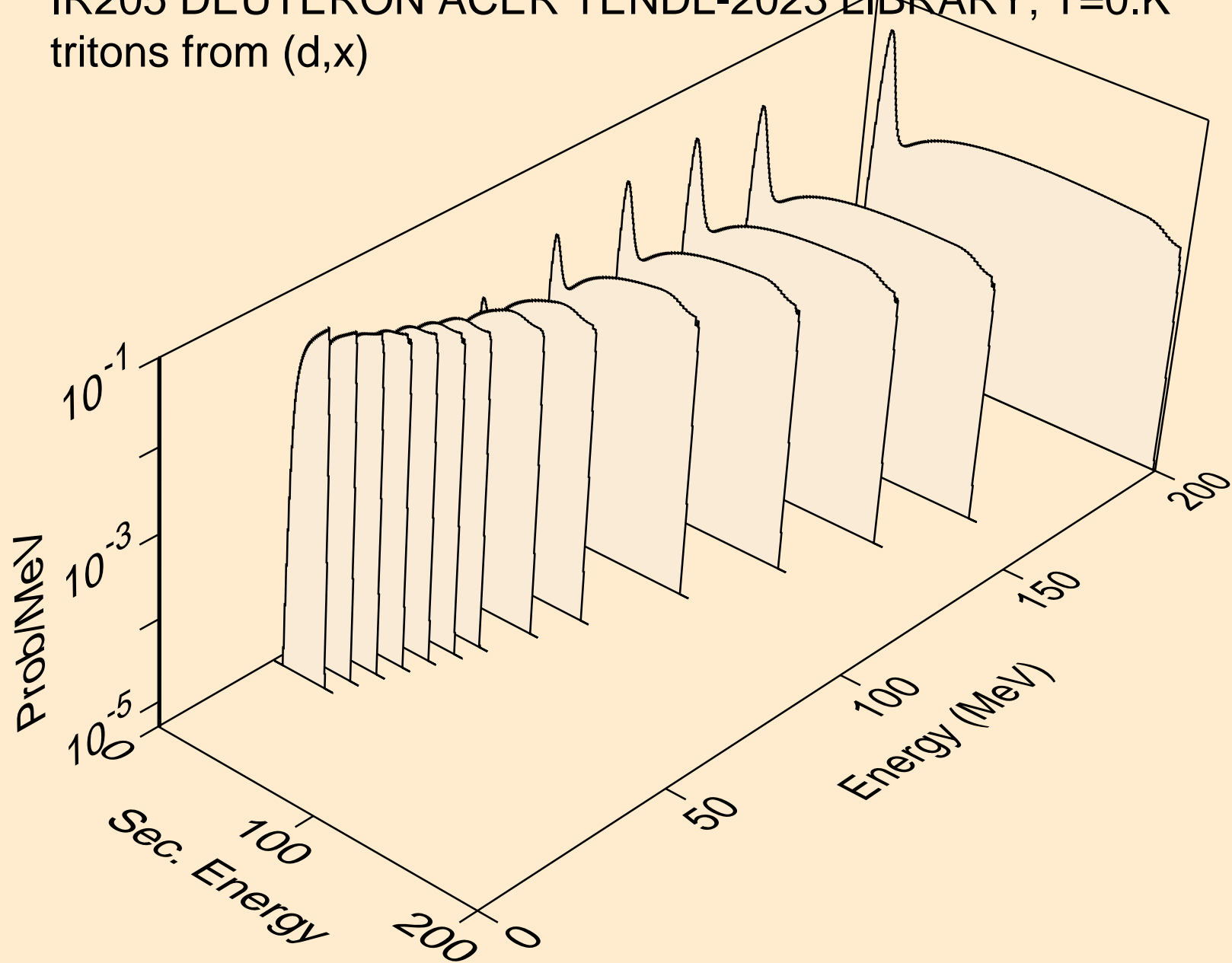

IR205 DEUTERON ACER TENDL-2023 LIBRARY; T=0.K
tritons from (d,n*)t

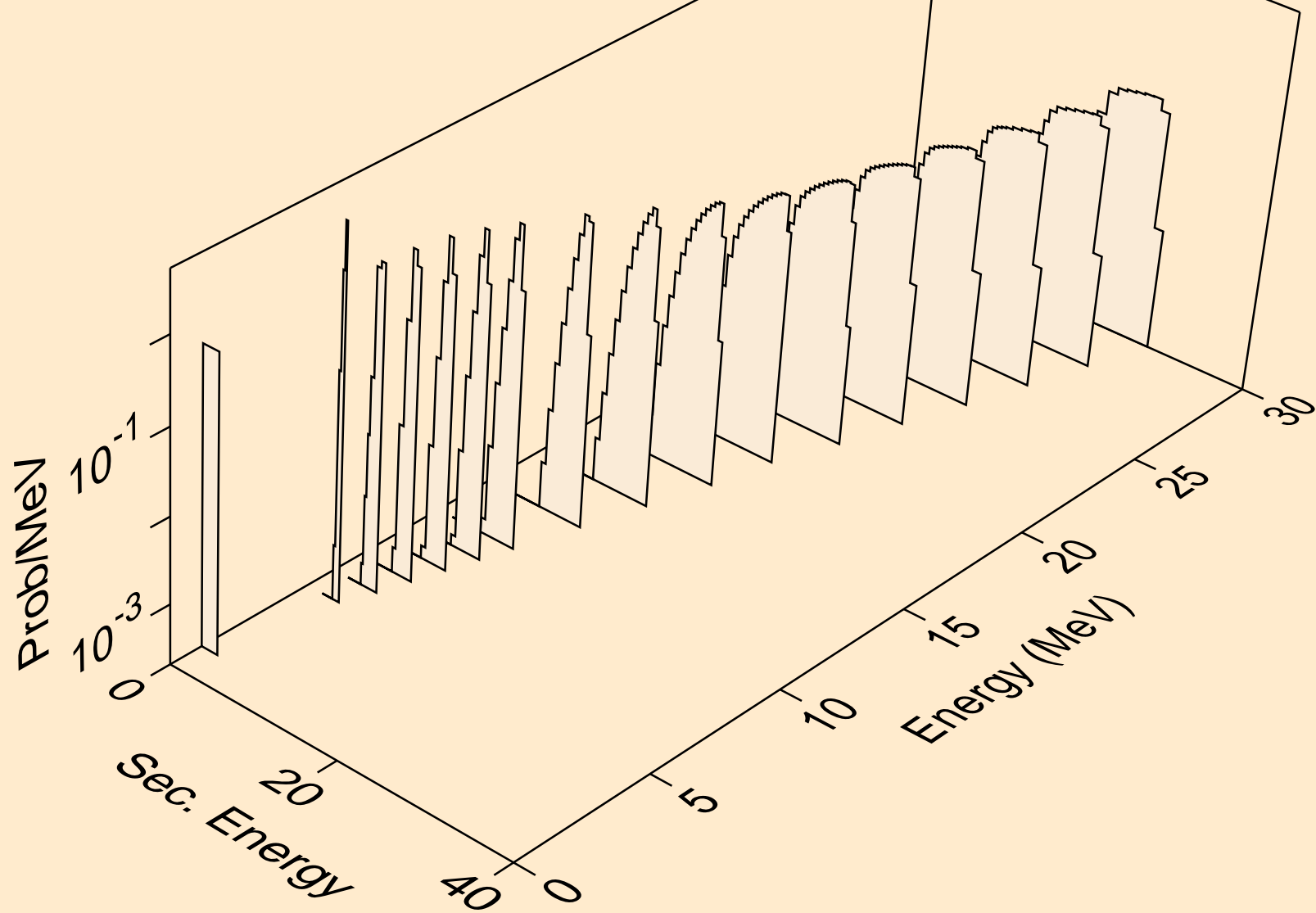

IR205 DEUTERON ACER TENDL-2023 LIBRARY; T=0.K
tritons from (d,t)

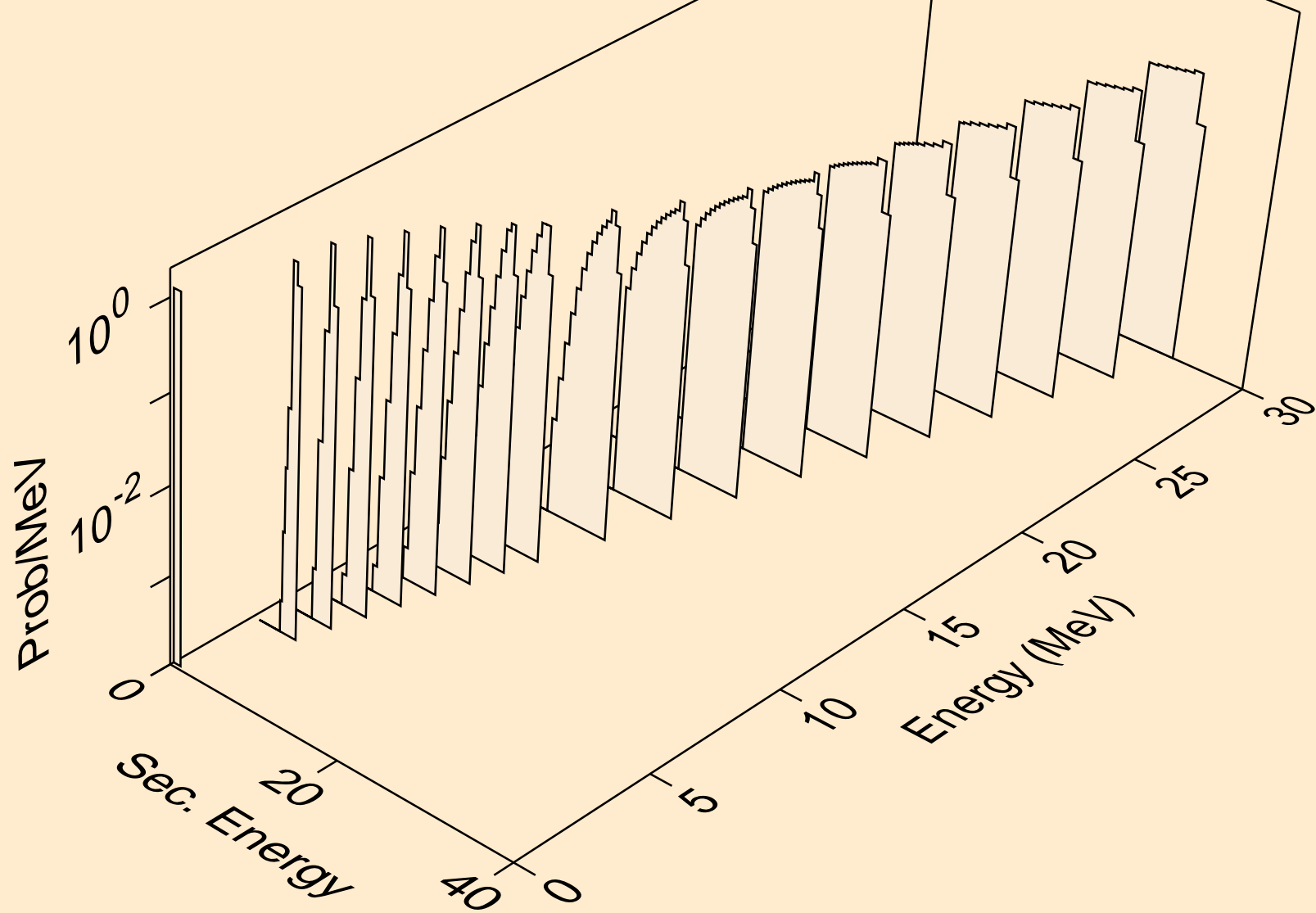

IR205 DEUTERON ACER TENDL-2023 LIBRARY; T=0.K
he3s from (d,x)

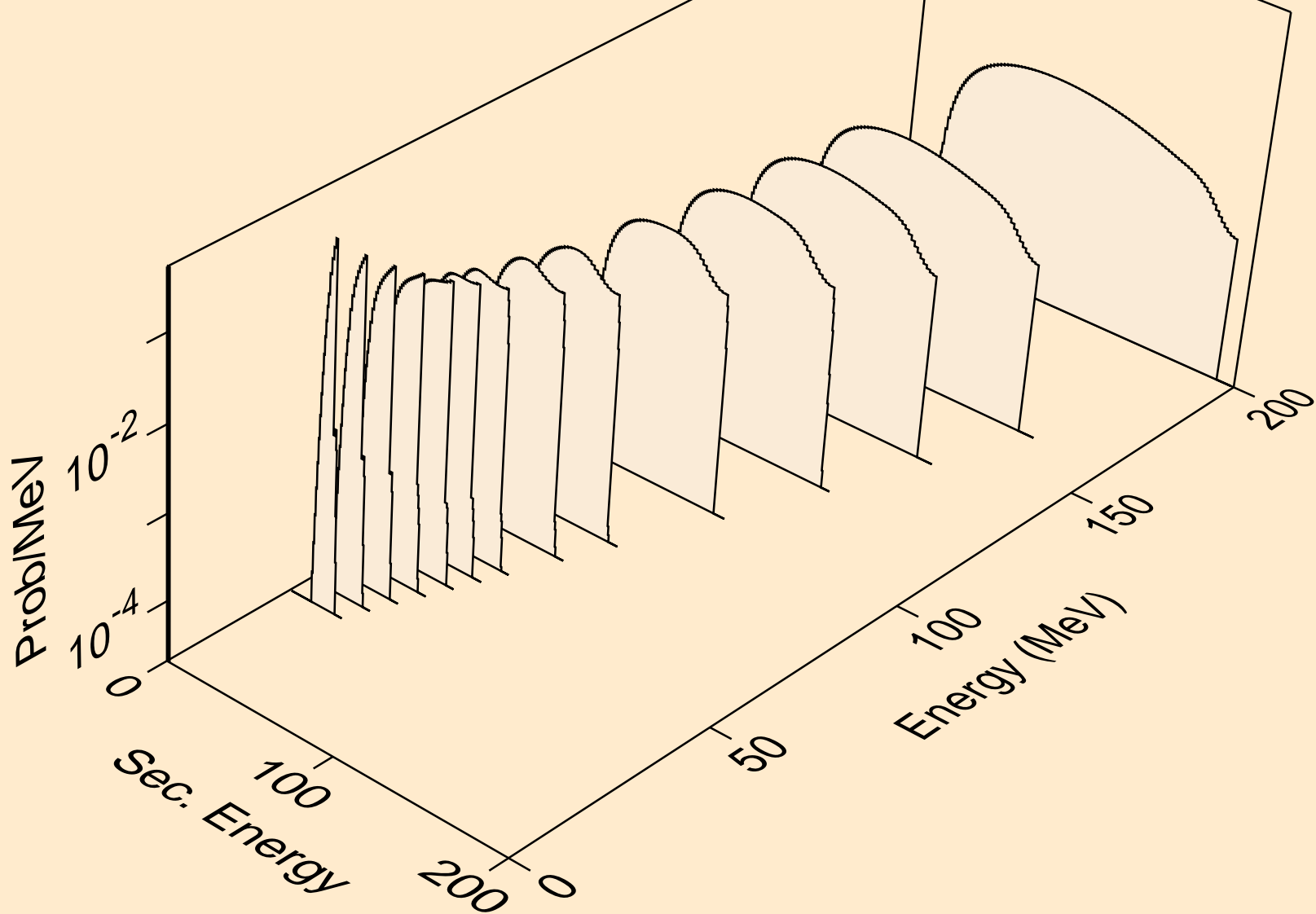

IR205 DEUTERON ACER TENDL-2023 LIBRARY; T=0.K
he3s from (d,n*)he3

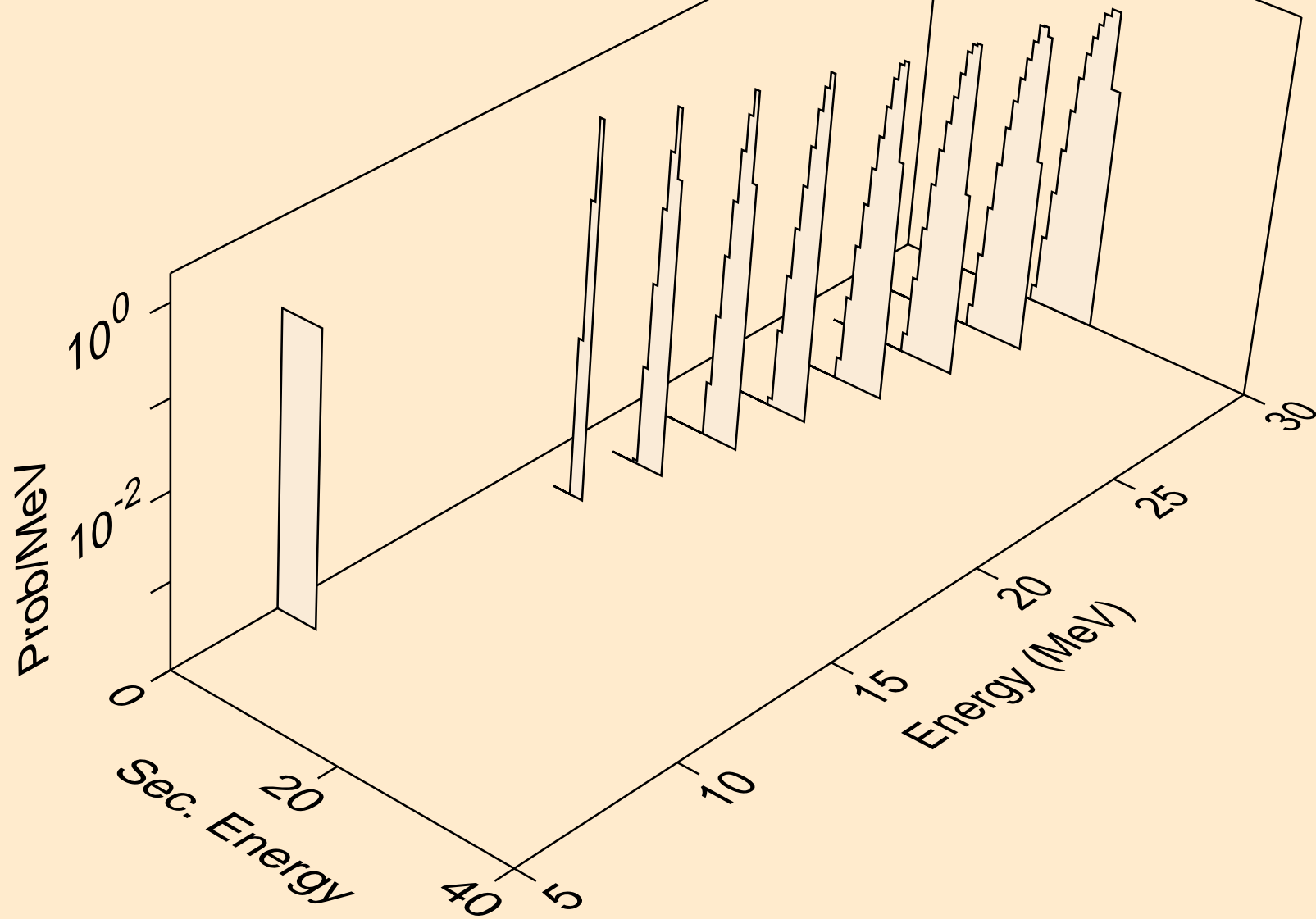

IR205 DEUTERON ACER TENDL-2023 LIBRARY; T=0.K
he3s from (d,he3)

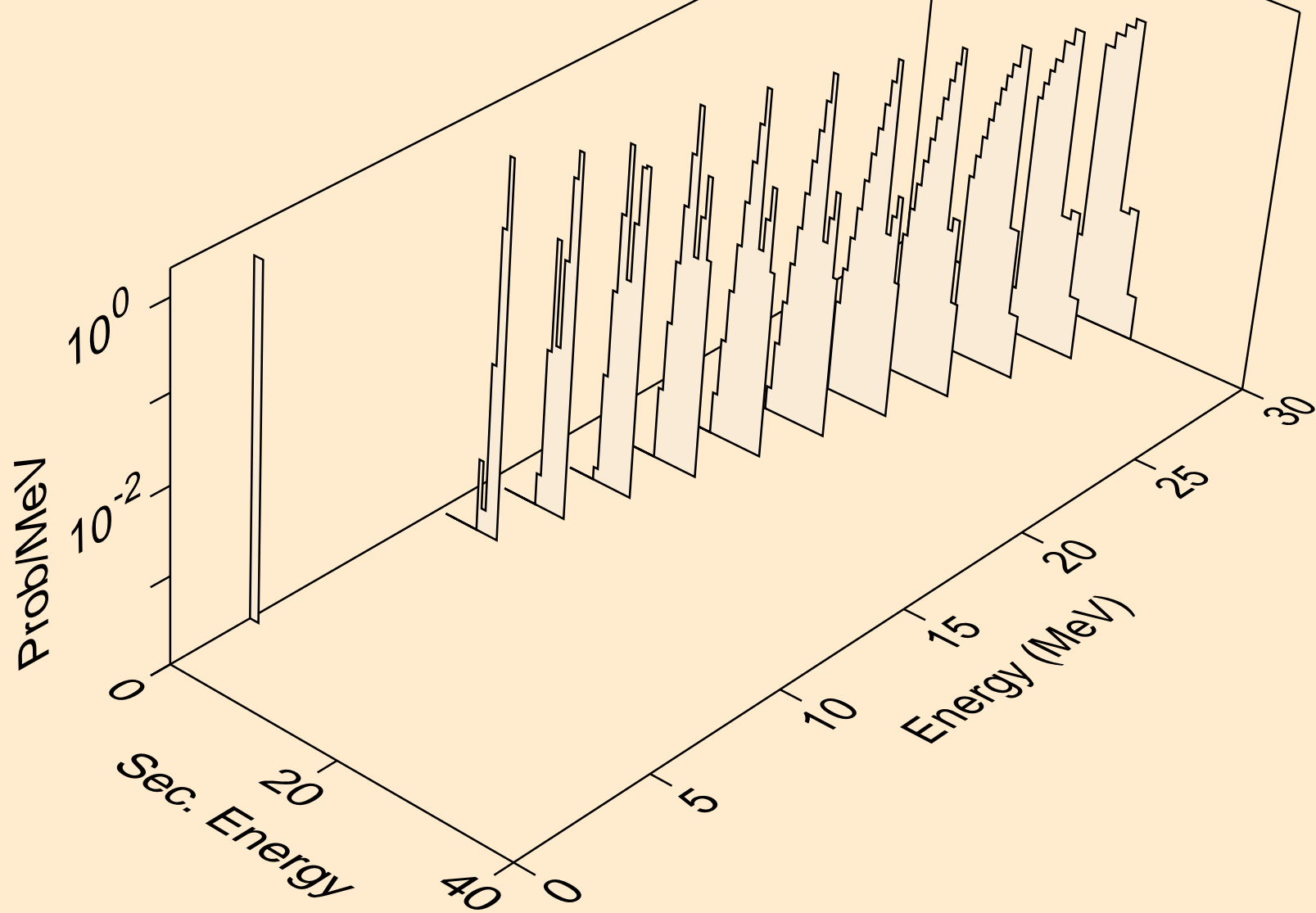

IR205 DEUTERON ACER TENDL-2023 LIBRARY; T=0.K
alphas from (d,x)

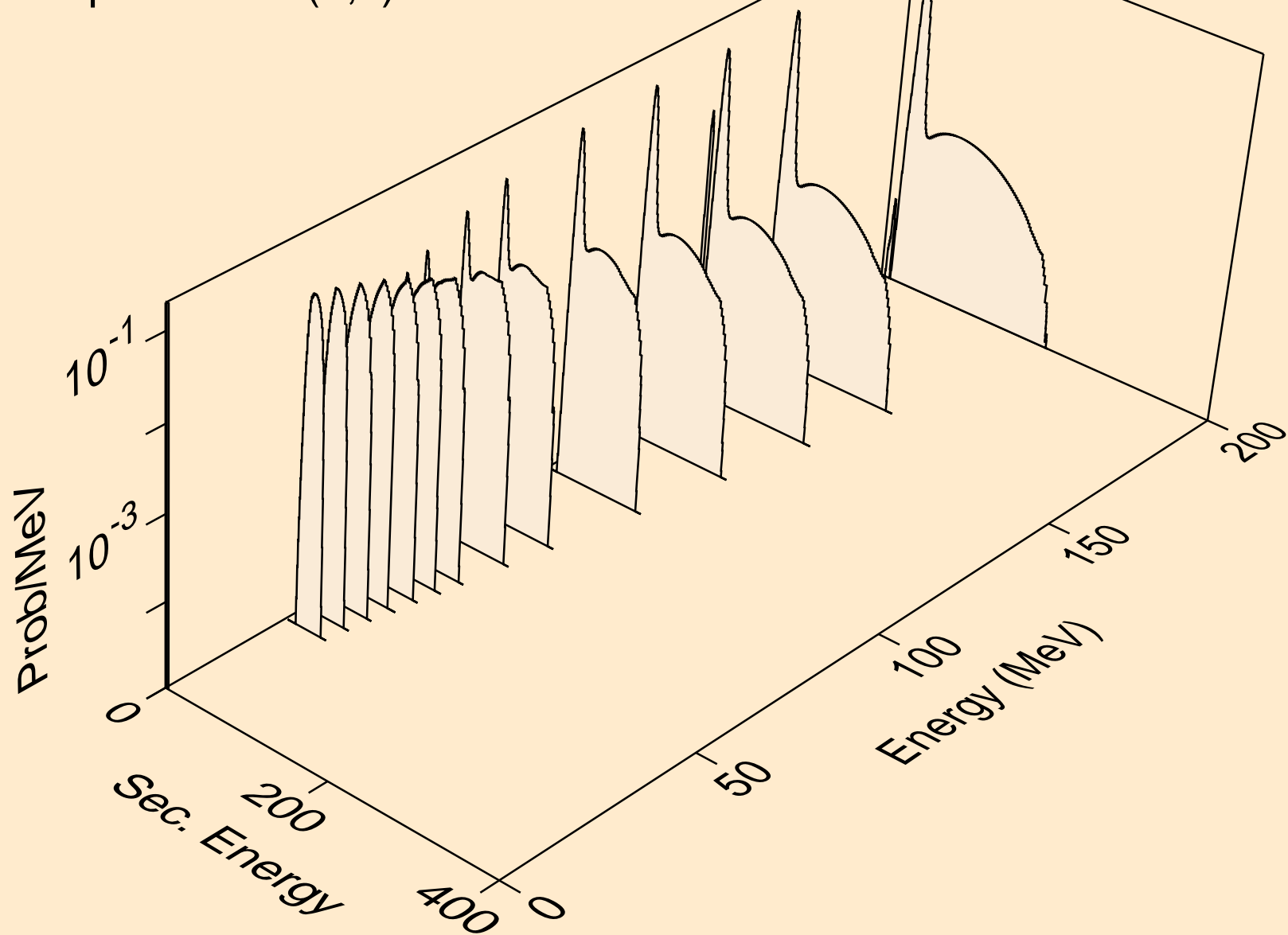

IR205 DEUTERON ACER TENDL-2023 LIBRARY; T=0.K
alphas from (d,n*)a

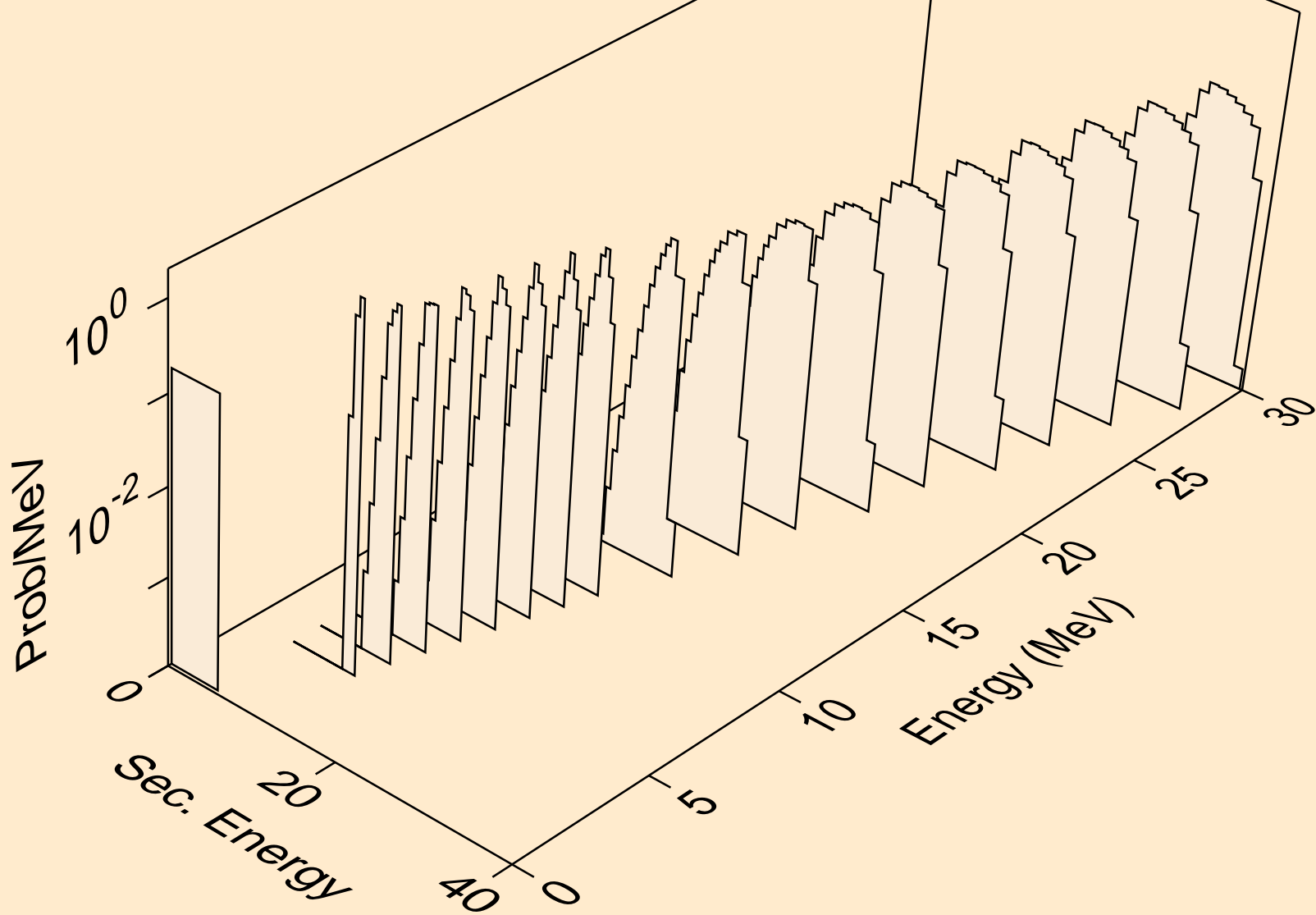

IR205 DEUTERON ACER TENDL-2023 LIBRARY; T=0.K
alphas from (d,2n)a

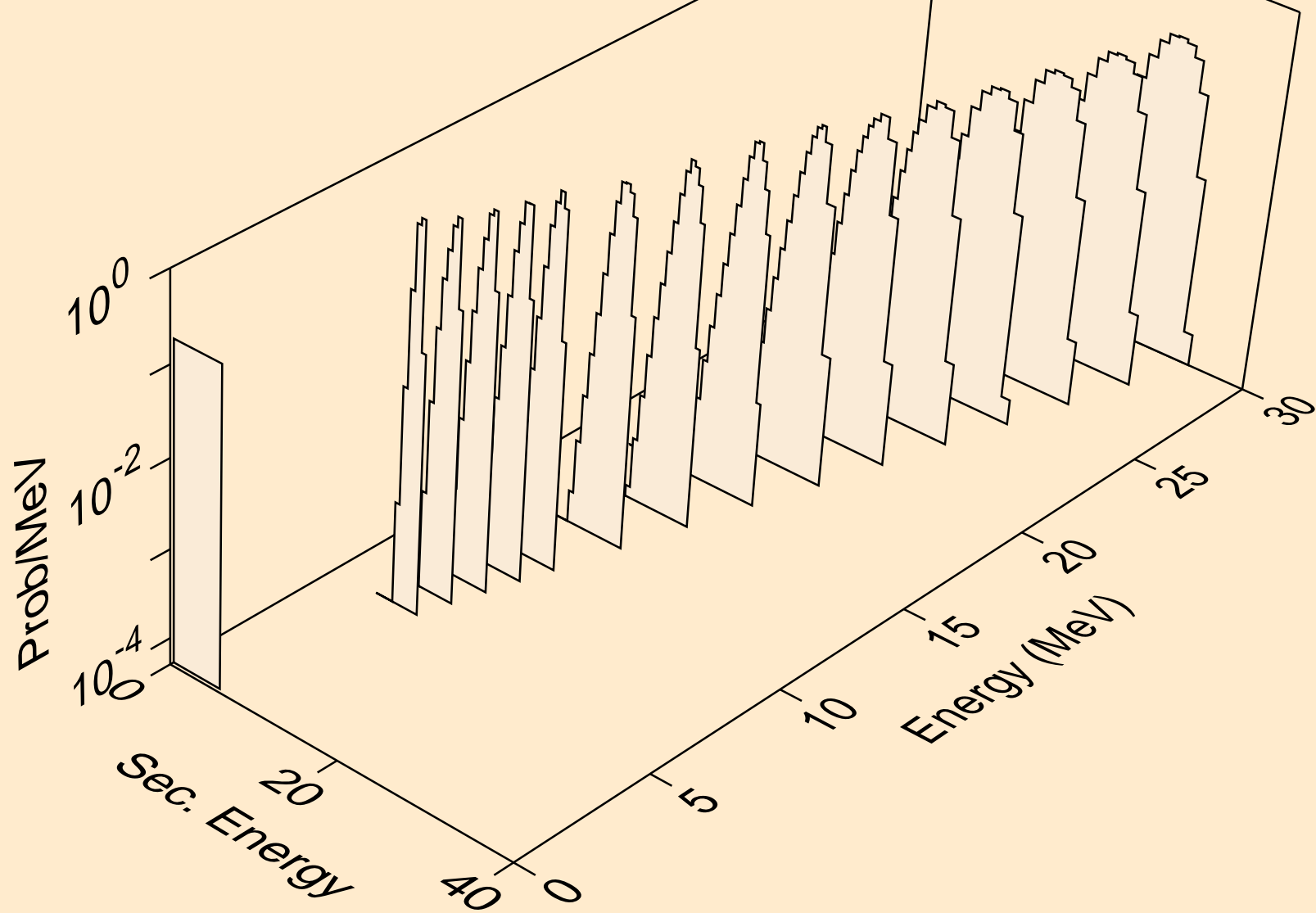

IR205 DEUTERON ACER TENDL-2023 LIBRARY; T=0.K
alphas from (d,3n)a

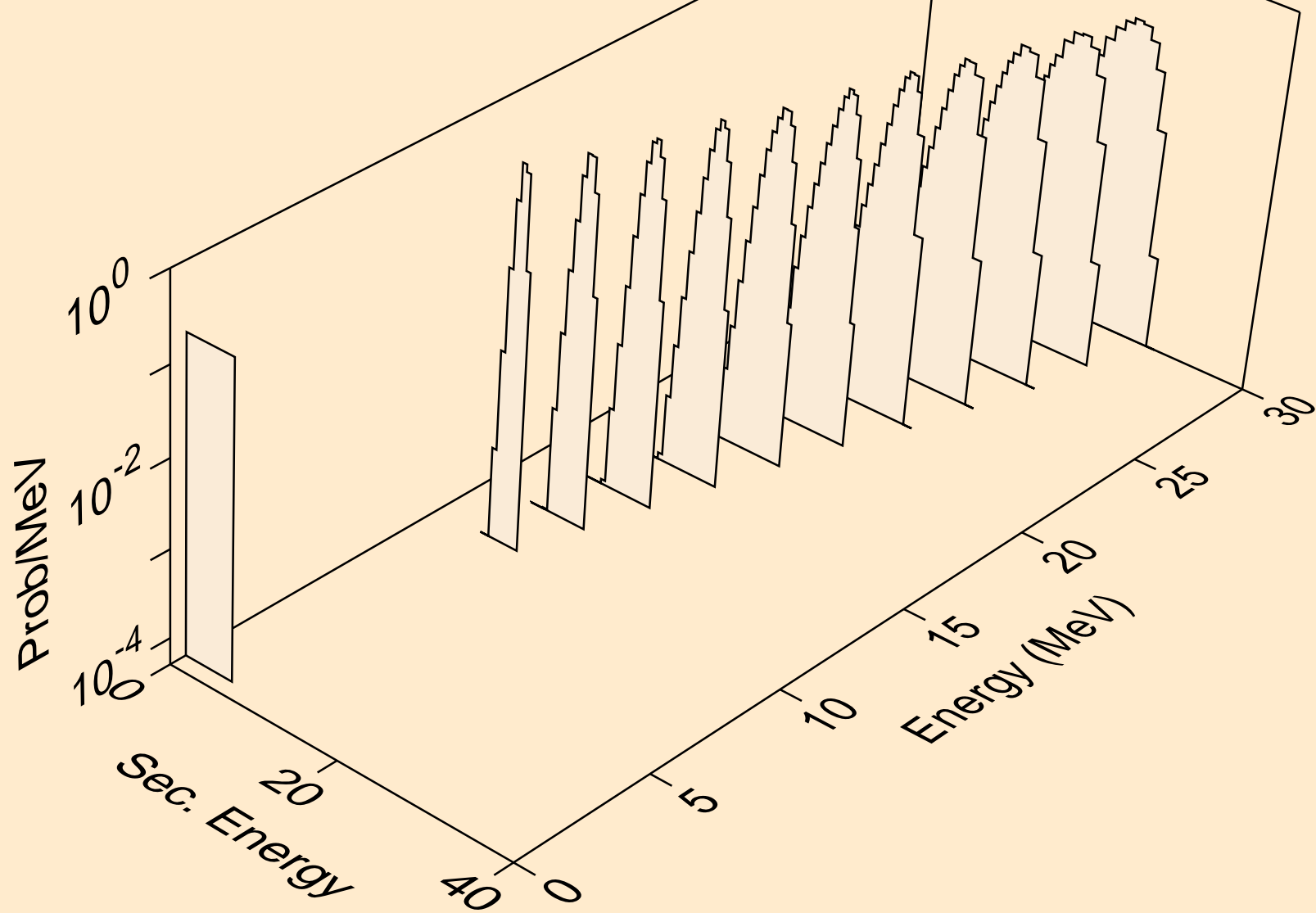

IR205 DEUTERON ACER TENDL-2023 LIBRARY; T=0.K
alphas from (d,a)

