

MD246M DEUTERON ACER TENDL-2023 LIBRARY; T=0.K
Principal cross sections

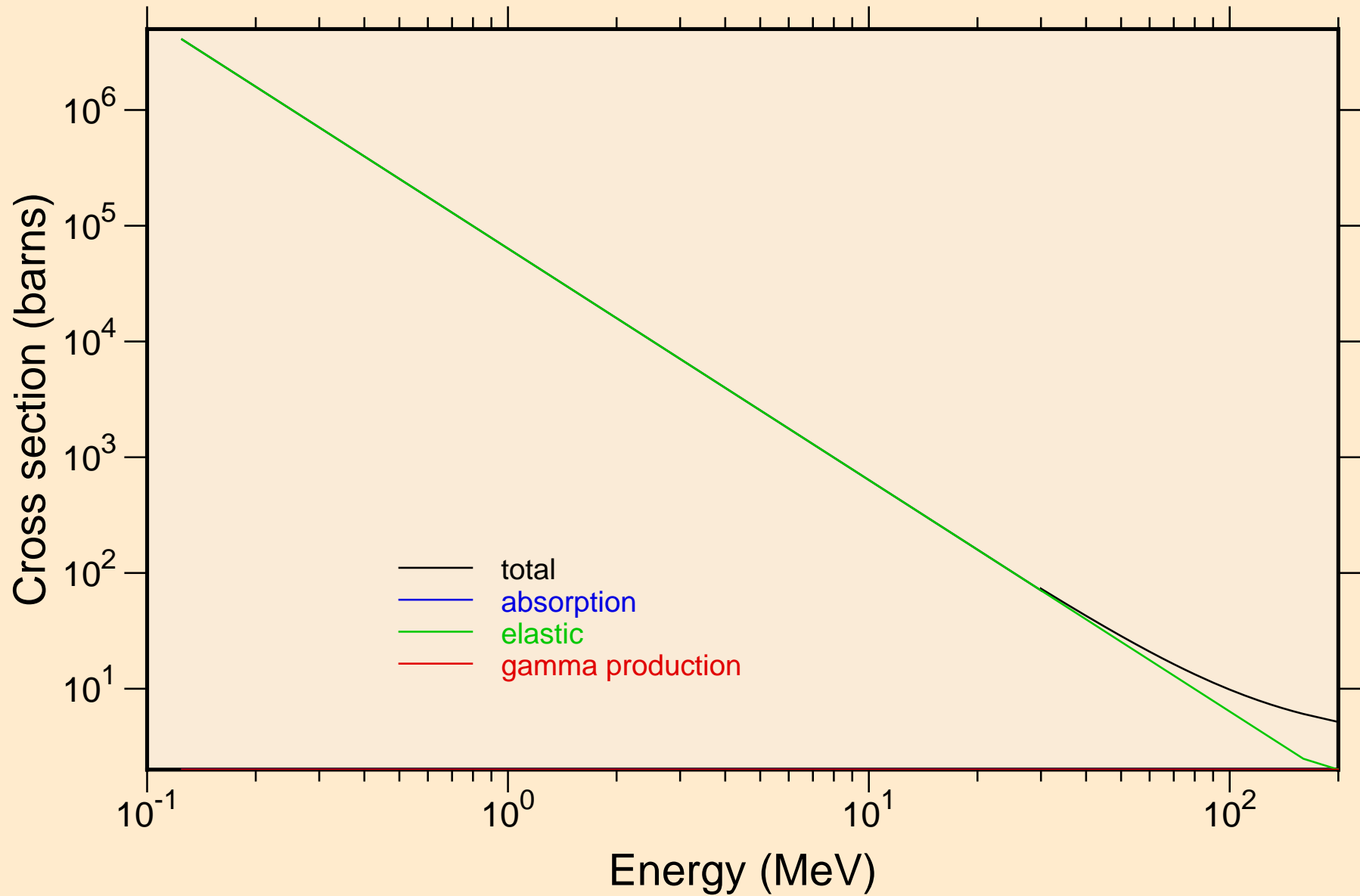

MD246M DEUTERON ACER TENDL-2023 LIBRARY; T=0.K
Heating

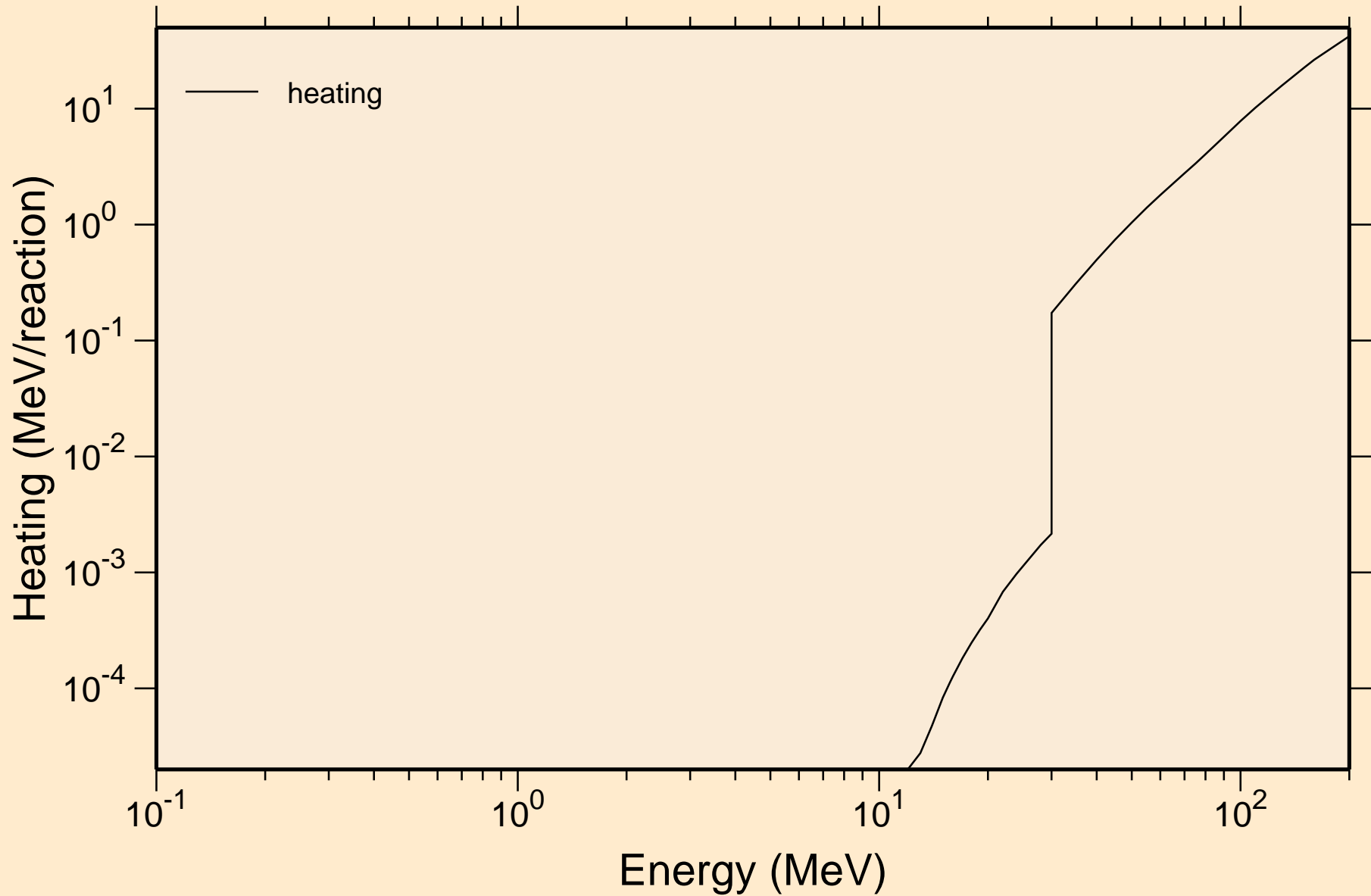

MD246M DEUTERON ACER TENDL-2023 LIBRARY; T=0.K
Principal cross sections

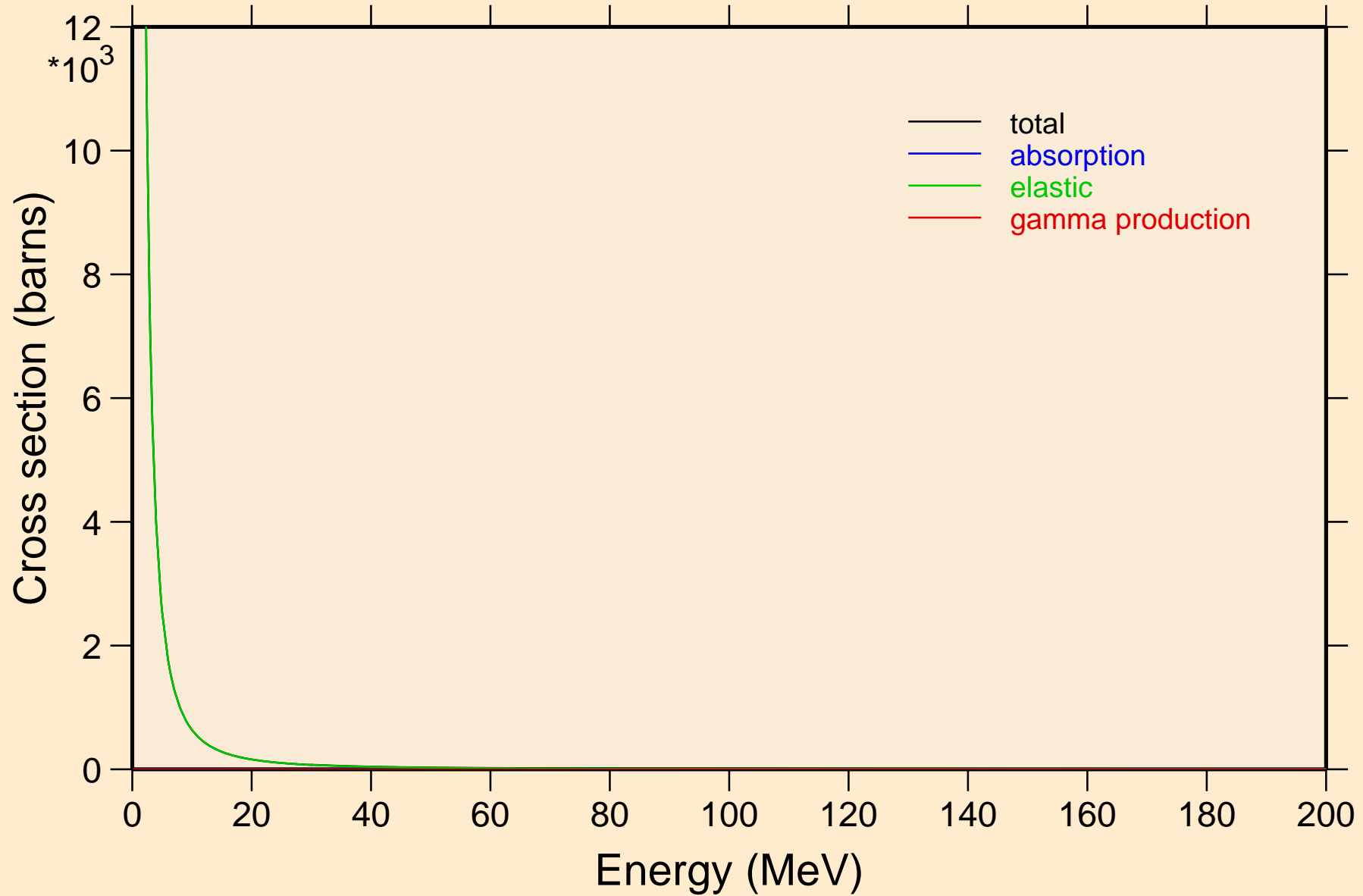

MD246M DEUTERON ACER TENDL-2023 LIBRARY; T=0.K

Heating

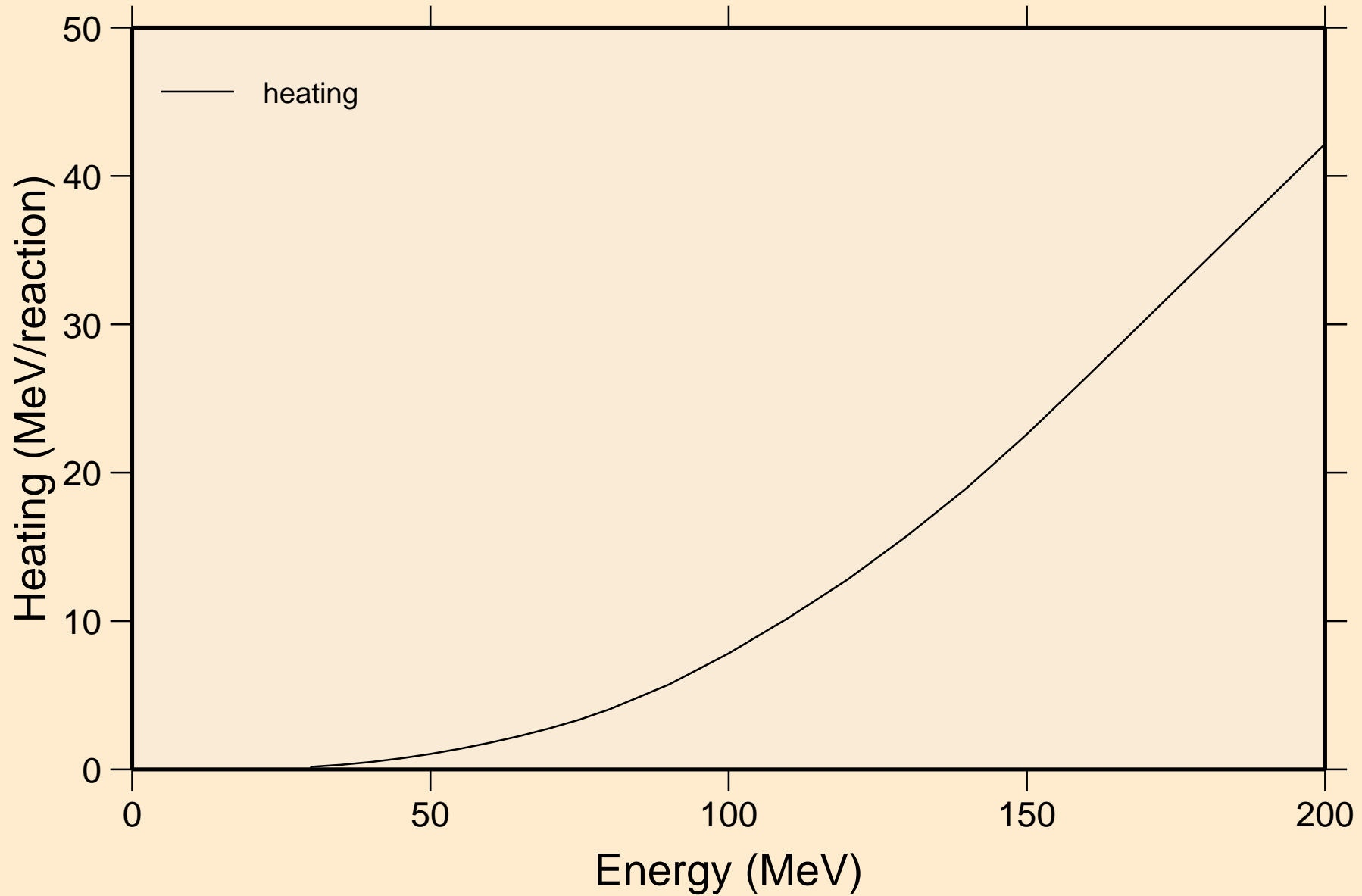

MD246M DEUTERON ACER TENDL-2023 LIBRARY; T=0.K

Threshold reactions

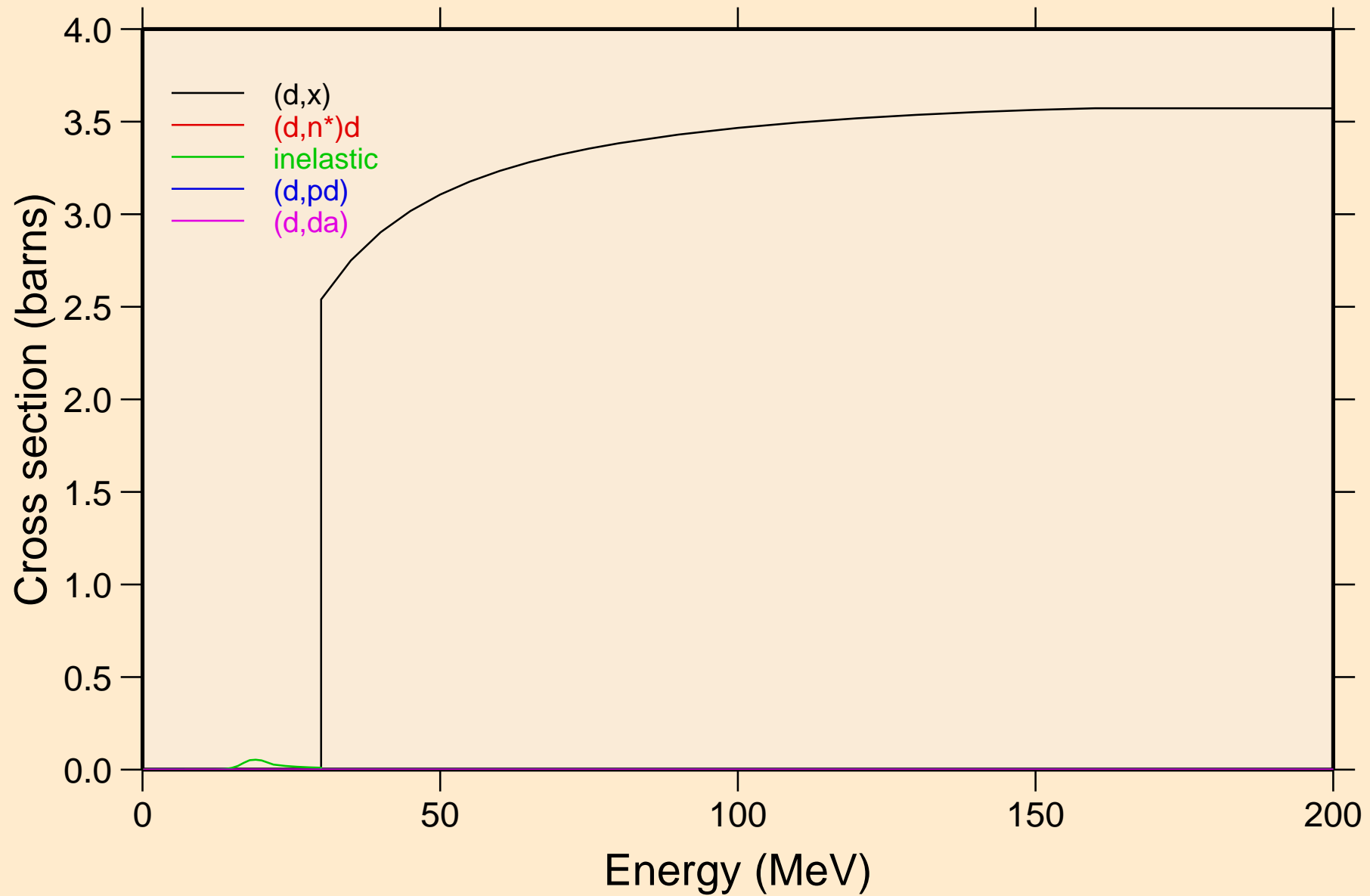

MD246M DEUTERON ACER TENDL-2023 LIBRARY; T=0.K
angular distribution for elastic

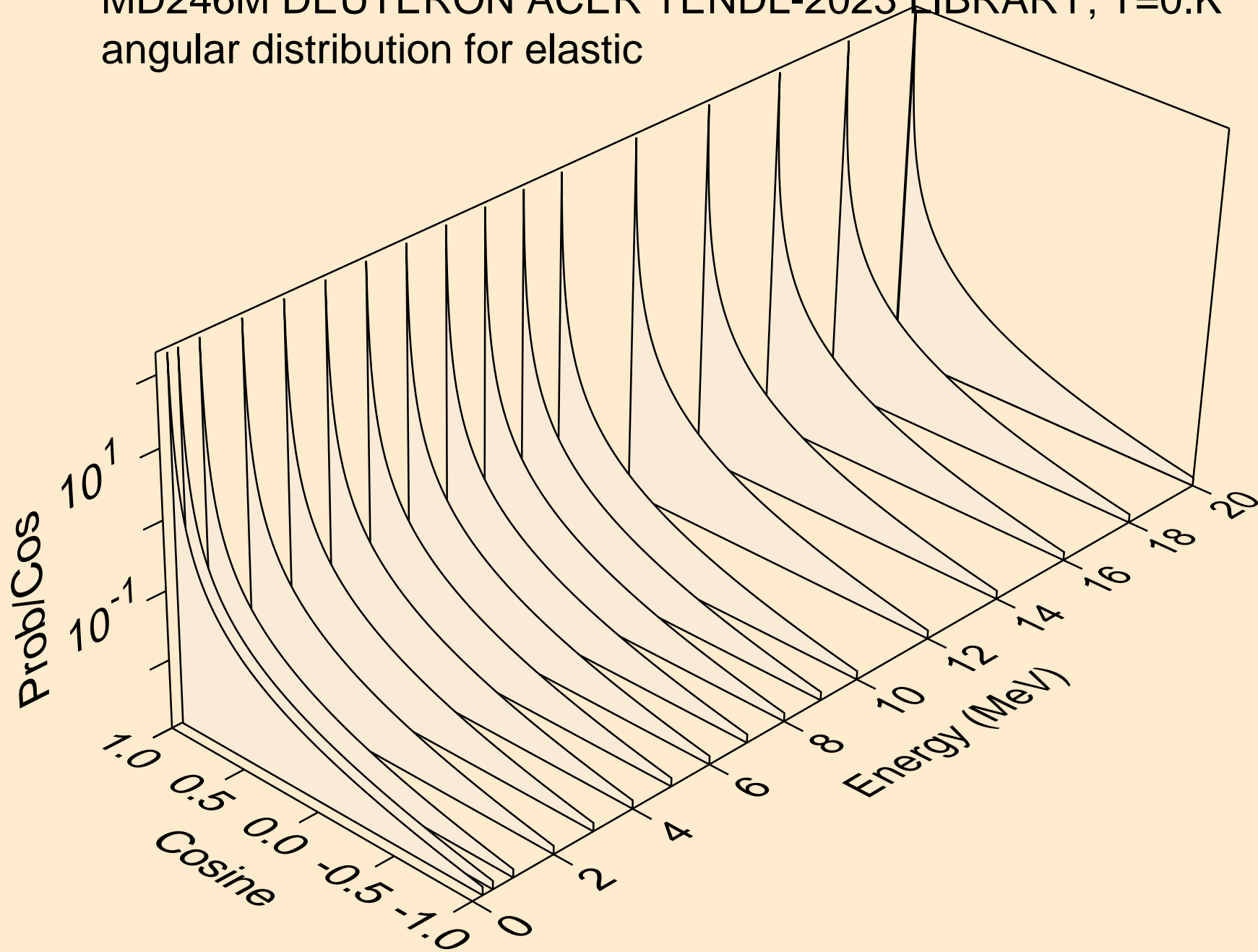

MD246M DEUTERON ACER TENDL-2023 LIBRARY; T=0.K
angular distribution for elastic

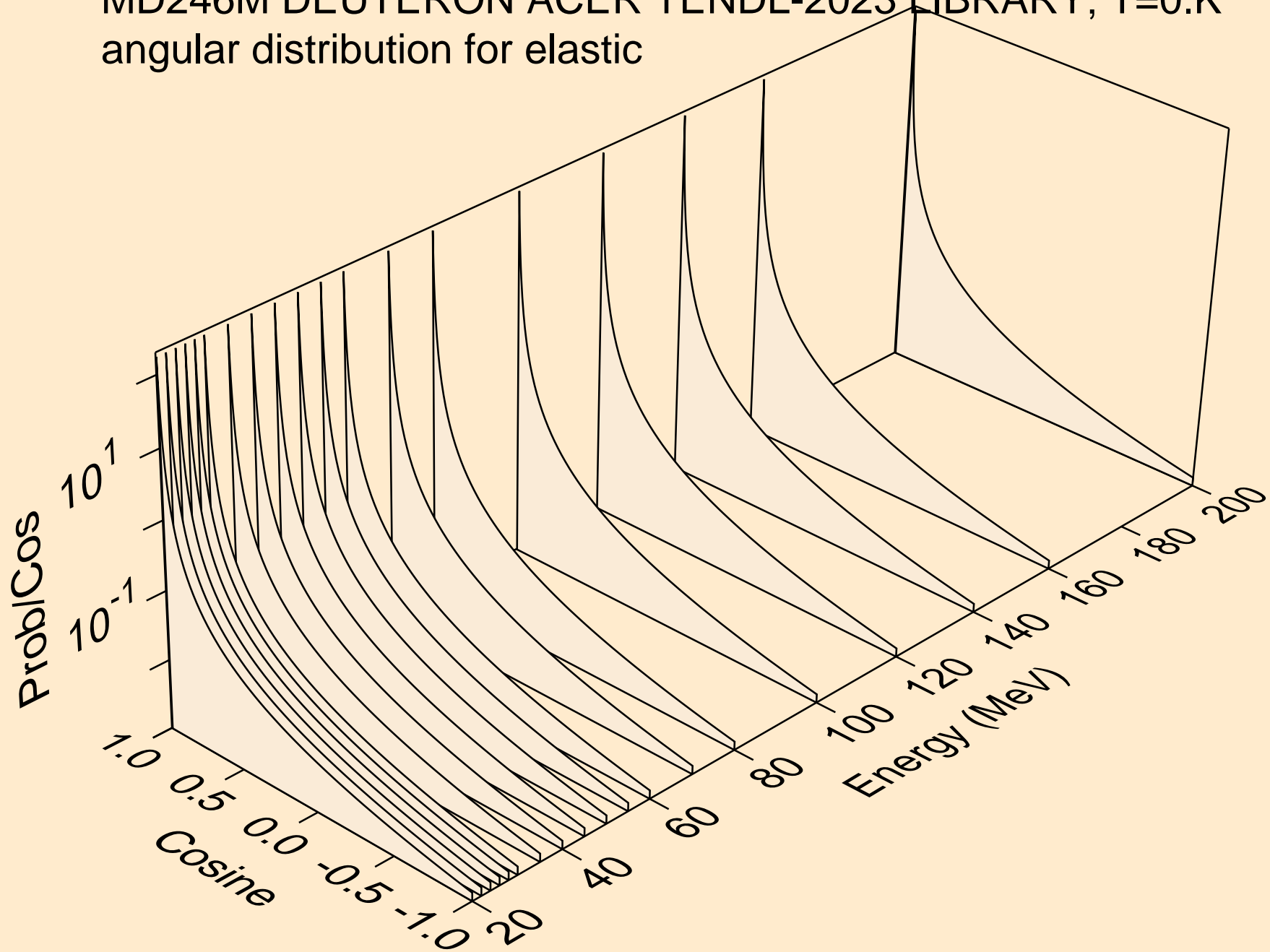

MD246M DEUTERON ACER TENDL-2023 LIBRARY; T=0.K
Deuteron emission for (d,x)

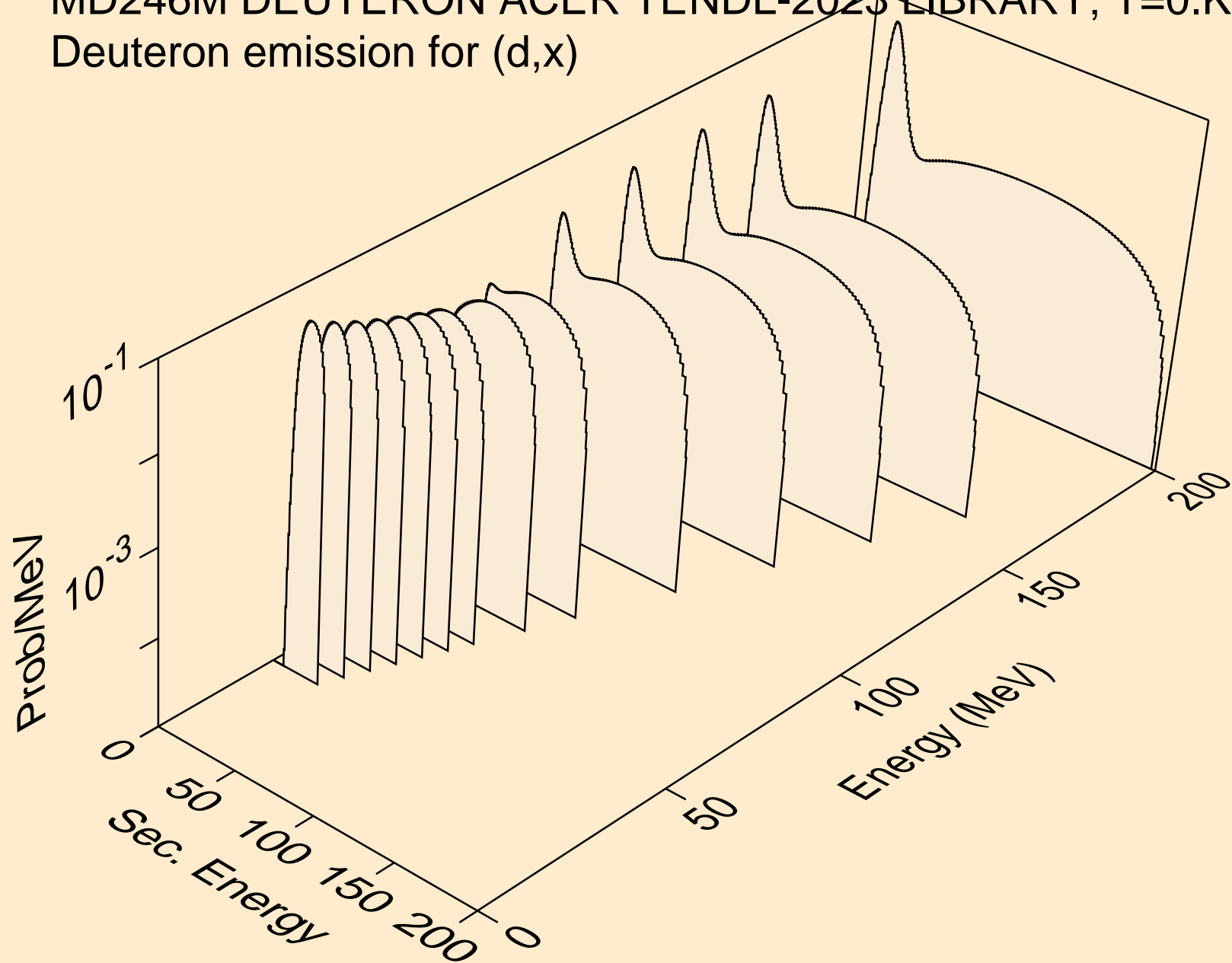

MD246M DEUTERON ACER TENDL-2023 LIBRARY; T=0.K
Deuteron emission for (d,n*)d

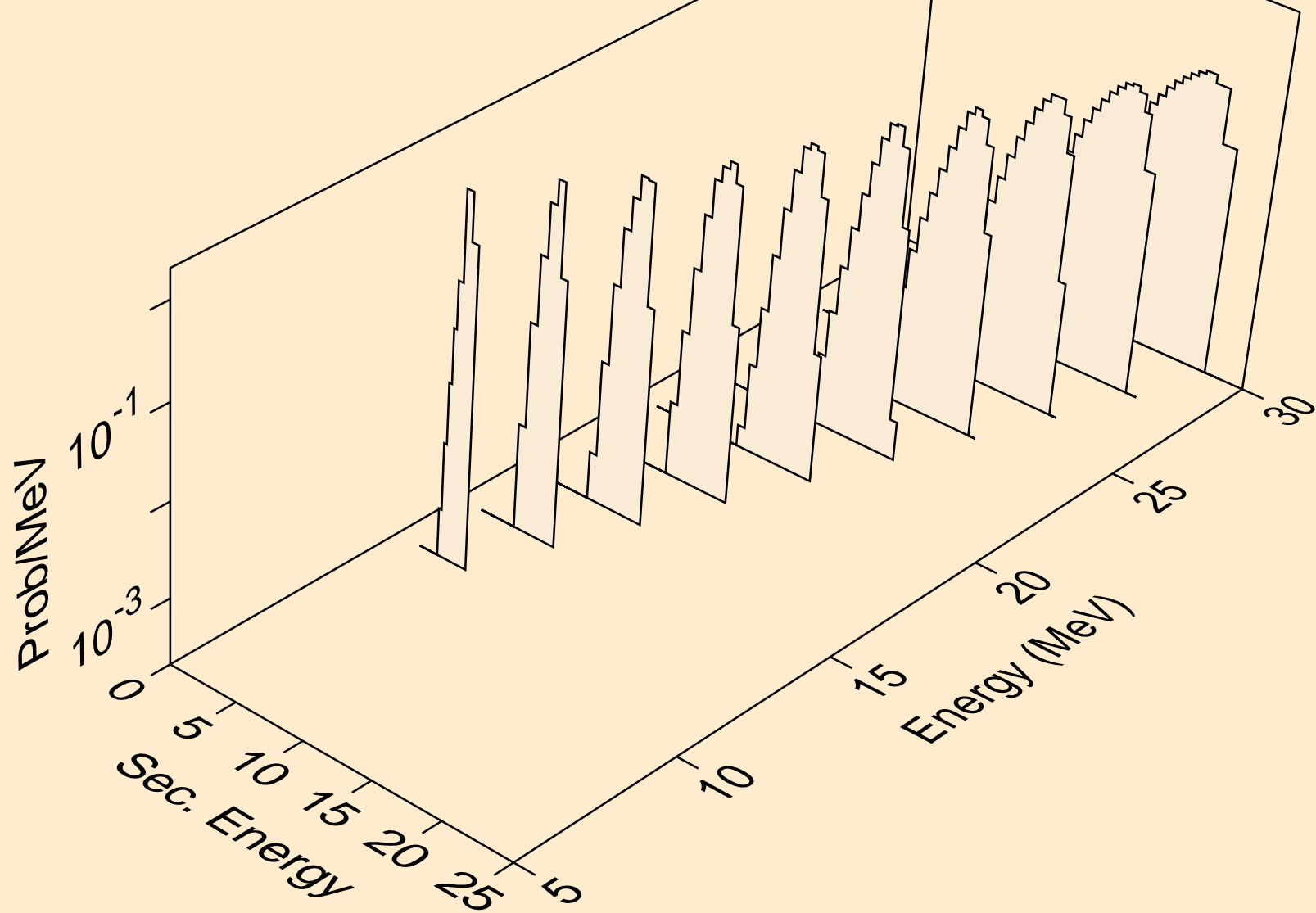

MD246M DEUTERON ACER TENDL-2023 LIBRARY; T=0.K
Deuteron emission for inelastic

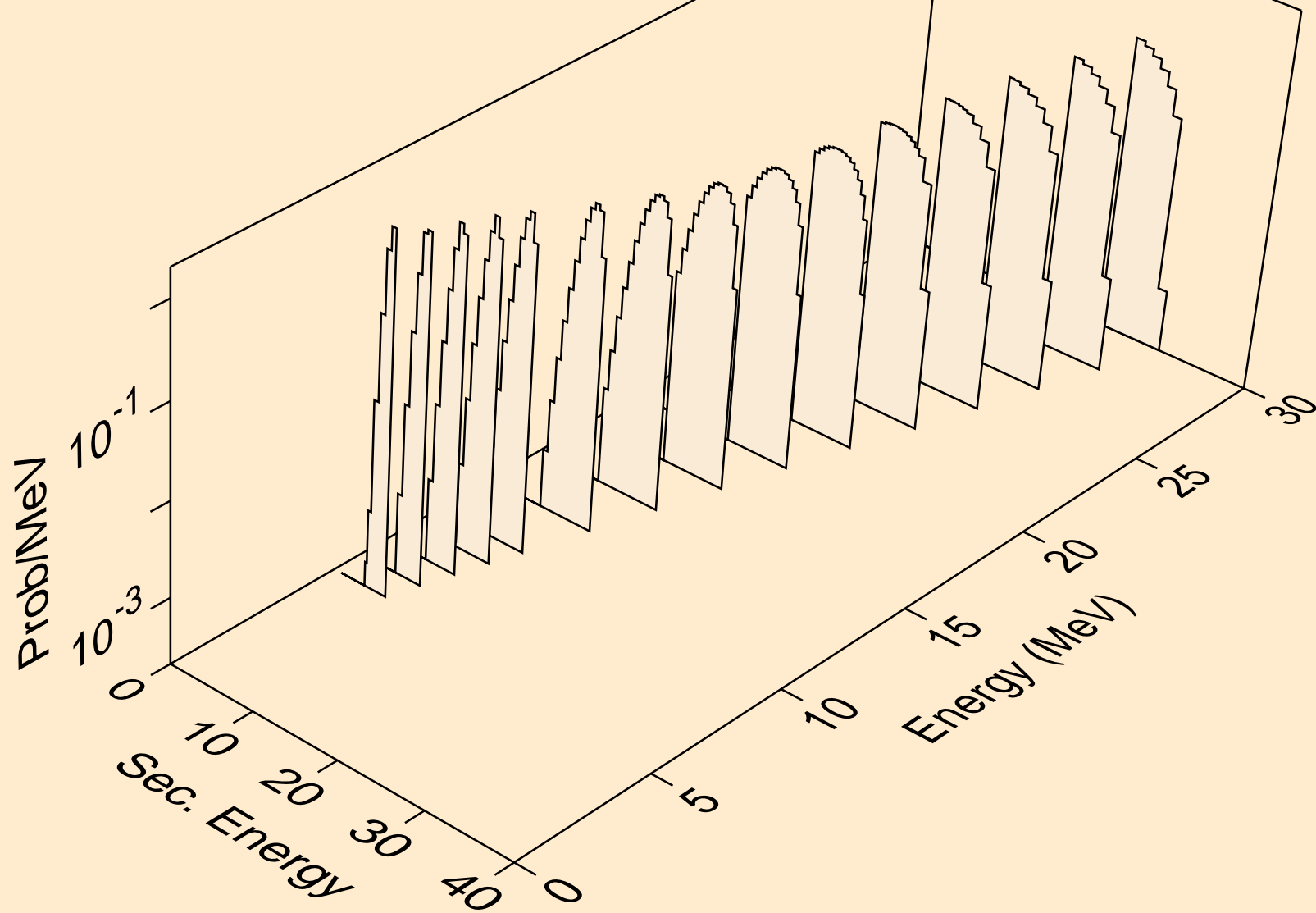

MD246M DEUTERON ACER TENDL-2023 LIBRARY; T=0.K
Deuteron emission for (d,pd)

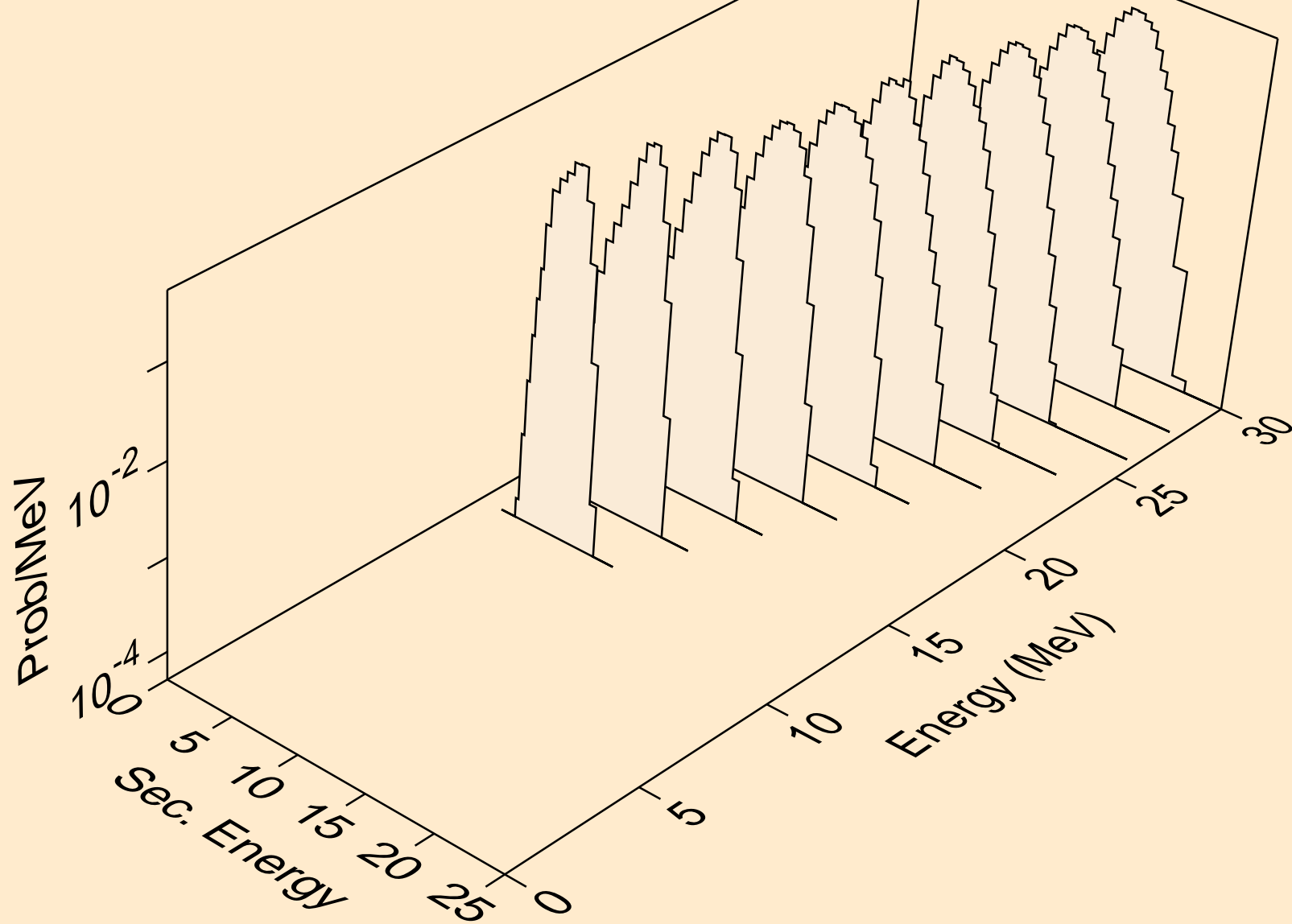

MD246M DEUTERON ACER TENDL-2023 LIBRARY; T=0.K
Deuteron emission for (d,da)

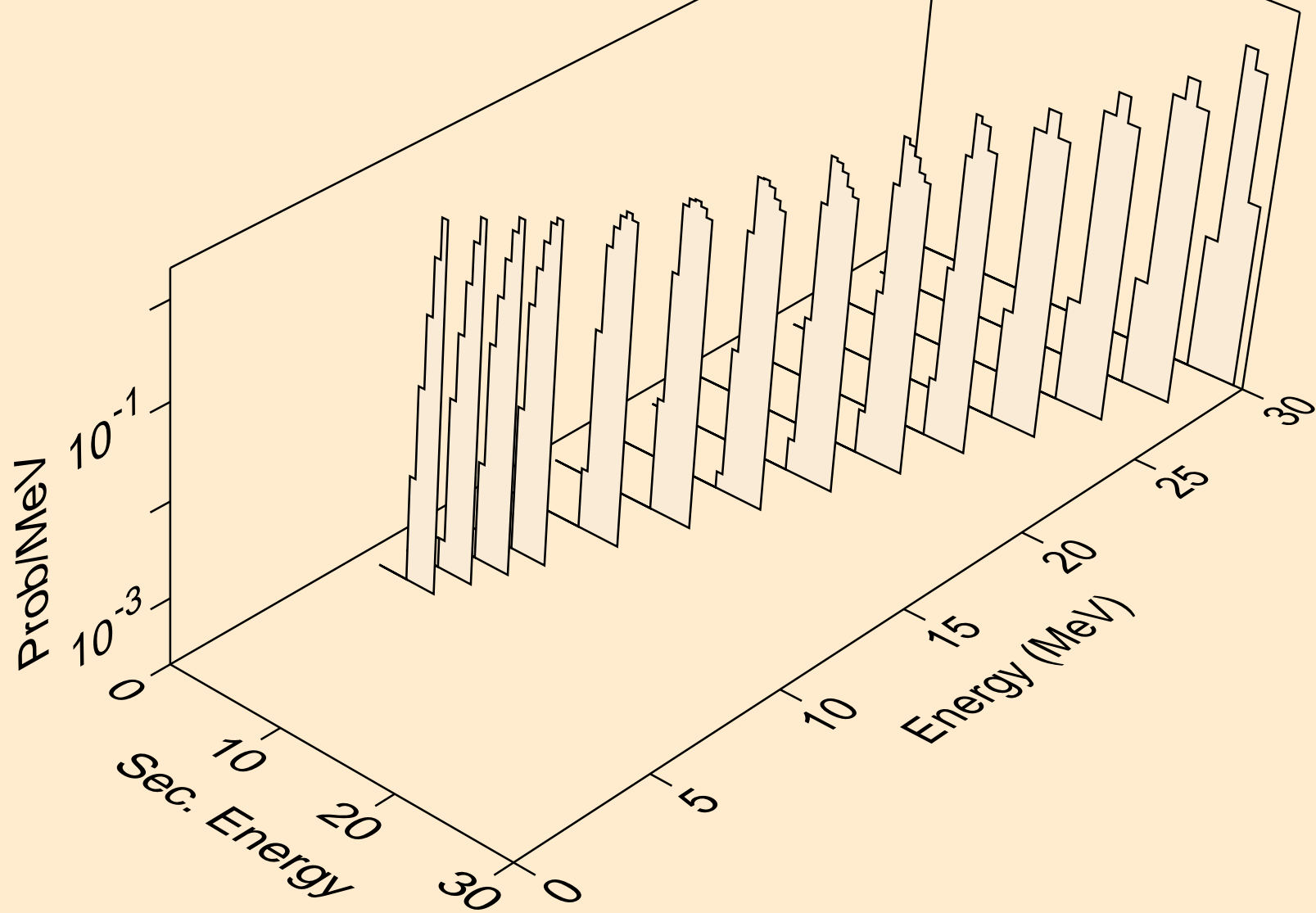

MD246M DEUTERON ACER TENDL-2023 LIBRARY; T=0.K
Photon emission for (z,n)

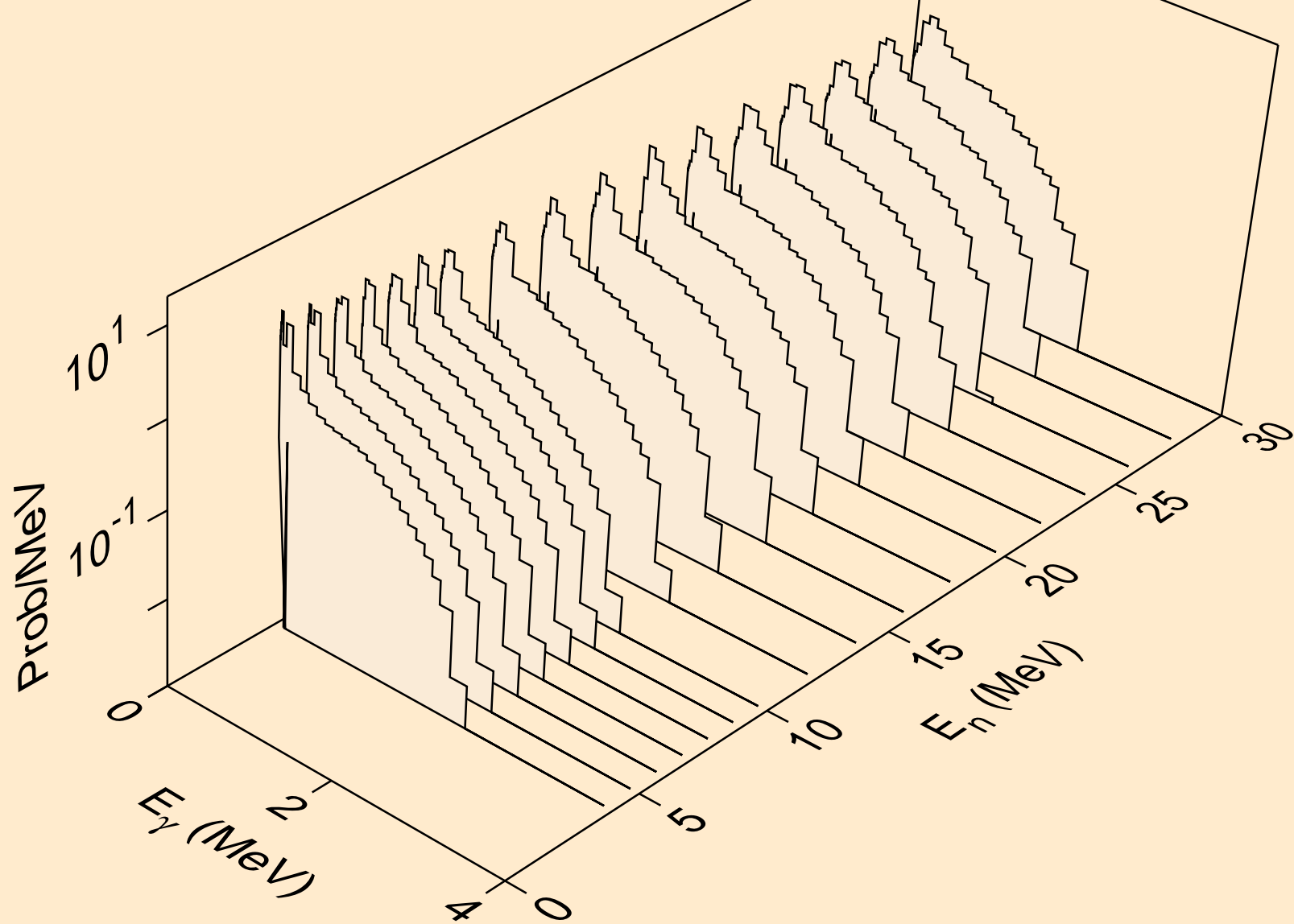

MD246M DEUTERON ACER TENDL-2023 LIBRARY; T=0.K
Photon emission for (z,x)

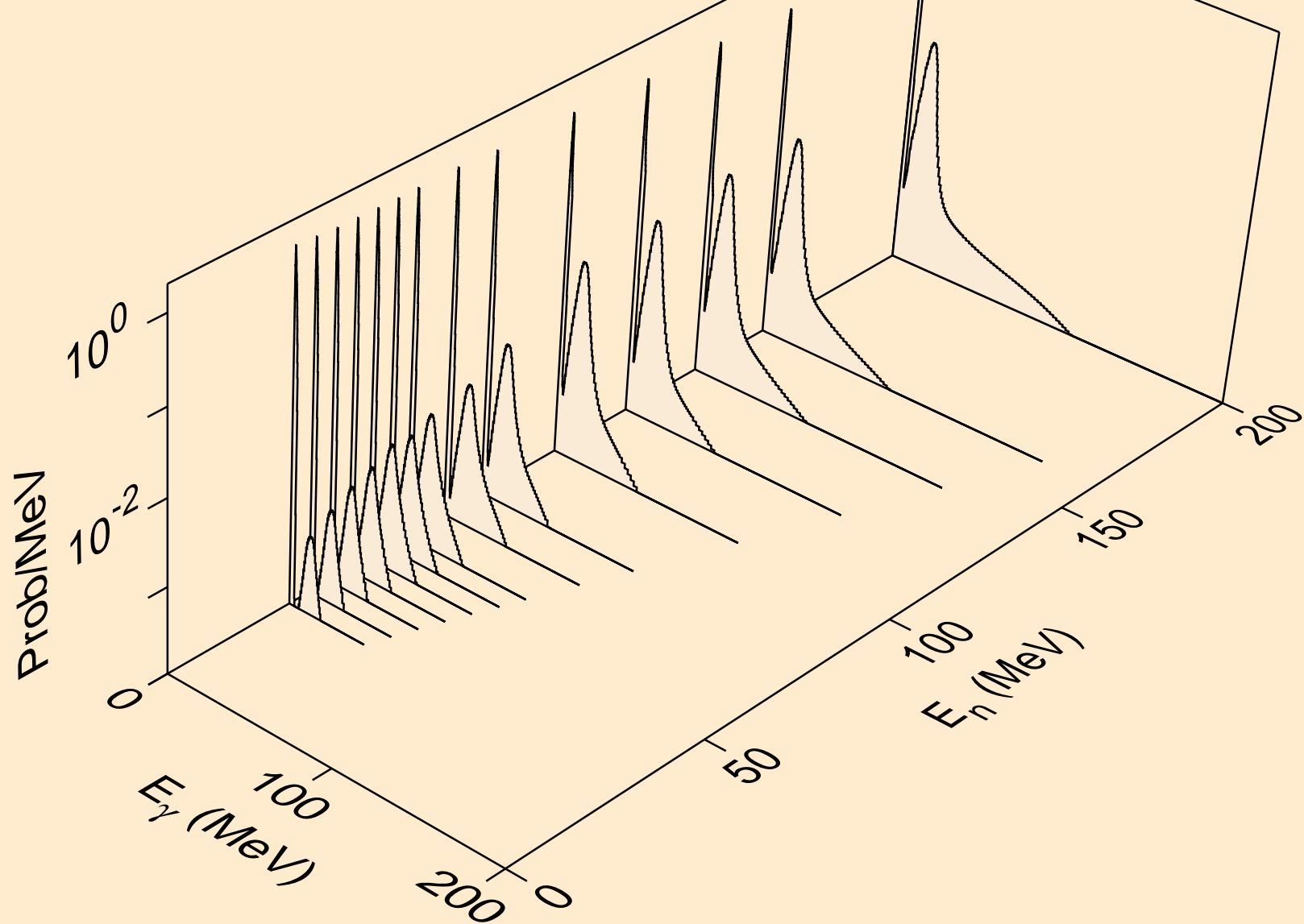

MD246M DEUTERON ACER TENDL-2023 LIBRARY; T=0.K
Photon emission for (n,2n)

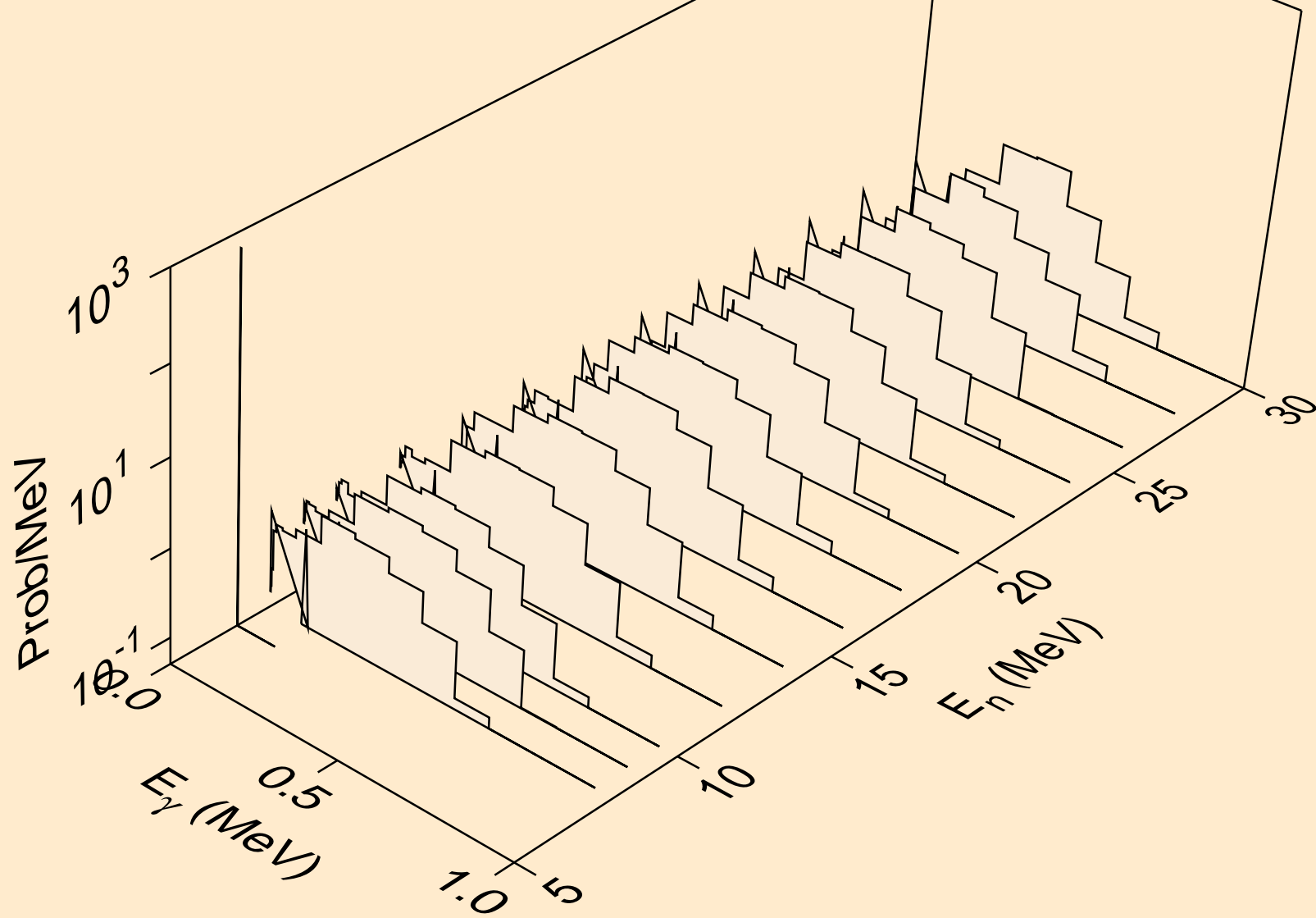

MD246M DEUTERON ACER TENDL-2023 LIBRARY; T=0.K
Photon emission for (n,3n)

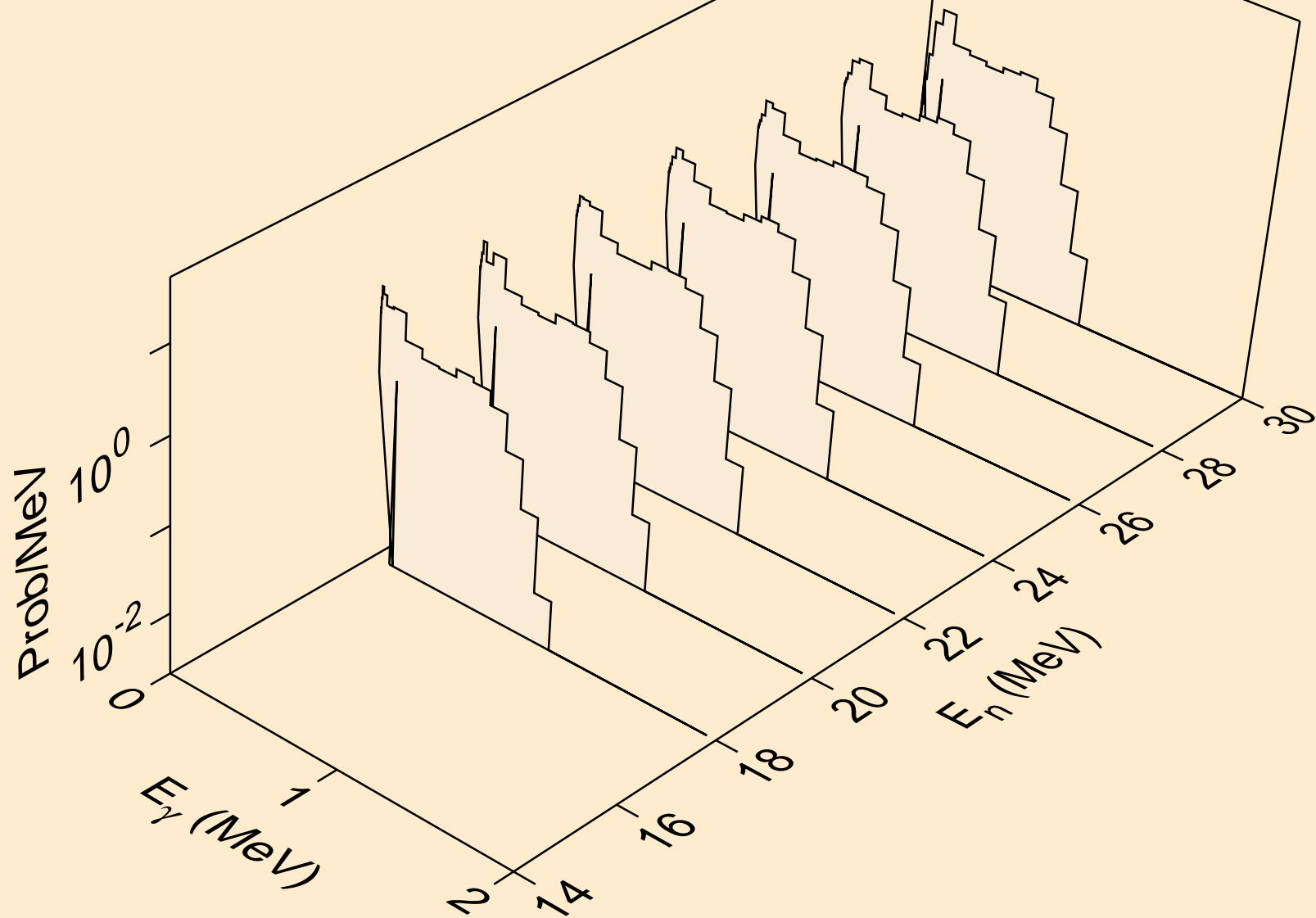

MD246M DEUTERON ACER TENDL-2023 LIBRARY; T=0.K
Photon emission for (n,n*)a

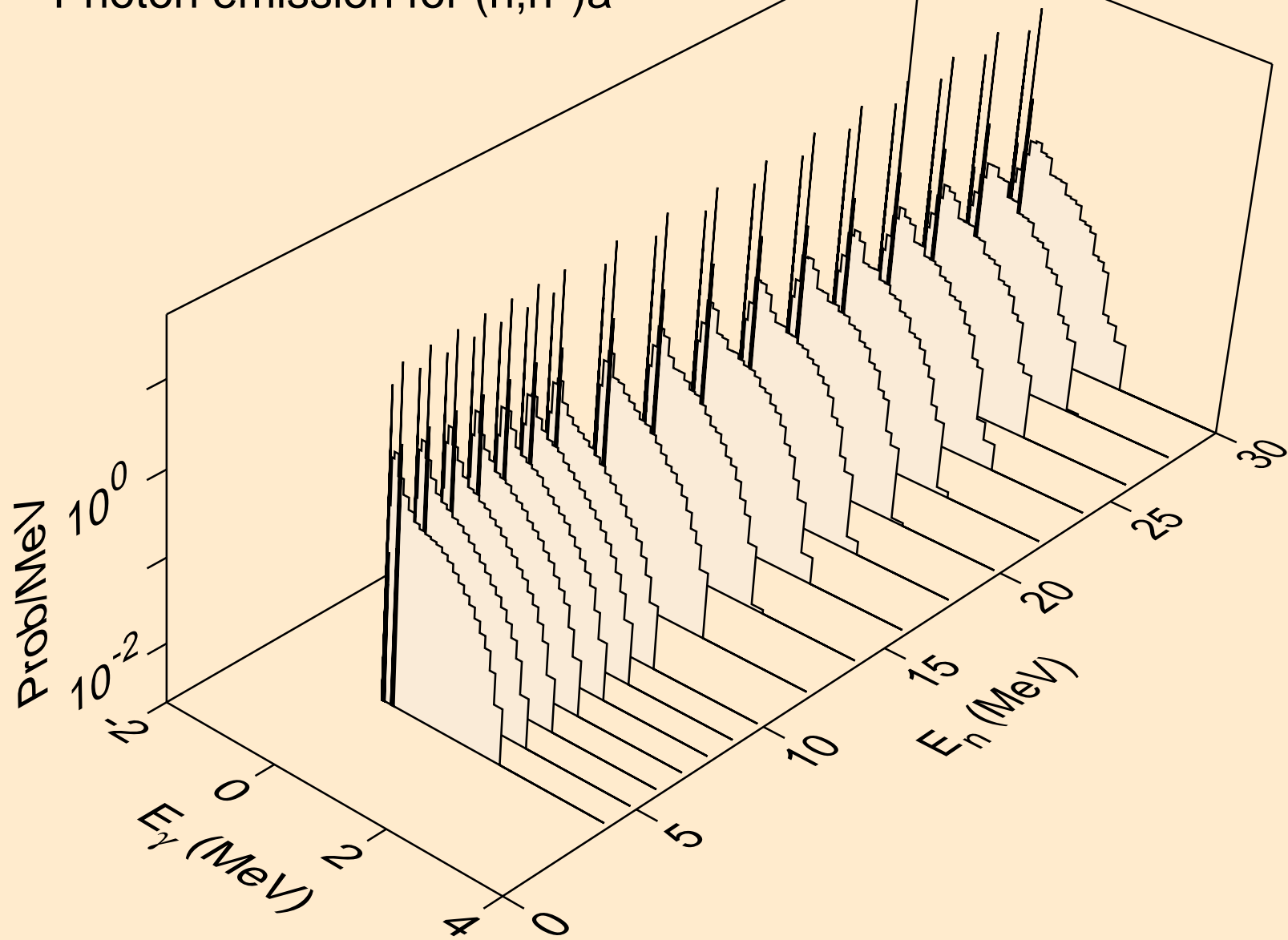

MD246M DEUTERON ACER TENDL-2023 LIBRARY; T=0.K
Photon emission for (n,3n)a

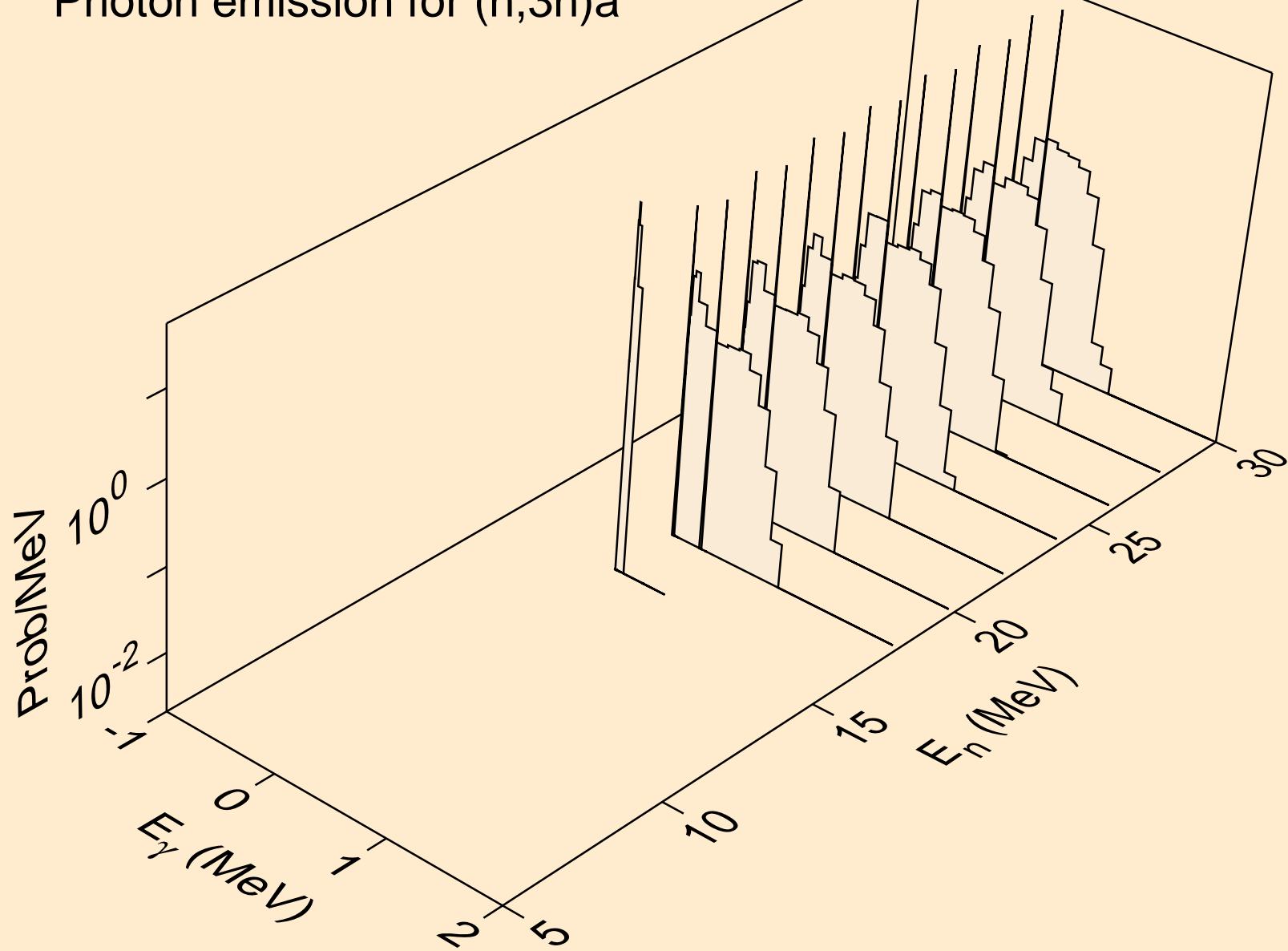

MD246M DEUTERON ACER TENDL-2023 LIBRARY; T=0.K
Photon emission for (n,n*)p

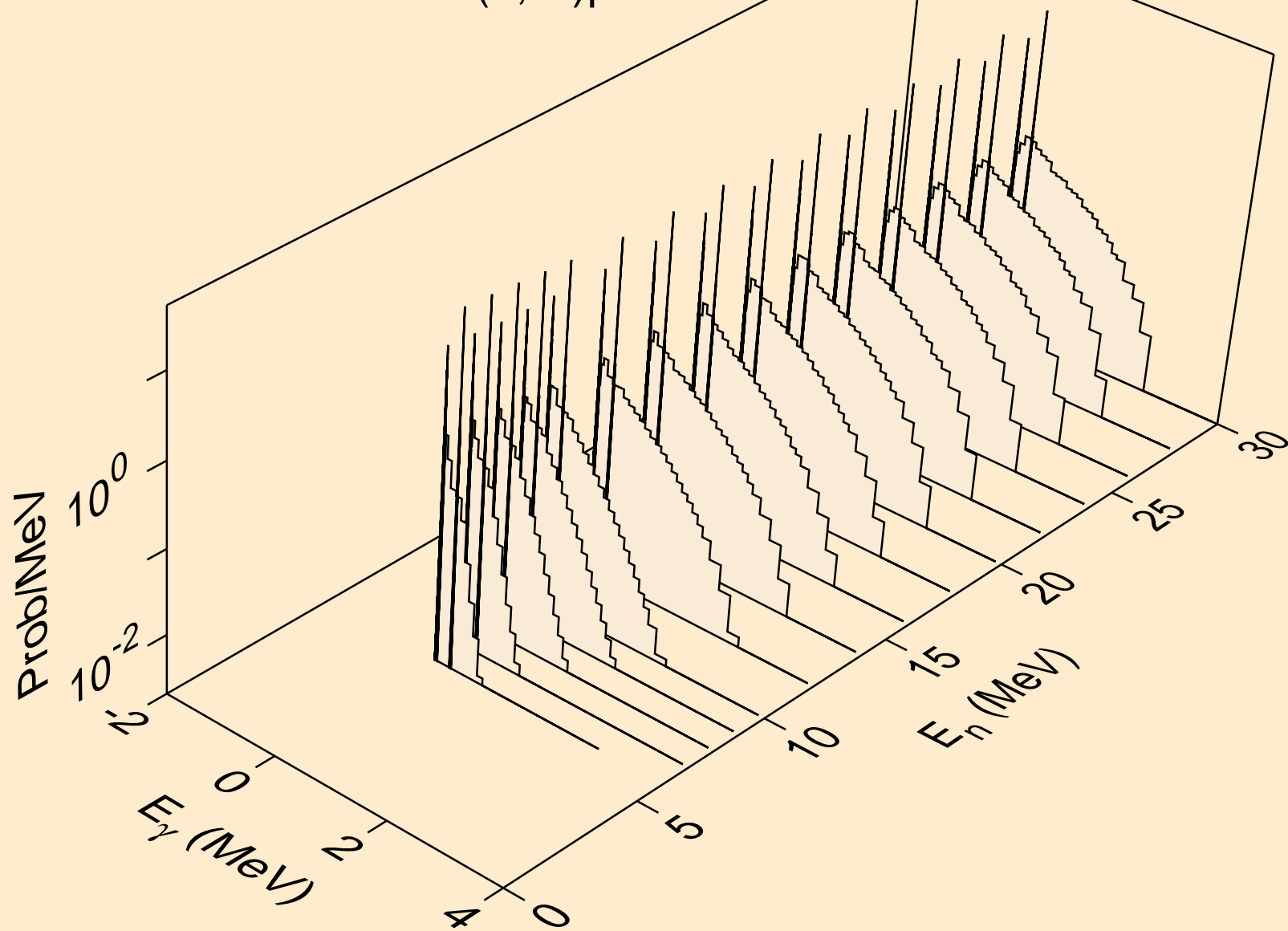

MD246M DEUTERON ACER TENDL-2023 LIBRARY; T=0.K
Photon emission for (n,n*)d

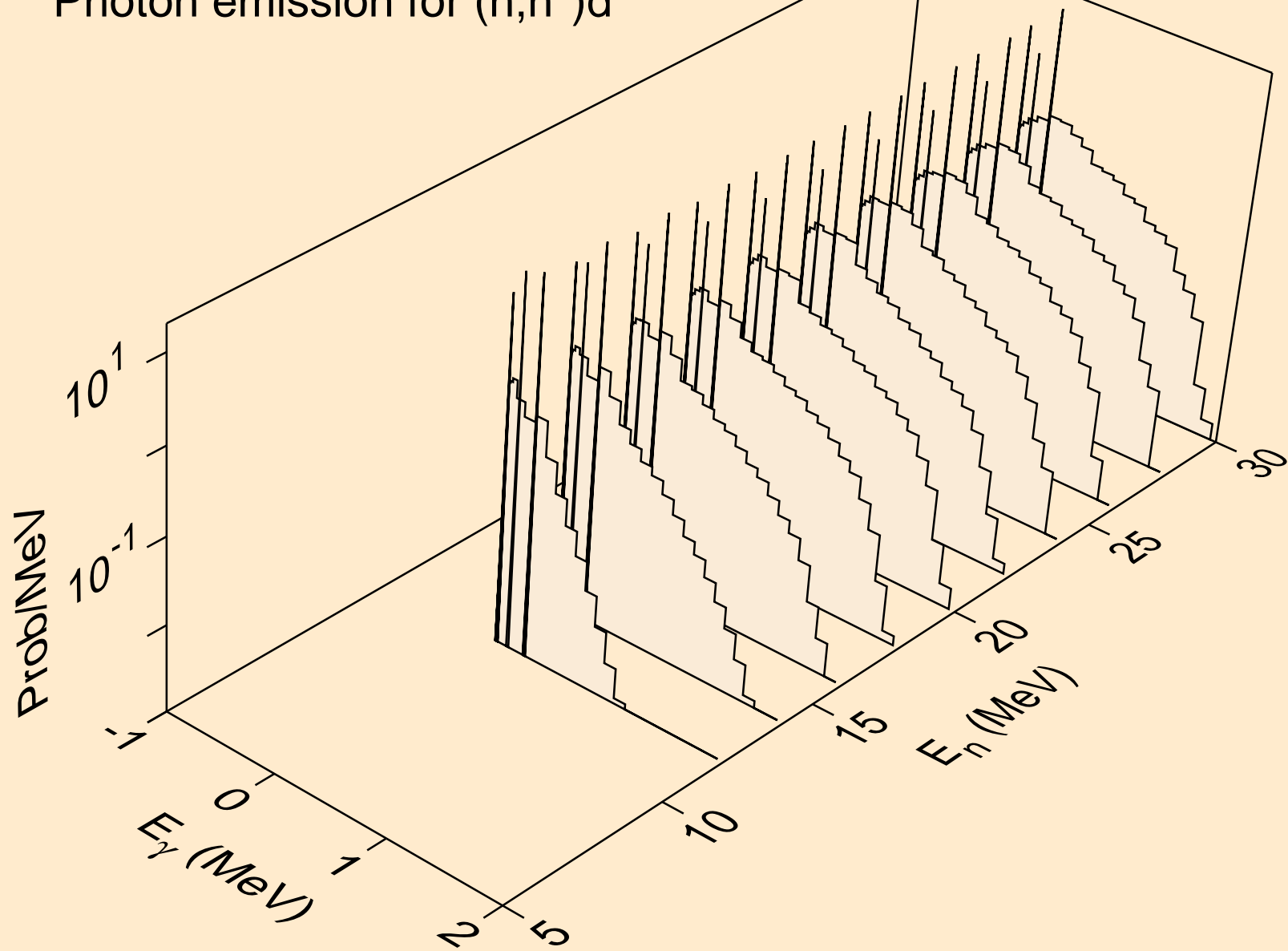

MD246M DEUTERON ACER TENDL-2023 LIBRARY; T=0.K
Photon emission for (n,n*)t

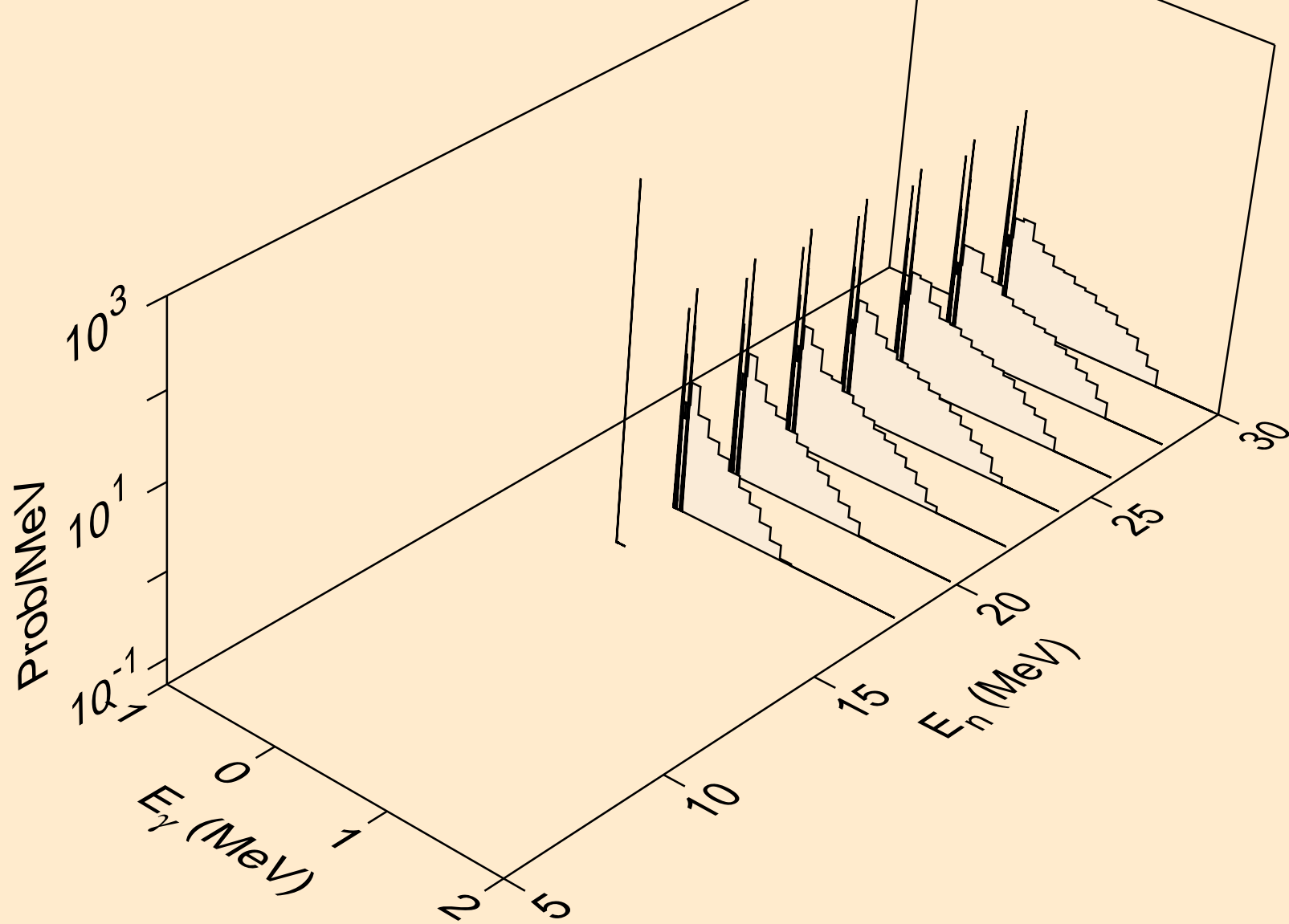

MD246M DEUTERON ACER TENDL-2023 LIBRARY; T=0.K
Photon emission for (n,2np)

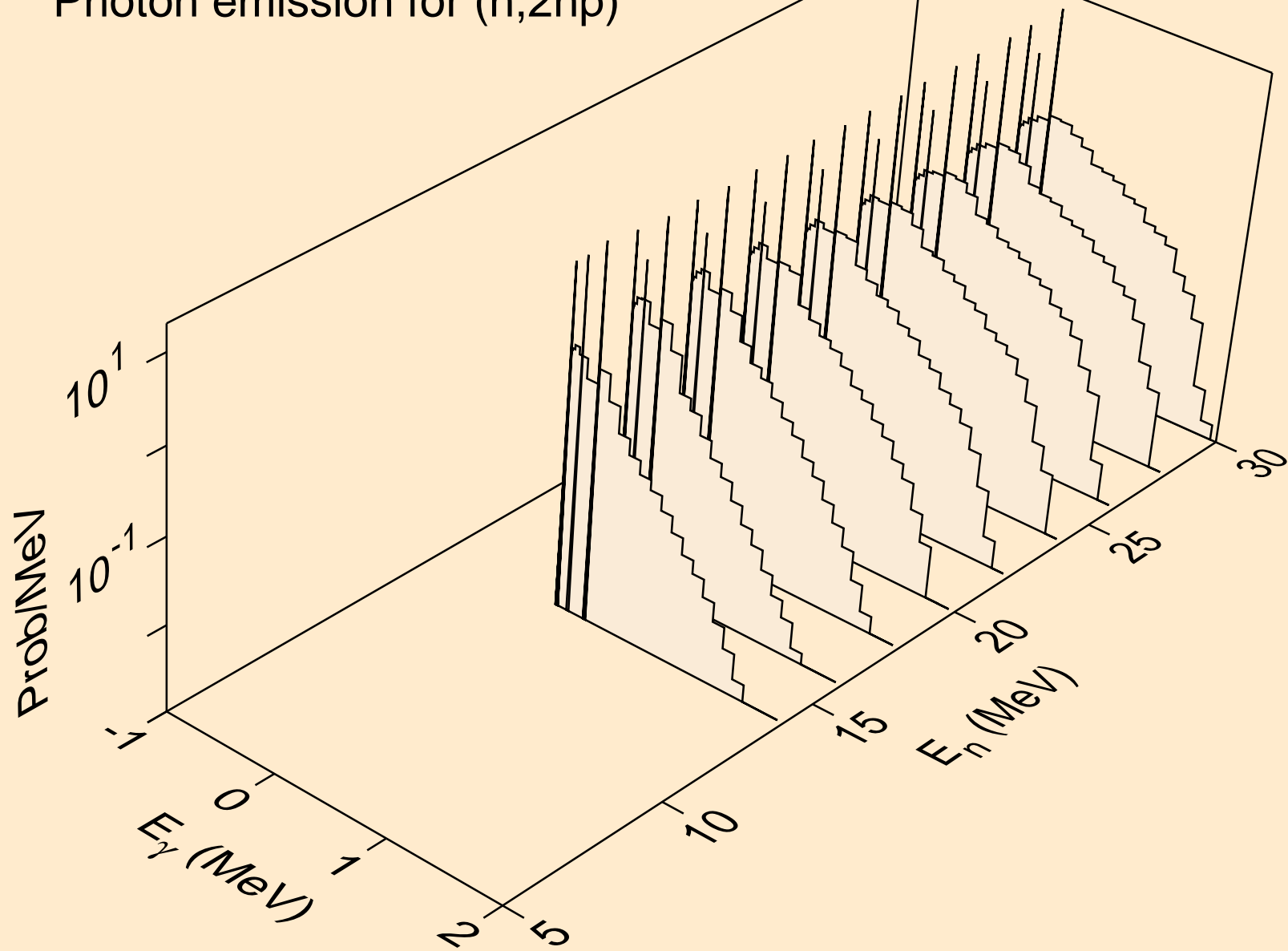

MD246M DEUTERON ACER TENDL-2023 LIBRARY; T=0.K
Photon emission for (n,n2p)

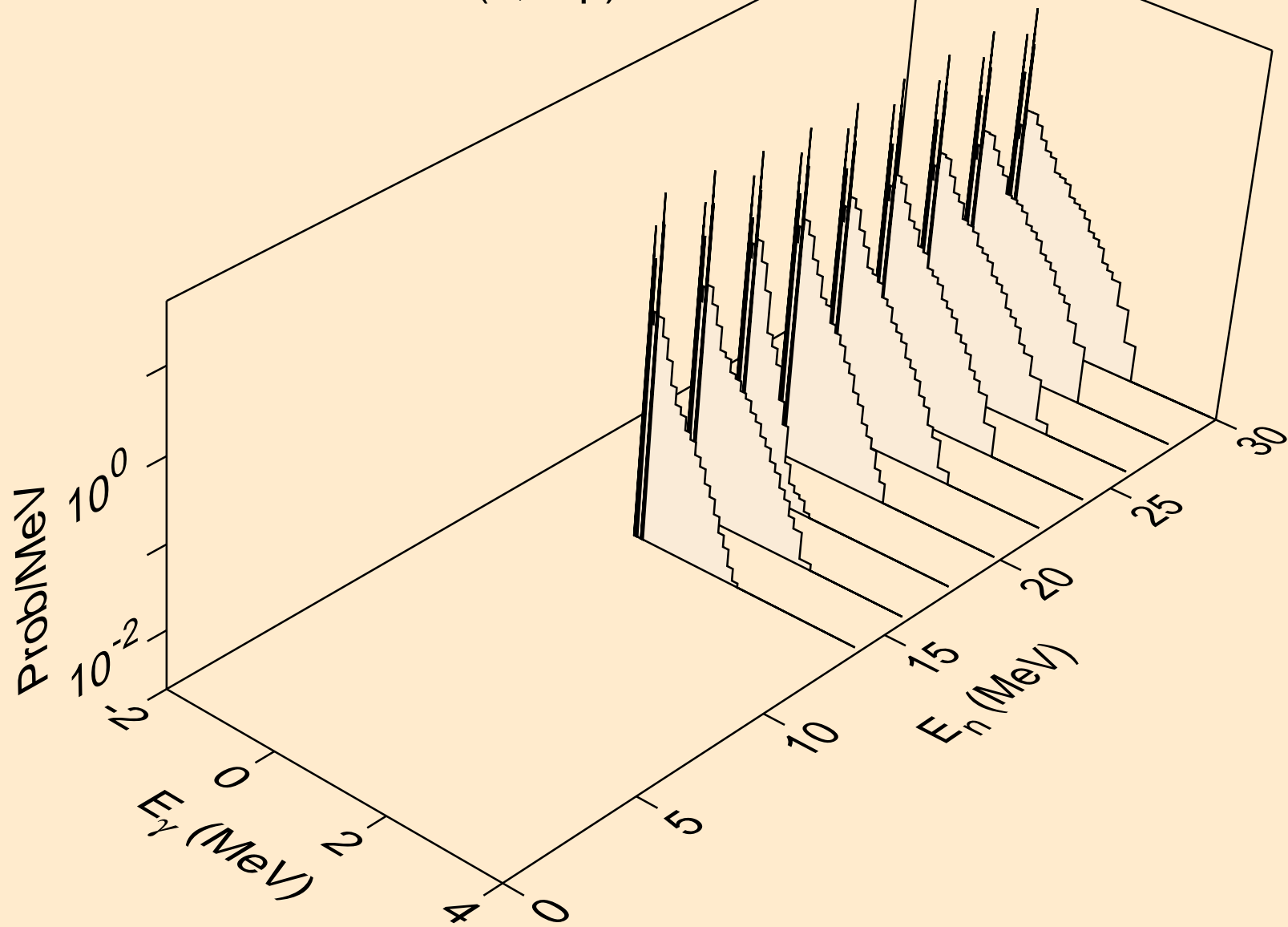

MD246M DEUTERON ACER TENDL-2023 LIBRARY; T=0.K
Photon emission for (n,npa)

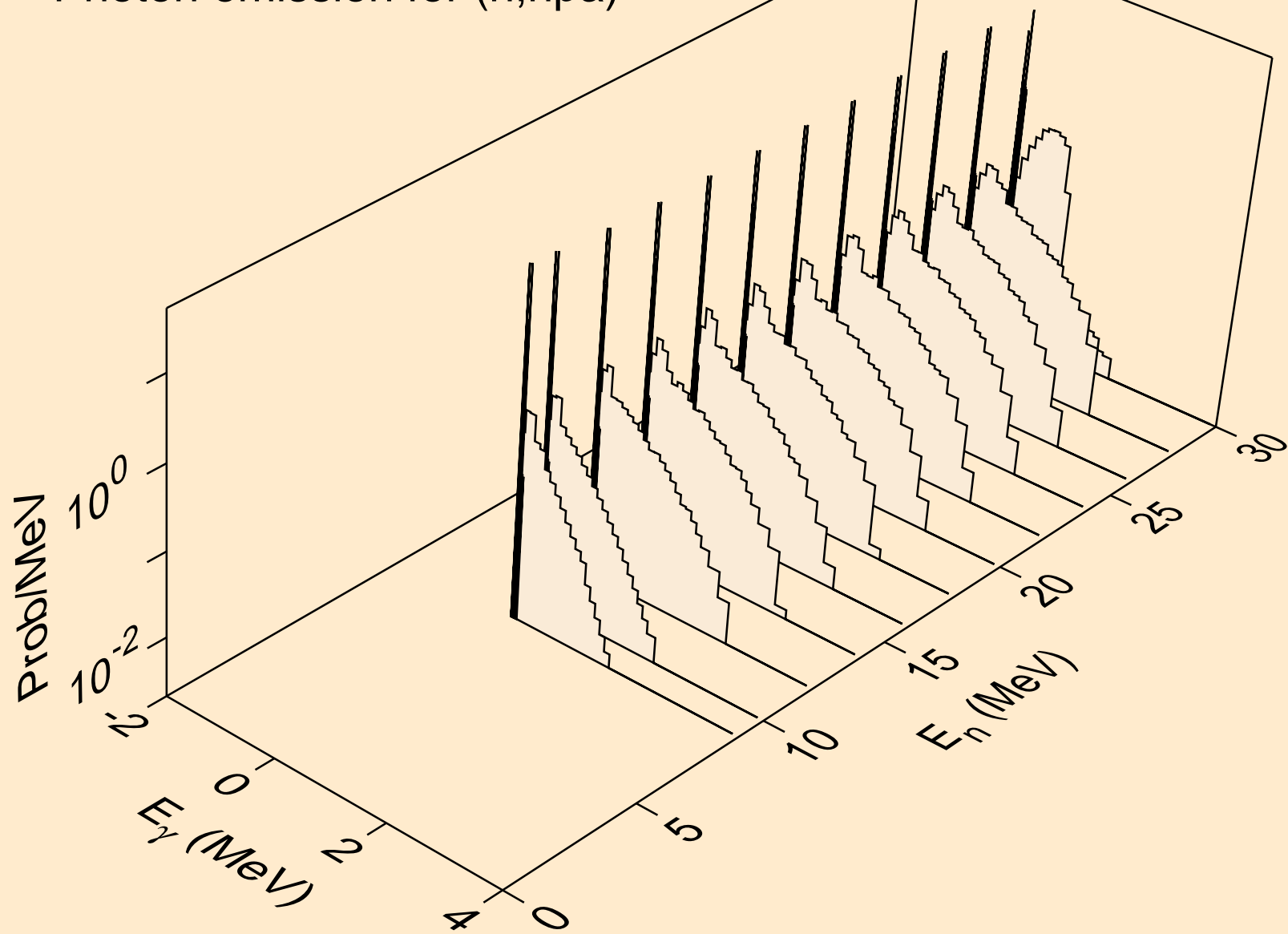

MD246M DEUTERON ACER TENDL-2023 LIBRARY; T=0.K
Photon emission for (n,gma)

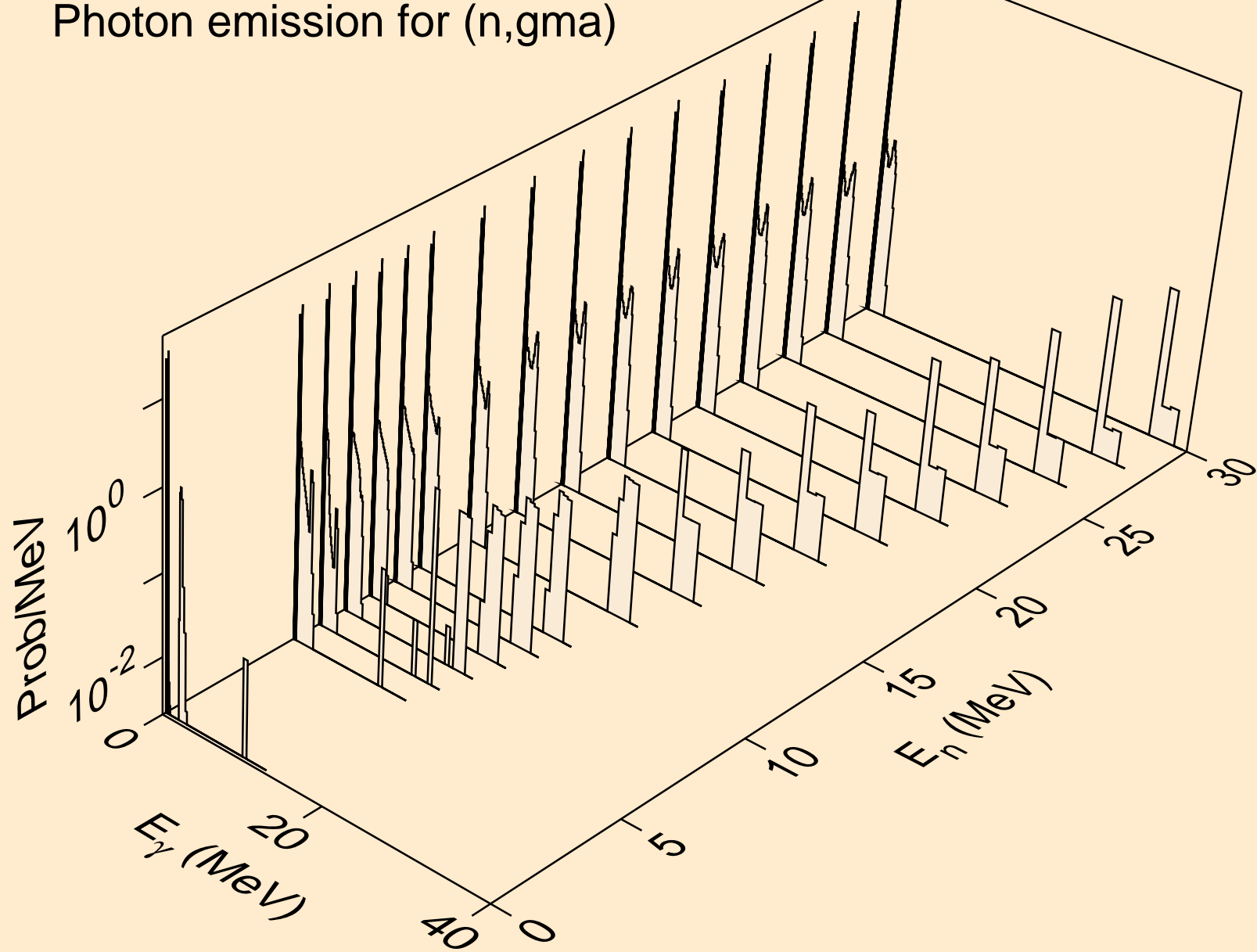

MD246M DEUTERON ACER TENDL-2023 LIBRARY; T=0.K
Photon emission for (n,p)

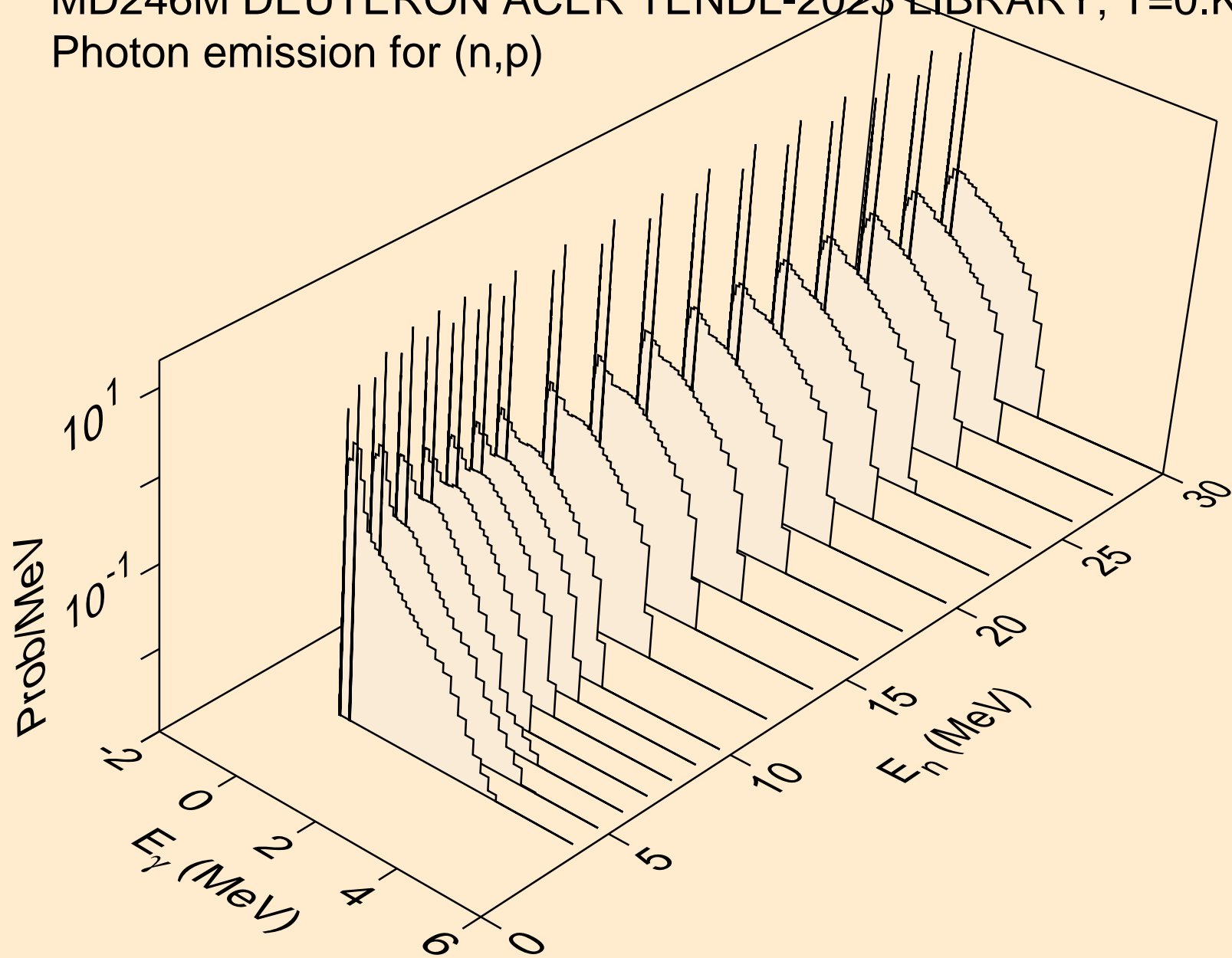

MD246M DEUTERON ACER TENDL-2023 LIBRARY; T=0.K
Photon emission for inelastic

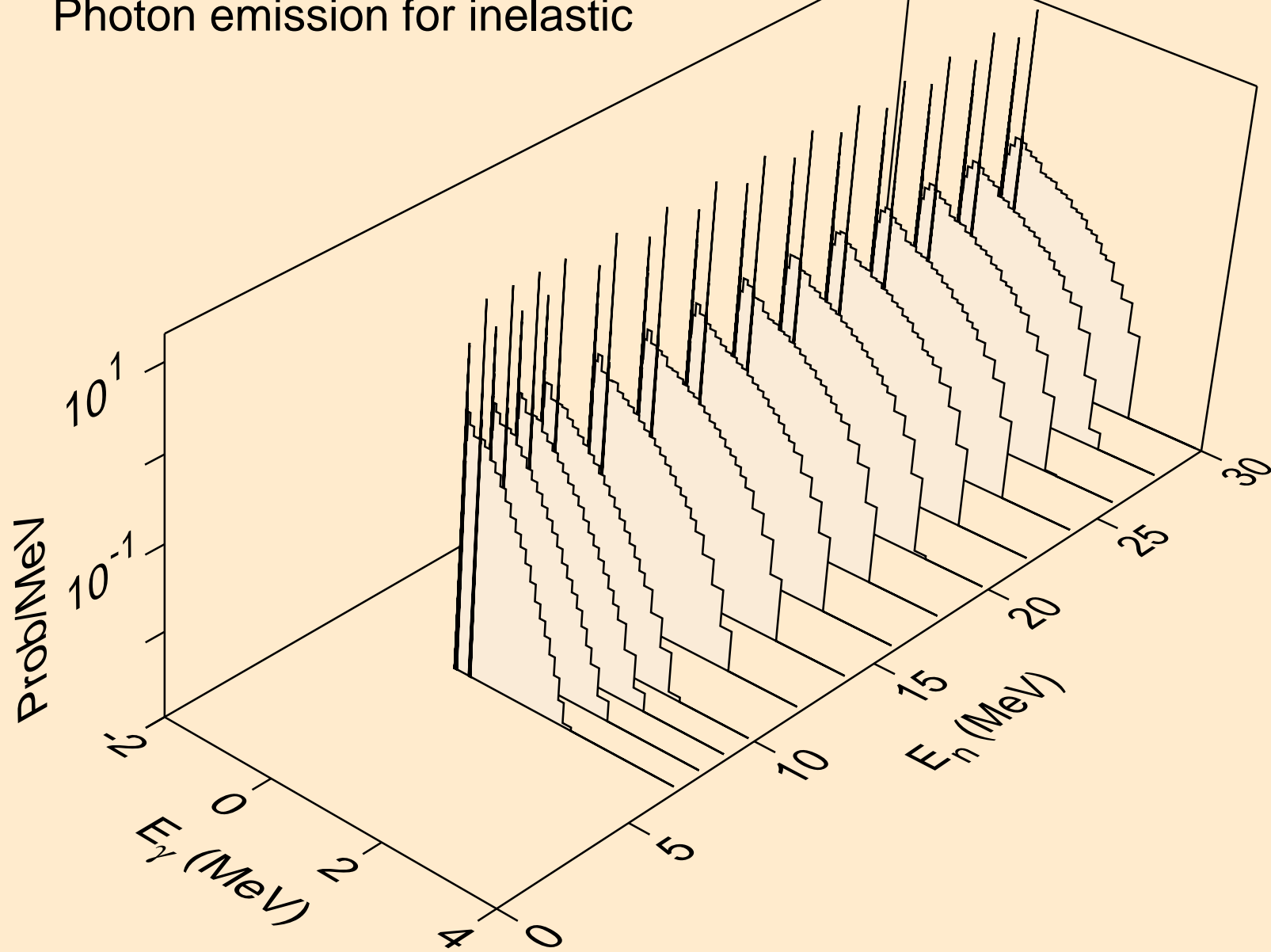

MD246M DEUTERON ACER TENDL-2023 LIBRARY; T=0.K
Photon emission for (n,t)

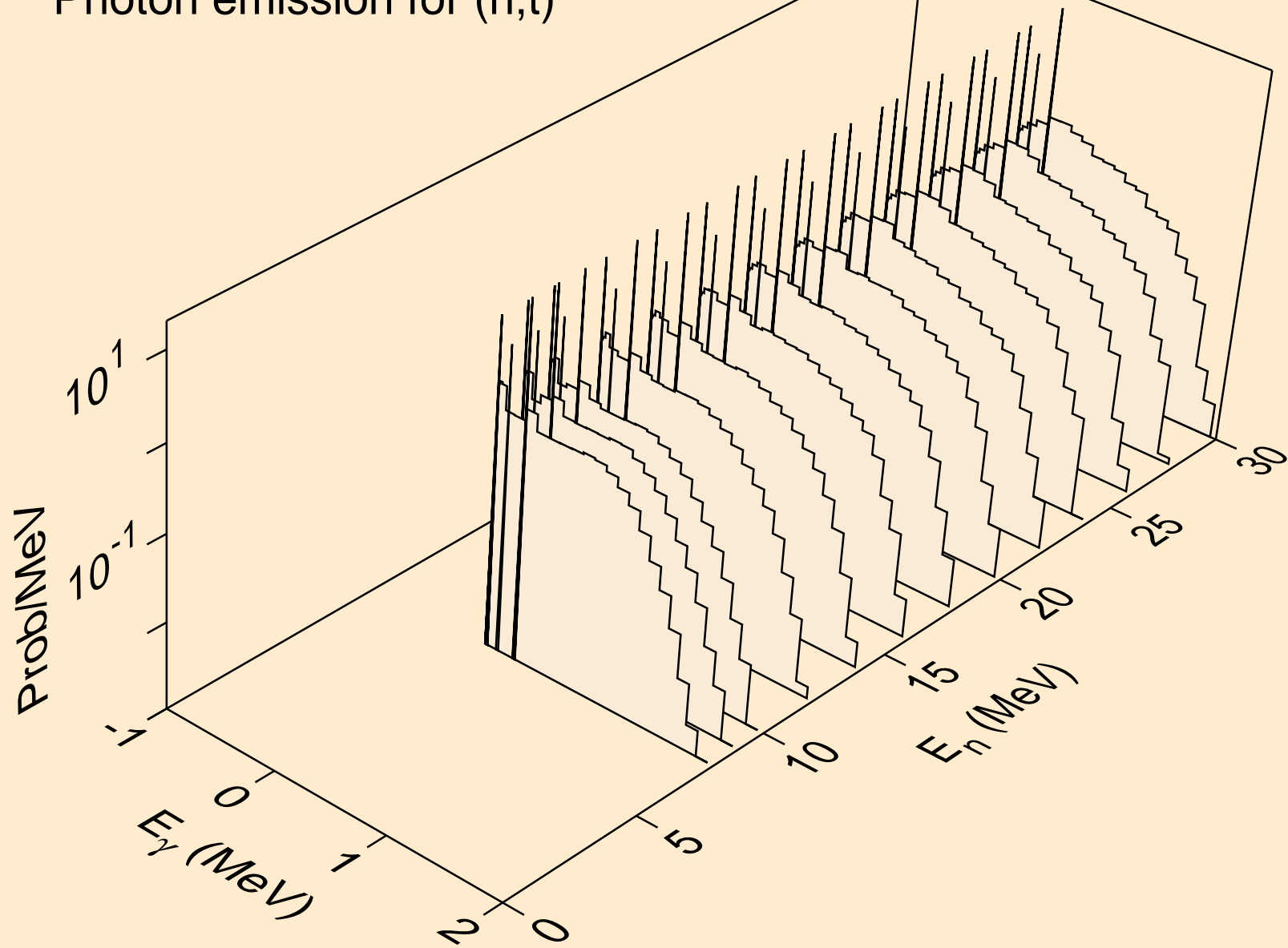

MD246M DEUTERON ACER TENDL-2023 LIBRARY; T=0.K
Photon emission for (n,he3)

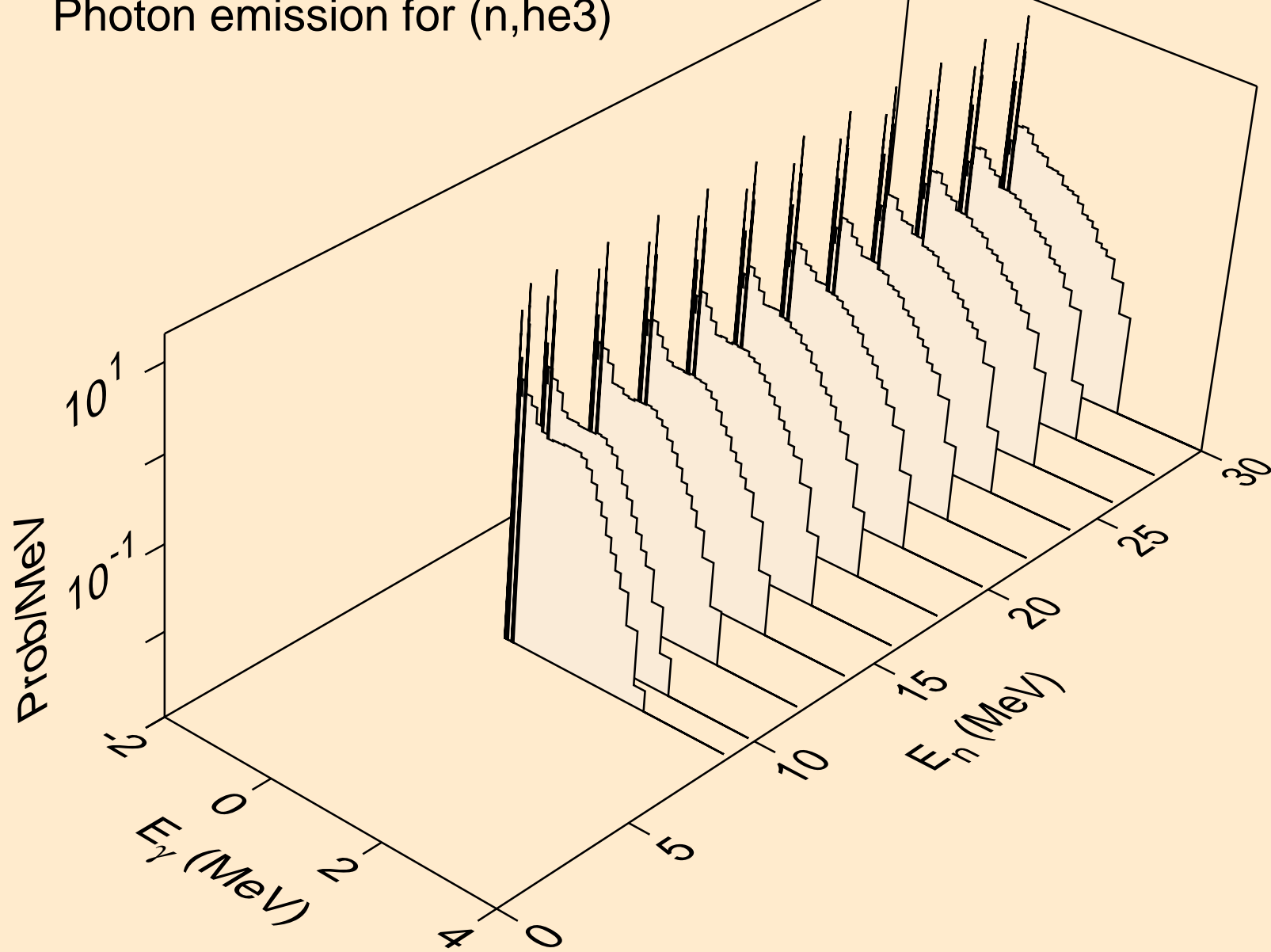

MD246M DEUTERON ACER TENDL-2023 LIBRARY; T=0.K
Photon emission for (n,a)

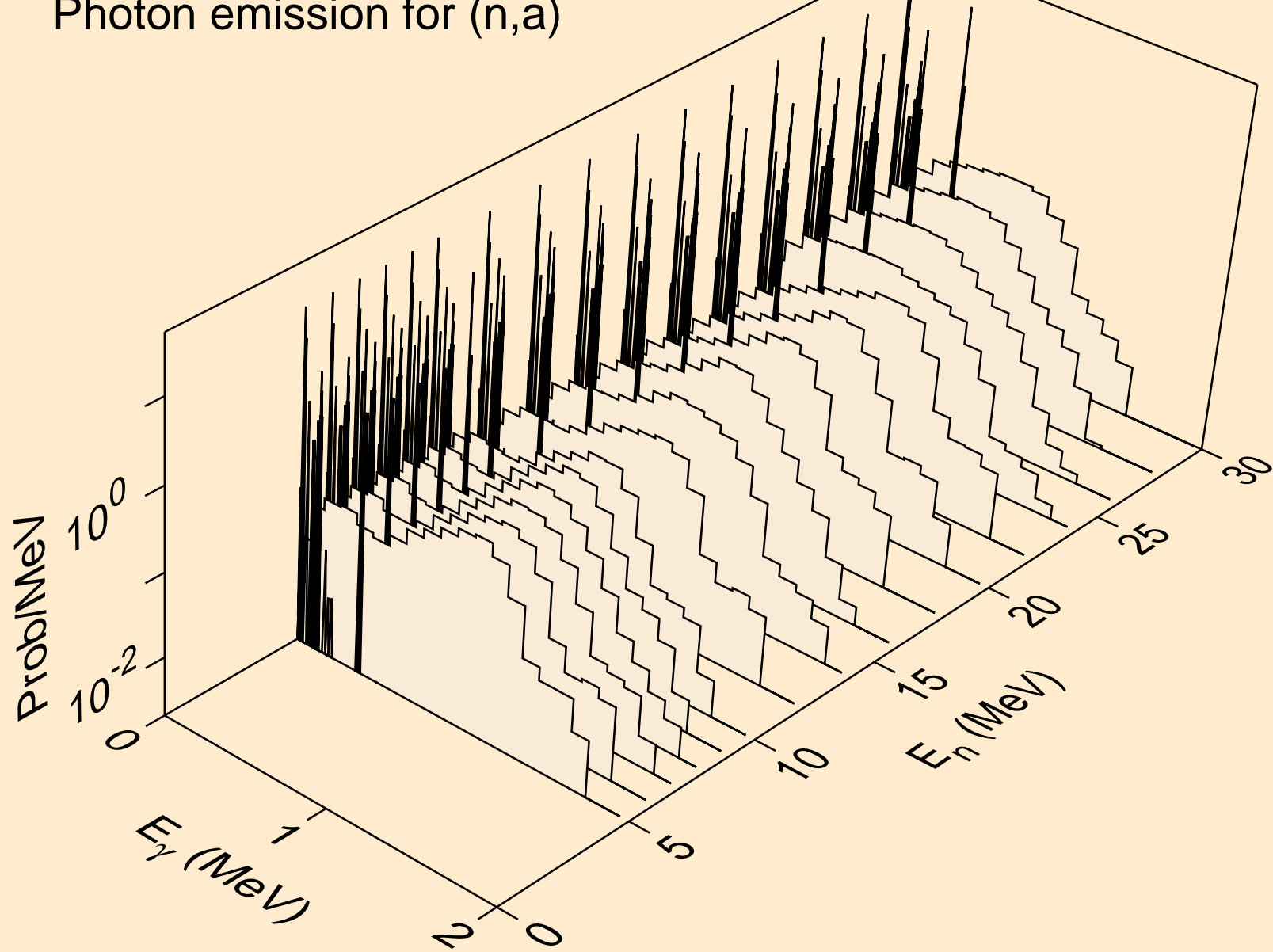

MD246M DEUTERON ACER TENDL-2023 LIBRARY; T=0.K
Photon emission for (n,2p)

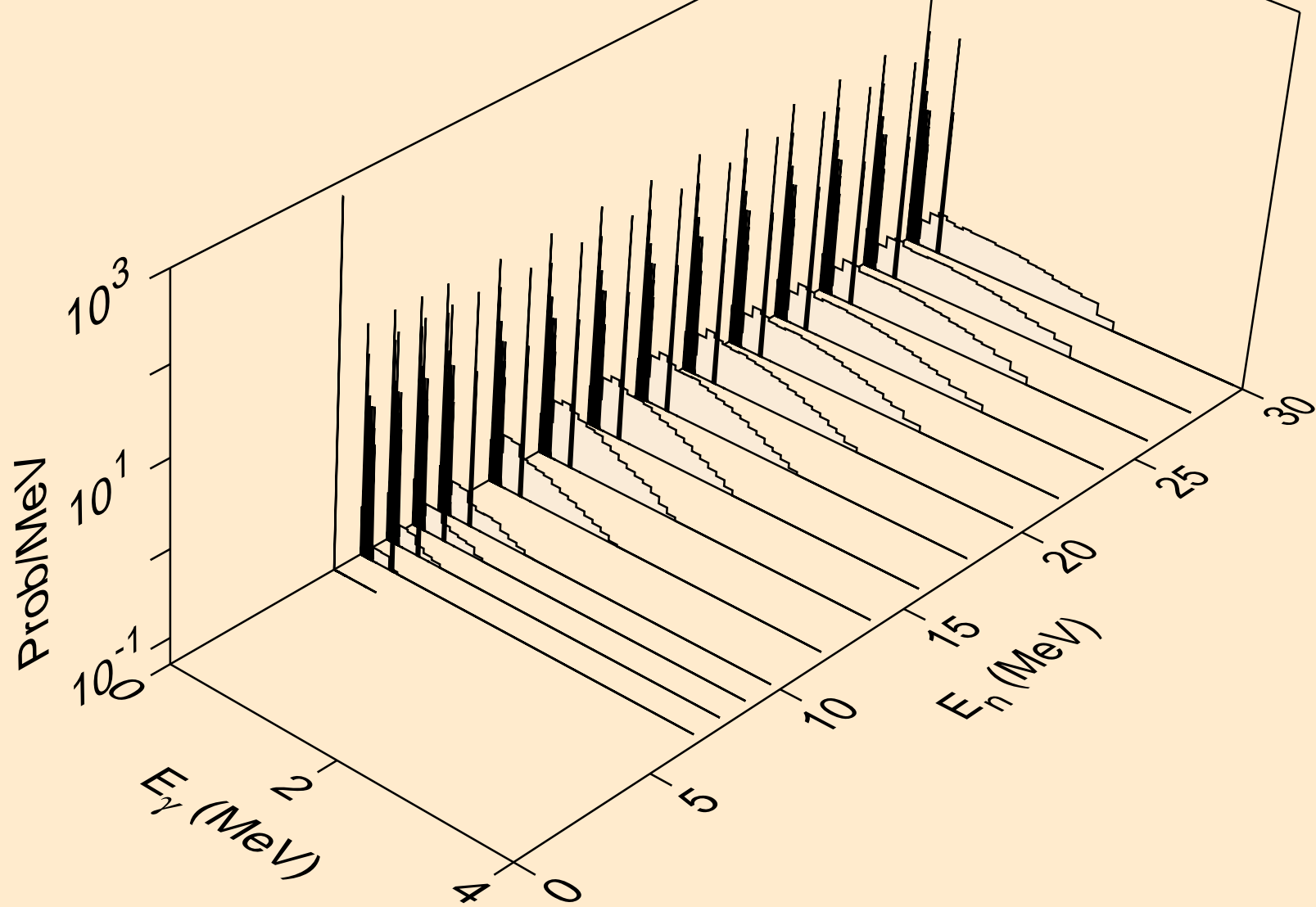

MD246M DEUTERON ACER TENDL-2023 LIBRARY; T=0.K
Photon emission for (n,p)

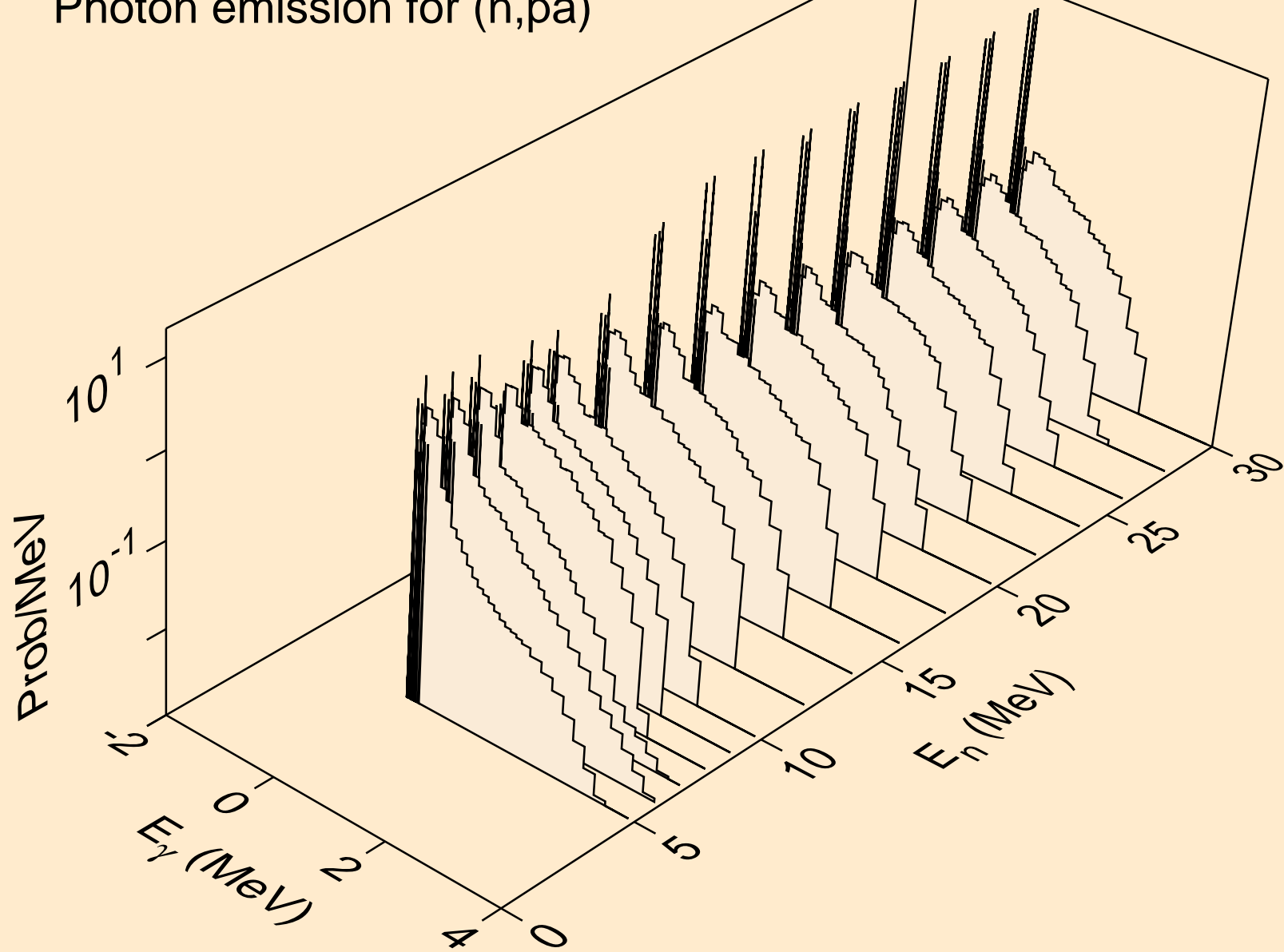

MD246M DEUTERON ACER TENDL-2023 LIBRARY; T=0.K
Photon emission for (n,pd)

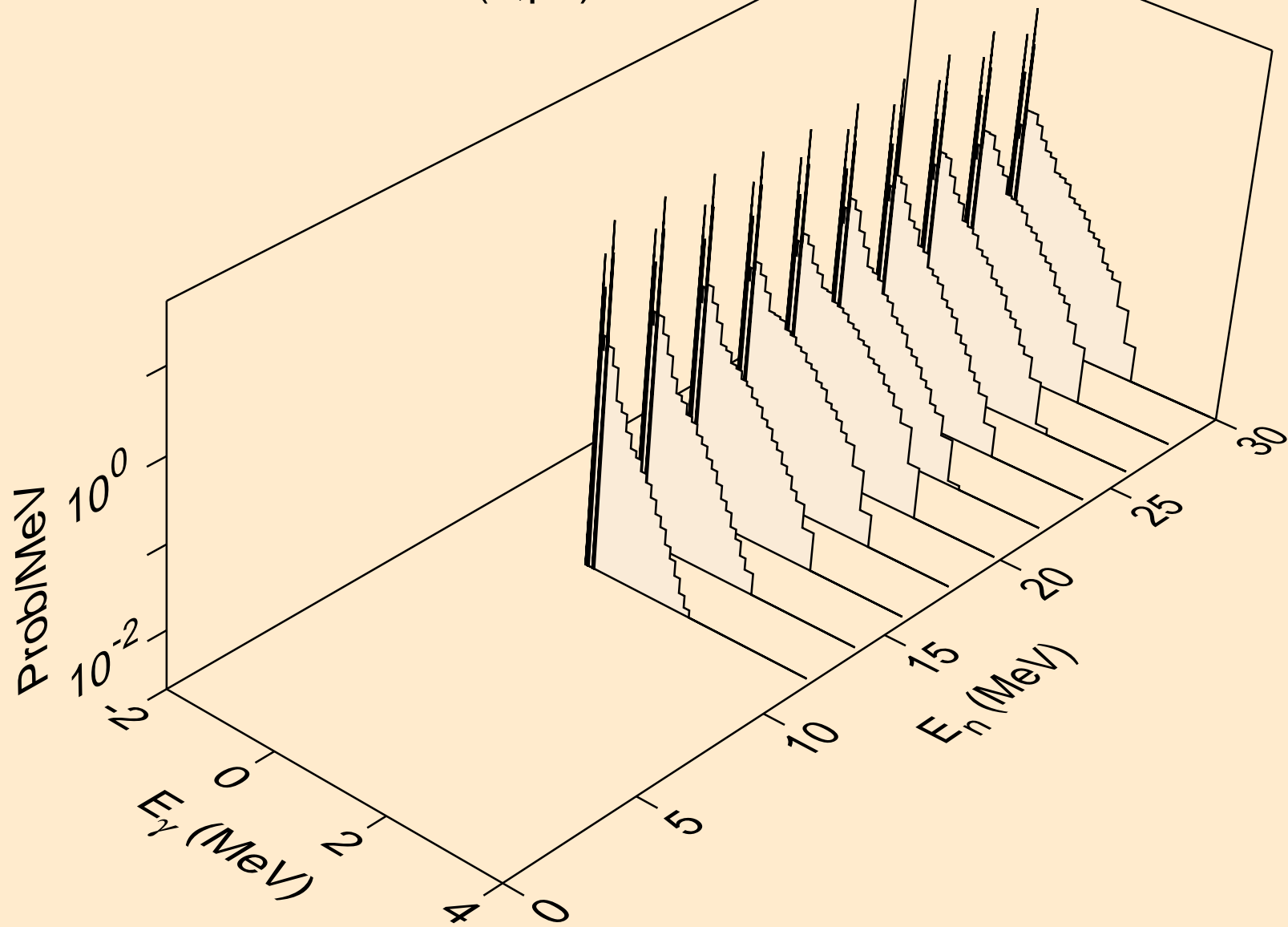

MD246M DEUTERON ACER TENDL-2023 LIBRARY; T=0.K
Photon emission for (n,da)

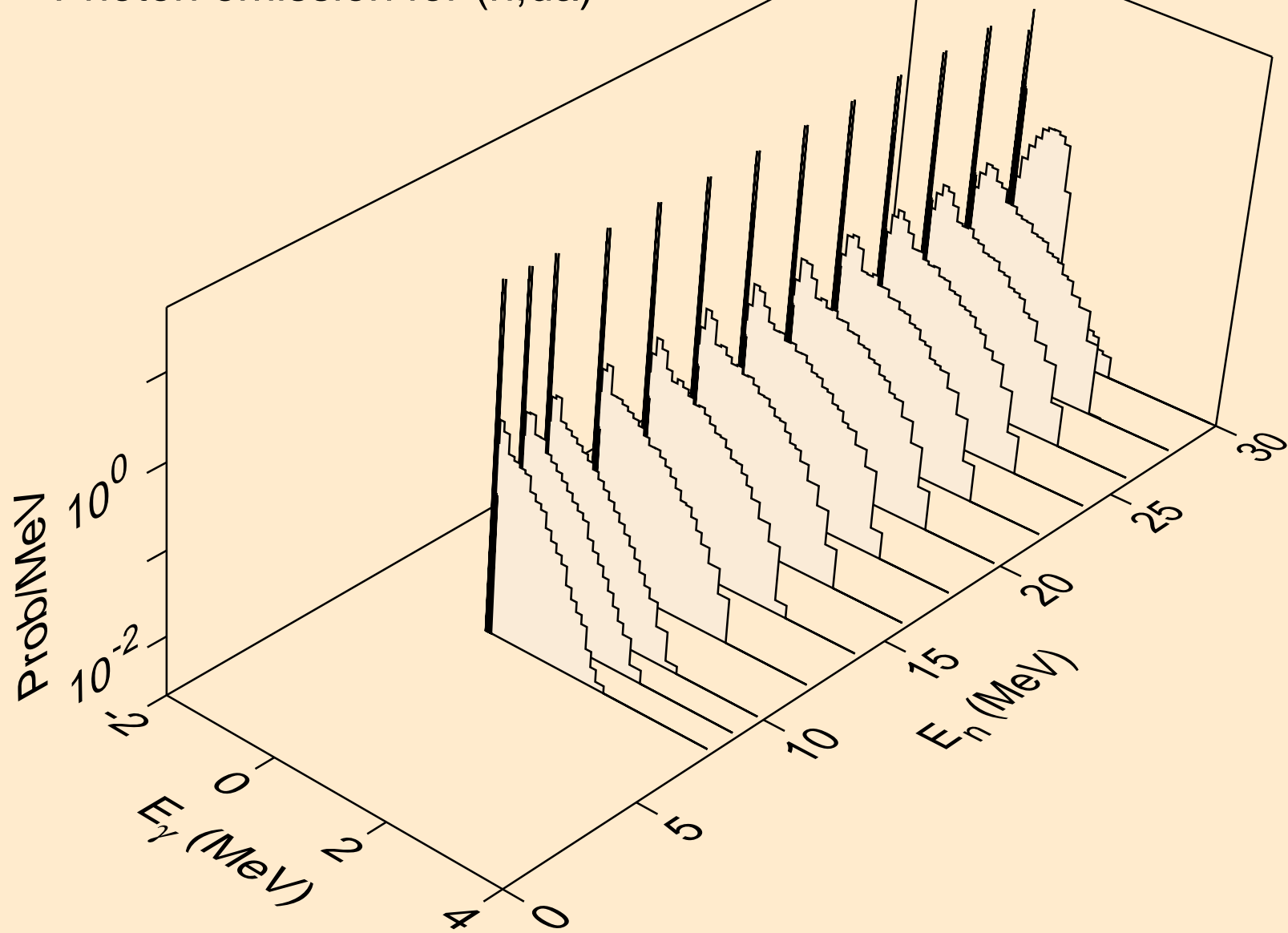

MD246M DEUTERON ACER TENDL-2023 LIBRARY; T=0.K

Particle heating contributions

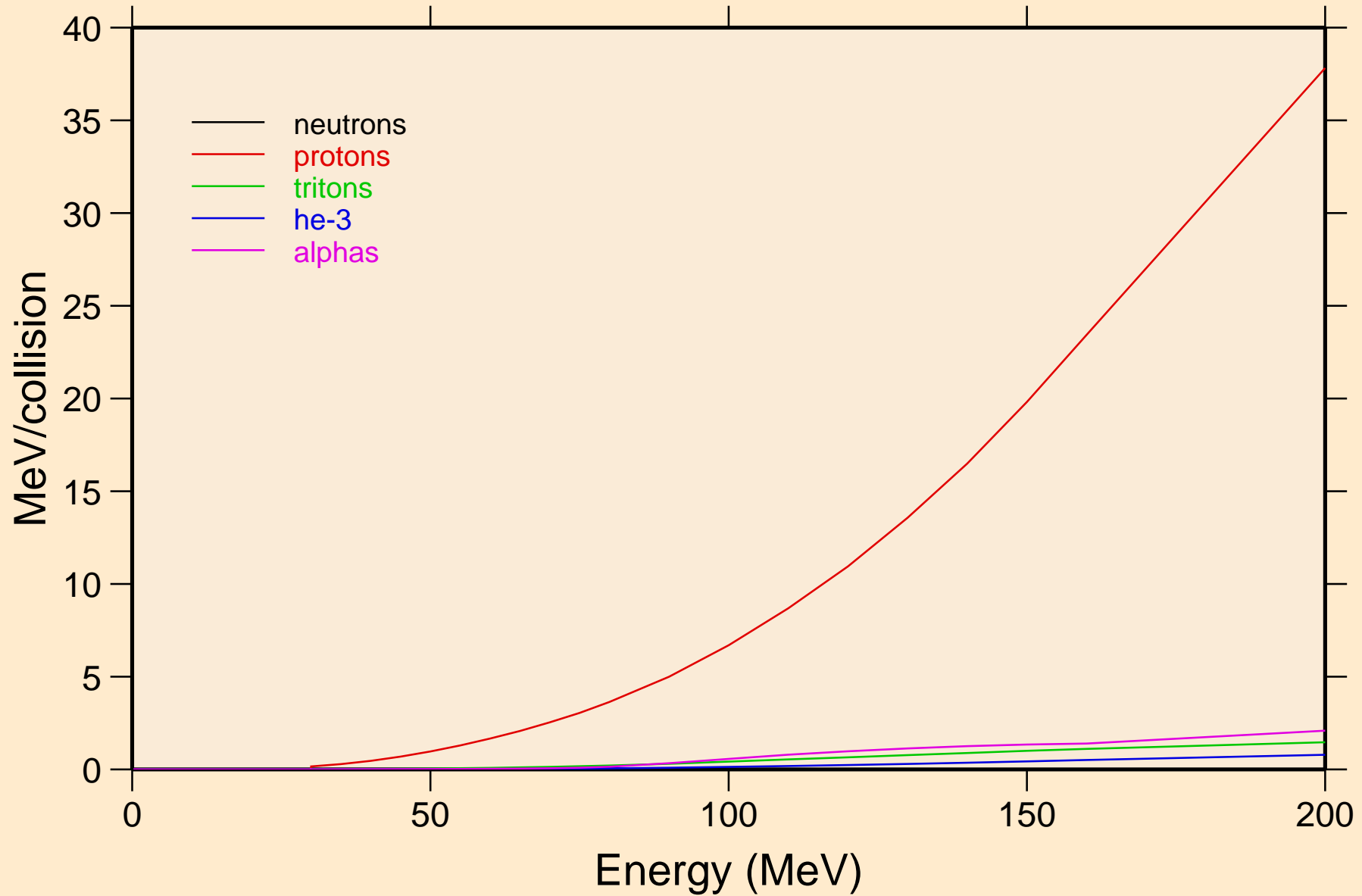

MD246M DEUTERON ACER TENDL-2023 LIBRARY; T=0.K
Recoil Heating

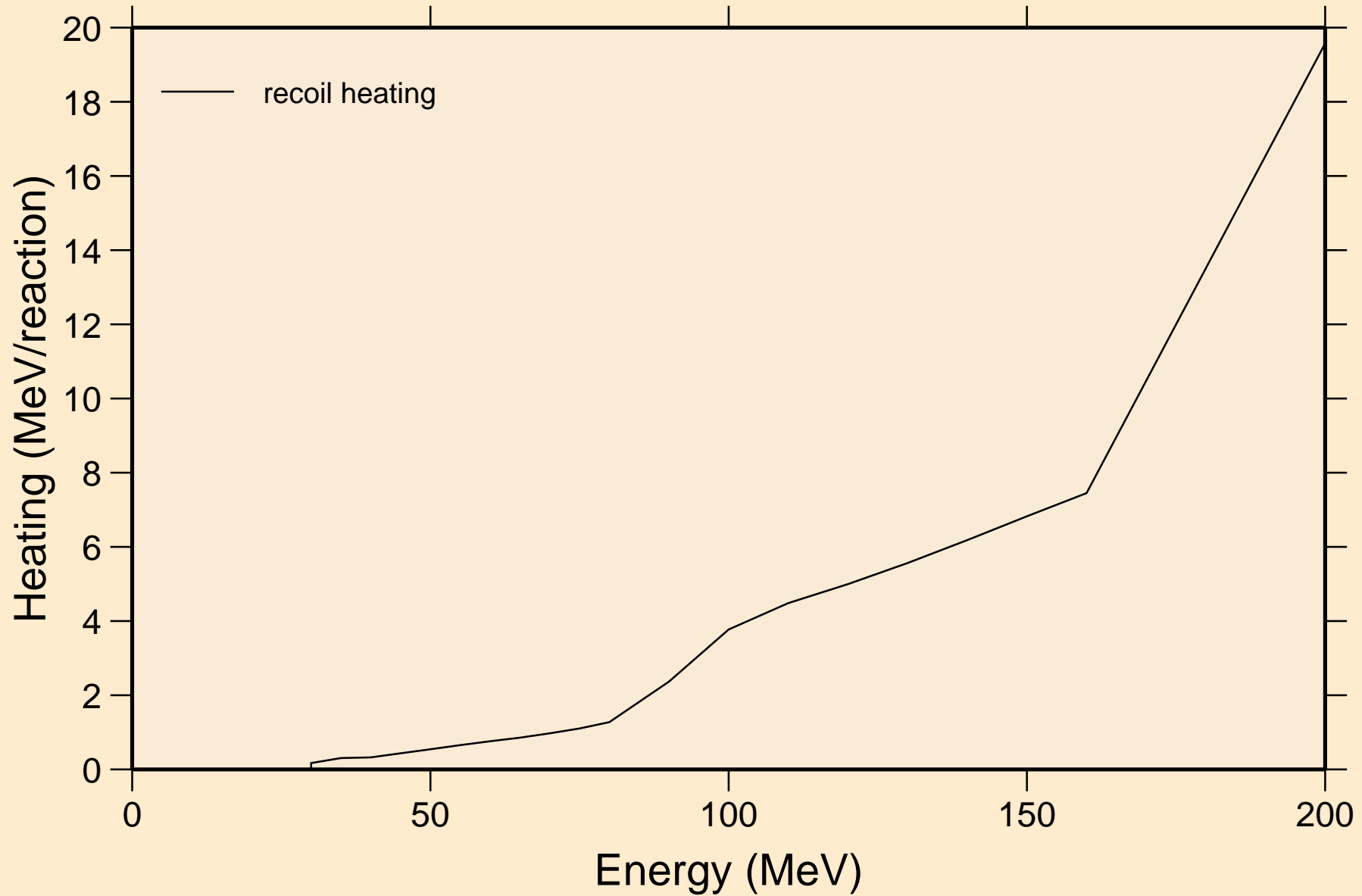

MD246M DEUTERON ACER TENDL-2023 LIBRARY; T=0.K
Particle production cross sections

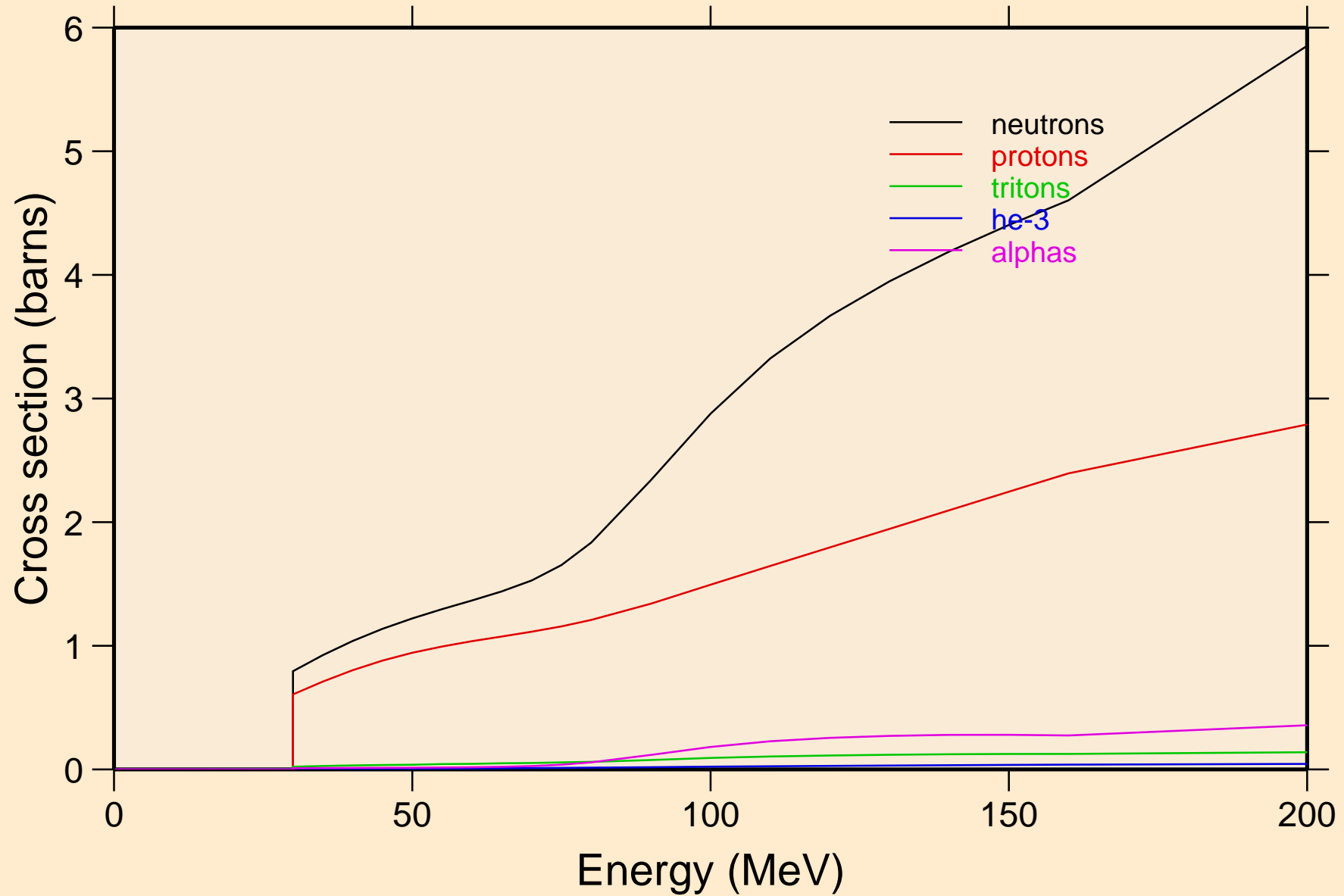

MD246M DEUTERON ACER TENDL-2023 LIBRARY; T=0.K
neutrons from (d,n)

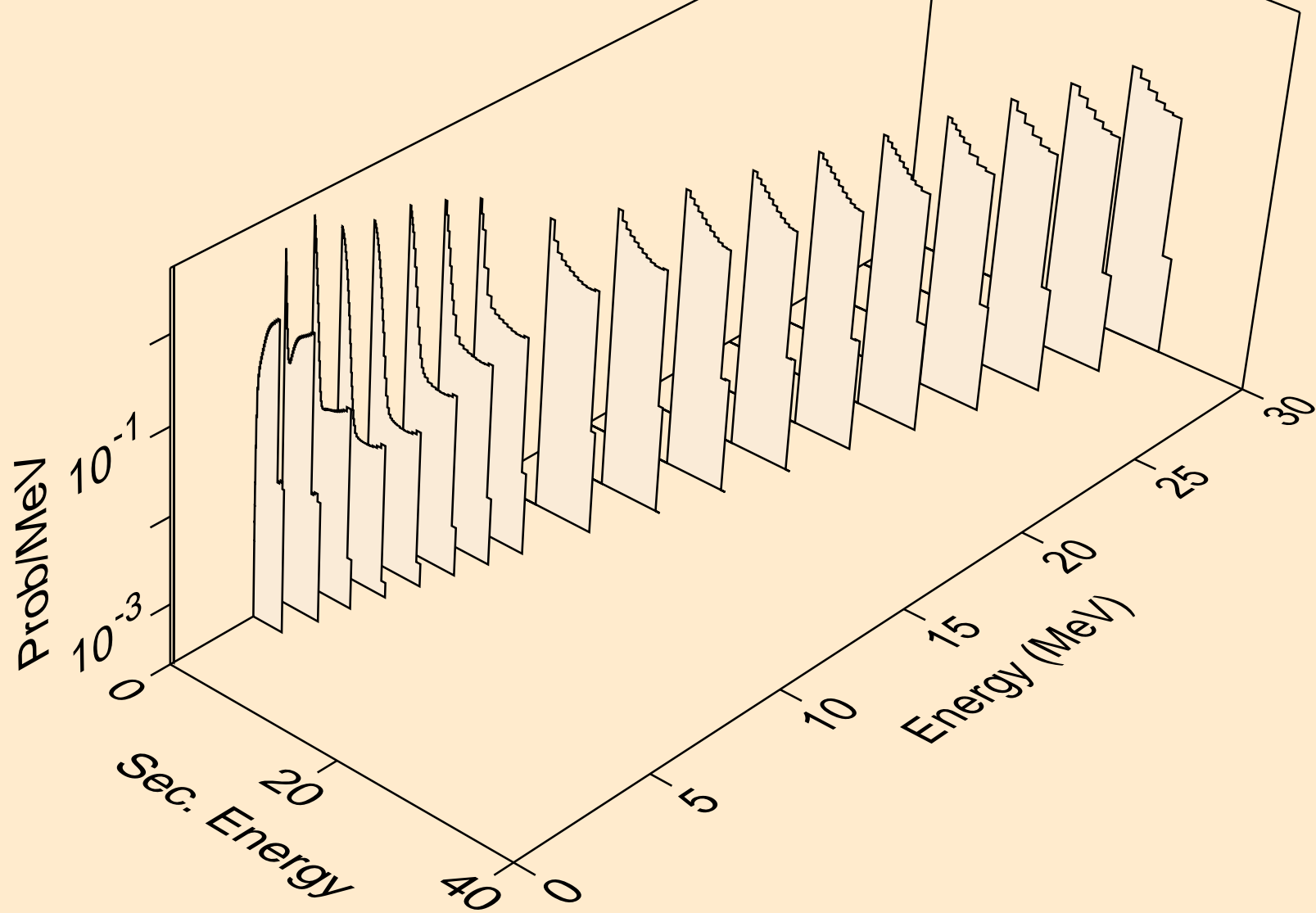

MD246M DEUTERON ACER TENDL-2023 LIBRARY; T=0.K
neutrons from (d,x)

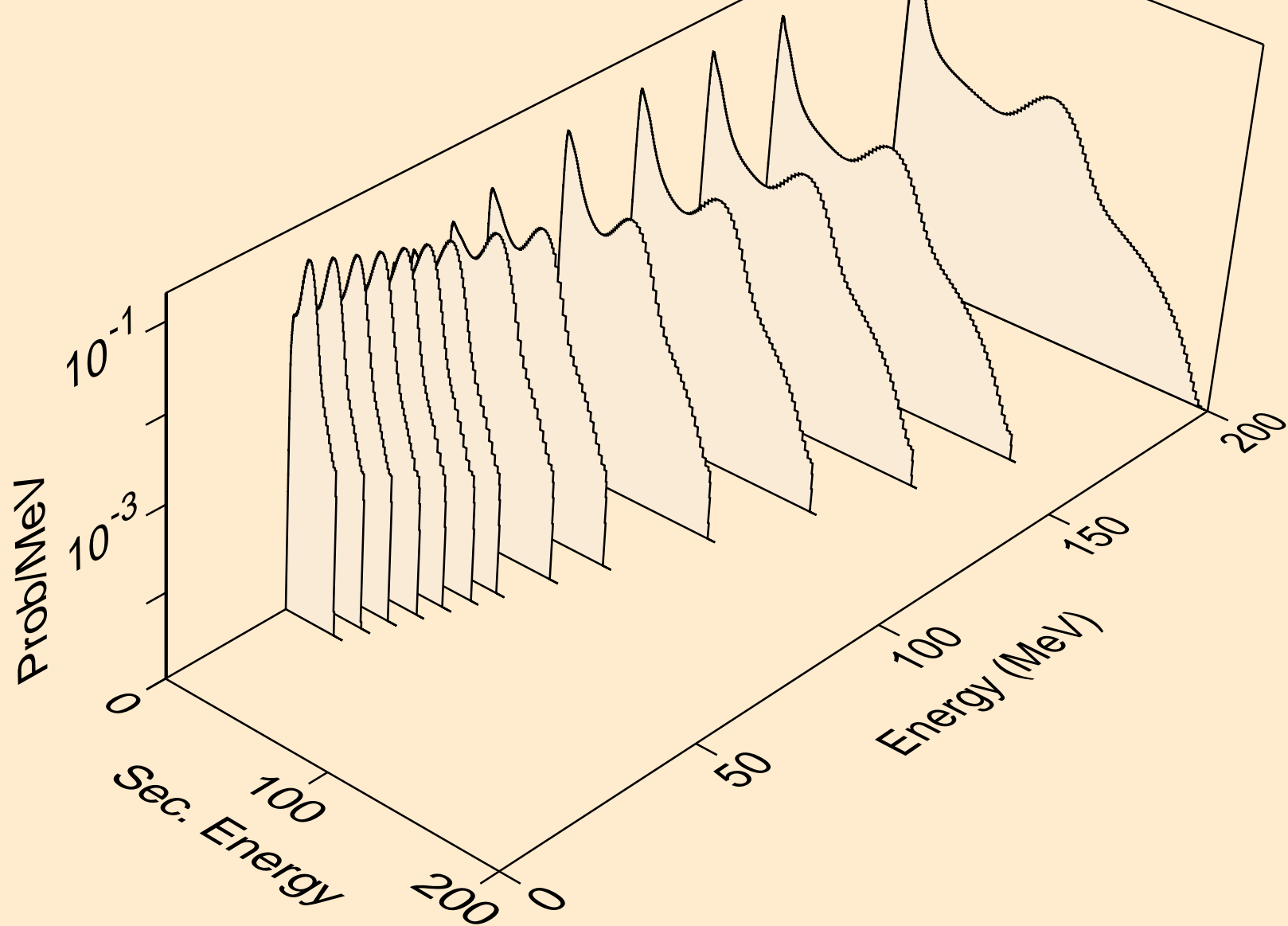

MD246M DEUTERON ACER TENDL-2023 LIBRARY; T=0.K
neutrons from (d,2n)

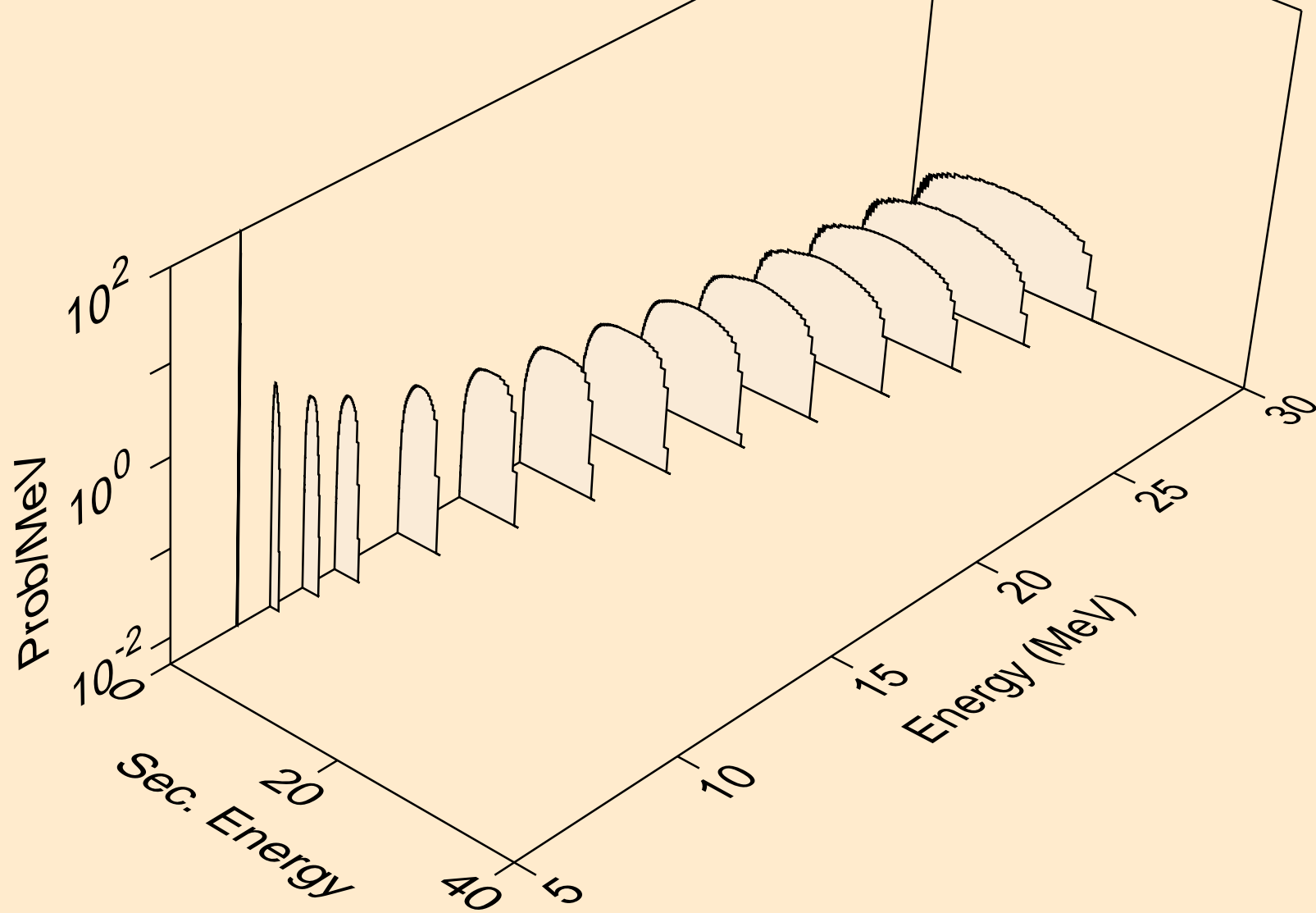

MD246M DEUTERON ACER TENDL-2023 LIBRARY; T=0.K
neutrons from (d,3n)

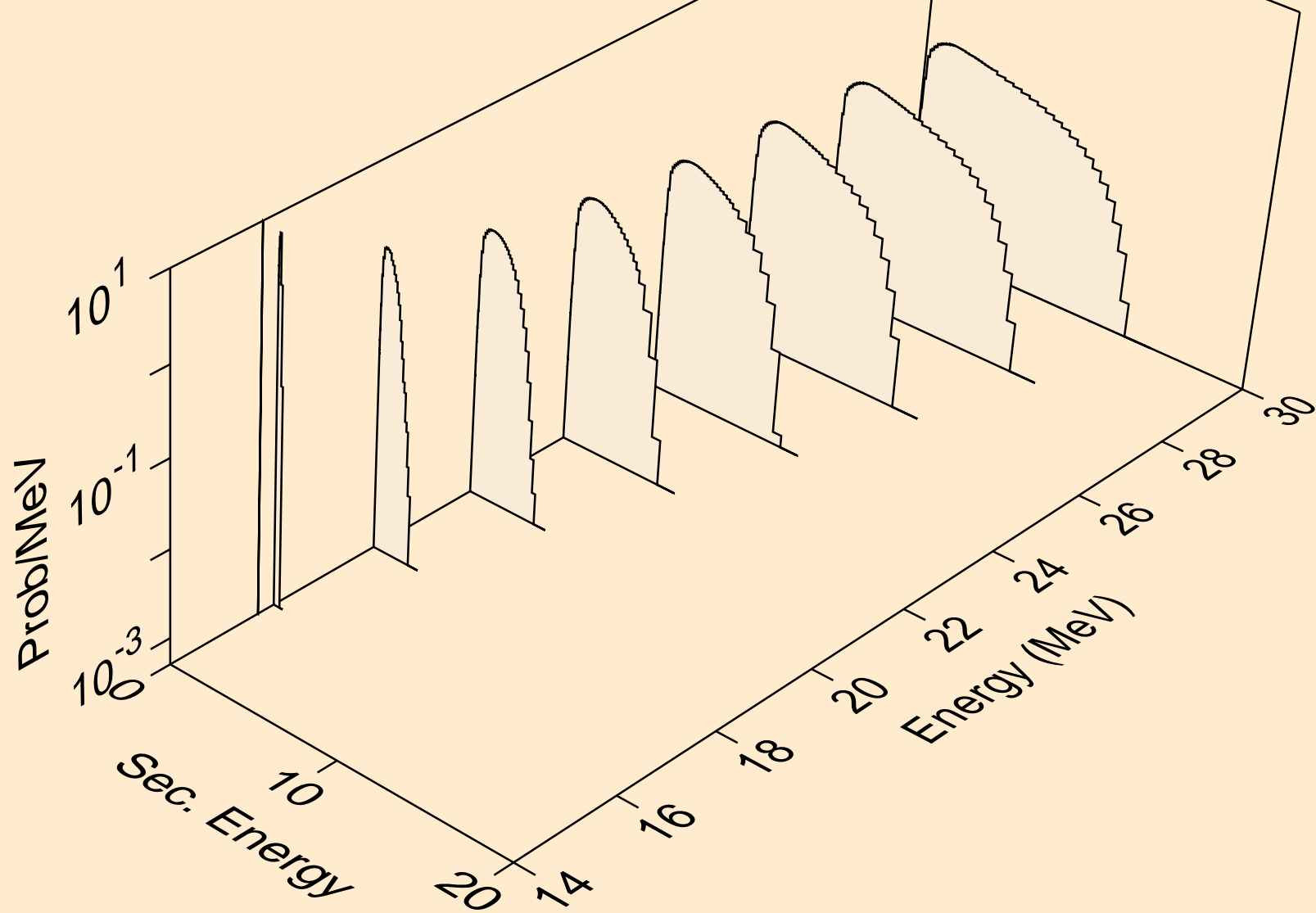

MD246M DEUTERON ACER TENDL-2023 LIBRARY; T=0.K
neutrons from (d,n*)a

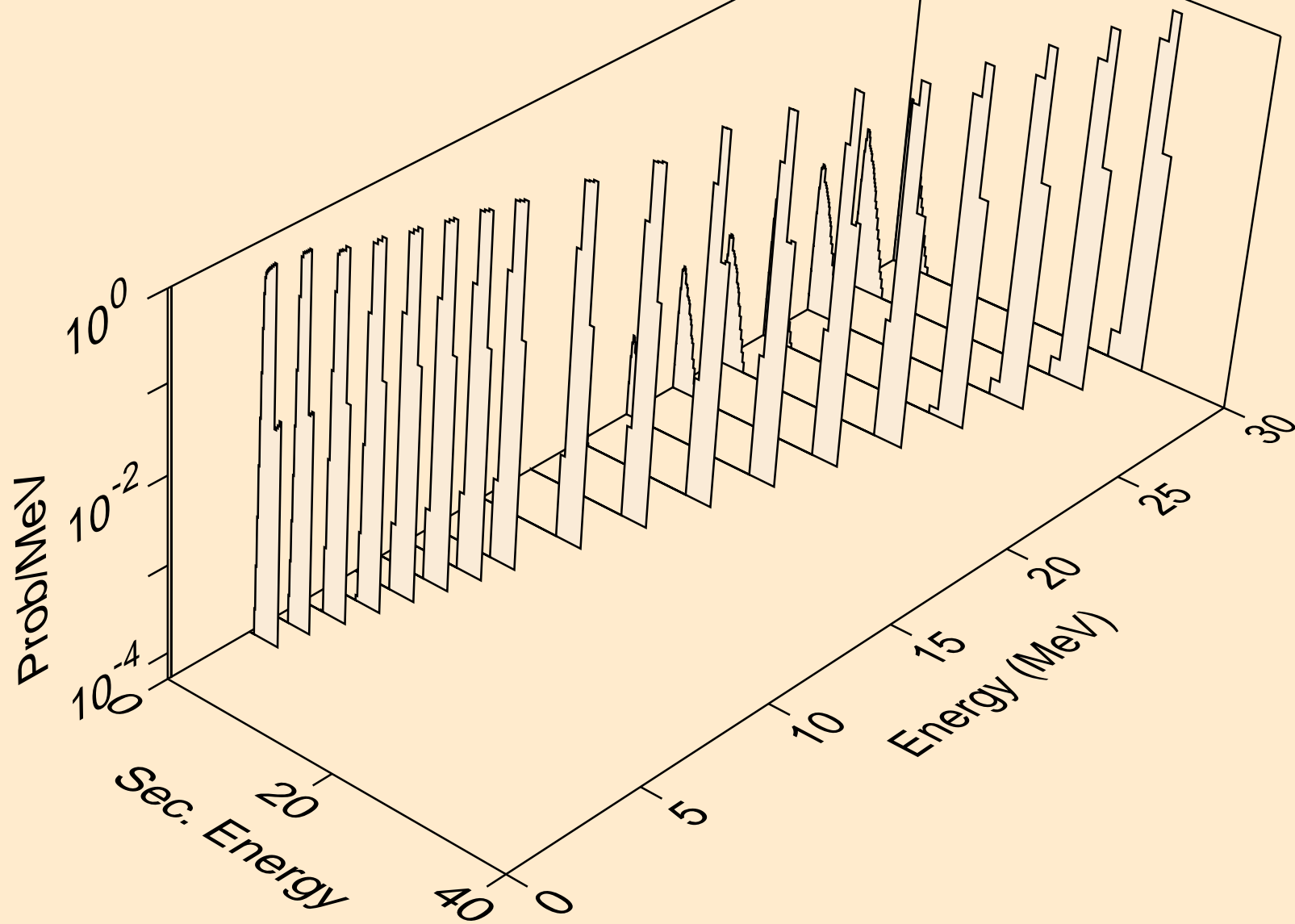

MD246M DEUTERON ACER TENDL-2023 LIBRARY; T=0.K
neutrons from (d,3n)a

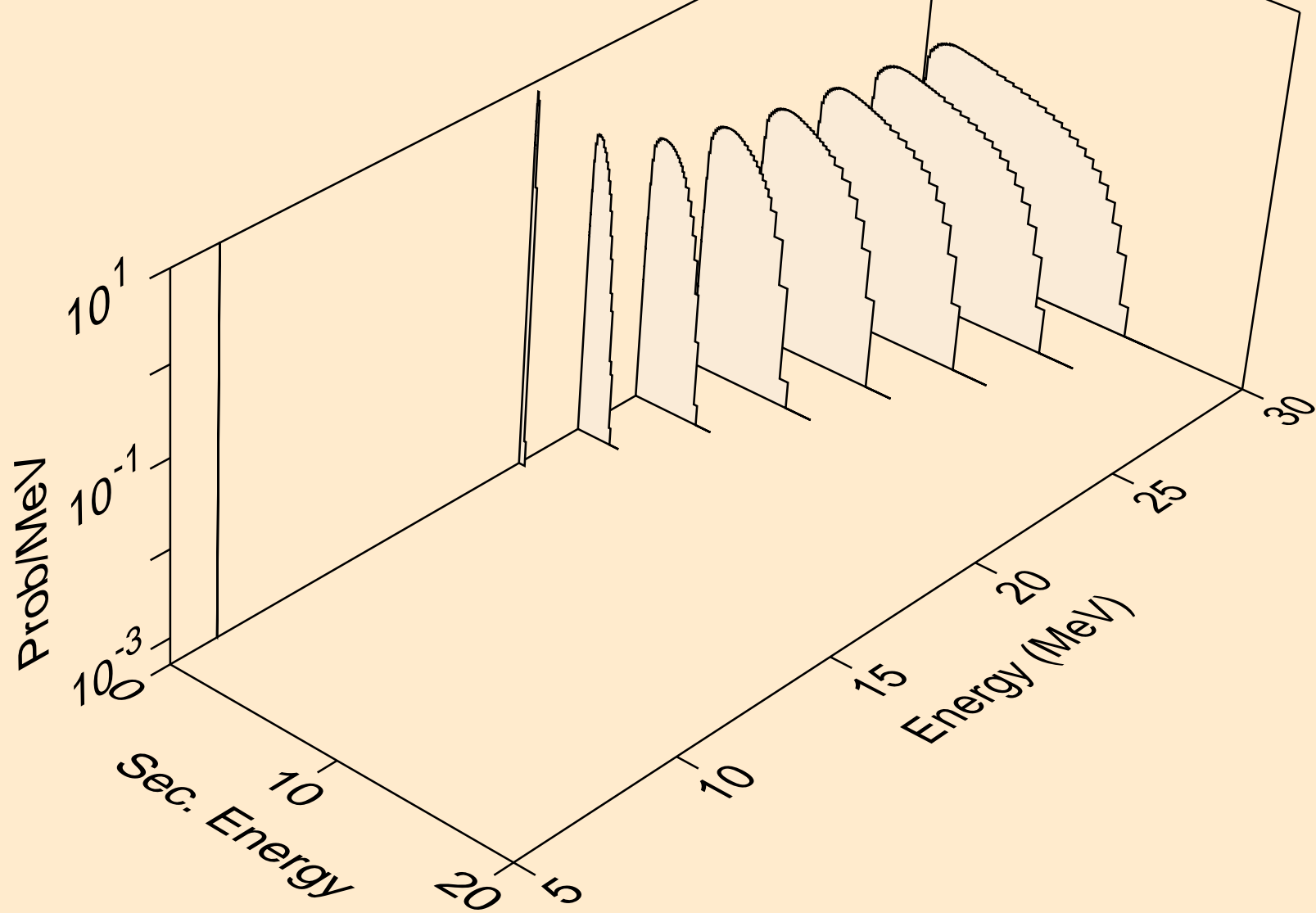

MD246M DEUTERON ACER TENDL-2023 LIBRARY; T=0.K
neutrons from (d,n*)p

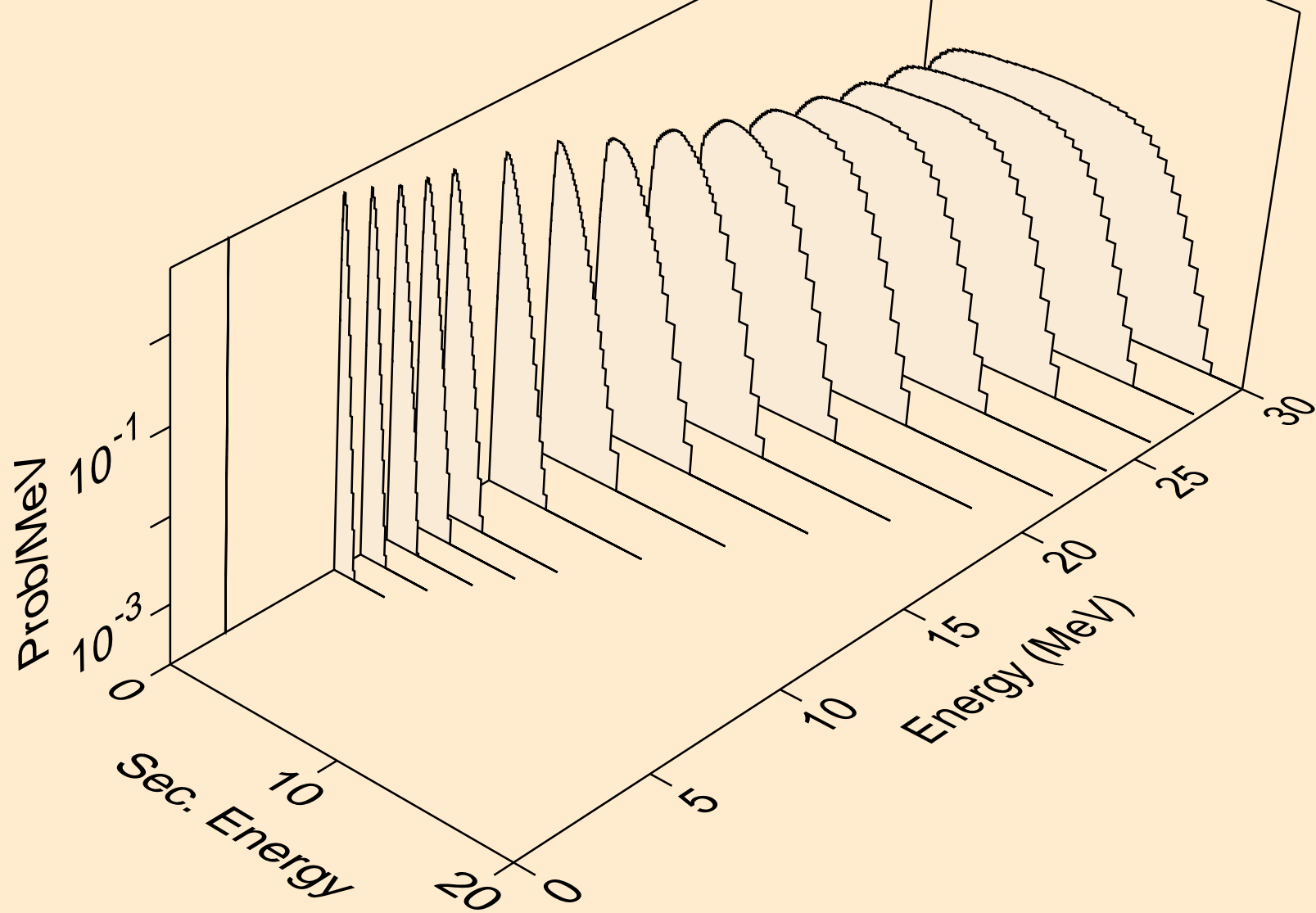

MD246M DEUTERON ACER TENDL-2023 LIBRARY; T=0.K
neutrons from (d,n*)d

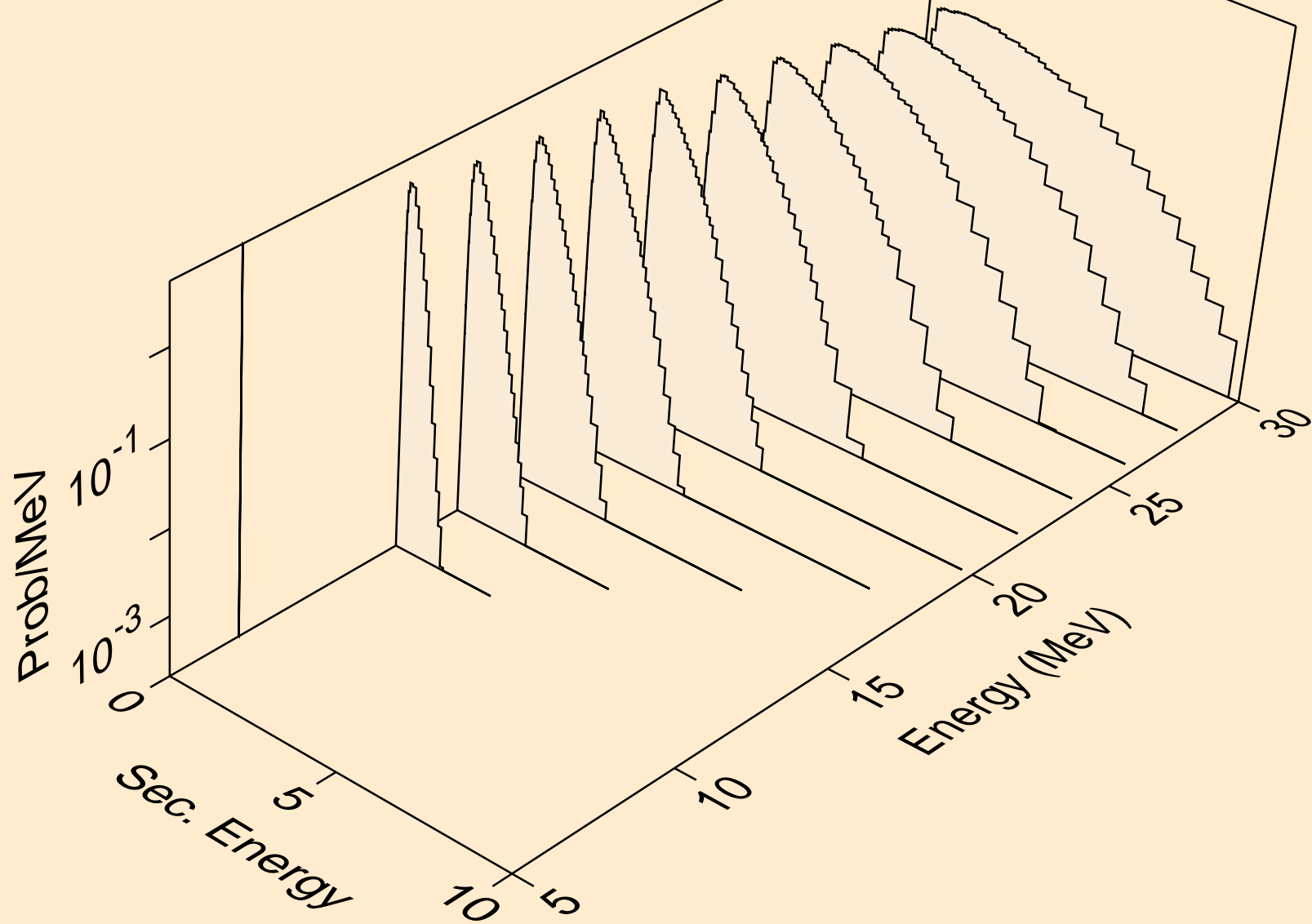

MD246M DEUTERON ACER TENDL-2023 LIBRARY; T=0.K
neutrons from (d,n*)t

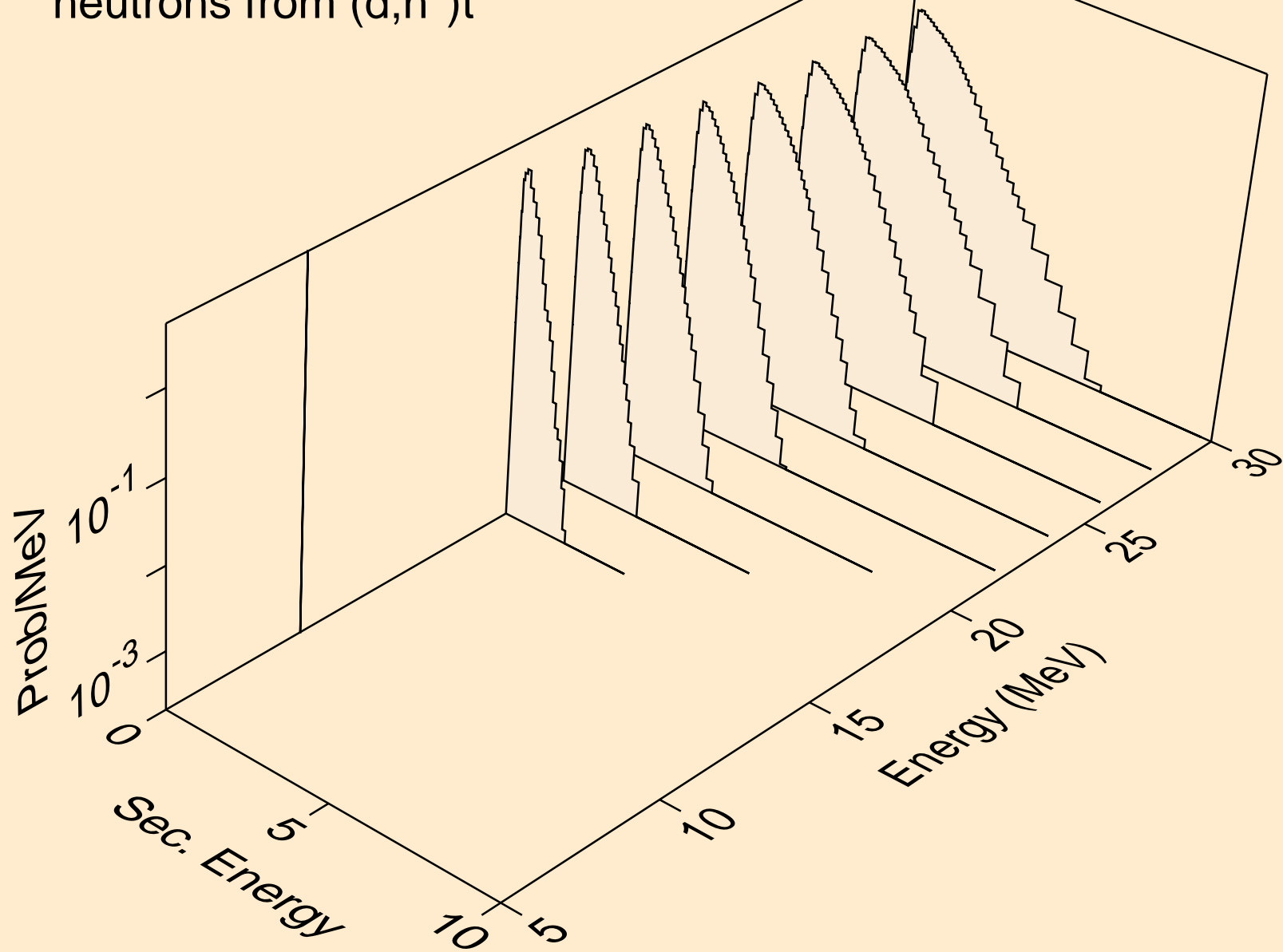

MD246M DEUTERON ACER TENDL-2023 LIBRARY; T=0.K
neutrons from (d,2np)

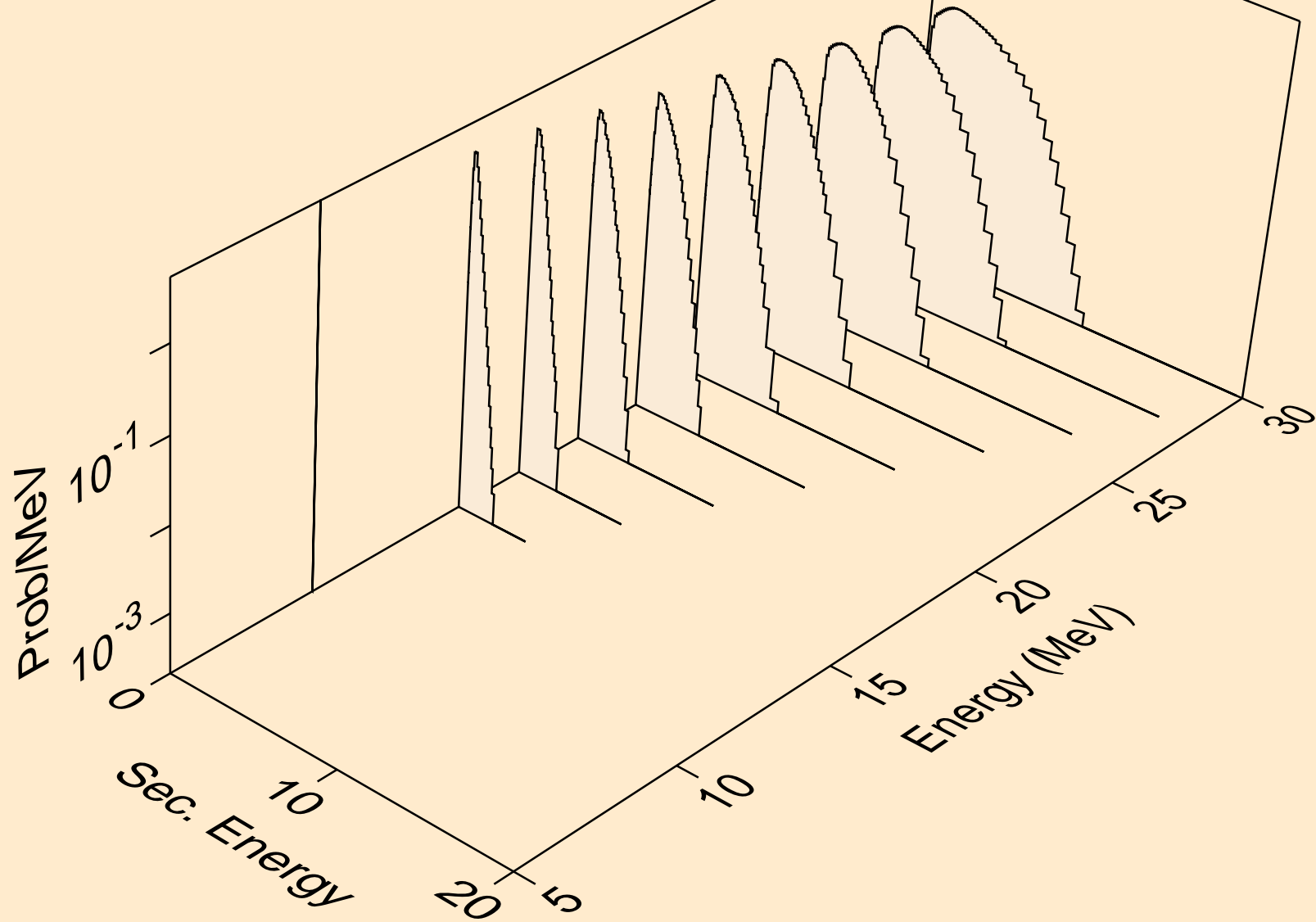

MD246M DEUTERON ACER TENDL-2023 LIBRARY; T=0.K
neutrons from (d,n2p)

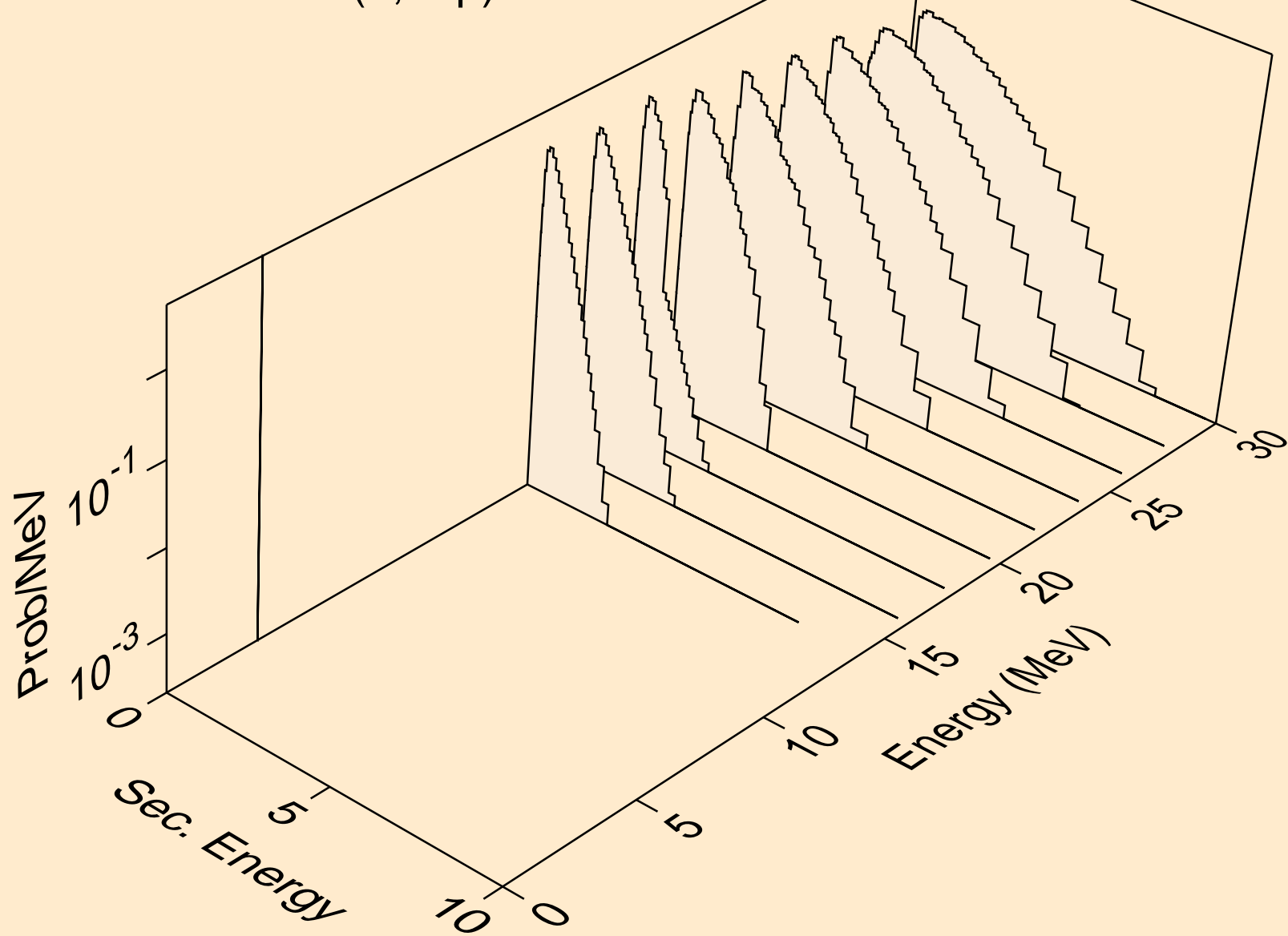

MD246M DEUTERON ACER TENDL-2023 LIBRARY; T=0.K
neutrons from (d,npa)

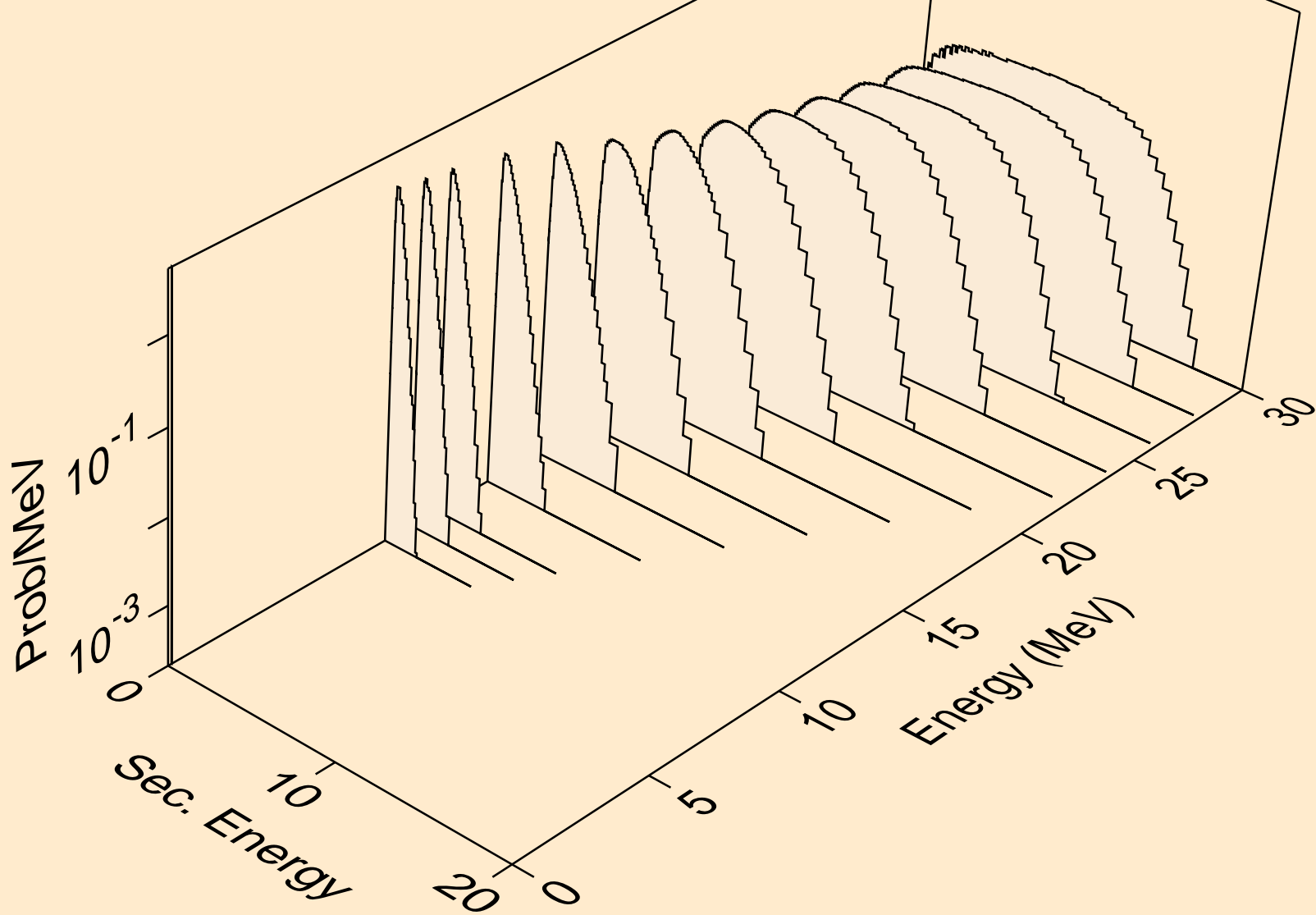

MD246M DEUTERON ACER TENDL-2023 LIBRARY; T=0.K
protons from (d,x)

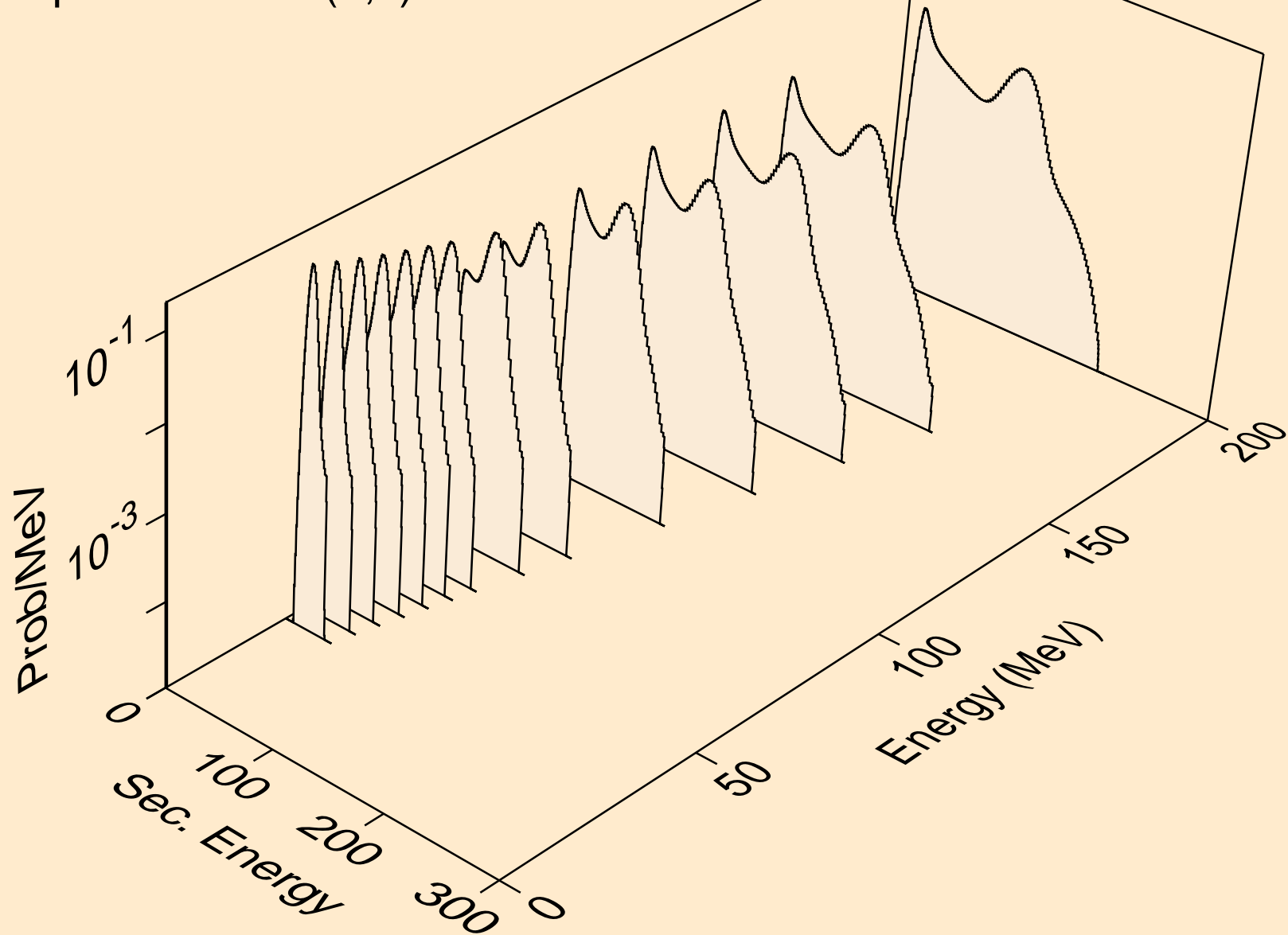

MD246M DEUTERON ACER TENDL-2023 LIBRARY; T=0.K
protons from (d,n*)p

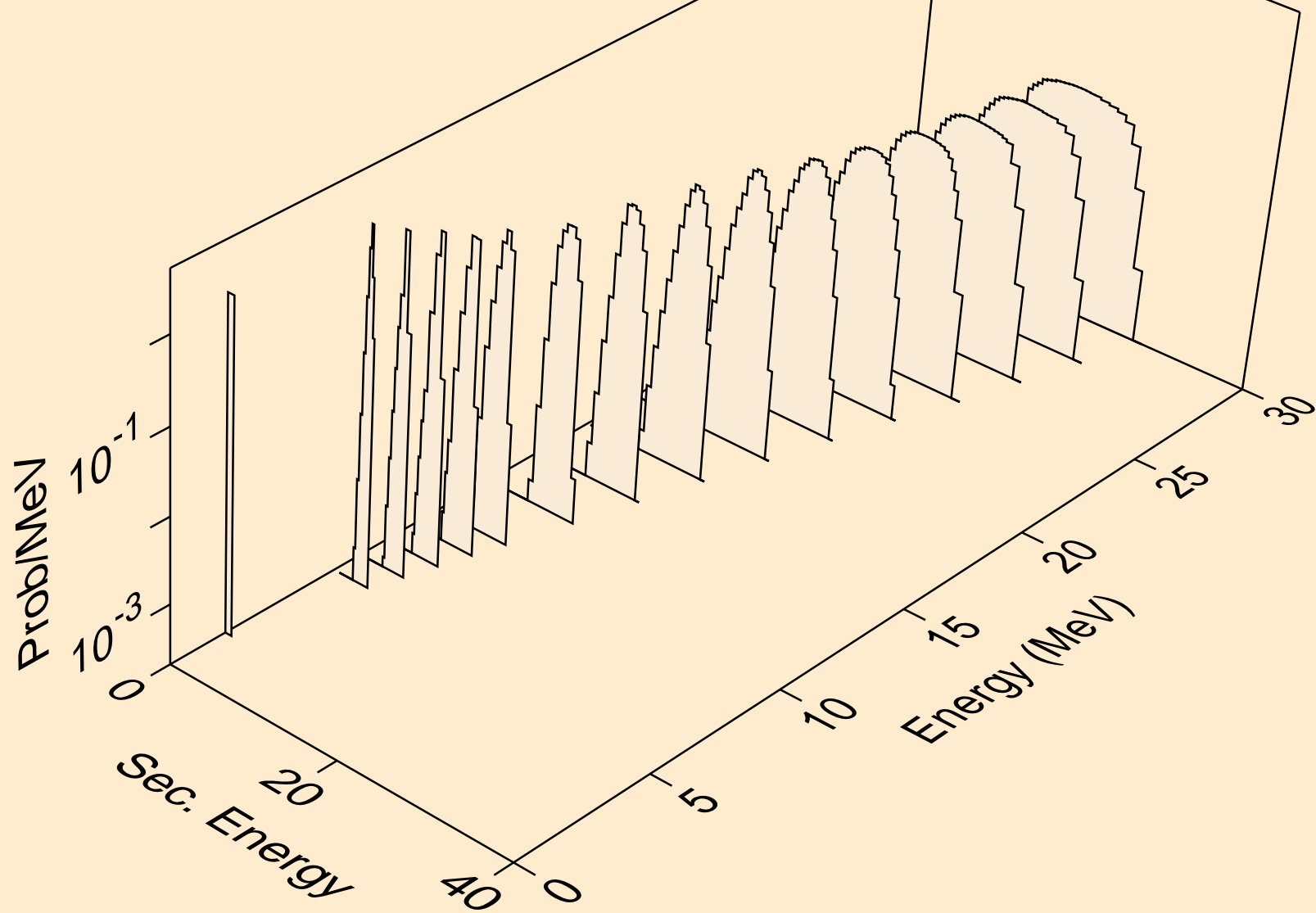

MD246M DEUTERON ACER TENDL-2023 LIBRARY; T=0.K
protons from (d,2np)

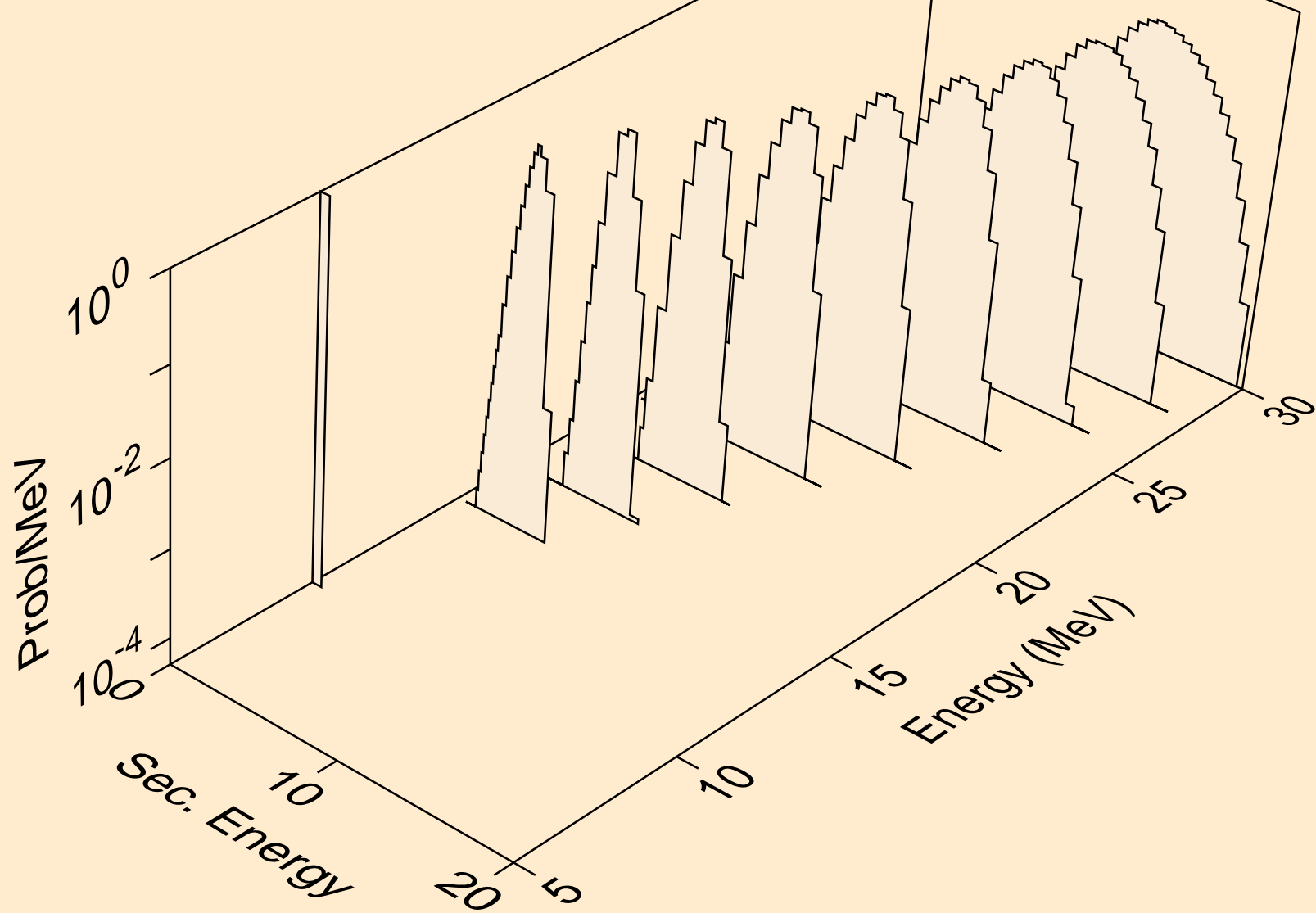

MD246M DEUTERON ACER TENDL-2023 LIBRARY; T=0.K
protons from (d,n2p)

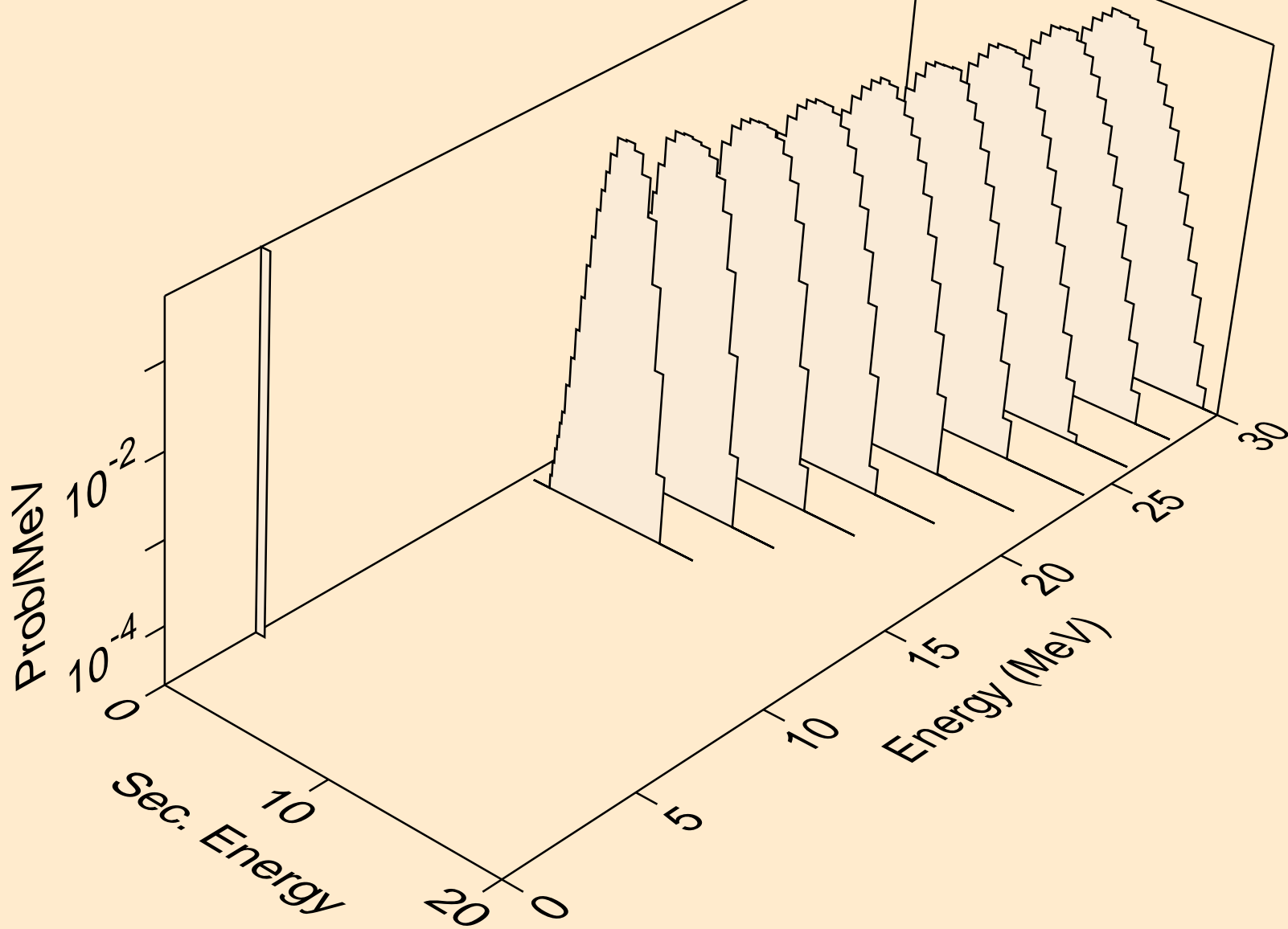

MD246M DEUTERON ACER TENDL-2023 LIBRARY; T=0.K
protons from (d,npa)

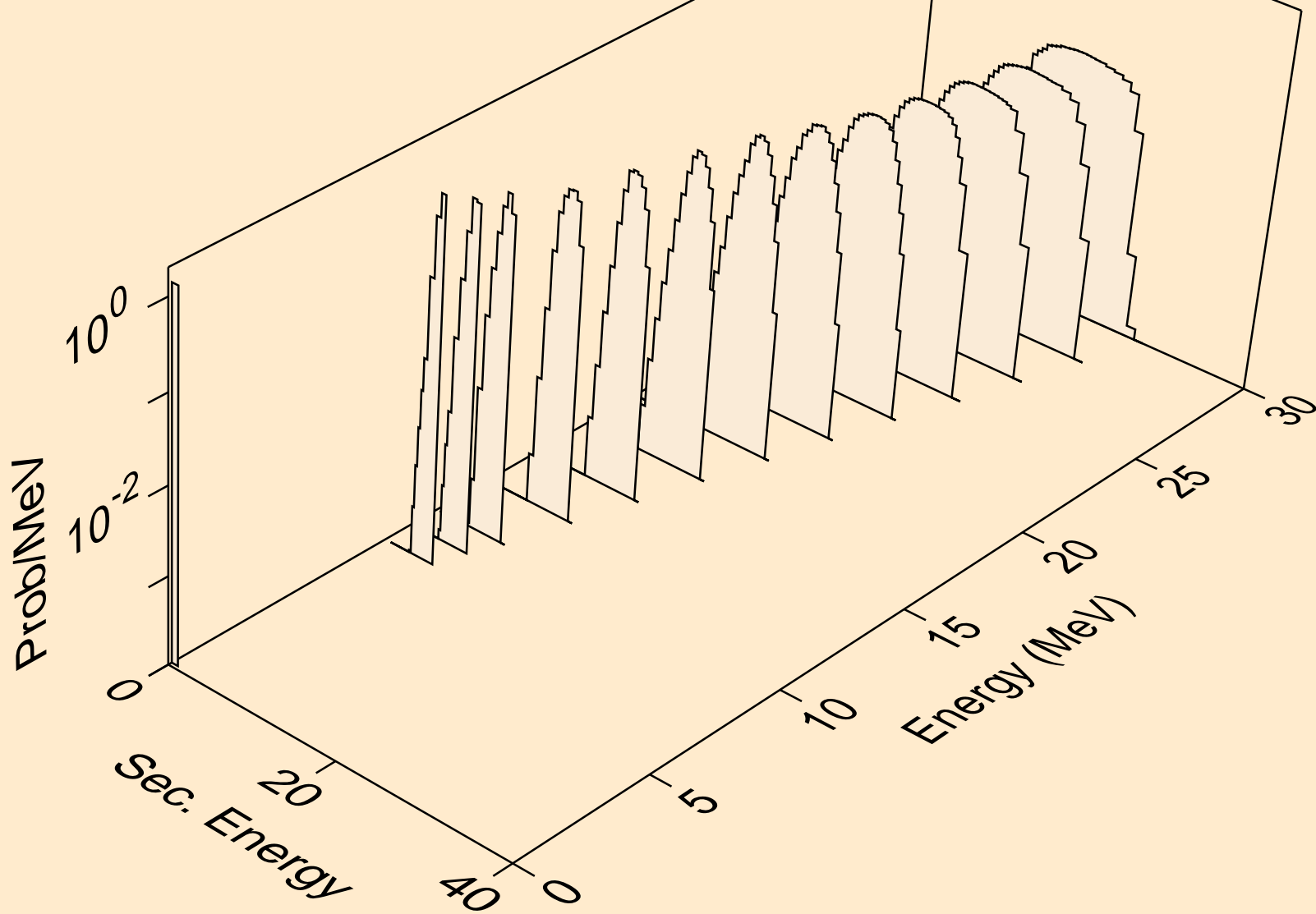

MD246M DEUTERON ACER TENDL-2023 LIBRARY; T=0.K
protons from (d,p)

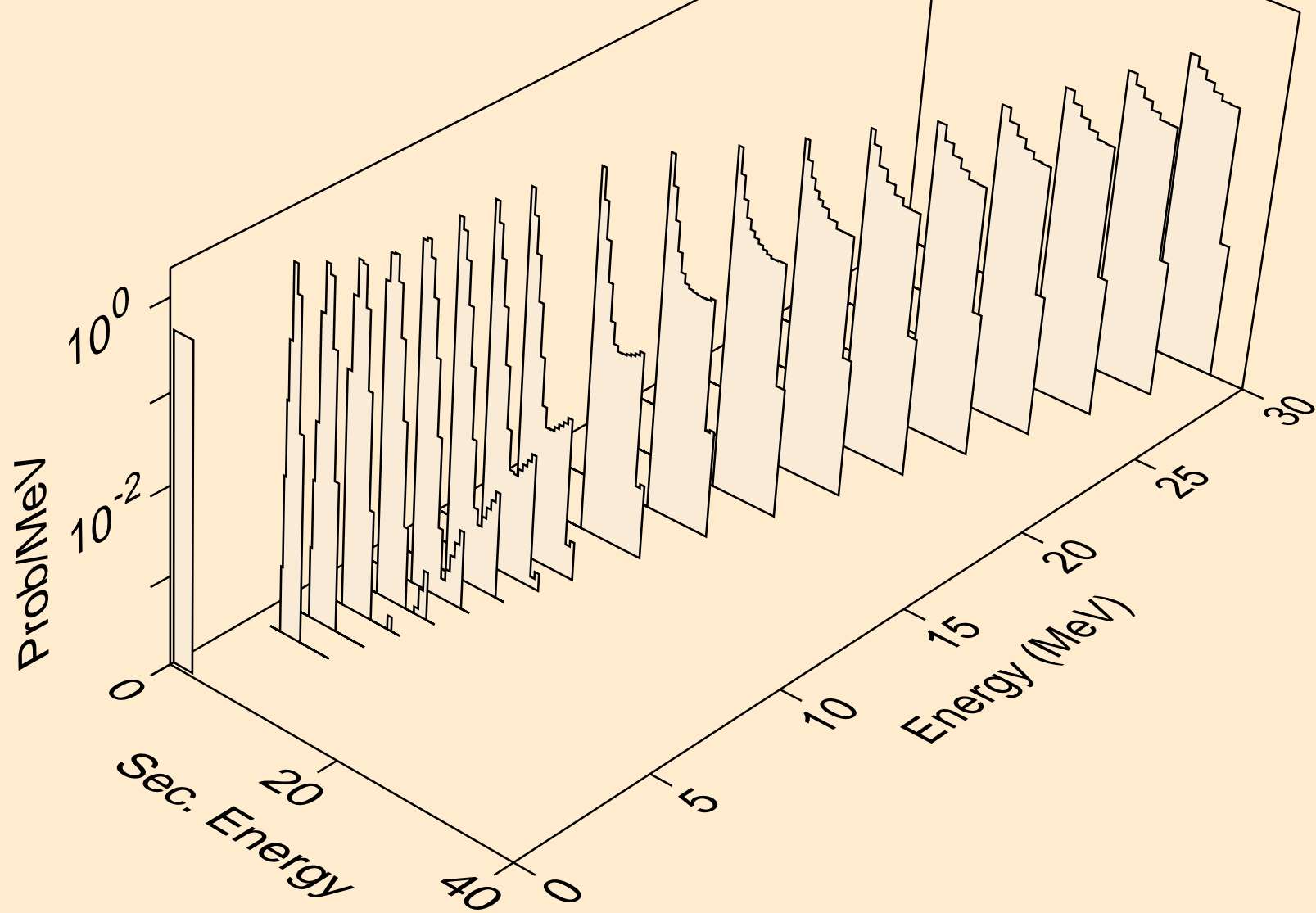

MD246M DEUTERON ACER TENDL-2023 LIBRARY; T=0.K
protons from (d,2p)

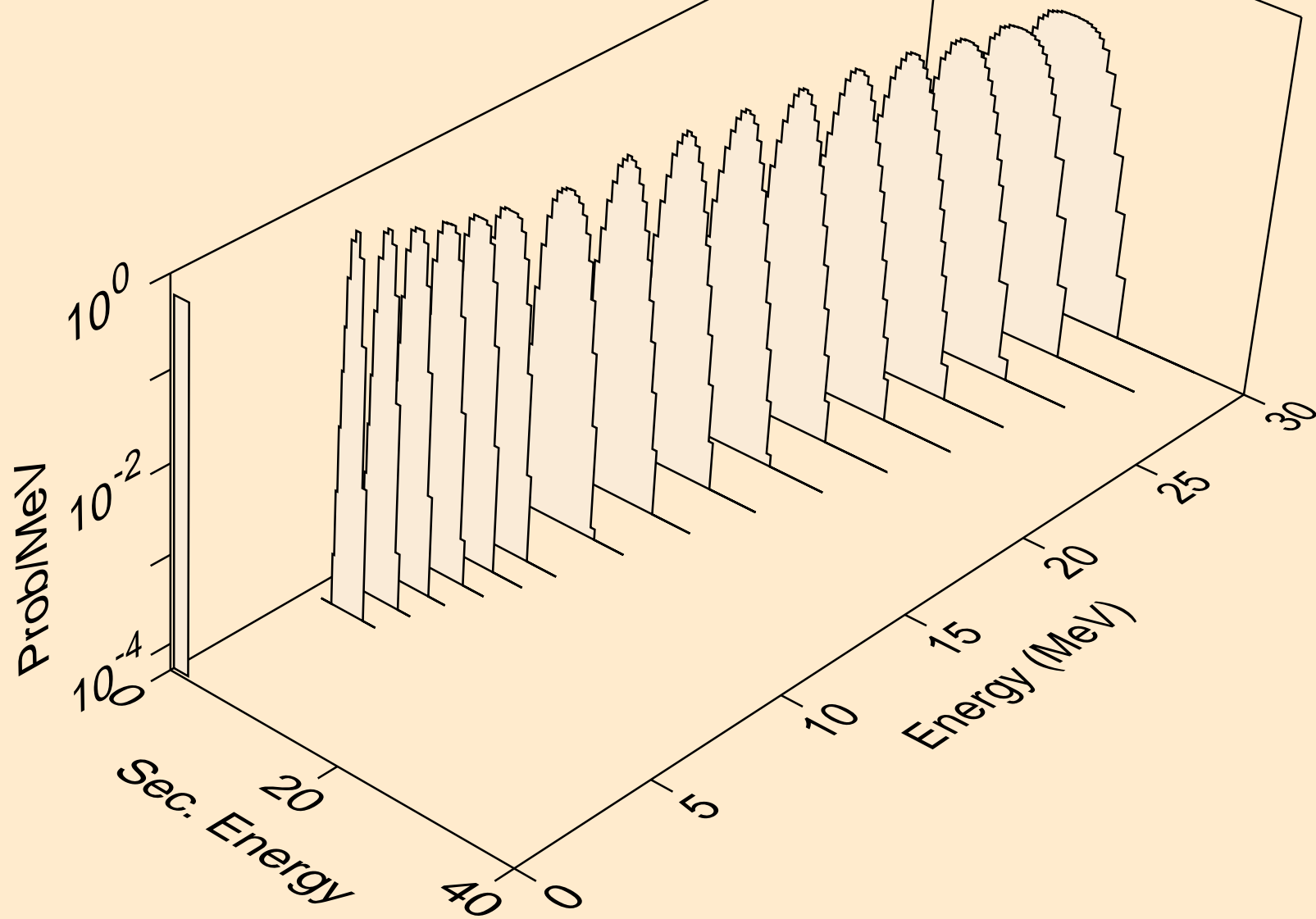

MD246M DEUTERON ACER TENDL-2023 LIBRARY; T=0.K
protons from (d,pa)

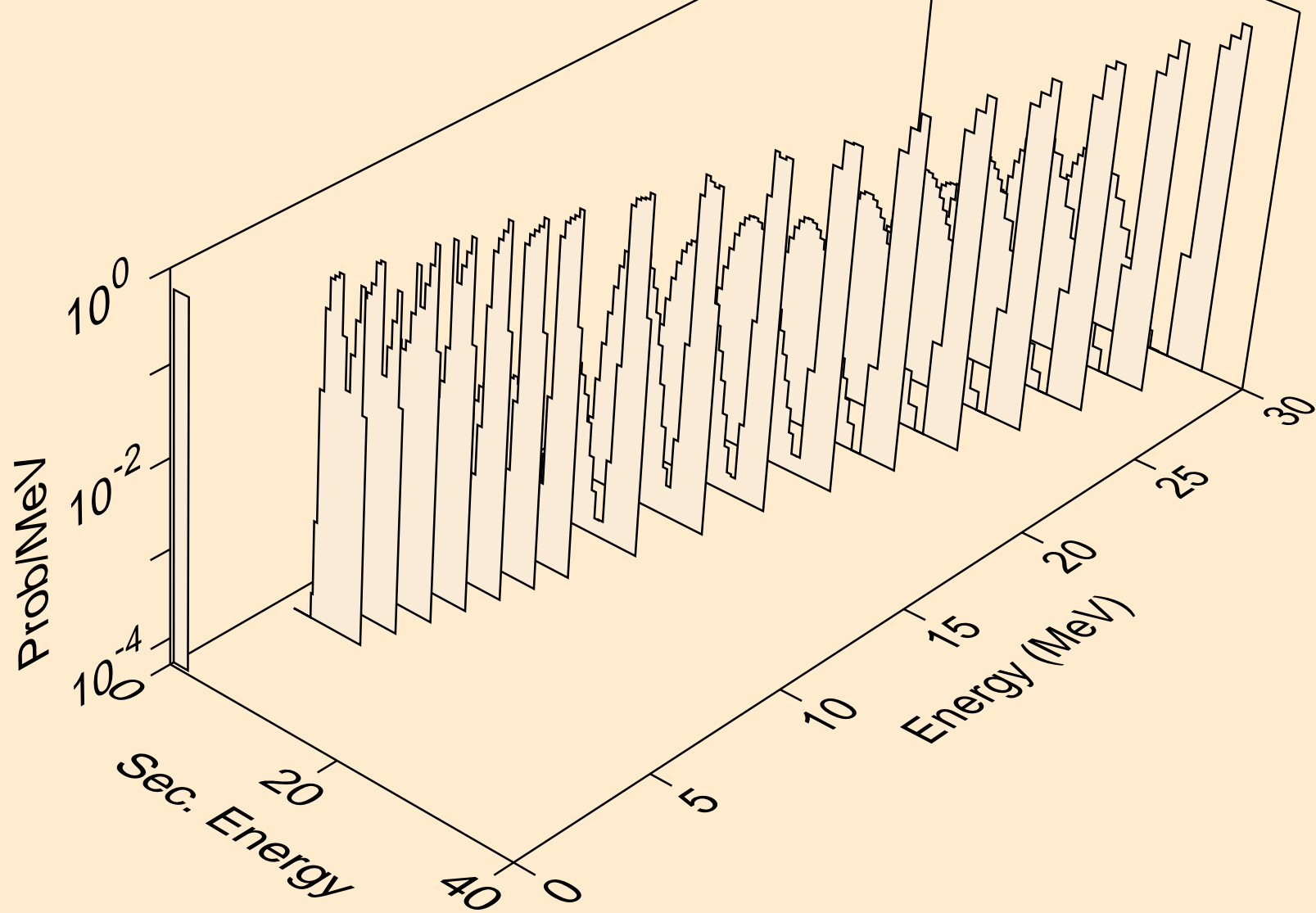

MD246M DEUTERON ACER TENDL-2023 LIBRARY; T=0.K
protons from (d,pd)

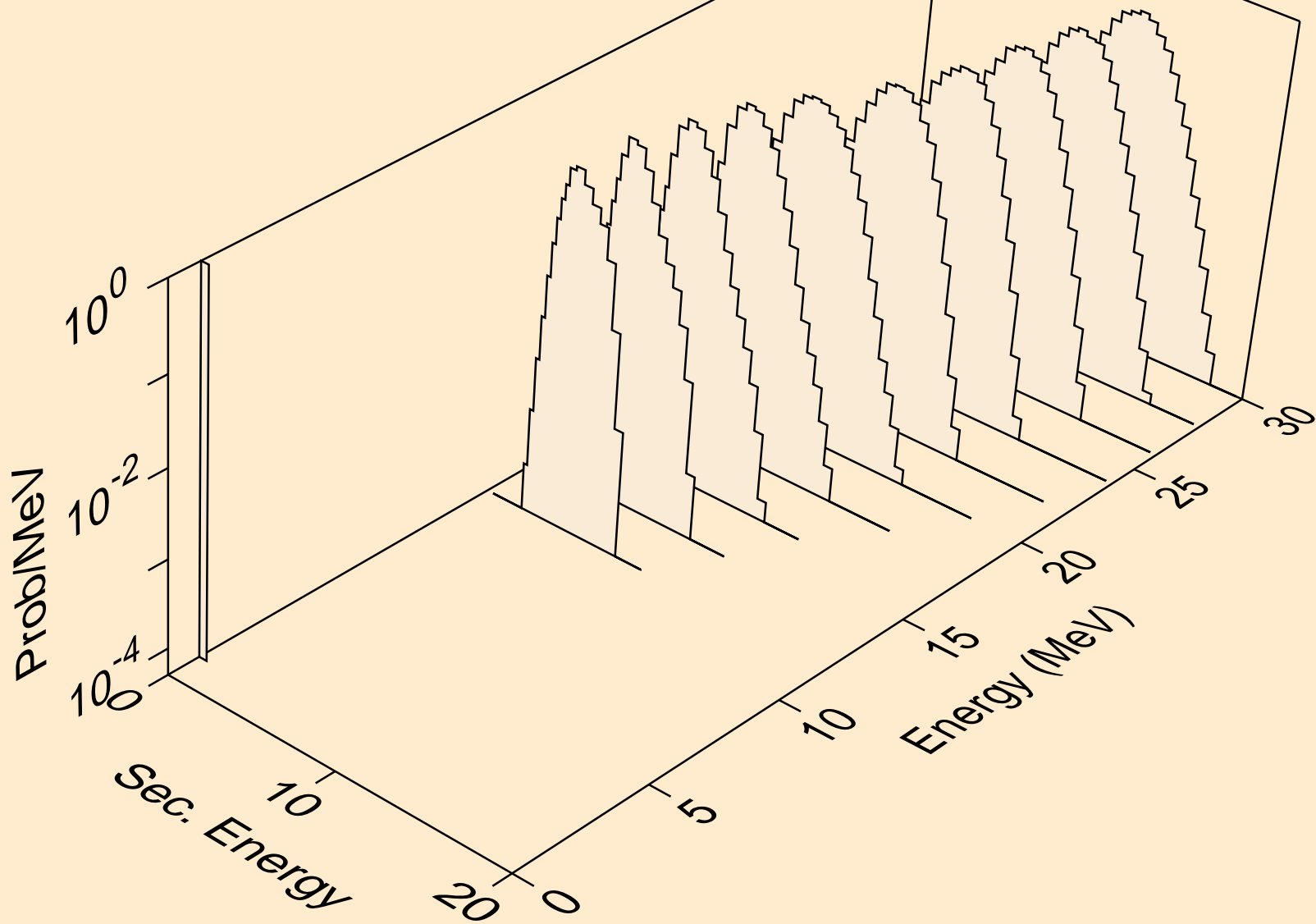

MD246M DEUTERON ACER TENDL-2023 LIBRARY; T=0.K
tritons from (d,x)

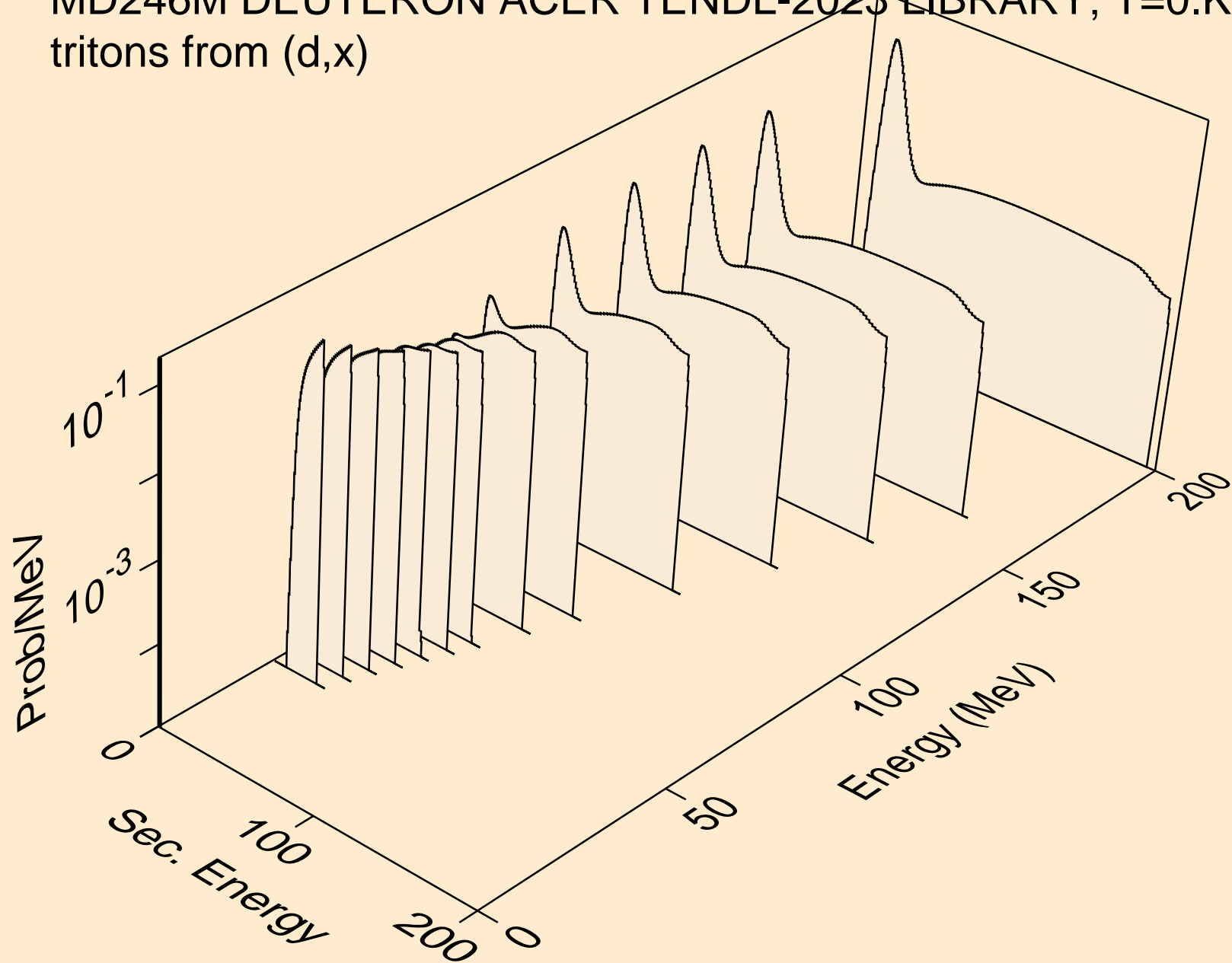

MD246M DEUTERON ACER TENDL-2023 LIBRARY; T=0.K
tritons from (d,n*)t

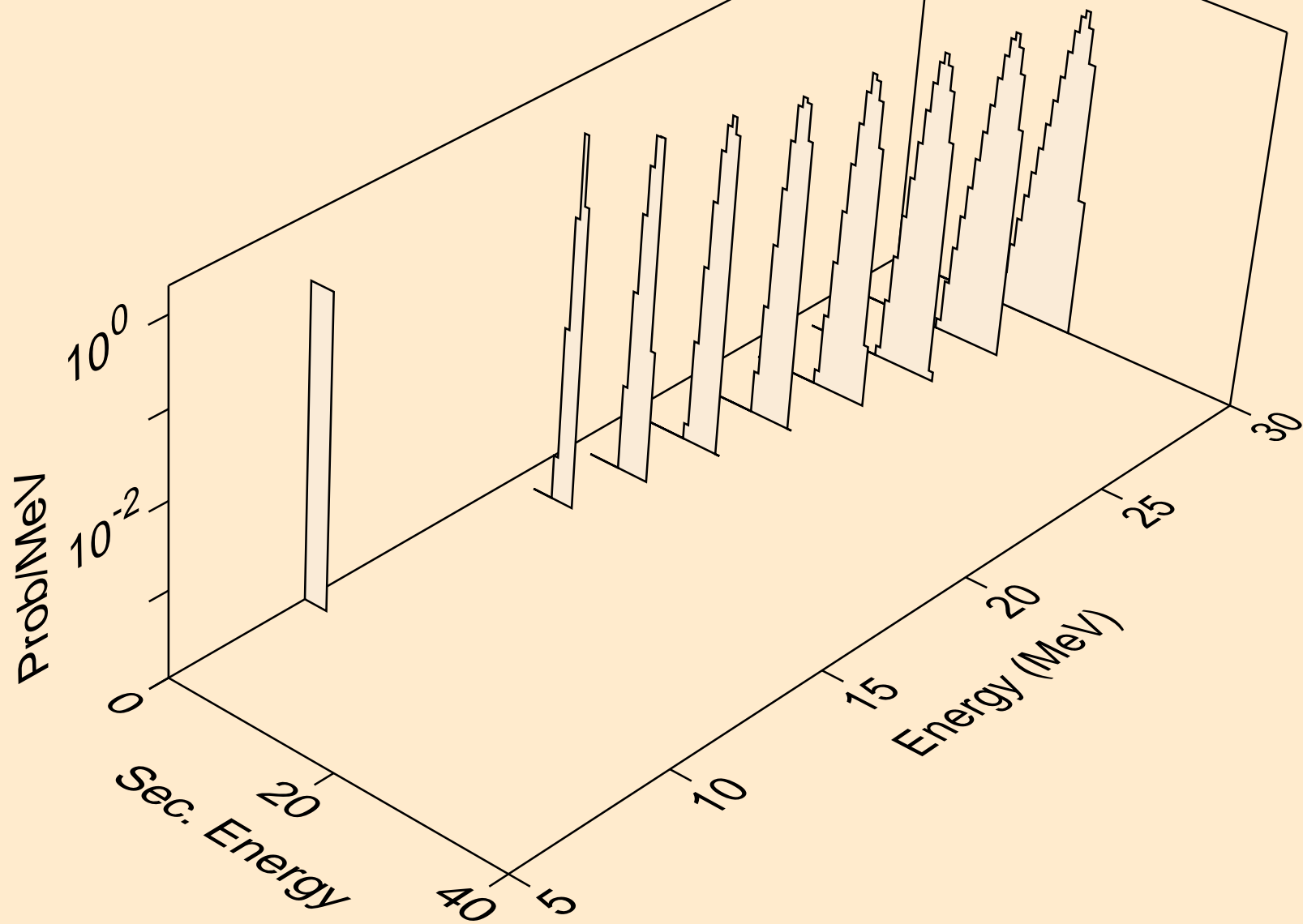

MD246M DEUTERON ACER TENDL-2023 LIBRARY; T=0.K
tritons from (d,t)

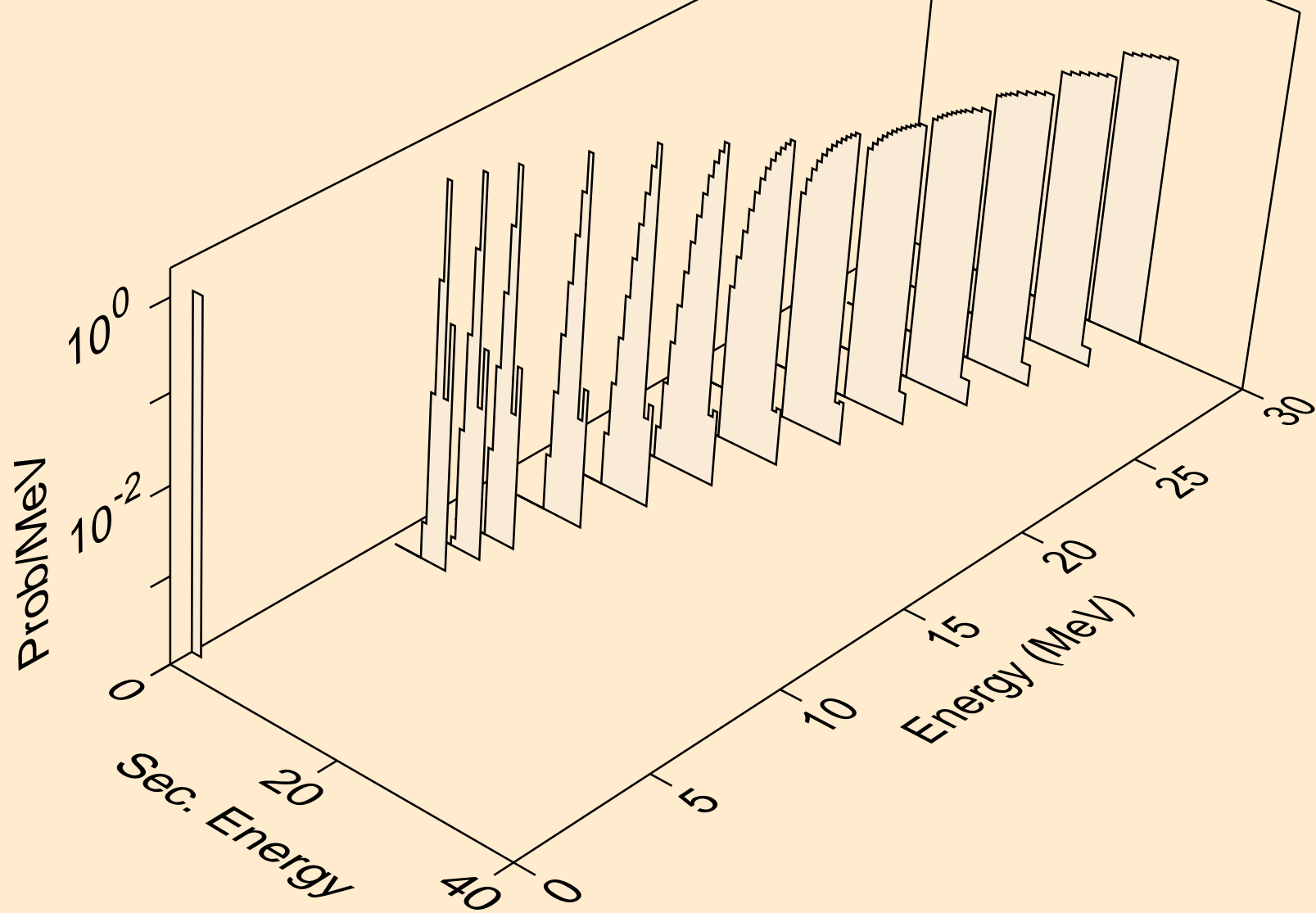

MD246M DEUTERON ACER TENDL-2023 LIBRARY; T=0.K
he3s from (d,x)

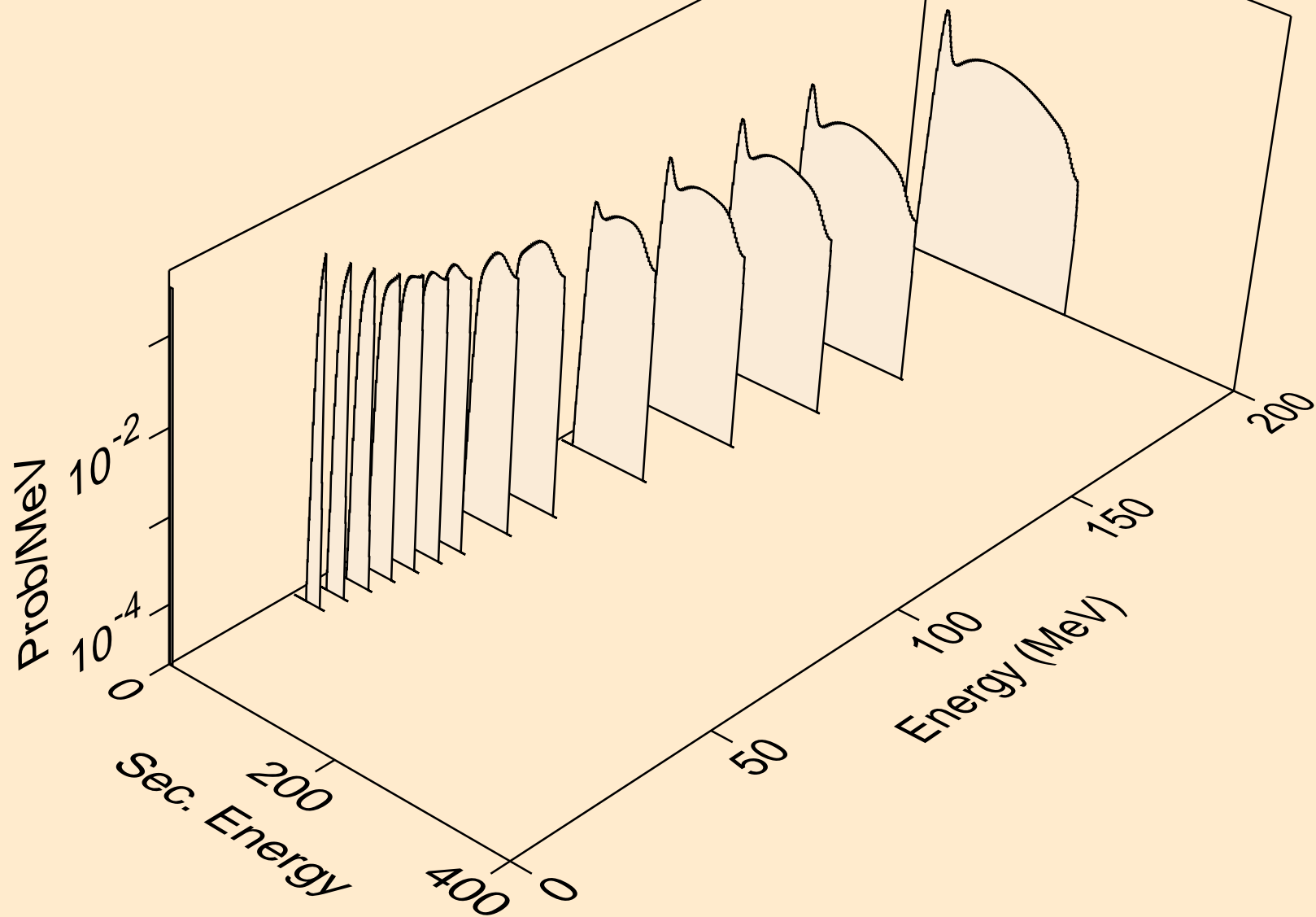

MD246M DEUTERON ACER TENDL-2023 LIBRARY; T=0.K
he3s from (d,he3)

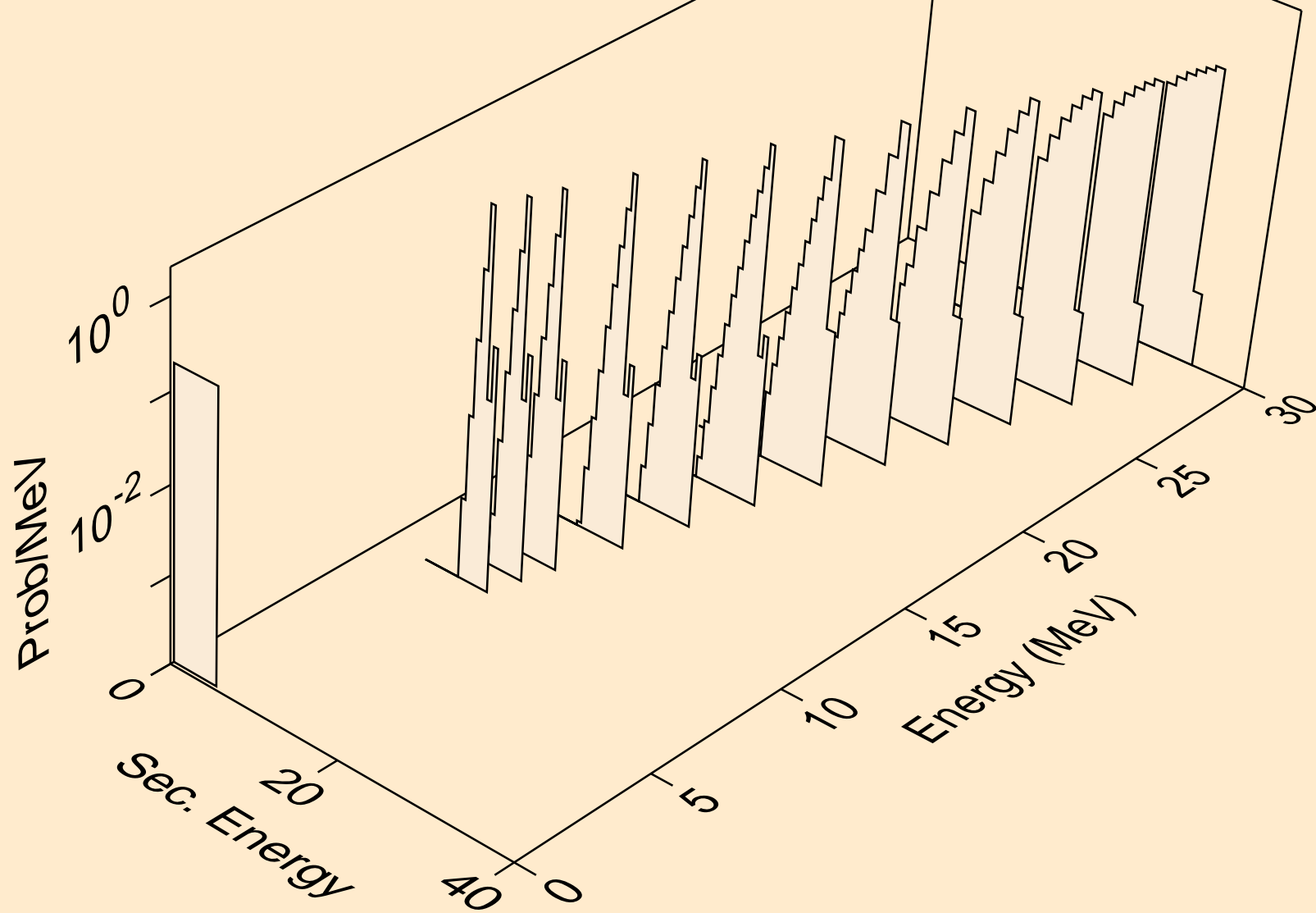

MD246M DEUTERON ACER TENDL-2023 LIBRARY; T=0.K
alphas from (d,x)

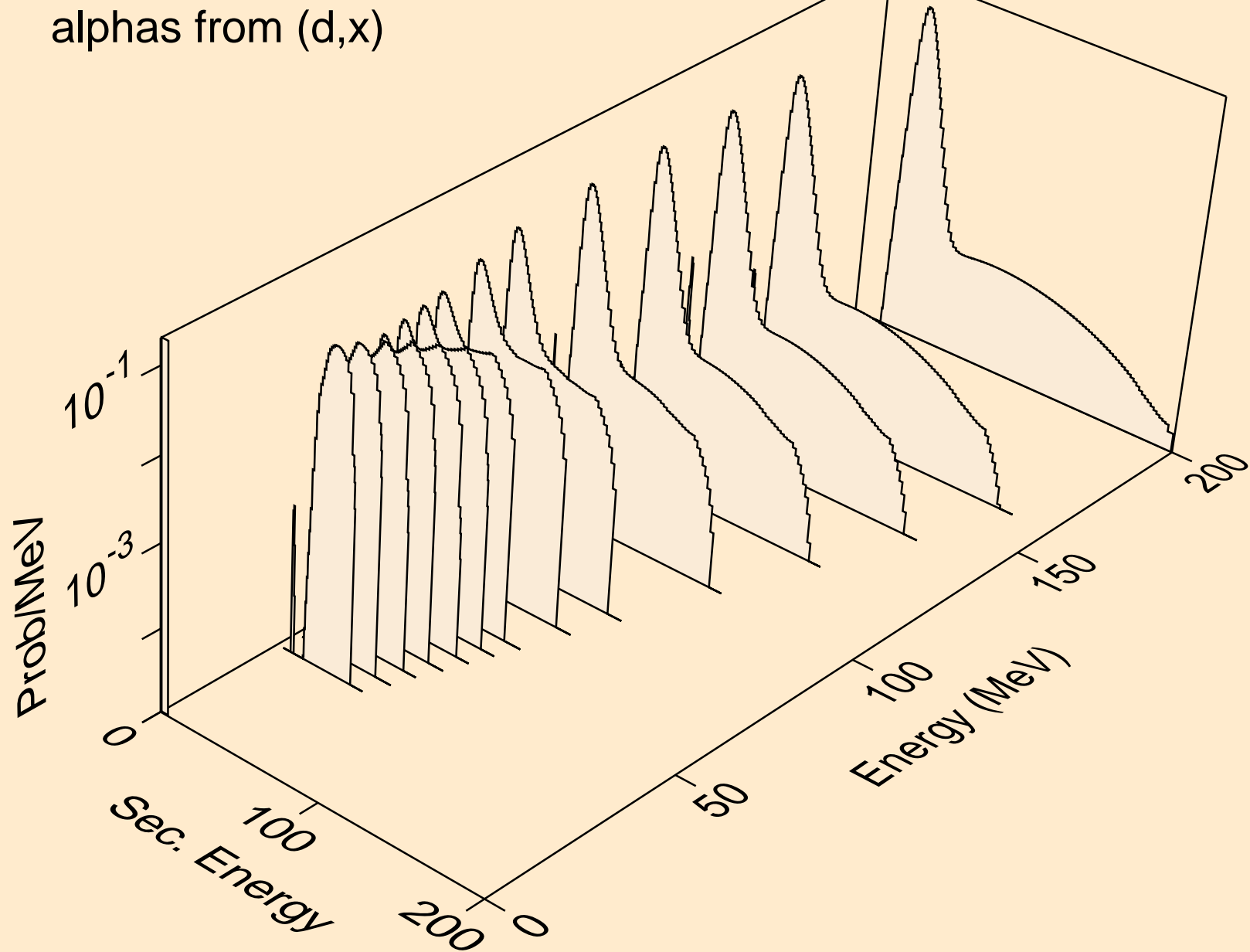

MD246M DEUTERON ACER TENDL-2023 LIBRARY; T=0.K
alphas from (d,n*)a

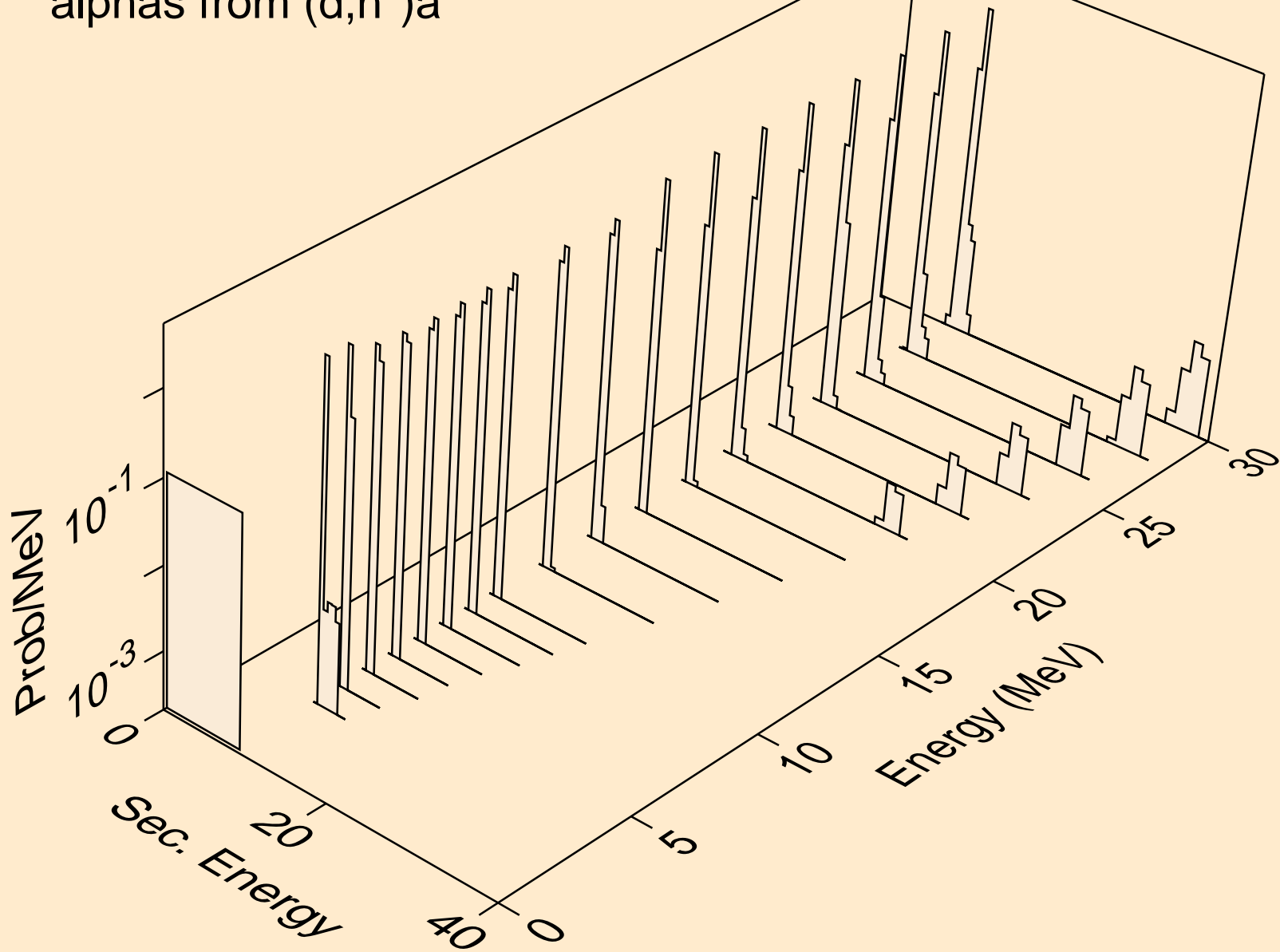

MD246M DEUTERON ACER TENDL-2023 LIBRARY; T=0.K
alphas from (d,3n)a

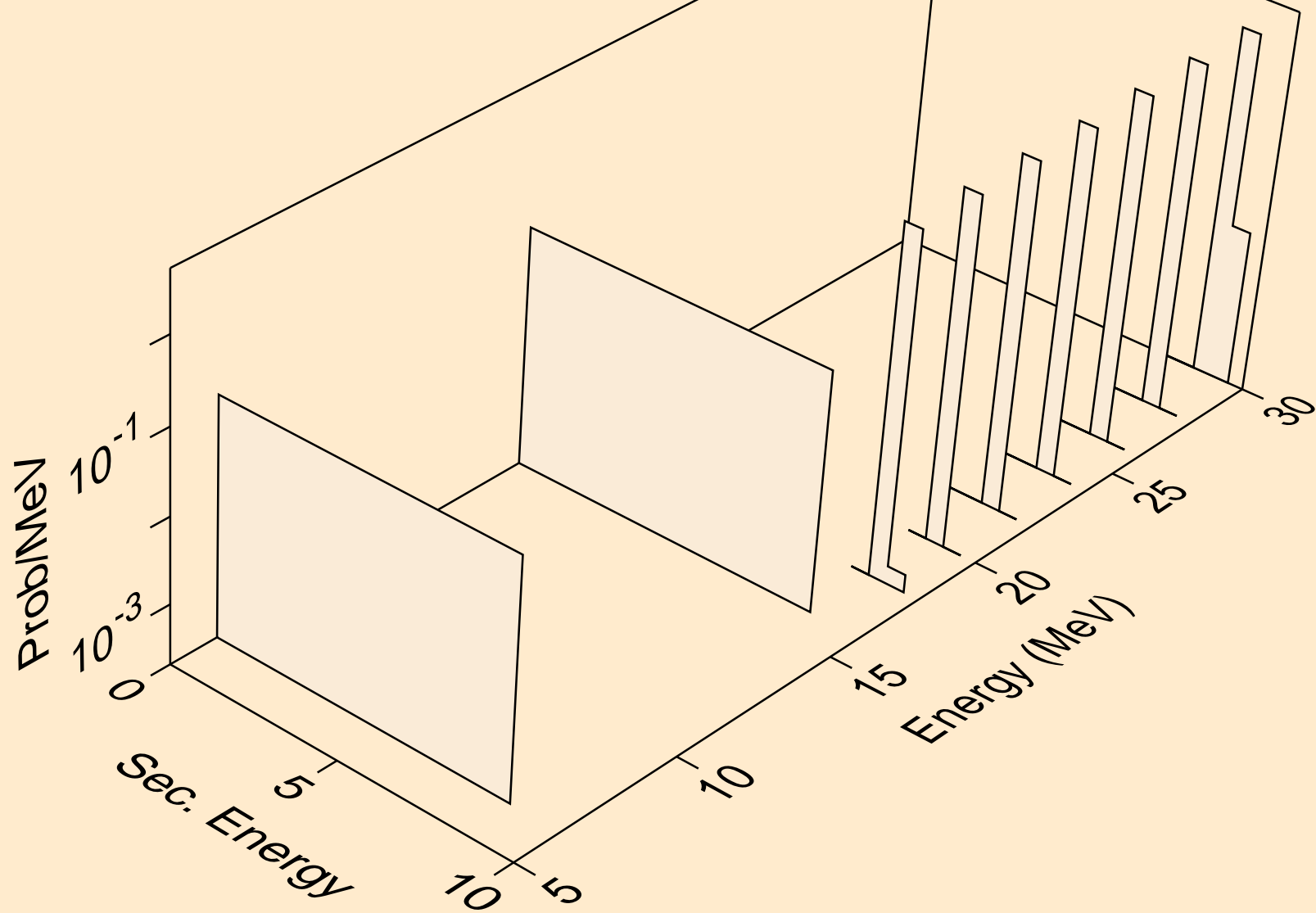

MD246M DEUTERON ACER TENDL-2023 LIBRARY; T=0.K
alphas from (d,npa)

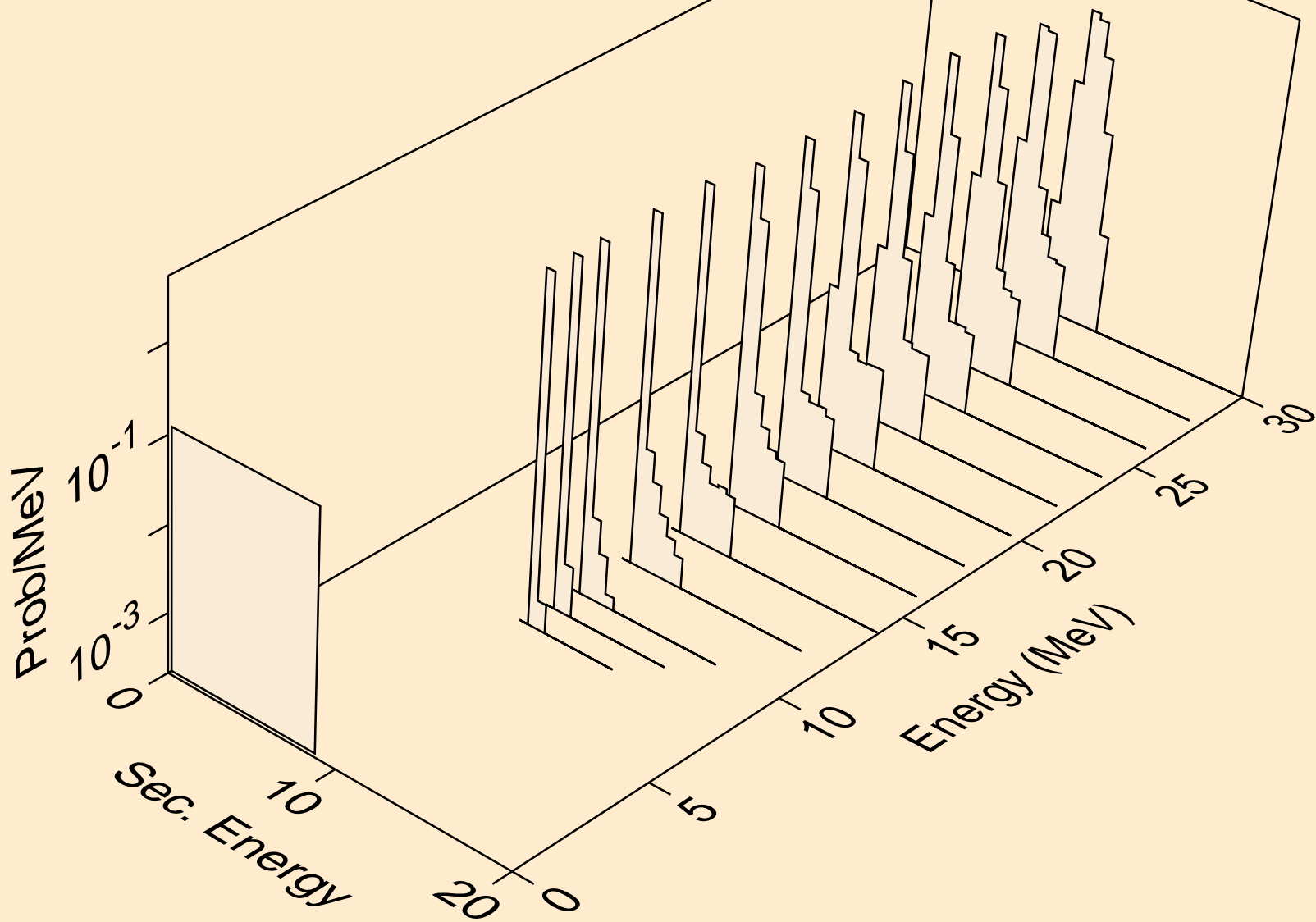

MD246M DEUTERON ACER TENDL-2023 LIBRARY; T=0.K
alphas from (d,a)

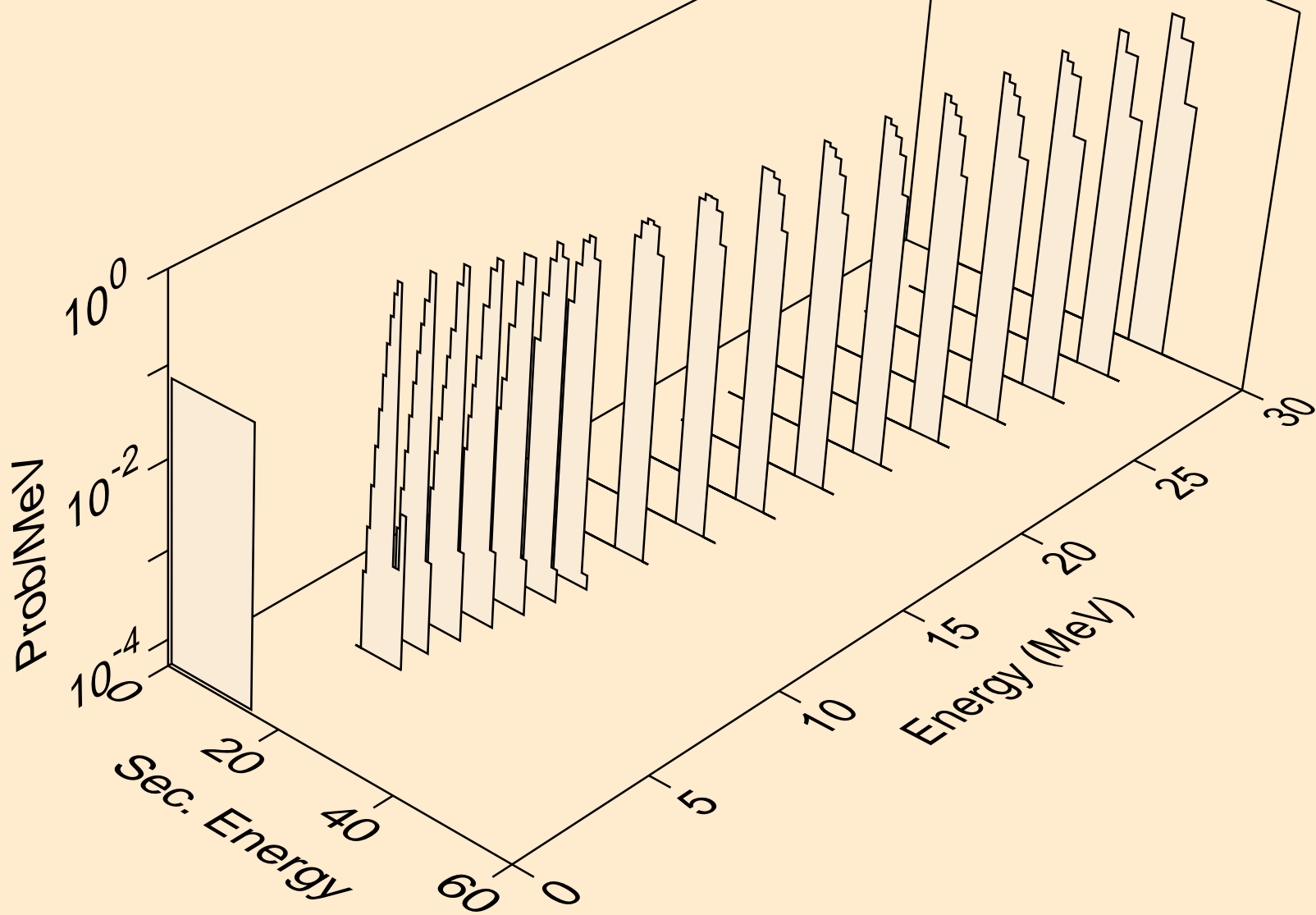

MD246M DEUTERON ACER TENDL-2023 LIBRARY; T=0.K
alphas from (d,pa)

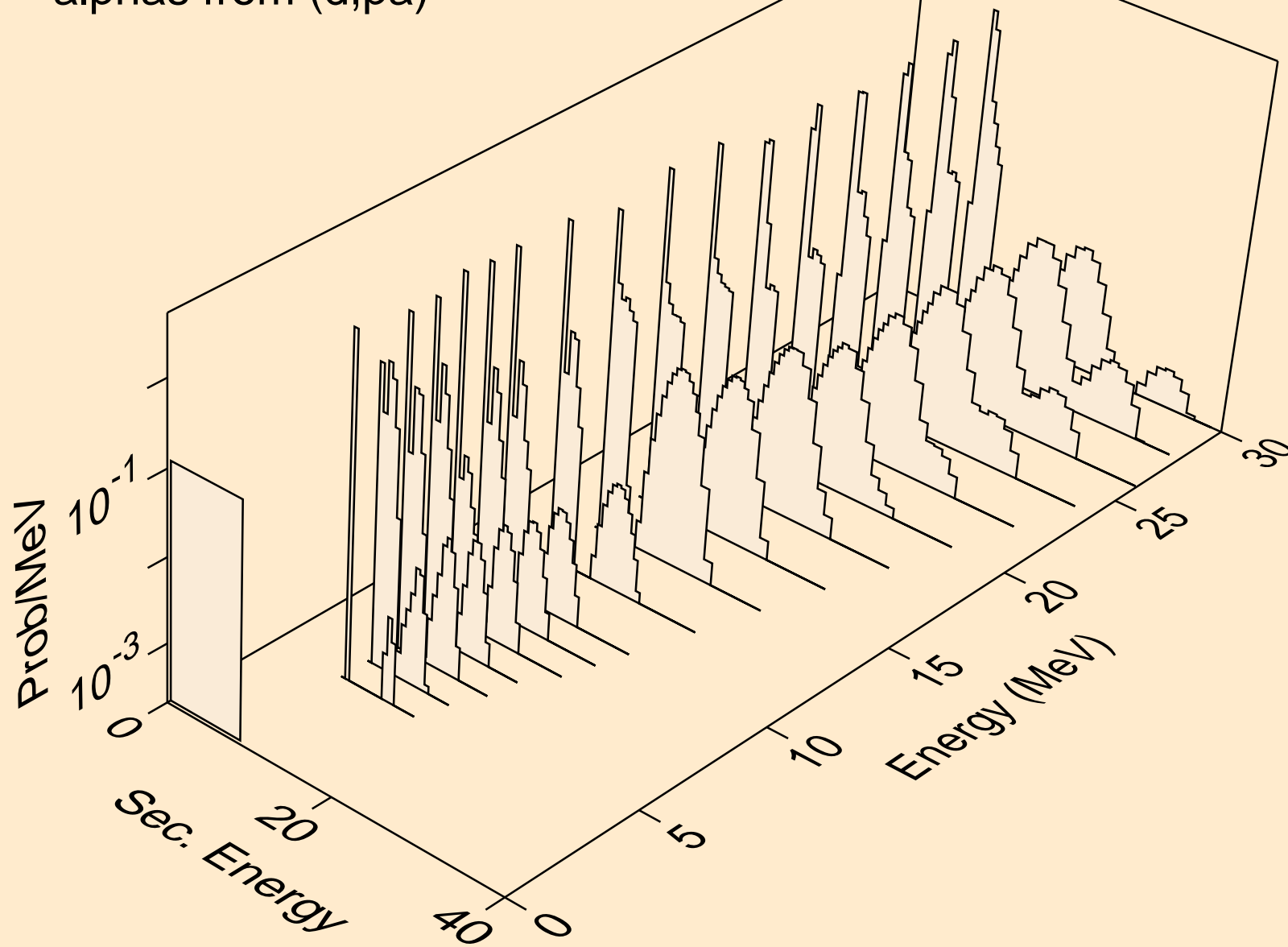

MD246M DEUTERON ACER TENDL-2023 LIBRARY; T=0.K
alphas from (d,da)

