

# MG026 DEUTERON ACER TENDL-2023 LIBRARY; T=0.K

## Principal cross sections

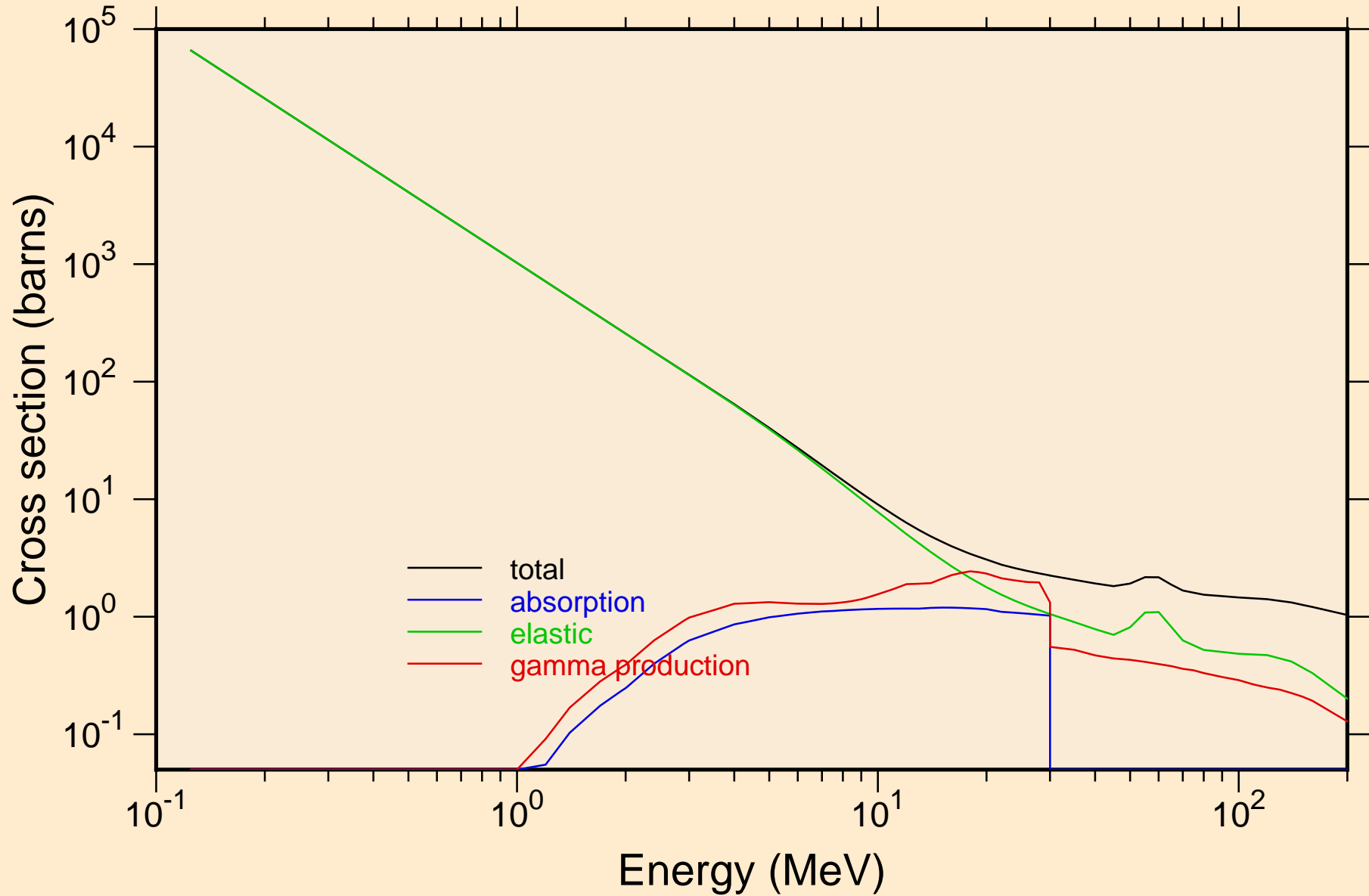

# MG026 DEUTERON ACER TENDL-2023 LIBRARY; T=0.K

## Heating

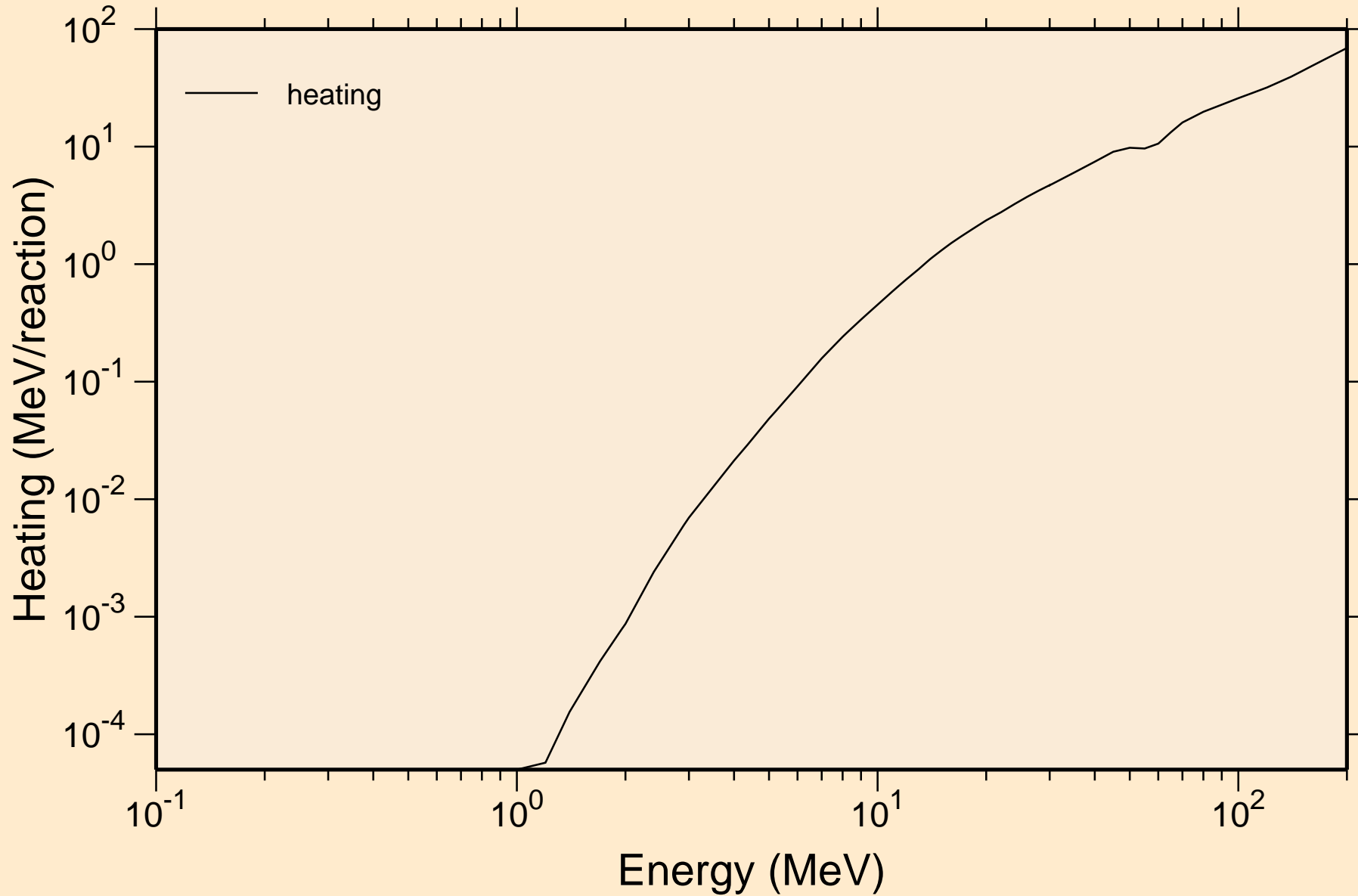

# MG026 DEUTERON ACER TENDL-2023 LIBRARY; T=0.K

## Principal cross sections

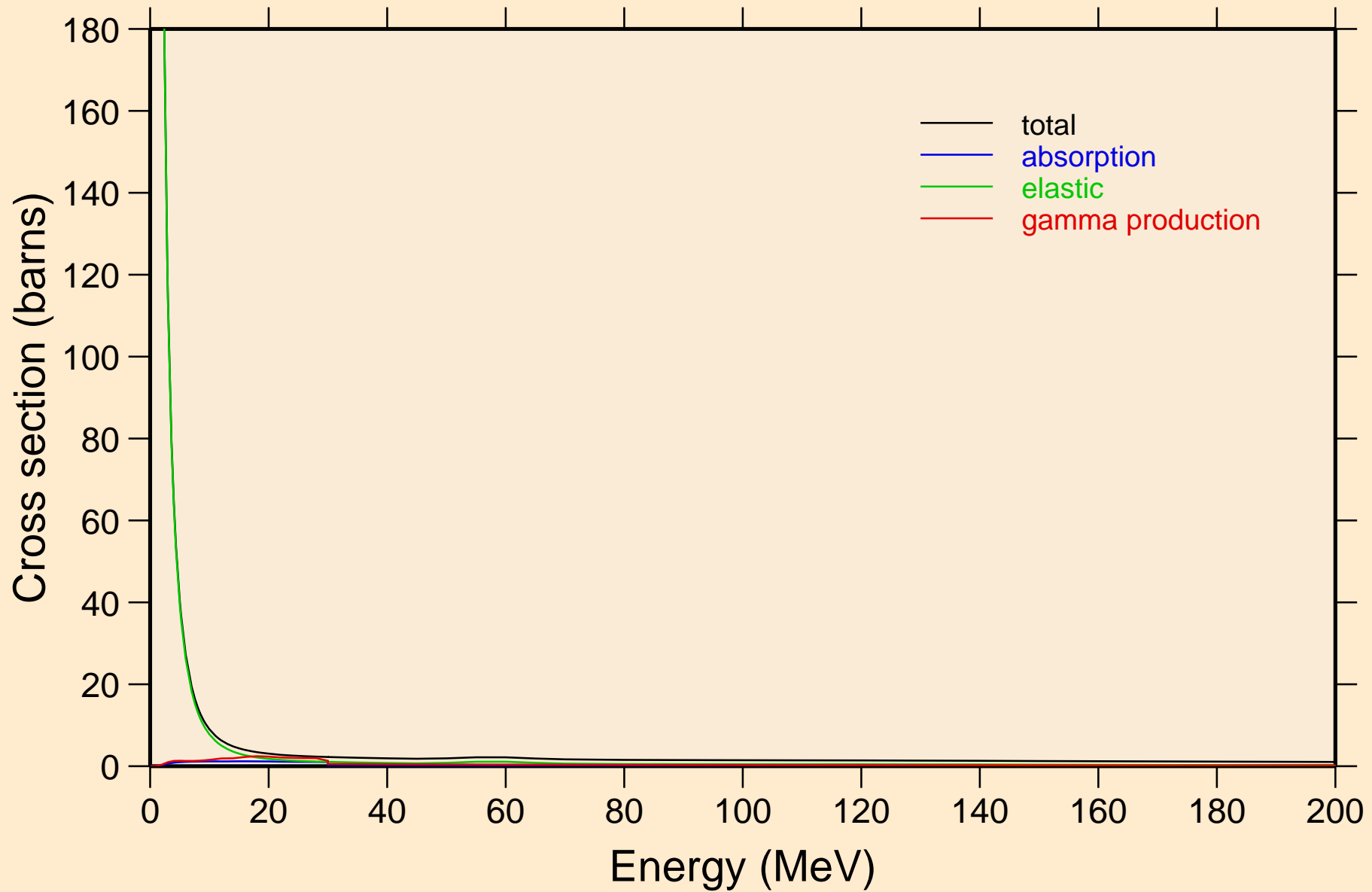

# MG026 DEUTERON ACER TENDL-2023 LIBRARY; T=0.K

## Heating

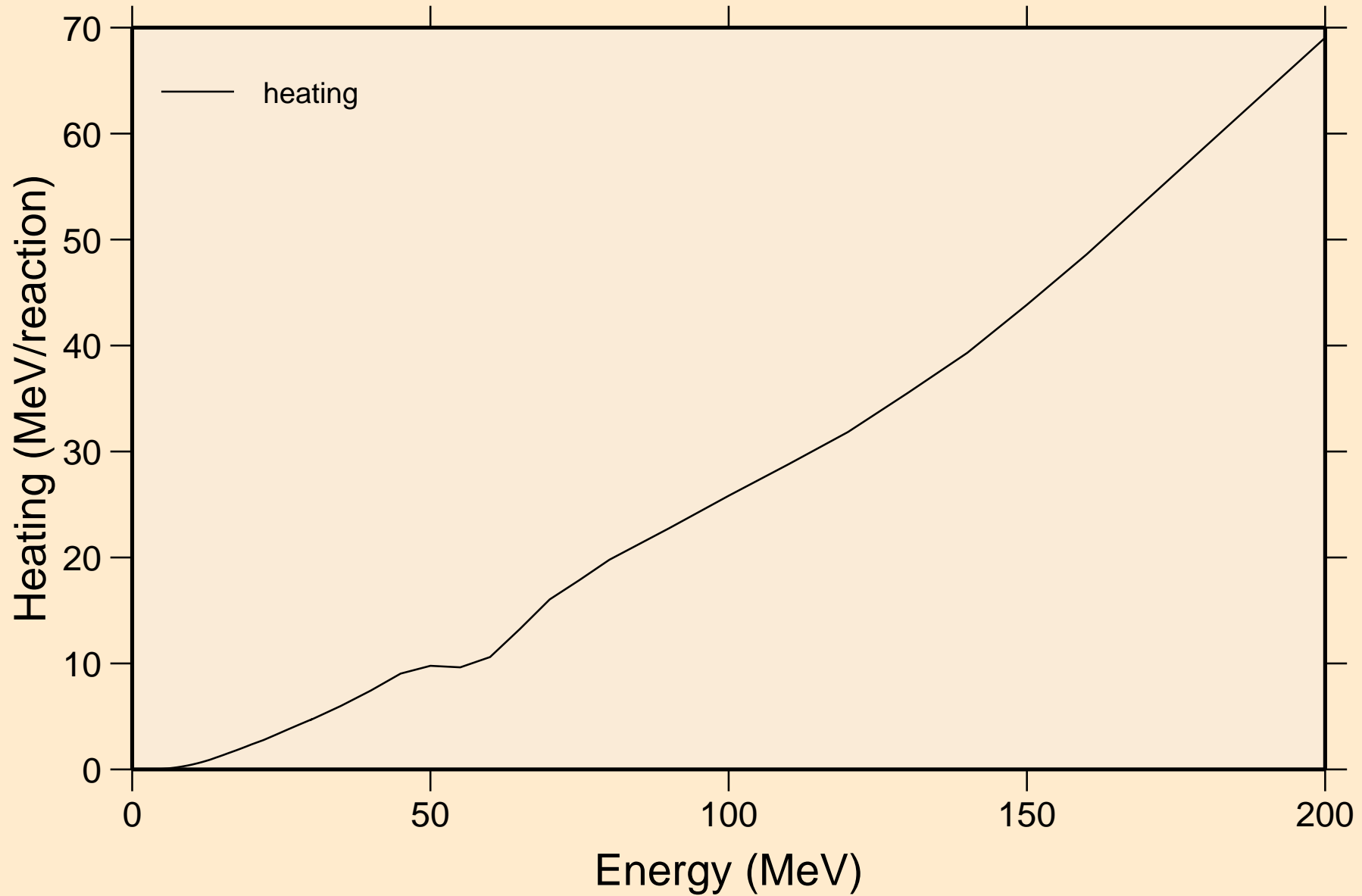

# MG026 DEUTERON ACER TENDL-2023 LIBRARY; T=0.K

## Threshold reactions

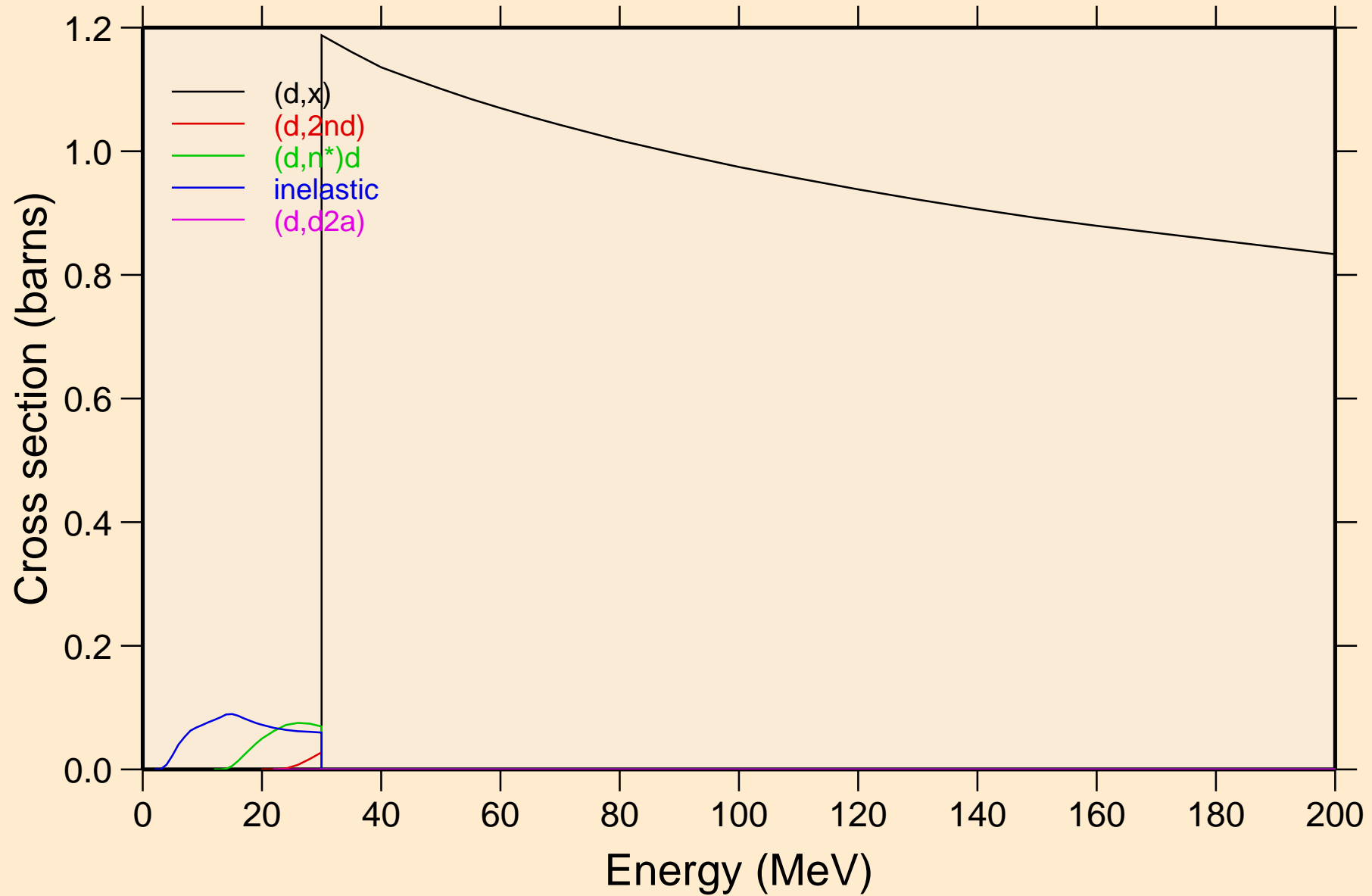

MG026 DEUTERON ACER TENDL-2023 LIBRARY; T=0.K  
Threshold reactions

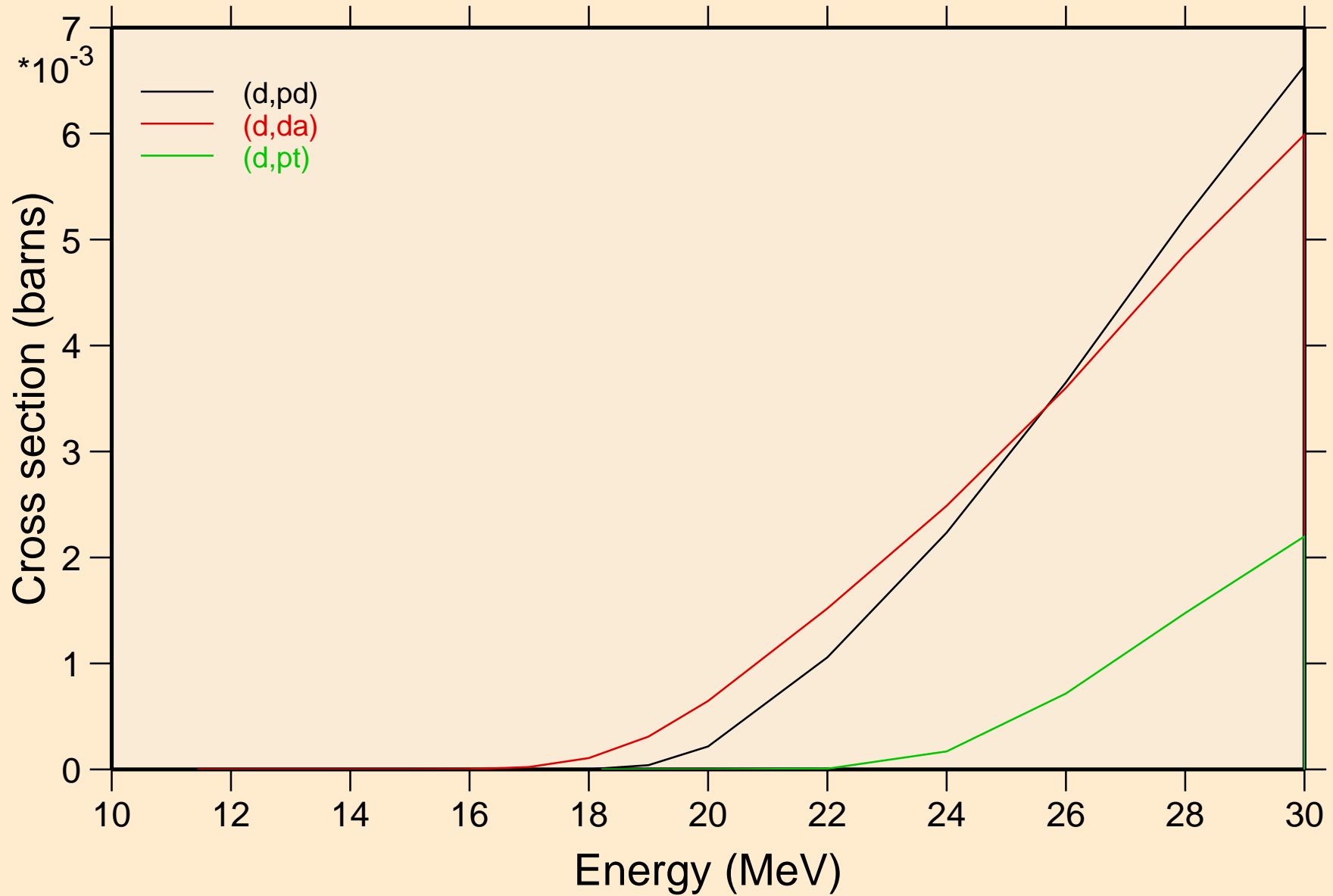

MG026 DEUTERON ACER TENDL-2023 LIBRARY; T=0.K  
Threshold reactions

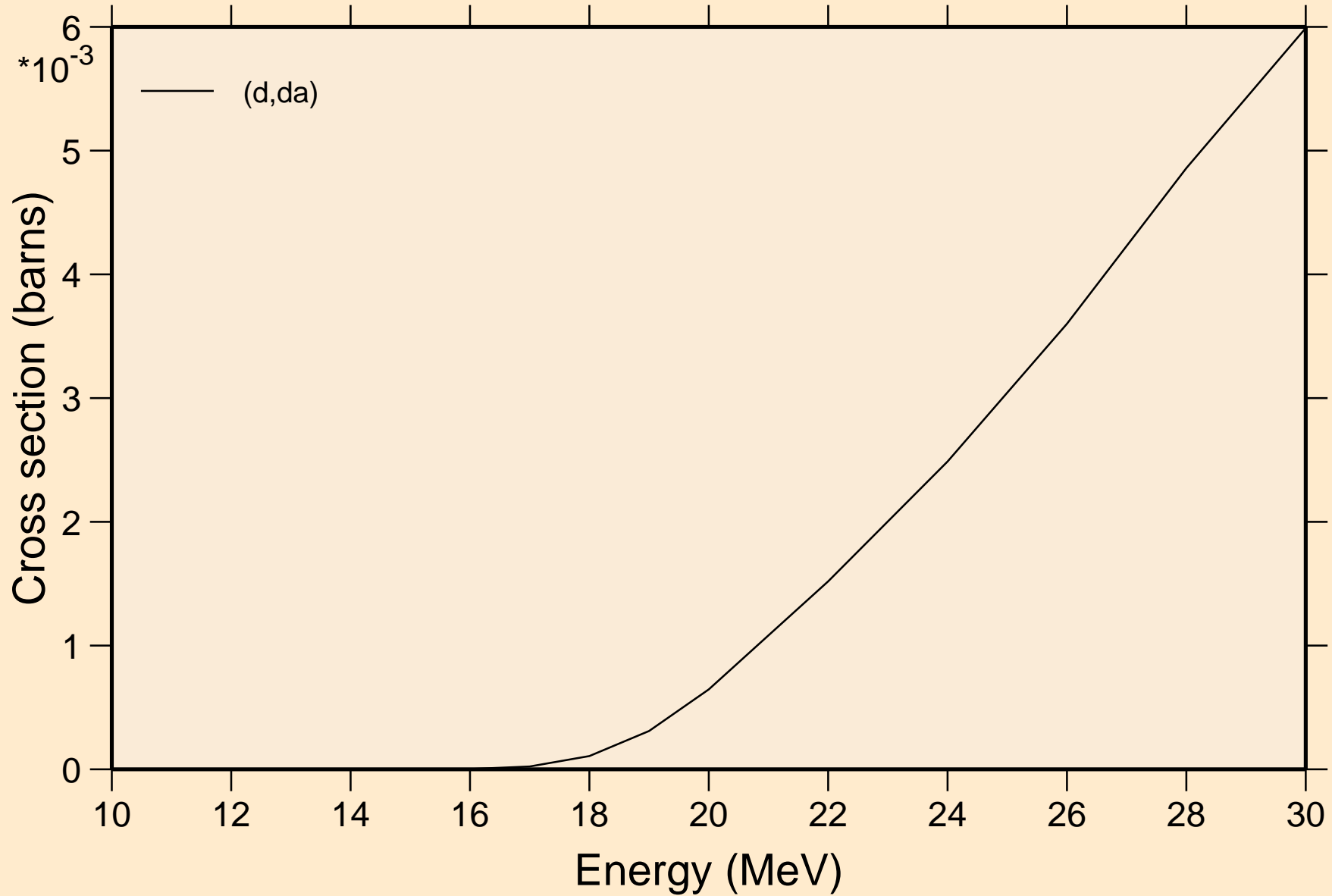

MG026 DEUTERON ACER TENDL-2023 LIBRARY; T=0.K  
angular distribution for elastic

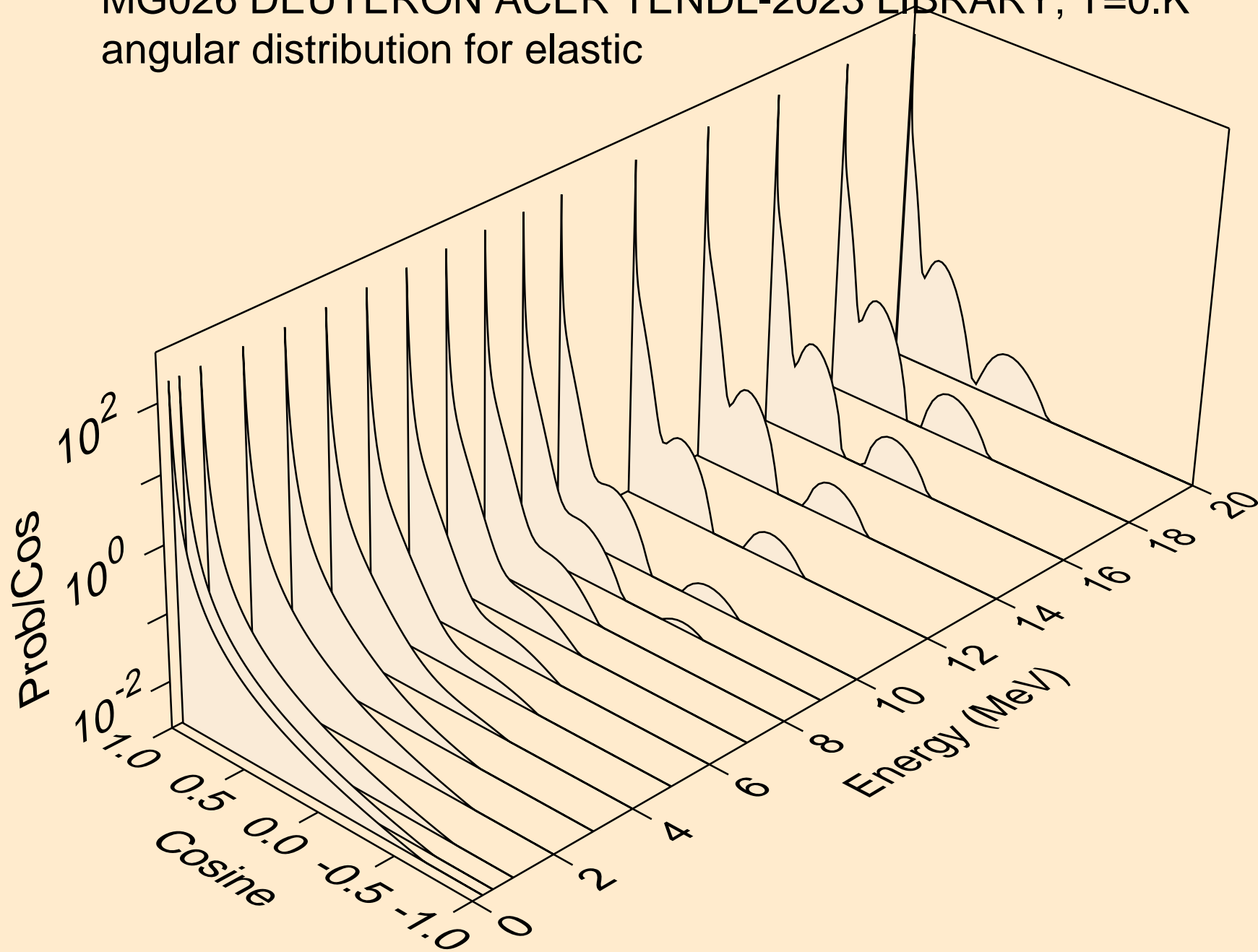



MG026 DEUTERON ACER TENDL-2023 LIBRARY; T=0.K  
angular distribution for elastic

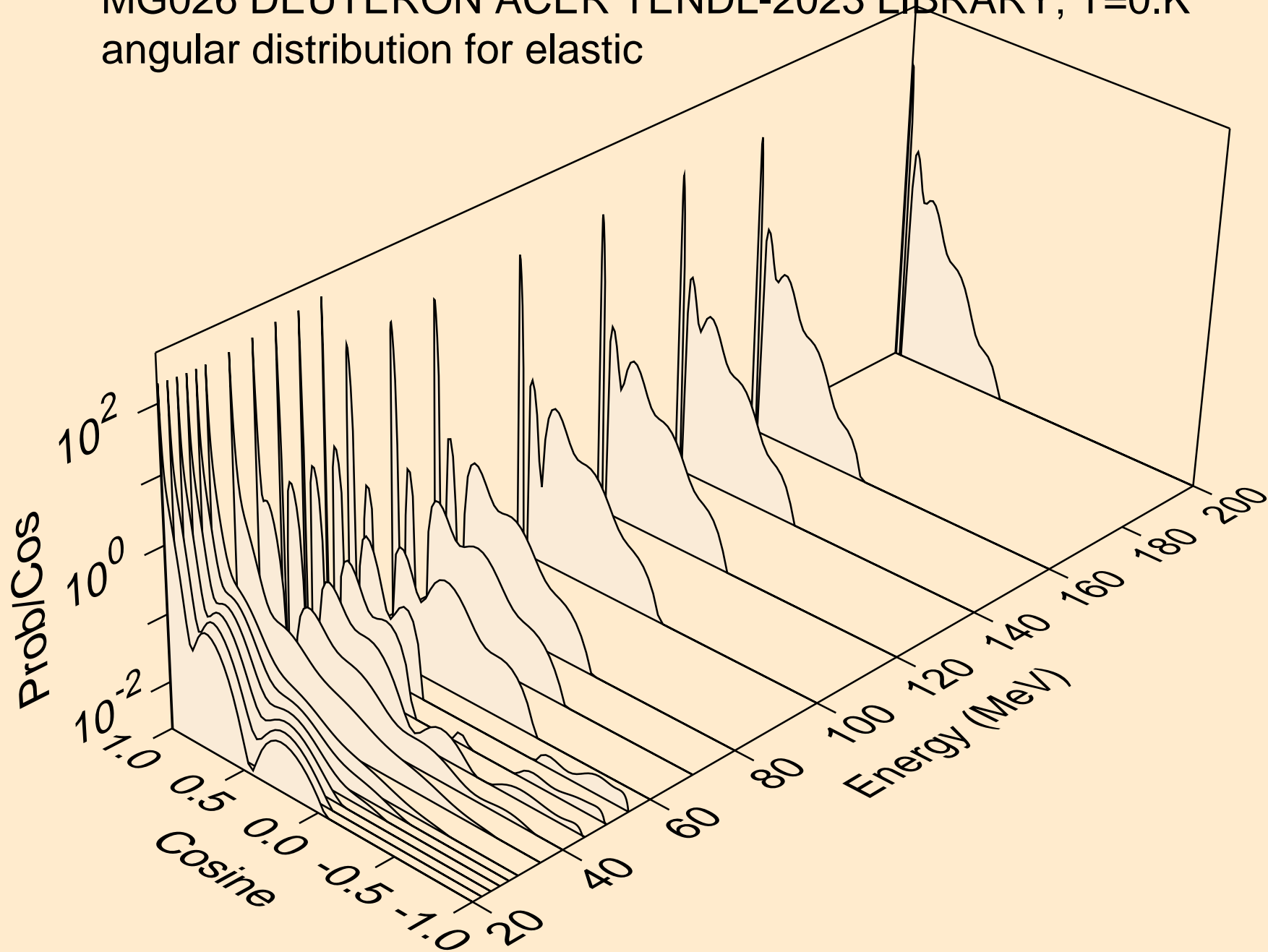

MG026 DEUTERON ACER TENDL-2023 LIBRARY; T=0.K  
Deuteron emission for (d,x)

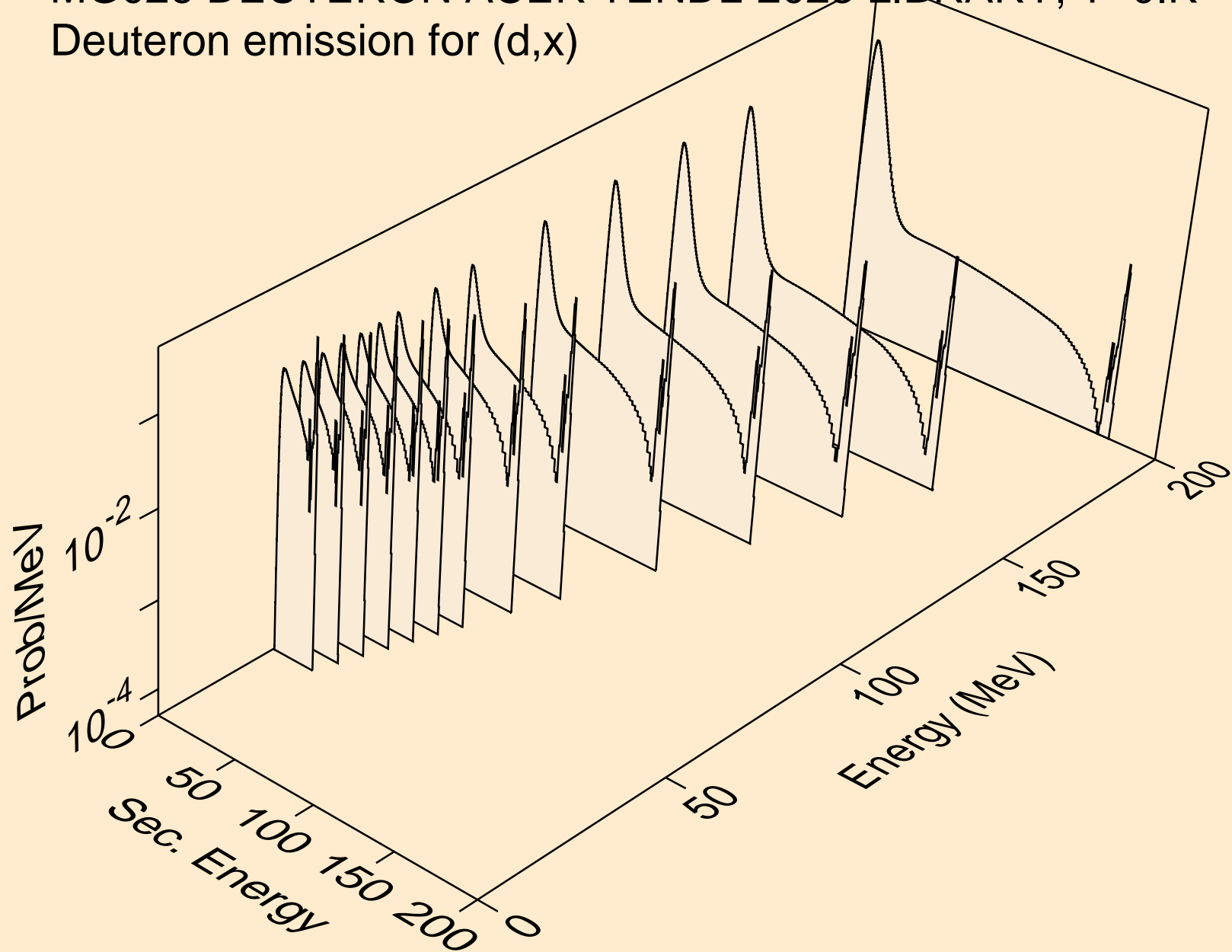

MG026 DEUTERON ACER TENDL-2023 LIBRARY; T=0.K  
Deuteron emission for (d,2nd)

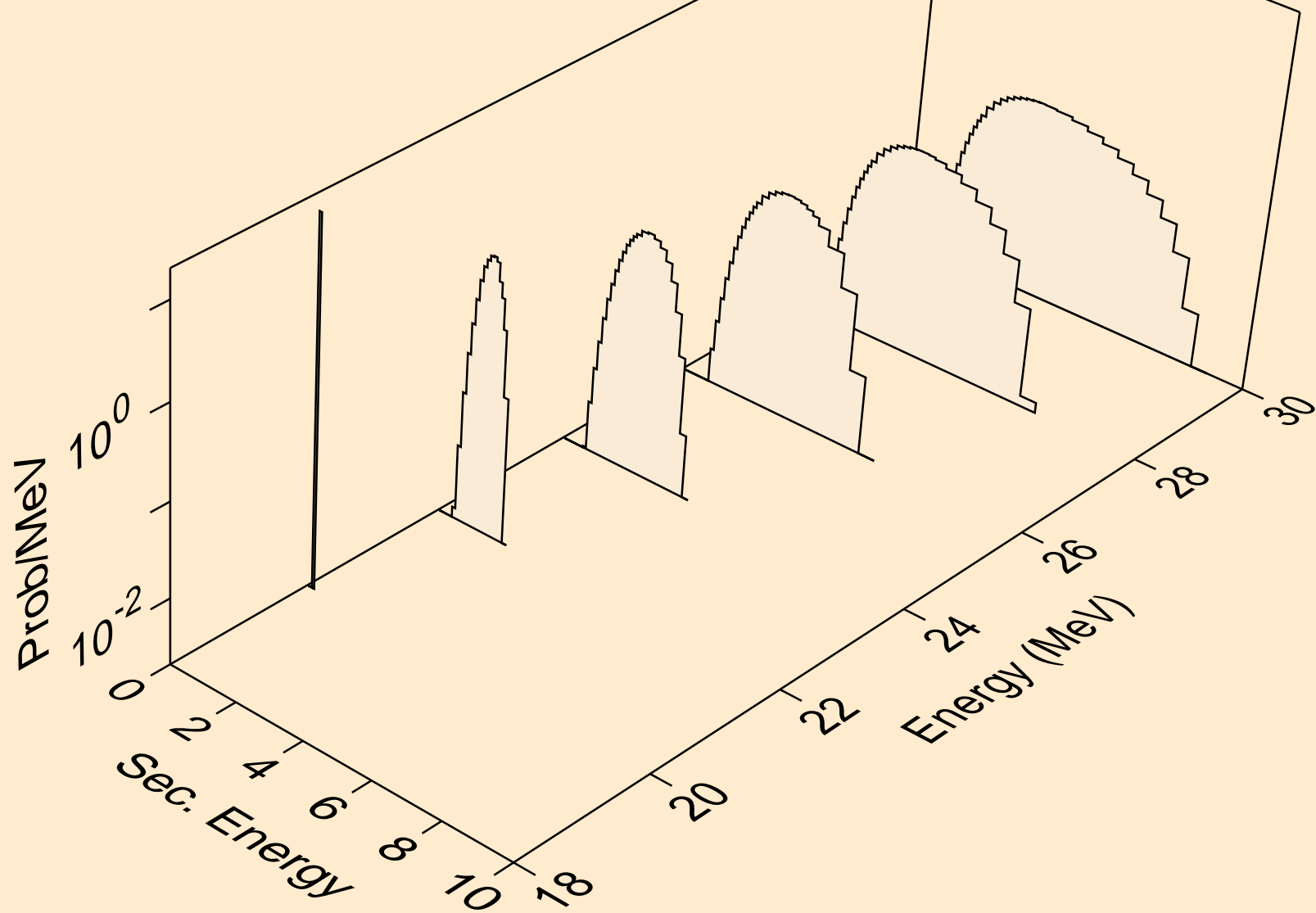

MG026 DEUTERON ACER TENDL-2023 LIBRARY; T=0.K  
Deuteron emission for (d,n\*)d

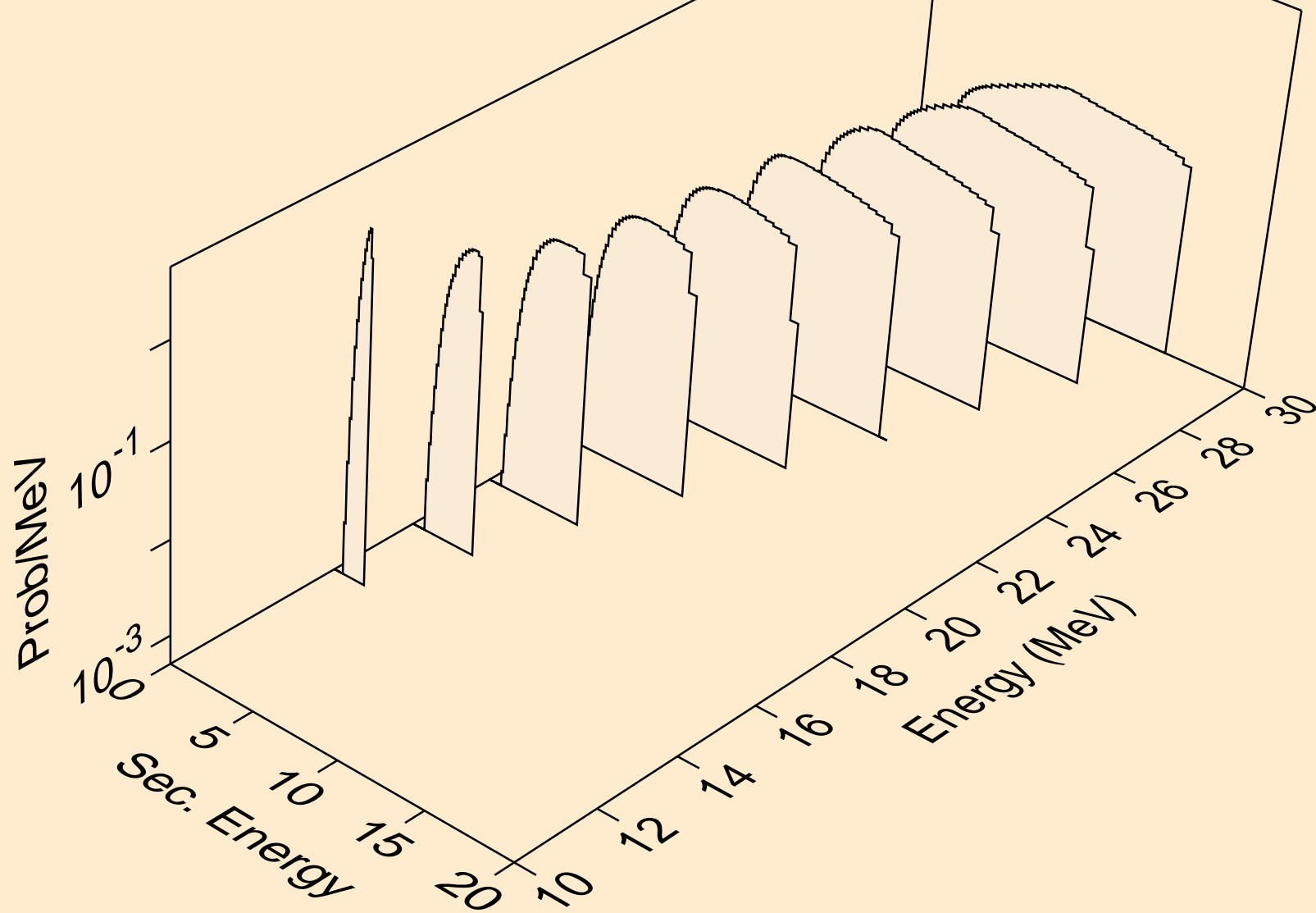

MG026 DEUTERON ACER TENDL-2023 LIBRARY; T=0.K  
Deuteron emission for inelastic

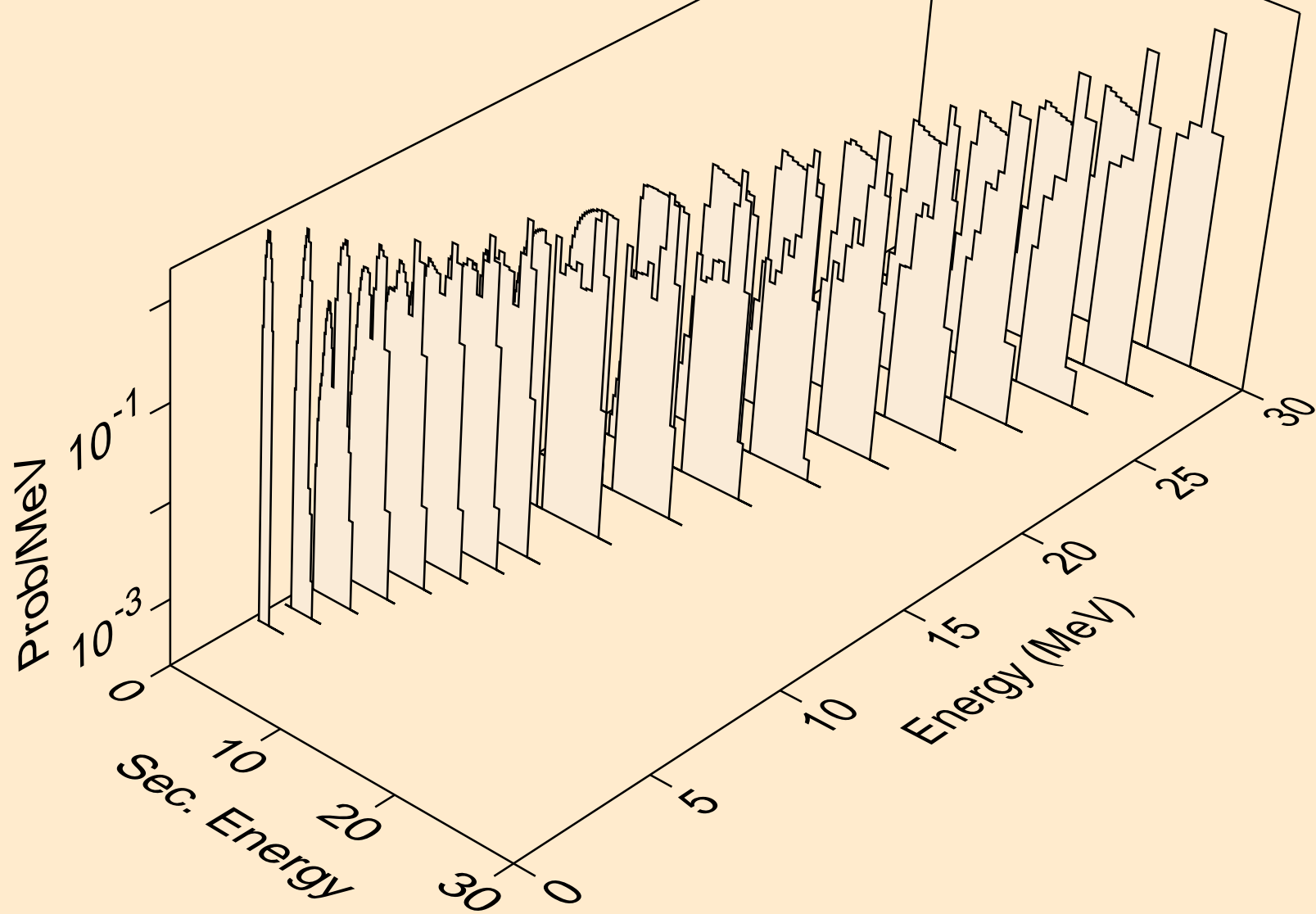

MG026 DEUTERON ACER TENDL-2023 LIBRARY; T=0.K  
Deuteron emission for (d,d2a)

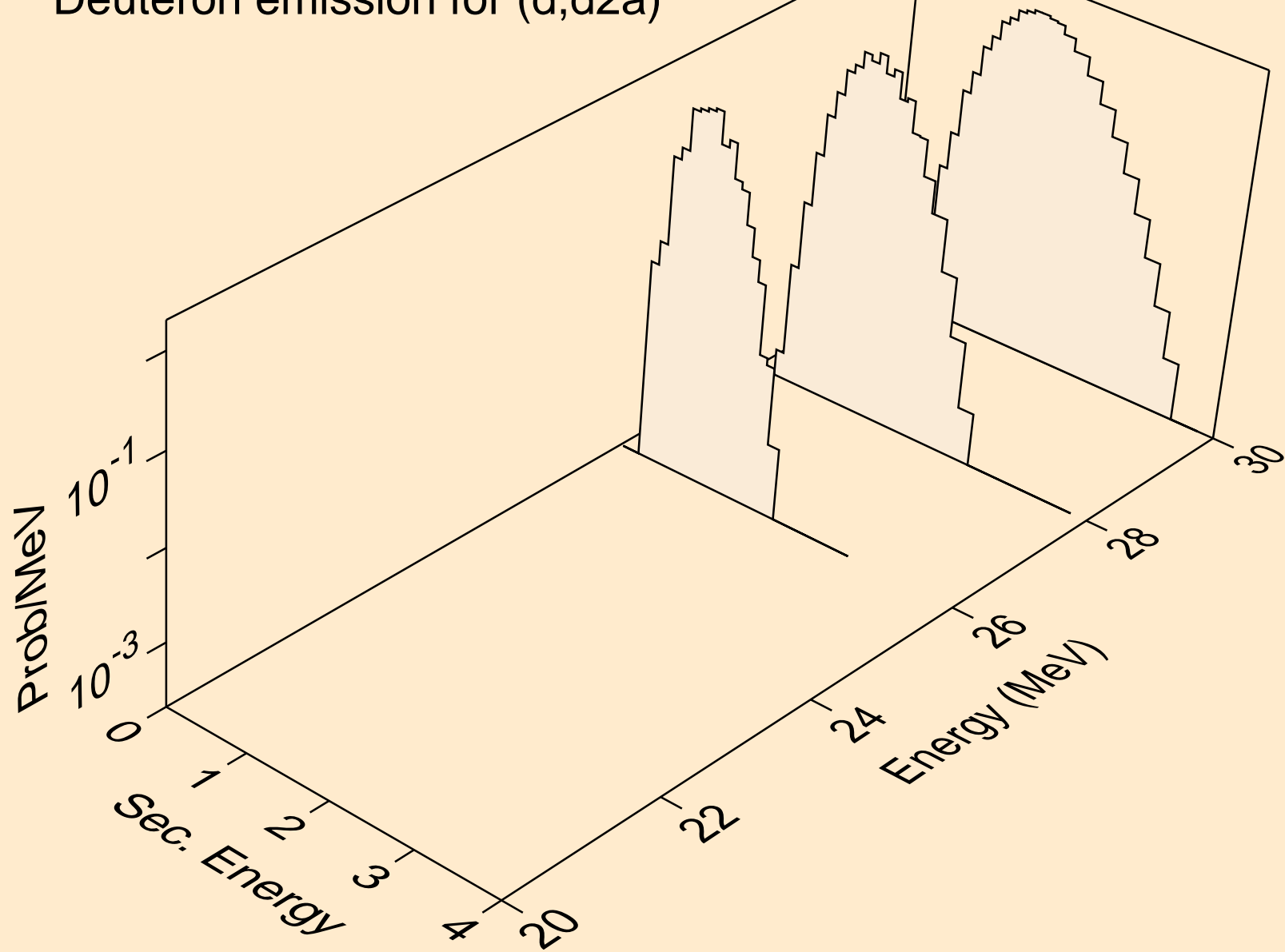

MG026 DEUTERON ACER TENDL-2023 LIBRARY; T=0.K  
Deuteron emission for (d,pd)

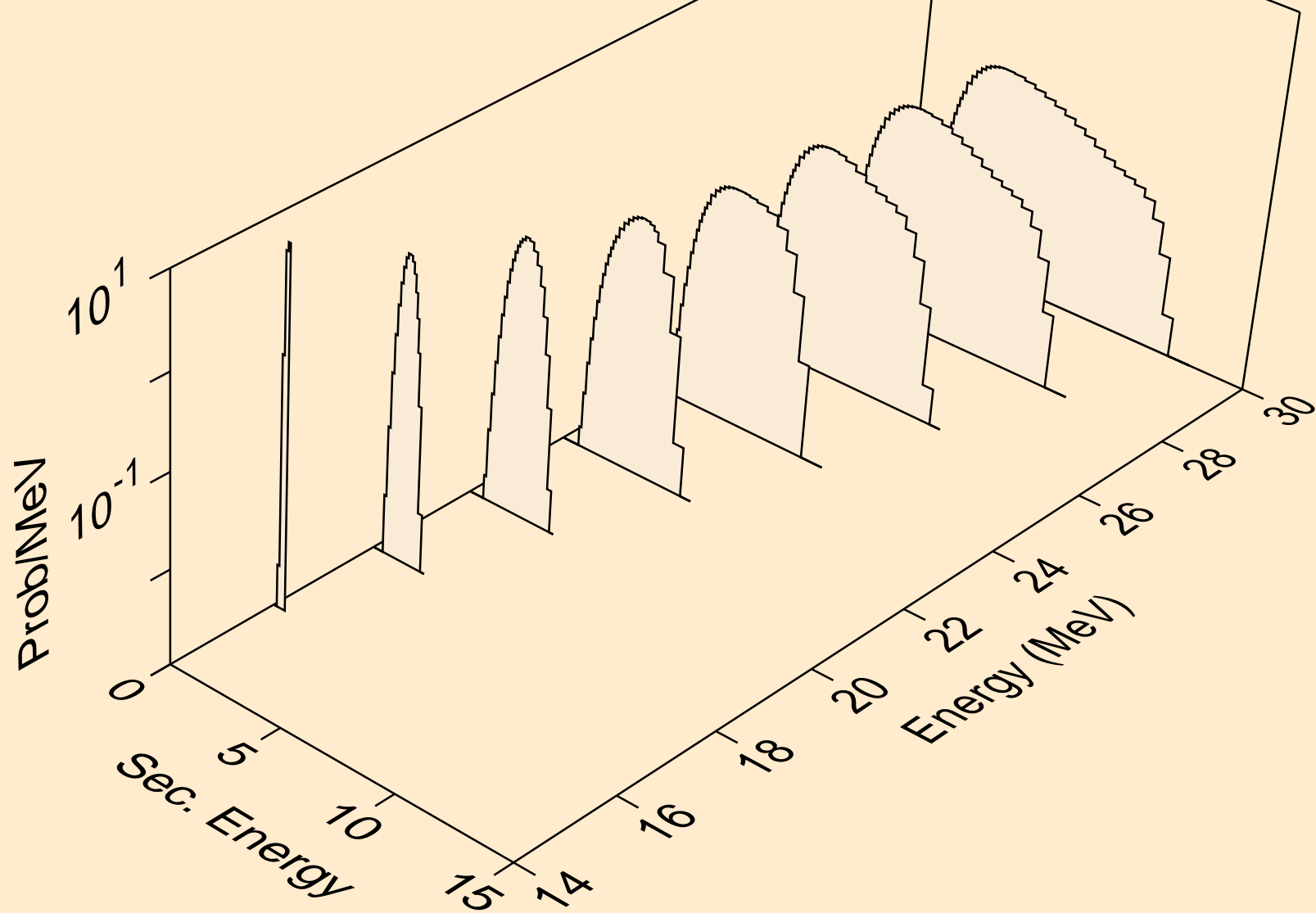

MG026 DEUTERON ACER TENDL-2023 LIBRARY; T=0.K  
Deuteron emission for (d,da)

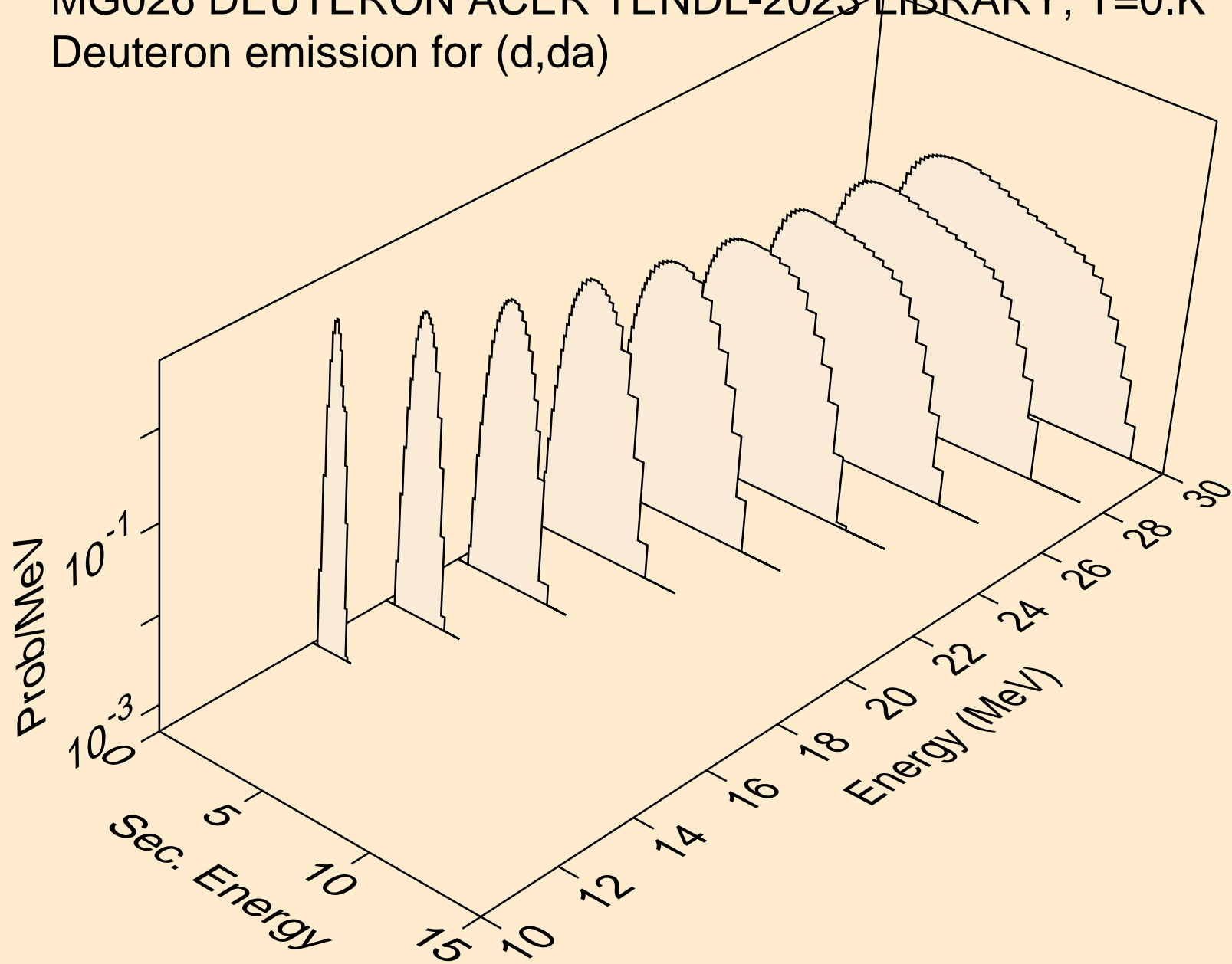



MG026 DEUTERON ACER TENDL-2023 LIBRARY; T=0.K  
Photon emission for (z,n)

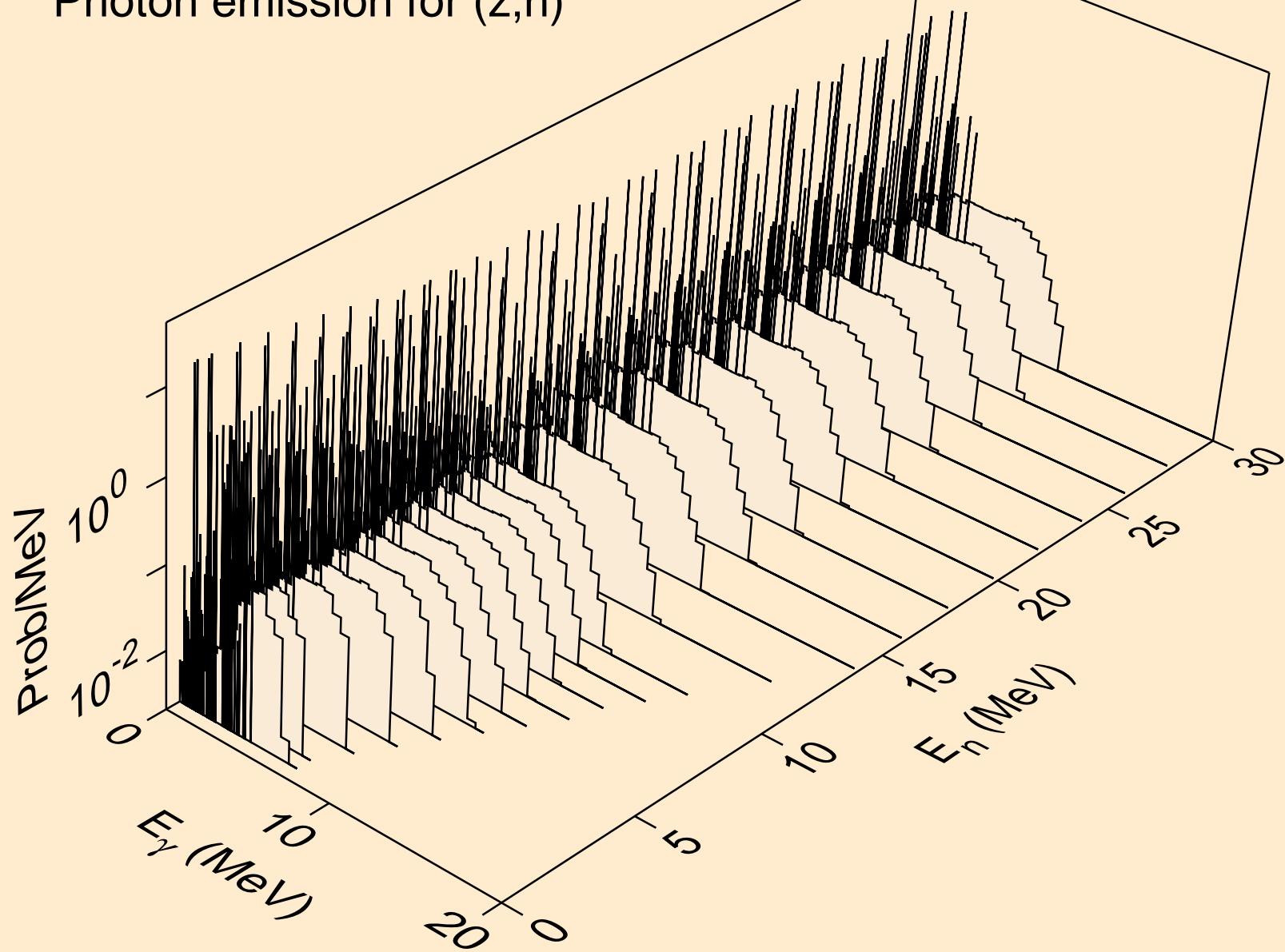

MG026 DEUTERON ACER TENDL-2023 LIBRARY; T=0.K  
Photon emission for (z,x)

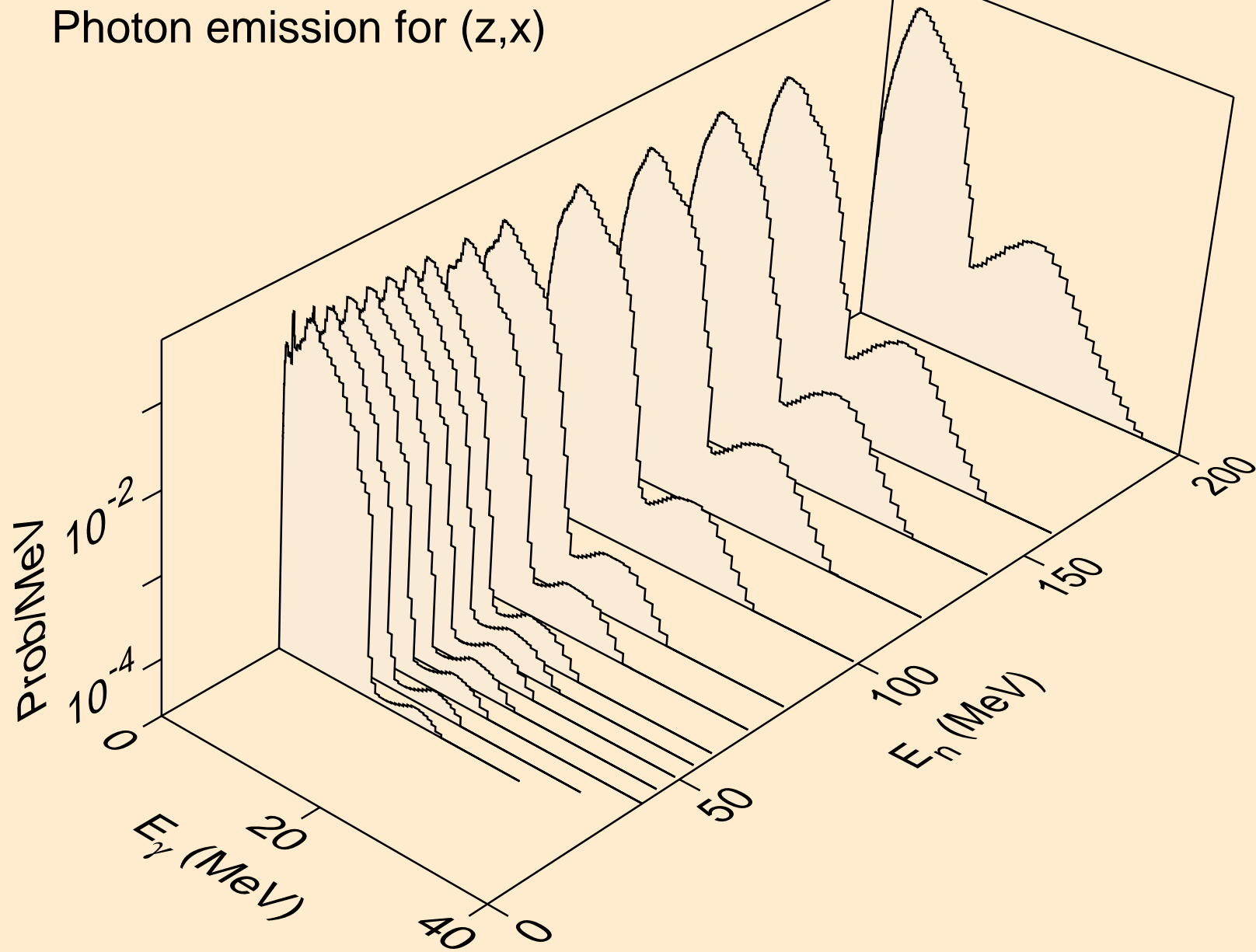

MG026 DEUTERON ACER TENDL-2023 LIBRARY; T=0.K  
Photon emission for (n,2nd)

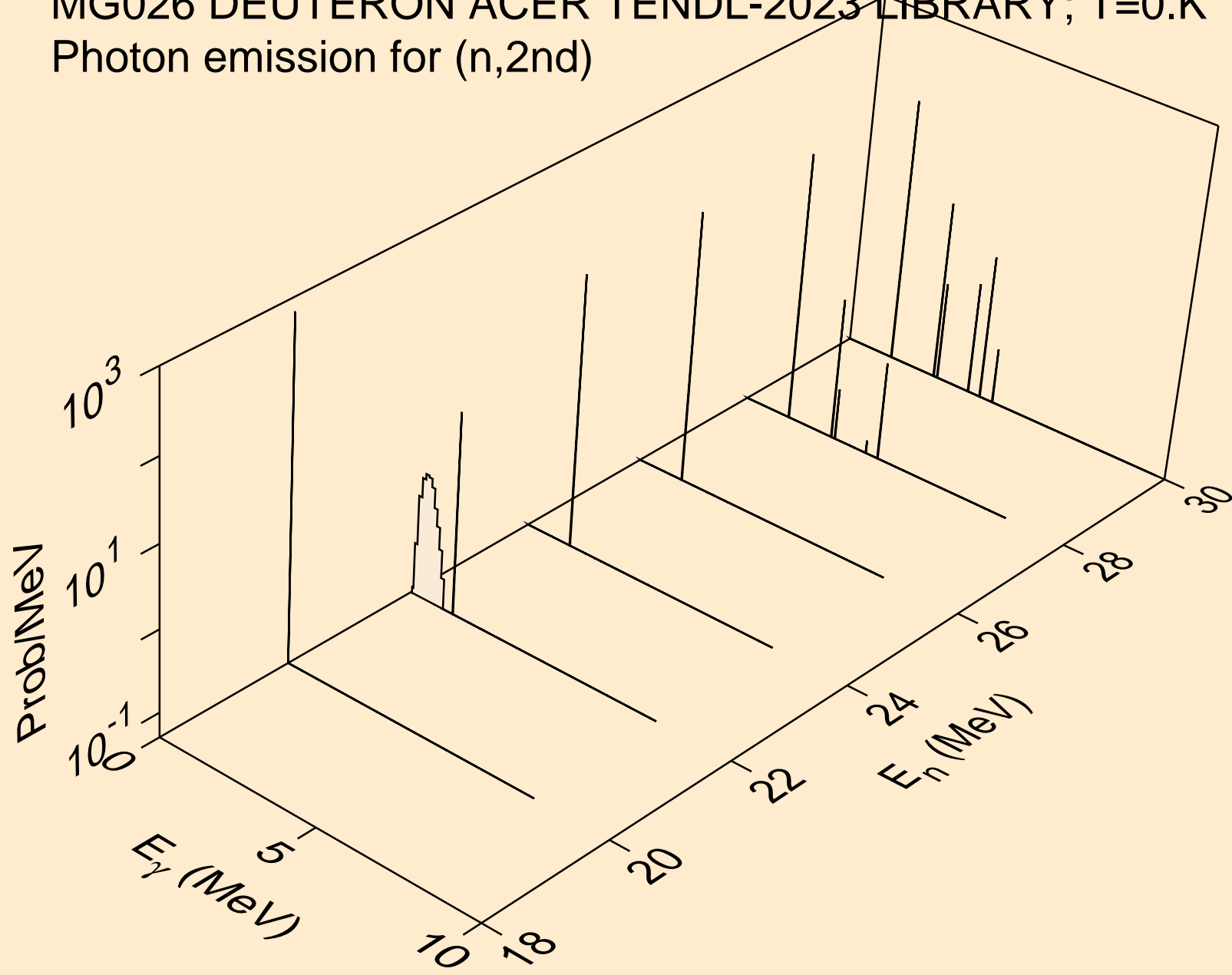

MG026 DEUTERON ACER TENDL-2023 LIBRARY; T=0.K  
Photon emission for (n,2n)

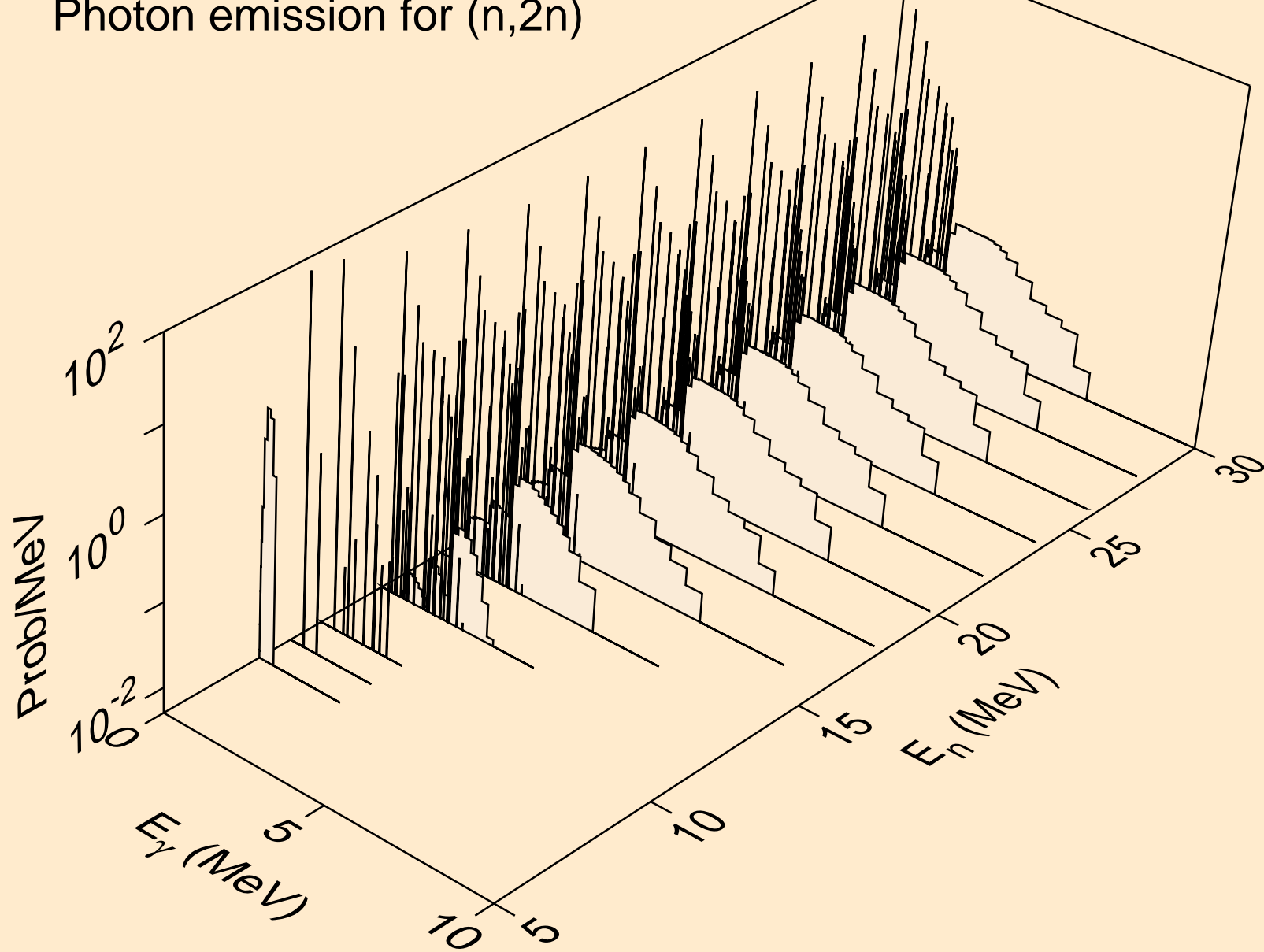

MG026 DEUTERON ACER TENDL-2023 LIBRARY; T=0.K  
Photon emission for (n,3n)

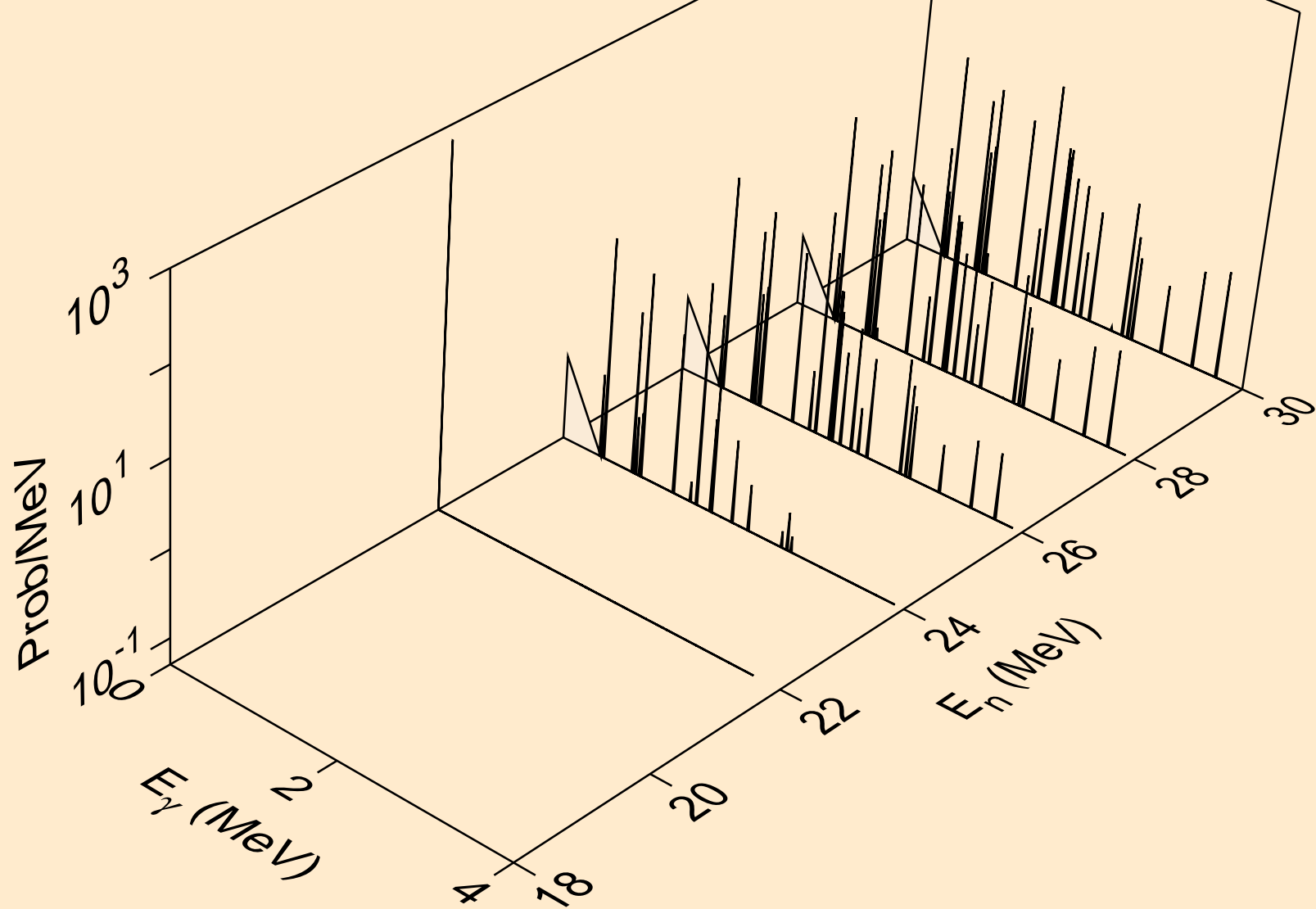

MG026 DEUTERON ACER TENDL-2023 LIBRARY; T=0.K  
Photon emission for (n,n\*)a

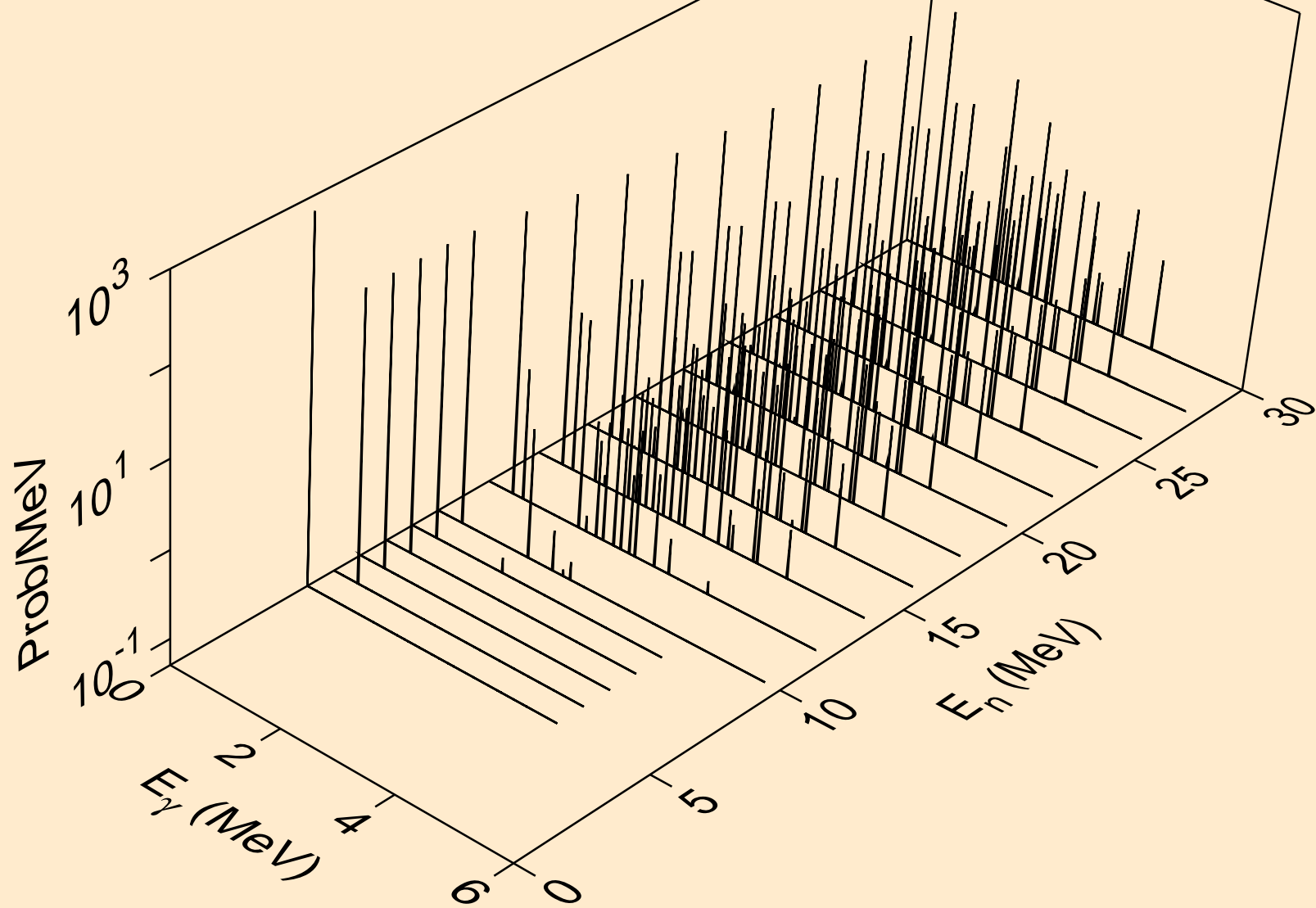

MG026 DEUTERON ACER TENDL-2023 LIBRARY; T=0.K  
Photon emission for (n,n\*)3a

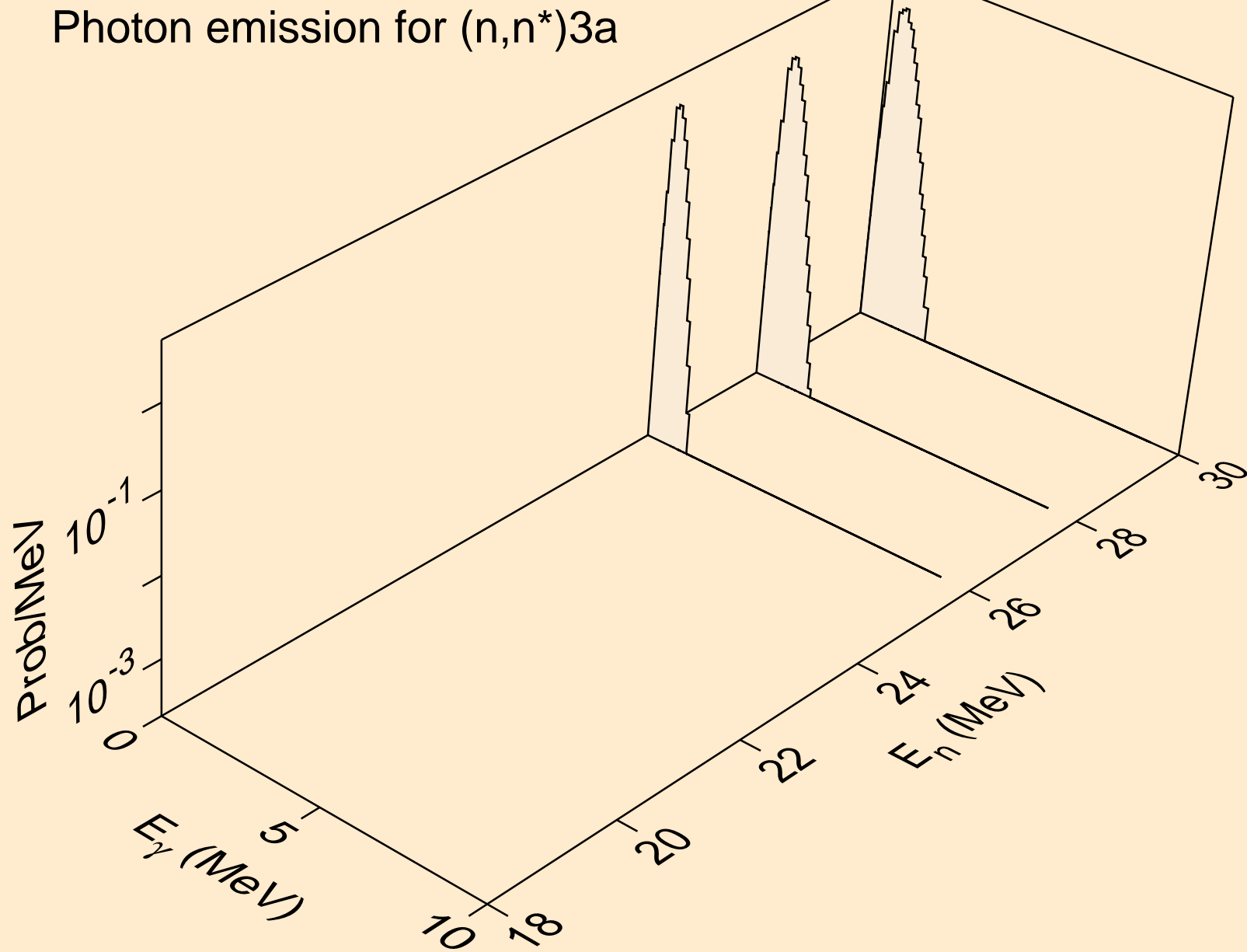

MG026 DEUTERON ACER TENDL-2023 LIBRARY; T=0.K  
Photon emission for (n,2n)a

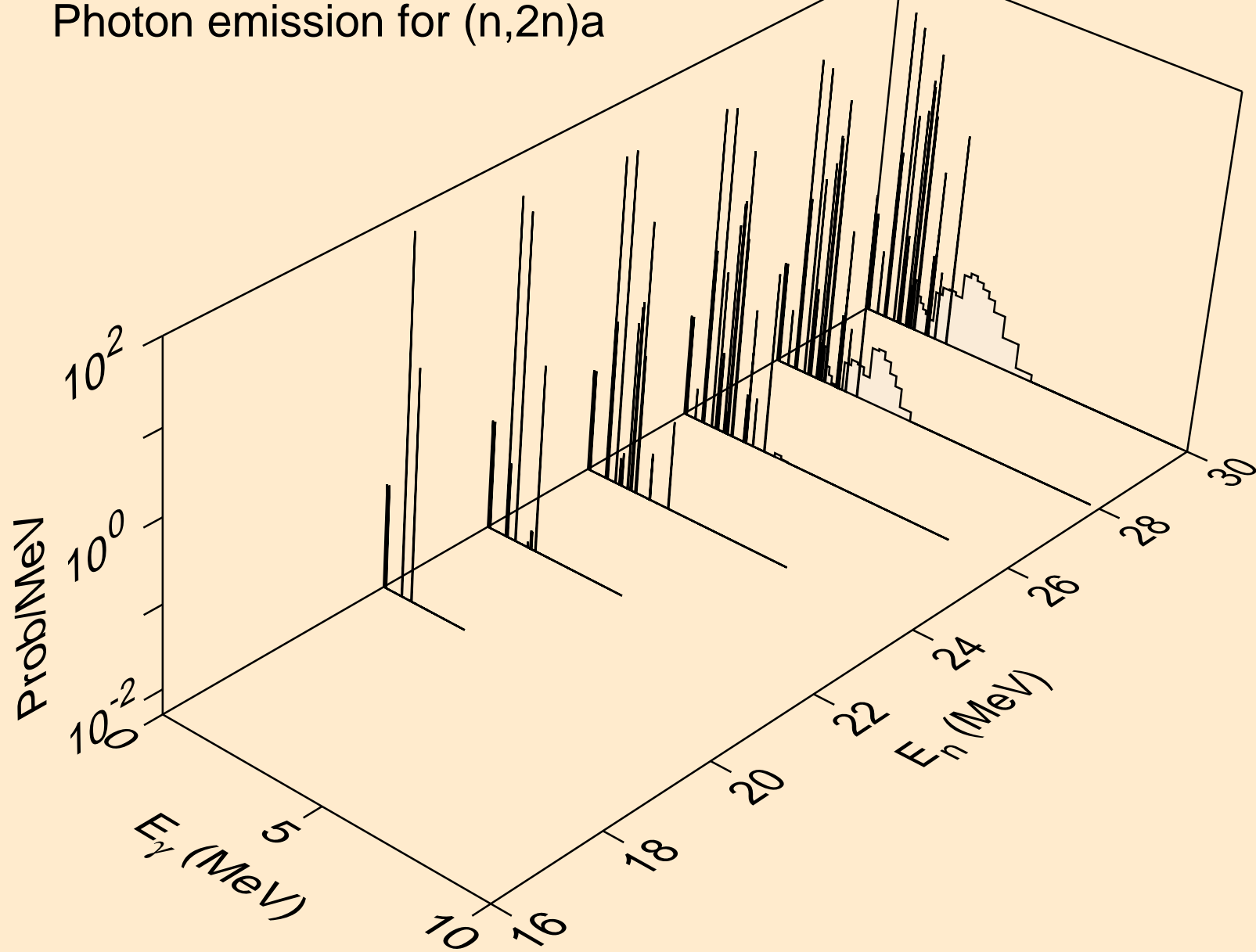



MG026 DEUTERON ACER TENDL-2023 LIBRARY; T=0.K  
Photon emission for (n,n\*)p

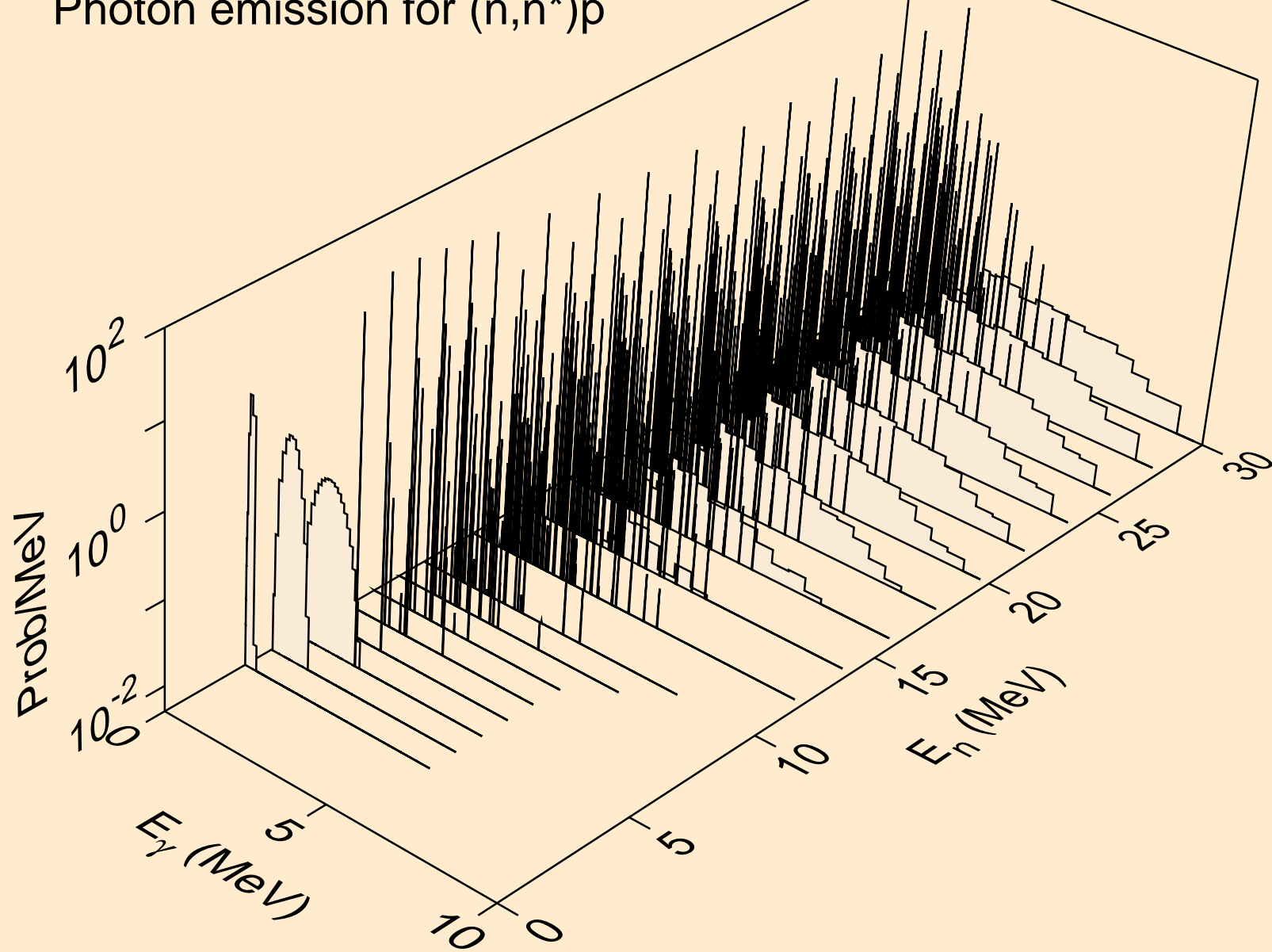

MG026 DEUTERON ACER TENDL-2023 LIBRARY; T=0.K  
Photon emission for (n,n\*)2a

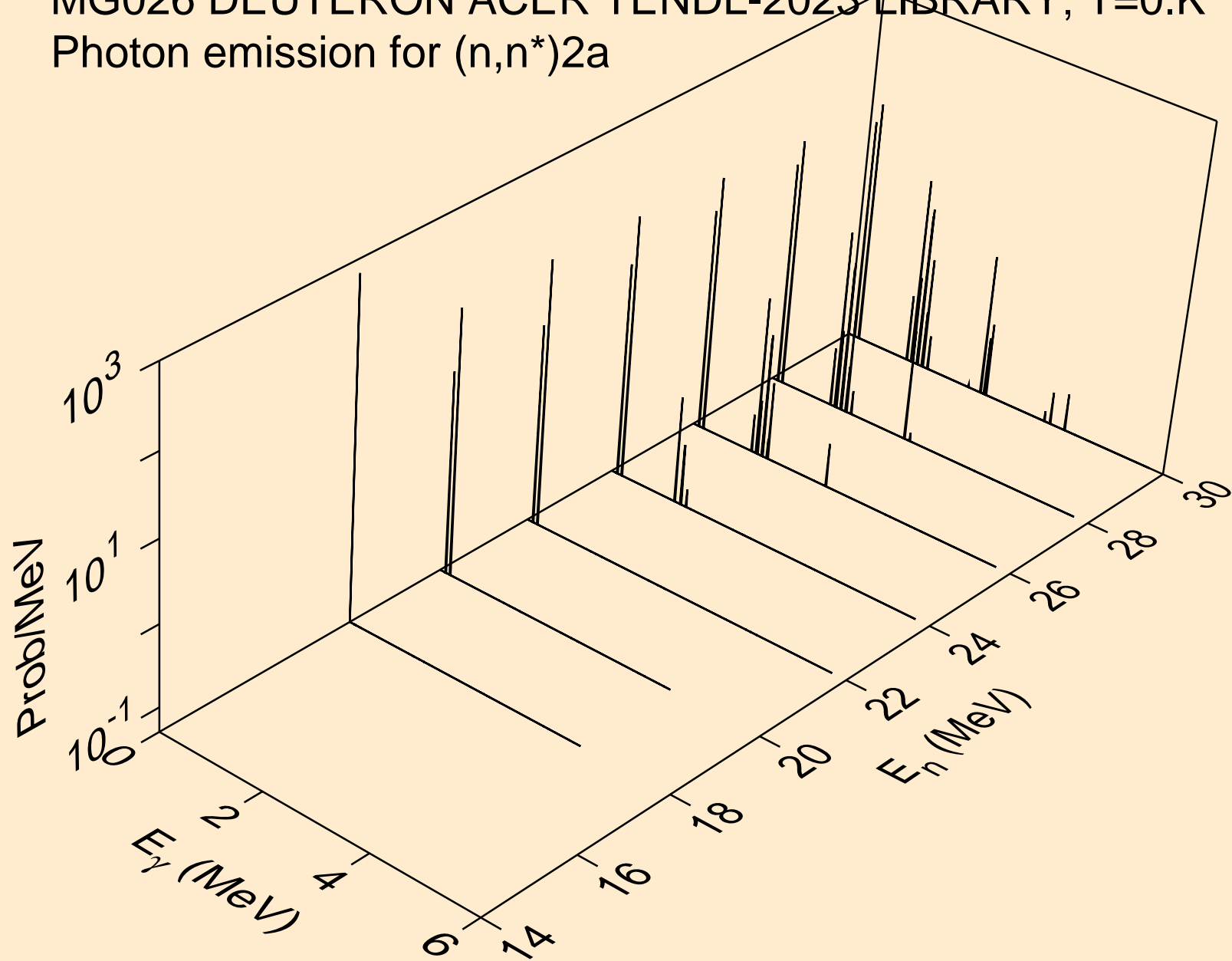

MG026 DEUTERON ACER TENDL-2023 LIBRARY; T=0.K  
Photon emission for (n,n\*)d

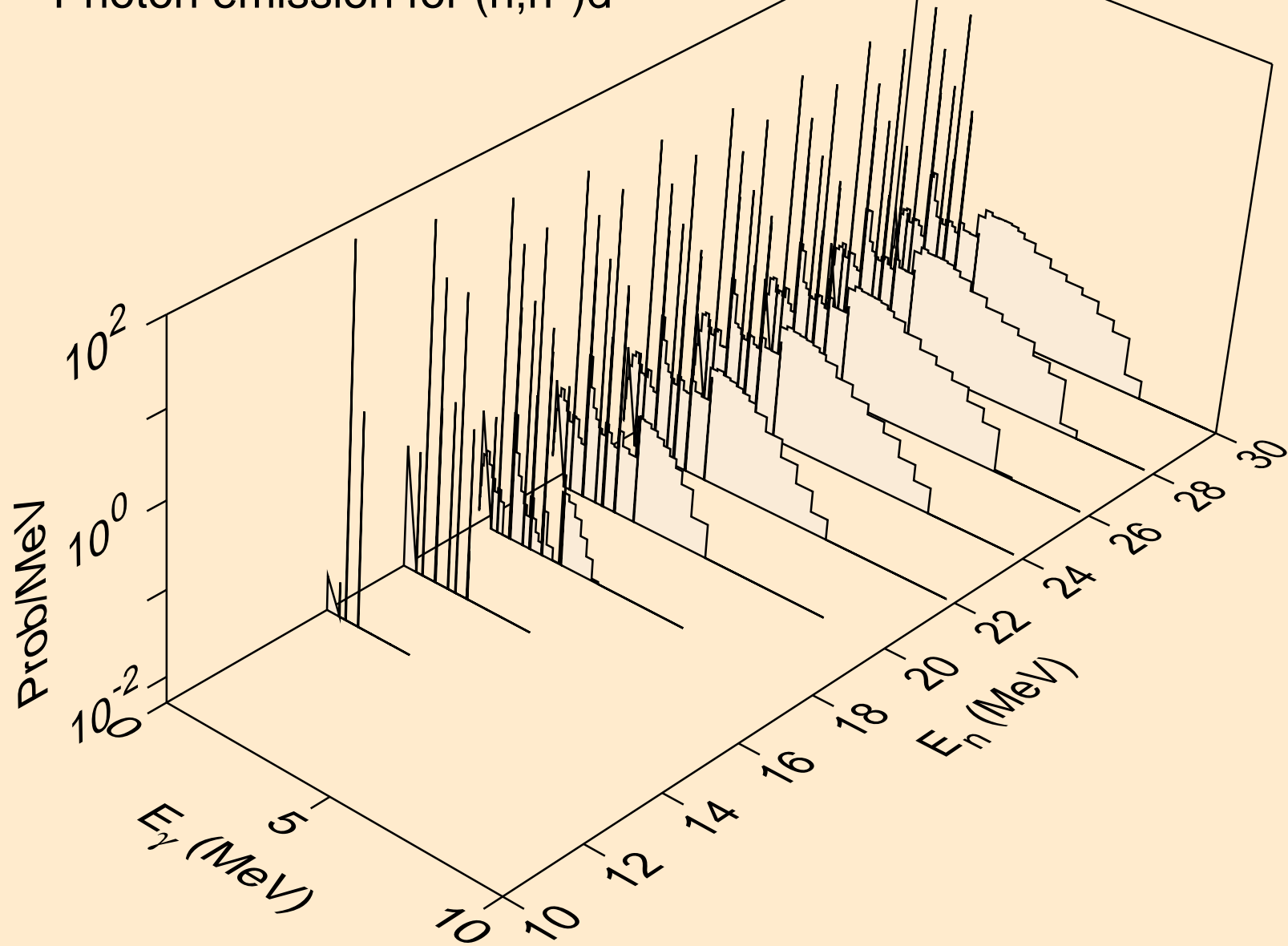

MG026 DEUTERON ACER TENDL-2023 LIBRARY; T=0.K  
Photon emission for (n,n\*)t

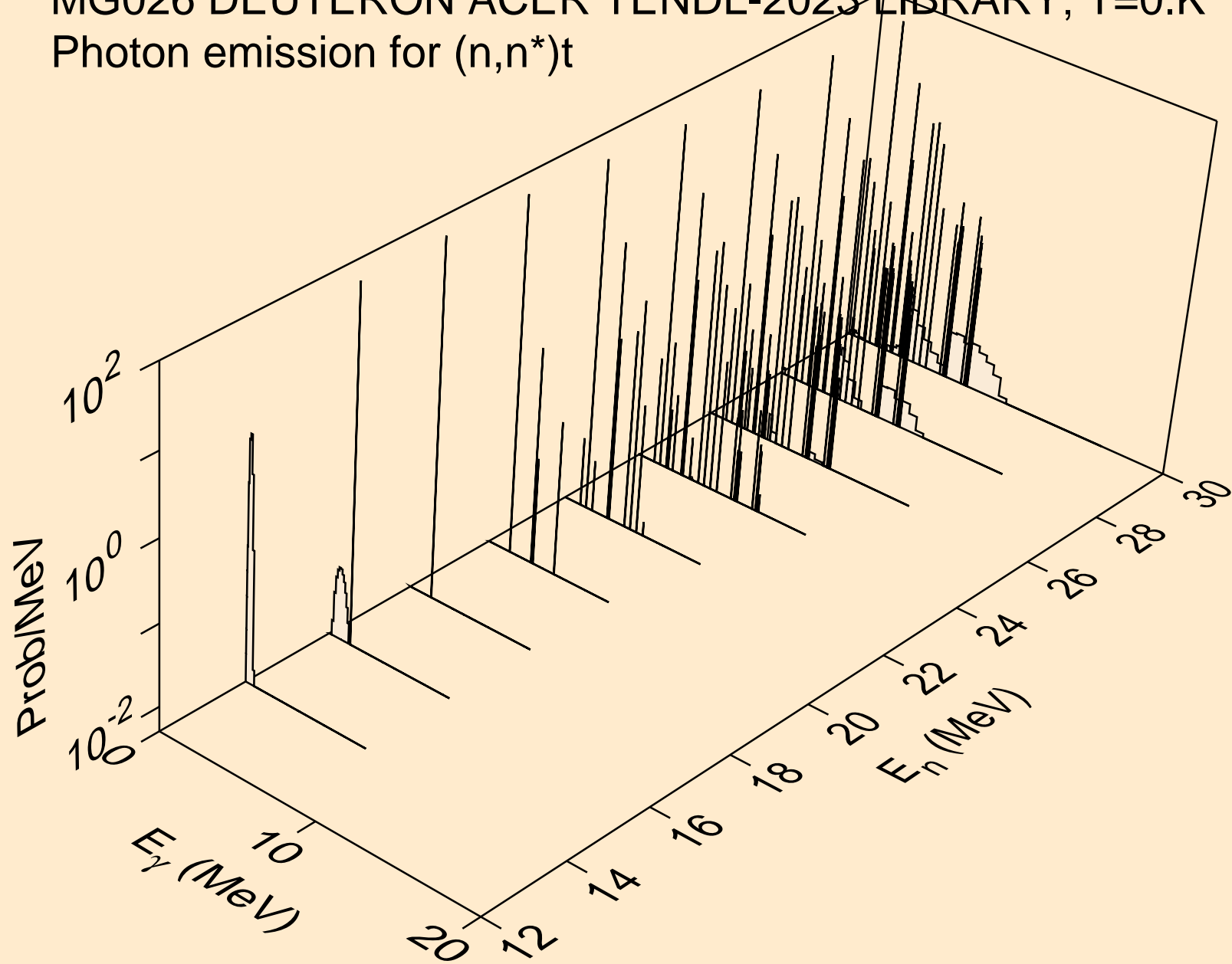

MG026 DEUTERON ACER TENDL-2023 LIBRARY; T=0.K  
Photon emission for (n,n\*)he3

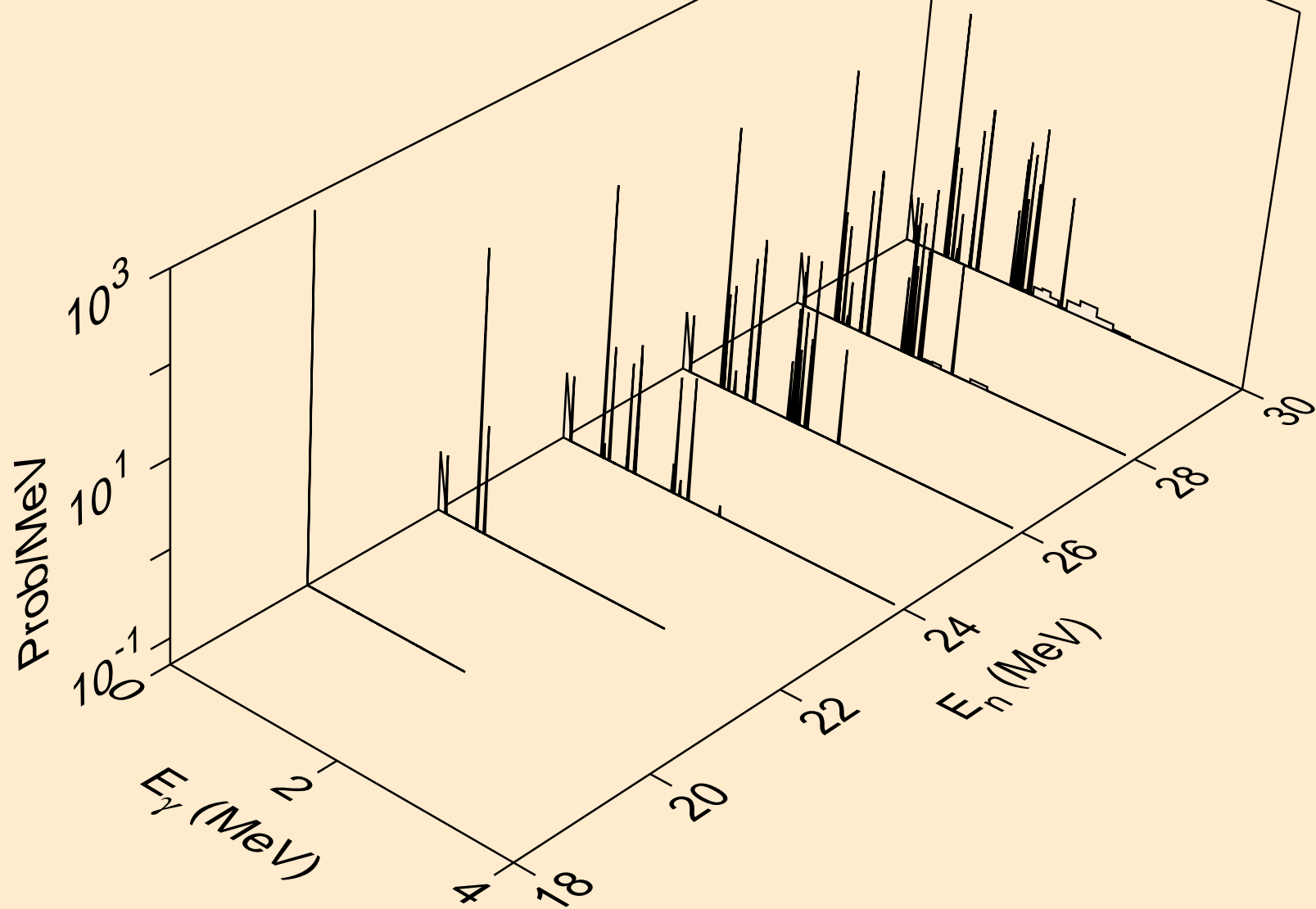

MG026 DEUTERON ACER TENDL-2023 LIBRARY; T=0.K  
Photon emission for (n,2np)

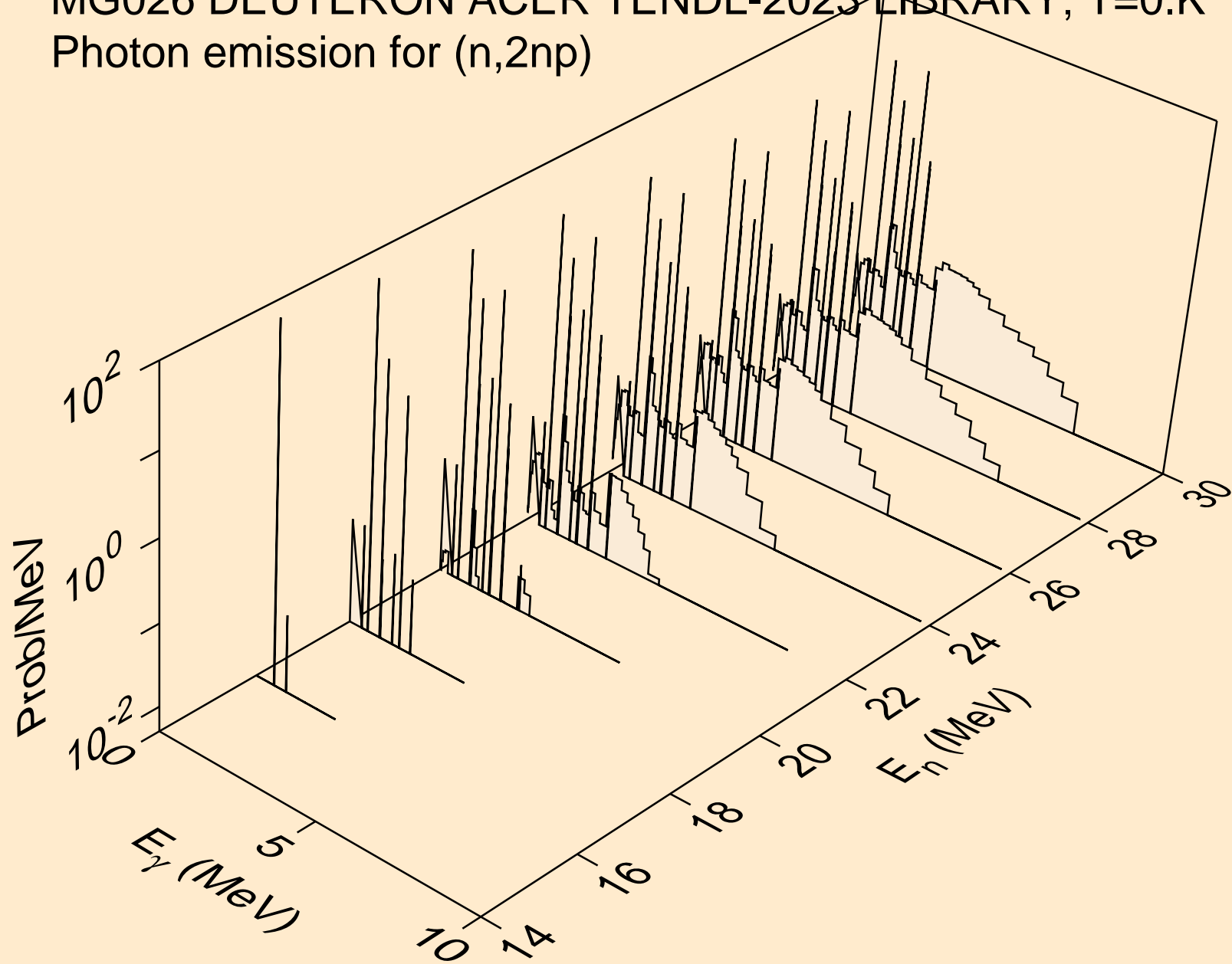

MG026 DEUTERON ACER TENDL-2023 LIBRARY; T=0.K  
Photon emission for (n,3np)

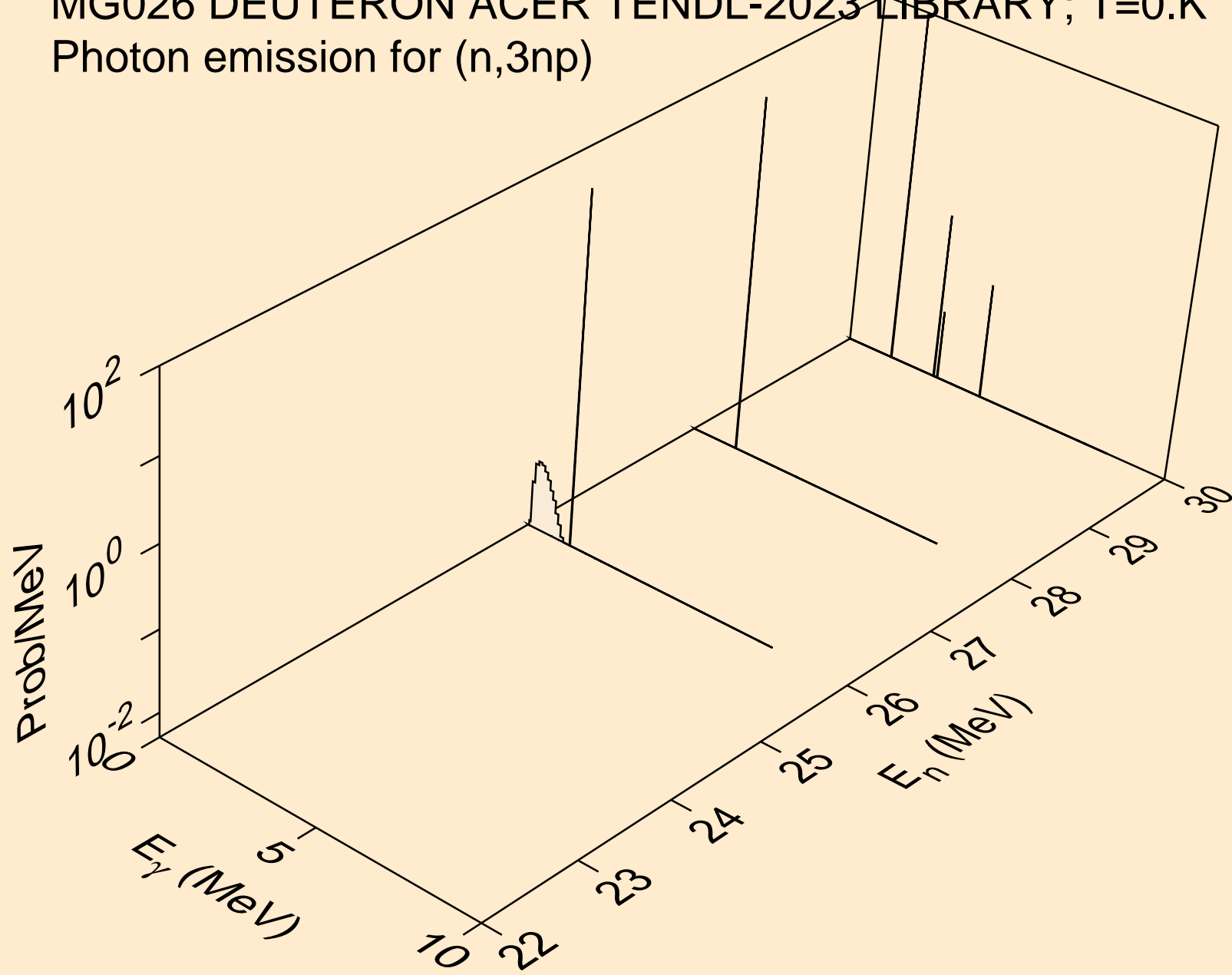

MG026 DEUTERON ACER TENDL-2023 LIBRARY; T=0.K  
Photon emission for (n,n2p)

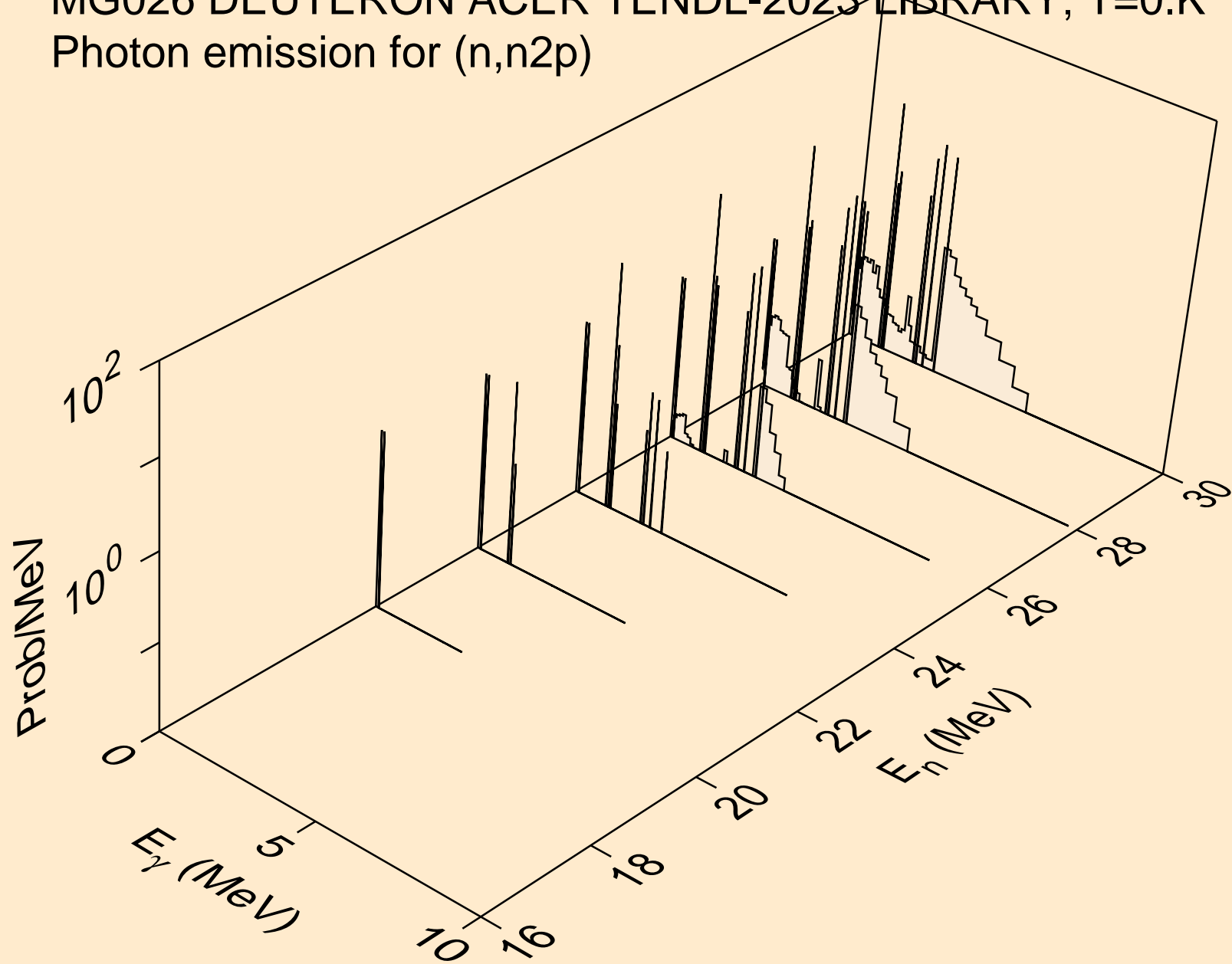



MG026 DEUTERON ACER TENDL-2023 LIBRARY; T=0.K  
Photon emission for (n,npa)

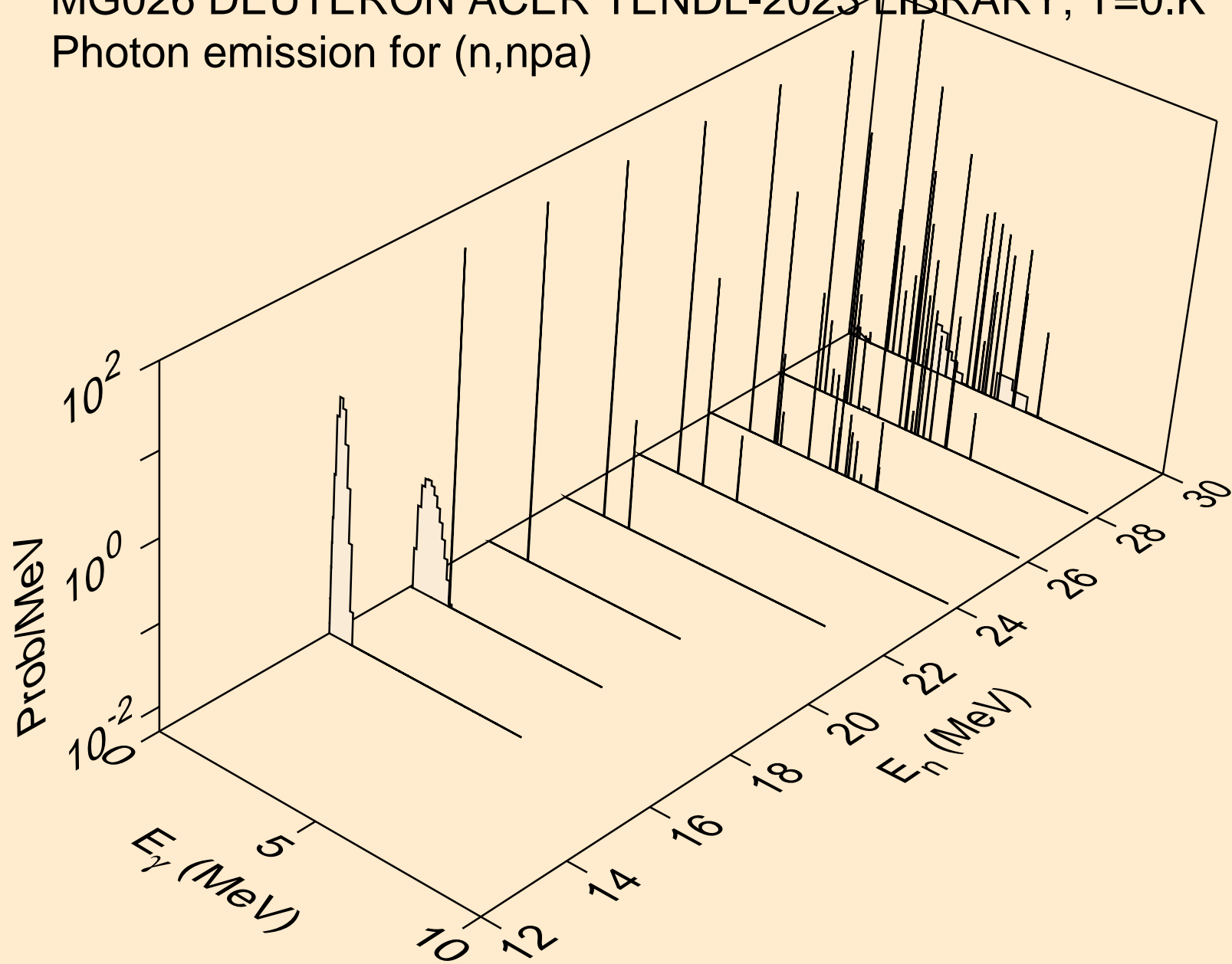

MG026 DEUTERON ACER TENDL-2023 LIBRARY; T=0.K  
Photon emission for (n,gma)

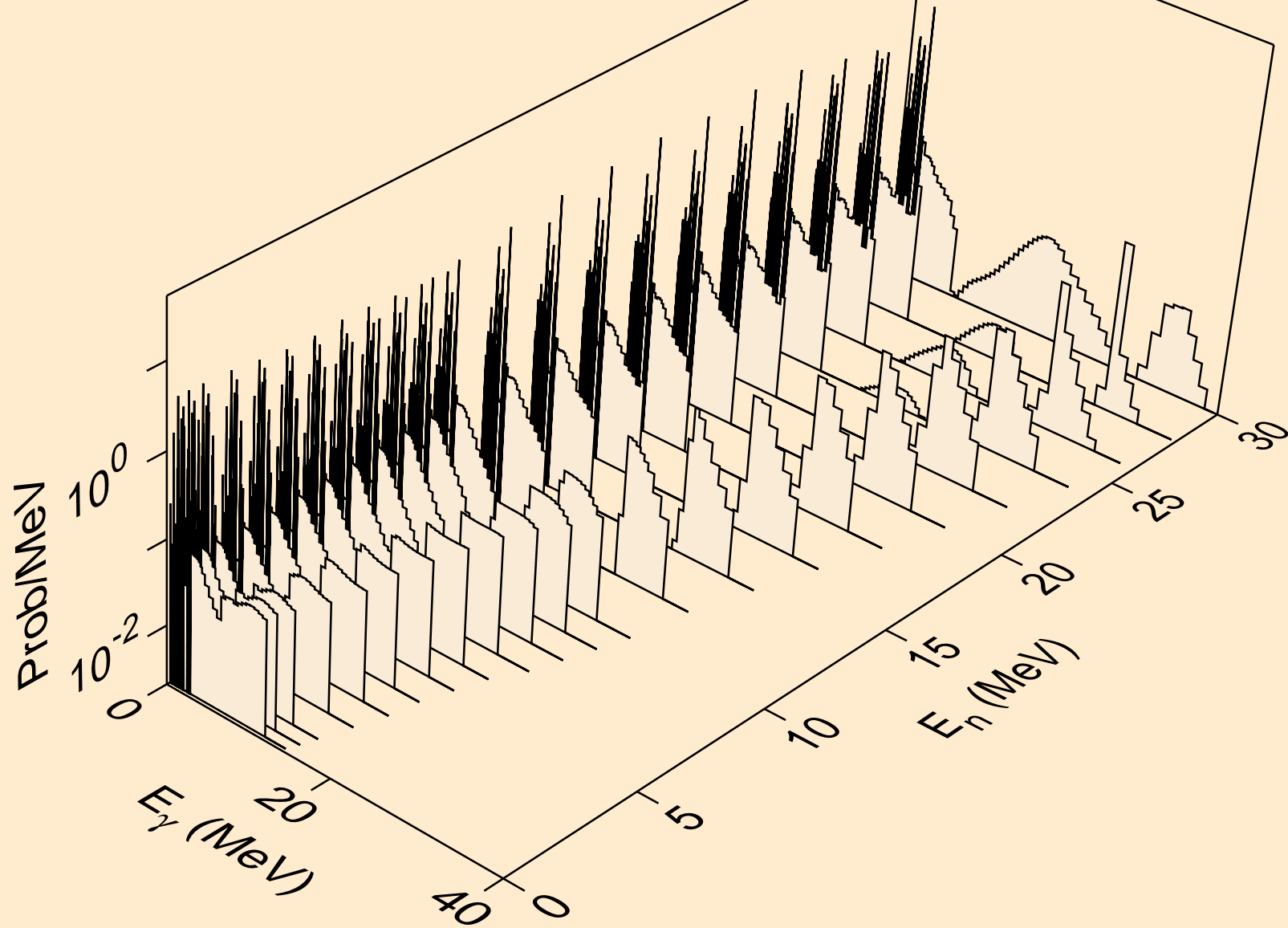

MG026 DEUTERON ACER TENDL-2023 LIBRARY; T=0.K  
Photon emission for (n,p)

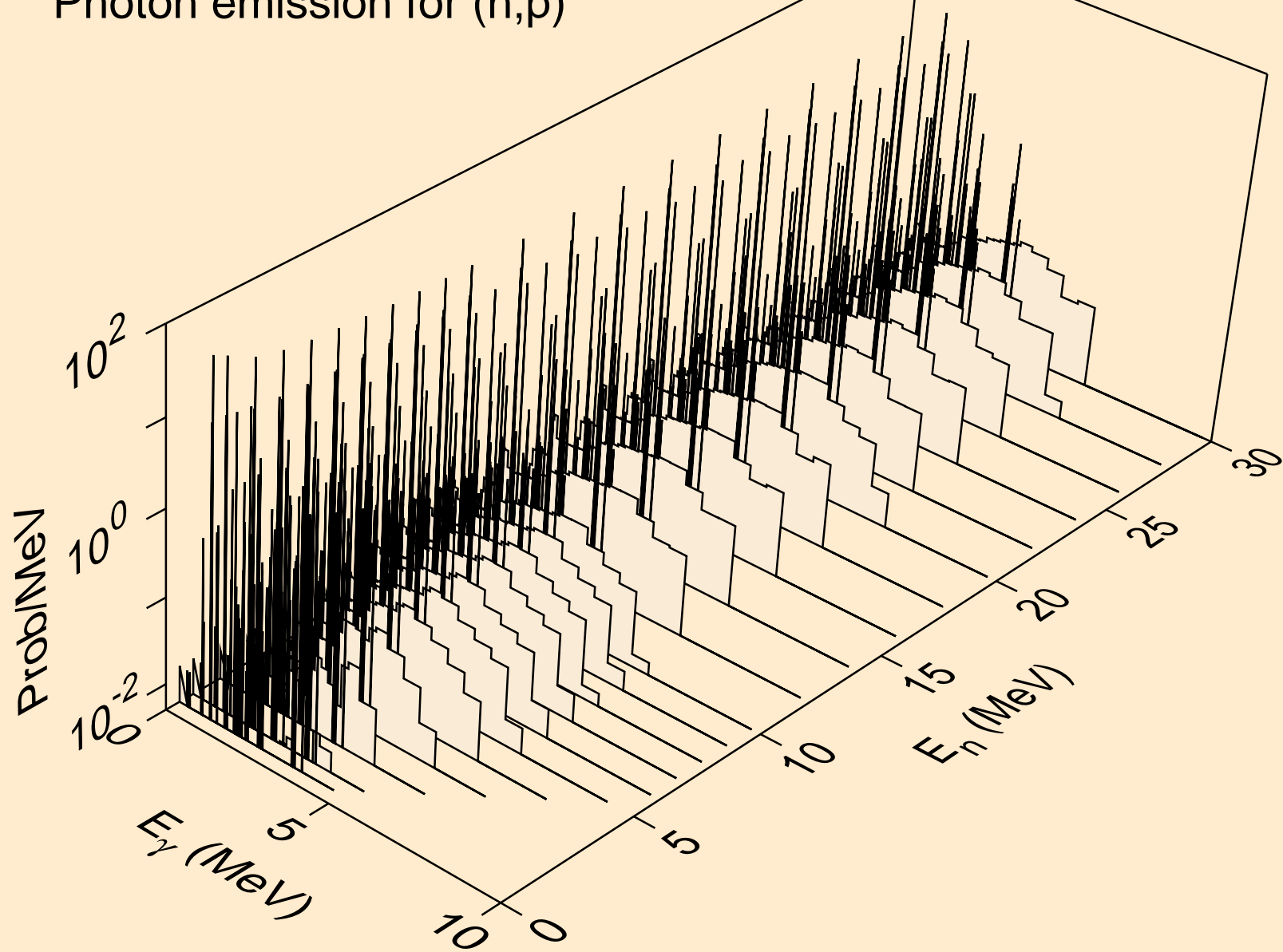

MG026 DEUTERON ACER TENDL-2023 LIBRARY; T=0.K  
Photon emission for inelastic

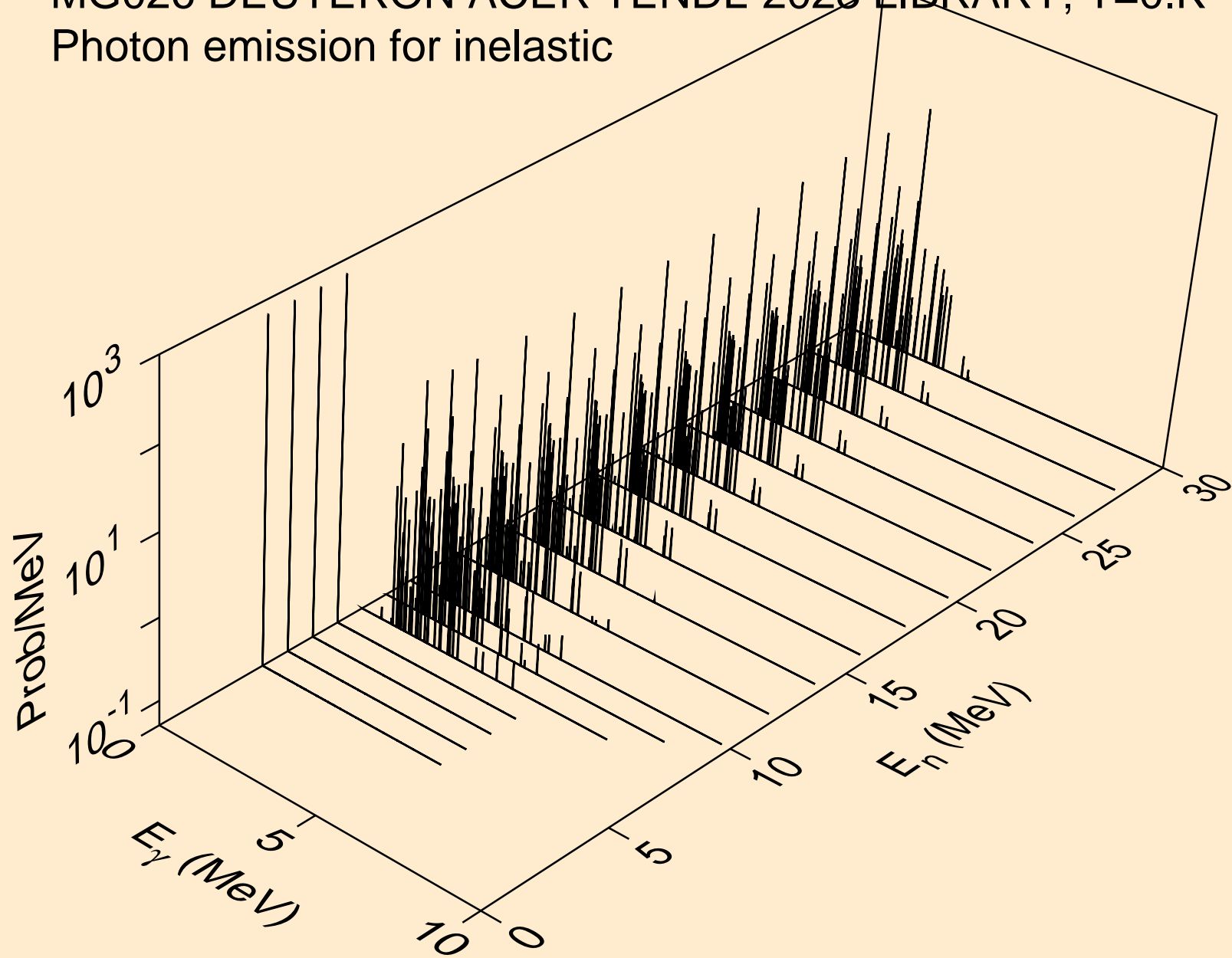

MG026 DEUTERON ACER TENDL-2023 LIBRARY; T=0.K  
Photon emission for (n,t)

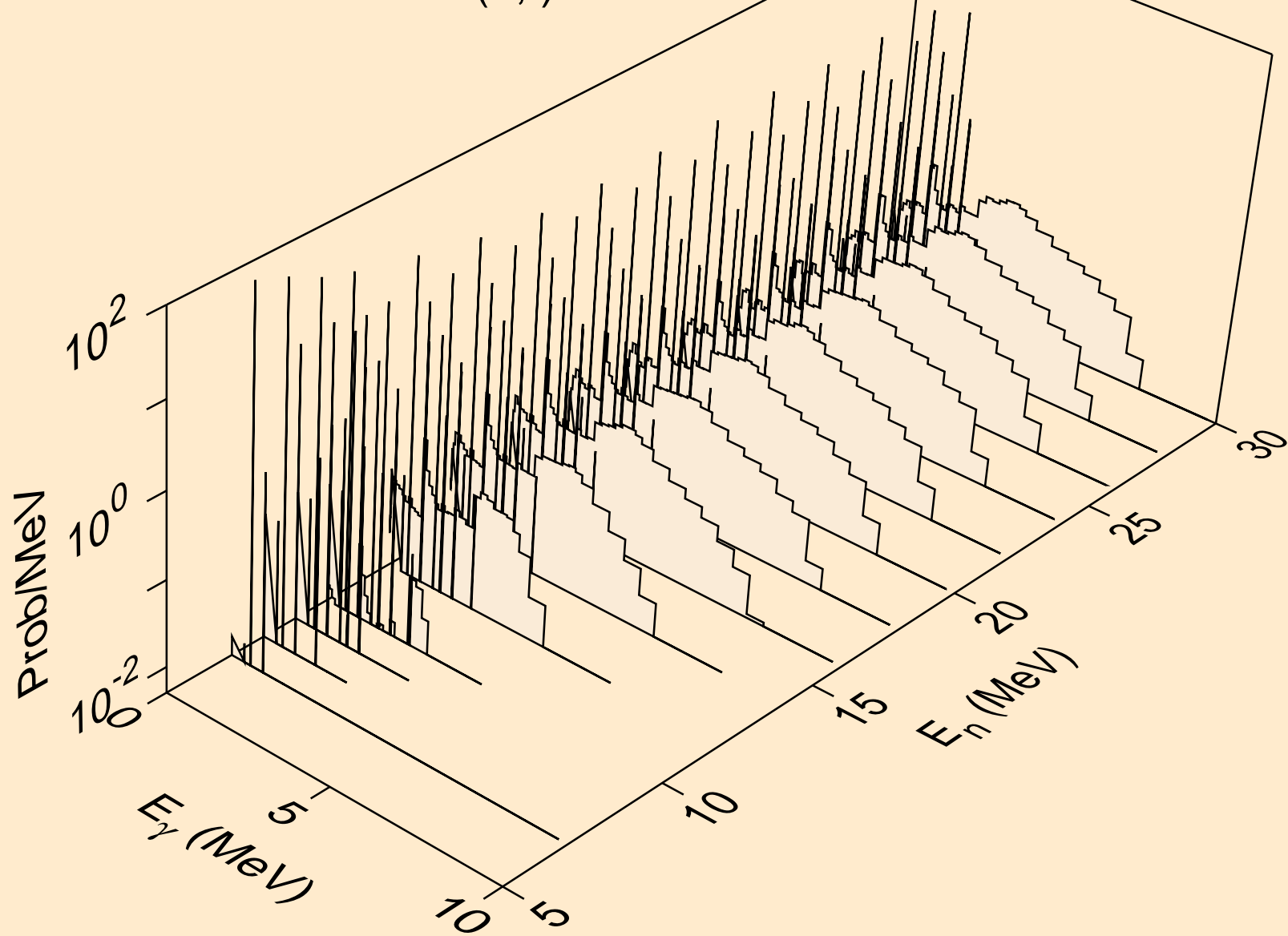

MG026 DEUTERON ACER TENDL-2023 LIBRARY; T=0.K  
Photon emission for (n,he3)

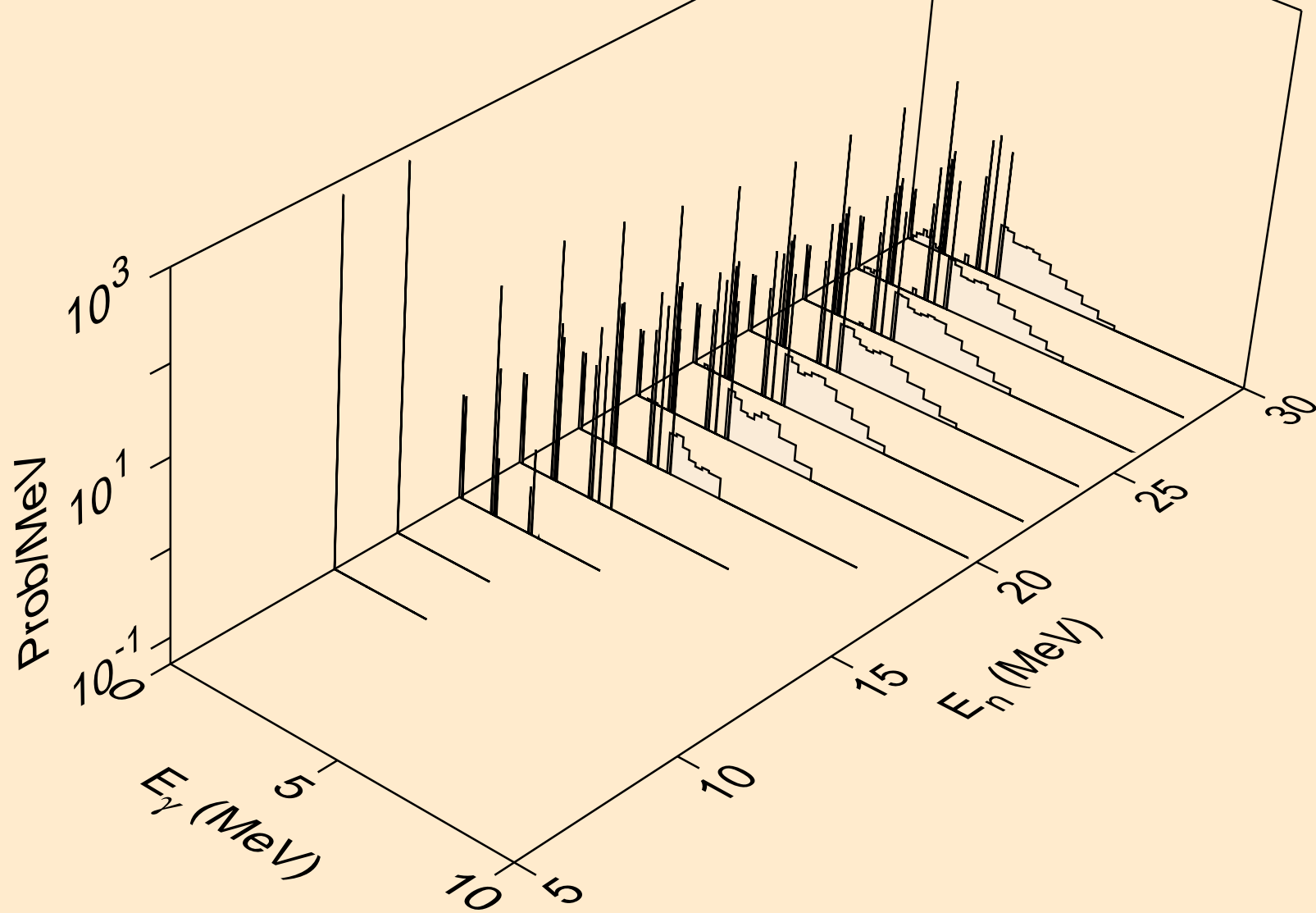

MG026 DEUTERON ACER TENDL-2023 LIBRARY; T=0.K  
Photon emission for (n,a)

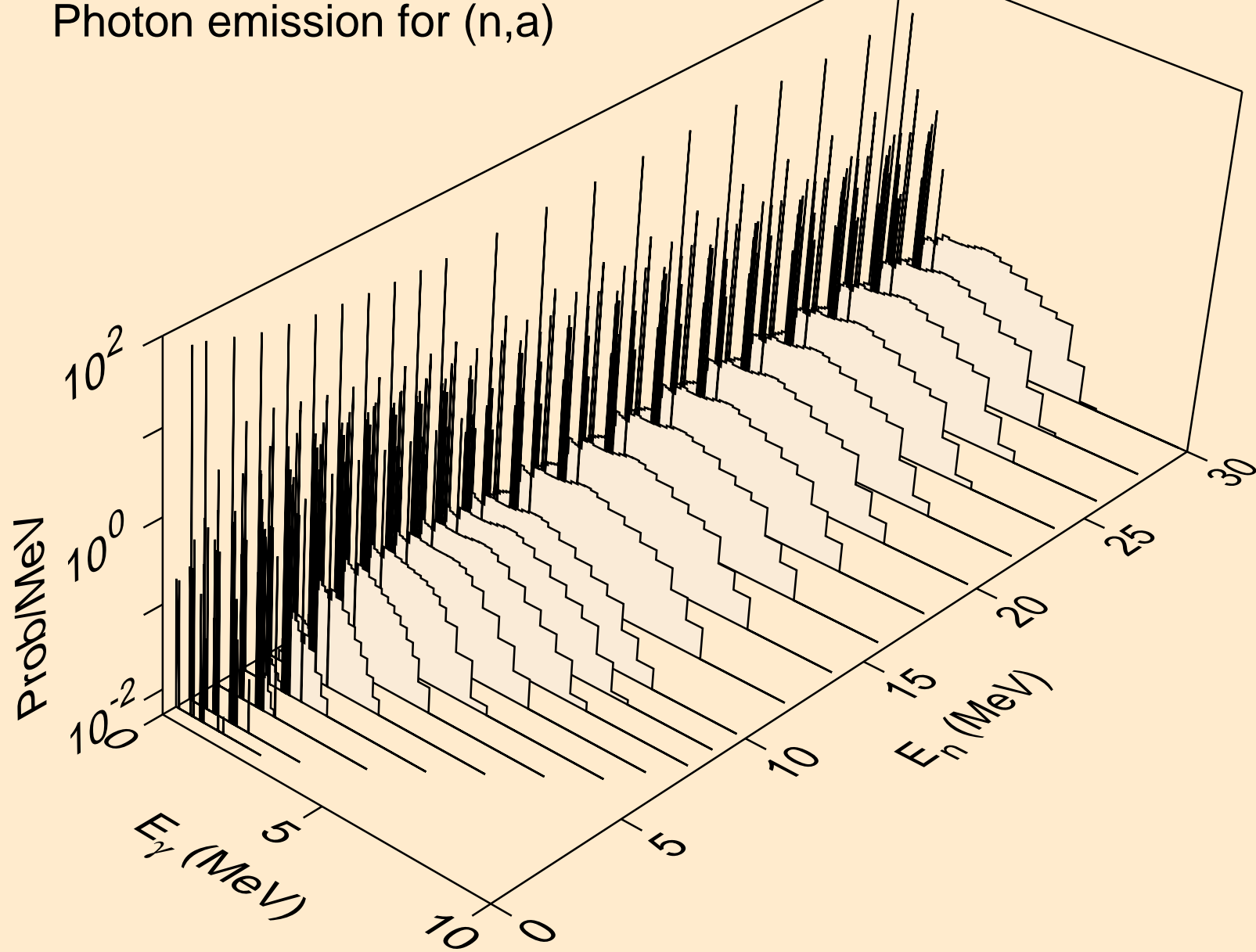

MG026 DEUTERON ACER TENDL-2023 LIBRARY; T=0.K  
Photon emission for (n,2a)

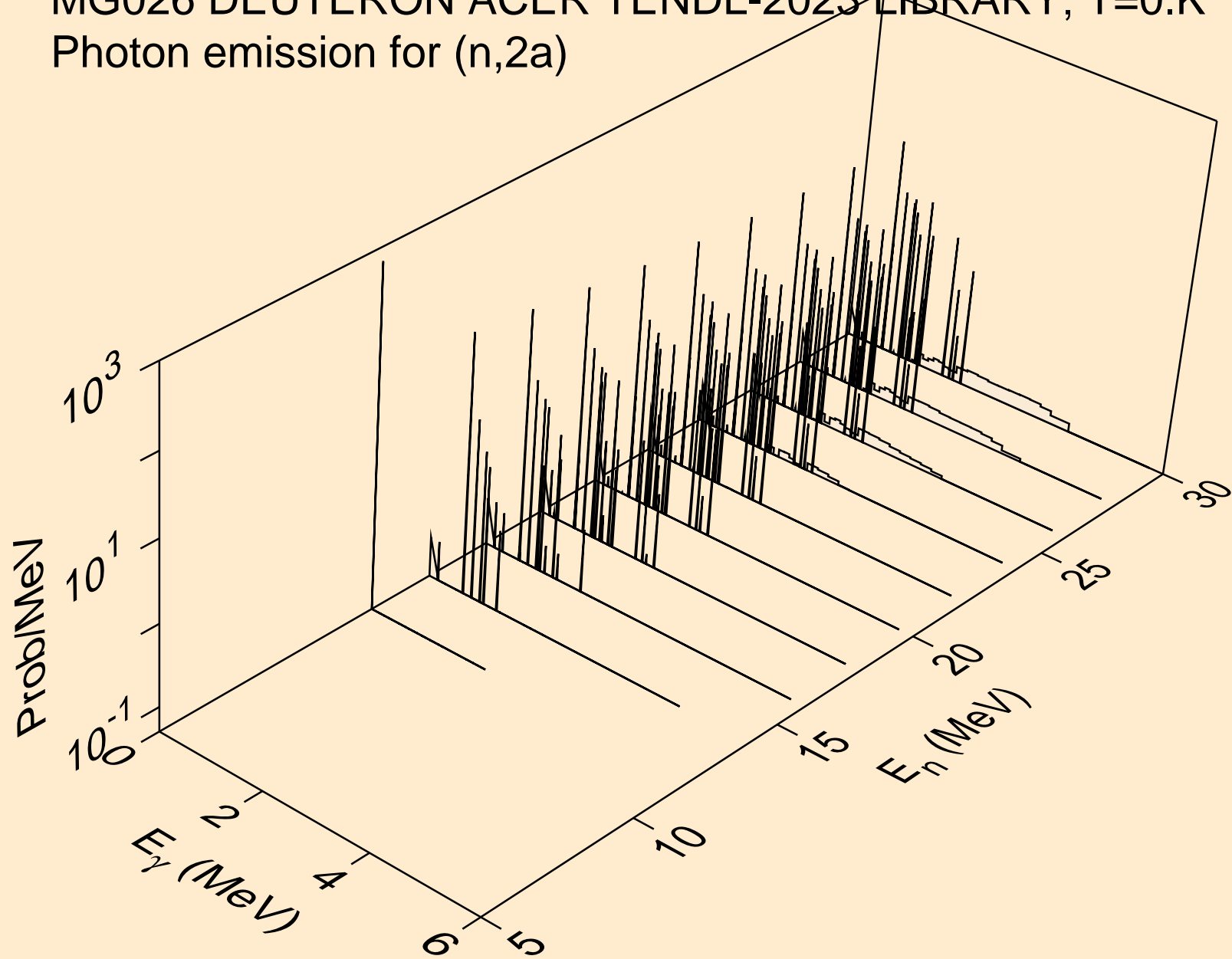



MG026 DEUTERON ACER TENDL-2023 LIBRARY; T=0.K  
Photon emission for (n,3a)

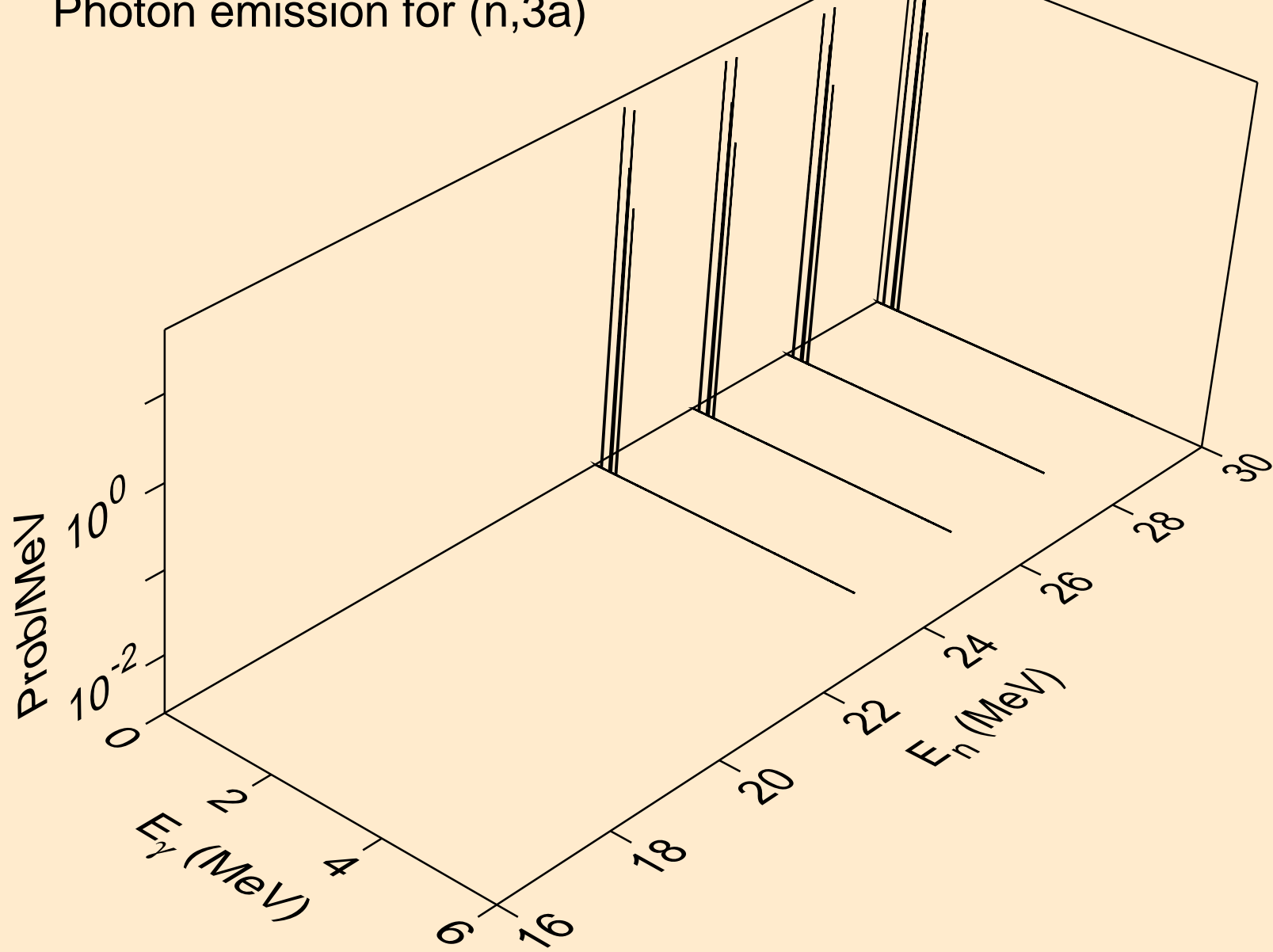

MG026 DEUTERON ACER TENDL-2023 LIBRARY; T=0.K  
Photon emission for (n,2p)

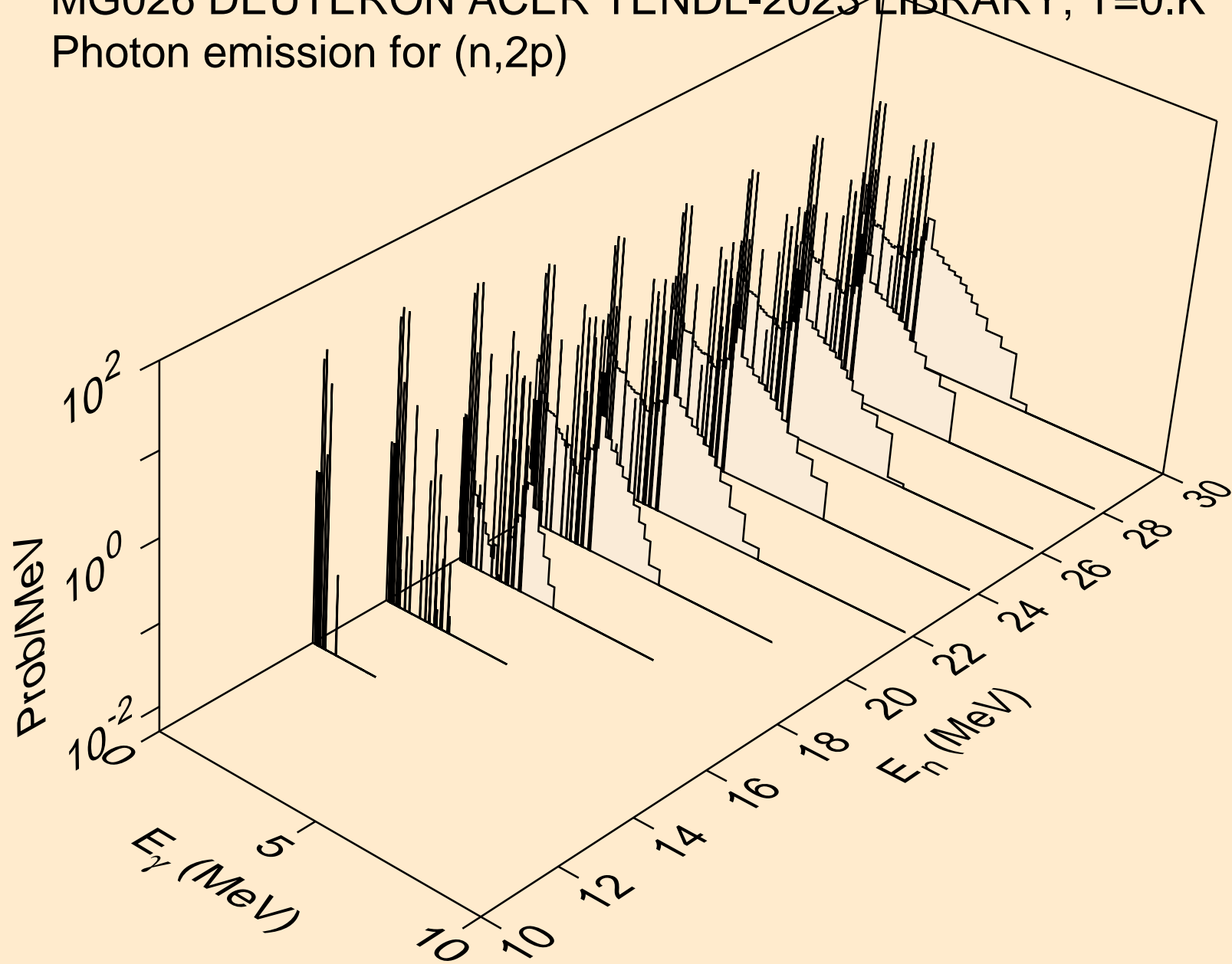

MG026 DEUTERON ACER TENDL-2023 LIBRARY; T=0.K  
Photon emission for (n,p)

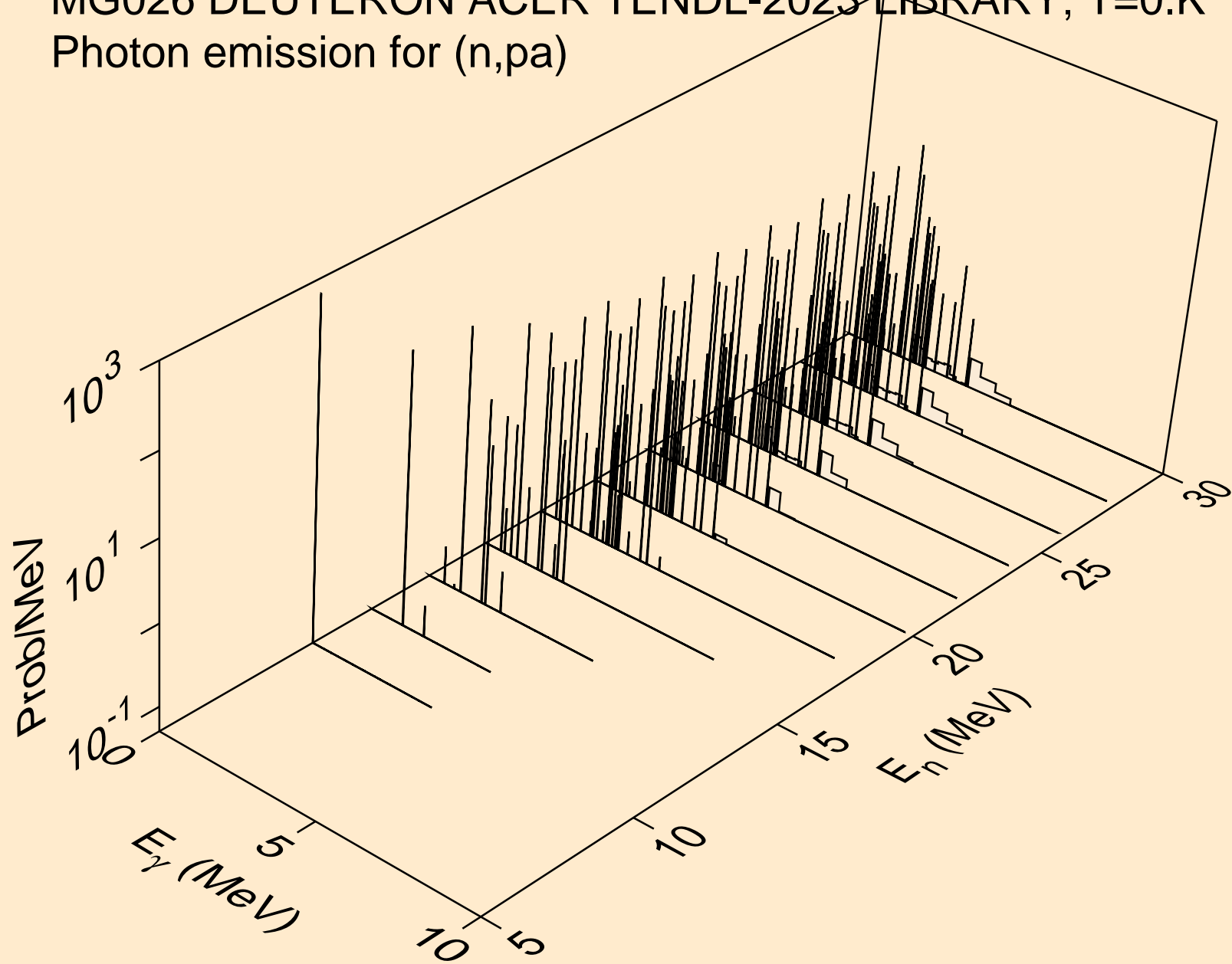

MG026 DEUTERON ACER TENDL-2023 LIBRARY; T=0.K  
Photon emission for (n,d2a)

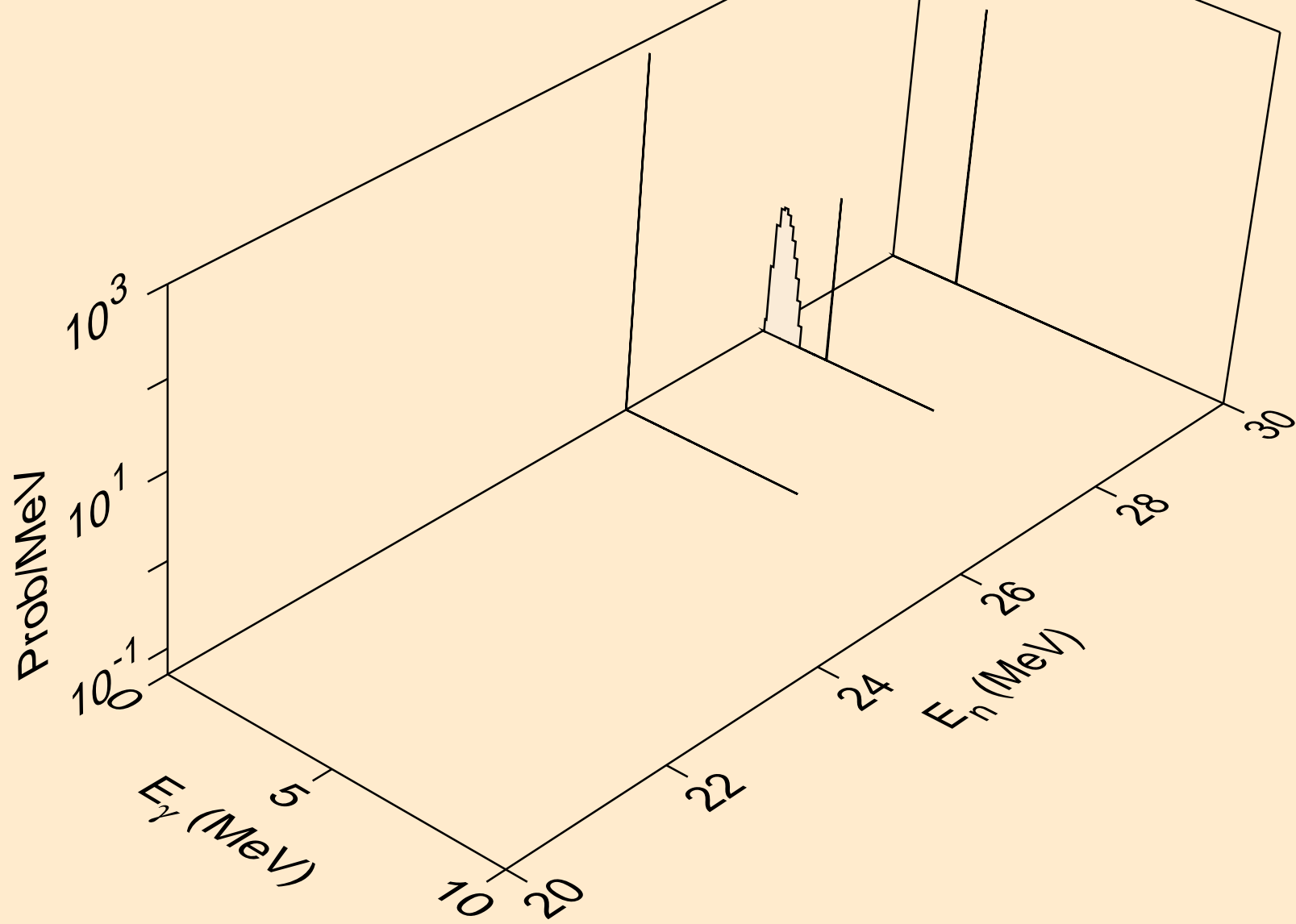

MG026 DEUTERON ACER TENDL-2023 LIBRARY; T=0.K  
Photon emission for (n,pd)

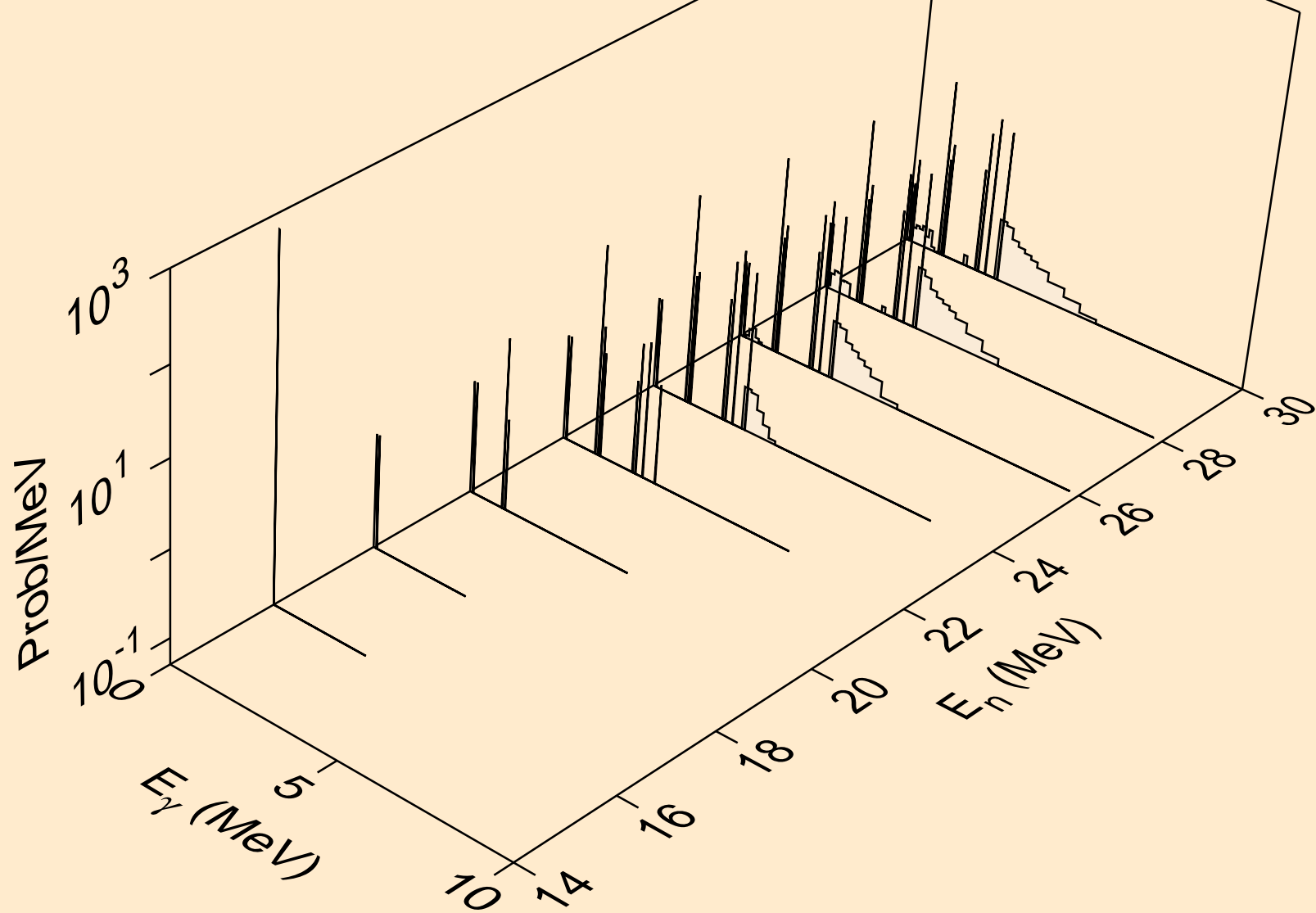

MG026 DEUTERON ACER TENDL-2023 LIBRARY; T=0.K  
Photon emission for (n,pt)

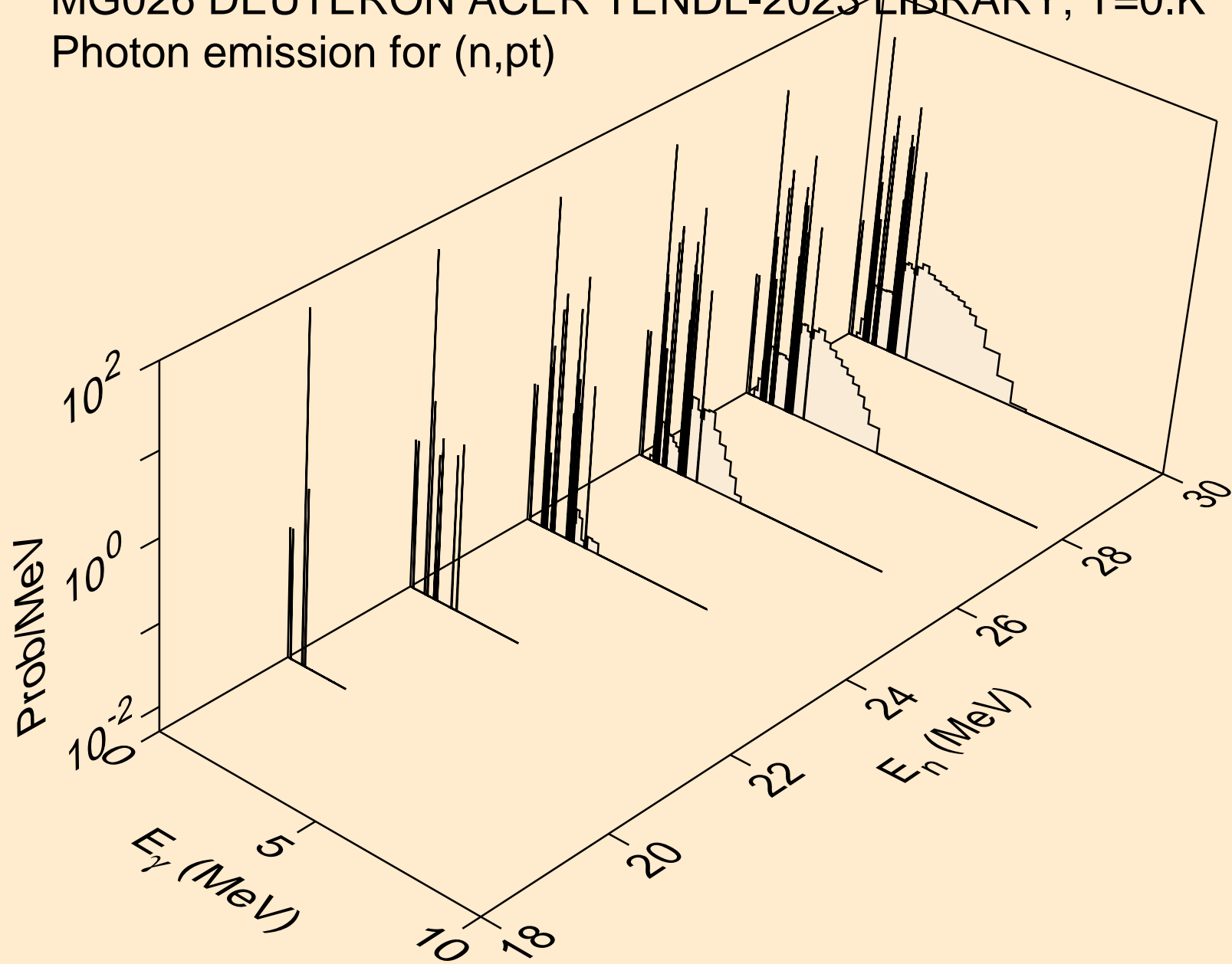

MG026 DEUTERON ACER TENDL-2023 LIBRARY; T=0.K  
Photon emission for (n,da)

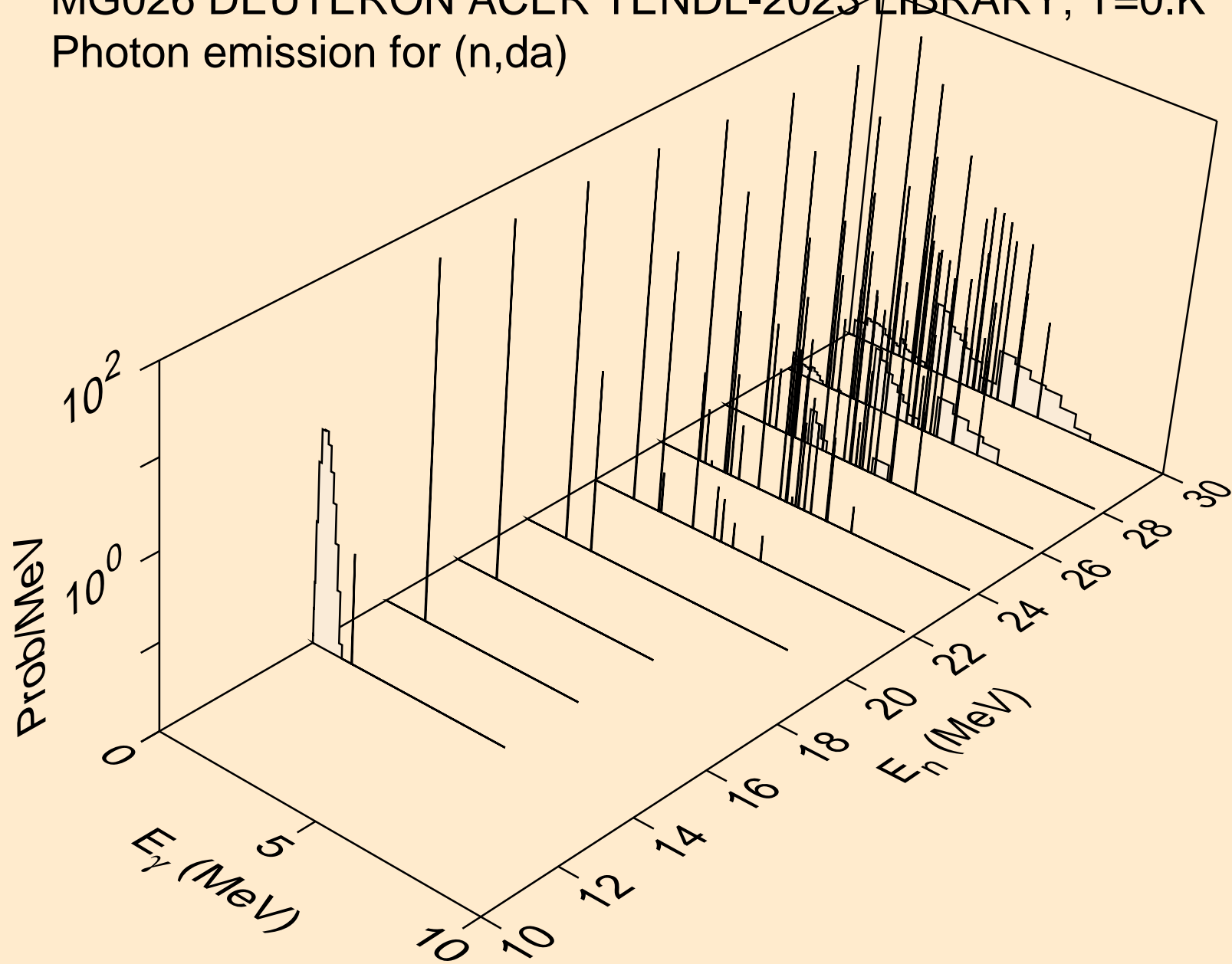

# MG026 DEUTERON ACER TENDL-2023 LIBRARY; T=0.K

## Particle heating contributions

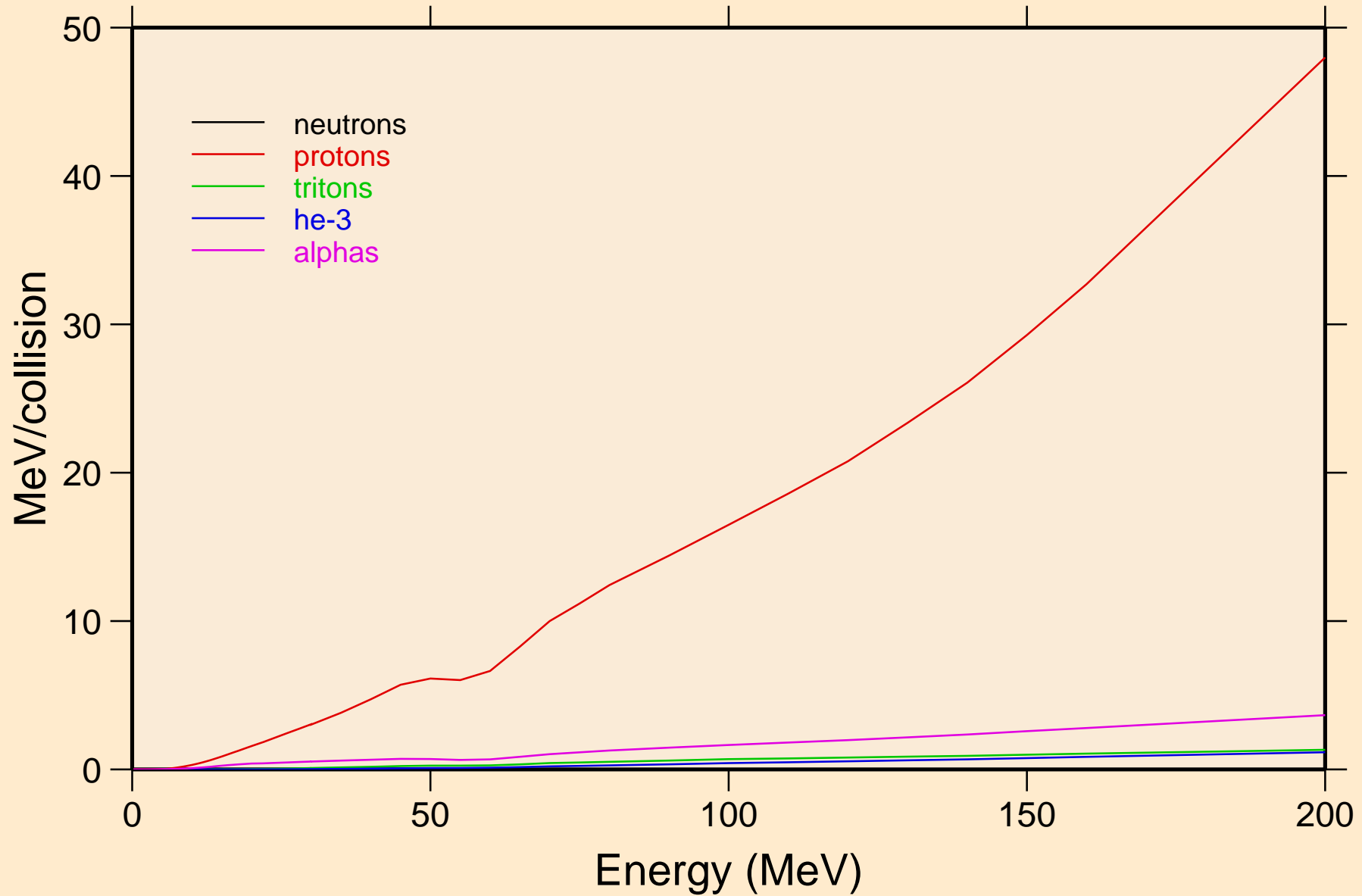



MG026 DEUTERON ACER TENDL-2023 LIBRARY; T=0.K  
Recoil Heating

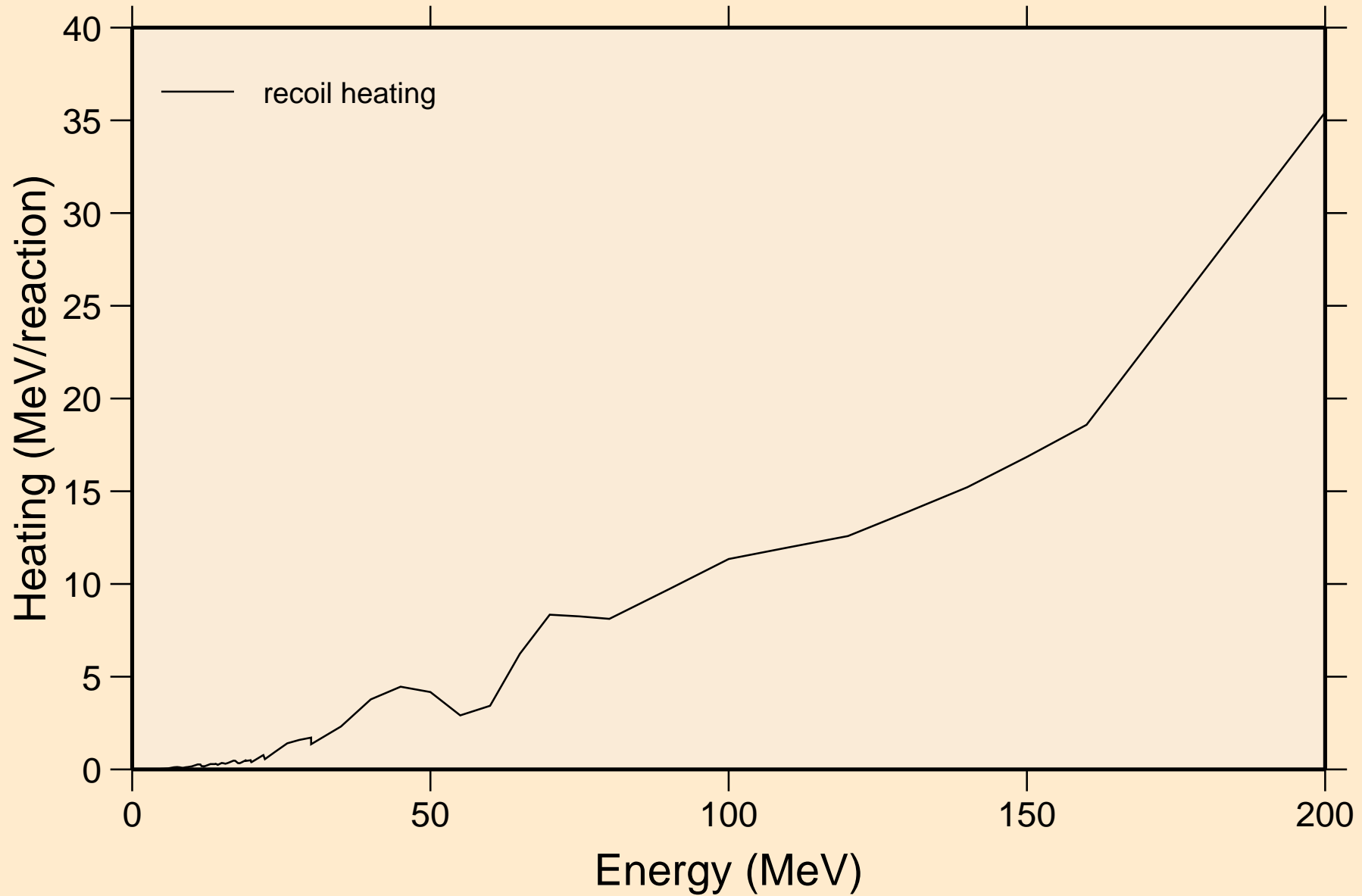

MG026 DEUTERON ACER TENDL-2023 LIBRARY; T=0.K  
Particle production cross sections

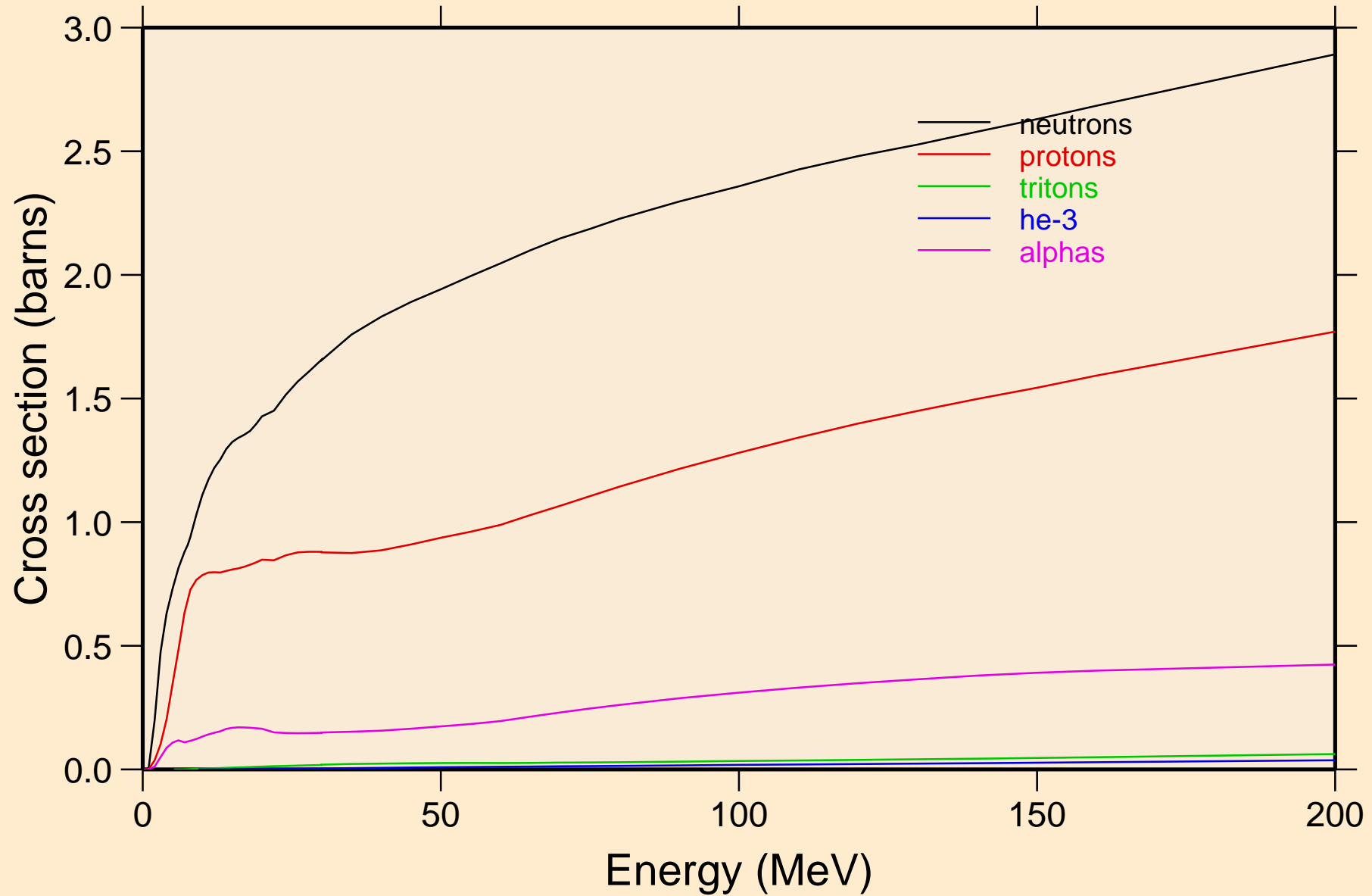

MG026 DEUTERON ACER TENDL-2023 LIBRARY; T=0.K  
neutrons from (d,n)

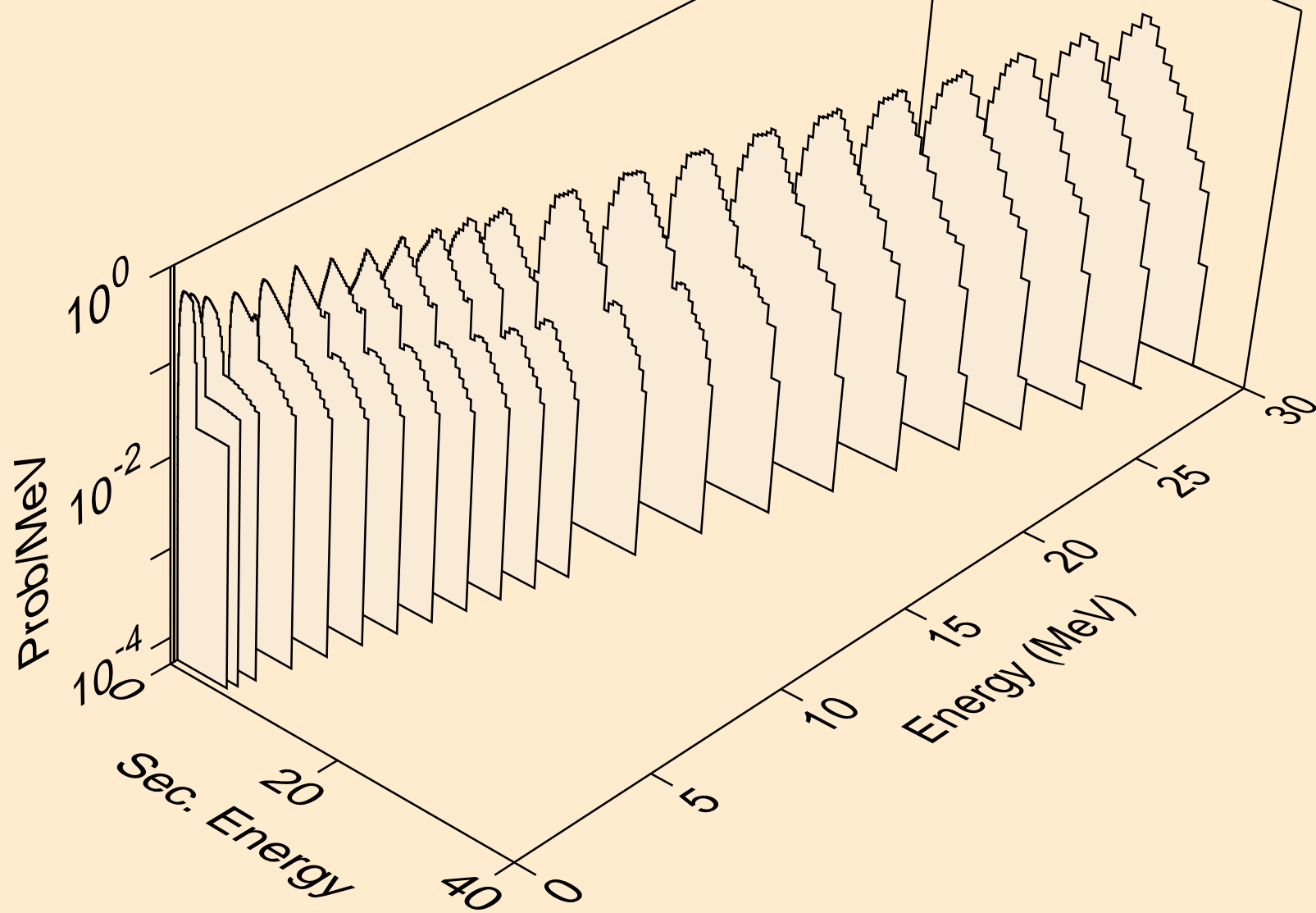

MG026 DEUTERON ACER TENDL-2023 LIBRARY; T=0.K  
neutrons from (d,x)

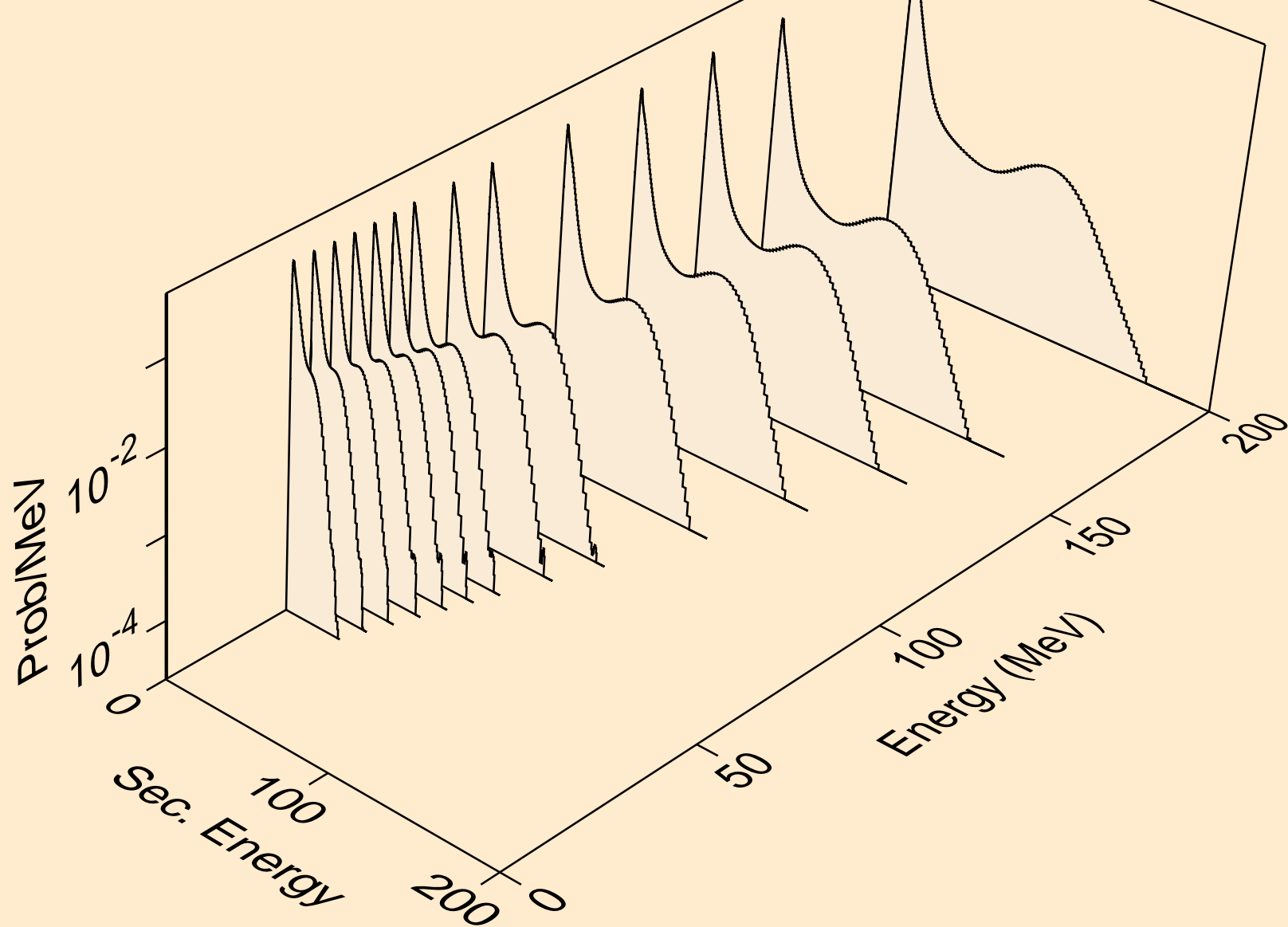

MG026 DEUTERON ACER TENDL-2023 LIBRARY; T=0.K  
neutrons from (d,2nd)

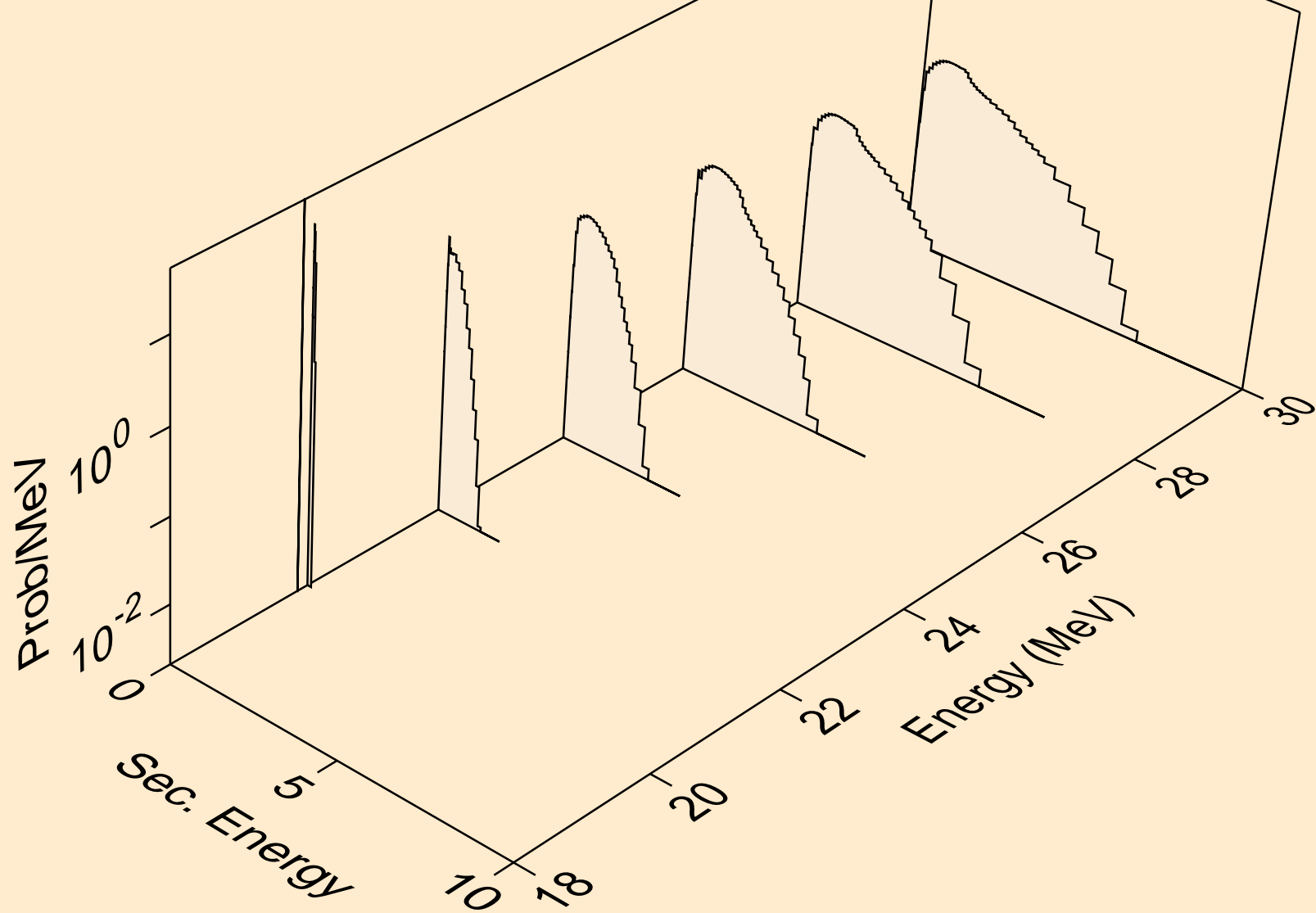

MG026 DEUTERON ACER TENDL-2023 LIBRARY; T=0.K  
neutrons from (d,2n)

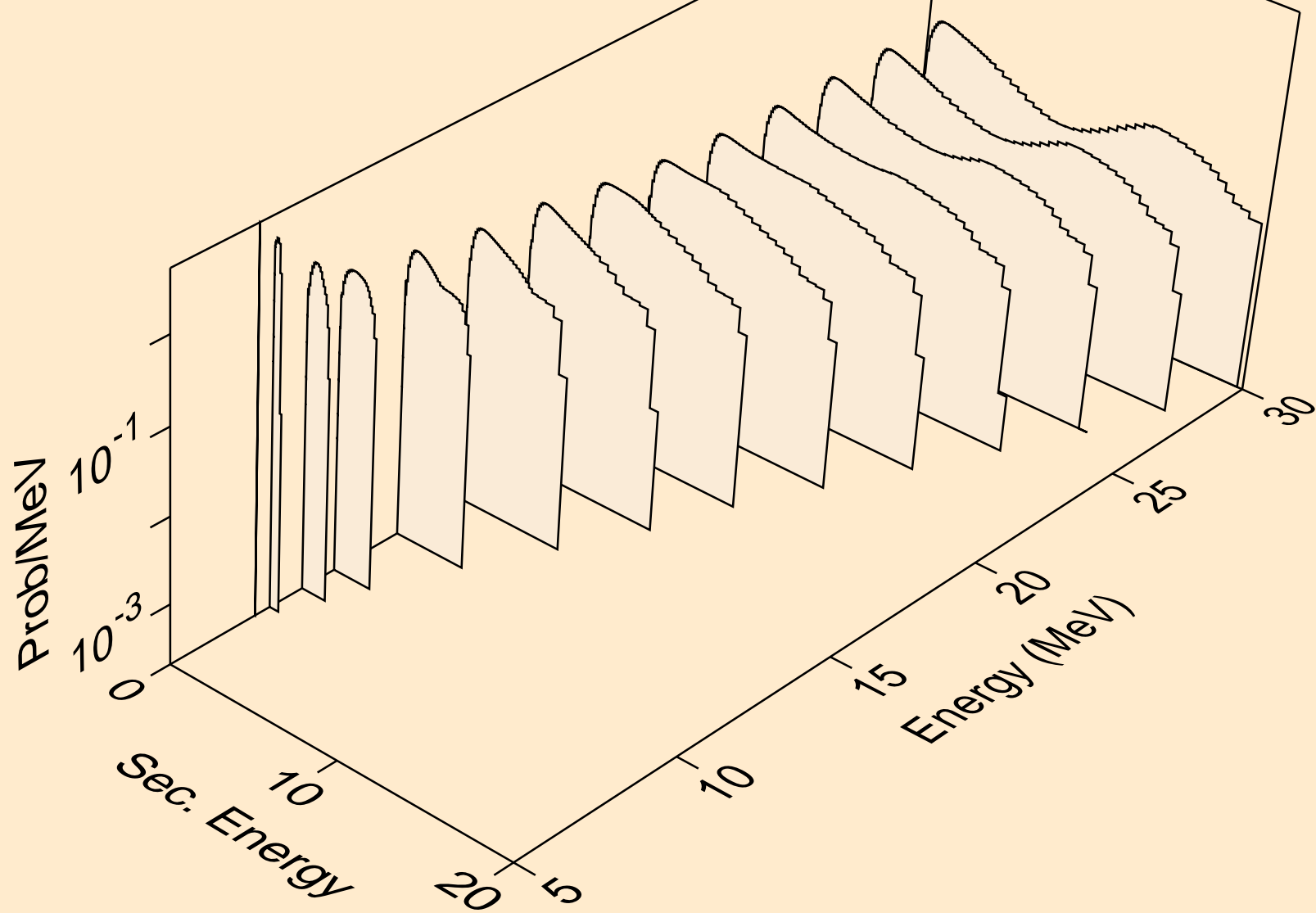

MG026 DEUTERON ACER TENDL-2023 LIBRARY; T=0.K  
neutrons from (d,3n)

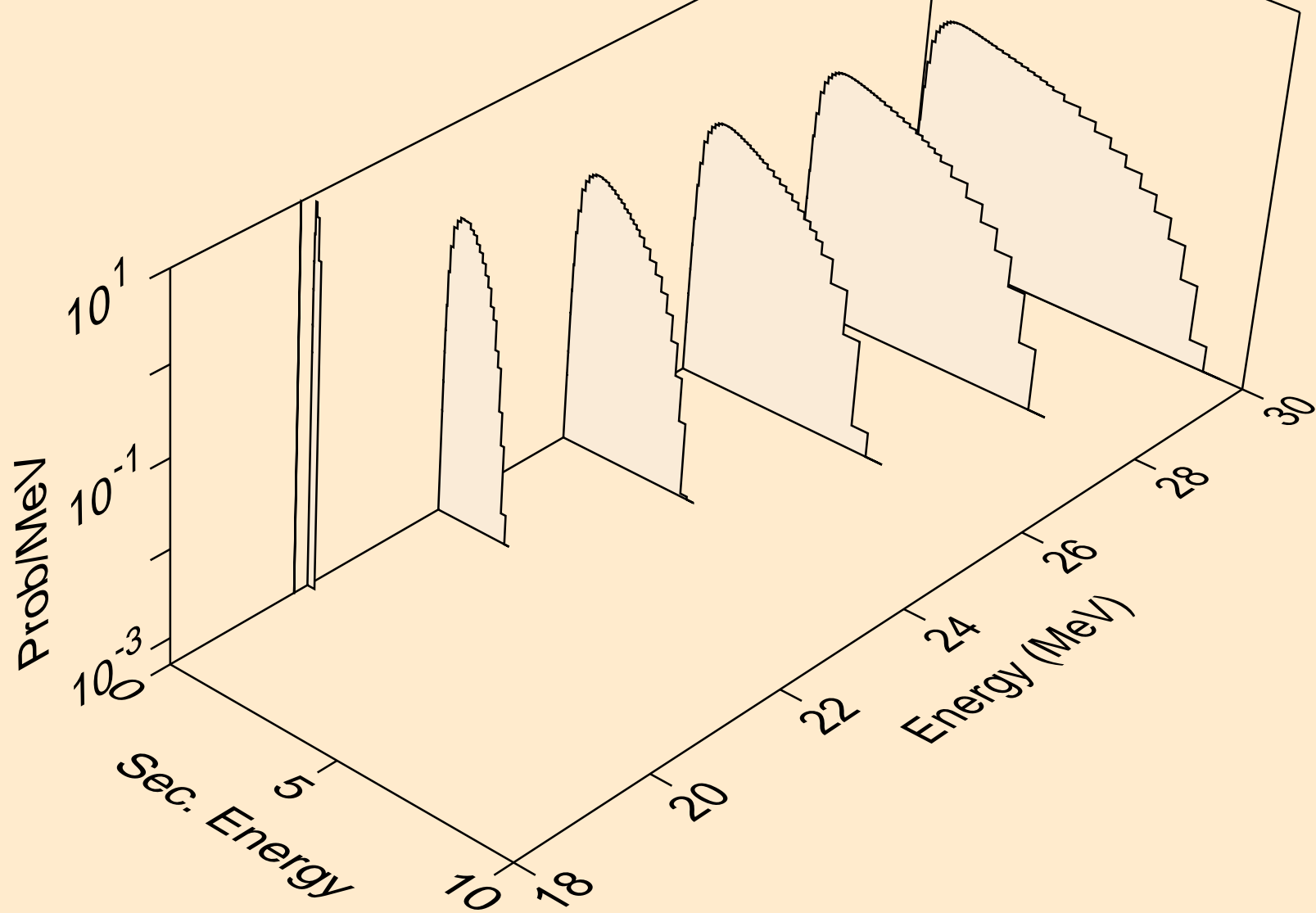

MG026 DEUTERON ACER TENDL-2023 LIBRARY; T=0.K  
neutrons from (d,n\*)a

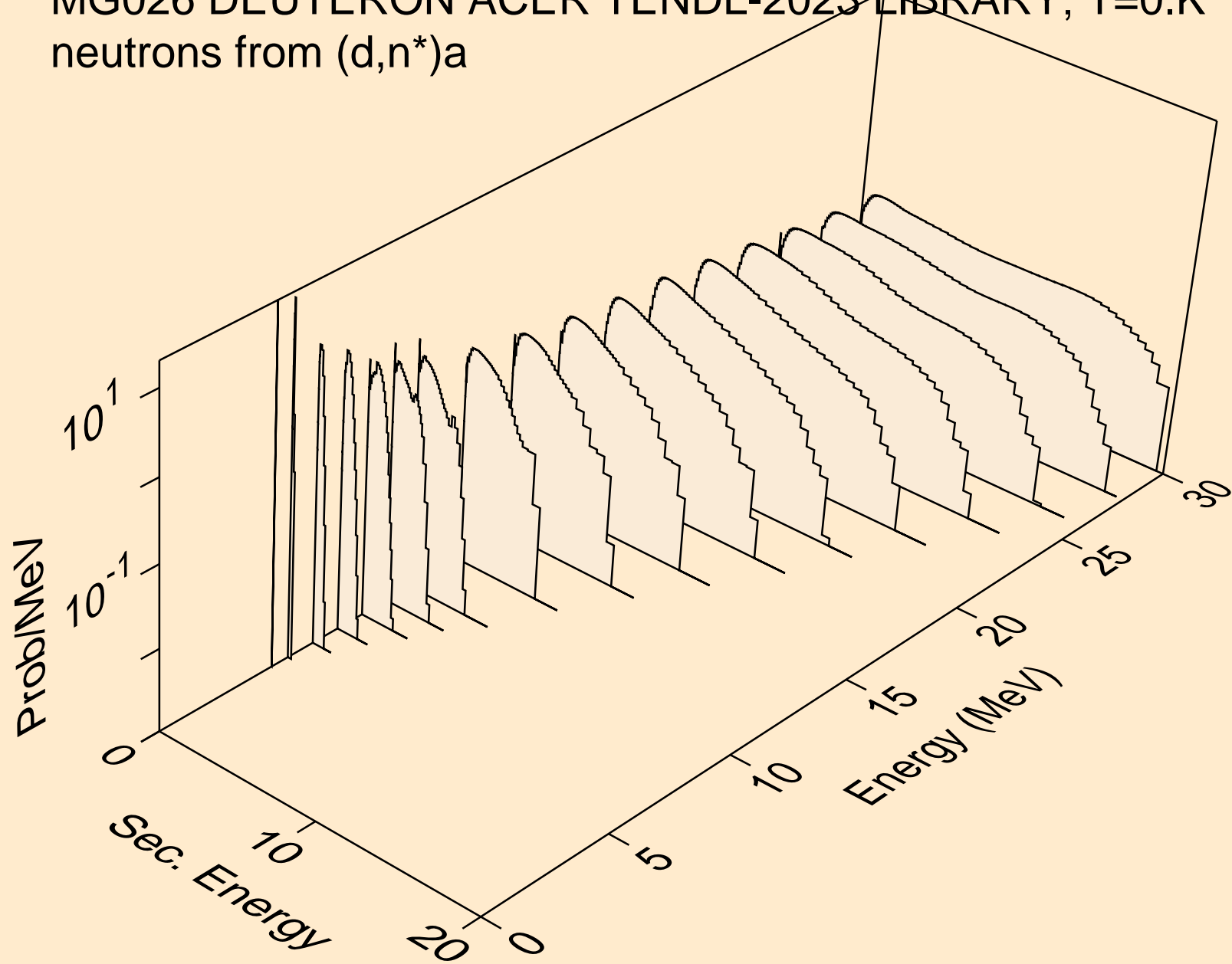



MG026 DEUTERON ACER TENDL-2023 LIBRARY; T=0.K  
neutrons from (d,n\*)3a

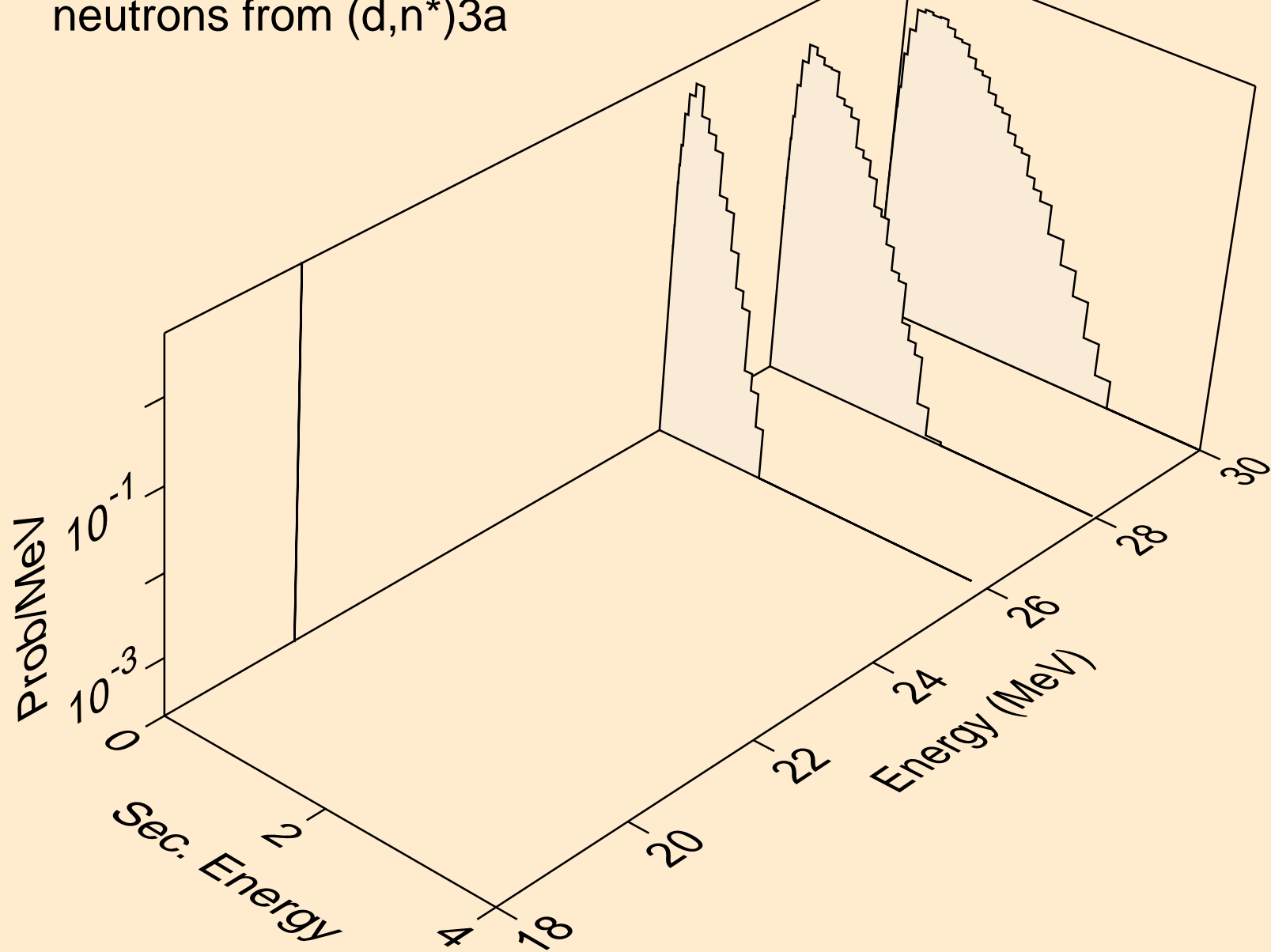

MG026 DEUTERON ACER TENDL-2023 LIBRARY; T=0.K  
neutrons from (d,2n)a

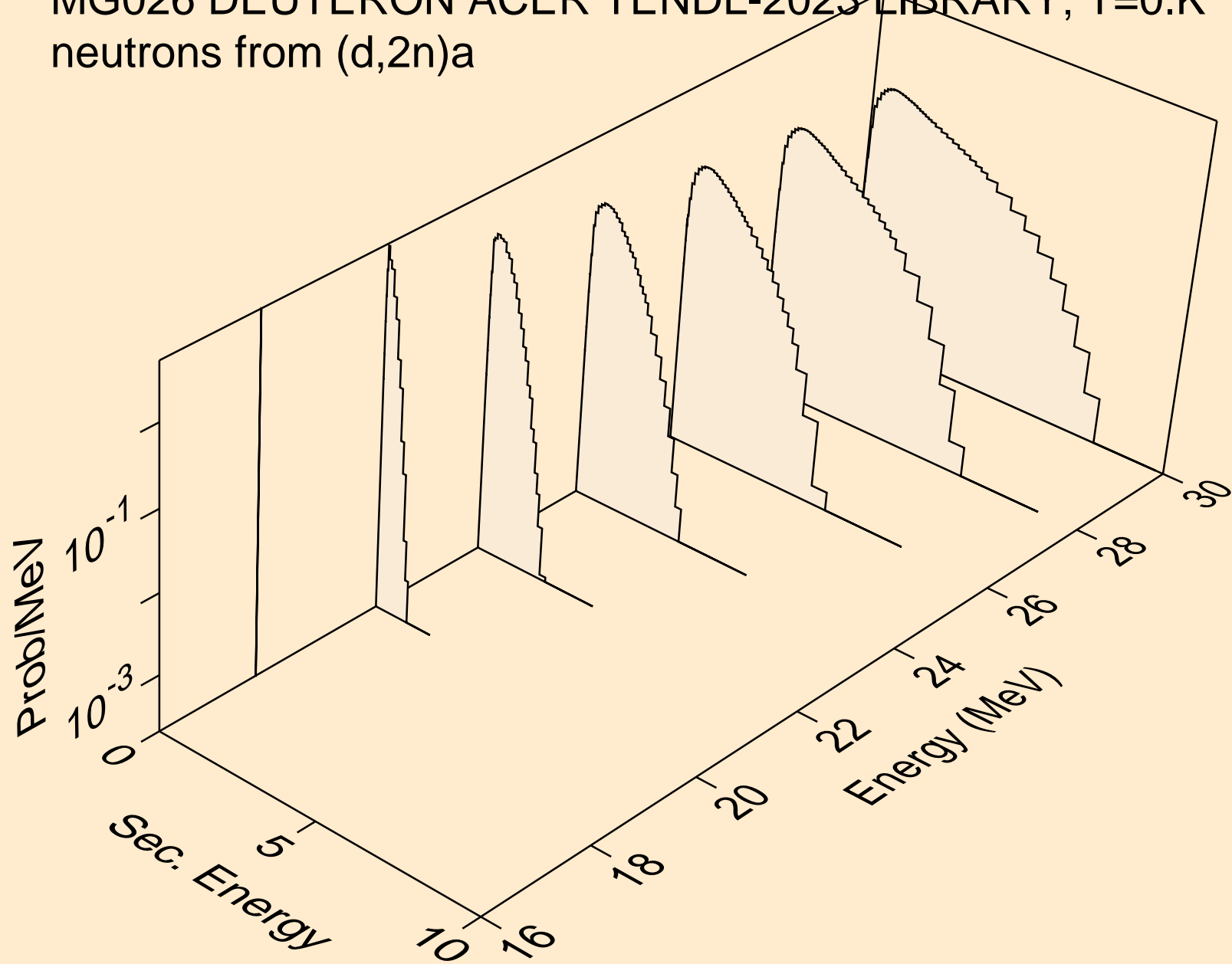

MG026 DEUTERON ACER TENDL-2023 LIBRARY; T=0.K  
neutrons from (d,n\*)p

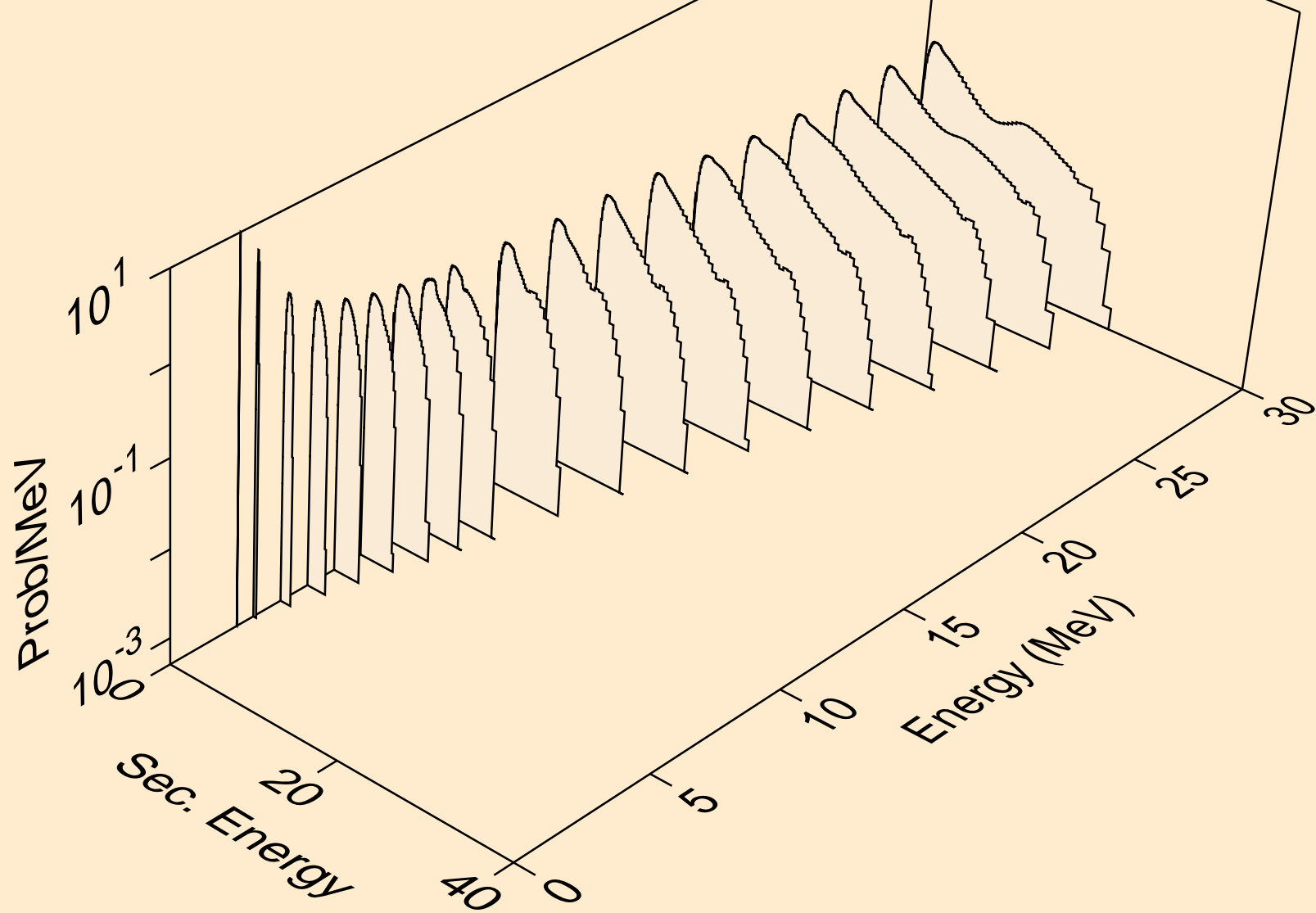

MG026 DEUTERON ACER TENDL-2023 LIBRARY; T=0.K  
neutrons from (d,n\*)2a

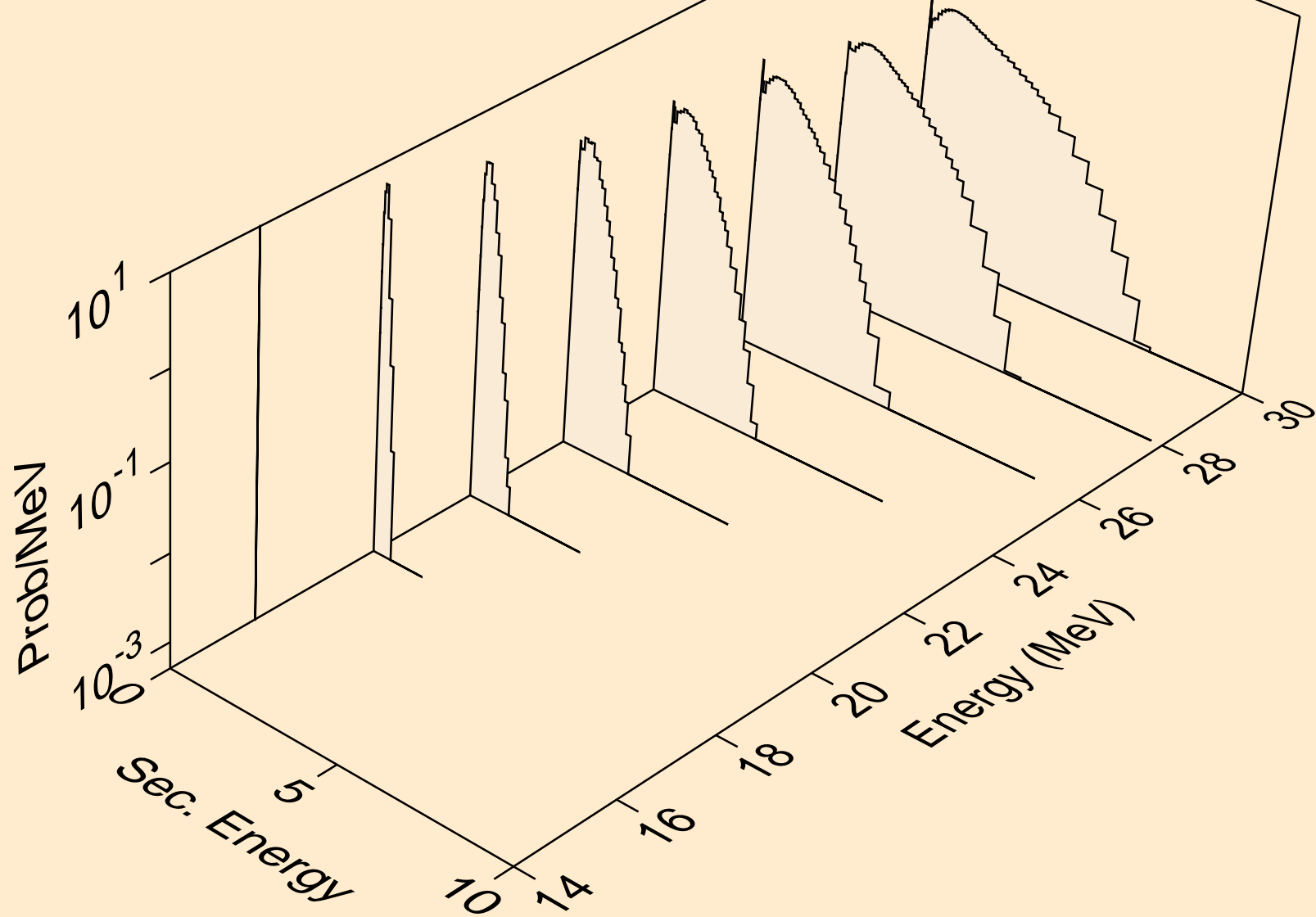

MG026 DEUTERON ACER TENDL-2023 LIBRARY; T=0.K  
neutrons from (d,n\*)d

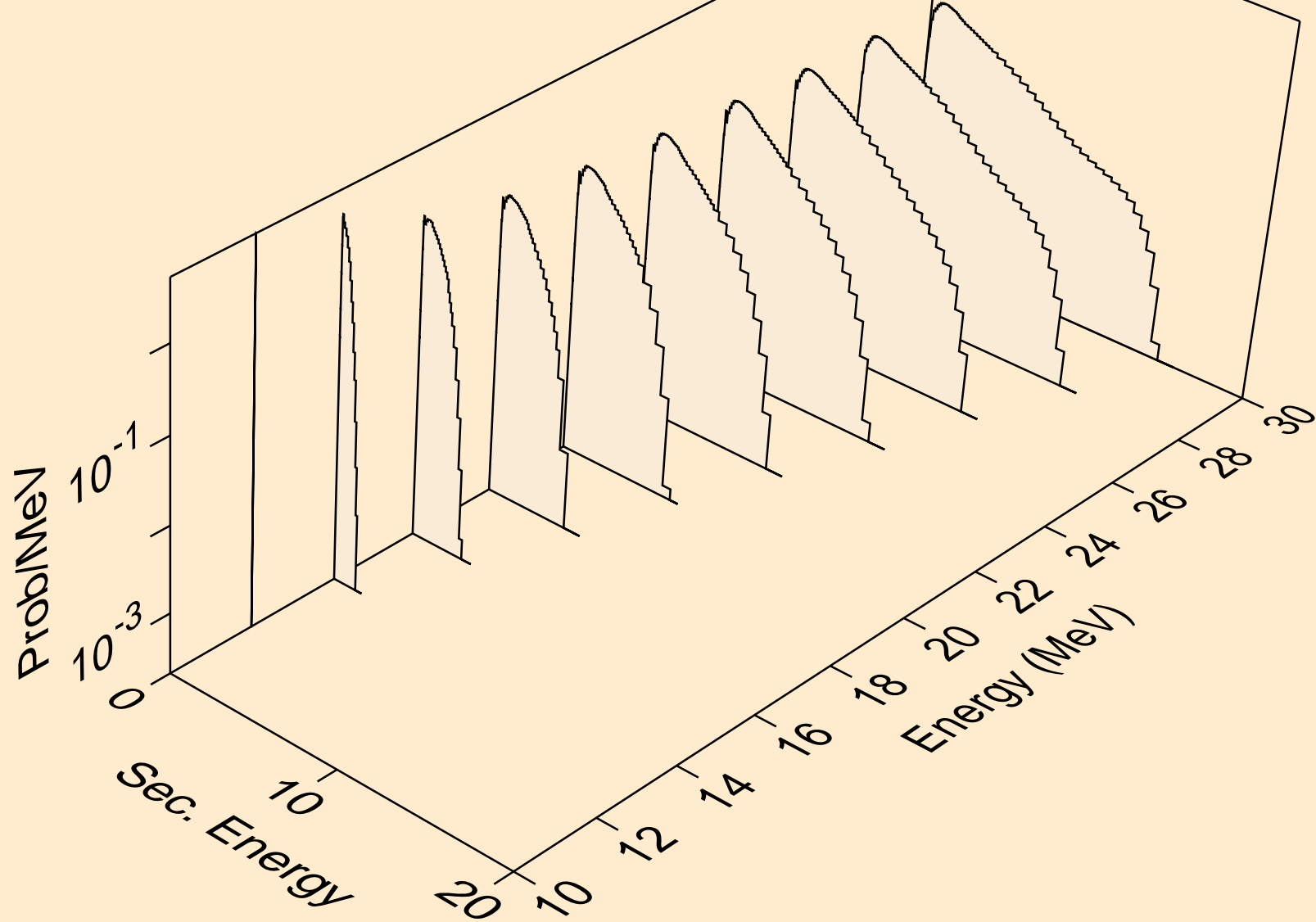

MG026 DEUTERON ACER TENDL-2023 LIBRARY; T=0.K  
neutrons from (d,n\*)t

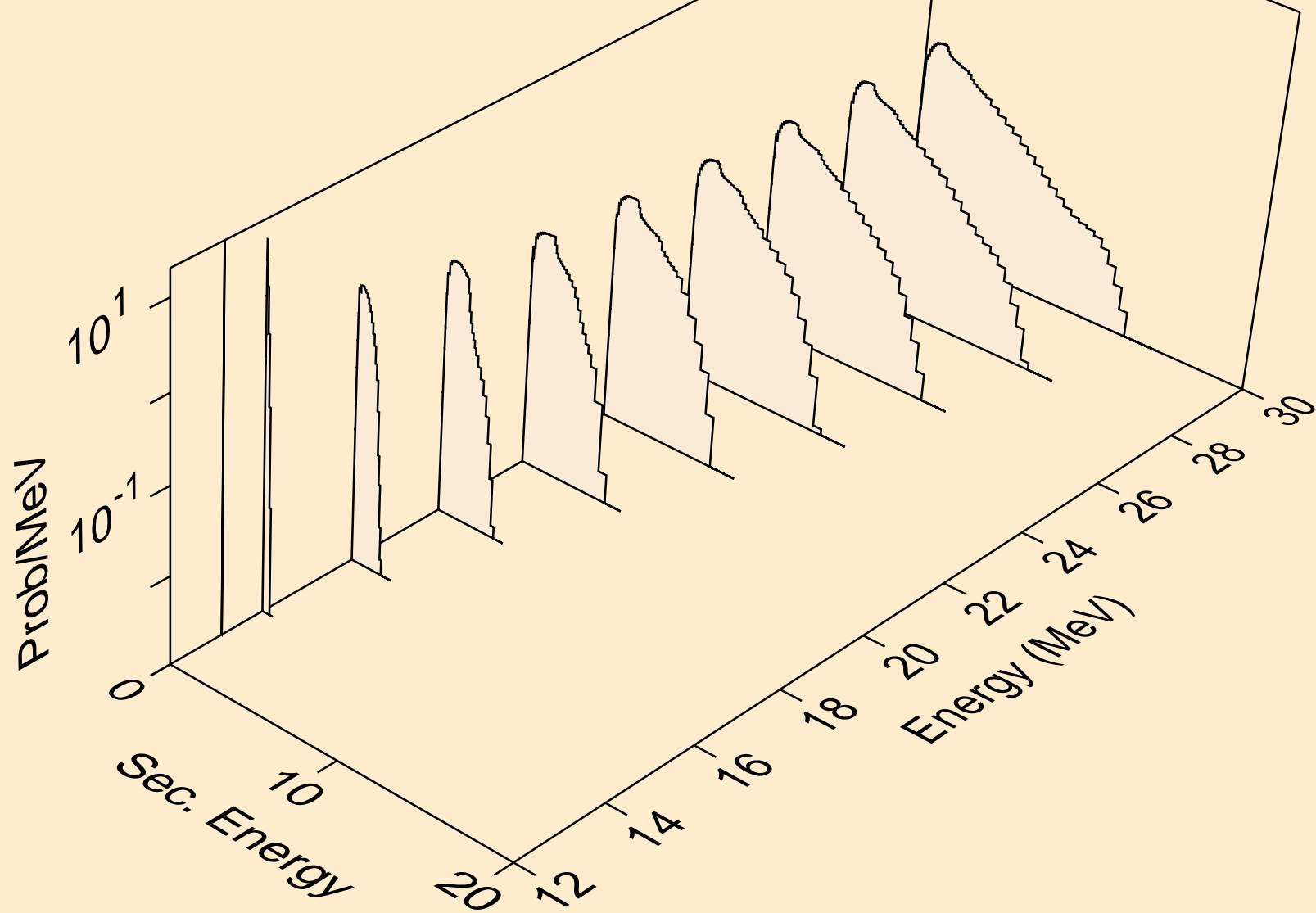

MG026 DEUTERON ACER TENDL-2023 LIBRARY; T=0.K  
neutrons from (d,n\*)he3

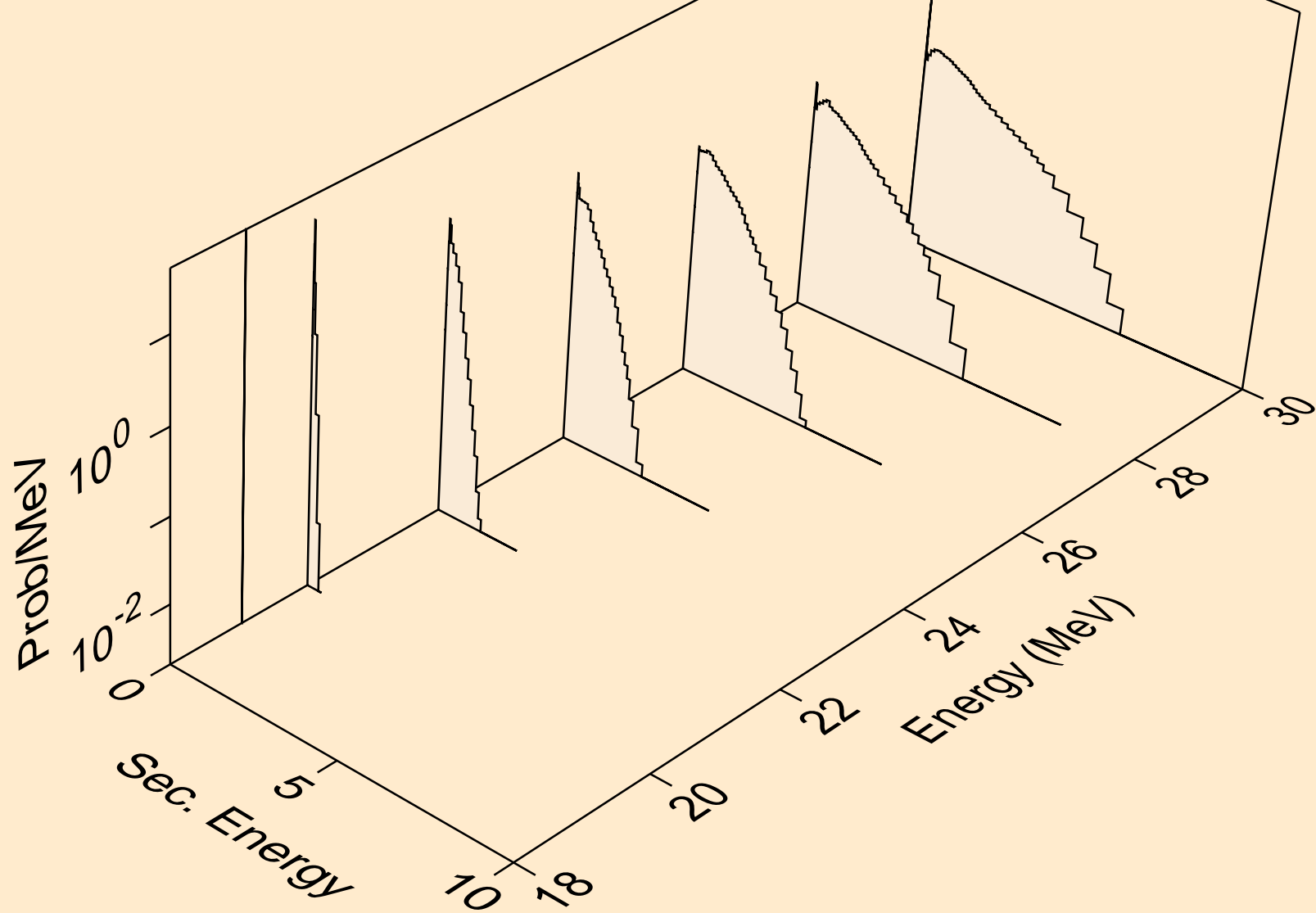

MG026 DEUTERON ACER TENDL-2023 LIBRARY; T=0.K  
neutrons from (d,2np)

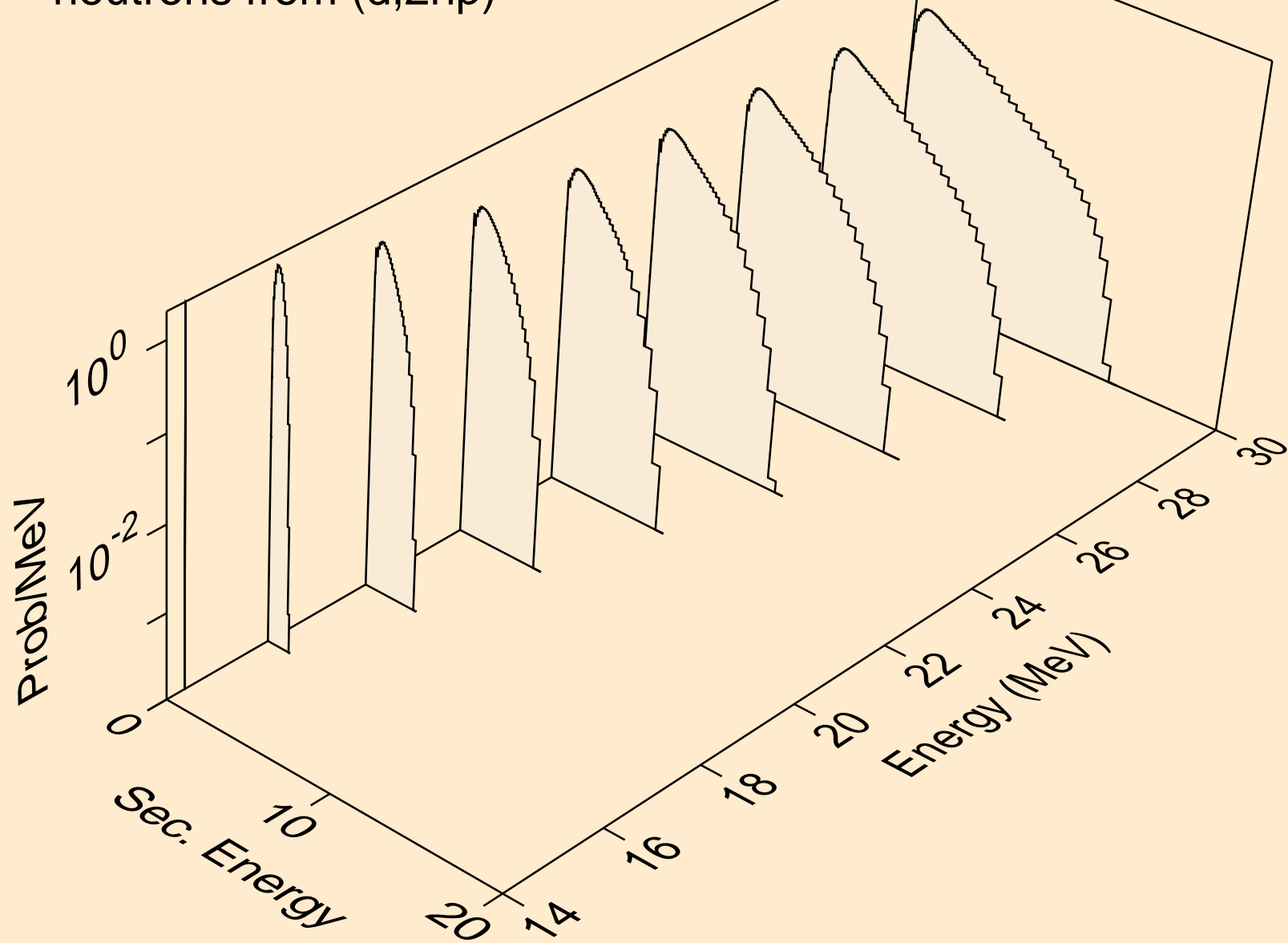



MG026 DEUTERON ACER TENDL-2023 LIBRARY; T=0.K  
neutrons from (d,3np)

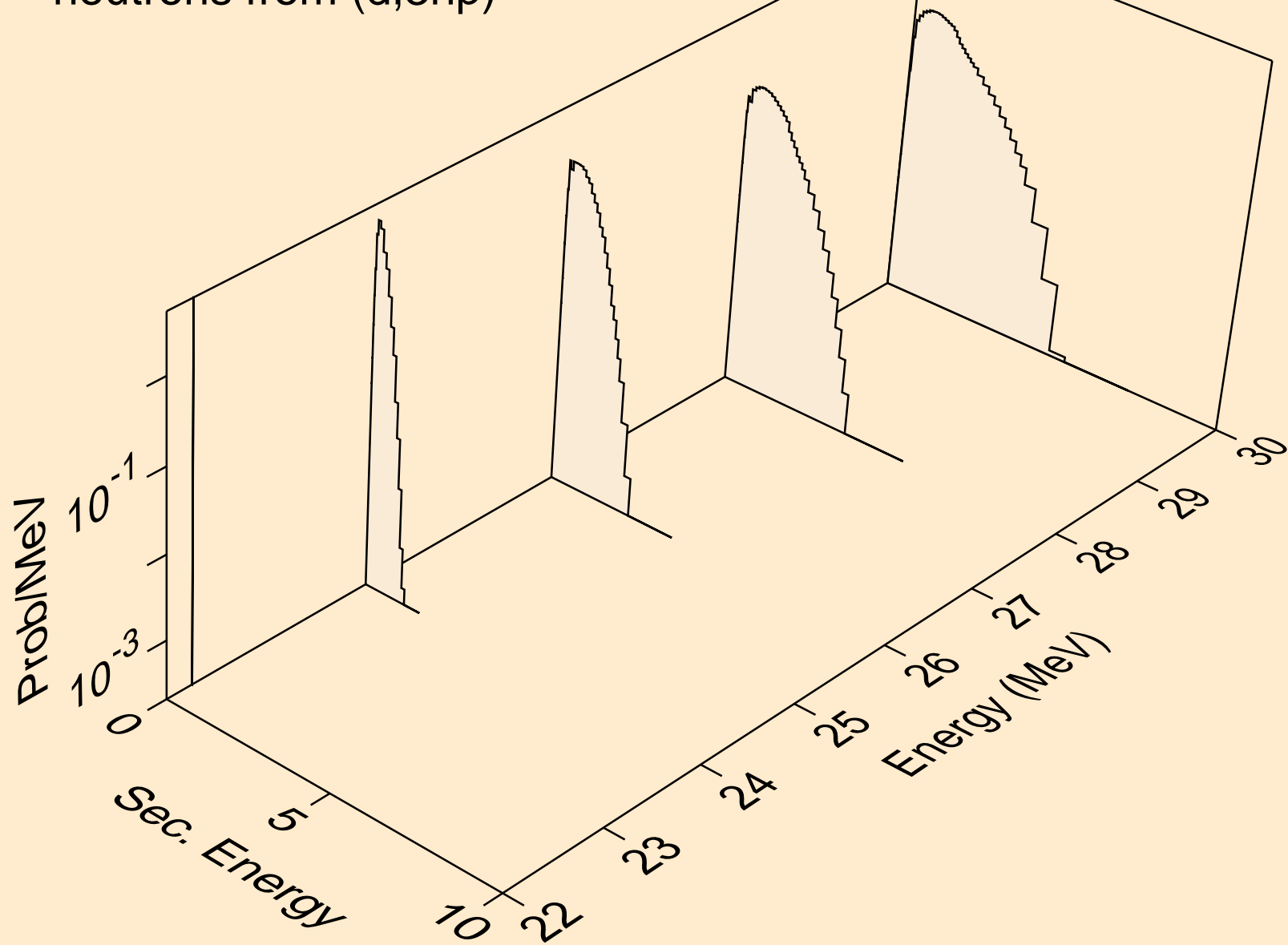

MG026 DEUTERON ACER TENDL-2023 LIBRARY; T=0.K  
neutrons from (d,n2p)

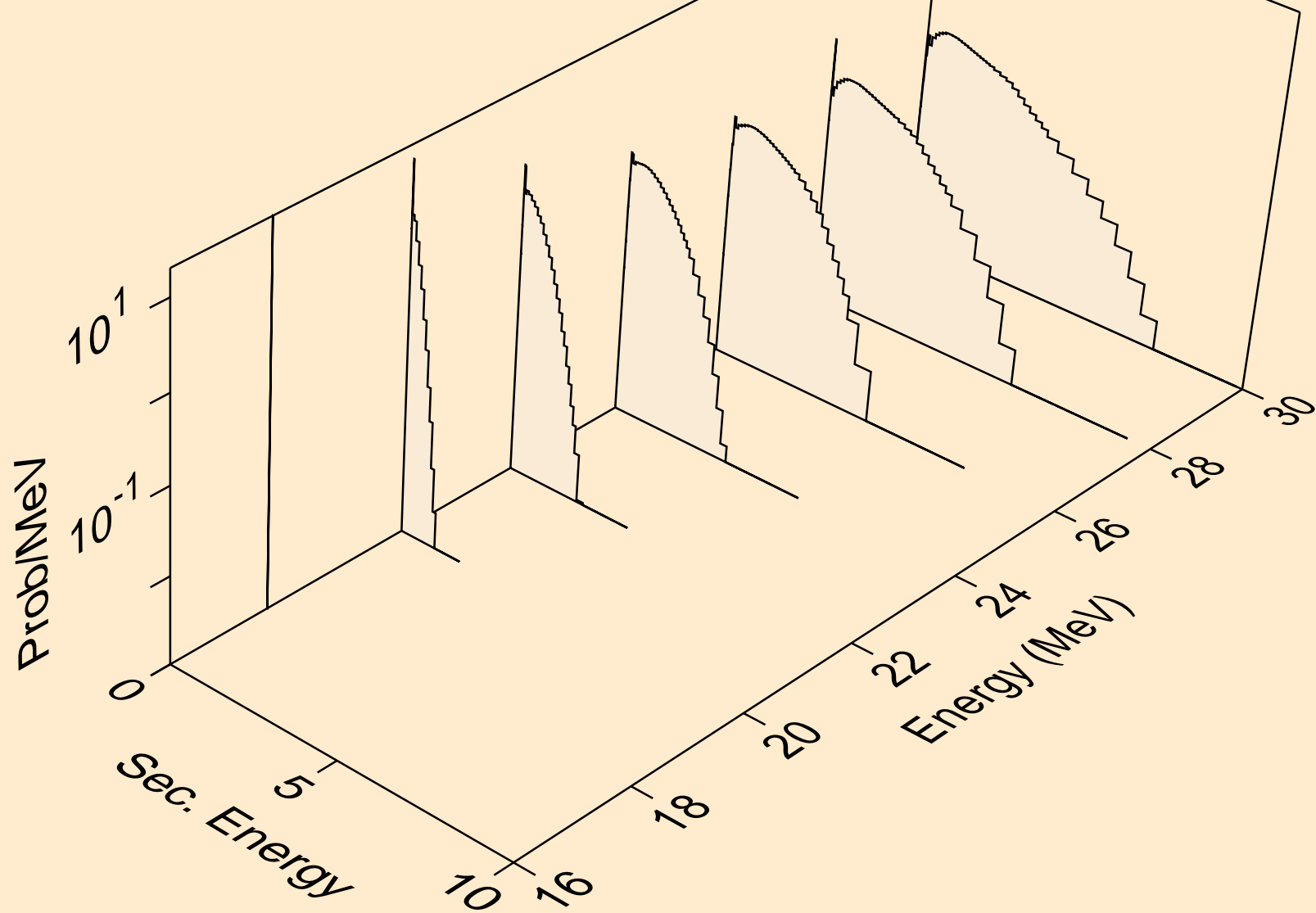

MG026 DEUTERON ACER TENDL-2023 LIBRARY; T=0.K  
neutrons from (d,npa)

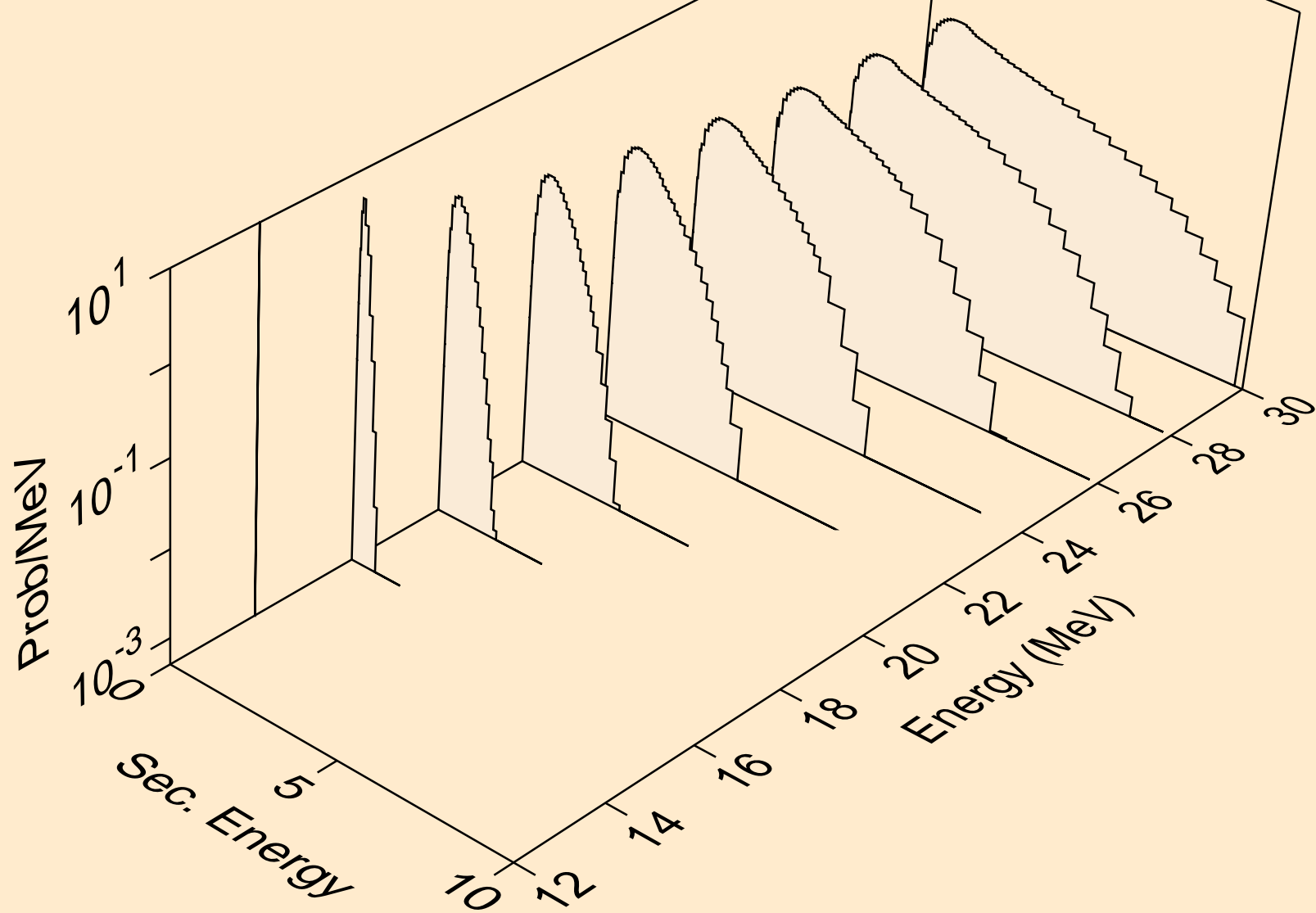

MG026 DEUTERON ACER TENDL-2023 LIBRARY; T=0.K  
protons from (d,x)

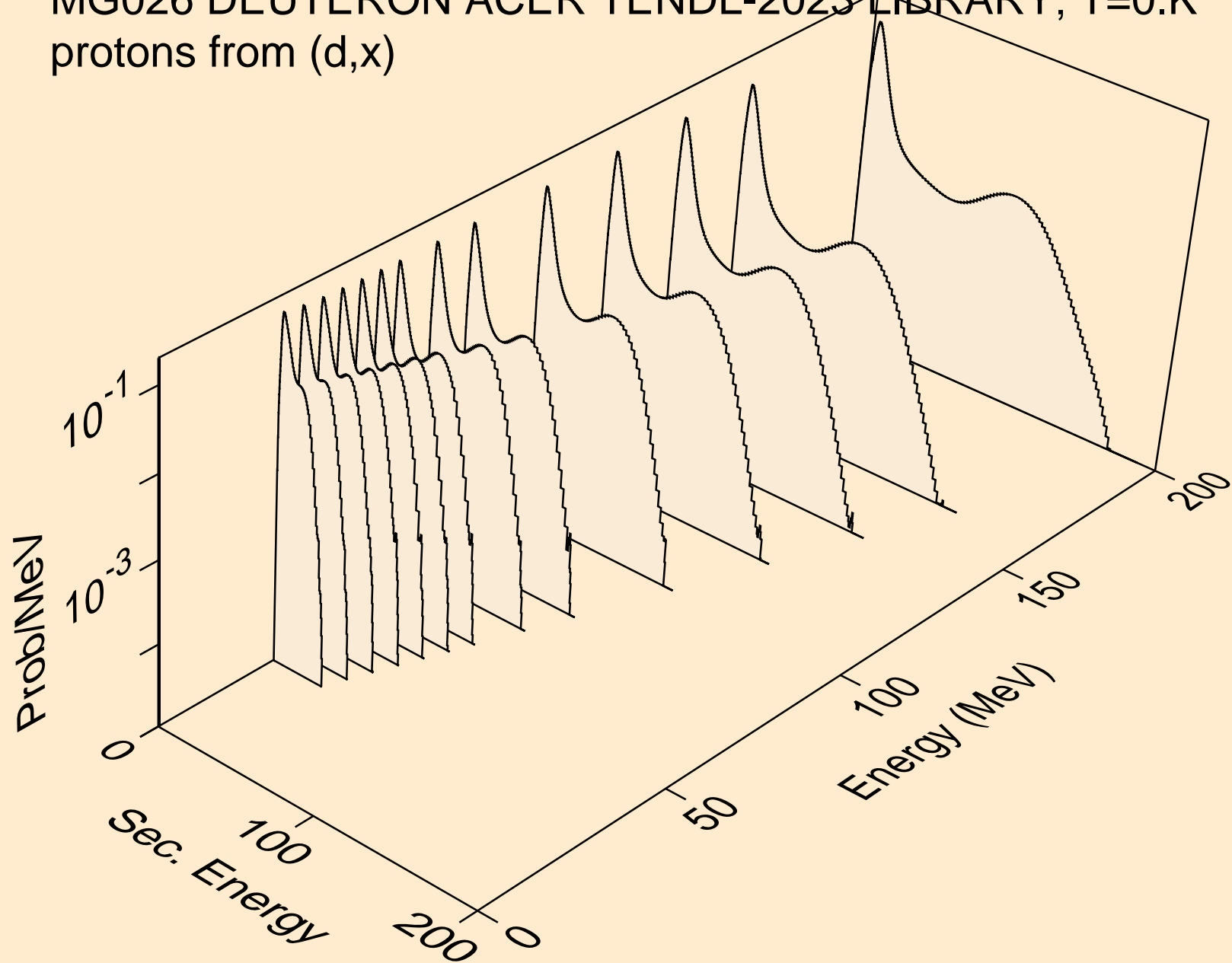

MG026 DEUTERON ACER TENDL-2023 LIBRARY; T=0.K  
protons from (d,n\*)p

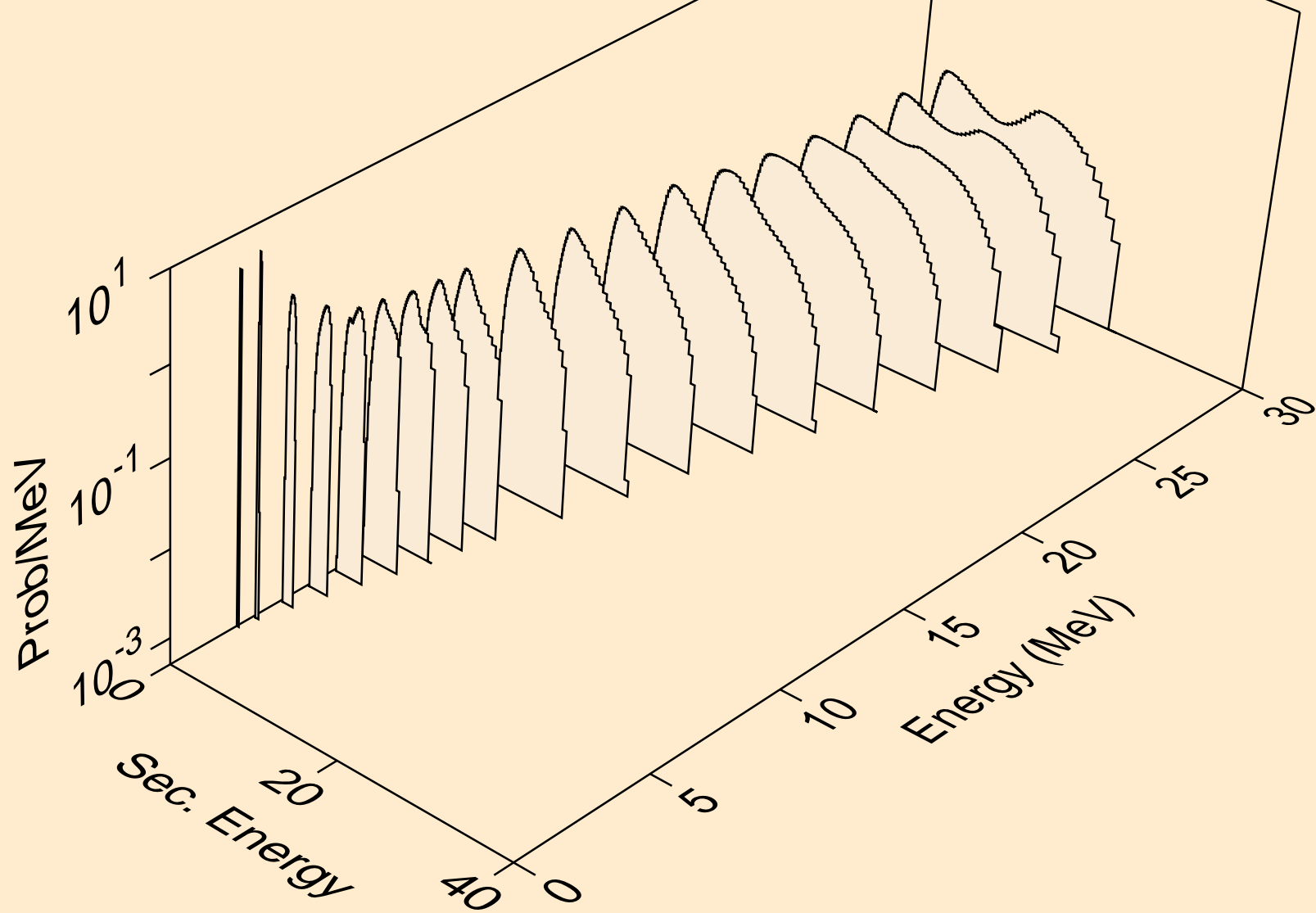

MG026 DEUTERON ACER TENDL-2023 LIBRARY; T=0.K  
protons from (d,2np)

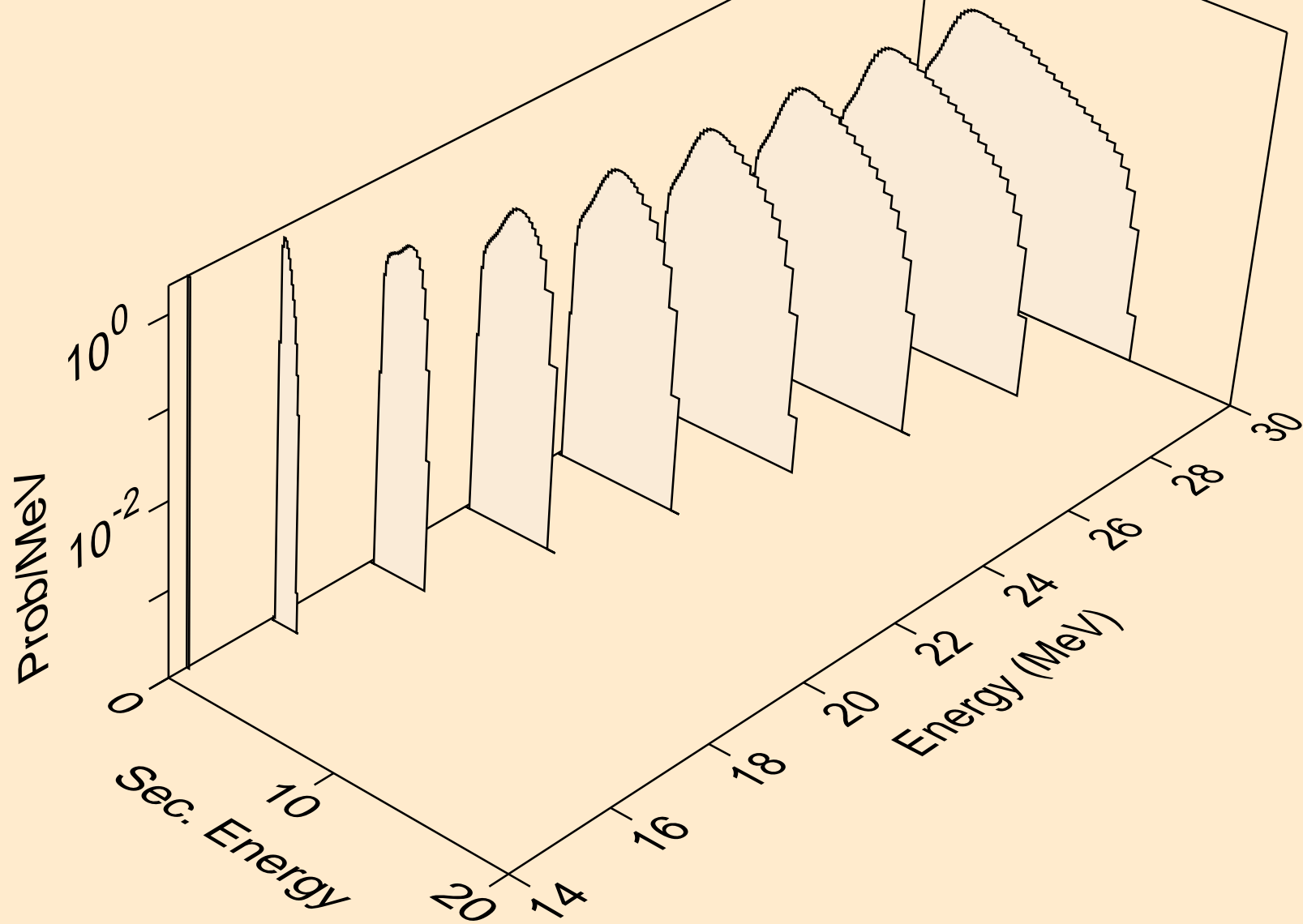

MG026 DEUTERON ACER TENDL-2023 LIBRARY; T=0.K  
protons from (d,3np)

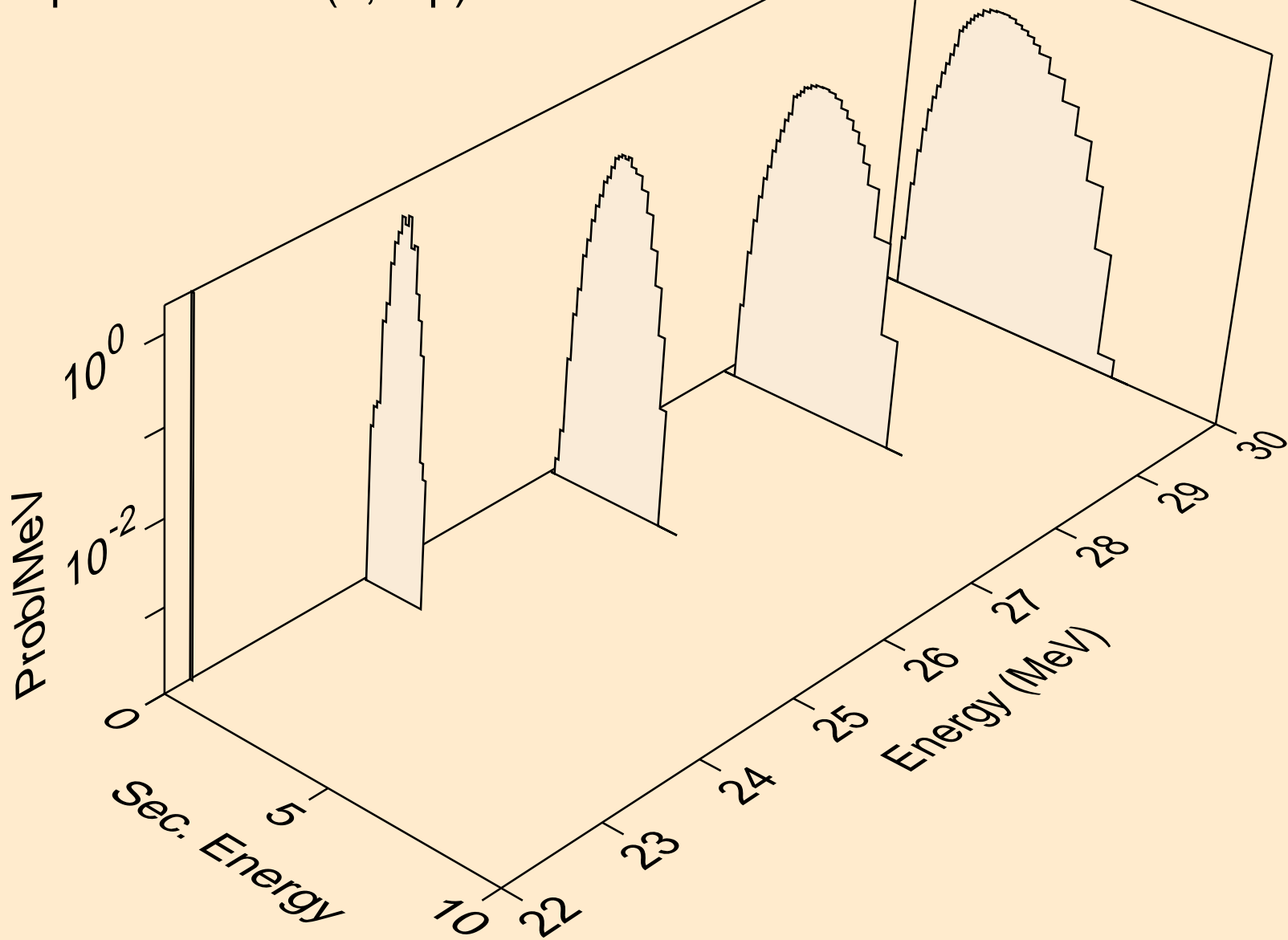

MG026 DEUTERON ACER TENDL-2023 LIBRARY; T=0.K  
protons from (d,n2p)

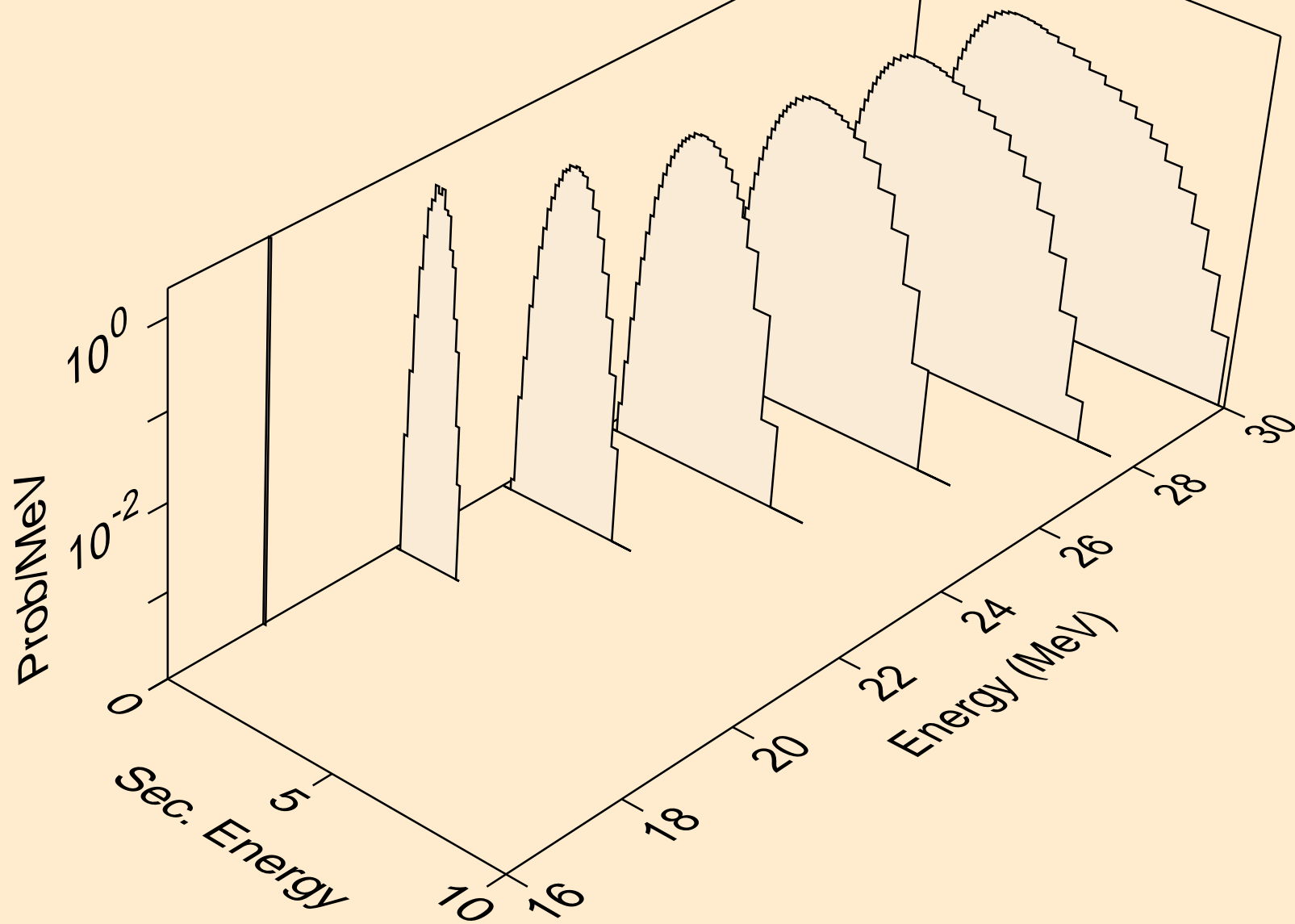



MG026 DEUTERON ACER TENDL-2023 LIBRARY; T=0.K  
protons from (d,npa)

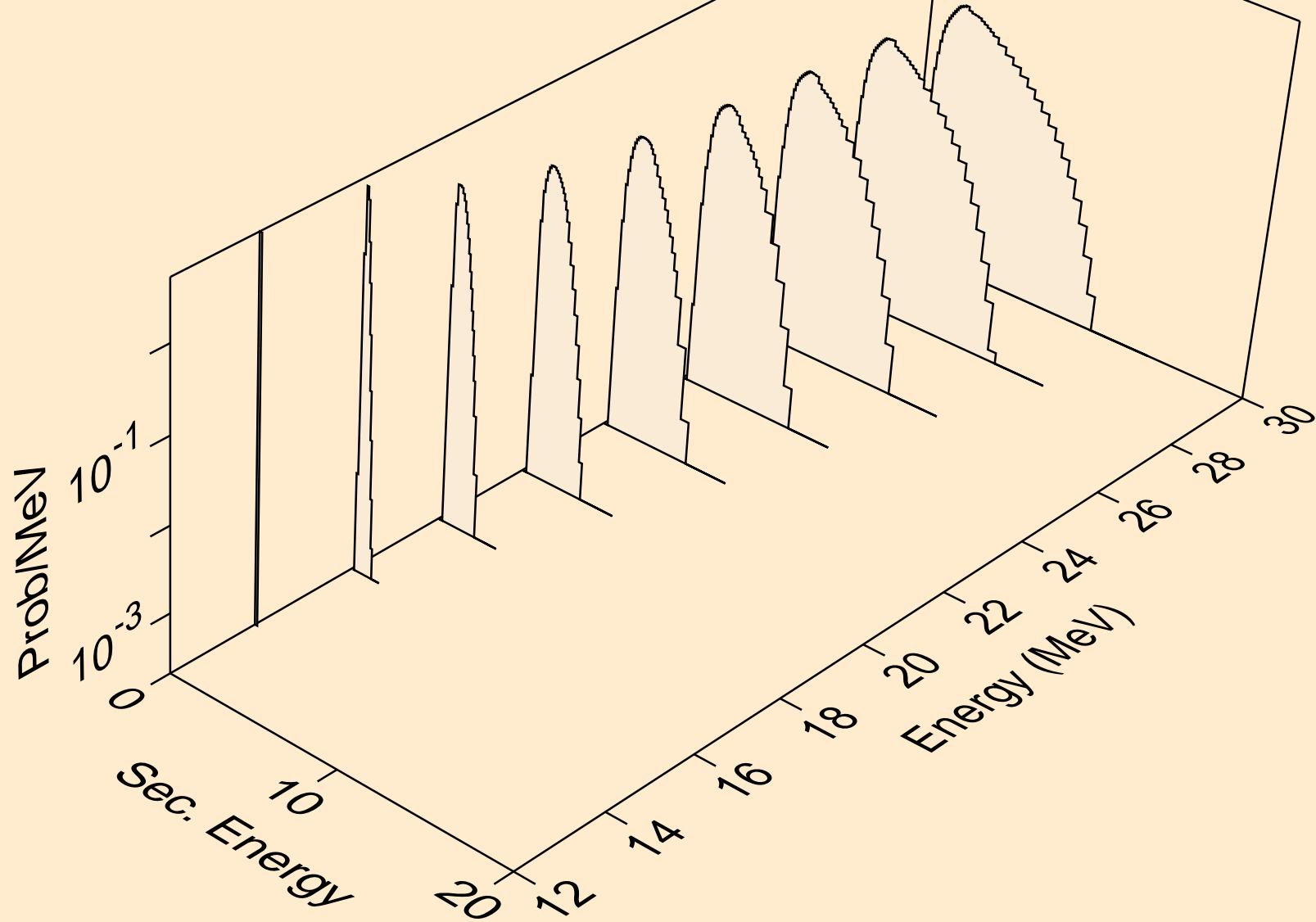

MG026 DEUTERON ACER TENDL-2023 LIBRARY; T=0.K  
protons from (d,p)

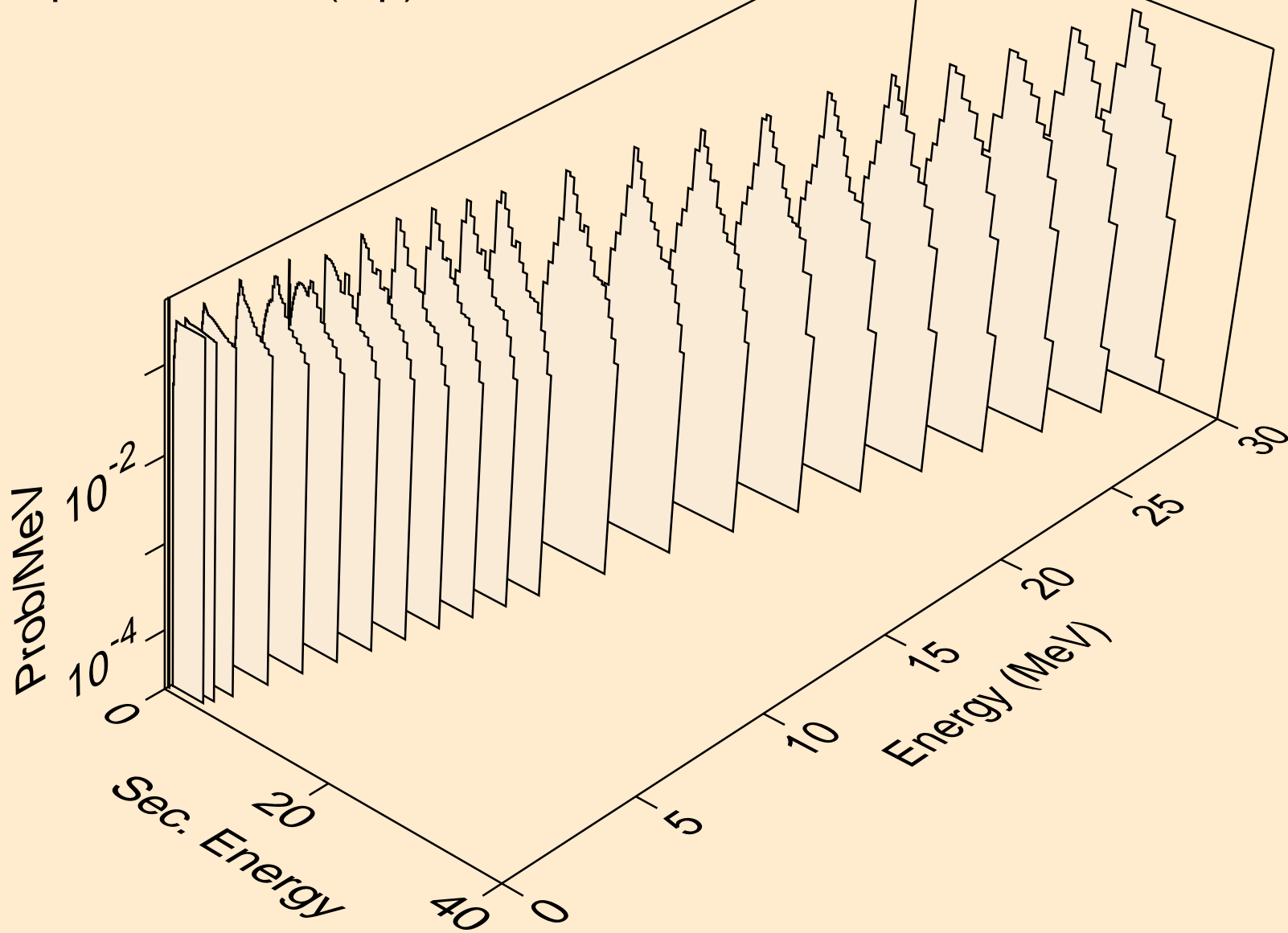

MG026 DEUTERON ACER TENDL-2023 LIBRARY; T=0.K  
protons from (d,2p)

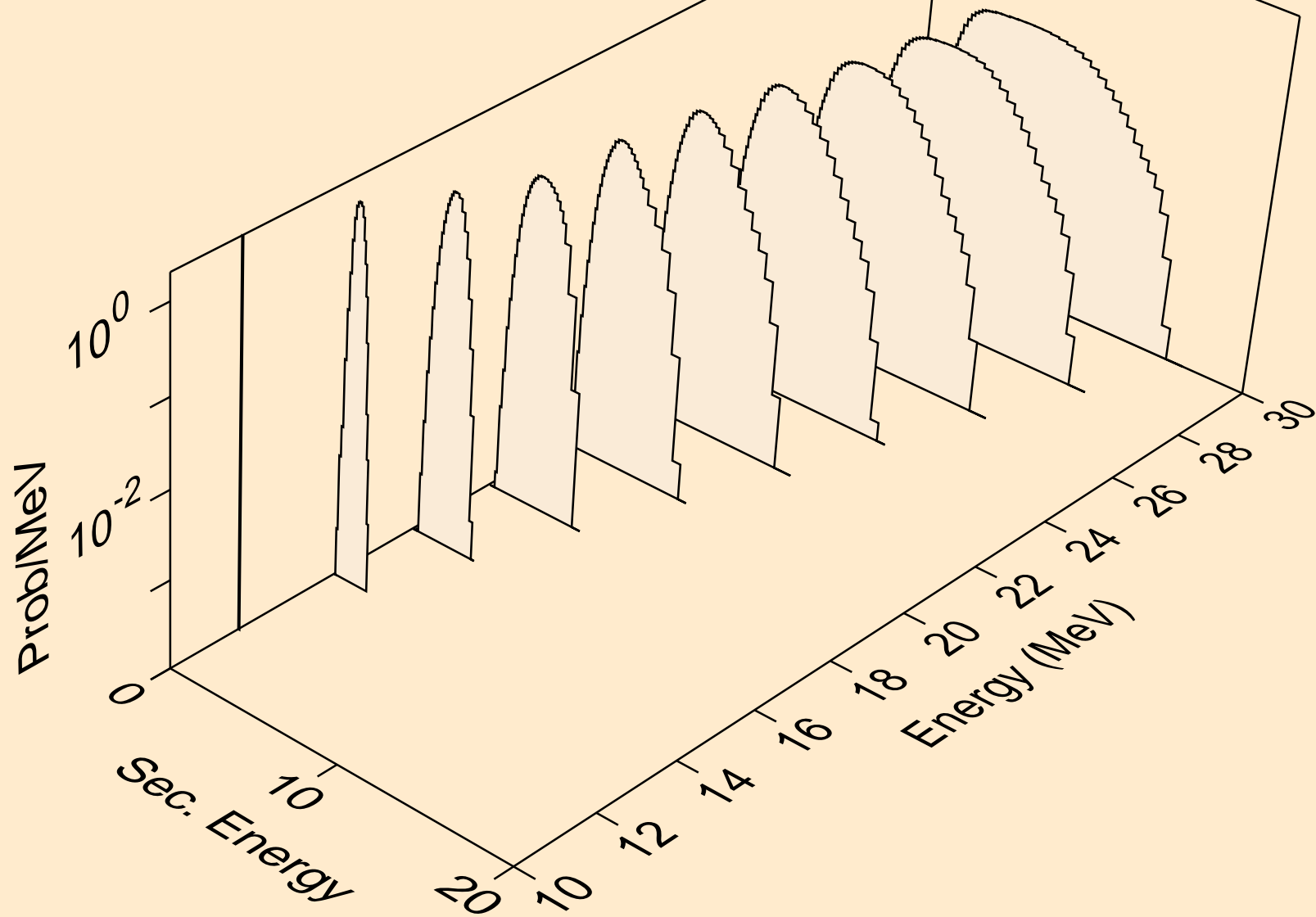

MG026 DEUTERON ACER TENDL-2023 LIBRARY; T=0.K  
protons from (d,pa)

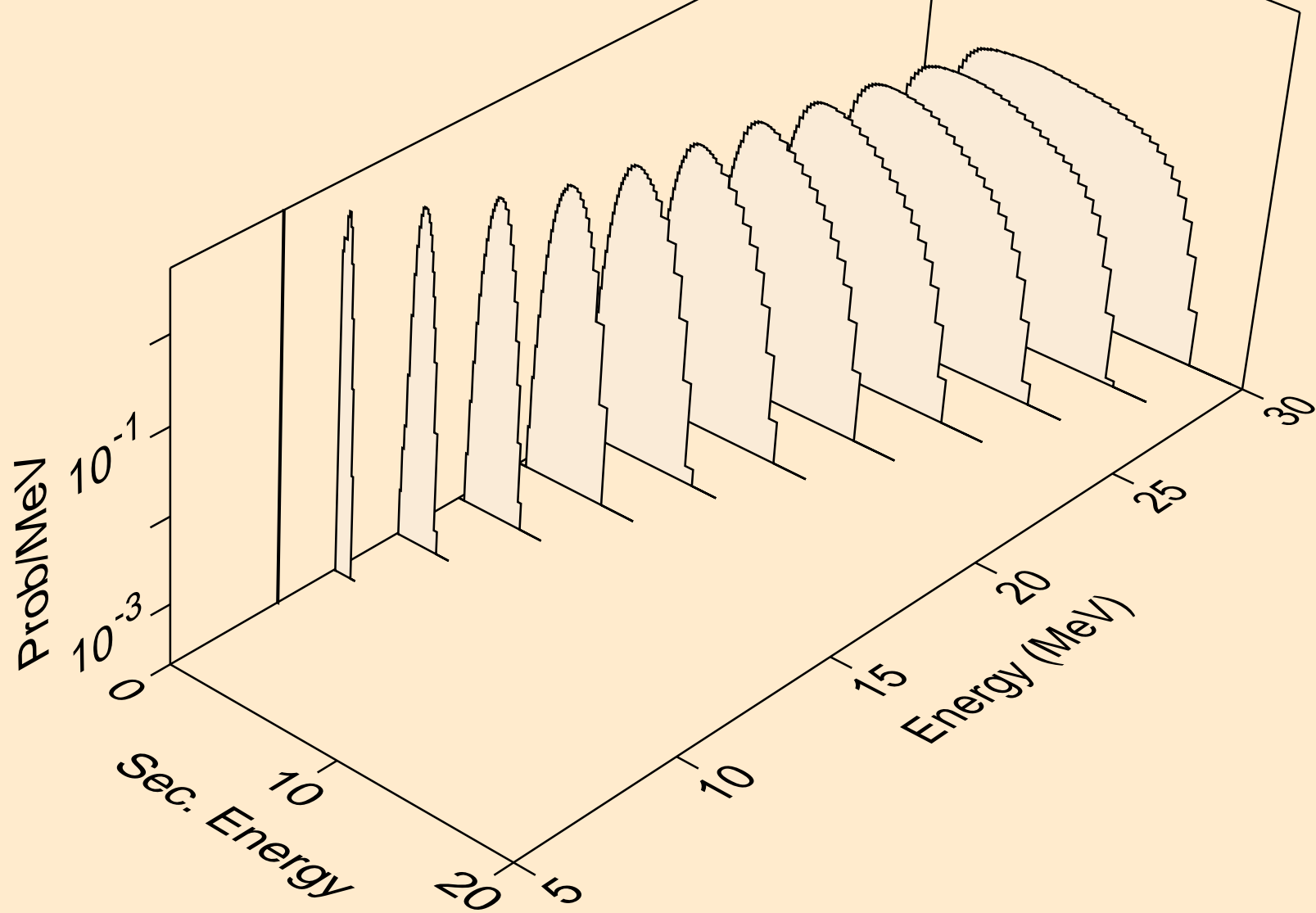

MG026 DEUTERON ACER TENDL-2023 LIBRARY; T=0.K  
protons from (d,pd)

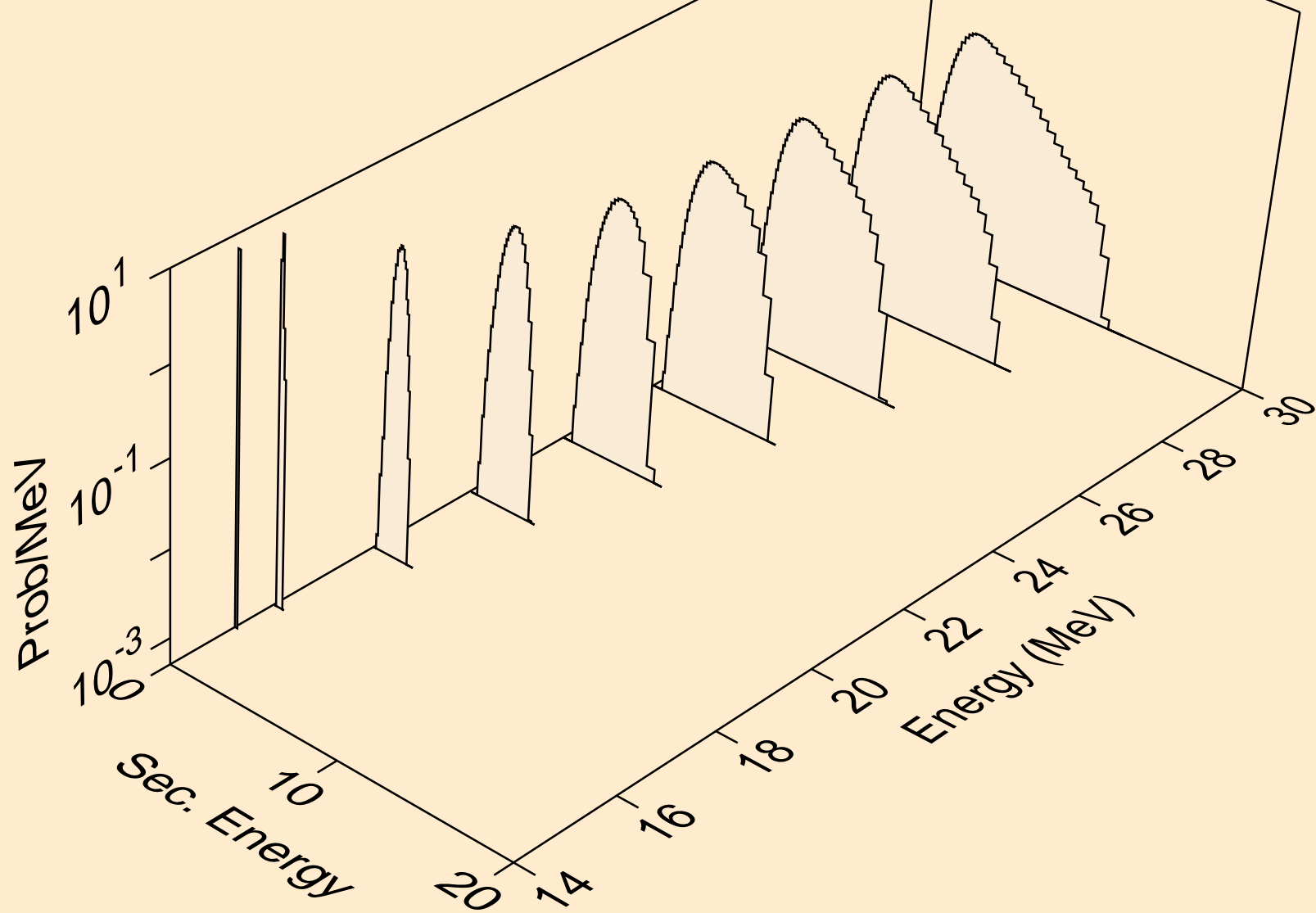

MG026 DEUTERON ACER TENDL-2023 LIBRARY; T=0.K  
protons from (d,pt)

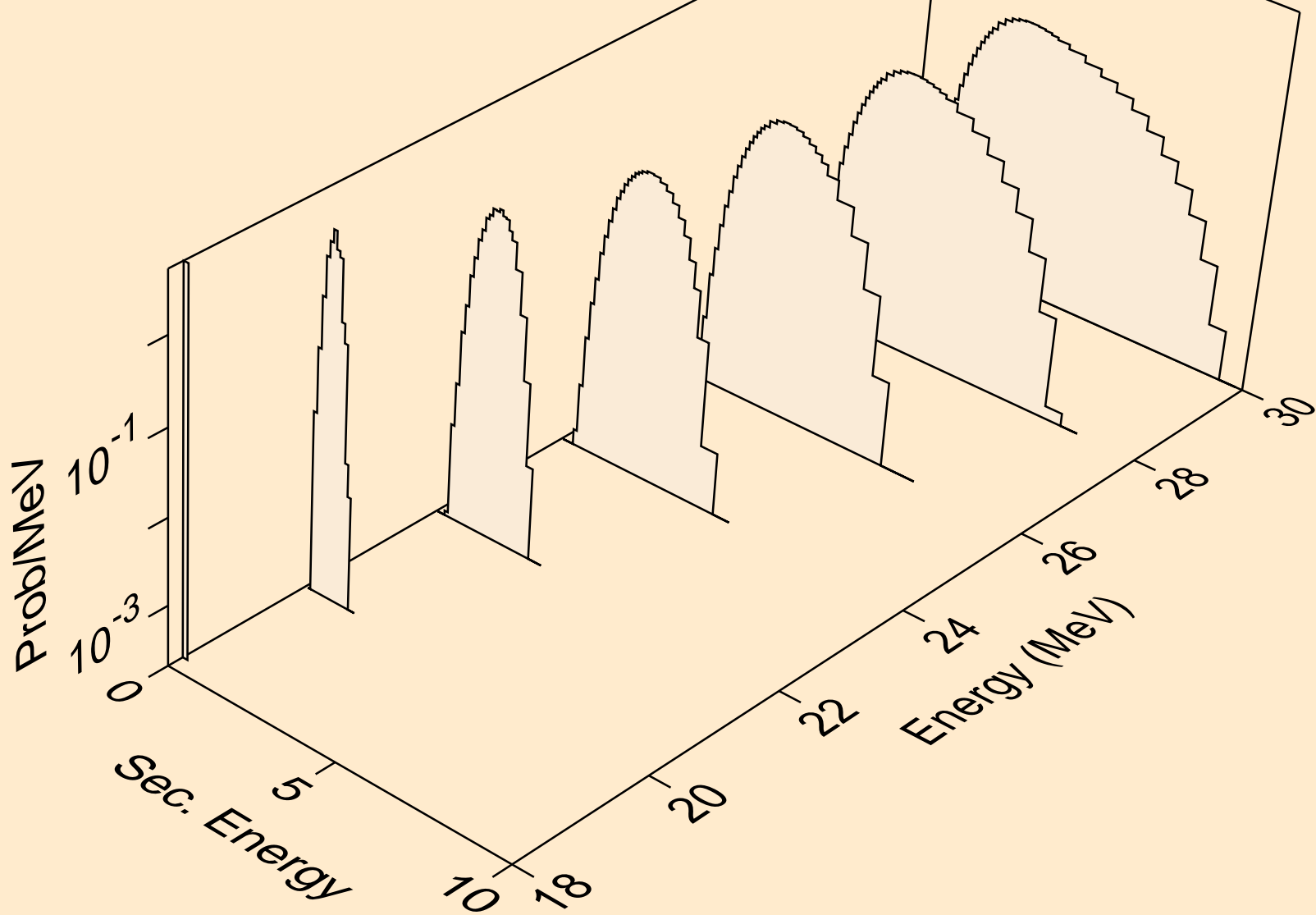

MG026 DEUTERON ACER TENDL-2023 LIBRARY; T=0.K  
tritons from (d,x)

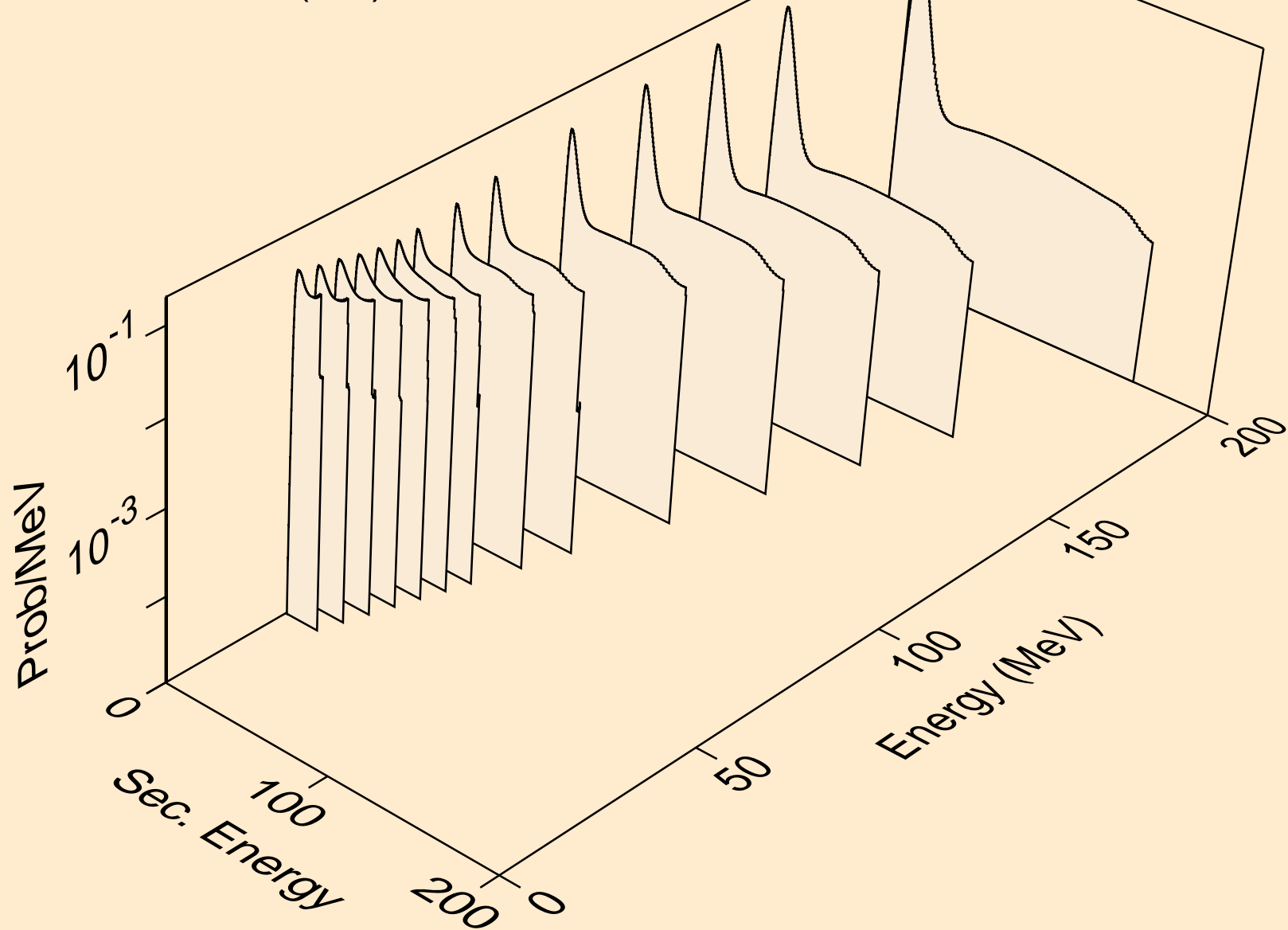

MG026 DEUTERON ACER TENDL-2023 LIBRARY; T=0.K  
tritons from (d,n\*)t

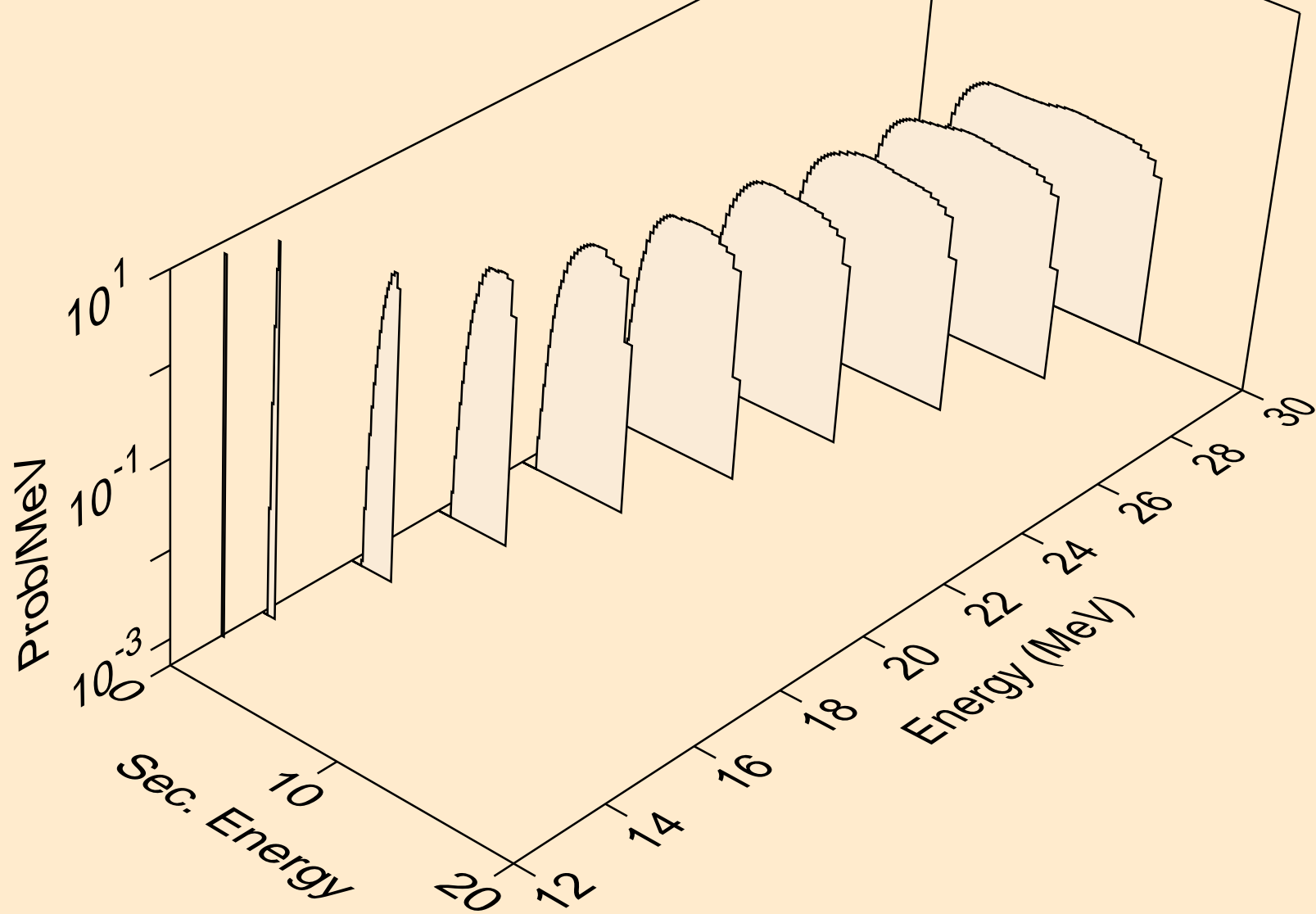



MG026 DEUTERON ACER TENDL-2023 LIBRARY; T=0.K  
tritons from (d,t)

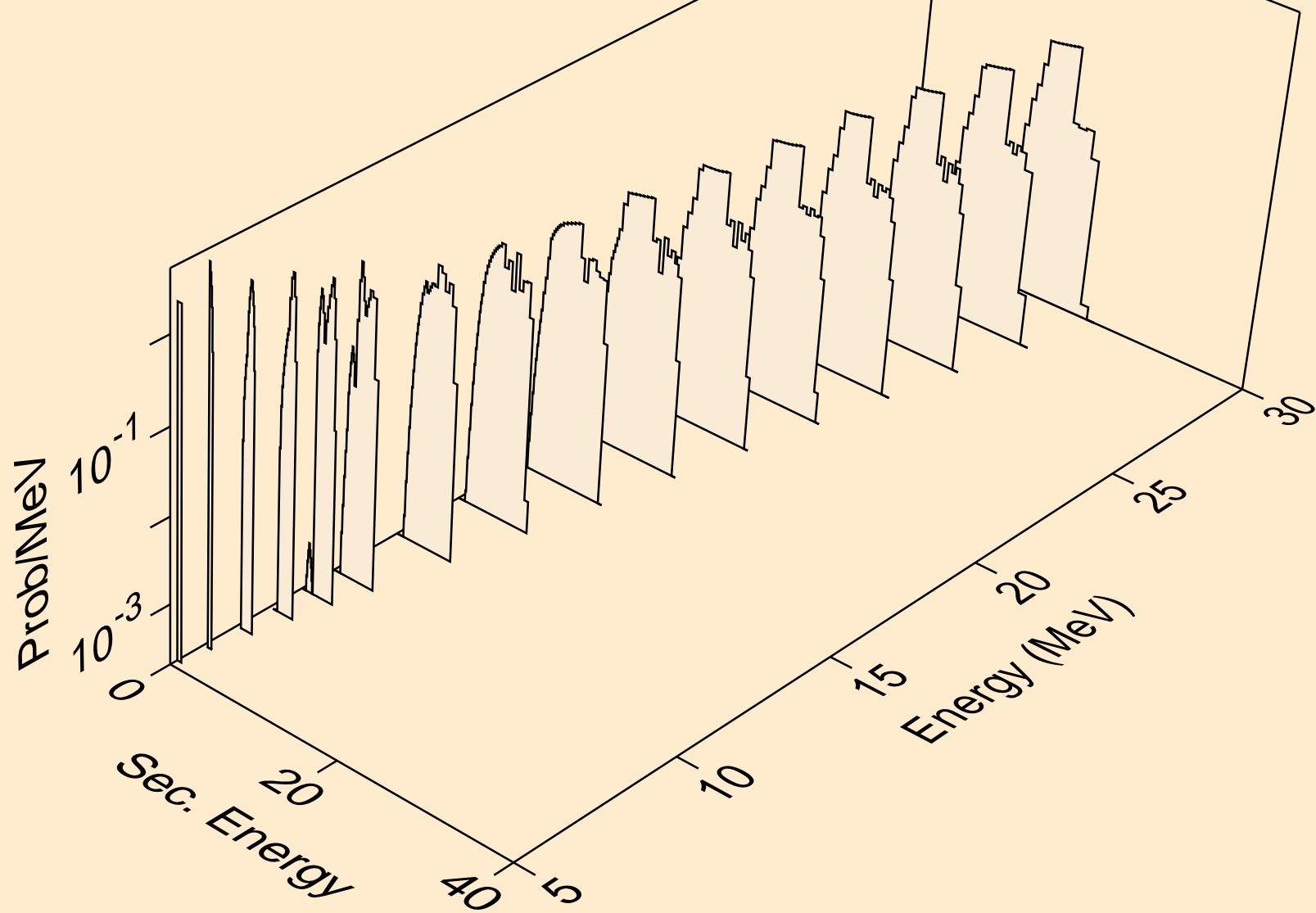

MG026 DEUTERON ACER TENDL-2023 LIBRARY; T=0.K  
tritons from (d,pt)

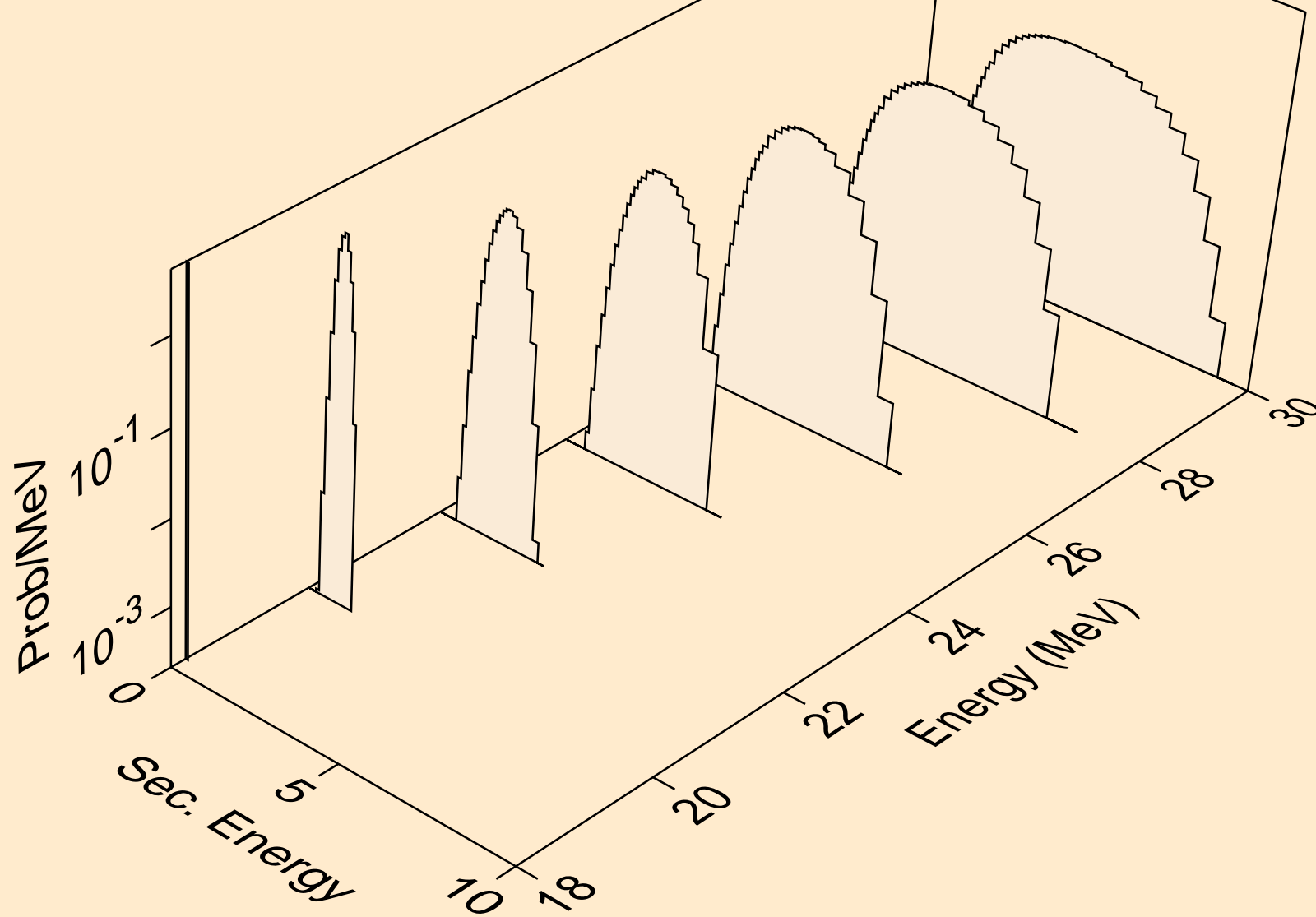

MG026 DEUTERON ACER TENDL-2023 LIBRARY; T=0.K  
he3s from (d,x)

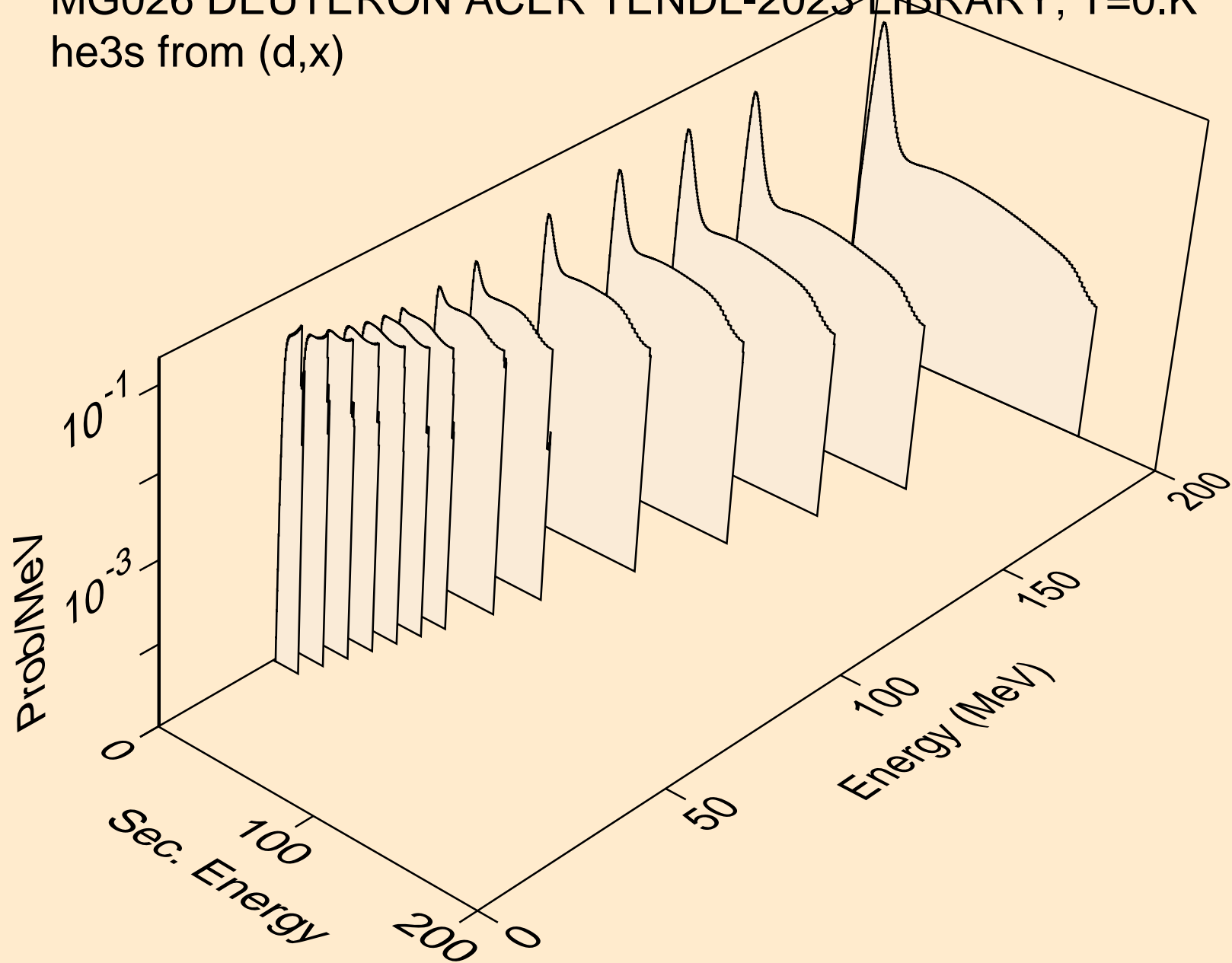

MG026 DEUTERON ACER TENDL-2023 LIBRARY; T=0.K  
he3s from (d,n\*)he3

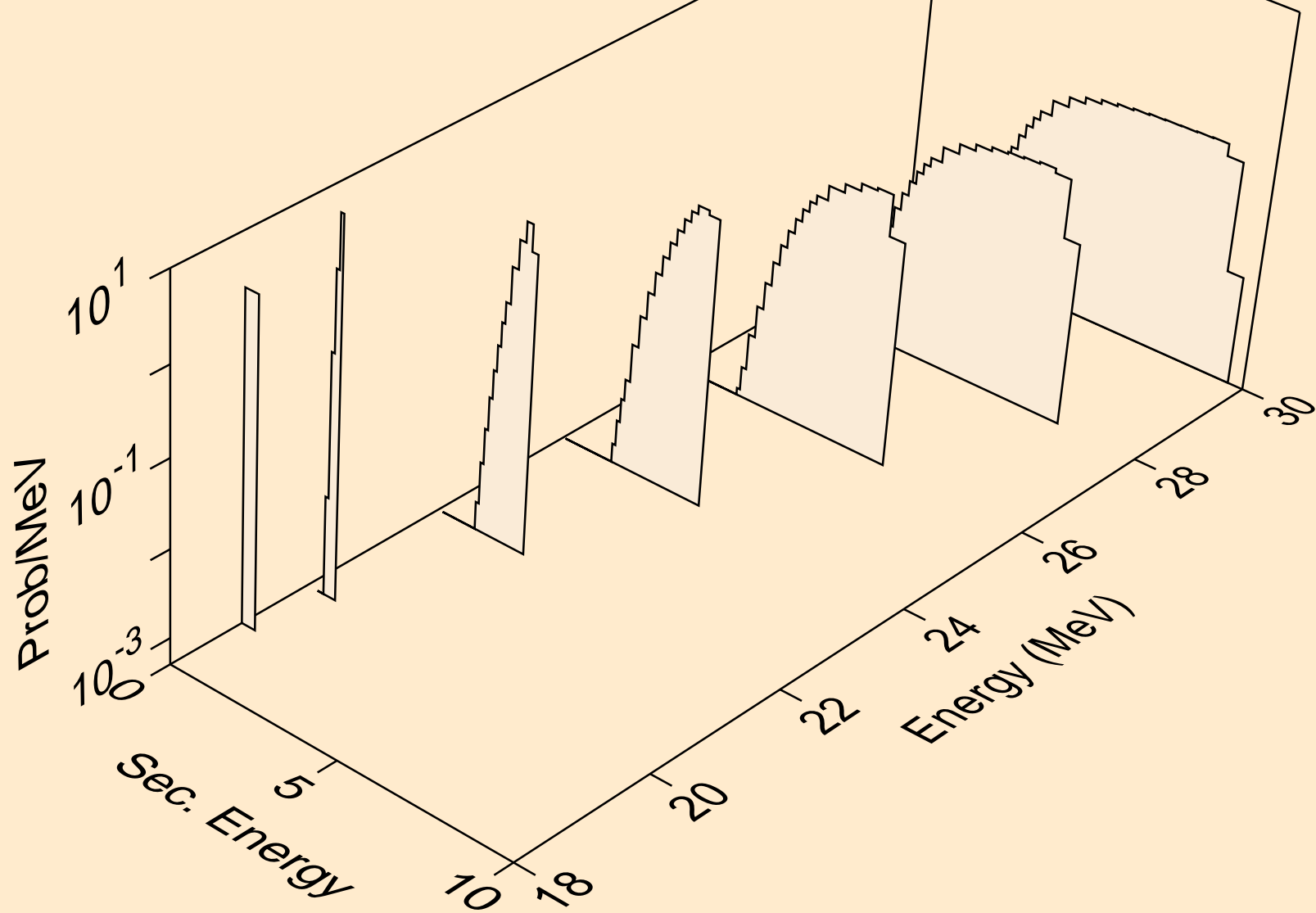

MG026 DEUTERON ACER TENDL-2023 LIBRARY; T=0.K  
he3s from (d,he3)

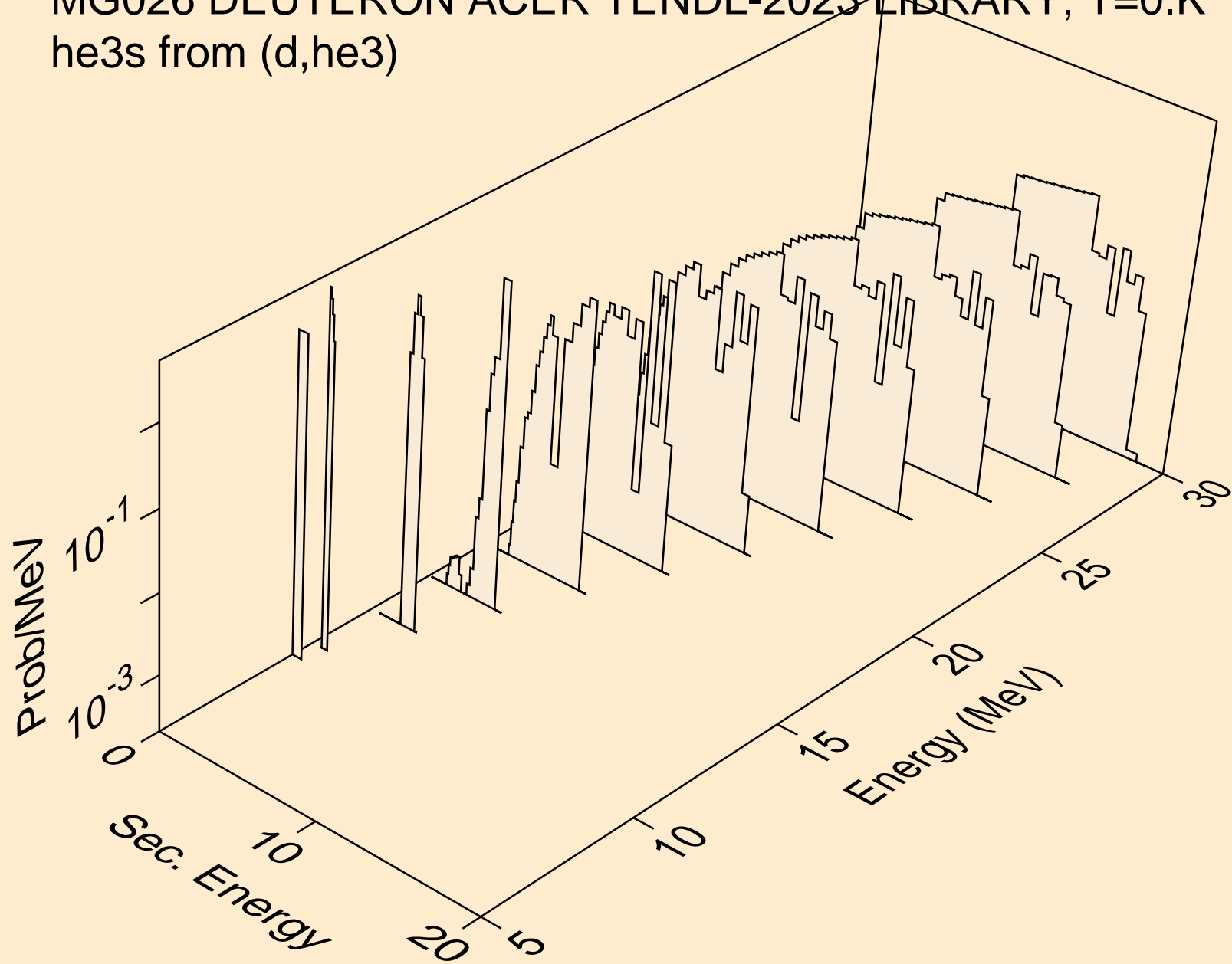

MG026 DEUTERON ACER TENDL-2023 LIBRARY; T=0.K  
alphas from (d,x)

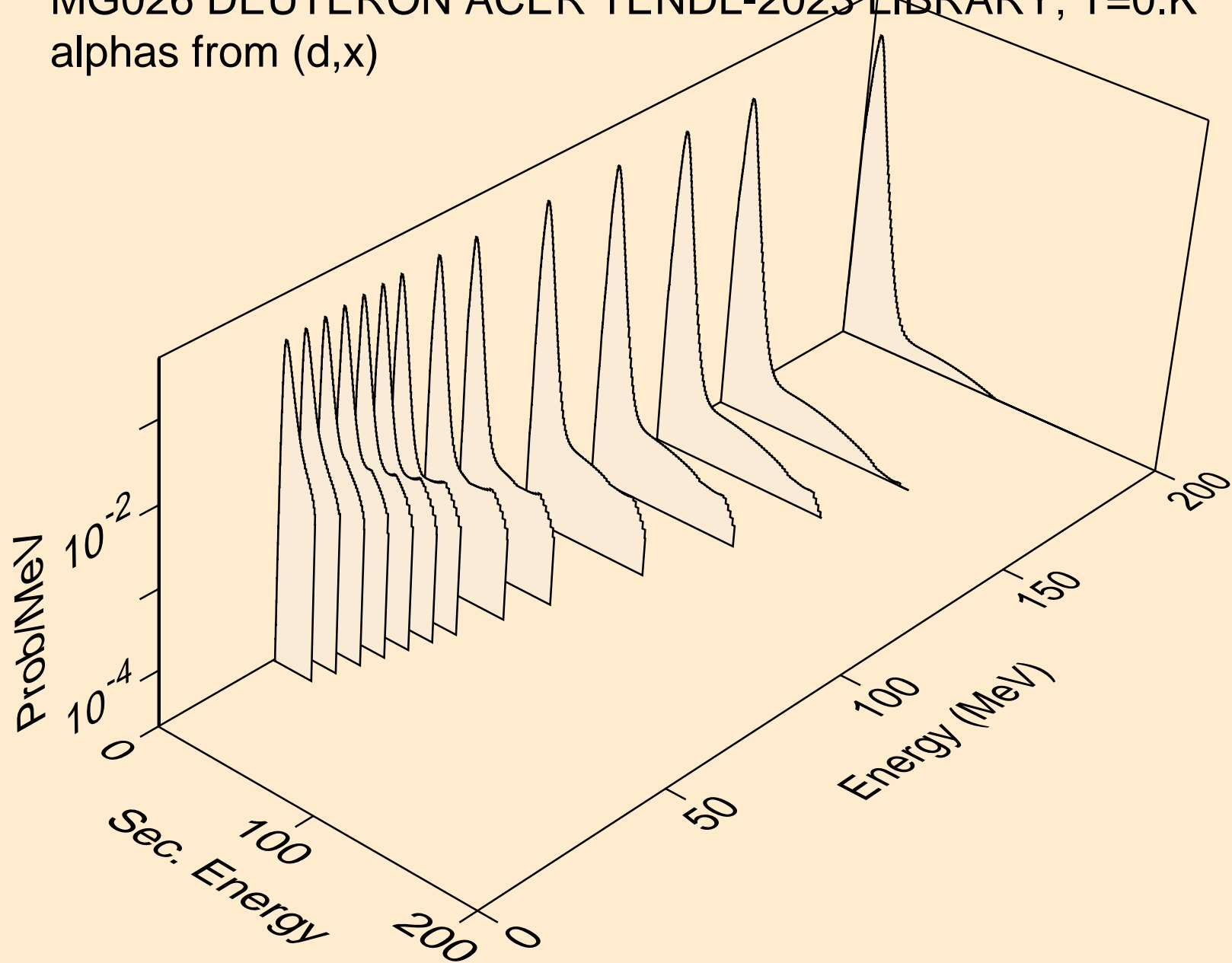

MG026 DEUTERON ACER TENDL-2023 LIBRARY; T=0.K  
alphas from (d,n\*)a

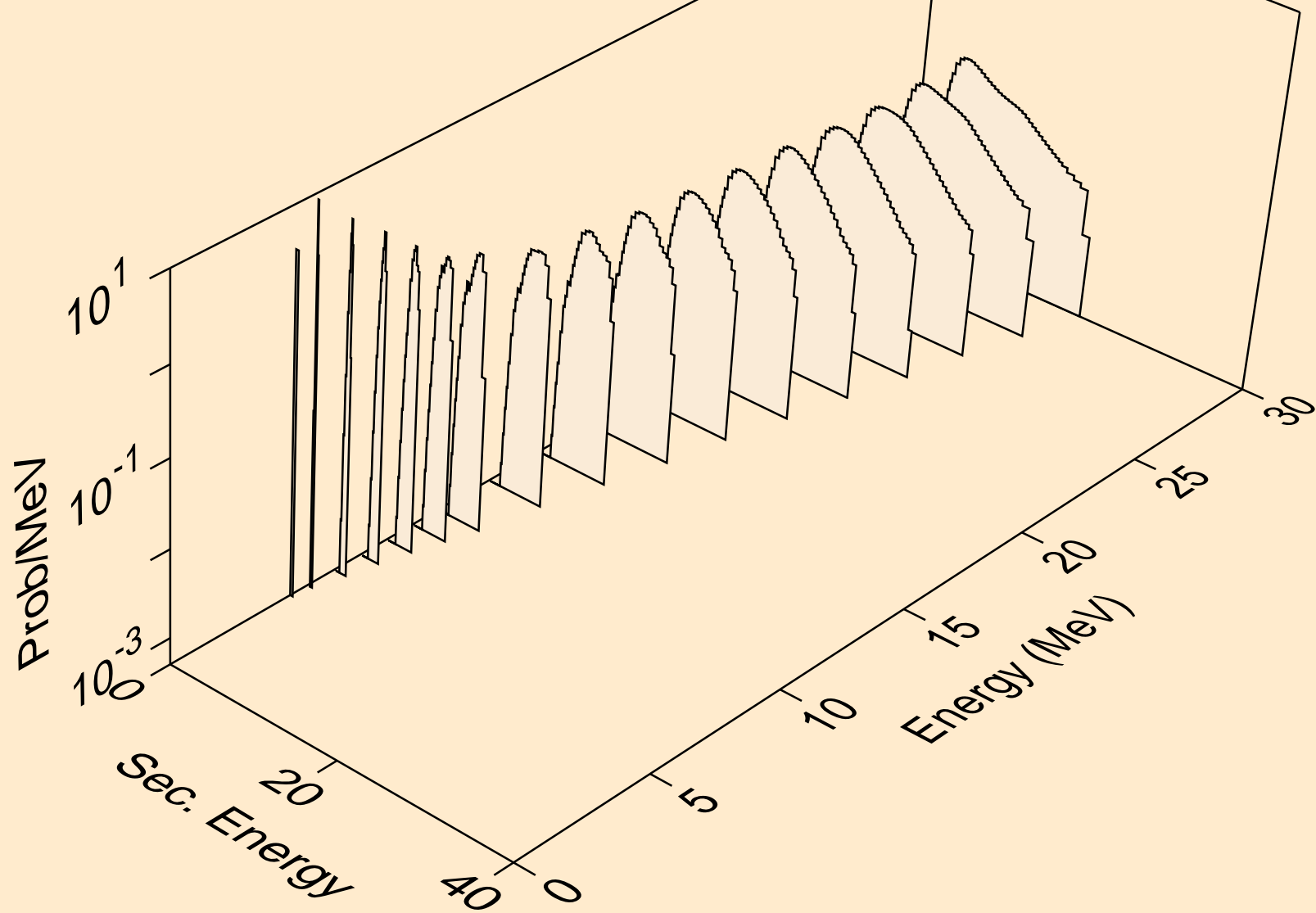

MG026 DEUTERON ACER TENDL-2023 LIBRARY; T=0.K  
alphas from (d,n\*)3a

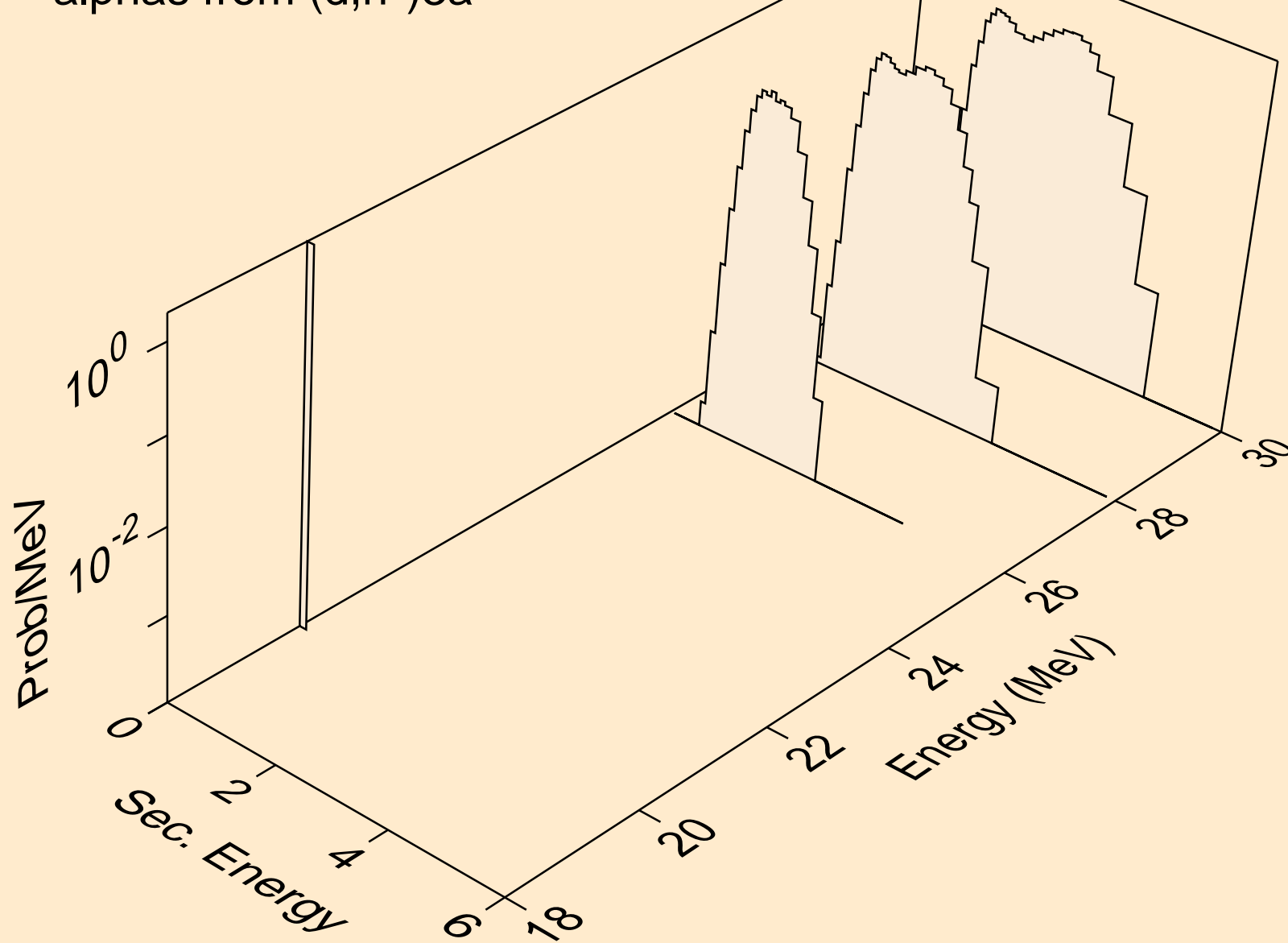



MG026 DEUTERON ACER TENDL-2023 LIBRARY; T=0.K  
alphas from (d,2n)a

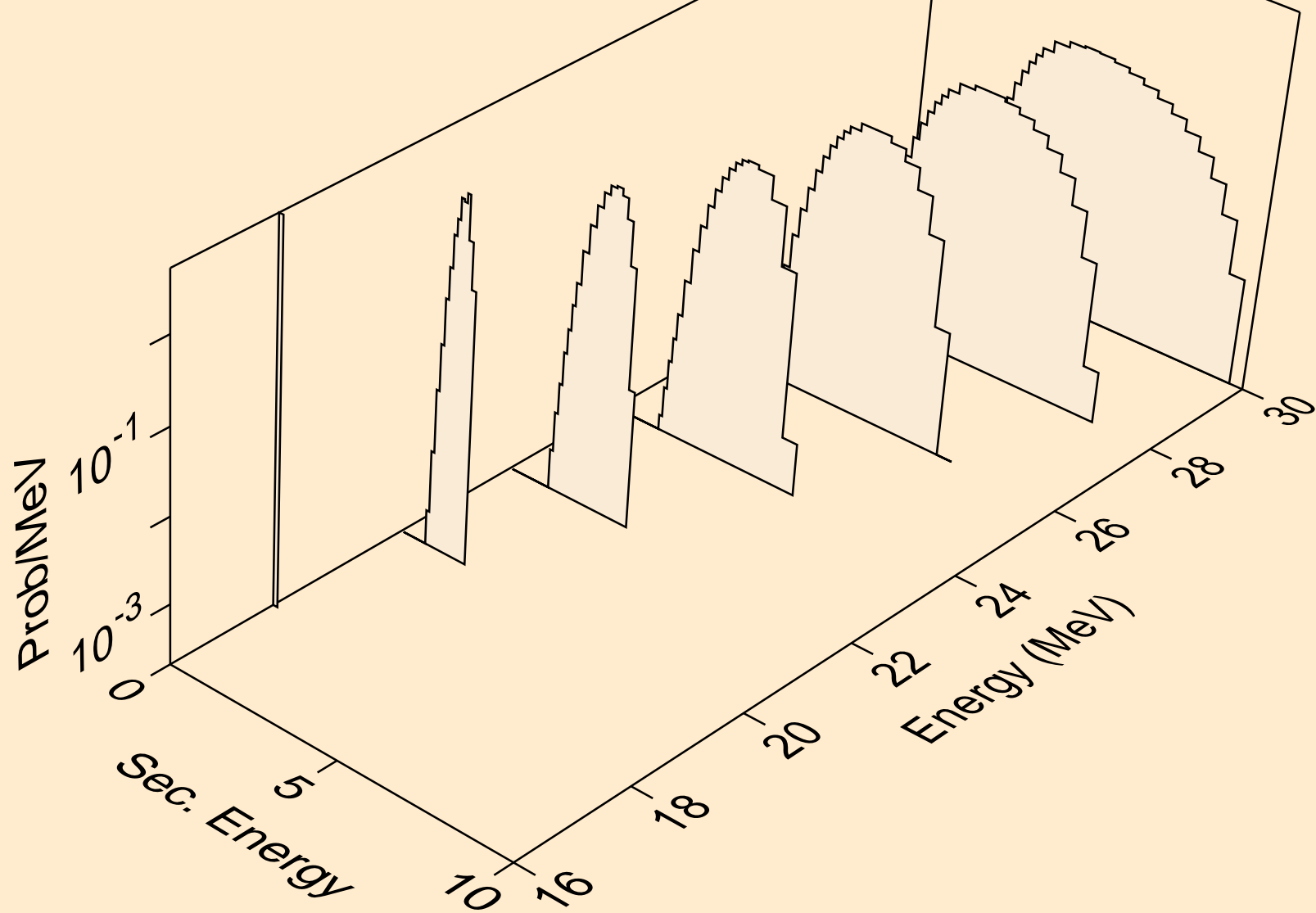

MG026 DEUTERON ACER TENDL-2023 LIBRARY; T=0.K  
alphas from (d,n\*)2a

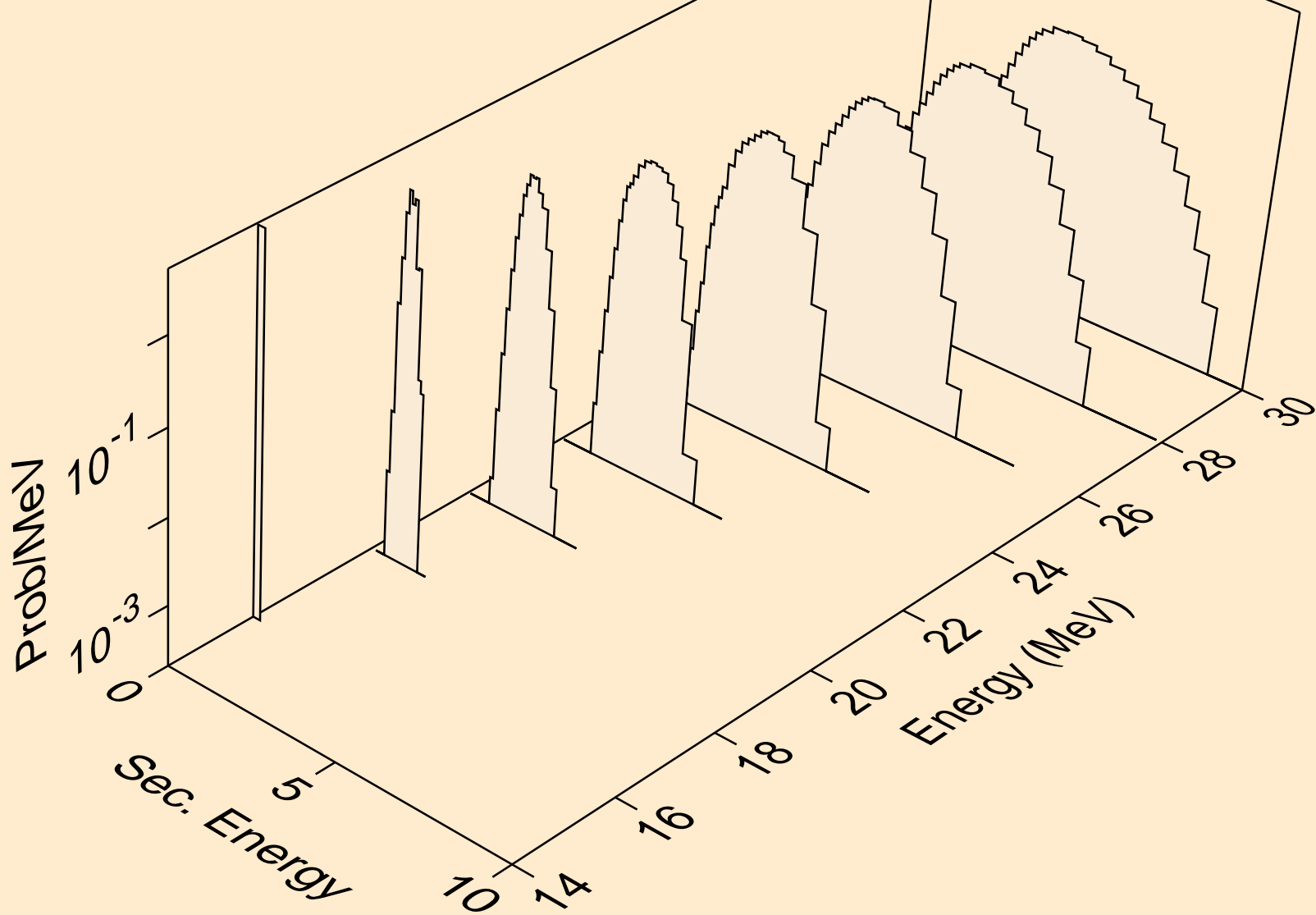

MG026 DEUTERON ACER TENDL-2023 LIBRARY; T=0.K  
alphas from (d,npa)

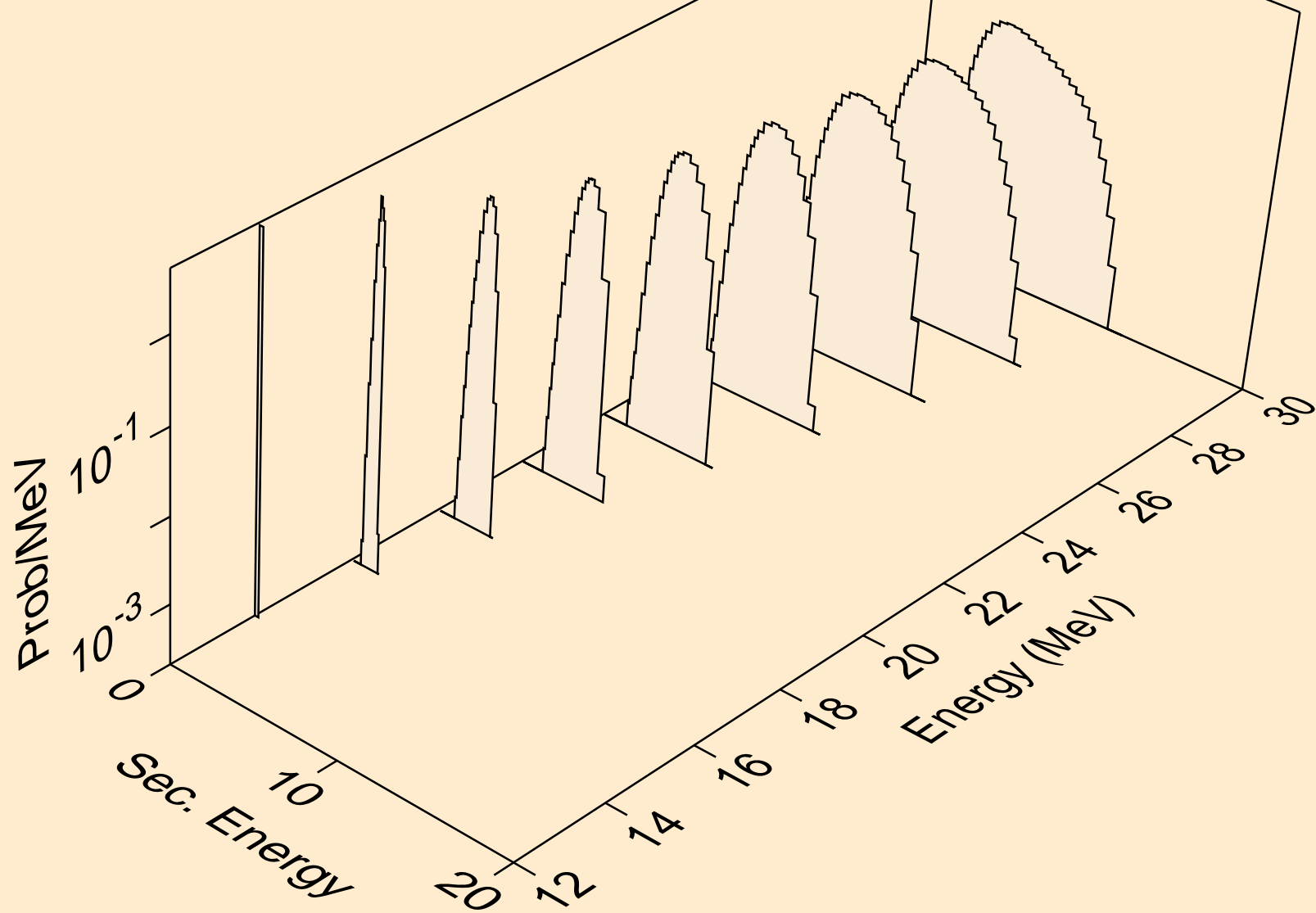

MG026 DEUTERON ACER TENDL-2023 LIBRARY; T=0.K  
alphas from (d,a)

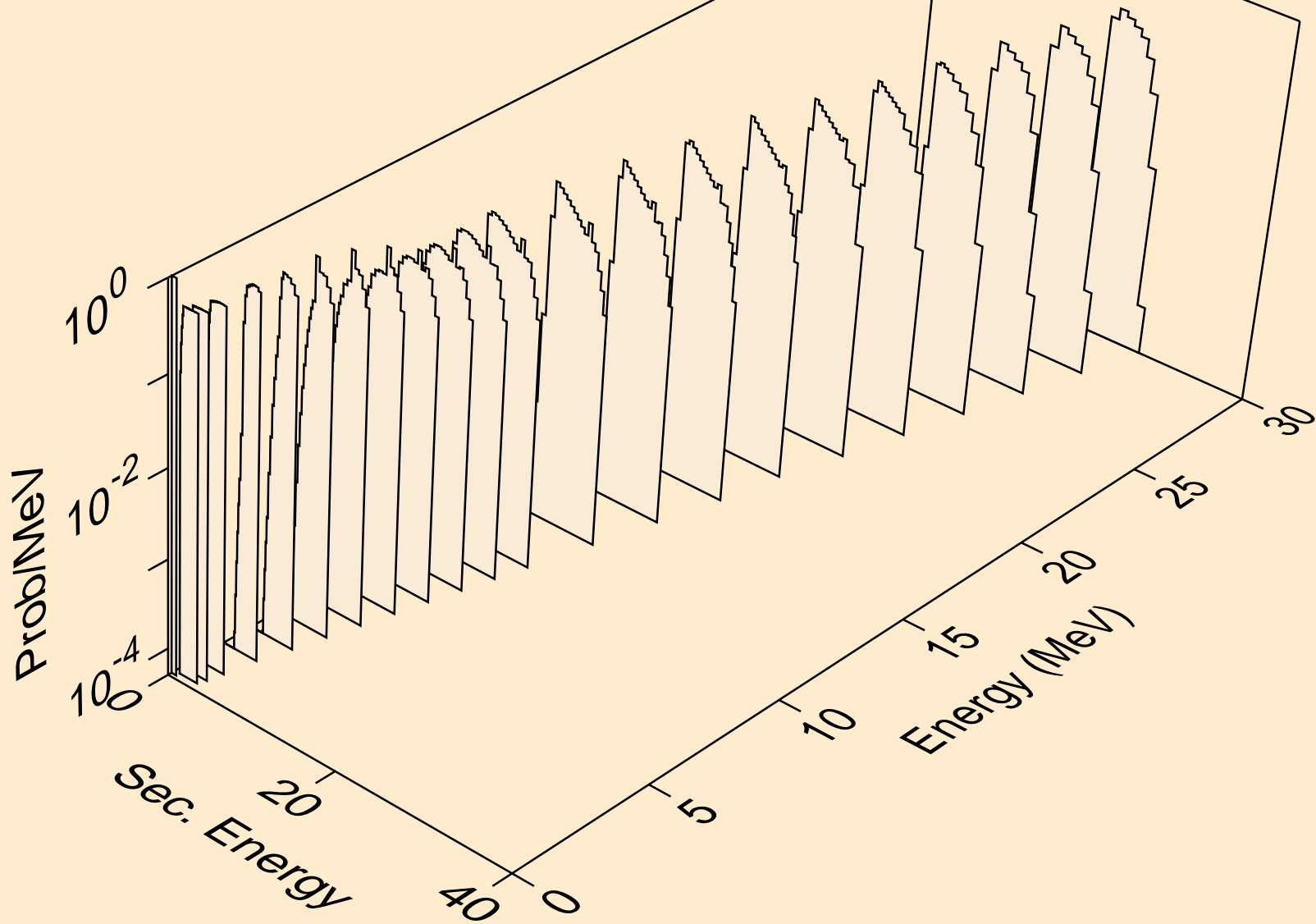

MG026 DEUTERON ACER TENDL-2023 LIBRARY; T=0.K  
alphas from (d,2a)

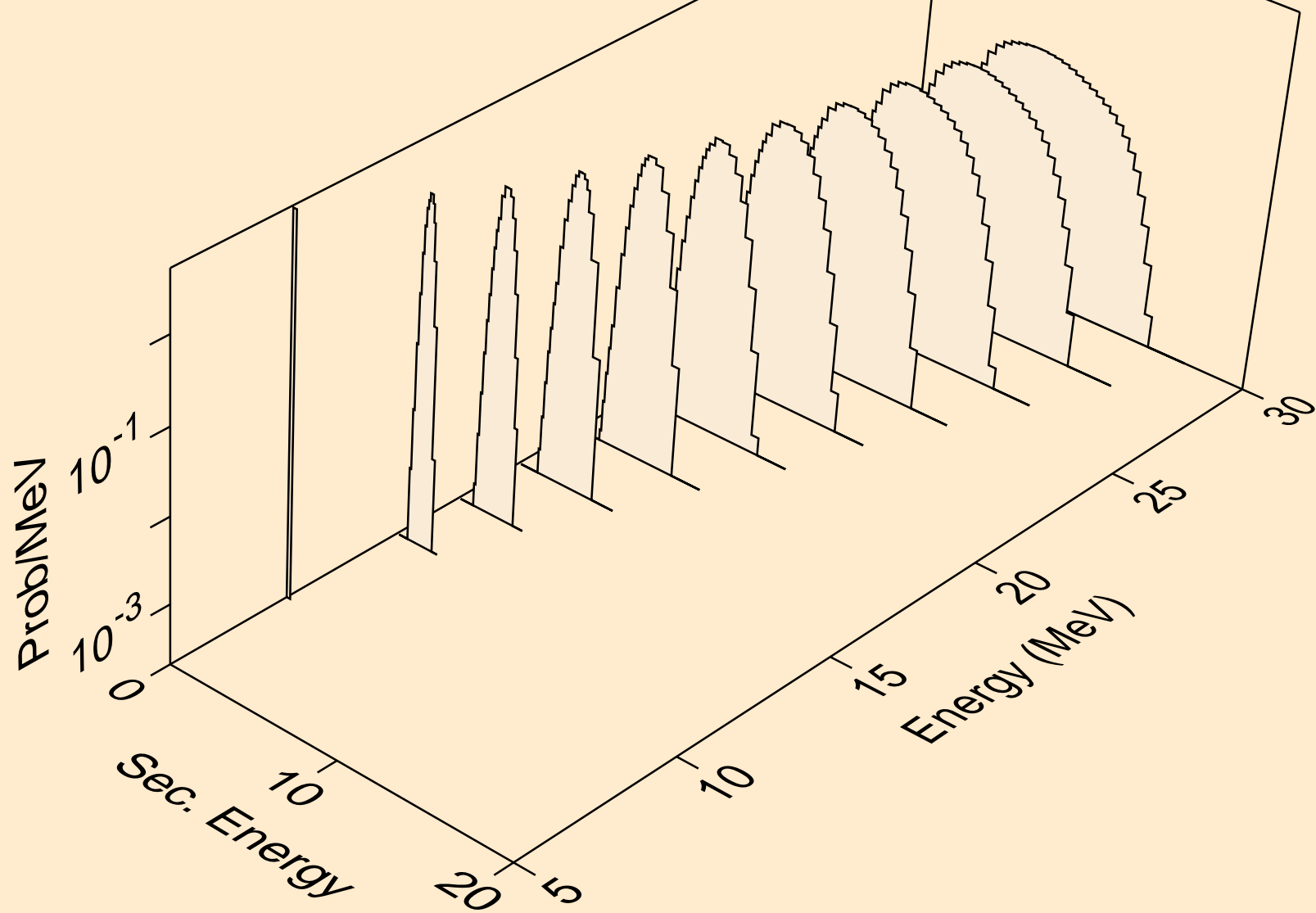

MG026 DEUTERON ACER TENDL-2023 LIBRARY; T=0.K  
alphas from (d,3a)

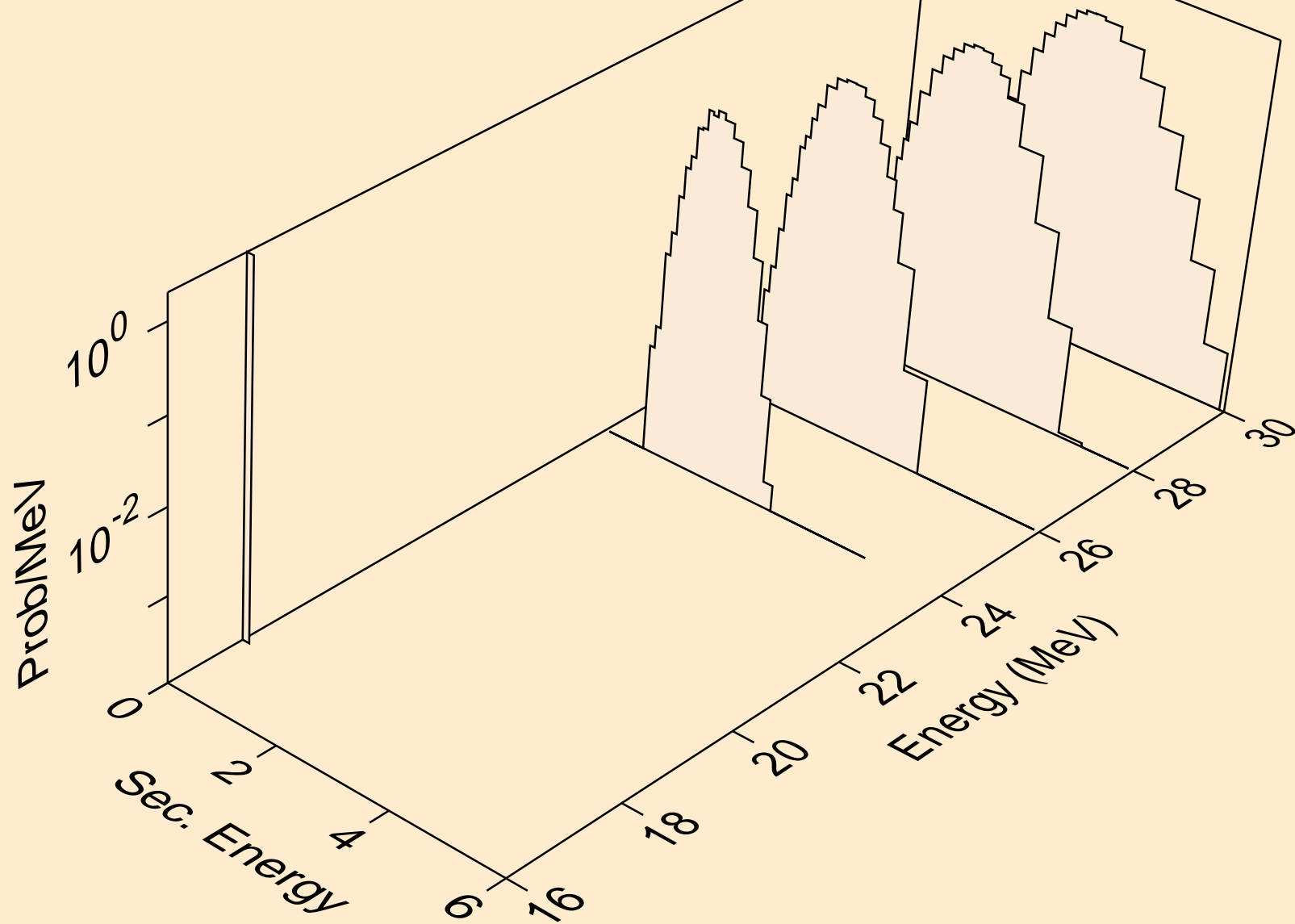

MG026 DEUTERON ACER TENDL-2023 LIBRARY; T=0.K  
alphas from (d,pa)

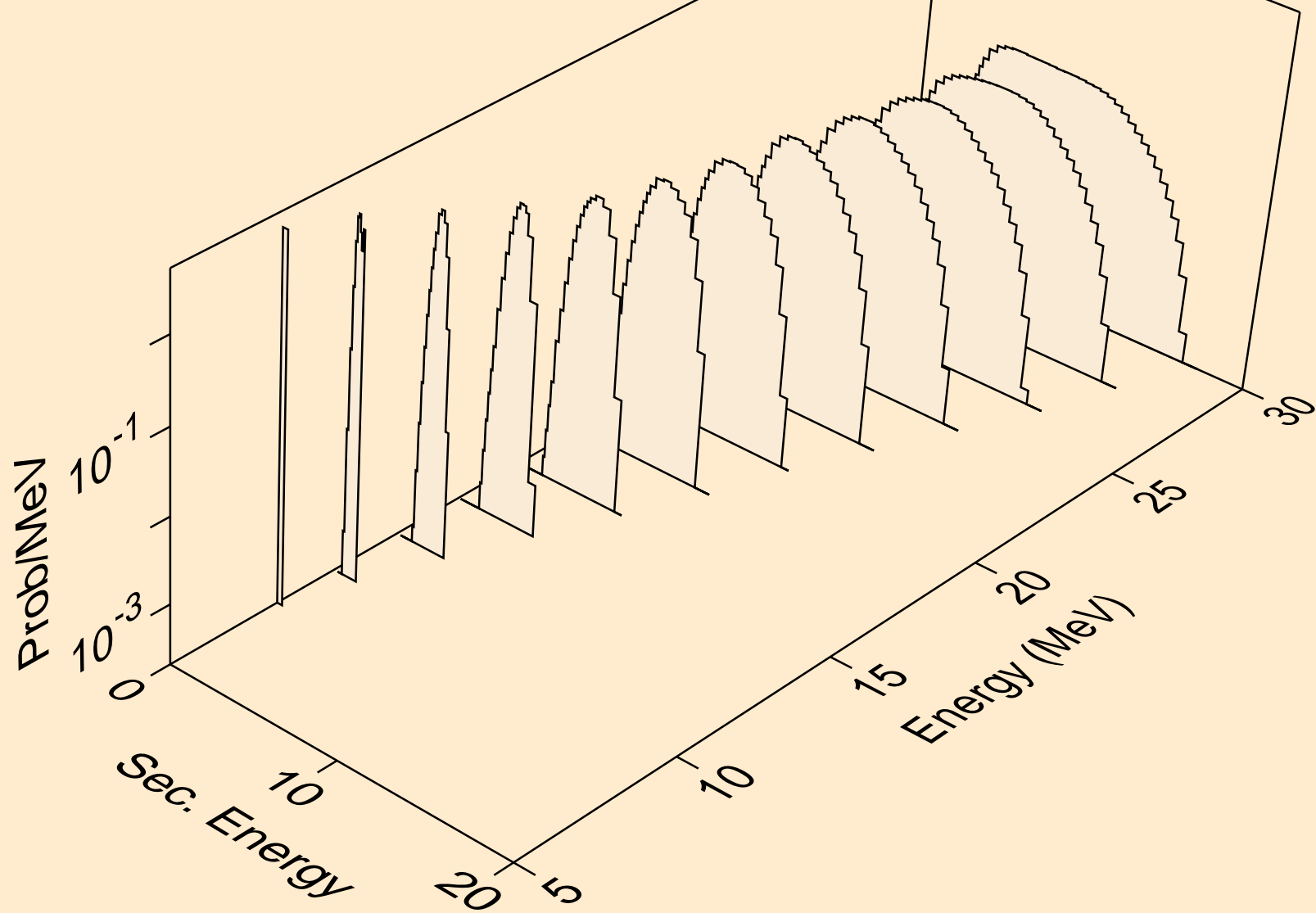

MG026 DEUTERON ACER TENDL-2023 LIBRARY; T=0.K  
alphas from (d,d2a)

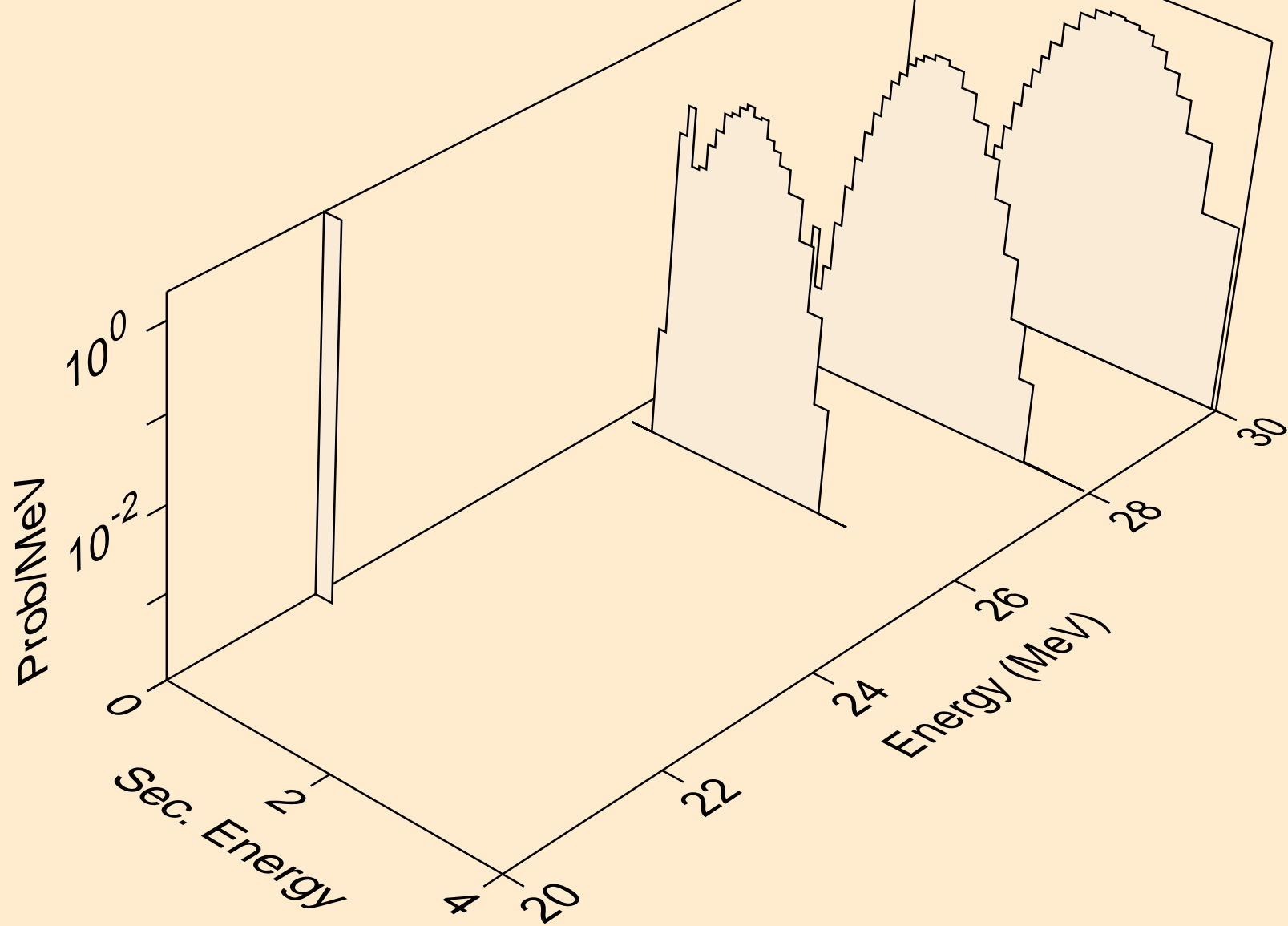



MG026 DEUTERON ACER TENDL-2023 LIBRARY; T=0.K  
alphas from (d,da)

