

MT281 DEUTERON ACER TENDL-2023 LIBRARY; T=0.K

Principal cross sections

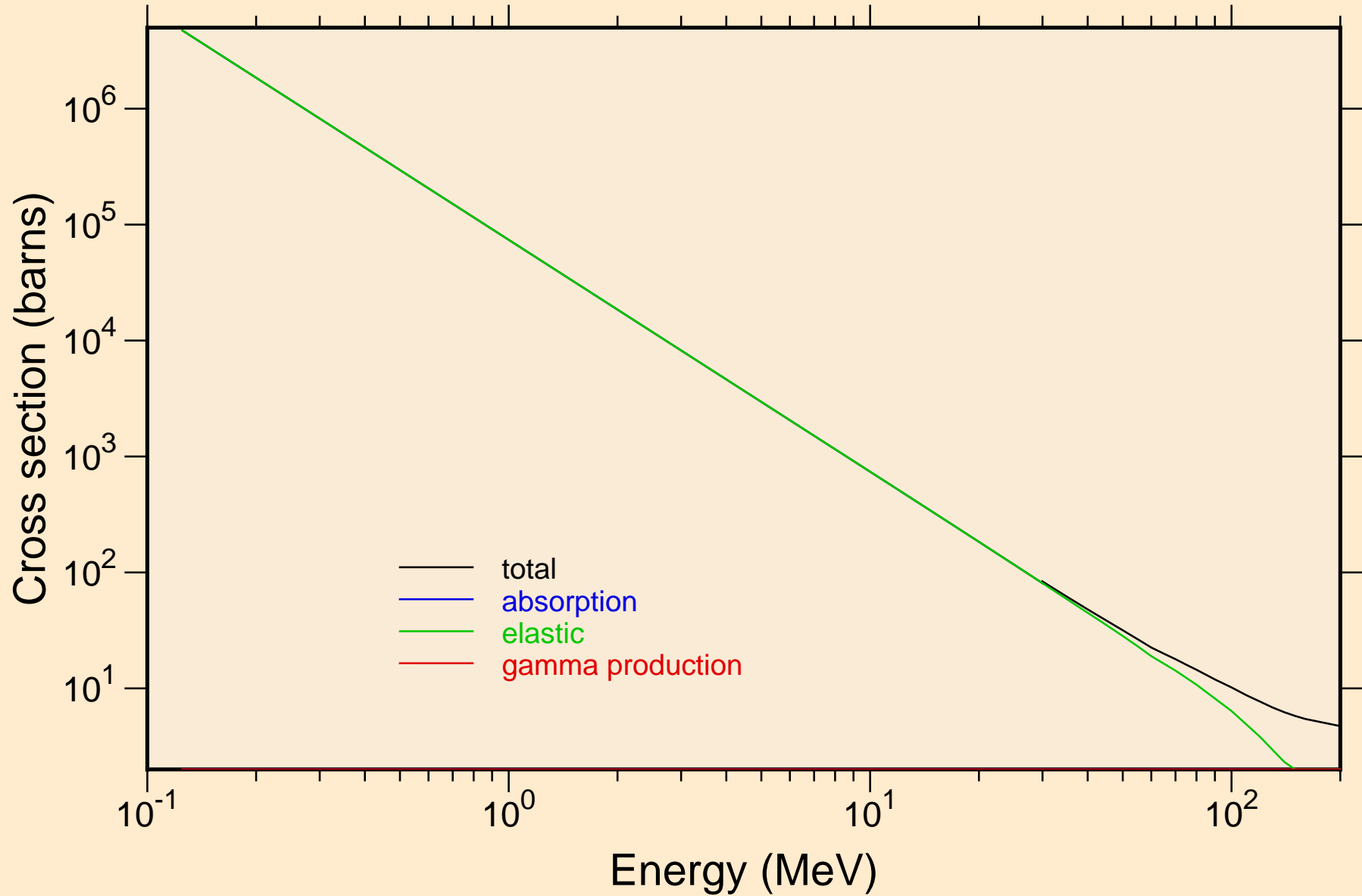

MT281 DEUTERON ACER TENDL-2023 LIBRARY; T=0.K
Heating

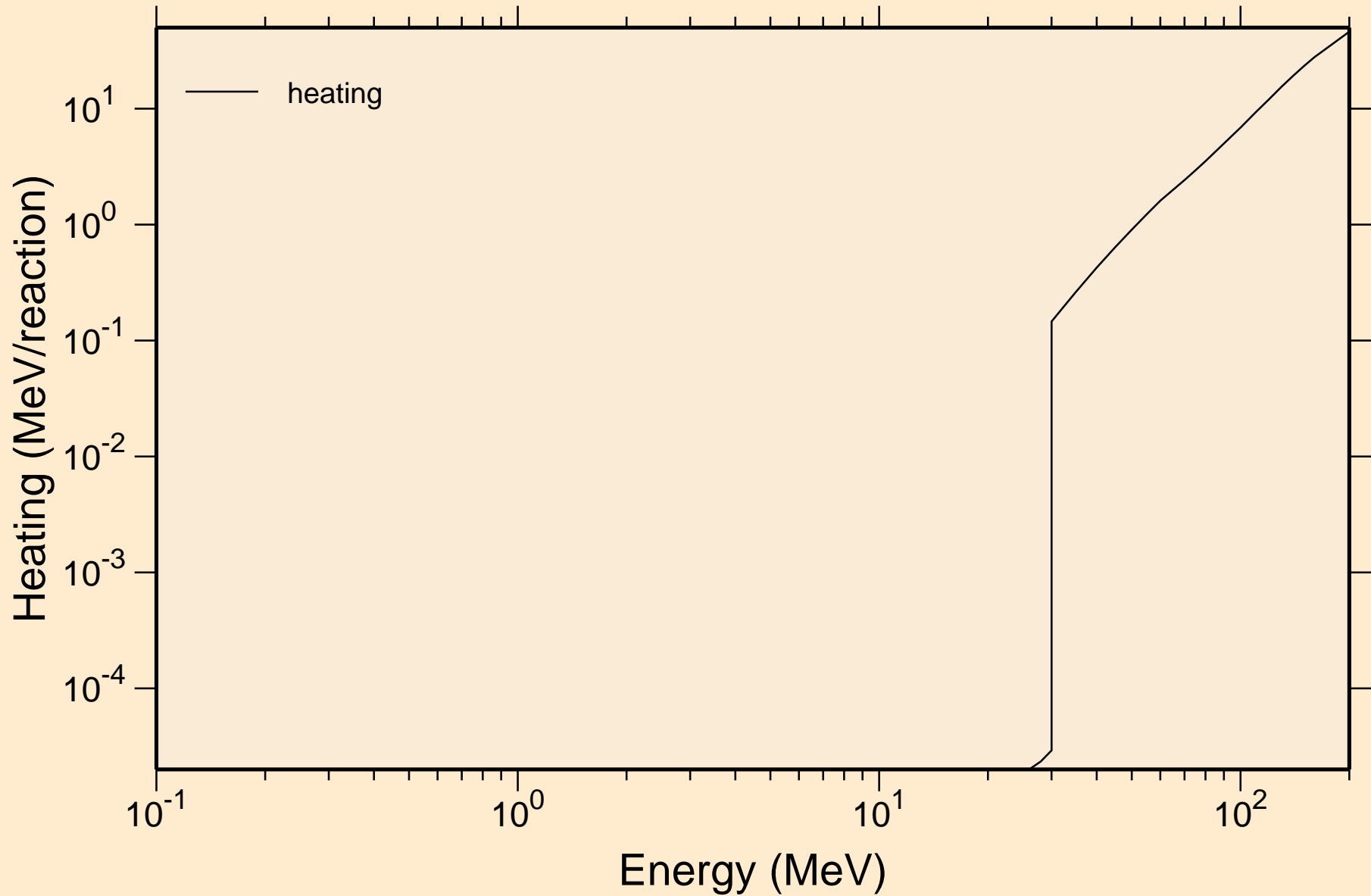

MT281 DEUTERON ACER TENDL-2023 LIBRARY; T=0.K
Principal cross sections

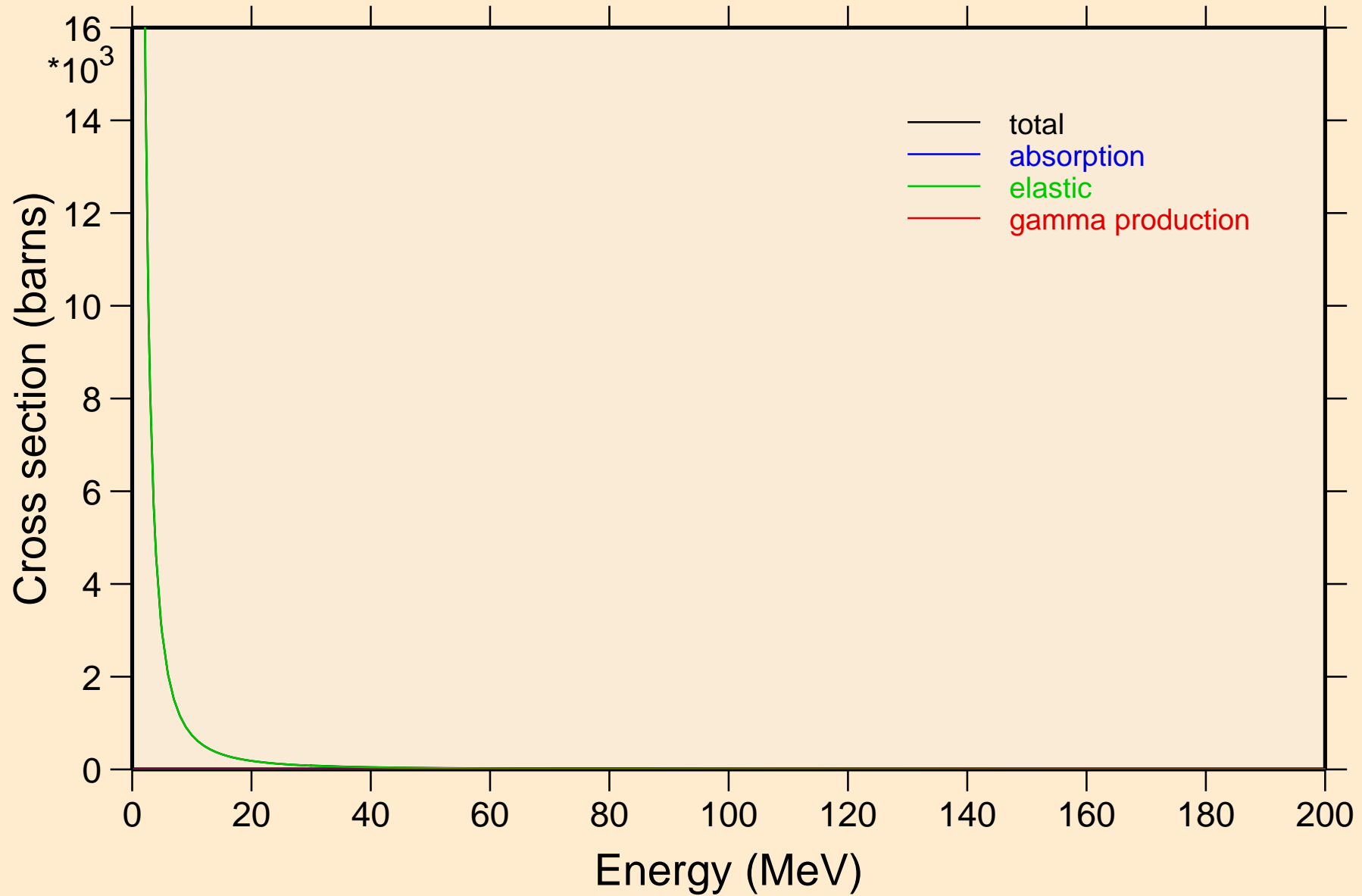

MT281 DEUTERON ACER TENDL-2023 LIBRARY; T=0.K

Heating

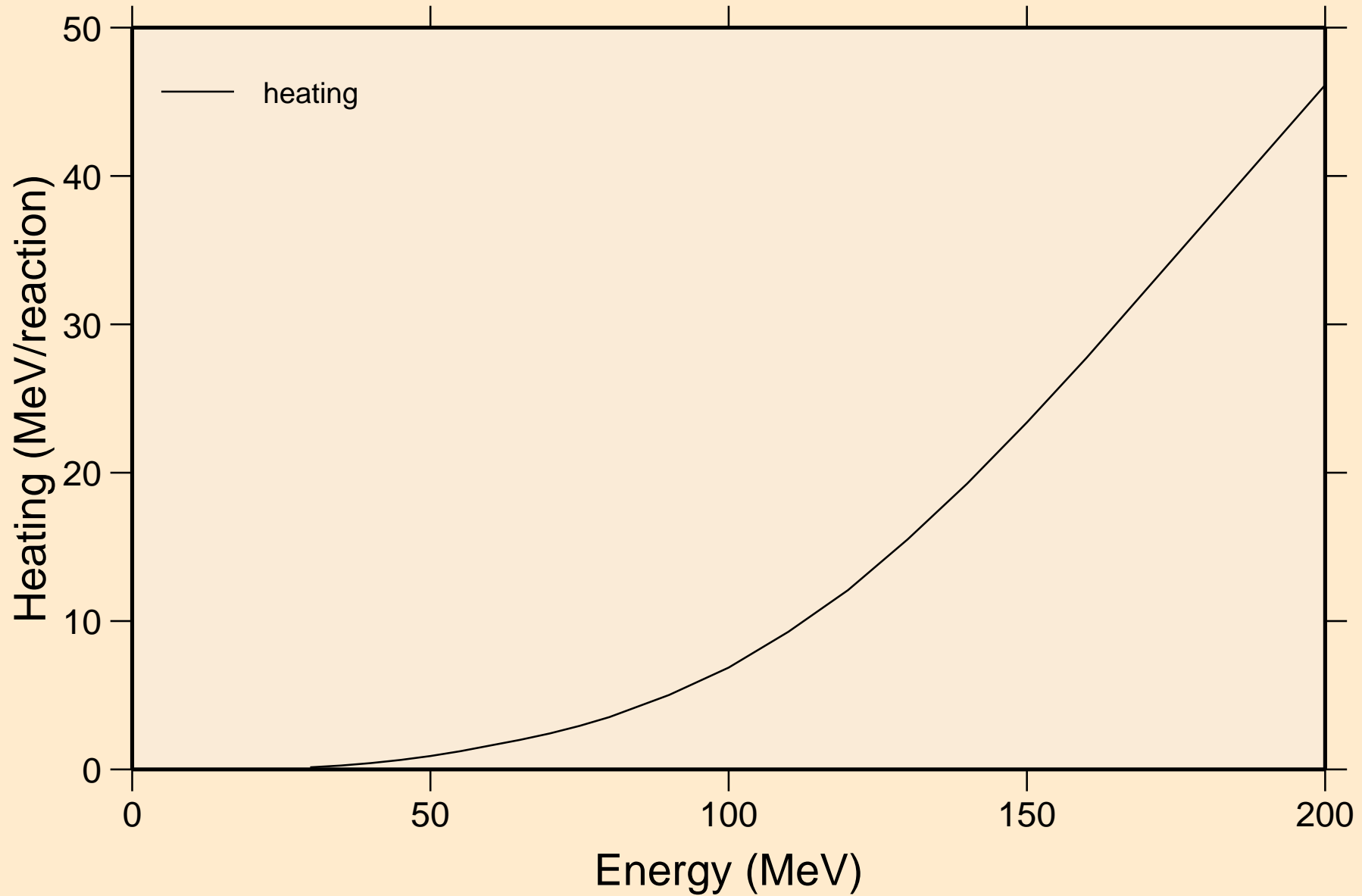

MT281 DEUTERON ACER TENDL-2023 LIBRARY; T=0.K

Threshold reactions

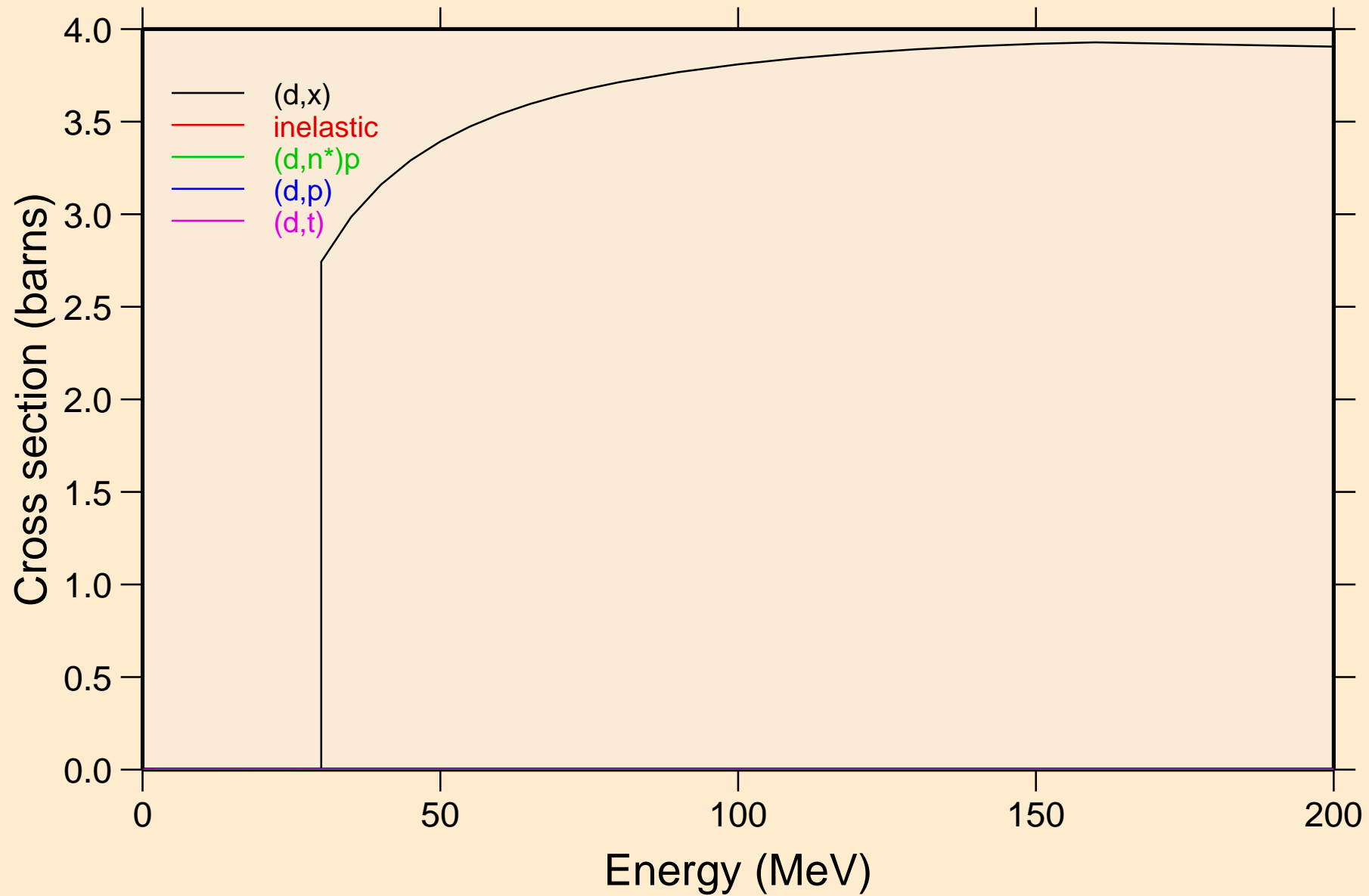

MT281 DEUTERON ACER TENDL-2023 LIBRARY; T=0.K
Threshold reactions

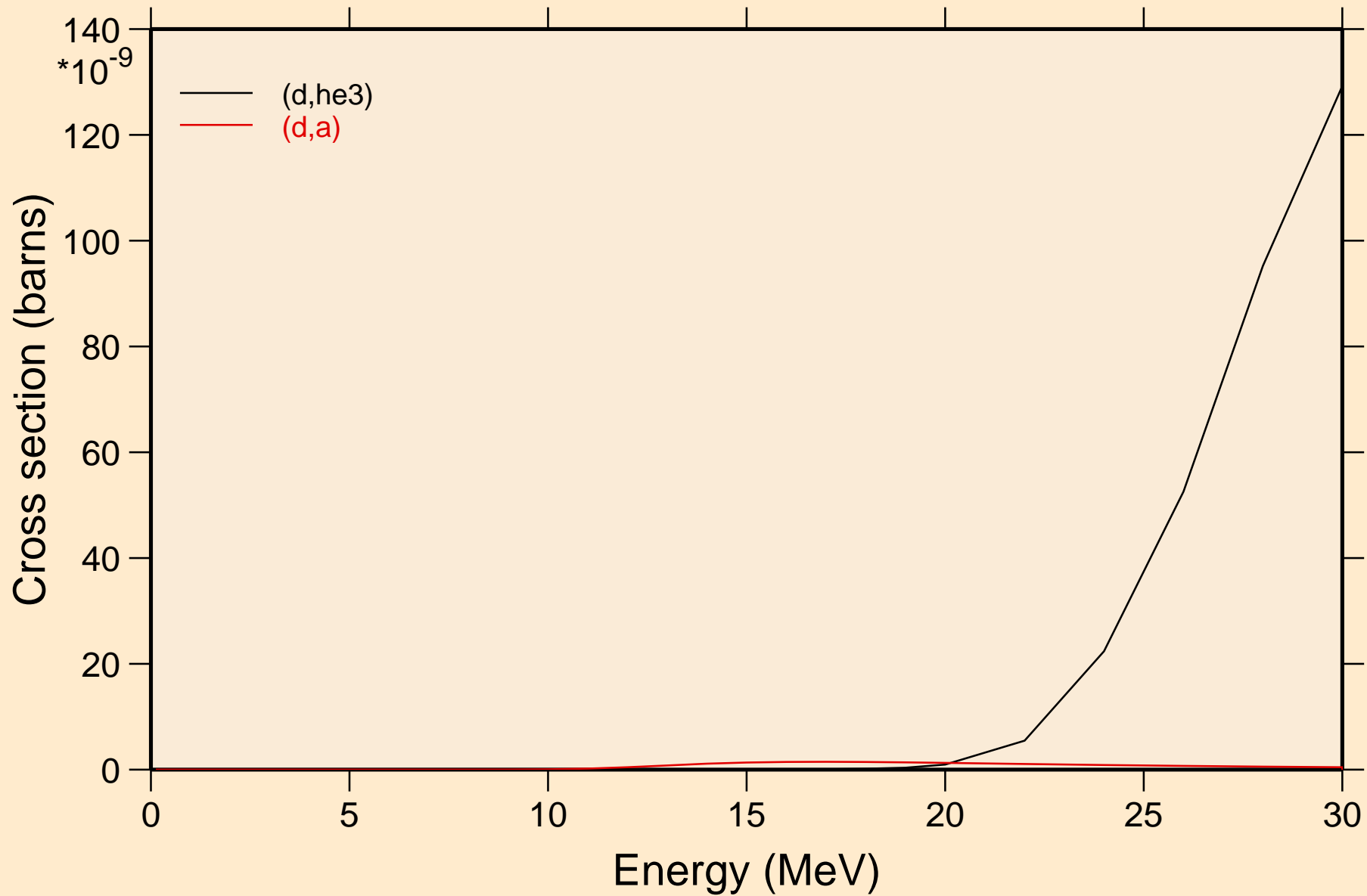

MT281 DEUTERON ACER TENDL-2023 LIBRARY; T=0.K
angular distribution for elastic

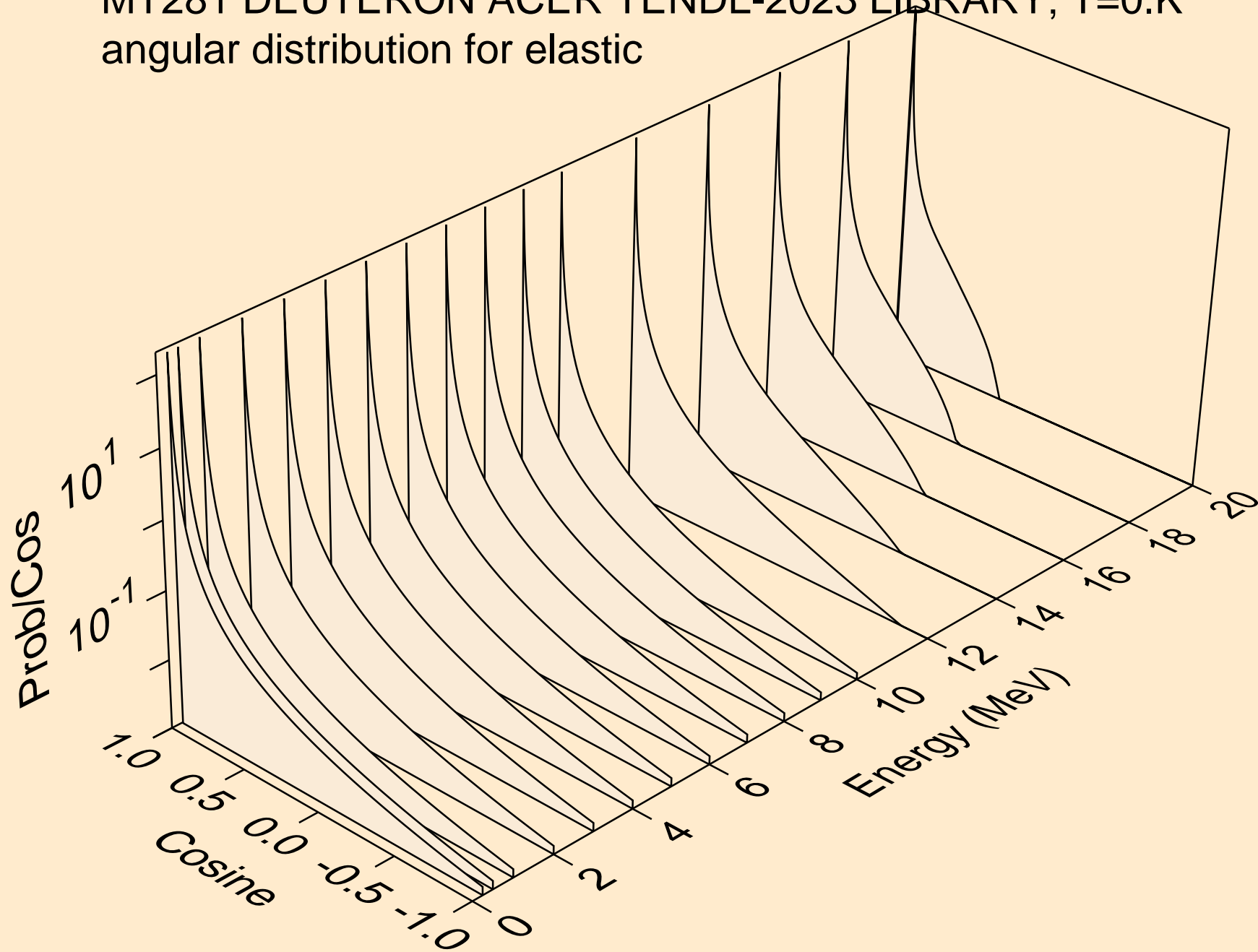

MT281 DEUTERON ACER TENDL-2023 LIBRARY; T=0.K
angular distribution for elastic

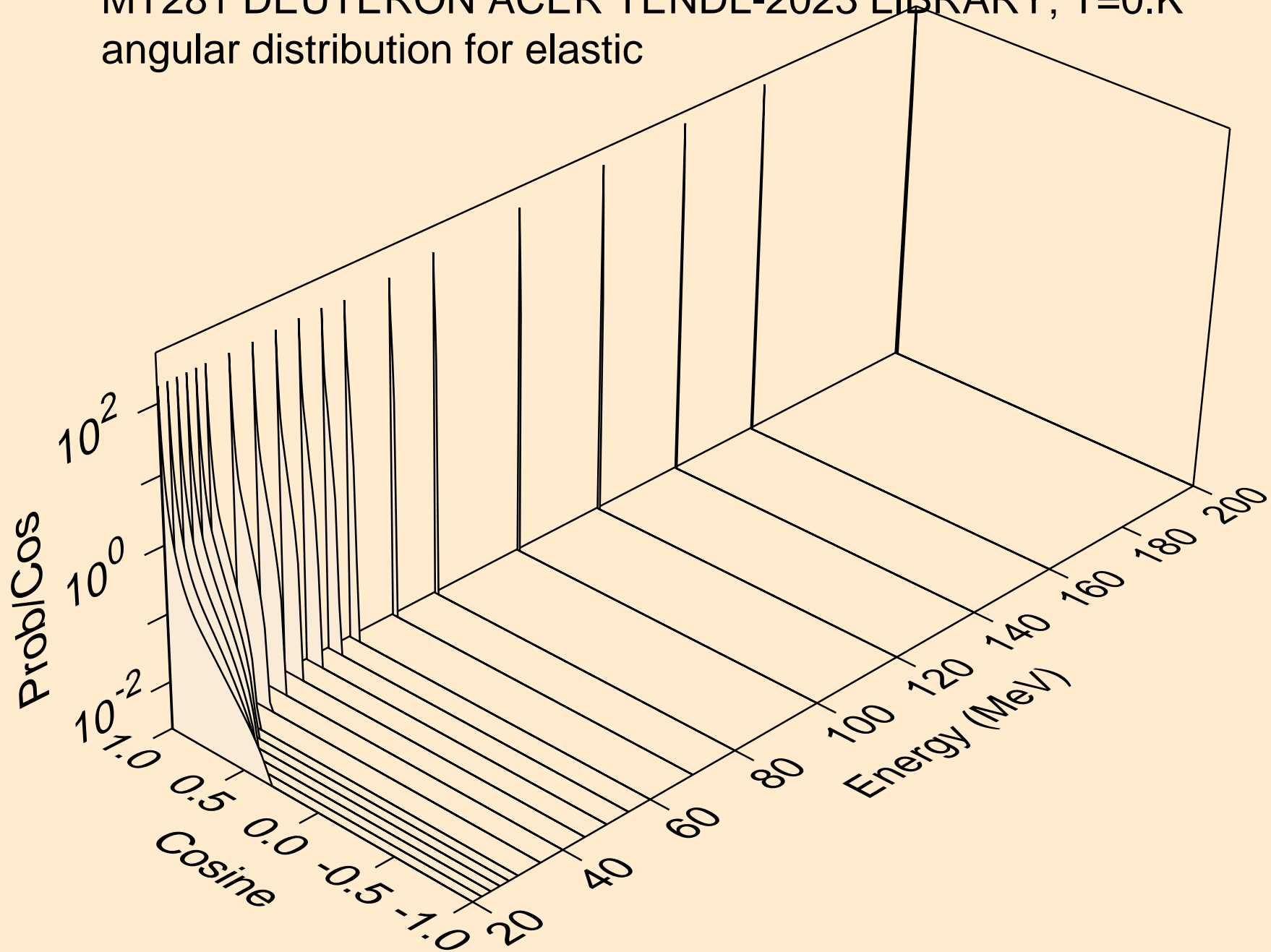

MT281 DEUTERON ACER TENDL-2023 LIBRARY; T=0.K
Deuteron emission for (d,x)

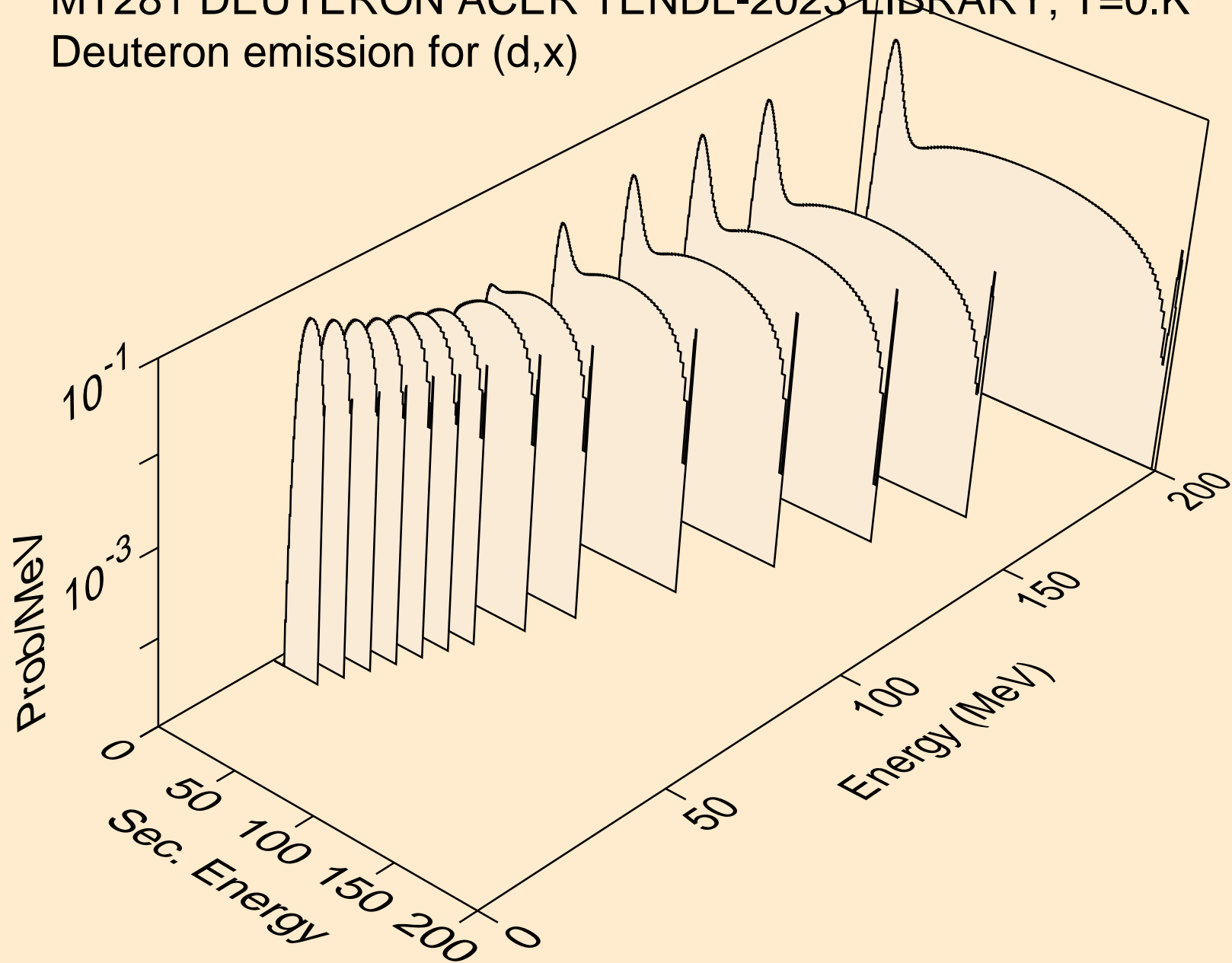

MT281 DEUTERON ACER TENDL-2023 LIBRARY; T=0.K
Deuteron emission for inelastic

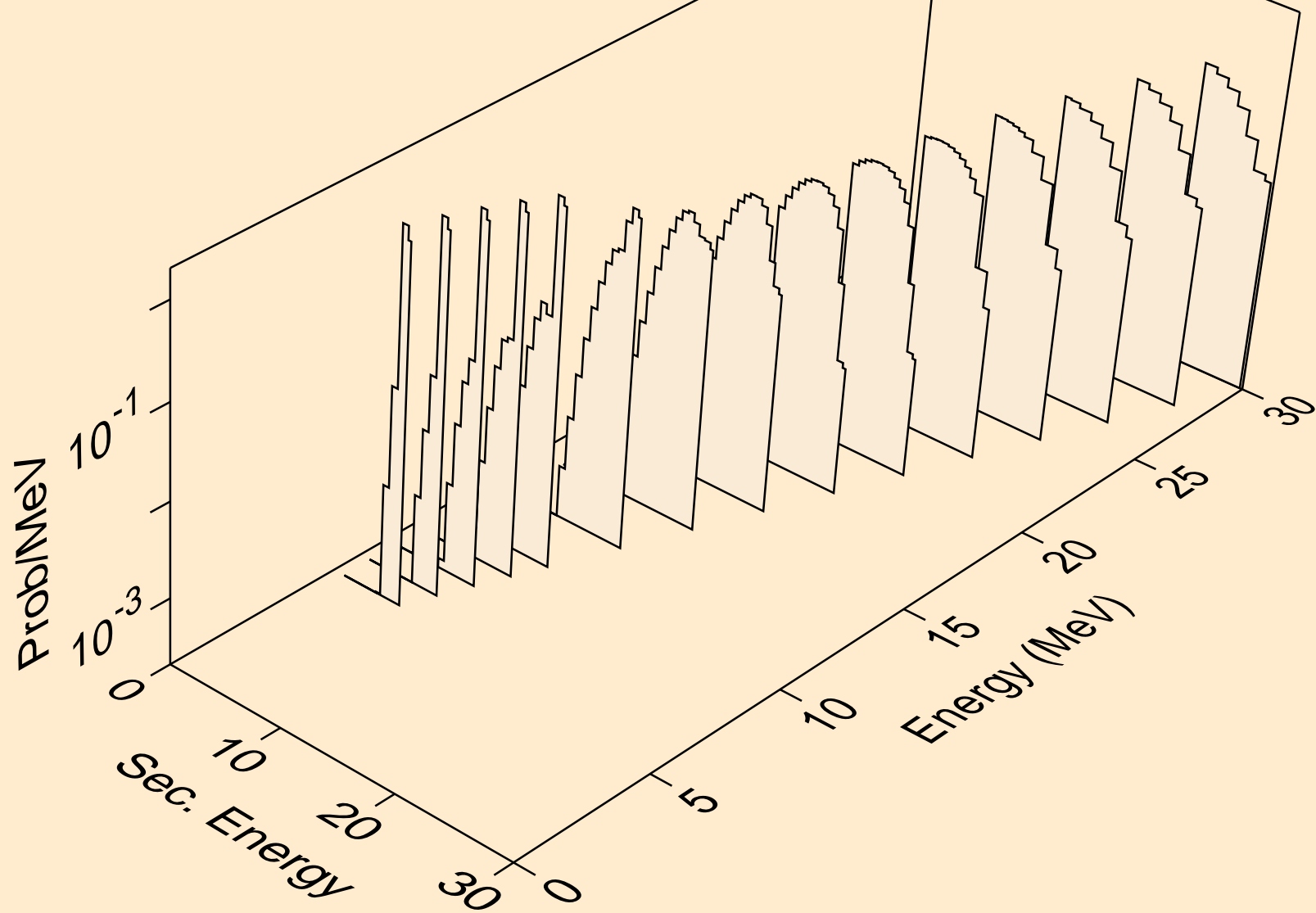

MT281 DEUTERON ACER TENDL-2023 LIBRARY; T=0.K
Photon emission for (z,n)

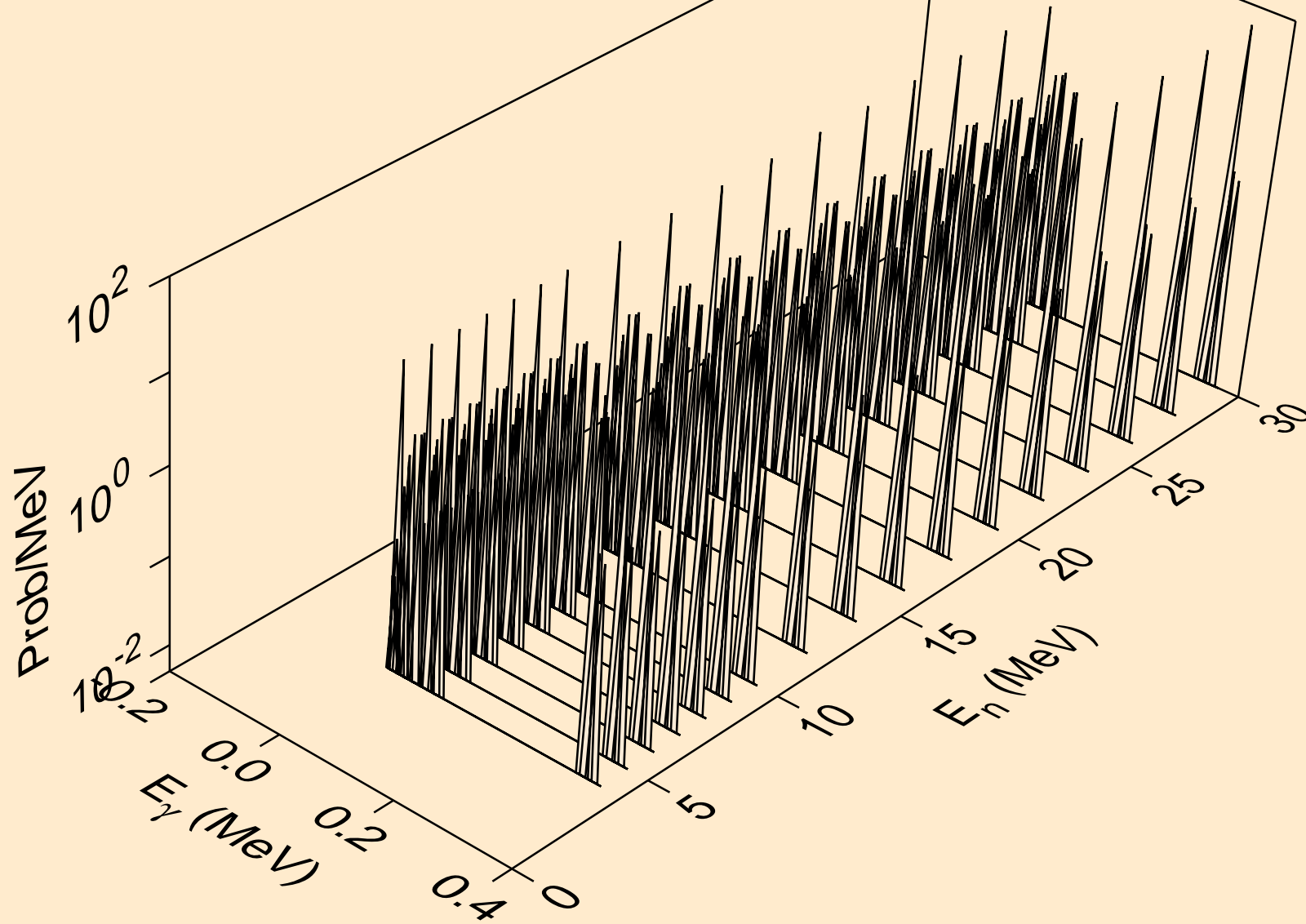

MT281 DEUTERON ACER TENDL-2023 LIBRARY; T=0.K
Photon emission for (z,x)

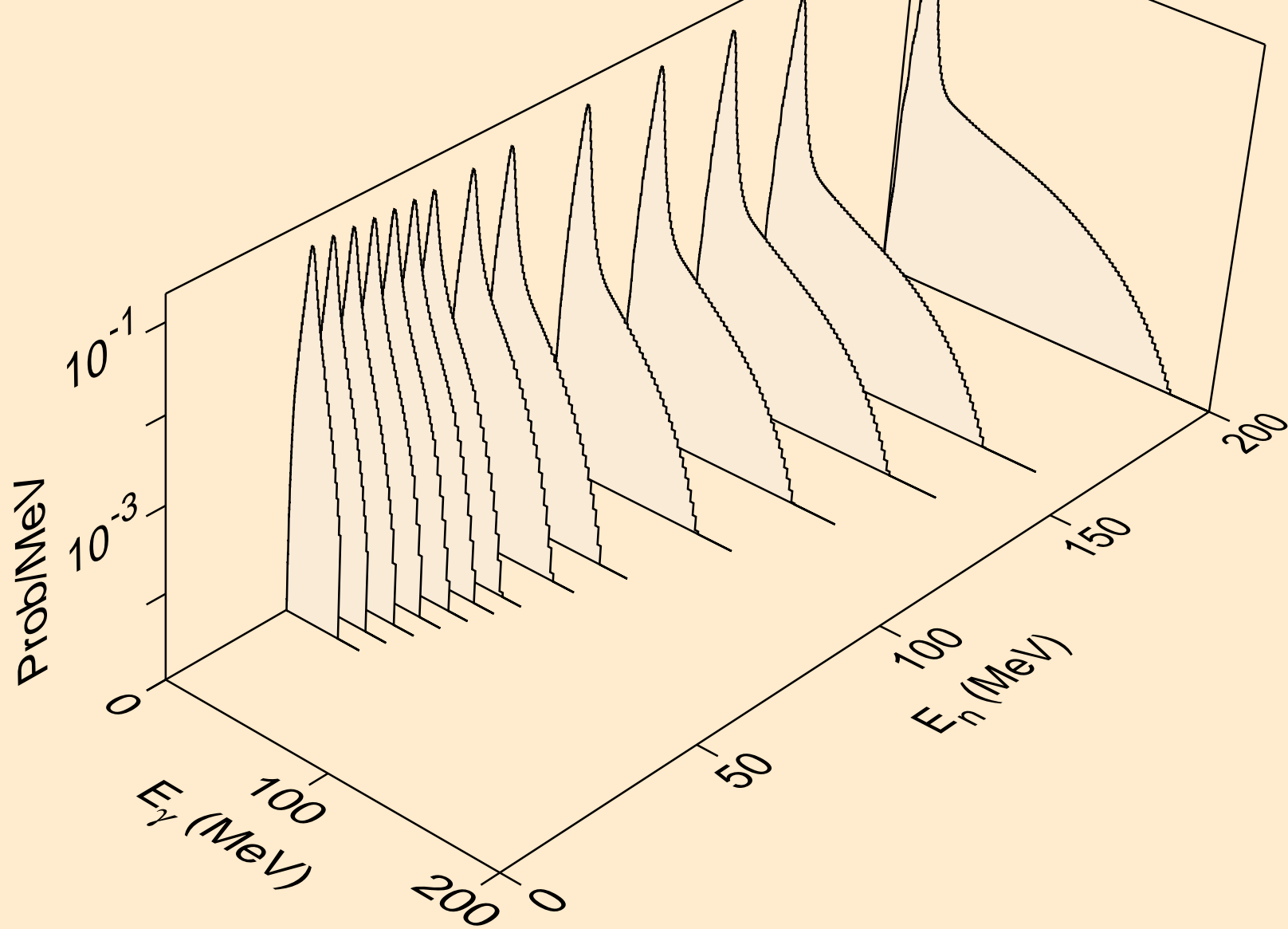

MT281 DEUTERON ACER TENDL-2023 LIBRARY; T=0.K
Photon emission for (n,n*)p

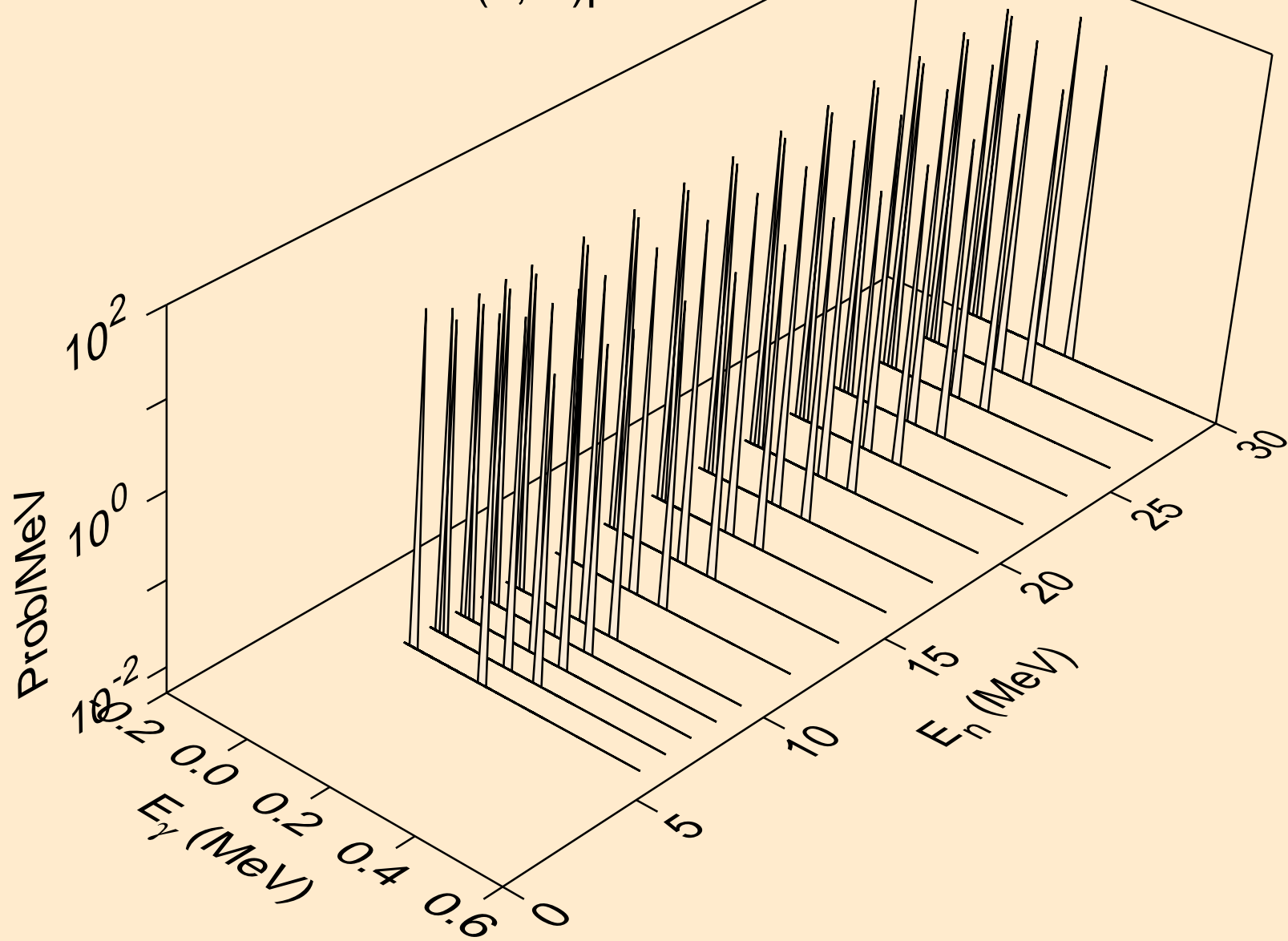

MT281 DEUTERON ACER TENDL-2023 LIBRARY; T=0.K
Photon emission for (n,p)

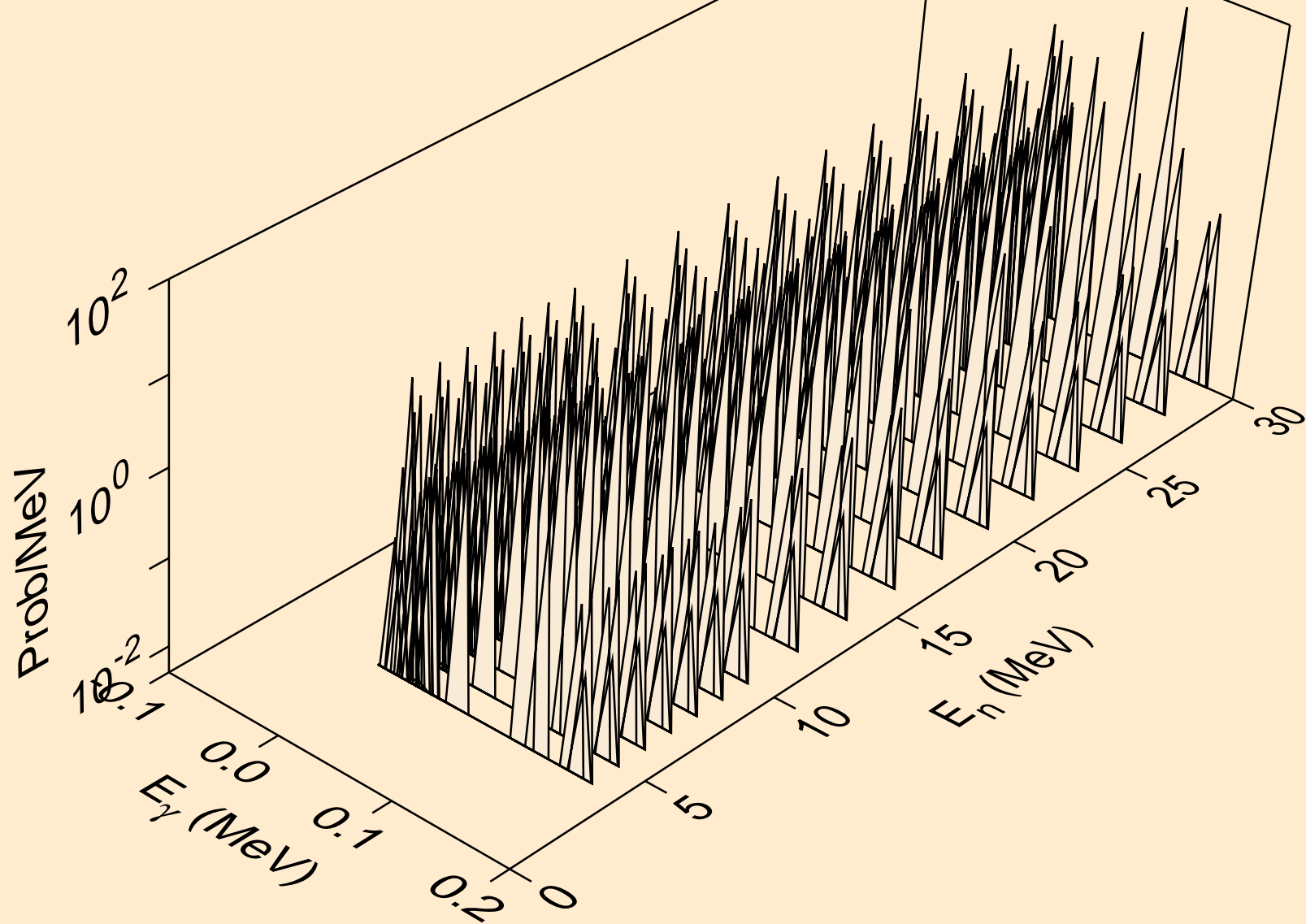

MT281 DEUTERON ACER TENDL-2023 LIBRARY; T=0.K
Photon emission for inelastic

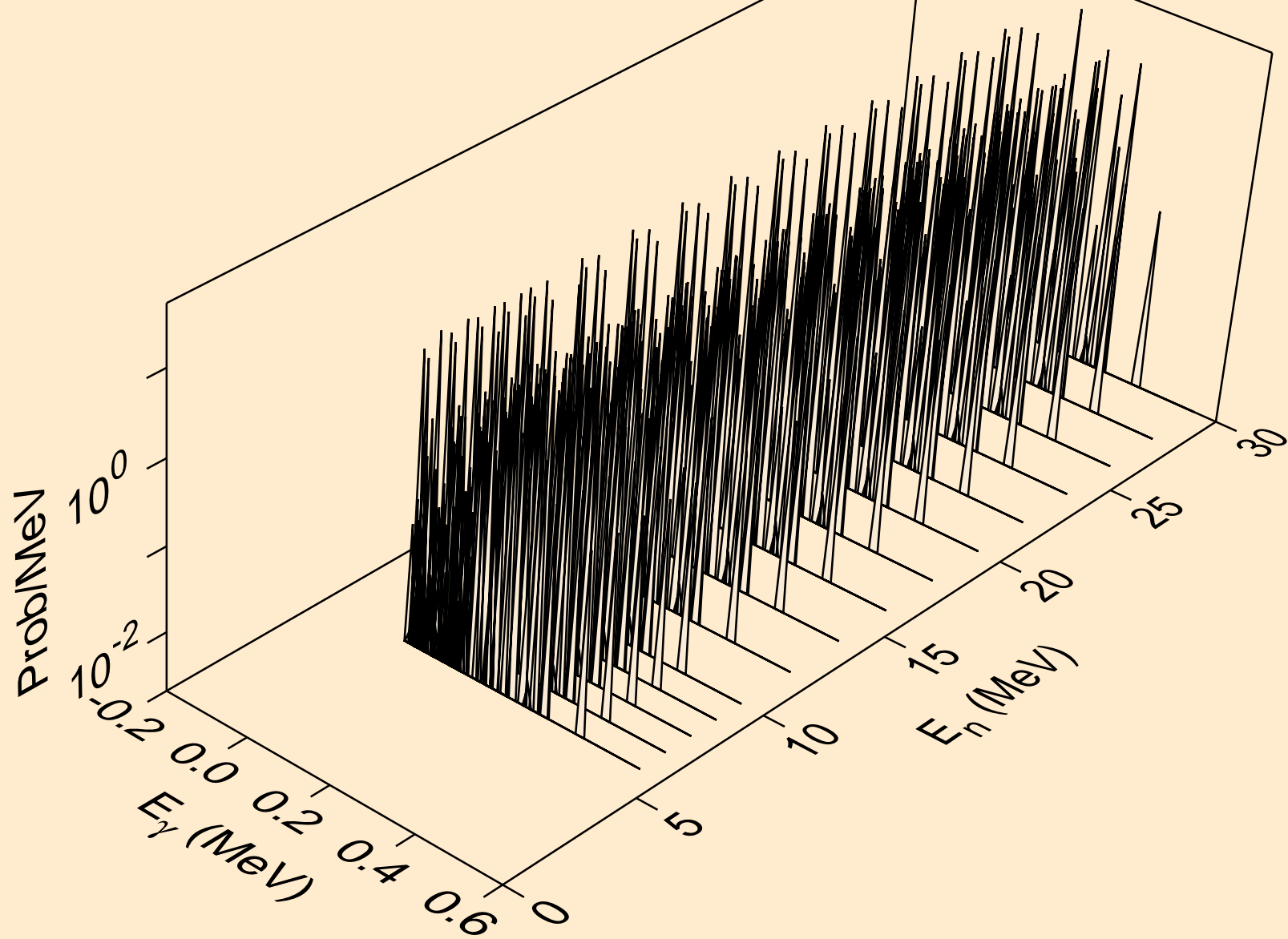

MT281 DEUTERON ACER TENDL-2023 LIBRARY; T=0.K
Photon emission for (n,t)

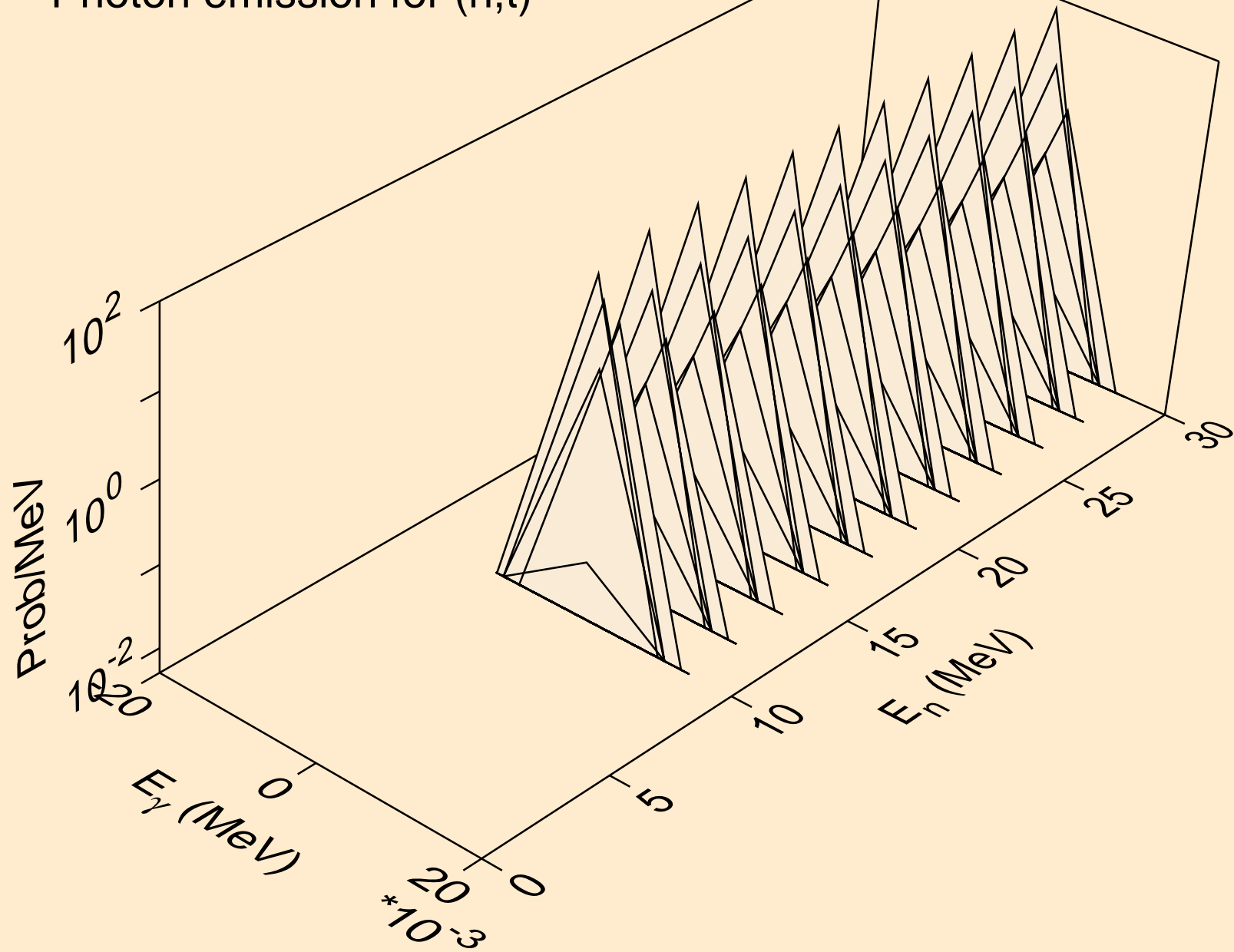

MT281 DEUTERON ACER TENDL-2023 LIBRARY; T=0.K
Photon emission for (n,he3)

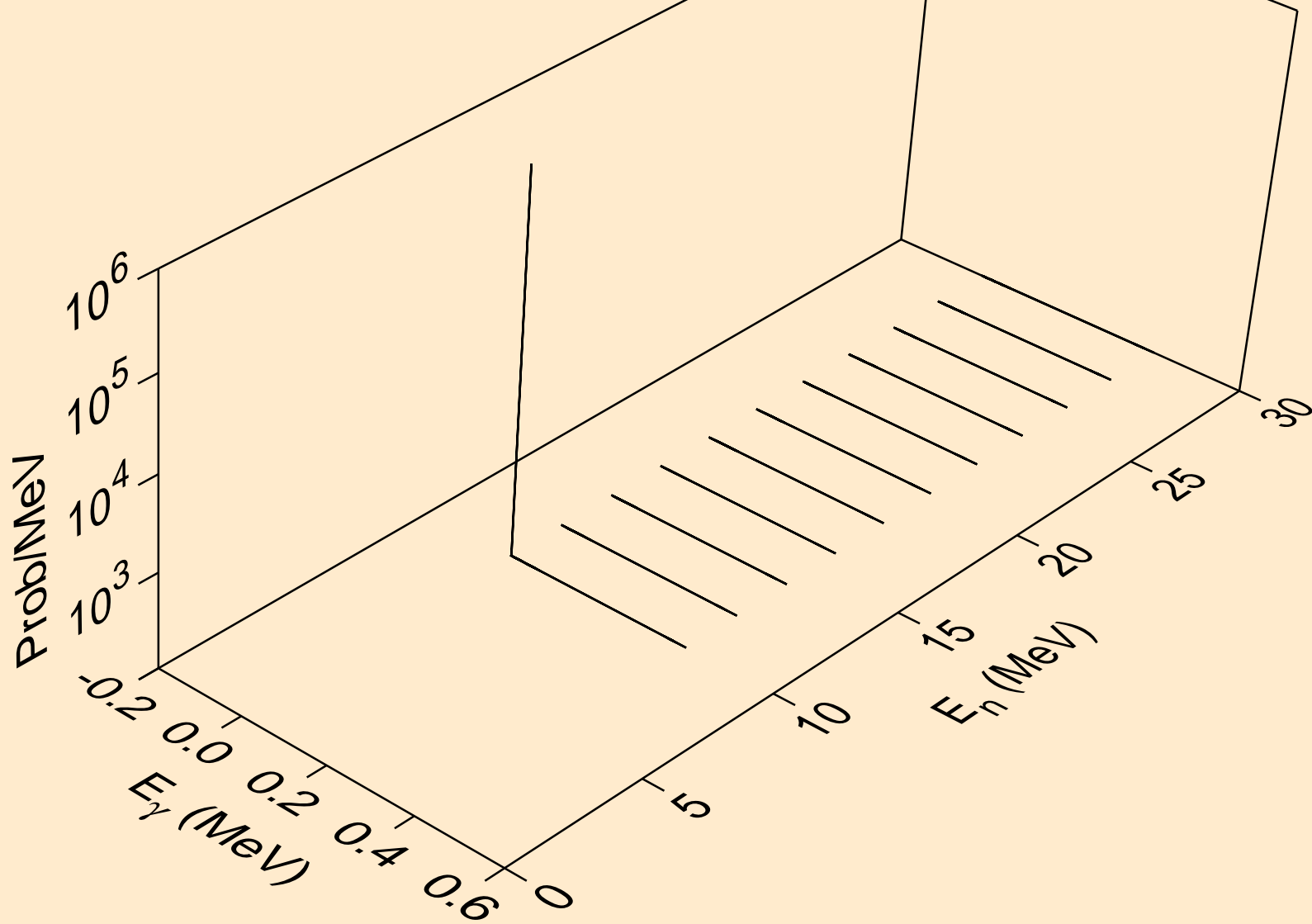

MT281 DEUTERON ACER TENDL-2023 LIBRARY; T=0.K
Photon emission for (n,a)

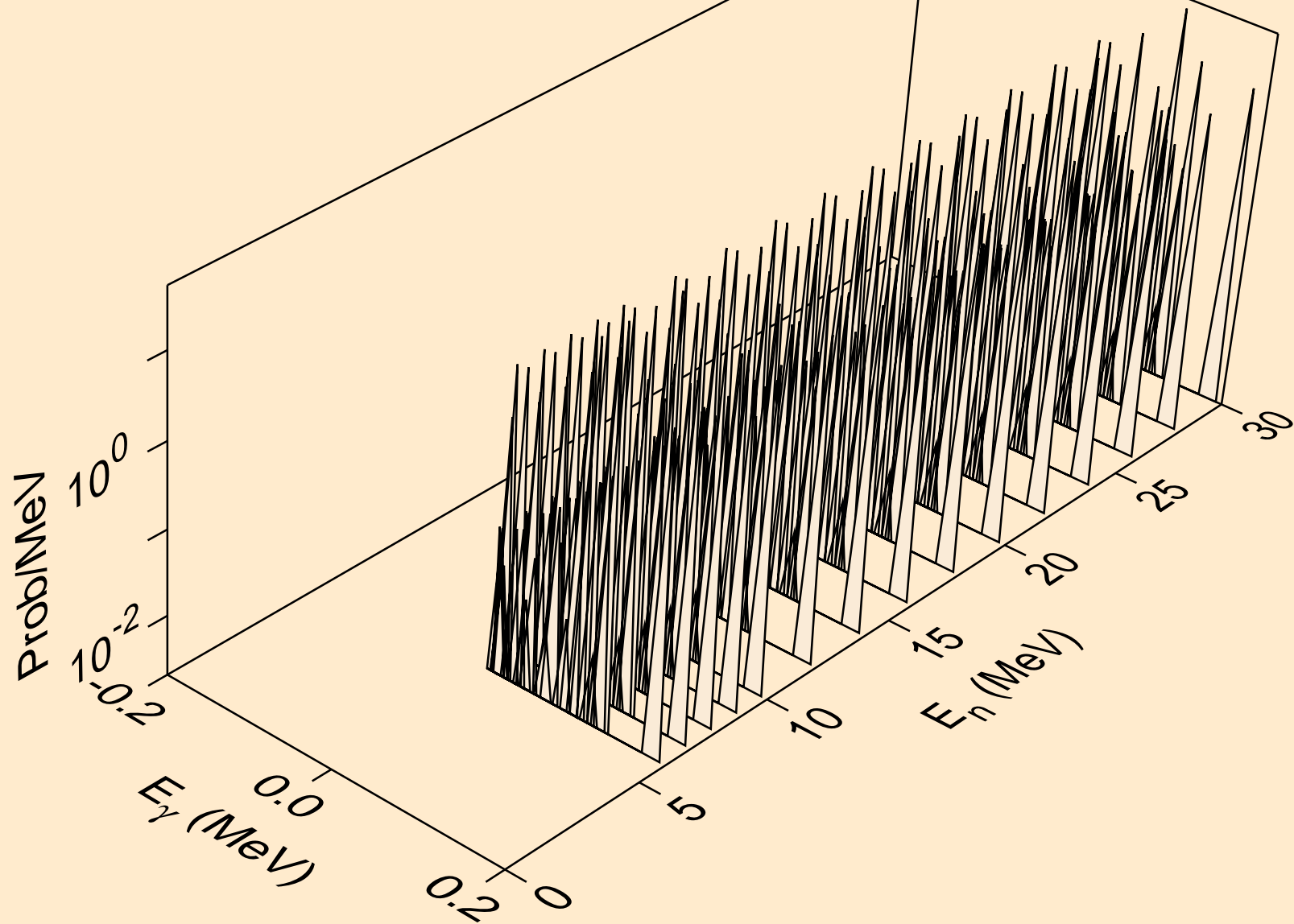

MT281 DEUTERON ACER TENDL-2023 LIBRARY; T=0.K
Particle heating contributions

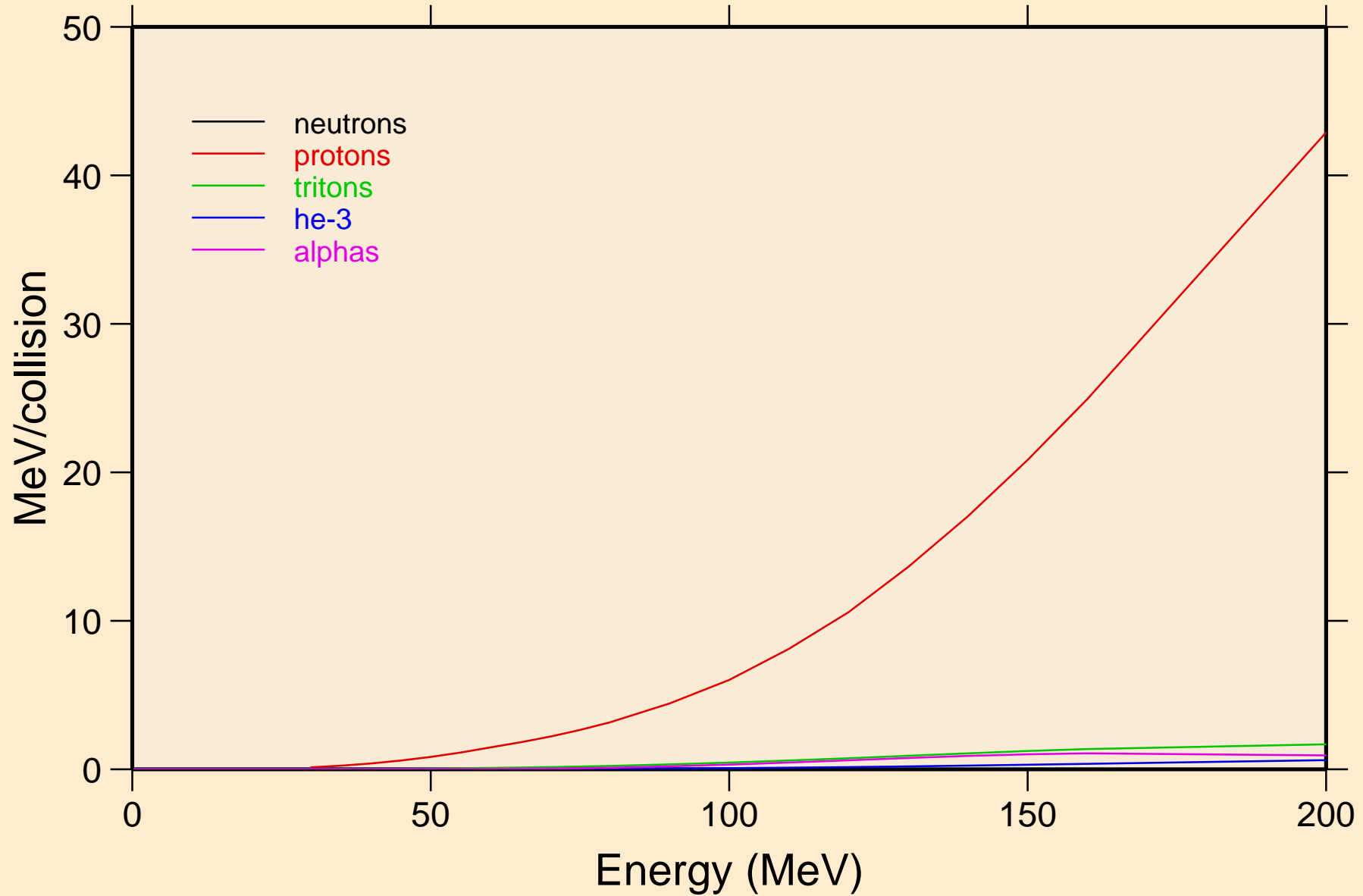

MT281 DEUTERON ACER TENDL-2023 LIBRARY; T=0.K
Recoil Heating

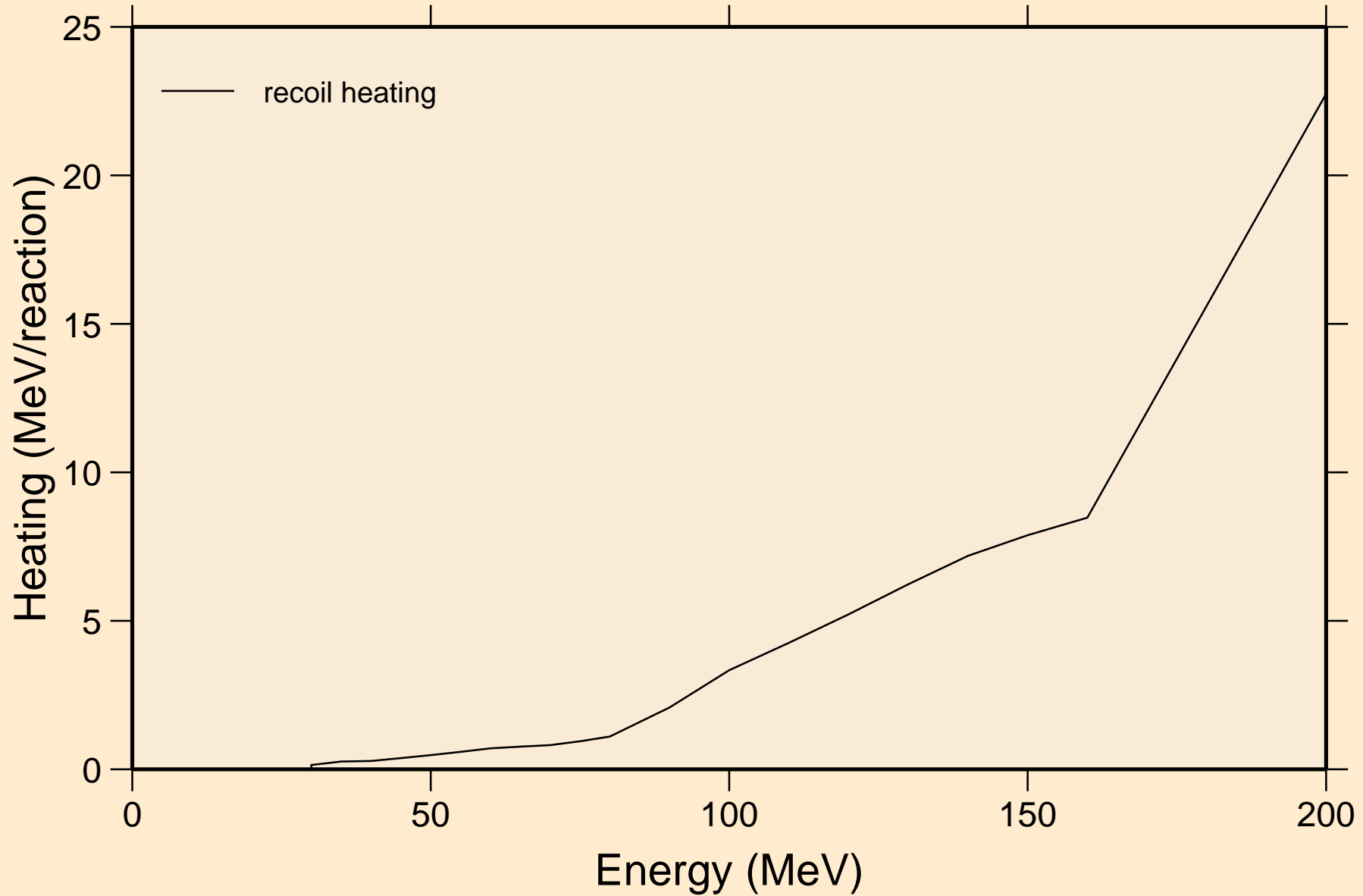

MT281 DEUTERON ACER TENDL-2023 LIBRARY; T=0.K
Particle production cross sections

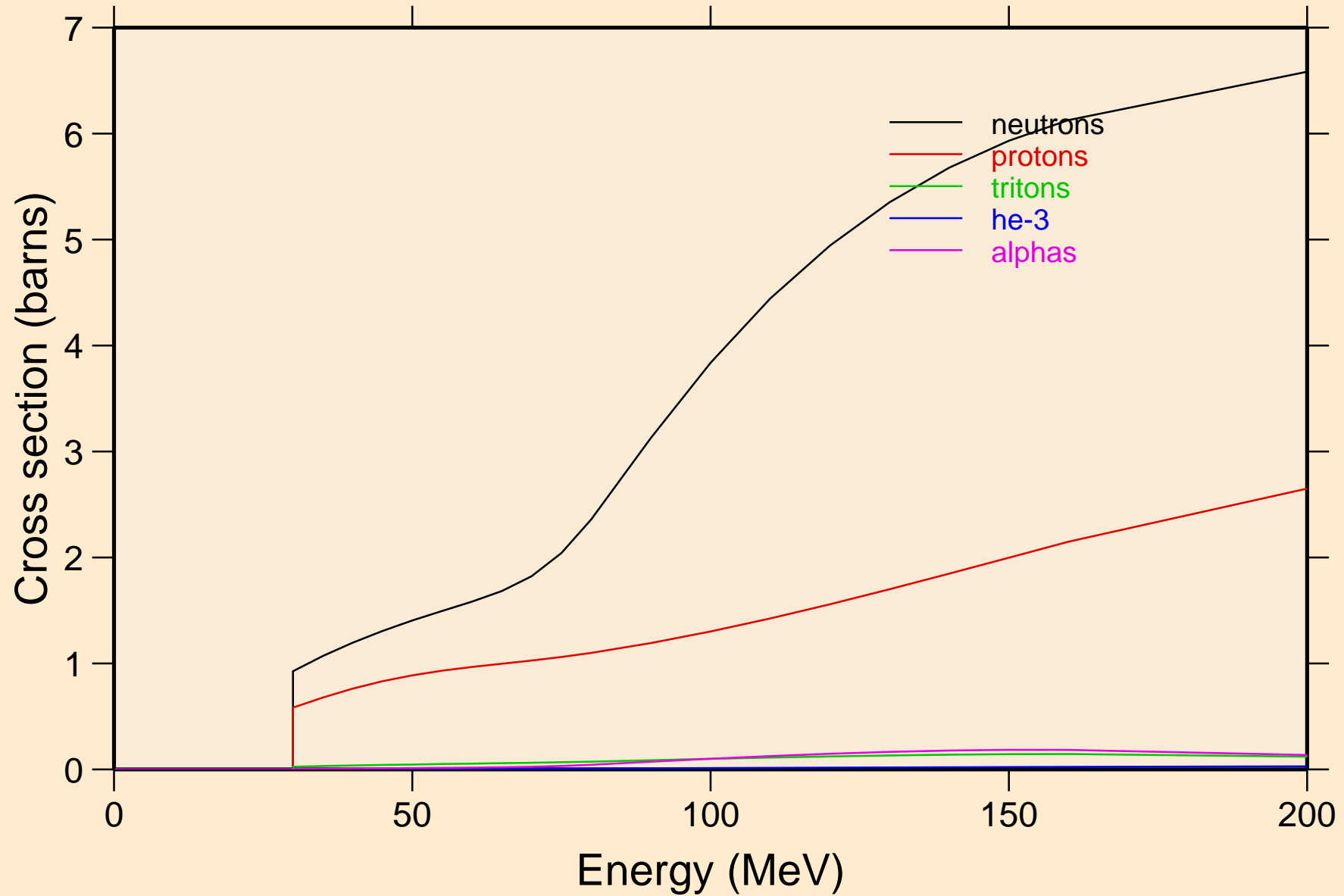

MT281 DEUTERON ACER TENDL-2023 LIBRARY; T=0.K
neutrons from (d,n)

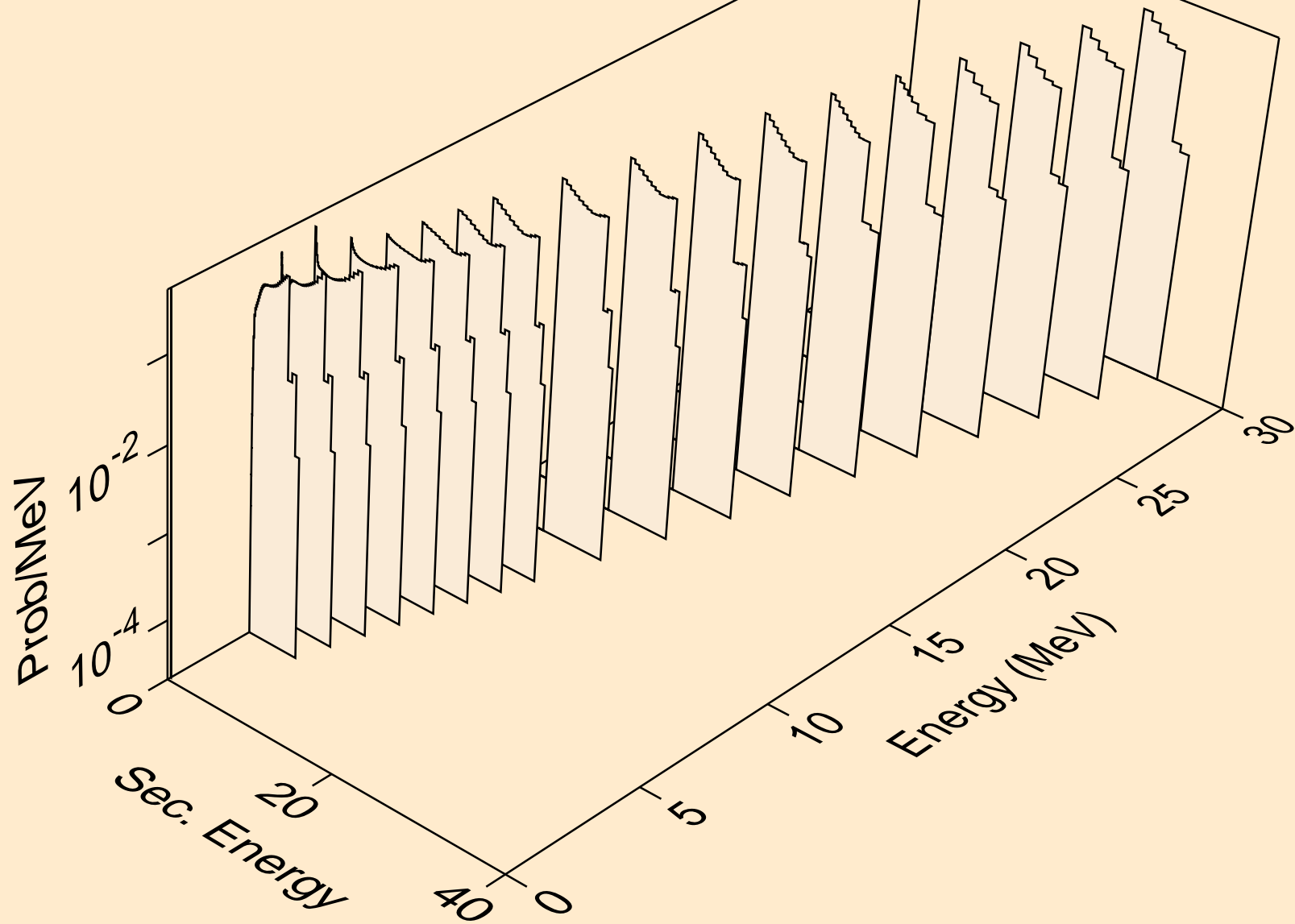

MT281 DEUTERON ACER TENDL-2023 LIBRARY; T=0.K
neutrons from (d,x)

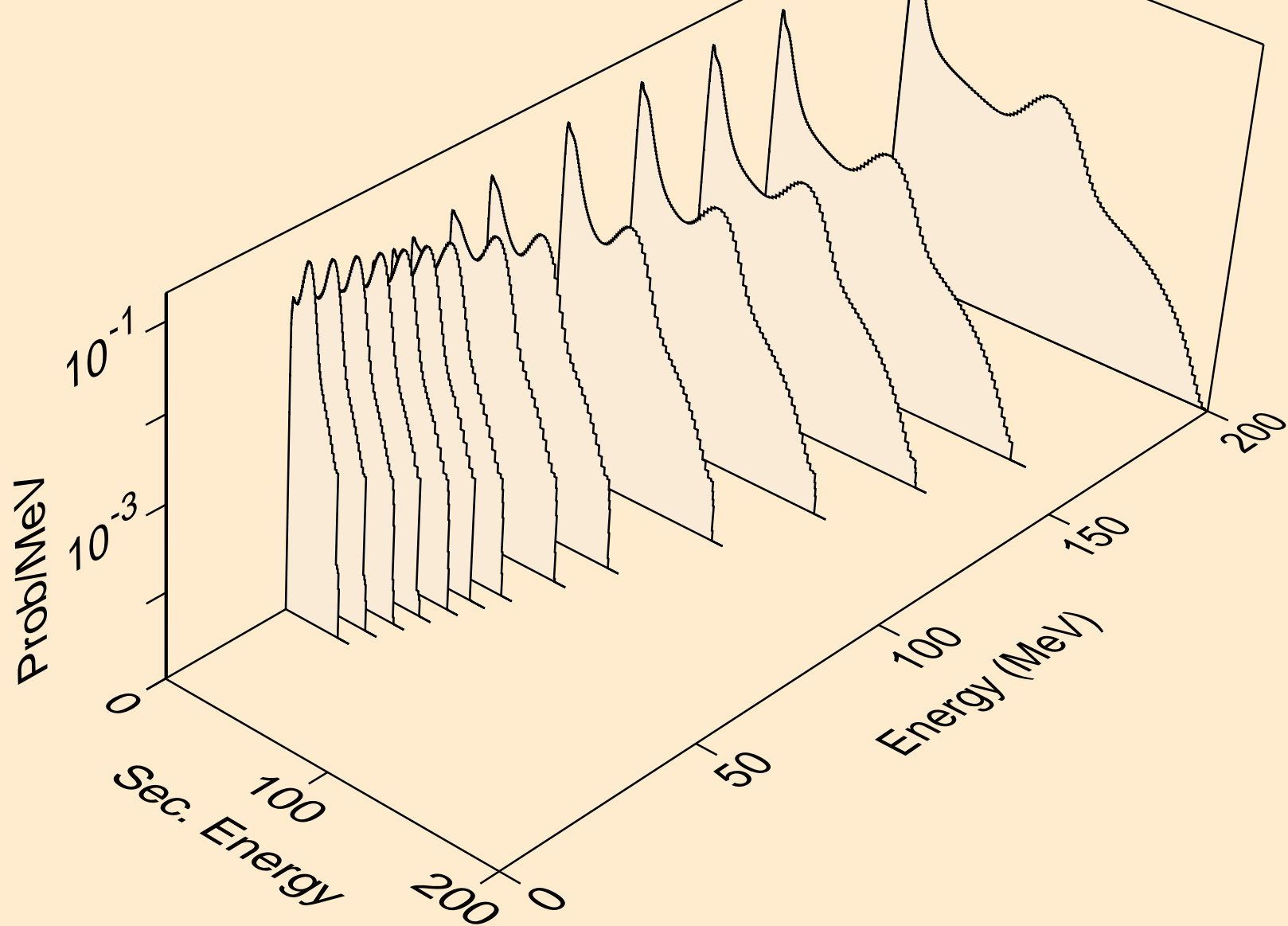

MT281 DEUTERON ACER TENDL-2023 LIBRARY; T=0.K
neutrons from (d,n*)p

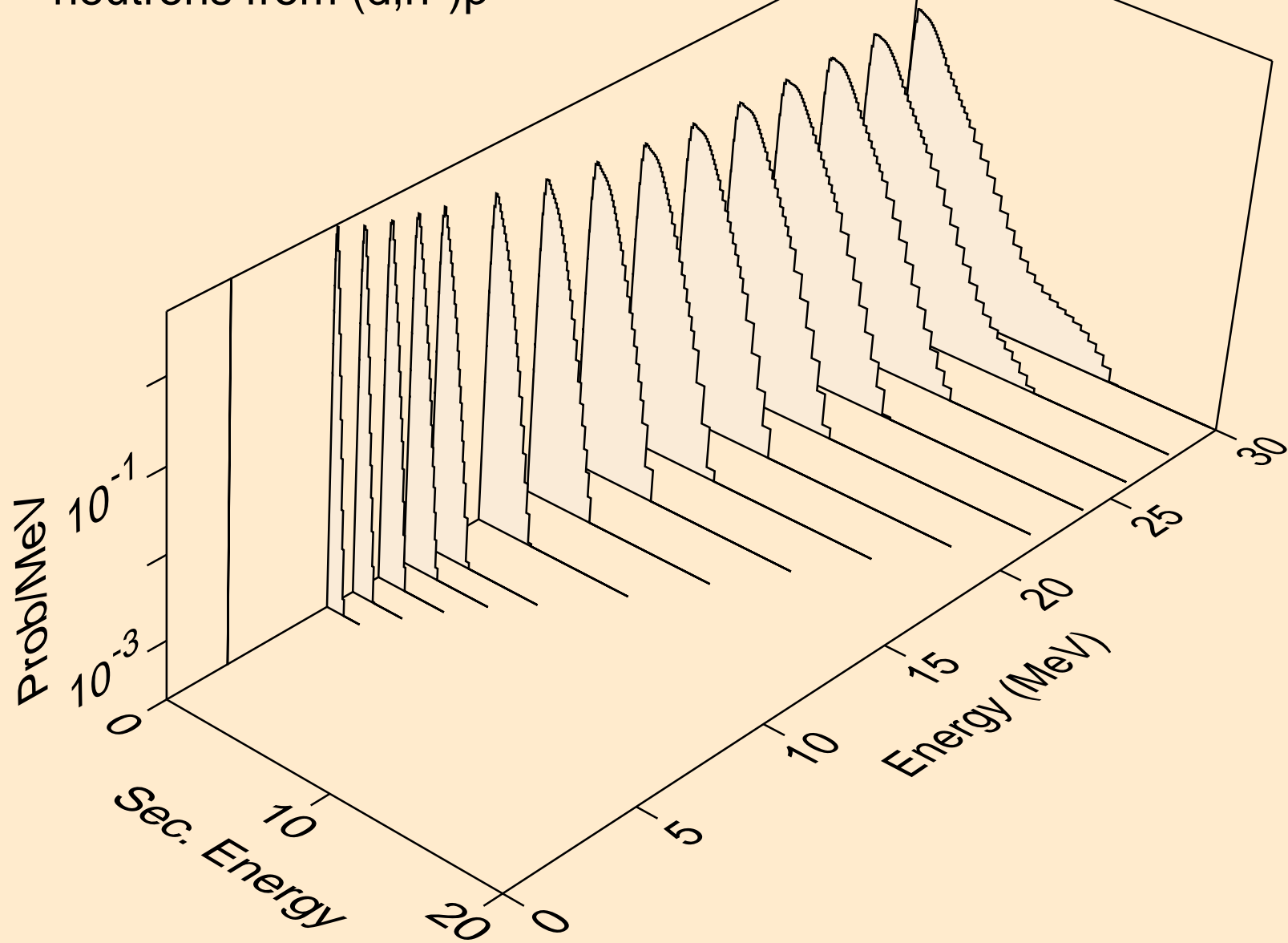

MT281 DEUTERON ACER TENDL-2023 LIBRARY; T=0.K
protons from (d,x)

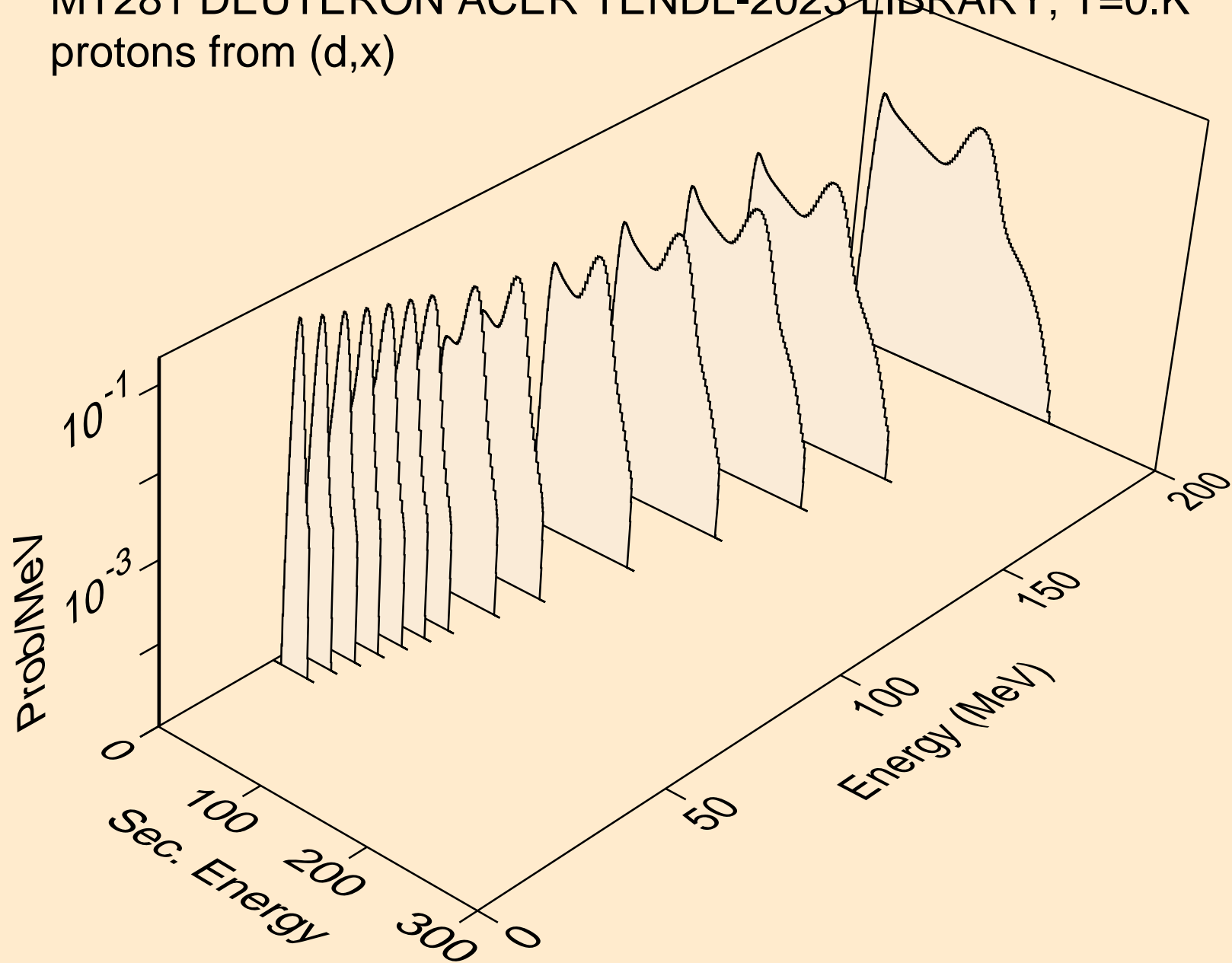

MT281 DEUTERON ACER TENDL-2023 LIBRARY; T=0.K
protons from (d,n*)p

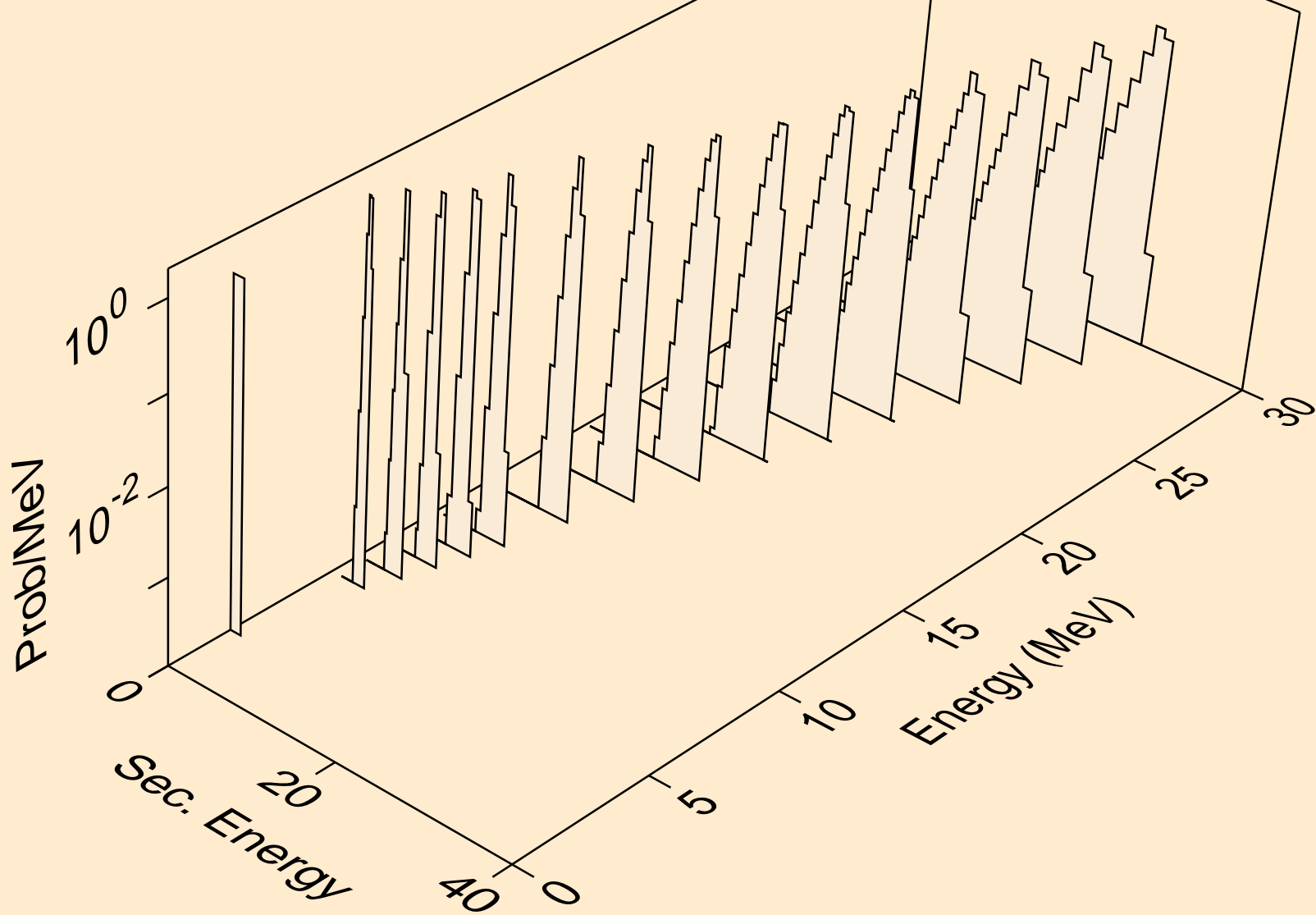

MT281 DEUTERON ACER TENDL-2023 LIBRARY; T=0.K
protons from (d,p)

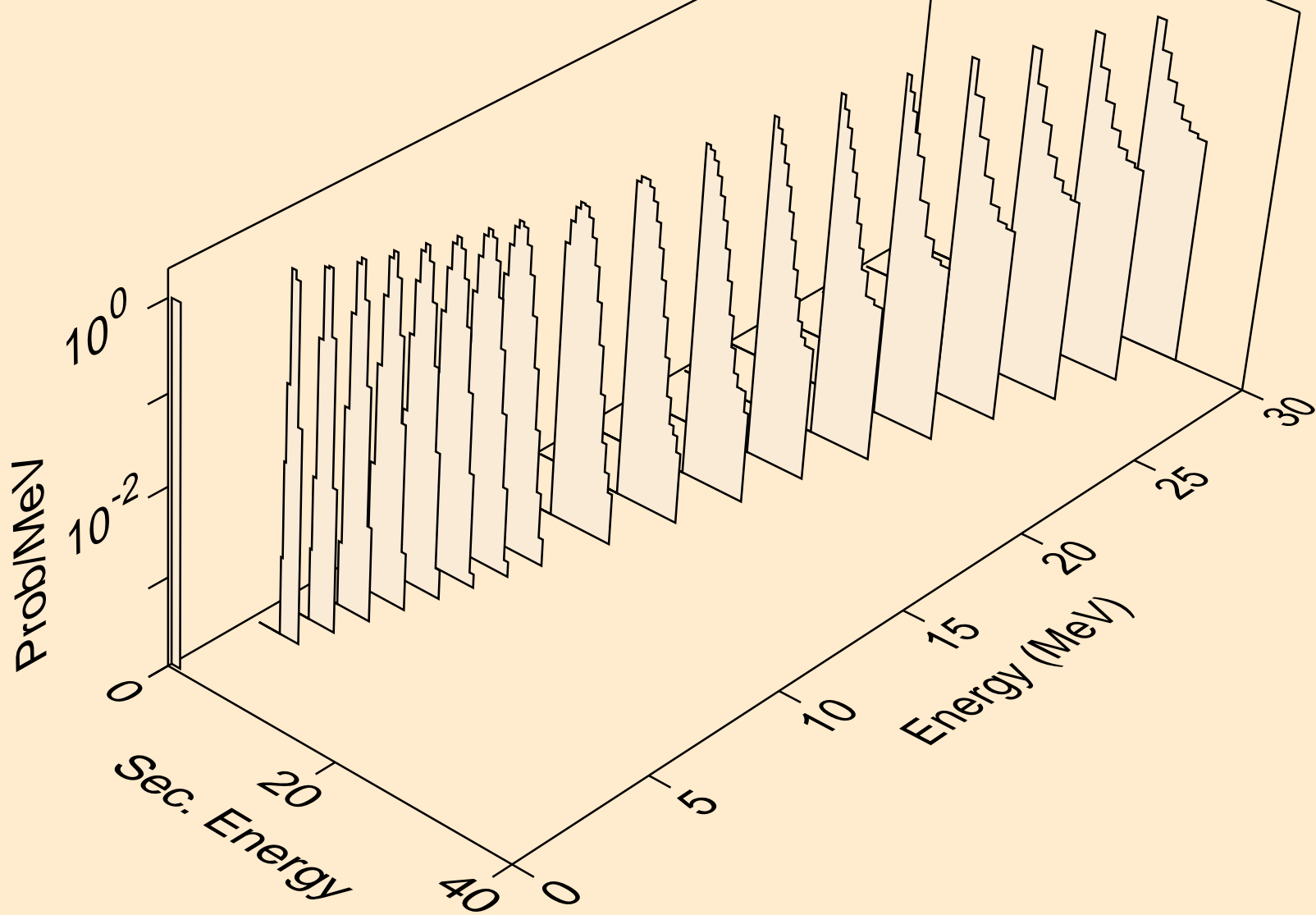

MT281 DEUTERON ACER TENDL-2023 LIBRARY; T=0.K
tritons from (d,x)

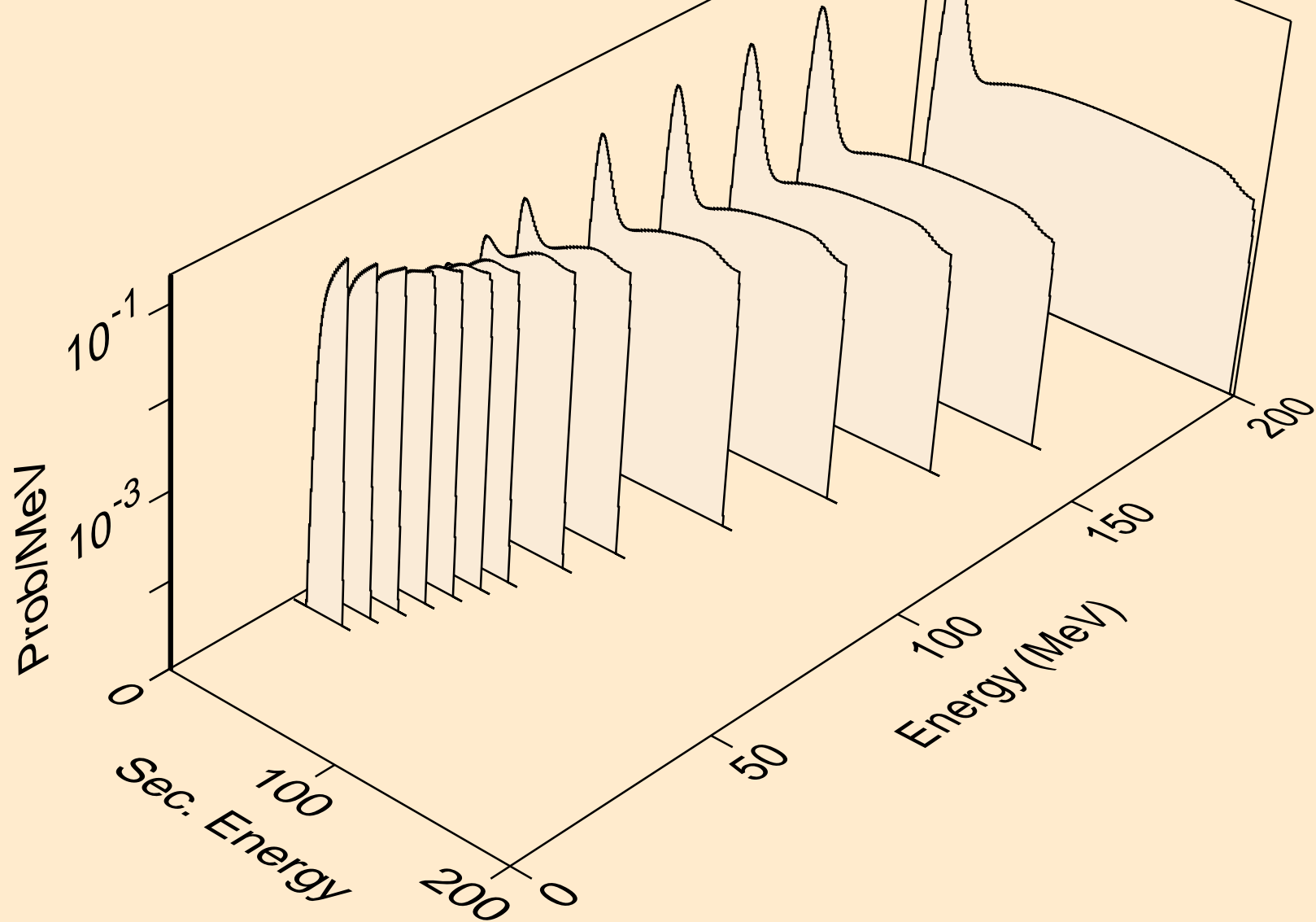

MT281 DEUTERON ACER TENDL-2023 LIBRARY; T=0.K
tritons from (d,t)

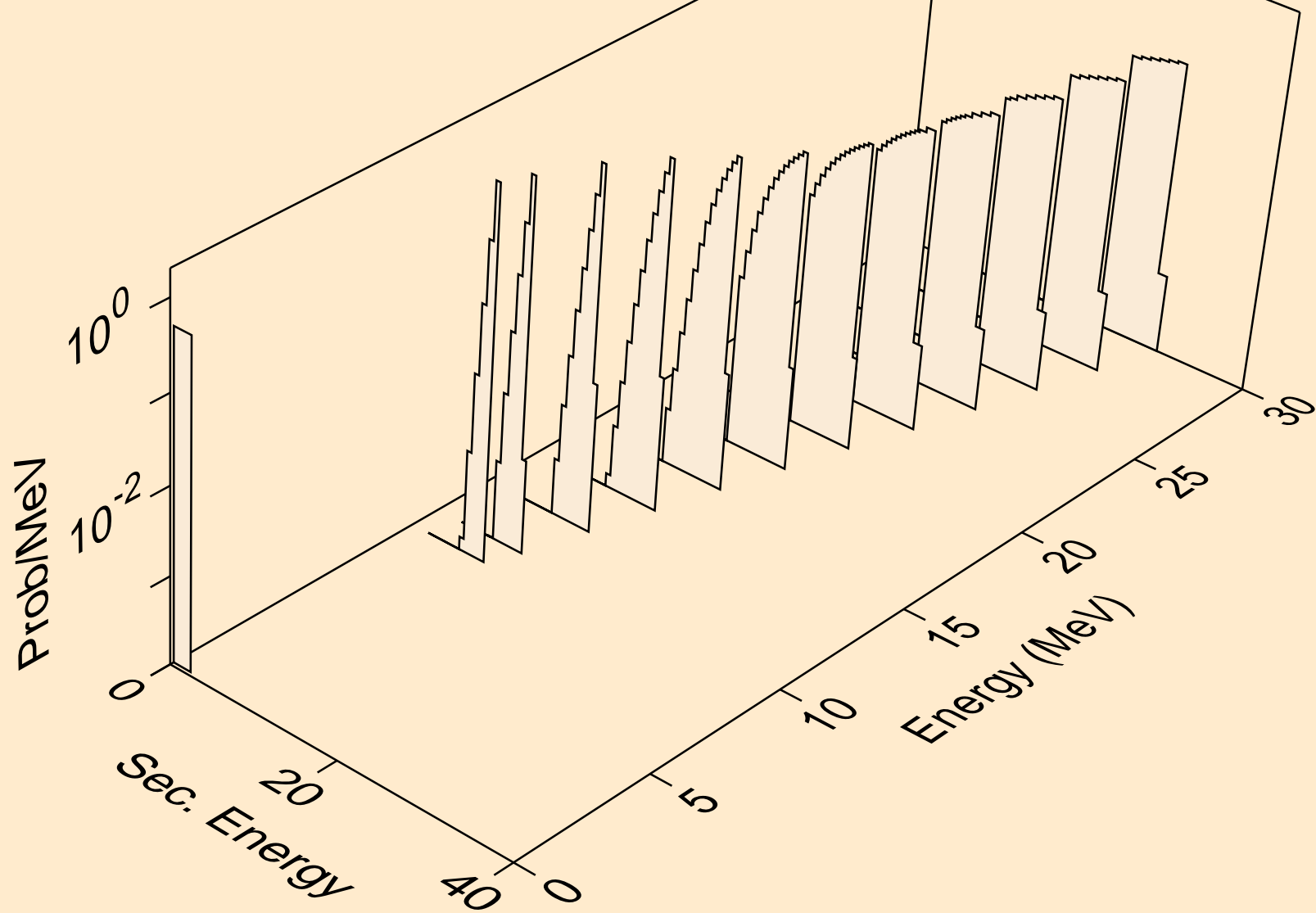

MT281 DEUTERON ACER TENDL-2023 LIBRARY; T=0.K
he3s from (d,x)

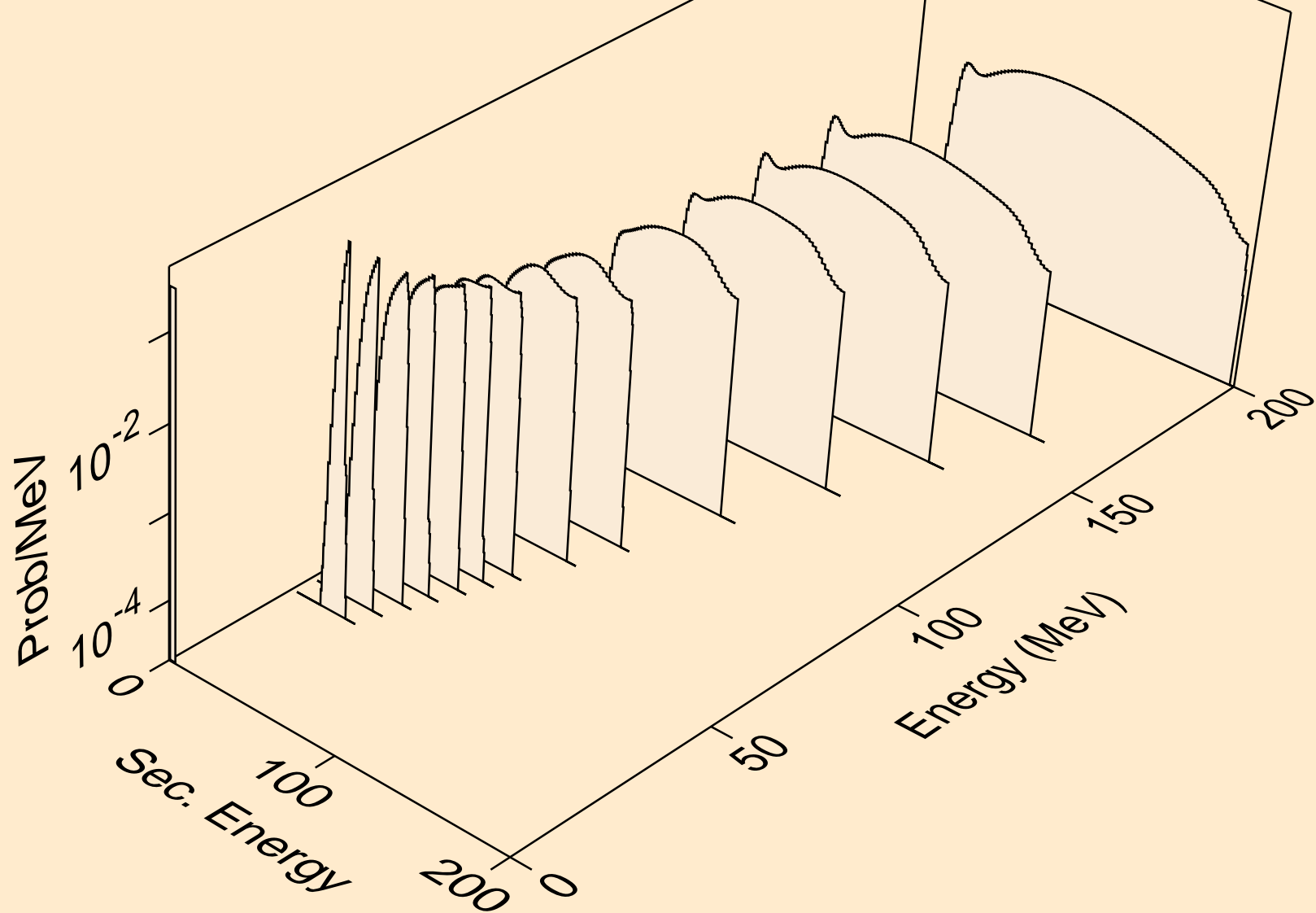

MT281 DEUTERON ACER TENDL-2023 LIBRARY; T=0.K
he3s from (d,he3)

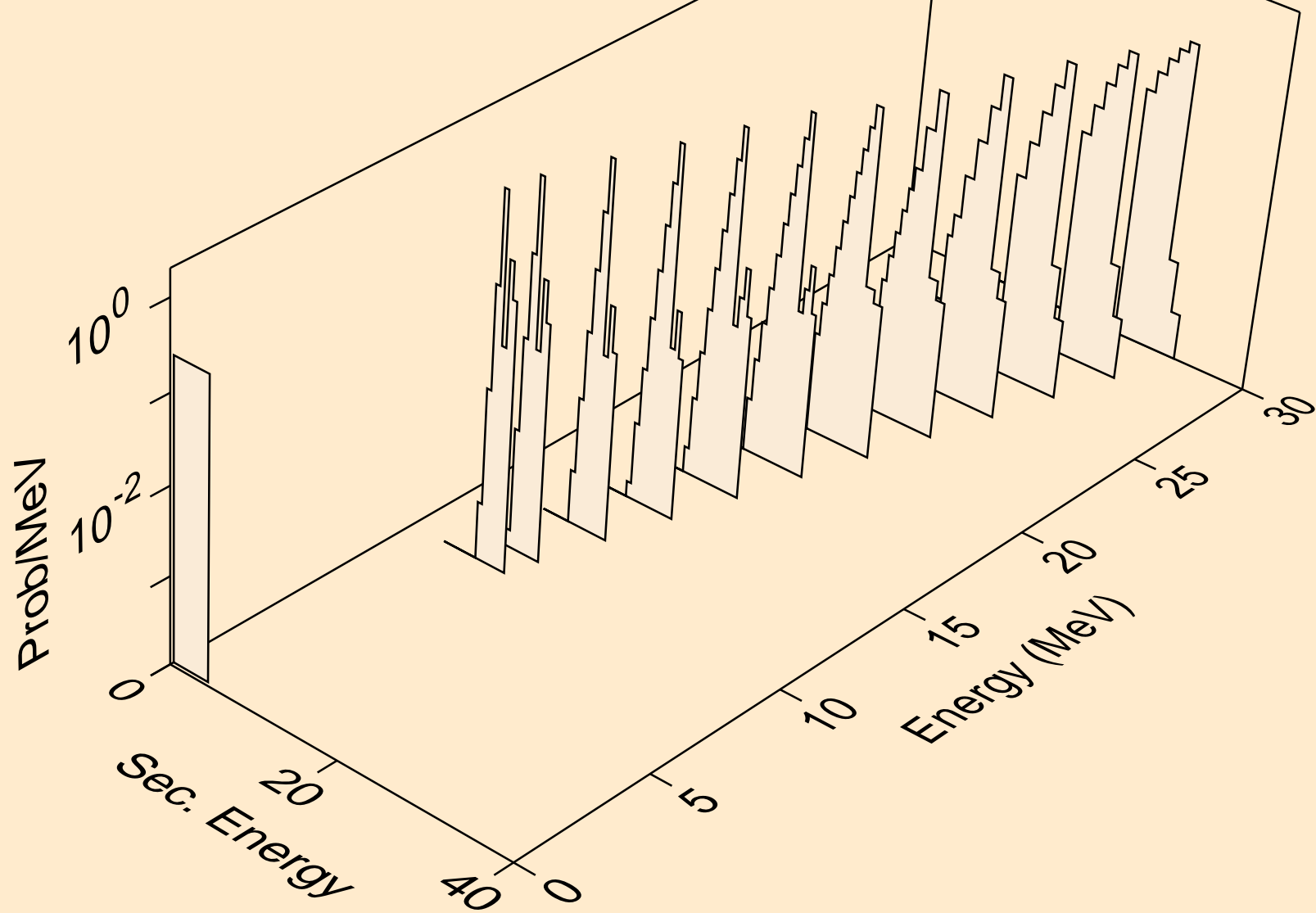

MT281 DEUTERON ACER TENDL-2023 LIBRARY; T=0.K
alphas from (d,x)

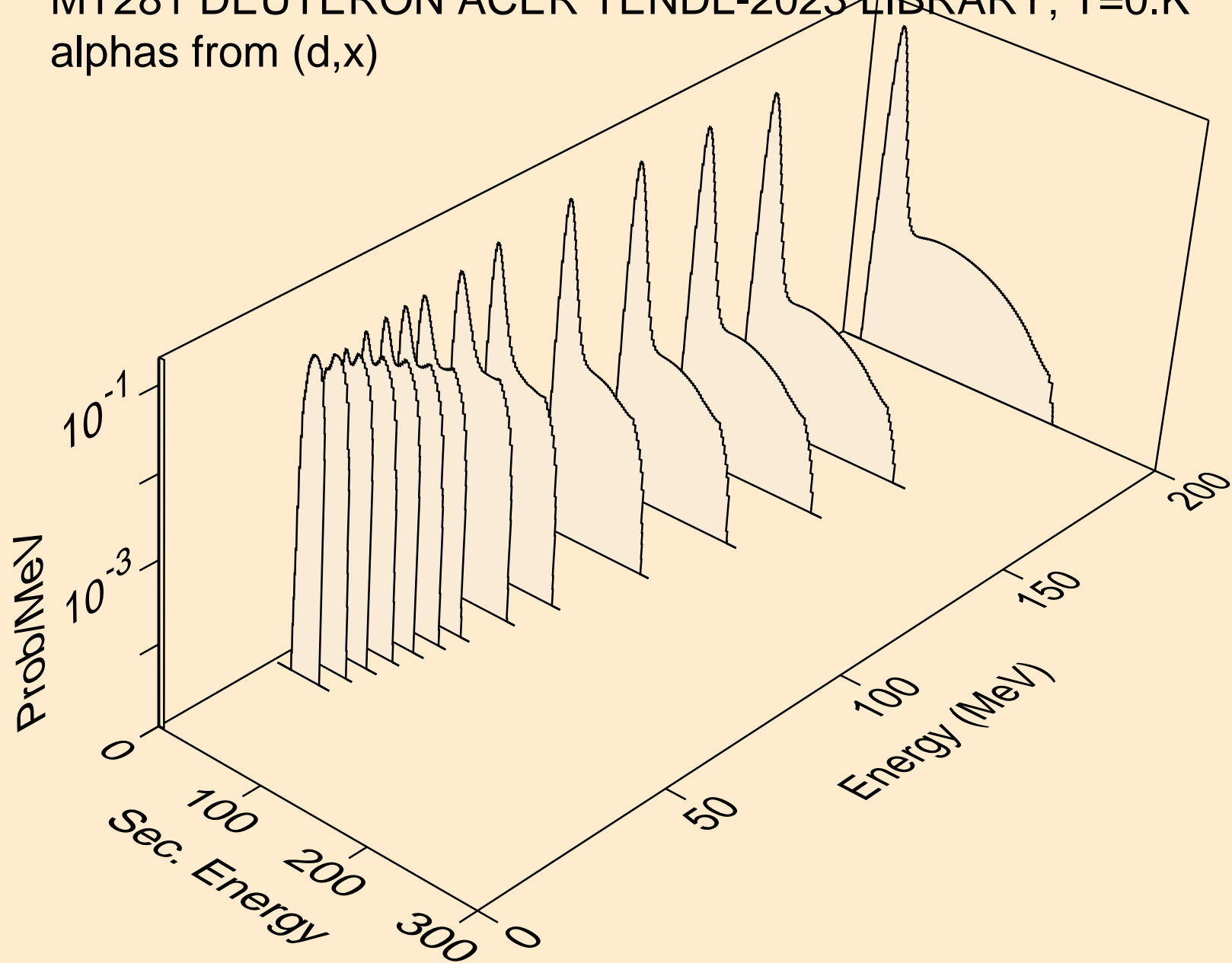

MT281 DEUTERON ACER TENDL-2023 LIBRARY; T=0.K
alphas from (d,a)

