

# N017 DEUTERON ACER TENDL-2023 LIBRARY; T=0.K

## Principal cross sections

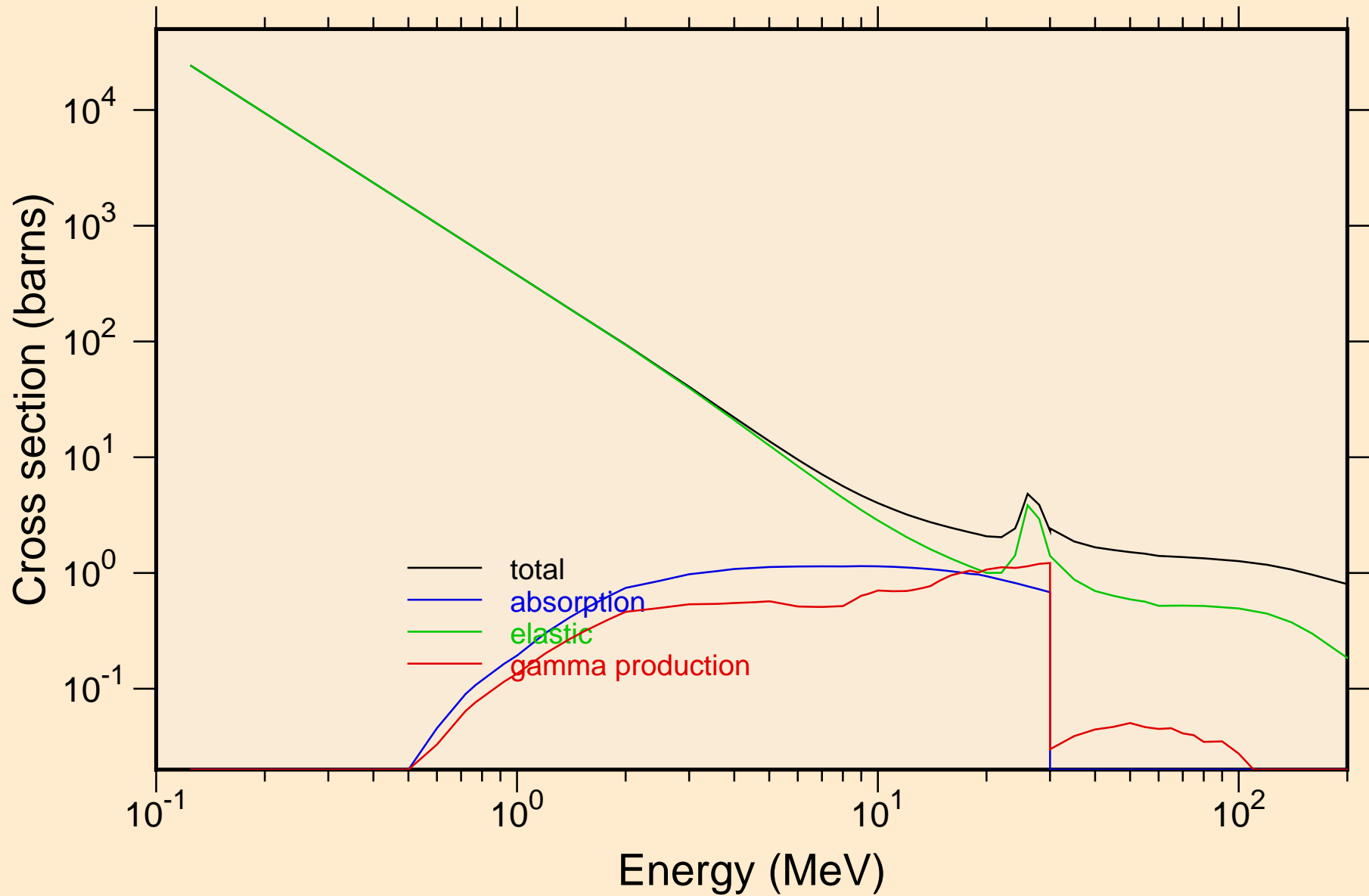

# N017 DEUTERON ACER TENDL-2023 LIBRARY; T=0.K

## Heating

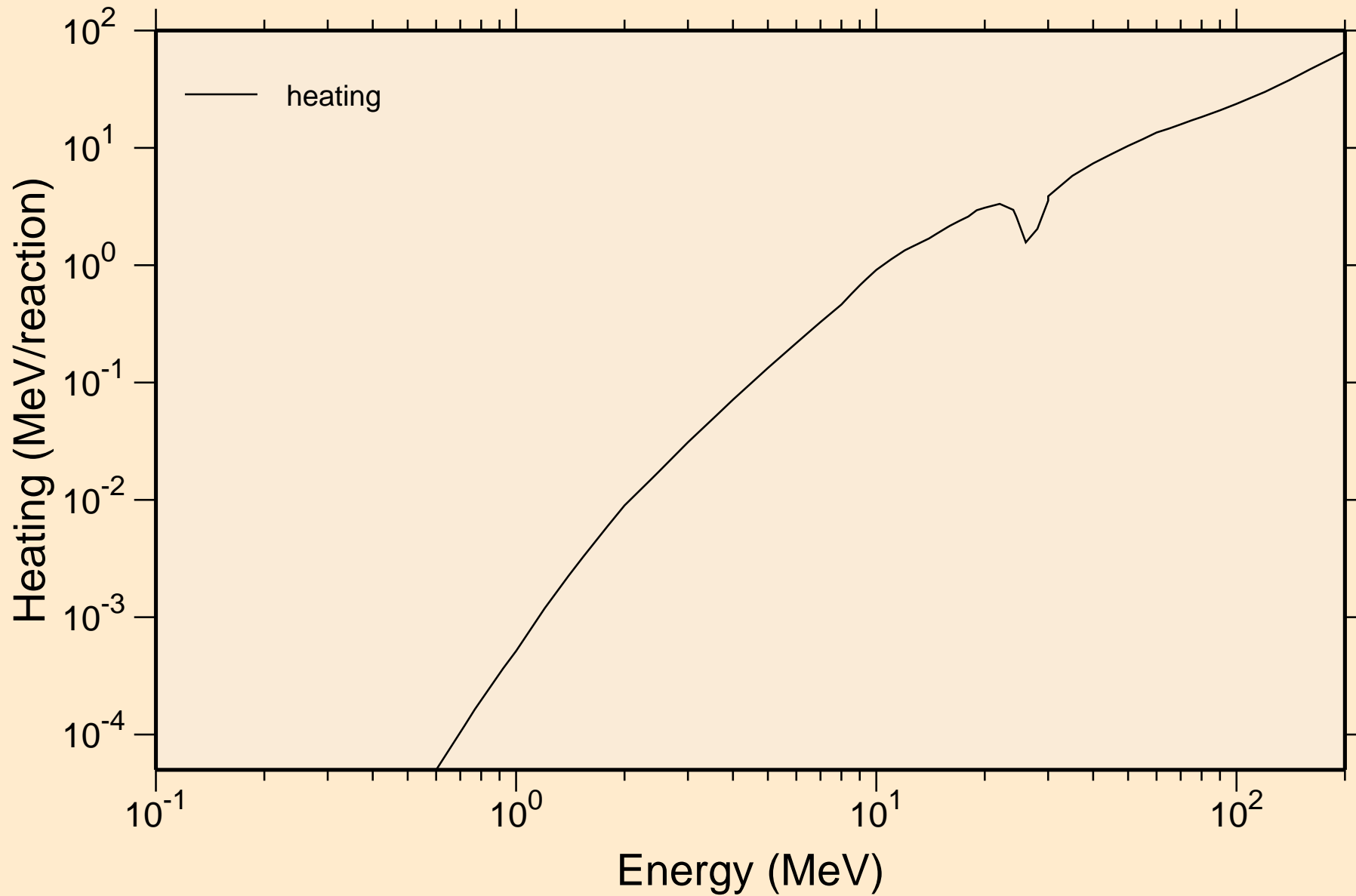

# N017 DEUTERON ACER TENDL-2023 LIBRARY; T=0.K

## Principal cross sections

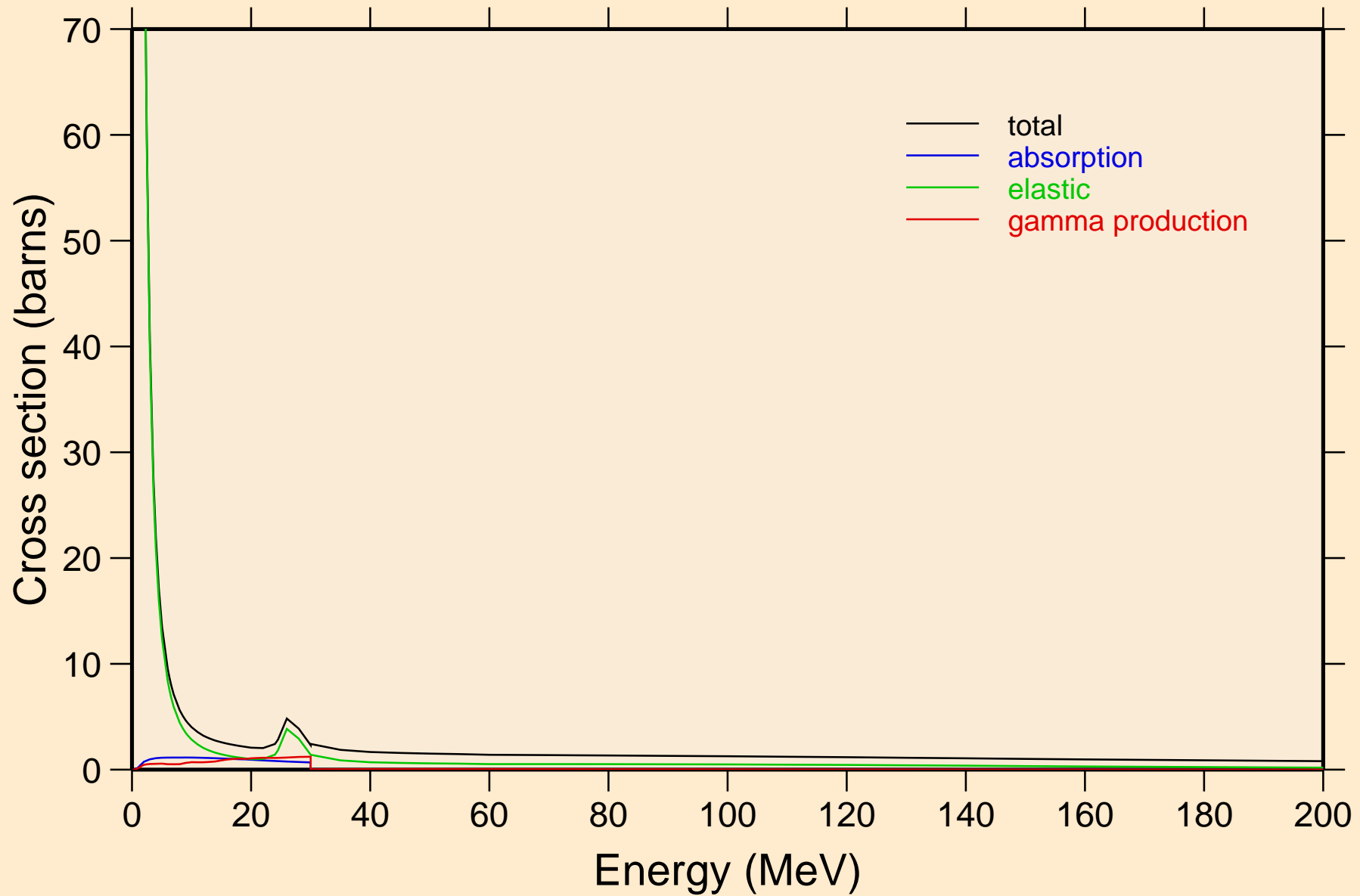

# N017 DEUTERON ACER TENDL-2023 LIBRARY; T=0.K

## Heating

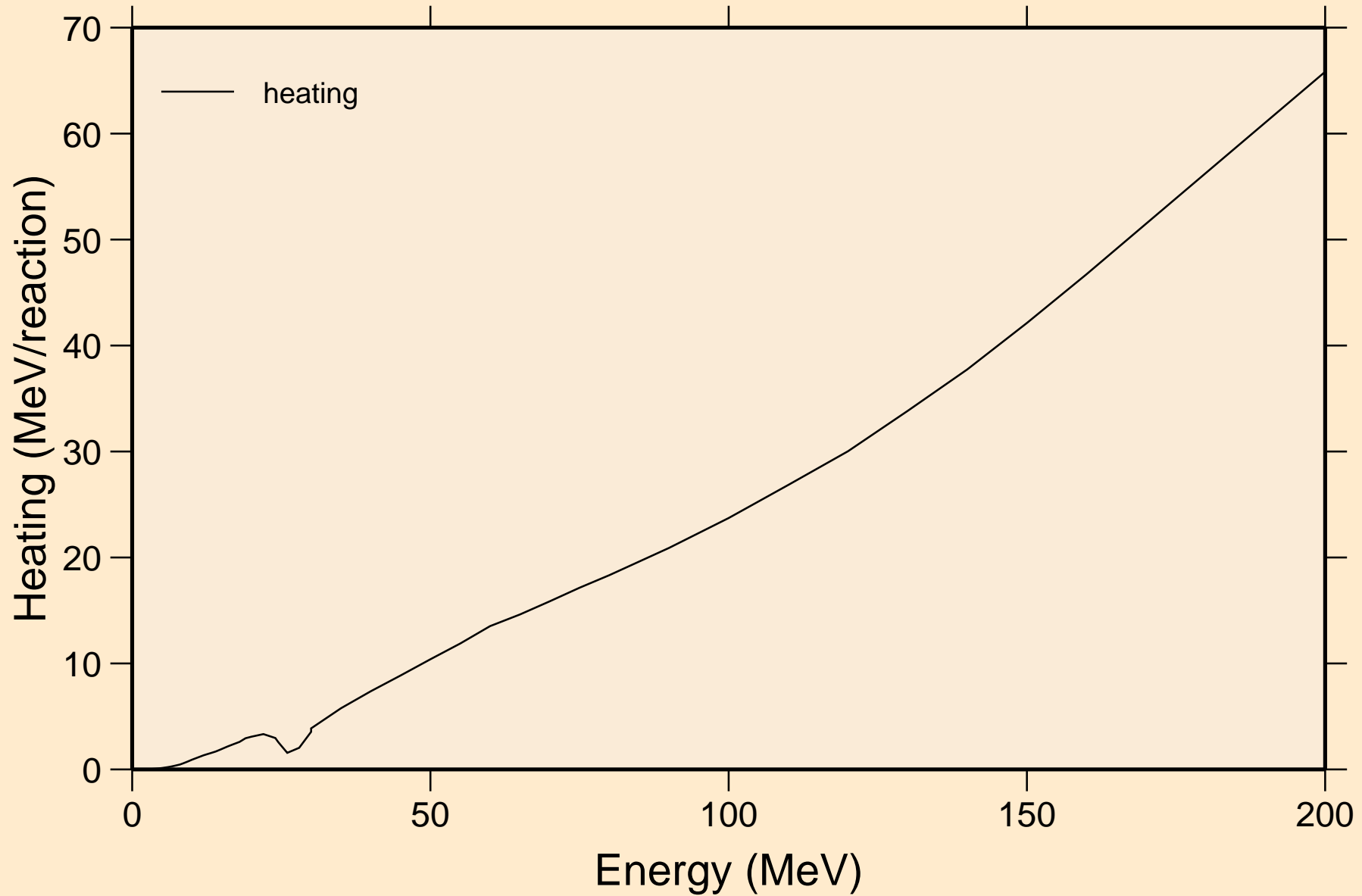

# N017 DEUTERON ACER TENDL-2023 LIBRARY; T=0.K

## Threshold reactions

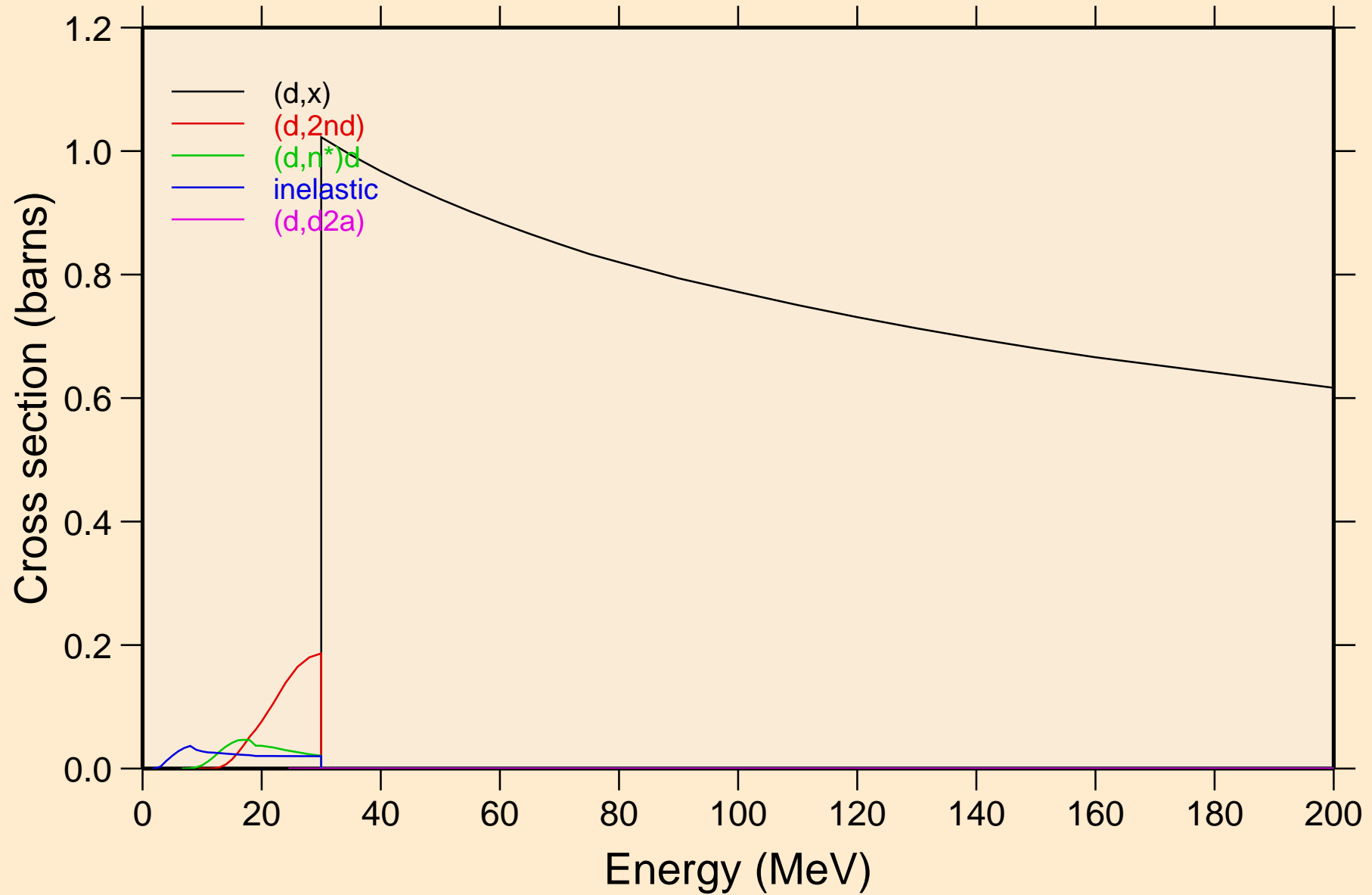

# N017 DEUTERON ACER TENDL-2023 LIBRARY; T=0.K

## Threshold reactions

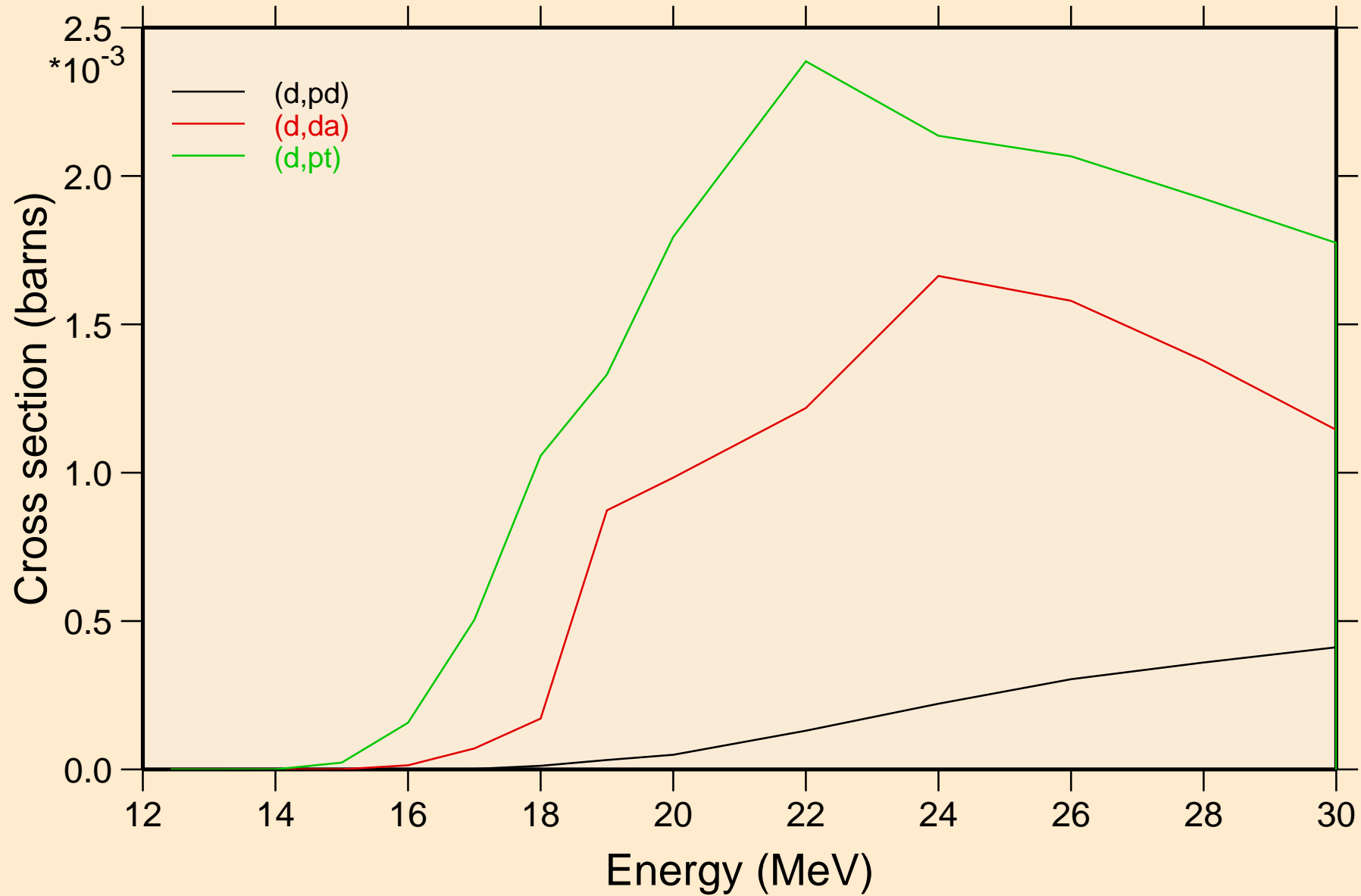

N017 DEUTERON ACER TENDL-2023 LIBRARY; T=0.K  
Threshold reactions

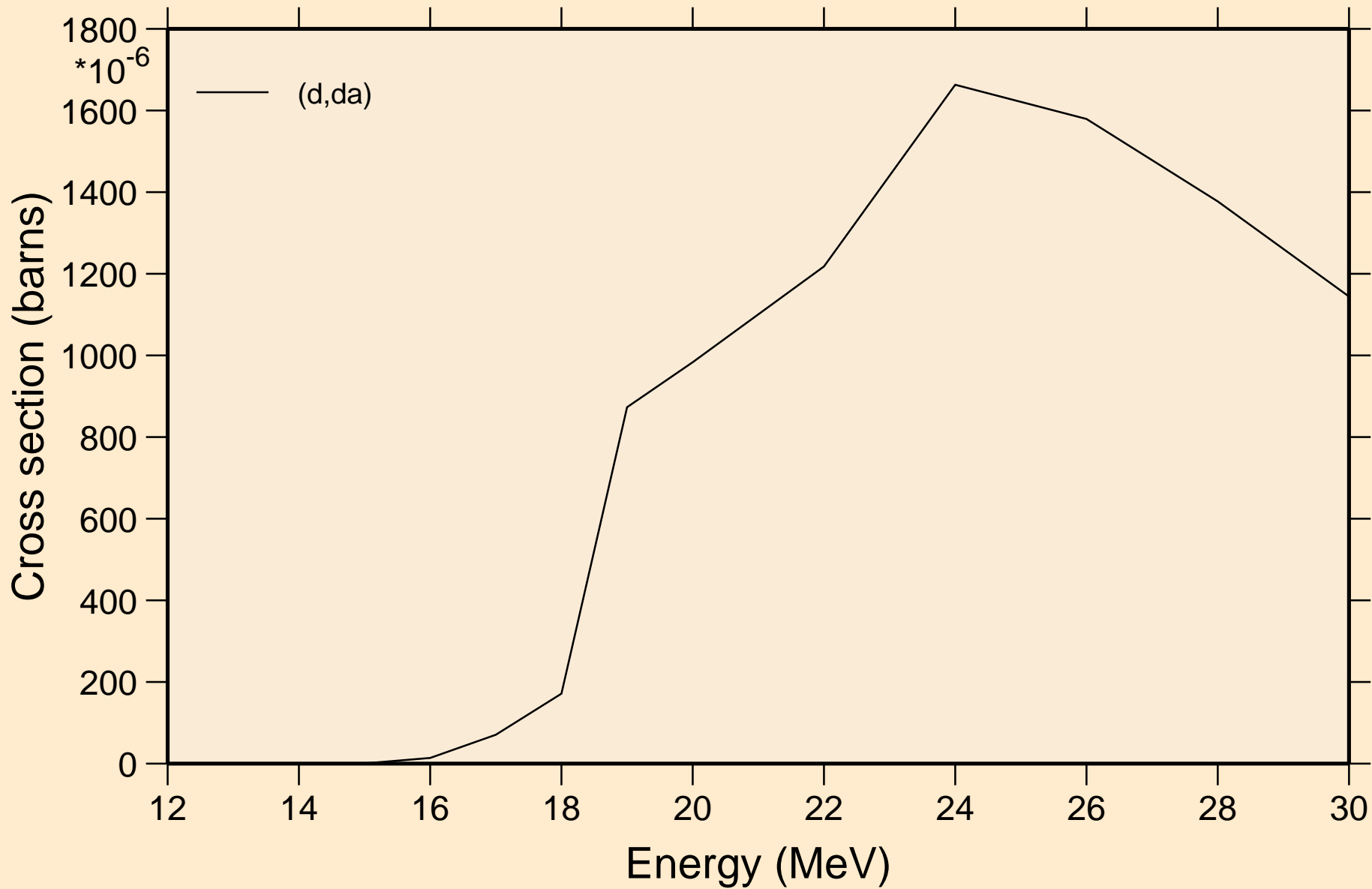

N017 DEUTERON ACER TENDL-2023 LIBRARY; T=0.K  
angular distribution for elastic

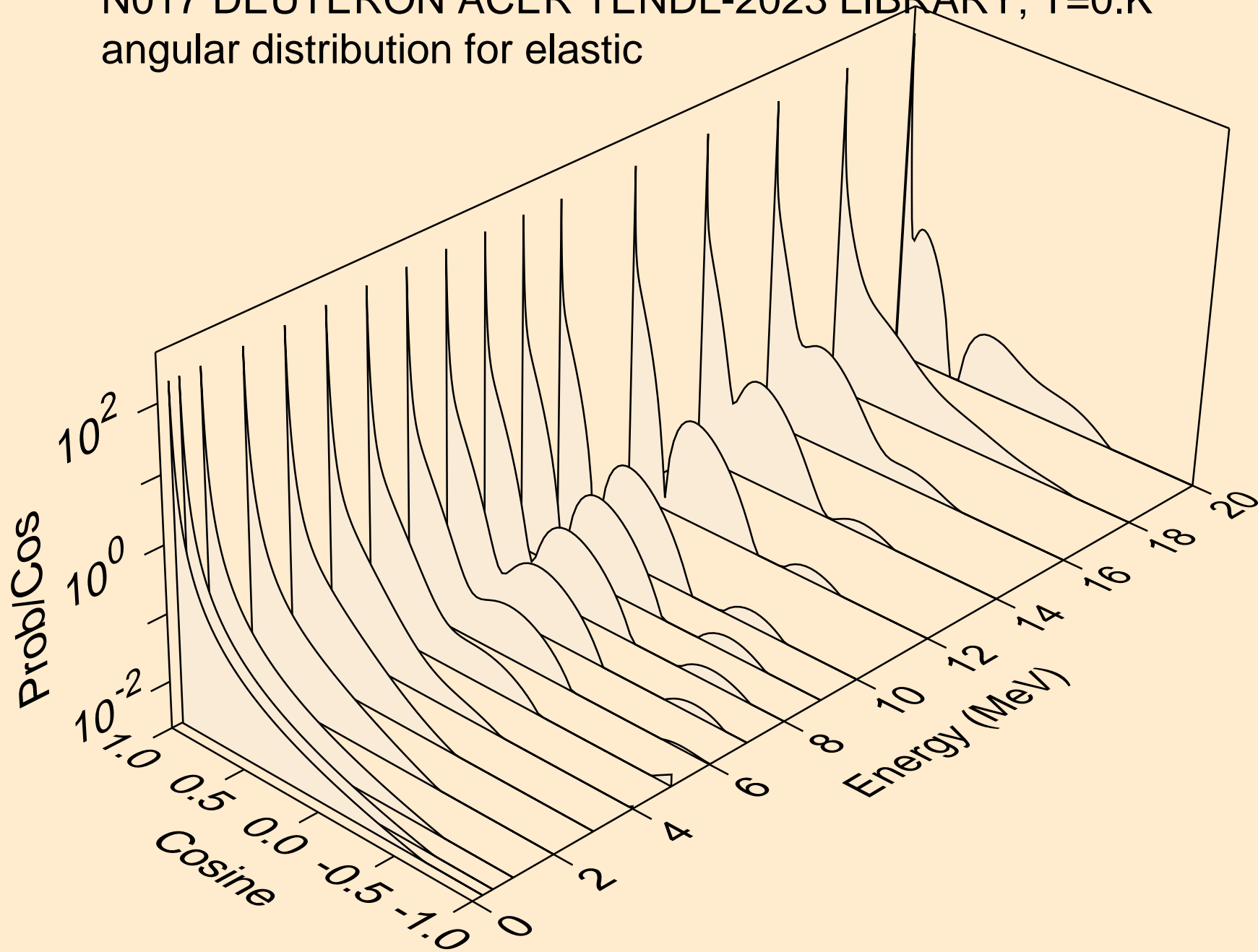



N017 DEUTERON ACER TENDL-2023 LIBRARY; T=0.K  
angular distribution for elastic

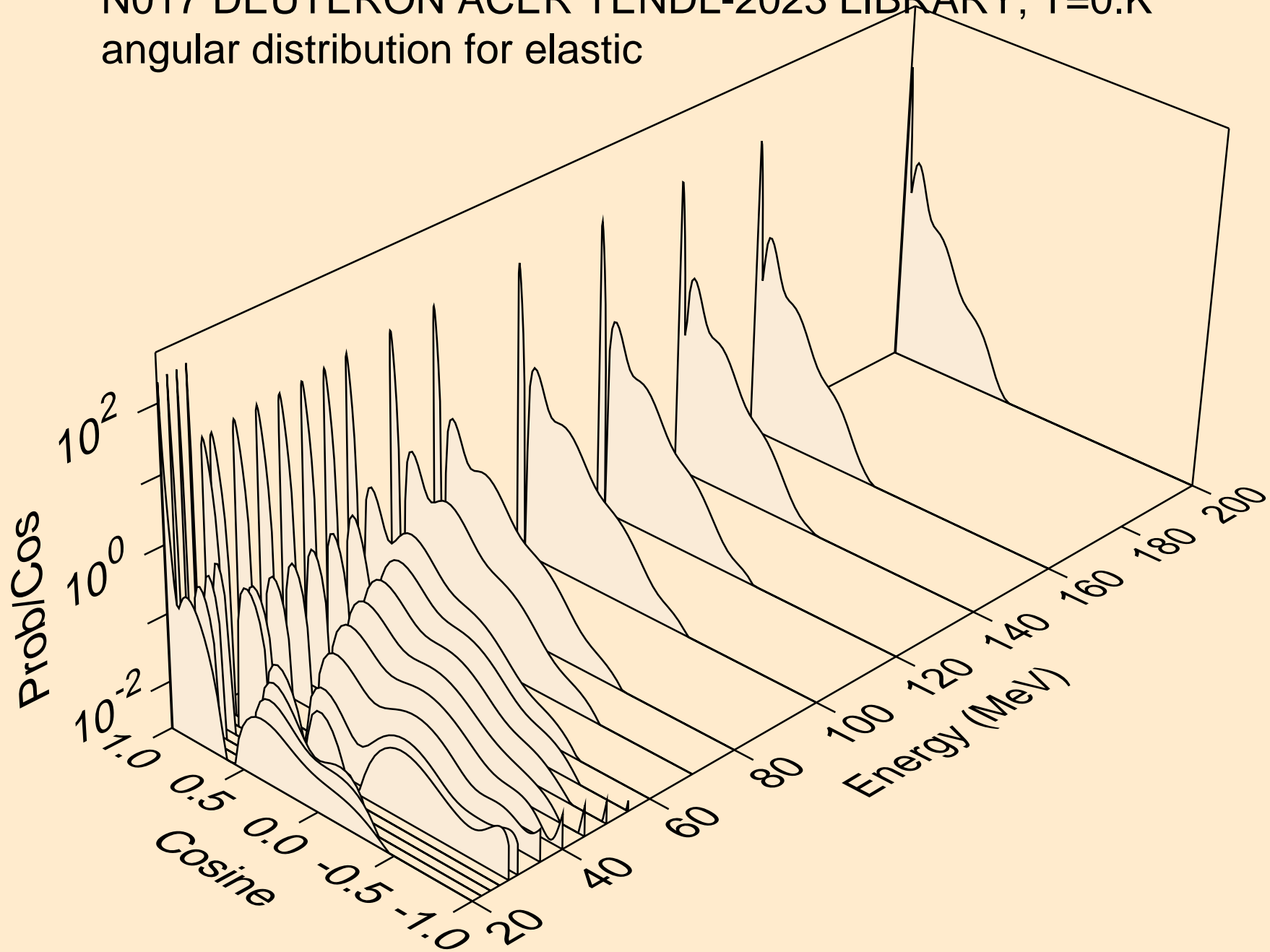

N017 DEUTERON ACER TENDL-2023 LIBRARY; T=0.K  
Deuteron emission for (d,x)

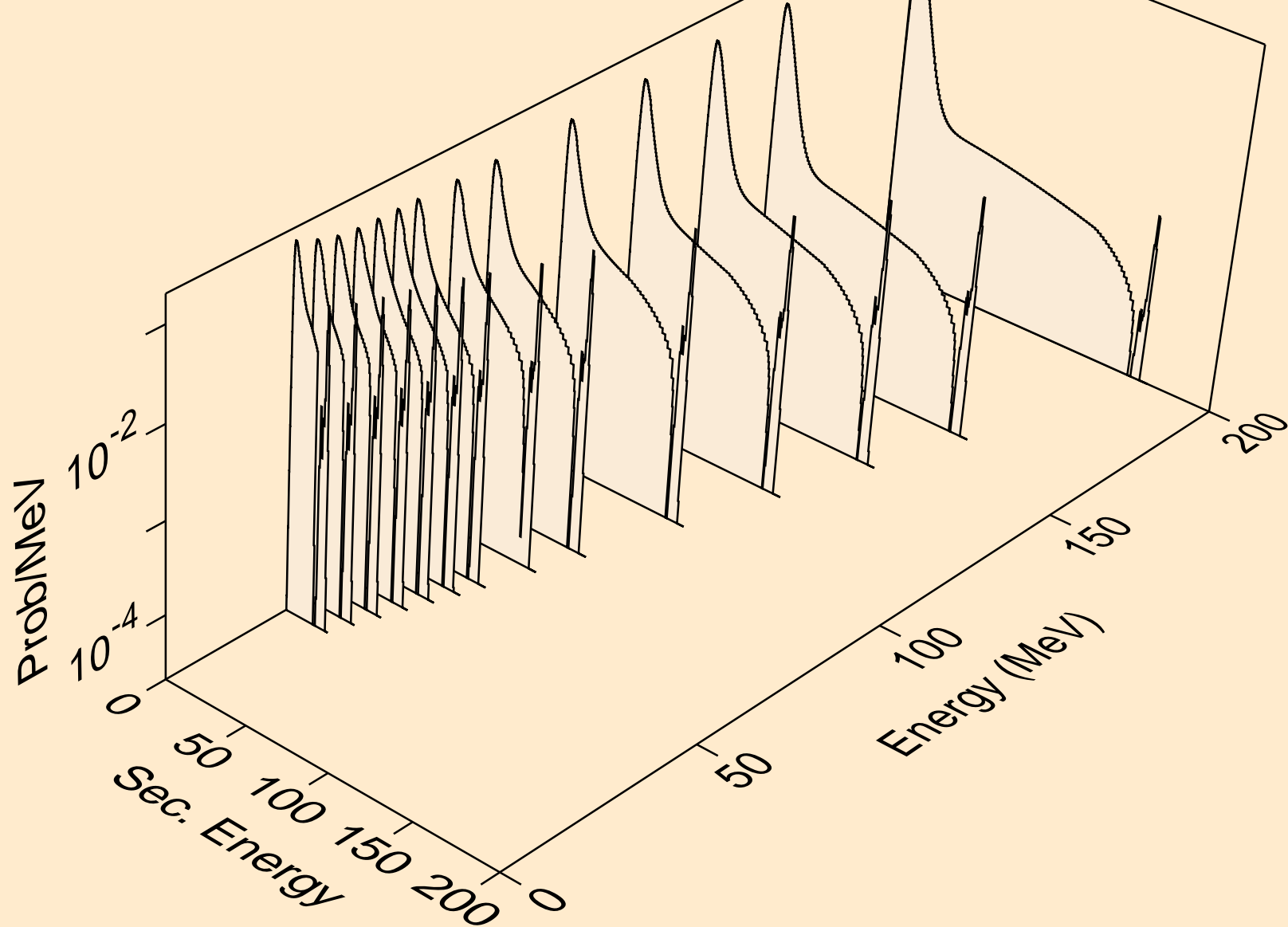

N017 DEUTERON ACER TENDL-2023 LIBRARY; T=0.K  
Deuteron emission for (d,2nd)

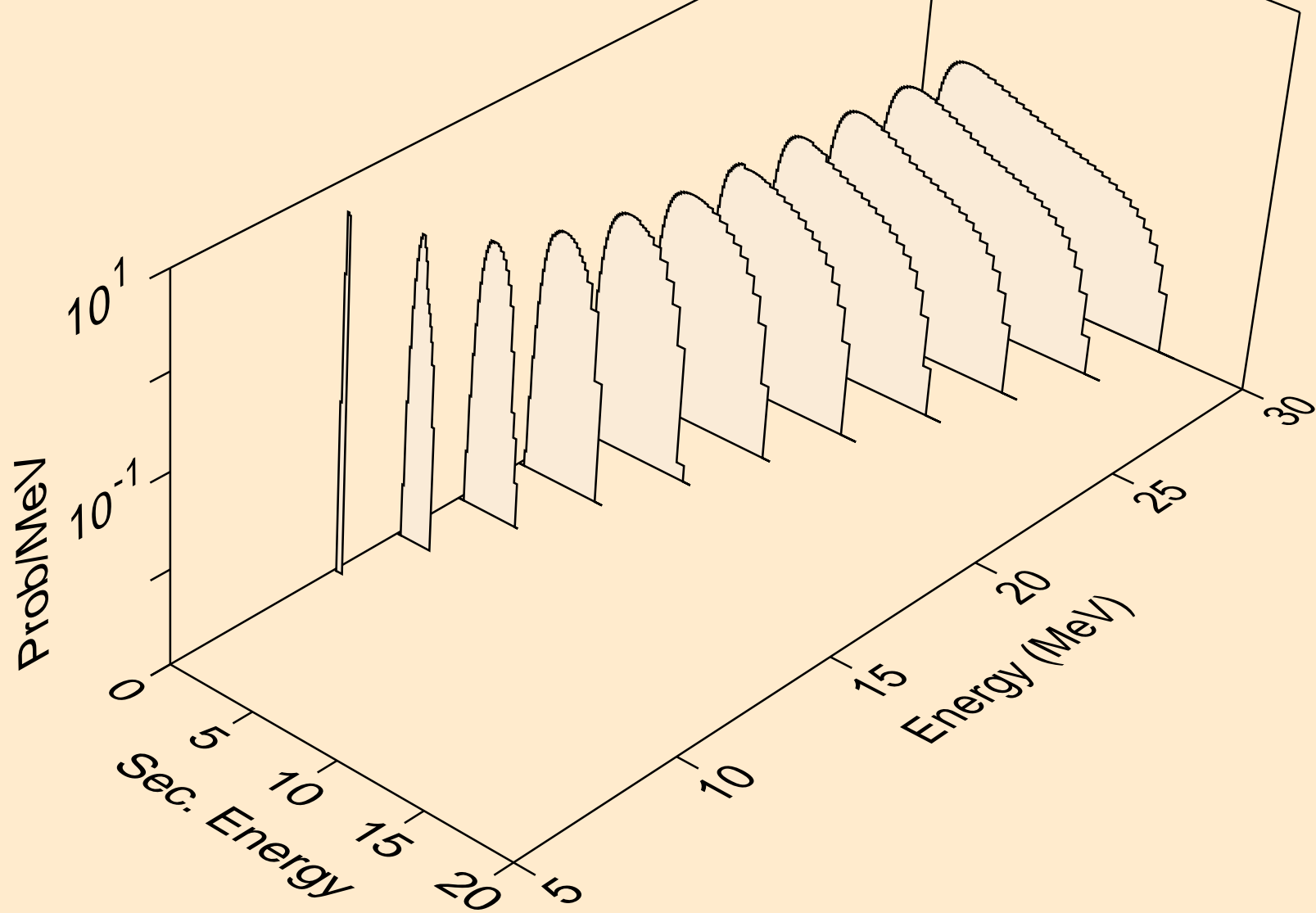

N017 DEUTERON ACER TENDL-2023 LIBRARY; T=0.K  
Deuteron emission for (d,n\*)d

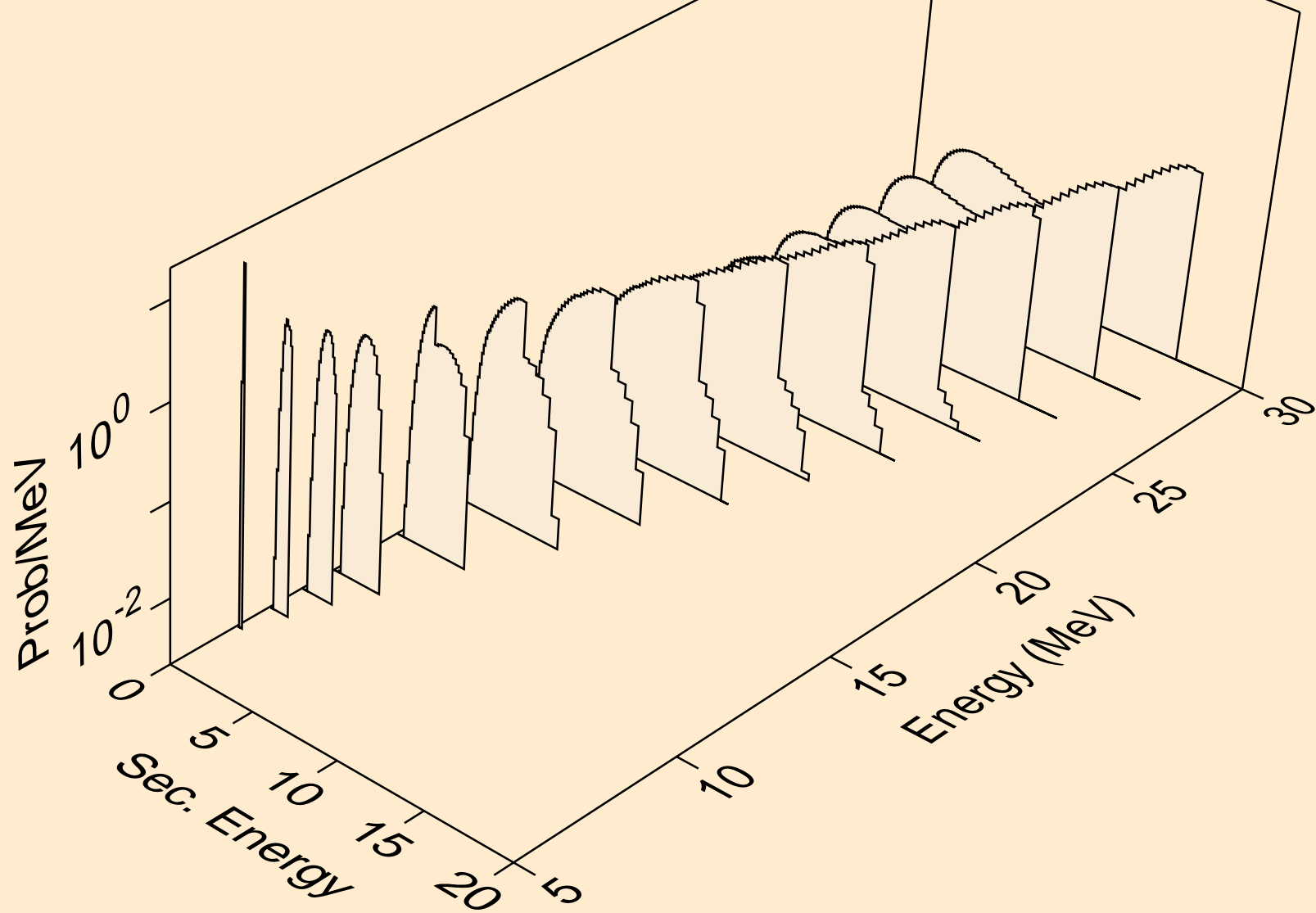

N017 DEUTERON ACER TENDL-2023 LIBRARY; T=0.K  
Deuteron emission for inelastic

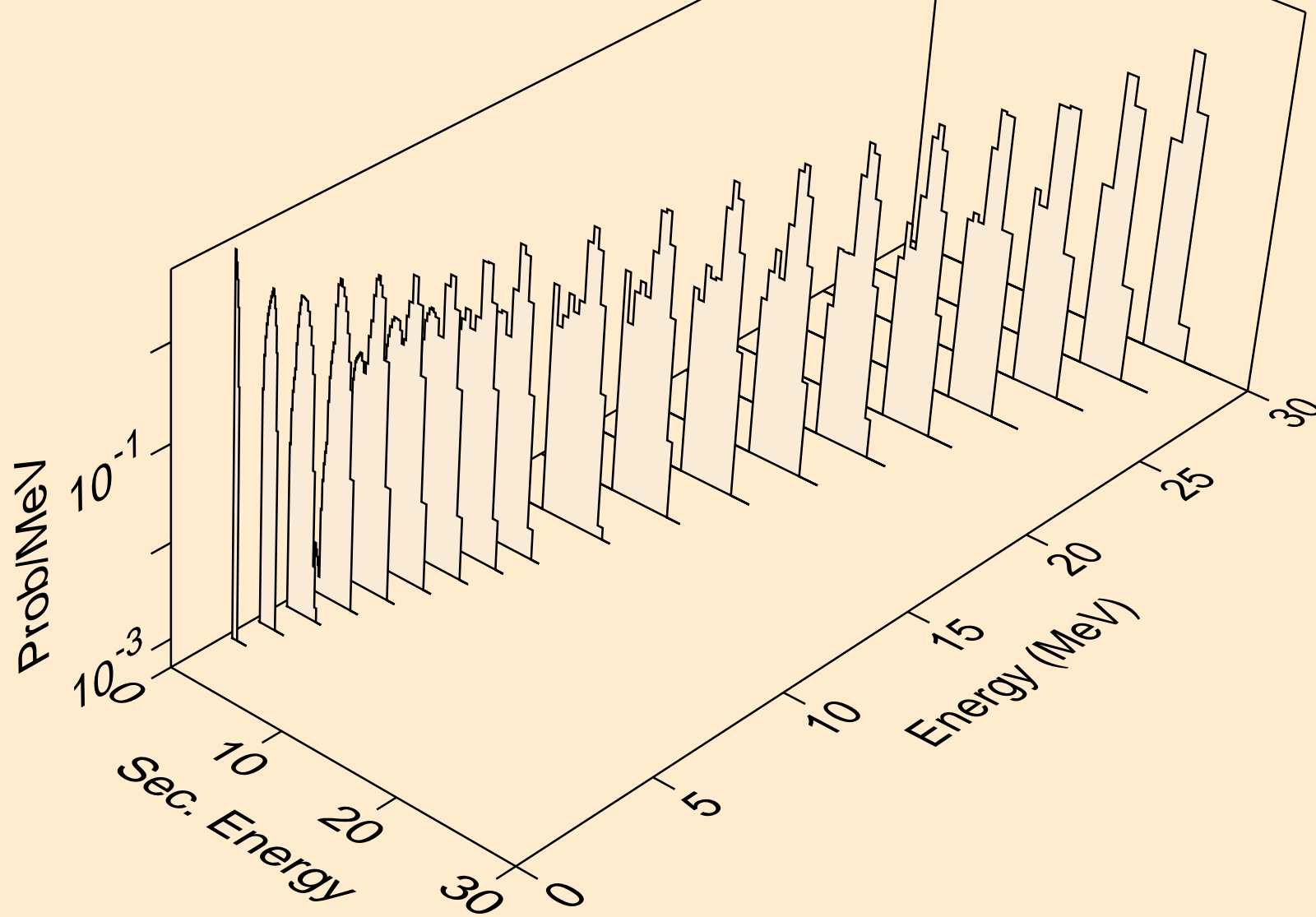

N017 DEUTERON ACER TENDL-2023 LIBRARY; T=0.K  
Deuteron emission for (d,d2a)

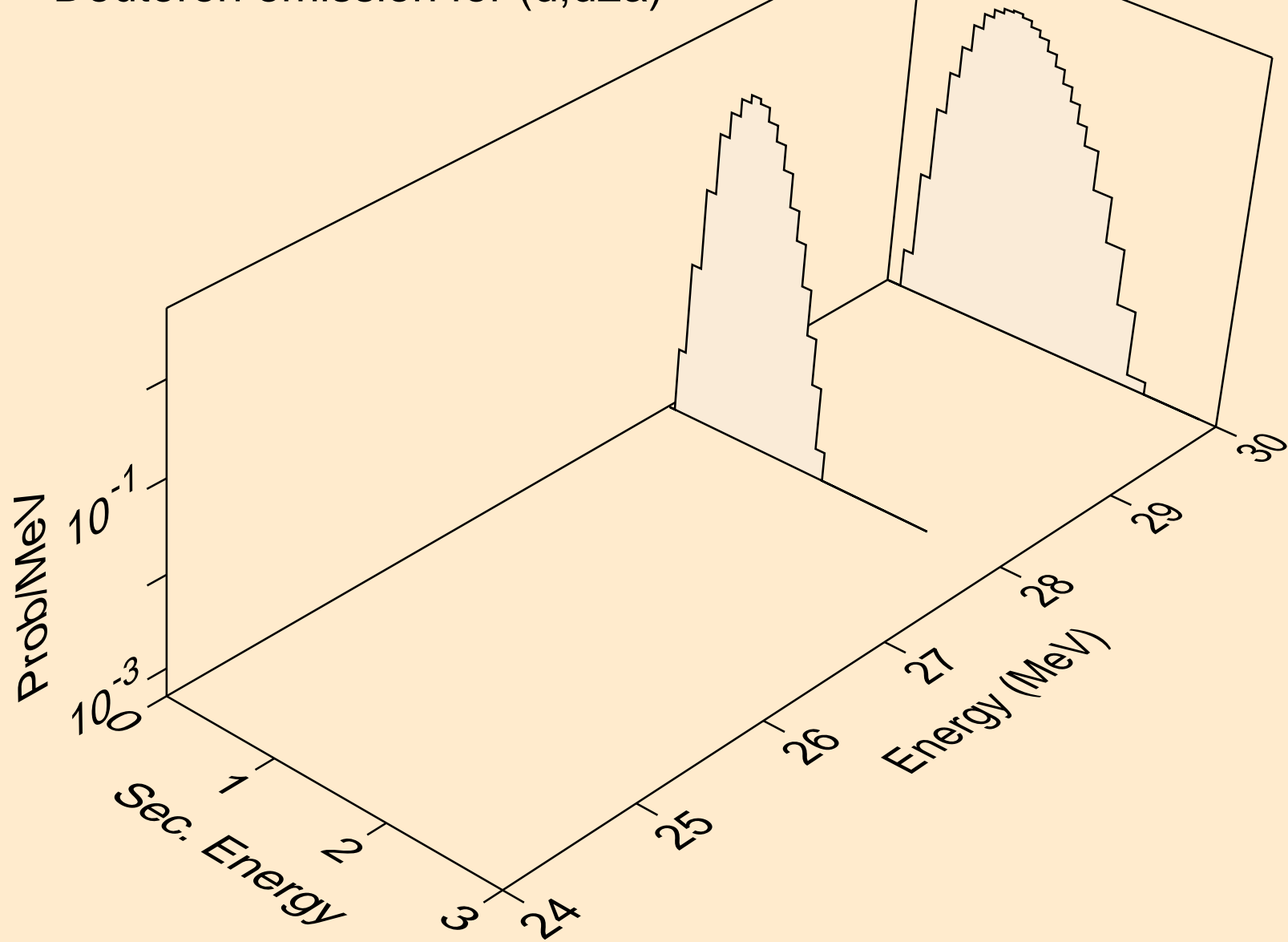

N017 DEUTERON ACER TENDL-2023 LIBRARY; T=0.K  
Deuteron emission for (d,pd)

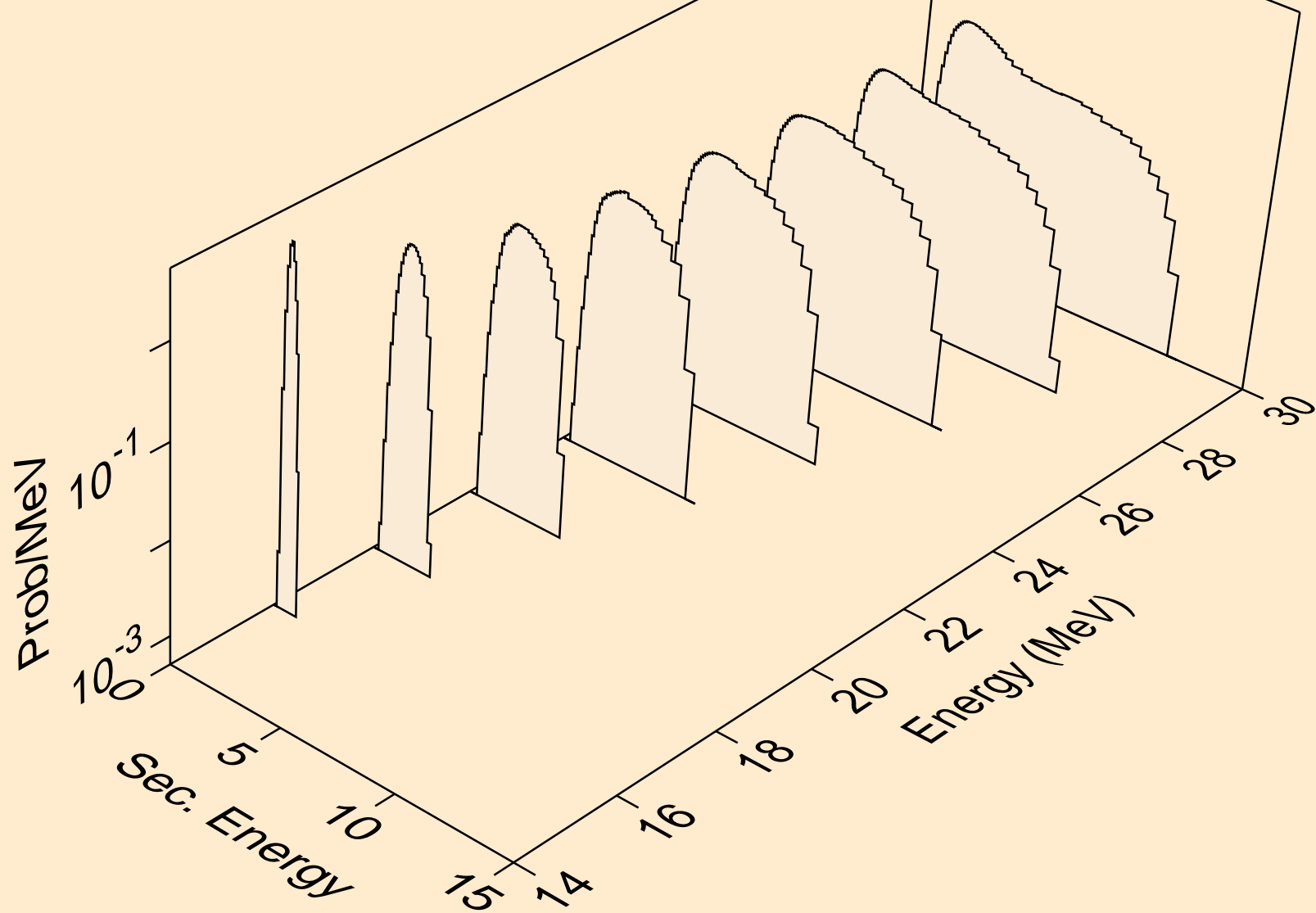

N017 DEUTERON ACER TENDL-2023 LIBRARY; T=0.K  
Deuteron emission for (d,da)

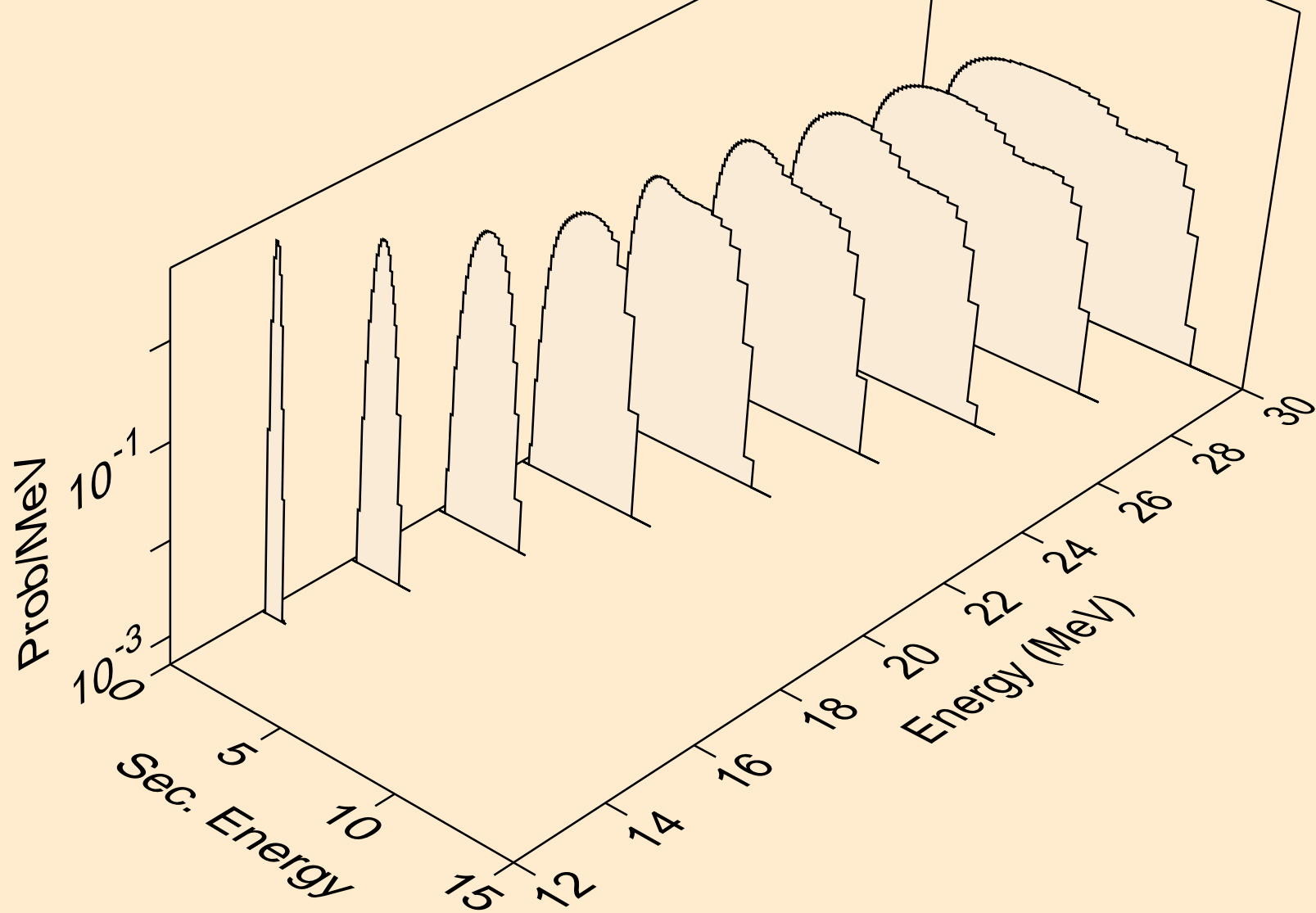



N017 DEUTERON ACER TENDL-2023 LIBRARY; T=0.K  
Photon emission for (z,n)

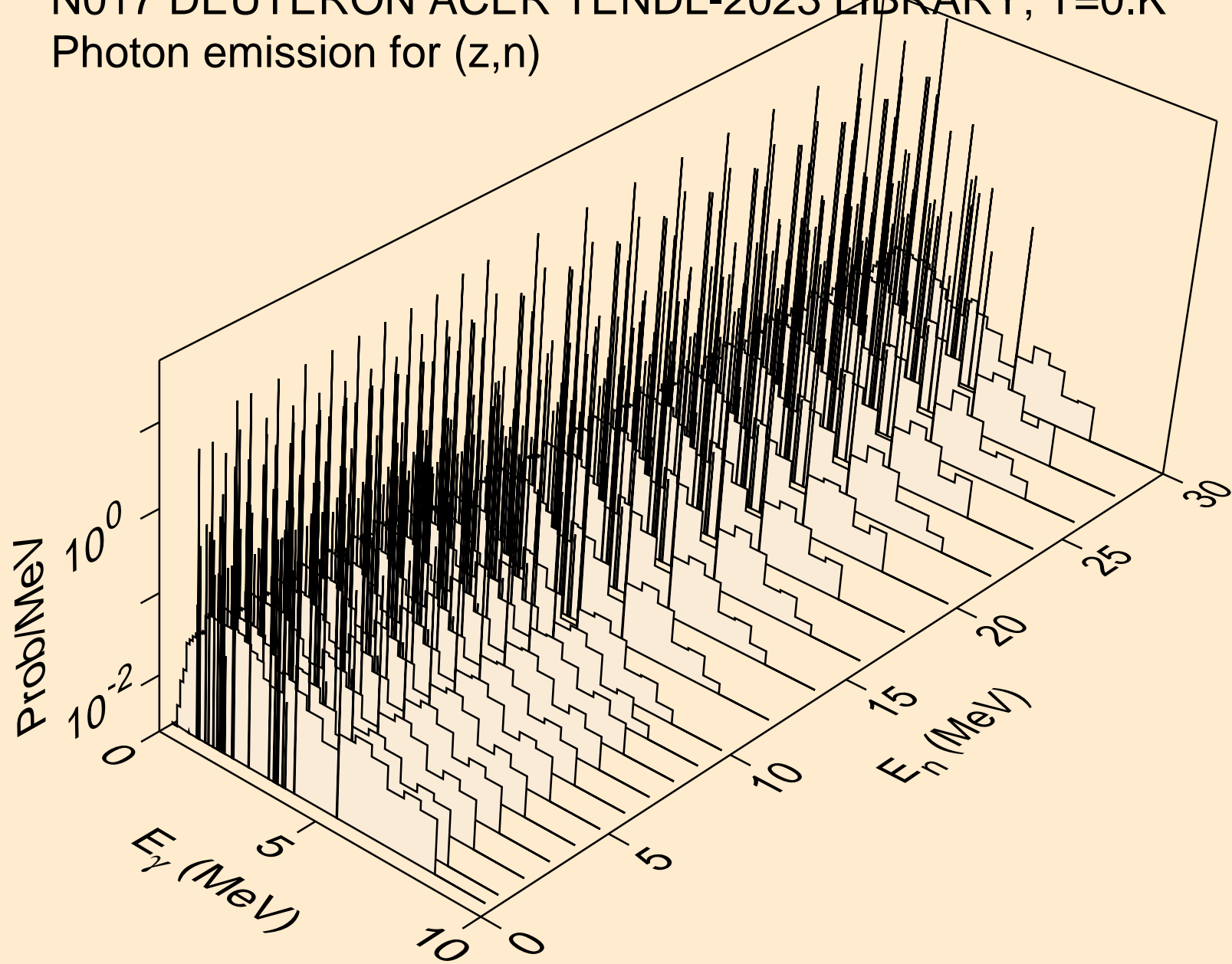

N017 DEUTERON ACER TENDL-2023 LIBRARY; T=0.K  
Photon emission for (z,x)

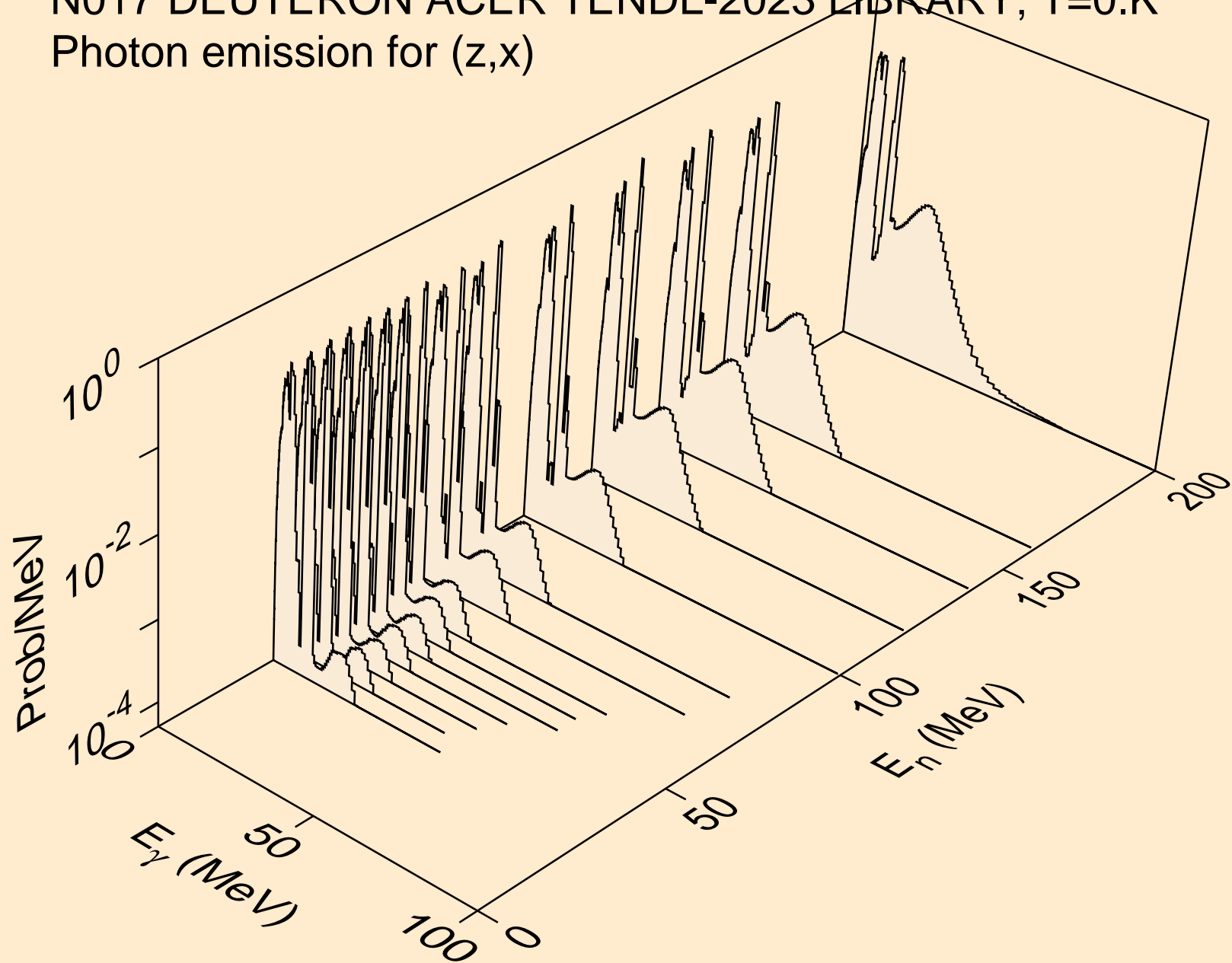

N017 DEUTERON ACER TENDL-2023 LIBRARY; T=0.K  
Photon emission for (n,2nd)

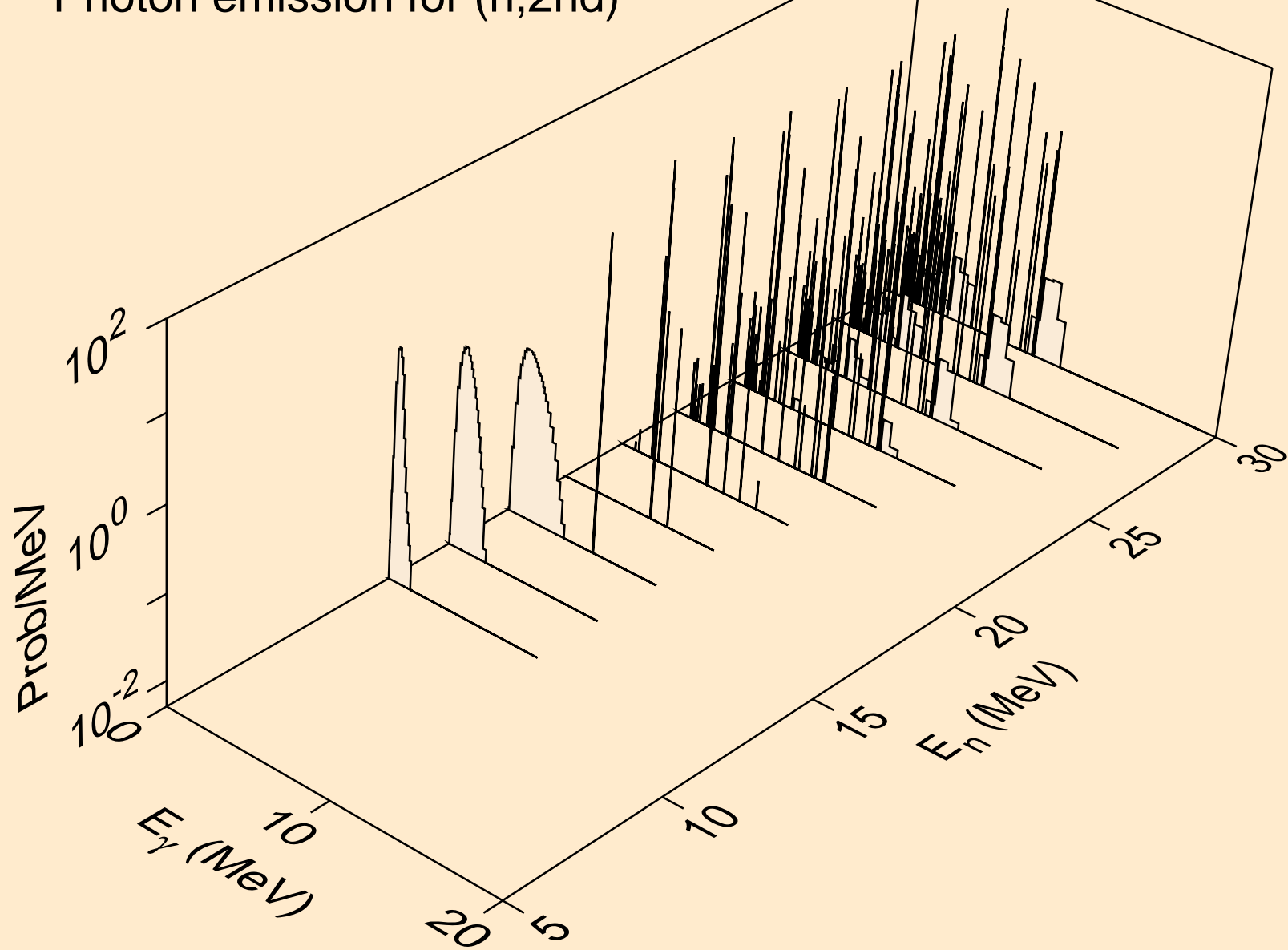

N017 DEUTERON ACER TENDL-2023 LIBRARY; T=0.K  
Photon emission for (n,2n)

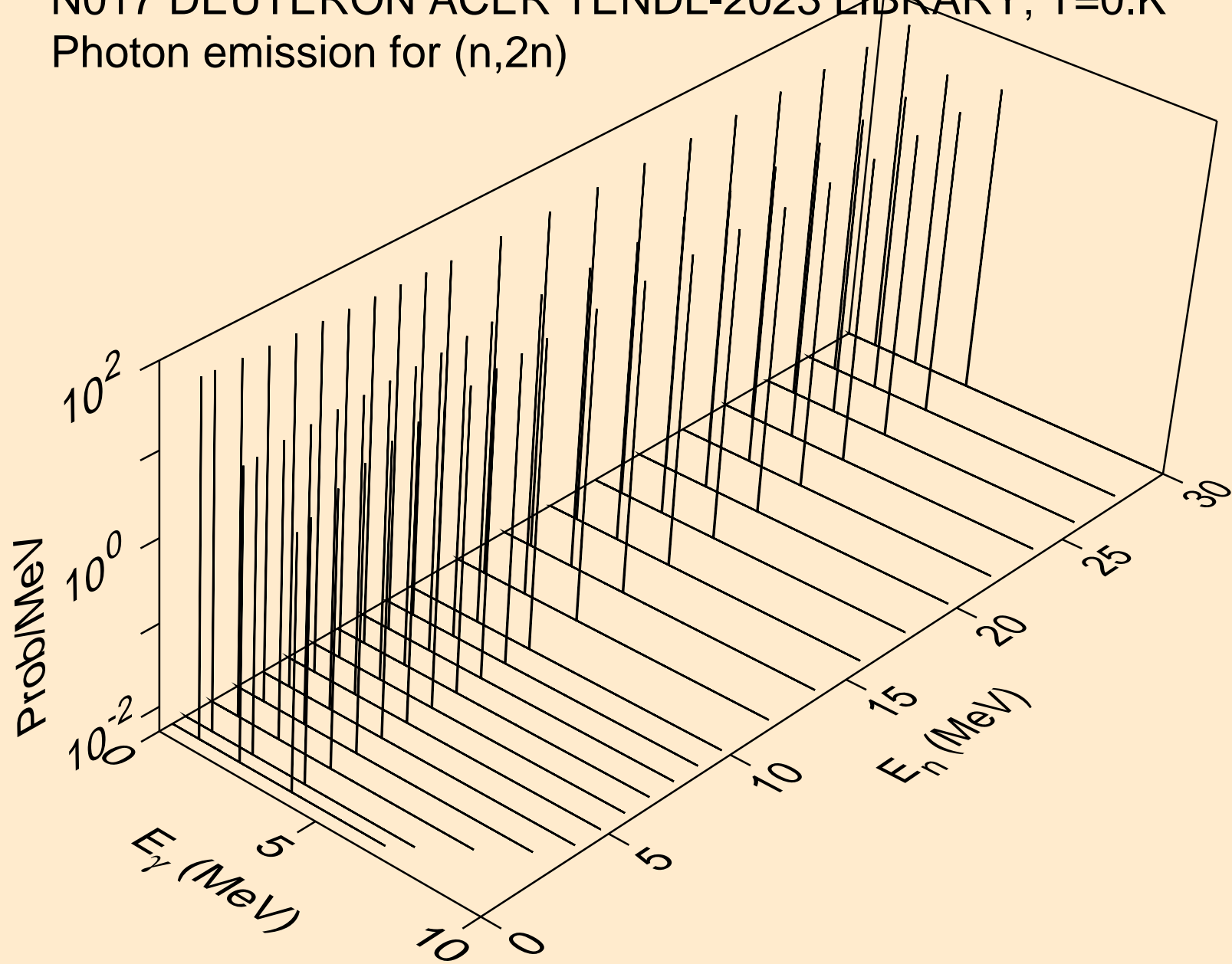

N017 DEUTERON ACER TENDL-2023 LIBRARY; T=0.K  
Photon emission for (n,3n)

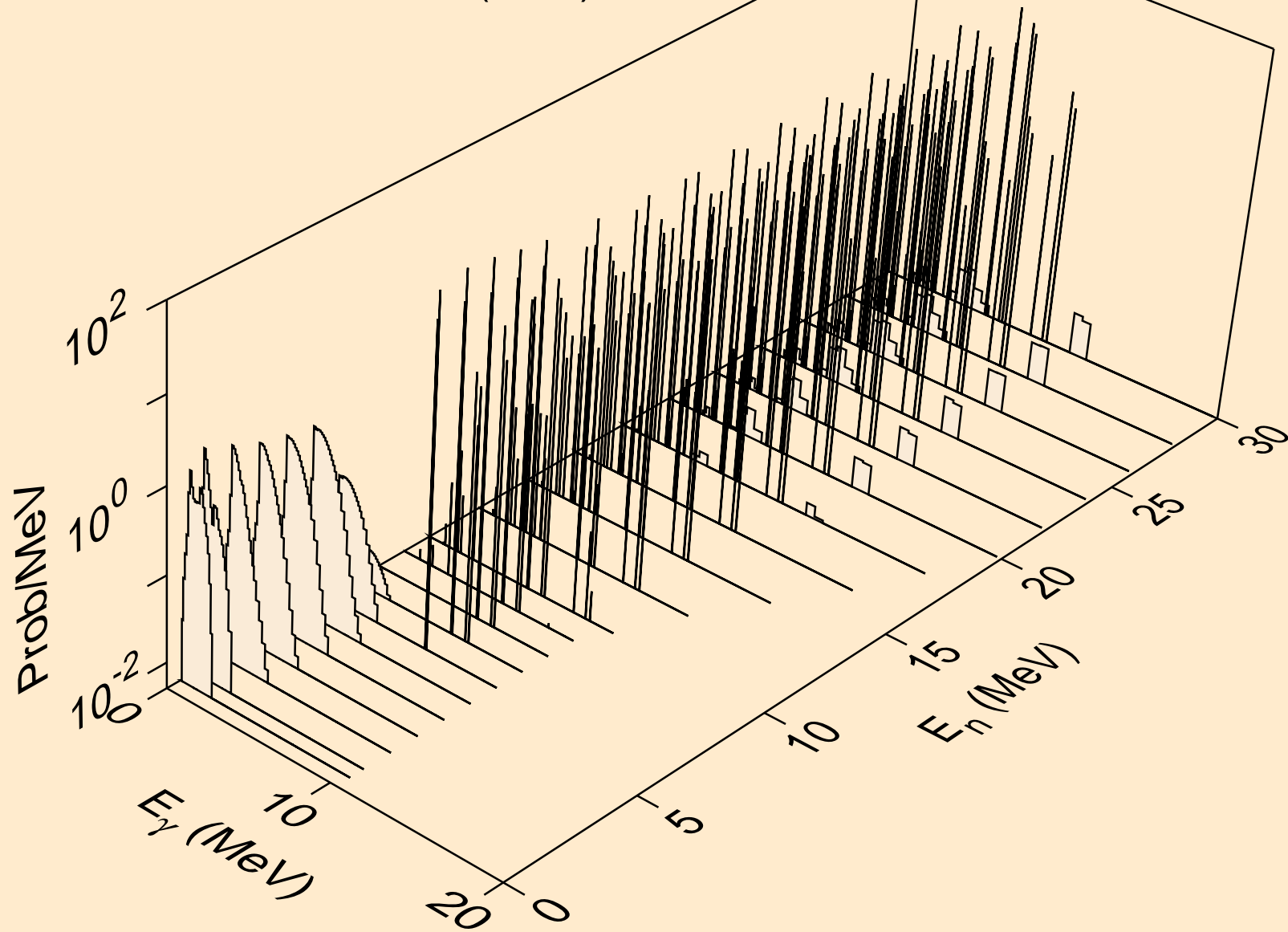

N017 DEUTERON ACER TENDL-2023 LIBRARY; T=0.K  
Photon emission for (n,n\*)a

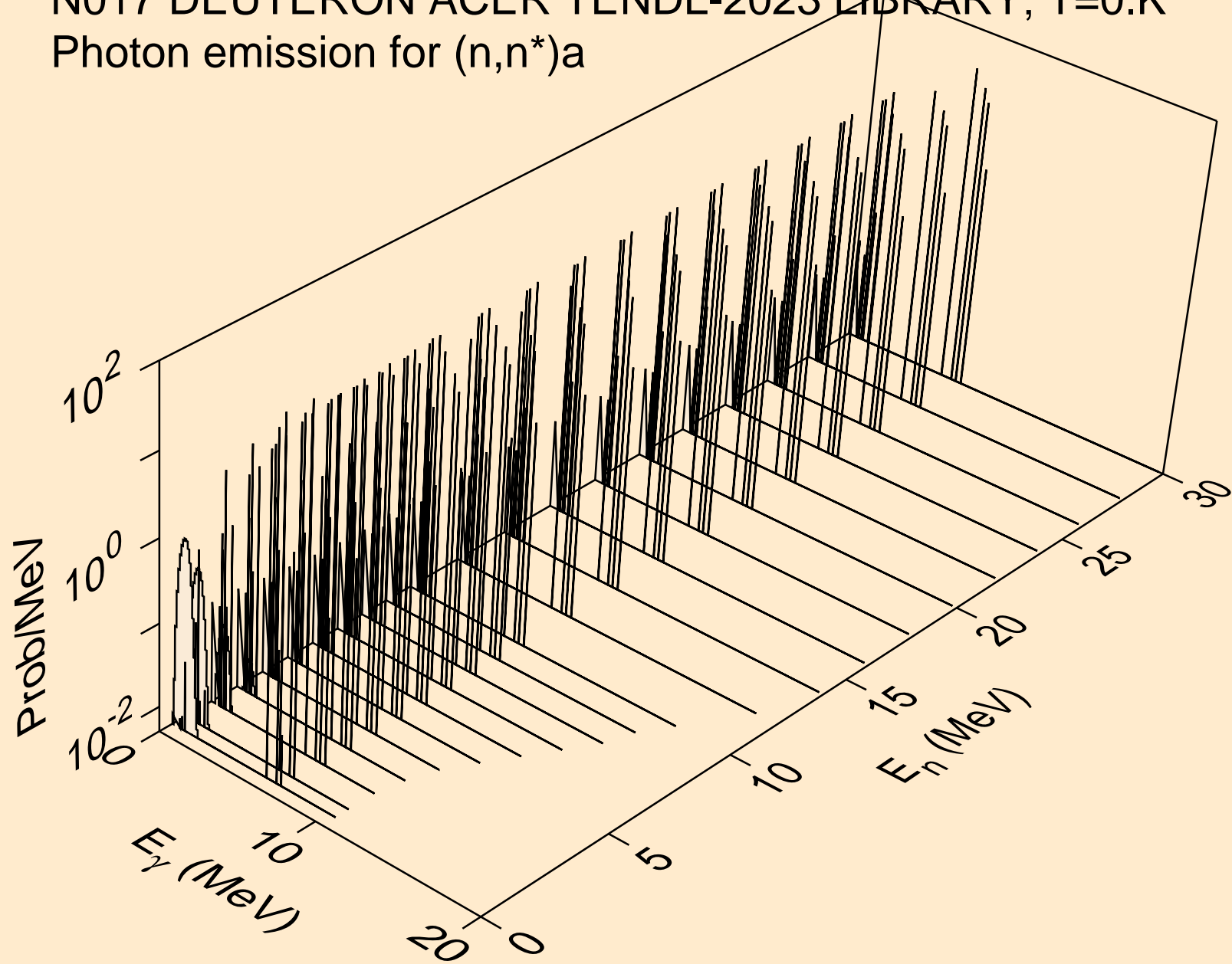

N017 DEUTERON ACER TENDL-2023 LIBRARY; T=0.K  
Photon emission for (n,2n)a

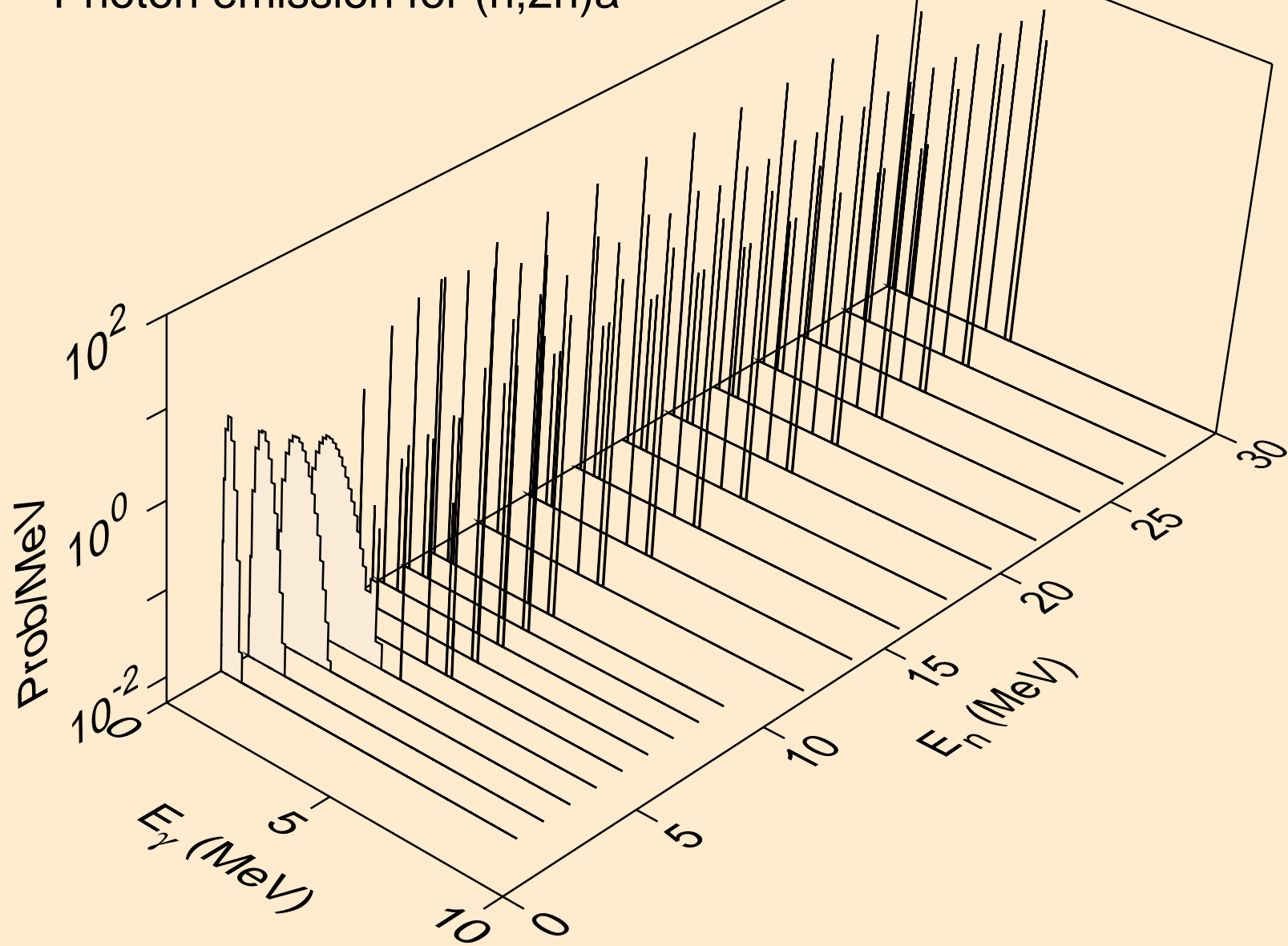

N017 DEUTERON ACER TENDL-2023 LIBRARY; T=0.K  
Photon emission for (n,3n)a

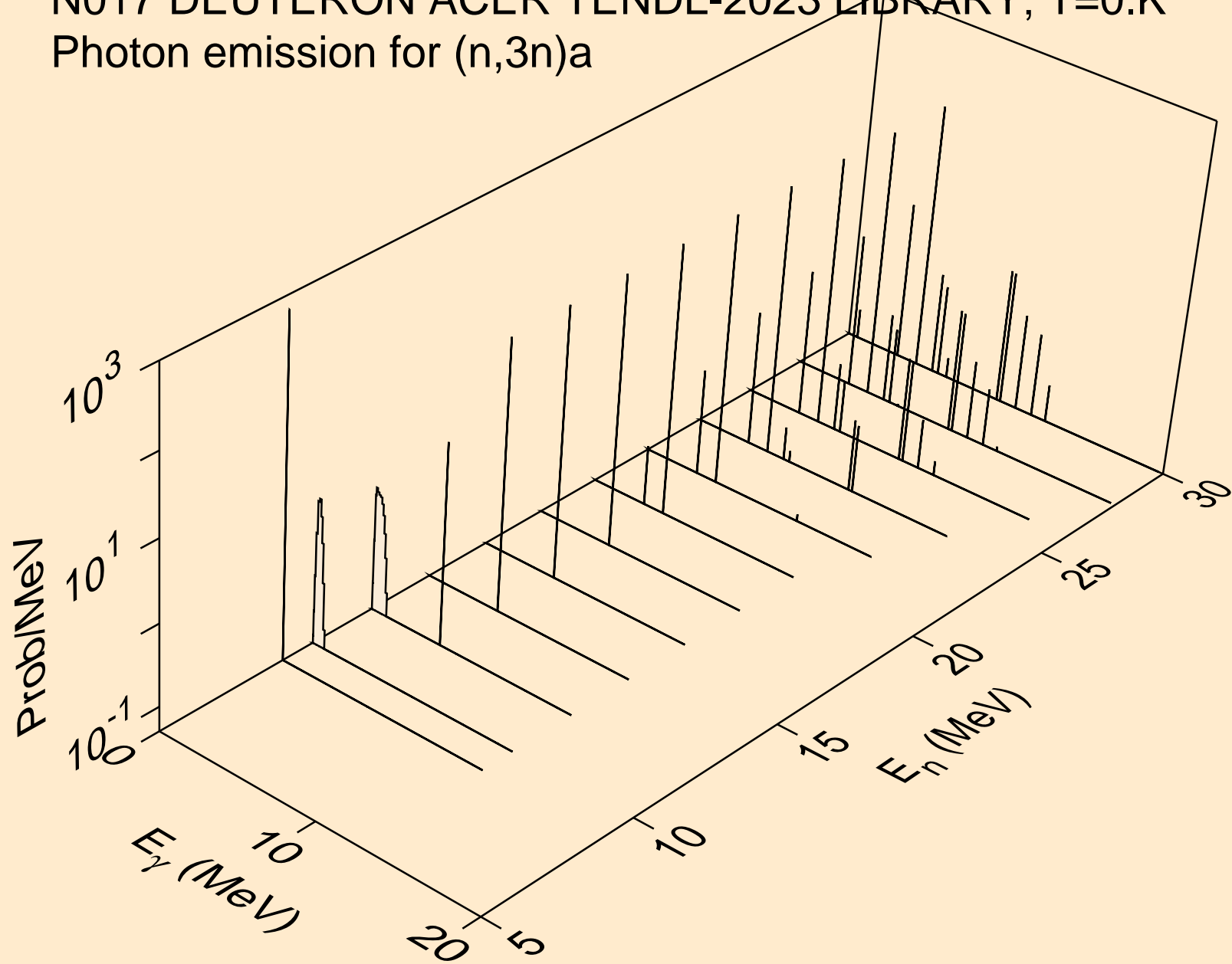



N017 DEUTERON ACER TENDL-2023 LIBRARY; T=0.K  
Photon emission for (n,n\*)p

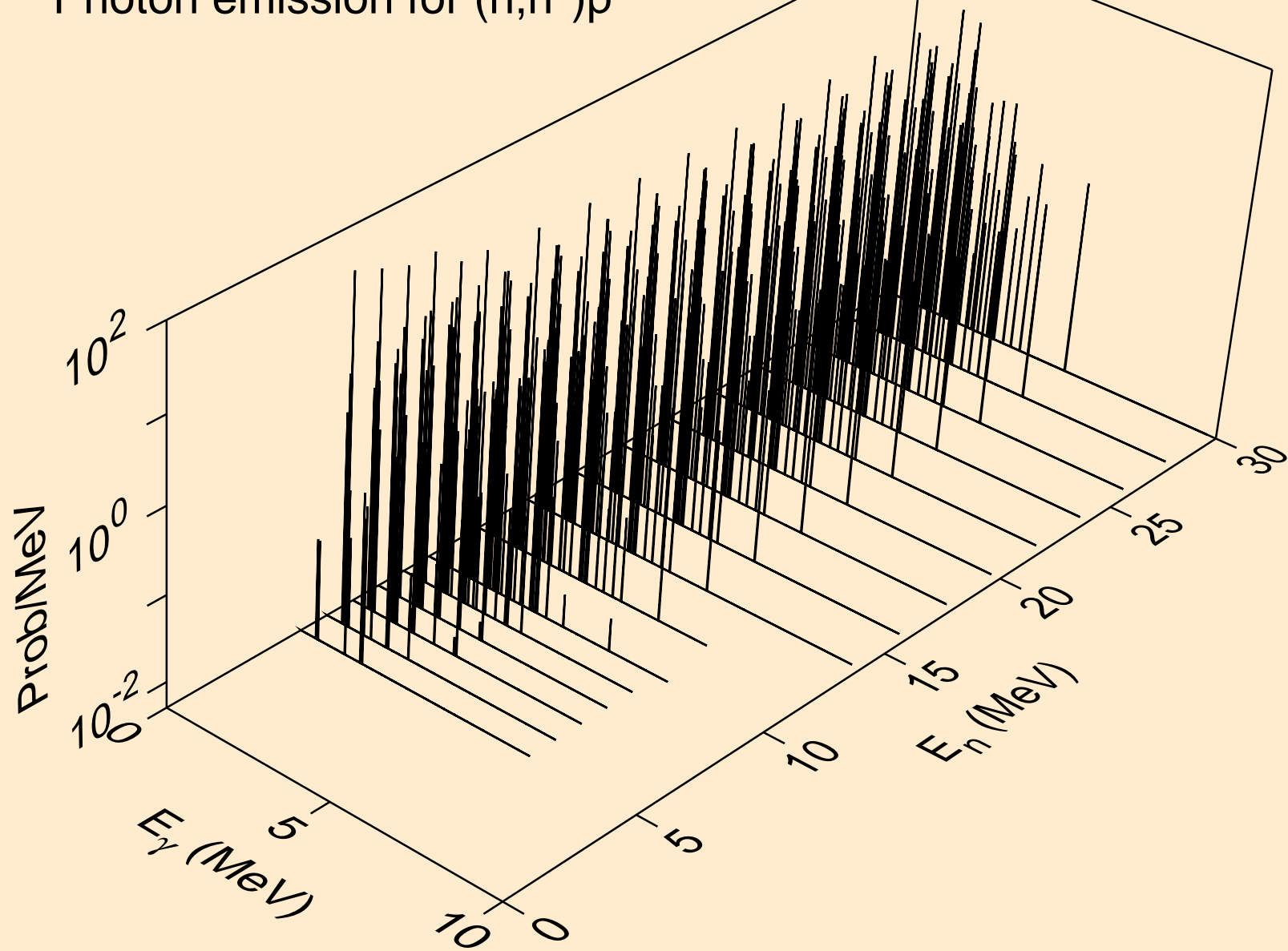

N017 DEUTERON ACER TENDL-2023 LIBRARY; T=0.K  
Photon emission for (n,n\*)2a

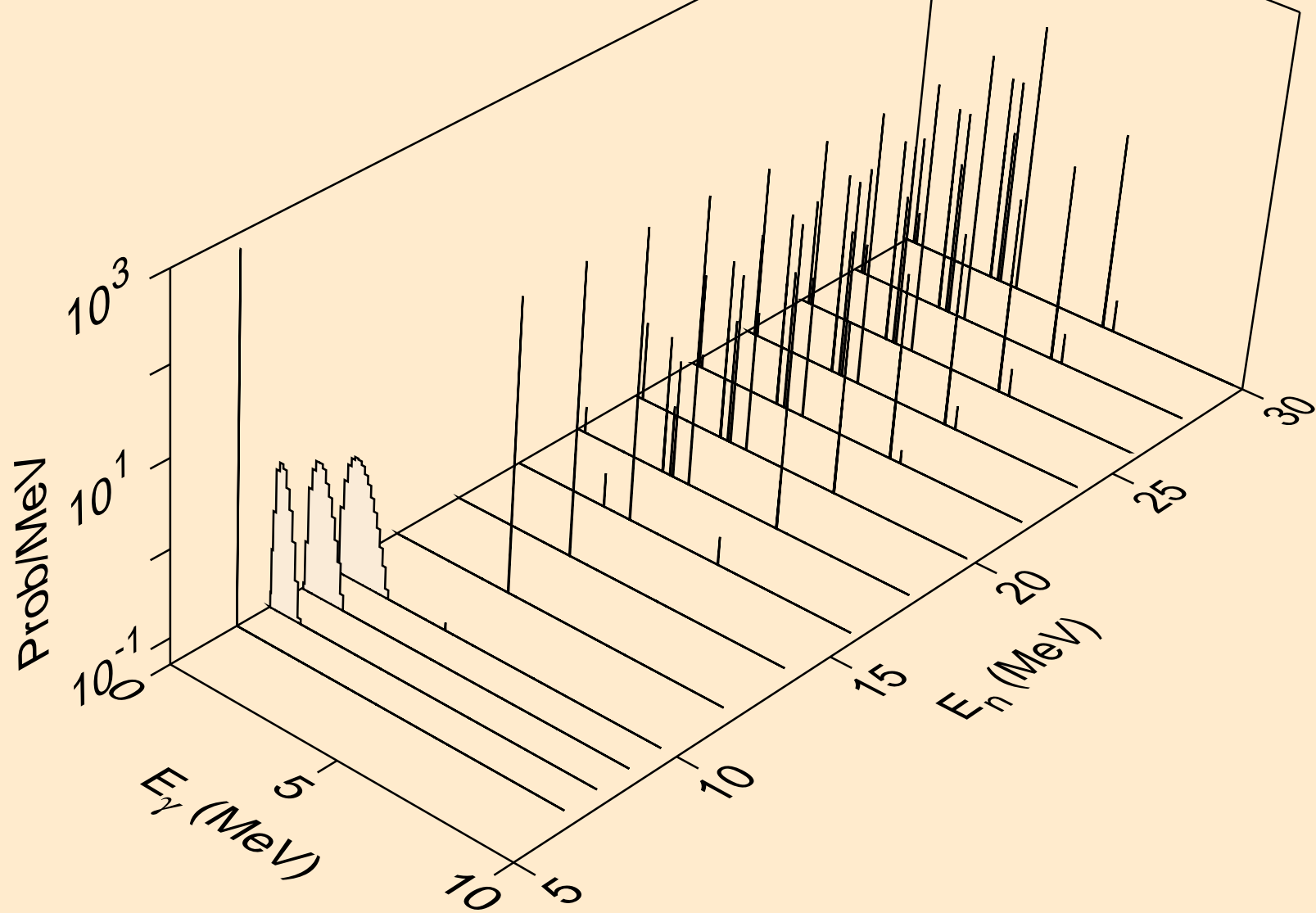

N017 DEUTERON ACER TENDL-2023 LIBRARY; T=0.K  
Photon emission for (n,2n)2a

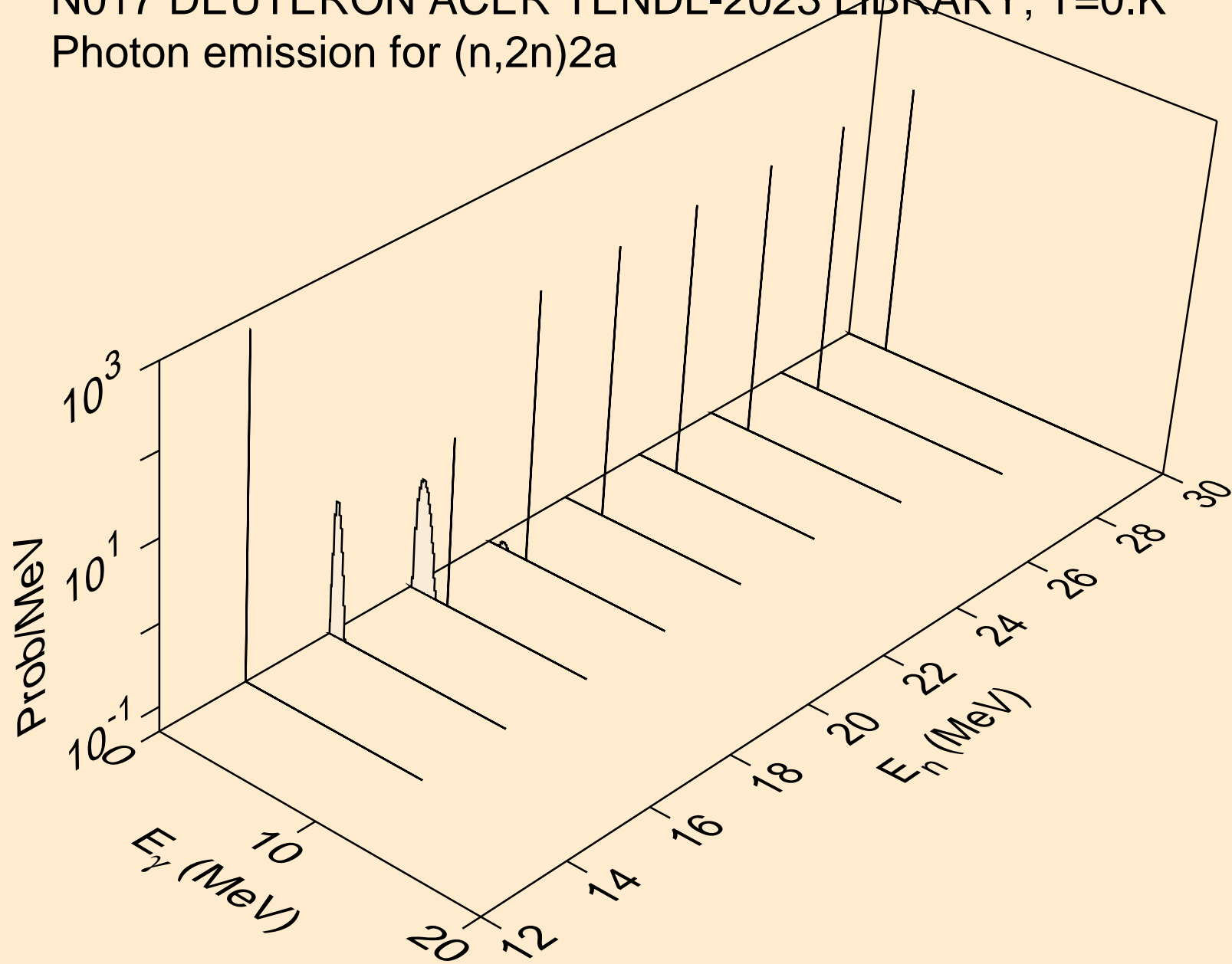

N017 DEUTERON ACER TENDL-2023 LIBRARY; T=0.K  
Photon emission for (n,n\*)d

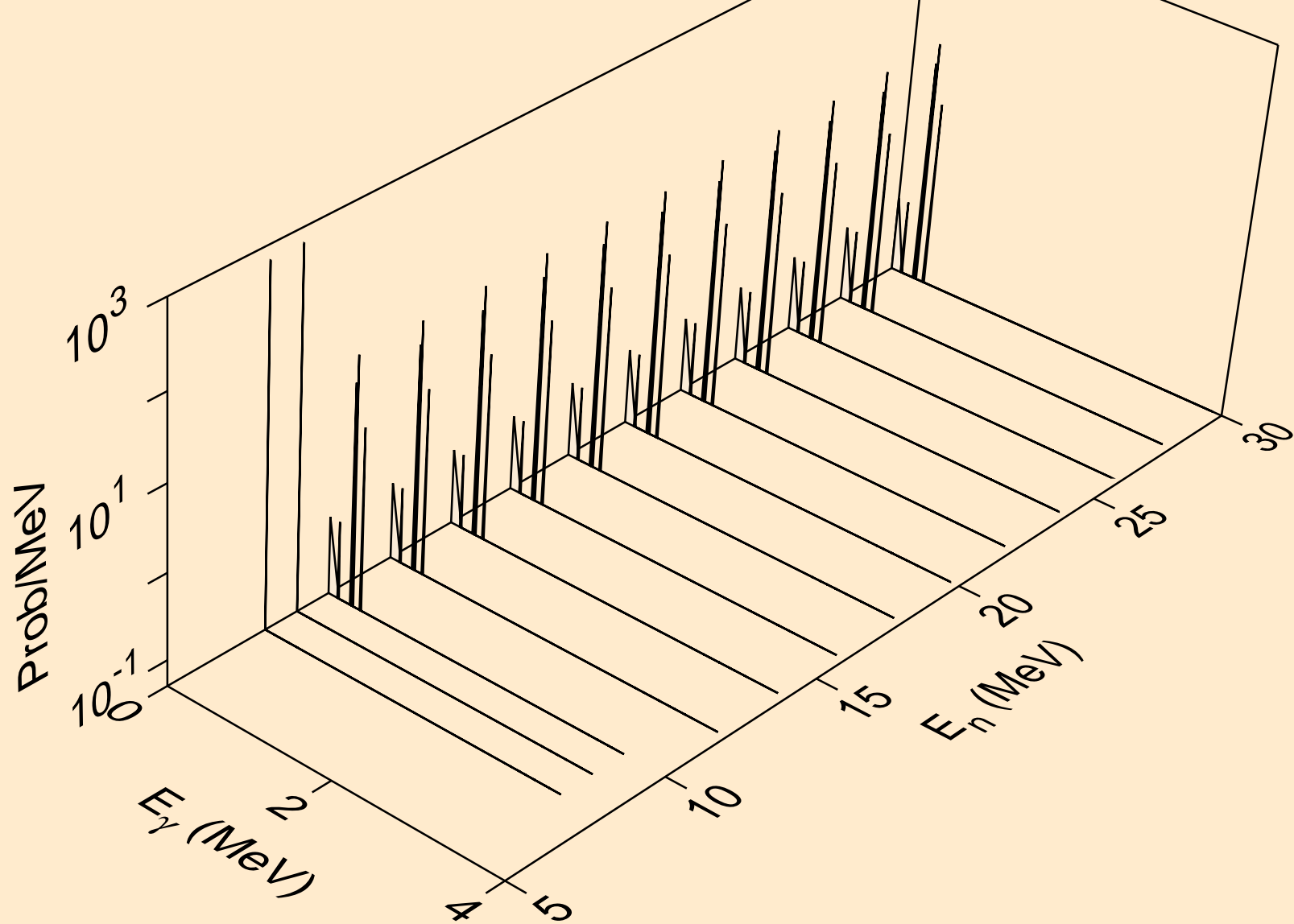

N017 DEUTERON ACER TENDL-2023 LIBRARY; T=0.K  
Photon emission for (n,n\*)t

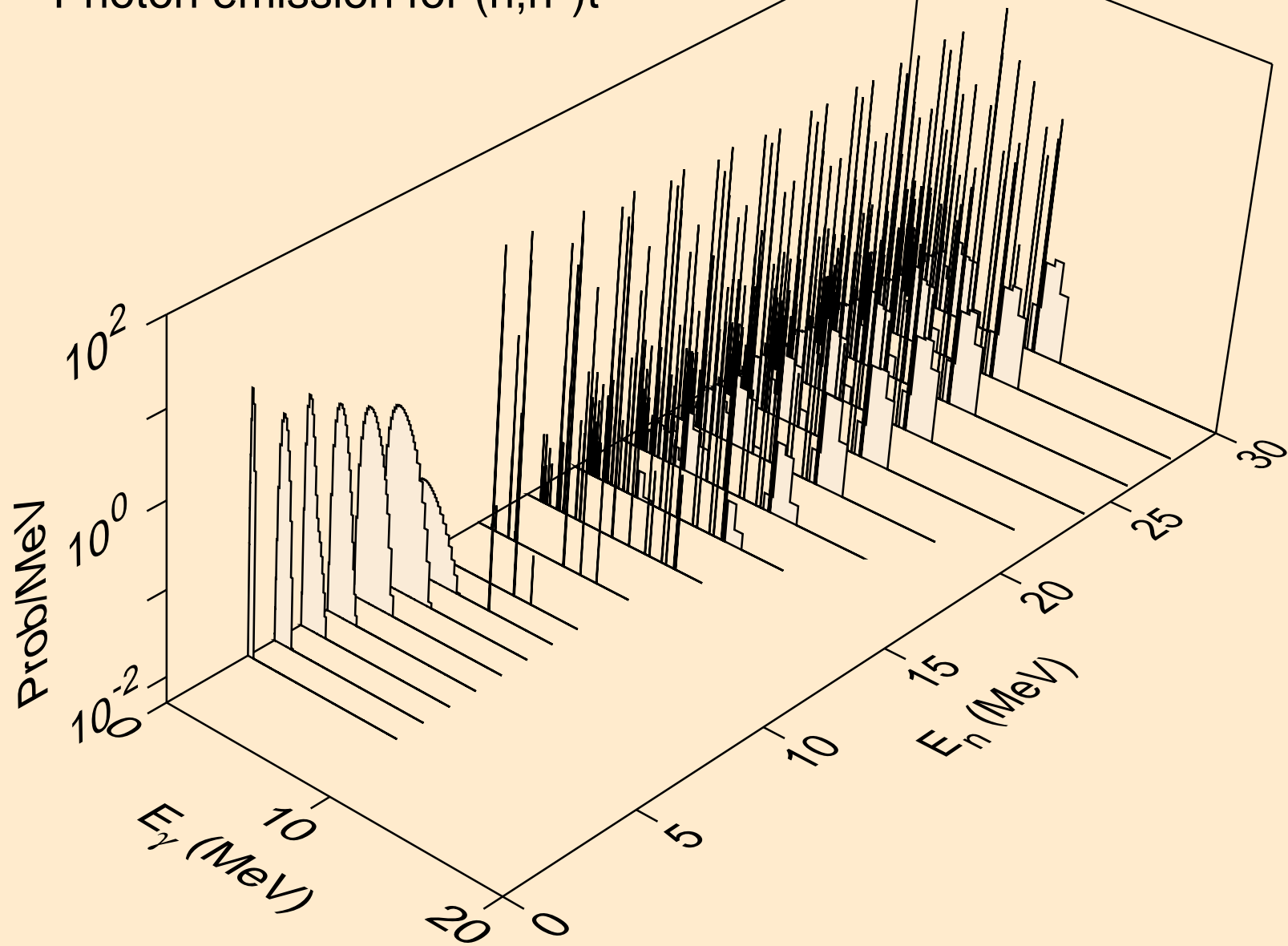

N017 DEUTERON ACER TENDL-2023 LIBRARY; T=0.K  
Photon emission for (n,n\*)he3

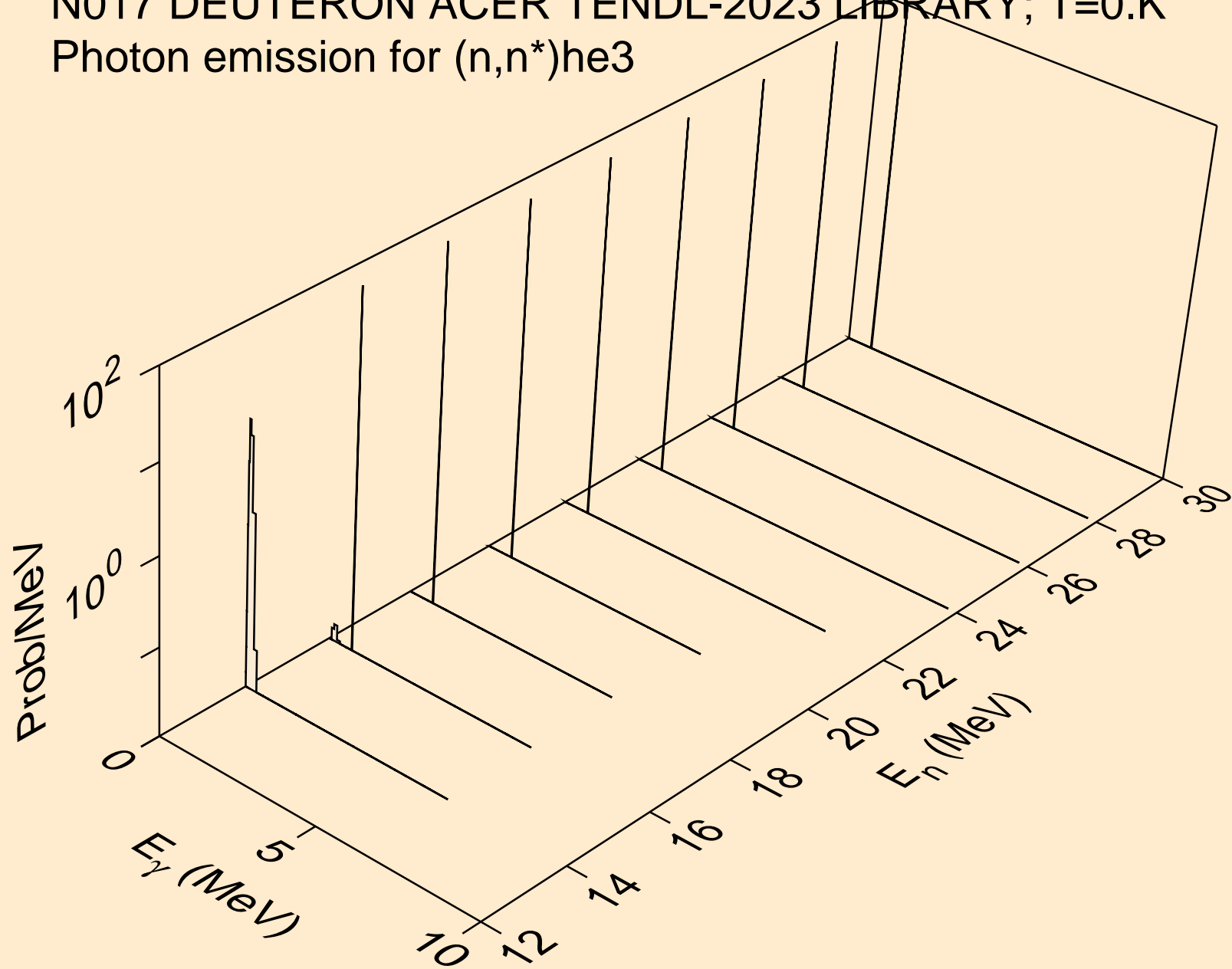

N017 DEUTERON ACER TENDL-2023 LIBRARY; T=0.K  
Photon emission for (n,n\*)t2a

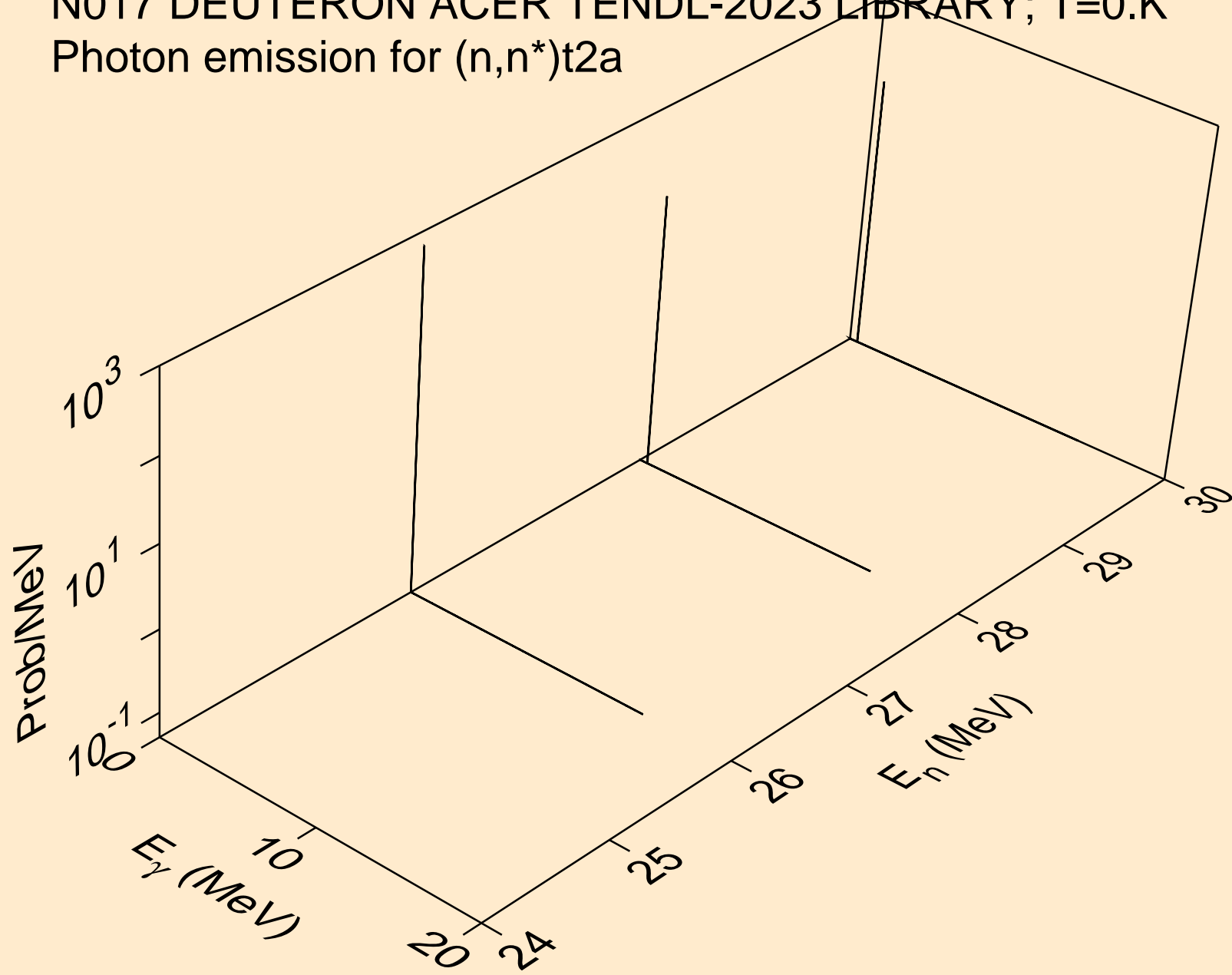

N017 DEUTERON ACER TENDL-2023 LIBRARY; T=0.K  
Photon emission for (n,4n)

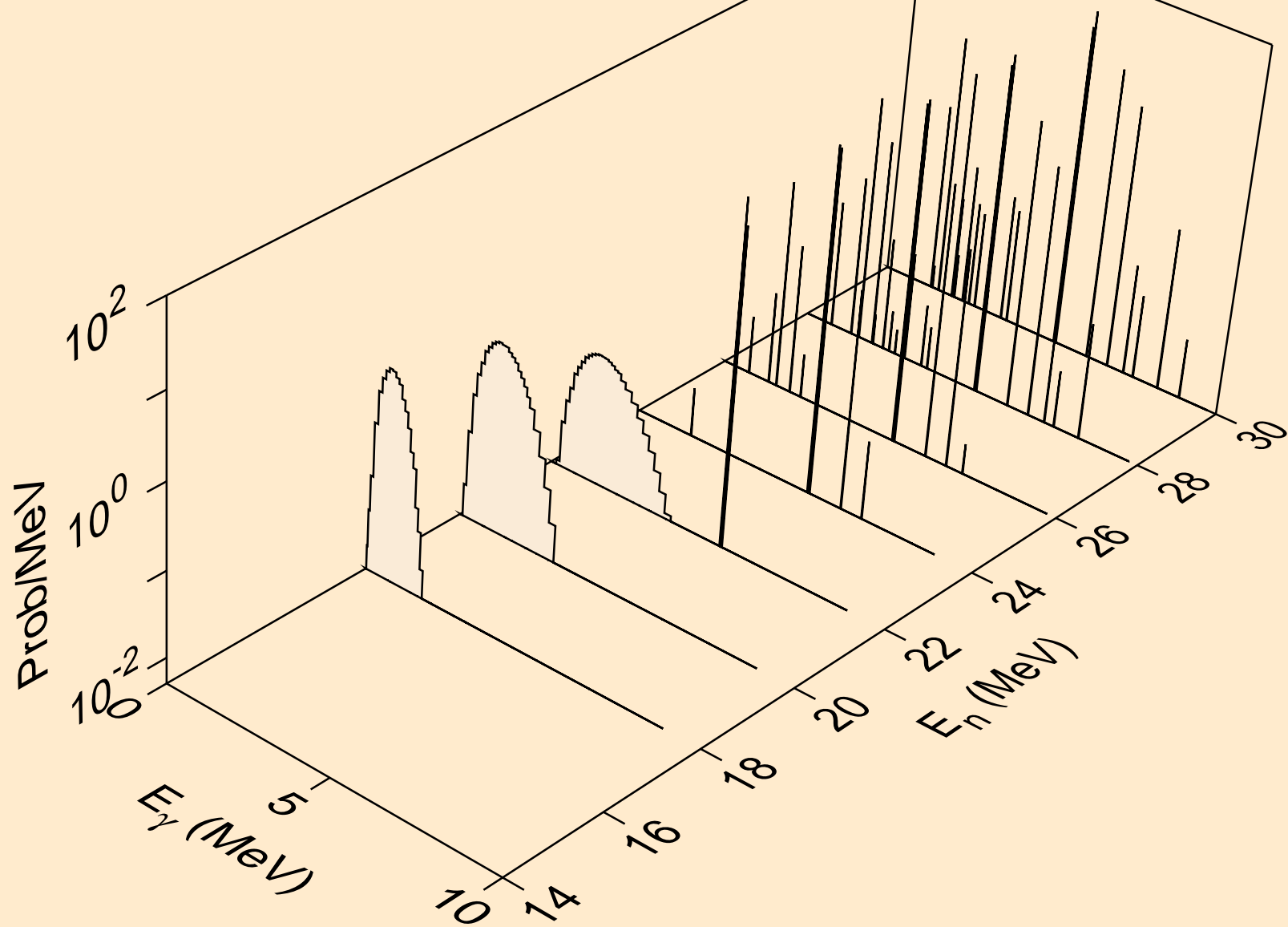



N017 DEUTERON ACER TENDL-2023 LIBRARY; T=0.K  
Photon emission for (n,2np)

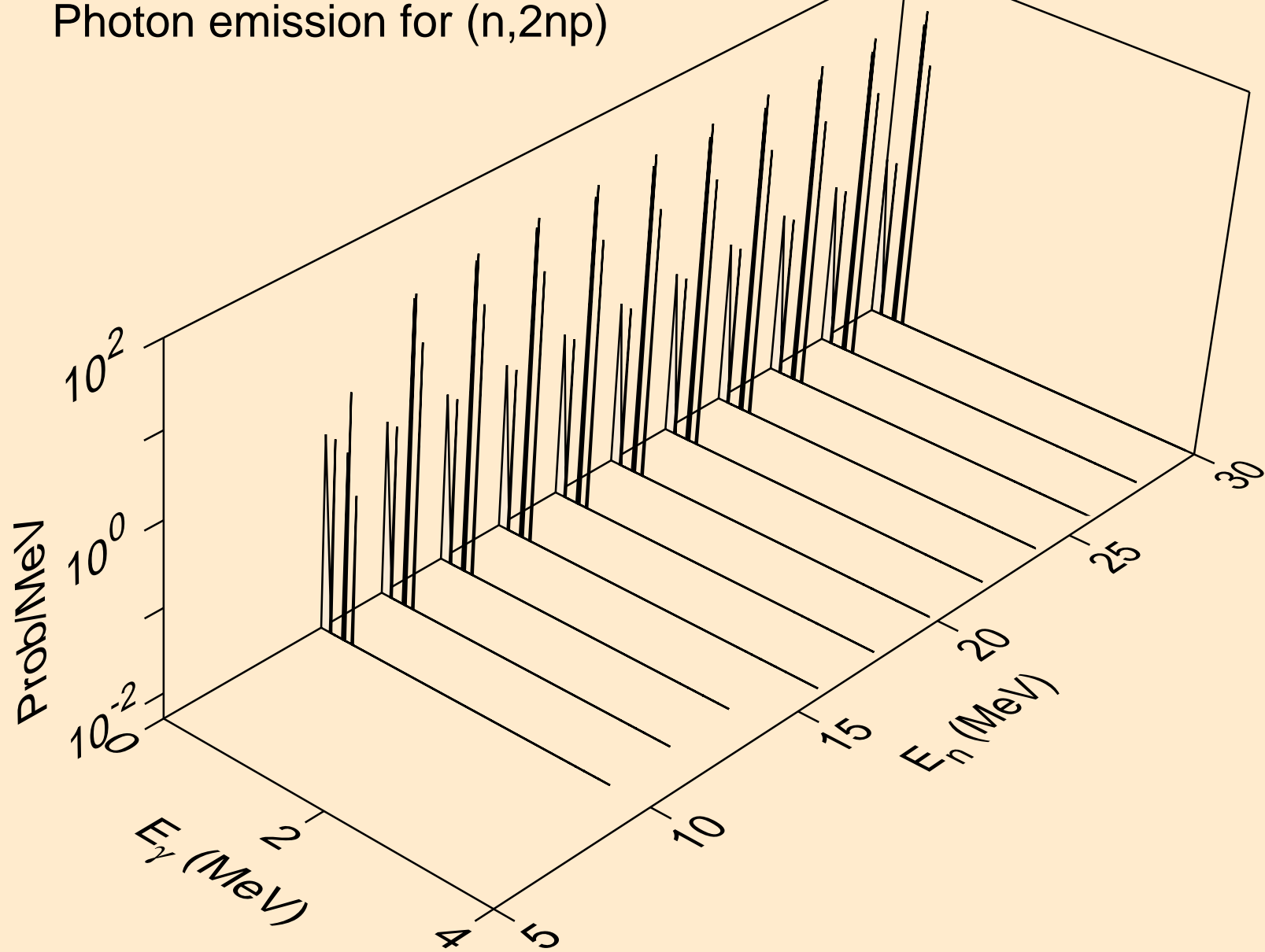

N017 DEUTERON ACER TENDL-2023 LIBRARY; T=0.K  
Photon emission for (n,3np)

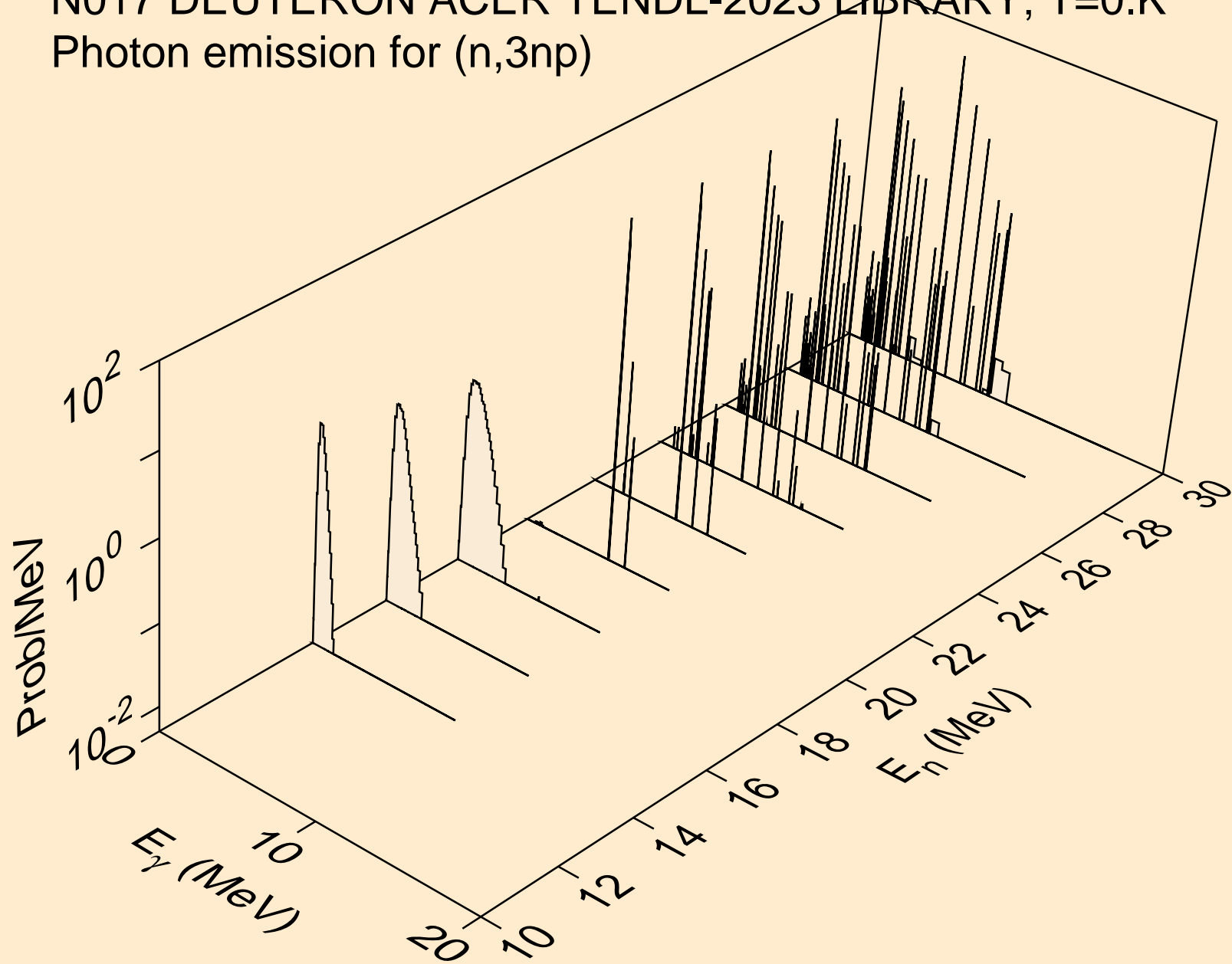

N017 DEUTERON ACER TENDL-2023 LIBRARY; T=0.K  
Photon emission for (n,n2p)

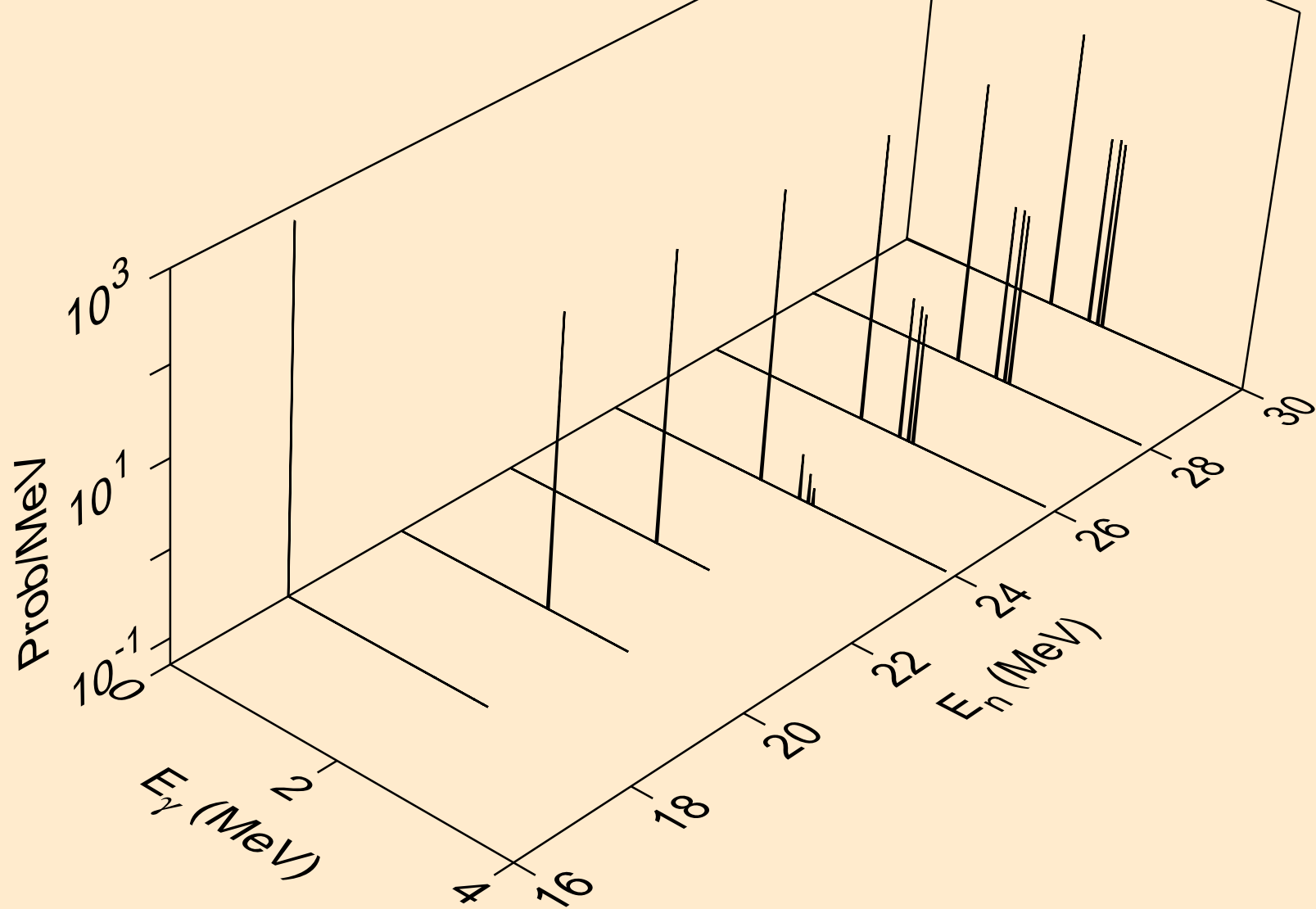

N017 DEUTERON ACER TENDL-2023 LIBRARY; T=0.K  
Photon emission for (n,npa)

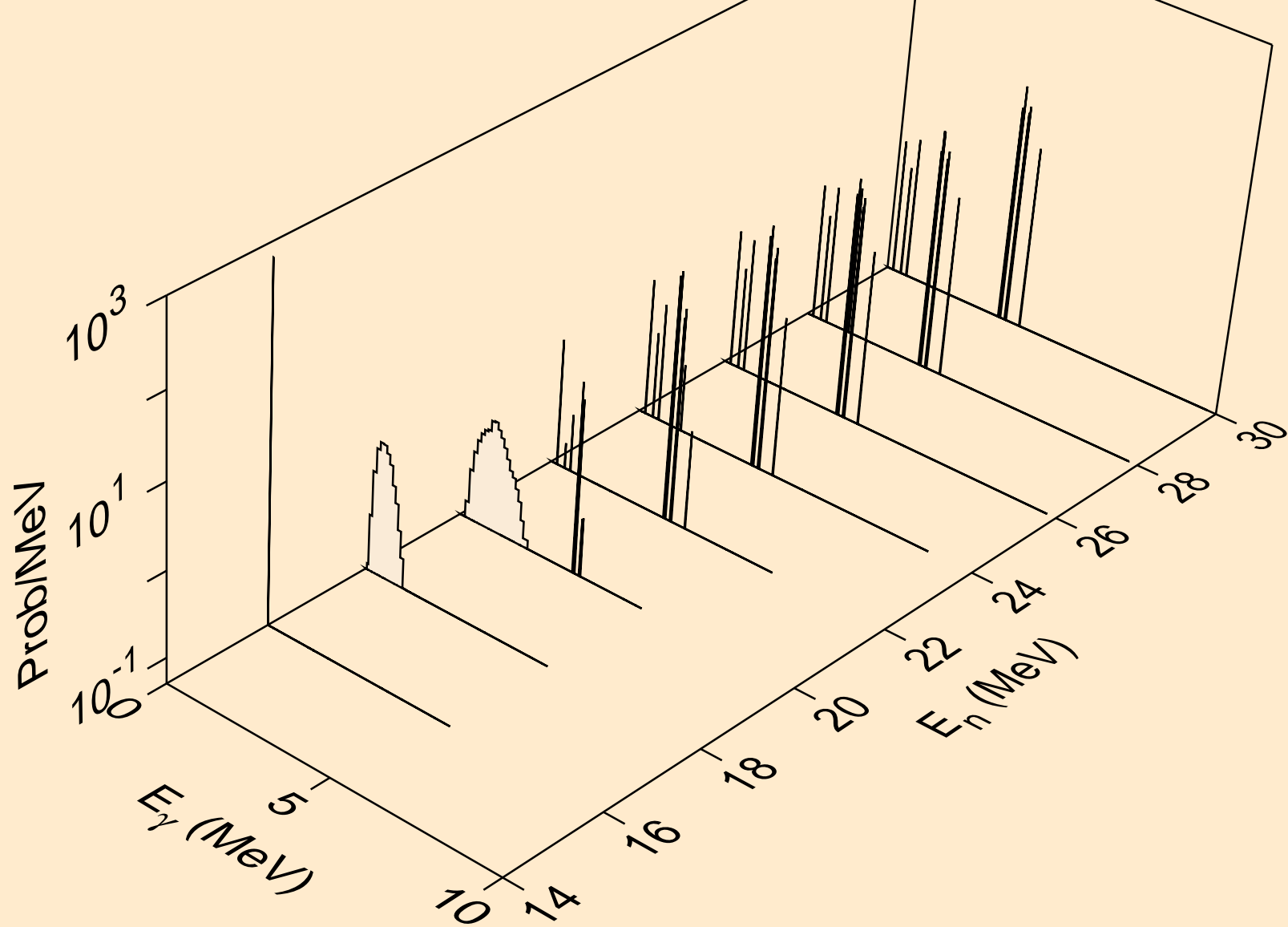

N017 DEUTERON ACER TENDL-2023 LIBRARY; T=0.K  
Photon emission for (n,gma)

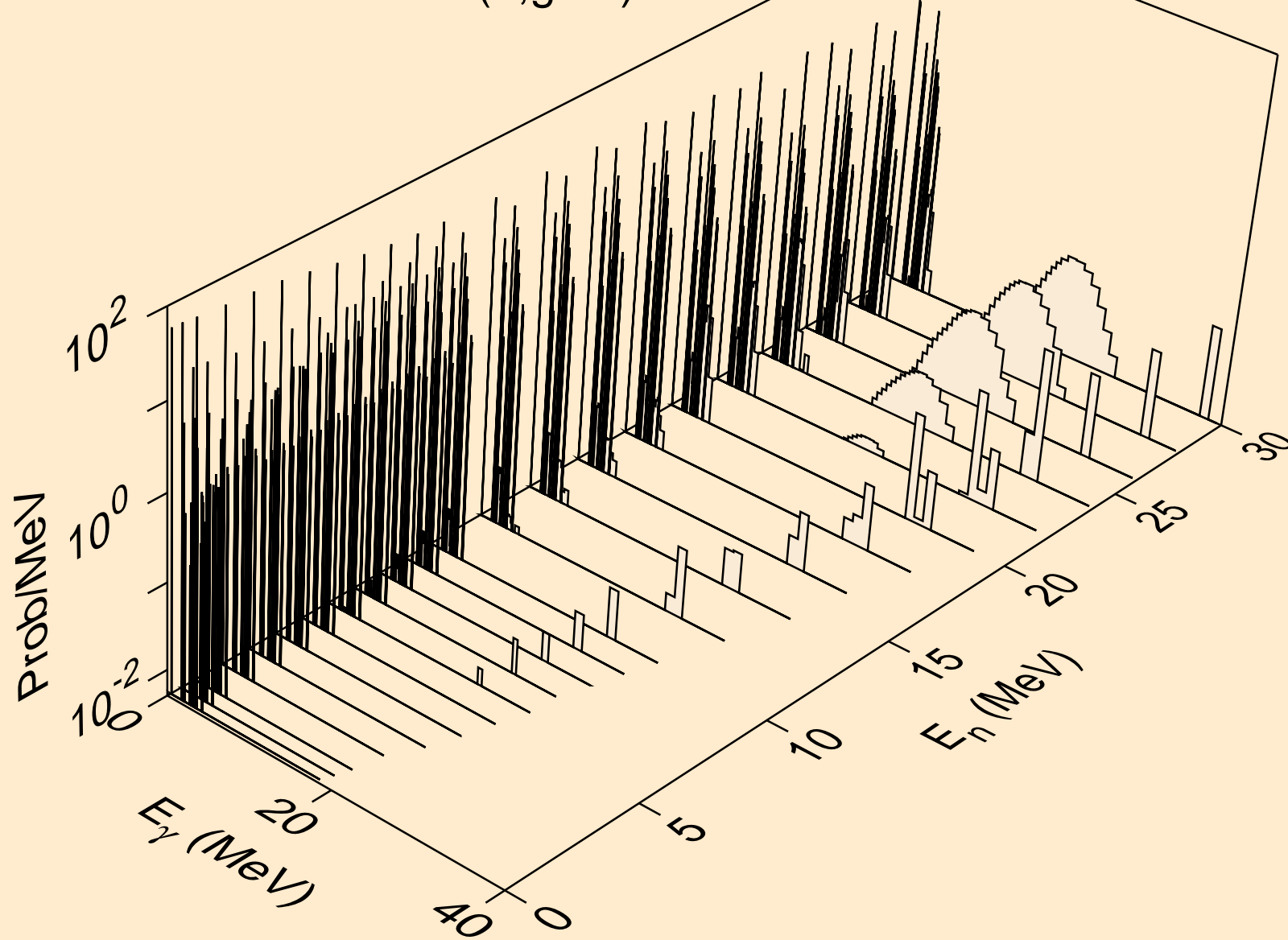

N017 DEUTERON ACER TENDL-2023 LIBRARY; T=0.K  
Photon emission for (n,p)

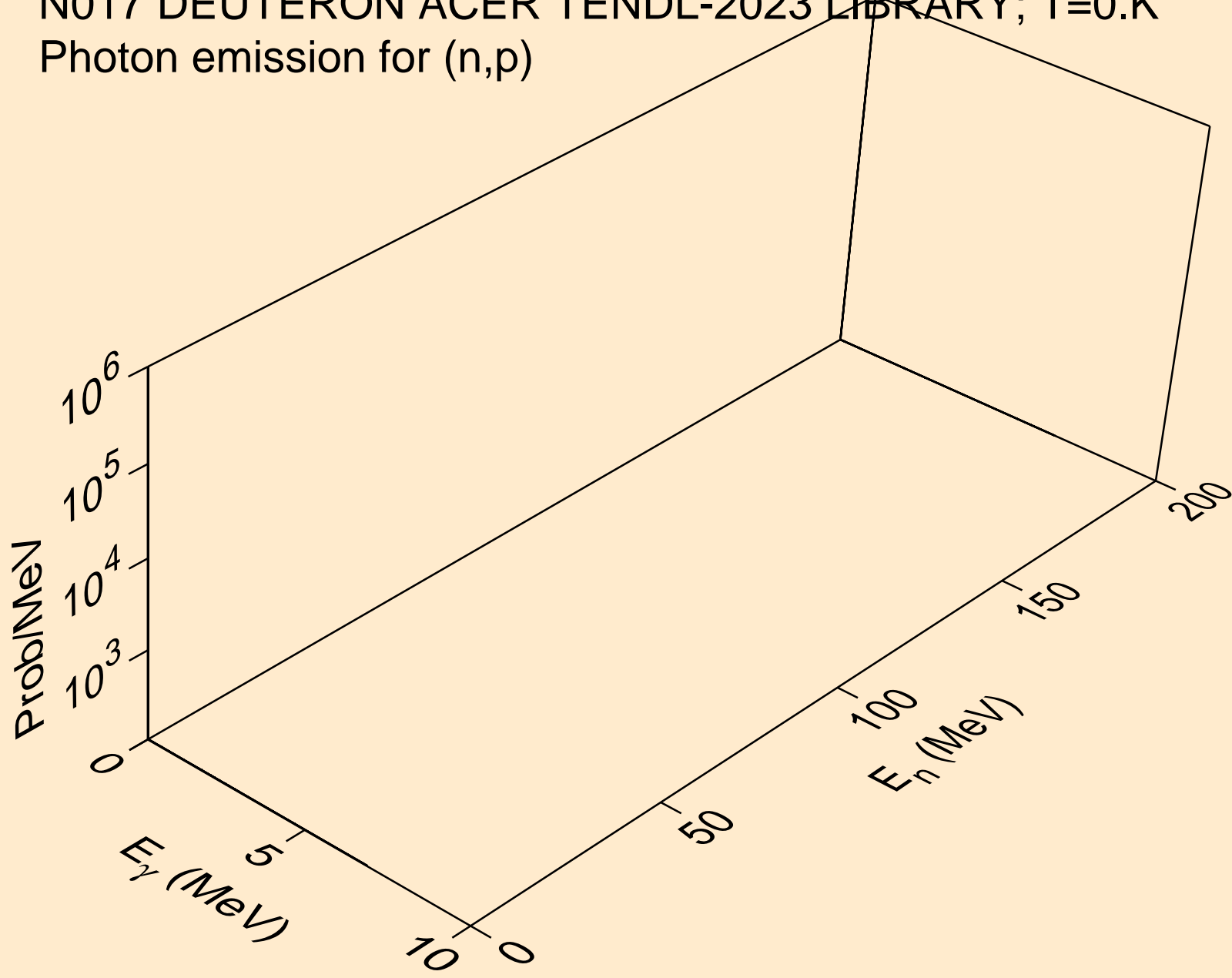

N017 DEUTERON ACER TENDL-2023 LIBRARY; T=0.K  
Photon emission for inelastic

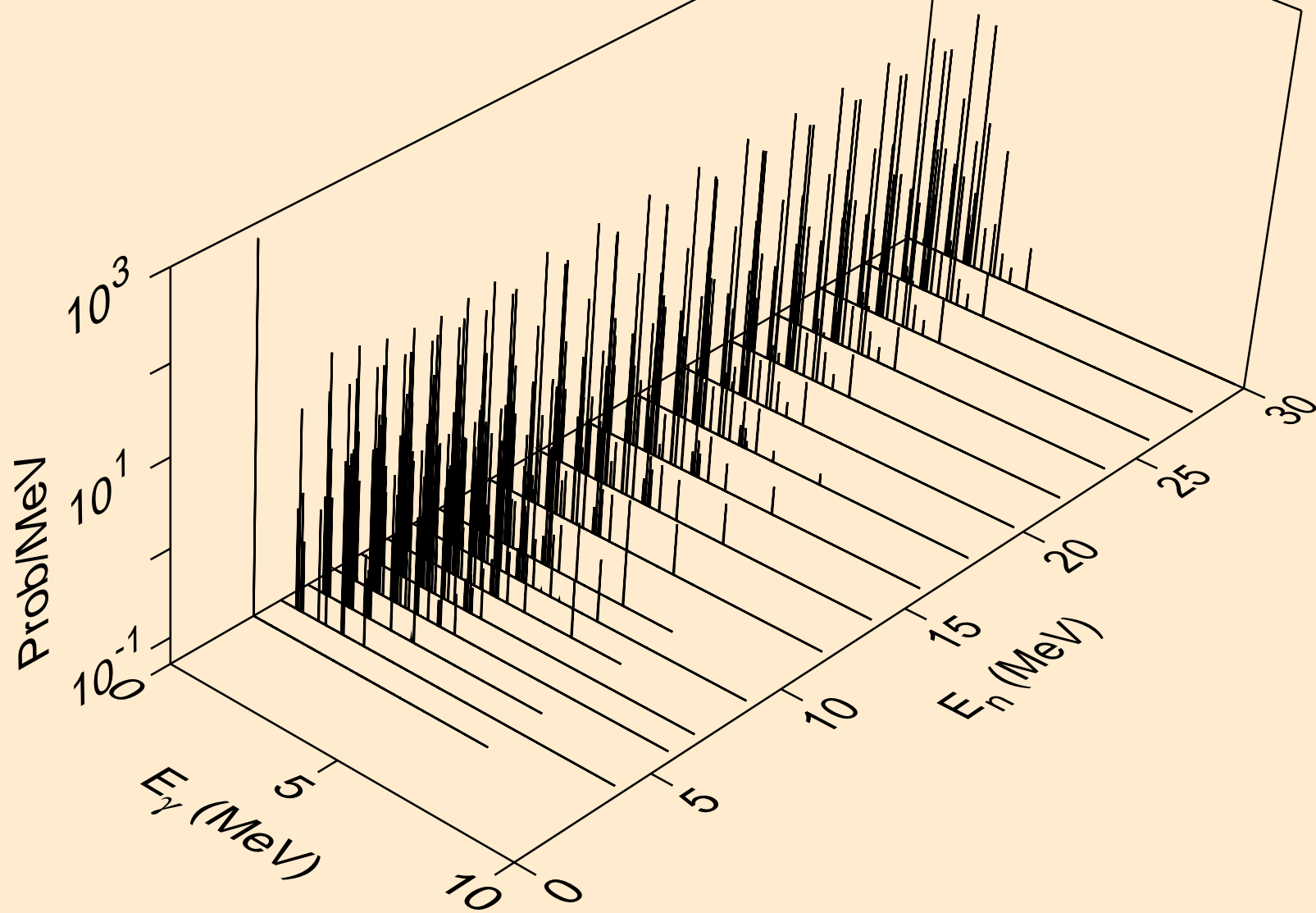

N017 DEUTERON ACER TENDL-2023 LIBRARY; T=0.K  
Photon emission for (n,t)

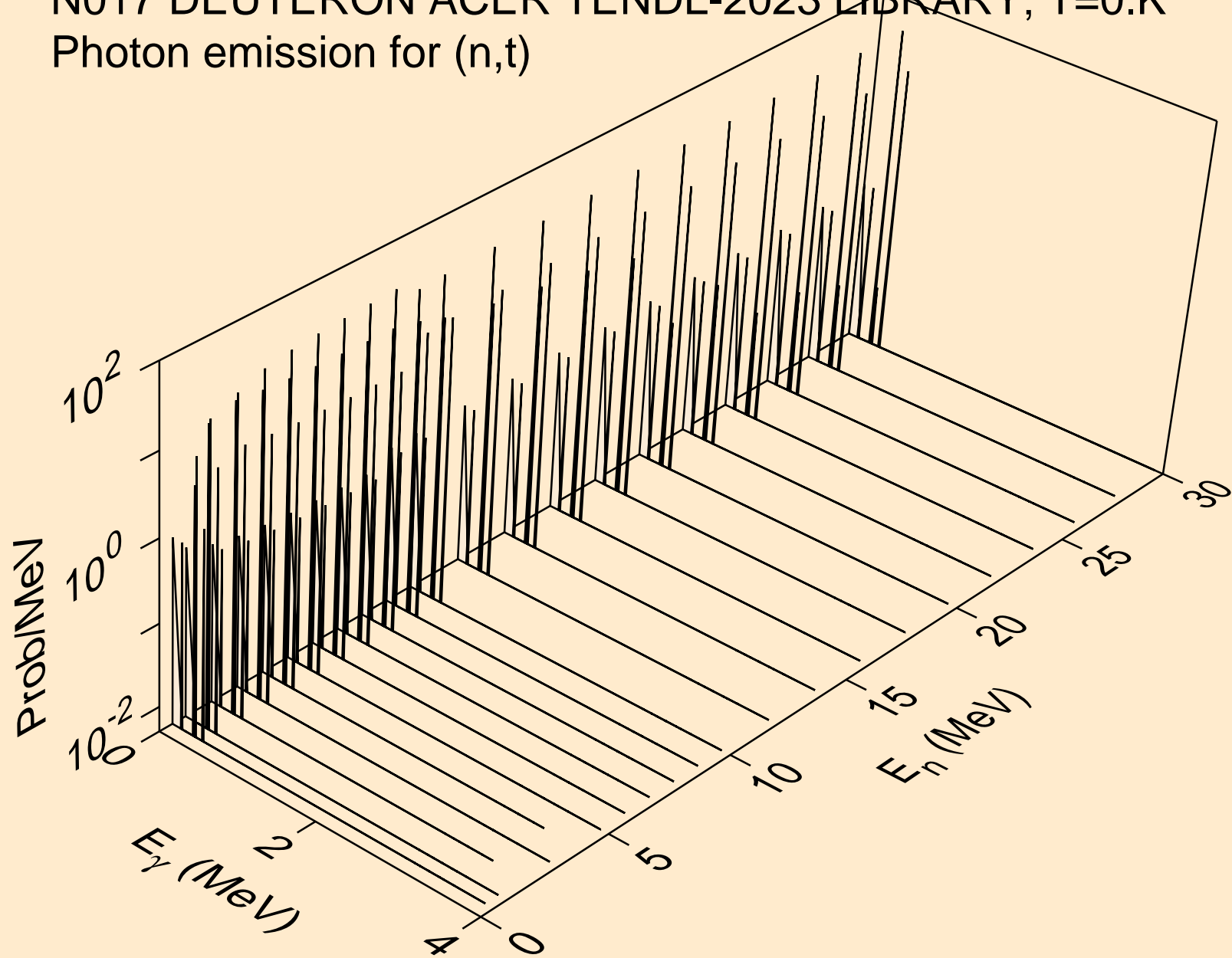



N017 DEUTERON ACER TENDL-2023 LIBRARY; T=0.K  
Photon emission for (n,he3)

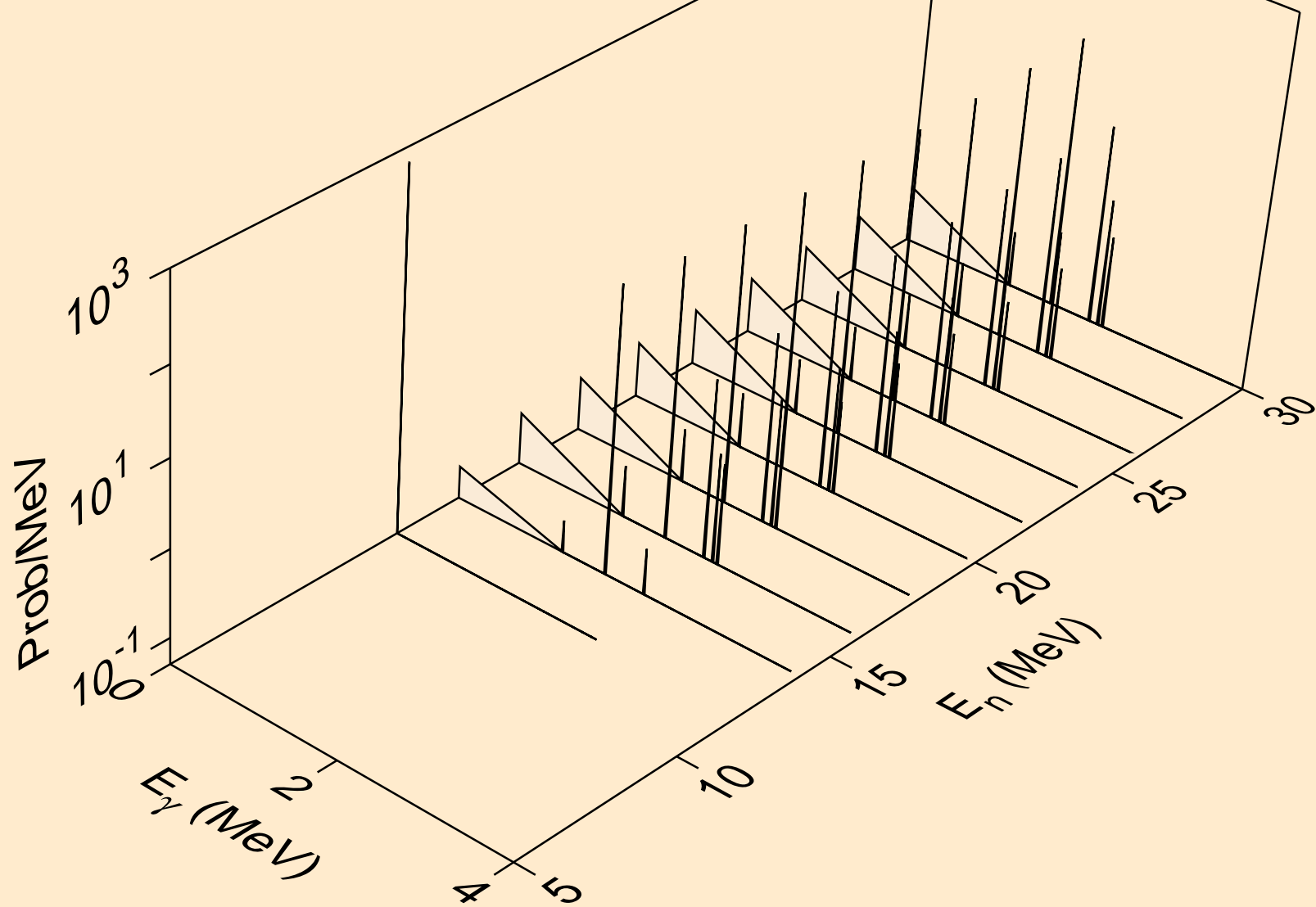

N017 DEUTERON ACER TENDL-2023 LIBRARY; T=0.K  
Photon emission for (n,a)

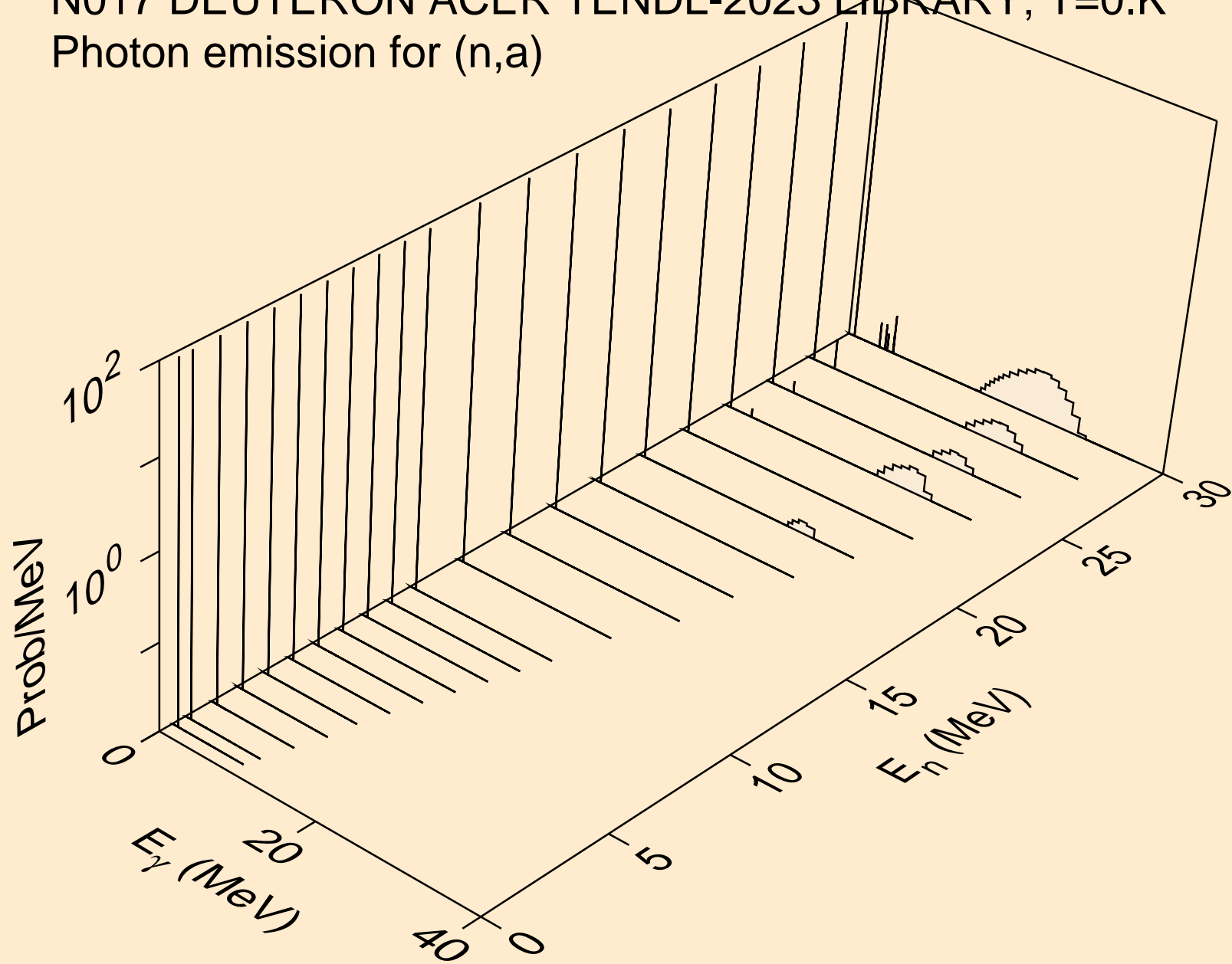

N017 DEUTERON ACER TENDL-2023 LIBRARY; T=0.K  
Photon emission for (n,2a)

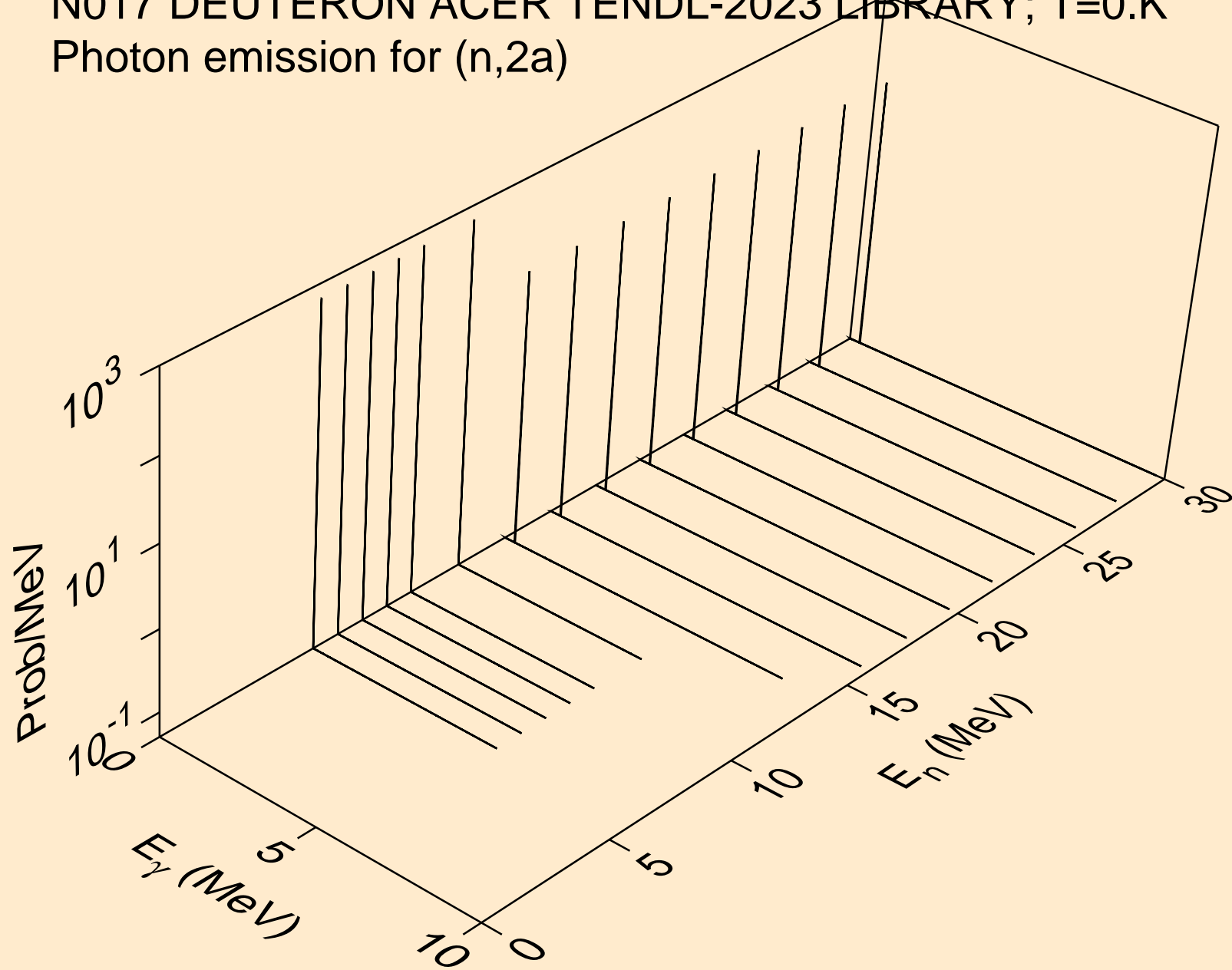

N017 DEUTERON ACER TENDL-2023 LIBRARY; T=0.K  
Photon emission for (n,2p)

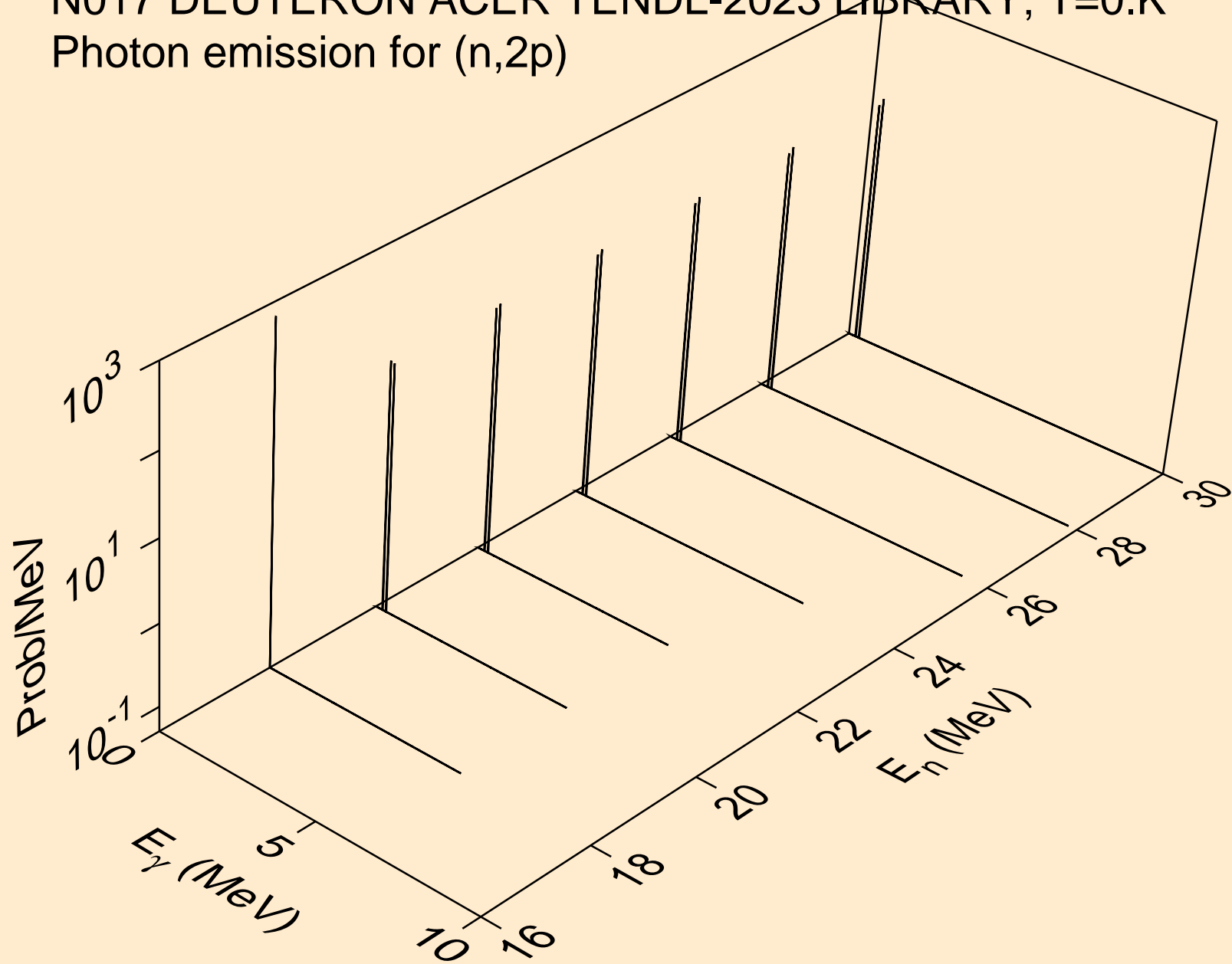

N017 DEUTERON ACER TENDL-2023 LIBRARY; T=0.K  
Photon emission for (n,p)

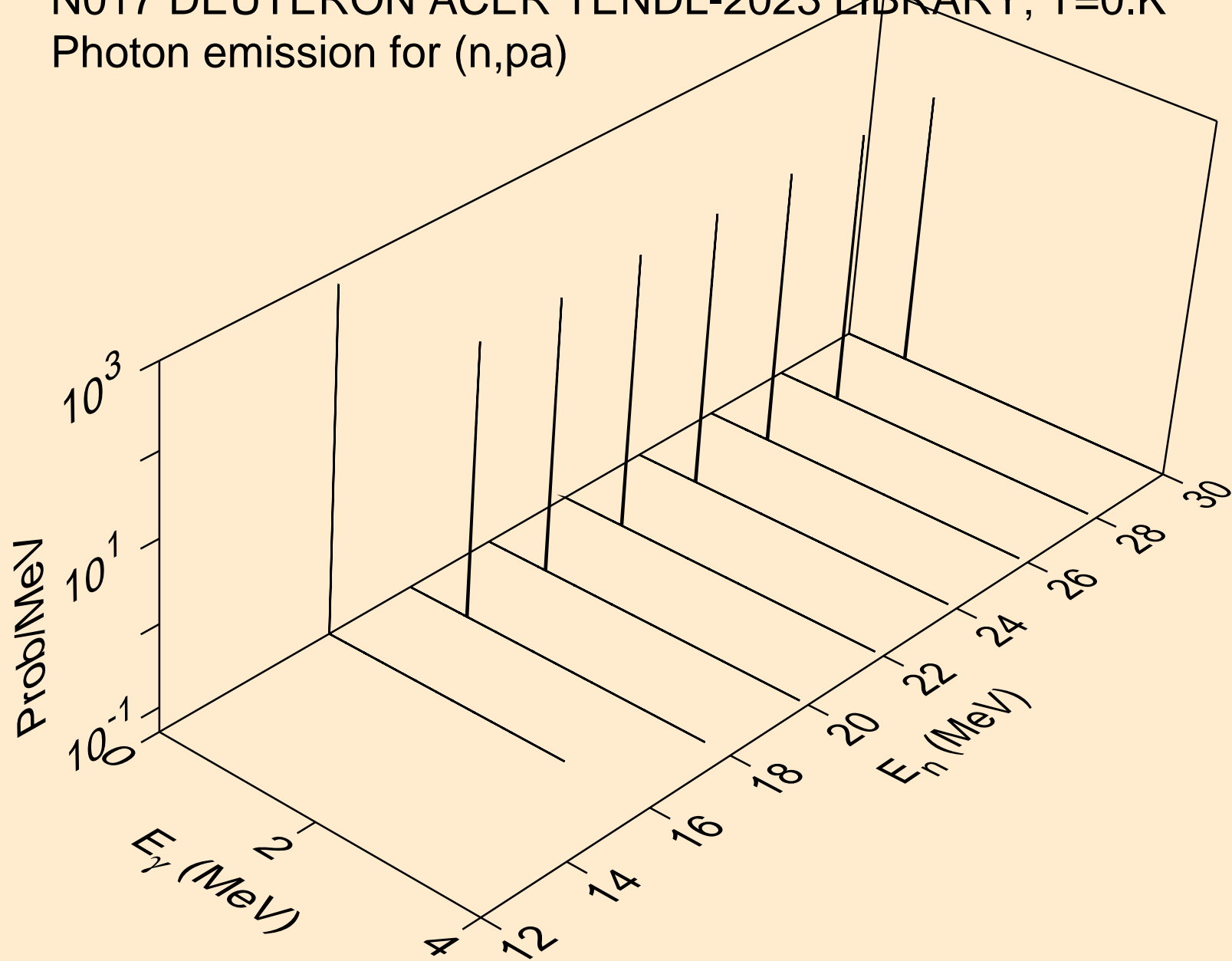

N017 DEUTERON ACER TENDL-2023 LIBRARY; T=0.K  
Photon emission for (n,t2a)

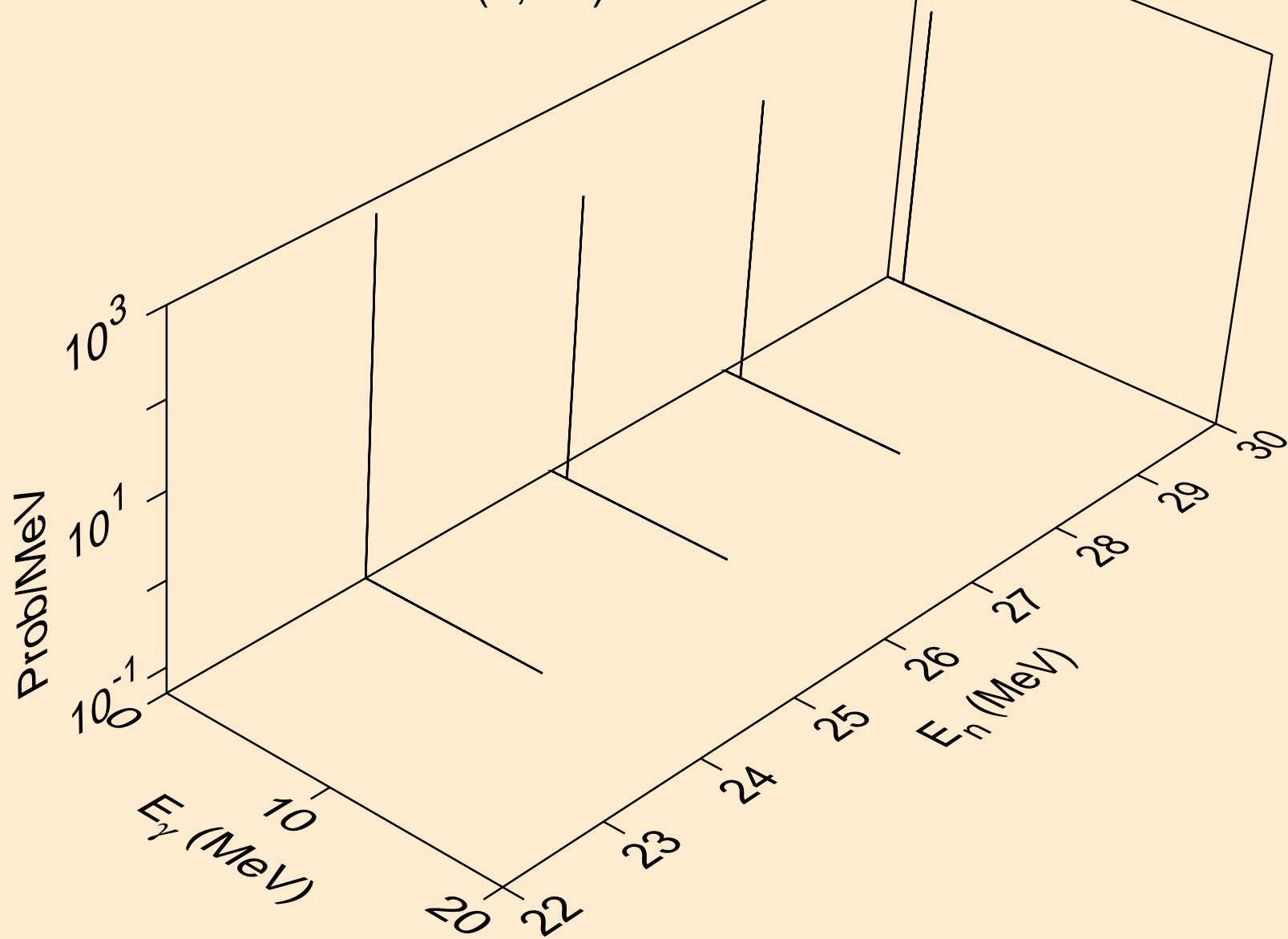

N017 DEUTERON ACER TENDL-2023 LIBRARY; T=0.K  
Photon emission for (n,d2a)

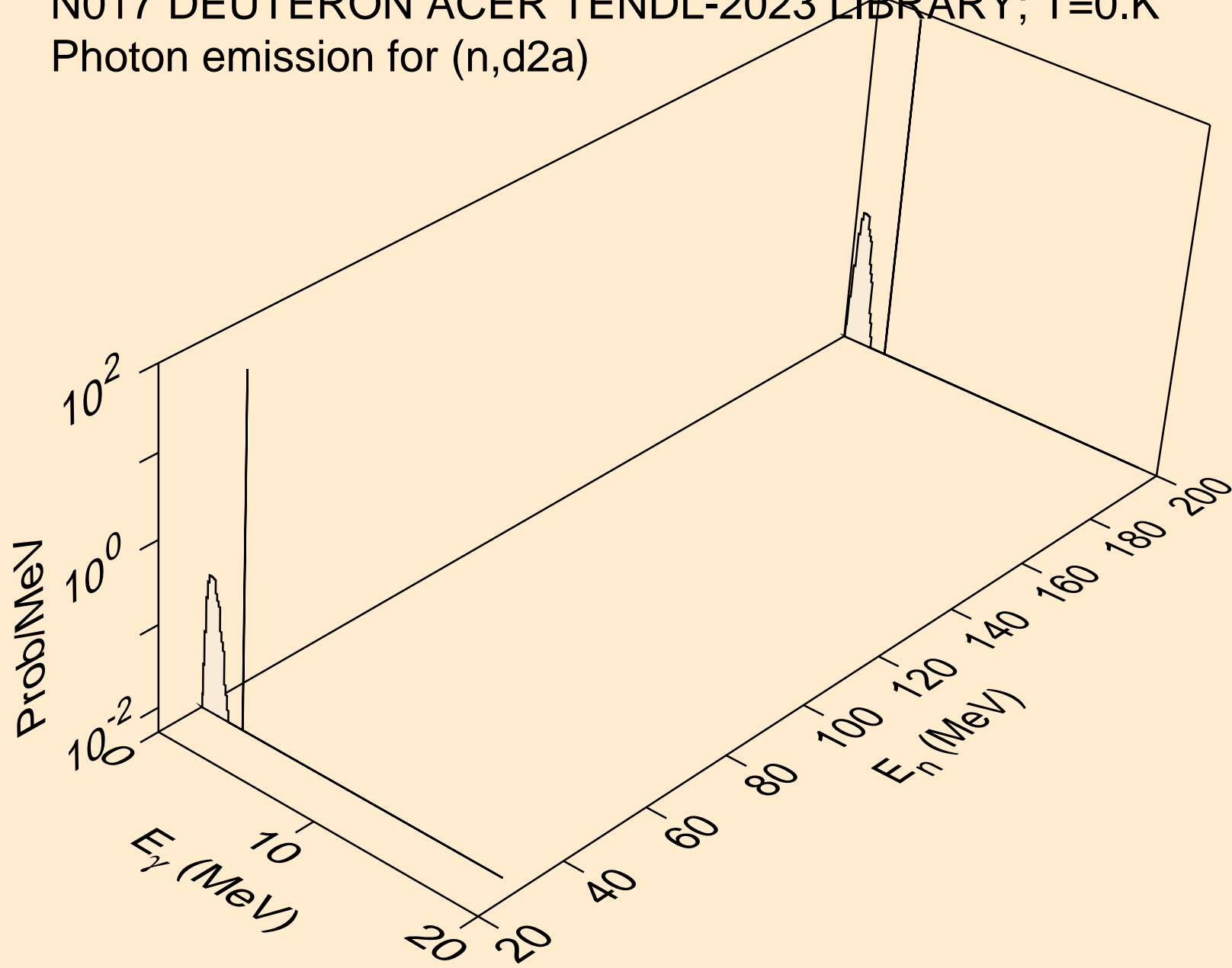

N017 DEUTERON ACER TENDL-2023 LIBRARY; T=0.K  
Photon emission for (n,pd)

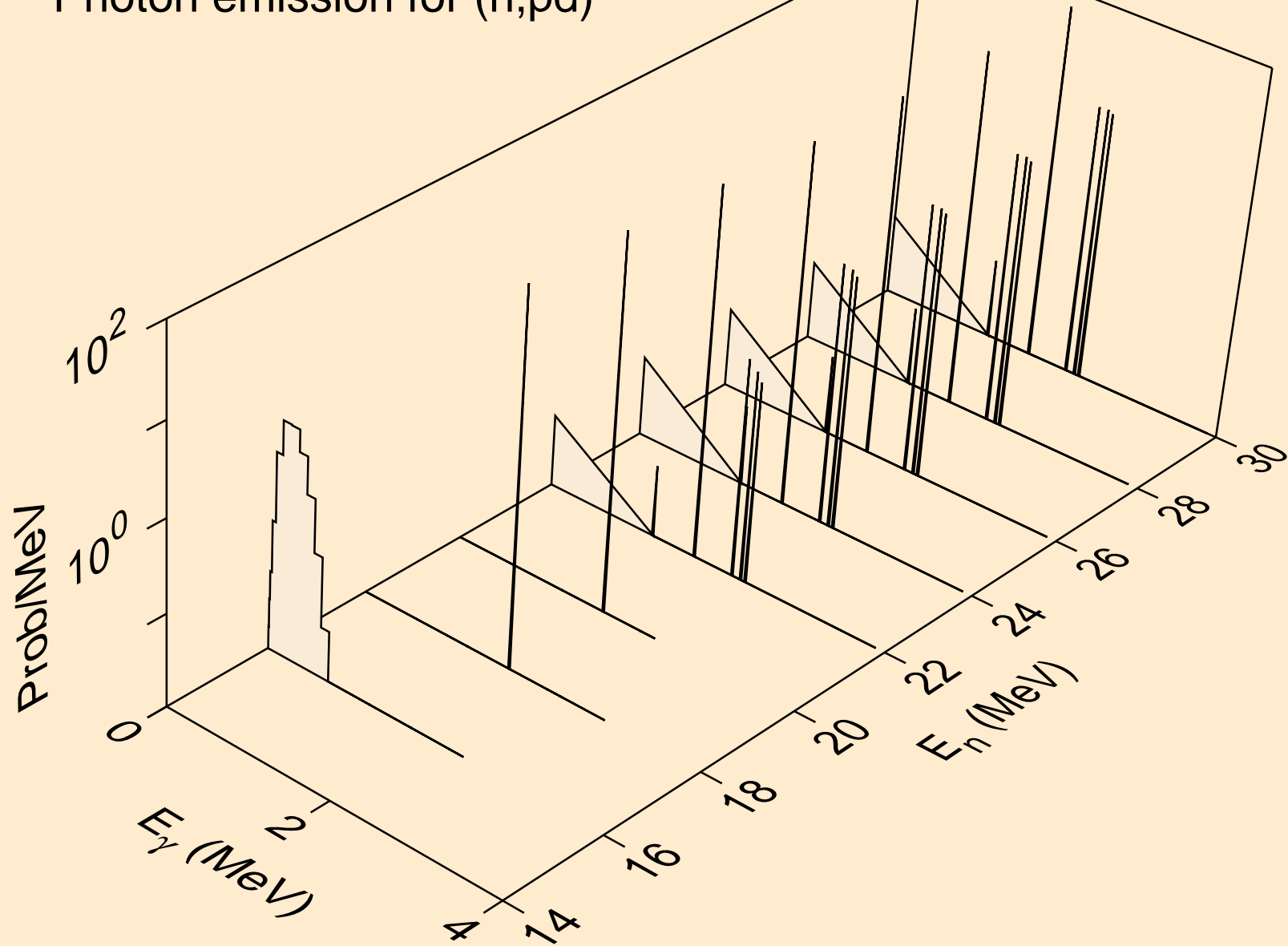



N017 DEUTERON ACER TENDL-2023 LIBRARY; T=0.K  
Photon emission for (n,pt)

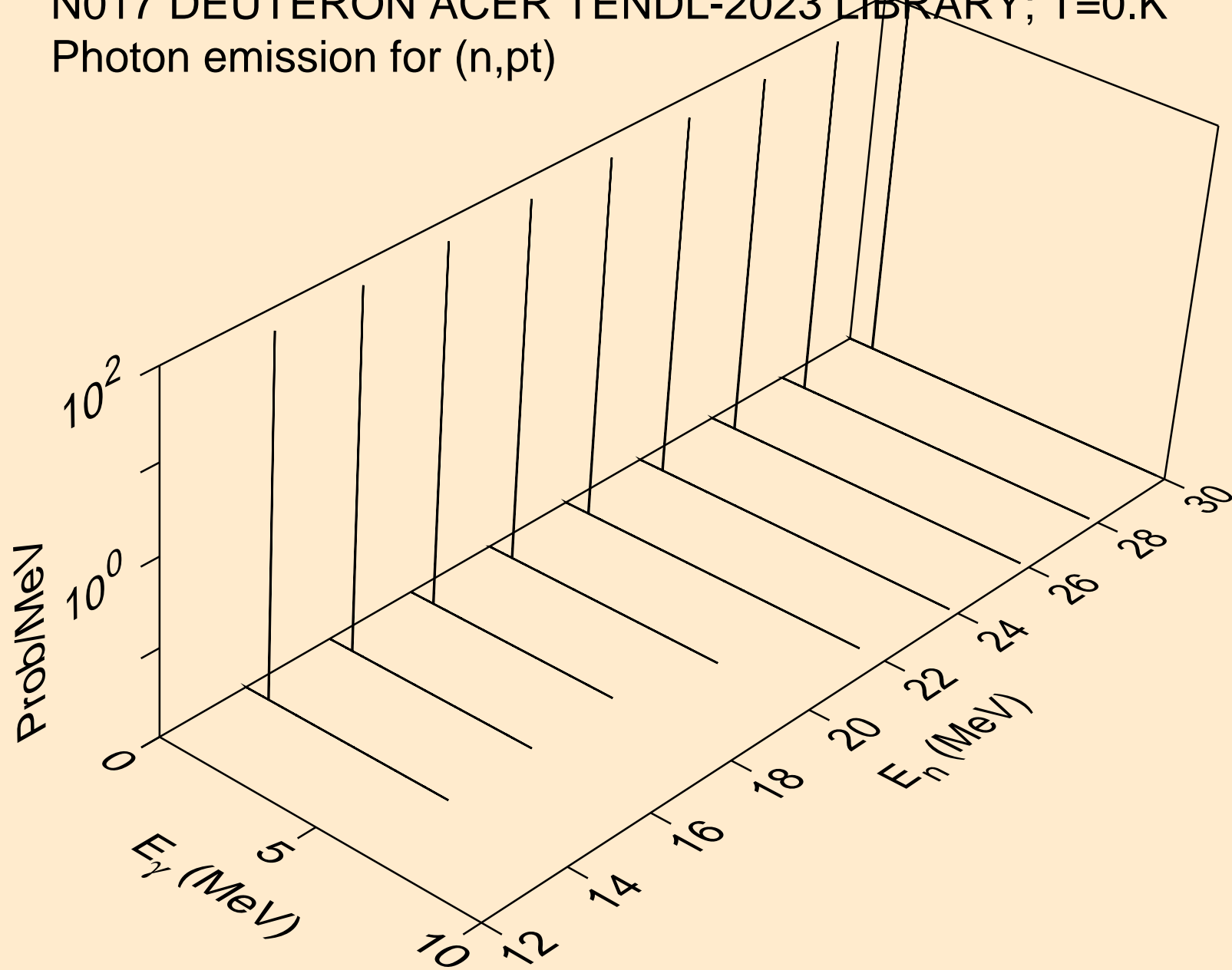

N017 DEUTERON ACER TENDL-2023 LIBRARY; T=0.K  
Photon emission for (n,da)

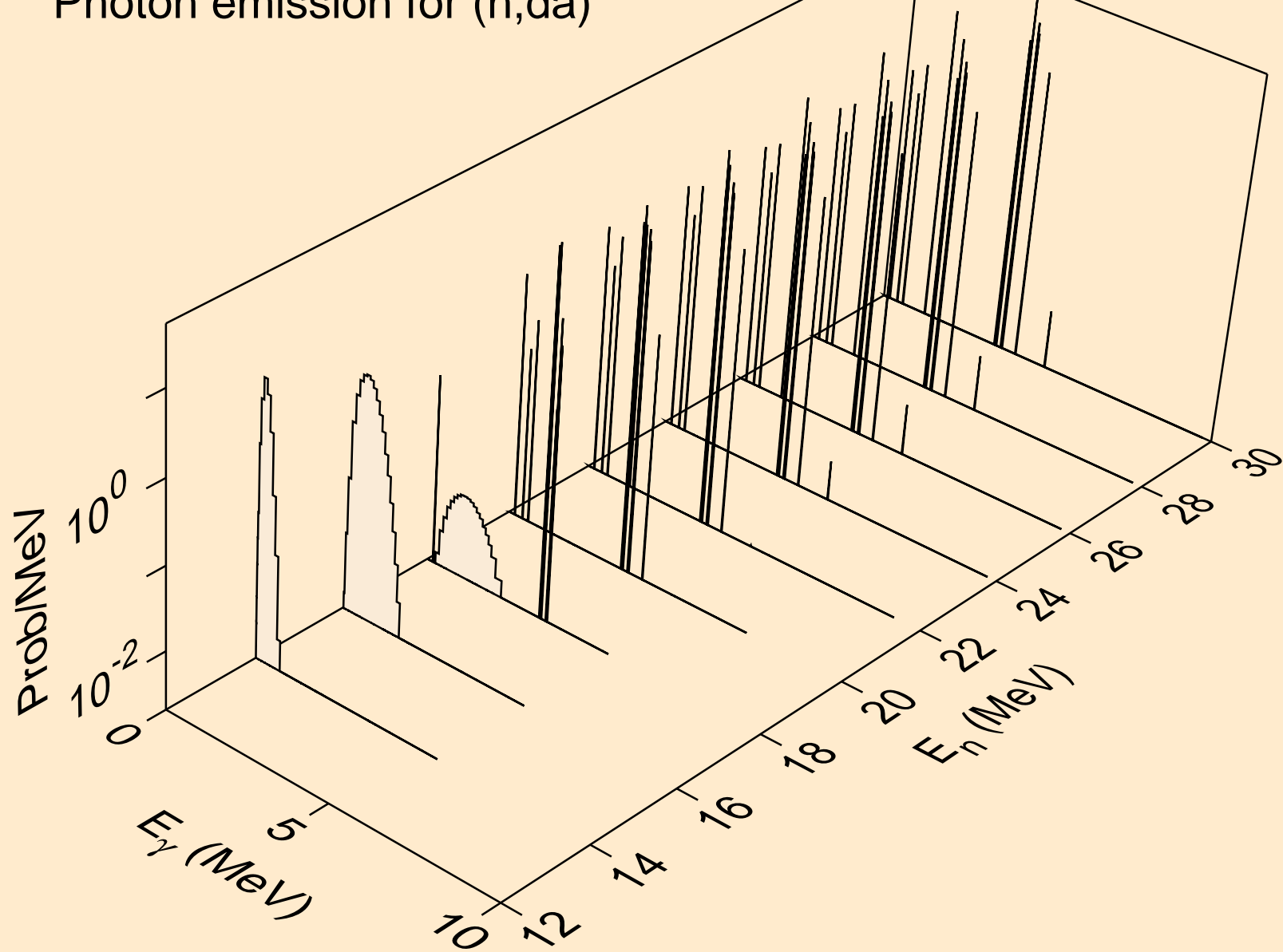

# N017 DEUTERON ACER TENDL-2023 LIBRARY; T=0.K

## Particle heating contributions

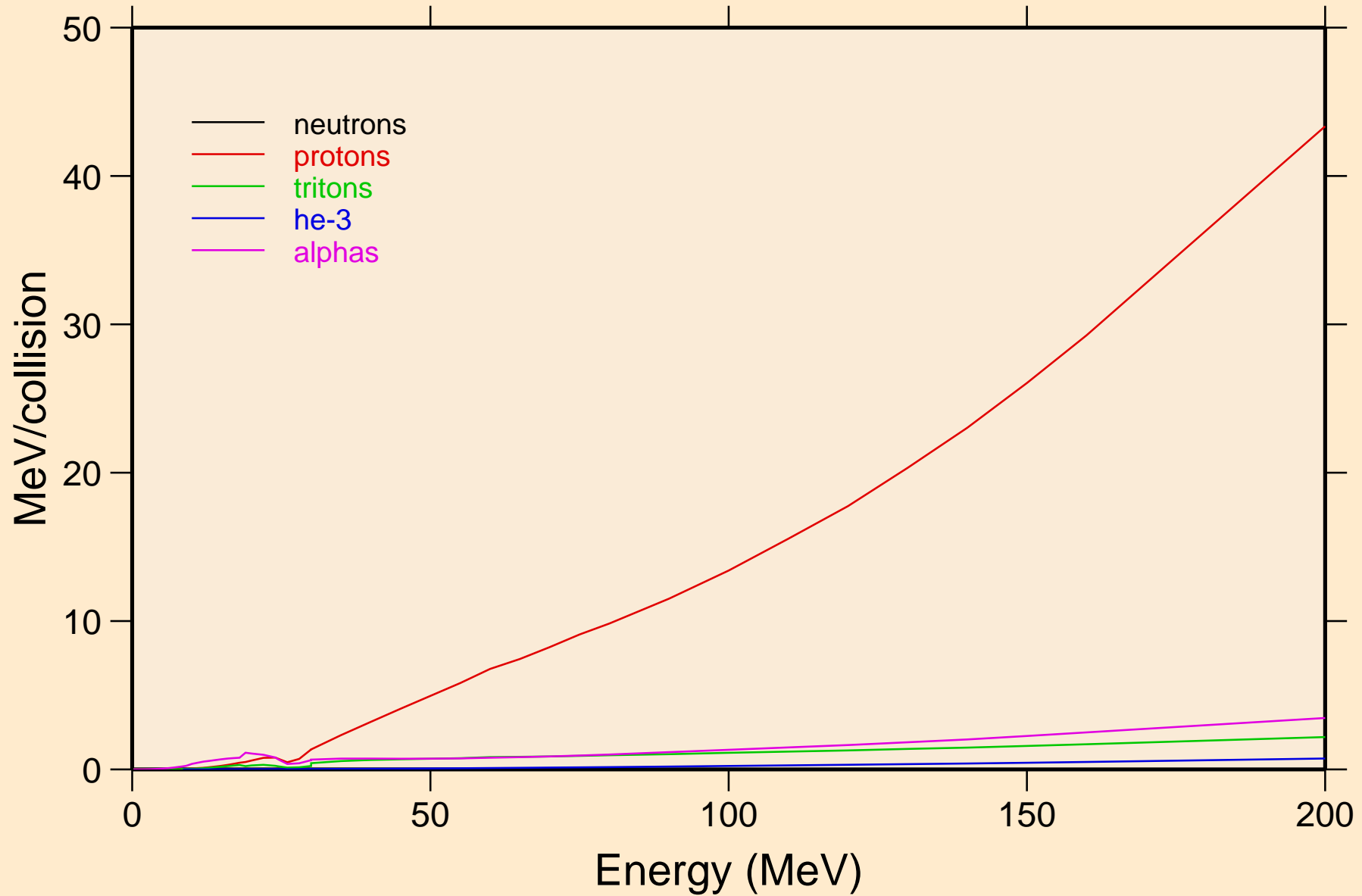

# N017 DEUTERON ACER TENDL-2023 LIBRARY; T=0.K

## Recoil Heating

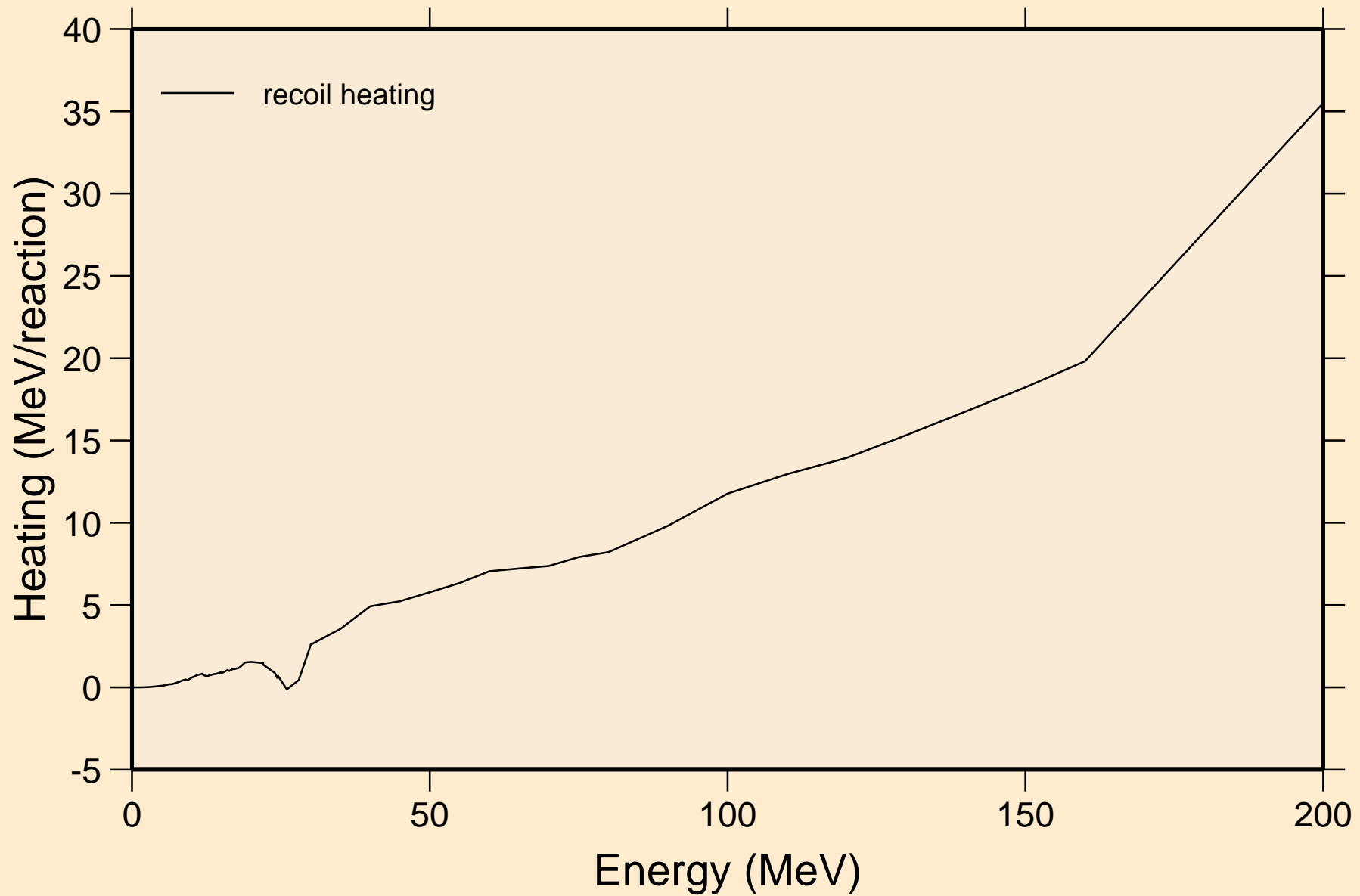

# N017 DEUTERON ACER TENDL-2023 LIBRARY; T=0.K

## Particle production cross sections

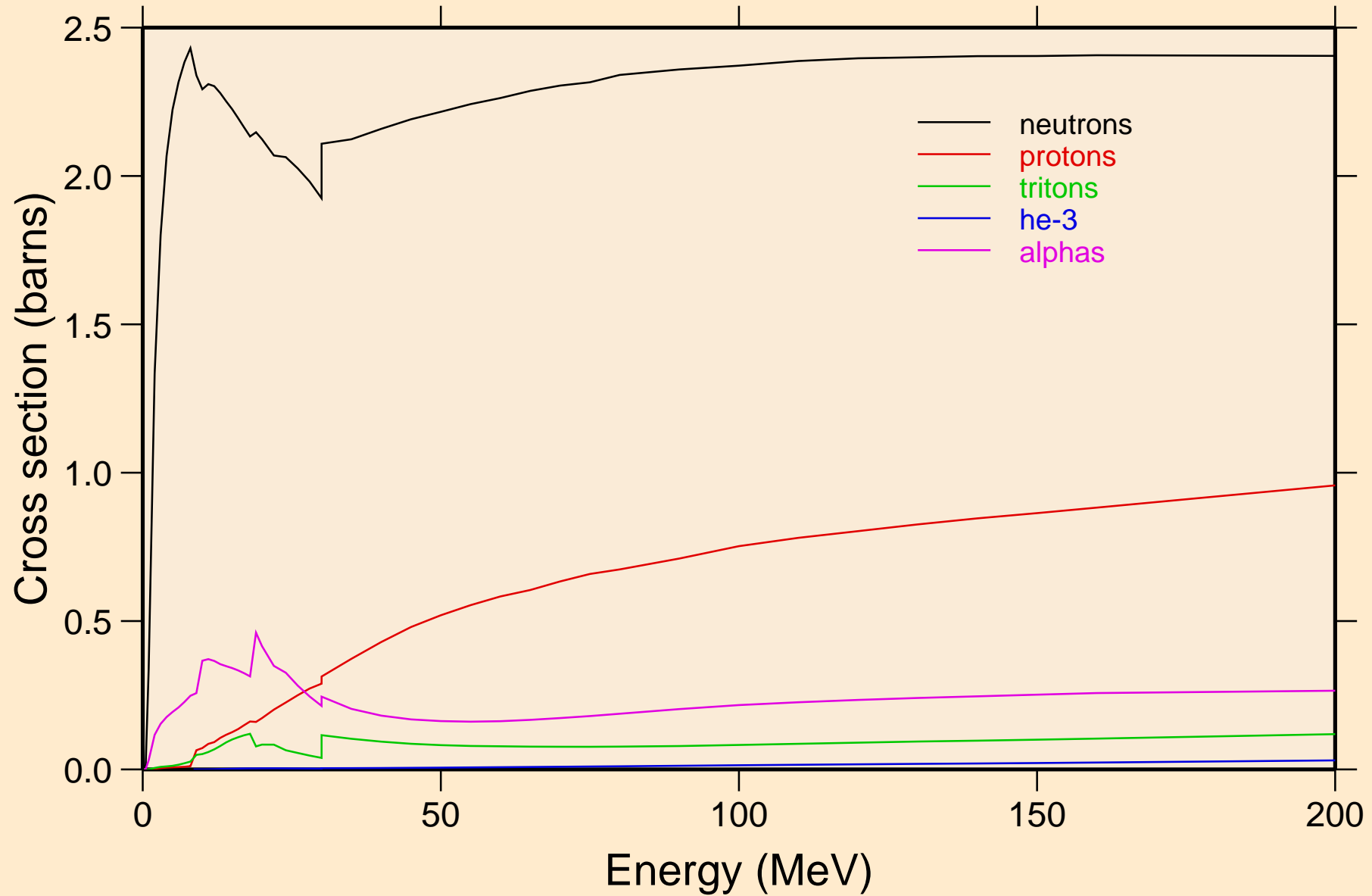

N017 DEUTERON ACER TENDL-2023 LIBRARY; T=0.K  
neutrons from (d,n)

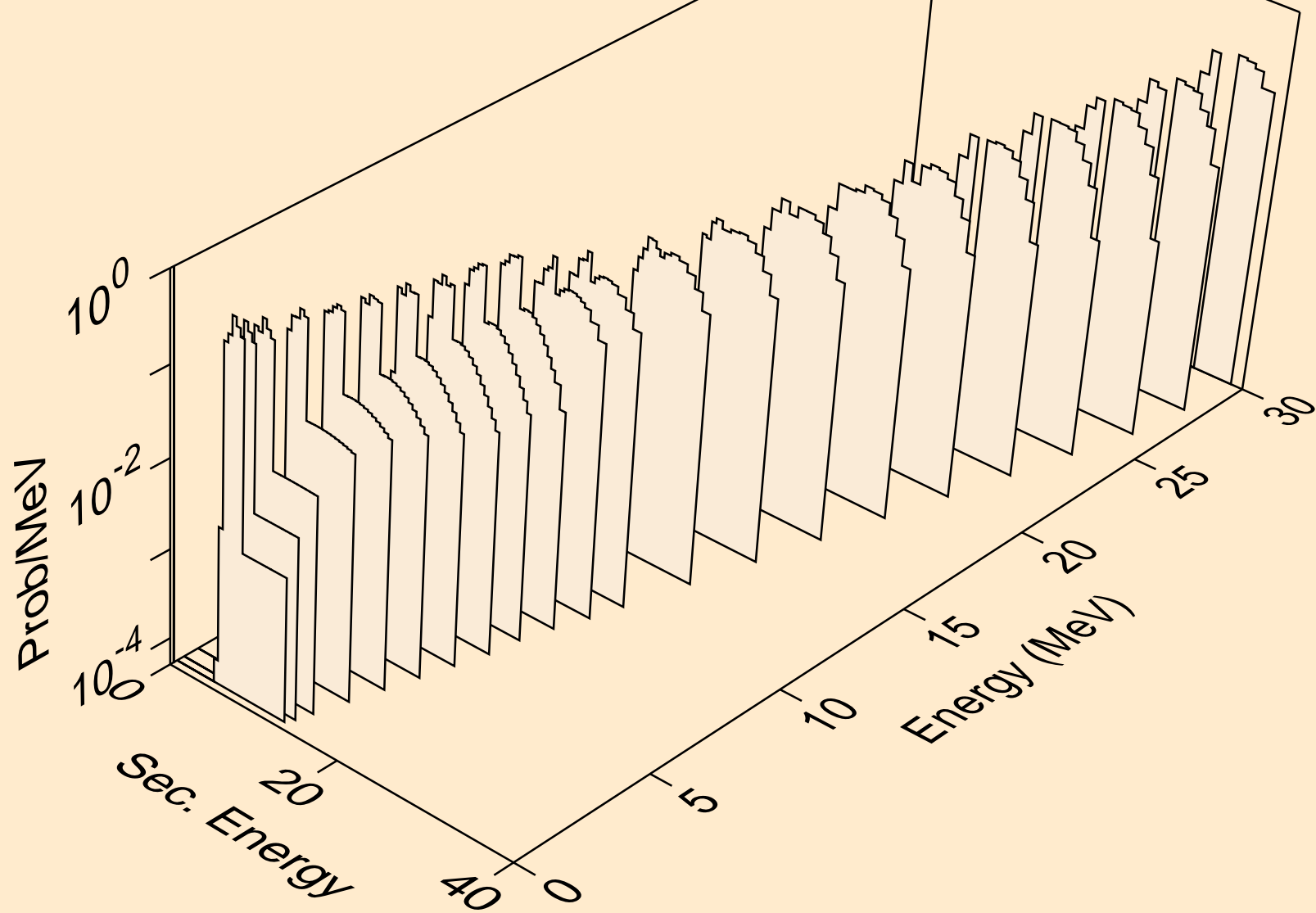

N017 DEUTERON ACER TENDL-2023 LIBRARY; T=0.K  
neutrons from (d,x)

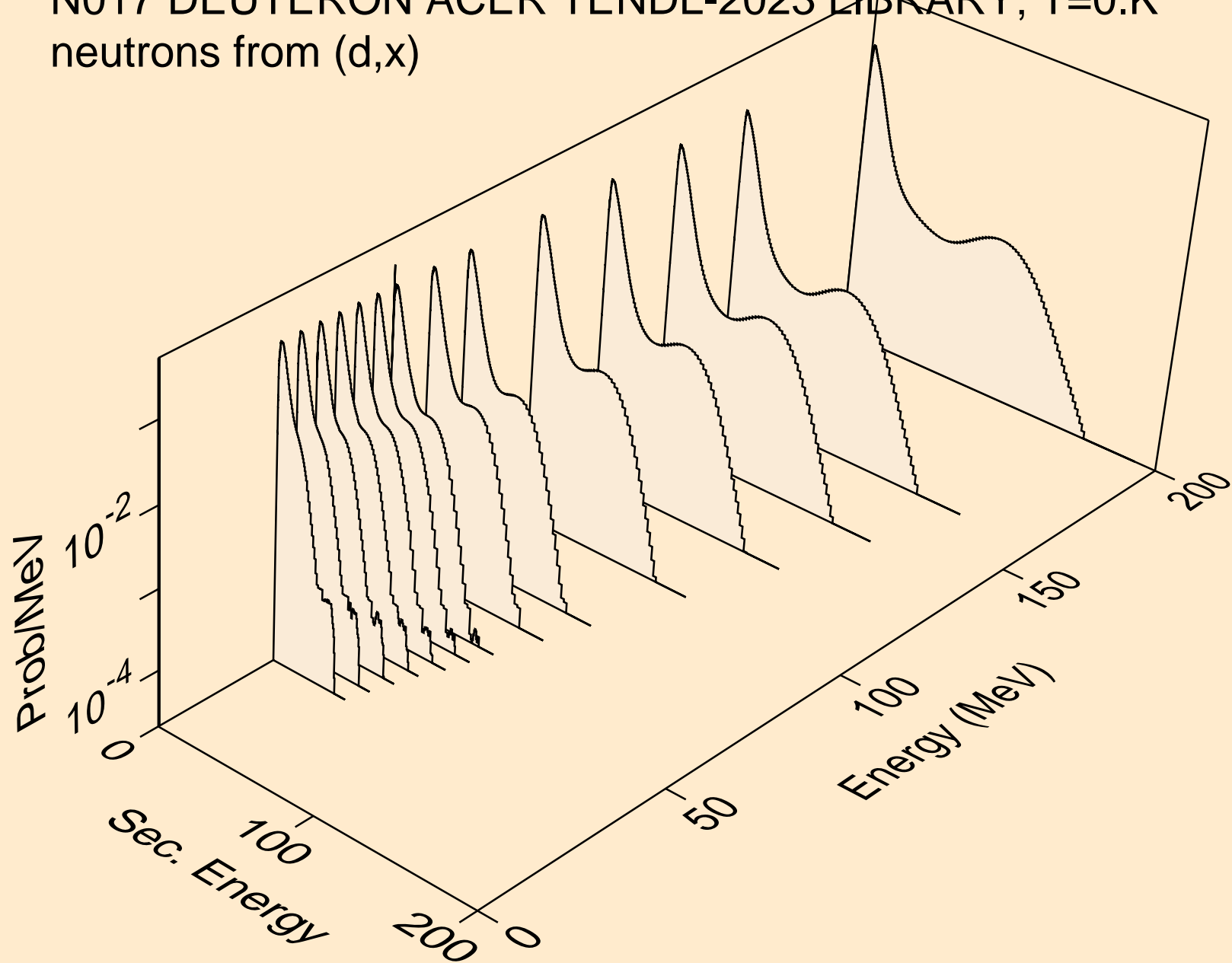

N017 DEUTERON ACER TENDL-2023 LIBRARY; T=0.K  
neutrons from (d,2nd)

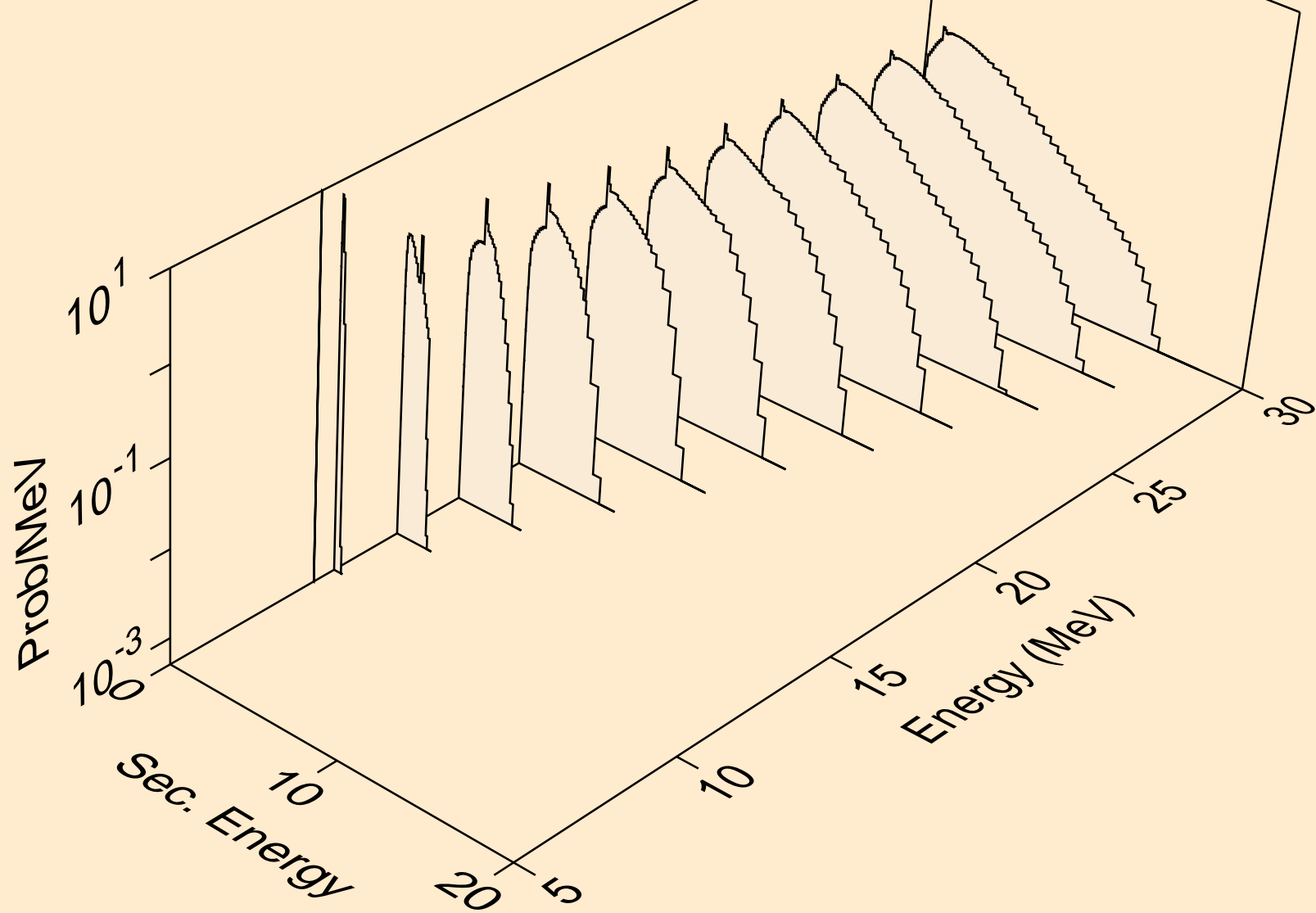



N017 DEUTERON ACER TENDL-2023 LIBRARY; T=0.K  
neutrons from (d,2n)

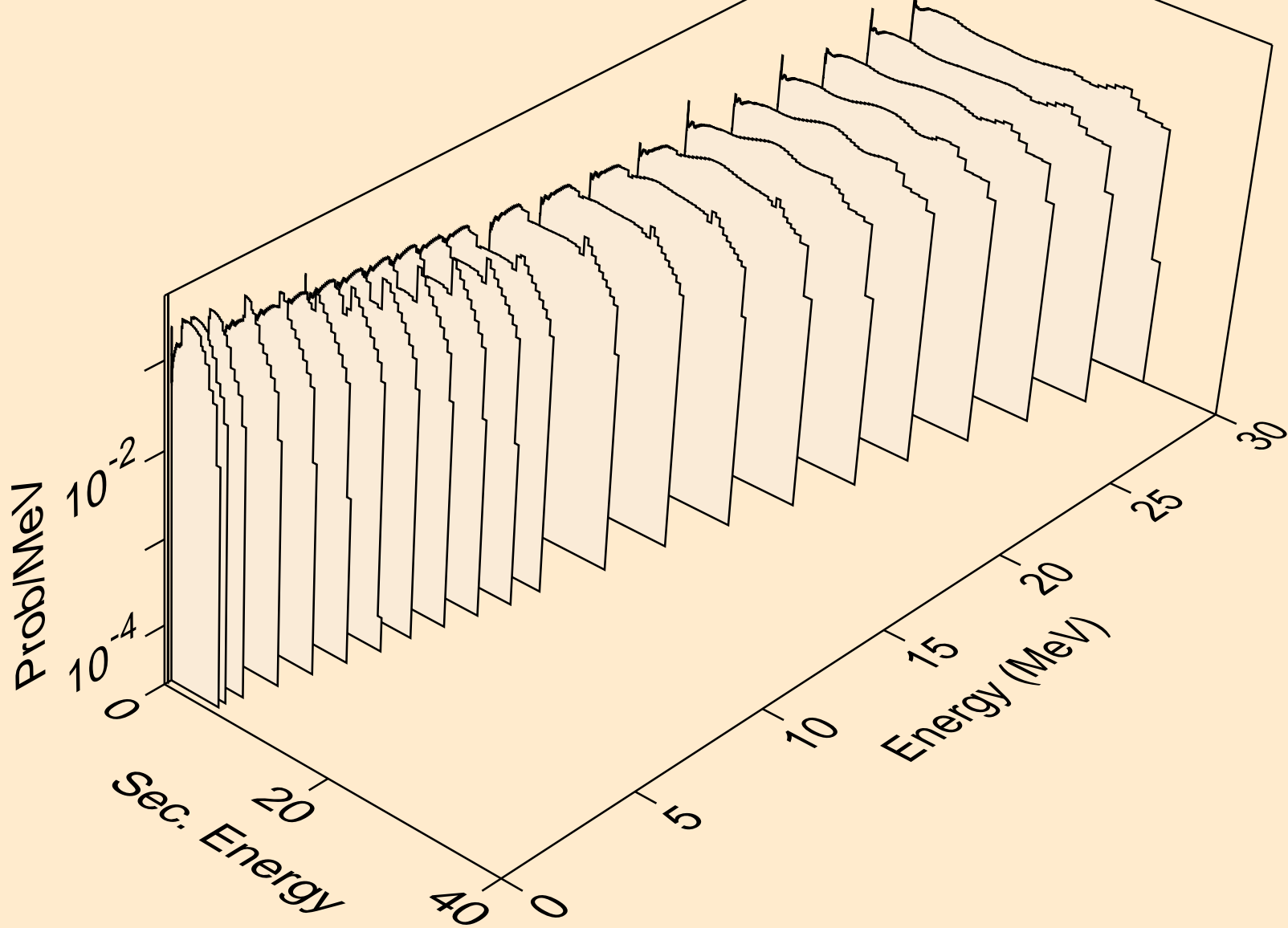

N017 DEUTERON ACER TENDL-2023 LIBRARY; T=0.K  
neutrons from (d,3n)

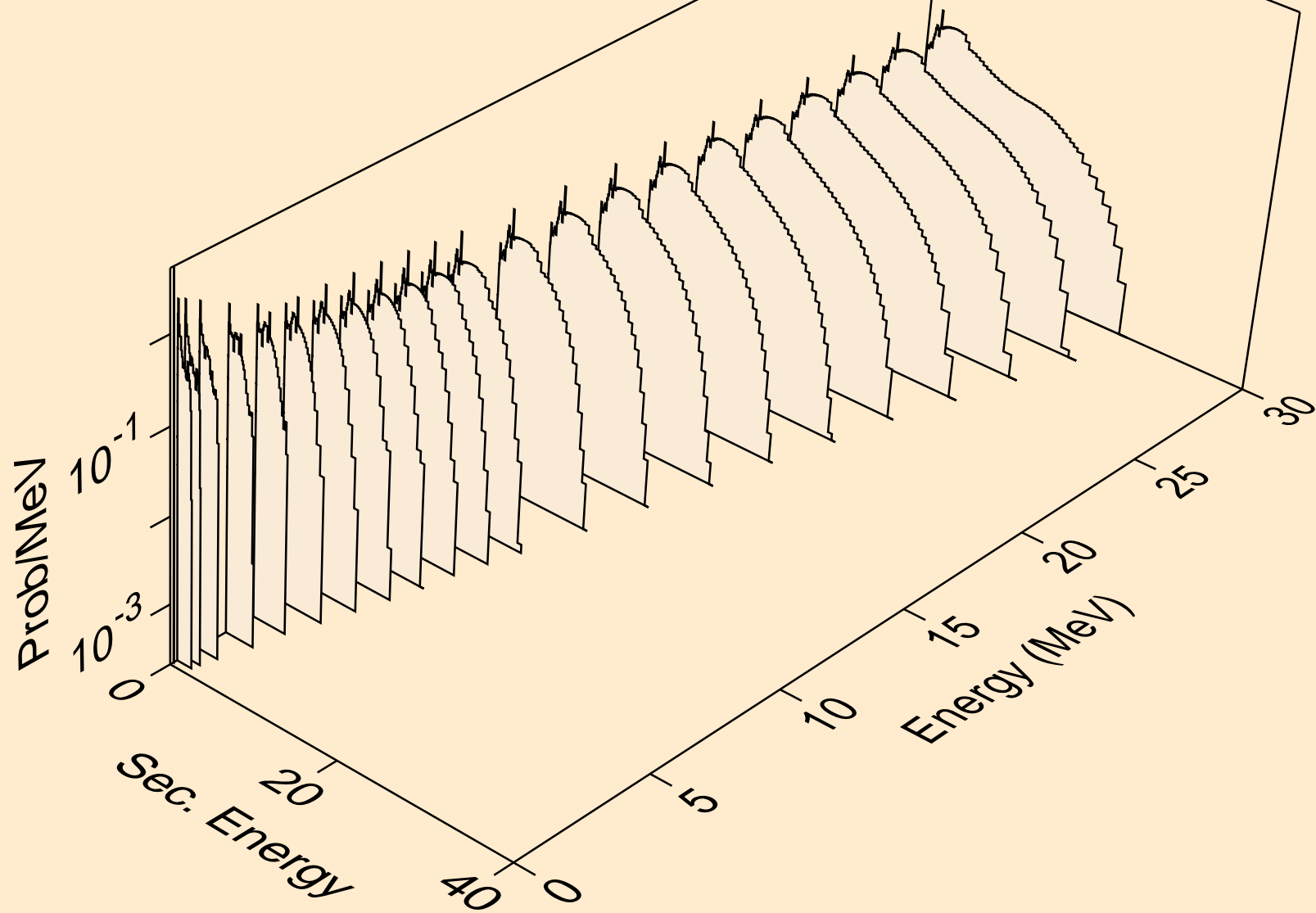

N017 DEUTERON ACER TENDL-2023 LIBRARY; T=0.K  
neutrons from (d,n\*)a

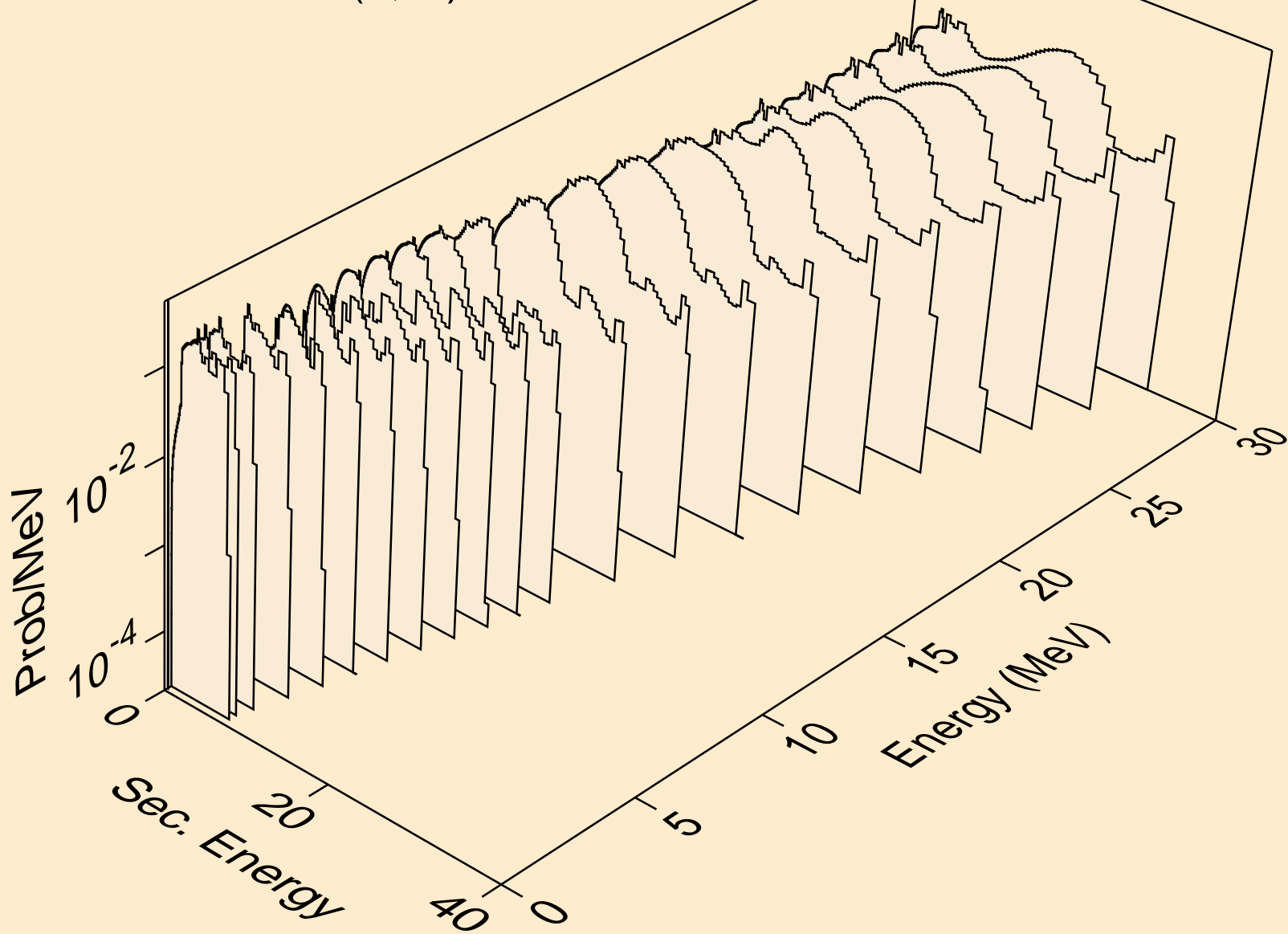

N017 DEUTERON ACER TENDL-2023 LIBRARY; T=0.K  
neutrons from (d,2n)a

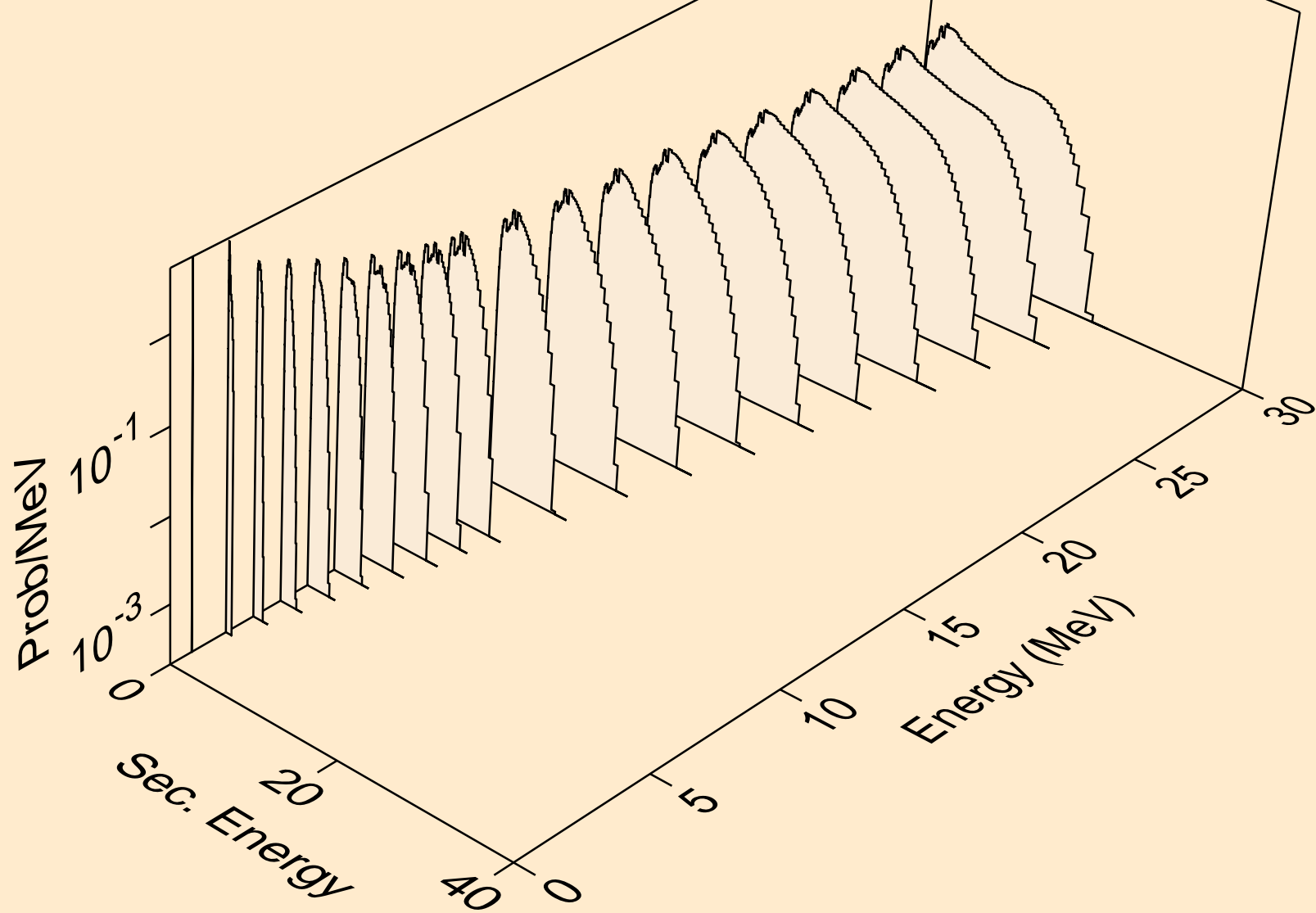

N017 DEUTERON ACER TENDL-2023 LIBRARY; T=0.K  
neutrons from (d,3n)a

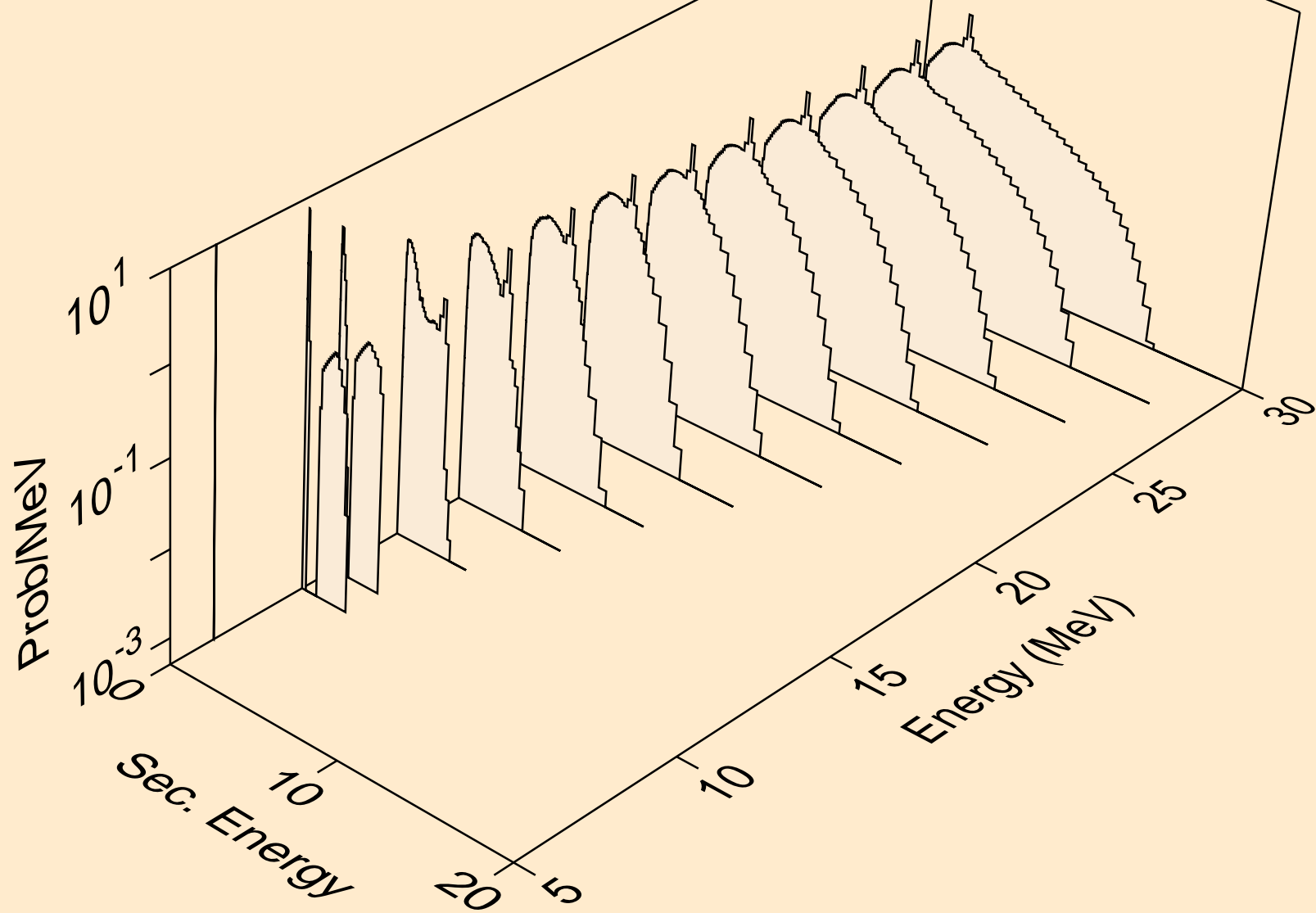

N017 DEUTERON ACER TENDL-2023 LIBRARY; T=0.K  
neutrons from (d,n\*)p

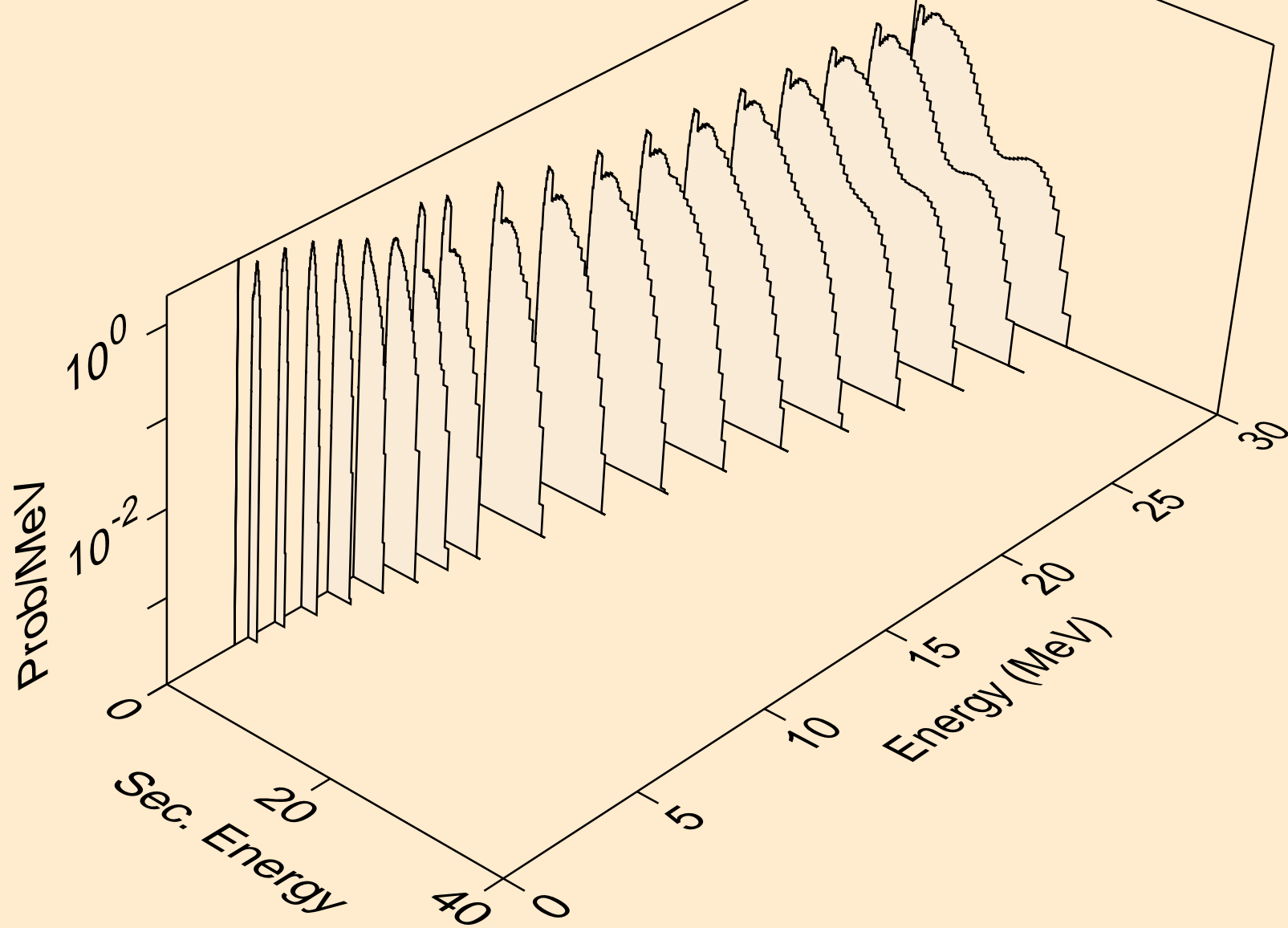

N017 DEUTERON ACER TENDL-2023 LIBRARY; T=0.K  
neutrons from (d,n\*)2a

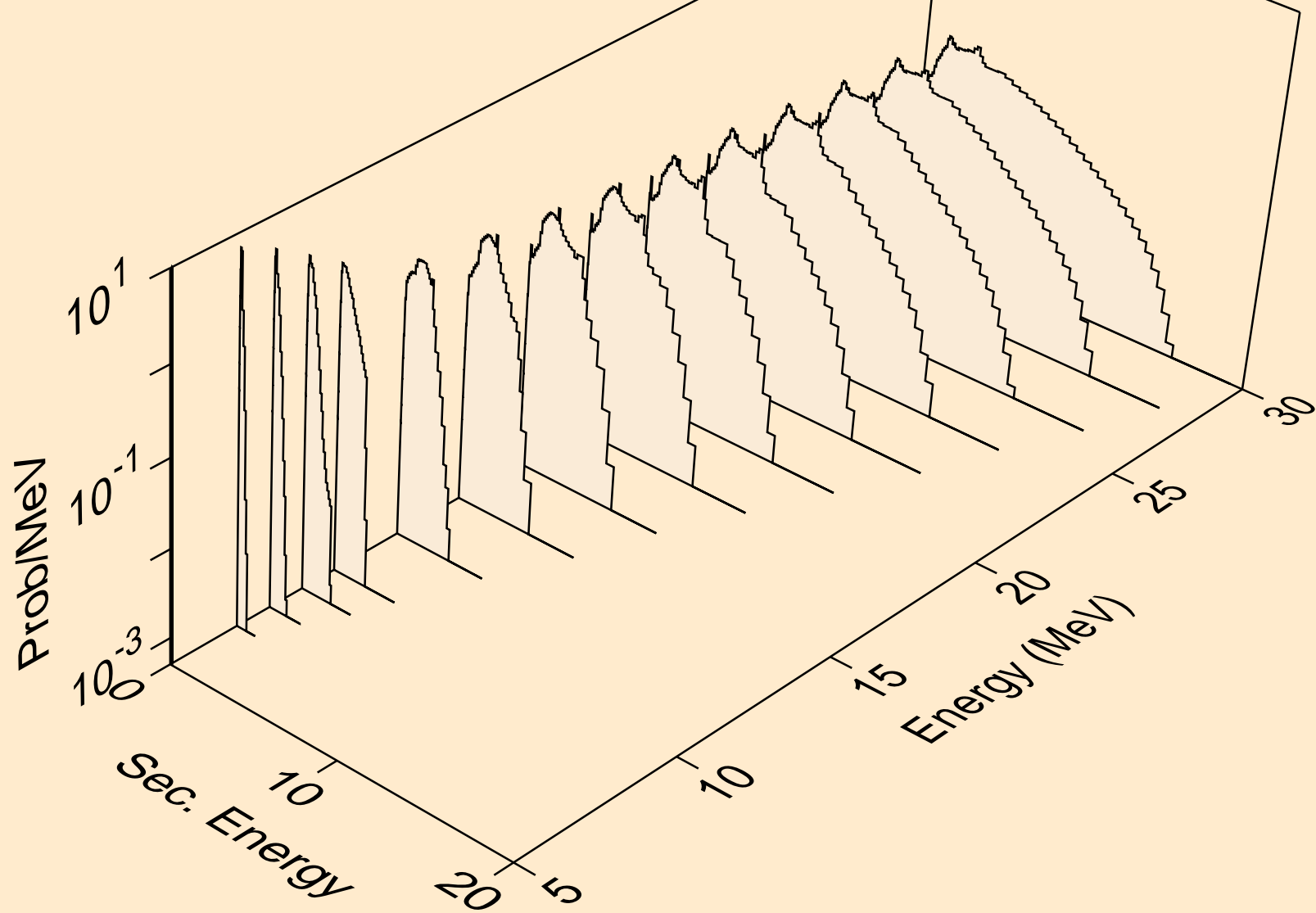

N017 DEUTERON ACER TENDL-2023 LIBRARY; T=0.K  
neutrons from (d,2n)2a

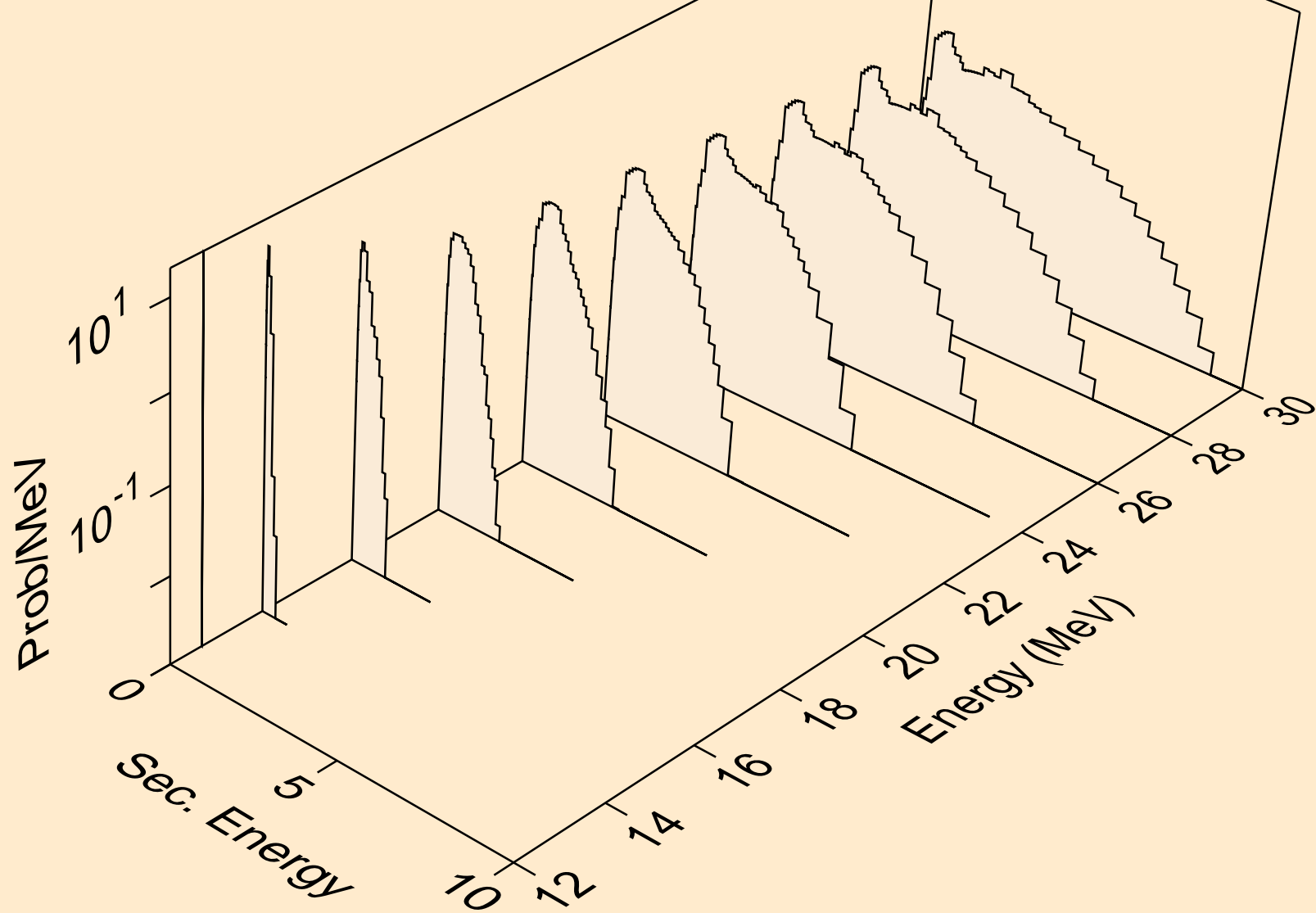



N017 DEUTERON ACER TENDL-2023 LIBRARY; T=0.K  
neutrons from (d,n\*)d

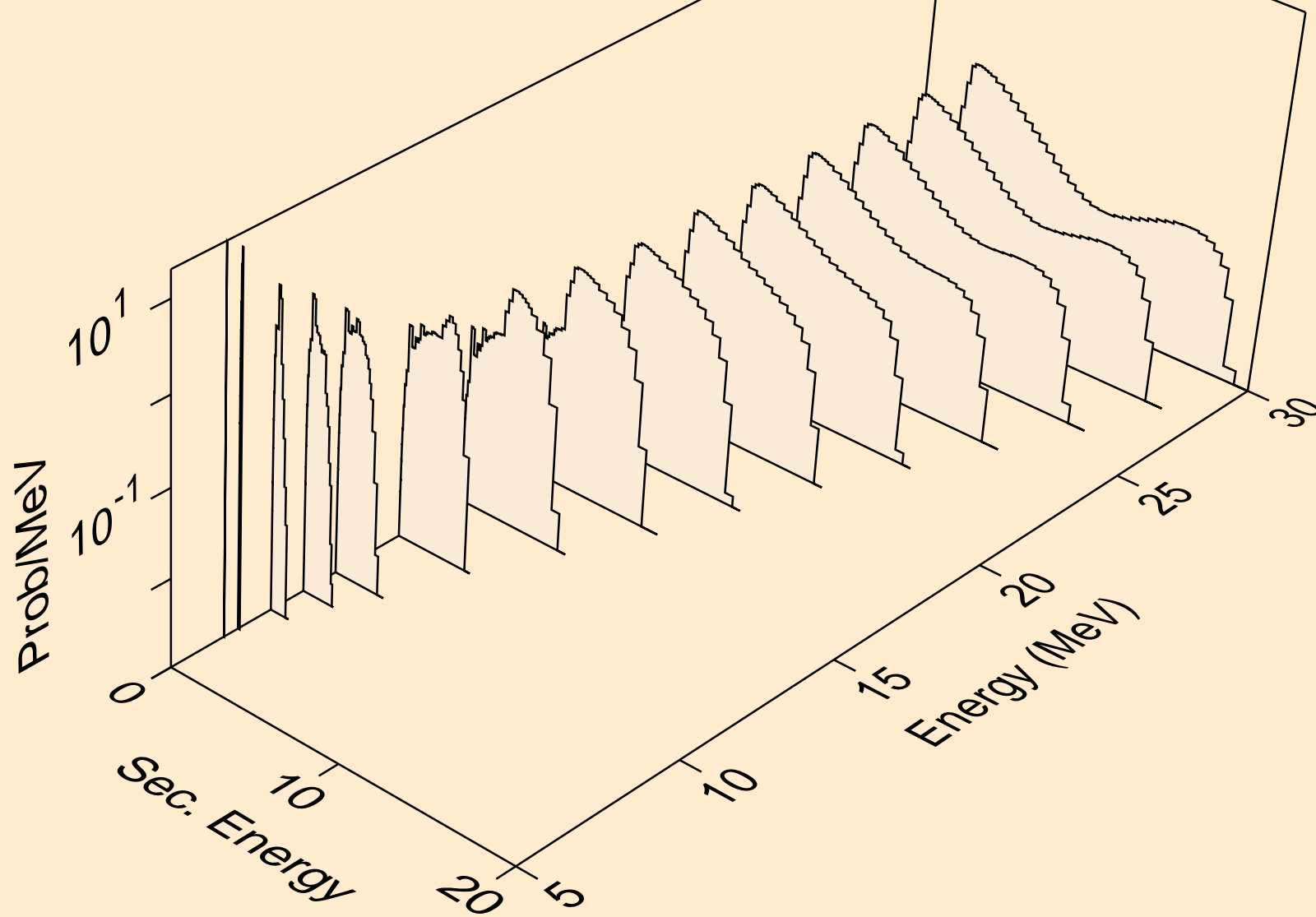

N017 DEUTERON ACER TENDL-2023 LIBRARY; T=0.K  
neutrons from (d,n\*)t

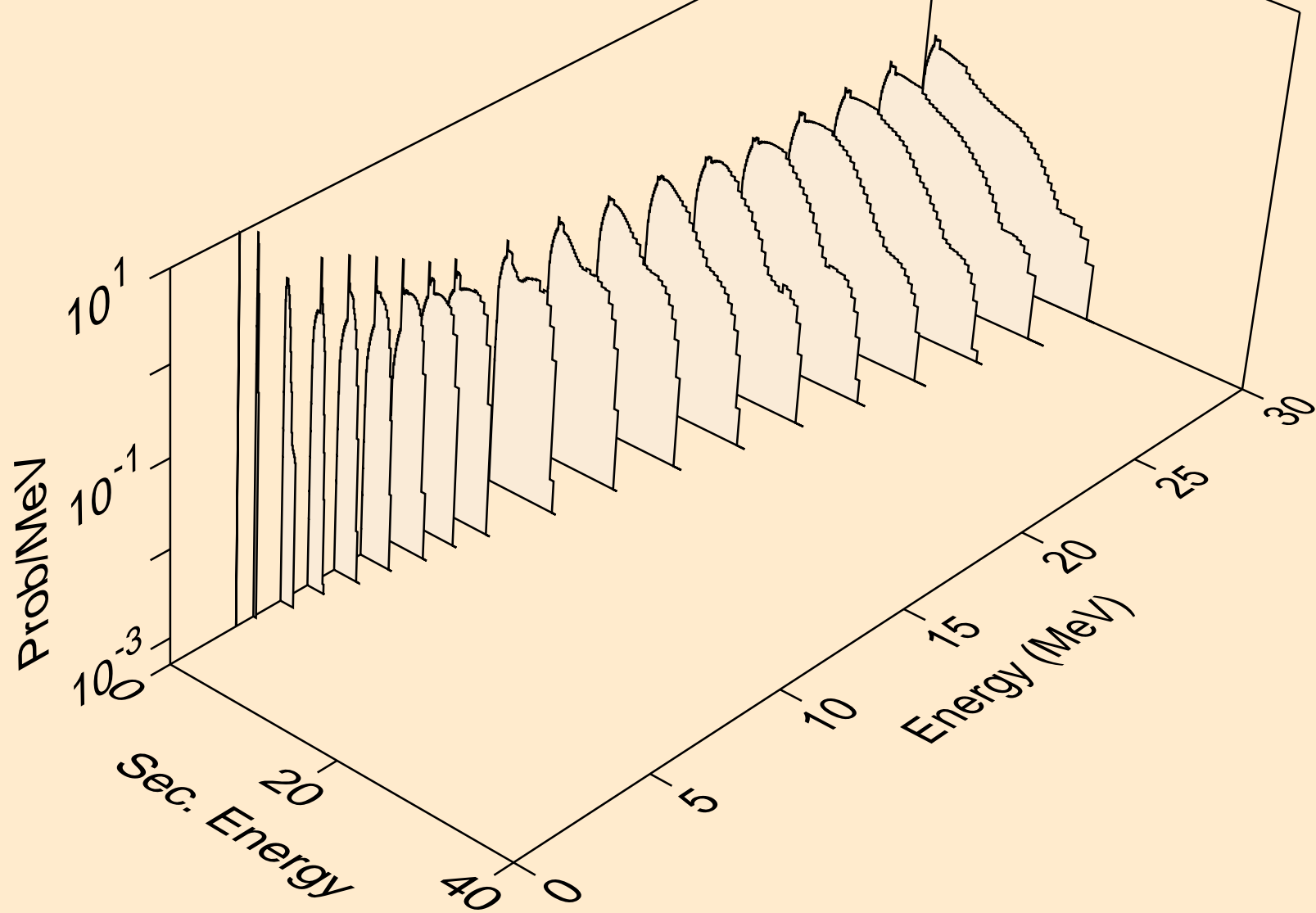

N017 DEUTERON ACER TENDL-2023 LIBRARY; T=0.K  
neutrons from (d,n\*)he3

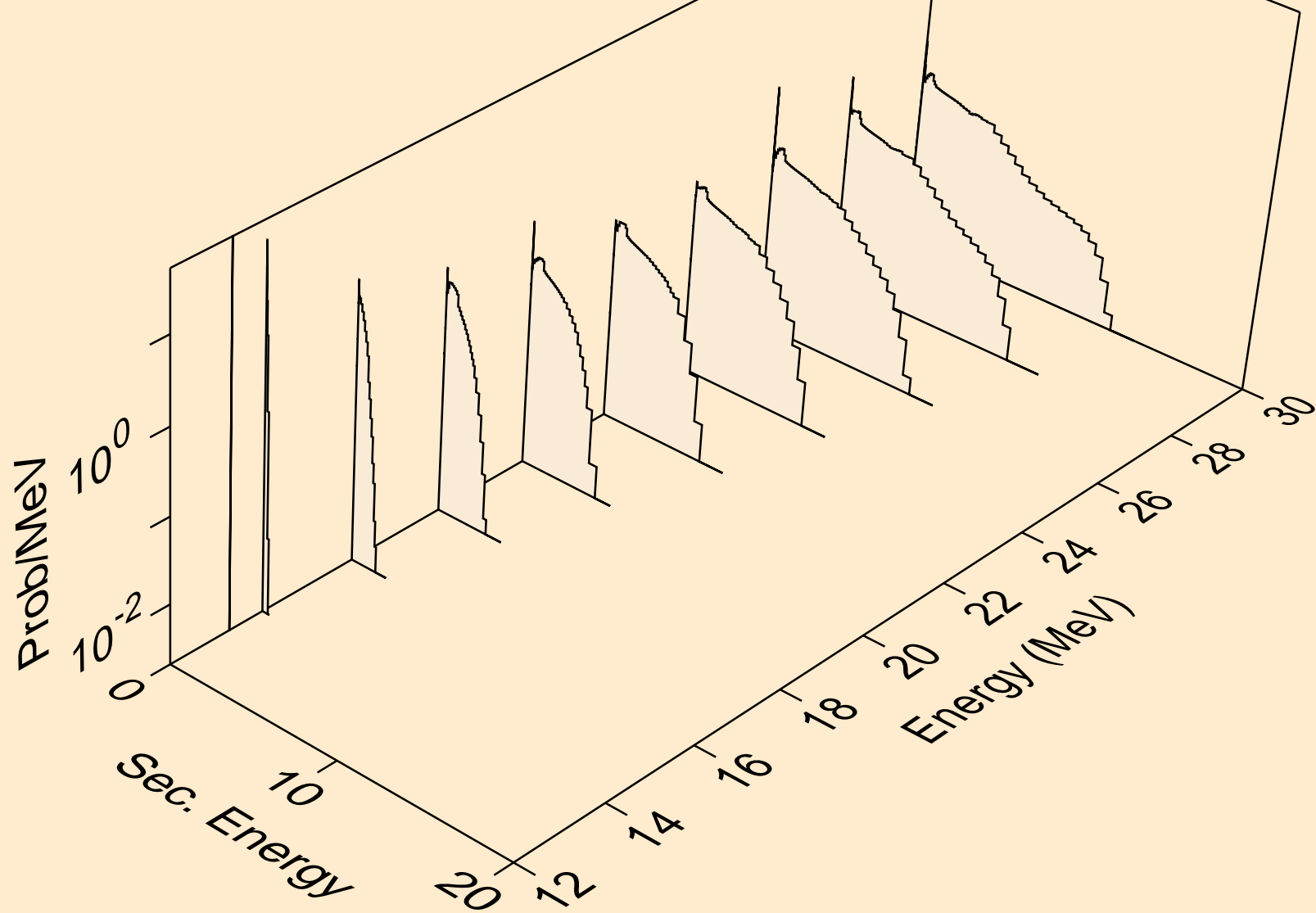

N017 DEUTERON ACER TENDL-2023 LIBRARY; T=0.K  
neutrons from (d,n\*)t2a

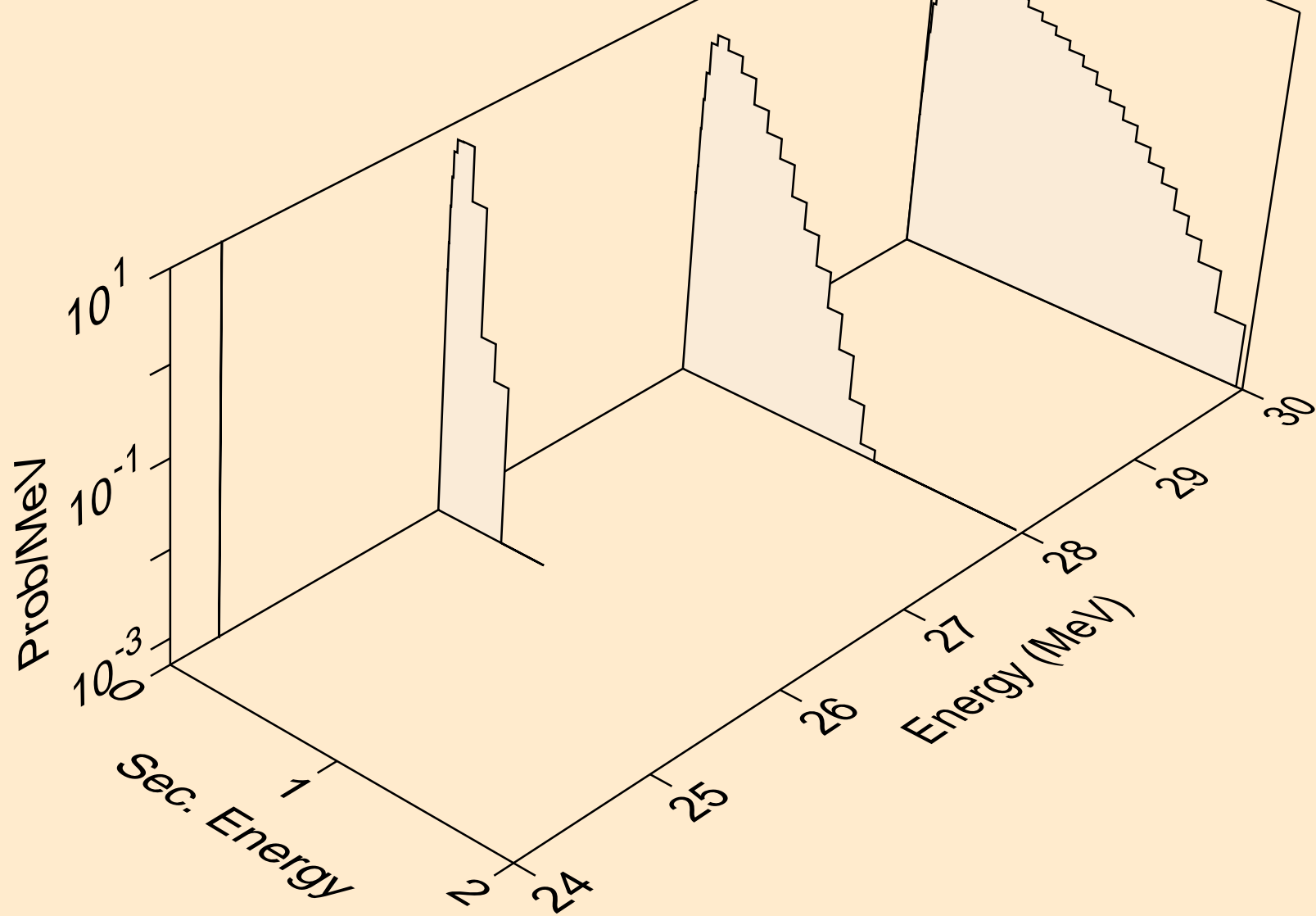

N017 DEUTERON ACER TENDL-2023 LIBRARY; T=0.K  
neutrons from (d,4n)

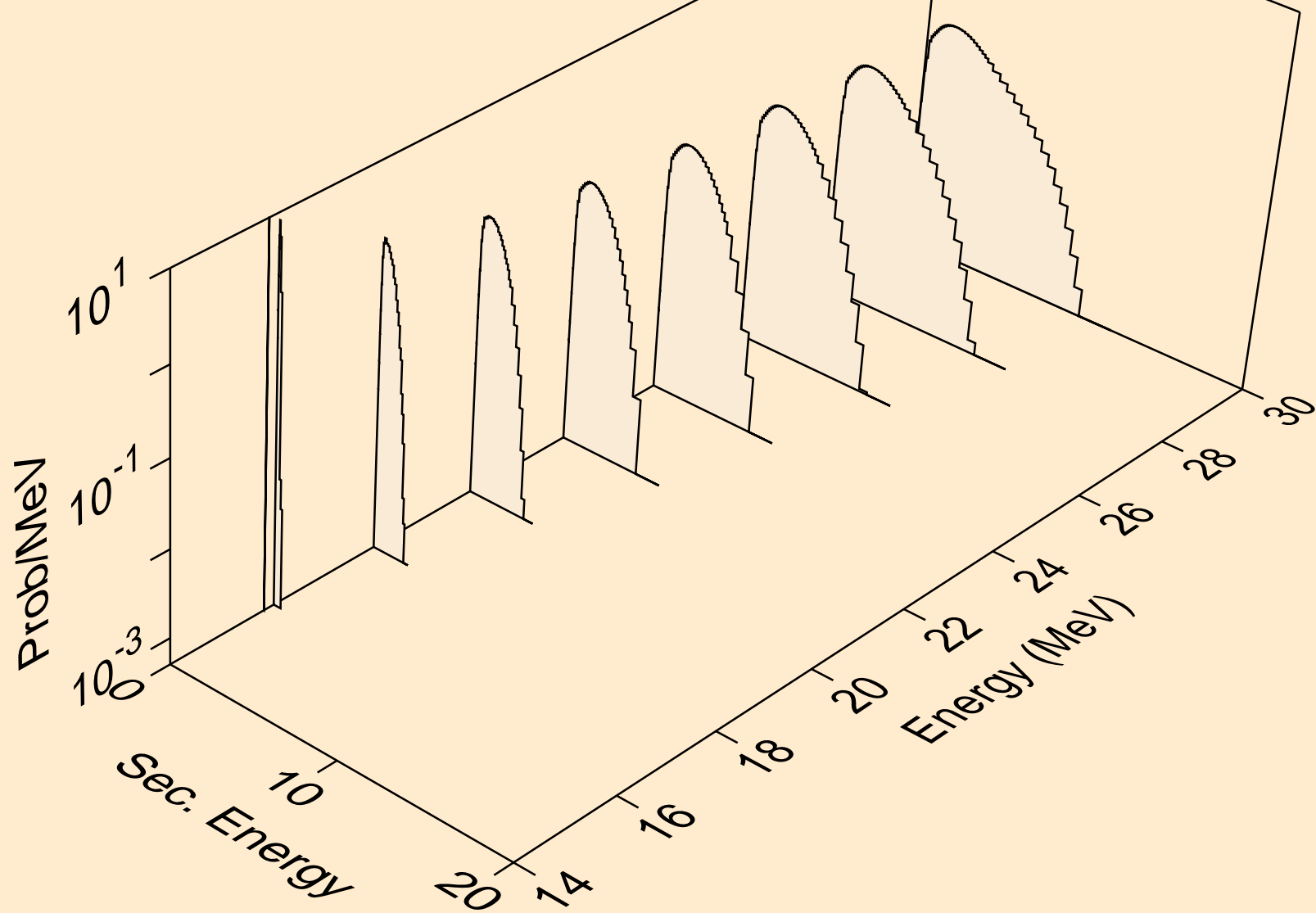

N017 DEUTERON ACER TENDL-2023 LIBRARY; T=0.K  
neutrons from (d,2np)

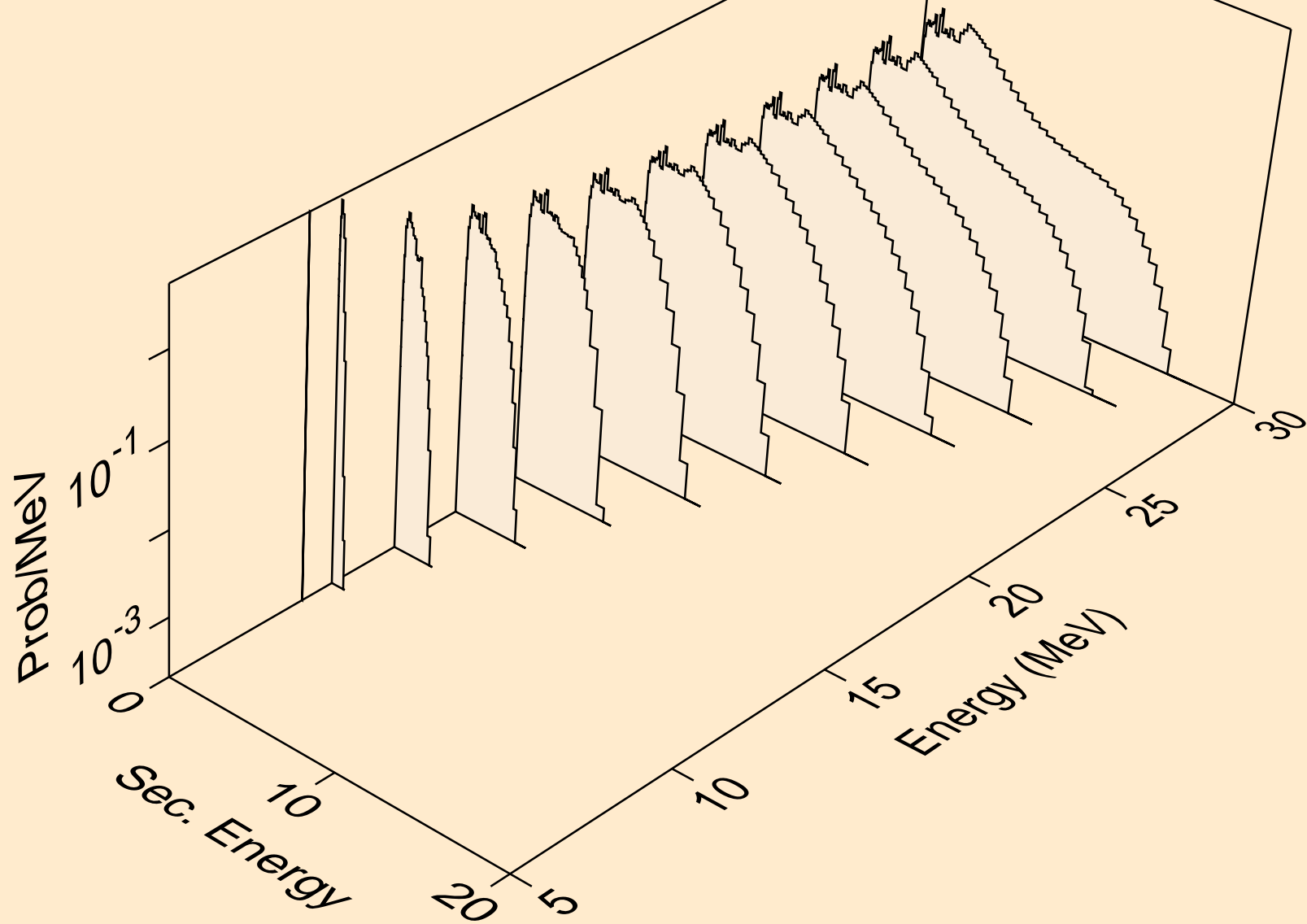

N017 DEUTERON ACER TENDL-2023 LIBRARY; T=0.K  
neutrons from (d,3np)

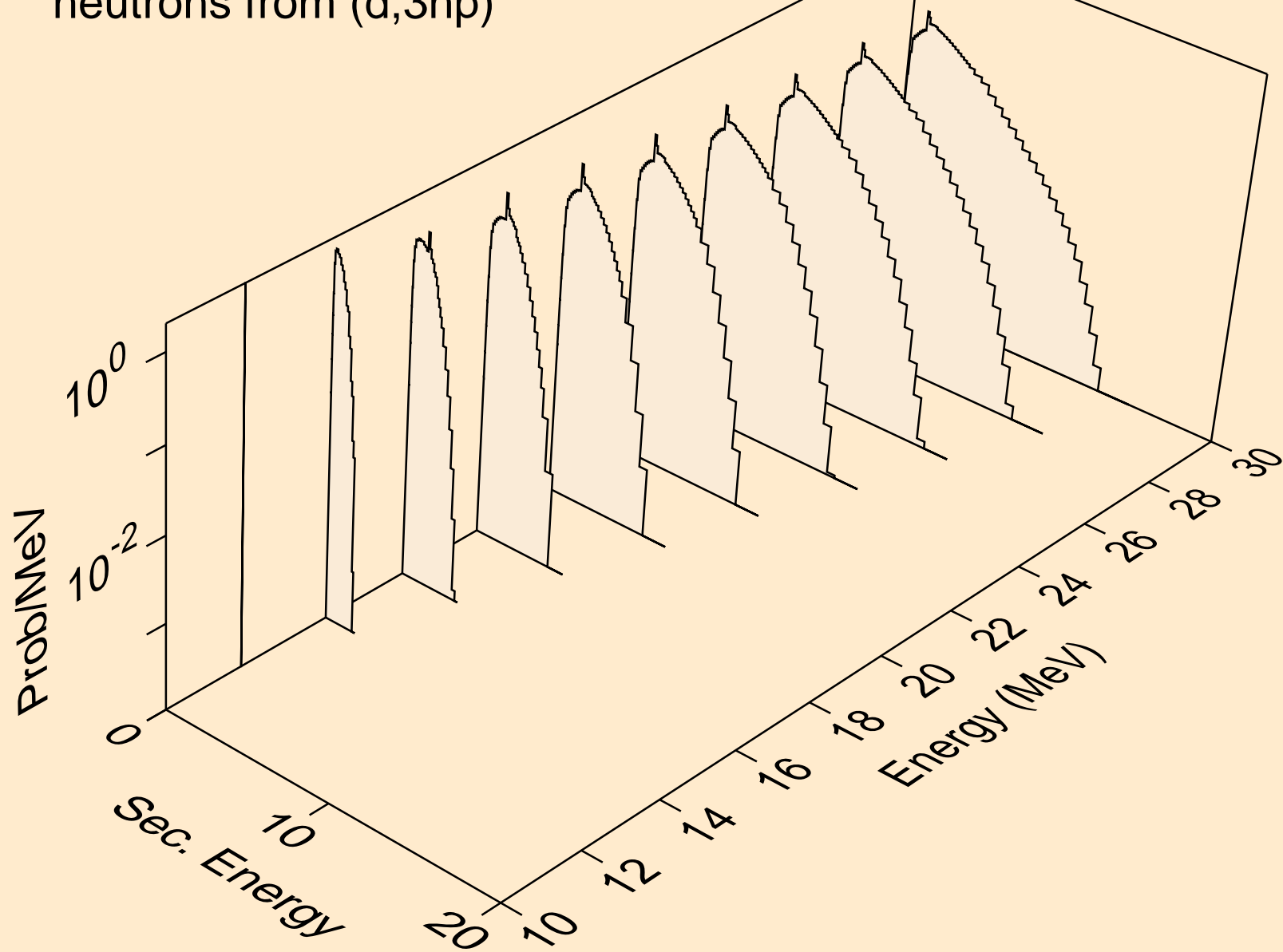

N017 DEUTERON ACER TENDL-2023 LIBRARY; T=0.K  
neutrons from (d,n2p)

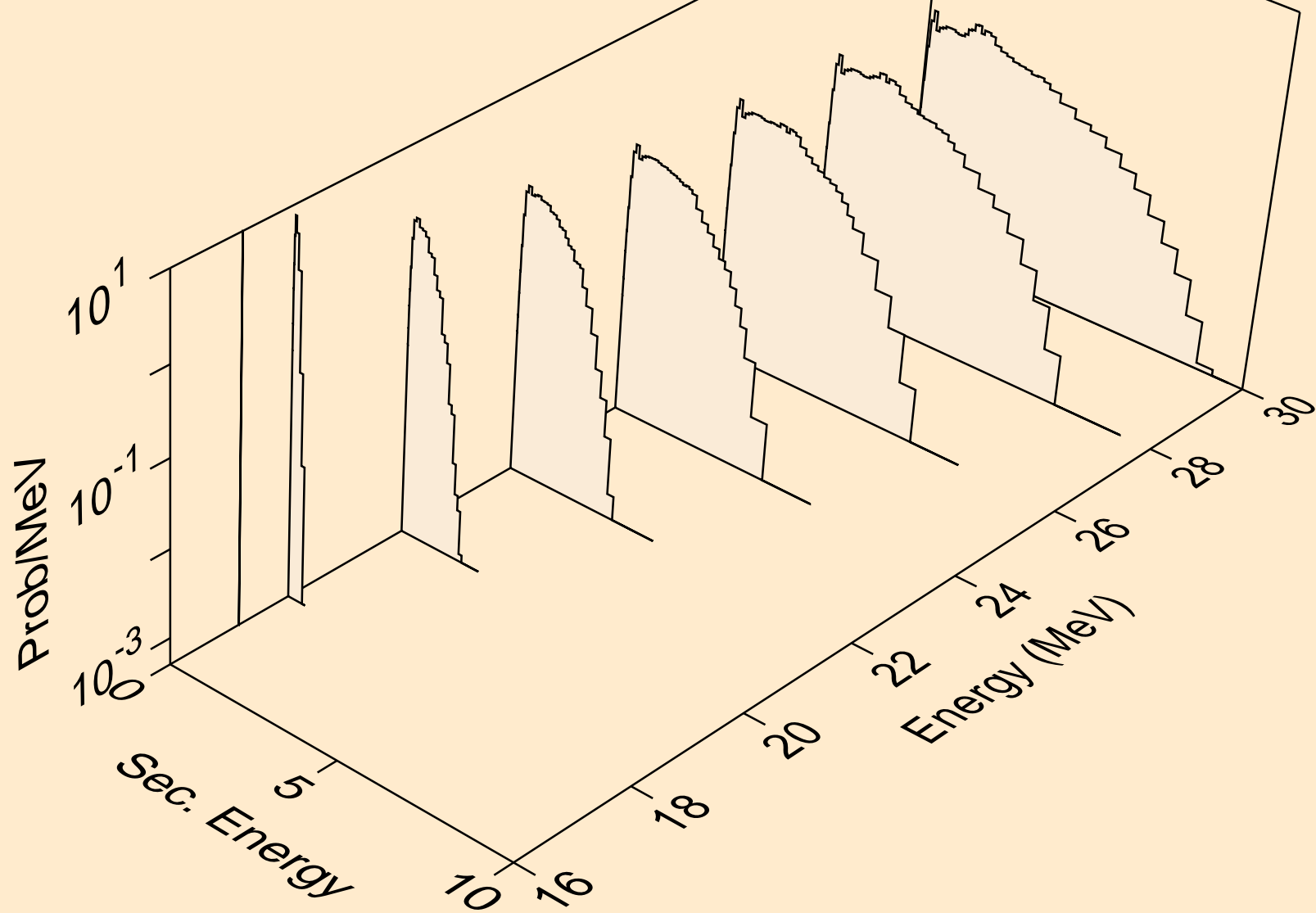



N017 DEUTERON ACER TENDL-2023 LIBRARY; T=0.K  
neutrons from (d,npa)

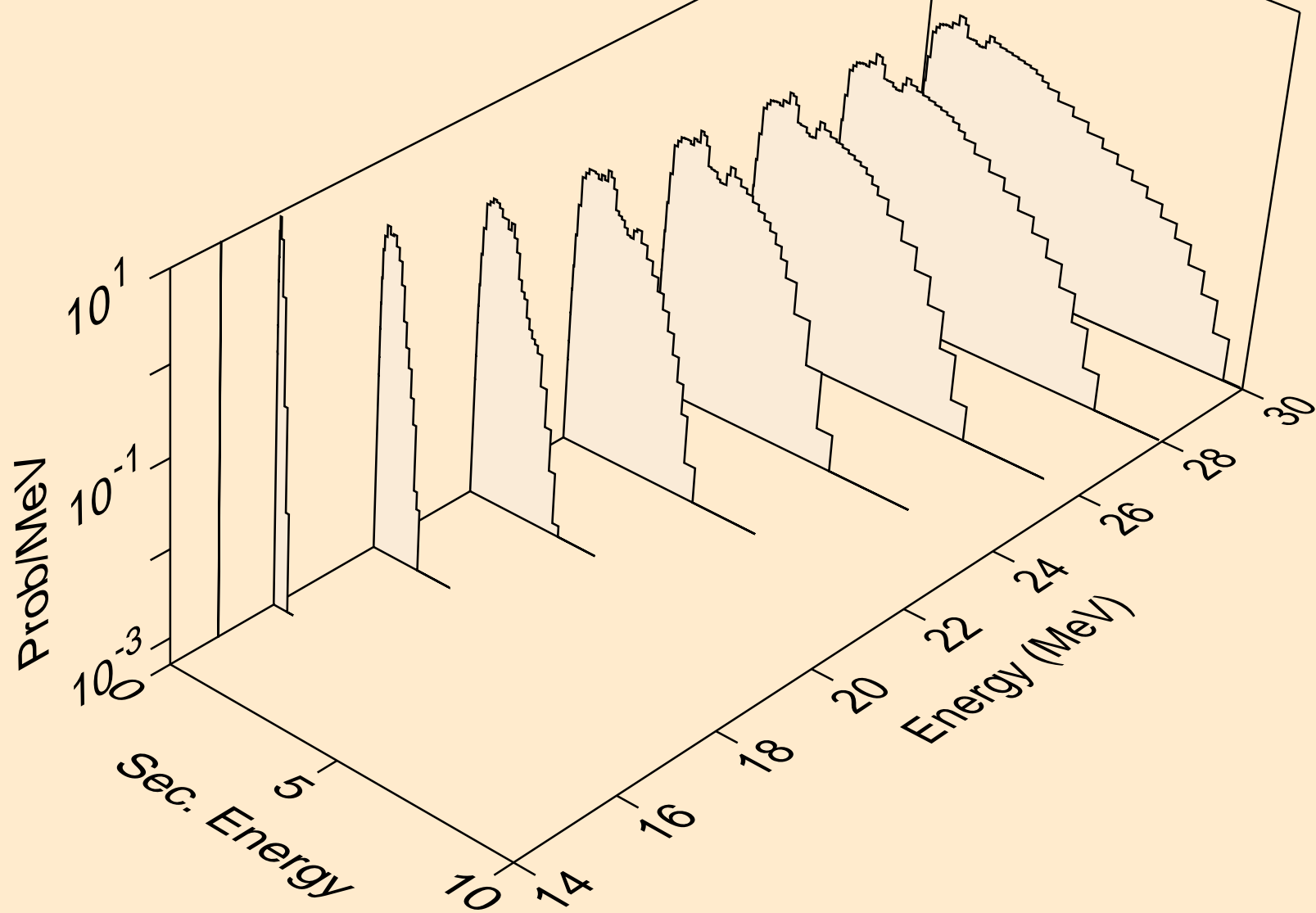

N017 DEUTERON ACER TENDL-2023 LIBRARY; T=0.K  
protons from (d,x)

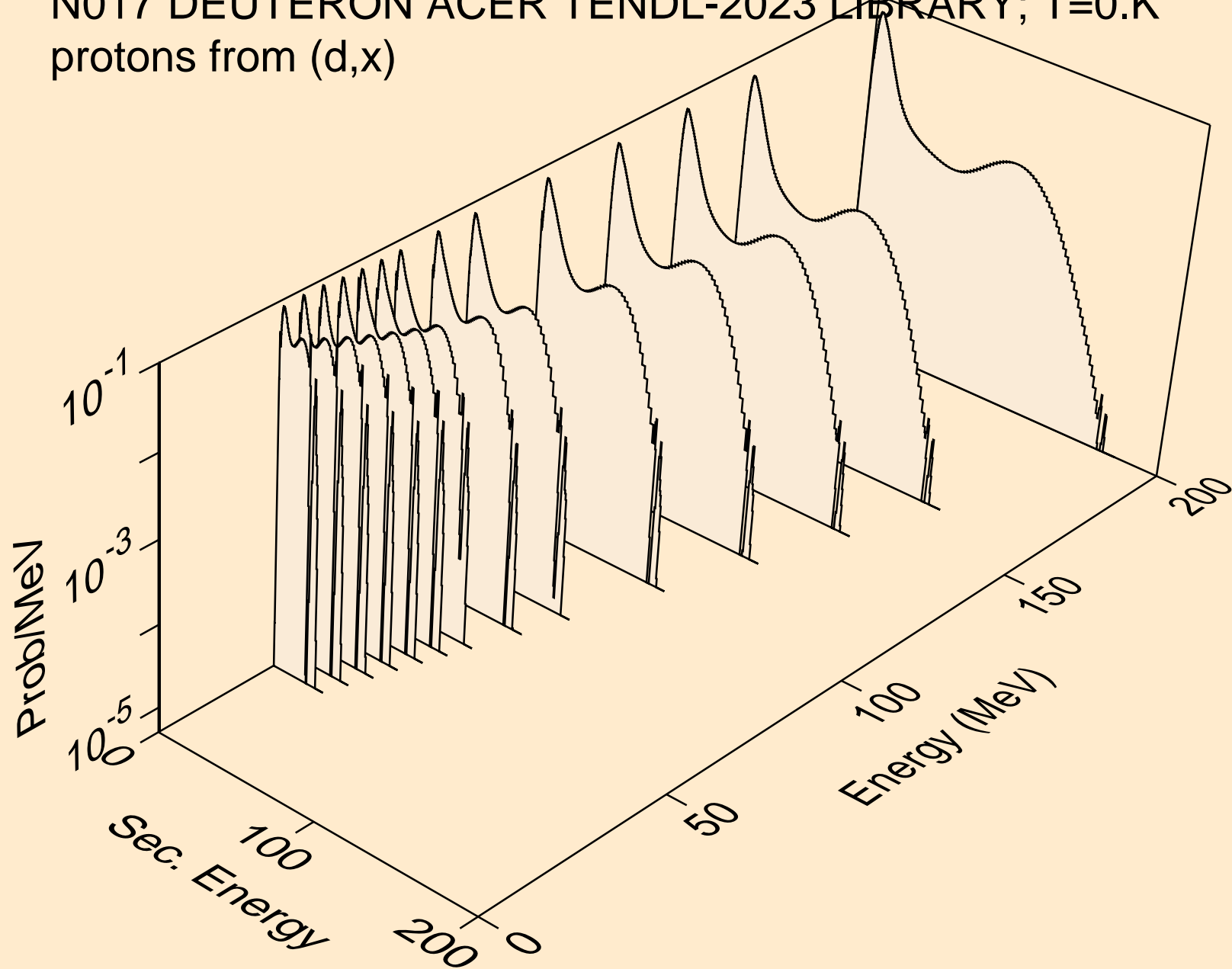

N017 DEUTERON ACER TENDL-2023 LIBRARY; T=0.K  
protons from (d,n\*)p

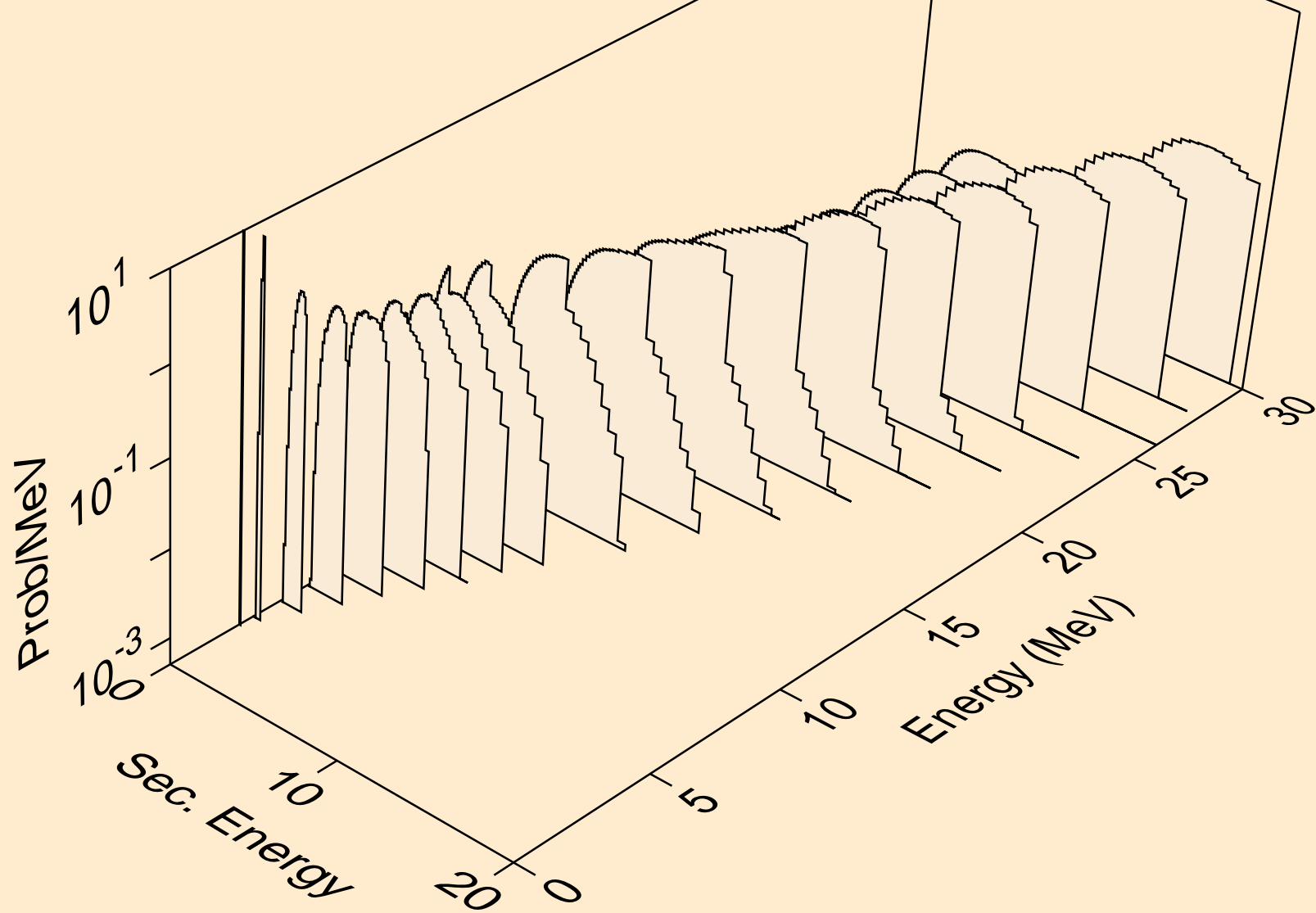

N017 DEUTERON ACER TENDL-2023 LIBRARY; T=0.K  
protons from (d,2np)

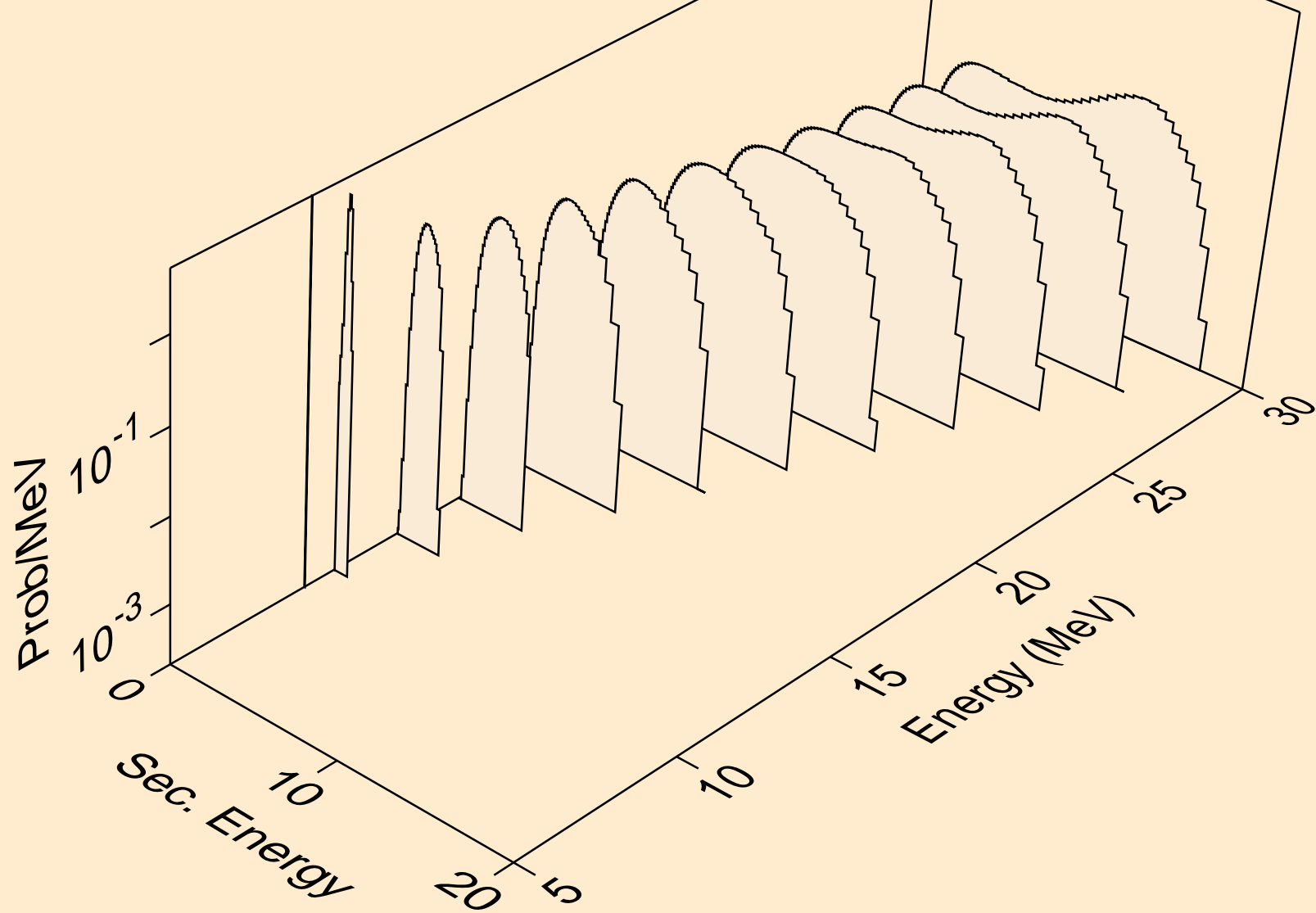

N017 DEUTERON ACER TENDL-2023 LIBRARY; T=0.K  
protons from (d,3np)

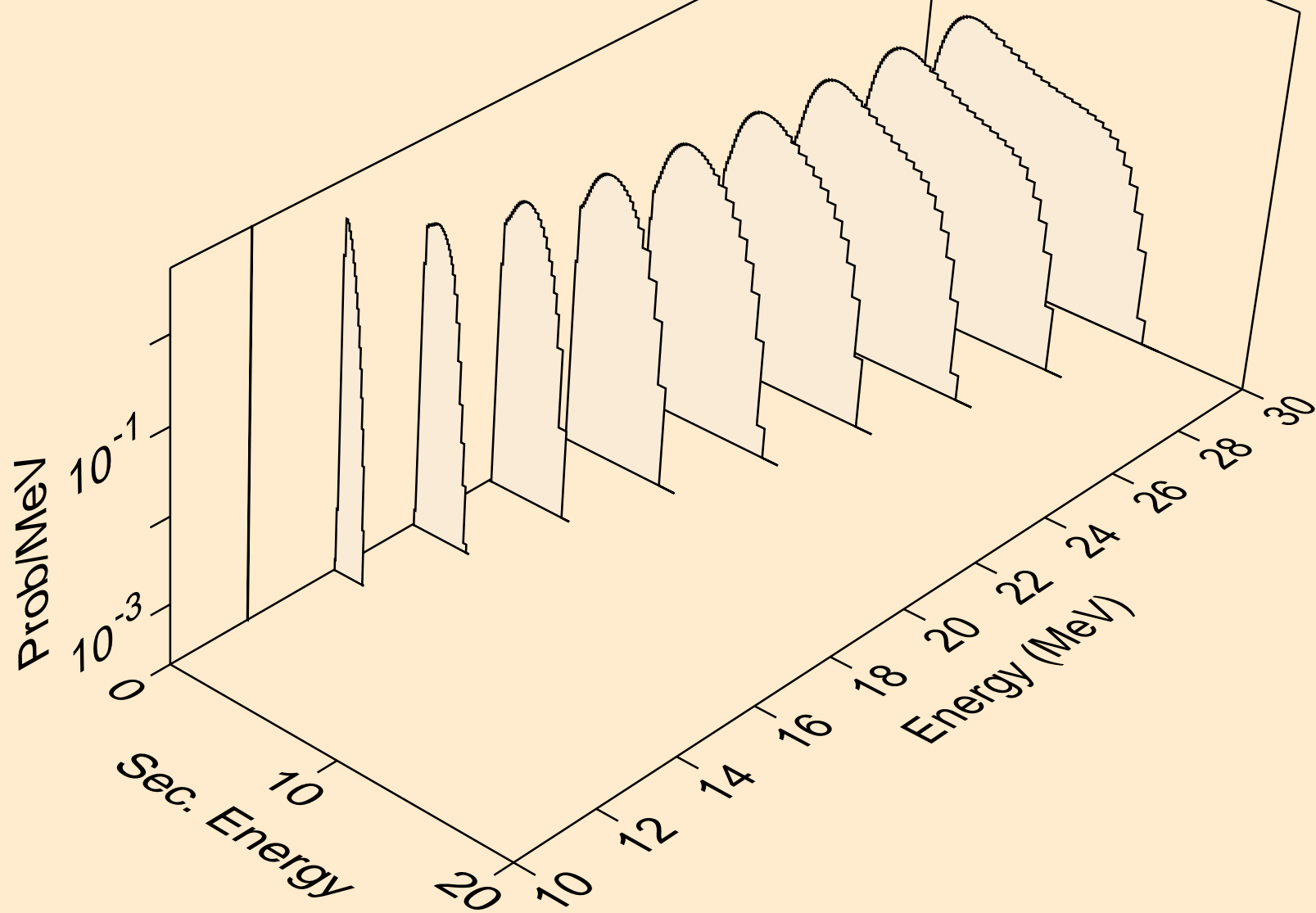

N017 DEUTERON ACER TENDL-2023 LIBRARY; T=0.K  
protons from (d,n2p)

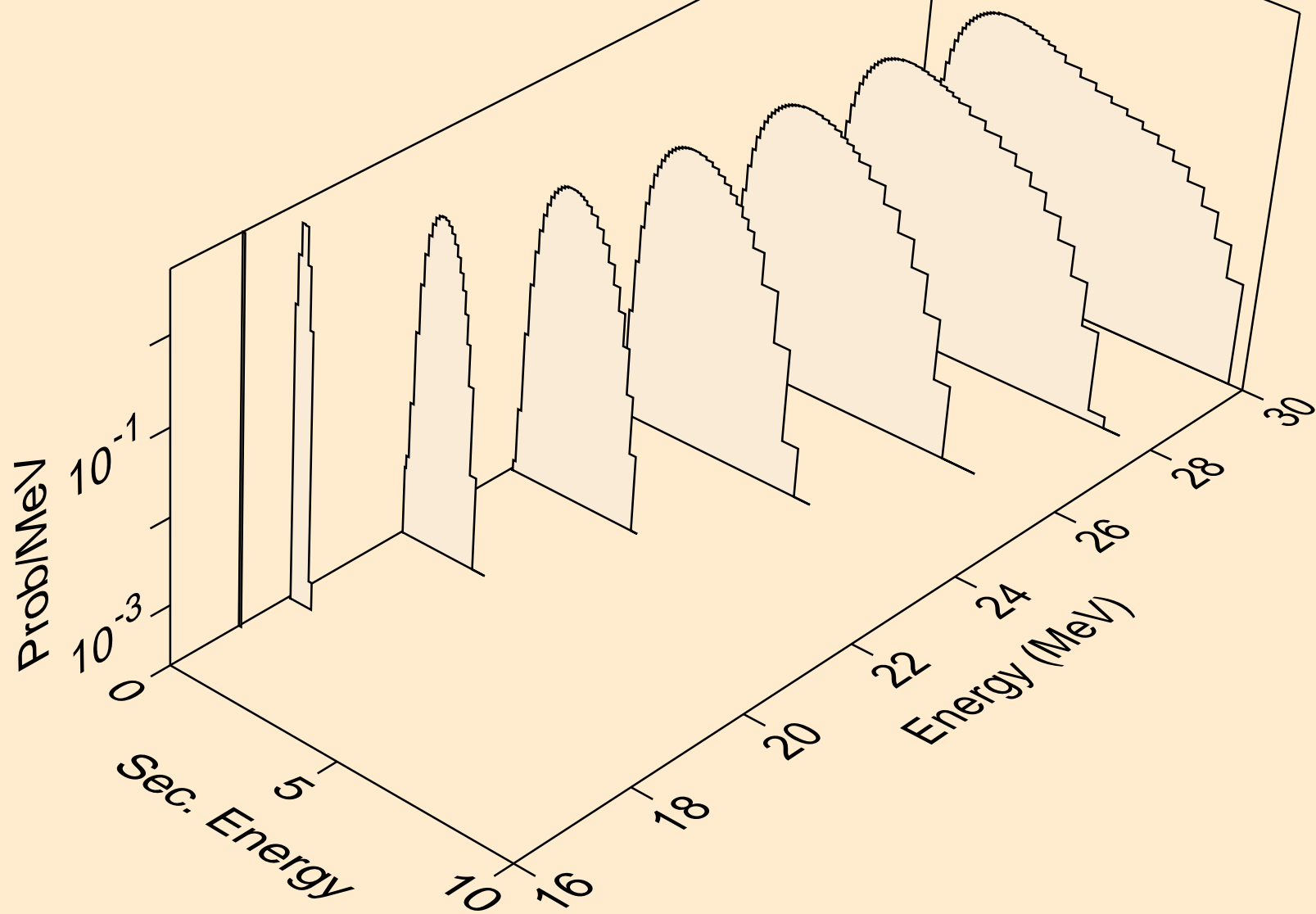

N017 DEUTERON ACER TENDL-2023 LIBRARY; T=0.K  
protons from (d,npa)

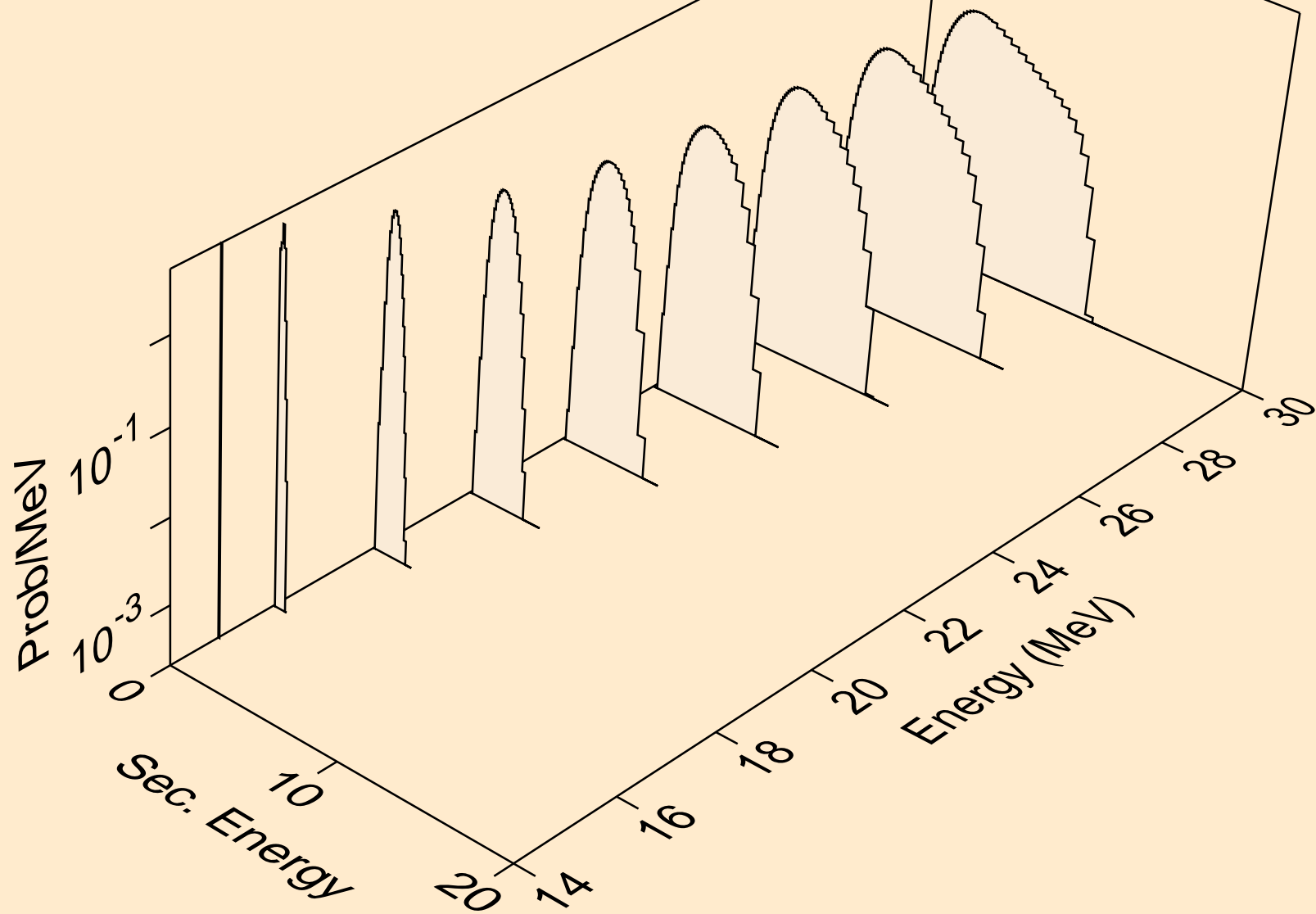

N017 DEUTERON ACER TENDL-2023 LIBRARY; T=0.K  
protons from (d,p)

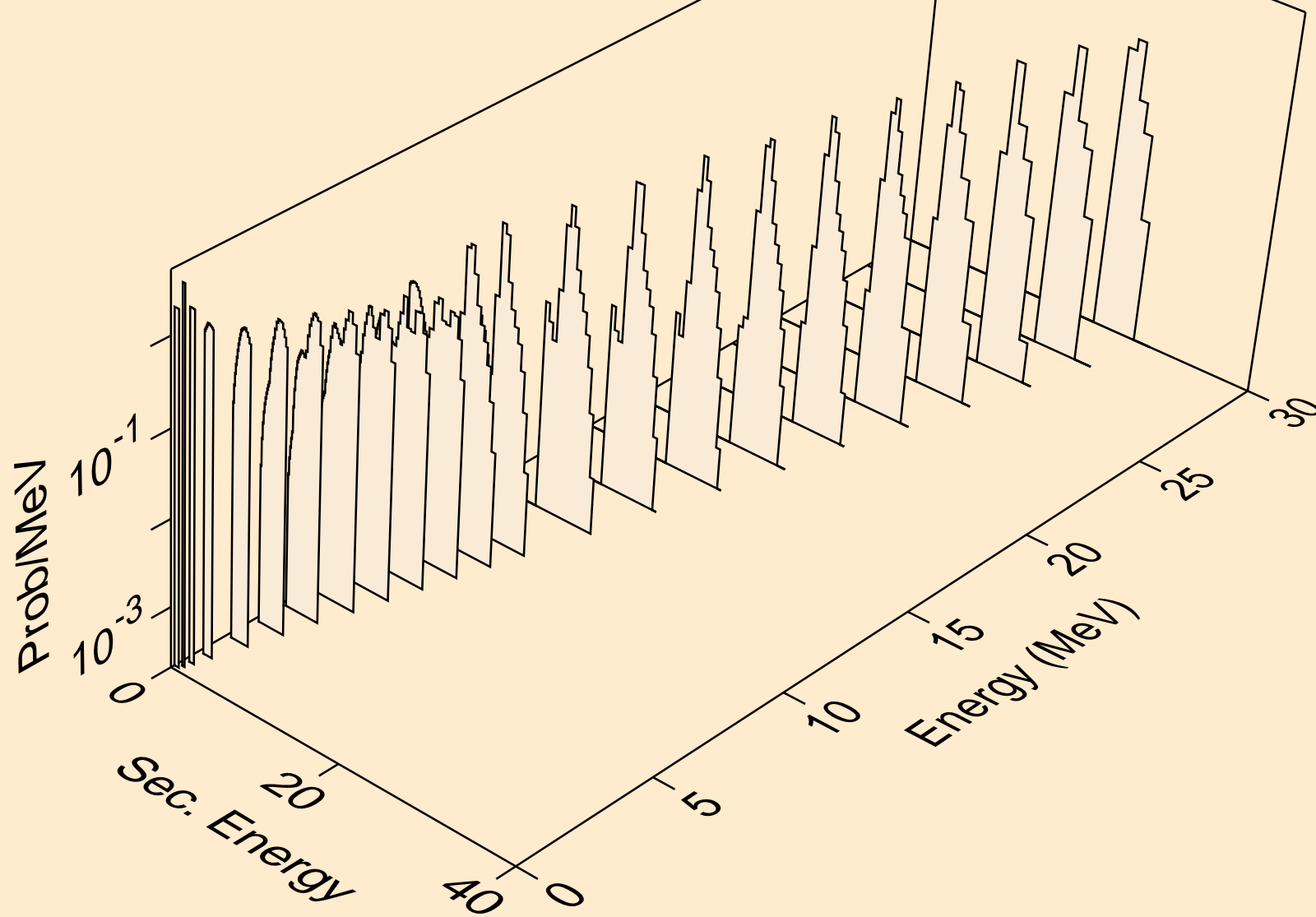



N017 DEUTERON ACER TENDL-2023 LIBRARY; T=0.K  
protons from (d,2p)

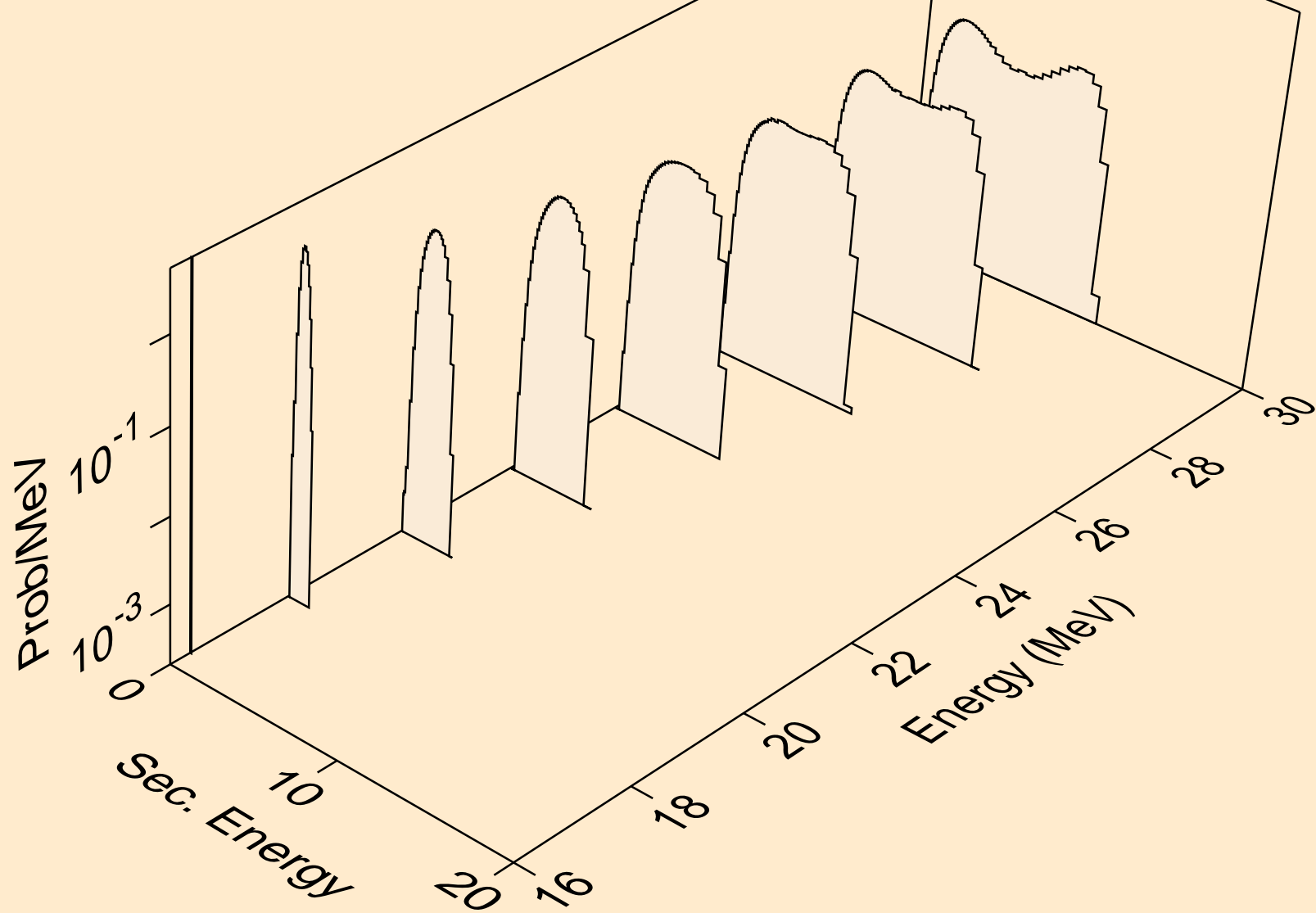

N017 DEUTERON ACER TENDL-2023 LIBRARY; T=0.K  
protons from (d,pa)

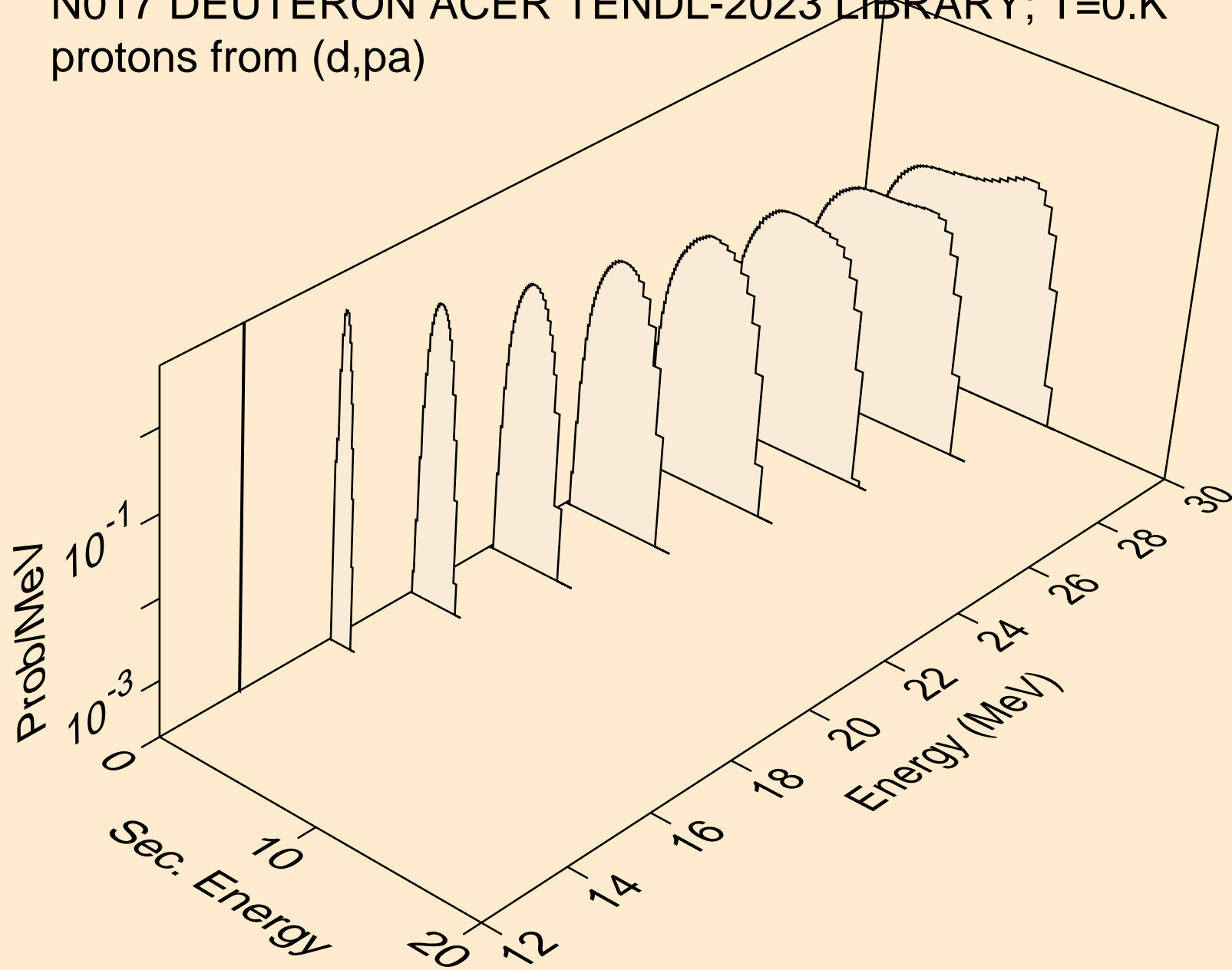

N017 DEUTERON ACER TENDL-2023 LIBRARY; T=0.K  
protons from (d,pd)

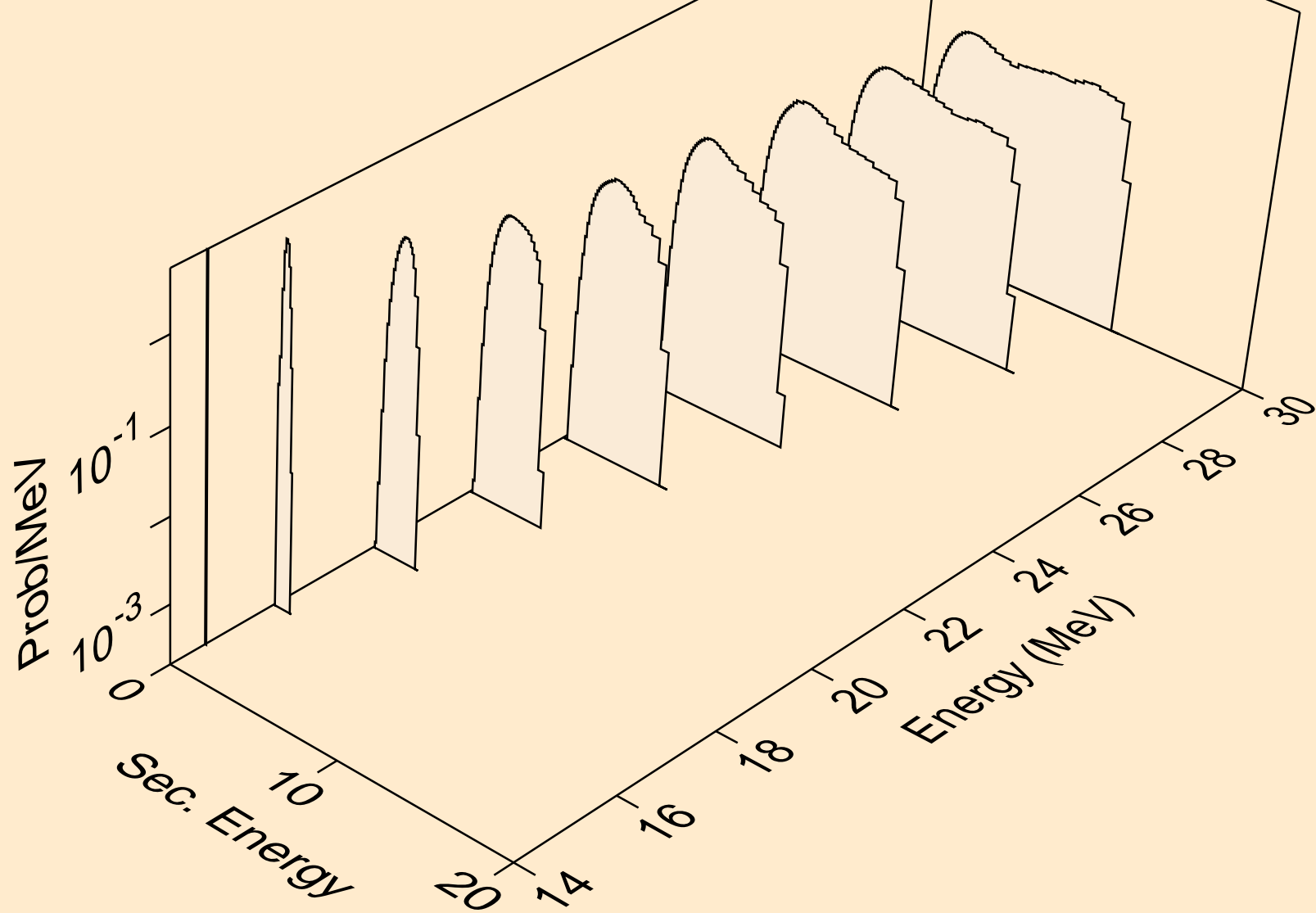

N017 DEUTERON ACER TENDL-2023 LIBRARY; T=0.K  
protons from (d,pt)

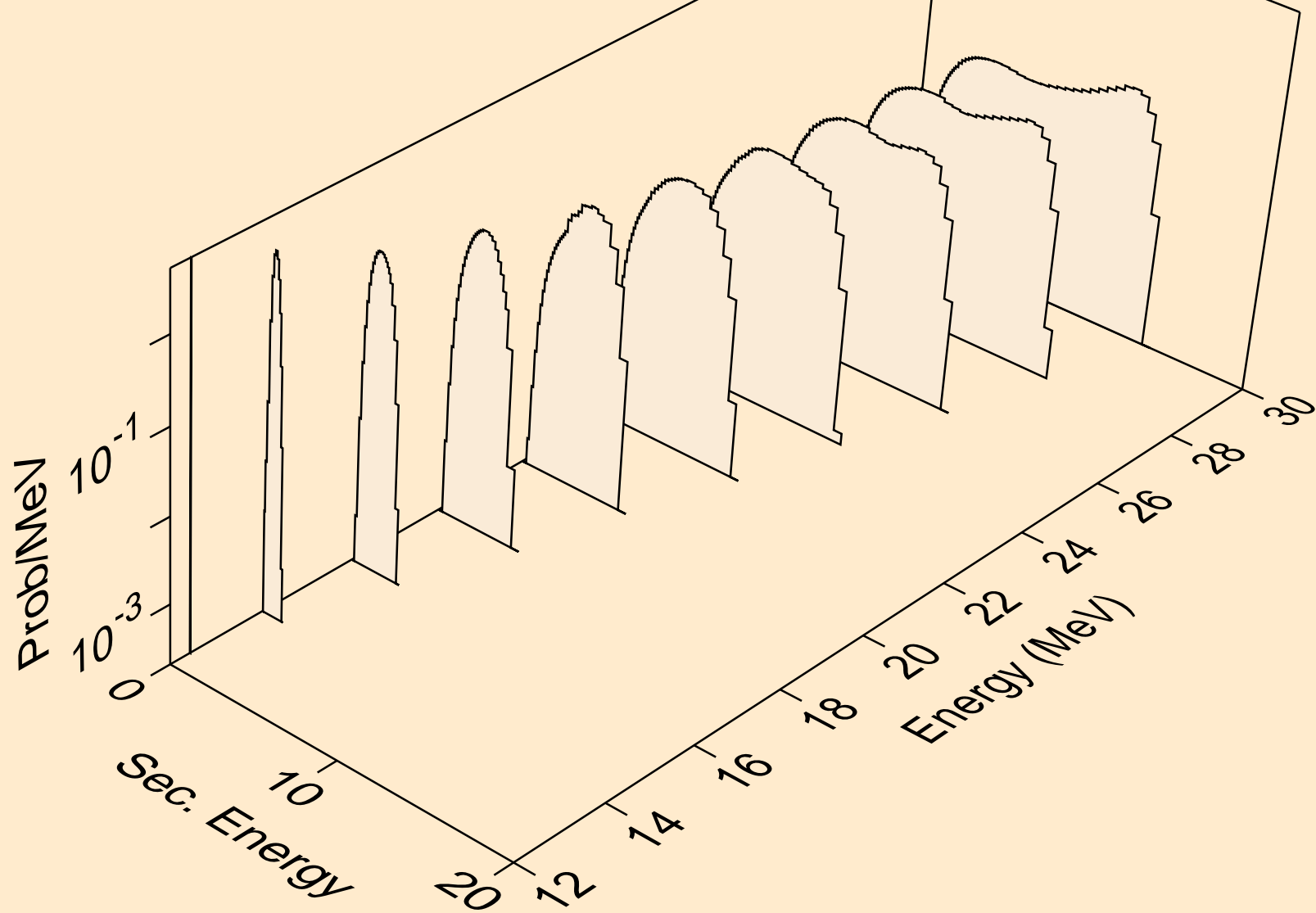

N017 DEUTERON ACER TENDL-2023 LIBRARY; T=0.K  
tritons from (d,x)

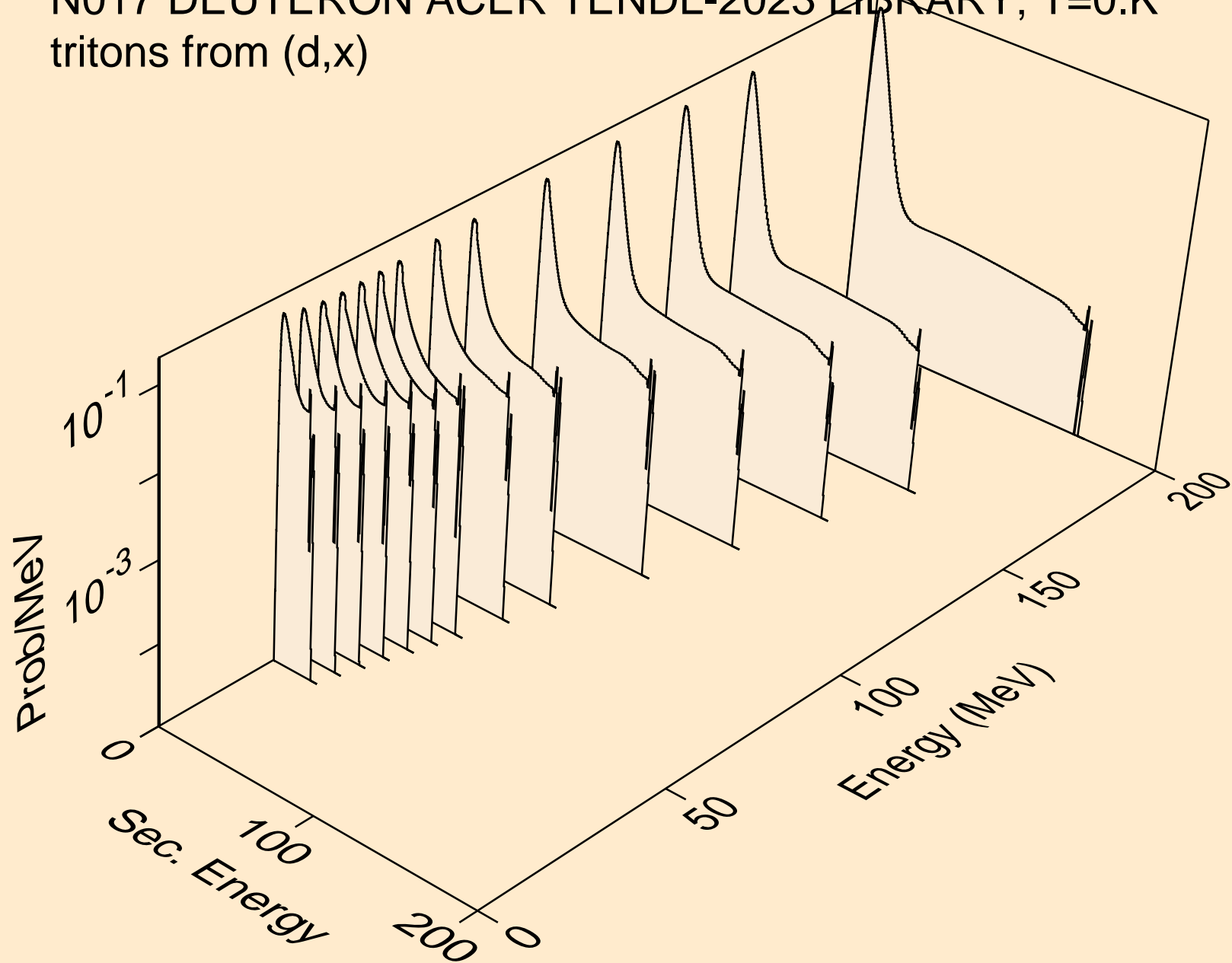

N017 DEUTERON ACER TENDL-2023 LIBRARY; T=0.K  
tritons from (d,n\*)t

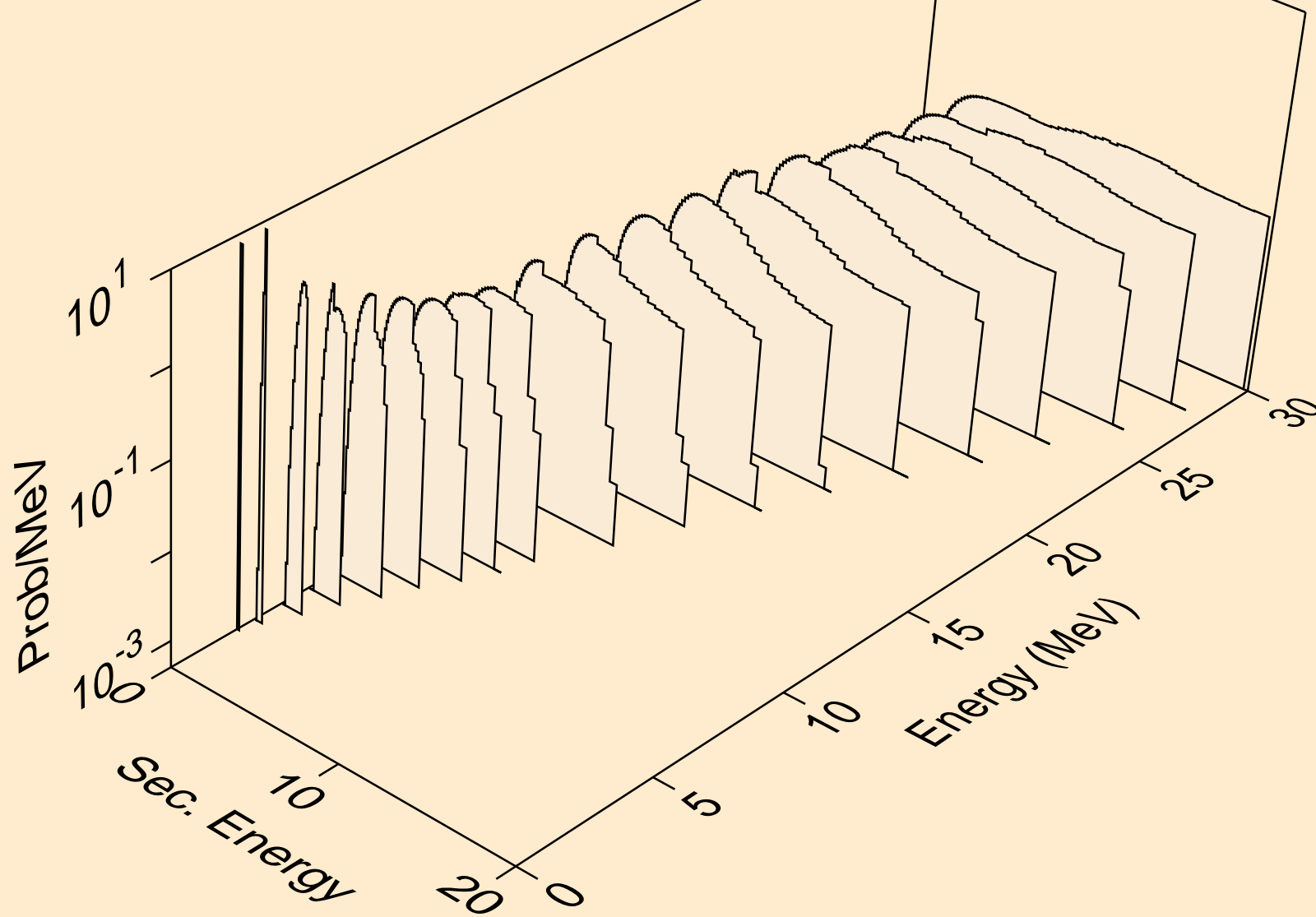

N017 DEUTERON ACER TENDL-2023 LIBRARY; T=0.K  
tritons from (d,n\*)t2a

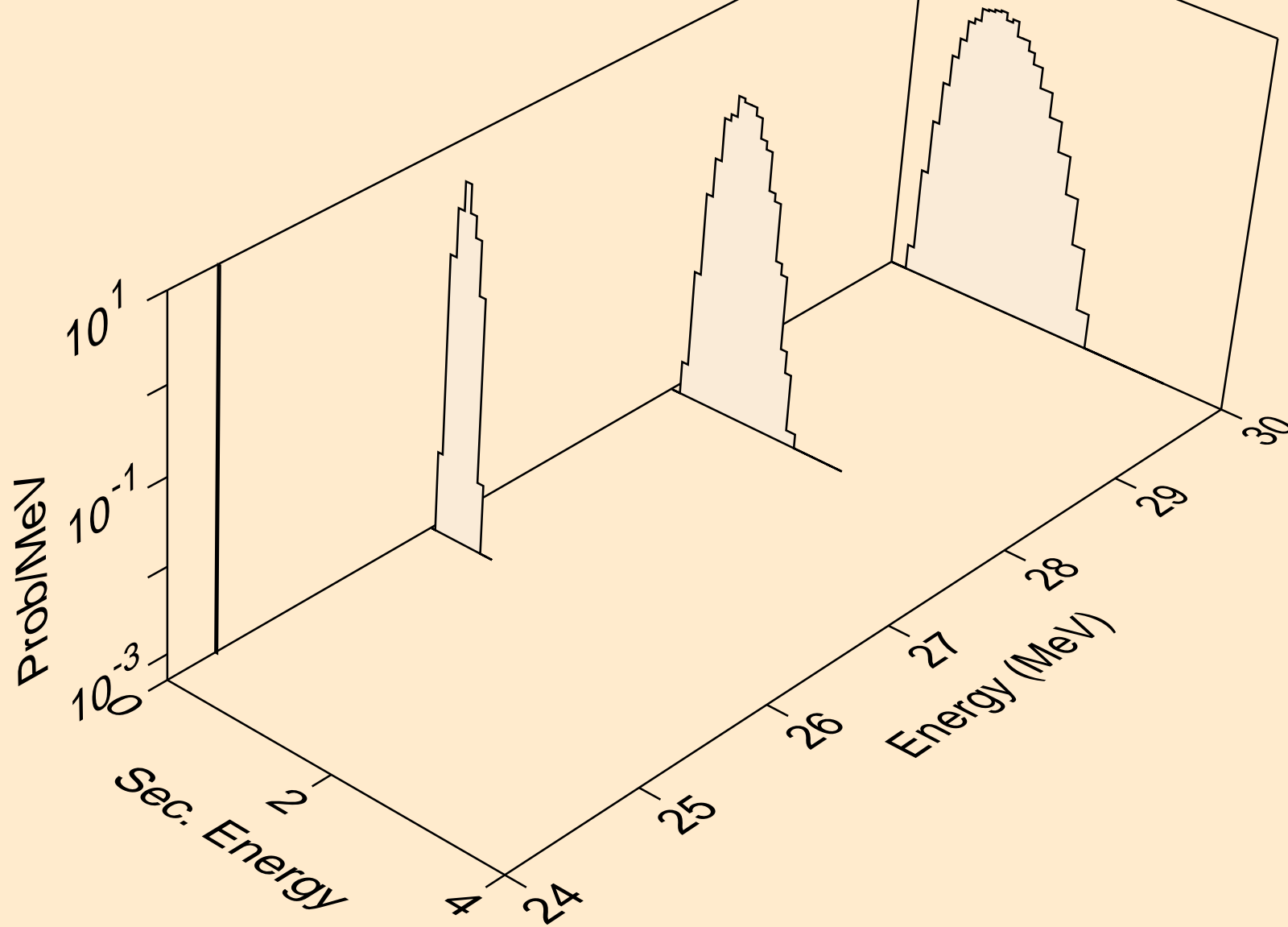

N017 DEUTERON ACER TENDL-2023 LIBRARY; T=0.K  
tritons from (d,t)

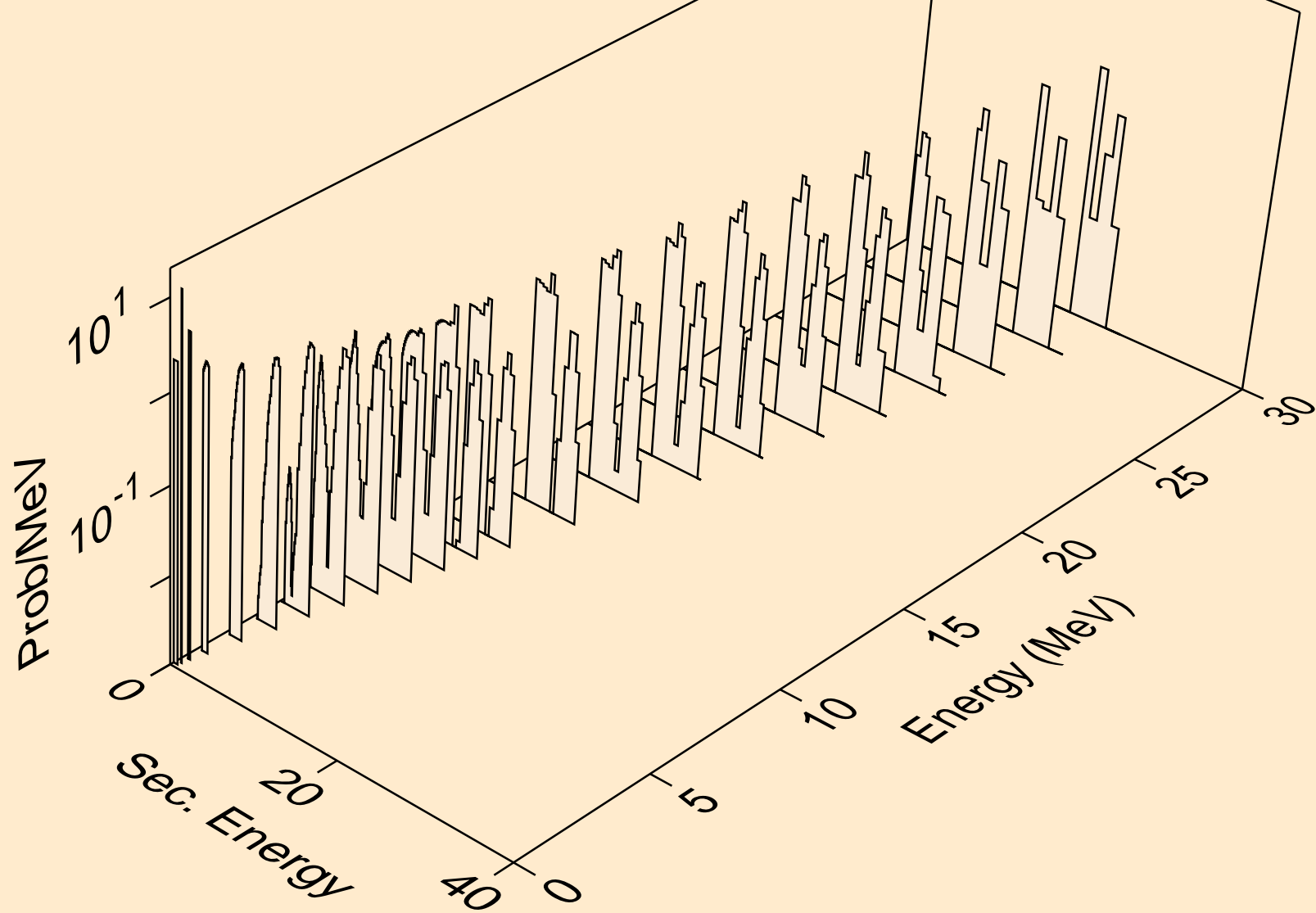



N017 DEUTERON ACER TENDL-2023 LIBRARY; T=0.K  
tritons from (d,t2a)

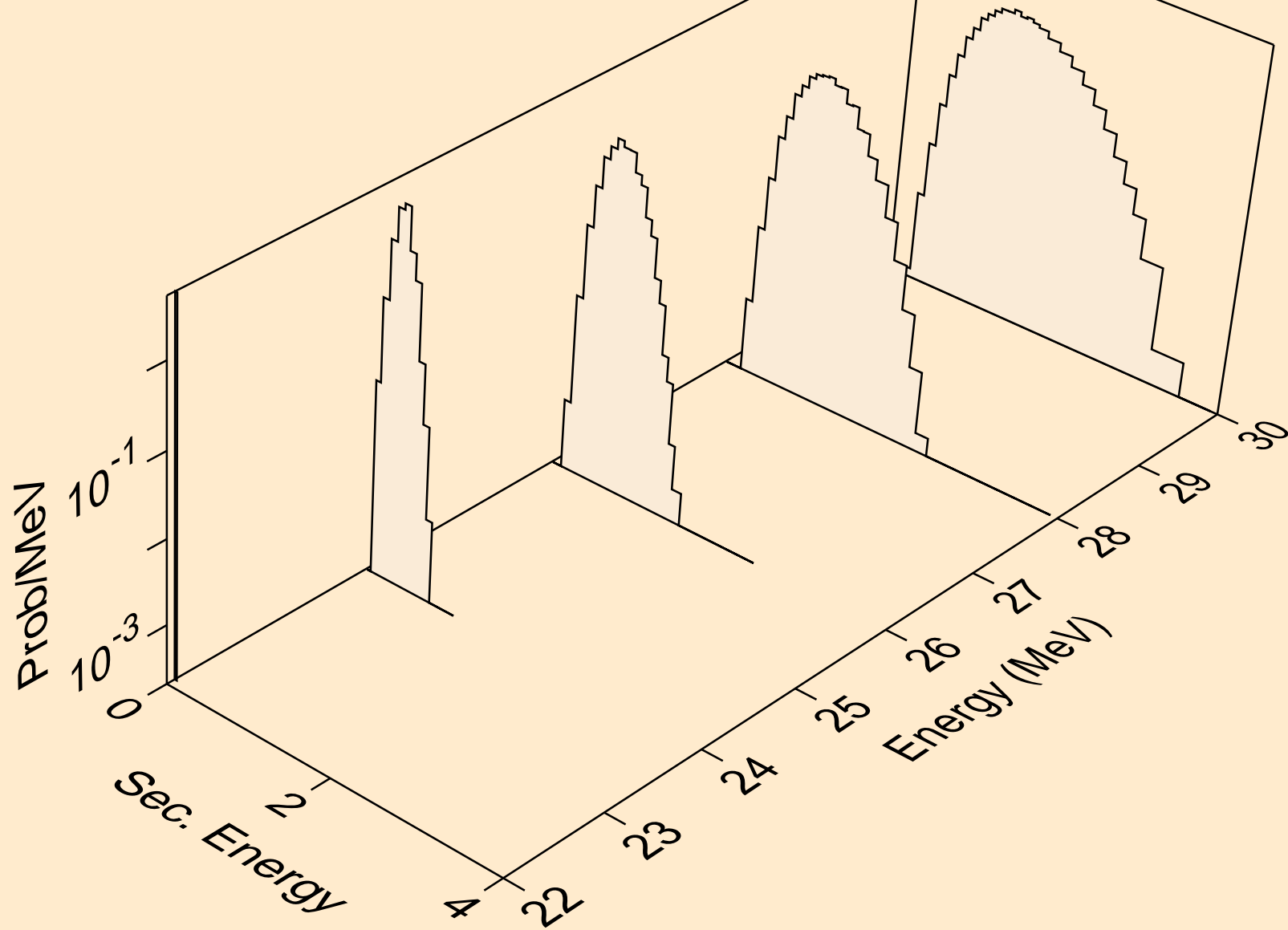

N017 DEUTERON ACER TENDL-2023 LIBRARY; T=0.K  
tritons from (d,pt)

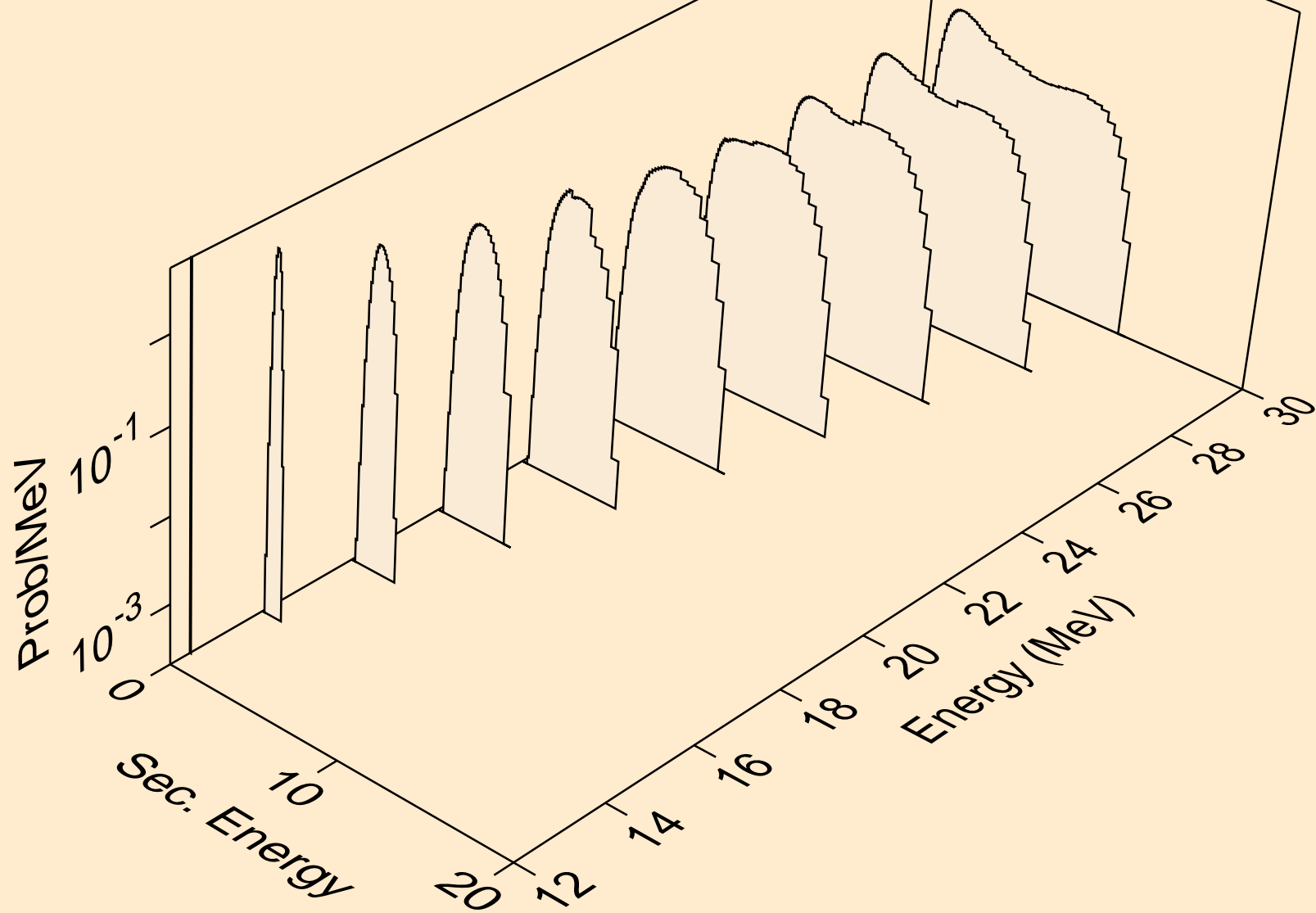

N017 DEUTERON ACER TENDL-2023 LIBRARY; T=0.K  
he3s from (d,x)

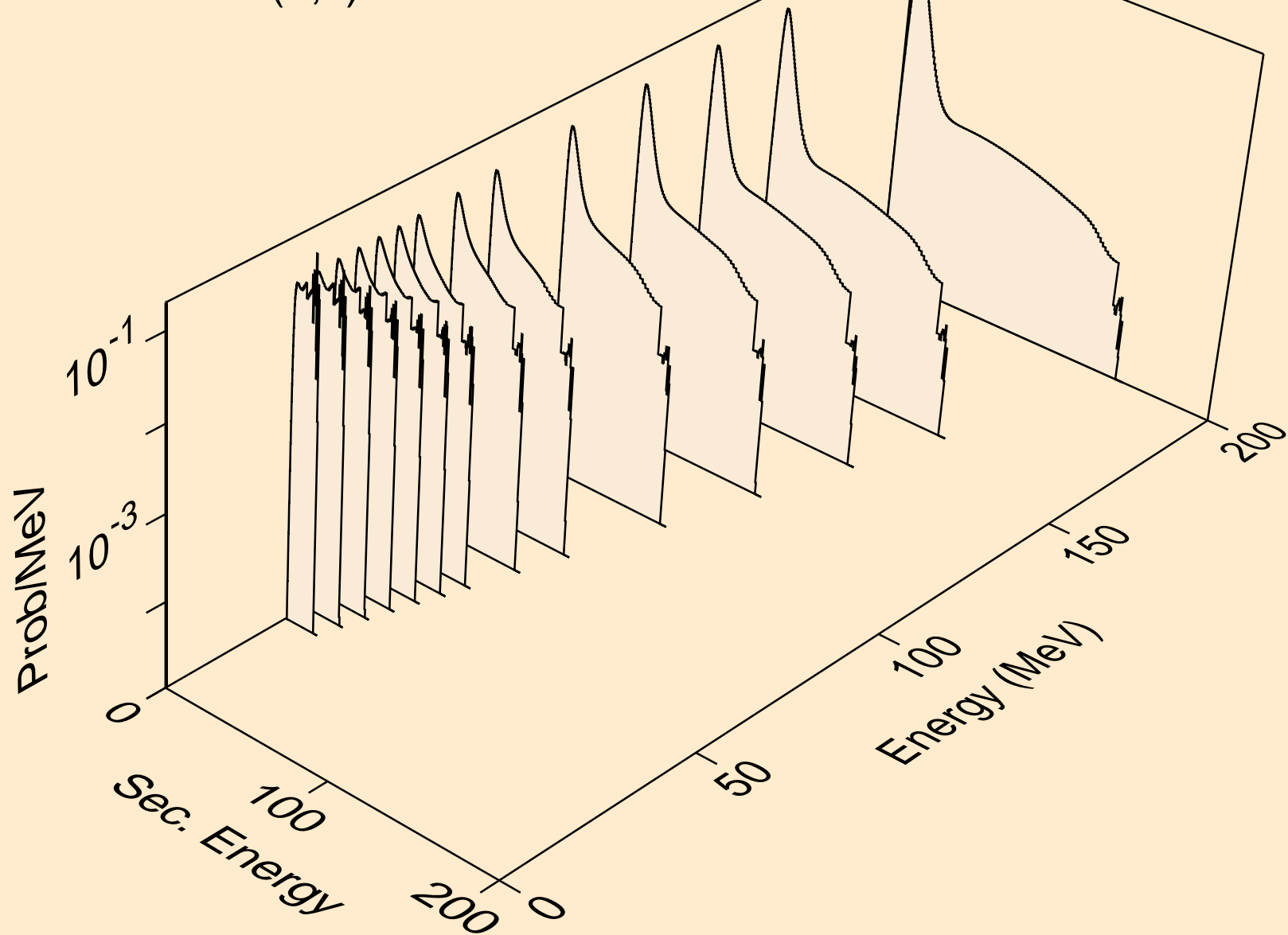

N017 DEUTERON ACER TENDL-2023 LIBRARY; T=0.K  
he3s from (d,n\*)he3

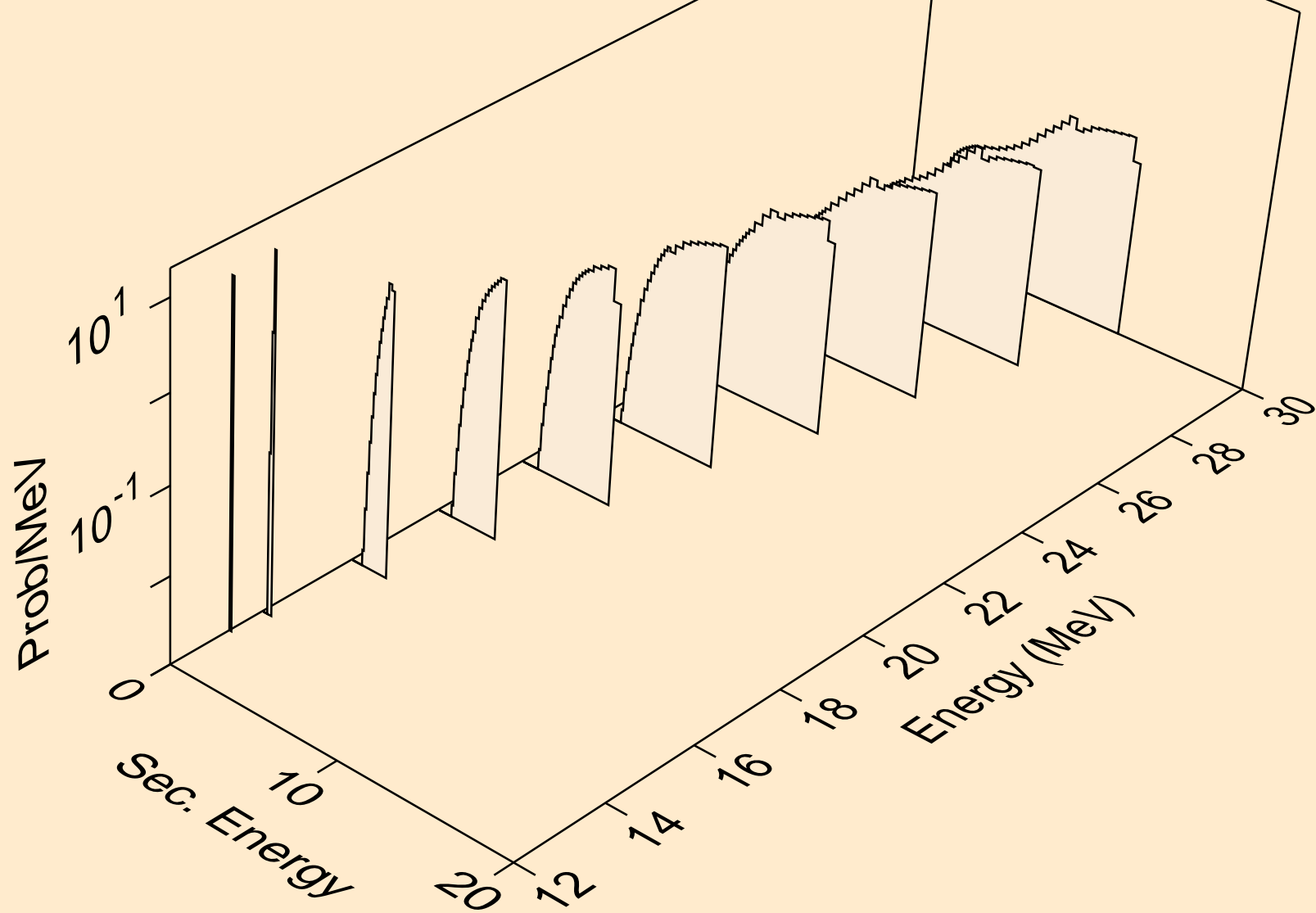

N017 DEUTERON ACER TENDL-2023 LIBRARY; T=0.K  
he3s from (d,he3)

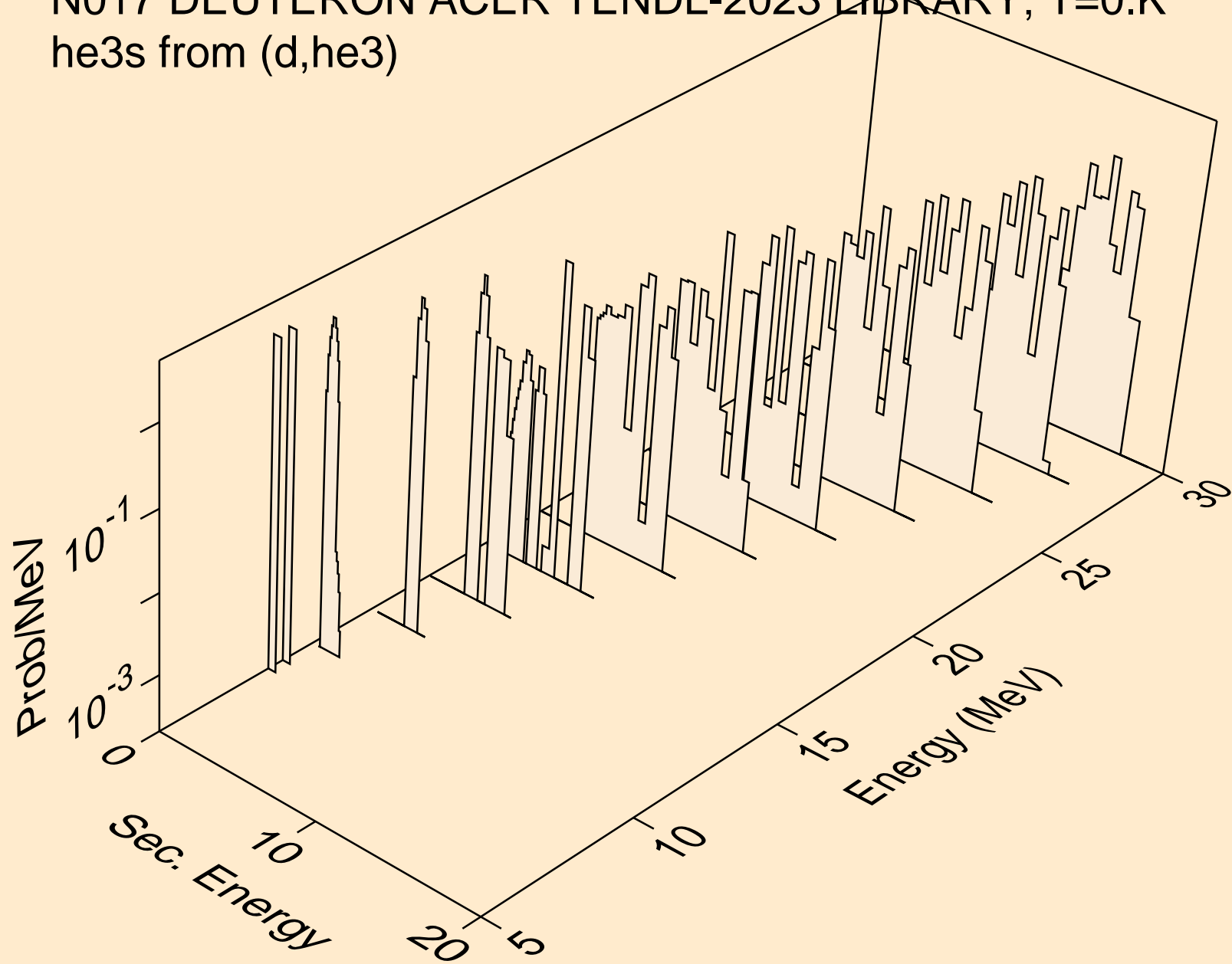

N017 DEUTERON ACER TENDL-2023 LIBRARY; T=0.K  
alphas from (d,x)

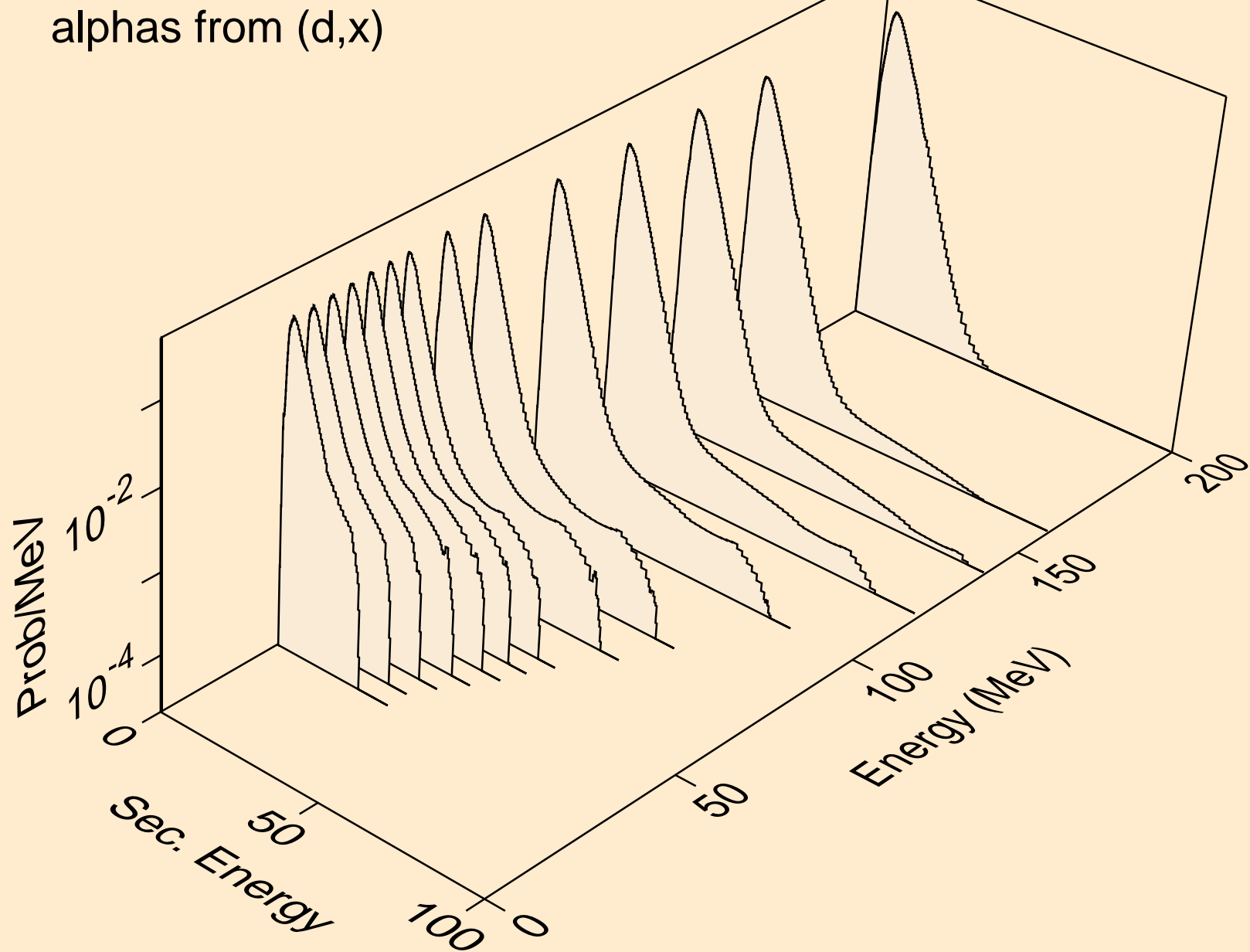

N017 DEUTERON ACER TENDL-2023 LIBRARY; T=0.K  
alphas from (d,n\*)a

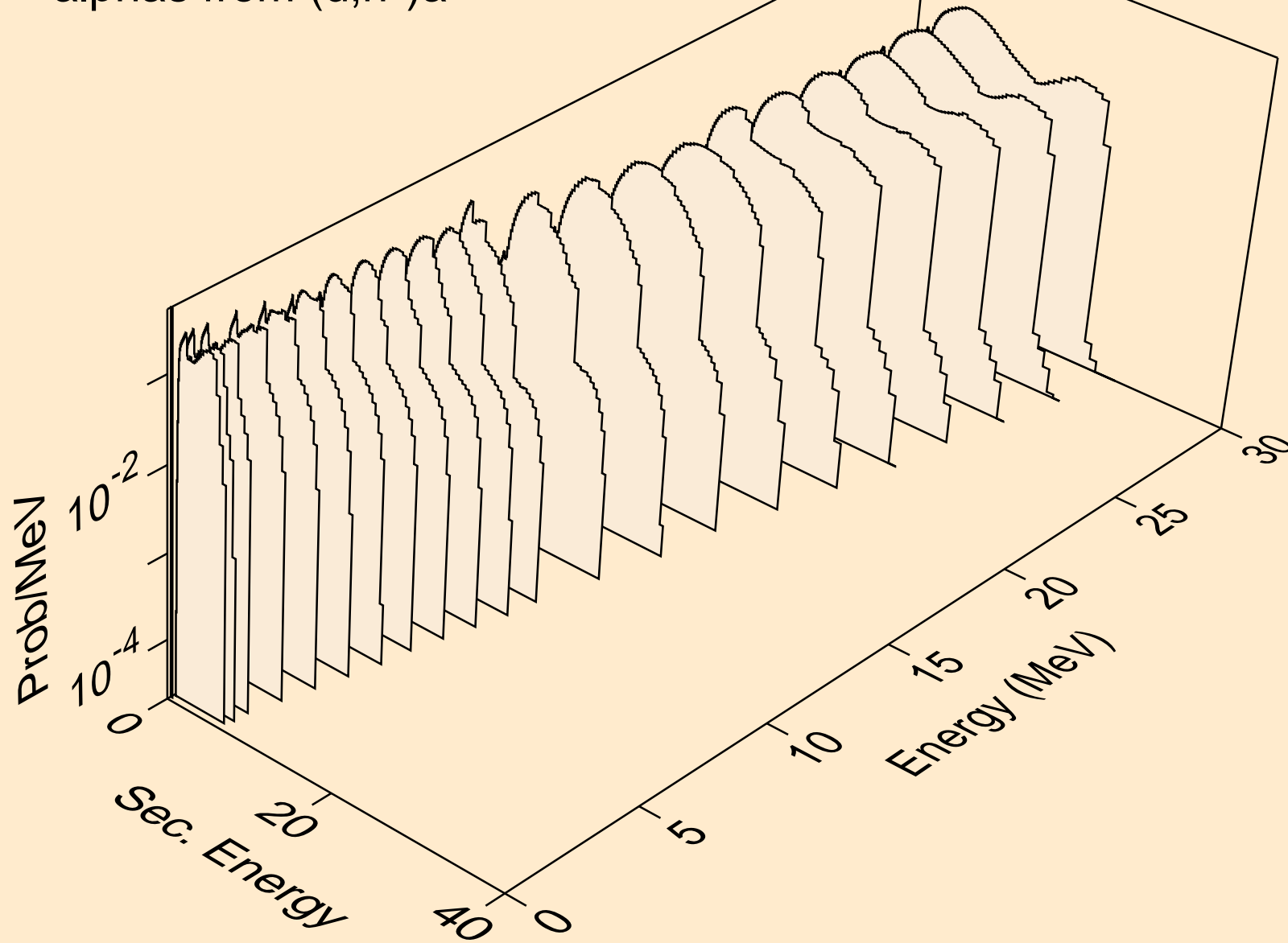

N017 DEUTERON ACER TENDL-2023 LIBRARY; T=0.K  
alphas from (d,2n)a

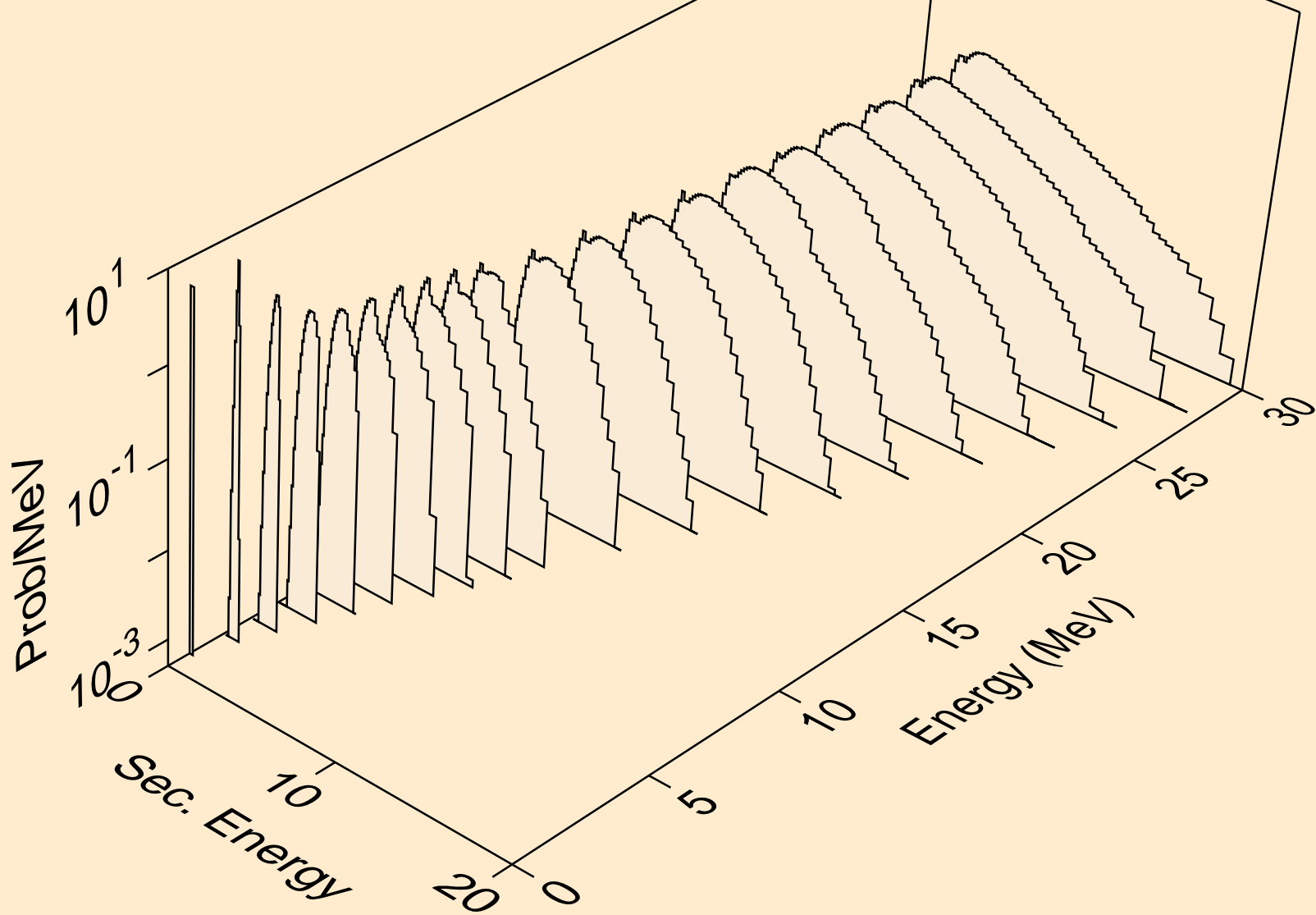



N017 DEUTERON ACER TENDL-2023 LIBRARY; T=0.K  
alphas from (d,3n)a

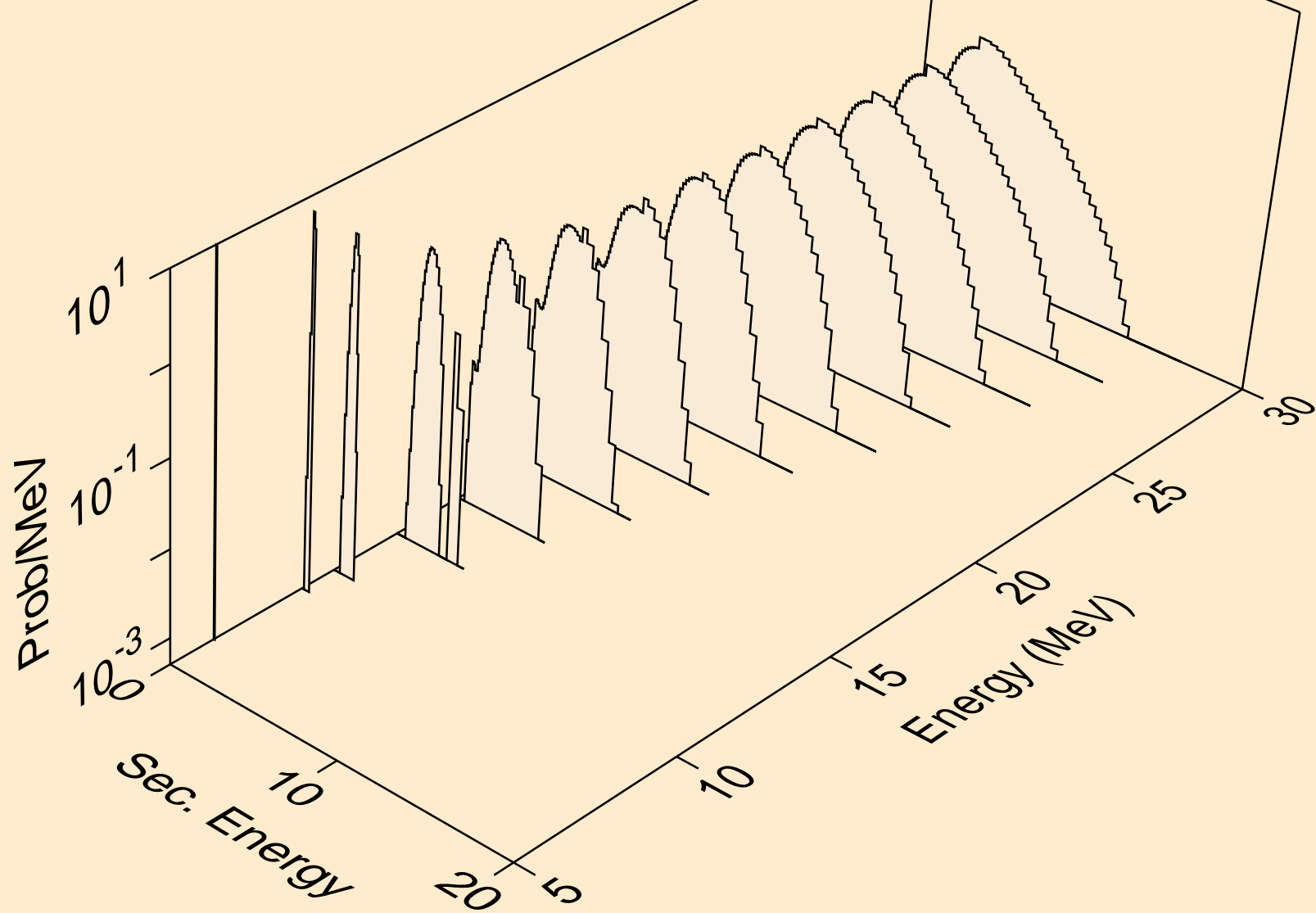

N017 DEUTERON ACER TENDL-2023 LIBRARY; T=0.K  
alphas from (d,n\*)2a

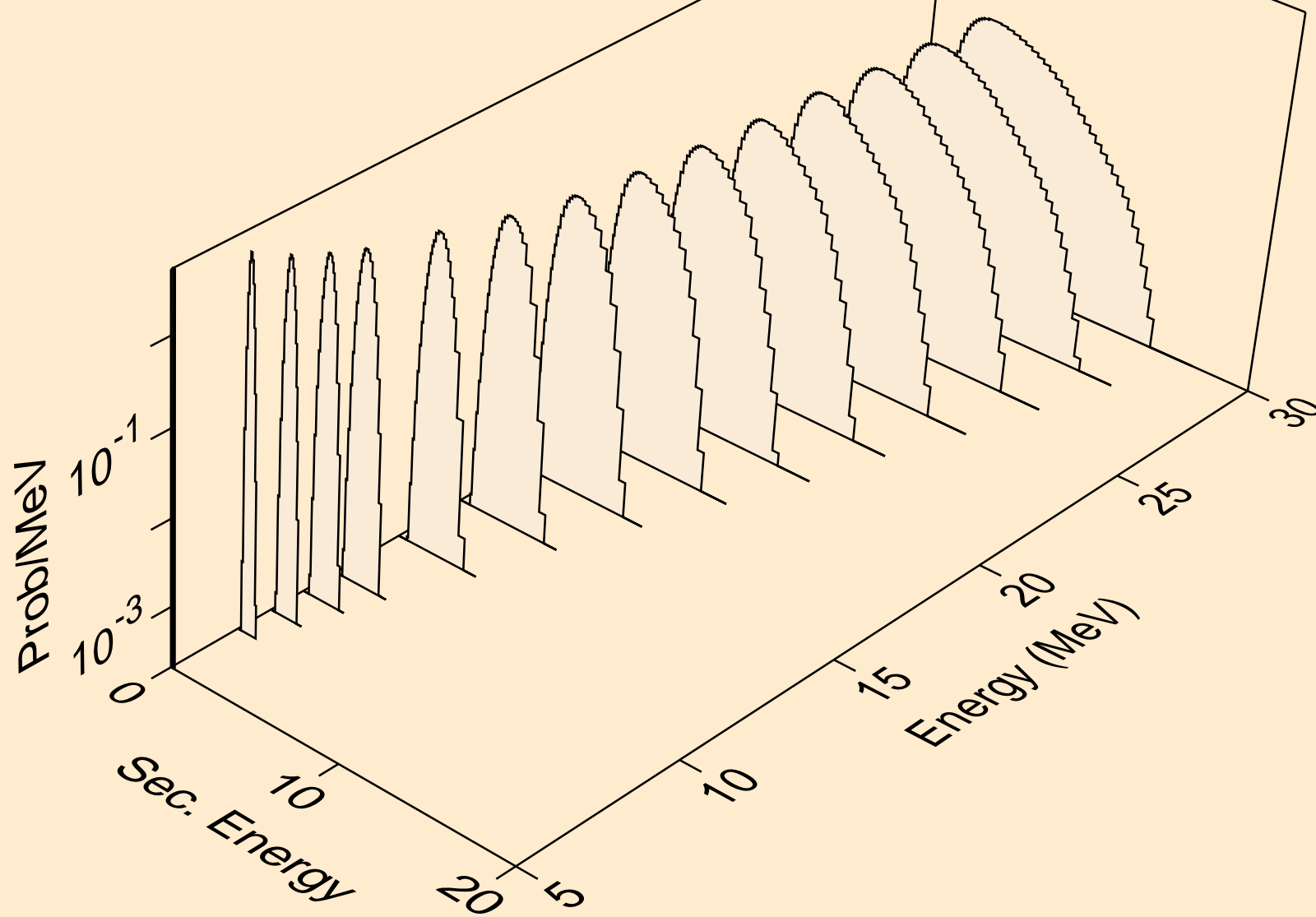

N017 DEUTERON ACER TENDL-2023 LIBRARY; T=0.K  
alphas from (d,2n)2a

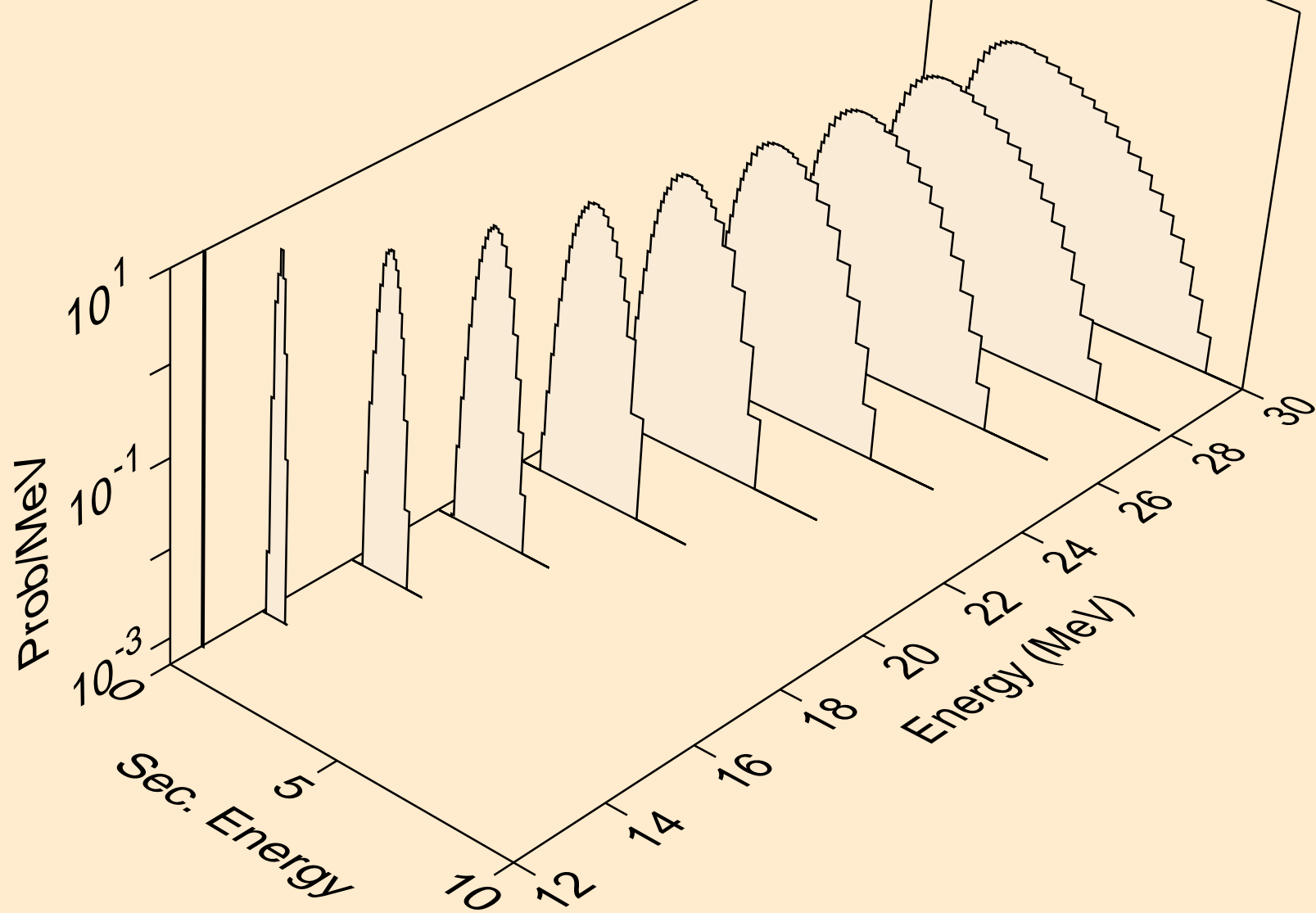

N017 DEUTERON ACER TENDL-2023 LIBRARY; T=0.K  
alphas from (d,n\*)t2a

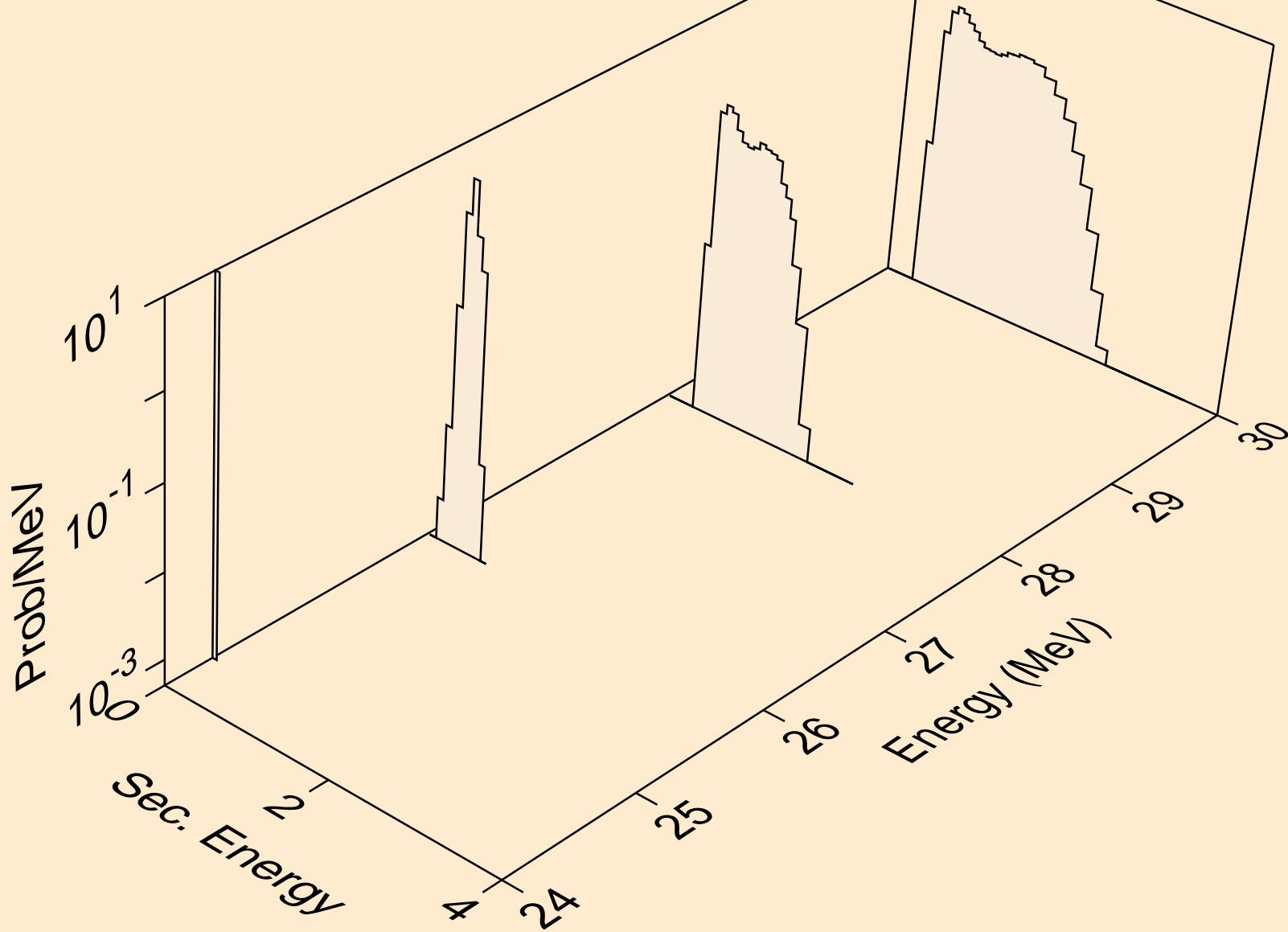

N017 DEUTERON ACER TENDL-2023 LIBRARY; T=0.K  
alphas from (d,npa)

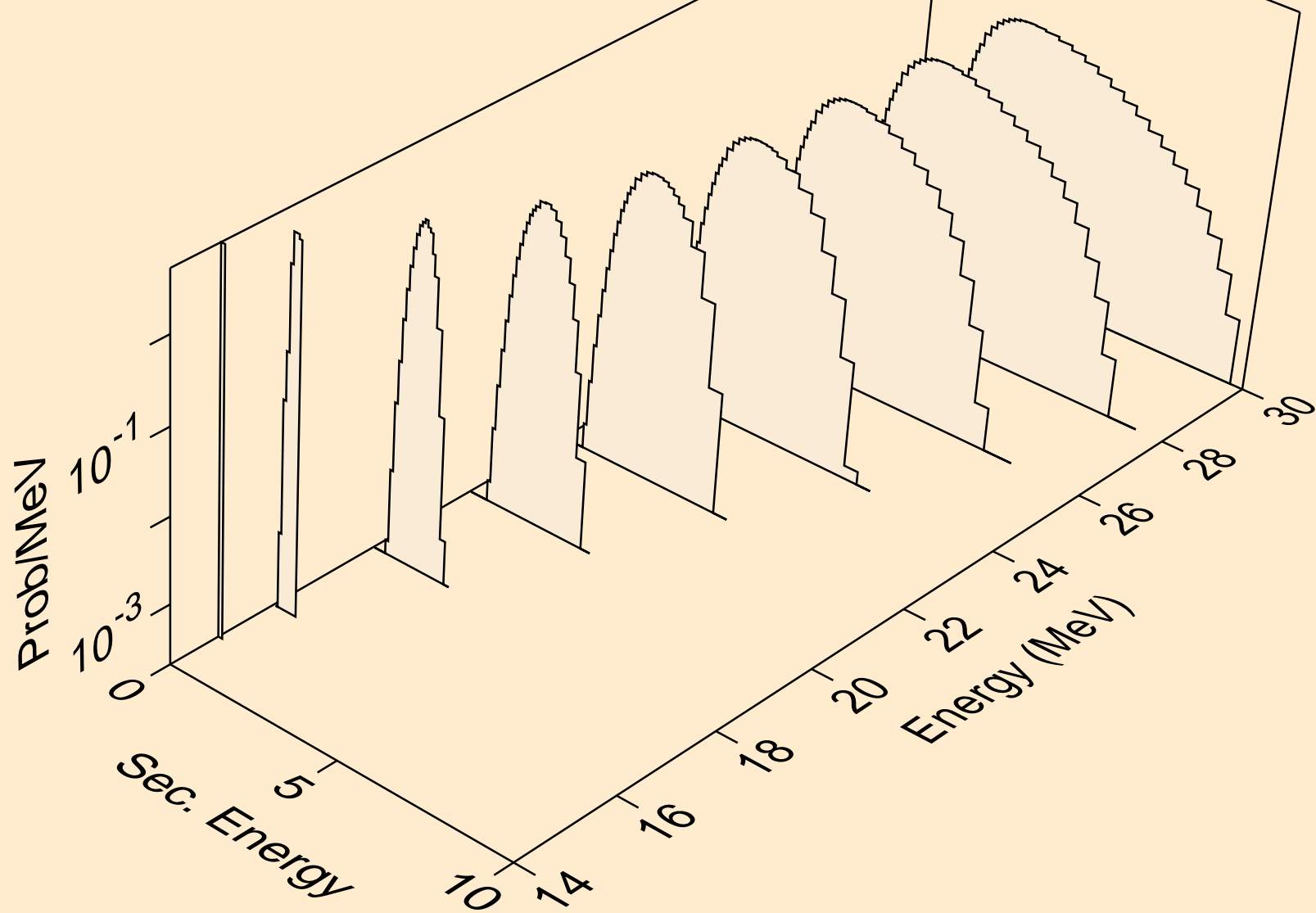

N017 DEUTERON ACER TENDL-2023 LIBRARY; T=0.K  
alphas from (d,a)

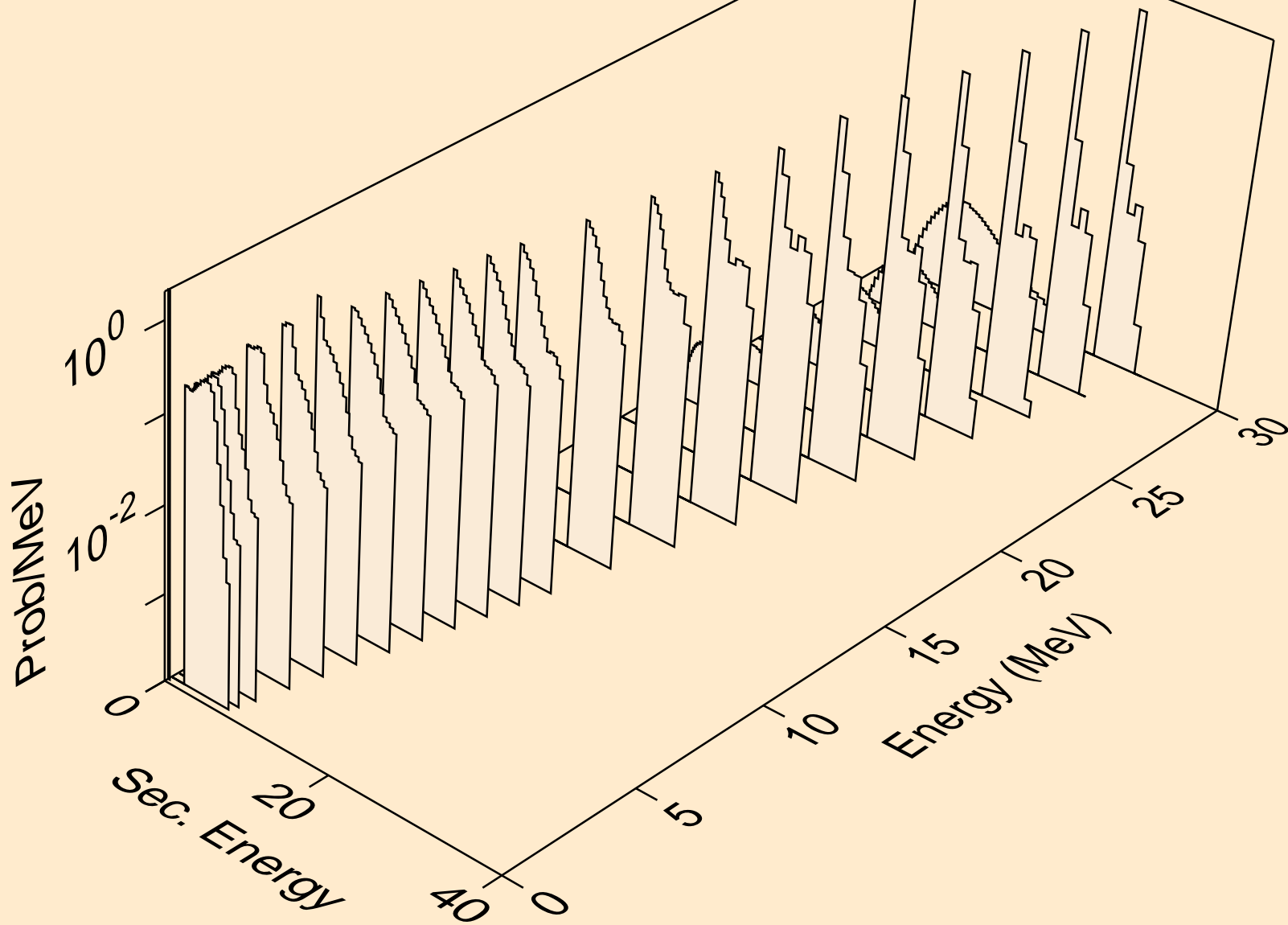

N017 DEUTERON ACER TENDL-2023 LIBRARY; T=0.K  
alphas from (d,2a)

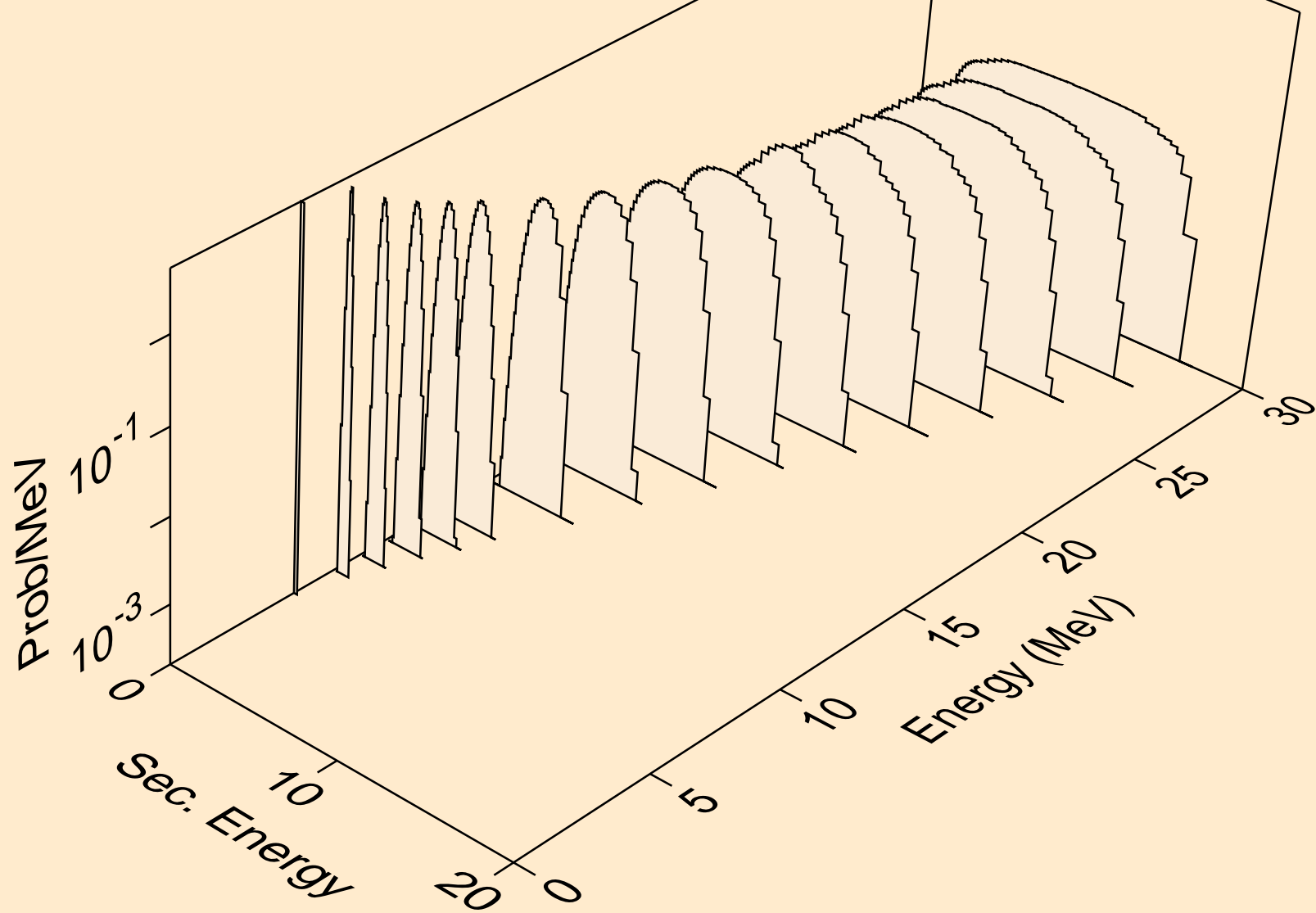

N017 DEUTERON ACER TENDL-2023 LIBRARY; T=0.K  
alphas from (d,pa)

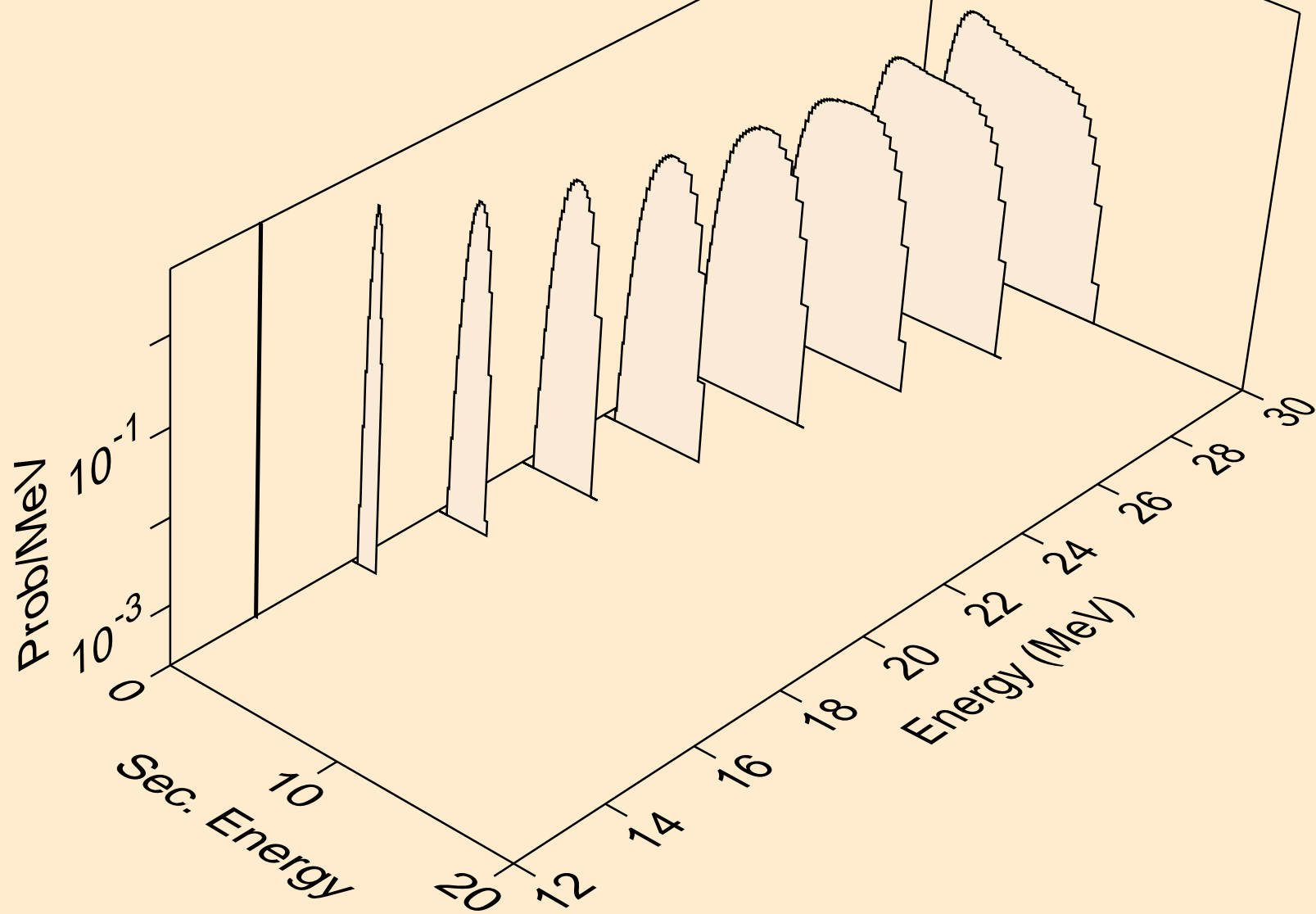



N017 DEUTERON ACER TENDL-2023 LIBRARY; T=0.K  
alphas from (d,t2a)

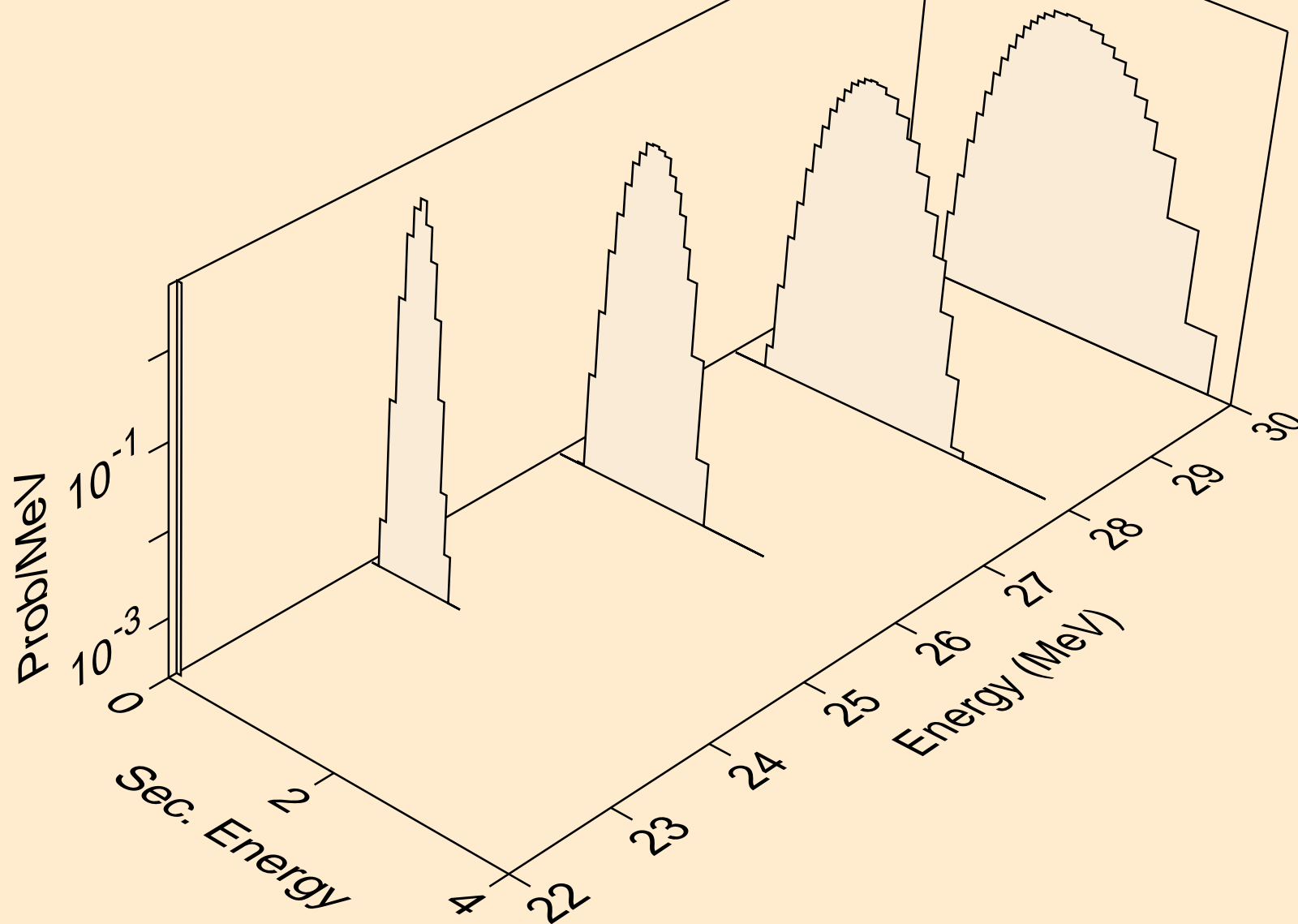

N017 DEUTERON ACER TENDL-2023 LIBRARY; T=0.K  
alphas from (d,d2a)

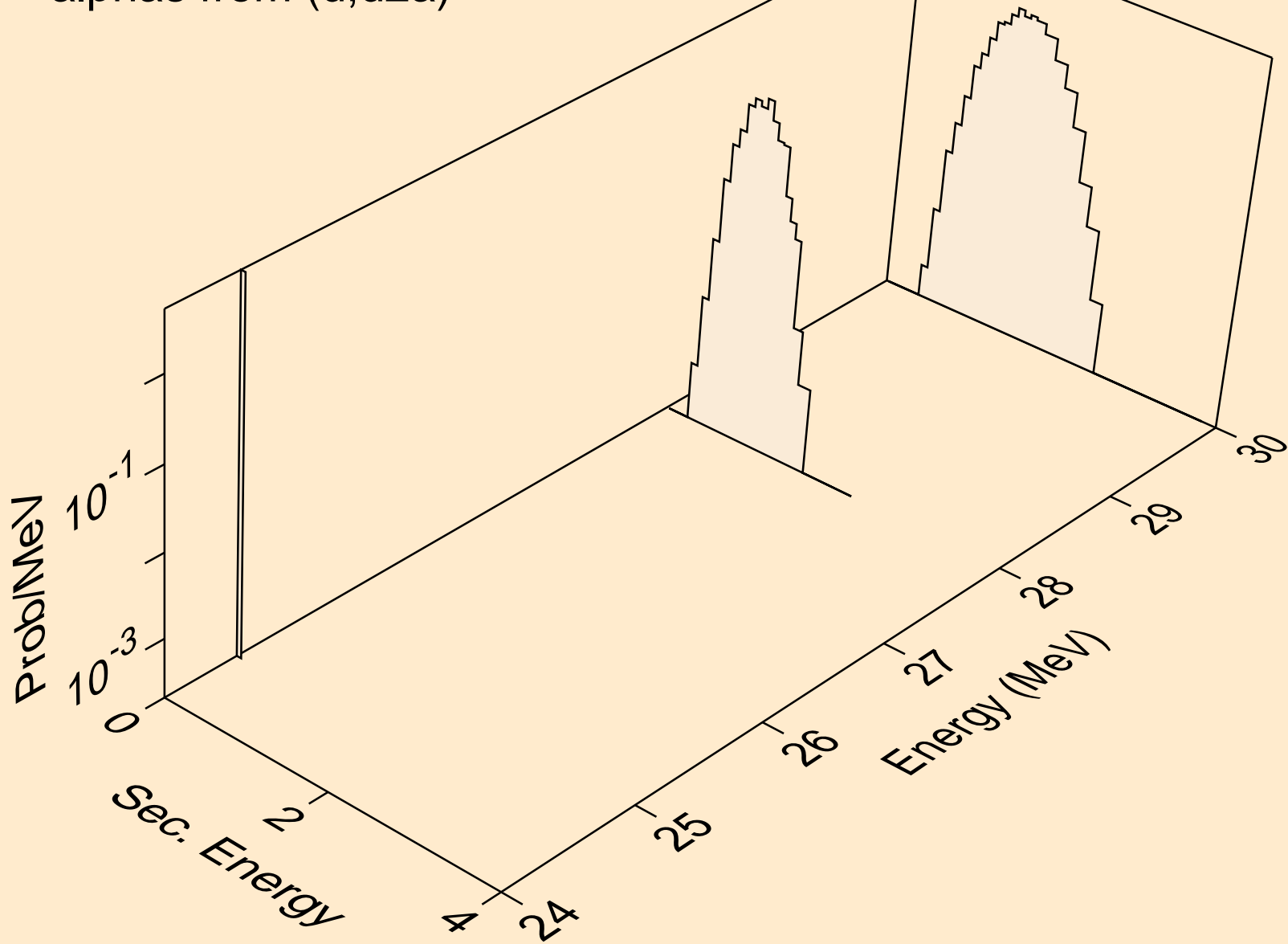

N017 DEUTERON ACER TENDL-2023 LIBRARY; T=0.K  
alphas from (d,da)

