

# OS201 DEUTERON ACER TENDL-2023 LIBRARY; T=0.K

## Principal cross sections

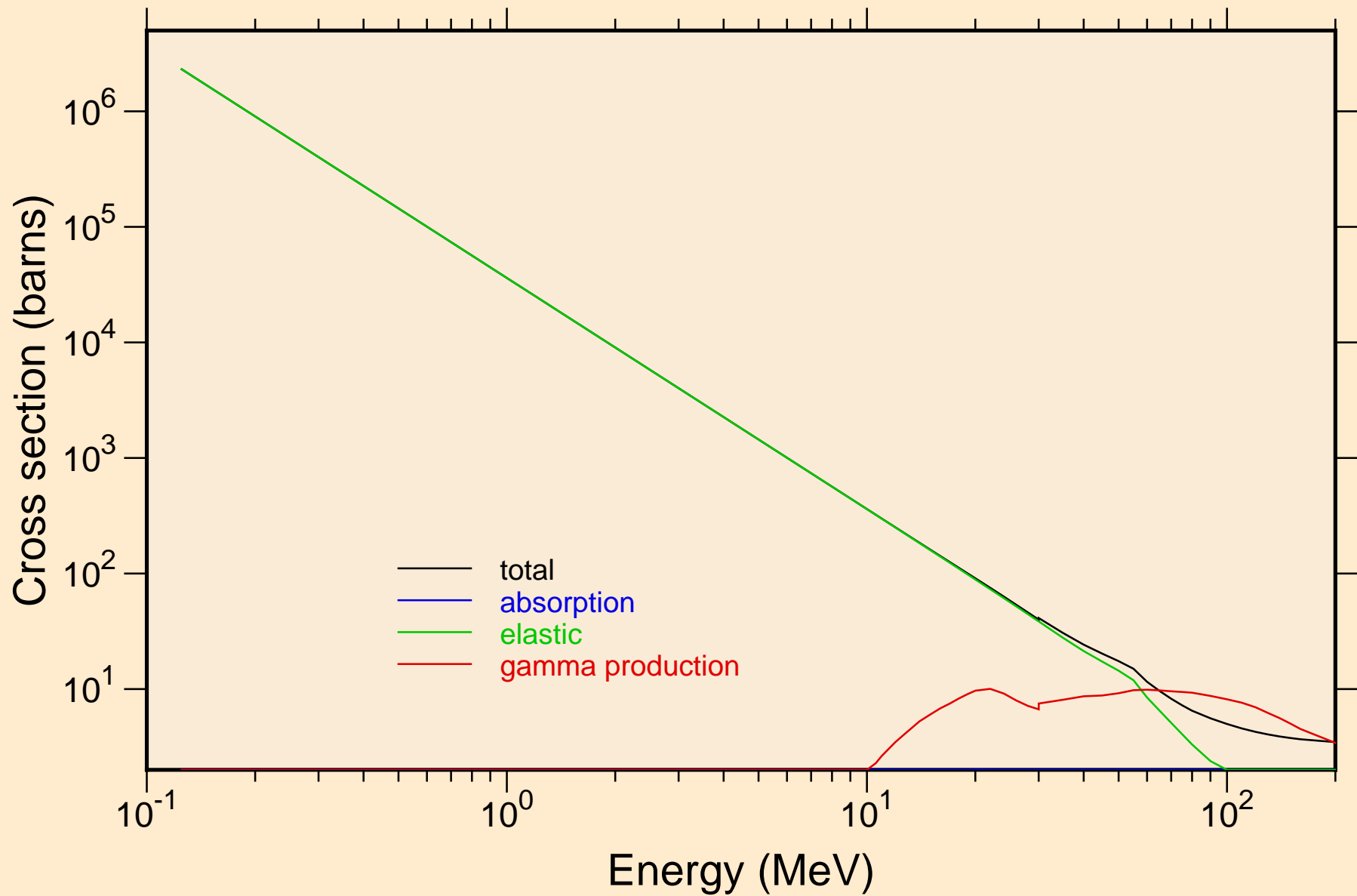

# OS201 DEUTERON ACER TENDL-2023 LIBRARY; T=0.K

## Heating

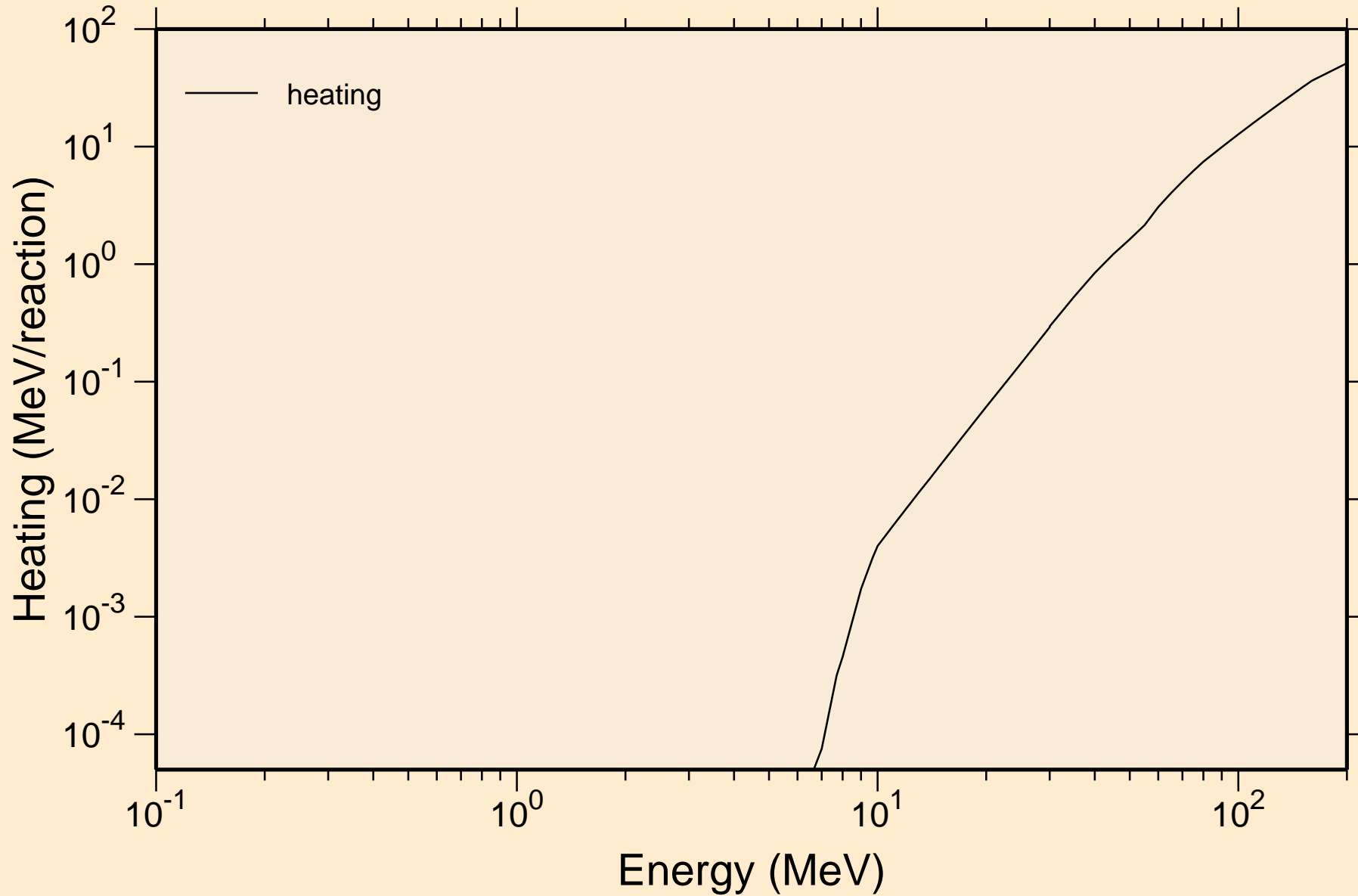

OS201 DEUTERON ACER TENDL-2023 LIBRARY; T=0.K  
Principal cross sections

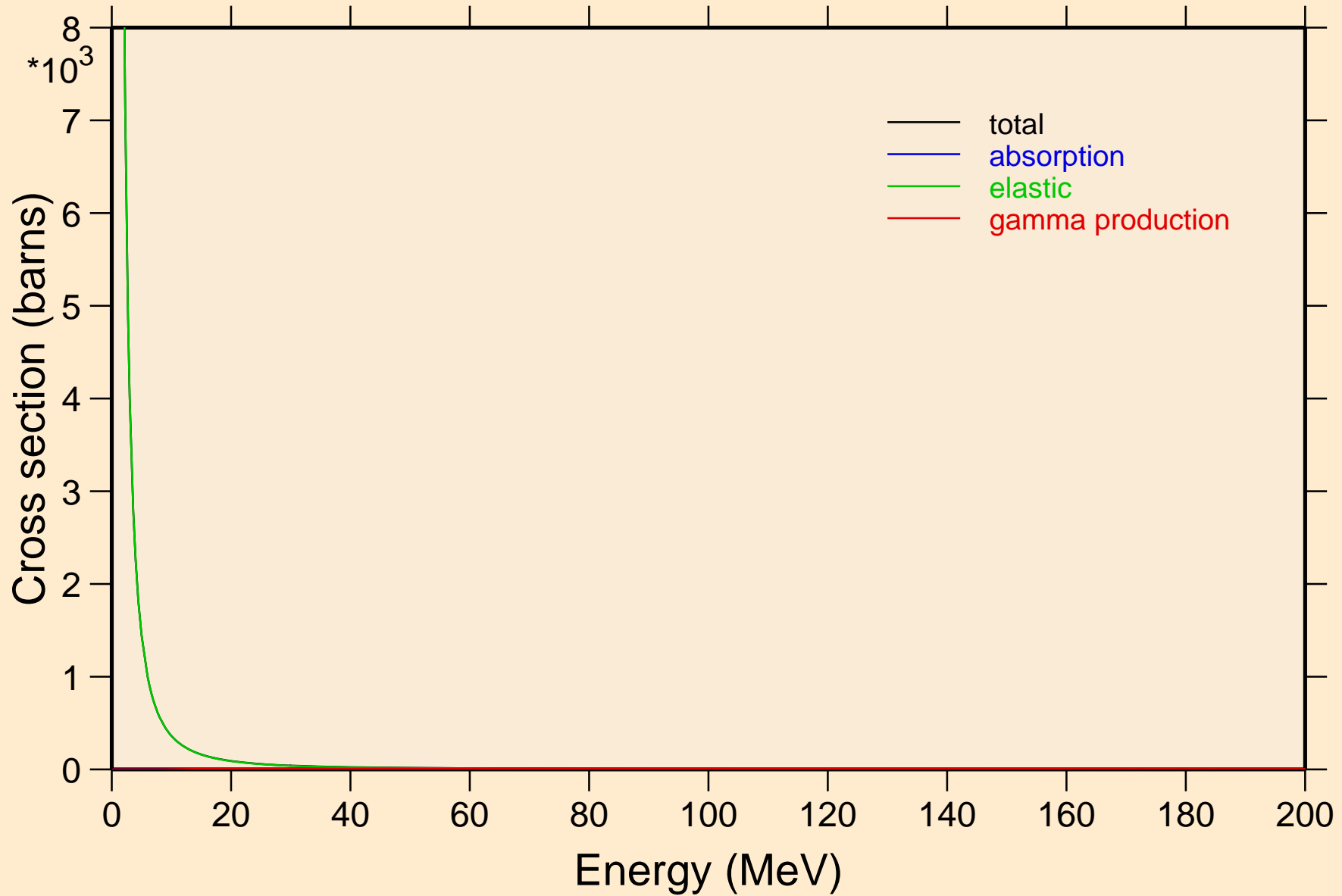

# OS201 DEUTERON ACER TENDL-2023 LIBRARY; T=0.K

## Heating

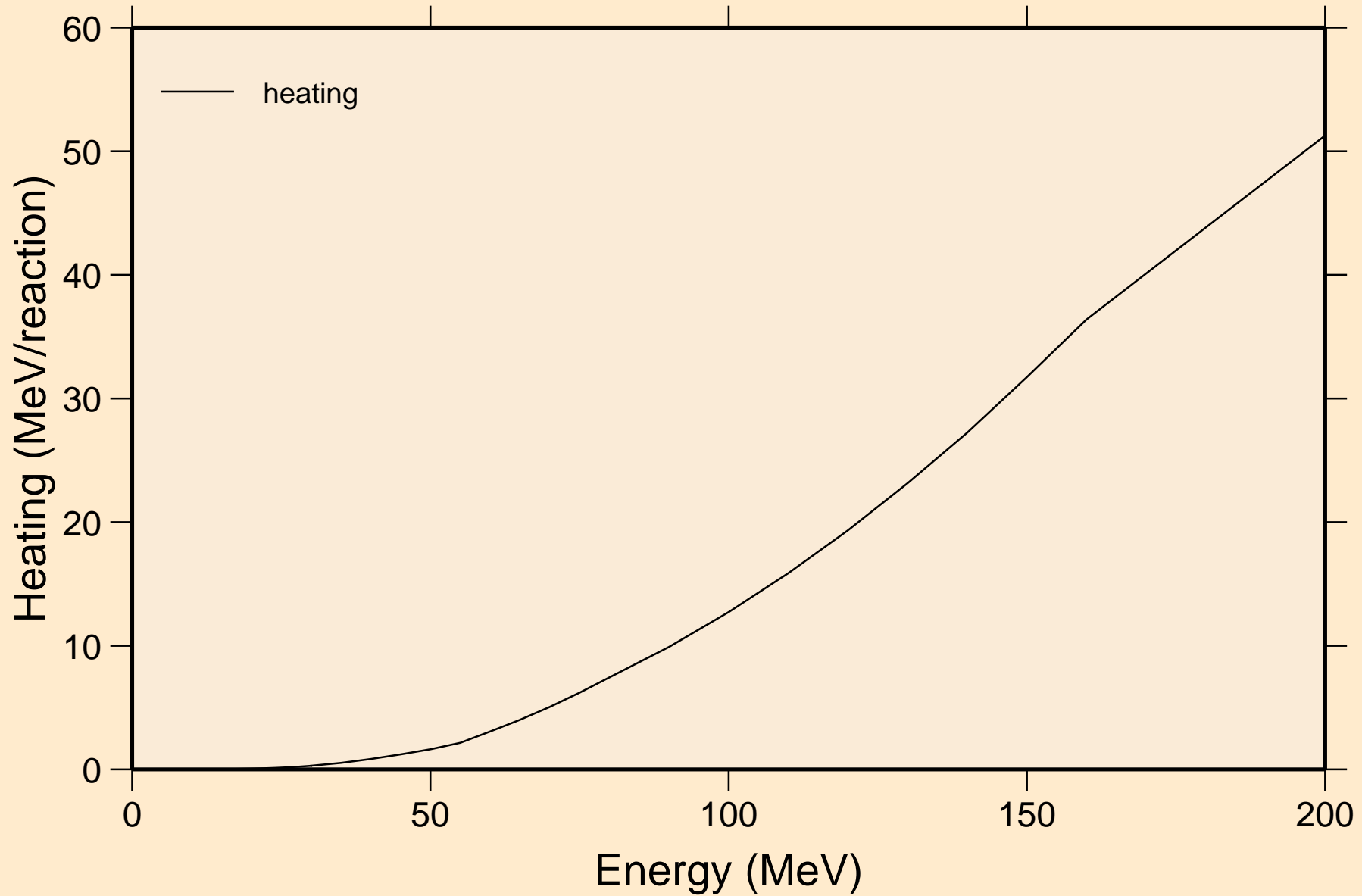

# OS201 DEUTERON ACER TENDL-2023 LIBRARY; T=0.K

## Threshold reactions

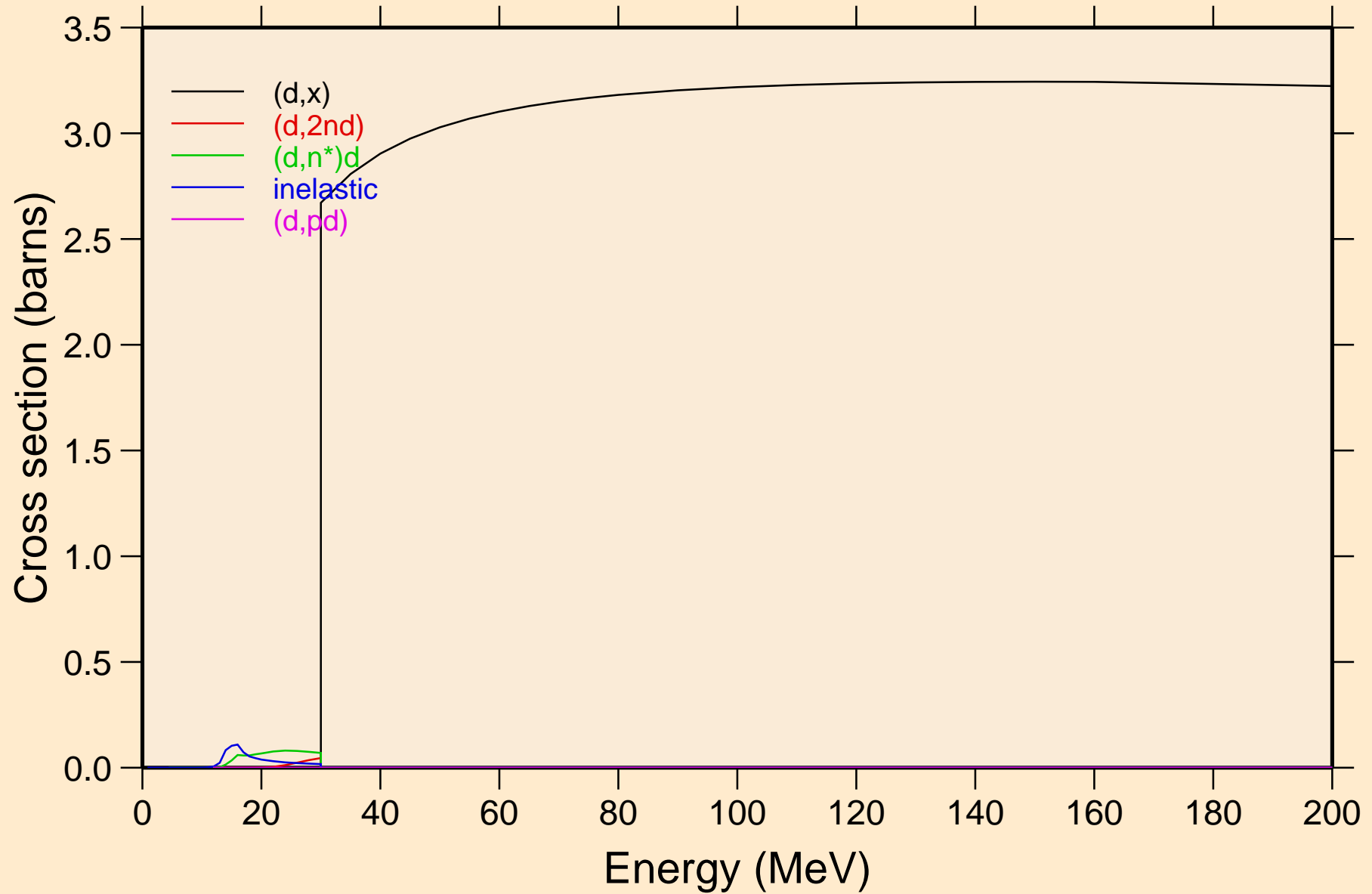

OS201 DEUTERON ACER TENDL-2023 LIBRARY; T=0.K  
angular distribution for elastic

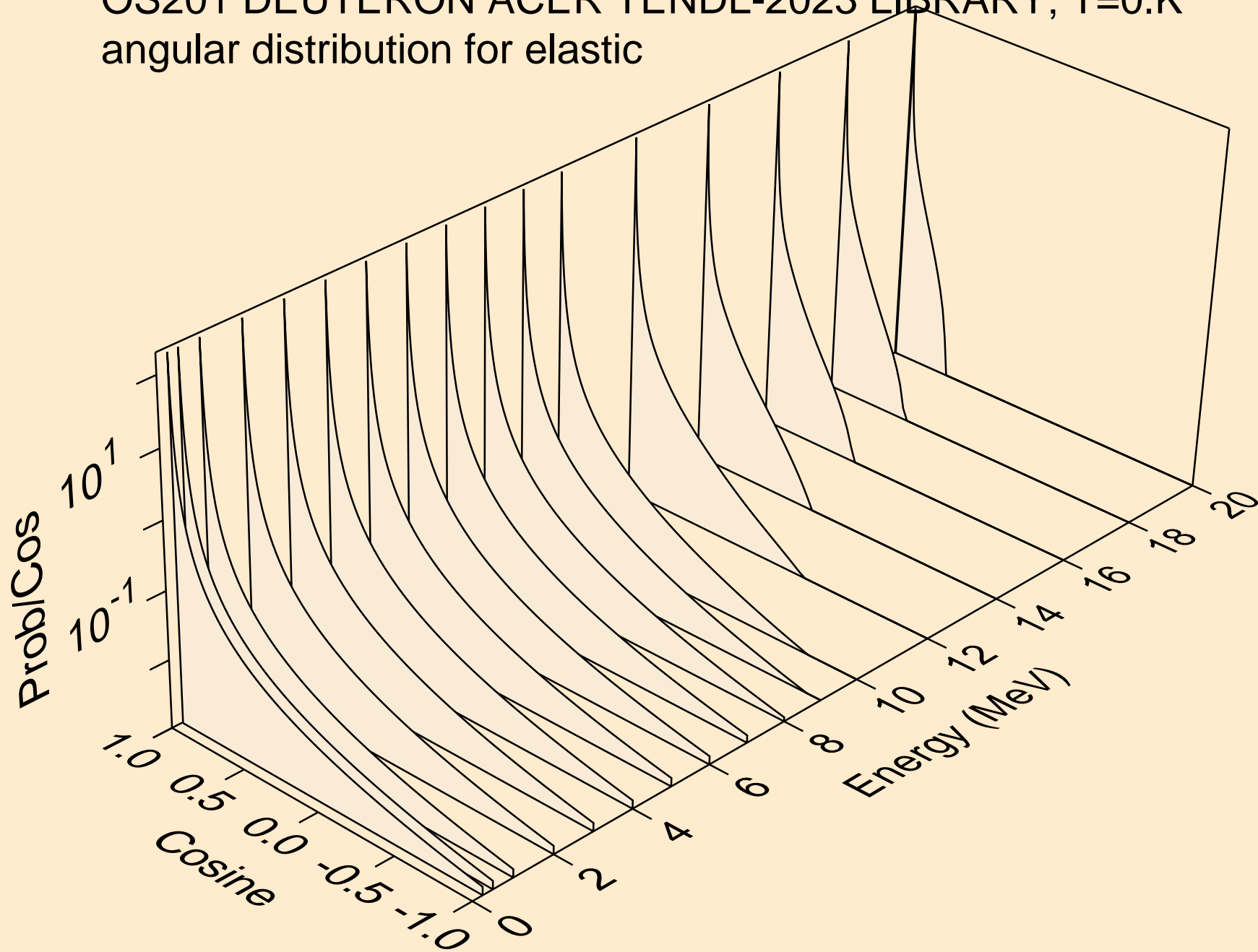

OS201 DEUTERON ACER TENDL-2023 LIBRARY; T=0.K  
angular distribution for elastic

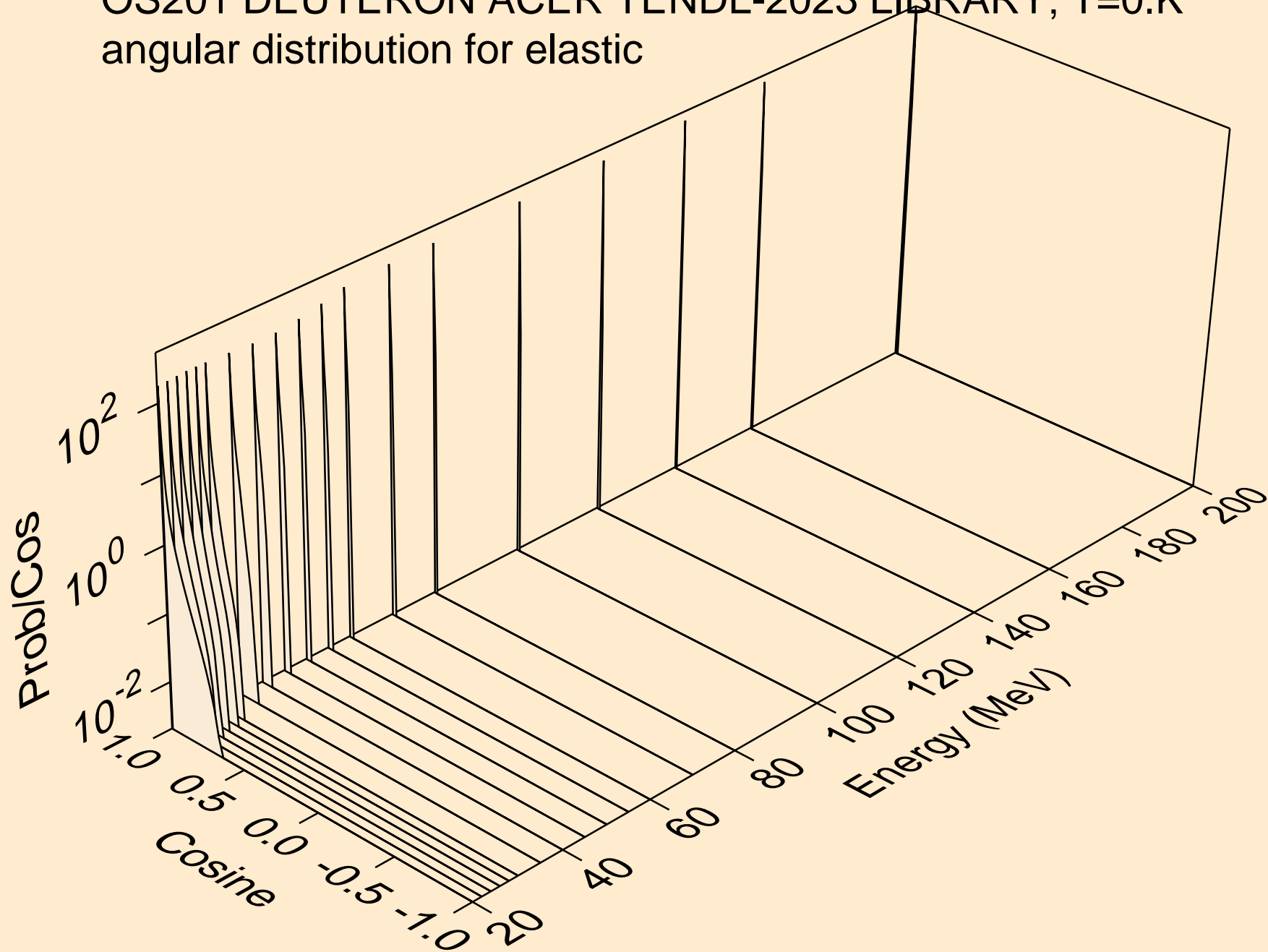

OS201 DEUTERON ACER TENDL-2023 LIBRARY; T=0.K  
Deuteron emission for (d,x)

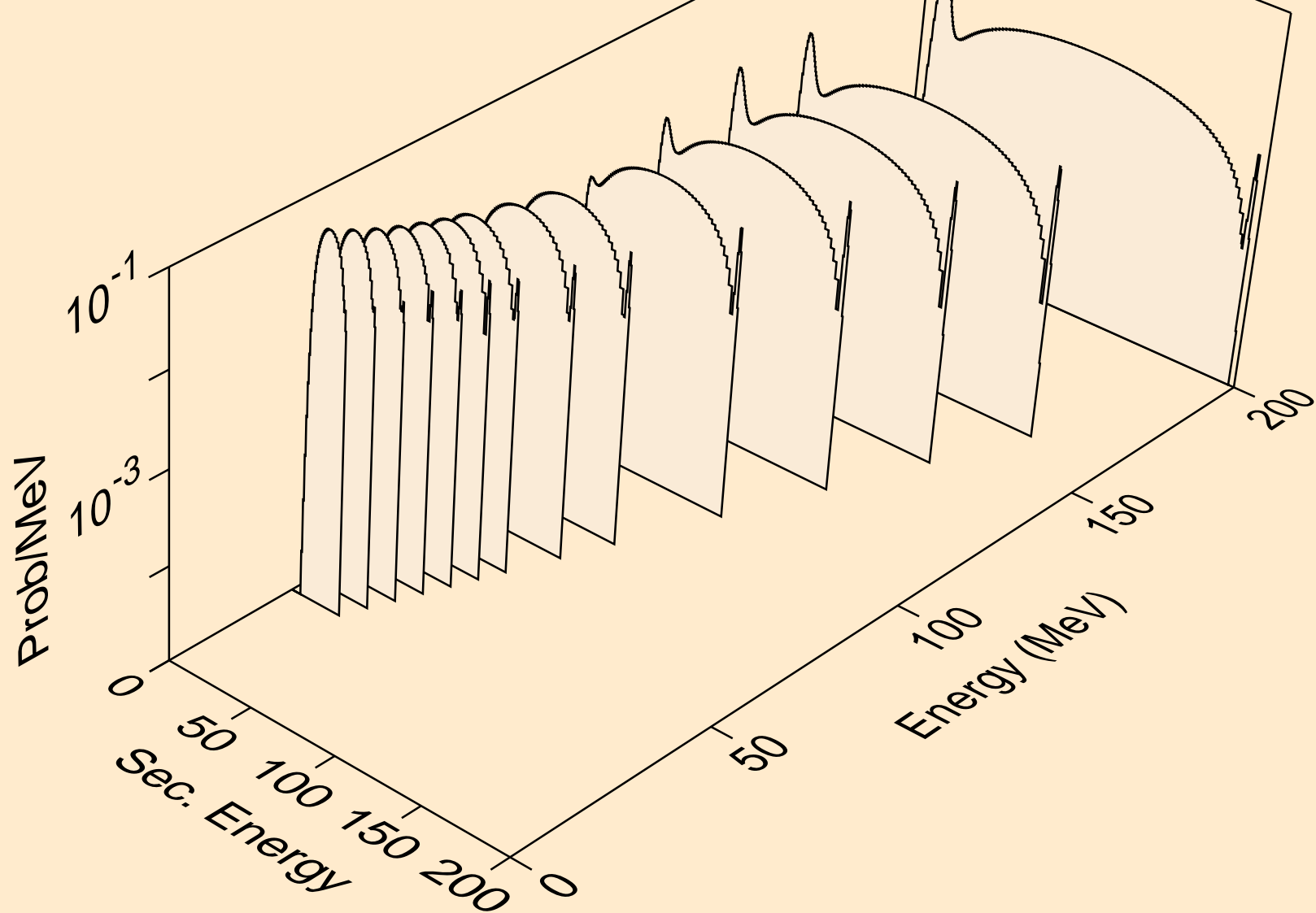



OS201 DEUTERON ACER TENDL-2023 LIBRARY; T=0.K  
Deuteron emission for (d,2nd)

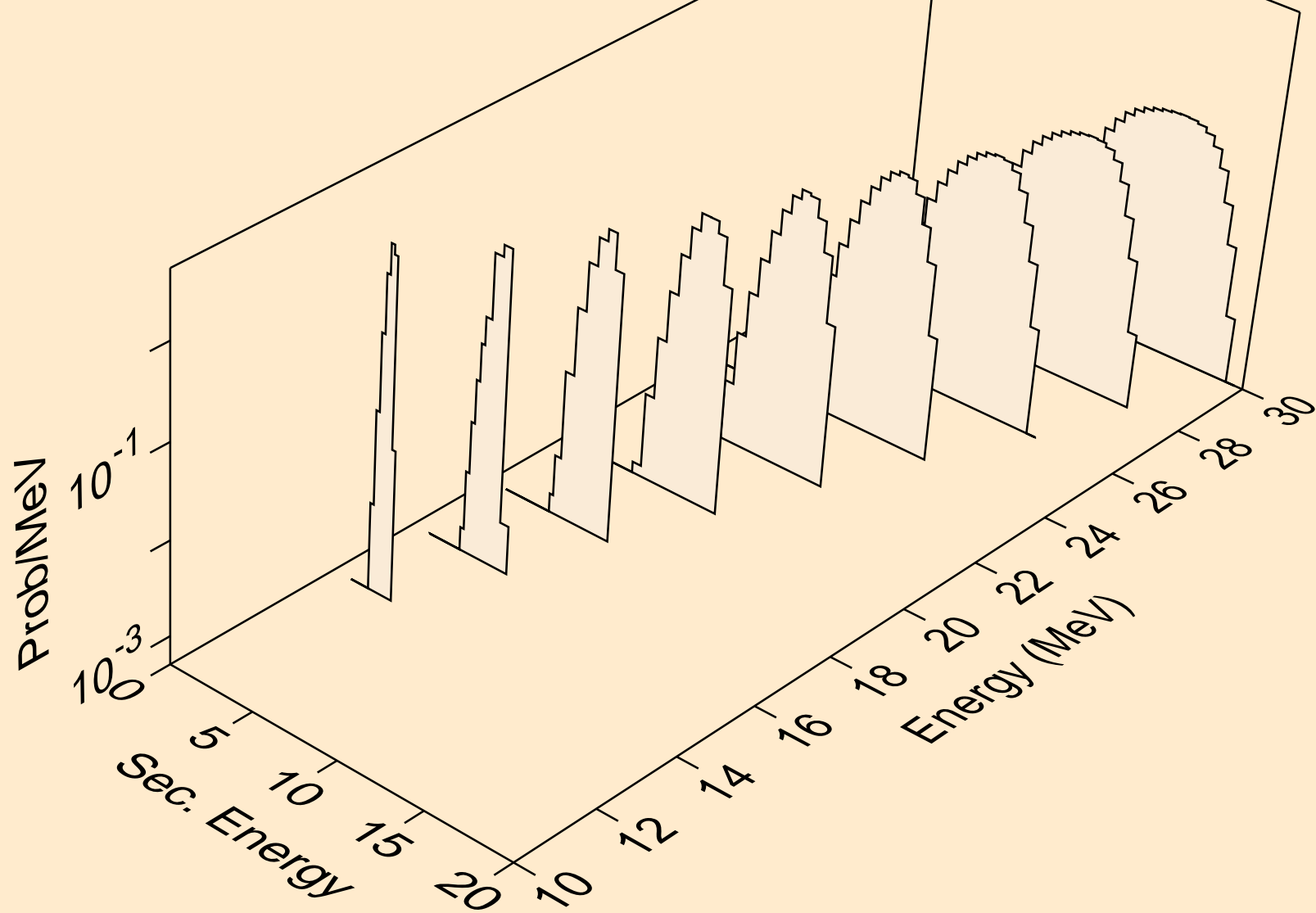

OS201 DEUTERON ACER TENDL-2023 LIBRARY; T=0.K  
Deuteron emission for (d,n\*)d

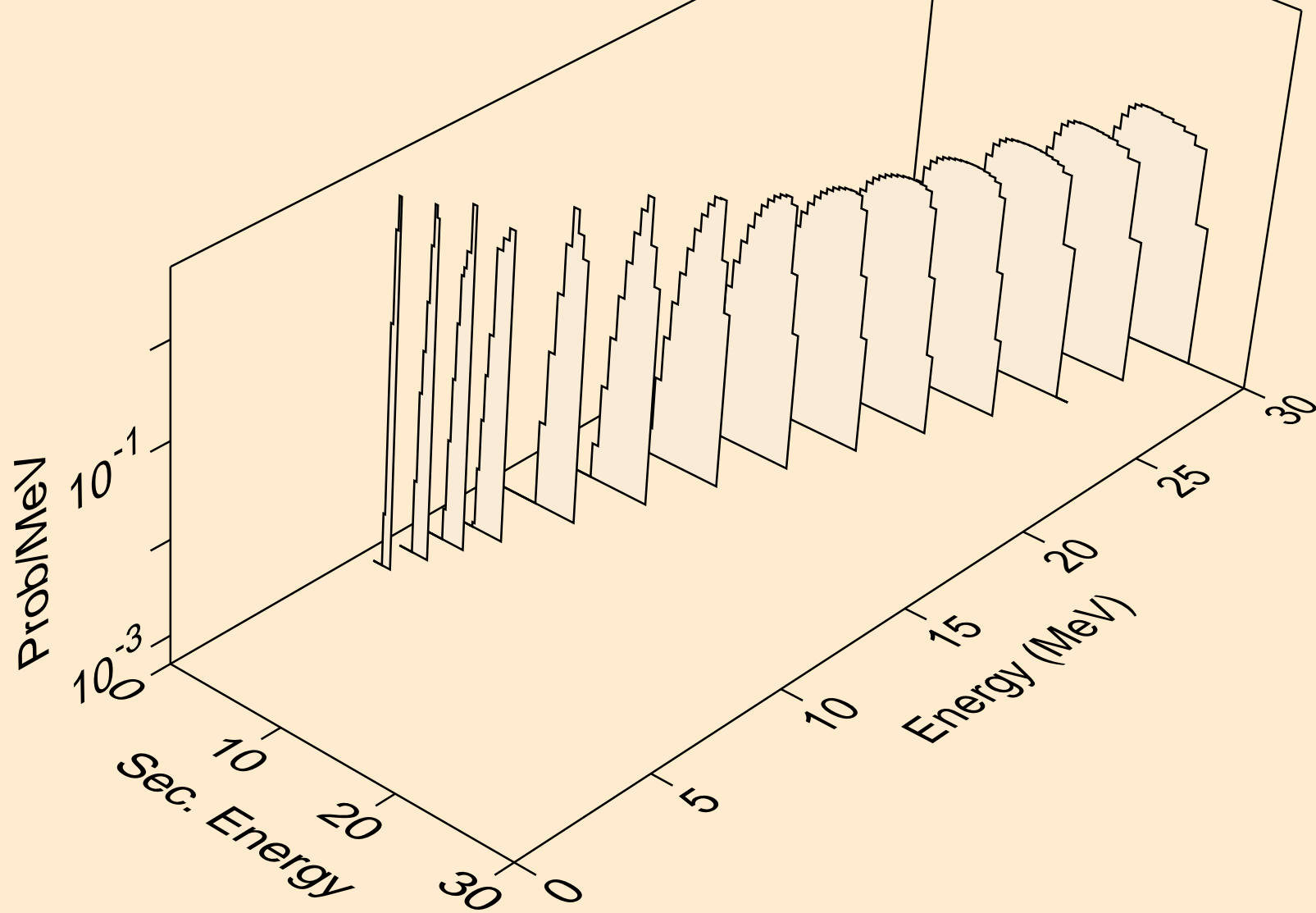

OS201 DEUTERON ACER TENDL-2023 LIBRARY; T=0.K  
Deuteron emission for inelastic

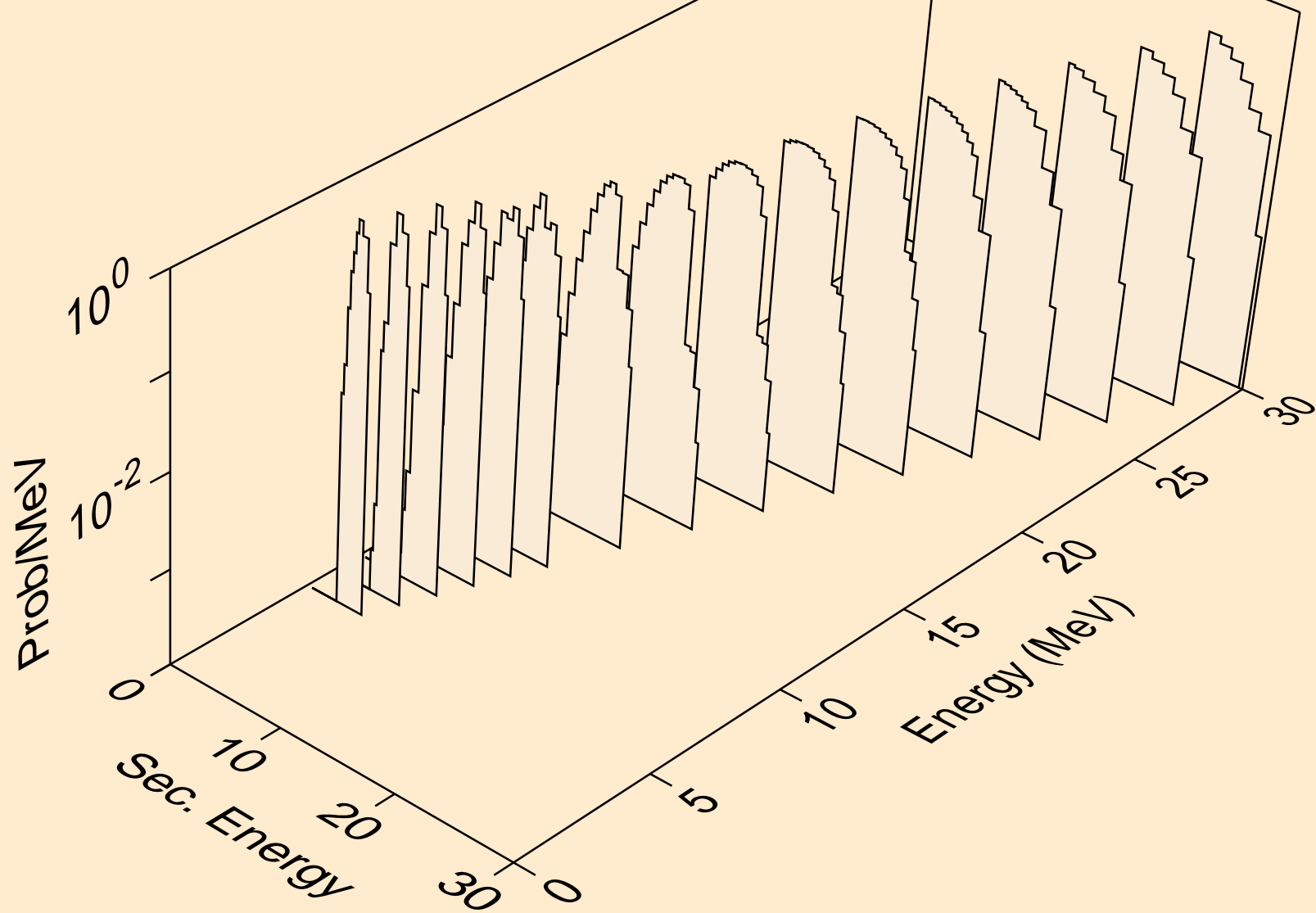

OS201 DEUTERON ACER TENDL-2023 LIBRARY; T=0.K  
Deuteron emission for (d,pd)

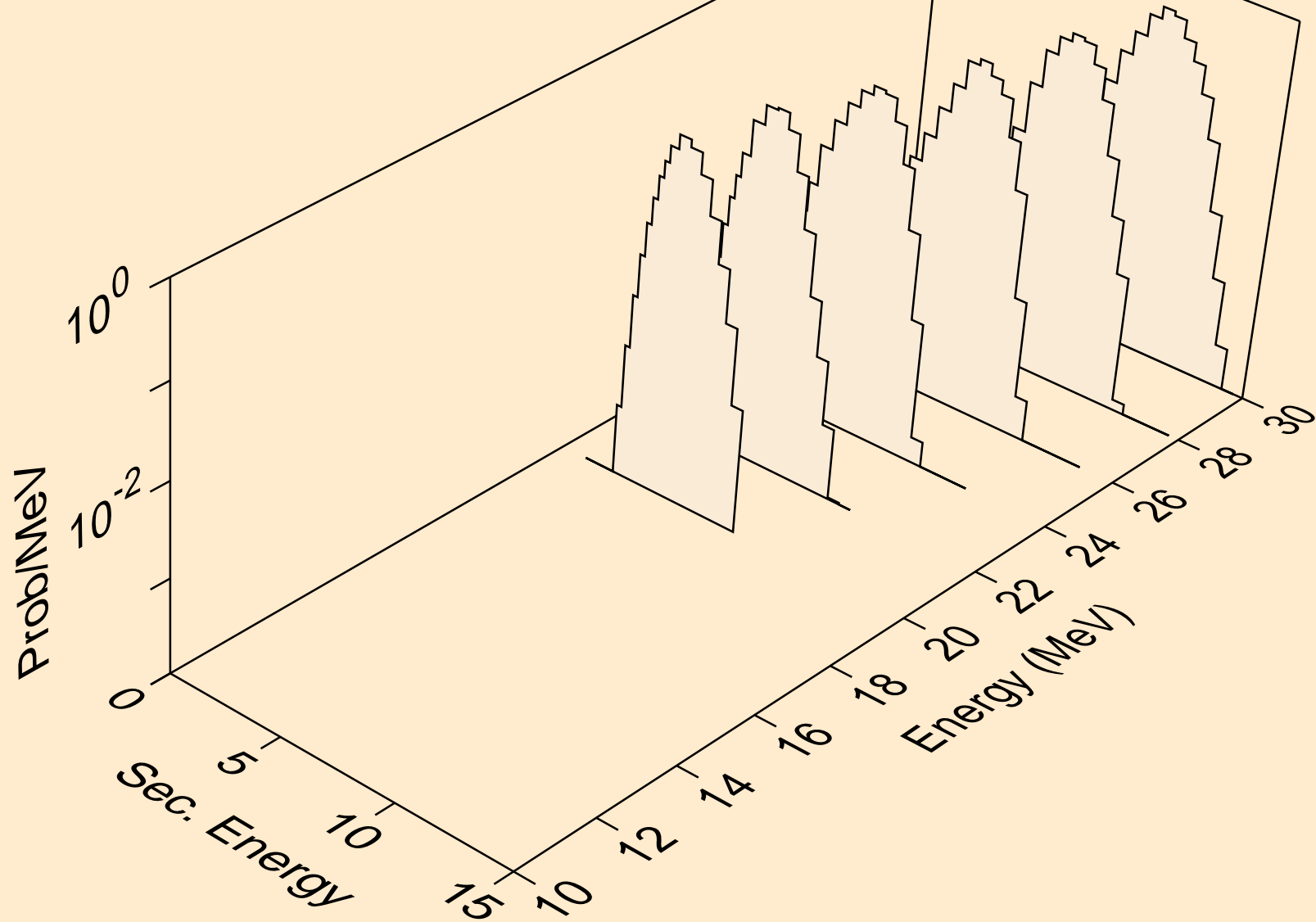

OS201 DEUTERON ACER TENDL-2023 LIBRARY; T=0.K  
Photon emission for (z,n)

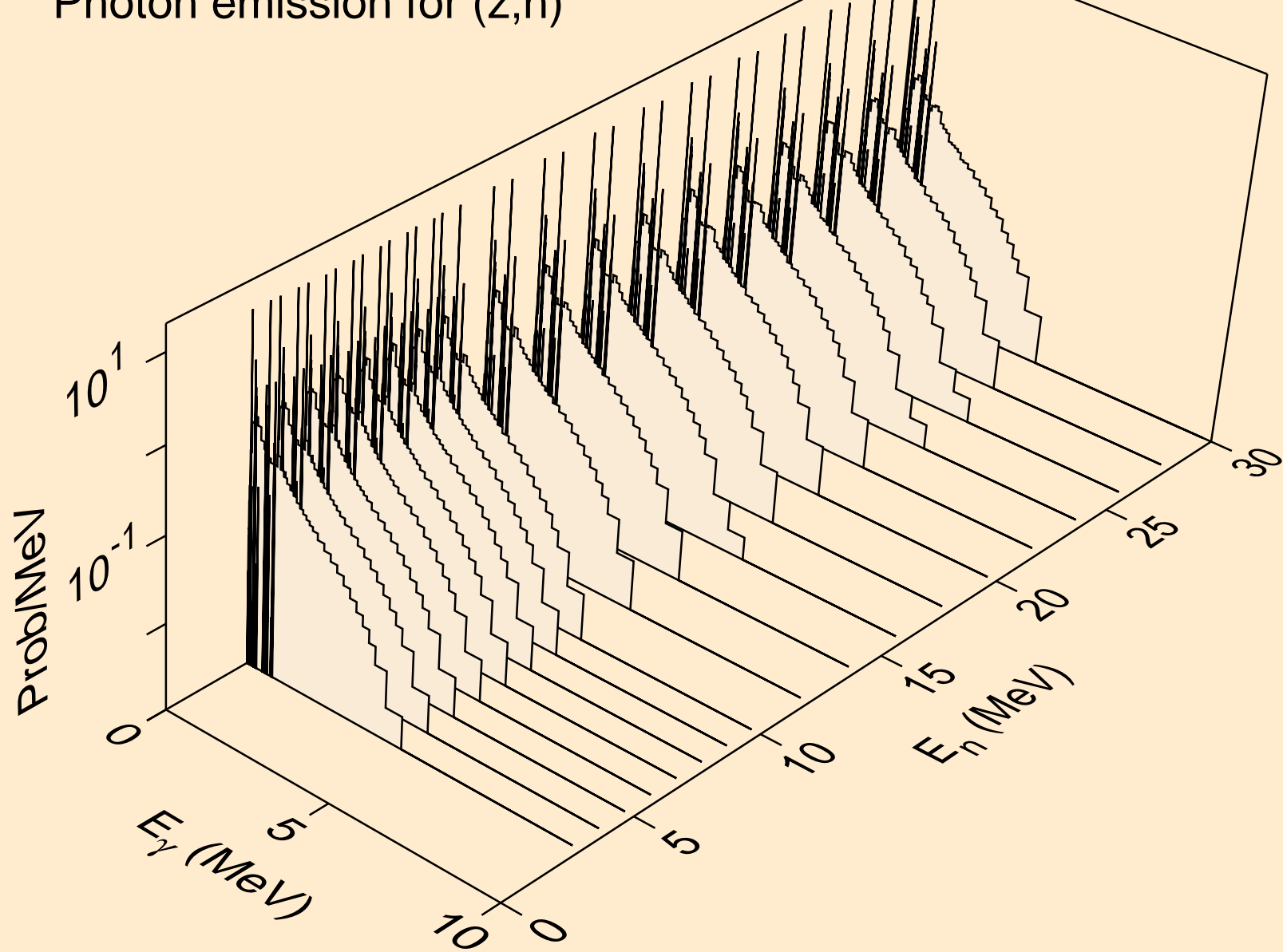

OS201 DEUTERON ACER TENDL-2023 LIBRARY; T=0.K  
Photon emission for (z,x)

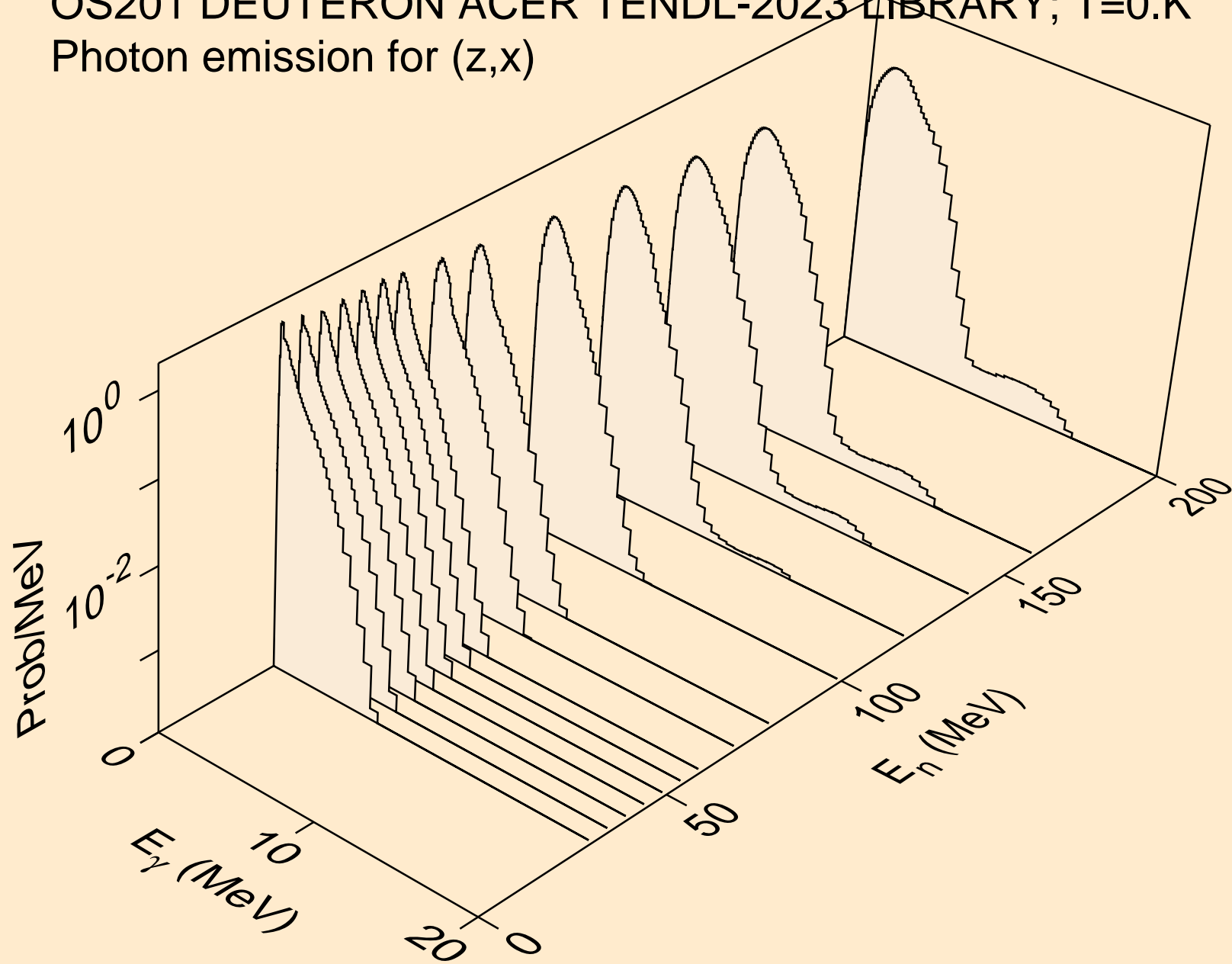

OS201 DEUTERON ACER TENDL-2023 LIBRARY; T=0.K  
Photon emission for (n,2nd)

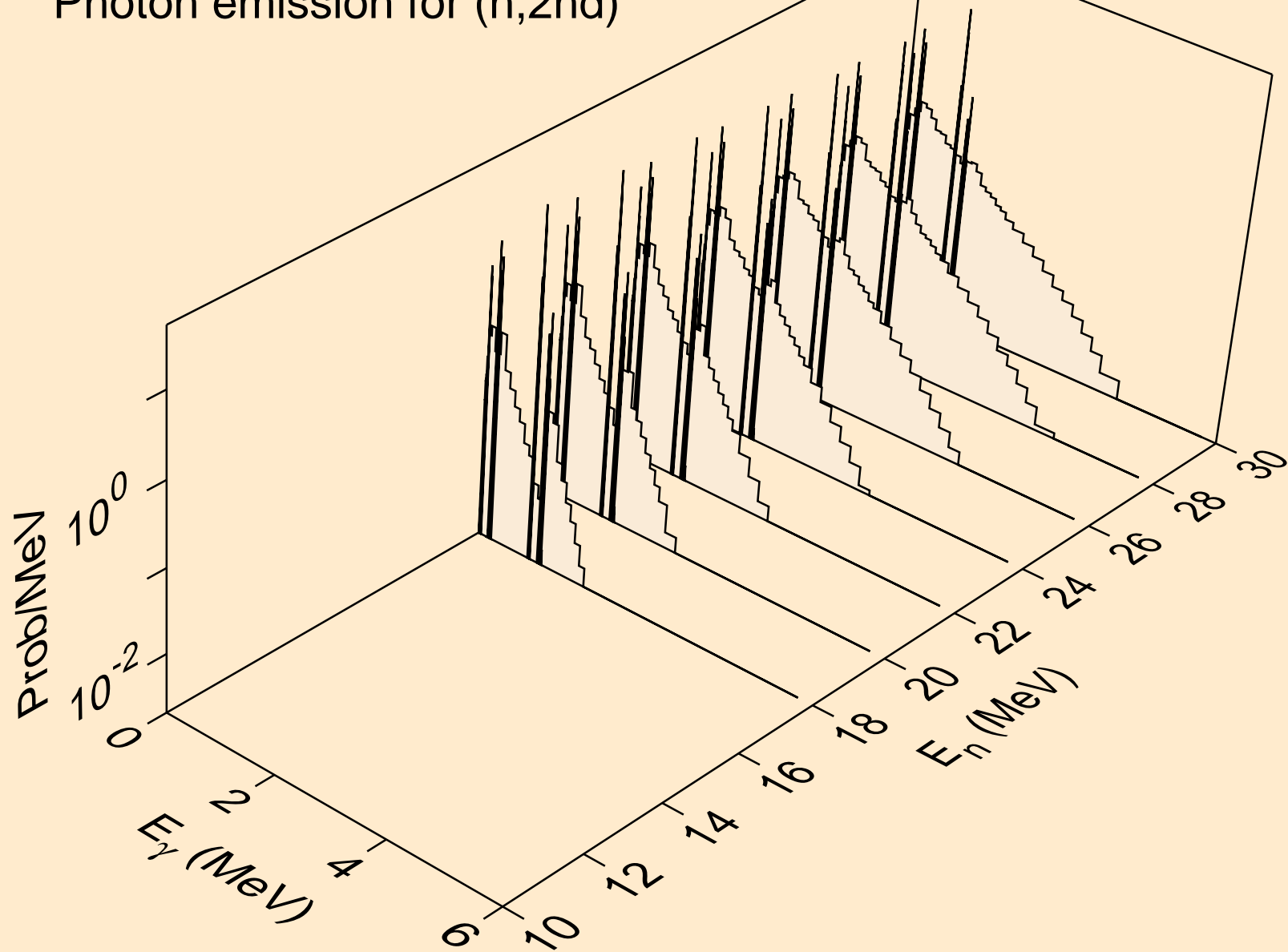

OS201 DEUTERON ACER TENDL-2023 LIBRARY; T=0.K  
Photon emission for (n,2n)

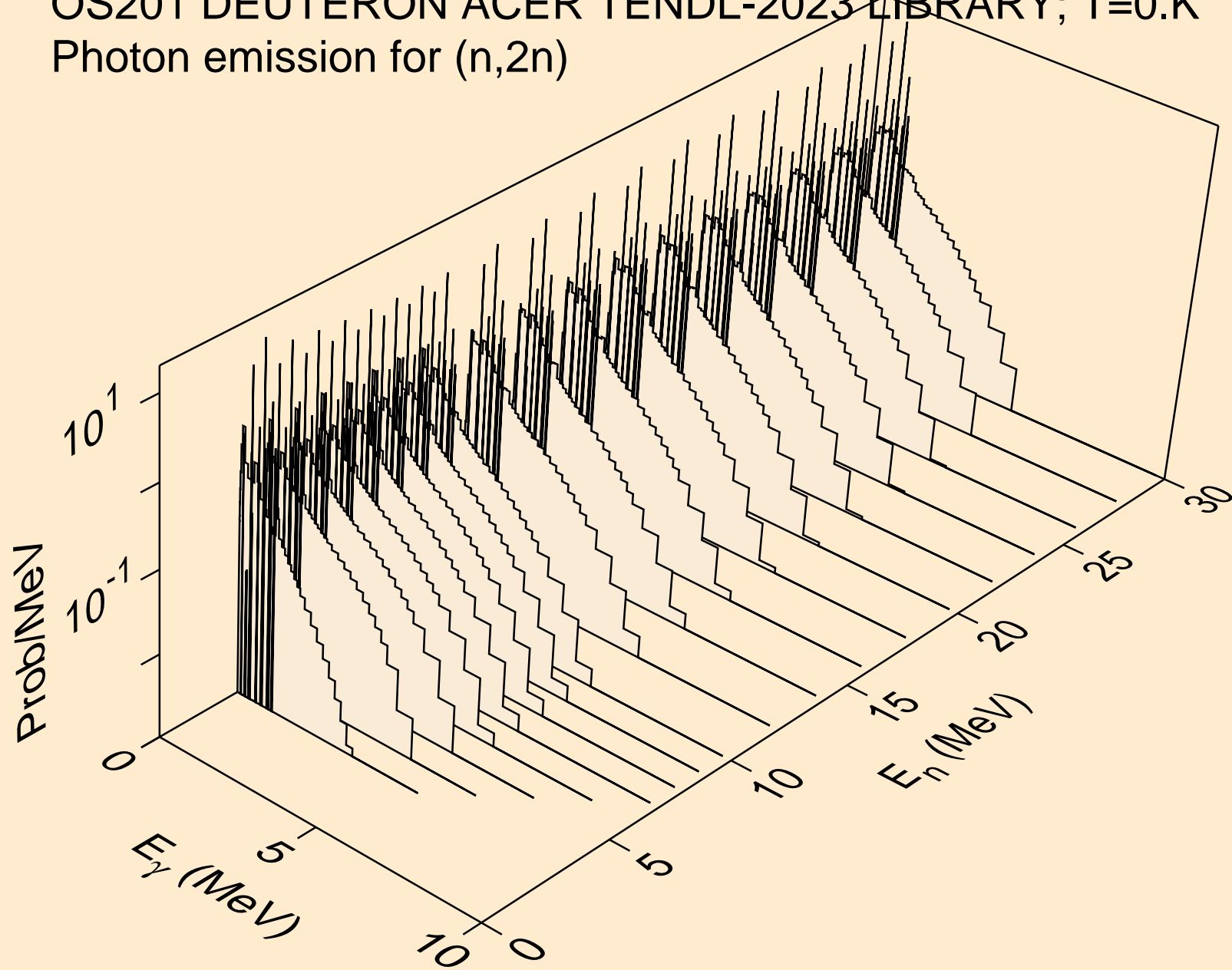



OS201 DEUTERON ACER TENDL-2023 LIBRARY; T=0.K  
Photon emission for (n,3n)

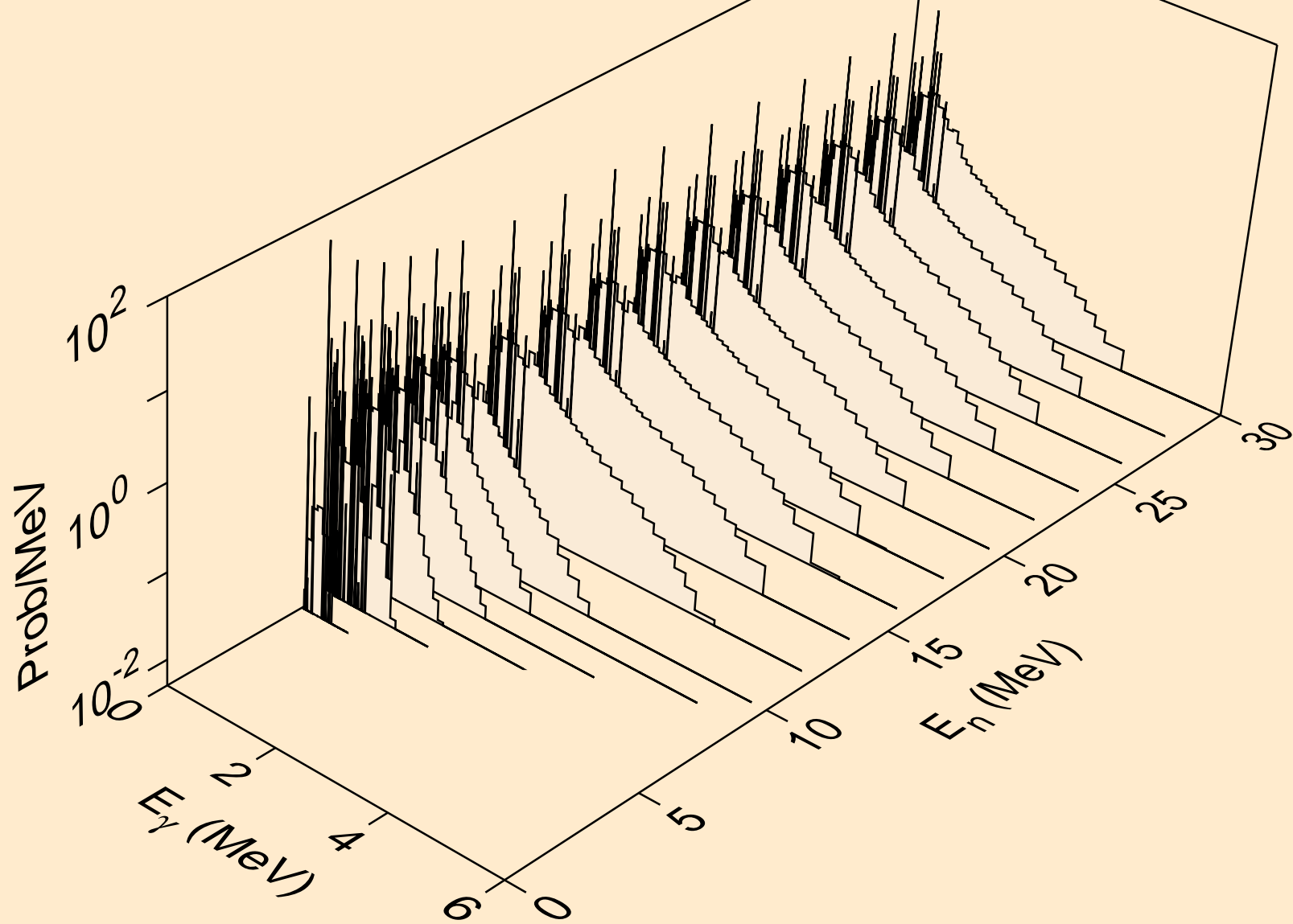

OS201 DEUTERON ACER TENDL-2023 LIBRARY; T=0.K  
Photon emission for (n,n\*)a

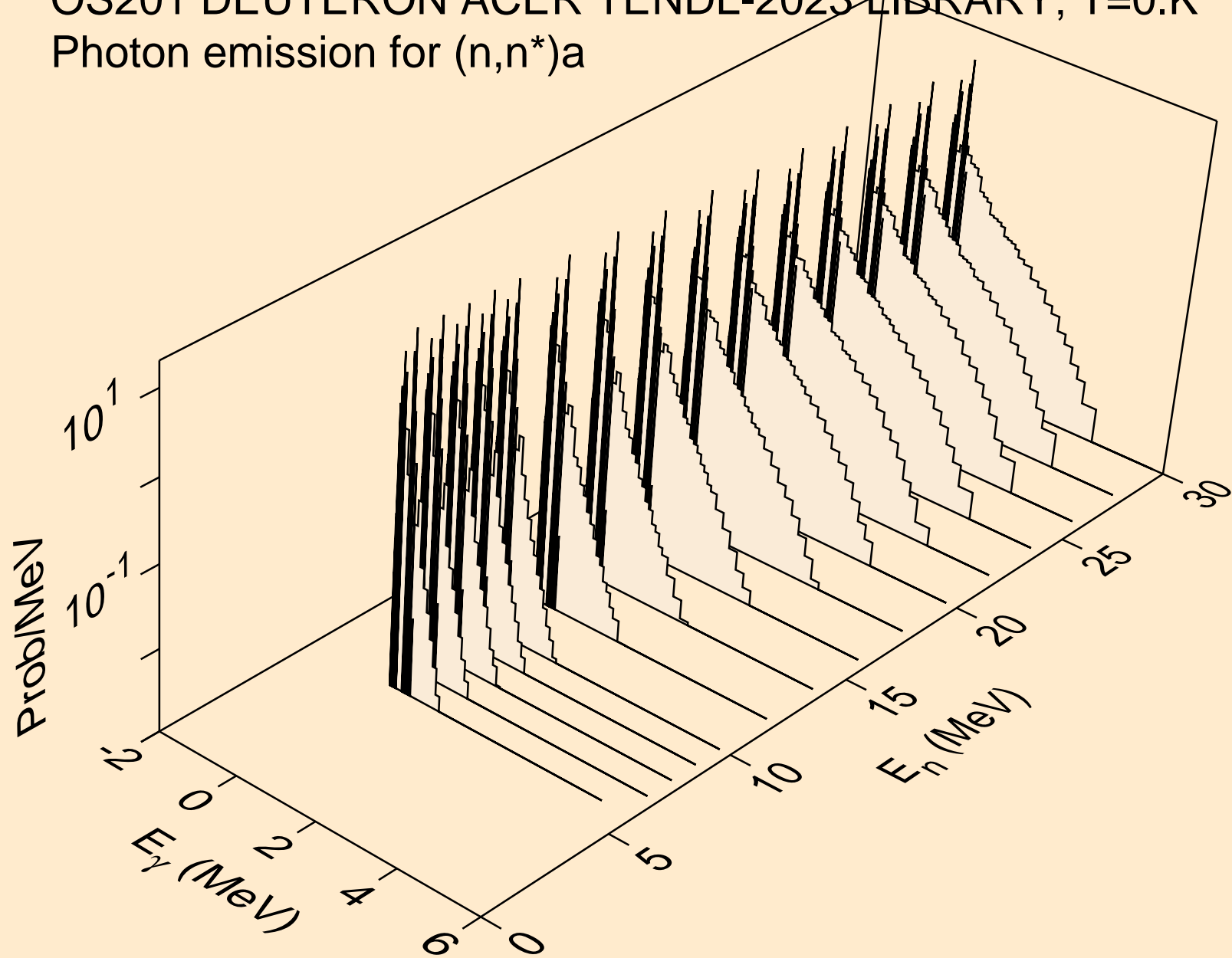

OS201 DEUTERON ACER TENDL-2023 LIBRARY; T=0.K  
Photon emission for (n,2n)a

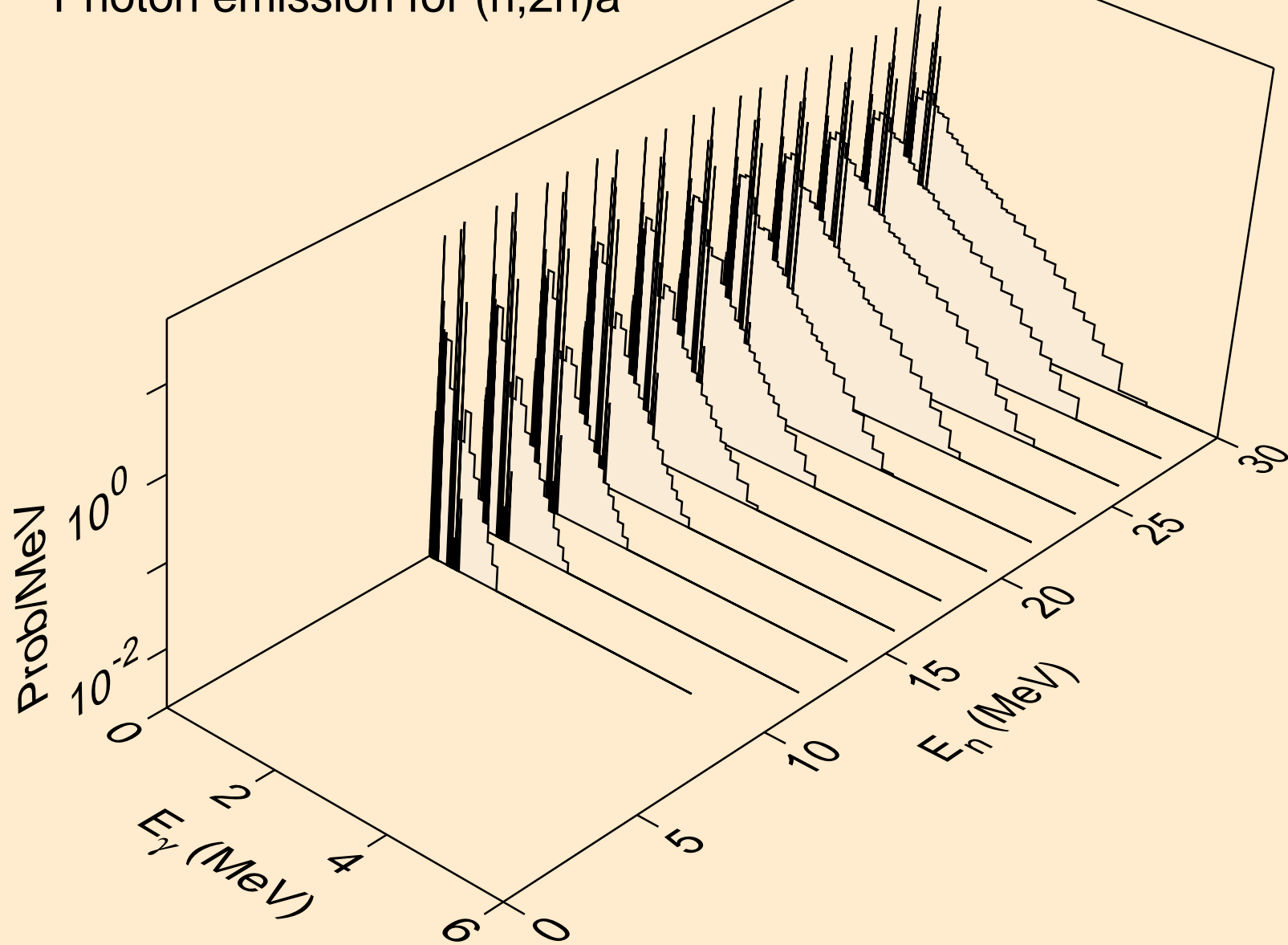

OS201 DEUTERON ACER TENDL-2023 LIBRARY; T=0.K  
Photon emission for (n,3n)a

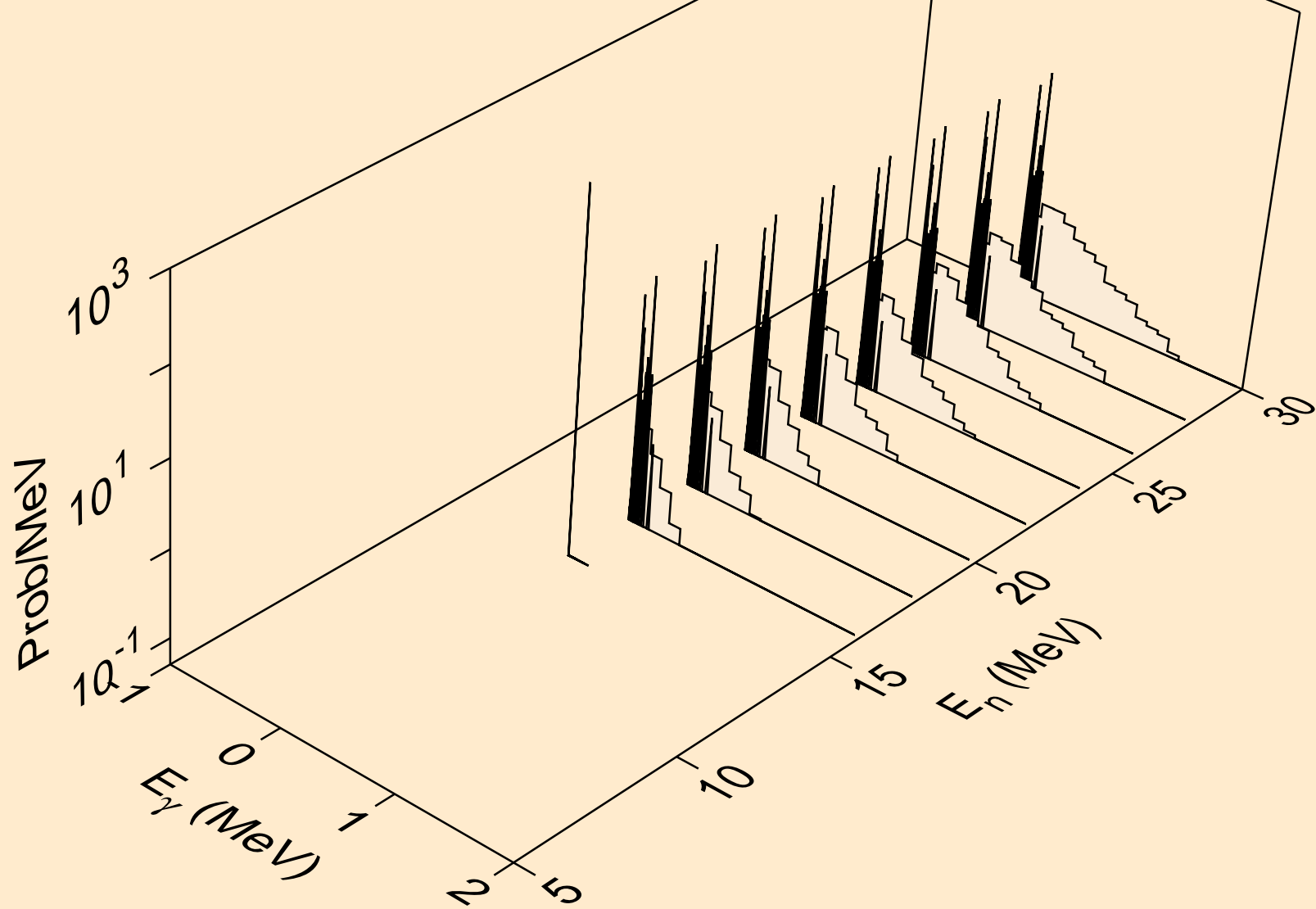

OS201 DEUTERON ACER TENDL-2023 LIBRARY; T=0.K  
Photon emission for (n,n\*)p

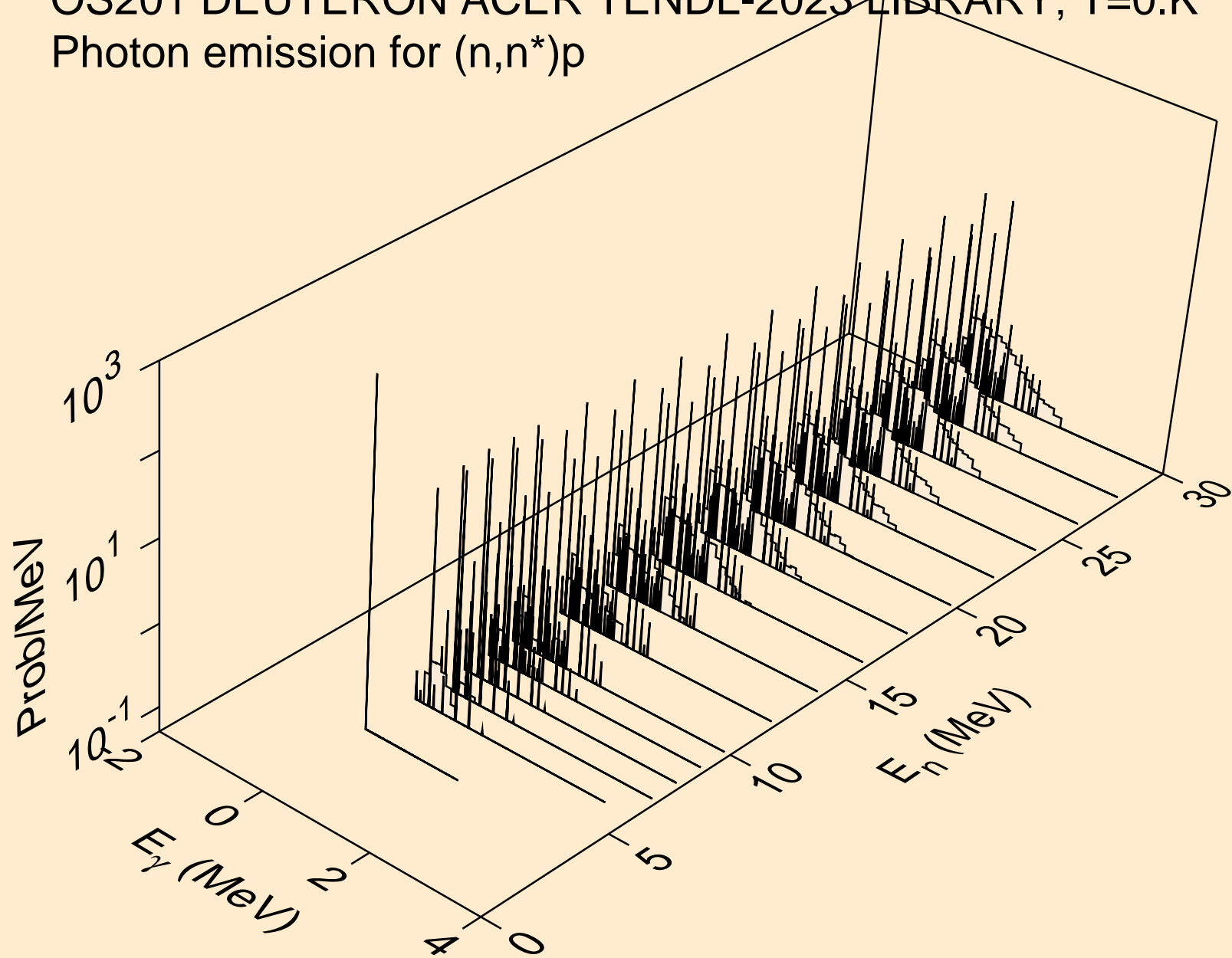

OS201 DEUTERON ACER TENDL-2023 LIBRARY; T=0.K  
Photon emission for (n,n\*)d

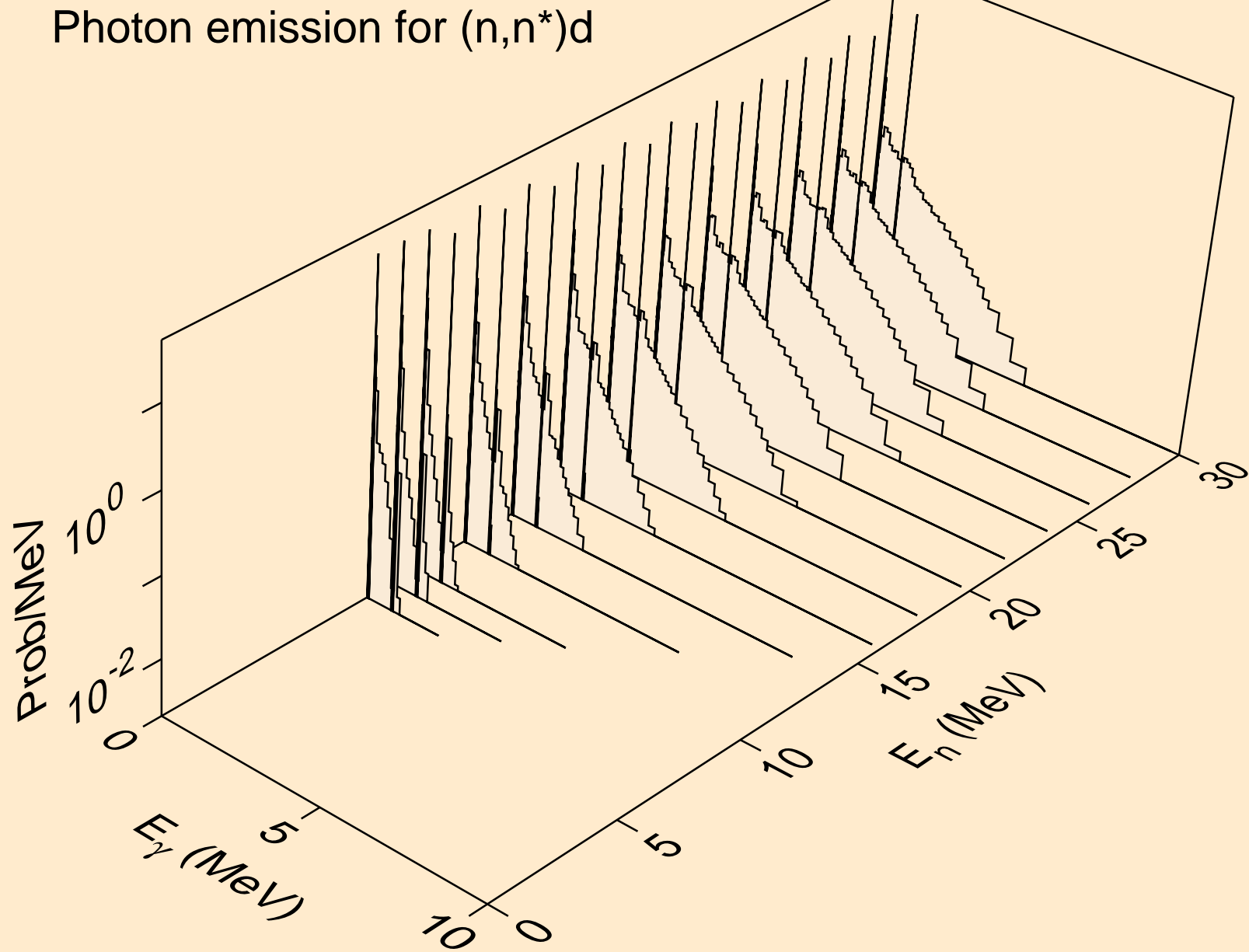

OS201 DEUTERON ACER TENDL-2023 LIBRARY; T=0.K  
Photon emission for (n,n\*)t

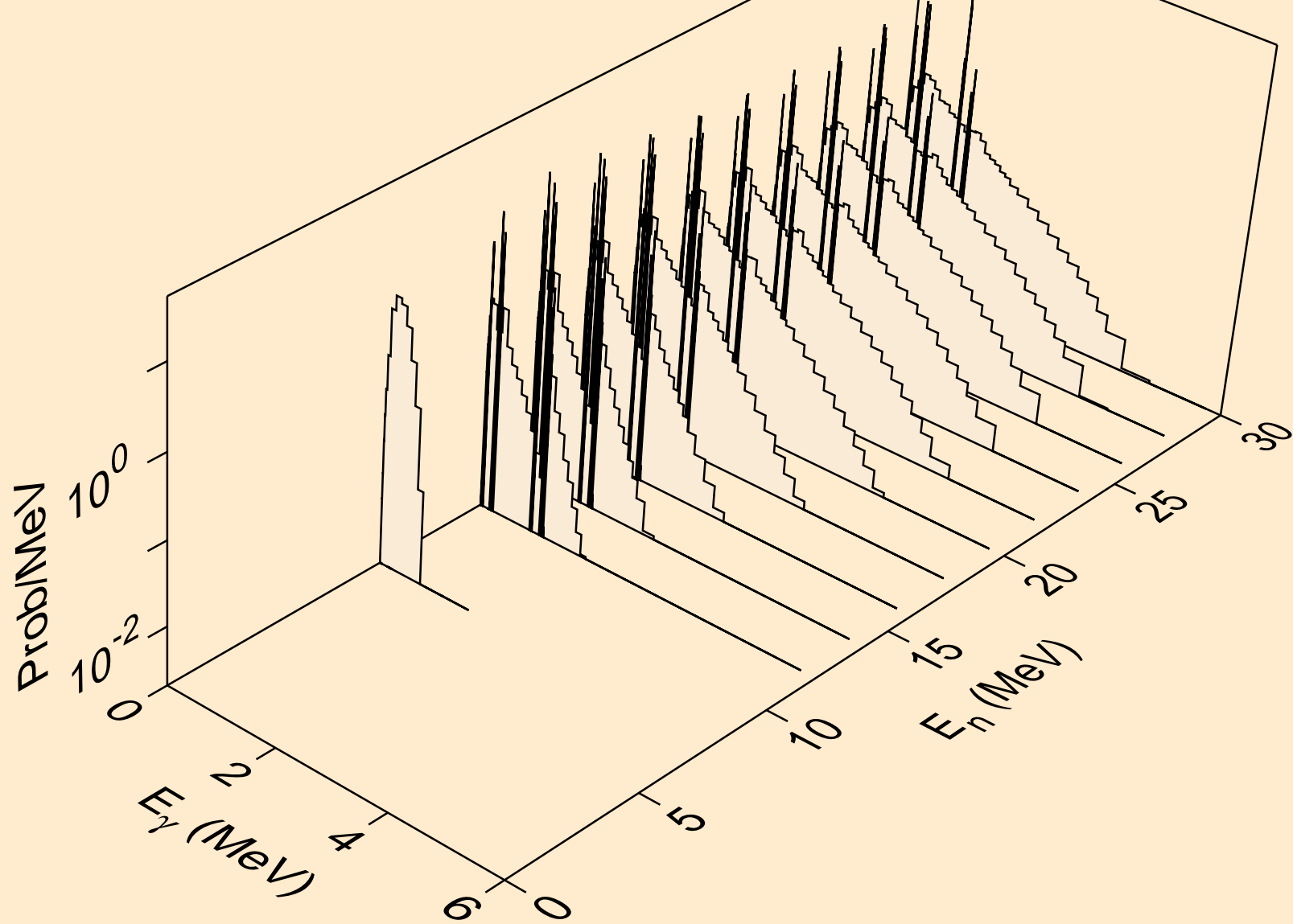

OS201 DEUTERON ACER TENDL-2023 LIBRARY; T=0.K  
Photon emission for (n,n\*)he3

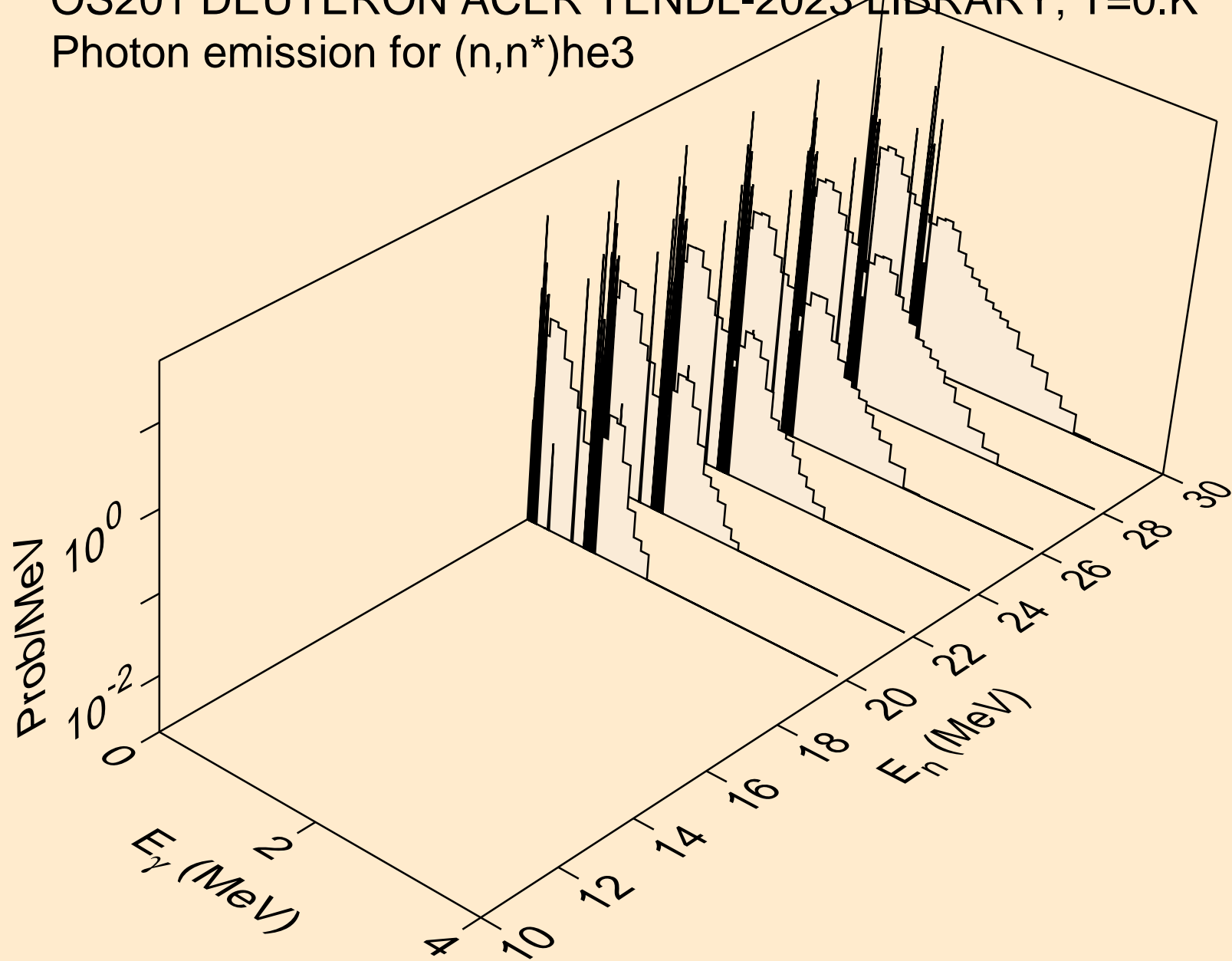



OS201 DEUTERON ACER TENDL-2023 LIBRARY; T=0.K  
Photon emission for (n,4n)

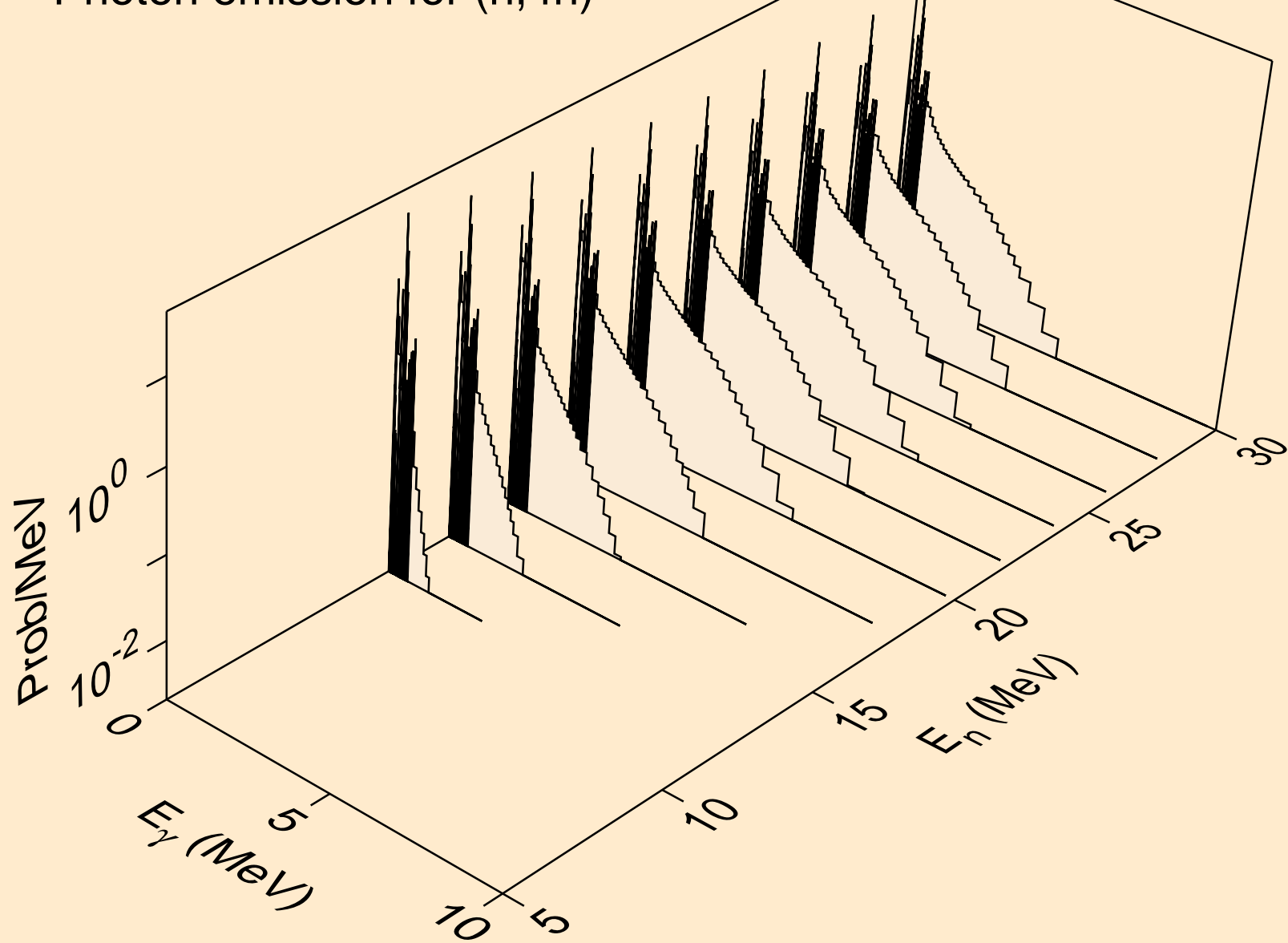

OS201 DEUTERON ACER TENDL-2023 LIBRARY; T=0.K  
Photon emission for (n,2np)

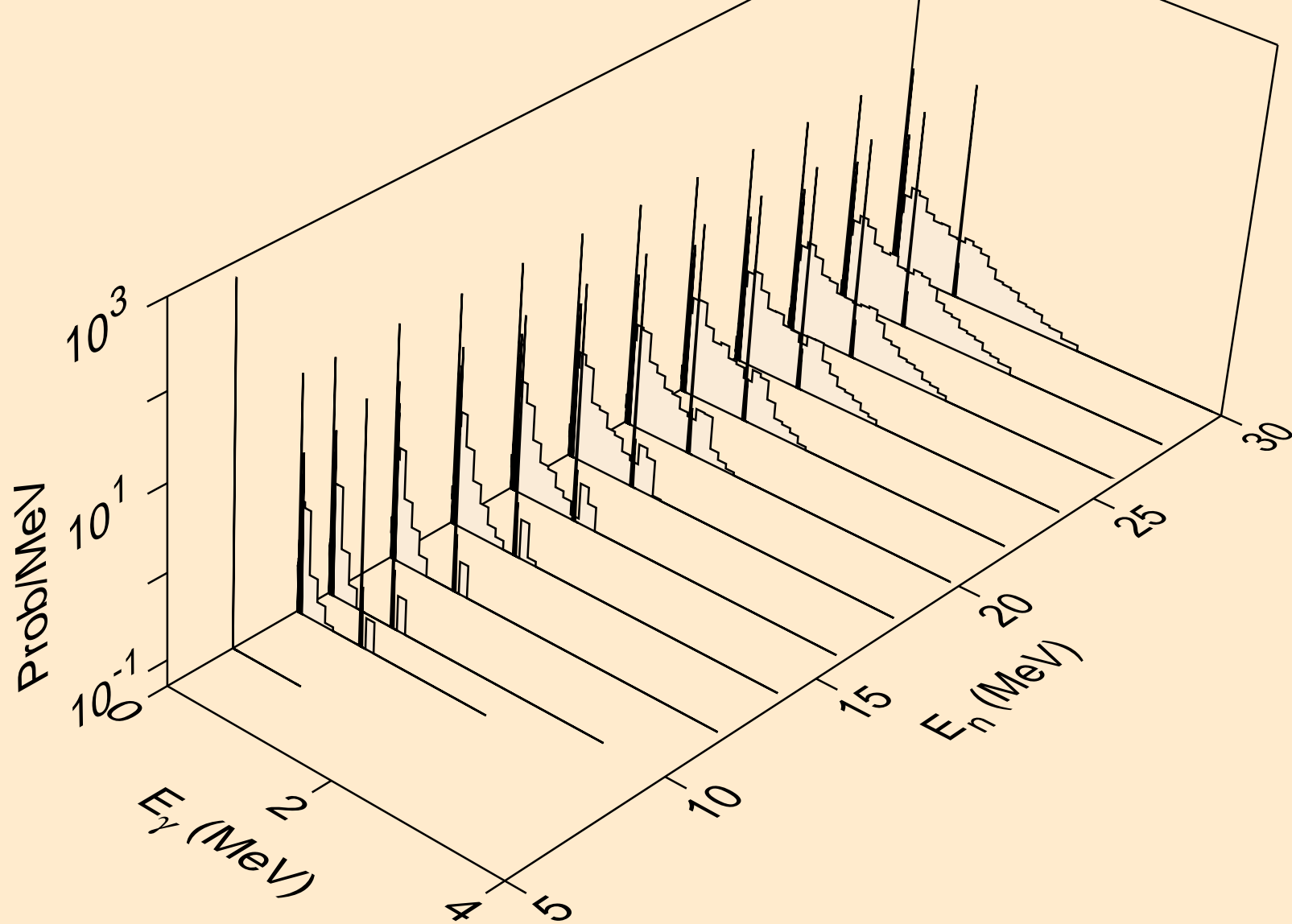

OS201 DEUTERON ACER TENDL-2023 LIBRARY; T=0.K  
Photon emission for (n,3np)

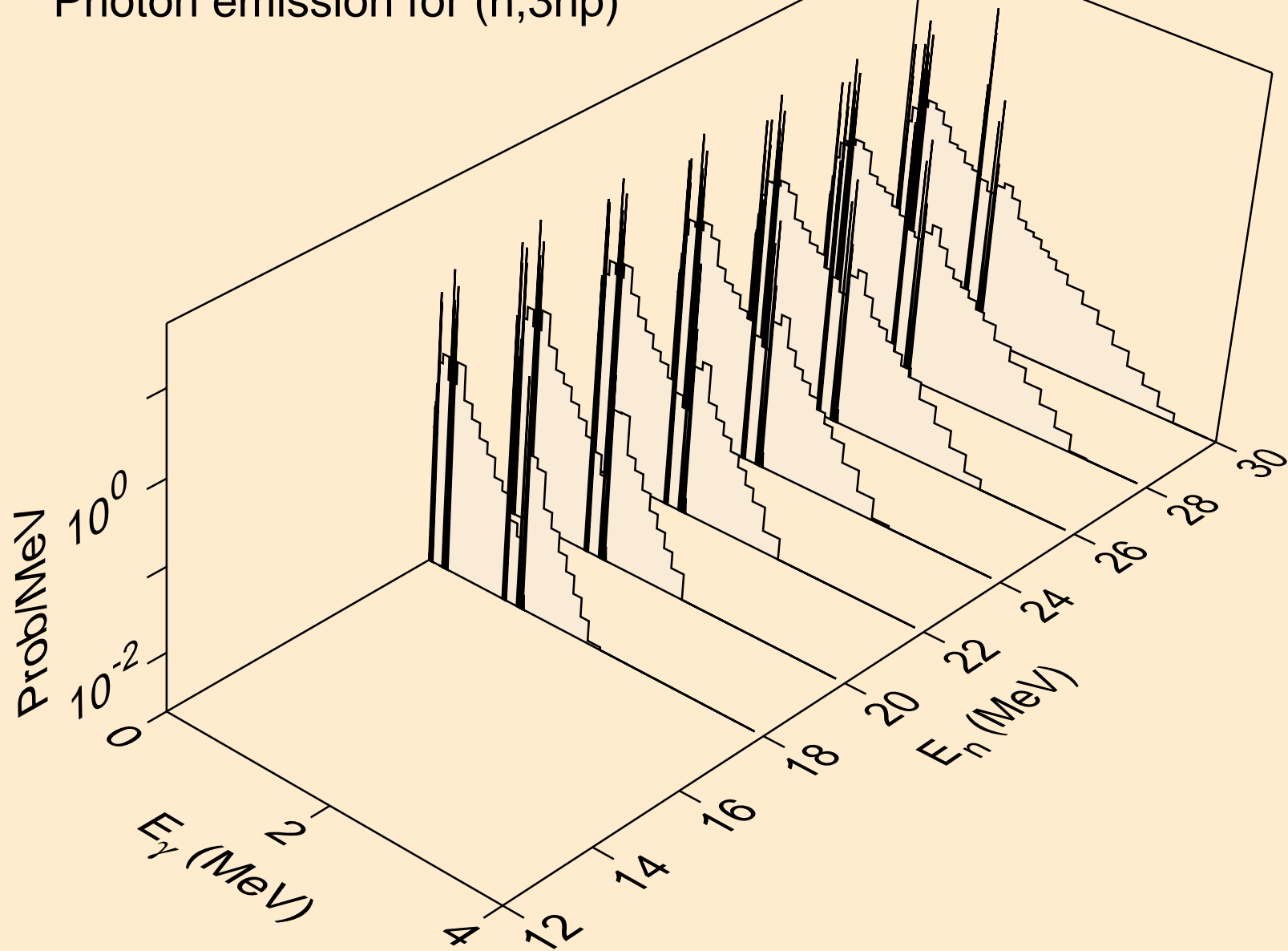

OS201 DEUTERON ACER TENDL-2023 LIBRARY; T=0.K  
Photon emission for (n,n2p)

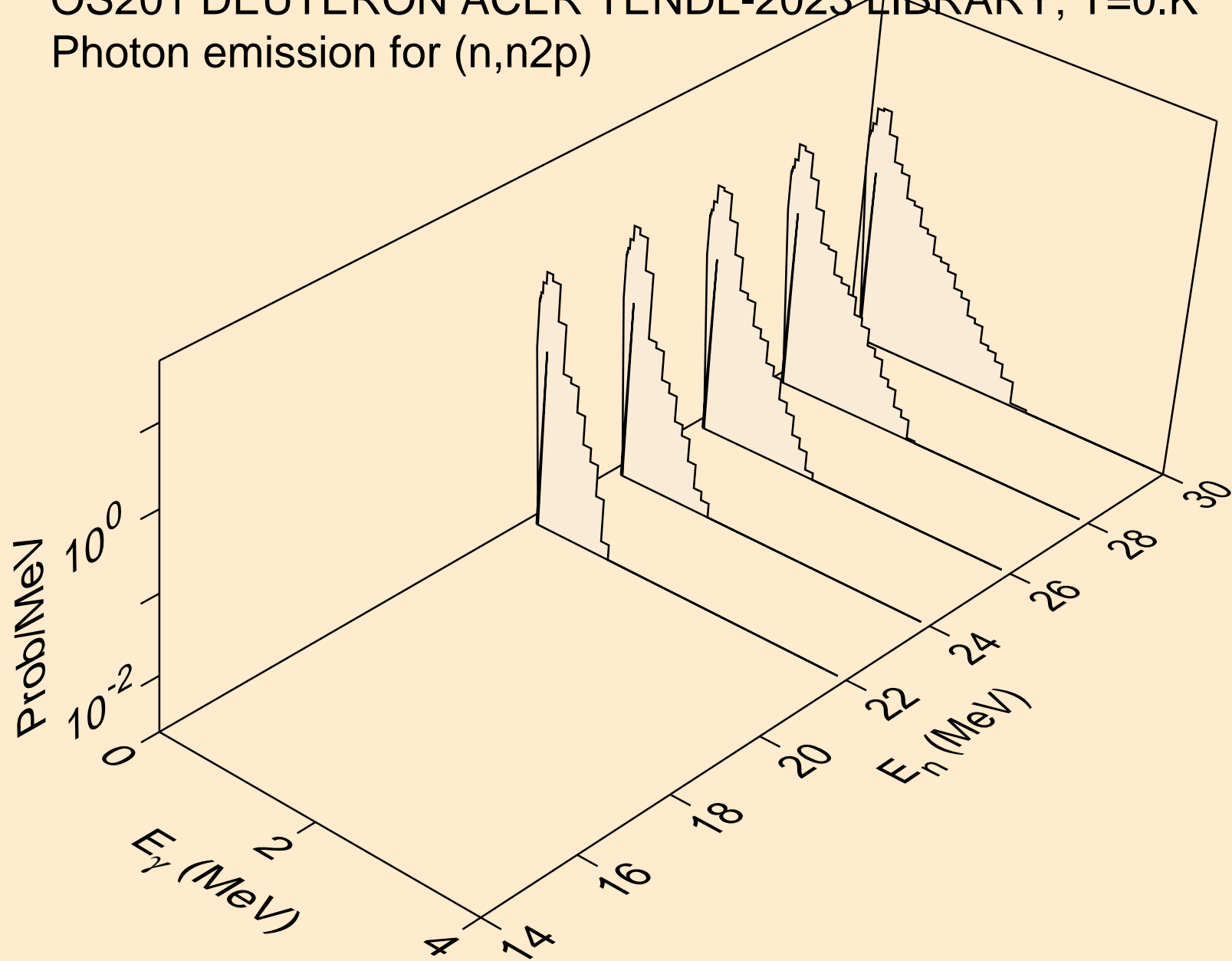

OS201 DEUTERON ACER TENDL-2023 LIBRARY; T=0.K  
Photon emission for (n,gma)

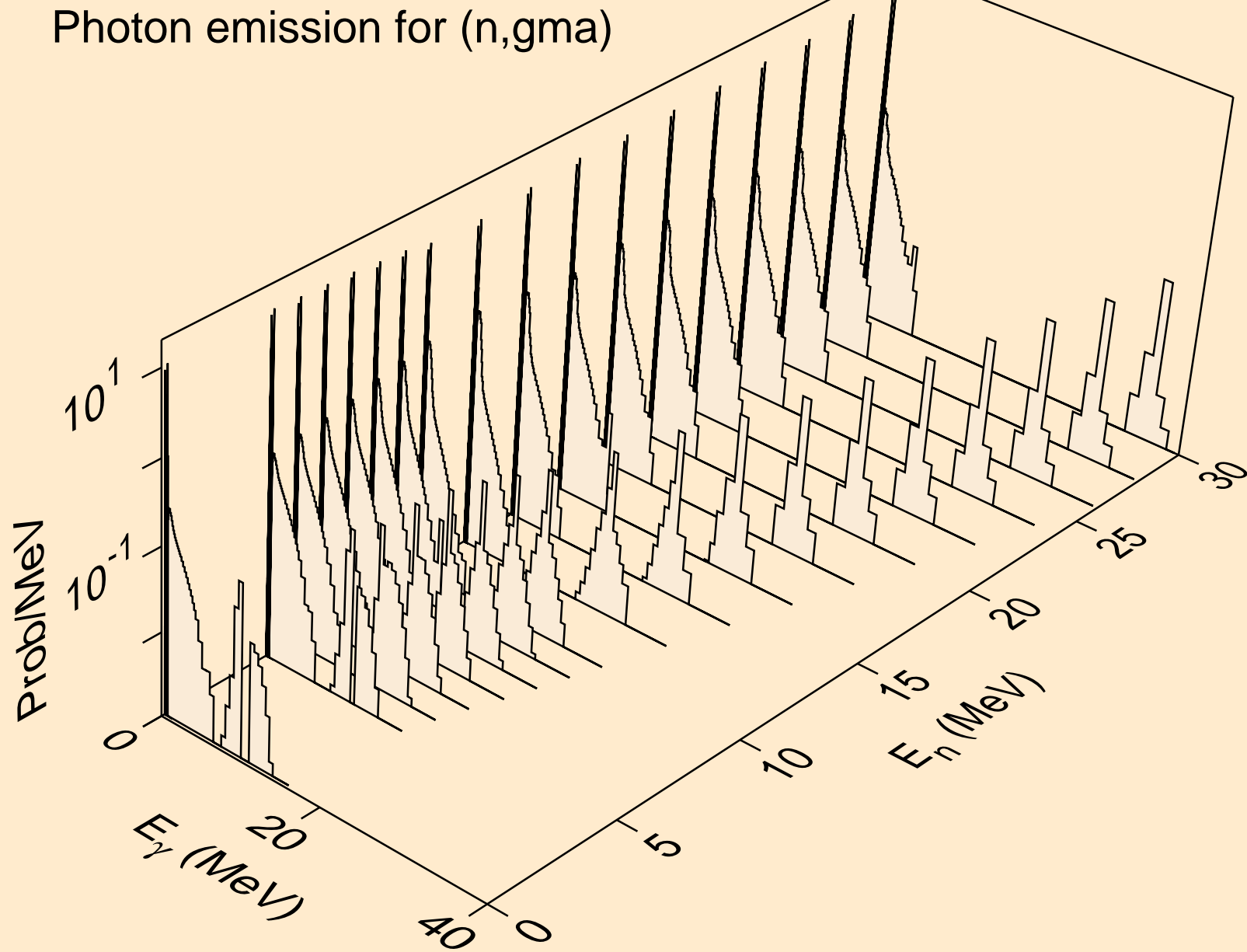

OS201 DEUTERON ACER TENDL-2023 LIBRARY; T=0.K  
Photon emission for (n,p)

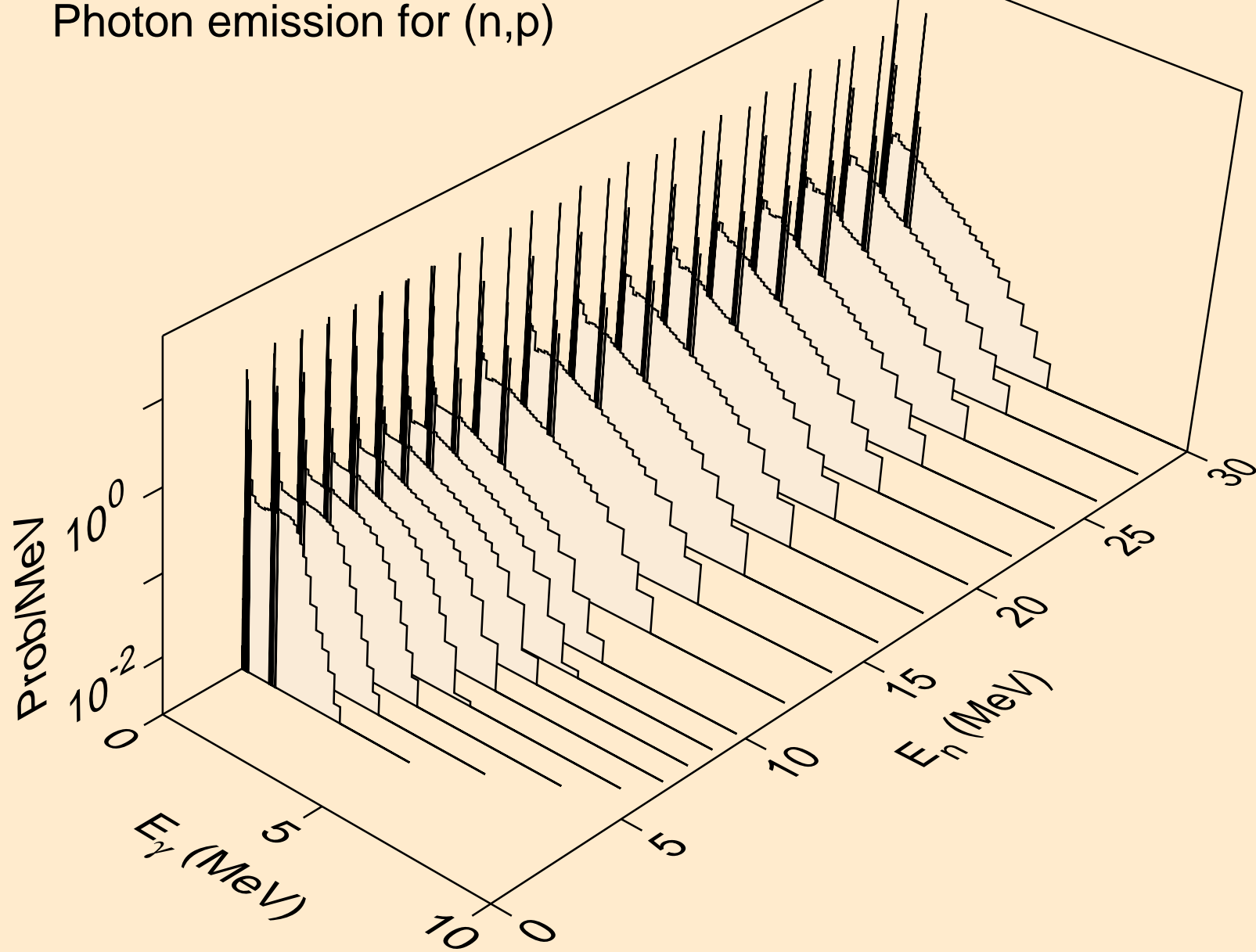

OS201 DEUTERON ACER TENDL-2023 LIBRARY; T=0.K  
Photon emission for inelastic

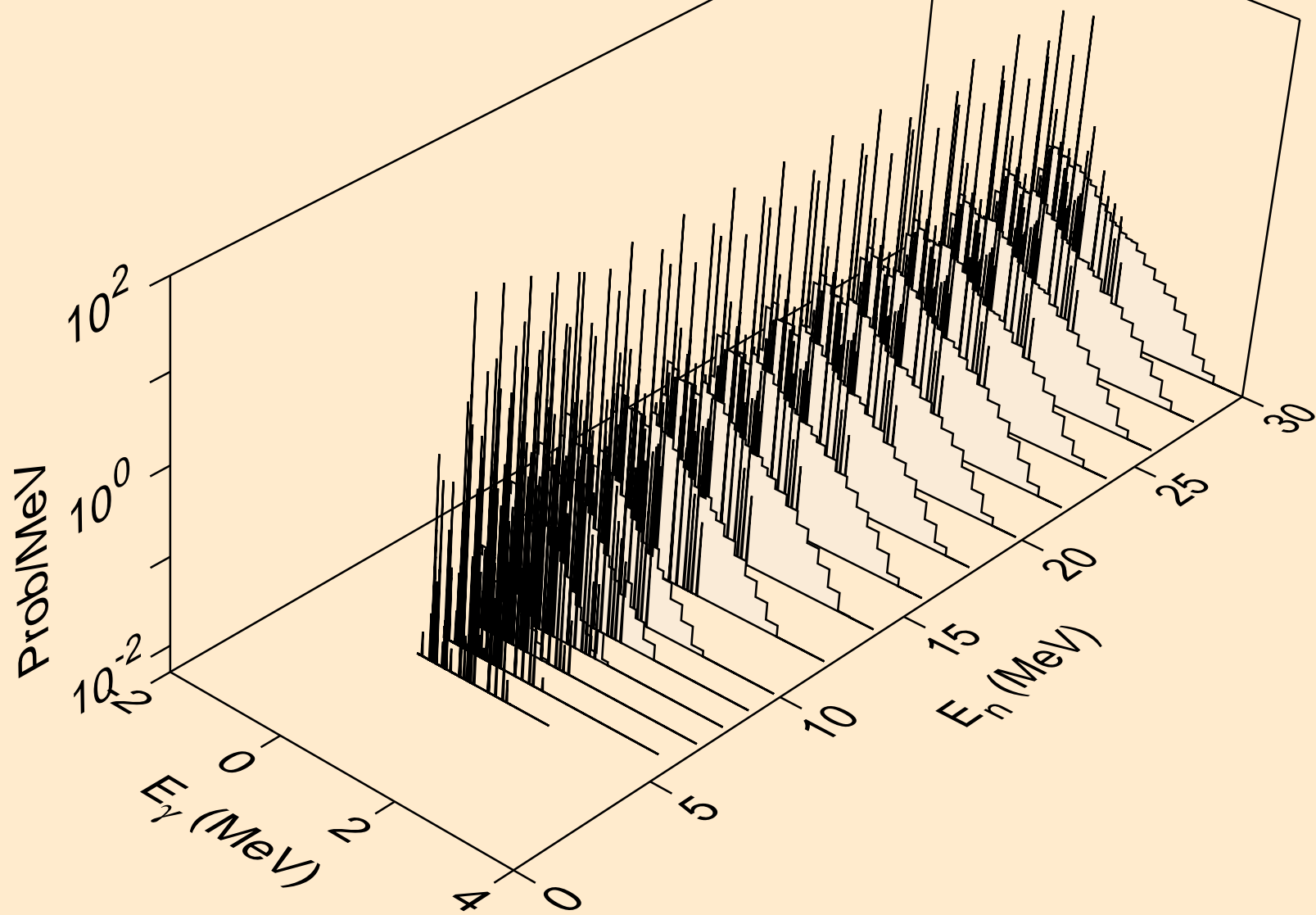

OS201 DEUTERON ACER TENDL-2023 LIBRARY; T=0.K  
Photon emission for (n,t)

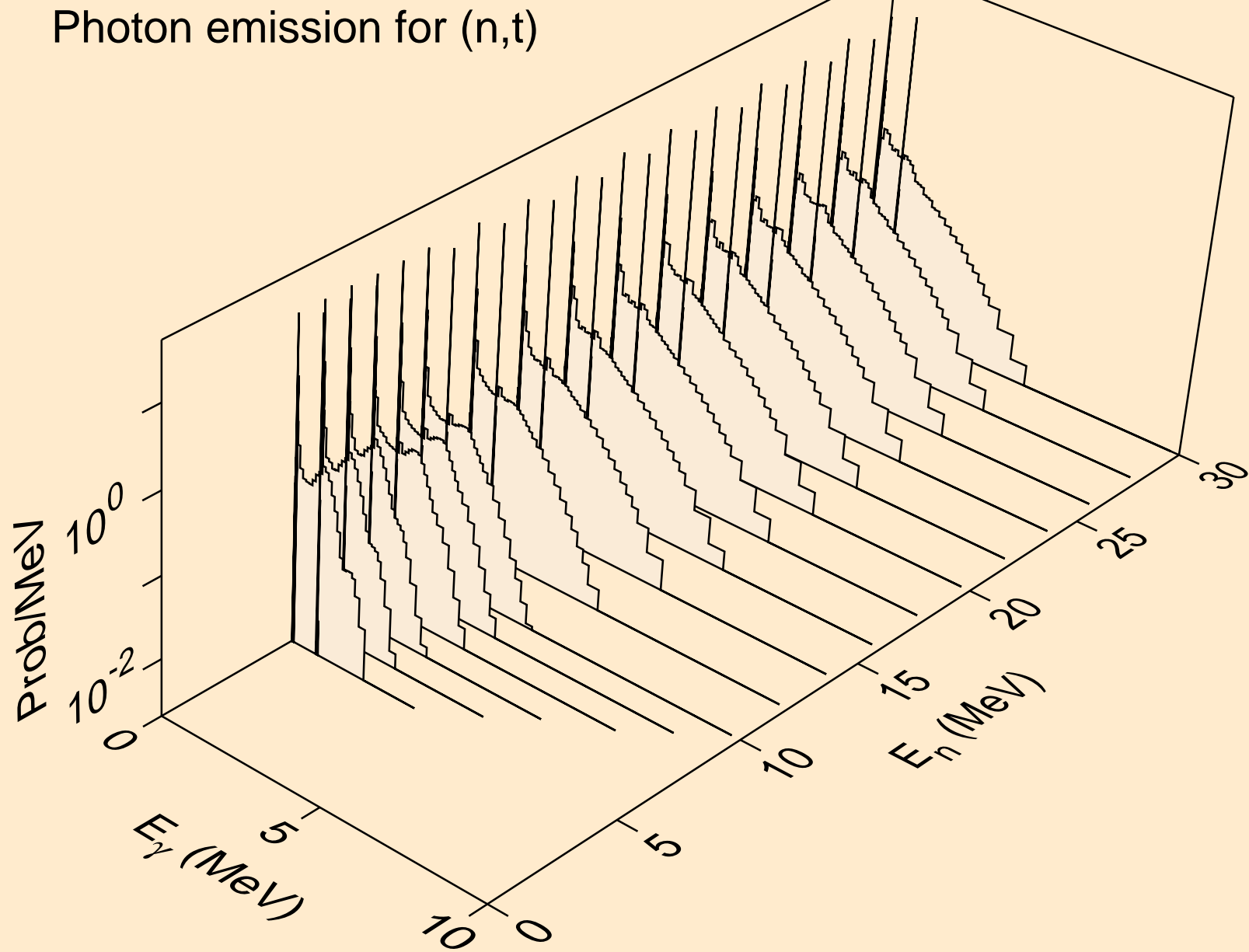



OS201 DEUTERON ACER TENDL-2023 LIBRARY; T=0.K  
Photon emission for (n,he3)

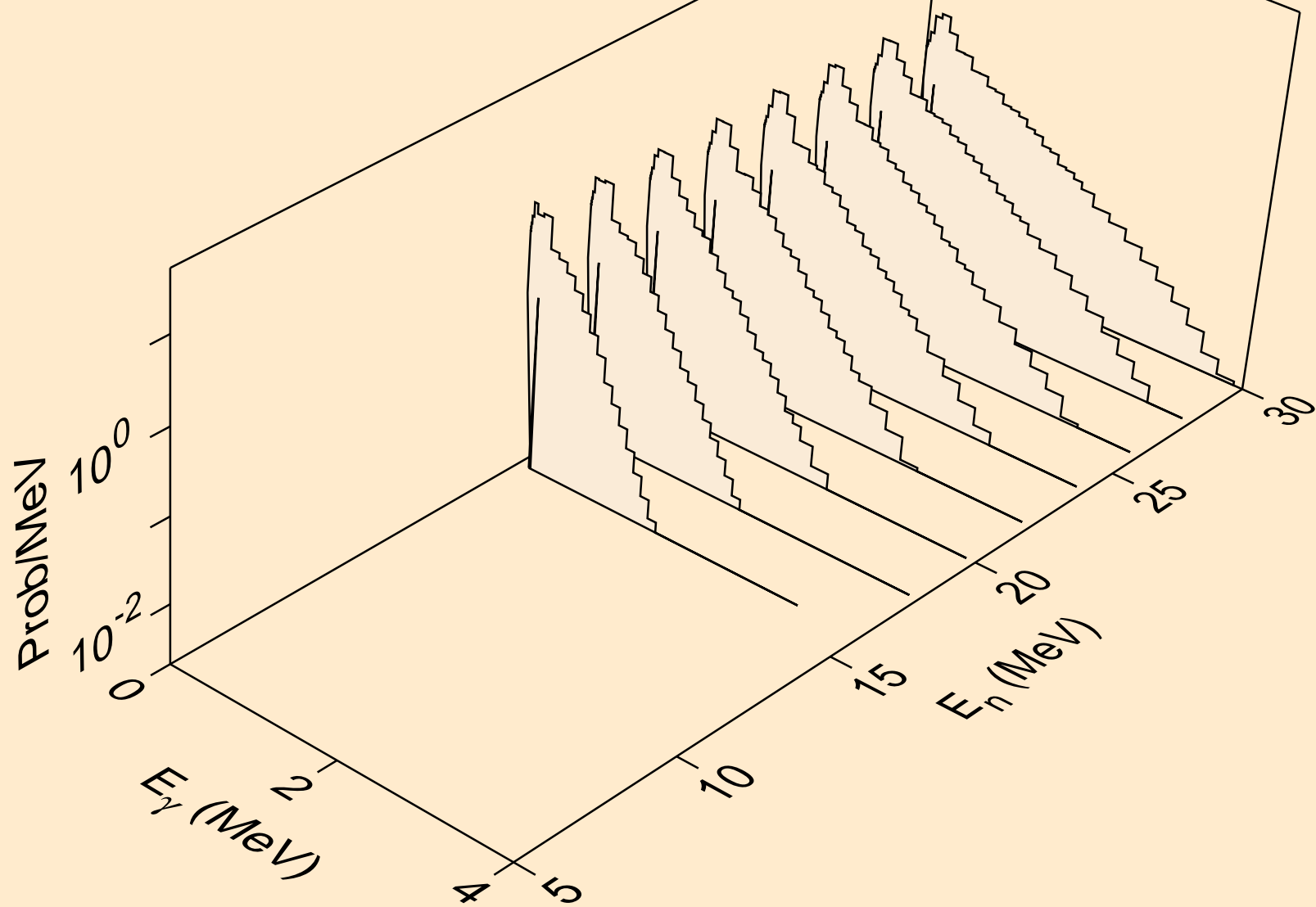

OS201 DEUTERON ACER TENDL-2023 LIBRARY; T=0.K  
Photon emission for (n,a)

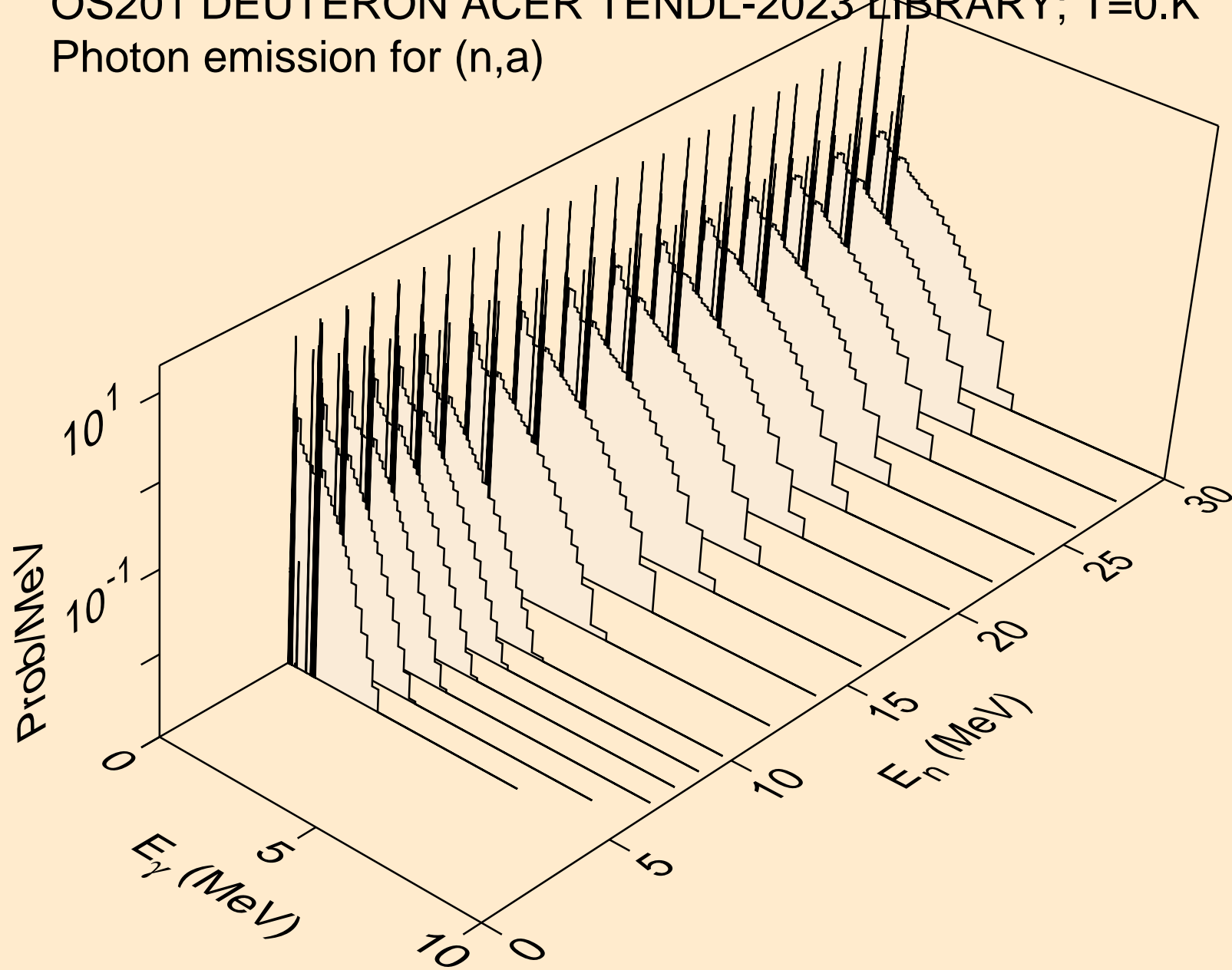

OS201 DEUTERON ACER TENDL-2023 LIBRARY; T=0.K  
Photon emission for (n,2p)

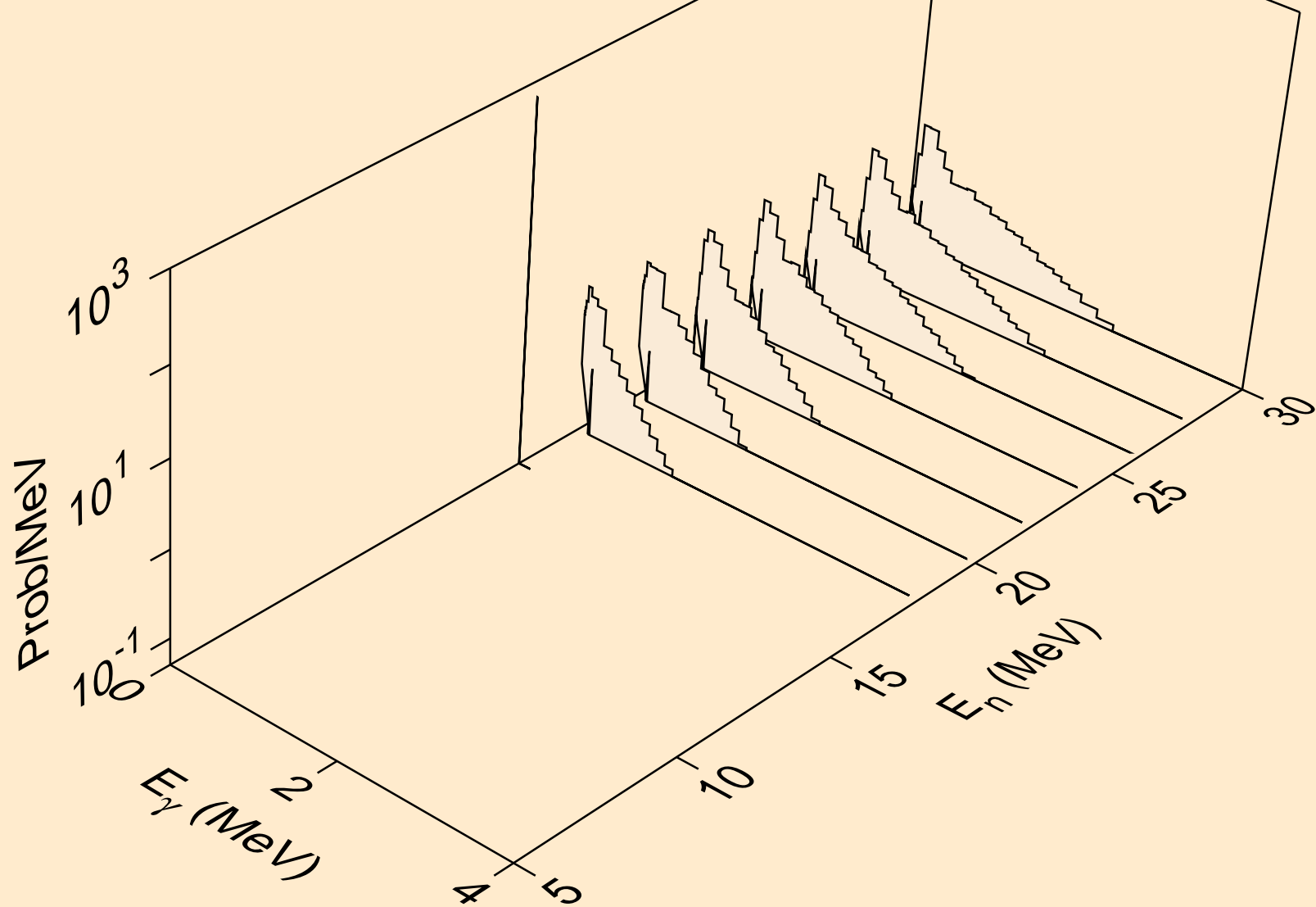

OS201 DEUTERON ACER TENDL-2023 LIBRARY; T=0.K  
Photon emission for (n,pd)

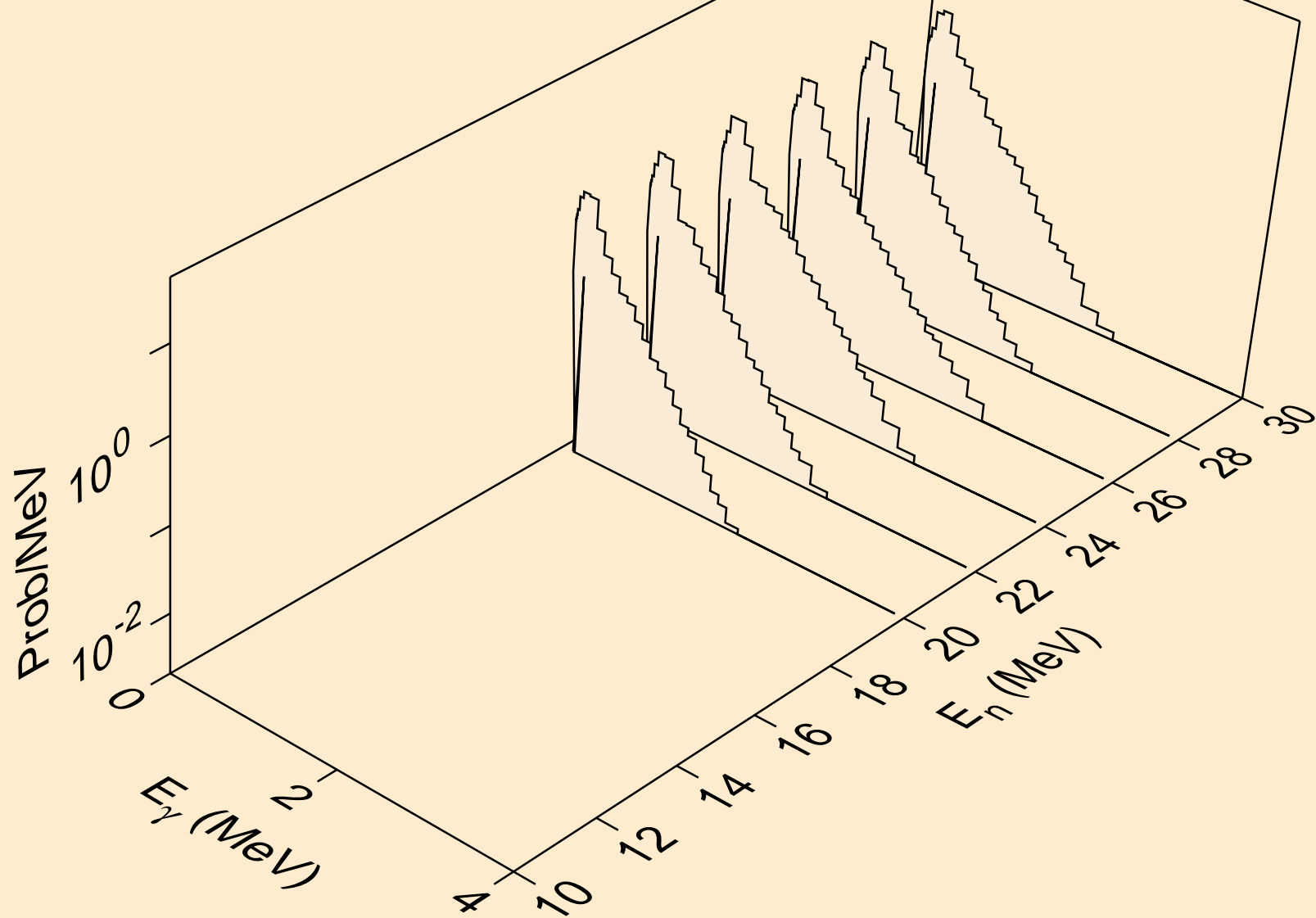

# OS201 DEUTERON ACER TENDL-2023 LIBRARY; T=0.K

## Particle heating contributions

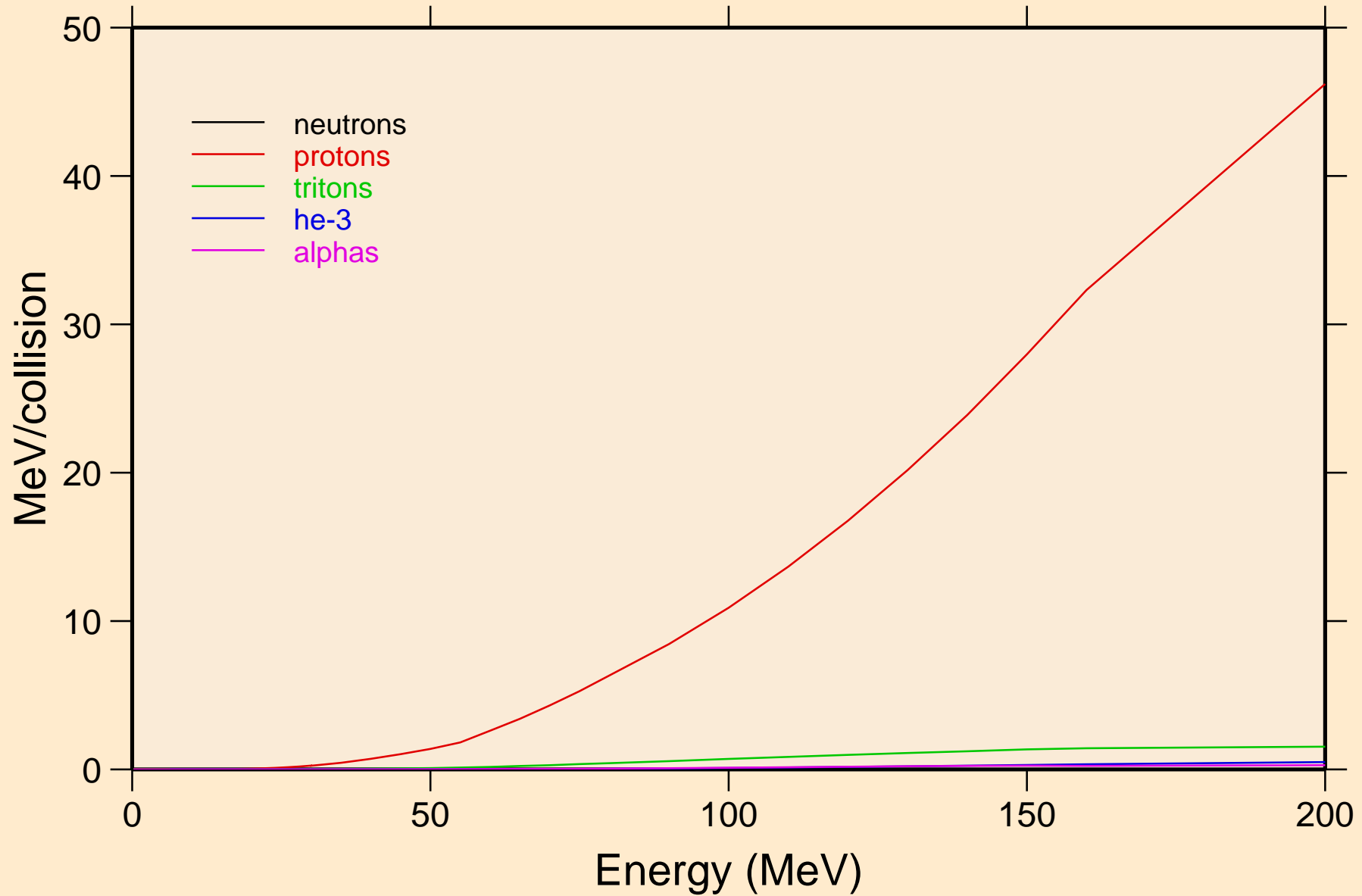

OS201 DEUTERON ACER TENDL-2023 LIBRARY; T=0.K  
Recoil Heating

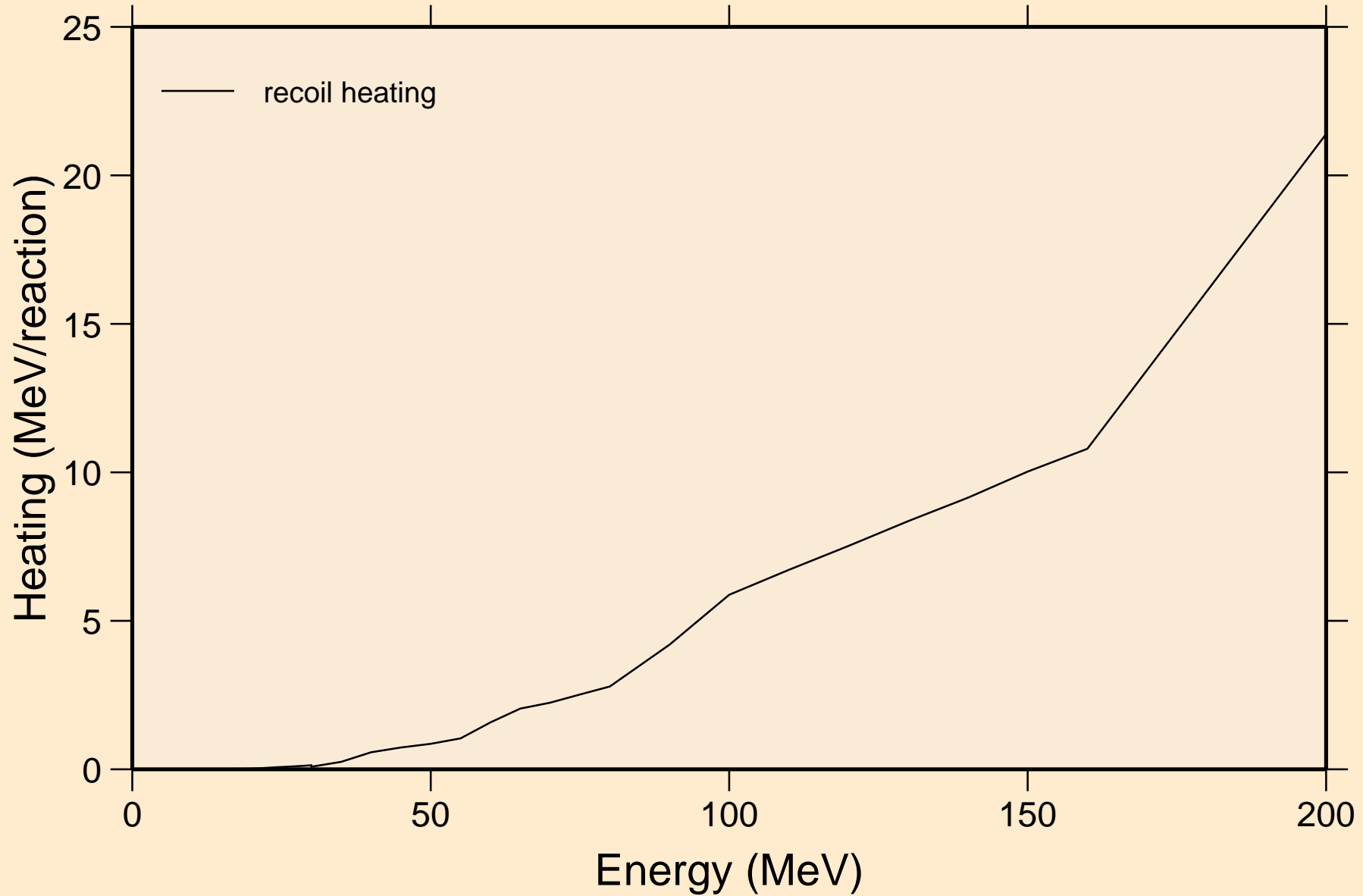

OS201 DEUTERON ACER TENDL-2023 LIBRARY; T=0.K  
Particle production cross sections

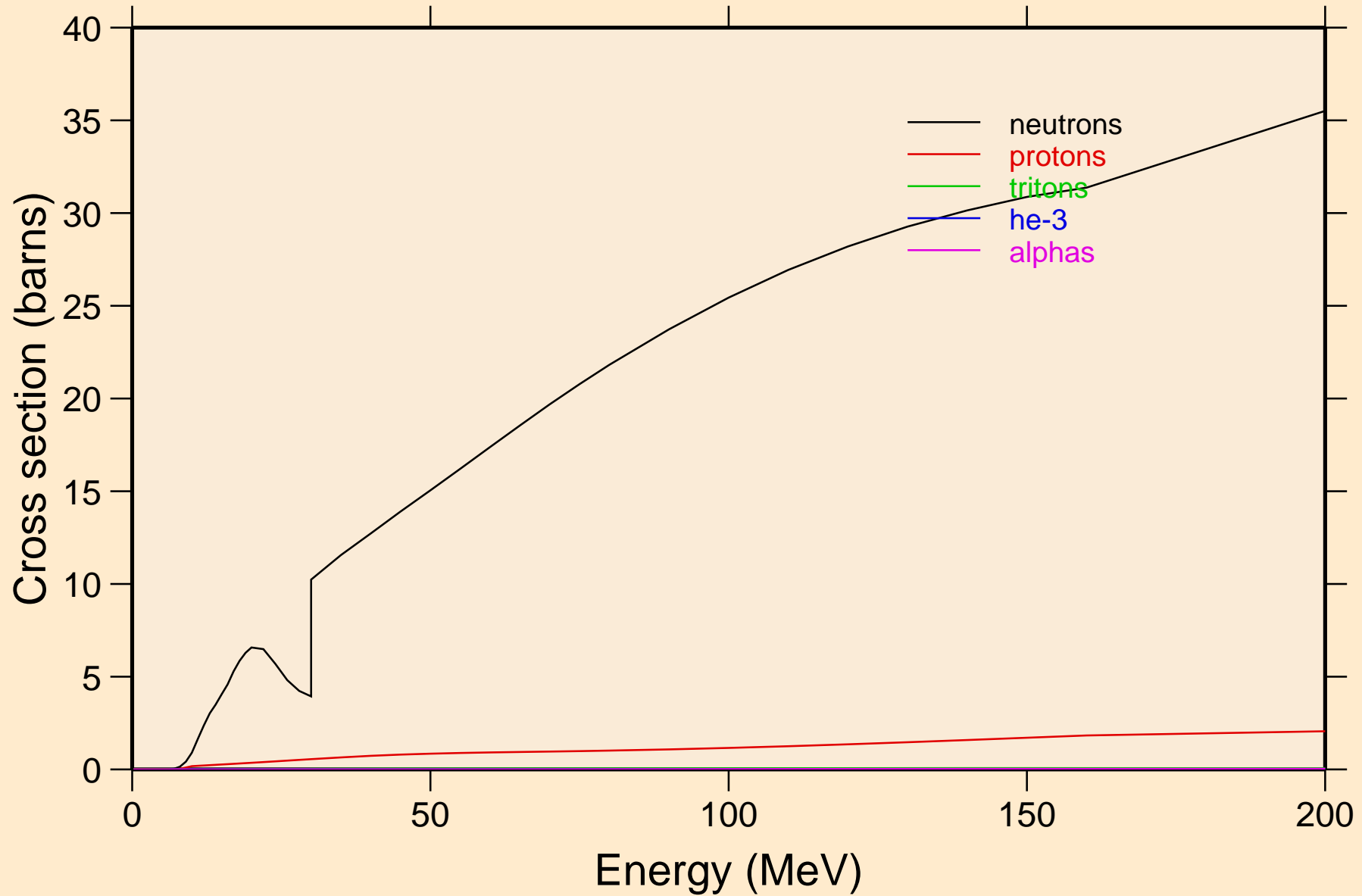

OS201 DEUTERON ACER TENDL-2023 LIBRARY; T=0.K  
neutrons from (d,n)

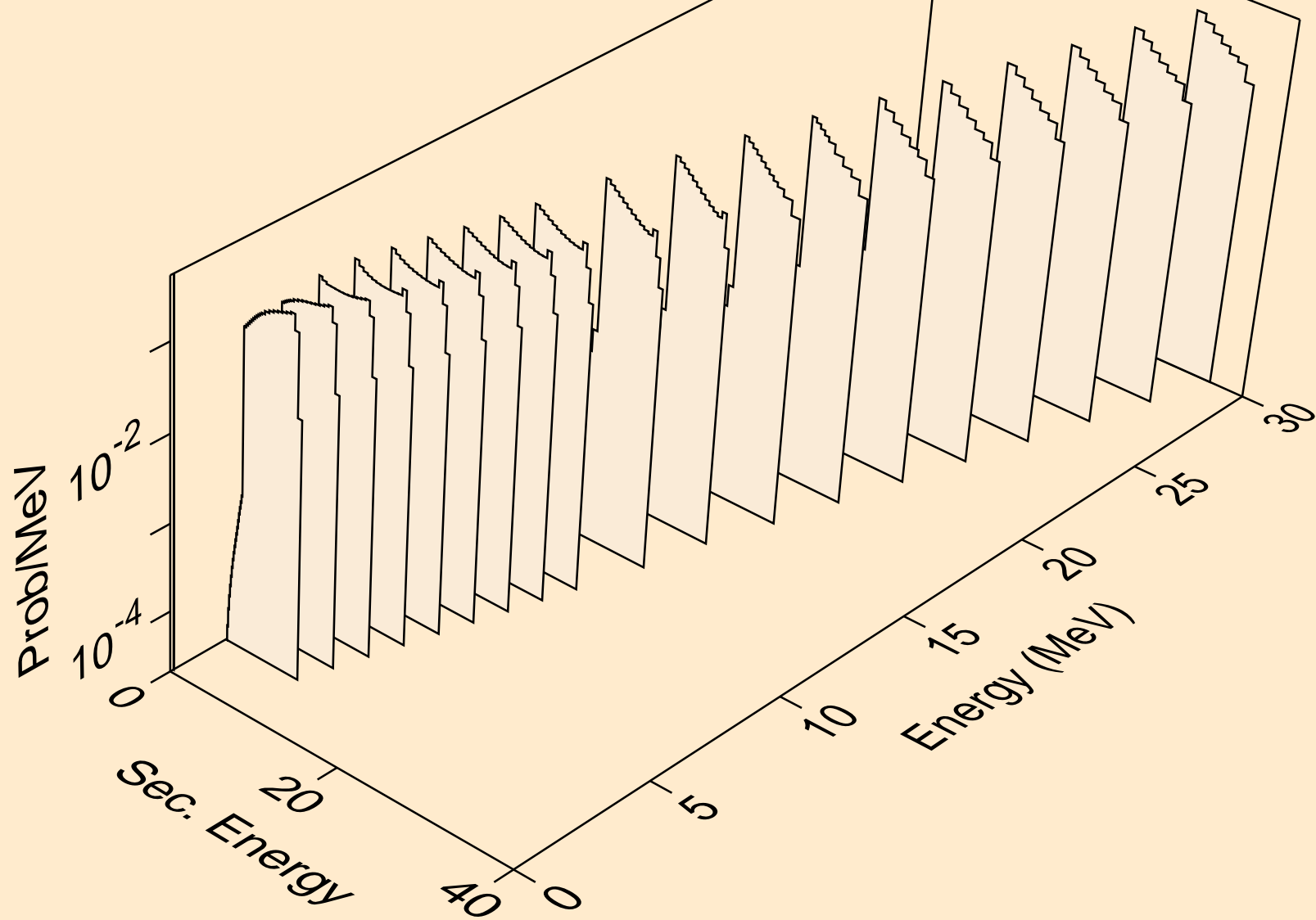



OS201 DEUTERON ACER TENDL-2023 LIBRARY; T=0.K  
neutrons from (d,x)

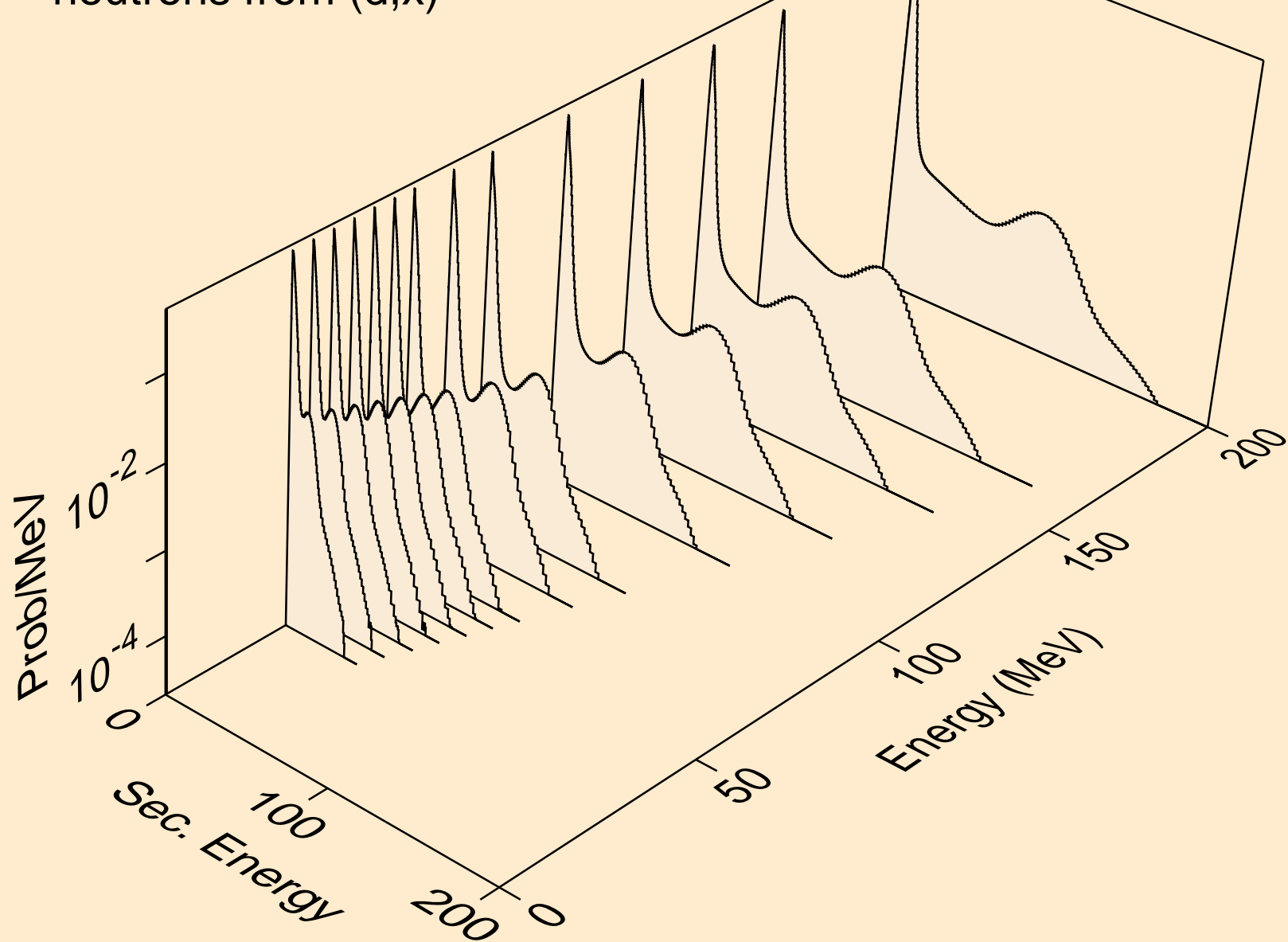

OS201 DEUTERON ACER TENDL-2023 LIBRARY; T=0.K  
neutrons from (d,2nd)

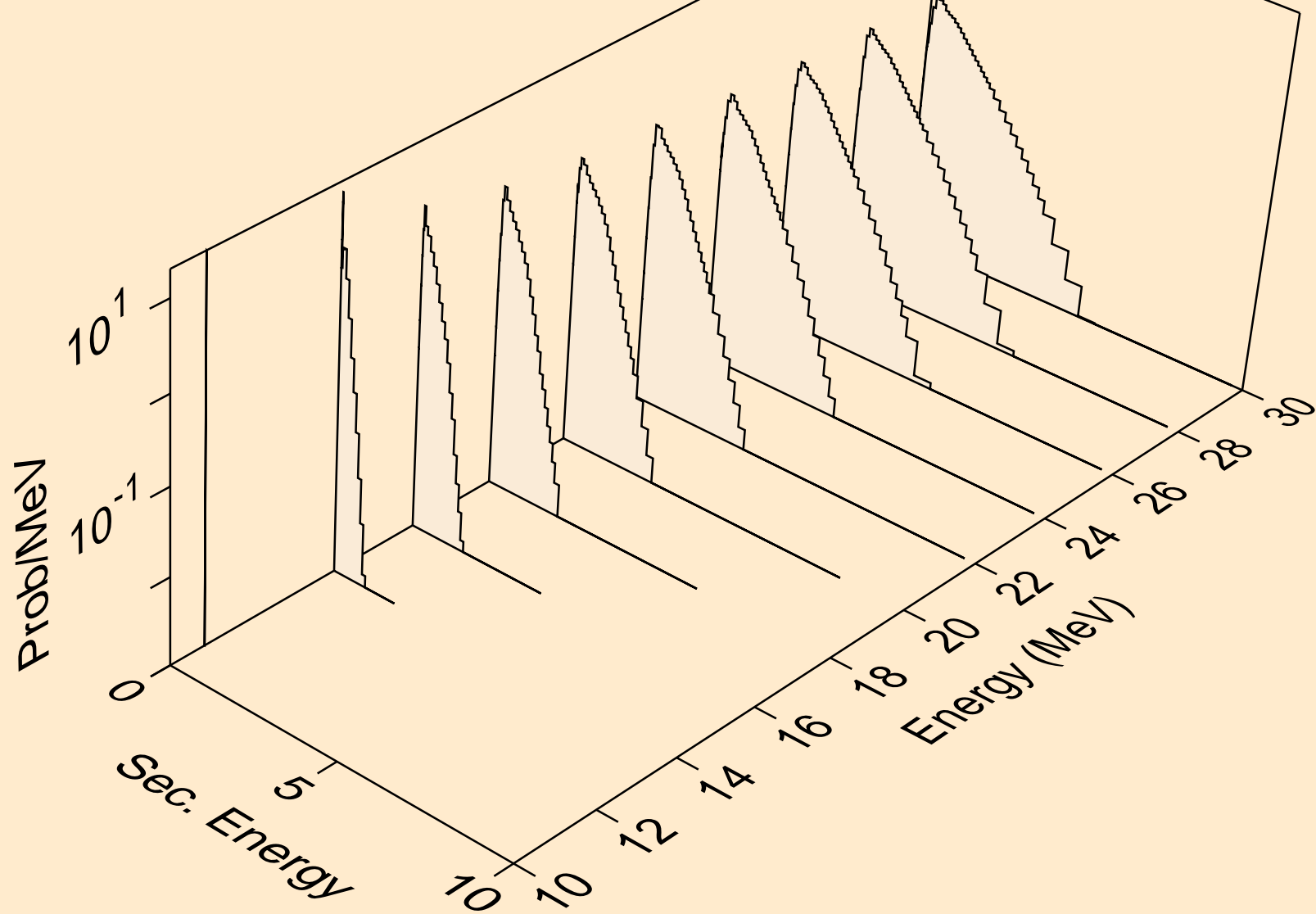

OS201 DEUTERON ACER TENDL-2023 LIBRARY; T=0.K  
neutrons from (d,2n)

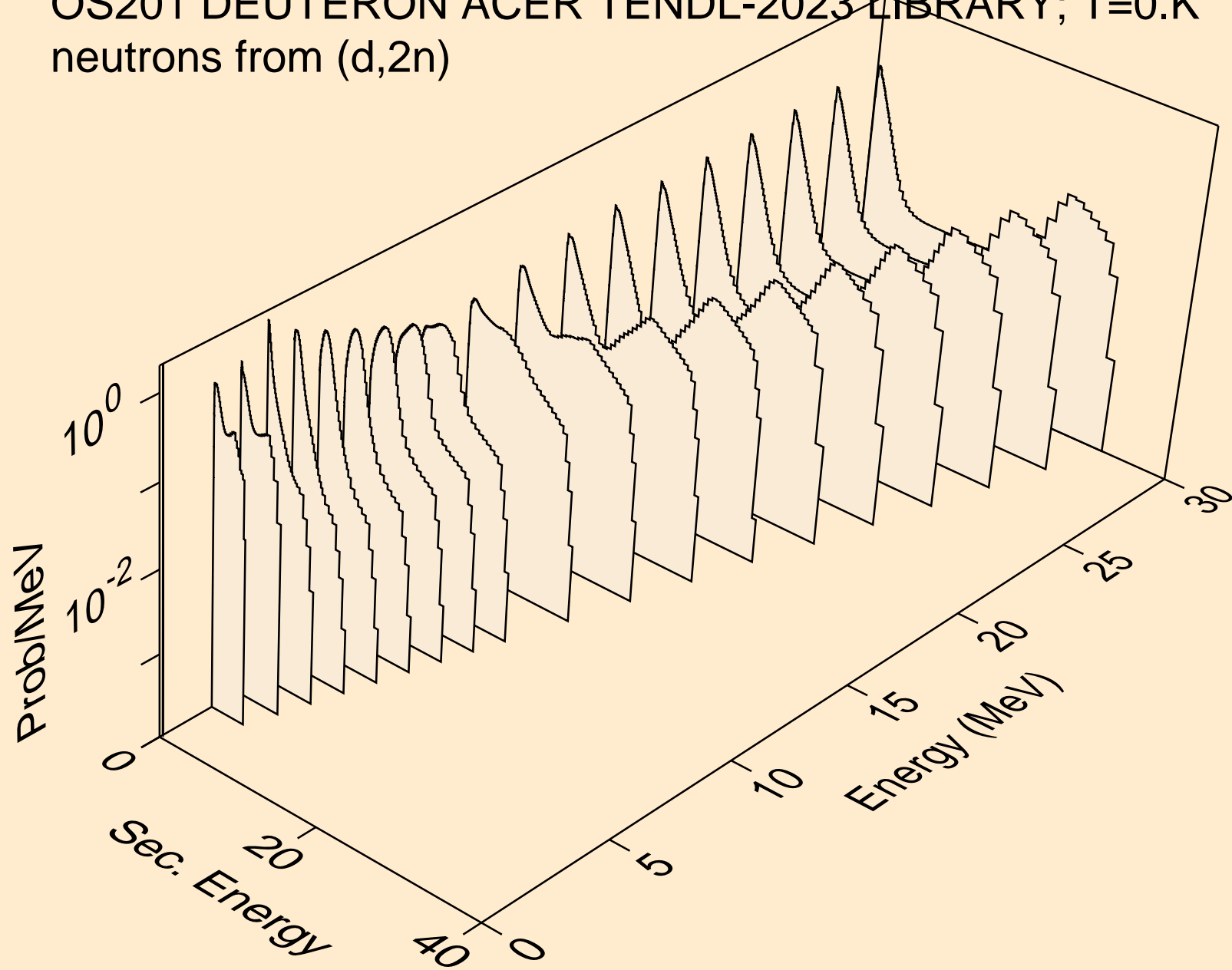

OS201 DEUTERON ACER TENDL-2023 LIBRARY; T=0.K  
neutrons from (d,3n)

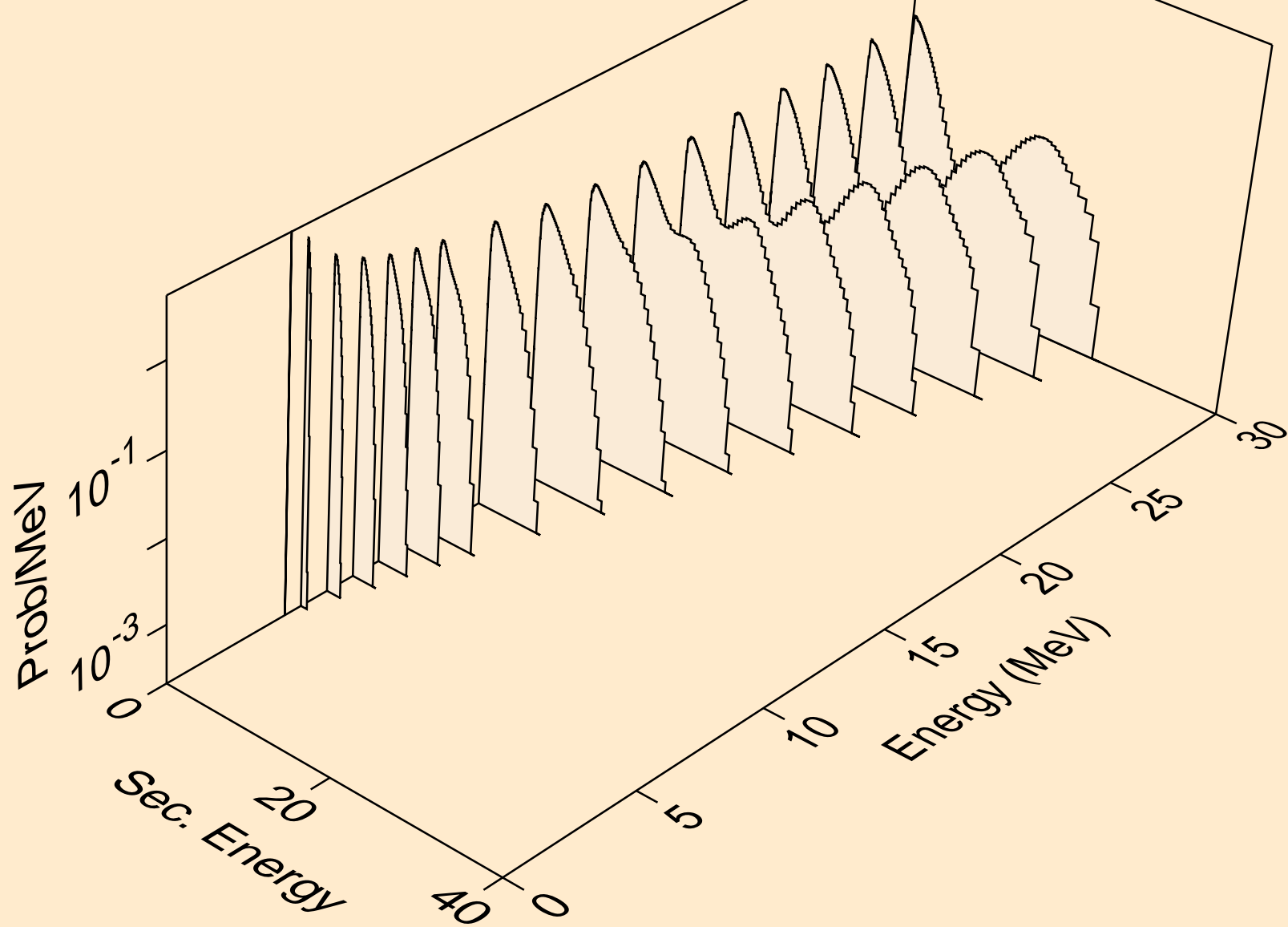

OS201 DEUTERON ACER TENDL-2023 LIBRARY; T=0.K  
neutrons from (d,n\*)a

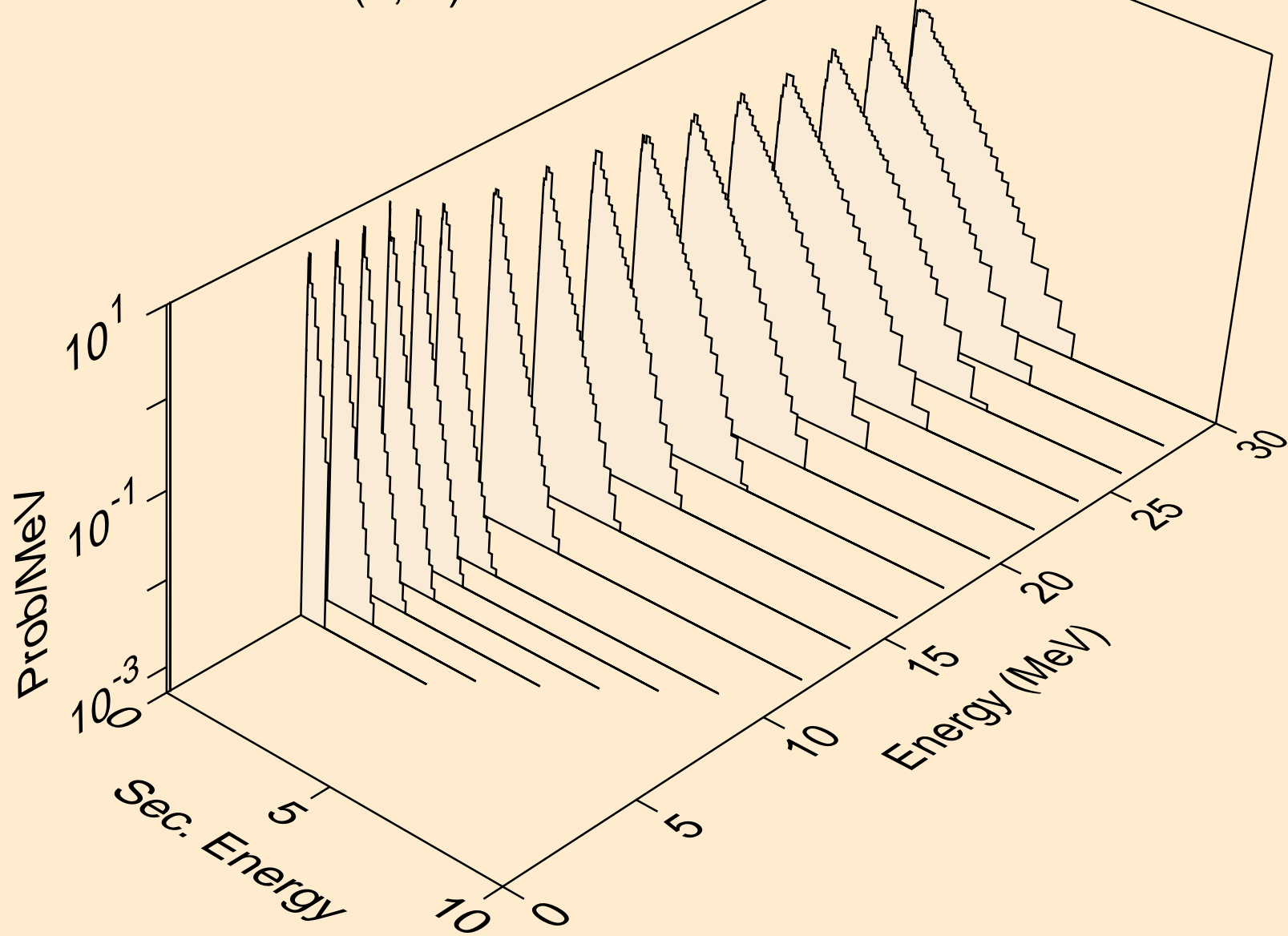

OS201 DEUTERON ACER TENDL-2023 LIBRARY; T=0.K  
neutrons from (d,2n)a

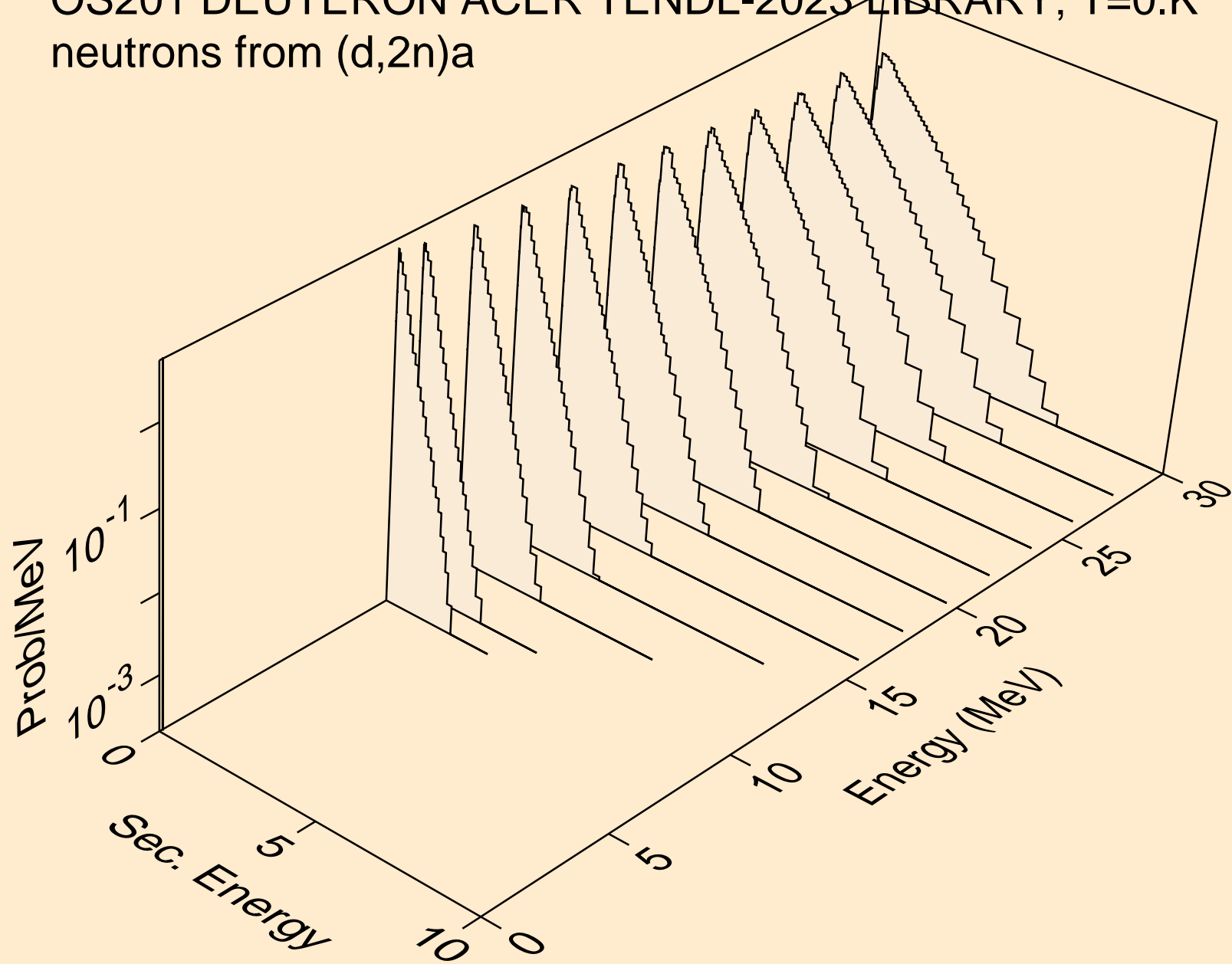

OS201 DEUTERON ACER TENDL-2023 LIBRARY; T=0.K  
neutrons from (d,3n)a

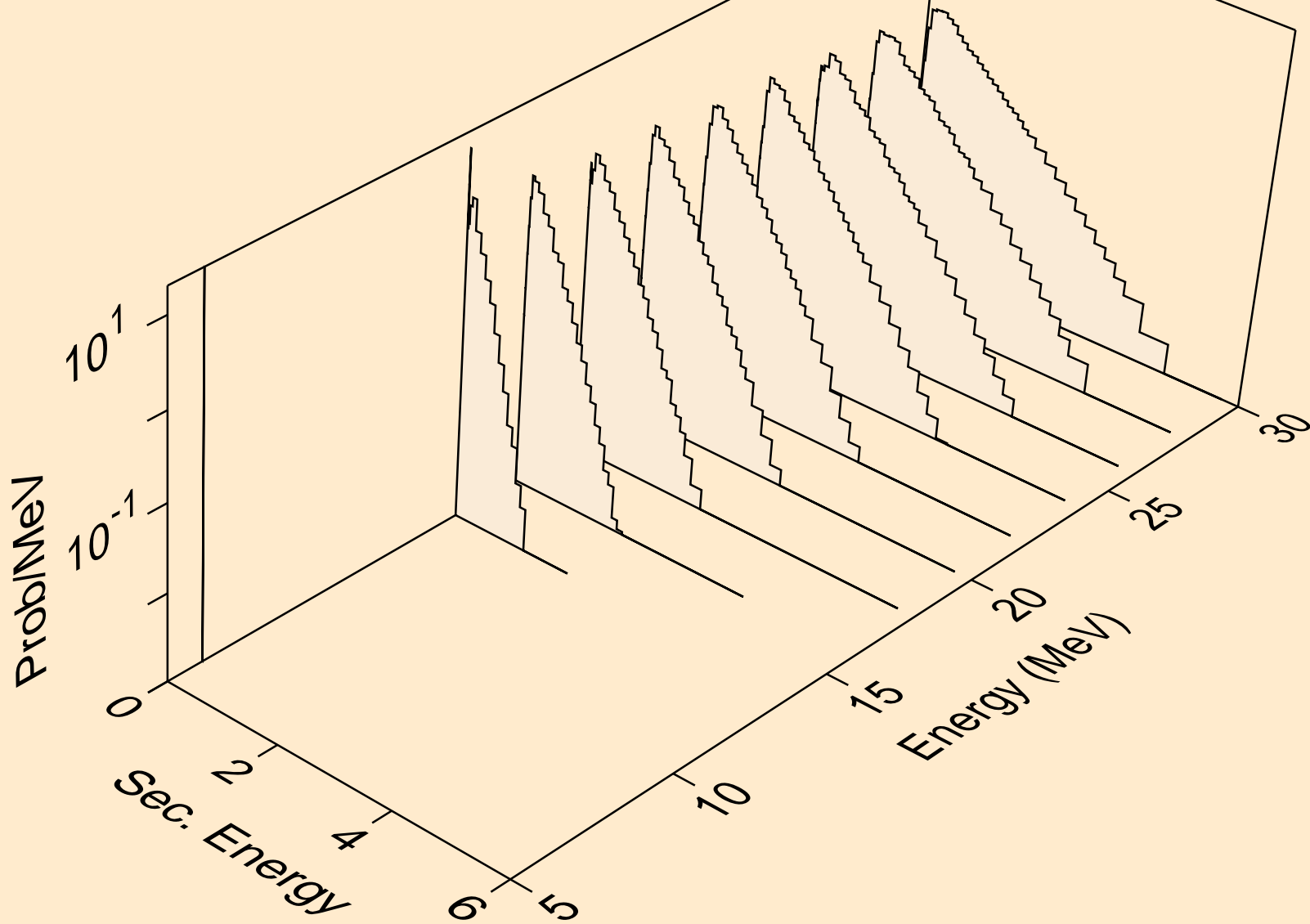

OS201 DEUTERON ACER TENDL-2023 LIBRARY; T=0.K  
neutrons from (d,n\*)p

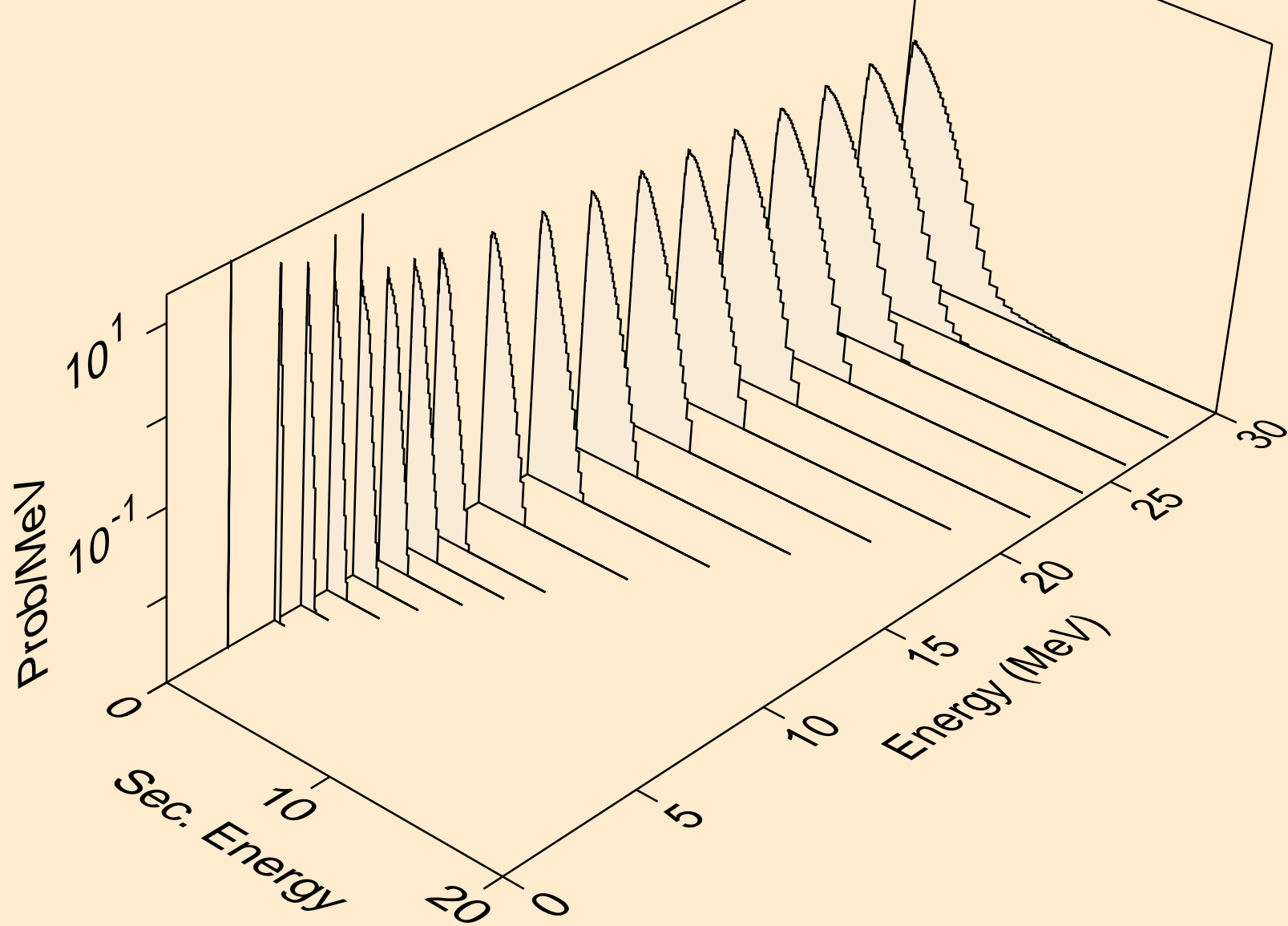



OS201 DEUTERON ACER TENDL-2023 LIBRARY; T=0.K  
neutrons from (d,n\*)d

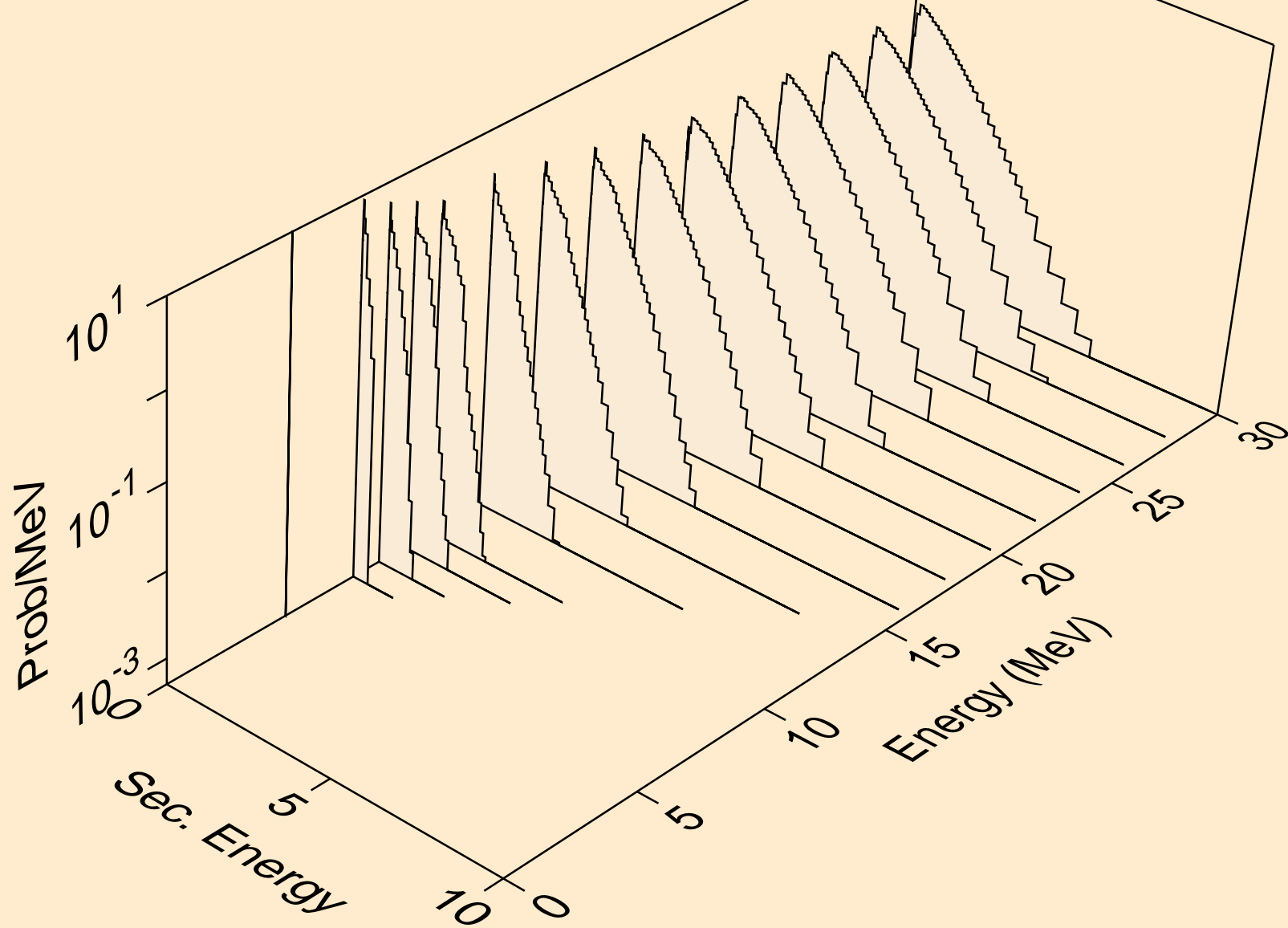

OS201 DEUTERON ACER TENDL-2023 LIBRARY; T=0.K  
neutrons from (d,n\*)t

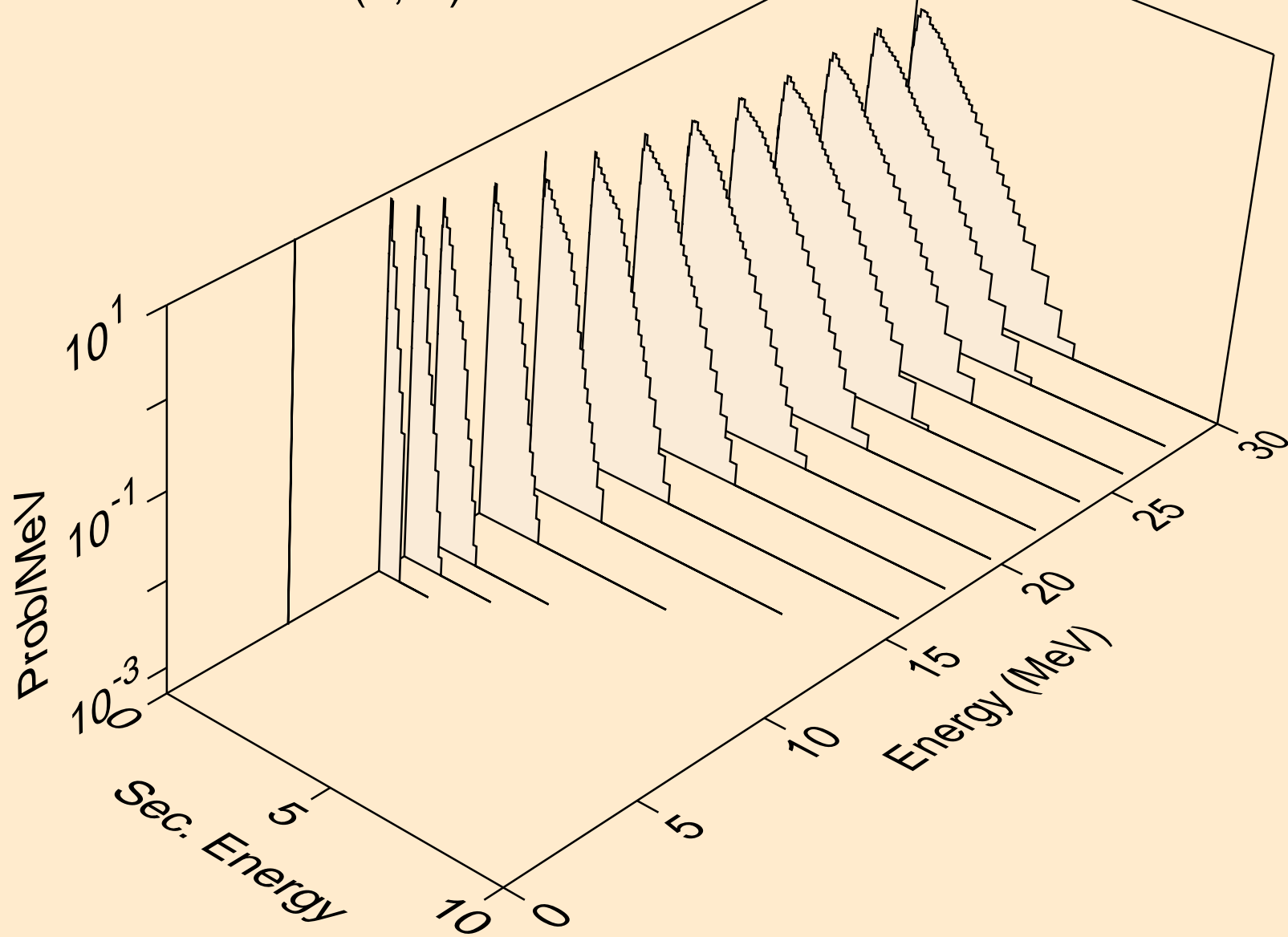

OS201 DEUTERON ACER TENDL-2023 LIBRARY; T=0.K  
neutrons from (d,n\*)he3

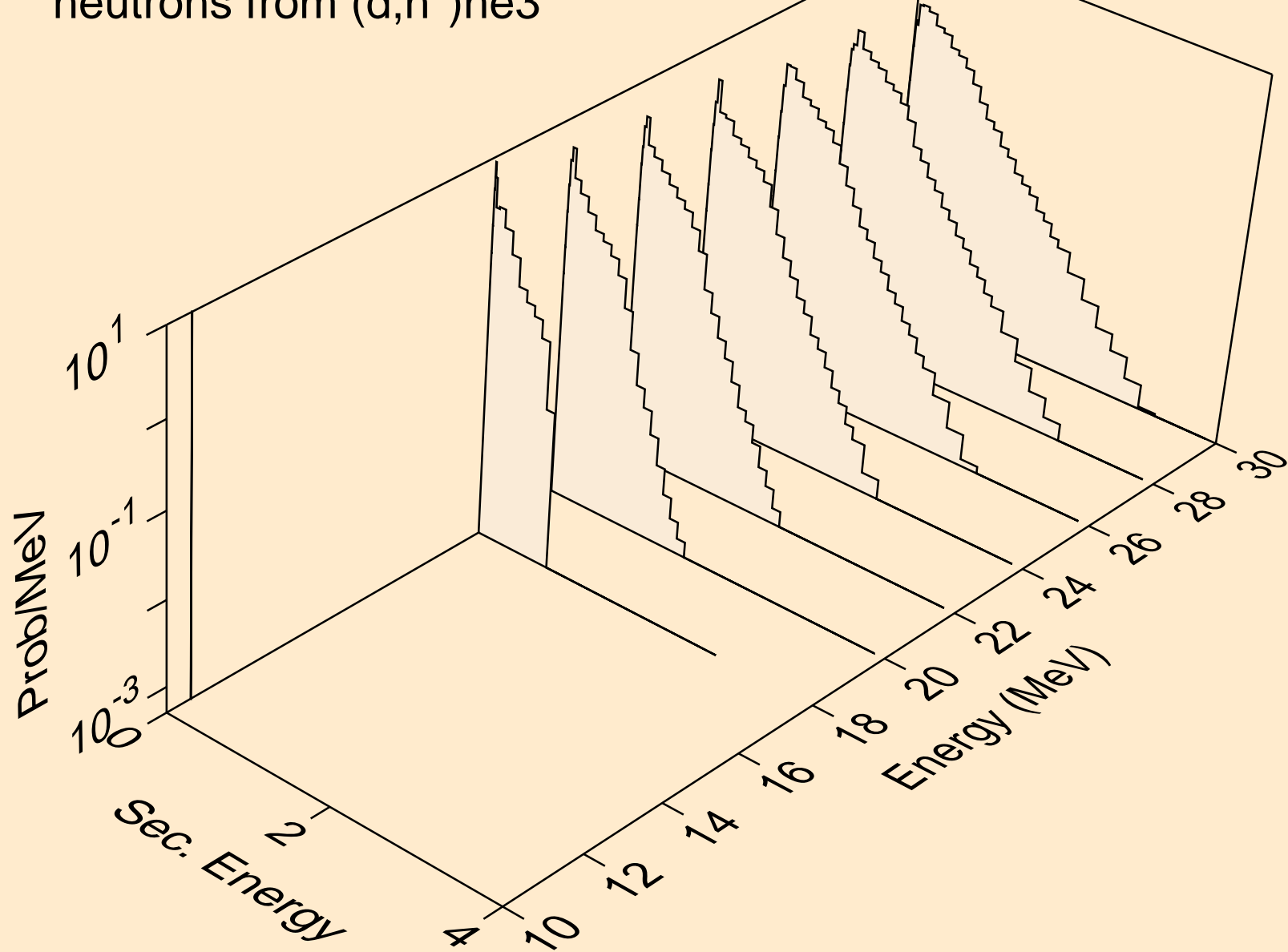

OS201 DEUTERON ACER TENDL-2023 LIBRARY; T=0.K  
neutrons from (d,4n)

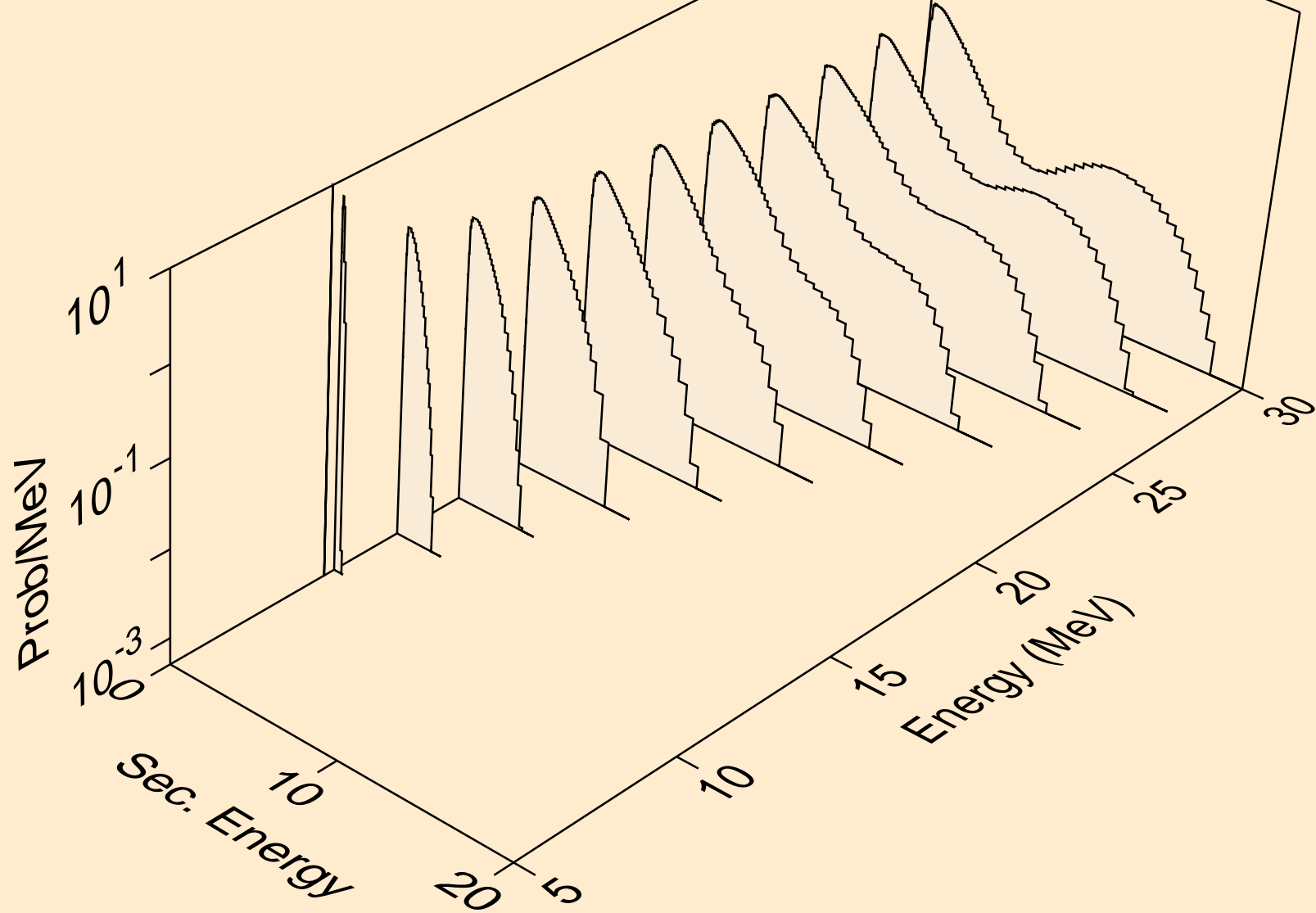

OS201 DEUTERON ACER TENDL-2023 LIBRARY; T=0.K  
neutrons from (d,2np)

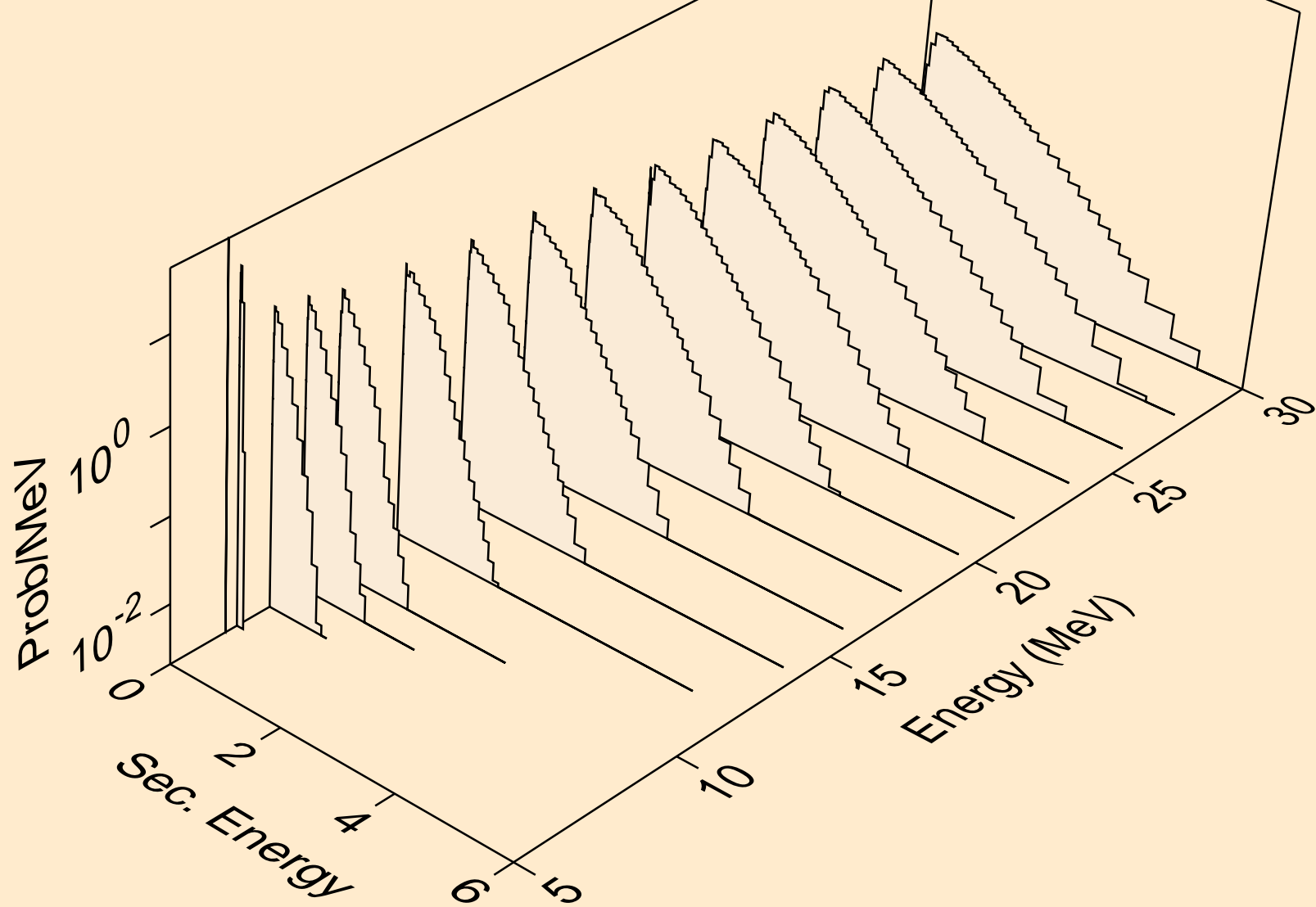

OS201 DEUTERON ACER TENDL-2023 LIBRARY; T=0.K  
neutrons from (d,3np)

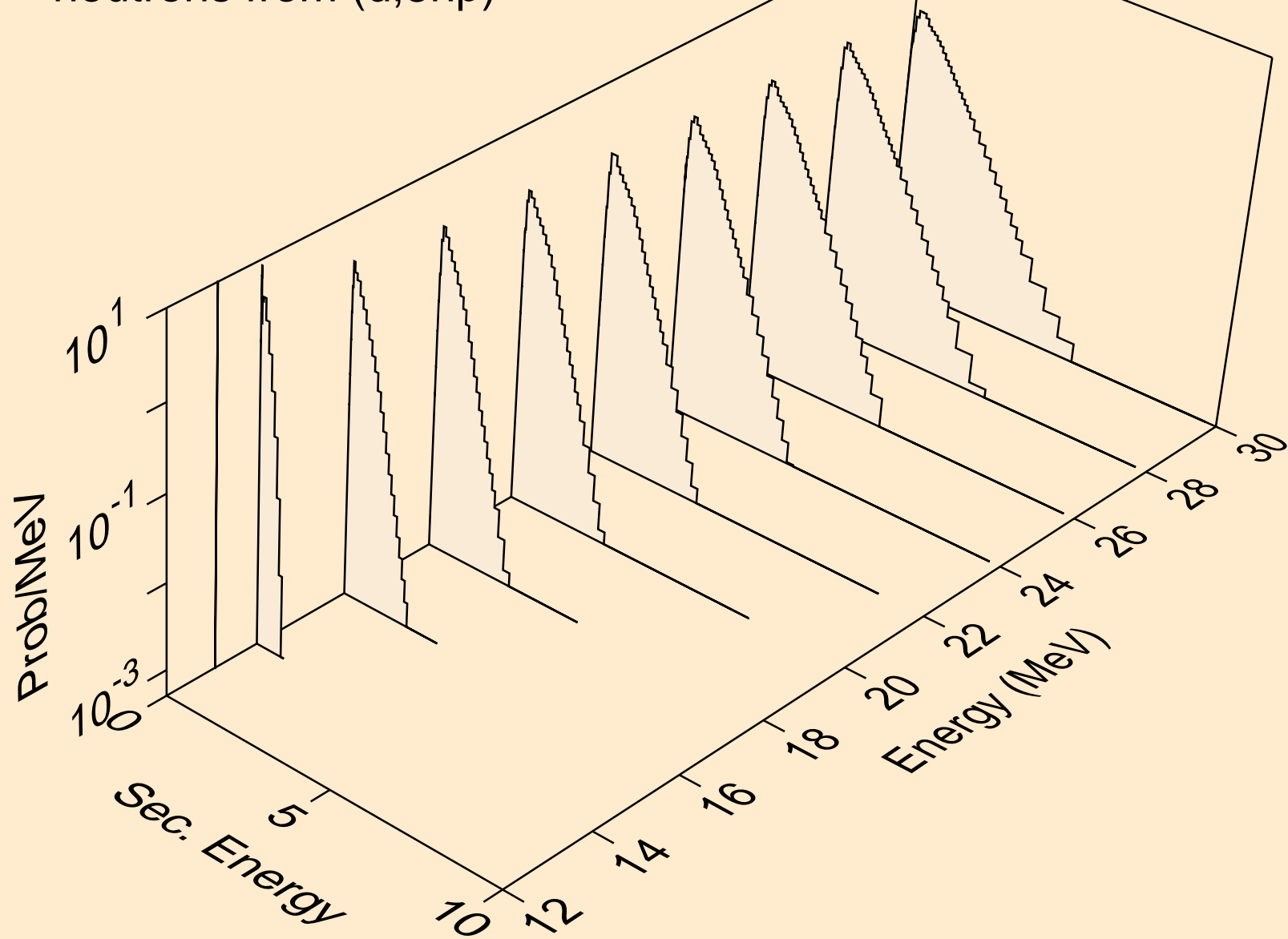

OS201 DEUTERON ACER TENDL-2023 LIBRARY; T=0.K  
neutrons from (d,n2p)

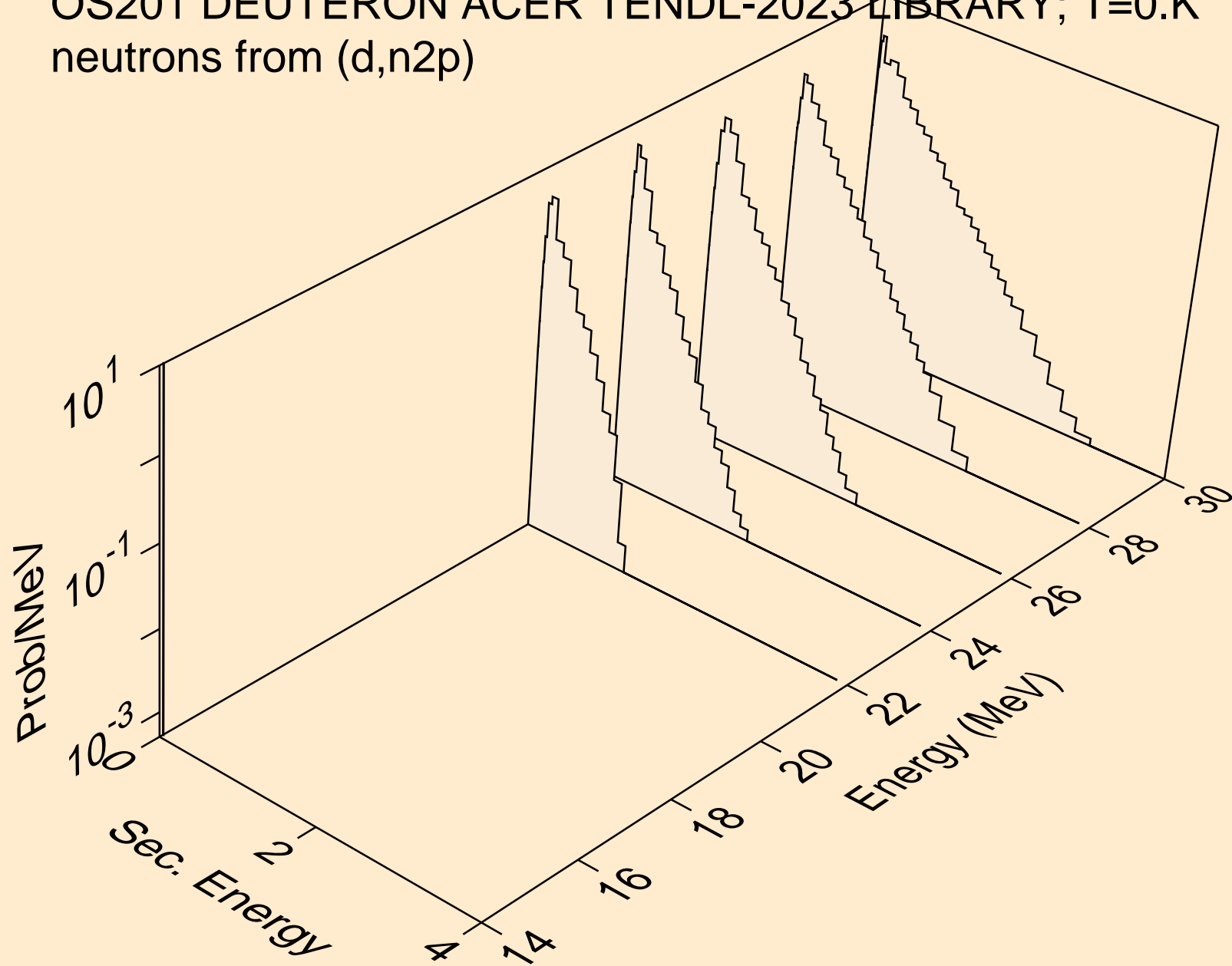

OS201 DEUTERON ACER TENDL-2023 LIBRARY; T=0.K  
protons from (d,x)

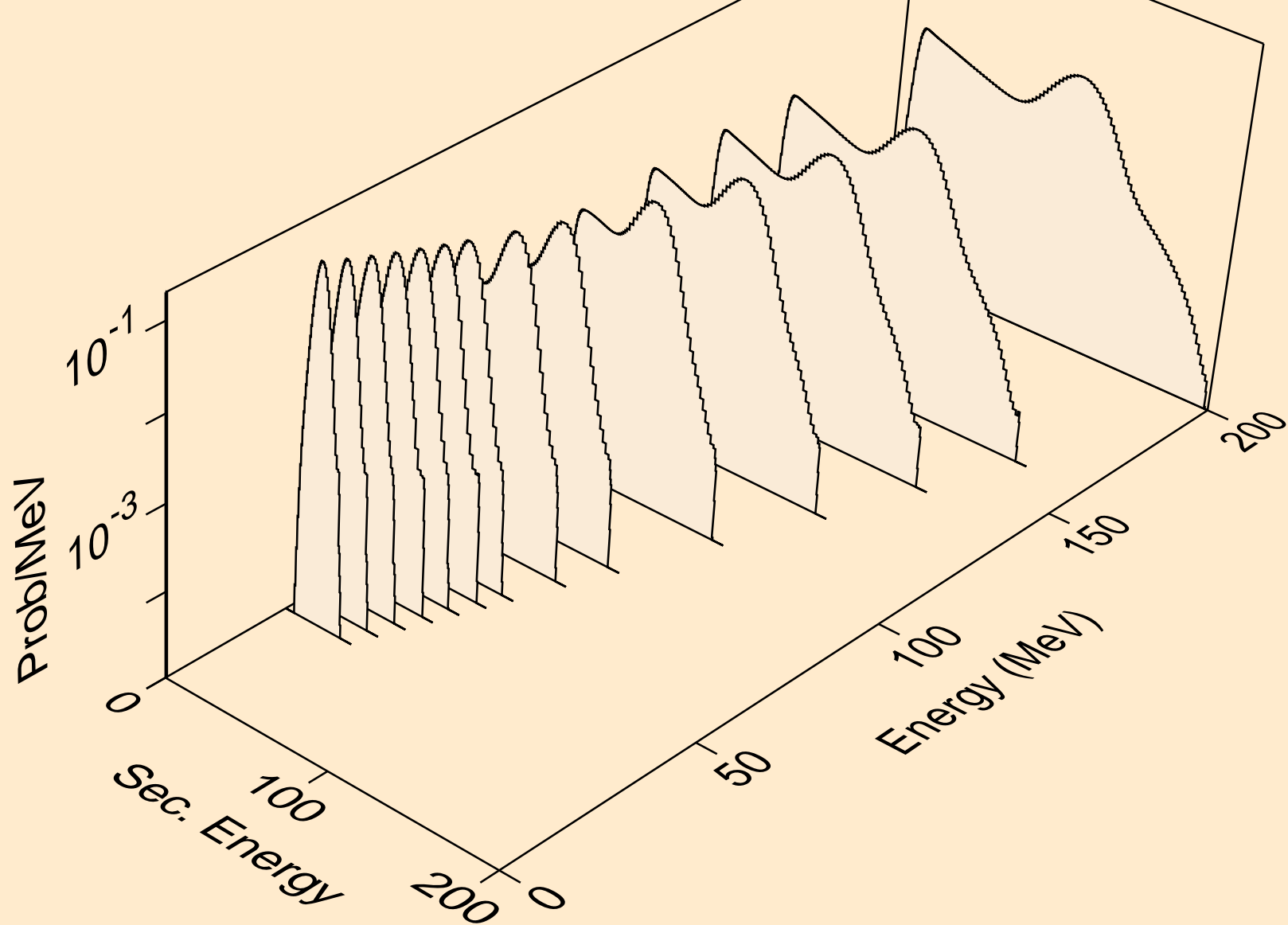



OS201 DEUTERON ACER TENDL-2023 LIBRARY; T=0.K  
protons from (d,n\*)p

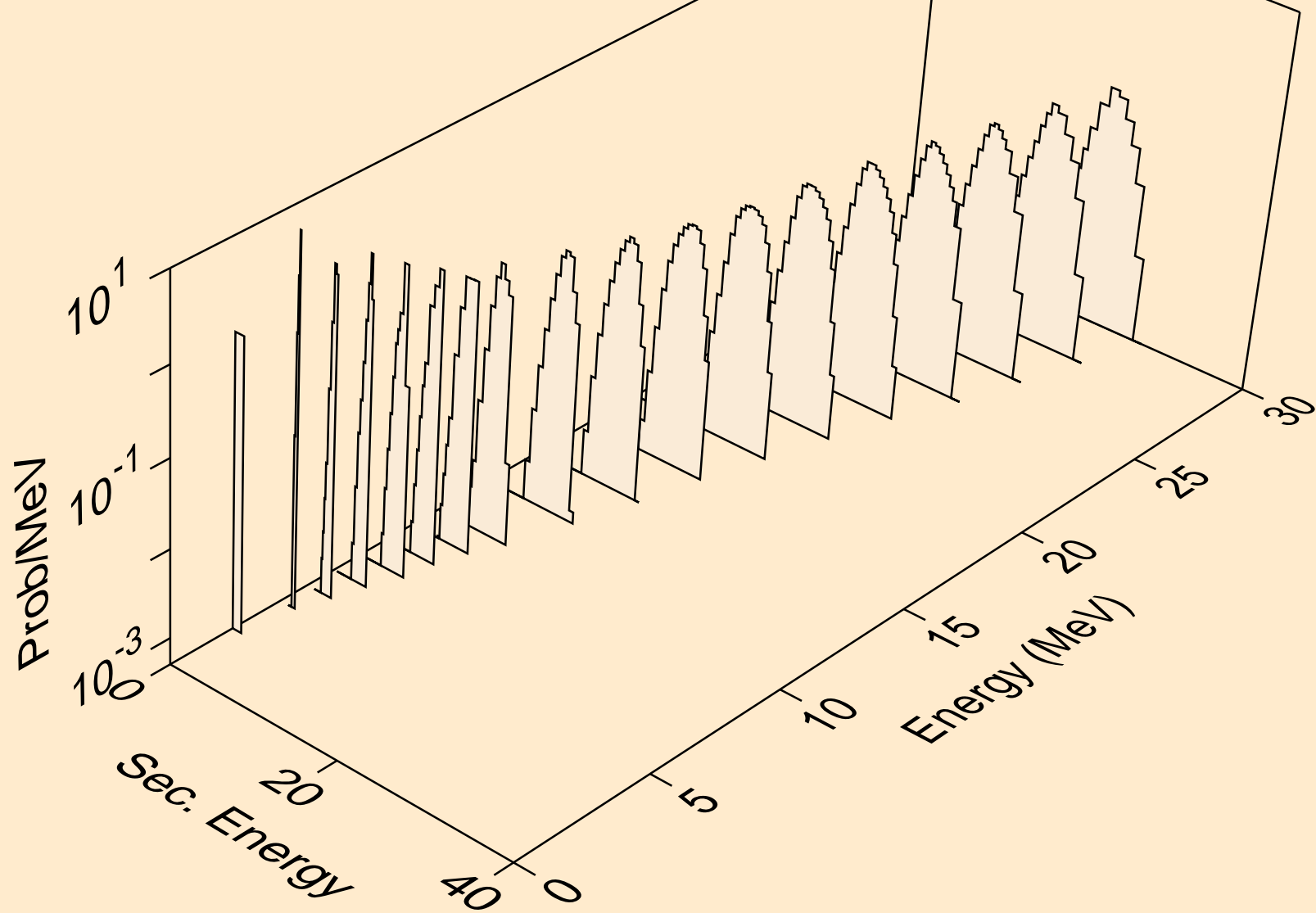

OS201 DEUTERON ACER TENDL-2023 LIBRARY; T=0.K  
protons from (d,2np)

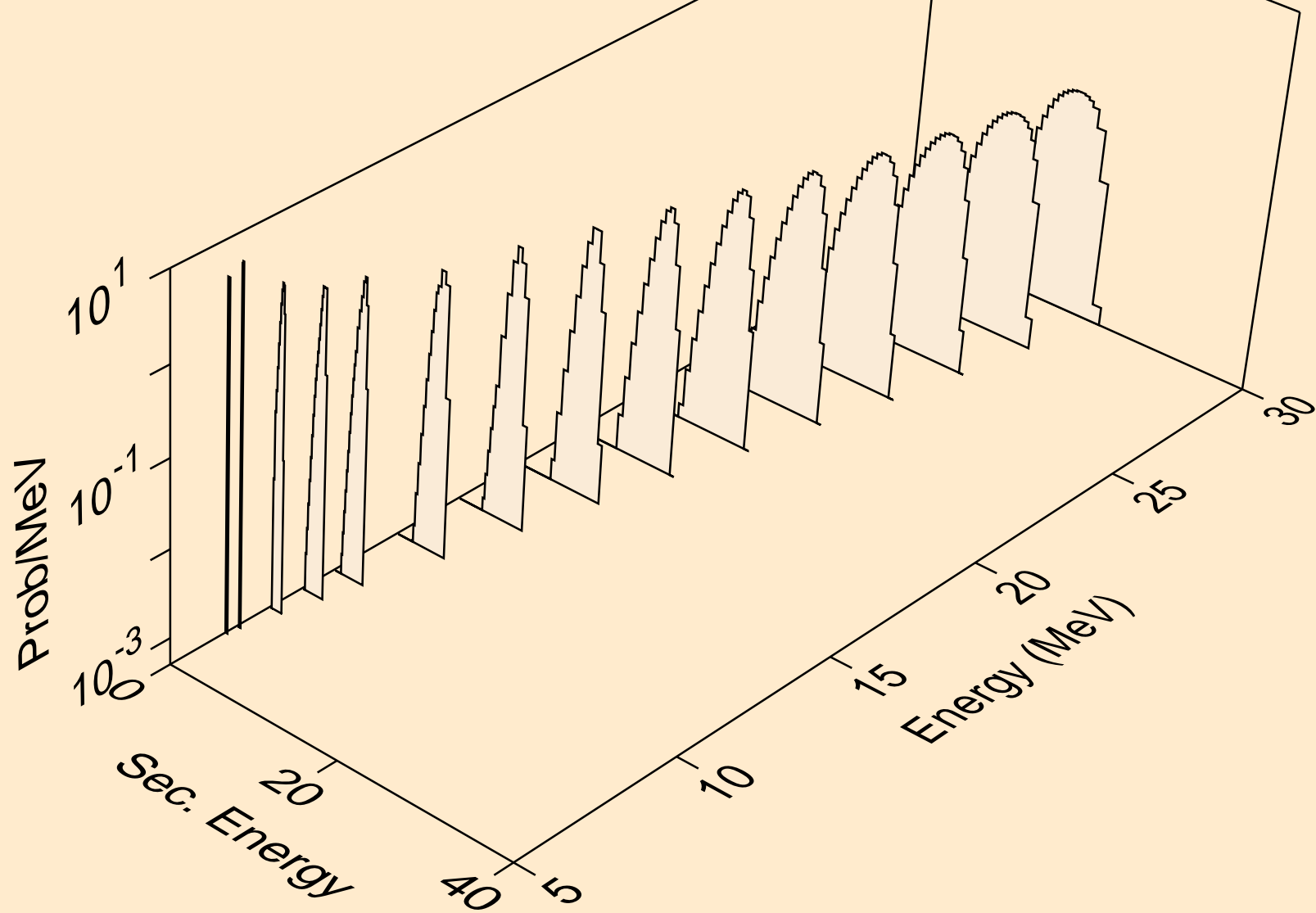

OS201 DEUTERON ACER TENDL-2023 LIBRARY; T=0.K  
protons from (d,3np)

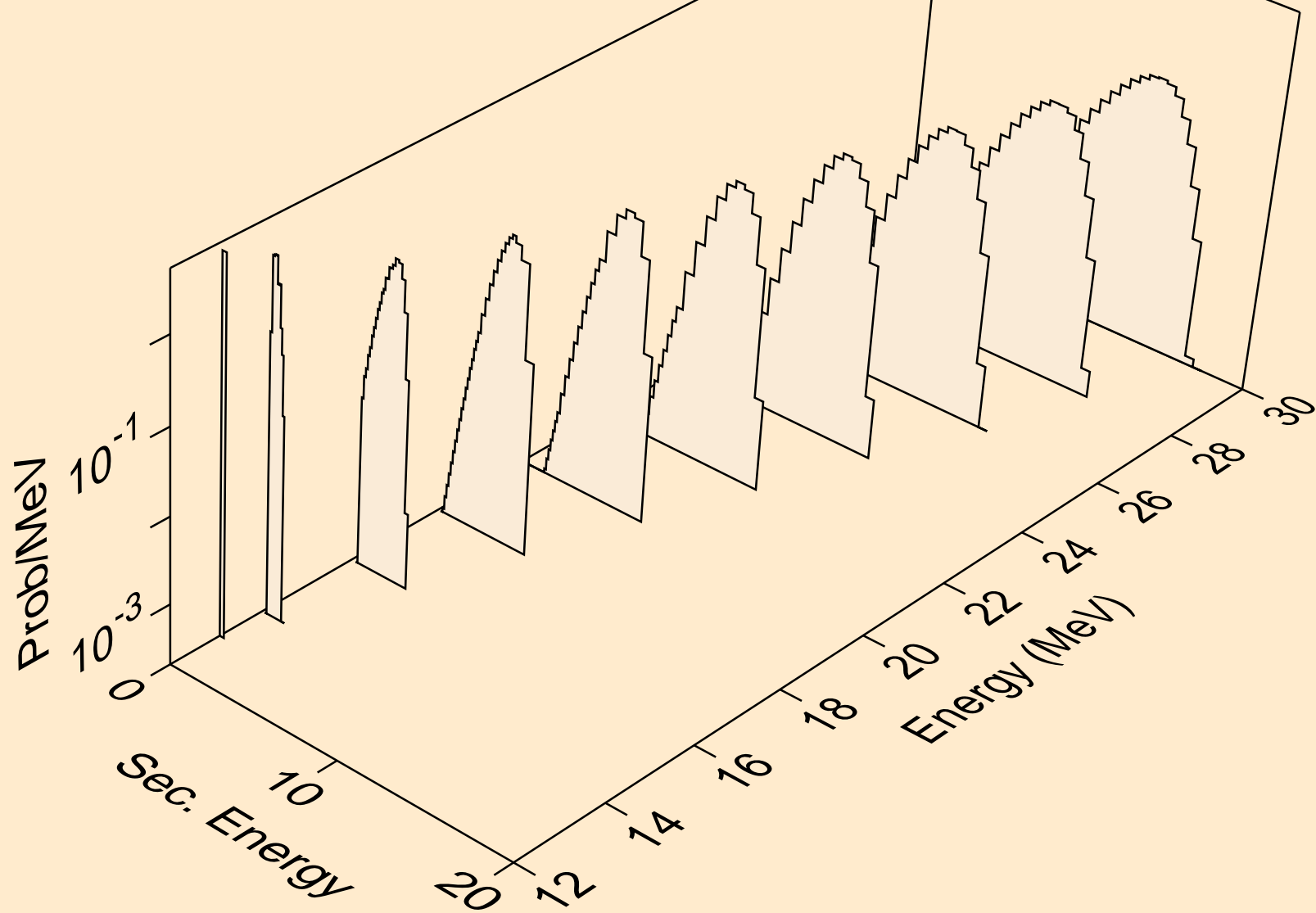

OS201 DEUTERON ACER TENDL-2023 LIBRARY; T=0.K  
protons from (d,n2p)

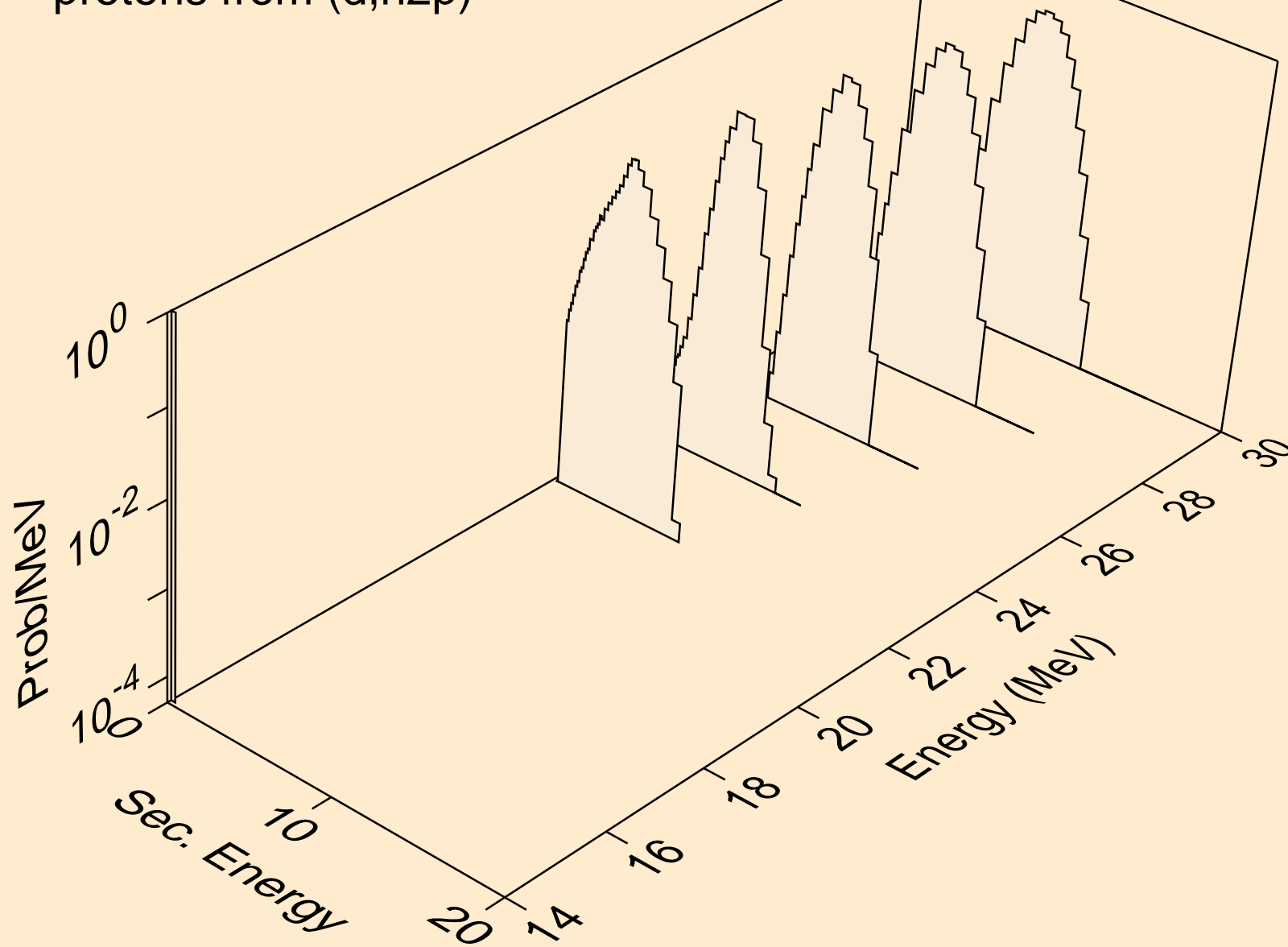

OS201 DEUTERON ACER TENDL-2023 LIBRARY; T=0.K  
protons from (d,p)

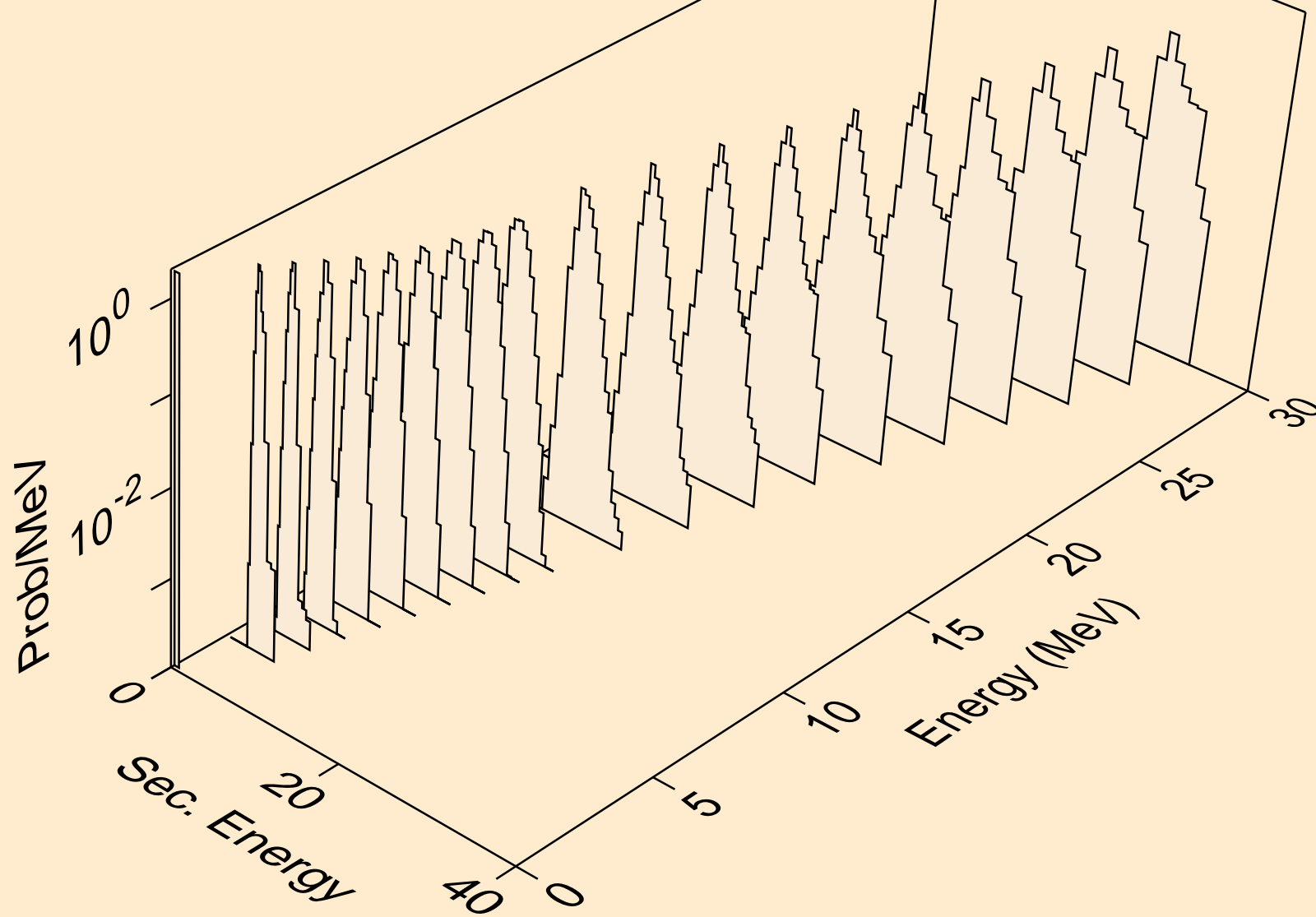

OS201 DEUTERON ACER TENDL-2023 LIBRARY; T=0.K  
protons from (d,2p)

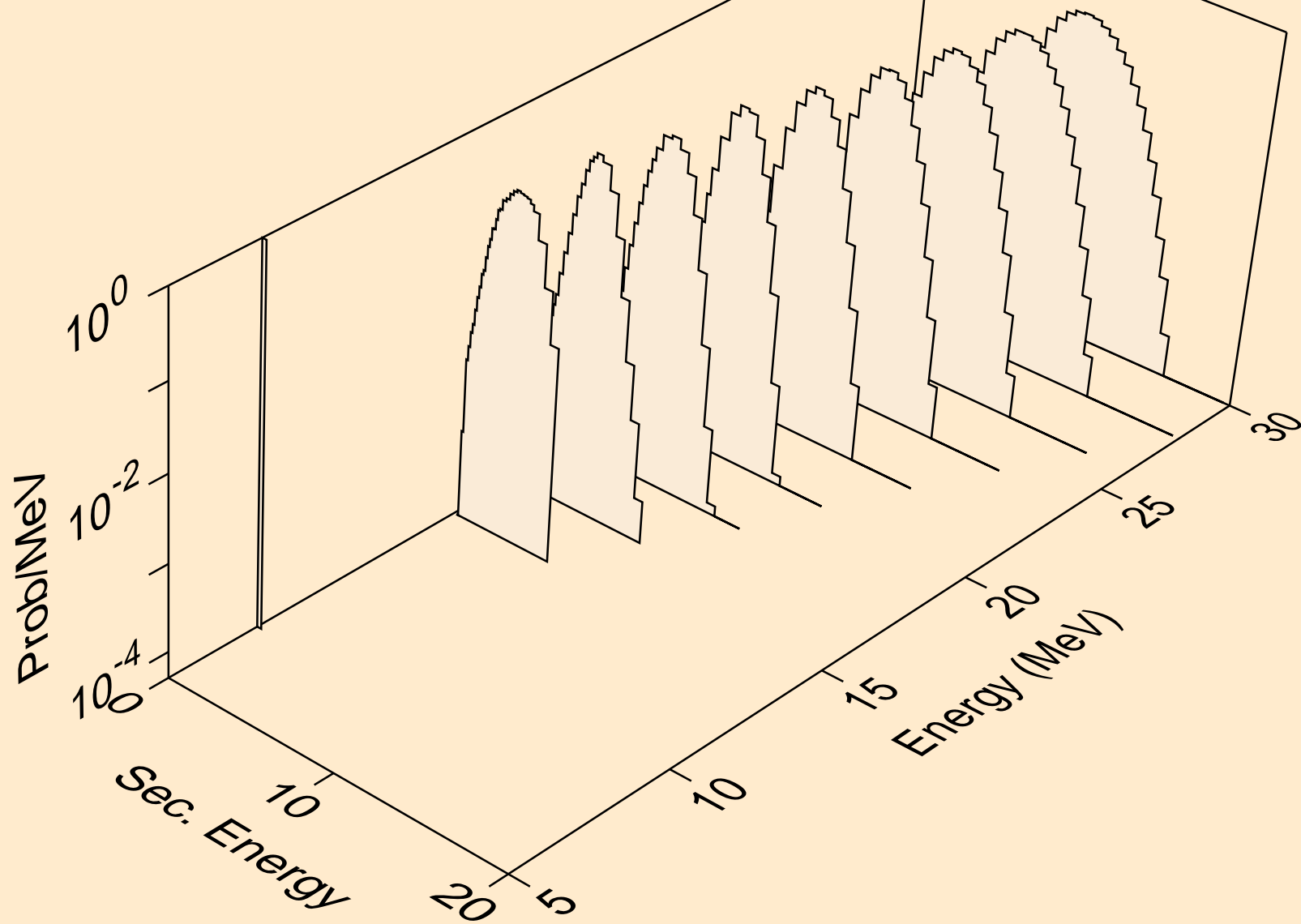

OS201 DEUTERON ACER TENDL-2023 LIBRARY; T=0.K  
protons from (d,pd)

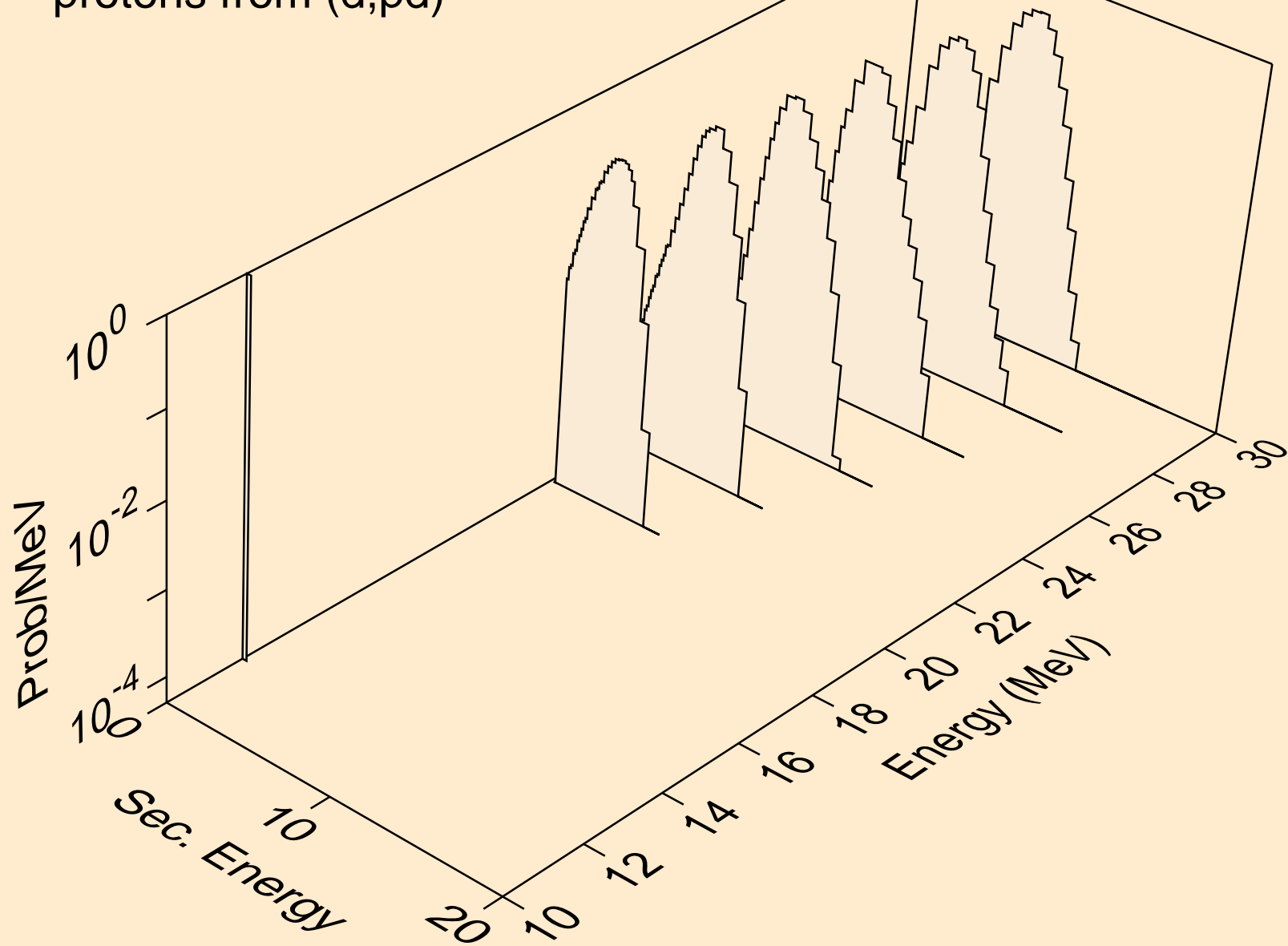

OS201 DEUTERON ACER TENDL-2023 LIBRARY; T=0.K  
tritons from (d,x)

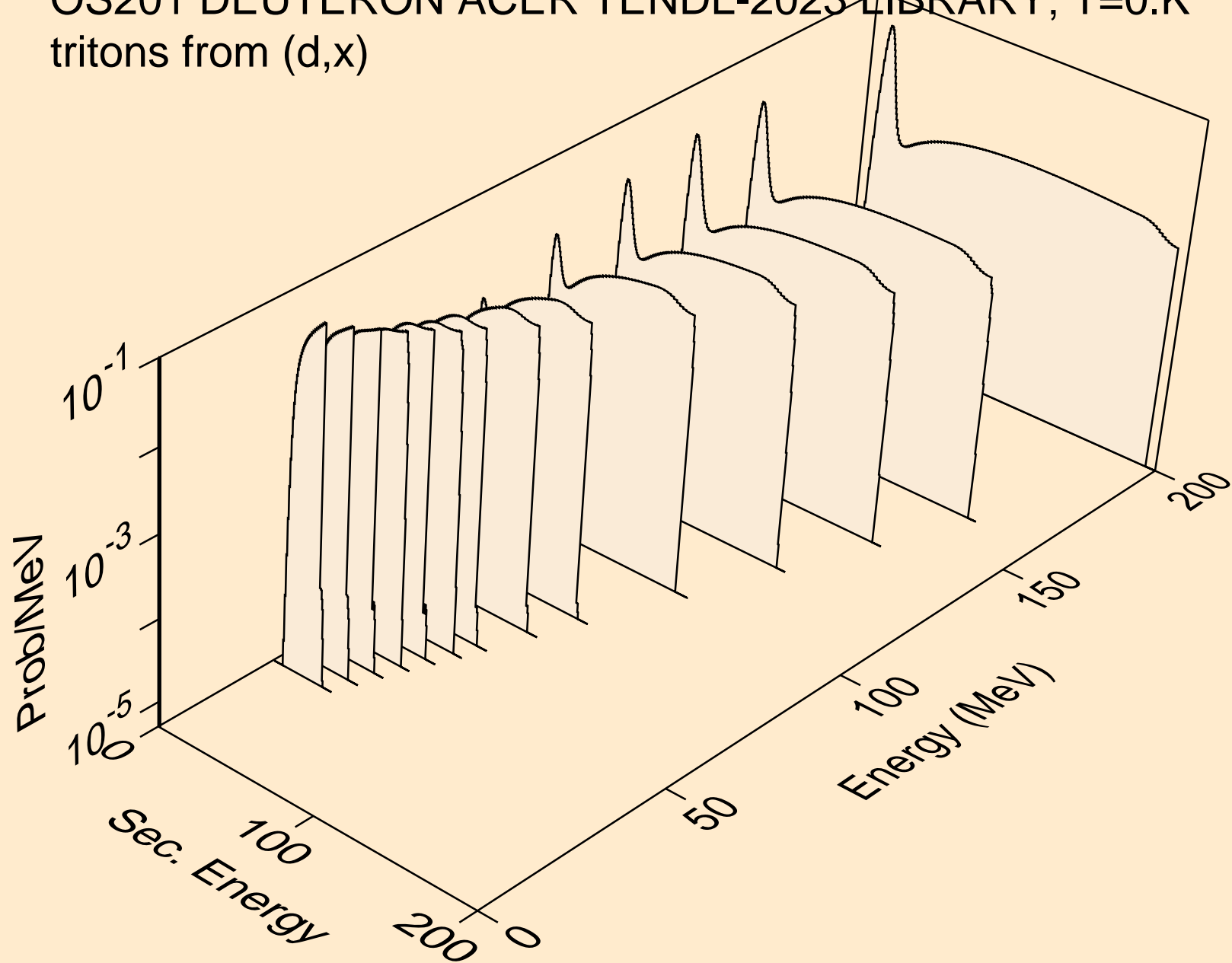



OS201 DEUTERON ACER TENDL-2023 LIBRARY; T=0.K  
tritons from (d,n\*)t

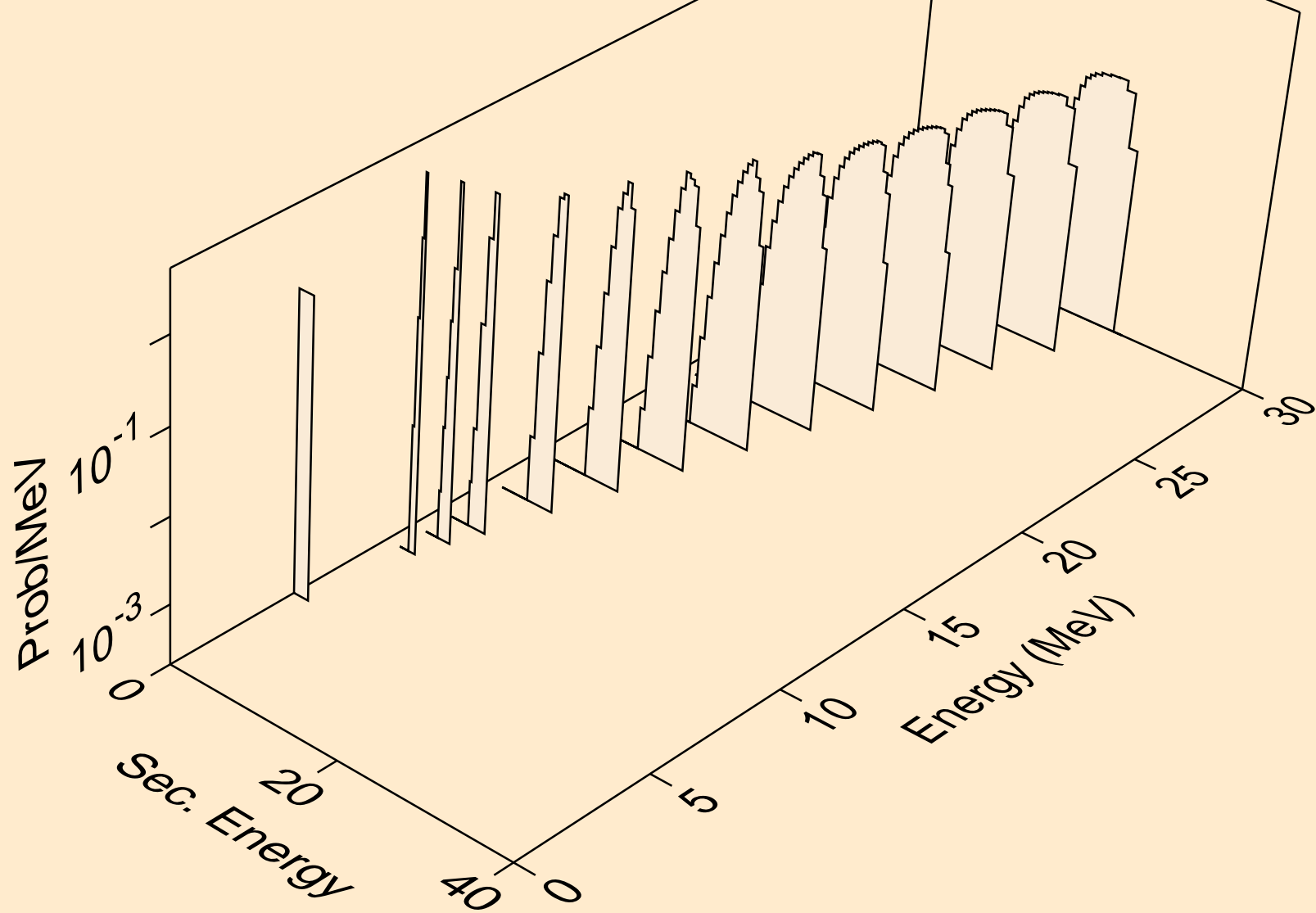

OS201 DEUTERON ACER TENDL-2023 LIBRARY; T=0.K  
tritons from (d,t)

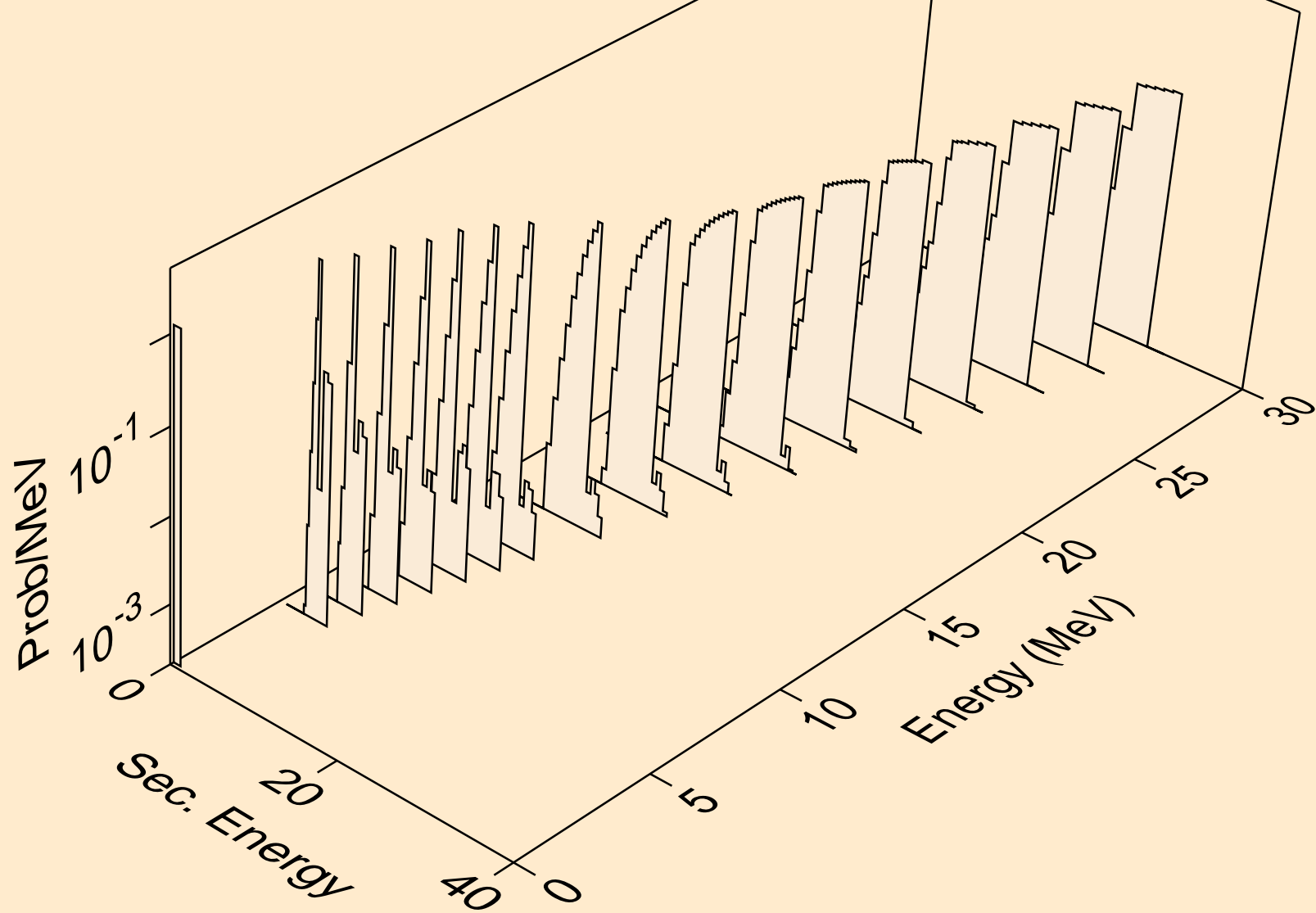

OS201 DEUTERON ACER TENDL-2023 LIBRARY; T=0.K  
he3s from (d,x)

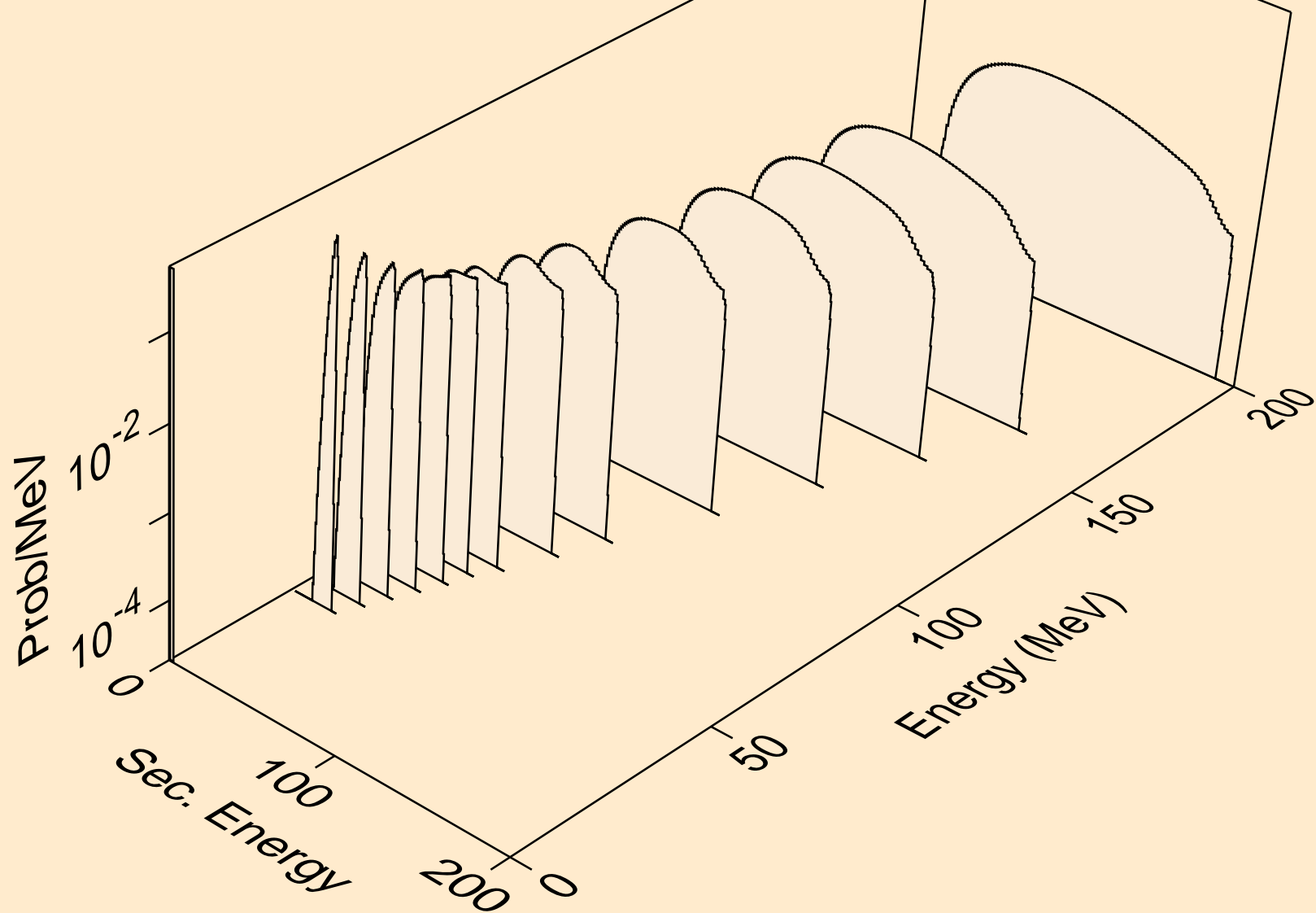

OS201 DEUTERON ACER TENDL-2023 LIBRARY; T=0.K  
he3s from (d,n\*)he3

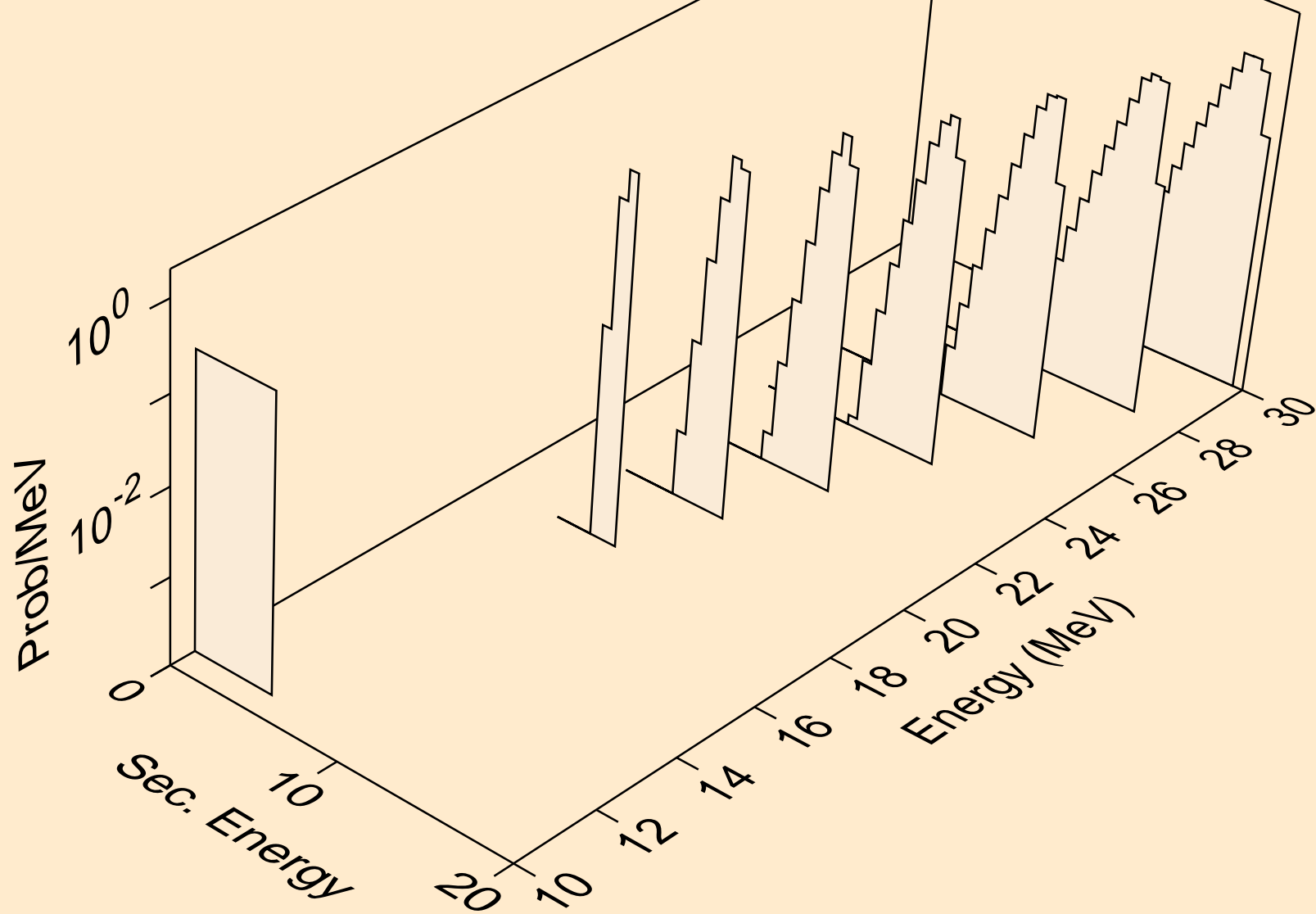

OS201 DEUTERON ACER TENDL-2023 LIBRARY; T=0.K  
he3s from (d,he3)

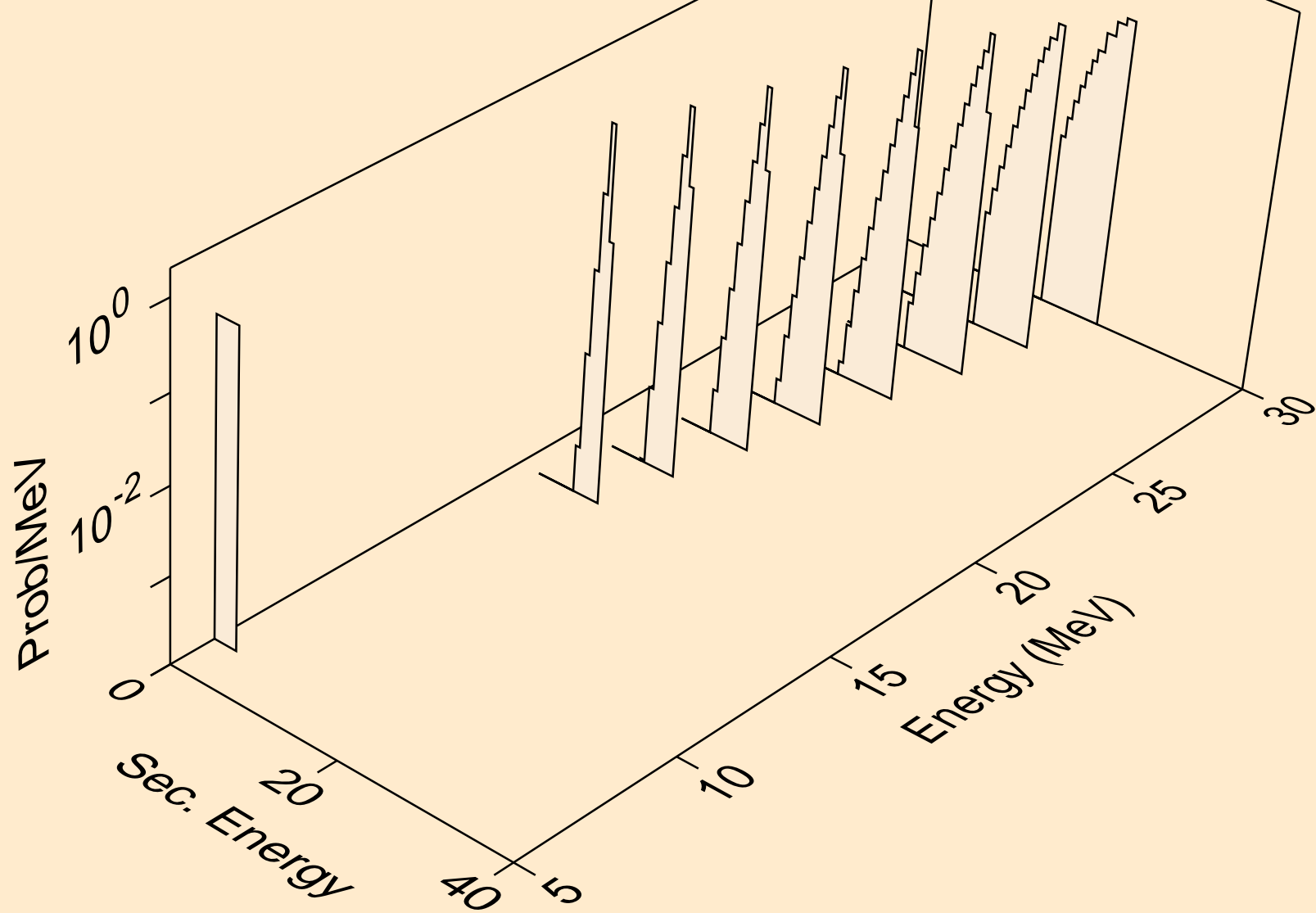

OS201 DEUTERON ACER TENDL-2023 LIBRARY; T=0.K  
alphas from (d,x)

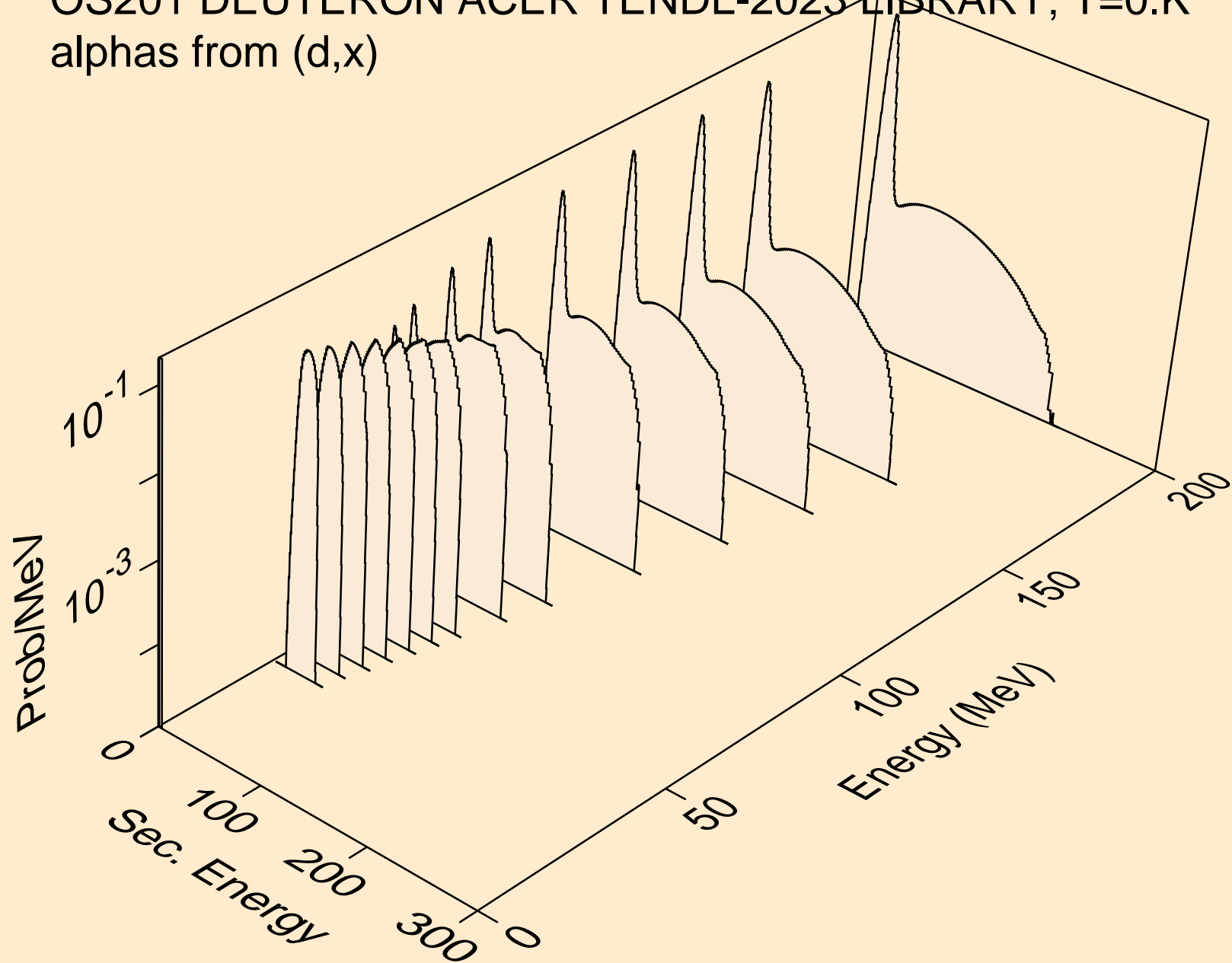

OS201 DEUTERON ACER TENDL-2023 LIBRARY; T=0.K  
alphas from (d,n\*)a

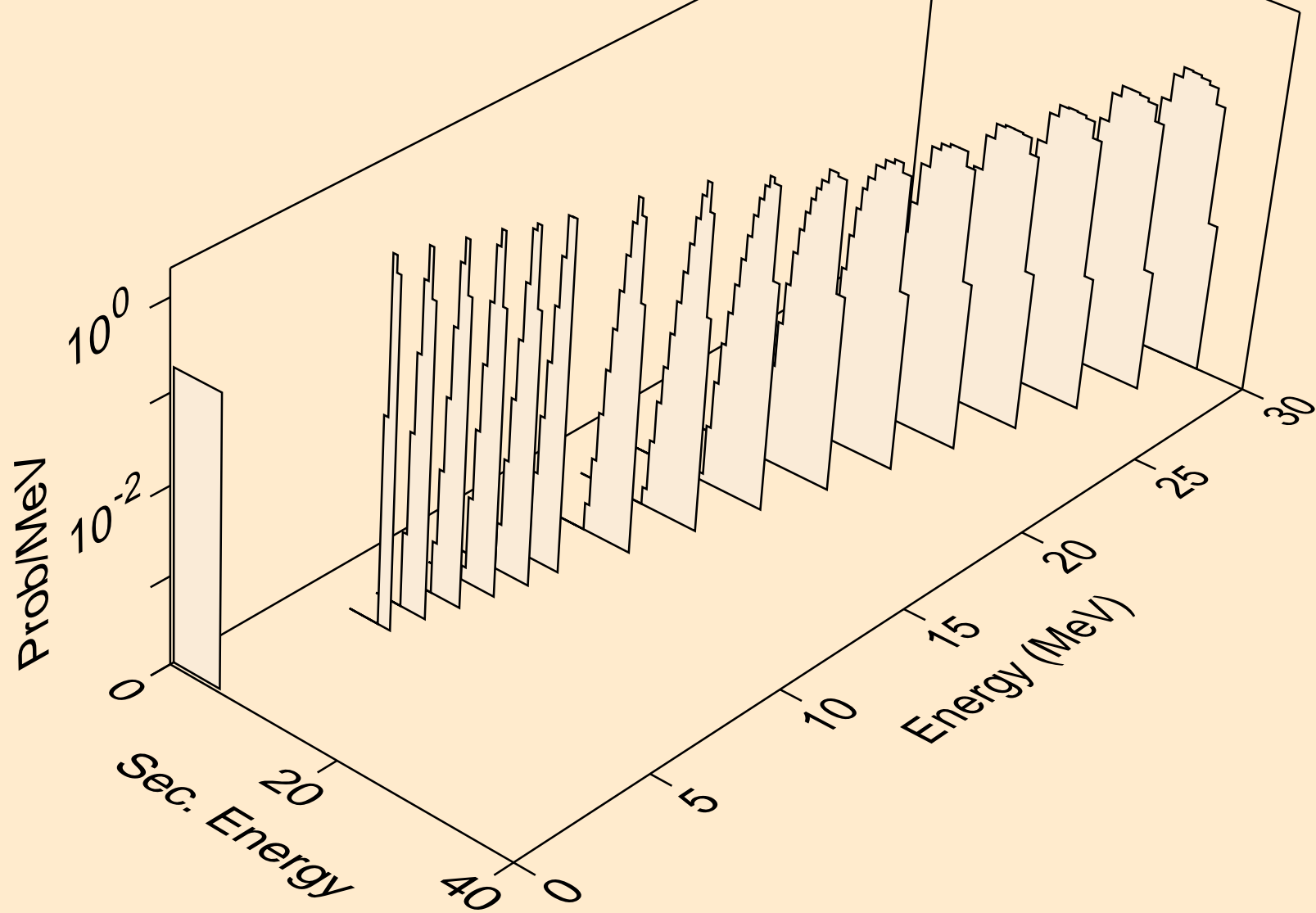

OS201 DEUTERON ACER TENDL-2023 LIBRARY; T=0.K  
alphas from (d,2n)a

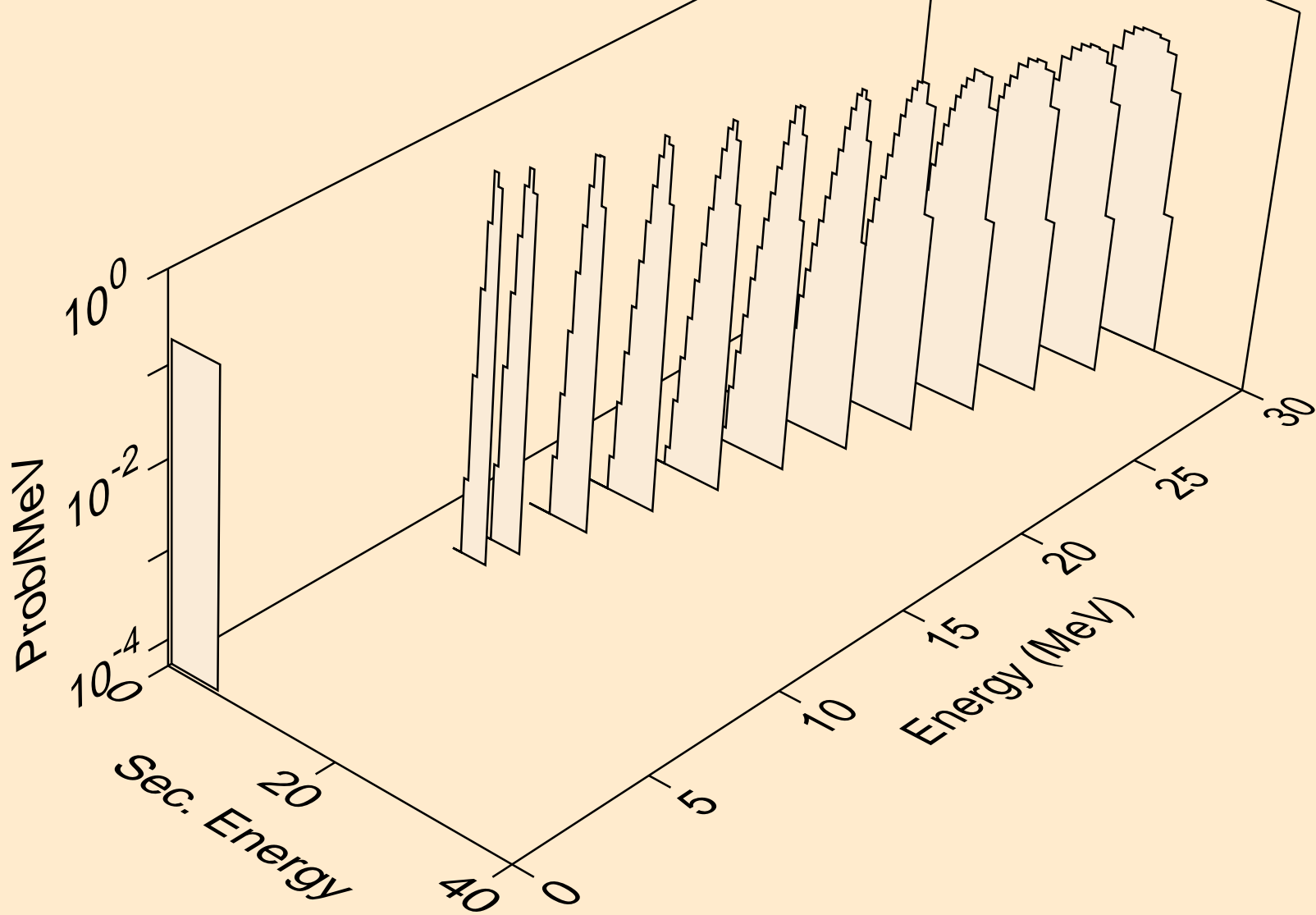



OS201 DEUTERON ACER TENDL-2023 LIBRARY; T=0.K  
alphas from (d,3n)a

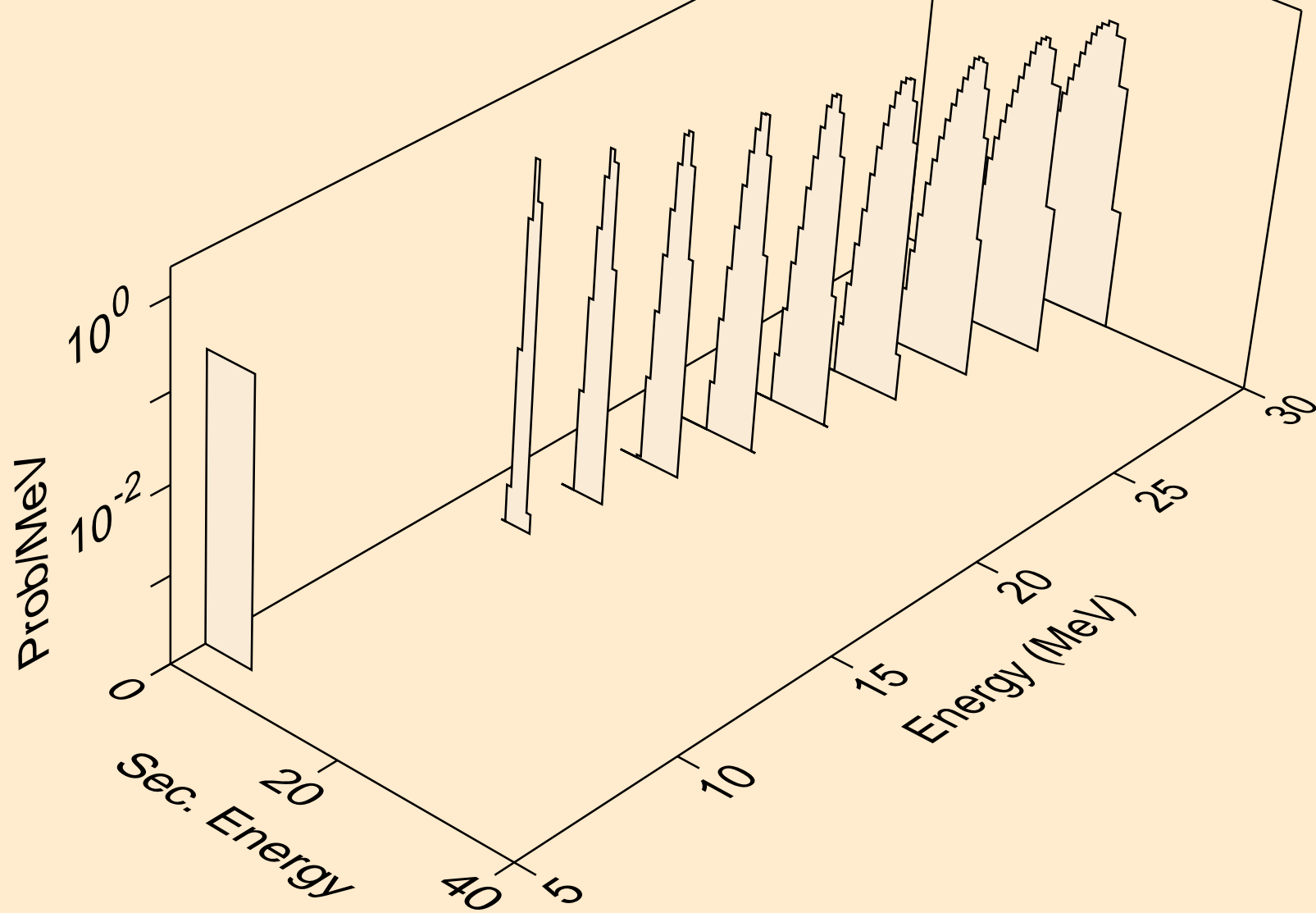

OS201 DEUTERON ACER TENDL-2023 LIBRARY; T=0.K  
alphas from (d,a)

