

PO227 DEUTERON ACER TENDL-2023 LIBRARY; T=0.K  
Principal cross sections

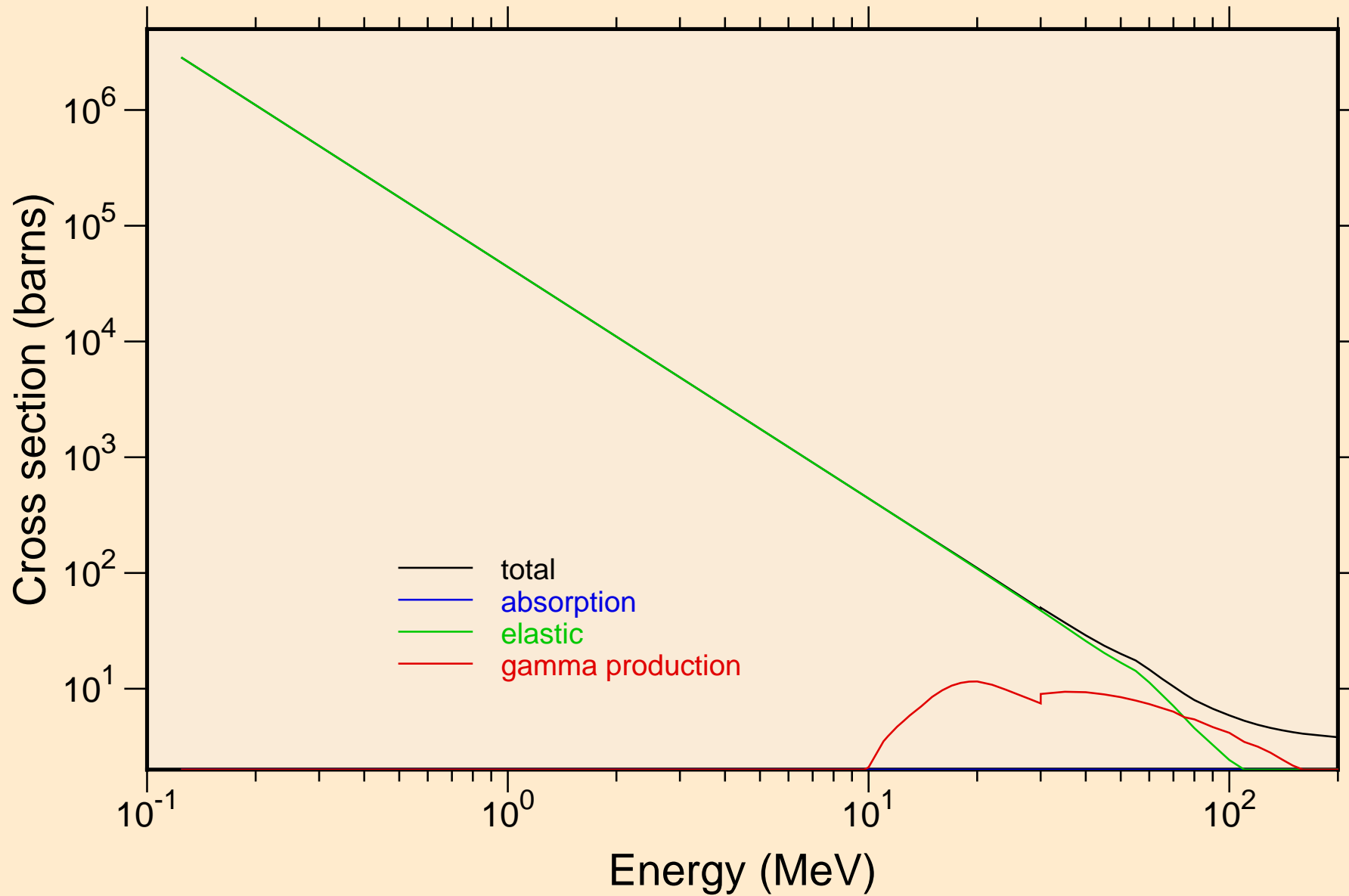

PO227 DEUTERON ACER TENDL-2023 LIBRARY; T=0.K  
Heating

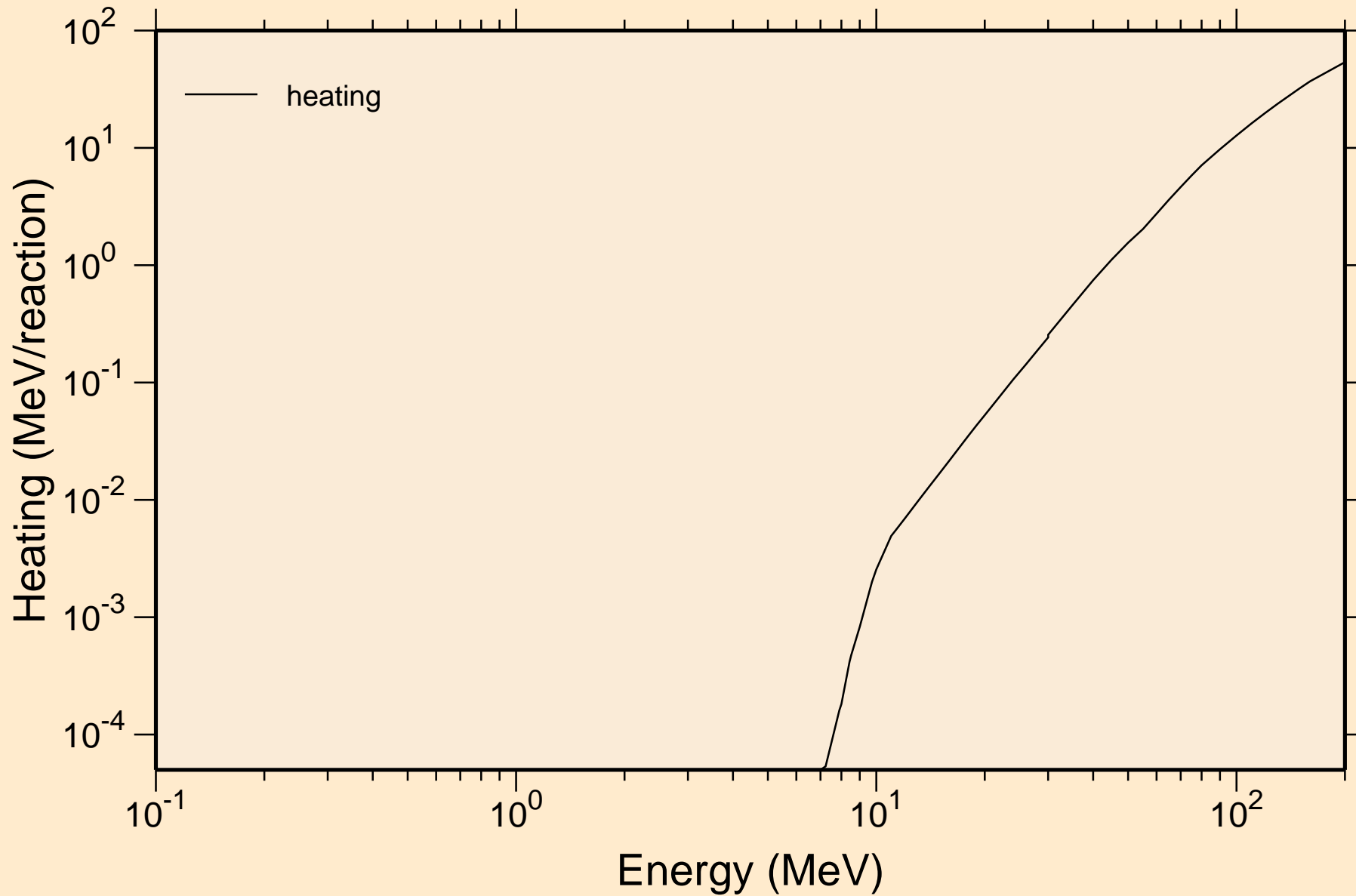

PO227 DEUTERON ACER TENDL-2023 LIBRARY; T=0.K  
Principal cross sections

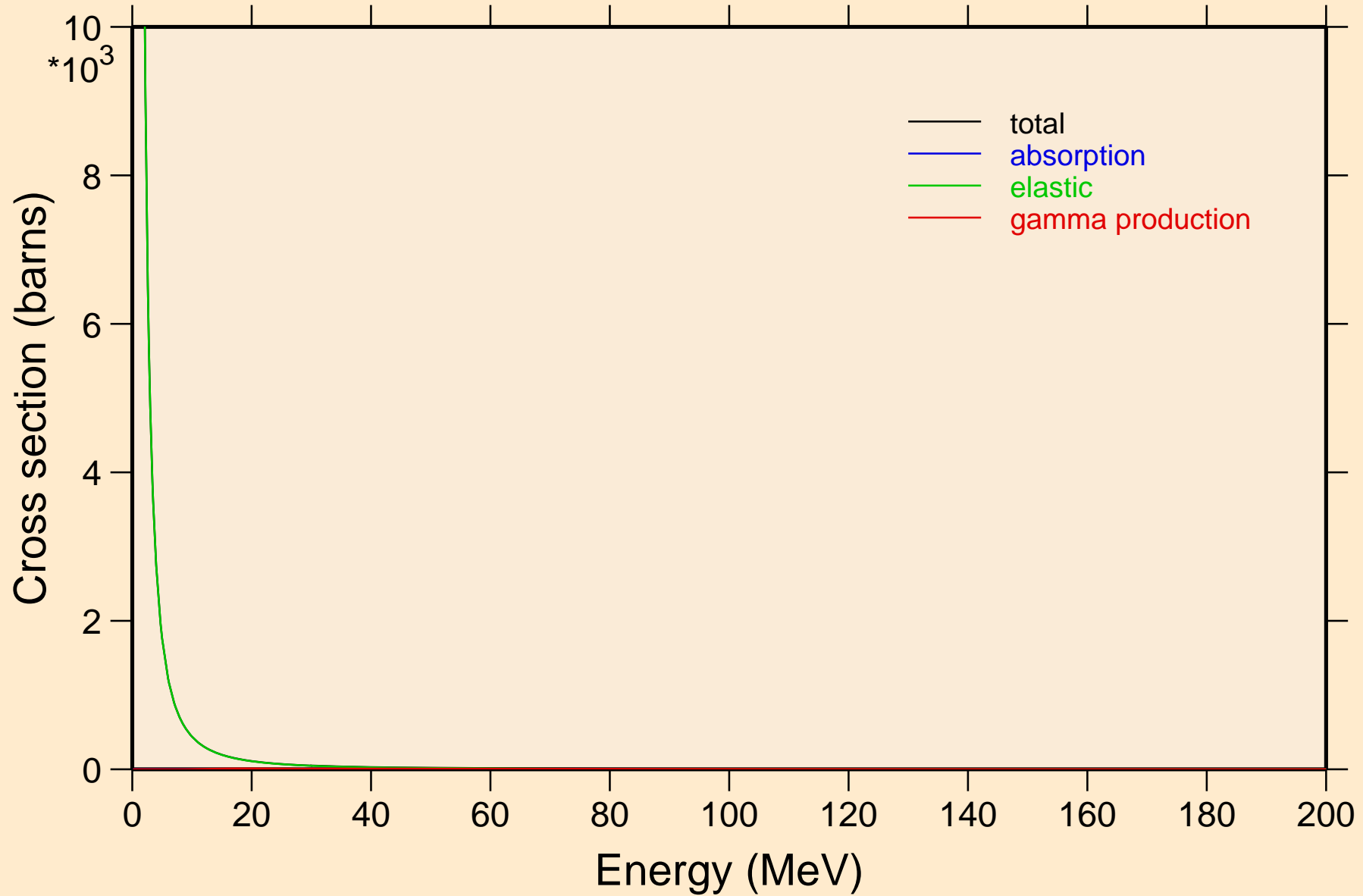

PO227 DEUTERON ACER TENDL-2023 LIBRARY; T=0.K

Heating

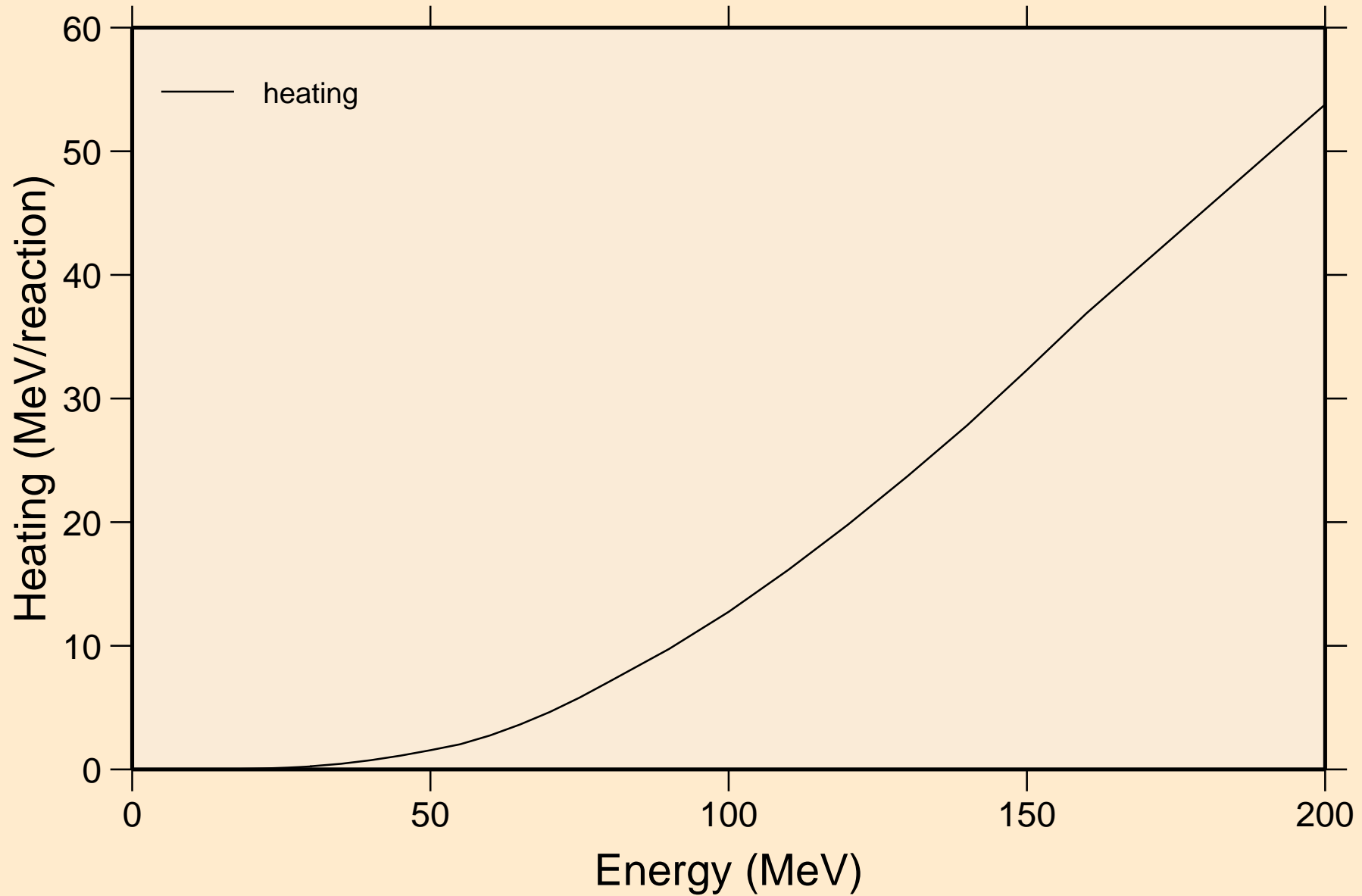

PO227 DEUTERON ACER TENDL-2023 LIBRARY; T=0.K  
Threshold reactions

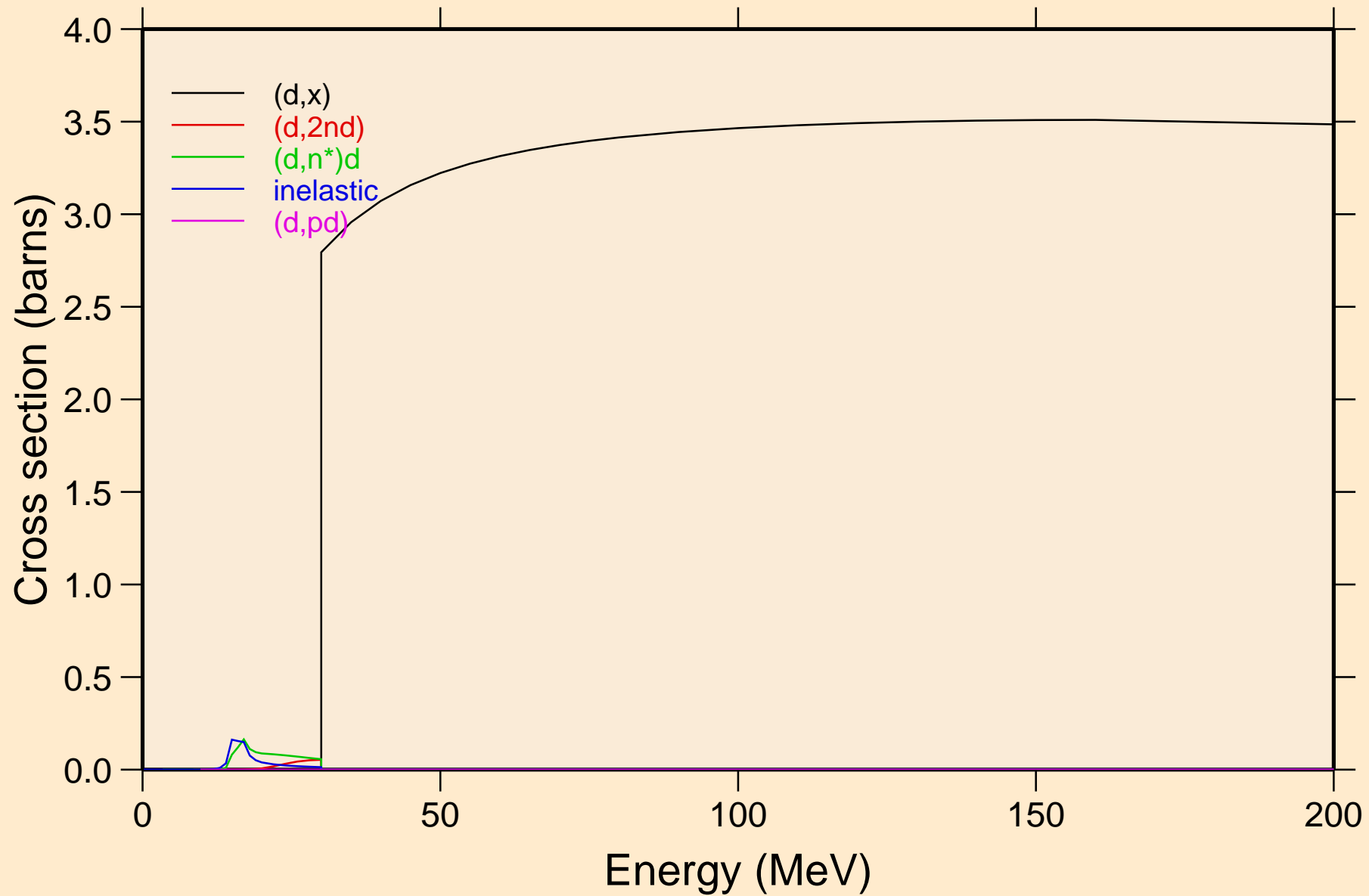

PO227 DEUTERON ACER TENDL-2023 LIBRARY; T=0.K  
angular distribution for elastic

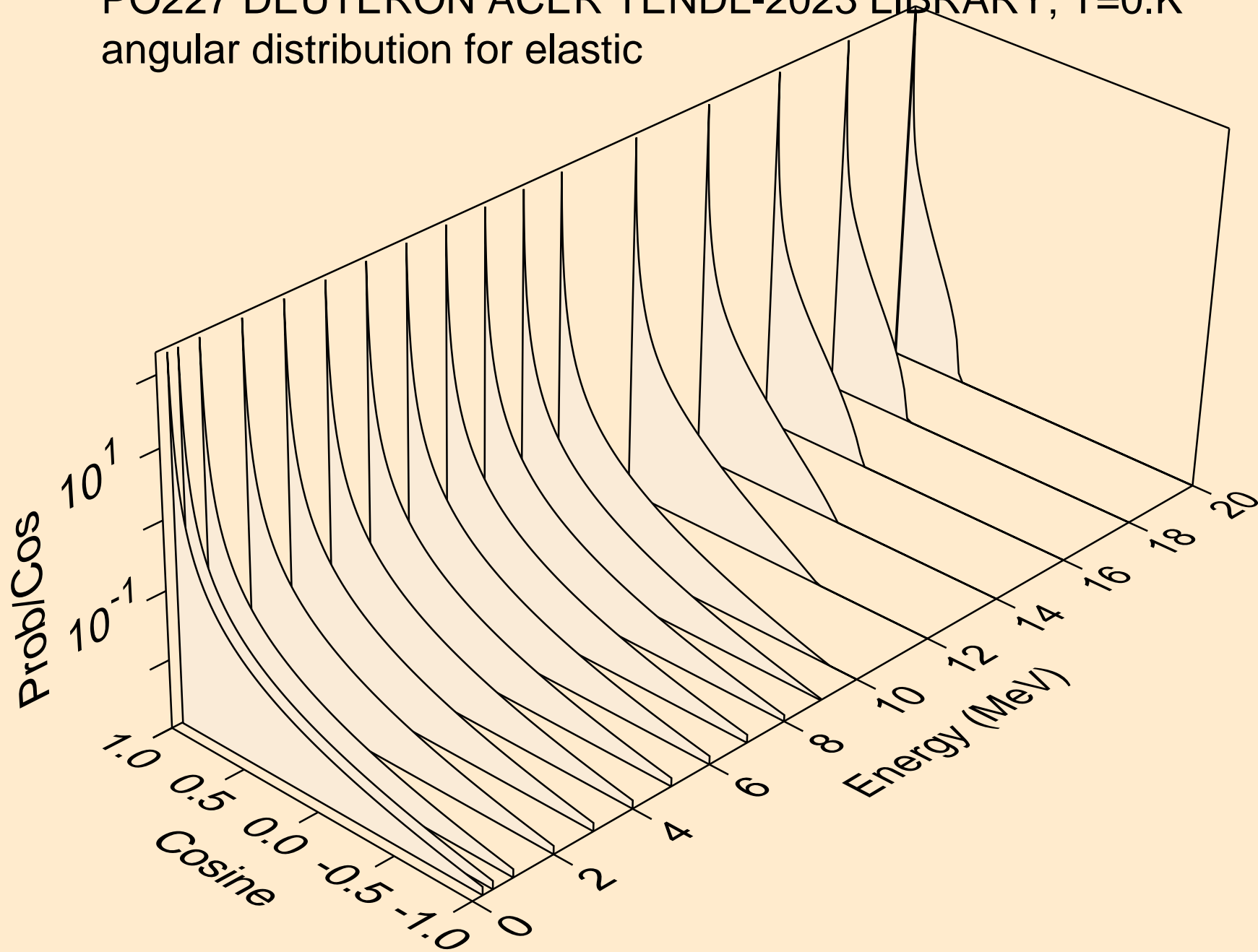

PO227 DEUTERON ACER TENDL-2023 LIBRARY; T=0.K  
angular distribution for elastic

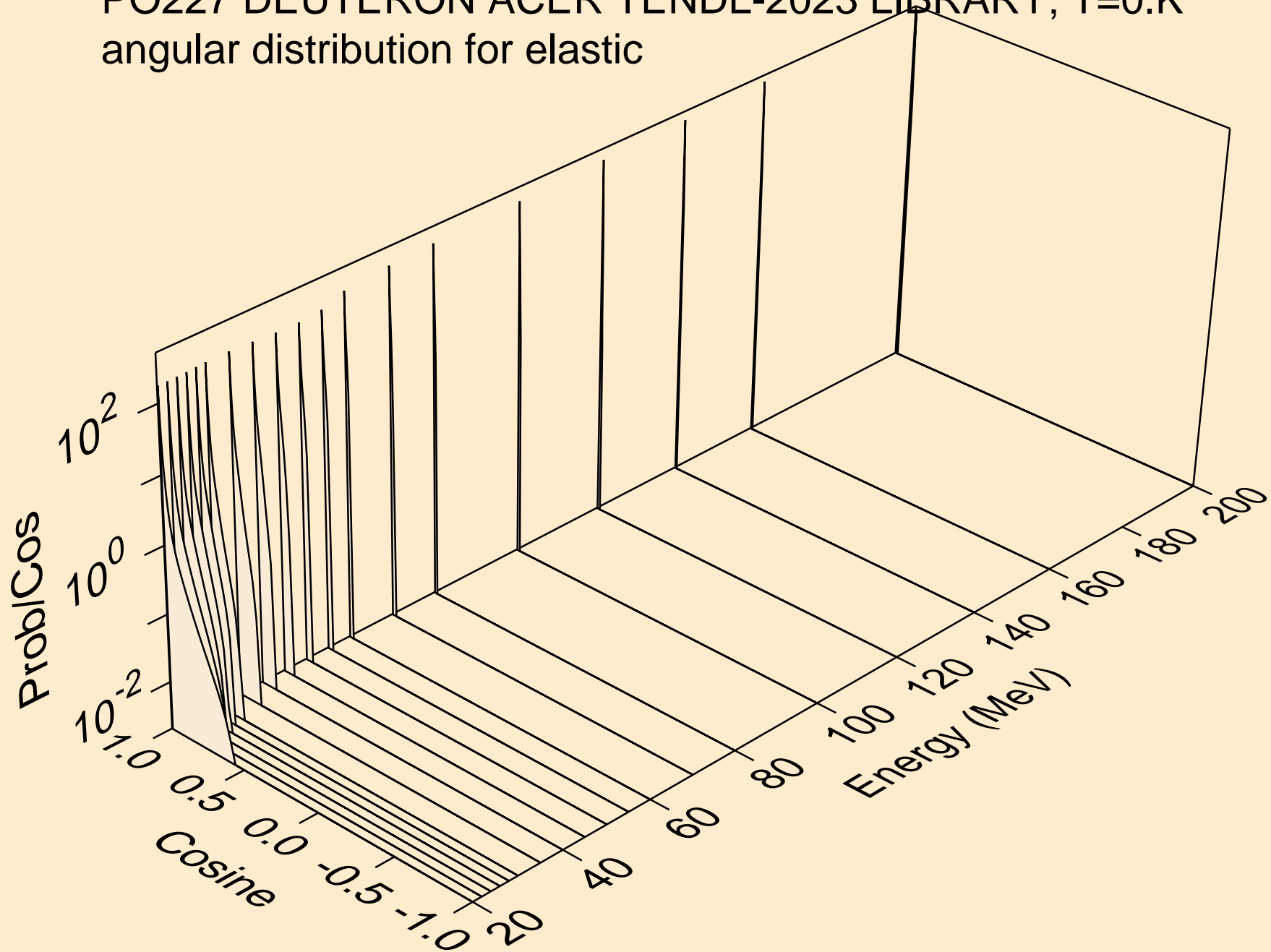

PO227 DEUTERON ACER TENDL-2023 LIBRARY; T=0.K  
Deuteron emission for (d,x)

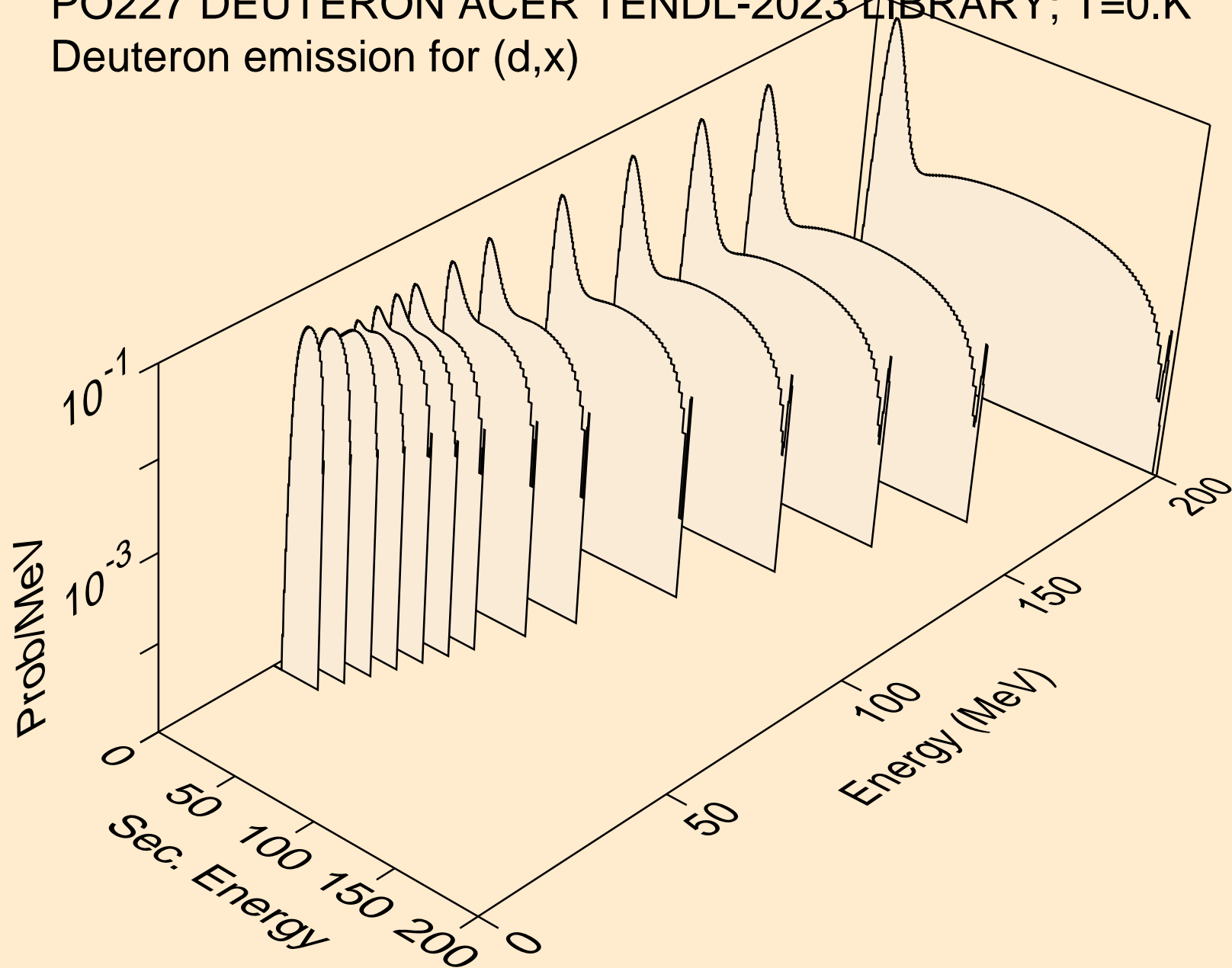



PO227 DEUTERON ACER TENDL-2023 LIBRARY; T=0.K  
Deuteron emission for (d,2nd)

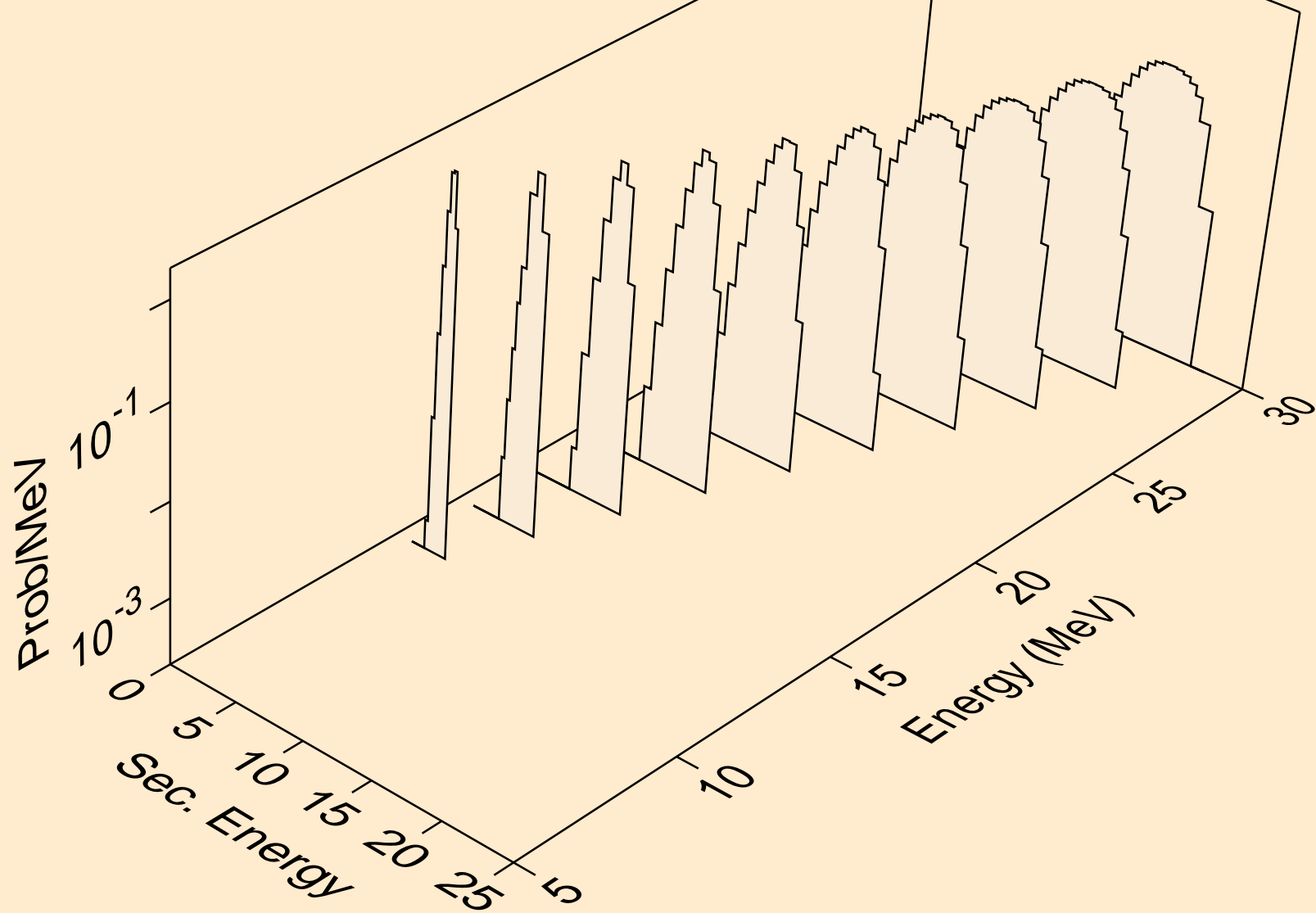

PO227 DEUTERON ACER TENDL-2023 LIBRARY; T=0.K  
Deuteron emission for (d,n\*)d

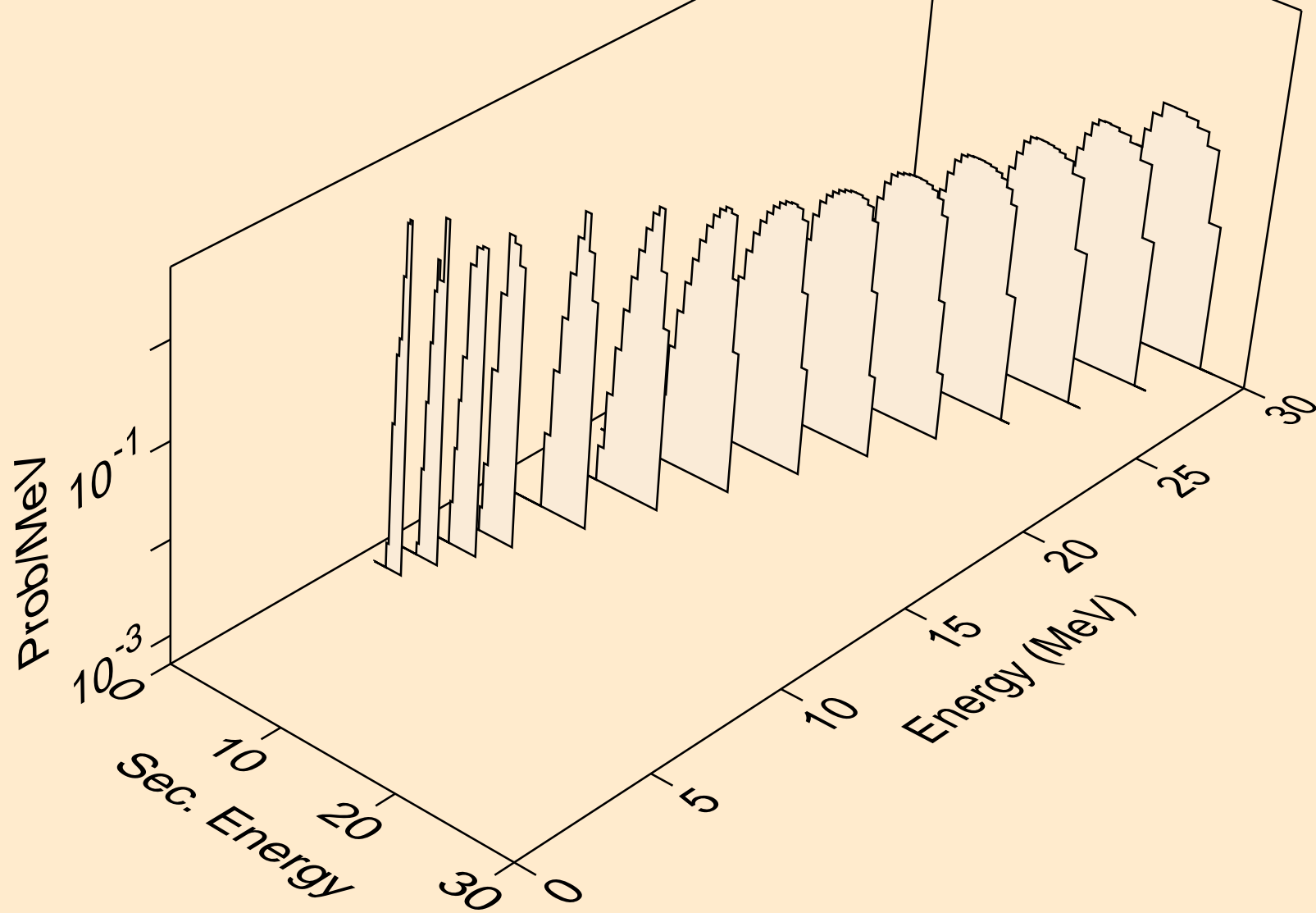

PO227 DEUTERON ACER TENDL-2023 LIBRARY; T=0.K  
Deuteron emission for inelastic

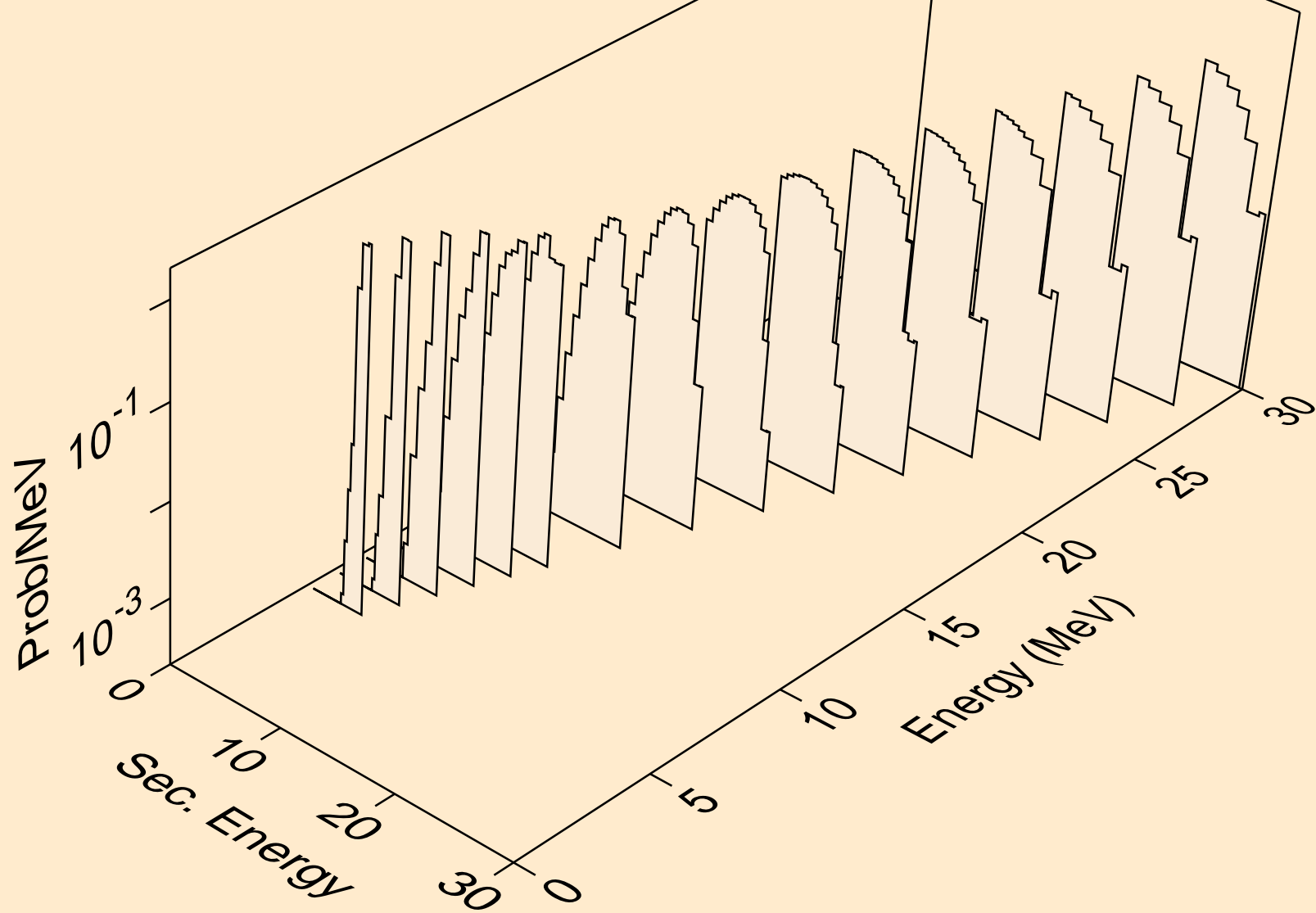

PO227 DEUTERON ACER TENDL-2023 LIBRARY; T=0.K  
Deuteron emission for (d,pd)

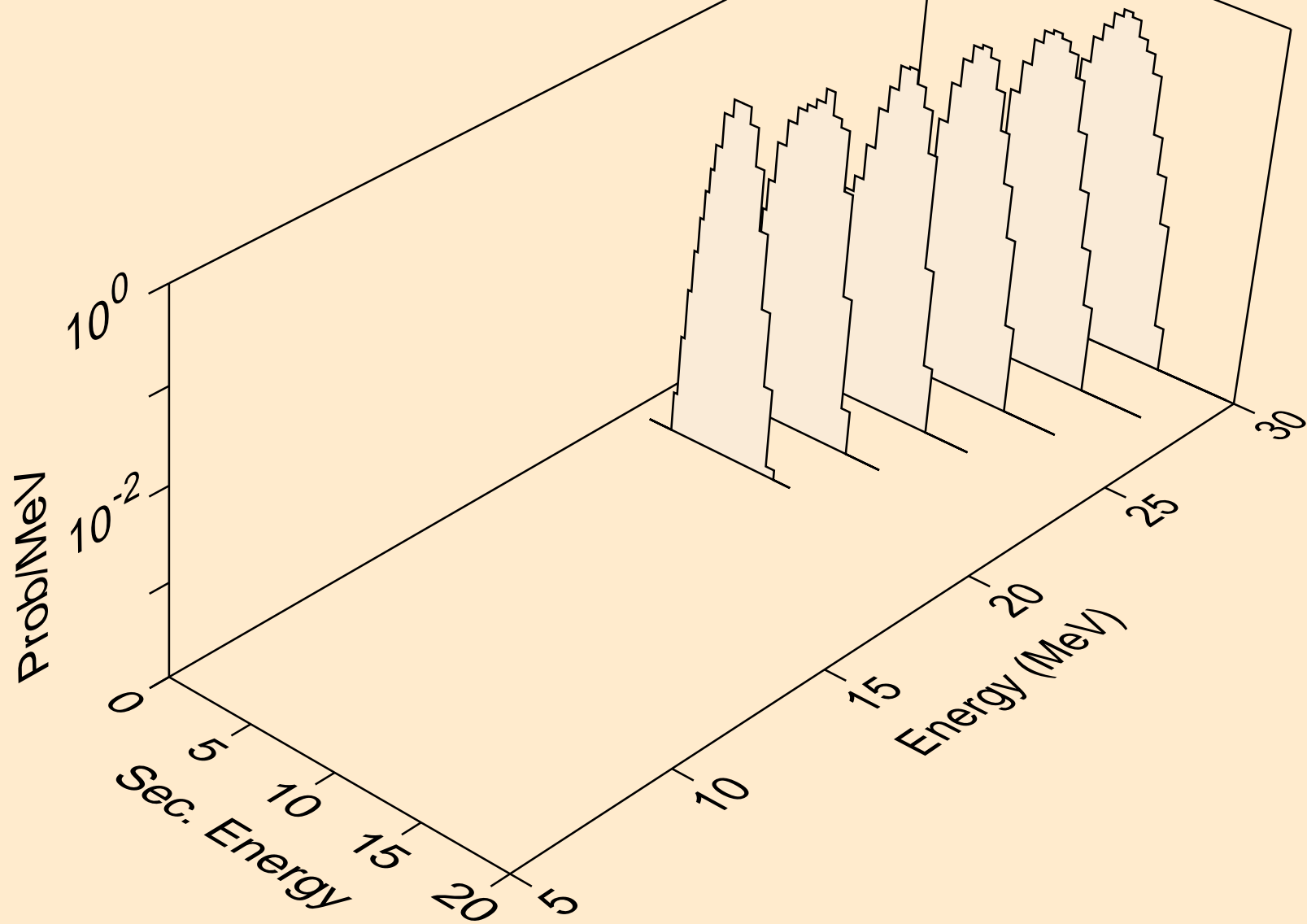

PO227 DEUTERON ACER TENDL-2023 LIBRARY; T=0.K  
Photon emission for (z,n)

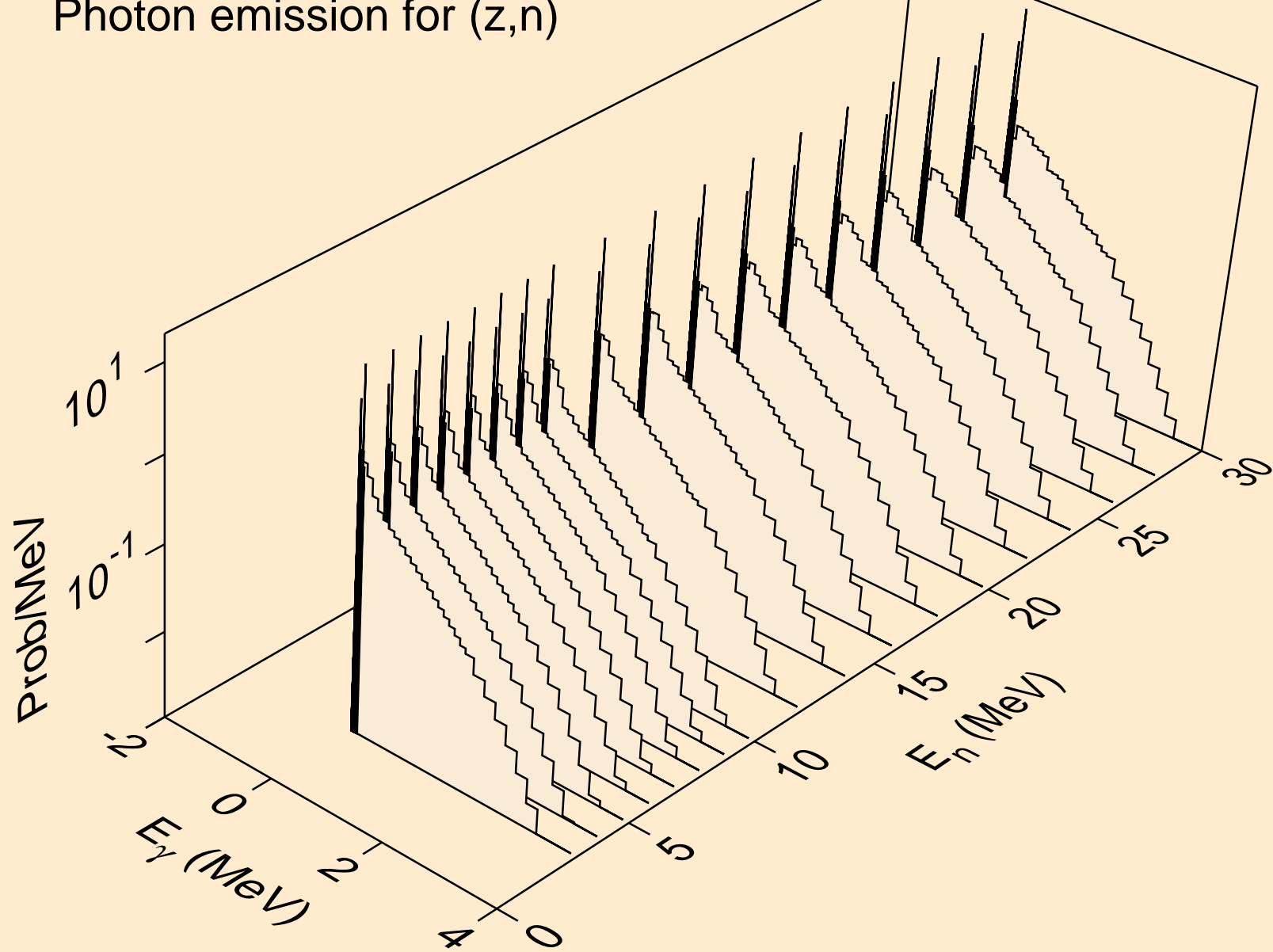

PO227 DEUTERON ACER TENDL-2023 LIBRARY; T=0.K  
Photon emission for (z,x)

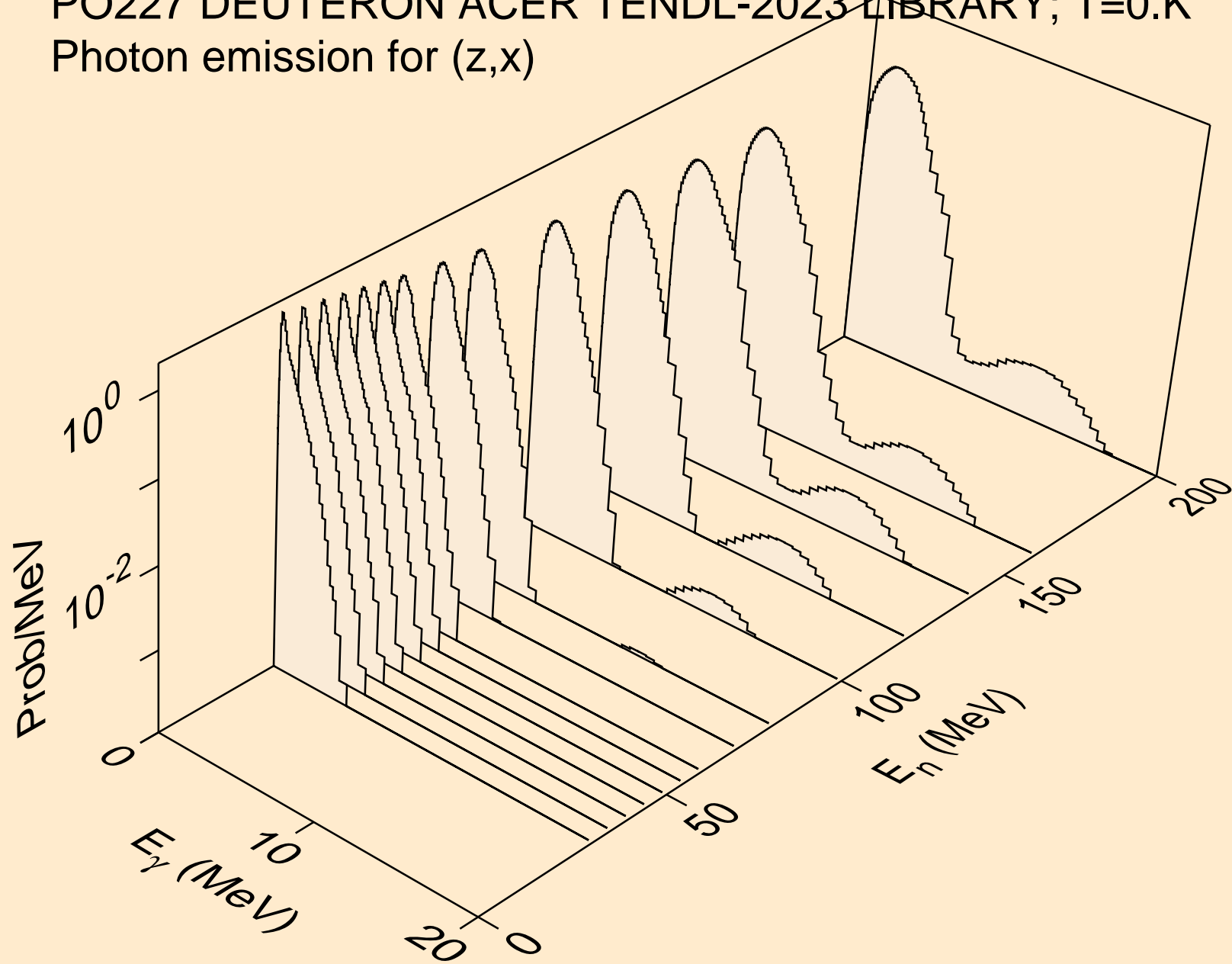

PO227 DEUTERON ACER TENDL-2023 LIBRARY; T=0.K  
Photon emission for (n,2nd)

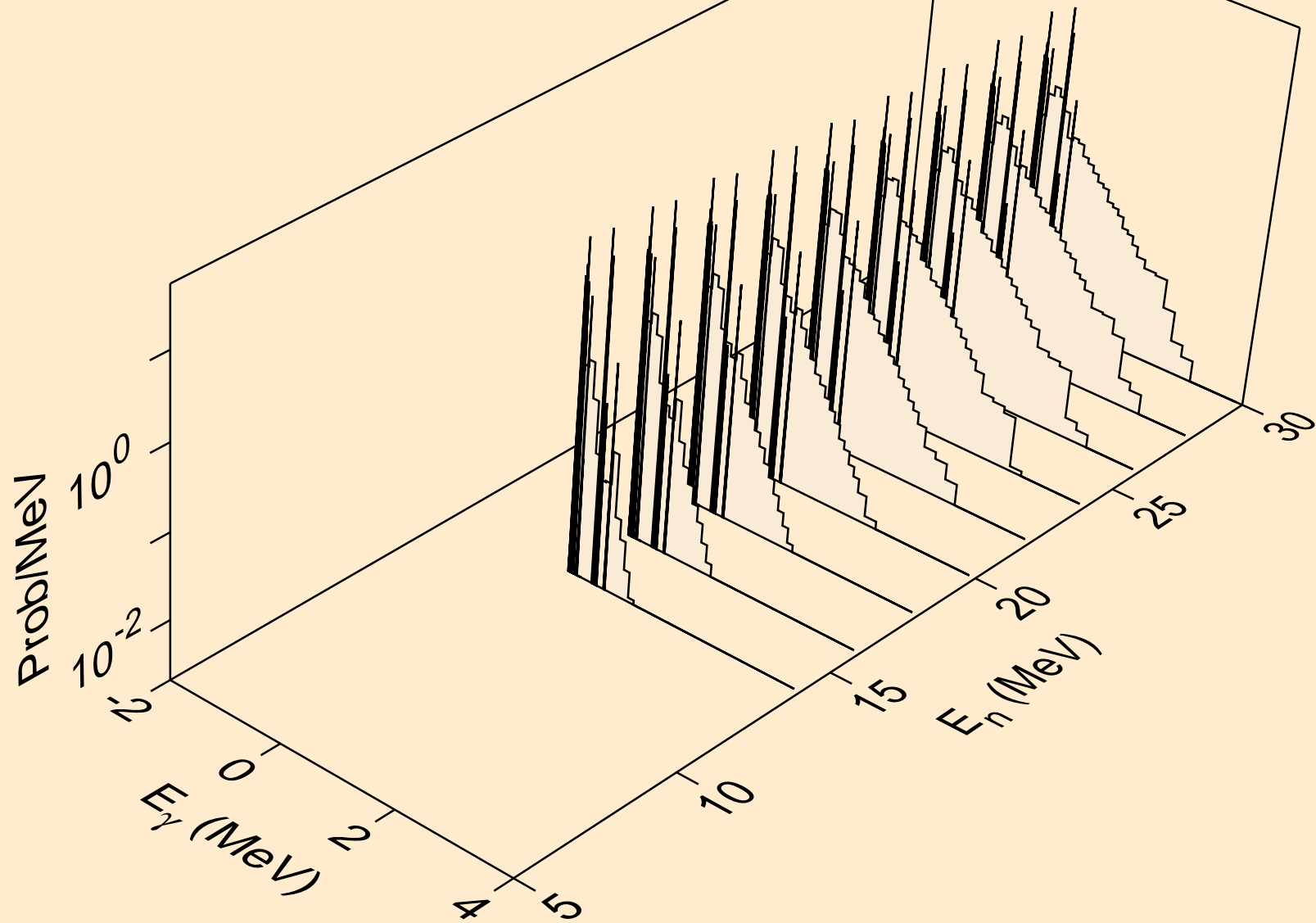

PO227 DEUTERON ACER TENDL-2023 LIBRARY; T=0.K  
Photon emission for (n,2n)

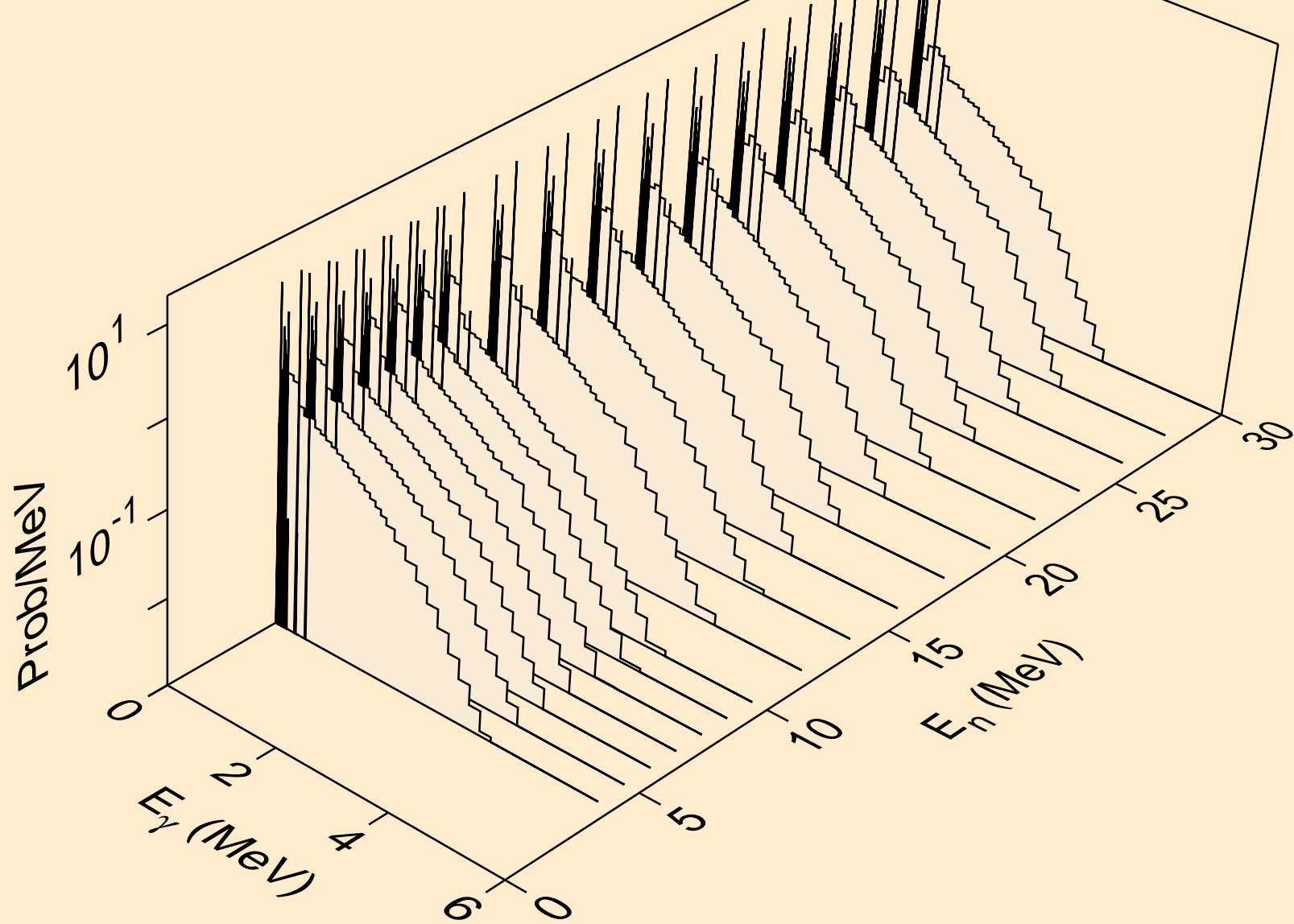



PO227 DEUTERON ACER TENDL-2023 LIBRARY; T=0.K  
Photon emission for (n,3n)

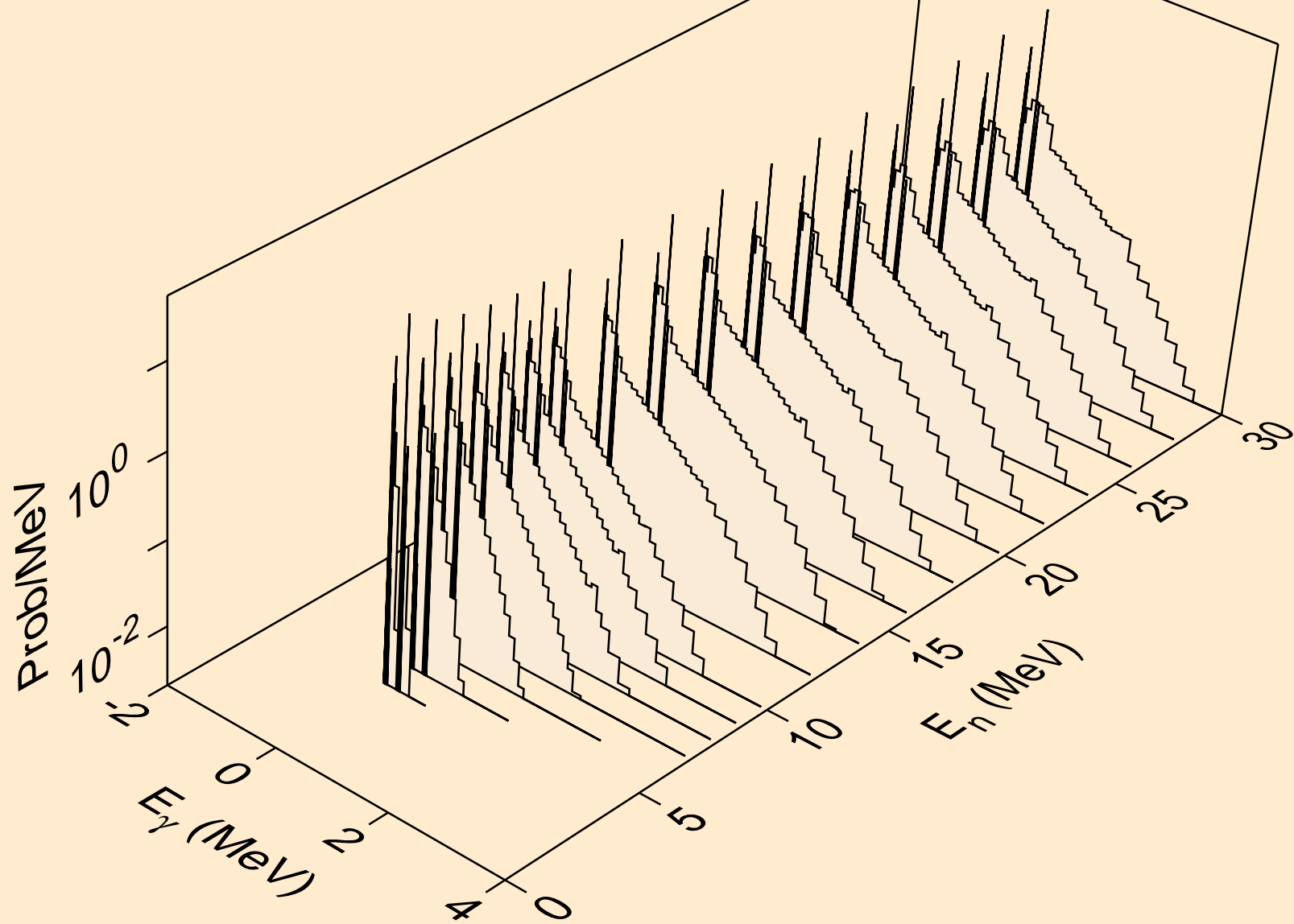

PO227 DEUTERON ACER TENDL-2023 LIBRARY; T=0.K  
Photon emission for (n,n\*)a

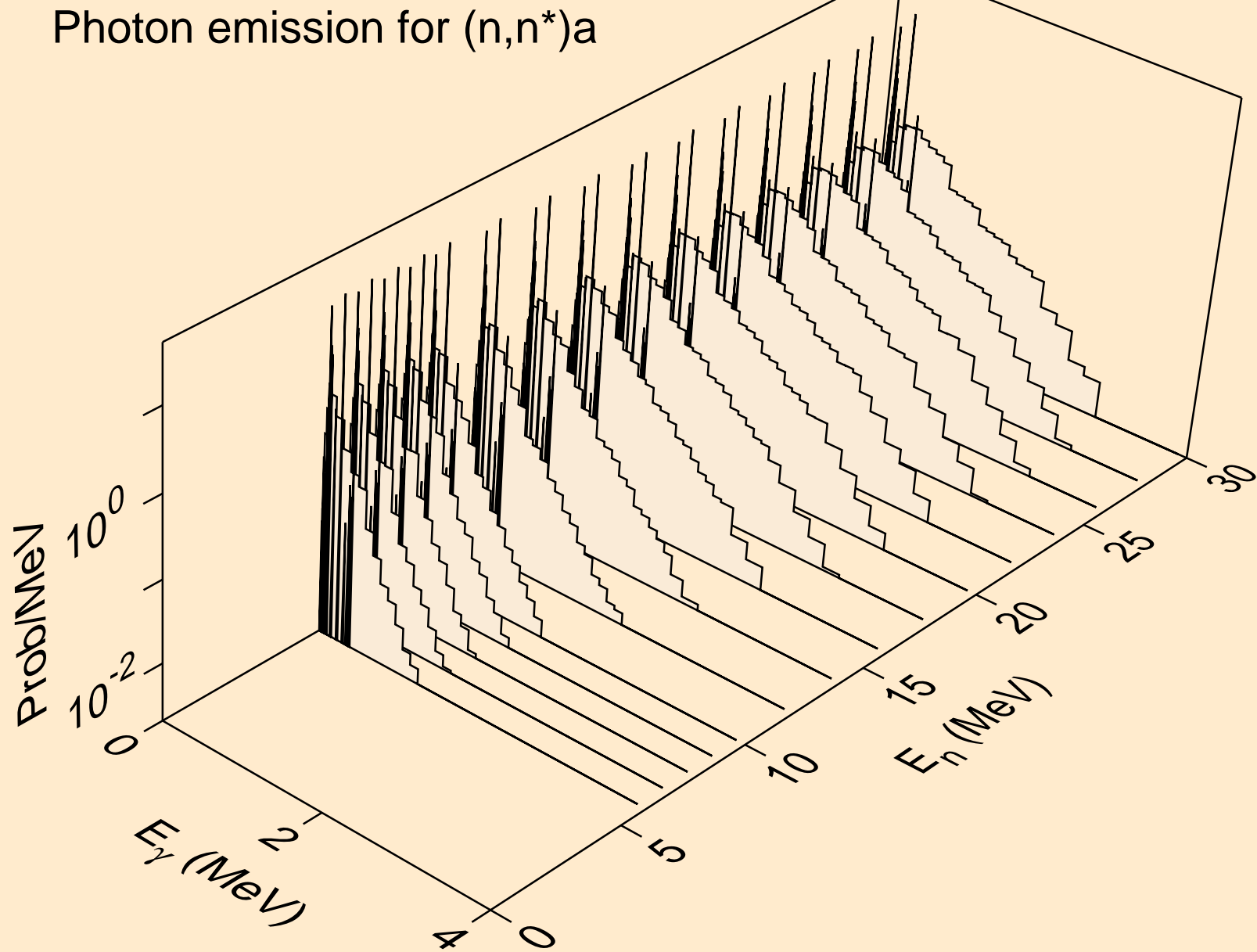

PO227 DEUTERON ACER TENDL-2023 LIBRARY; T=0.K  
Photon emission for (n,2n)a

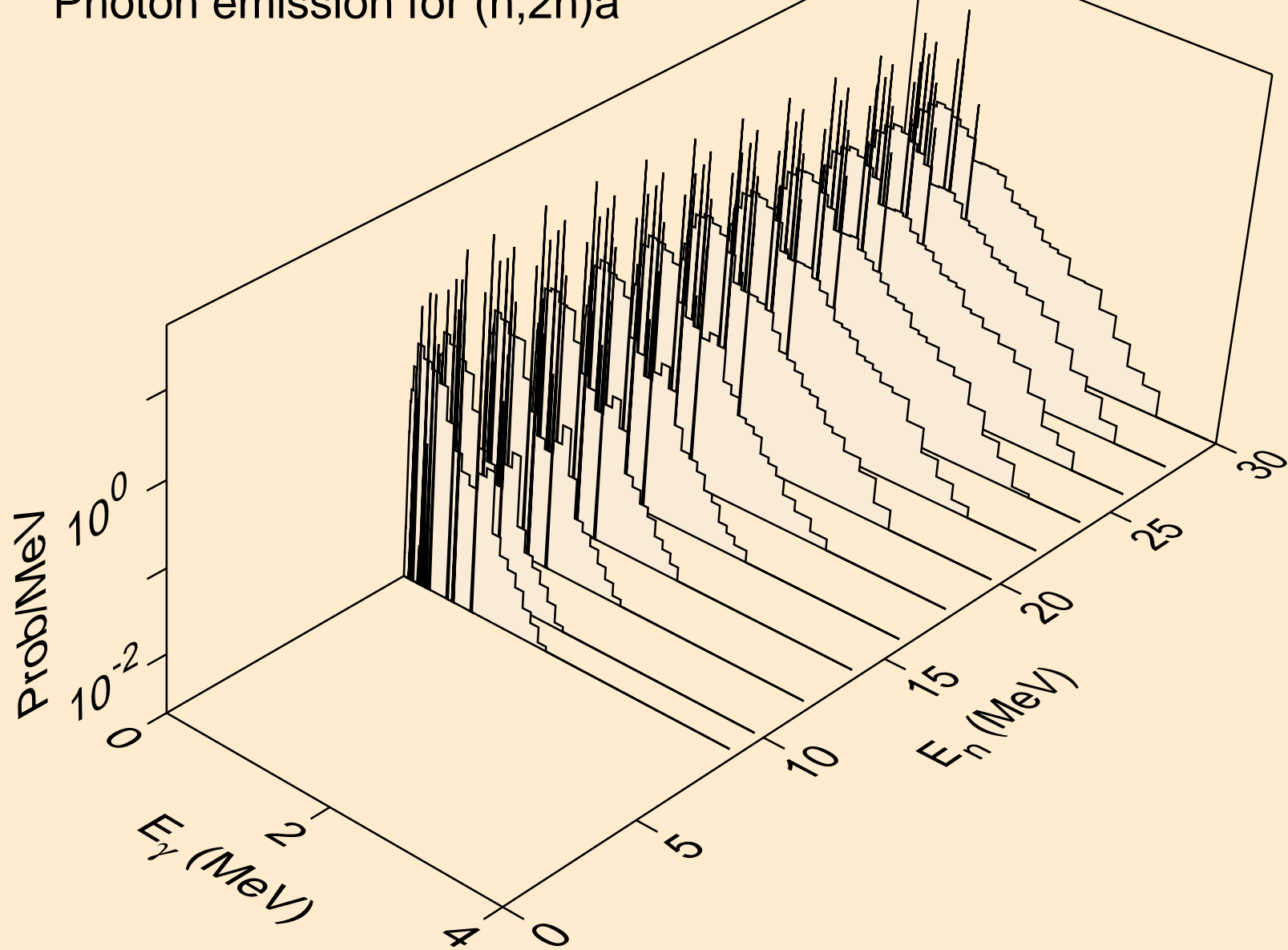

PO227 DEUTERON ACER TENDL-2023 LIBRARY; T=0.K  
Photon emission for (n,3n)a

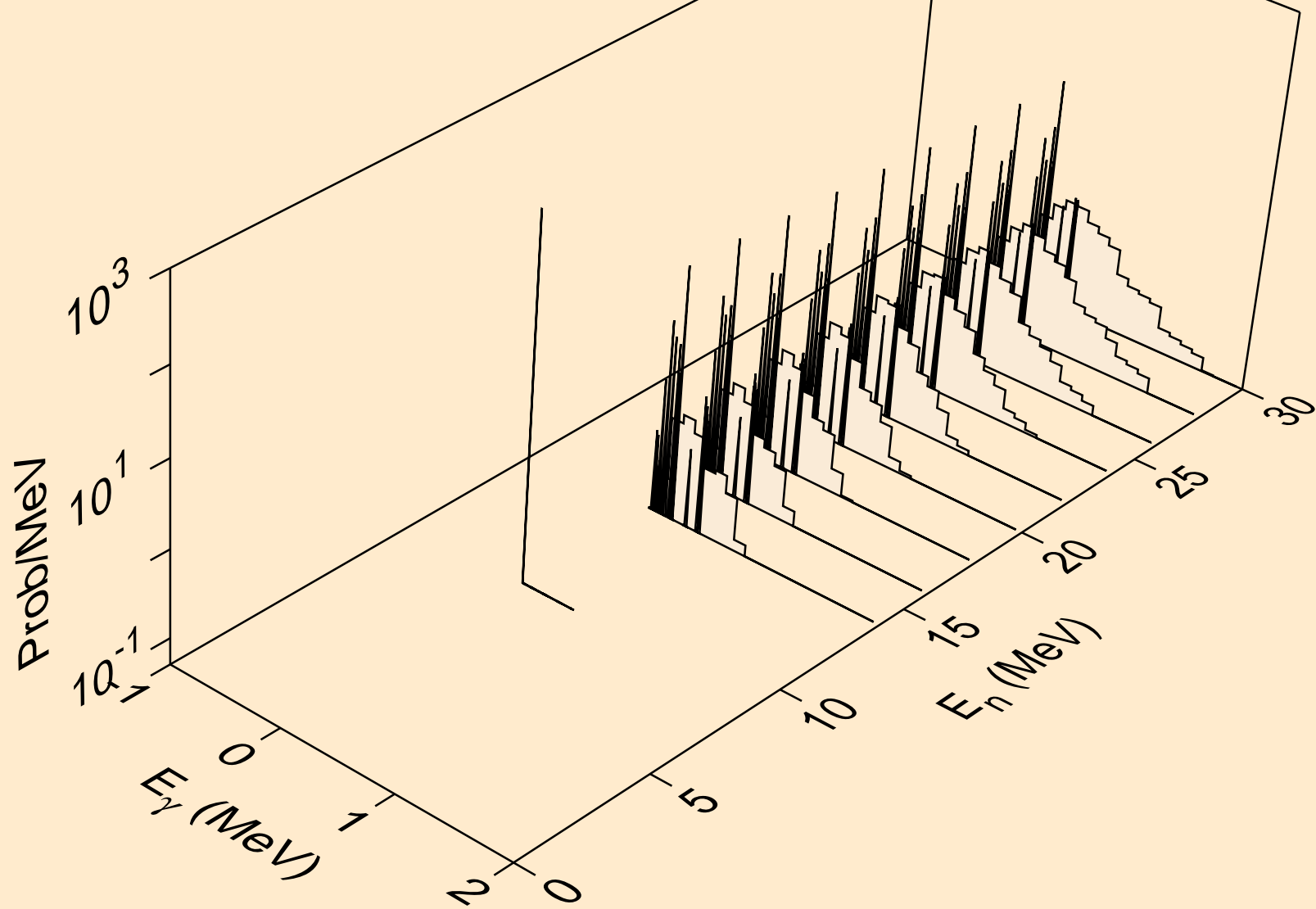

PO227 DEUTERON ACER TENDL-2023 LIBRARY; T=0.K  
Photon emission for (n,n\*)p

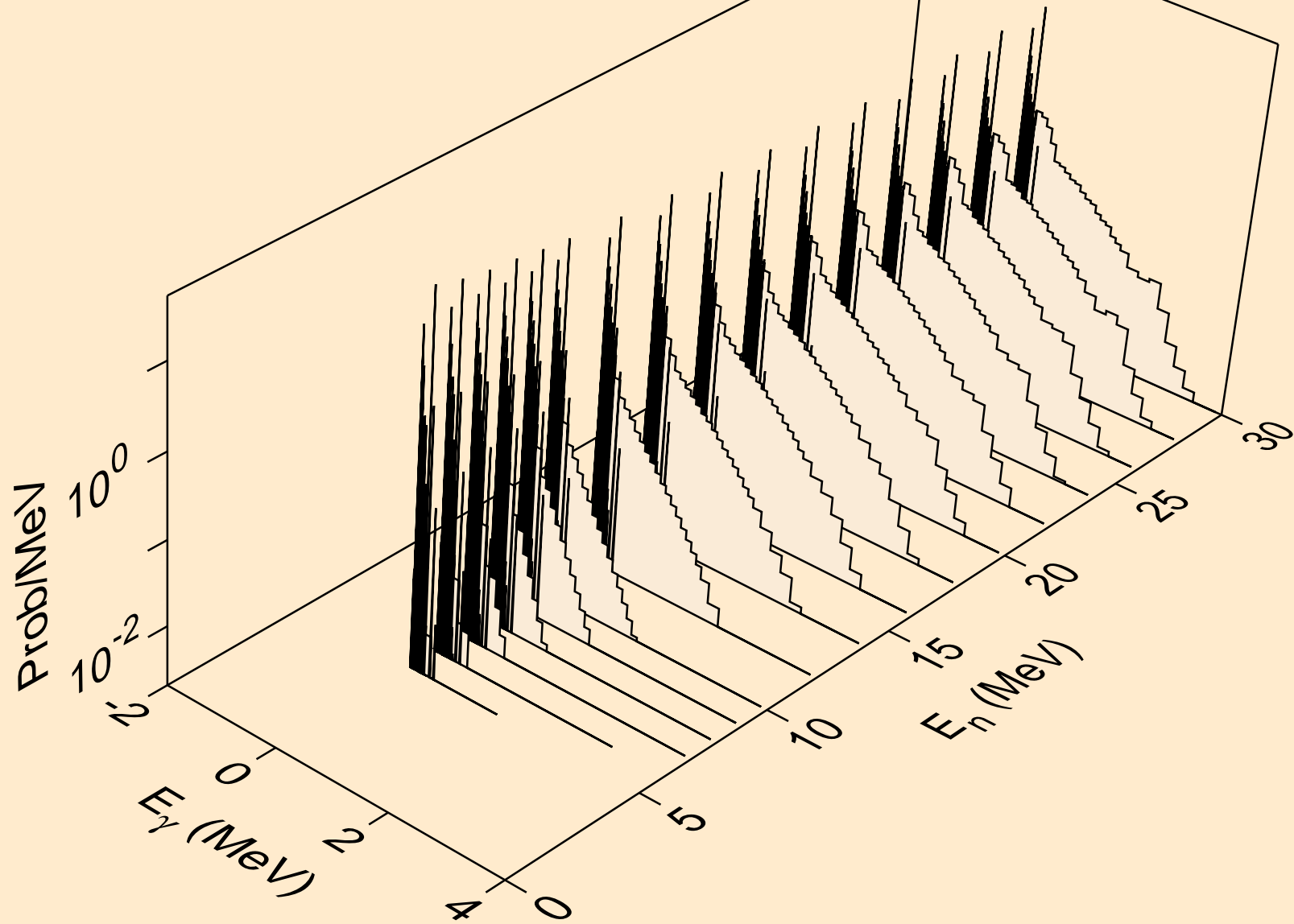

PO227 DEUTERON ACER TENDL-2023 LIBRARY; T=0.K  
Photon emission for (n,n\*)d

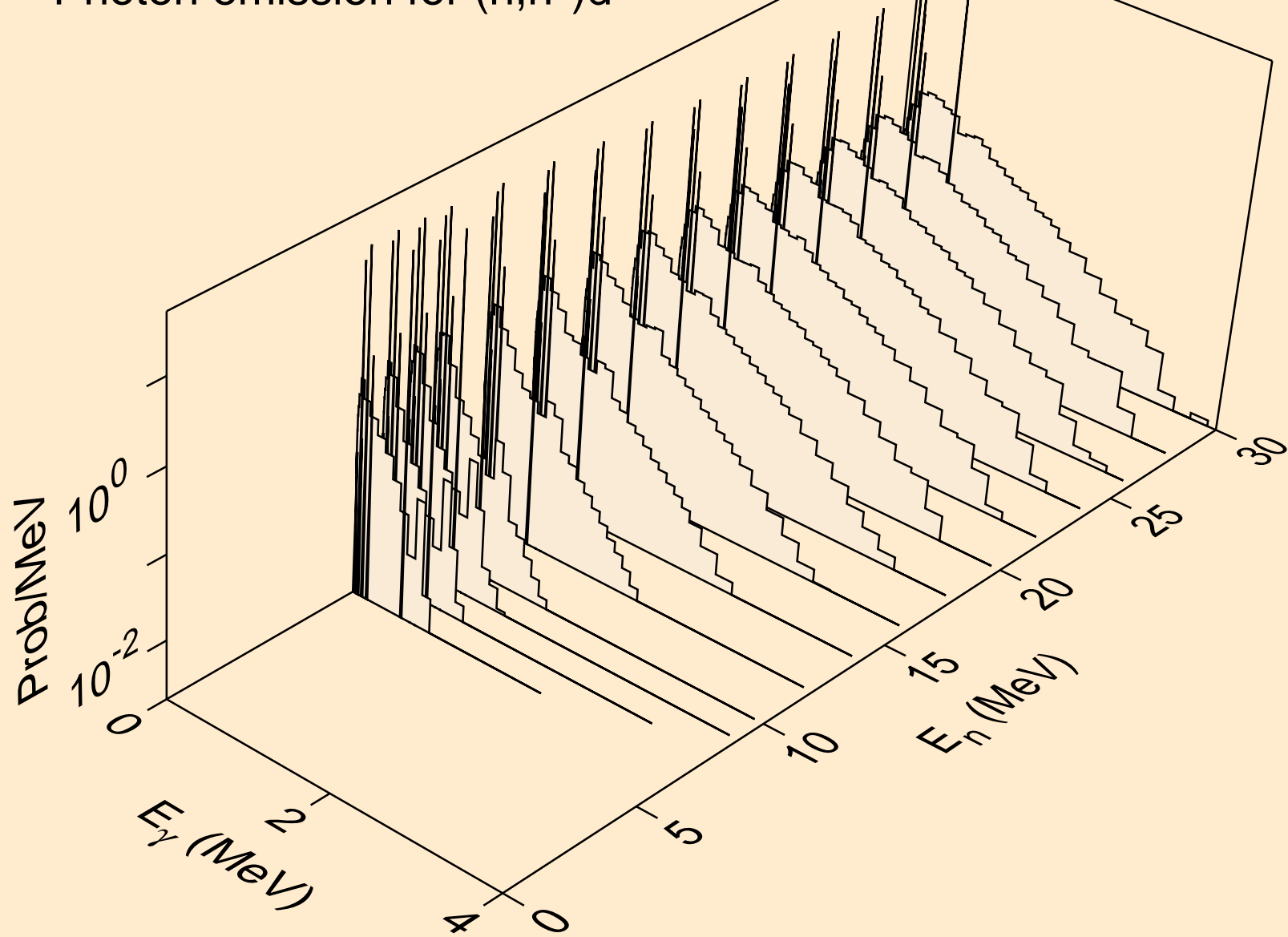

PO227 DEUTERON ACER TENDL-2023 LIBRARY; T=0.K  
Photon emission for (n,n\*)t

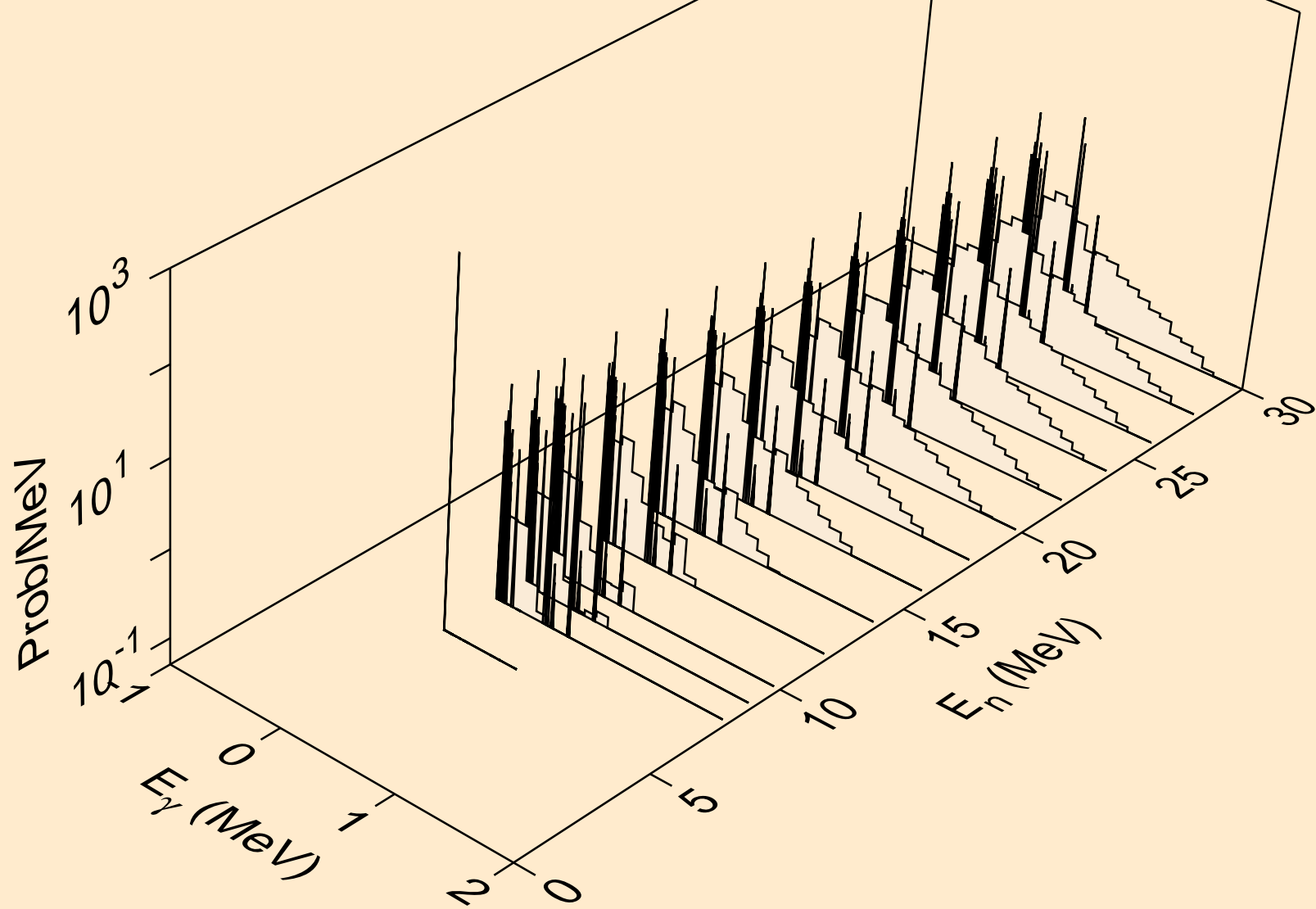

PO227 DEUTERON ACER TENDL-2023 LIBRARY; T=0.K  
Photon emission for (n,n\*)he3

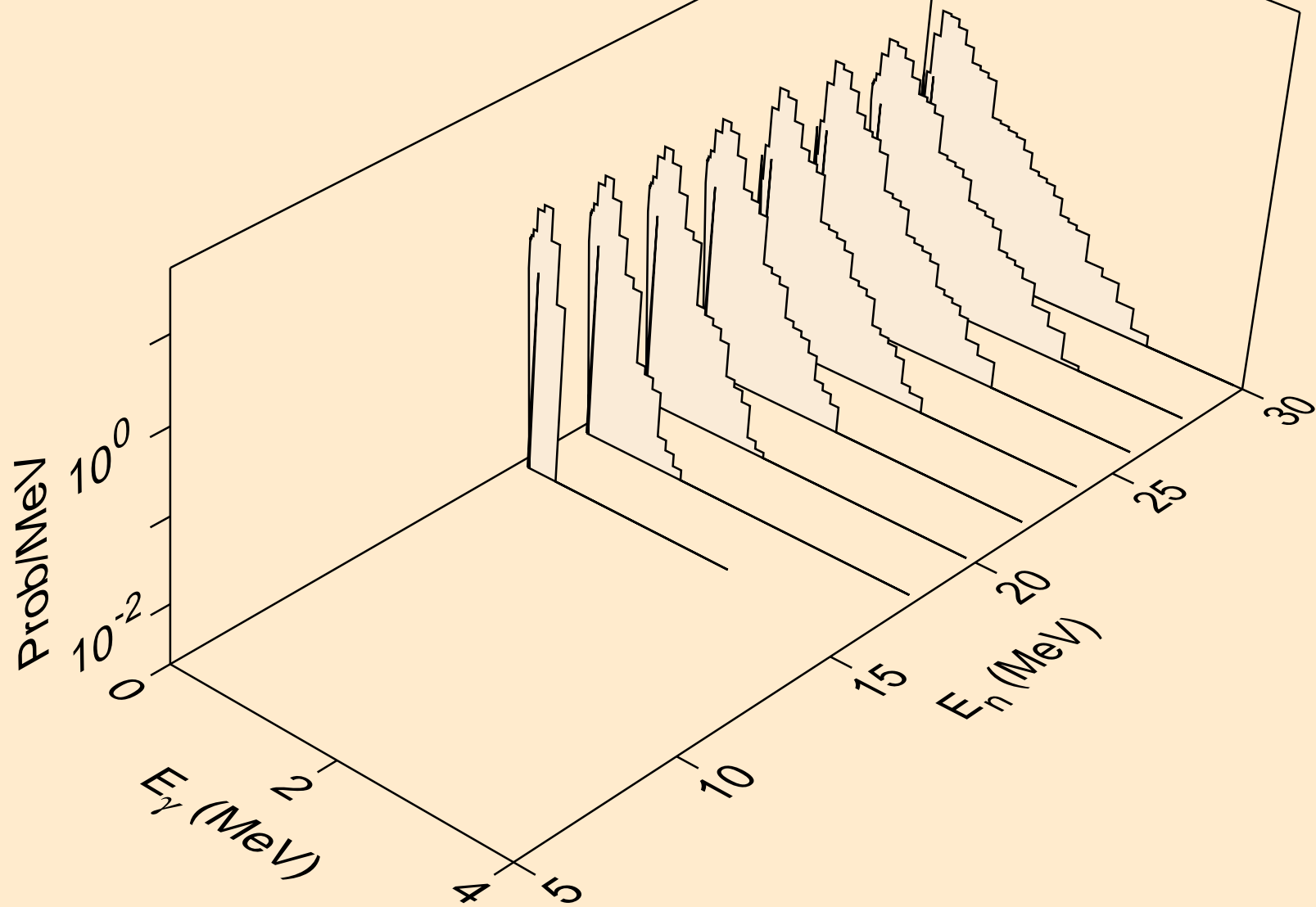



PO227 DEUTERON ACER TENDL-2023 LIBRARY; T=0.K  
Photon emission for (n,4n)

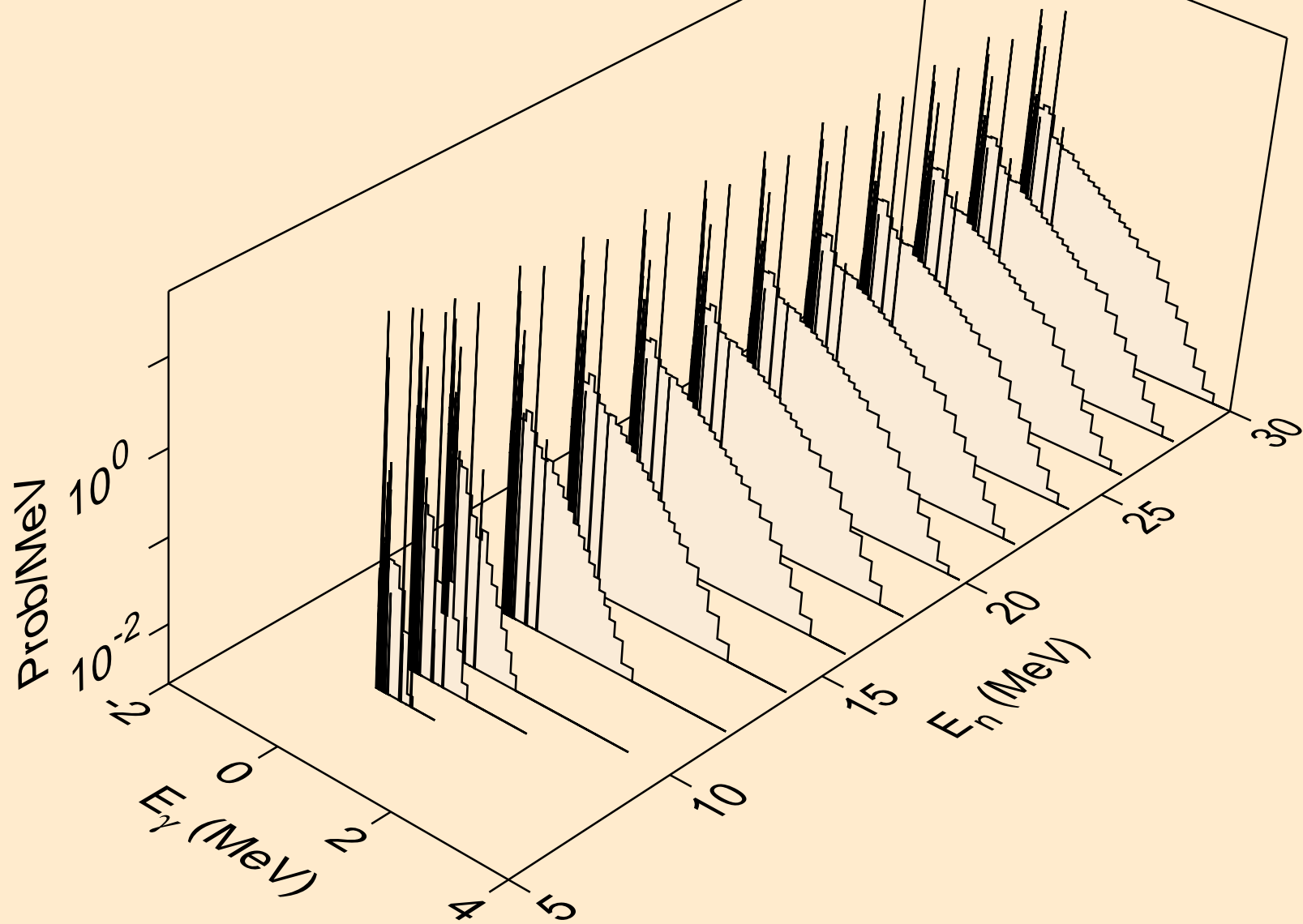

PO227 DEUTERON ACER TENDL-2023 LIBRARY; T=0.K  
Photon emission for (n,2np)

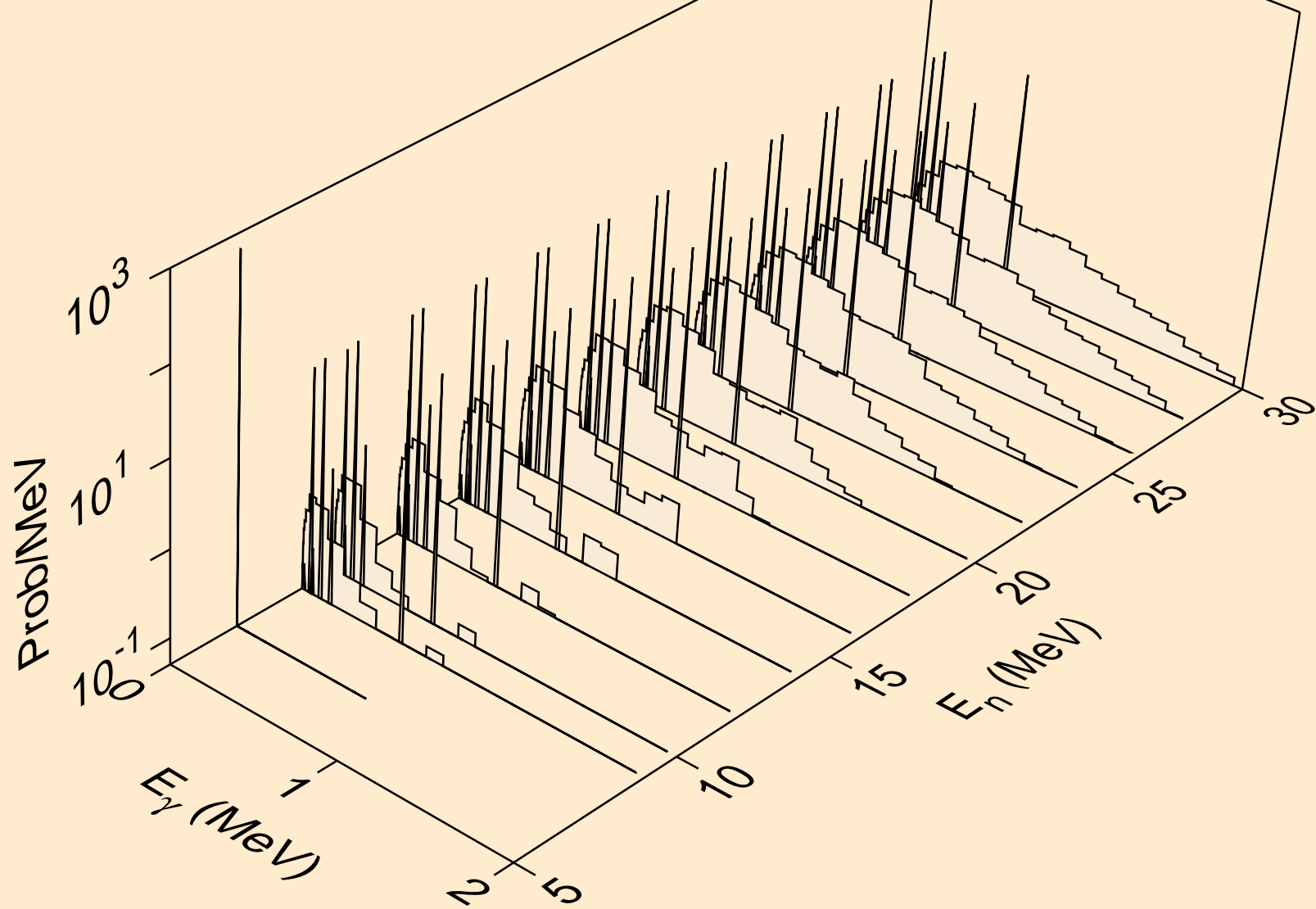

PO227 DEUTERON ACER TENDL-2023 LIBRARY; T=0.K  
Photon emission for (n,3np)

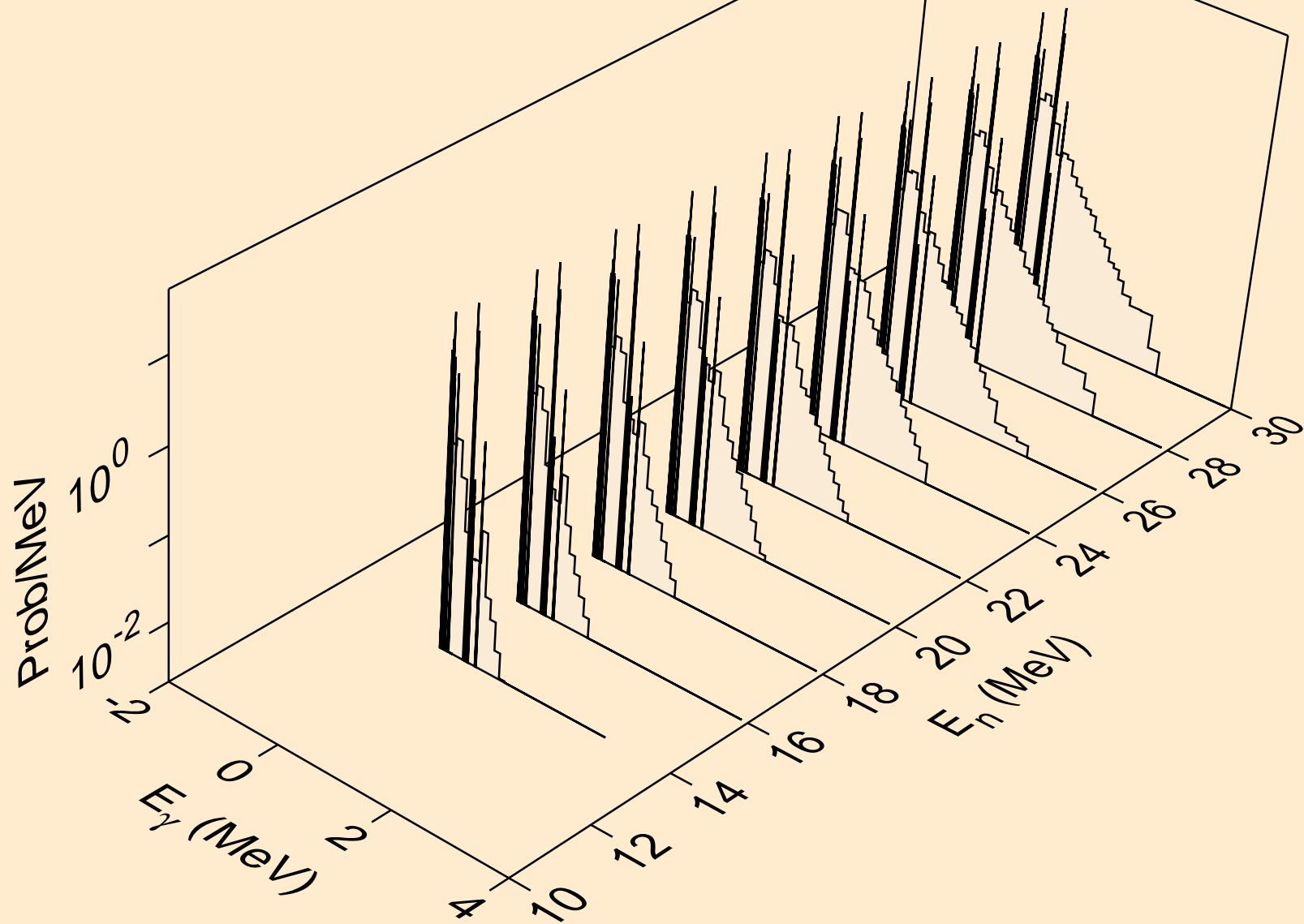

PO227 DEUTERON ACER TENDL-2023 LIBRARY; T=0.K  
Photon emission for (n,n2p)

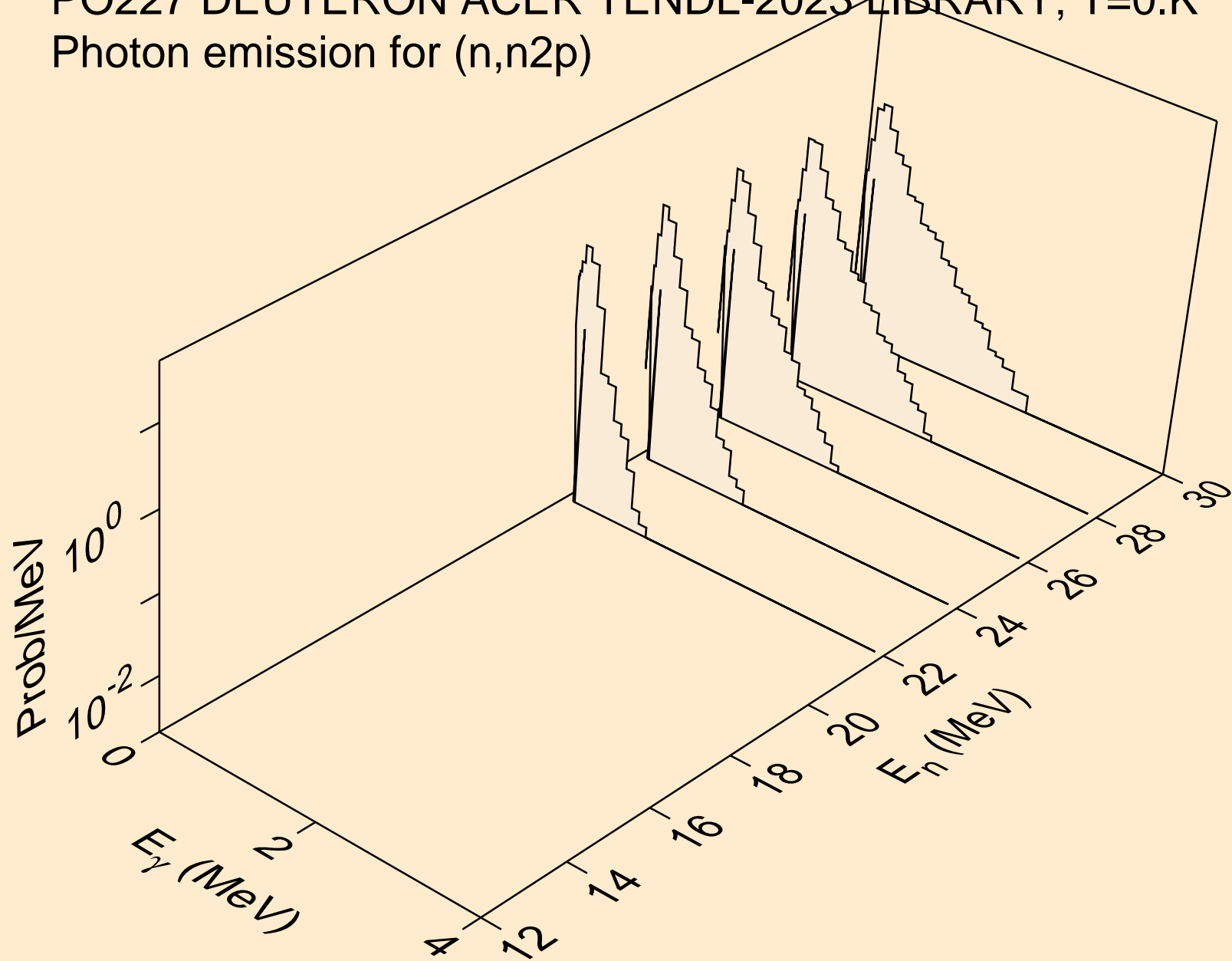

PO227 DEUTERON ACER TENDL-2023 LIBRARY; T=0.K  
Photon emission for (n,gma)

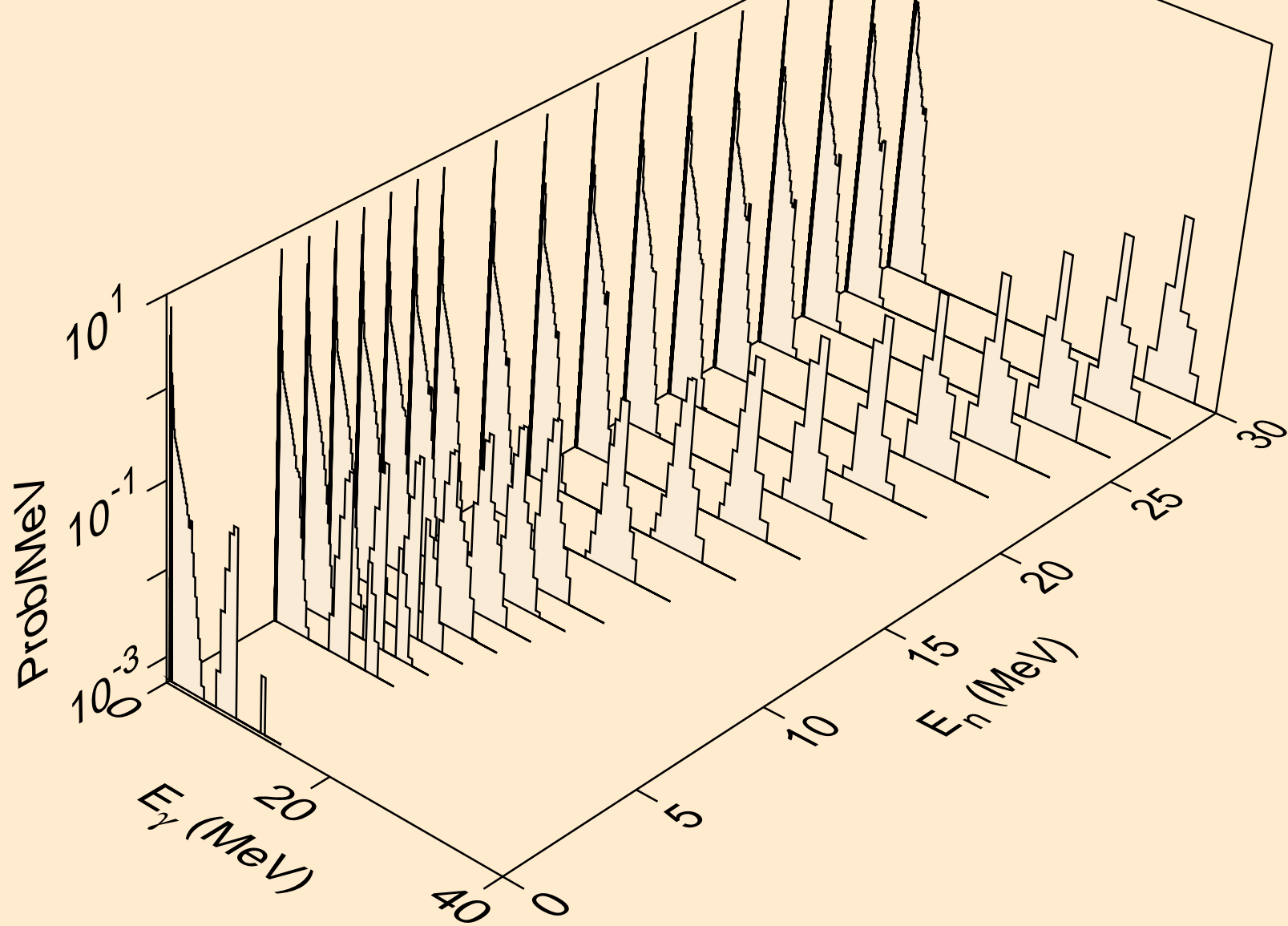

PO227 DEUTERON ACER TENDL-2023 LIBRARY; T=0.K  
Photon emission for (n,p)

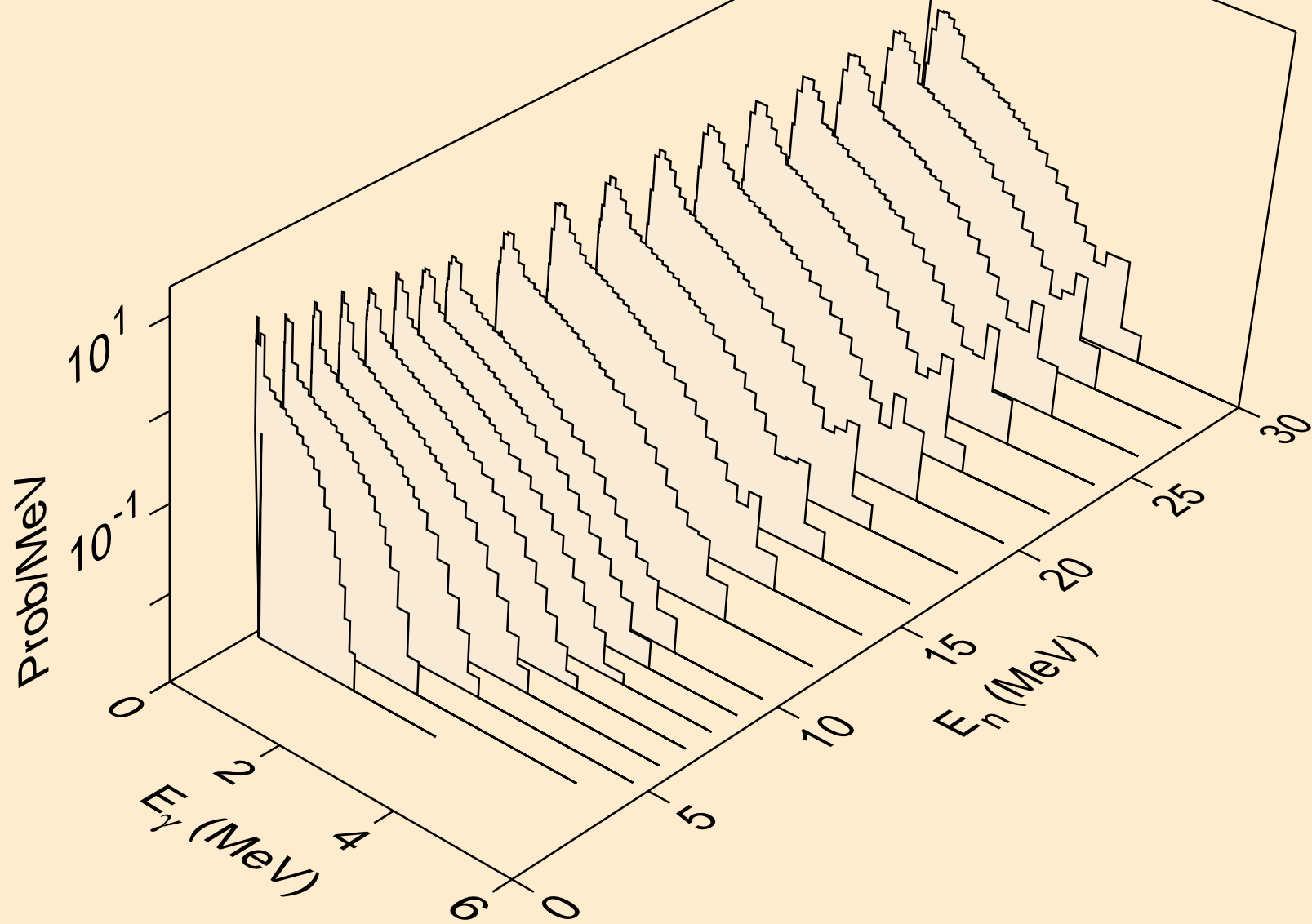

PO227 DEUTERON ACER TENDL-2023 LIBRARY; T=0.K  
Photon emission for inelastic

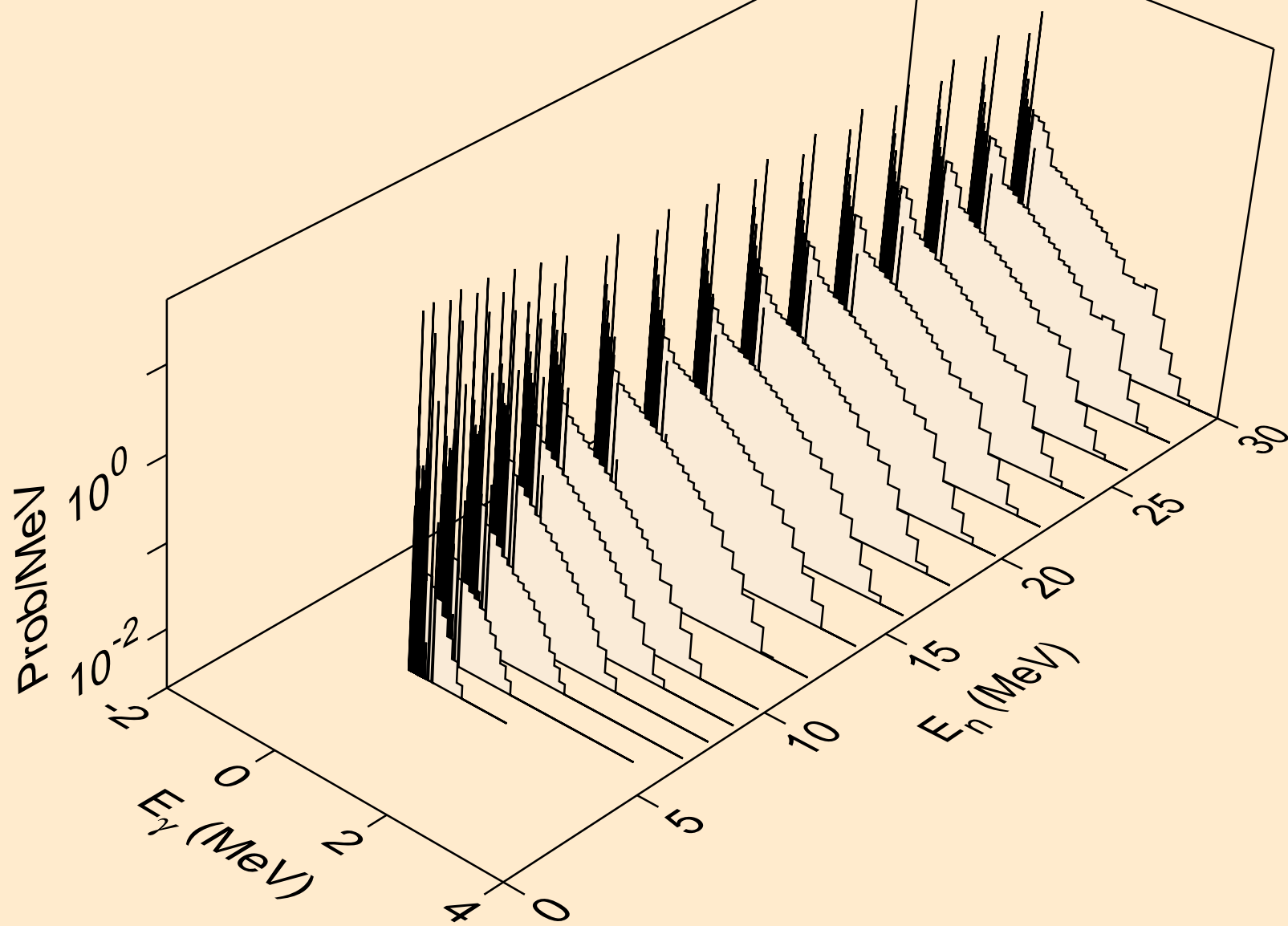

PO227 DEUTERON ACER TENDL-2023 LIBRARY; T=0.K  
Photon emission for (n,t)

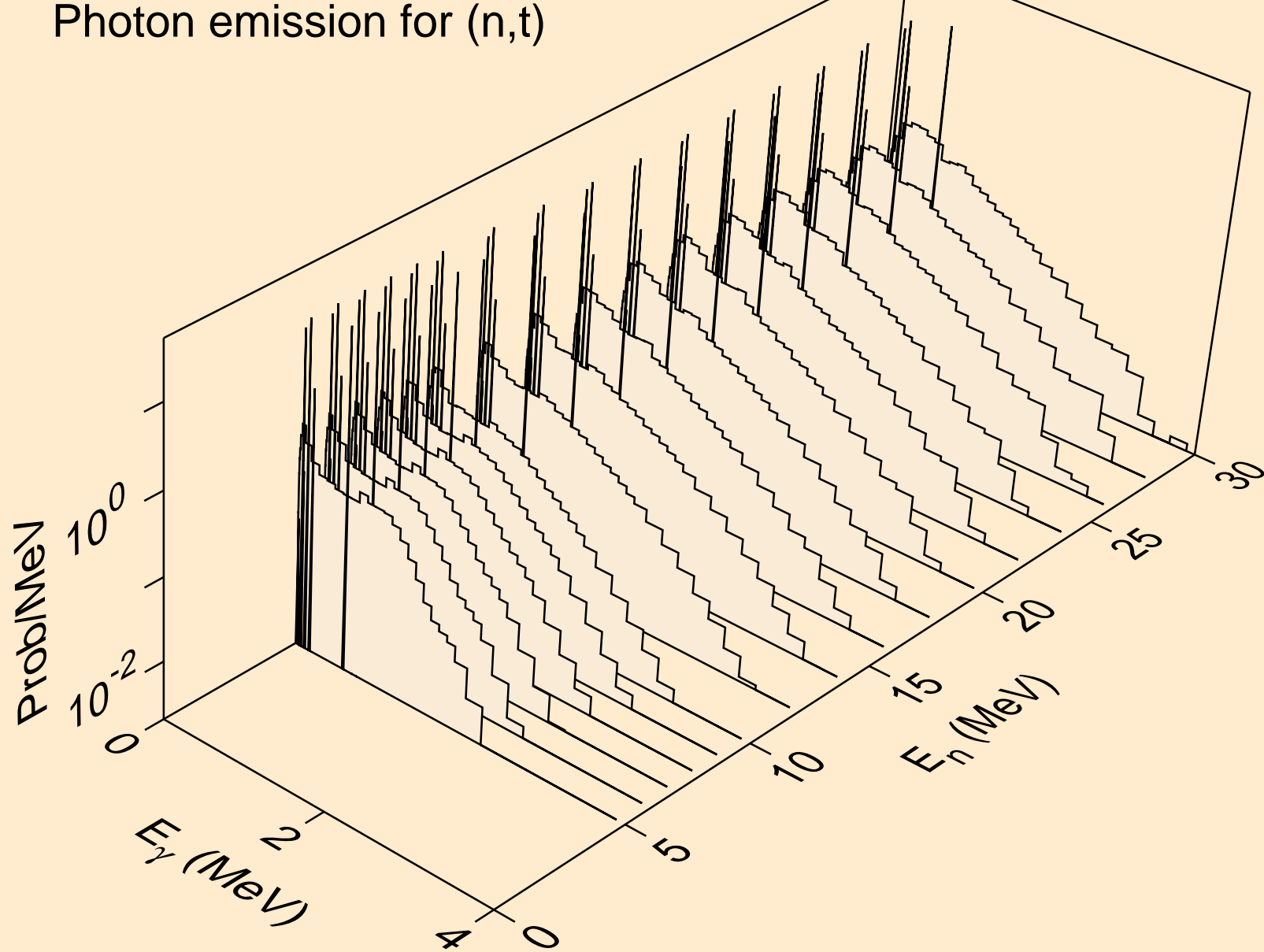



PO227 DEUTERON ACER TENDL-2023 LIBRARY; T=0.K  
Photon emission for (n,he3)

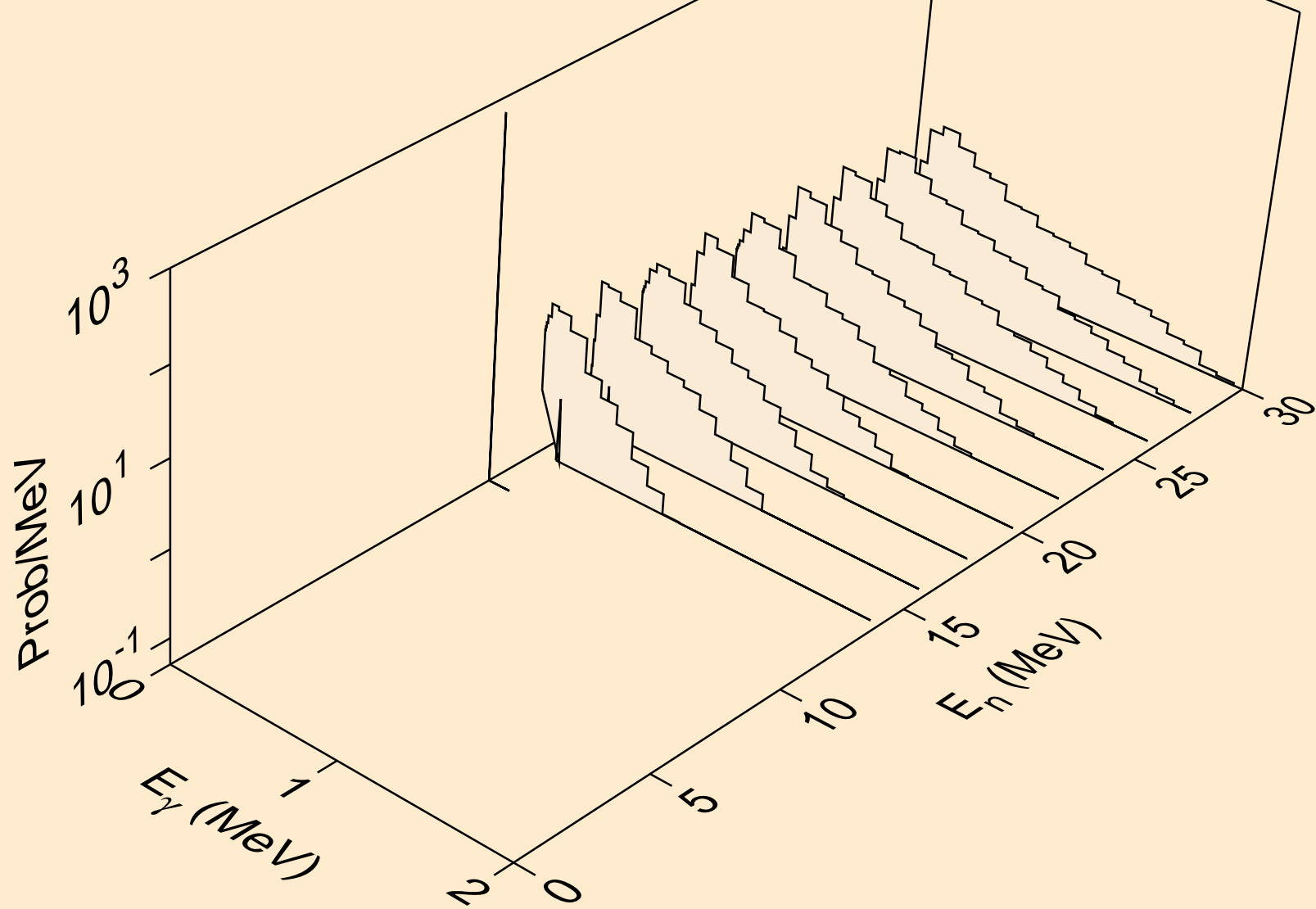

PO227 DEUTERON ACER TENDL-2023 LIBRARY; T=0.K  
Photon emission for (n,a)

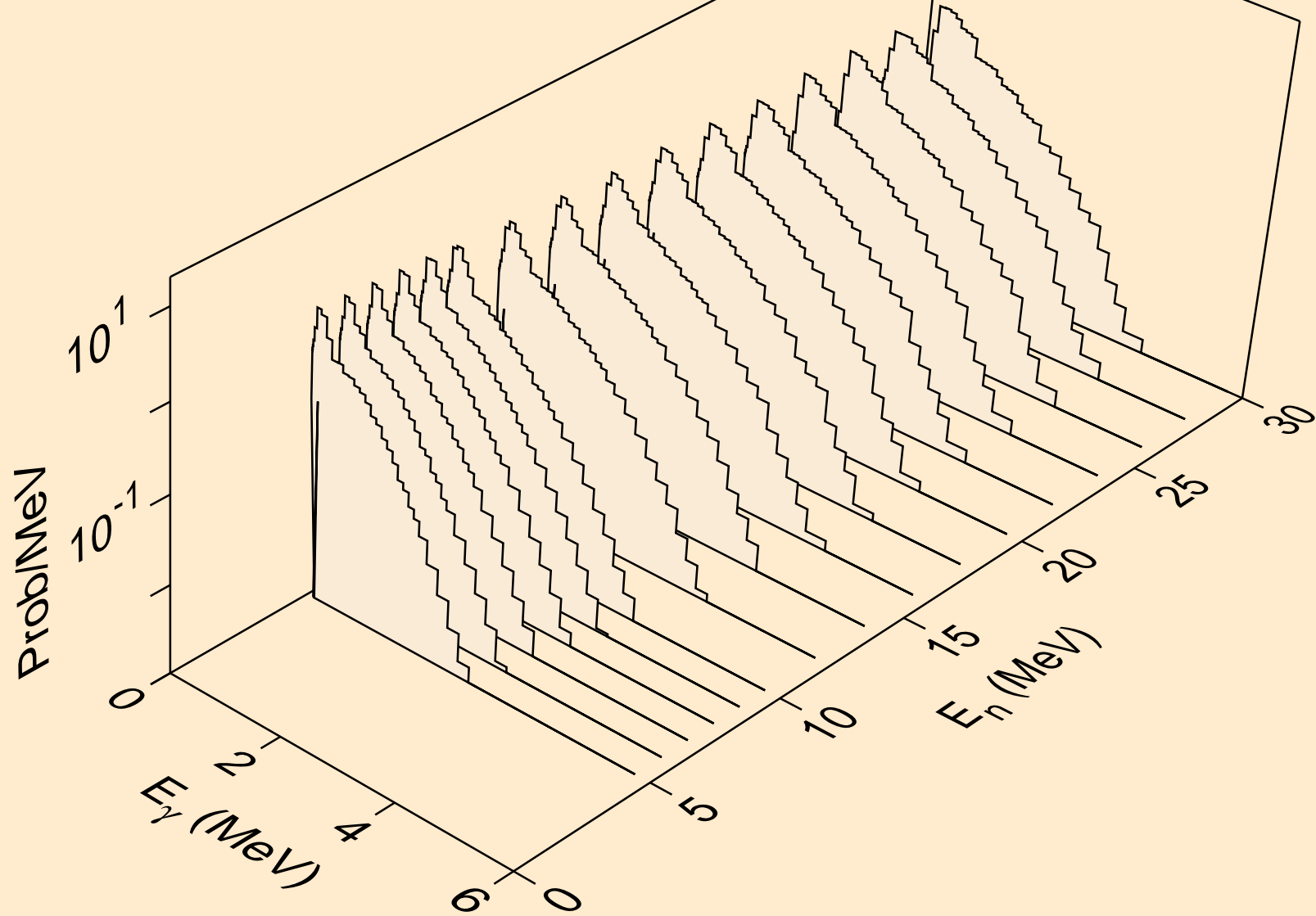

PO227 DEUTERON ACER TENDL-2023 LIBRARY; T=0.K  
Photon emission for (n,2p)

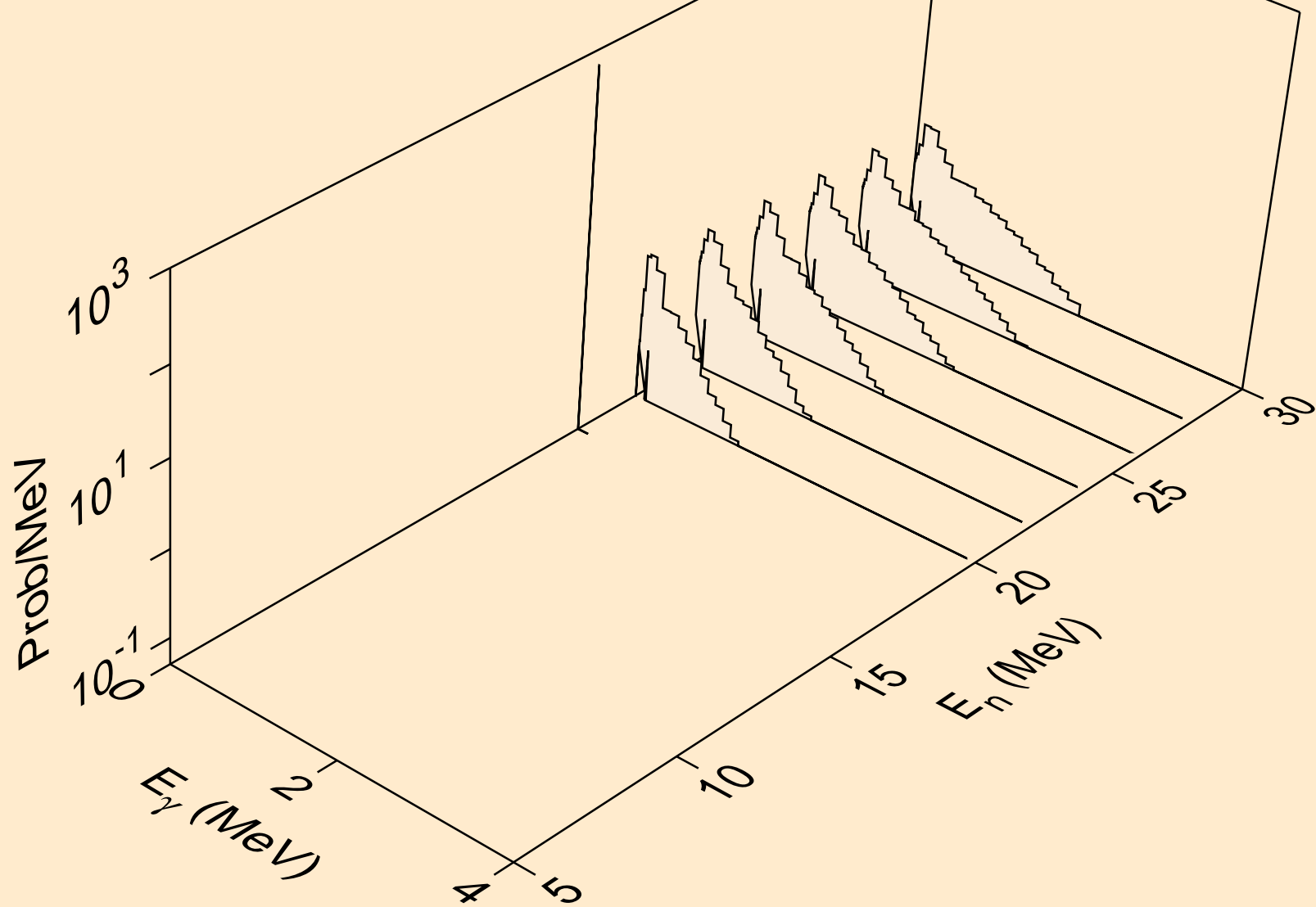

PO227 DEUTERON ACER TENDL-2023 LIBRARY; T=0.K  
Photon emission for (n,pd)

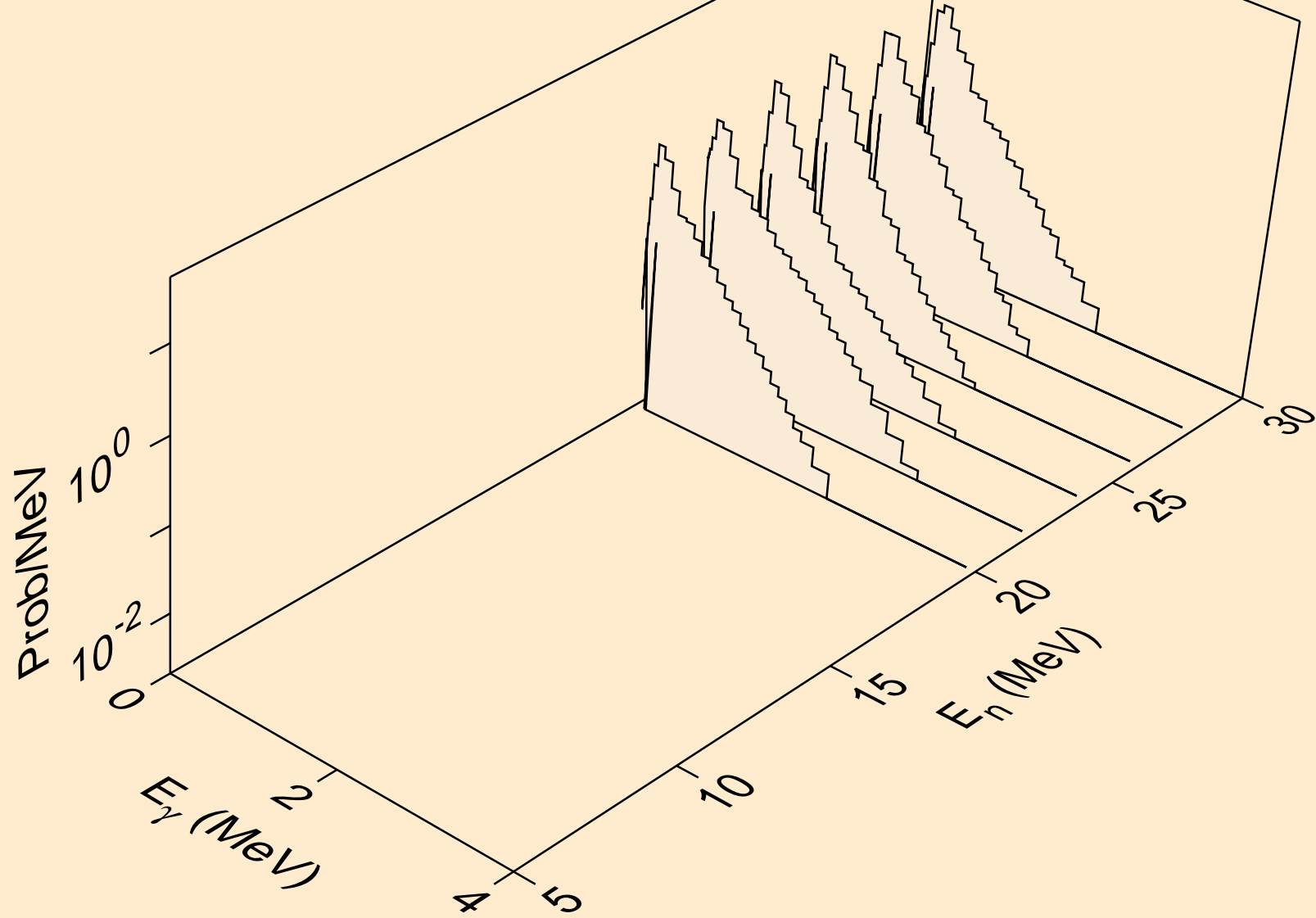

PO227 DEUTERON ACER TENDL-2023 LIBRARY; T=0.K  
Particle heating contributions

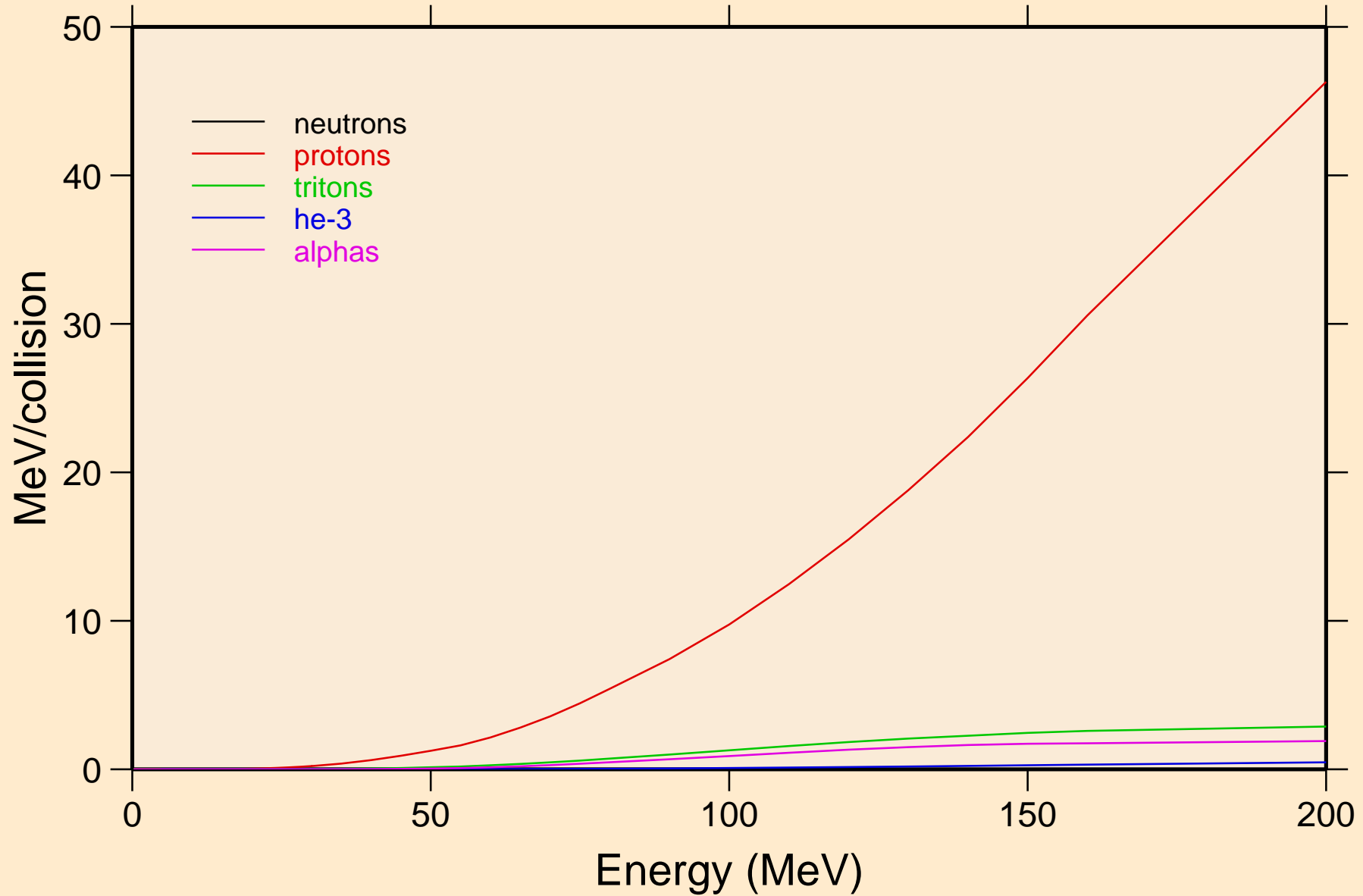

PO227 DEUTERON ACER TENDL-2023 LIBRARY; T=0.K  
Recoil Heating

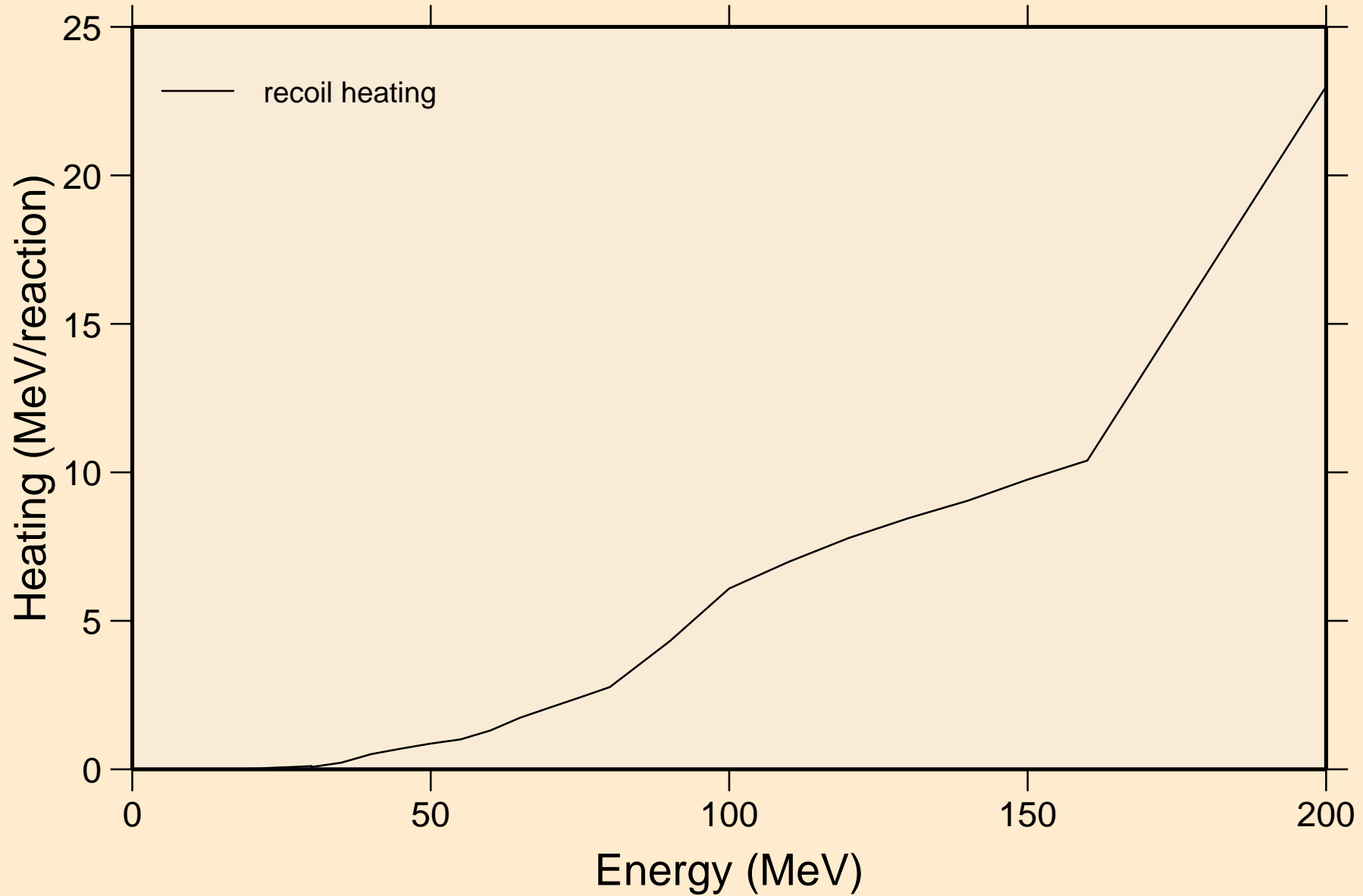

PO227 DEUTERON ACER TENDL-2023 LIBRARY; T=0.K  
Particle production cross sections

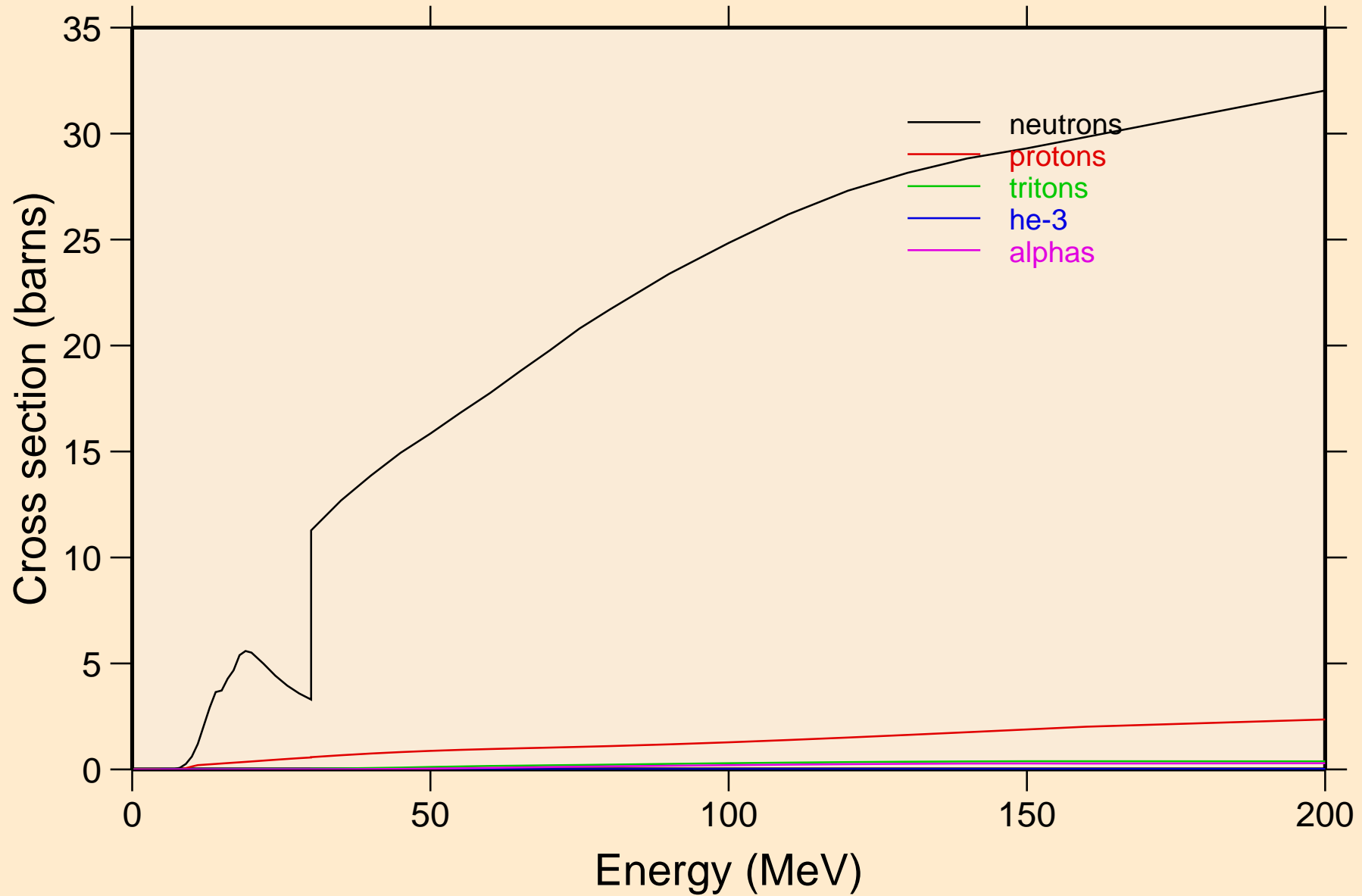

PO227 DEUTERON ACER TENDL-2023 LIBRARY; T=0.K  
neutrons from (d,n)

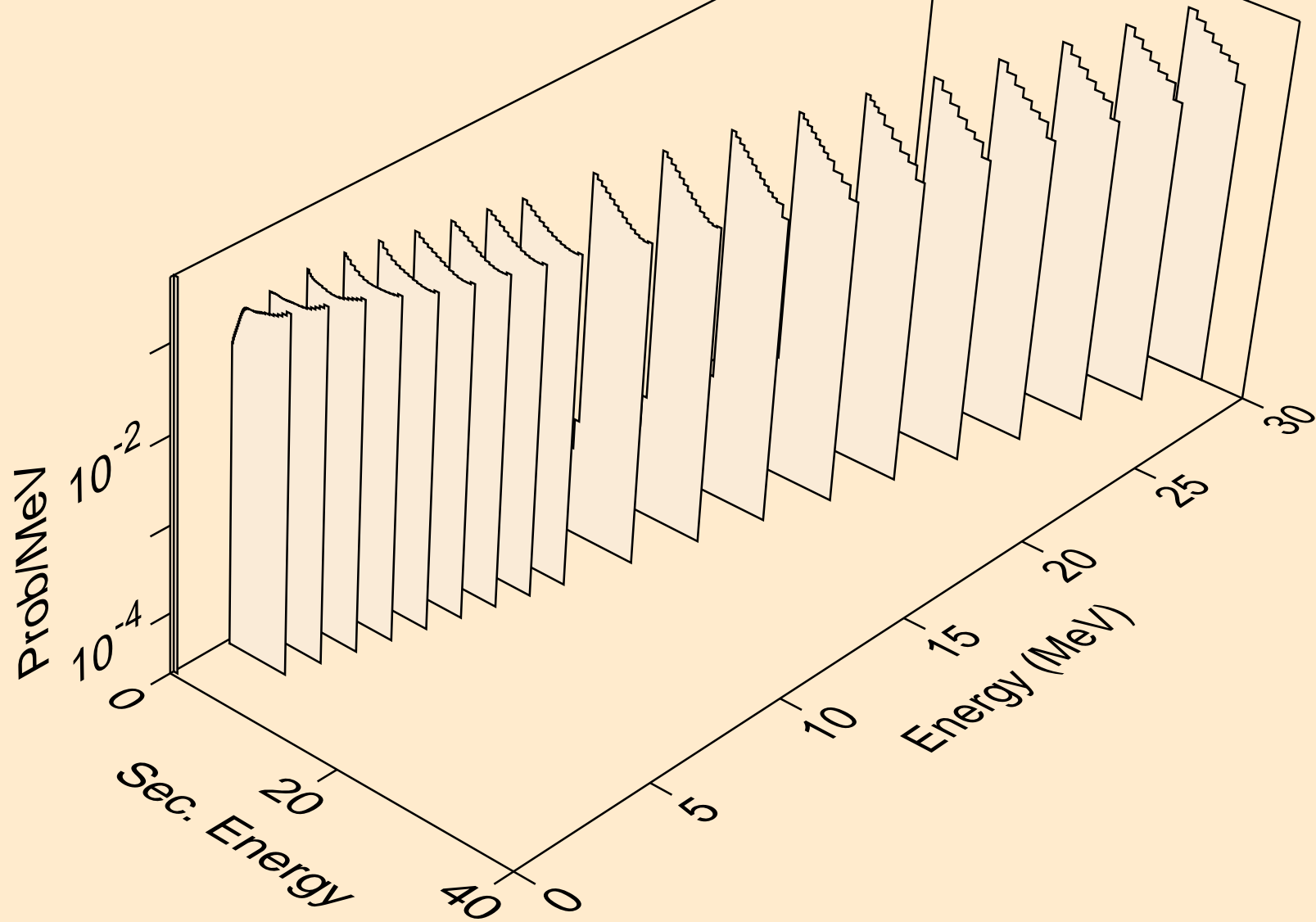



PO227 DEUTERON ACER TENDL-2023 LIBRARY; T=0.K  
neutrons from (d,x)

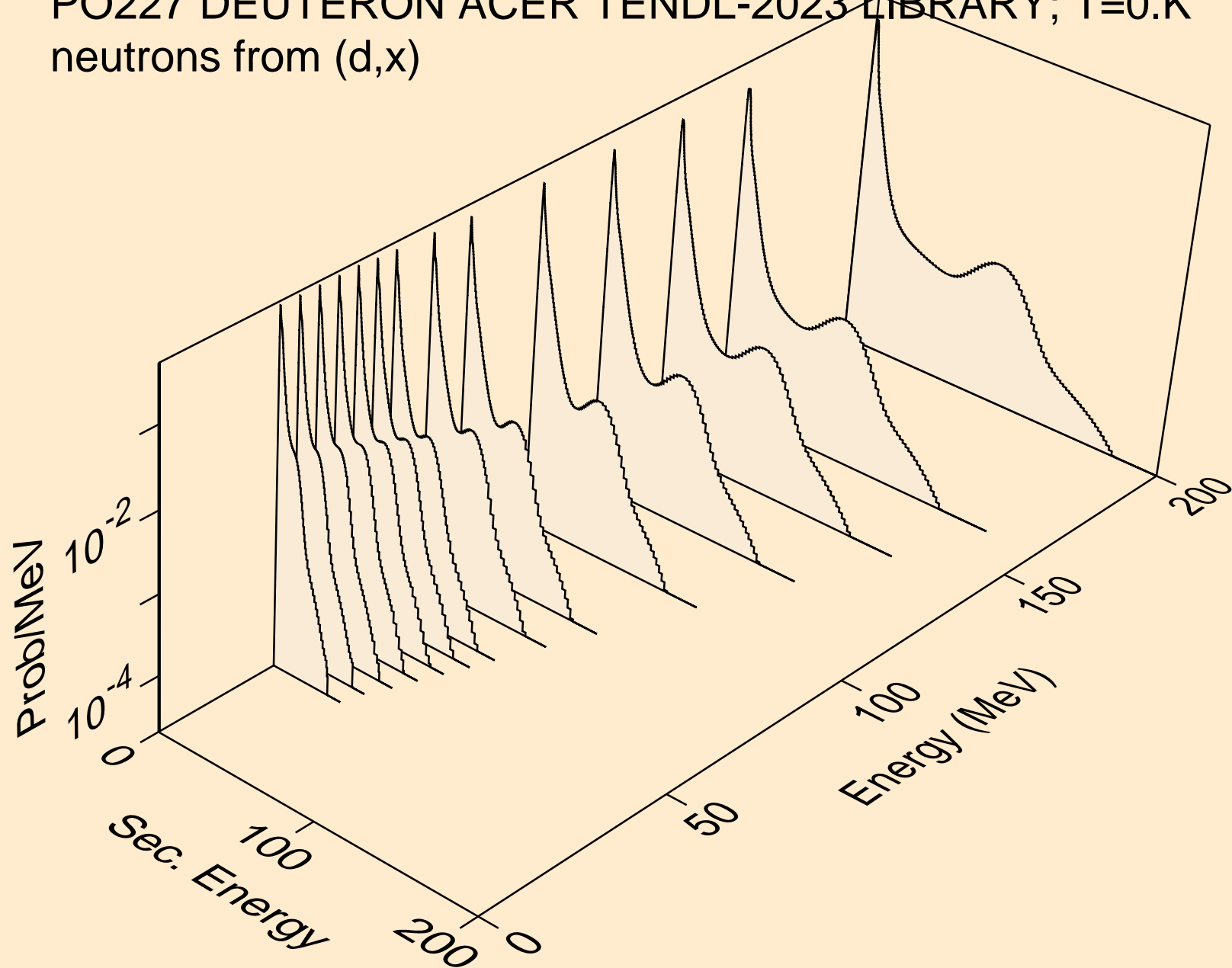

PO227 DEUTERON ACER TENDL-2023 LIBRARY; T=0.K  
neutrons from (d,2nd)

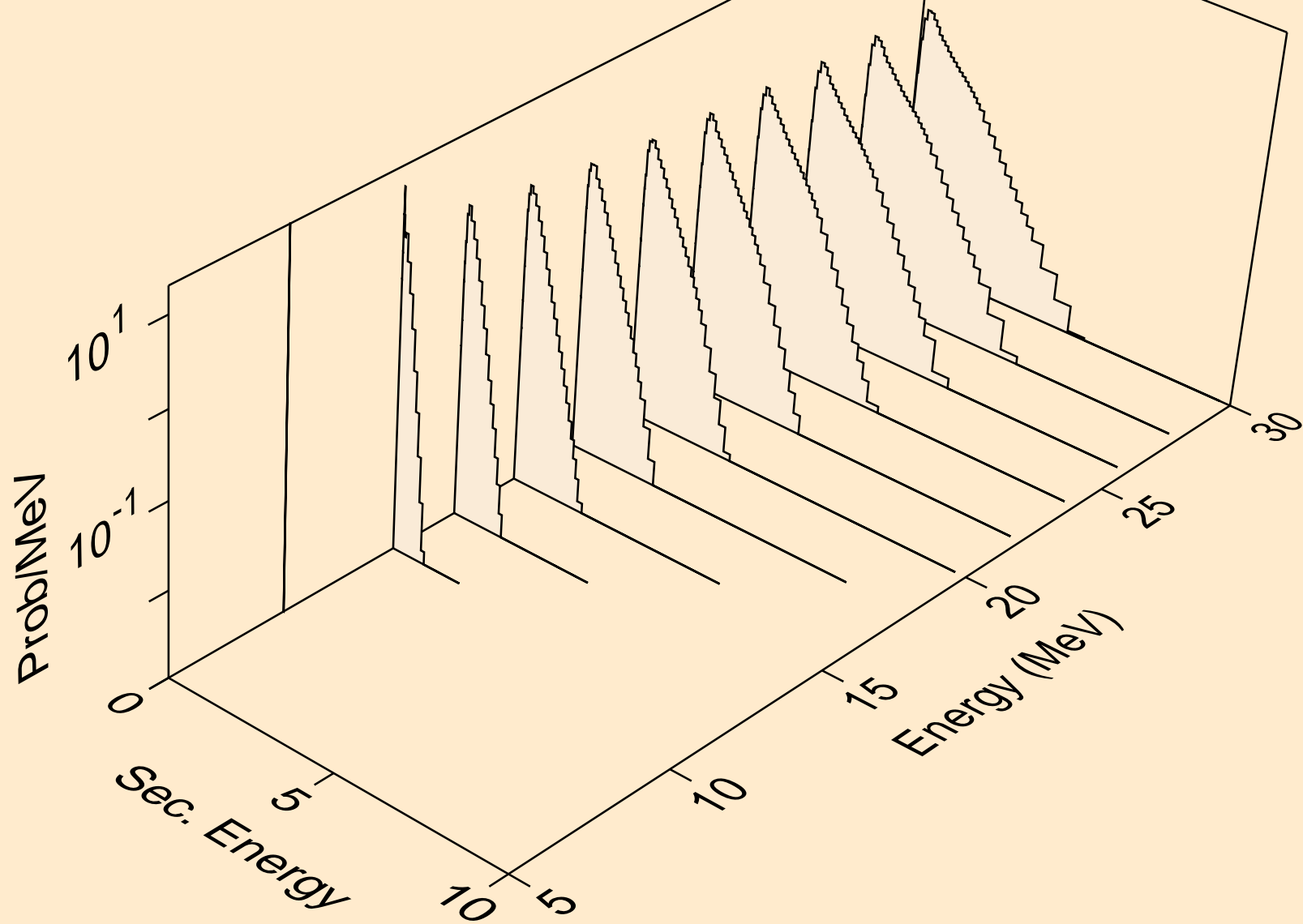

PO227 DEUTERON ACER TENDL-2023 LIBRARY; T=0.K  
neutrons from (d,2n)

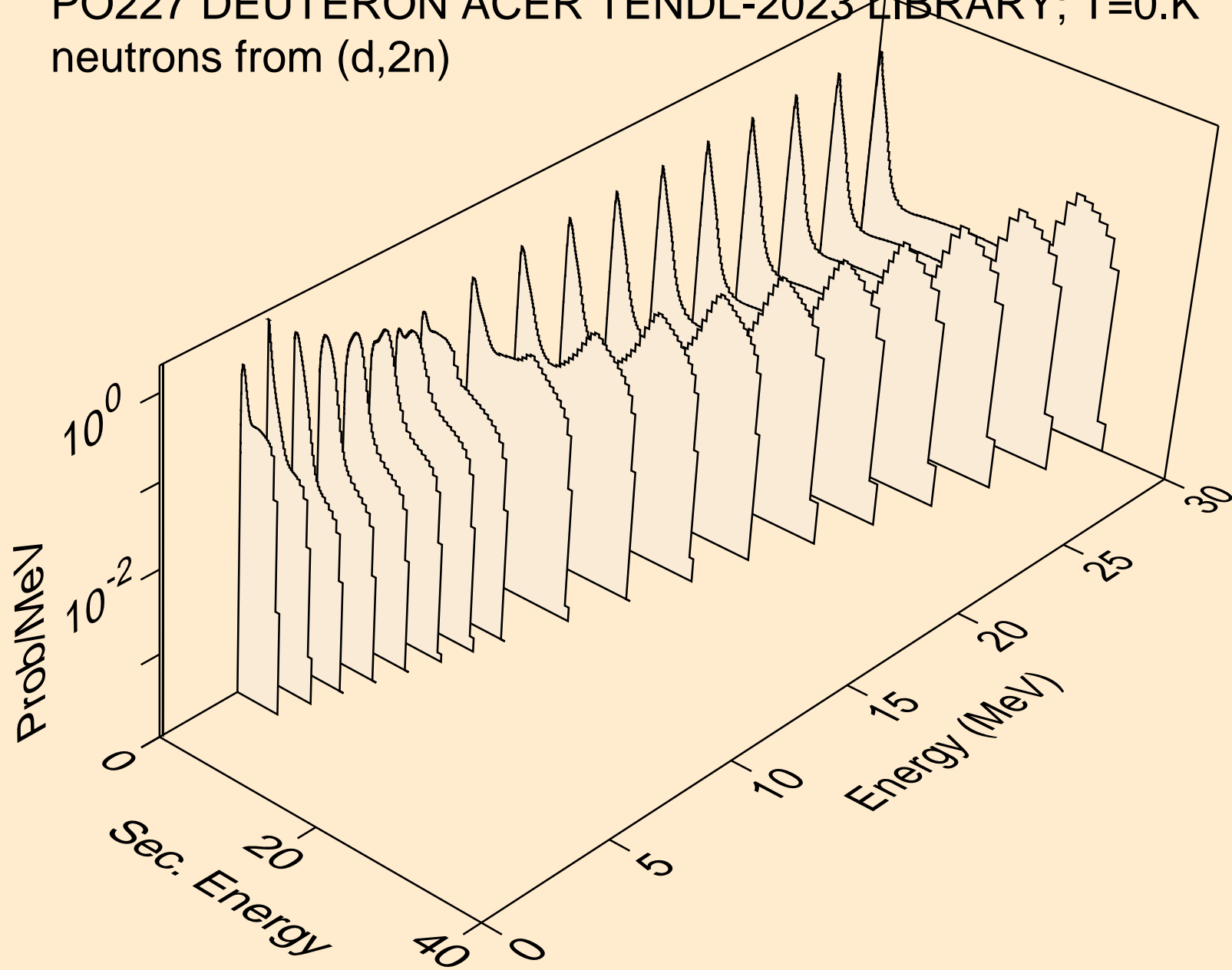

PO227 DEUTERON ACER TENDL-2023 LIBRARY; T=0.K  
neutrons from (d,3n)

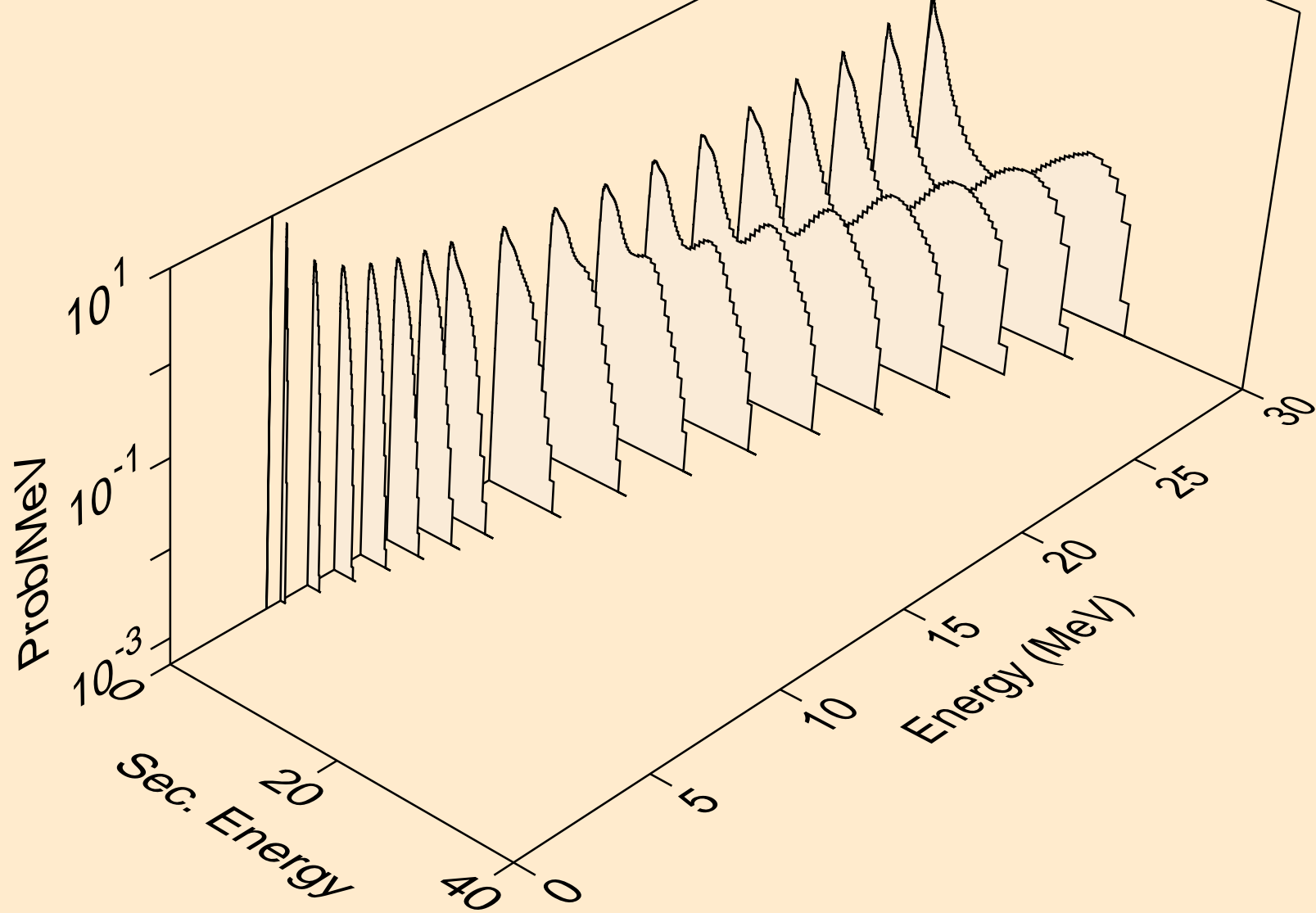

PO227 DEUTERON ACER TENDL-2023 LIBRARY; T=0.K  
neutrons from (d,n\*)a

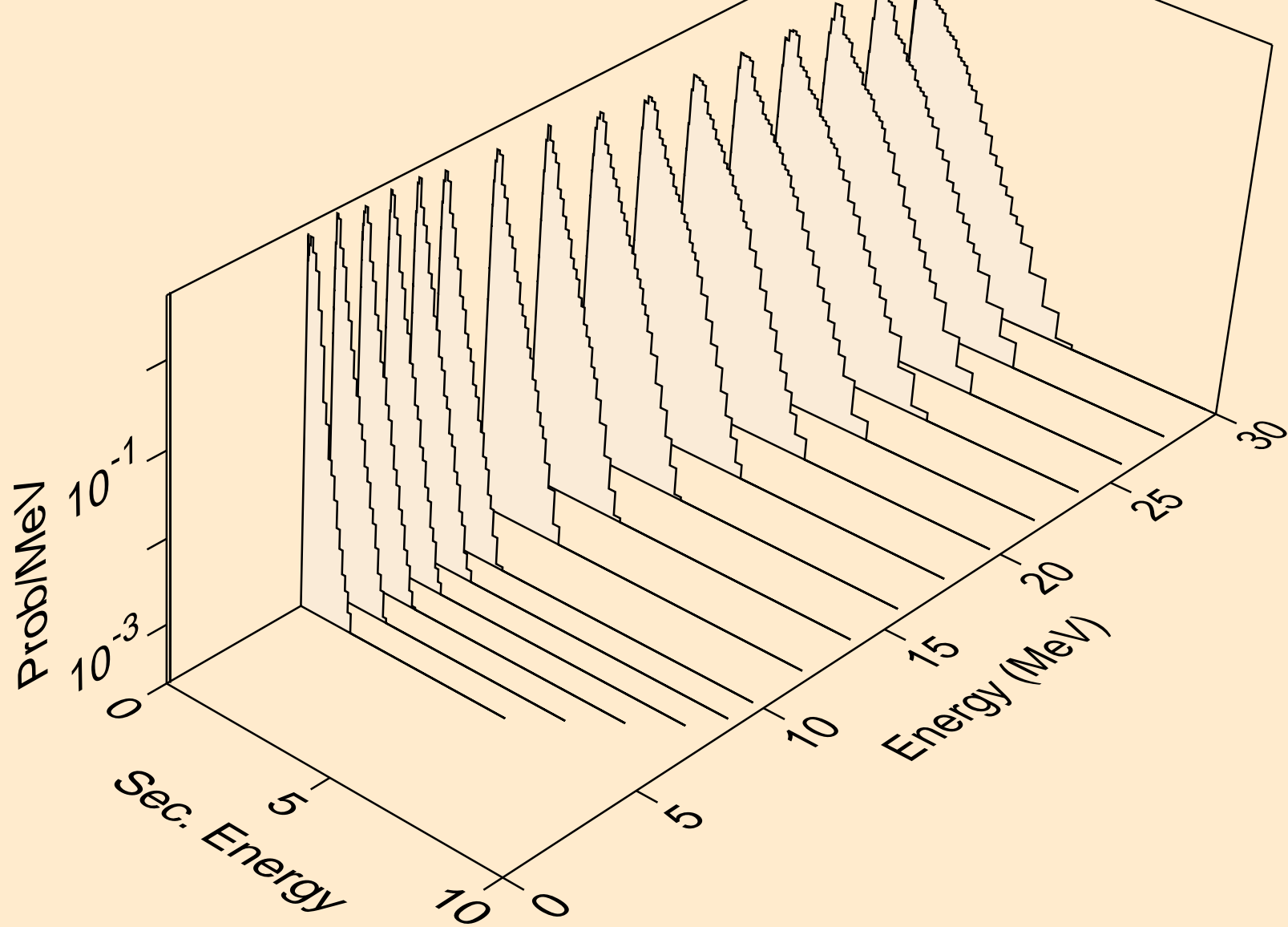

PO227 DEUTERON ACER TENDL-2023 LIBRARY; T=0.K  
neutrons from (d,2n)a

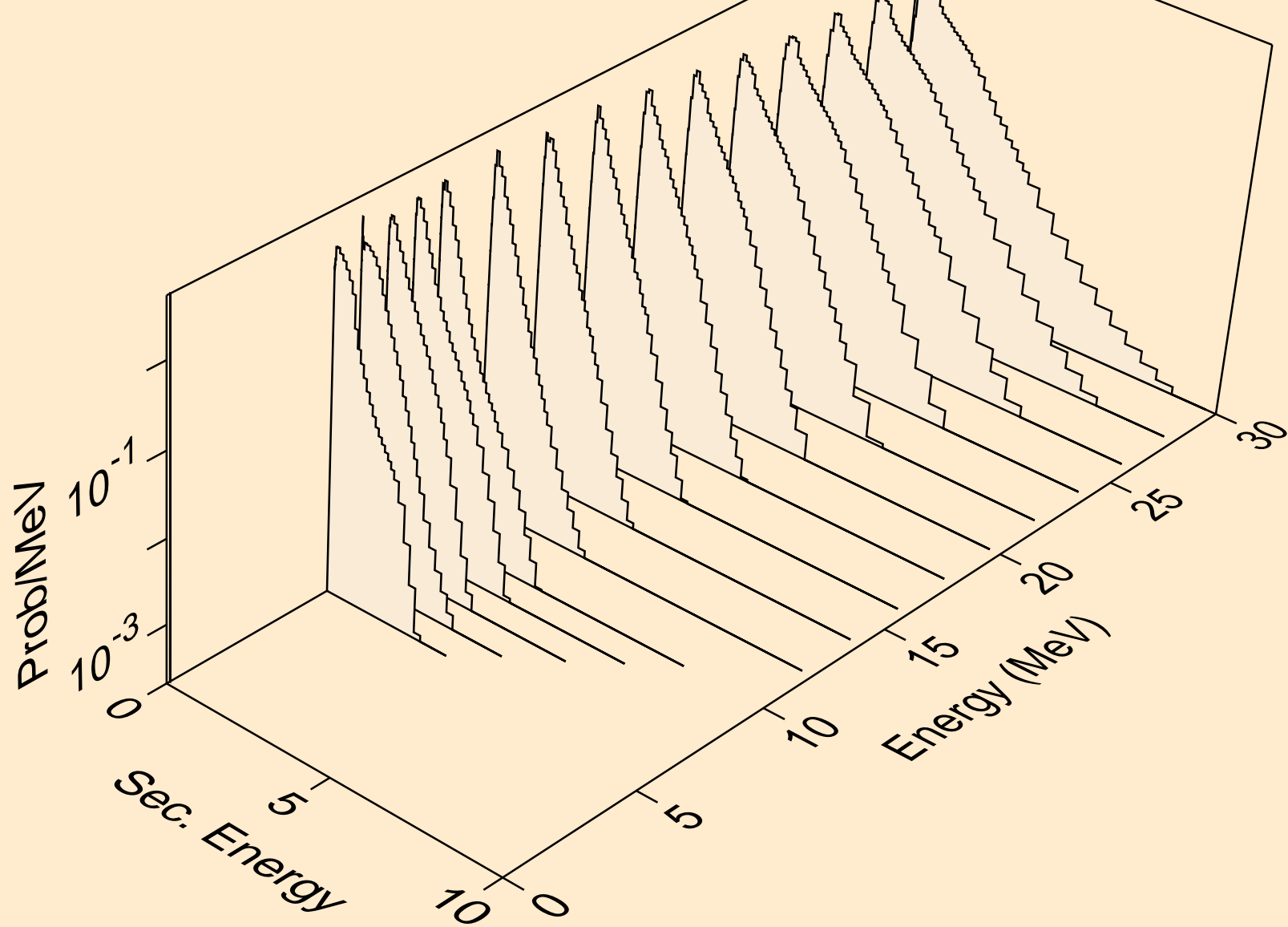

PO227 DEUTERON ACER TENDL-2023 LIBRARY; T=0.K  
neutrons from (d,3n)a

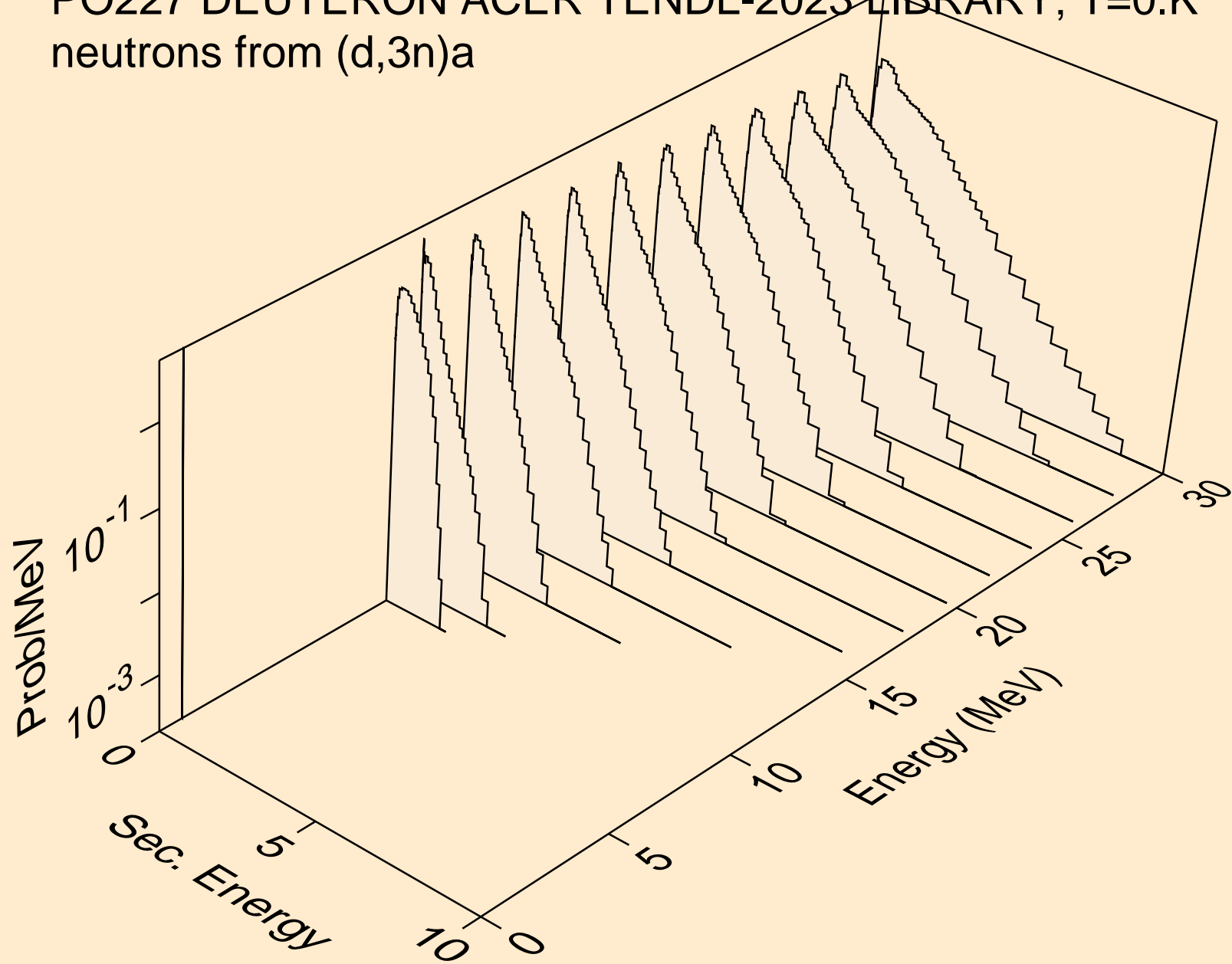

PO227 DEUTERON ACER TENDL-2023 LIBRARY; T=0.K  
neutrons from (d,n\*)p

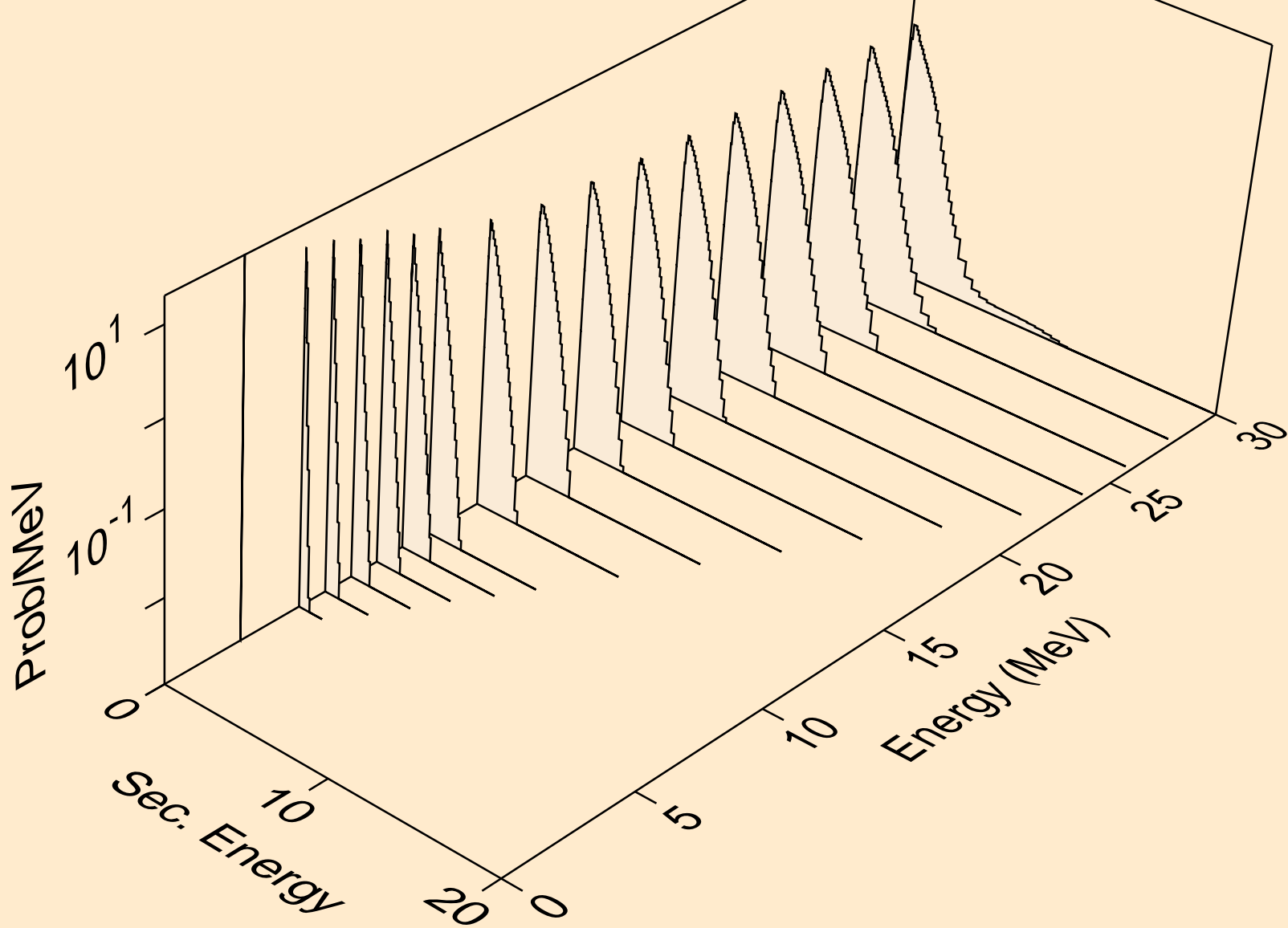



PO227 DEUTERON ACER TENDL-2023 LIBRARY; T=0.K  
neutrons from (d,n\*)d

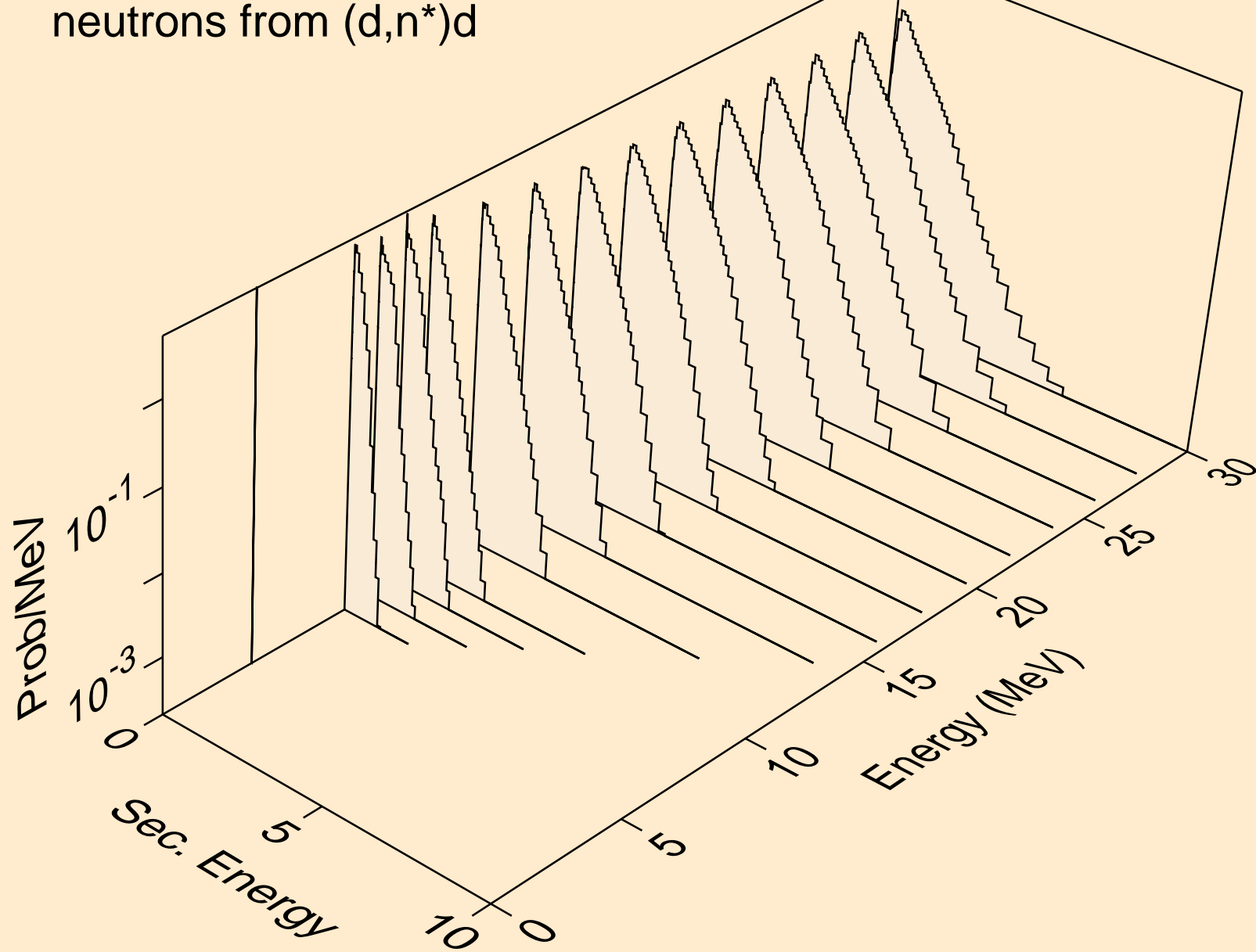

PO227 DEUTERON ACER TENDL-2023 LIBRARY; T=0.K  
neutrons from (d,n\*)t

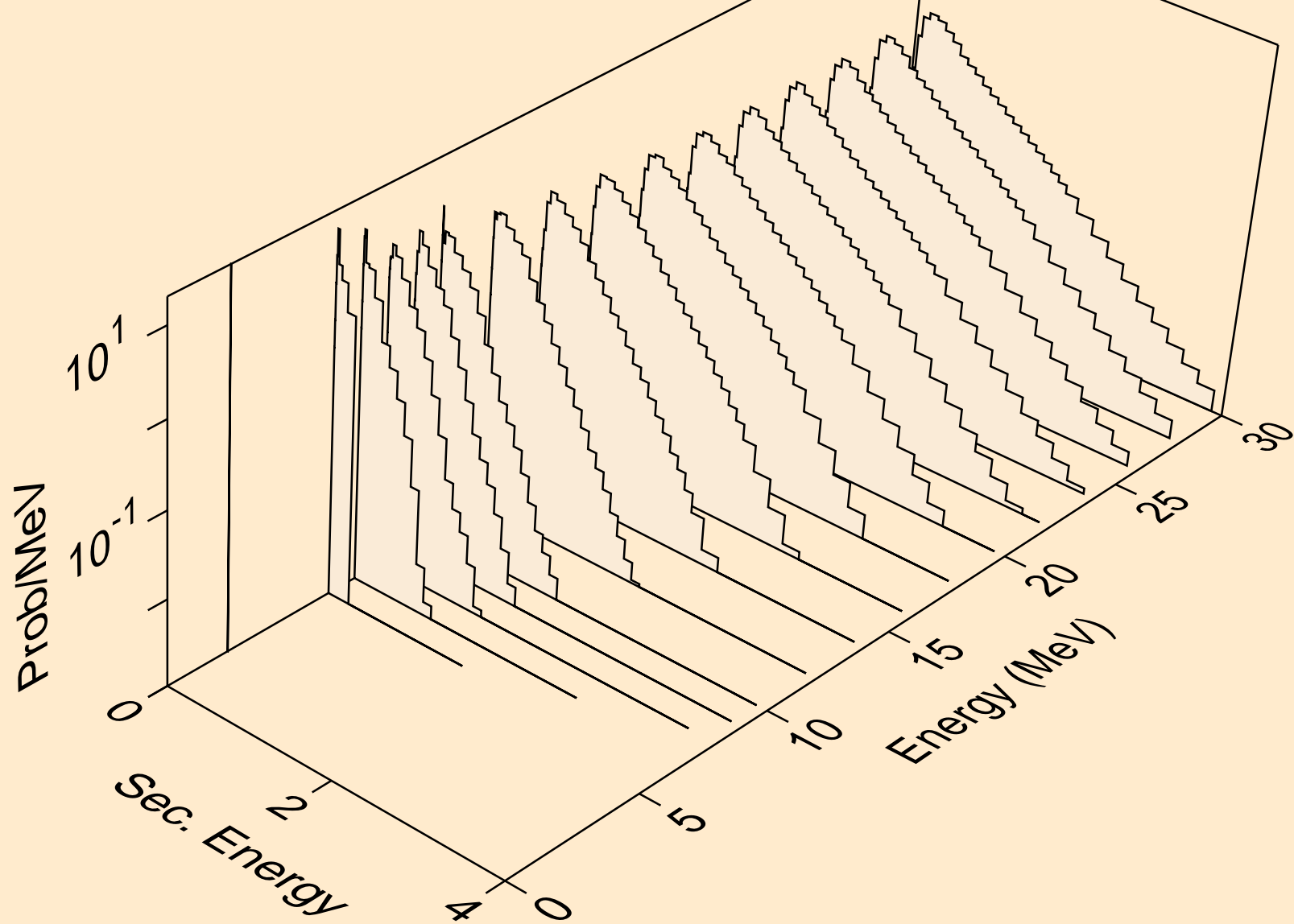

PO227 DEUTERON ACER TENDL-2023 LIBRARY; T=0.K  
neutrons from (d,n\*)he3

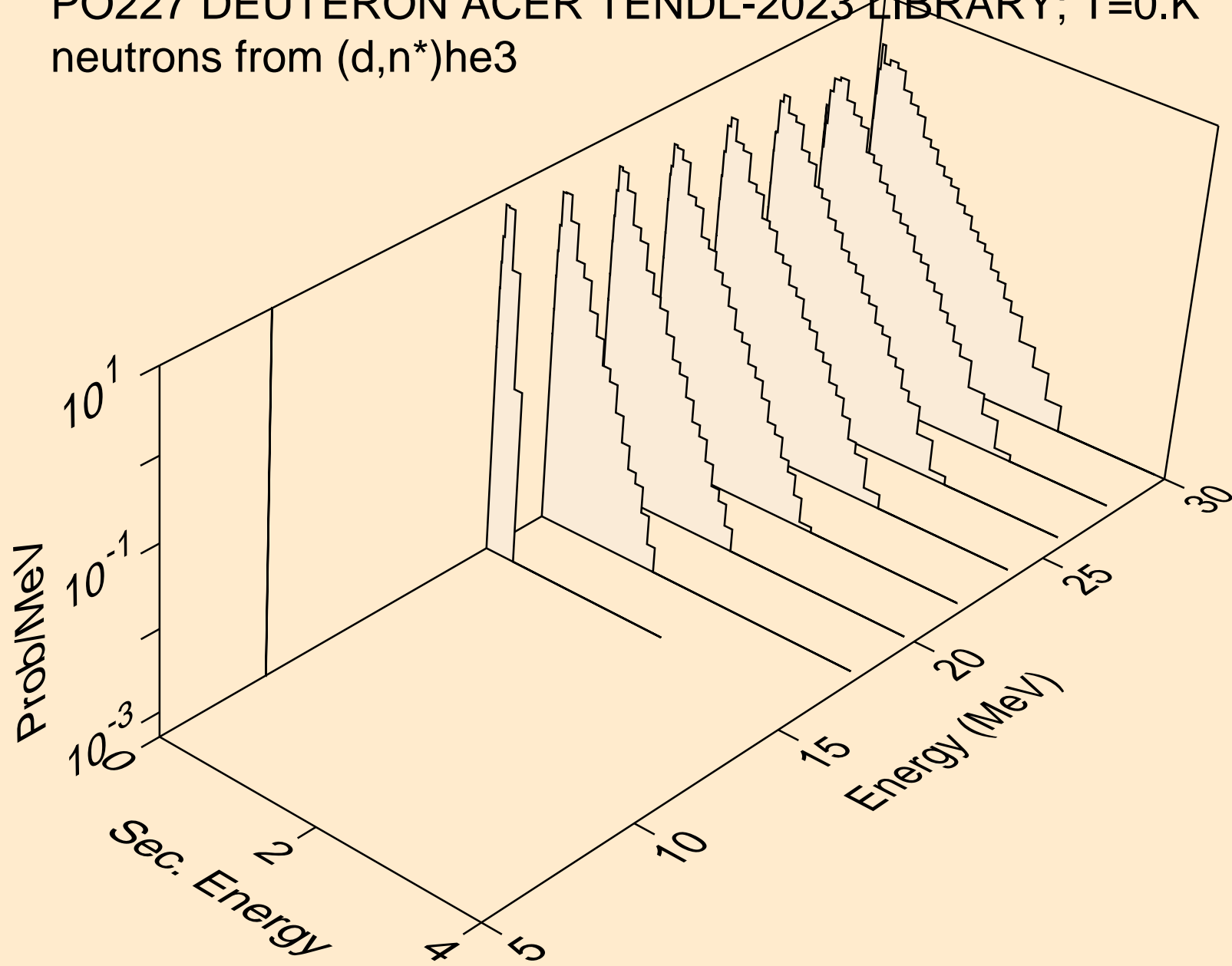

PO227 DEUTERON ACER TENDL-2023 LIBRARY; T=0.K  
neutrons from (d,4n)

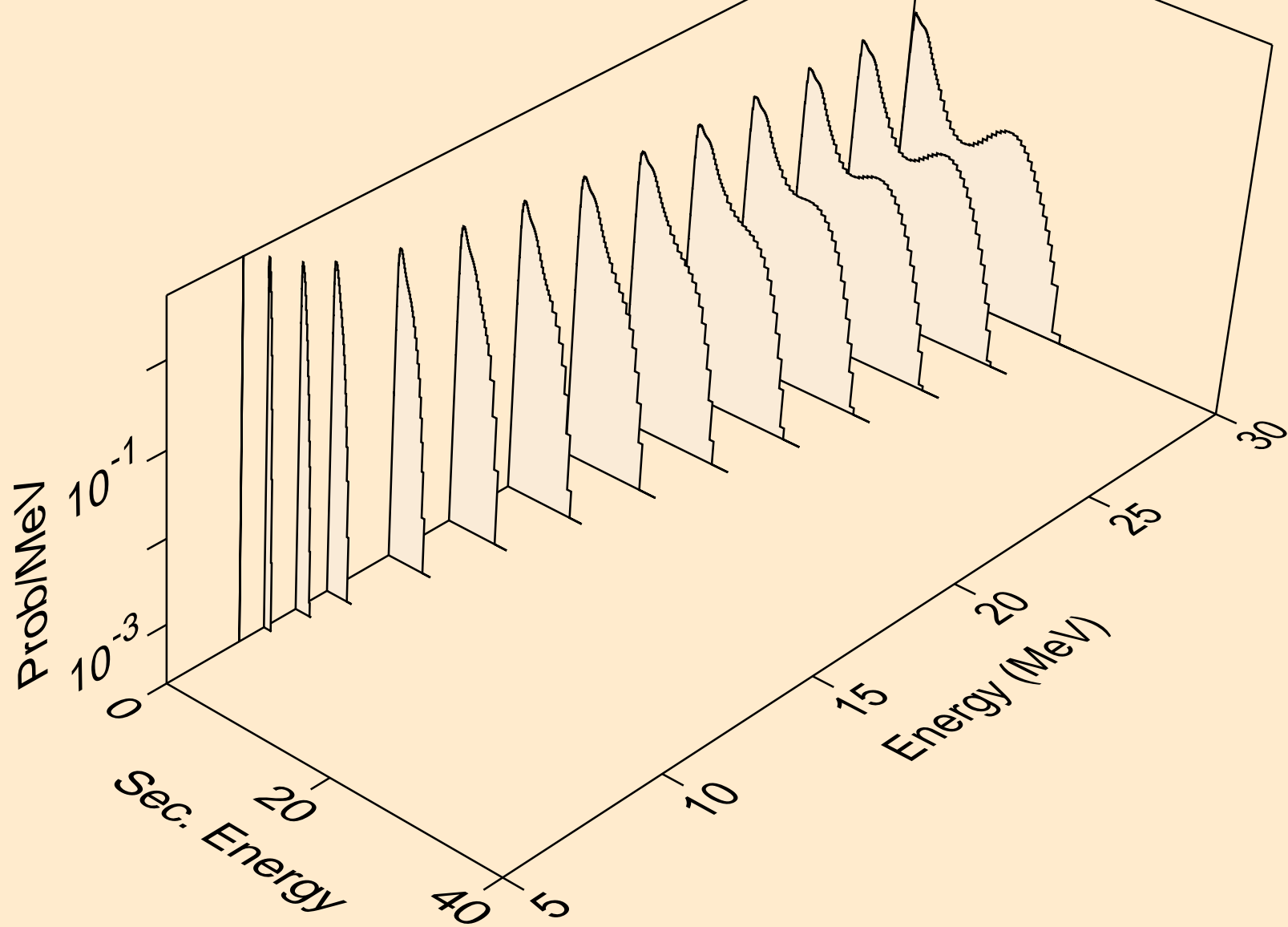

PO227 DEUTERON ACER TENDL-2023 LIBRARY; T=0.K  
neutrons from (d,2np)

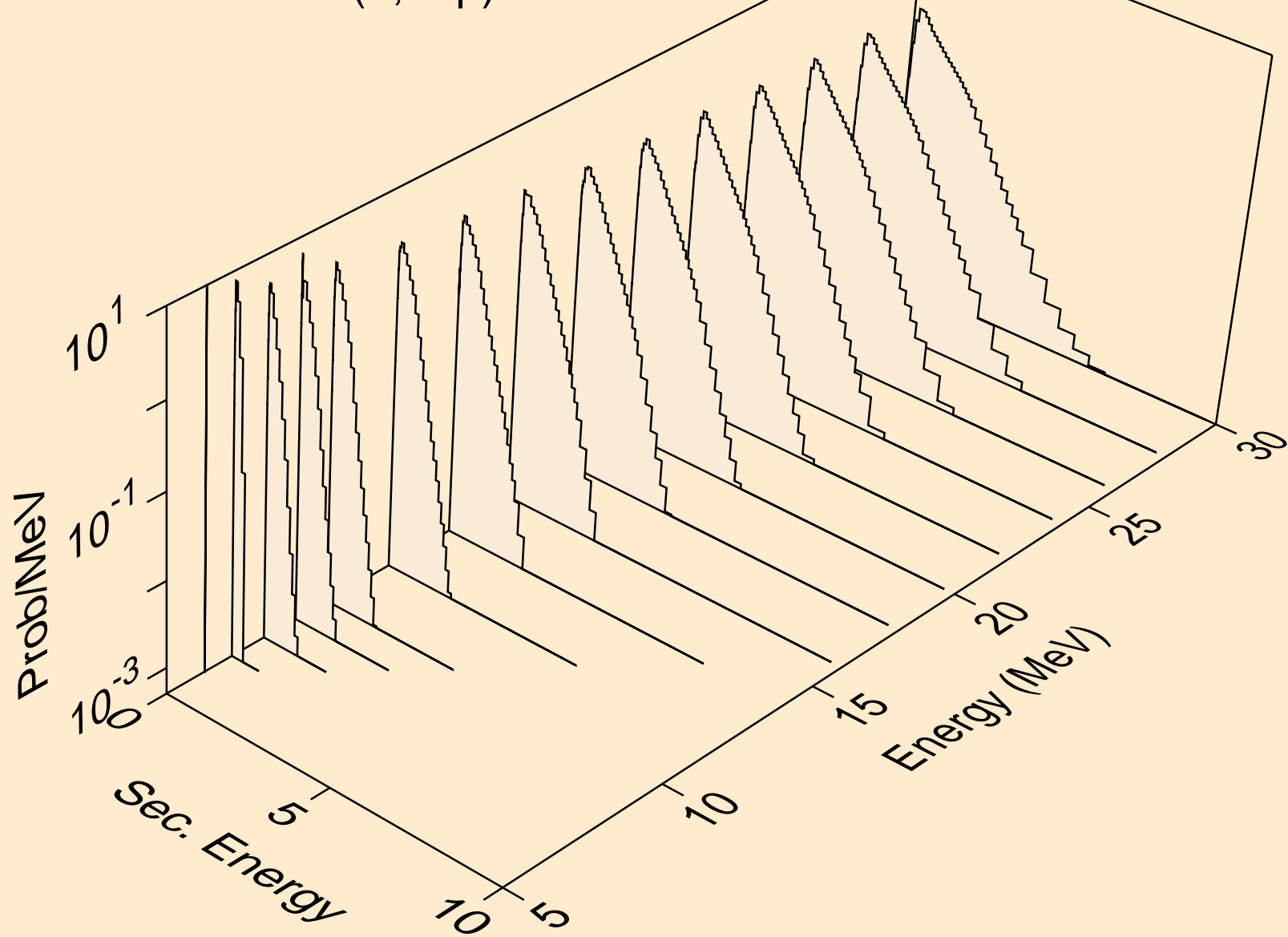

PO227 DEUTERON ACER TENDL-2023 LIBRARY; T=0.K  
neutrons from (d,3np)

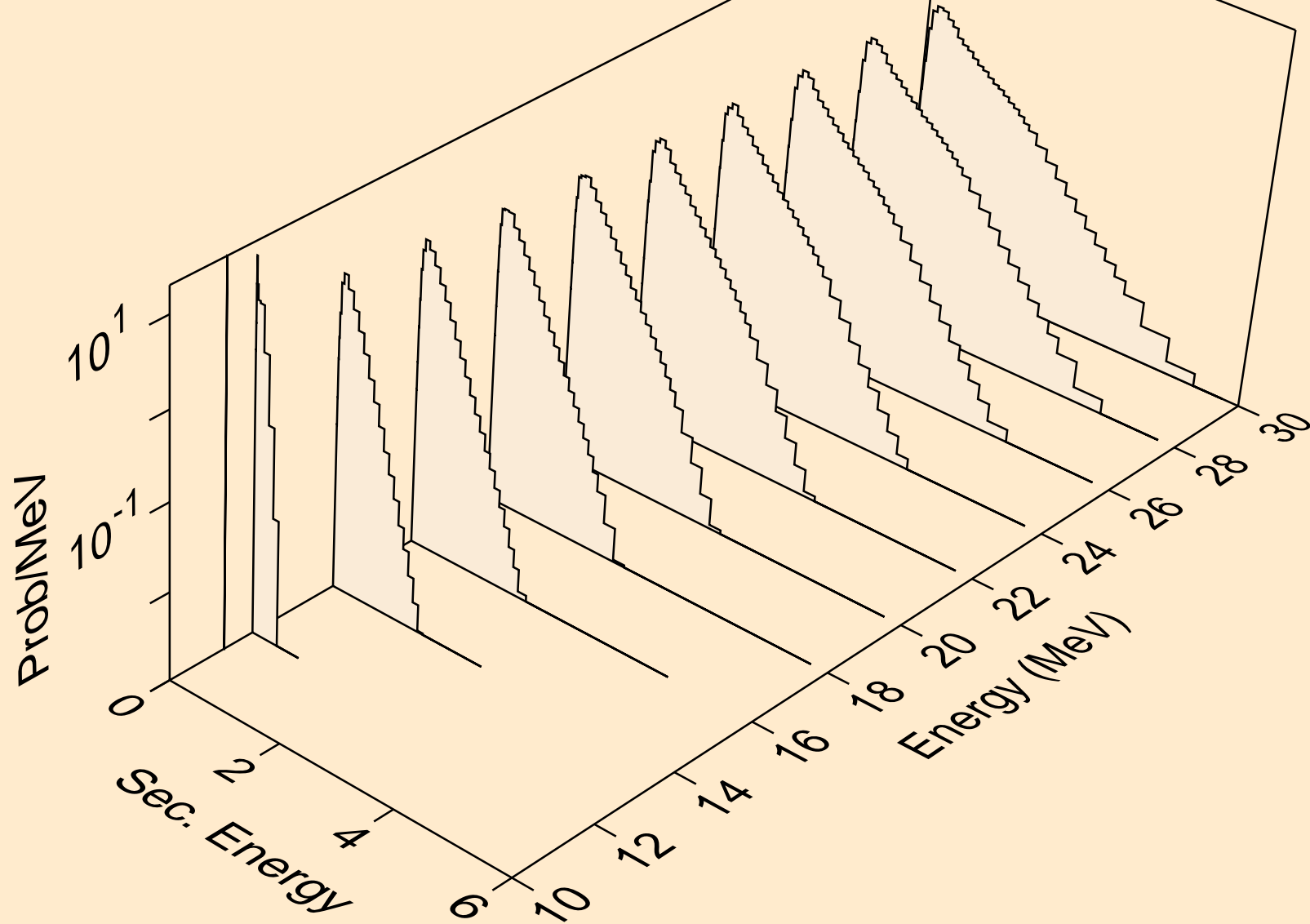

PO227 DEUTERON ACER TENDL-2023 LIBRARY; T=0.K  
neutrons from (d,n2p)

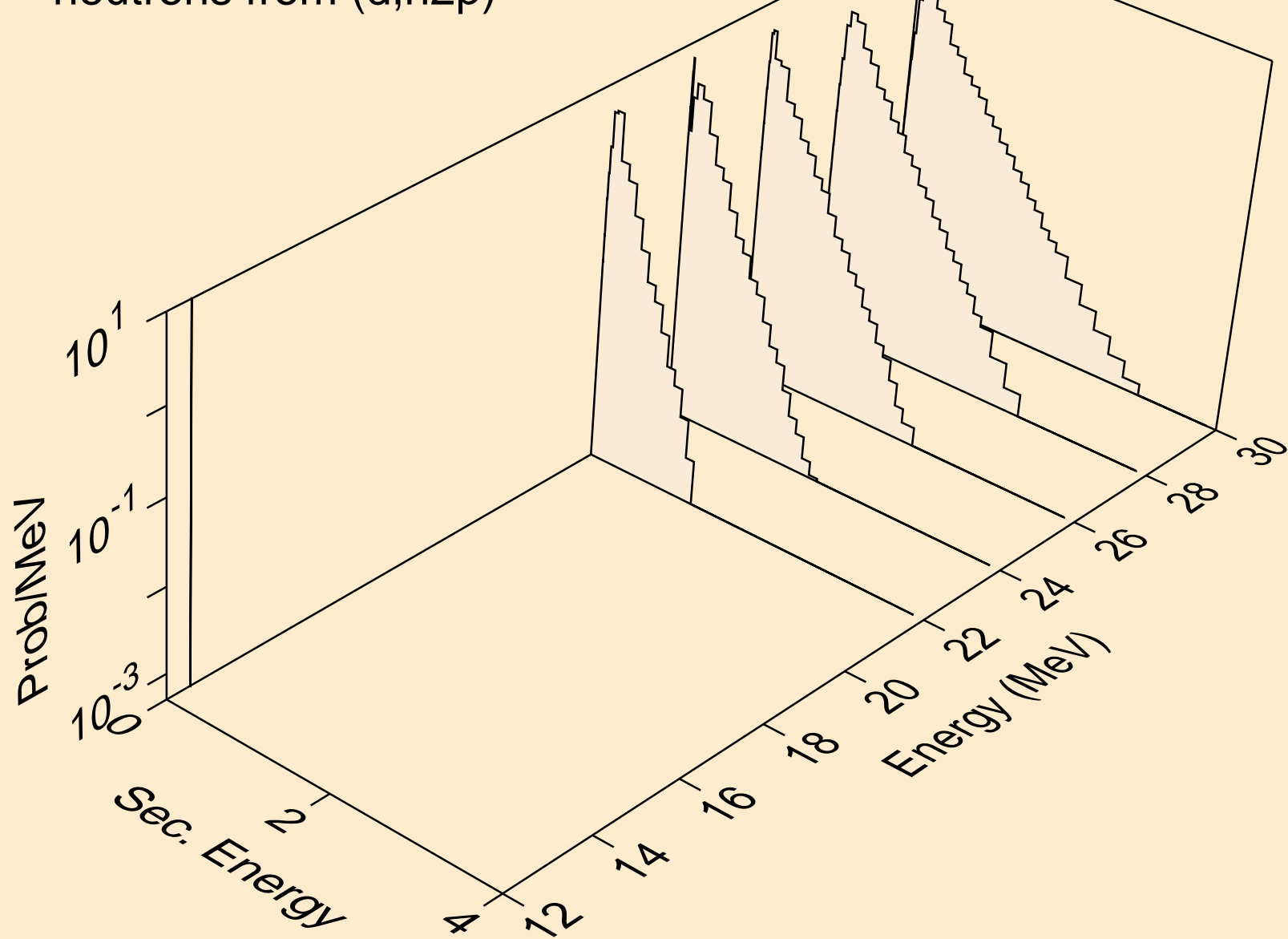

PO227 DEUTERON ACER TENDL-2023 LIBRARY; T=0.K  
protons from (d,x)

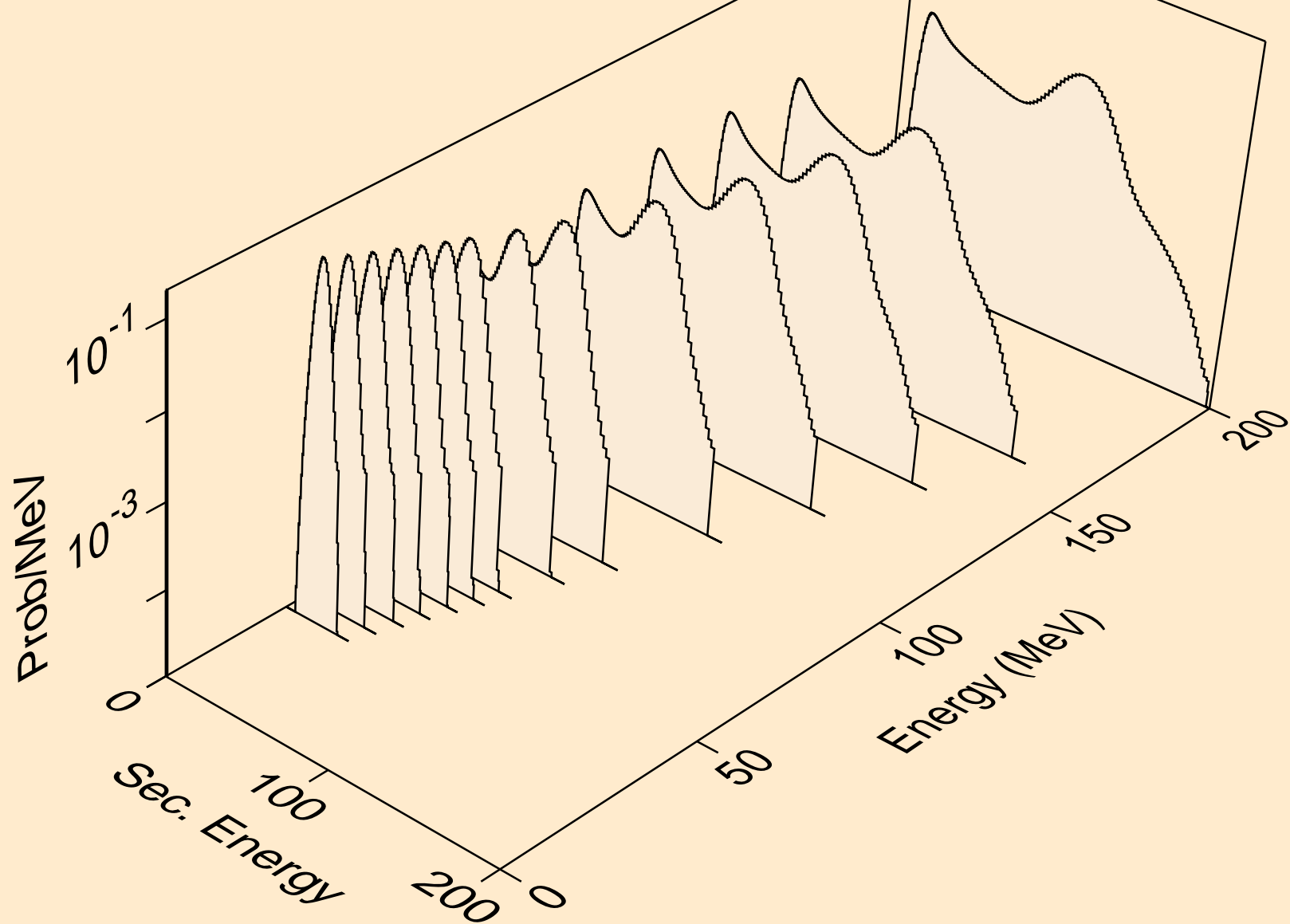



PO227 DEUTERON ACER TENDL-2023 LIBRARY; T=0.K  
protons from (d,n\*)p

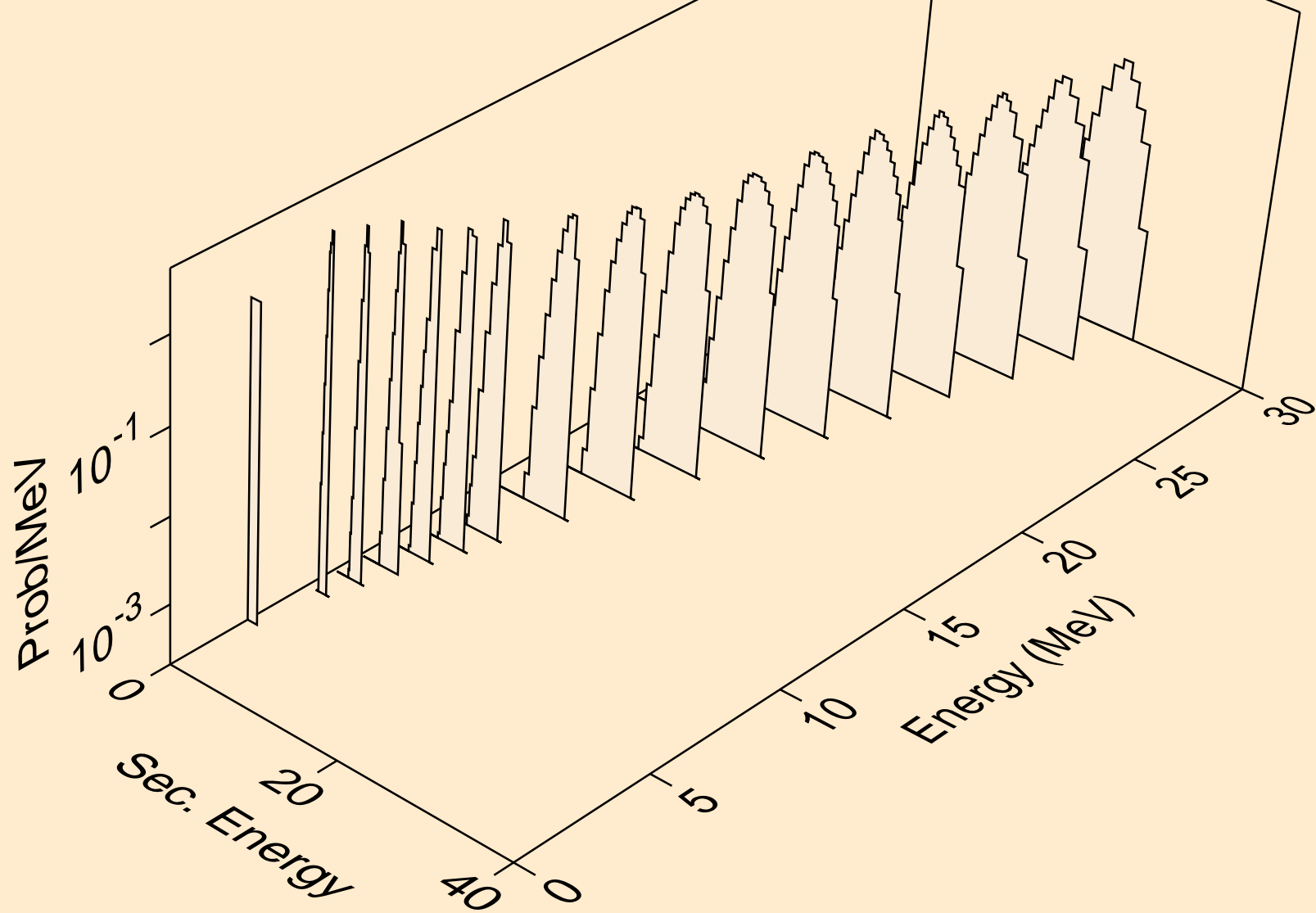

PO227 DEUTERON ACER TENDL-2023 LIBRARY; T=0.K  
protons from (d,2np)

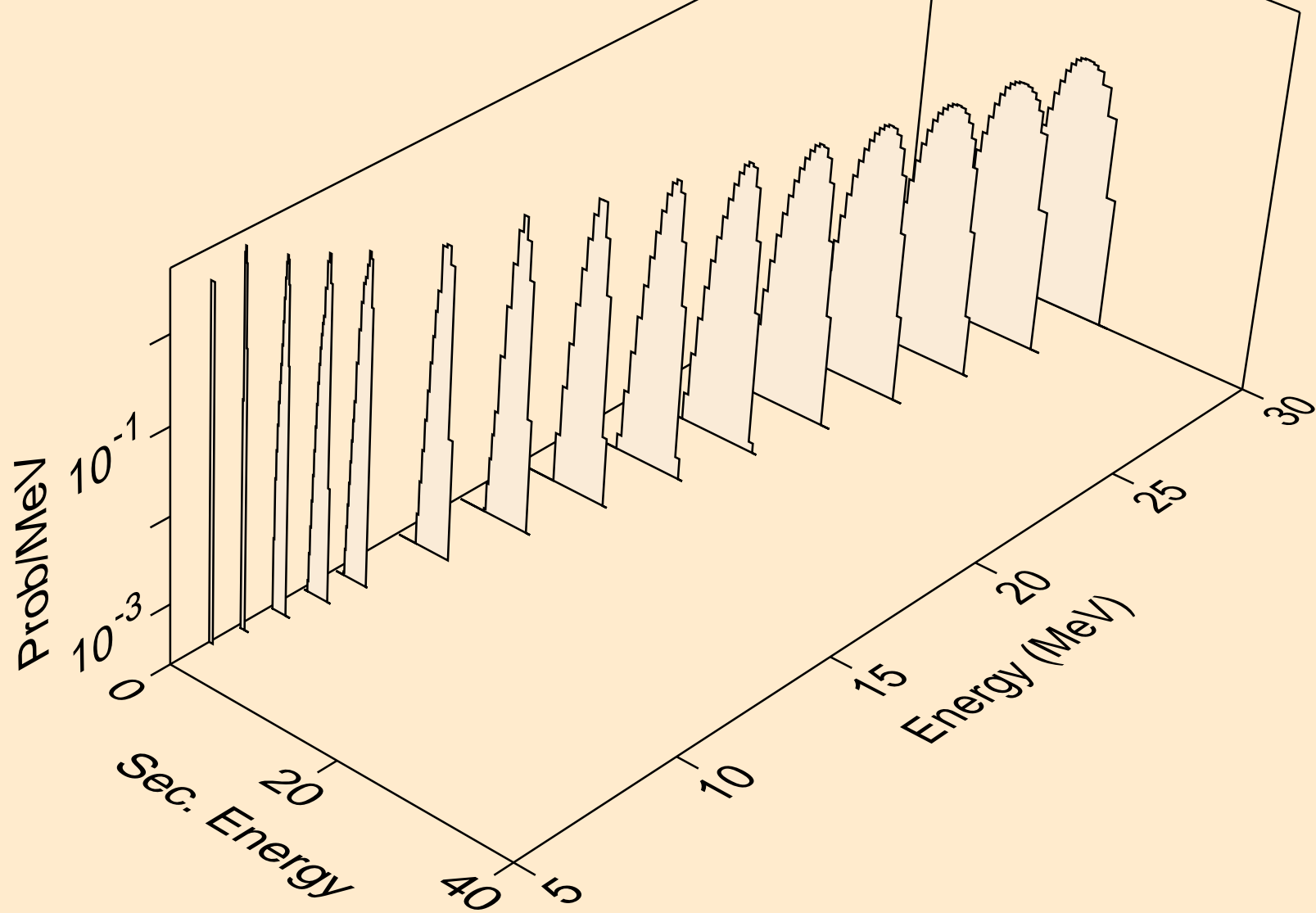

PO227 DEUTERON ACER TENDL-2023 LIBRARY; T=0.K  
protons from (d,3np)

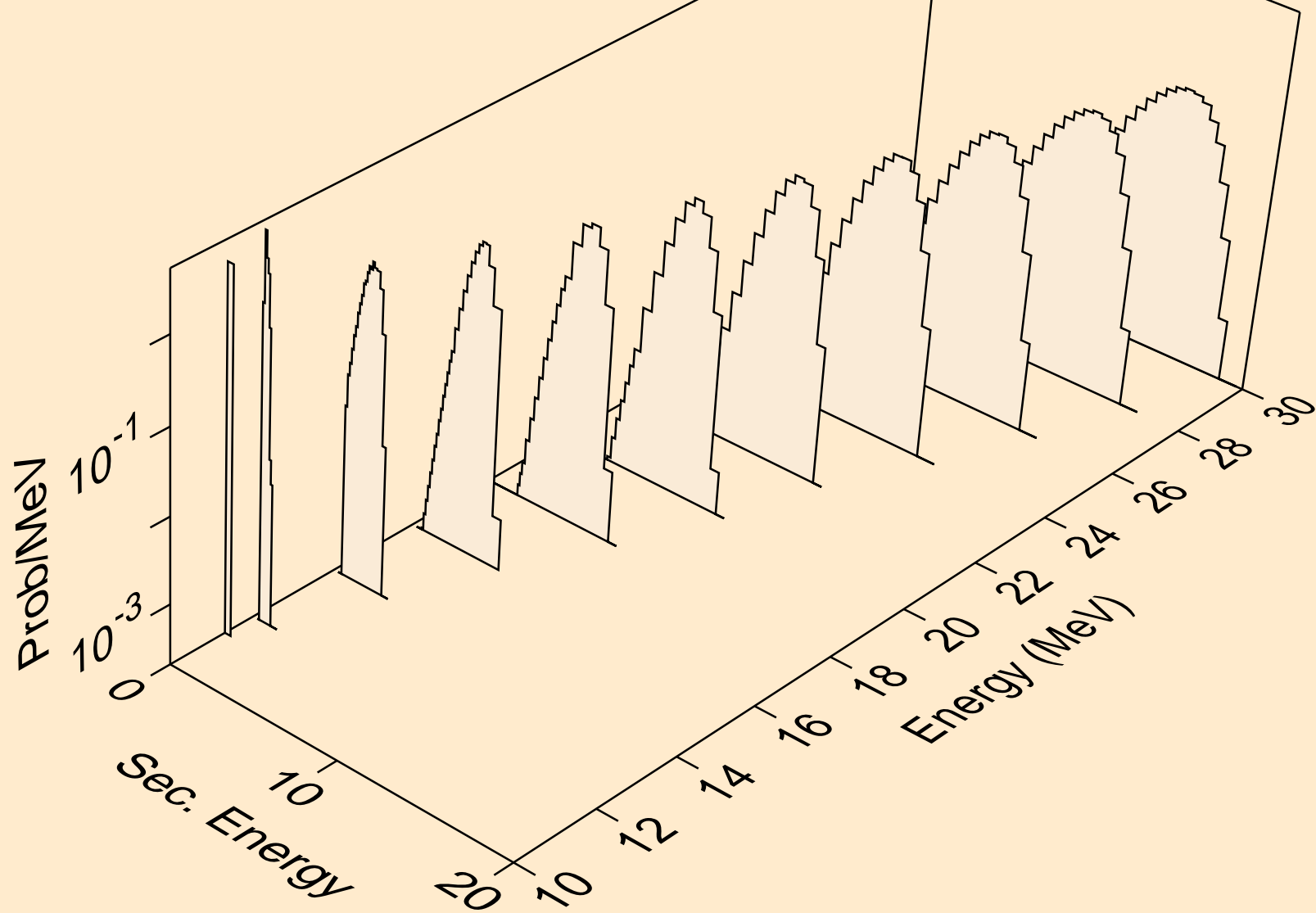

PO227 DEUTERON ACER TENDL-2023 LIBRARY; T=0.K  
protons from (d,n2p)

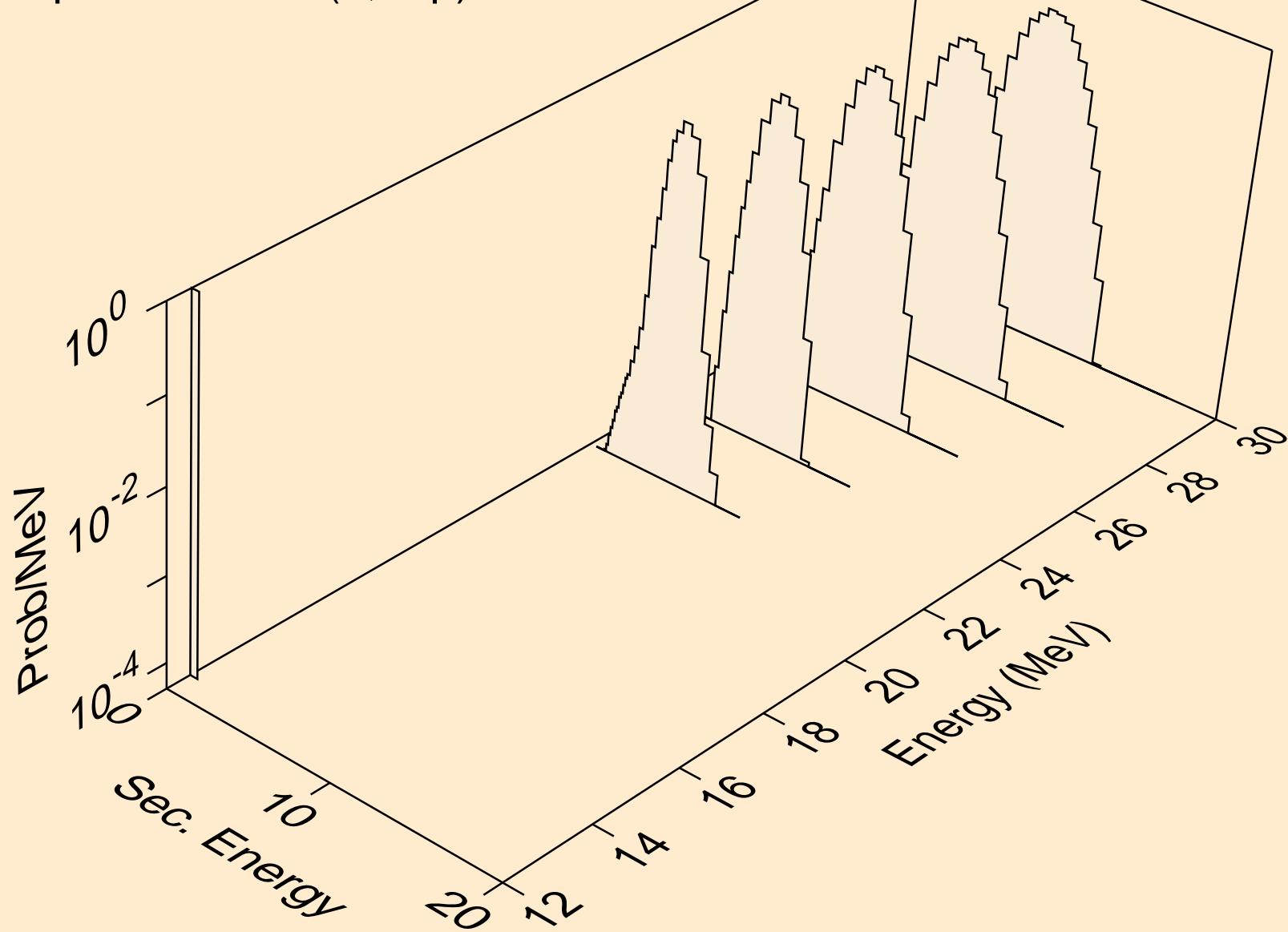

PO227 DEUTERON ACER TENDL-2023 LIBRARY; T=0.K  
protons from (d,p)

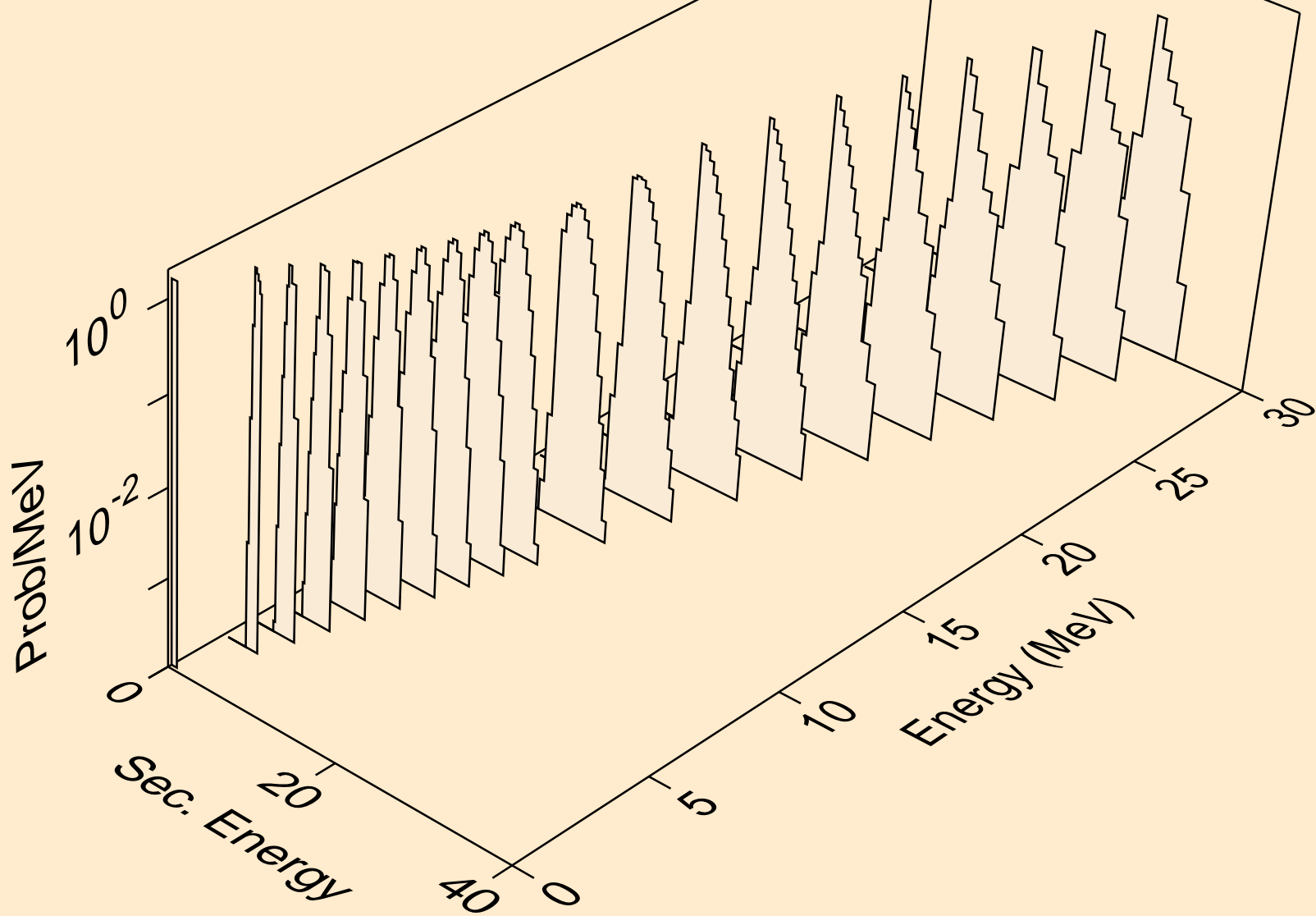

PO227 DEUTERON ACER TENDL-2023 LIBRARY; T=0.K  
protons from (d,2p)

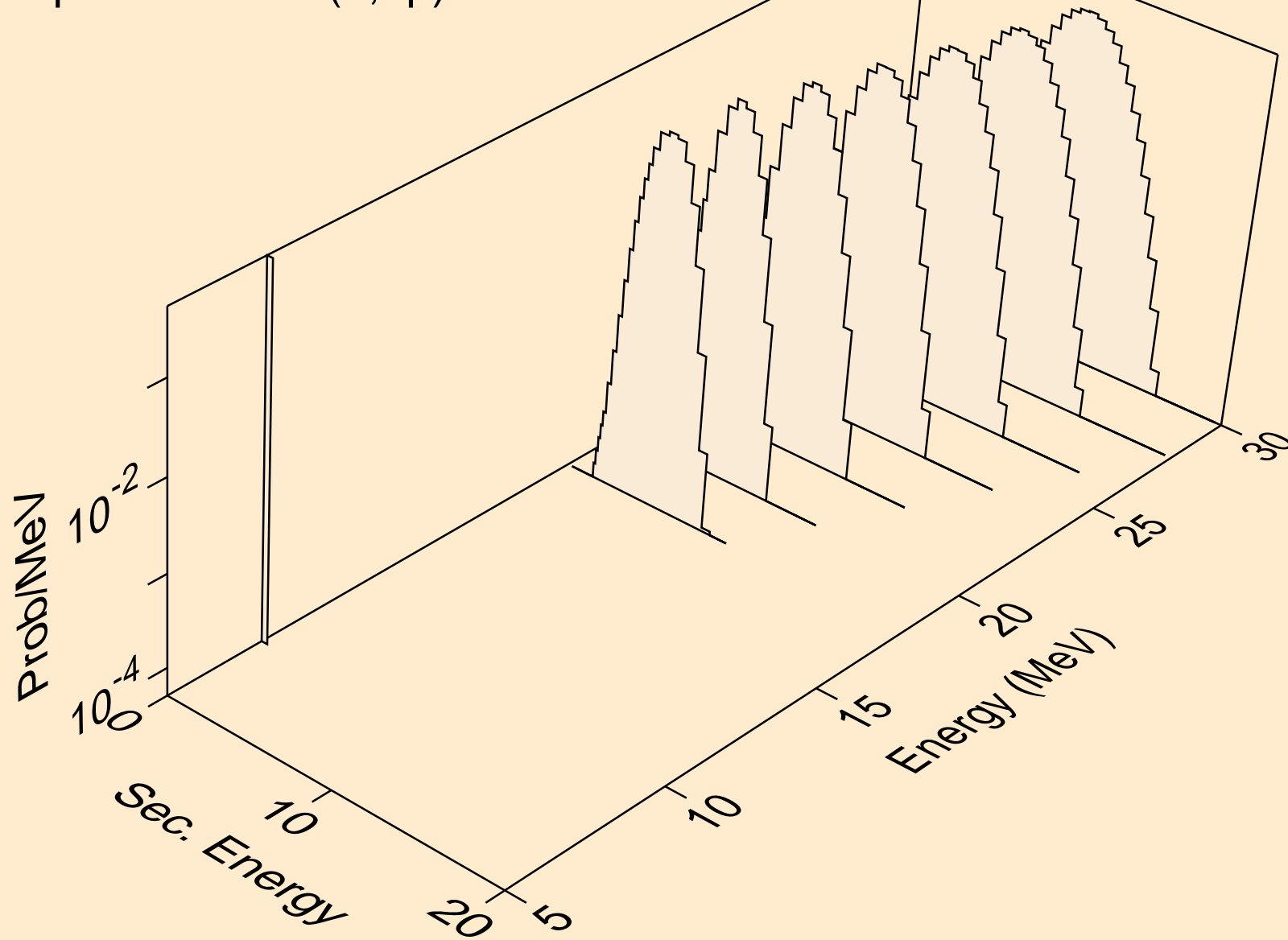

PO227 DEUTERON ACER TENDL-2023 LIBRARY; T=0.K  
protons from (d,pd)

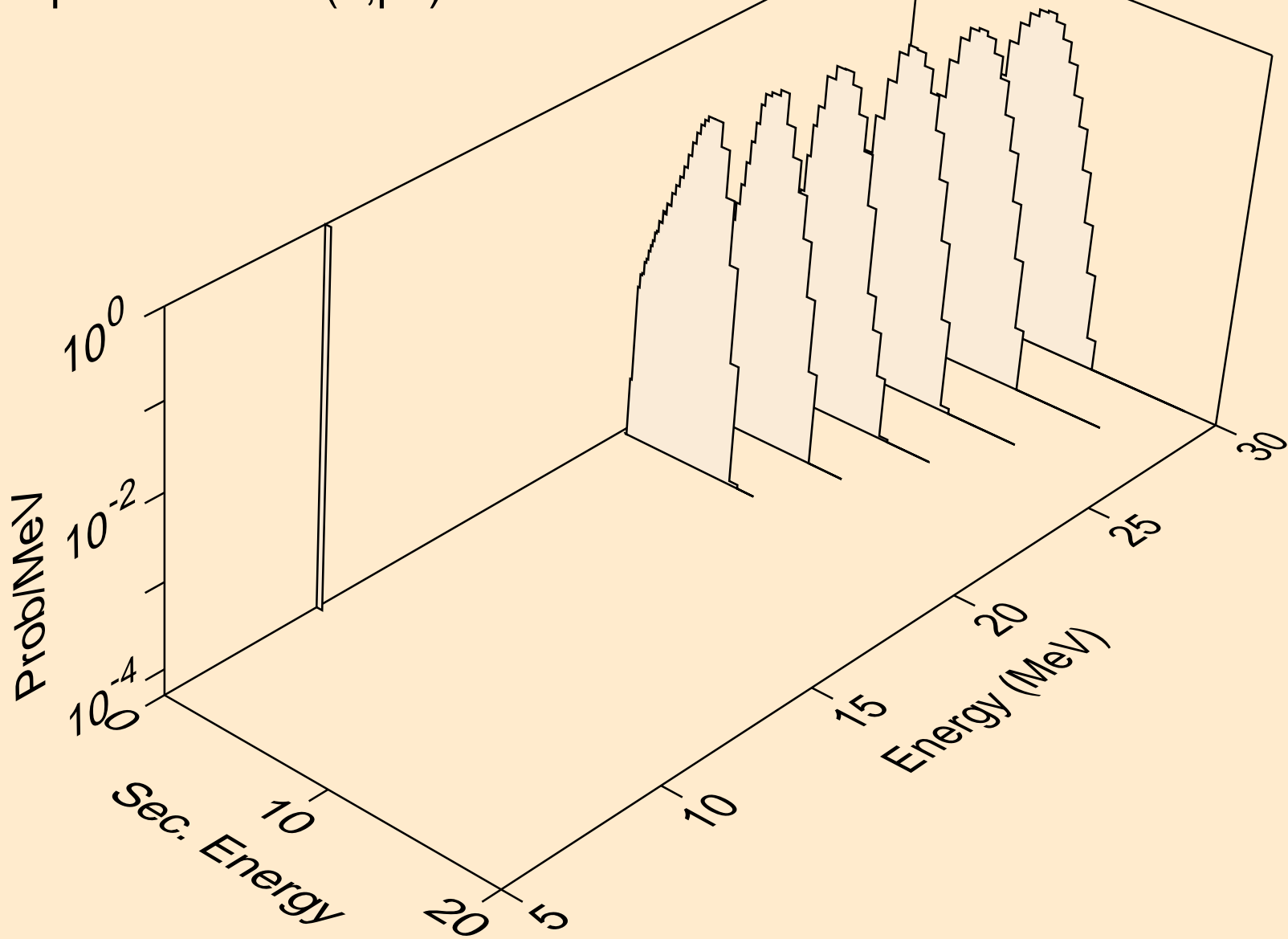

PO227 DEUTERON ACER TENDL-2023 LIBRARY; T=0.K  
tritons from (d,x)

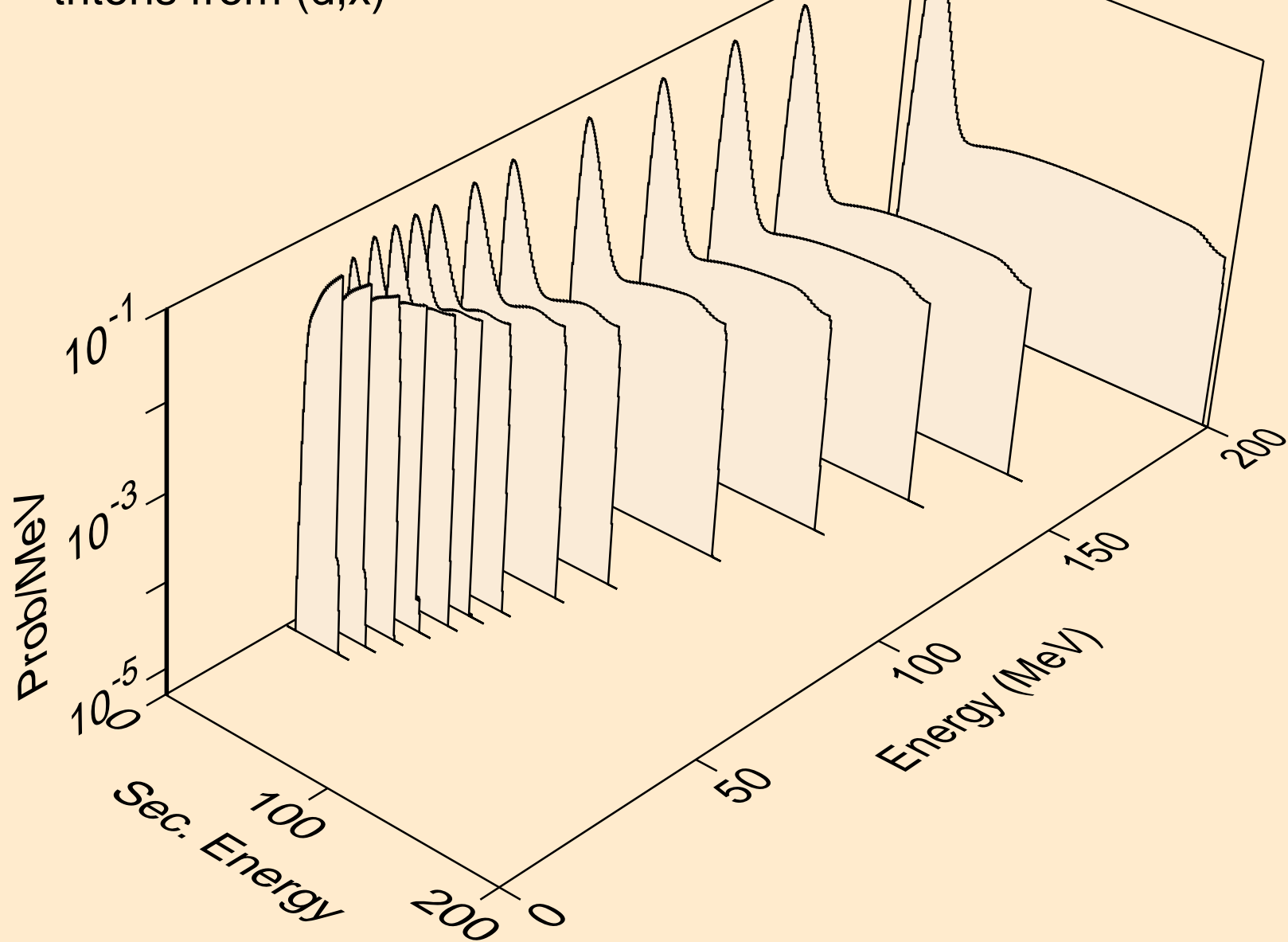



PO227 DEUTERON ACER TENDL-2023 LIBRARY; T=0.K  
tritons from (d,n\*)t

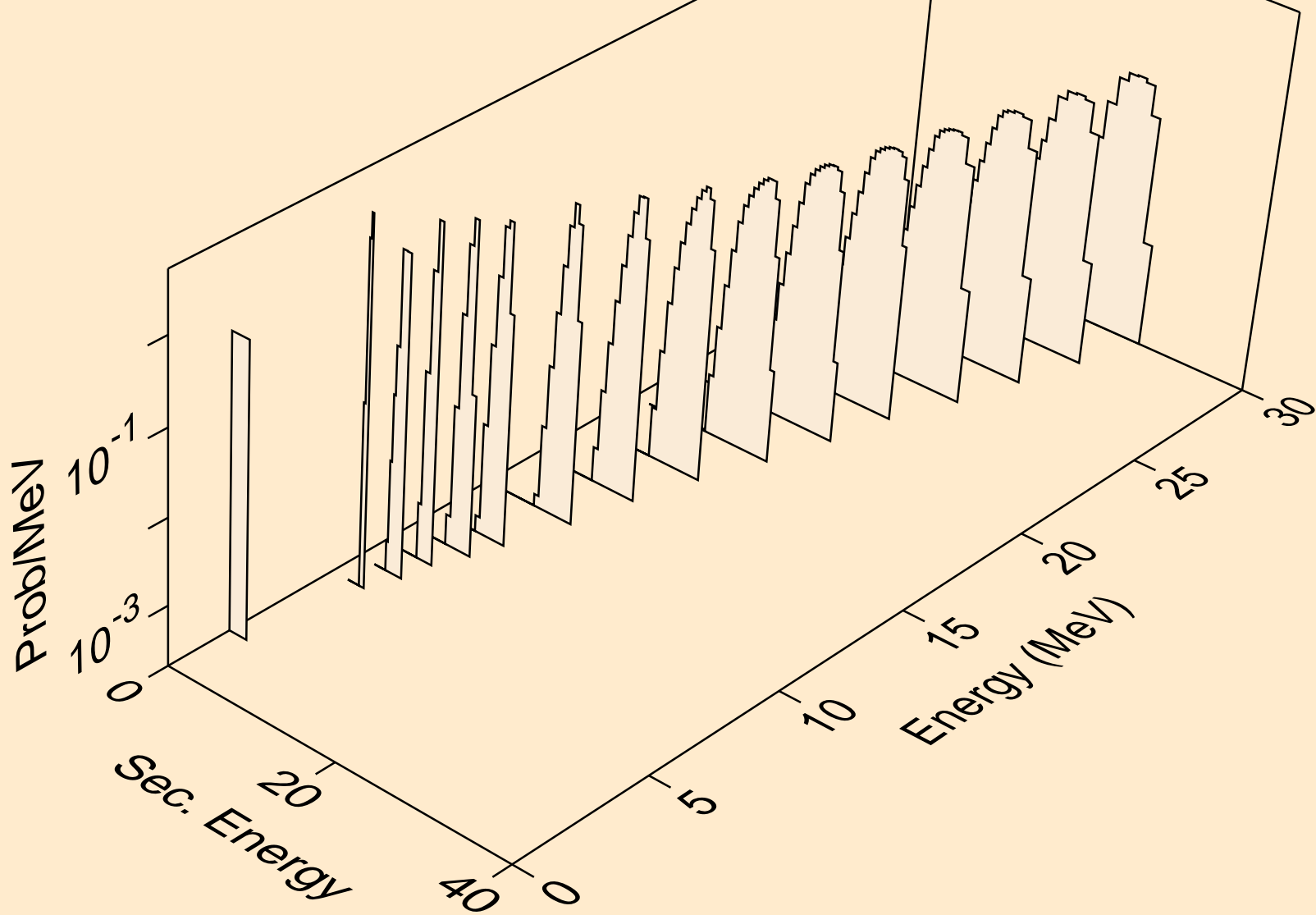

PO227 DEUTERON ACER TENDL-2023 LIBRARY; T=0.K  
tritons from (d,t)

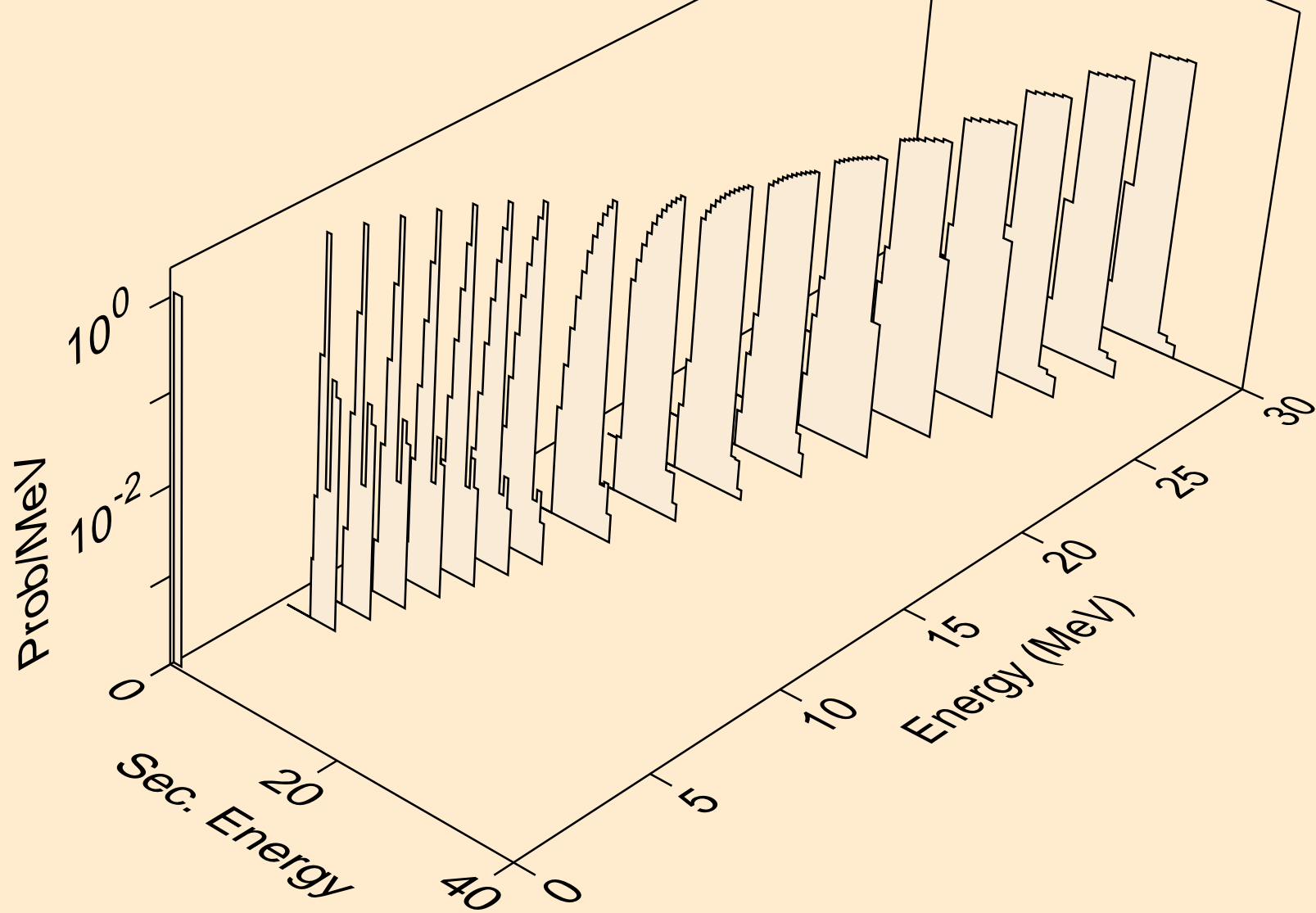

PO227 DEUTERON ACER TENDL-2023 LIBRARY; T=0.K  
he3s from (d,x)

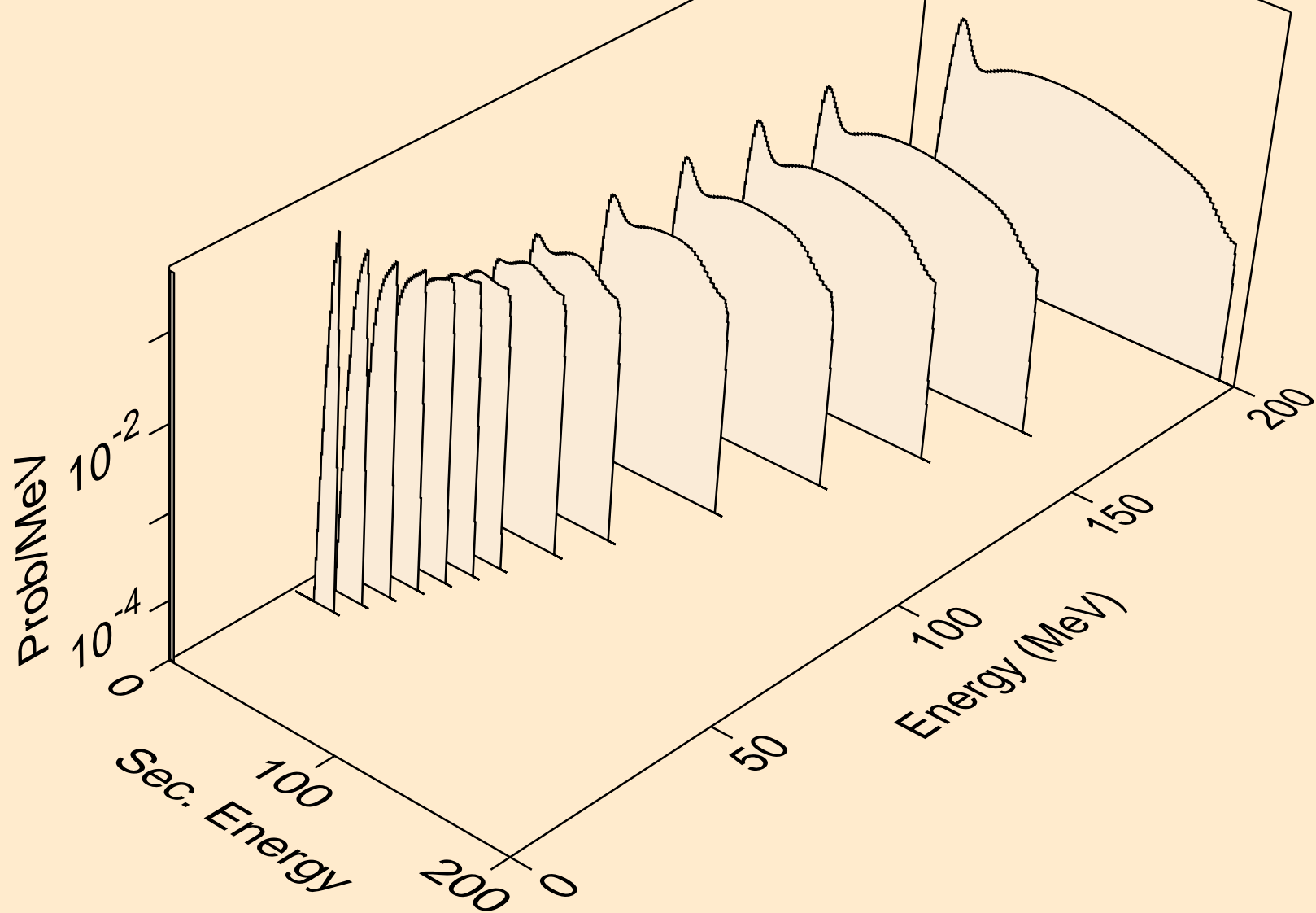

PO227 DEUTERON ACER TENDL-2023 LIBRARY; T=0.K  
he3s from (d,n\*)he3

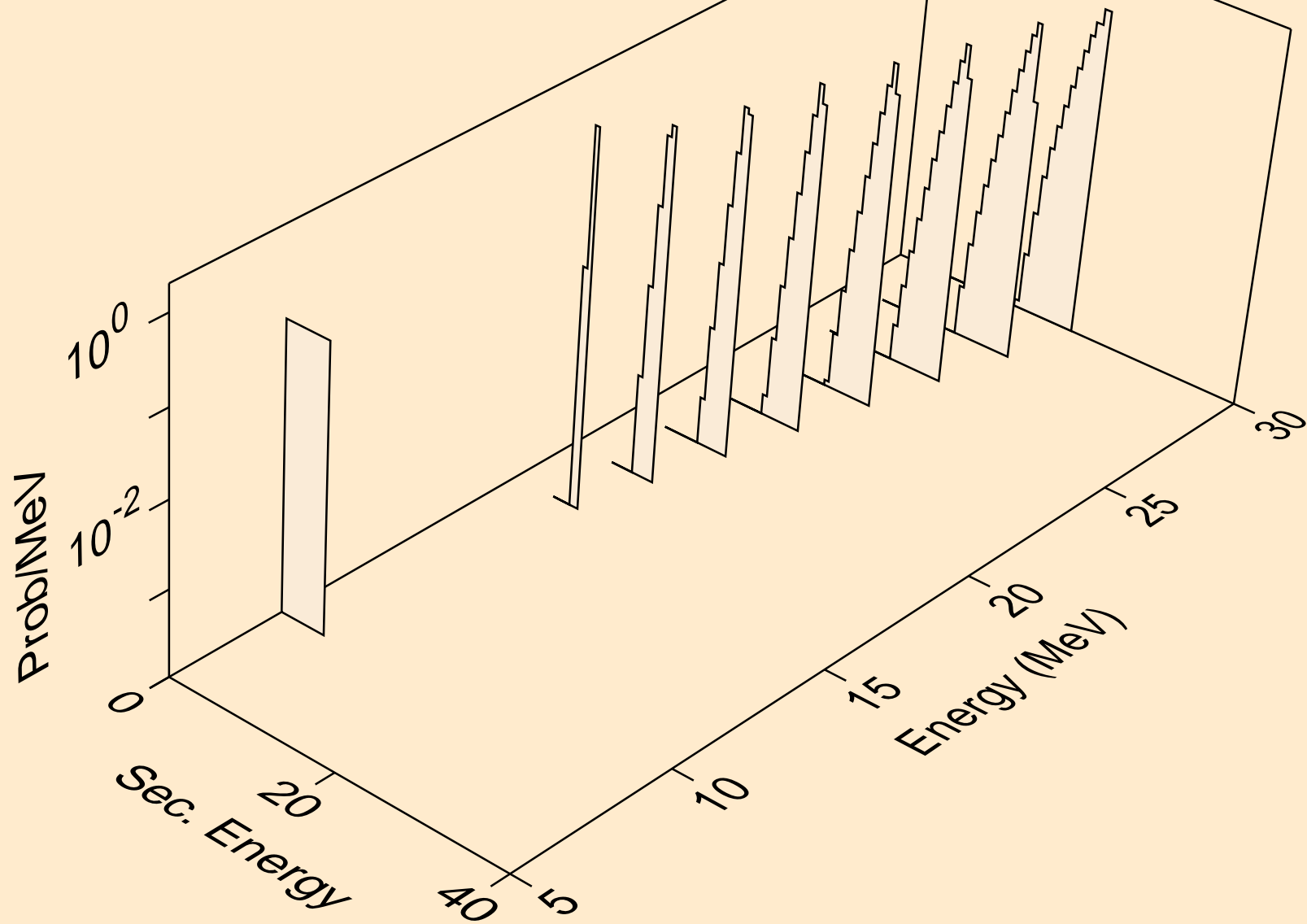

PO227 DEUTERON ACER TENDL-2023 LIBRARY; T=0.K  
he3s from (d,he3)

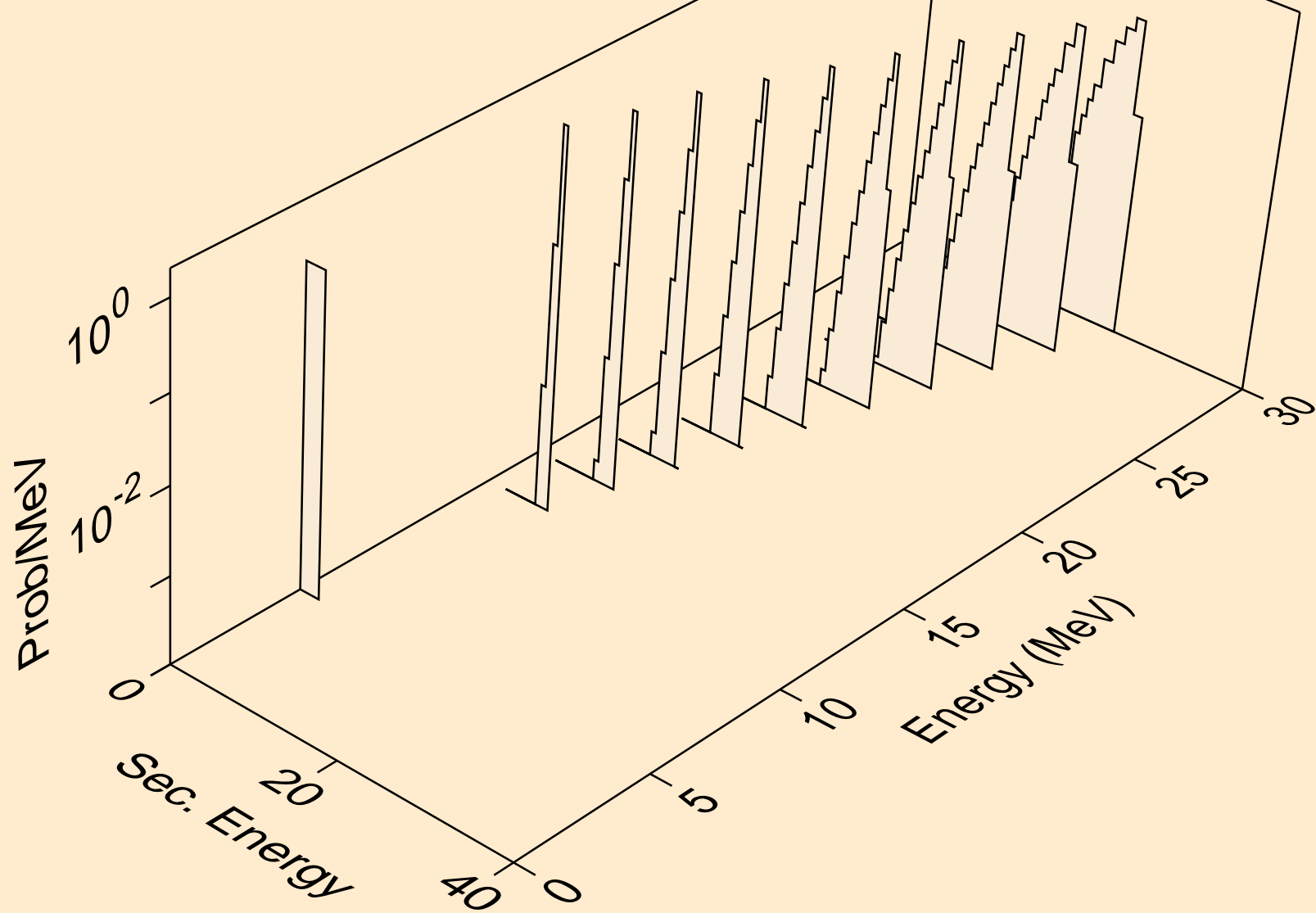

PO227 DEUTERON ACER TENDL-2023 LIBRARY; T=0.K  
alphas from (d,x)

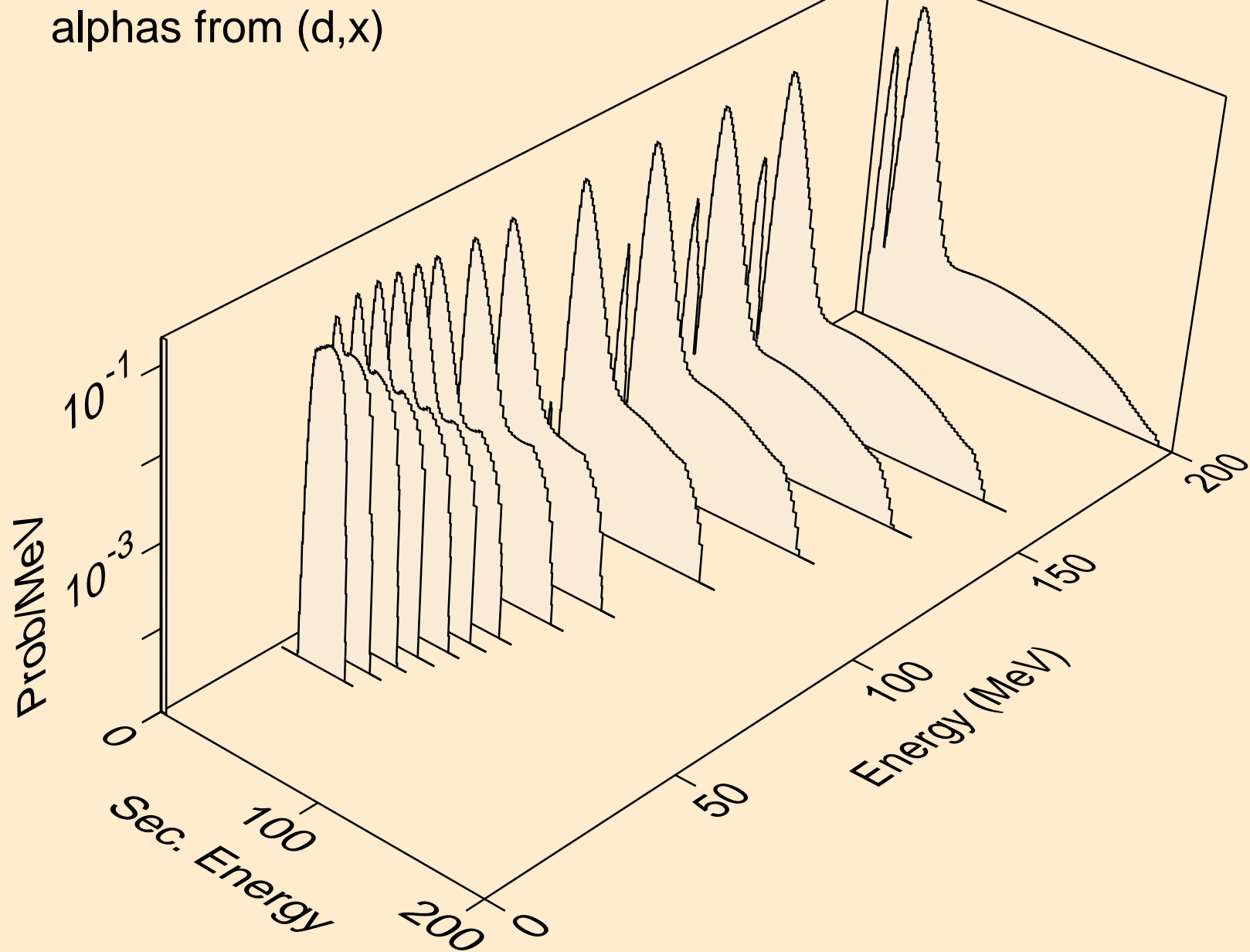

PO227 DEUTERON ACER TENDL-2023 LIBRARY; T=0.K  
alphas from (d,n\*)a

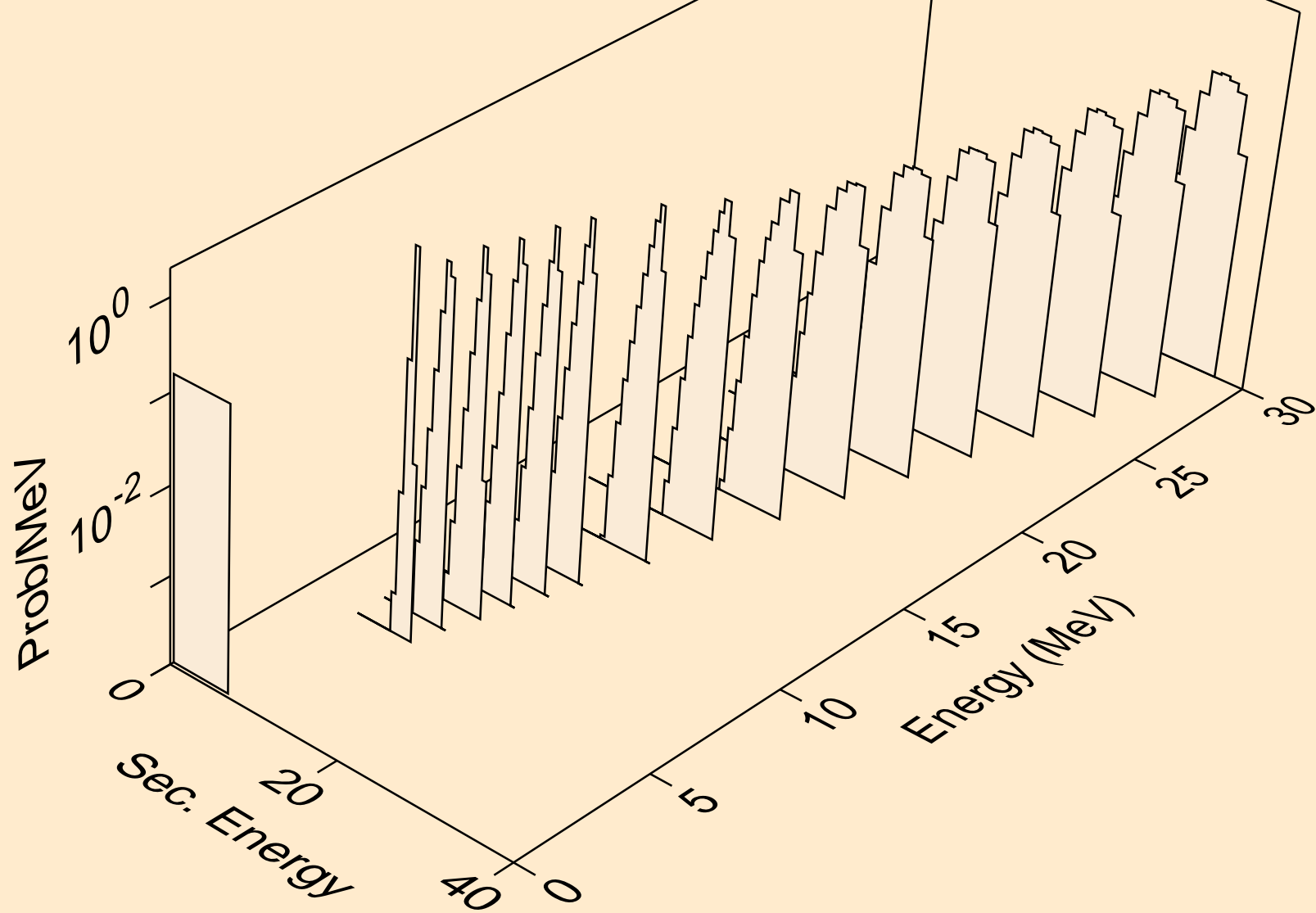

PO227 DEUTERON ACER TENDL-2023 LIBRARY; T=0.K  
alphas from (d,2n)a

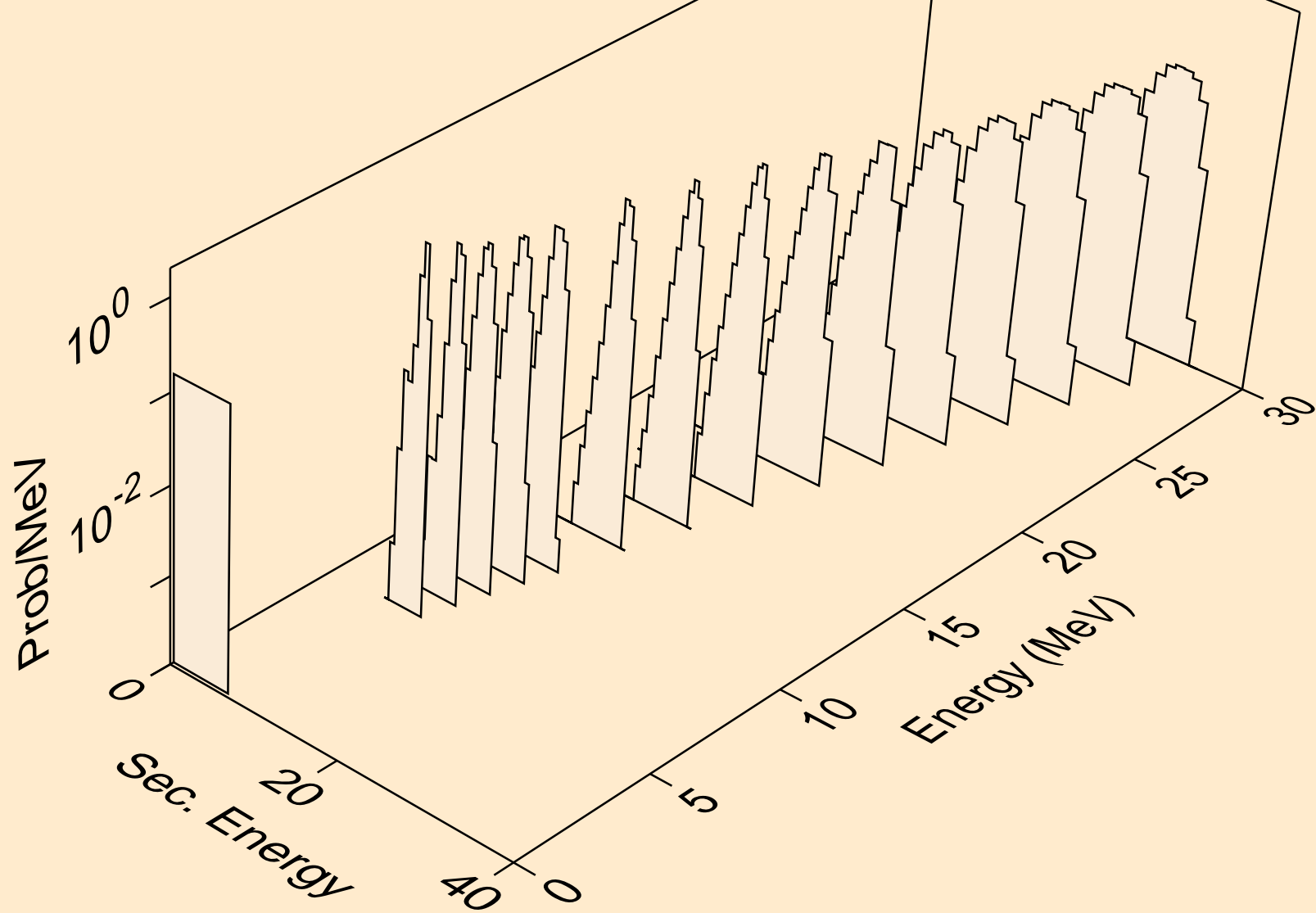



PO227 DEUTERON ACER TENDL-2023 LIBRARY; T=0.K  
alphas from (d,3n)a

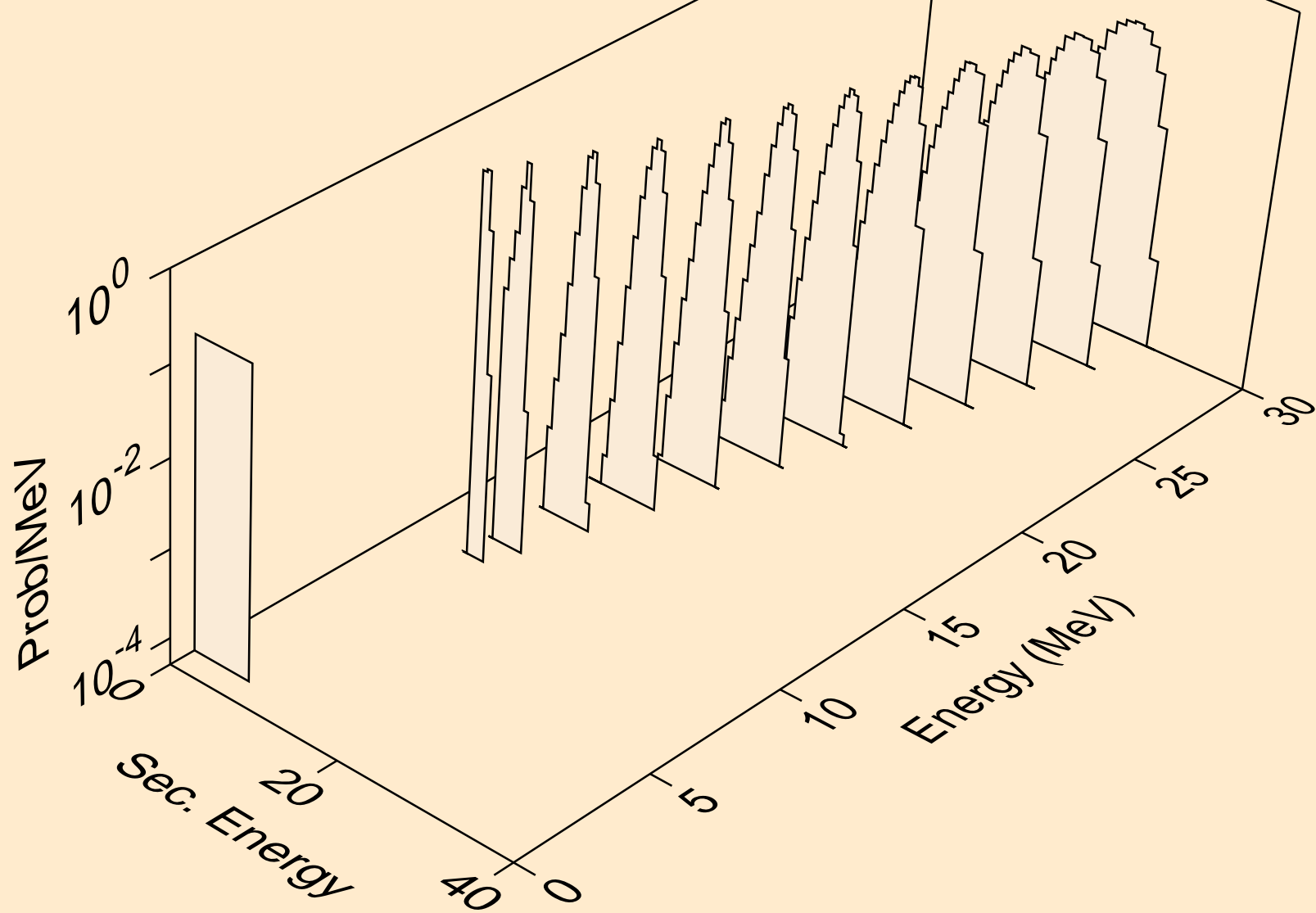

PO227 DEUTERON ACER TENDL-2023 LIBRARY; T=0.K  
alphas from (d,a)

