

PT203 DEUTERON ACER TENDL-2023 LIBRARY; T=0.K  
Principal cross sections

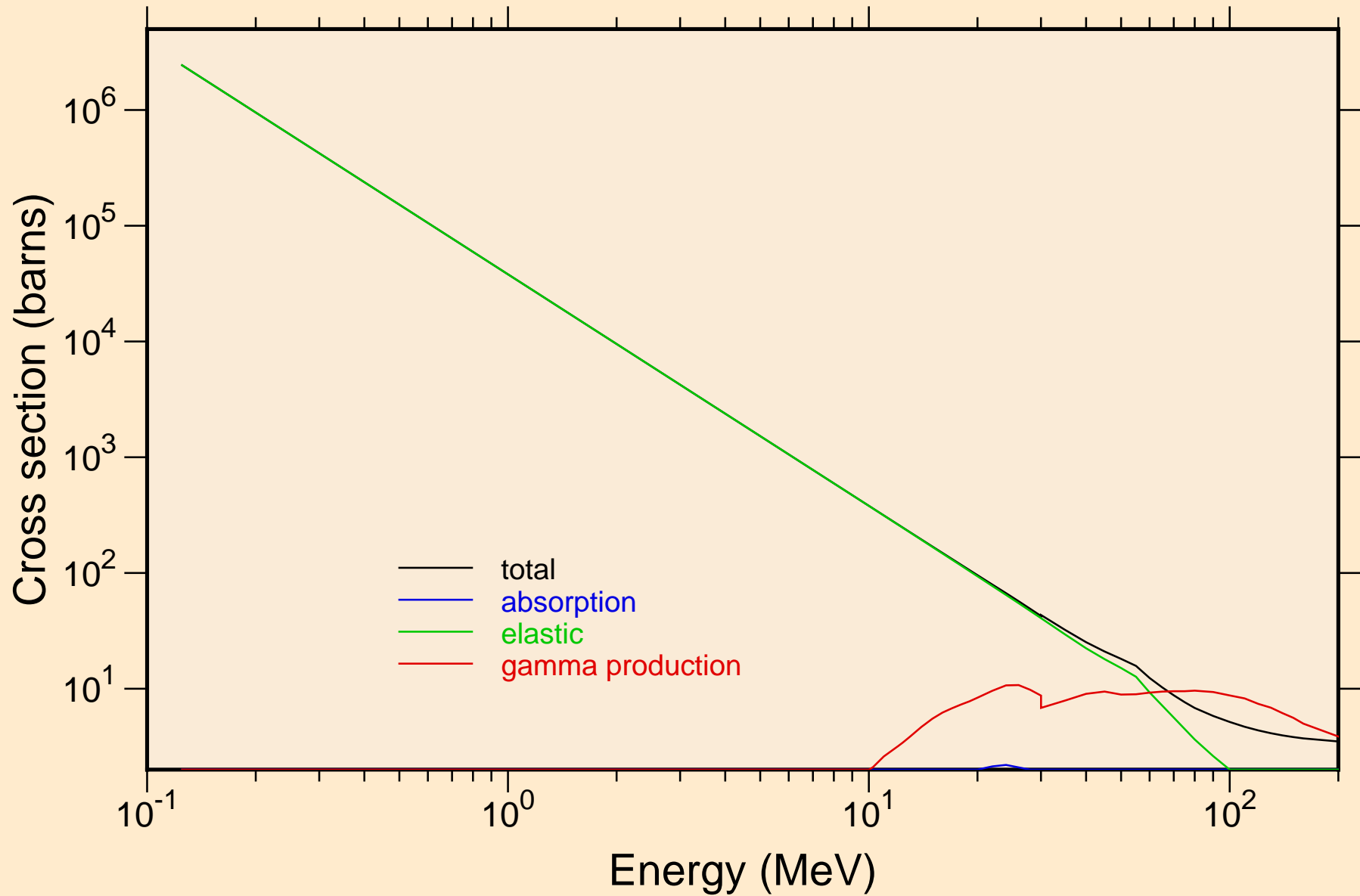

PT203 DEUTERON ACER TENDL-2023 LIBRARY; T=0.K  
Heating

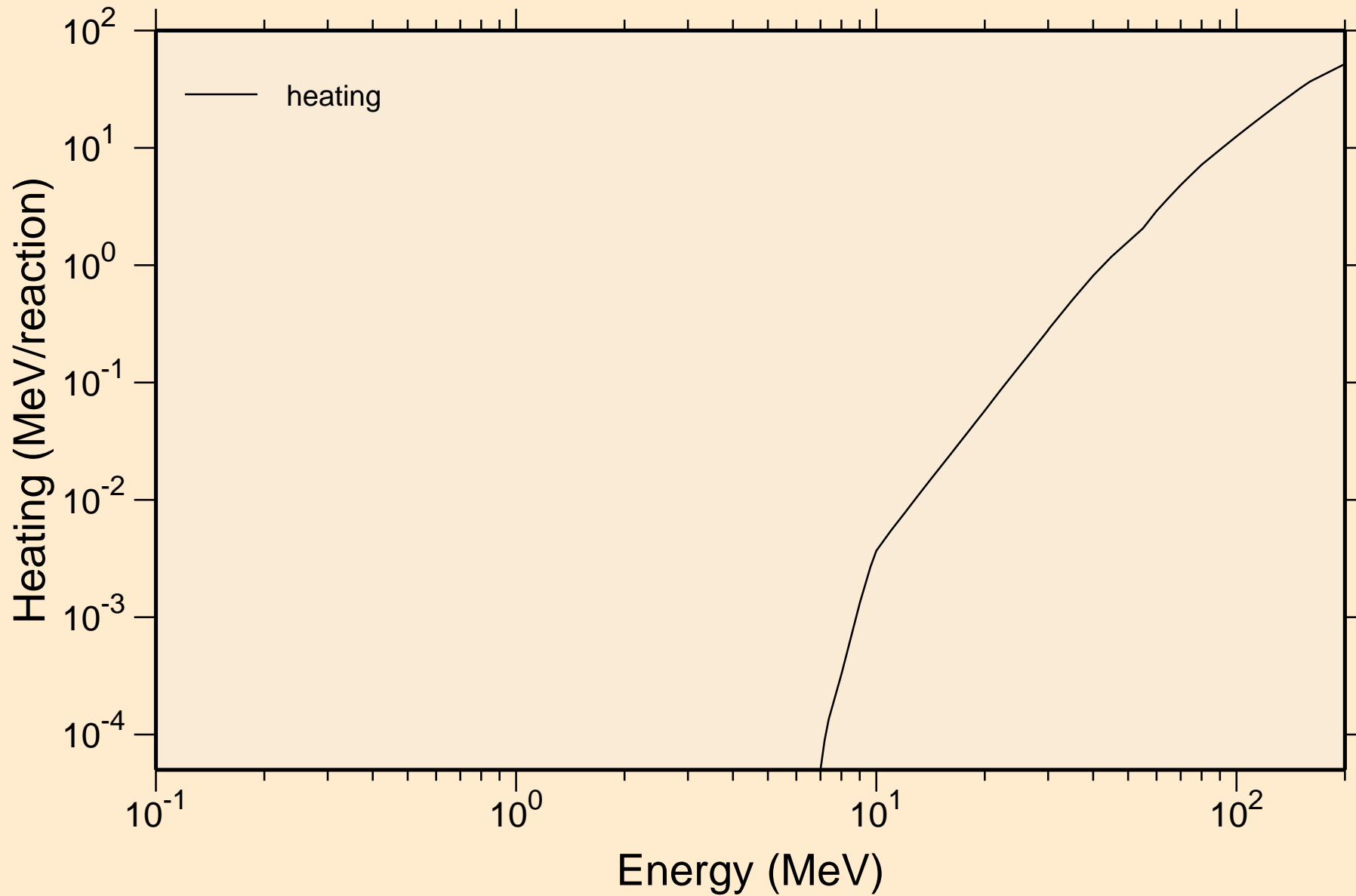

PT203 DEUTERON ACER TENDL-2023 LIBRARY; T=0.K  
Principal cross sections

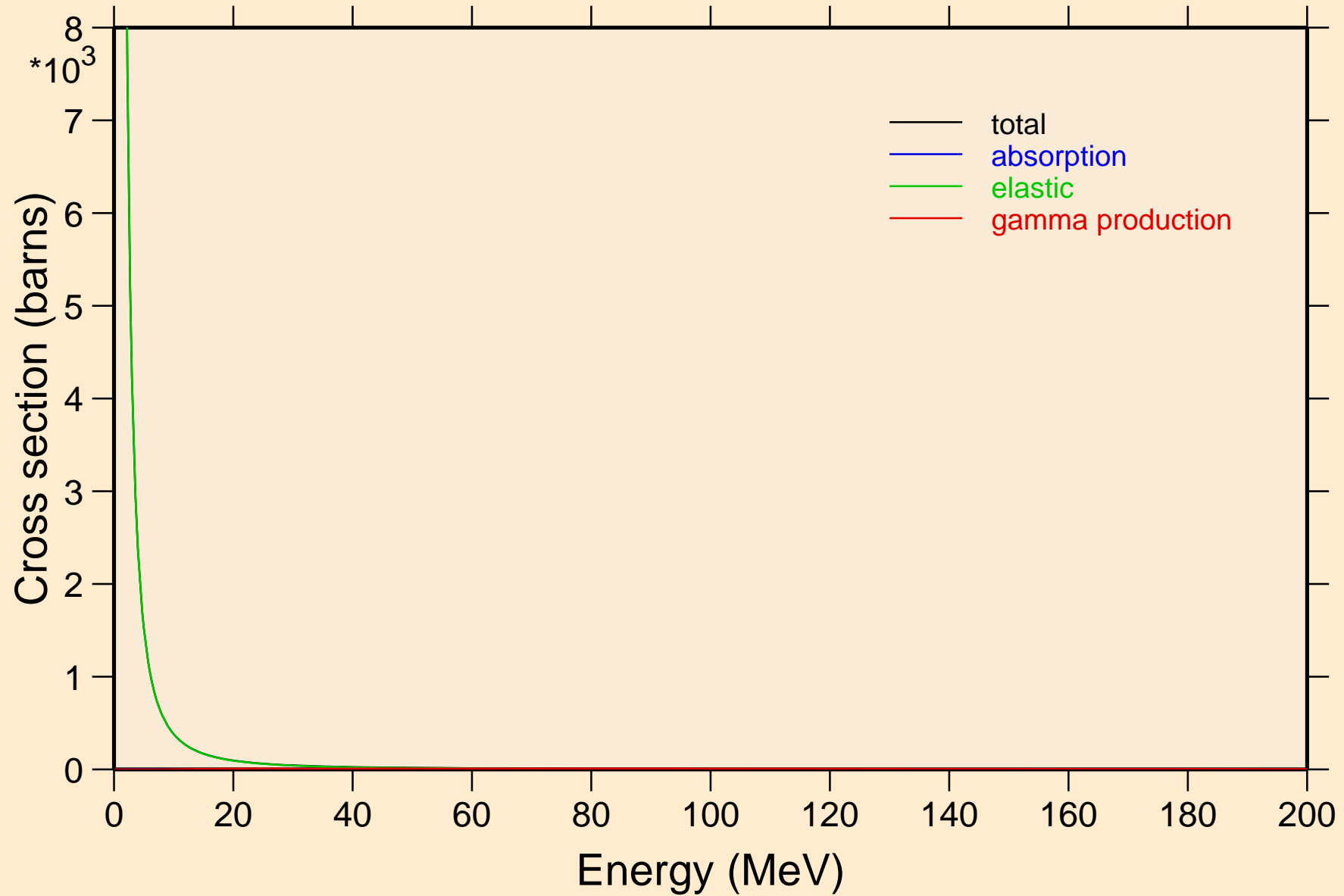

PT203 DEUTERON ACER TENDL-2023 LIBRARY; T=0.K

Heating

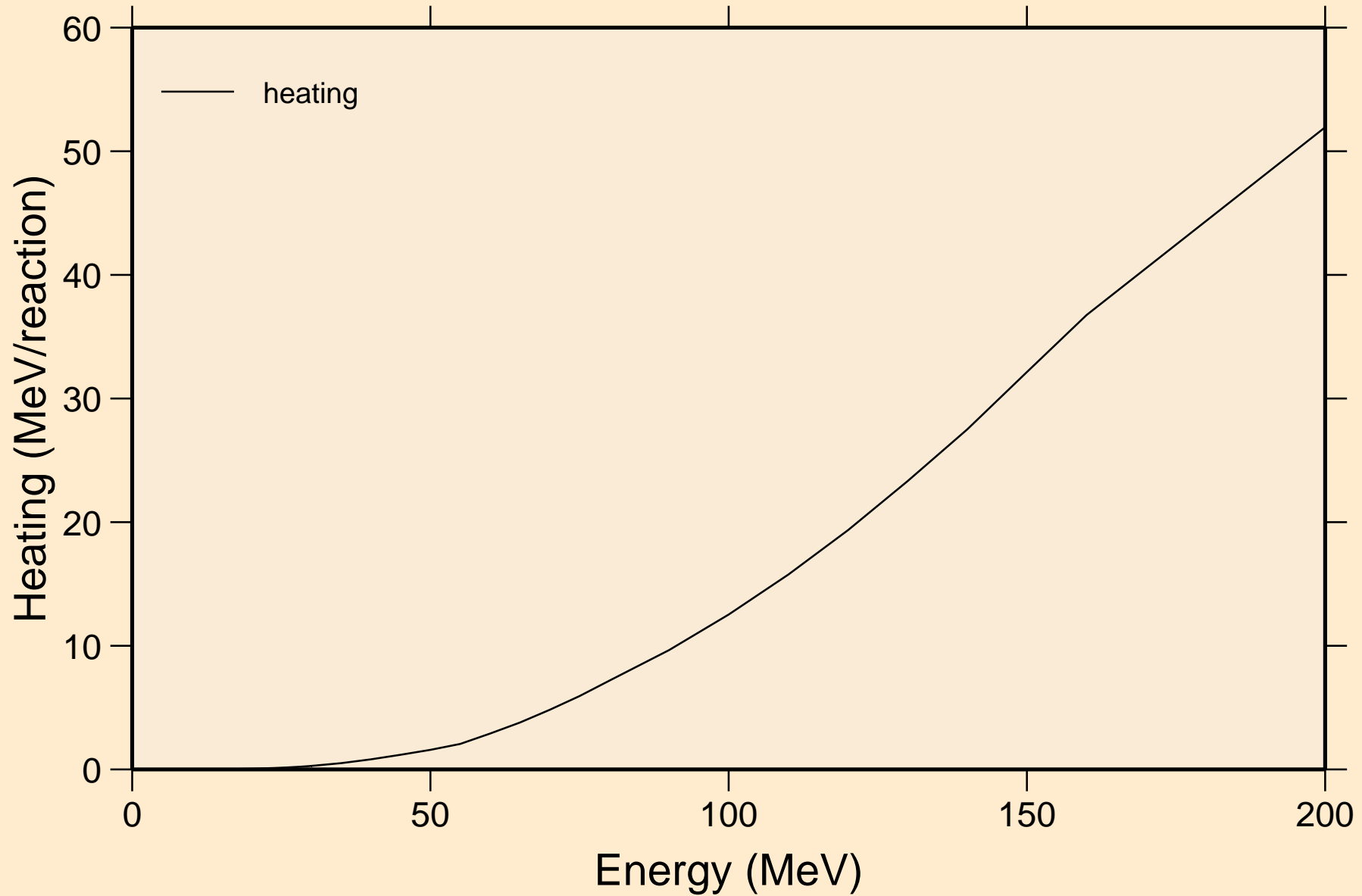

PT203 DEUTERON ACER TENDL-2023 LIBRARY; T=0.K  
Threshold reactions

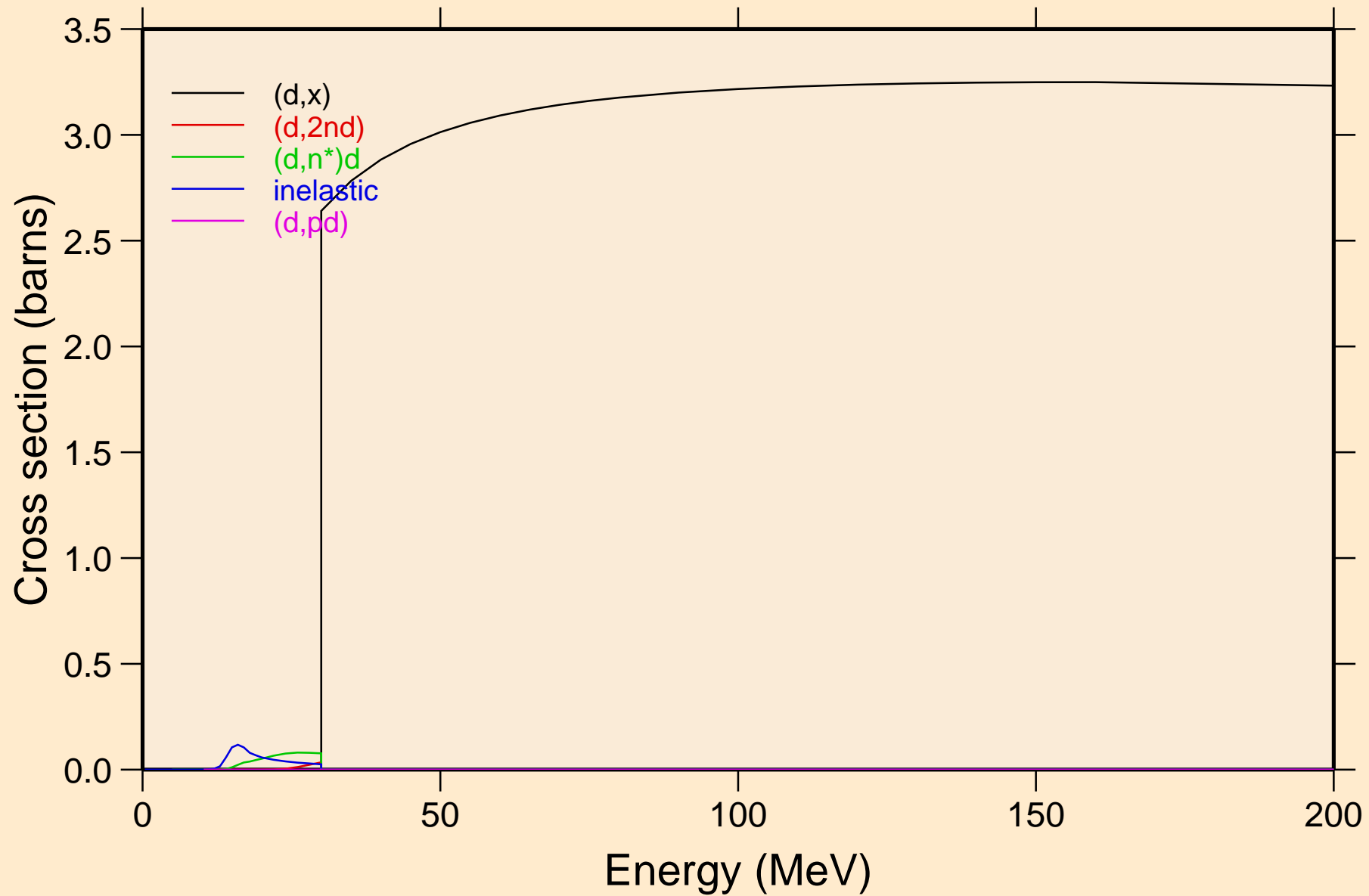

PT203 DEUTERON ACER TENDL-2023 LIBRARY; T=0.K  
angular distribution for elastic

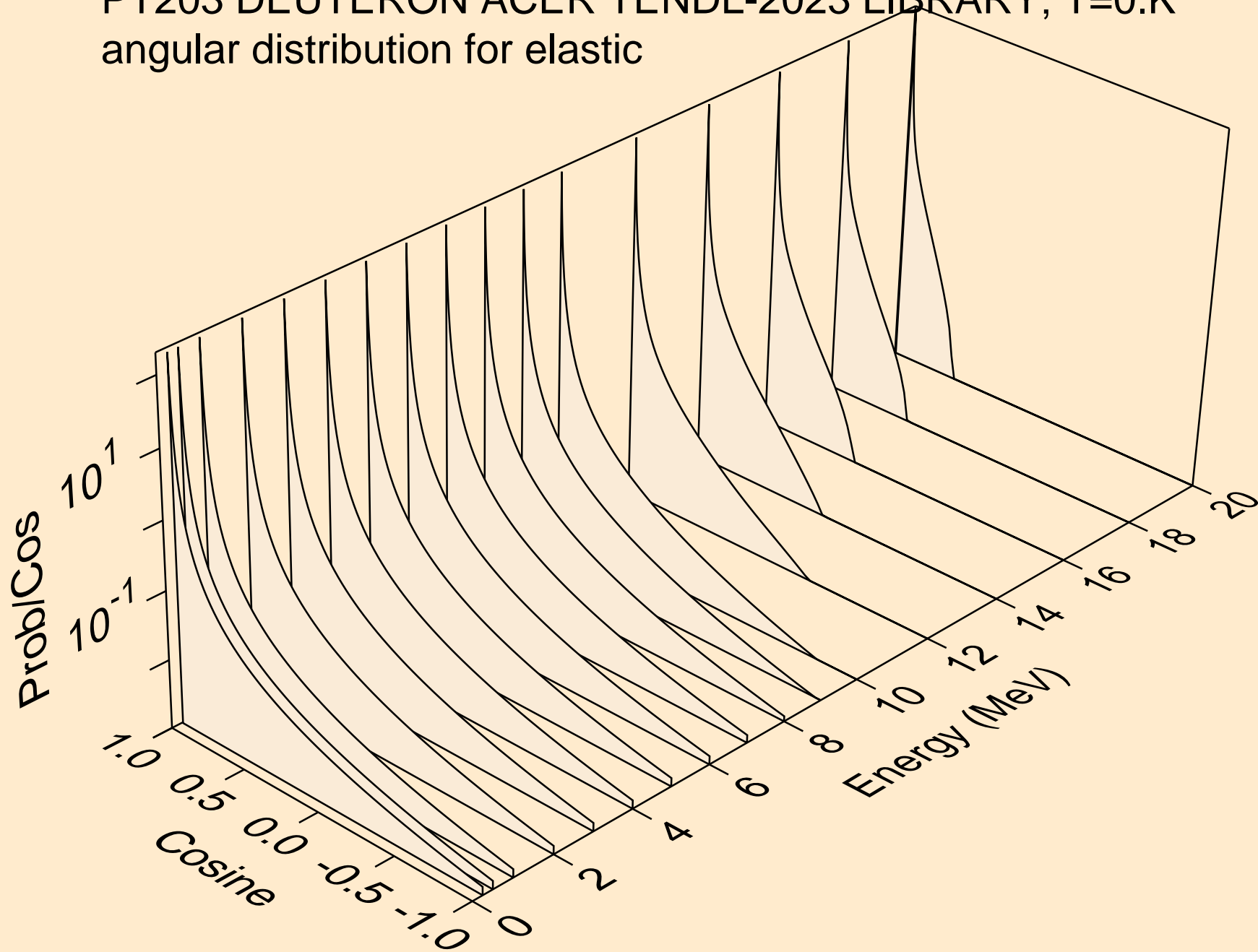

PT203 DEUTERON ACER TENDL-2023 LIBRARY; T=0.K  
angular distribution for elastic

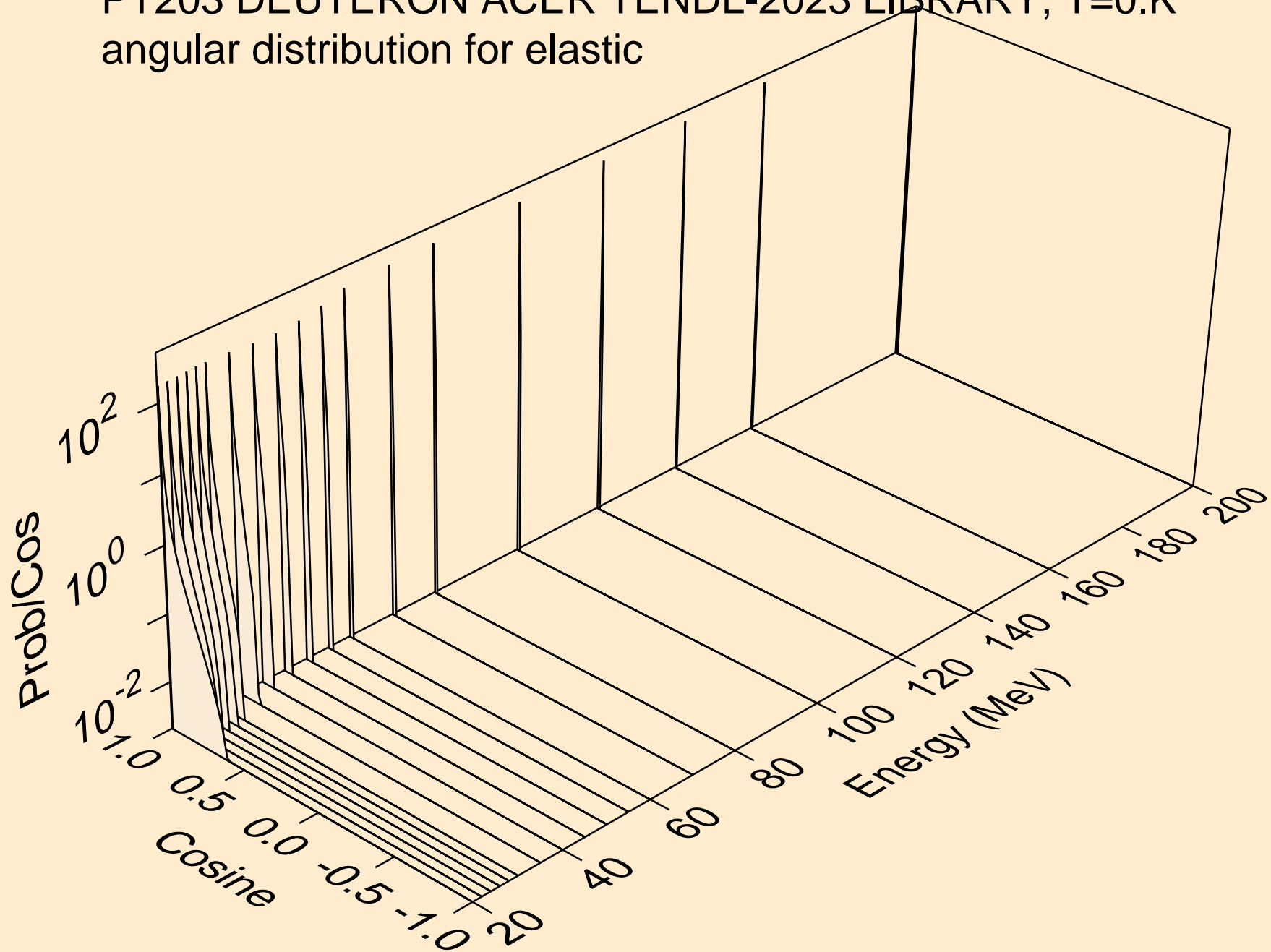

PT203 DEUTERON ACER TENDL-2023 LIBRARY; T=0.K  
Deuteron emission for (d,x)

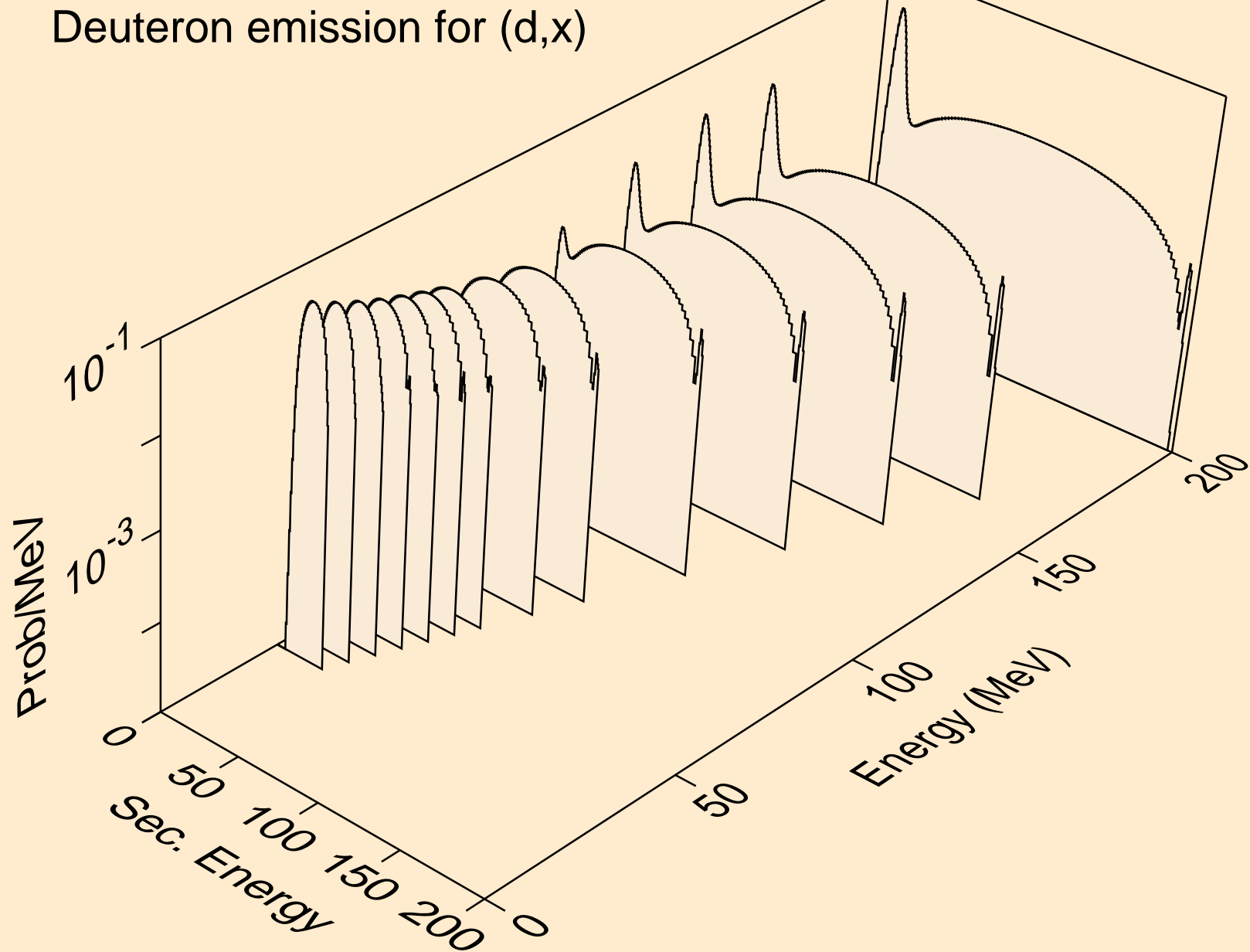



PT203 DEUTERON ACER TENDL-2023 LIBRARY; T=0.K  
Deuteron emission for (d,2nd)

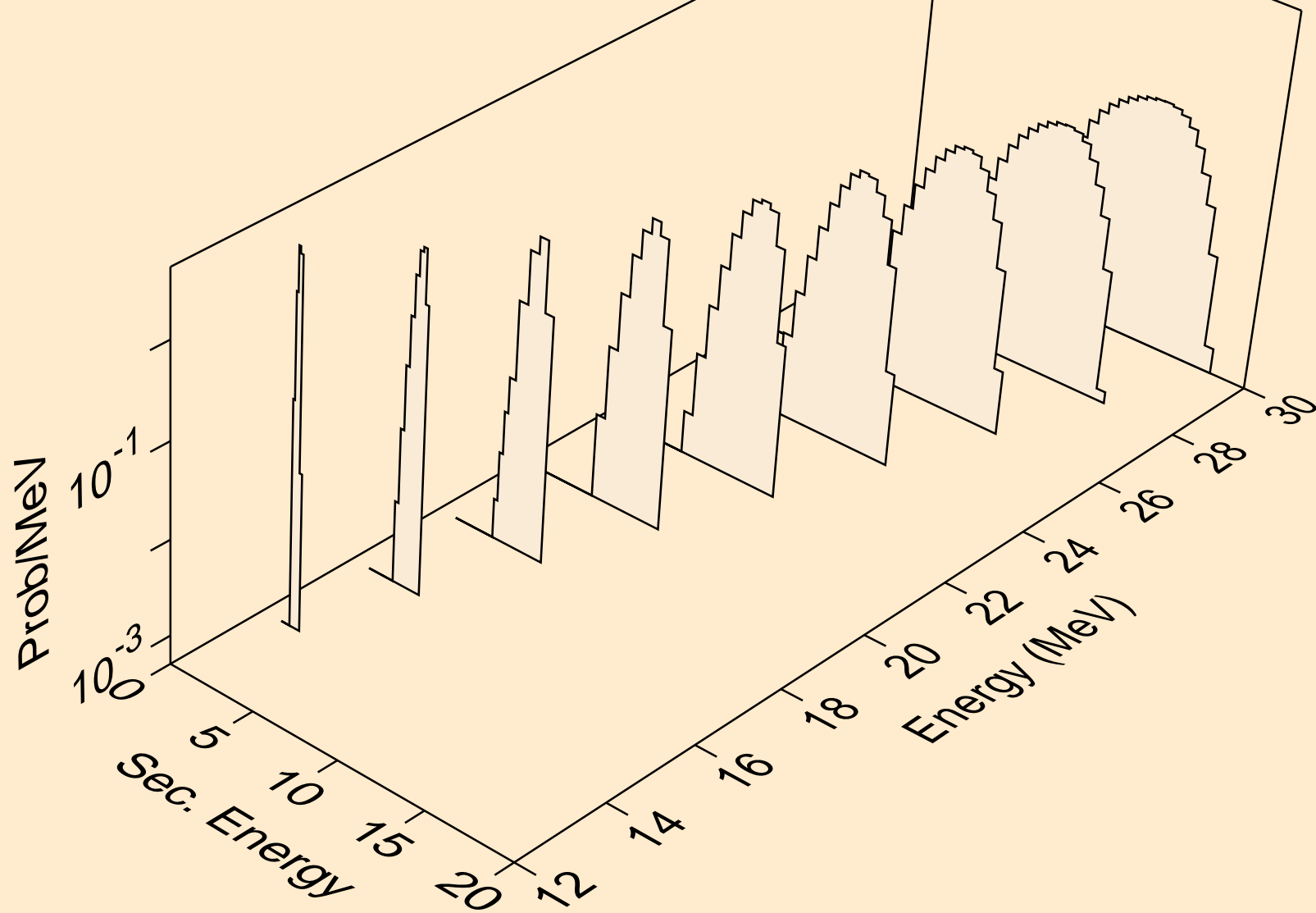

PT203 DEUTERON ACER TENDL-2023 LIBRARY; T=0.K  
Deuteron emission for (d,n\*)d

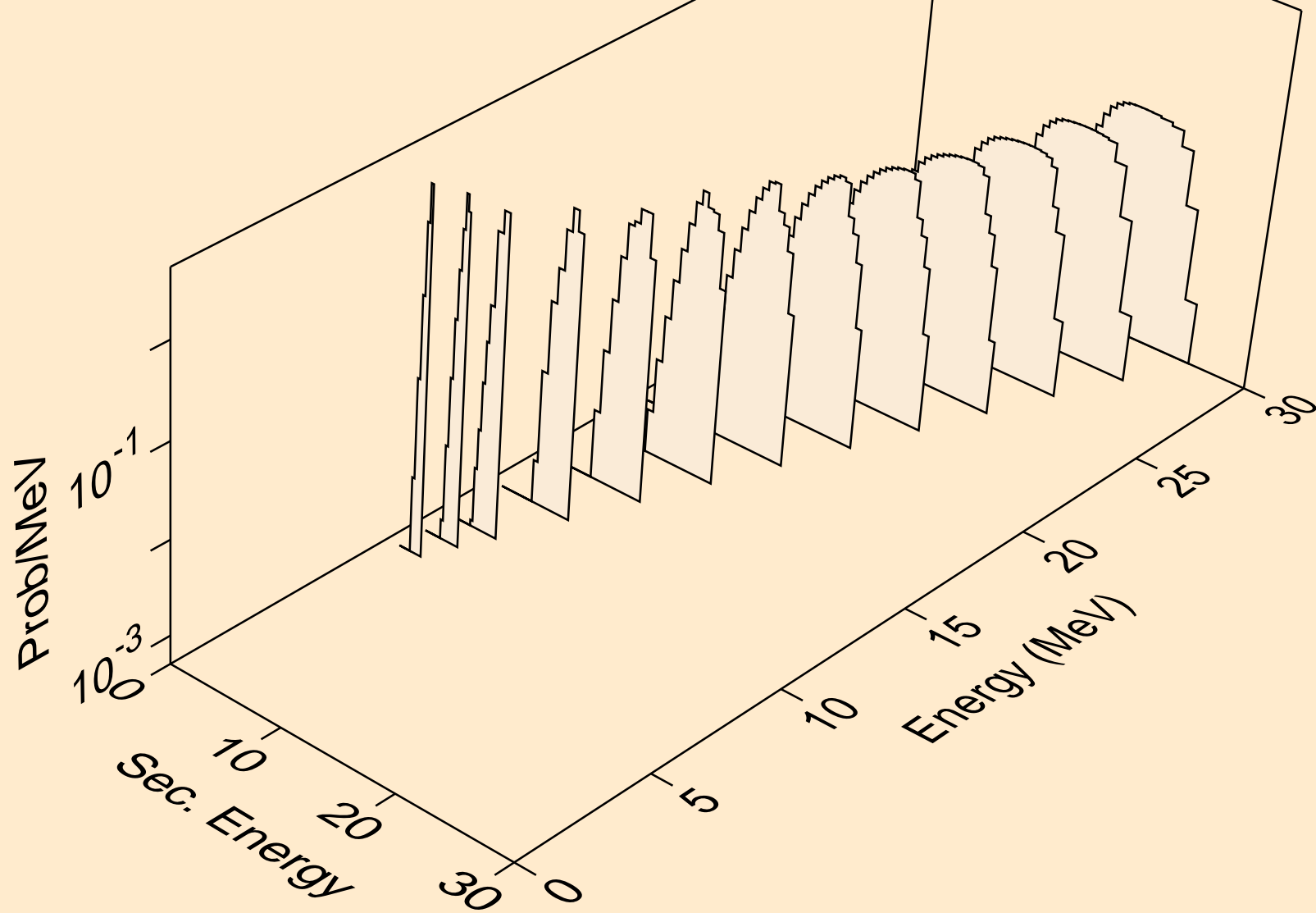

PT203 DEUTERON ACER TENDL-2023 LIBRARY; T=0.K  
Deuteron emission for inelastic

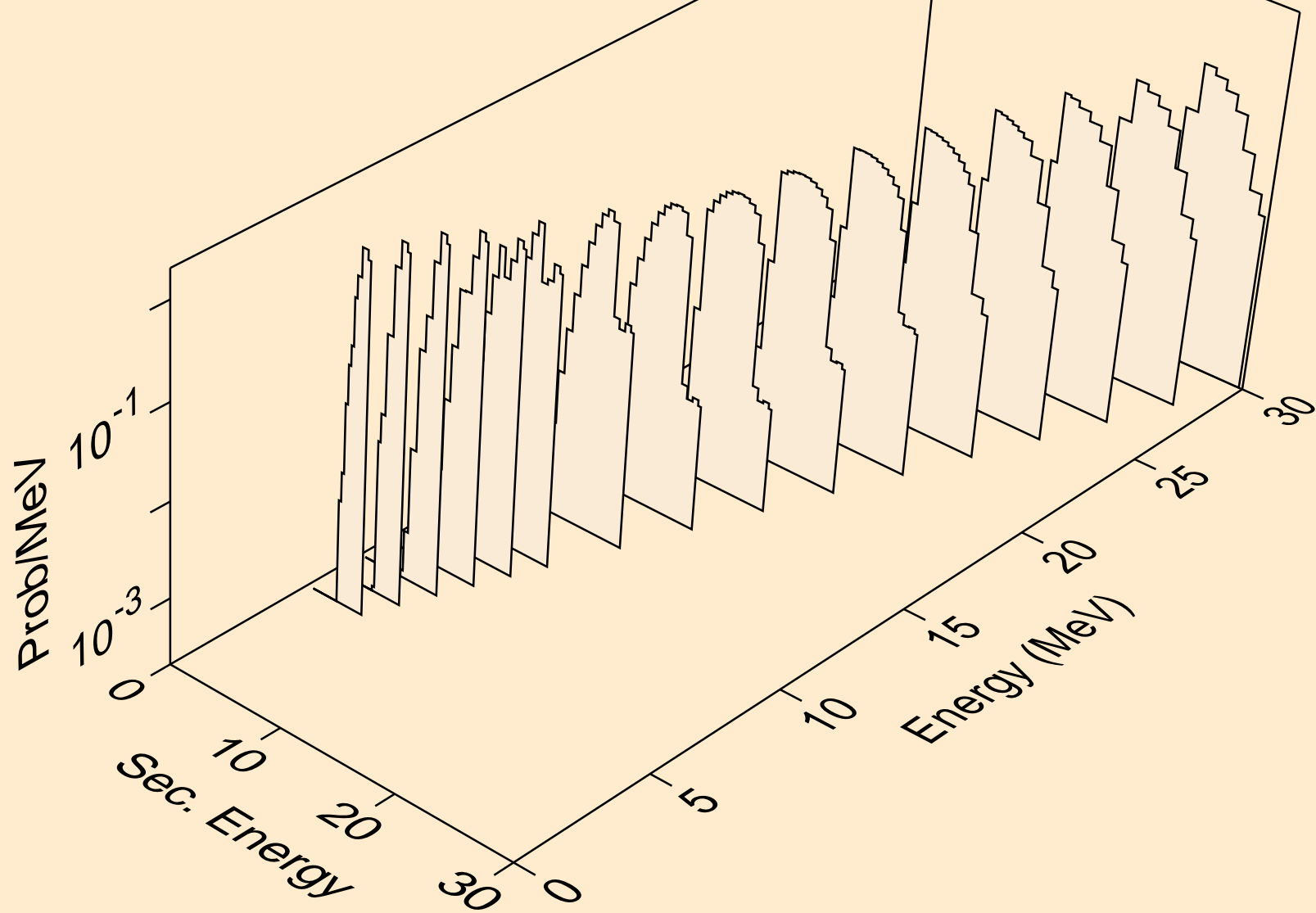

PT203 DEUTERON ACER TENDL-2023 LIBRARY; T=0.K  
Deuteron emission for (d,pd)

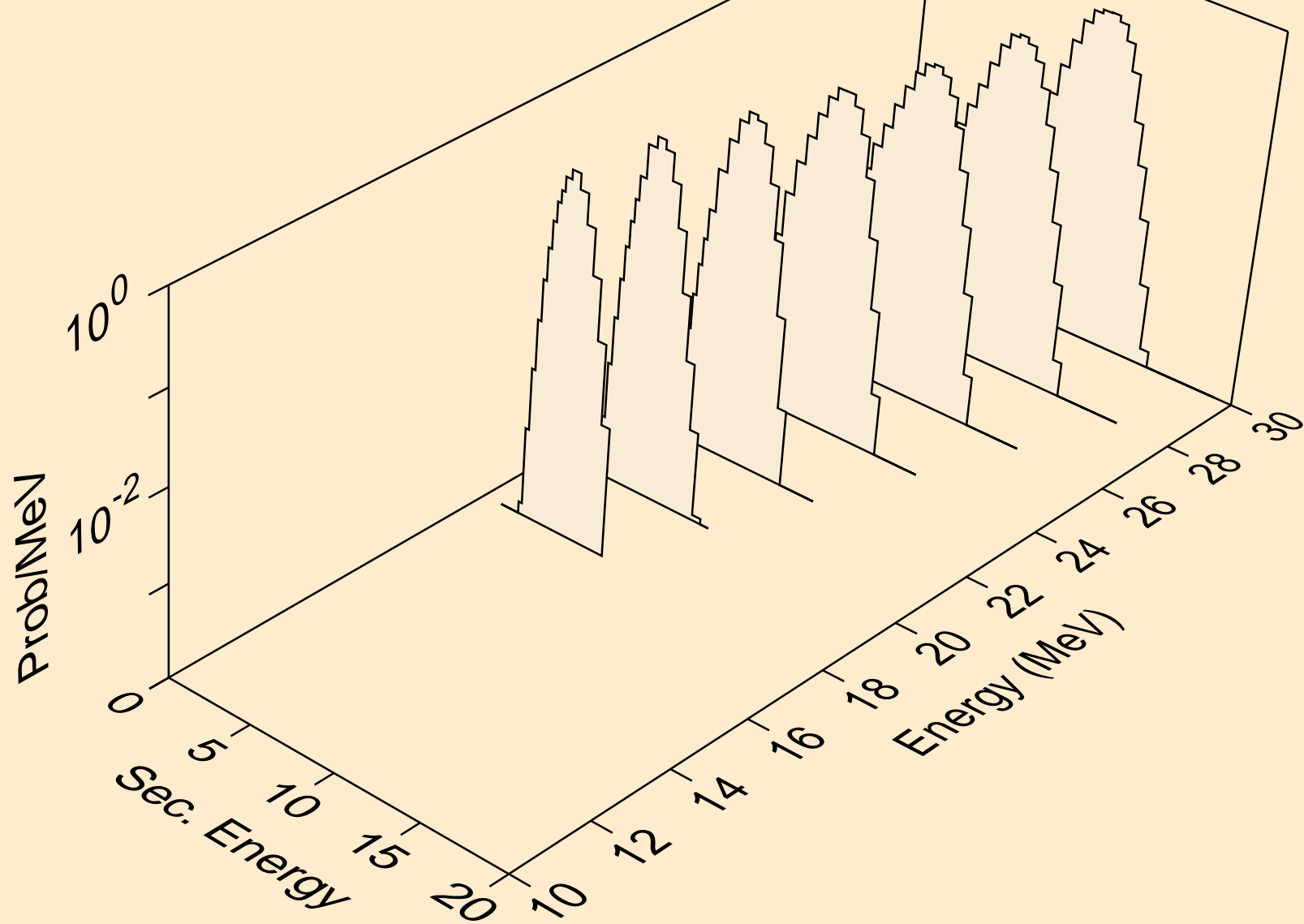

PT203 DEUTERON ACER TENDL-2023 LIBRARY; T=0.K  
Photon emission for (z,n)

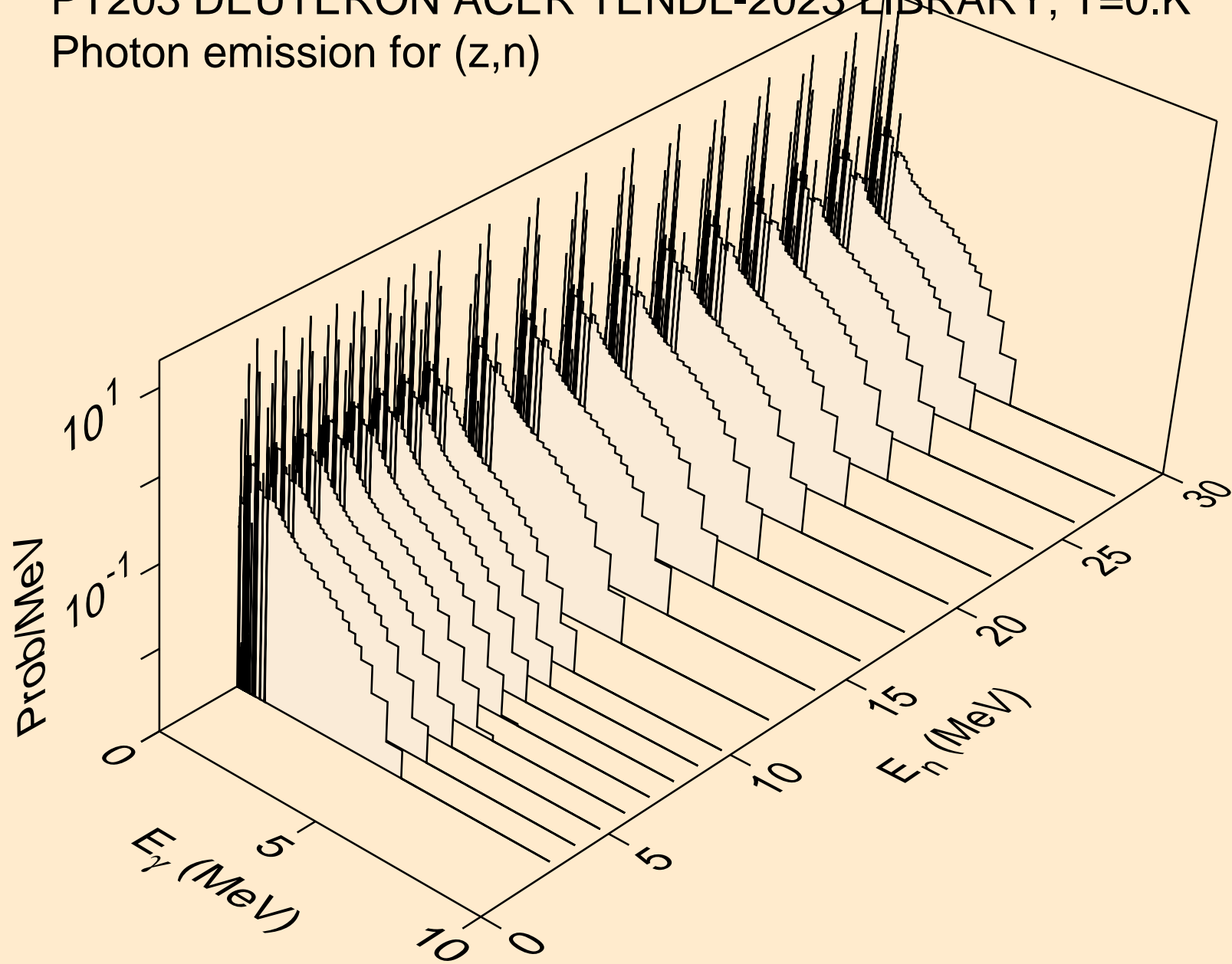

PT203 DEUTERON ACER TENDL-2023 LIBRARY; T=0.K  
Photon emission for (z,x)

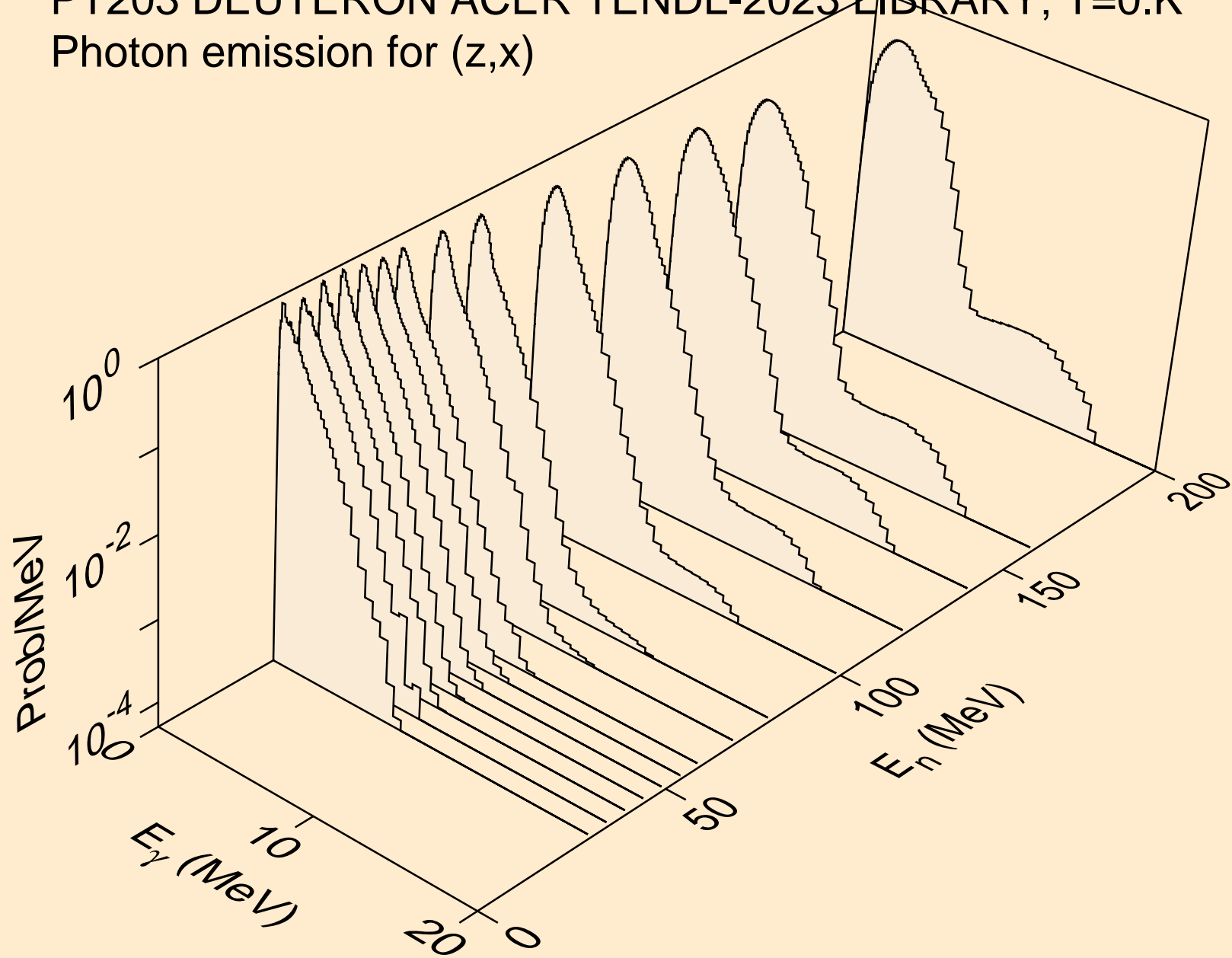

PT203 DEUTERON ACER TENDL-2023 LIBRARY; T=0.K  
Photon emission for (n,2nd)

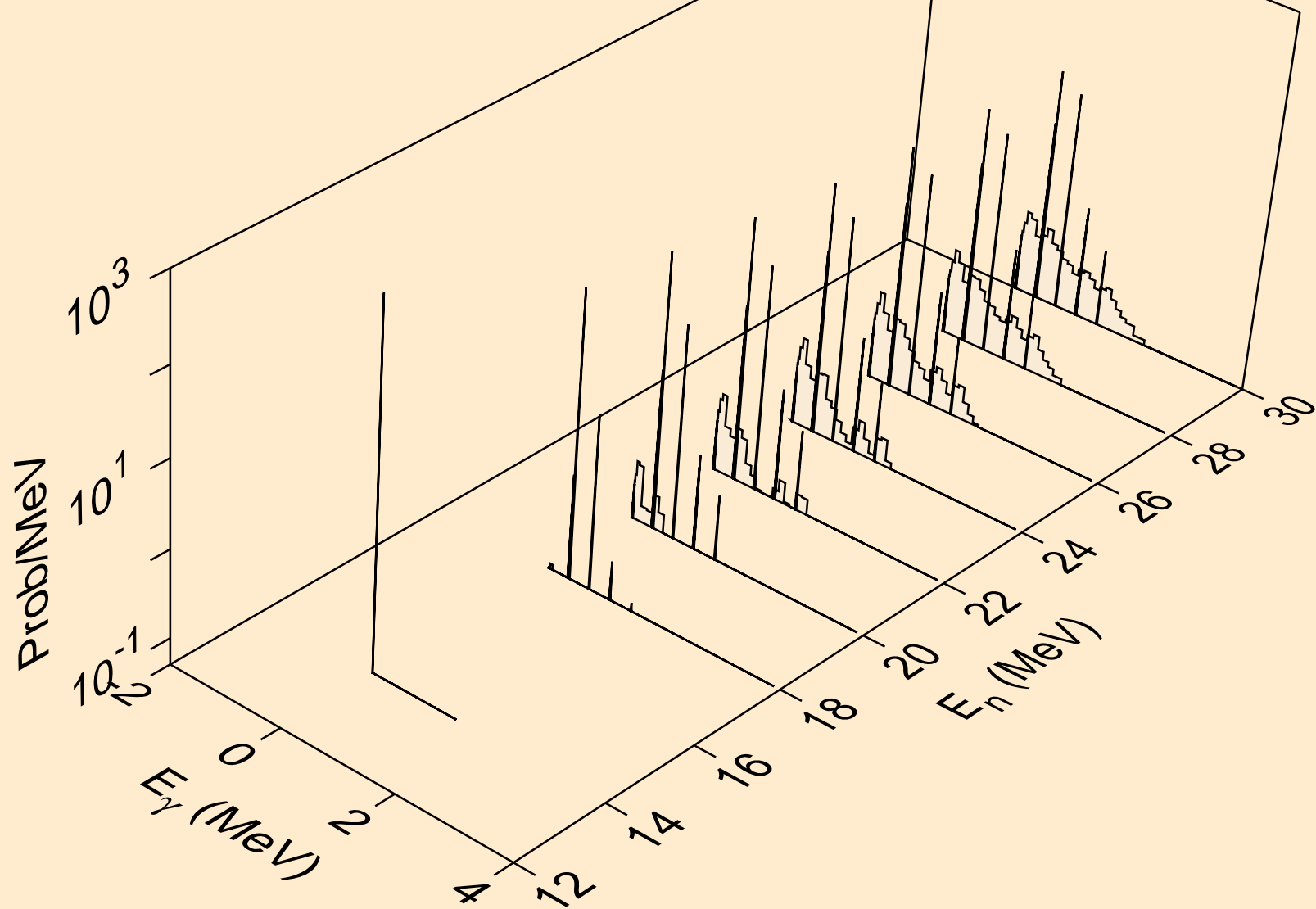

PT203 DEUTERON ACER TENDL-2023 LIBRARY; T=0.K  
Photon emission for (n,2n)

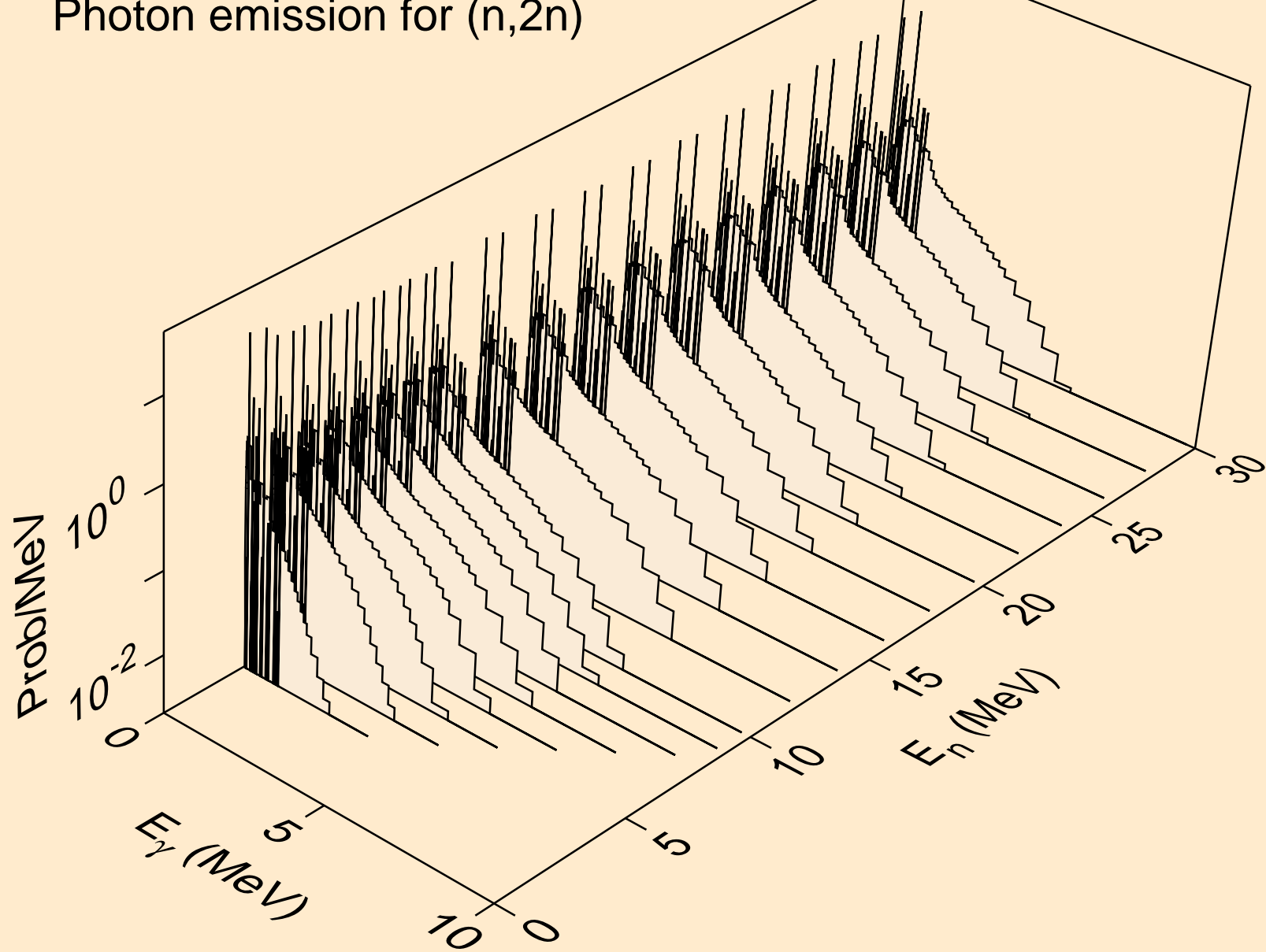



PT203 DEUTERON ACER TENDL-2023 LIBRARY; T=0.K  
Photon emission for (n,3n)

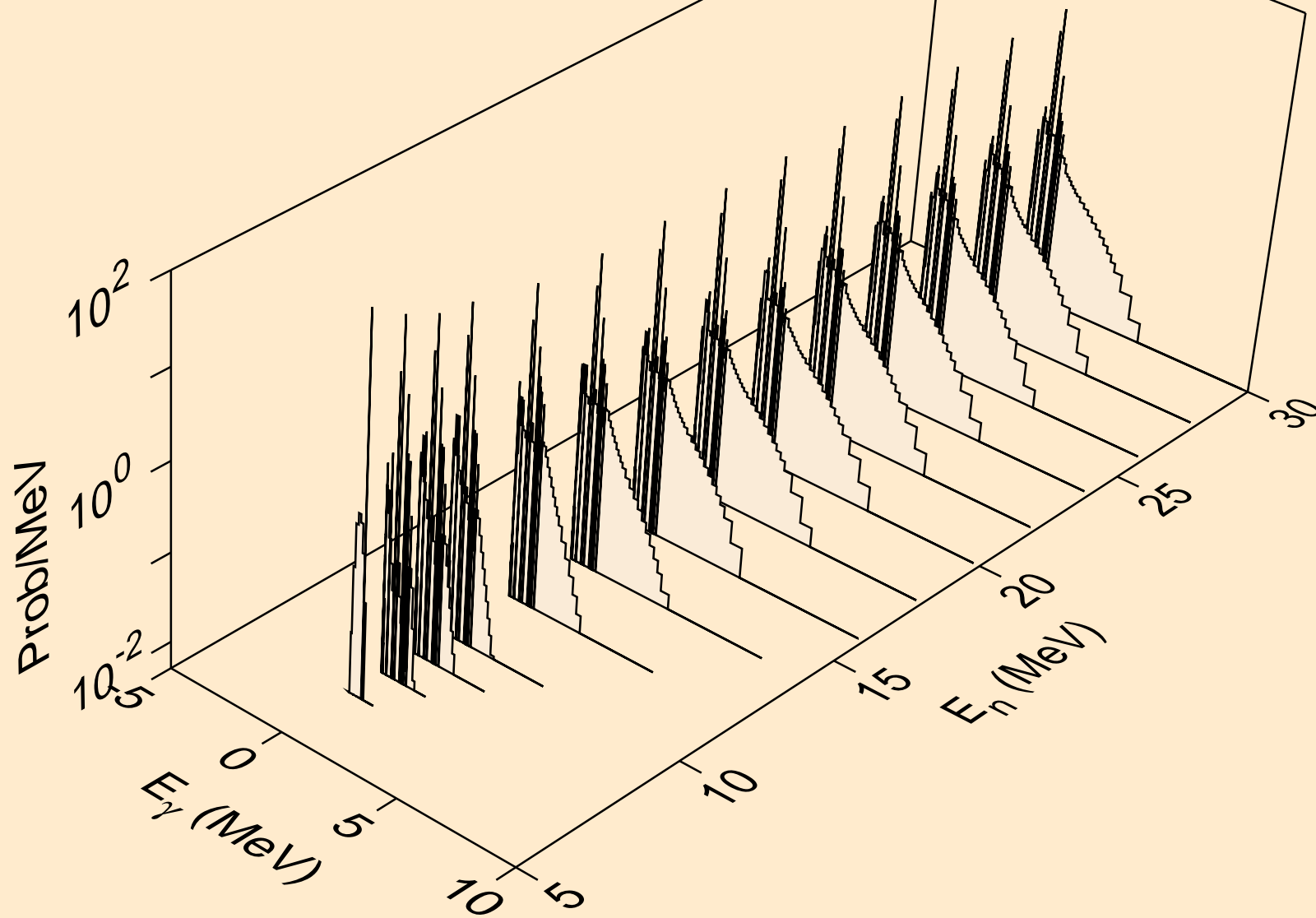

PT203 DEUTERON ACER TENDL-2023 LIBRARY; T=0.K  
Photon emission for (n,n\*)a

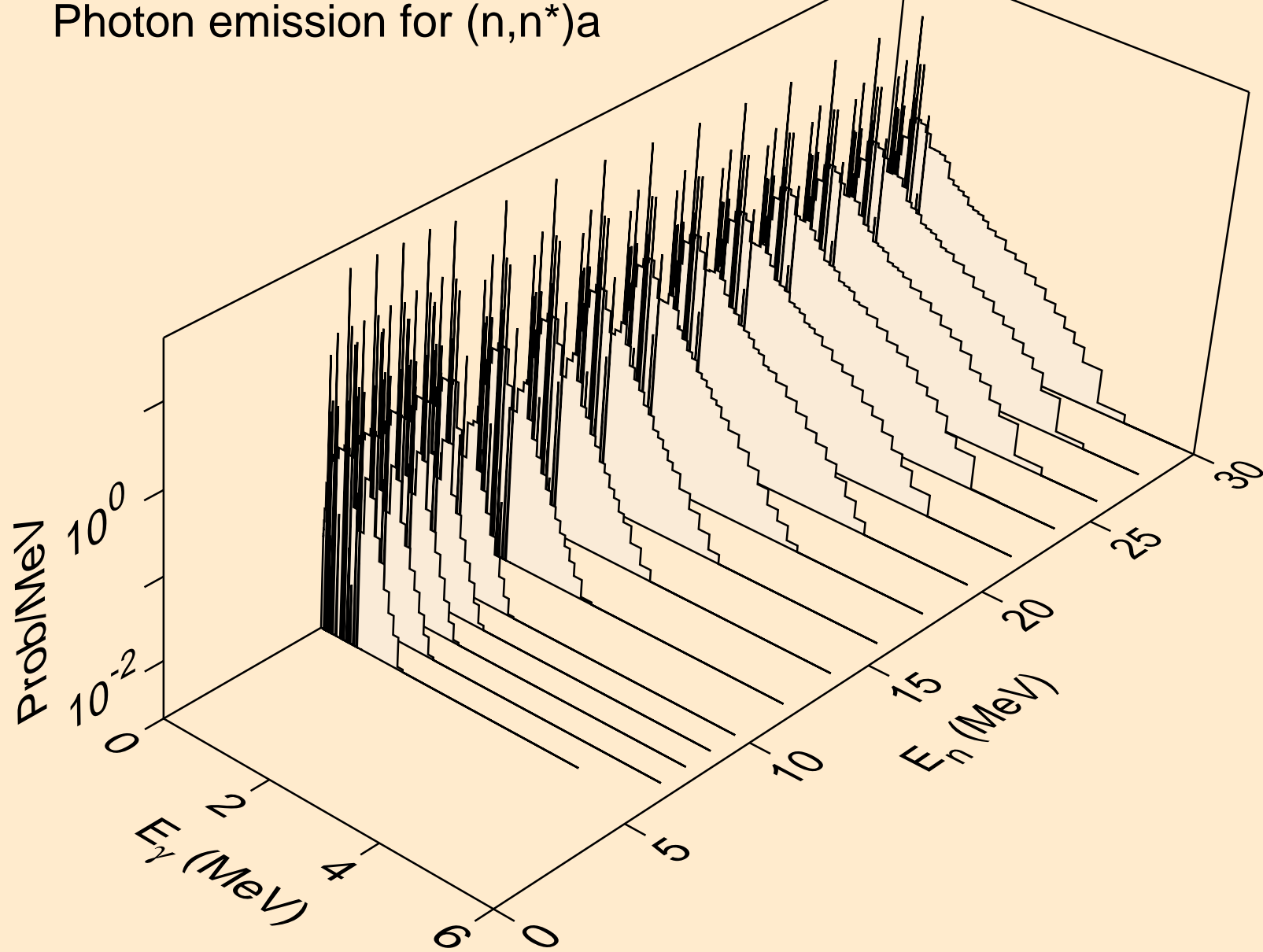

PT203 DEUTERON ACER TENDL-2023 LIBRARY; T=0.K  
Photon emission for (n,2n)a

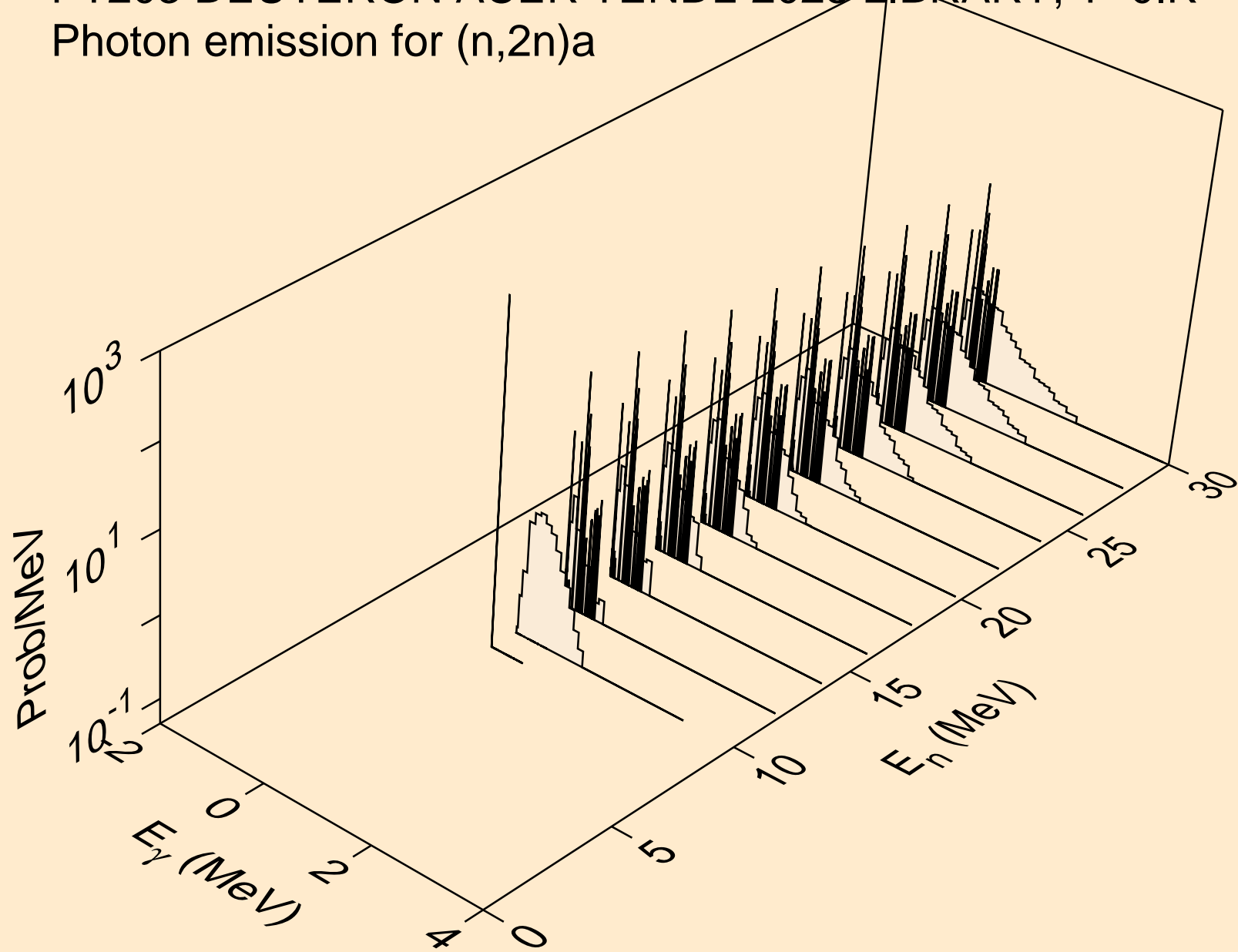

PT203 DEUTERON ACER TENDL-2023 LIBRARY; T=0.K  
Photon emission for (n,3n)a

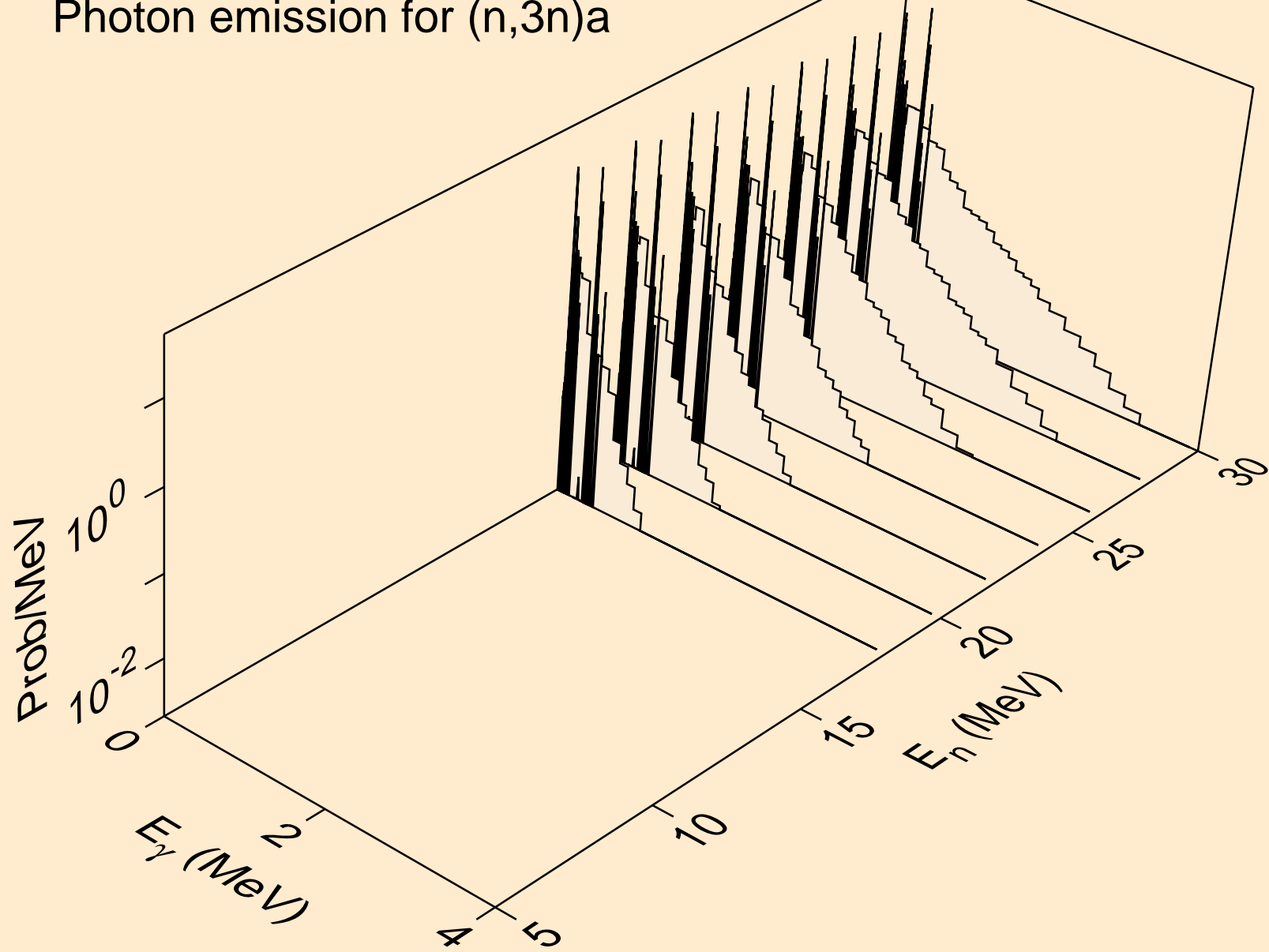

PT203 DEUTERON ACER TENDL-2023 LIBRARY; T=0.K  
Photon emission for (n,n\*)p

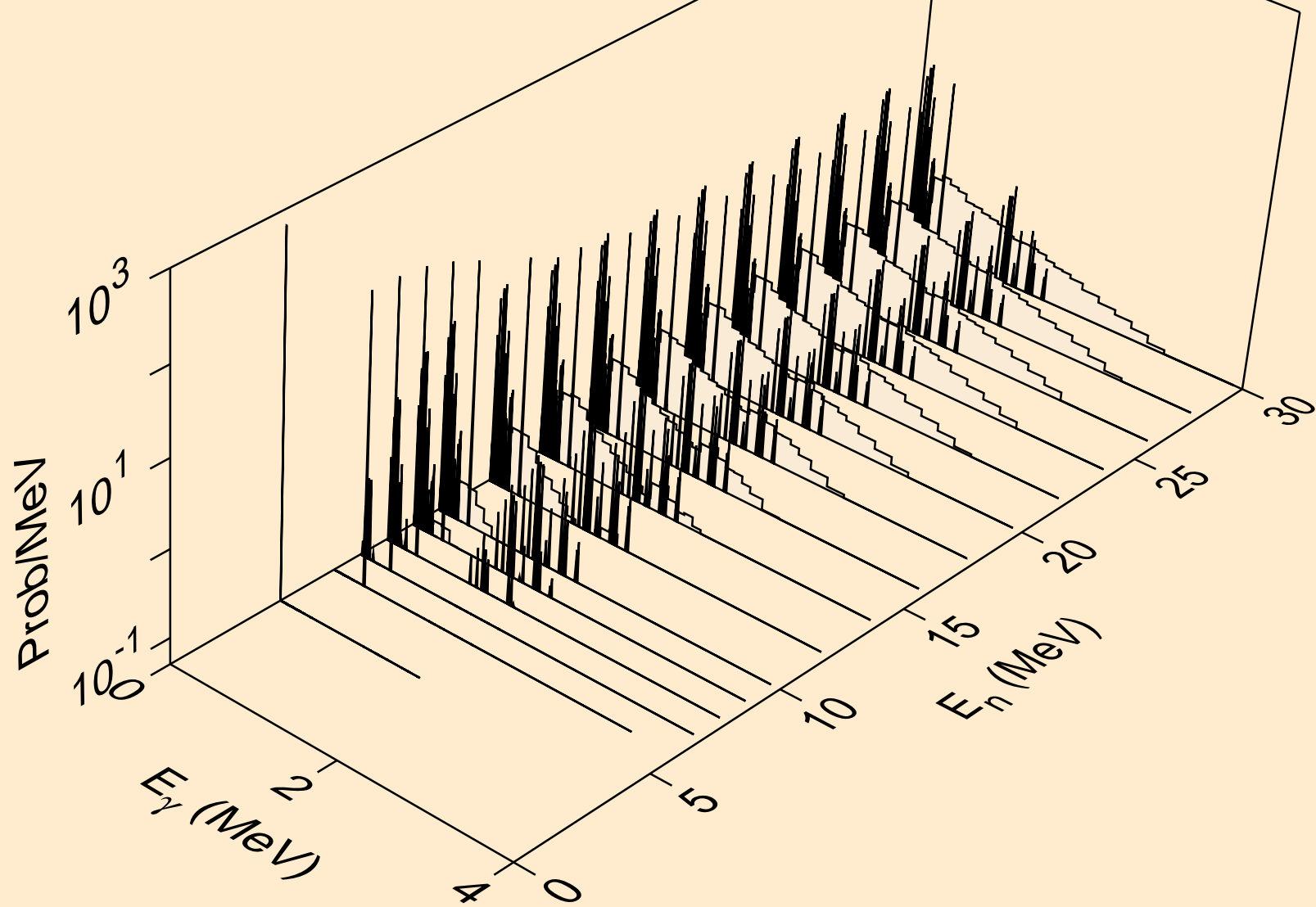

PT203 DEUTERON ACER TENDL-2023 LIBRARY; T=0.K  
Photon emission for (n,n\*)d

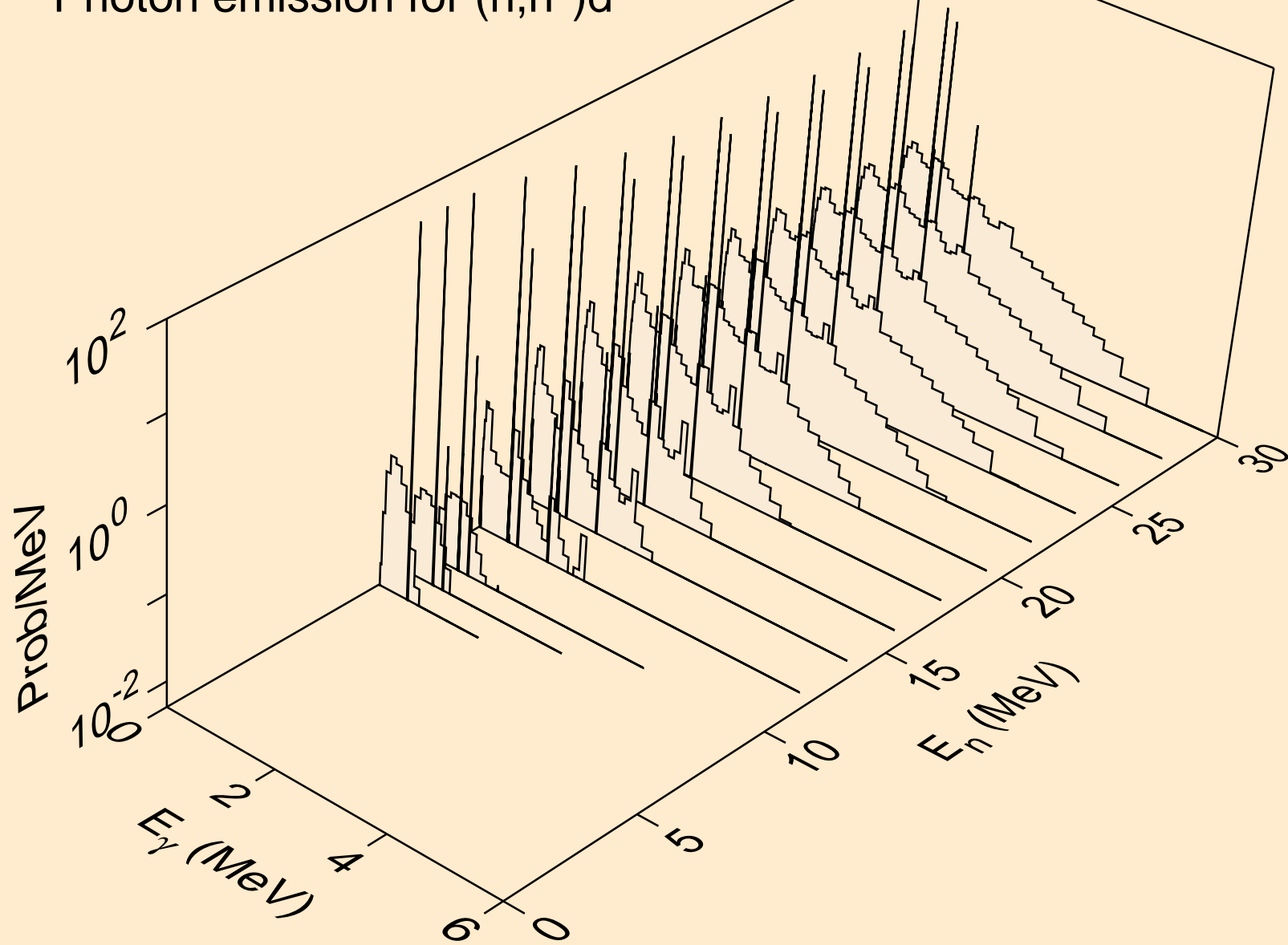

PT203 DEUTERON ACER TENDL-2023 LIBRARY; T=0.K  
Photon emission for (n,n\*)t

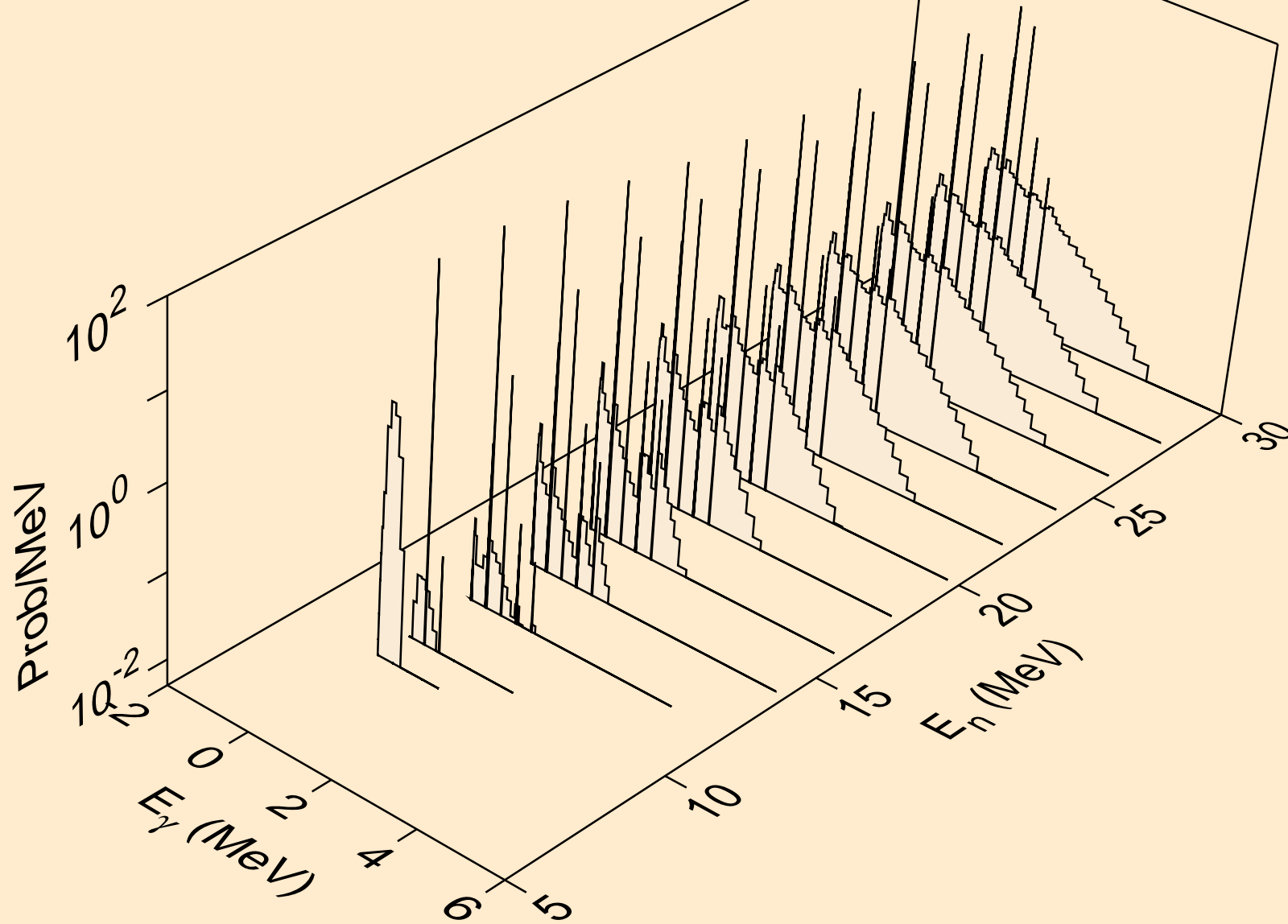

PT203 DEUTERON ACER TENDL-2023 LIBRARY; T=0.K  
Photon emission for (n,n\*)he3

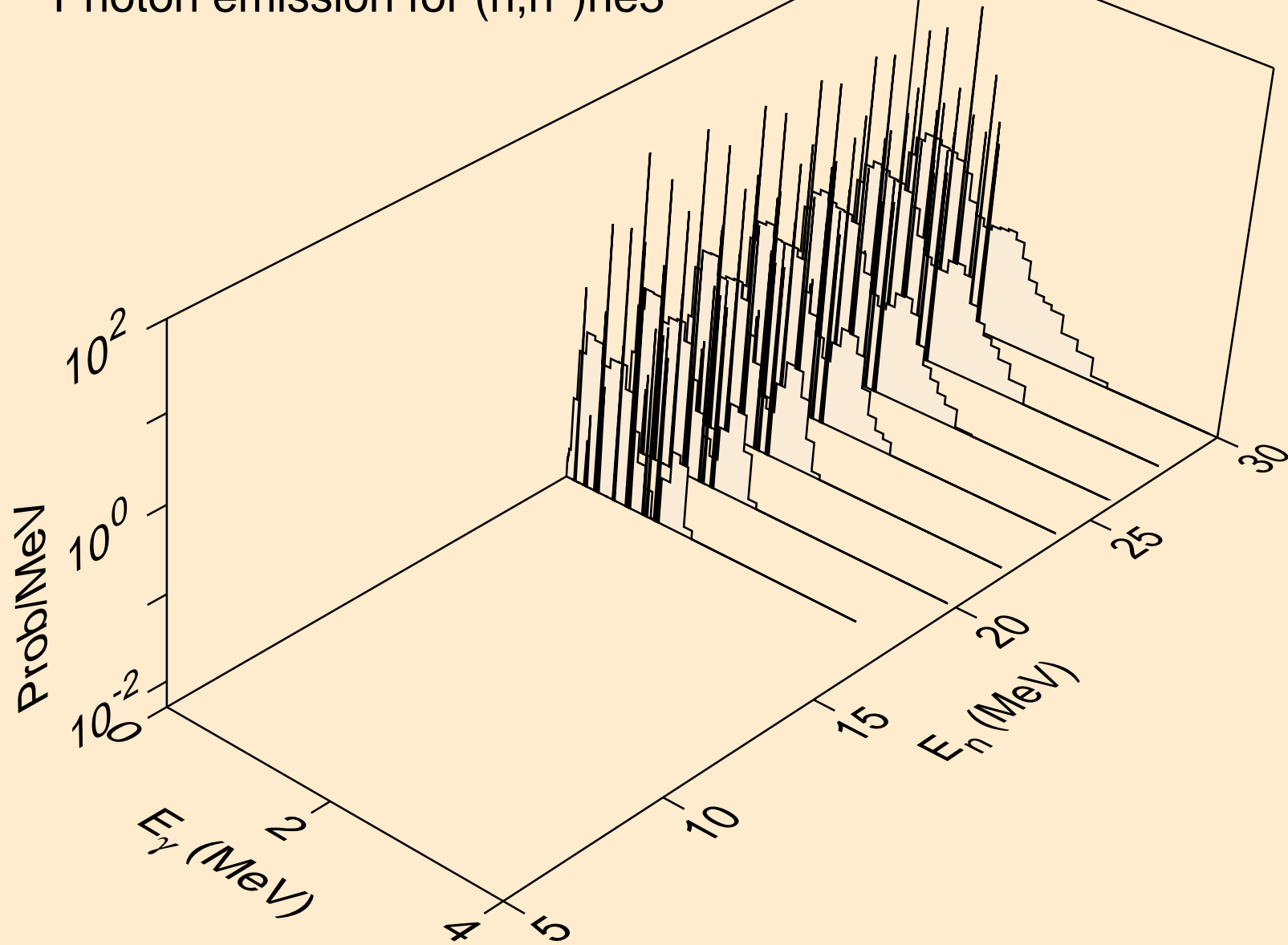



PT203 DEUTERON ACER TENDL-2023 LIBRARY; T=0.K  
Photon emission for (n,4n)

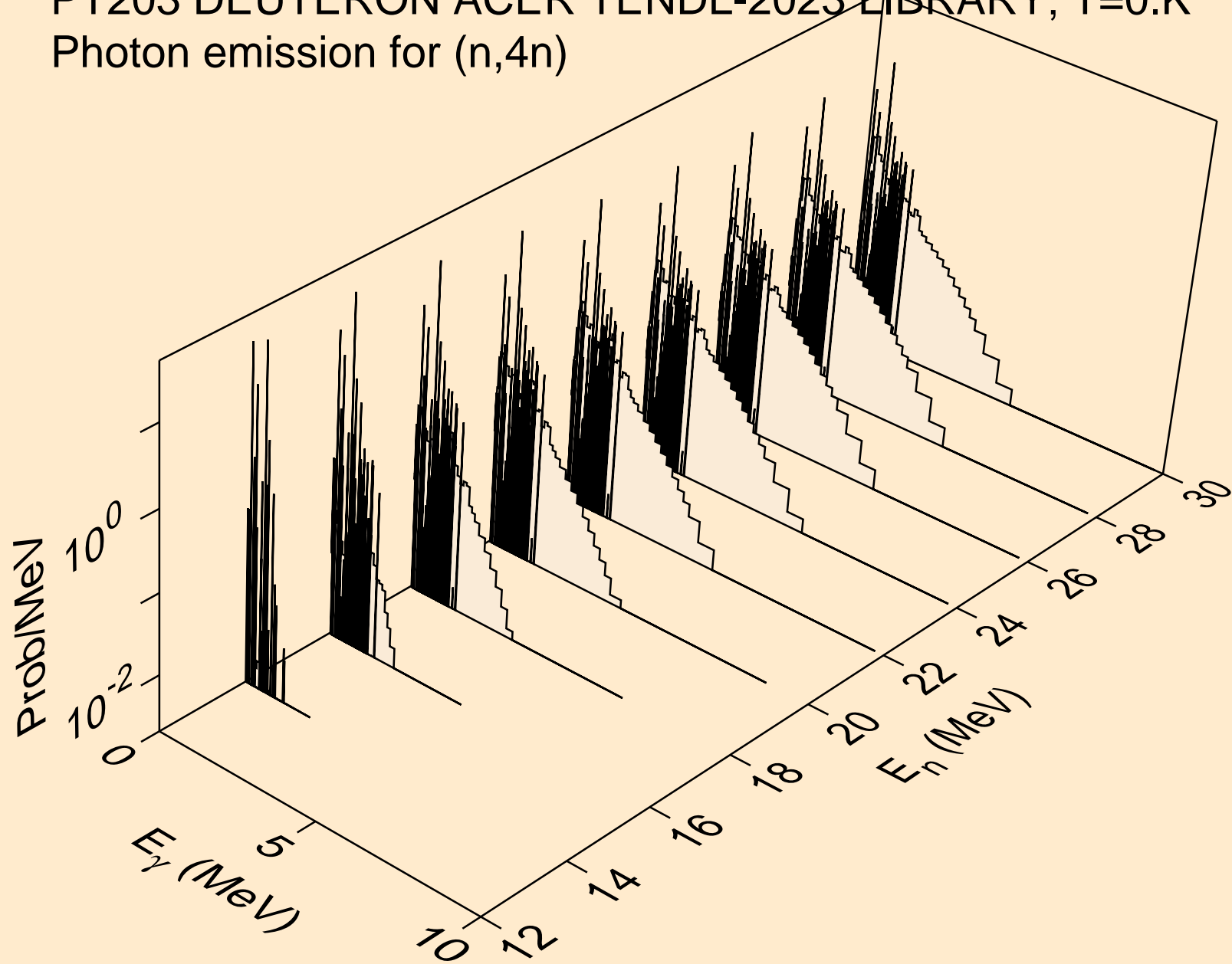

PT203 DEUTERON ACER TENDL-2023 LIBRARY; T=0.K  
Photon emission for (n,2np)

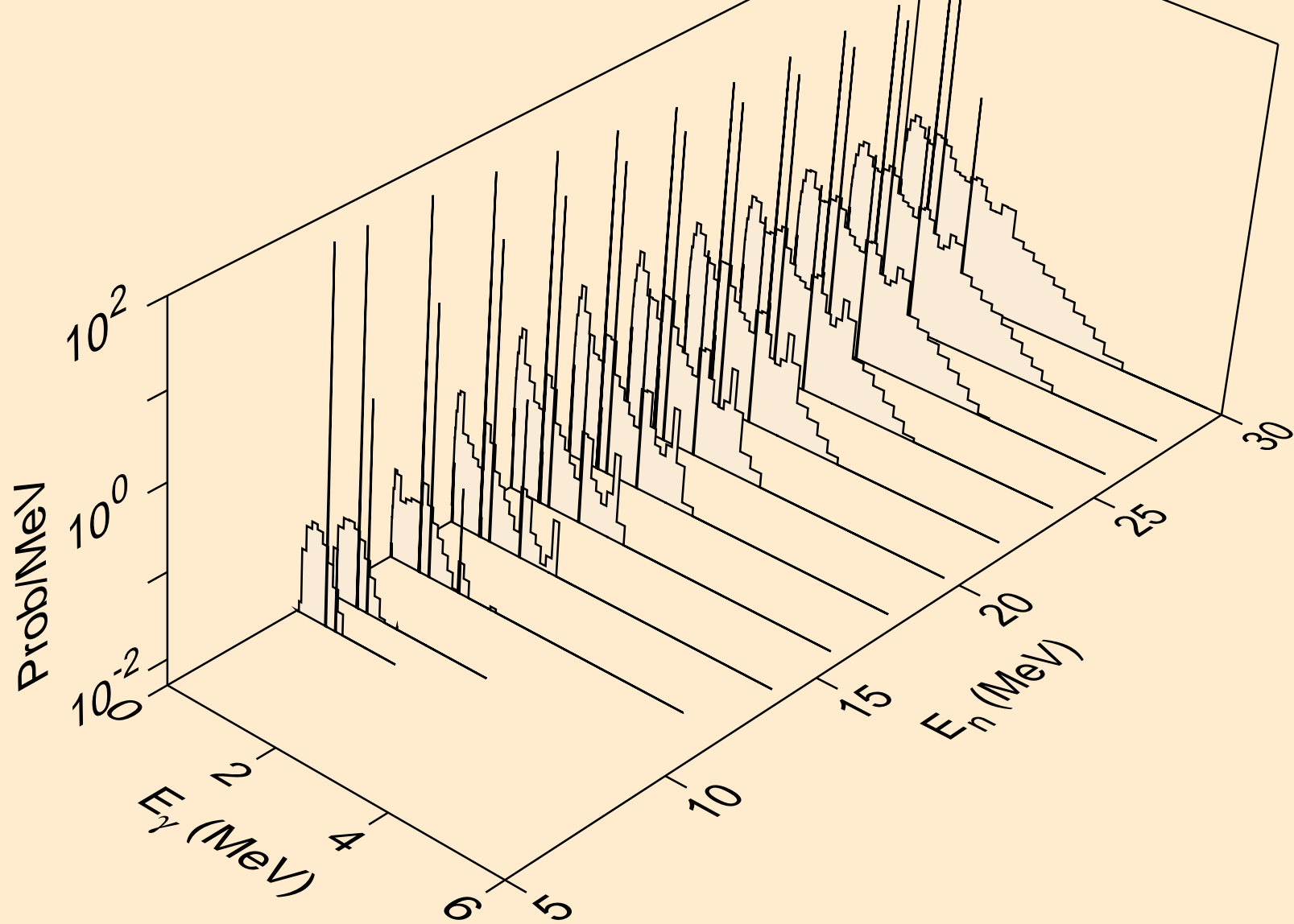

PT203 DEUTERON ACER TENDL-2023 LIBRARY; T=0.K  
Photon emission for (n,3np)

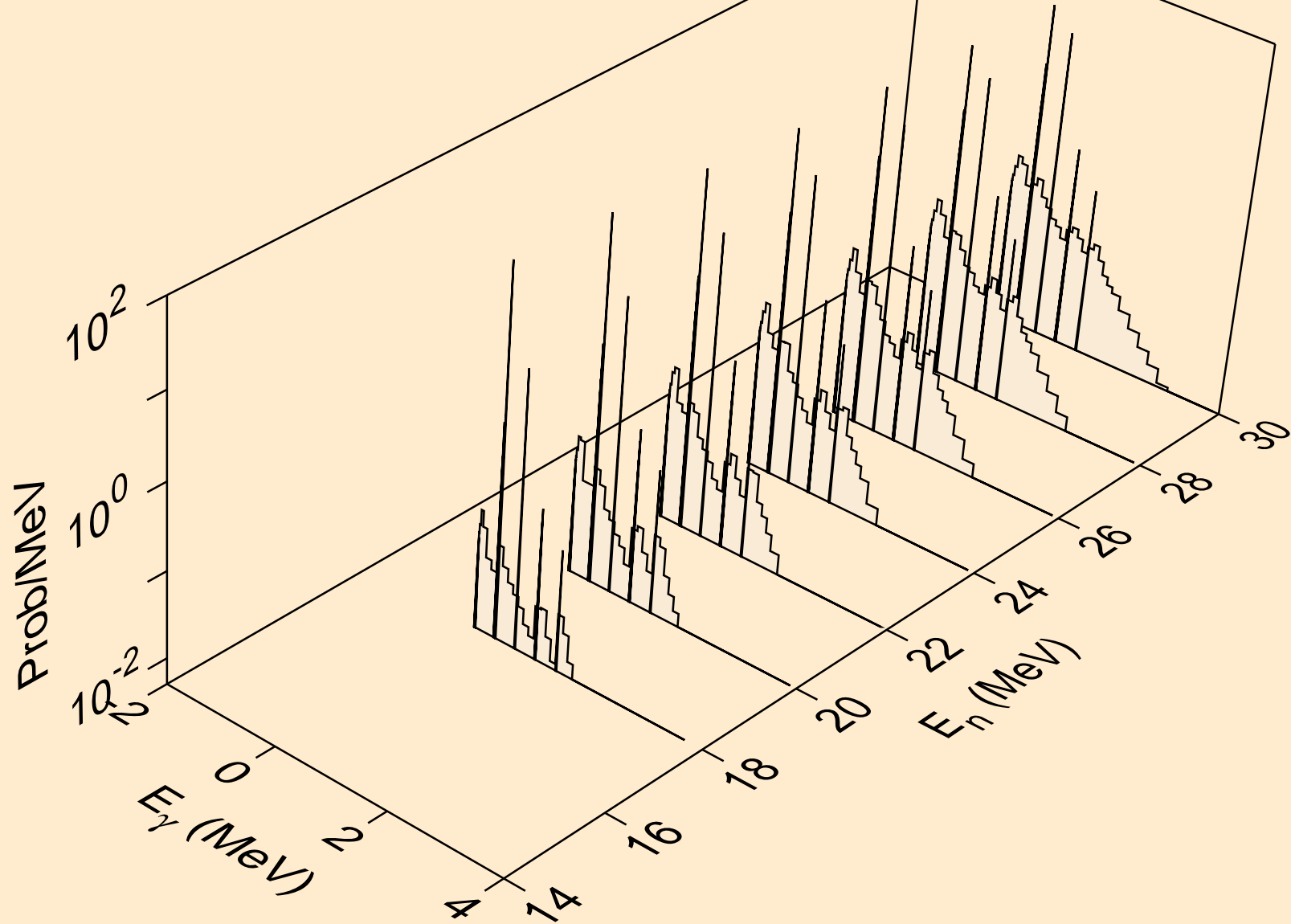

PT203 DEUTERON ACER TENDL-2023 LIBRARY; T=0.K  
Photon emission for (n,n2p)

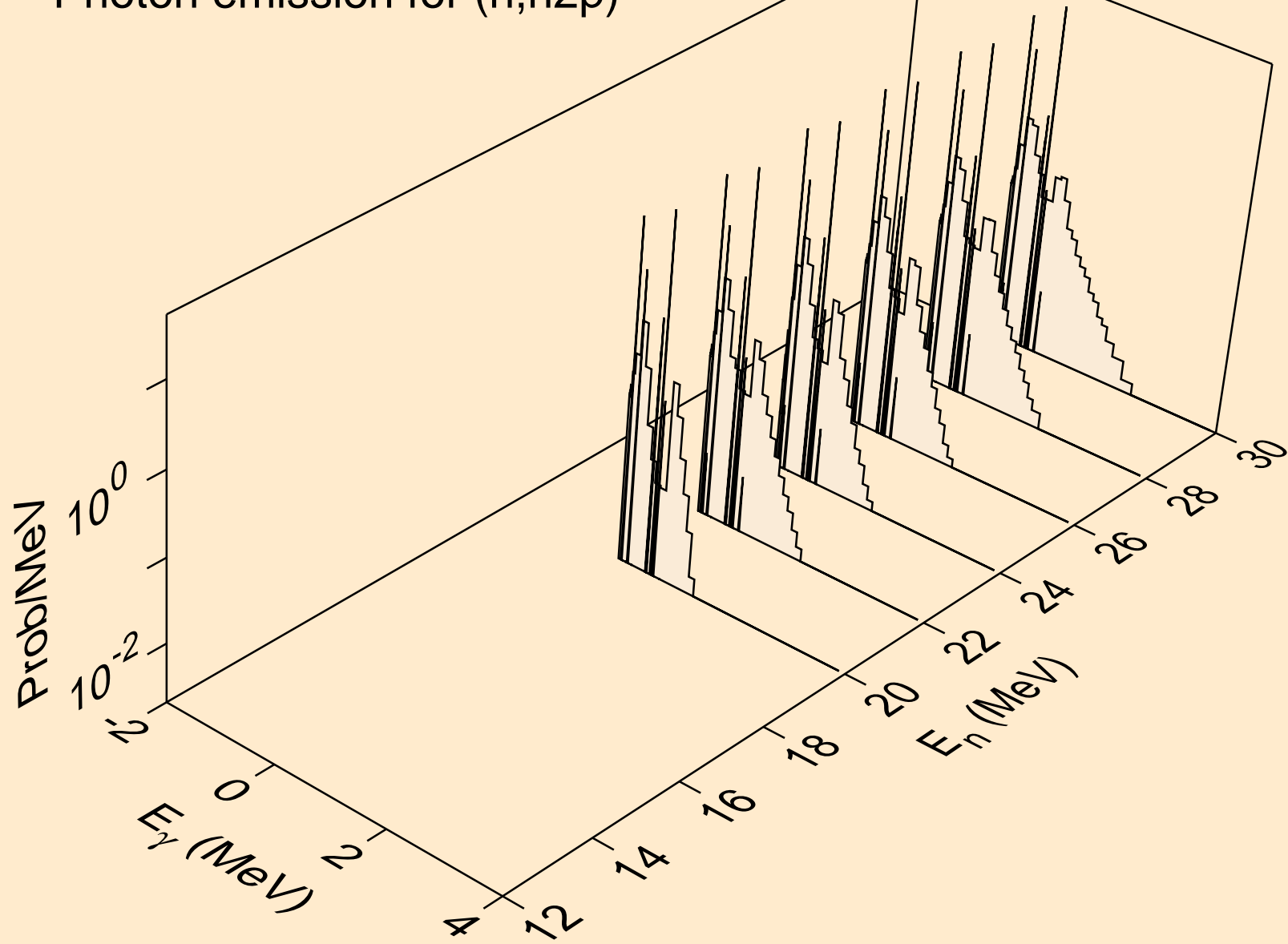

PT203 DEUTERON ACER TENDL-2023 LIBRARY; T=0.K  
Photon emission for (n,gma)

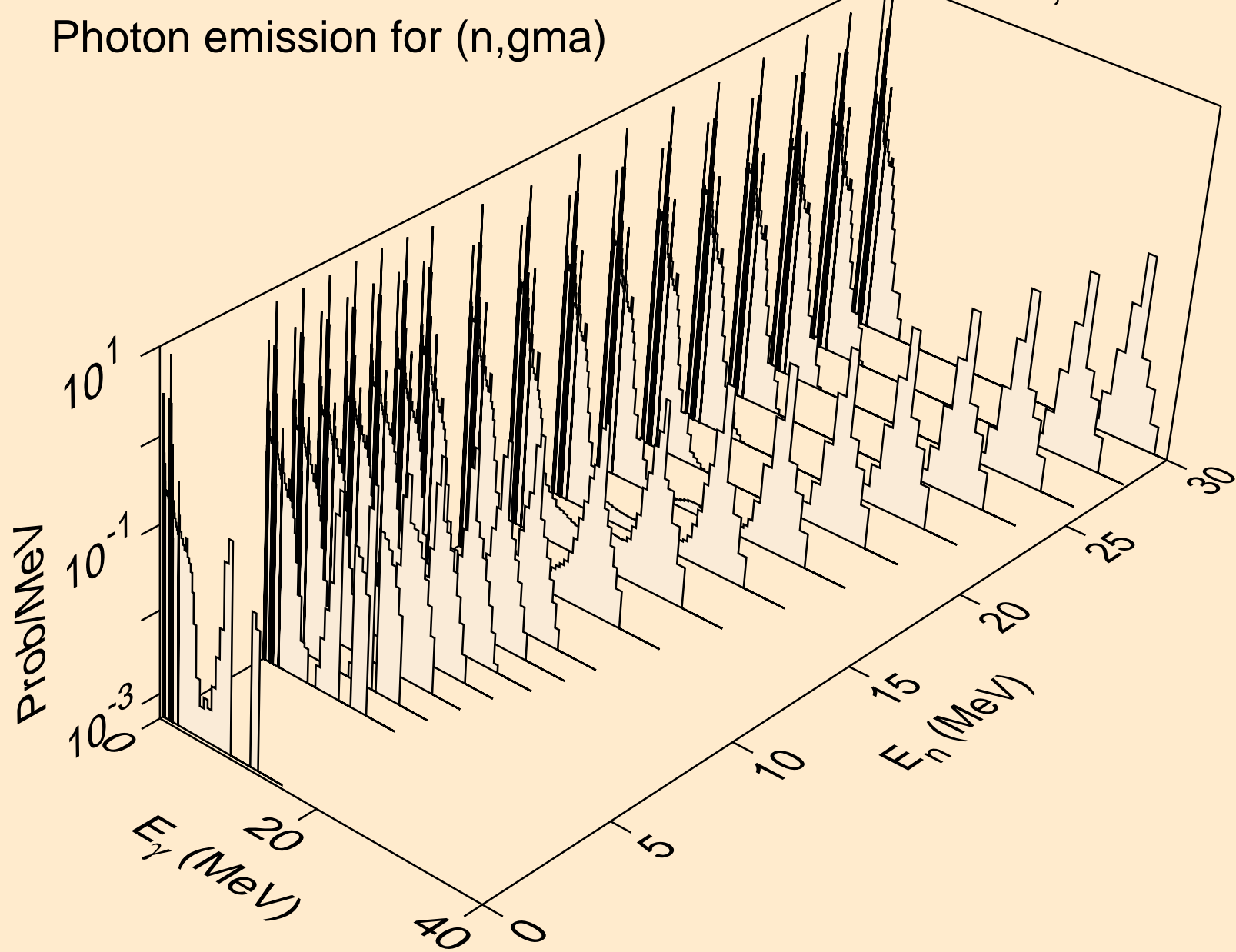

PT203 DEUTERON ACER TENDL-2023 LIBRARY; T=0.K  
Photon emission for (n,p)

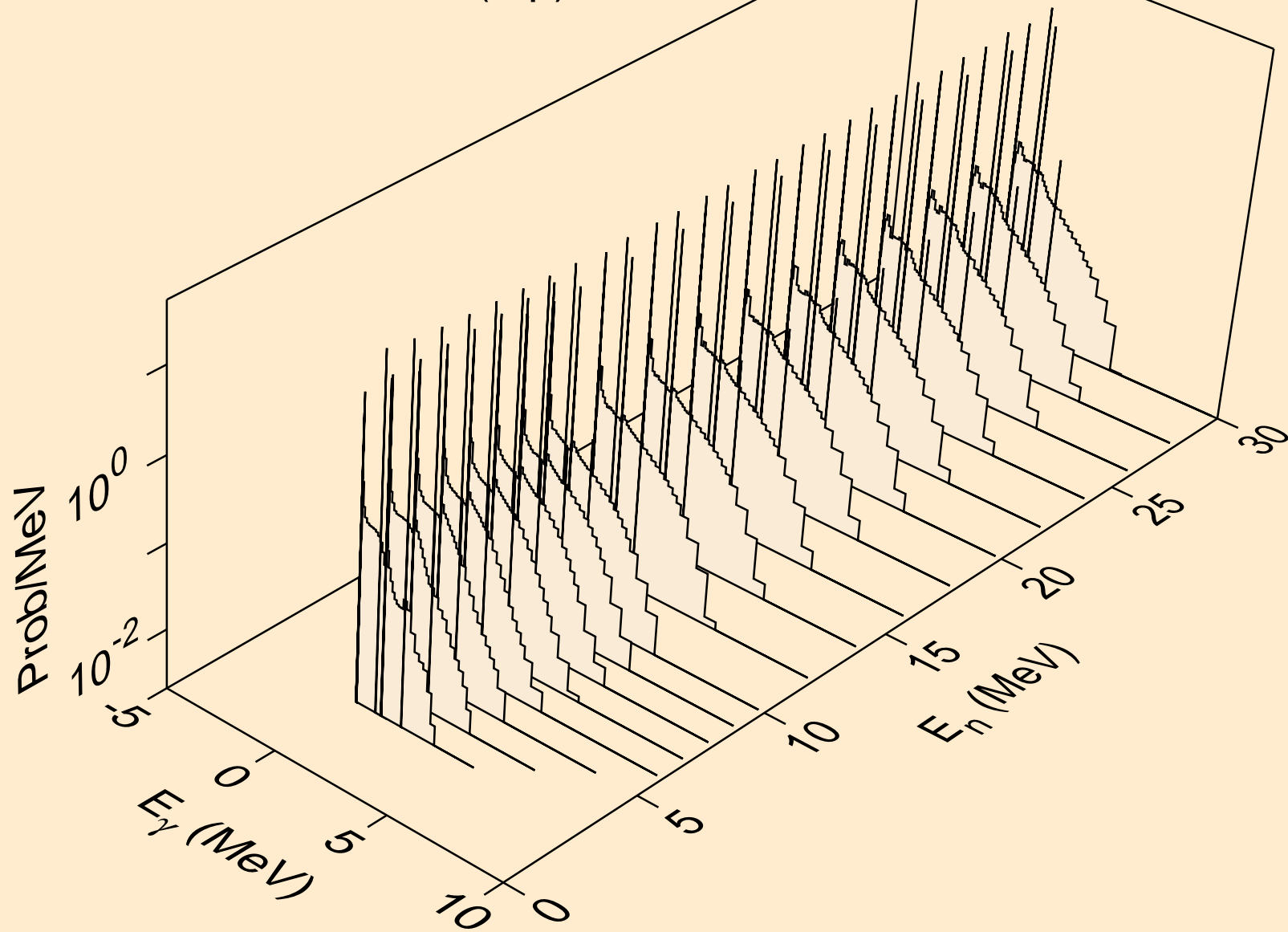

PT203 DEUTERON ACER TENDL-2023 LIBRARY; T=0.K  
Photon emission for inelastic

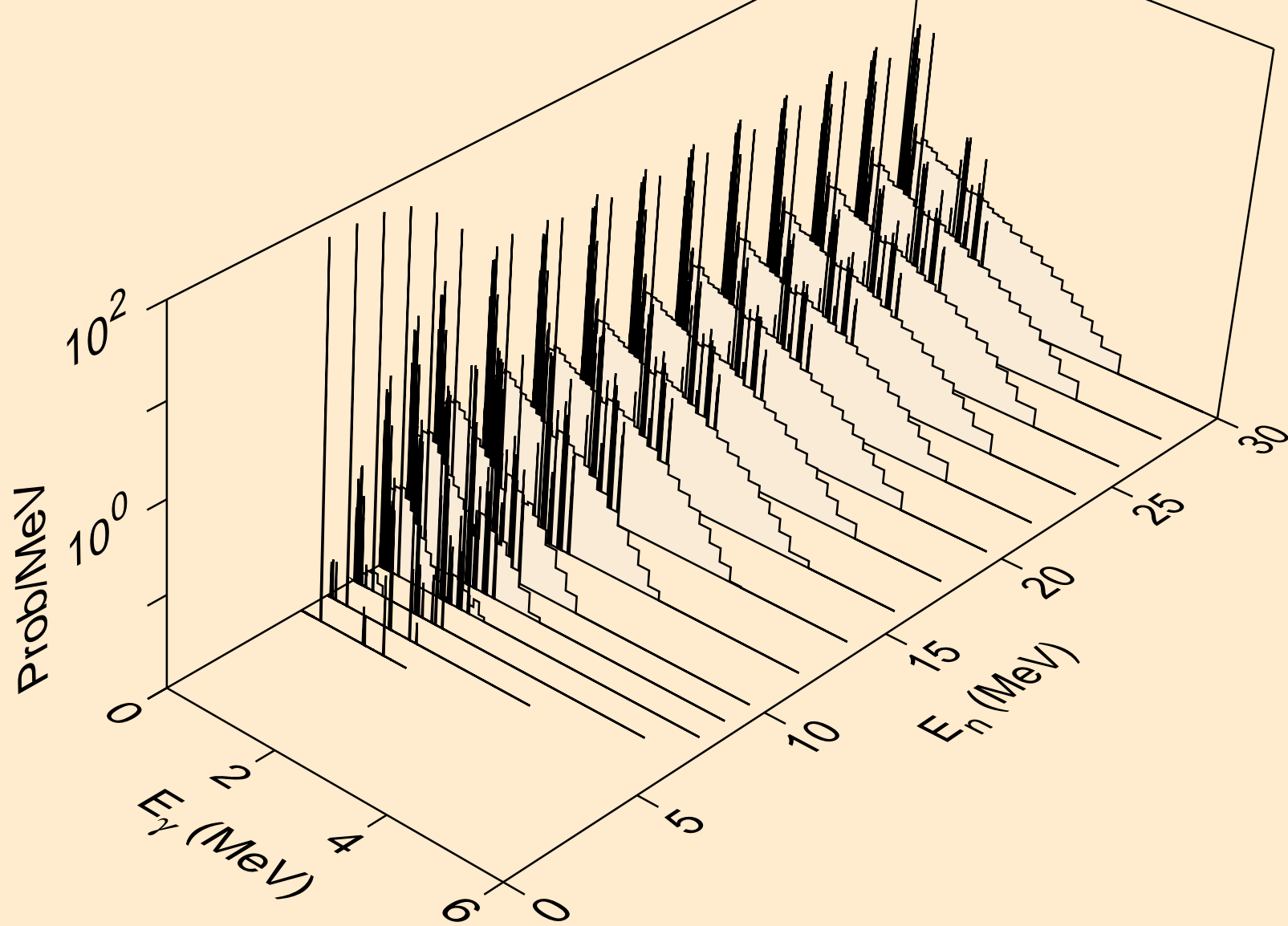

PT203 DEUTERON ACER TENDL-2023 LIBRARY; T=0.K  
Photon emission for (n,t)

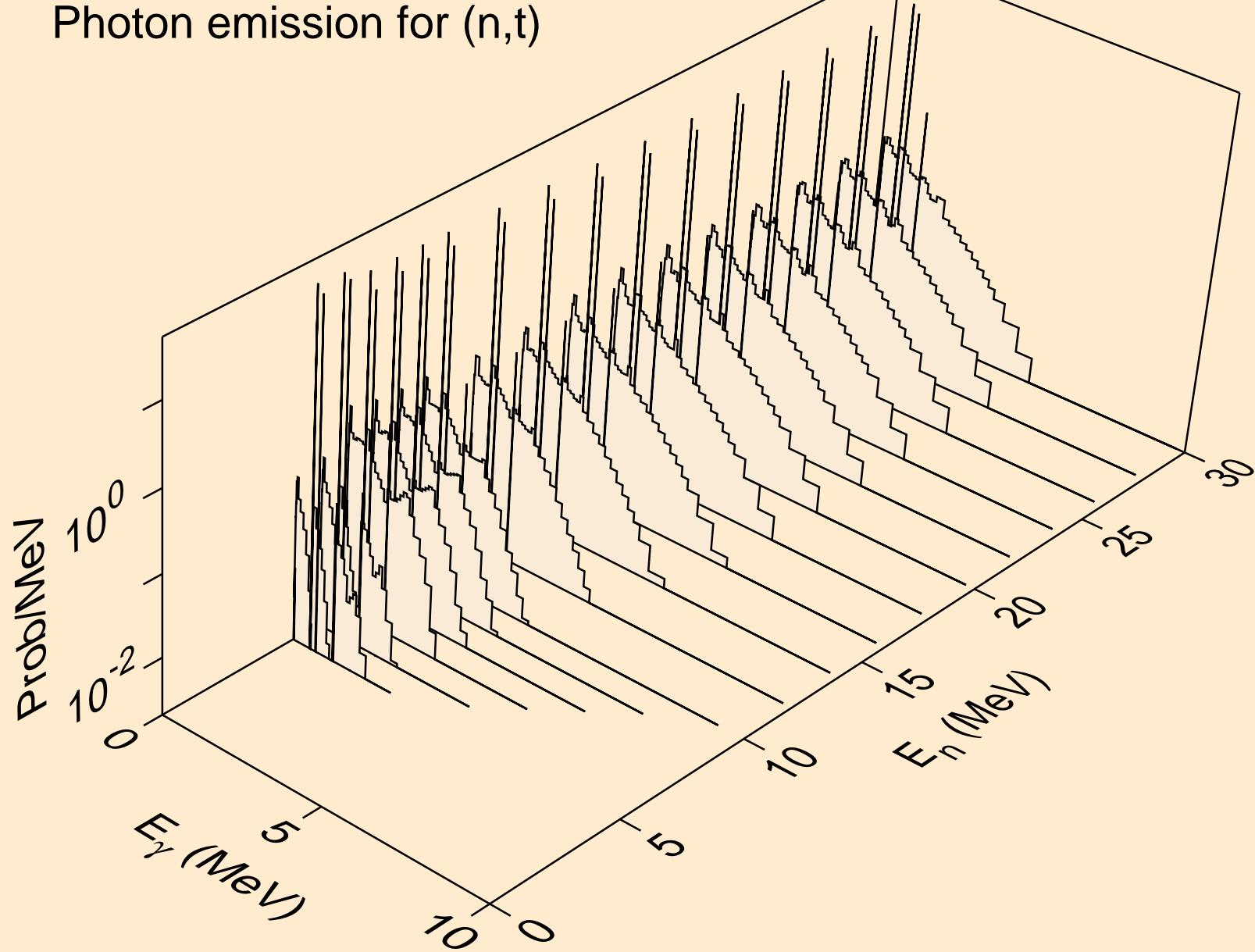



PT203 DEUTERON ACER TENDL-2023 LIBRARY; T=0.K  
Photon emission for (n,he3)

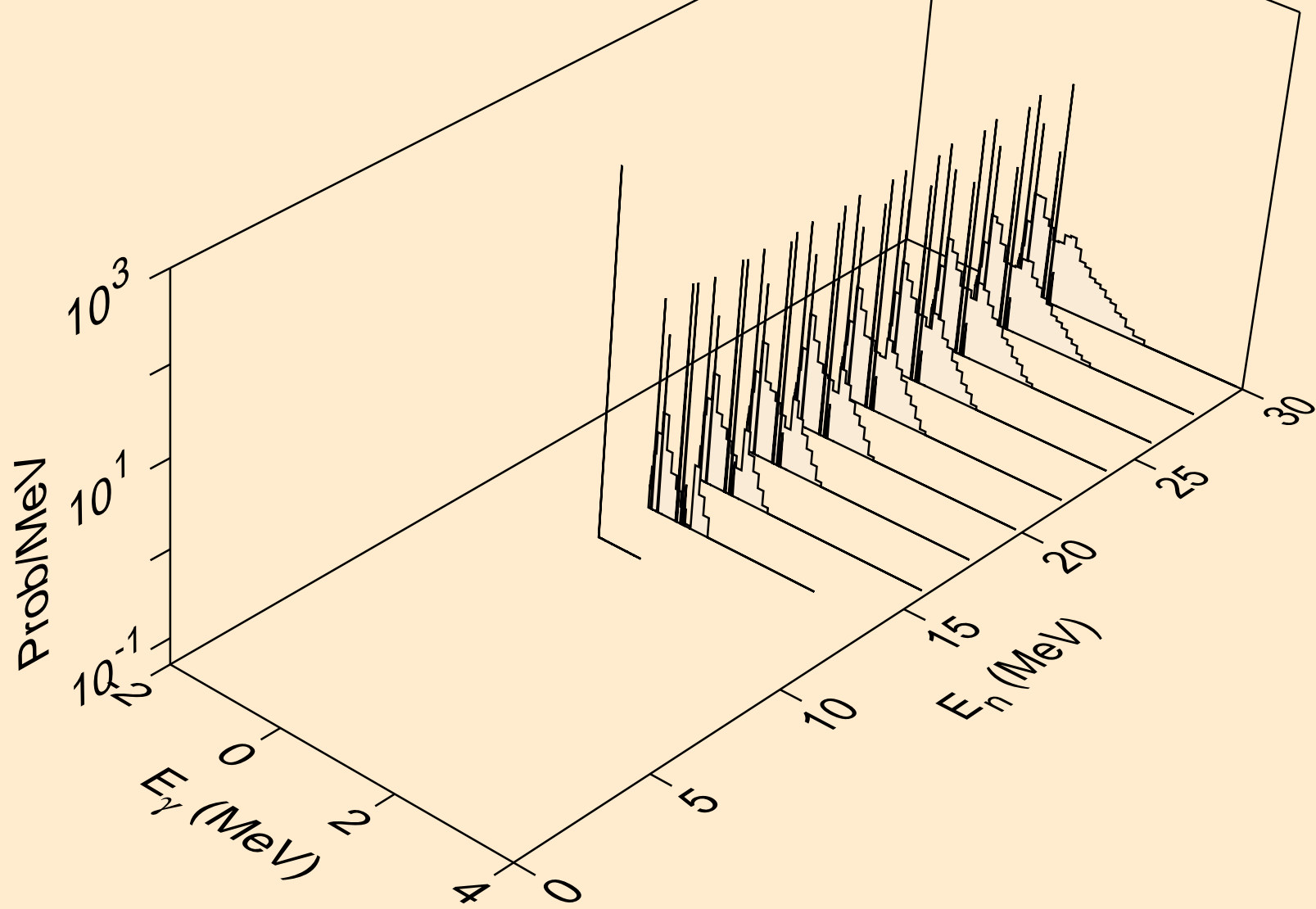

PT203 DEUTERON ACER TENDL-2023 LIBRARY; T=0.K  
Photon emission for (n,a)

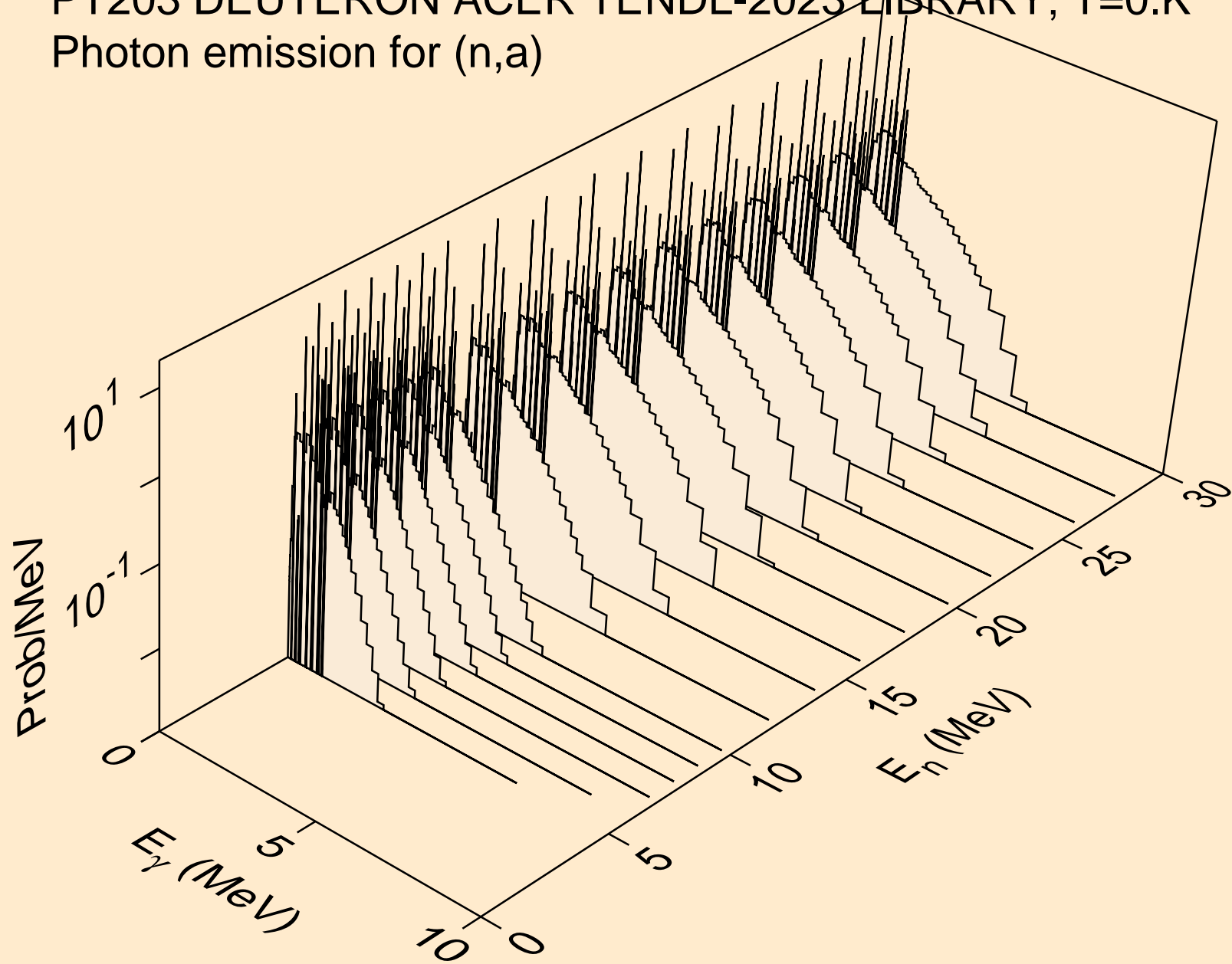

PT203 DEUTERON ACER TENDL-2023 LIBRARY; T=0.K  
Photon emission for (n,2p)

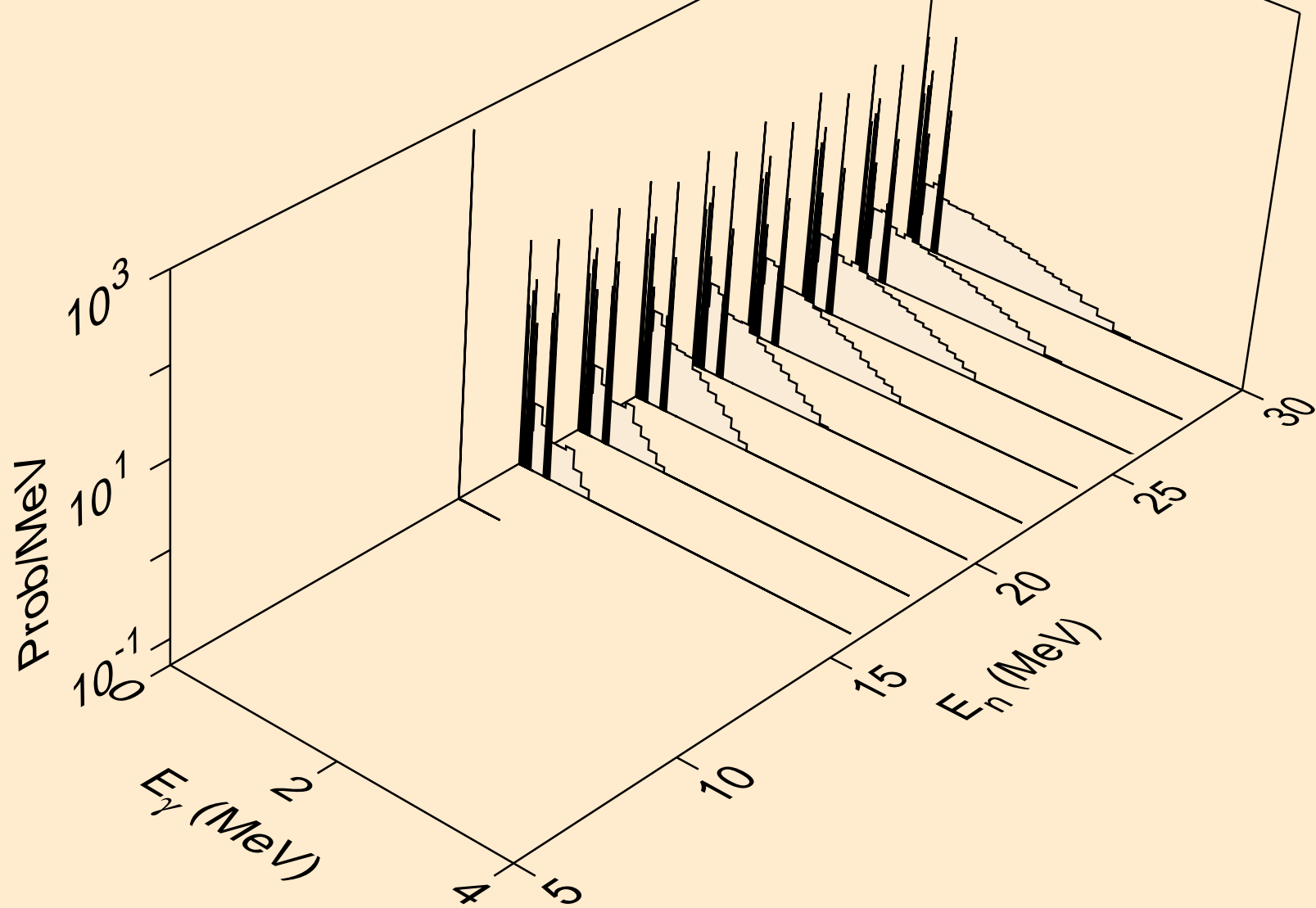

PT203 DEUTERON ACER TENDL-2023 LIBRARY; T=0.K  
Photon emission for (n,pd)

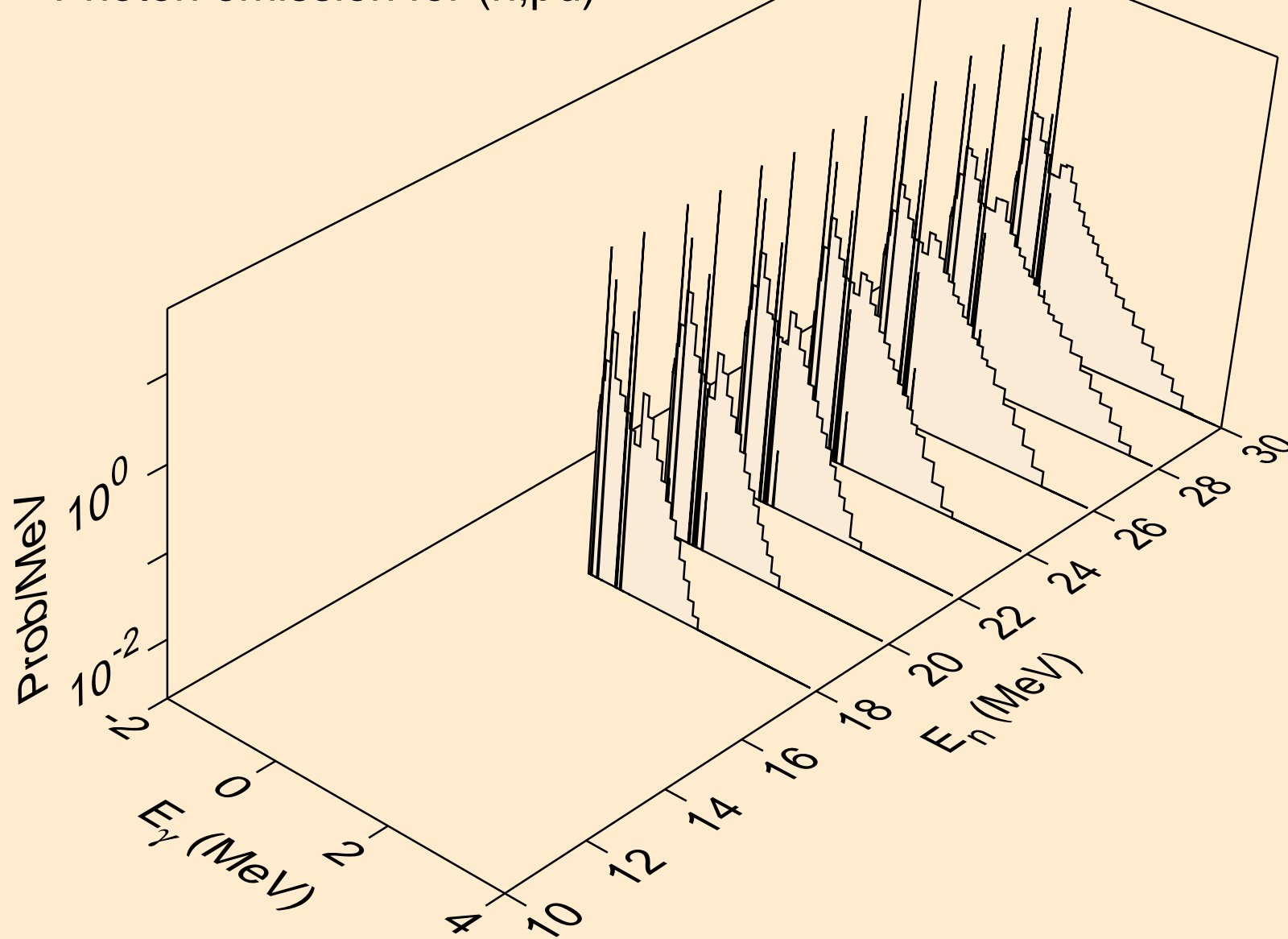

PT203 DEUTERON ACER TENDL-2023 LIBRARY; T=0.K  
Particle heating contributions

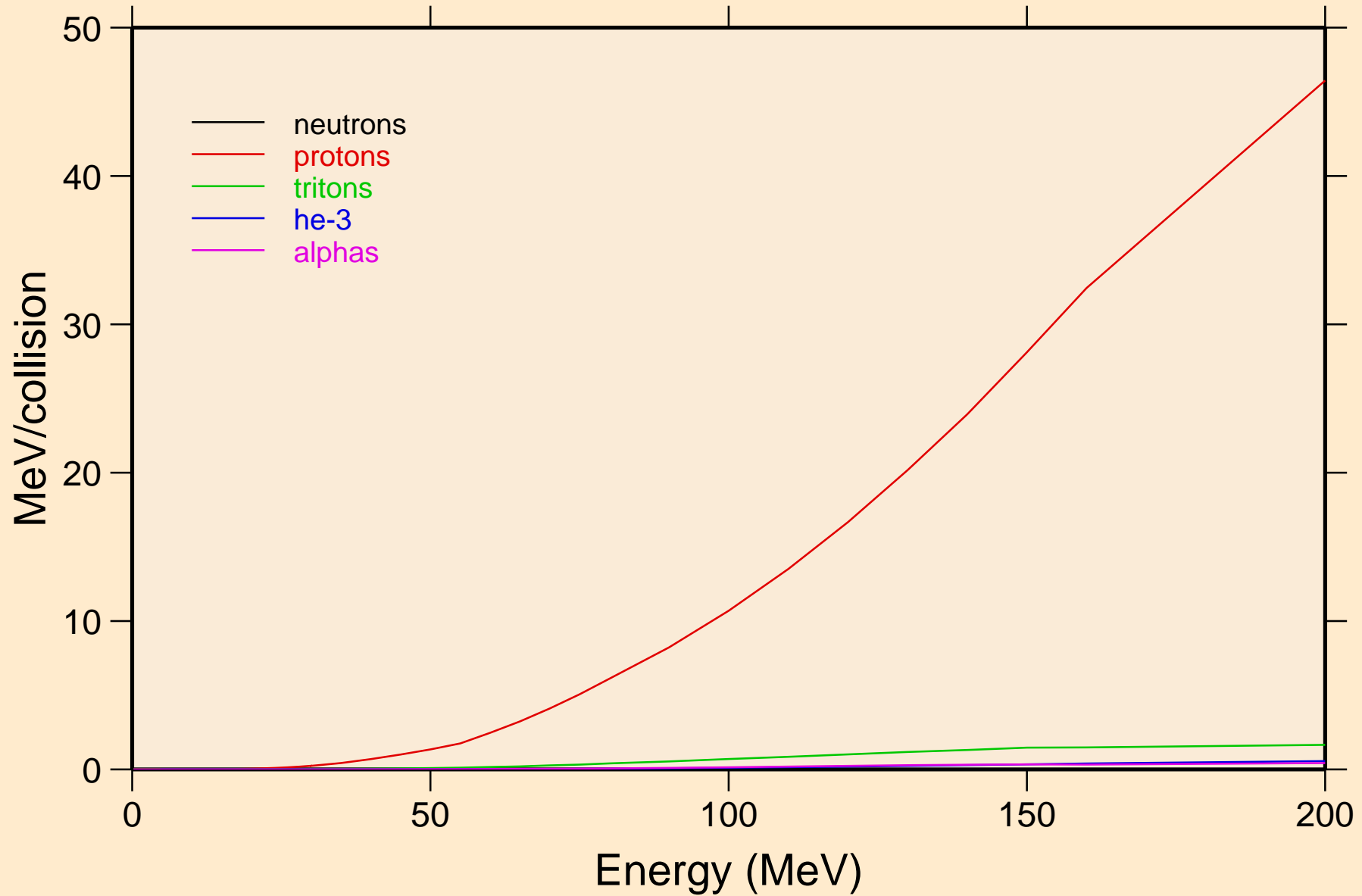

PT203 DEUTERON ACER TENDL-2023 LIBRARY; T=0.K  
Recoil Heating

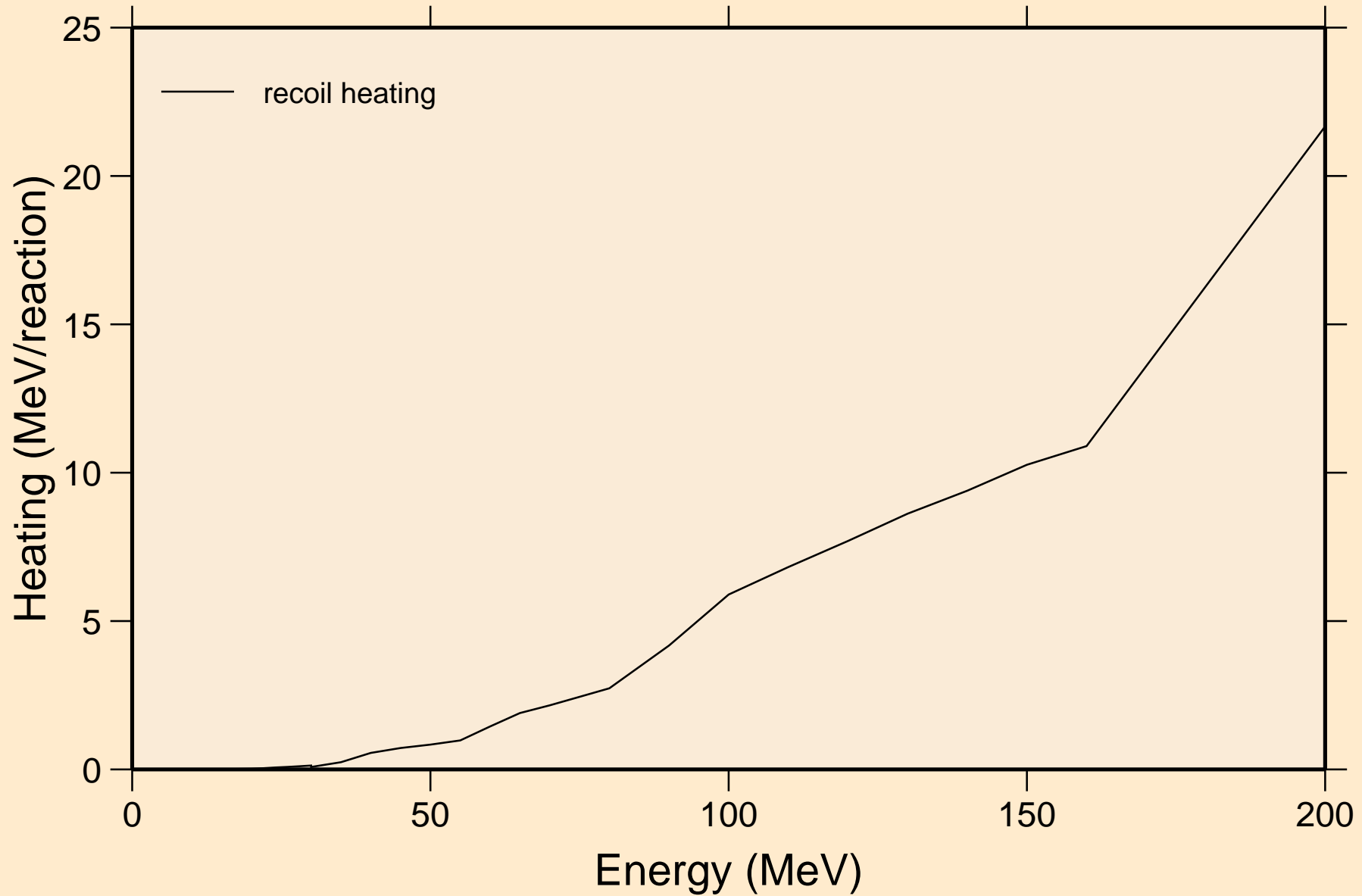

PT203 DEUTERON ACER TENDL-2023 LIBRARY; T=0.K  
Particle production cross sections

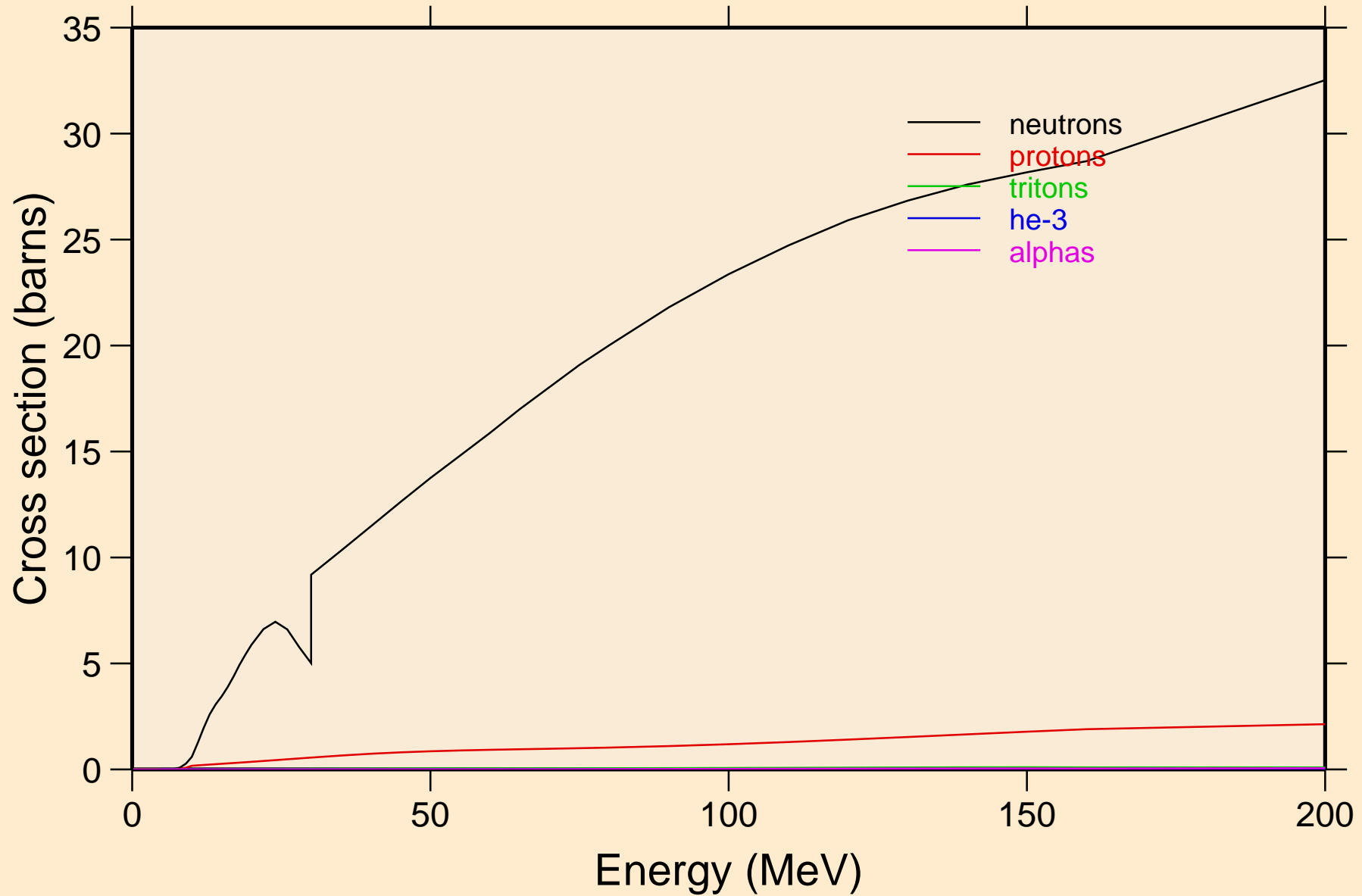

PT203 DEUTERON ACER TENDL-2023 LIBRARY; T=0.K  
neutrons from (d,n)

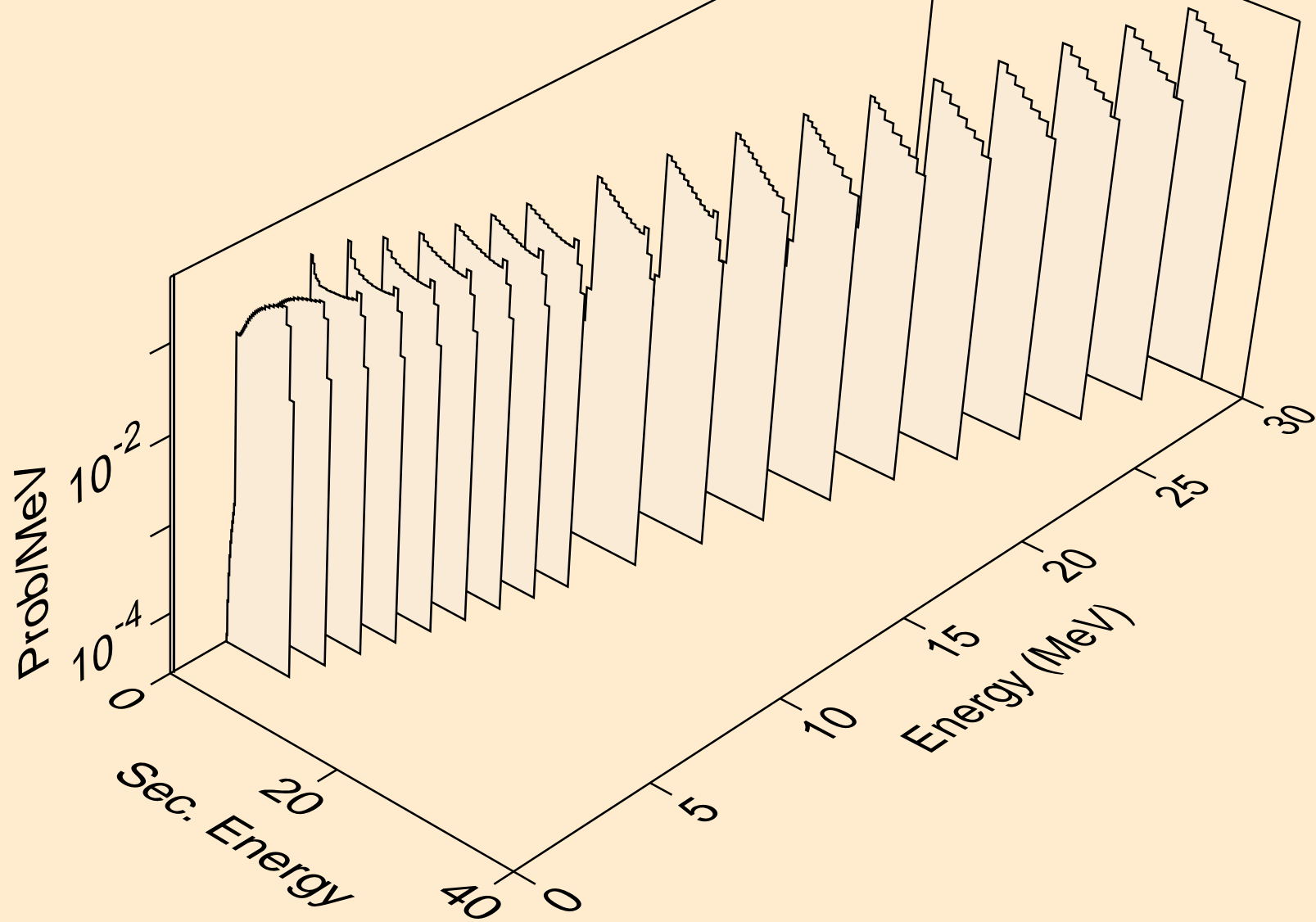



PT203 DEUTERON ACER TENDL-2023 LIBRARY; T=0.K  
neutrons from (d,x)

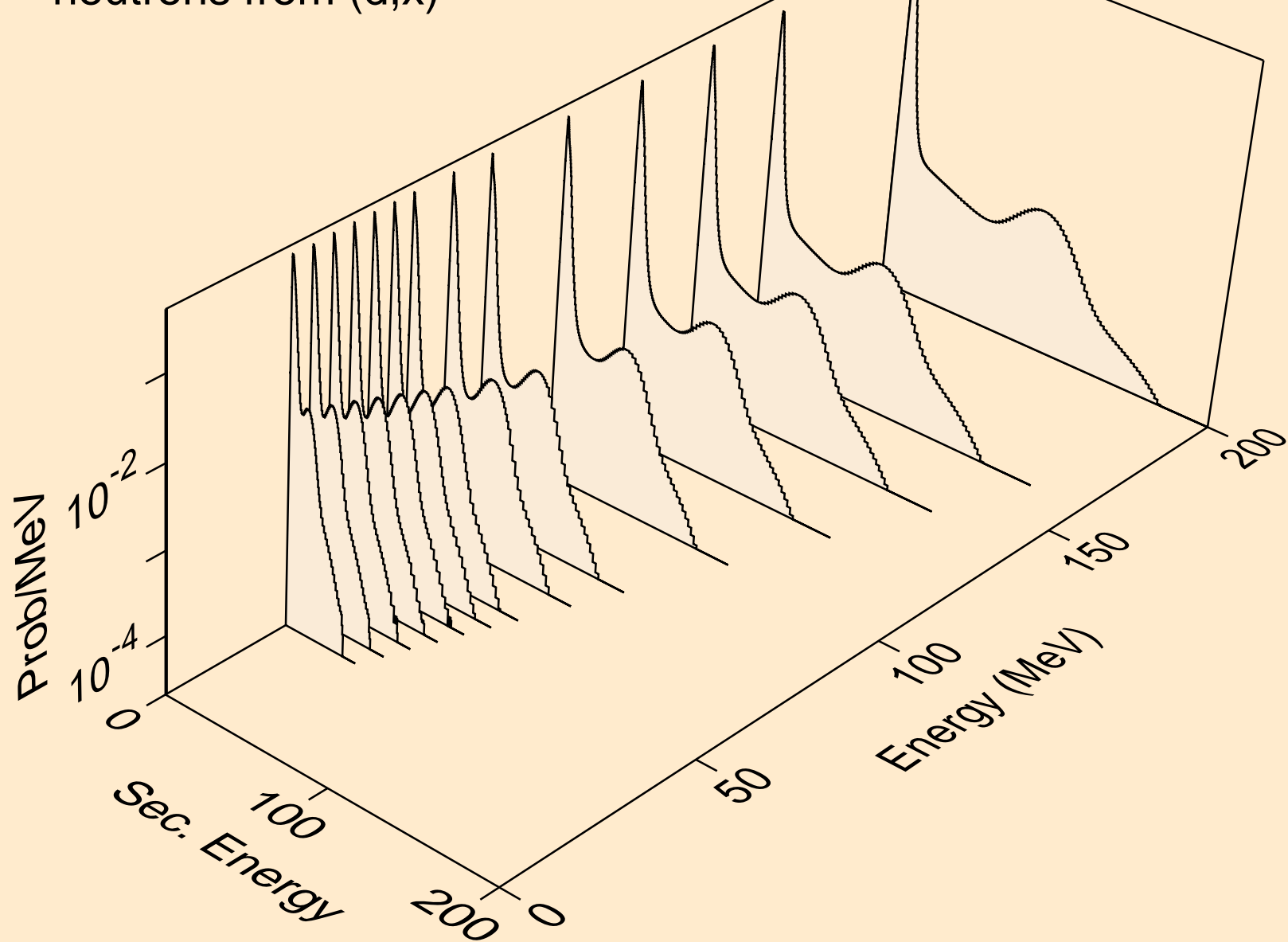

PT203 DEUTERON ACER TENDL-2023 LIBRARY; T=0.K  
neutrons from (d,2nd)

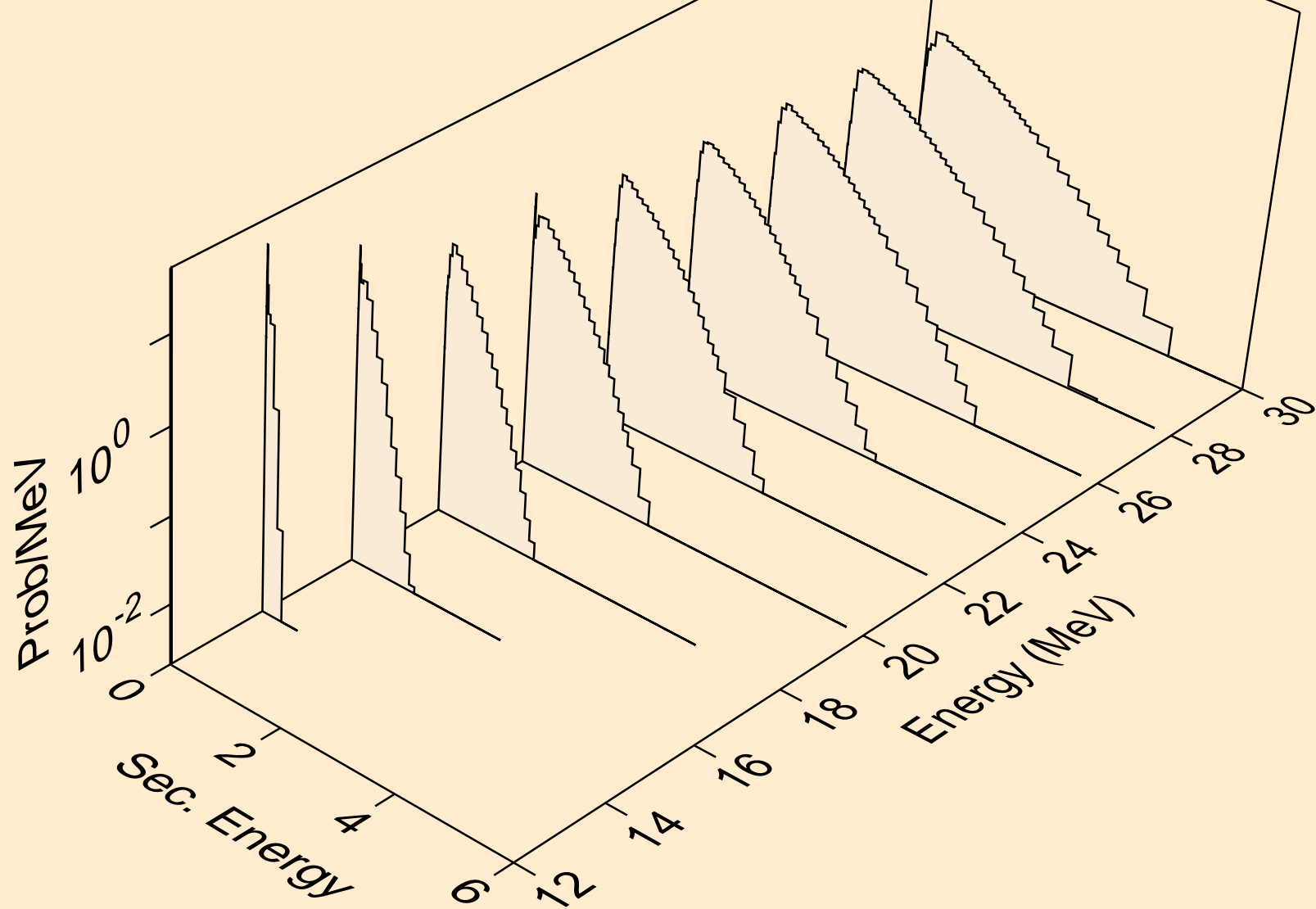

PT203 DEUTERON ACER TENDL-2023 LIBRARY; T=0.K  
neutrons from (d,2n)

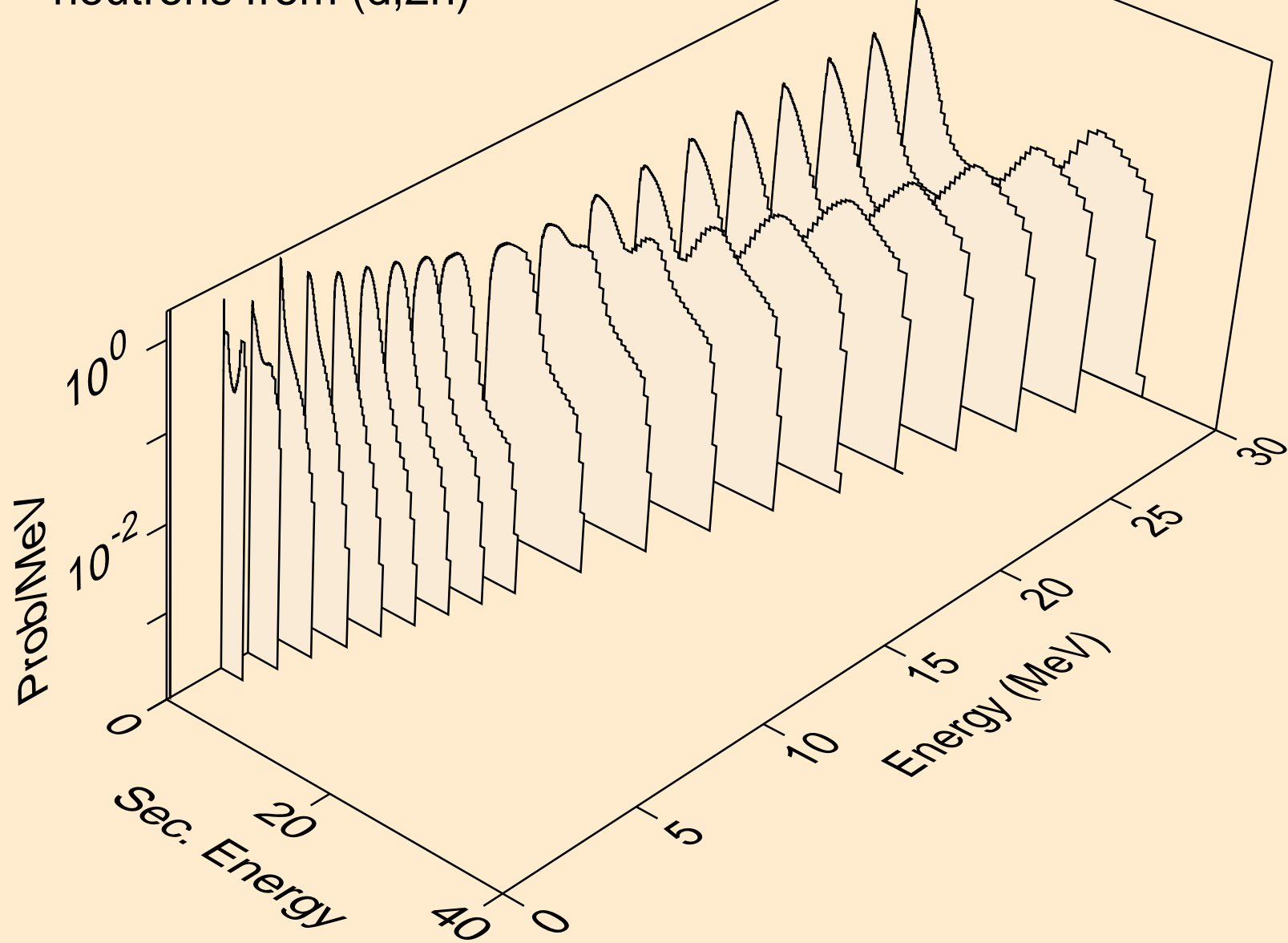

PT203 DEUTERON ACER TENDL-2023 LIBRARY; T=0.K  
neutrons from (d,3n)

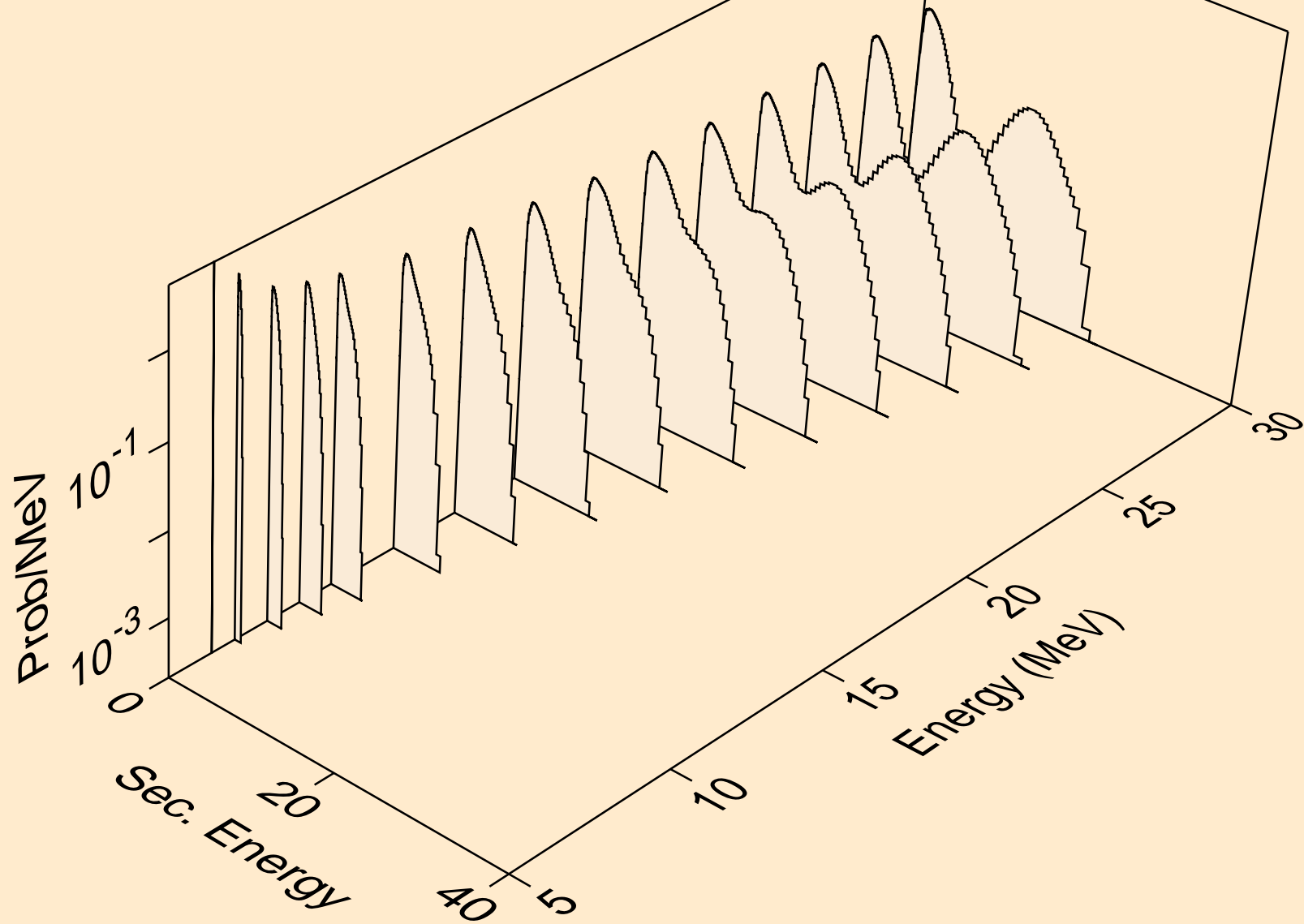

PT203 DEUTERON ACER TENDL-2023 LIBRARY; T=0.K  
neutrons from (d,n\*)a

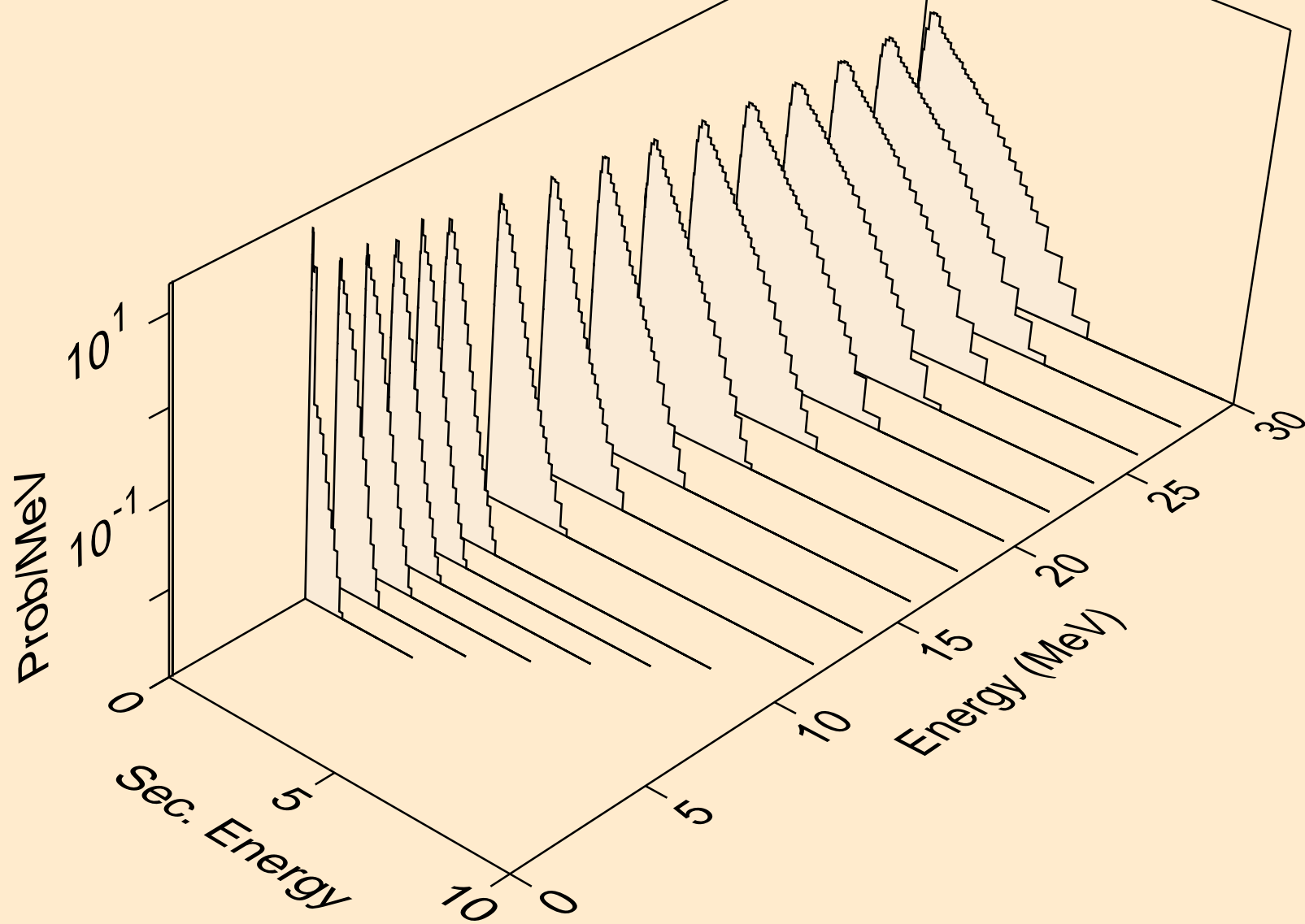

PT203 DEUTERON ACER TENDL-2023 LIBRARY; T=0.K  
neutrons from (d,2n)a

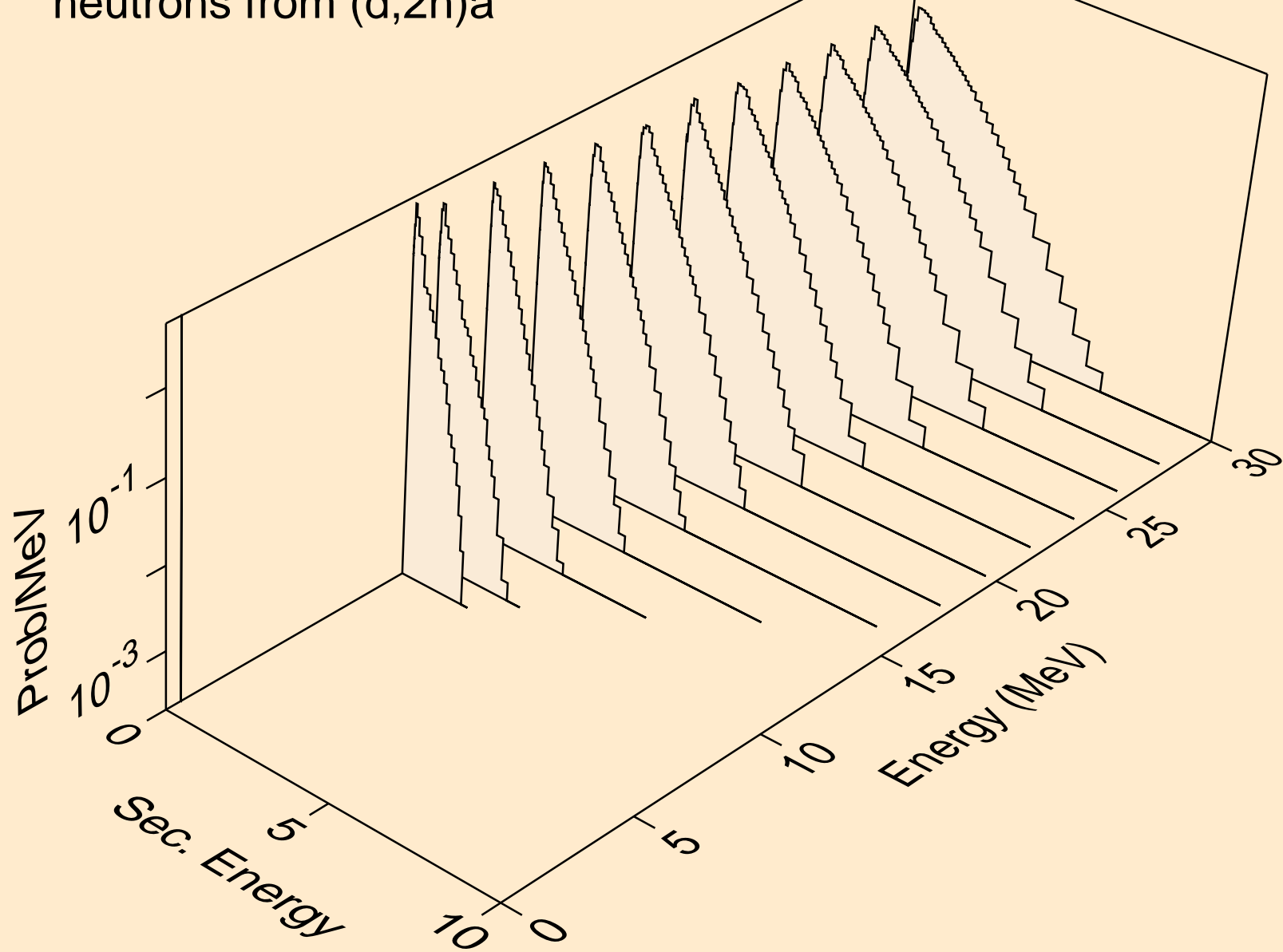

PT203 DEUTERON ACER TENDL-2023 LIBRARY; T=0.K  
neutrons from (d,3n)a

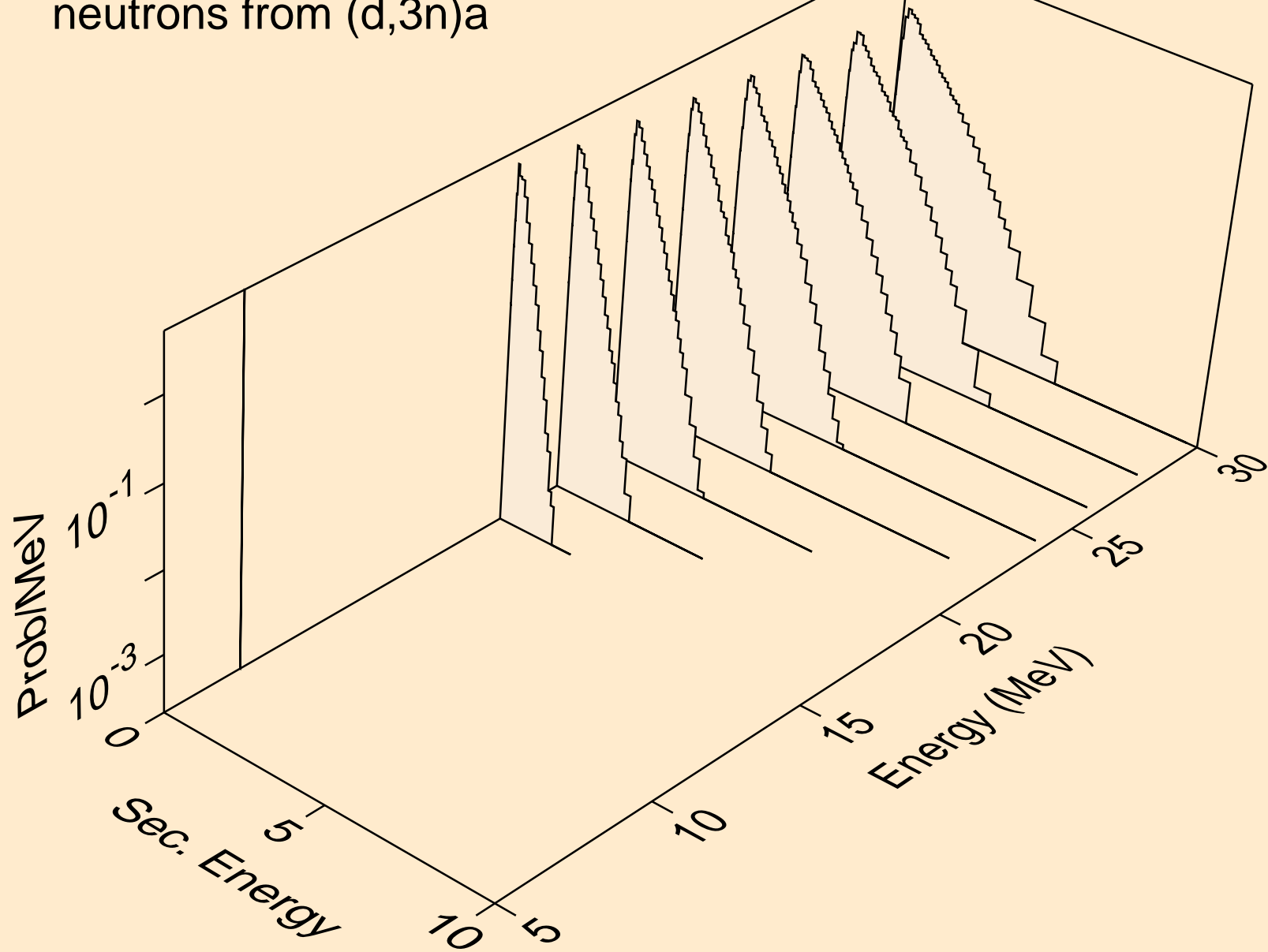

PT203 DEUTERON ACER TENDL-2023 LIBRARY; T=0.K  
neutrons from (d,n\*)p

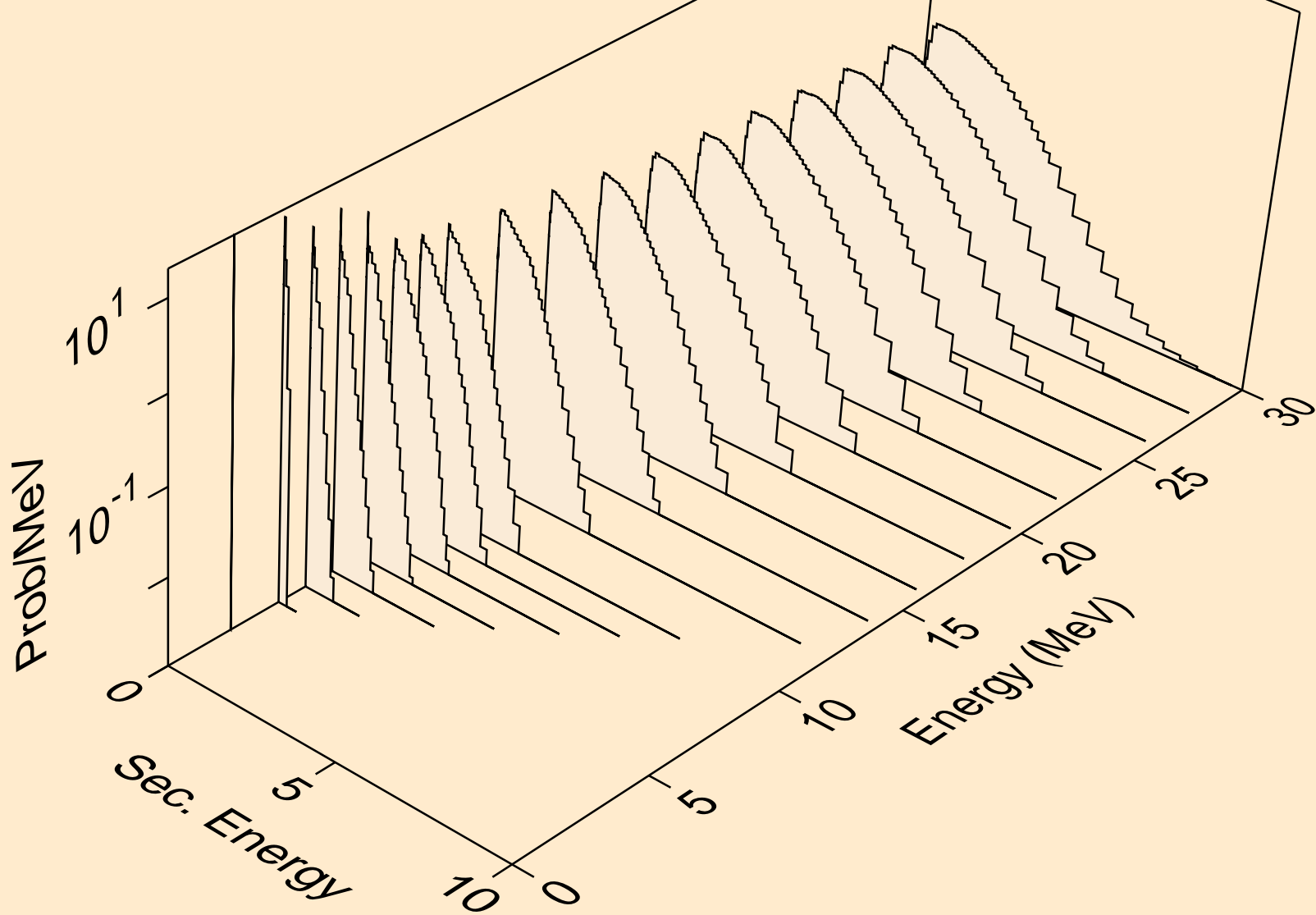



PT203 DEUTERON ACER TENDL-2023 LIBRARY; T=0.K  
neutrons from (d,n\*)d

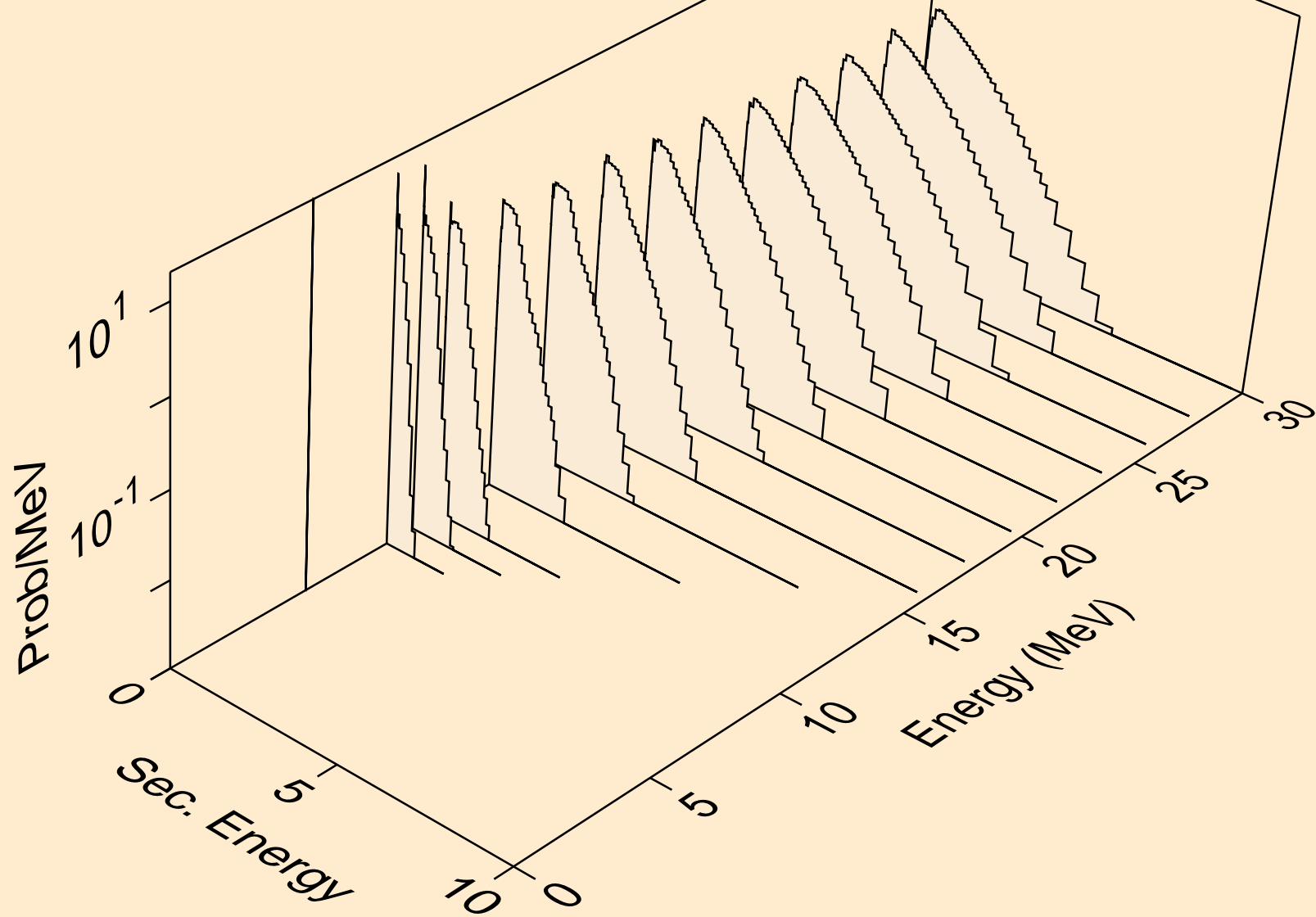

PT203 DEUTERON ACER TENDL-2023 LIBRARY; T=0.K  
neutrons from (d,n\*)t

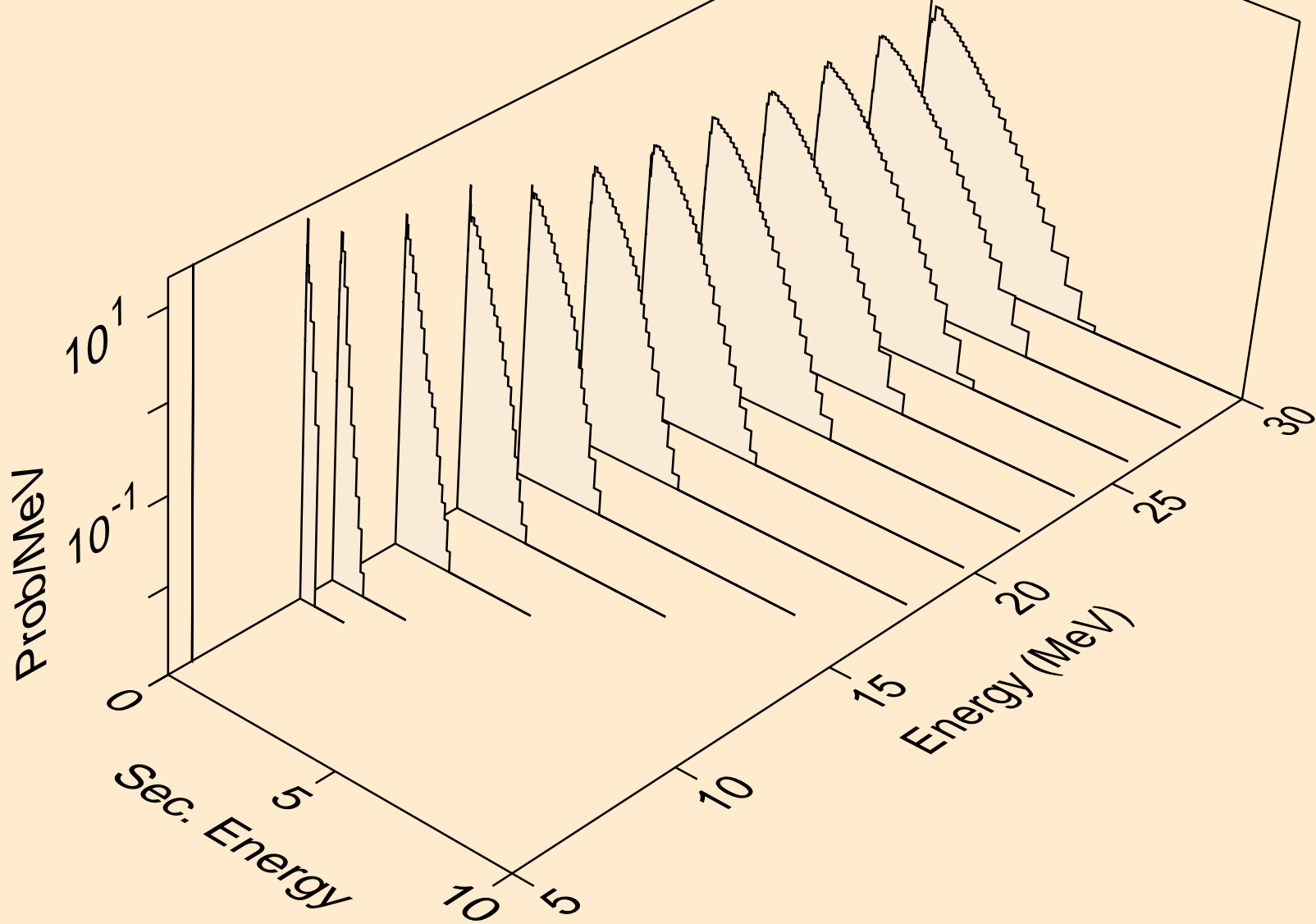

PT203 DEUTERON ACER TENDL-2023 LIBRARY; T=0.K  
neutrons from (d,n\*)he3

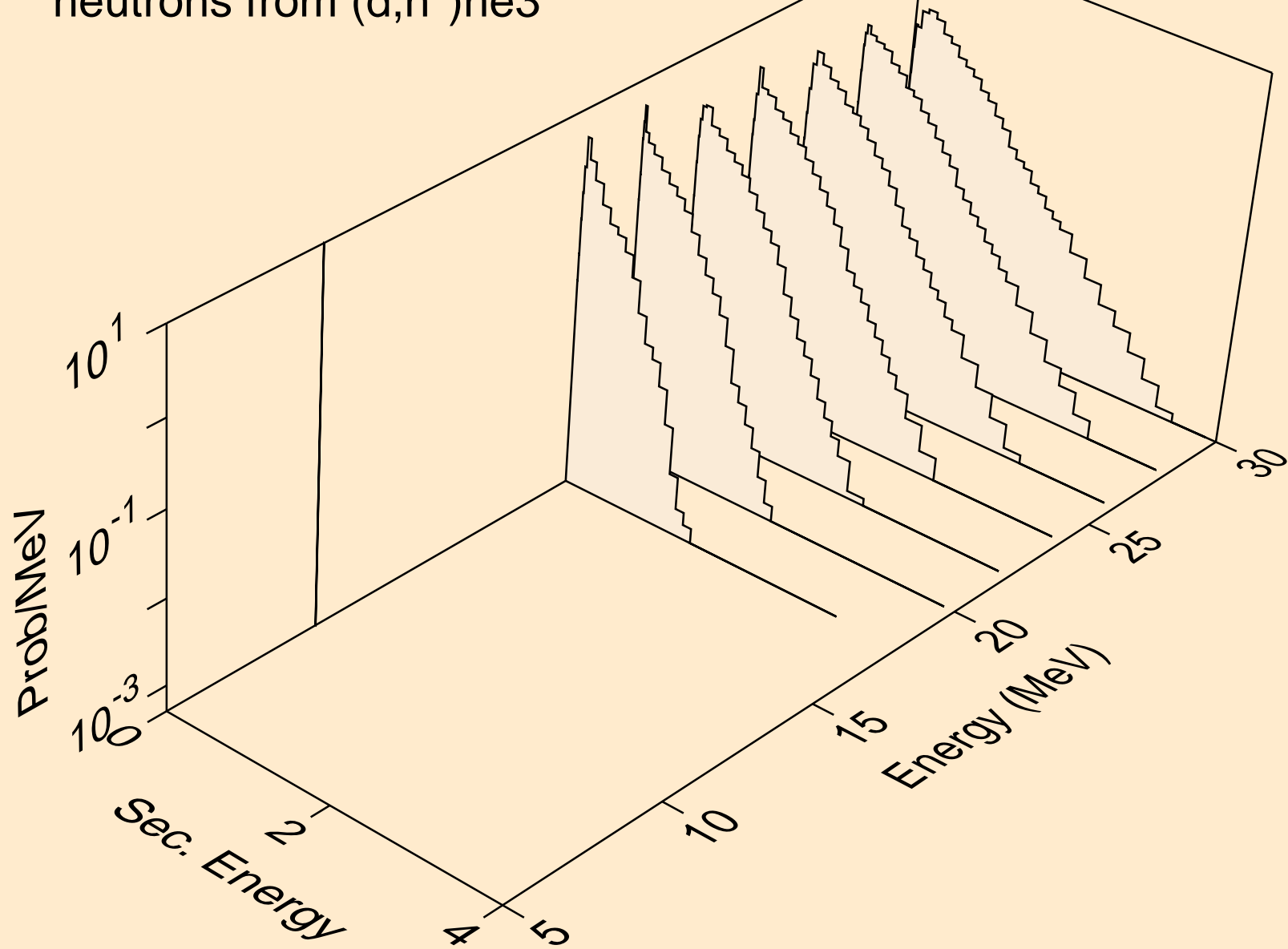

PT203 DEUTERON ACER TENDL-2023 LIBRARY; T=0.K  
neutrons from (d,4n)

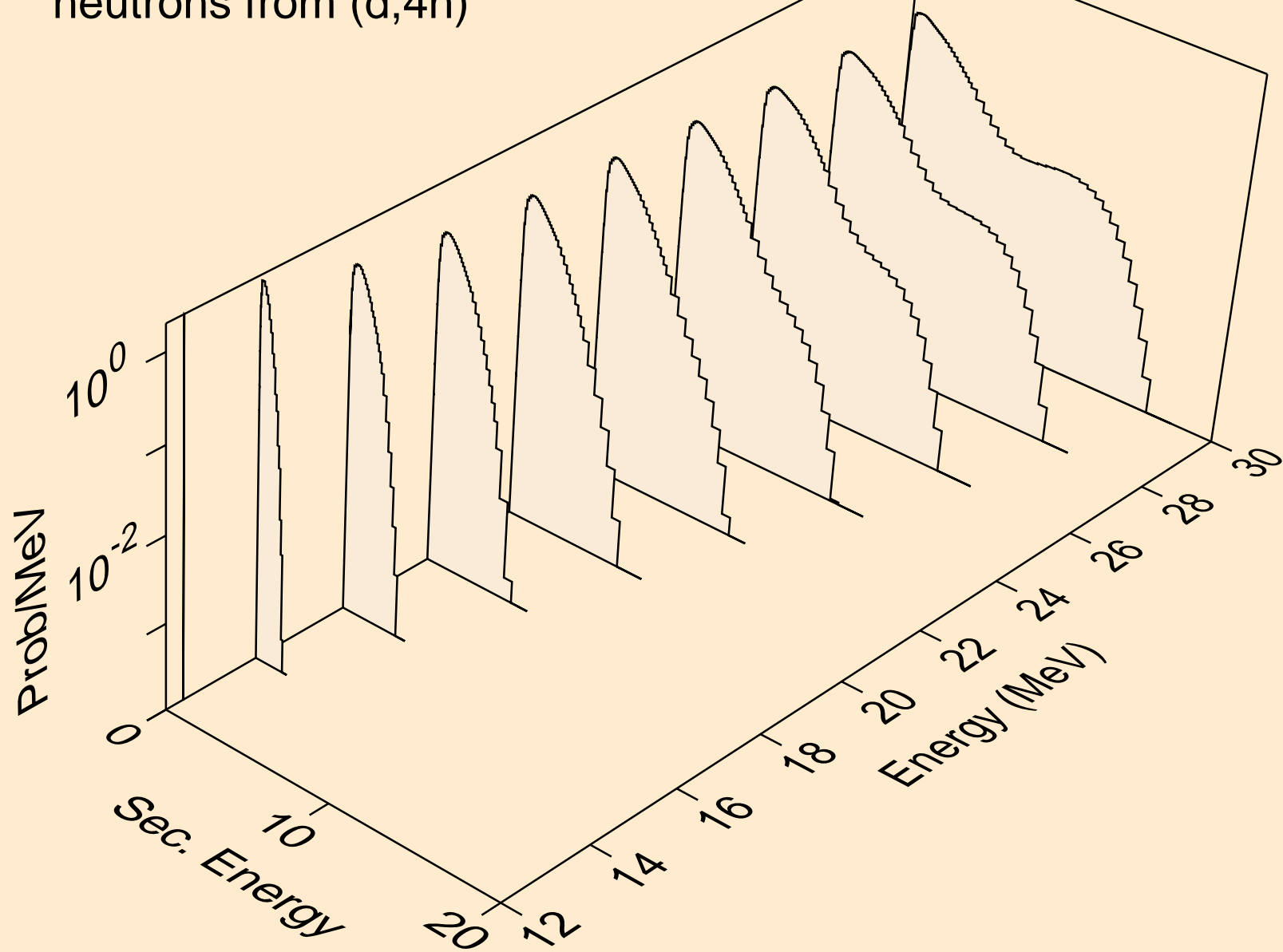

PT203 DEUTERON ACER TENDL-2023 LIBRARY; T=0.K  
neutrons from (d,2np)

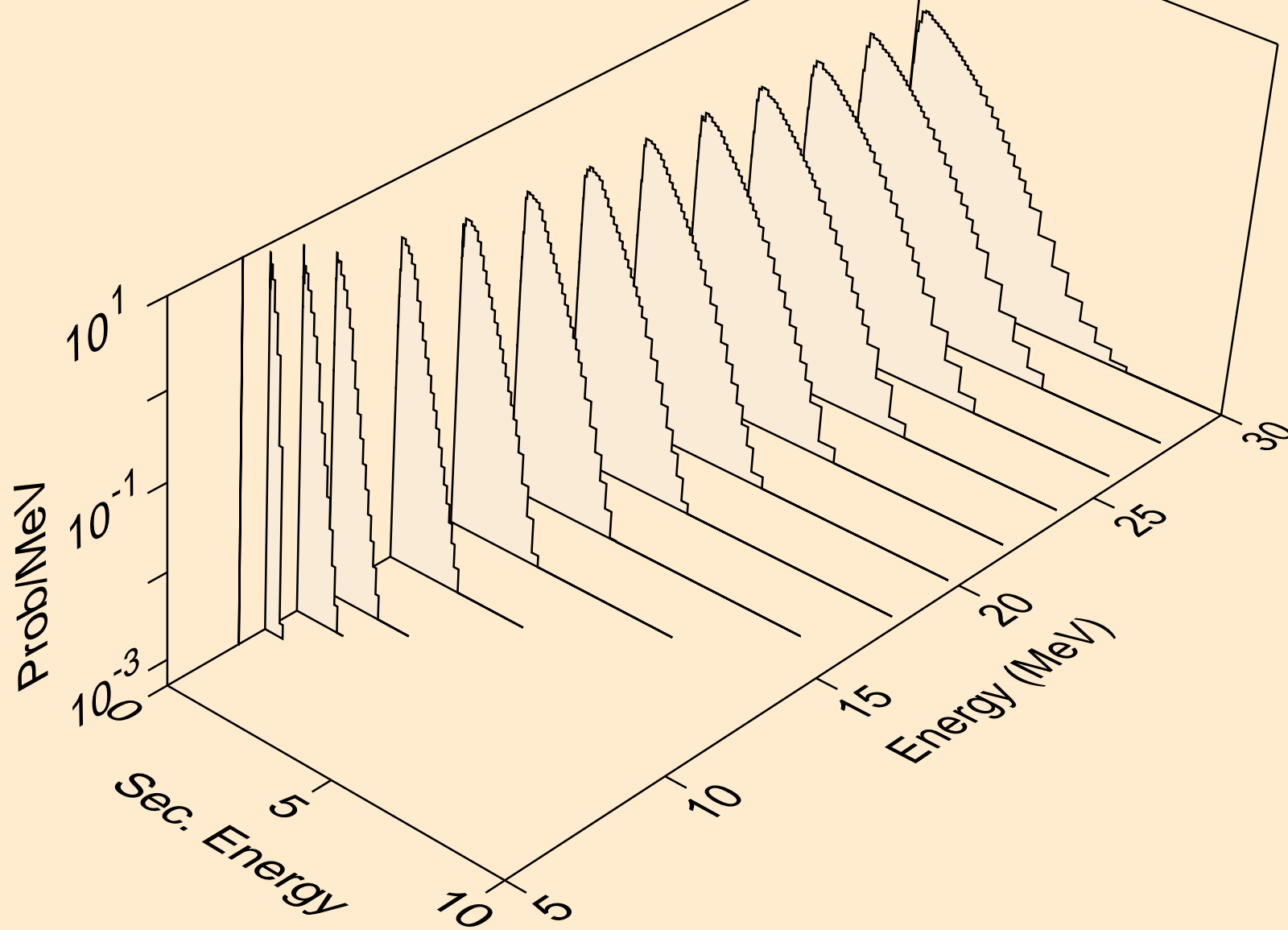

PT203 DEUTERON ACER TENDL-2023 LIBRARY; T=0.K  
neutrons from (d,3np)

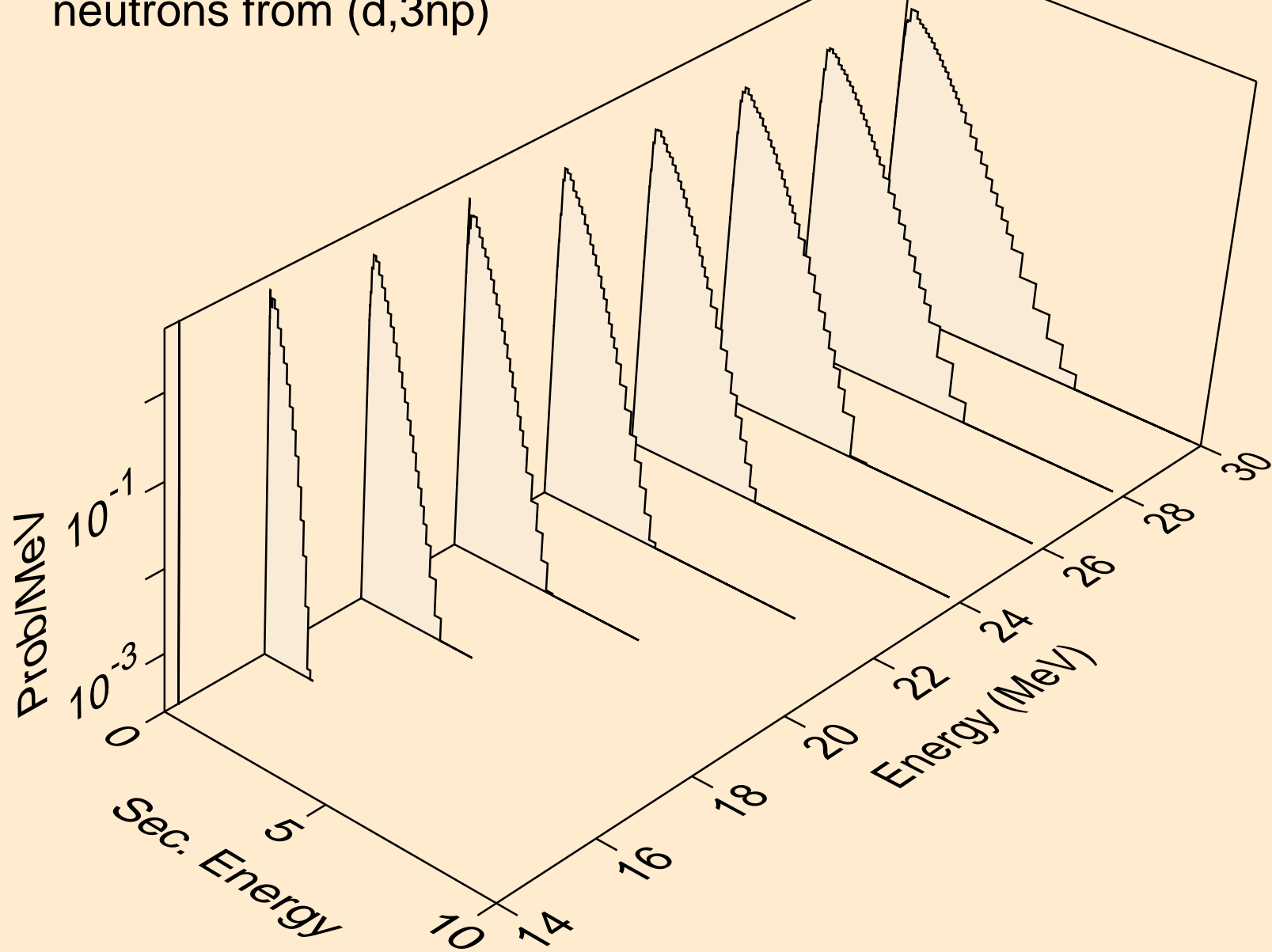

PT203 DEUTERON ACER TENDL-2023 LIBRARY; T=0.K  
neutrons from (d,n2p)

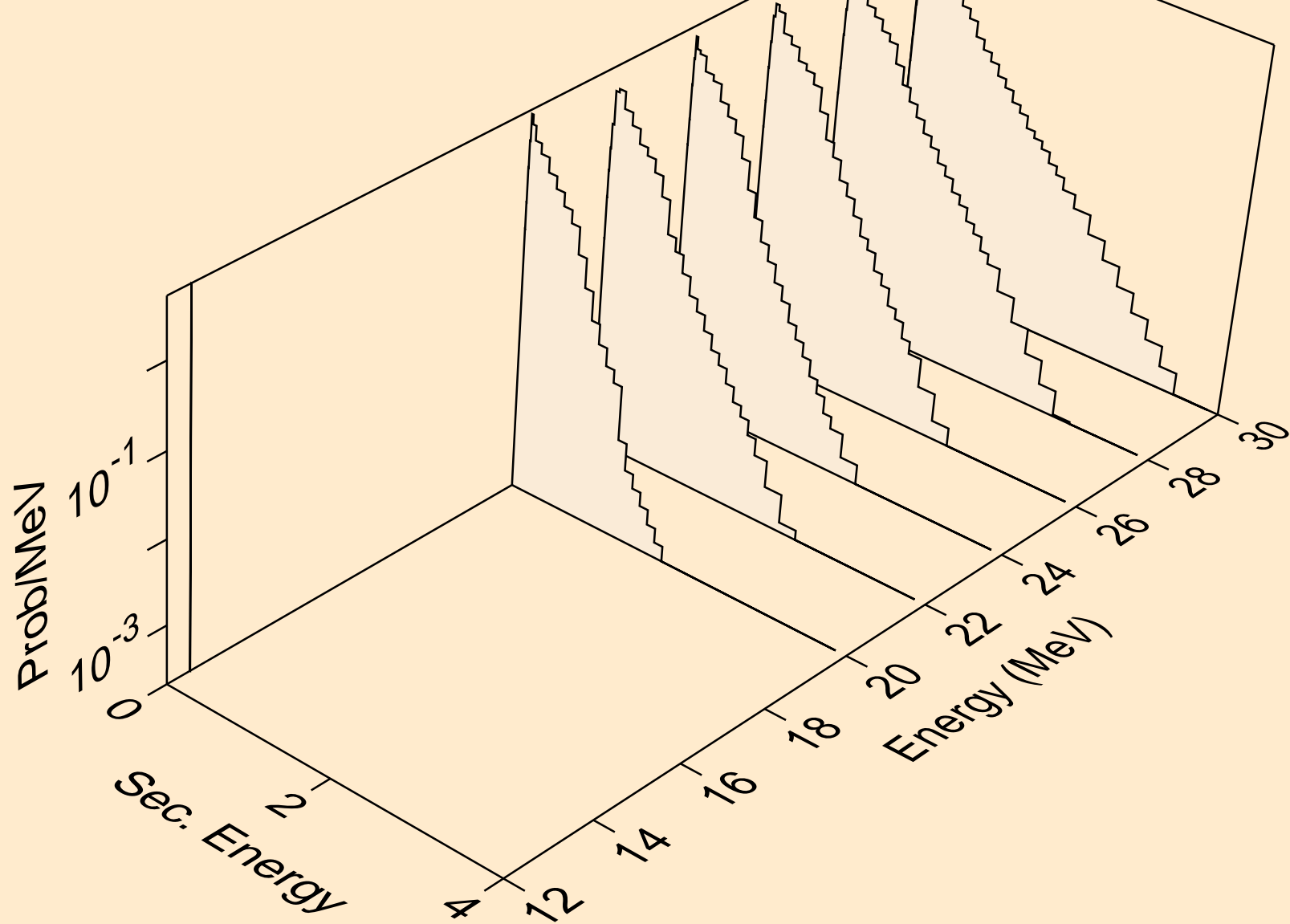

PT203 DEUTERON ACER TENDL-2023 LIBRARY; T=0.K  
protons from (d,x)

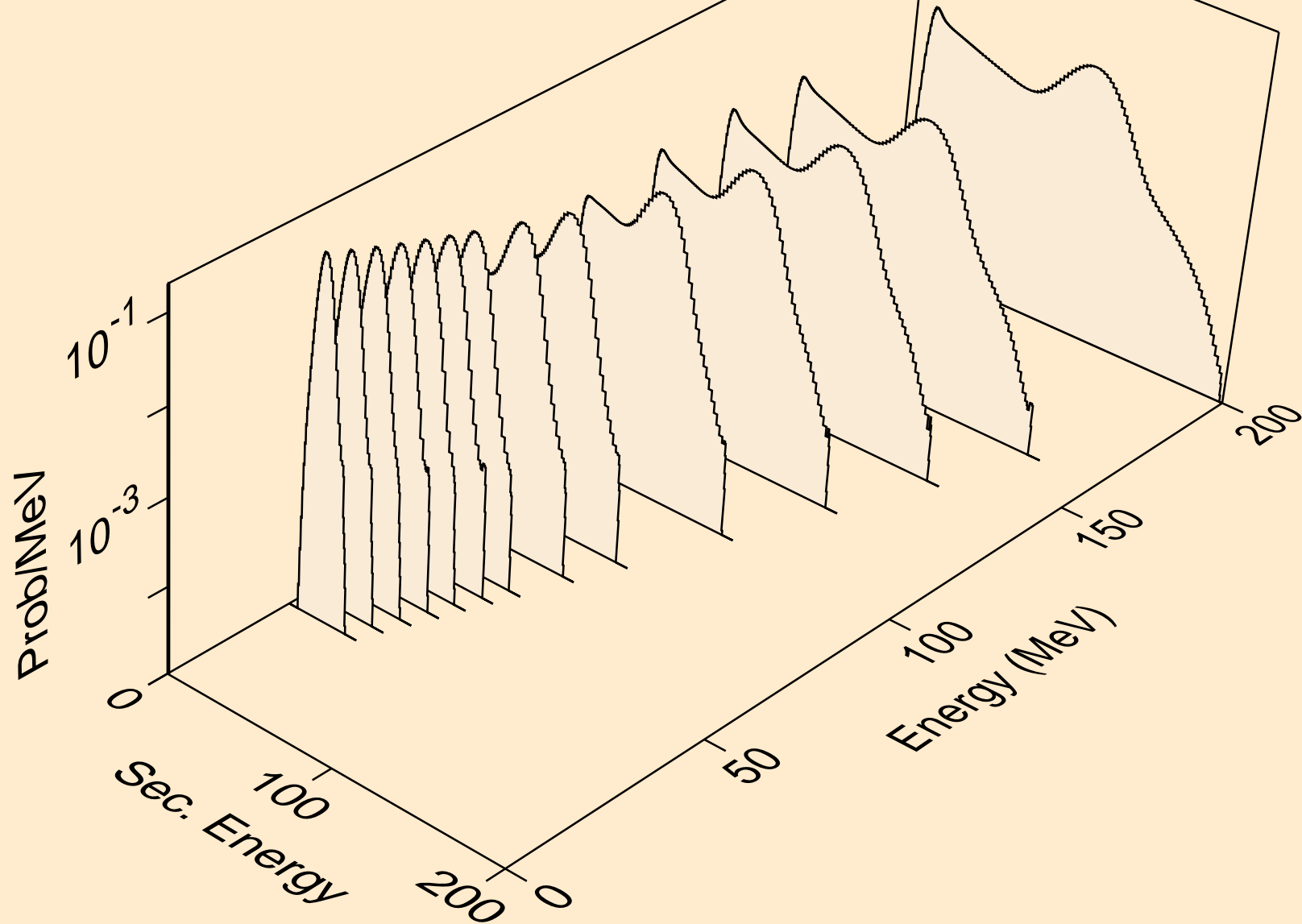



PT203 DEUTERON ACER TENDL-2023 LIBRARY; T=0.K  
protons from (d,n\*)p

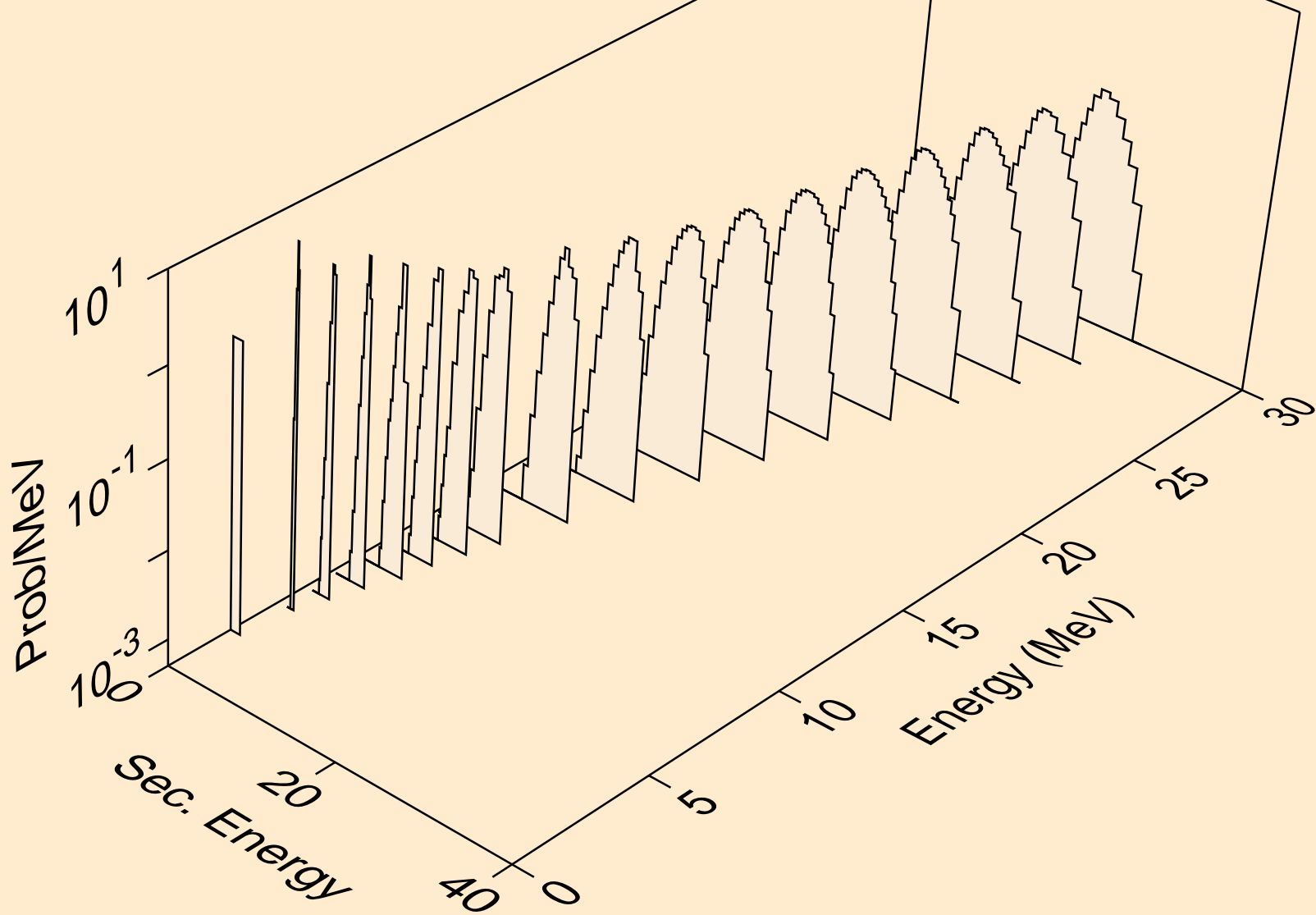

PT203 DEUTERON ACER TENDL-2023 LIBRARY; T=0.K  
protons from (d,2np)

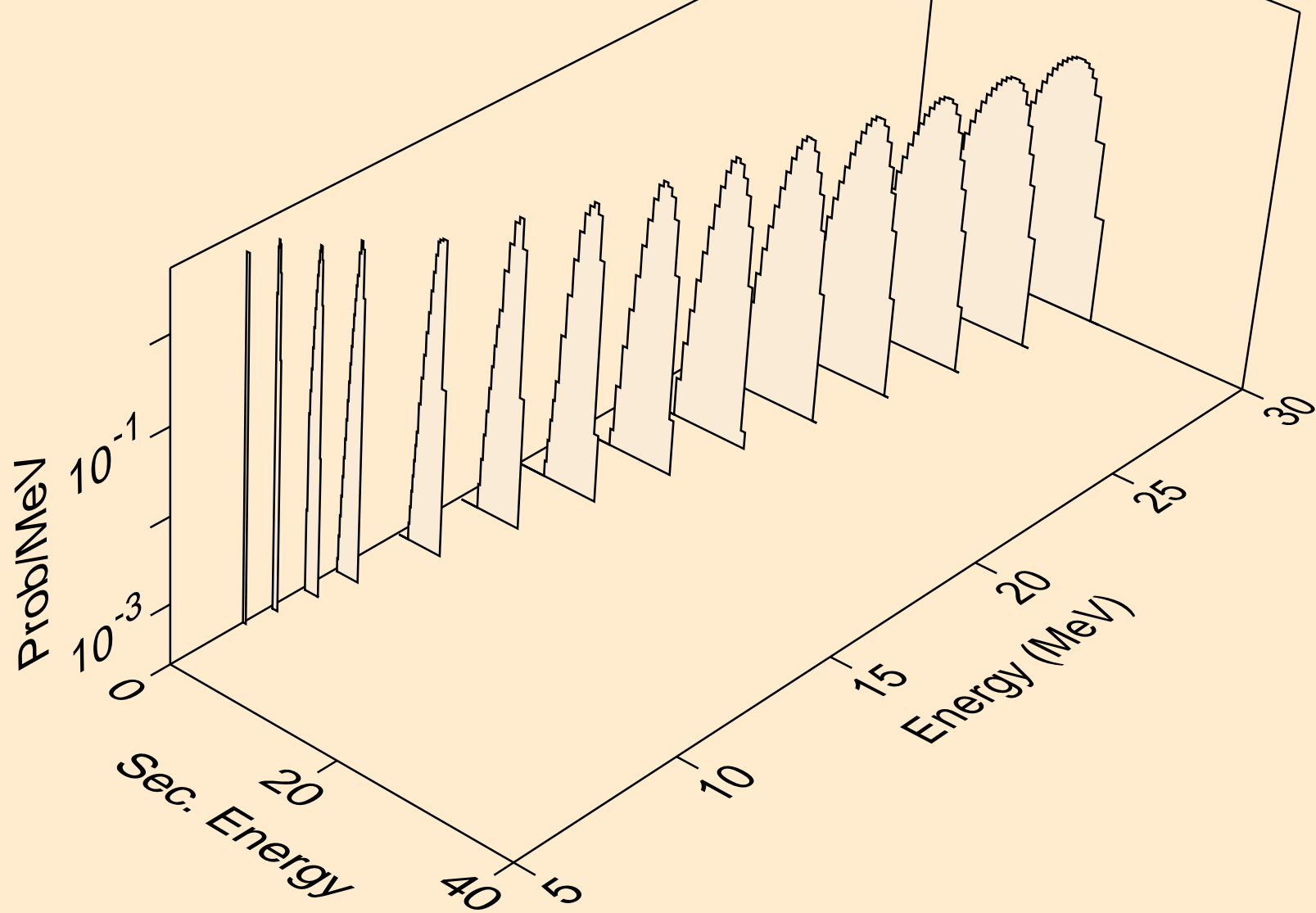

PT203 DEUTERON ACER TENDL-2023 LIBRARY; T=0.K  
protons from (d,3np)

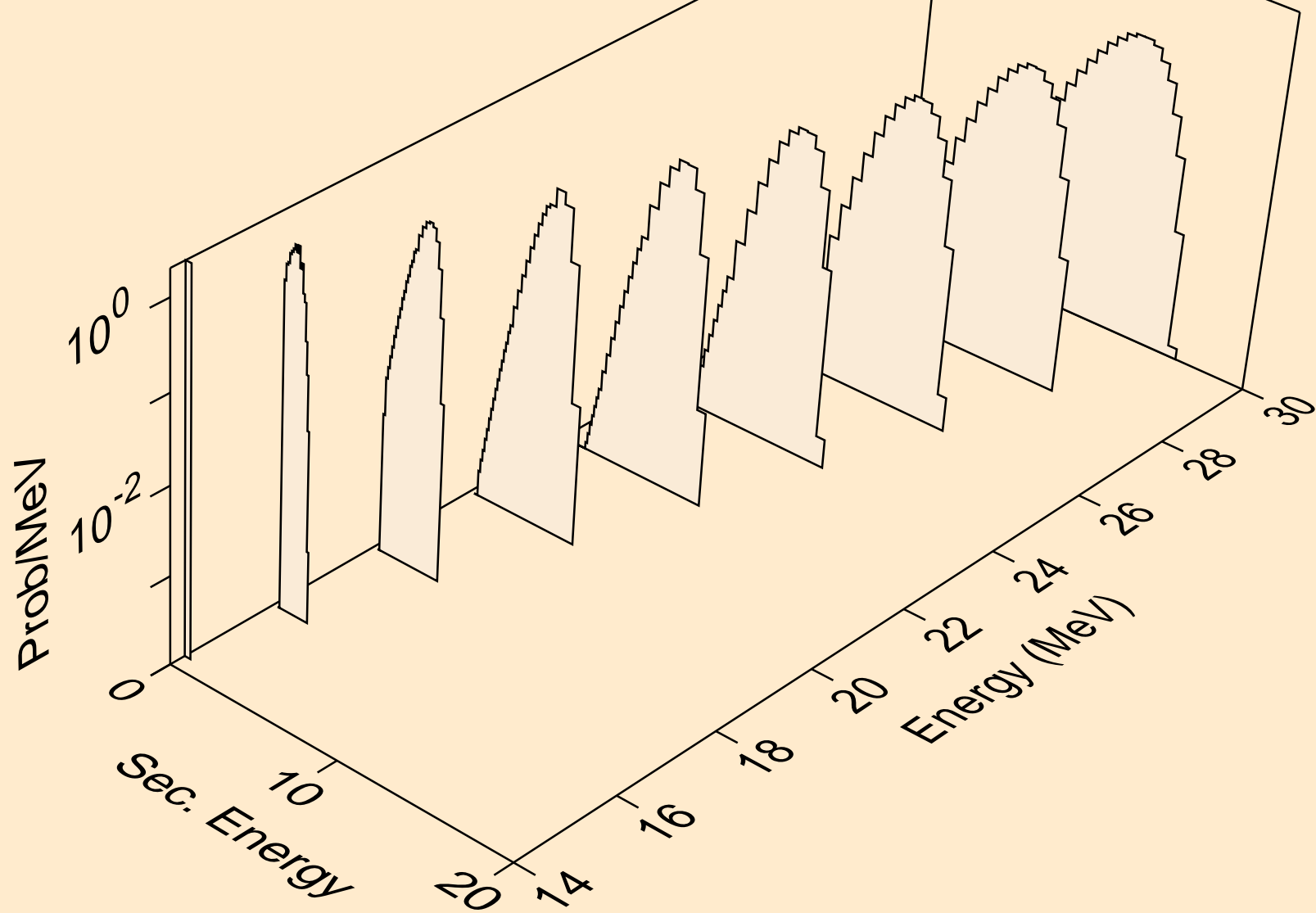

PT203 DEUTERON ACER TENDL-2023 LIBRARY; T=0.K  
protons from (d,n2p)

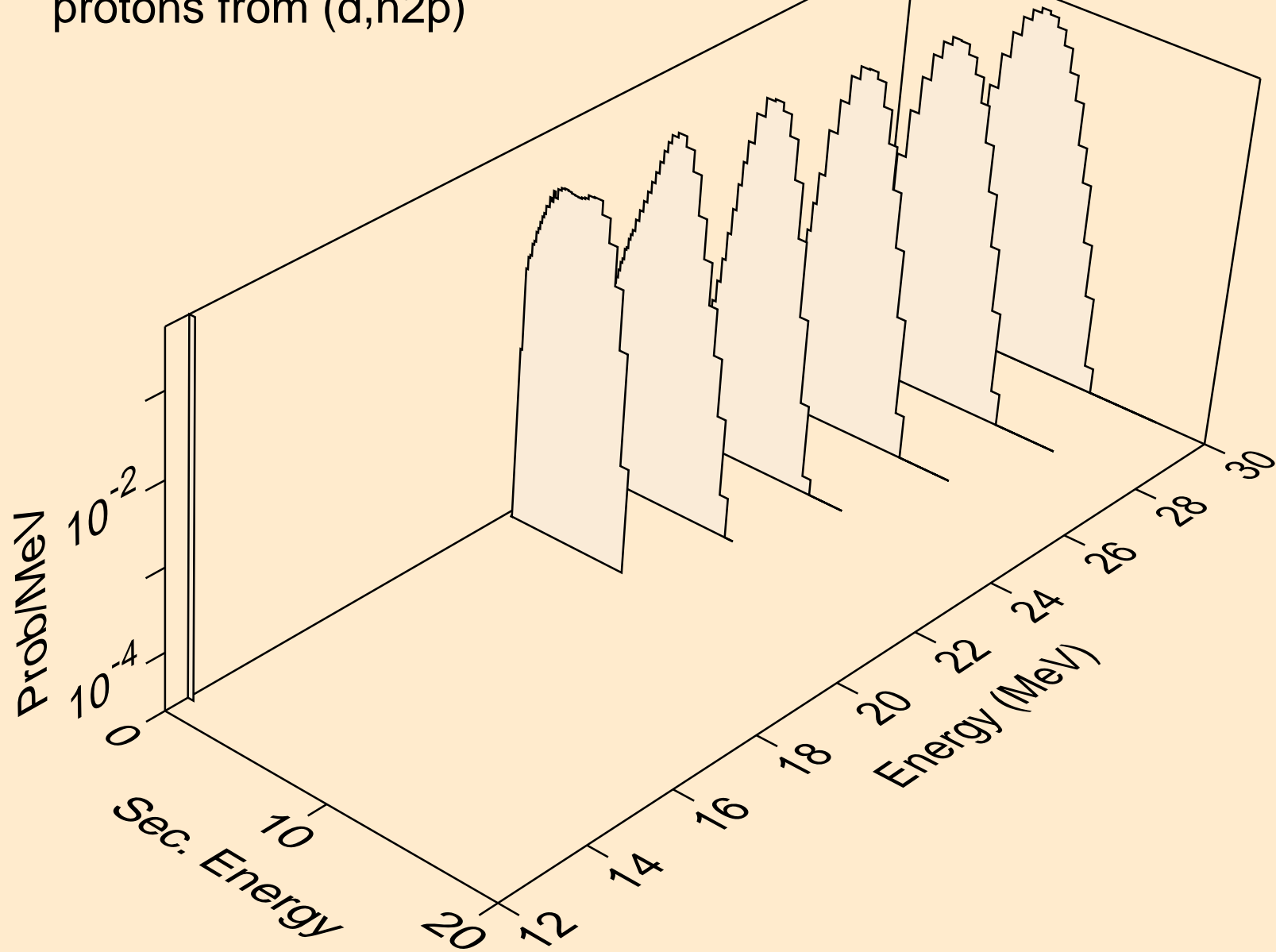

PT203 DEUTERON ACER TENDL-2023 LIBRARY; T=0.K  
protons from (d,p)

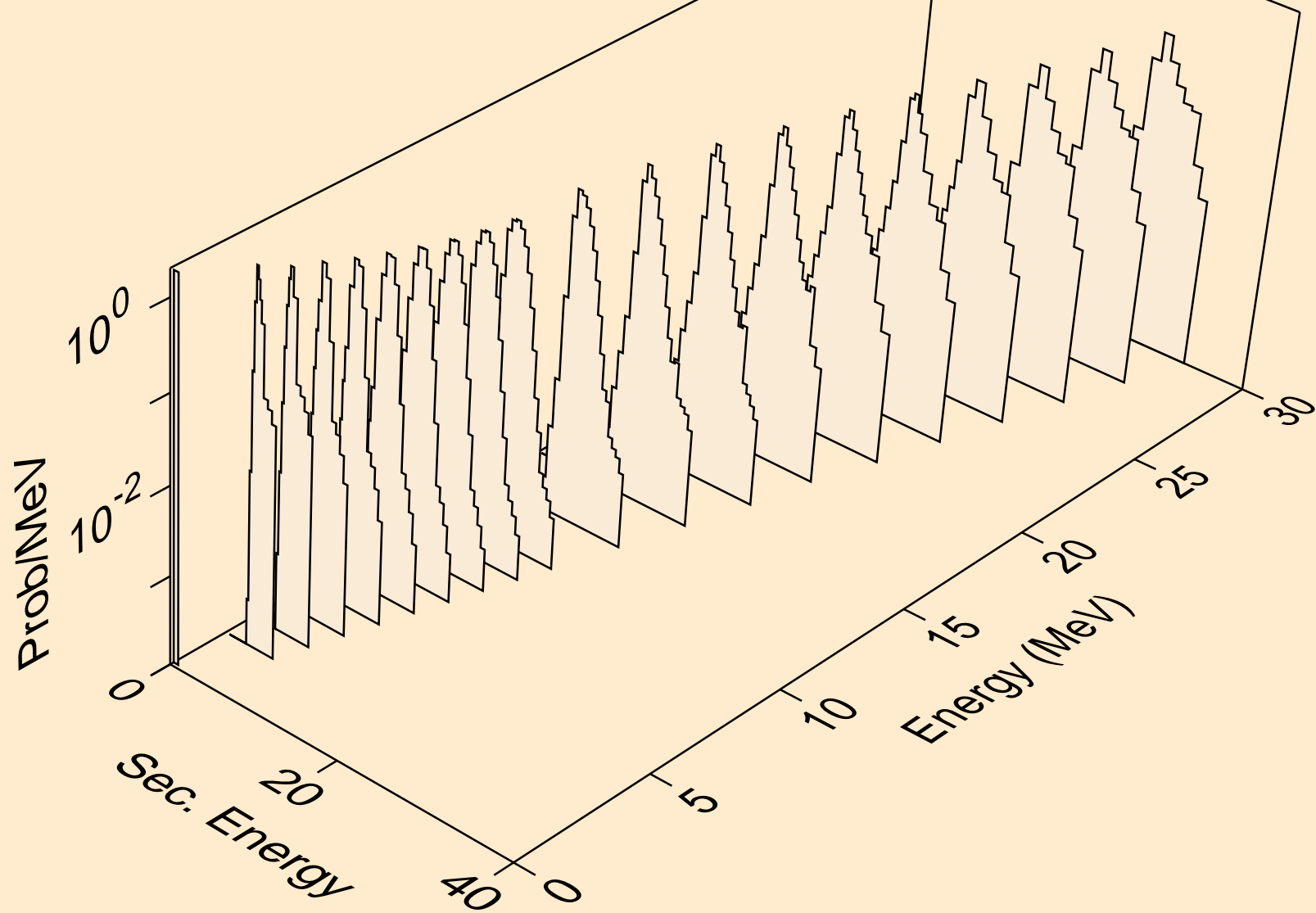

PT203 DEUTERON ACER TENDL-2023 LIBRARY; T=0.K  
protons from (d,2p)

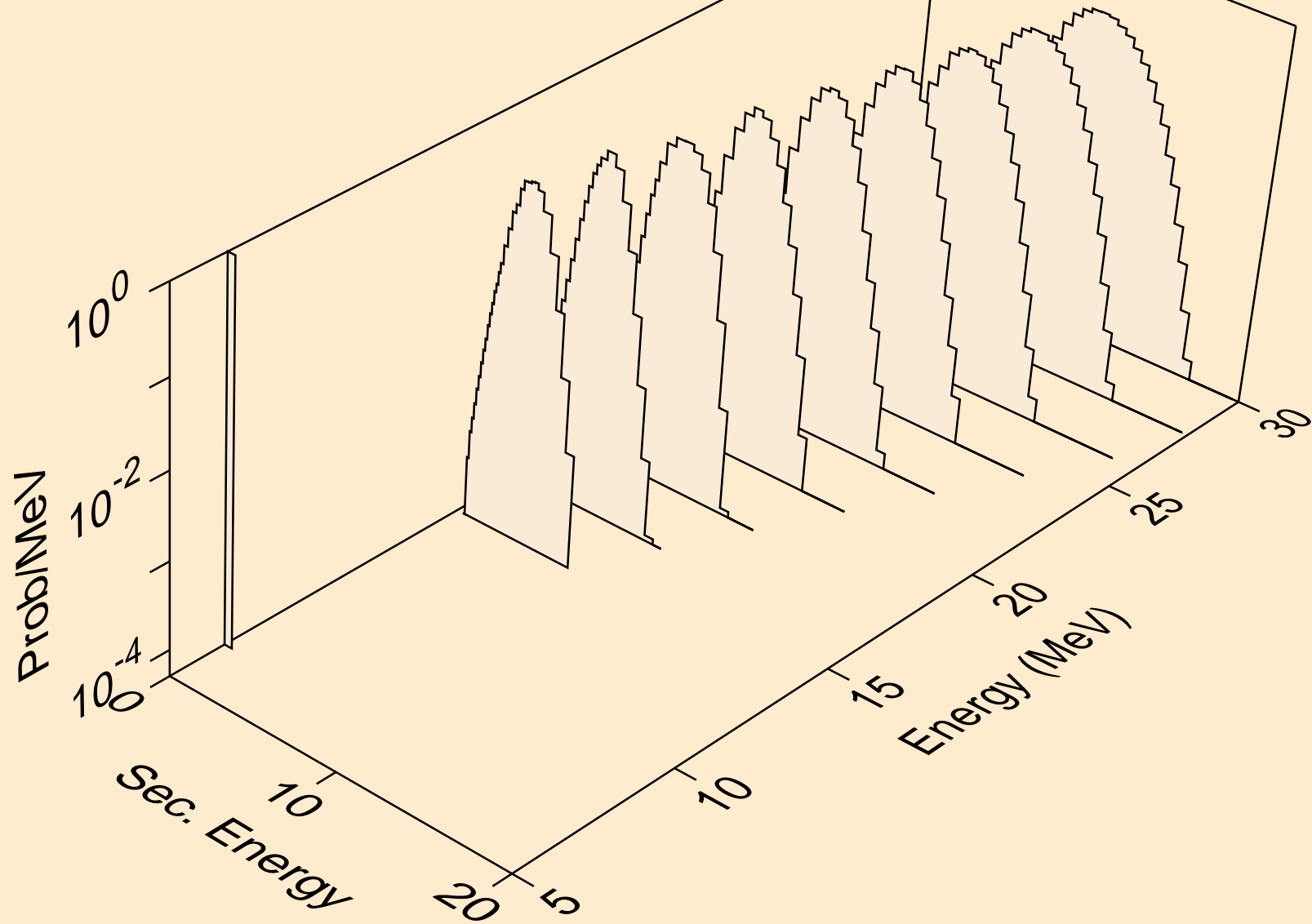

PT203 DEUTERON ACER TENDL-2023 LIBRARY; T=0.K  
protons from (d,pd)

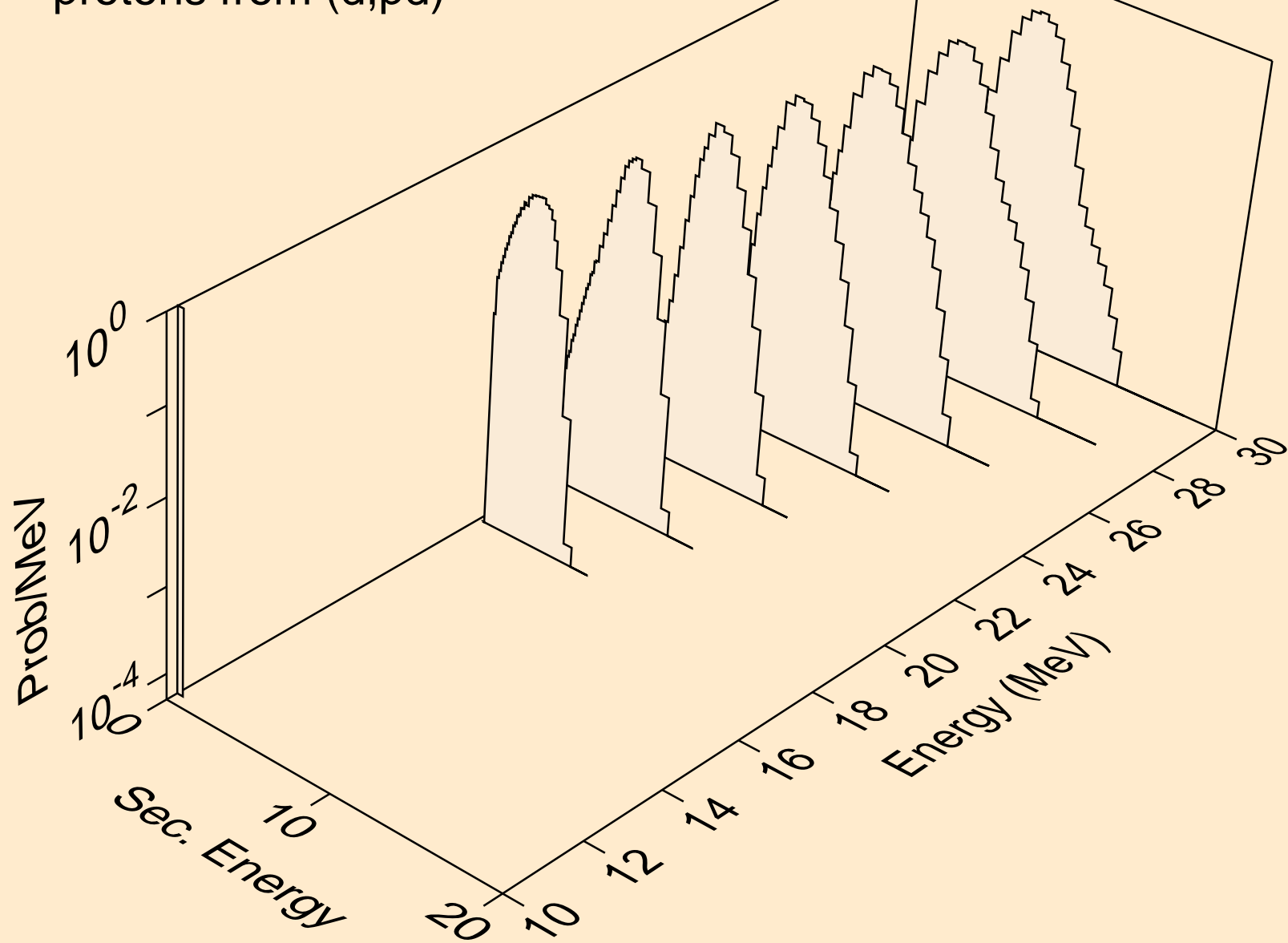

PT203 DEUTERON ACER TENDL-2023 LIBRARY; T=0.K  
tritons from (d,x)

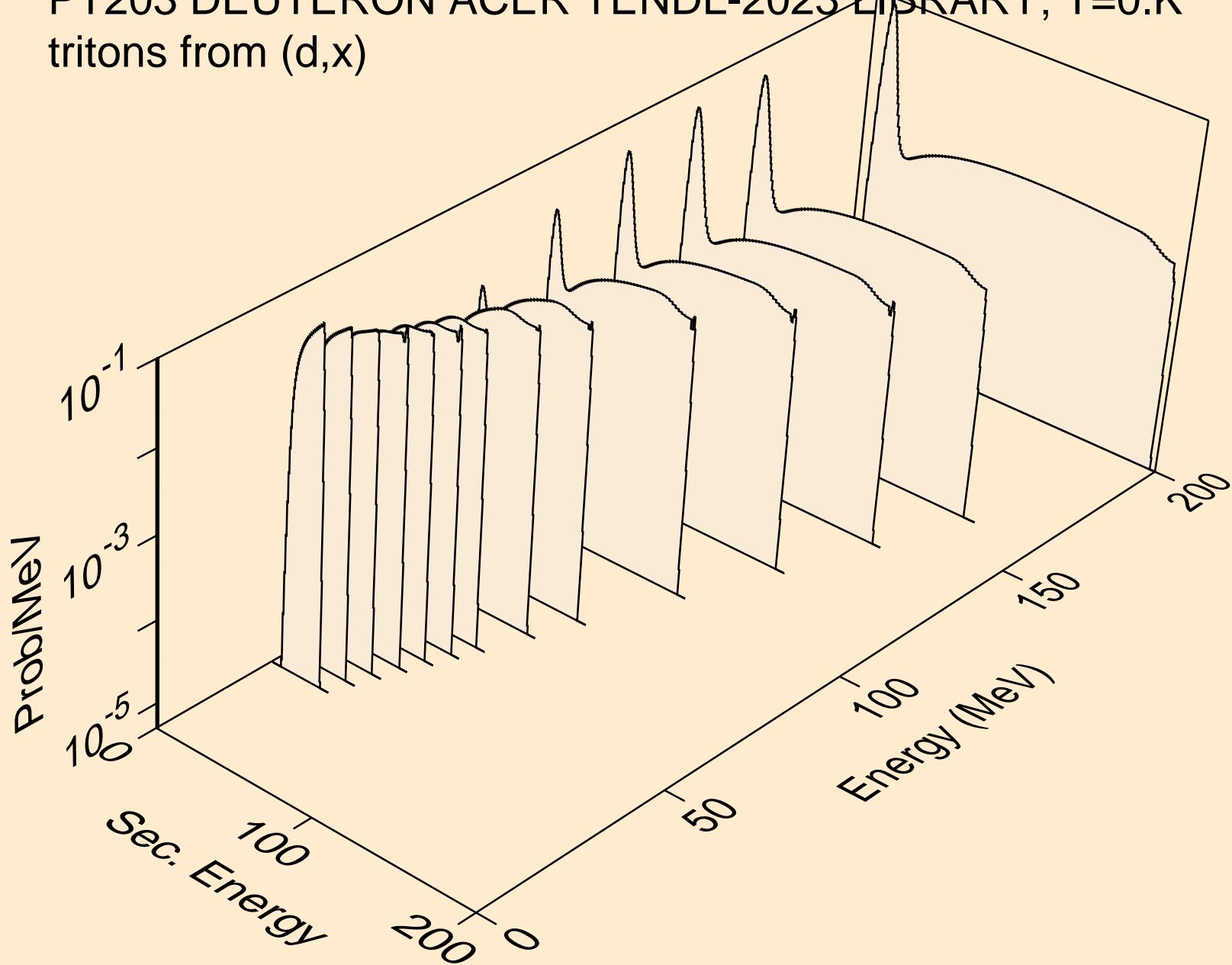



PT203 DEUTERON ACER TENDL-2023 LIBRARY; T=0.K  
tritons from (d,n\*)t

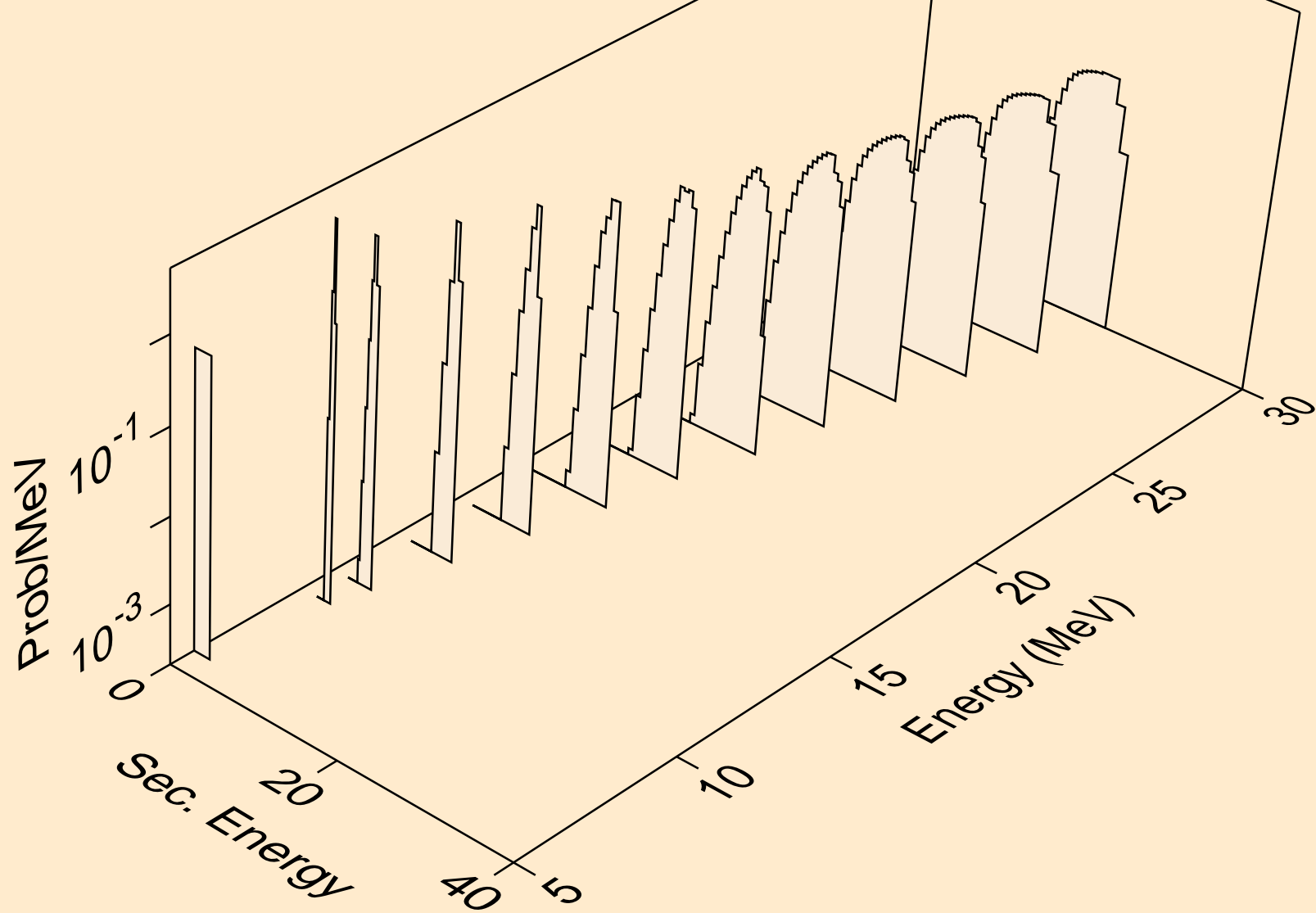

PT203 DEUTERON ACER TENDL-2023 LIBRARY; T=0.K  
tritons from (d,t)

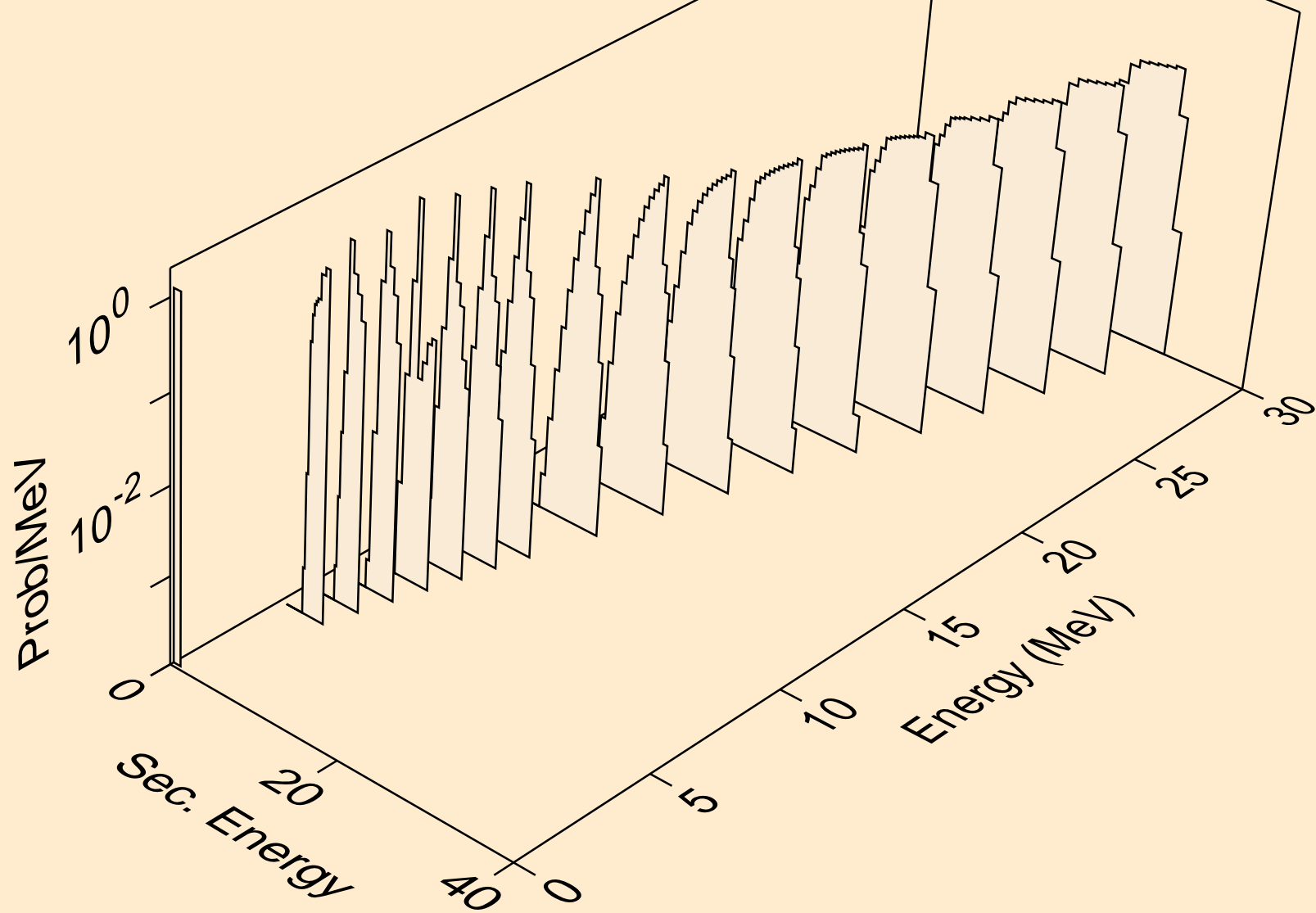

PT203 DEUTERON ACER TENDL-2023 LIBRARY; T=0.K  
he3s from (d,x)

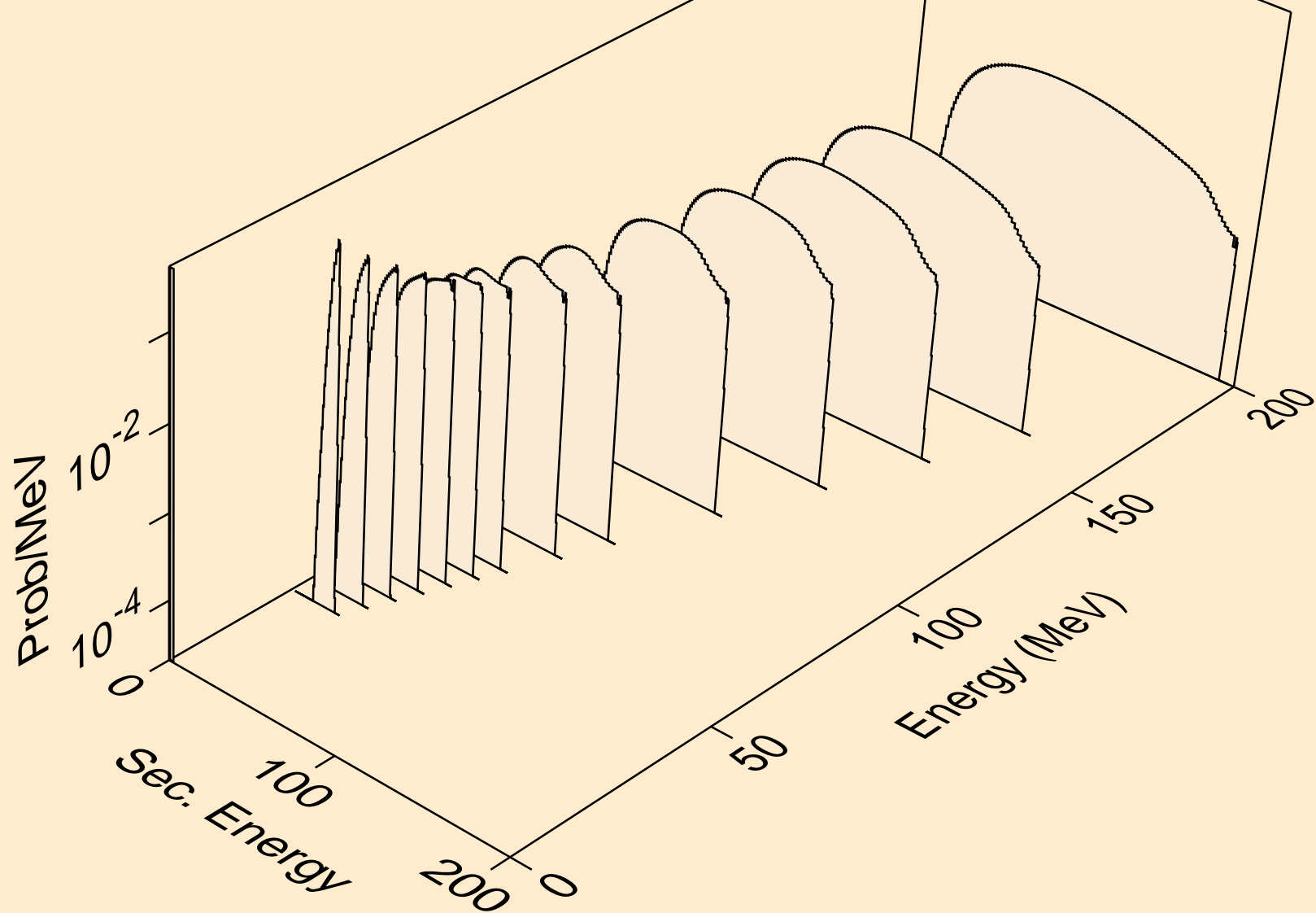

PT203 DEUTERON ACER TENDL-2023 LIBRARY; T=0.K  
he3s from (d,n\*)he3

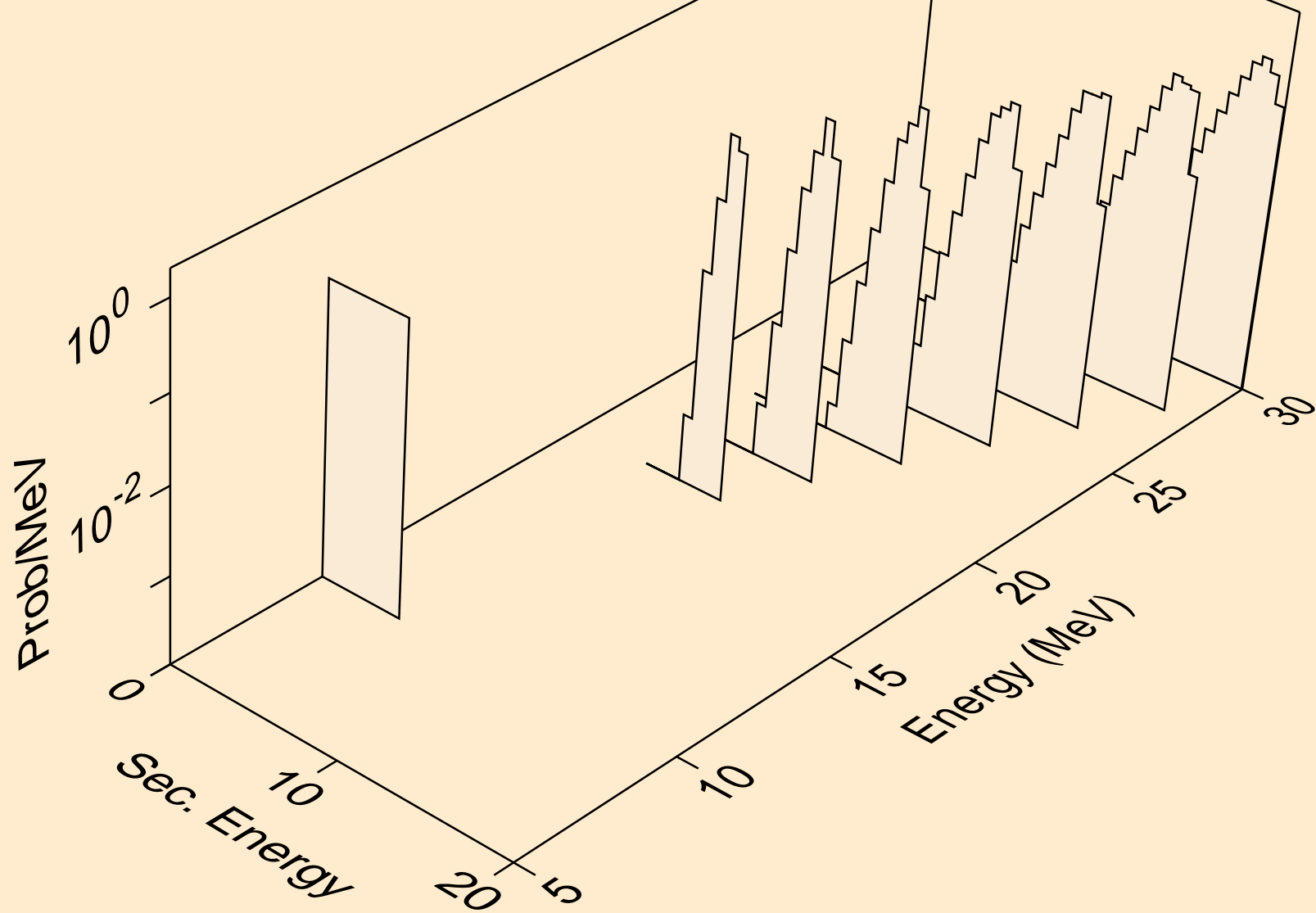

PT203 DEUTERON ACER TENDL-2023 LIBRARY; T=0.K  
he3s from (d,he3)

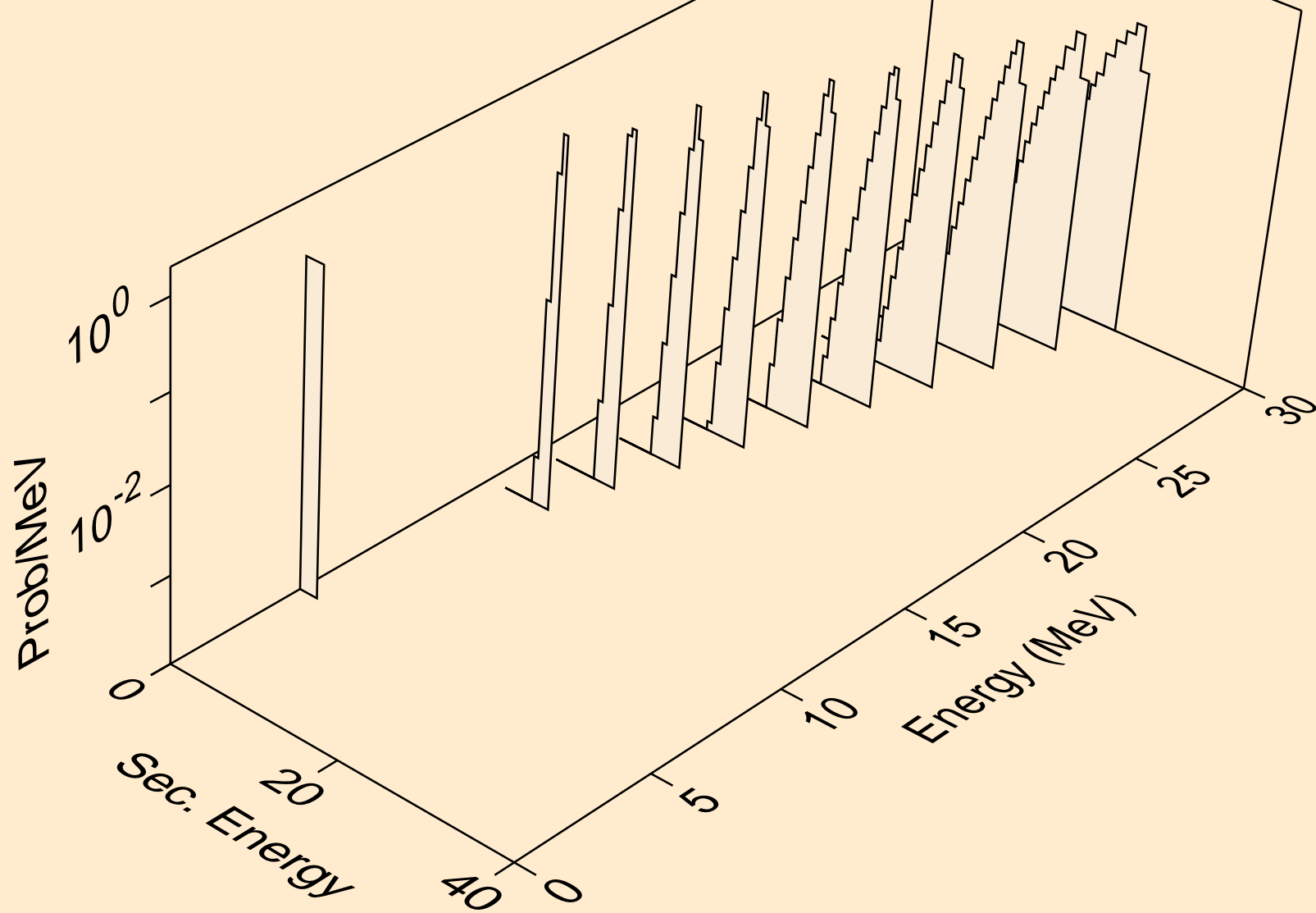

PT203 DEUTERON ACER TENDL-2023 LIBRARY; T=0.K  
alphas from (d,x)

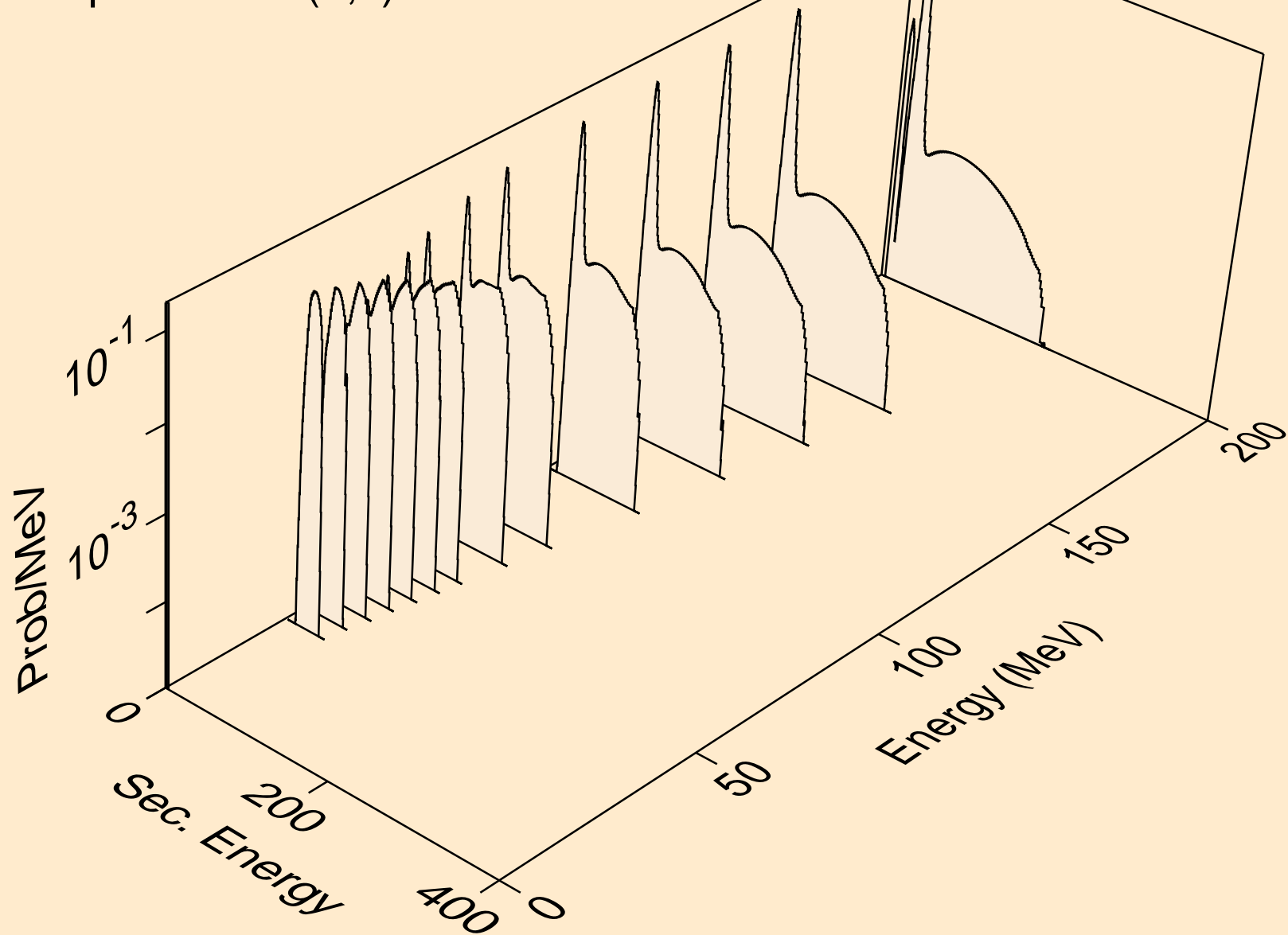

PT203 DEUTERON ACER TENDL-2023 LIBRARY; T=0.K  
alphas from (d,n\*)a

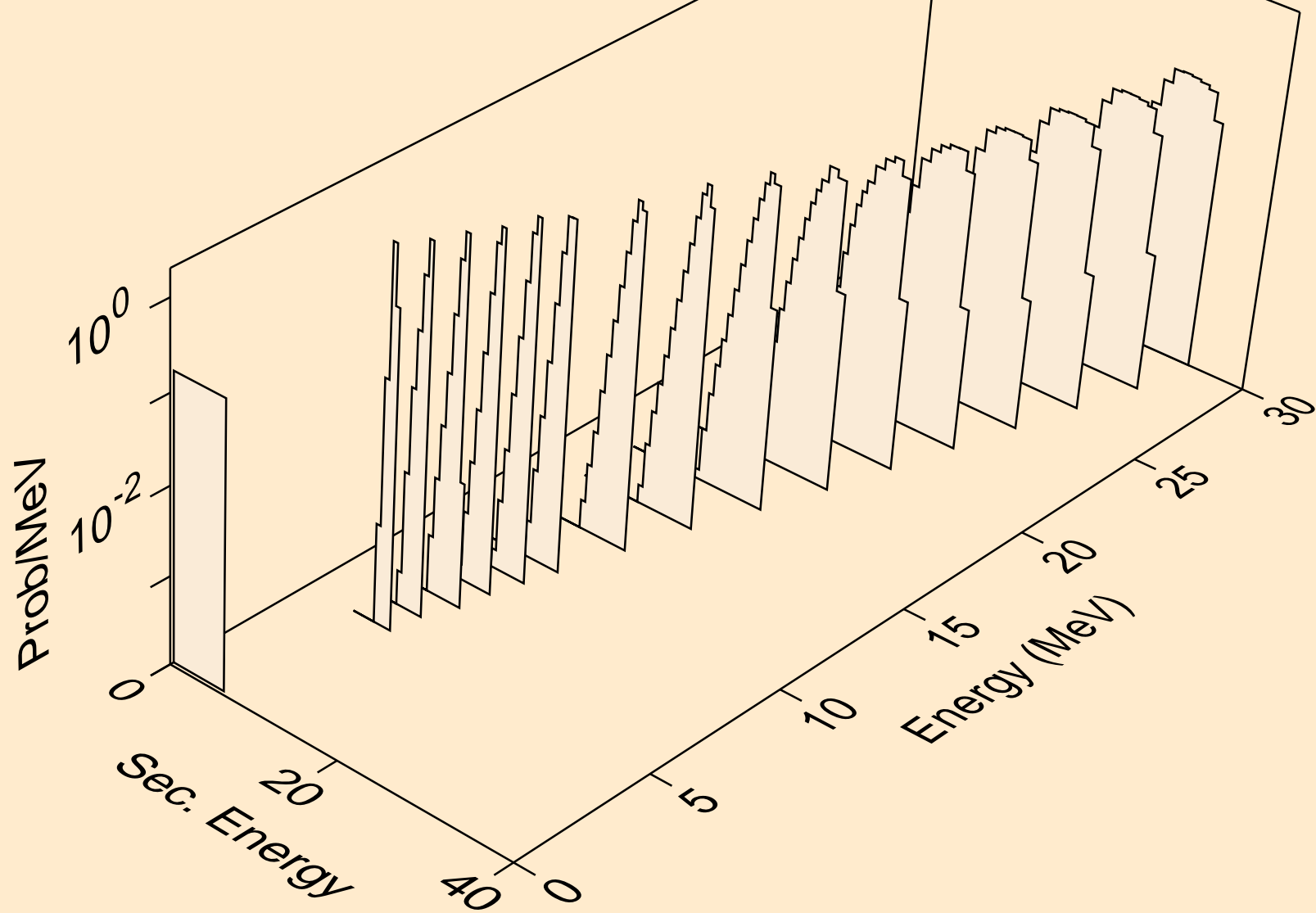

PT203 DEUTERON ACER TENDL-2023 LIBRARY; T=0.K  
alphas from (d,2n)a

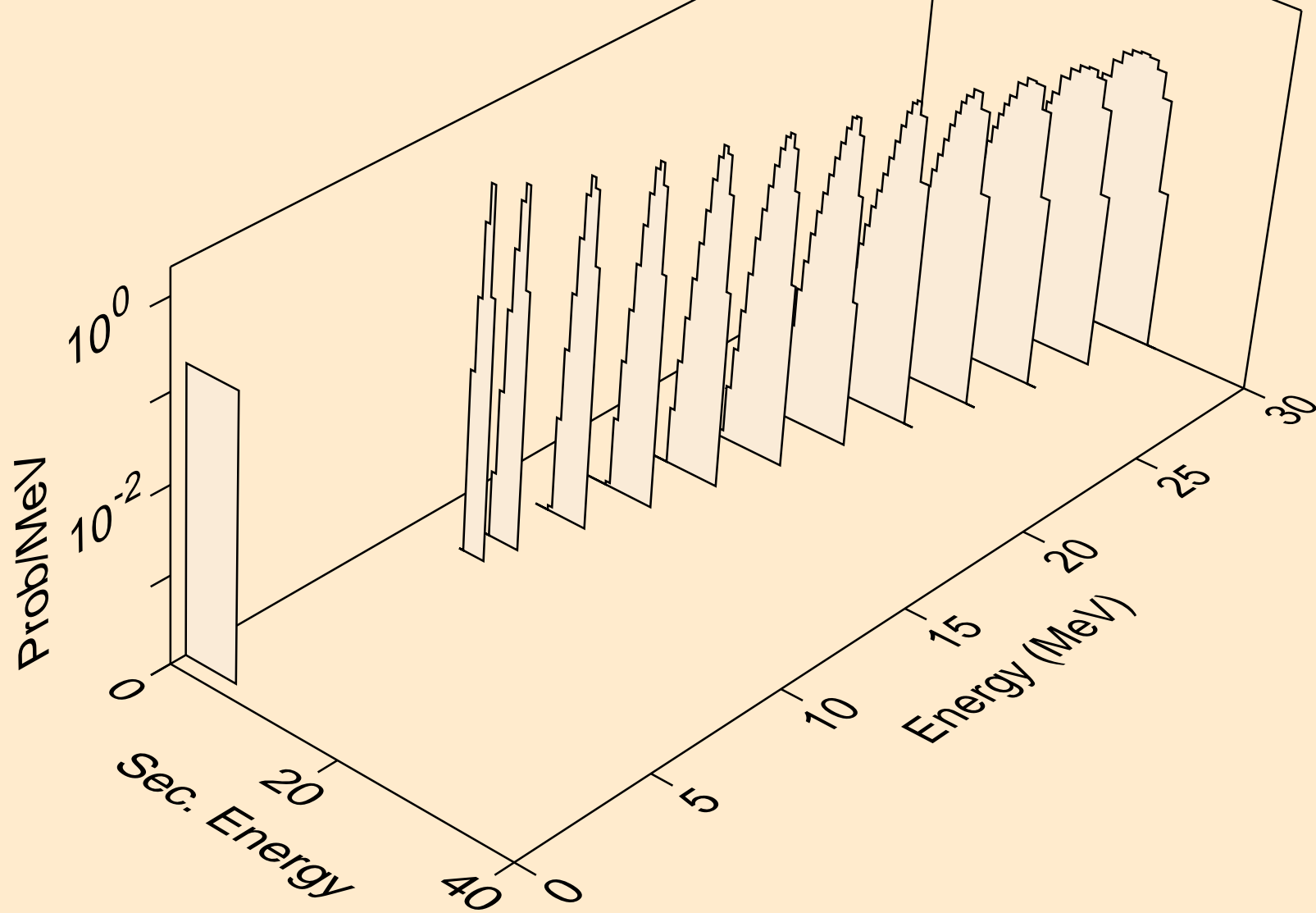



PT203 DEUTERON ACER TENDL-2023 LIBRARY; T=0.K  
alphas from (d,3n)a

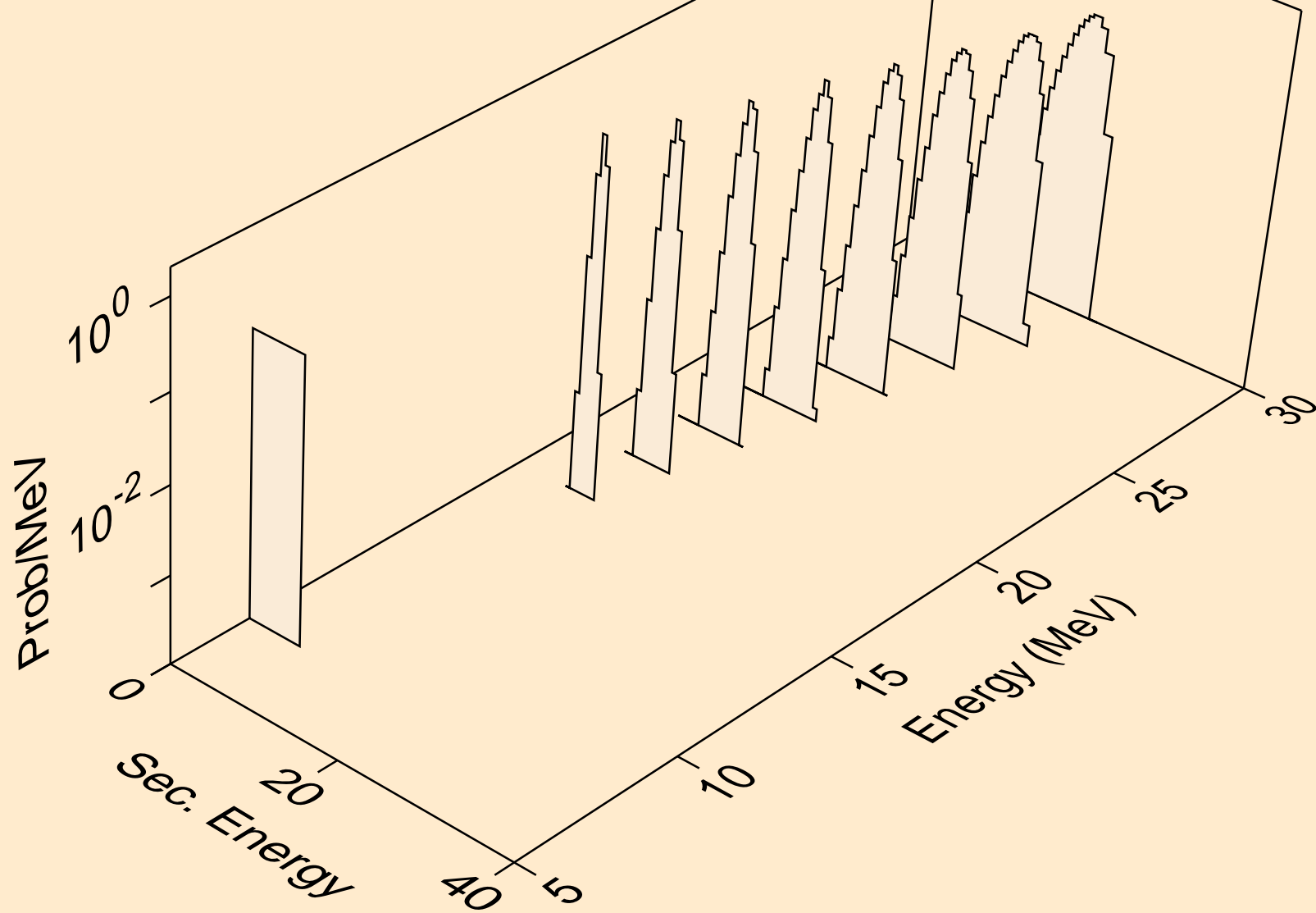

PT203 DEUTERON ACER TENDL-2023 LIBRARY; T=0.K  
alphas from (d,a)

