

RN227 DEUTERON ACER TENDL-2023 LIBRARY; T=0.K

Principal cross sections

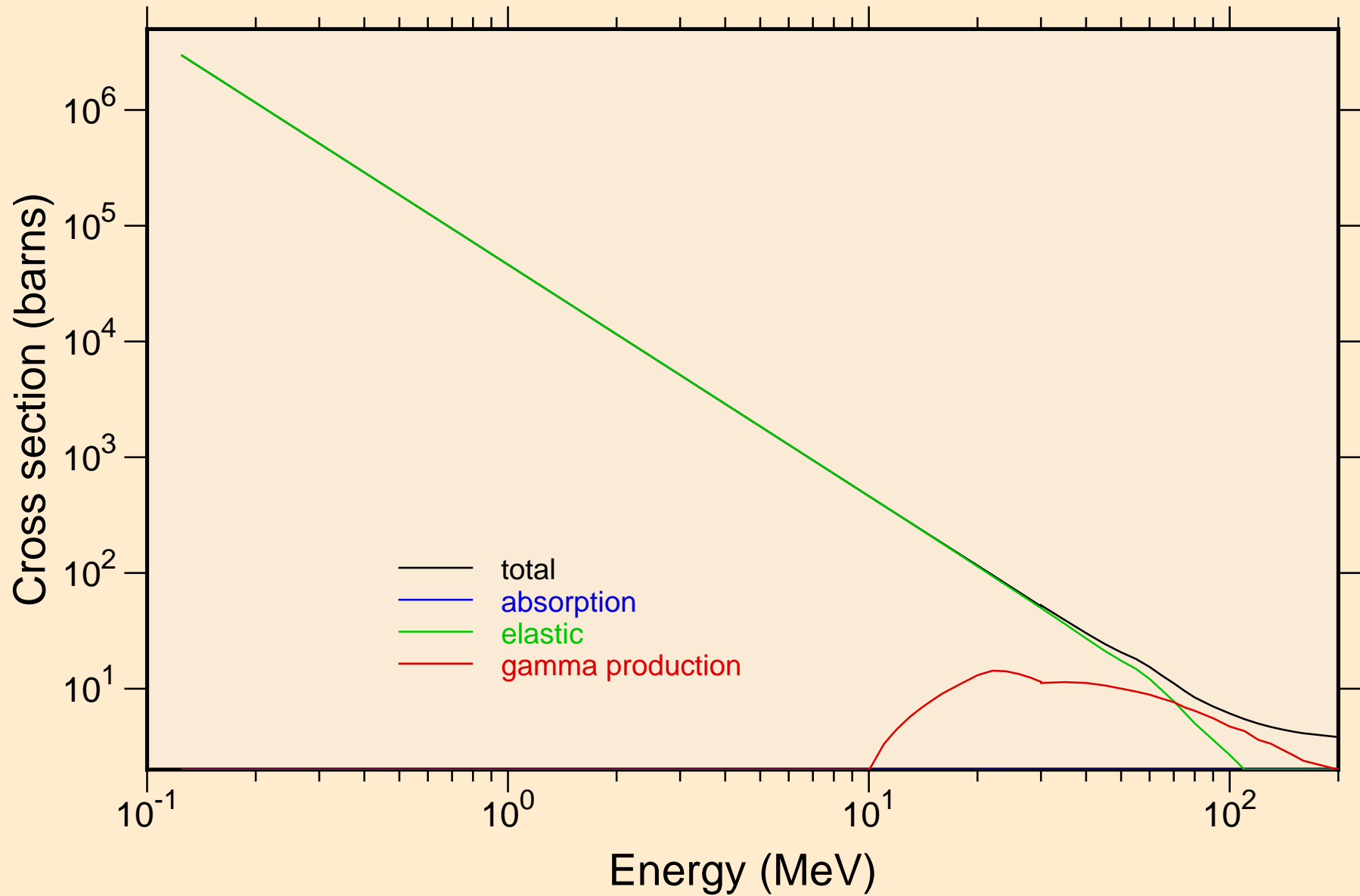

RN227 DEUTERON ACER TENDL-2023 LIBRARY; T=0.K
Heating

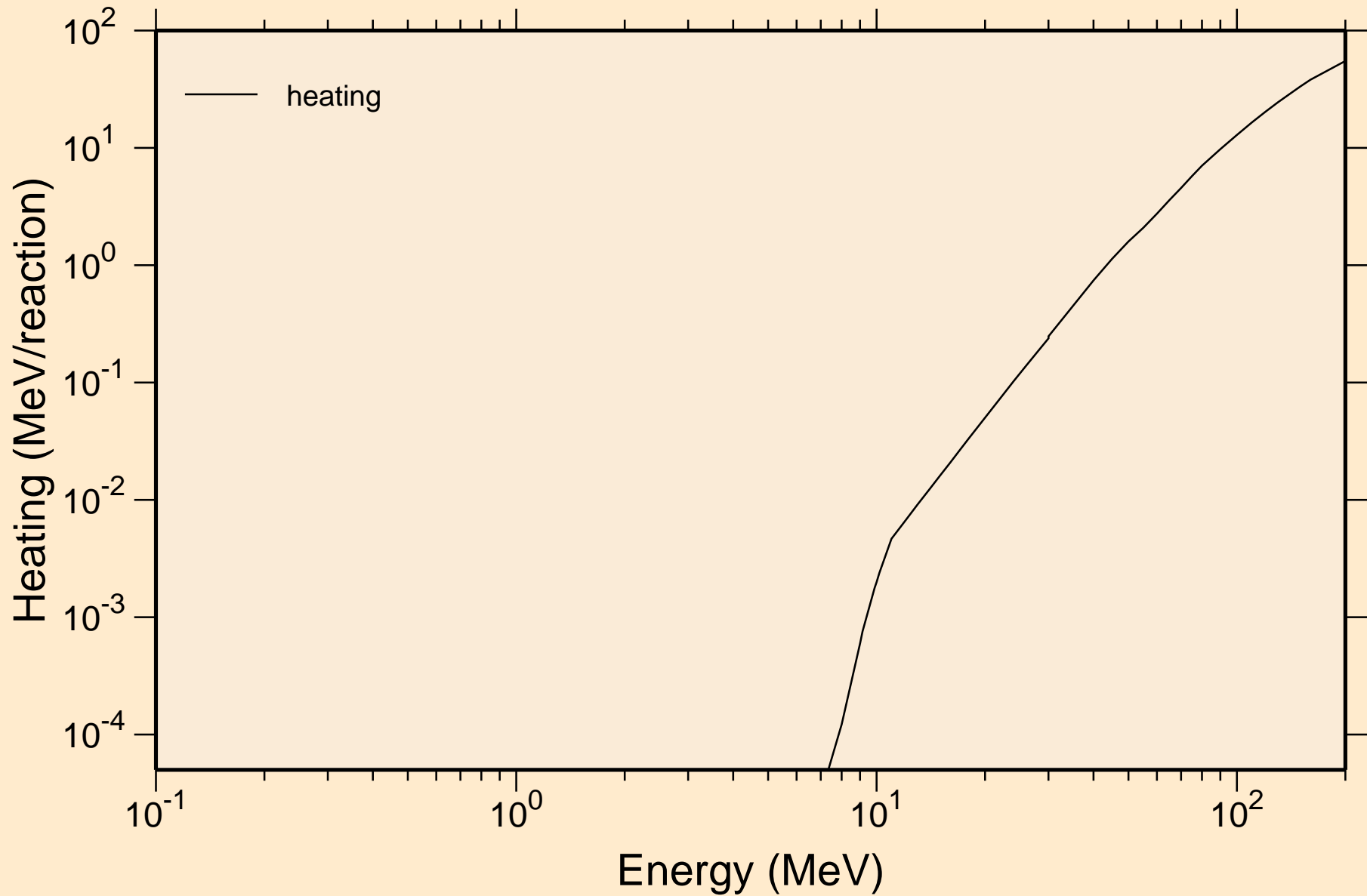

RN227 DEUTERON ACER TENDL-2023 LIBRARY; T=0.K

Principal cross sections

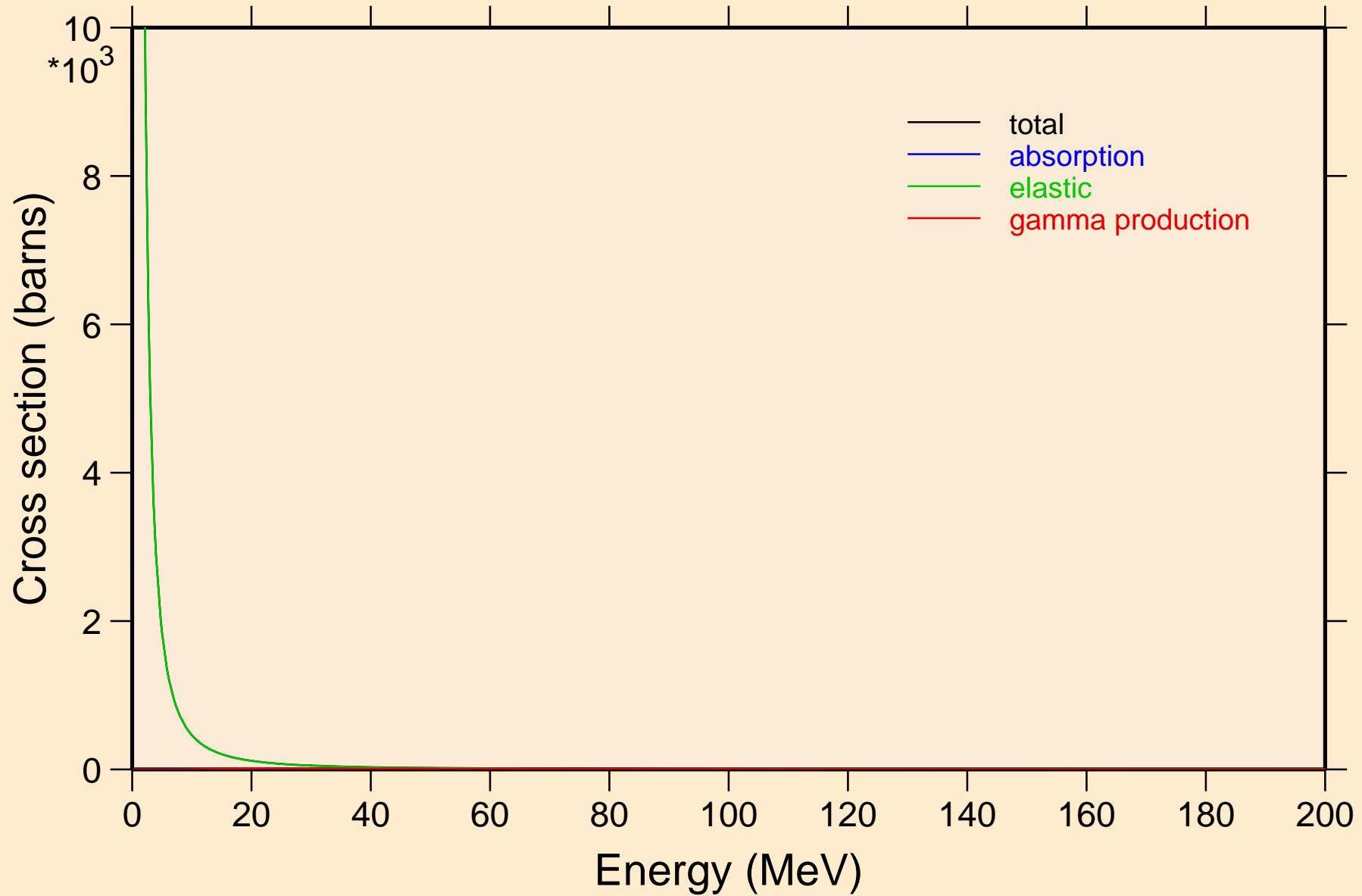

RN227 DEUTERON ACER TENDL-2023 LIBRARY; T=0.K

Heating

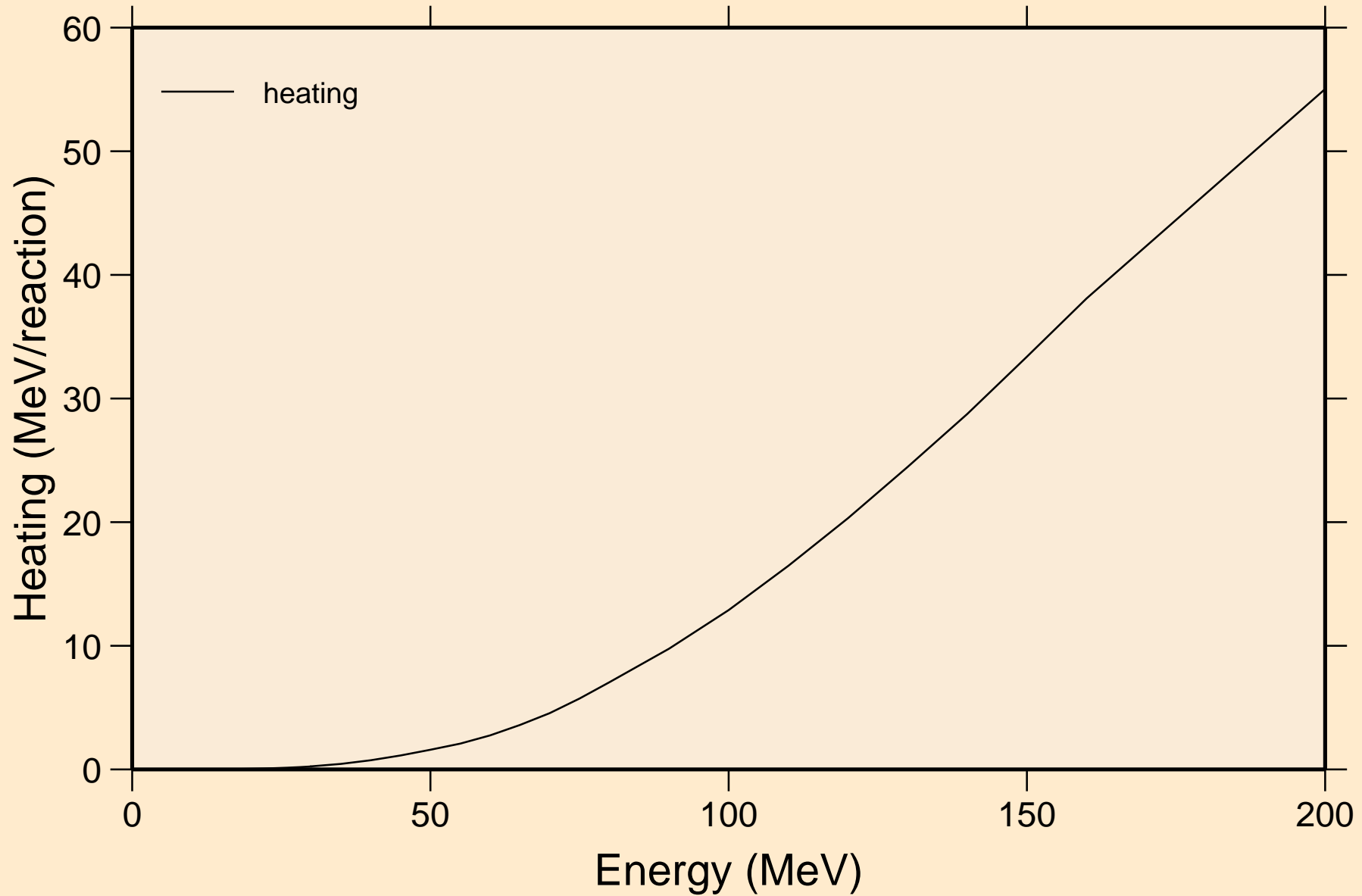

RN227 DEUTERON ACER TENDL-2023 LIBRARY; T=0.K

Threshold reactions

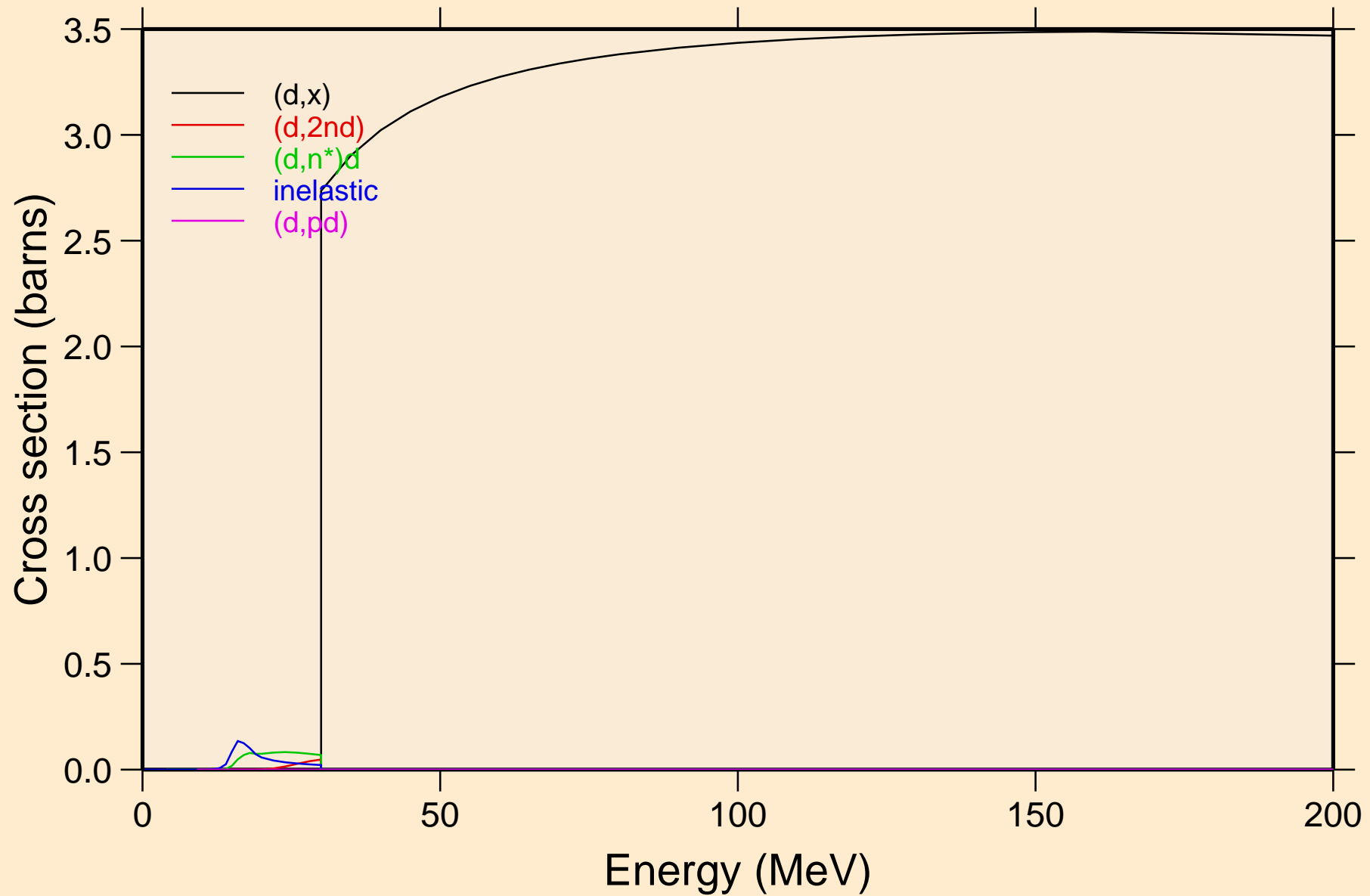

RN227 DEUTERON ACER TENDL-2023 LIBRARY; T=0.K
angular distribution for elastic

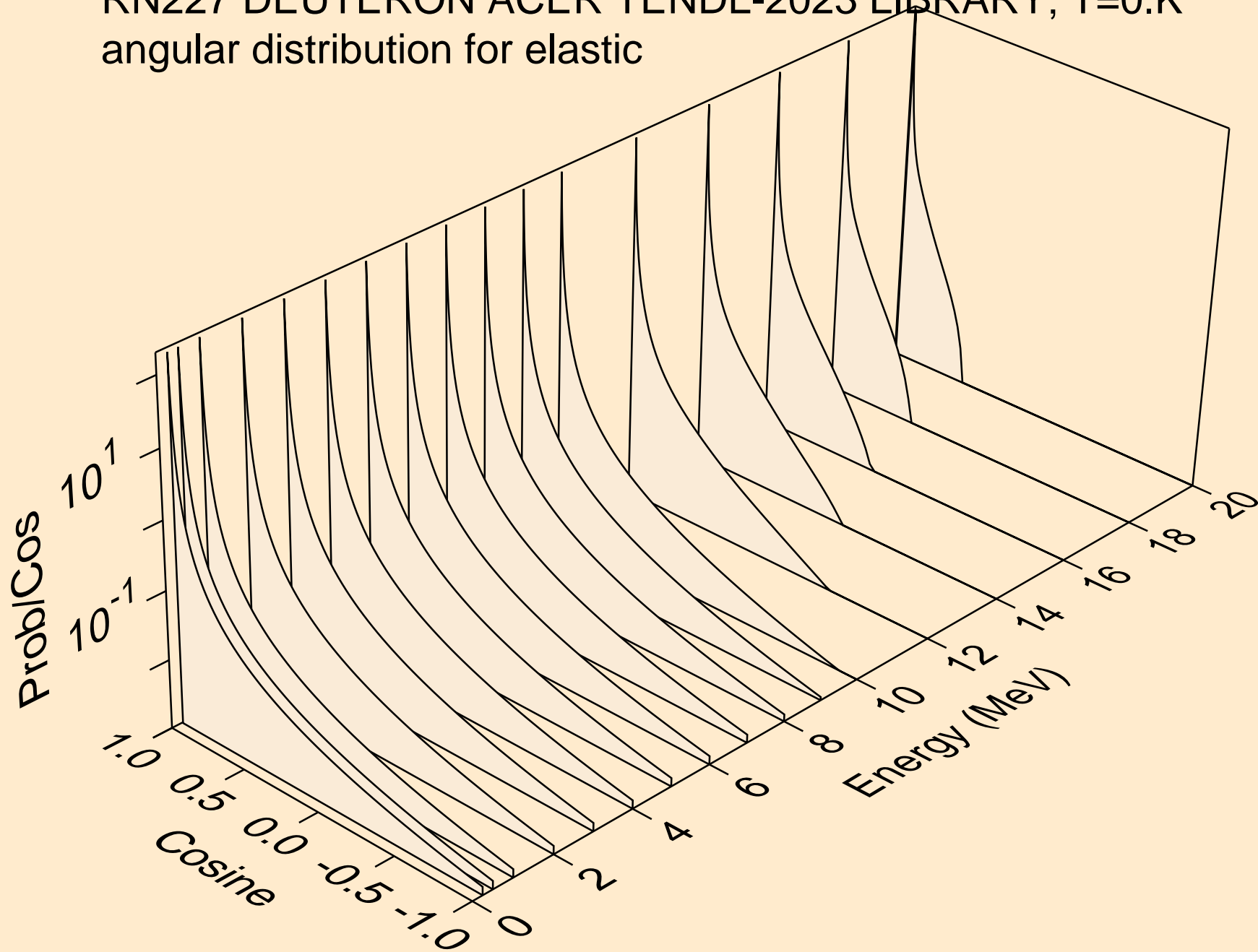

RN227 DEUTERON ACER TENDL-2023 LIBRARY; T=0.K
angular distribution for elastic

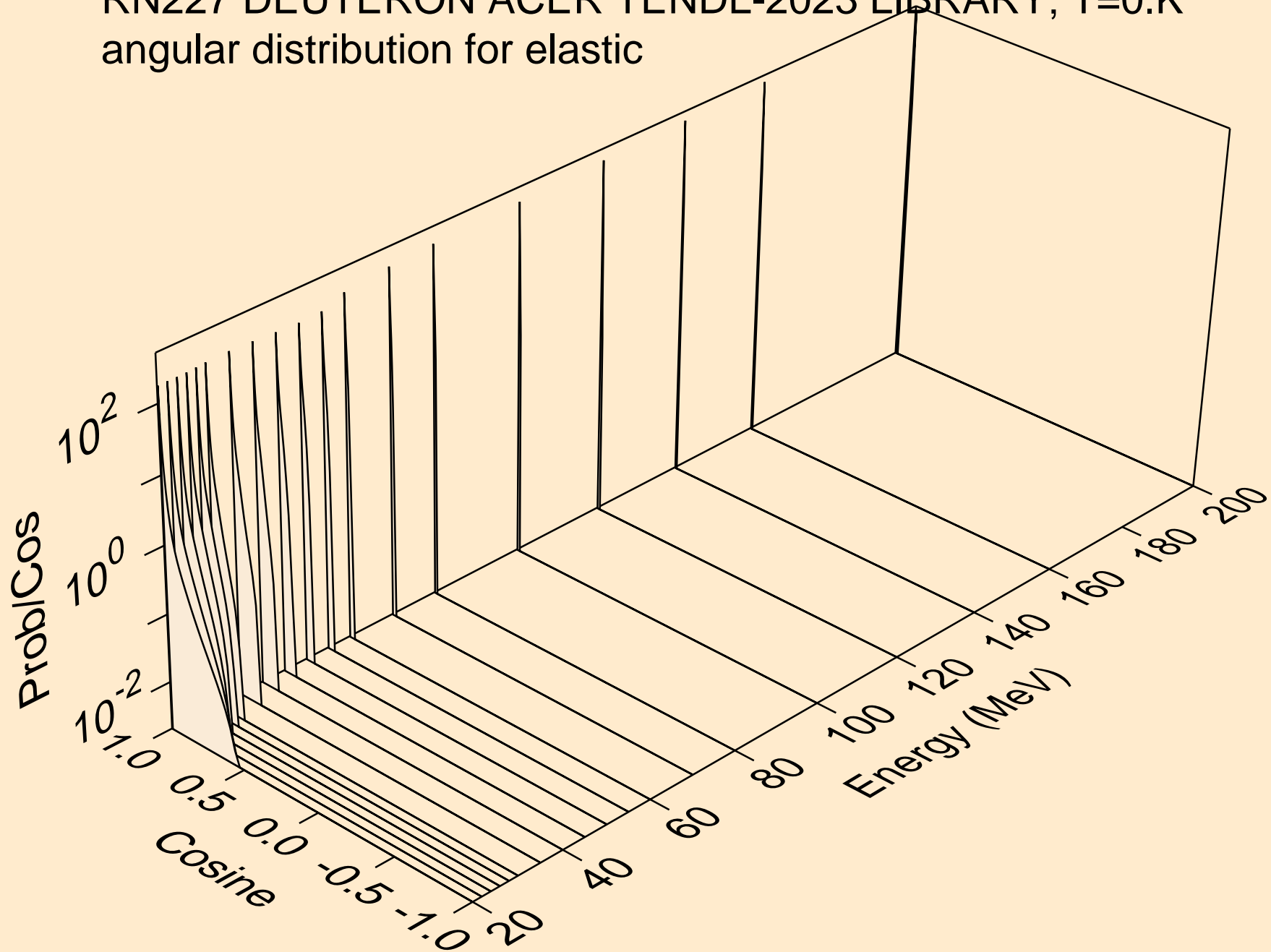

RN227 DEUTERON ACER TENDL-2023 LIBRARY; T=0.K
Deuteron emission for (d,x)

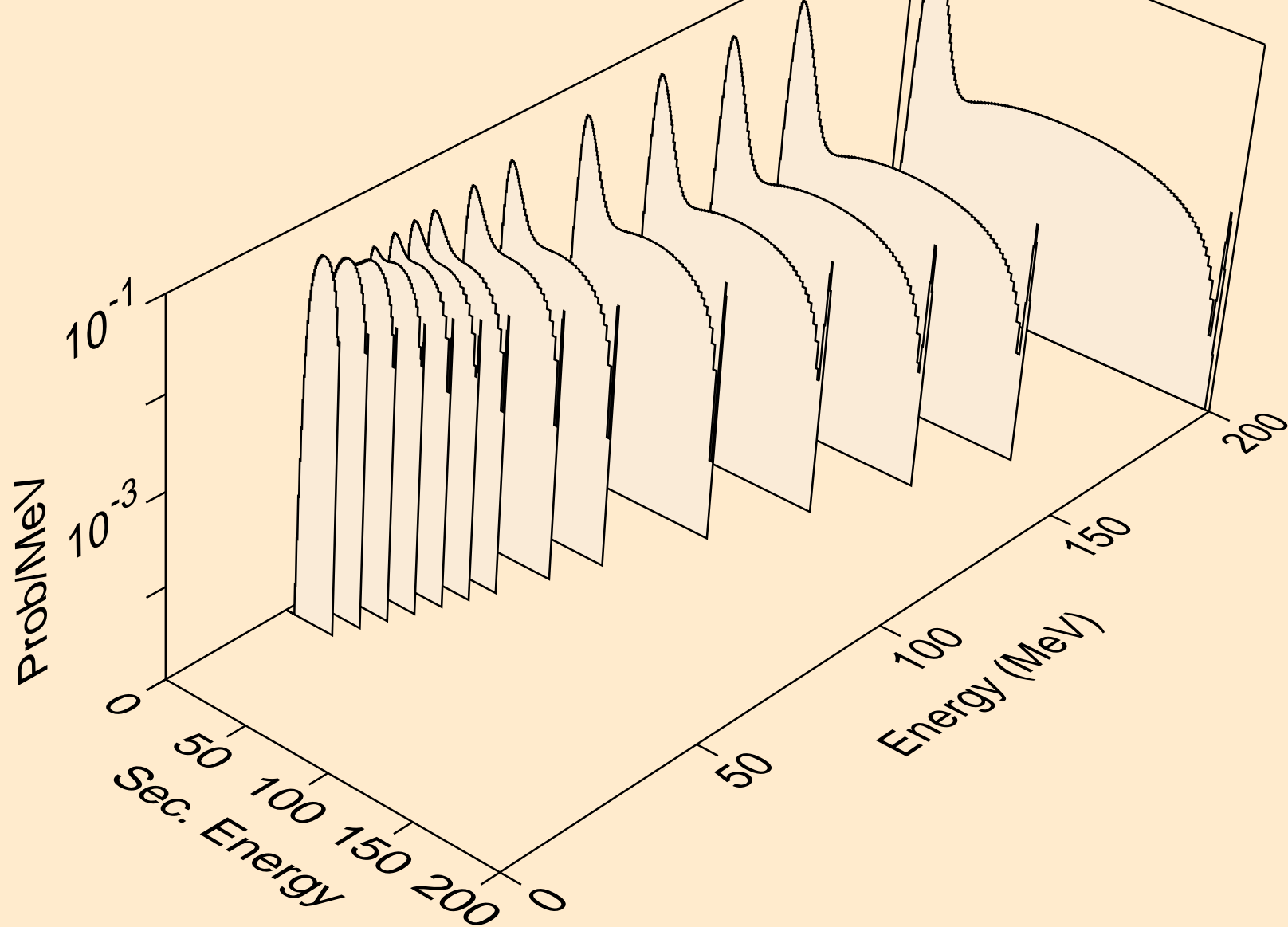

RN227 DEUTERON ACER TENDL-2023 LIBRARY; T=0.K
Deuteron emission for (d,2nd)

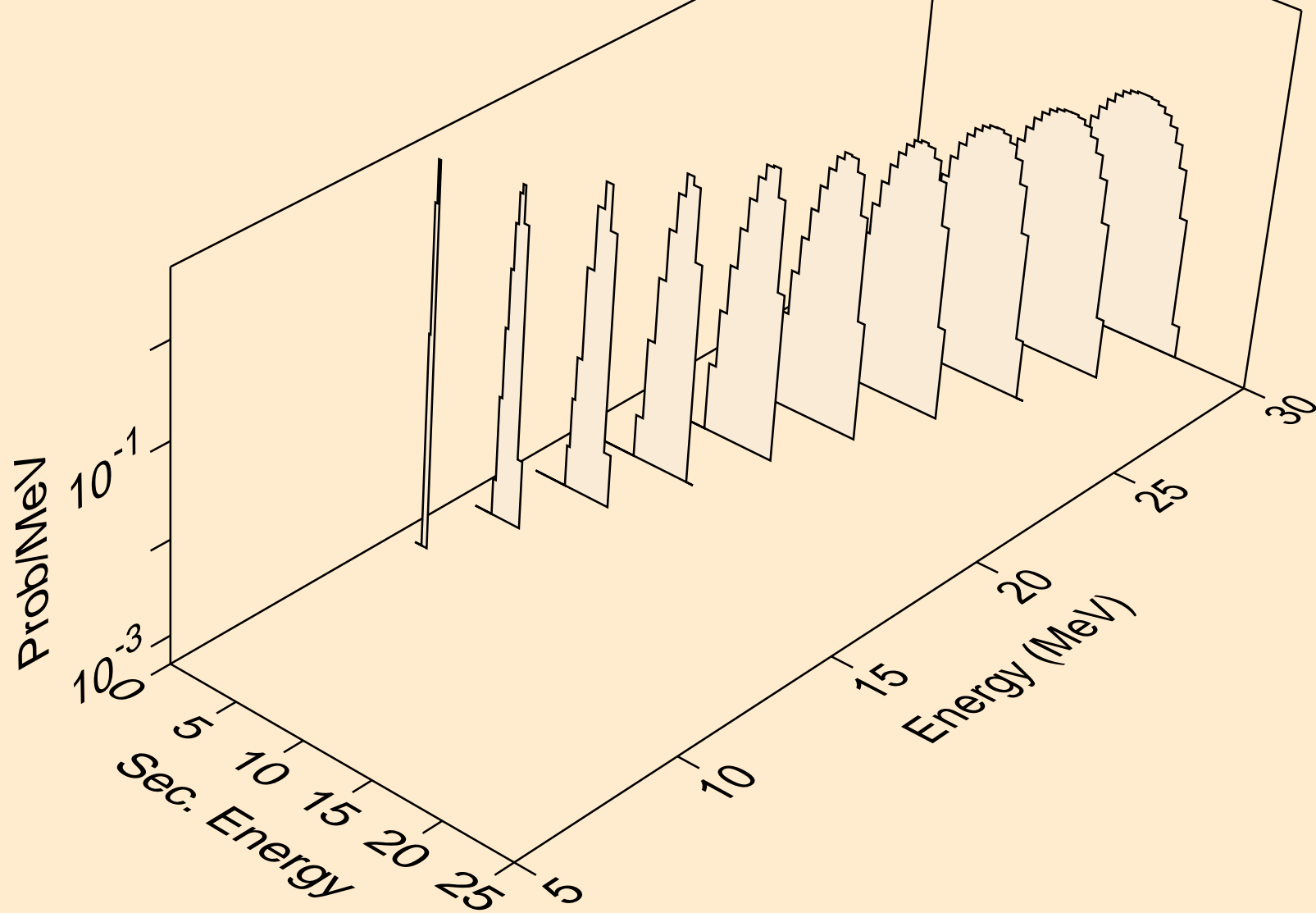

RN227 DEUTERON ACER TENDL-2023 LIBRARY; T=0.K
Deuteron emission for (d,n*)d

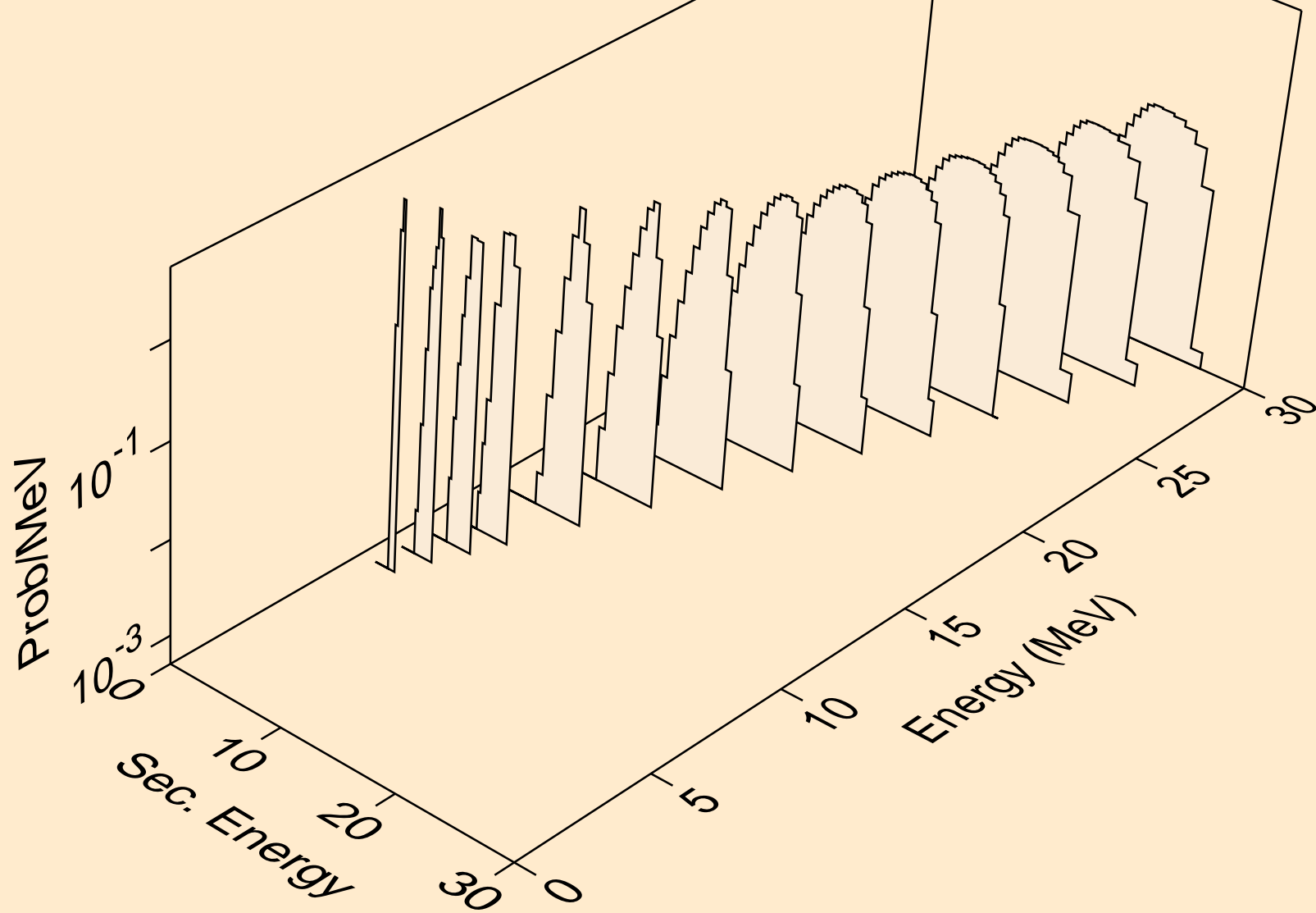

RN227 DEUTERON ACER TENDL-2023 LIBRARY; T=0.K
Deuteron emission for inelastic

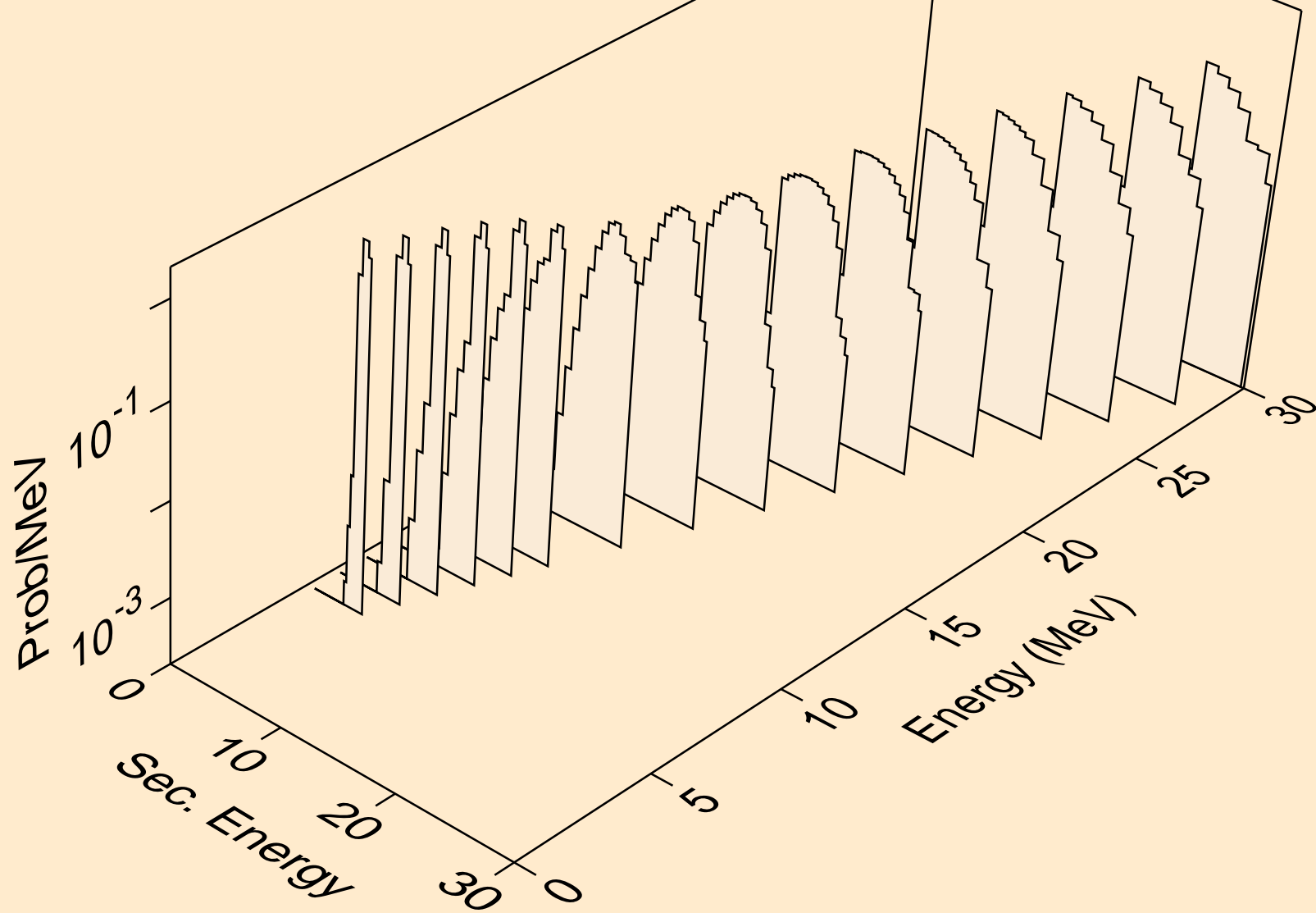

RN227 DEUTERON ACER TENDL-2023 LIBRARY; T=0.K
Deuteron emission for (d,pd)

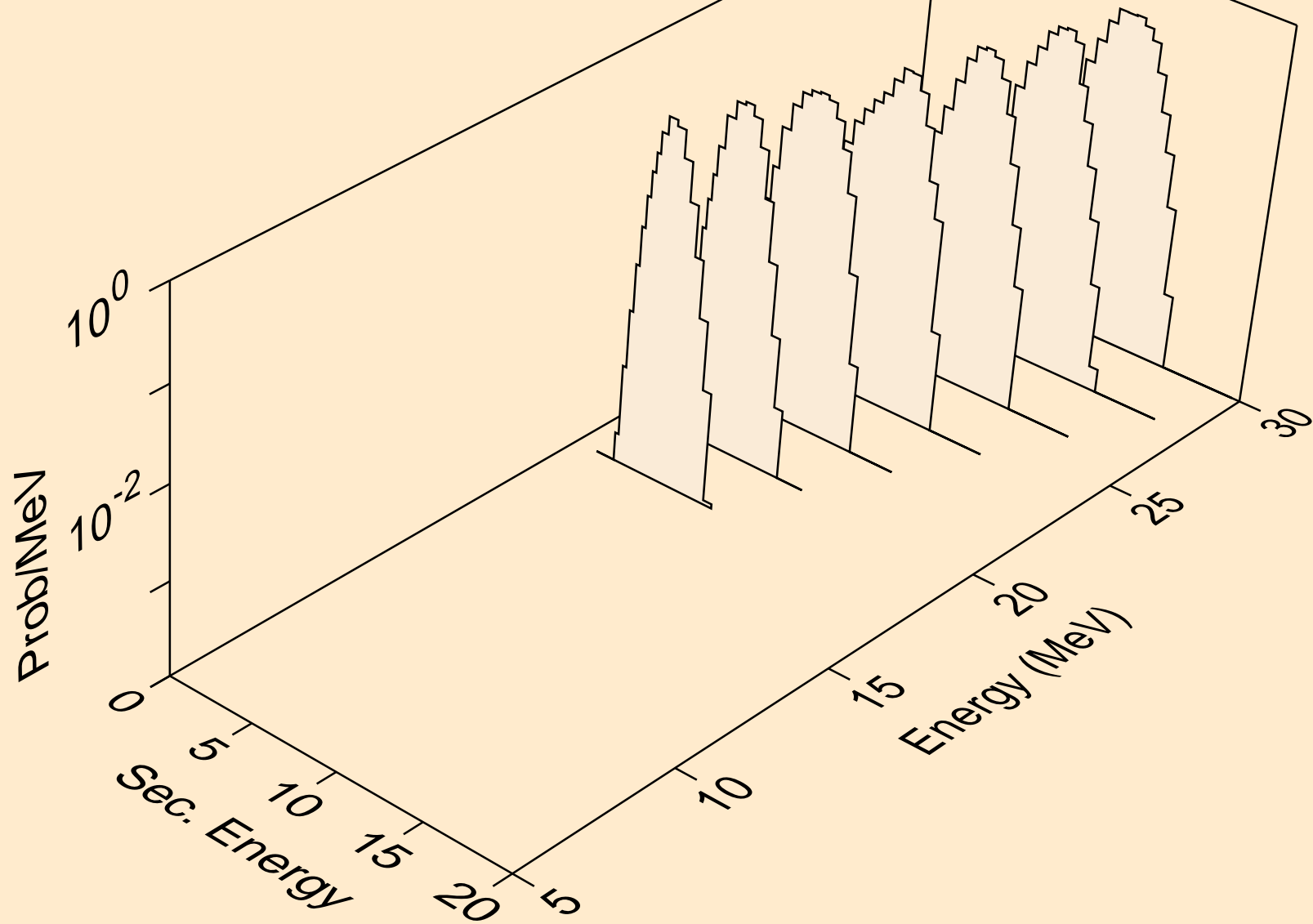

RN227 DEUTERON ACER TENDL-2023 LIBRARY; T=0.K
Photon emission for (z,n)

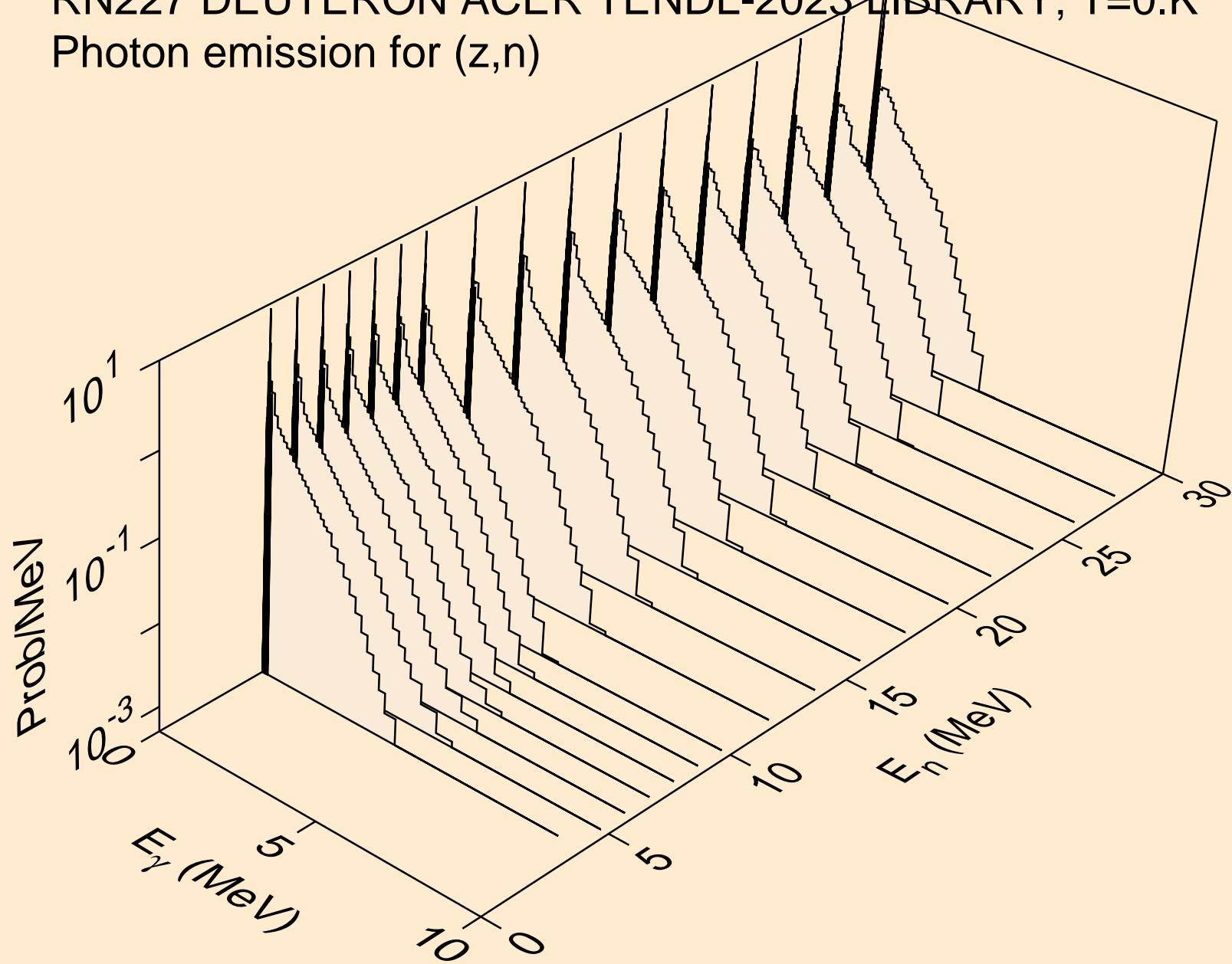

RN227 DEUTERON ACER TENDL-2023 LIBRARY; T=0.K
Photon emission for (z,x)

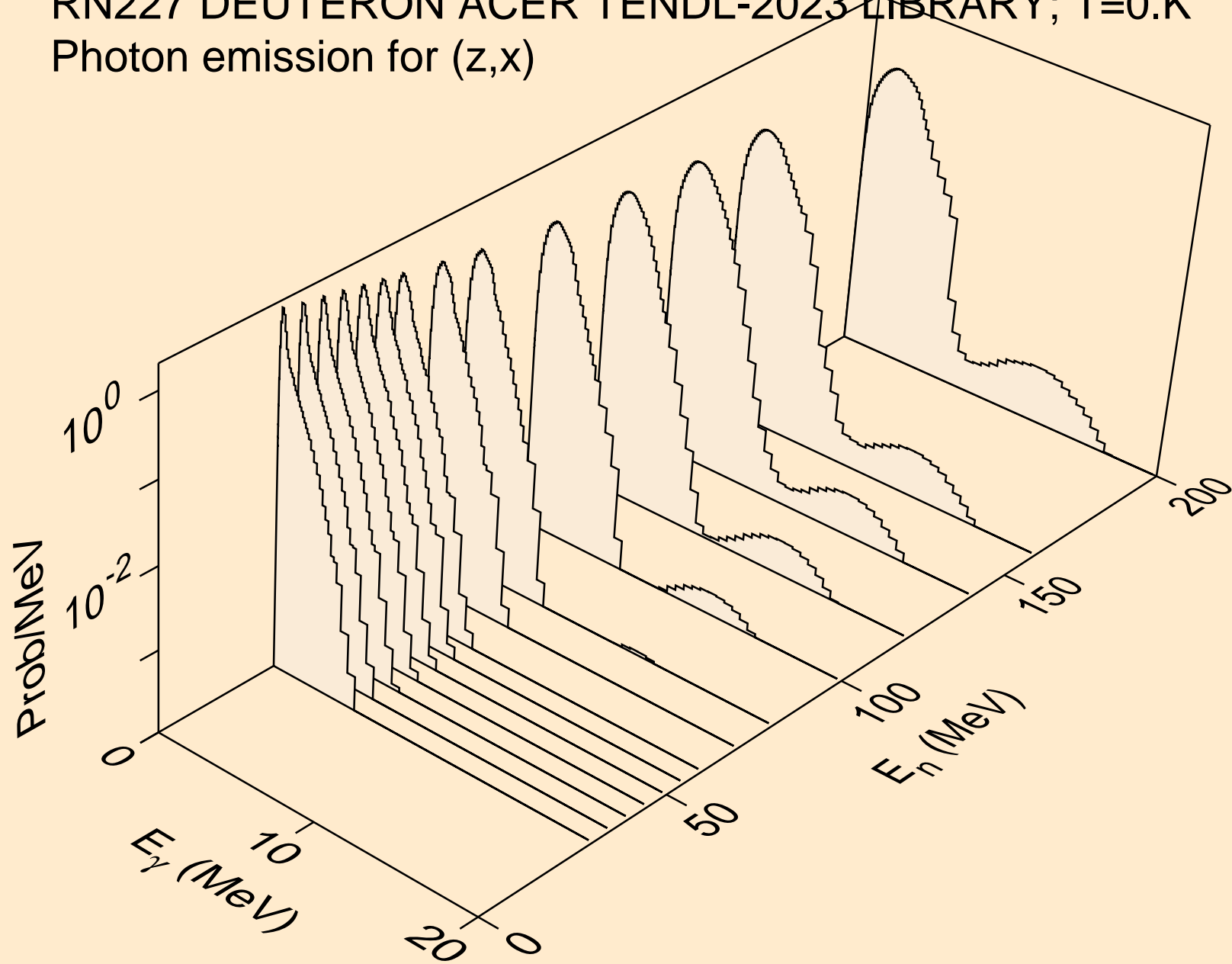

RN227 DEUTERON ACER TENDL-2023 LIBRARY; T=0.K
Photon emission for (n,2nd)

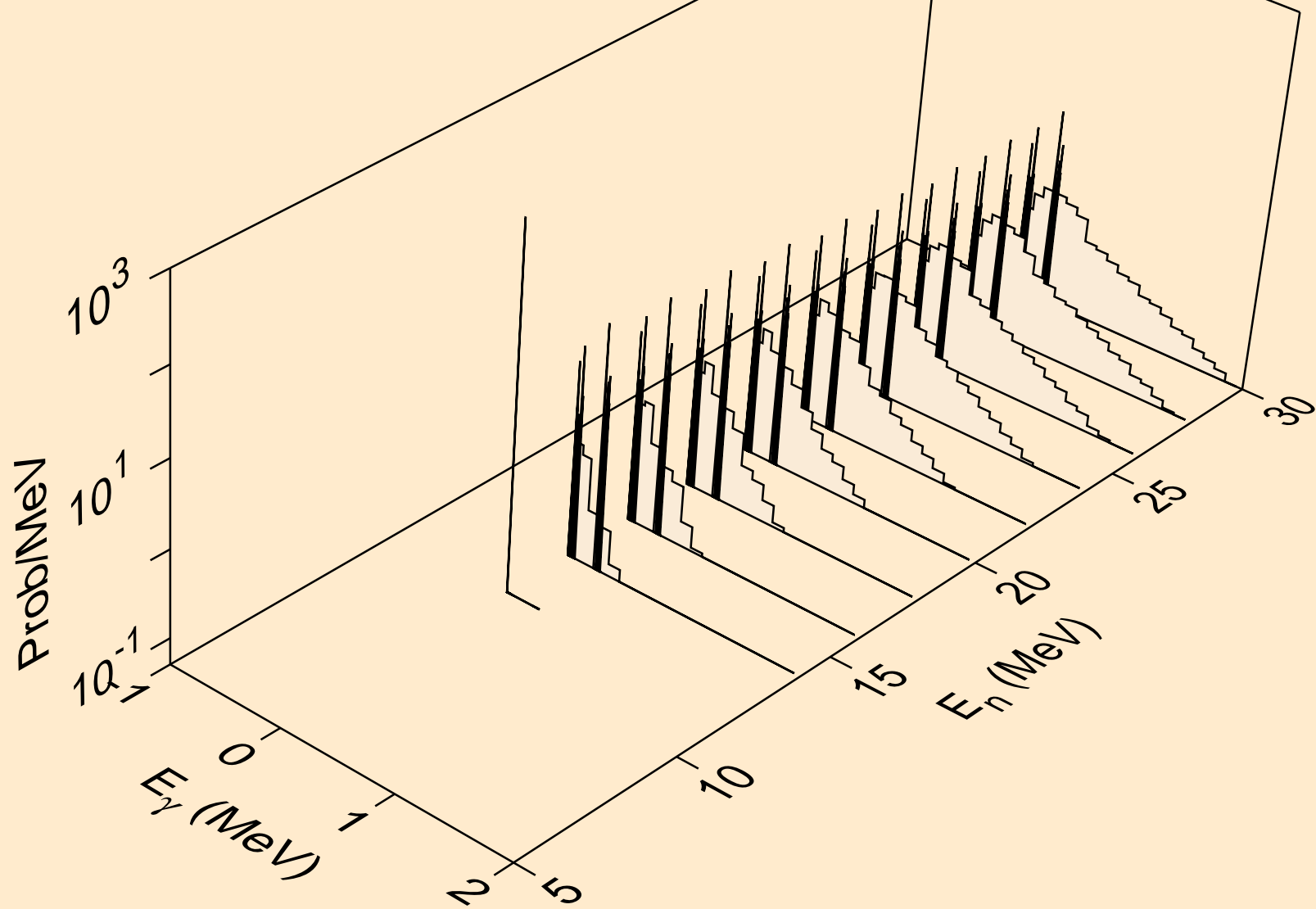

RN227 DEUTERON ACER TENDL-2023 LIBRARY; T=0.K
Photon emission for (n,2n)

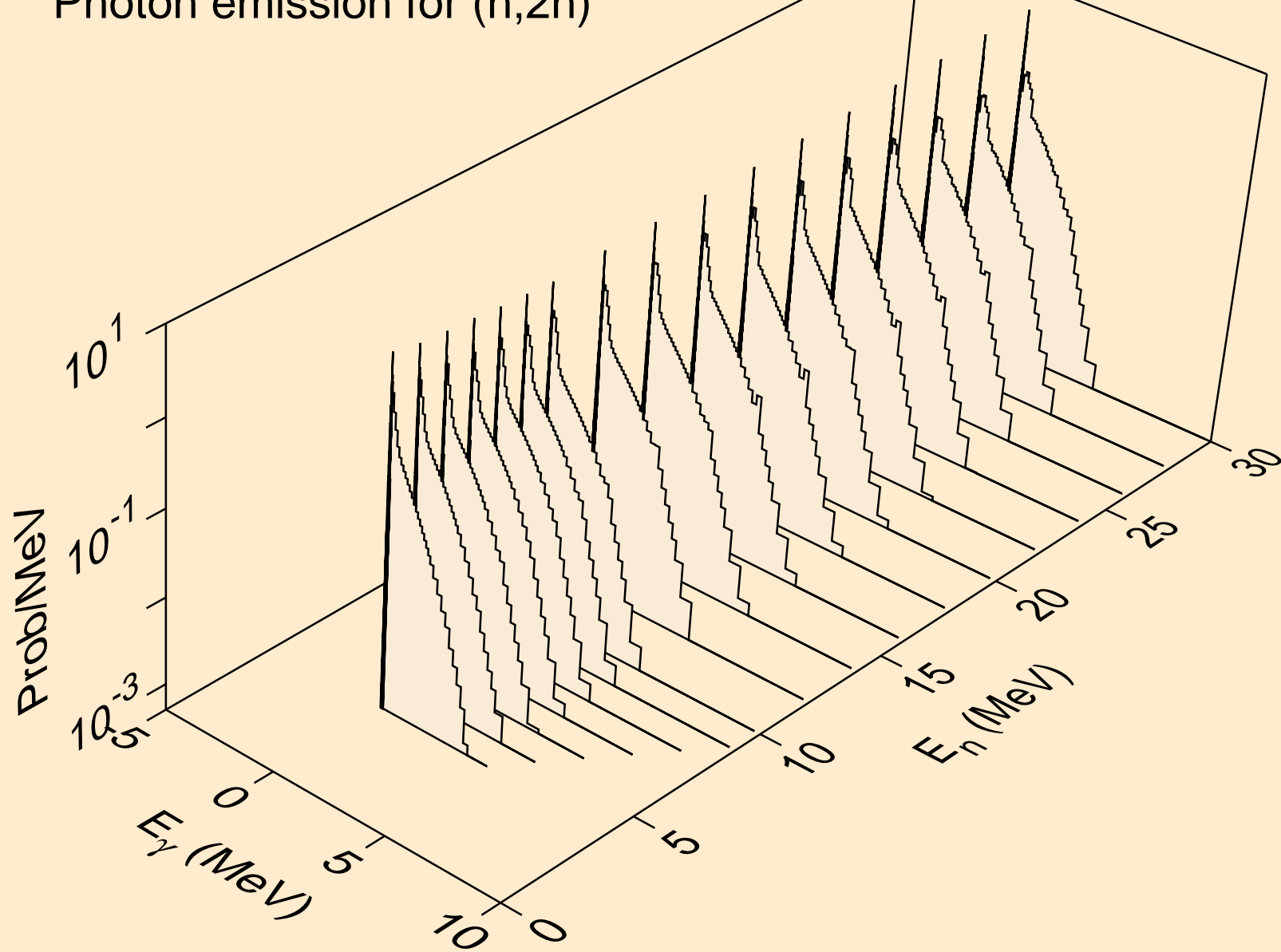

RN227 DEUTERON ACER TENDL-2023 LIBRARY; T=0.K
Photon emission for (n,3n)

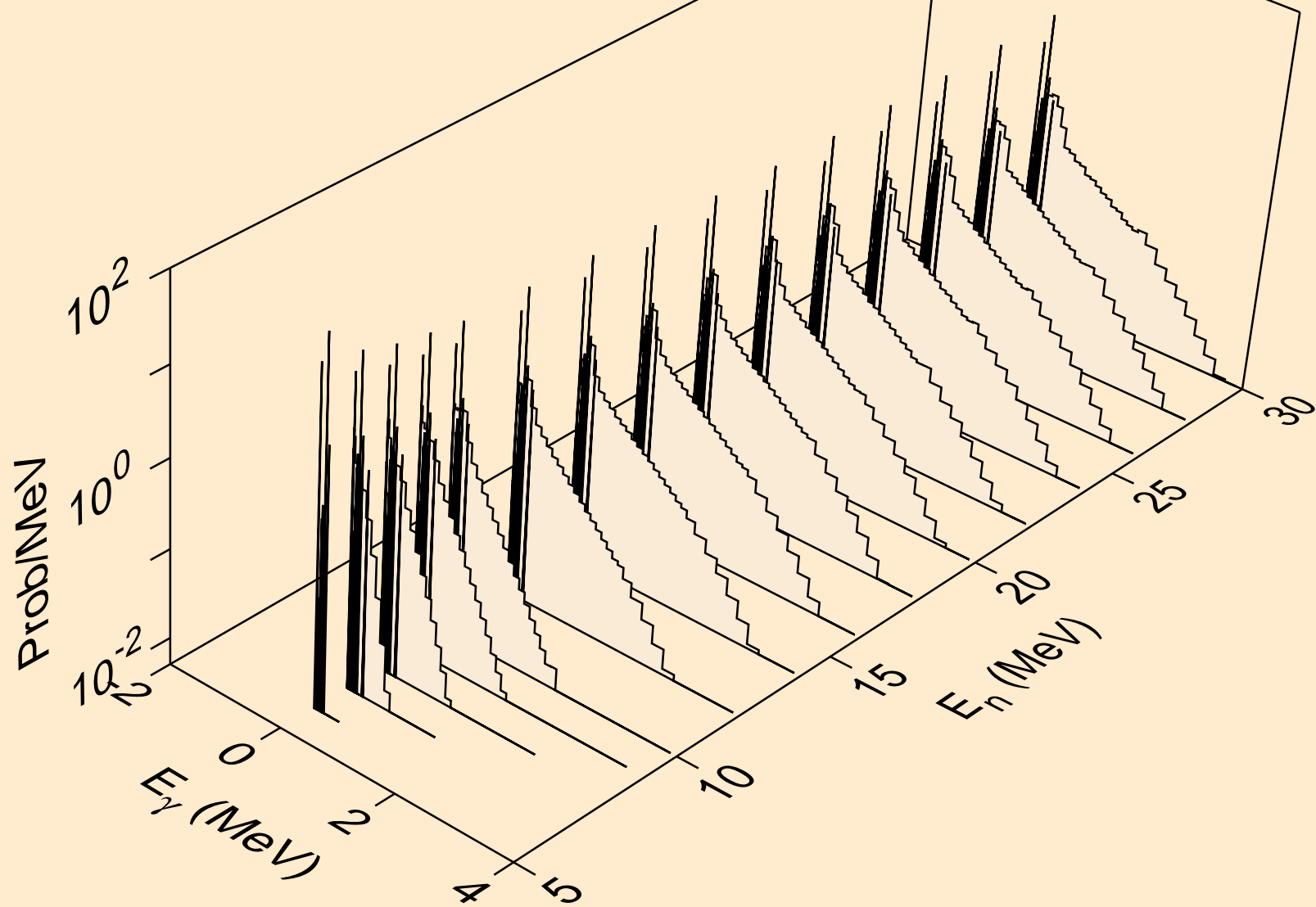

RN227 DEUTERON ACER TENDL-2023 LIBRARY; T=0.K
Photon emission for (n,n*)a

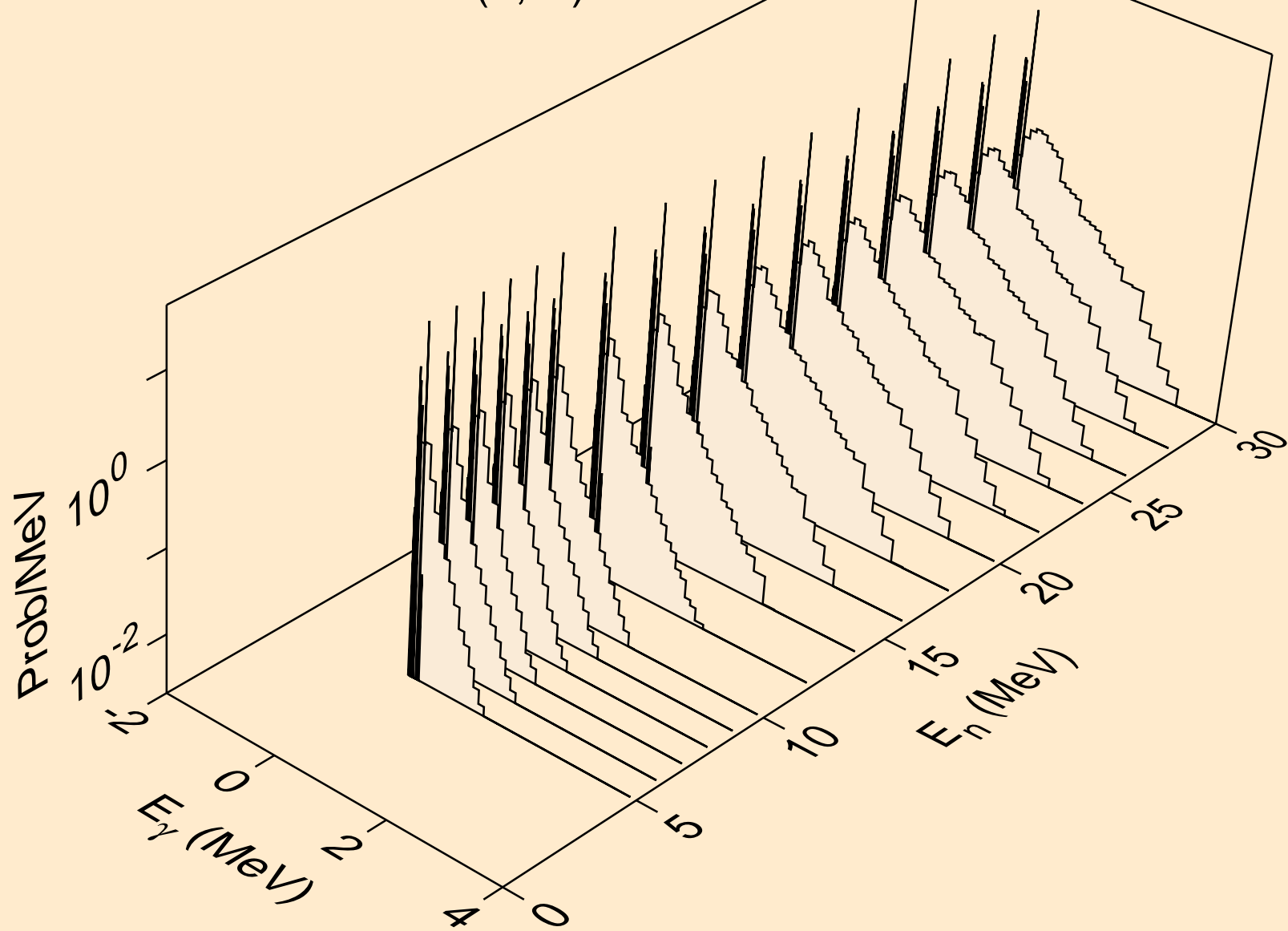

RN227 DEUTERON ACER TENDL-2023 LIBRARY; T=0.K
Photon emission for (n,2n)a

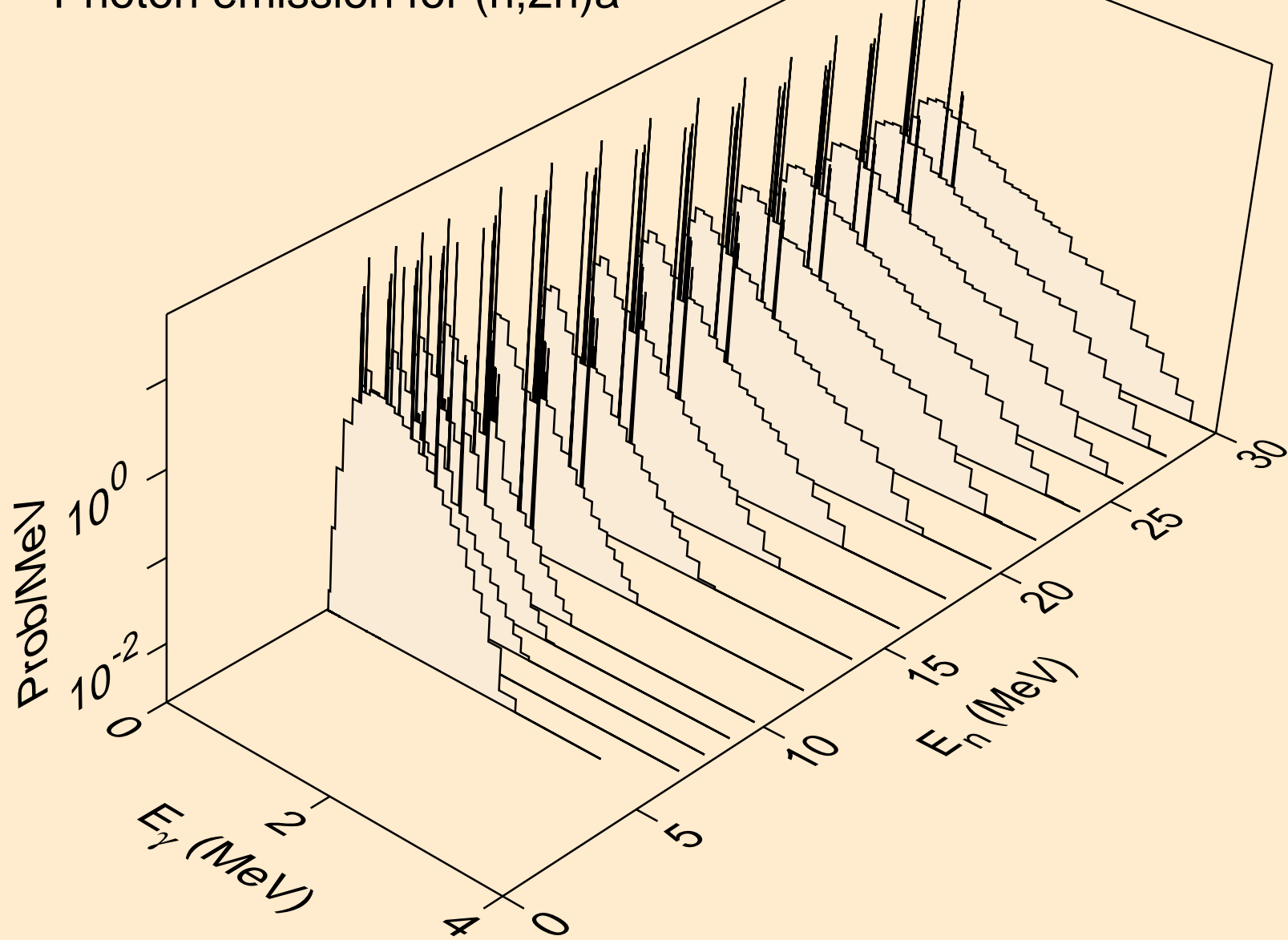

RN227 DEUTERON ACER TENDL-2023 LIBRARY; T=0.K
Photon emission for (n,3n)a

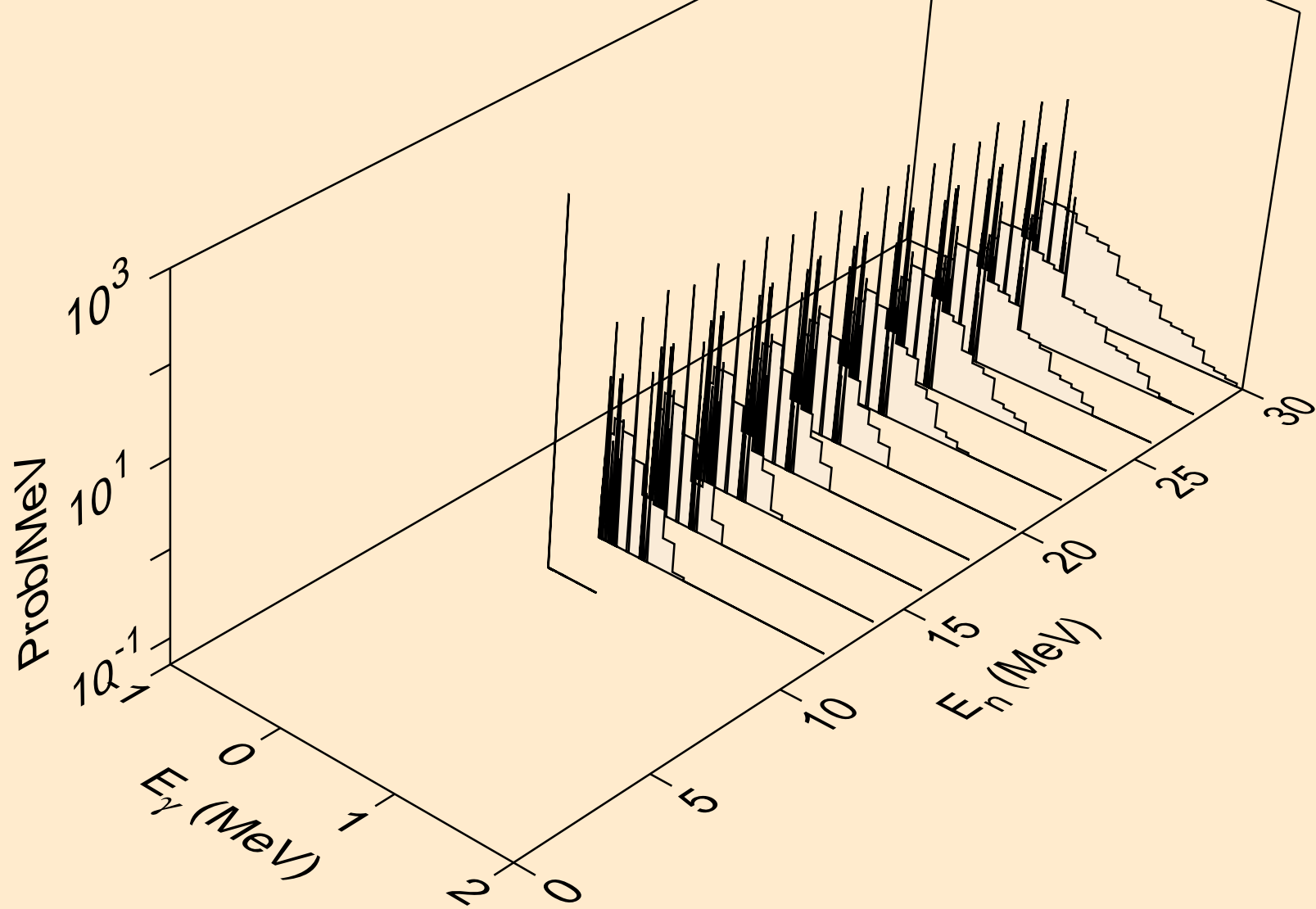

RN227 DEUTERON ACER TENDL-2023 LIBRARY; T=0.K
Photon emission for (n,n*)p

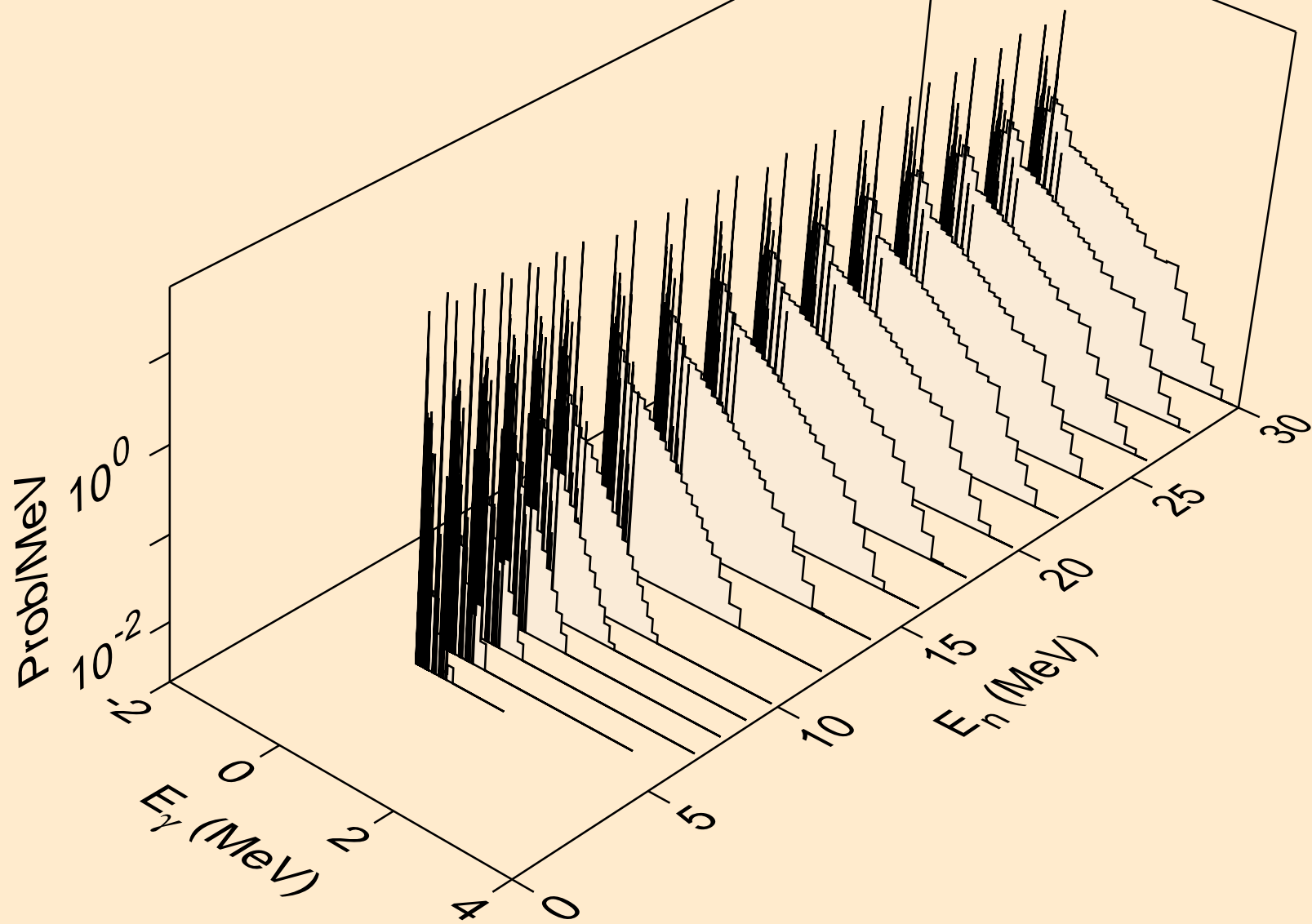

RN227 DEUTERON ACER TENDL-2023 LIBRARY; T=0.K
Photon emission for (n,n*)2a

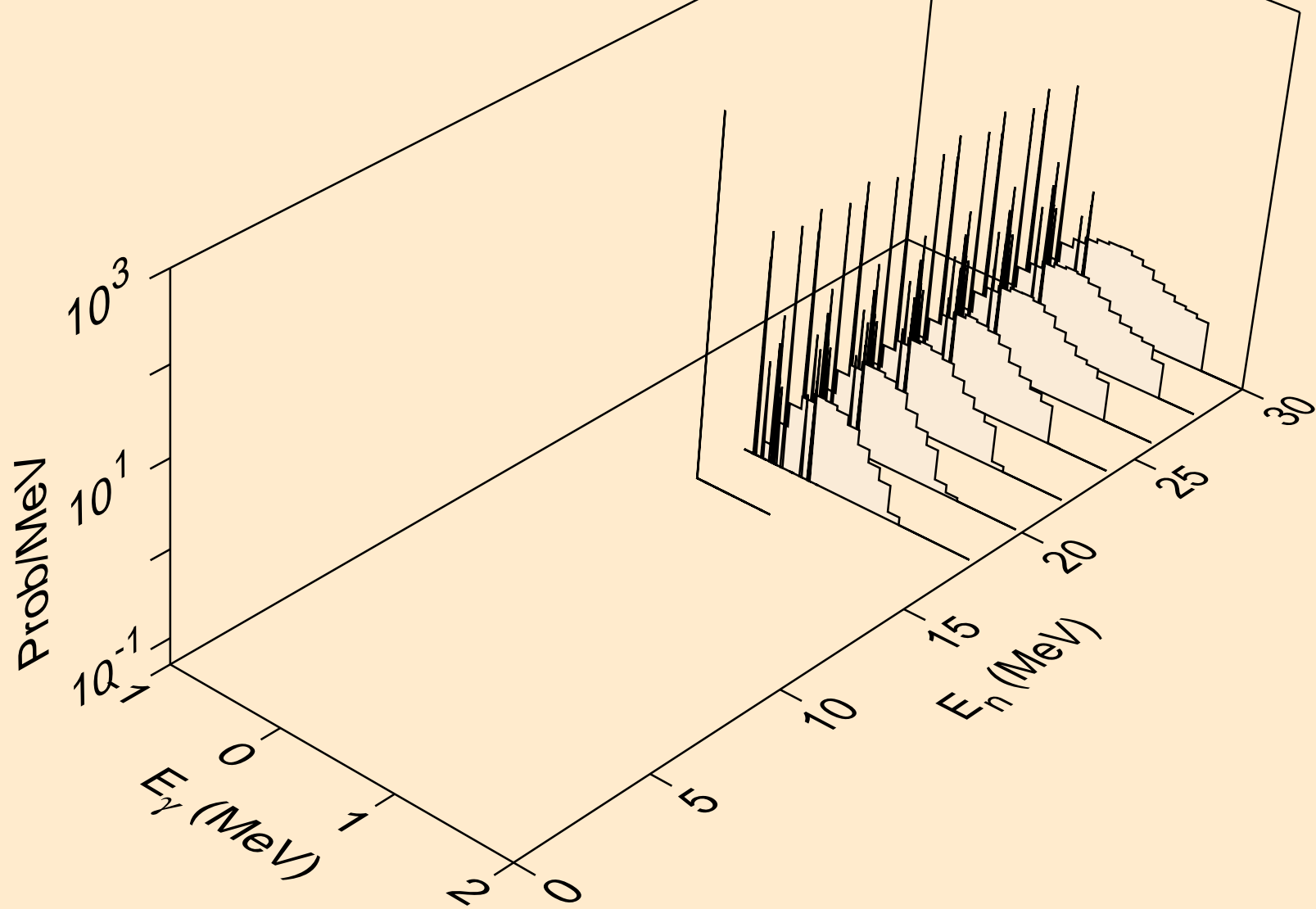

RN227 DEUTERON ACER TENDL-2023 LIBRARY; T=0.K
Photon emission for (n,2n)2a

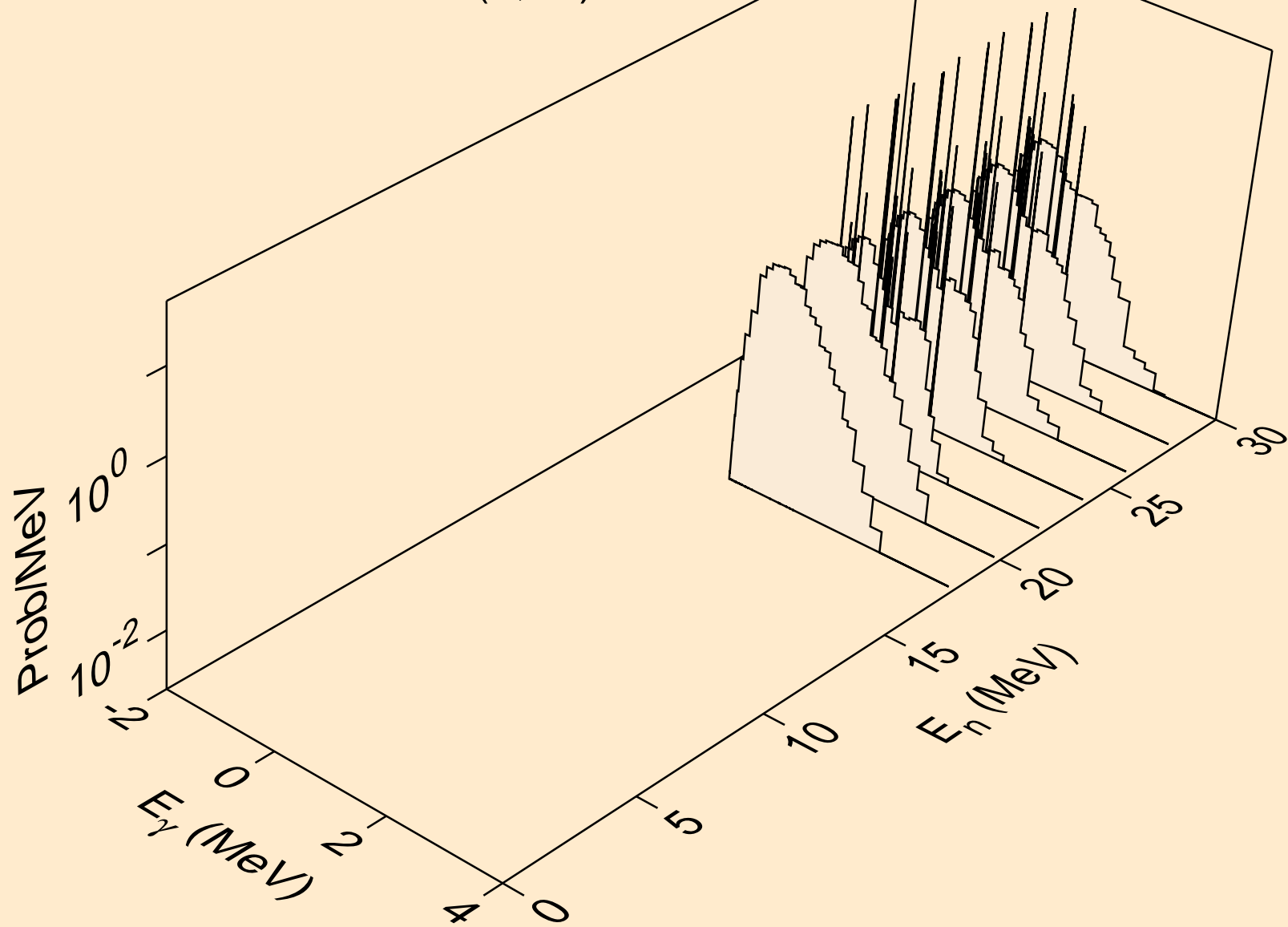

RN227 DEUTERON ACER TENDL-2023 LIBRARY; T=0.K
Photon emission for (n,n*)d

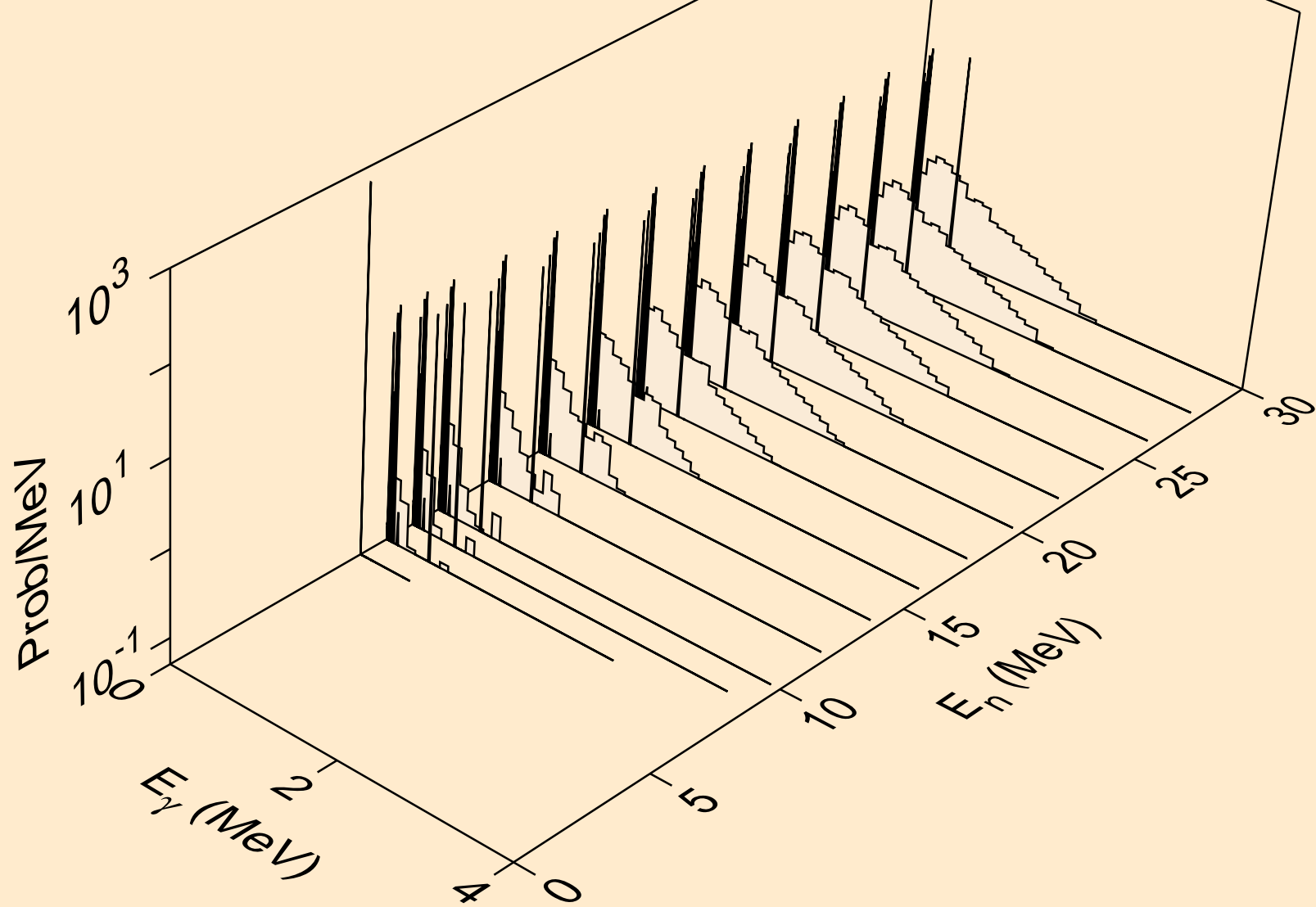

RN227 DEUTERON ACER TENDL-2023 LIBRARY; T=0.K
Photon emission for (n,n*)t

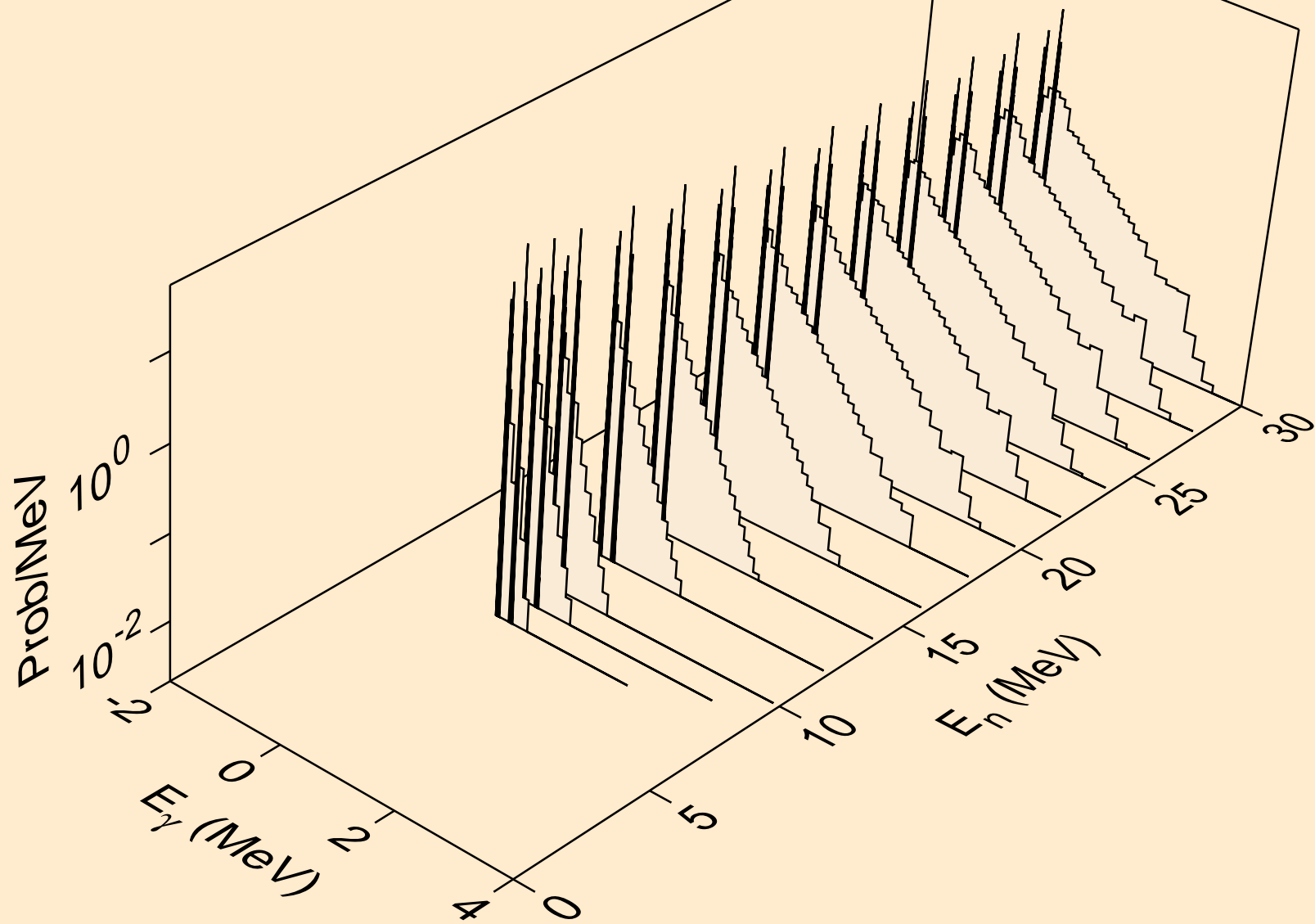

RN227 DEUTERON ACER TENDL-2023 LIBRARY; T=0.K
Photon emission for (n,n*)he3

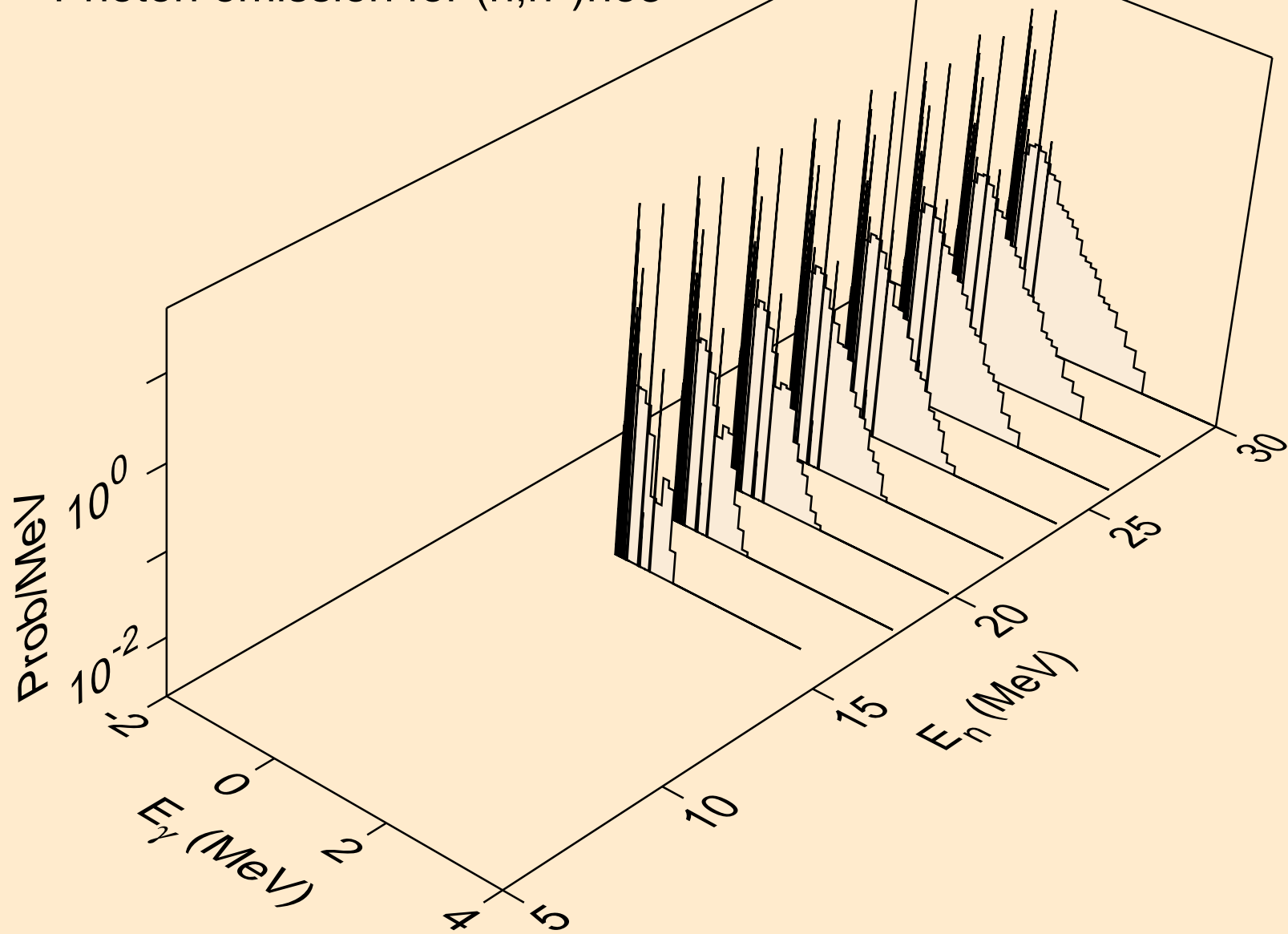

RN227 DEUTERON ACER TENDL-2023 LIBRARY; T=0.K
Photon emission for (n,4n)

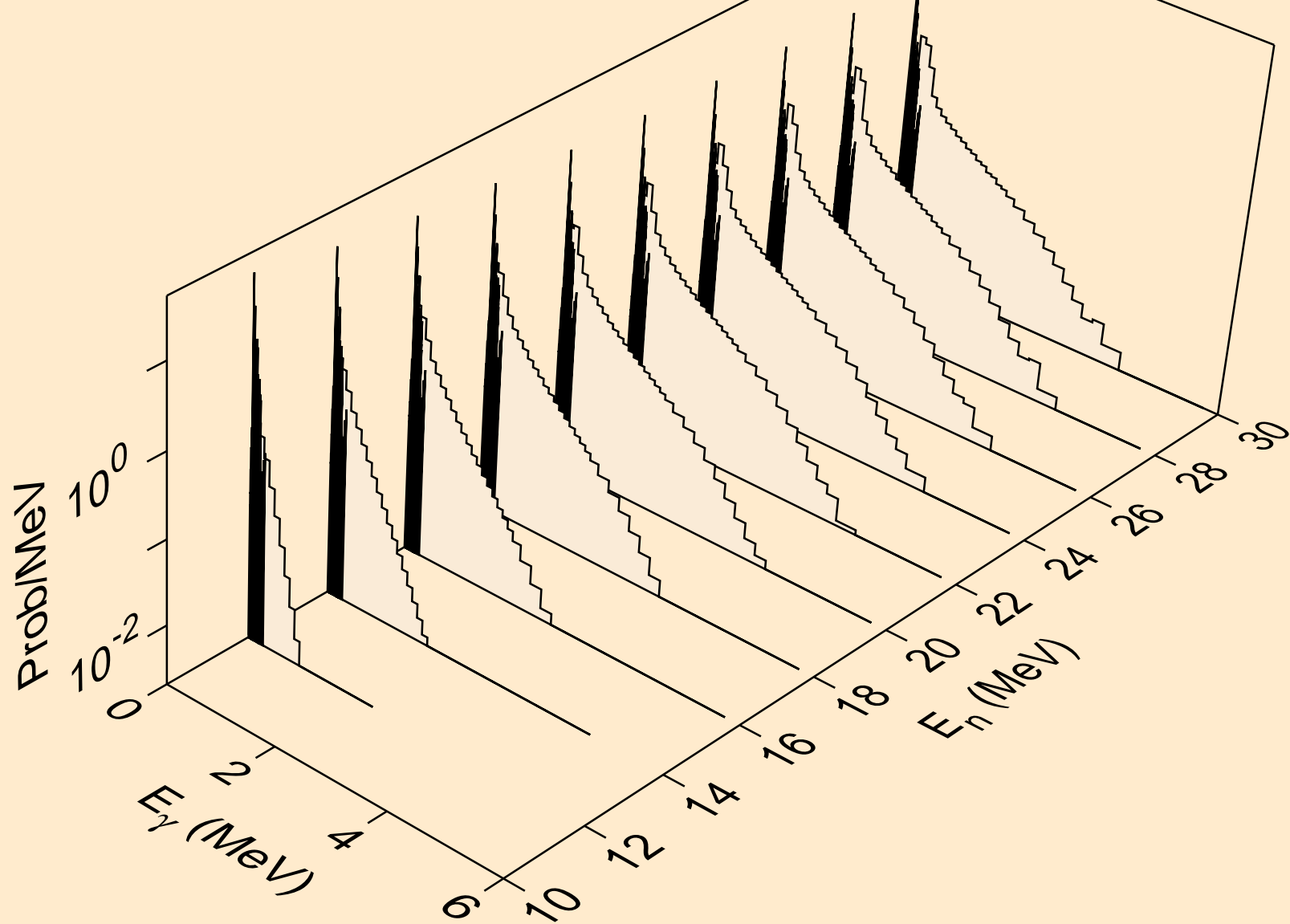

RN227 DEUTERON ACER TENDL-2023 LIBRARY; T=0.K
Photon emission for (n,2np)

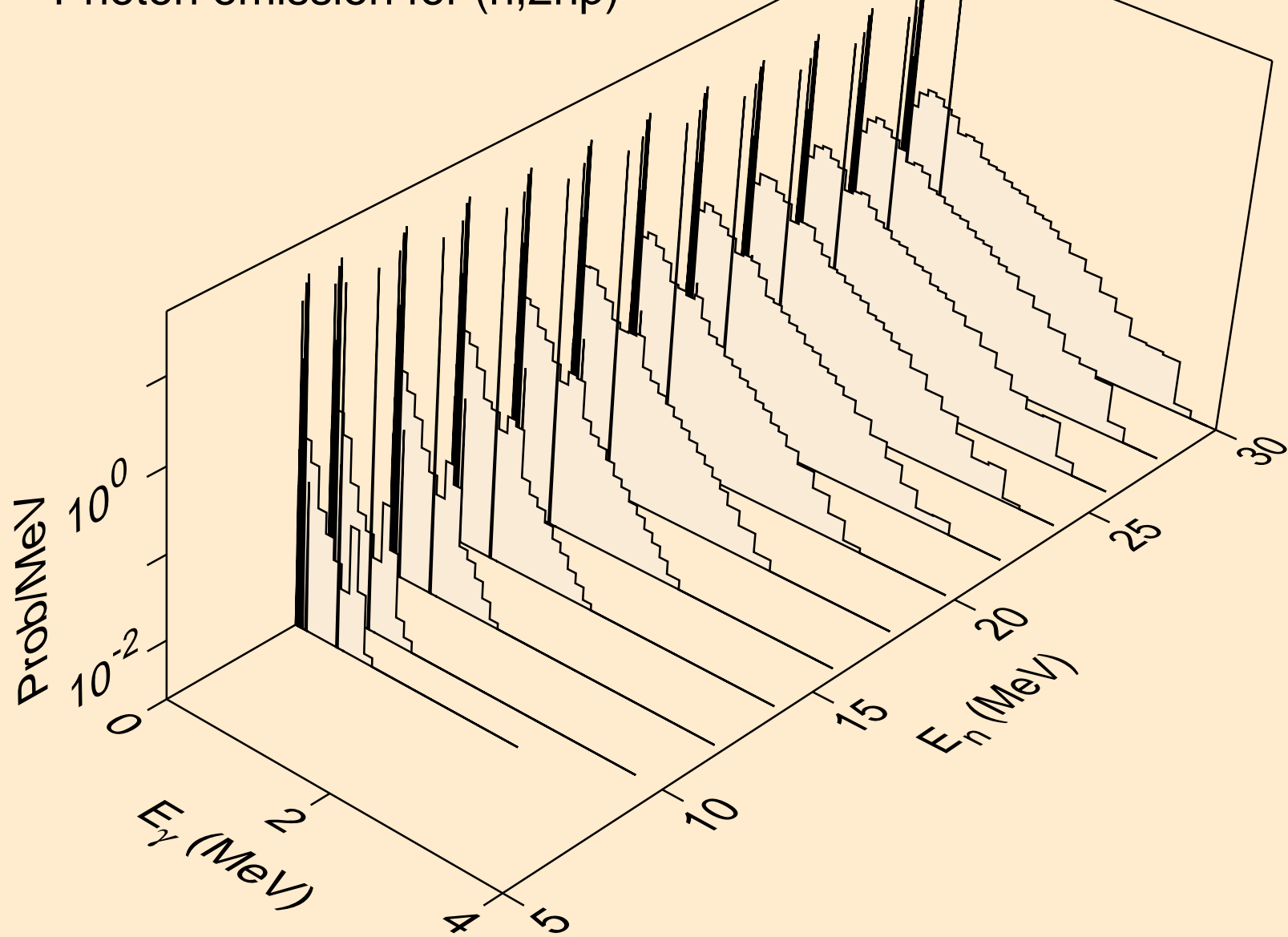

RN227 DEUTERON ACER TENDL-2023 LIBRARY; T=0.K
Photon emission for (n,3np)

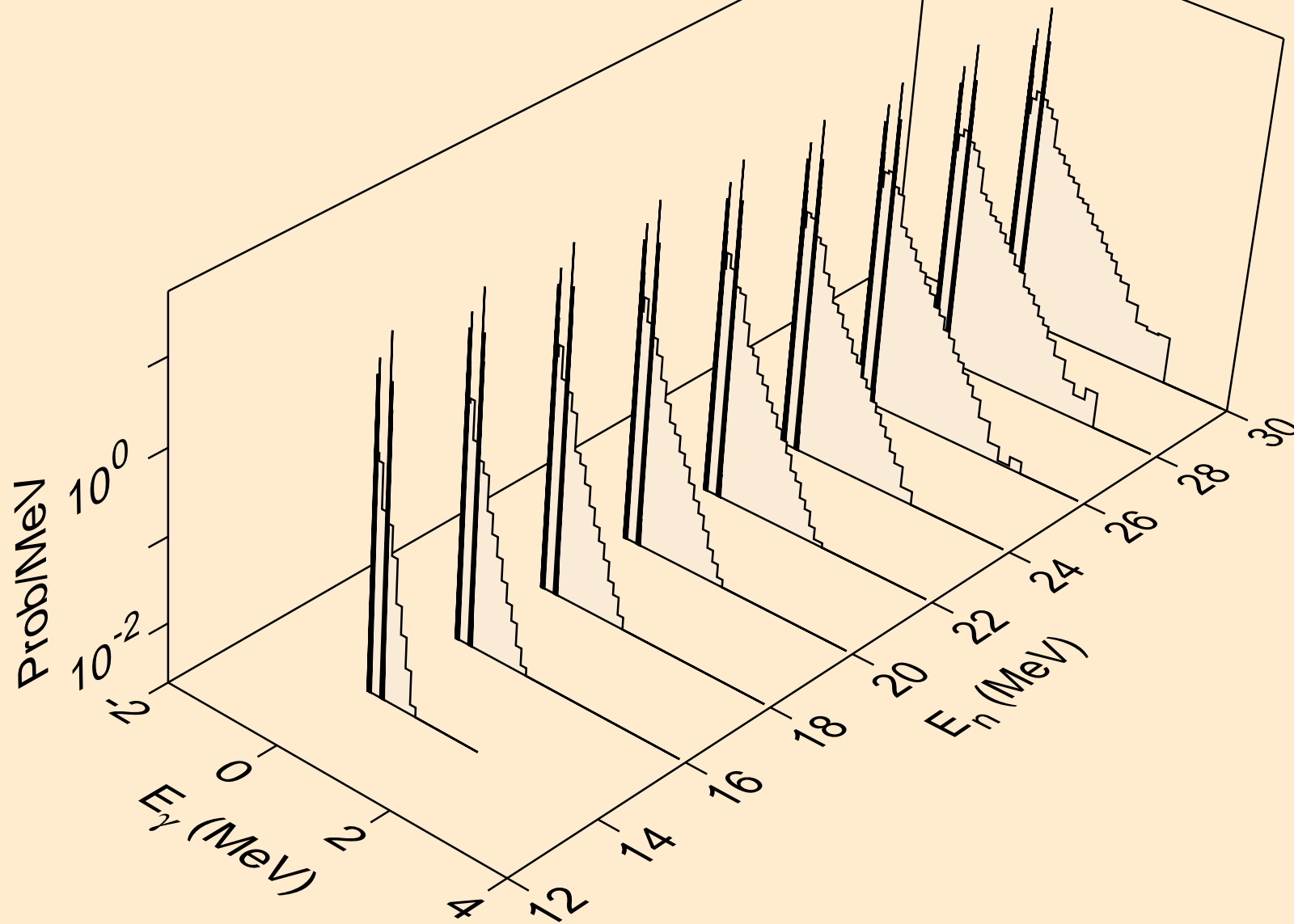

RN227 DEUTERON ACER TENDL-2023 LIBRARY; T=0.K
Photon emission for (n,n2p)

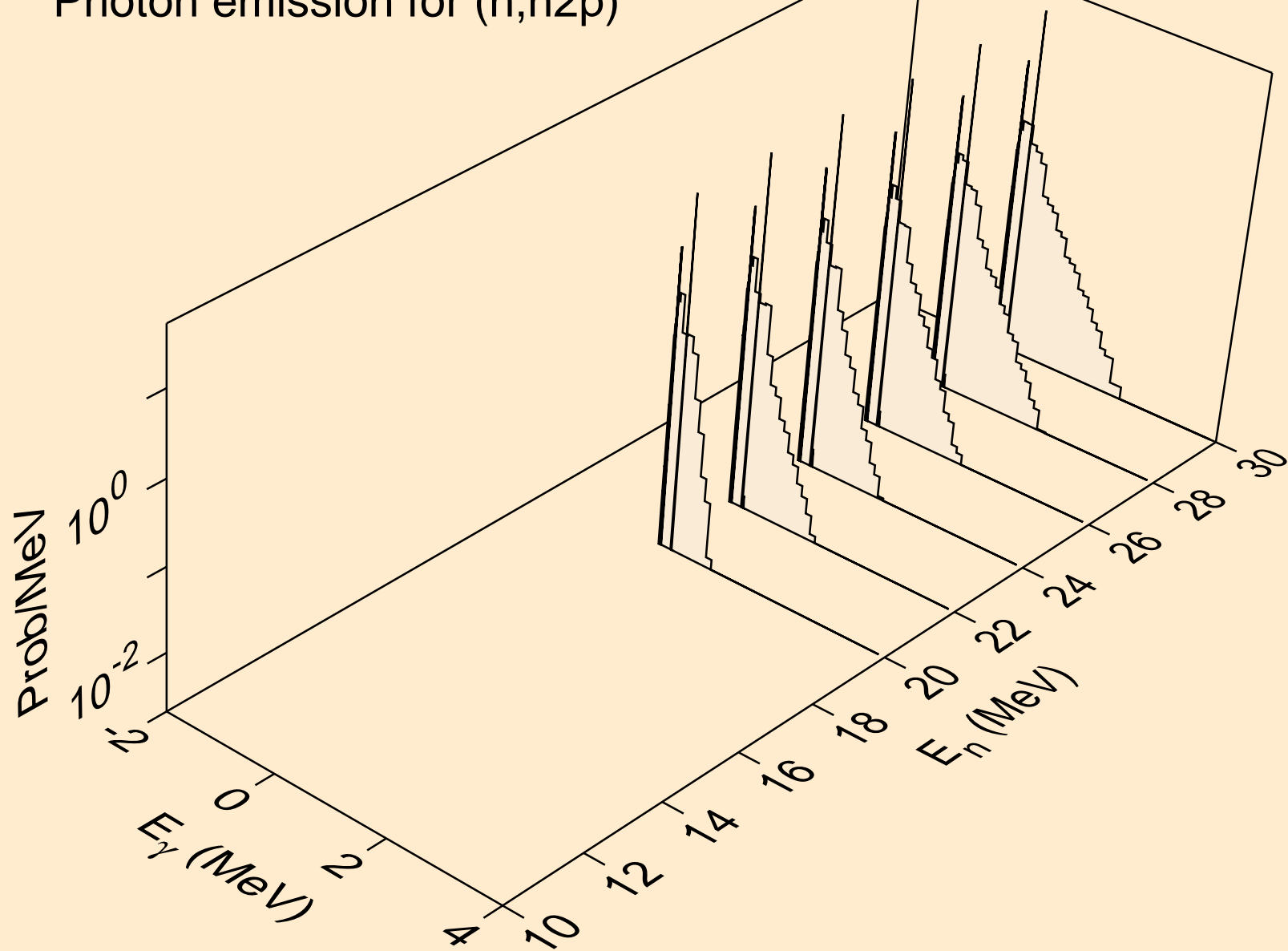

RN227 DEUTERON ACER TENDL-2023 LIBRARY; T=0.K
Photon emission for (n,npa)

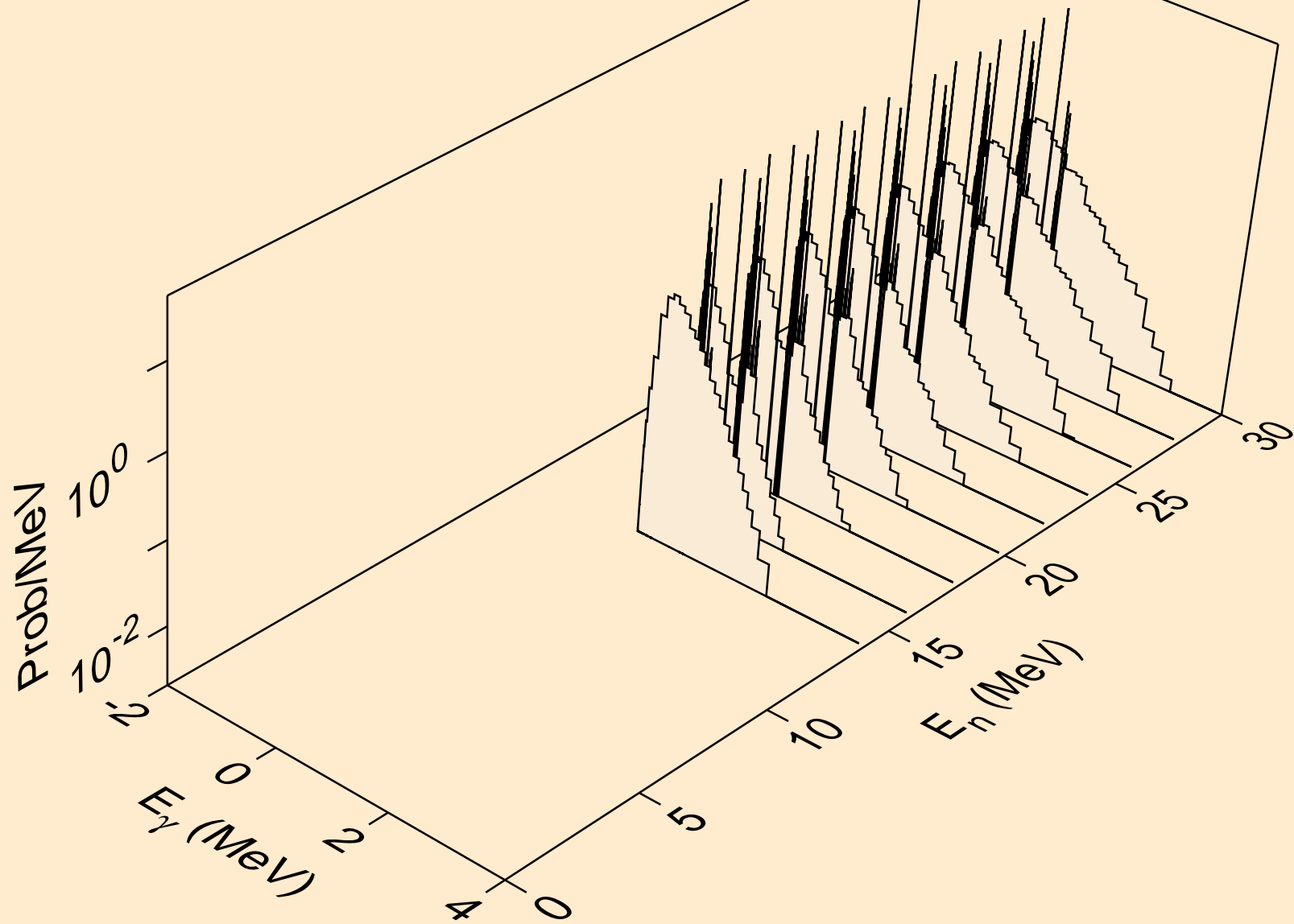

RN227 DEUTERON ACER TENDL-2023 LIBRARY; T=0.K
Photon emission for (n,gma)

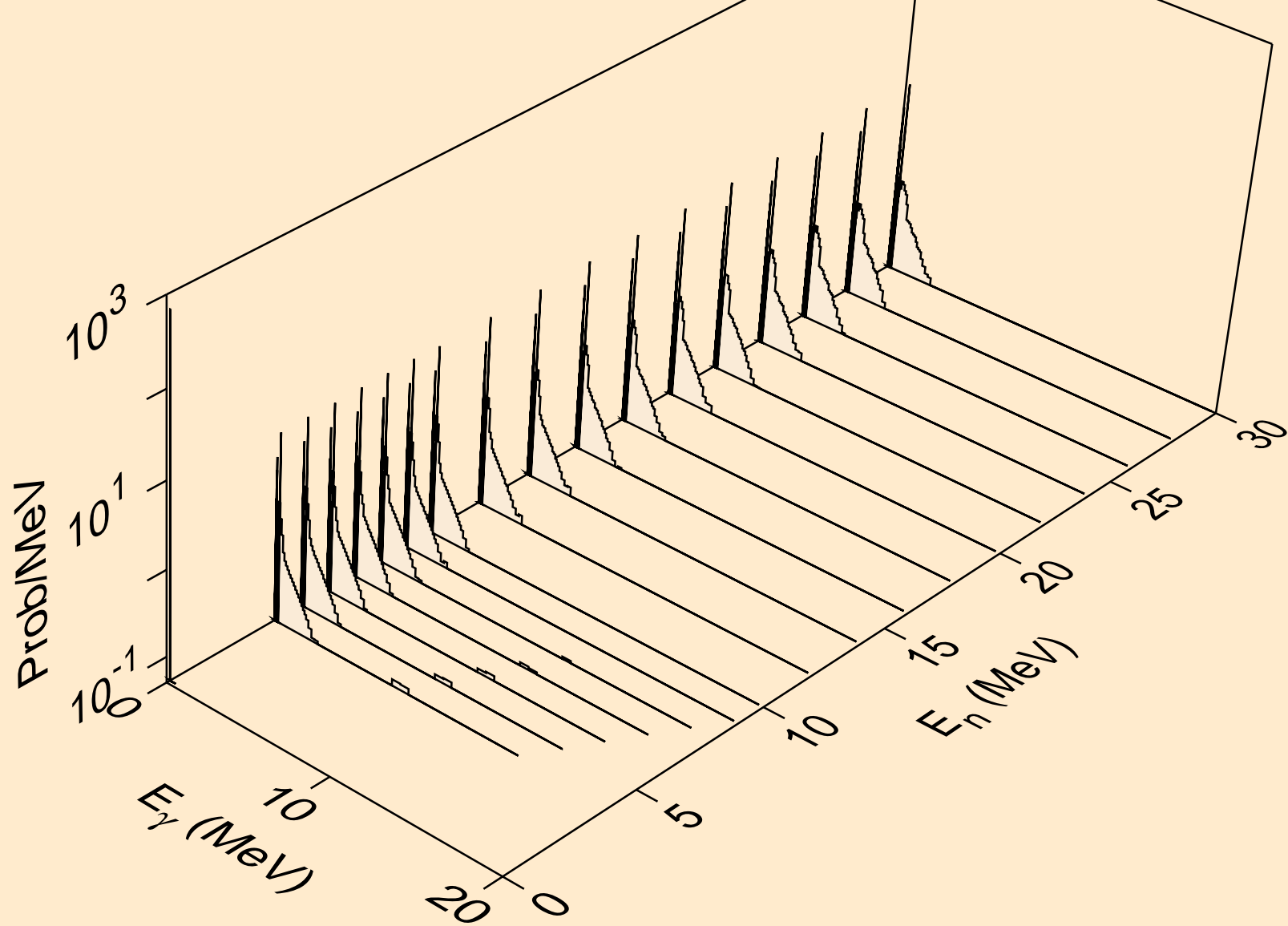

RN227 DEUTERON ACER TENDL-2023 LIBRARY; T=0.K
Photon emission for (n,p)

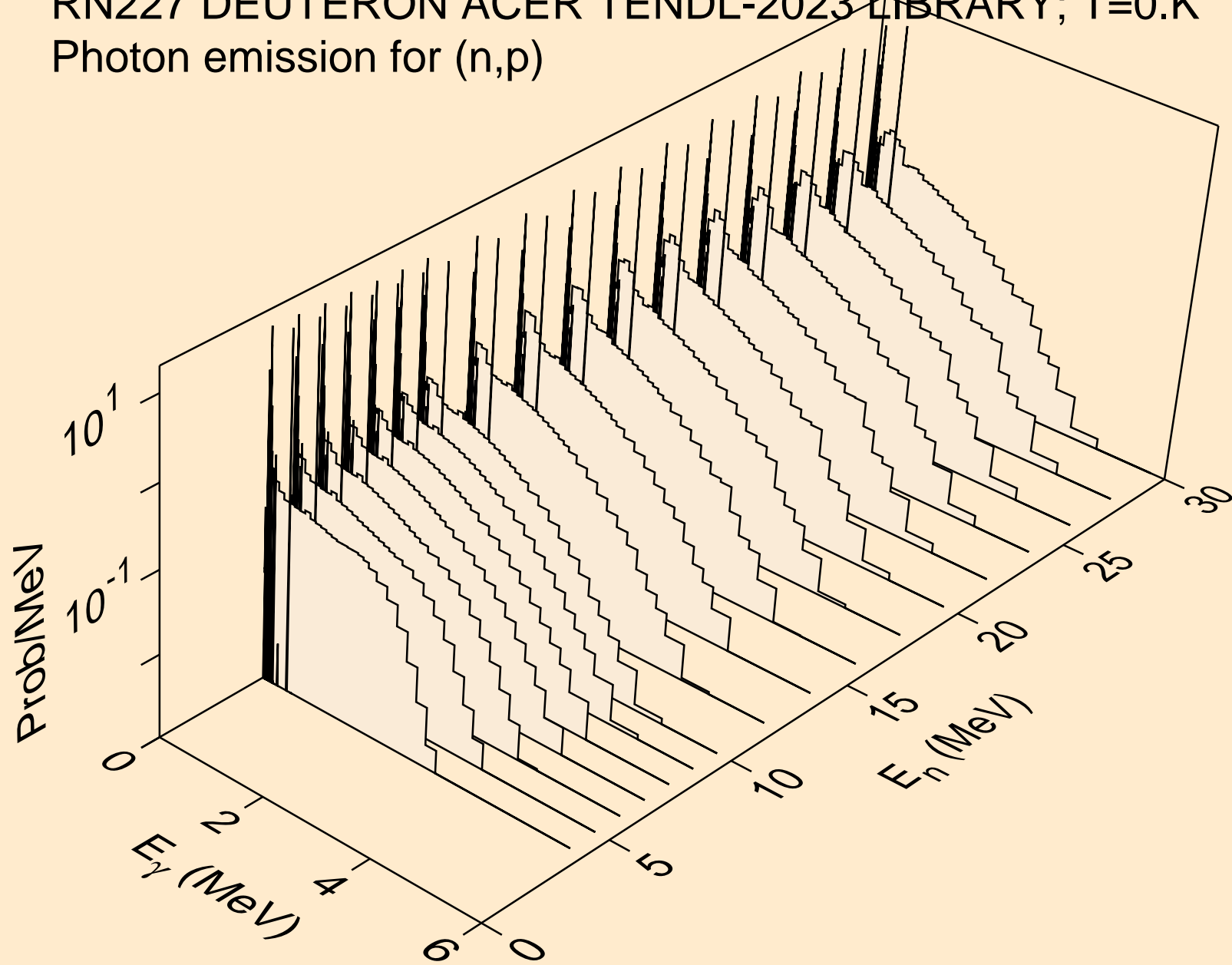

RN227 DEUTERON ACER TENDL-2023 LIBRARY; T=0.K
Photon emission for inelastic

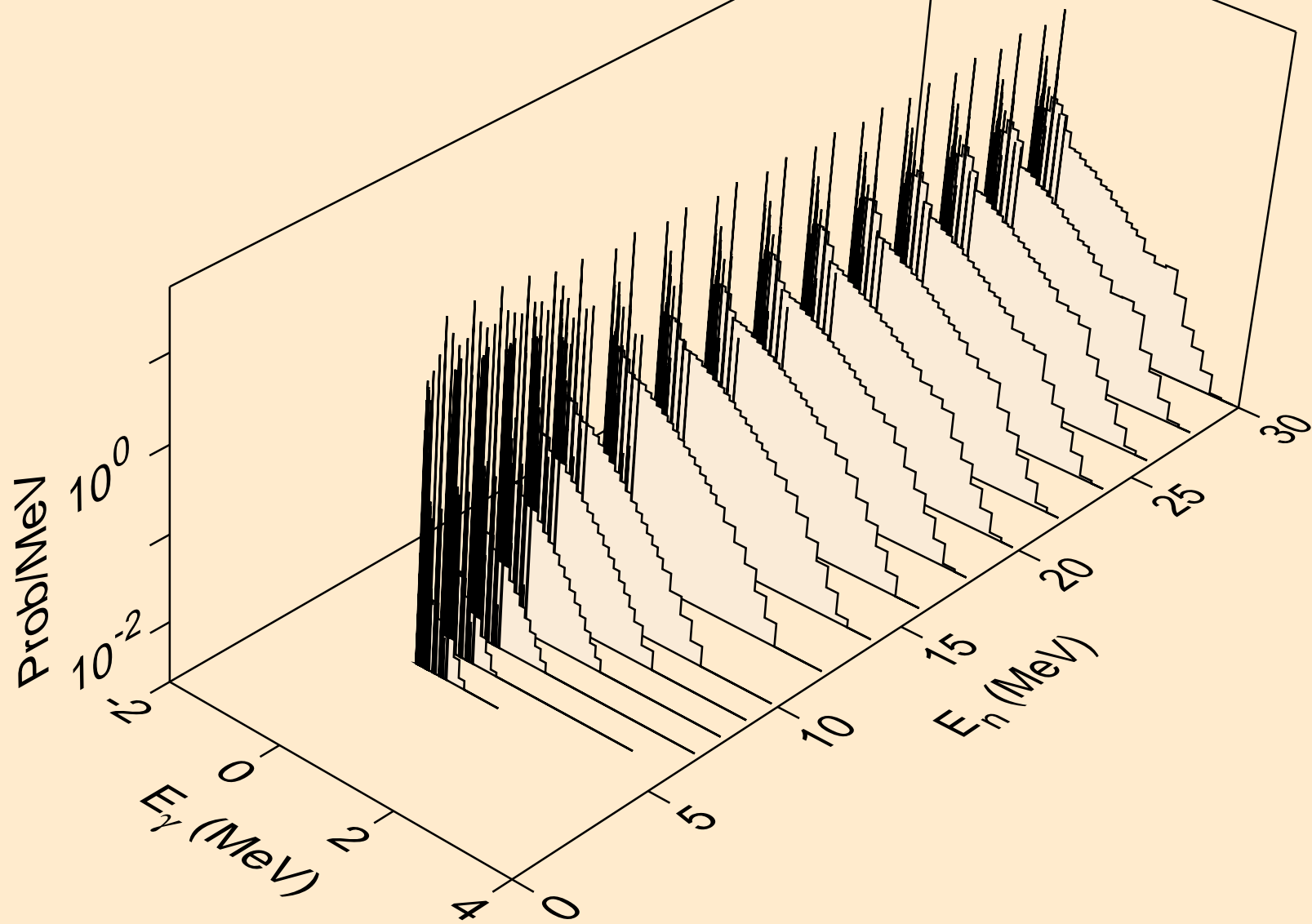

RN227 DEUTERON ACER TENDL-2023 LIBRARY; T=0.K
Photon emission for (n,t)

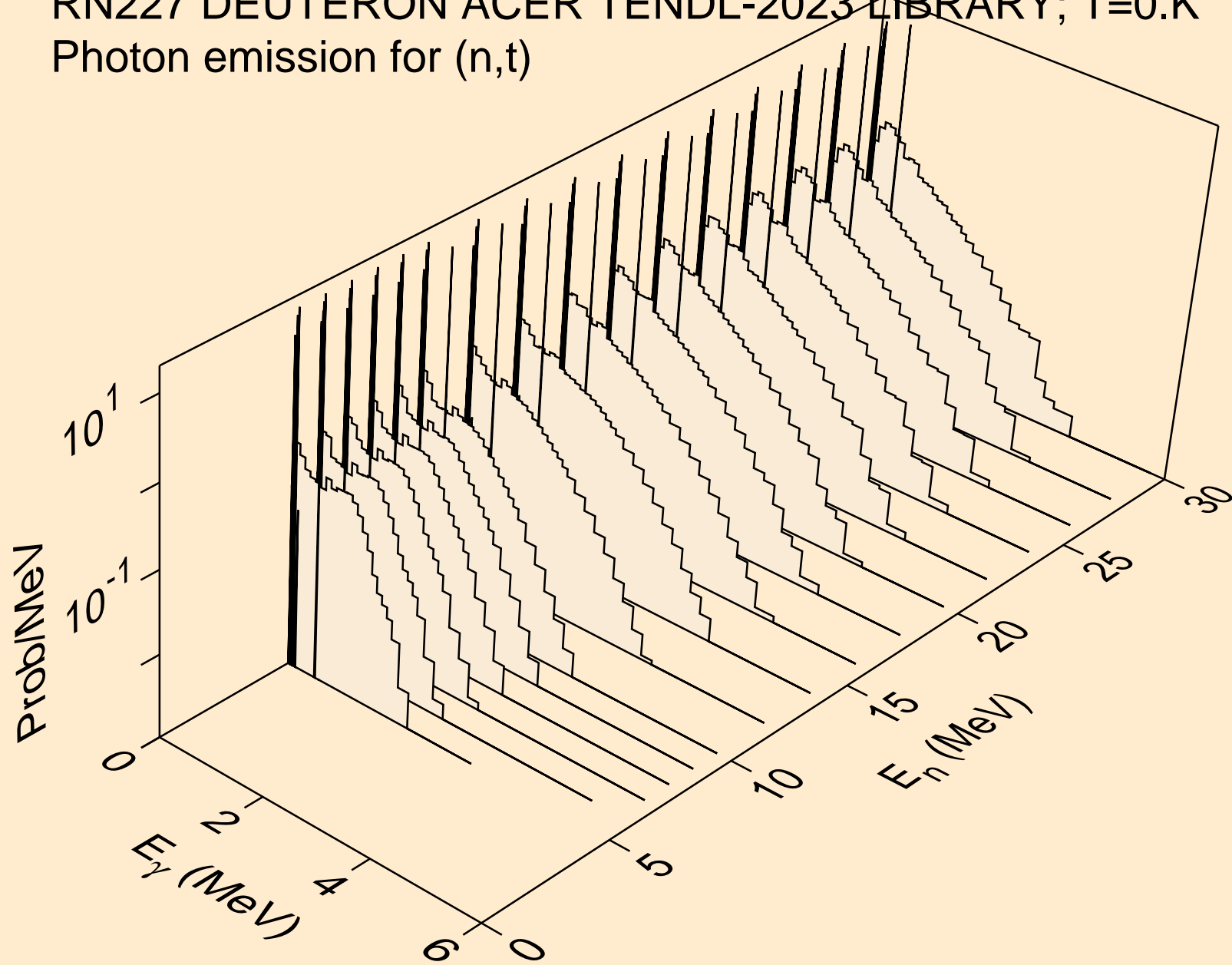

RN227 DEUTERON ACER TENDL-2023 LIBRARY; T=0.K
Photon emission for (n,he3)

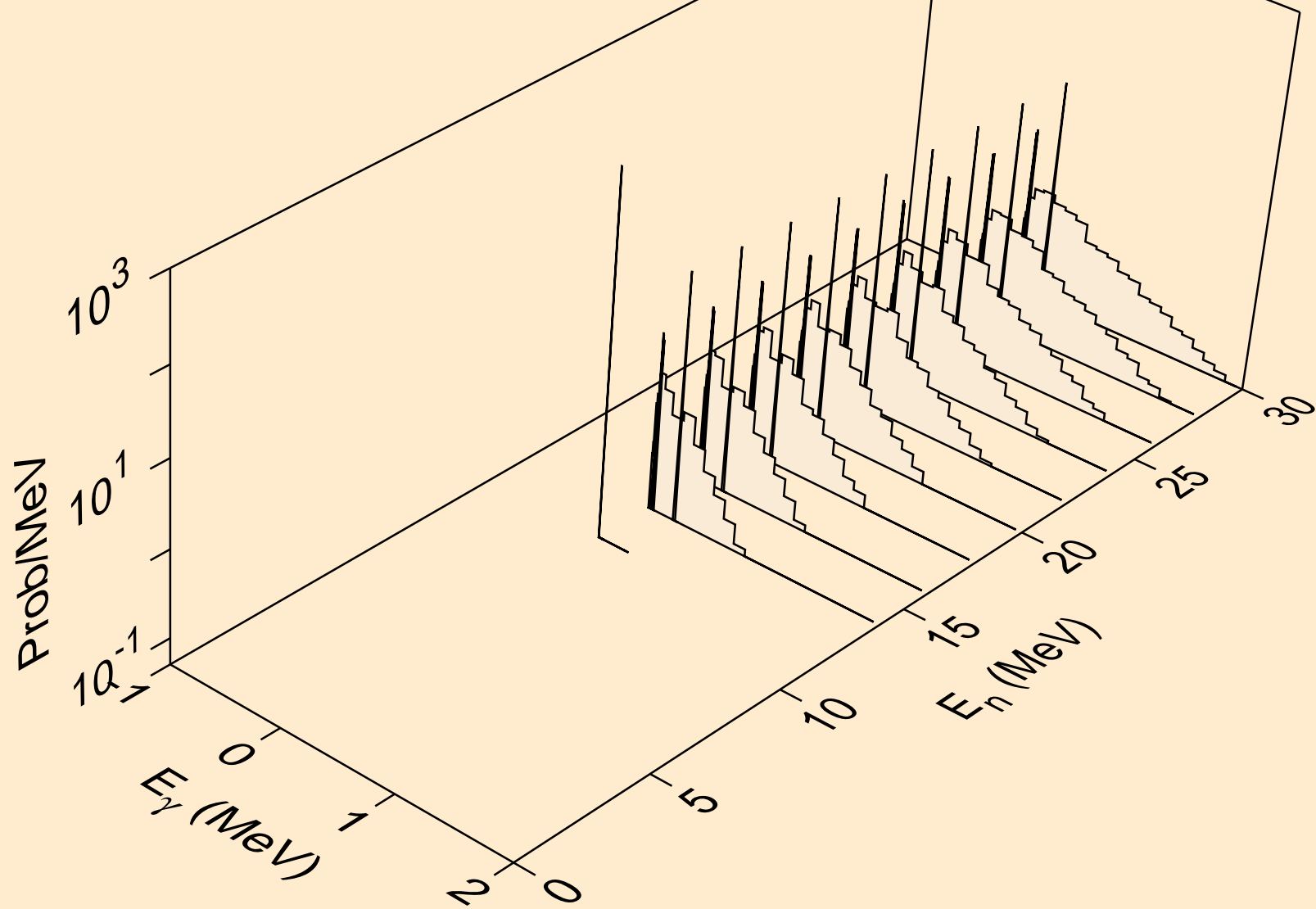

RN227 DEUTERON ACER TENDL-2023 LIBRARY; T=0.K
Photon emission for (n,a)

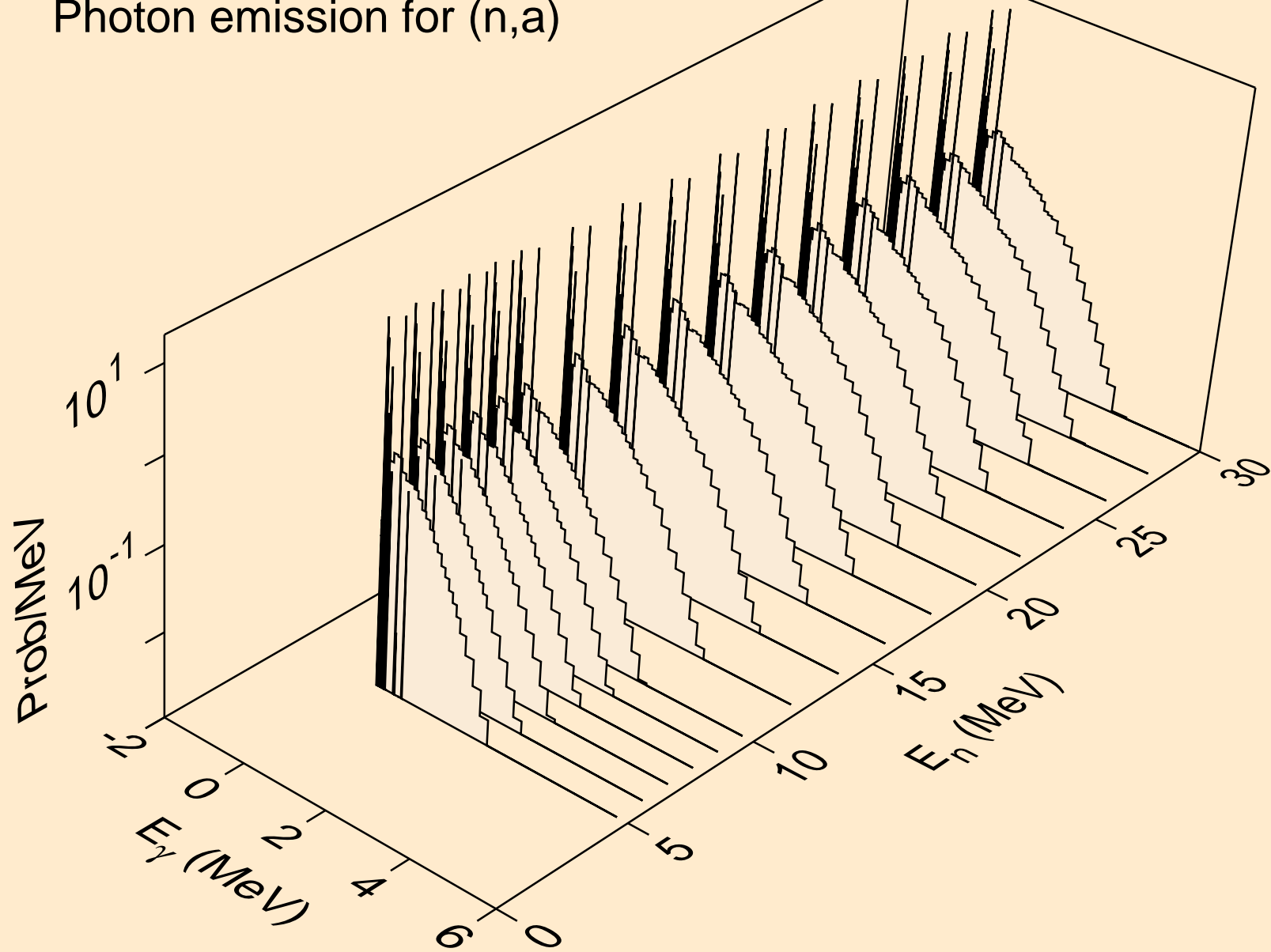

RN227 DEUTERON ACER TENDL-2023 LIBRARY; T=0.K
Photon emission for (n,2p)

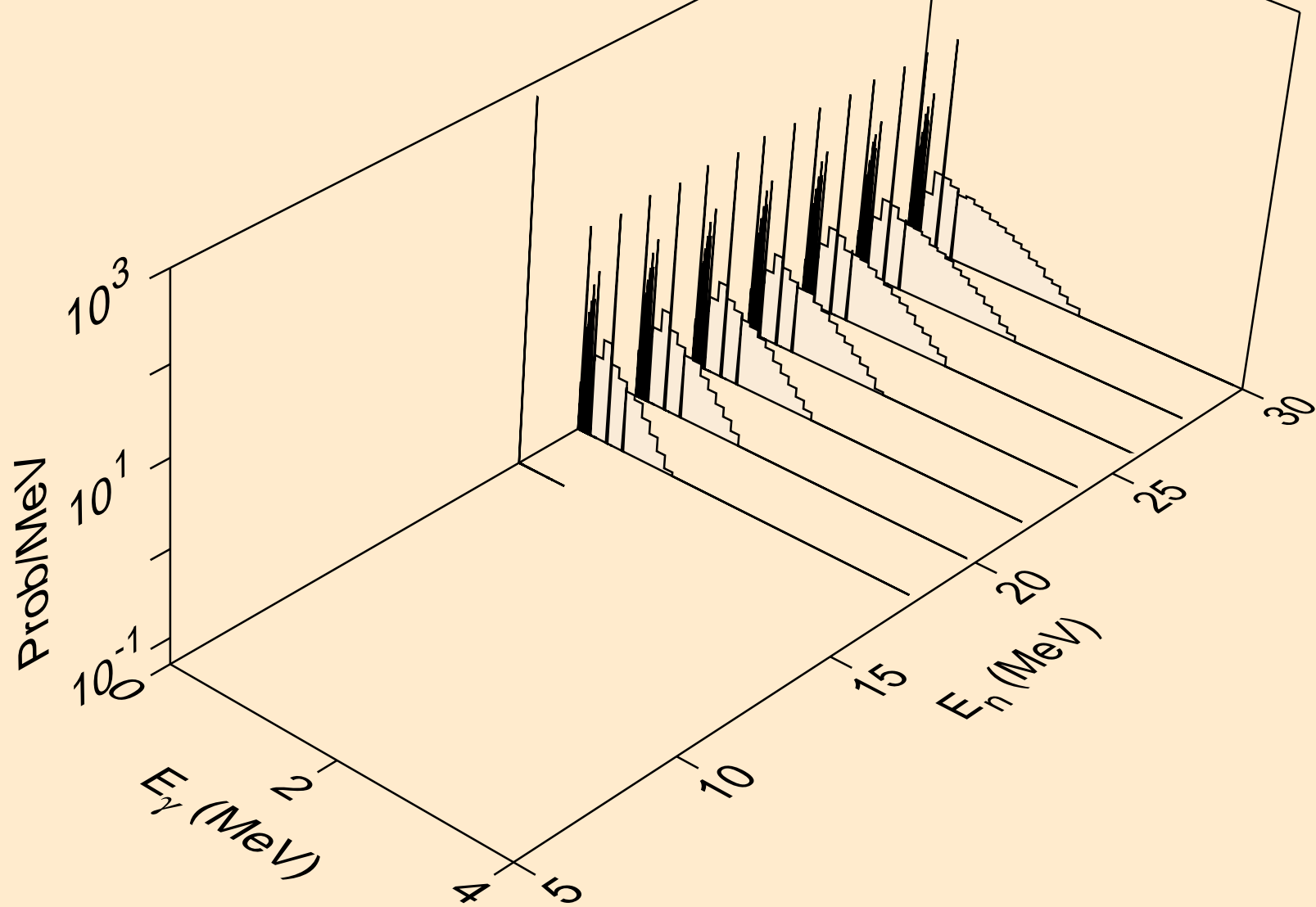

RN227 DEUTERON ACER TENDL-2023 LIBRARY; T=0.K
Photon emission for (n,pd)

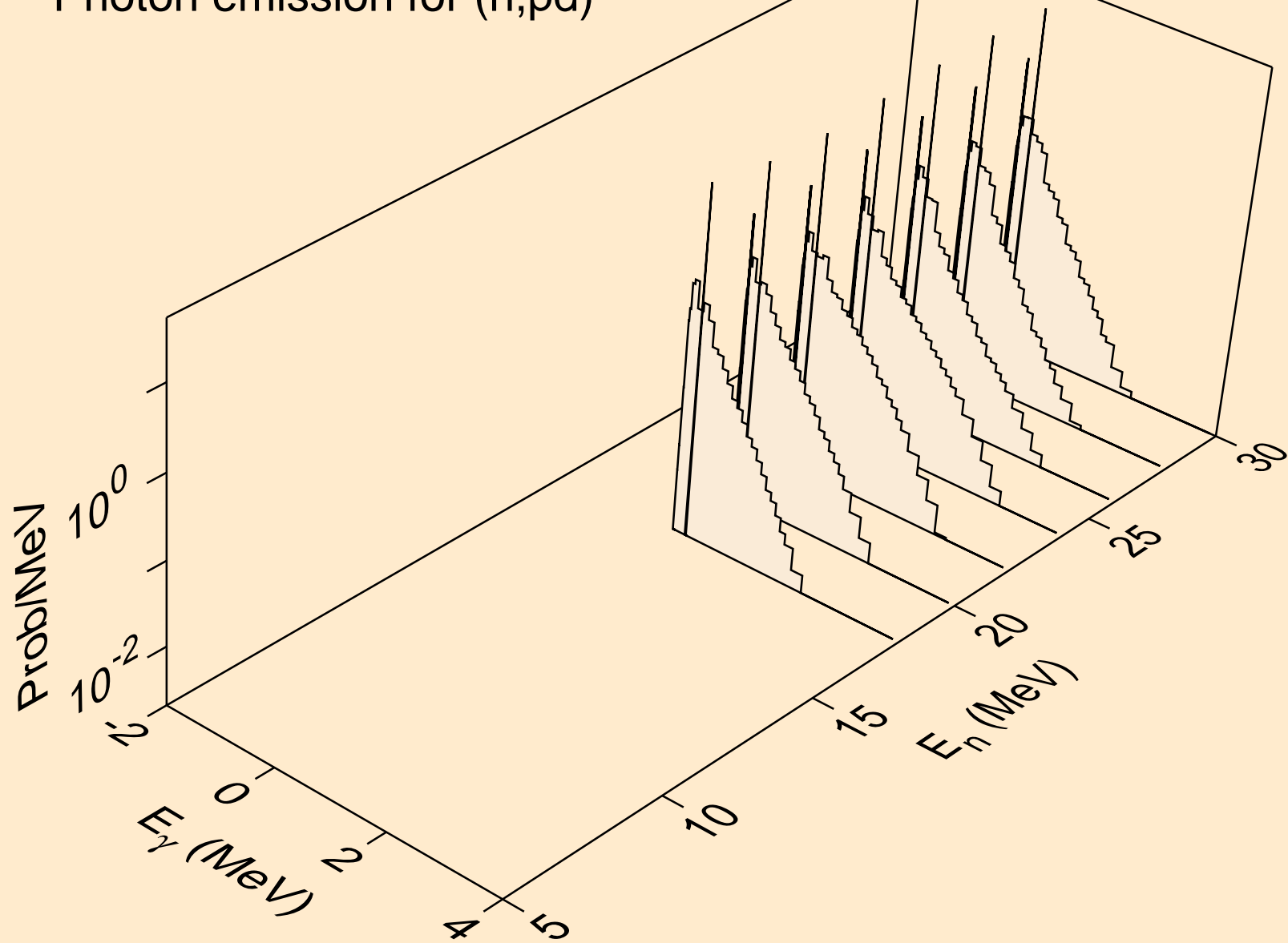

RN227 DEUTERON ACER TENDL-2023 LIBRARY; T=0.K
Particle heating contributions

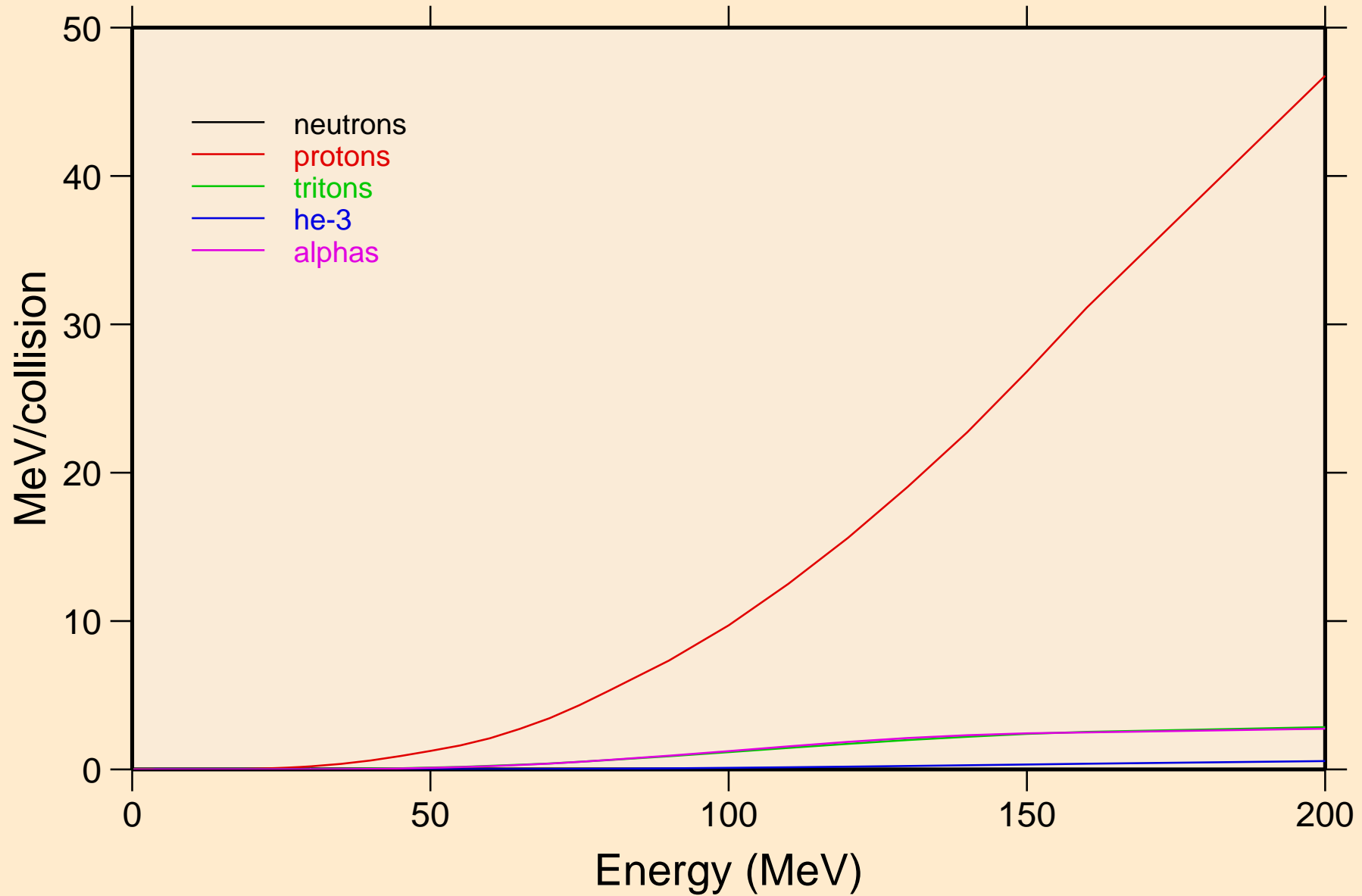

RN227 DEUTERON ACER TENDL-2023 LIBRARY; T=0.K
Recoil Heating

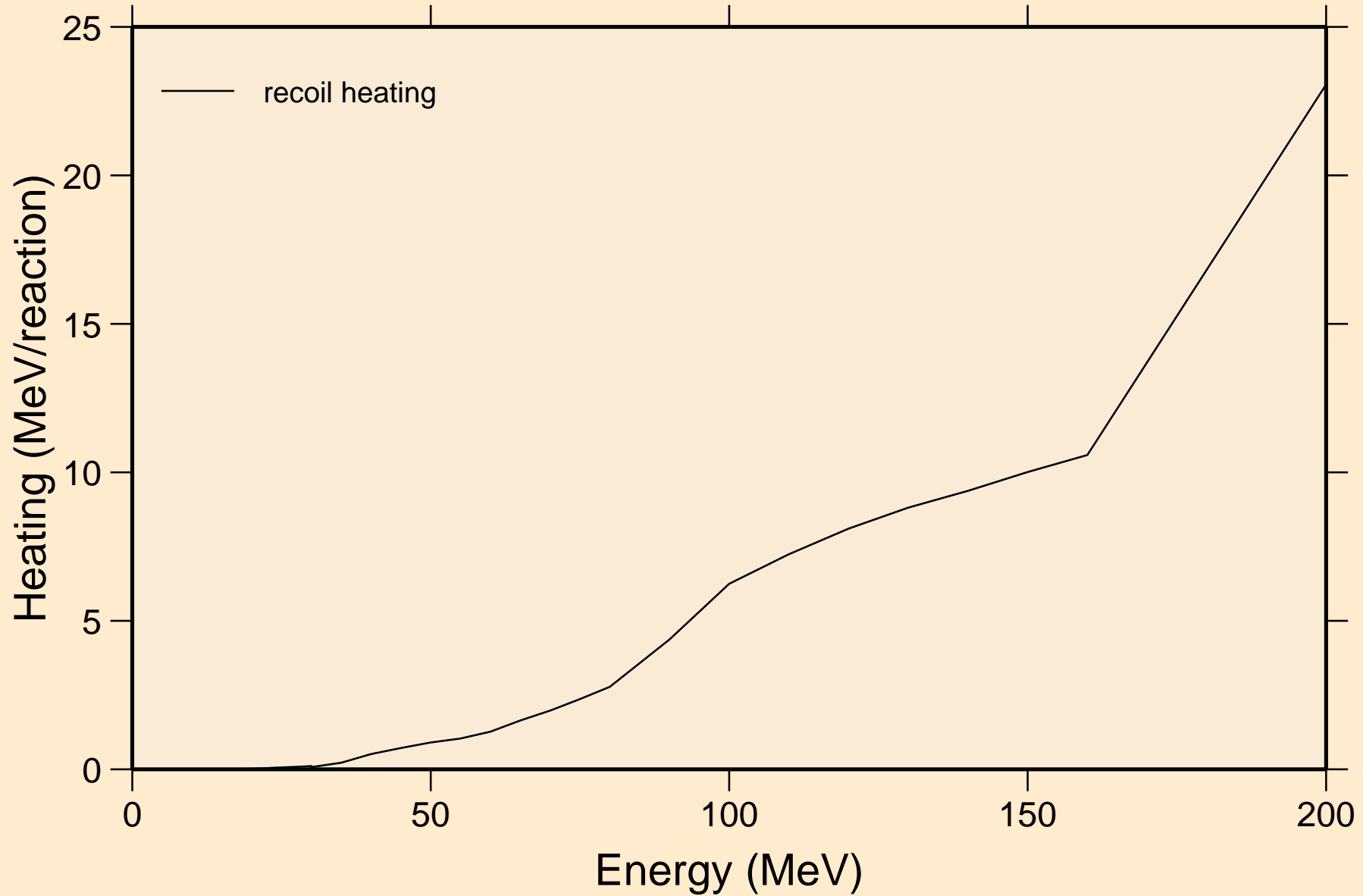

RN227 DEUTERON ACER TENDL-2023 LIBRARY; T=0.K

Particle production cross sections

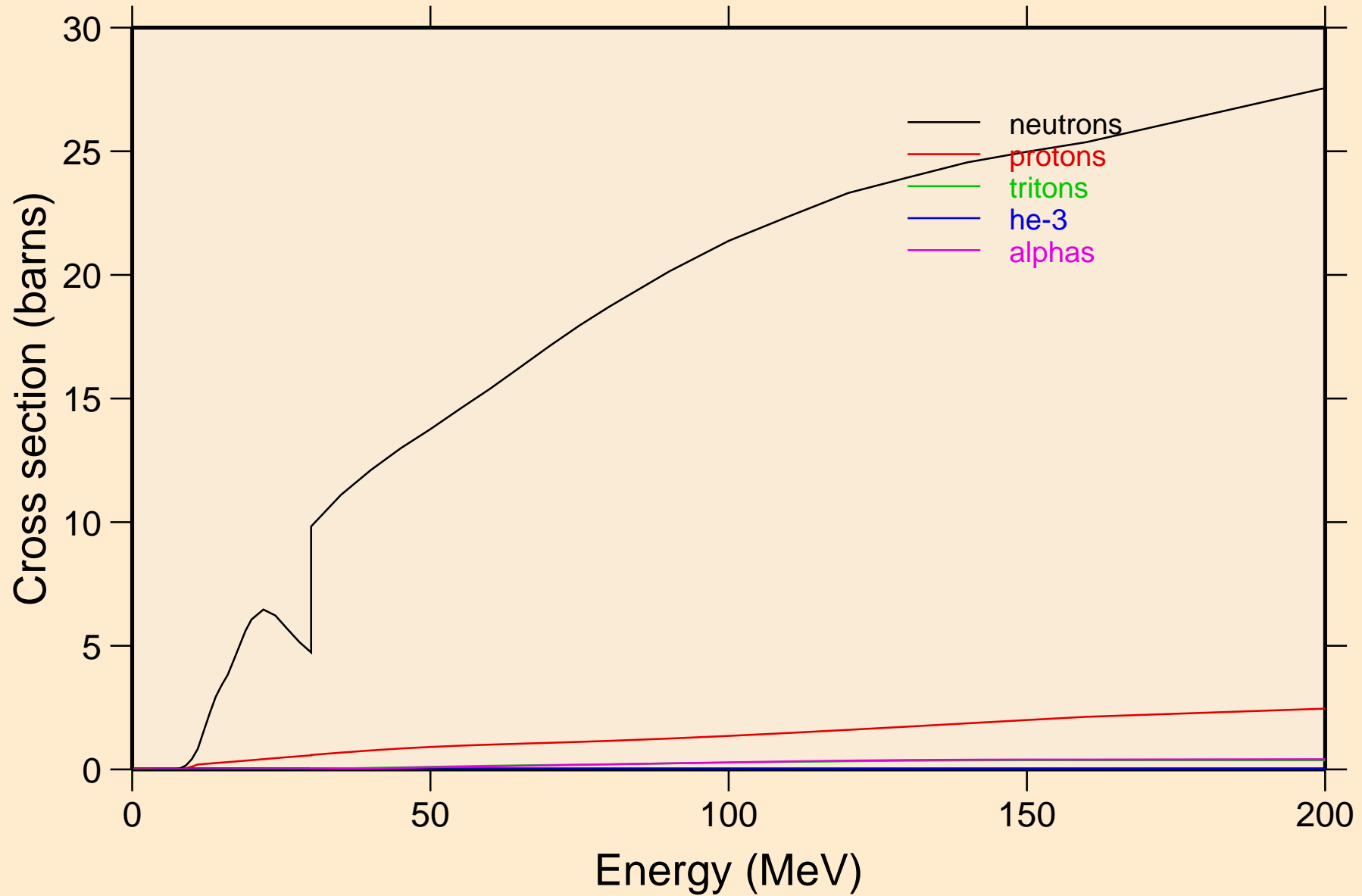

RN227 DEUTERON ACER TENDL-2023 LIBRARY; T=0.K
neutrons from (d,n)

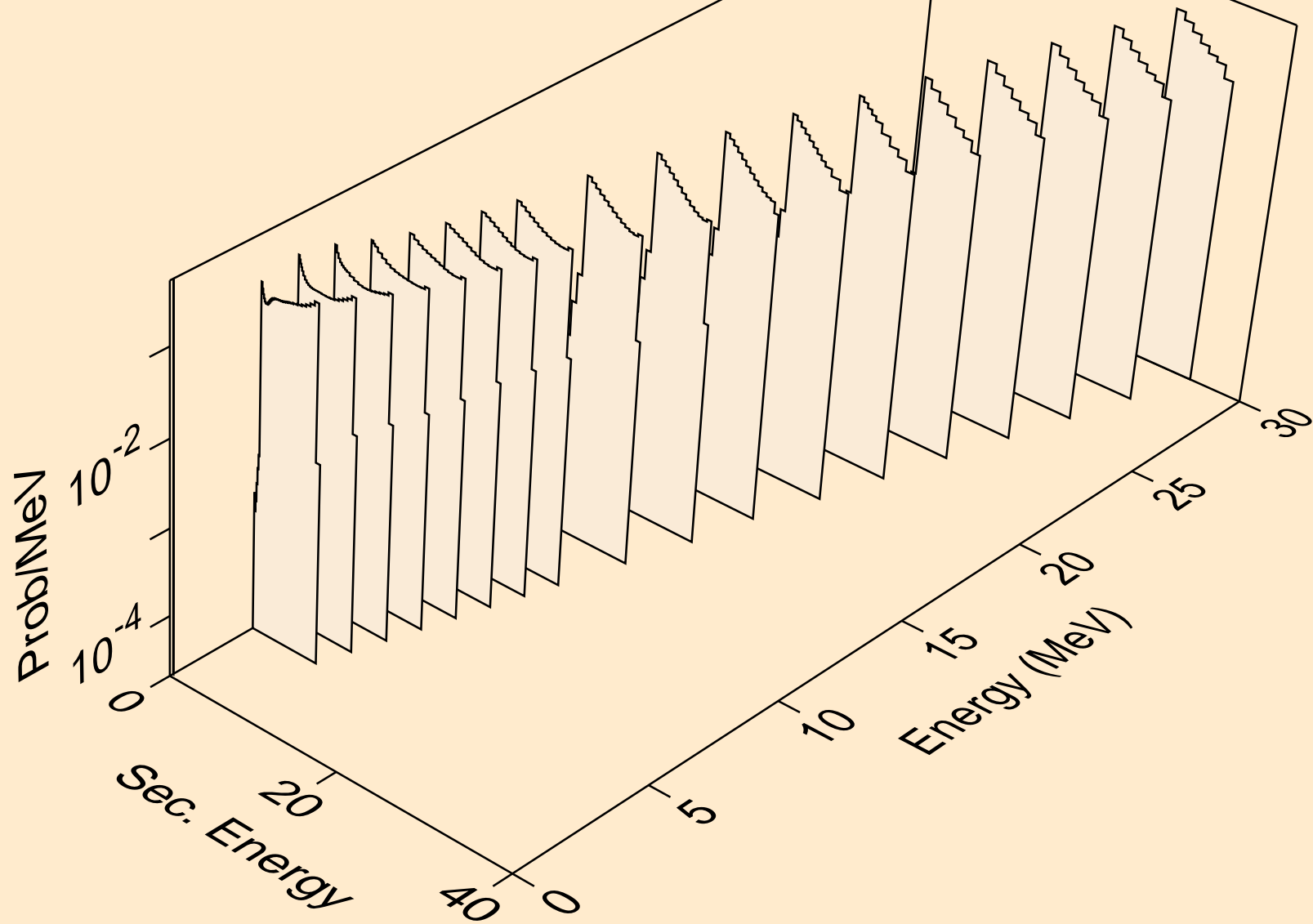

RN227 DEUTERON ACER TENDL-2023 LIBRARY; T=0.K
neutrons from (d,x)

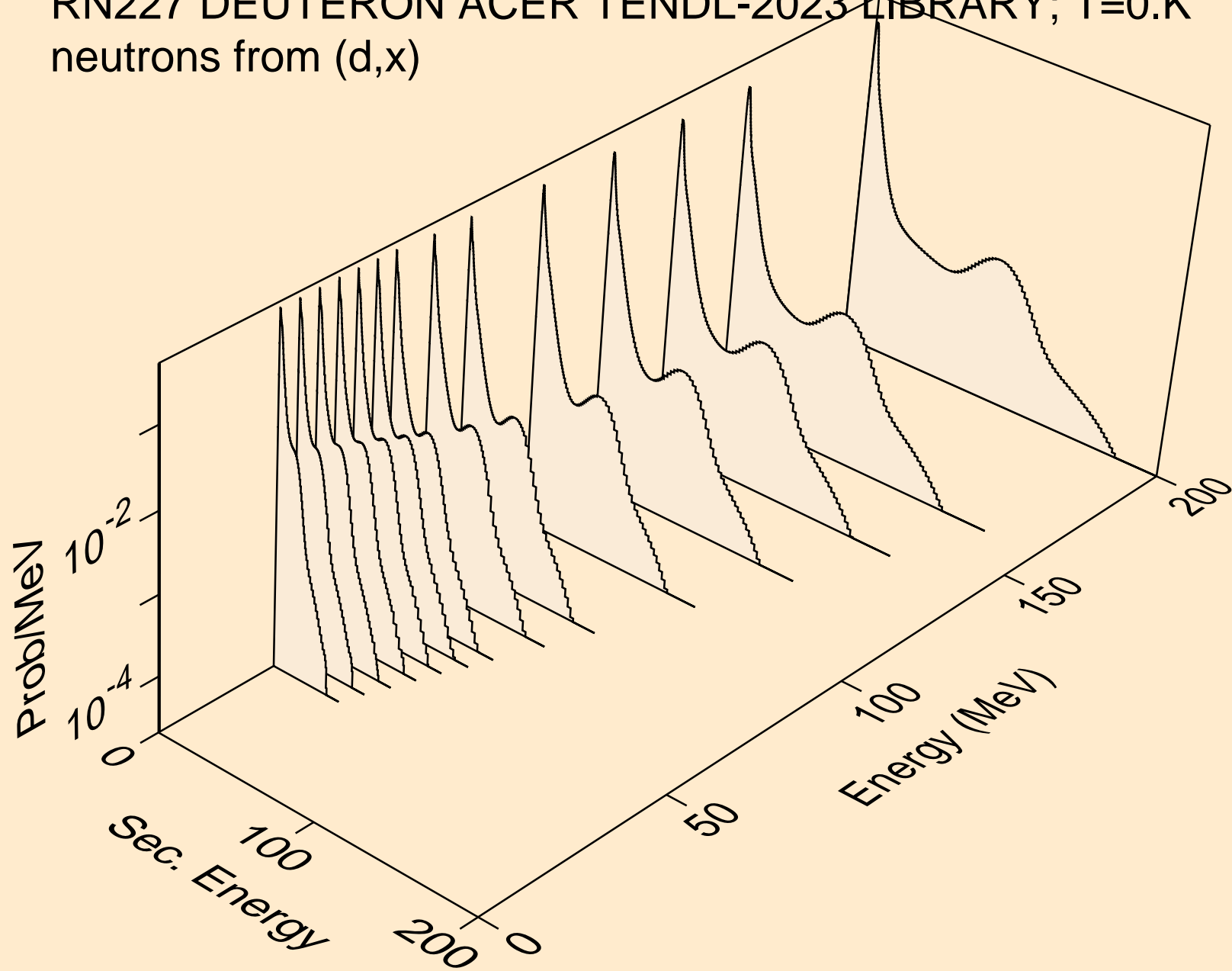

RN227 DEUTERON ACER TENDL-2023 LIBRARY; T=0.K
neutrons from (d,2nd)

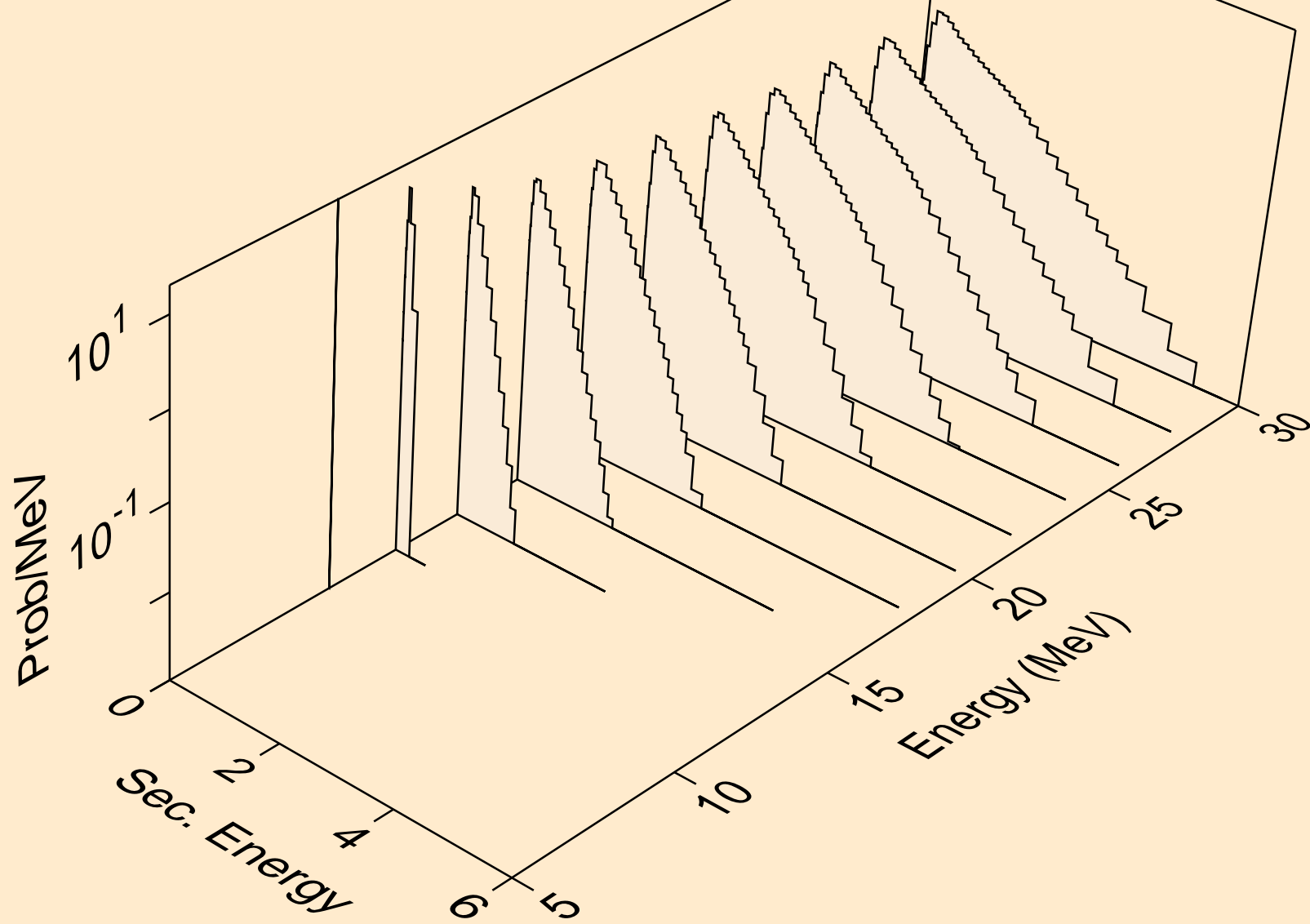

RN227 DEUTERON ACER TENDL-2023 LIBRARY; T=0.K
neutrons from (d,2n)

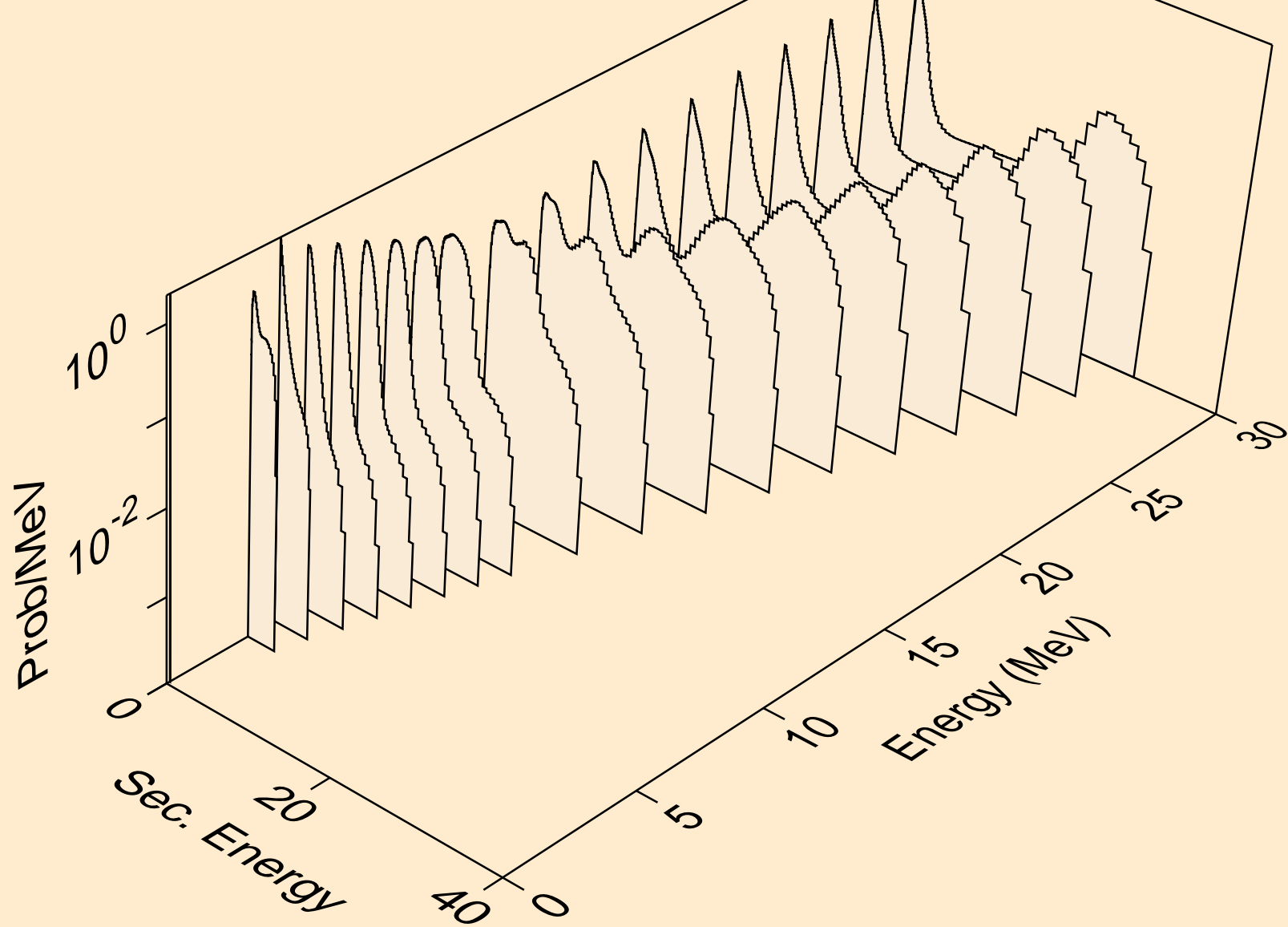

RN227 DEUTERON ACER TENDL-2023 LIBRARY; T=0.K
neutrons from (d,3n)

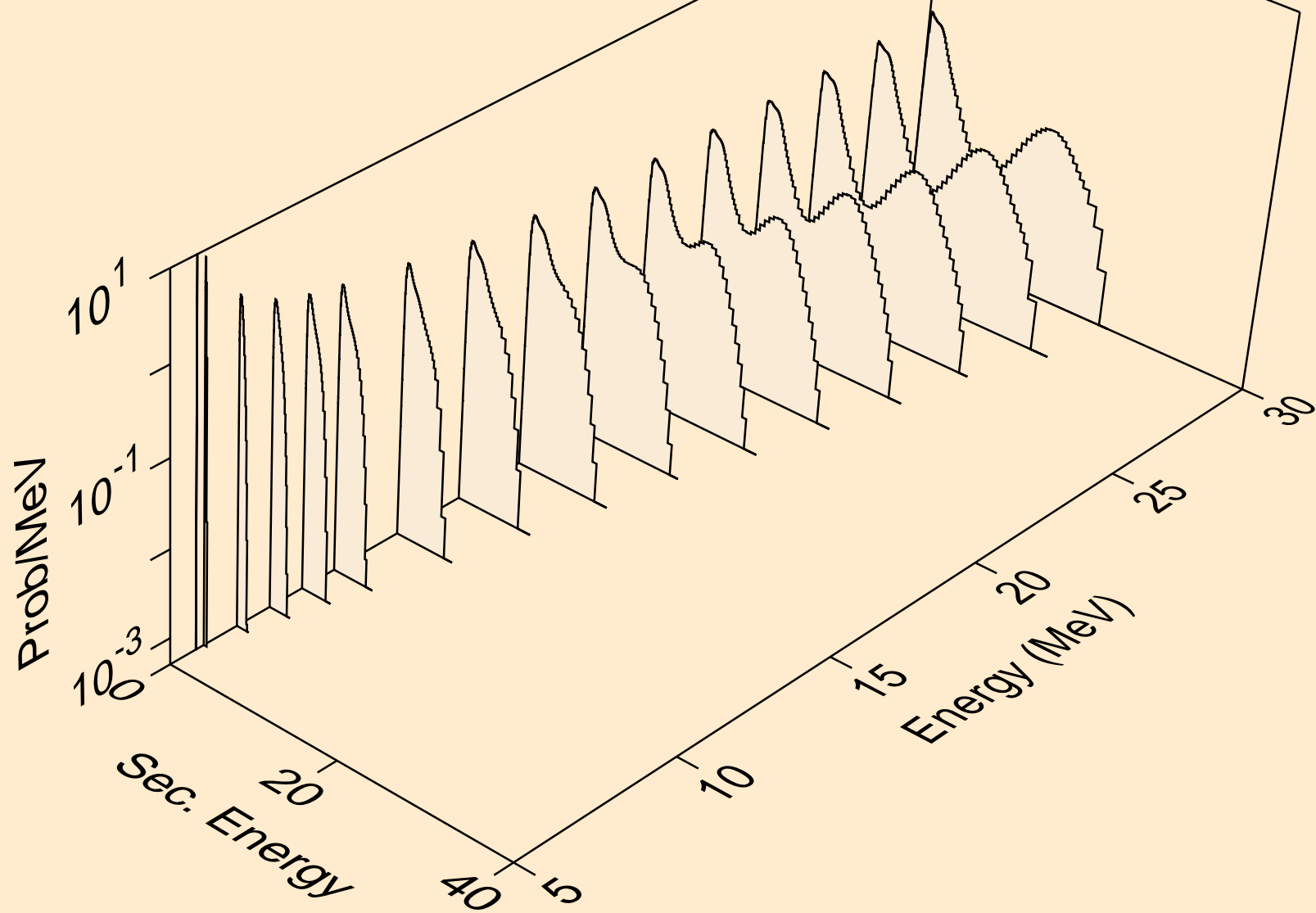

RN227 DEUTERON ACER TENDL-2023 LIBRARY; T=0.K
neutrons from (d,n*)a

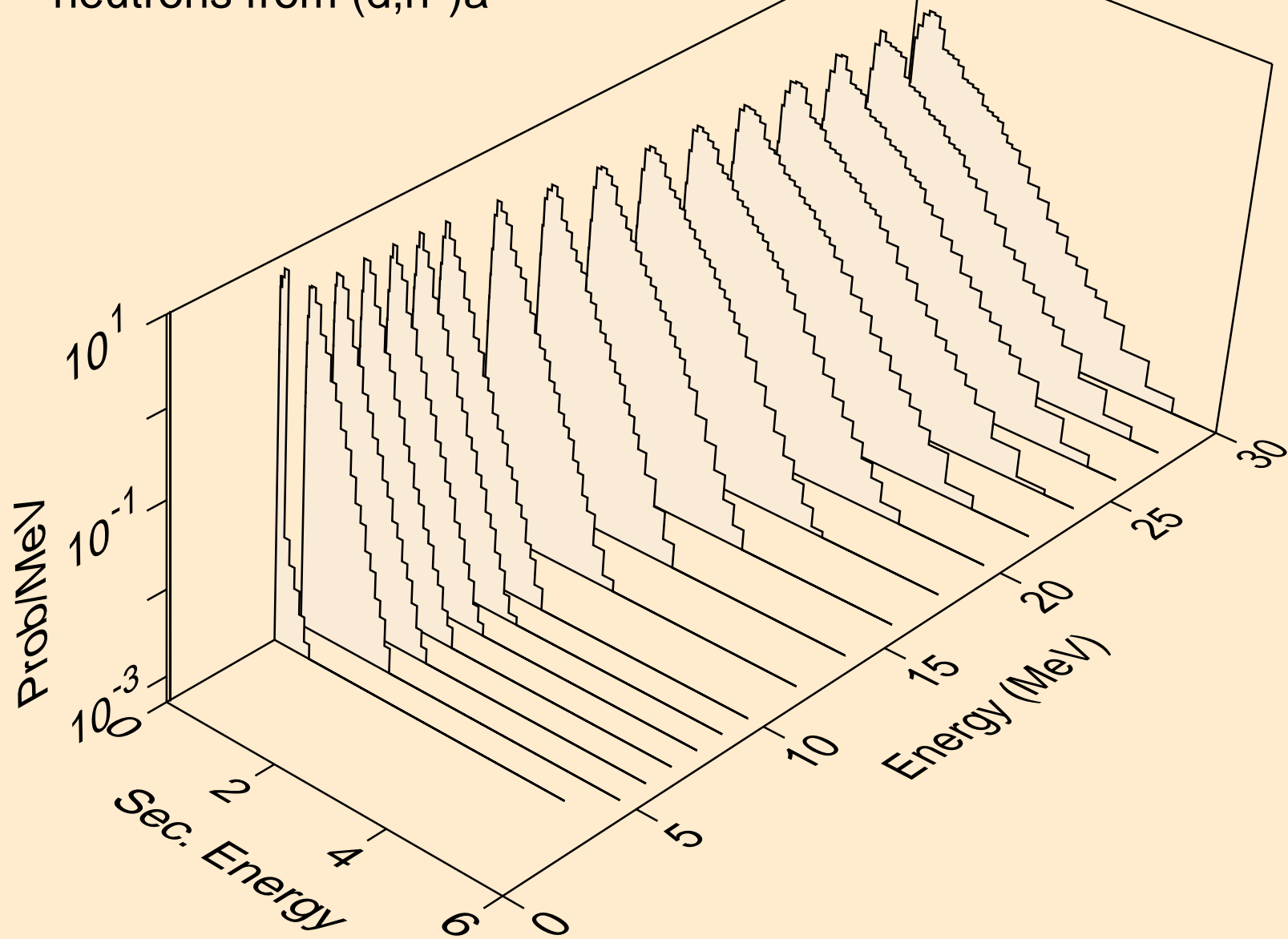

RN227 DEUTERON ACER TENDL-2023 LIBRARY; T=0.K
neutrons from (d,2n)a

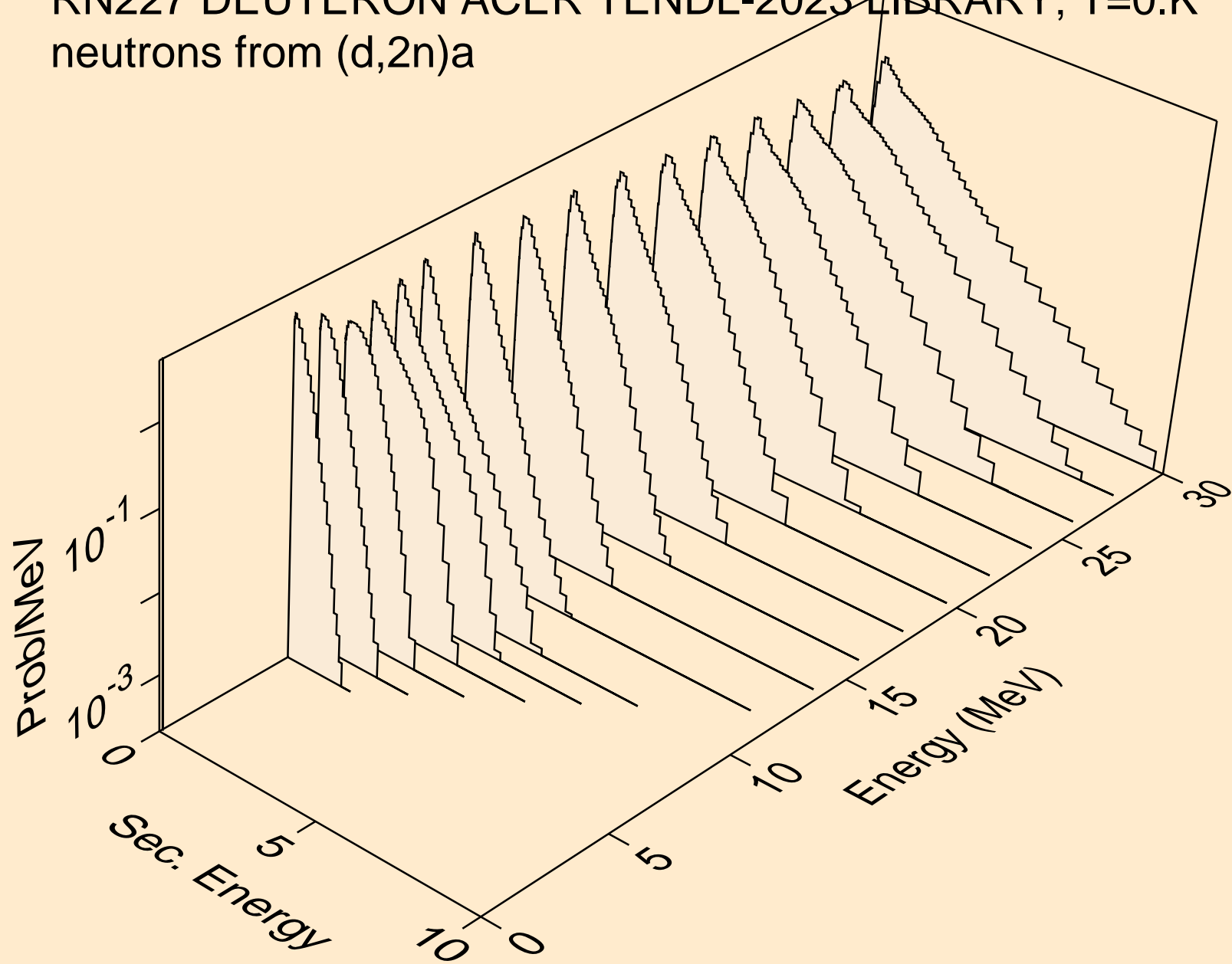

RN227 DEUTERON ACER TENDL-2023 LIBRARY; T=0.K
neutrons from (d,3n)a

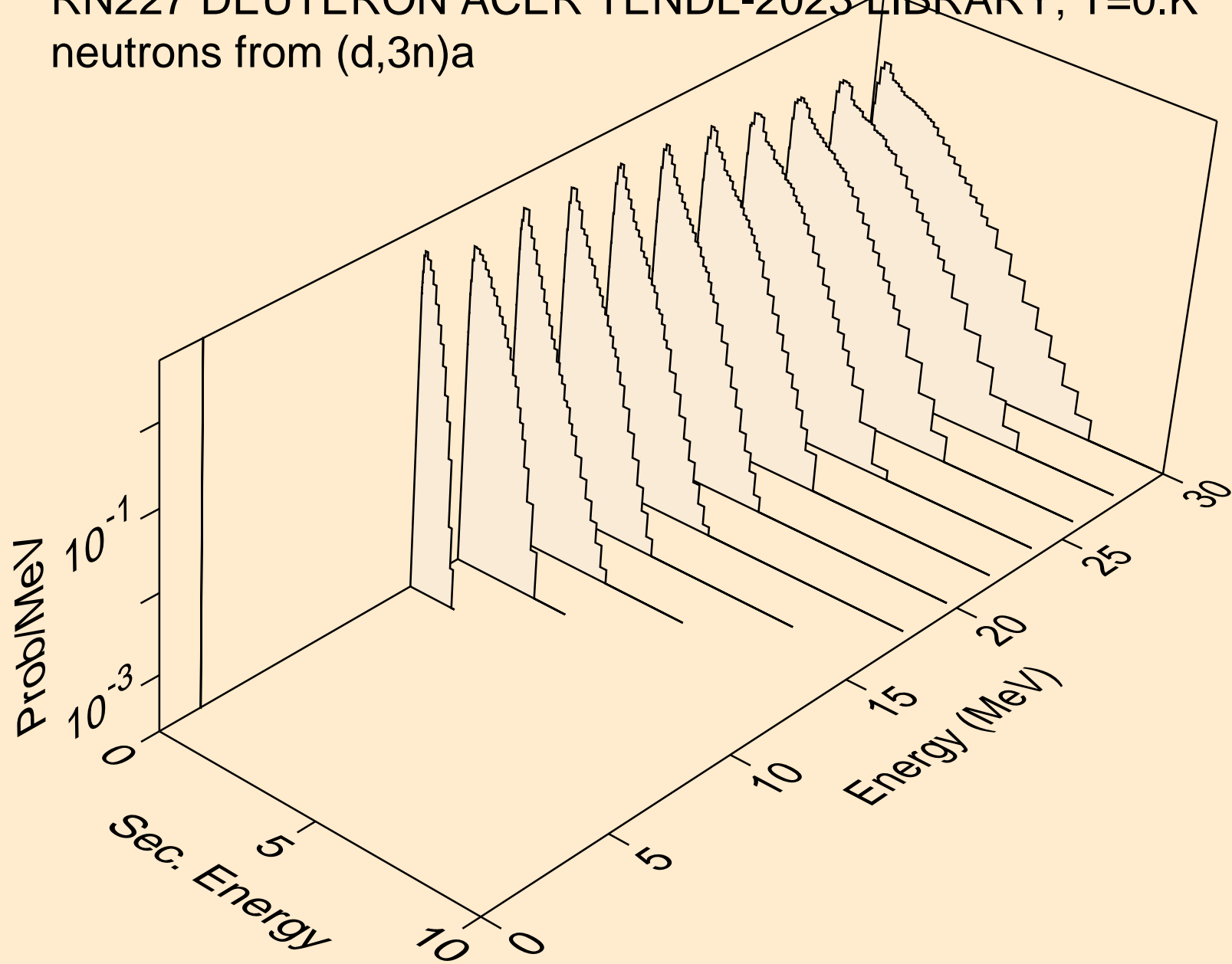

RN227 DEUTERON ACER TENDL-2023 LIBRARY; T=0.K
neutrons from (d,n*)p

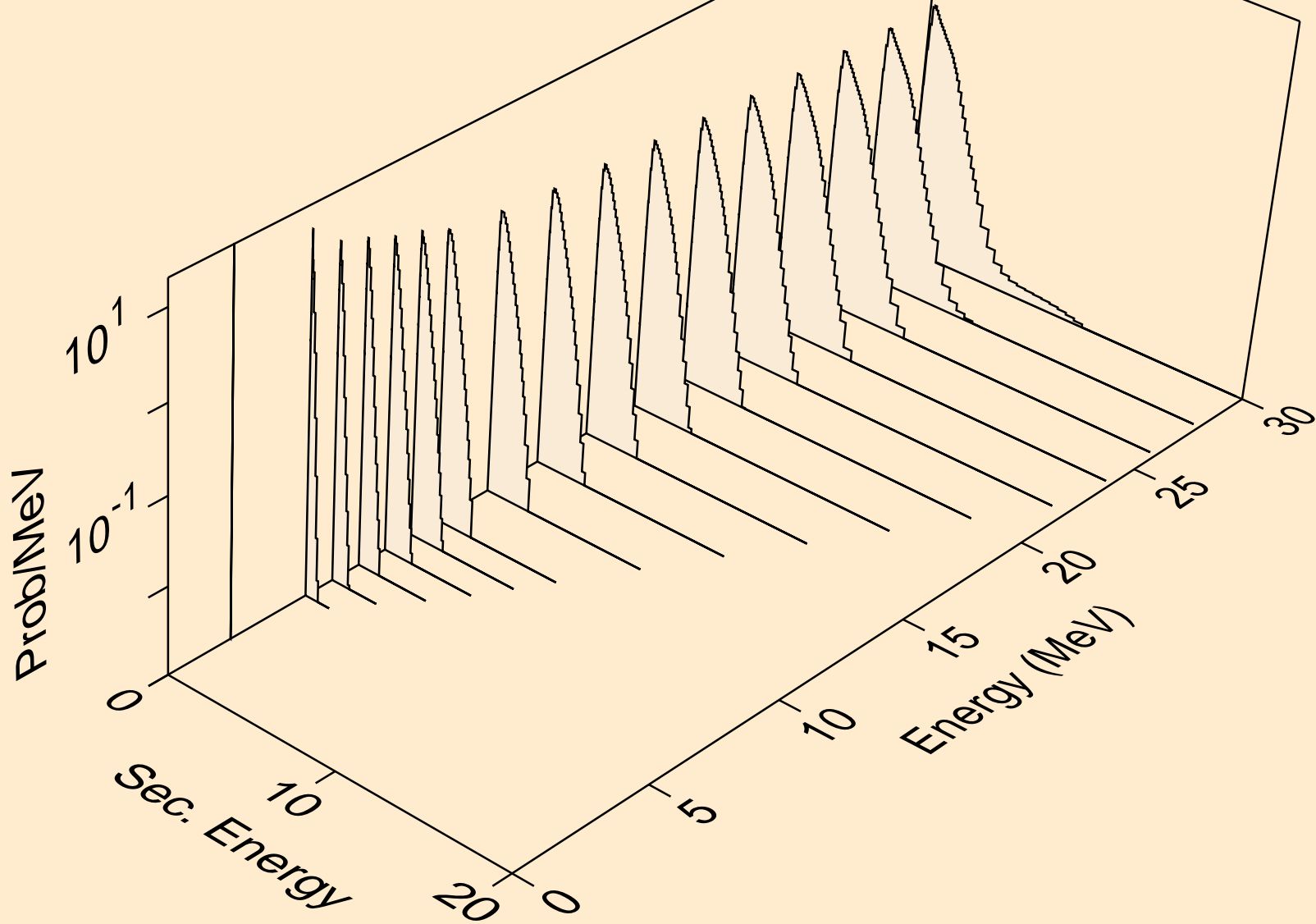

RN227 DEUTERON ACER TENDL-2023 LIBRARY; T=0.K
neutrons from (d,n*)2a

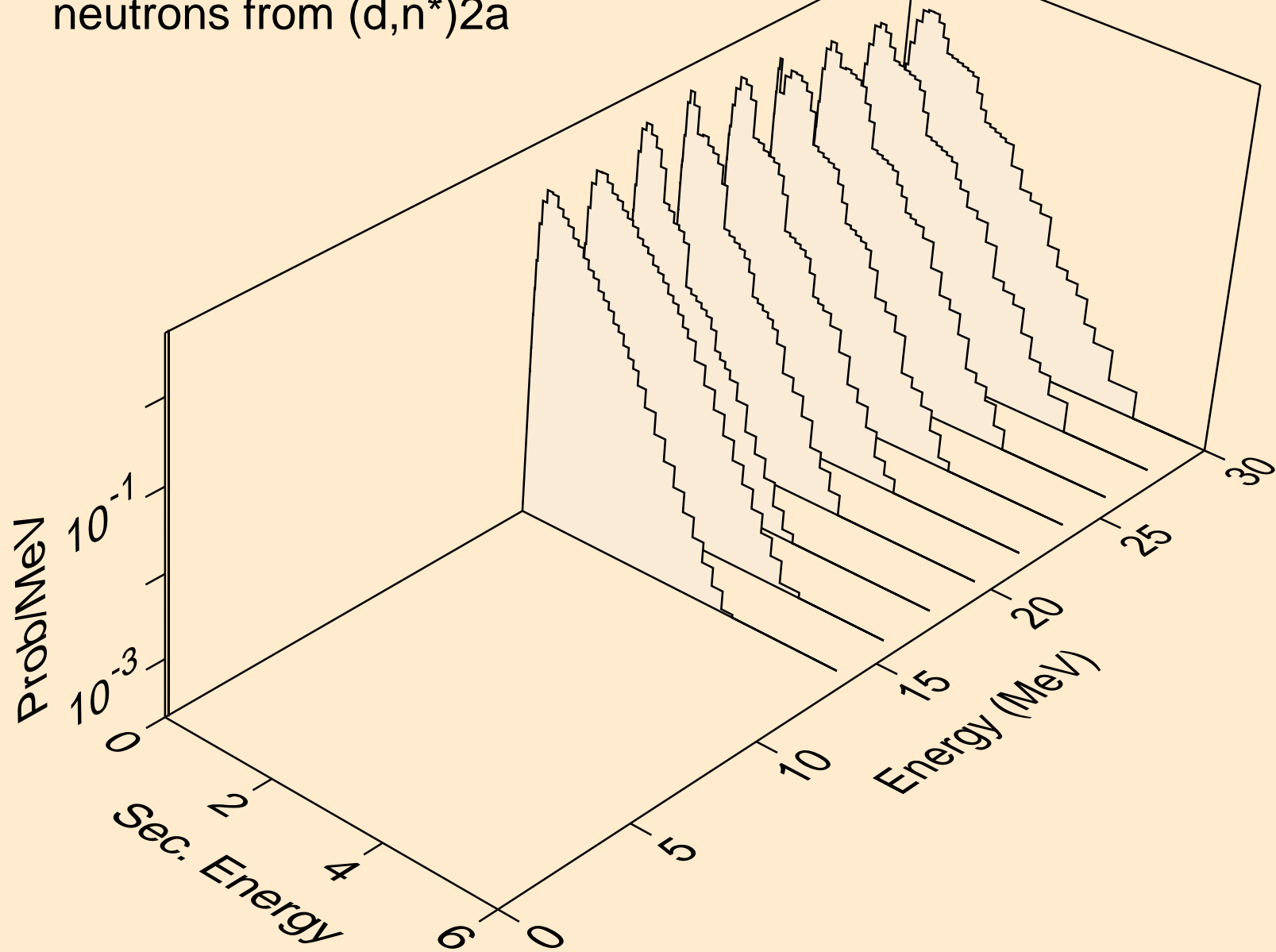

RN227 DEUTERON ACER TENDL-2023 LIBRARY; T=0.K
neutrons from (d,2n)2a

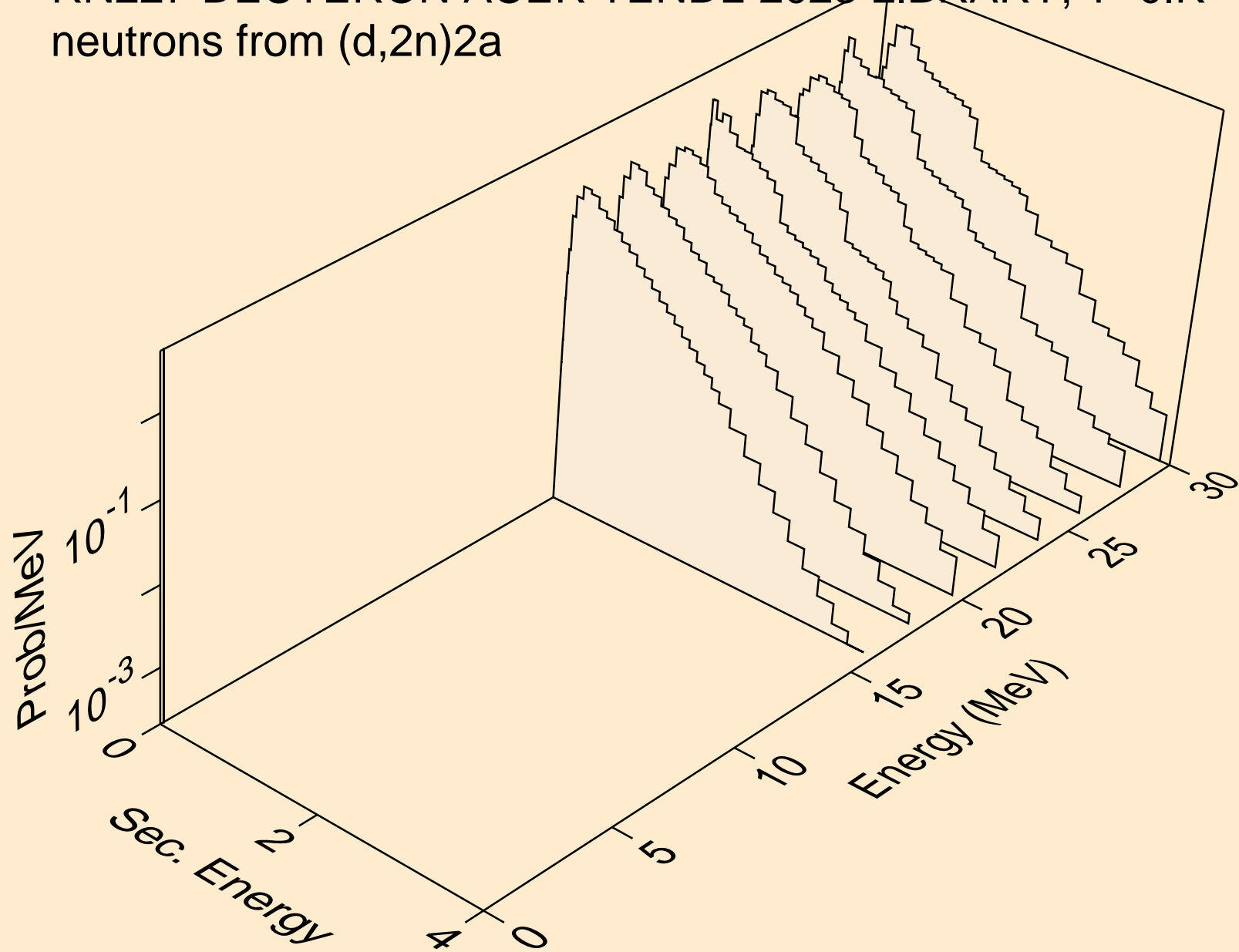

RN227 DEUTERON ACER TENDL-2023 LIBRARY; T=0.K
neutrons from (d,n*)d

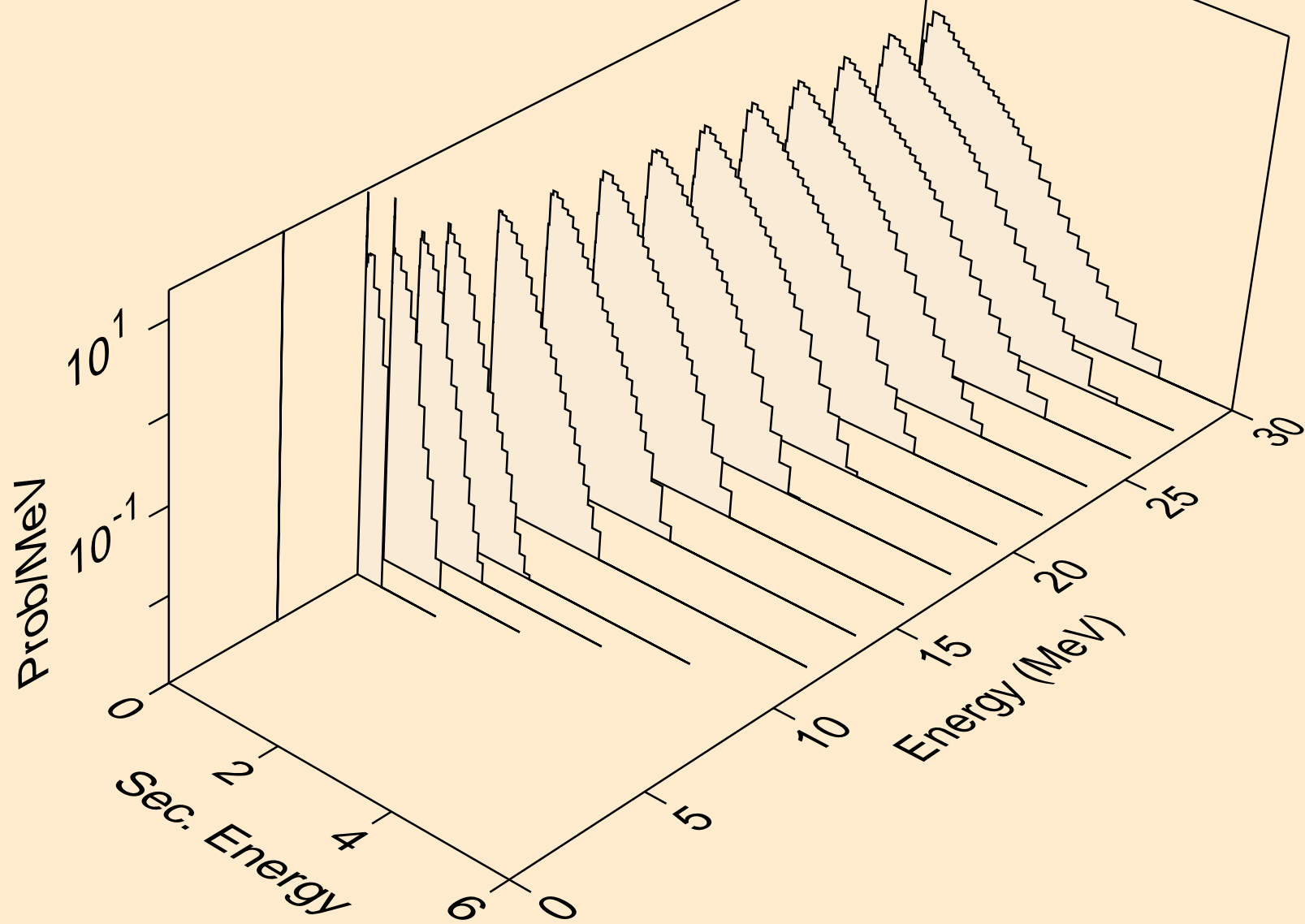

RN227 DEUTERON ACER TENDL-2023 LIBRARY; T=0.K
neutrons from (d,n*)t

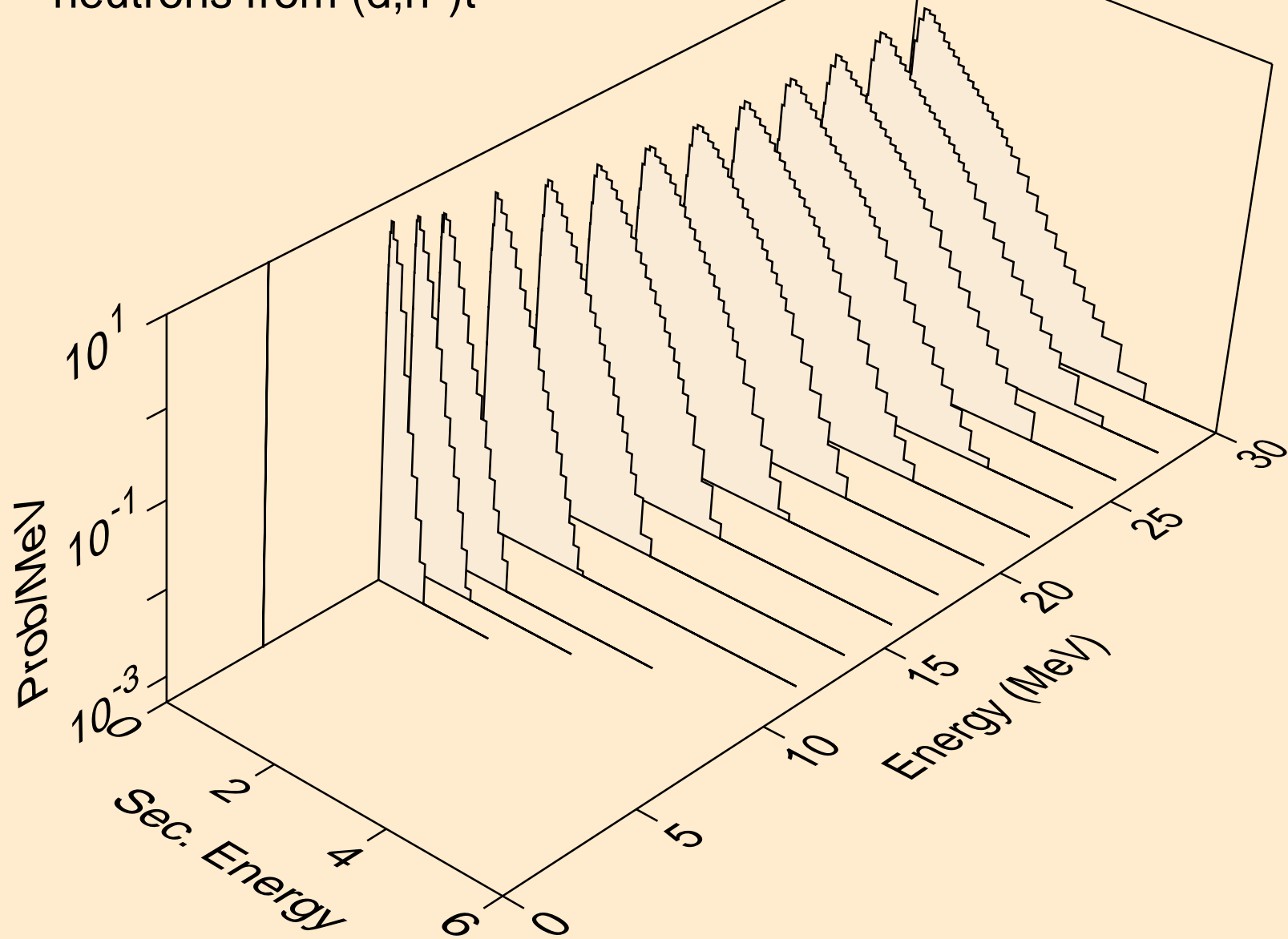

RN227 DEUTERON ACER TENDL-2023 LIBRARY; T=0.K
neutrons from (d,n*)he3

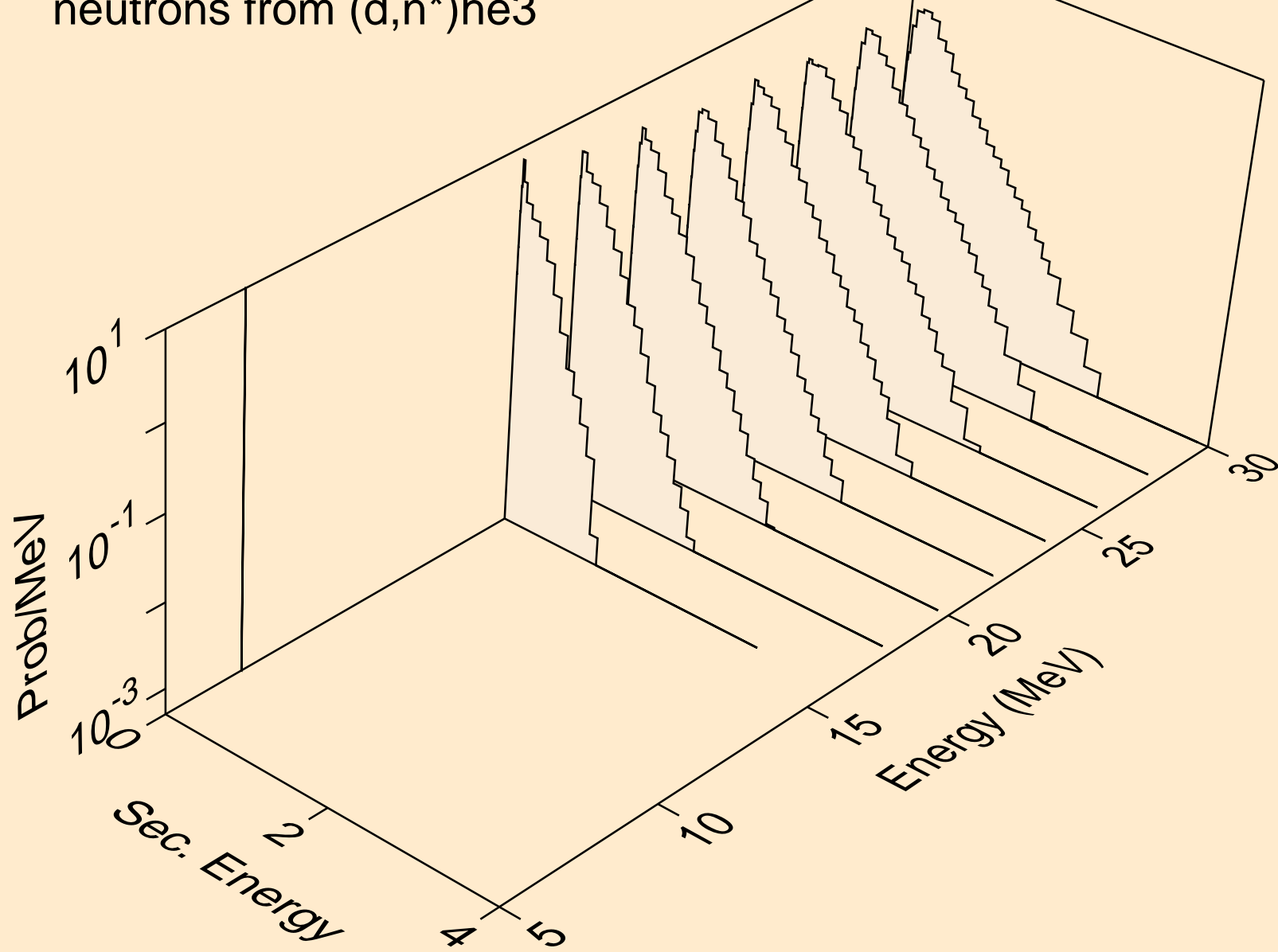

RN227 DEUTERON ACER TENDL-2023 LIBRARY; T=0.K
neutrons from (d,4n)

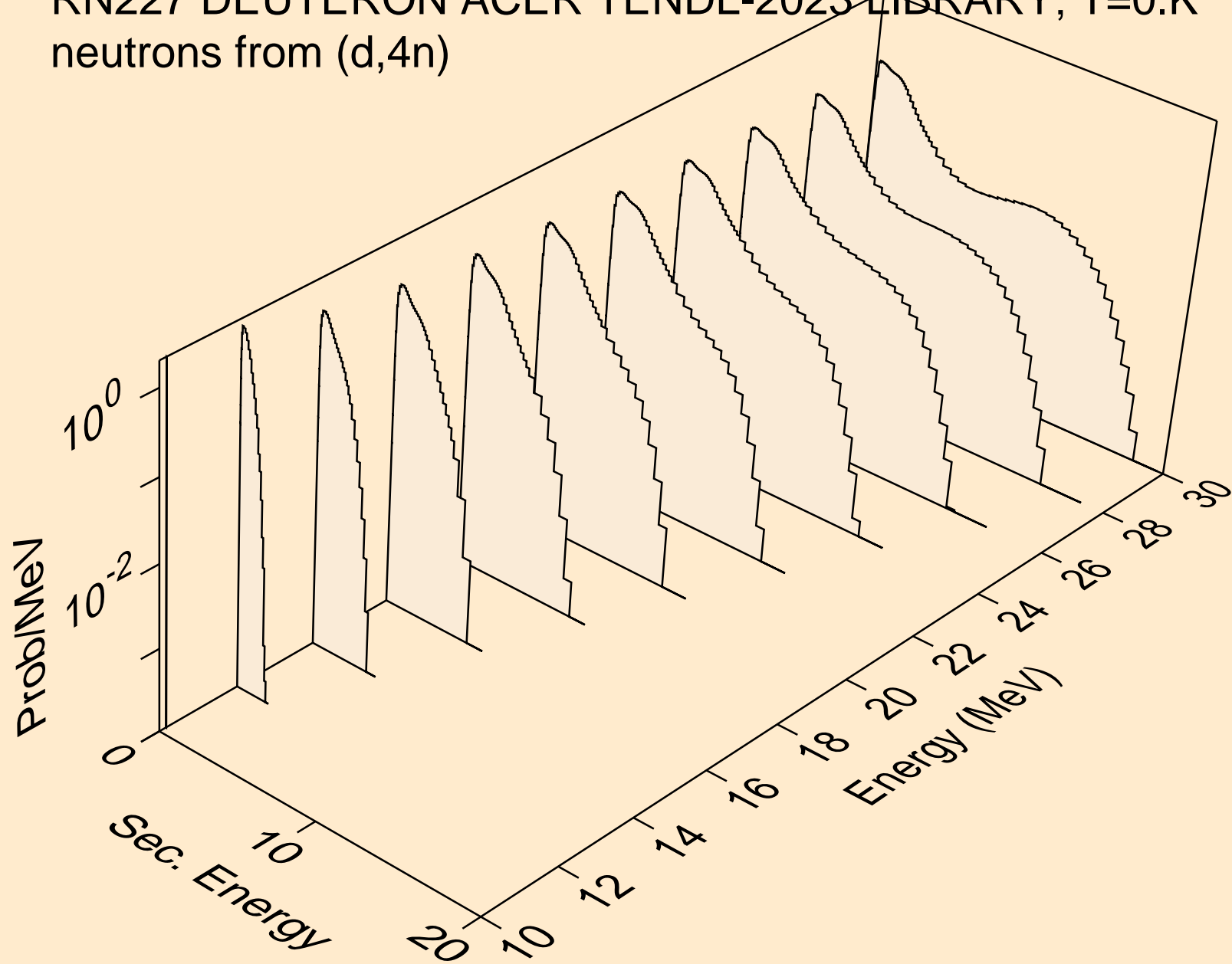

RN227 DEUTERON ACER TENDL-2023 LIBRARY; T=0.K
neutrons from (d,2np)

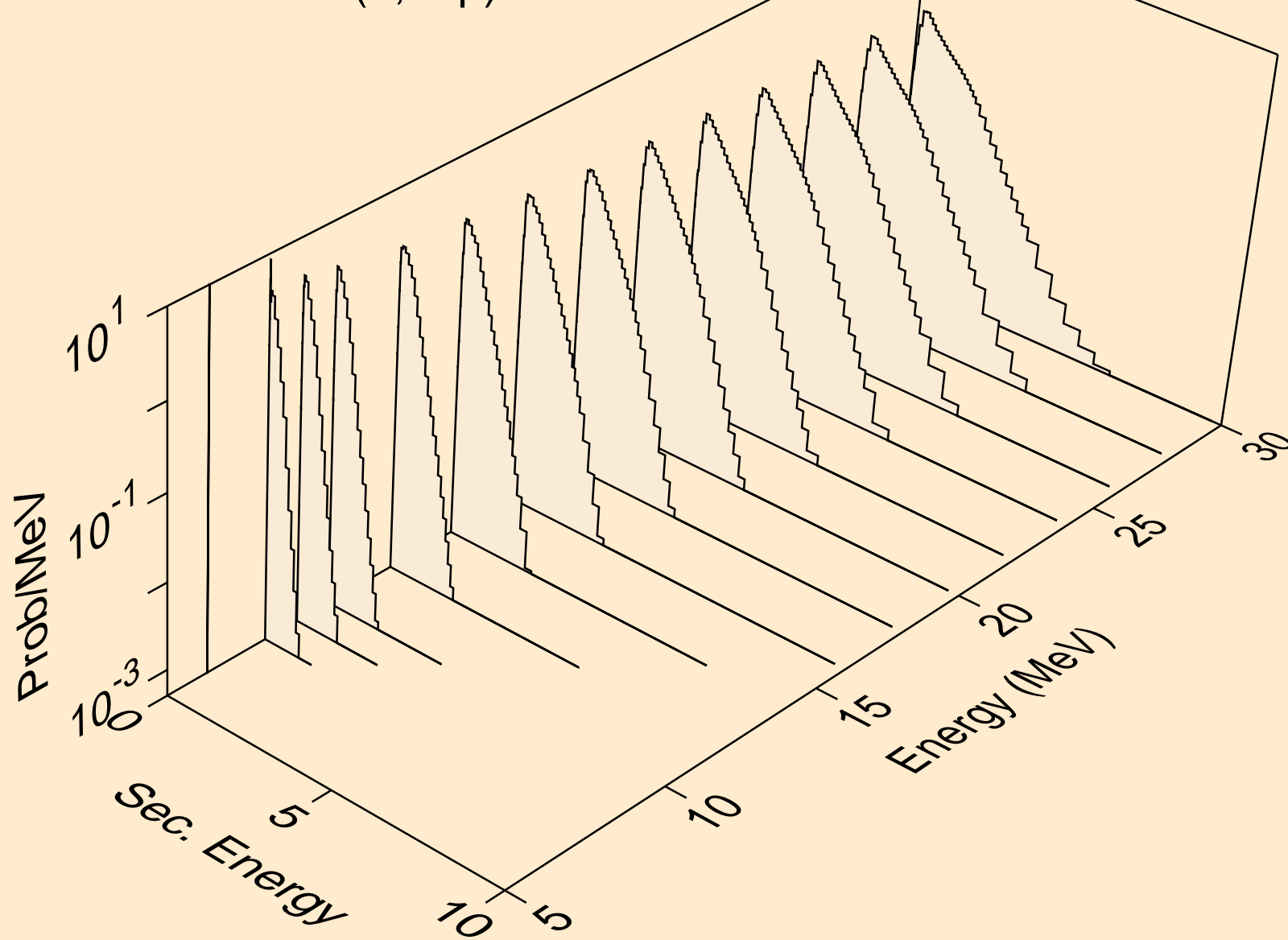

RN227 DEUTERON ACER TENDL-2023 LIBRARY; T=0.K
neutrons from (d,3np)

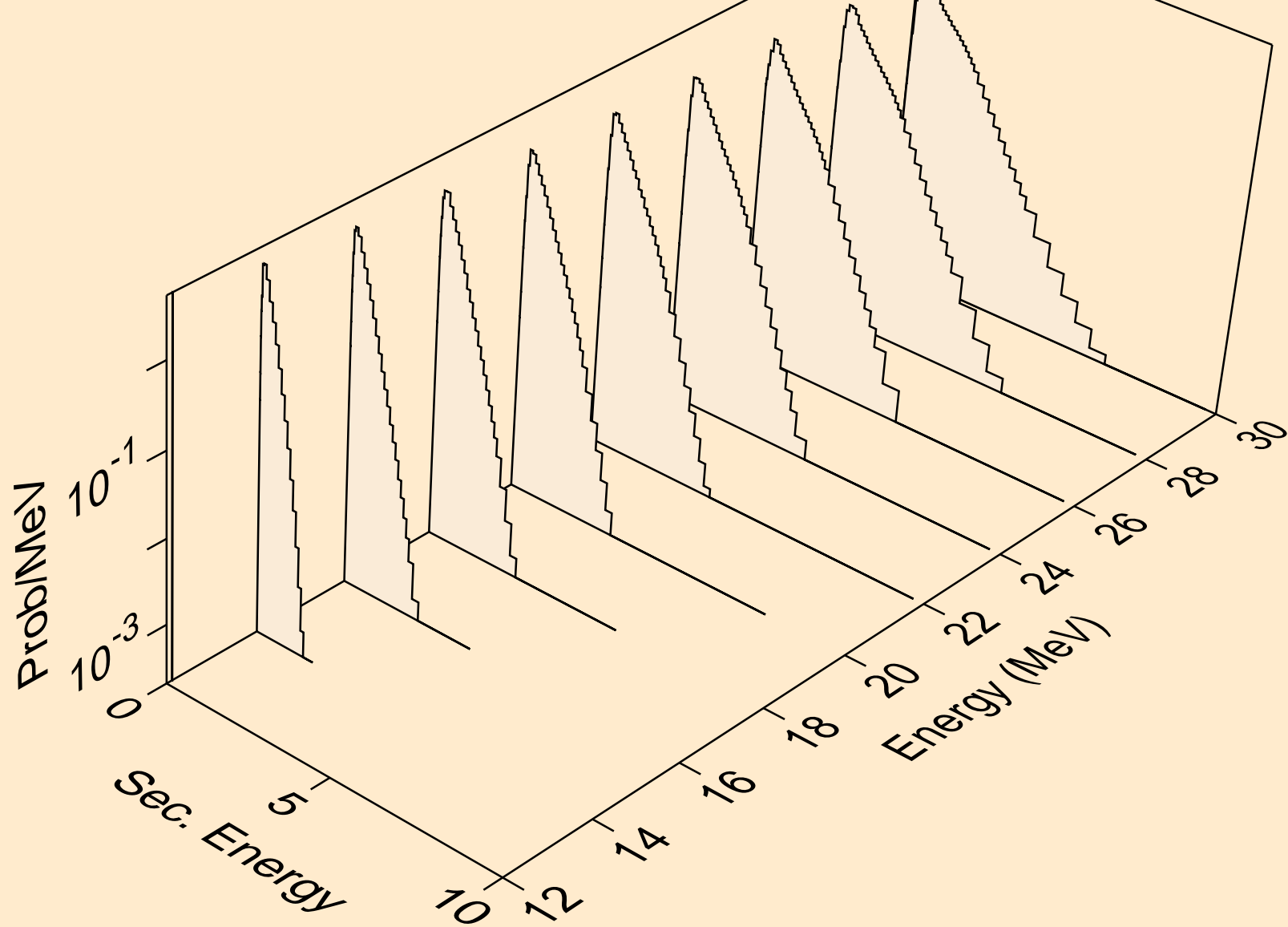

RN227 DEUTERON ACER TENDL-2023 LIBRARY; T=0.K
neutrons from (d,n2p)

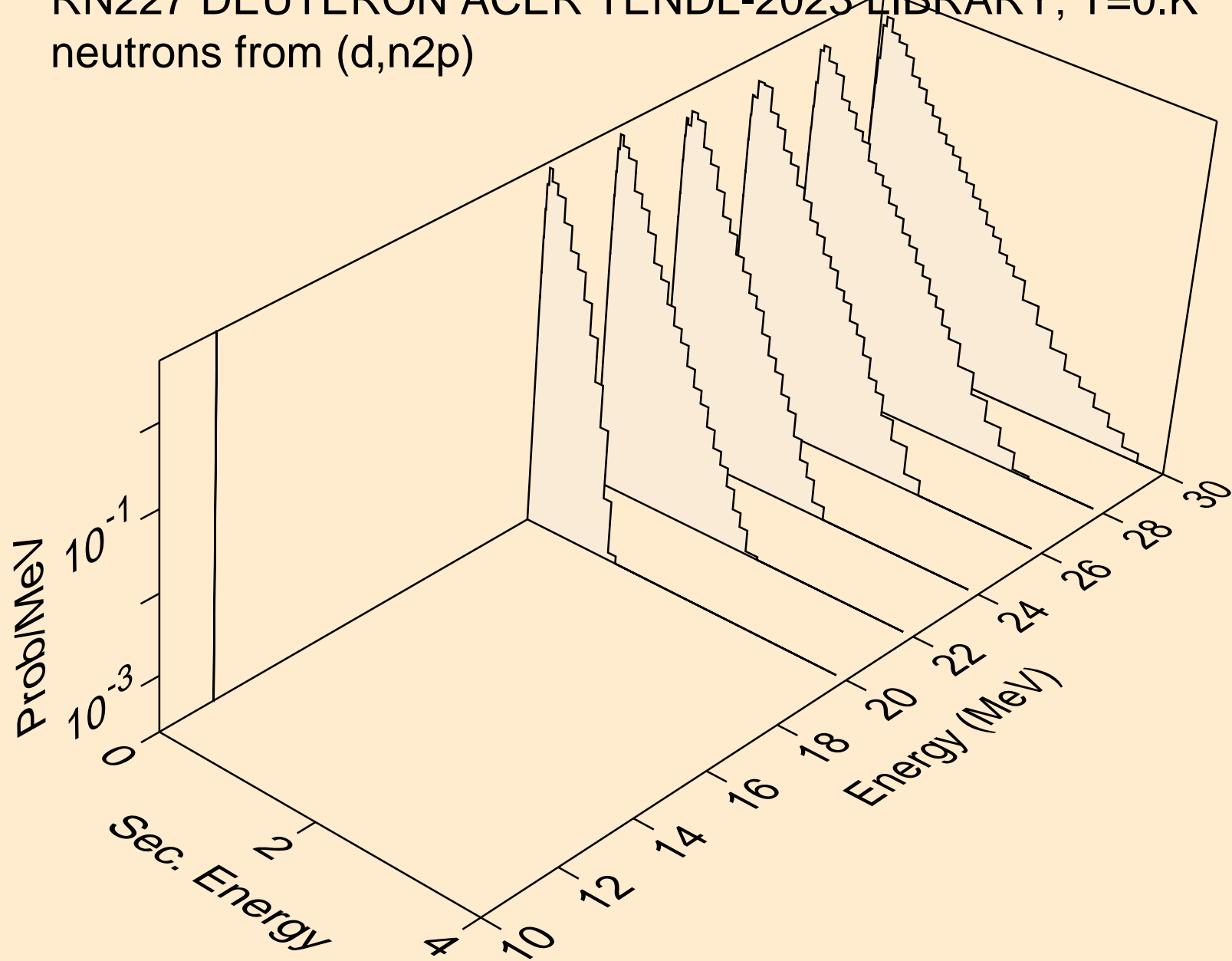

RN227 DEUTERON ACER TENDL-2023 LIBRARY; T=0.K
neutrons from (d,npa)

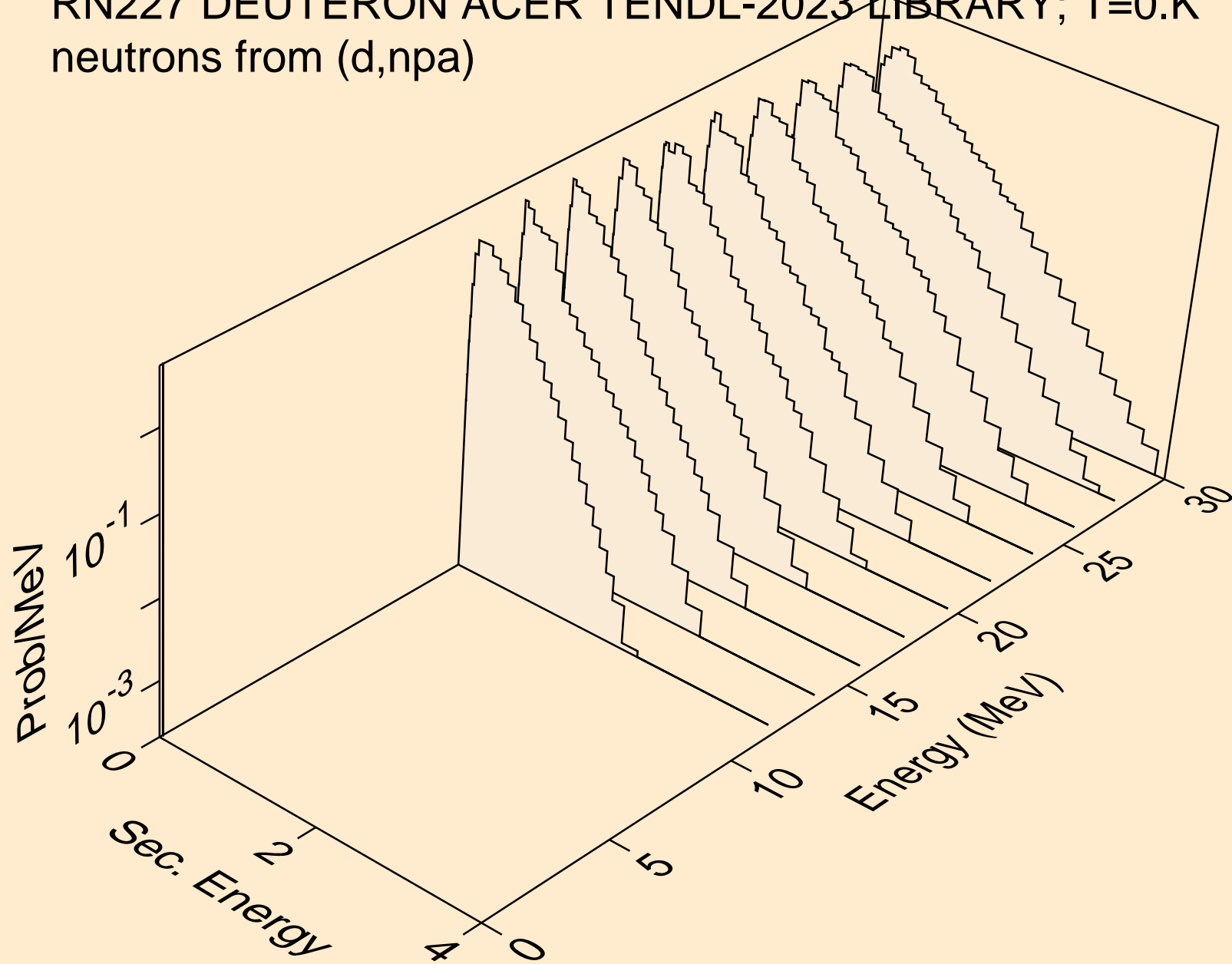

RN227 DEUTERON ACER TENDL-2023 LIBRARY; T=0.K
protons from (d,x)

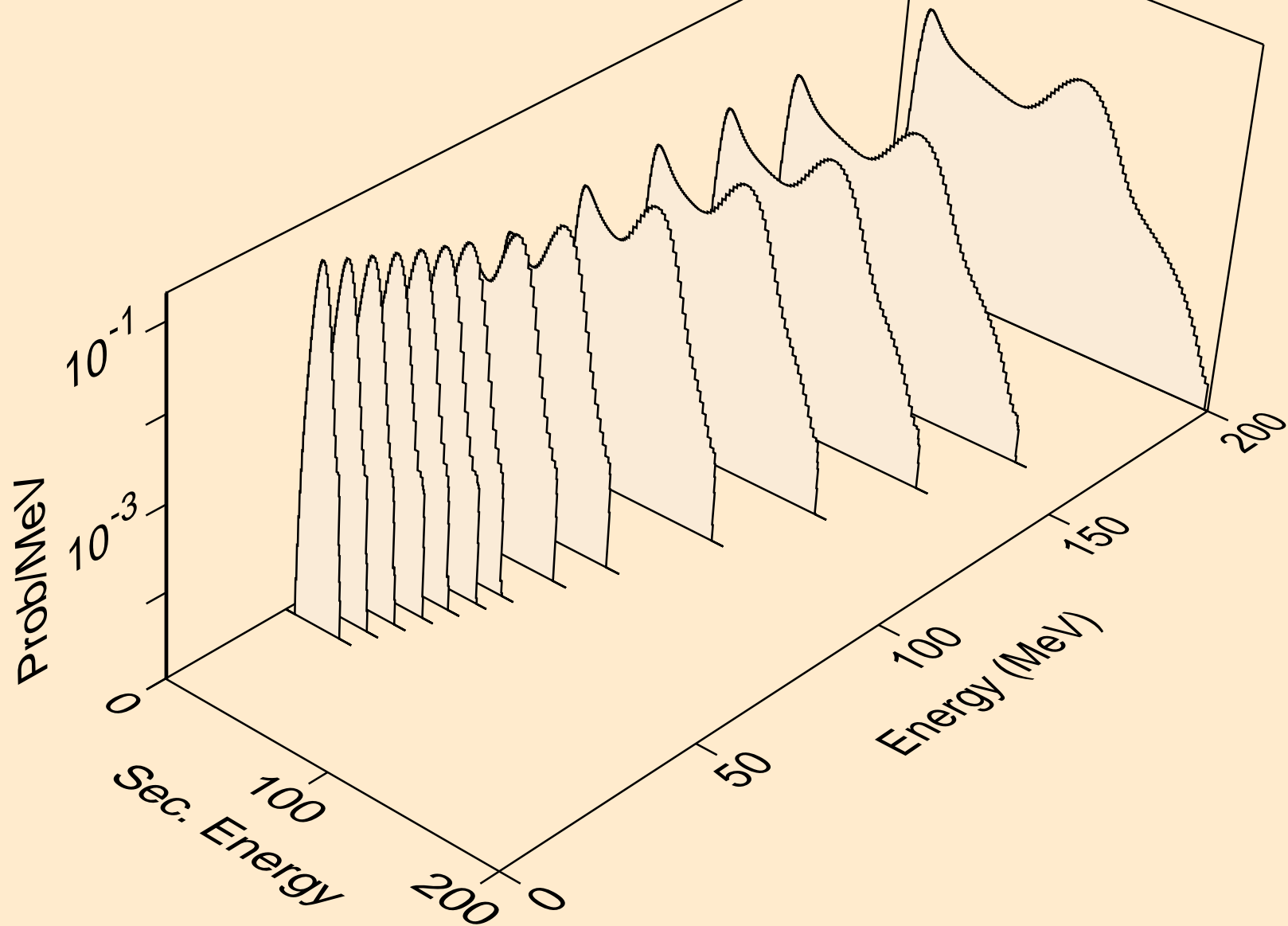

RN227 DEUTERON ACER TENDL-2023 LIBRARY; T=0.K
protons from (d,n*)p

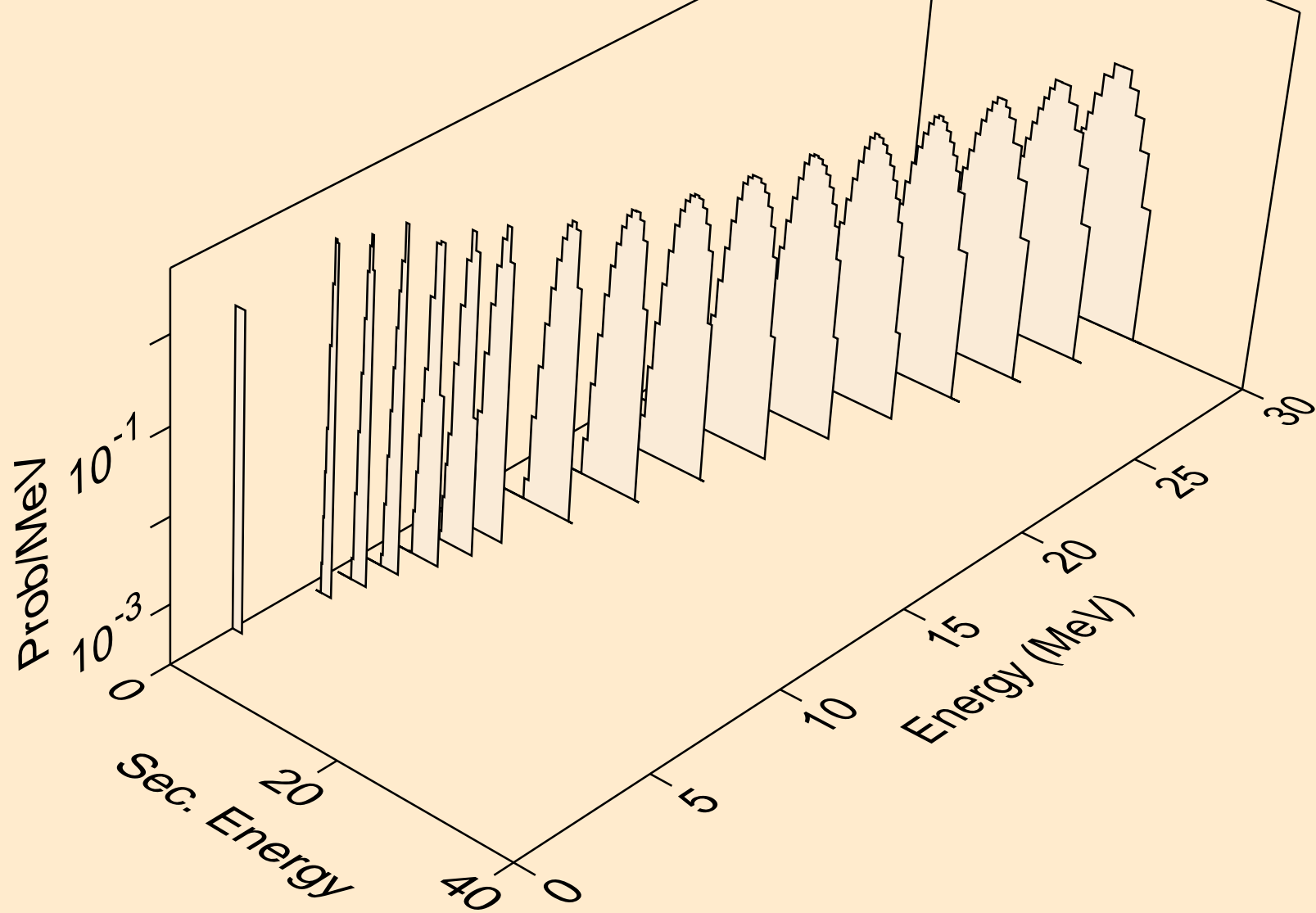

RN227 DEUTERON ACER TENDL-2023 LIBRARY; T=0.K
protons from (d,2np)

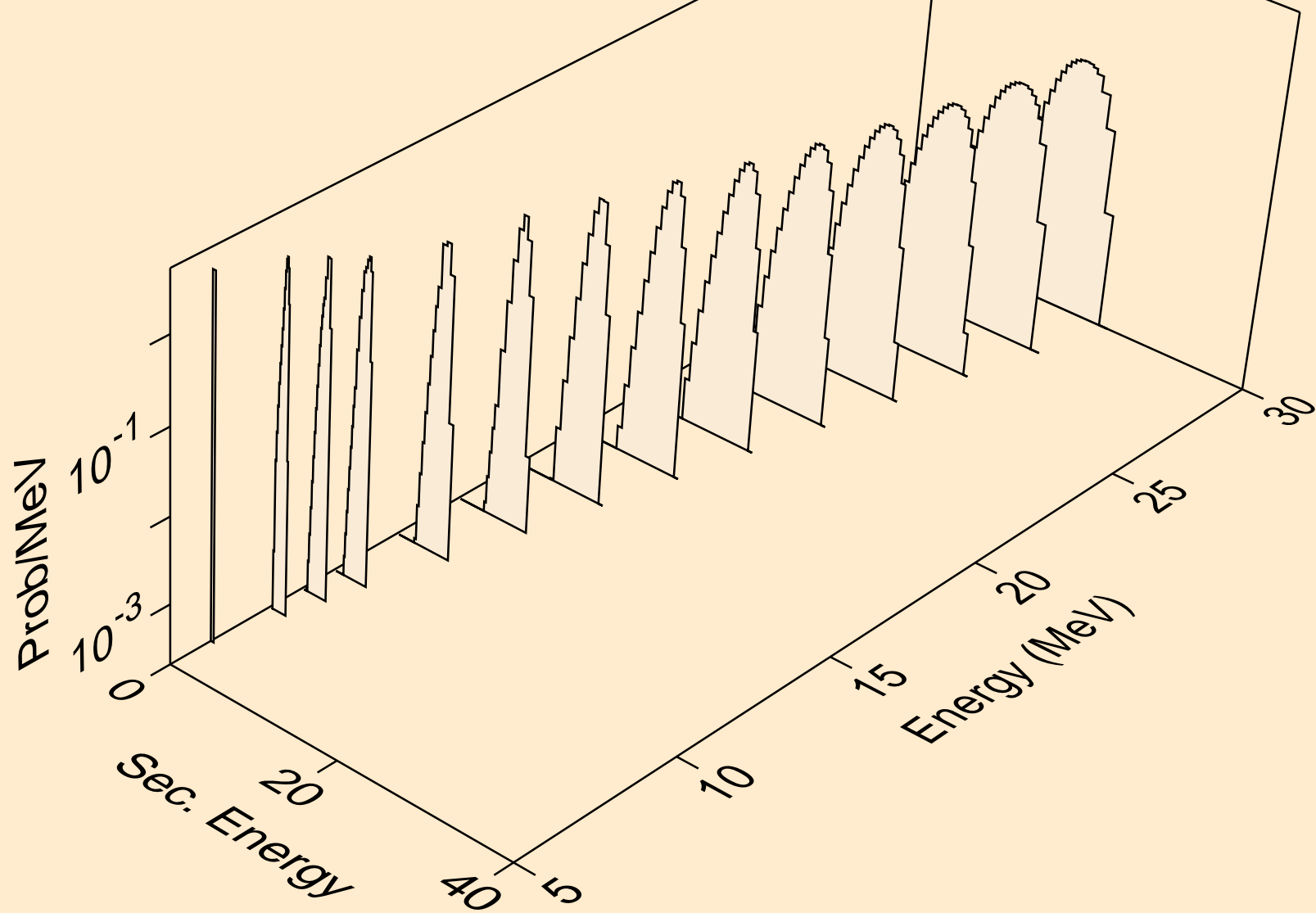

RN227 DEUTERON ACER TENDL-2023 LIBRARY; T=0.K
protons from (d,3np)

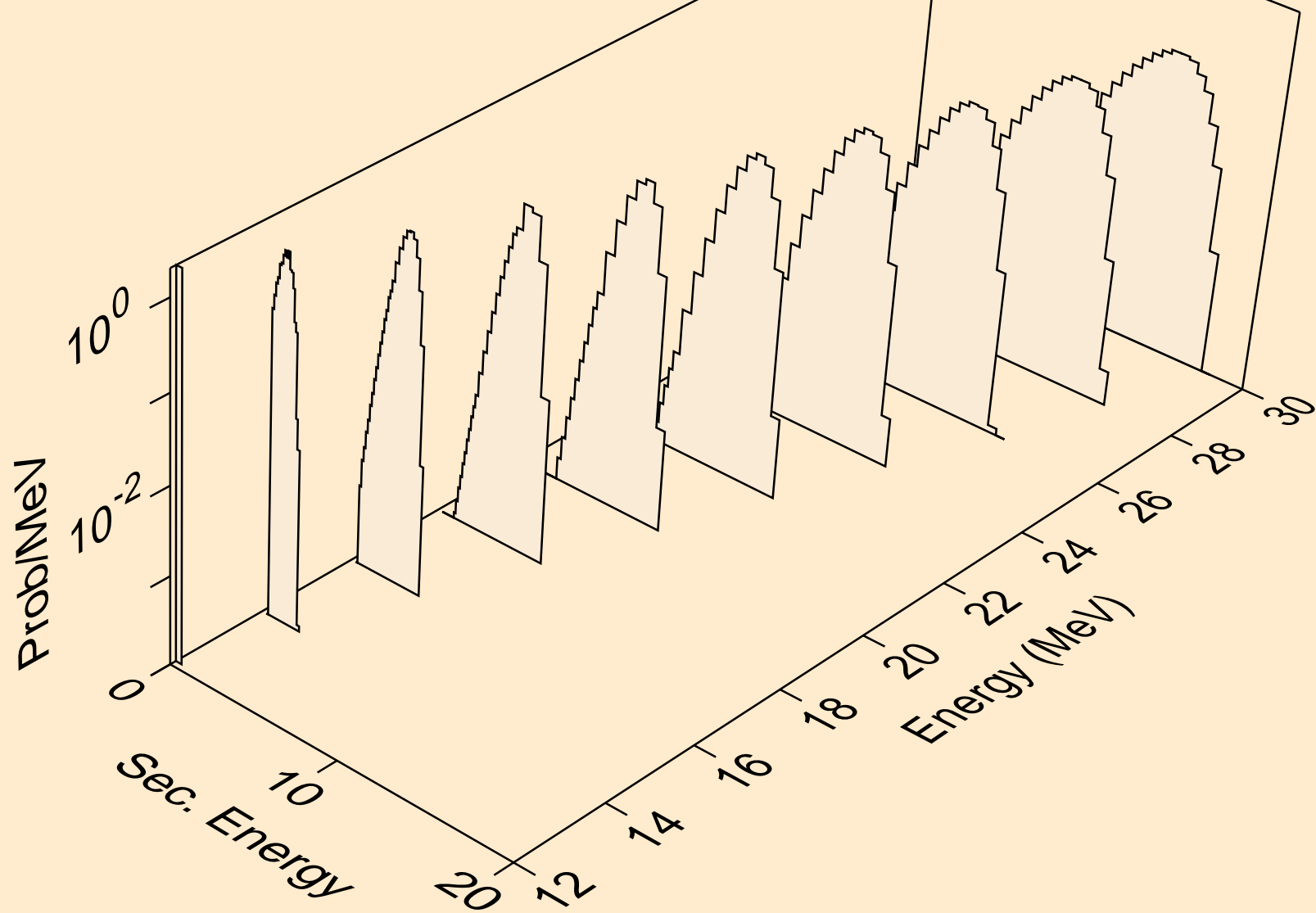

RN227 DEUTERON ACER TENDL-2023 LIBRARY; T=0.K
protons from (d,n2p)

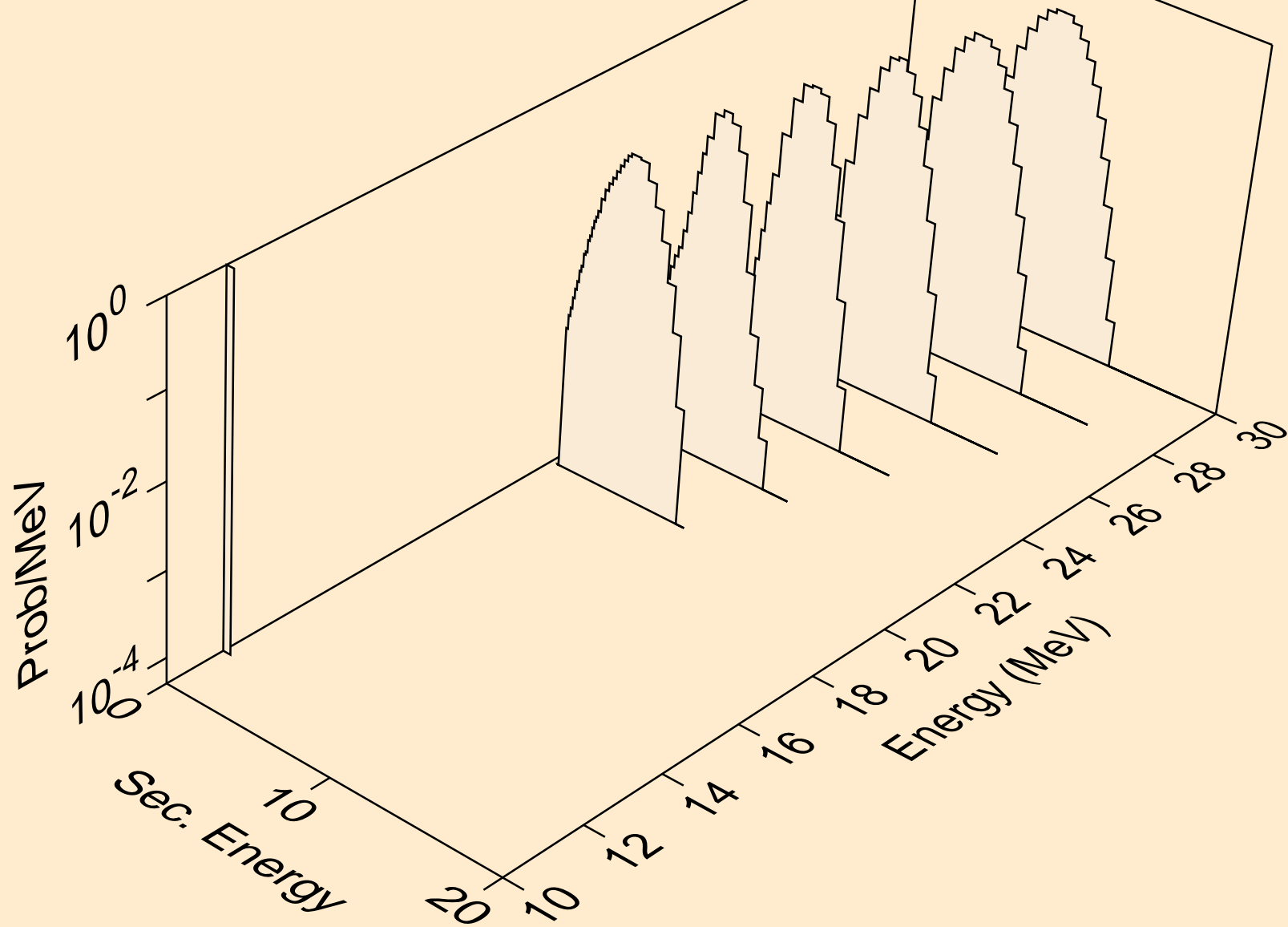

RN227 DEUTERON ACER TENDL-2023 LIBRARY; T=0.K
protons from (d,npa)

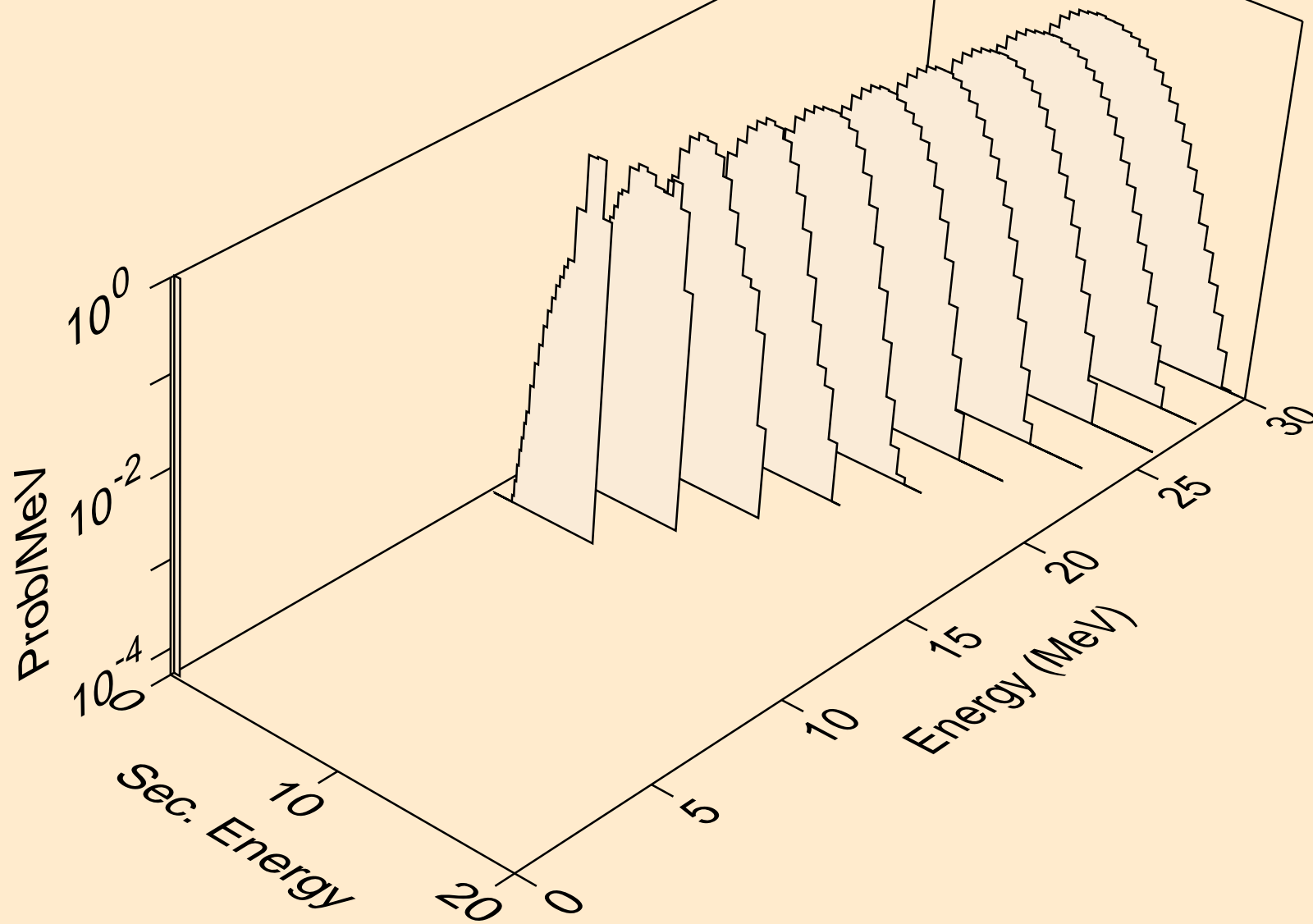

RN227 DEUTERON ACER TENDL-2023 LIBRARY; T=0.K
protons from (d,p)

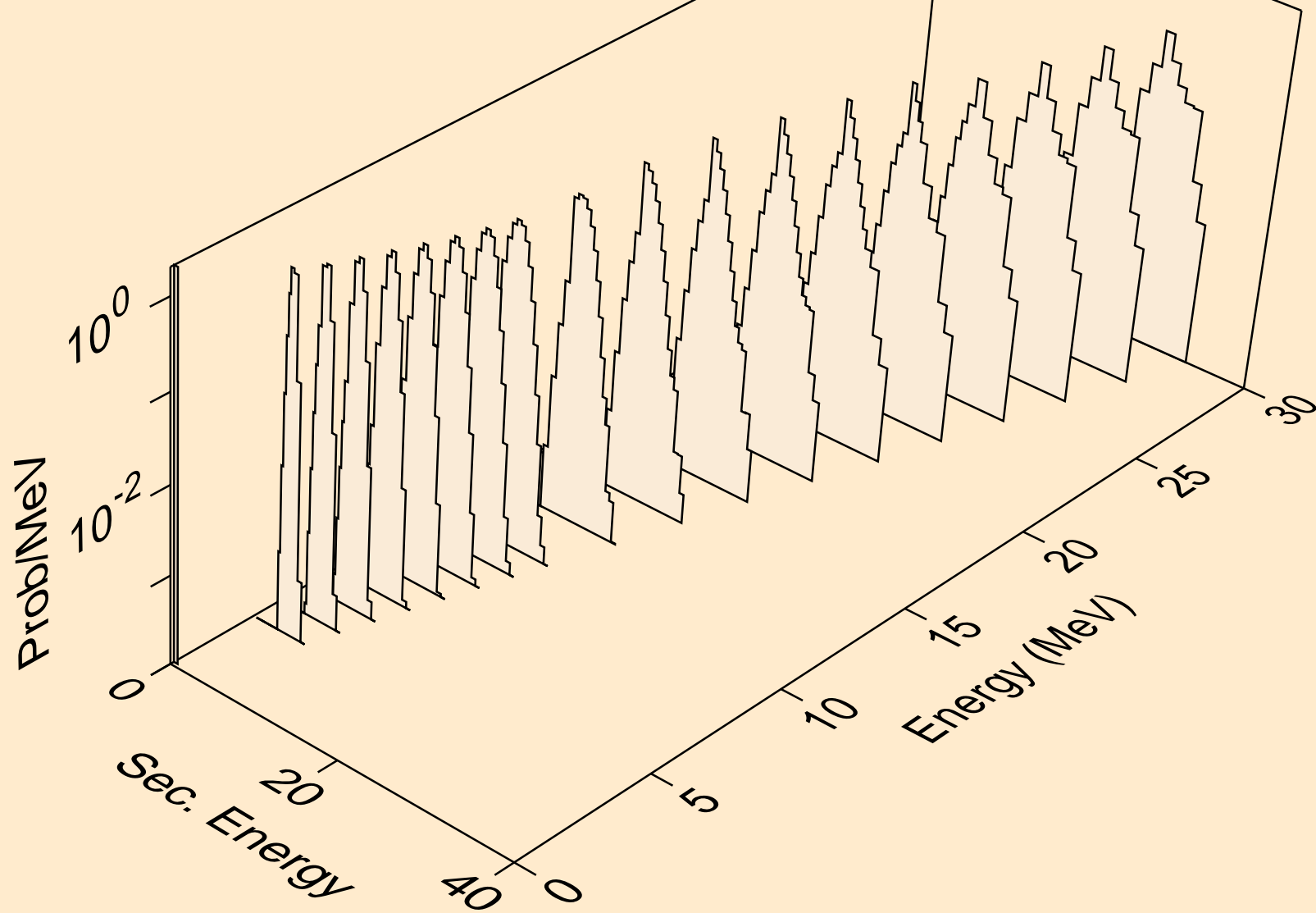

RN227 DEUTERON ACER TENDL-2023 LIBRARY; T=0.K
protons from (d,2p)

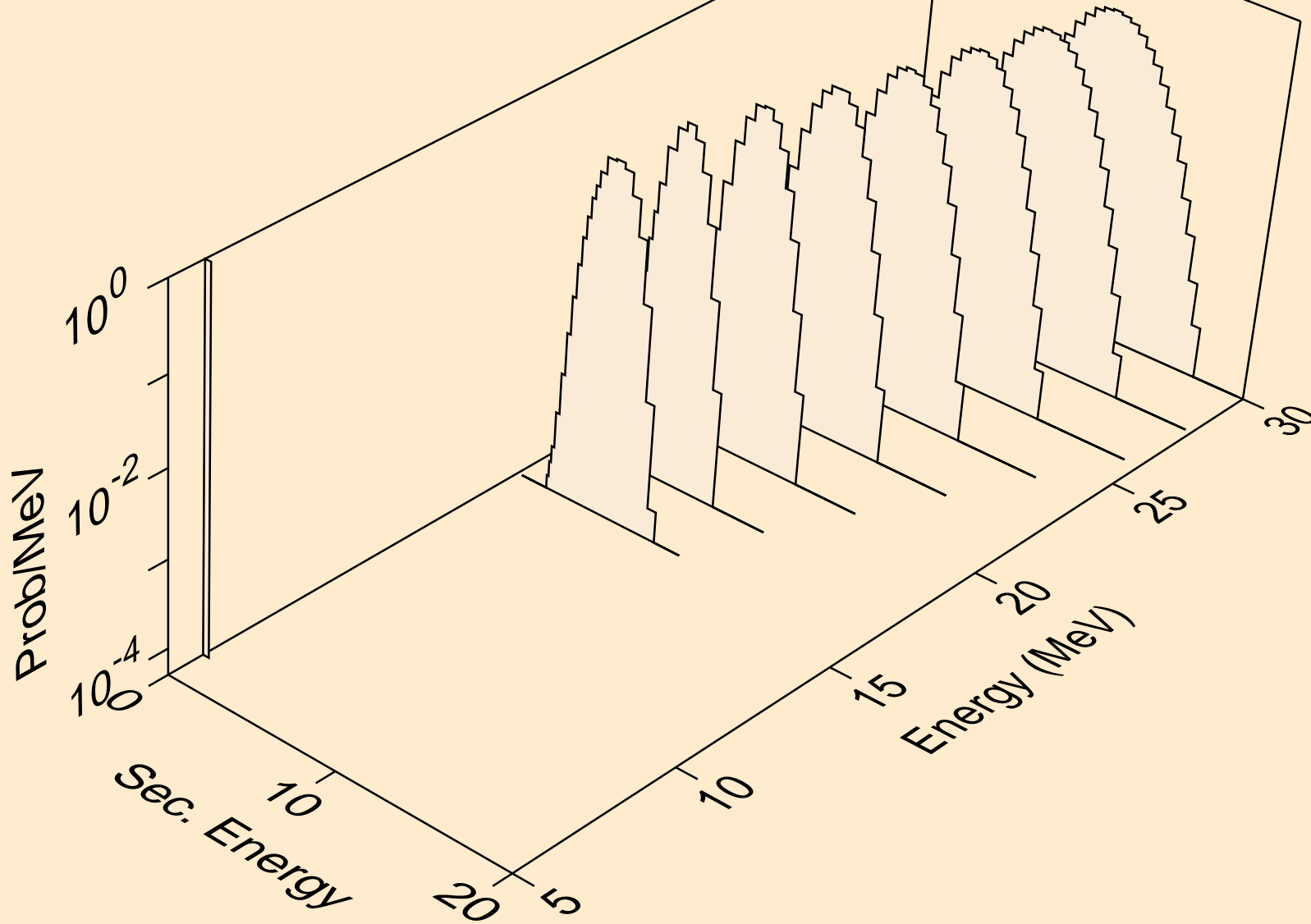

RN227 DEUTERON ACER TENDL-2023 LIBRARY; T=0.K
protons from (d,pd)

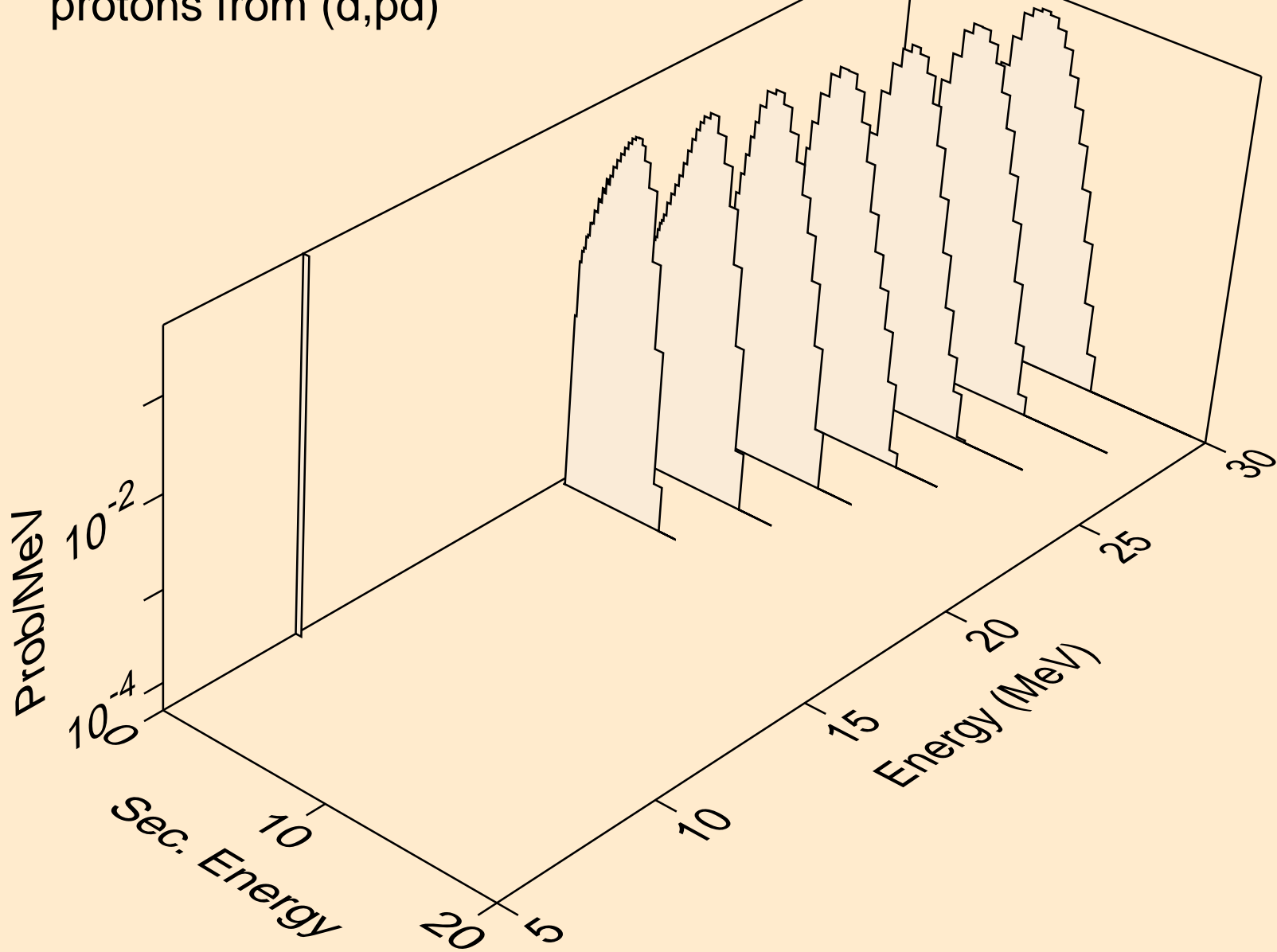

RN227 DEUTERON ACER TENDL-2023 LIBRARY; T=0.K
tritons from (d,x)

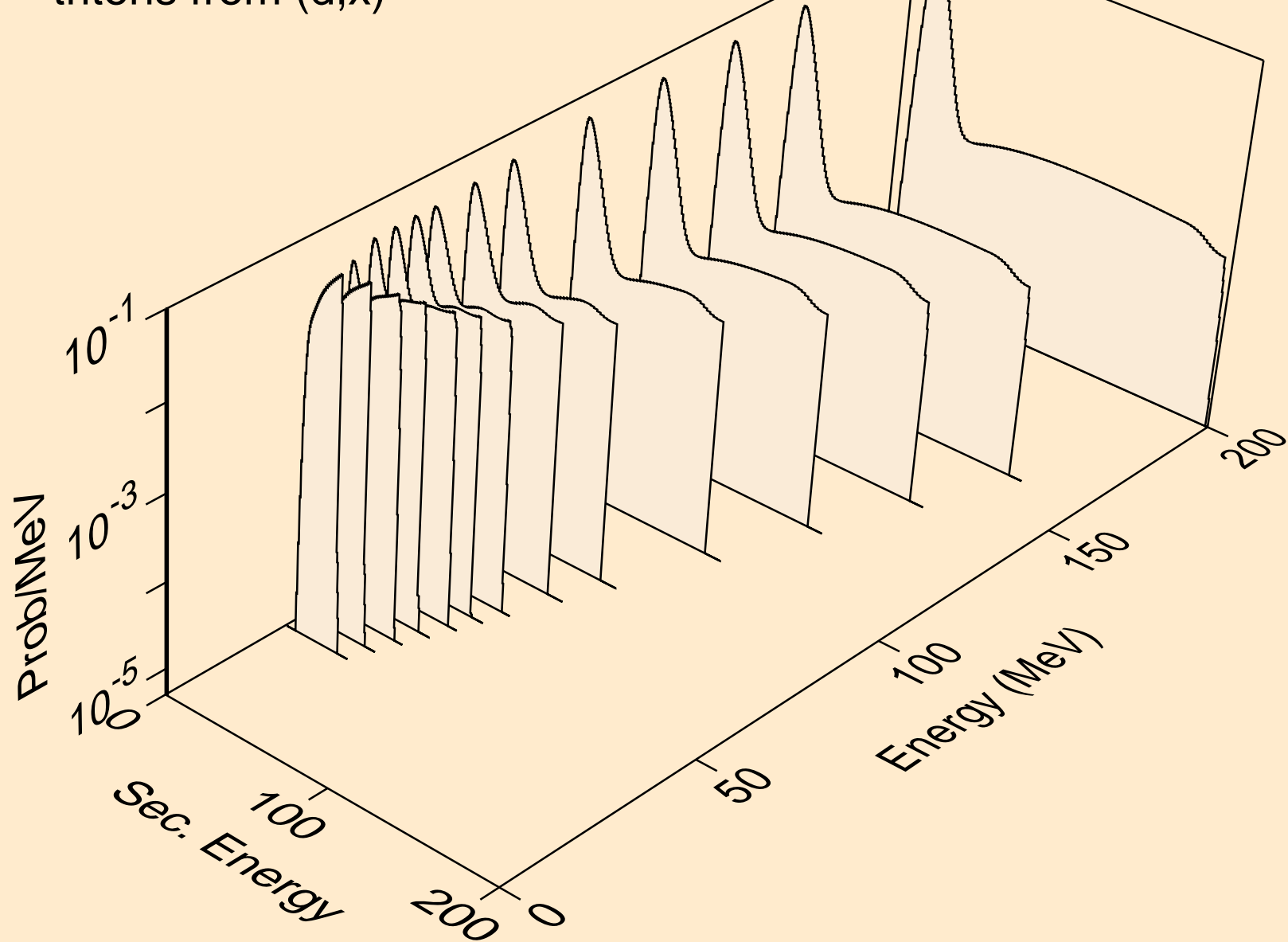

RN227 DEUTERON ACER TENDL-2023 LIBRARY; T=0.K
tritons from (d,n*)t

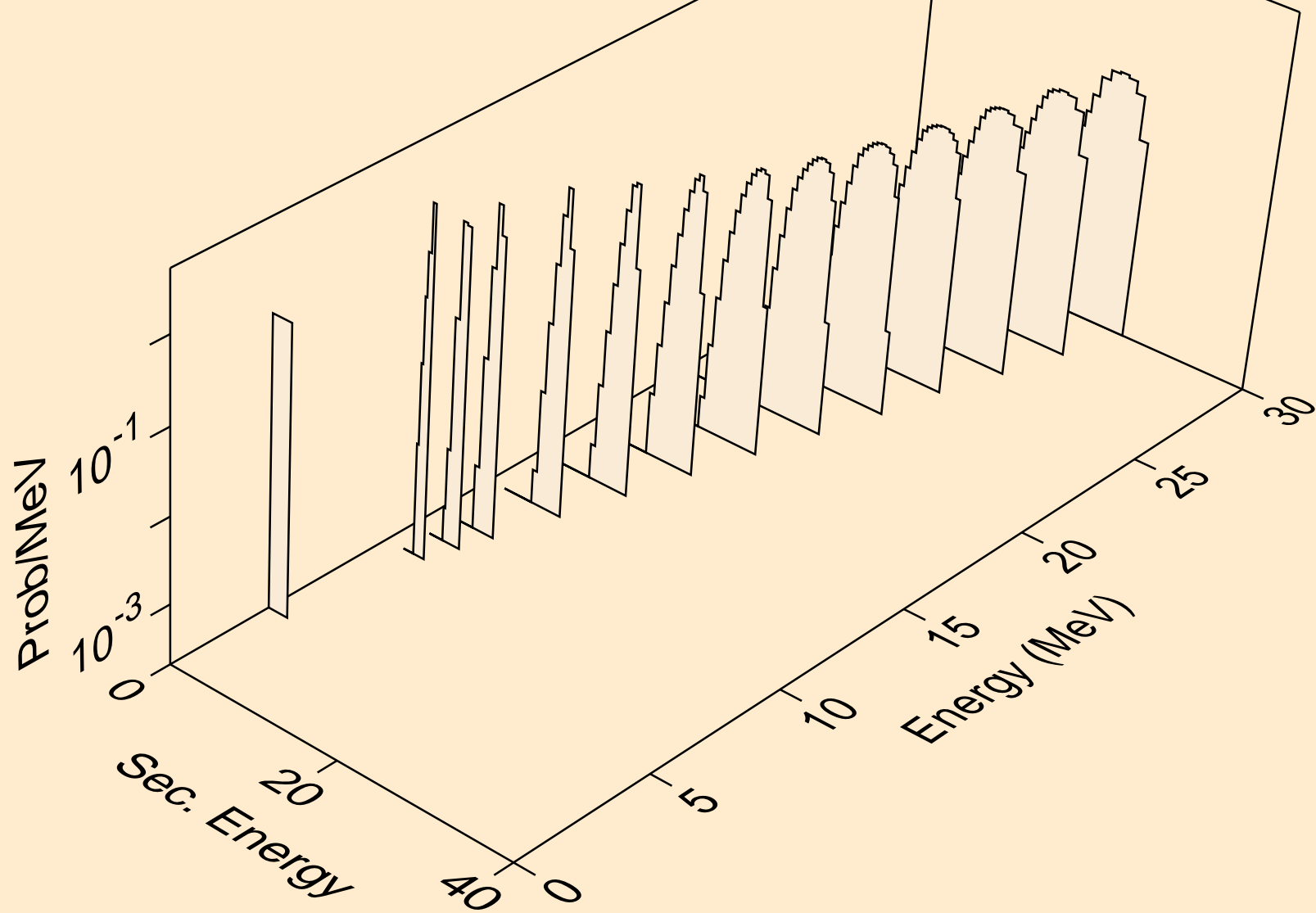

RN227 DEUTERON ACER TENDL-2023 LIBRARY; T=0.K
tritons from (d,t)

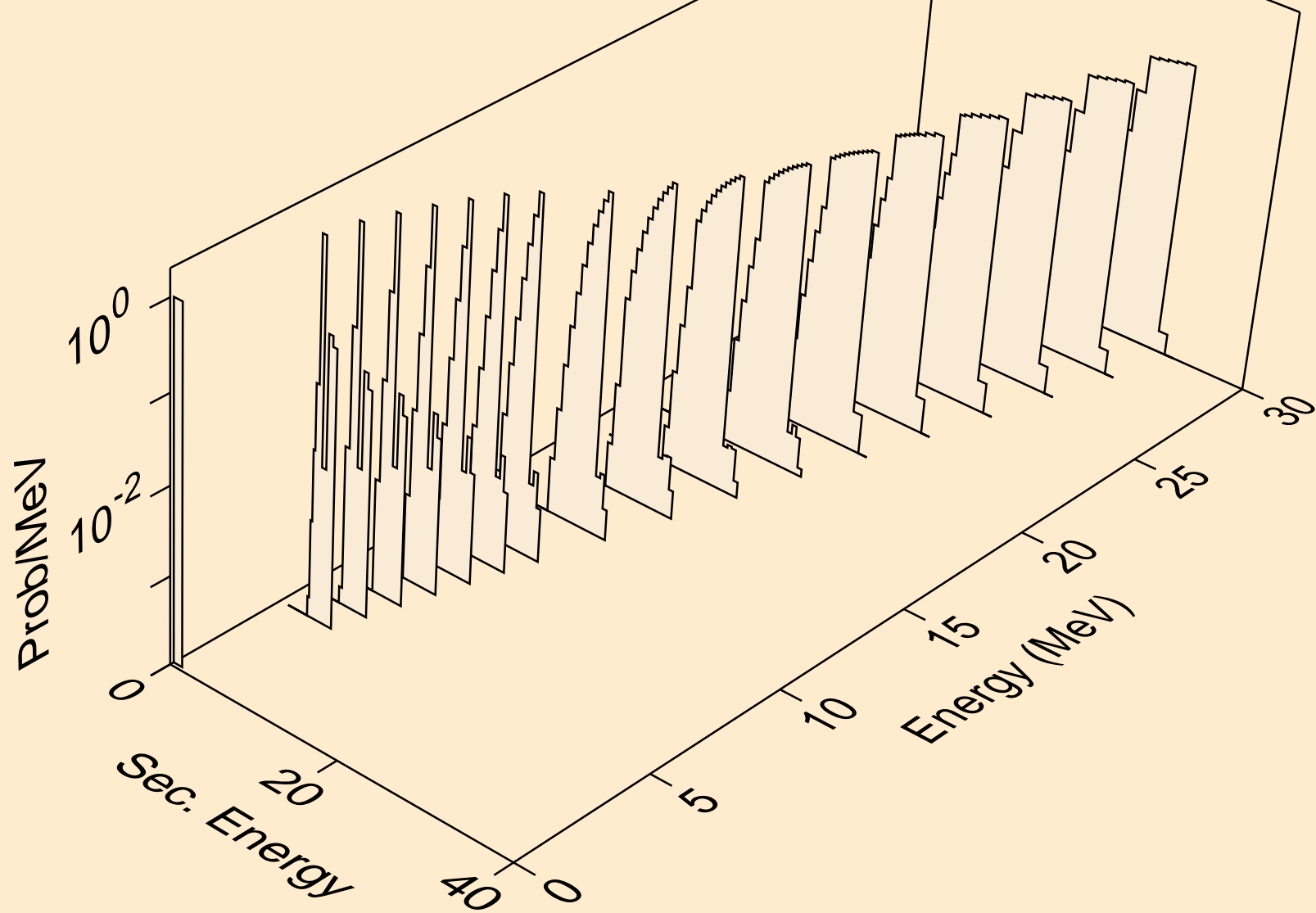

RN227 DEUTERON ACER TENDL-2023 LIBRARY; T=0.K
he3s from (d,x)

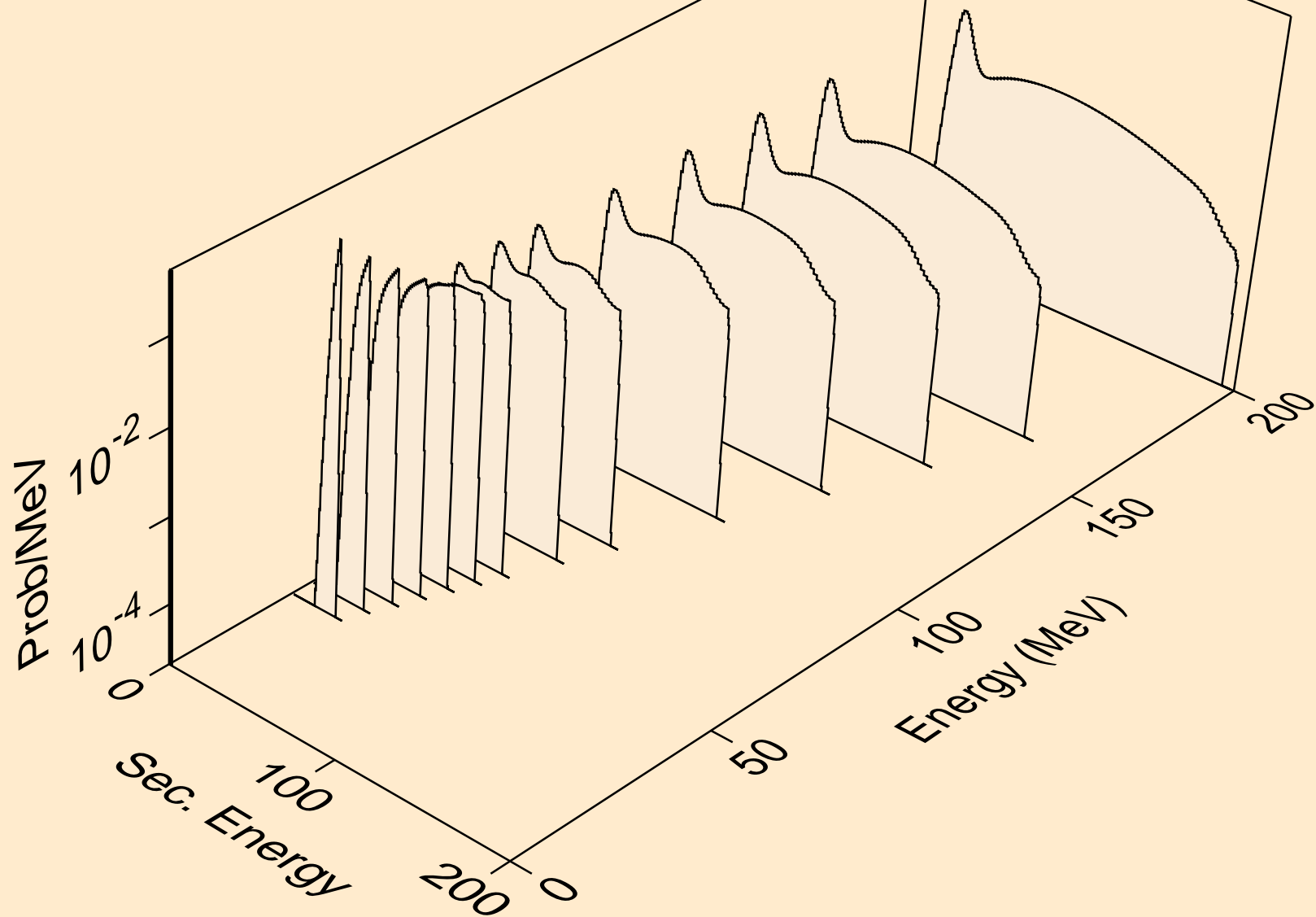

RN227 DEUTERON ACER TENDL-2023 LIBRARY; T=0.K
he3s from (d,n*)he3

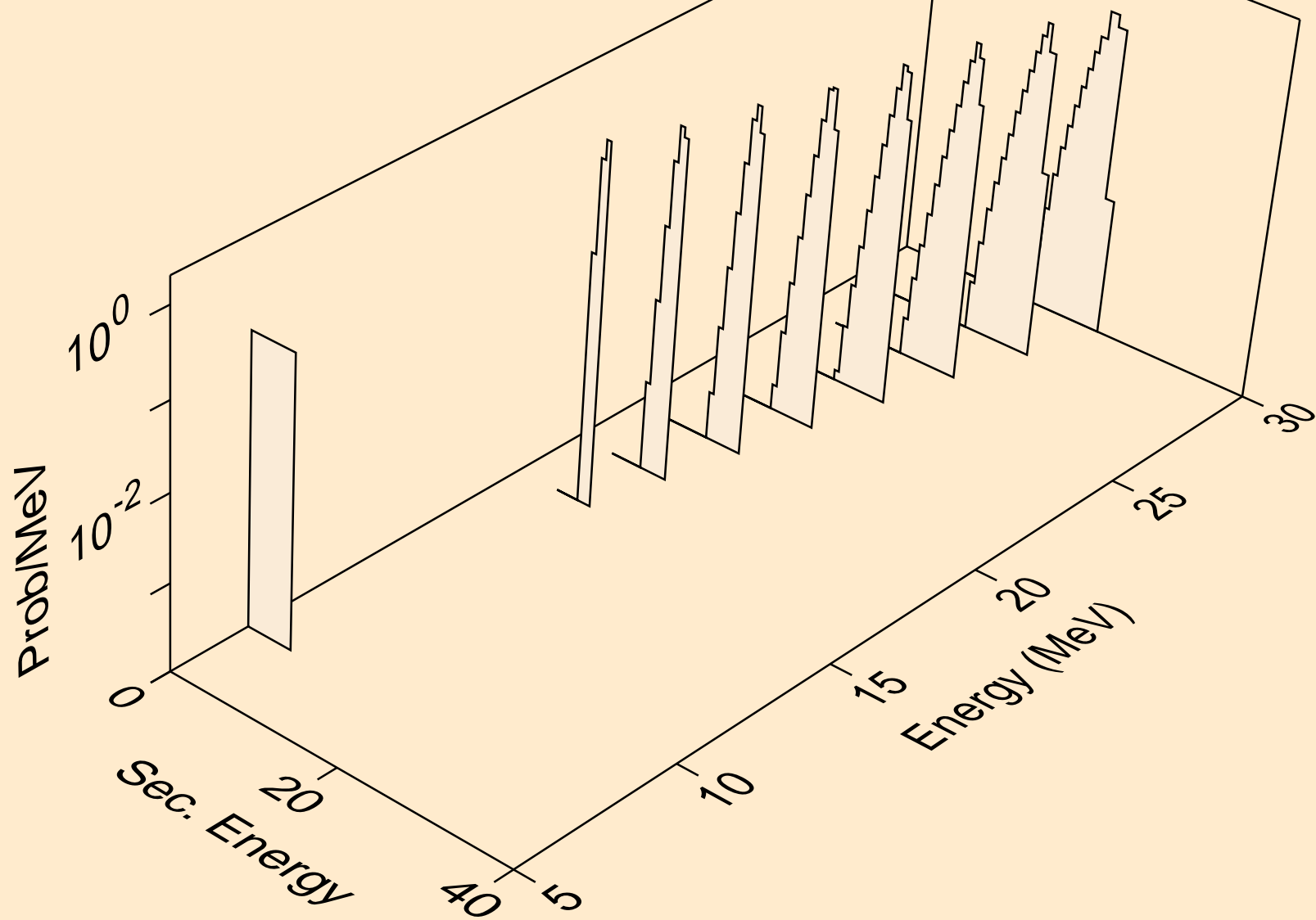

RN227 DEUTERON ACER TENDL-2023 LIBRARY; T=0.K
he3s from (d,he3)

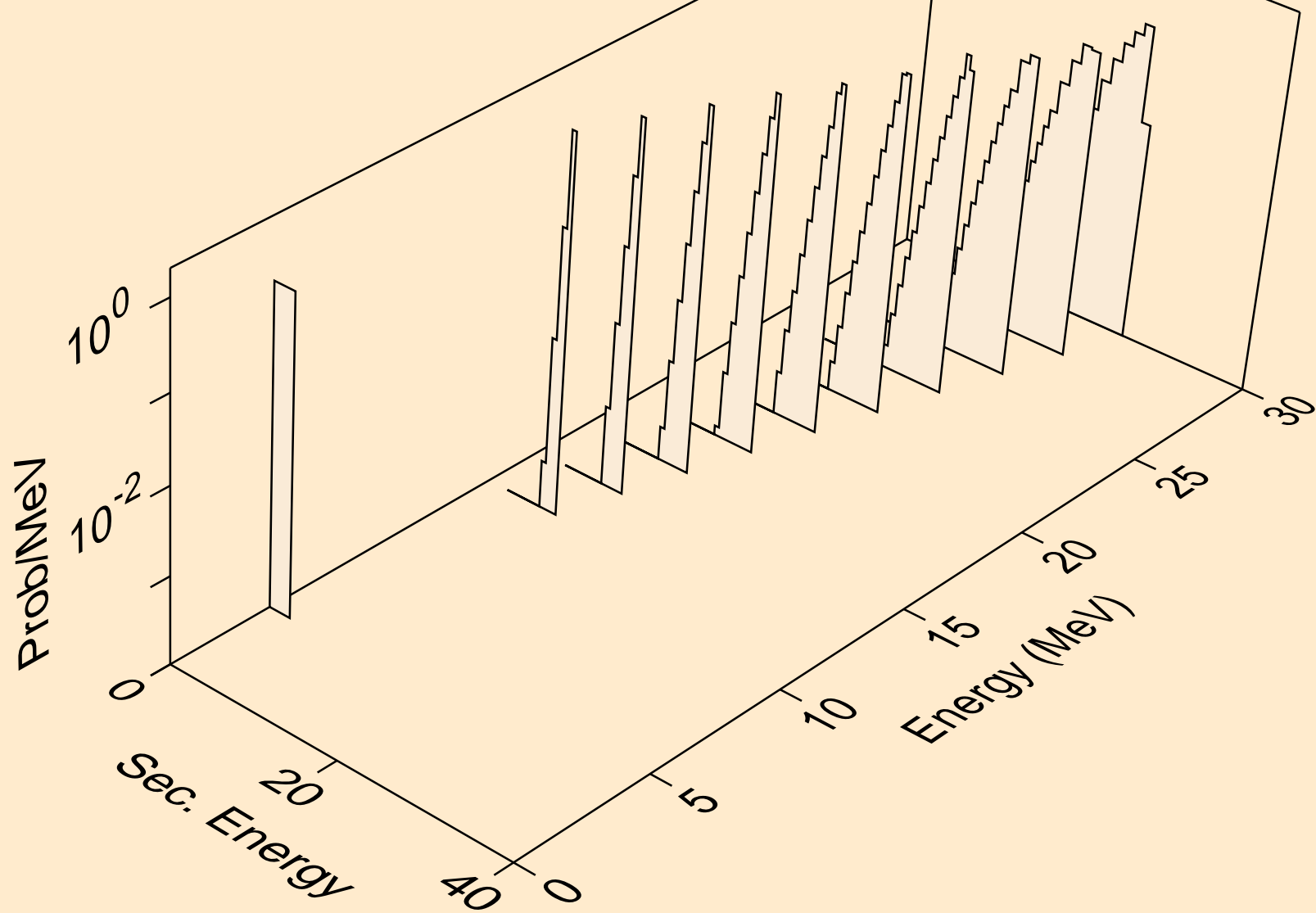

RN227 DEUTERON ACER TENDL-2023 LIBRARY; T=0.K
alphas from (d,x)

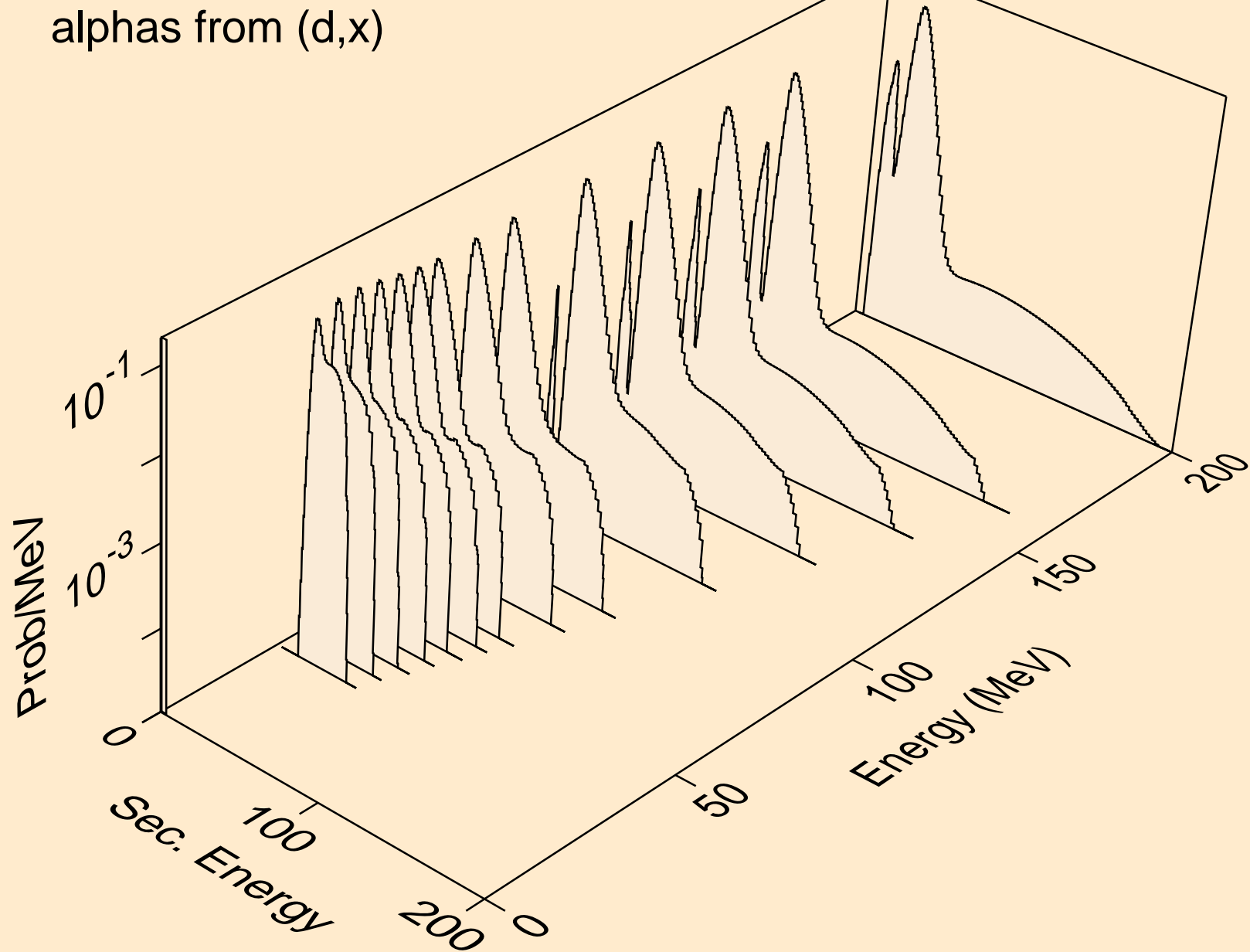

RN227 DEUTERON ACER TENDL-2023 LIBRARY; T=0.K
alphas from (d,n*)a

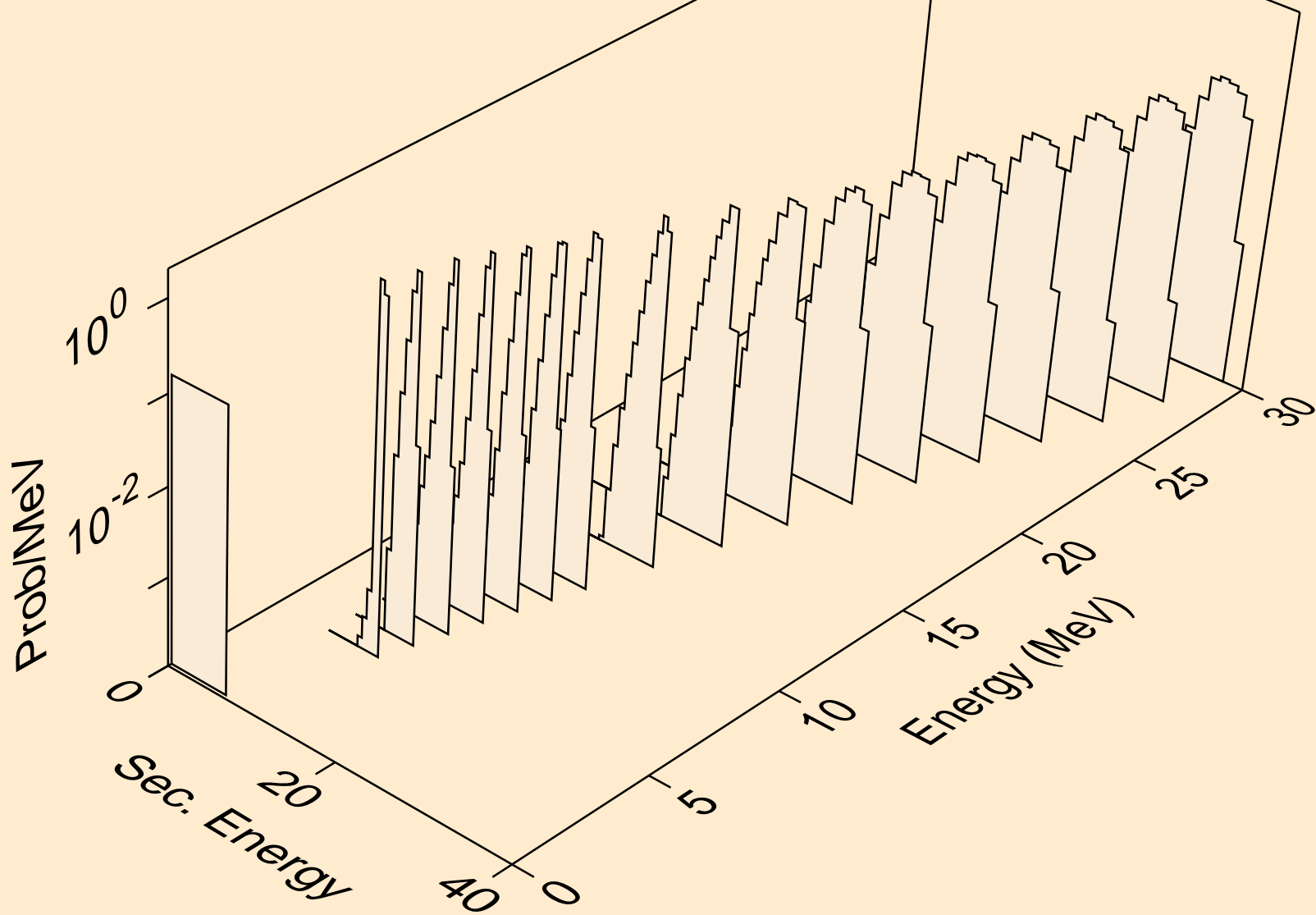

RN227 DEUTERON ACER TENDL-2023 LIBRARY; T=0.K
alphas from (d,2n)a

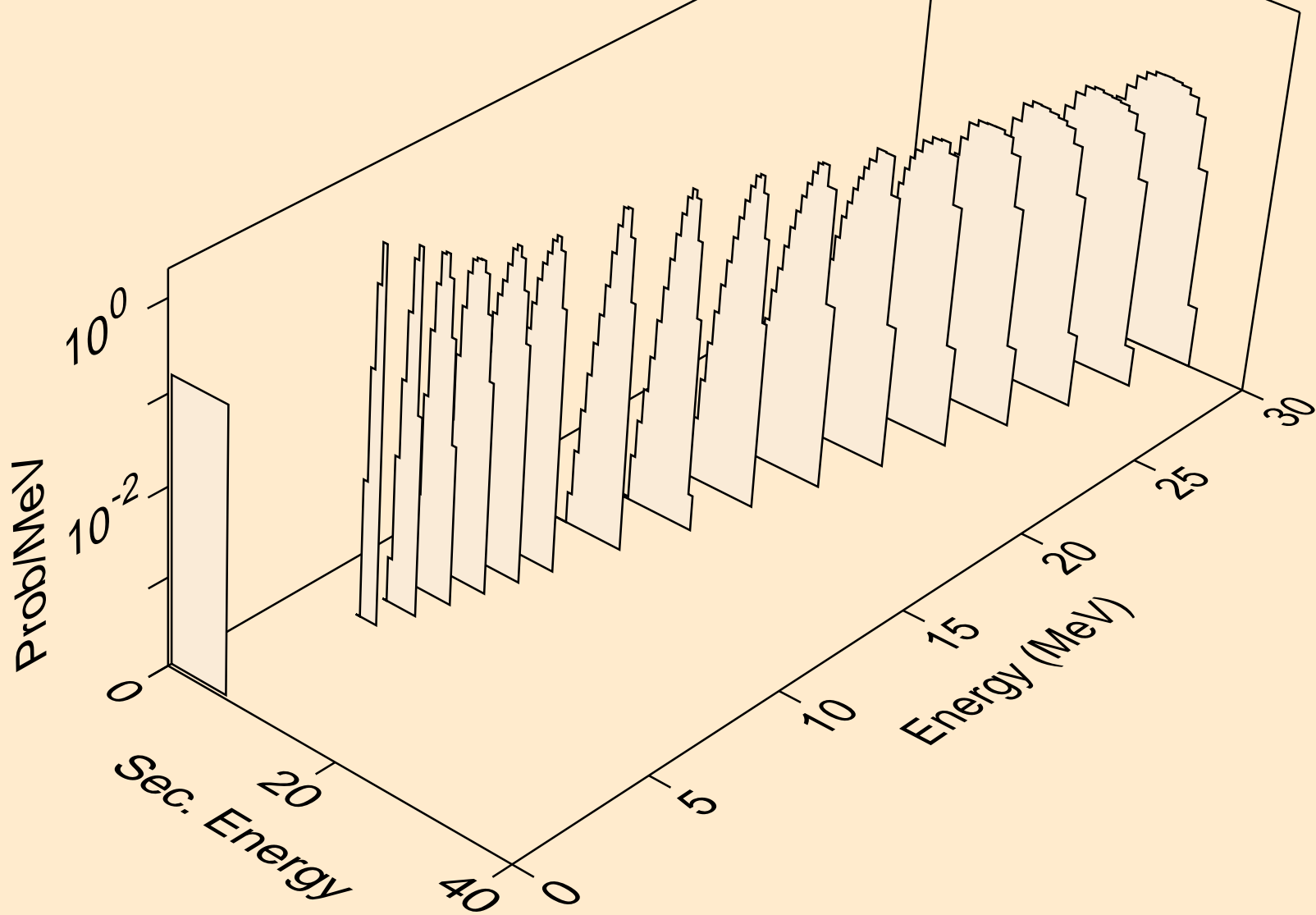

RN227 DEUTERON ACER TENDL-2023 LIBRARY; T=0.K
alphas from (d,3n)a

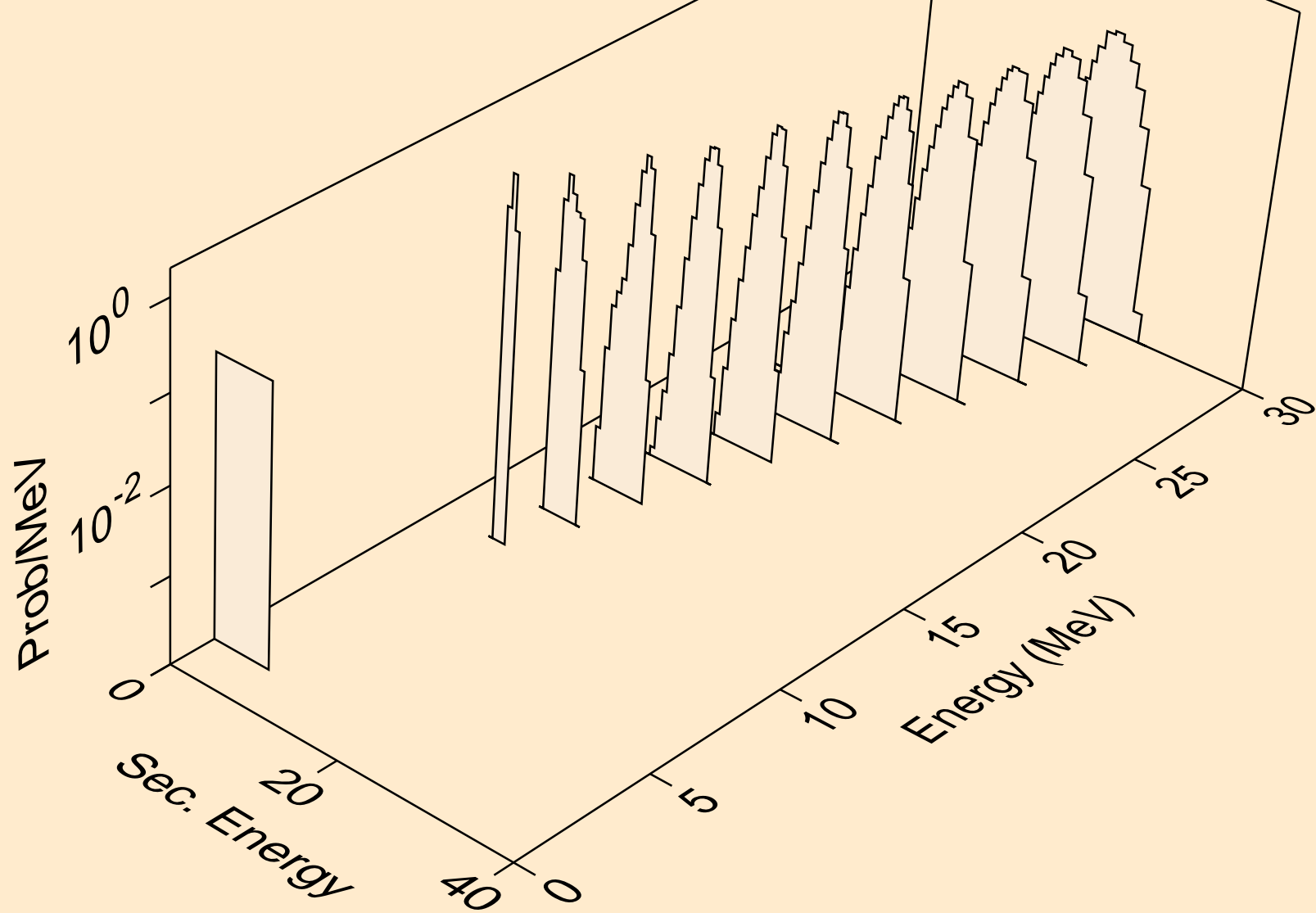

RN227 DEUTERON ACER TENDL-2023 LIBRARY; T=0.K
alphas from (d,n*)2a

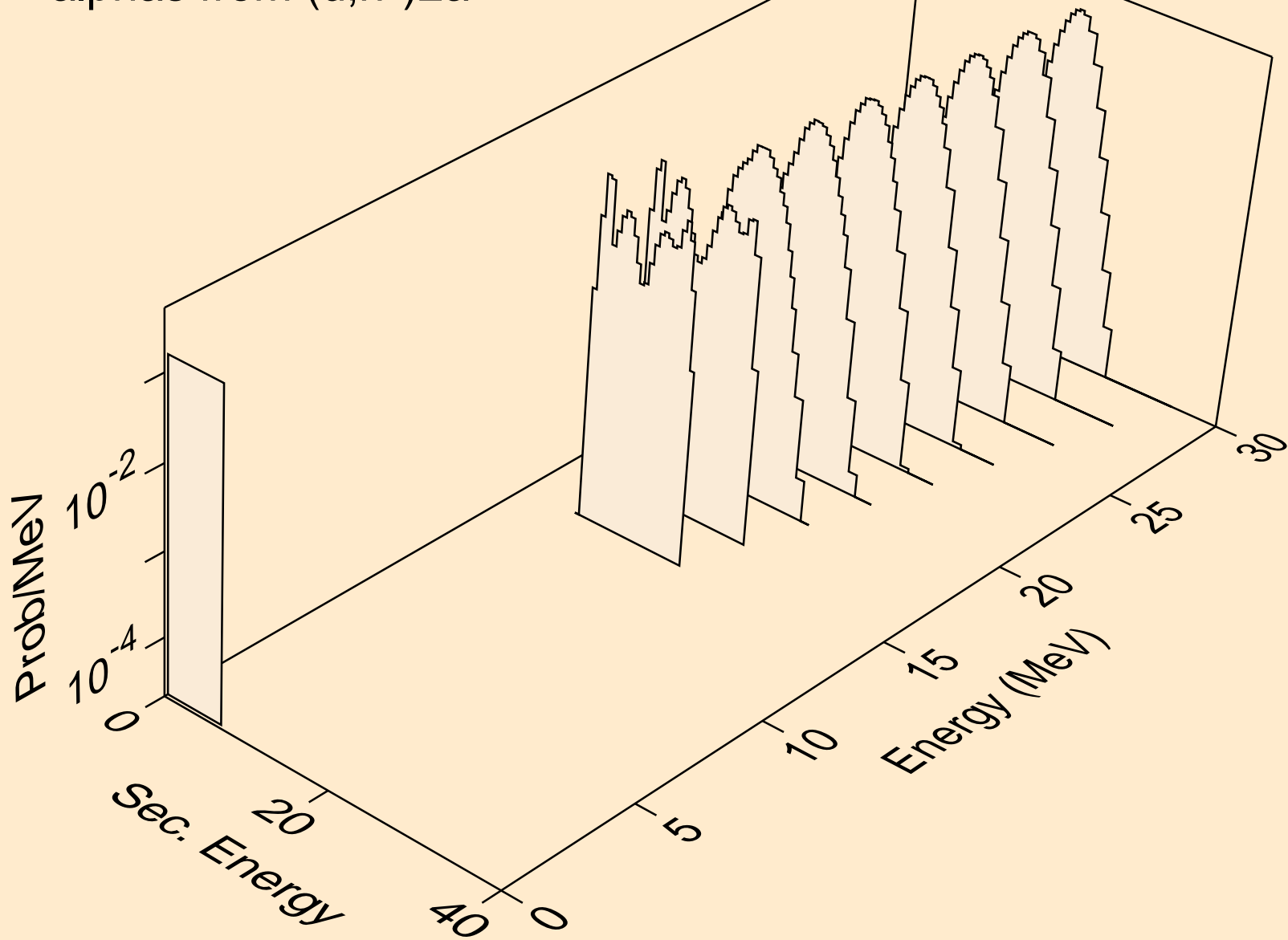

RN227 DEUTERON ACER TENDL-2023 LIBRARY; T=0.K
alphas from (d,2n)2a

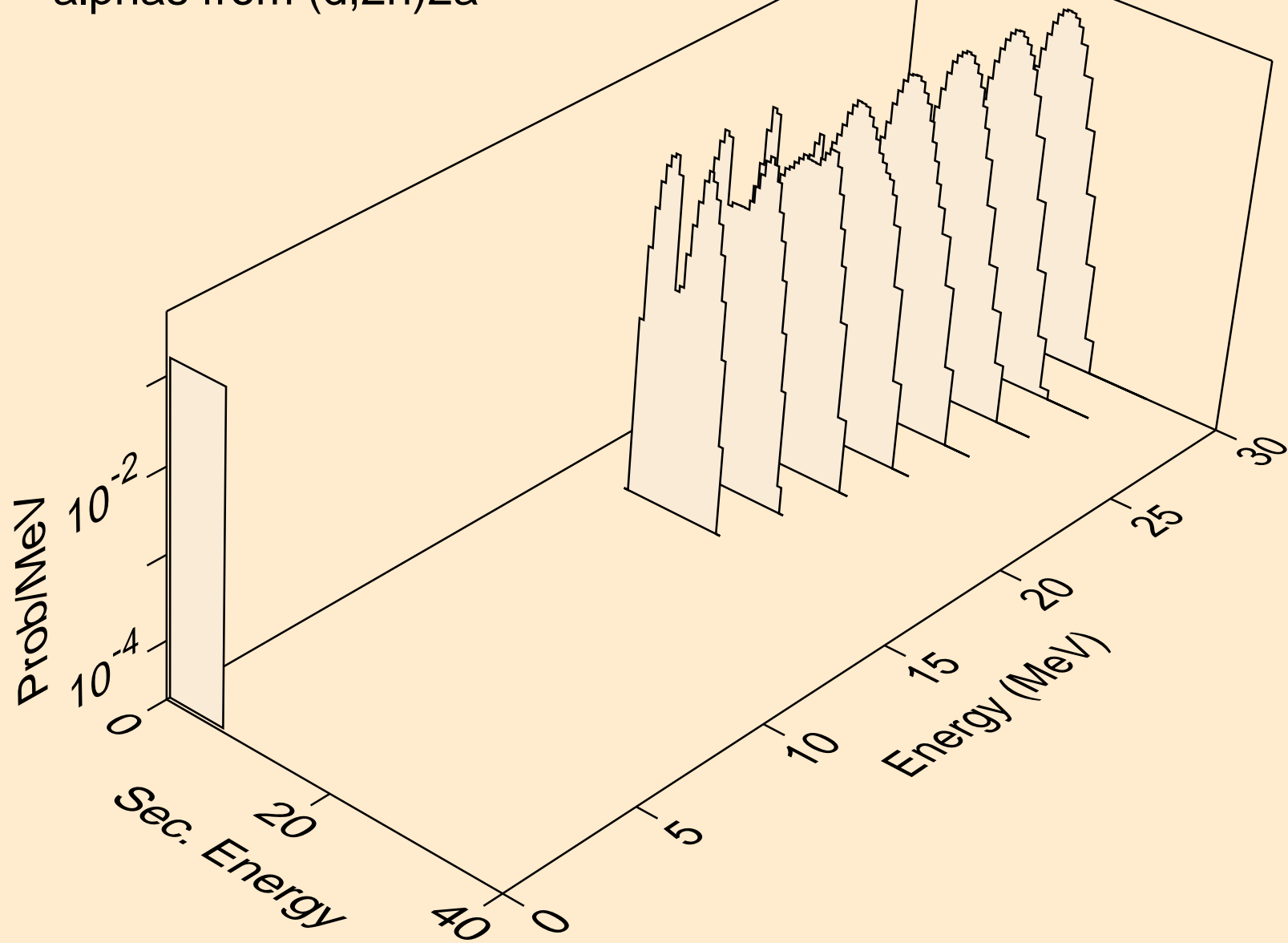

RN227 DEUTERON ACER TENDL-2023 LIBRARY; T=0.K
alphas from (d,npa)

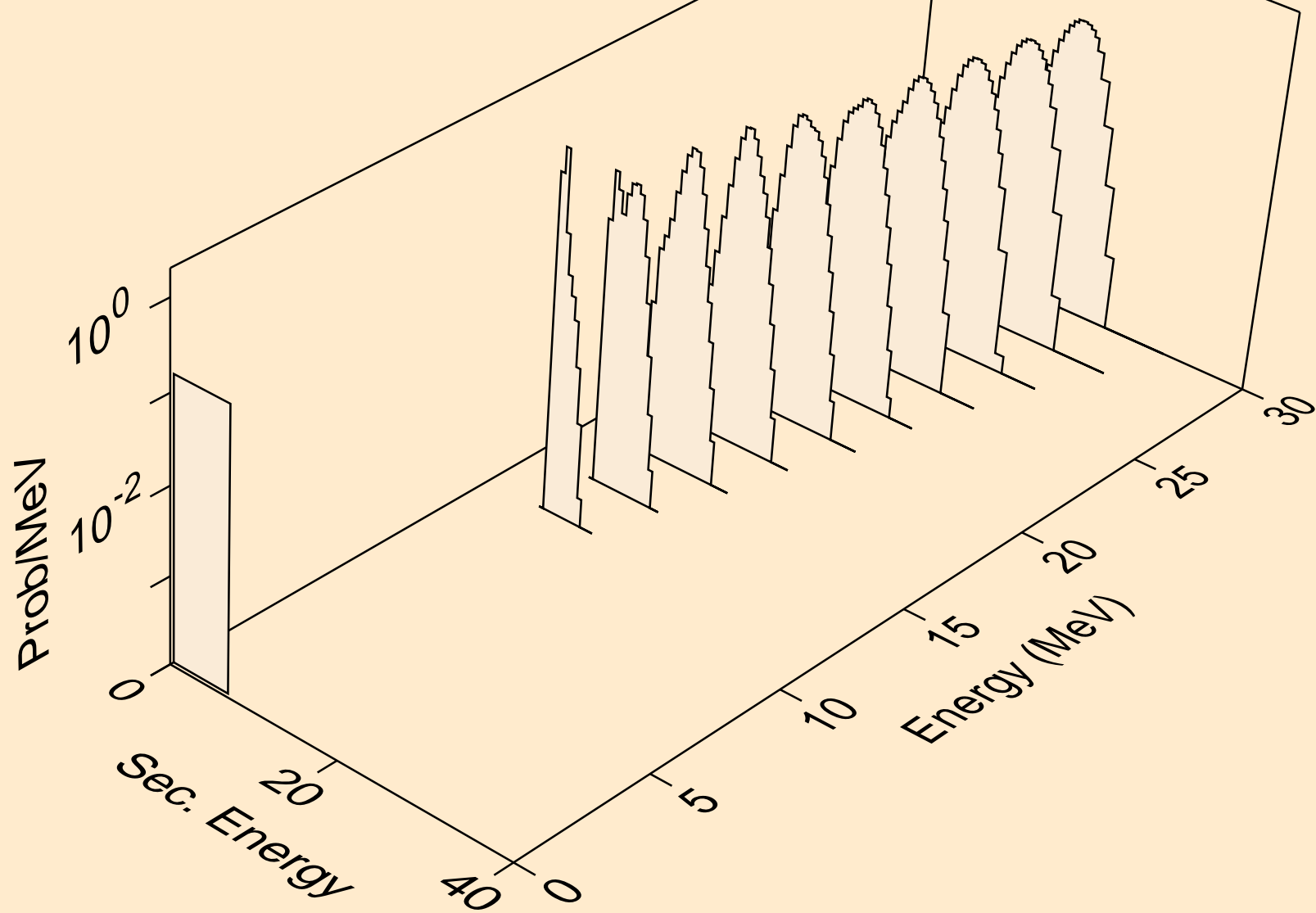

RN227 DEUTERON ACER TENDL-2023 LIBRARY; T=0.K
alphas from (d,a)

