

TA163 DEUTERON ACER TENDL-2023 LIBRARY; T=0.K  
Principal cross sections

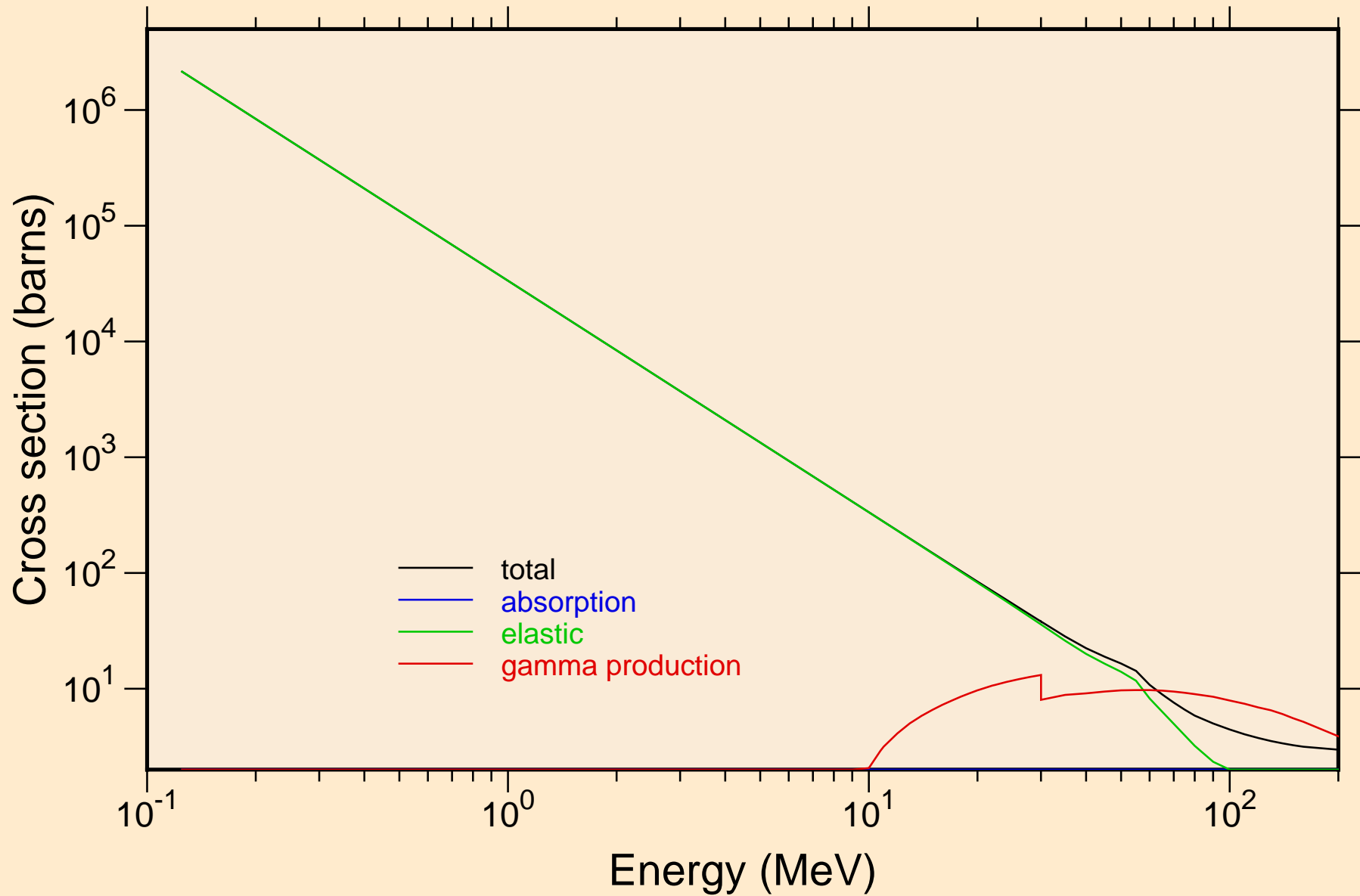

TA163 DEUTERON ACER TENDL-2023 LIBRARY; T=0.K  
Heating

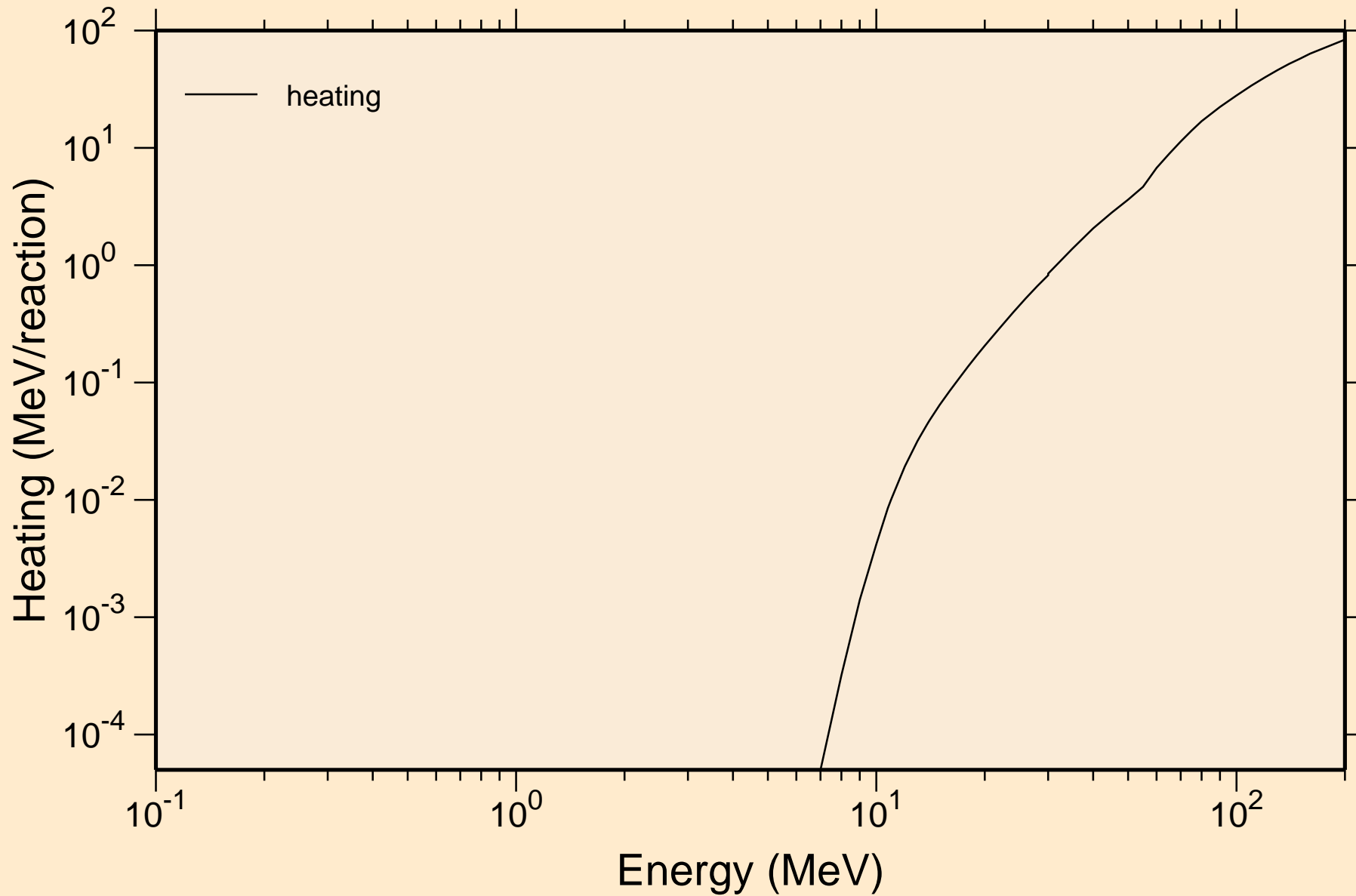

TA163 DEUTERON ACER TENDL-2023 LIBRARY; T=0.K  
Principal cross sections

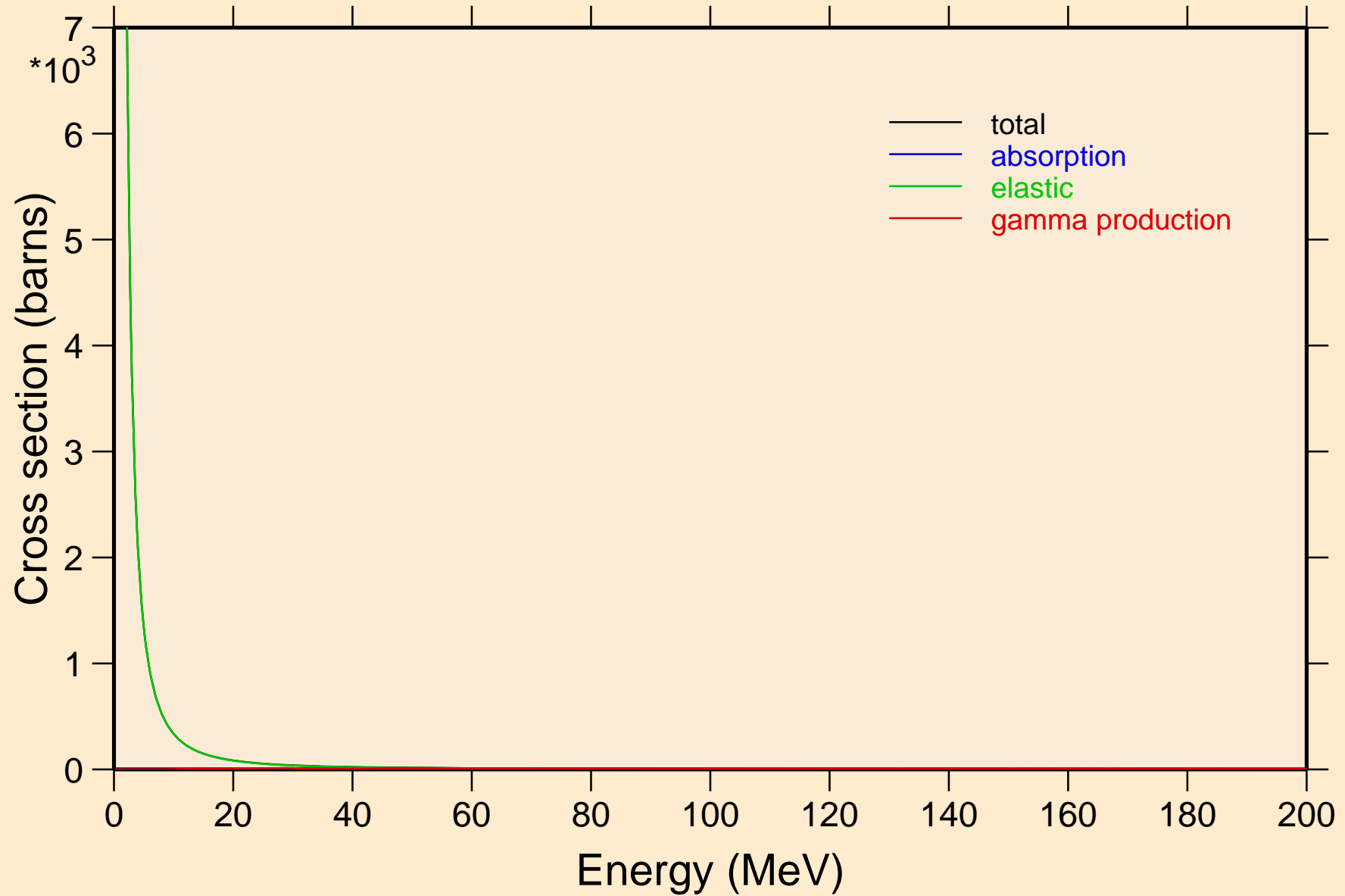

TA163 DEUTERON ACER TENDL-2023 LIBRARY; T=0.K  
Heating

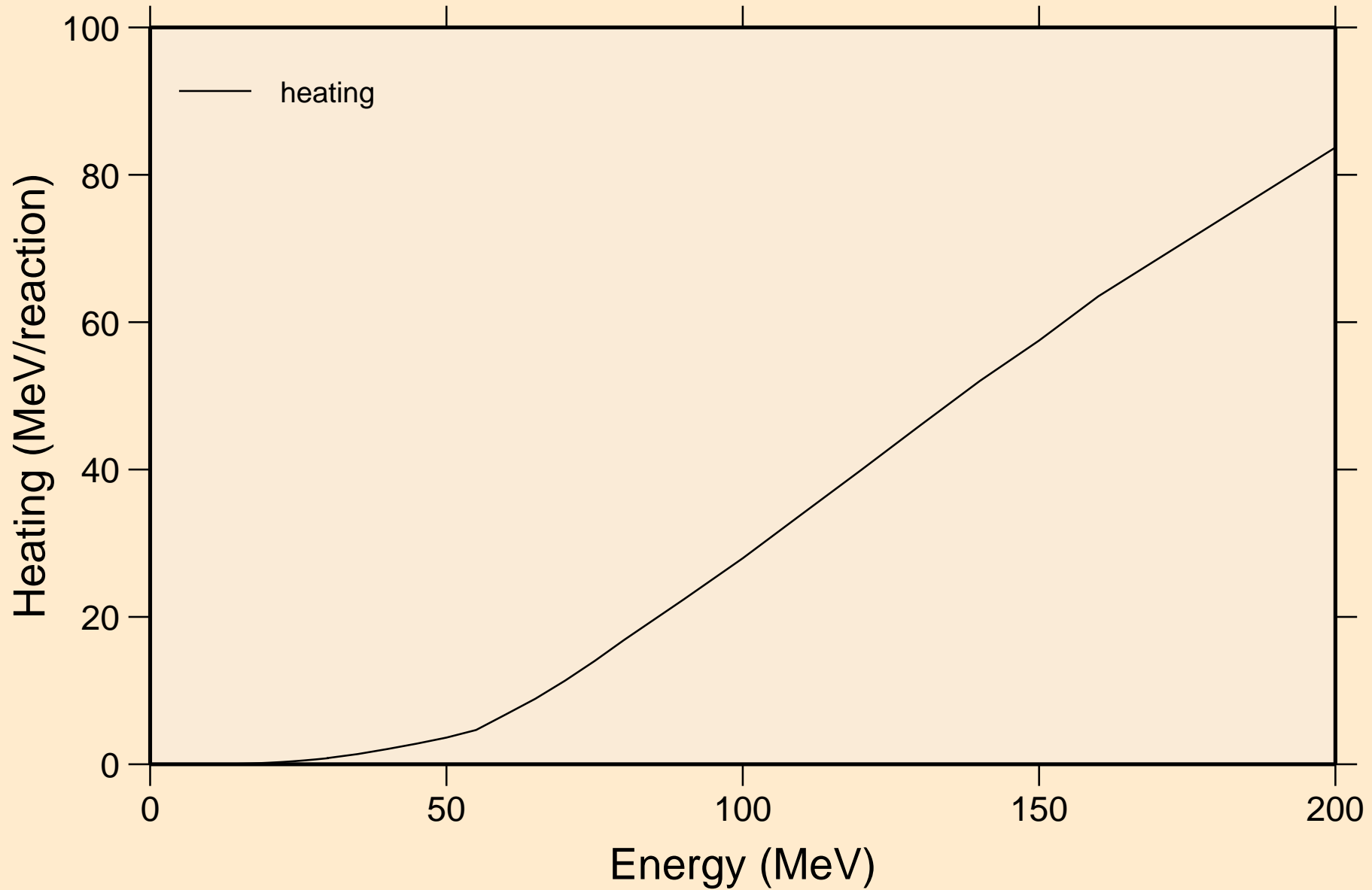

# TA163 DEUTERON ACER TENDL-2023 LIBRARY; T=0.K

## Threshold reactions

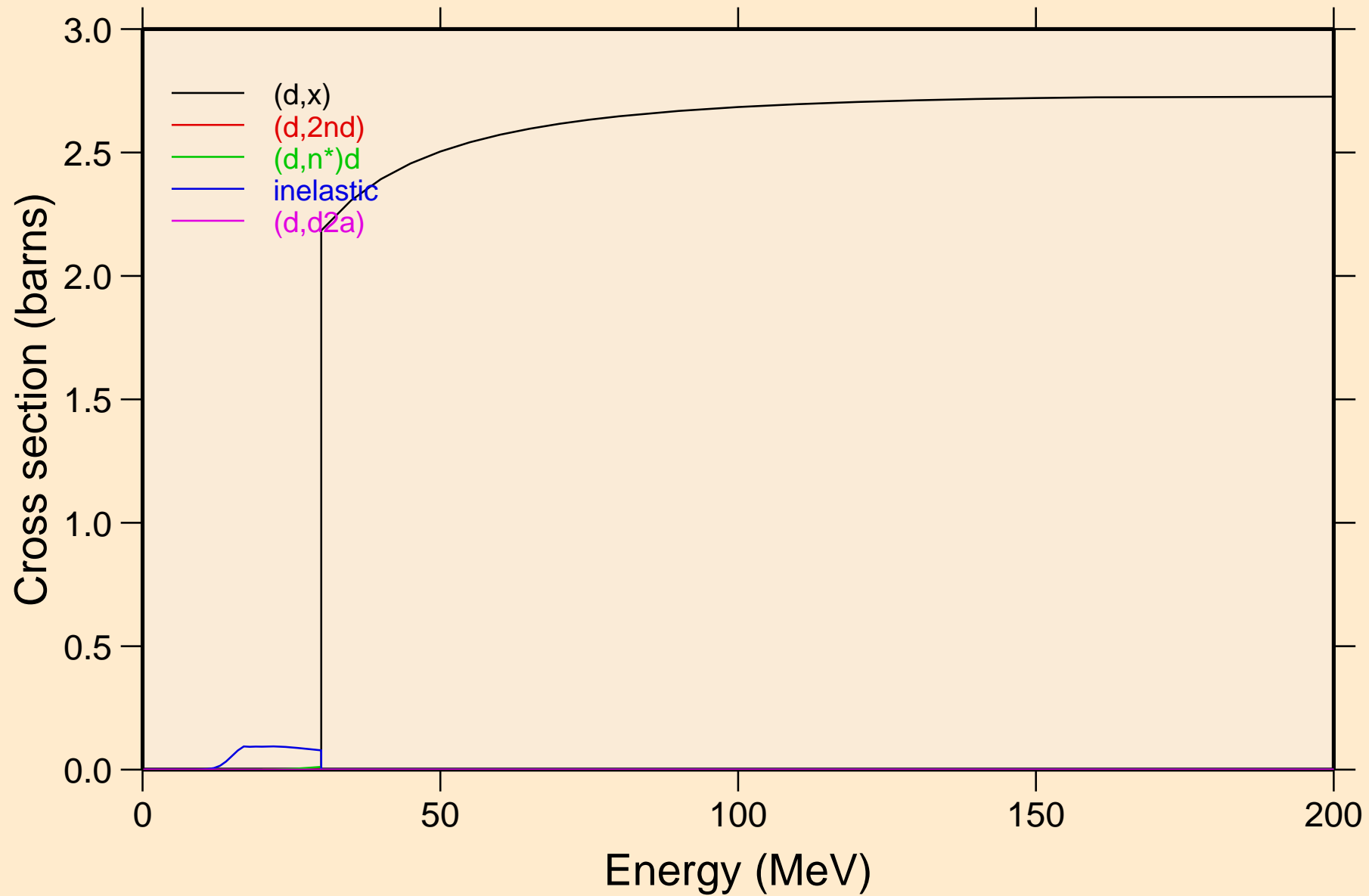

TA163 DEUTERON ACER TENDL-2023 LIBRARY; T=0.K  
Threshold reactions

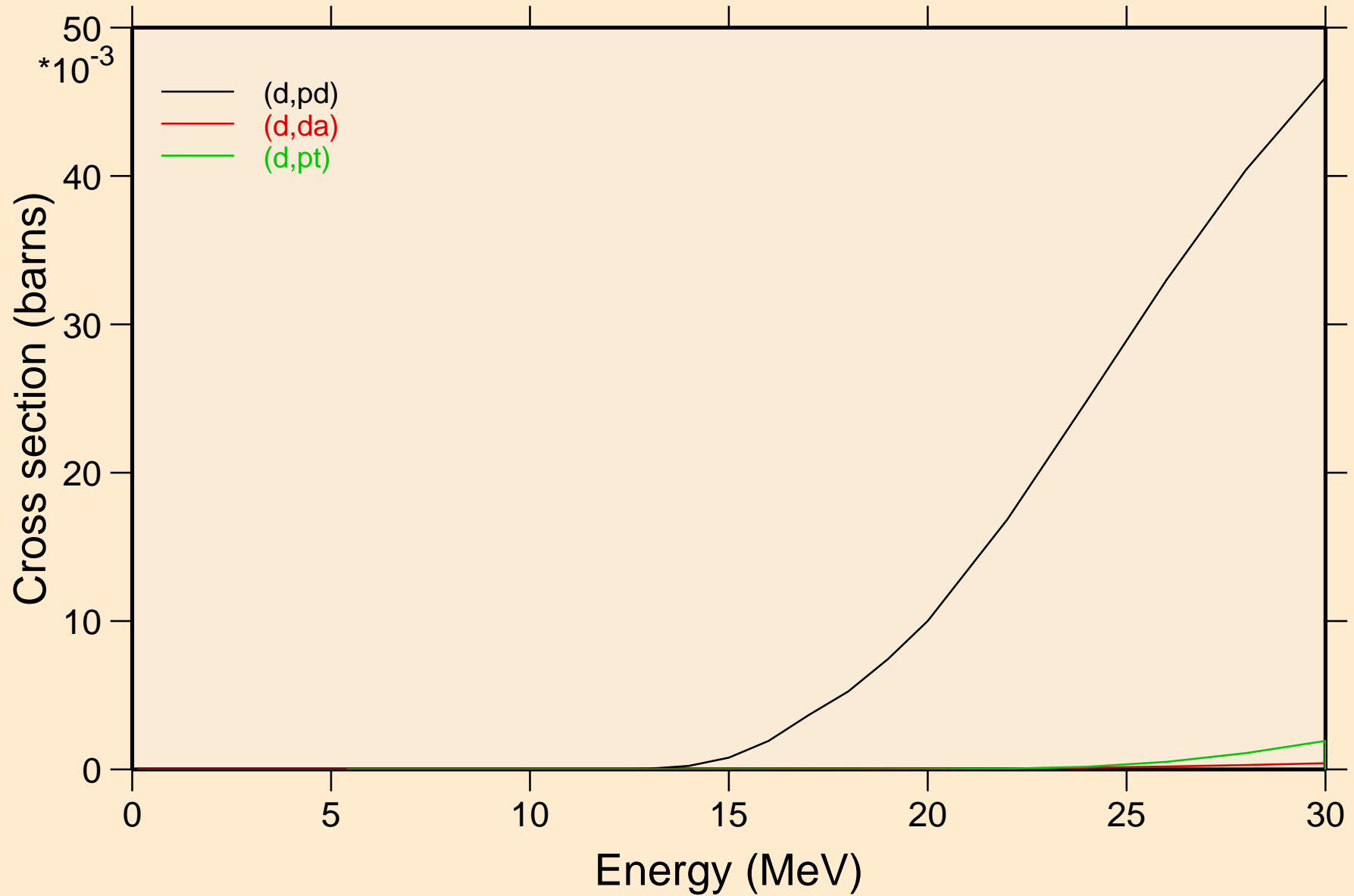

TA163 DEUTERON ACER TENDL-2023 LIBRARY; T=0.K  
Threshold reactions

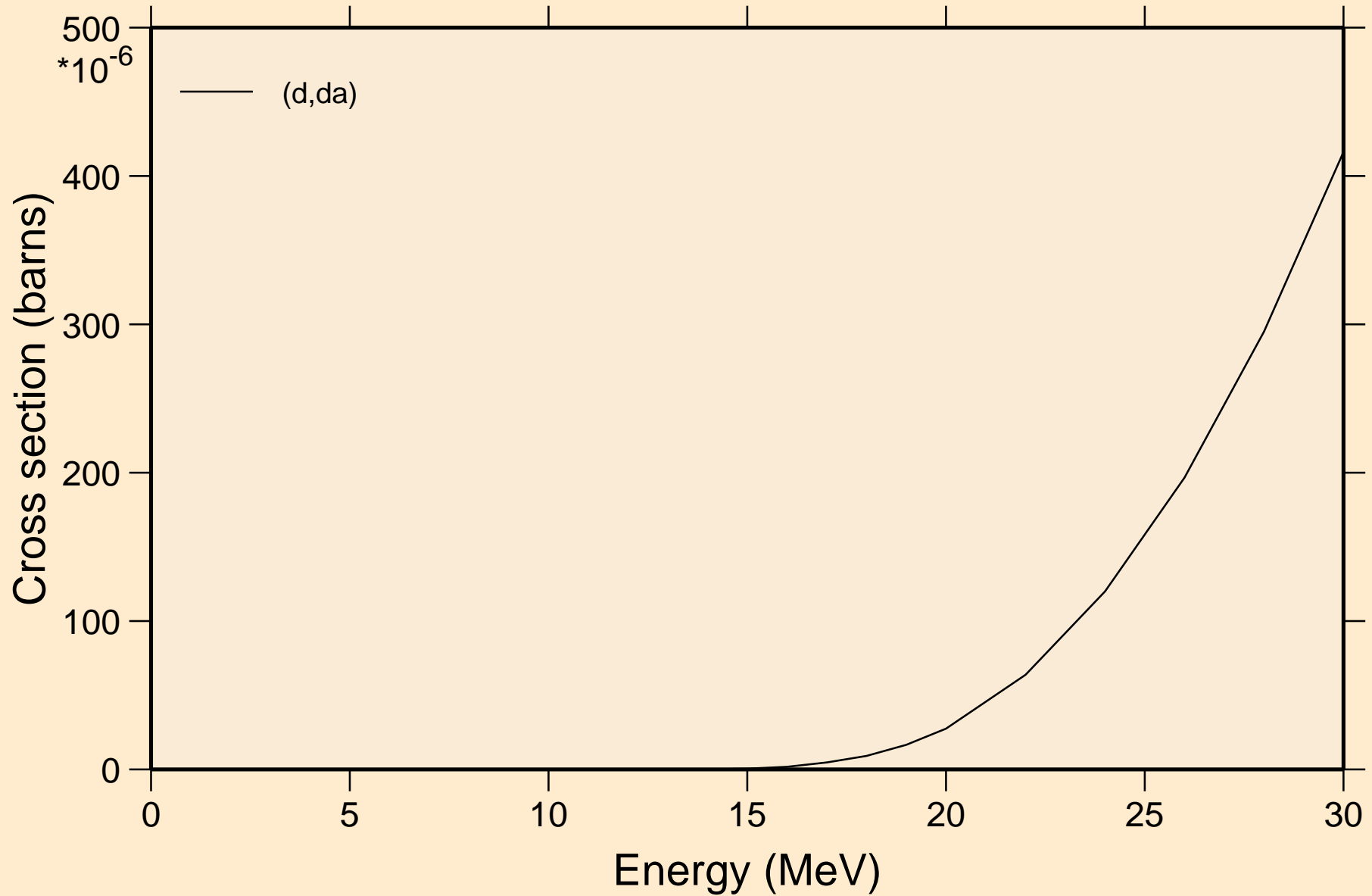

TA163 DEUTERON ACER TENDL-2023 LIBRARY; T=0.K  
angular distribution for elastic

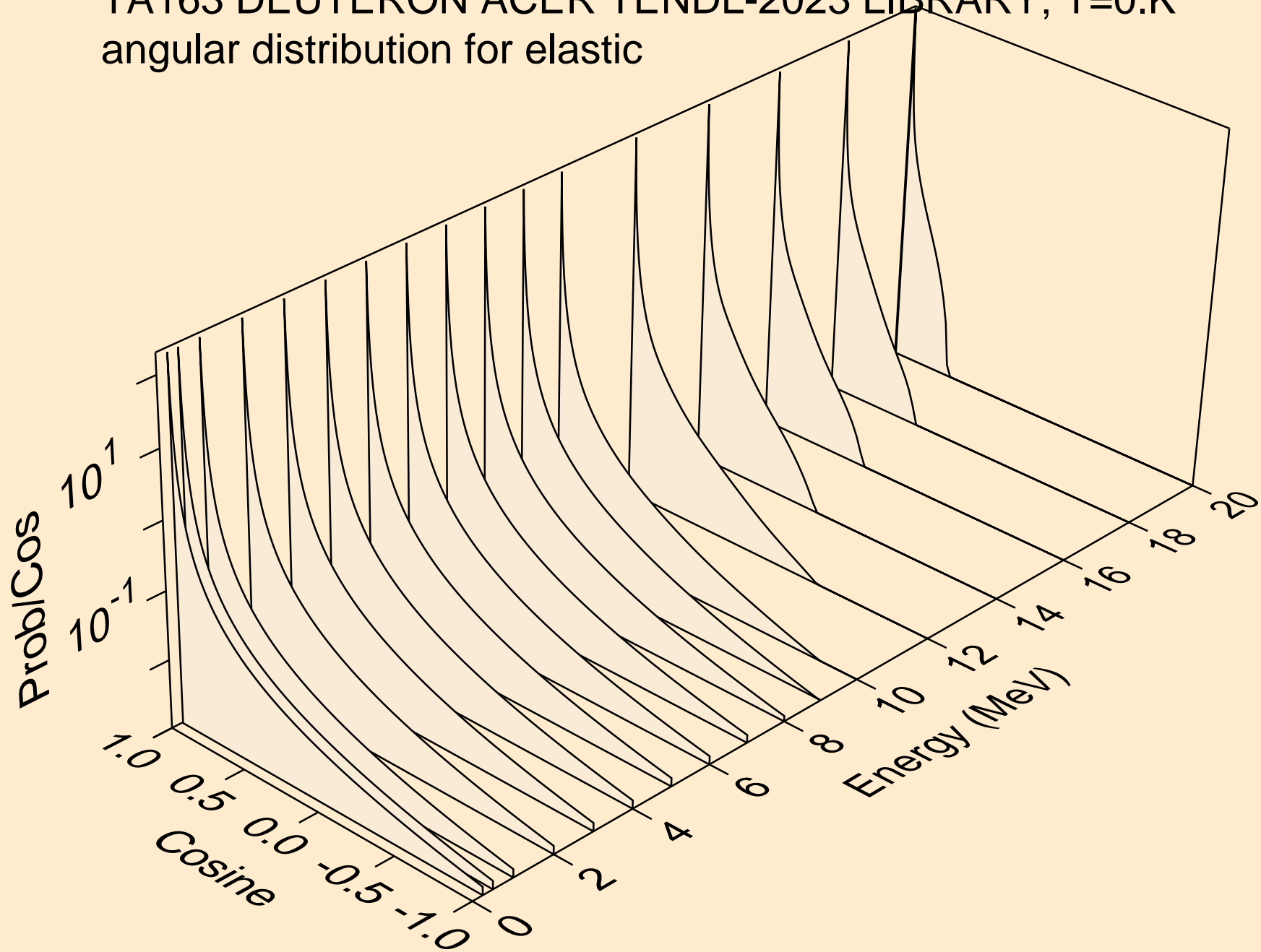



TA163 DEUTERON ACER TENDL-2023 LIBRARY; T=0.K  
angular distribution for elastic

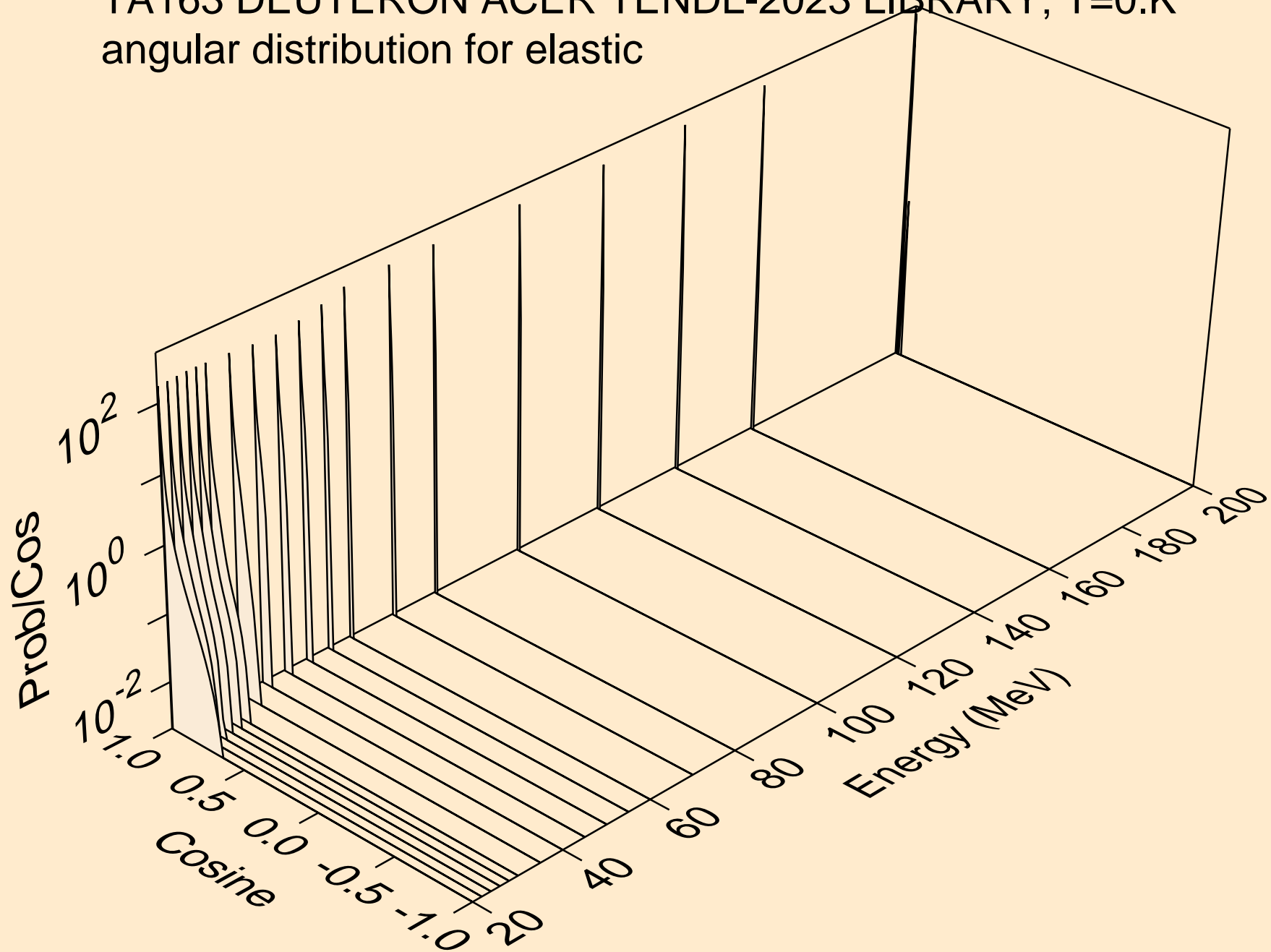

TA163 DEUTERON ACER TENDL-2023 LIBRARY; T=0.K  
Deuteron emission for (d,x)

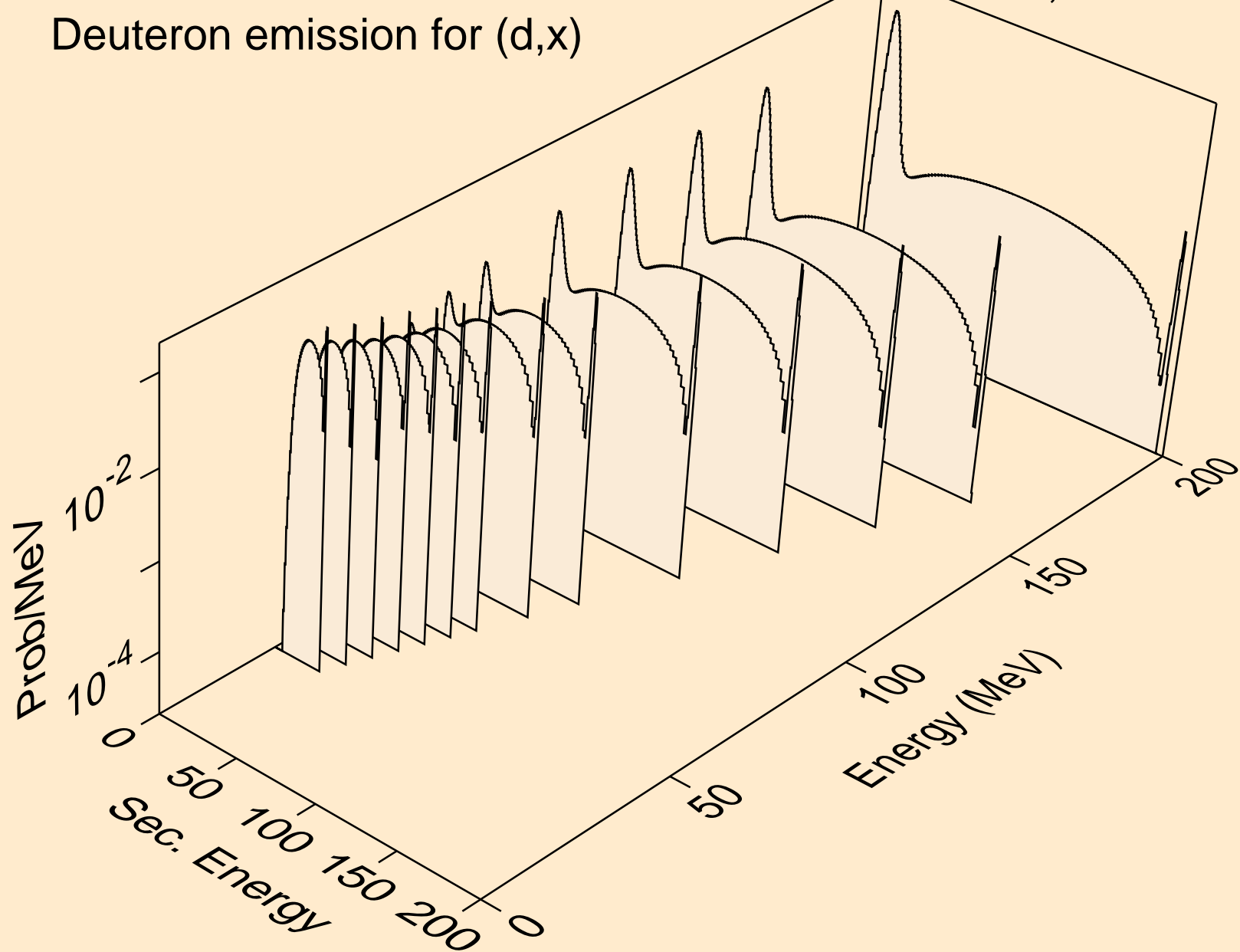

TA163 DEUTERON ACER TENDL-2023 LIBRARY; T=0.K  
Deuteron emission for (d,2nd)

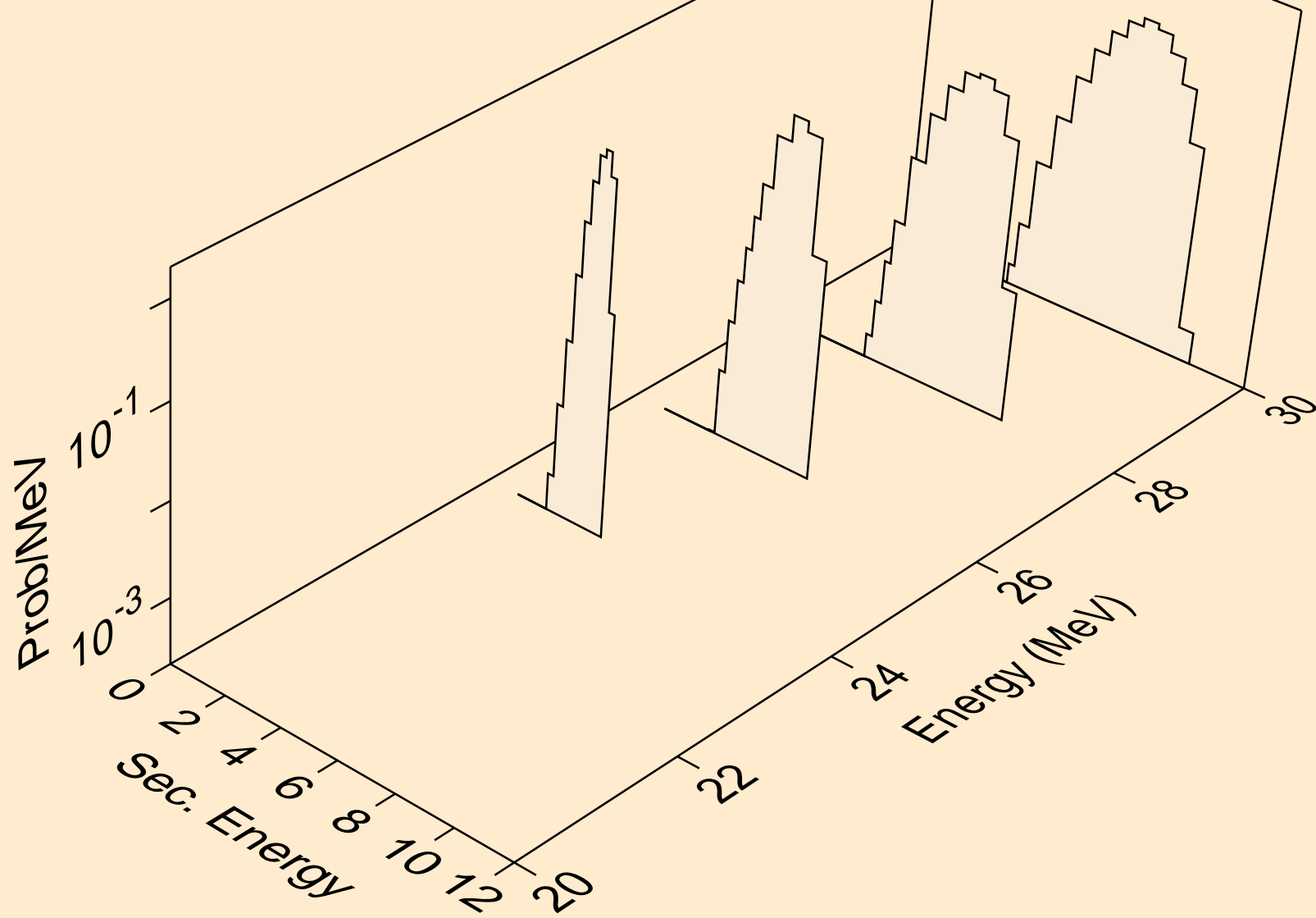

TA163 DEUTERON ACER TENDL-2023 LIBRARY; T=0.K  
Deuteron emission for (d,n\*)d

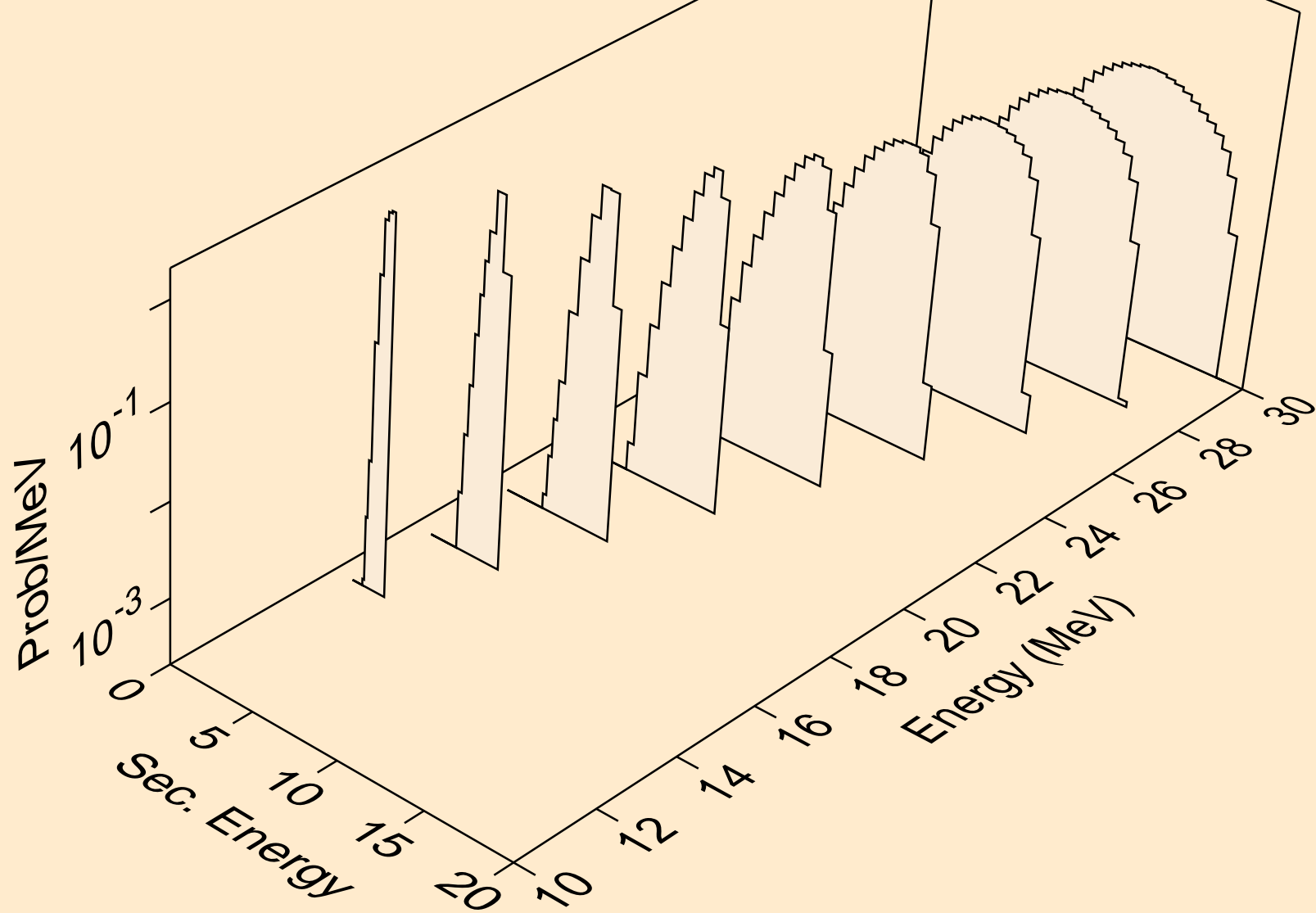

TA163 DEUTERON ACER TENDL-2023 LIBRARY; T=0.K  
Deuteron emission for inelastic

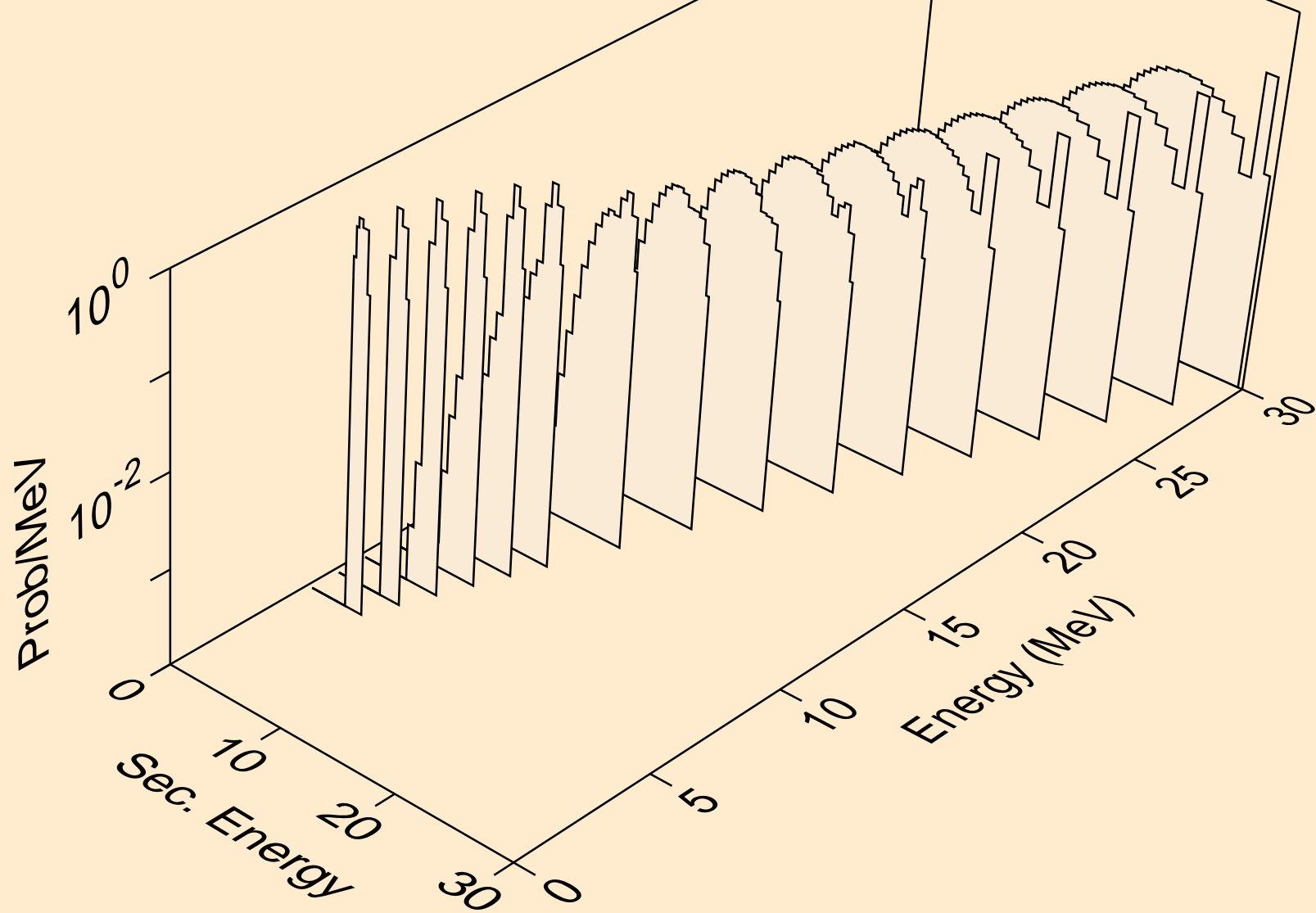

TA163 DEUTERON ACER TENDL-2023 LIBRARY; T=0.K  
Deuteron emission for (d,d2a)

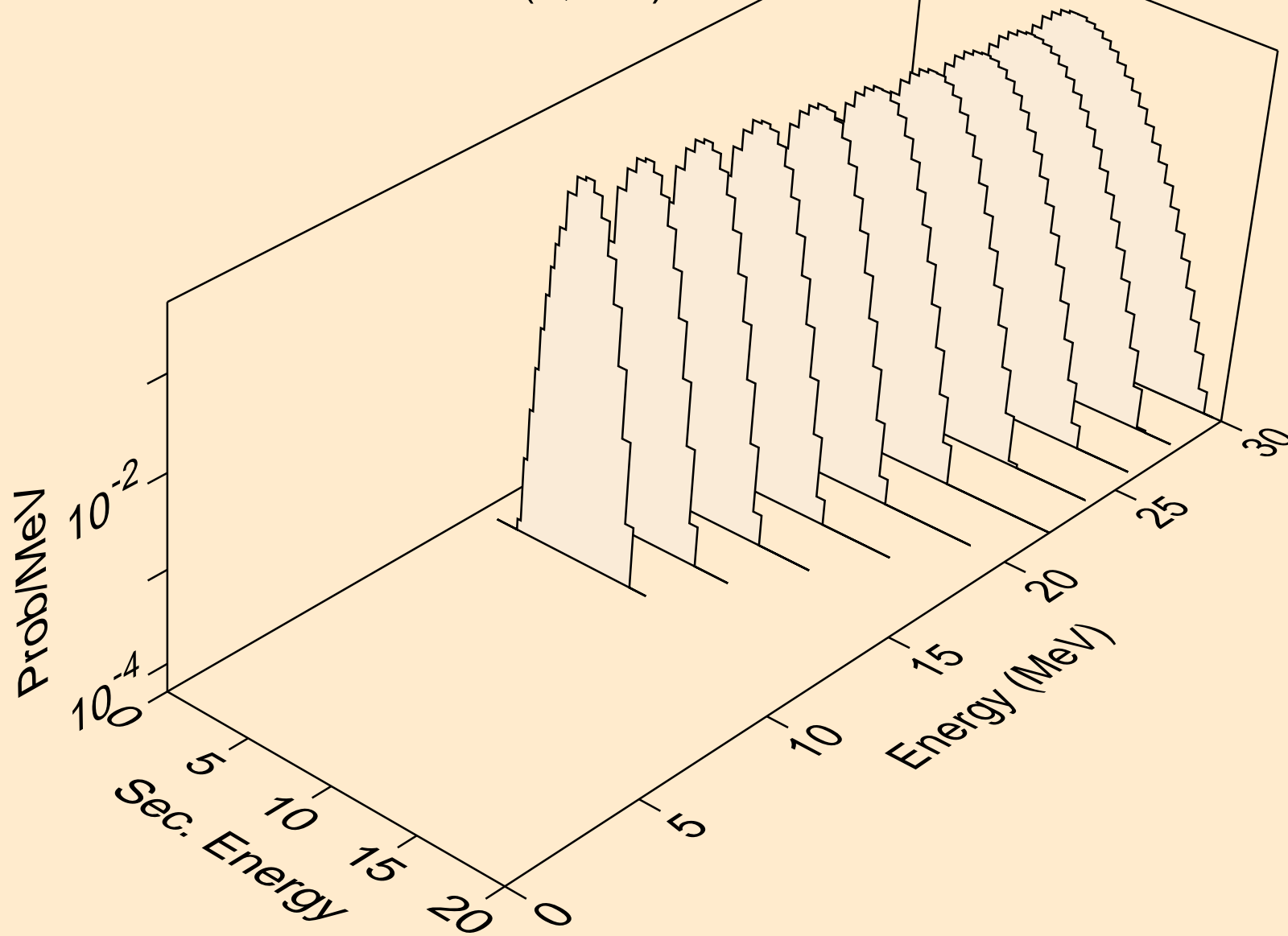

TA163 DEUTERON ACER TENDL-2023 LIBRARY; T=0.K  
Deuteron emission for (d,pd)

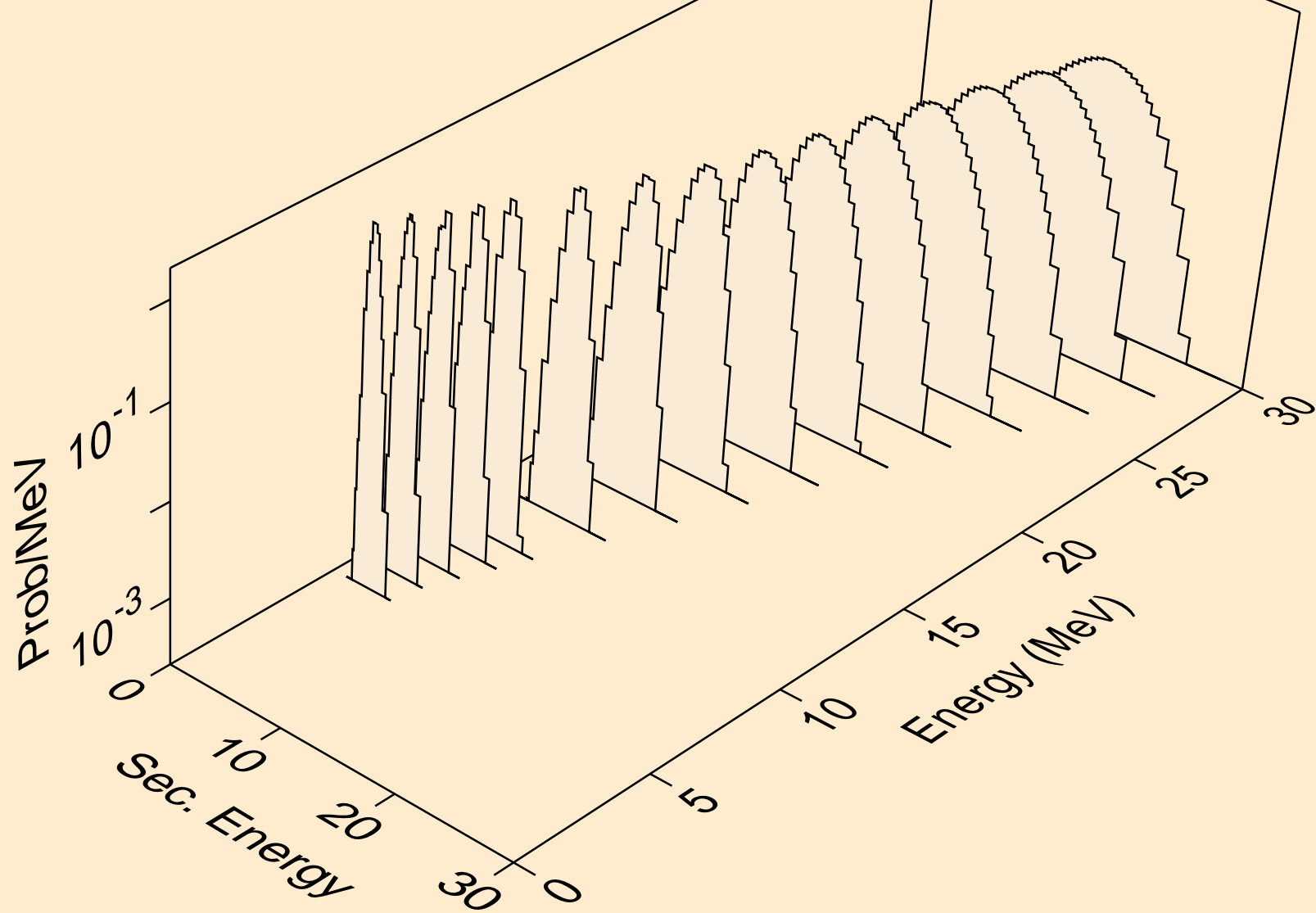

TA163 DEUTERON ACER TENDL-2023 LIBRARY; T=0.K  
Deuteron emission for (d,da)

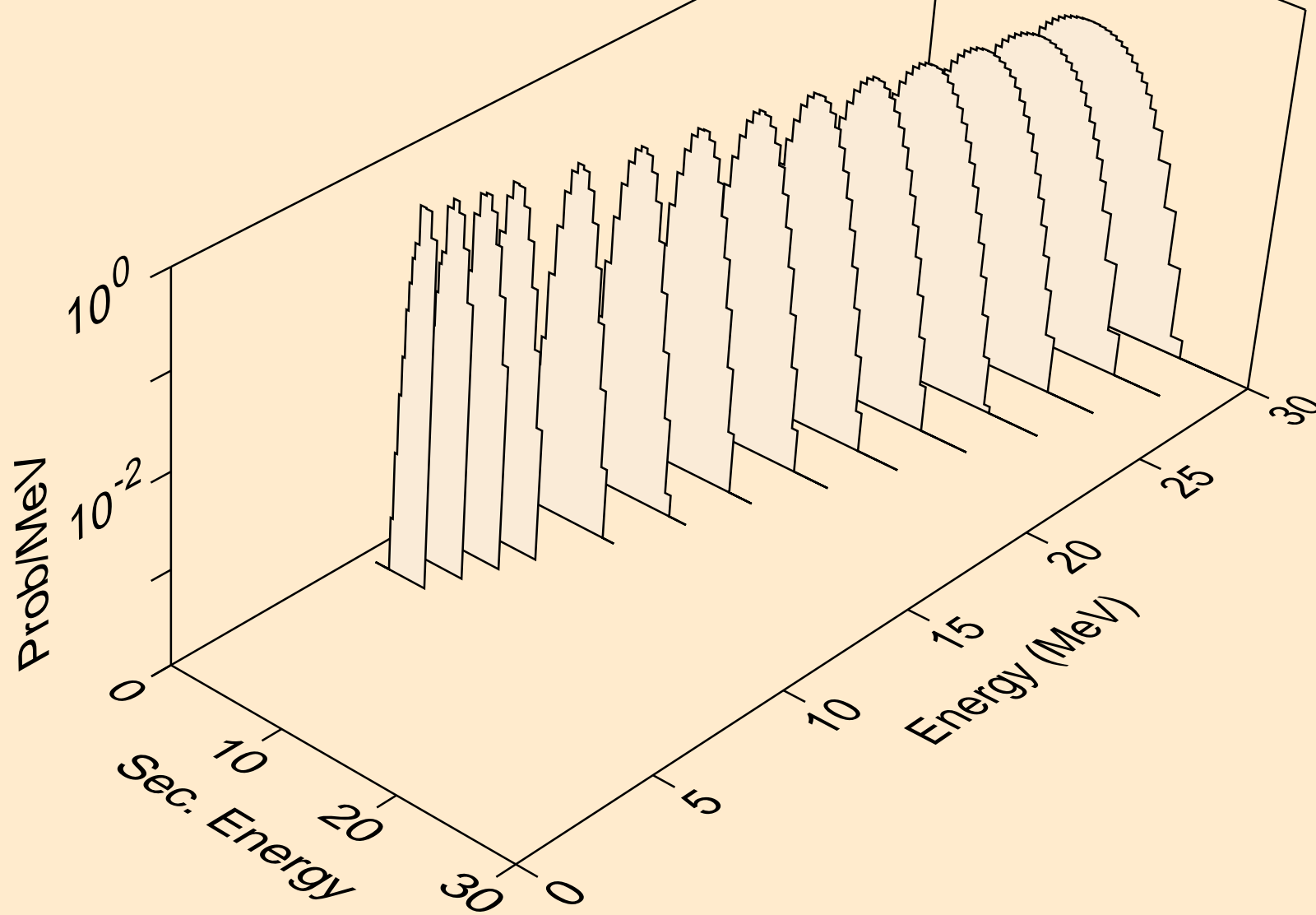



TA163 DEUTERON ACER TENDL-2023 LIBRARY; T=0.K  
Photon emission for (z,n)

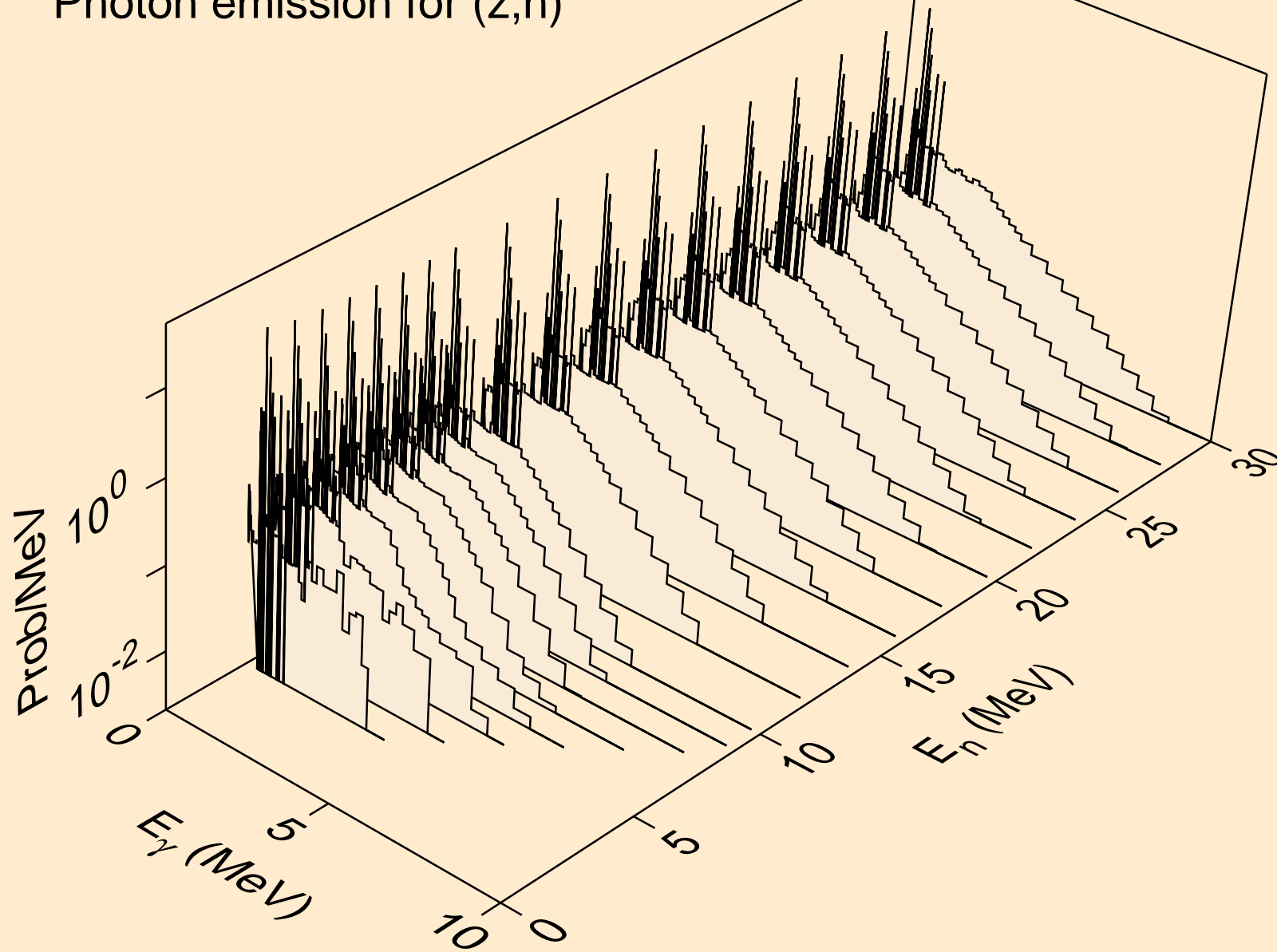

TA163 DEUTERON ACER TENDL-2023 LIBRARY; T=0.K  
Photon emission for (z,x)

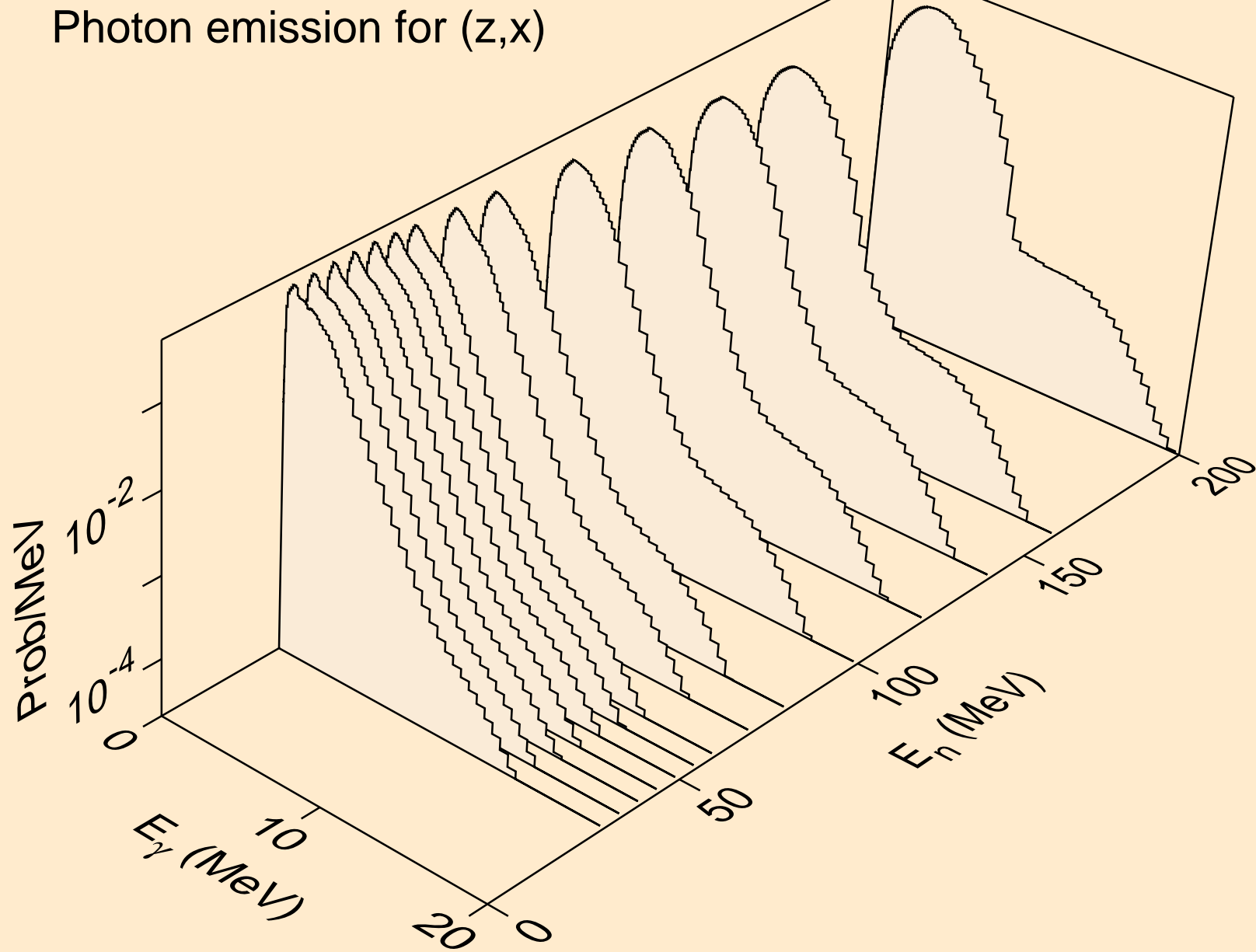

TA163 DEUTERON ACER TENDL-2023 LIBRARY; T=0.K  
Photon emission for (n,2nd)

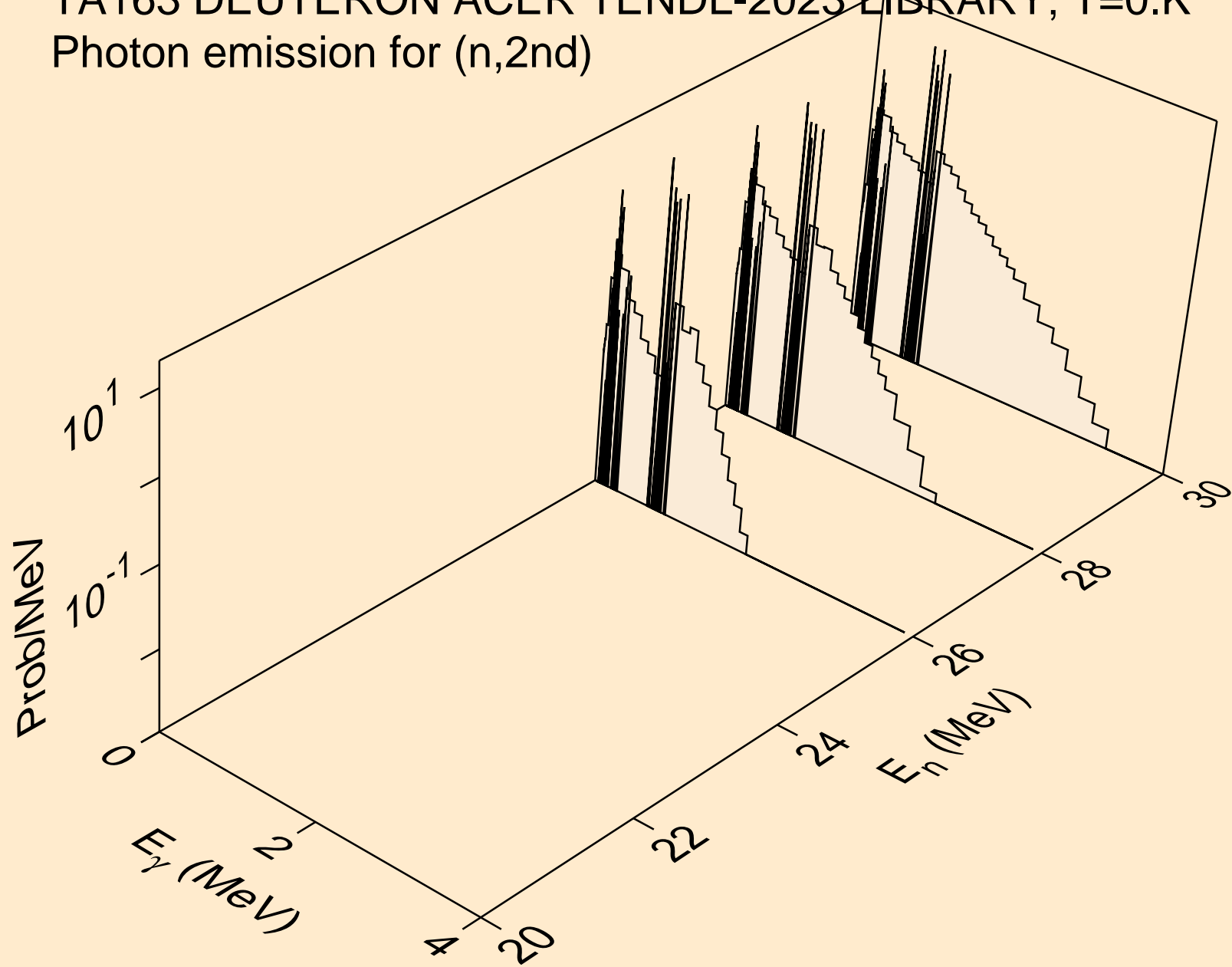

TA163 DEUTERON ACER TENDL-2023 LIBRARY; T=0.K  
Photon emission for (n,2n)

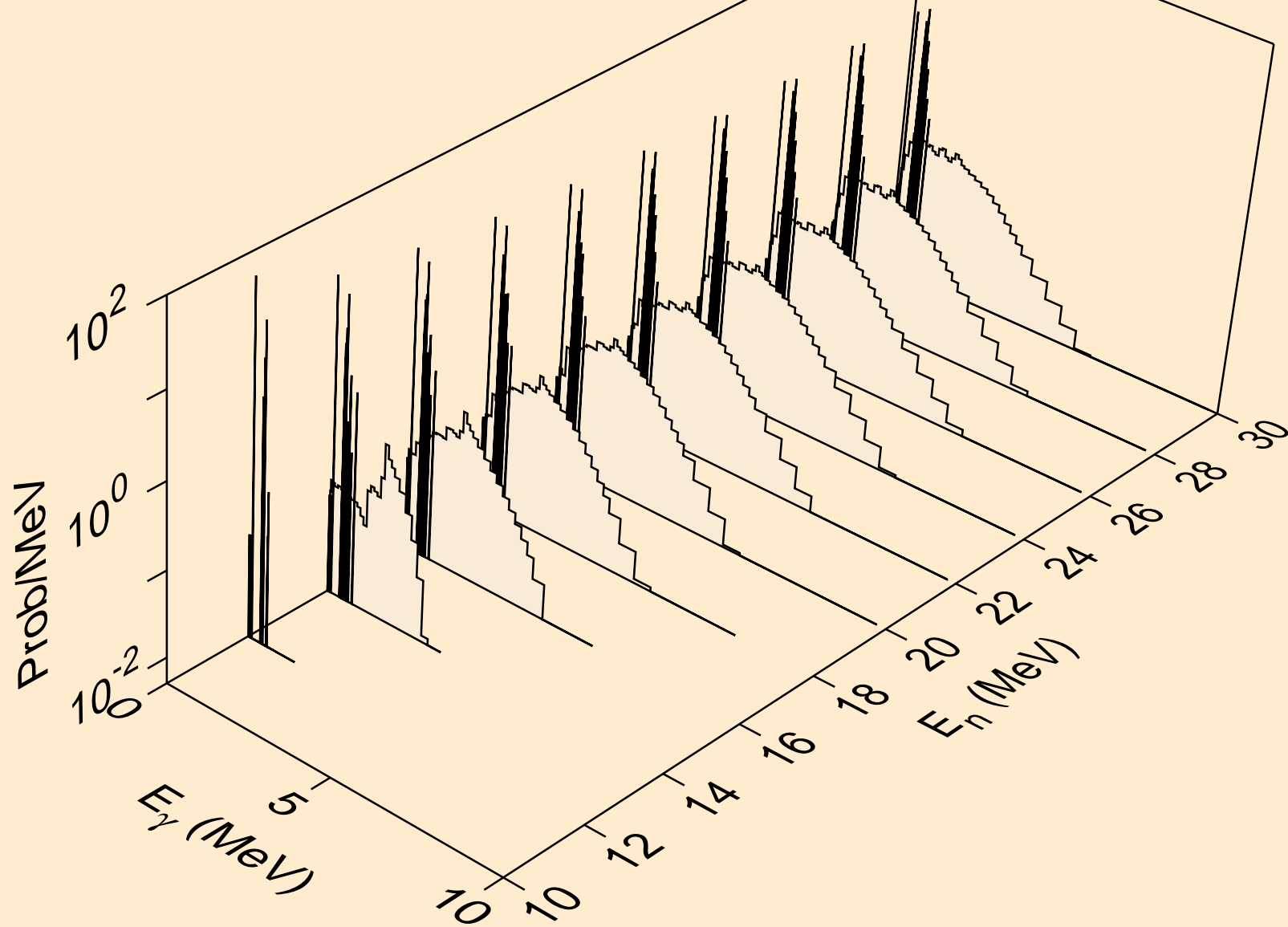

TA163 DEUTERON ACER TENDL-2023 LIBRARY; T=0.K  
Photon emission for (n,3n)

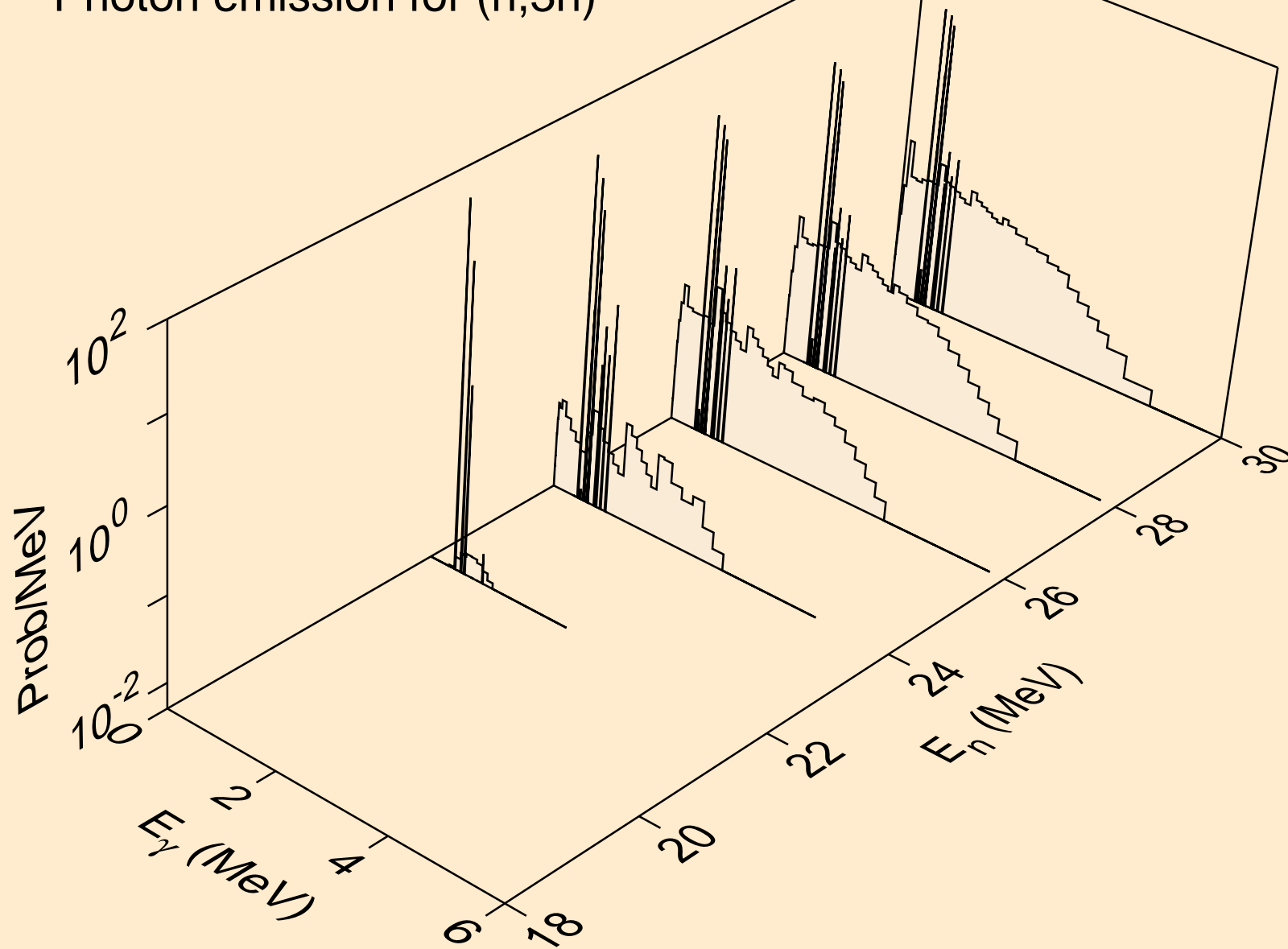

TA163 DEUTERON ACER TENDL-2023 LIBRARY; T=0.K  
Photon emission for (n,n\*)a

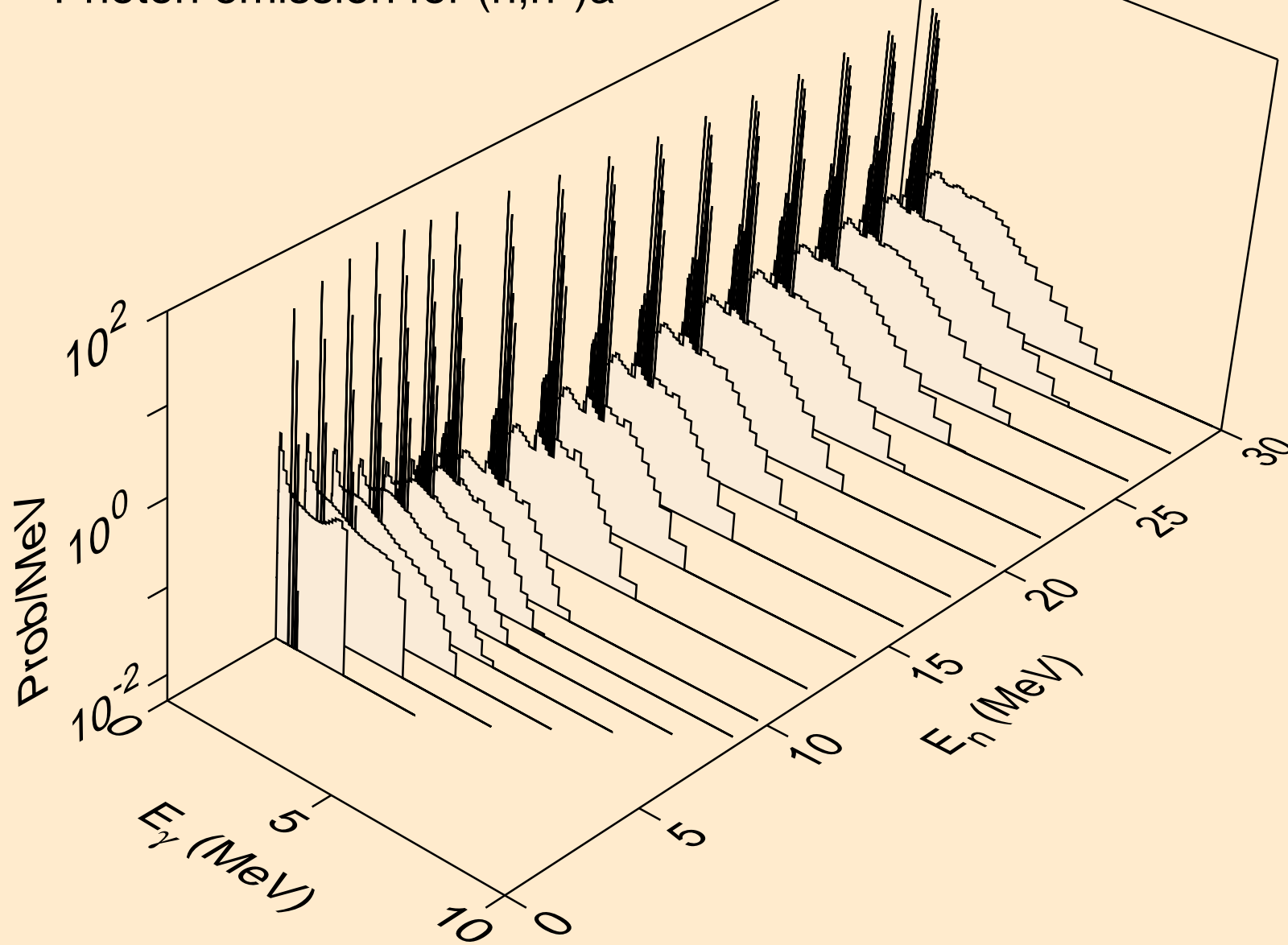

TA163 DEUTERON ACER TENDL-2023 LIBRARY; T=0.K  
Photon emission for (n,n\*)3a

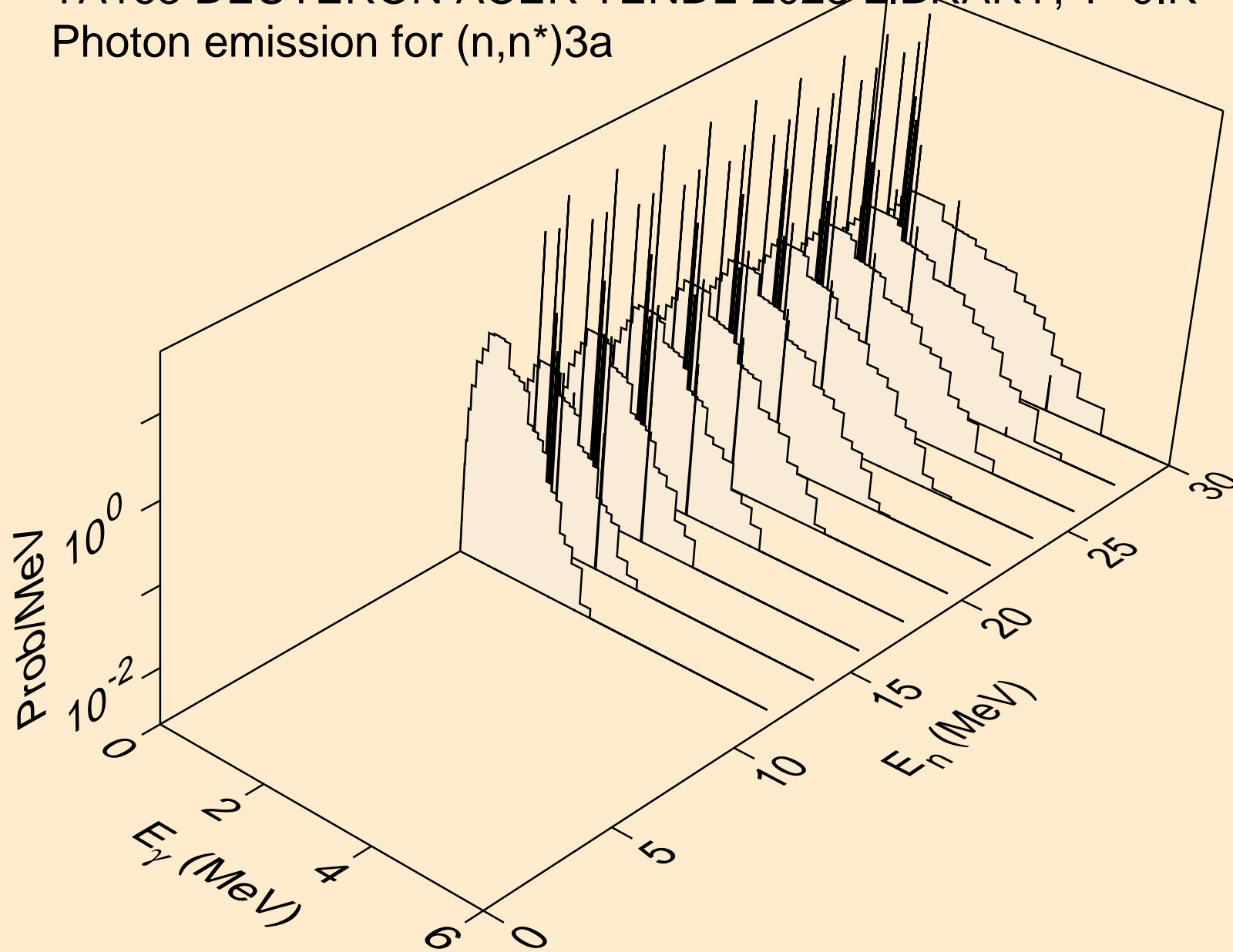

TA163 DEUTERON ACER TENDL-2023 LIBRARY; T=0.K  
Photon emission for (n,2n) $\alpha$

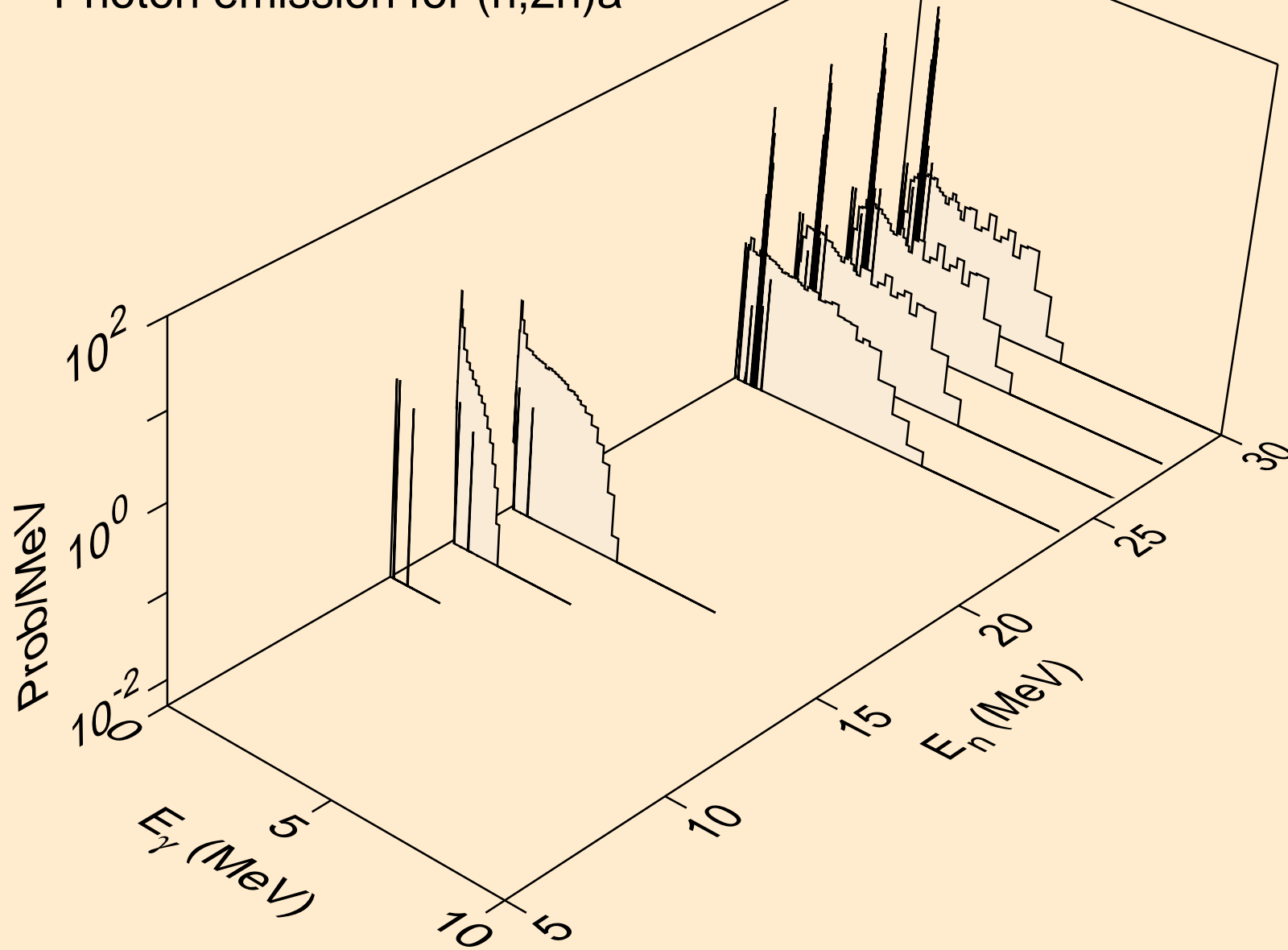



TA163 DEUTERON ACER TENDL-2023 LIBRARY; T=0.K  
Photon emission for (n,3n)a

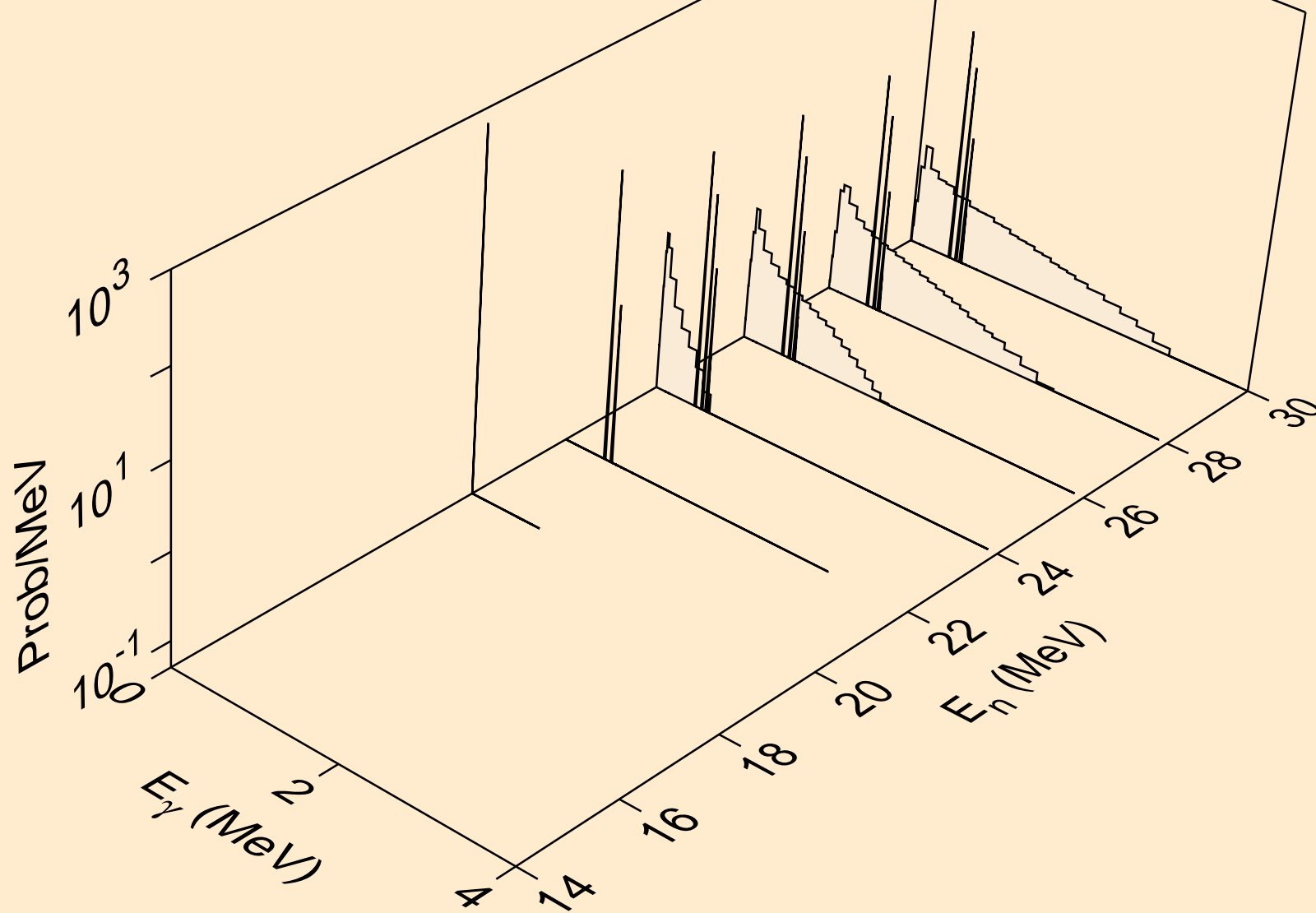

TA163 DEUTERON ACER TENDL-2023 LIBRARY; T=0.K  
Photon emission for (n,n\*)p

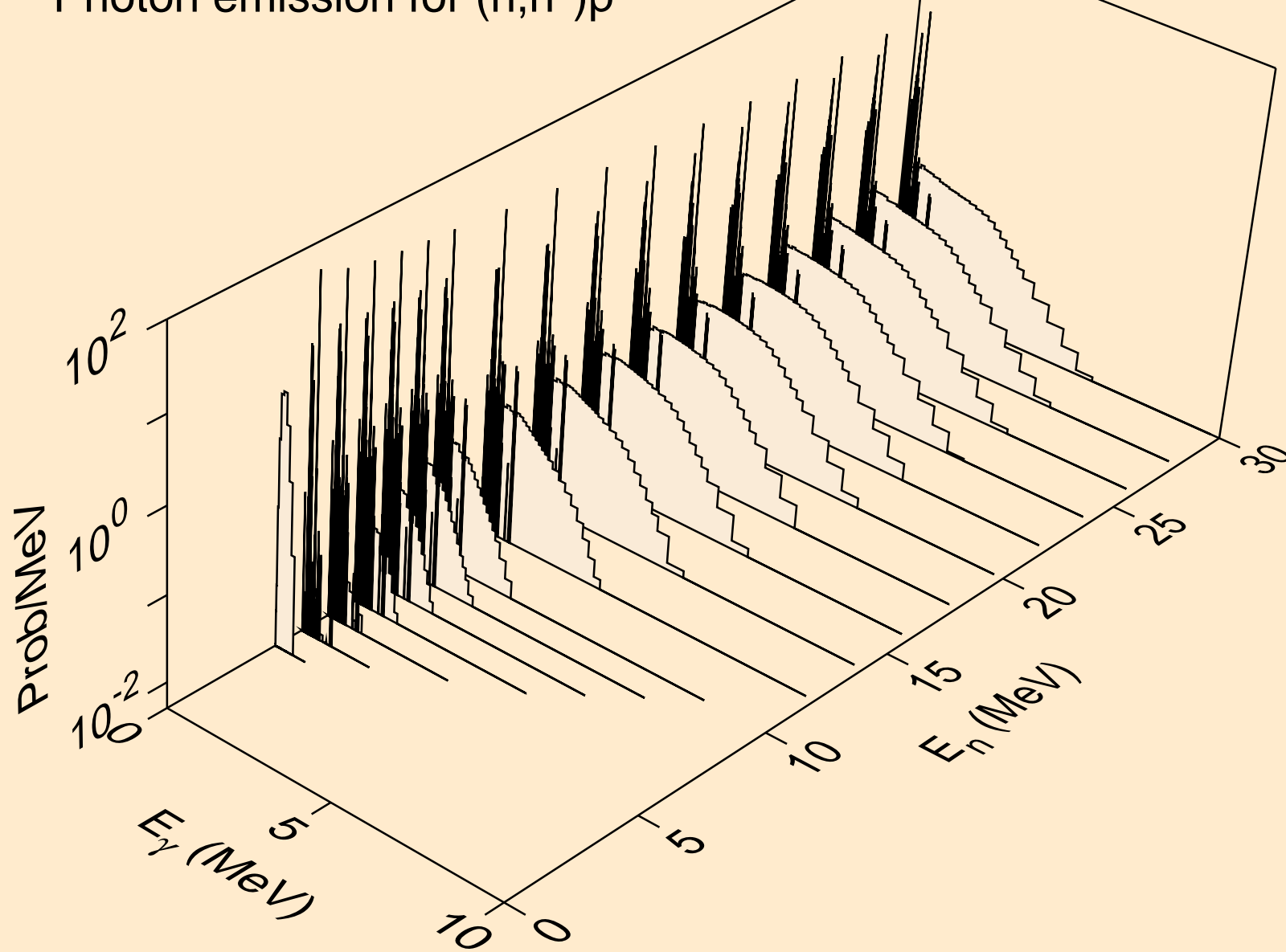

TA163 DEUTERON ACER TENDL-2023 LIBRARY; T=0.K  
Photon emission for (n,n\*)2a

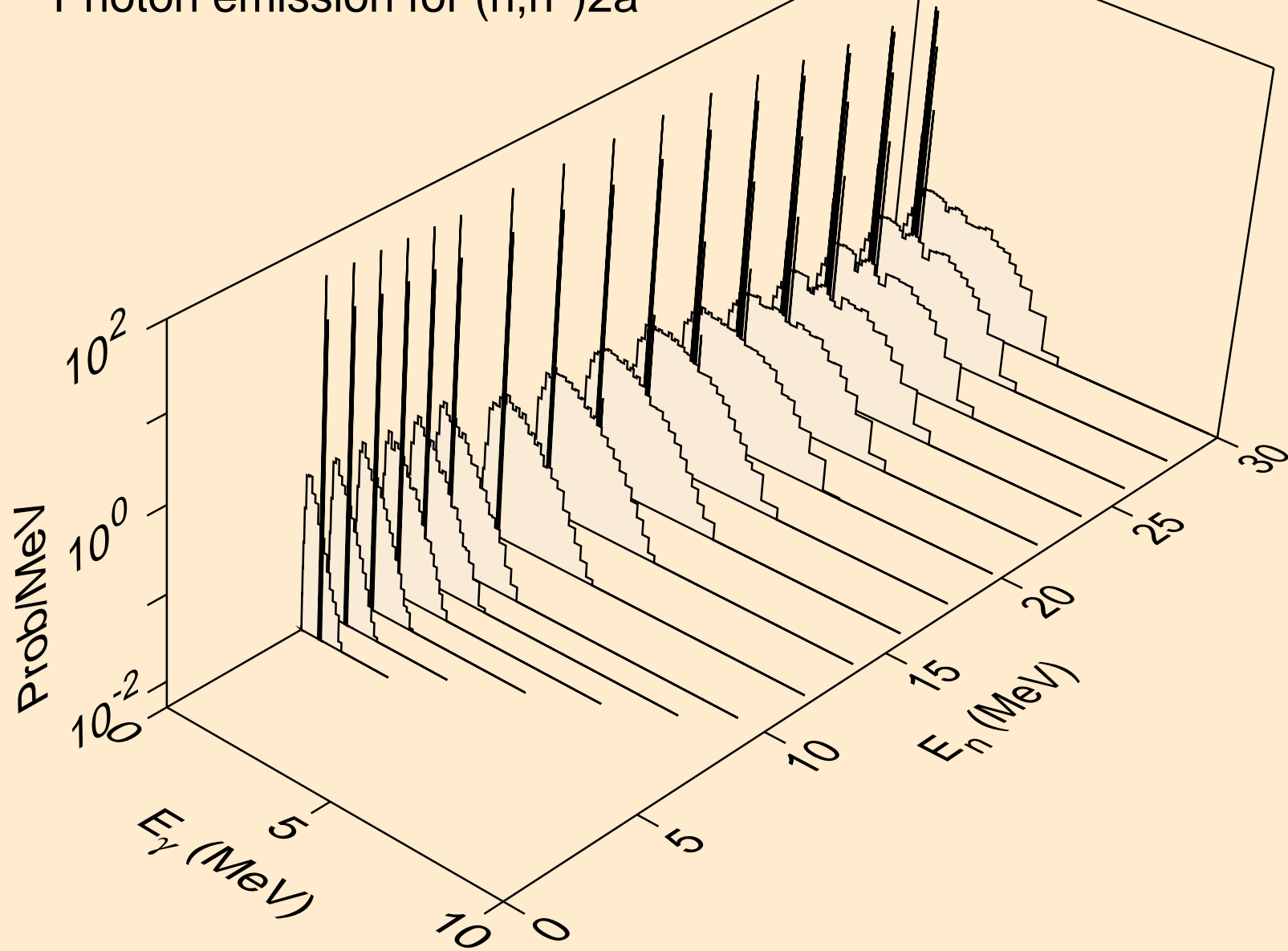

TA163 DEUTERON ACER TENDL-2023 LIBRARY; T=0.K  
Photon emission for (n,2n)2a

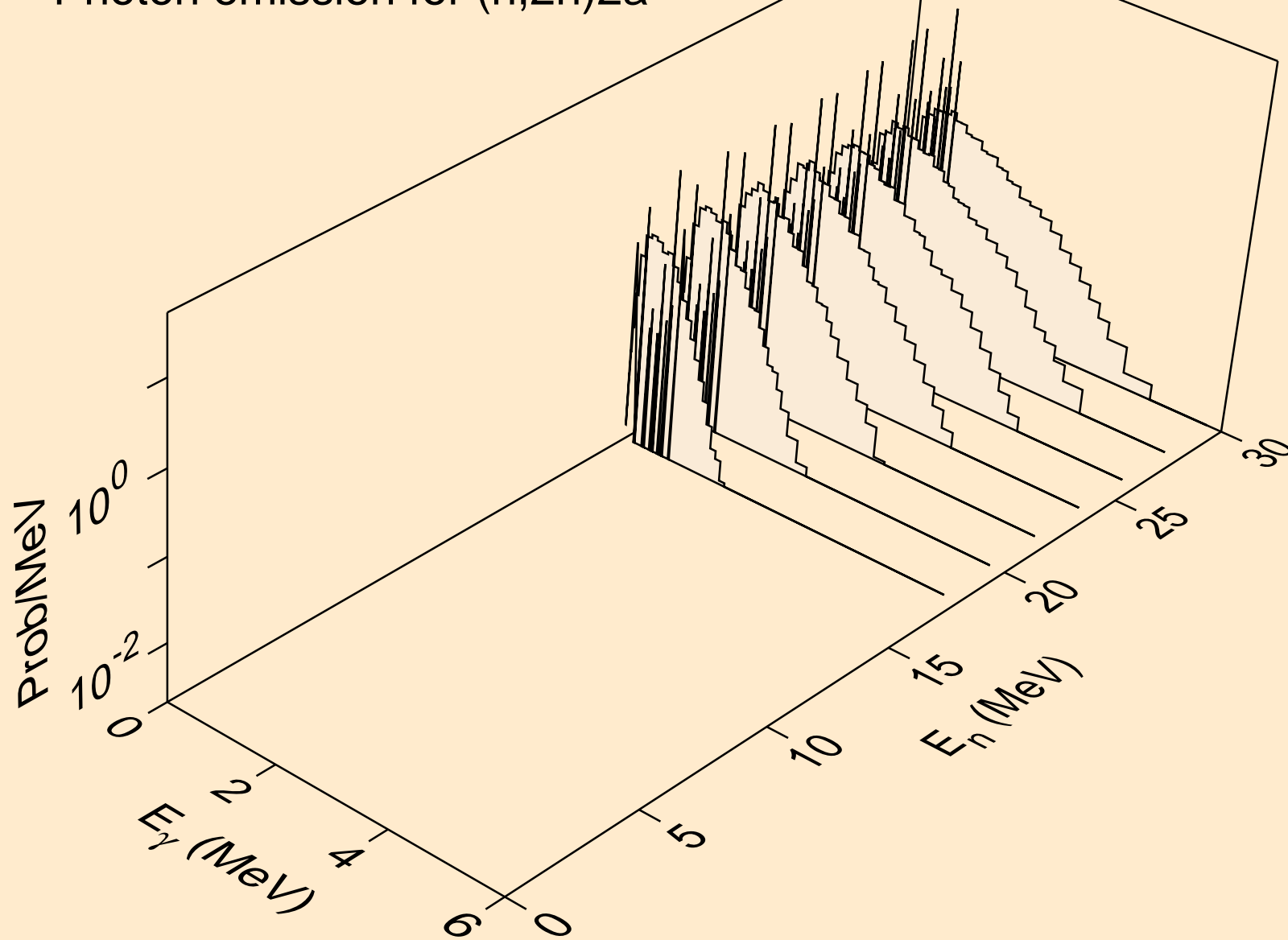

TA163 DEUTERON ACER TENDL-2023 LIBRARY; T=0.K  
Photon emission for (n,n\*)d

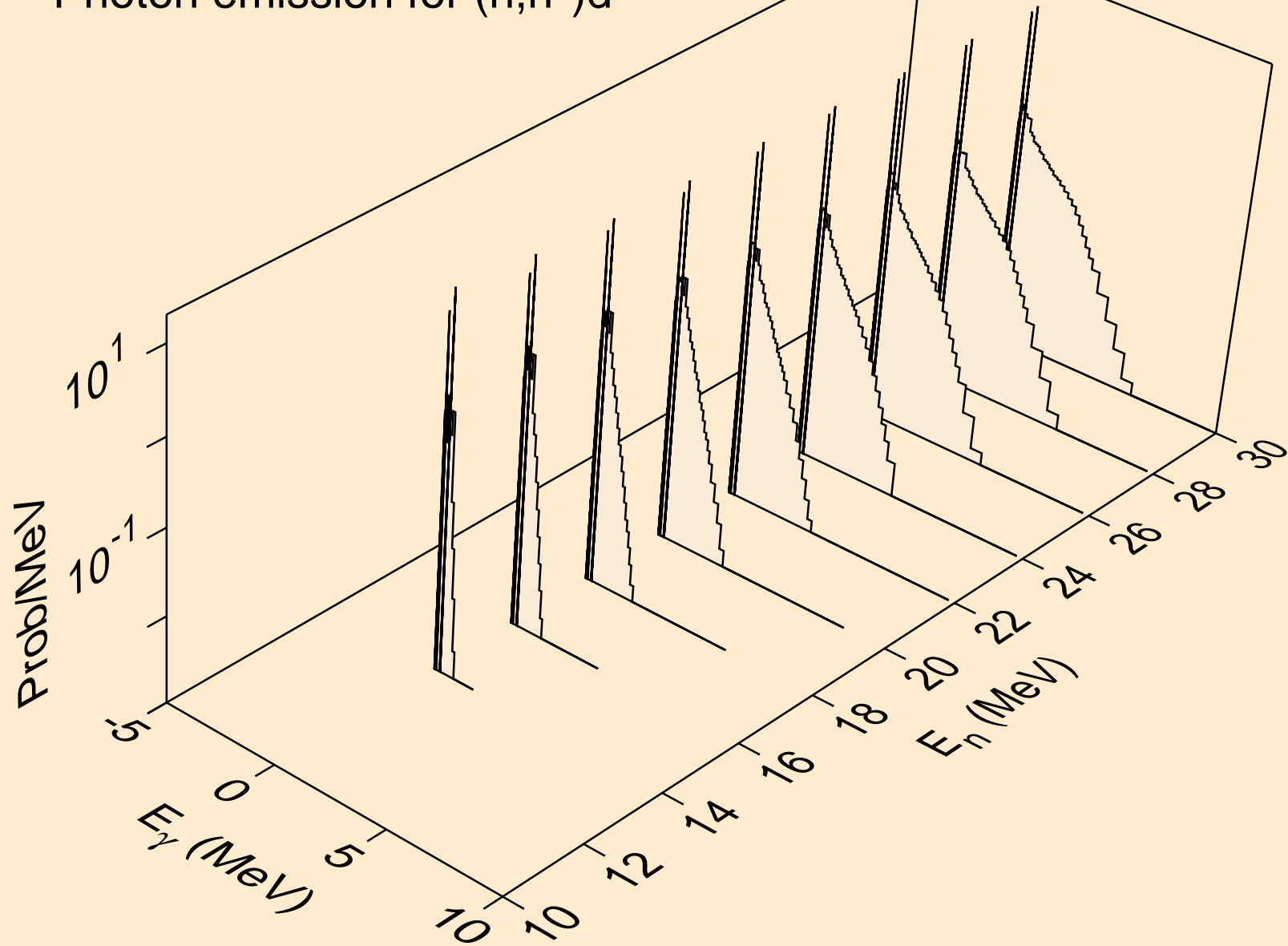

TA163 DEUTERON ACER TENDL-2023 LIBRARY; T=0.K  
Photon emission for (n,n\*)t

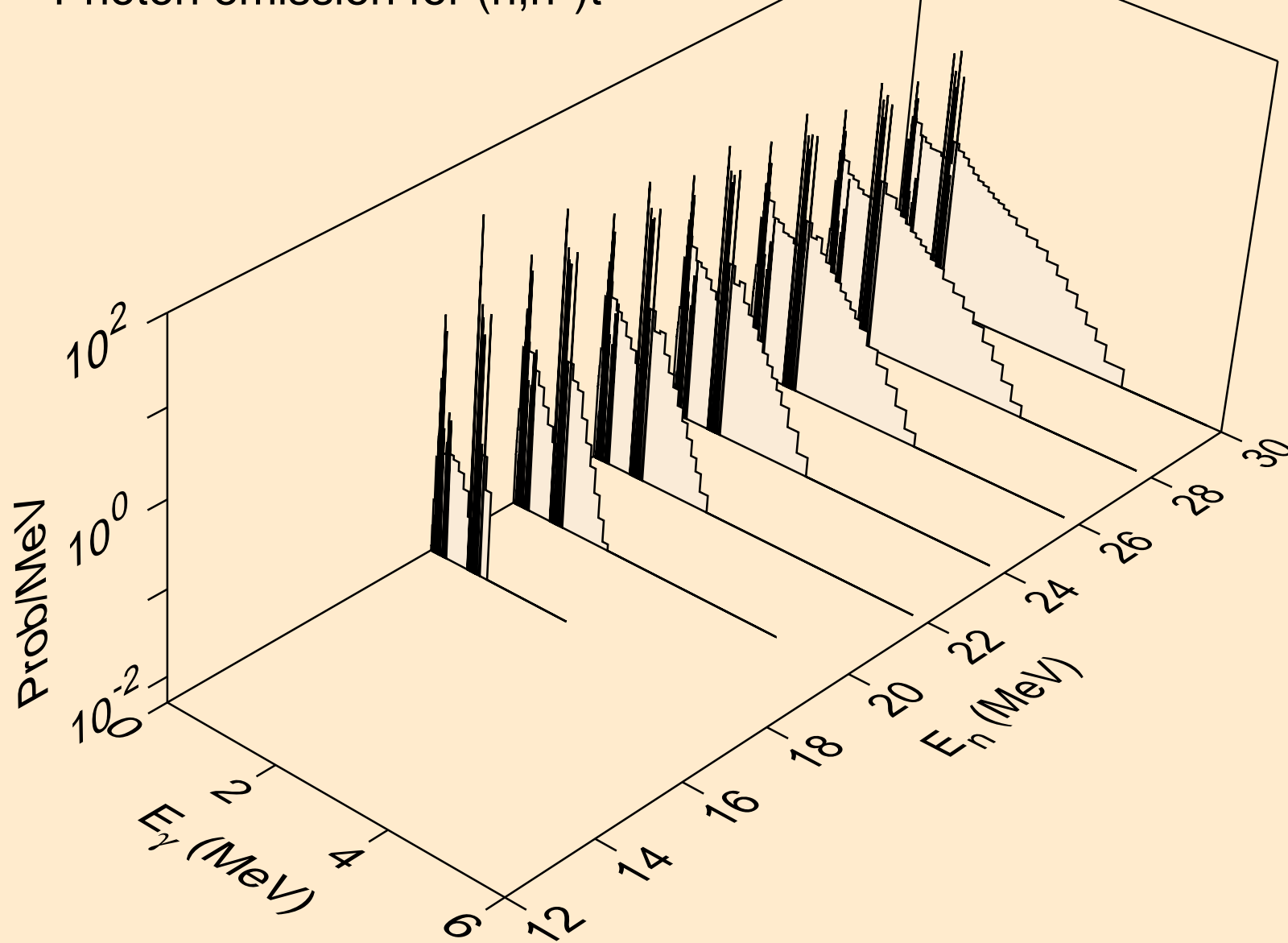

TA163 DEUTERON ACER TENDL-2023 LIBRARY; T=0.K  
Photon emission for (n,n\*)he3

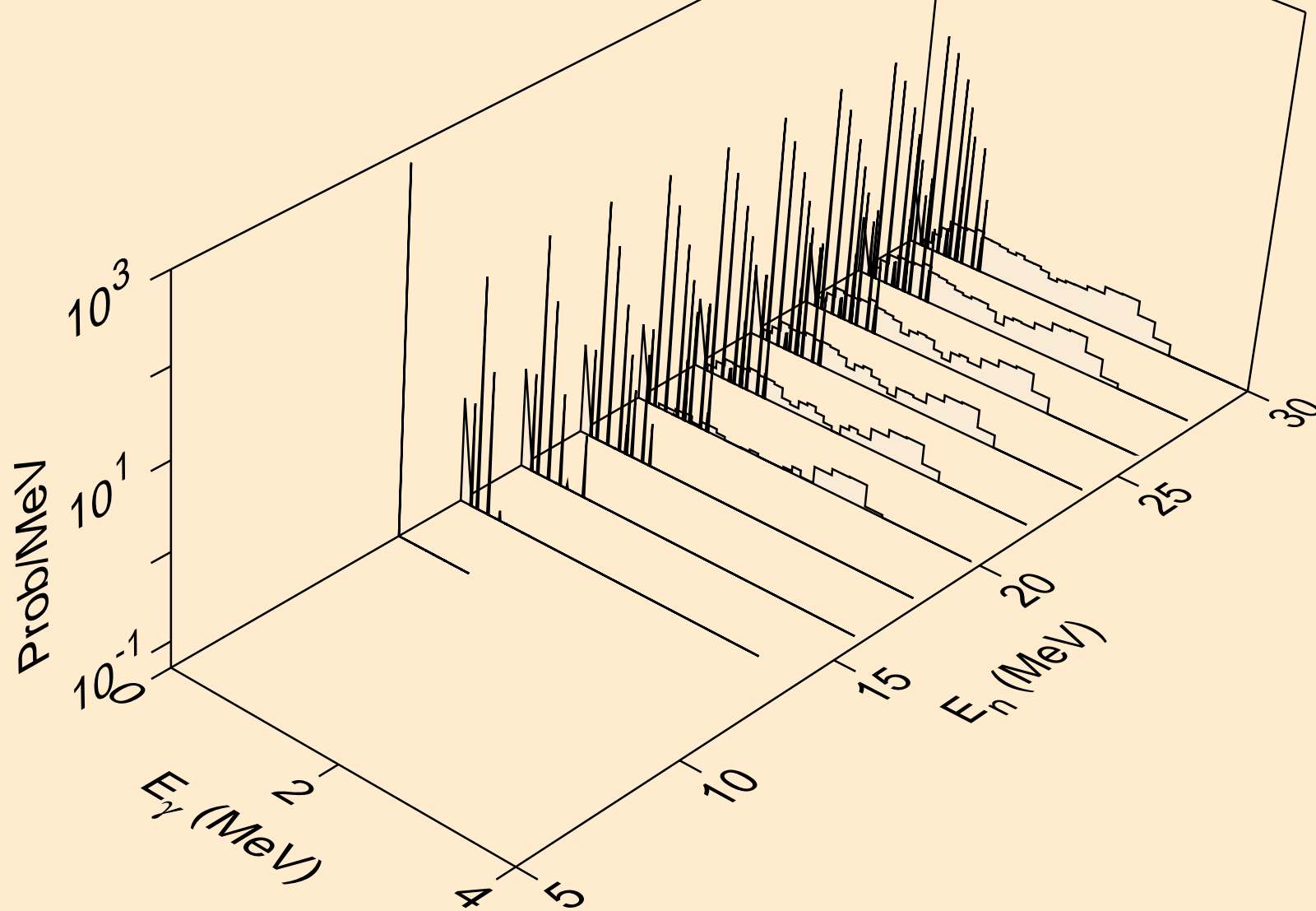

TA163 DEUTERON ACER TENDL-2023 LIBRARY; T=0.K  
Photon emission for (n,2np)

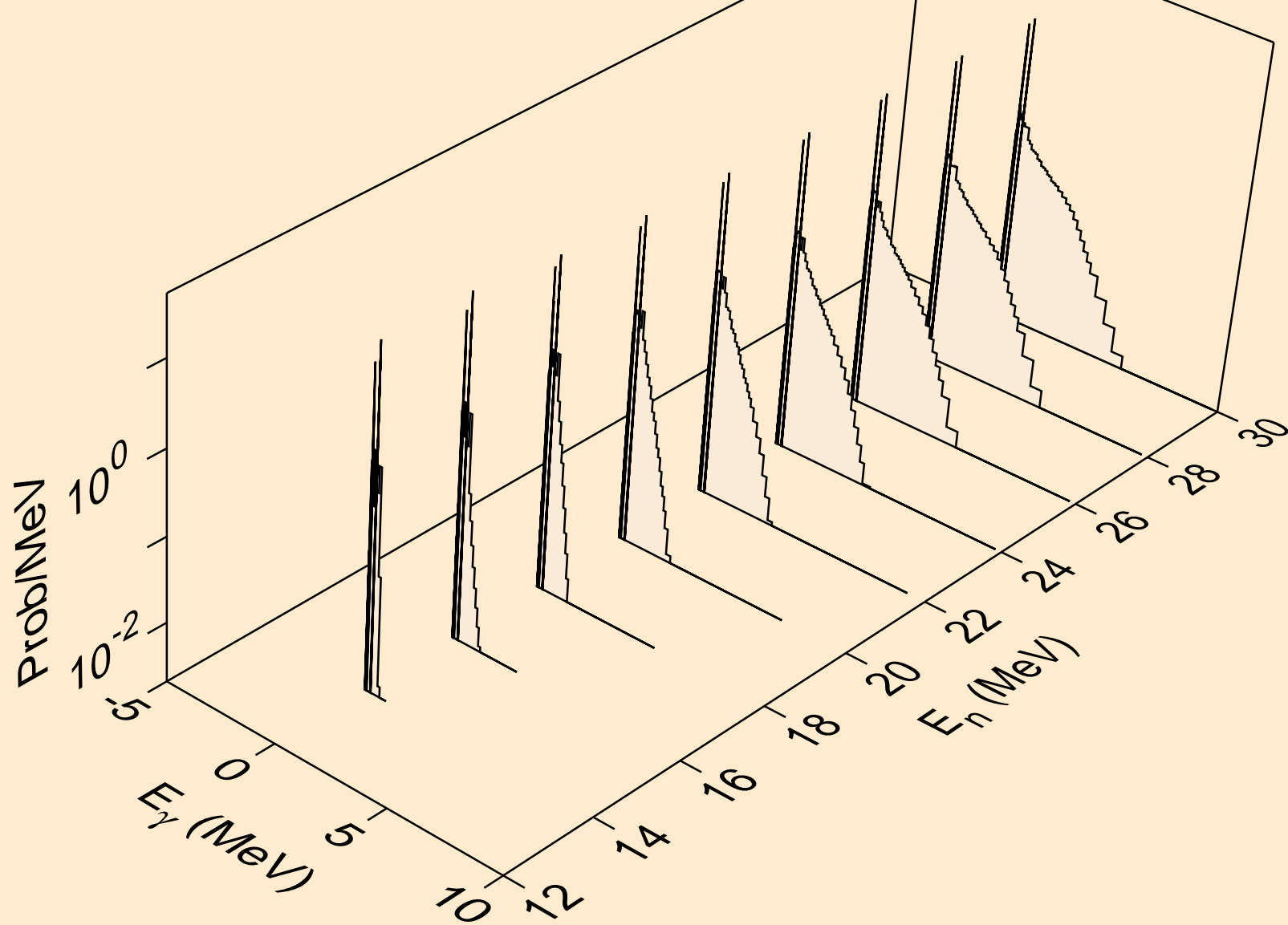



TA163 DEUTERON ACER TENDL-2023 LIBRARY; T=0.K  
Photon emission for (n,3np)

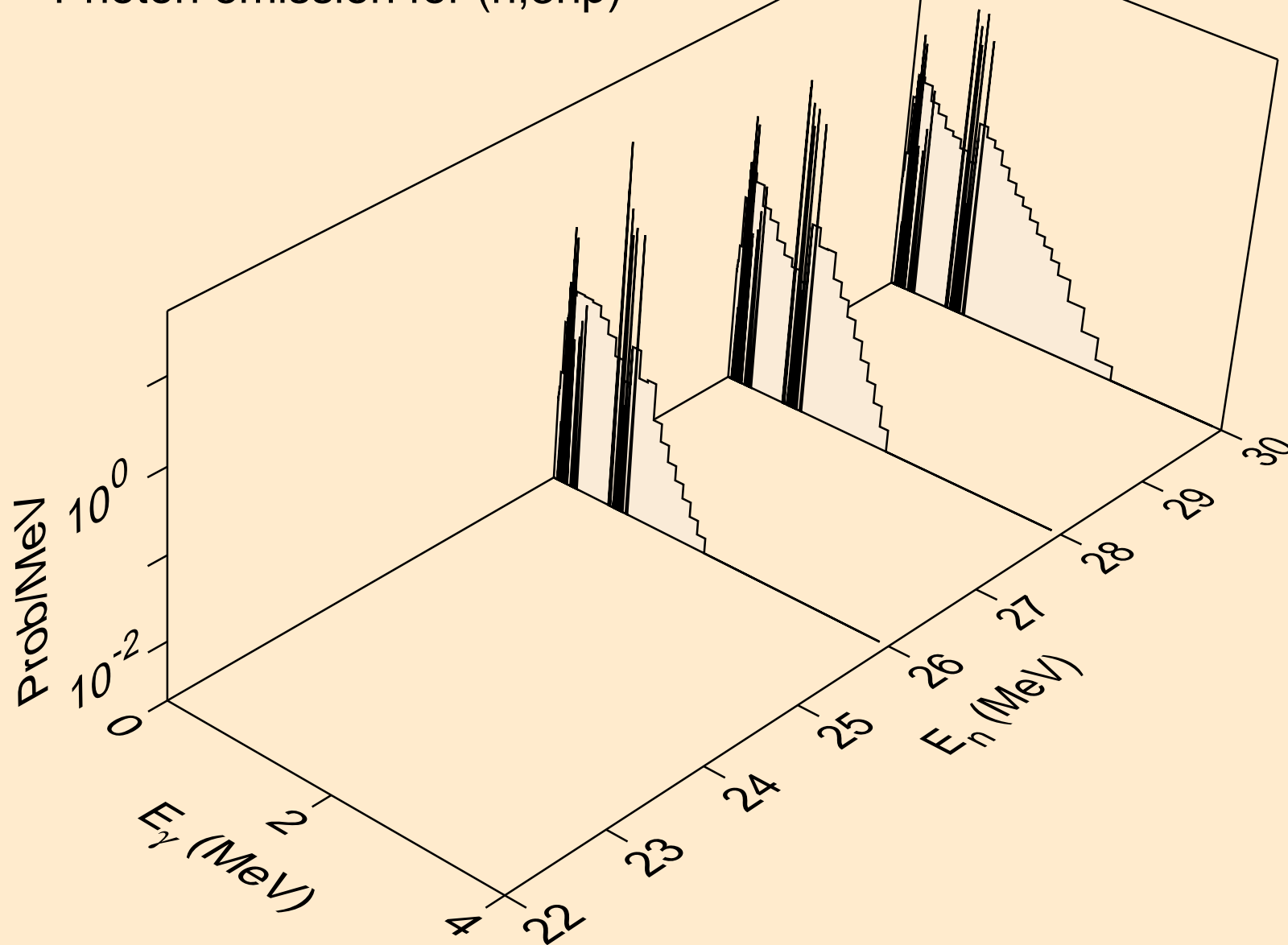

TA163 DEUTERON ACER TENDL-2023 LIBRARY; T=0.K  
Photon emission for (n,n2p)

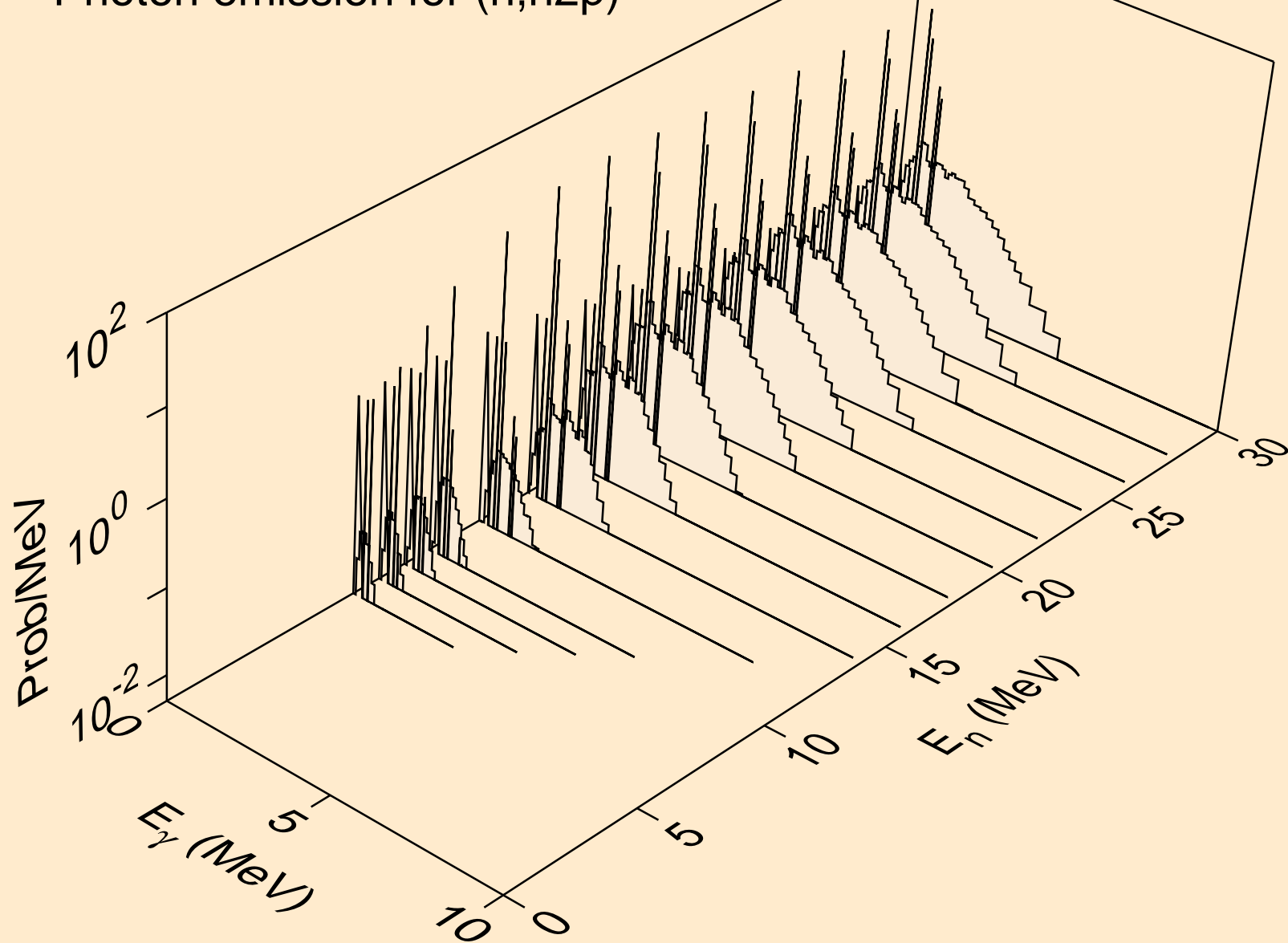

TA163 DEUTERON ACER TENDL-2023 LIBRARY; T=0.K  
Photon emission for (n,npa)

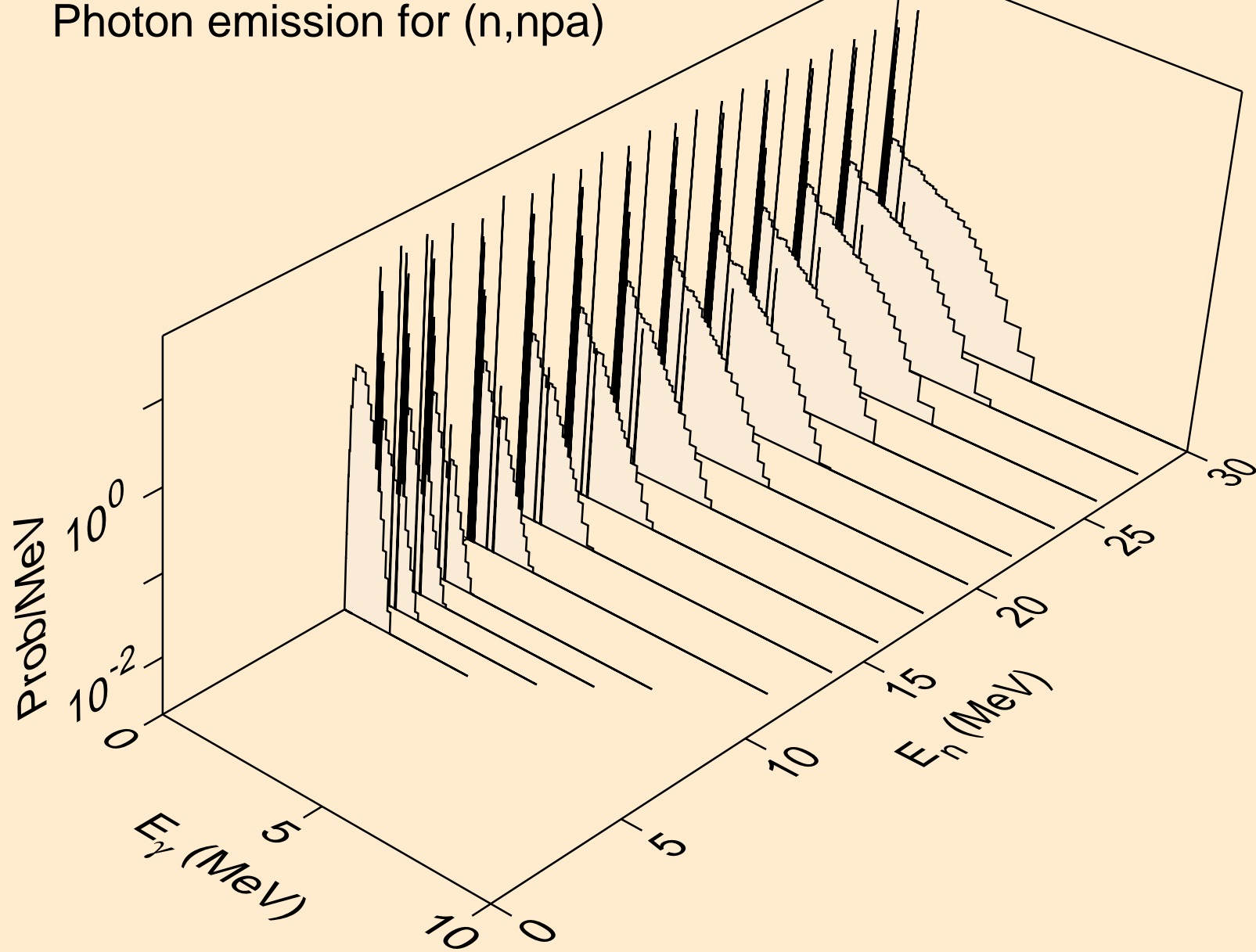

TA163 DEUTERON ACER TENDL-2023 LIBRARY; T=0.K  
Photon emission for (n,gma)

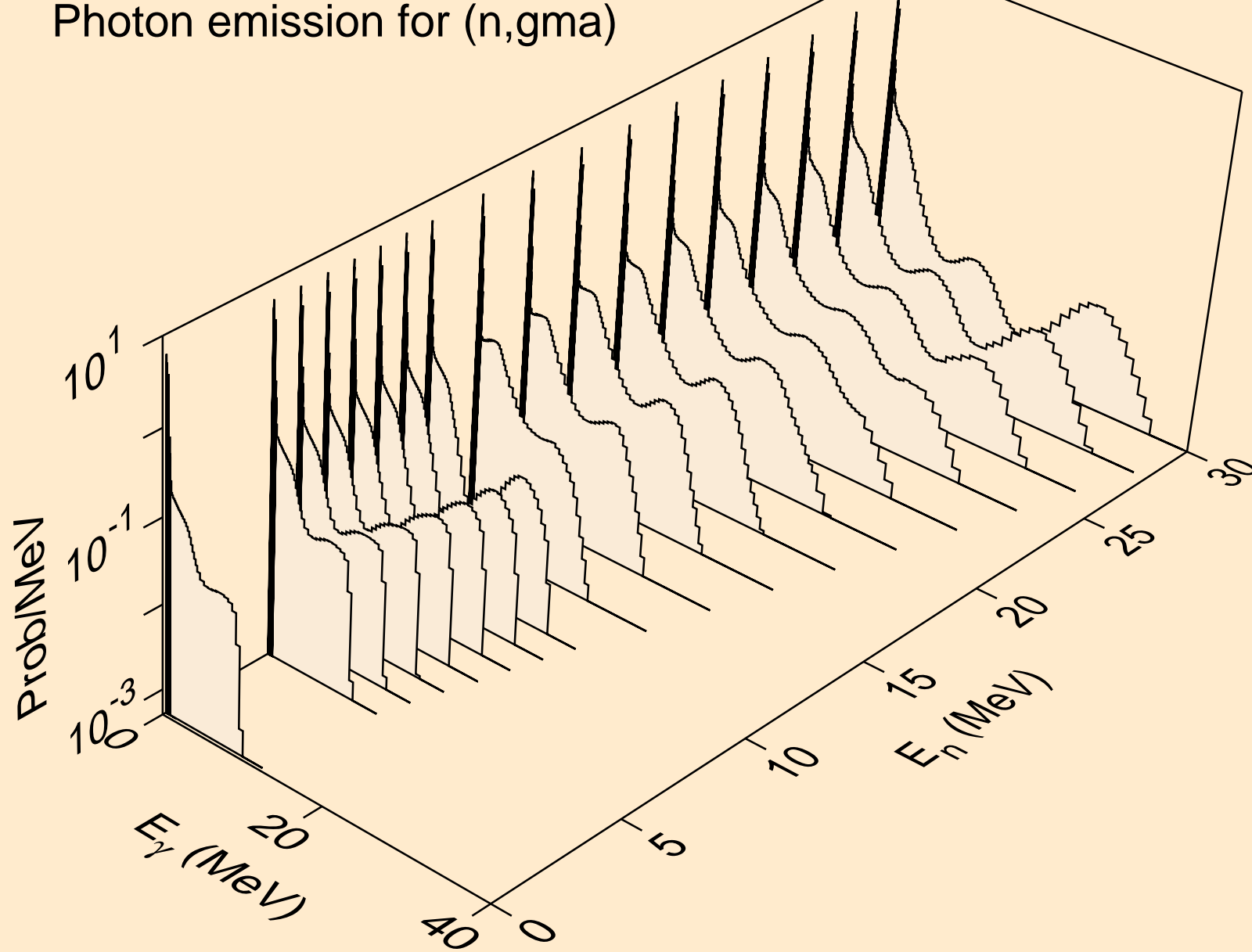

TA163 DEUTERON ACER TENDL-2023 LIBRARY; T=0.K  
Photon emission for (n,p)

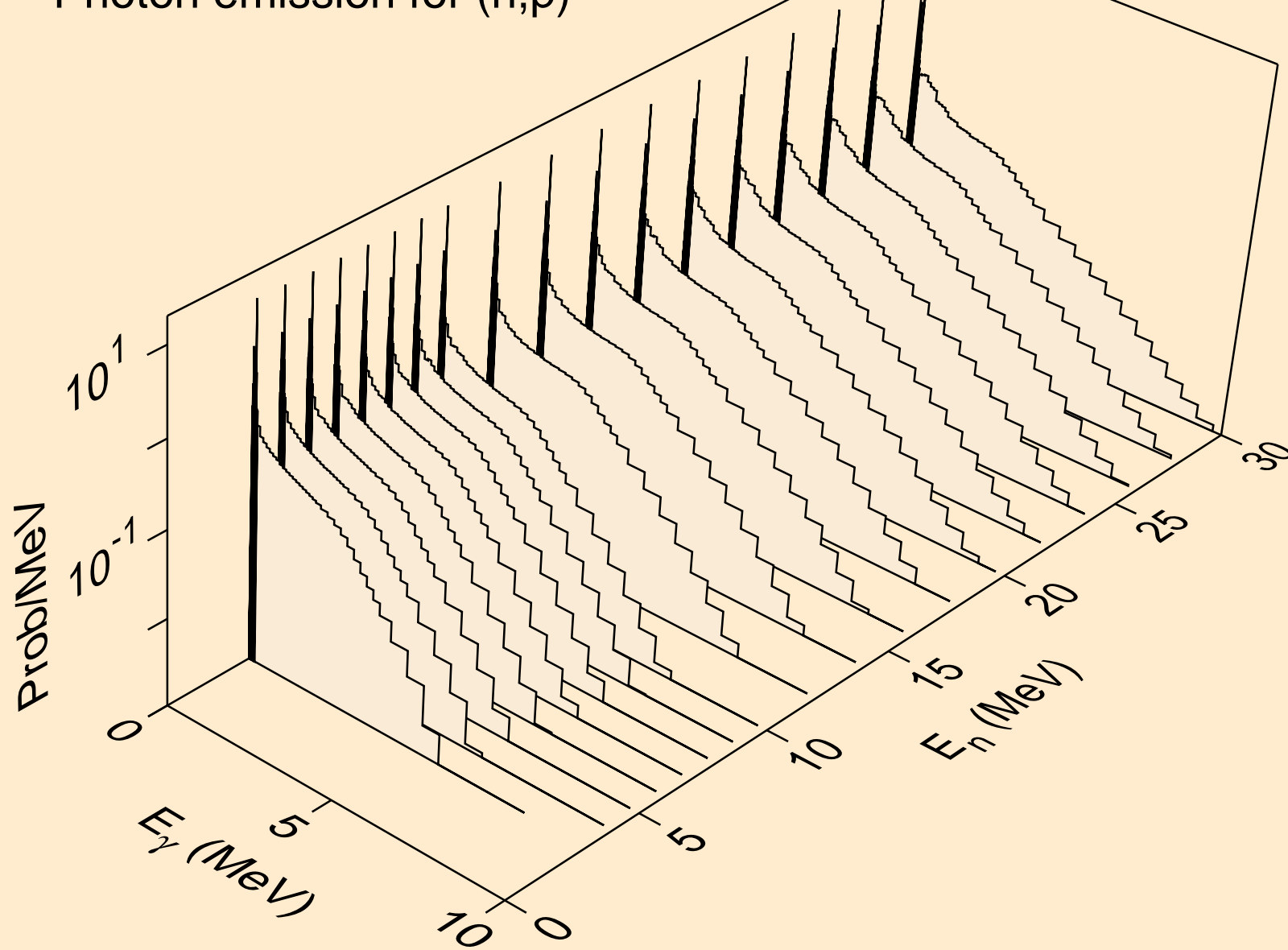

TA163 DEUTERON ACER TENDL-2023 LIBRARY; T=0.K  
Photon emission for inelastic

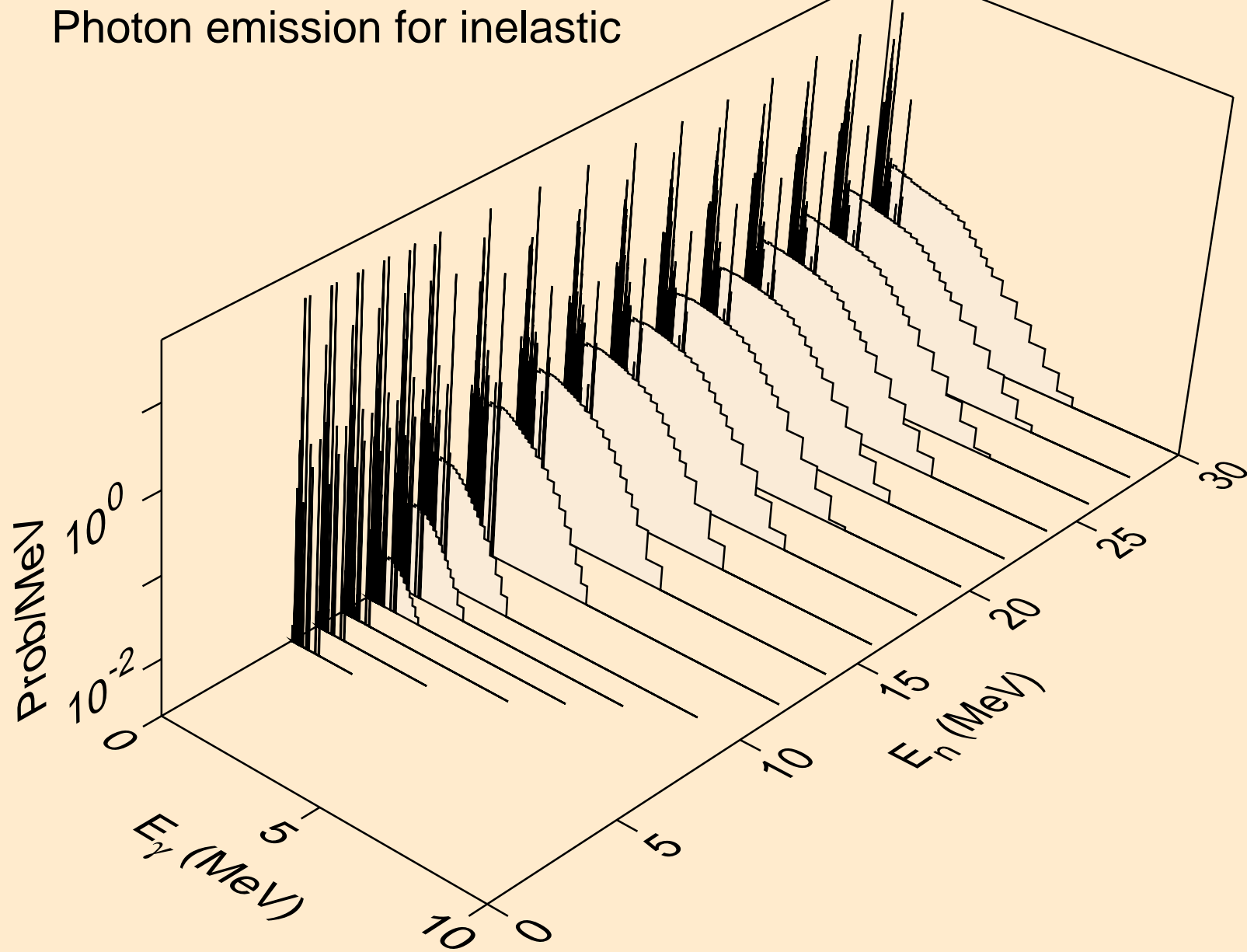

TA163 DEUTERON ACER TENDL-2023 LIBRARY; T=0.K  
Photon emission for (n,t)

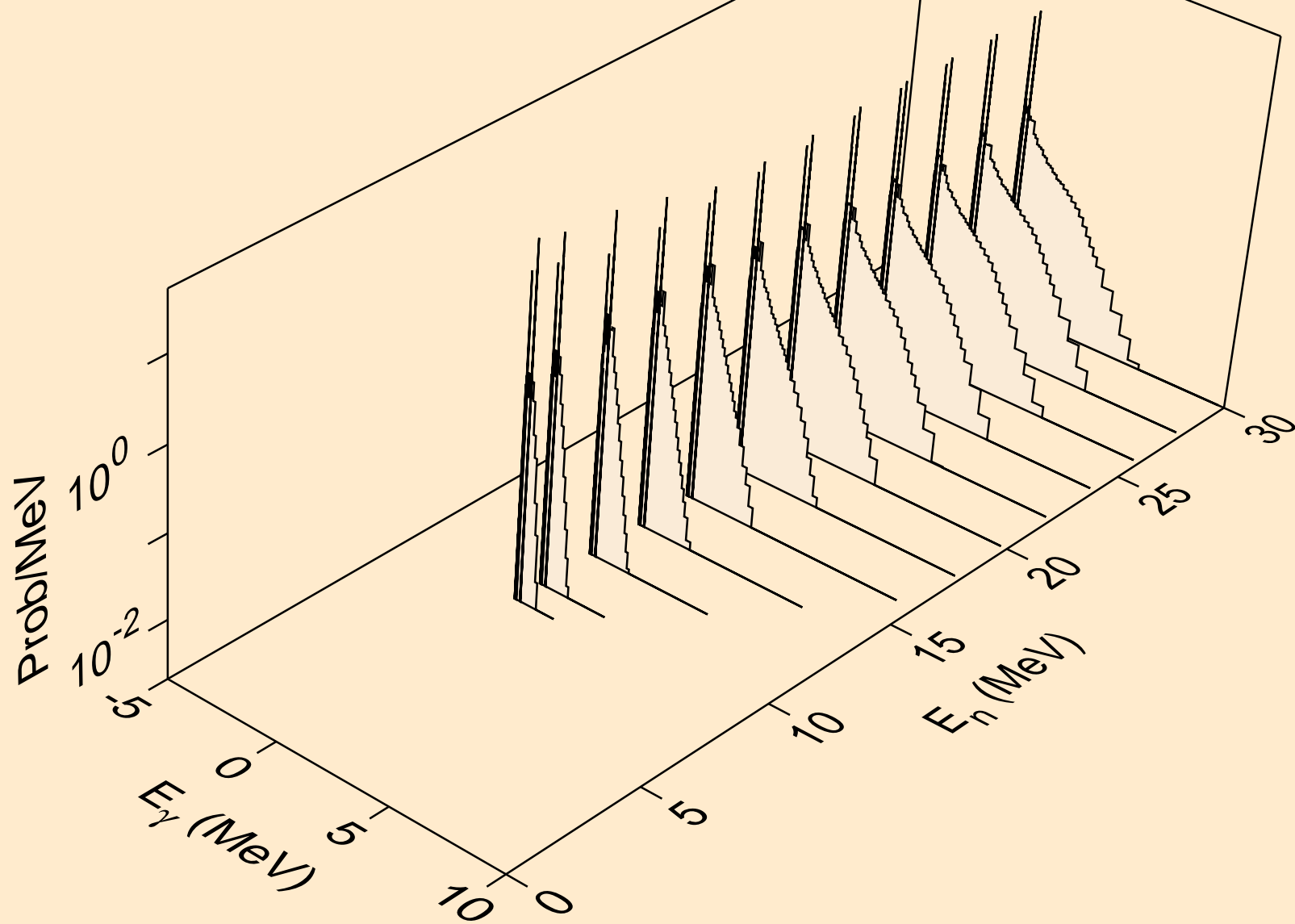

TA163 DEUTERON ACER TENDL-2023 LIBRARY; T=0.K  
Photon emission for (n,he3)

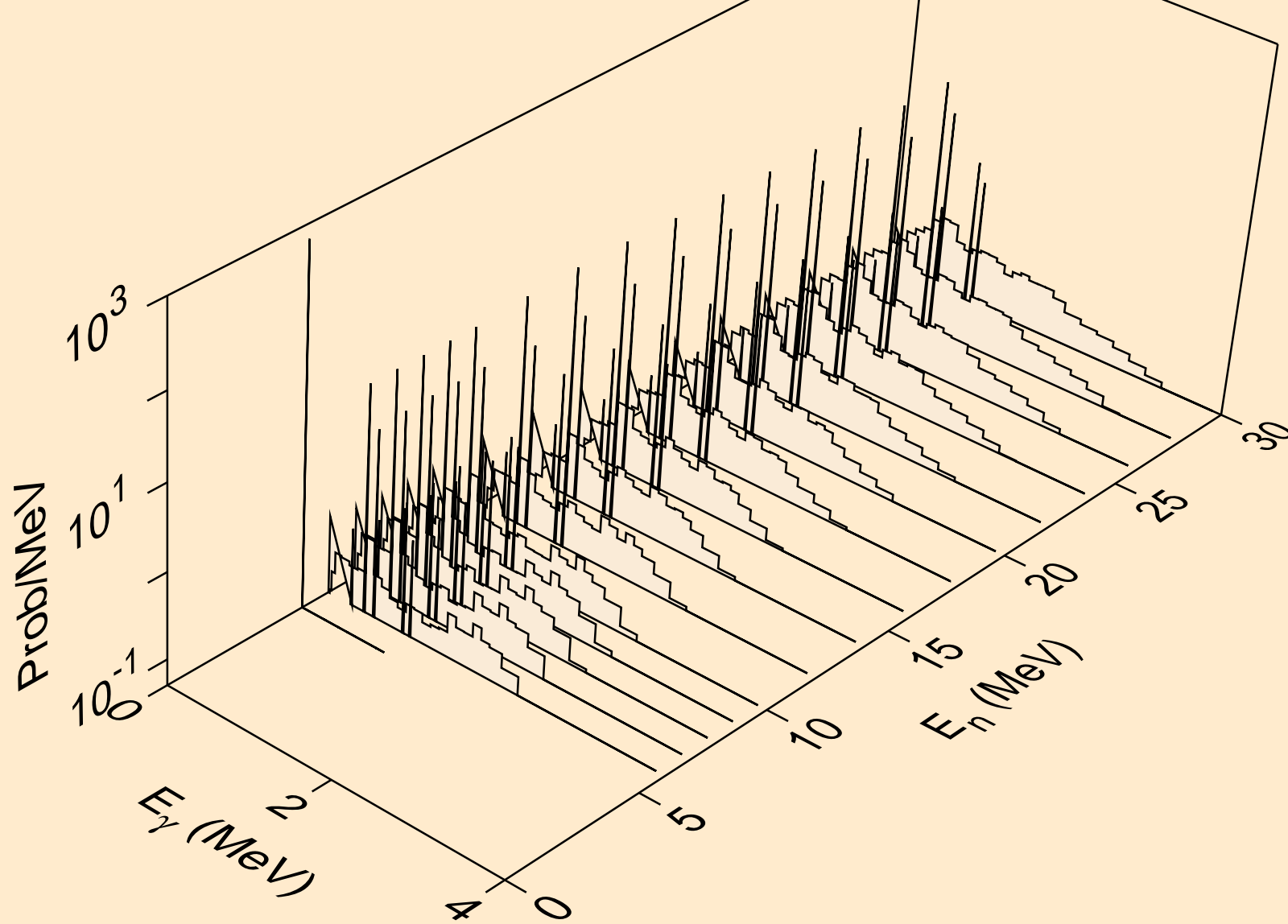



TA163 DEUTERON ACER TENDL-2023 LIBRARY; T=0.K  
Photon emission for (n,a)

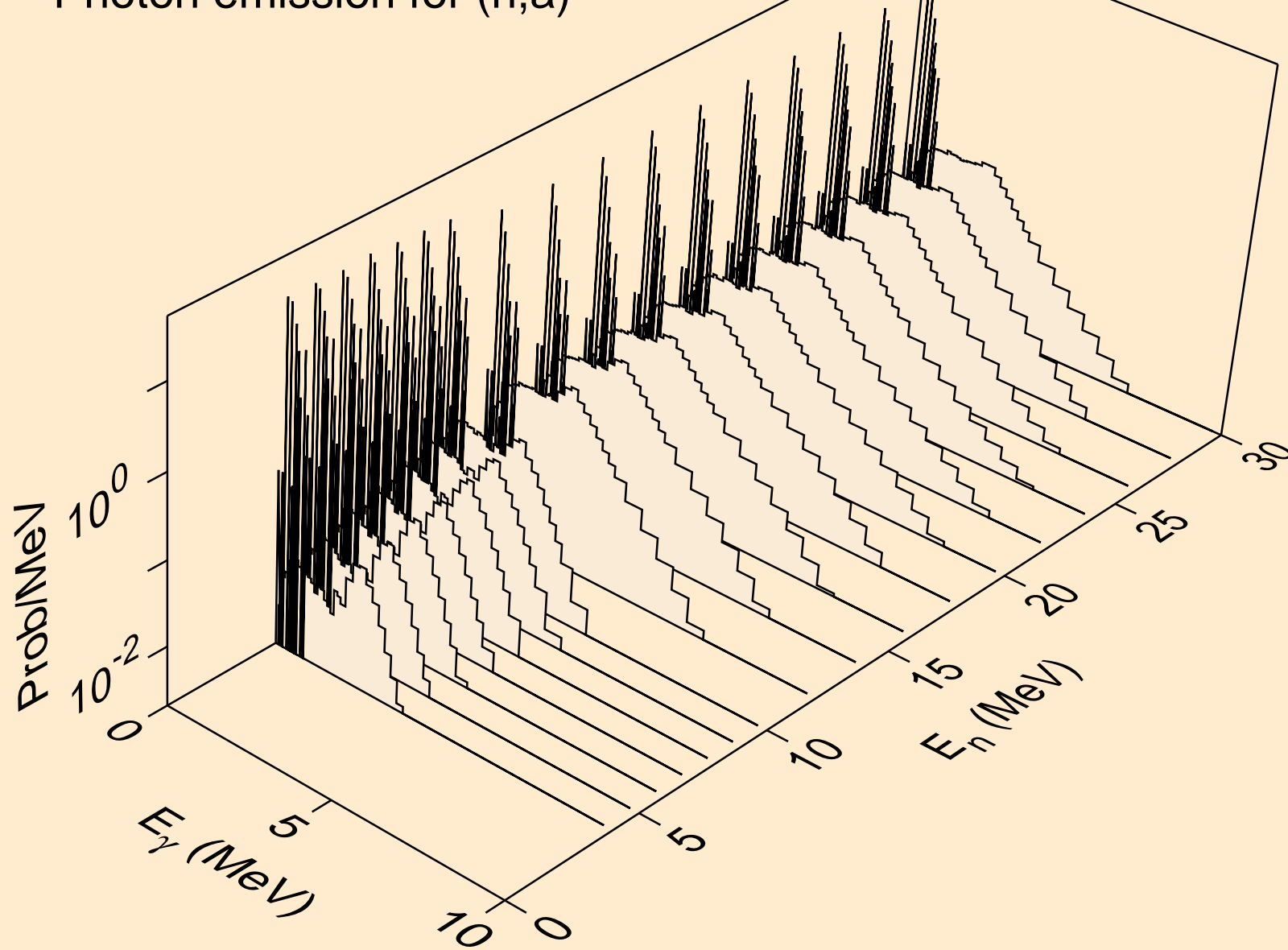

TA163 DEUTERON ACER TENDL-2023 LIBRARY; T=0.K  
Photon emission for (n,2a)

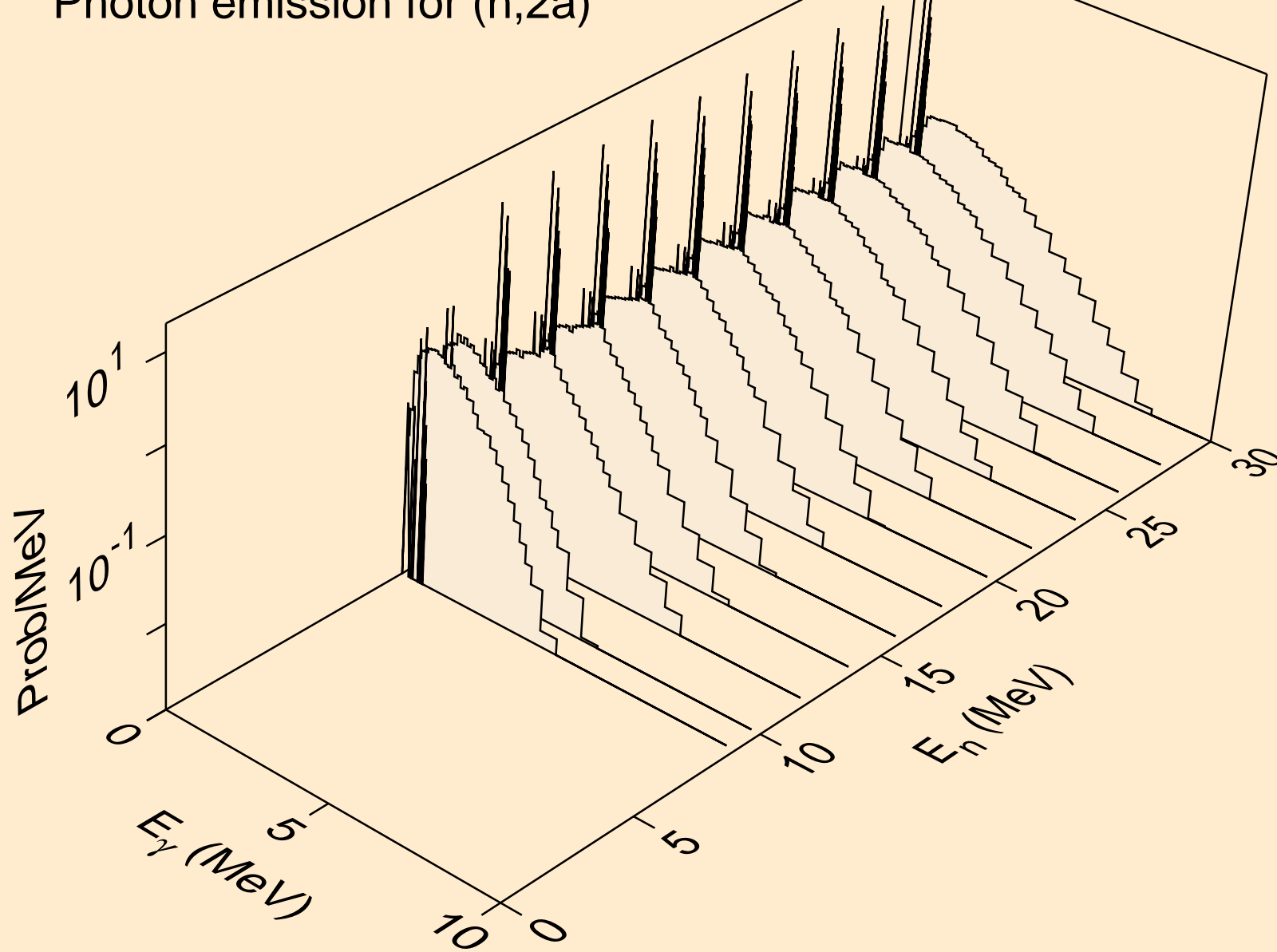

TA163 DEUTERON ACER TENDL-2023 LIBRARY; T=0.K  
Photon emission for (n,3a)

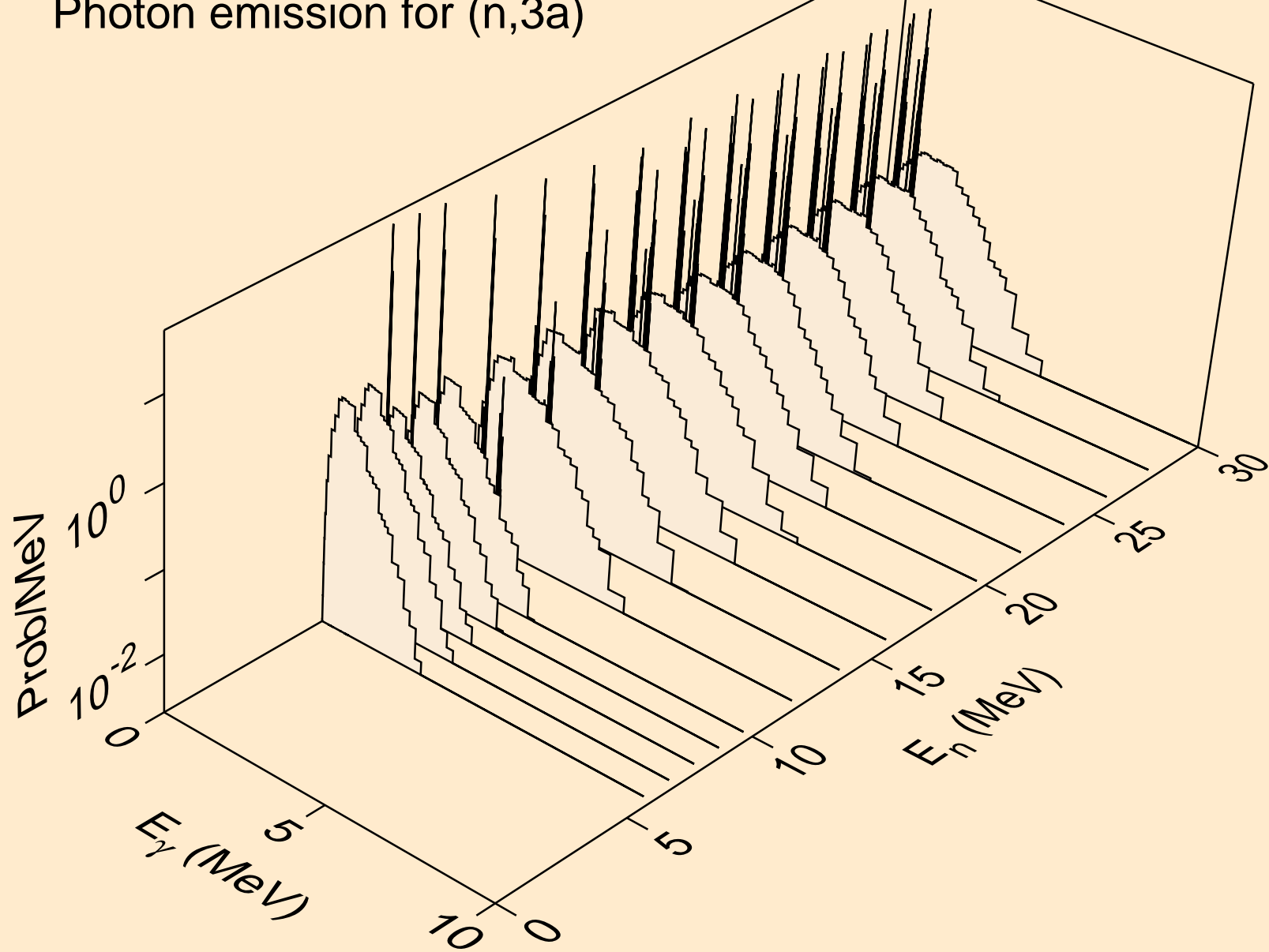

TA163 DEUTERON ACER TENDL-2023 LIBRARY; T=0.K  
Photon emission for (n,2p)

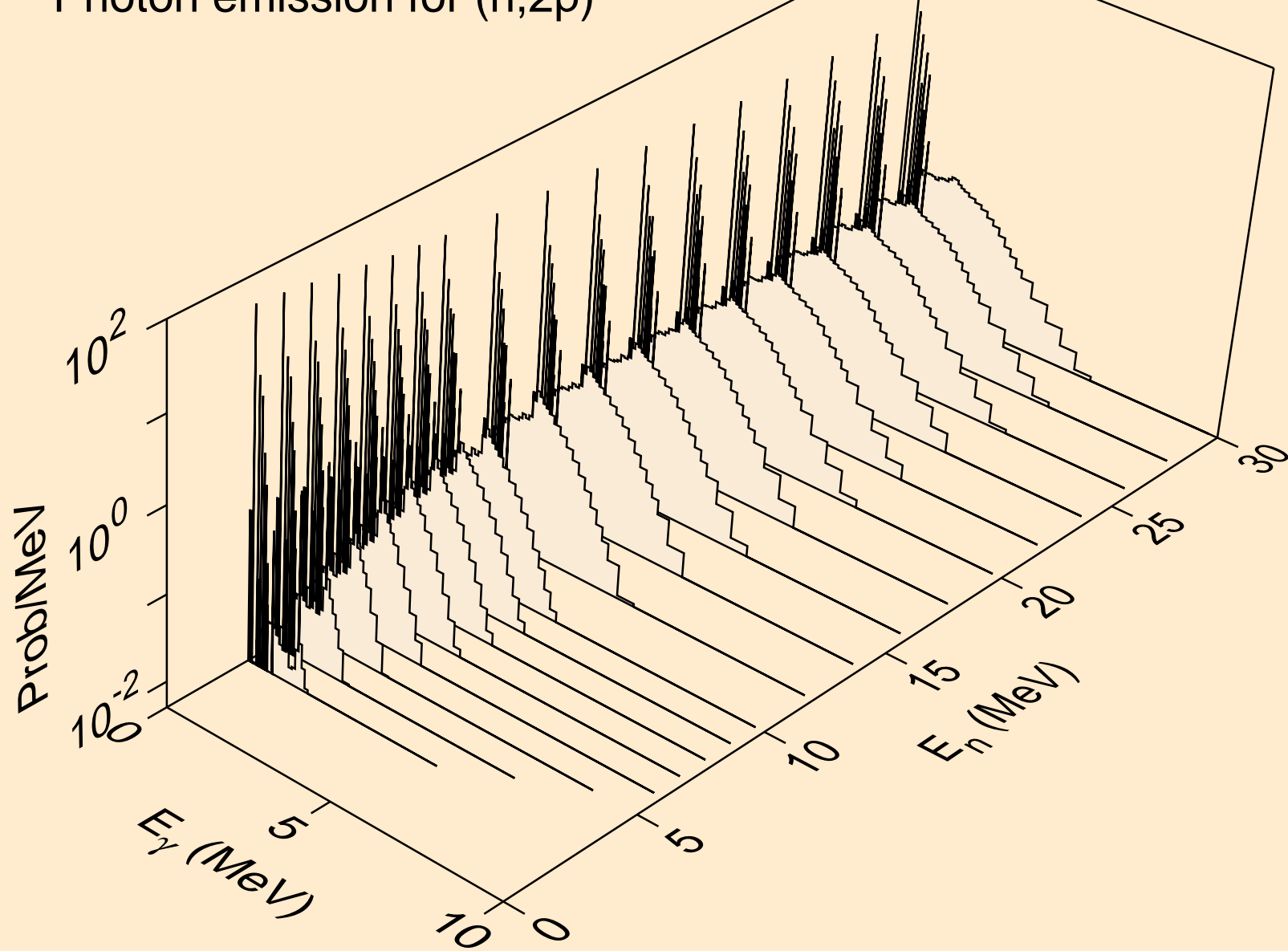

TA163 DEUTERON ACER TENDL-2023 LIBRARY; T=0.K  
Photon emission for (n,p)

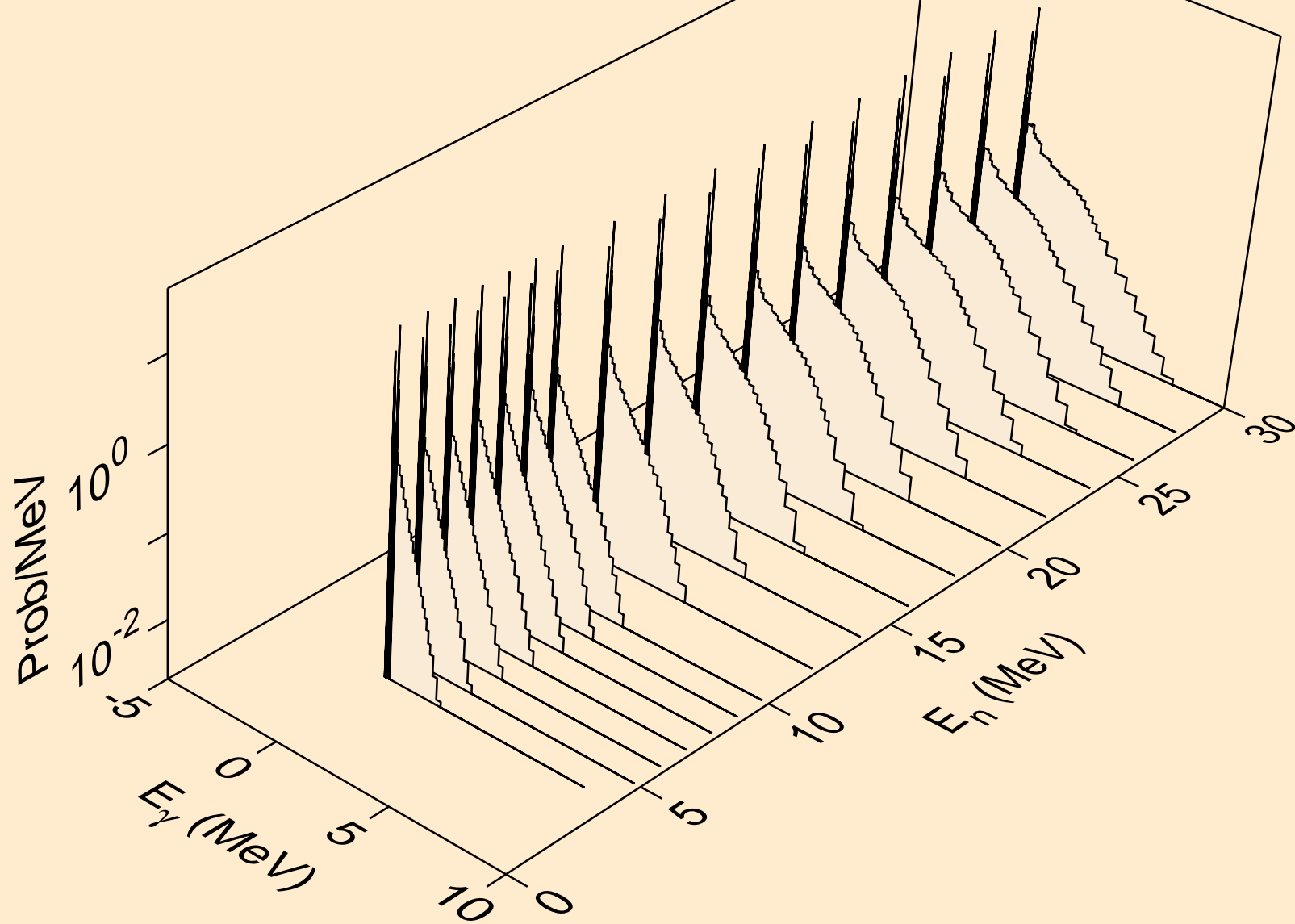

TA163 DEUTERON ACER TENDL-2023 LIBRARY; T=0.K  
Photon emission for (n,d2a)

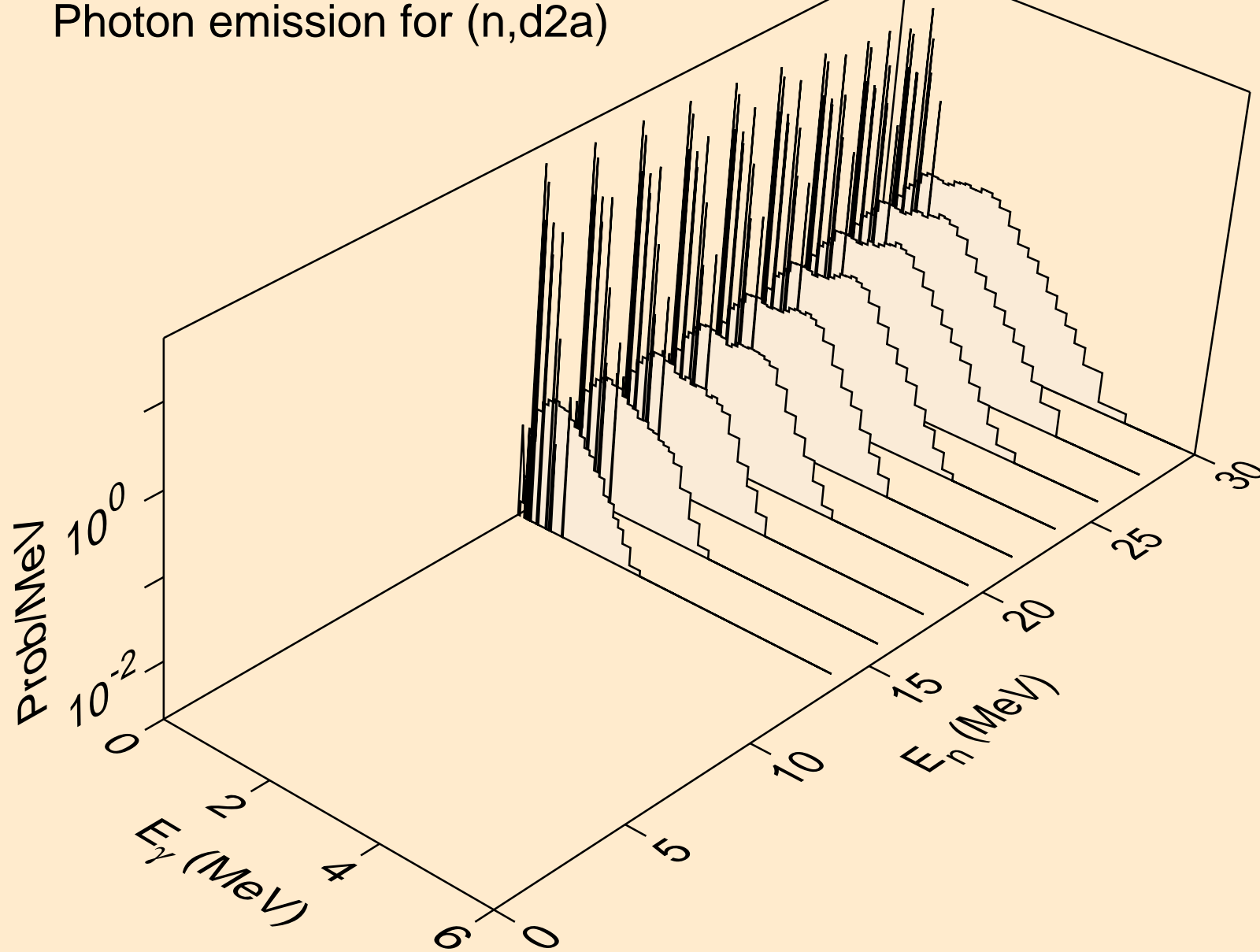

TA163 DEUTERON ACER TENDL-2023 LIBRARY; T=0.K  
Photon emission for (n,pd)

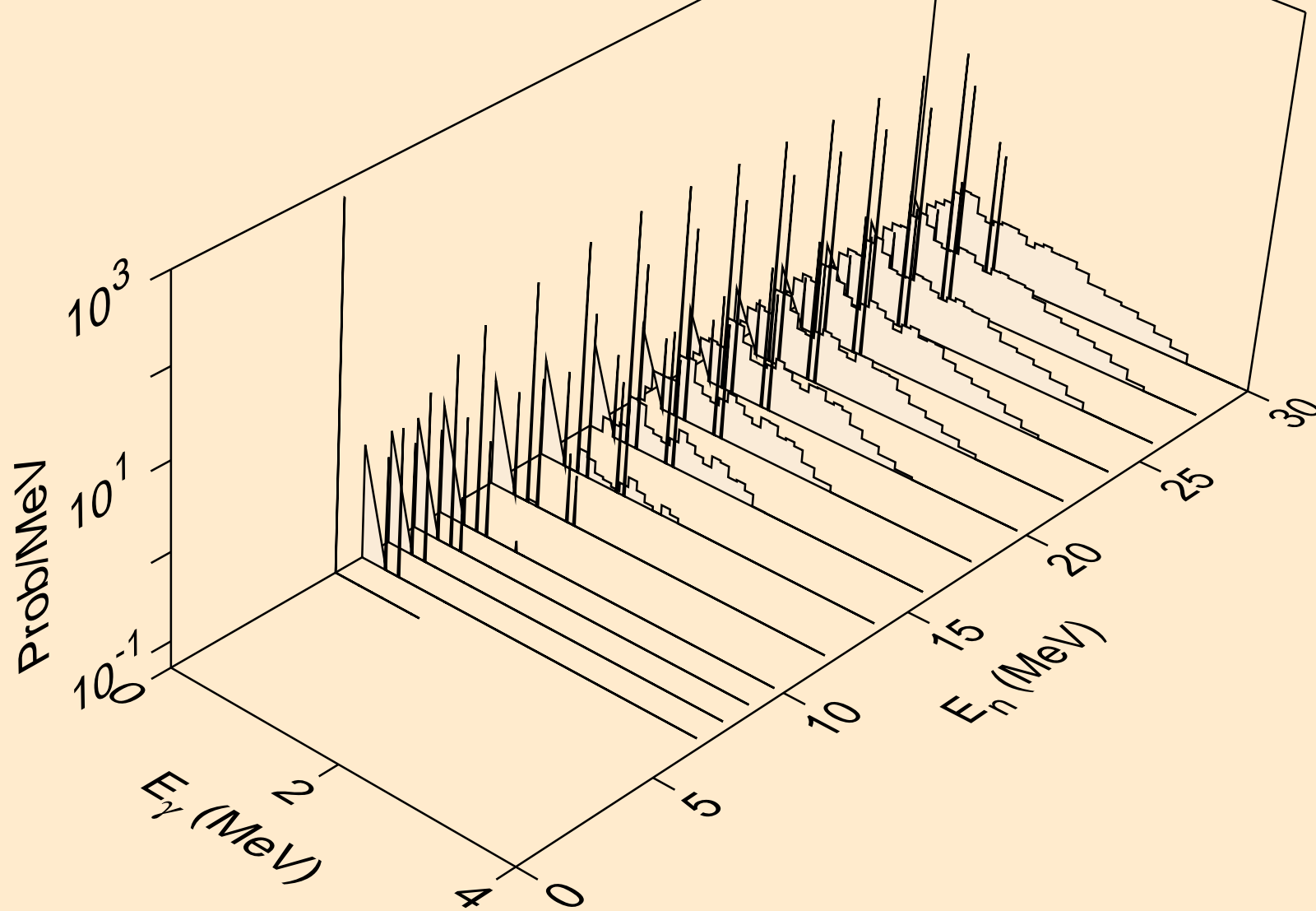

TA163 DEUTERON ACER TENDL-2023 LIBRARY; T=0.K  
Photon emission for (n,pt)

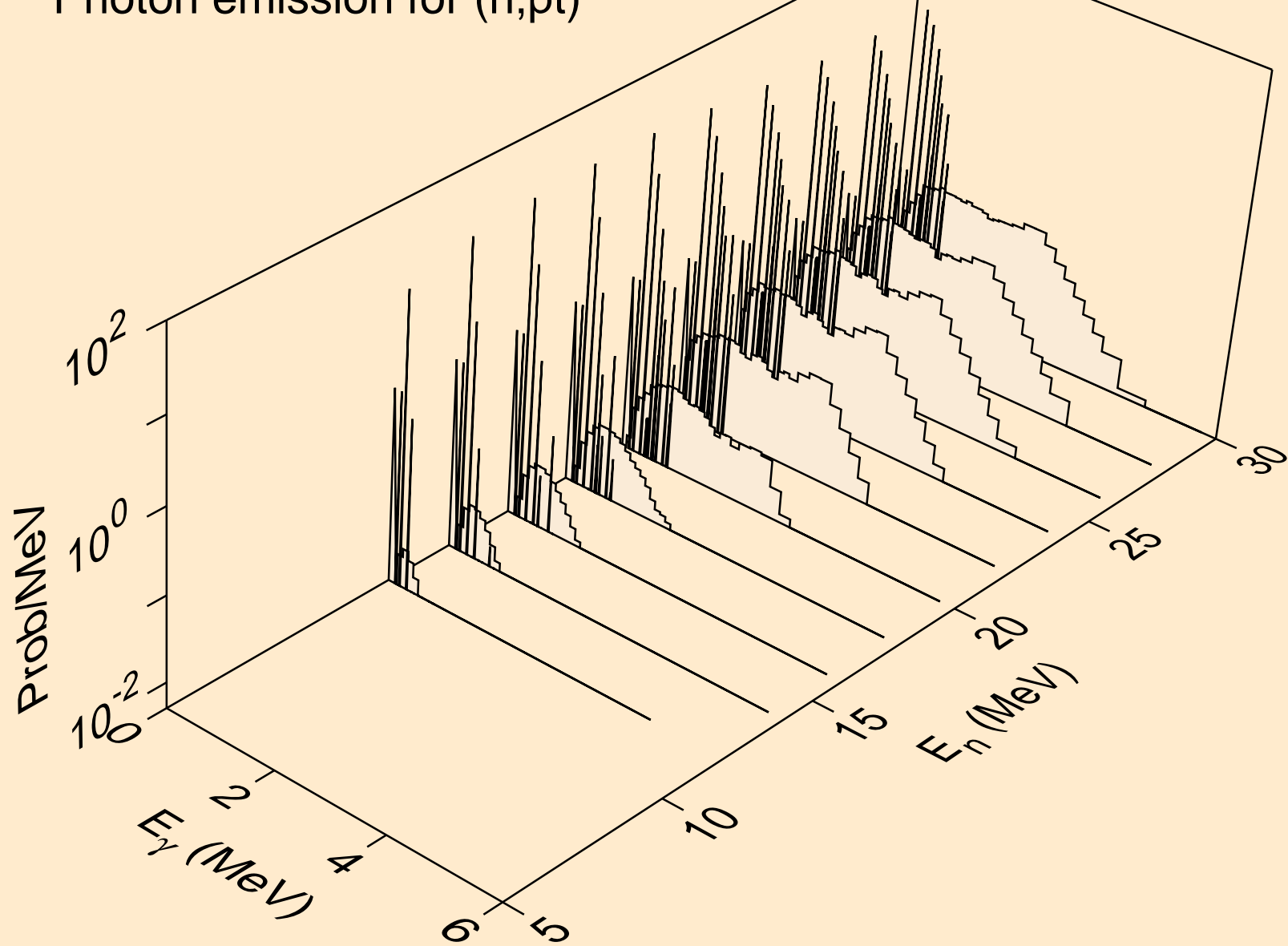



TA163 DEUTERON ACER TENDL-2023 LIBRARY; T=0.K  
Photon emission for (n,da)

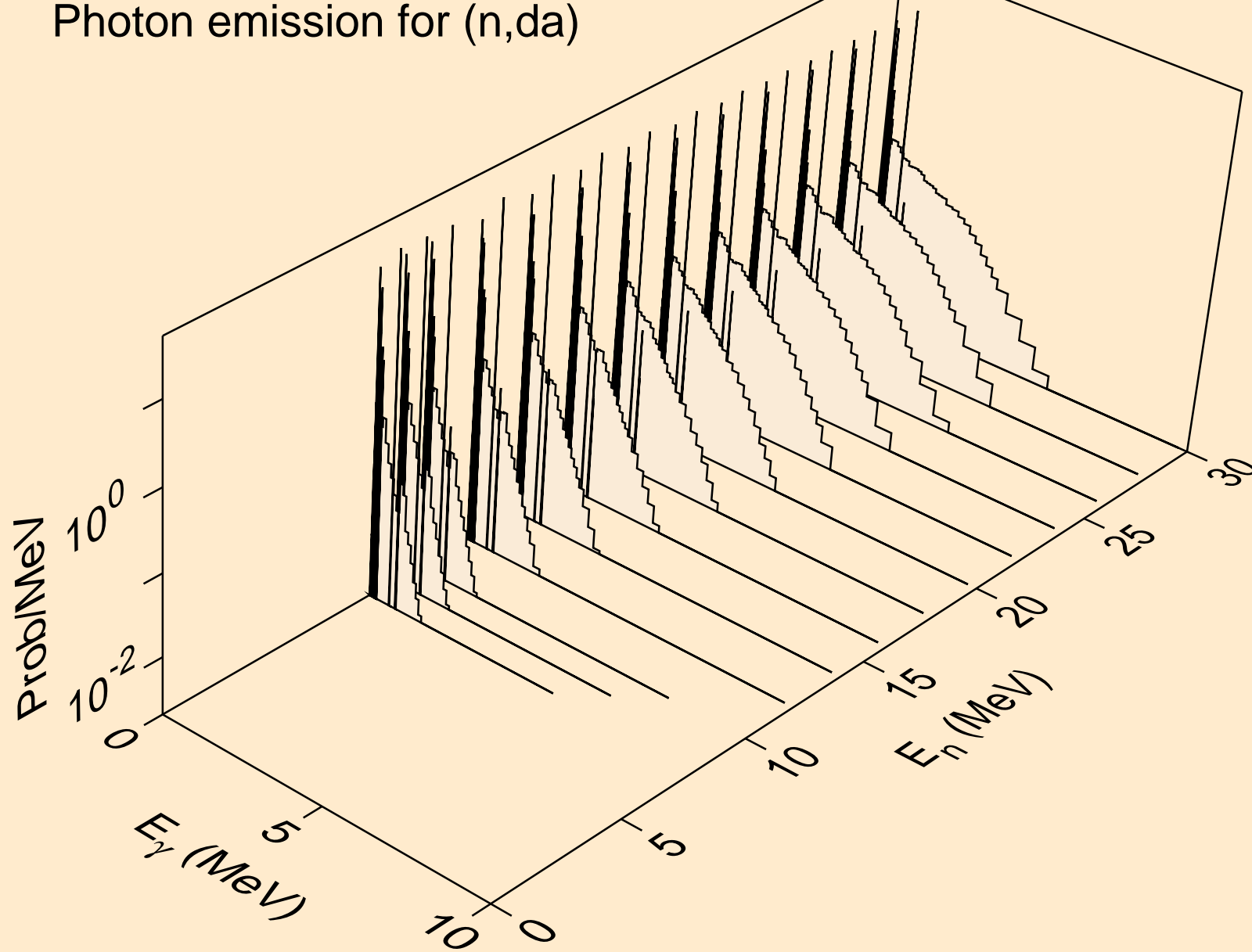

# TA163 DEUTERON ACER TENDL-2023 LIBRARY; T=0.K

## Particle heating contributions

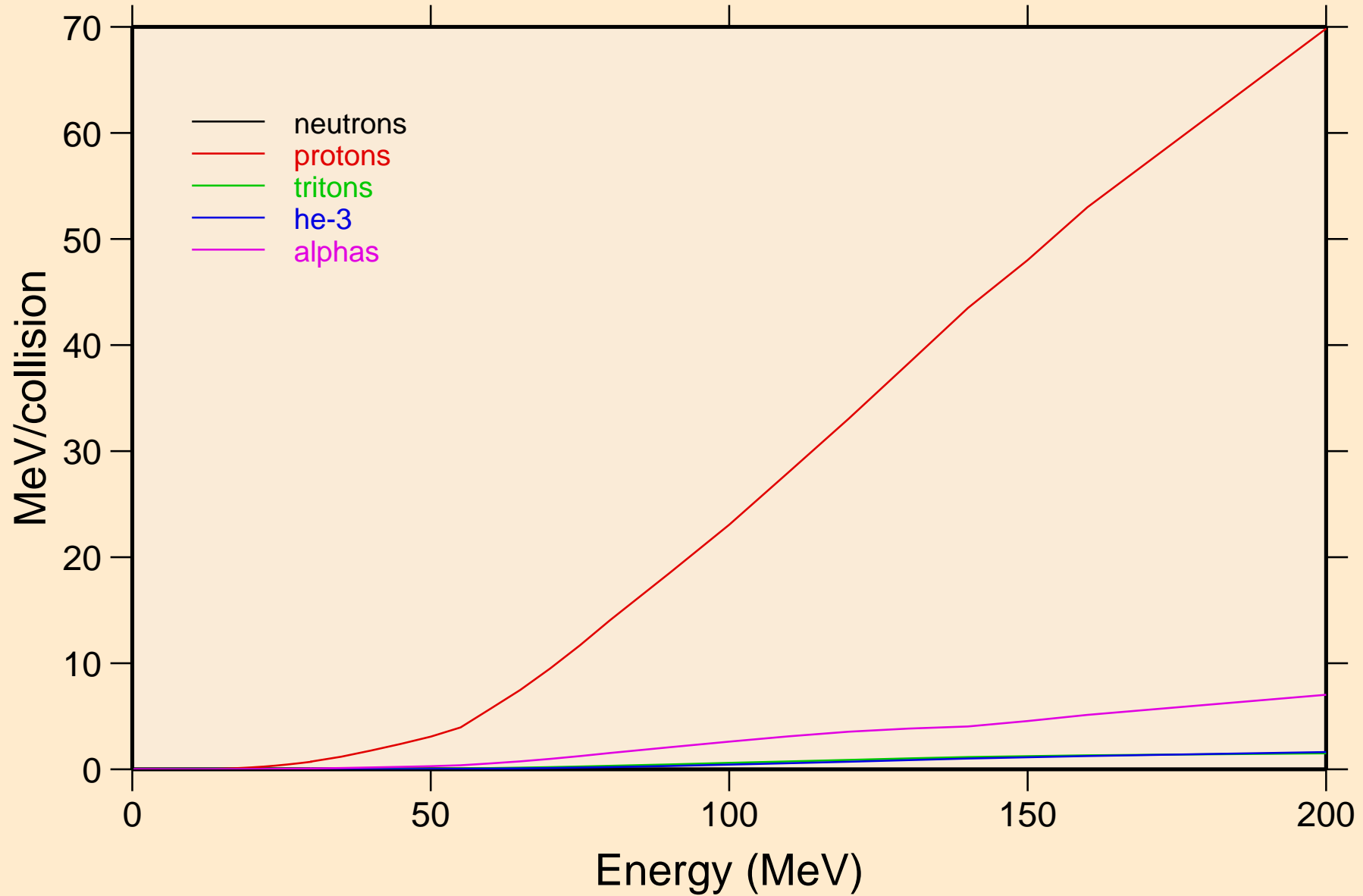

TA163 DEUTERON ACER TENDL-2023 LIBRARY; T=0.K  
Recoil Heating

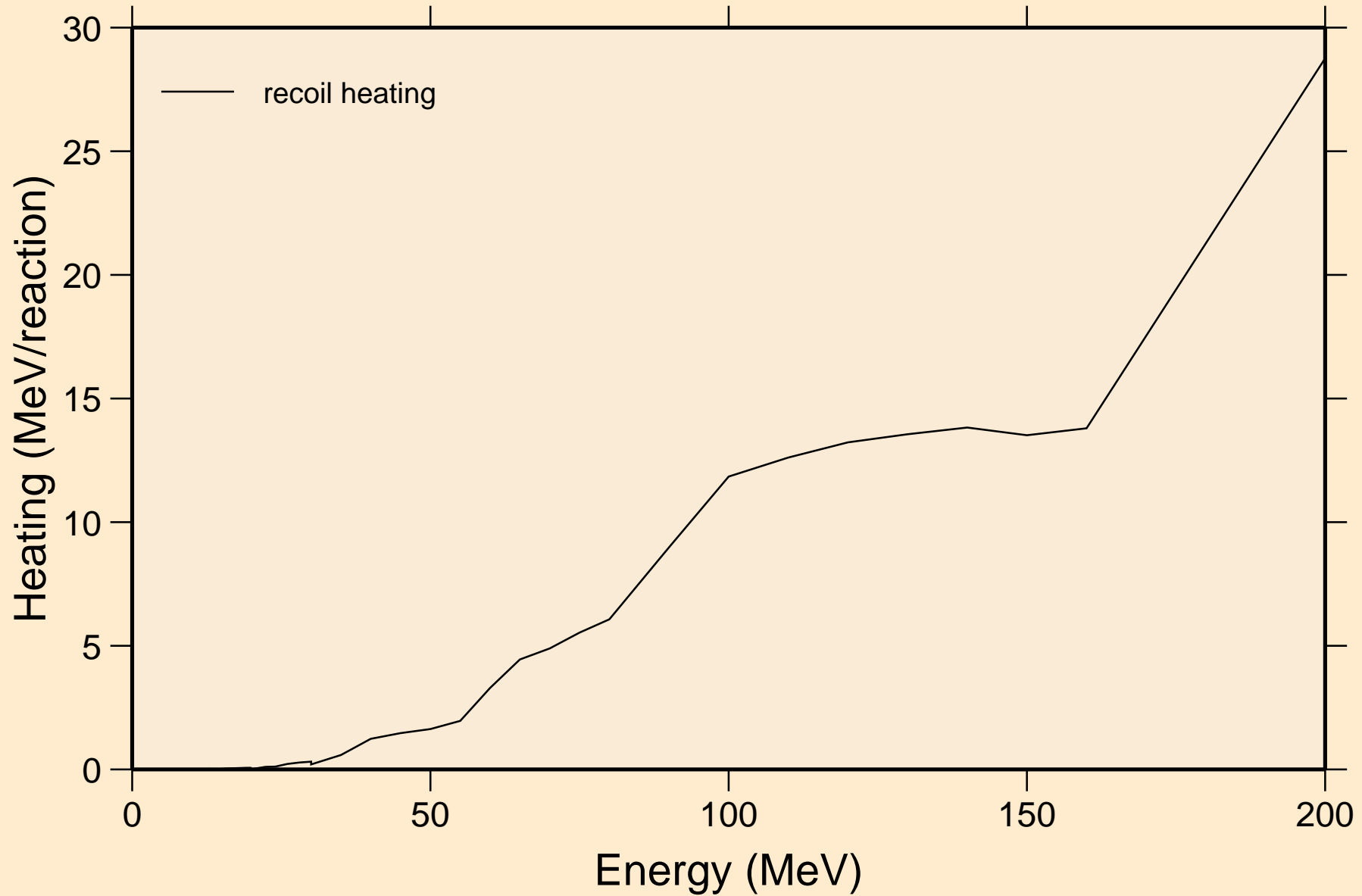

TA163 DEUTERON ACER TENDL-2023 LIBRARY; T=0.K  
Particle production cross sections

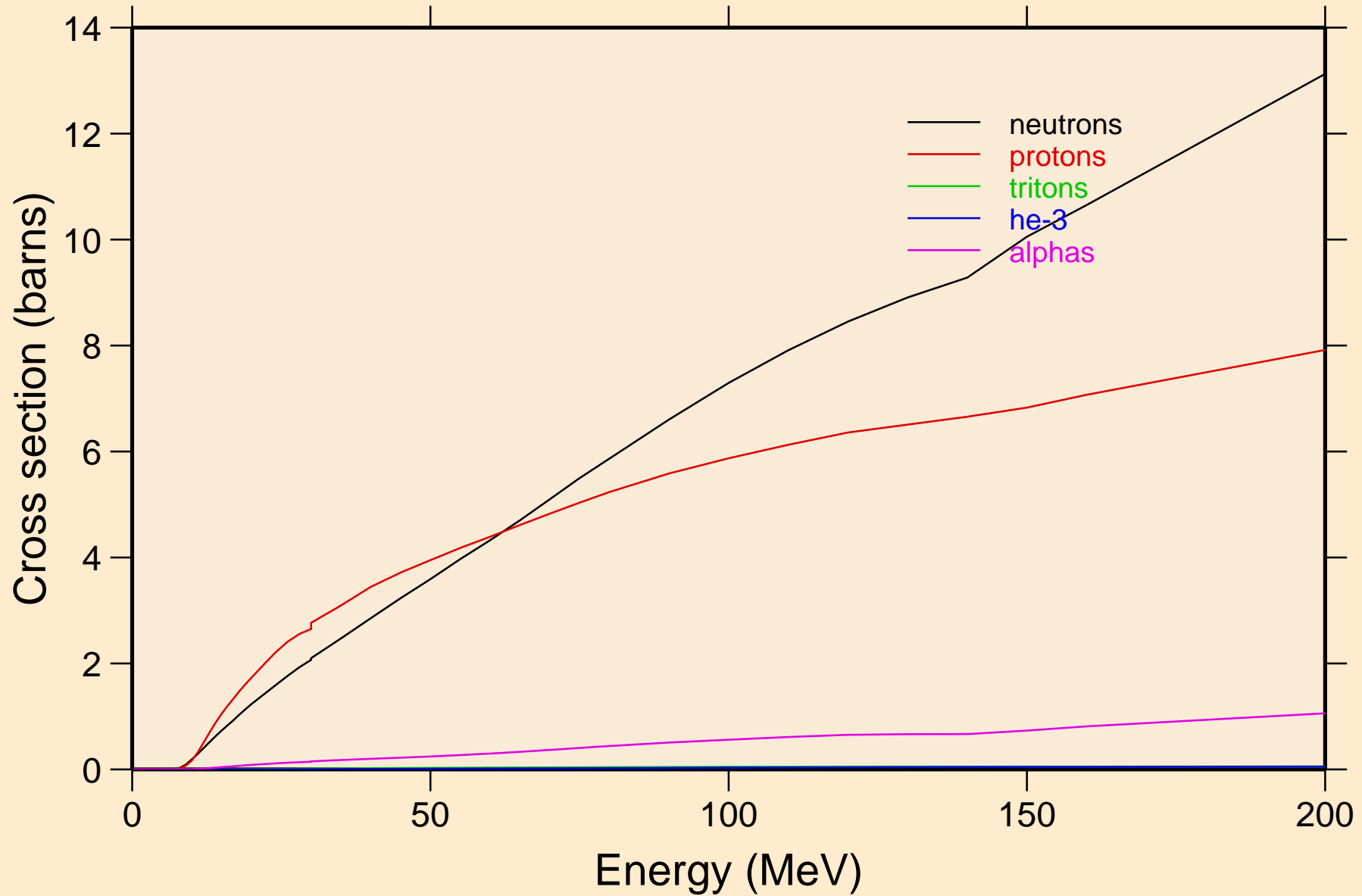

TA163 DEUTERON ACER TENDL-2023 LIBRARY; T=0.K  
neutrons from (d,n)

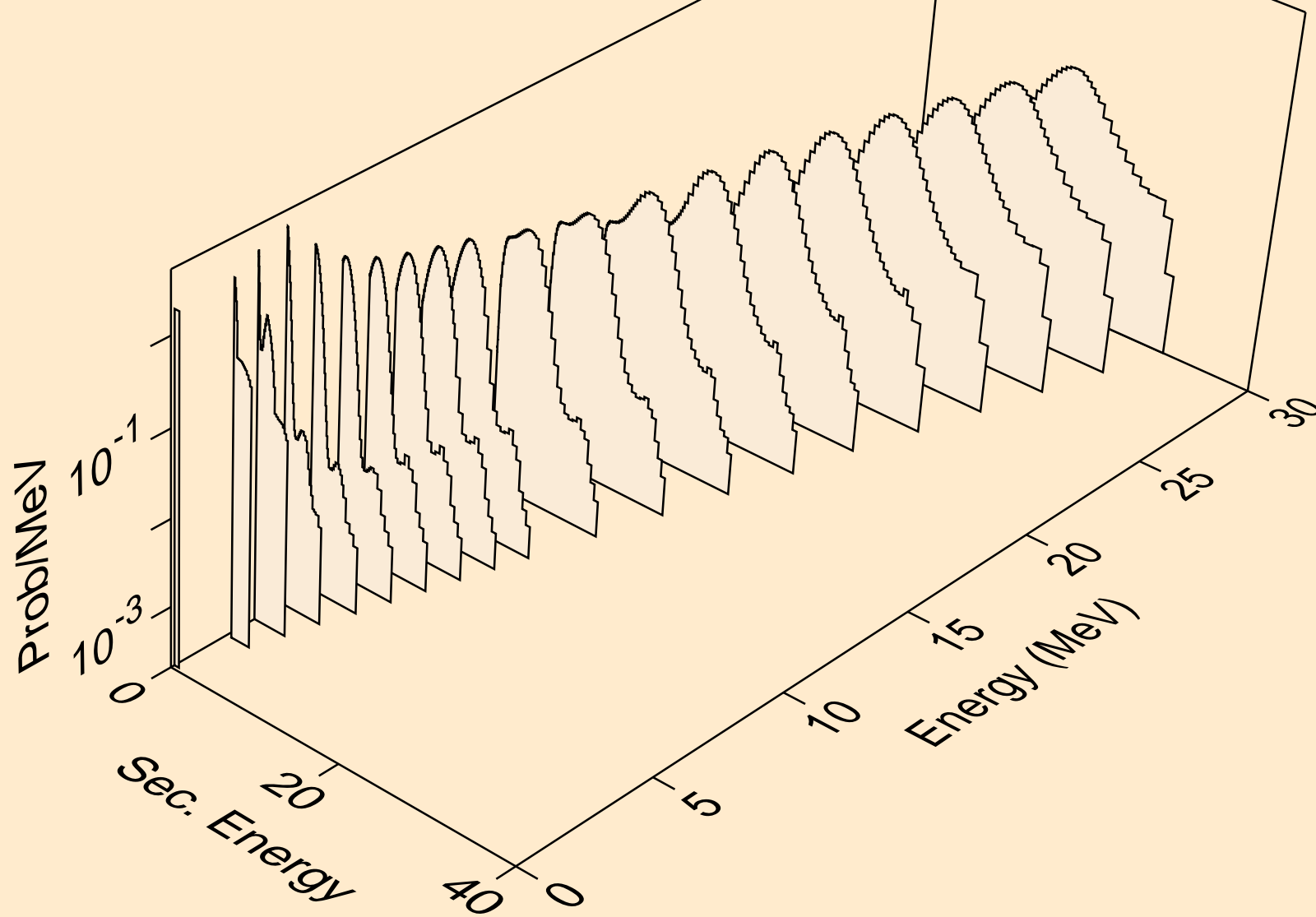

TA163 DEUTERON ACER TENDL-2023 LIBRARY; T=0.K  
neutrons from (d,x)

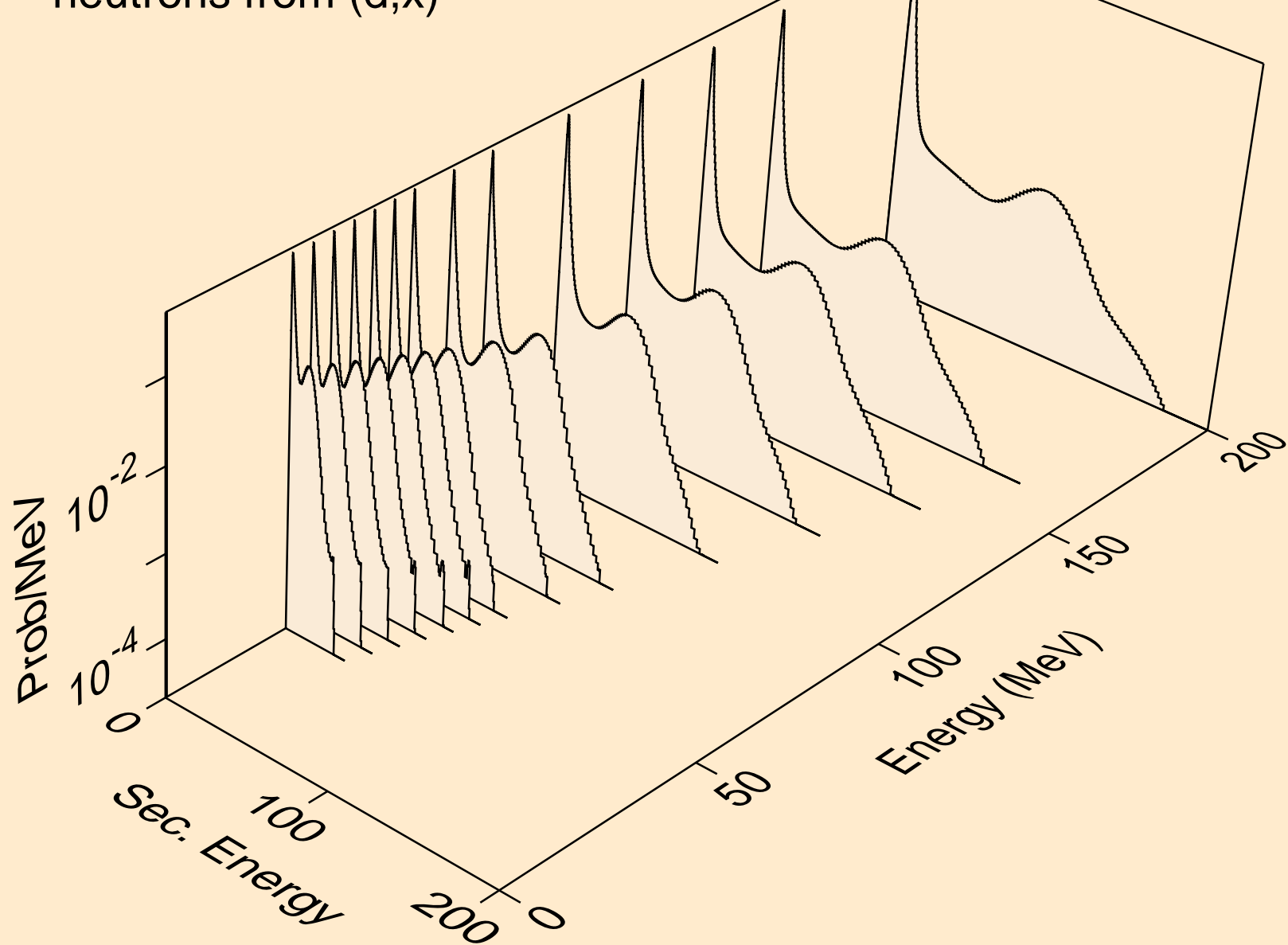

TA163 DEUTERON ACER TENDL-2023 LIBRARY; T=0.K  
neutrons from (d,2nd)

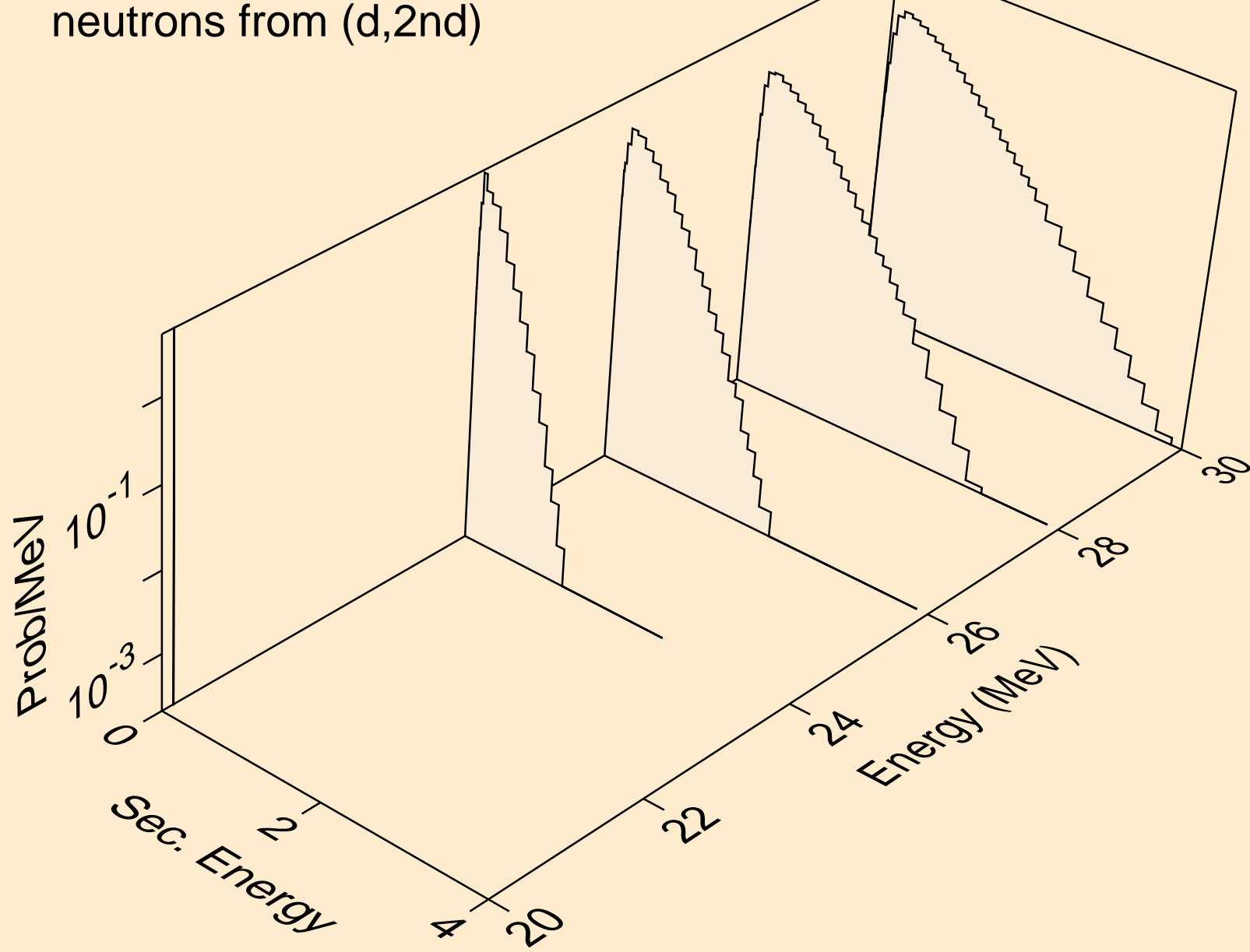

TA163 DEUTERON ACER TENDL-2023 LIBRARY; T=0.K  
neutrons from (d,2n)

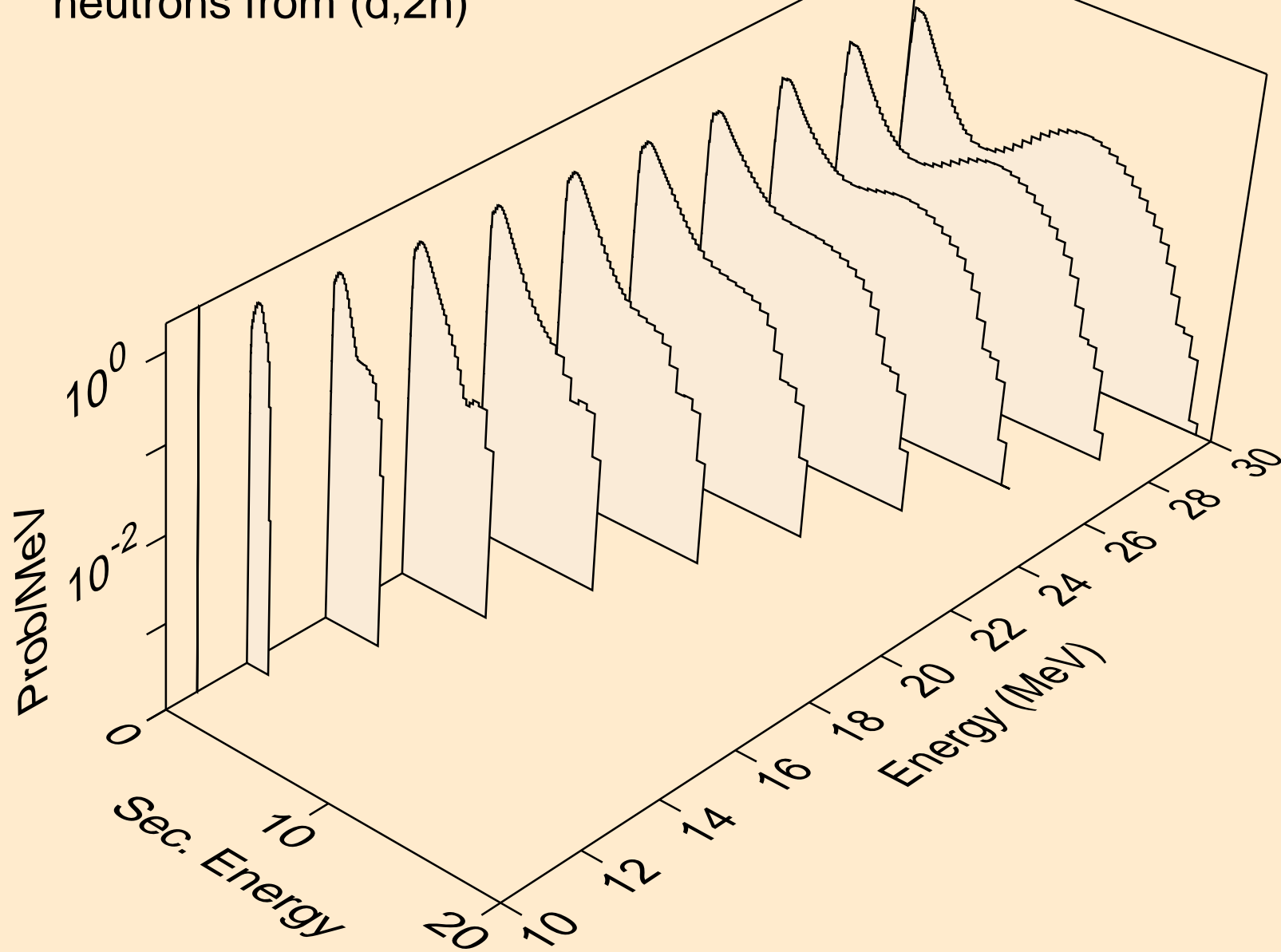



TA163 DEUTERON ACER TENDL-2023 LIBRARY; T=0.K  
neutrons from (d,3n)

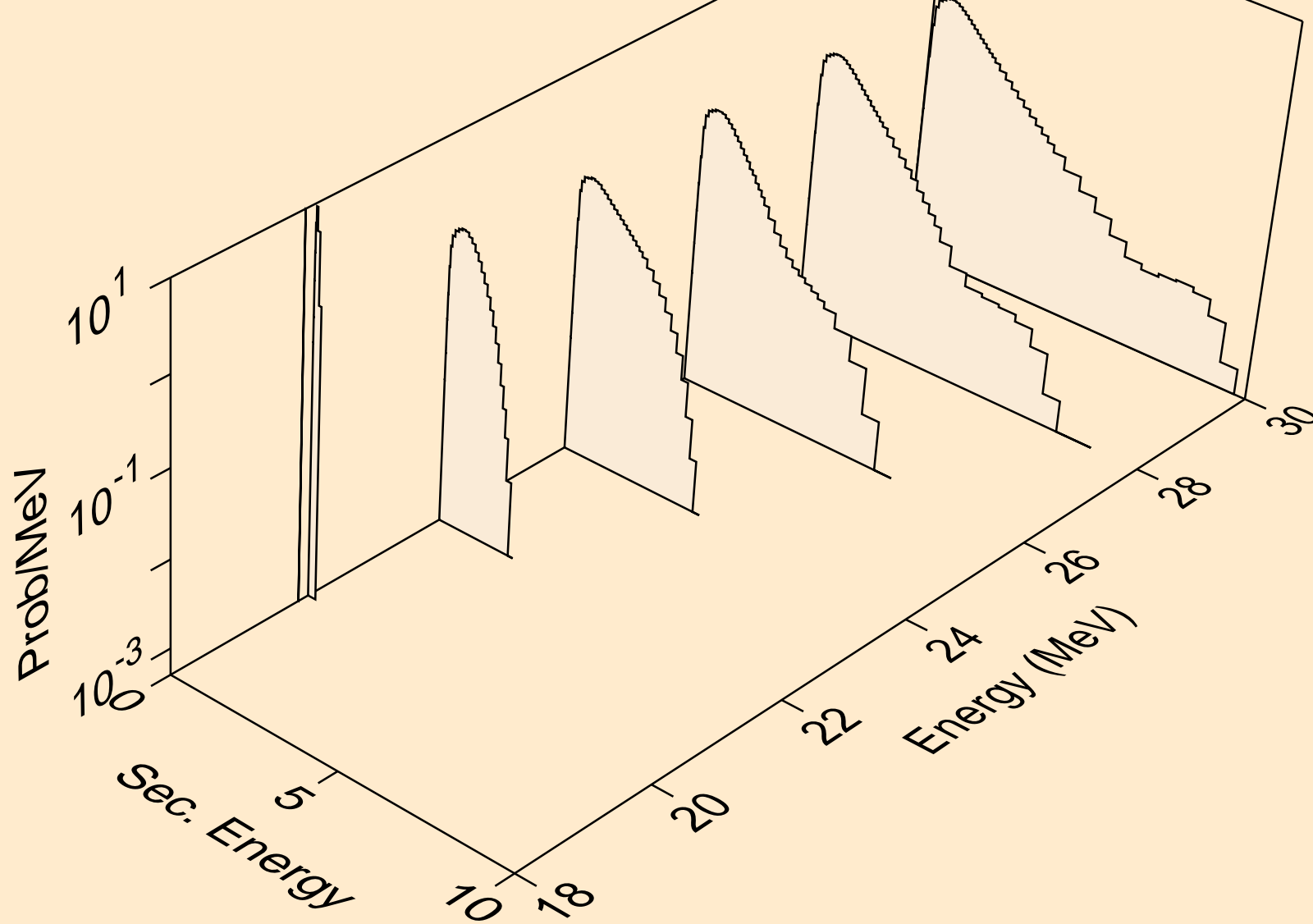

TA163 DEUTERON ACER TENDL-2023 LIBRARY; T=0.K  
neutrons from (d,n\*)a

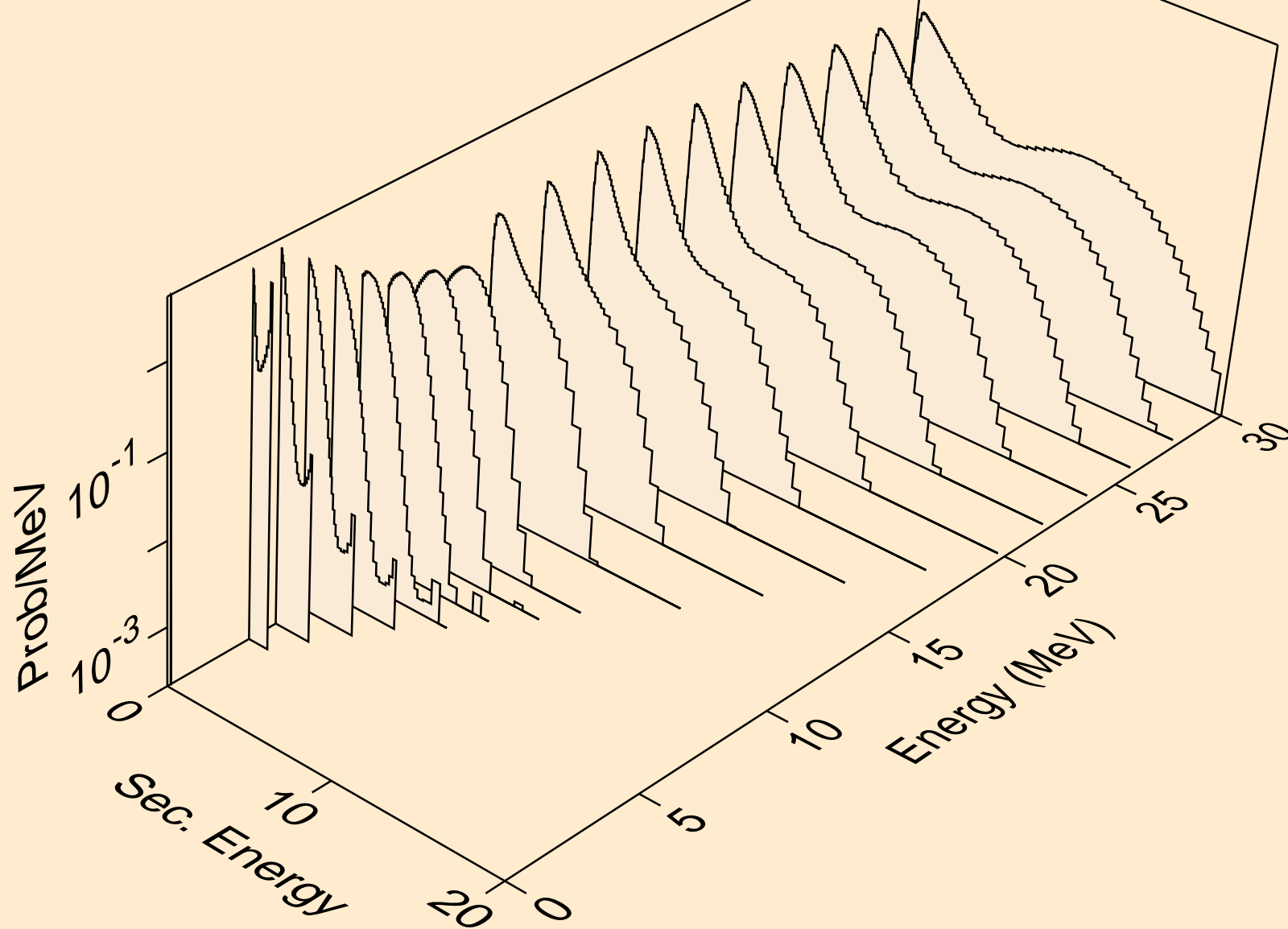

TA163 DEUTERON ACER TENDL-2023 LIBRARY; T=0.K  
neutrons from (d,n\*)3a

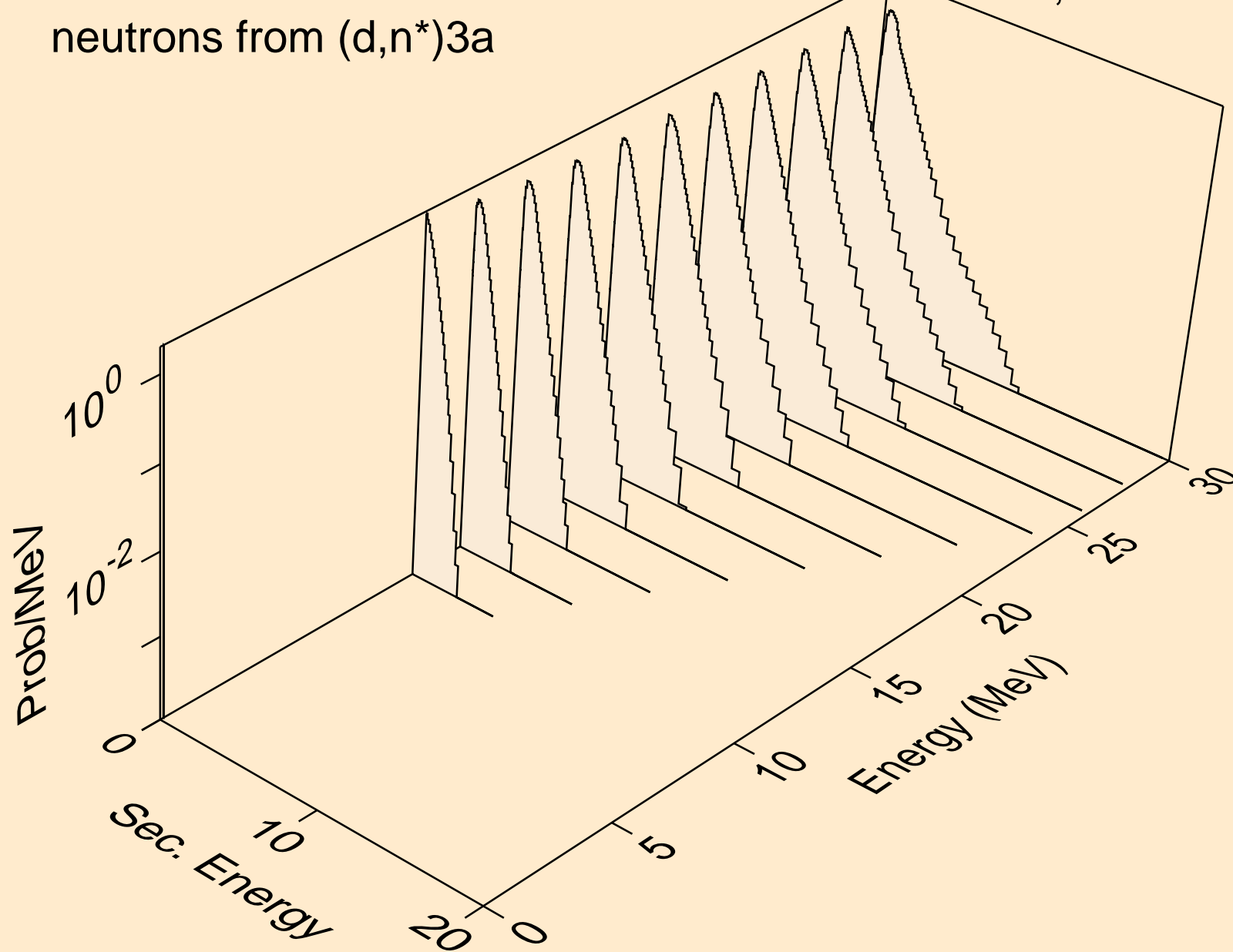

TA163 DEUTERON ACER TENDL-2023 LIBRARY; T=0.K  
neutrons from (d,2n)a

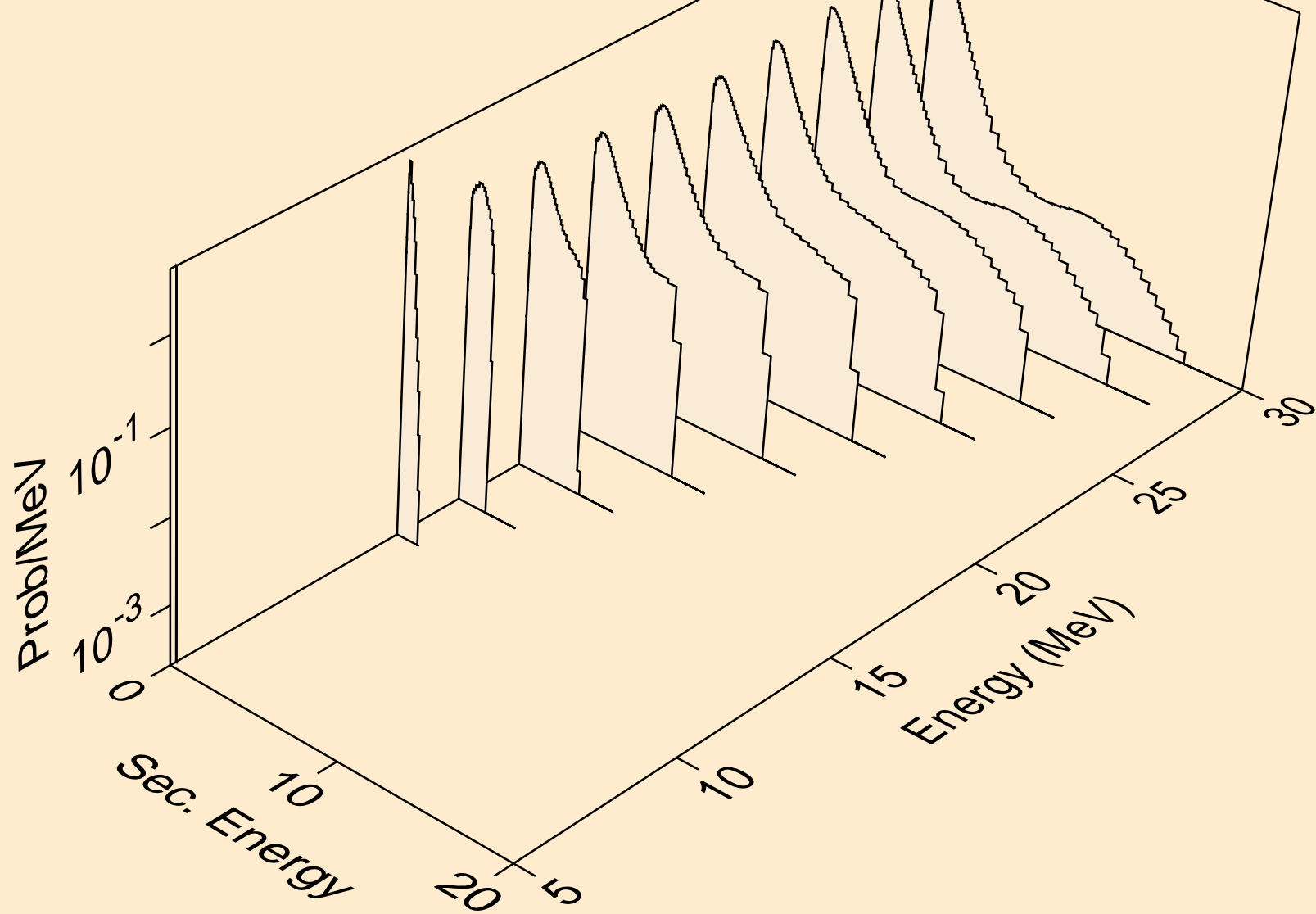

TA163 DEUTERON ACER TENDL-2023 LIBRARY; T=0.K  
neutrons from (d,3n)a

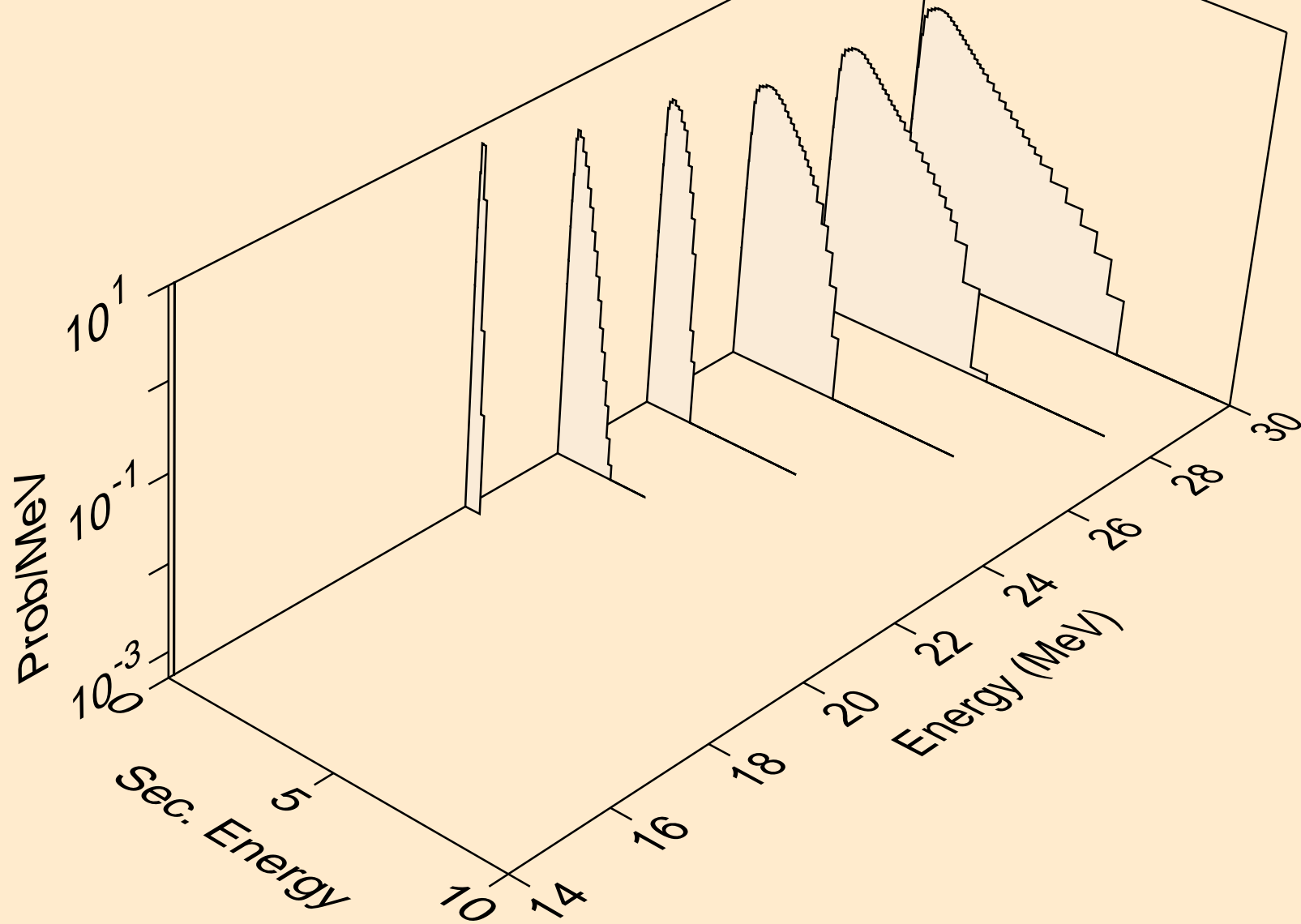

TA163 DEUTERON ACER TENDL-2023 LIBRARY; T=0.K  
neutrons from (d,n\*)p

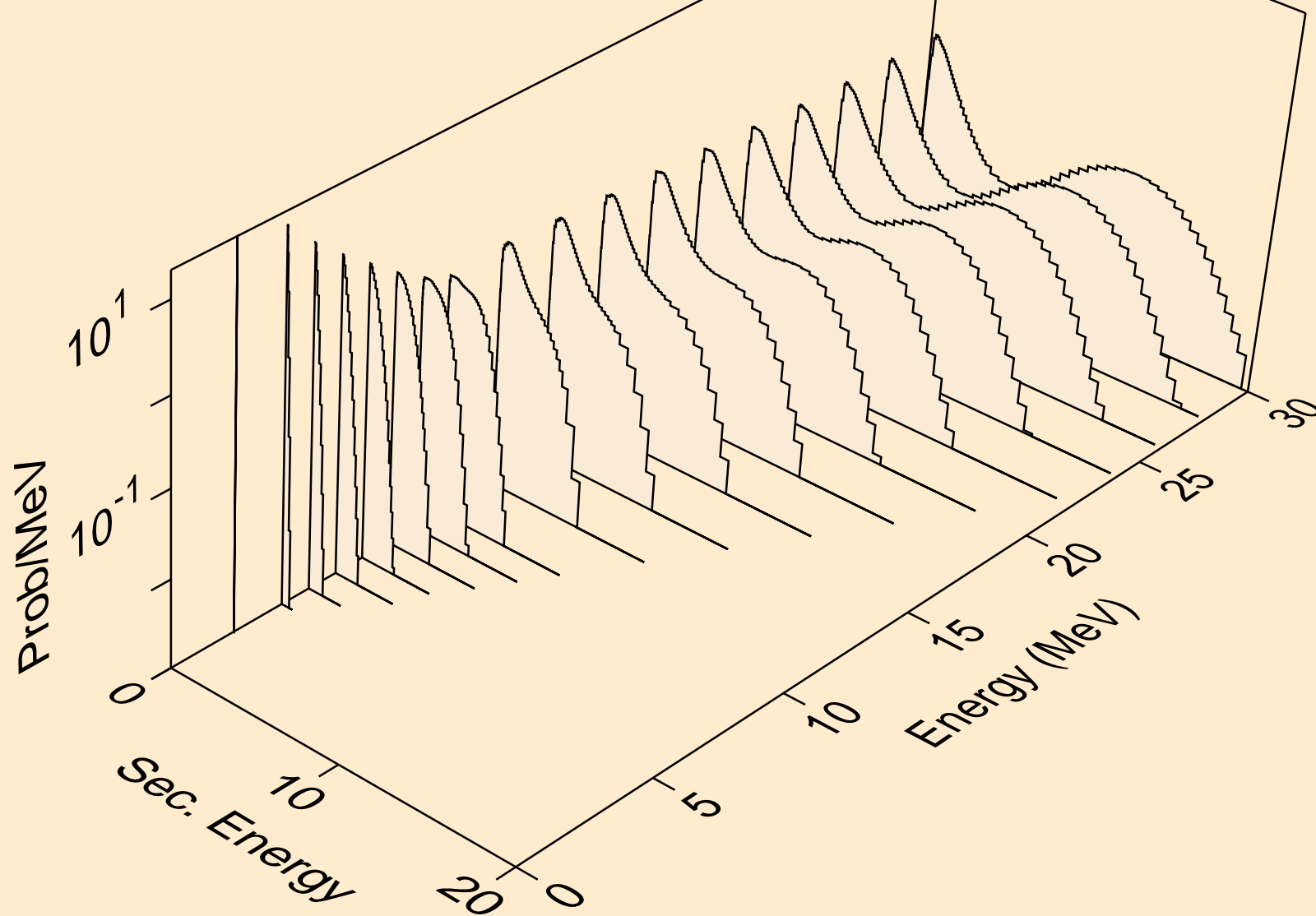

TA163 DEUTERON ACER TENDL-2023 LIBRARY; T=0.K  
neutrons from (d,n\*)2a

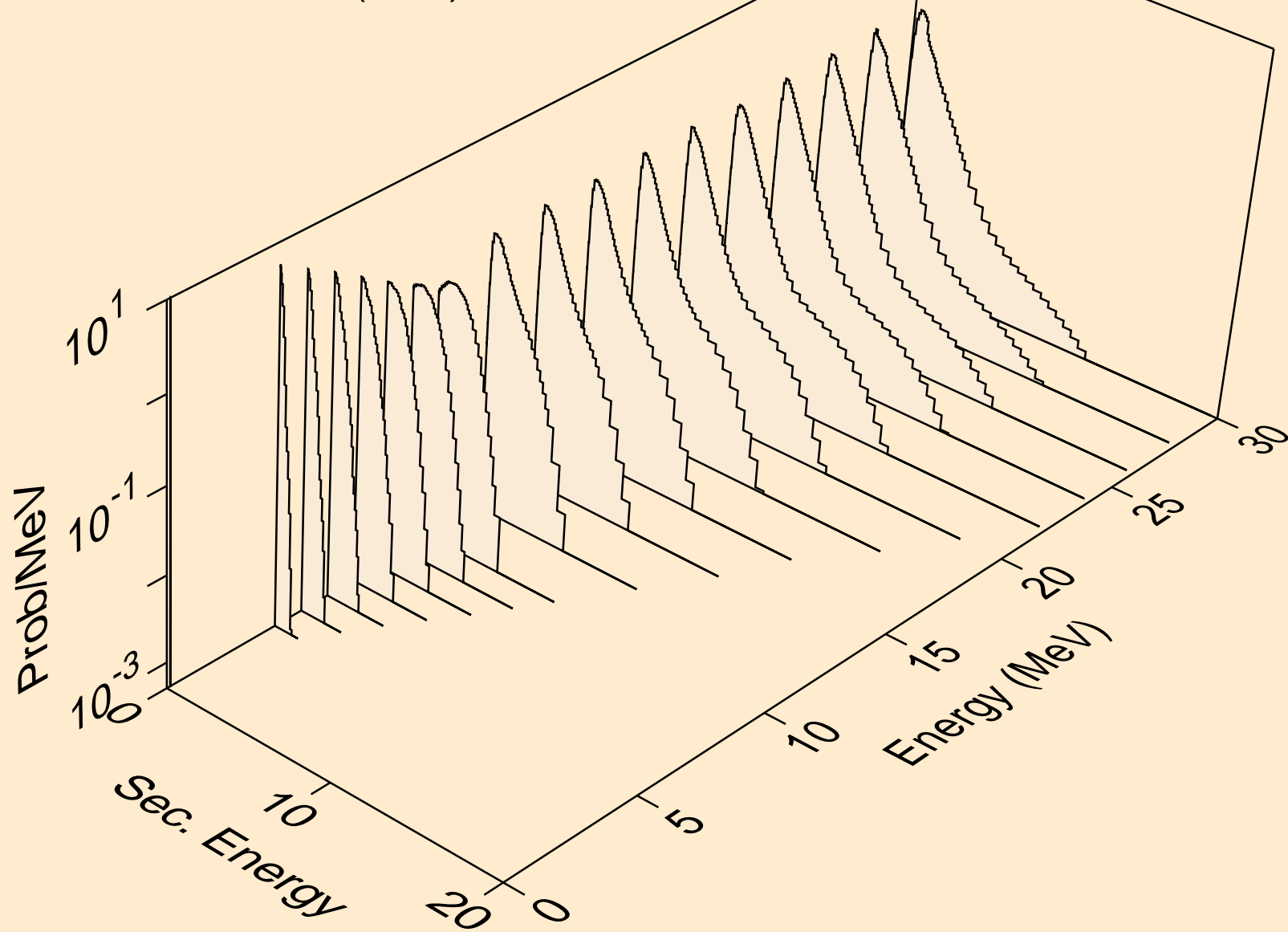

TA163 DEUTERON ACER TENDL-2023 LIBRARY; T=0.K  
neutrons from (d,2n)2a

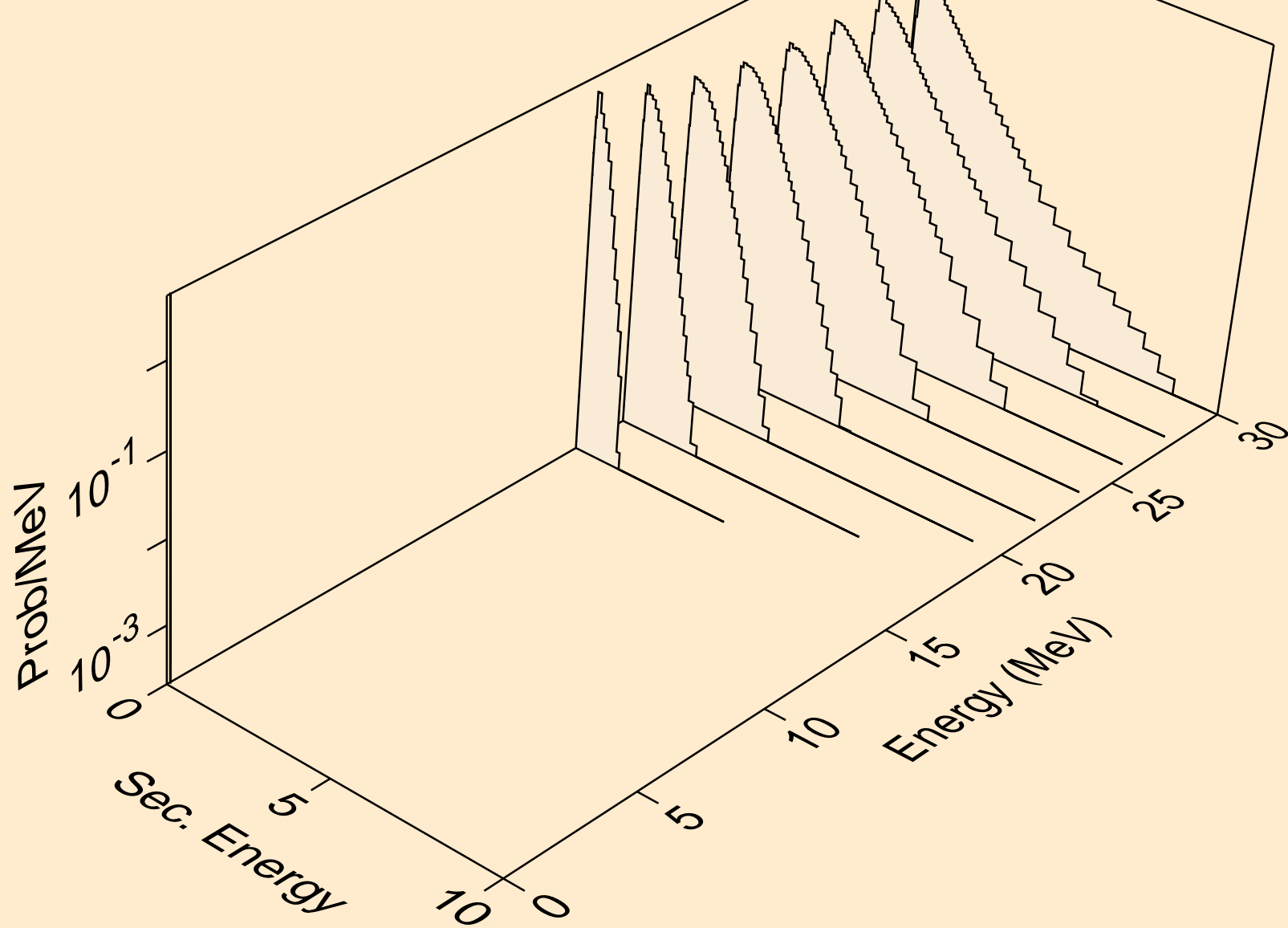



TA163 DEUTERON ACER TENDL-2023 LIBRARY; T=0.K  
neutrons from (d,n\*)d

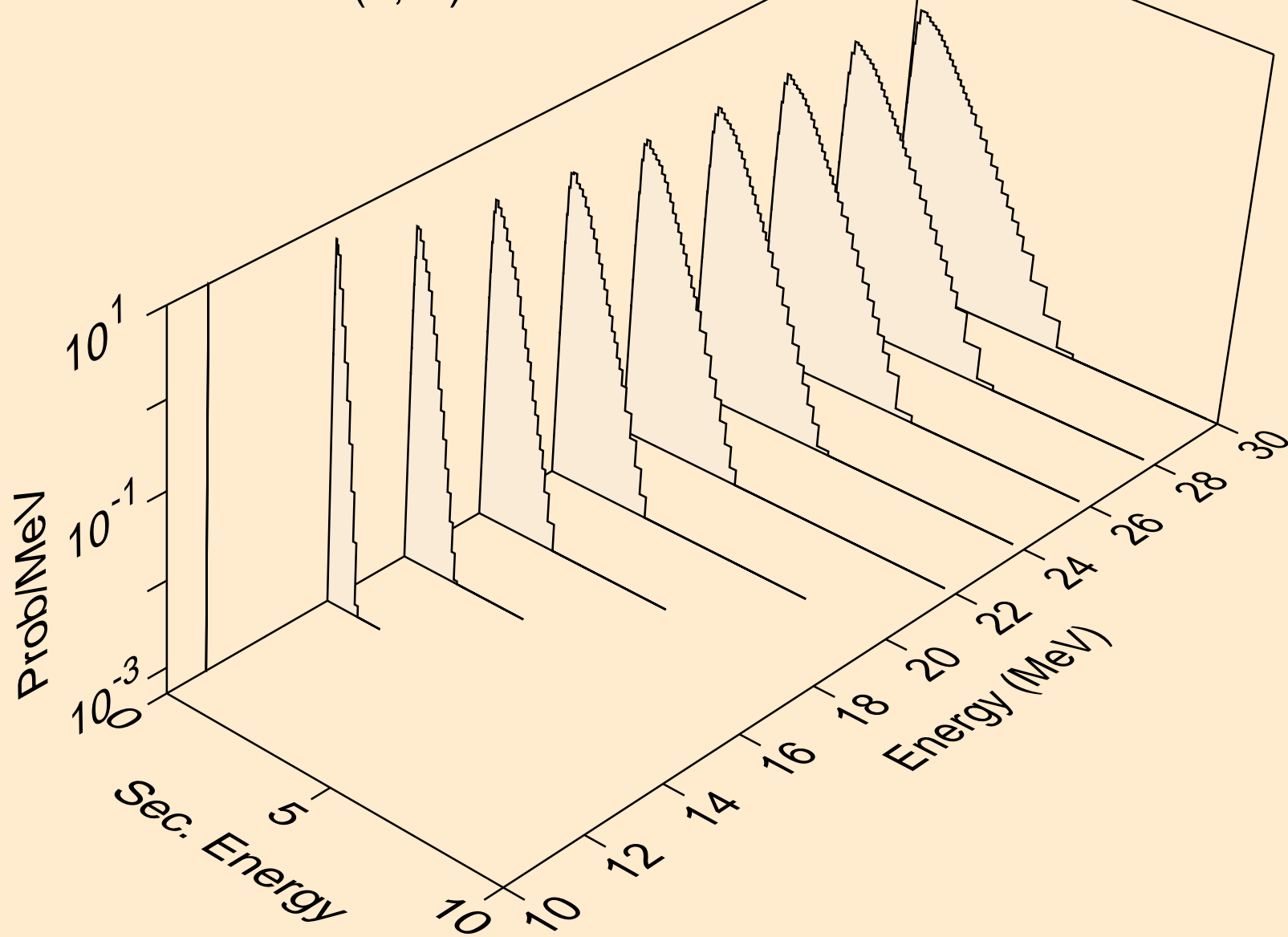

TA163 DEUTERON ACER TENDL-2023 LIBRARY; T=0.K  
neutrons from (d,n\*)t

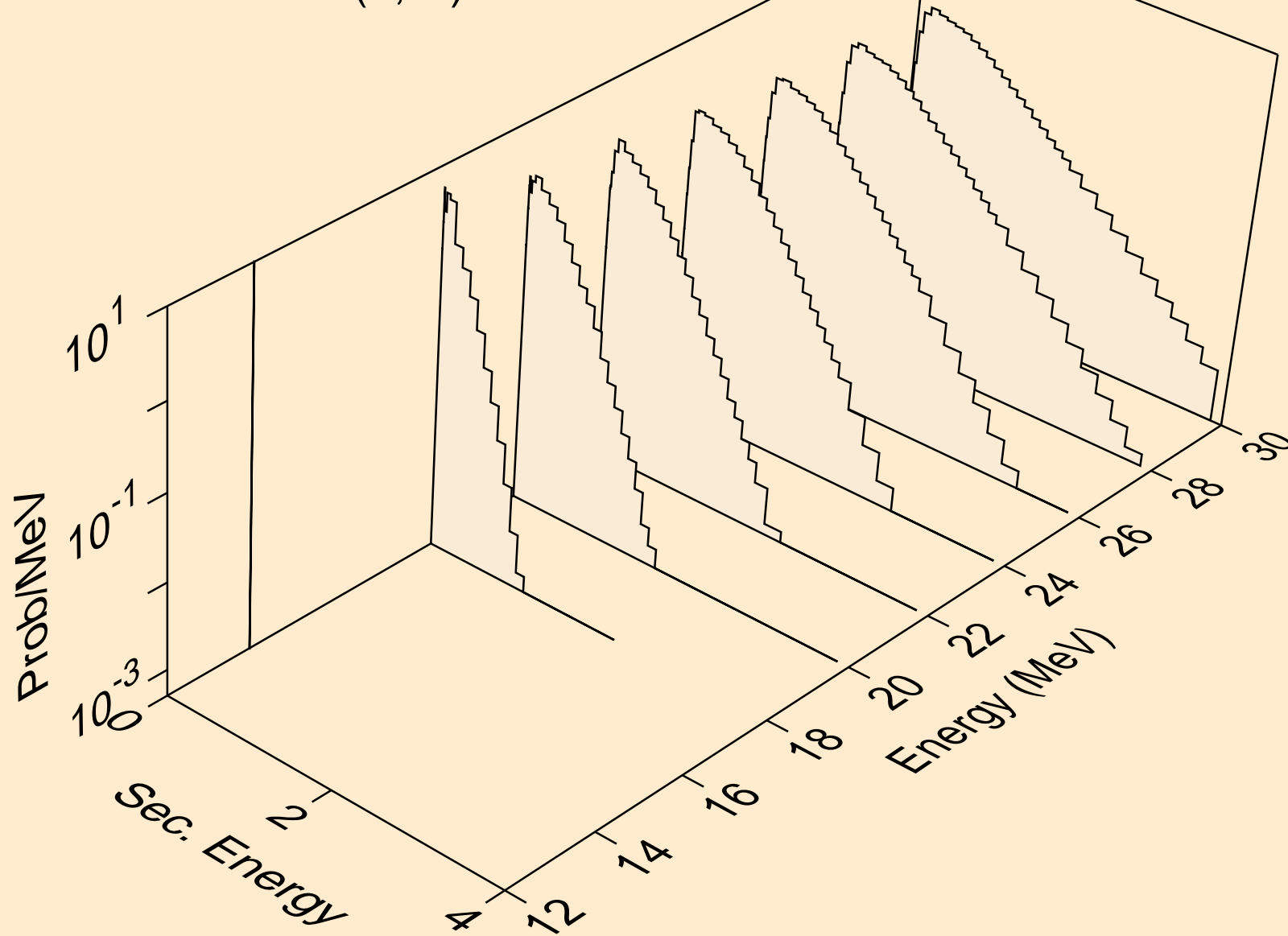

TA163 DEUTERON ACER TENDL-2023 LIBRARY; T=0.K  
neutrons from (d,n\*)he3

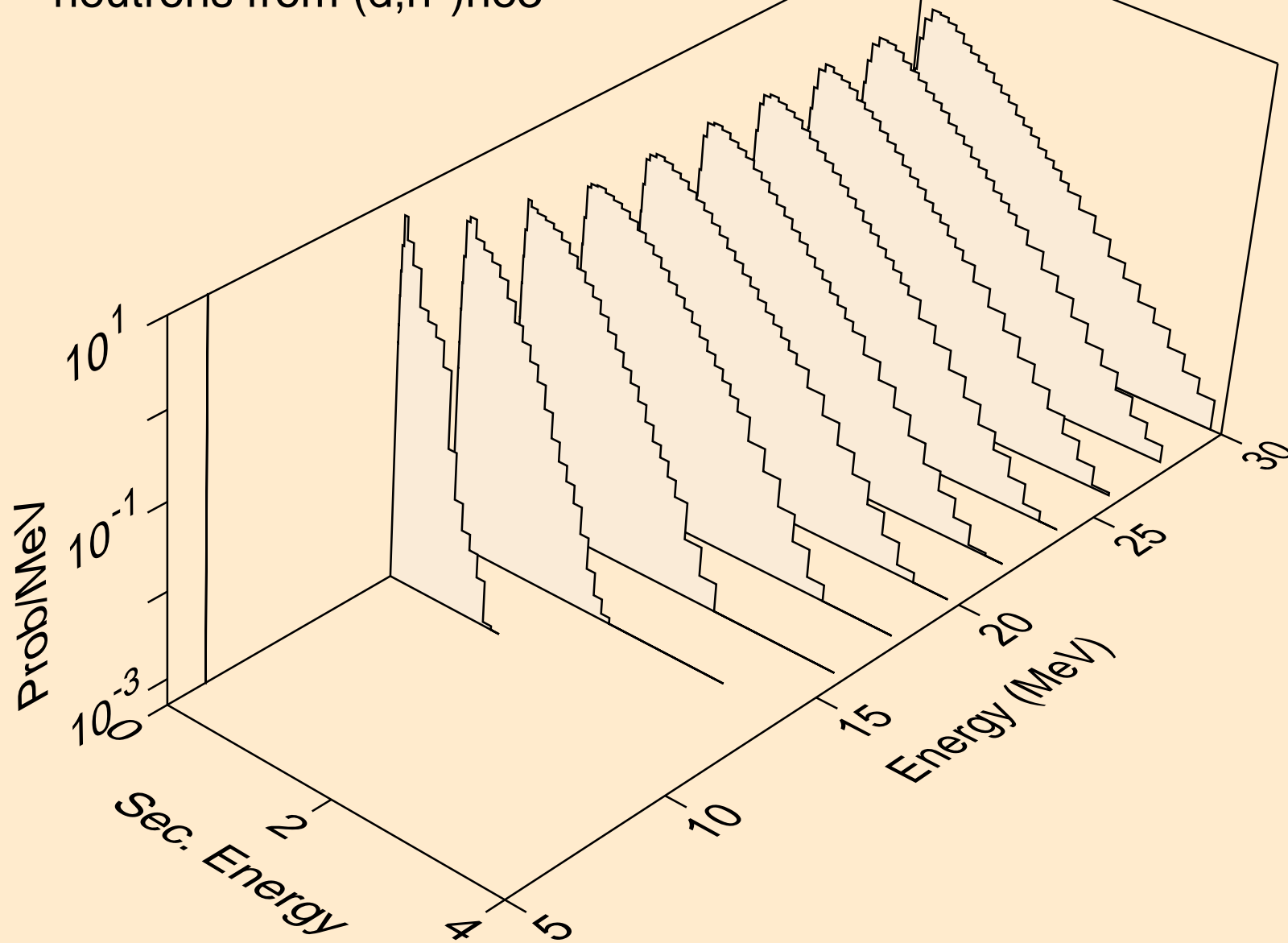

TA163 DEUTERON ACER TENDL-2023 LIBRARY; T=0.K  
neutrons from (d,2np)

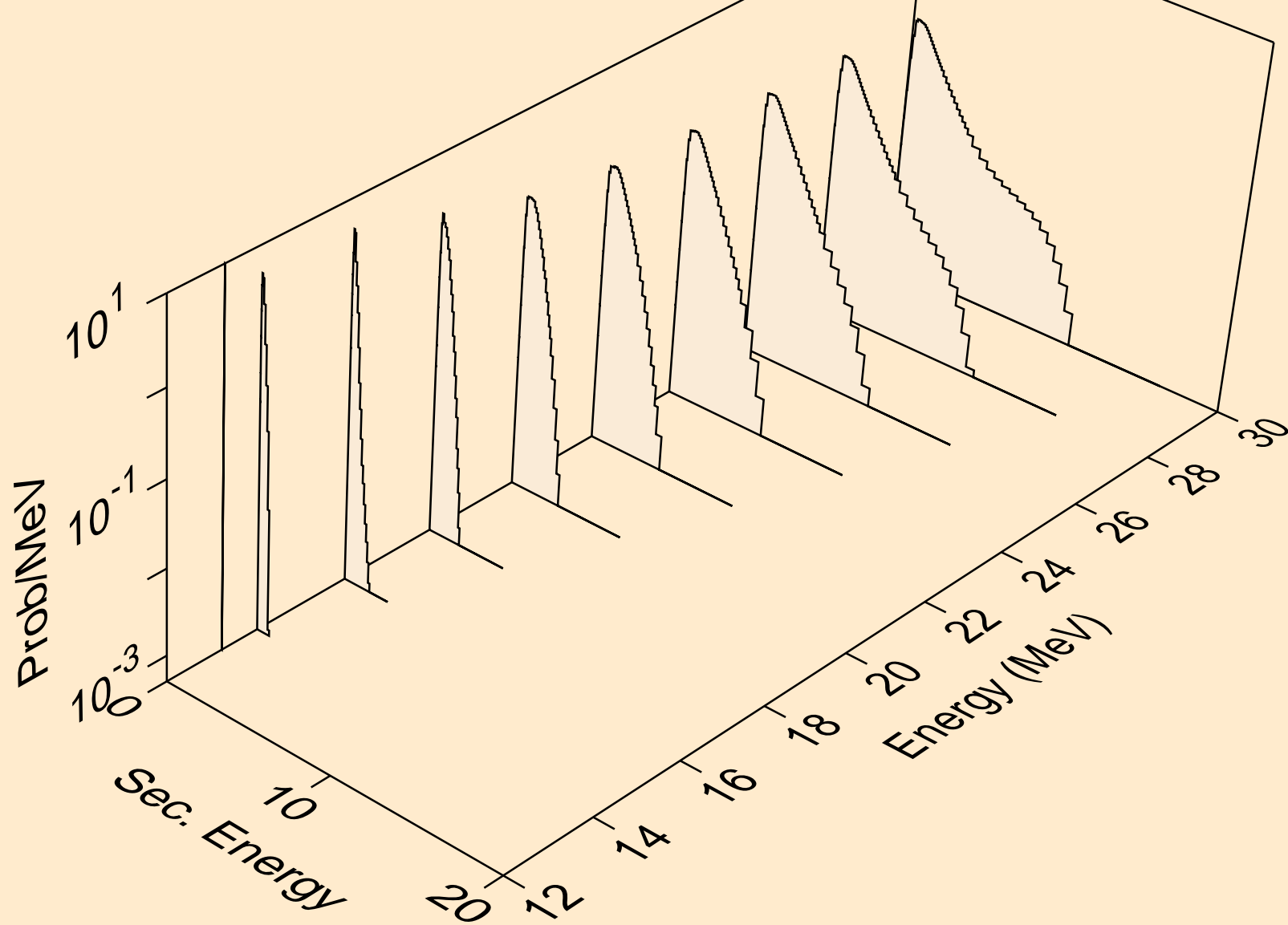

TA163 DEUTERON ACER TENDL-2023 LIBRARY; T=0.K  
neutrons from (d,3np)

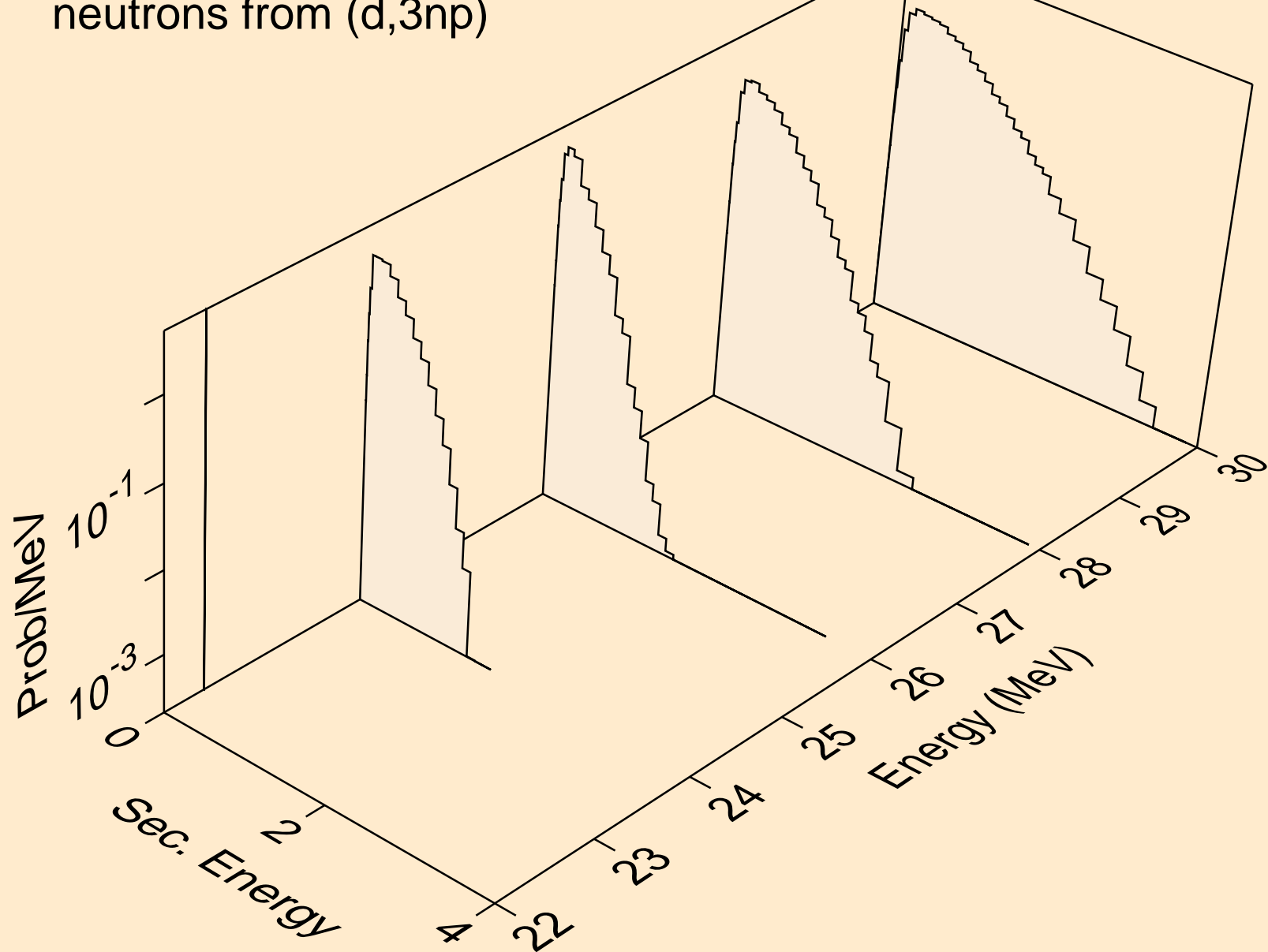

TA163 DEUTERON ACER TENDL-2023 LIBRARY; T=0.K  
neutrons from (d,n2p)

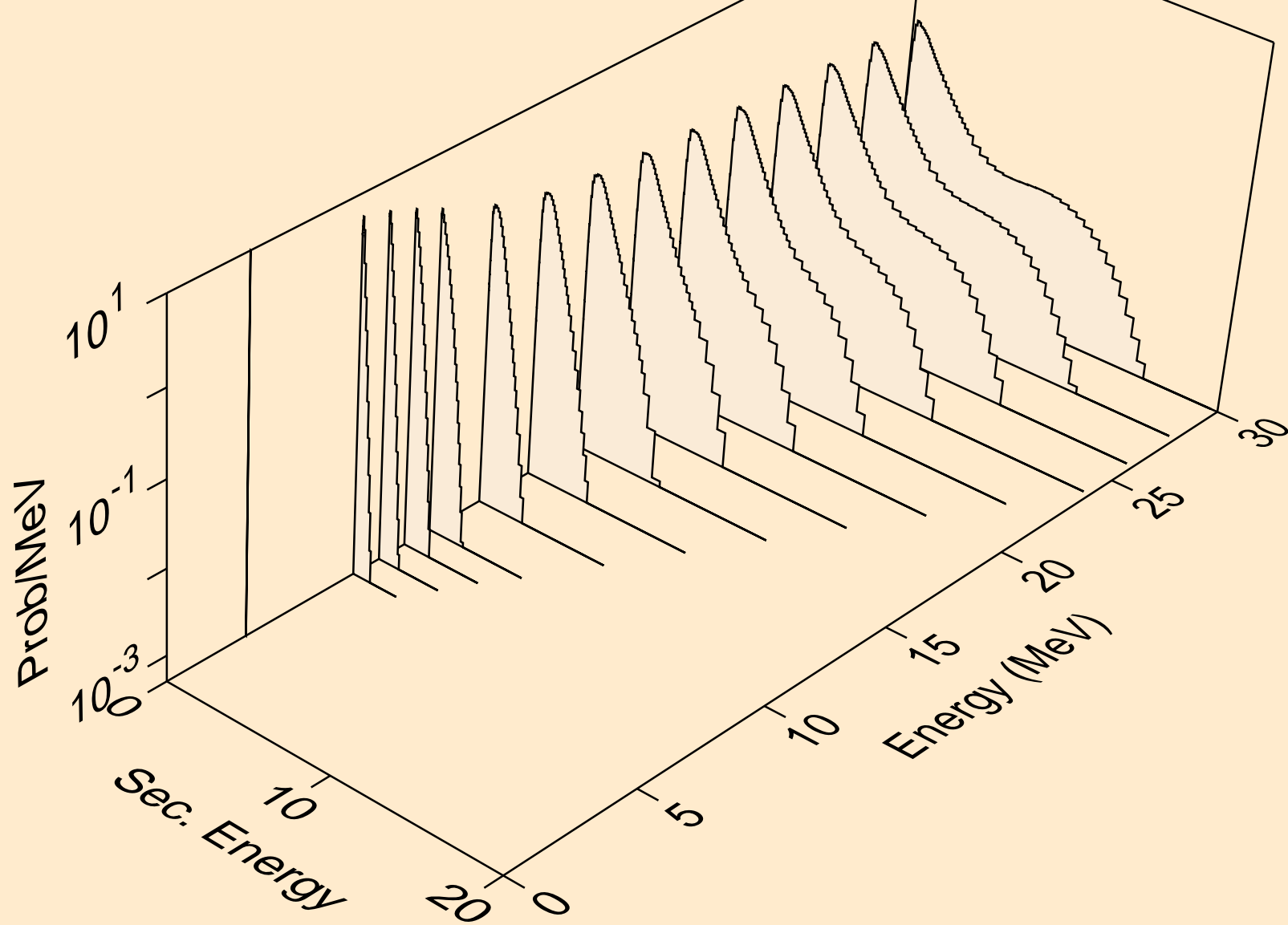

TA163 DEUTERON ACER TENDL-2023 LIBRARY; T=0.K  
neutrons from (d,npa)

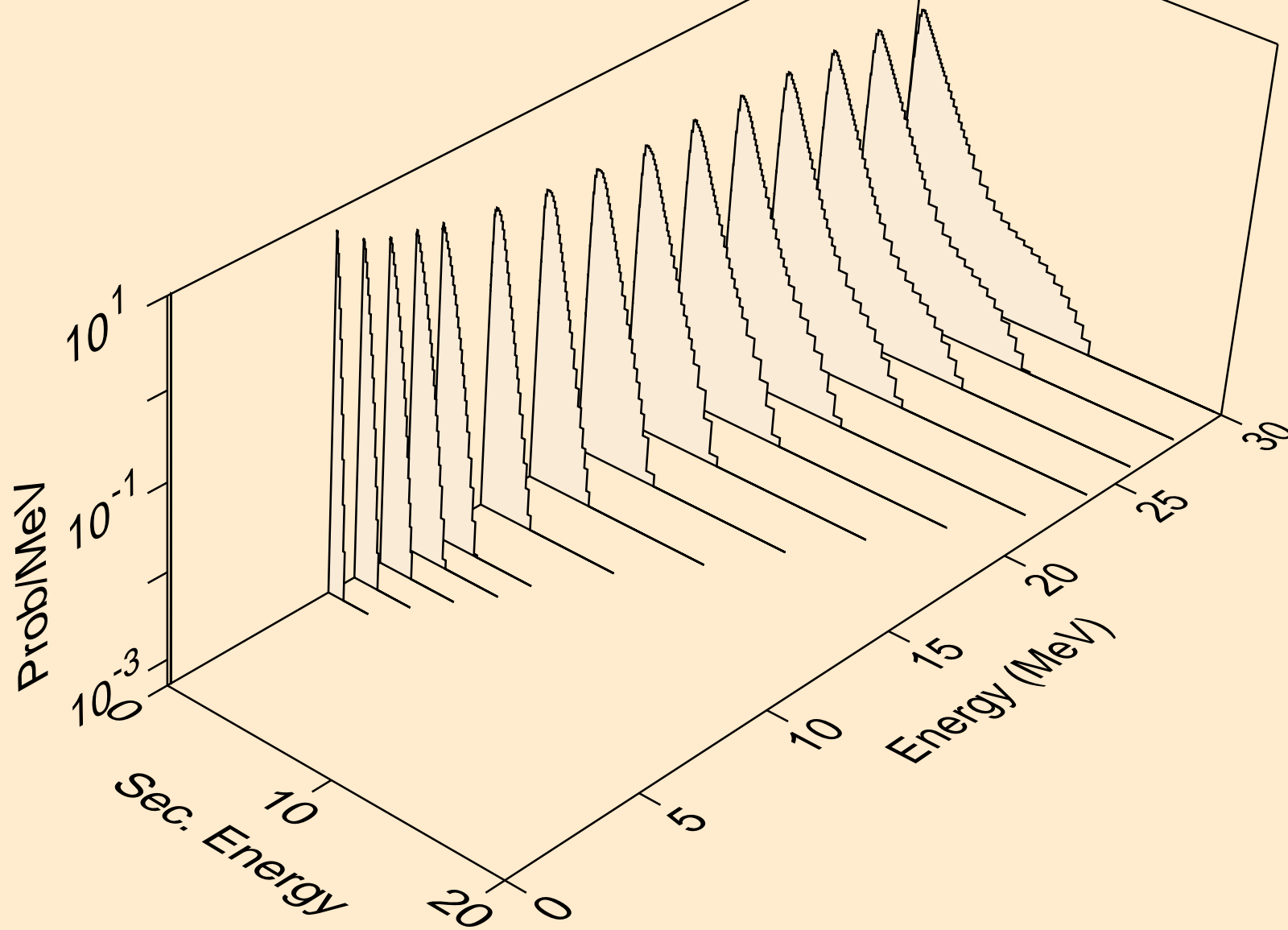

TA163 DEUTERON ACER TENDL-2023 LIBRARY; T=0.K  
protons from (d,x)

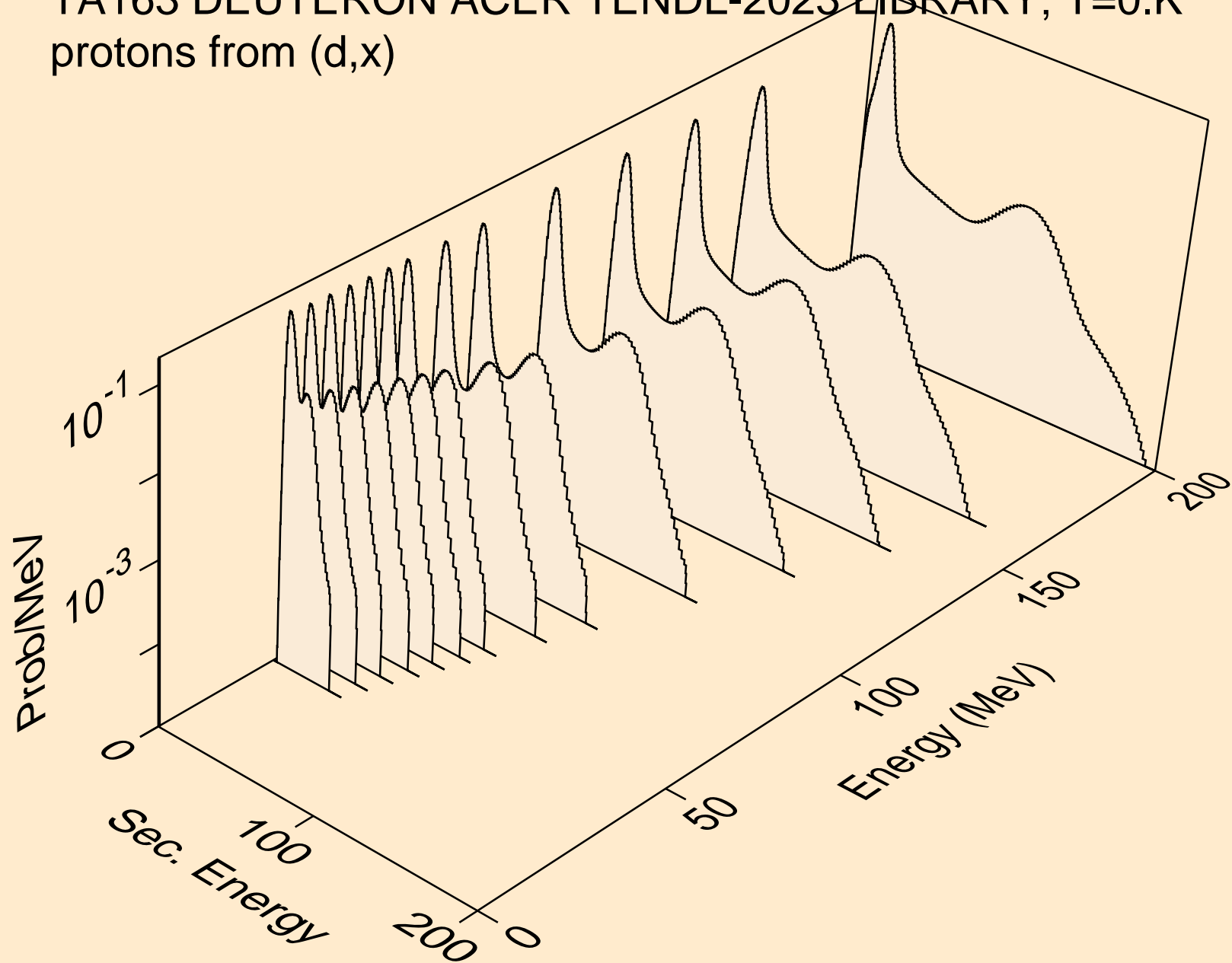



TA163 DEUTERON ACER TENDL-2023 LIBRARY; T=0.K  
protons from (d,n\*)p

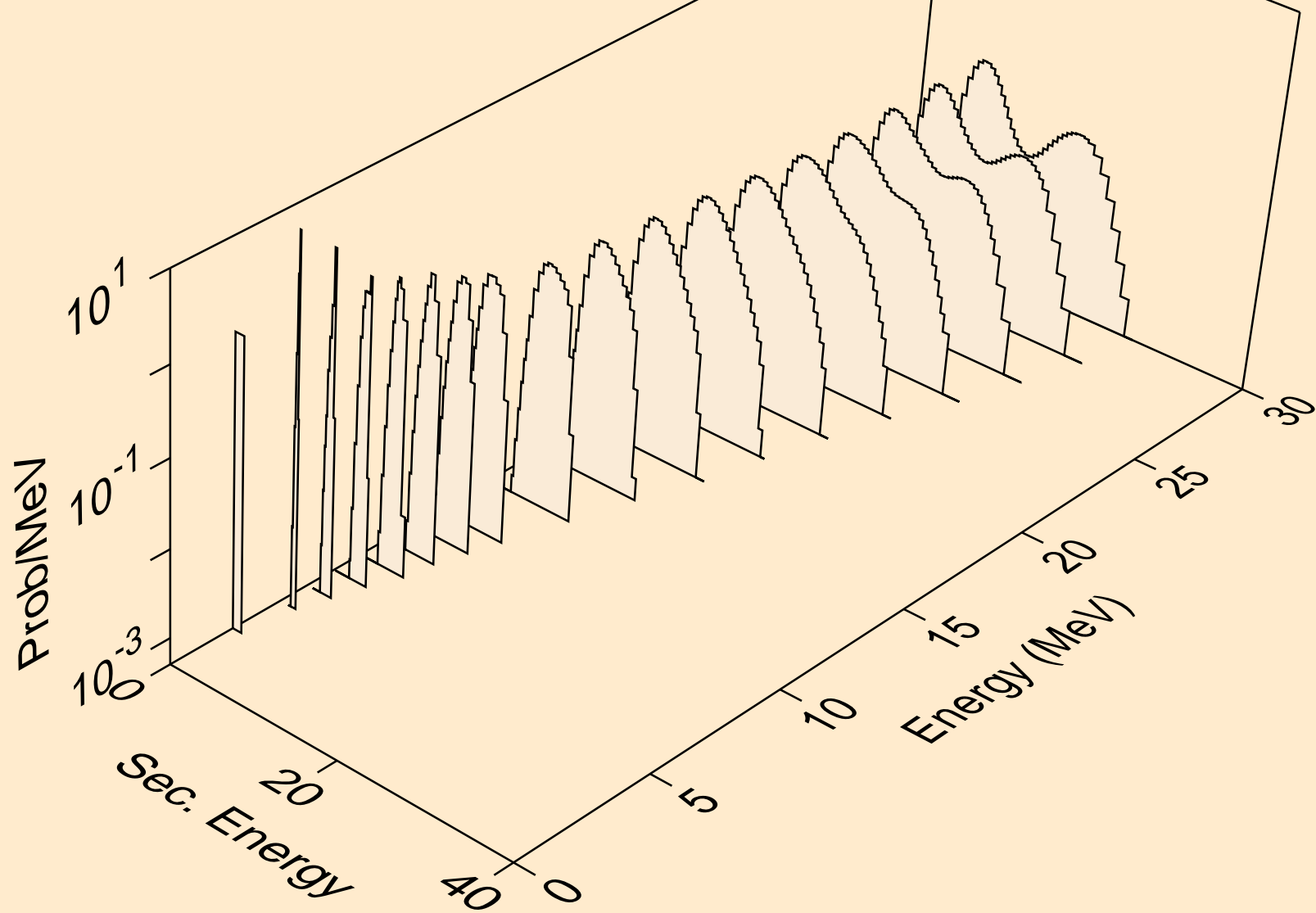

TA163 DEUTERON ACER TENDL-2023 LIBRARY; T=0.K  
protons from (d,2np)

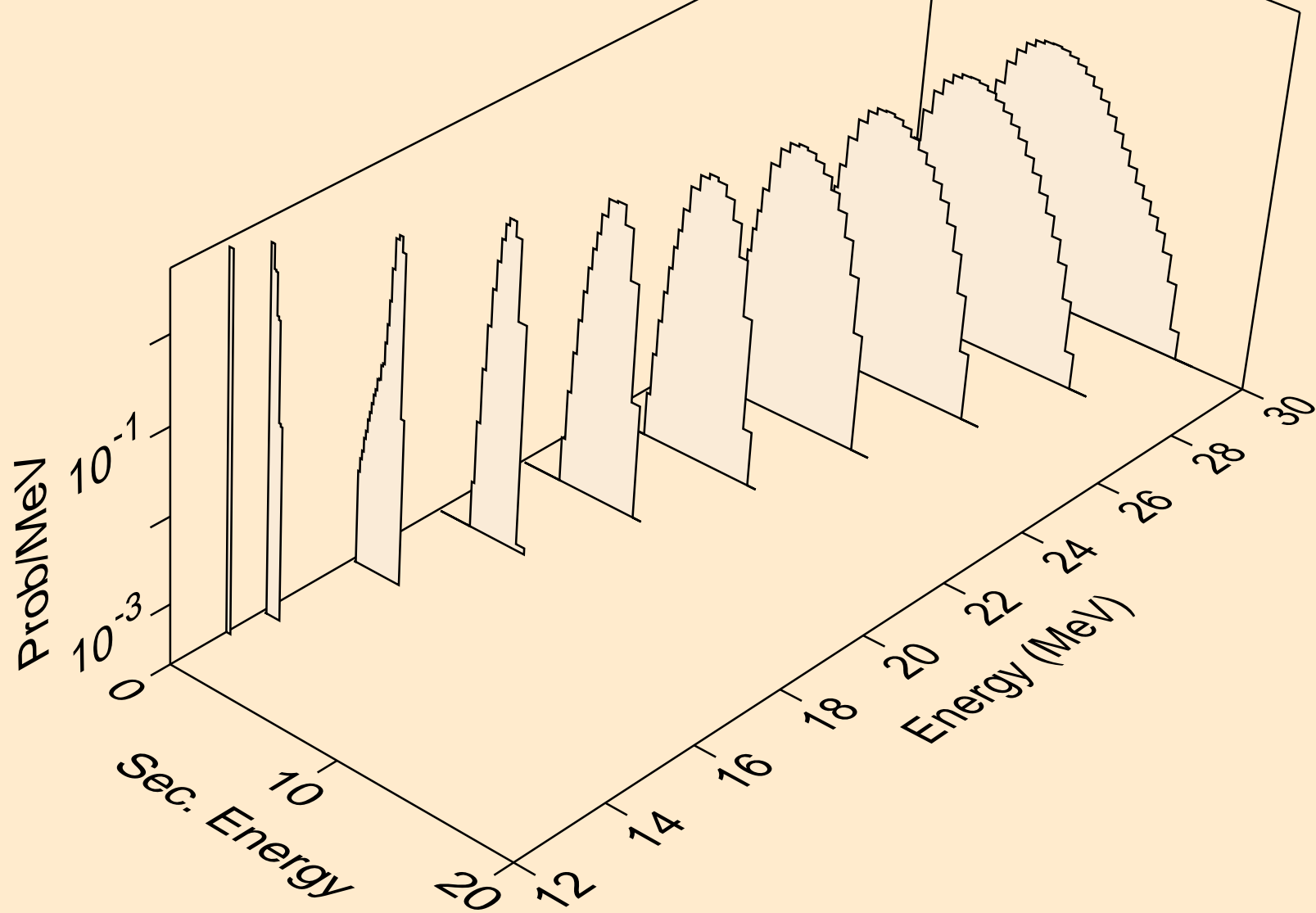

TA163 DEUTERON ACER TENDL-2023 LIBRARY; T=0.K  
protons from (d,3np)

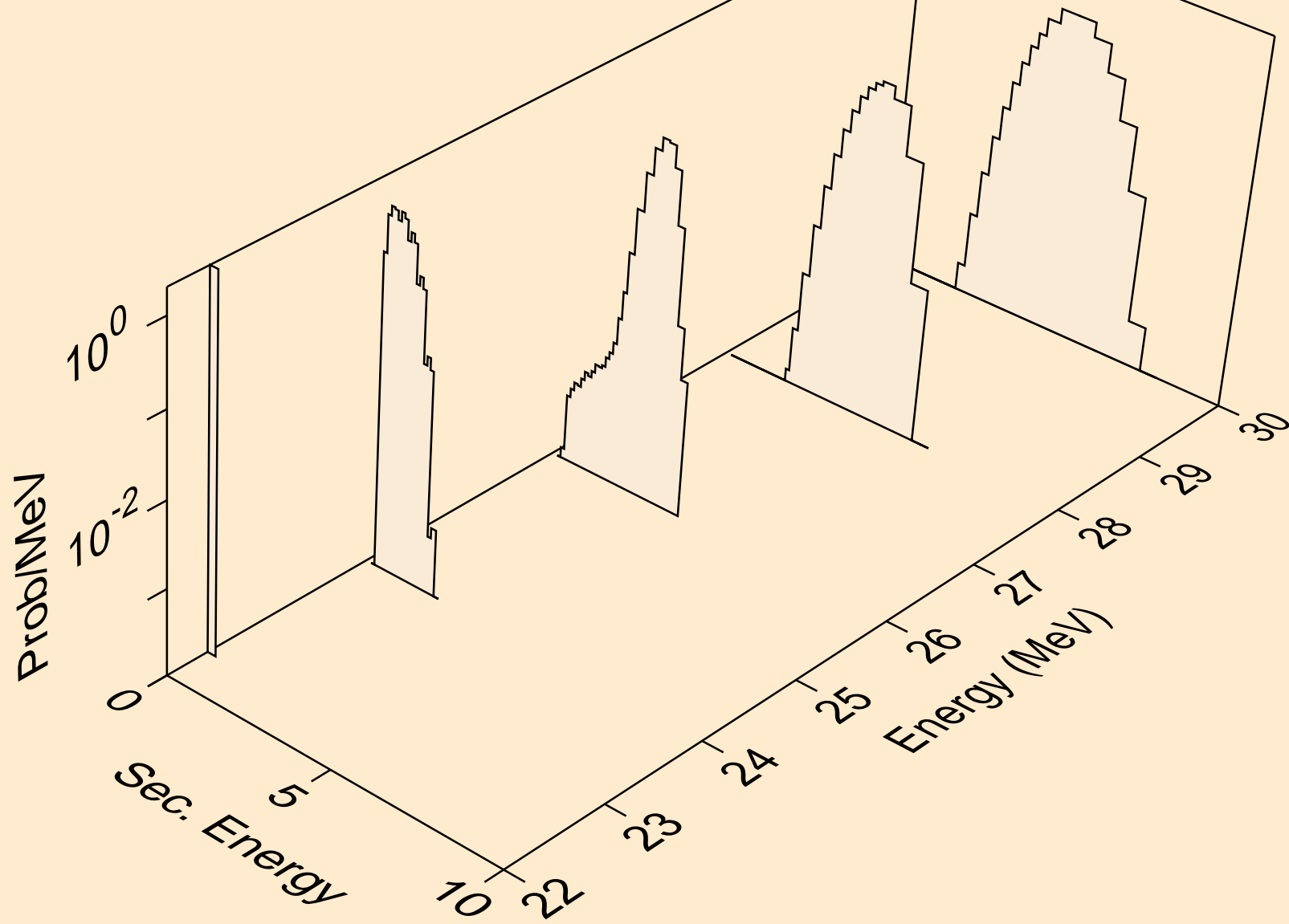

TA163 DEUTERON ACER TENDL-2023 LIBRARY; T=0.K  
protons from (d,n2p)

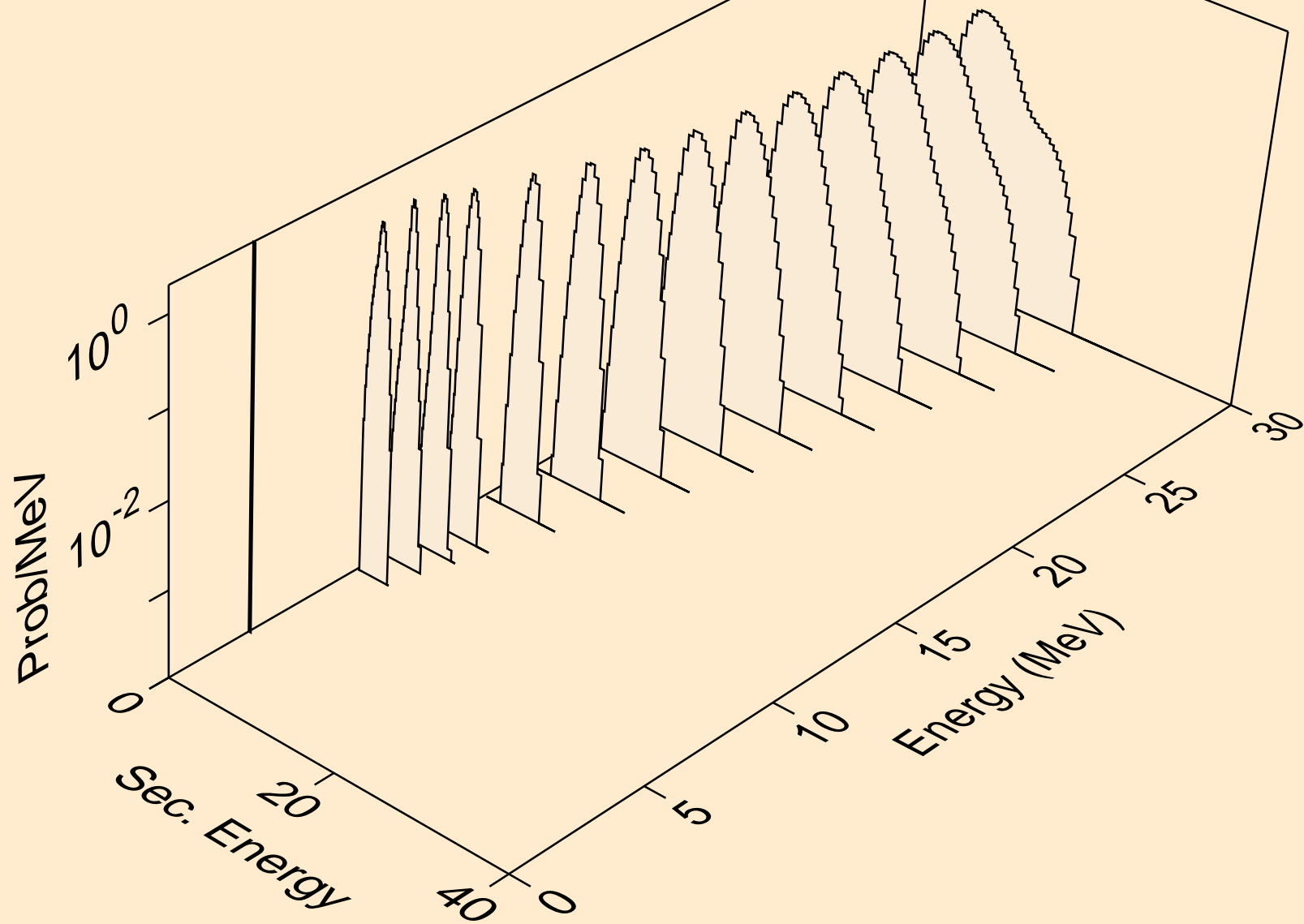

TA163 DEUTERON ACER TENDL-2023 LIBRARY; T=0.K  
protons from (d,npa)

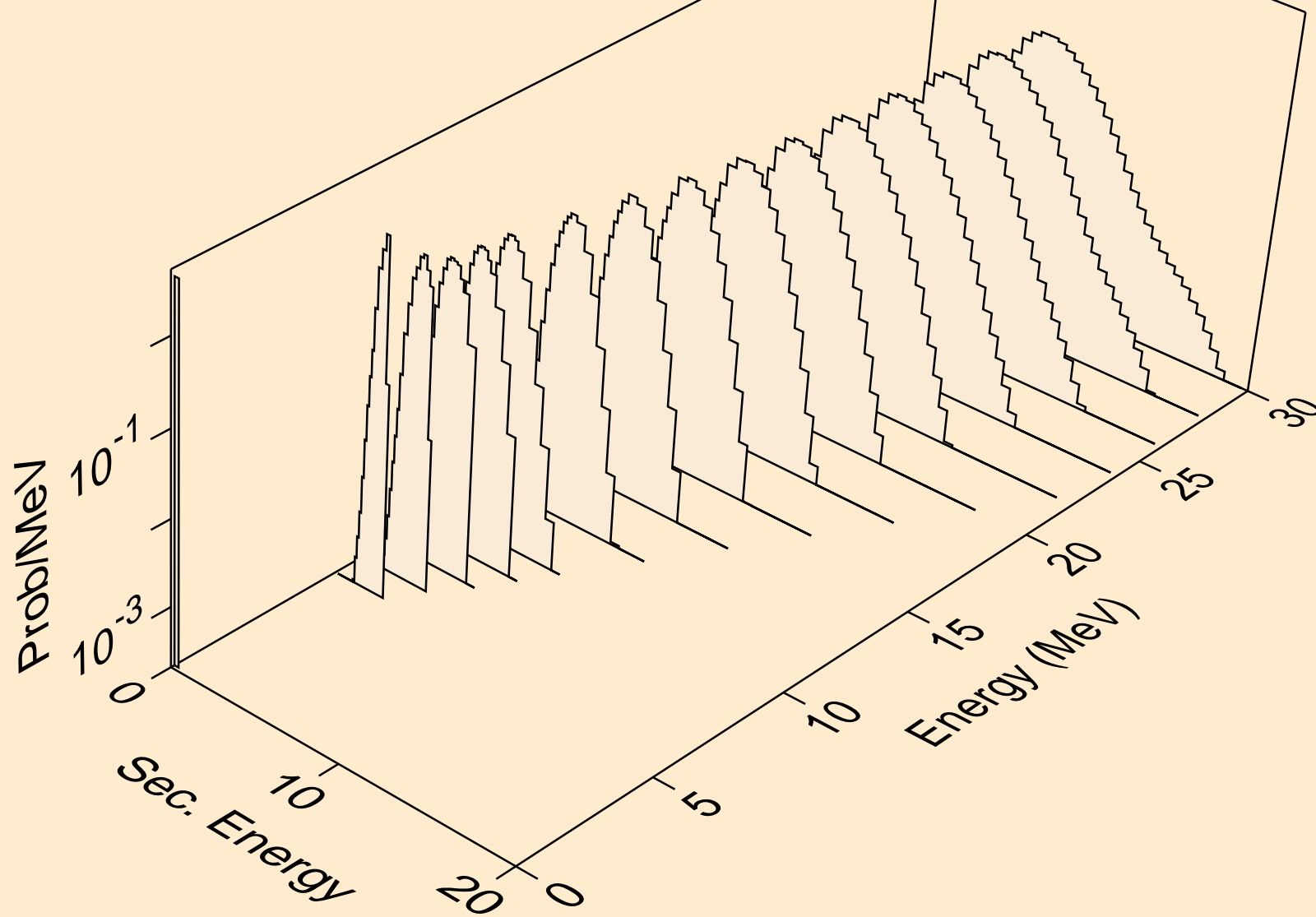

TA163 DEUTERON ACER TENDL-2023 LIBRARY; T=0.K  
protons from (d,p)

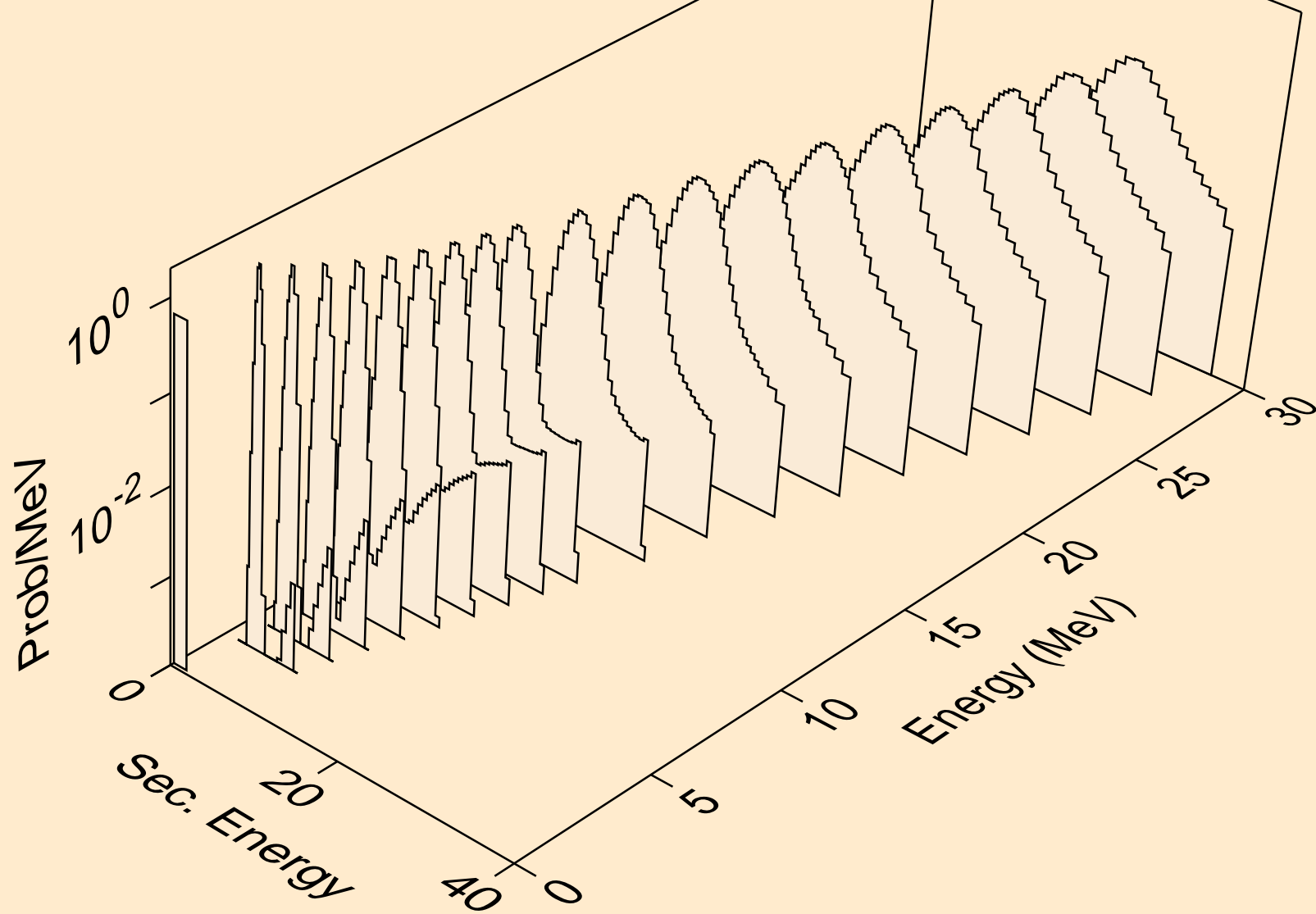

TA163 DEUTERON ACER TENDL-2023 LIBRARY; T=0.K  
protons from (d,2p)

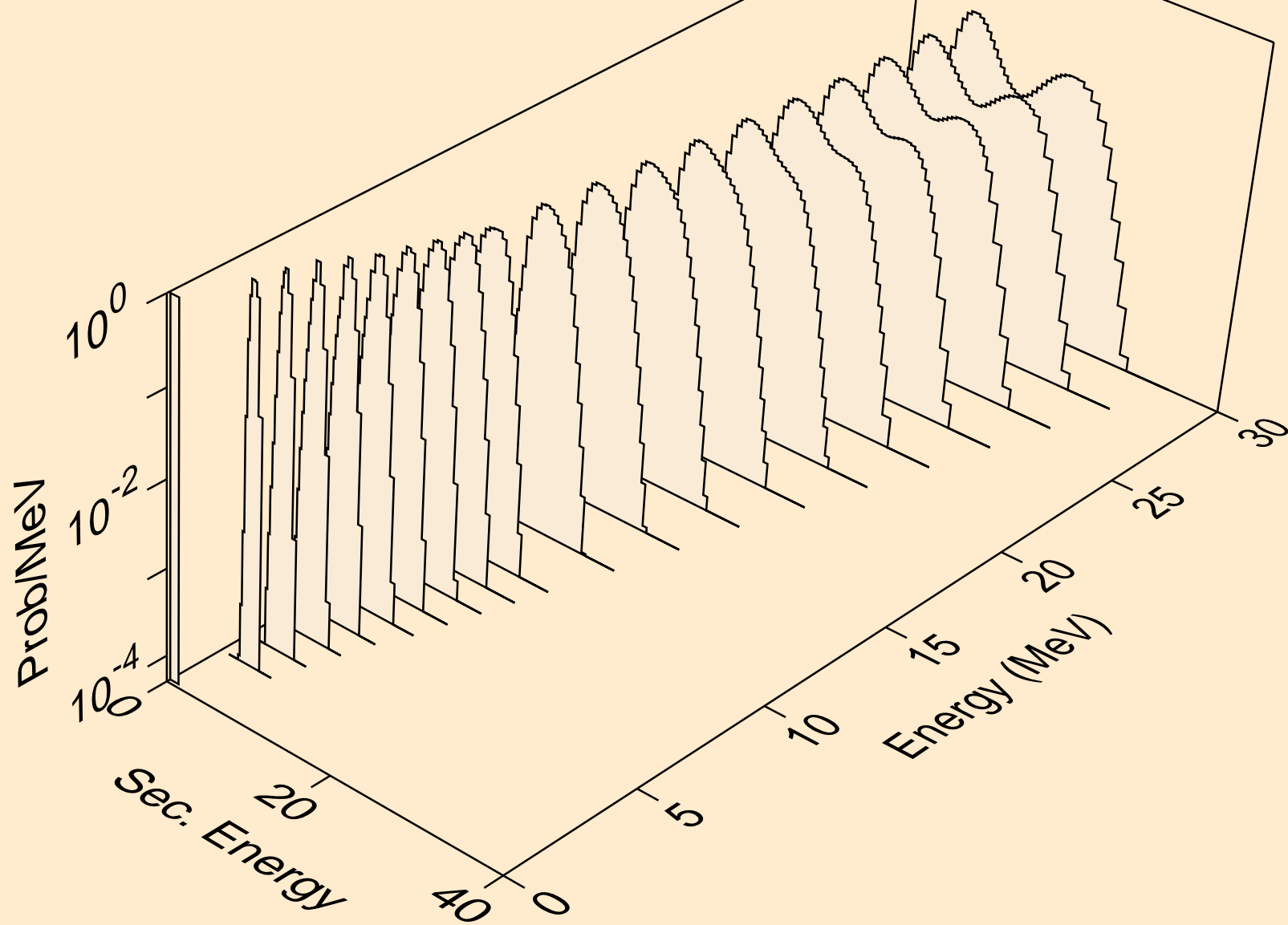

TA163 DEUTERON ACER TENDL-2023 LIBRARY; T=0.K  
protons from (d,pa)

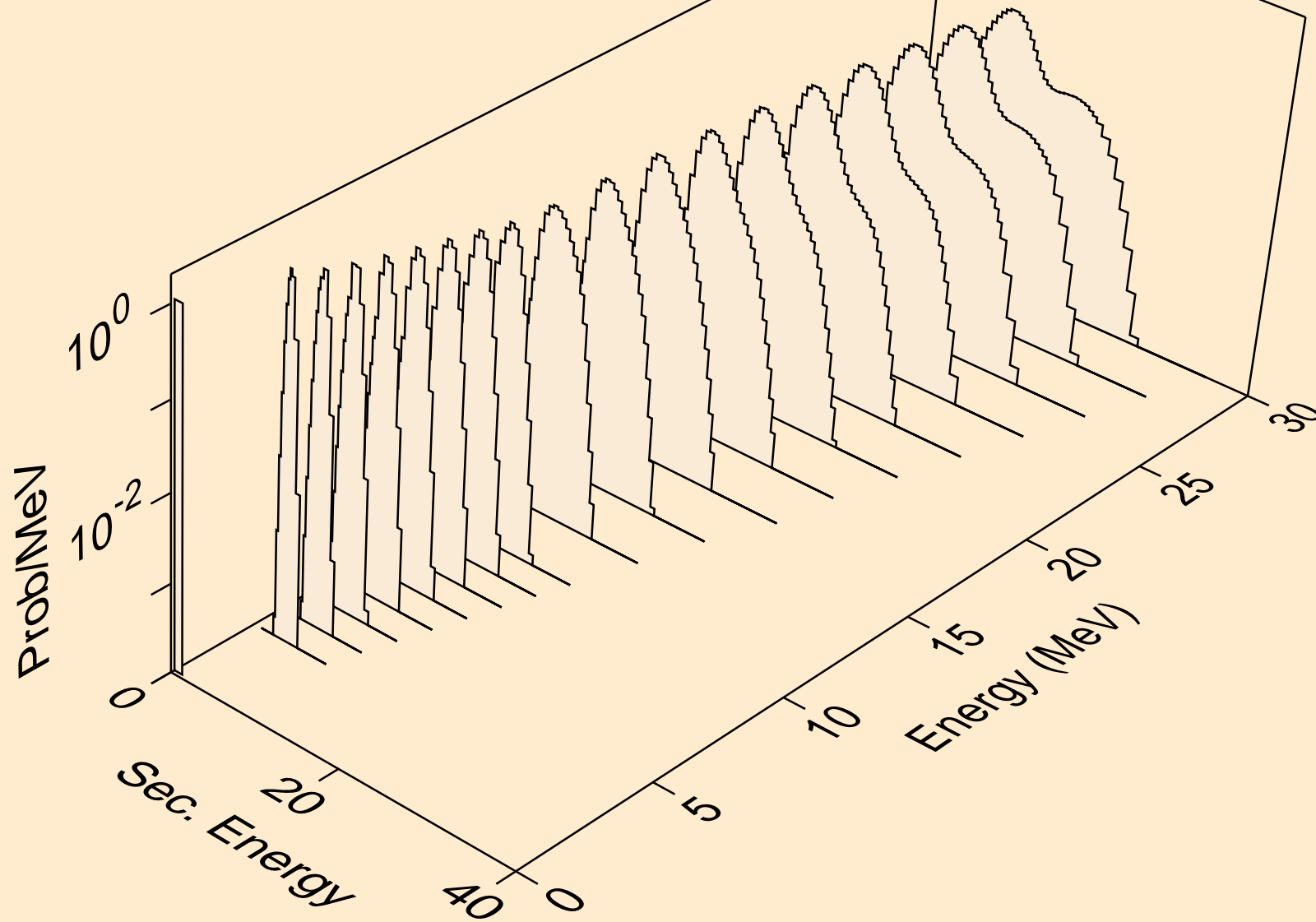



TA163 DEUTERON ACER TENDL-2023 LIBRARY; T=0.K  
protons from (d,pd)

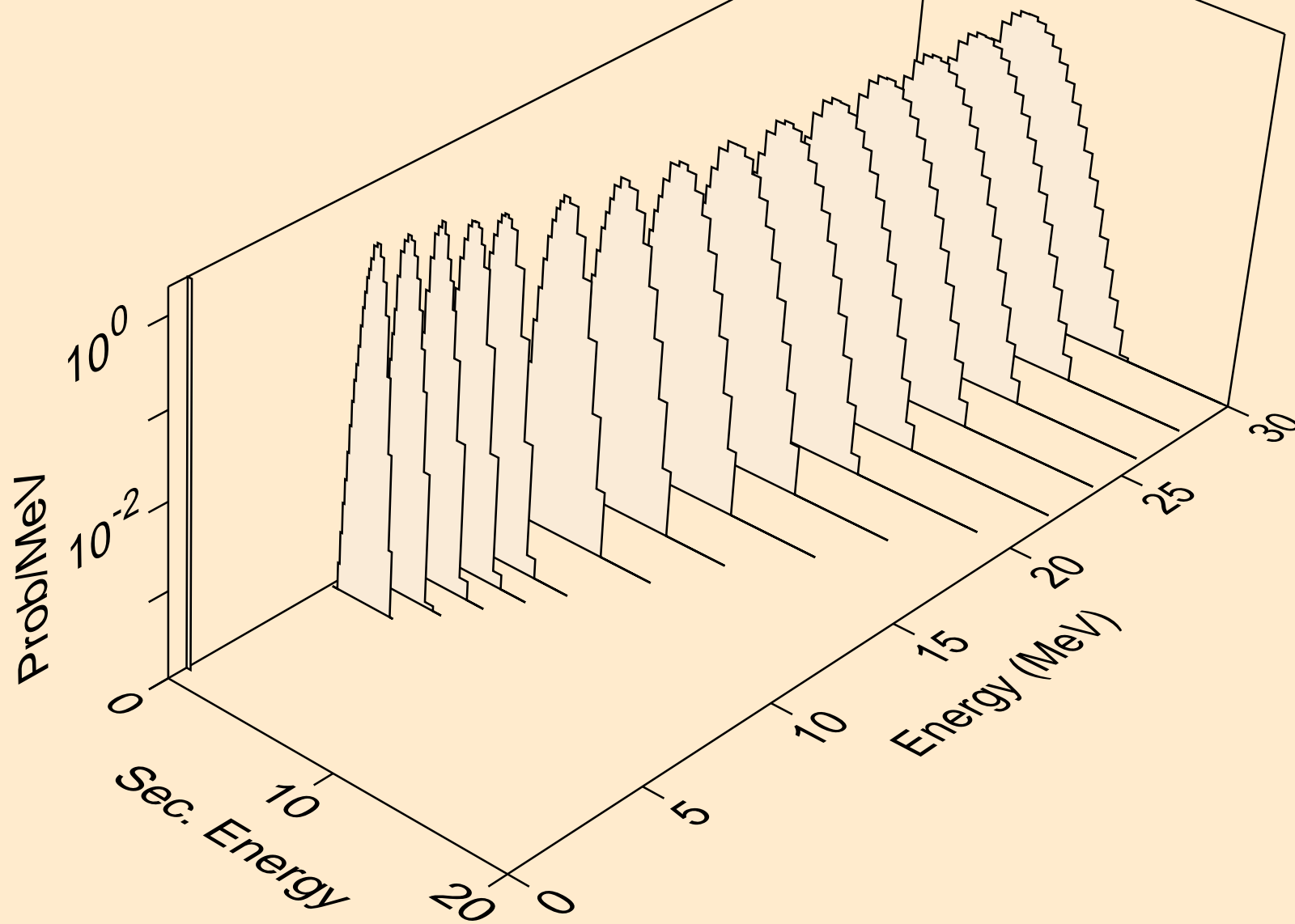

TA163 DEUTERON ACER TENDL-2023 LIBRARY; T=0.K  
protons from (d,pt)

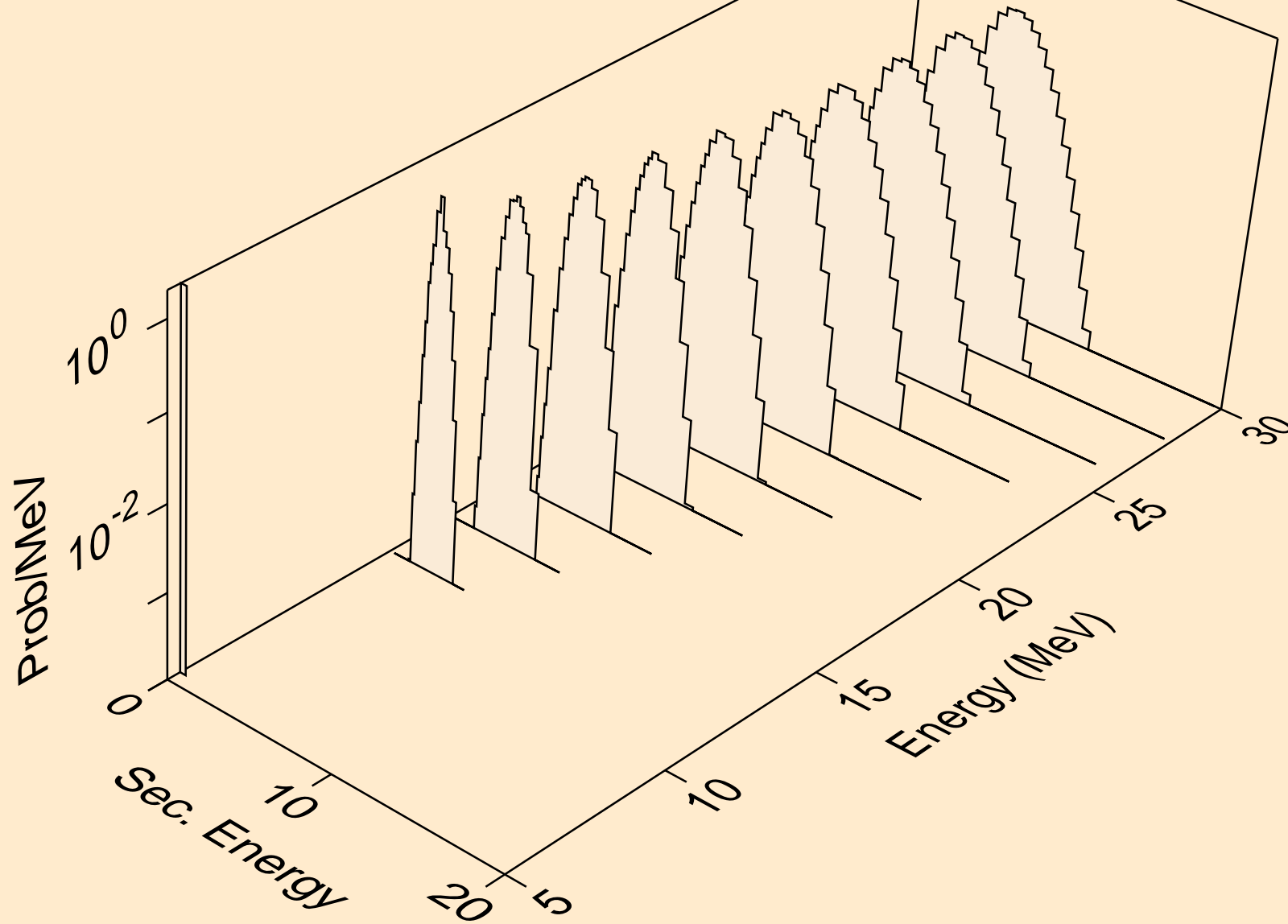

TA163 DEUTERON ACER TENDL-2023 LIBRARY; T=0.K  
tritons from (d,x)

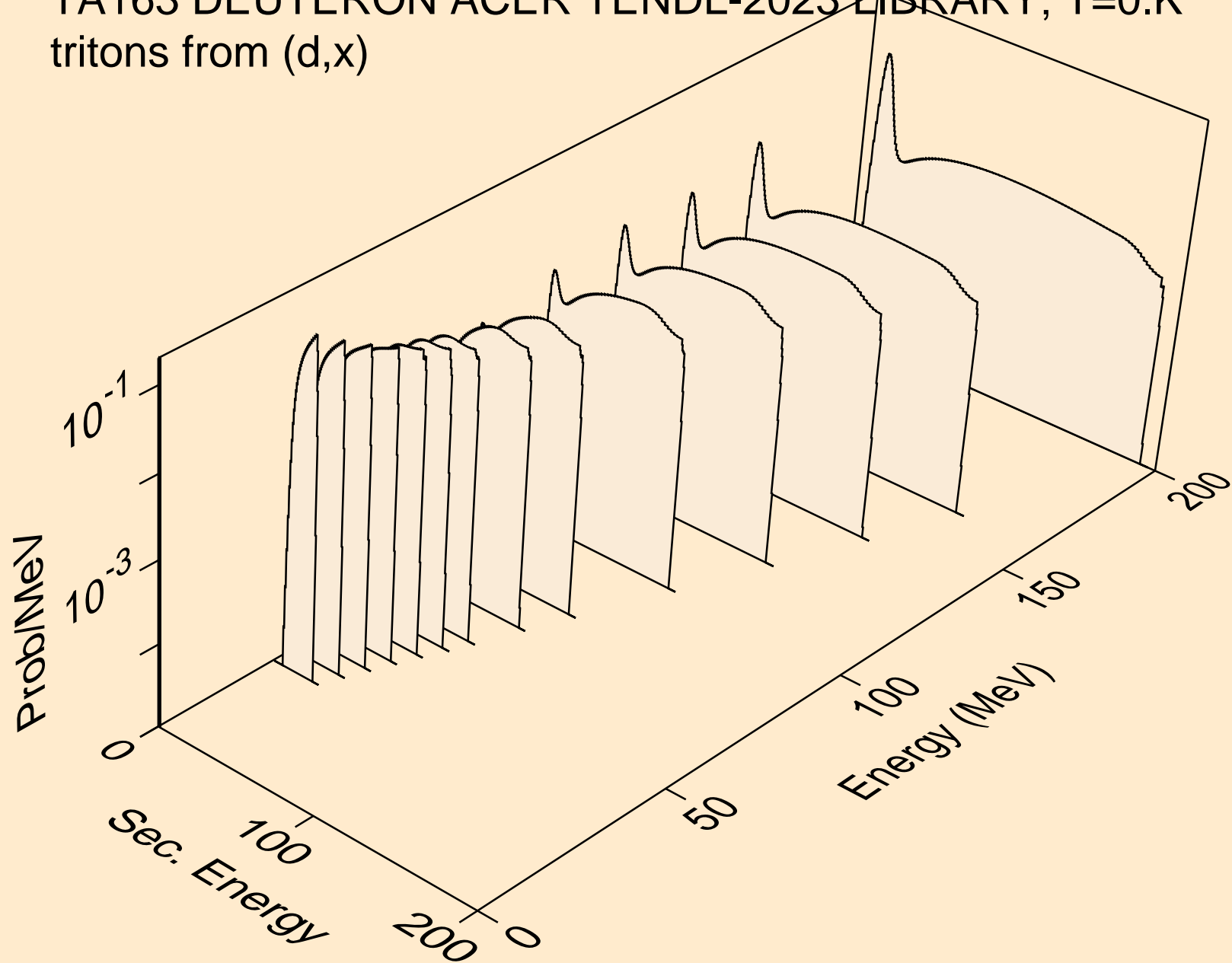

TA163 DEUTERON ACER TENDL-2023 LIBRARY; T=0.K  
tritons from (d,n\*)t

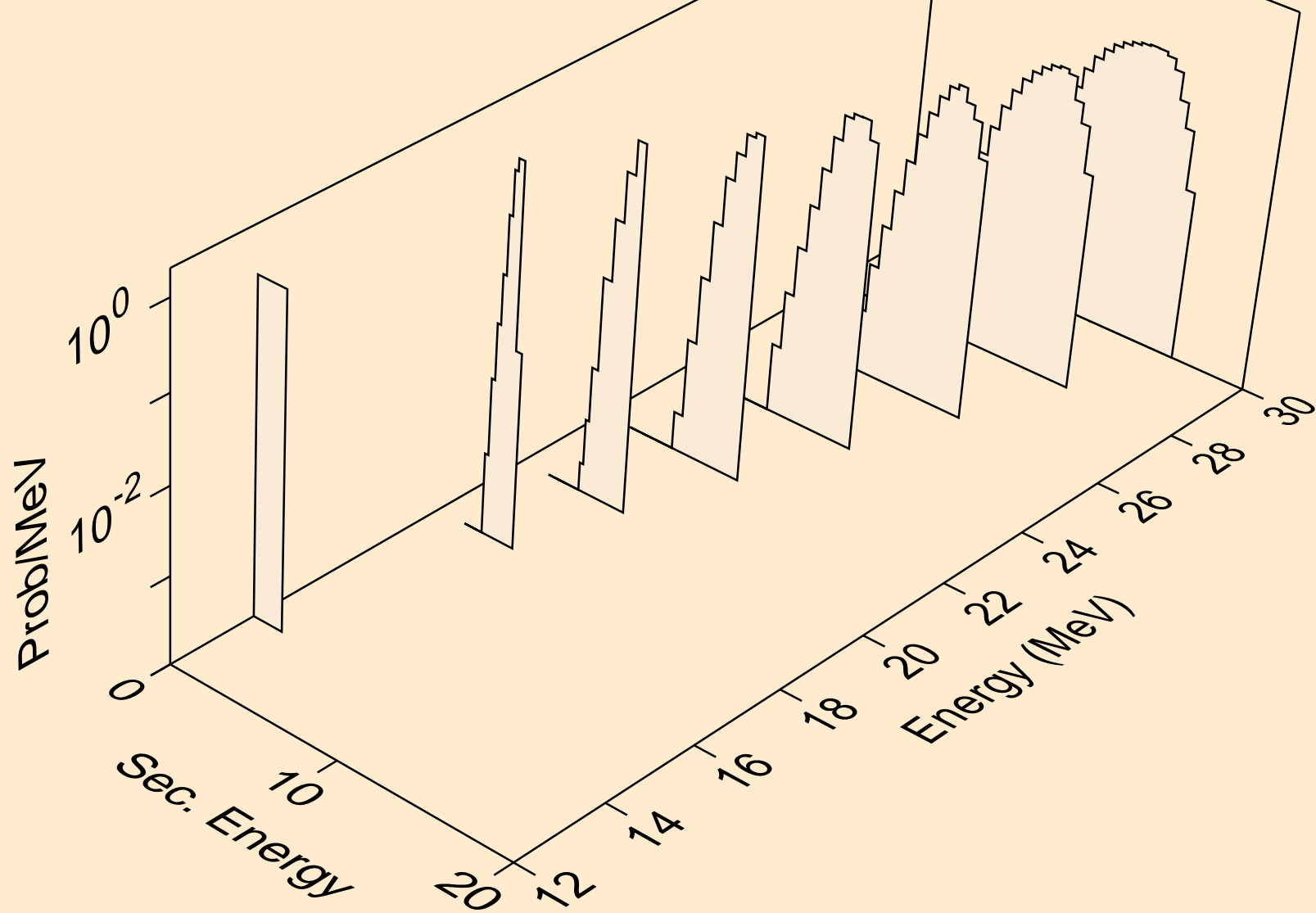

TA163 DEUTERON ACER TENDL-2023 LIBRARY; T=0.K  
tritons from (d,t)

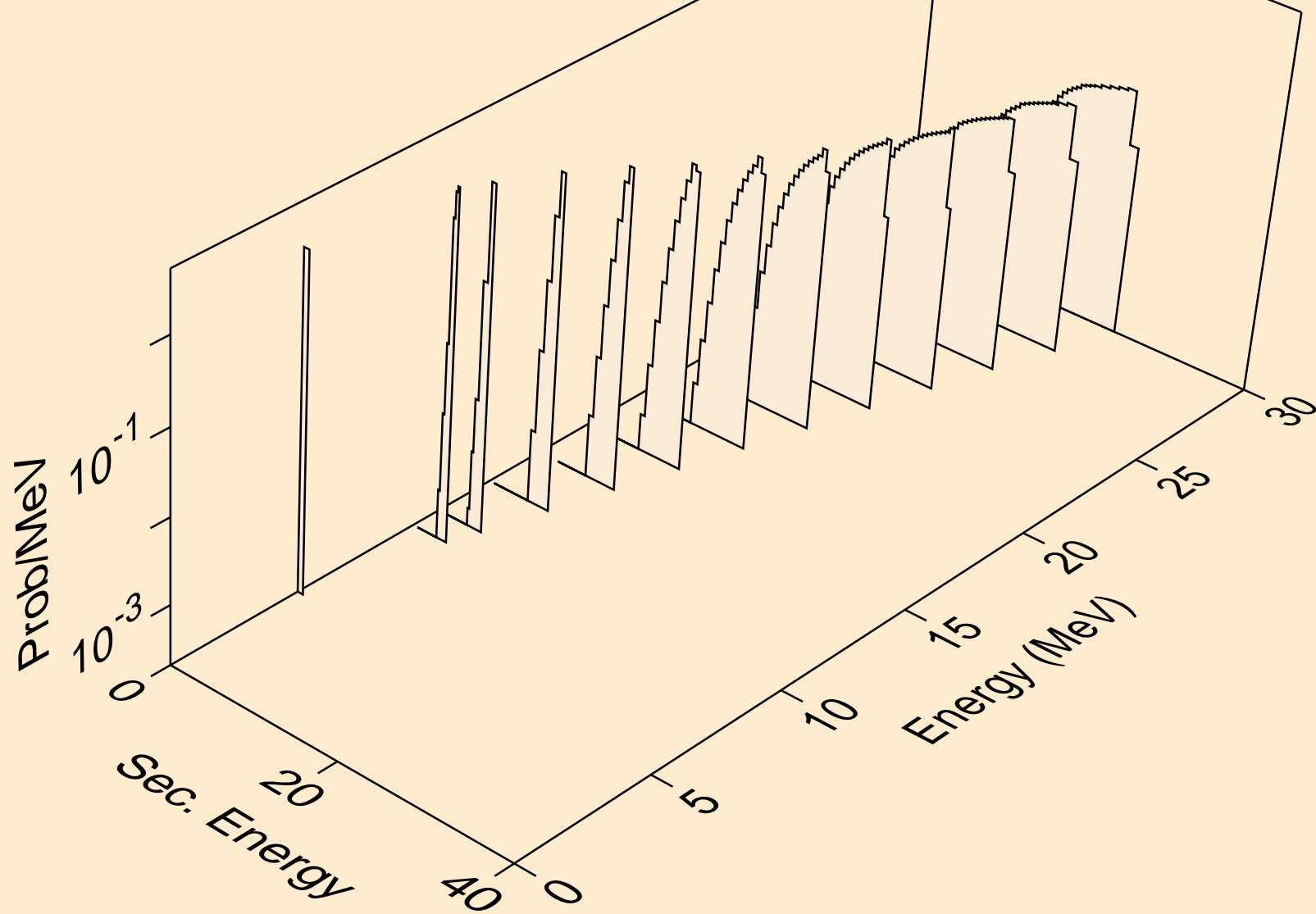

TA163 DEUTERON ACER TENDL-2023 LIBRARY; T=0.K  
tritons from (d,pt)

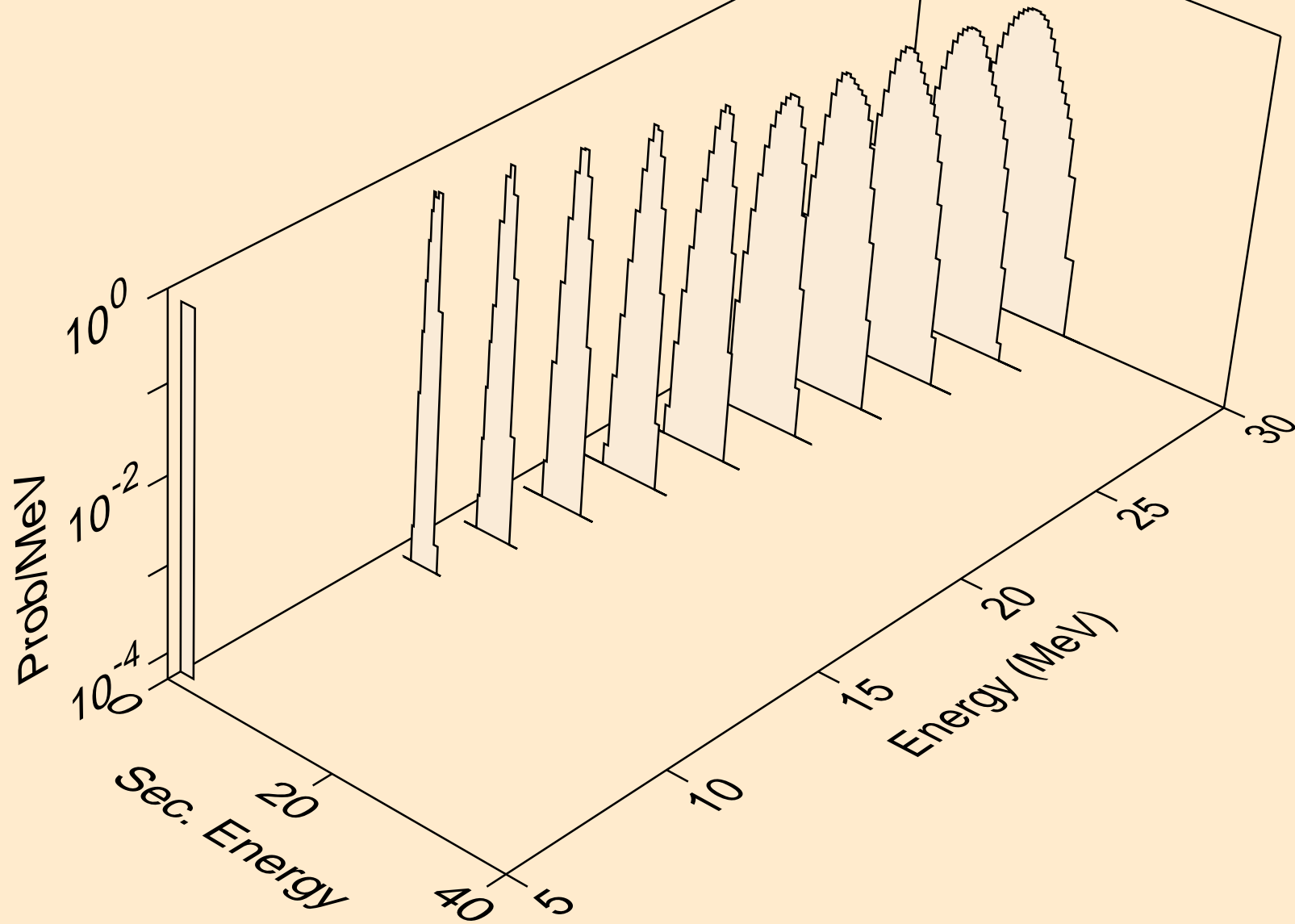

TA163 DEUTERON ACER TENDL-2023 LIBRARY; T=0.K  
he3s from (d,x)

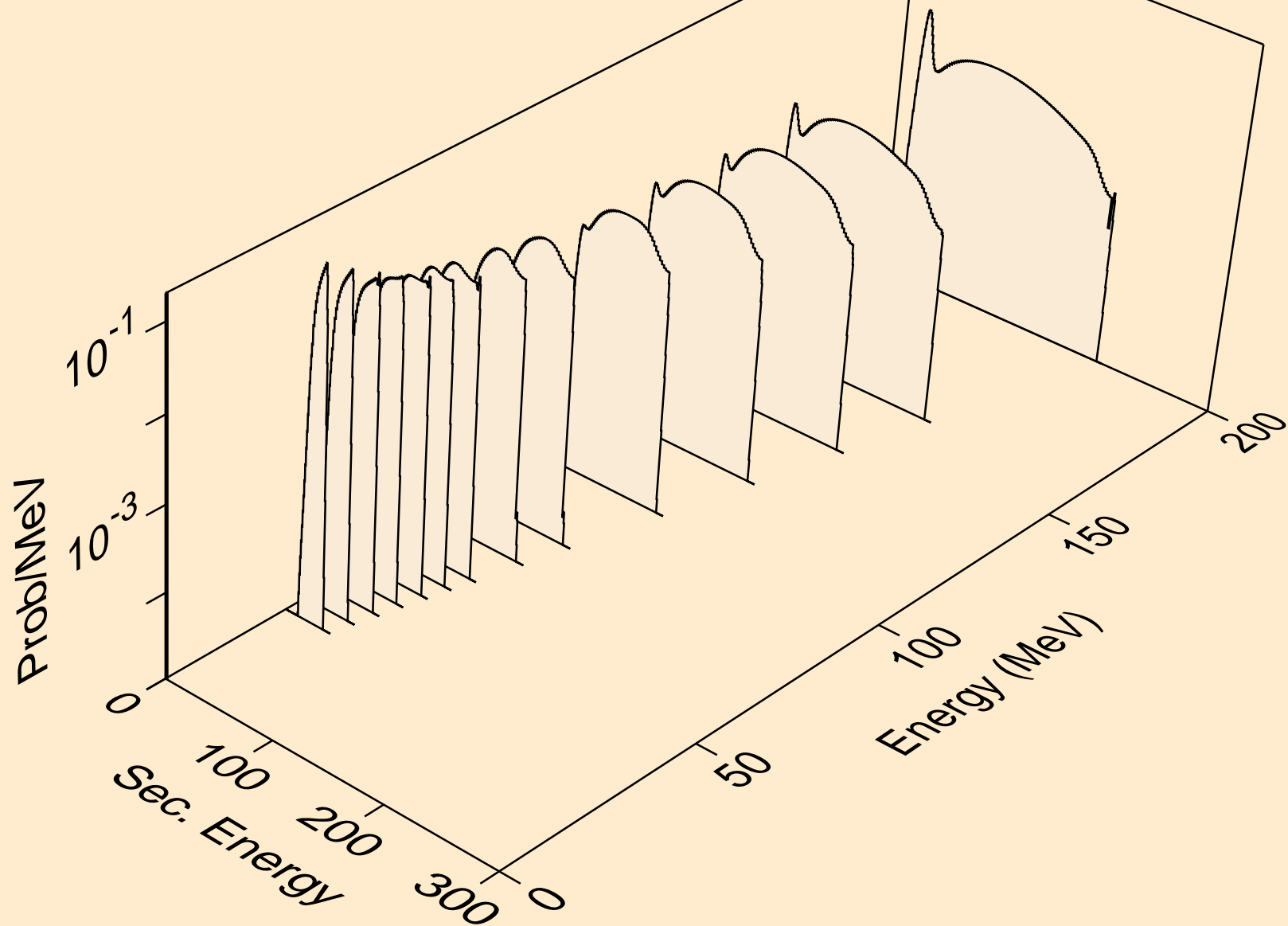

TA163 DEUTERON ACER TENDL-2023 LIBRARY; T=0.K  
he3s from (d,n\*)he3

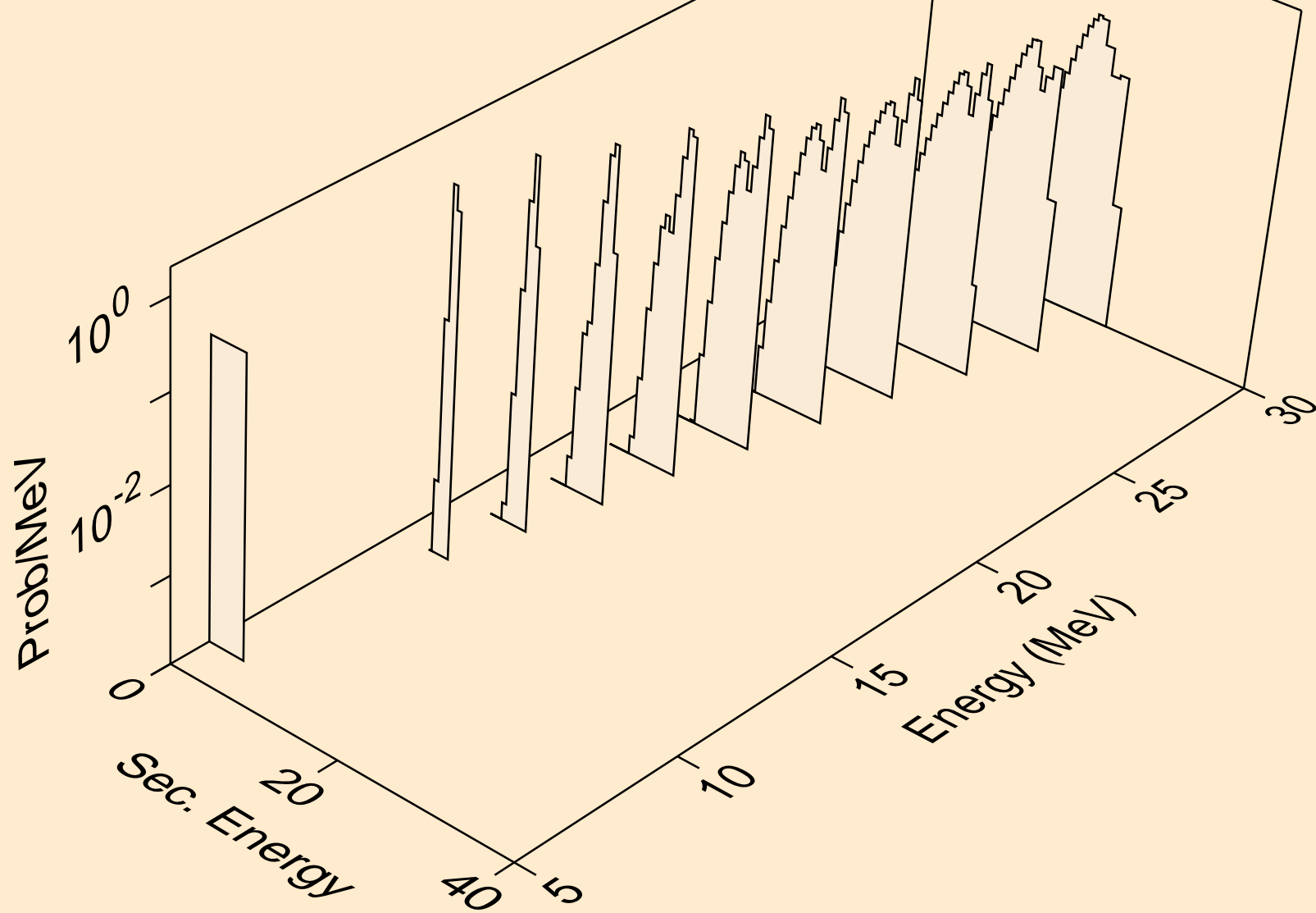



TA163 DEUTERON ACER TENDL-2023 LIBRARY; T=0.K  
he3s from (d,he3)

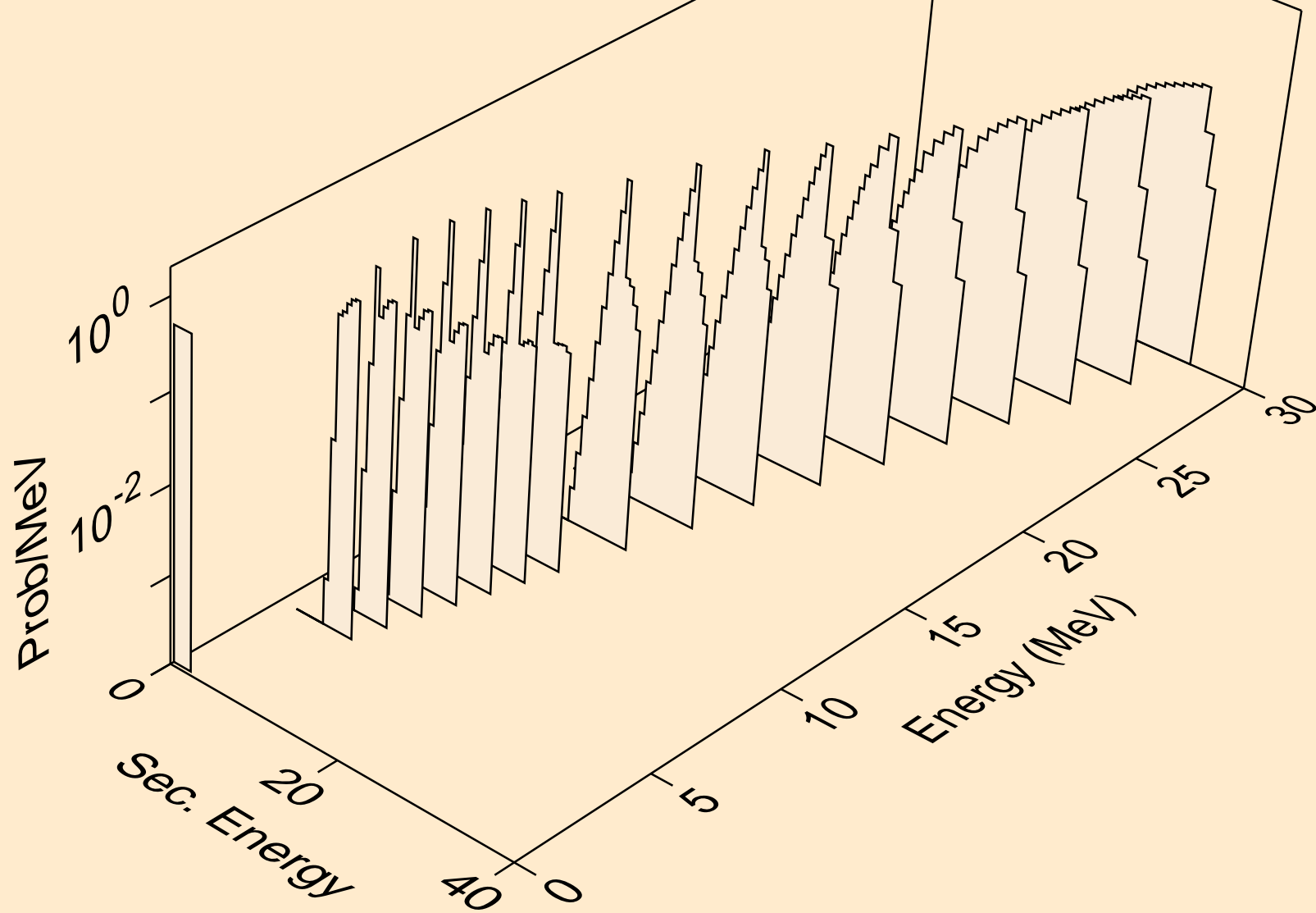

TA163 DEUTERON ACER TENDL-2023 LIBRARY; T=0.K  
alphas from (d,x)

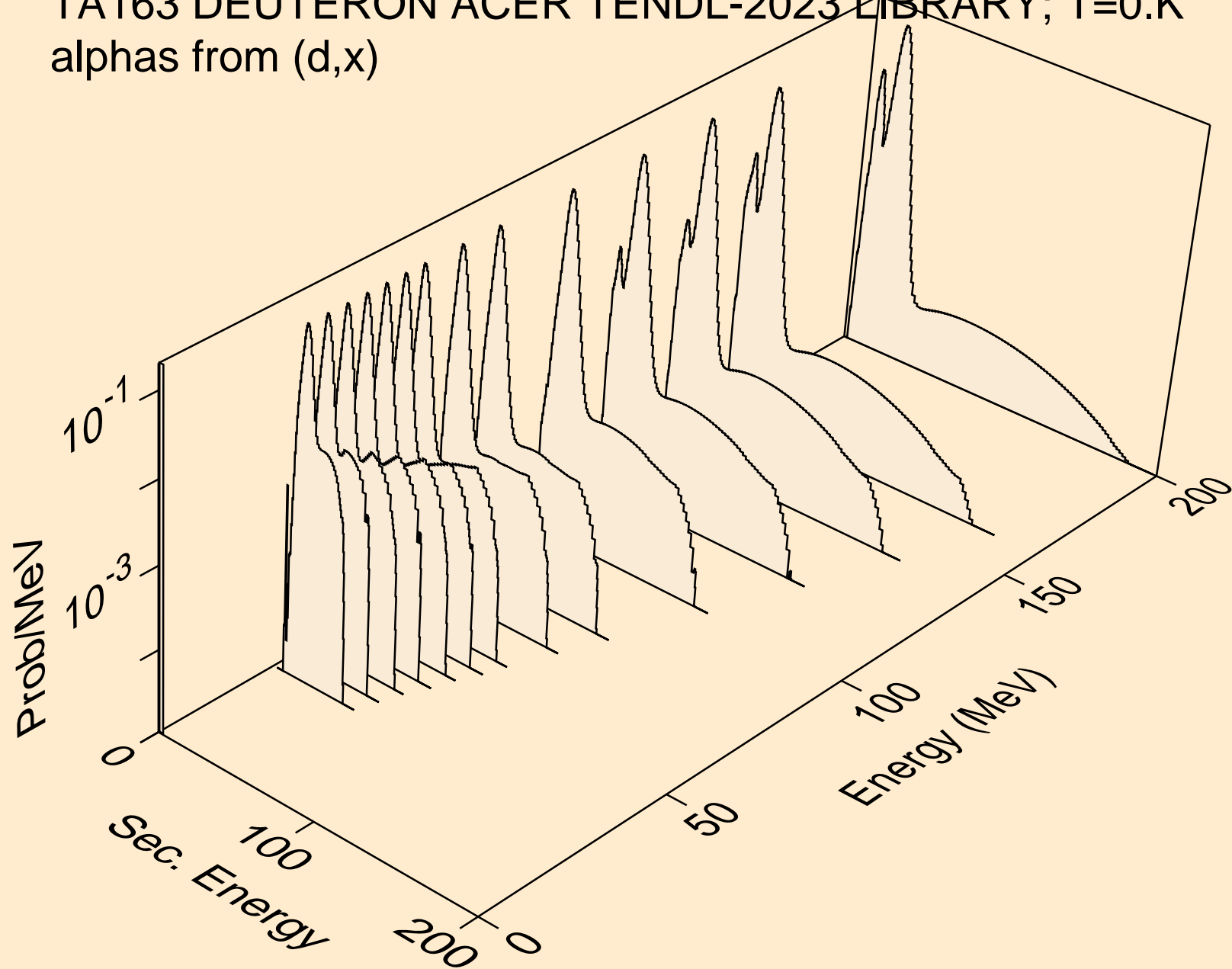

TA163 DEUTERON ACER TENDL-2023 LIBRARY; T=0.K  
alphas from (d,n\*)a

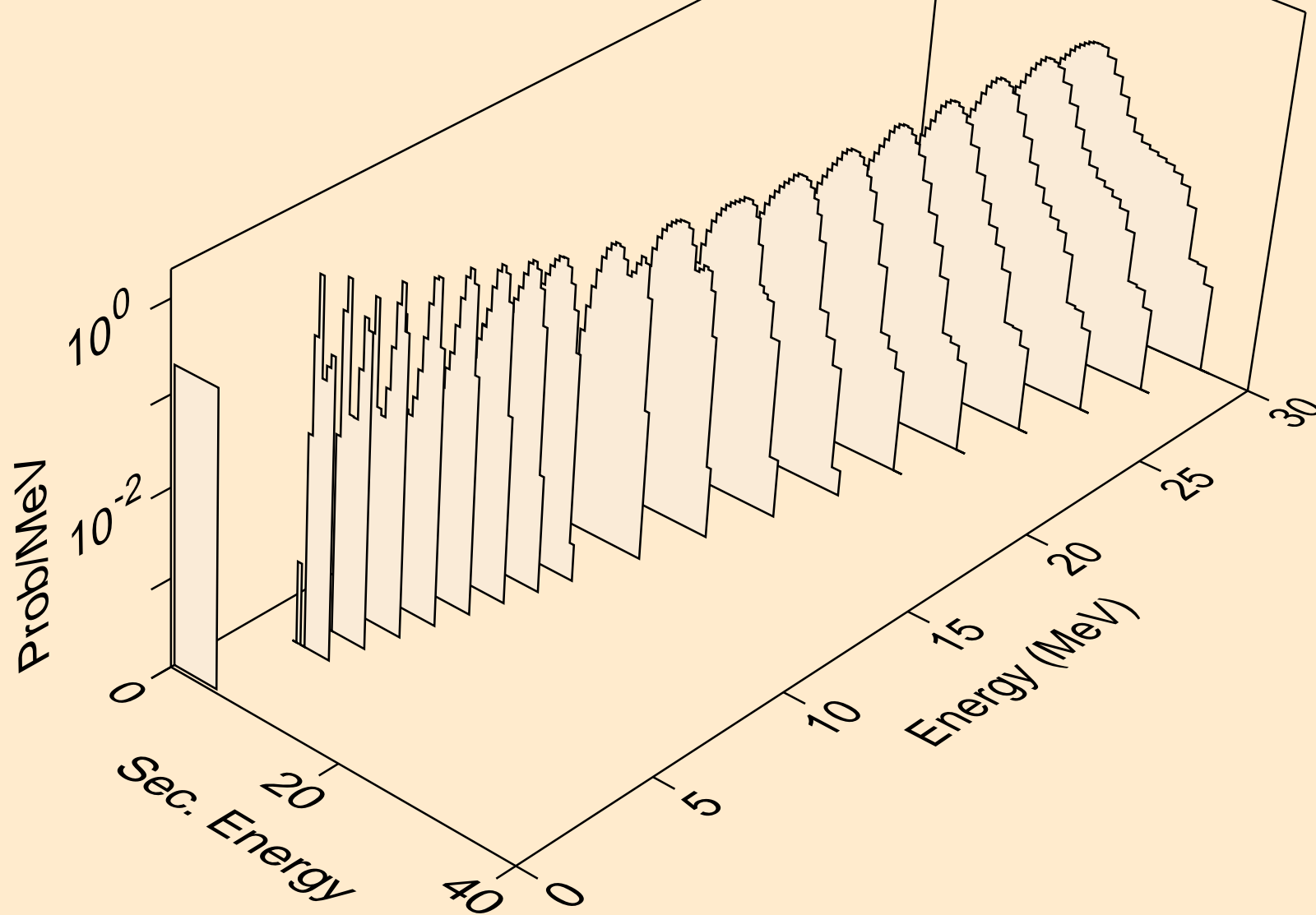

TA163 DEUTERON ACER TENDL-2023 LIBRARY; T=0.K  
alphas from (d,n\*)3a

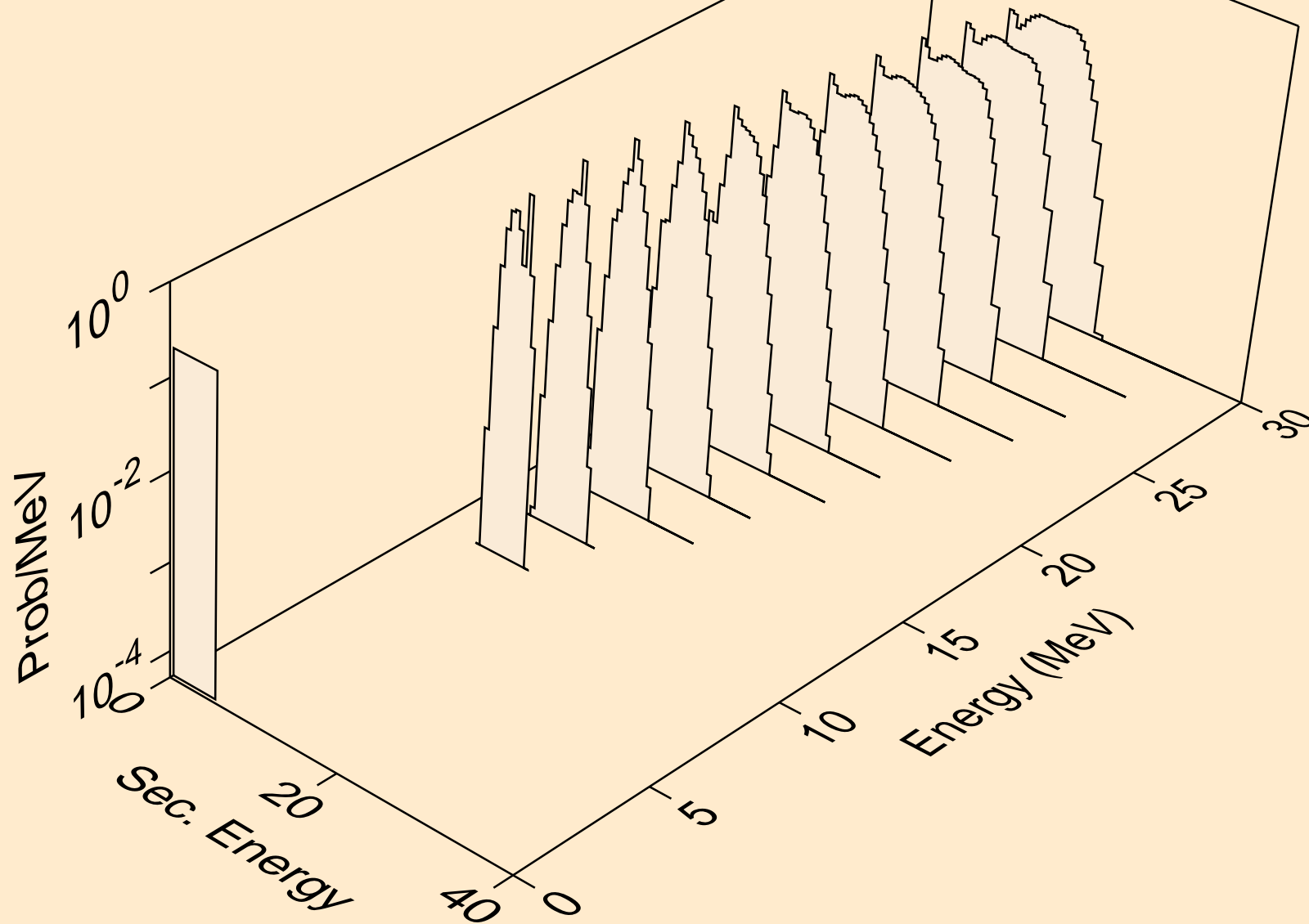

TA163 DEUTERON ACER TENDL-2023 LIBRARY; T=0.K  
alphas from (d,2n)a

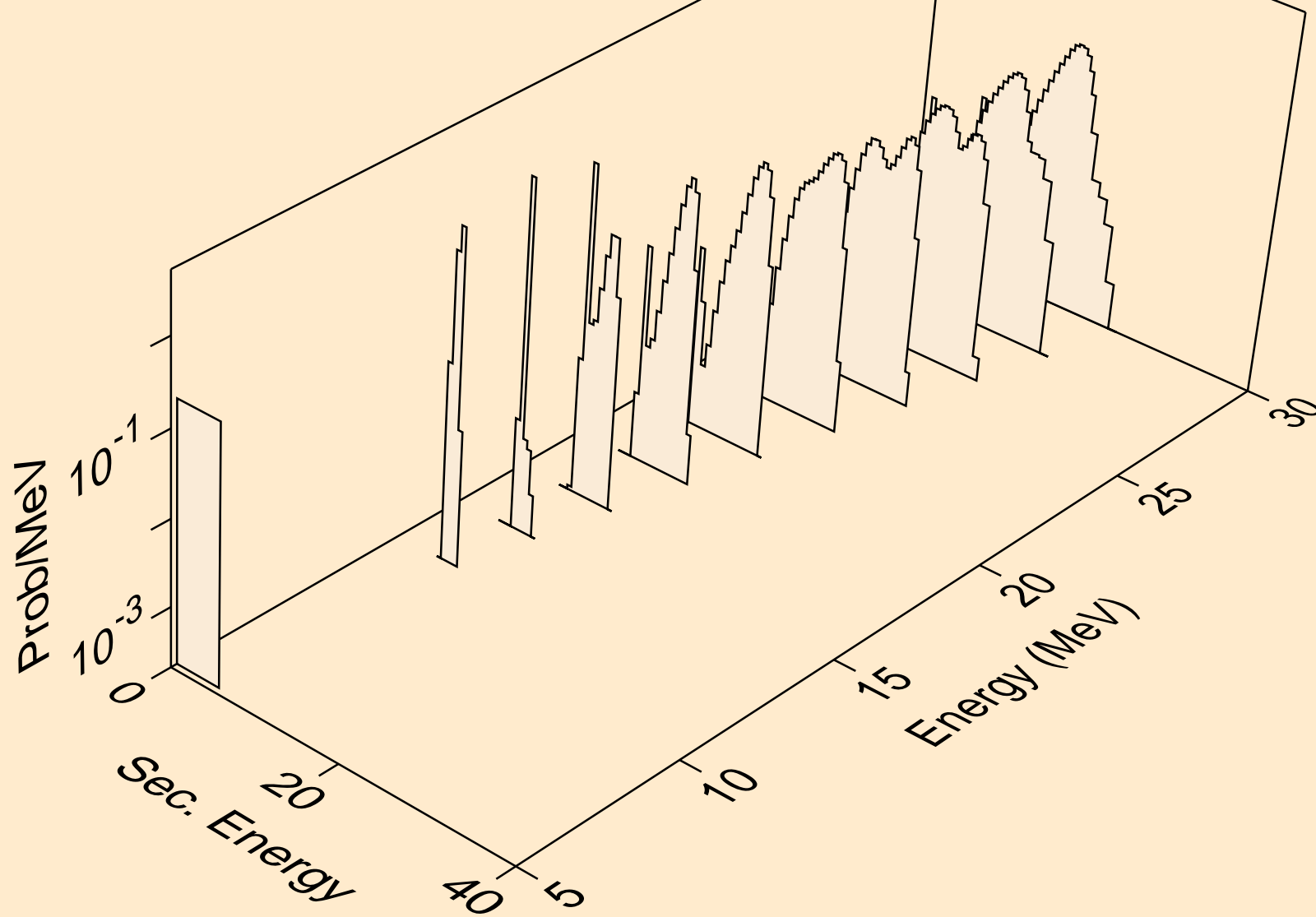

TA163 DEUTERON ACER TENDL-2023 LIBRARY; T=0.K  
alphas from (d,3n)a

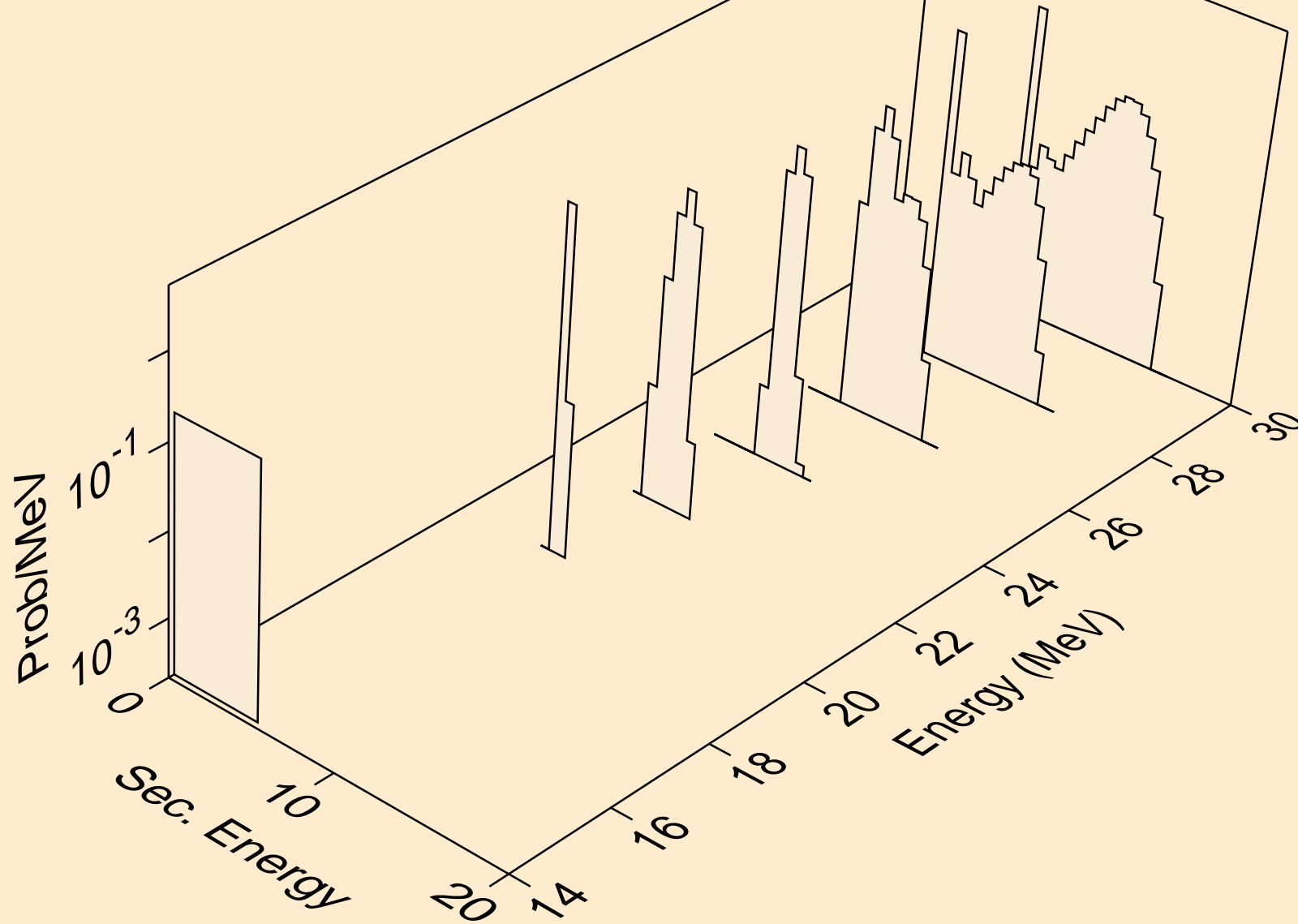

TA163 DEUTERON ACER TENDL-2023 LIBRARY; T=0.K  
alphas from (d,n\*)2a

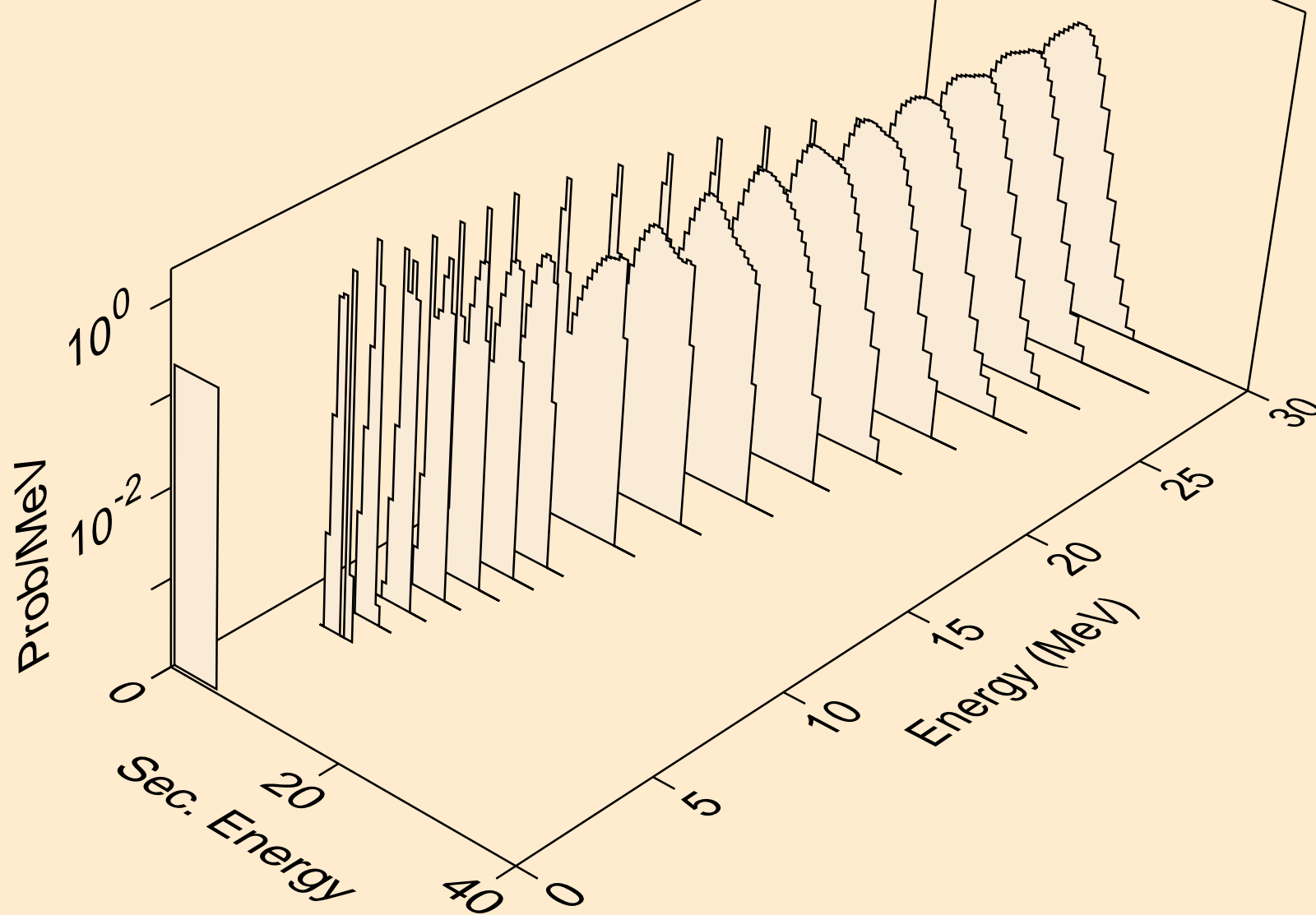

TA163 DEUTERON ACER TENDL-2023 LIBRARY; T=0.K  
alphas from (d,2n)2a

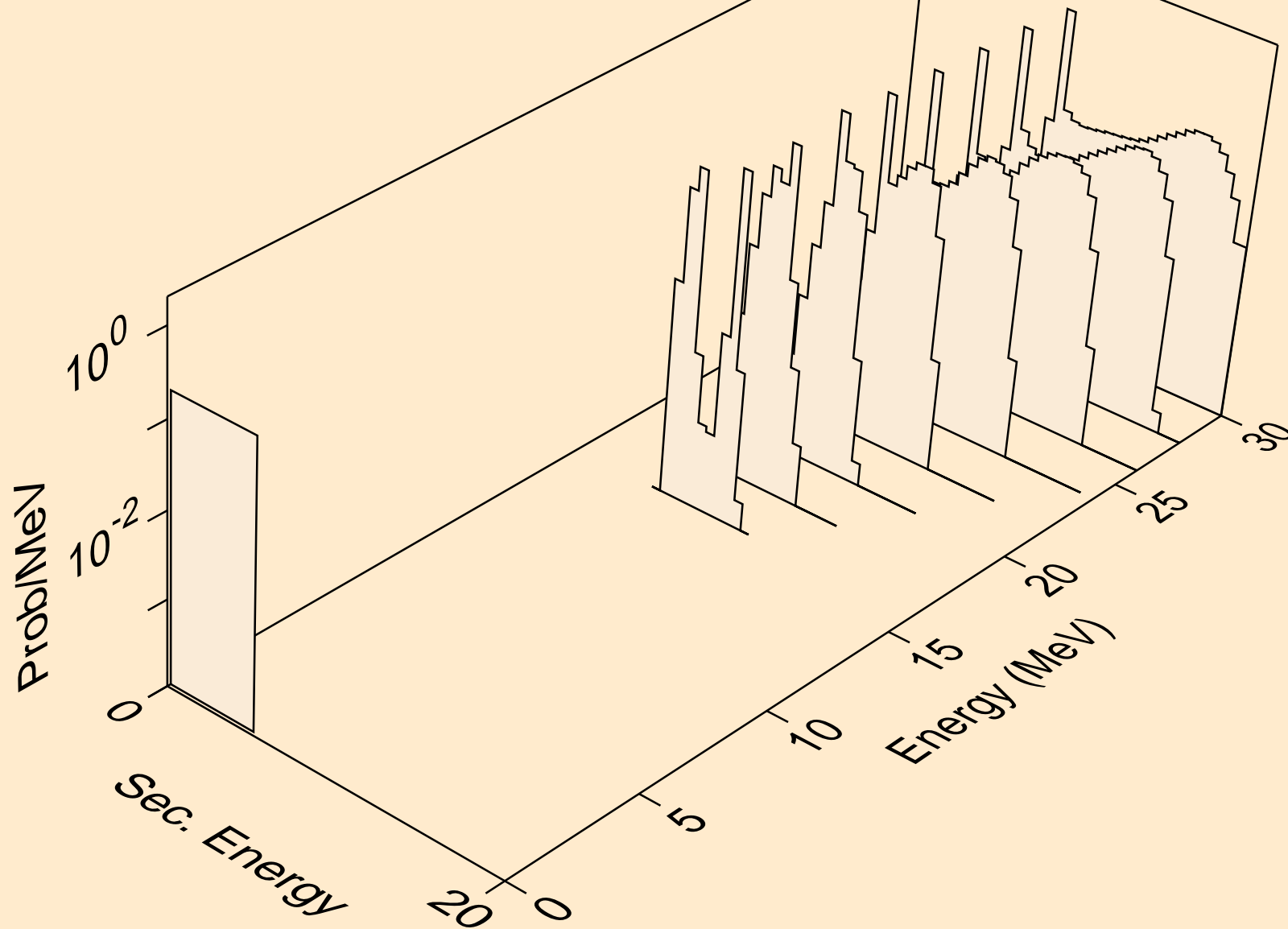



TA163 DEUTERON ACER TENDL-2023 LIBRARY; T=0.K  
alphas from (d,npa)

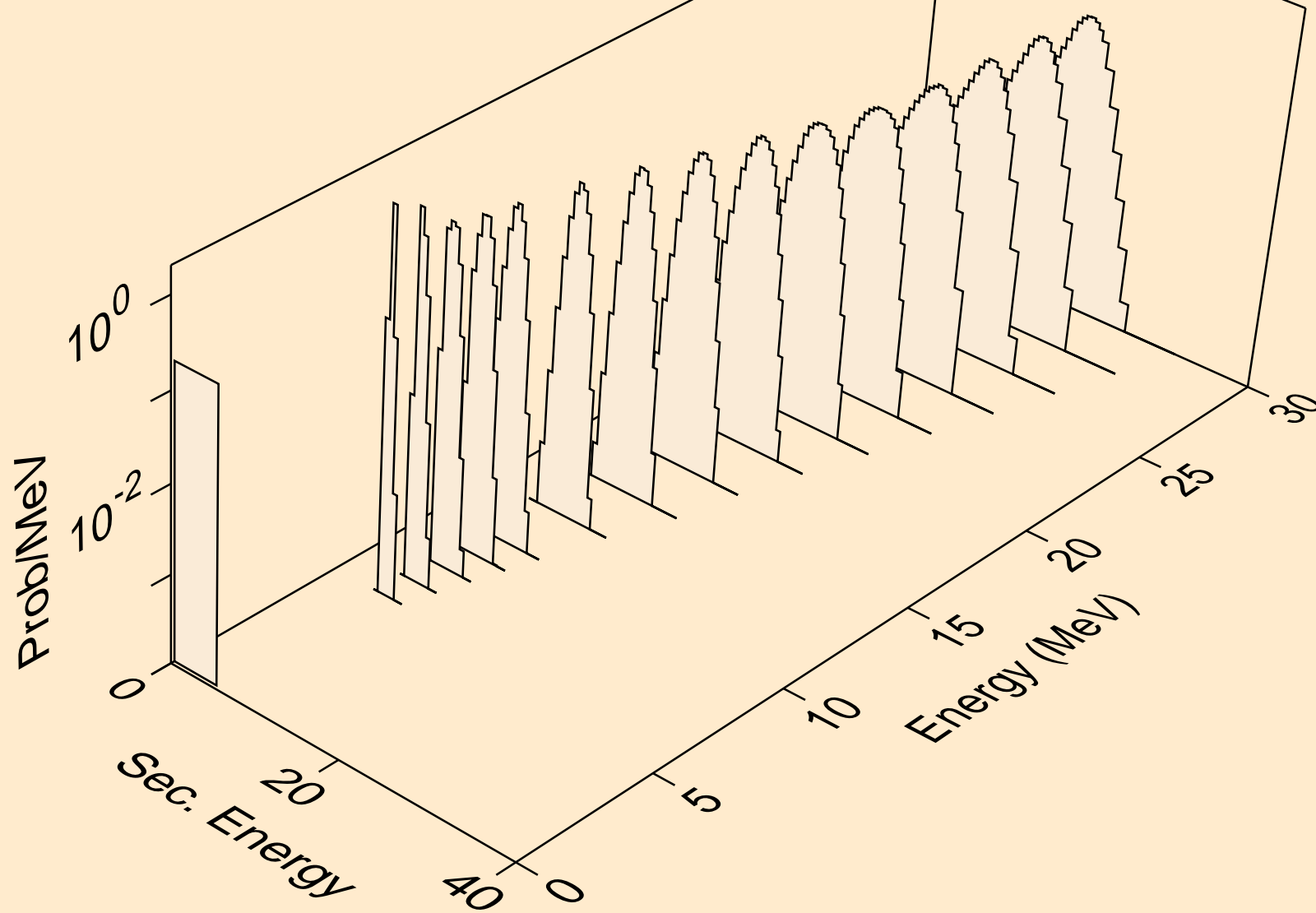

TA163 DEUTERON ACER TENDL-2023 LIBRARY; T=0.K  
alphas from (d,a)

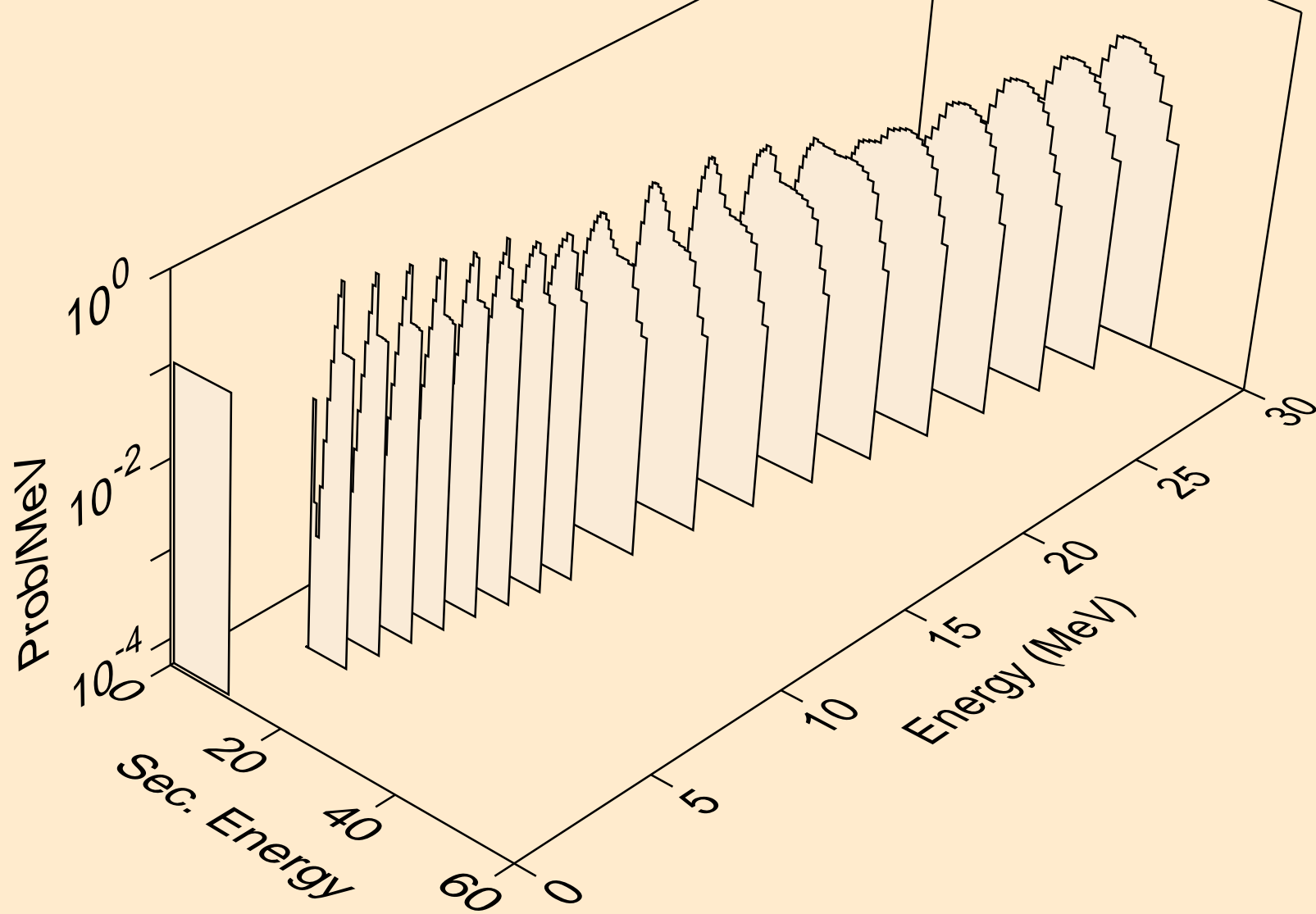

TA163 DEUTERON ACER TENDL-2023 LIBRARY; T=0.K  
alphas from (d,2a)

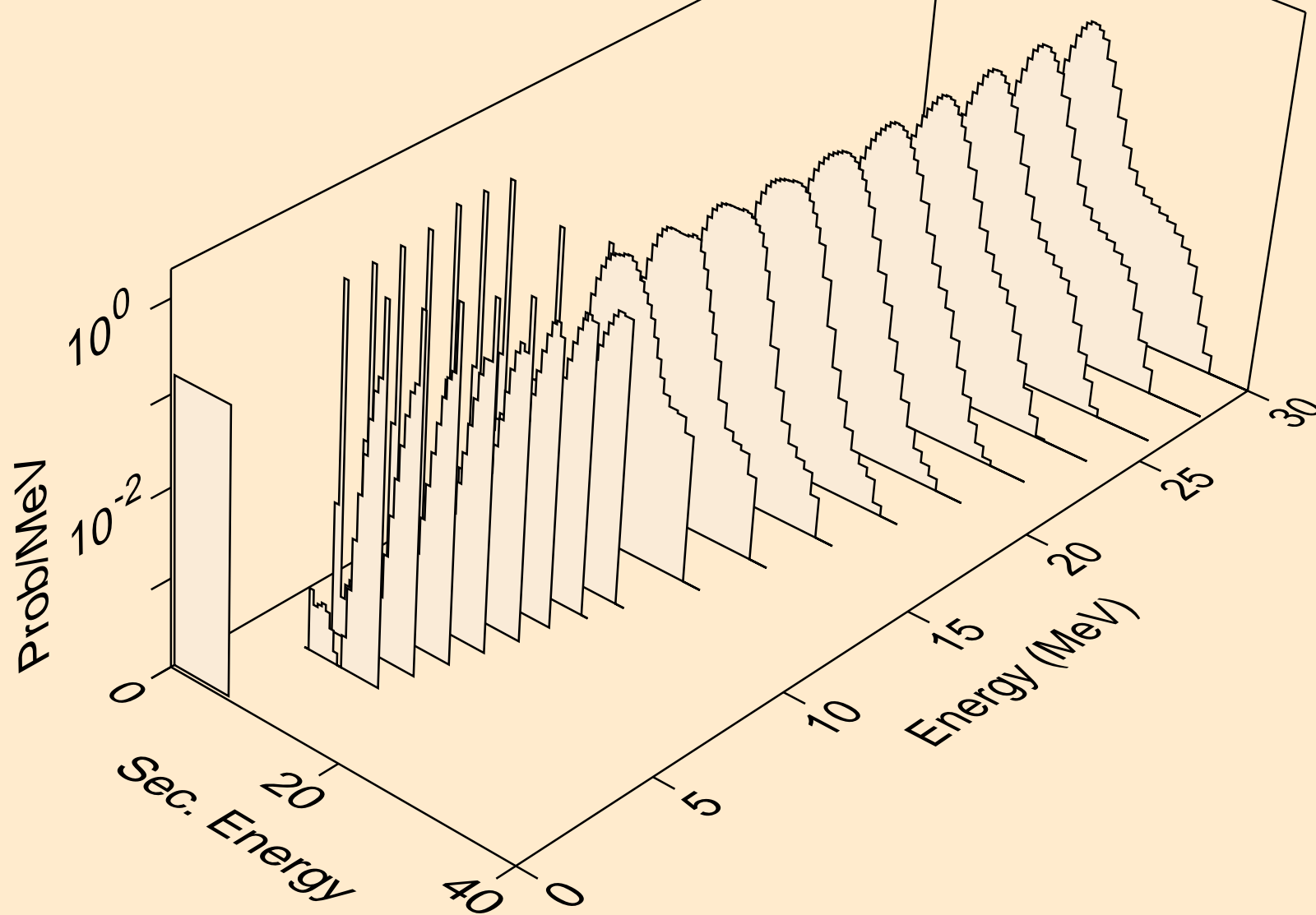

TA163 DEUTERON ACER TENDL-2023 LIBRARY; T=0.K  
alphas from (d,3a)

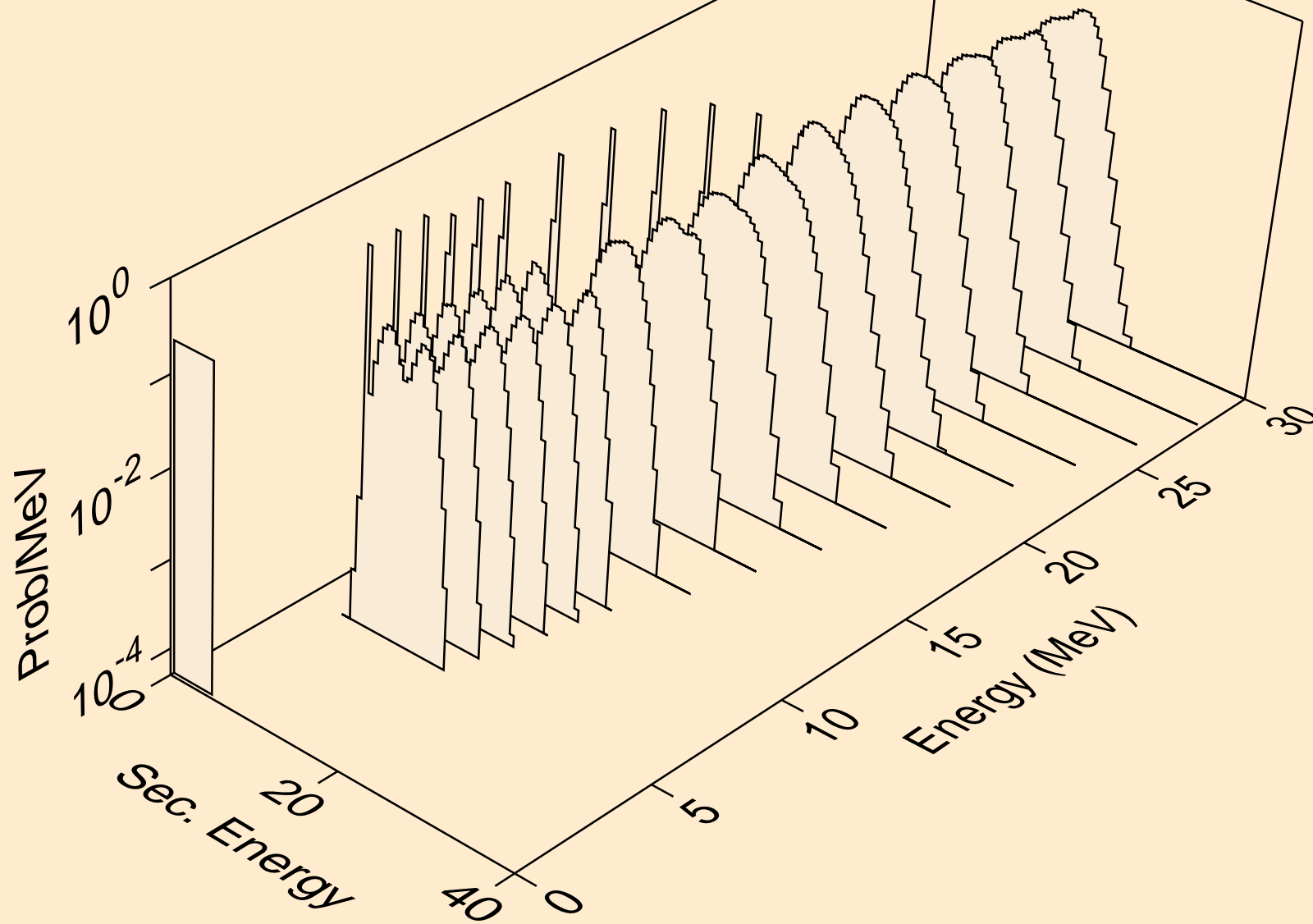

TA163 DEUTERON ACER TENDL-2023 LIBRARY; T=0.K  
alphas from (d,pa)

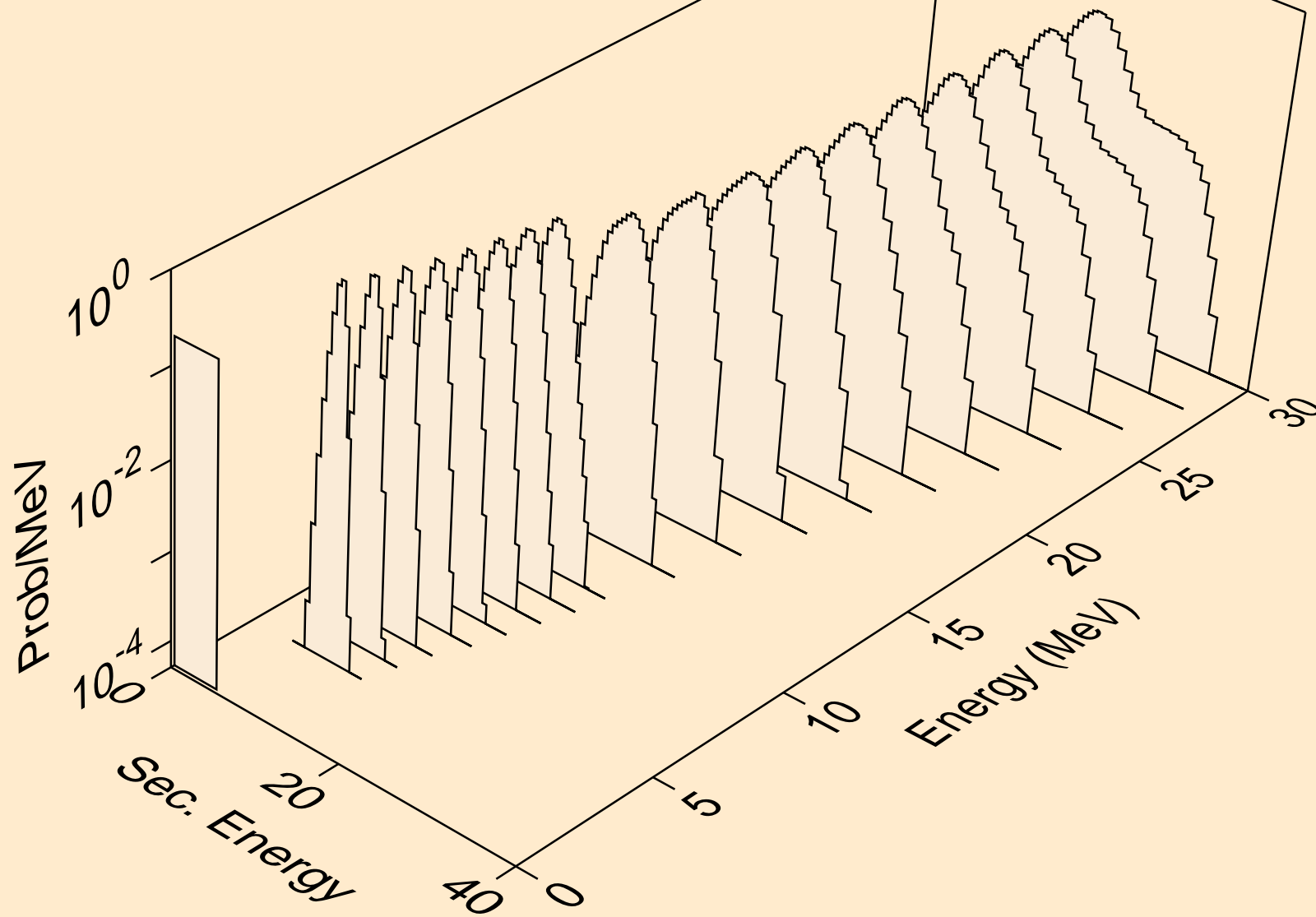

TA163 DEUTERON ACER TENDL-2023 LIBRARY; T=0.K  
alphas from (d,d2a)

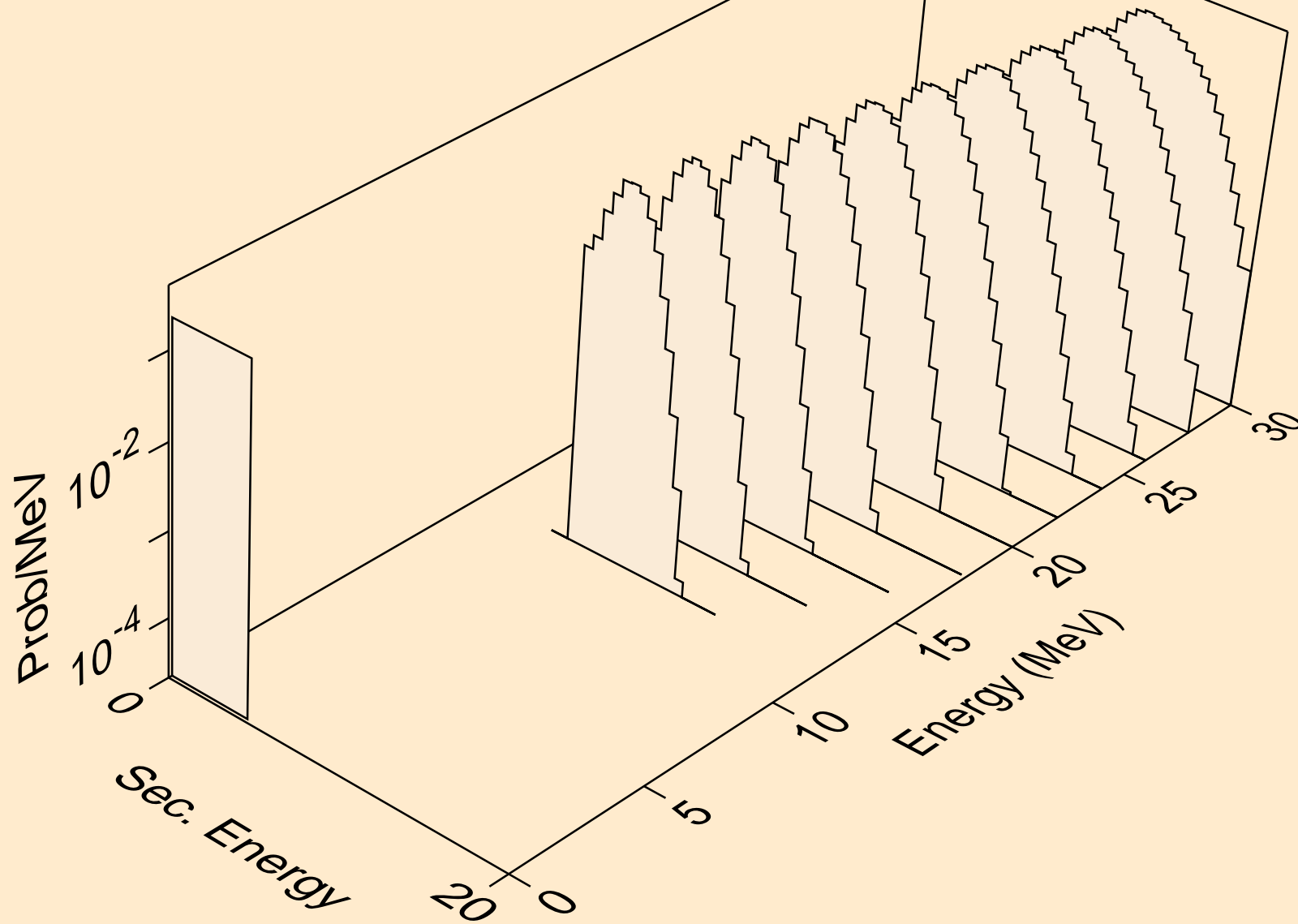

TA163 DEUTERON ACER TENDL-2023 LIBRARY; T=0.K  
alphas from (d,da)

