

CA042 PHOTON ACER TENDL-2023 LIBRARY; T=0.K
Principal cross sections

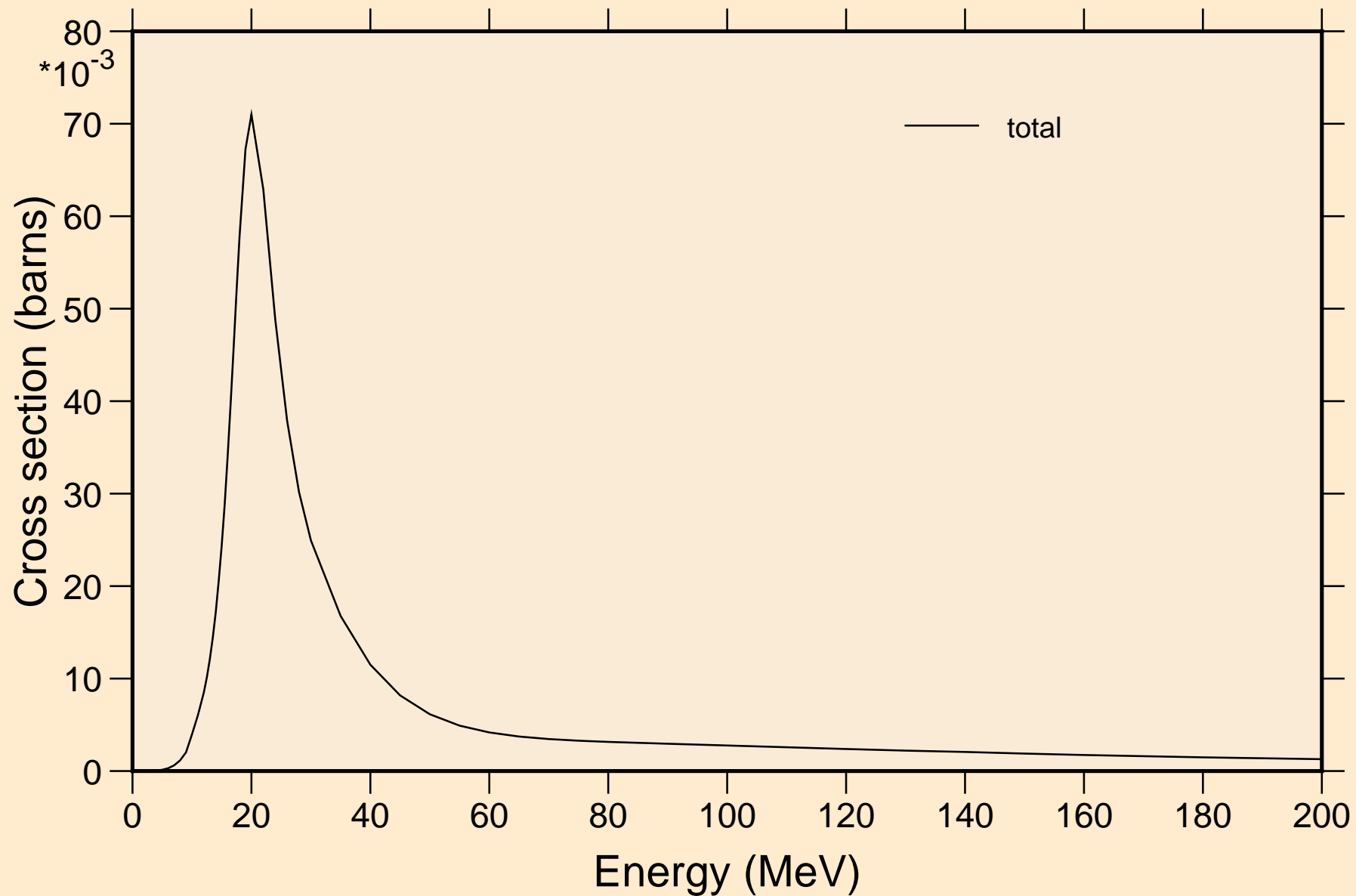

CA042 PHOTON ACER TENDL-2023 LIBRARY; T=0.K

Partial cross sections

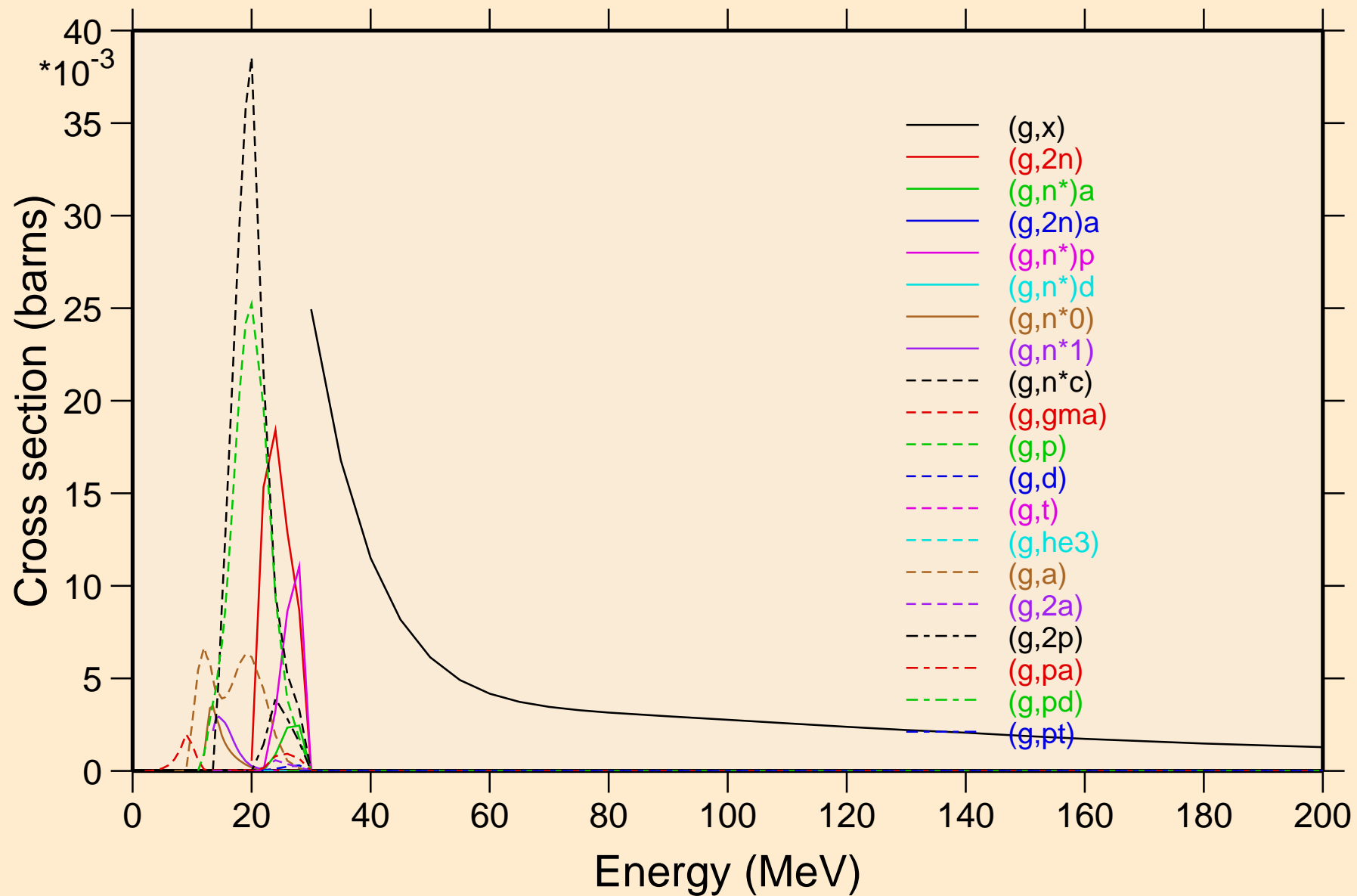

CA042 PHOTON ACER TENDL-2023 LIBRARY; T=0.K

Heating

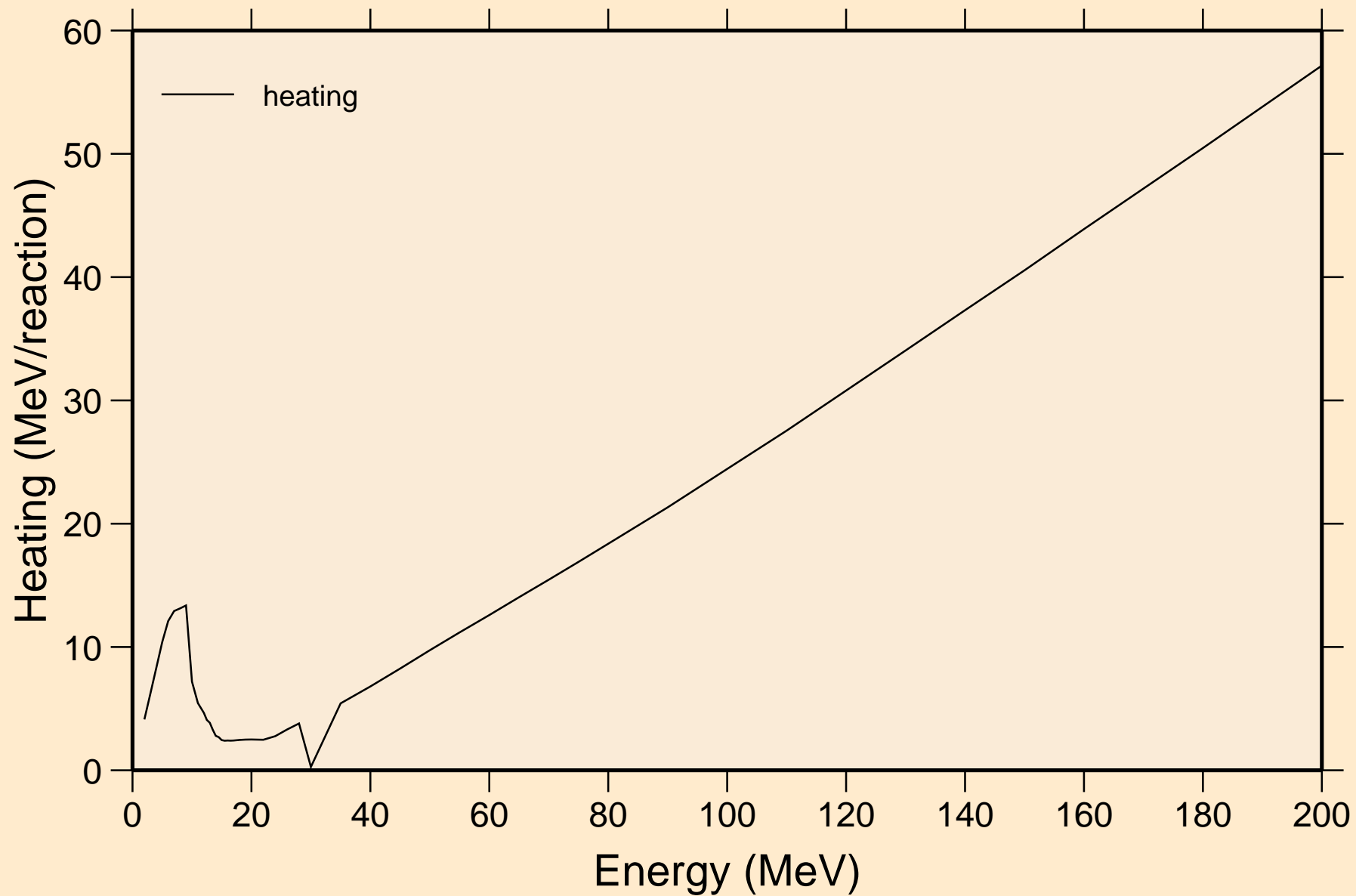

CA042 PHOTON ACER TENDL-2023 LIBRARY; T=0.K

Particle heating contributions

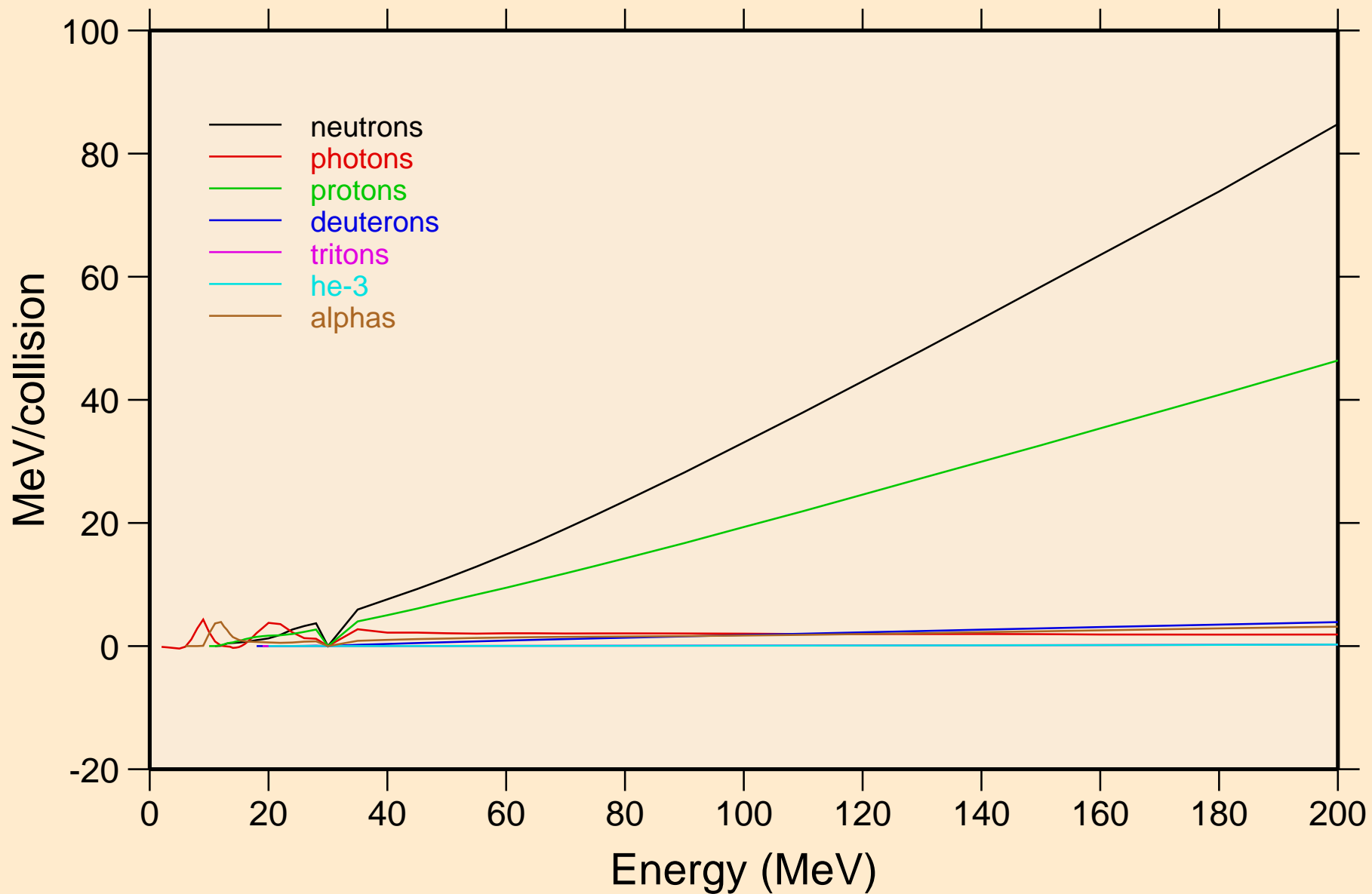

CA042 PHOTON ACER TENDL-2023 LIBRARY; T=0.K

Particle production cross sections

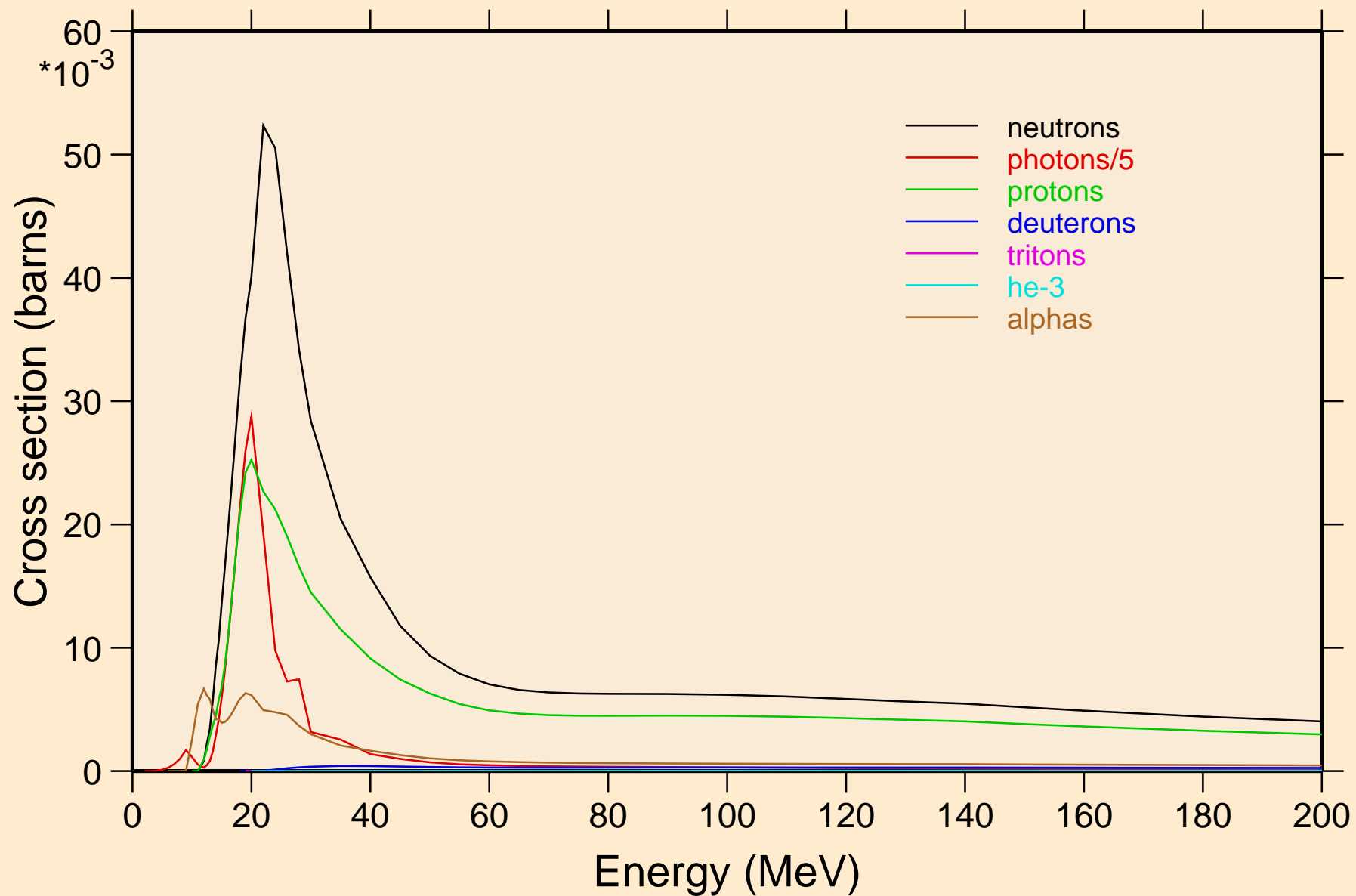

CA042 PHOTON ACER TENDL-2023 LIBRARY; T=0.K
neutrons from (g,x)

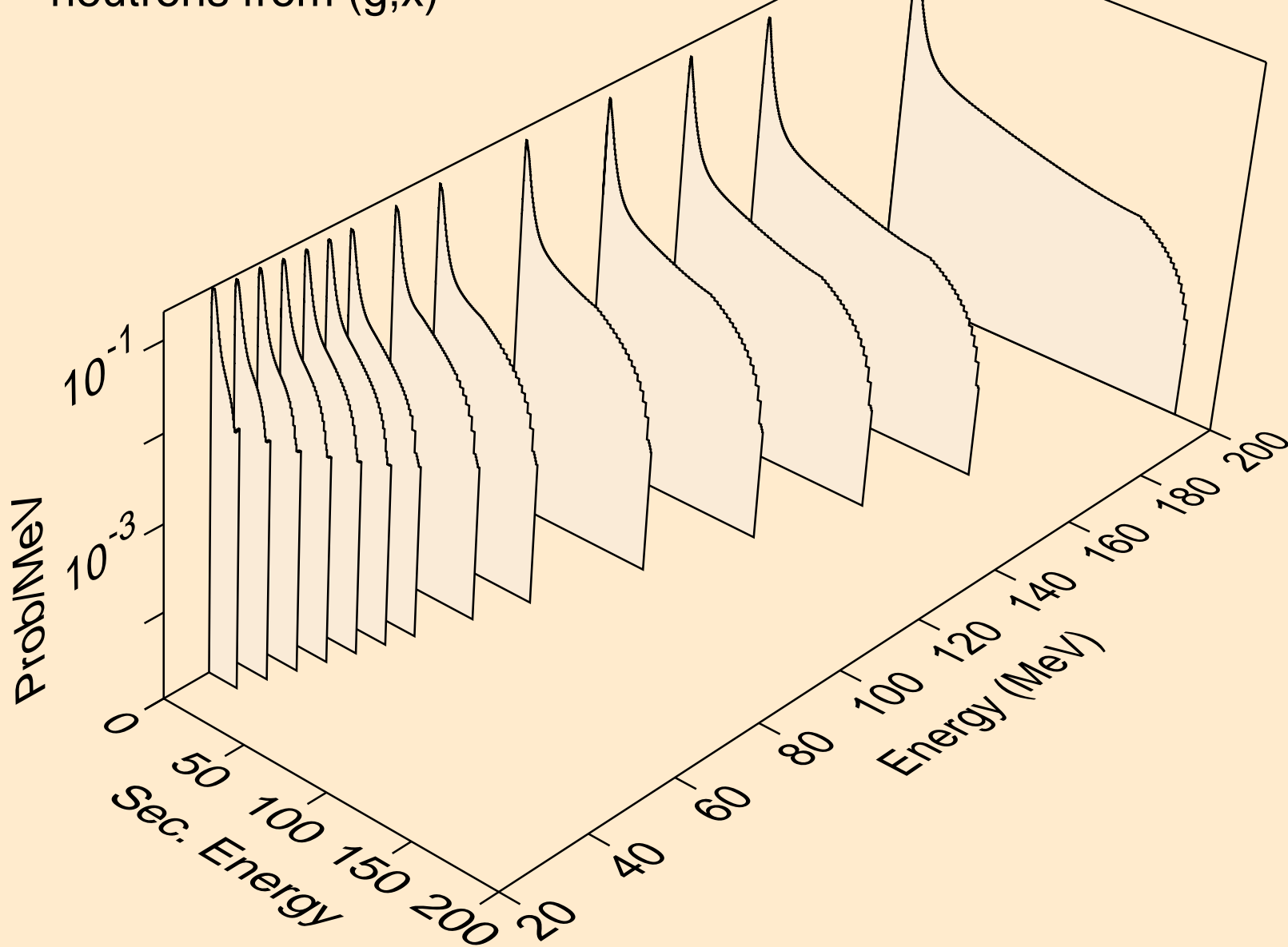

CA042 PHOTON ACER TENDL-2023 LIBRARY; T=0.K
neutrons from (g,2n)

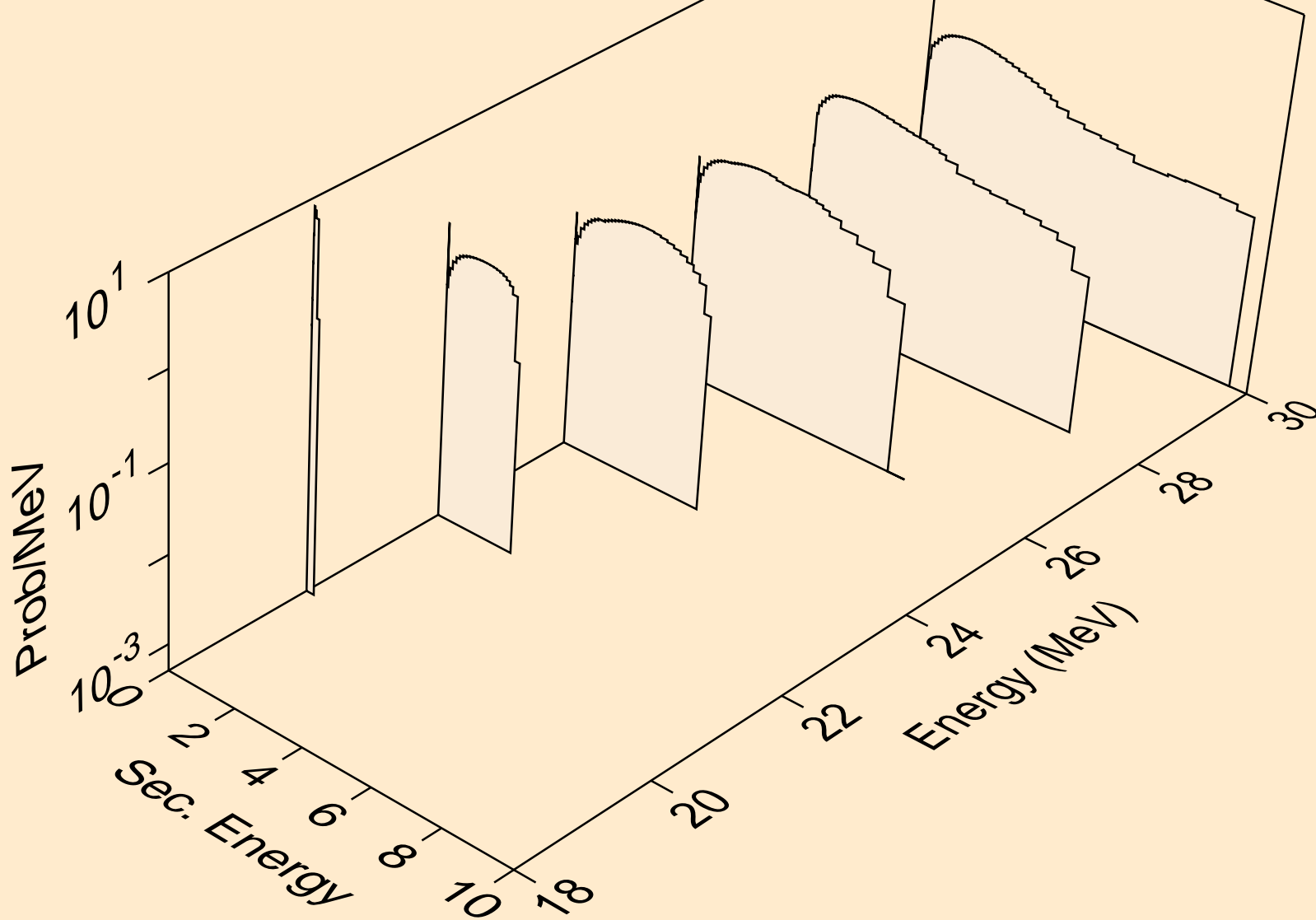

CA042 PHOTON ACER TENDL-2023 LIBRARY; T=0.K
neutrons from (g,n*)a

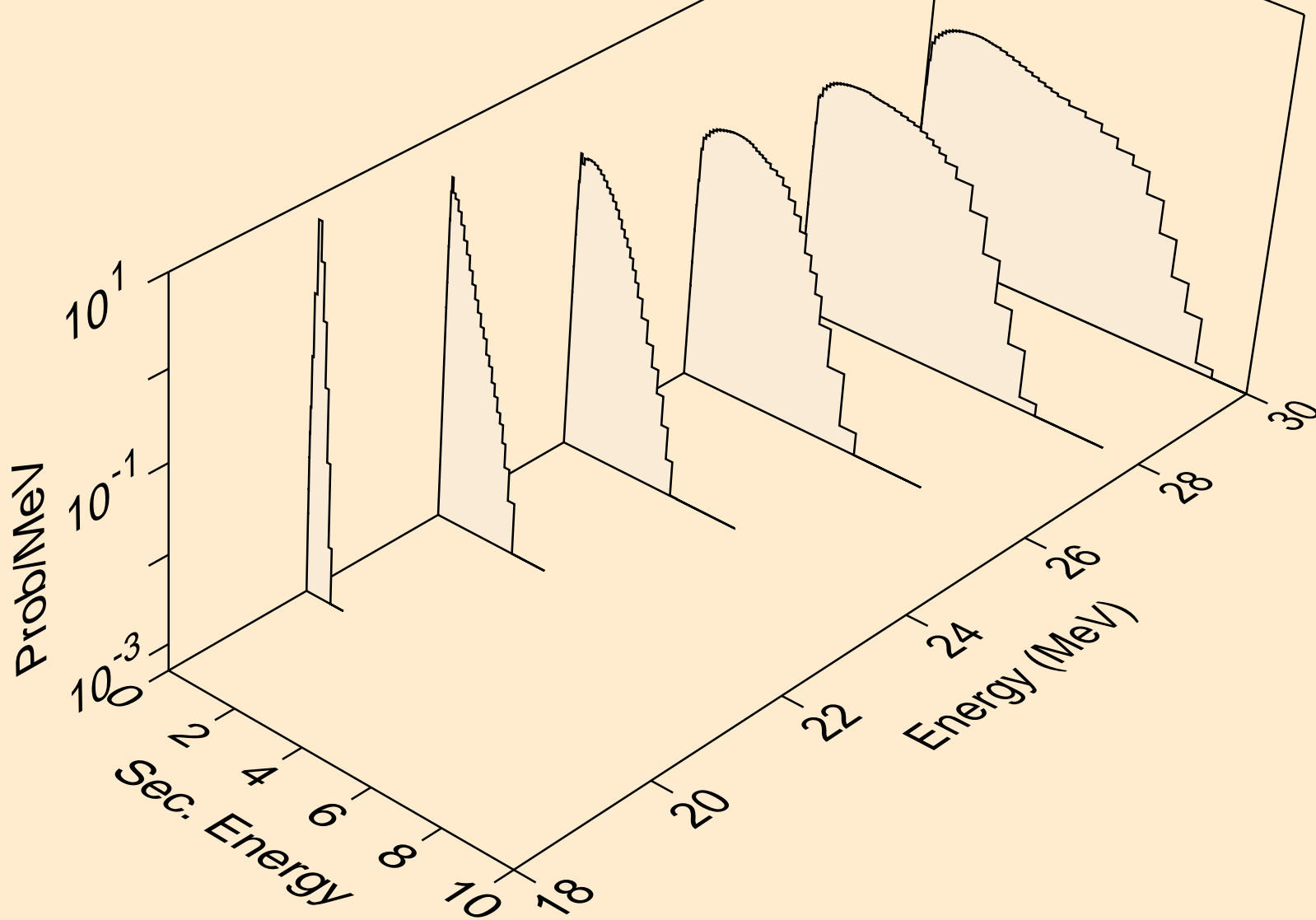

CA042 PHOTON ACER TENDL-2023 LIBRARY; T=0.K
neutrons from (g,2n)a

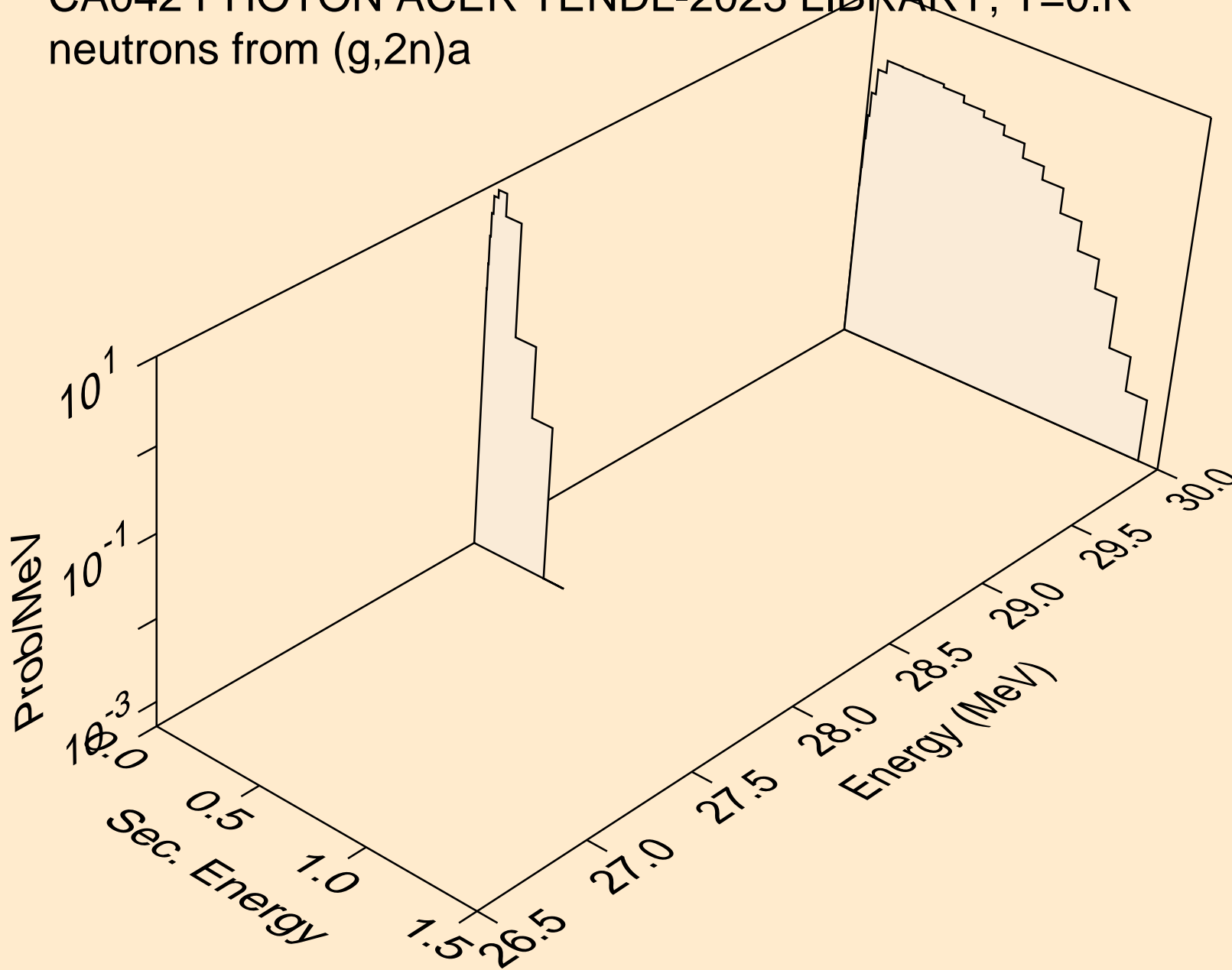

CA042 PHOTON ACER TENDL-2023 LIBRARY; T=0.K
neutrons from (g,n*)p

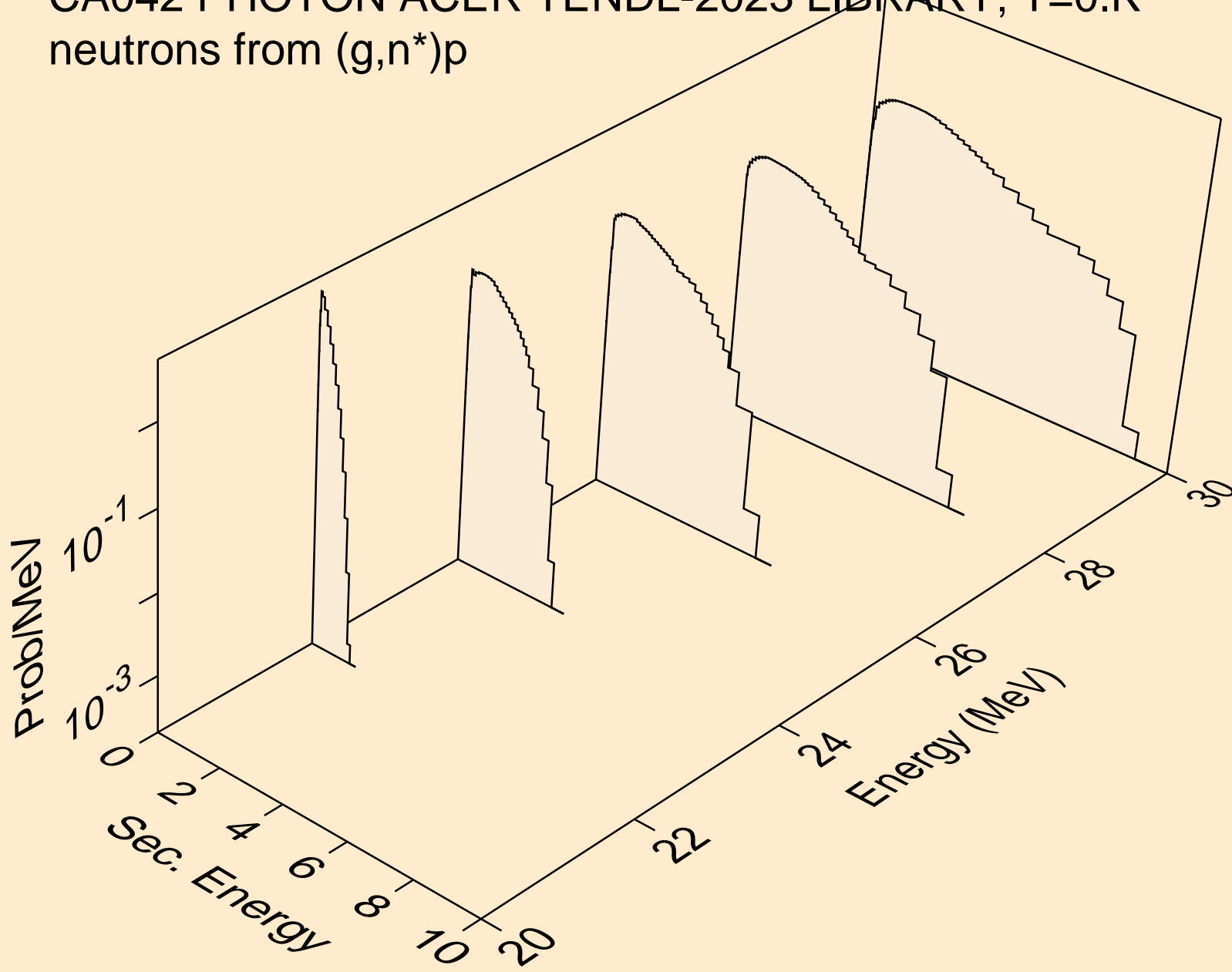

CA042 PHOTON ACER TENDL-2023 LIBRARY; T=0.K
neutrons from (g,n*)d

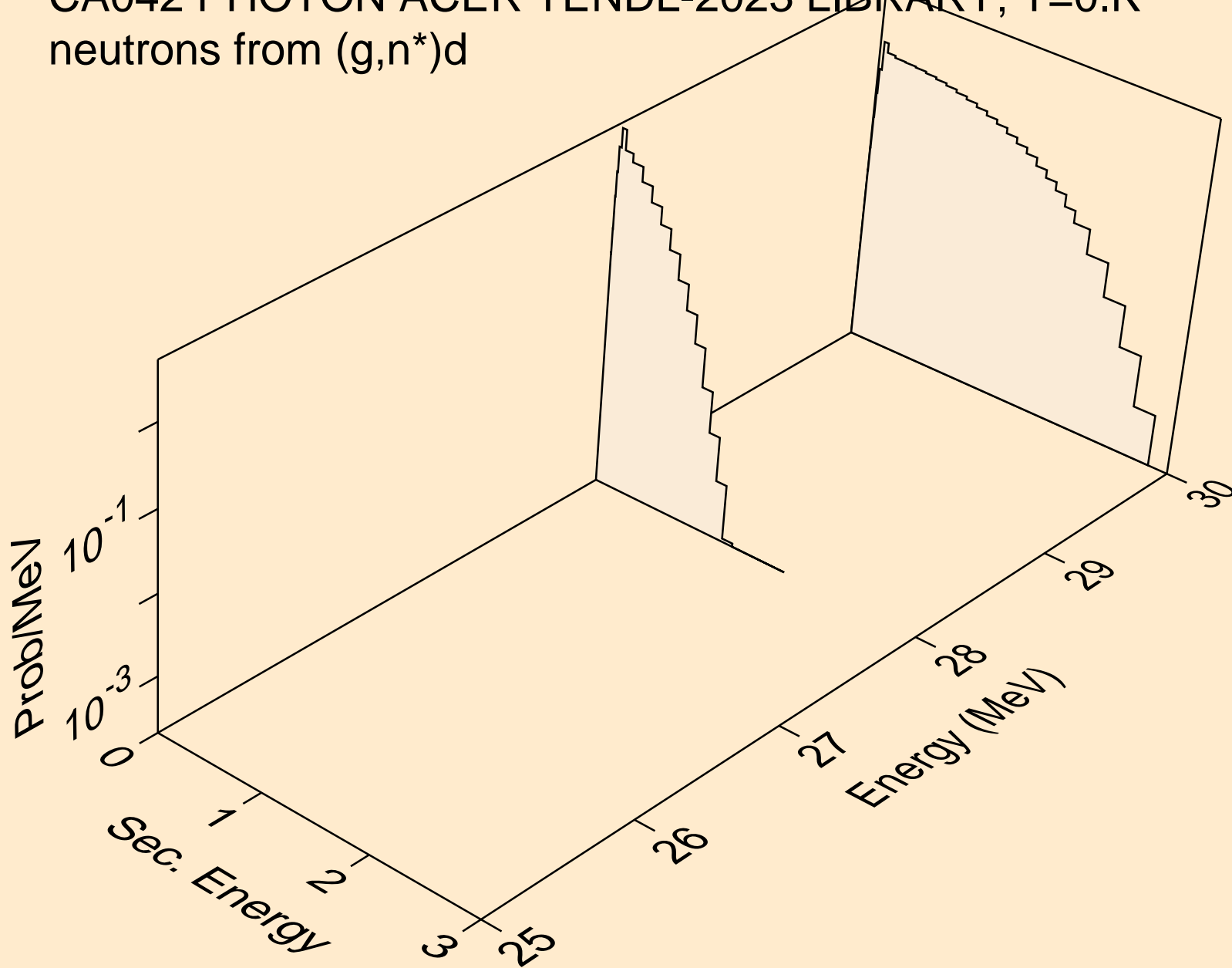

CA042 PHOTON ACER TENDL-2023 LIBRARY; T=0.K
angular distribution for (g,n*0) neutron

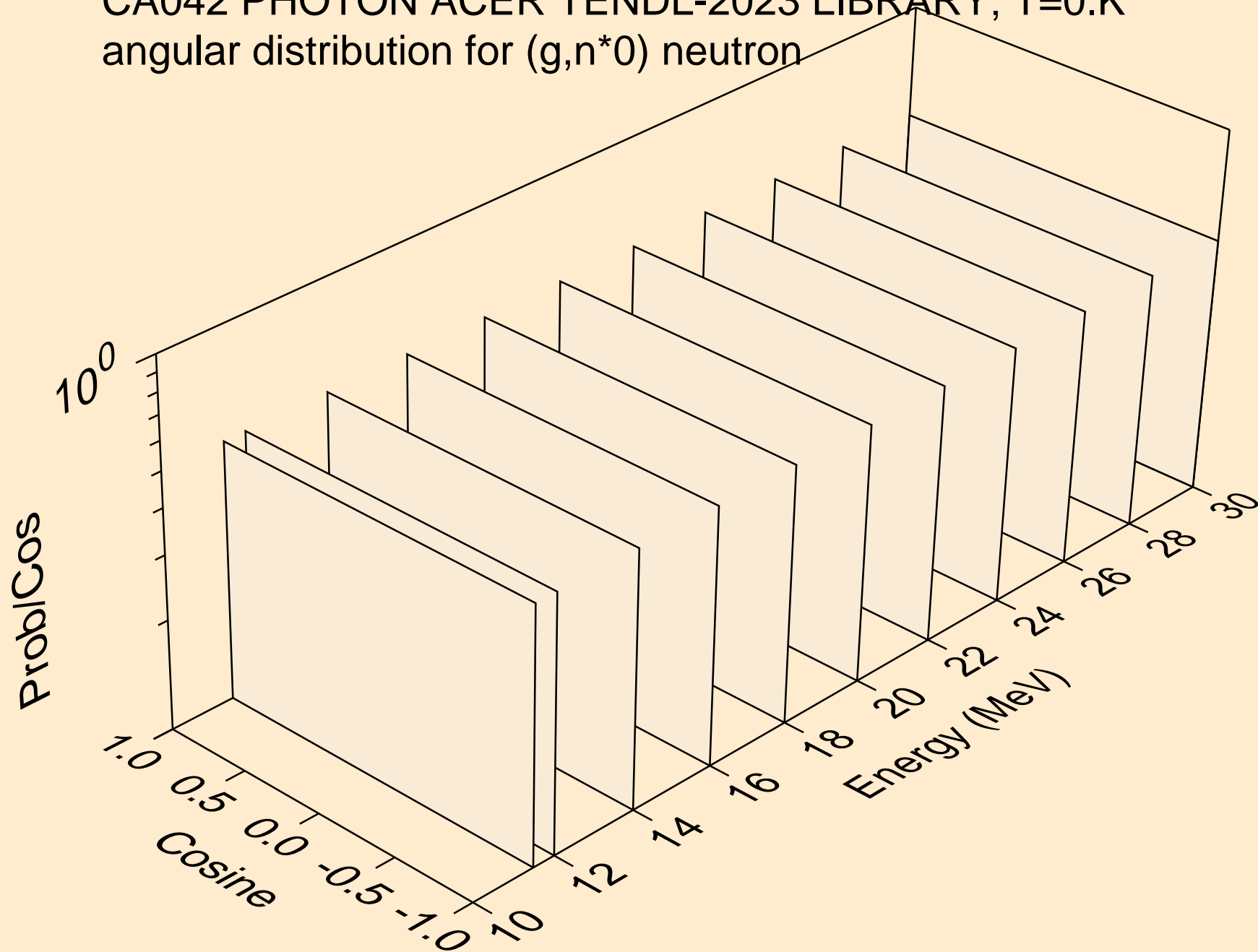

CA042 PHOTON ACER TENDL-2023 LIBRARY; T=0.K
angular distribution for (g,n*1) neutron

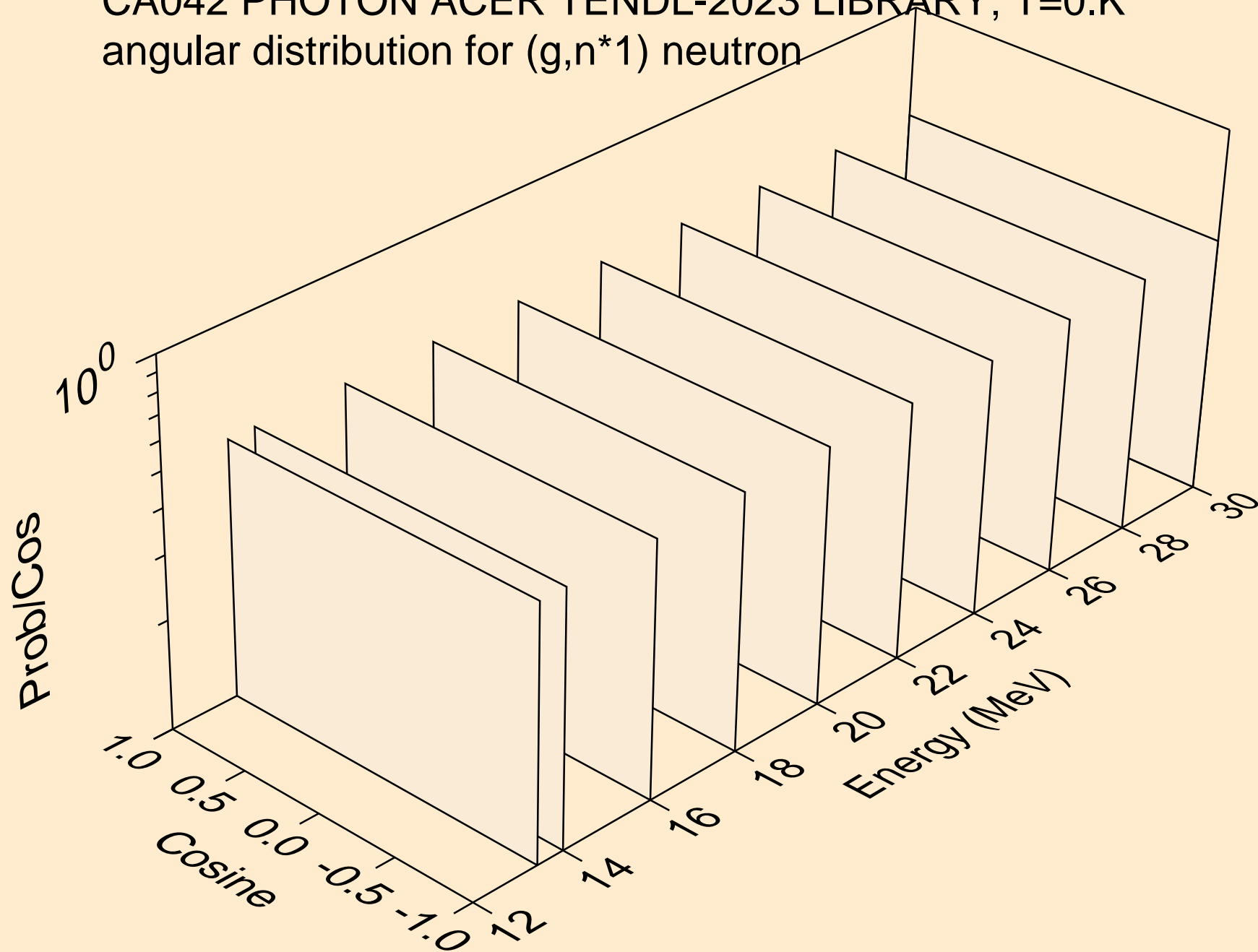

CA042 PHOTON ACER TENDL-2023 LIBRARY; T=0.K
neutrons from (g,n*c)

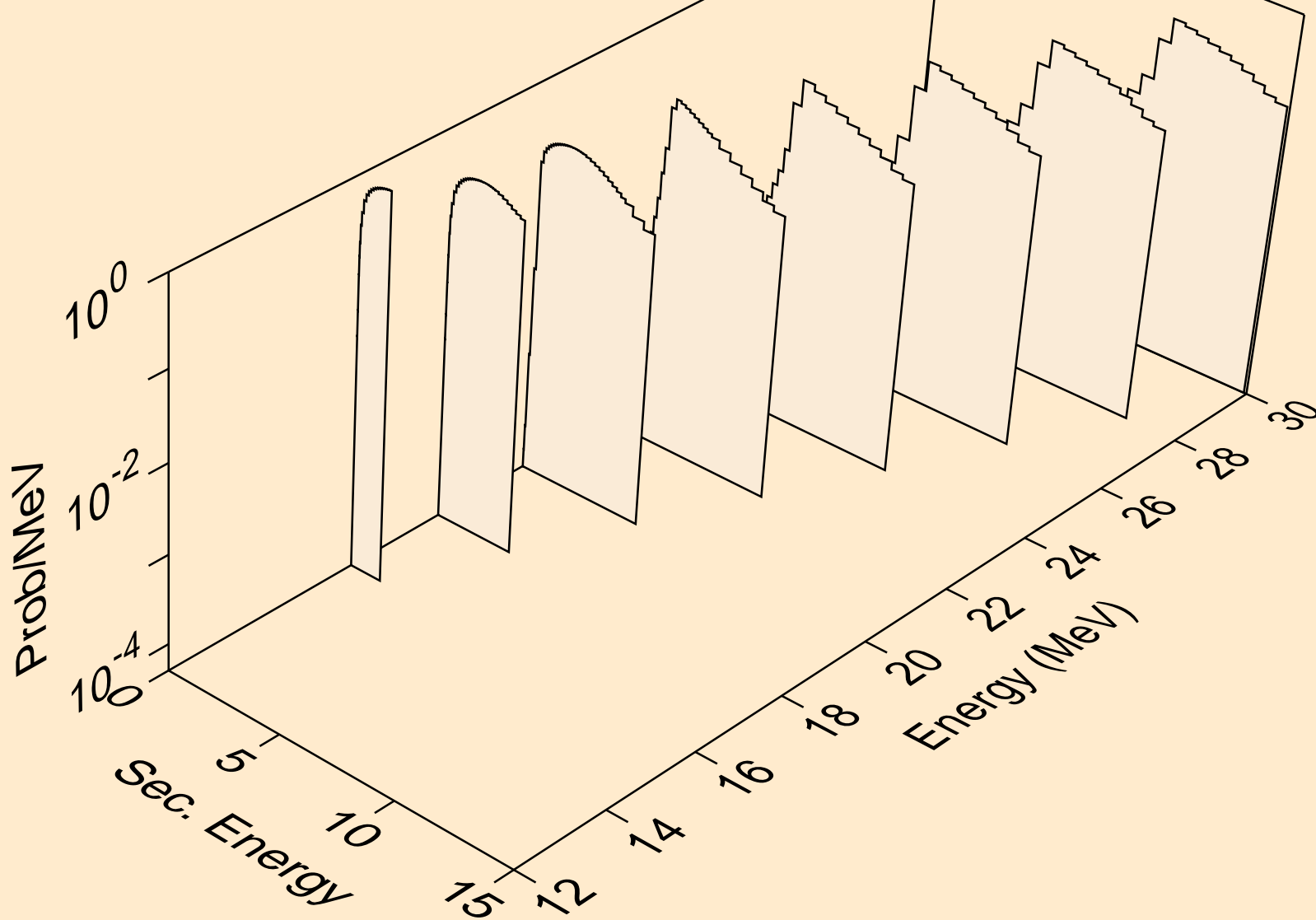

CA042 PHOTON ACER TENDL-2023 LIBRARY; T=0.K
photons from (g,x)

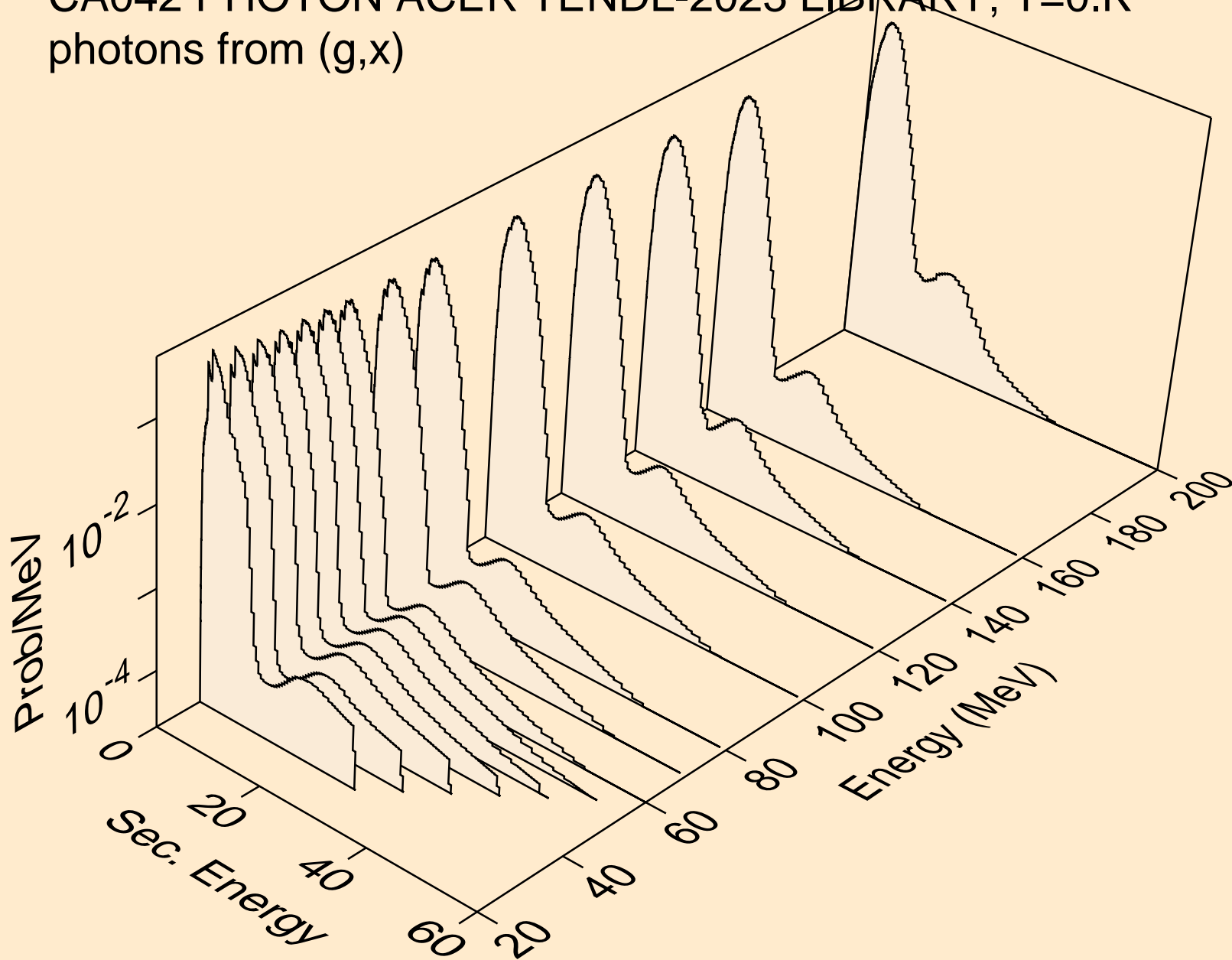

CA042 PHOTON ACER TENDL-2023 LIBRARY; T=0.K
photons from (g,2n)

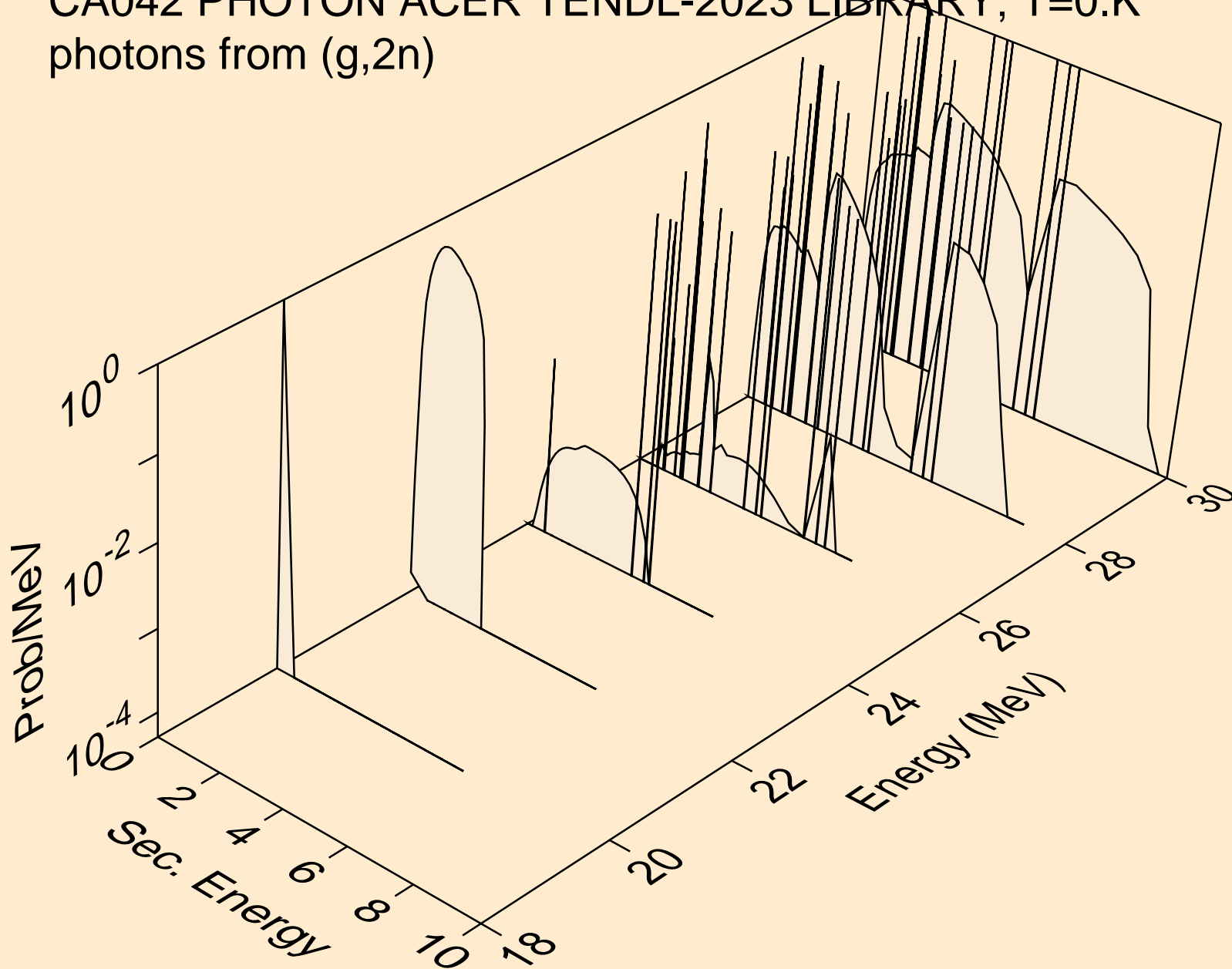

CA042 PHOTON ACER TENDL-2023 LIBRARY; T=0.K
photons from (g,n*)a

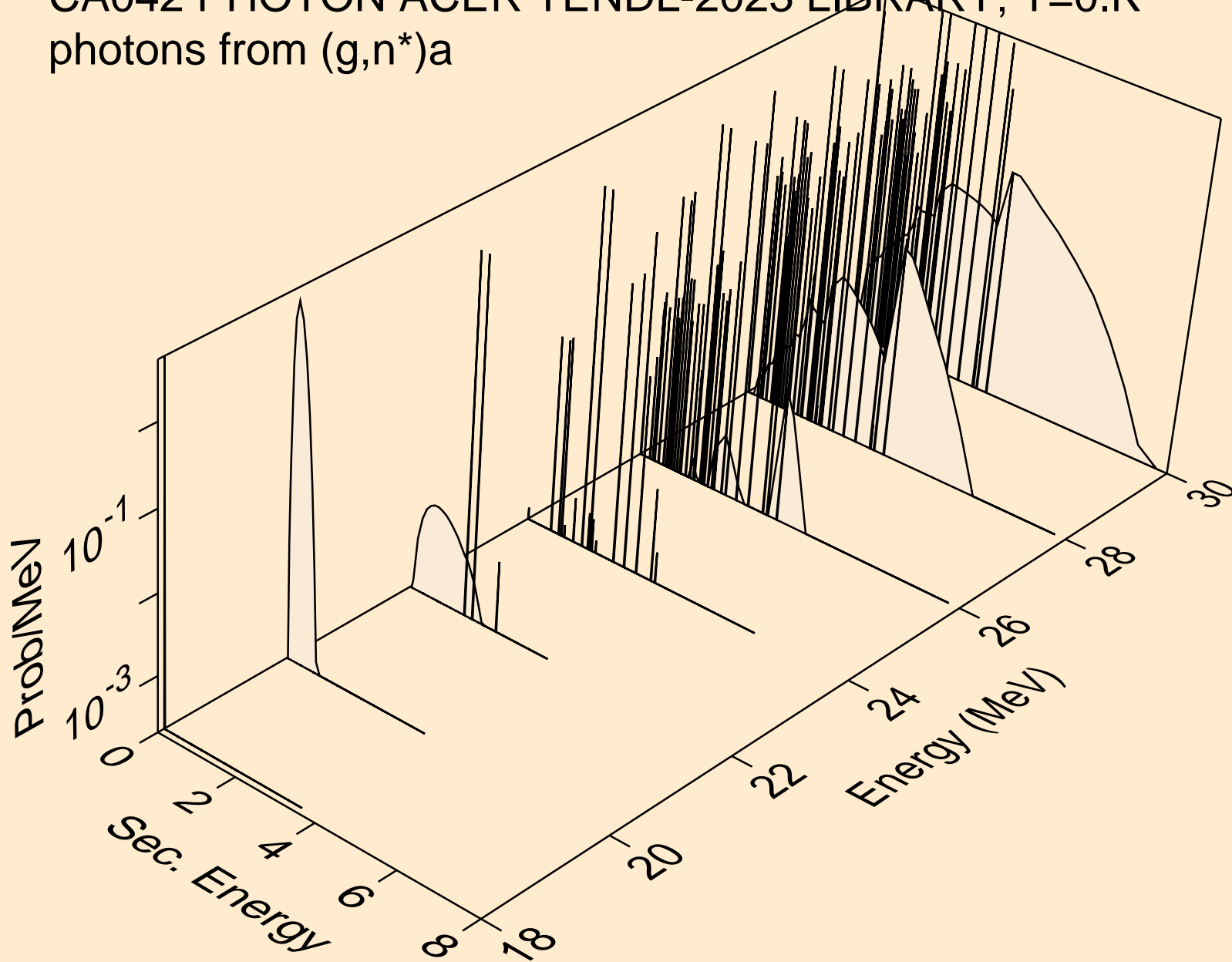

CA042 PHOTON ACER TENDL-2023 LIBRARY; T=0.K
photons from (g,2n)a

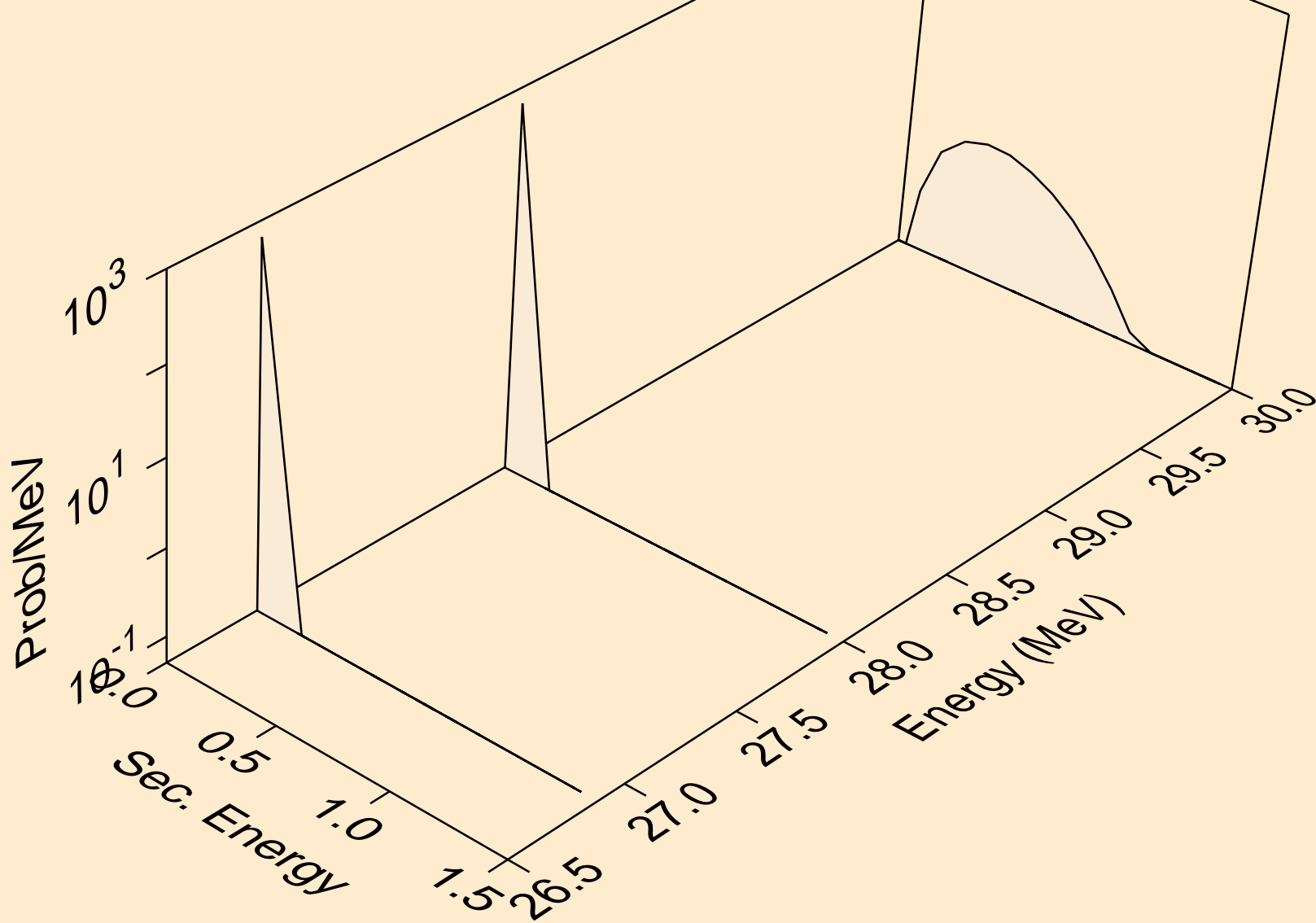

CA042 PHOTON ACER TENDL-2023 LIBRARY; T=0.K
photons from (g,n*)p

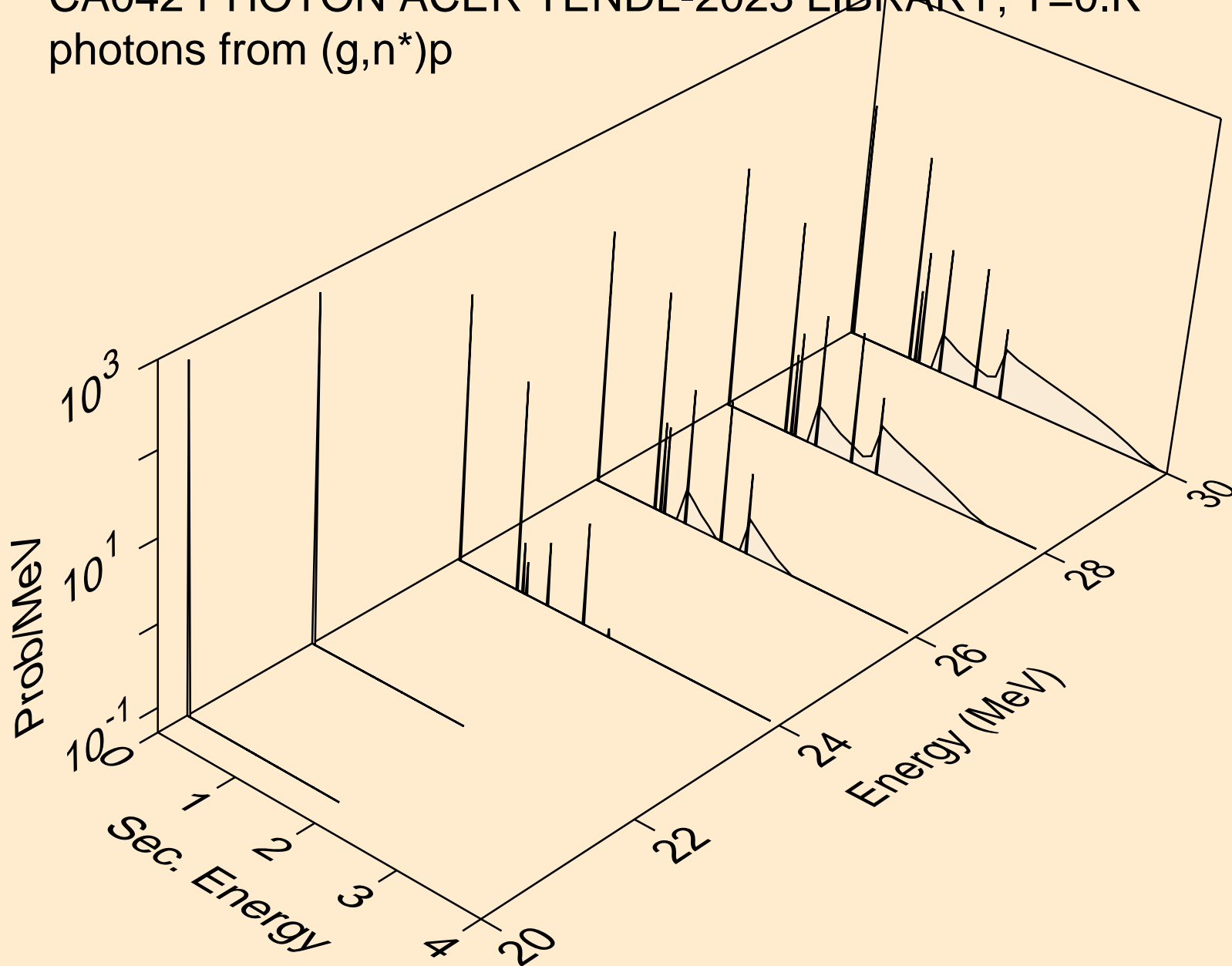

CA042 PHOTON ACER TENDL-2023 LIBRARY; T=0.K
photons from (g,n*)d

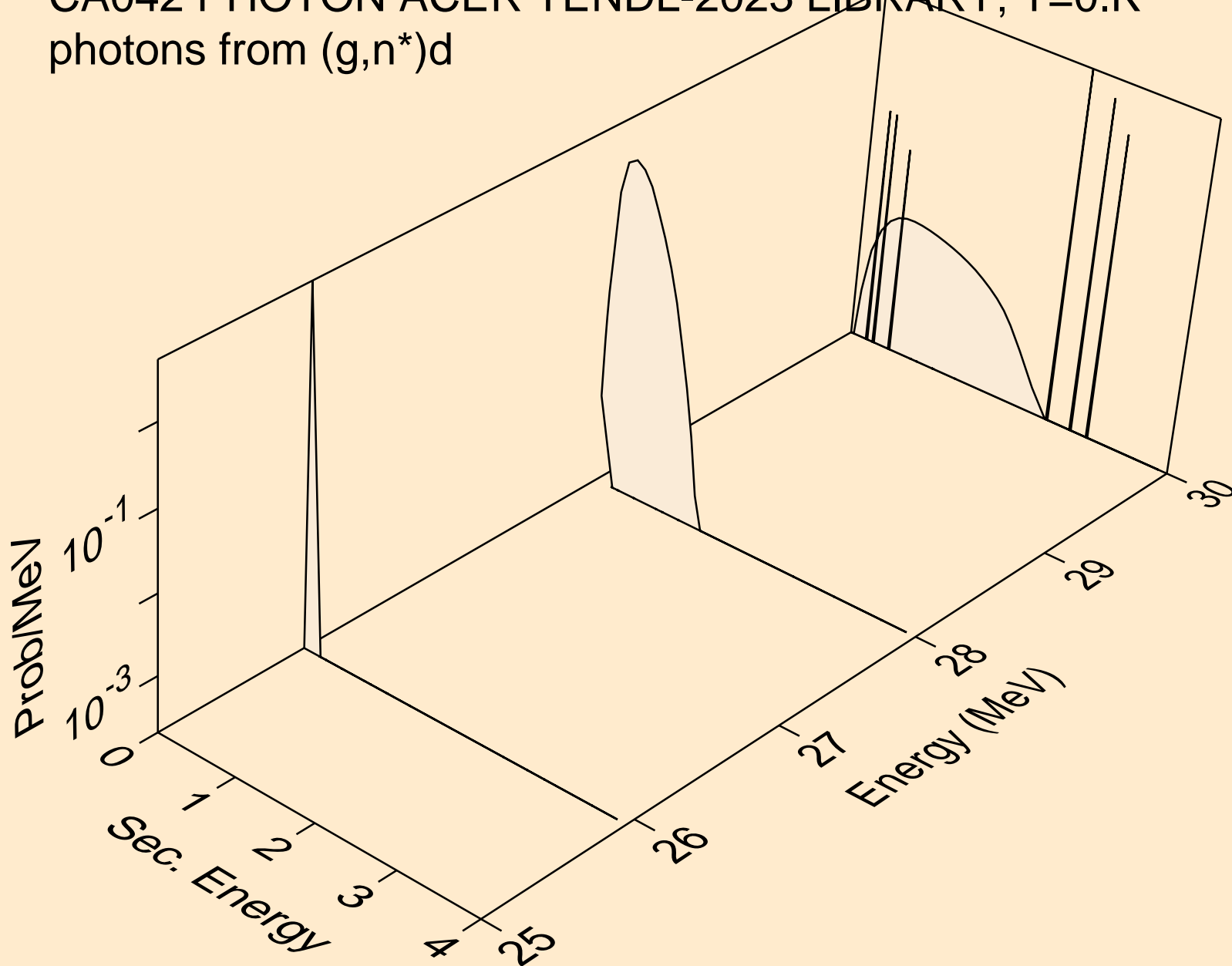

CA042 PHOTON ACER TENDL-2023 LIBRARY; T=0.K
photons from (g,n*c)

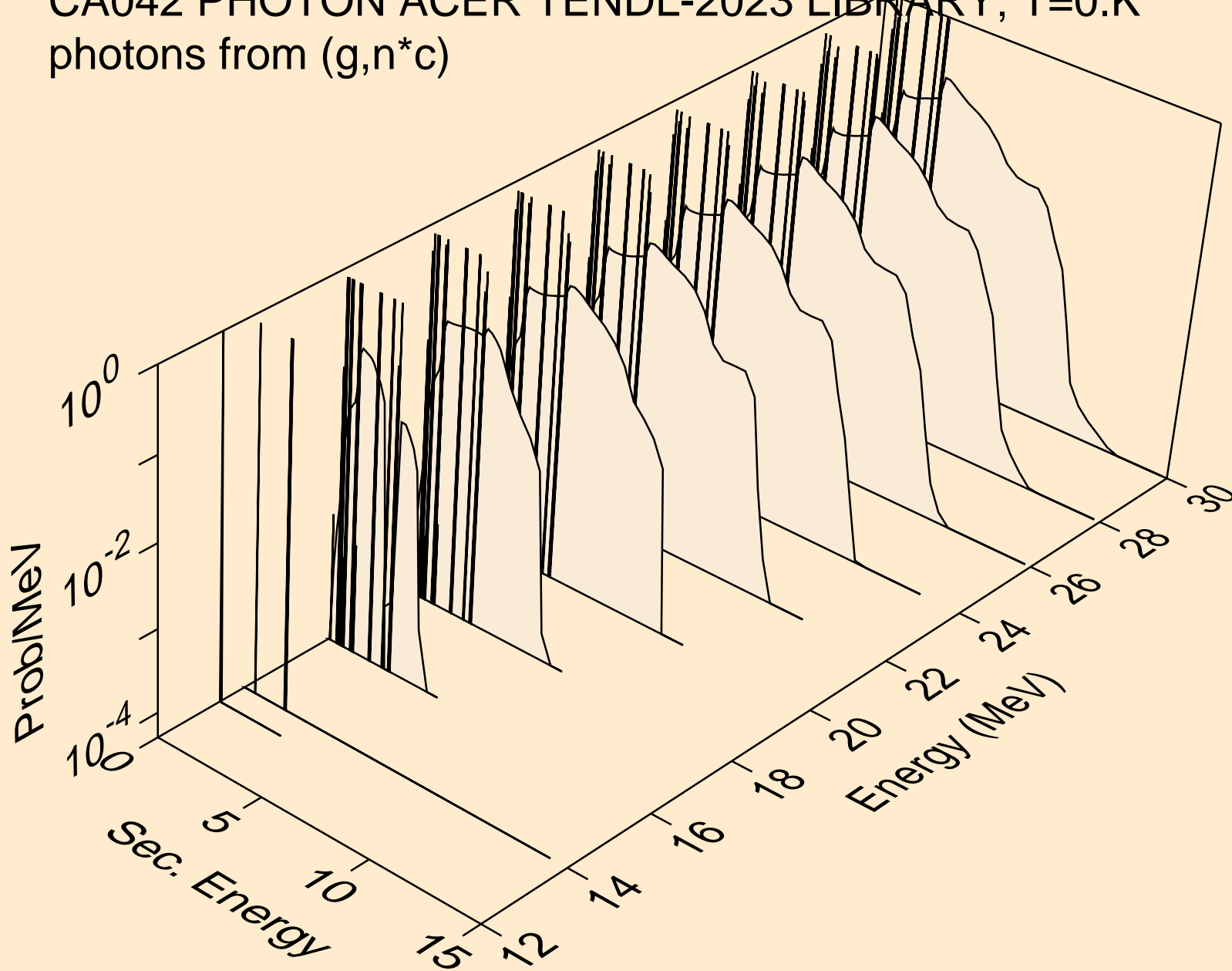

CA042 PHOTON ACER TENDL-2023 LIBRARY; T=0.K
photons from (g,gma)

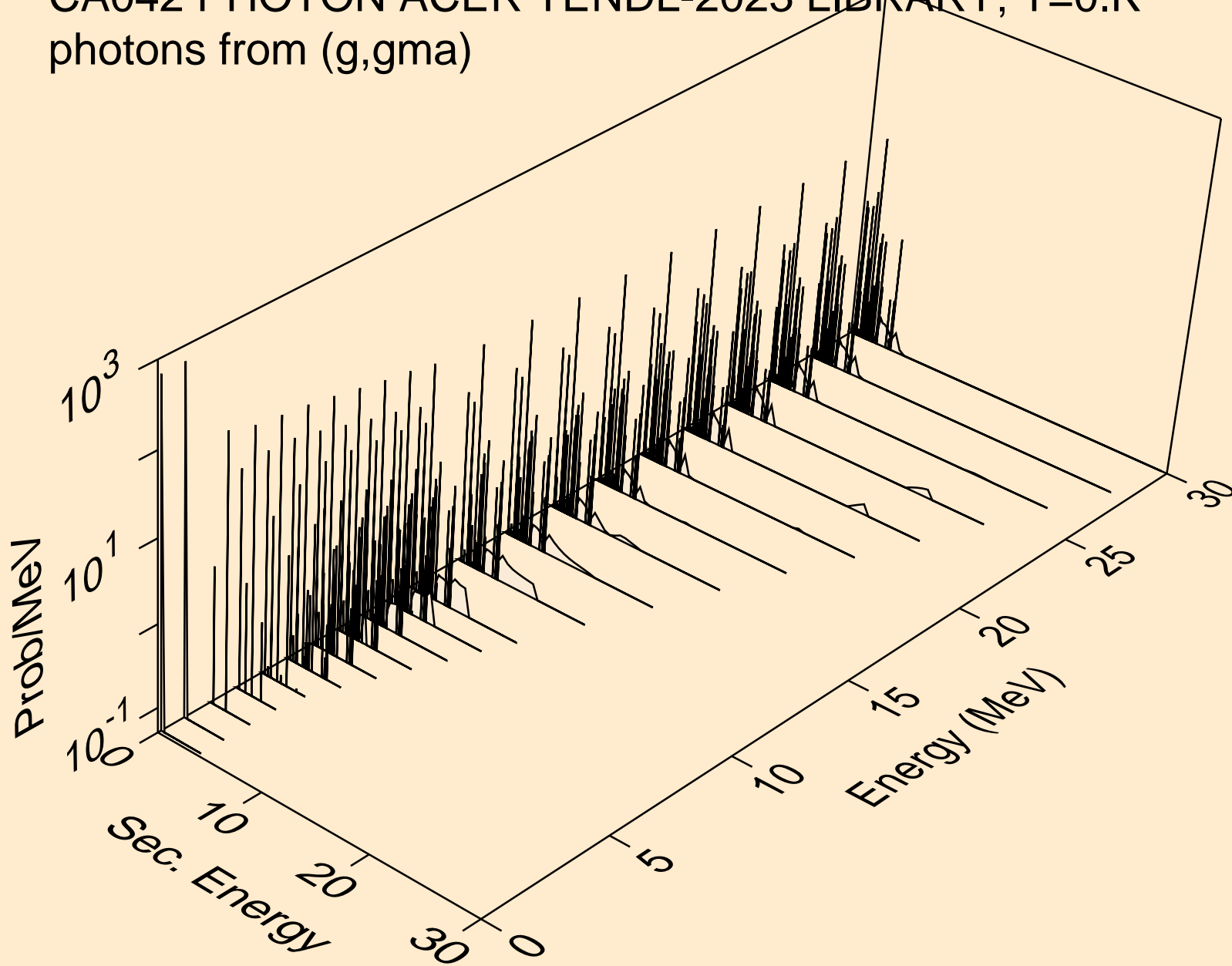

CA042 PHOTON ACER TENDL-2023 LIBRARY; T=0.K
photons from (g,p)

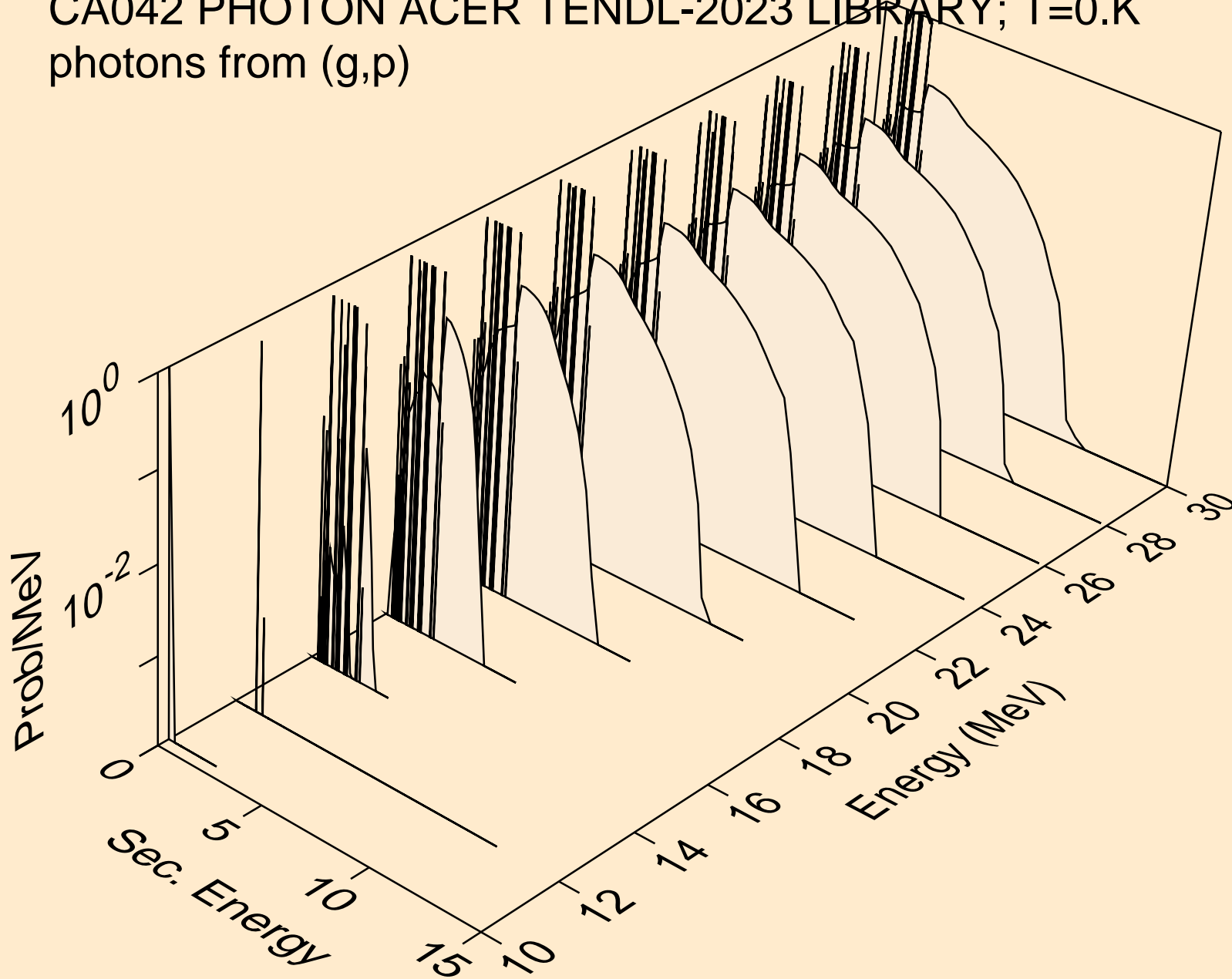

CA042 PHOTON ACER TENDL-2023 LIBRARY; T=0.K
photons from (g,d)

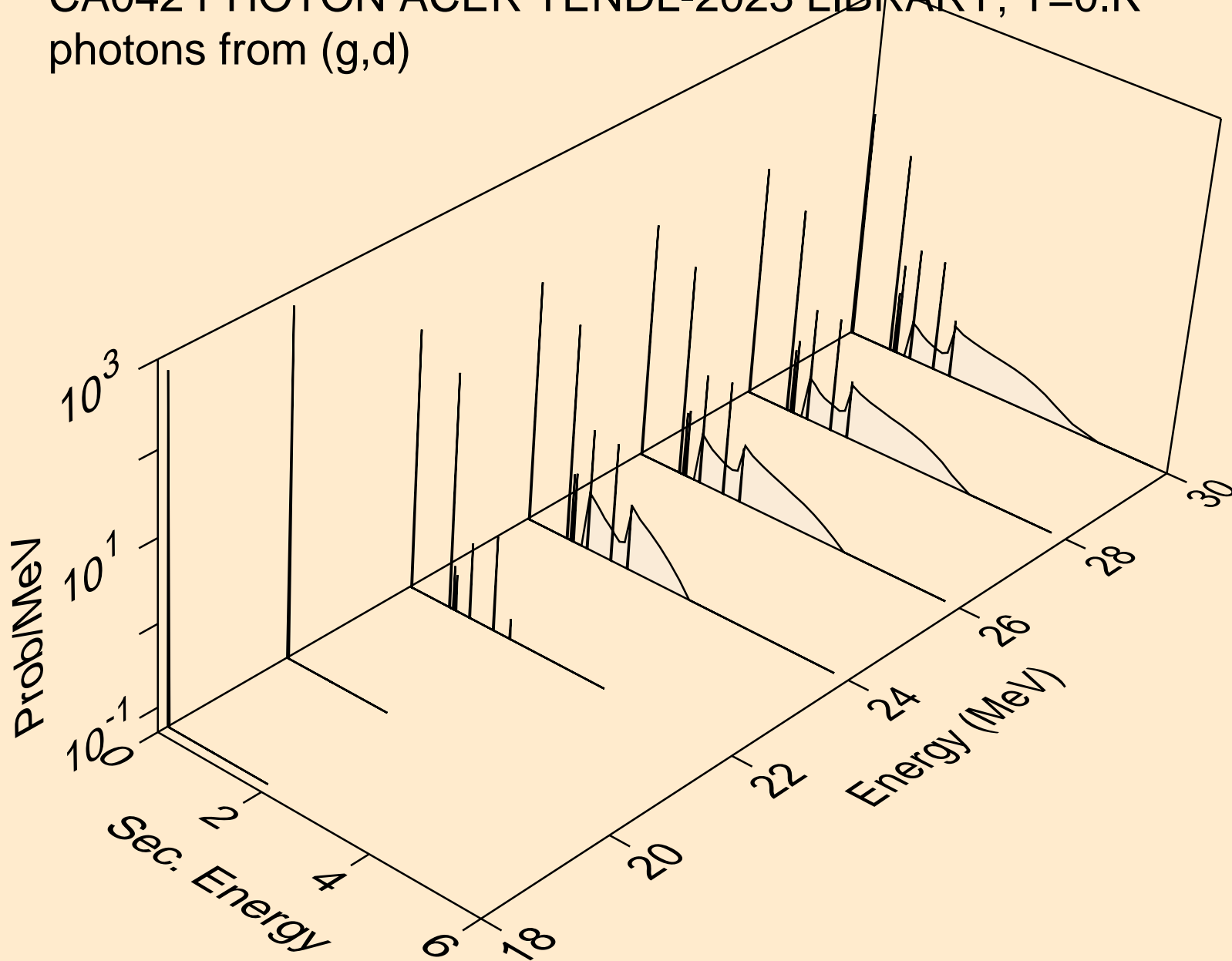

CA042 PHOTON ACER TENDL-2023 LIBRARY; T=0.K
photons from (g,t)

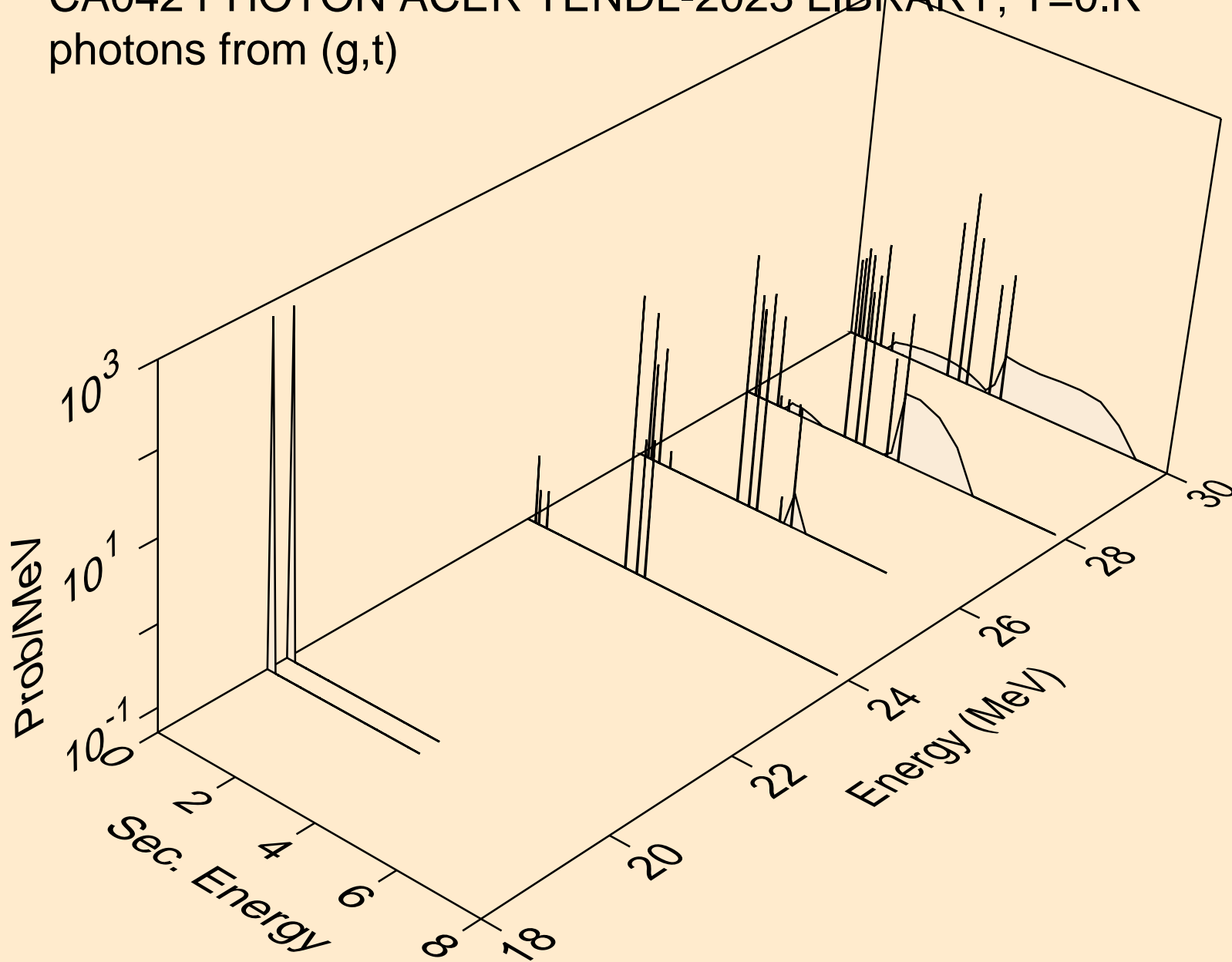

CA042 PHOTON ACER TENDL-2023 LIBRARY; T=0.K
photons from (g,he3)

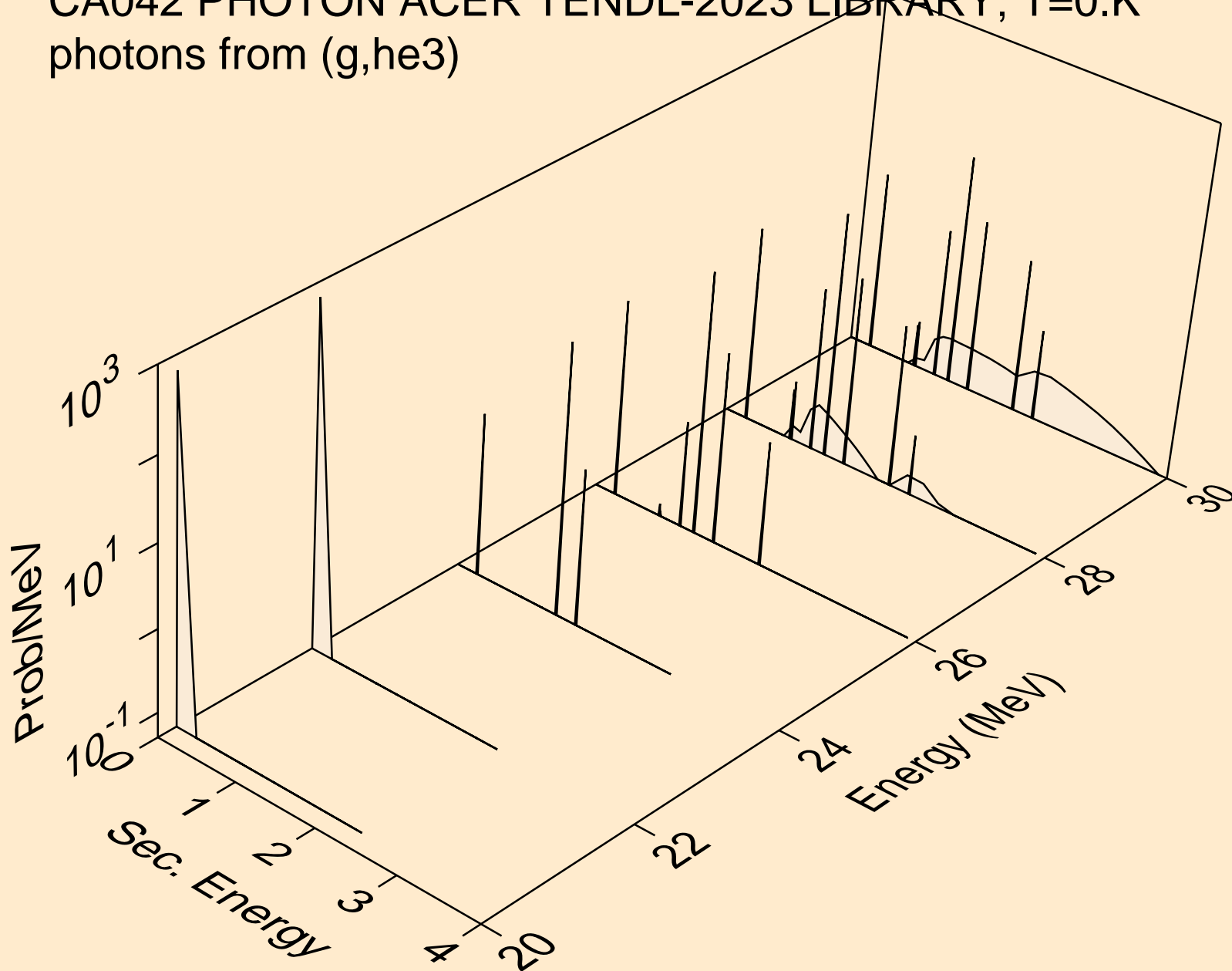

CA042 PHOTON ACER TENDL-2023 LIBRARY; T=0.K
photons from (g,a)

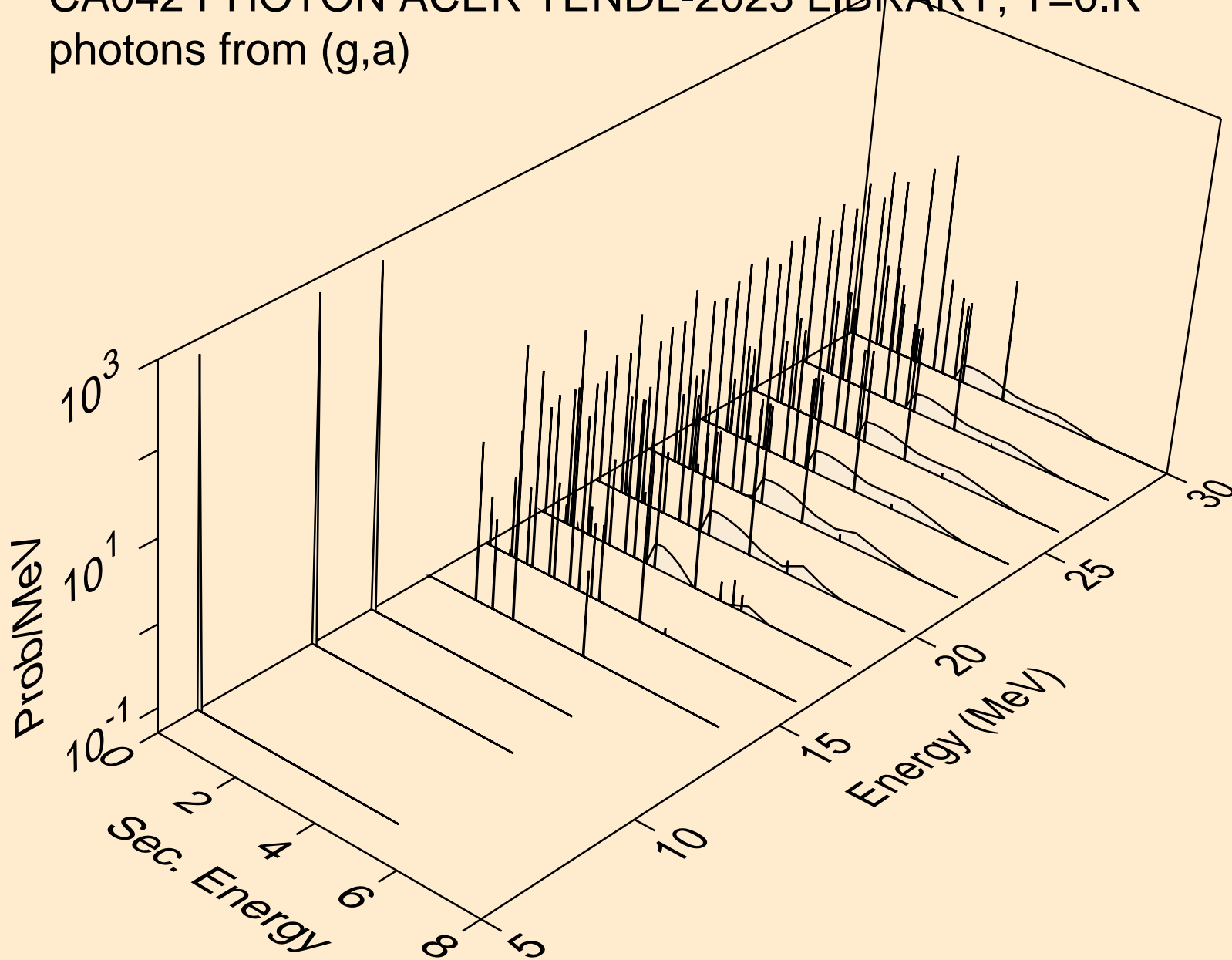

CA042 PHOTON ACER TENDL-2023 LIBRARY; T=0.K
photons from (g,2a)

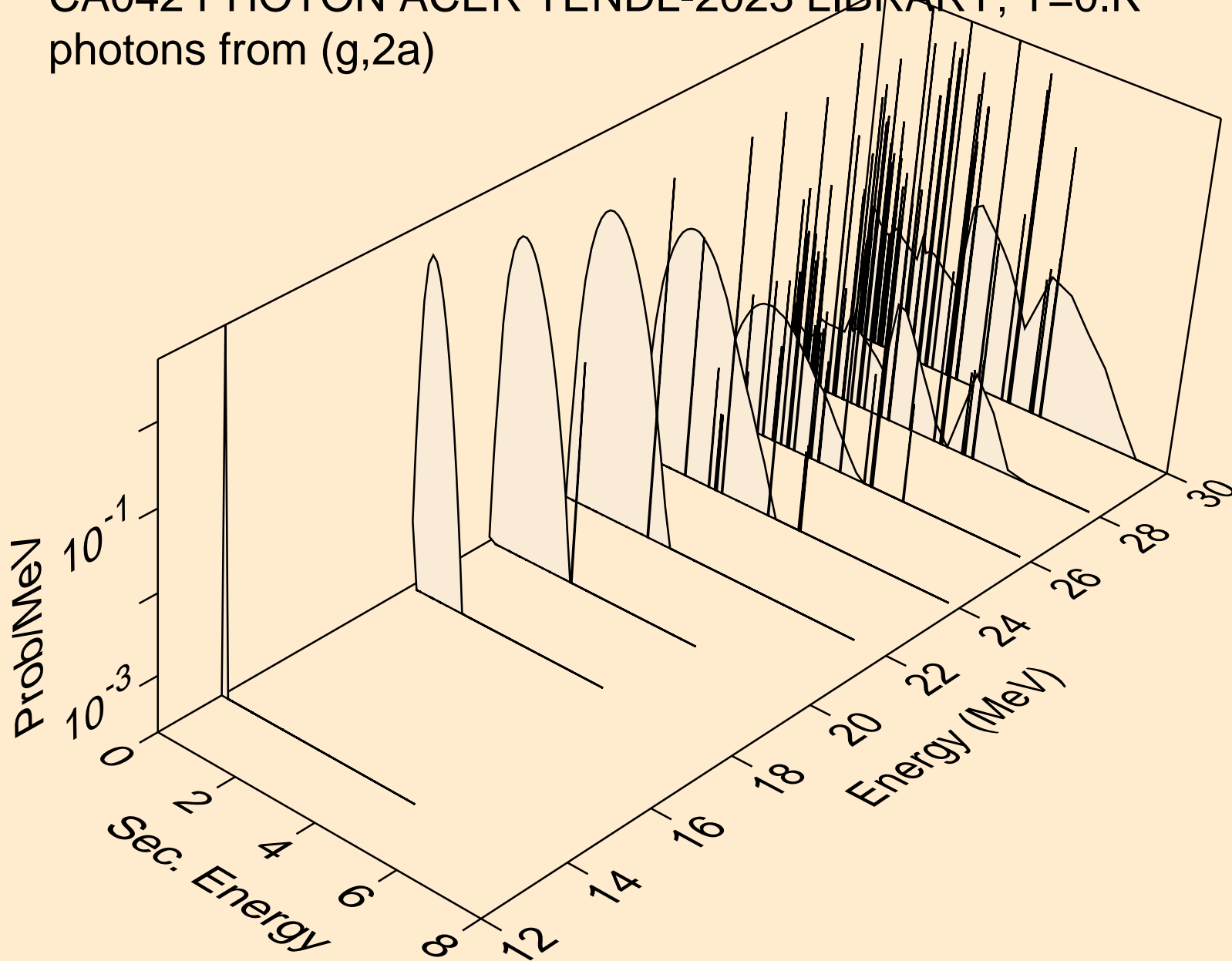

CA042 PHOTON ACER TENDL-2023 LIBRARY; T=0.K
photons from (g,2p)

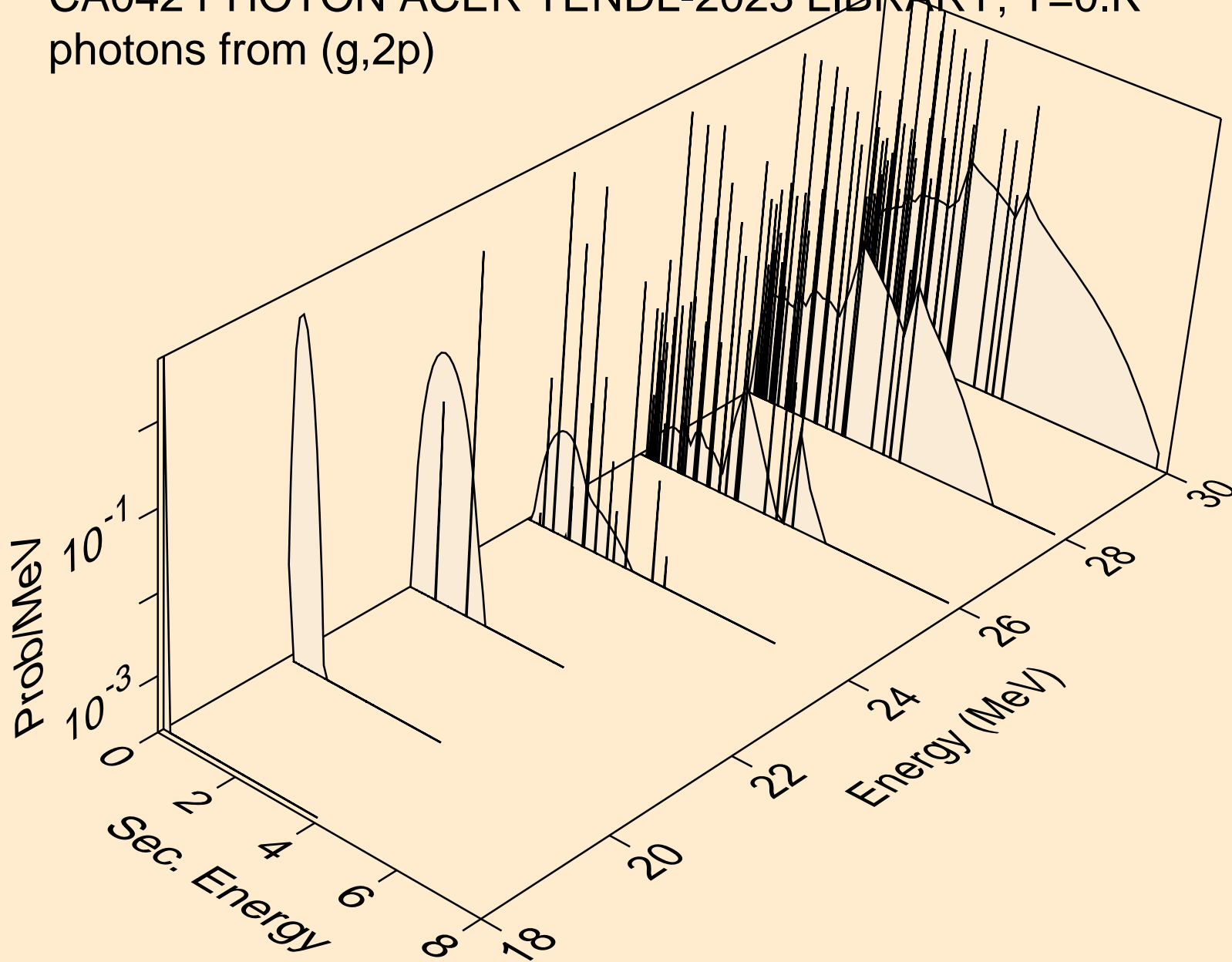

CA042 PHOTON ACER TENDL-2023 LIBRARY; T=0.K
photons from (g,pa)

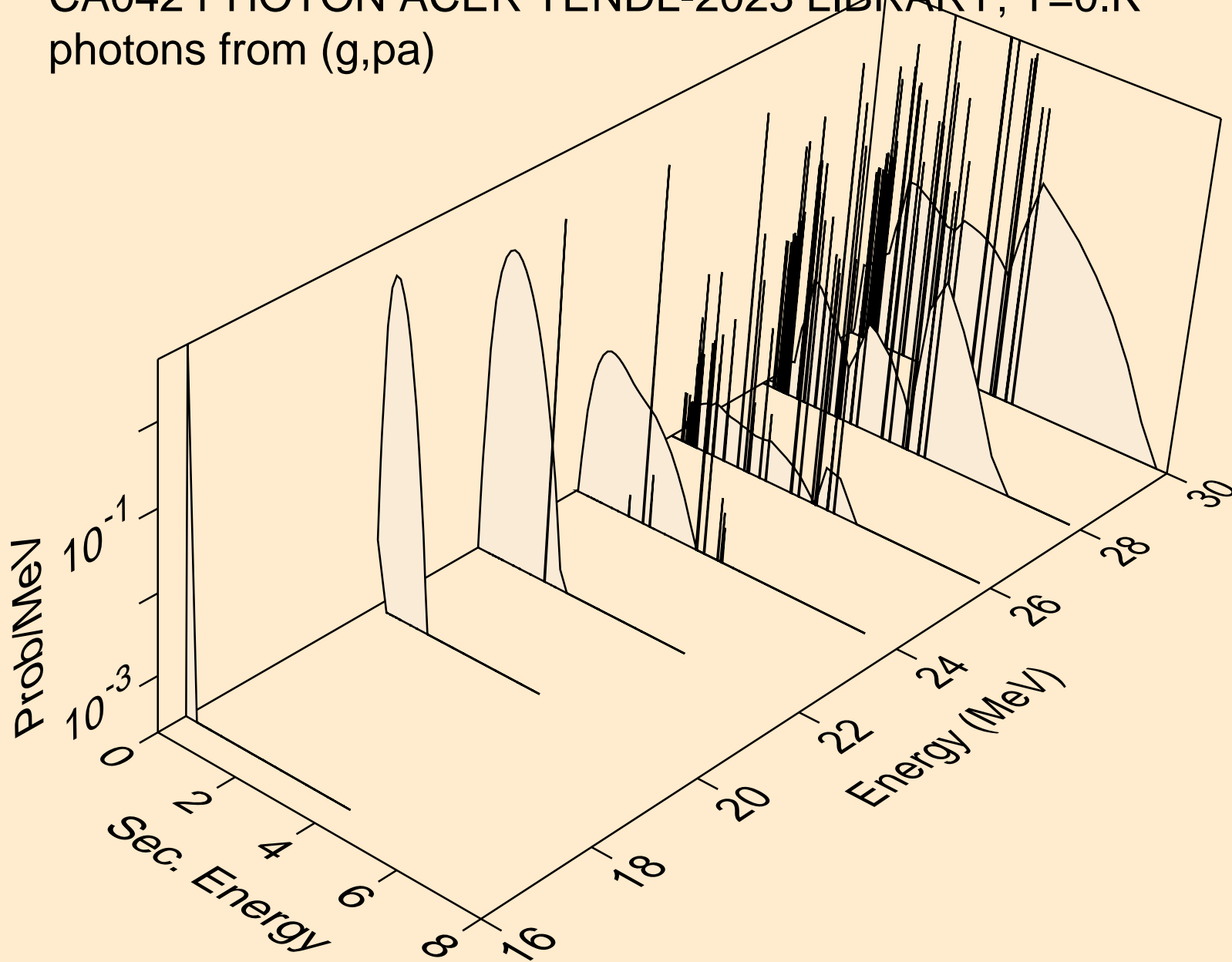

CA042 PHOTON ACER TENDL-2023 LIBRARY; T=0.K
photons from (g,pd)

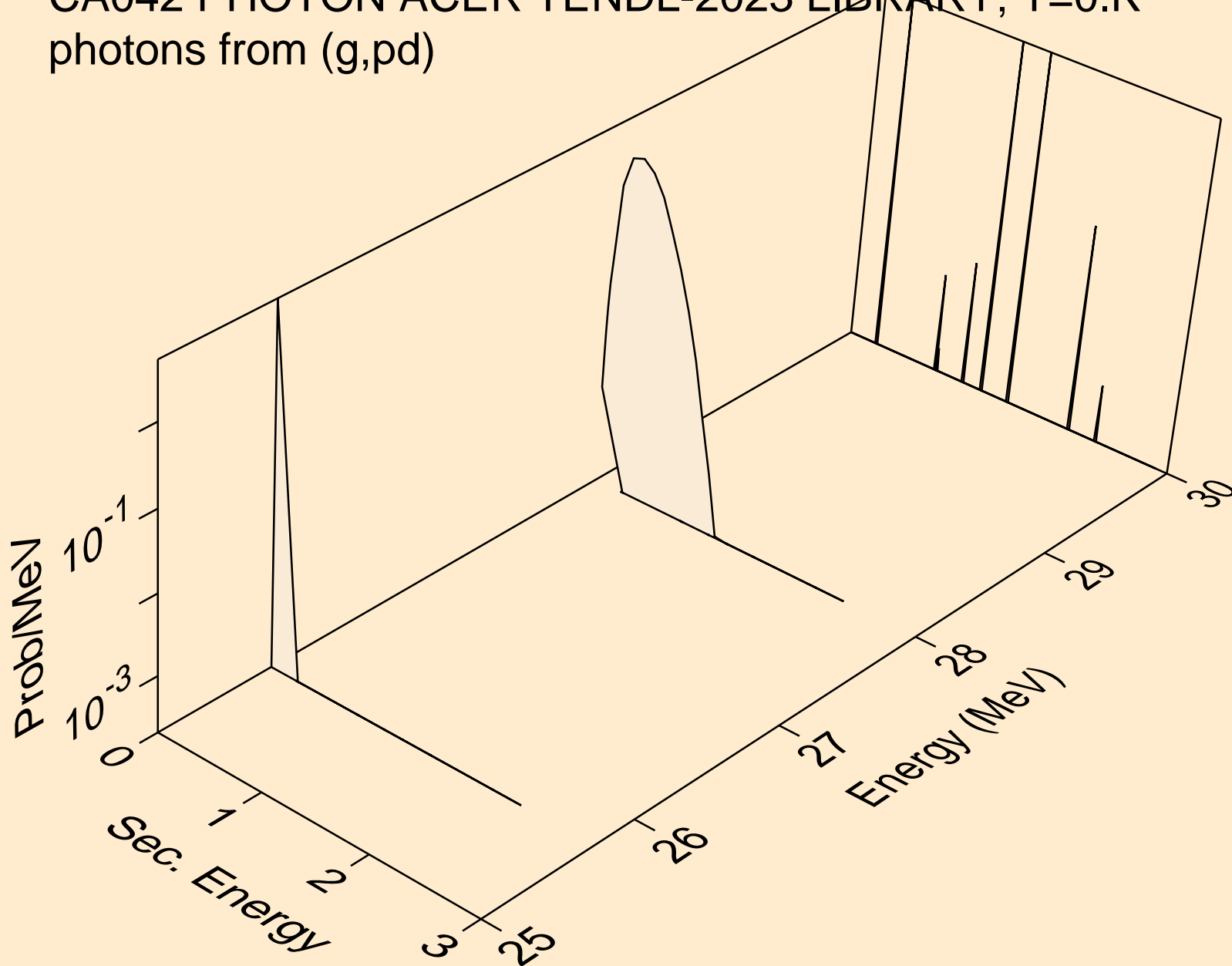

CA042 PHOTON ACER TENDL-2023 LIBRARY; T=0.K
photons from (g,pt)

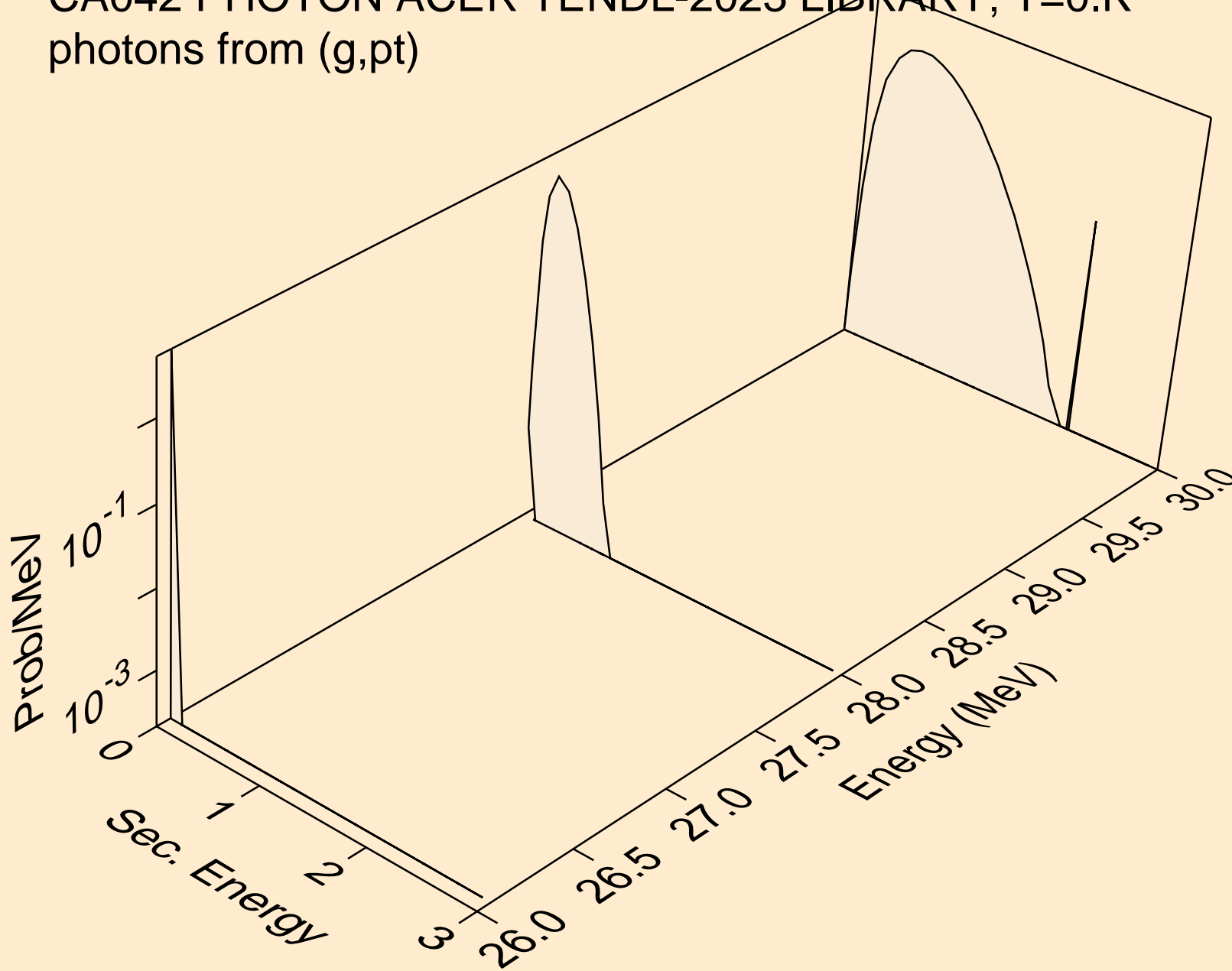

CA042 PHOTON ACER TENDL-2023 LIBRARY; T=0.K
protons from (g,x)

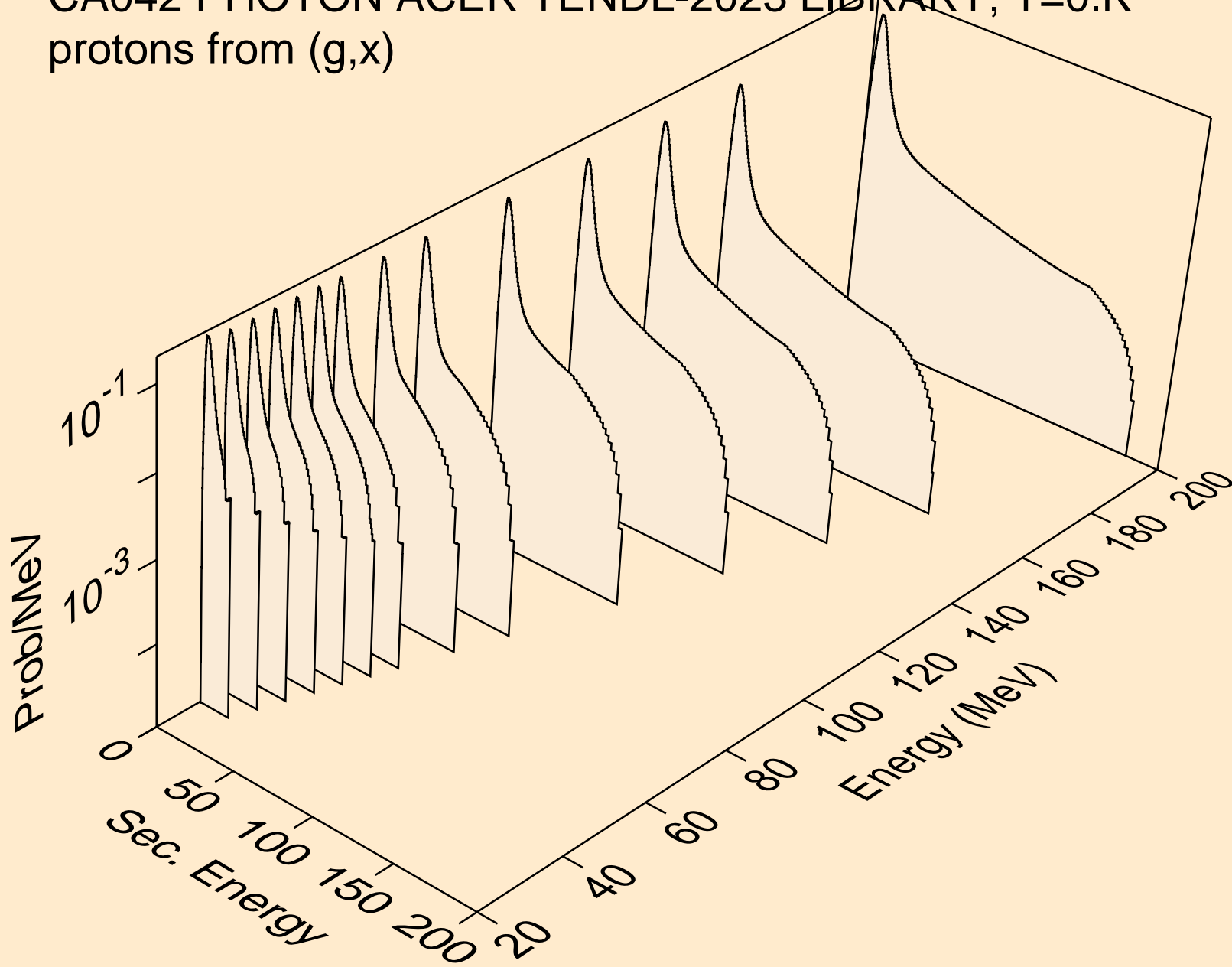

CA042 PHOTON ACER TENDL-2023 LIBRARY; T=0.K
protons from (g,n*)p

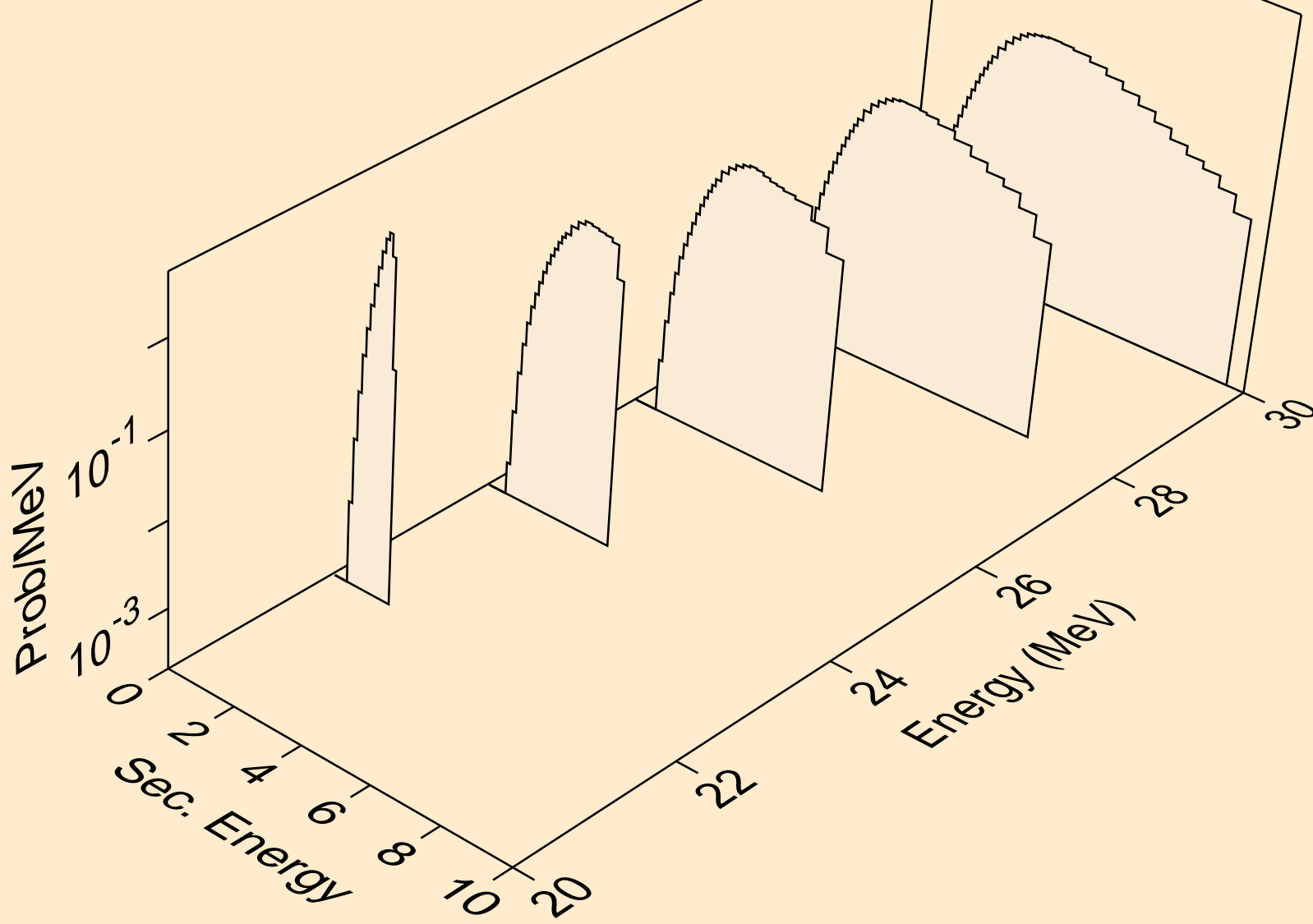

CA042 PHOTON ACER TENDL-2023 LIBRARY; T=0.K
protons from (g,p)

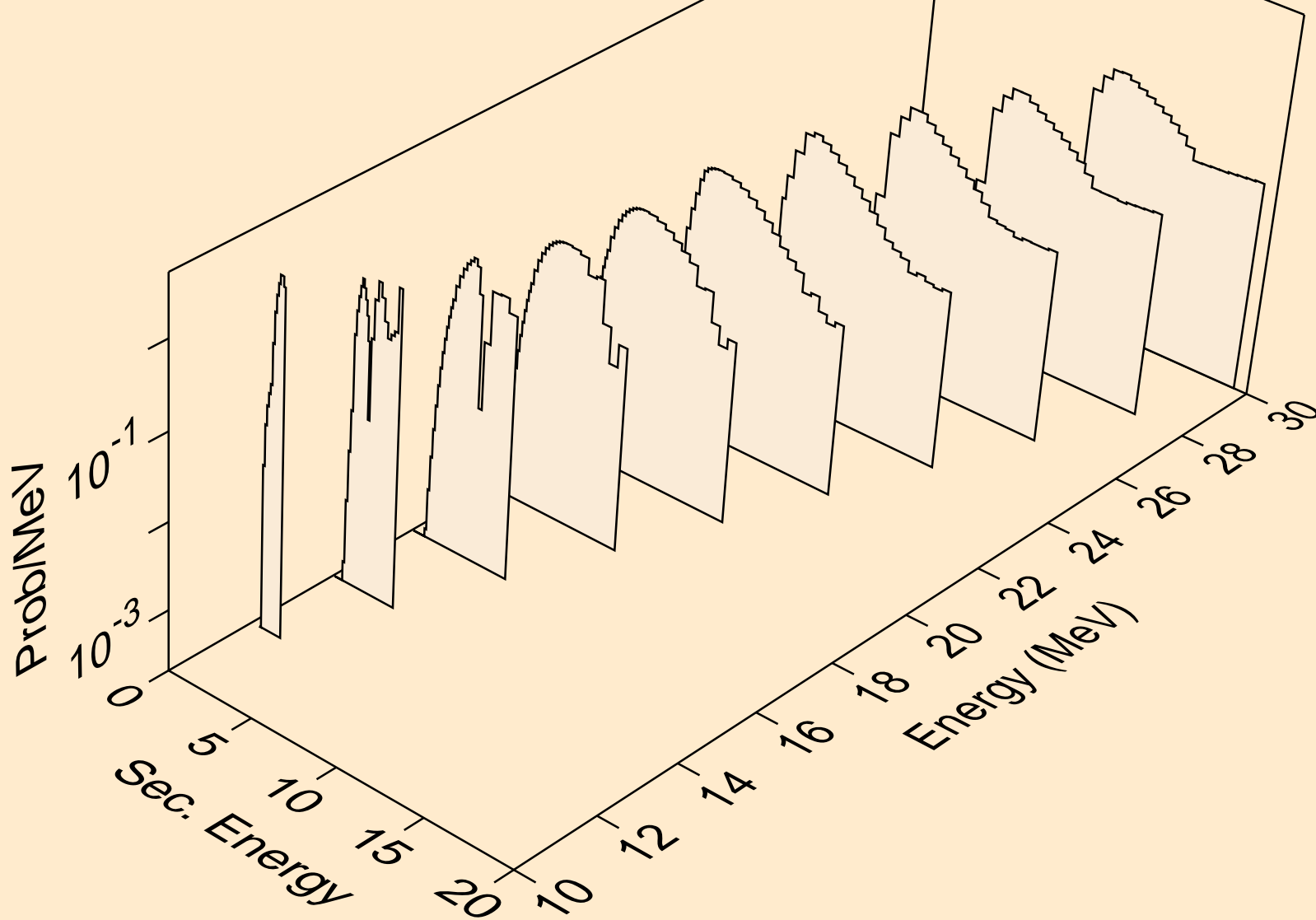

CA042 PHOTON ACER TENDL-2023 LIBRARY; T=0.K
protons from (g,2p)

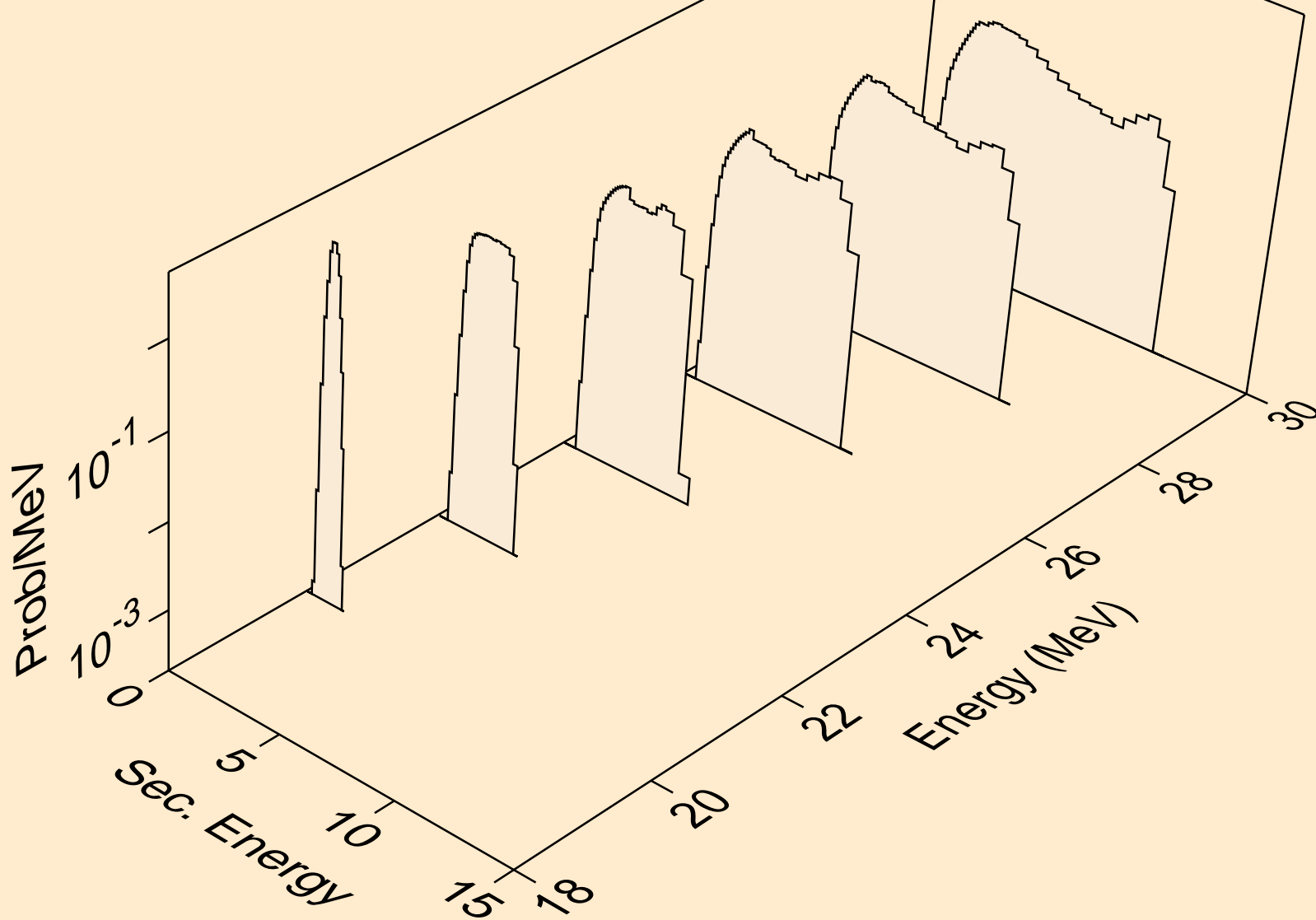

CA042 PHOTON ACER TENDL-2023 LIBRARY; T=0.K
protons from (g,pa)

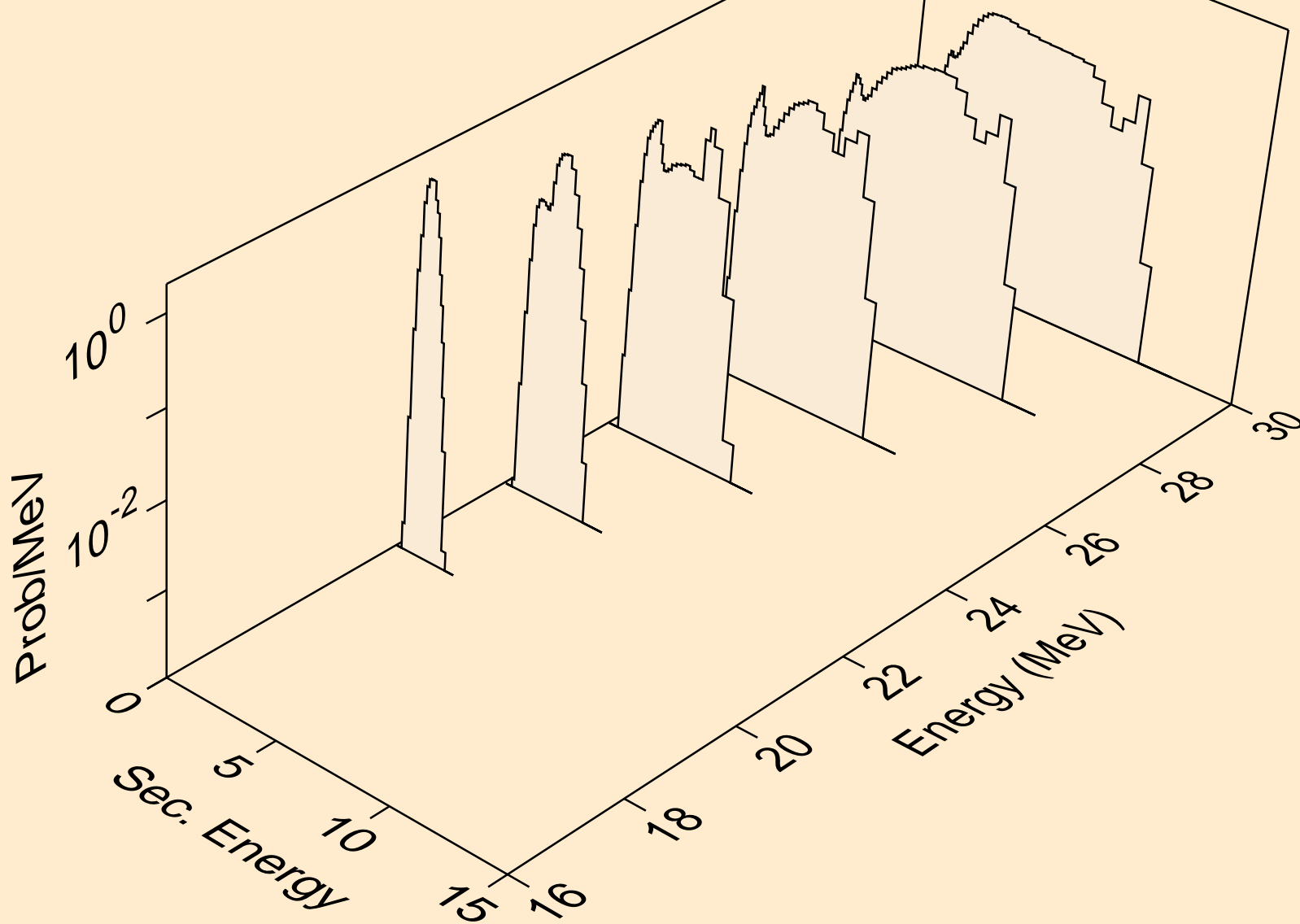

CA042 PHOTON ACER TENDL-2023 LIBRARY; T=0.K
protons from (g,pd)

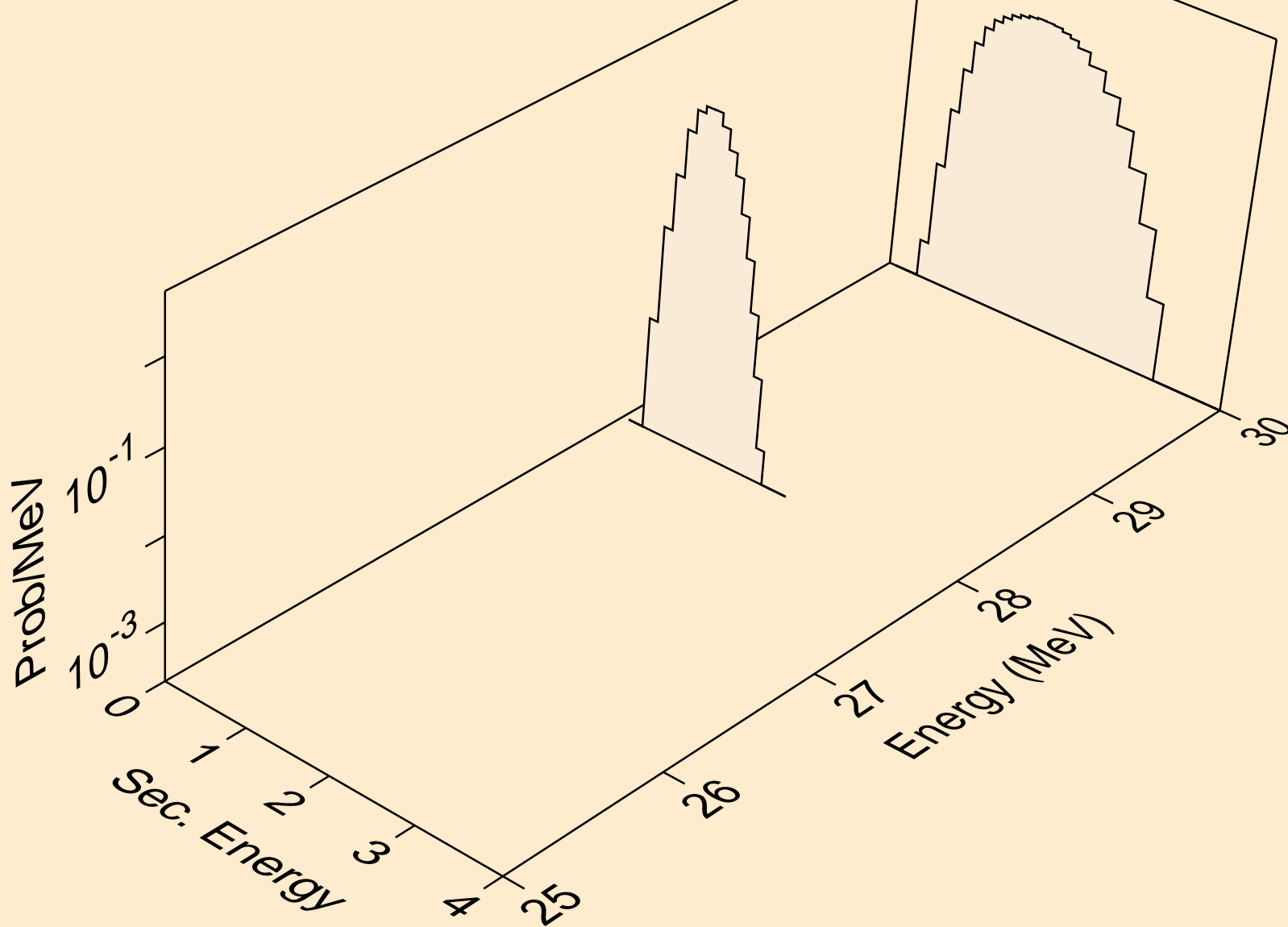

CA042 PHOTON ACER TENDL-2023 LIBRARY; T=0.K
protons from (g,pt)

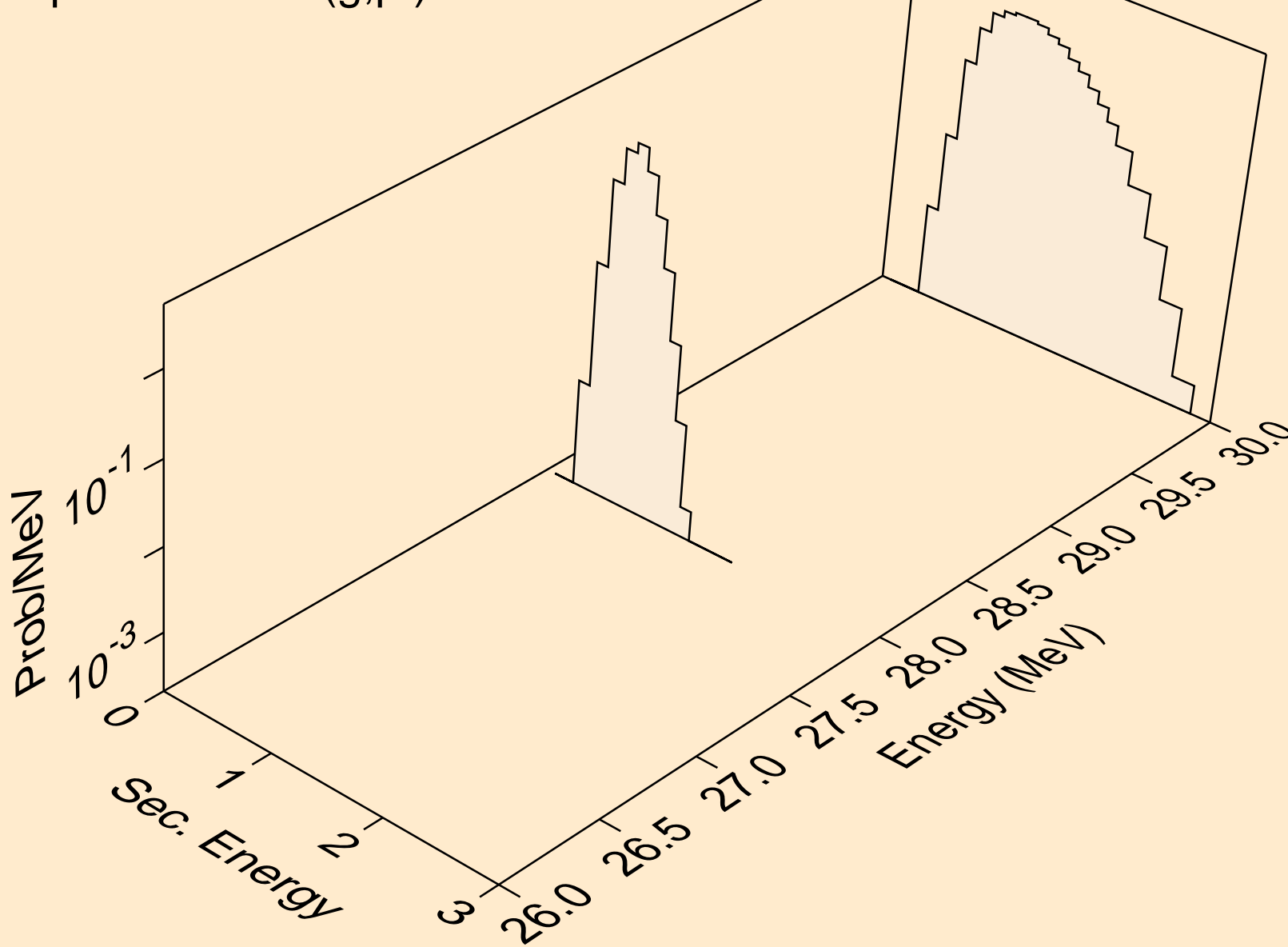

CA042 PHOTON ACER TENDL-2023 LIBRARY; T=0.K
deuterons from (g,x)

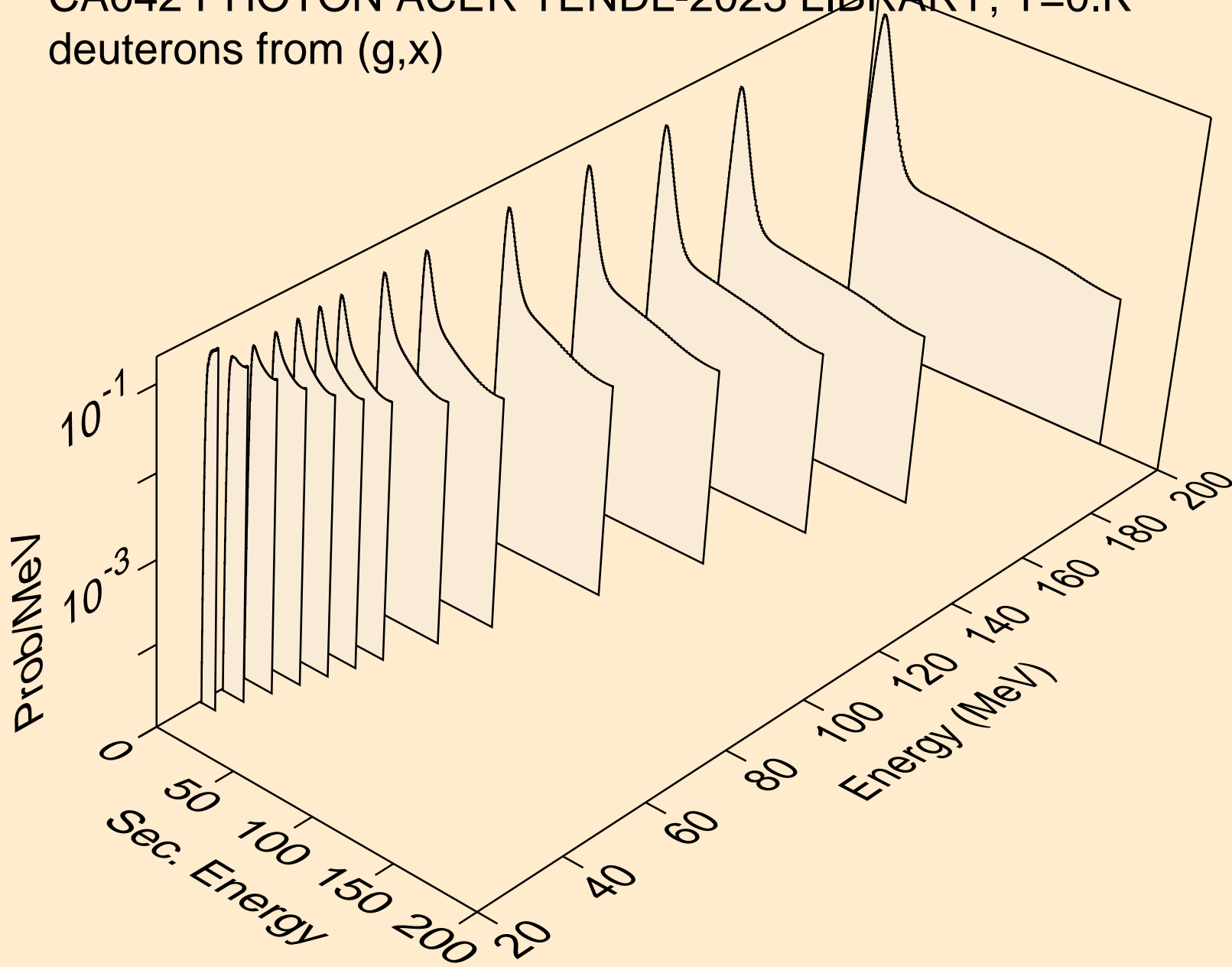

CA042 PHOTON ACER TENDL-2023 LIBRARY; T=0.K
deuterons from (g,n*)d

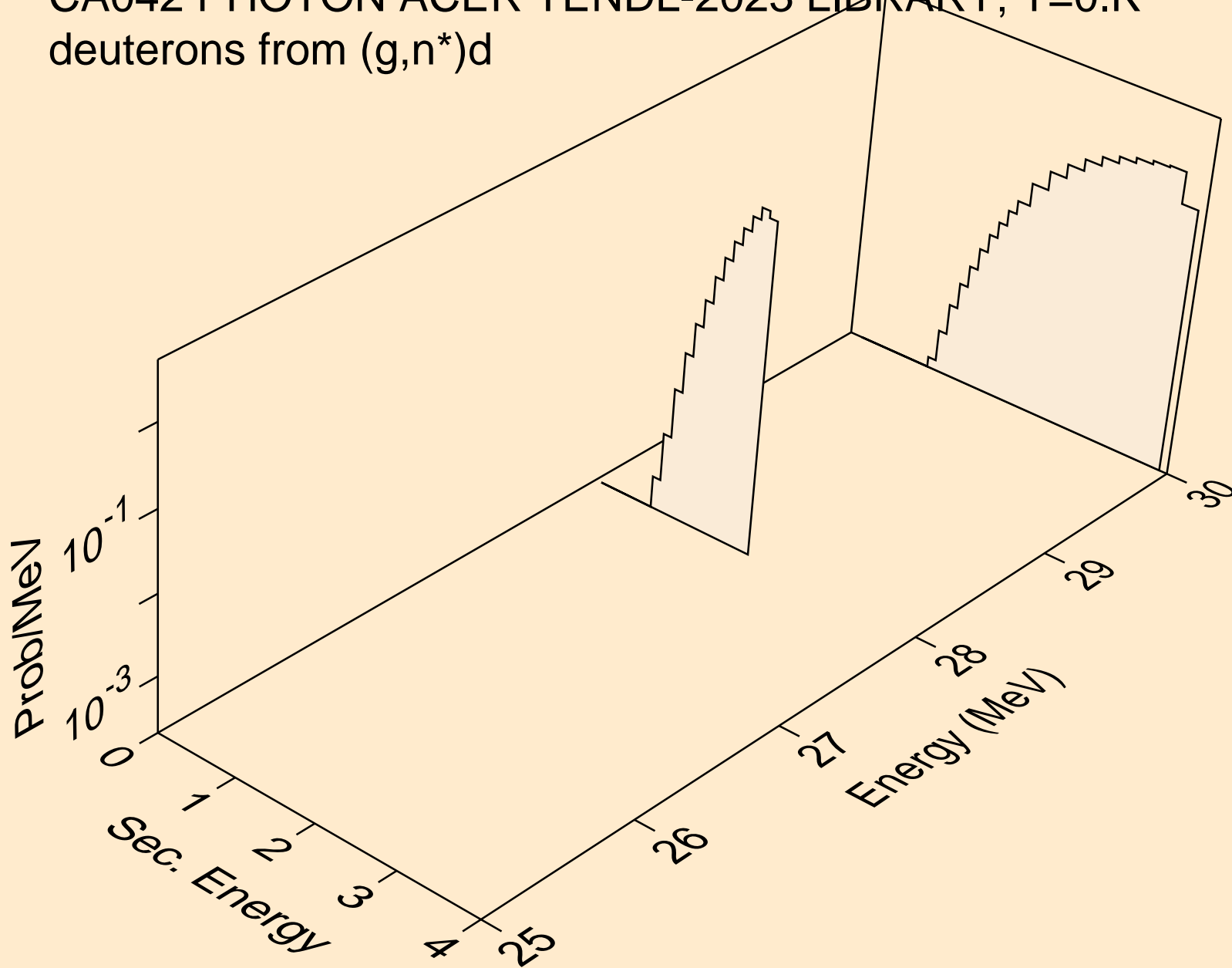

CA042 PHOTON ACER TENDL-2023 LIBRARY; T=0.K
deuterons from (g,d)

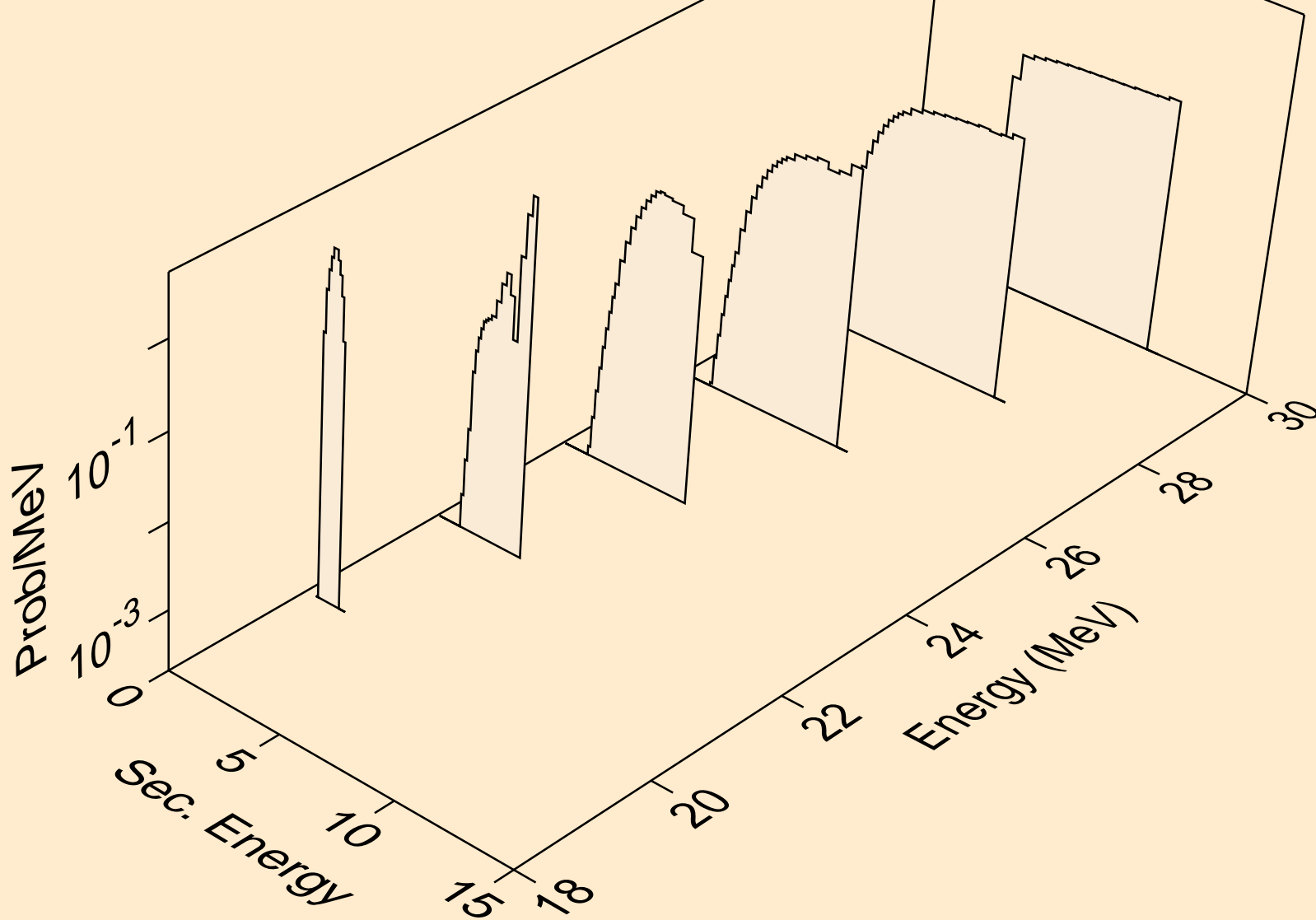

CA042 PHOTON ACER TENDL-2023 LIBRARY; T=0.K
deuterons from (g,pd)

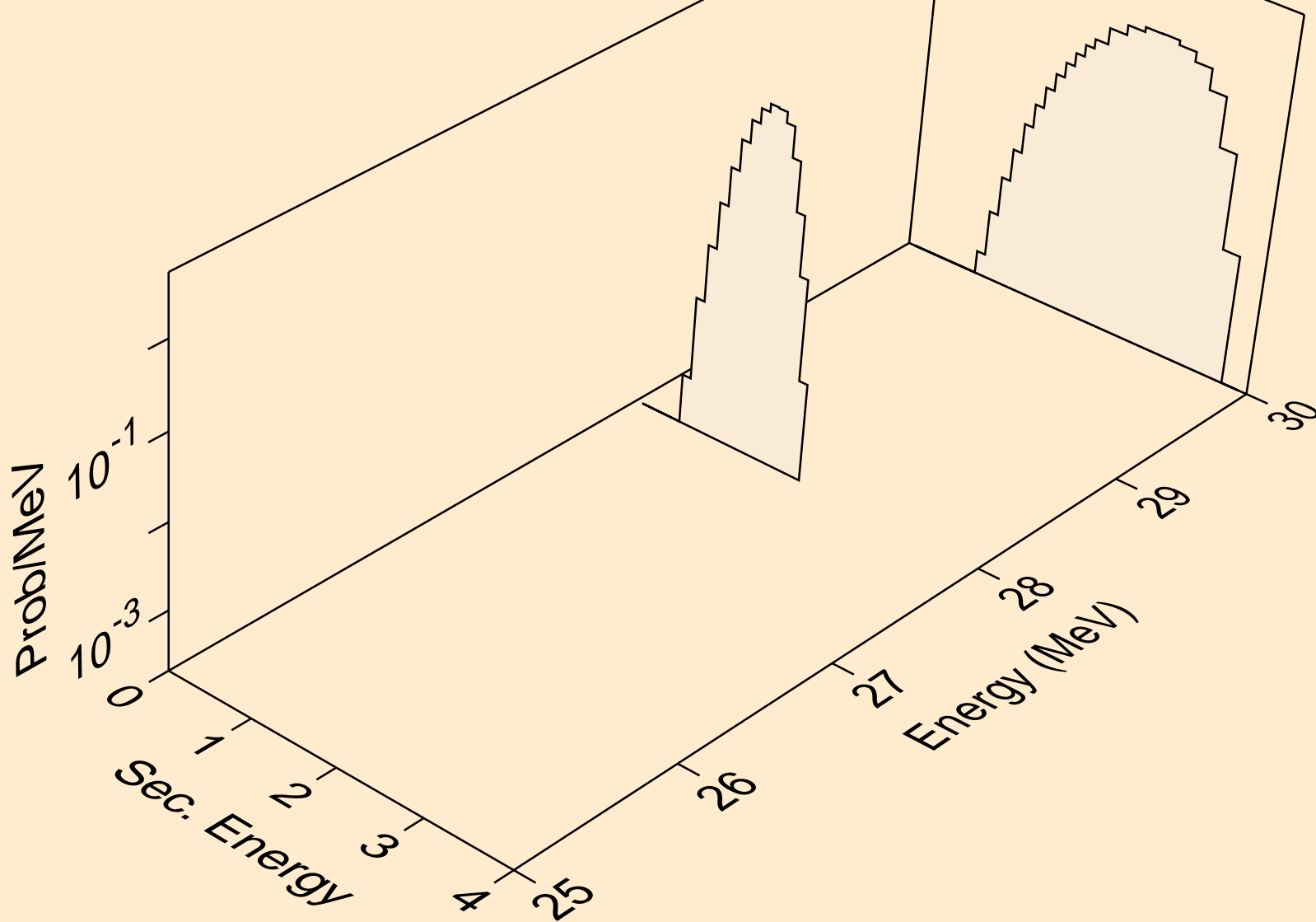

CA042 PHOTON ACER TENDL-2023 LIBRARY; T=0.K
tritons from (g,x)

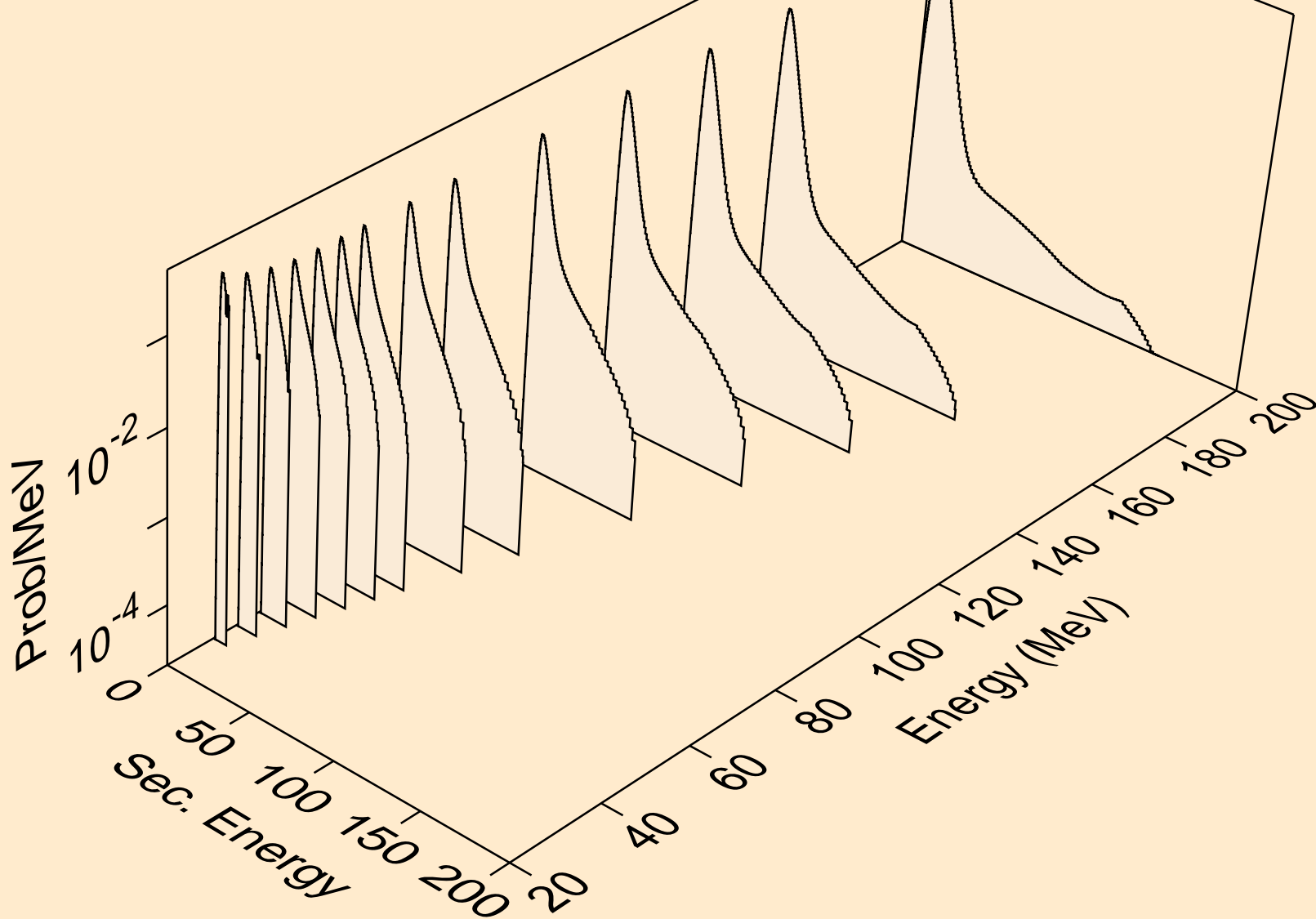

CA042 PHOTON ACER TENDL-2023 LIBRARY; T=0.K
tritons from (g,t)

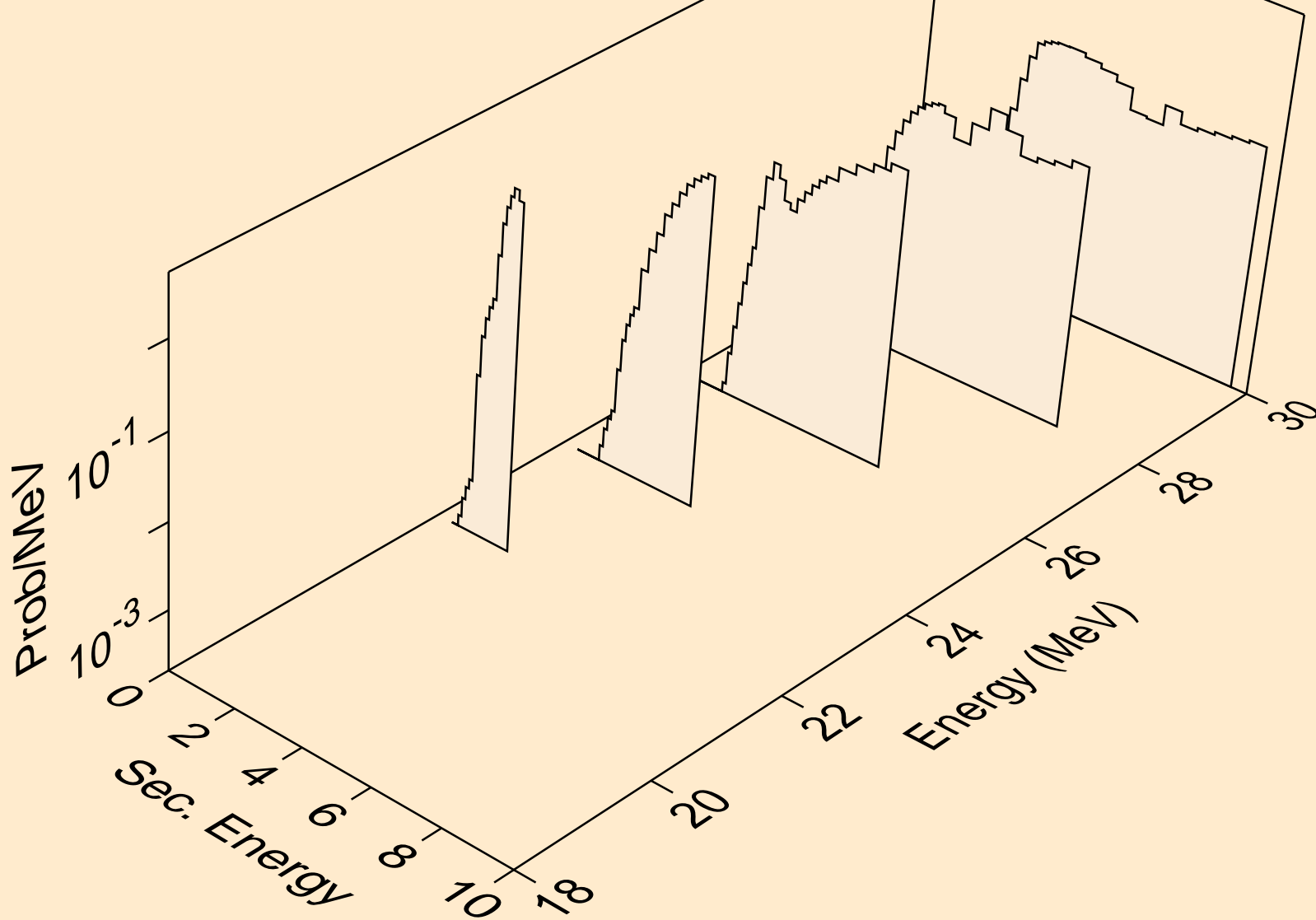

CA042 PHOTON ACER TENDL-2023 LIBRARY; T=0.K
tritons from (g,pt)

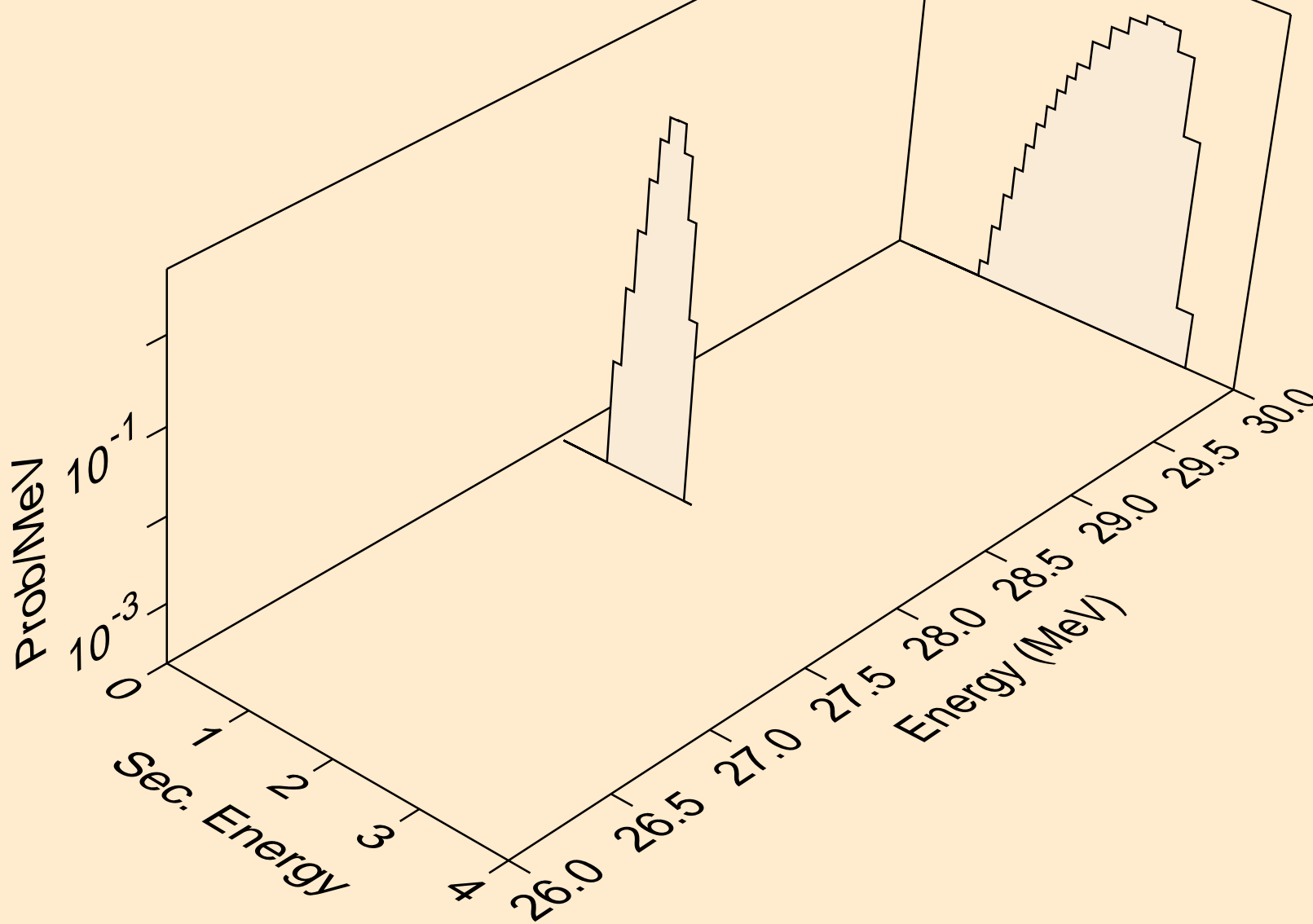

CA042 PHOTON ACER TENDL-2023 LIBRARY; T=0.K
he3s from (g,x)

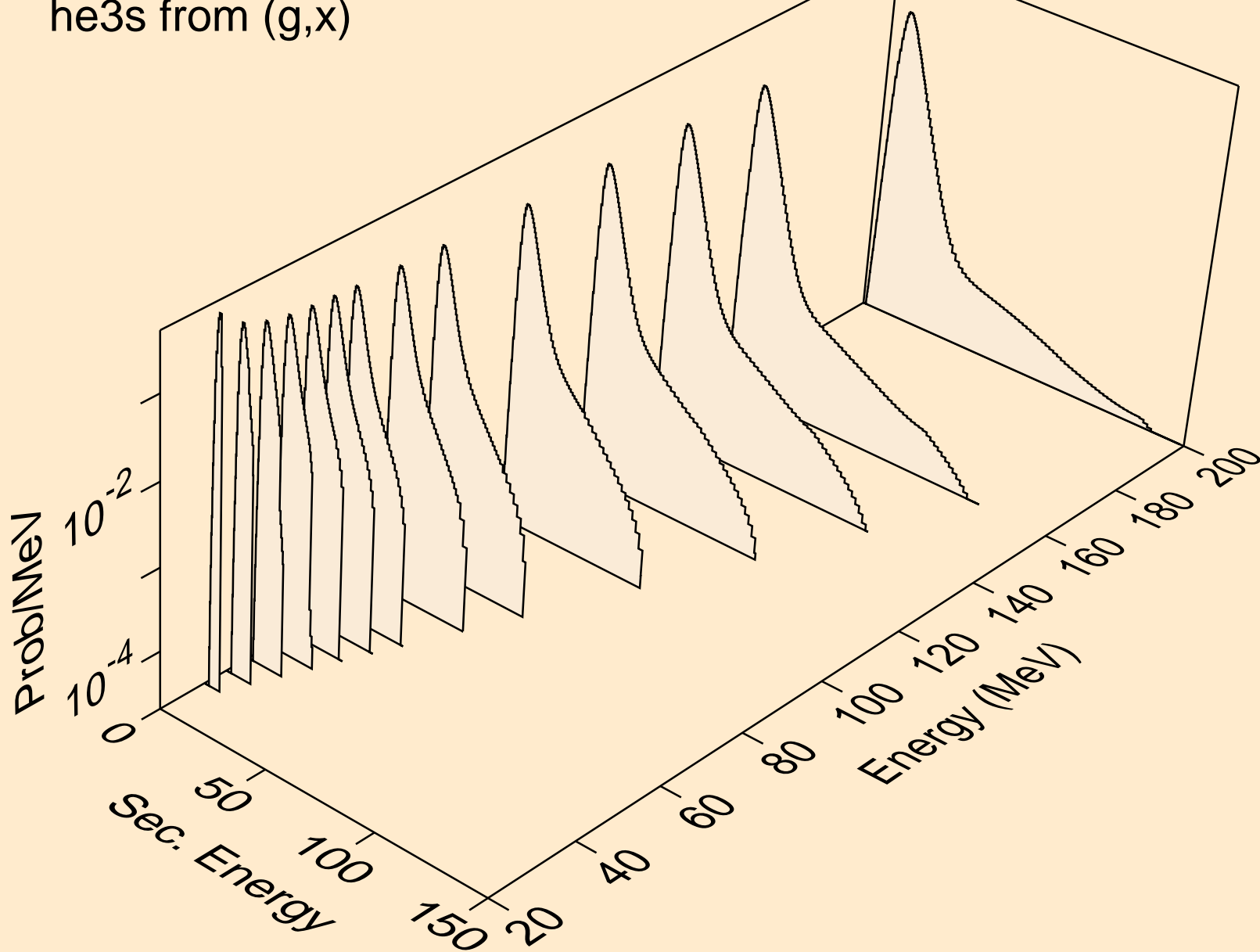

CA042 PHOTON ACER TENDL-2023 LIBRARY; T=0.K
he3s from (g,he3)

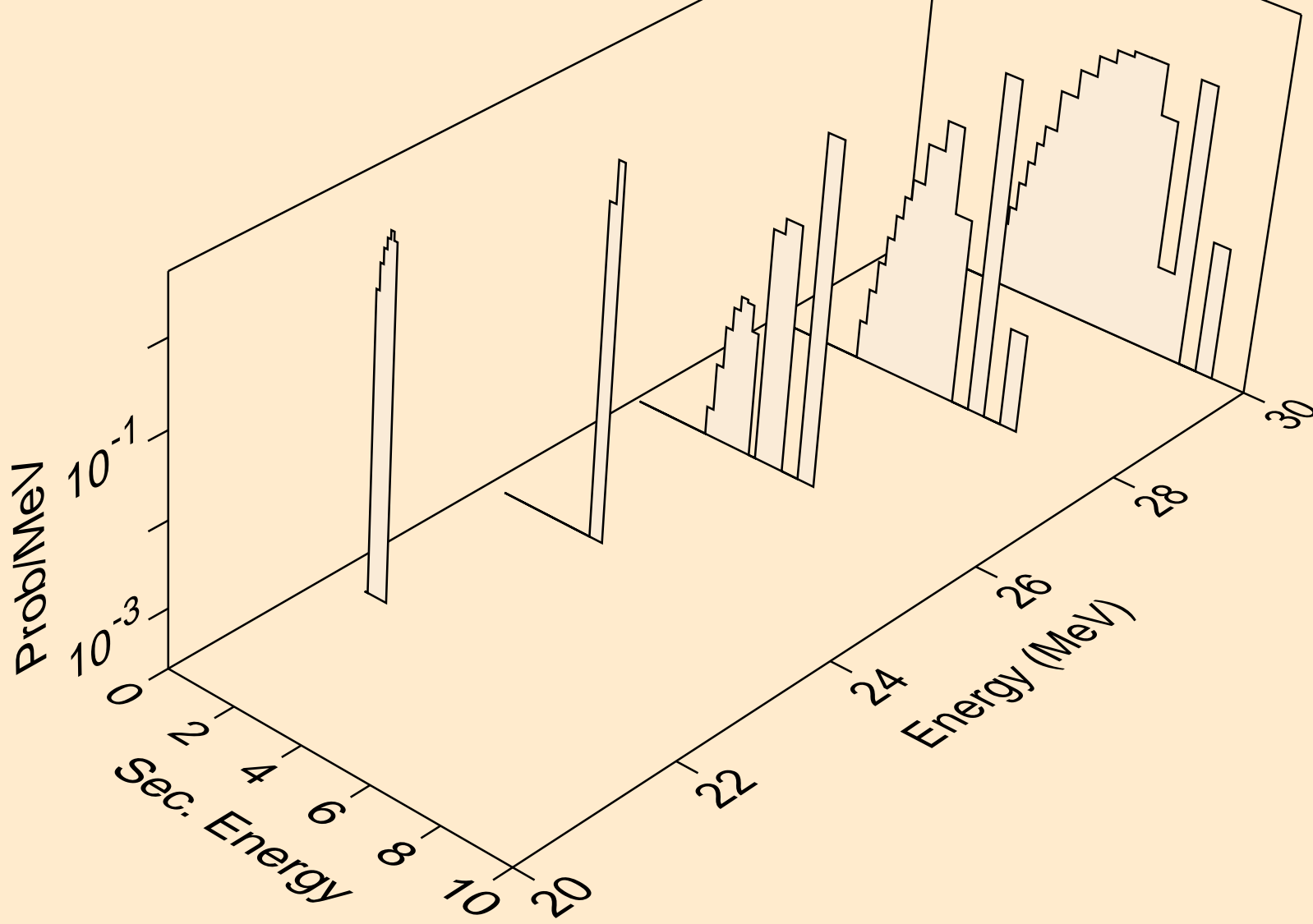

CA042 PHOTON ACER TENDL-2023 LIBRARY; T=0.K
alphas from (g,x)

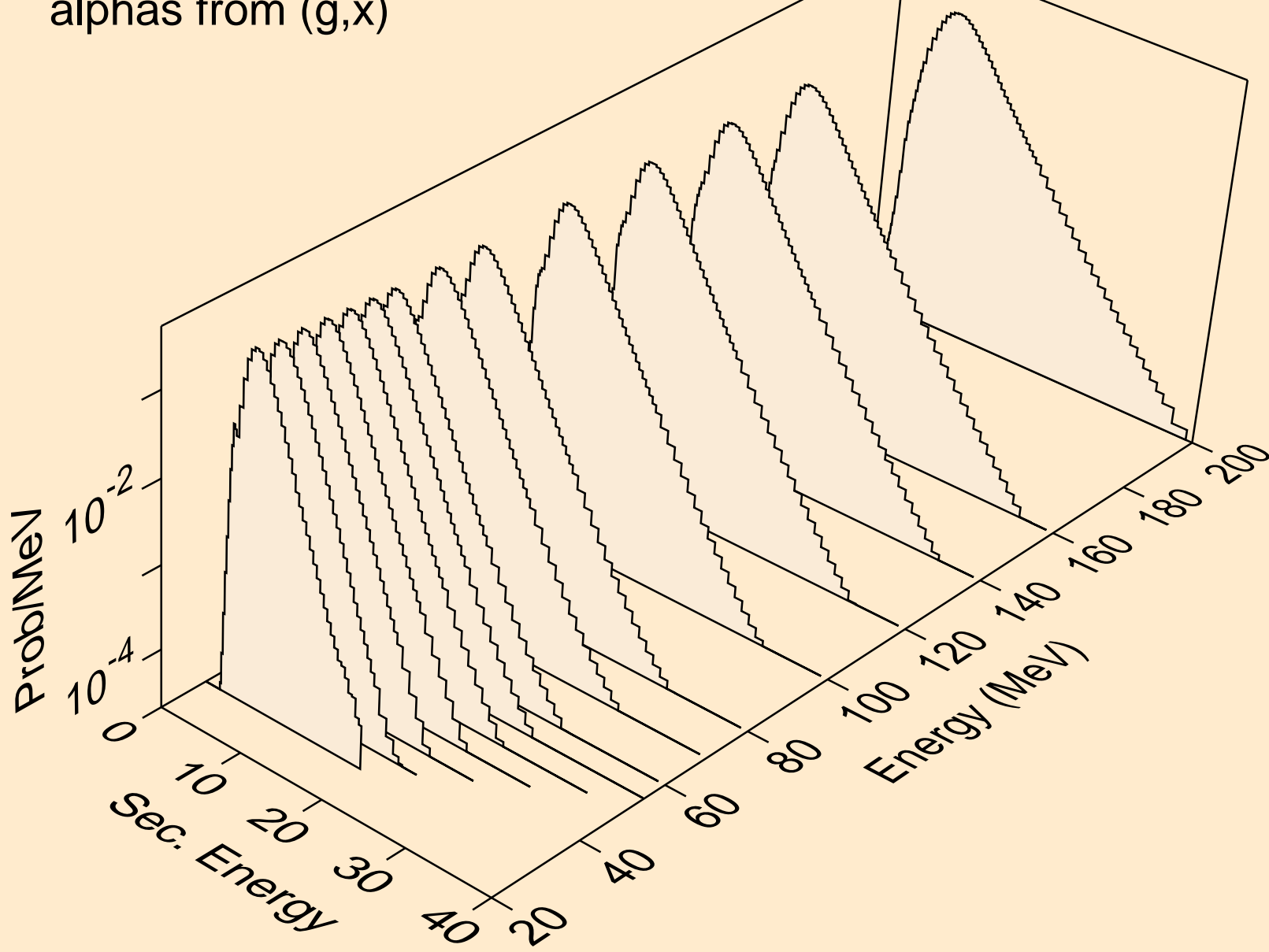

CA042 PHOTON ACER TENDL-2023 LIBRARY; T=0.K
alphas from (g,n*)a

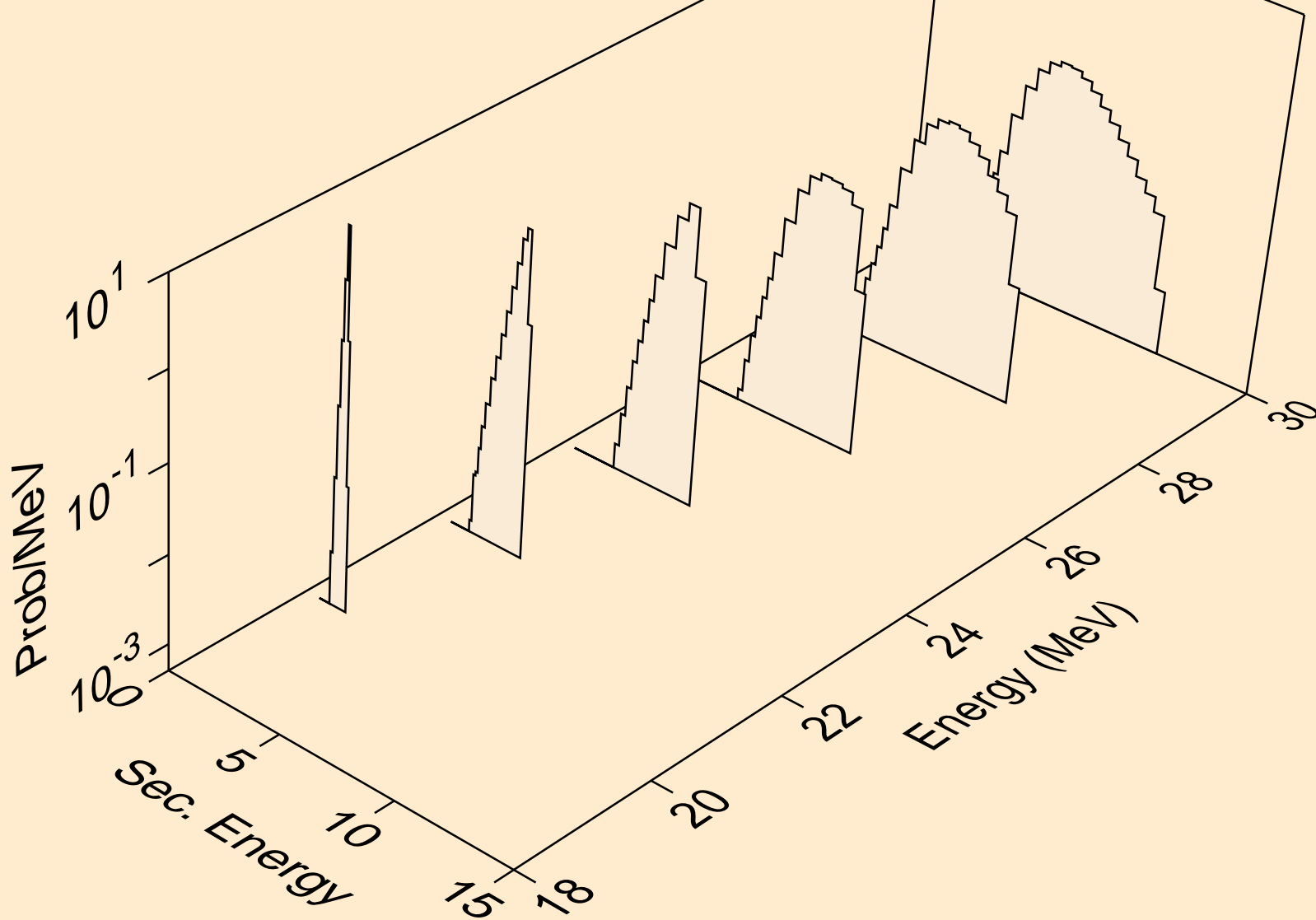

CA042 PHOTON ACER TENDL-2023 LIBRARY; T=0.K
alphas from (g,2n)a

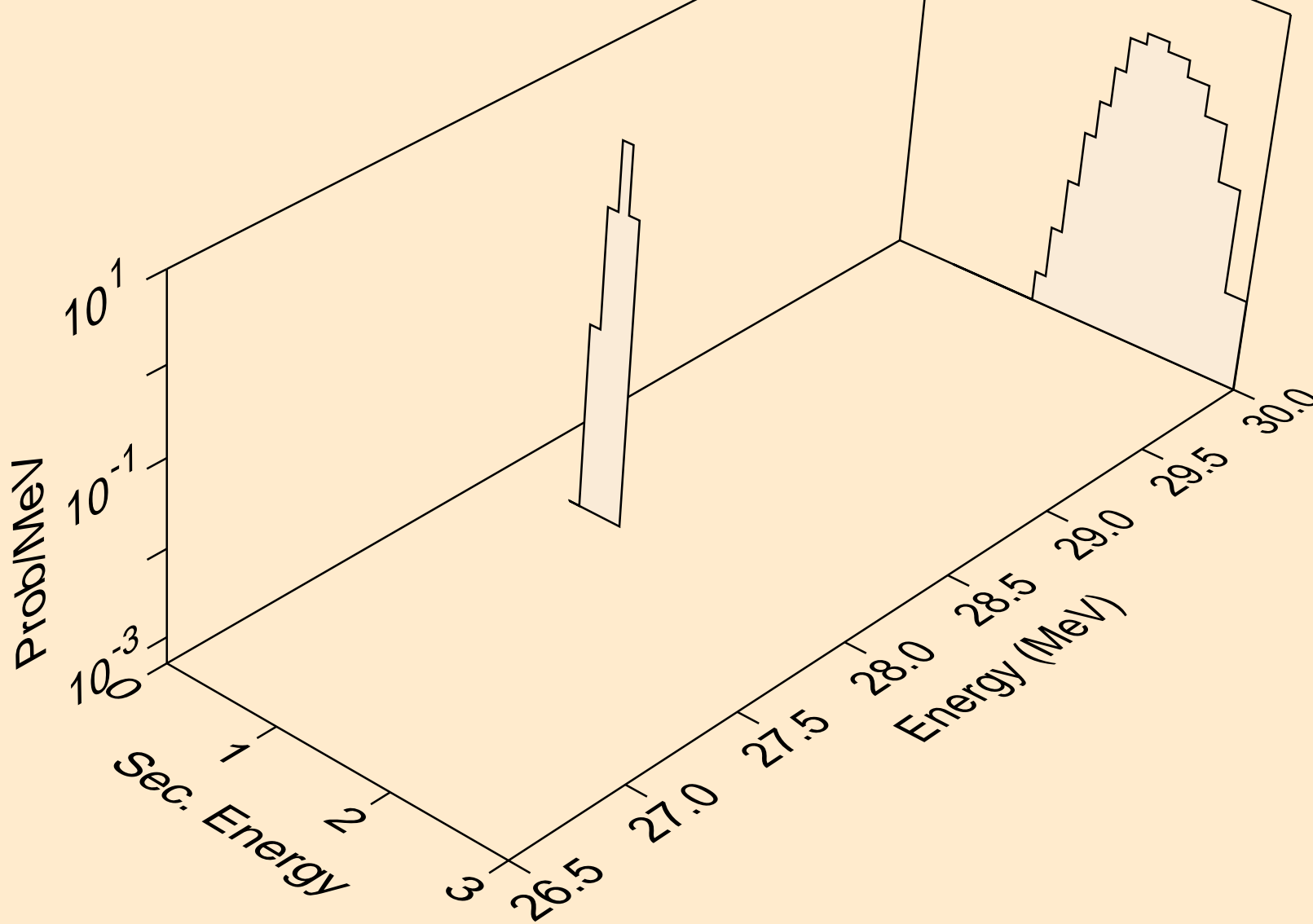

CA042 PHOTON ACER TENDL-2023 LIBRARY; T=0.K
alphas from (g,a)

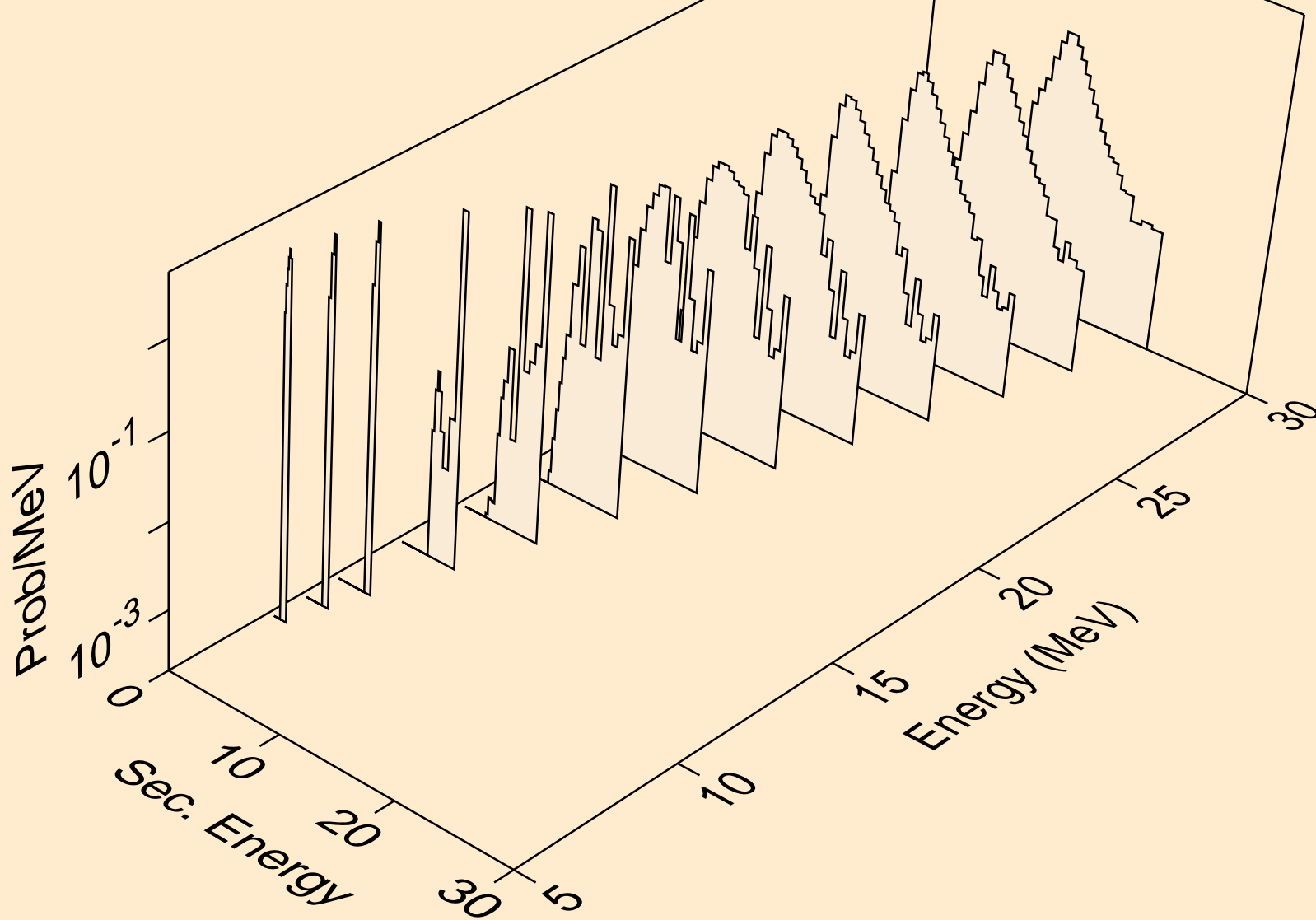

CA042 PHOTON ACER TENDL-2023 LIBRARY; T=0.K
alphas from (g,2a)

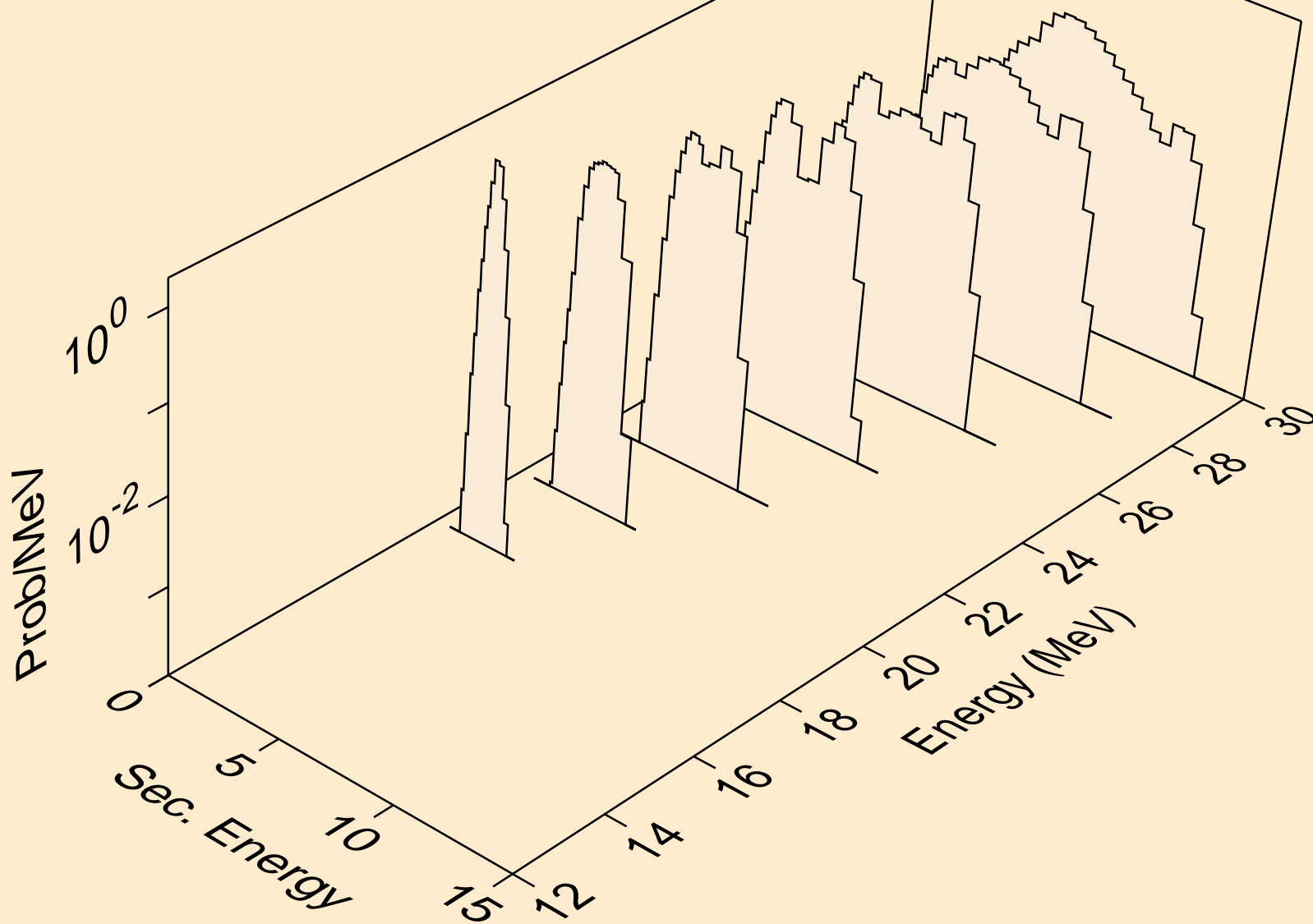

CA042 PHOTON ACER TENDL-2023 LIBRARY; T=0.K
alphas from (g,pa)

