

LA132 PHOTON ACER TENDL-2023 LIBRARY; T=0.K  
Principal cross sections

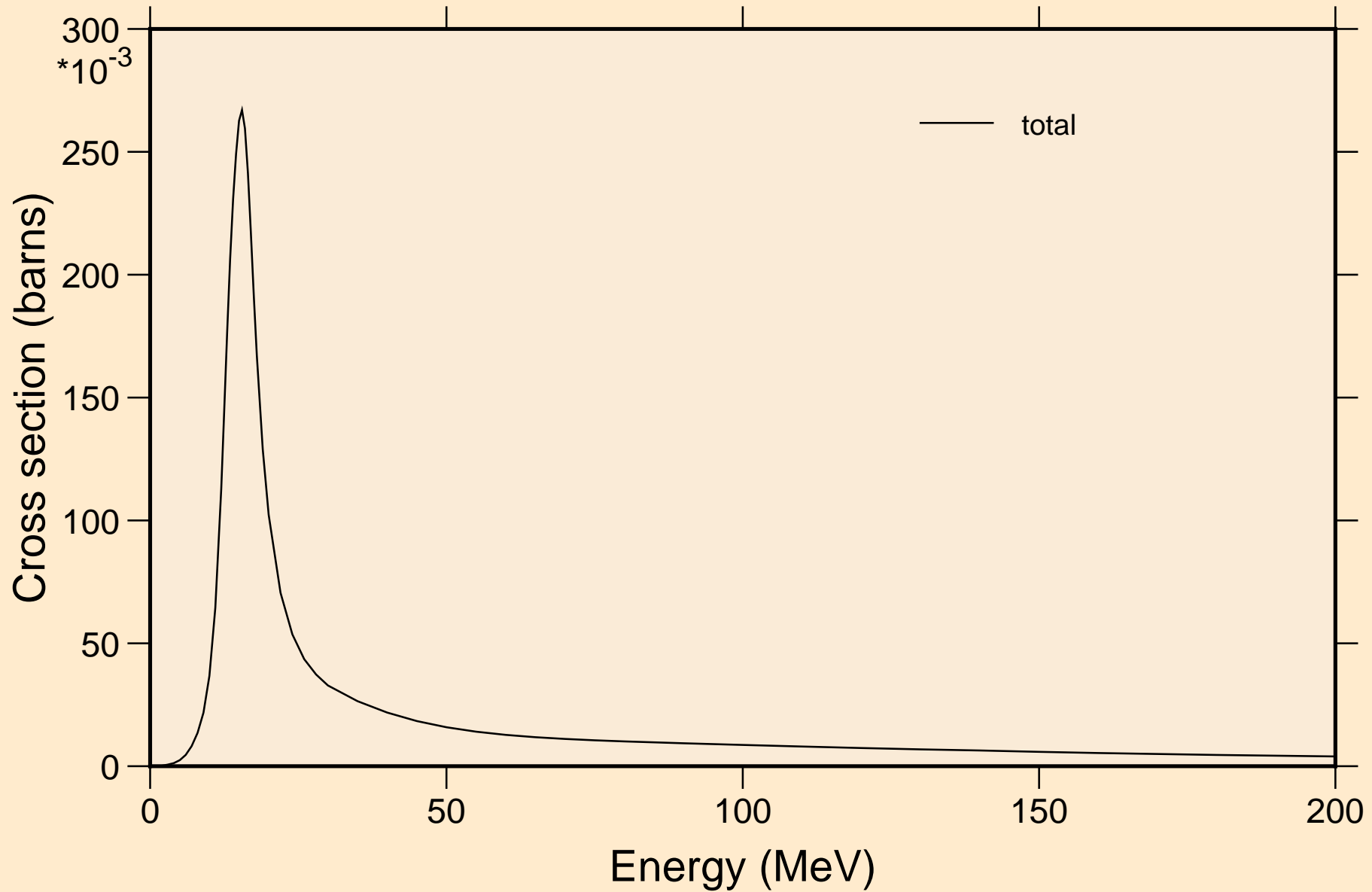



LA132 PHOTON ACER TENDL-2023 LIBRARY; T=0.K

Heating

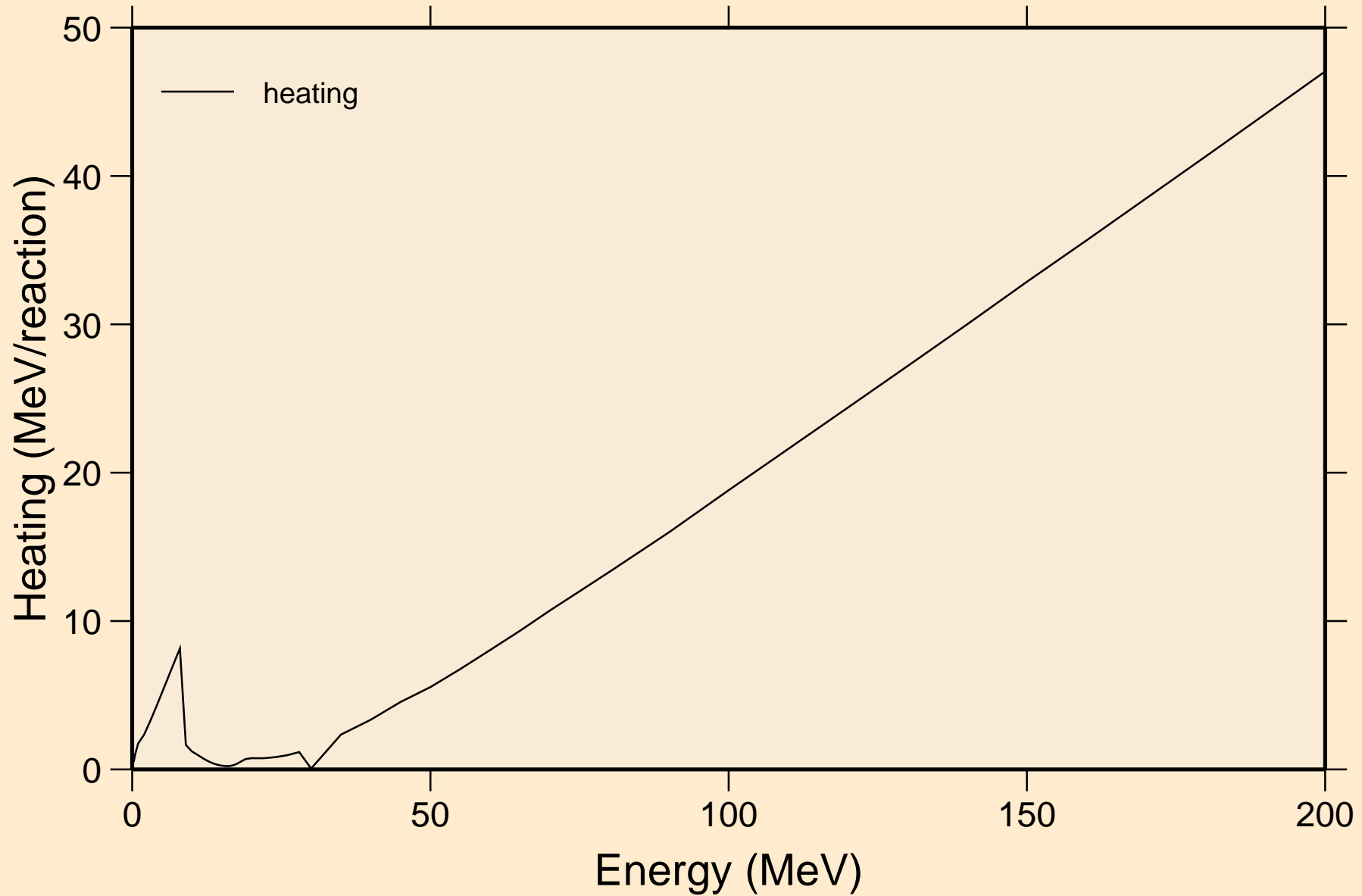

# LA132 PHOTON ACER TENDL-2023 LIBRARY; T=0.K

## Particle heating contributions

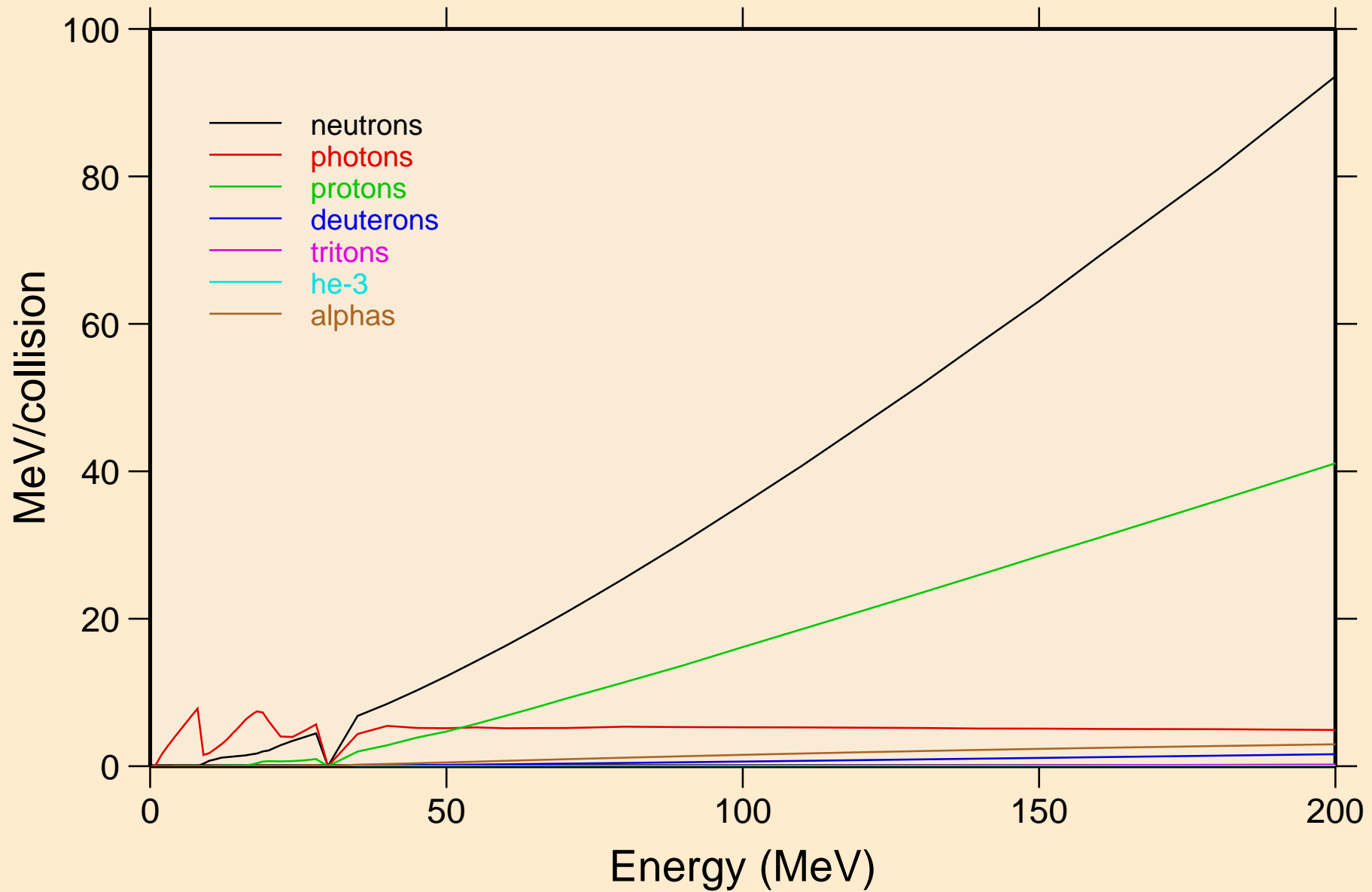

LA132 PHOTON ACER TENDL-2023 LIBRARY; T=0.K  
Particle production cross sections

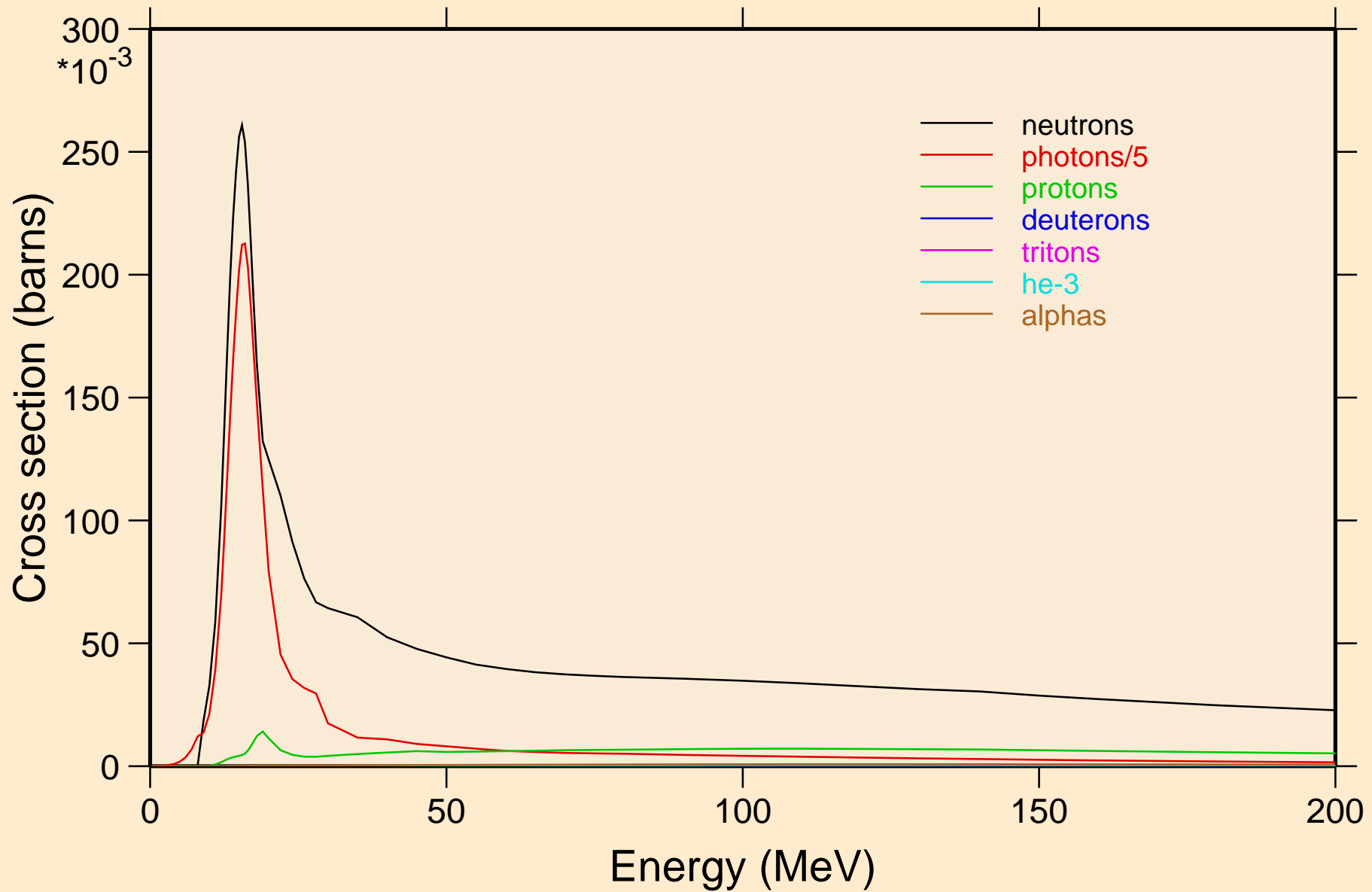

LA132 PHOTON ACER TENDL-2023 LIBRARY; T=0.K  
neutrons from (g,x)

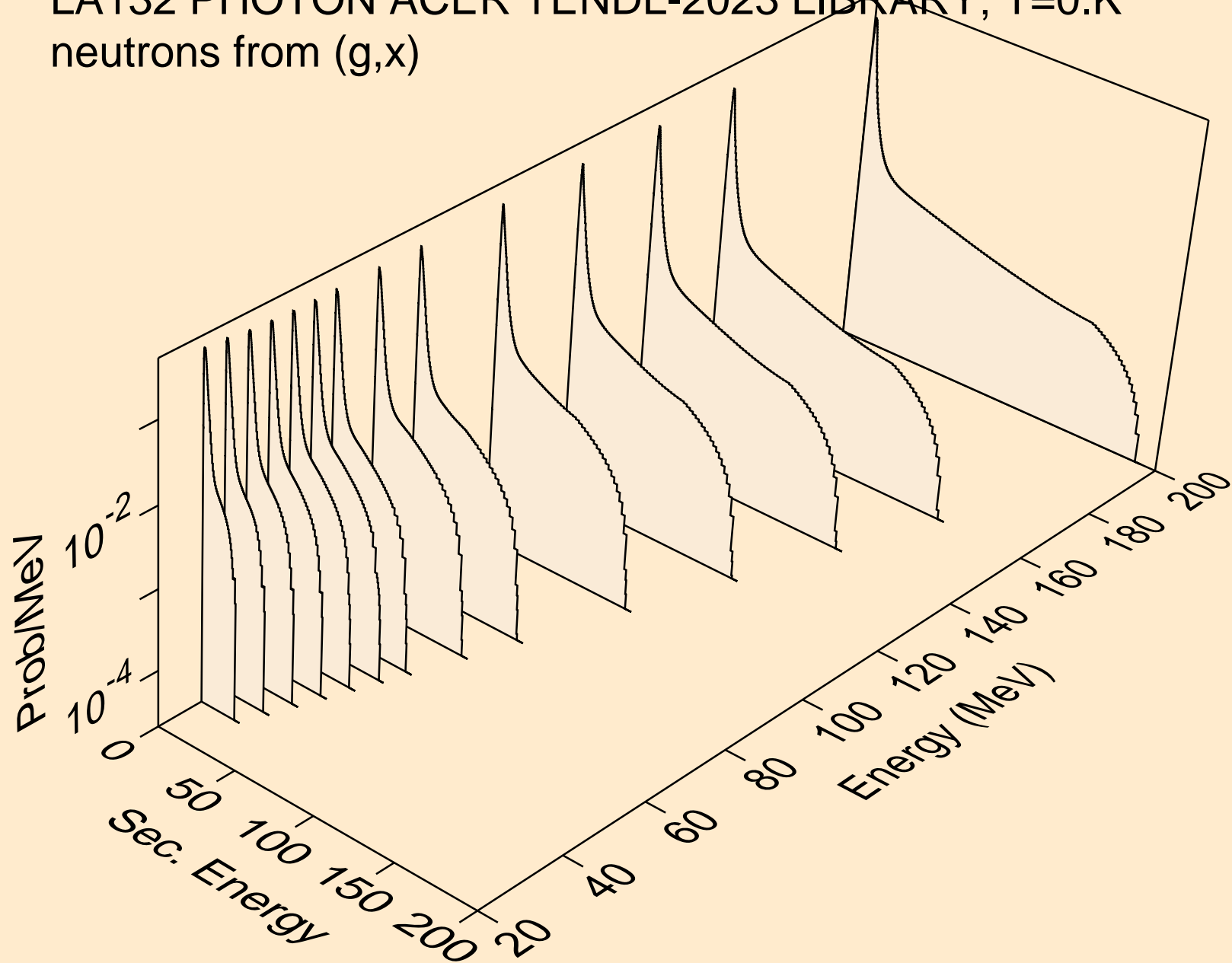

LA132 PHOTON ACER TENDL-2023 LIBRARY; T=0.K  
neutrons from (g,2n)

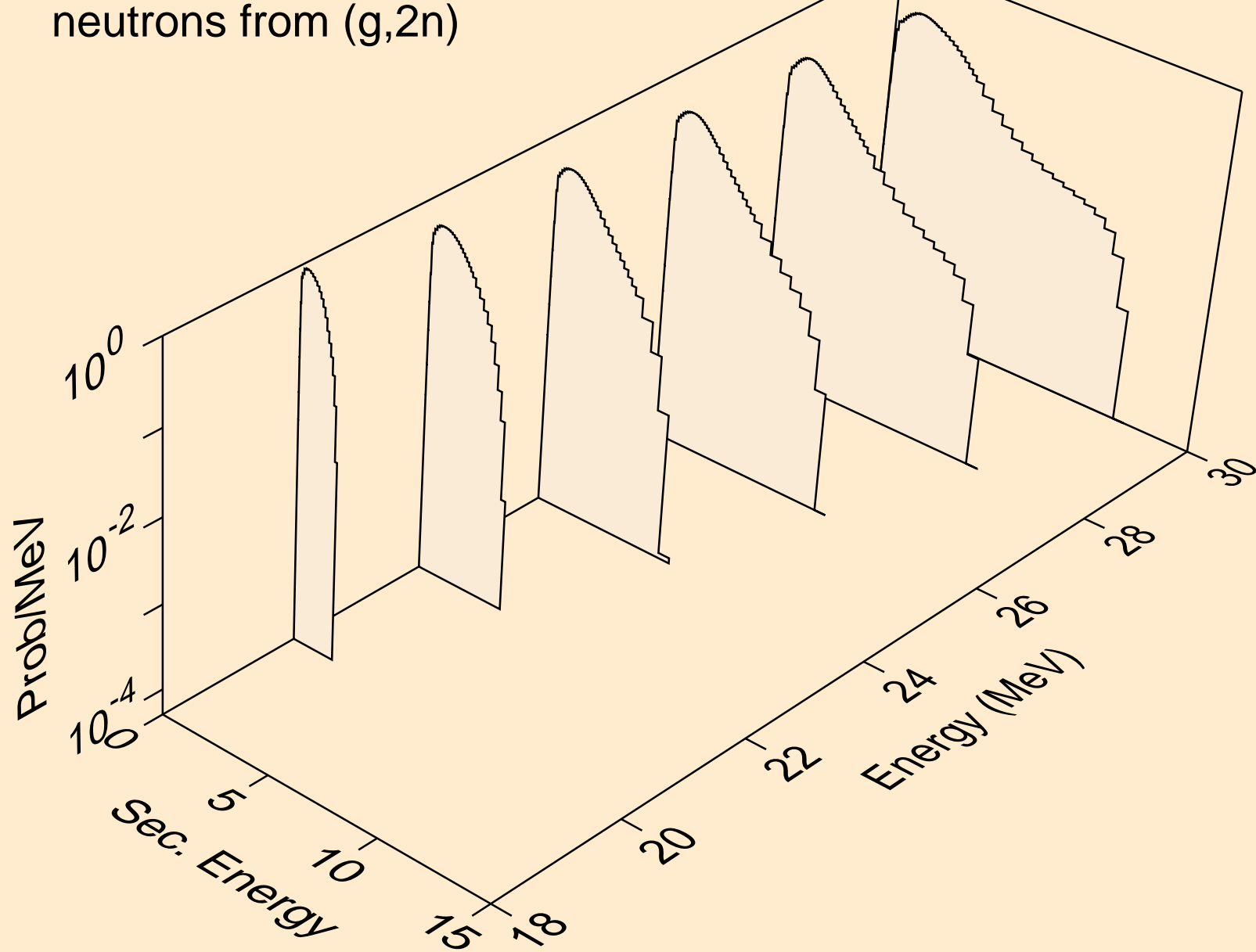

LA132 PHOTON ACER TENDL-2023 LIBRARY; T=0.K  
neutrons from (g,3n)

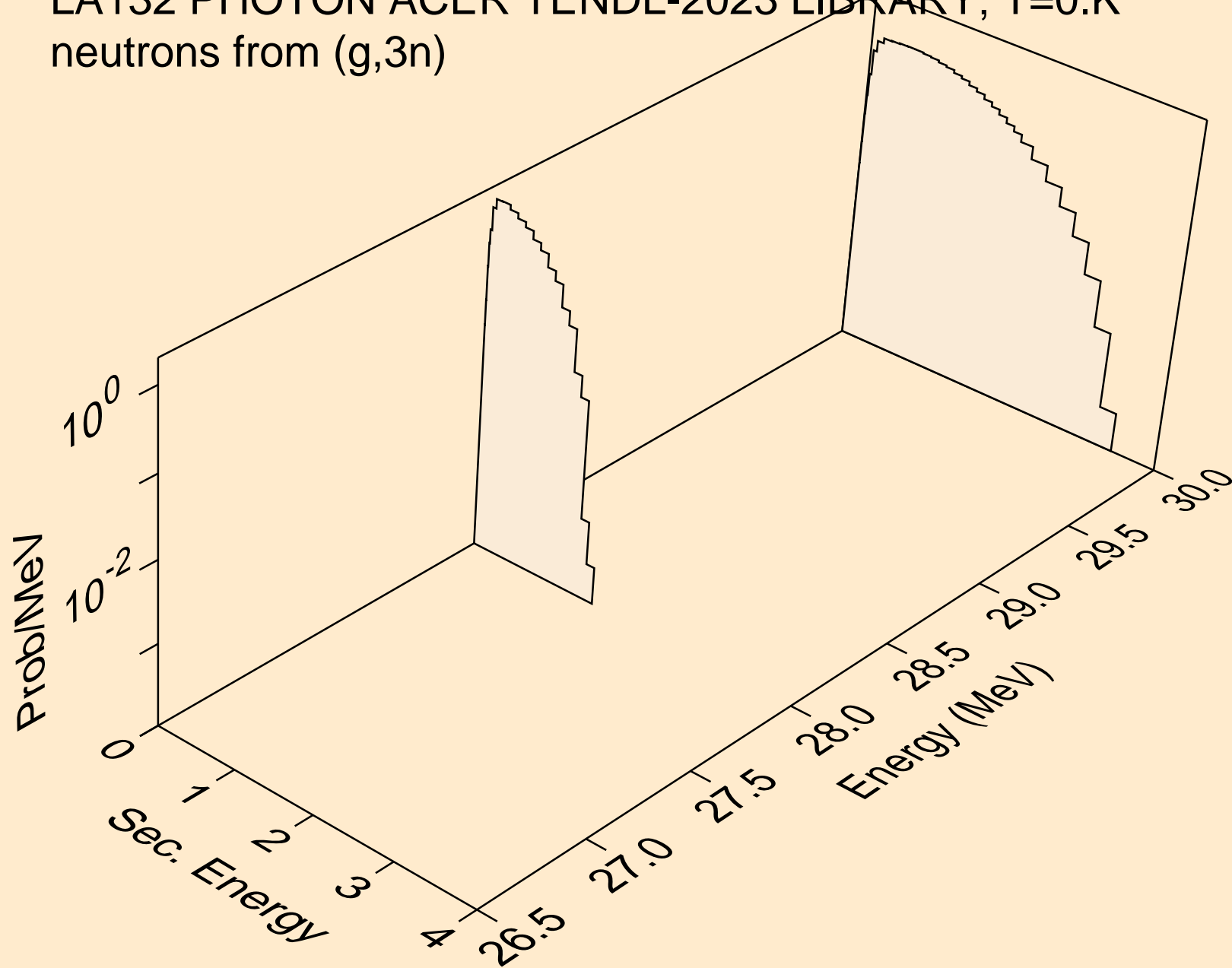



LA132 PHOTON ACER TENDL-2023 LIBRARY; T=0.K  
neutrons from (g,n\*)a

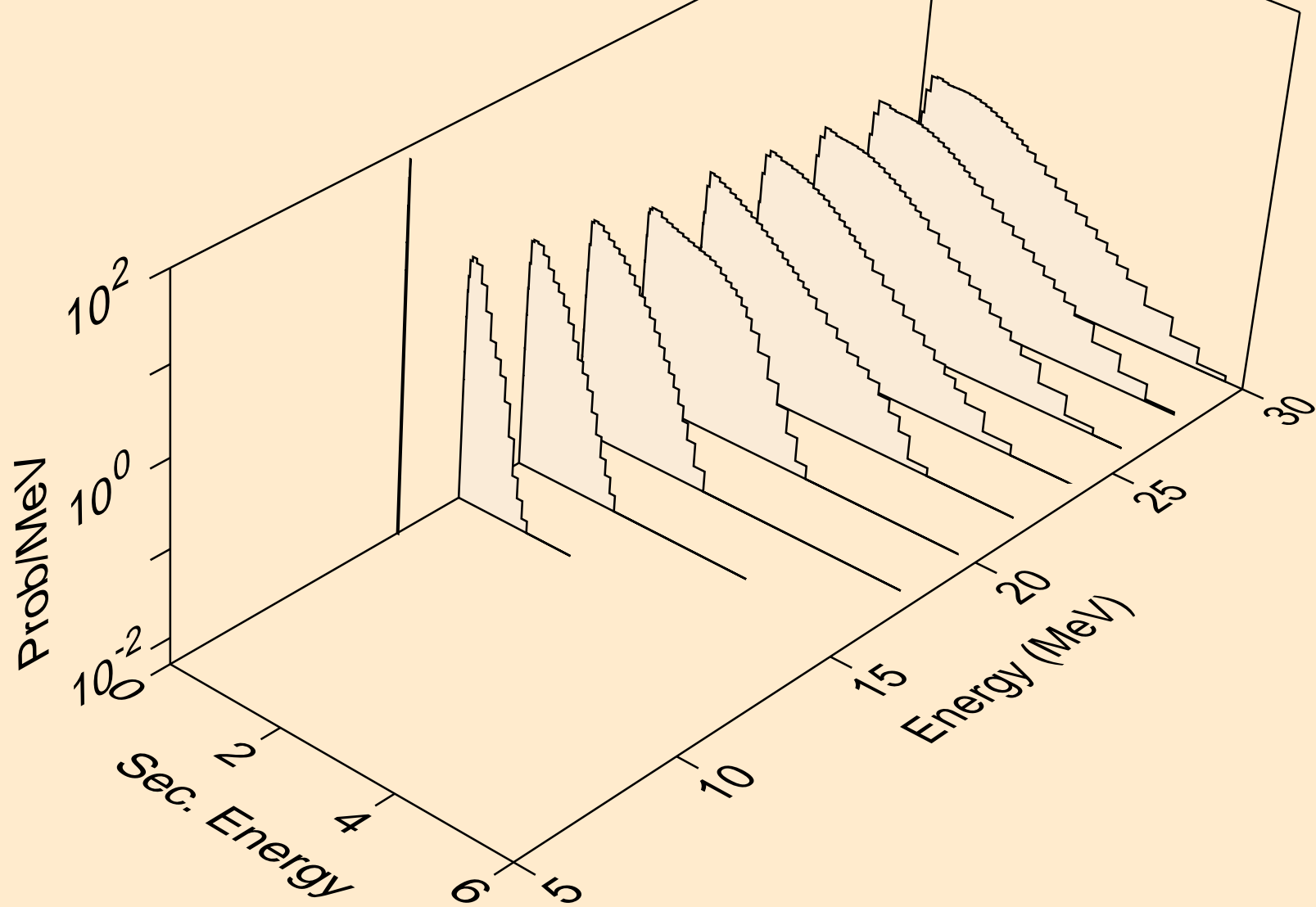

LA132 PHOTON ACER TENDL-2023 LIBRARY; T=0.K  
neutrons from (g,2n)a

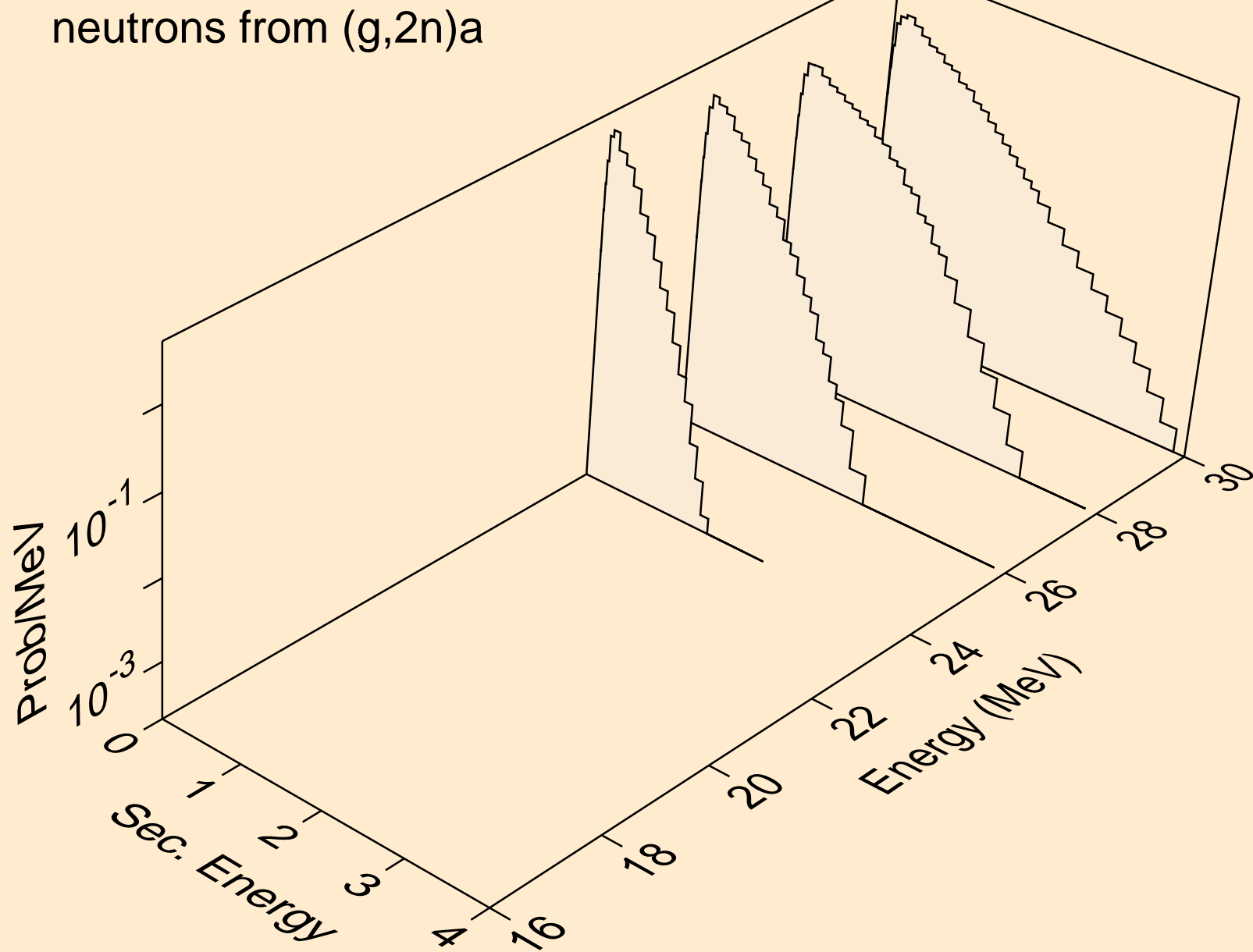

LA132 PHOTON ACER TENDL-2023 LIBRARY; T=0.K  
neutrons from (g,n\*)p

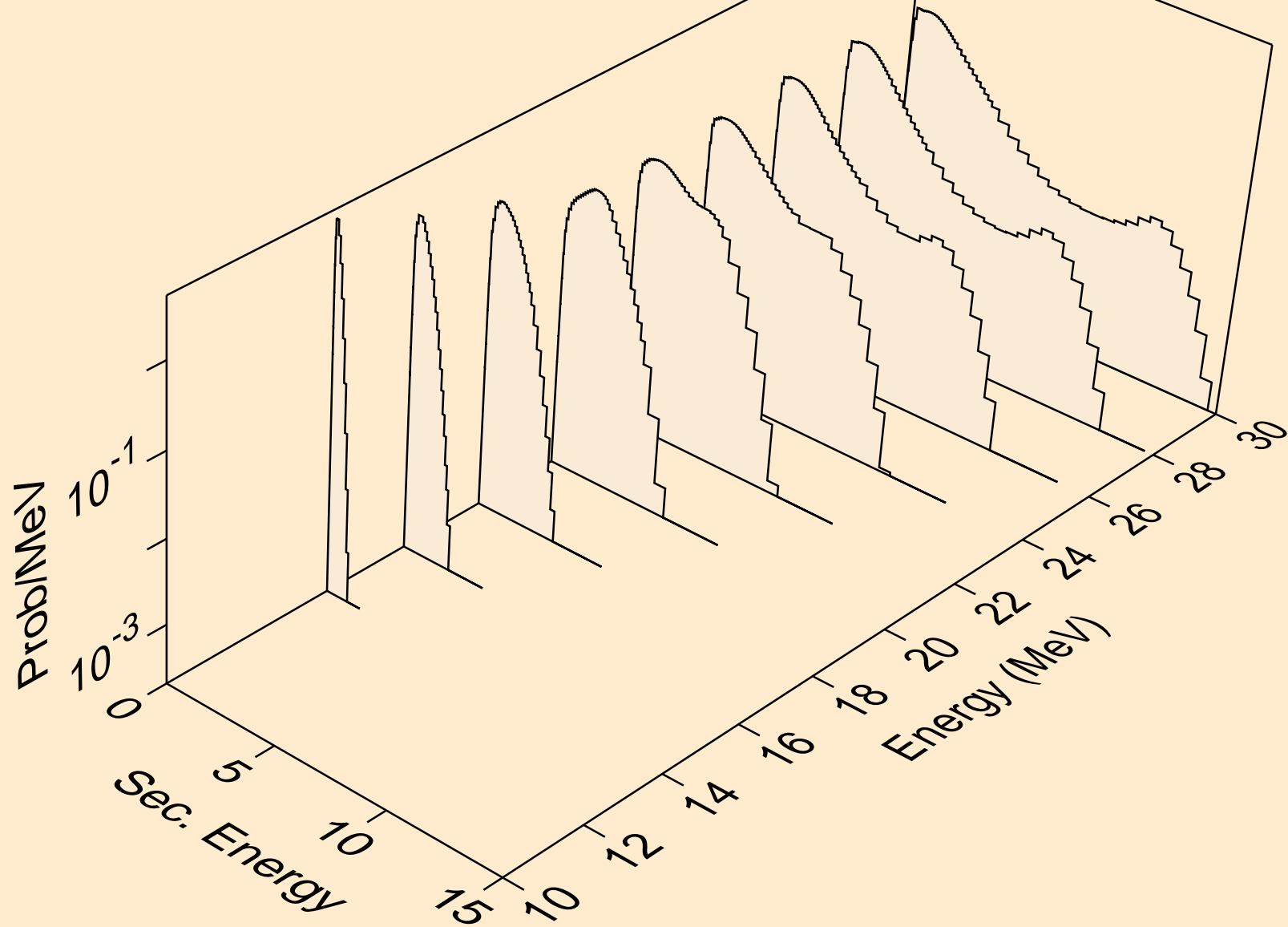

LA132 PHOTON ACER TENDL-2023 LIBRARY; T=0.K  
neutrons from (g,n\*)d

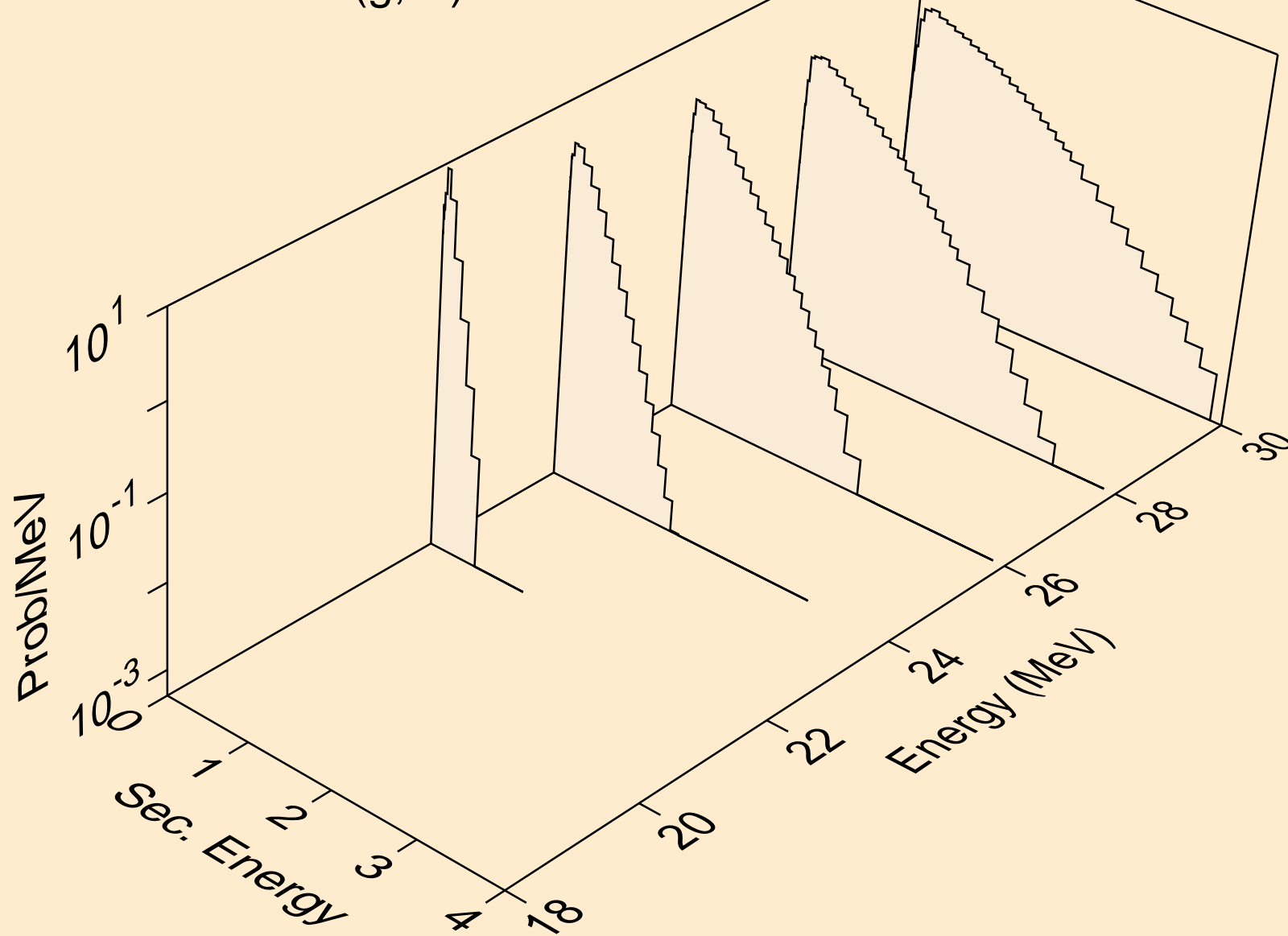

LA132 PHOTON ACER TENDL-2023 LIBRARY; T=0.K  
neutrons from (g,n\*)t

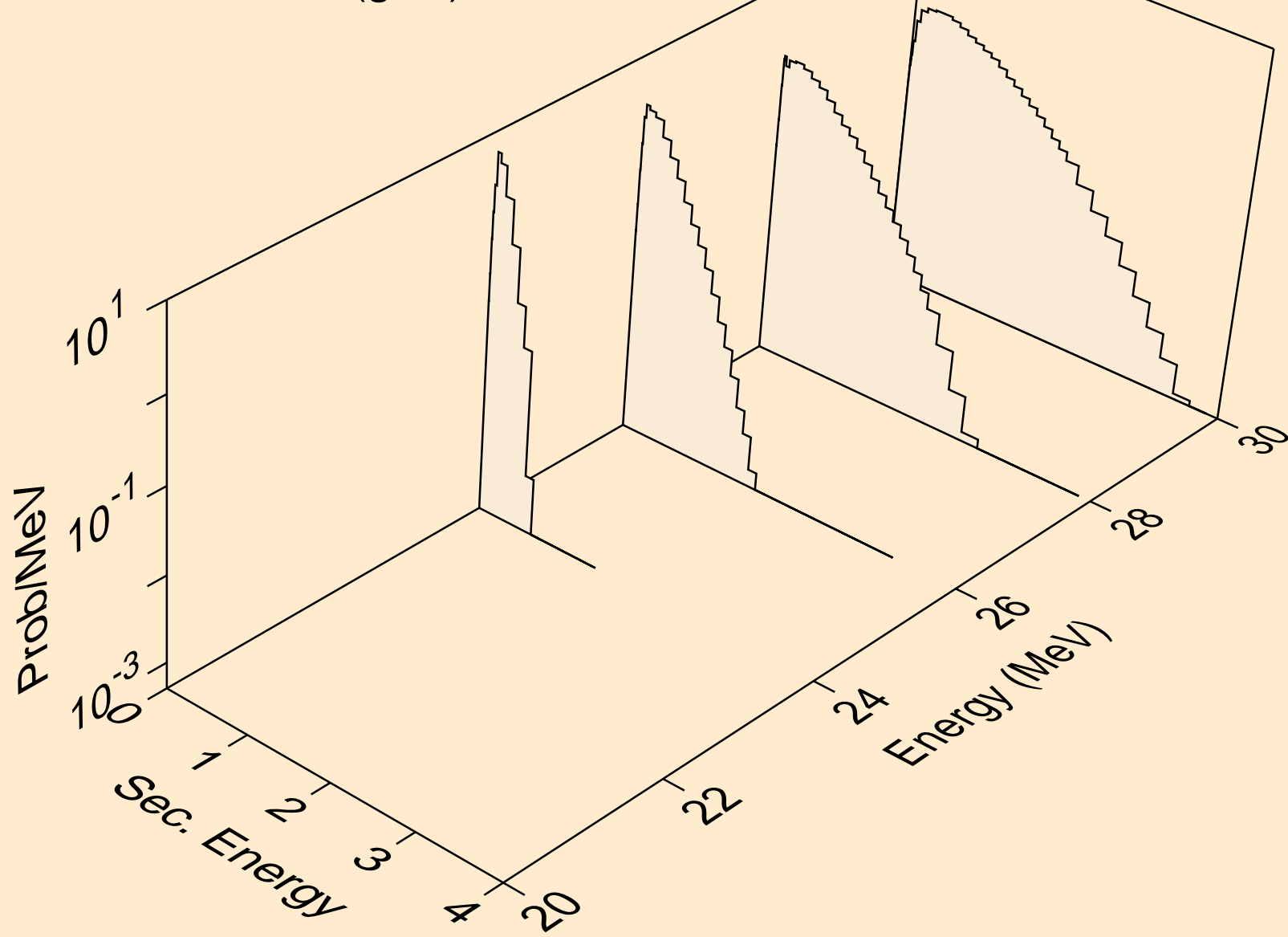

LA132 PHOTON ACER TENDL-2023 LIBRARY; T=0.K  
neutrons from (g,2np)

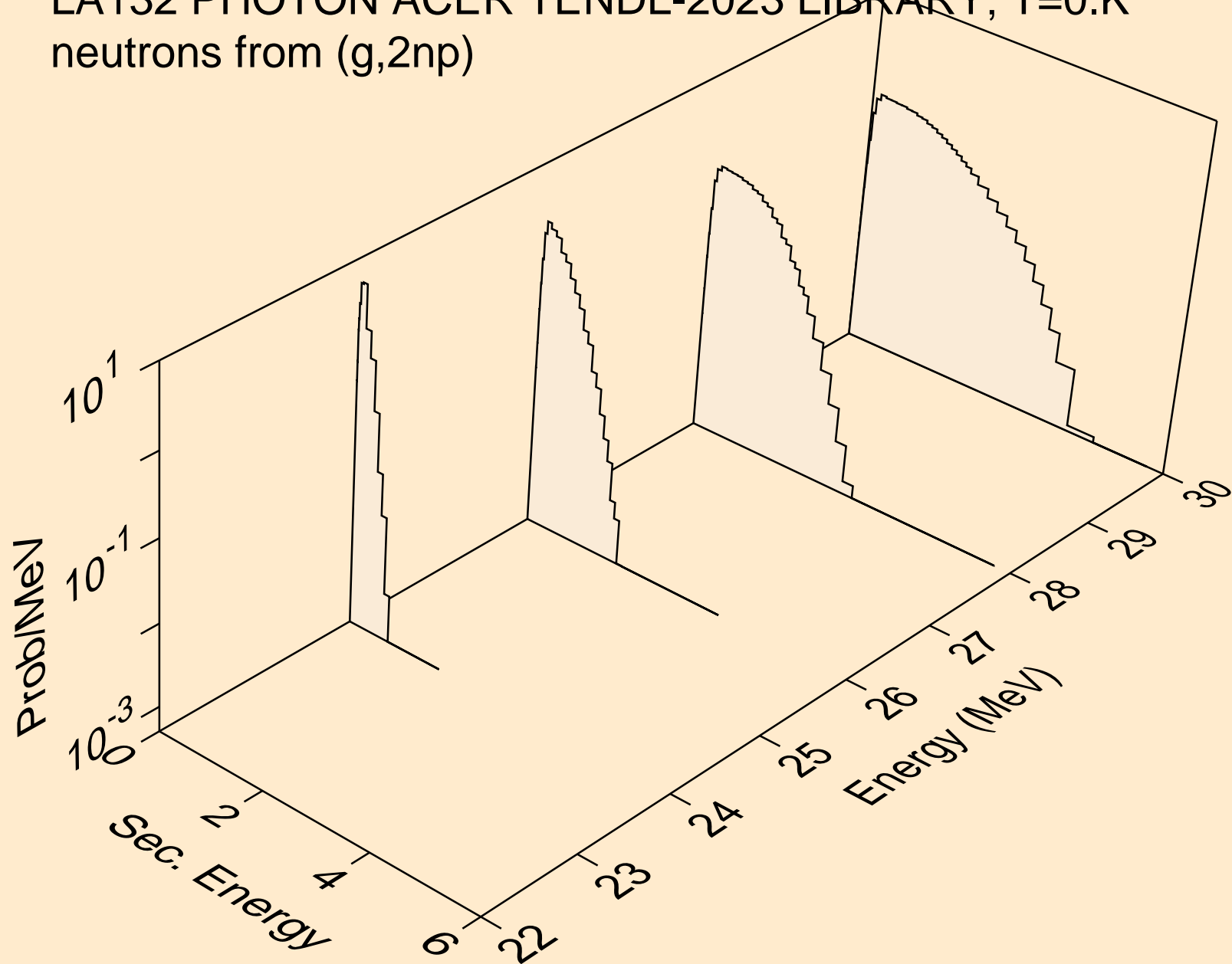

LA132 PHOTON ACER TENDL-2023 LIBRARY; T=0.K  
neutrons from (g,n2p)

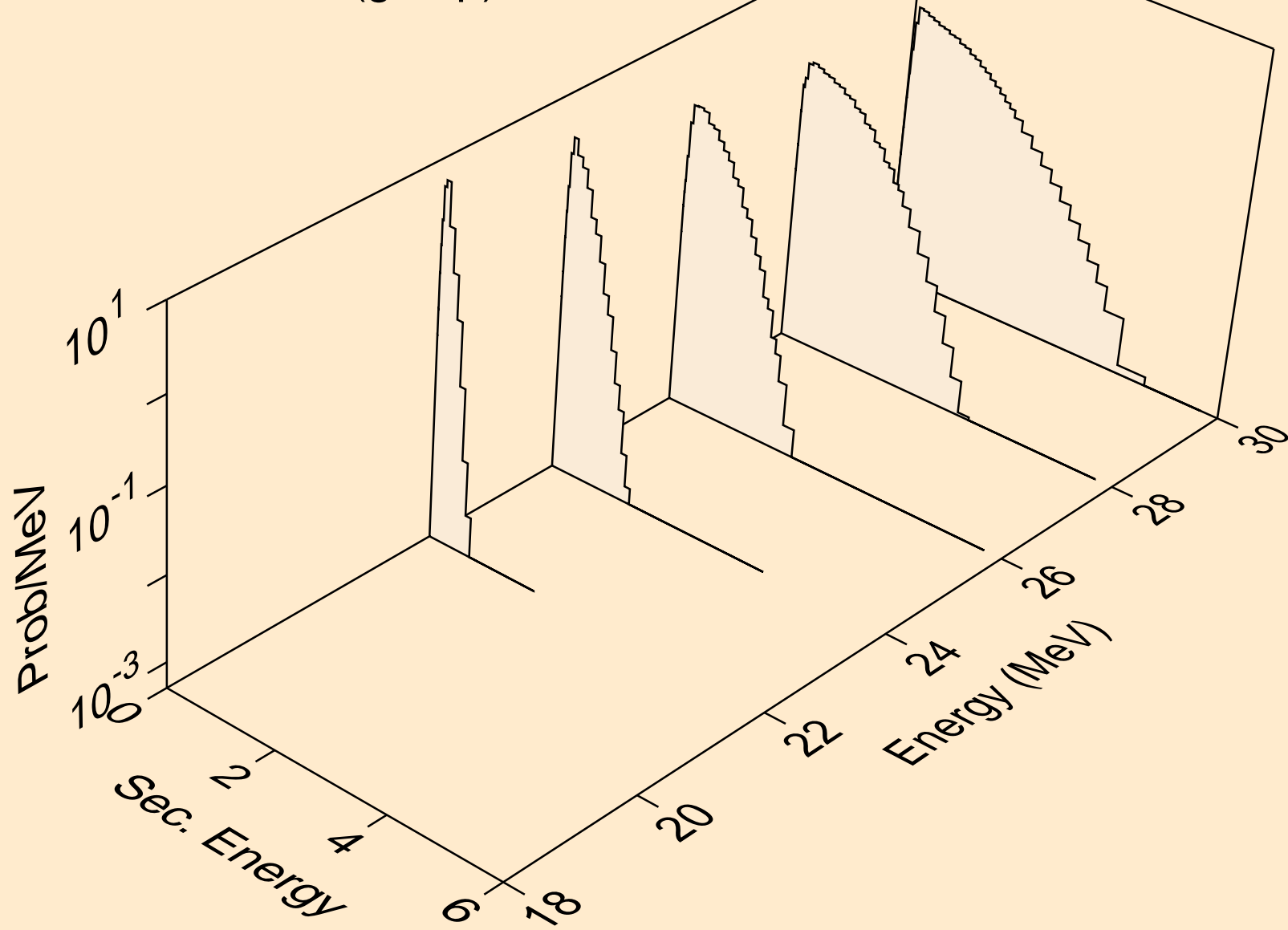

LA132 PHOTON ACER TENDL-2023 LIBRARY; T=0.K  
neutrons from (g,npa)

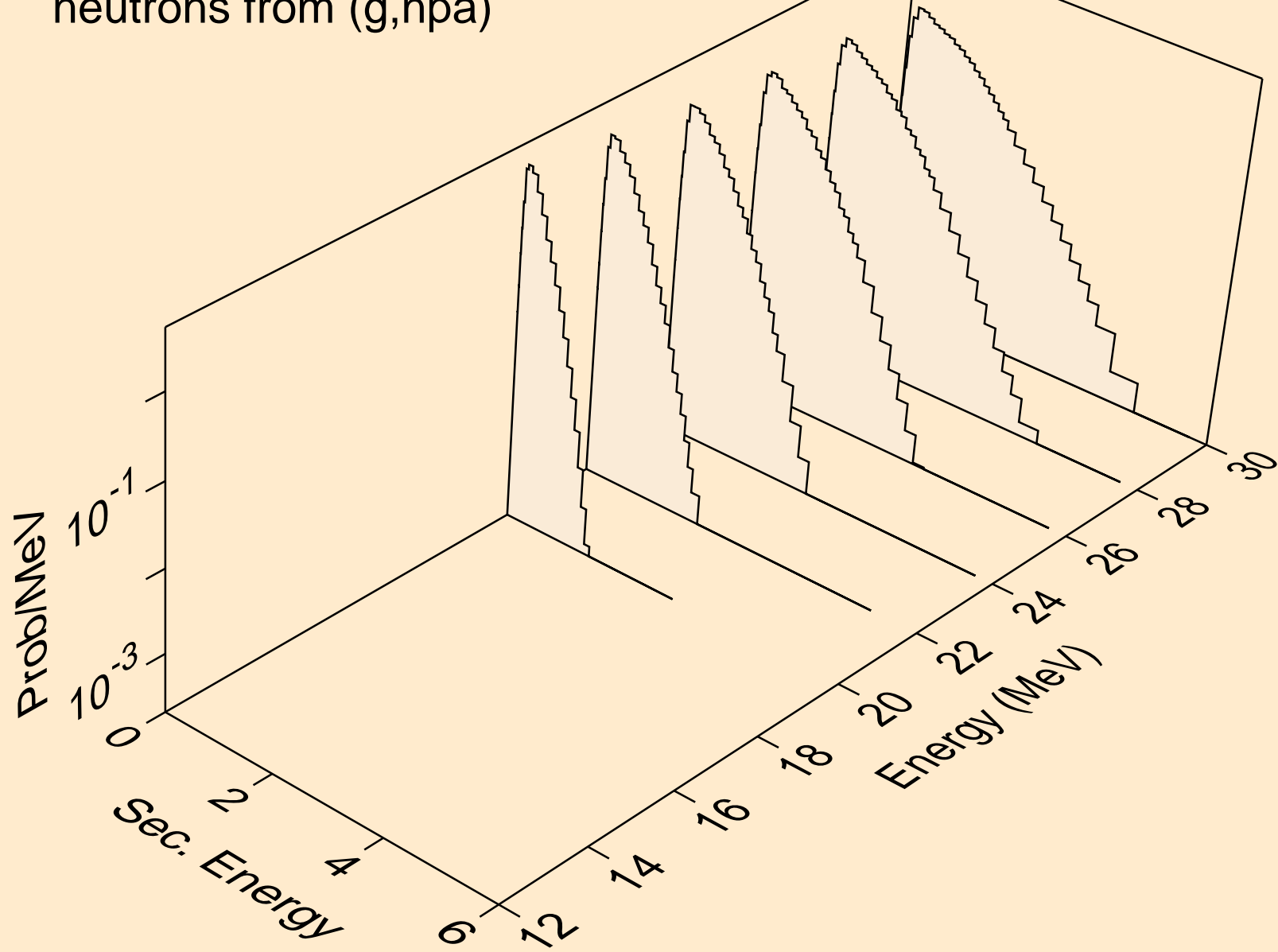



LA132 PHOTON ACER TENDL-2023 LIBRARY; T=0.K  
angular distribution for (g,n\*0) neutron

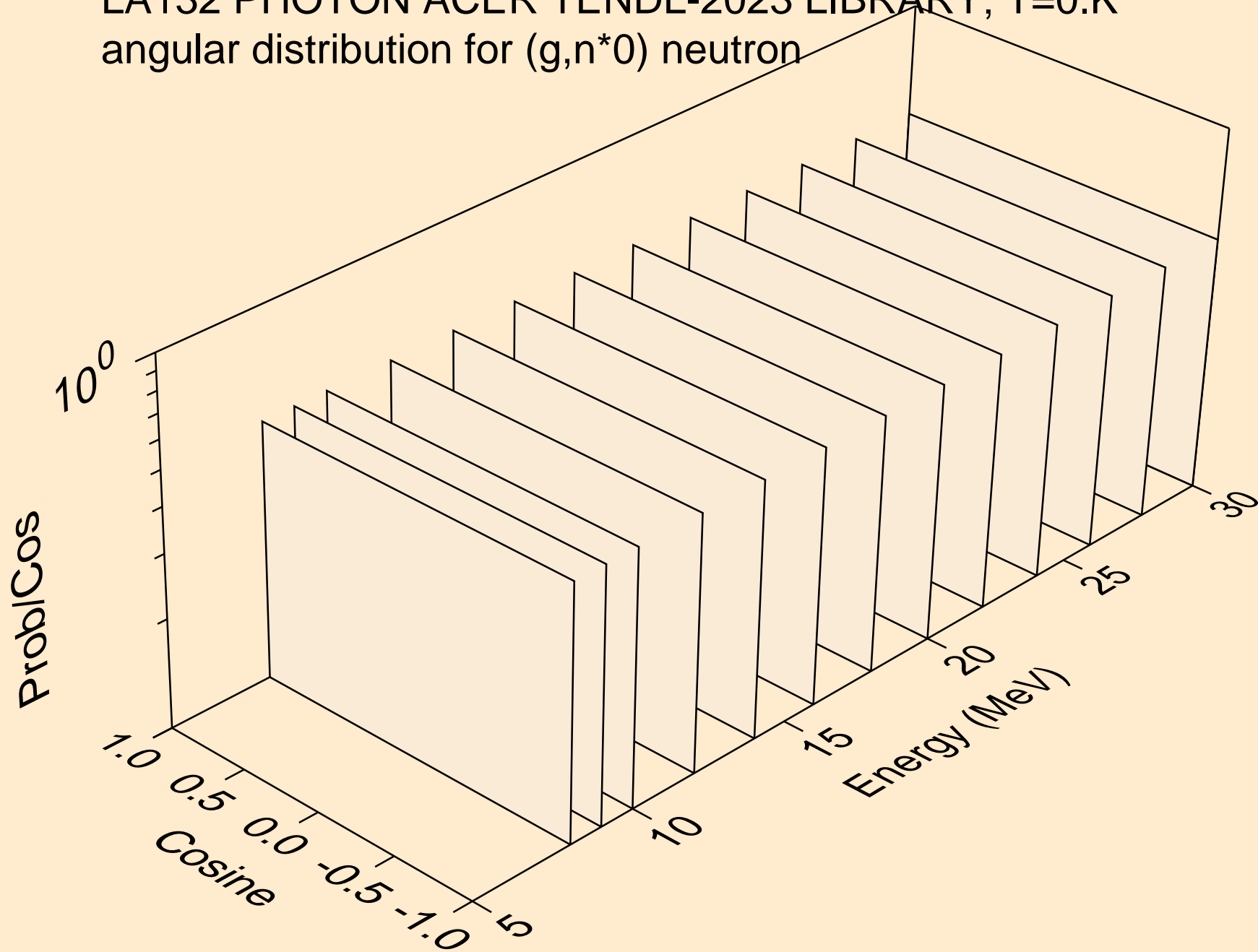

LA132 PHOTON ACER TENDL-2023 LIBRARY; T=0.K  
angular distribution for (g,n\*1) neutron

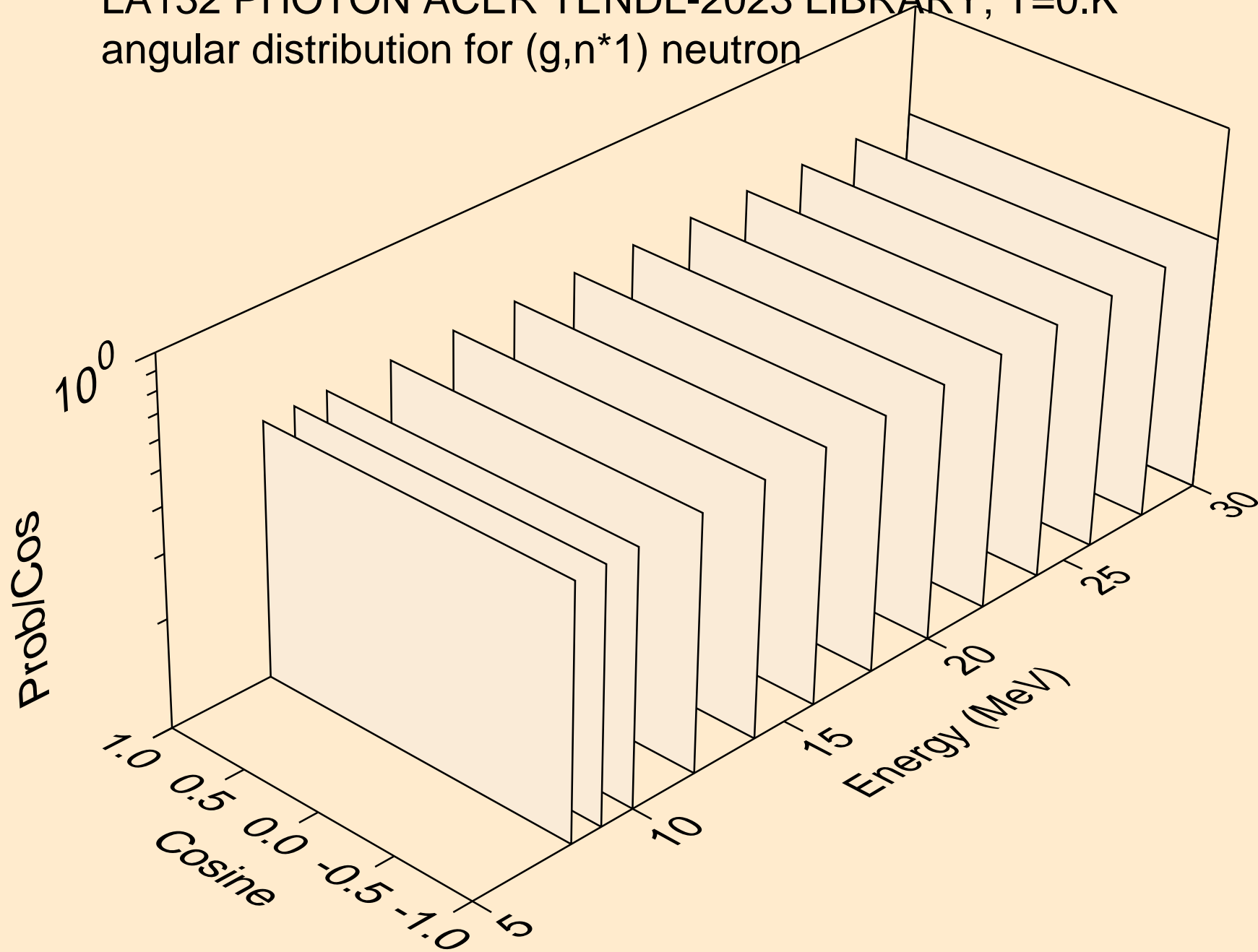

LA132 PHOTON ACER TENDL-2023 LIBRARY; T=0.K  
neutrons from (g,n\*c)

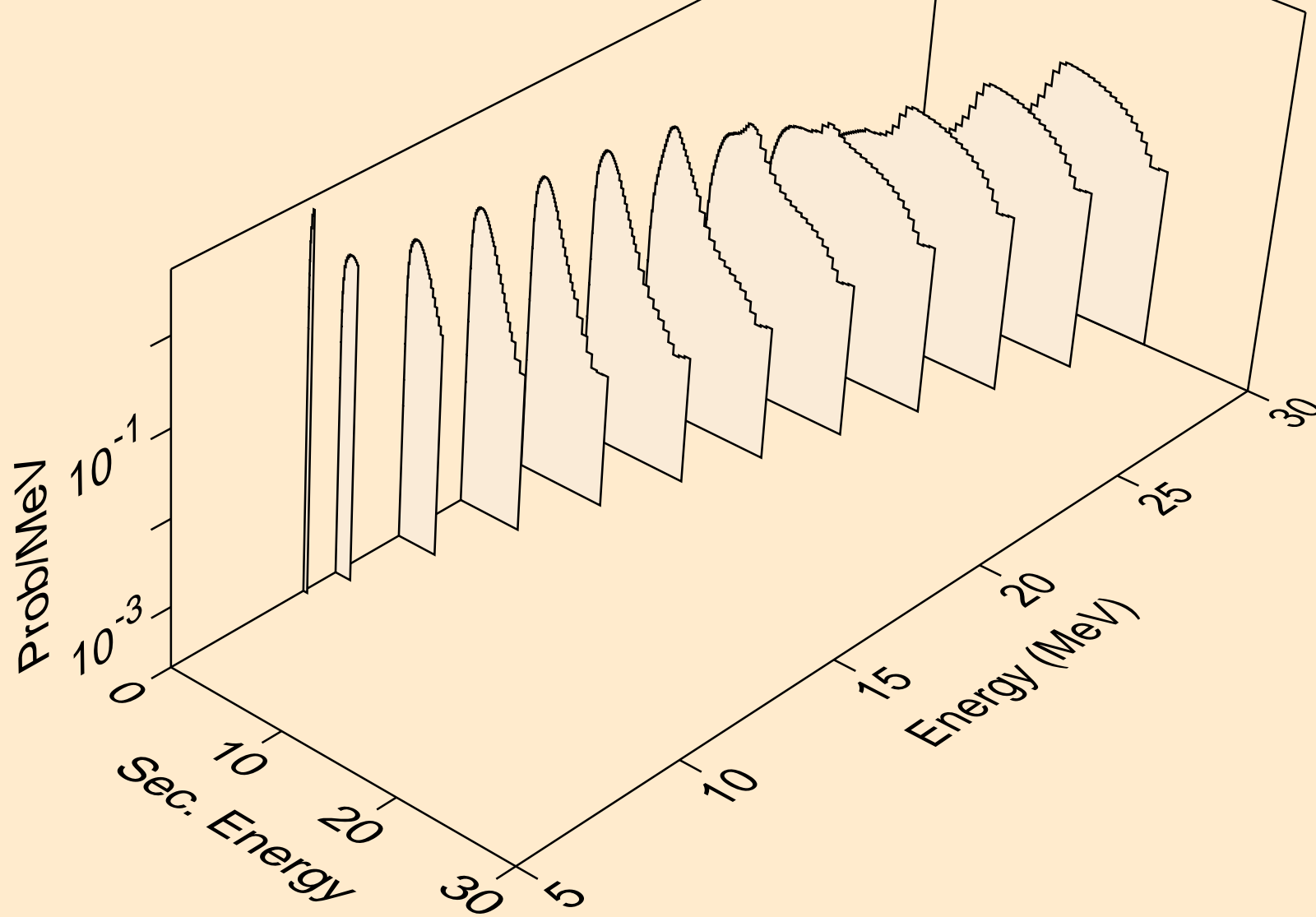

LA132 PHOTON ACER TENDL-2023 LIBRARY; T=0.K  
photons from (g,x)

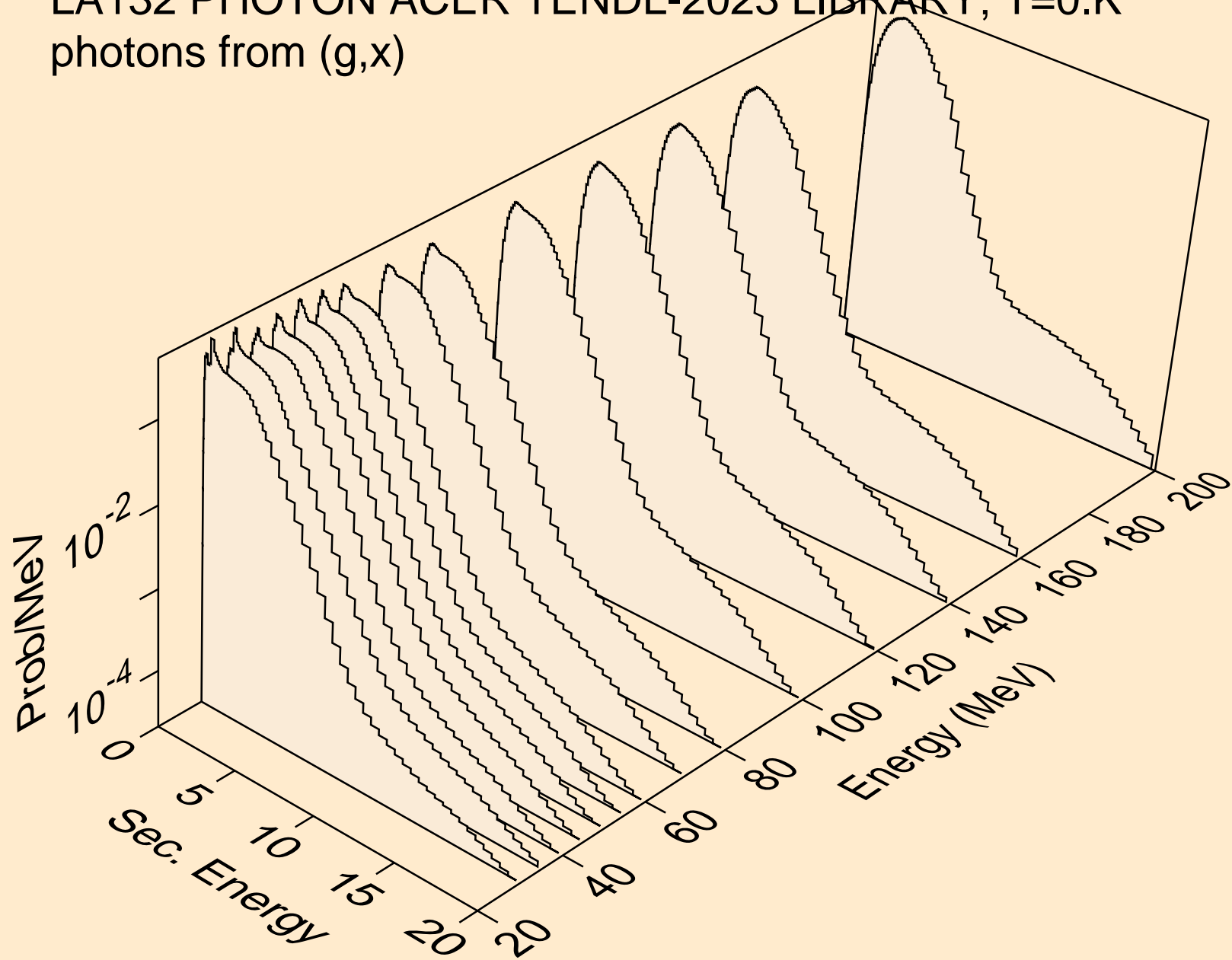

LA132 PHOTON ACER TENDL-2023 LIBRARY; T=0.K  
photons from (g,2n)

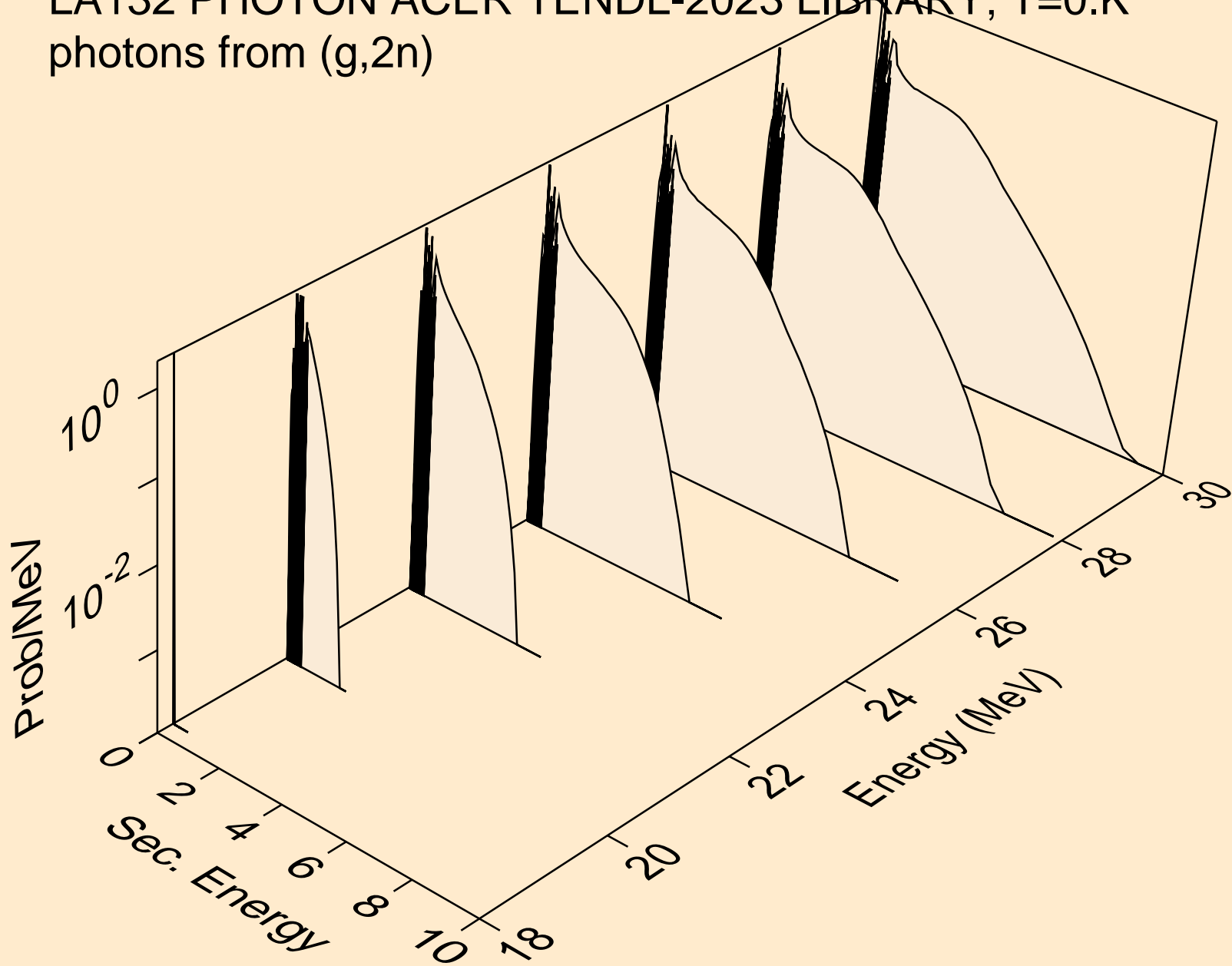

LA132 PHOTON ACER TENDL-2023 LIBRARY; T=0.K  
photons from (g,3n)

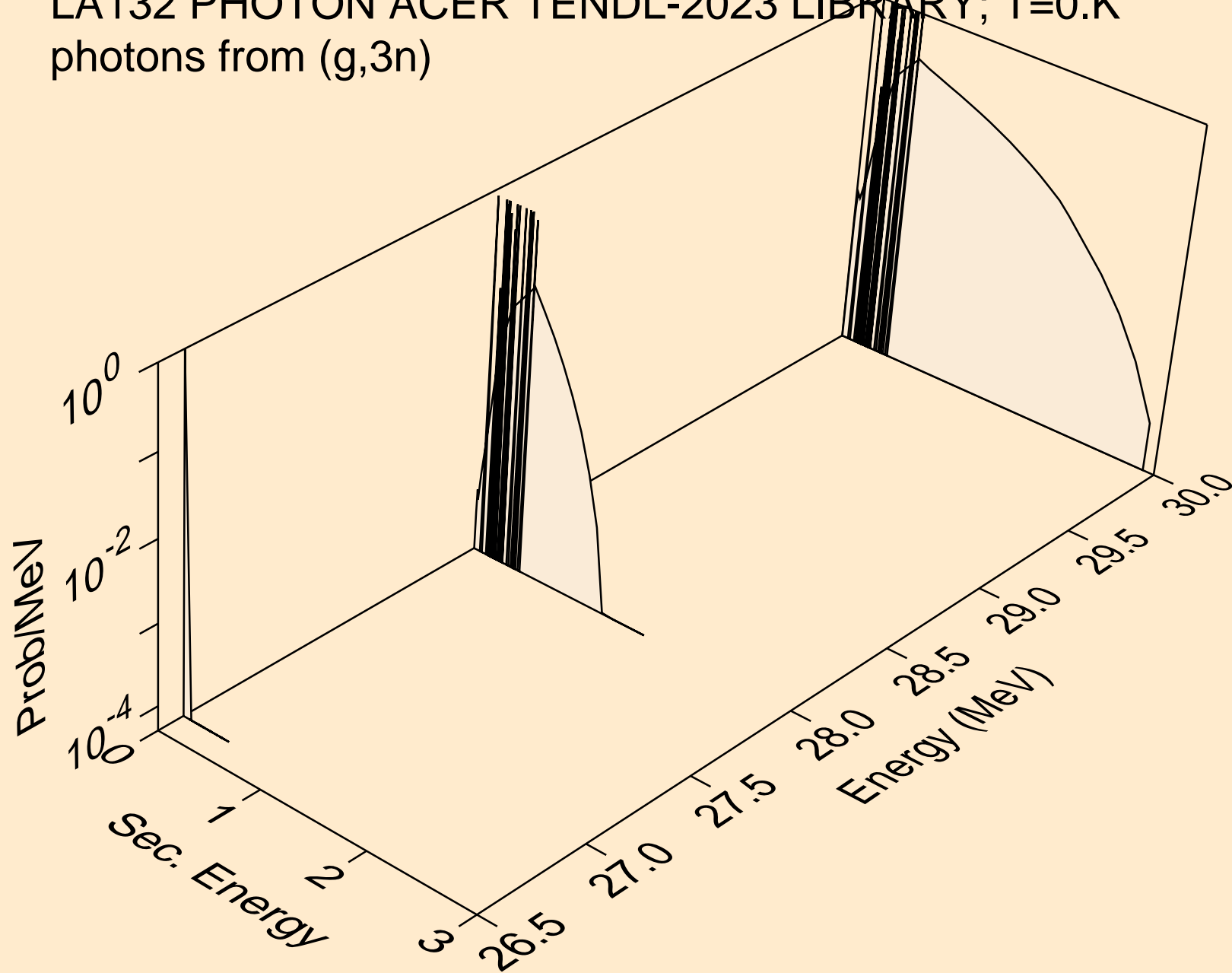

LA132 PHOTON ACER TENDL-2023 LIBRARY; T=0.K  
photons from (g,n\*)a

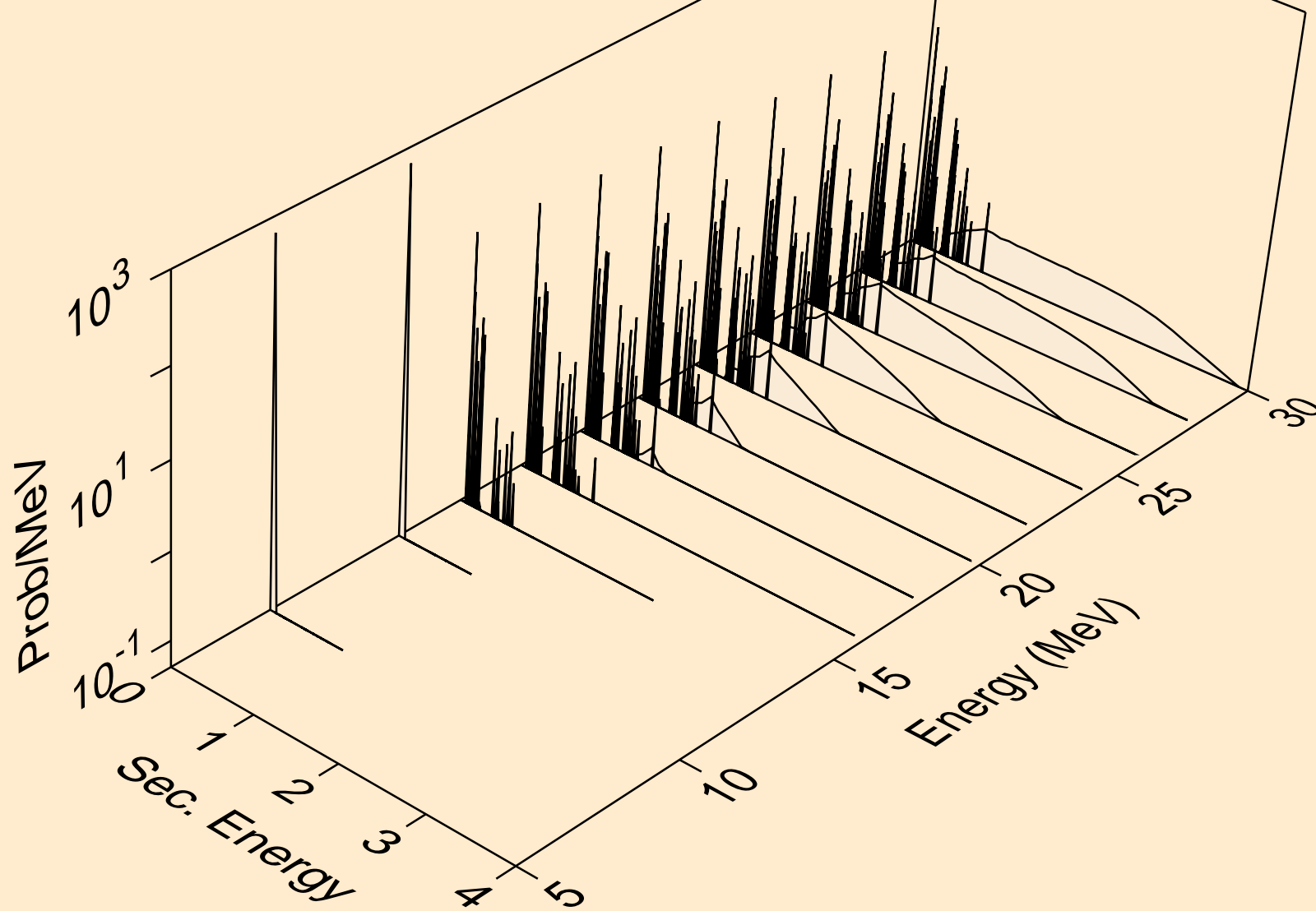

LA132 PHOTON ACER TENDL-2023 LIBRARY; T=0.K  
photons from (g,2n)a

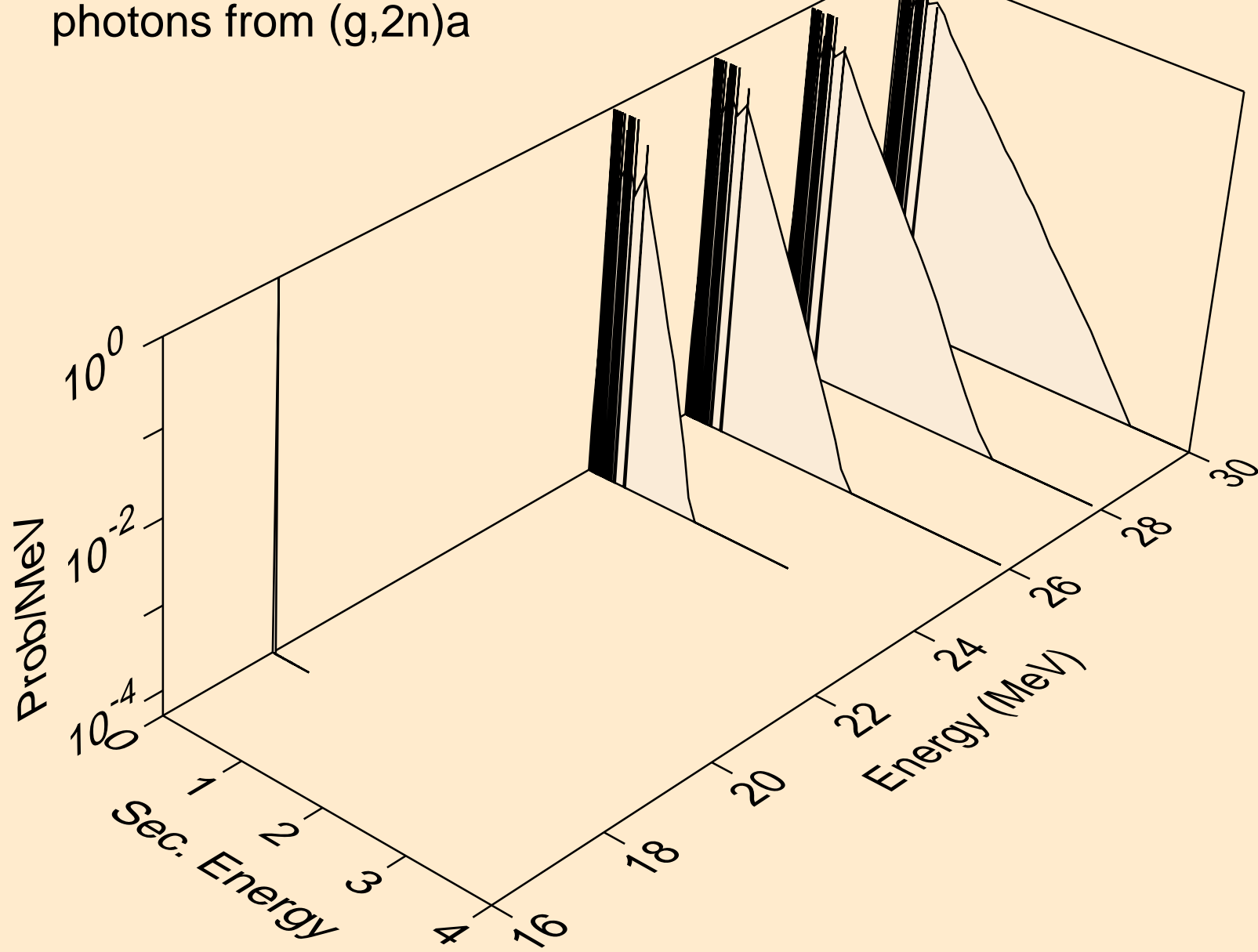



LA132 PHOTON ACER TENDL-2023 LIBRARY; T=0.K  
photons from (g,n\*)p

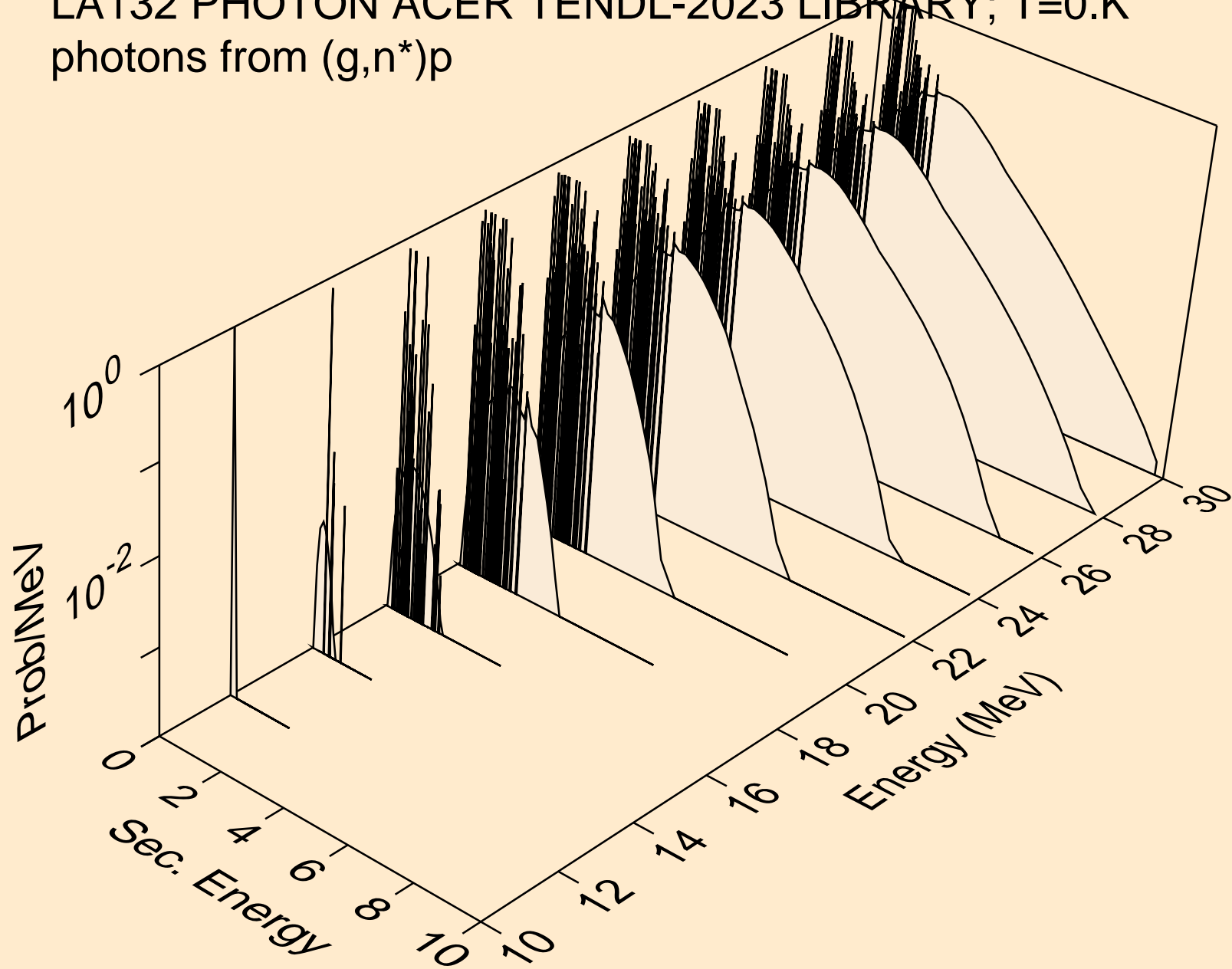

LA132 PHOTON ACER TENDL-2023 LIBRARY; T=0.K  
photons from (g,n\*)d

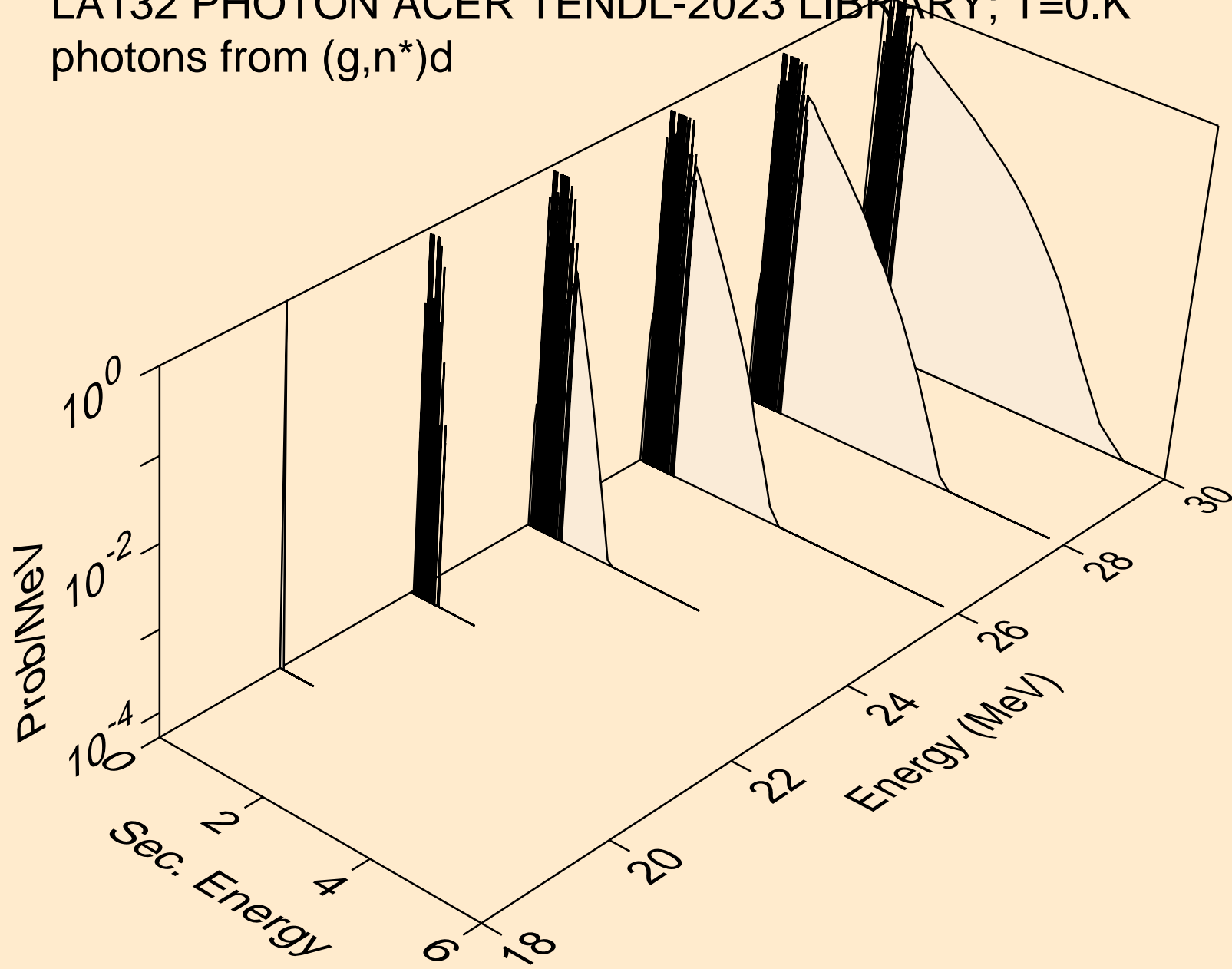

LA132 PHOTON ACER TENDL-2023 LIBRARY; T=0.K  
photons from (g,n\*)t

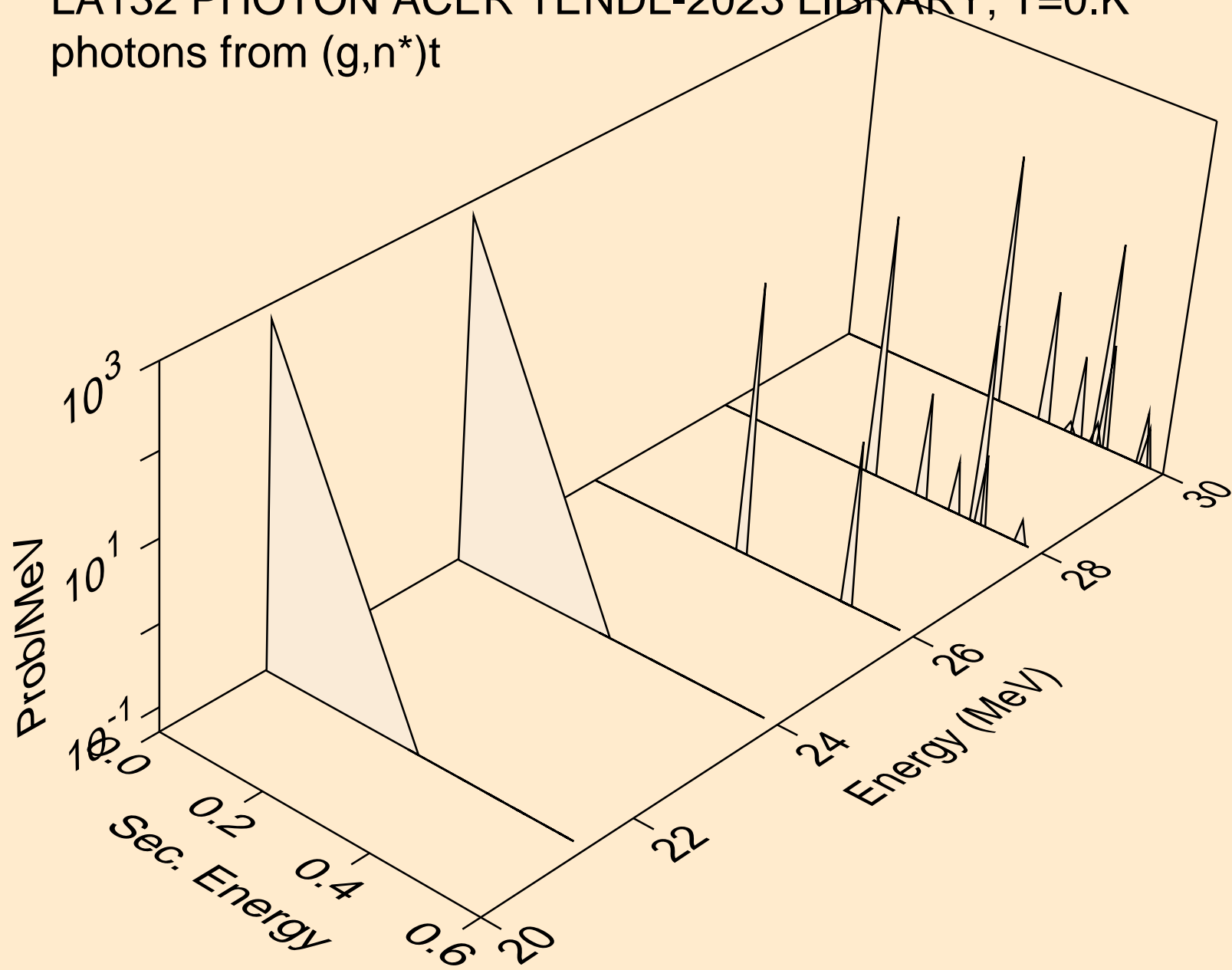

LA132 PHOTON ACER TENDL-2023 LIBRARY; T=0.K  
photons from (g,2np)

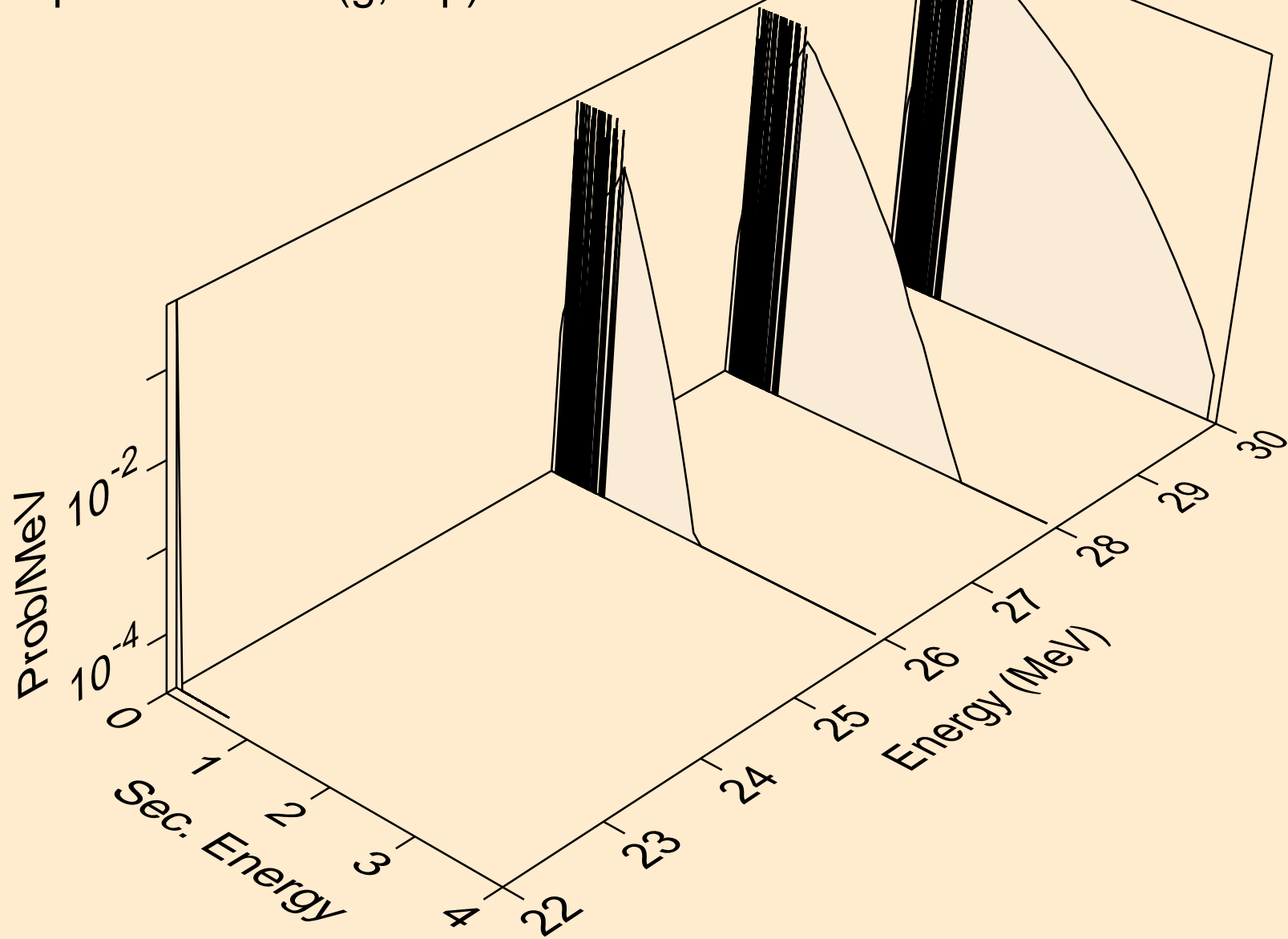

LA132 PHOTON ACER TENDL-2023 LIBRARY; T=0.K  
photons from (g,n2p)

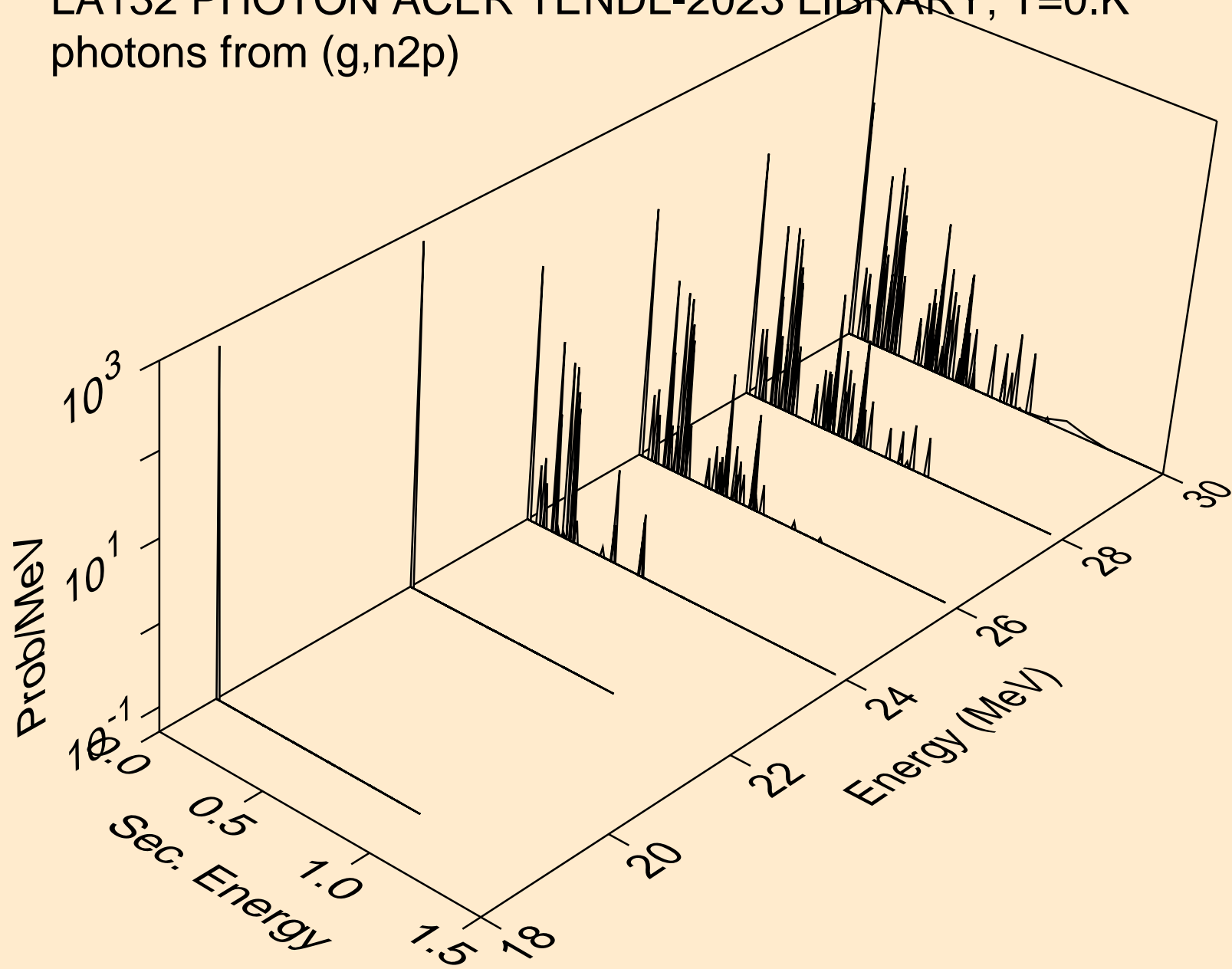

LA132 PHOTON ACER TENDL-2023 LIBRARY; T=0.K  
photons from (g,npa)

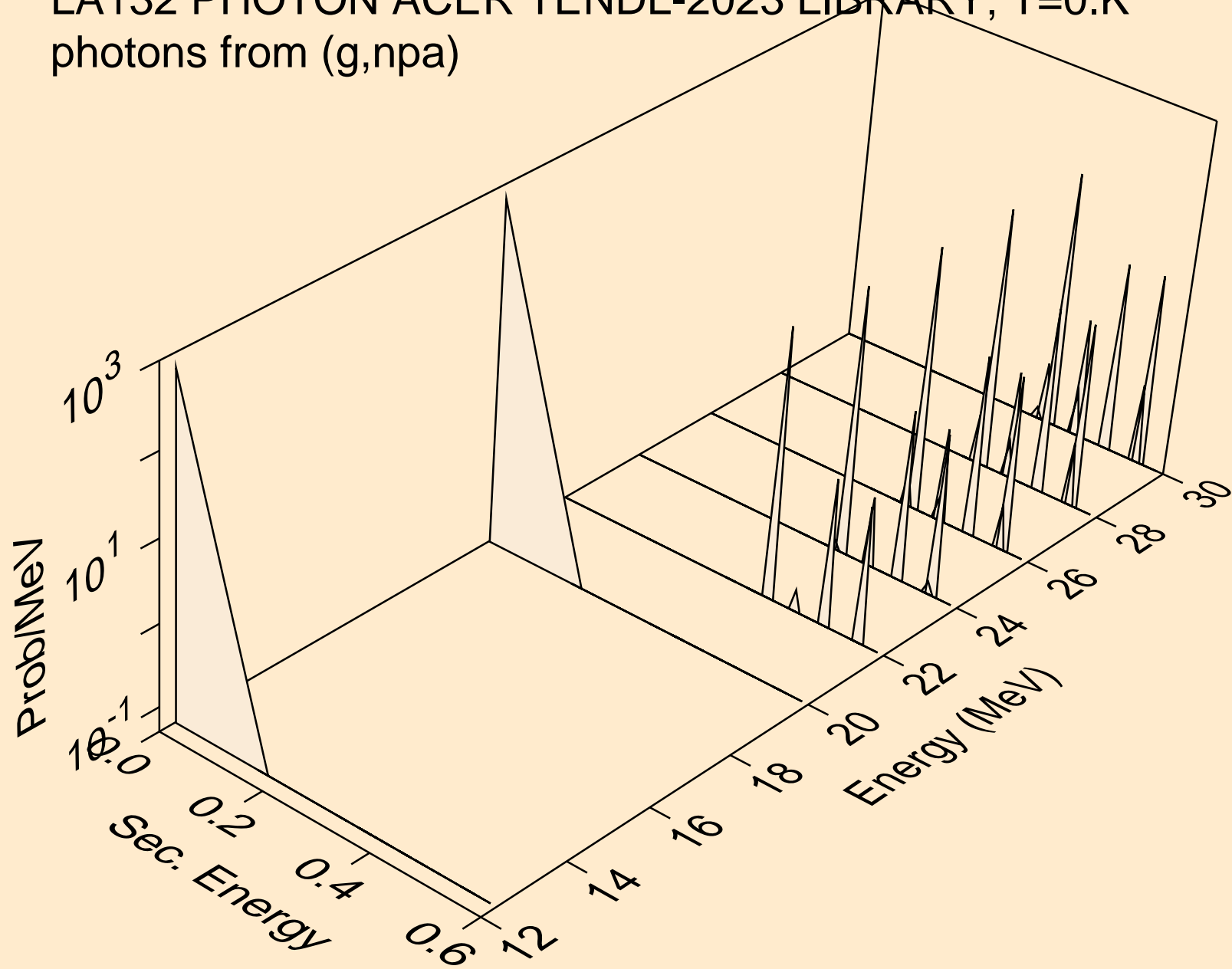

LA132 PHOTON ACER TENDL-2023 LIBRARY; T=0.K  
photons from (g,n\*c)

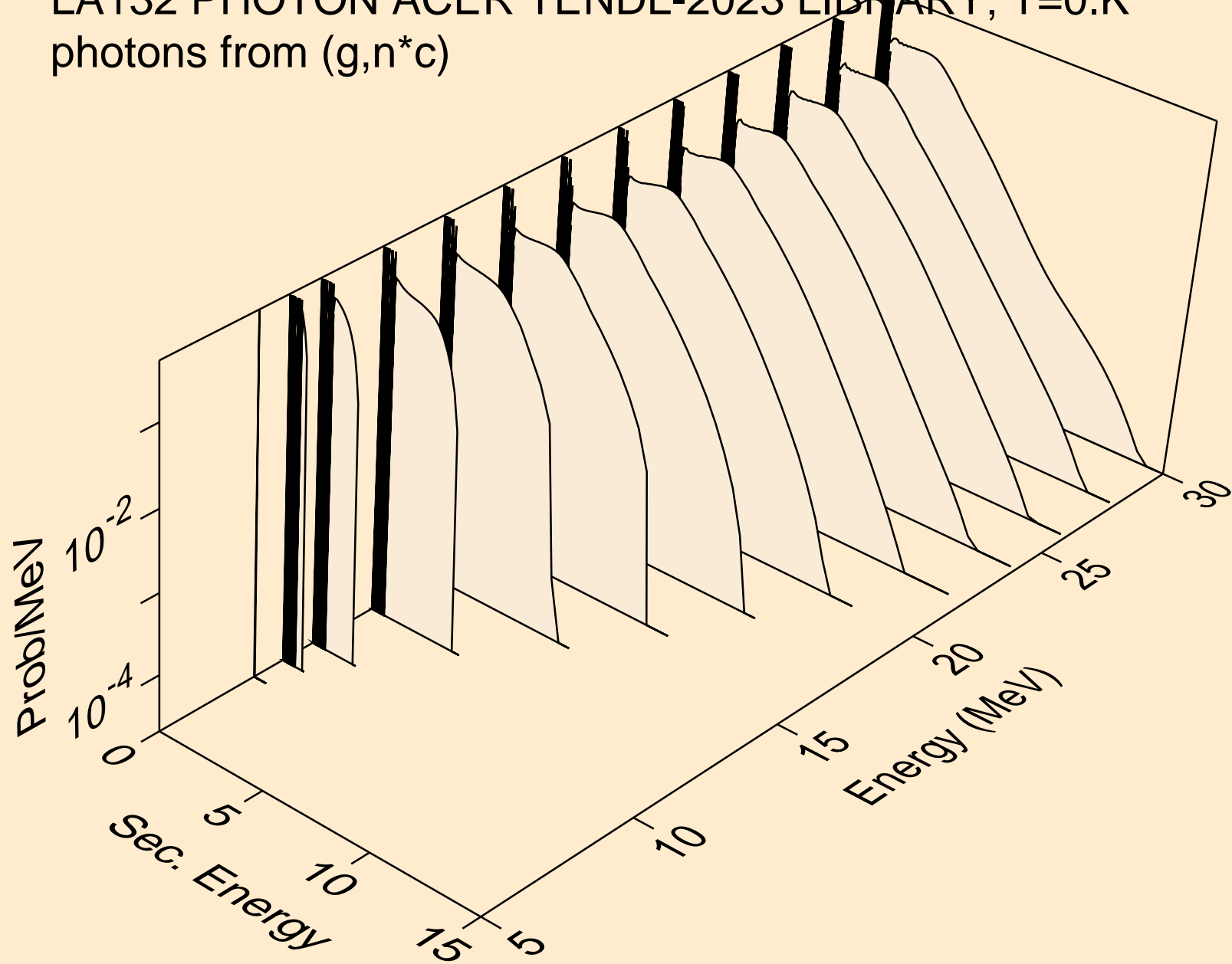

LA132 PHOTON ACER TENDL-2023 LIBRARY; T=0.K  
photons from (g,gma)

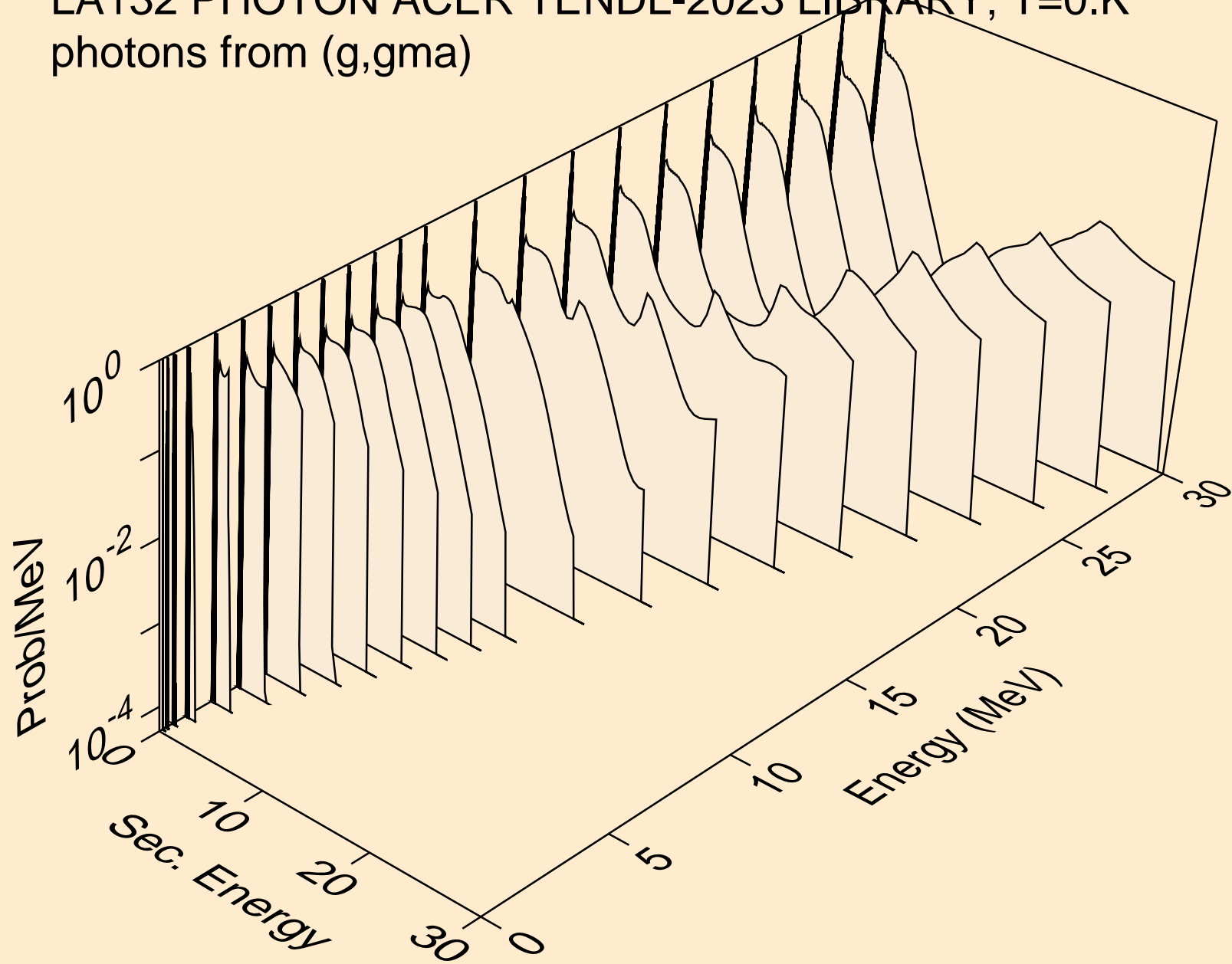



LA132 PHOTON ACER TENDL-2023 LIBRARY; T=0.K  
photons from (g,p)

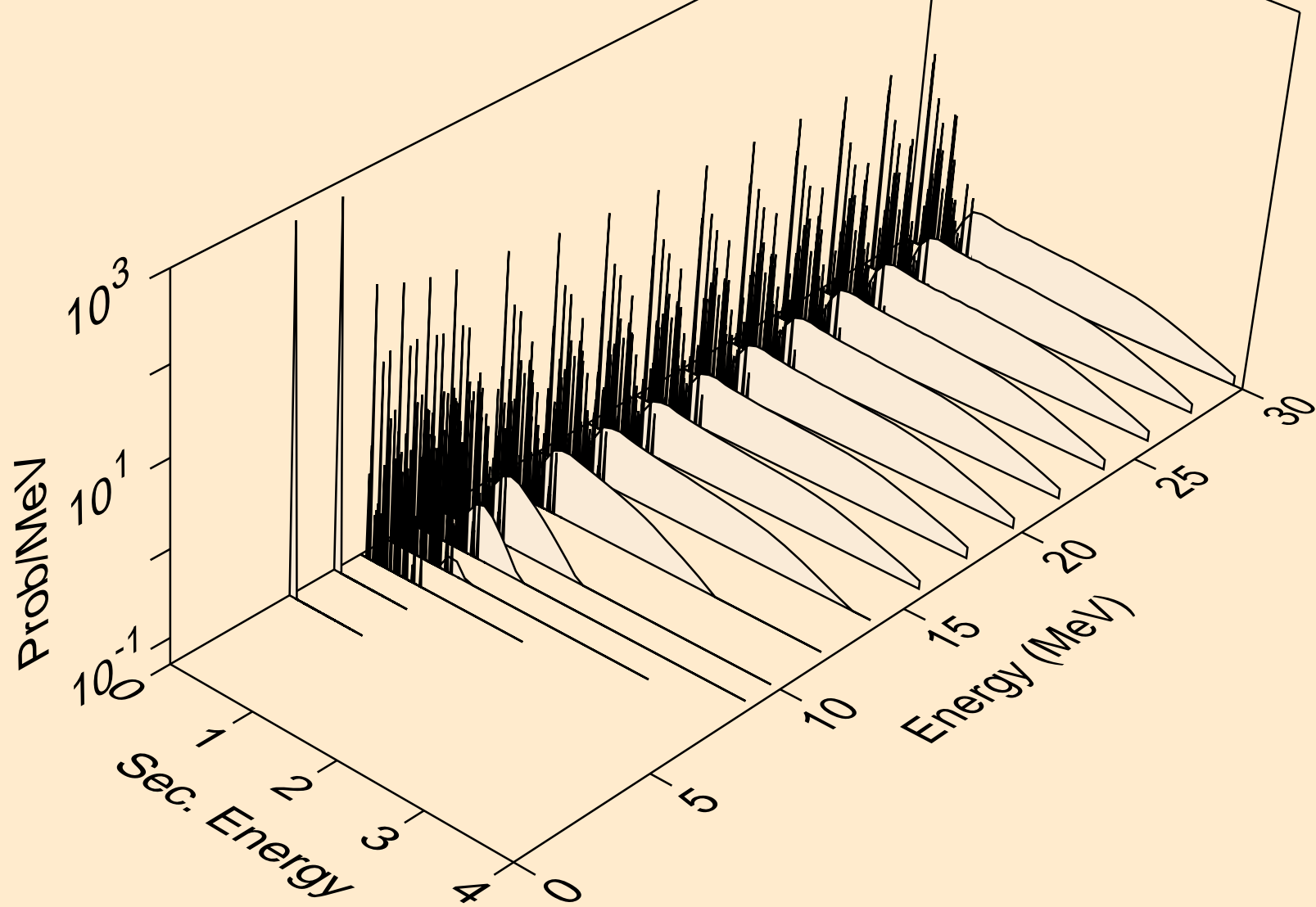

LA132 PHOTON ACER TENDL-2023 LIBRARY; T=0.K  
photons from (g,d)

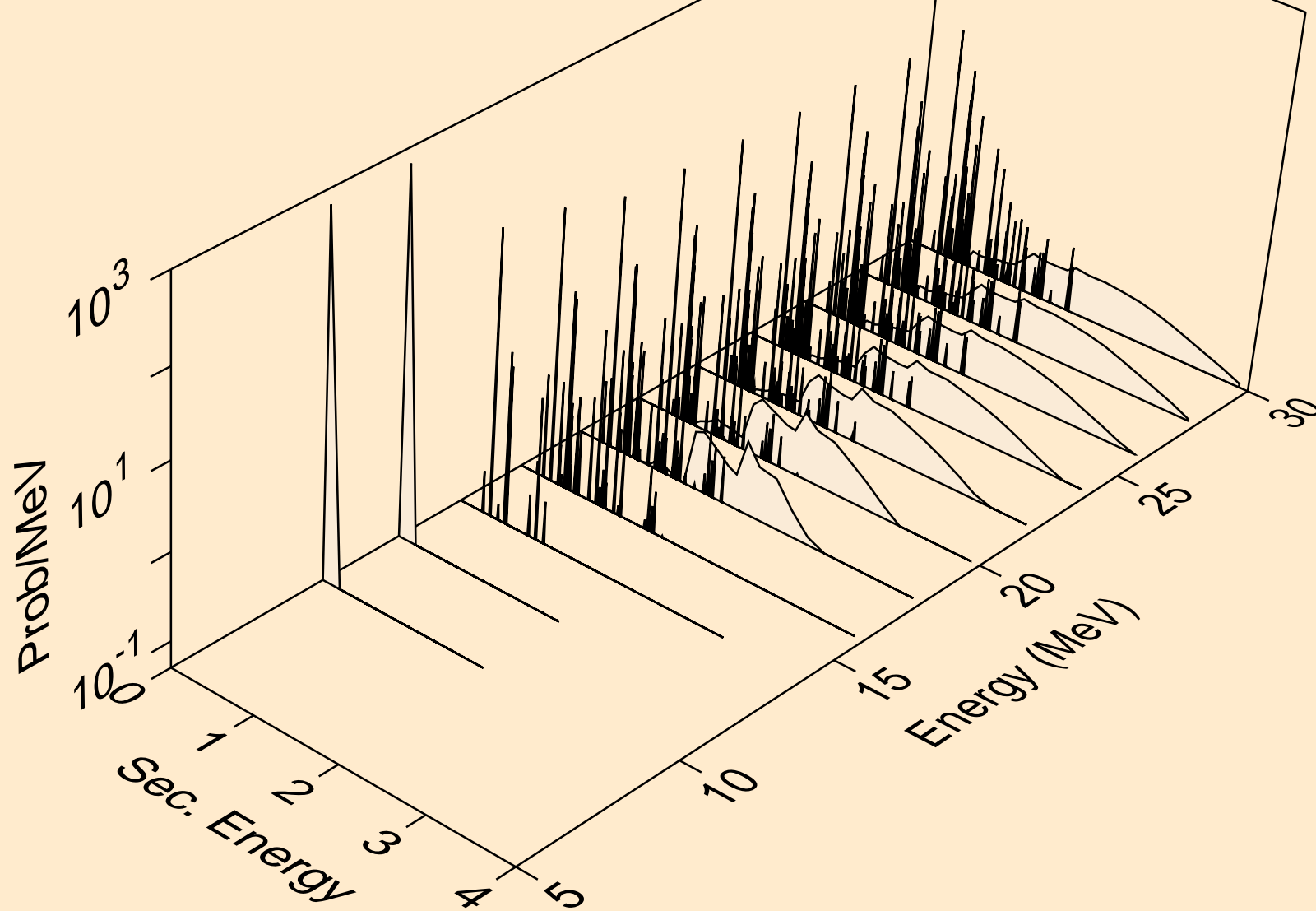

LA132 PHOTON ACER TENDL-2023 LIBRARY; T=0.K  
photons from (g,t)

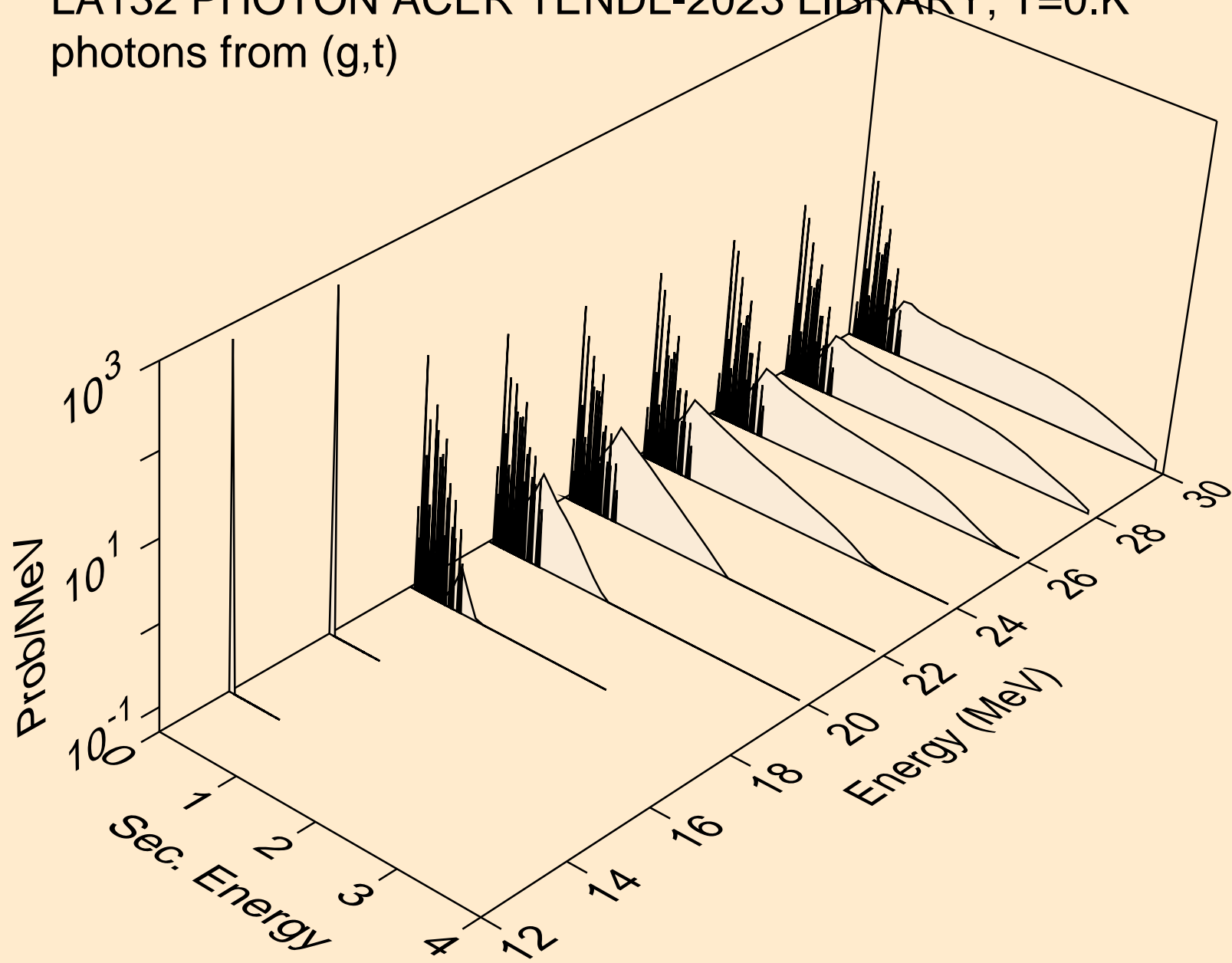

LA132 PHOTON ACER TENDL-2023 LIBRARY; T=0.K  
photons from (g,he3)

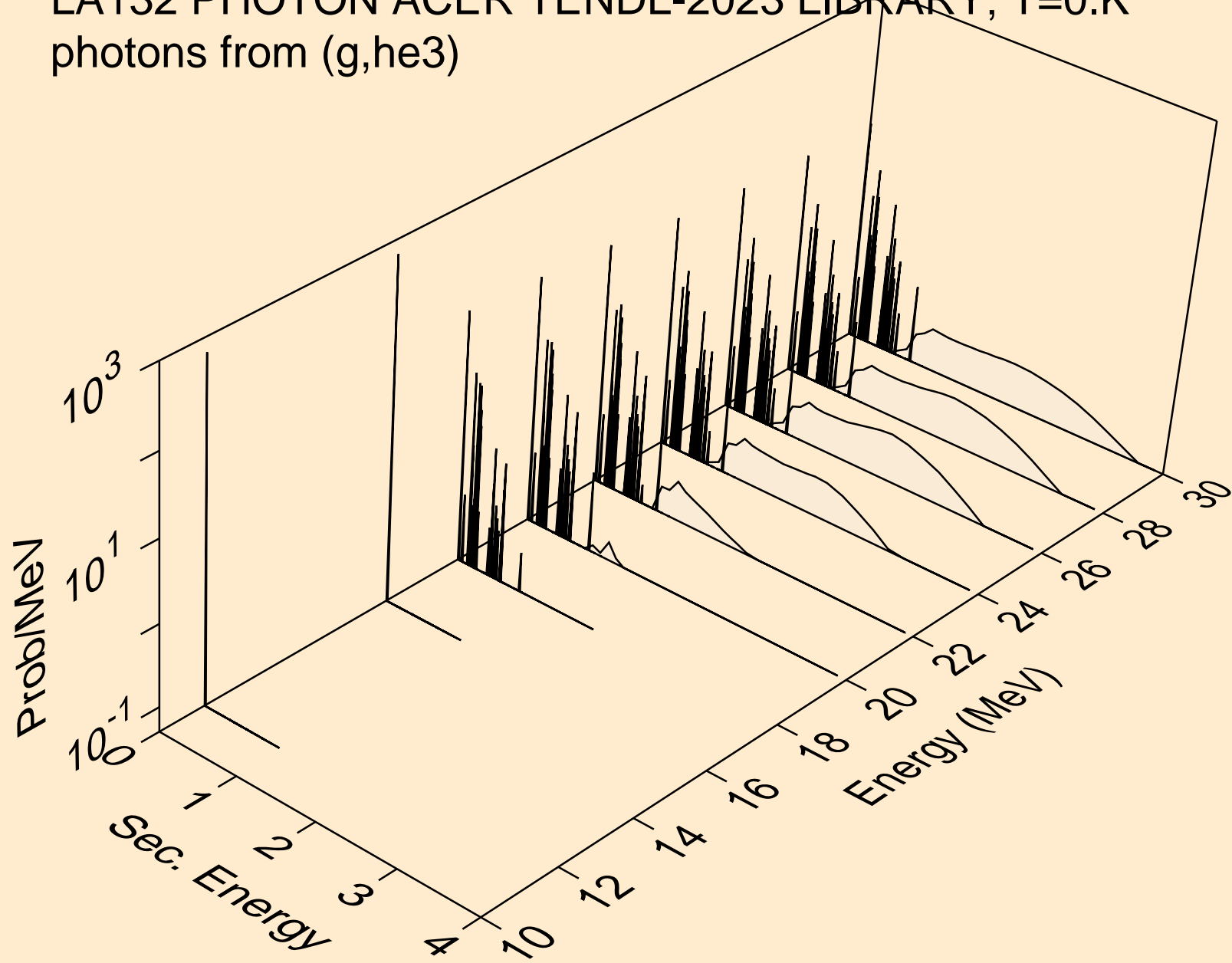

LA132 PHOTON ACER TENDL-2023 LIBRARY; T=0.K  
photons from (g,a)

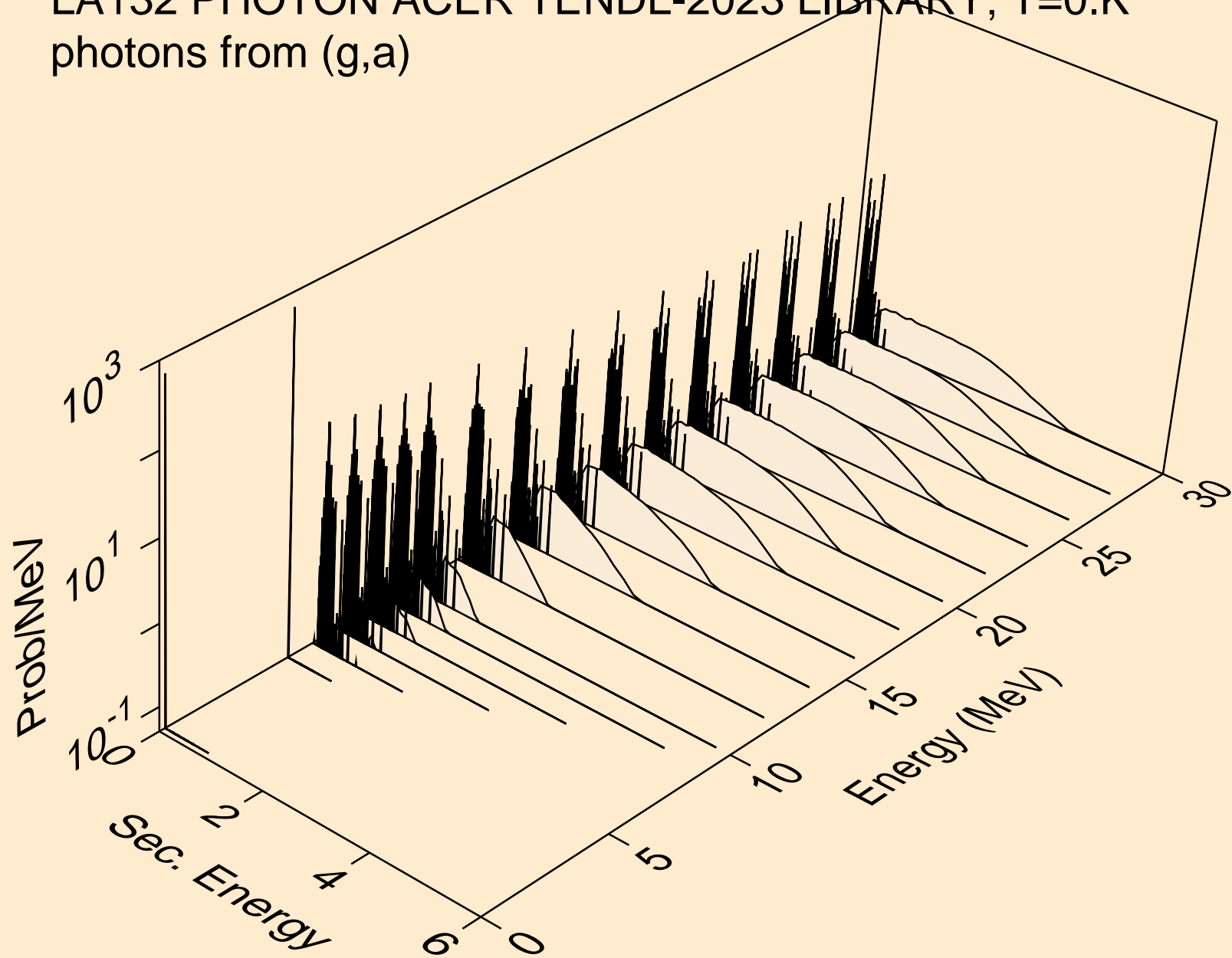

LA132 PHOTON ACER TENDL-2023 LIBRARY; T=0.K  
photons from (g,2a)

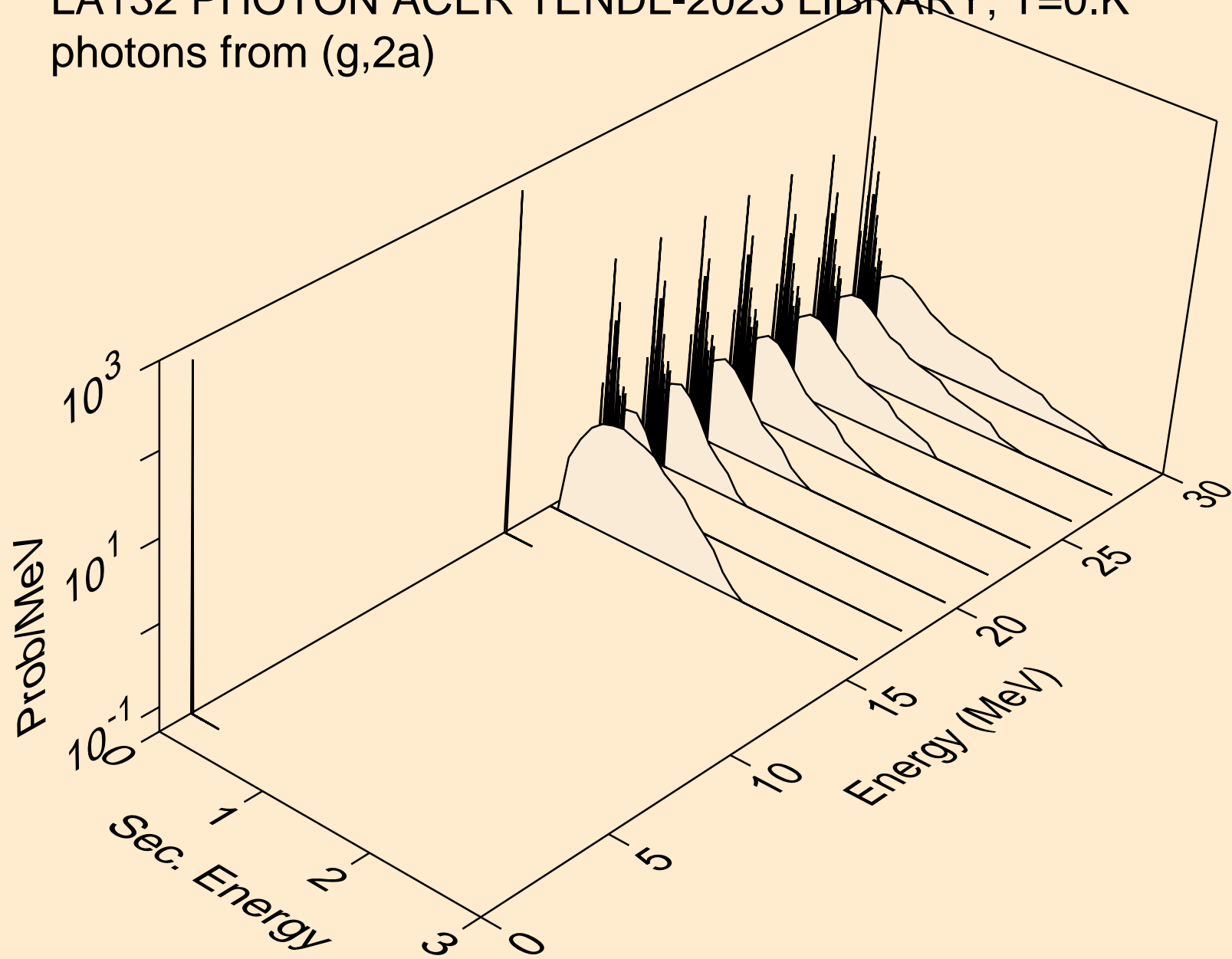

LA132 PHOTON ACER TENDL-2023 LIBRARY; T=0.K  
photons from (g,2p)

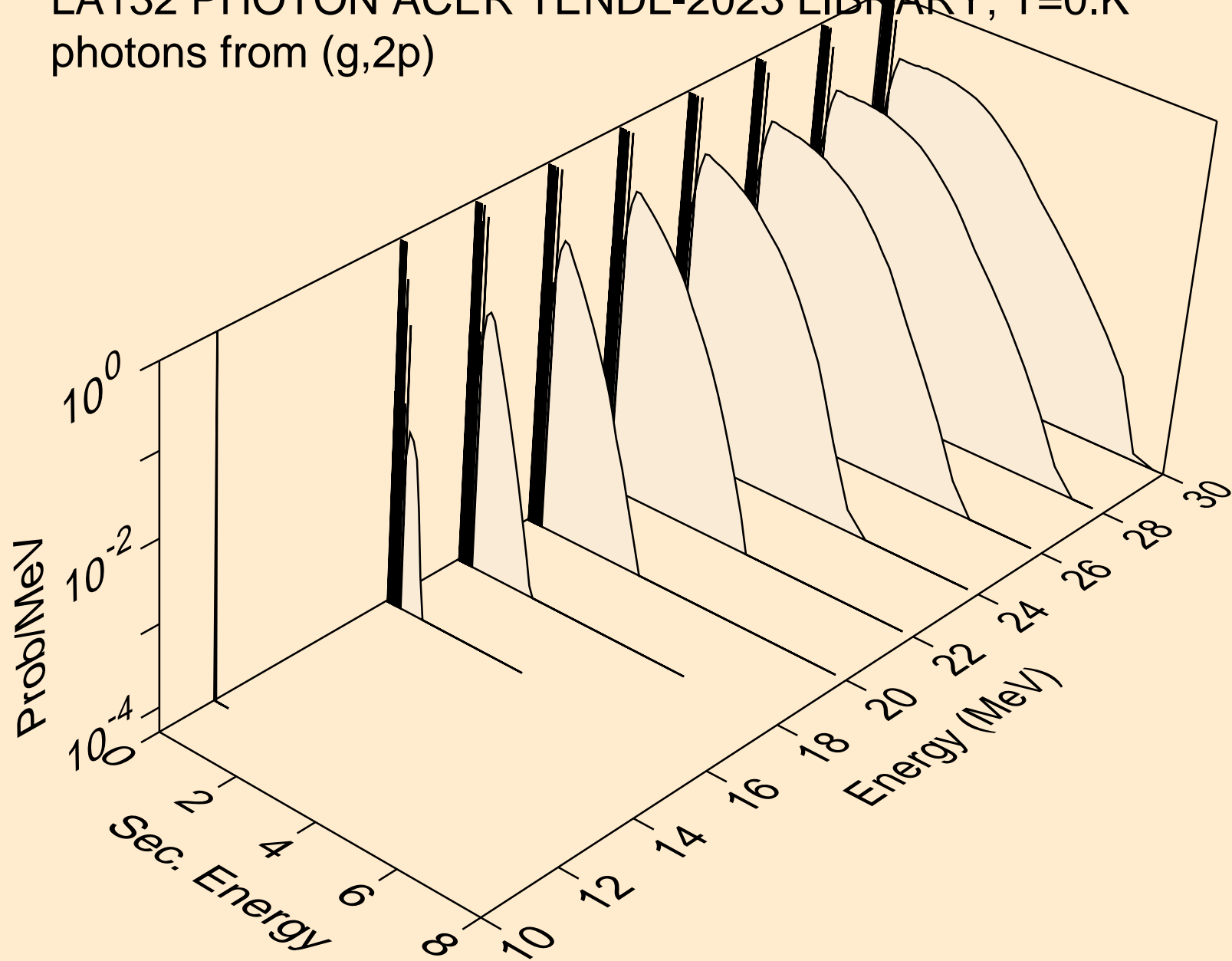

LA132 PHOTON ACER TENDL-2023 LIBRARY; T=0.K  
photons from (g,pa)

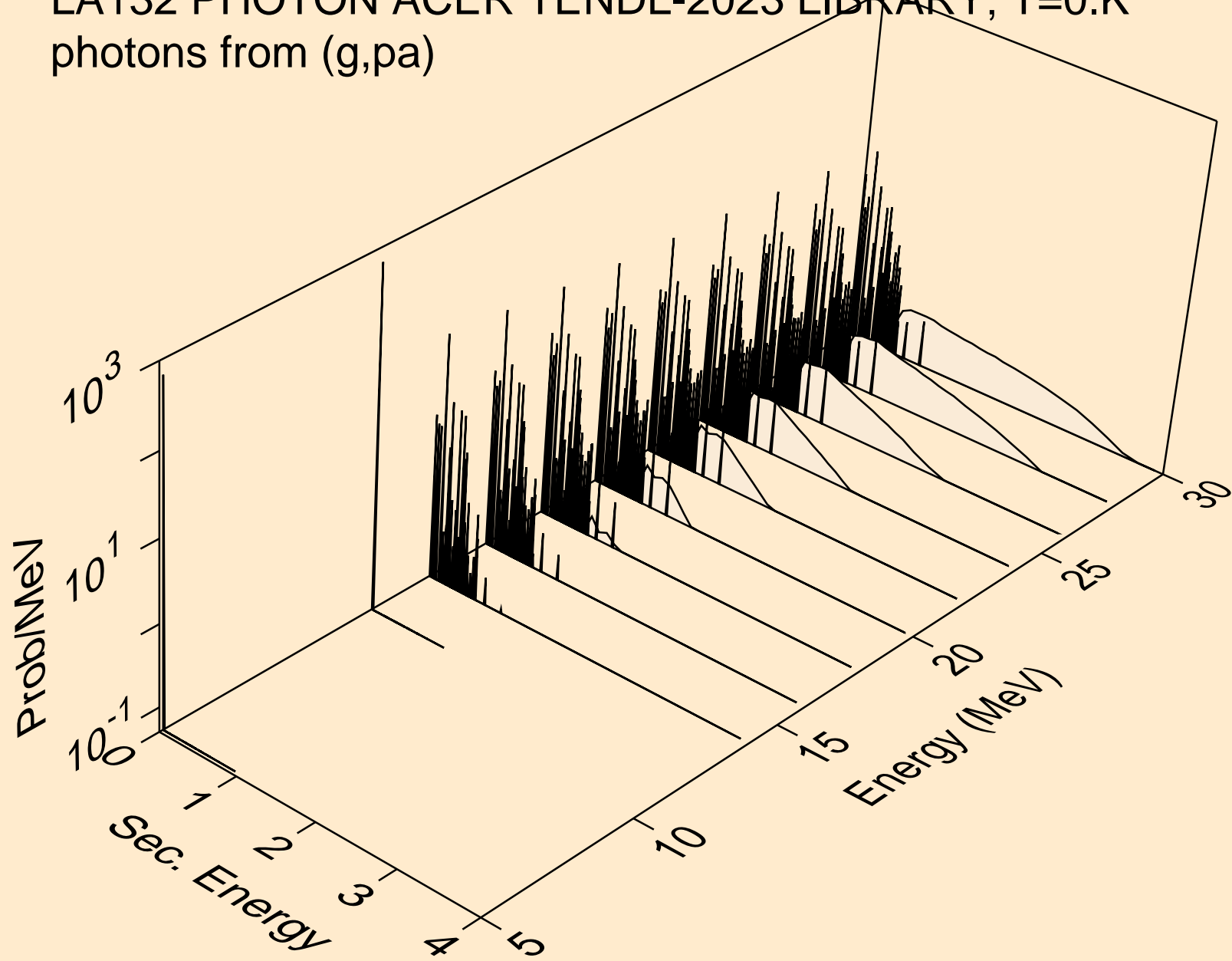



LA132 PHOTON ACER TENDL-2023 LIBRARY; T=0.K  
photons from (g,pd)

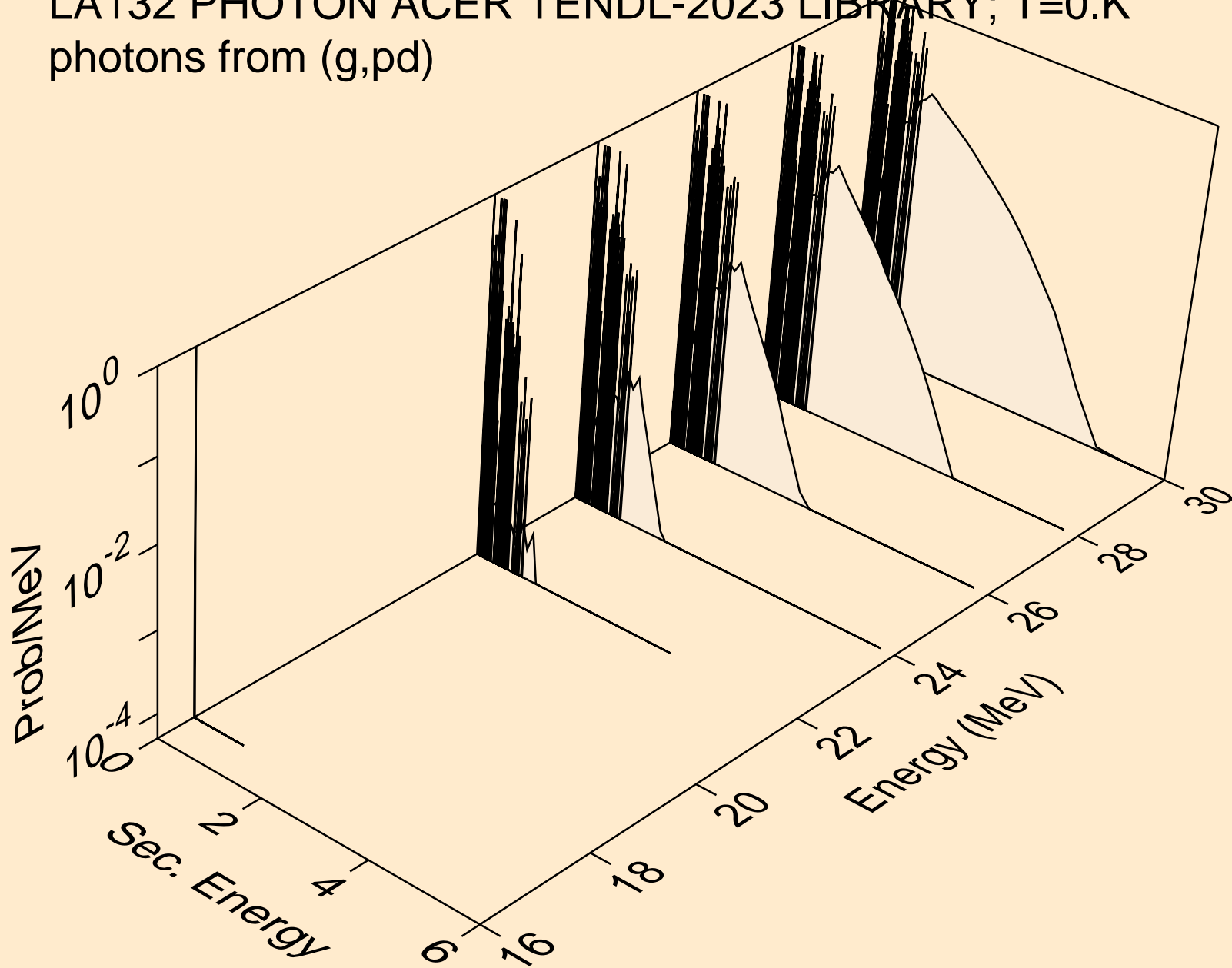

LA132 PHOTON ACER TENDL-2023 LIBRARY; T=0.K  
protons from (g,x)

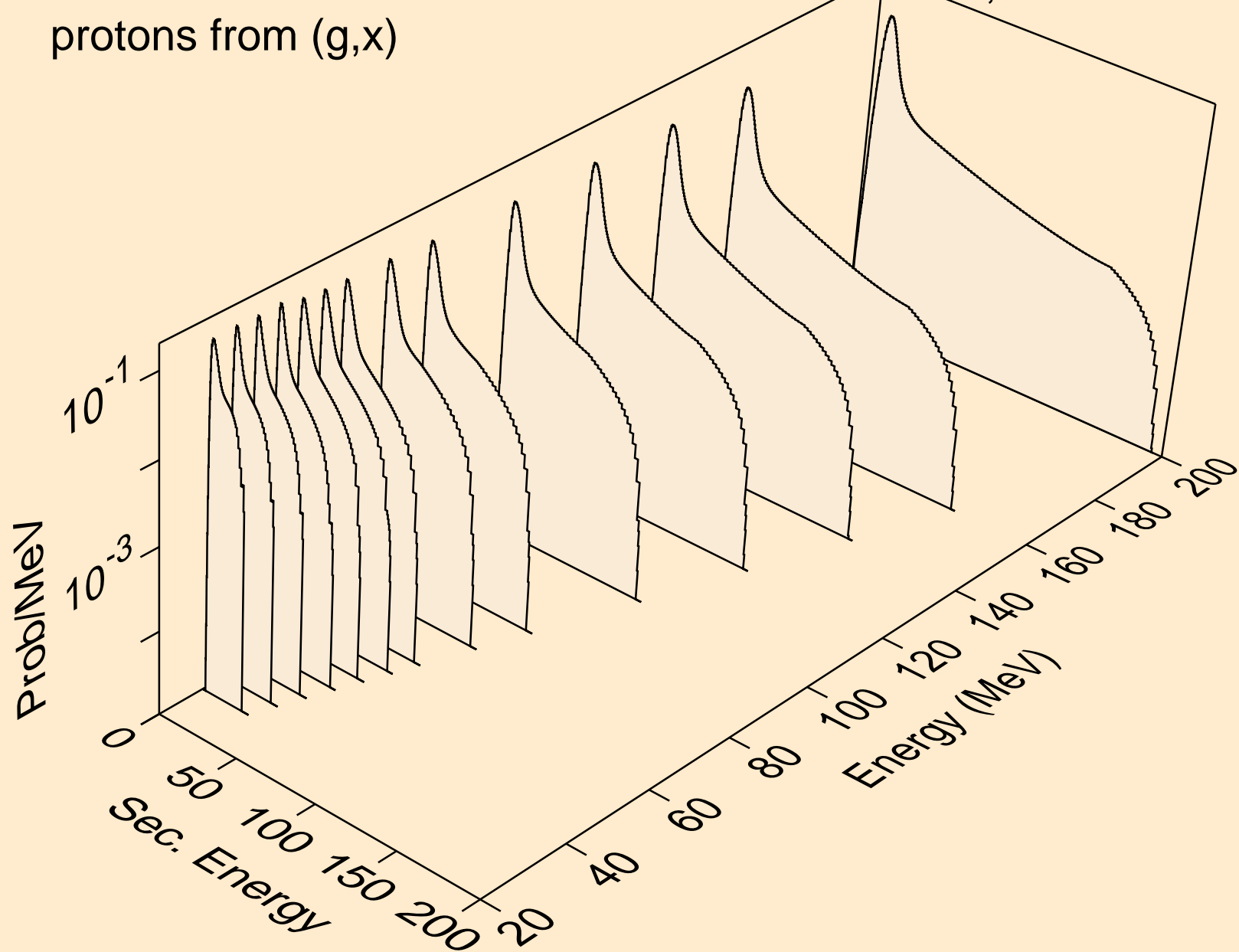

LA132 PHOTON ACER TENDL-2023 LIBRARY; T=0.K  
protons from (g,n\*)p

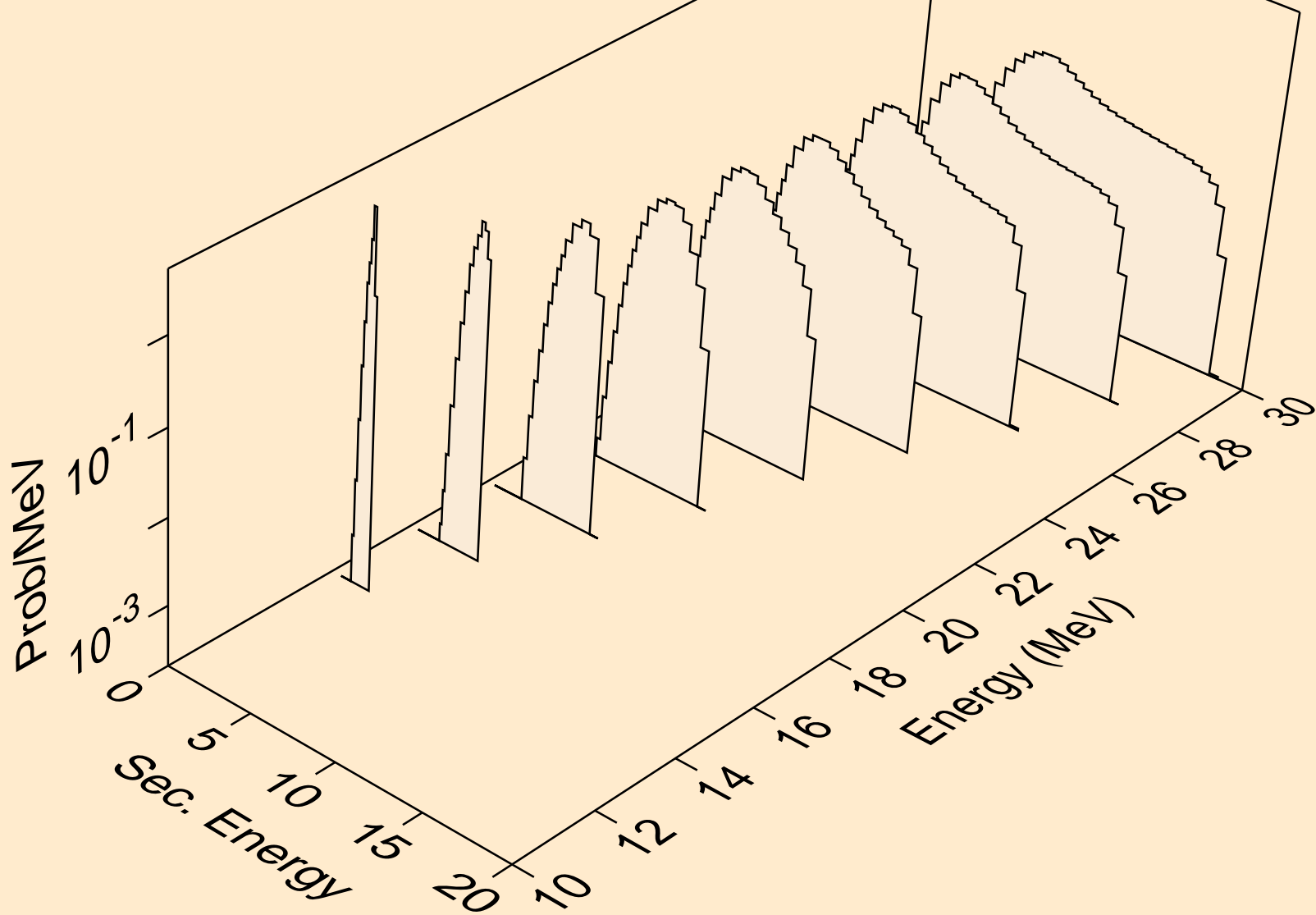

LA132 PHOTON ACER TENDL-2023 LIBRARY; T=0.K  
protons from (g,2np)

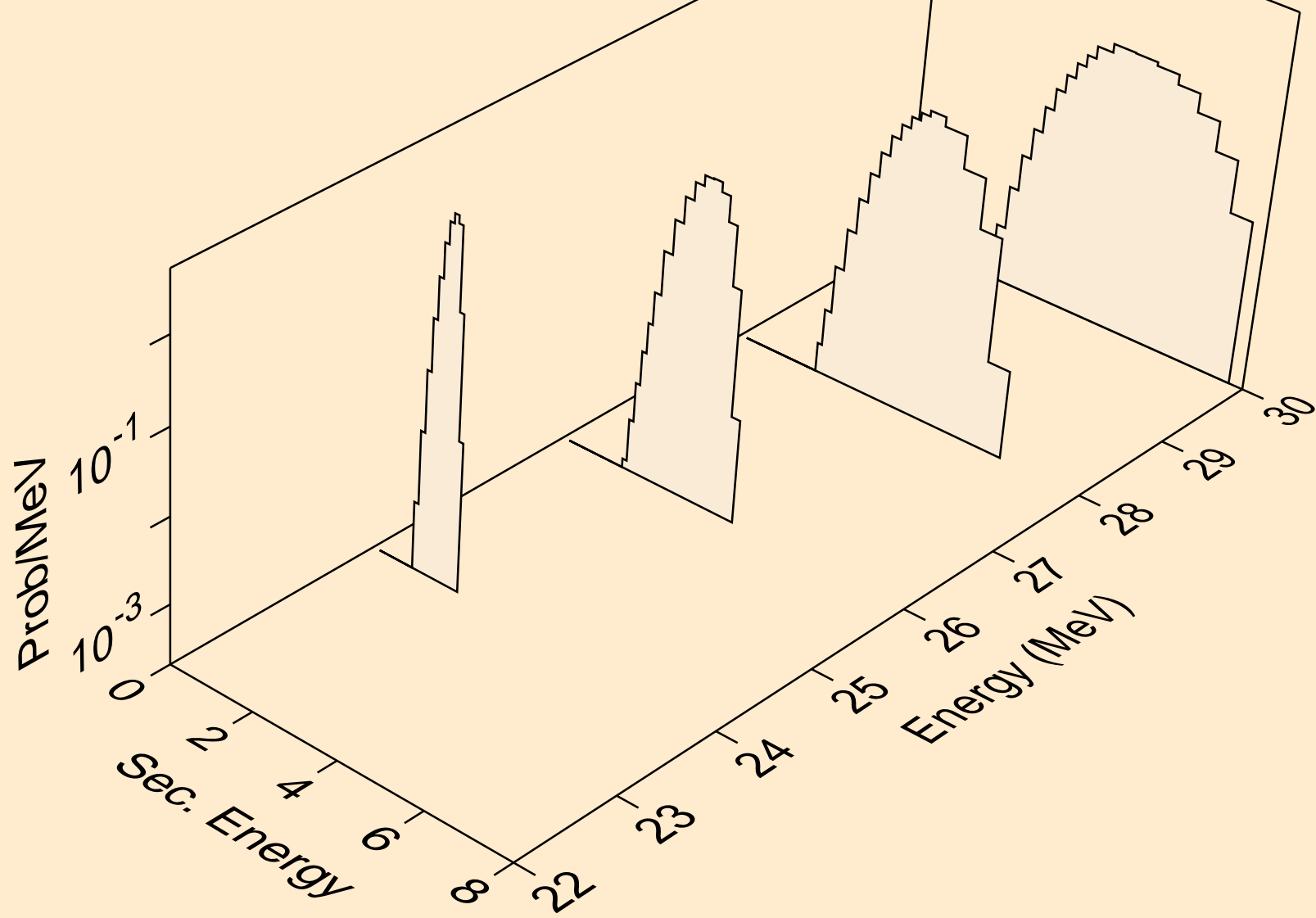

LA132 PHOTON ACER TENDL-2023 LIBRARY; T=0.K  
protons from (g,n2p)

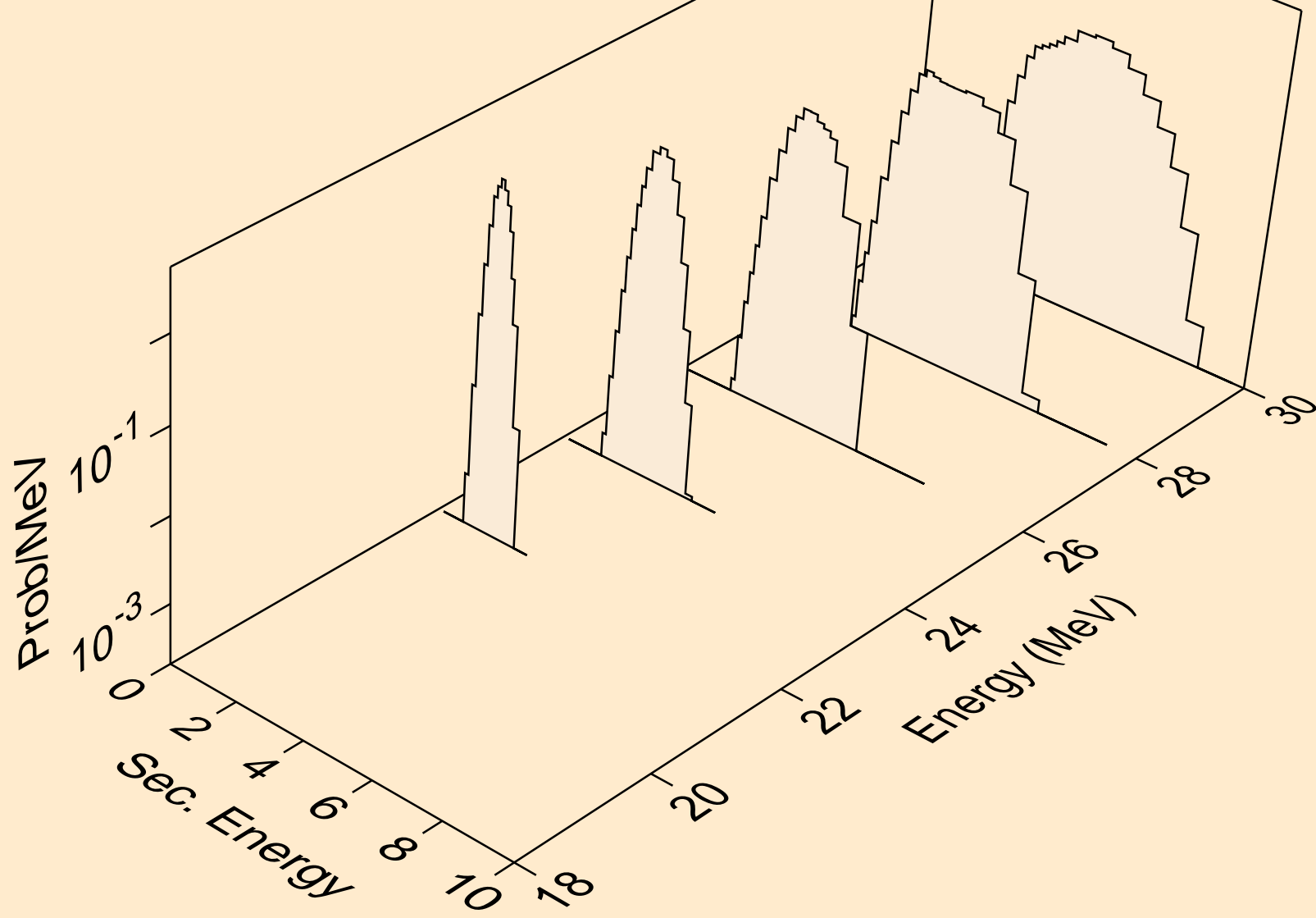

LA132 PHOTON ACER TENDL-2023 LIBRARY; T=0.K  
protons from (g,npa)

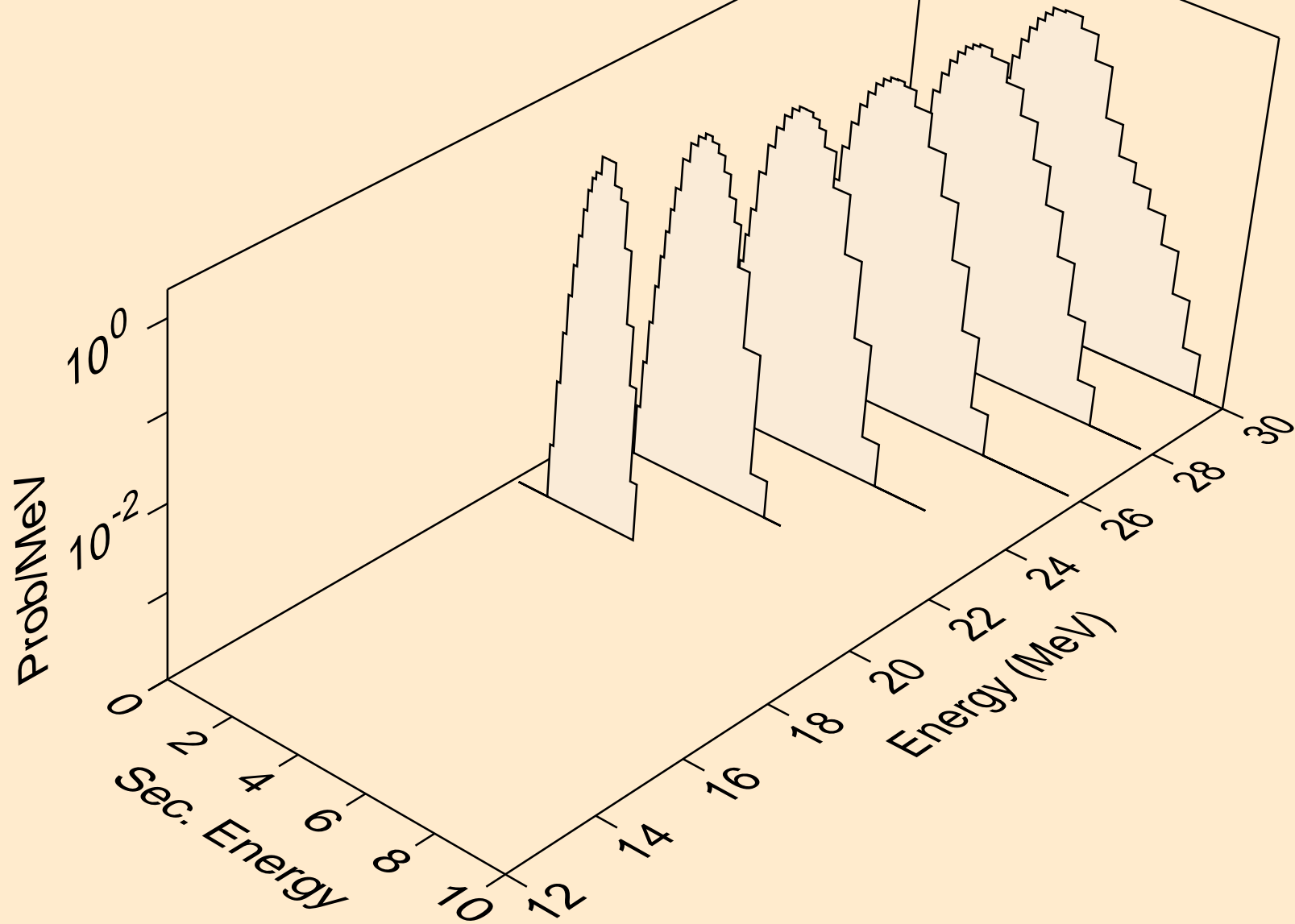

LA132 PHOTON ACER TENDL-2023 LIBRARY; T=0.K  
protons from (g,p)

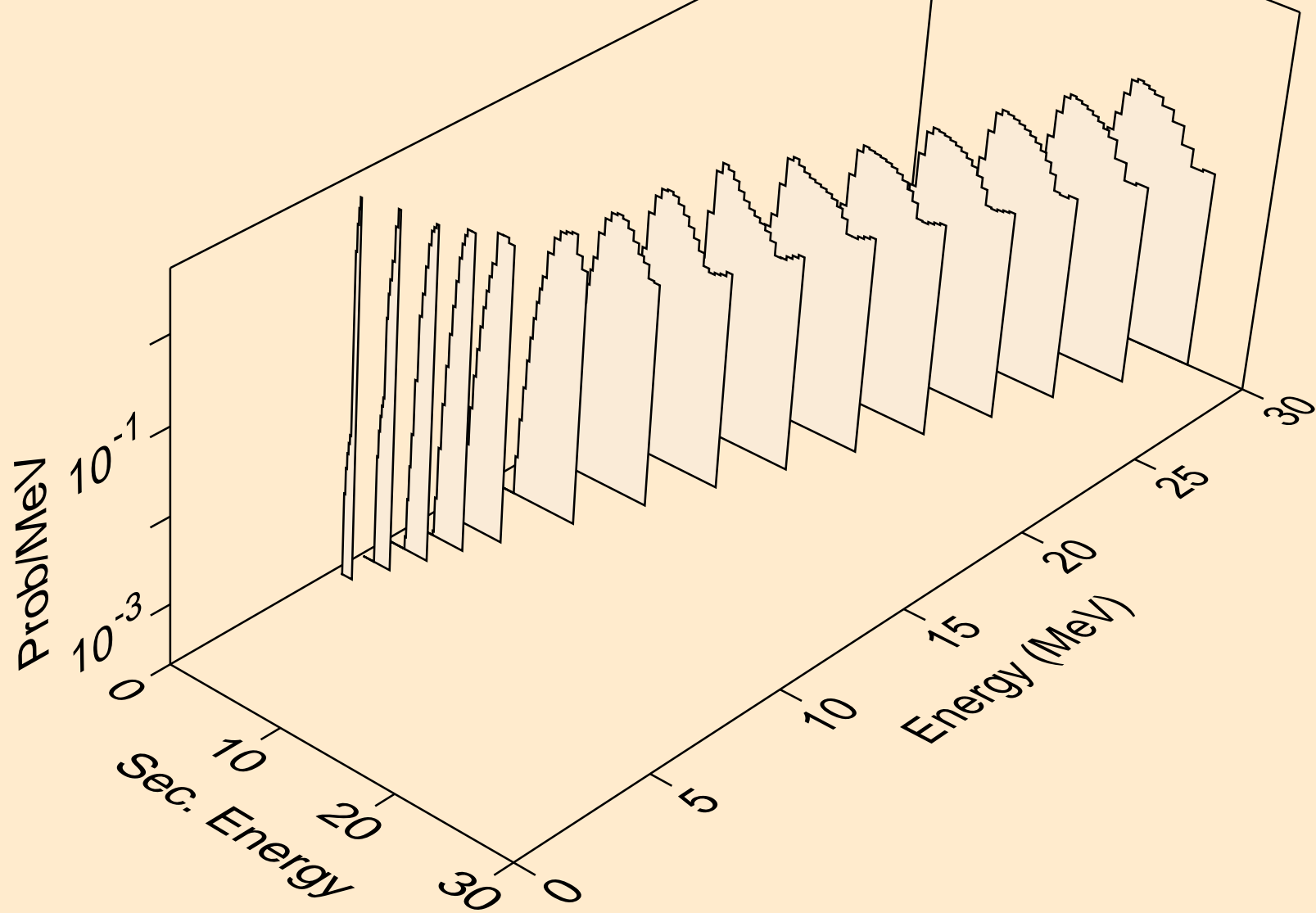

LA132 PHOTON ACER TENDL-2023 LIBRARY; T=0.K  
protons from (g,2p)

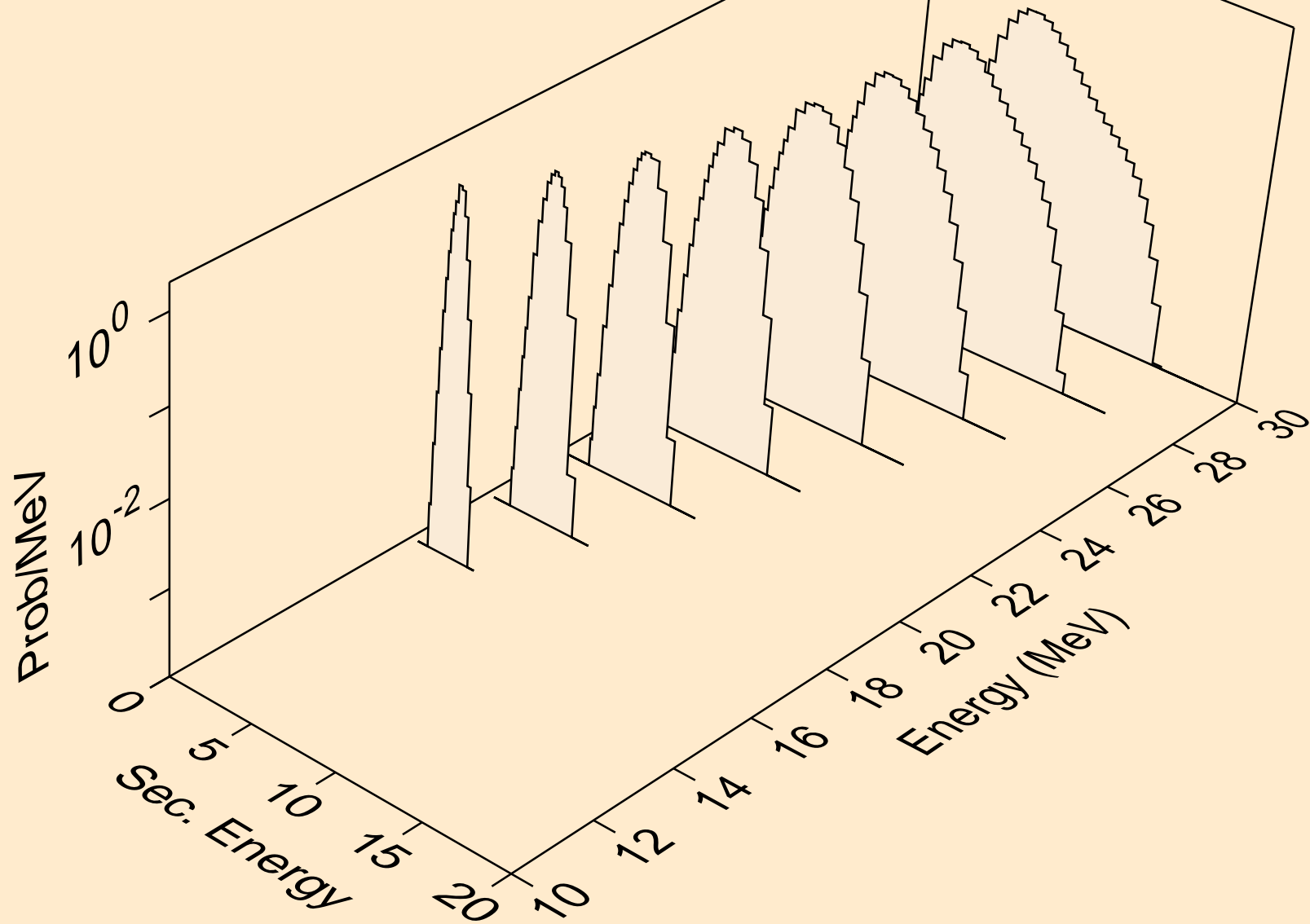



LA132 PHOTON ACER TENDL-2023 LIBRARY; T=0.K  
protons from (g,pa)

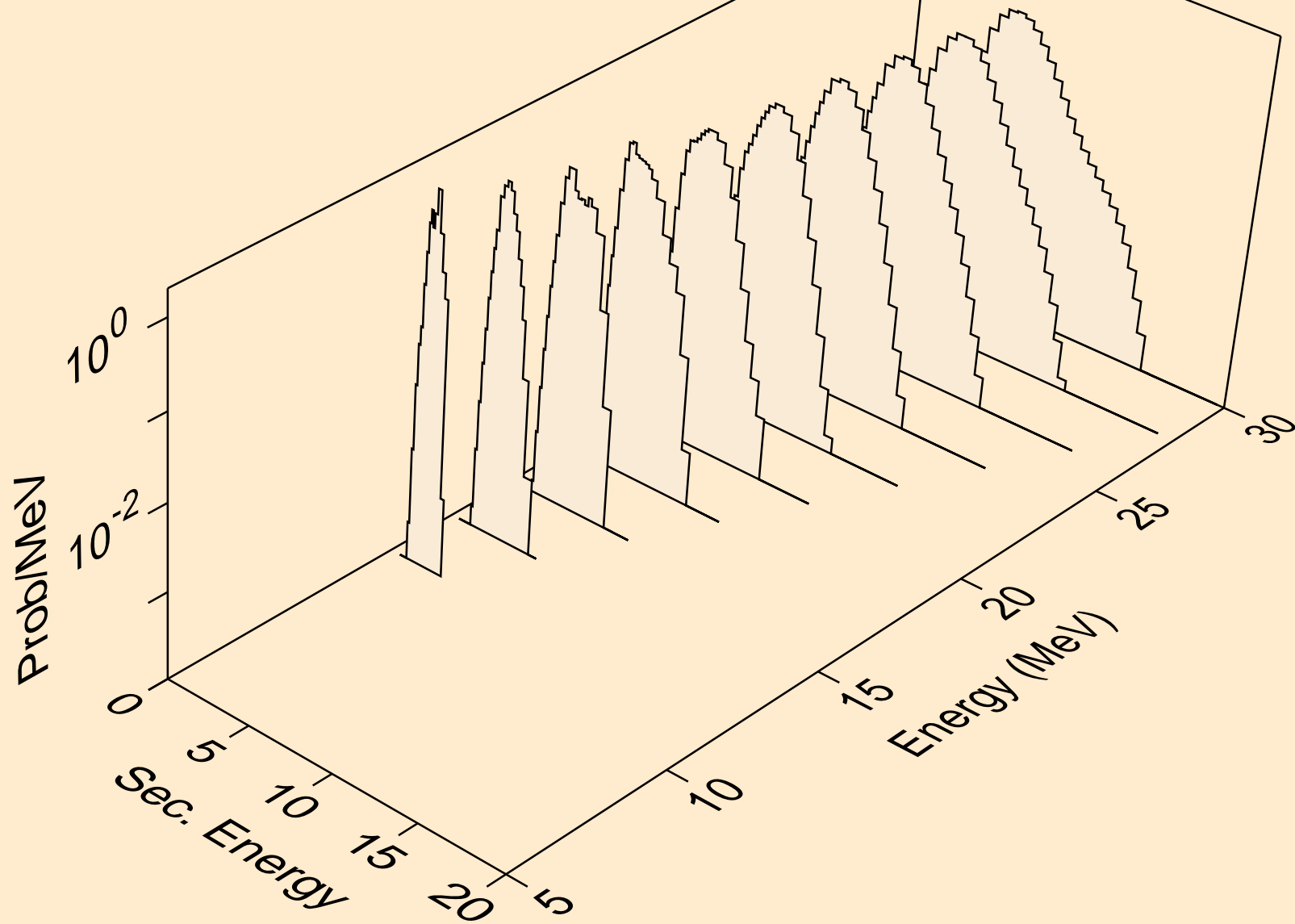

LA132 PHOTON ACER TENDL-2023 LIBRARY; T=0.K  
protons from (g,pd)

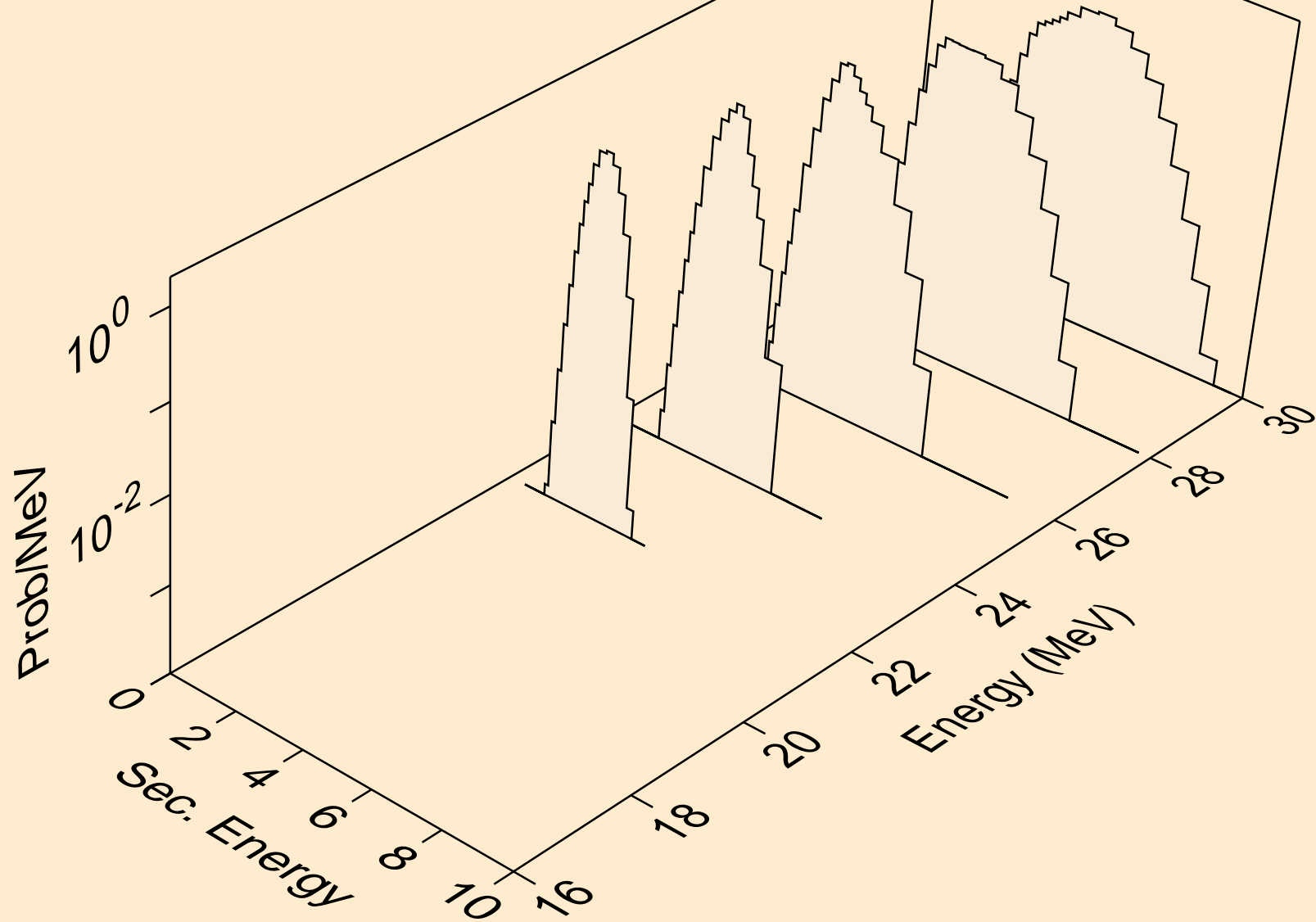

LA132 PHOTON ACER TENDL-2023 LIBRARY; T=0.K  
deuterons from (g,x)

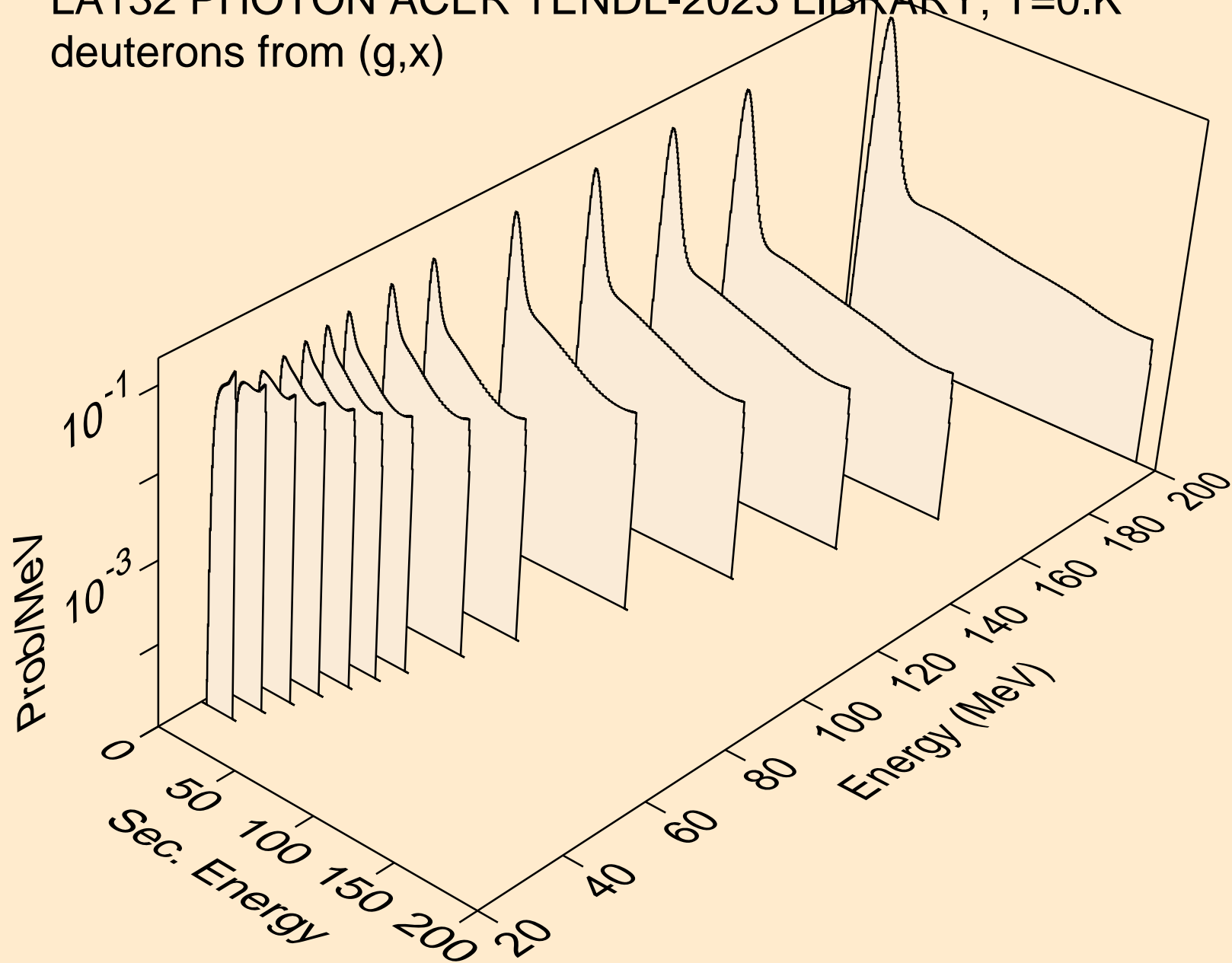

LA132 PHOTON ACER TENDL-2023 LIBRARY; T=0.K  
deuterons from (g,n\*)d

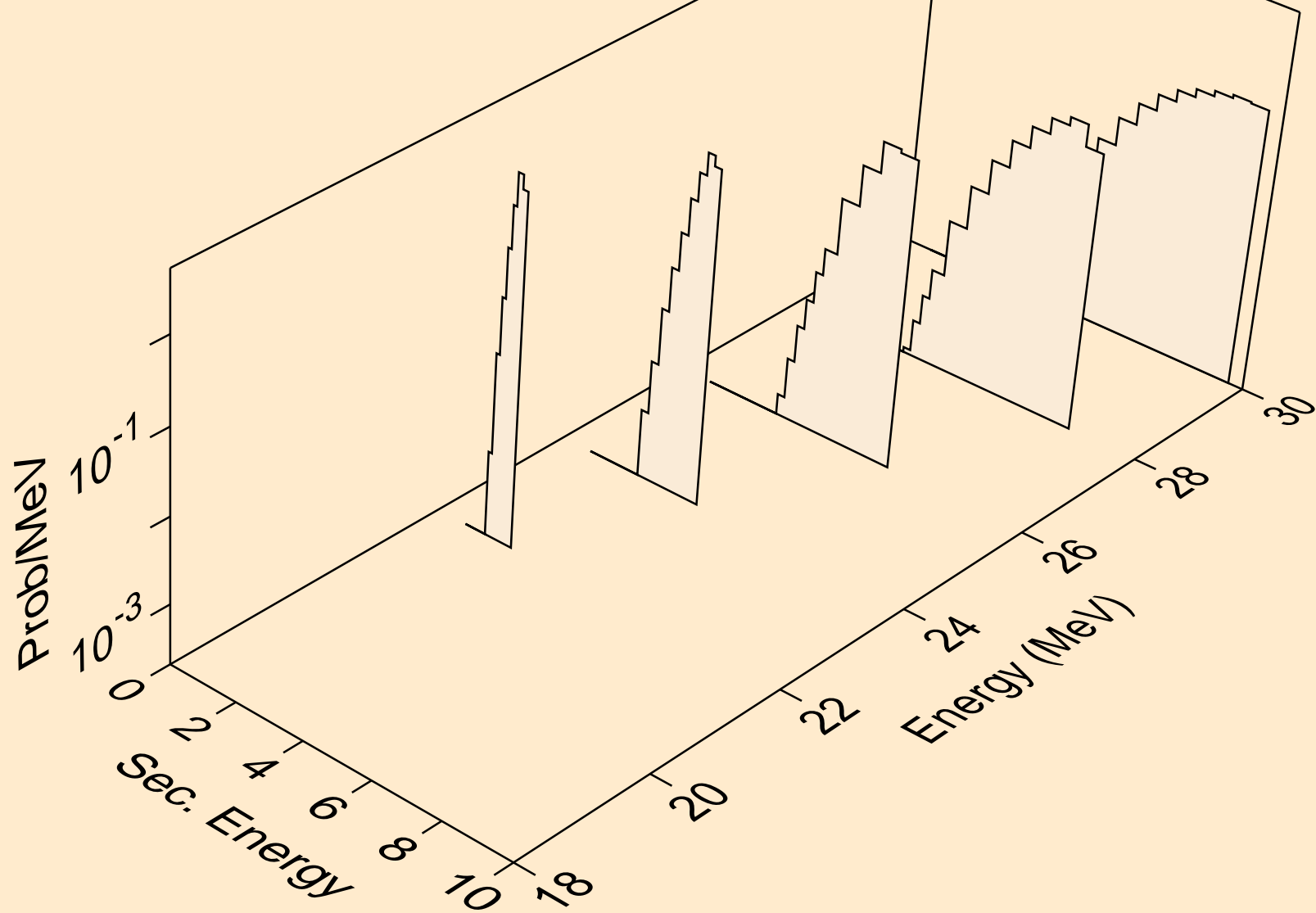

LA132 PHOTON ACER TENDL-2023 LIBRARY; T=0.K  
deuterons from (g,d)

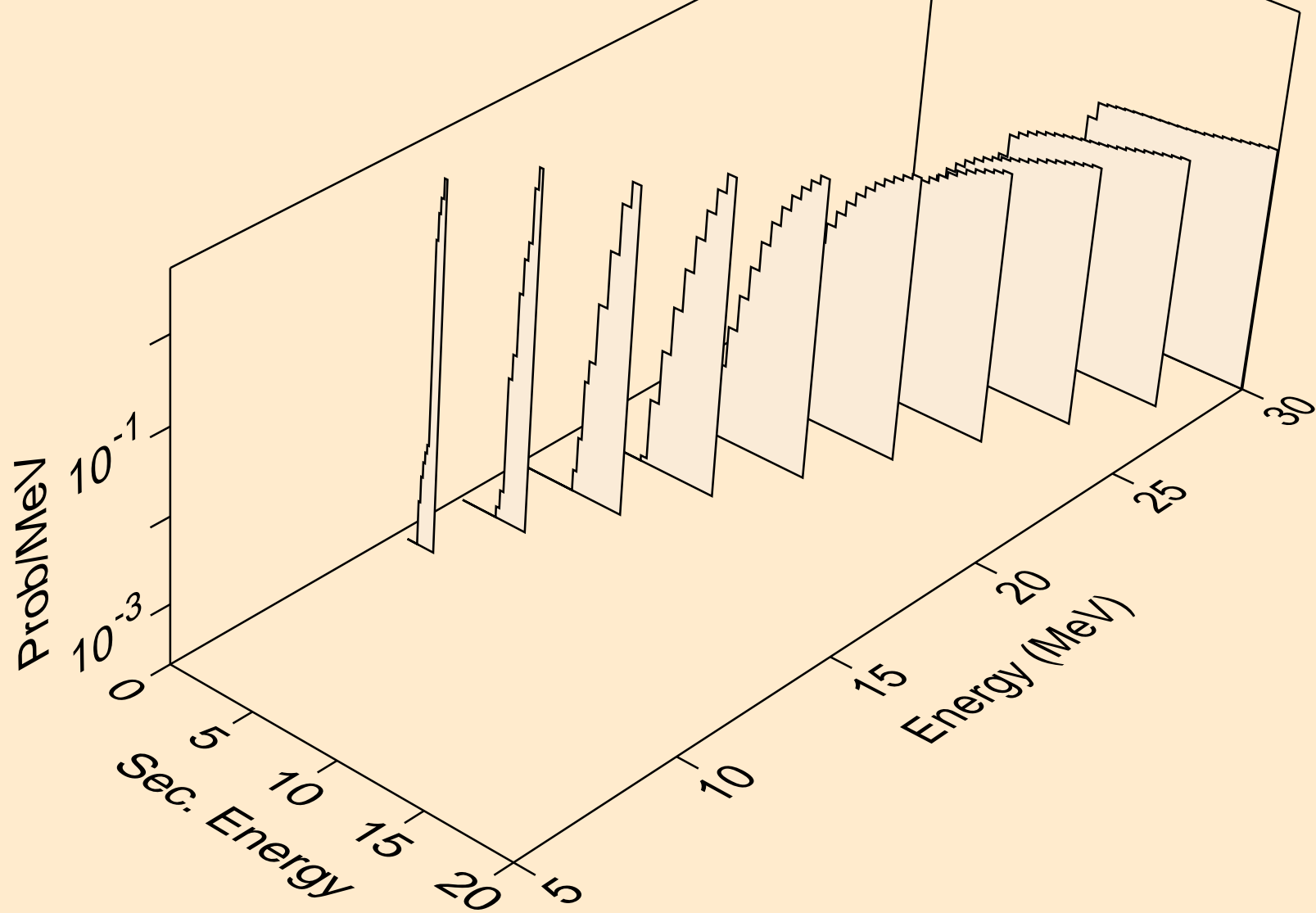

LA132 PHOTON ACER TENDL-2023 LIBRARY; T=0.K  
deuterons from (g,pd)

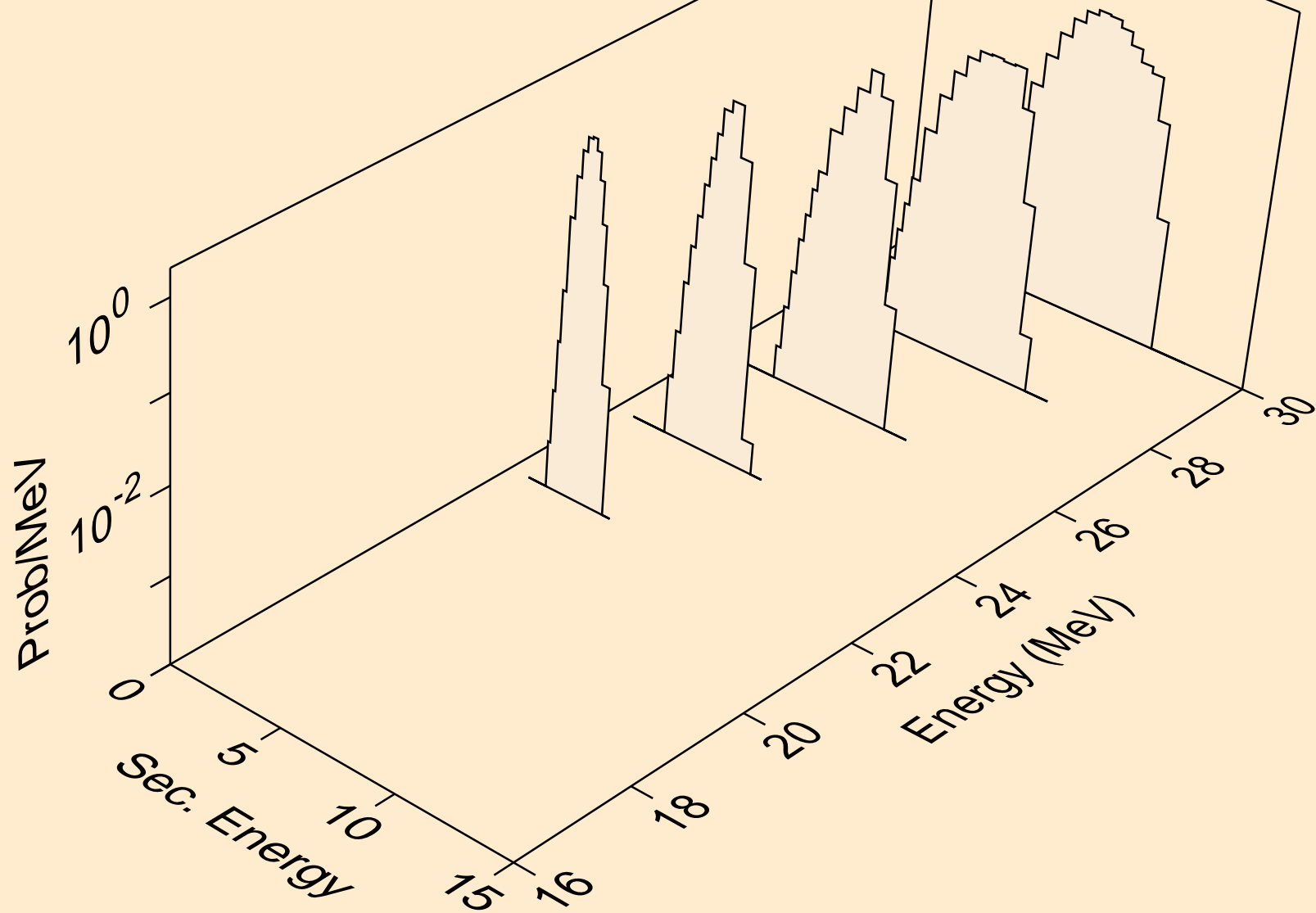

LA132 PHOTON ACER TENDL-2023 LIBRARY; T=0.K  
tritons from (g,x)

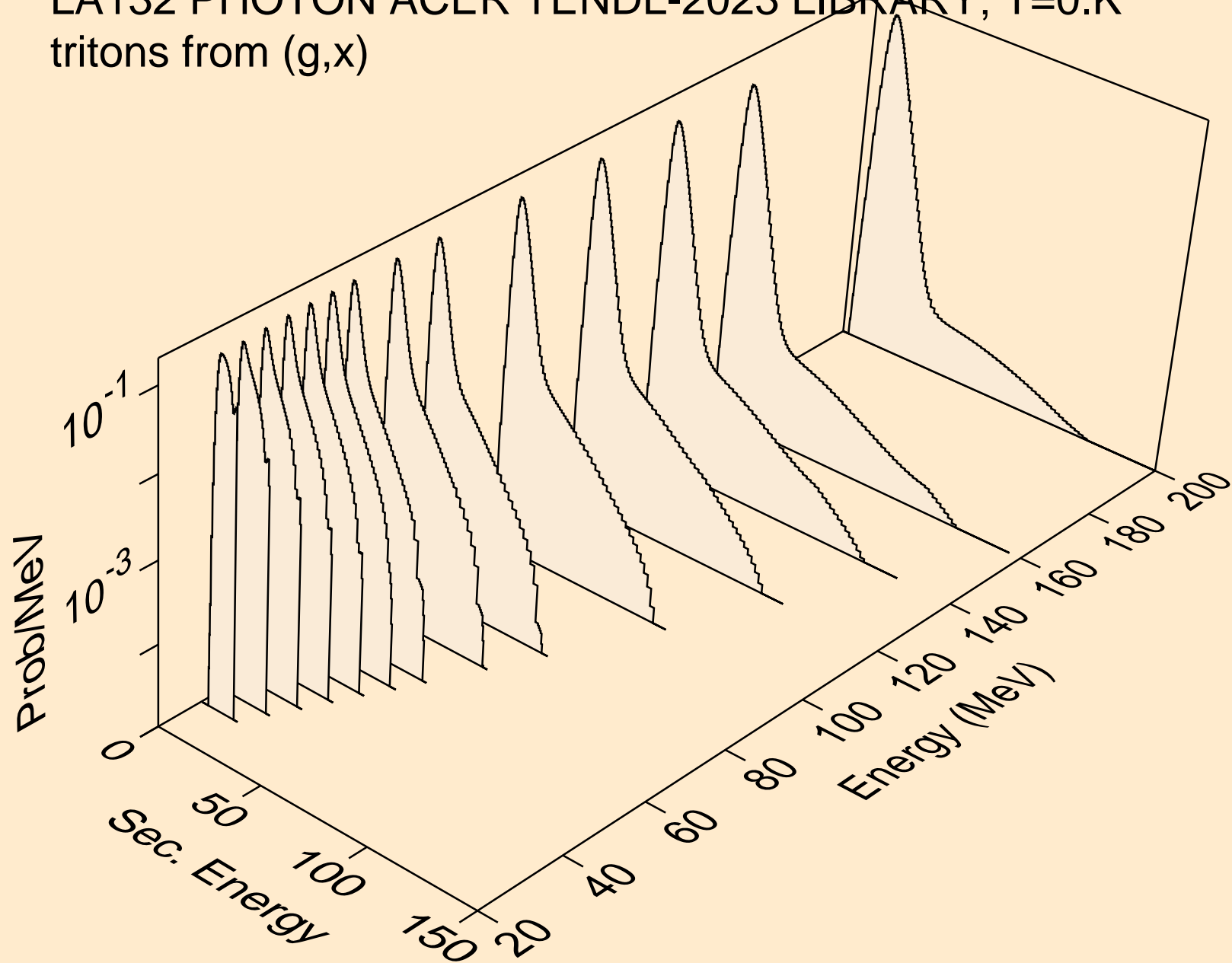

LA132 PHOTON ACER TENDL-2023 LIBRARY; T=0.K  
tritons from (g,n\*)t

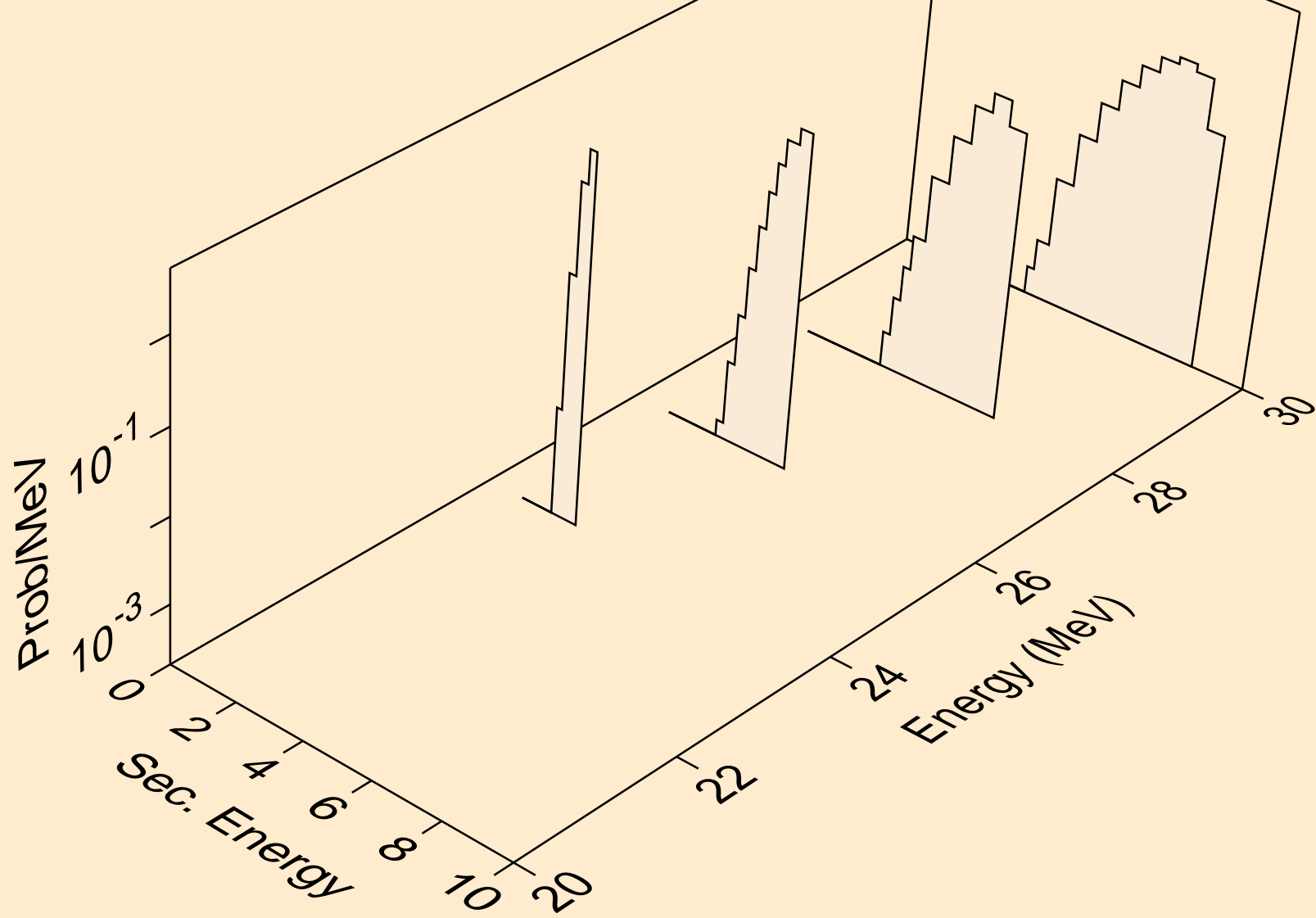



LA132 PHOTON ACER TENDL-2023 LIBRARY; T=0.K  
tritons from (g,t)

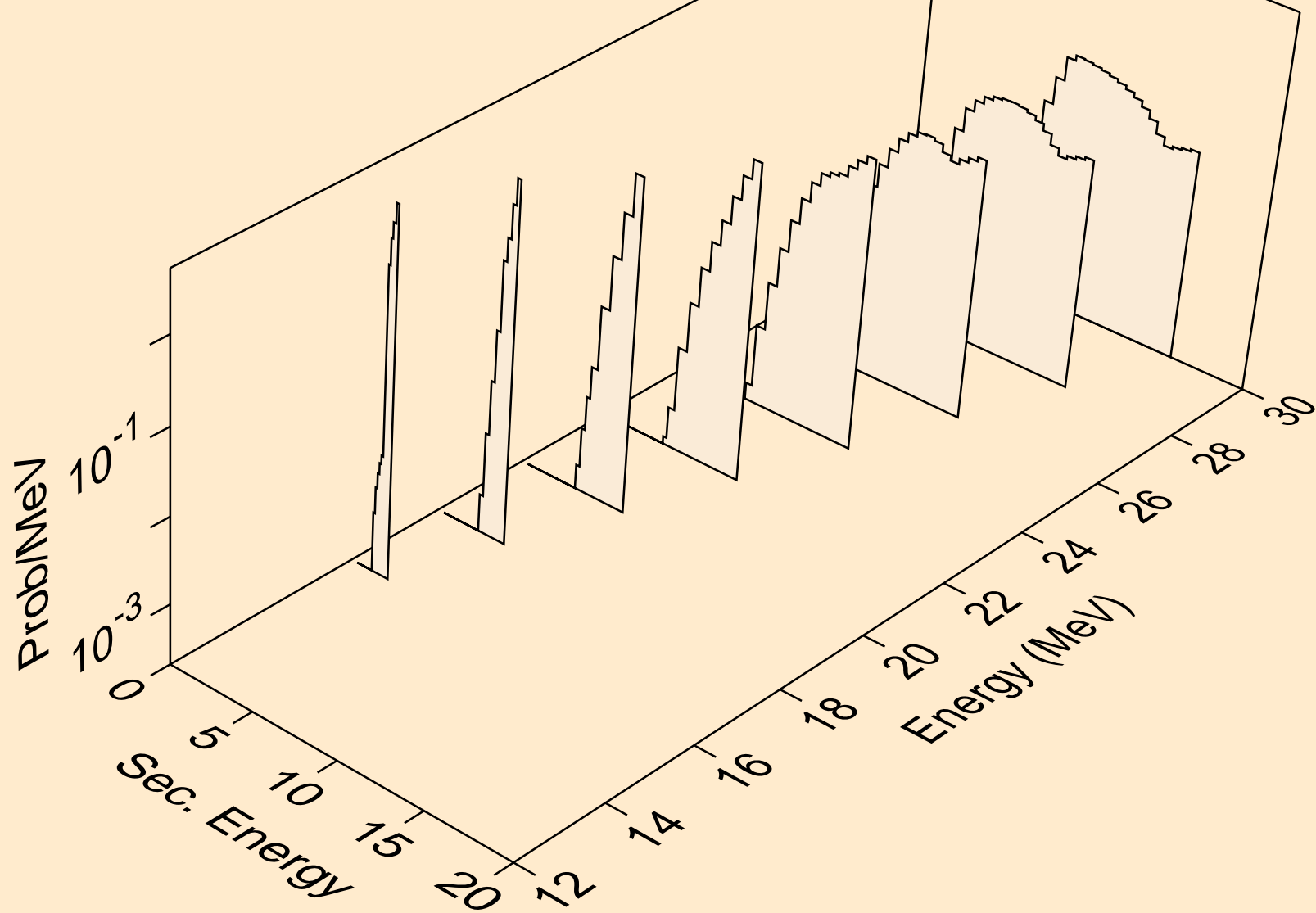

LA132 PHOTON ACER TENDL-2023 LIBRARY; T=0.K  
he3s from (g,x)

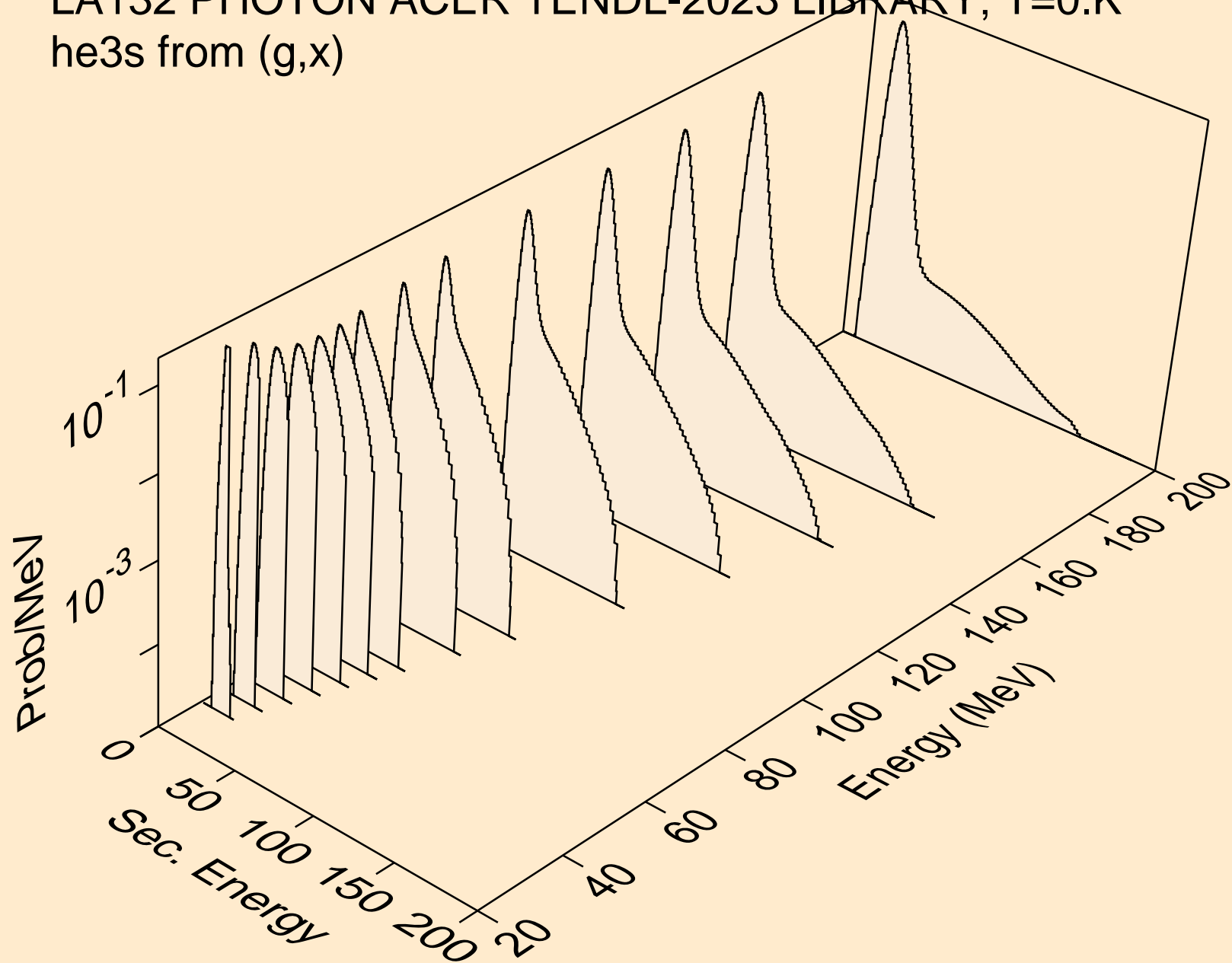

LA132 PHOTON ACER TENDL-2023 LIBRARY; T=0.K  
he3s from (g,he3)

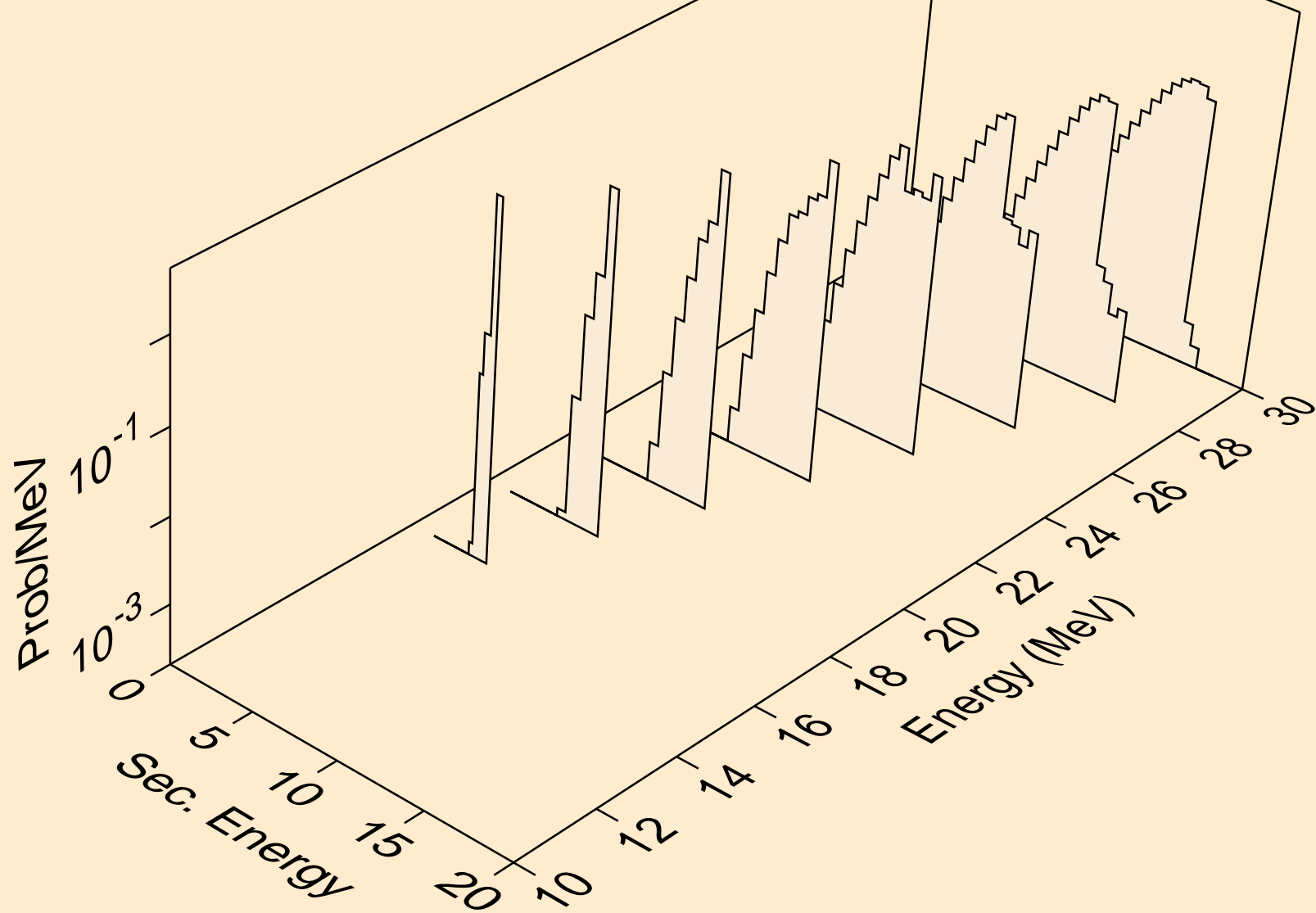

LA132 PHOTON ACER TENDL-2023 LIBRARY; T=0.K  
alphas from (g,x)

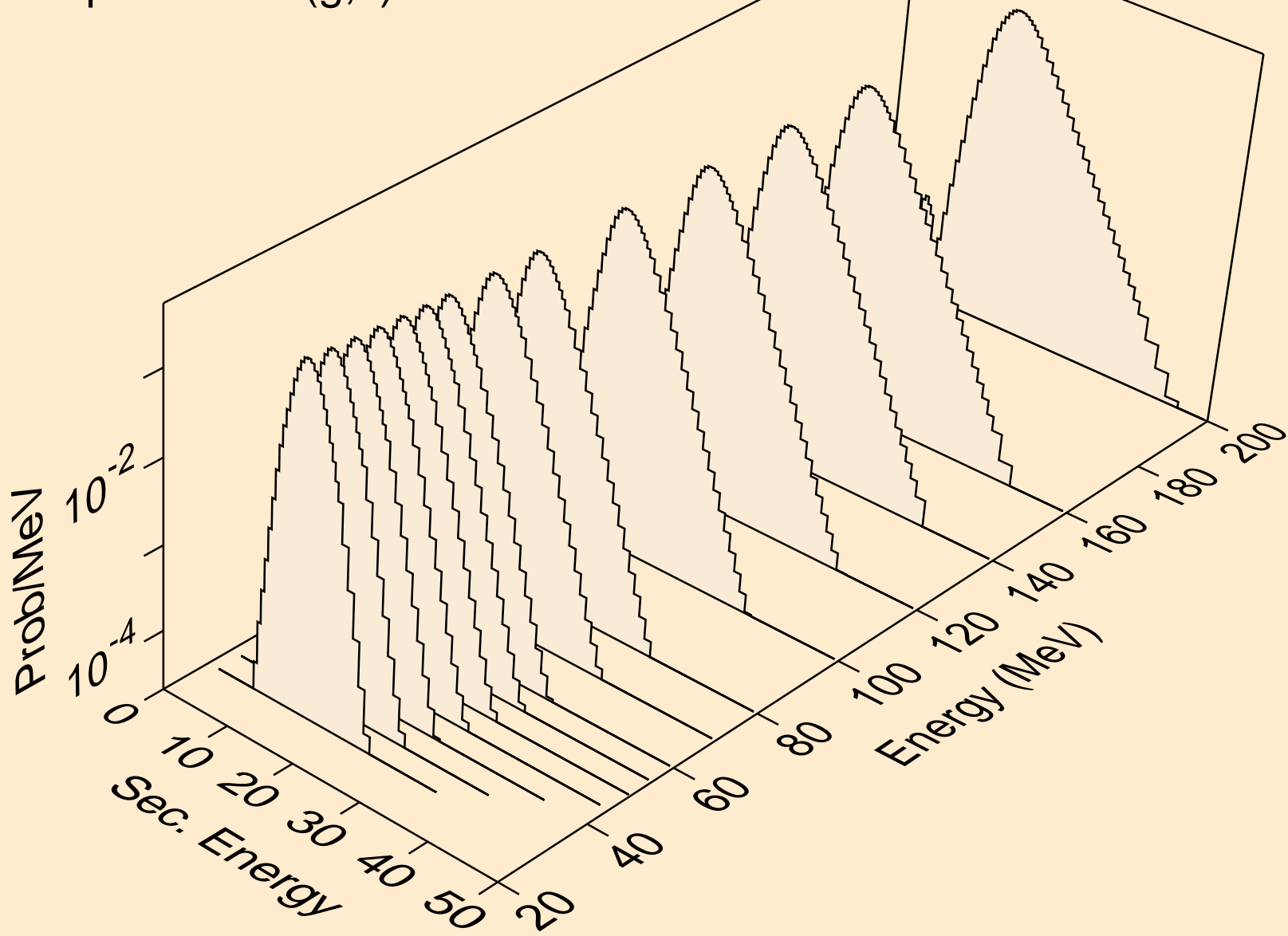

LA132 PHOTON ACER TENDL-2023 LIBRARY; T=0.K  
alphas from (g,n\*)a

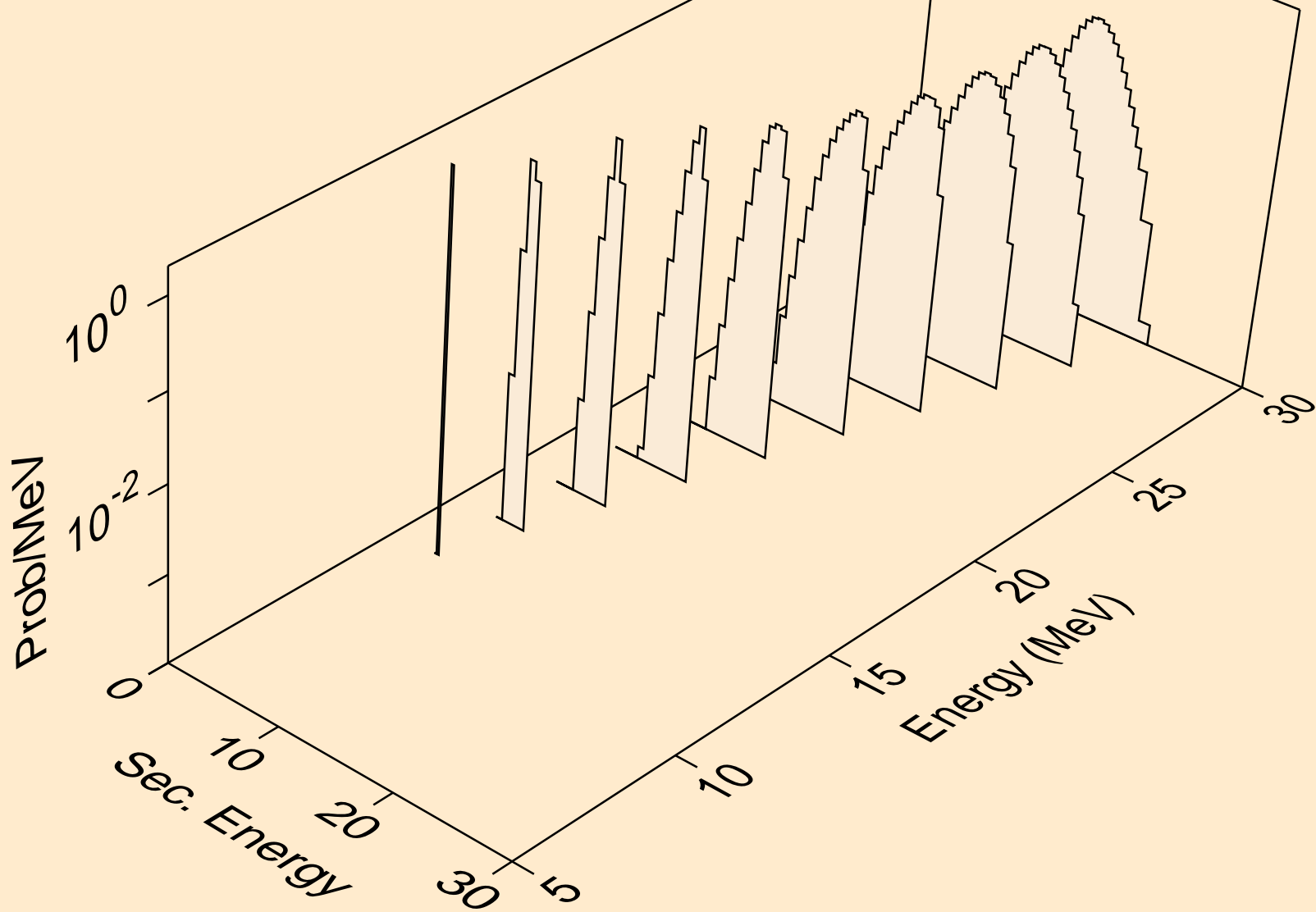

LA132 PHOTON ACER TENDL-2023 LIBRARY; T=0.K  
alphas from (g,2n)a

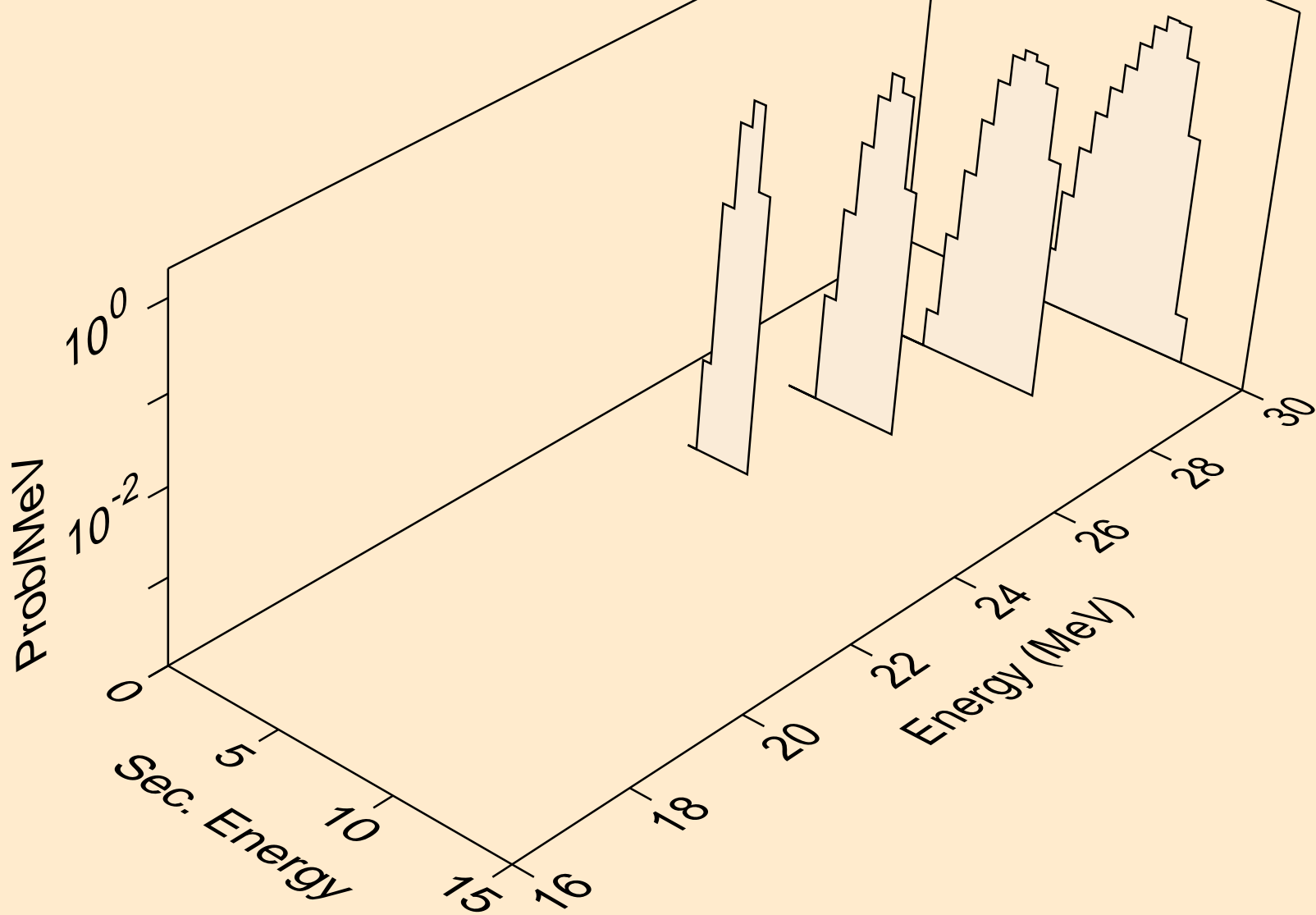

LA132 PHOTON ACER TENDL-2023 LIBRARY; T=0.K  
alphas from (g,npa)

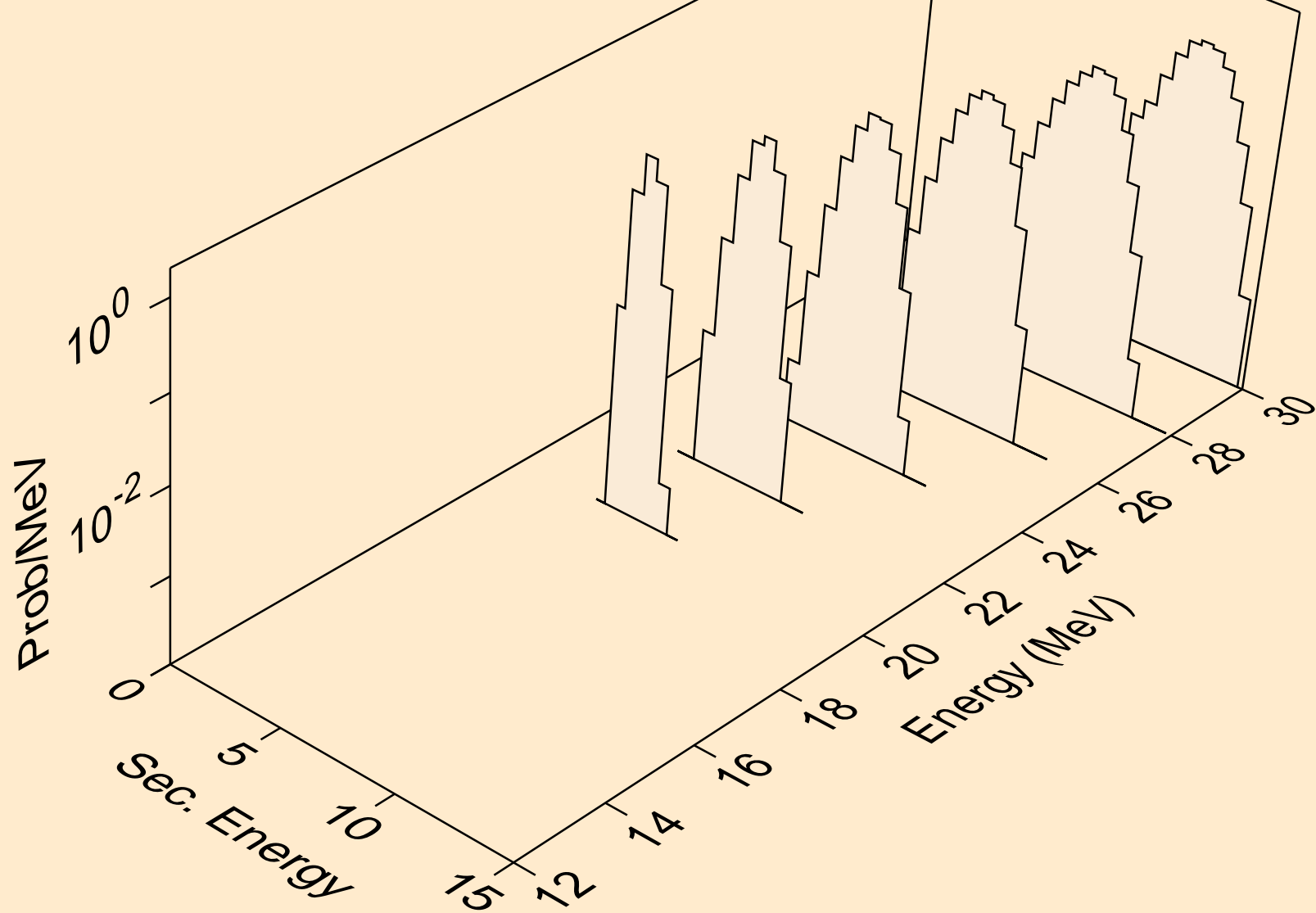

LA132 PHOTON ACER TENDL-2023 LIBRARY; T=0.K  
alphas from (g,a)

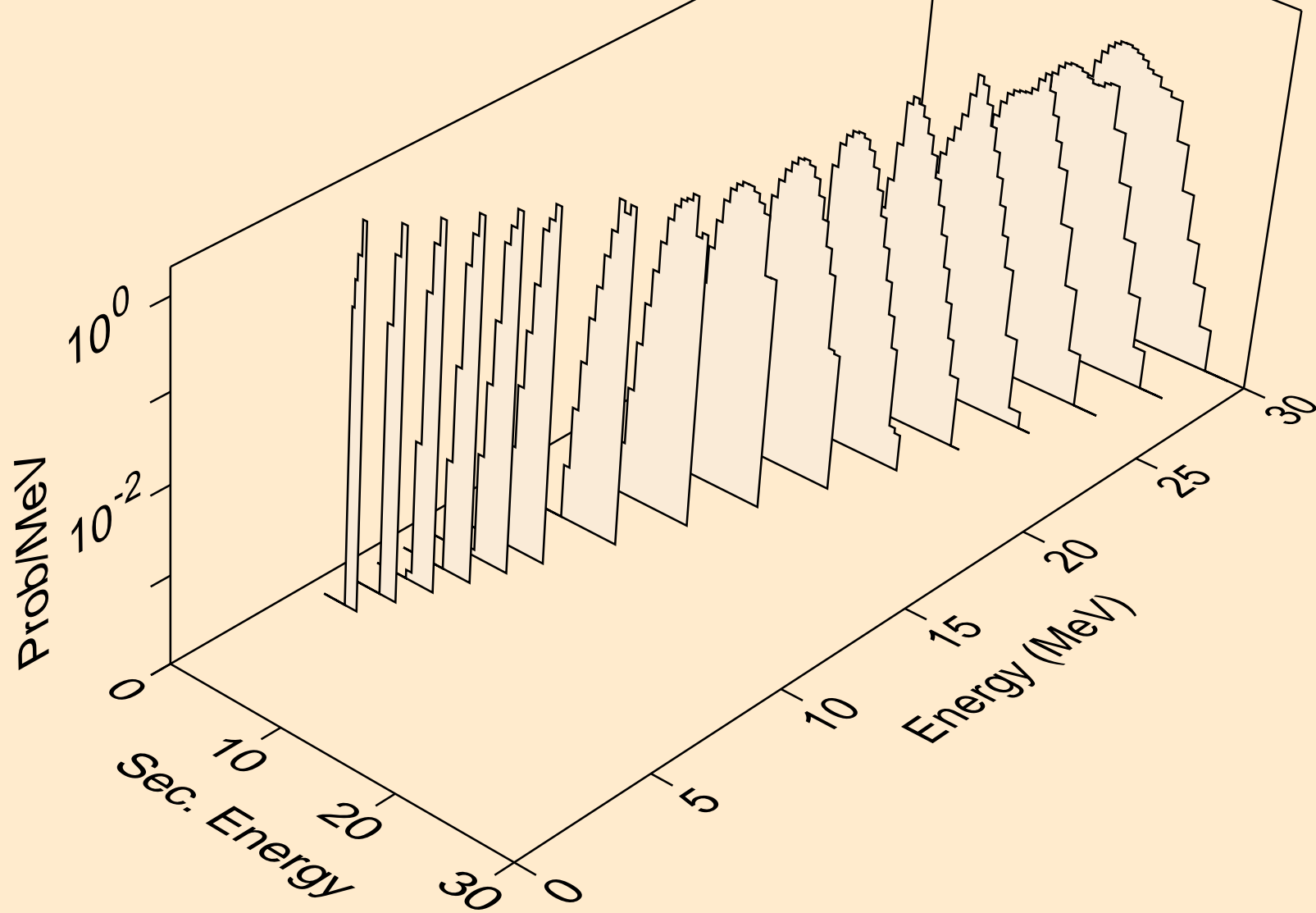



LA132 PHOTON ACER TENDL-2023 LIBRARY; T=0.K  
alphas from (g,2a)

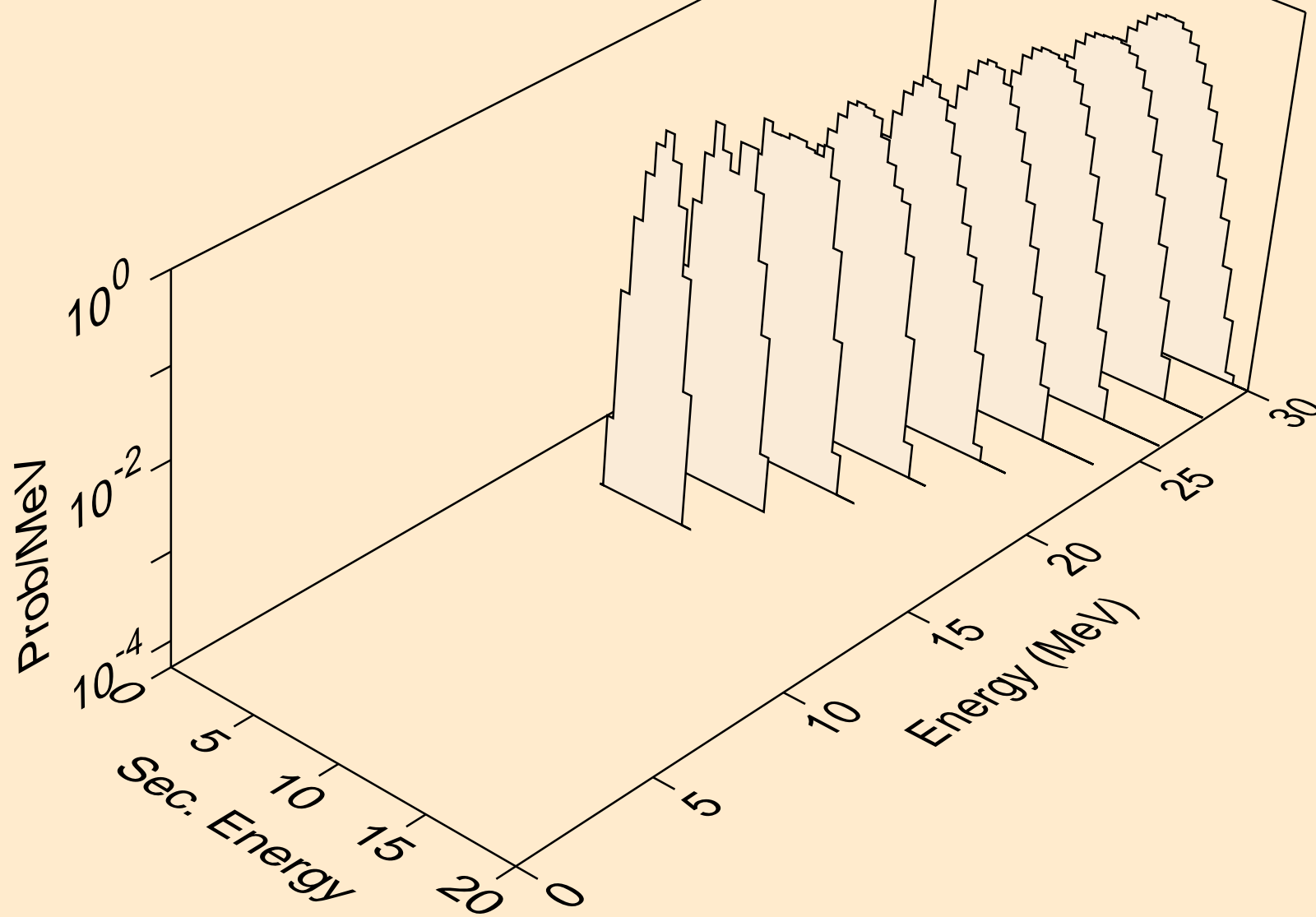

LA132 PHOTON ACER TENDL-2023 LIBRARY; T=0.K  
alphas from (g,pa)

