

LR254 PHOTON ACER TENDL-2023 LIBRARY; T=0.K

Principal cross sections

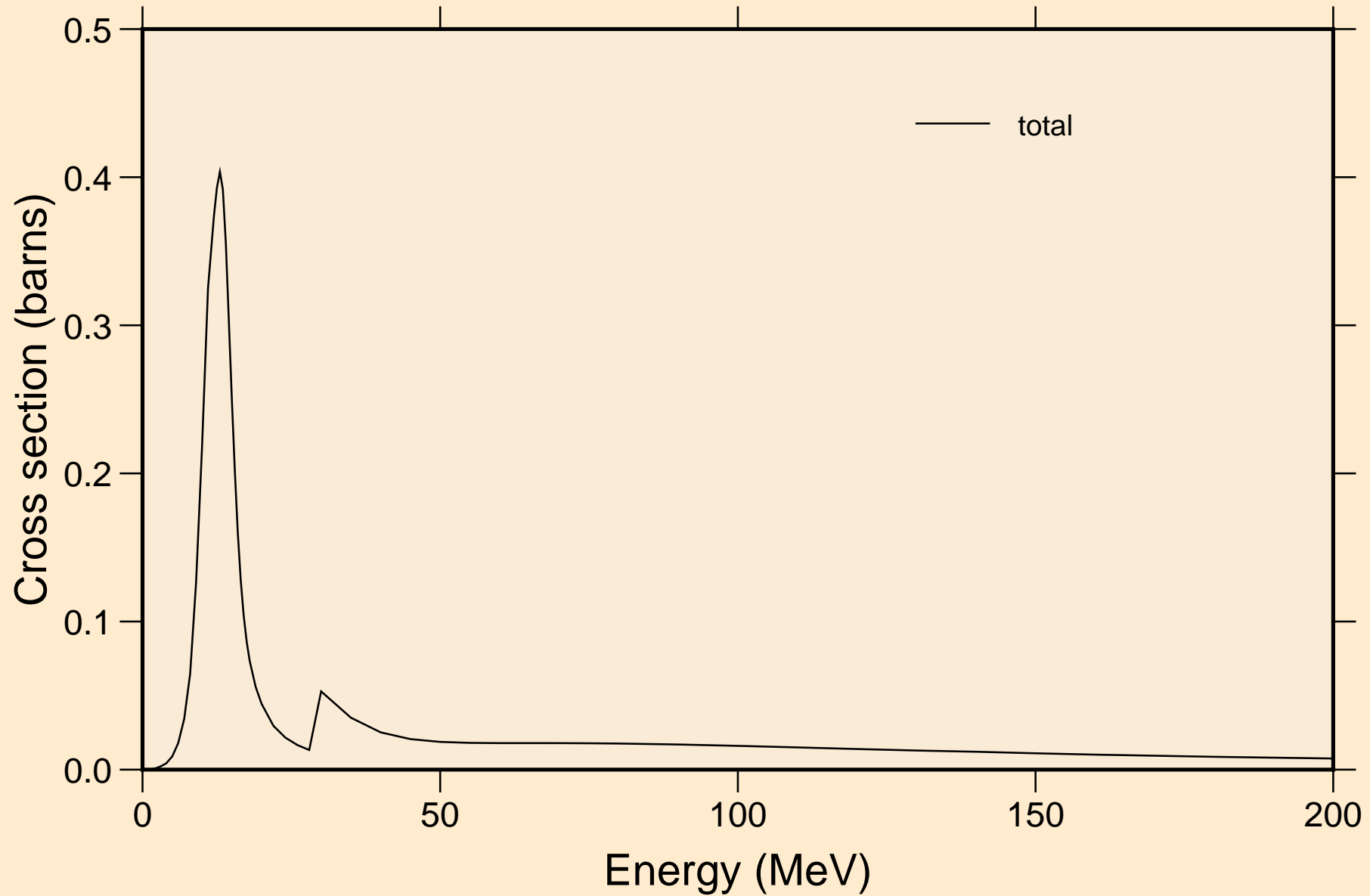

LR254 PHOTON ACER TENDL-2023 LIBRARY; T=0.K

Partial cross sections

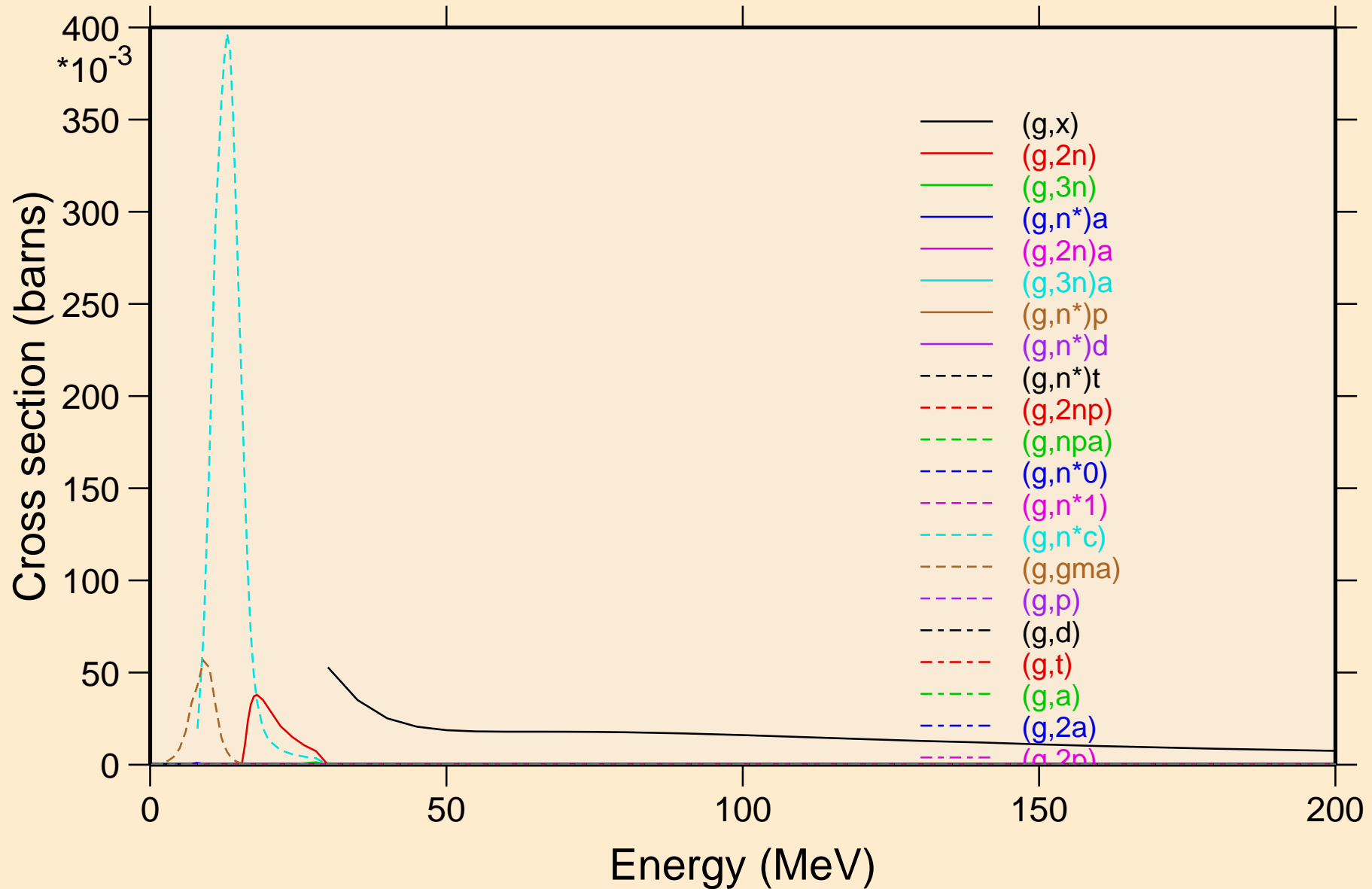

LR254 PHOTON ACER TENDL-2023 LIBRARY; T=0.K

Heating

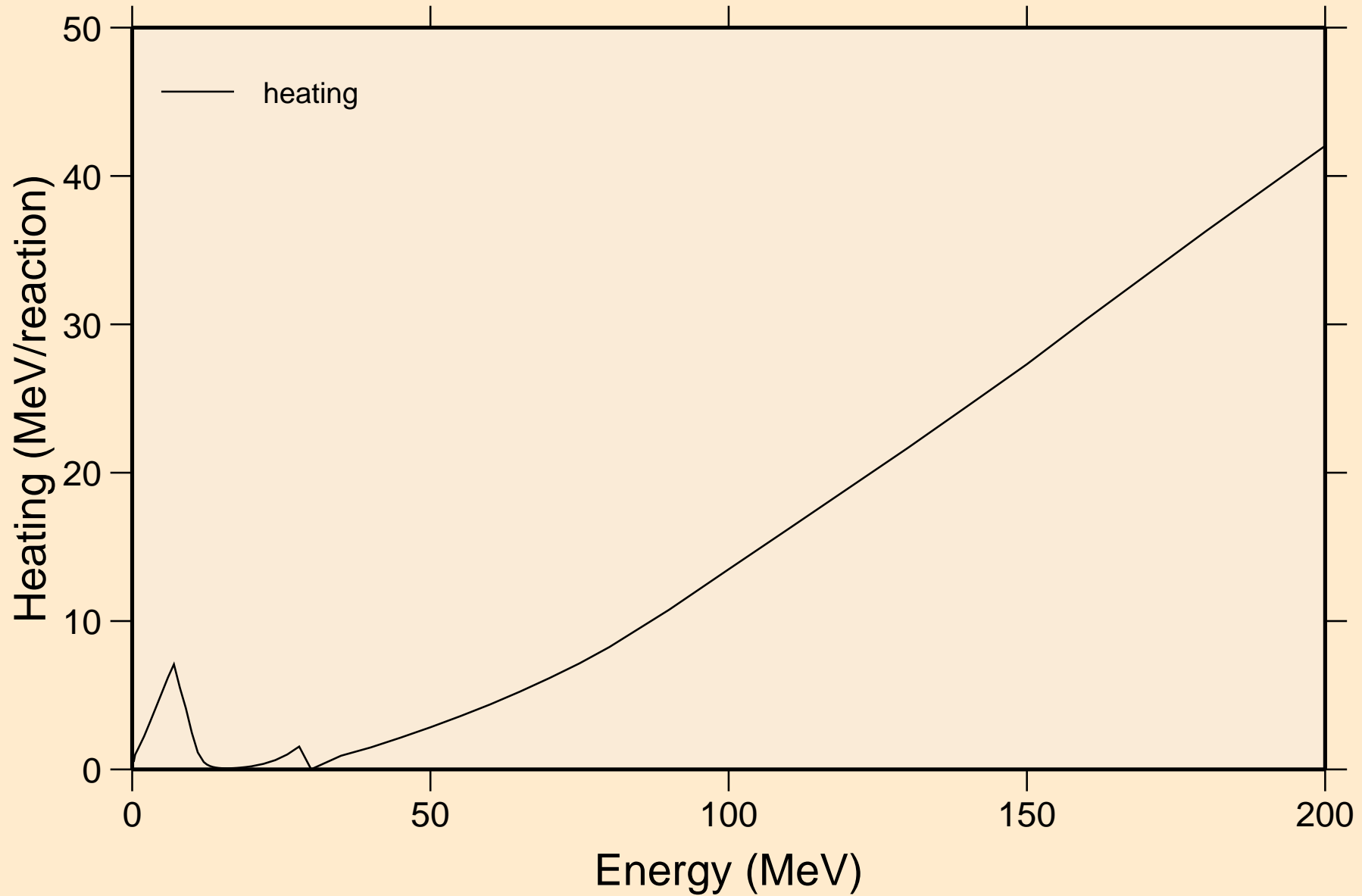

LR254 PHOTON ACER TENDL-2023 LIBRARY; T=0.K

Particle heating contributions

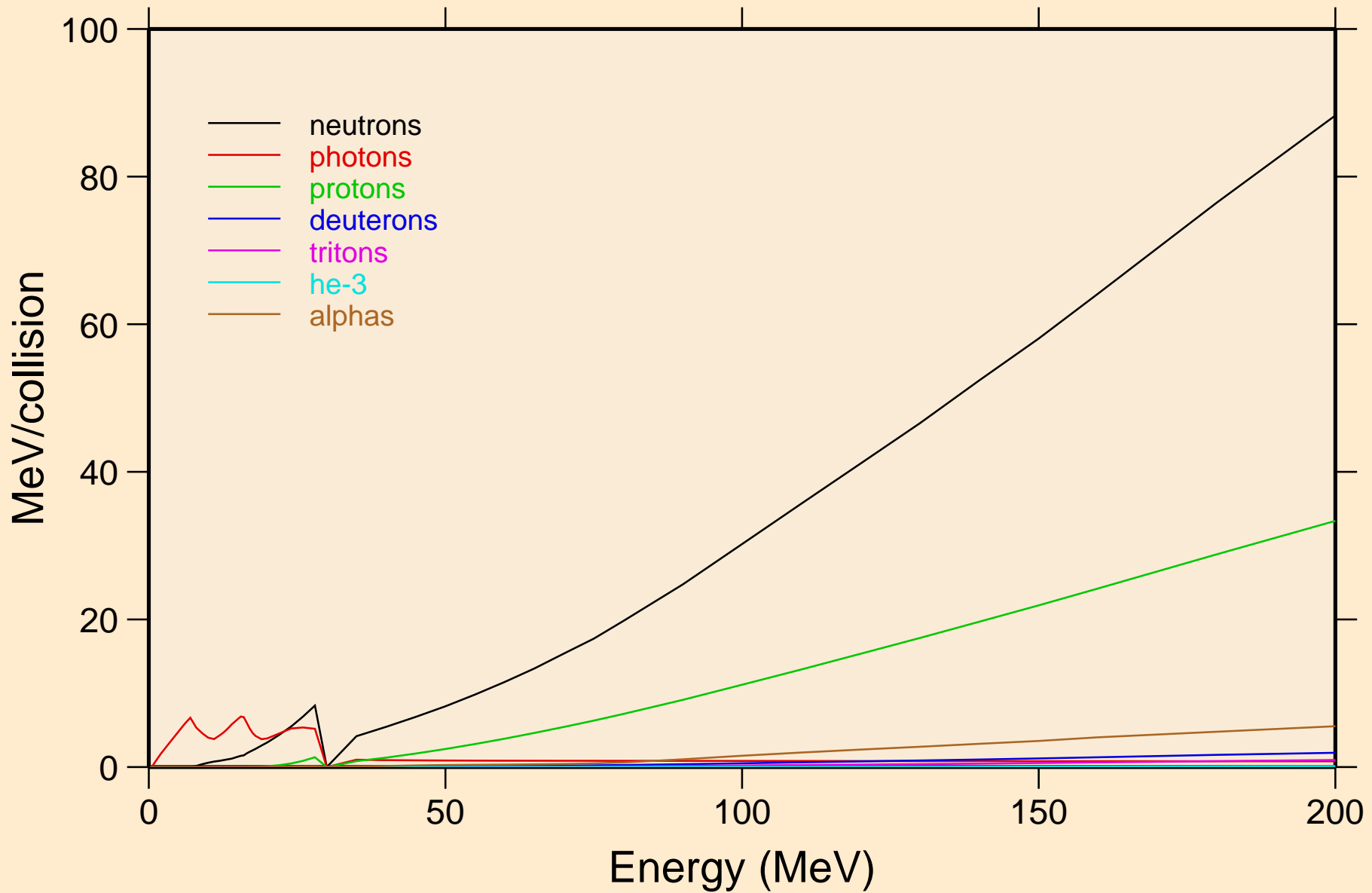

LR254 PHOTON ACER TENDL-2023 LIBRARY; T=0.K
Particle production cross sections

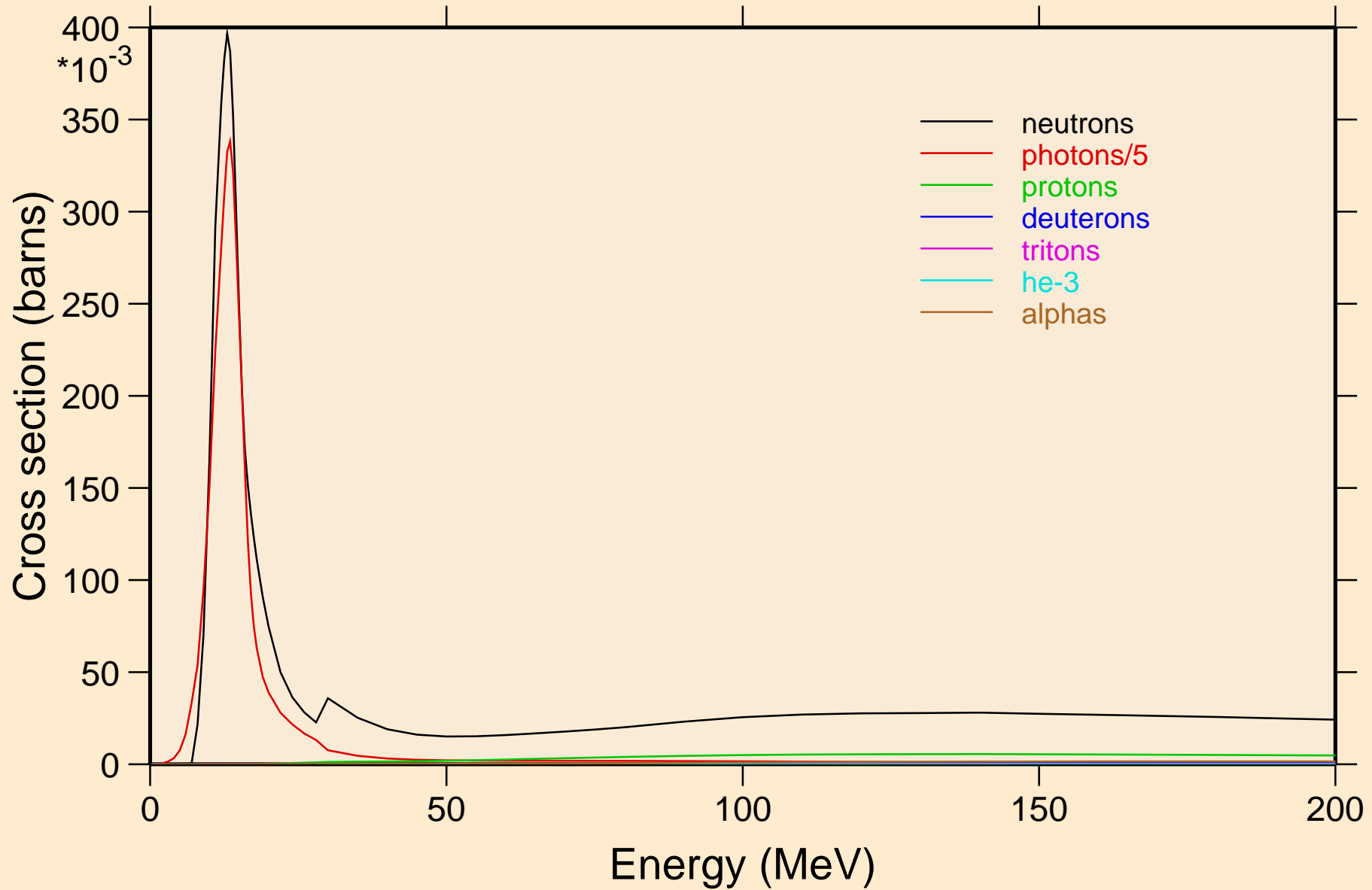

LR254 PHOTON ACER TENDL-2023 LIBRARY; T=0.K
neutrons from (g,x)

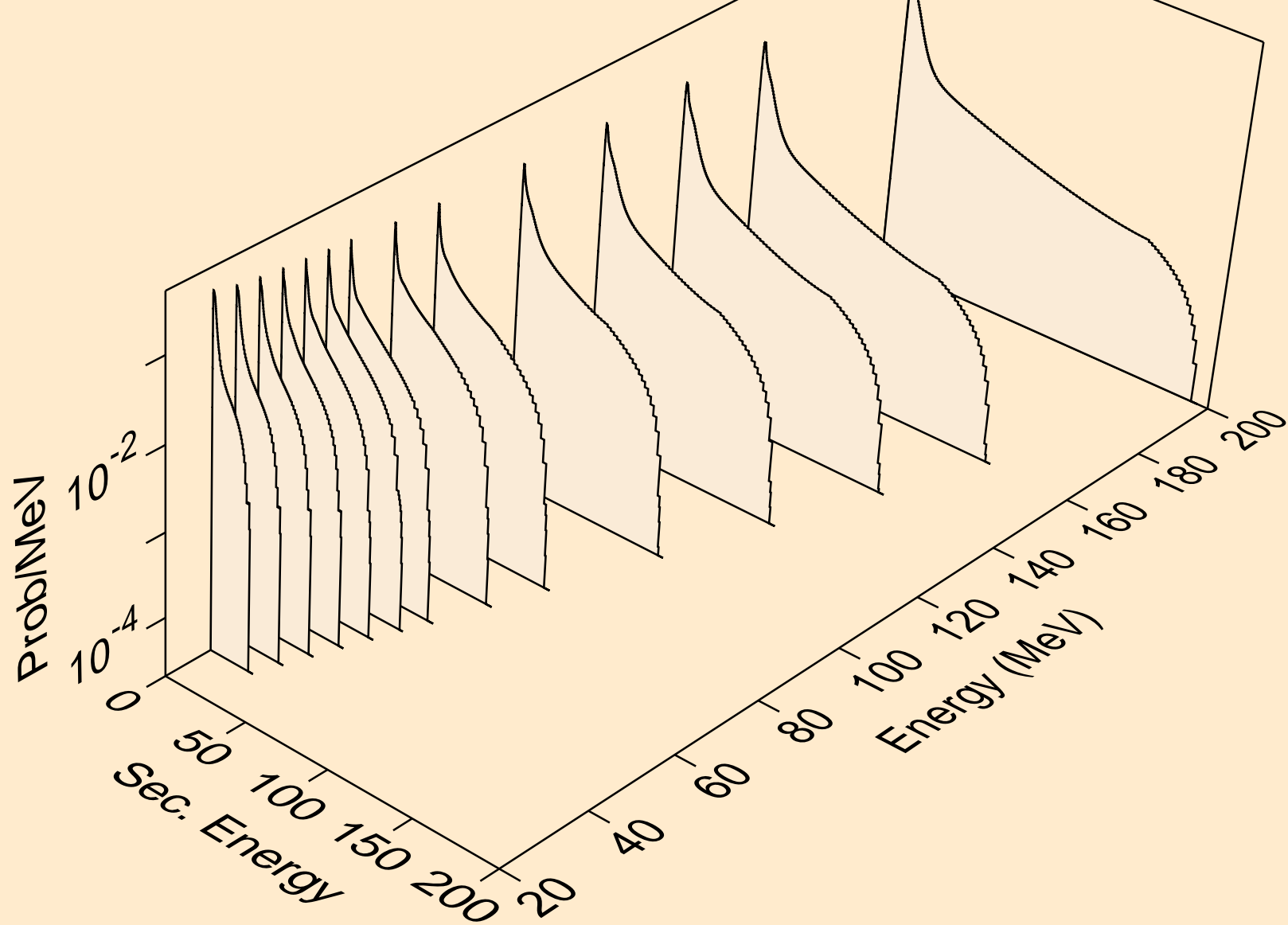

LR254 PHOTON ACER TENDL-2023 LIBRARY; T=0.K
neutrons from (g,2n)

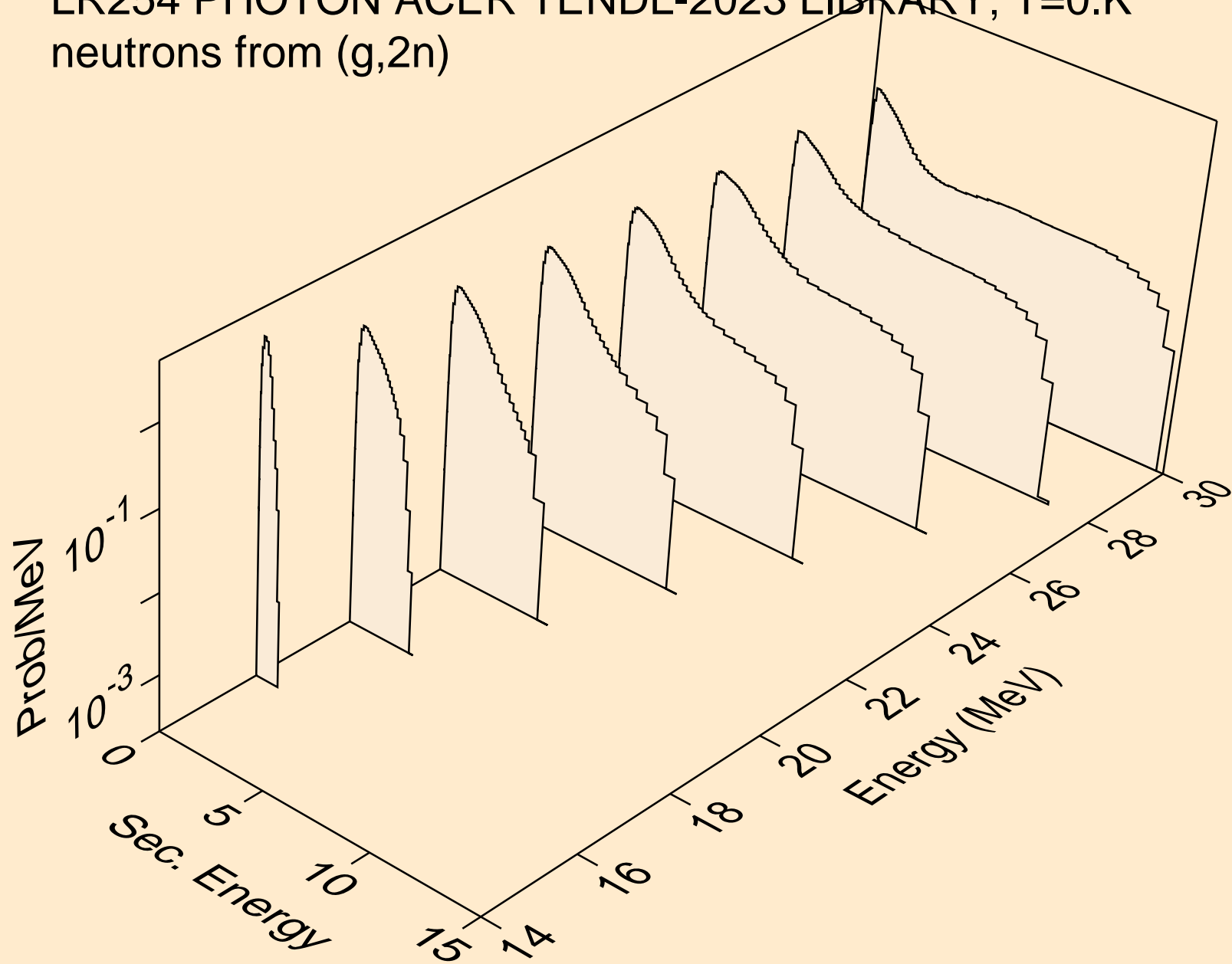

LR254 PHOTON ACER TENDL-2023 LIBRARY; T=0.K
neutrons from (g,3n)

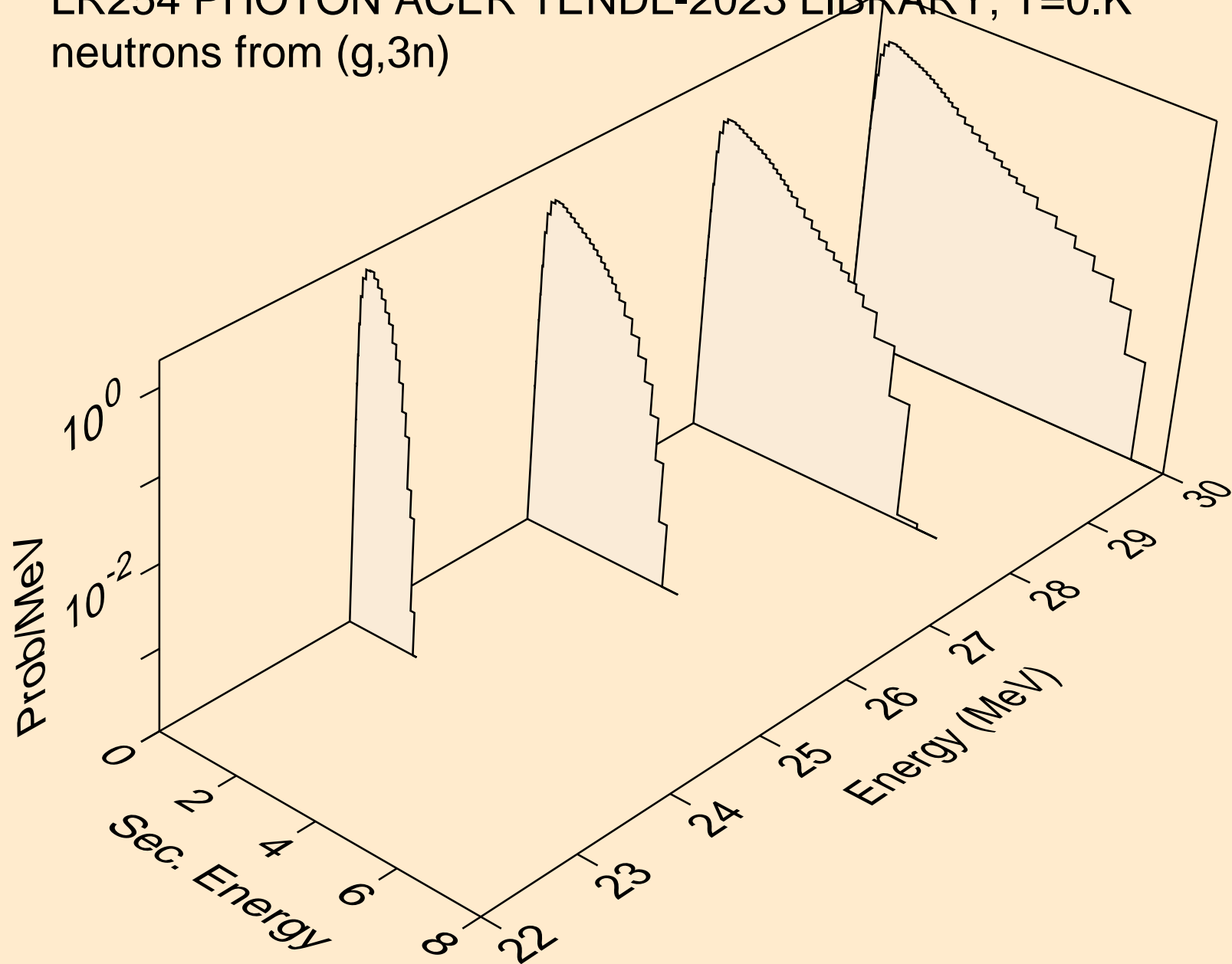

LR254 PHOTON ACER TENDL-2023 LIBRARY; T=0.K
neutrons from (g,n*)a

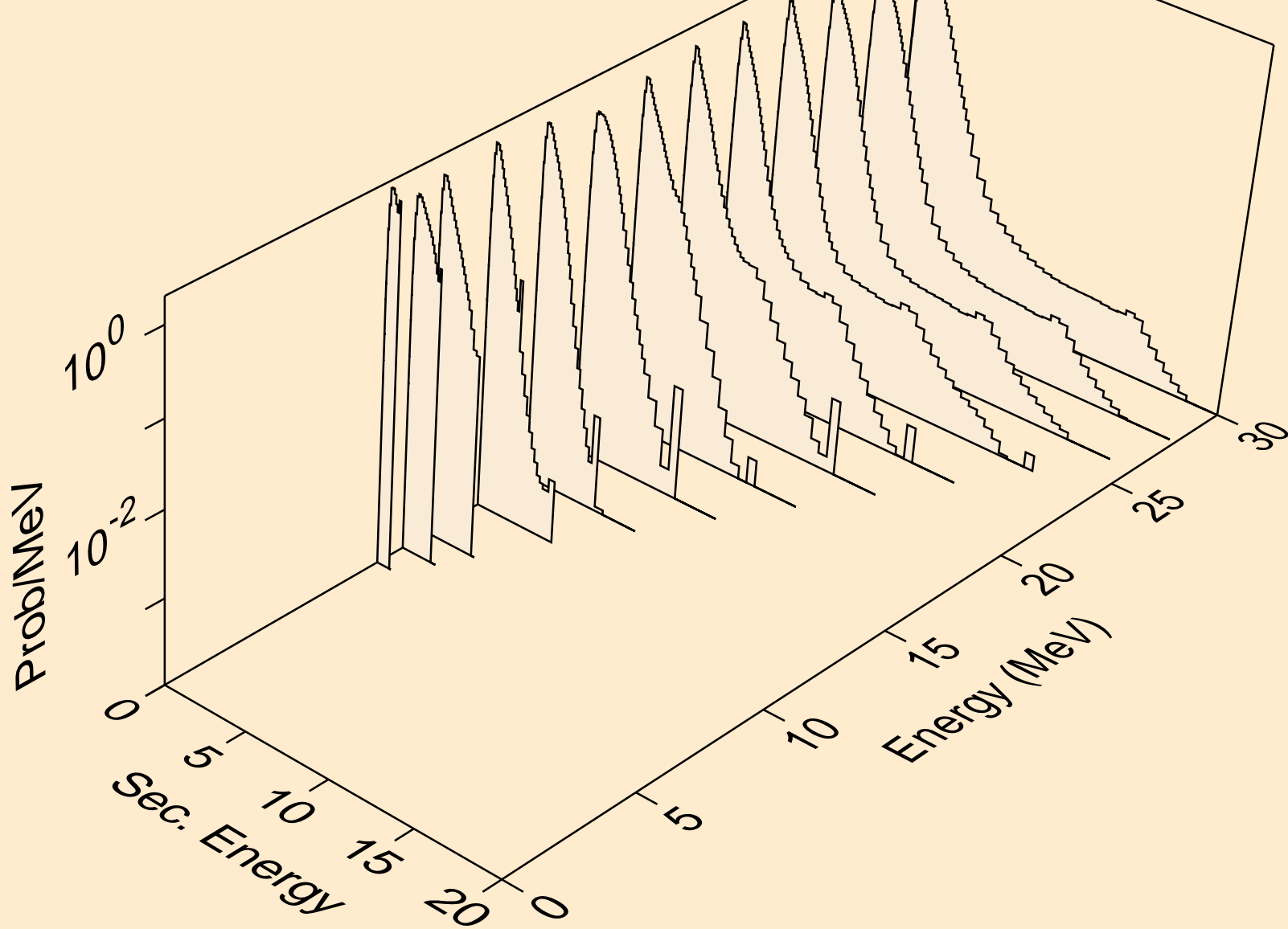

LR254 PHOTON ACER TENDL-2023 LIBRARY; T=0.K
neutrons from (g,2n)a

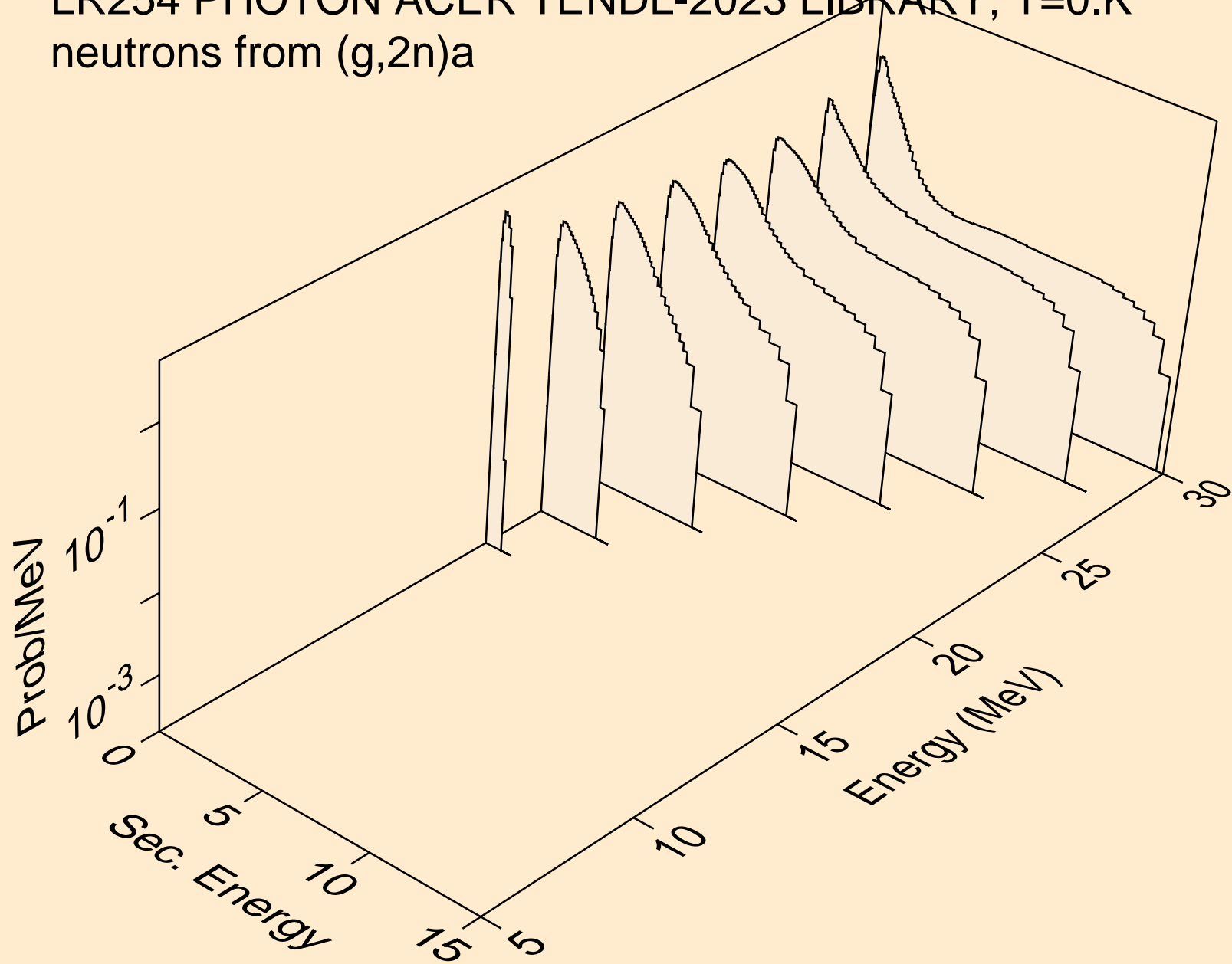

LR254 PHOTON ACER TENDL-2023 LIBRARY; T=0.K
neutrons from (g,3n)a

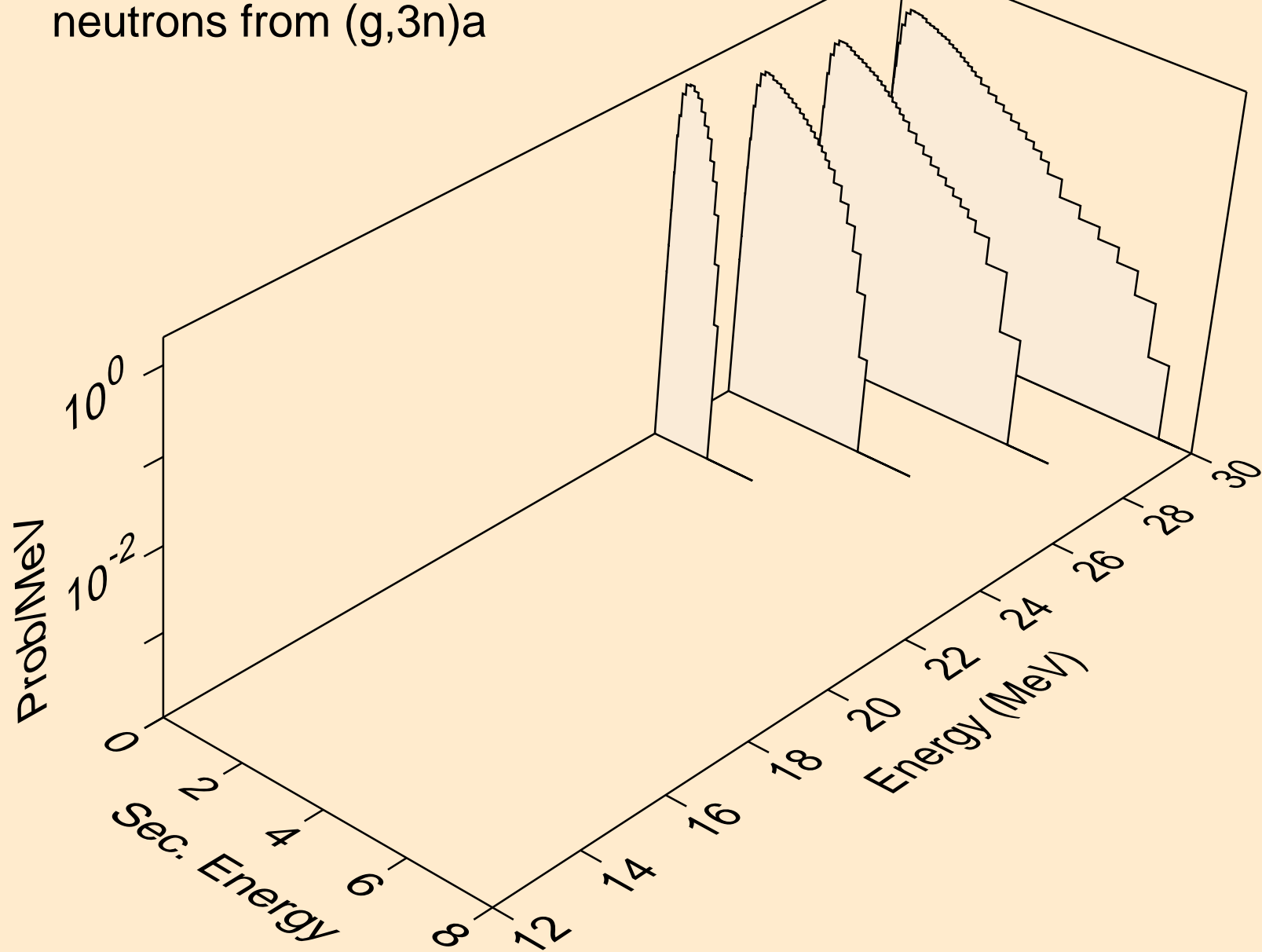

LR254 PHOTON ACER TENDL-2023 LIBRARY; T=0.K
neutrons from (g,n*)p

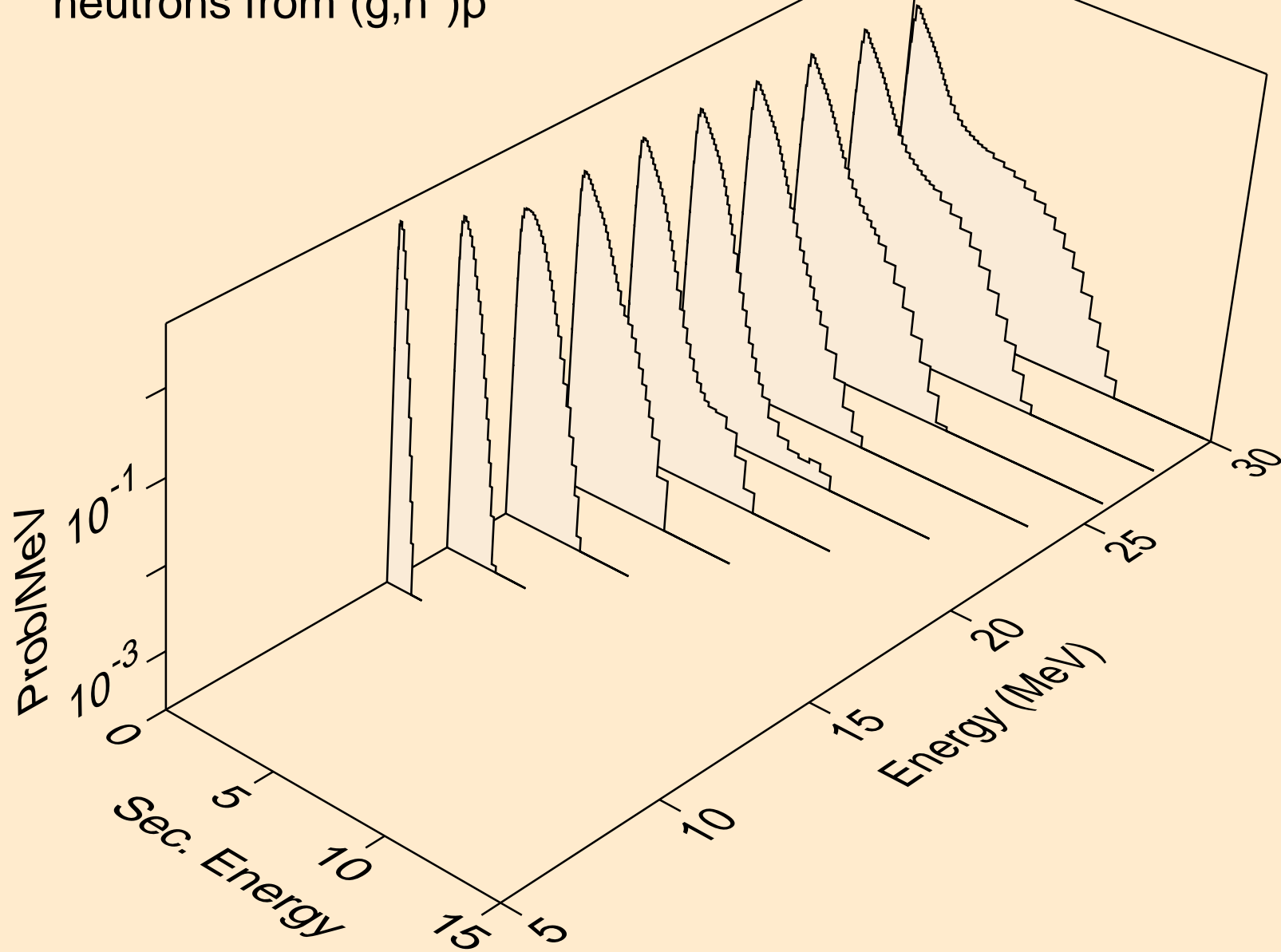

LR254 PHOTON ACER TENDL-2023 LIBRARY; T=0.K
neutrons from (g,n*)d

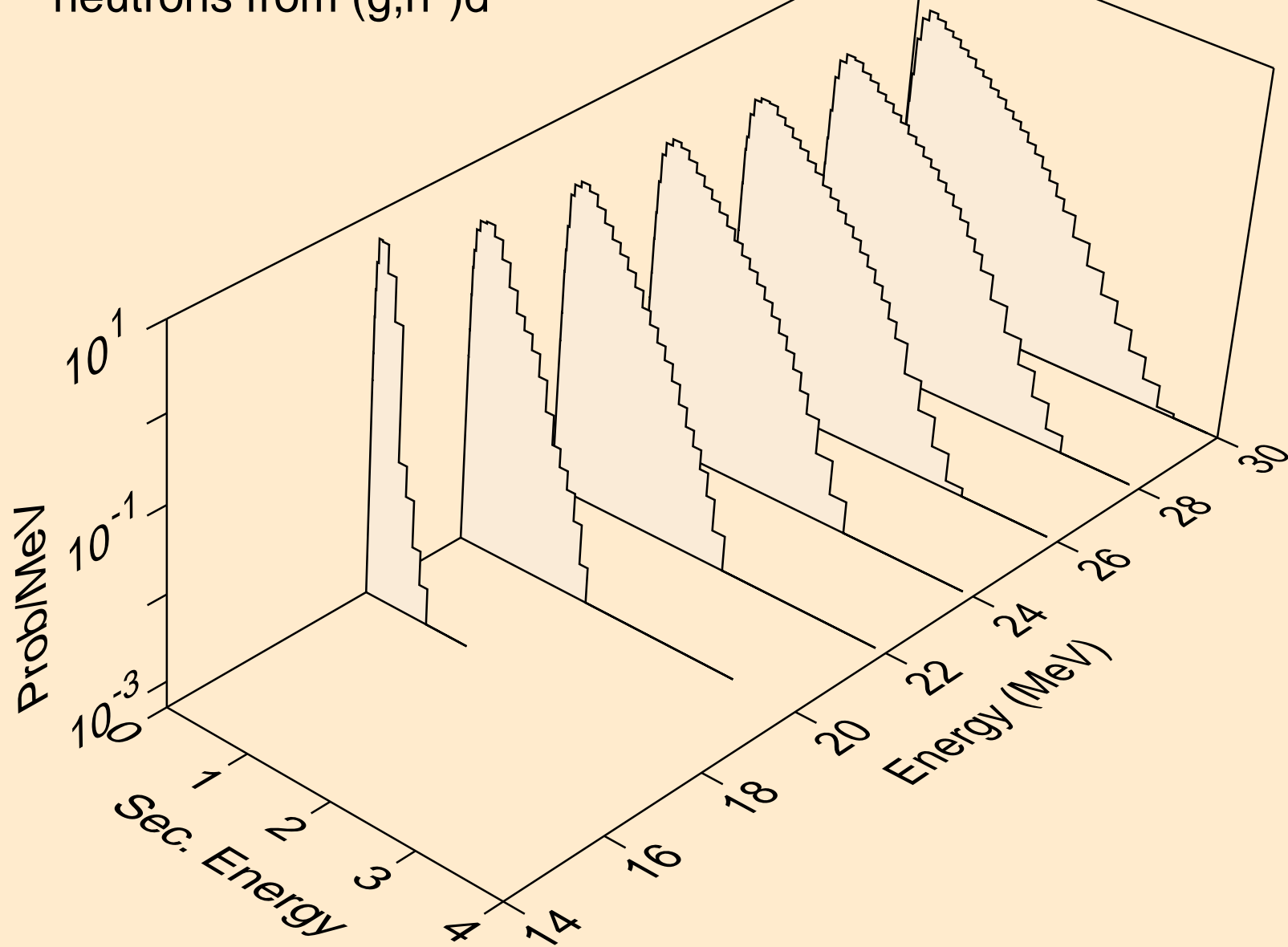

LR254 PHOTON ACER TENDL-2023 LIBRARY; T=0.K
neutrons from (g,n*)t

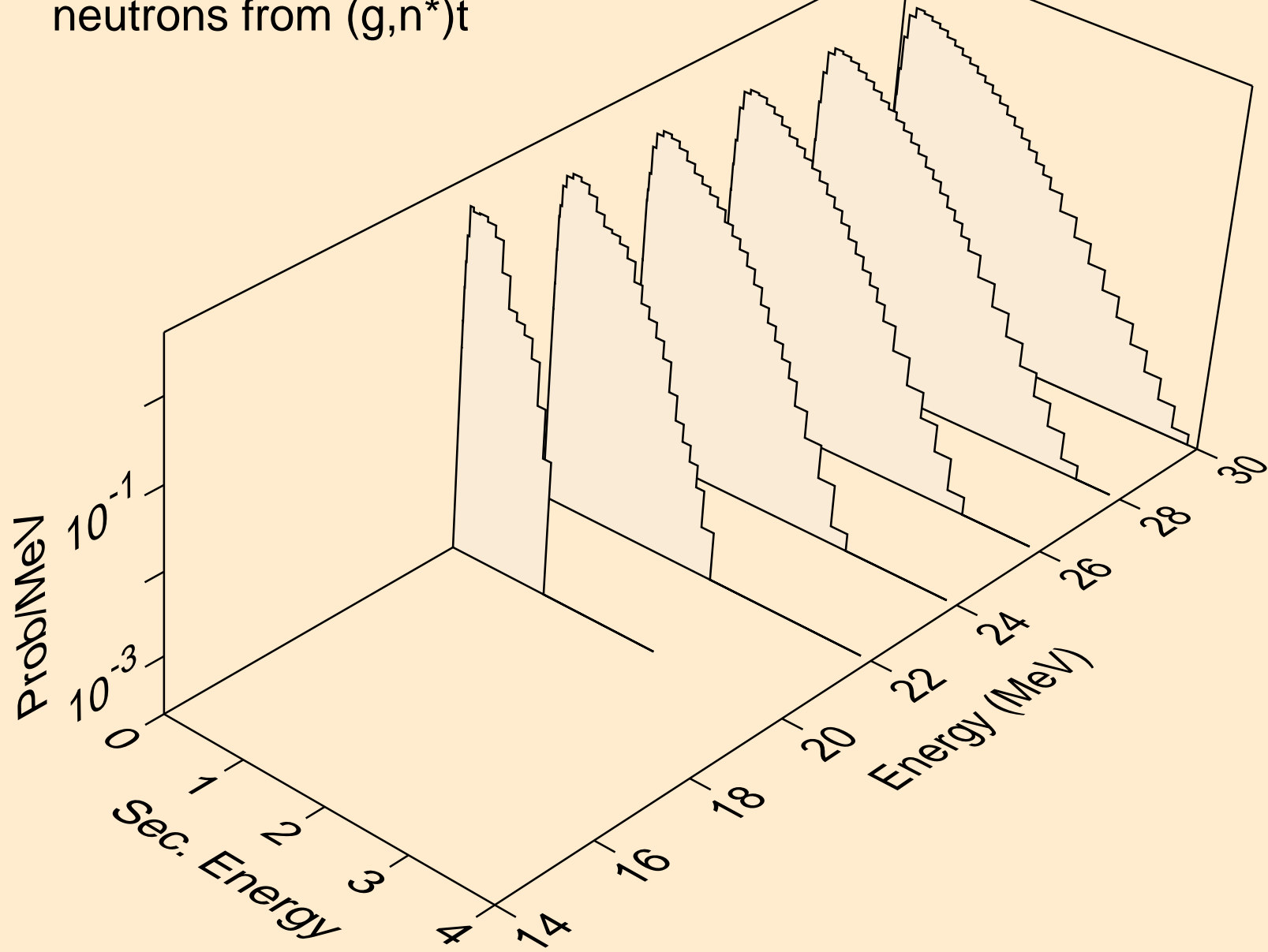

LR254 PHOTON ACER TENDL-2023 LIBRARY; T=0.K
neutrons from (g,2np)

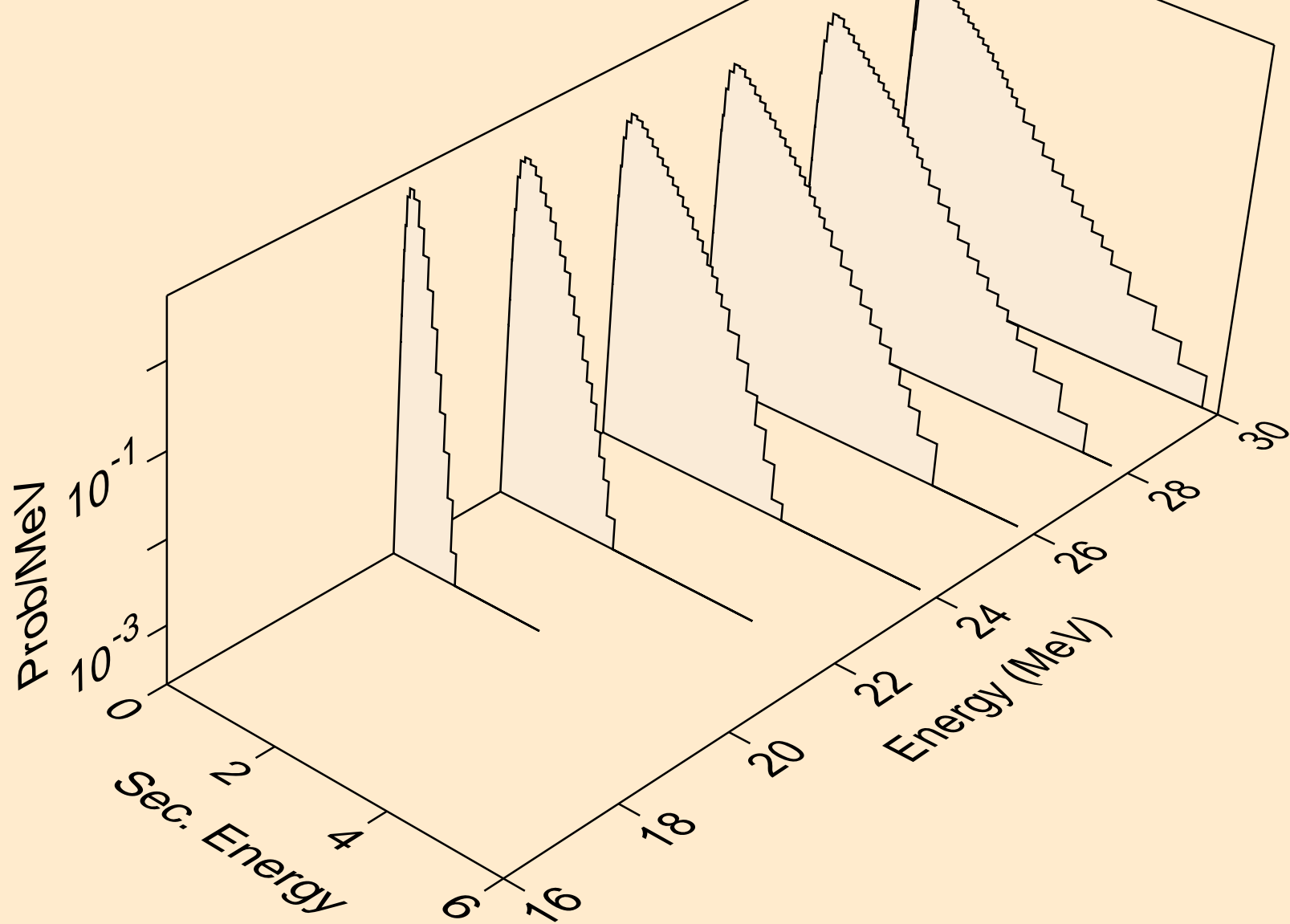

LR254 PHOTON ACER TENDL-2023 LIBRARY; T=0.K
neutrons from (g,npa)

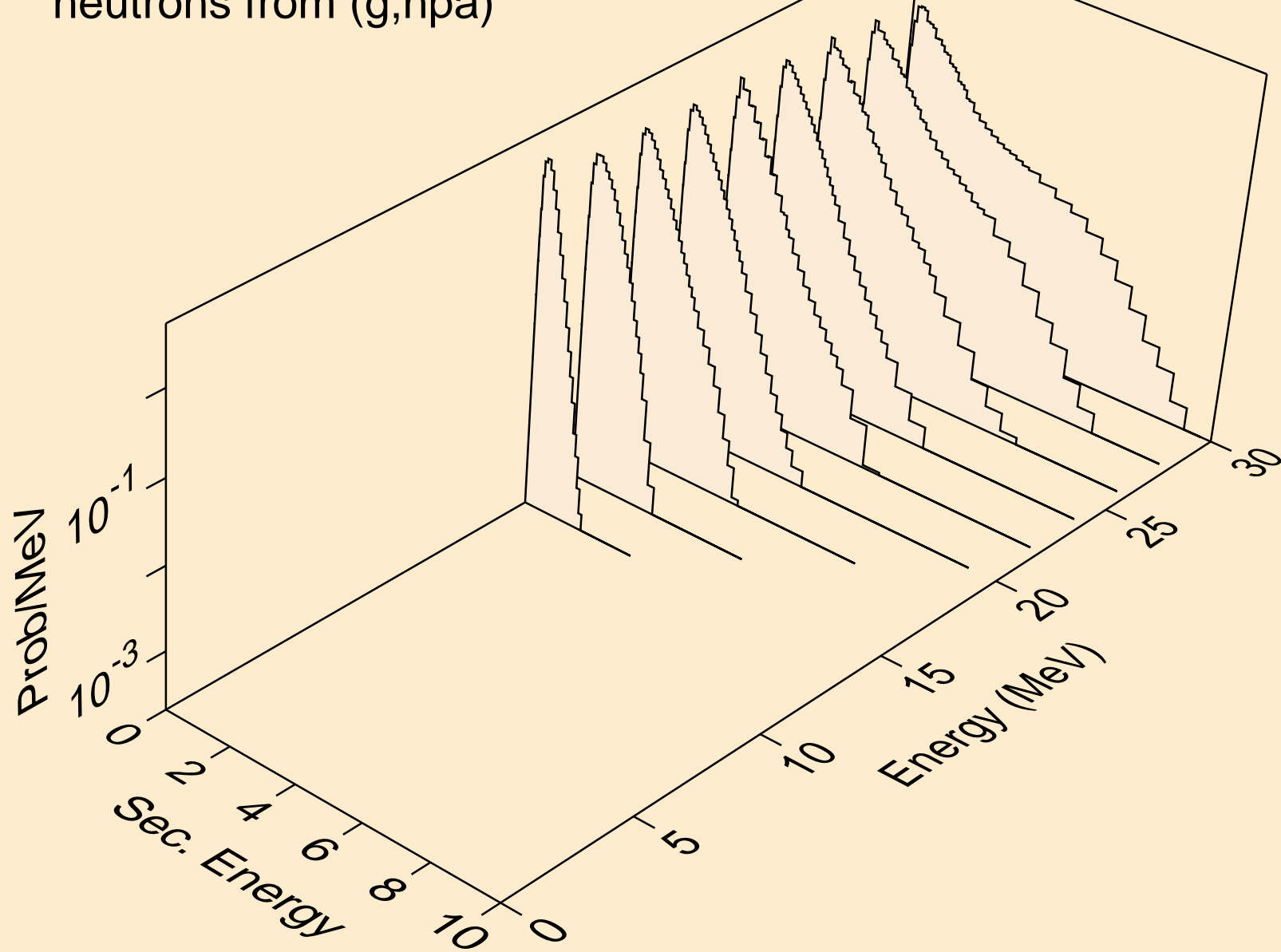

LR254 PHOTON ACER TENDL-2023 LIBRARY; T=0.K
angular distribution for (g,n*0) neutron

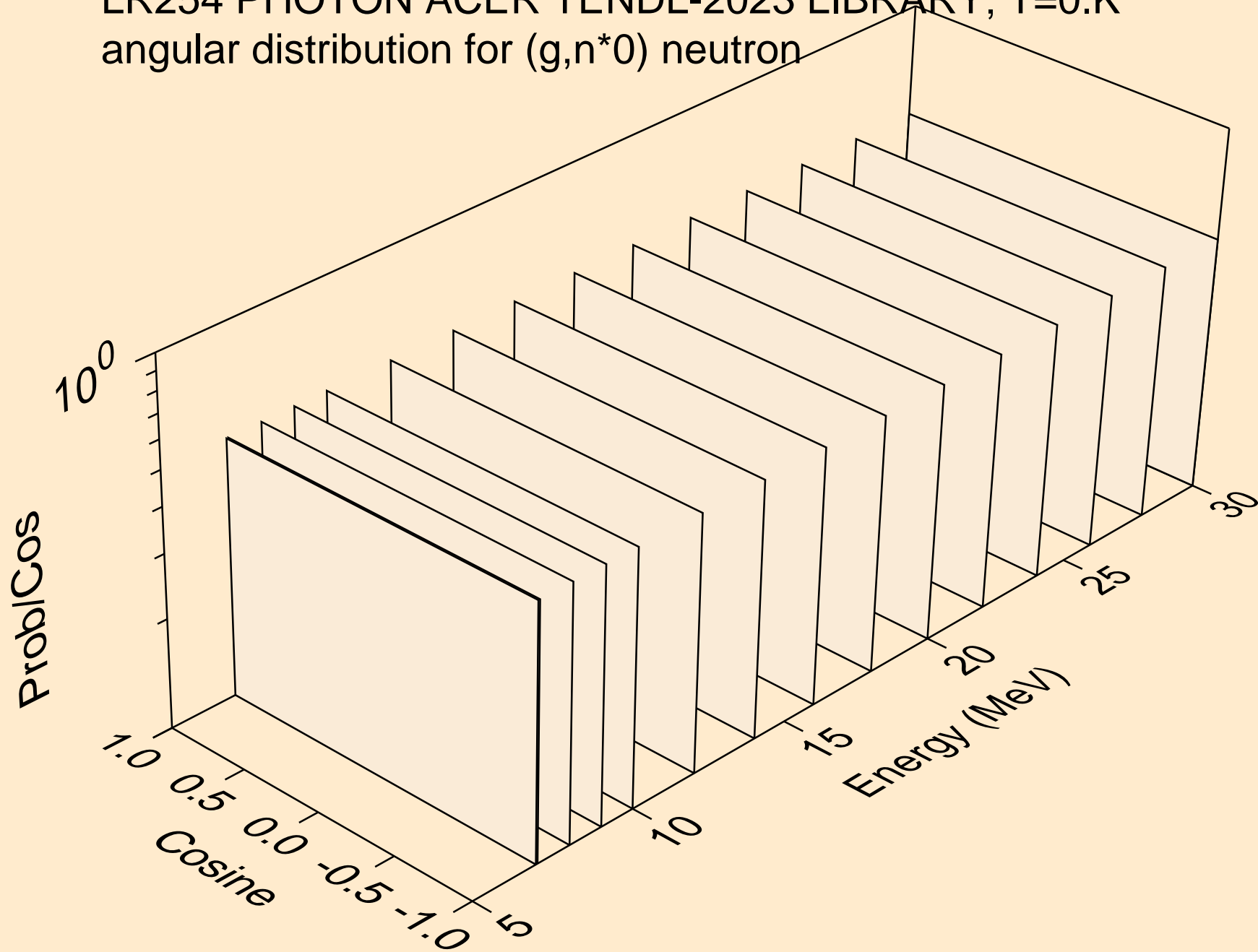

LR254 PHOTON ACER TENDL-2023 LIBRARY; T=0.K
angular distribution for (g,n*1) neutron

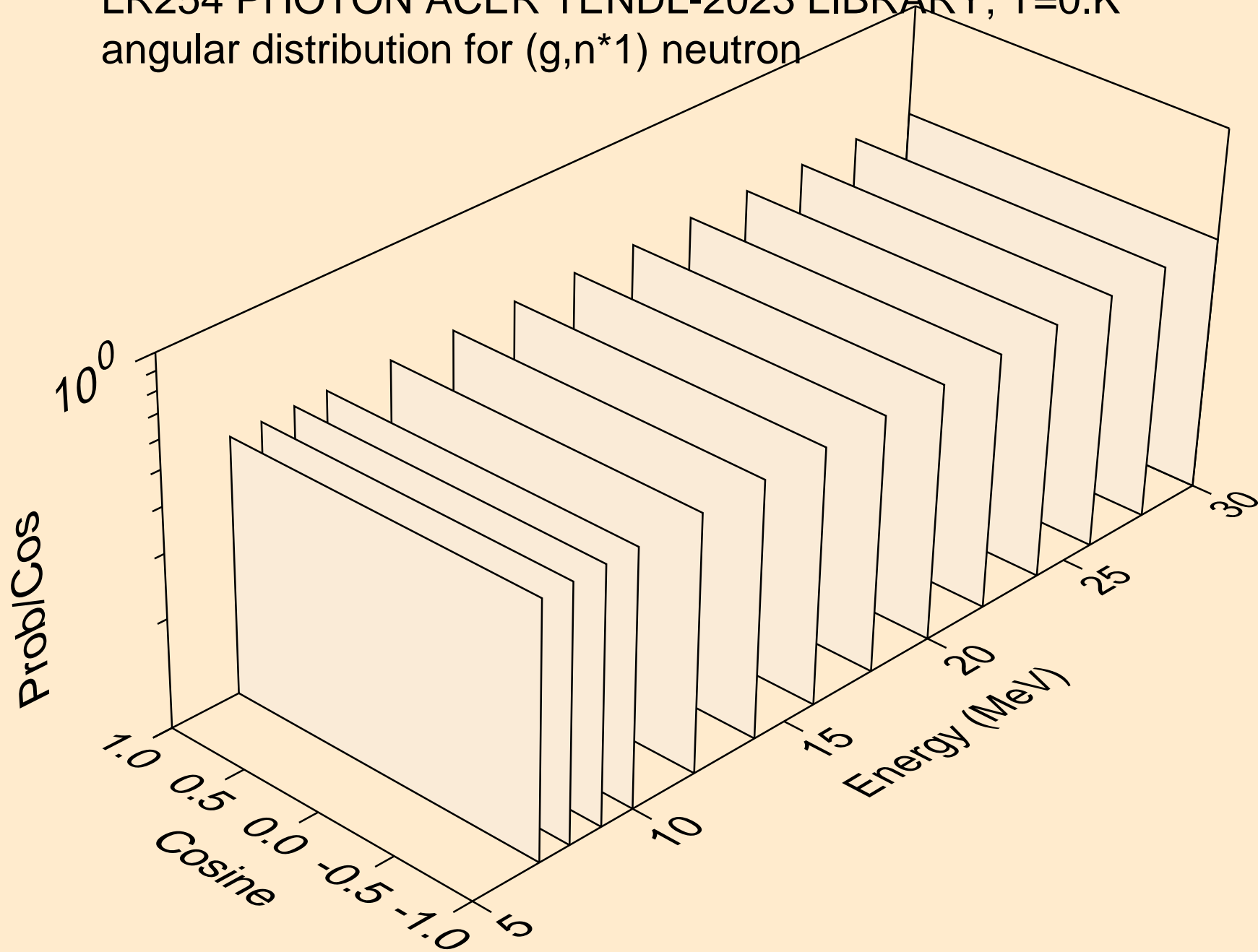

LR254 PHOTON ACER TENDL-2023 LIBRARY; T=0.K
neutrons from (g,n*c)

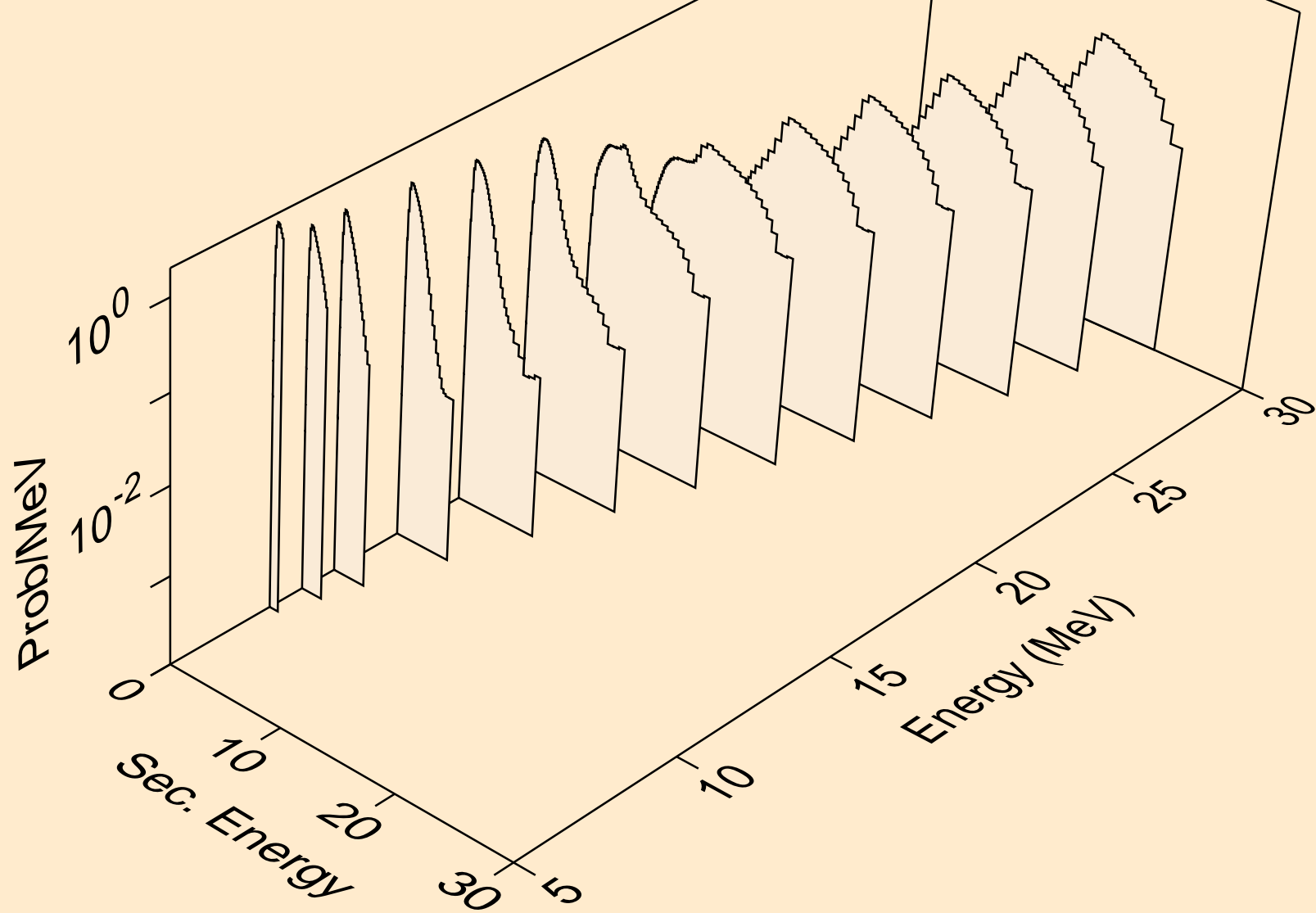

LR254 PHOTON ACER TENDL-2023 LIBRARY; T=0.K
photons from (g,x)

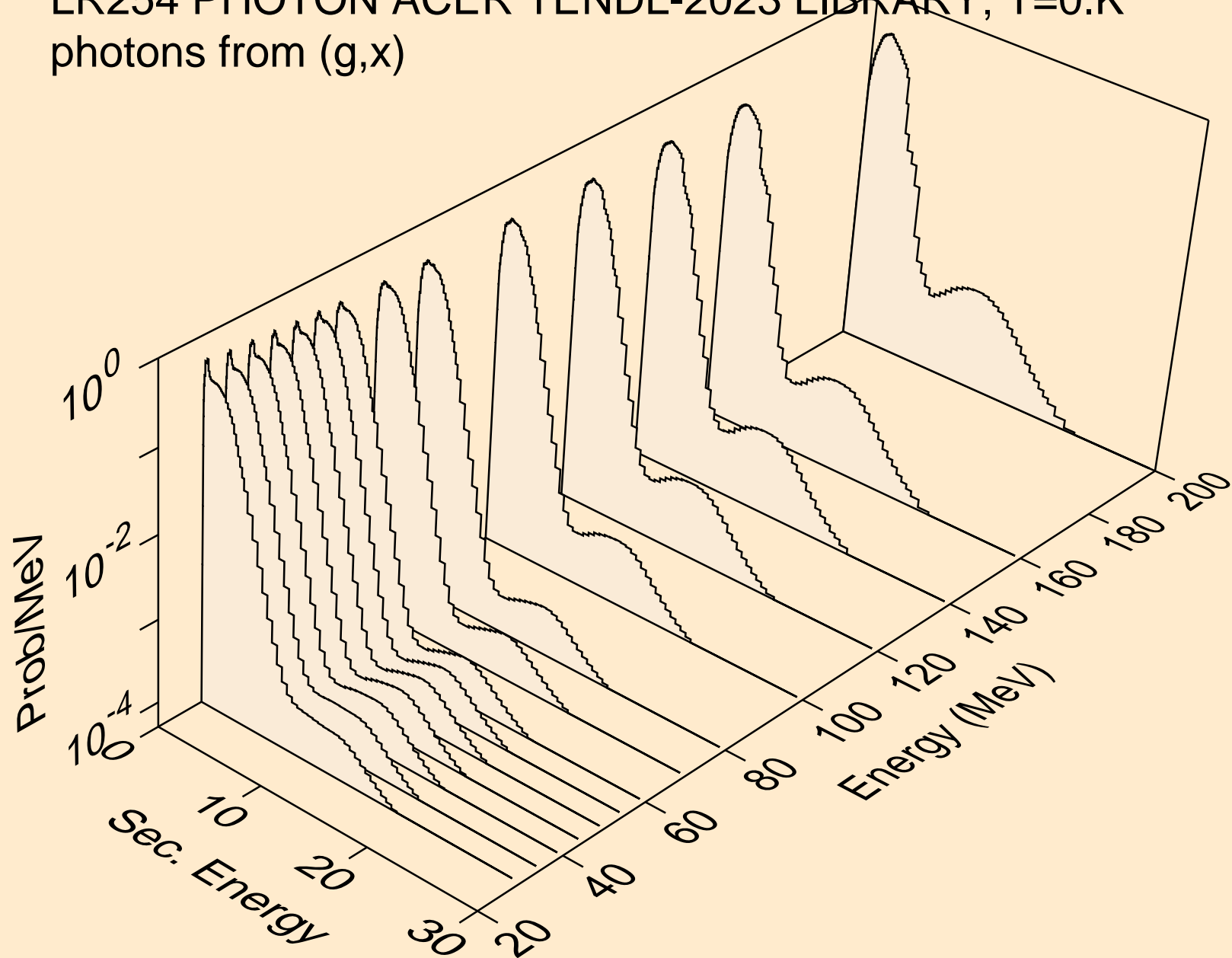

LR254 PHOTON ACER TENDL-2023 LIBRARY; T=0.K
photons from (g,2n)

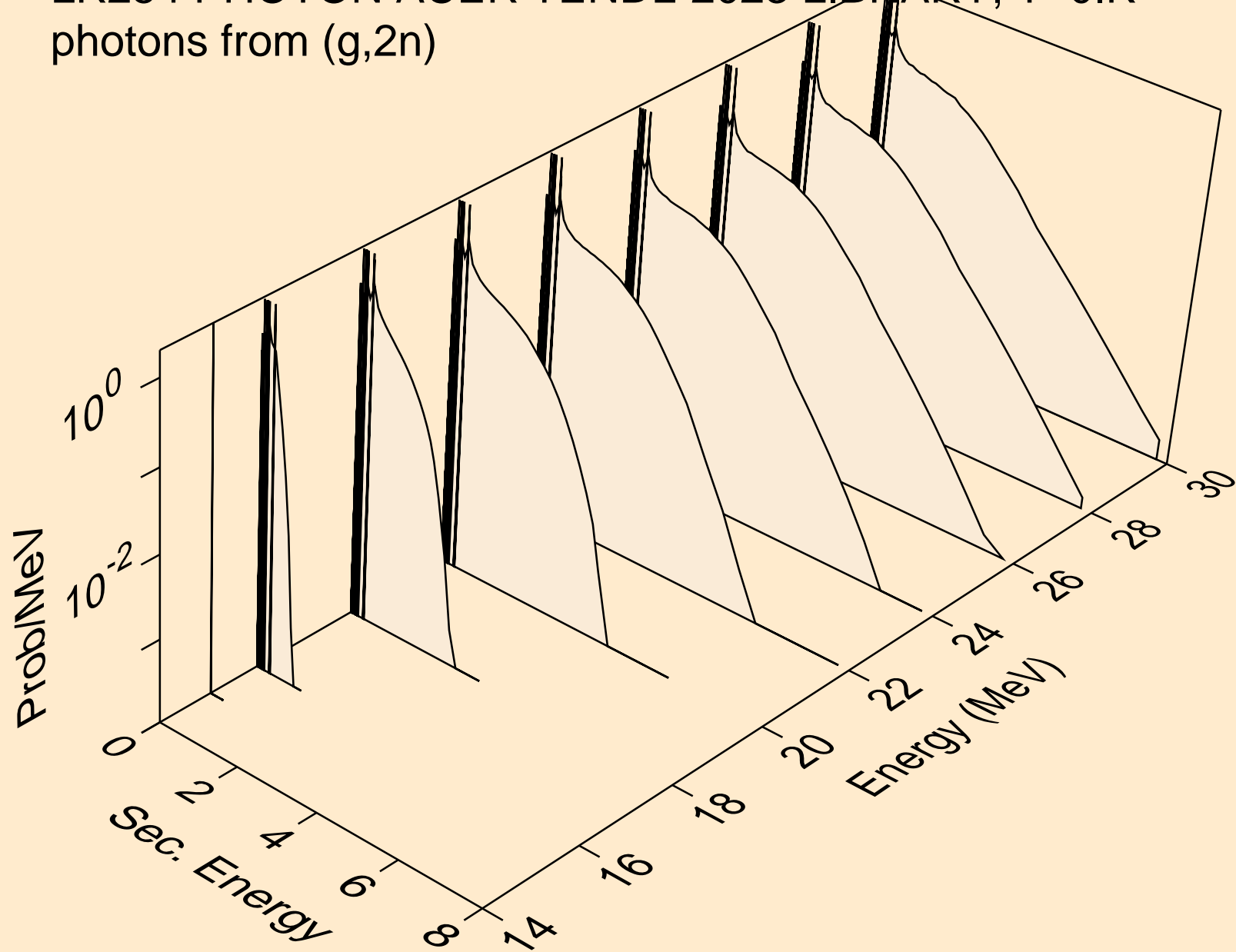

LR254 PHOTON ACER TENDL-2023 LIBRARY; T=0.K
photons from (g,3n)

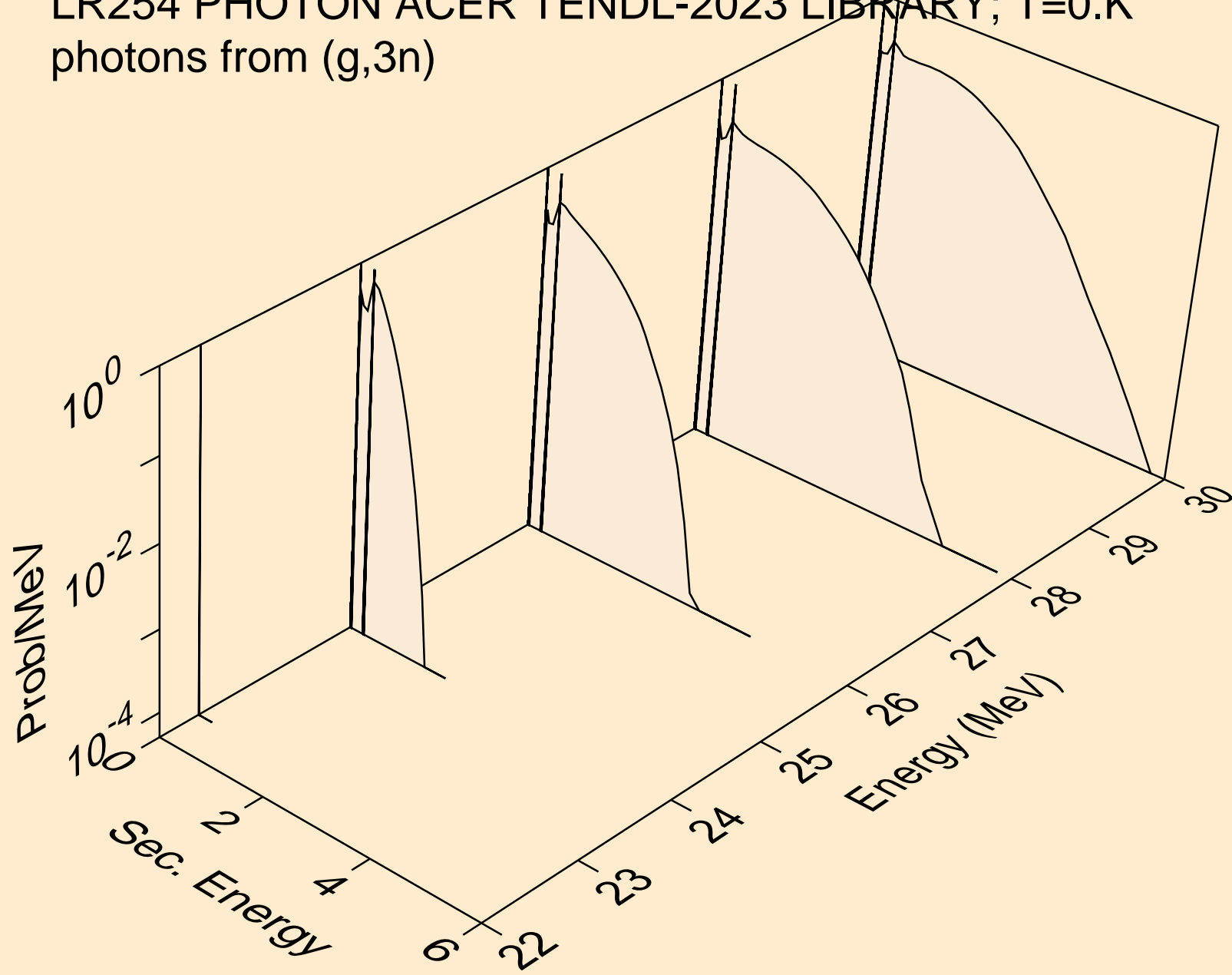

LR254 PHOTON ACER TENDL-2023 LIBRARY; T=0.K
photons from (g,n*)a

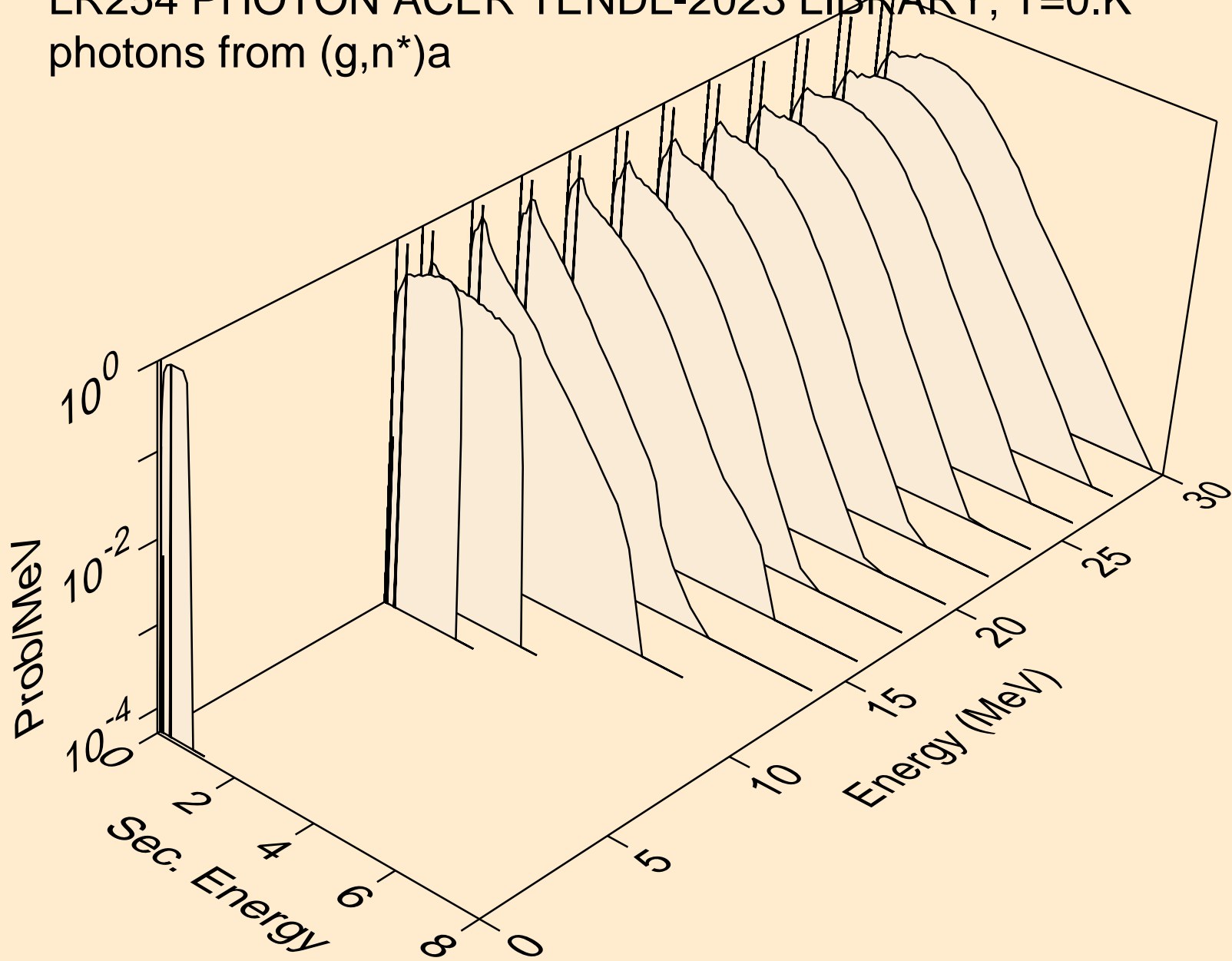

LR254 PHOTON ACER TENDL-2023 LIBRARY; T=0.K
photons from (g,2n)a

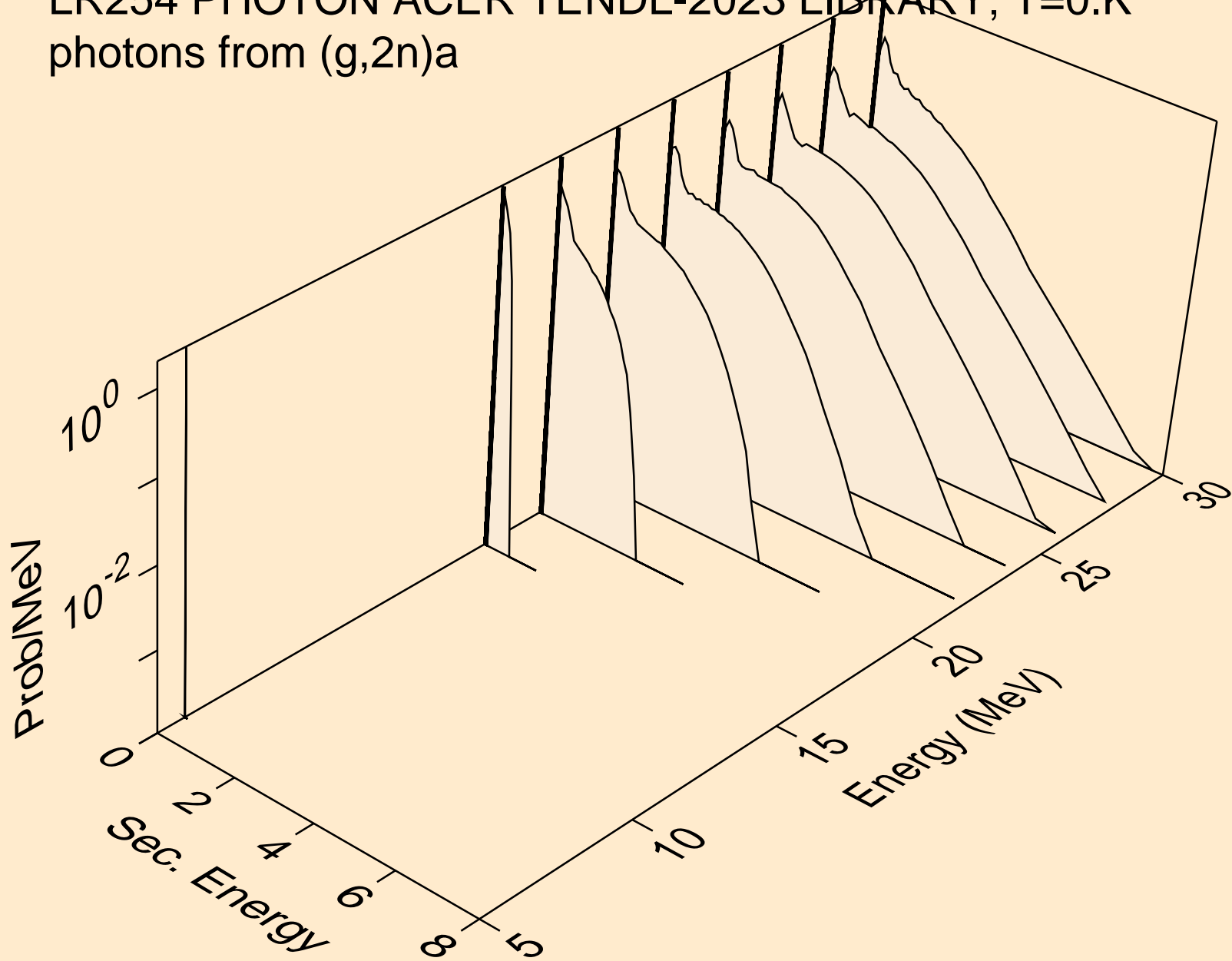

LR254 PHOTON ACER TENDL-2023 LIBRARY; T=0.K
photons from (g,3n)a

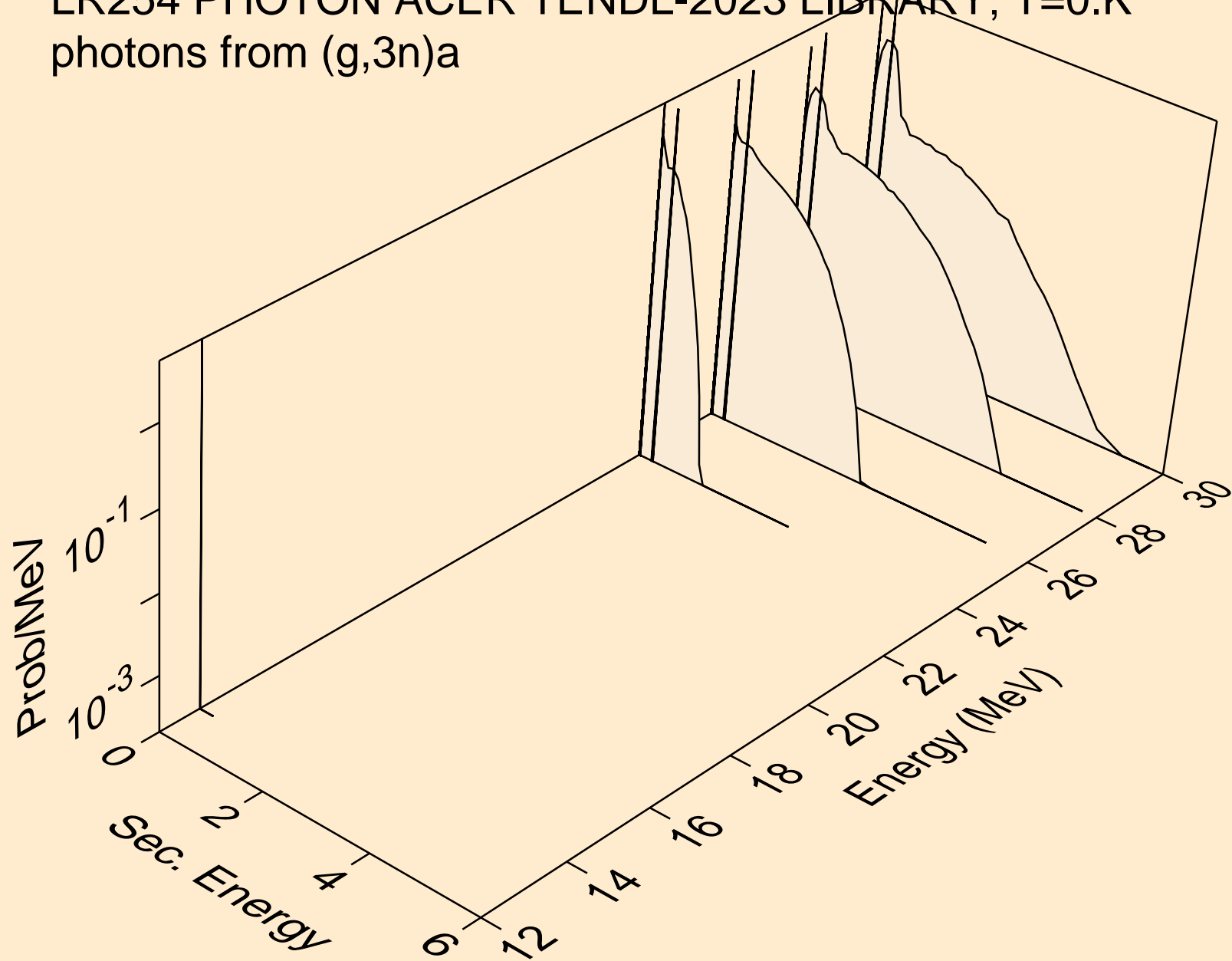

LR254 PHOTON ACER TENDL-2023 LIBRARY; T=0.K
photons from (g,n*)p

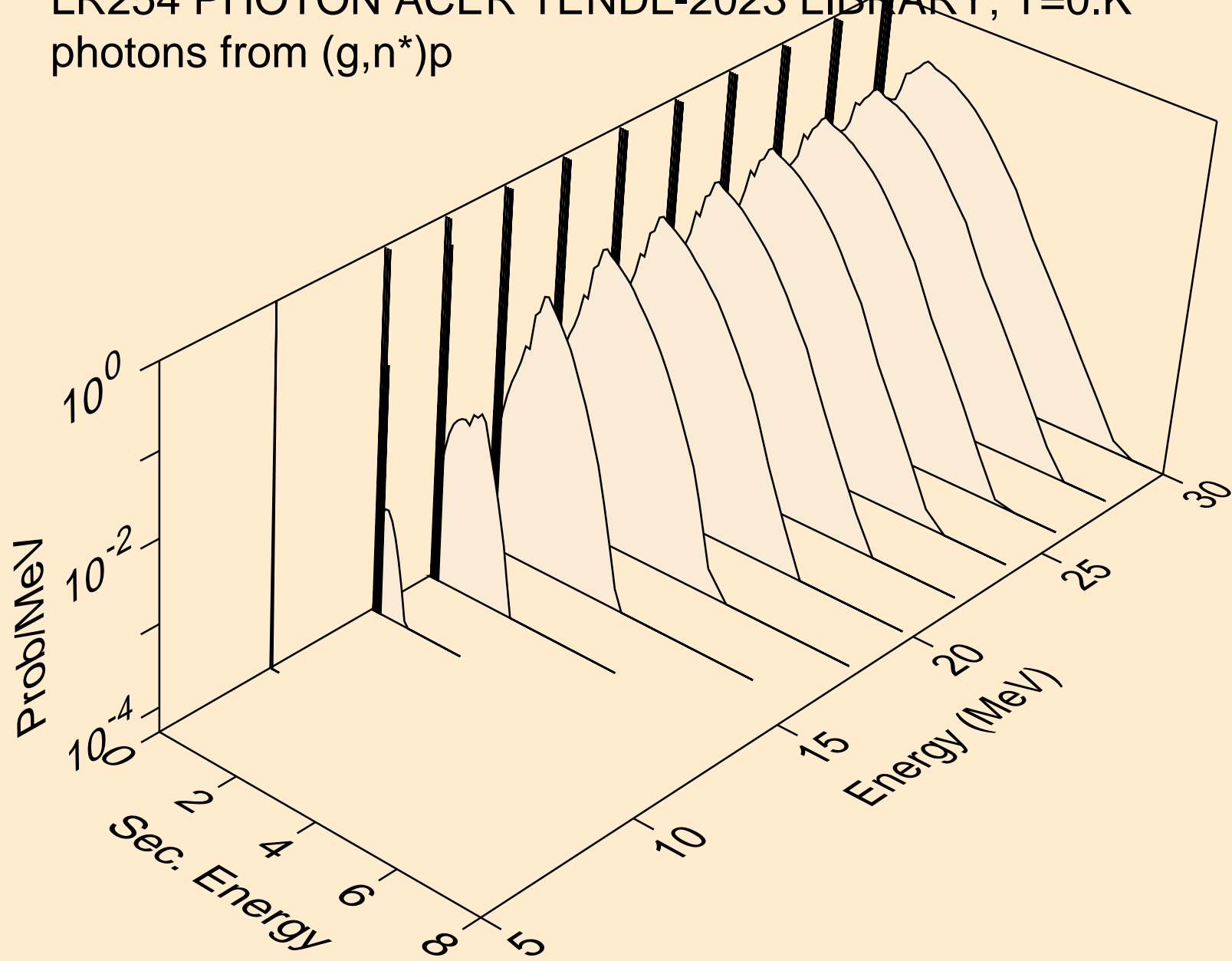

LR254 PHOTON ACER TENDL-2023 LIBRARY; T=0.K
photons from (g,n*)d

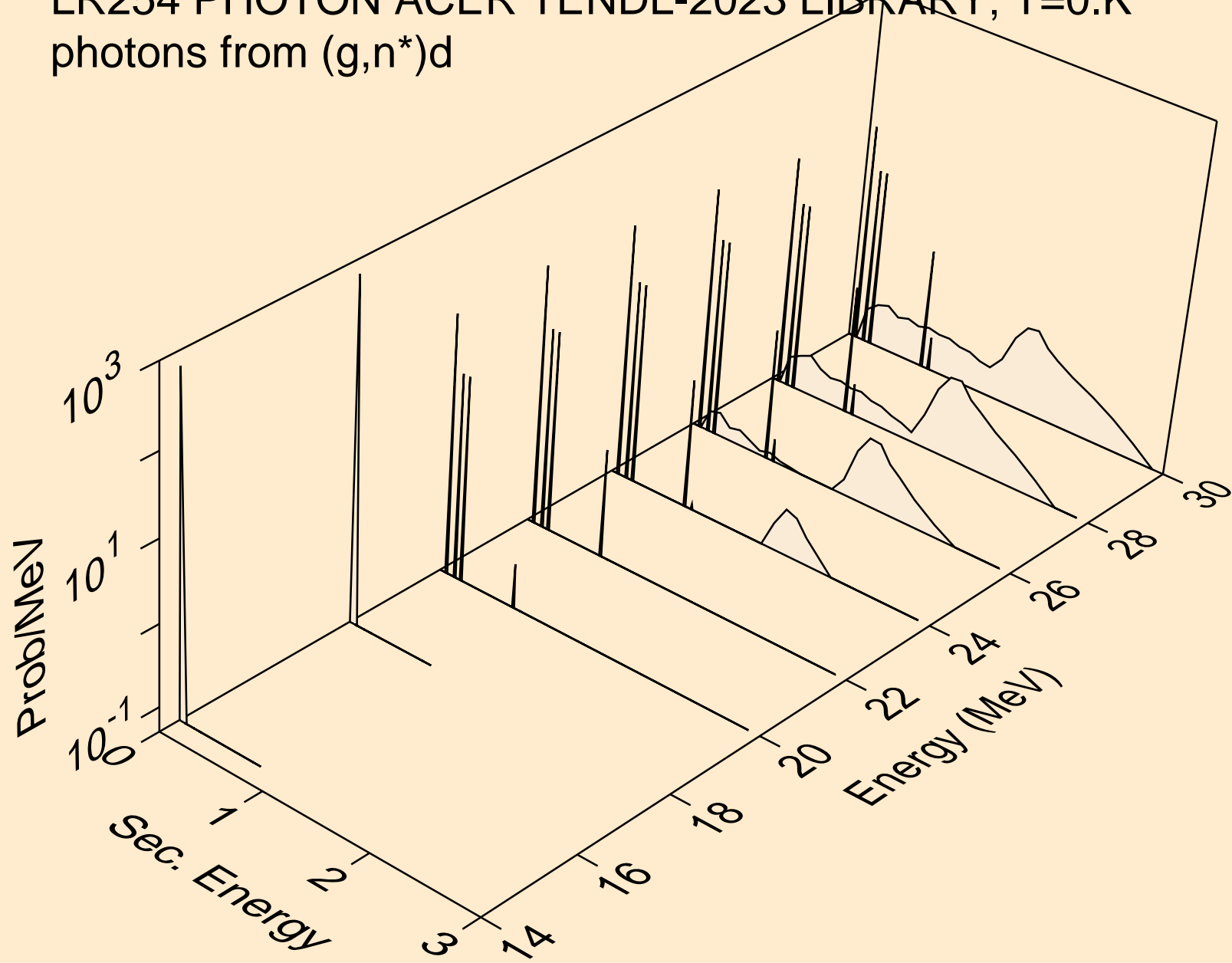

LR254 PHOTON ACER TENDL-2023 LIBRARY; T=0.K
photons from (g,n*)t

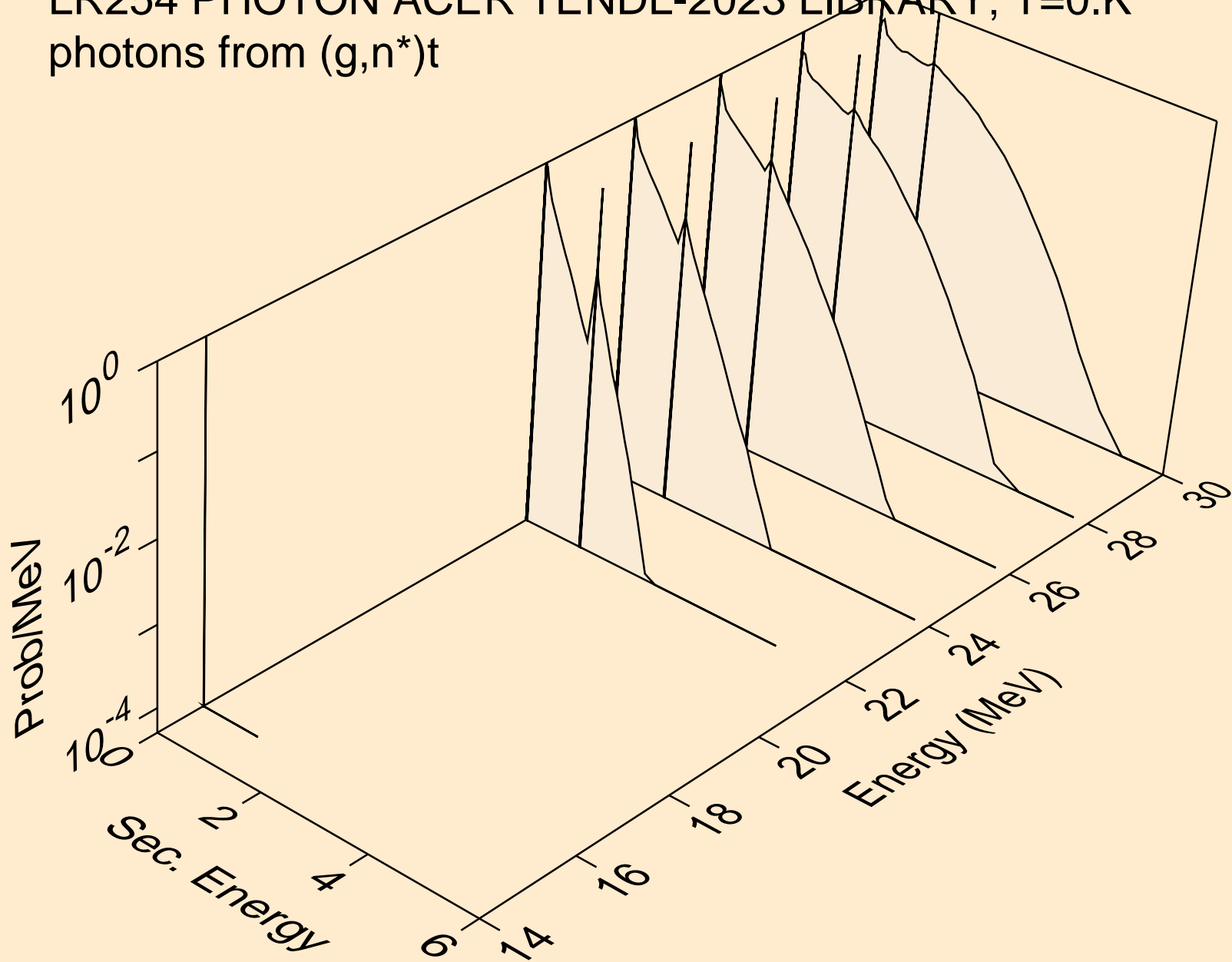

LR254 PHOTON ACER TENDL-2023 LIBRARY; T=0.K
photons from (g,2np)

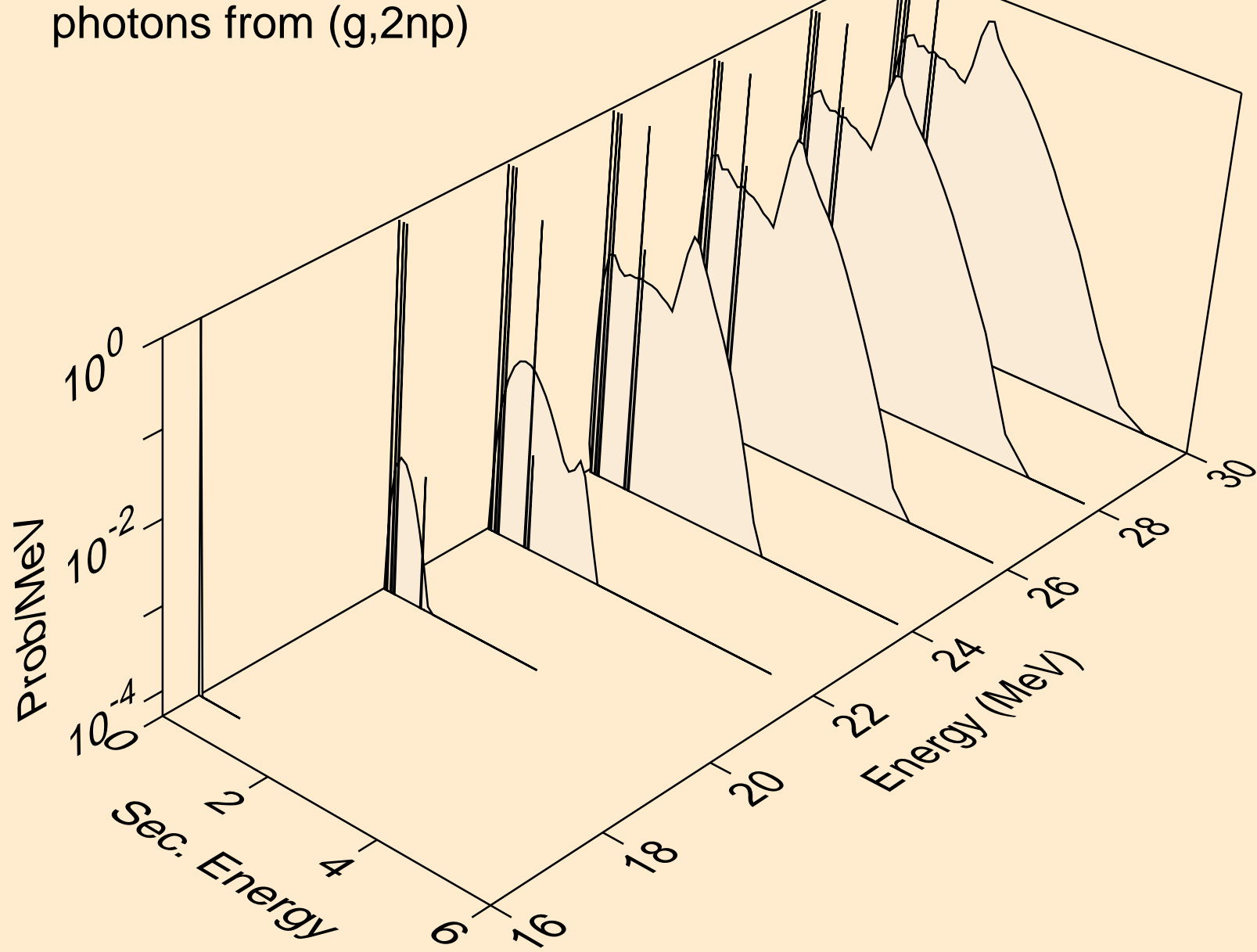

LR254 PHOTON ACER TENDL-2023 LIBRARY; T=0.K
photons from (g,npa)

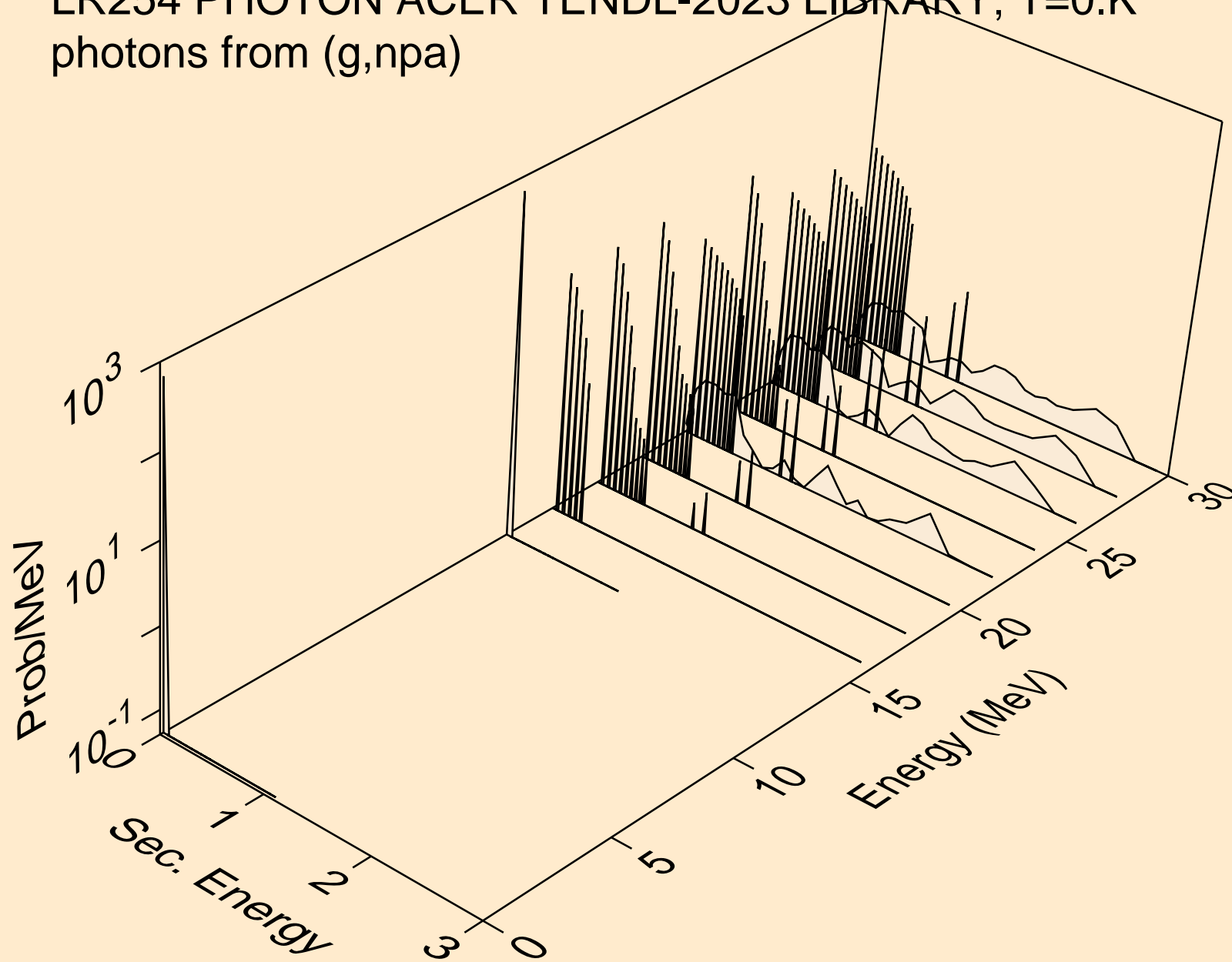

LR254 PHOTON ACER TENDL-2023 LIBRARY; T=0.K
photons from (g,n*c)

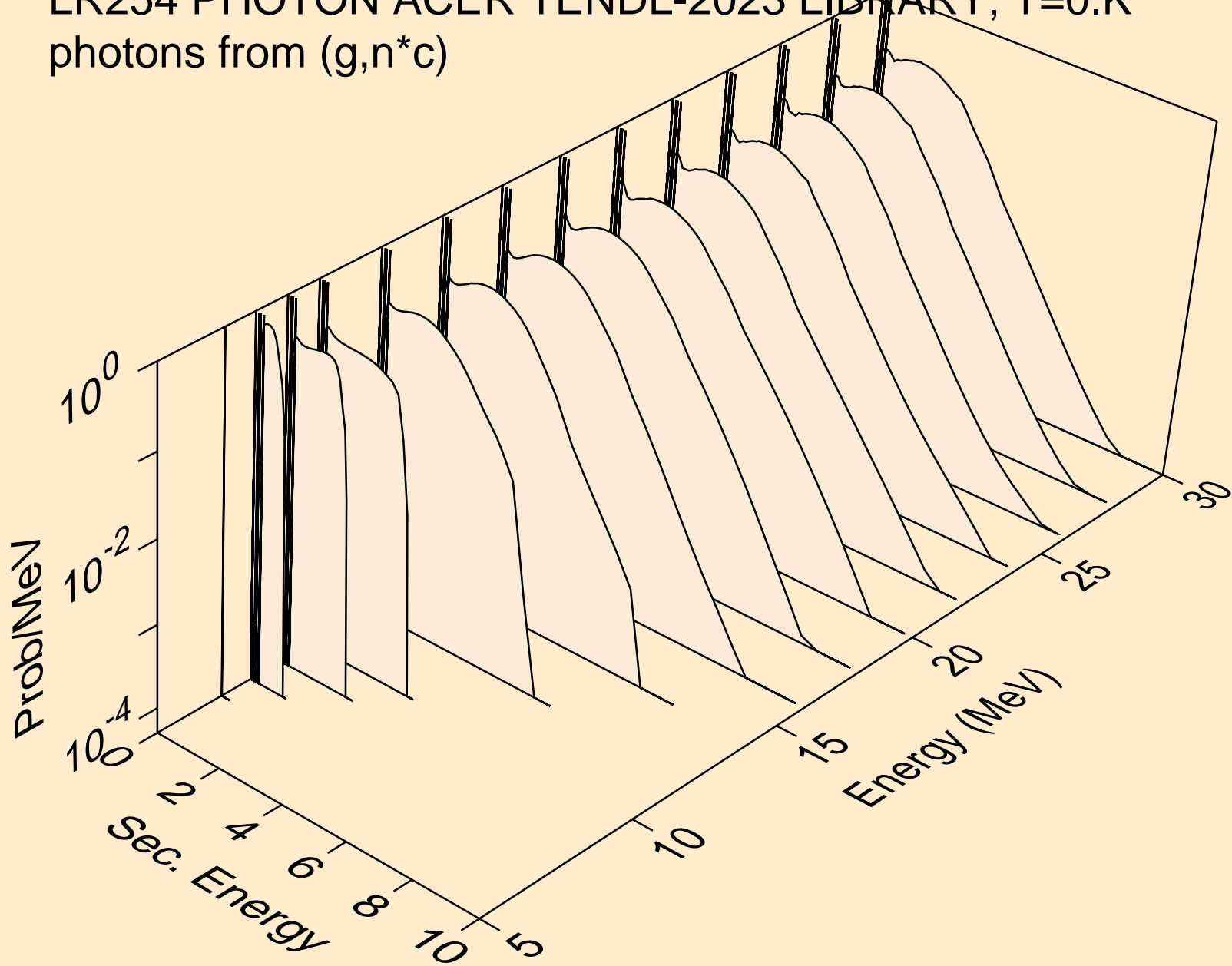

LR254 PHOTON ACER TENDL-2023 LIBRARY; T=0.K
photons from (g,gma)

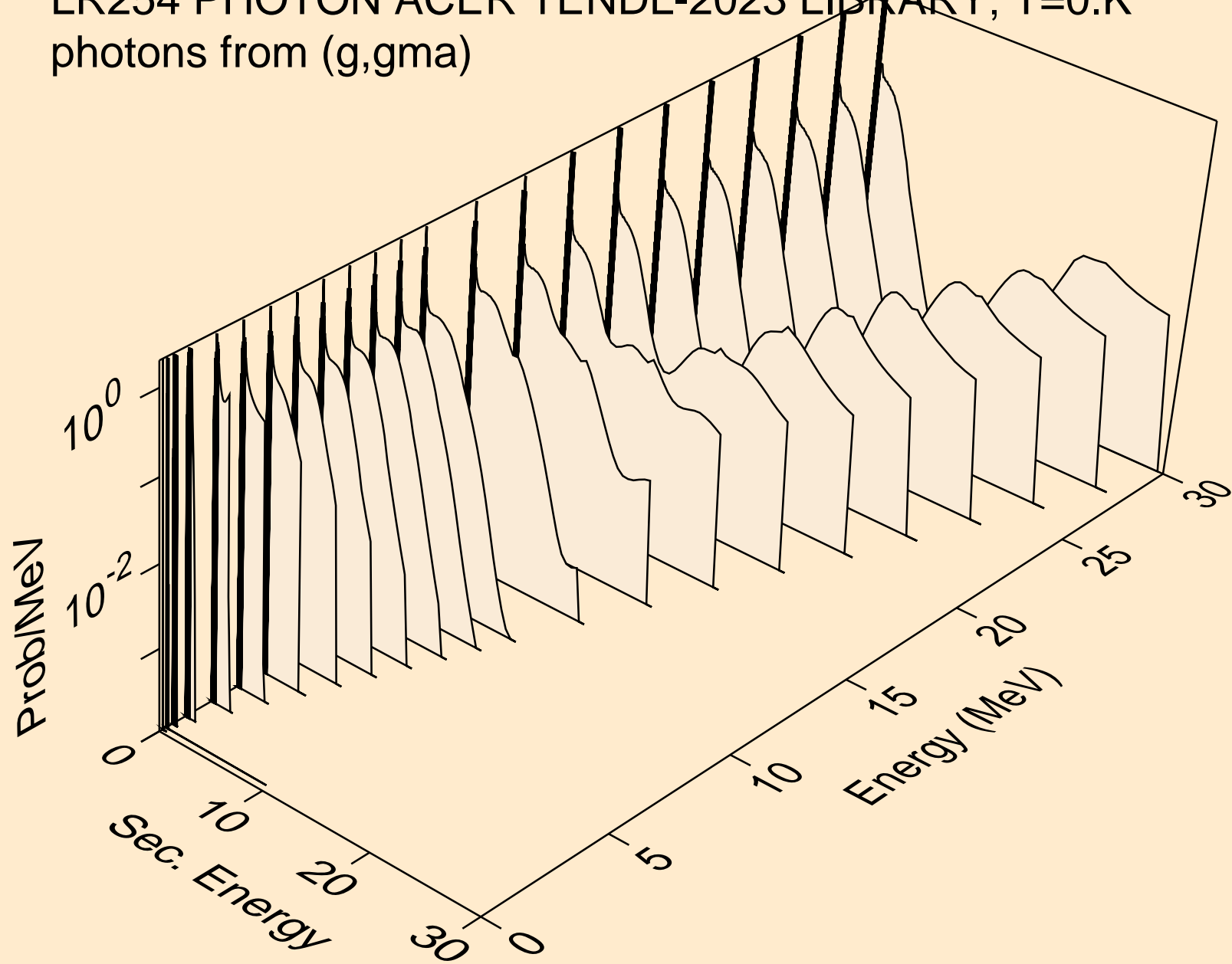

LR254 PHOTON ACER TENDL-2023 LIBRARY; T=0.K
photons from (g,p)

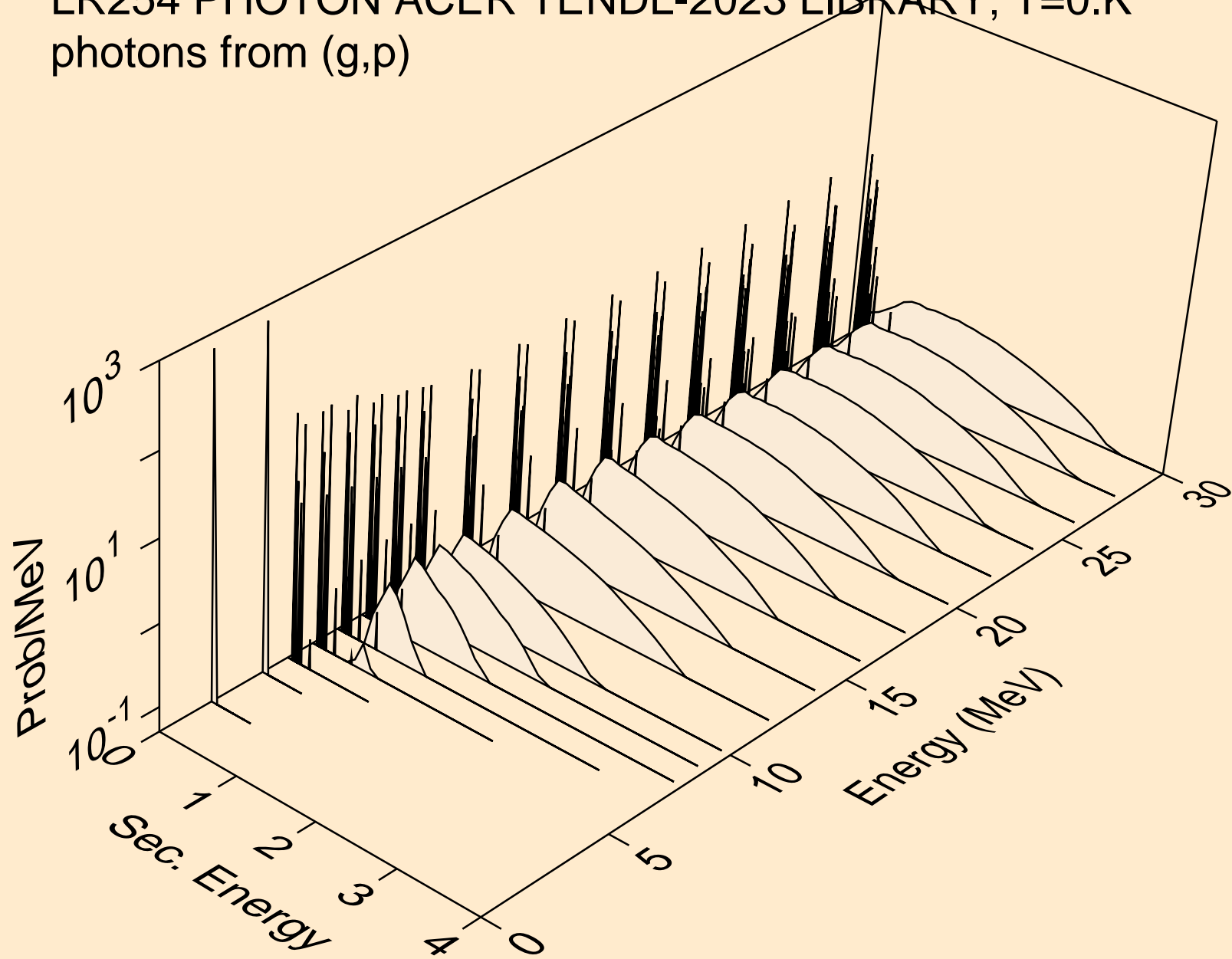

LR254 PHOTON ACER TENDL-2023 LIBRARY; T=0.K
photons from (g,d)

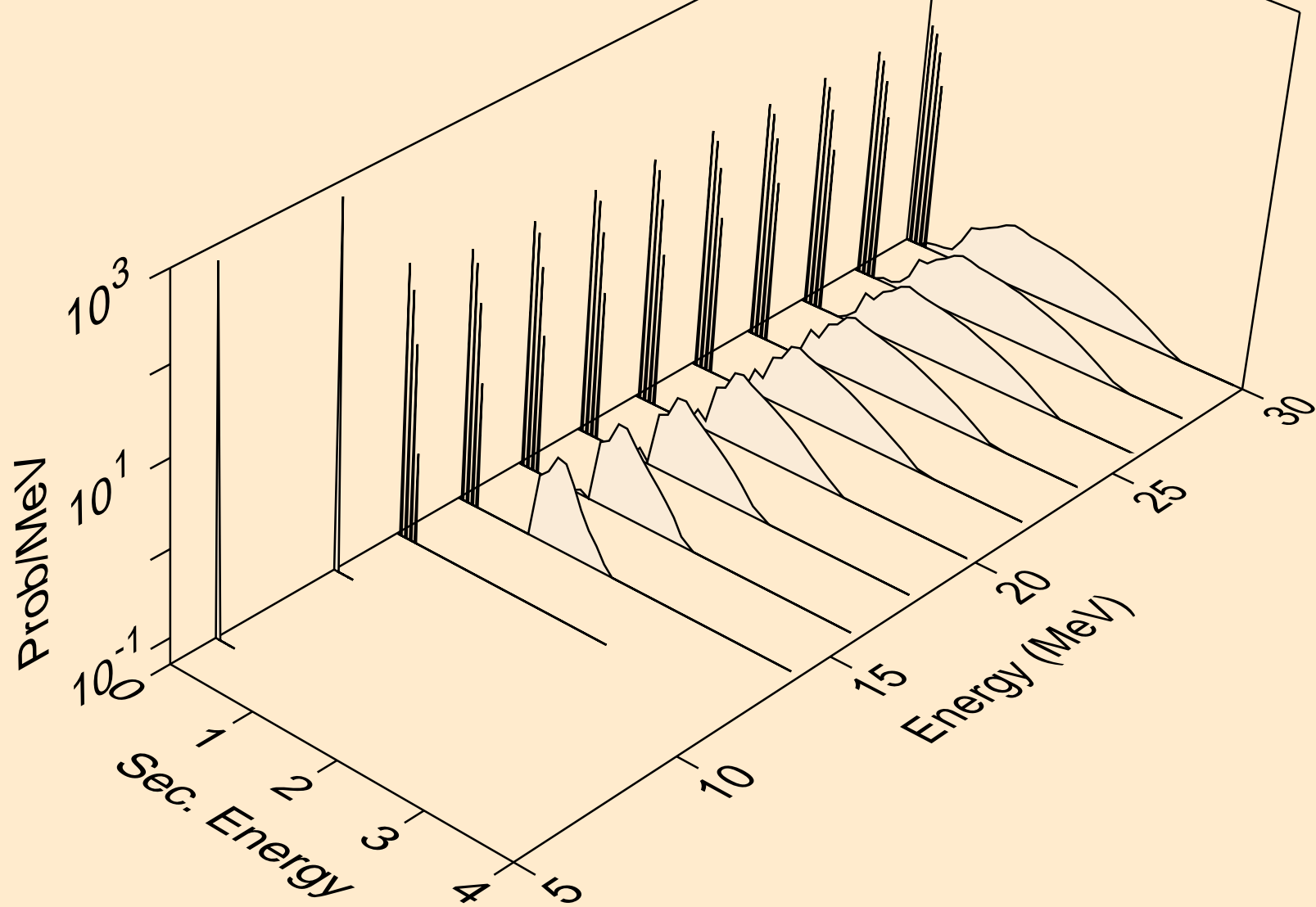

LR254 PHOTON ACER TENDL-2023 LIBRARY; T=0.K
photons from (g,t)

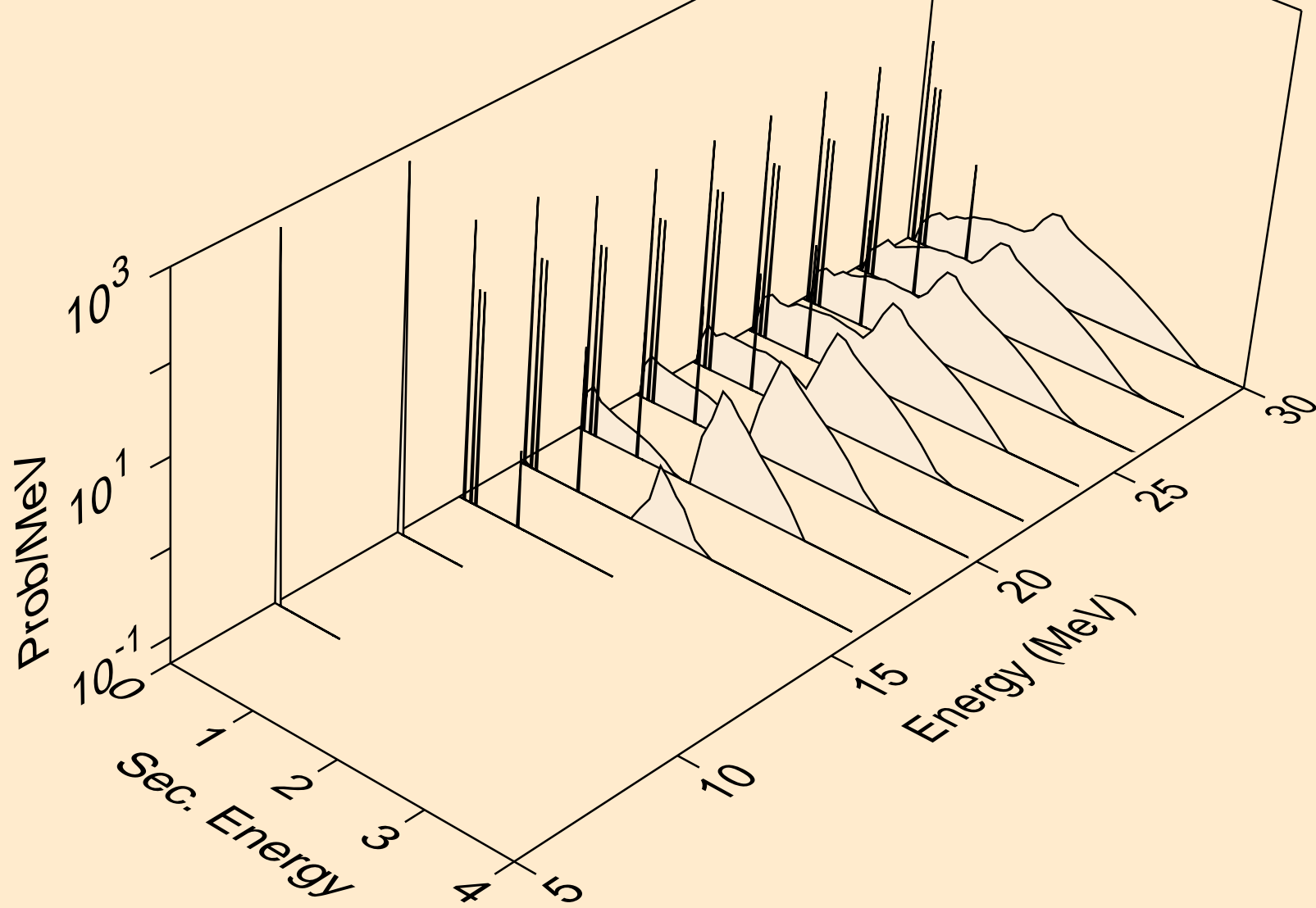

LR254 PHOTON ACER TENDL-2023 LIBRARY; T=0.K
photons from (g,a)

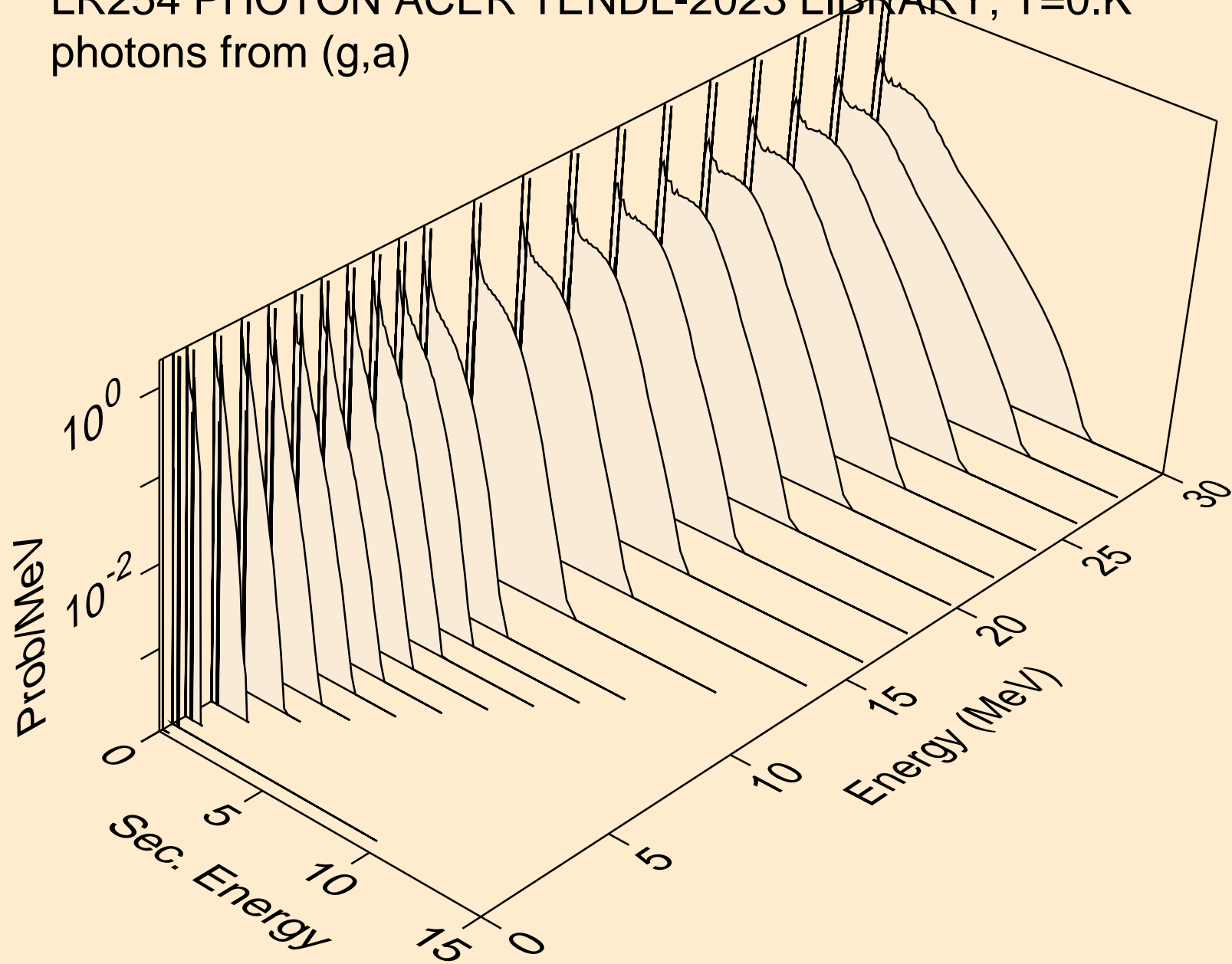

LR254 PHOTON ACER TENDL-2023 LIBRARY; T=0.K
photons from (g,2a)

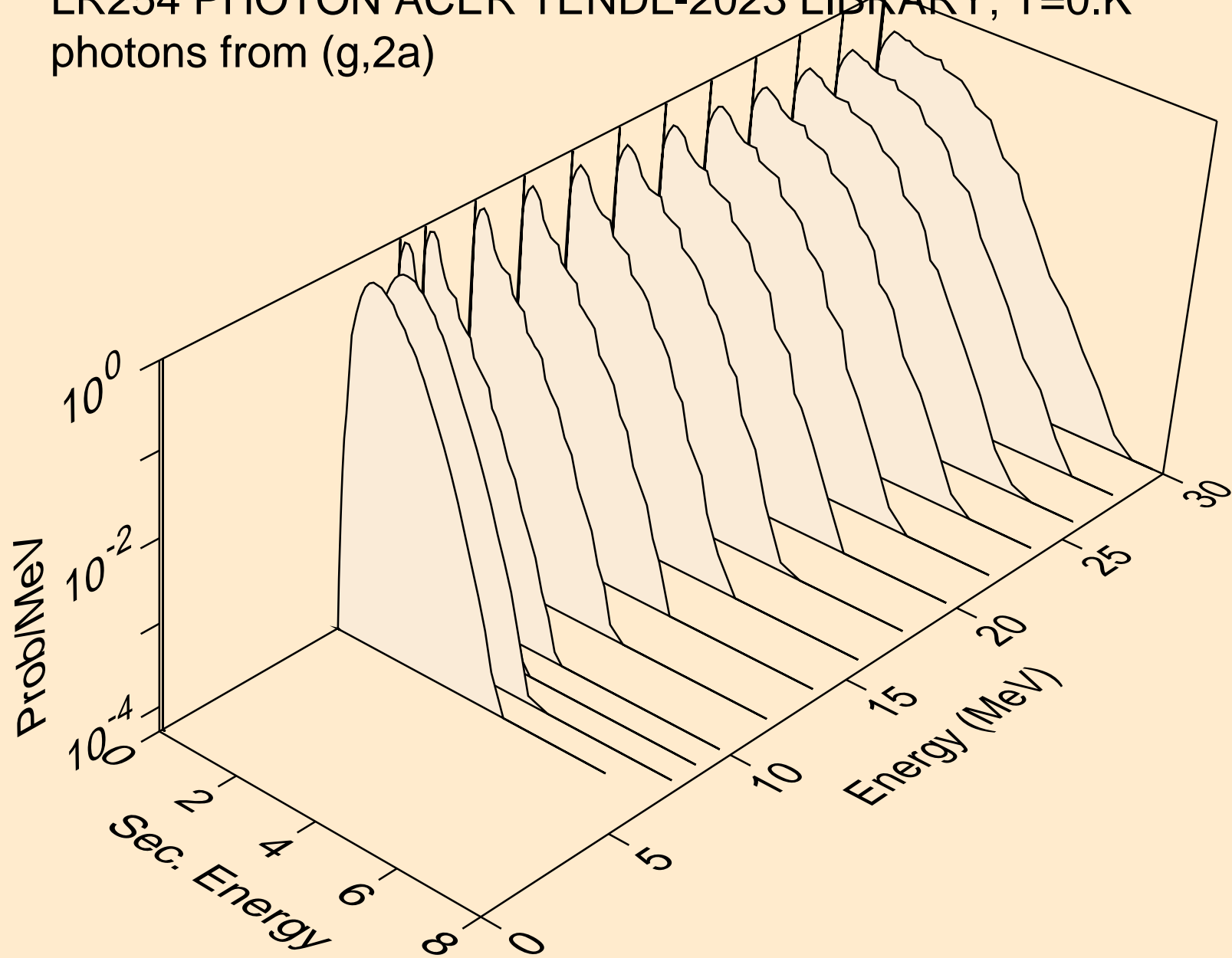

LR254 PHOTON ACER TENDL-2023 LIBRARY; T=0.K
photons from (g,2p)

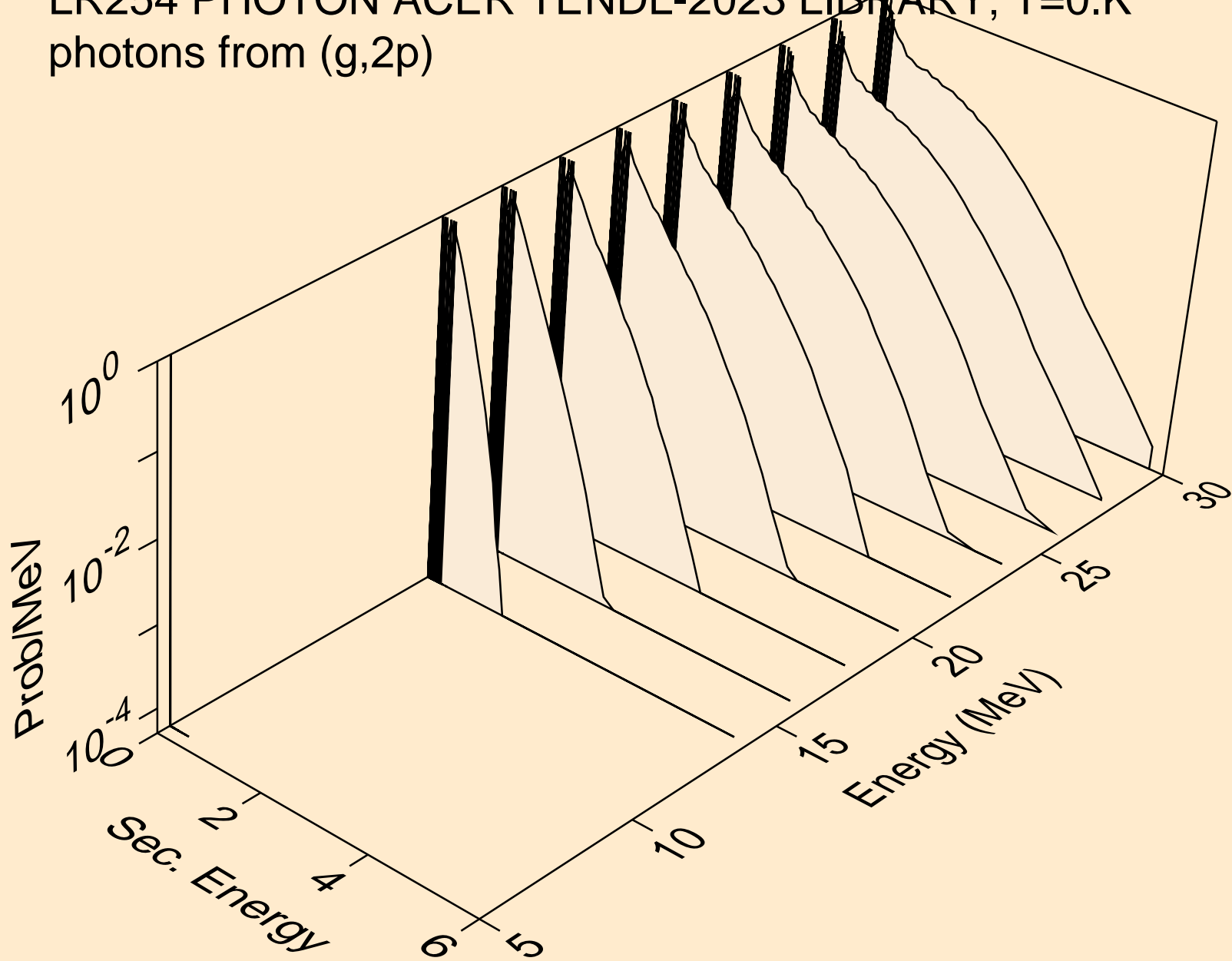

LR254 PHOTON ACER TENDL-2023 LIBRARY; T=0.K
photons from (g,pa)

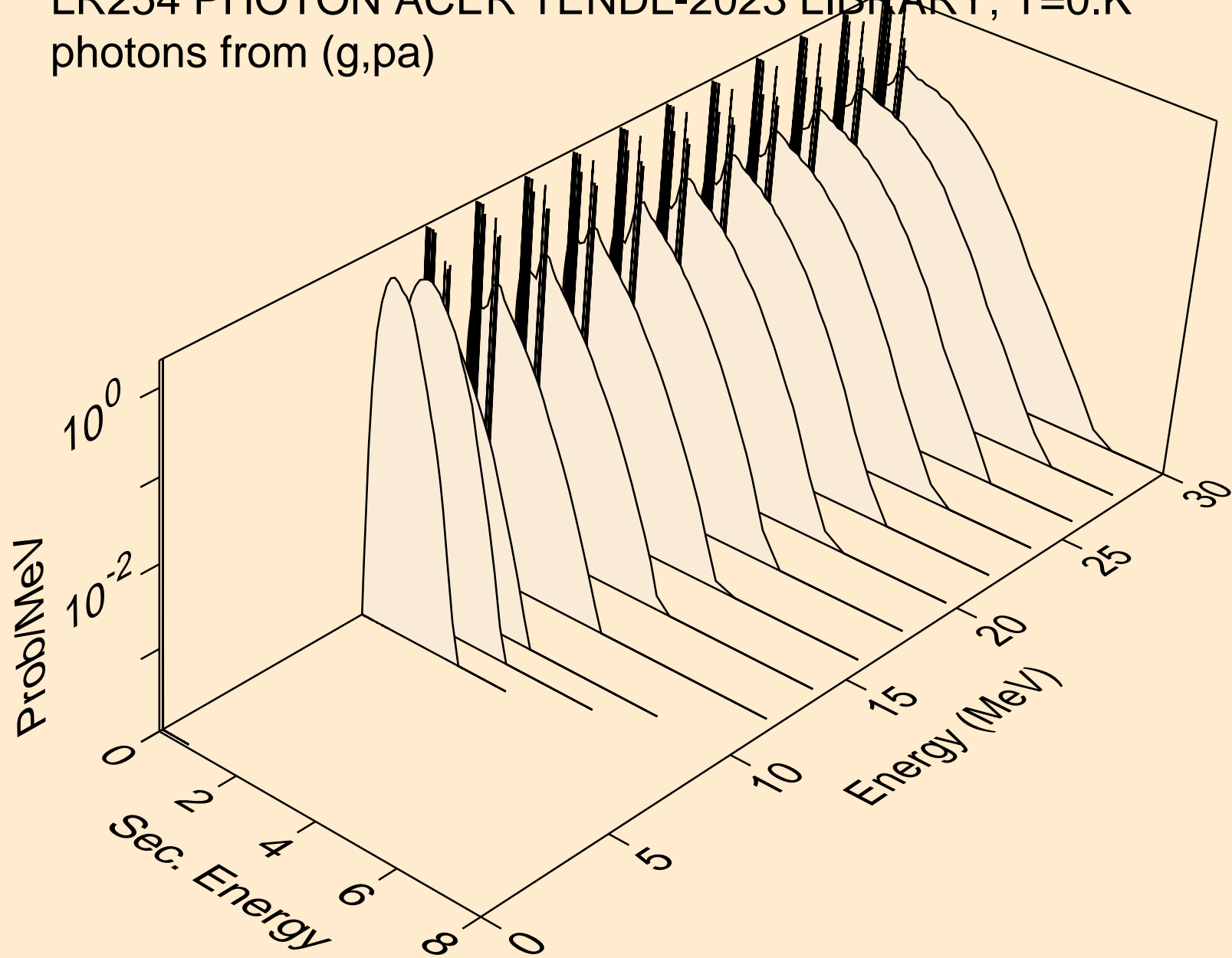

LR254 PHOTON ACER TENDL-2023 LIBRARY; T=0.K
photons from (g,da)

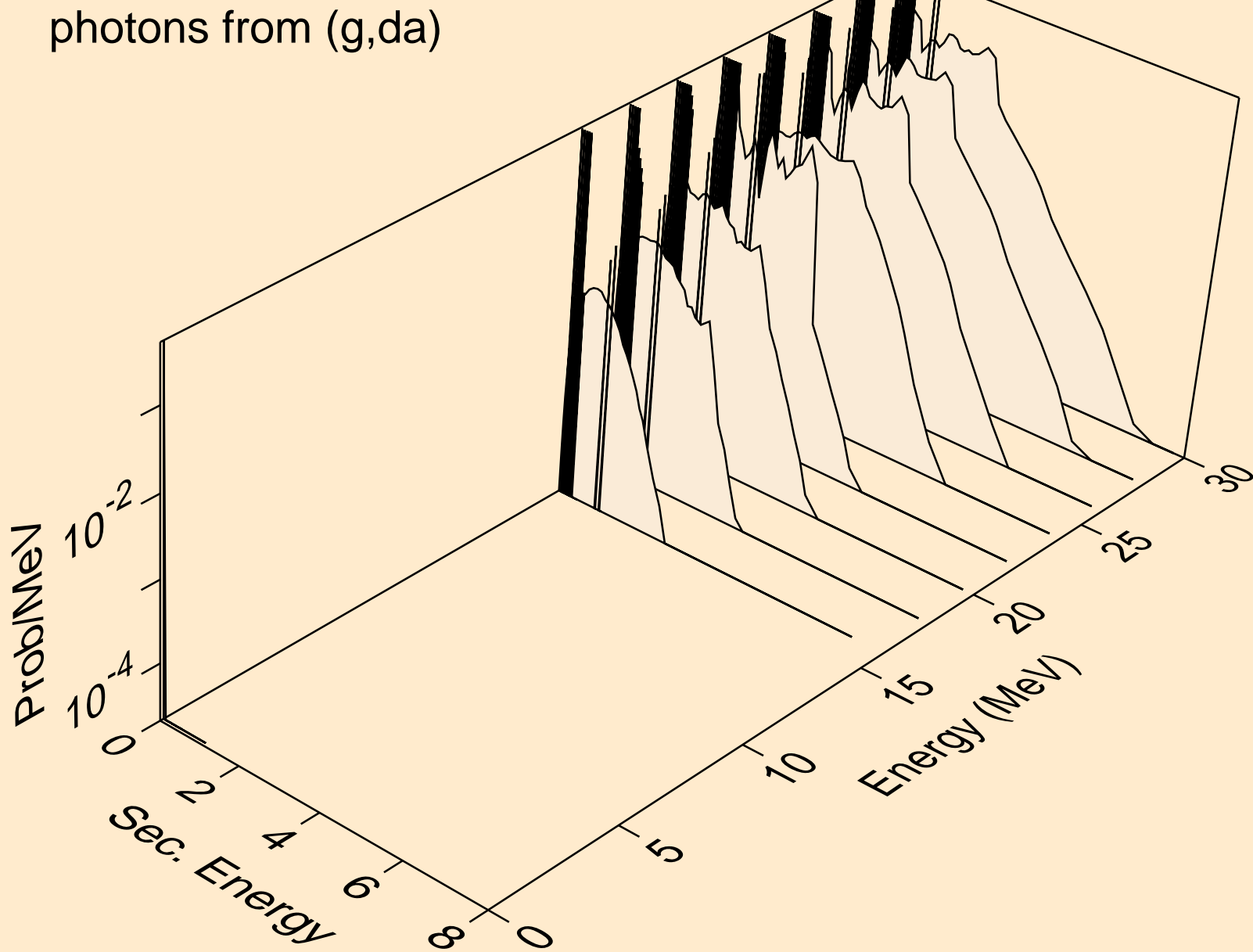

LR254 PHOTON ACER TENDL-2023 LIBRARY; T=0.K
protons from (g,x)

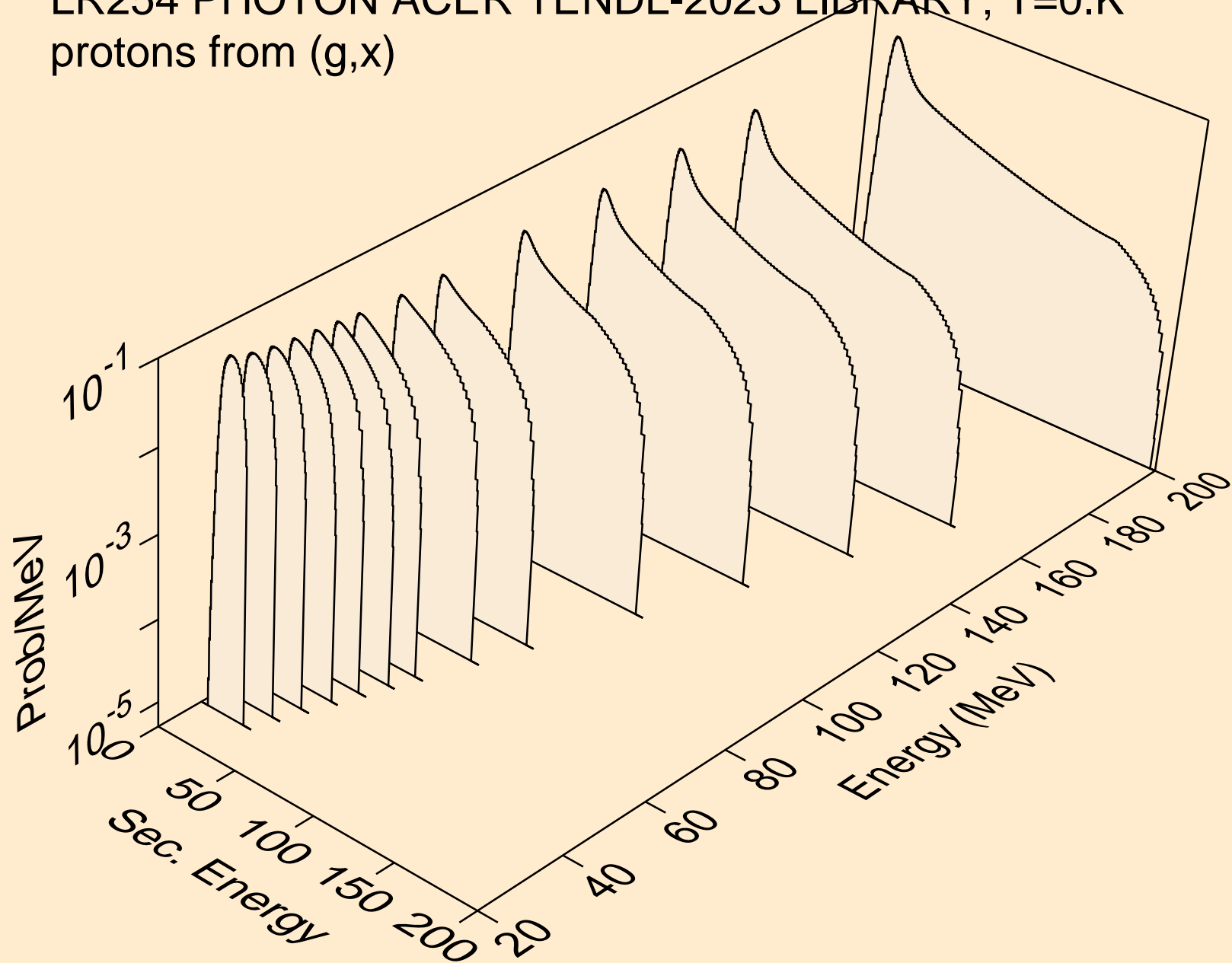

LR254 PHOTON ACER TENDL-2023 LIBRARY; T=0.K
protons from (g,n*)p

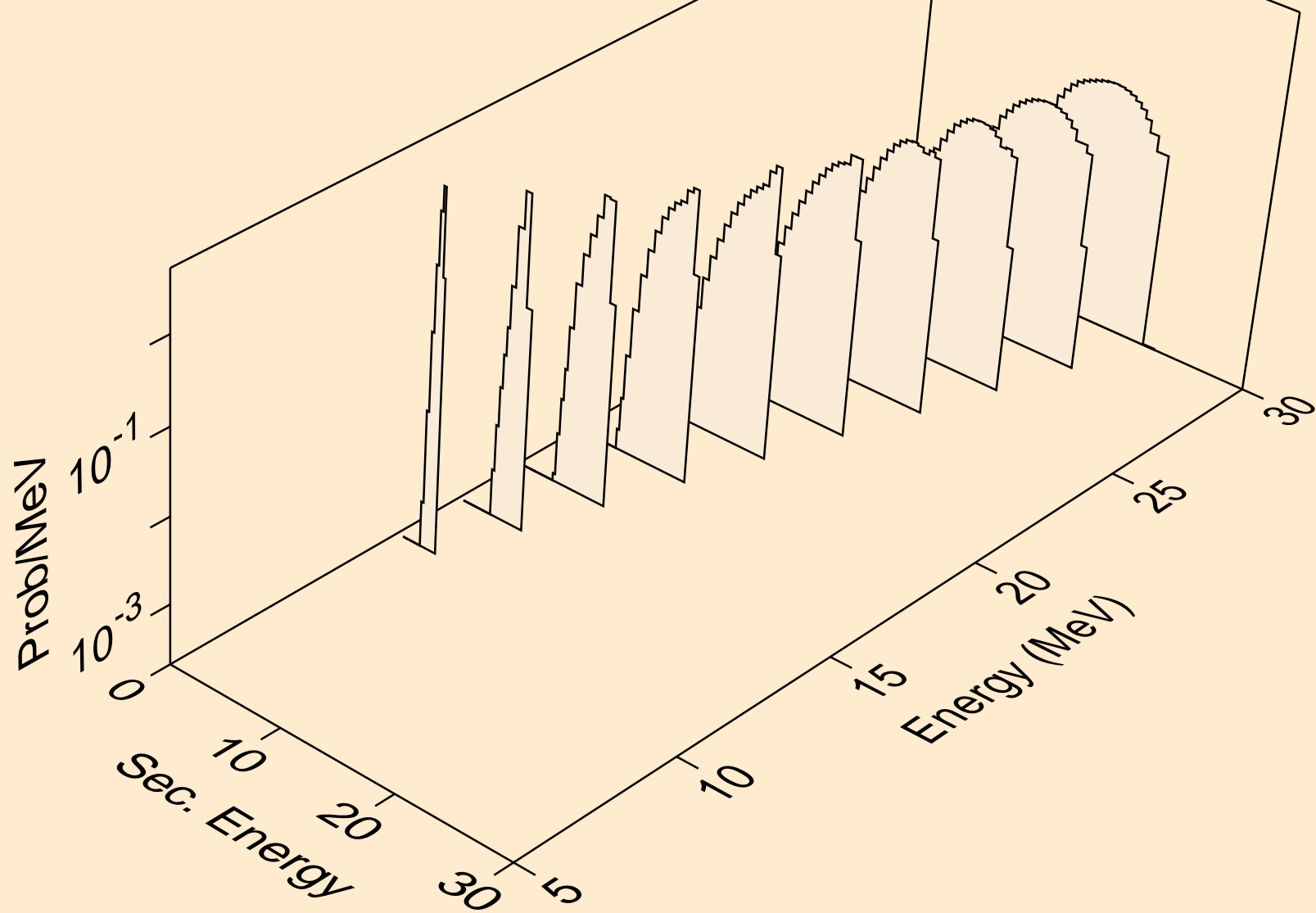

LR254 PHOTON ACER TENDL-2023 LIBRARY; T=0.K
protons from (g,2np)

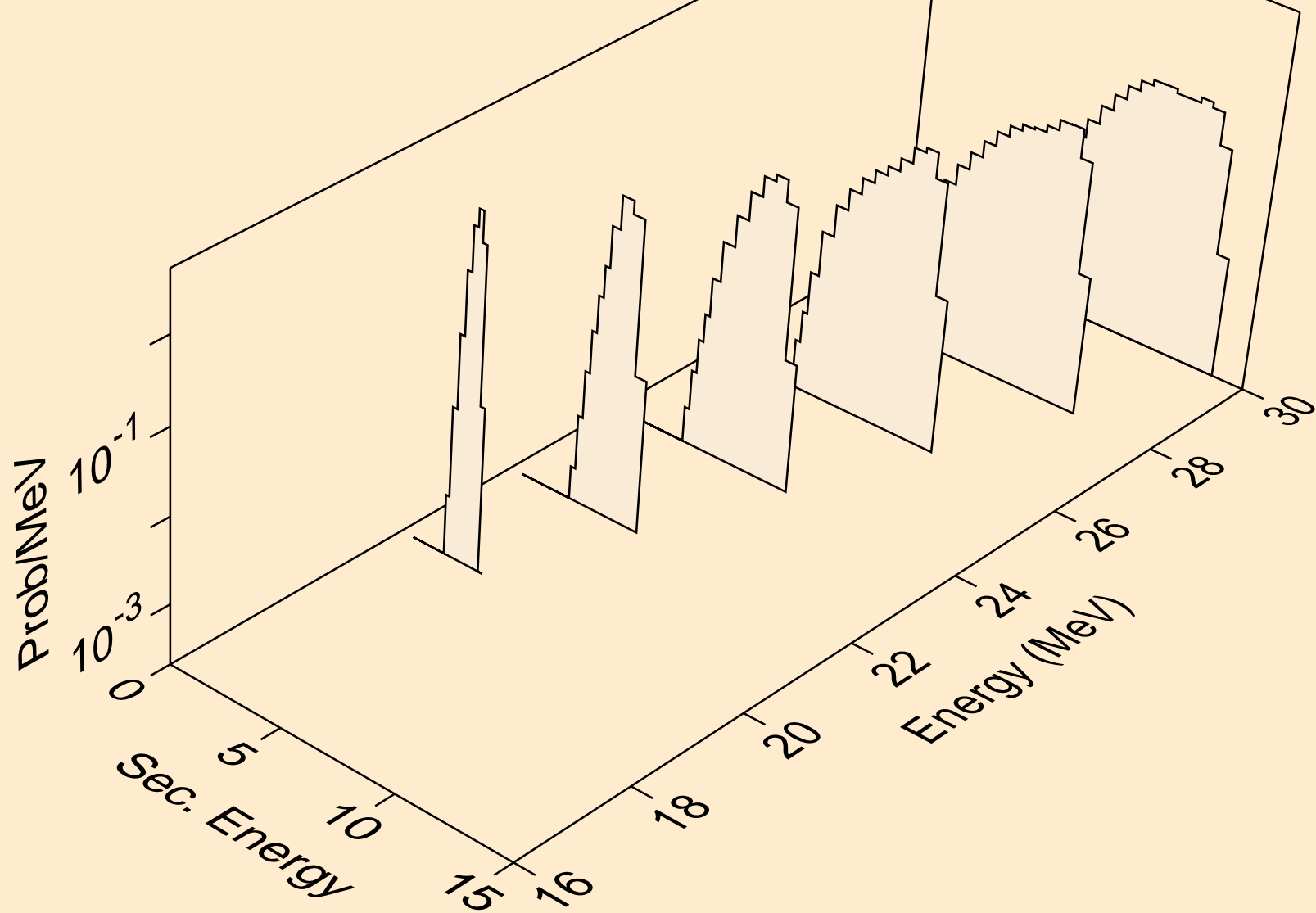

LR254 PHOTON ACER TENDL-2023 LIBRARY; T=0.K
protons from (g,npa)

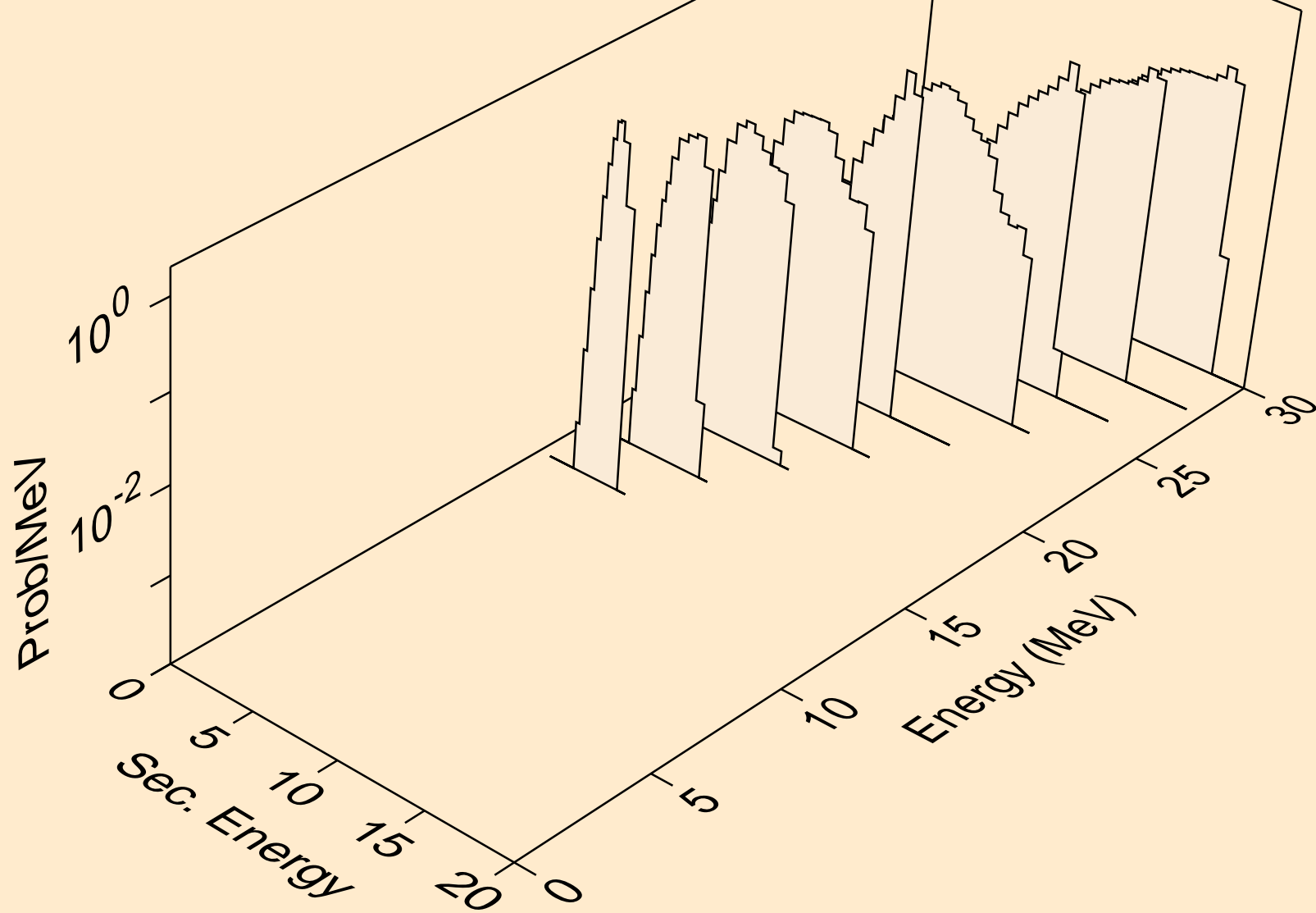

LR254 PHOTON ACER TENDL-2023 LIBRARY; T=0.K
protons from (g,p)

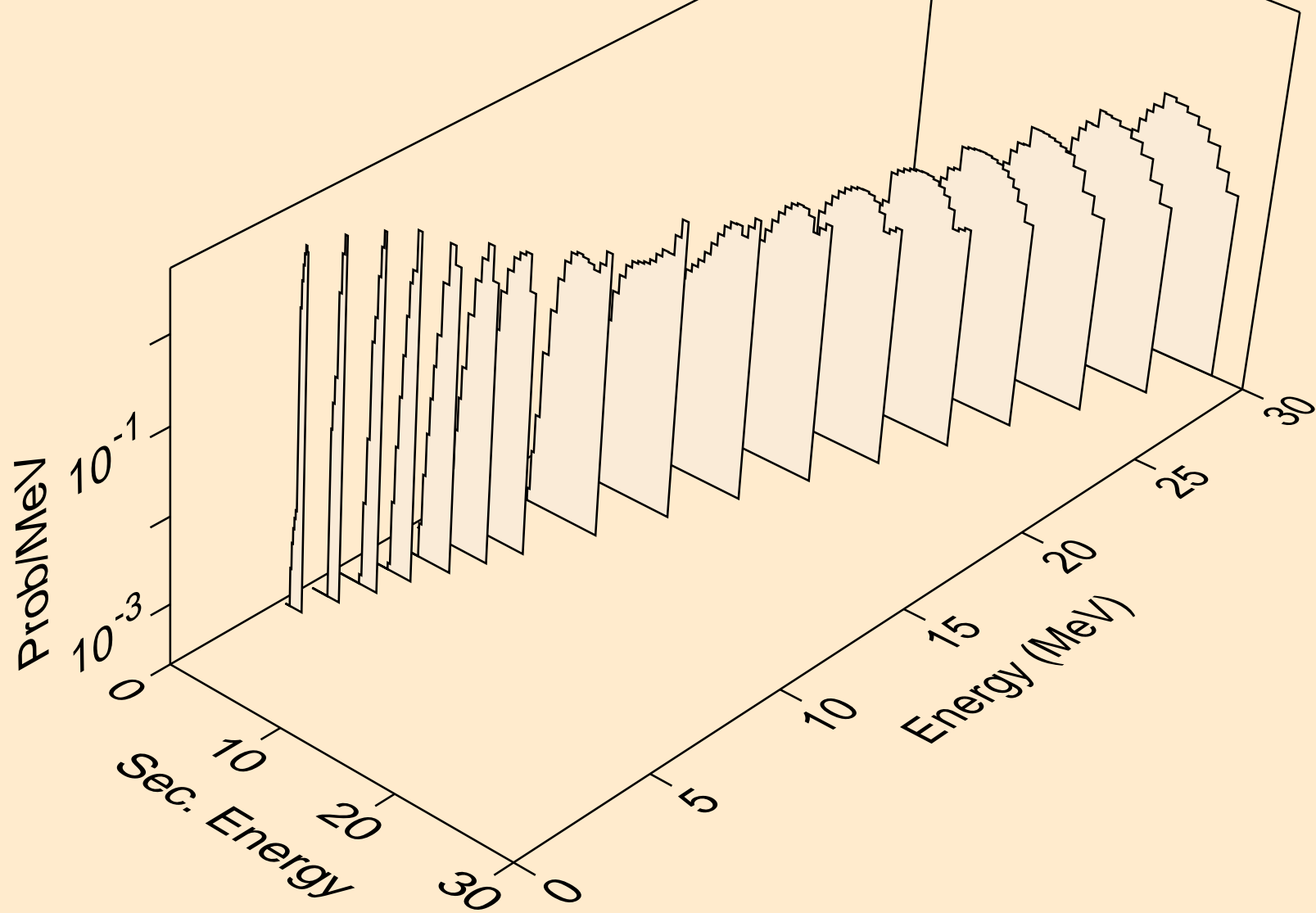

LR254 PHOTON ACER TENDL-2023 LIBRARY; T=0.K
protons from (g,2p)

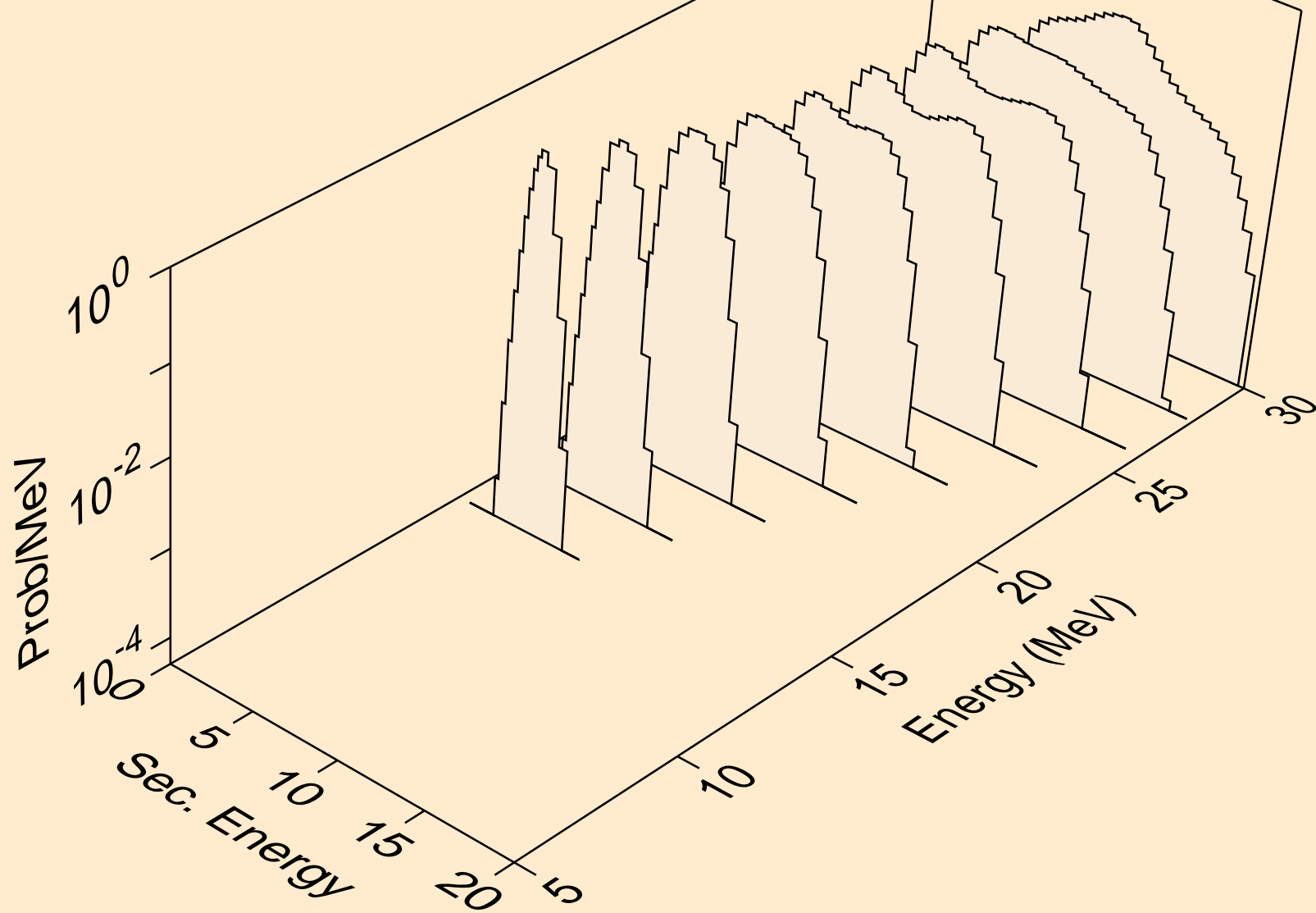

LR254 PHOTON ACER TENDL-2023 LIBRARY; T=0.K
protons from (g,pa)

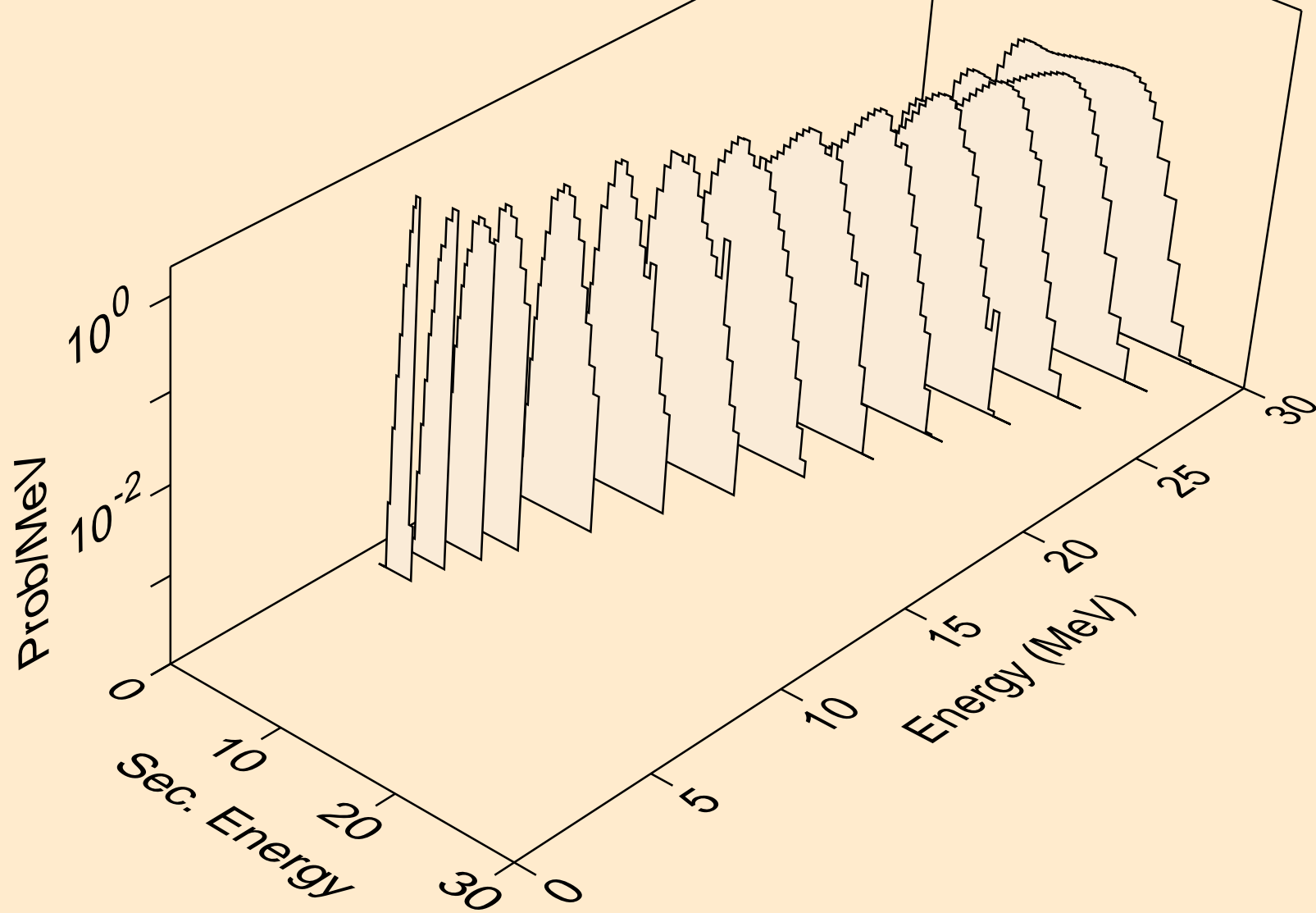

LR254 PHOTON ACER TENDL-2023 LIBRARY; T=0.K
deuterons from (g,x)

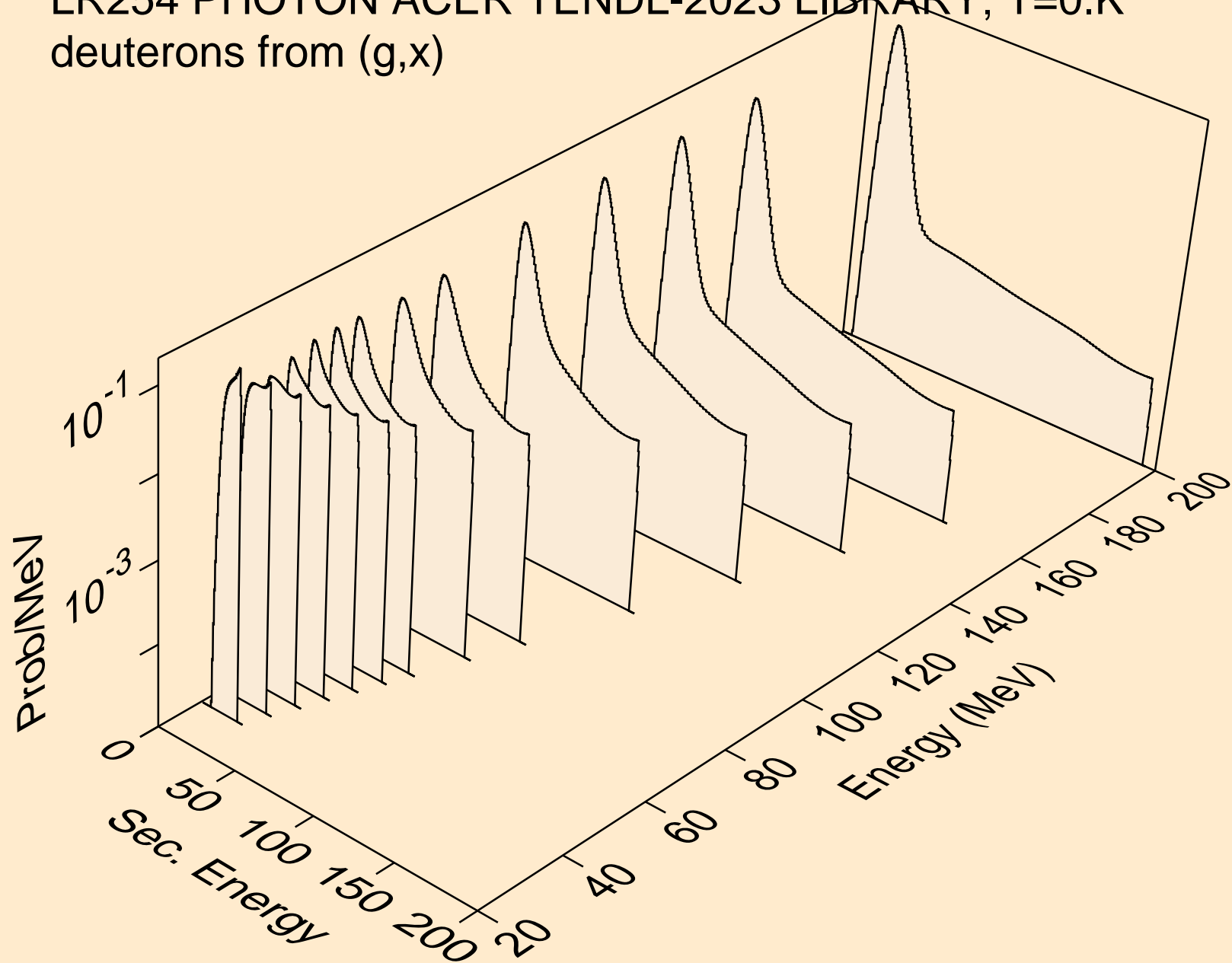

LR254 PHOTON ACER TENDL-2023 LIBRARY; T=0.K
deuterons from (g,n*)d

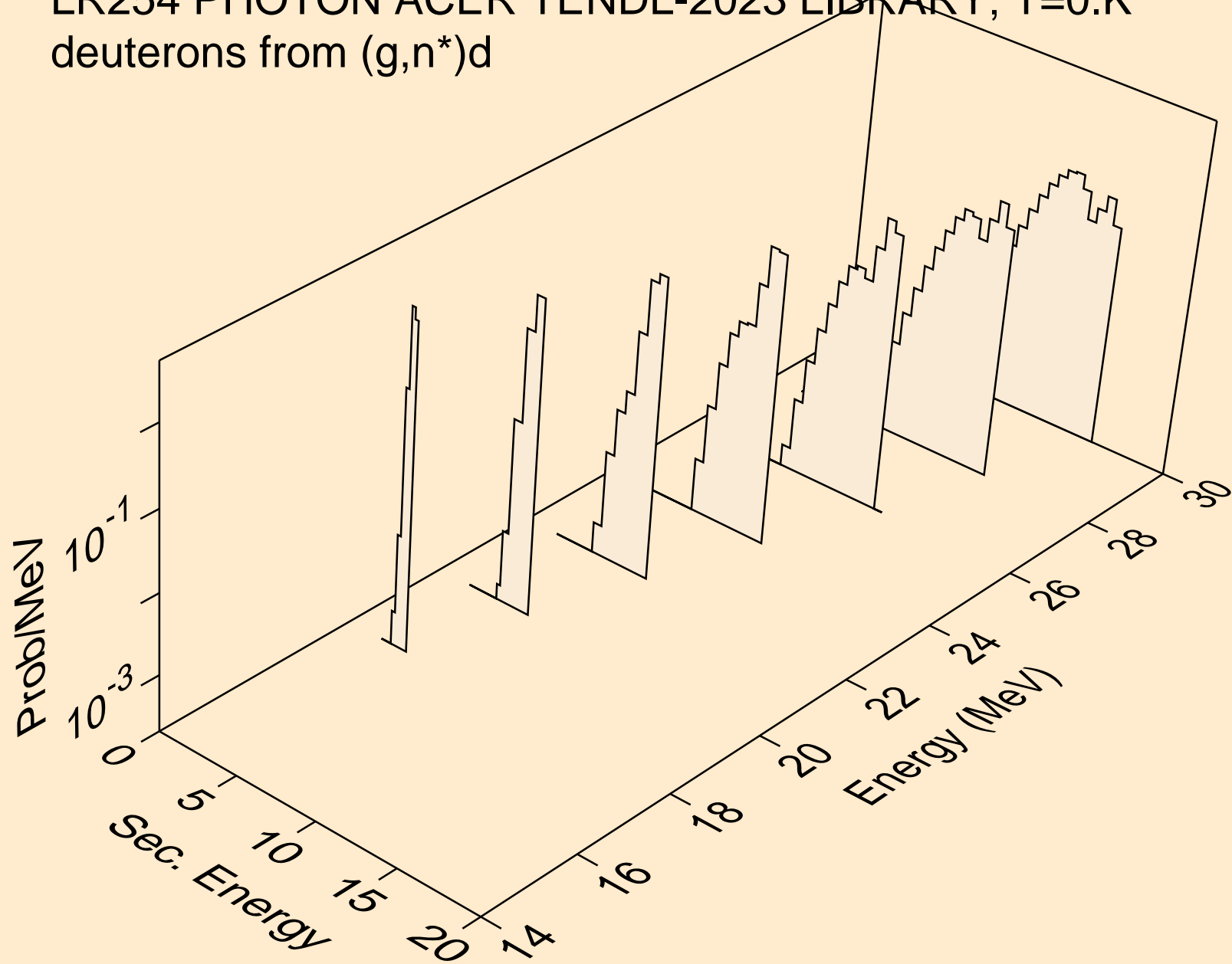

LR254 PHOTON ACER TENDL-2023 LIBRARY; T=0.K
deuterons from (g,d)

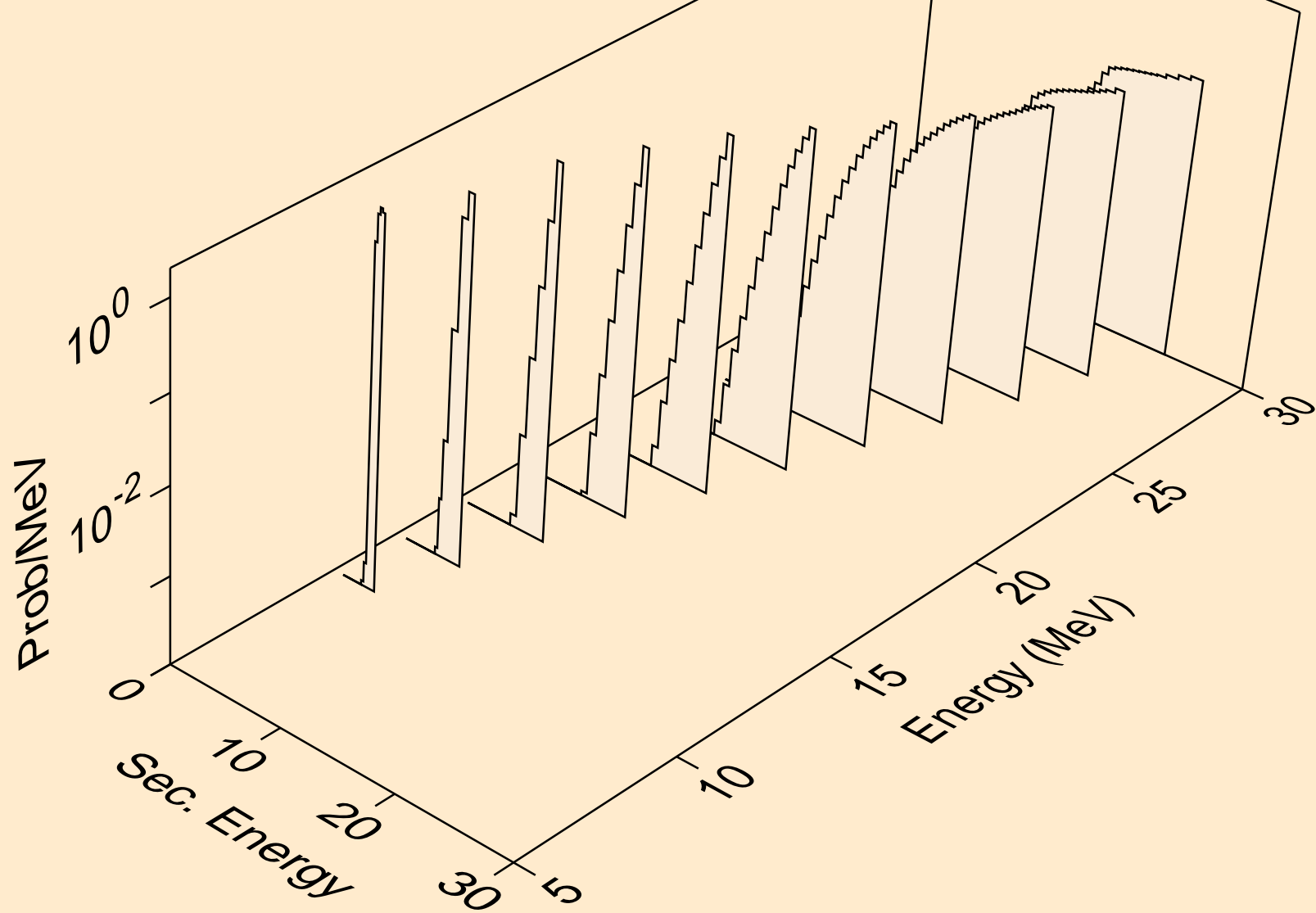

LR254 PHOTON ACER TENDL-2023 LIBRARY; T=0.K
deuterons from (g,da)

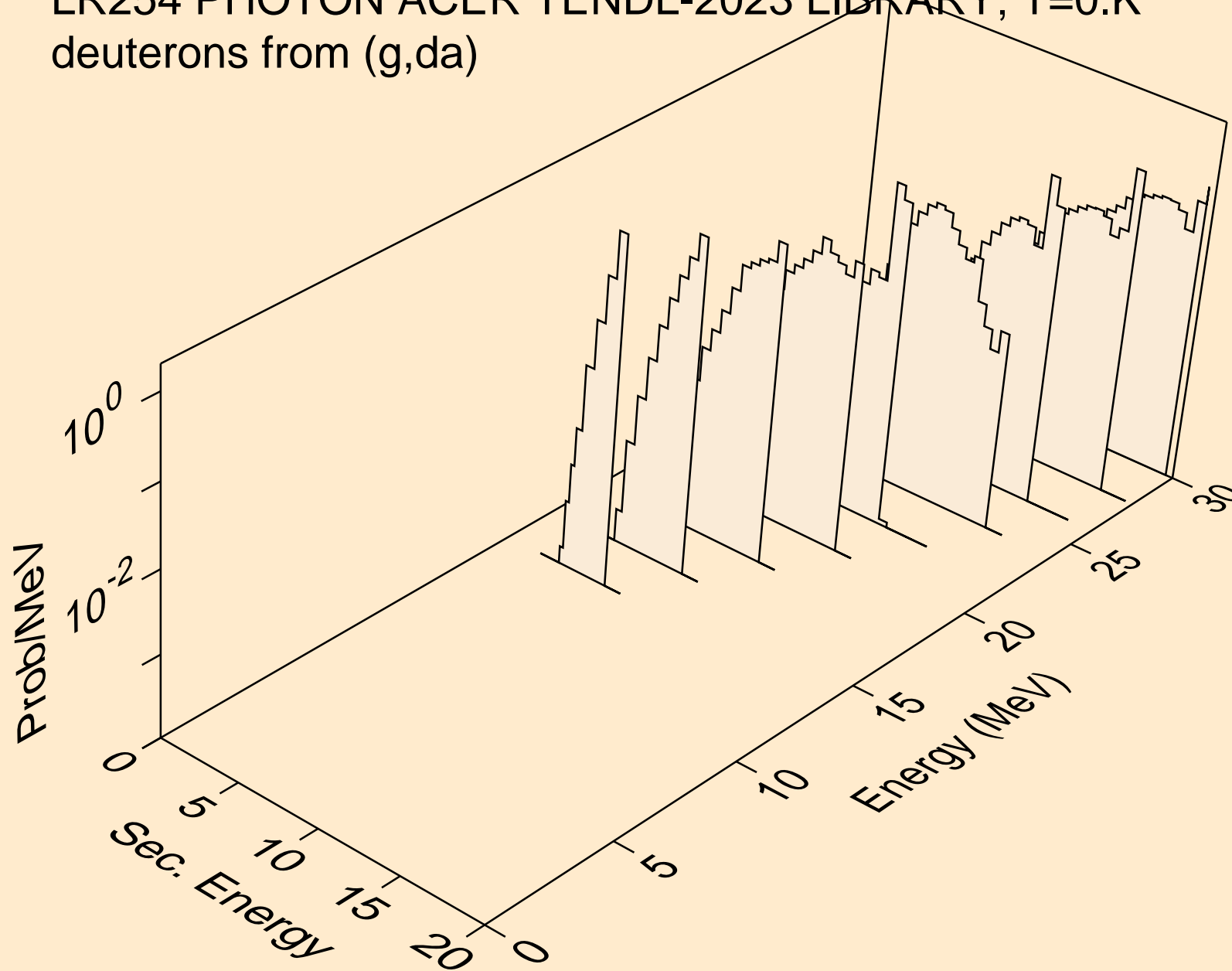

LR254 PHOTON ACER TENDL-2023 LIBRARY; T=0.K
tritons from (g,x)

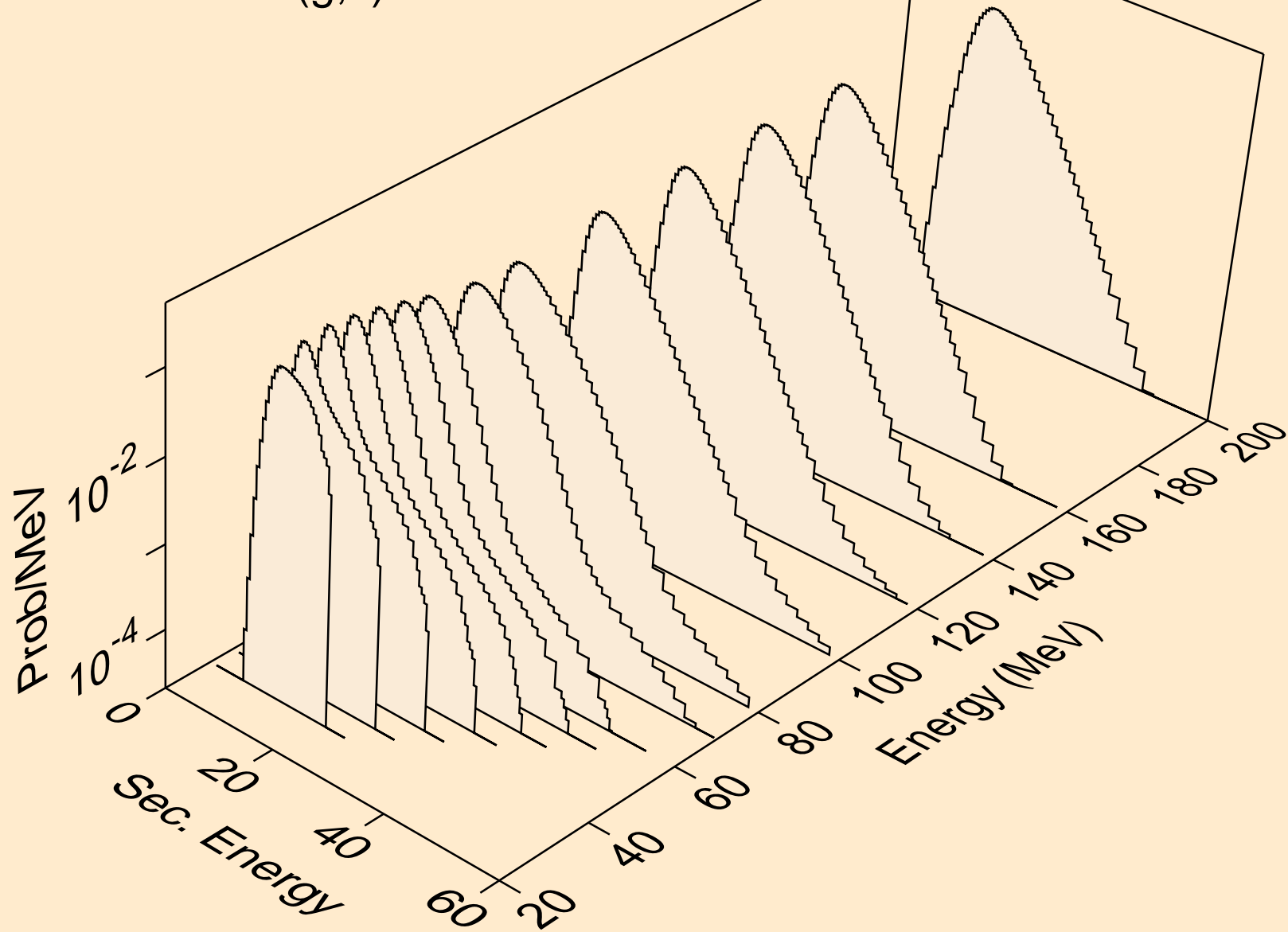

LR254 PHOTON ACER TENDL-2023 LIBRARY; T=0.K
tritons from (g,n*)t

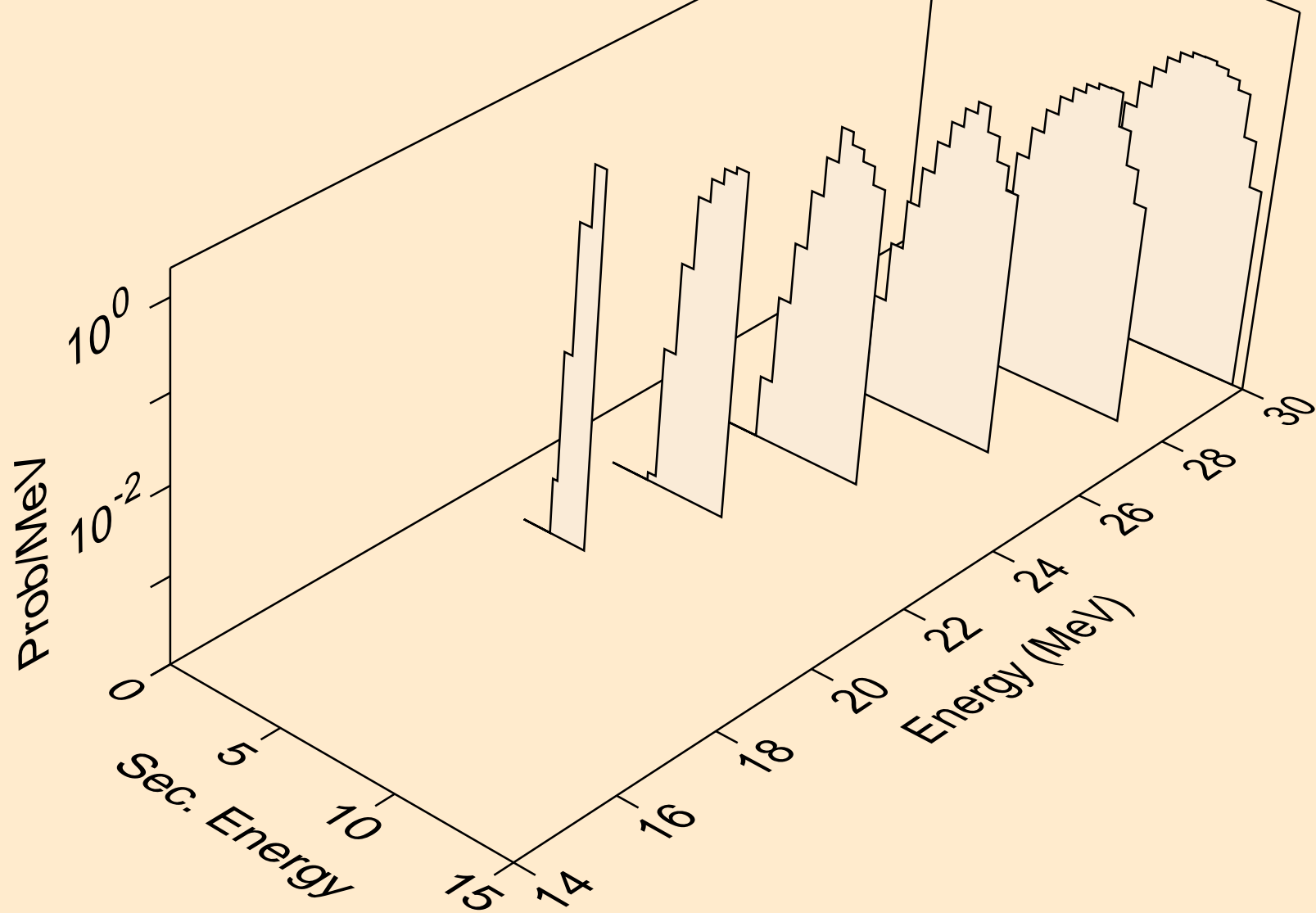

LR254 PHOTON ACER TENDL-2023 LIBRARY; T=0.K
tritons from (g,t)

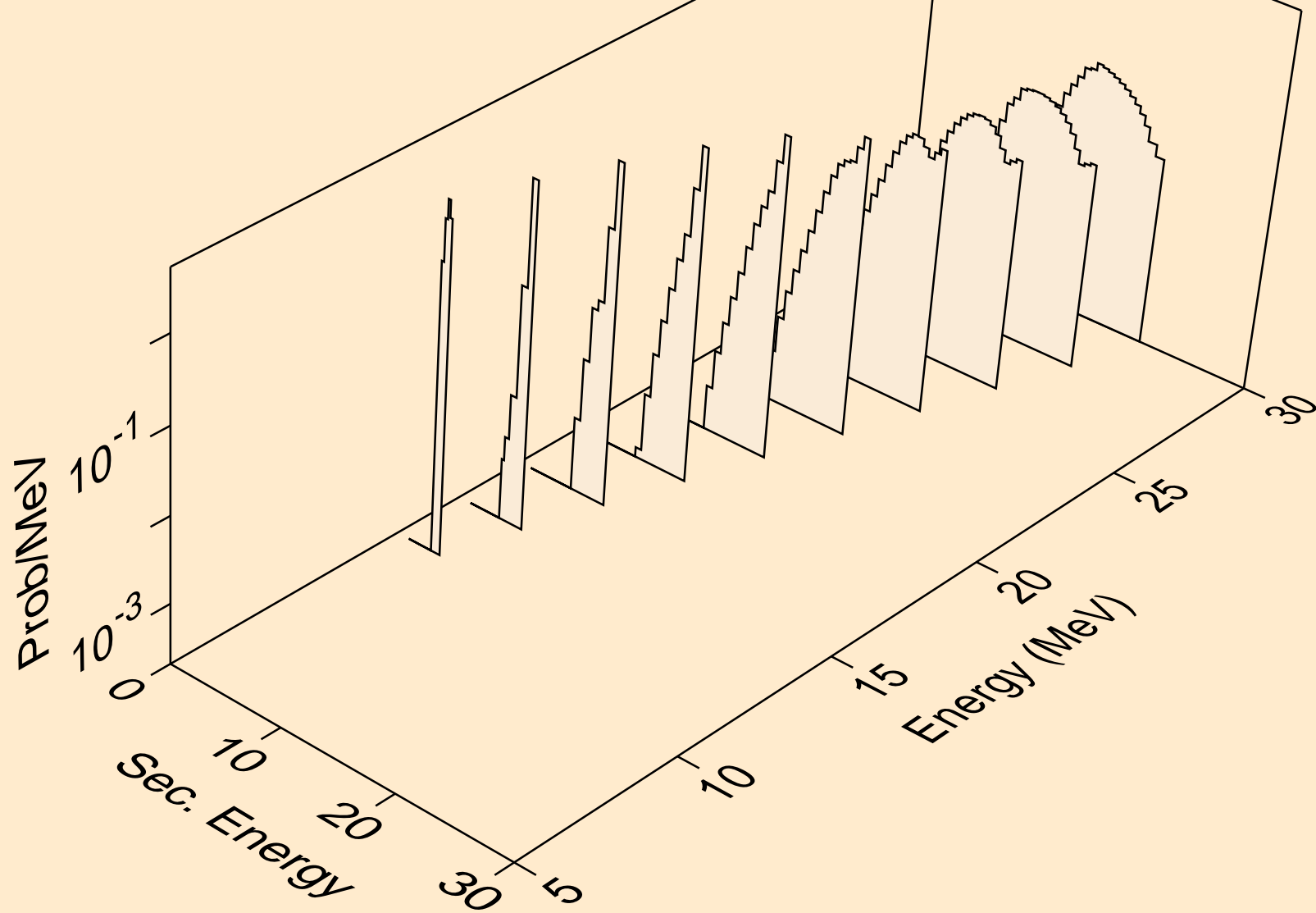

LR254 PHOTON ACER TENDL-2023 LIBRARY; T=0.K
he3s from (g,x)

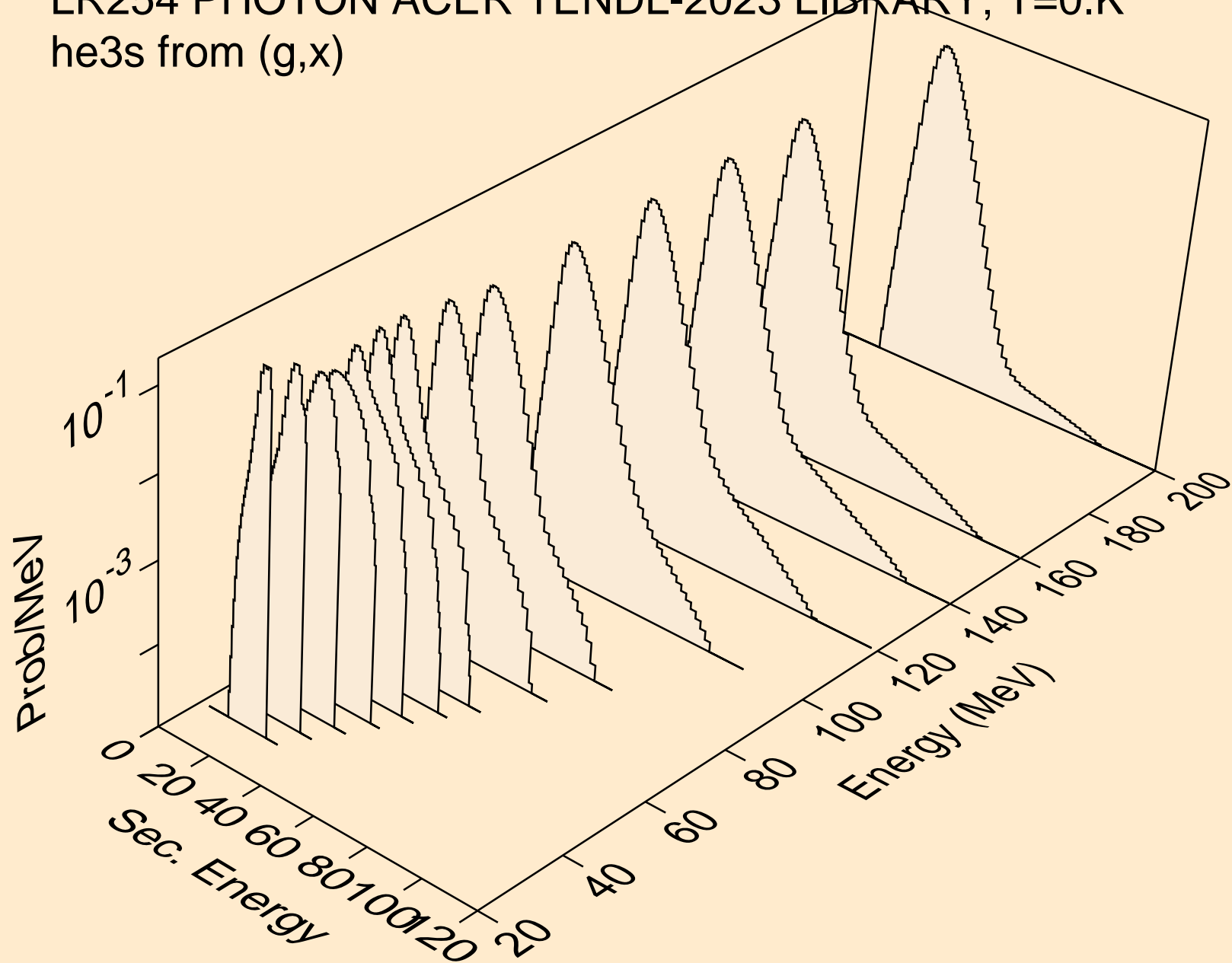

LR254 PHOTON ACER TENDL-2023 LIBRARY; T=0.K
alphas from (g,x)

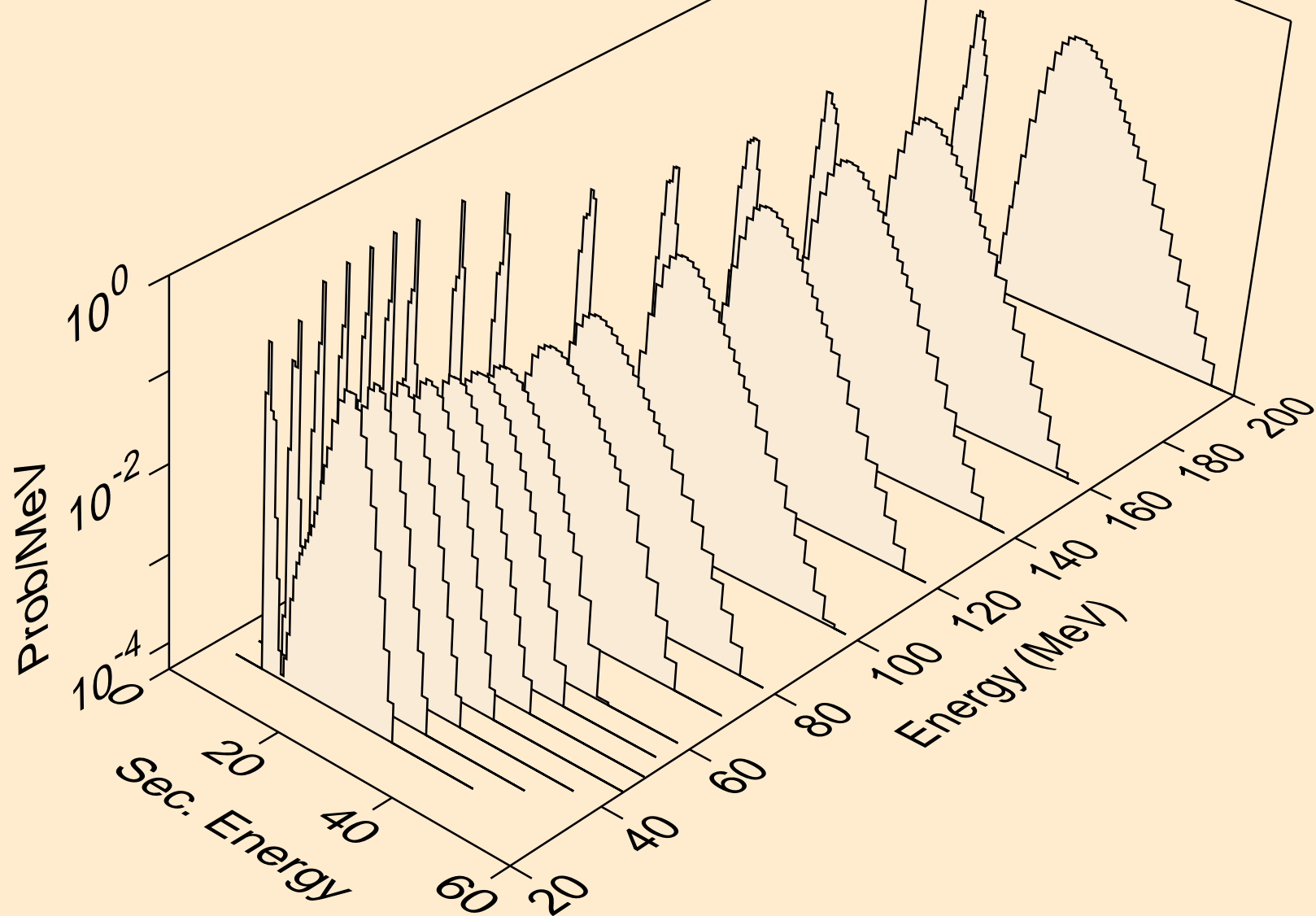

LR254 PHOTON ACER TENDL-2023 LIBRARY; T=0.K
alphas from (g,n*)a

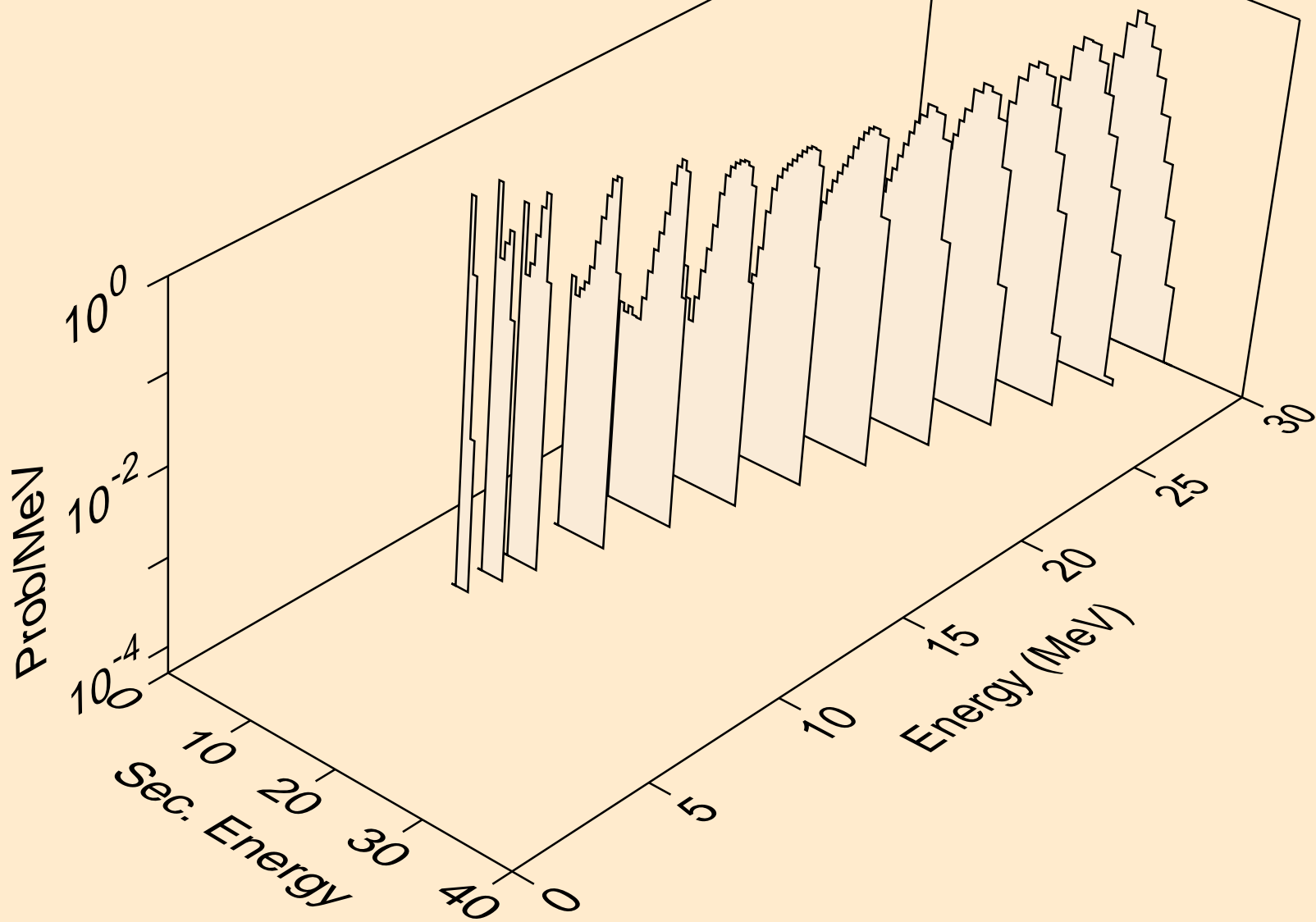

LR254 PHOTON ACER TENDL-2023 LIBRARY; T=0.K
alphas from (g,2n)a

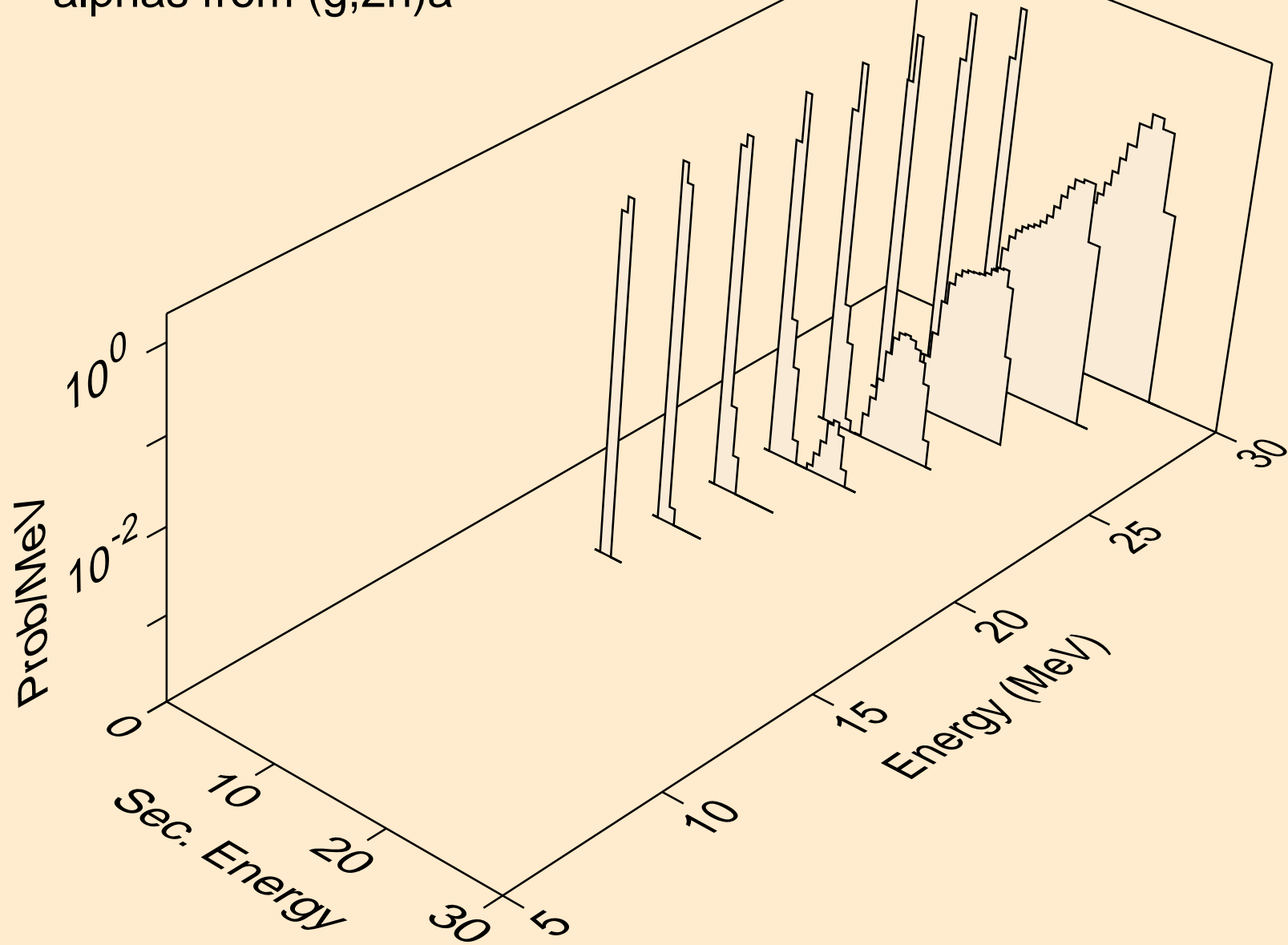

LR254 PHOTON ACER TENDL-2023 LIBRARY; T=0.K
alphas from (g,3n)a

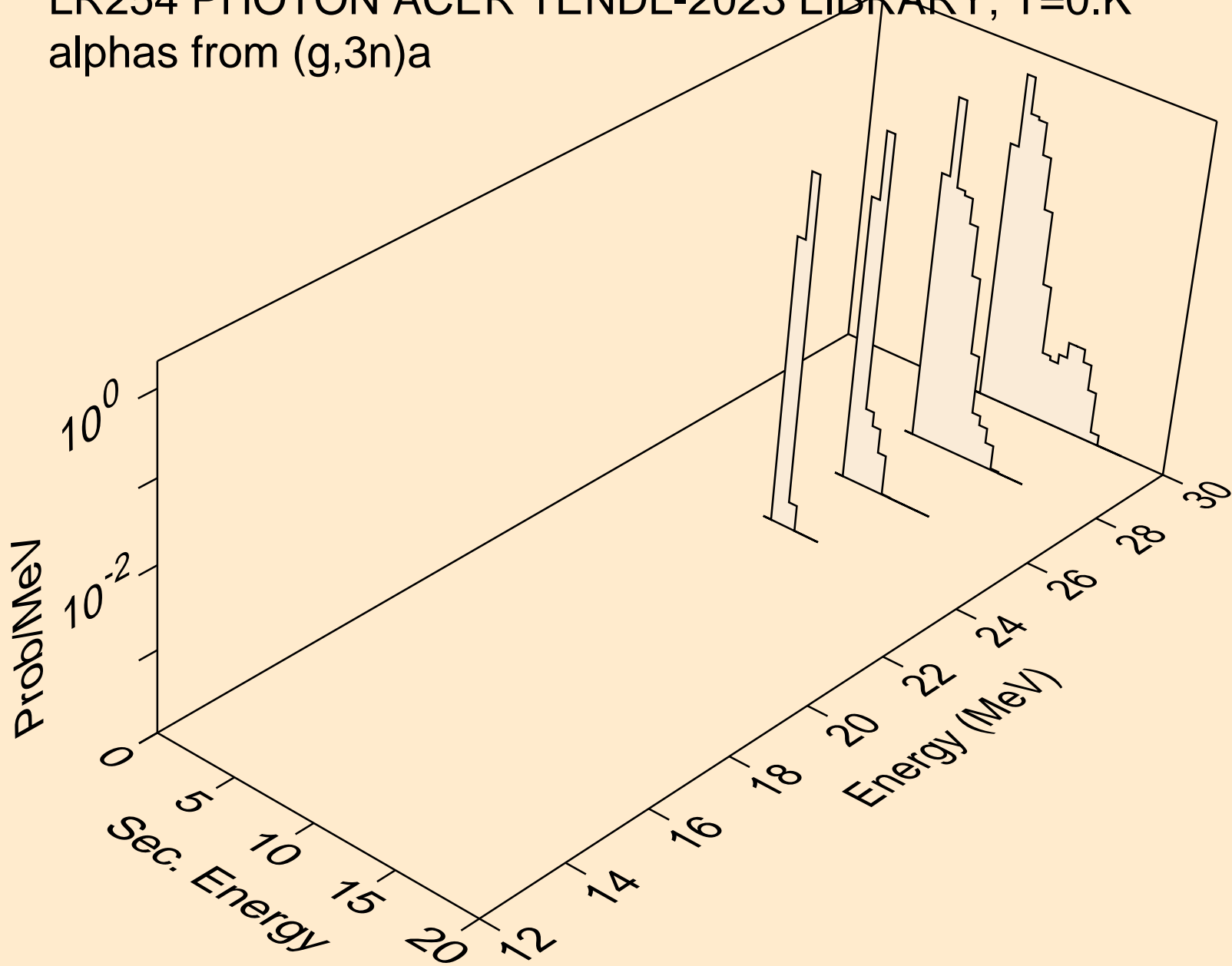

LR254 PHOTON ACER TENDL-2023 LIBRARY; T=0.K
alphas from (g,npa)

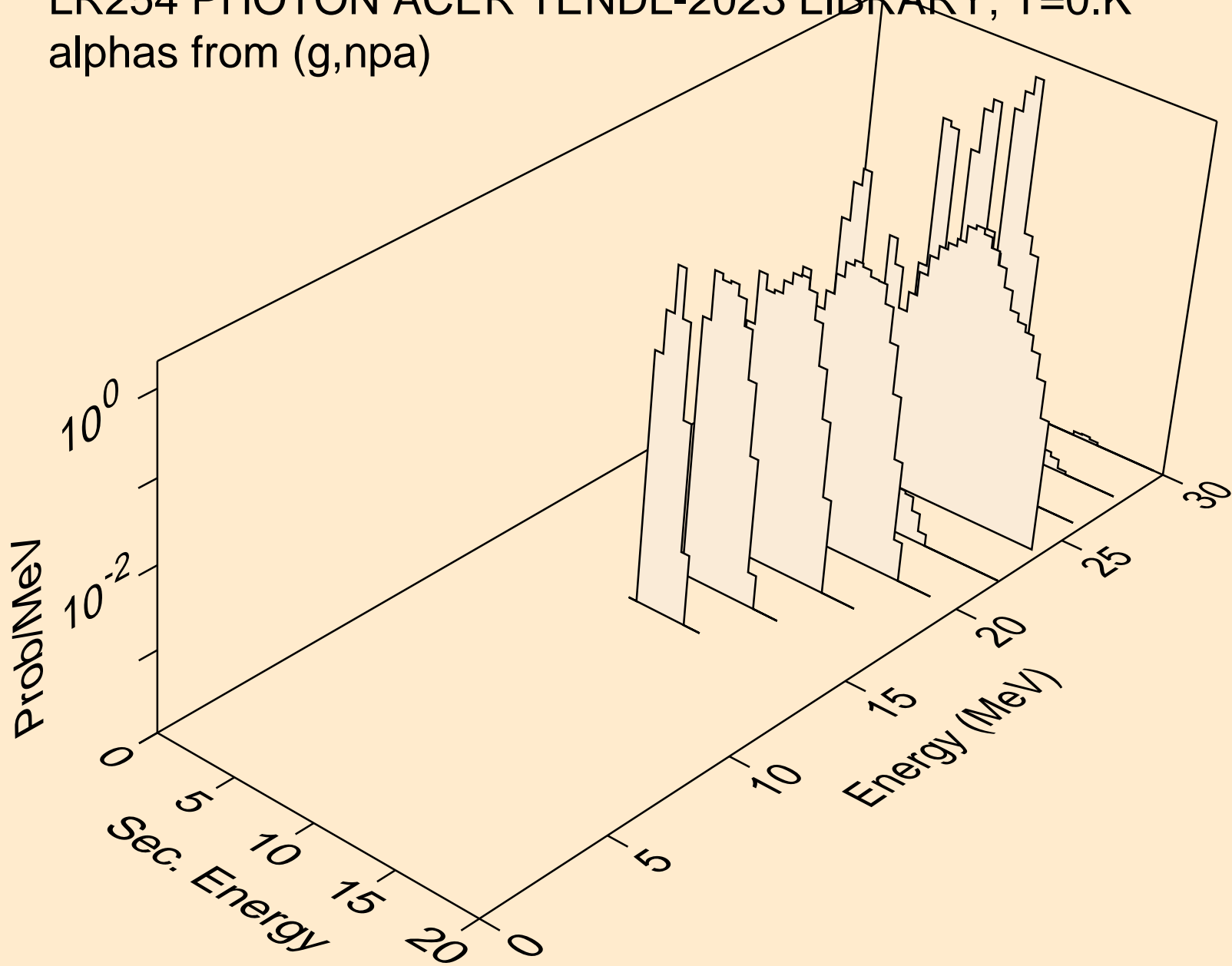

LR254 PHOTON ACER TENDL-2023 LIBRARY; T=0.K
alphas from (g,a)

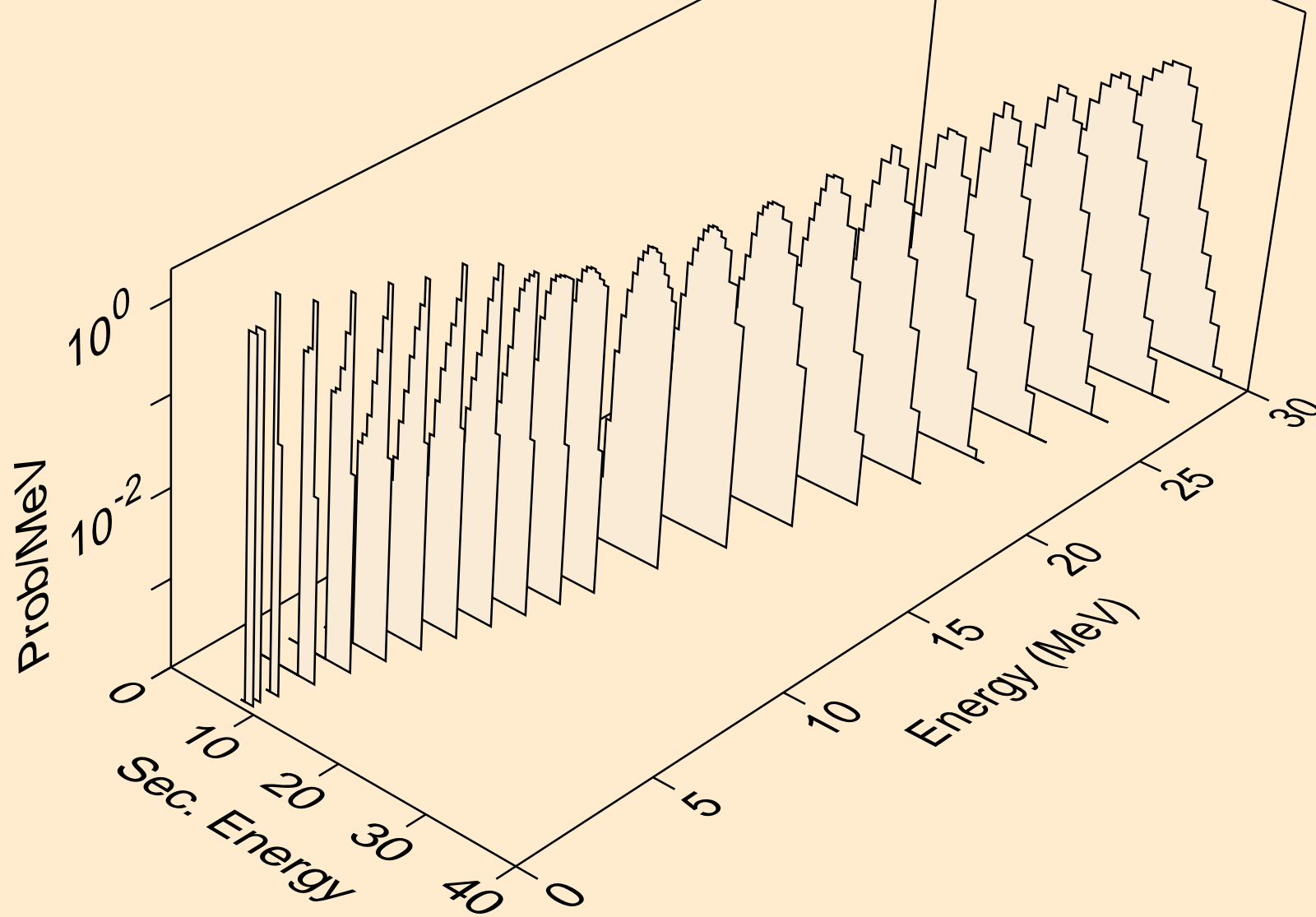

LR254 PHOTON ACER TENDL-2023 LIBRARY; T=0.K
alphas from (g,2a)

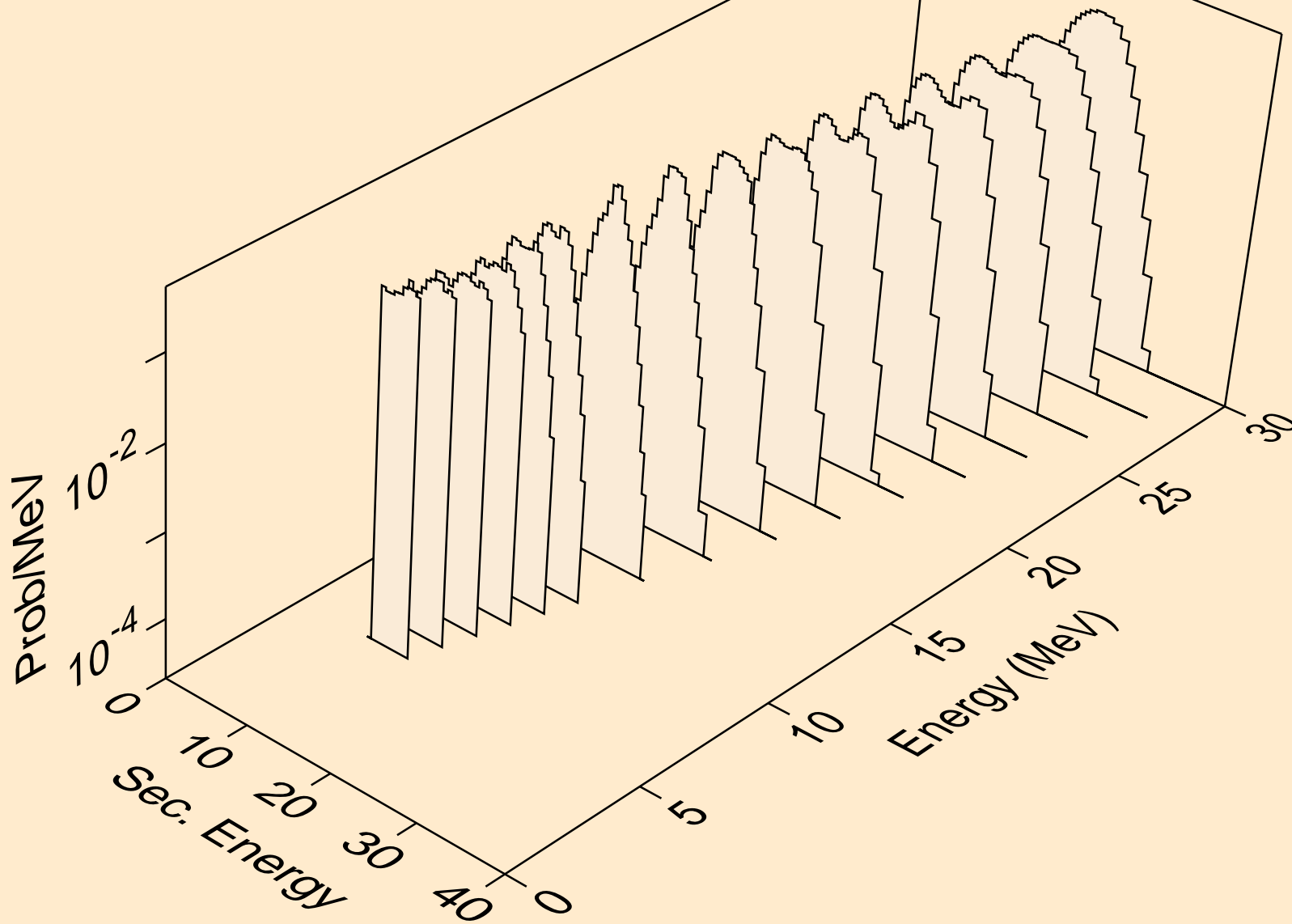

LR254 PHOTON ACER TENDL-2023 LIBRARY; T=0.K
alphas from (g,pa)

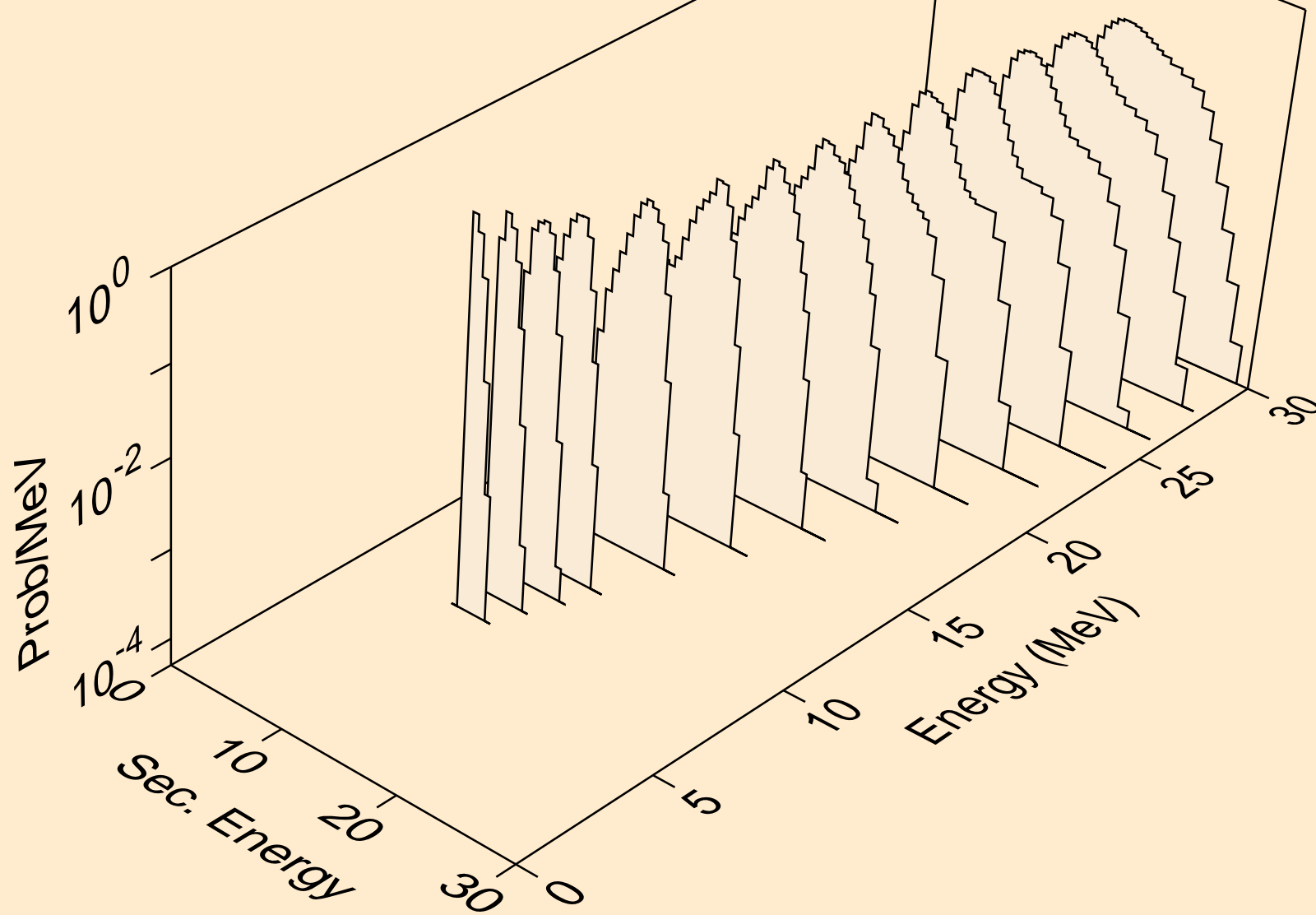

LR254 PHOTON ACER TENDL-2023 LIBRARY; T=0.K
alphas from (g,da)

