

ND127 PHOTON ACER TENDL-2023 LIBRARY; T=0.K
Principal cross sections

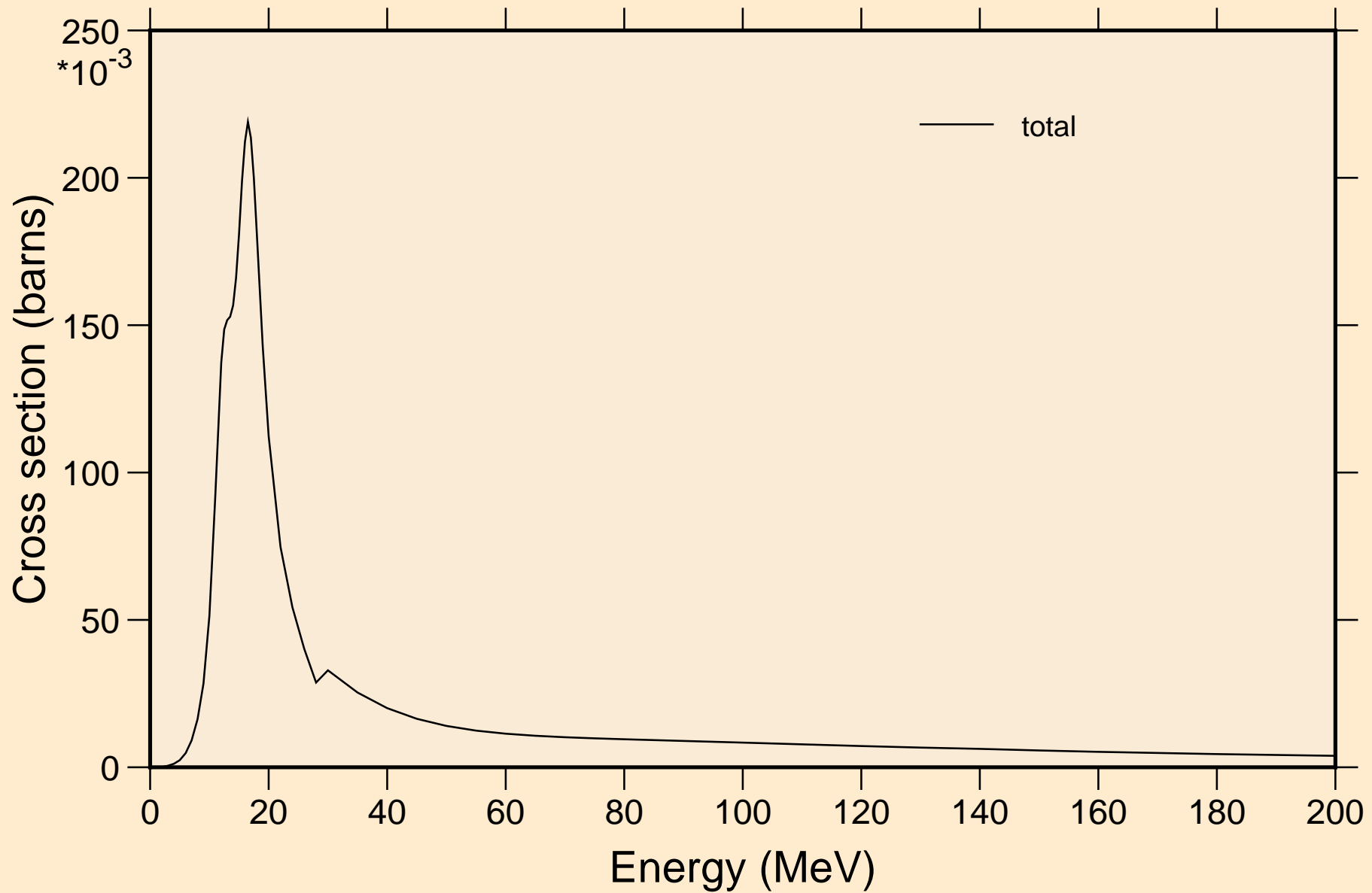

ND127 PHOTON ACER TENDL-2023 LIBRARY; T=0.K

Partial cross sections

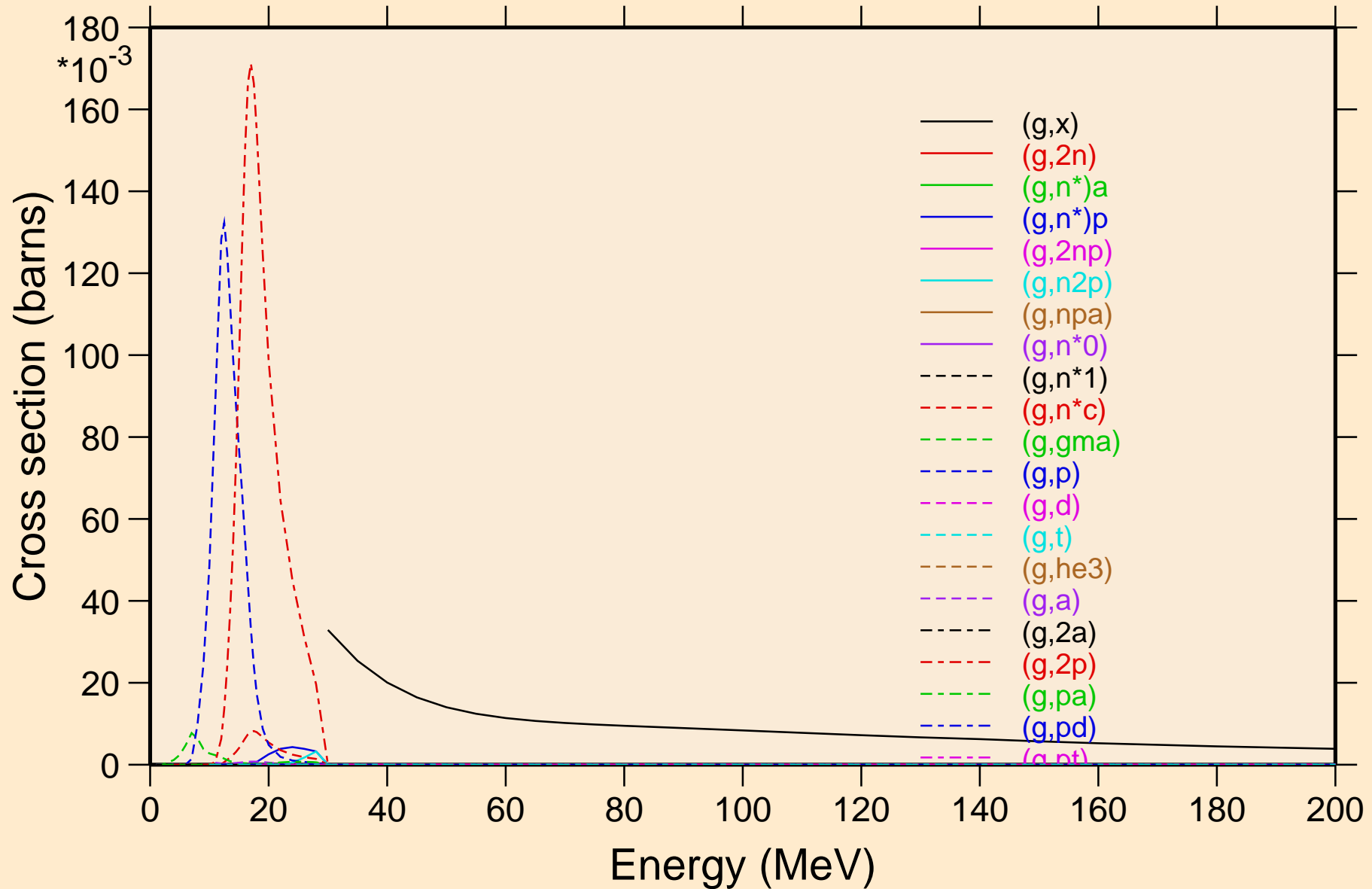

ND127 PHOTON ACER TENDL-2023 LIBRARY; T=0.K

Heating

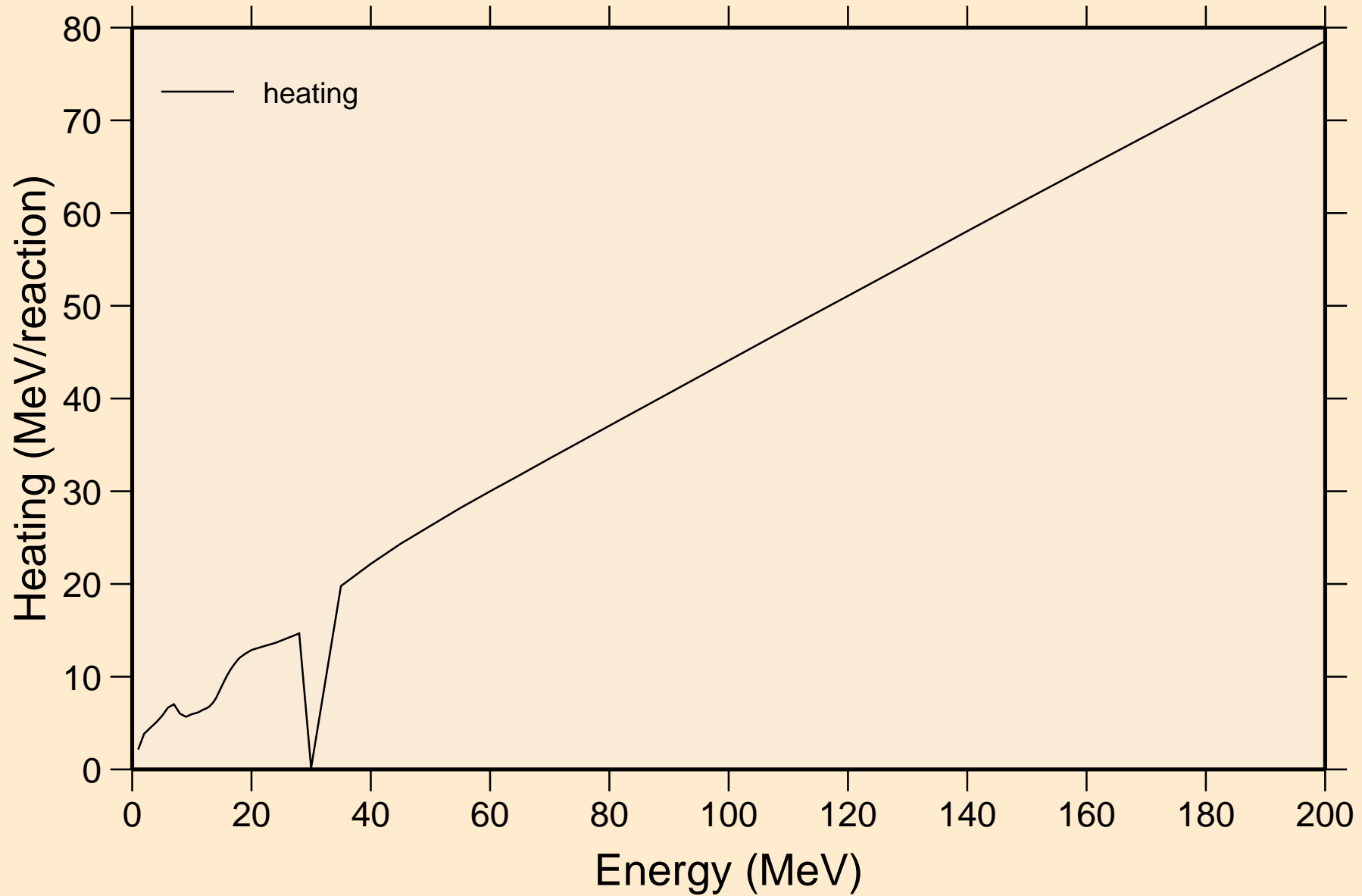

ND127 PHOTON ACER TENDL-2023 LIBRARY; T=0.K

Particle heating contributions

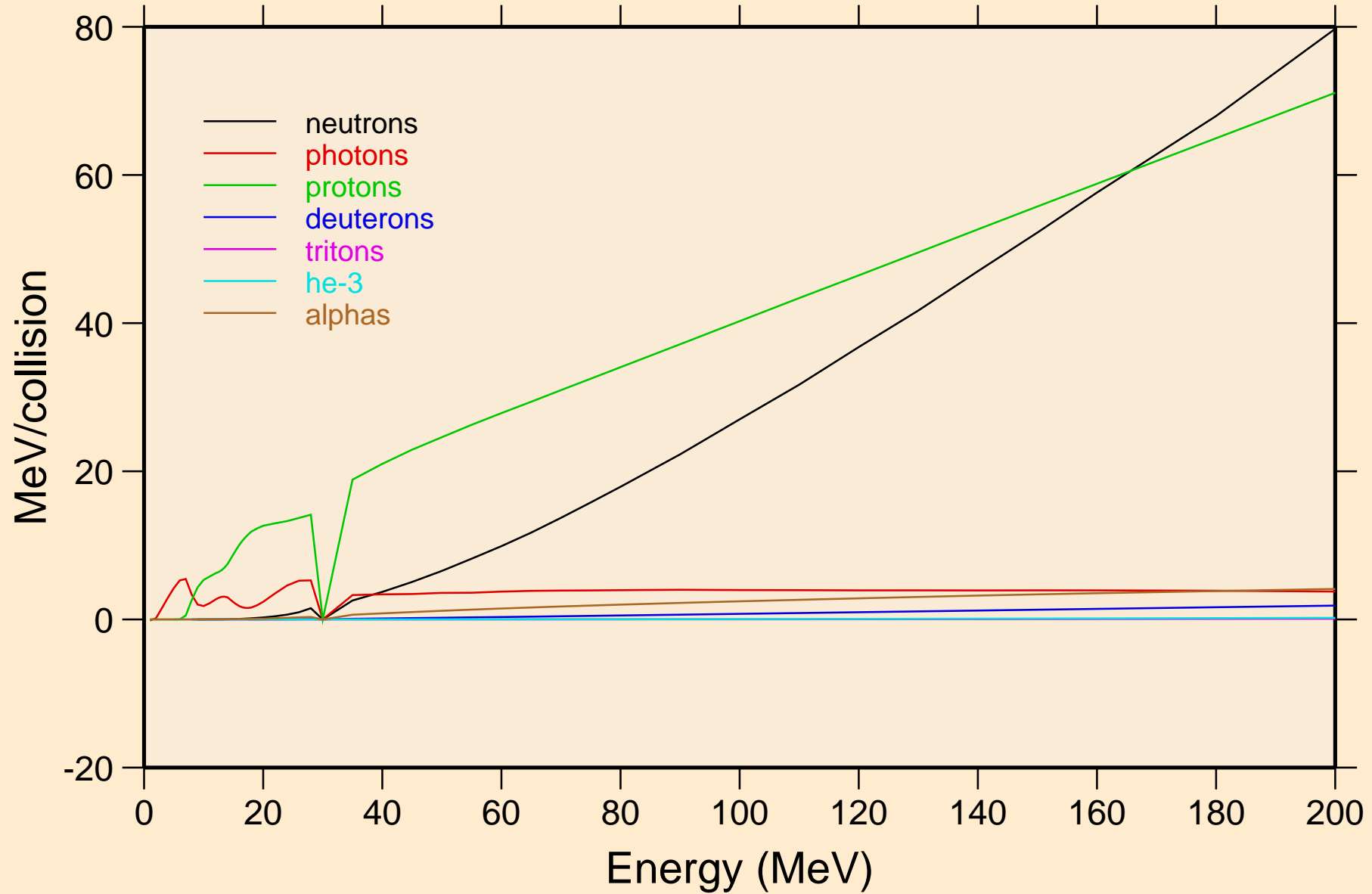

ND127 PHOTON ACER TENDL-2023 LIBRARY; T=0.K

Particle production cross sections

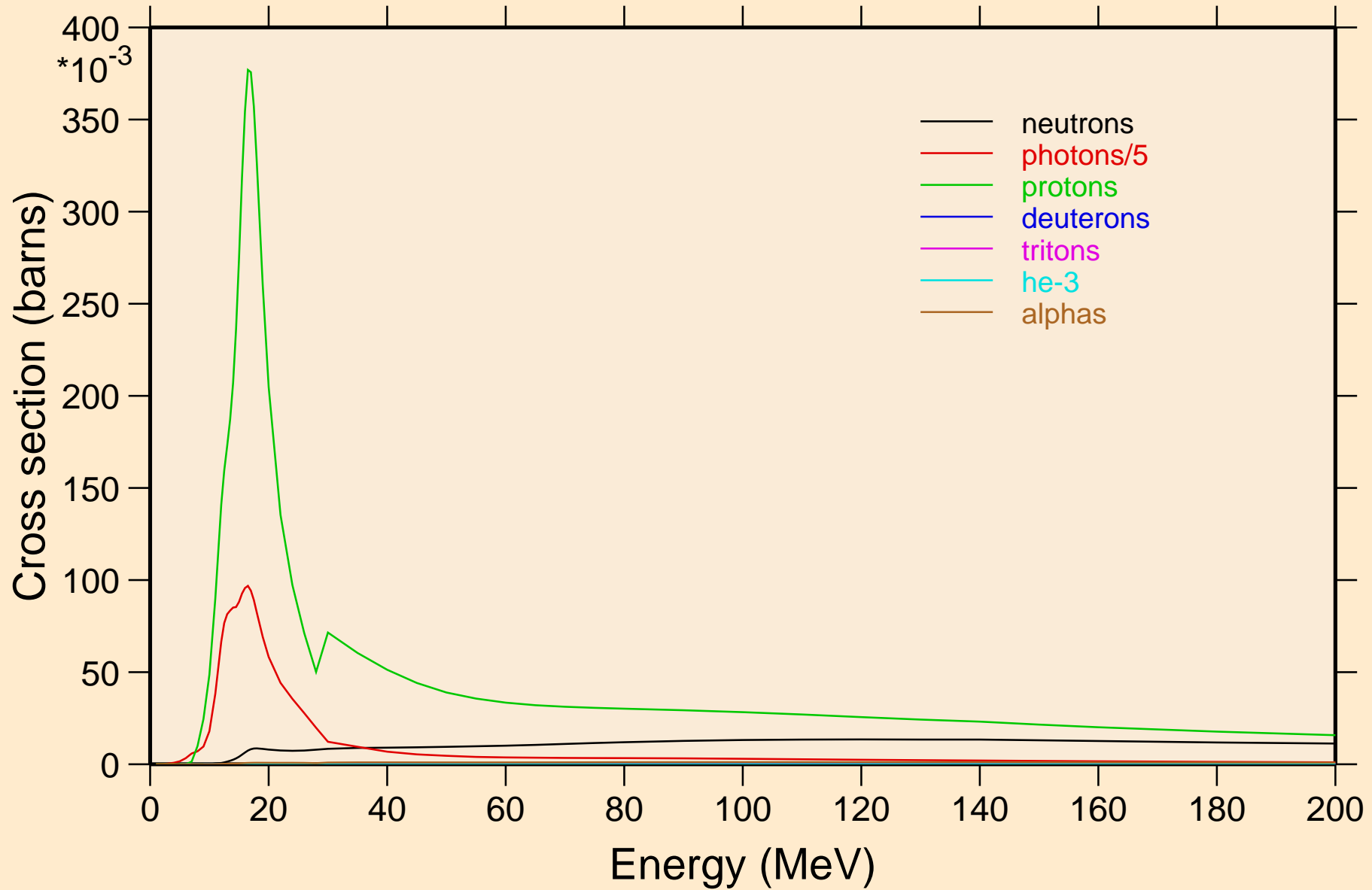

ND127 PHOTON ACER TENDL-2023 LIBRARY; T=0.K
neutrons from (g,x)

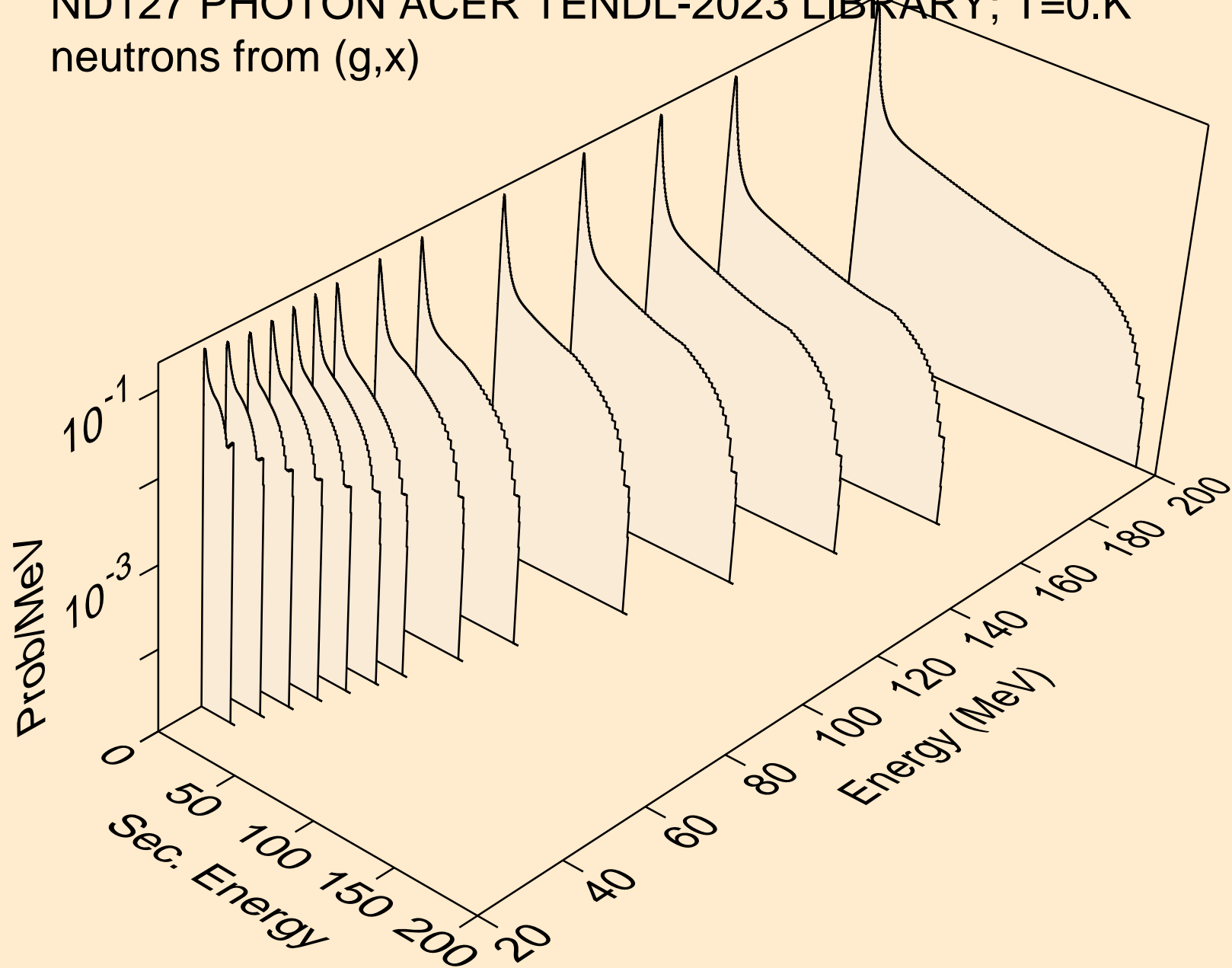

ND127 PHOTON ACER TENDL-2023 LIBRARY; T=0.K
neutrons from (g,2n)

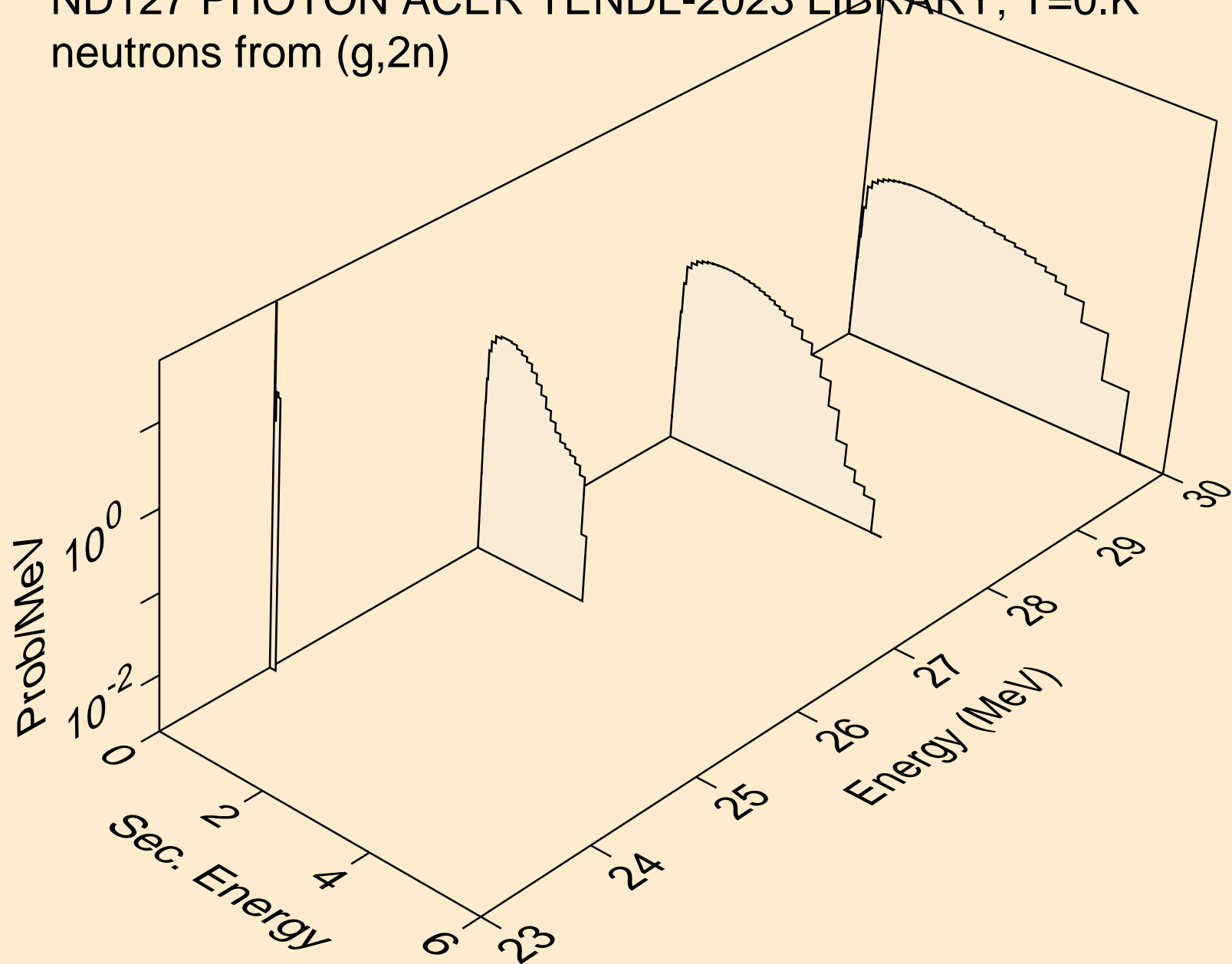

ND127 PHOTON ACER TENDL-2023 LIBRARY; T=0.K
neutrons from (g,n*)a

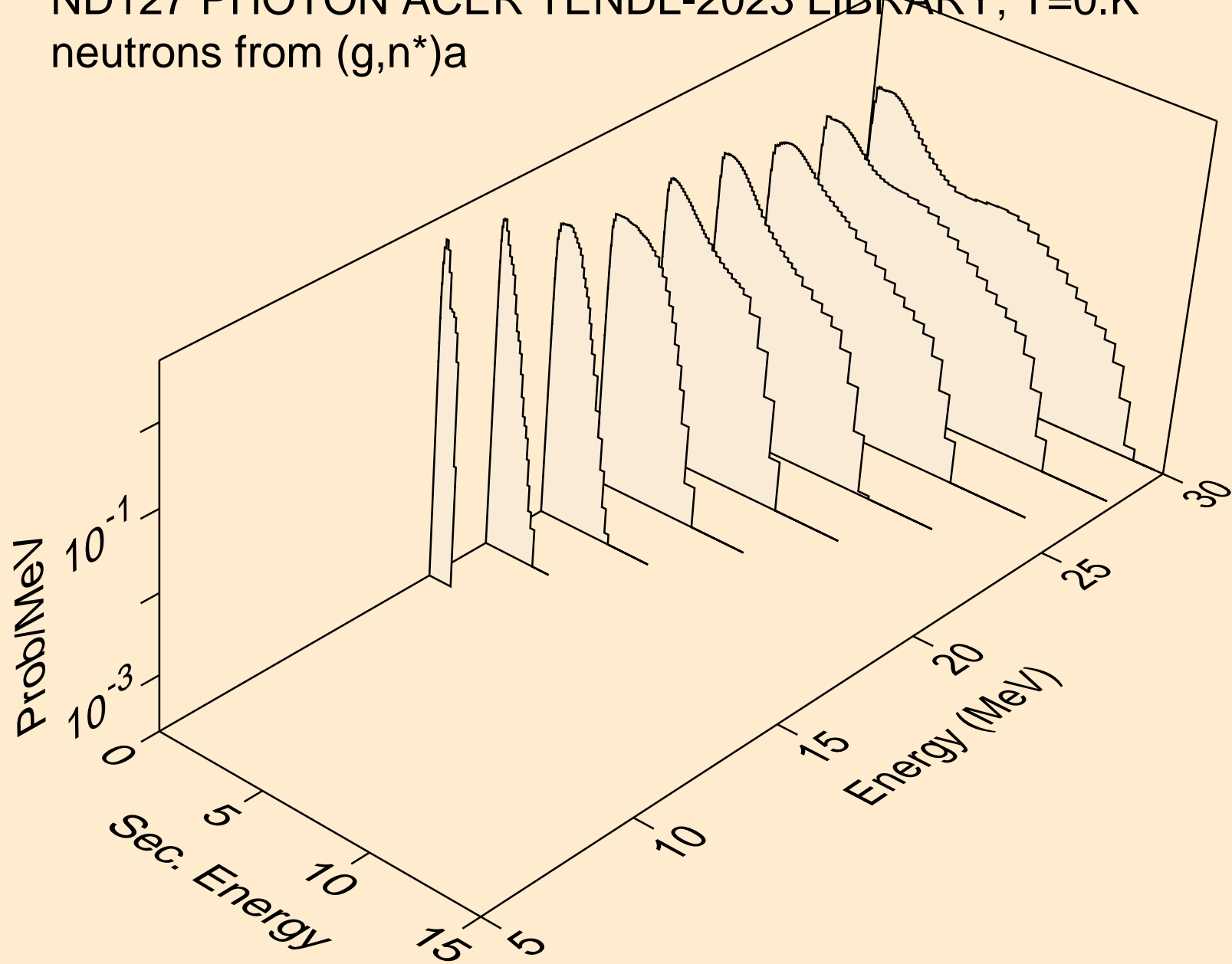

ND127 PHOTON ACER TENDL-2023 LIBRARY; T=0.K
neutrons from (g,n*)p

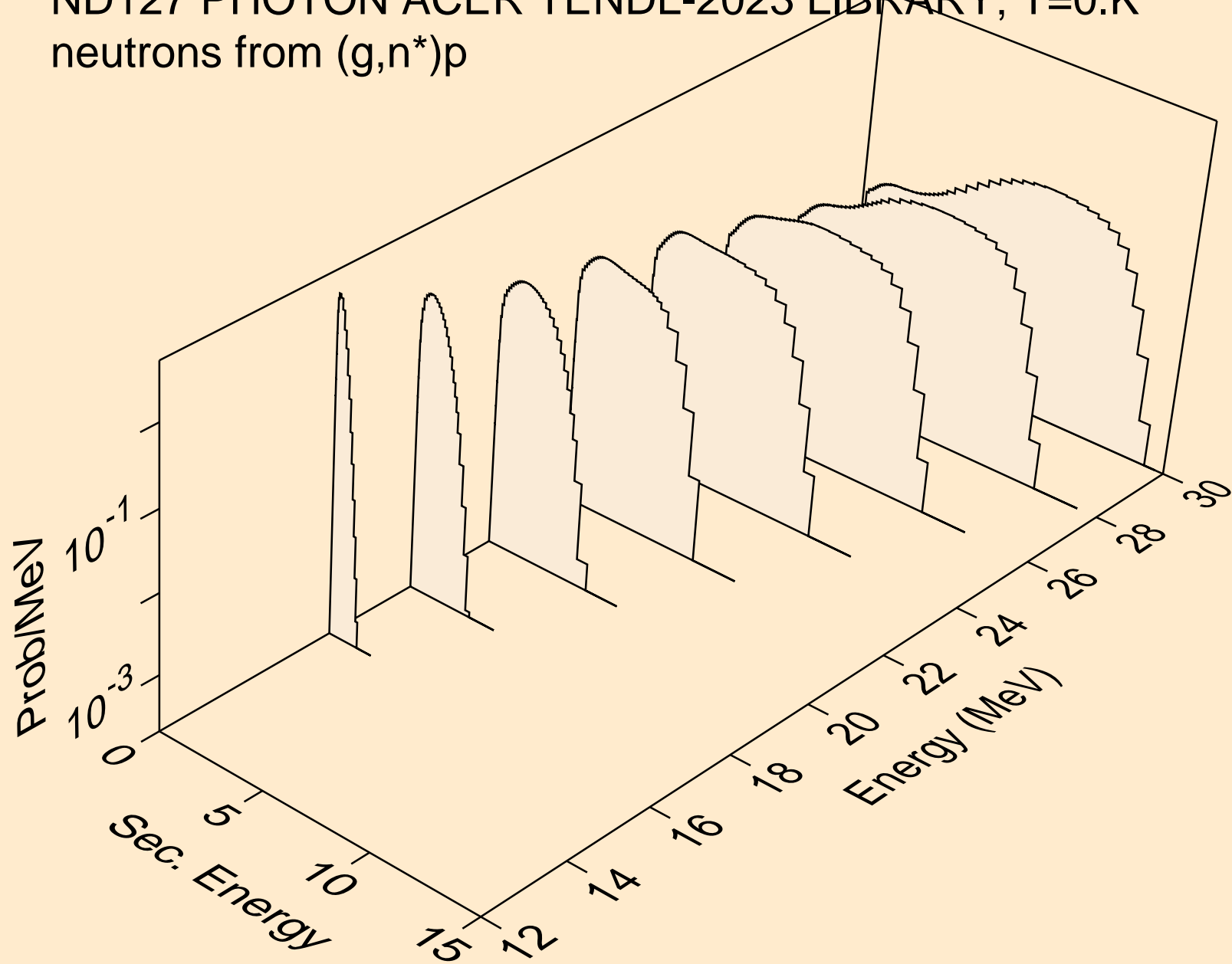

ND127 PHOTON ACER TENDL-2023 LIBRARY; T=0.K
neutrons from (g,2np)

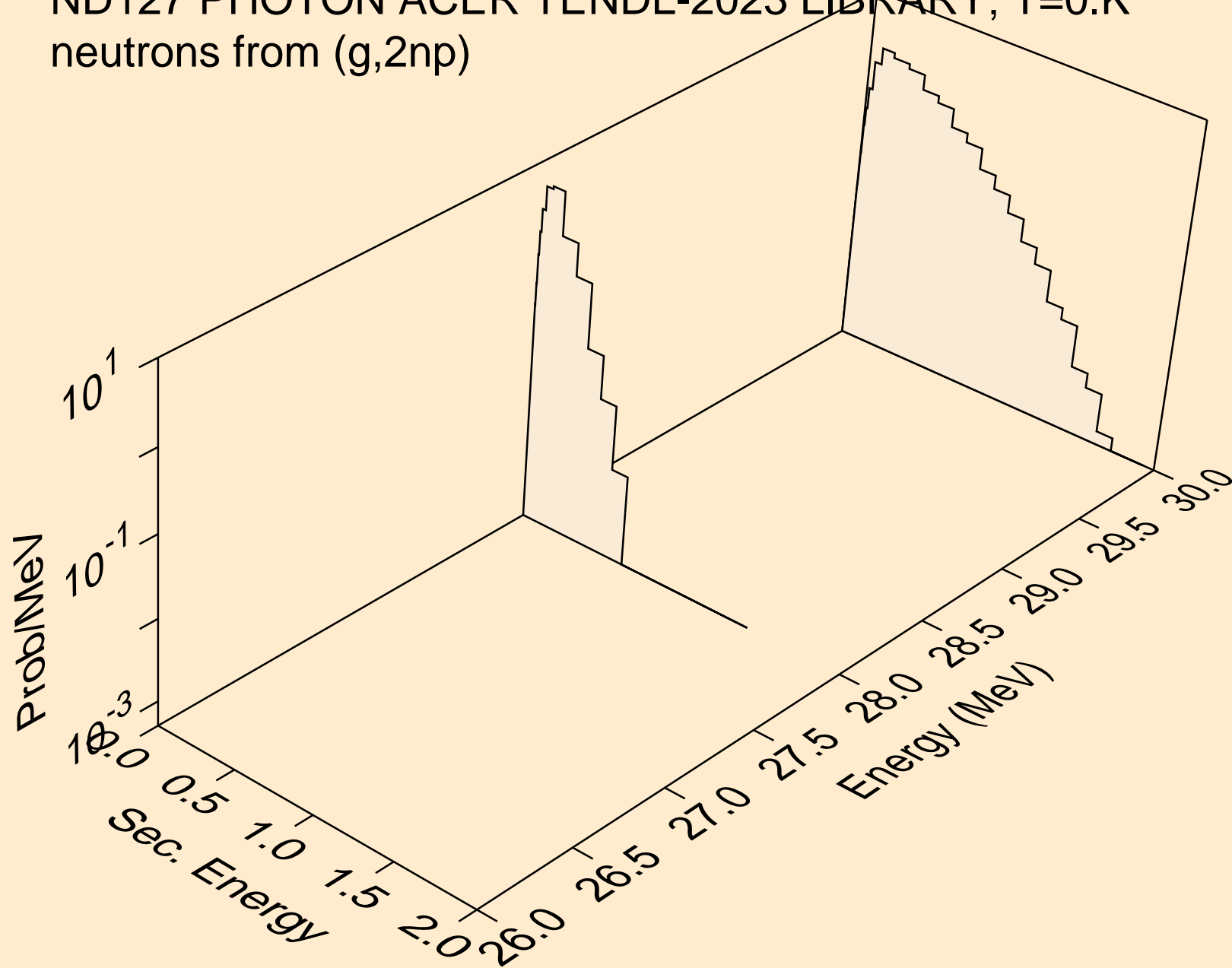

ND127 PHOTON ACER TENDL-2023 LIBRARY; T=0.K
neutrons from (g,n2p)

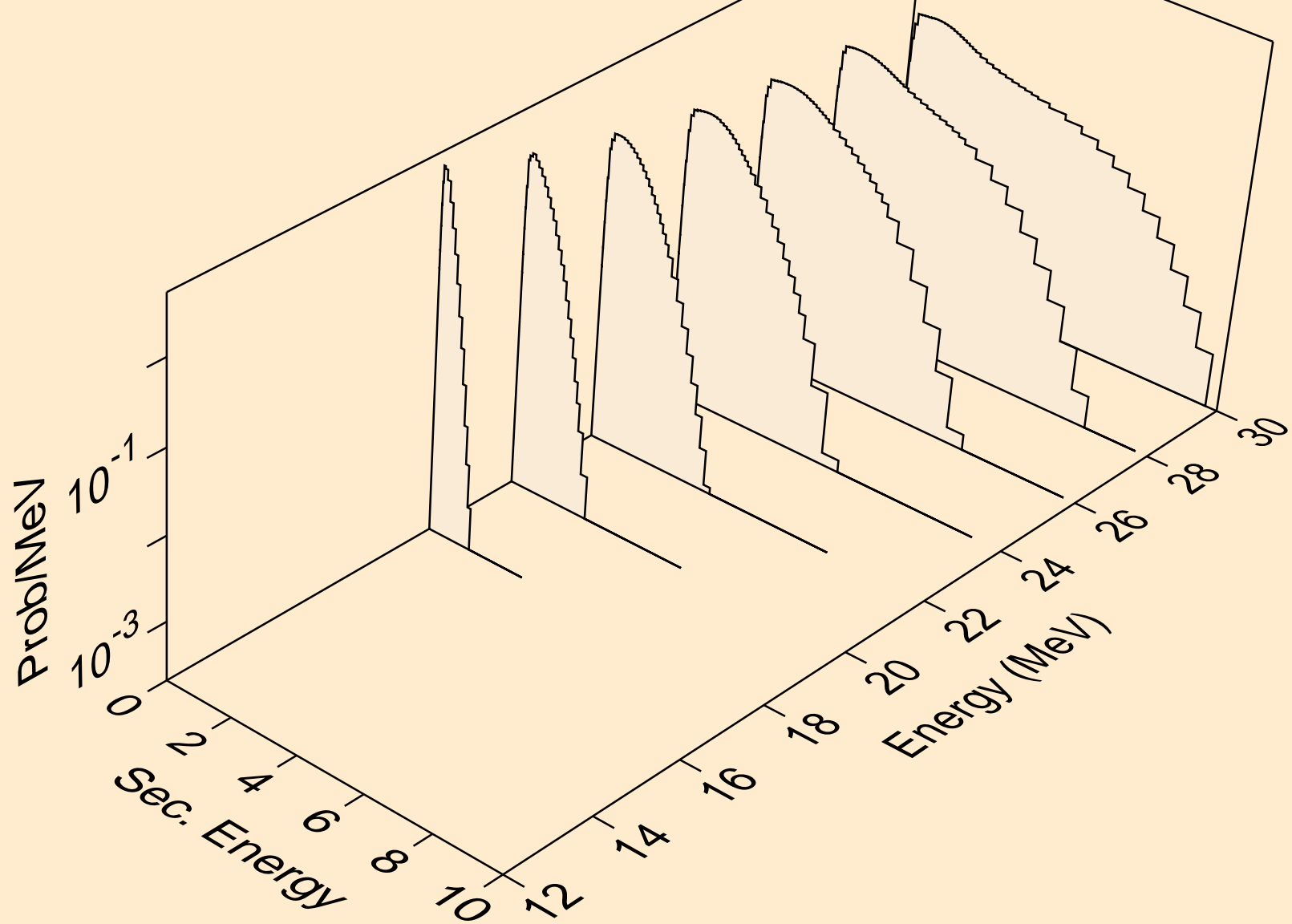

ND127 PHOTON ACER TENDL-2023 LIBRARY; T=0.K
neutrons from (g,npa)

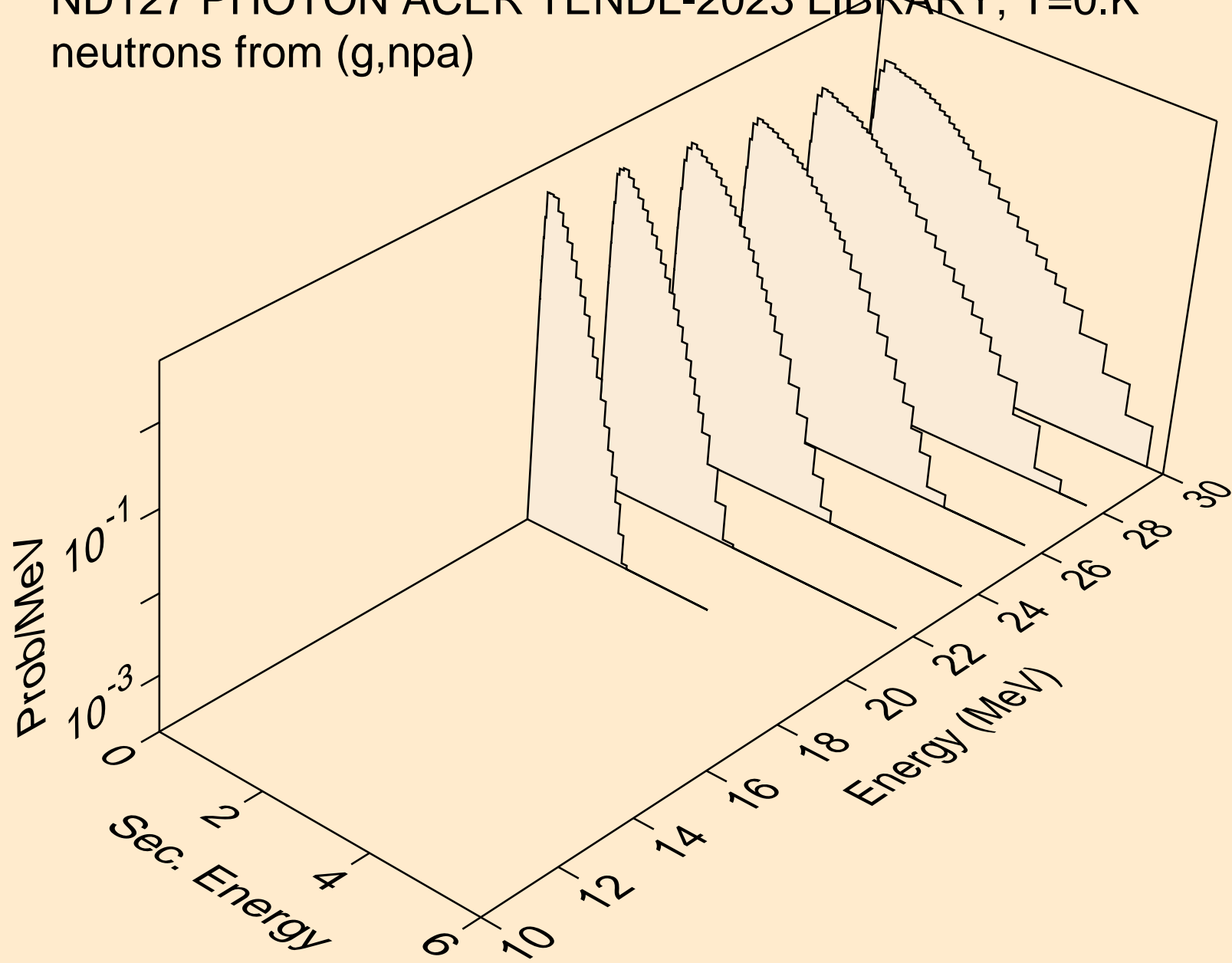

ND127 PHOTON ACER TENDL-2023 LIBRARY; T=0.K
angular distribution for (g,n*0) neutron

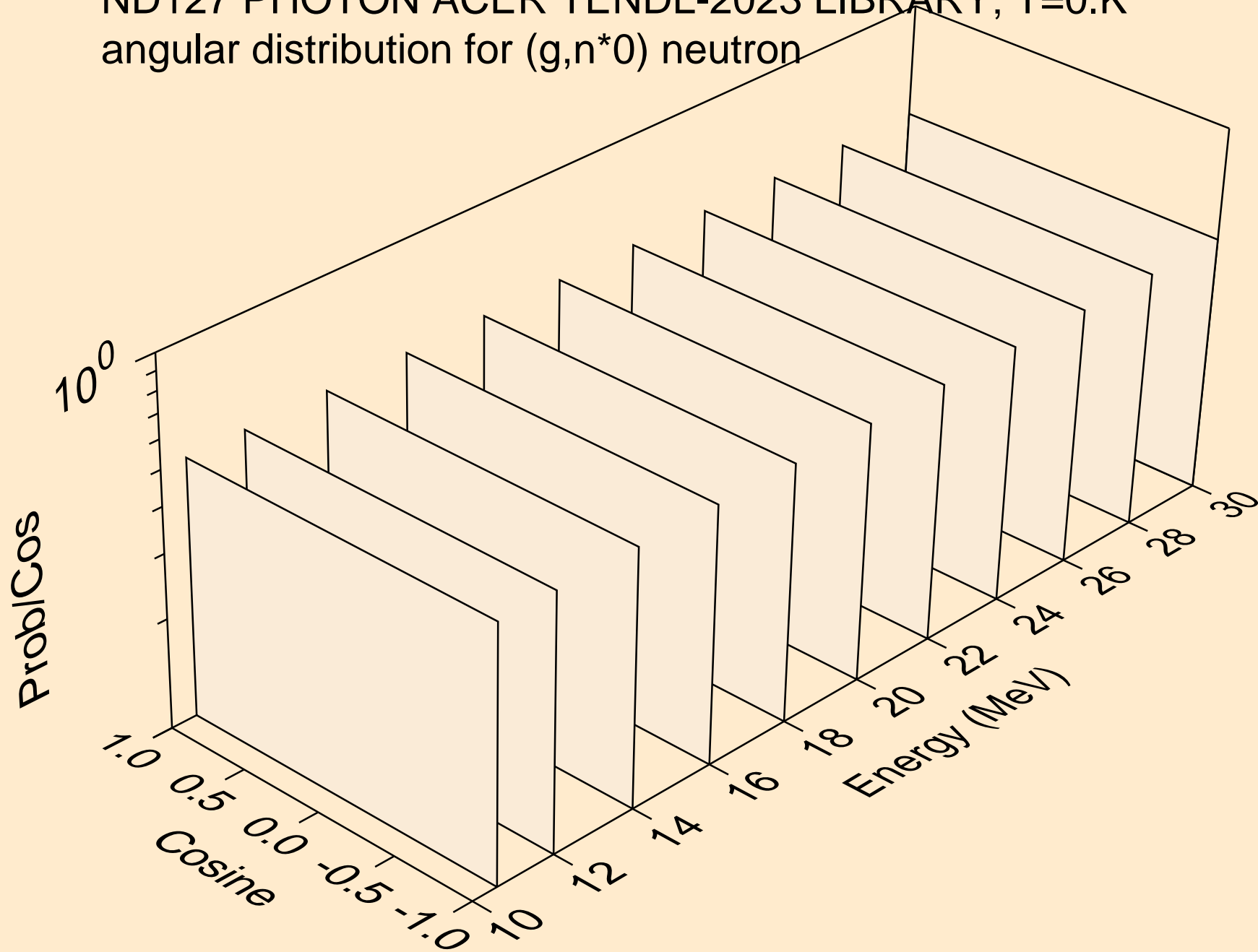

ND127 PHOTON ACER TENDL-2023 LIBRARY; T=0.K
angular distribution for (g,n*1) neutron

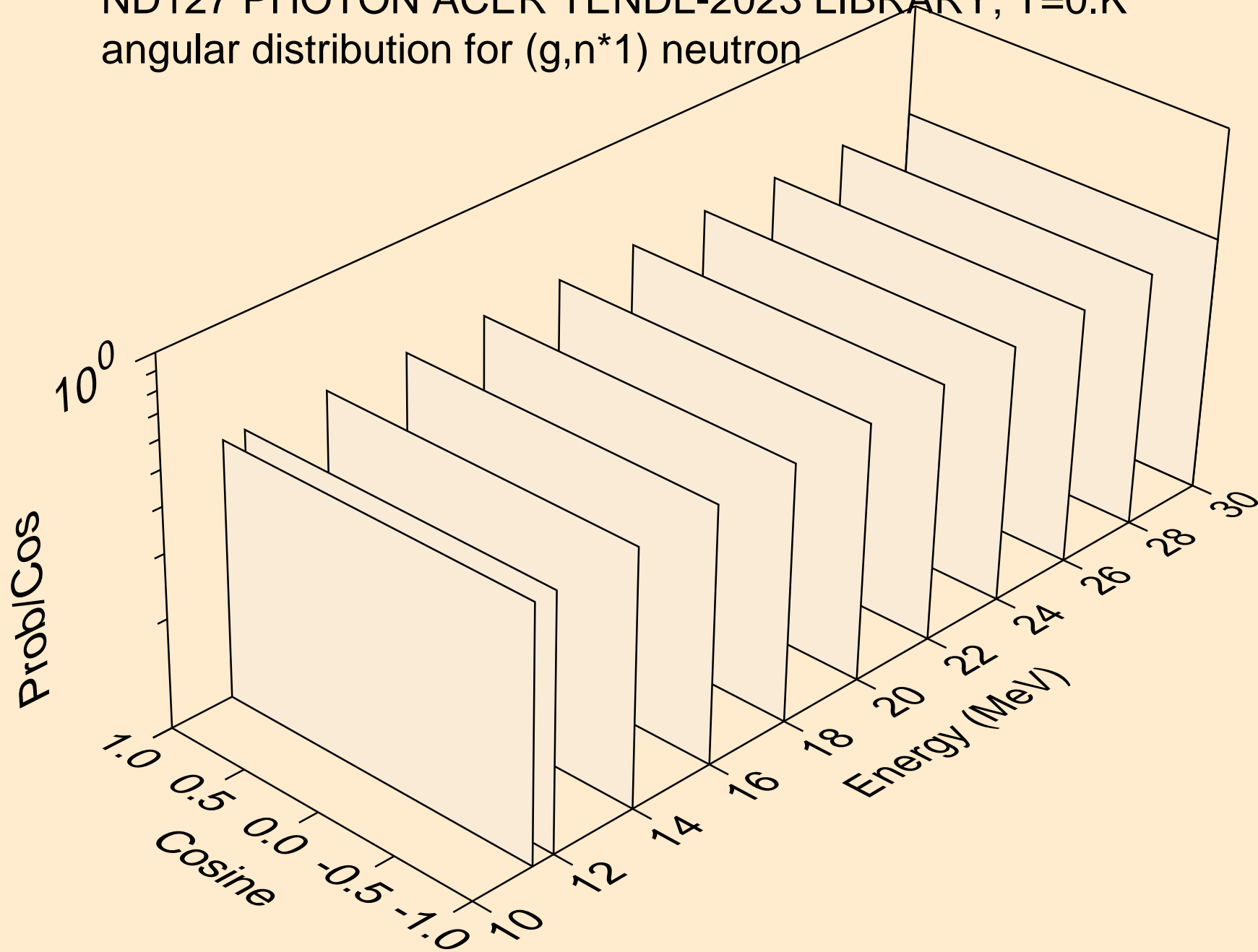

ND127 PHOTON ACER TENDL-2023 LIBRARY; T=0.K
neutrons from (g,n*c)

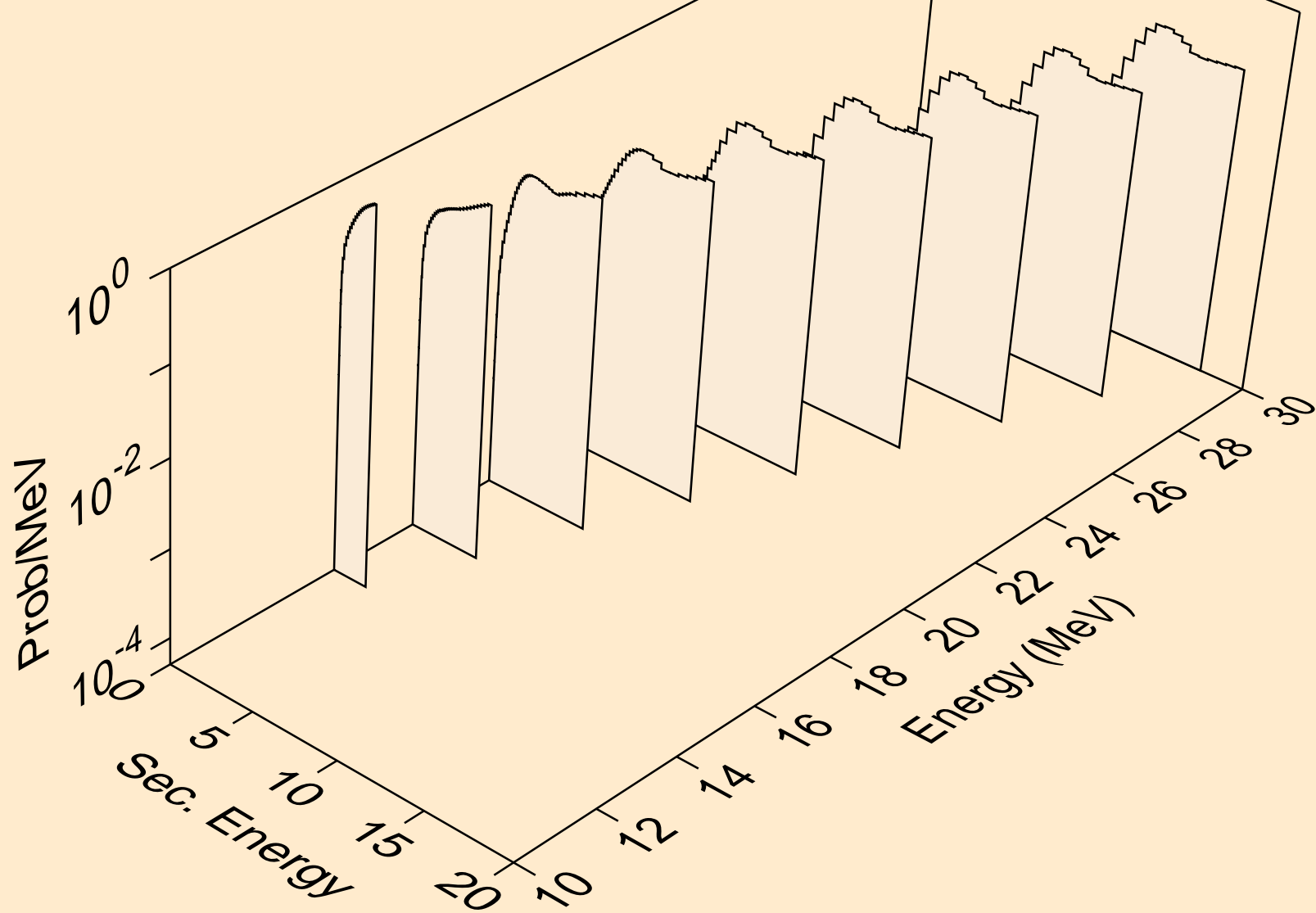

ND127 PHOTON ACER TENDL-2023 LIBRARY; T=0.K
photons from (g,x)

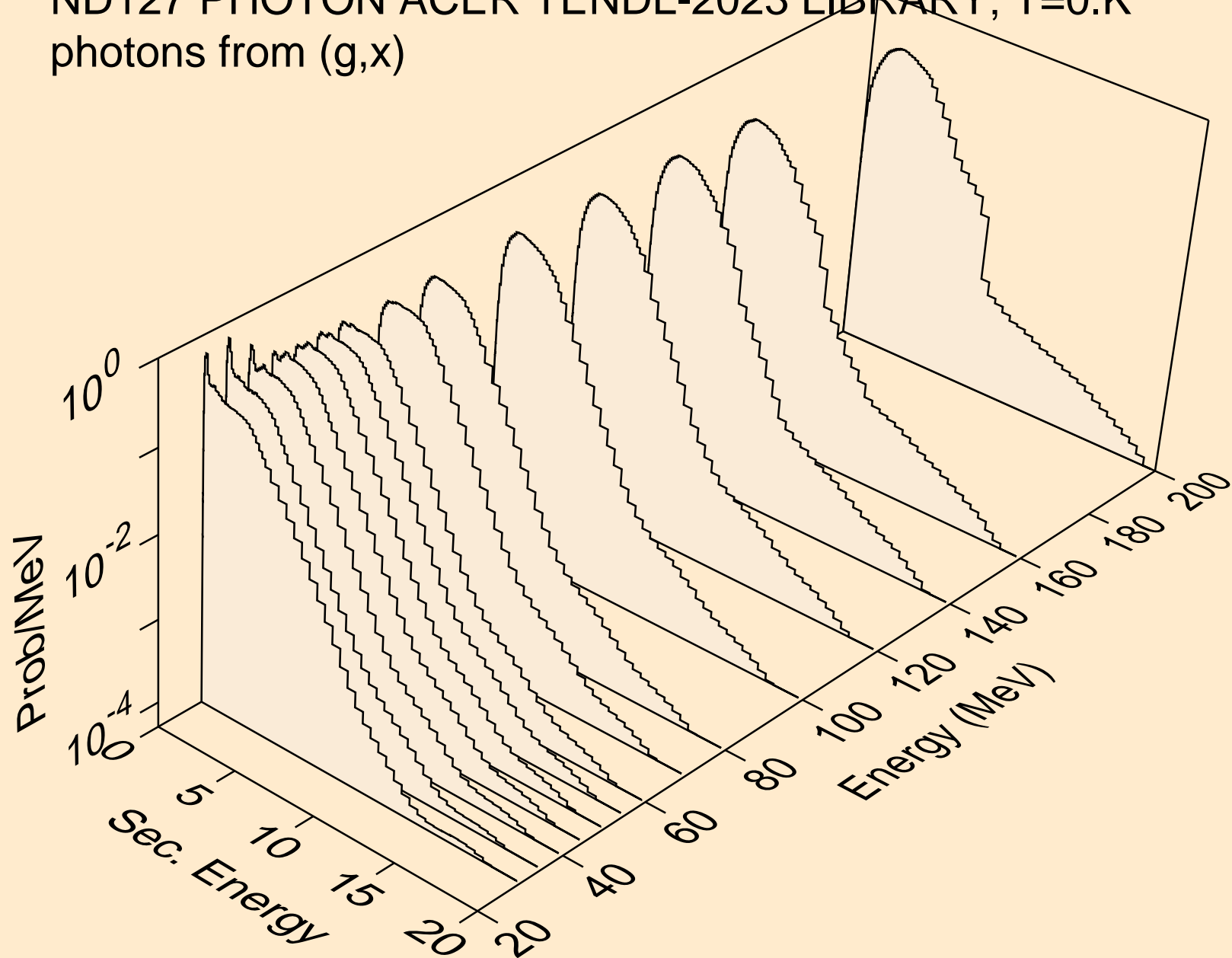

ND127 PHOTON ACER TENDL-2023 LIBRARY; T=0.K
photons from (g,2n)

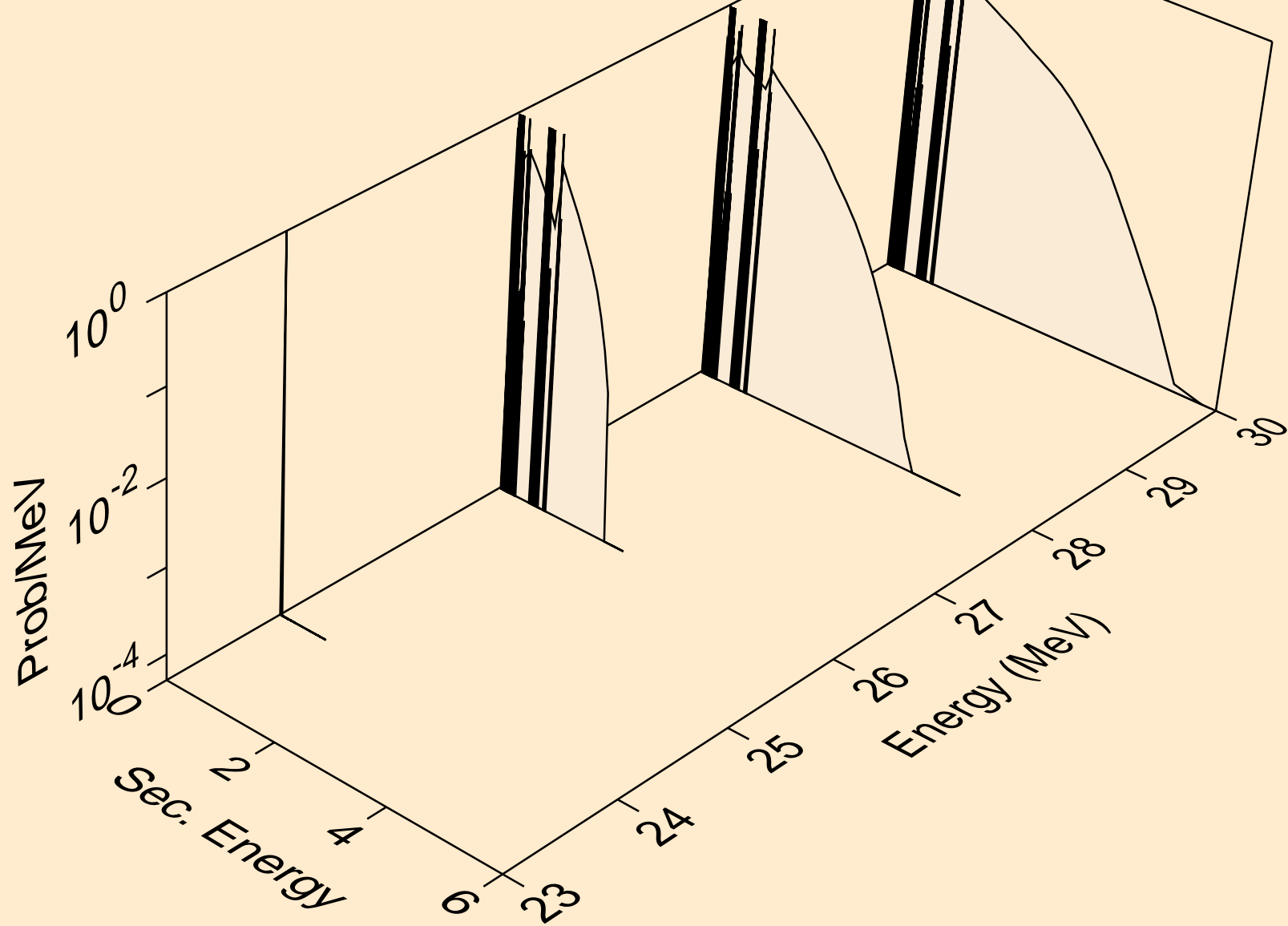

ND127 PHOTON ACER TENDL-2023 LIBRARY; T=0.K
photons from (g,n*)a

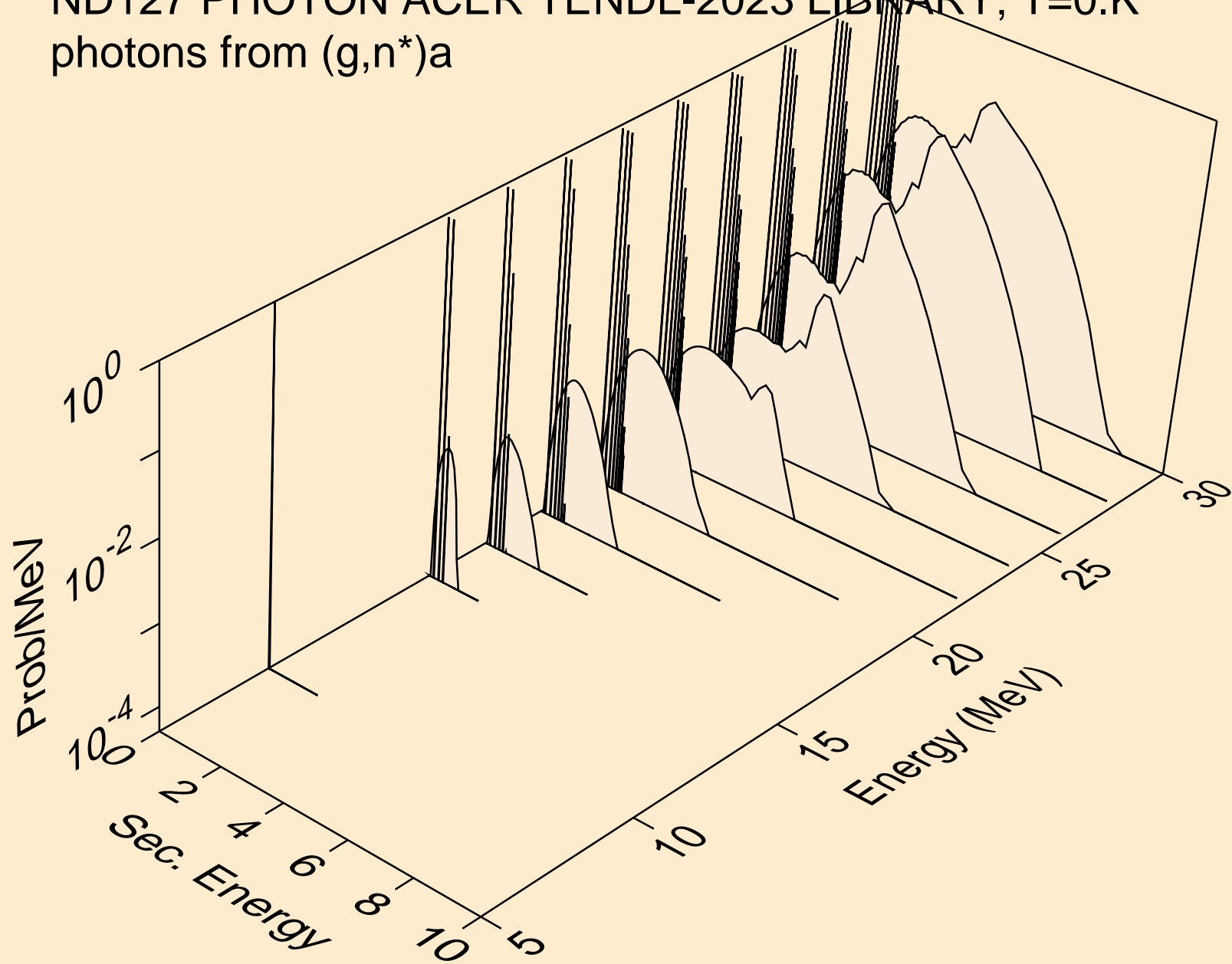

ND127 PHOTON ACER TENDL-2023 LIBRARY; T=0.K
photons from (g,n*)p

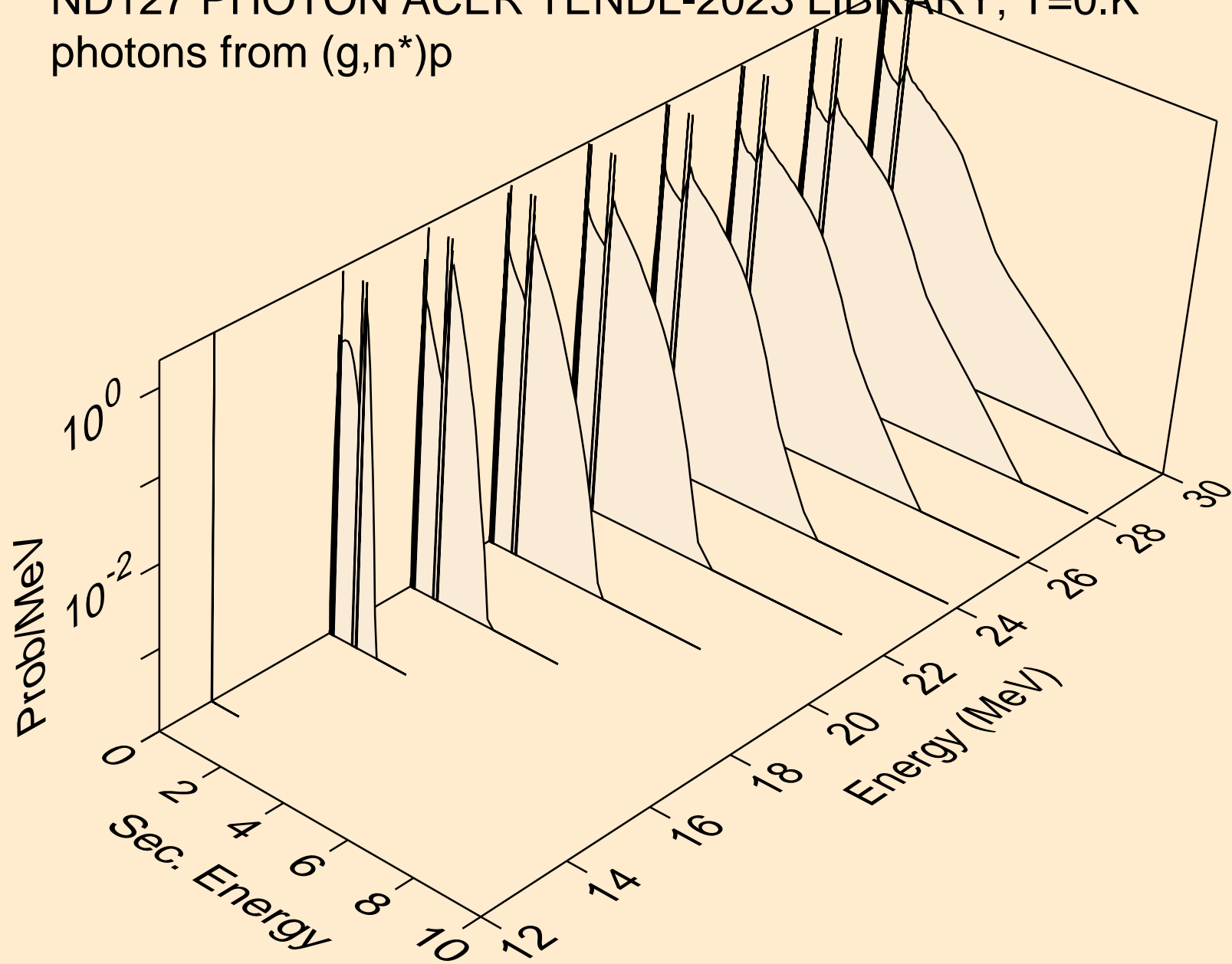

ND127 PHOTON ACER TENDL-2023 LIBRARY; T=0.K
photons from (g,2np)

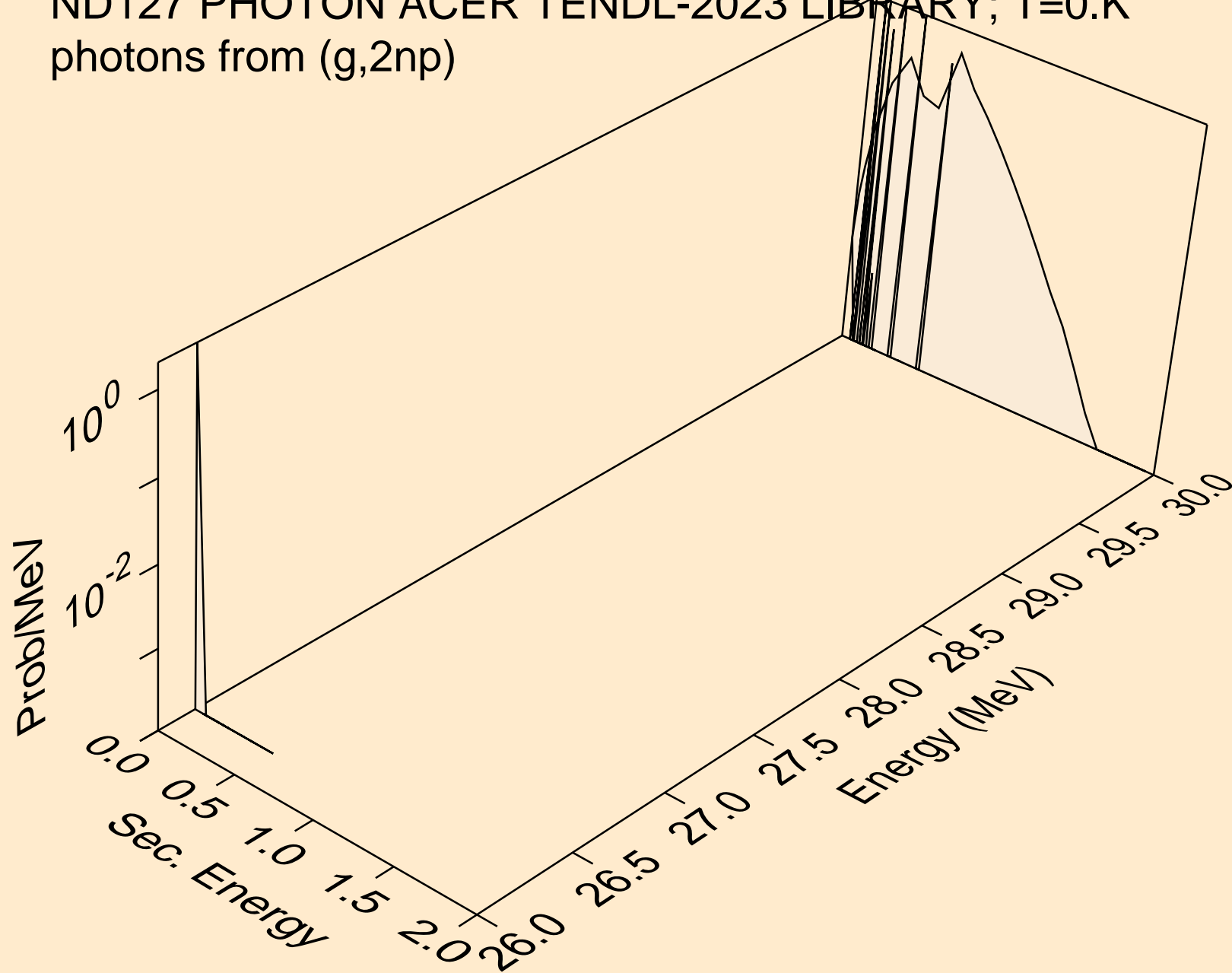

ND127 PHOTON ACER TENDL-2023 LIBRARY; T=0.K
photons from (g,n2p)

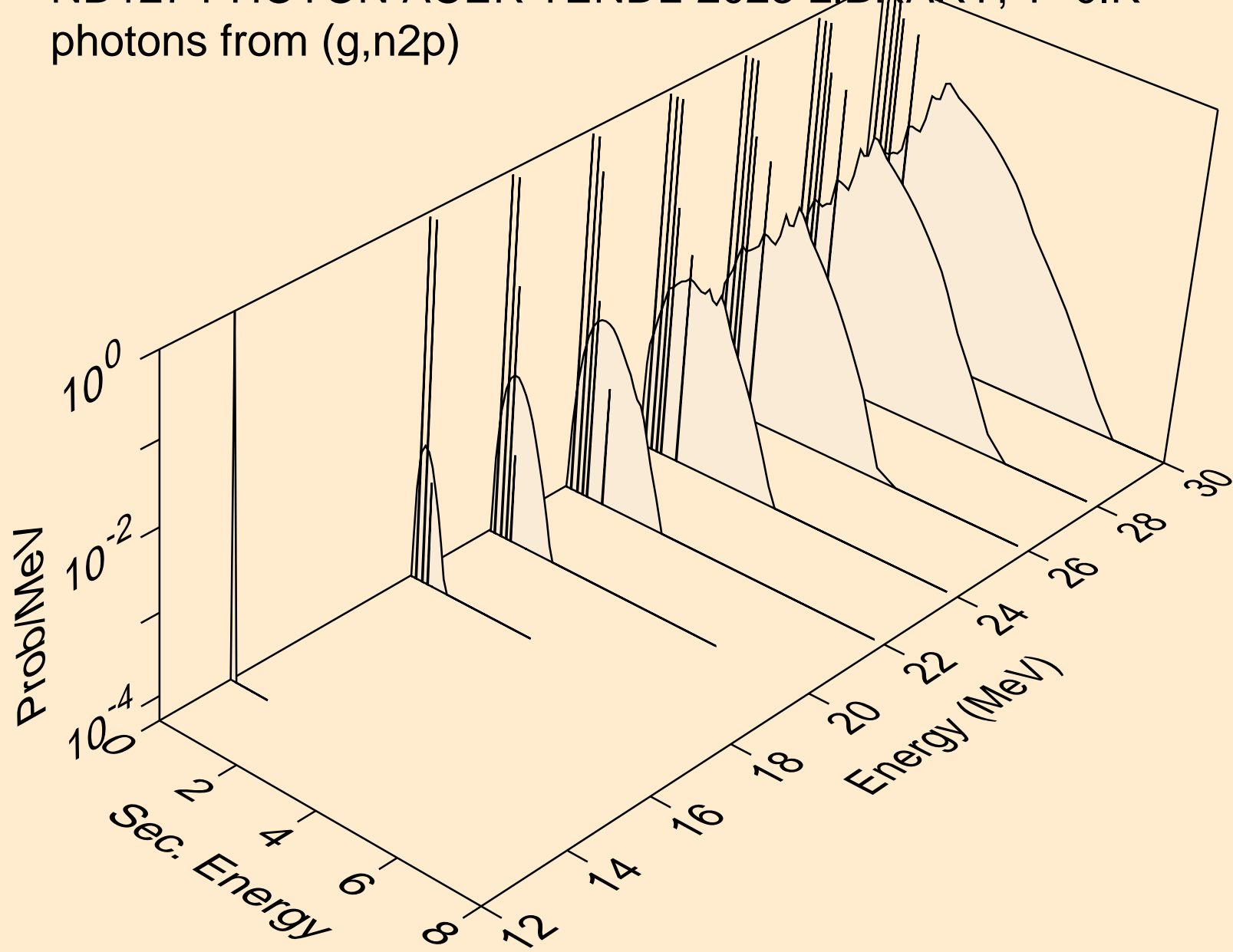

ND127 PHOTON ACER TENDL-2023 LIBRARY; T=0.K
photons from (g,npa)

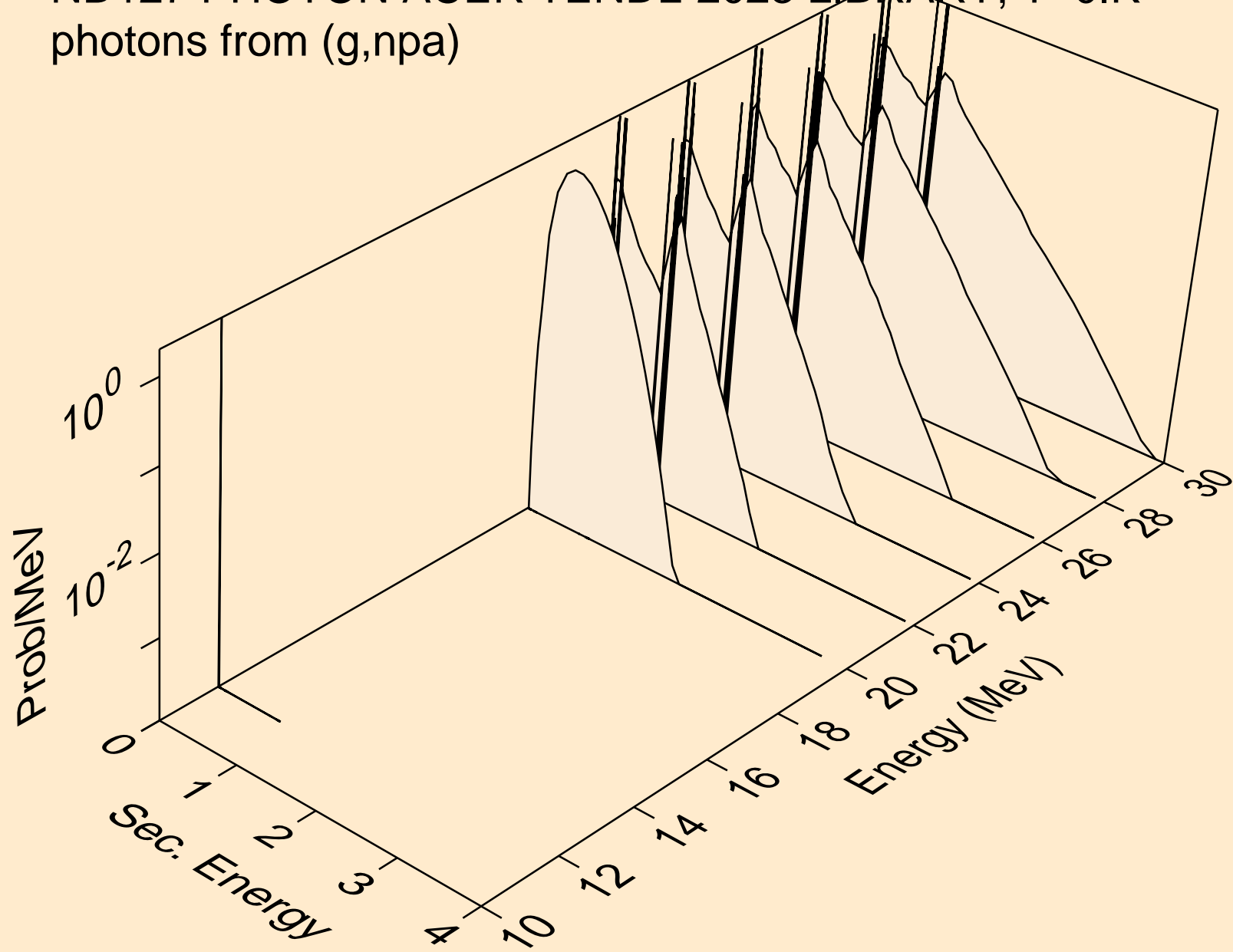

ND127 PHOTON ACER TENDL-2023 LIBRARY; T=0.K
photons from (g,n*c)

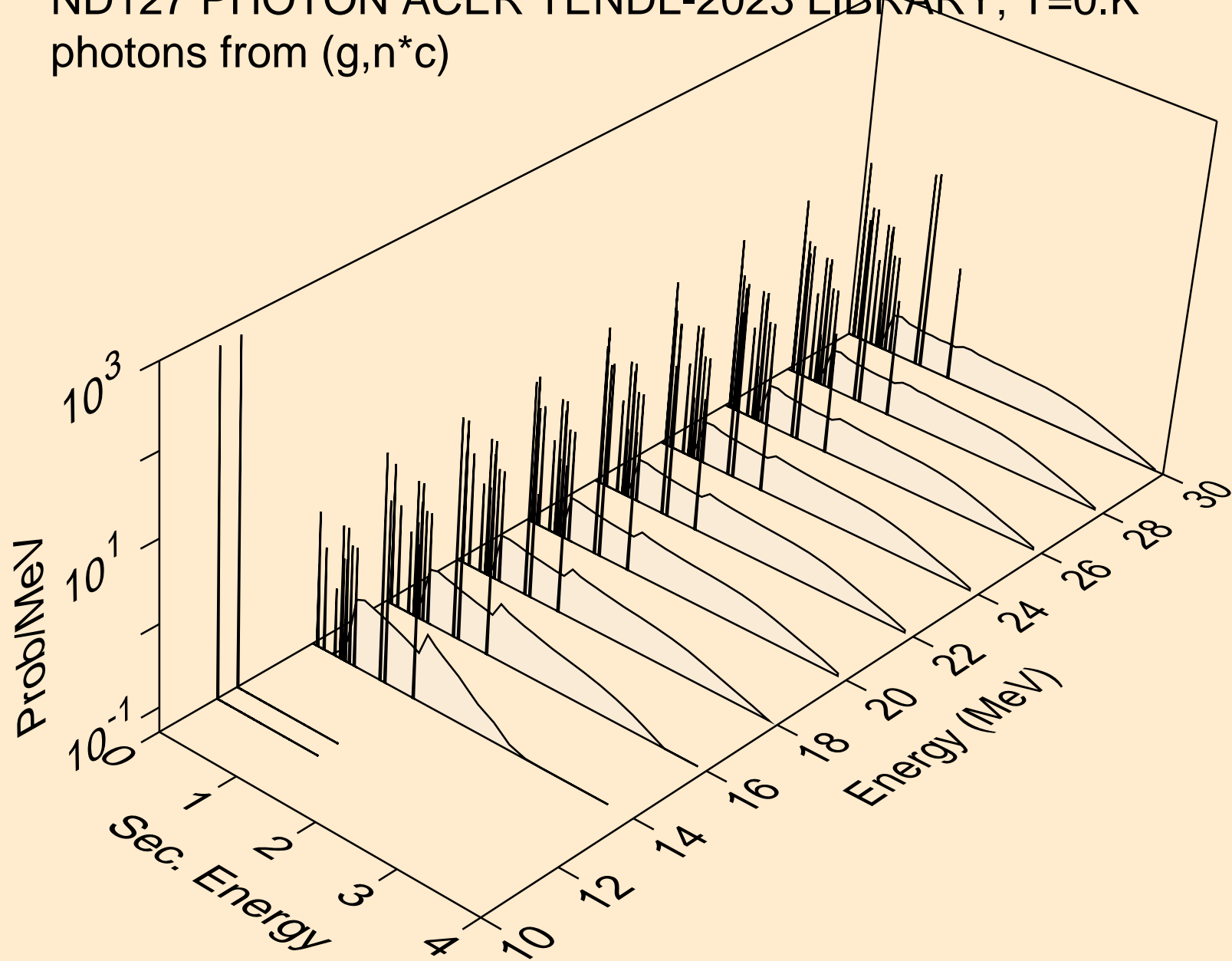

ND127 PHOTON ACER TENDL-2023 LIBRARY; T=0.K
photons from (g,gma)

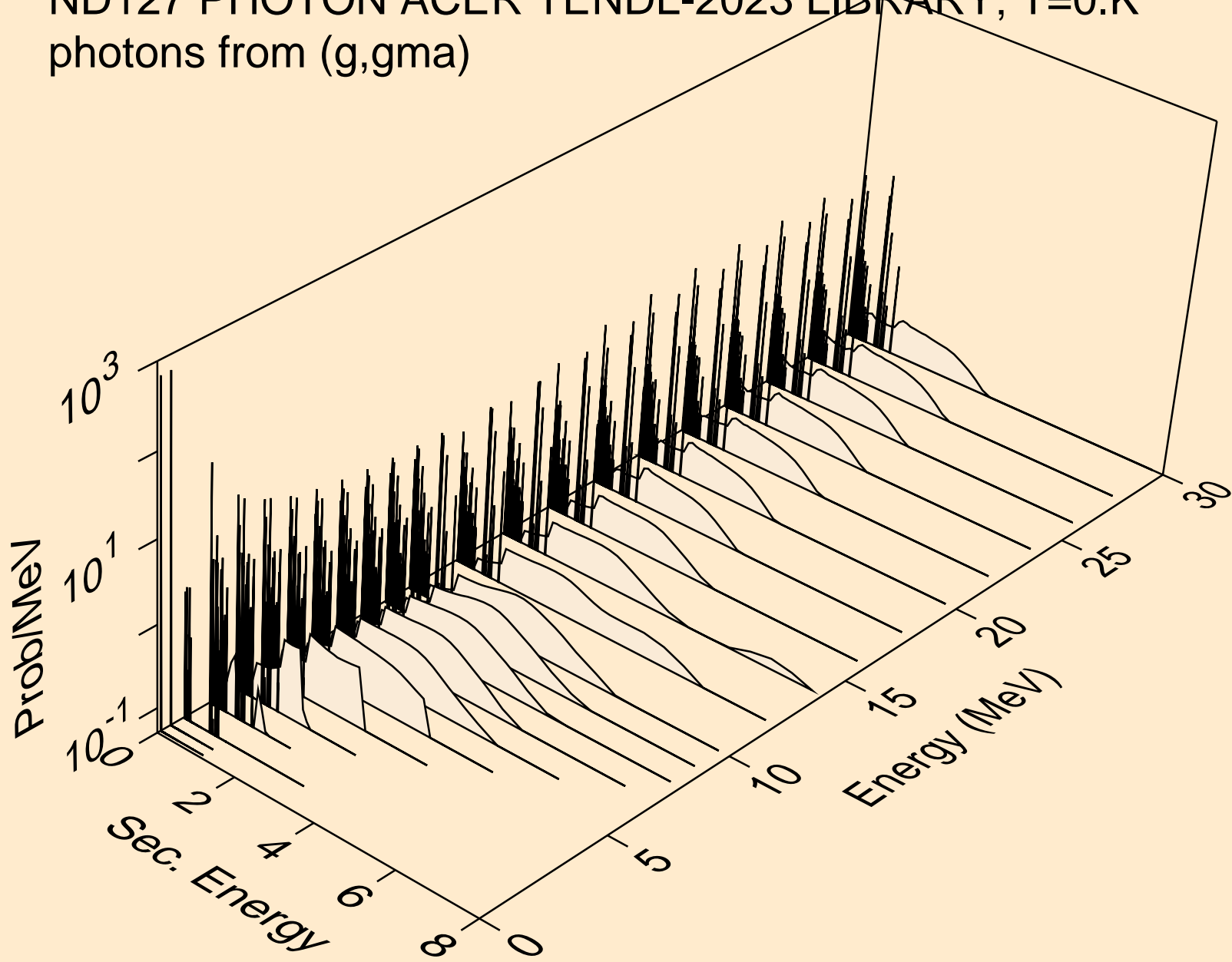

ND127 PHOTON ACER TENDL-2023 LIBRARY; T=0.K
photons from (g,p)

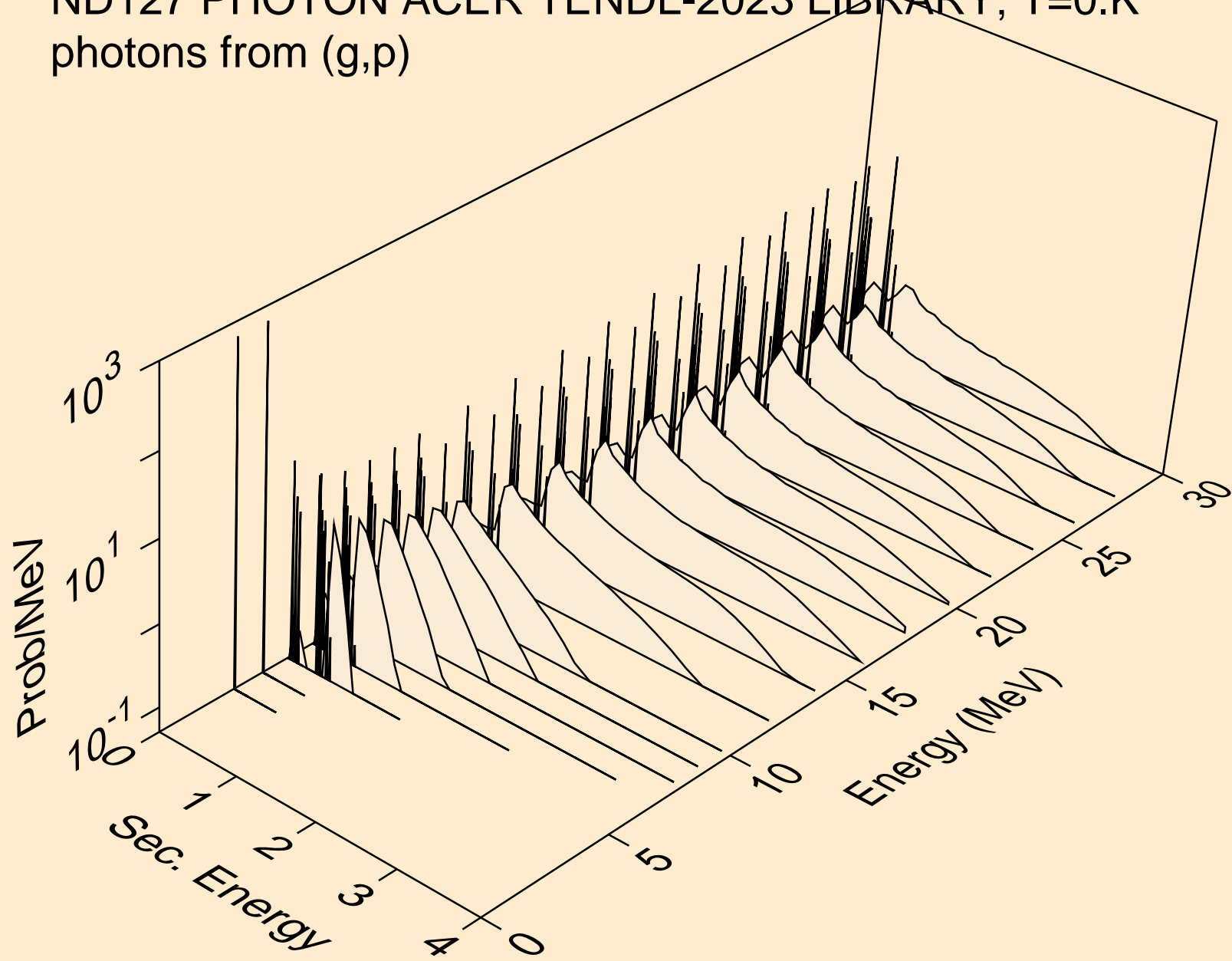

ND127 PHOTON ACER TENDL-2023 LIBRARY; T=0.K
photons from (g,d)

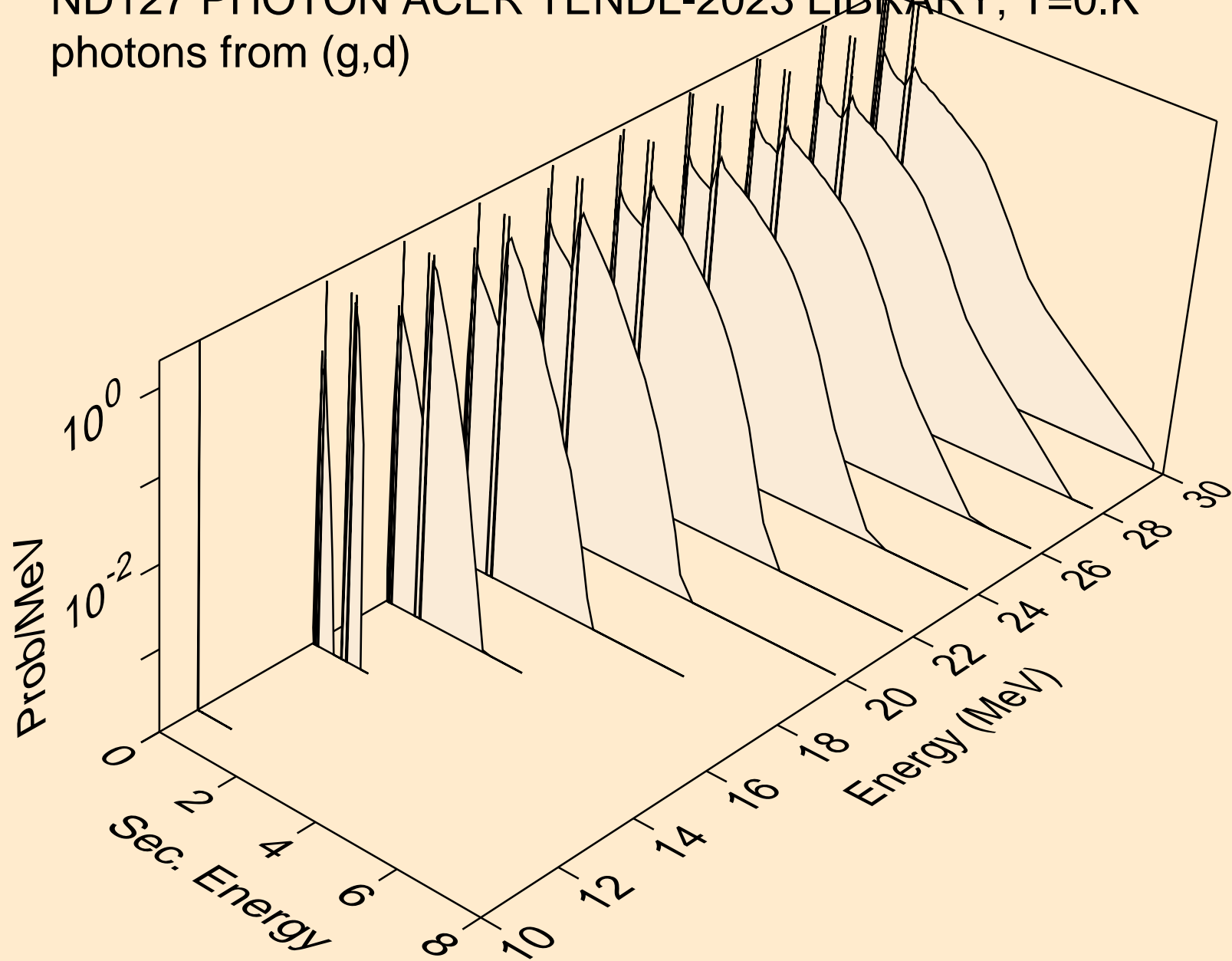

ND127 PHOTON ACER TENDL-2023 LIBRARY; T=0.K
photons from (g,t)

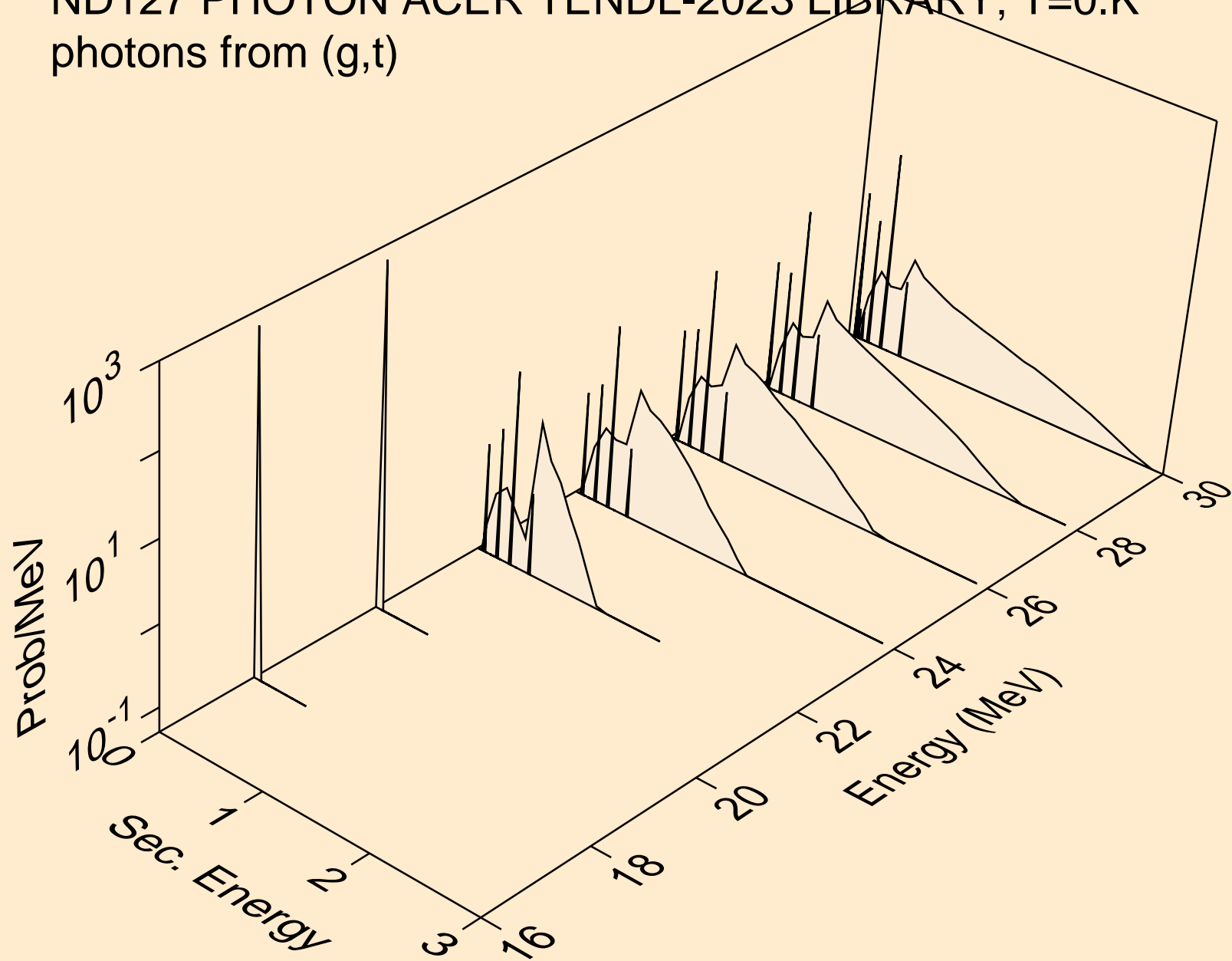

ND127 PHOTON ACER TENDL-2023 LIBRARY; T=0.K
photons from (g,he3)

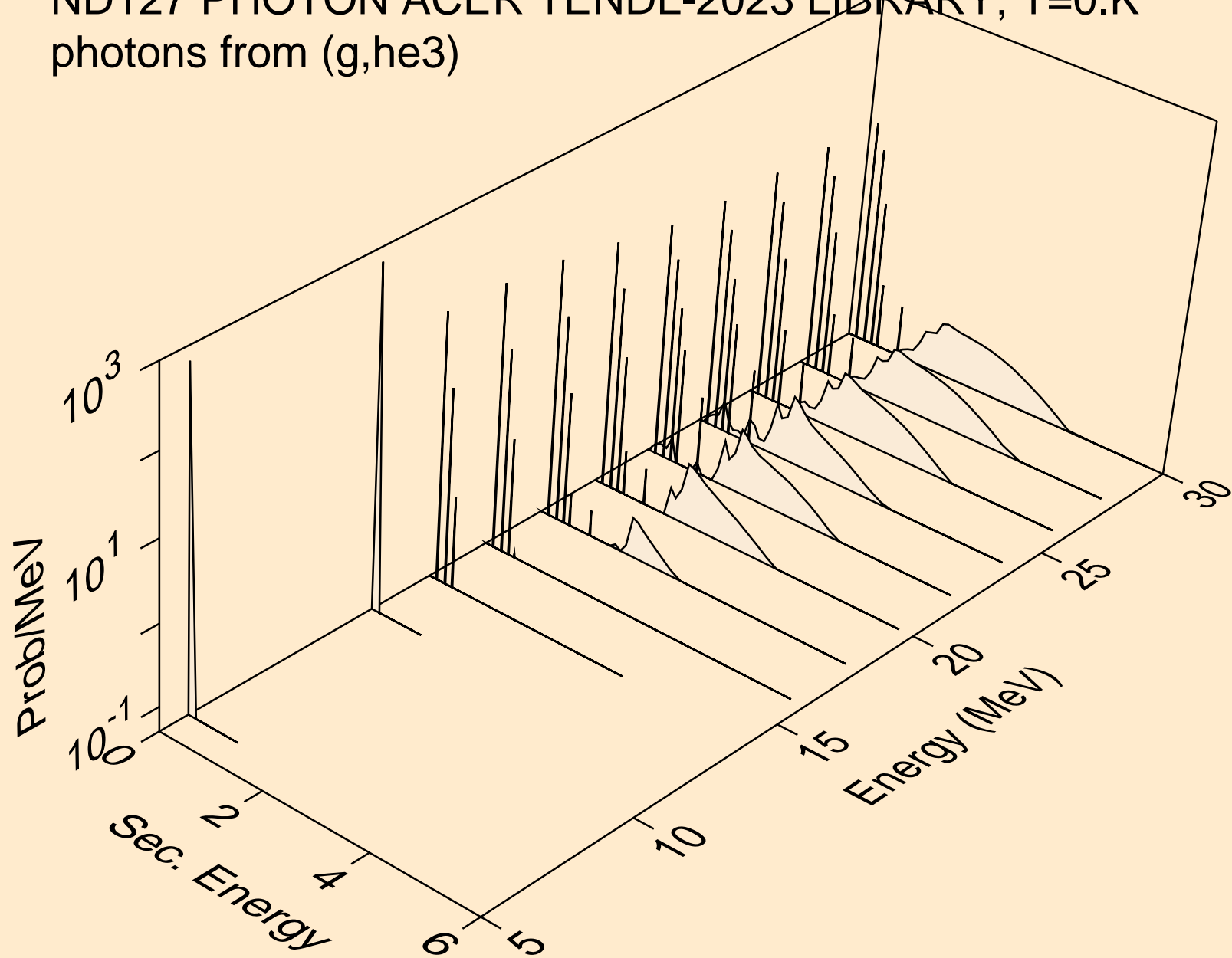

ND127 PHOTON ACER TENDL-2023 LIBRARY; T=0.K
photons from (g,a)

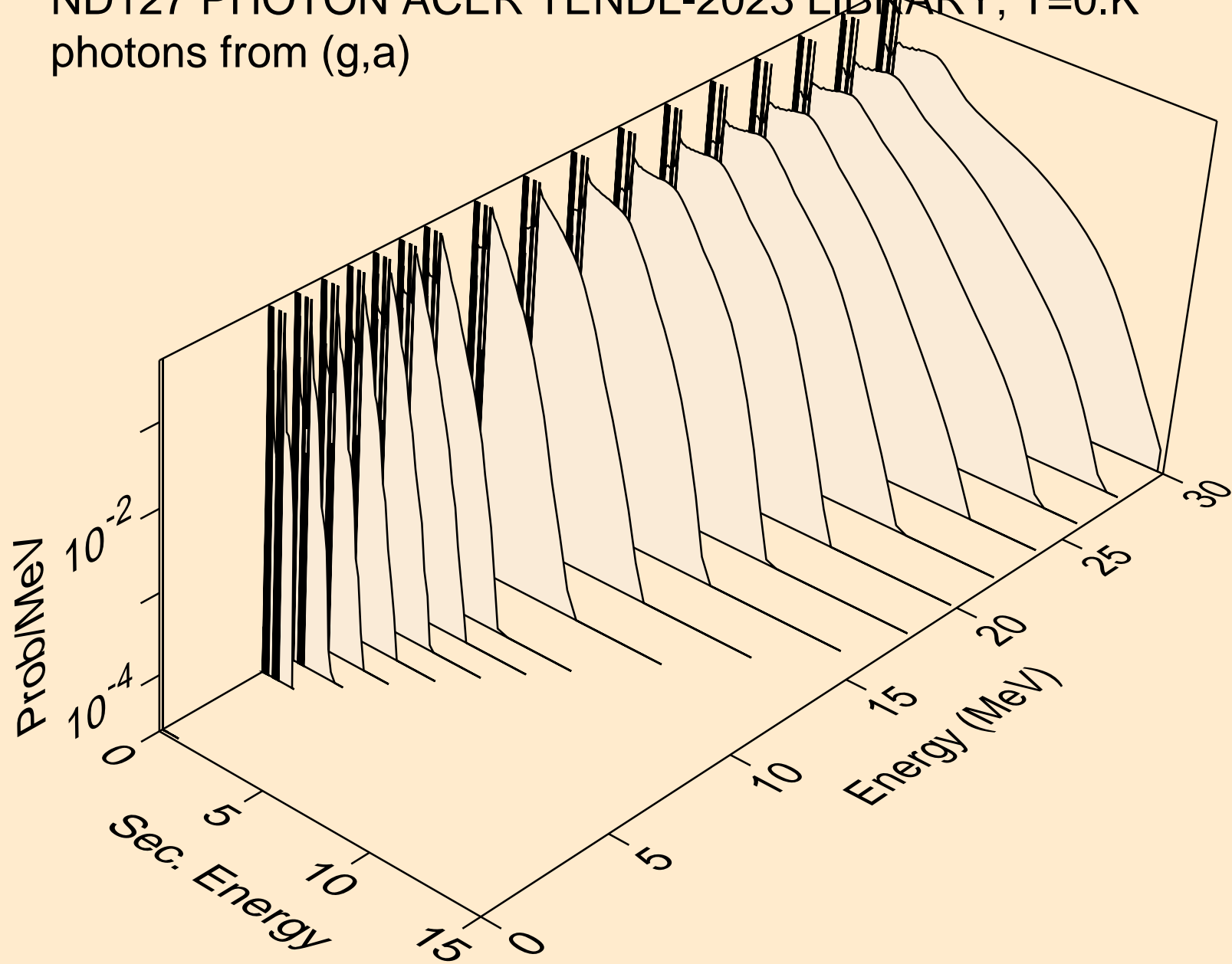

ND127 PHOTON ACER TENDL-2023 LIBRARY; T=0.K
photons from (g,2a)

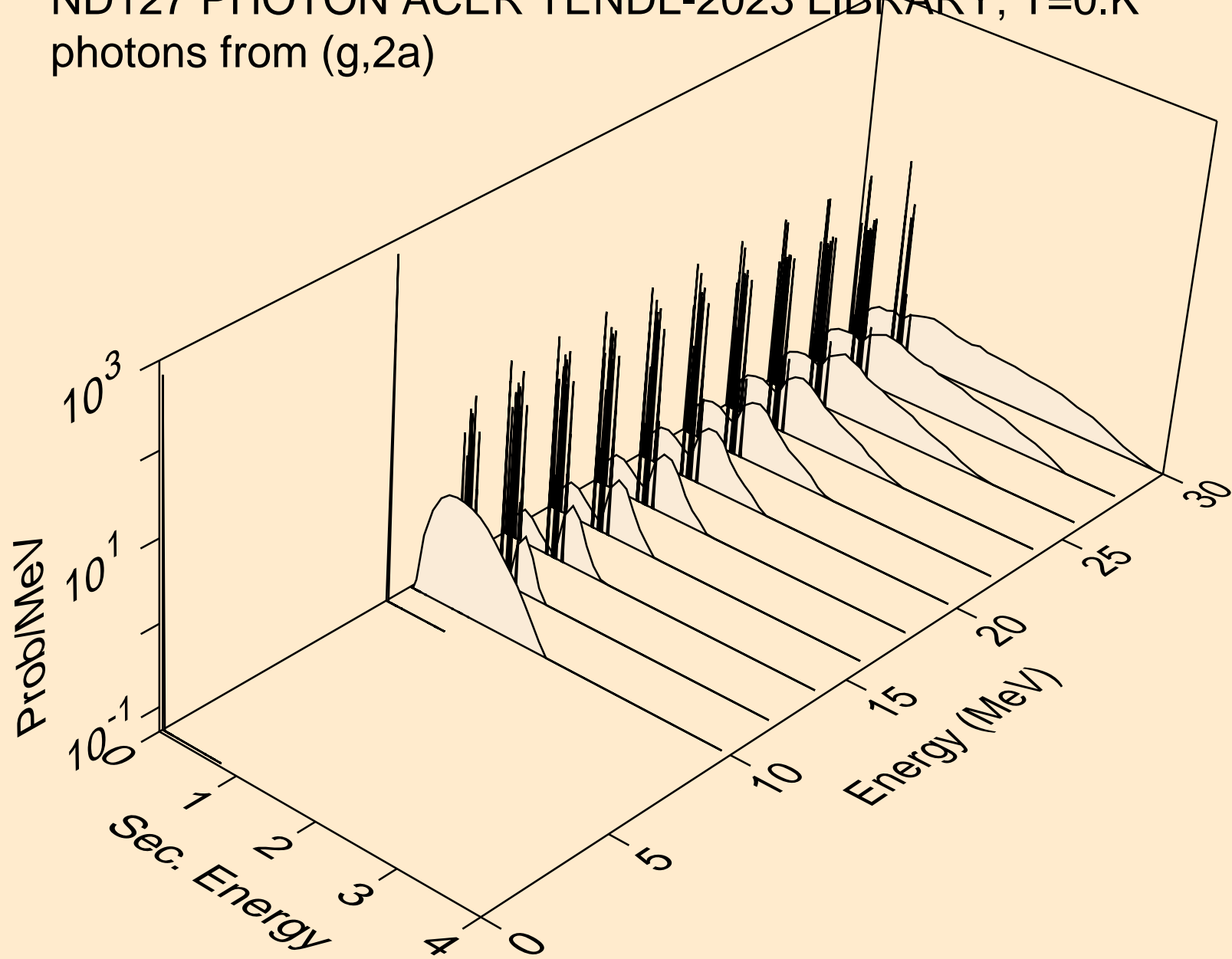

ND127 PHOTON ACER TENDL-2023 LIBRARY; T=0.K
photons from (g,2p)

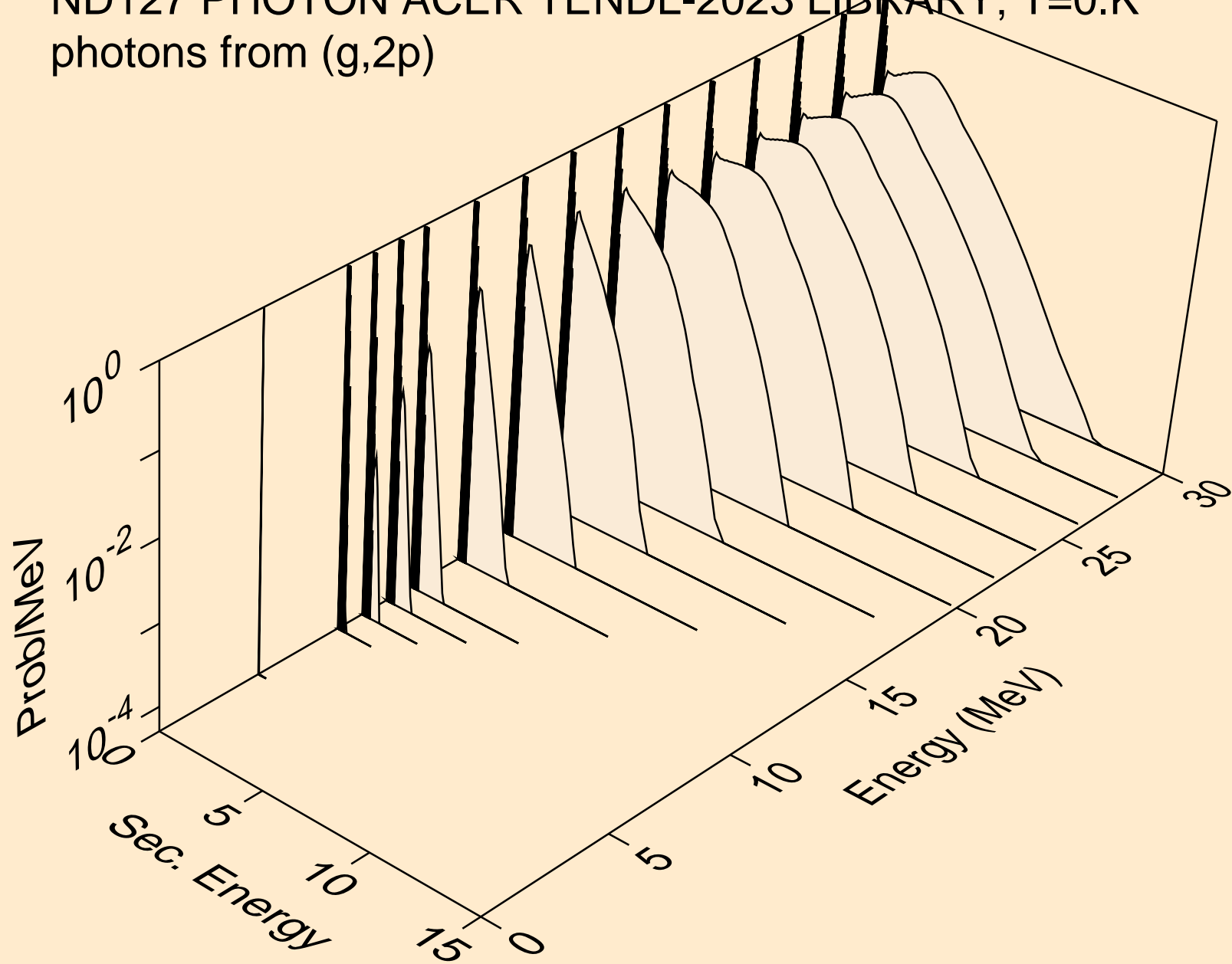

ND127 PHOTON ACER TENDL-2023 LIBRARY; T=0.K
photons from (g,pa)

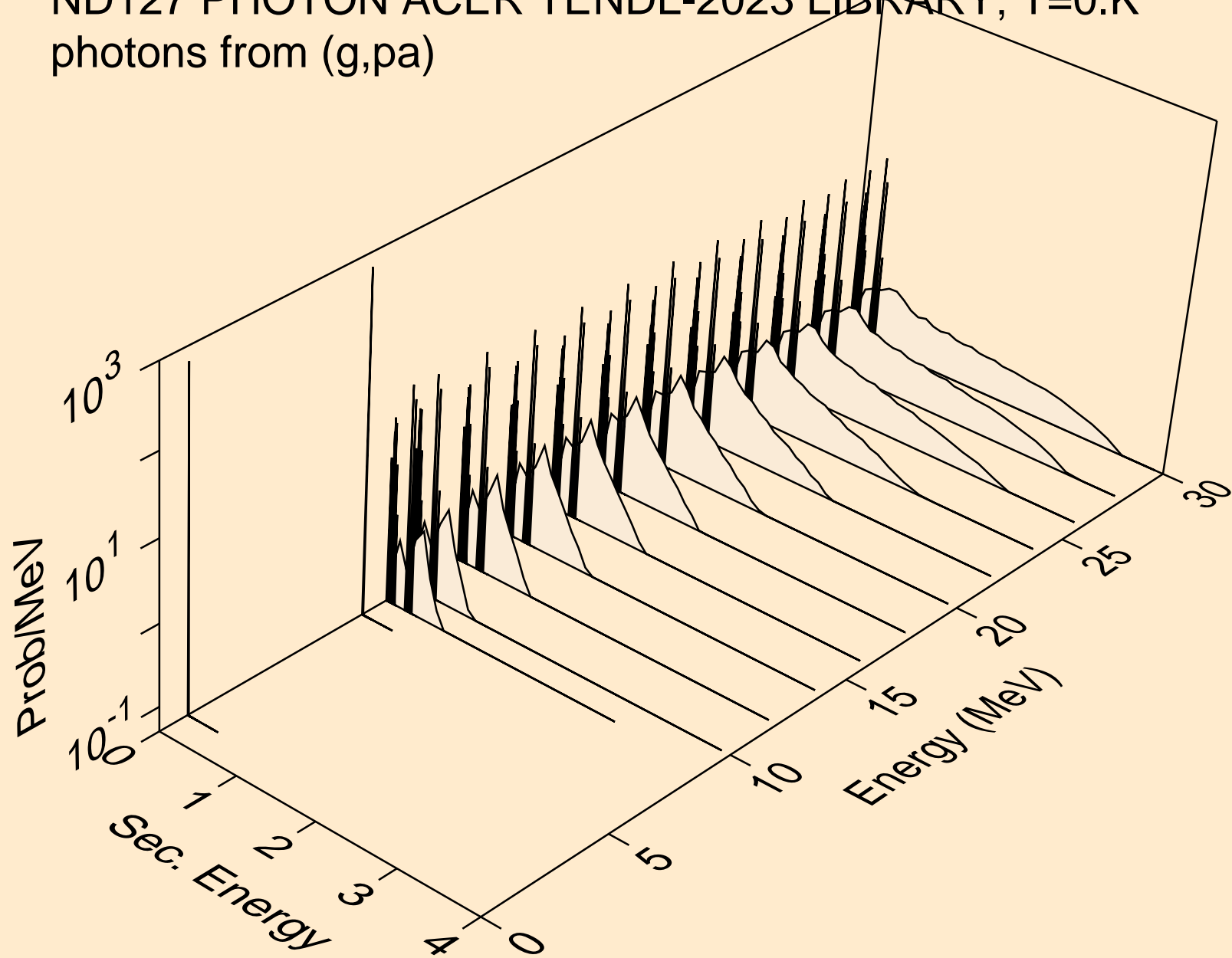

ND127 PHOTON ACER TENDL-2023 LIBRARY; T=0.K
photons from (g,pd)

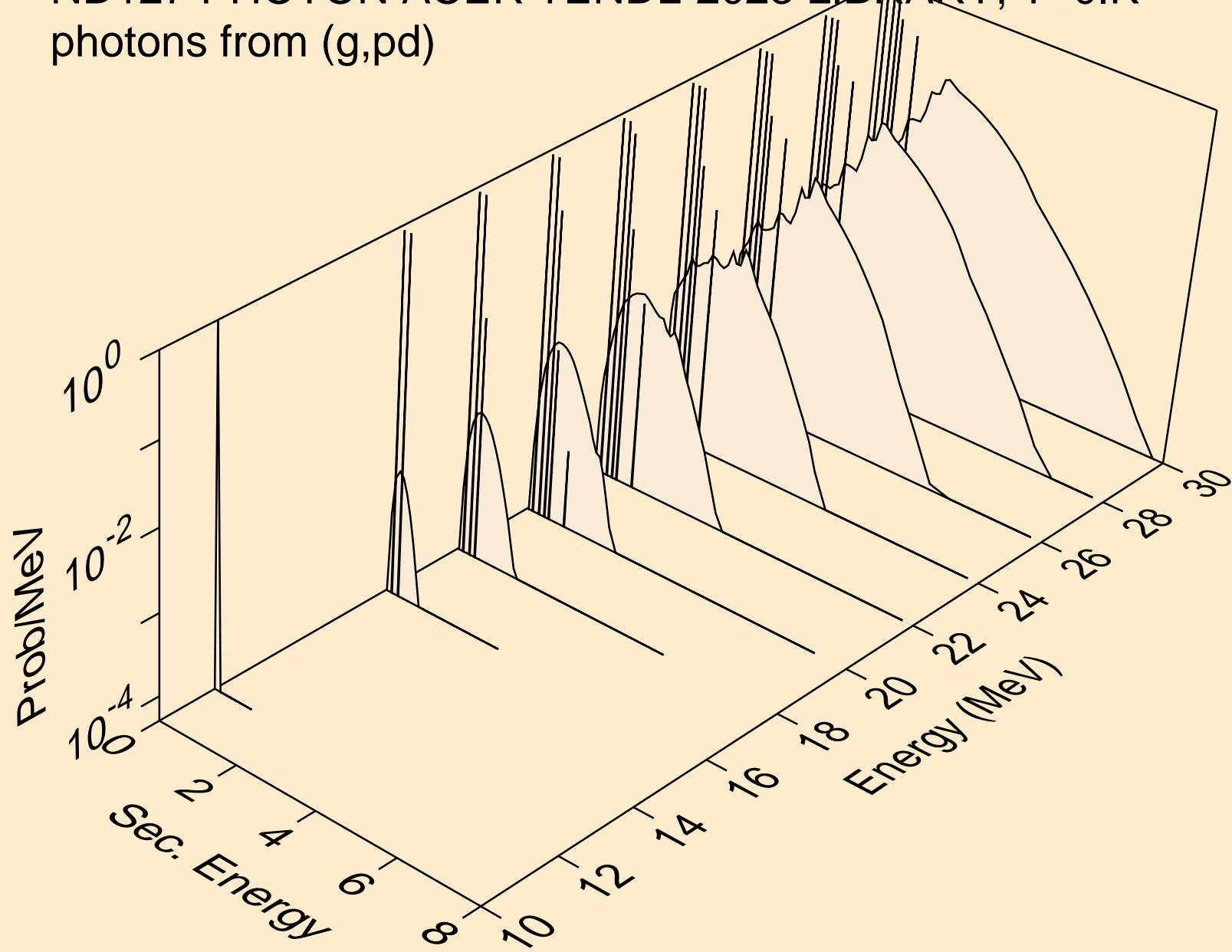

ND127 PHOTON ACER TENDL-2023 LIBRARY; T=0.K
photons from (g,pt)

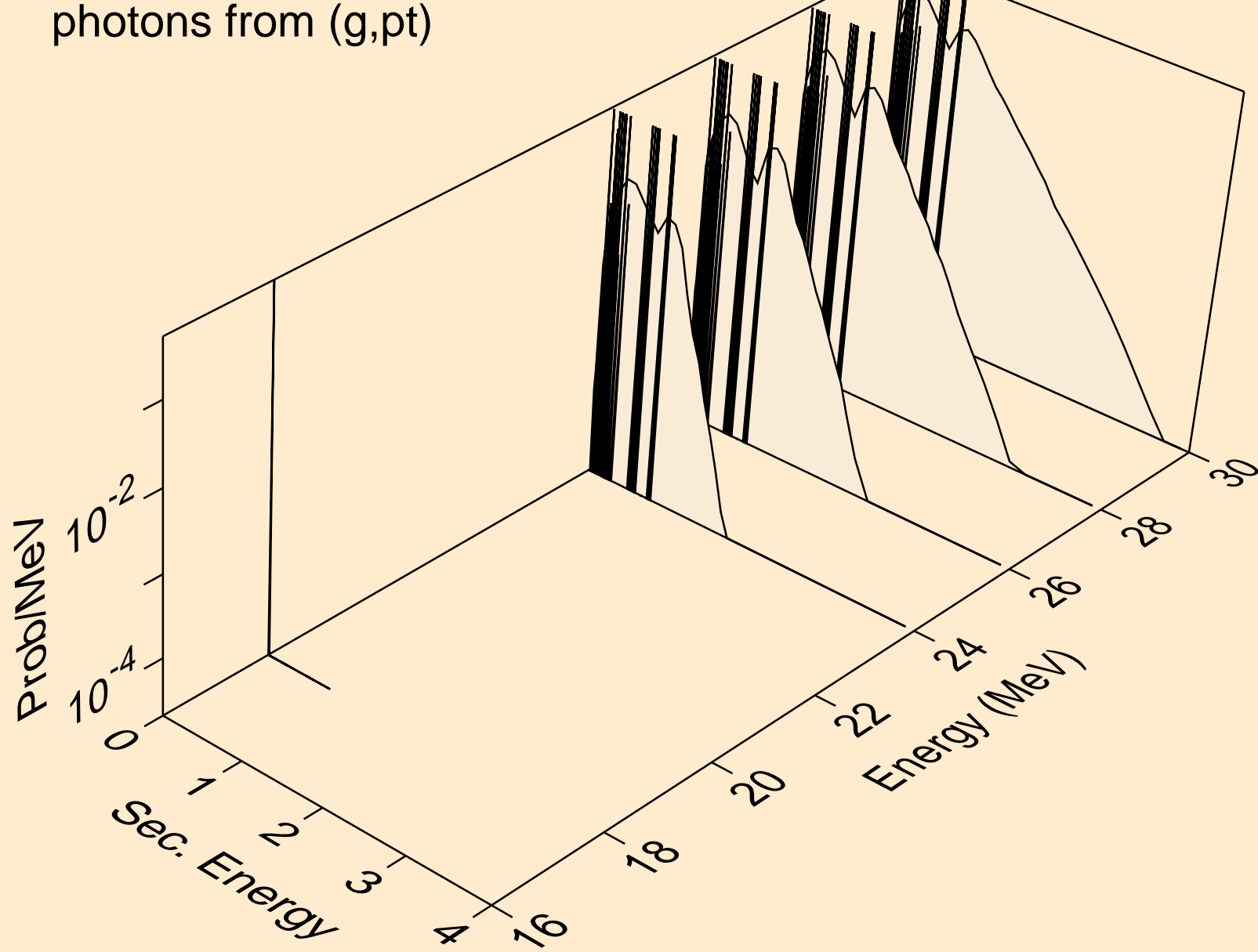

ND127 PHOTON ACER TENDL-2023 LIBRARY; T=0.K
photons from (g,da)

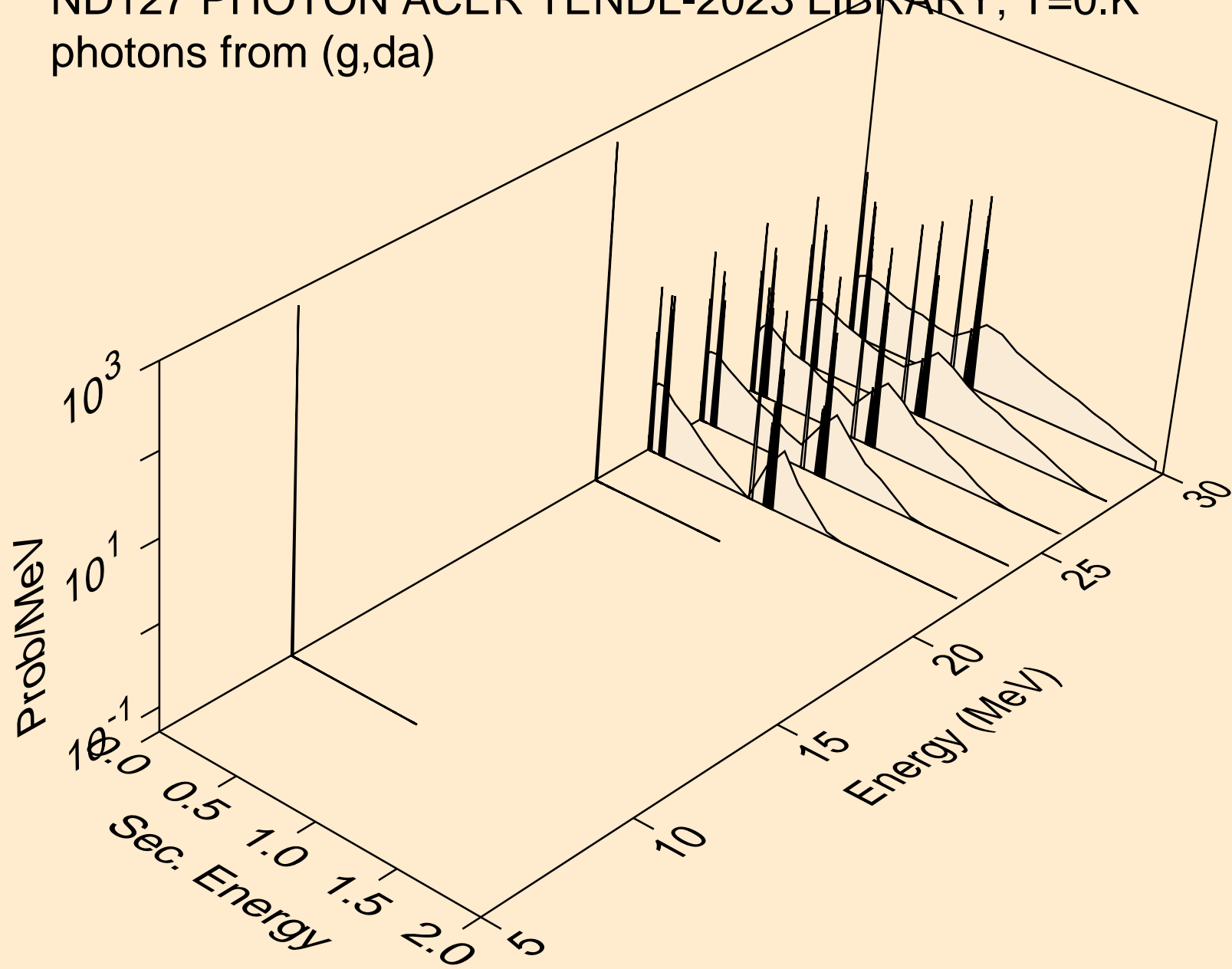

ND127 PHOTON ACER TENDL-2023 LIBRARY; T=0.K
protons from (g,x)

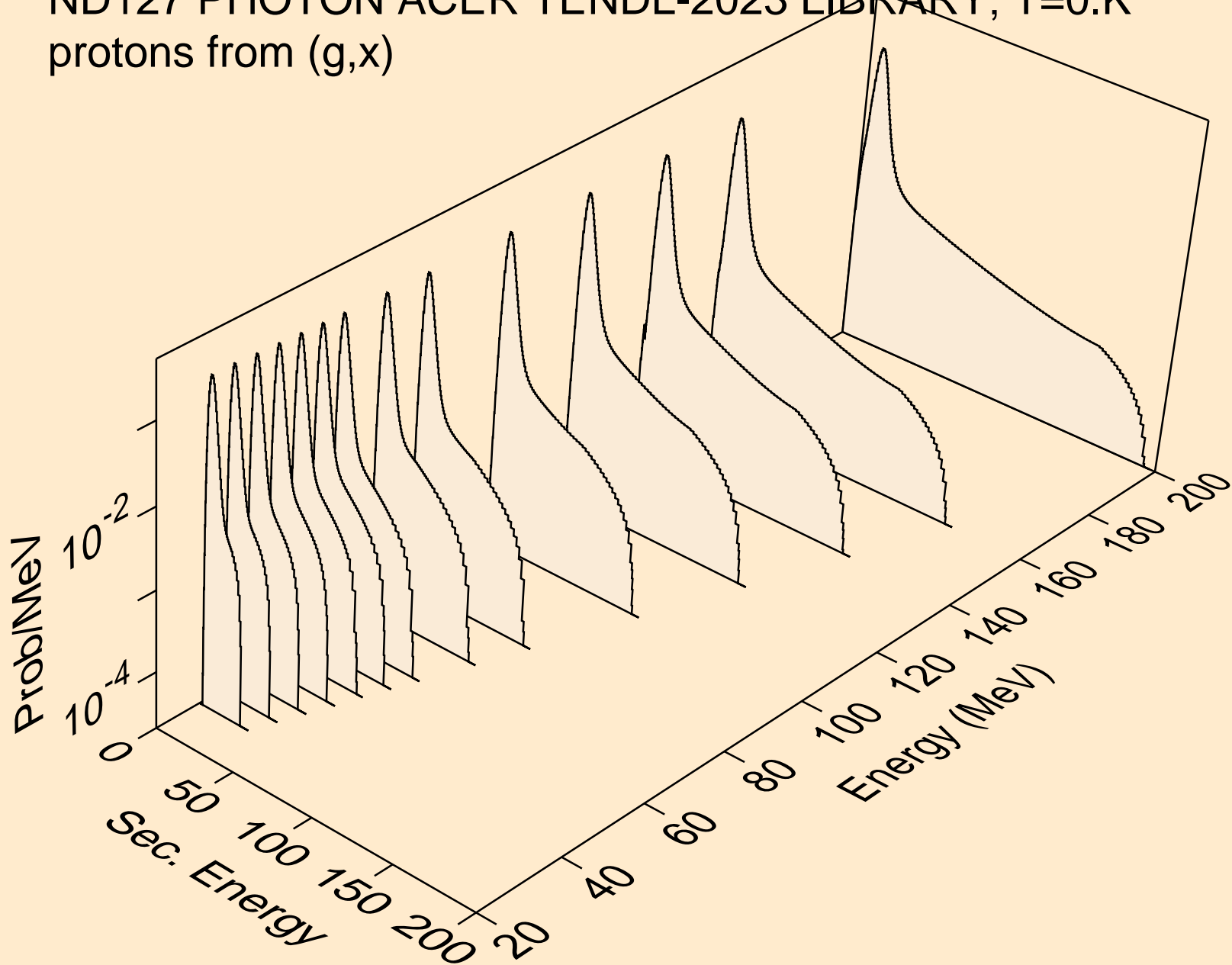

ND127 PHOTON ACER TENDL-2023 LIBRARY; T=0.K
protons from (g,n*)p

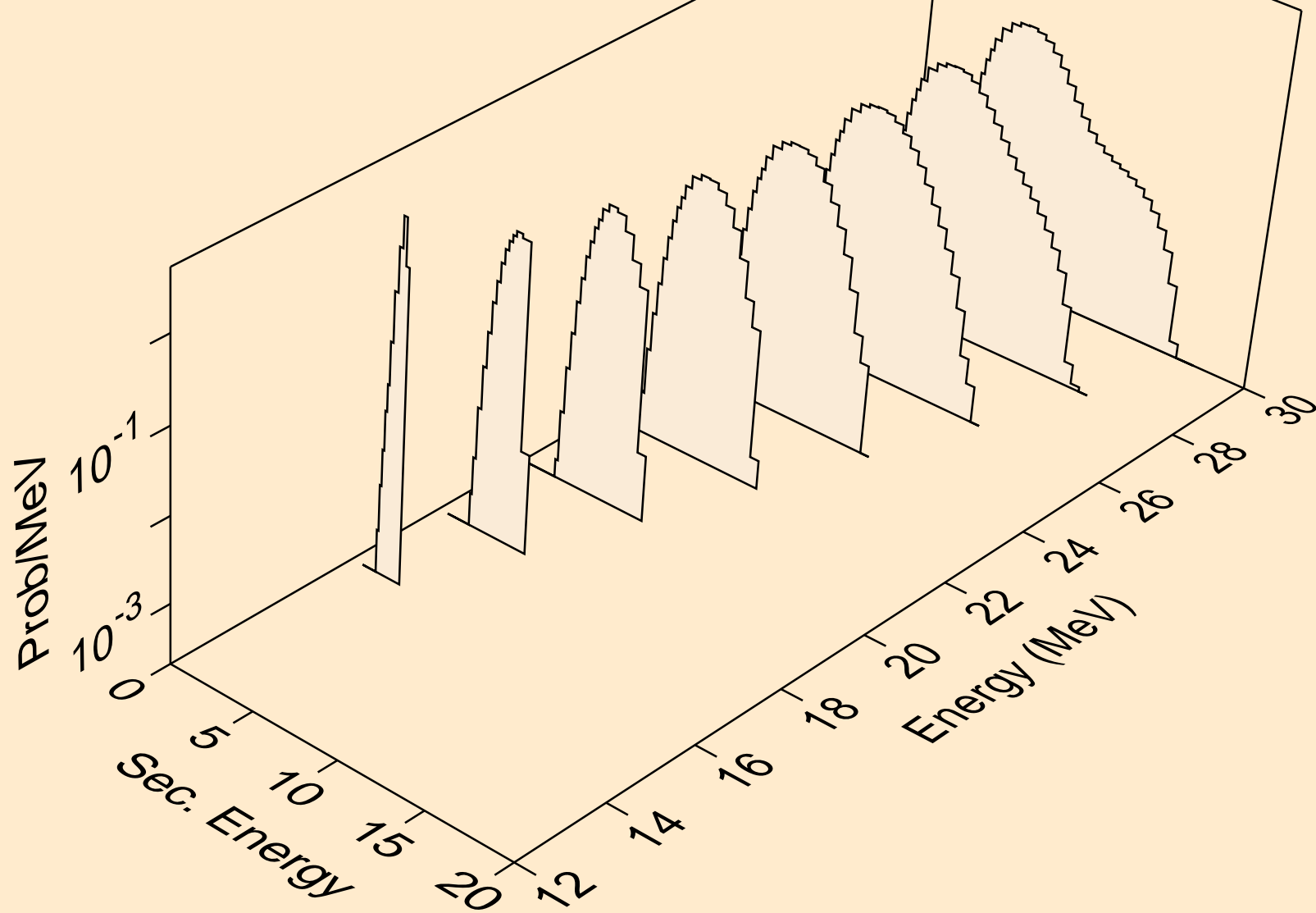

ND127 PHOTON ACER TENDL-2023 LIBRARY; T=0.K
protons from (g,2np)

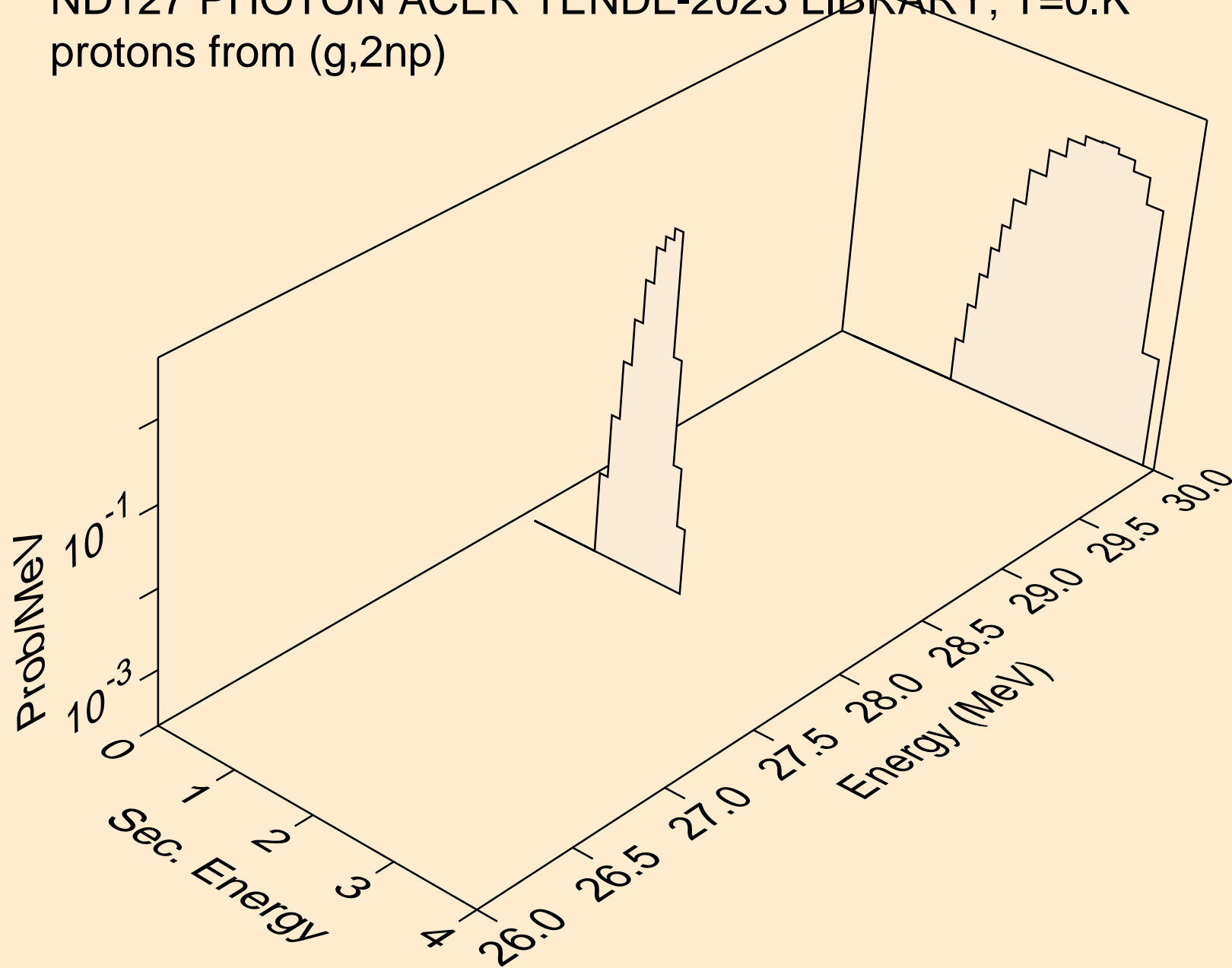

ND127 PHOTON ACER TENDL-2023 LIBRARY; T=0.K
protons from (g,n2p)

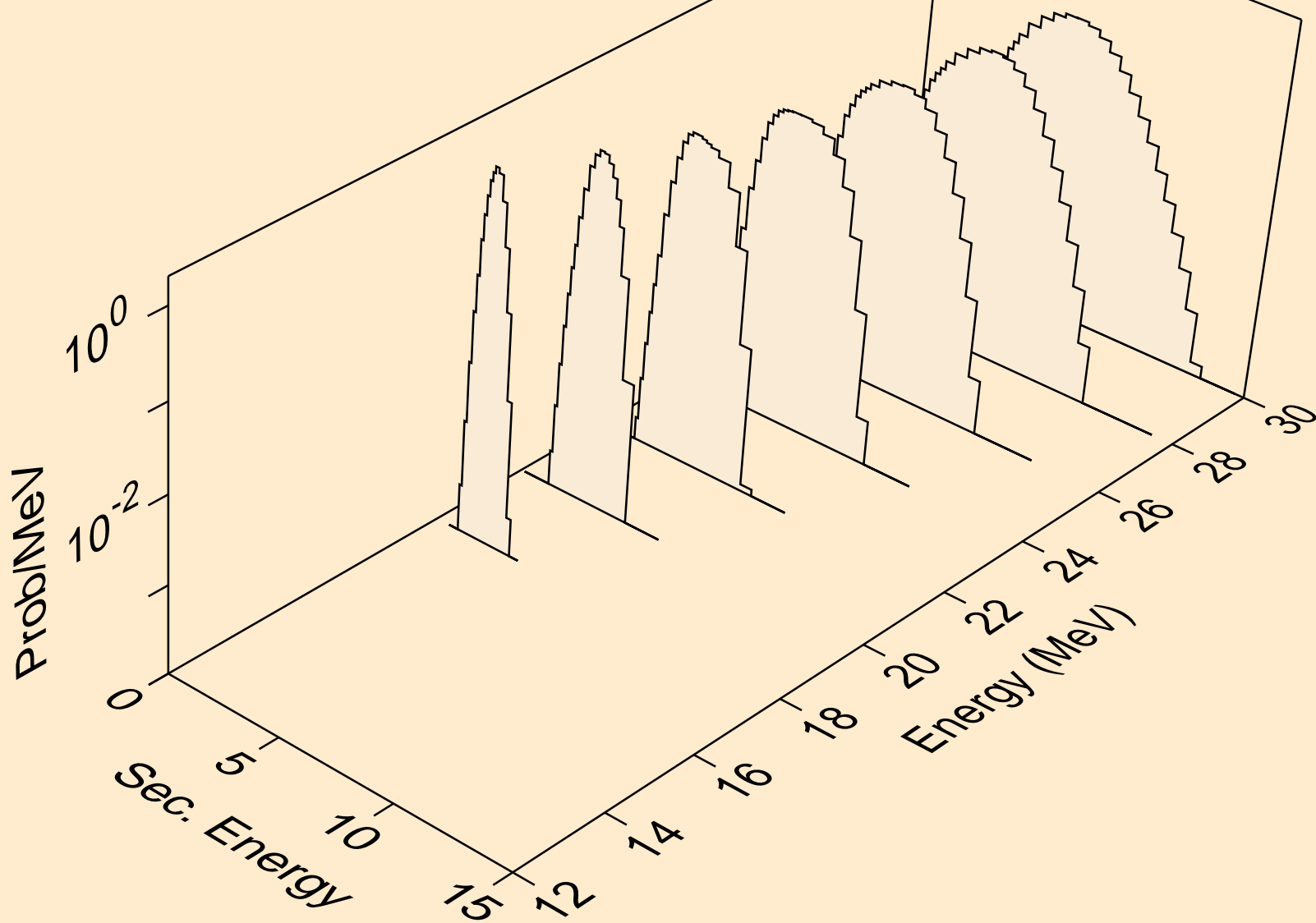

ND127 PHOTON ACER TENDL-2023 LIBRARY; T=0.K
protons from (g,npa)

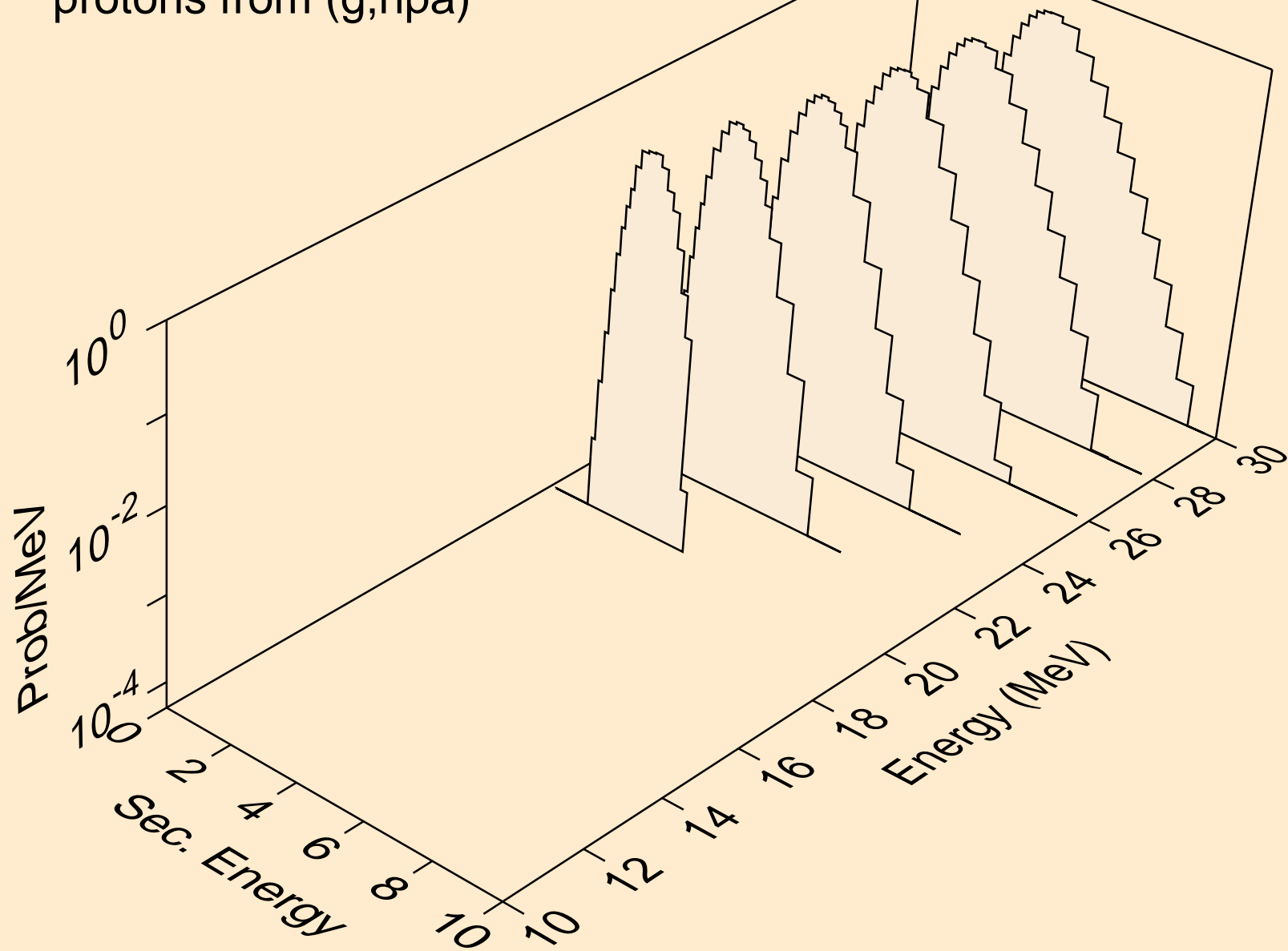

ND127 PHOTON ACER TENDL-2023 LIBRARY; T=0.K
protons from (g,p)

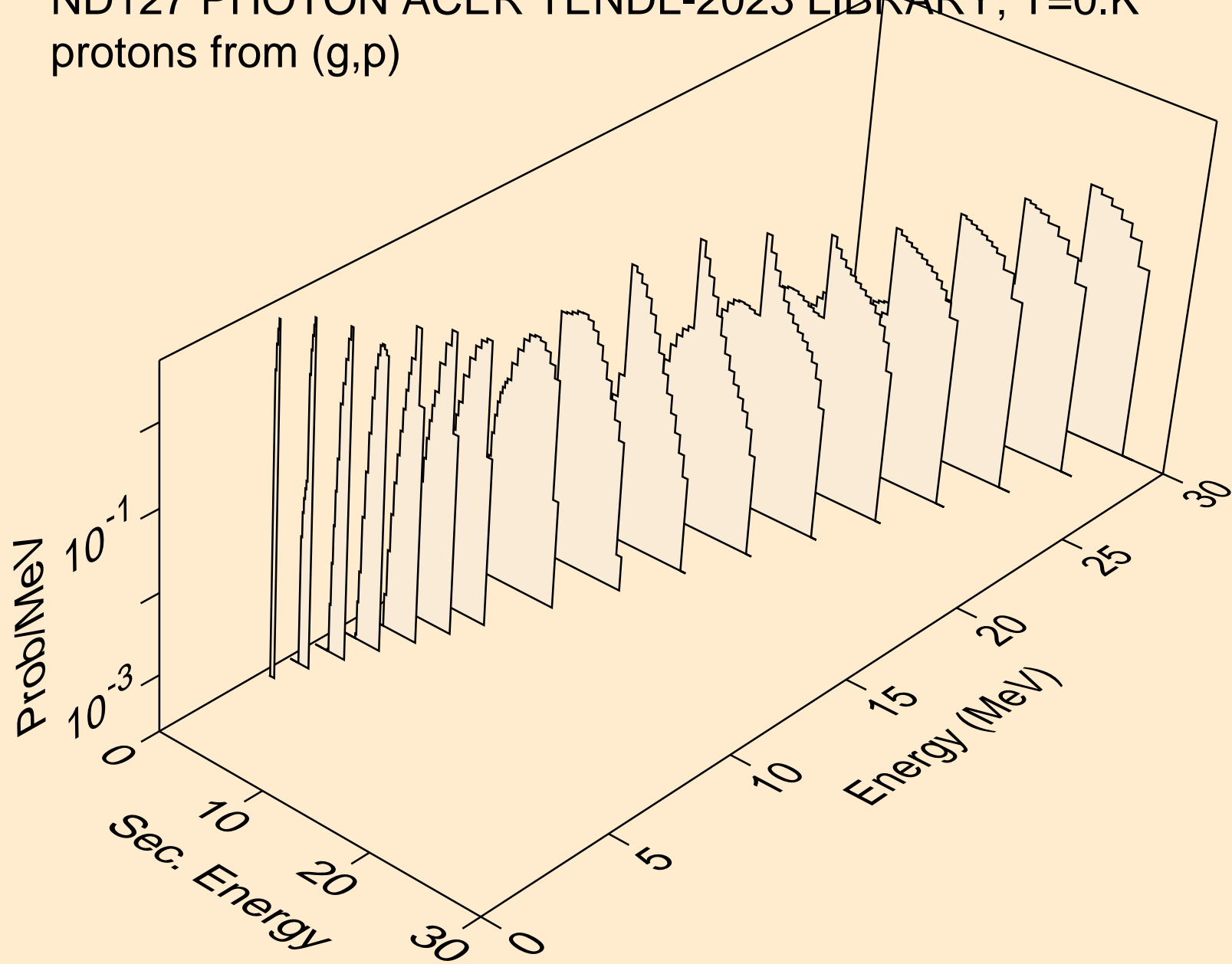

ND127 PHOTON ACER TENDL-2023 LIBRARY; T=0.K
protons from (g,2p)

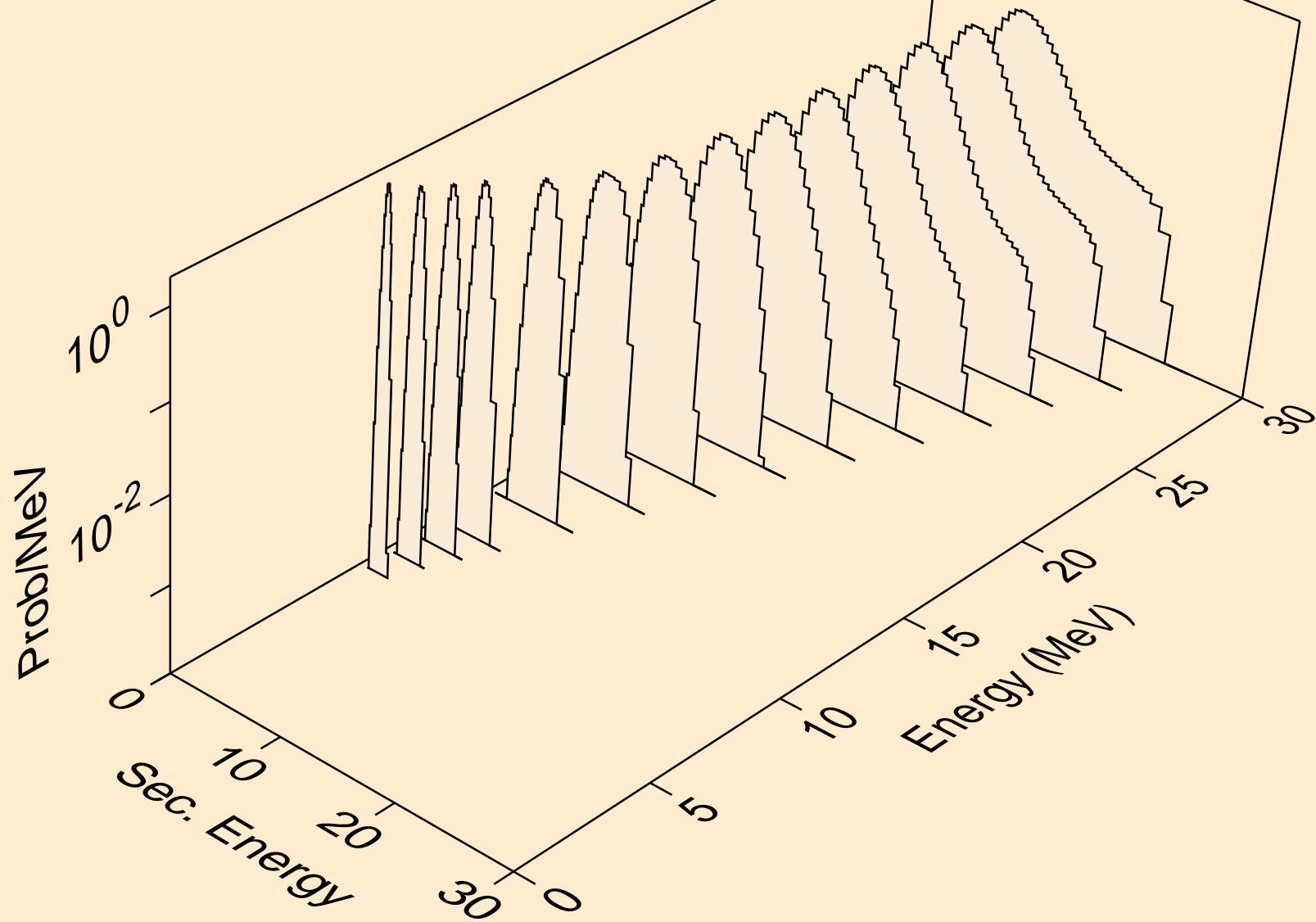

ND127 PHOTON ACER TENDL-2023 LIBRARY; T=0.K
protons from (g,pa)

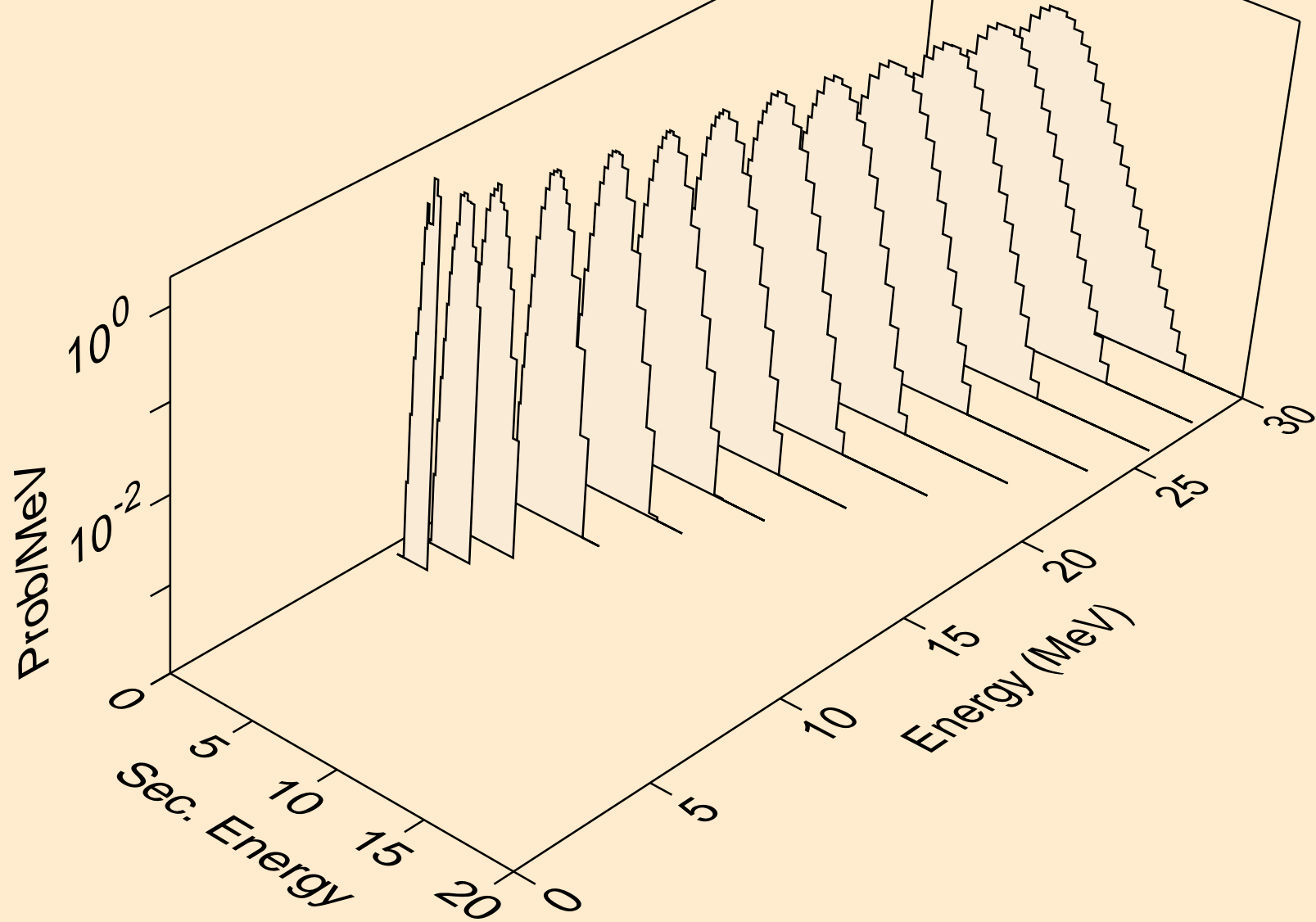

ND127 PHOTON ACER TENDL-2023 LIBRARY; T=0.K
protons from (g,pd)

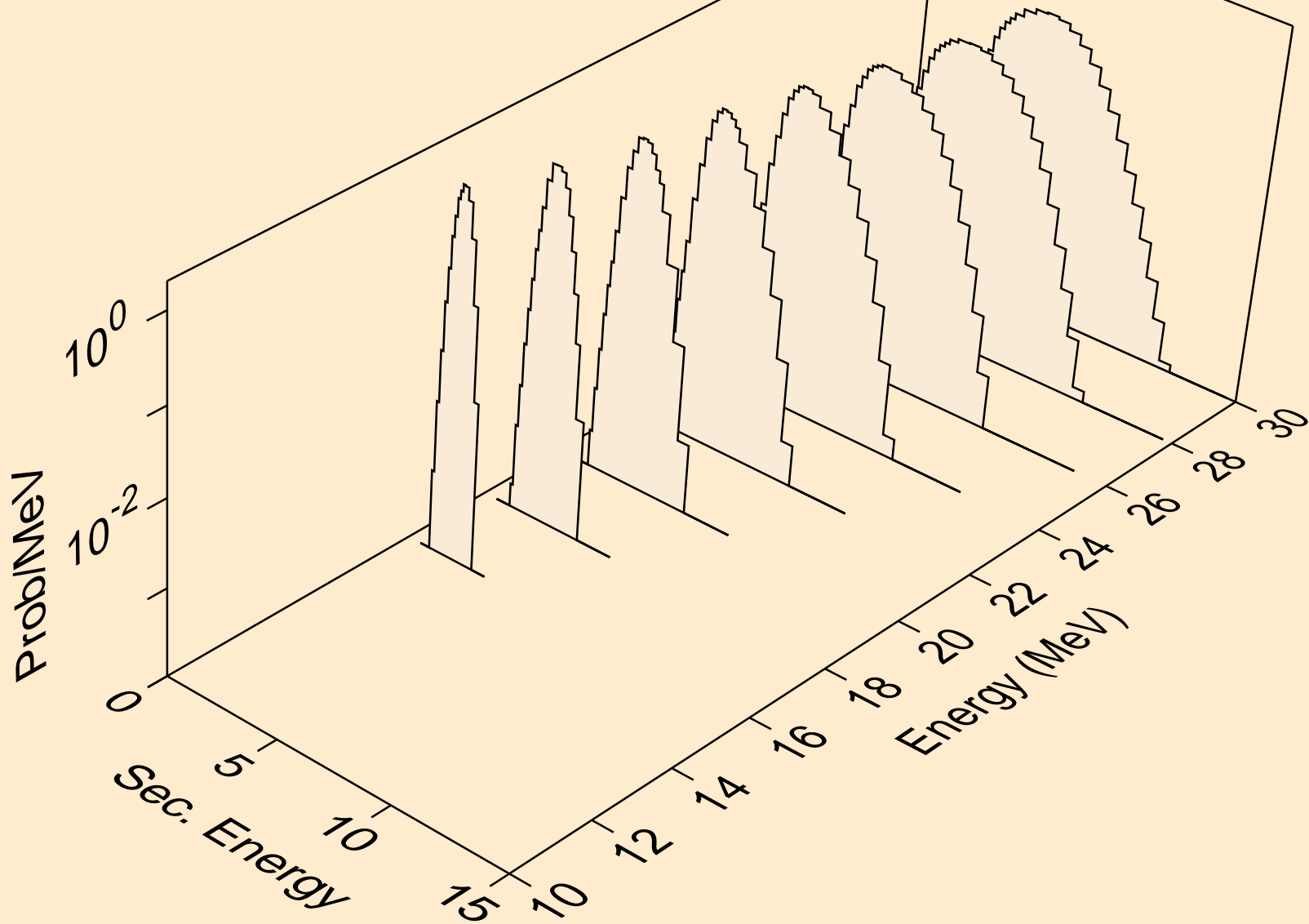

ND127 PHOTON ACER TENDL-2023 LIBRARY; T=0.K
protons from (g,pt)

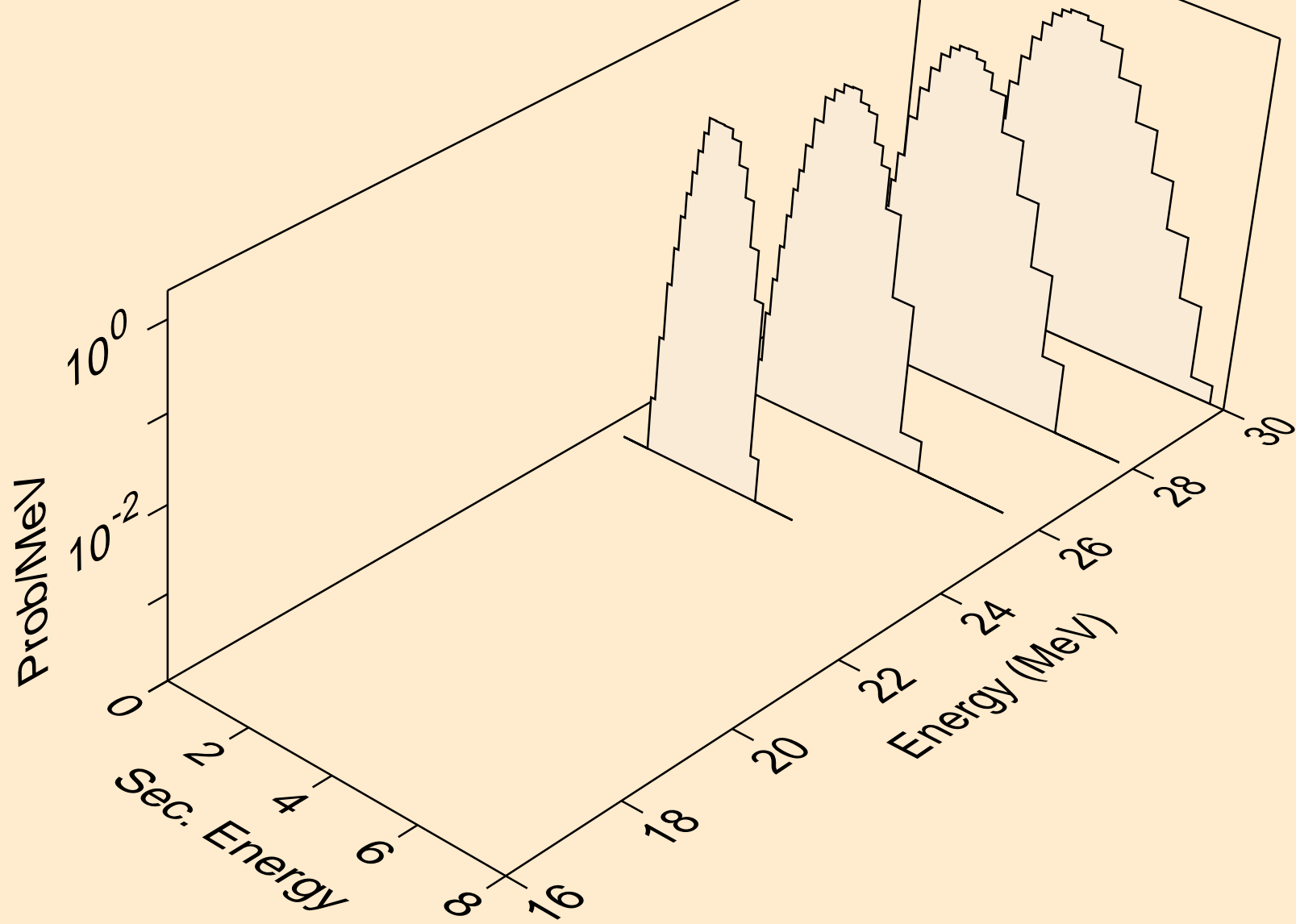

ND127 PHOTON ACER TENDL-2023 LIBRARY; T=0.K
deuterons from (g,x)

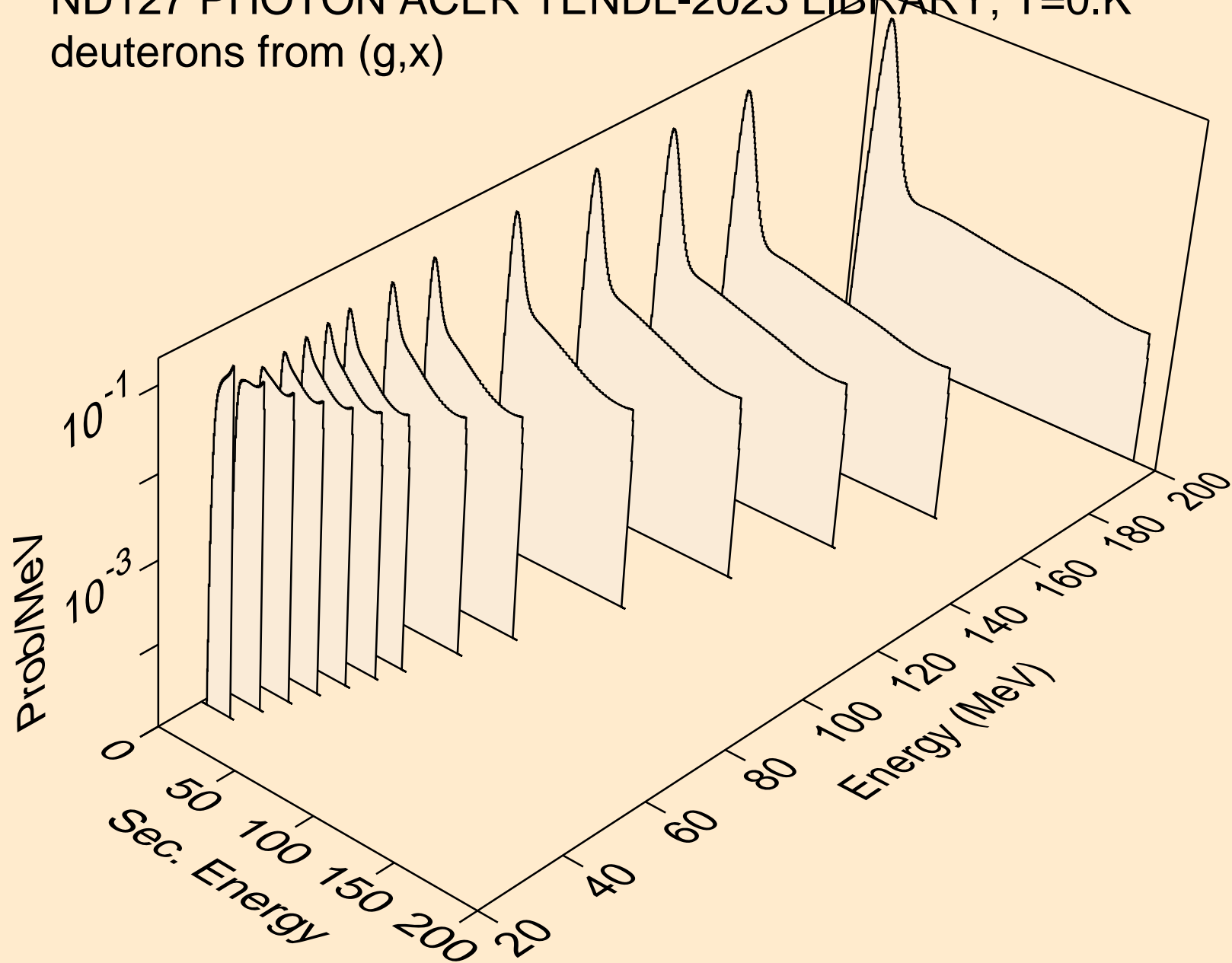

ND127 PHOTON ACER TENDL-2023 LIBRARY; T=0.K
deuterons from (g,d)

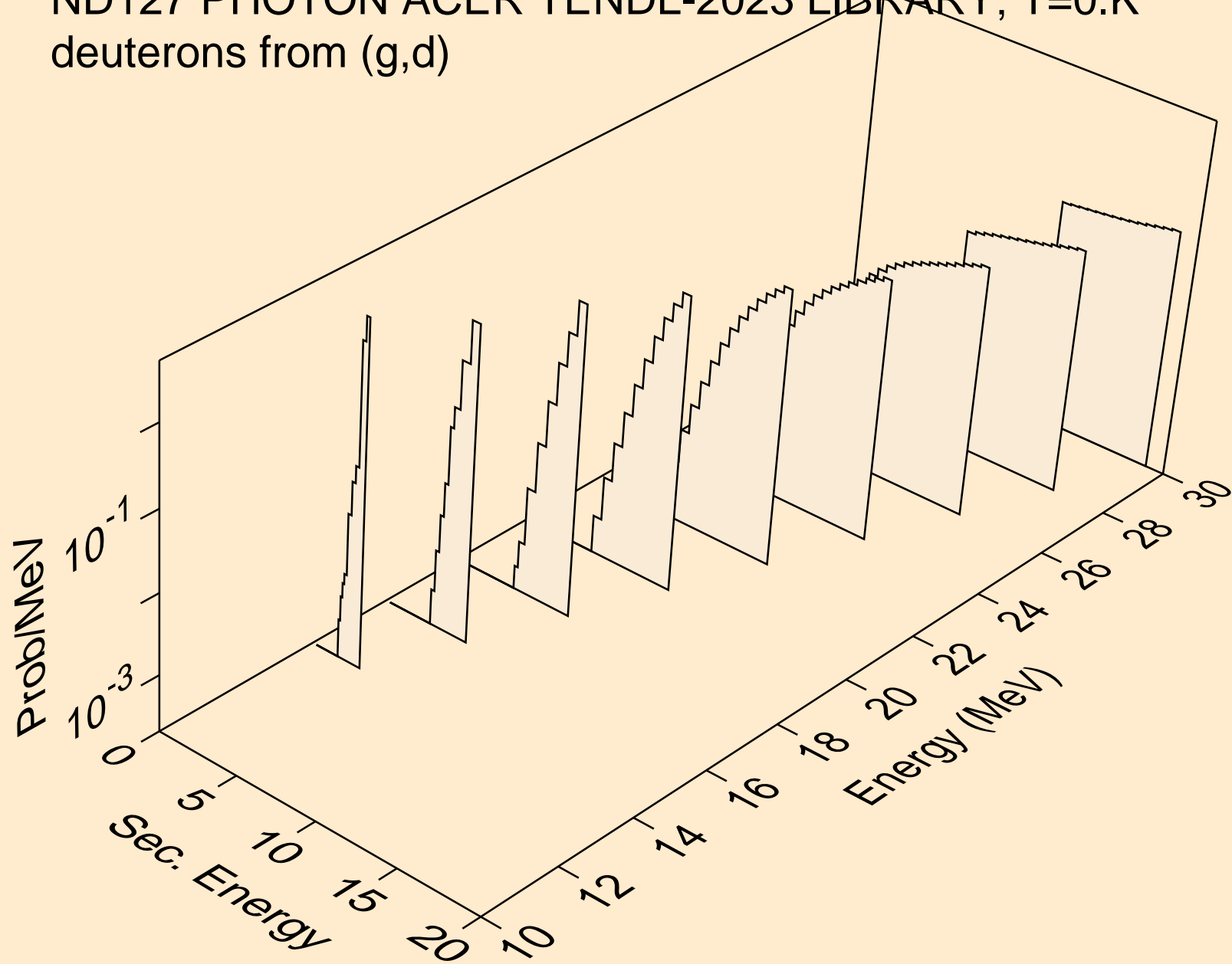

ND127 PHOTON ACER TENDL-2023 LIBRARY; T=0.K
deuterons from (g,pd)

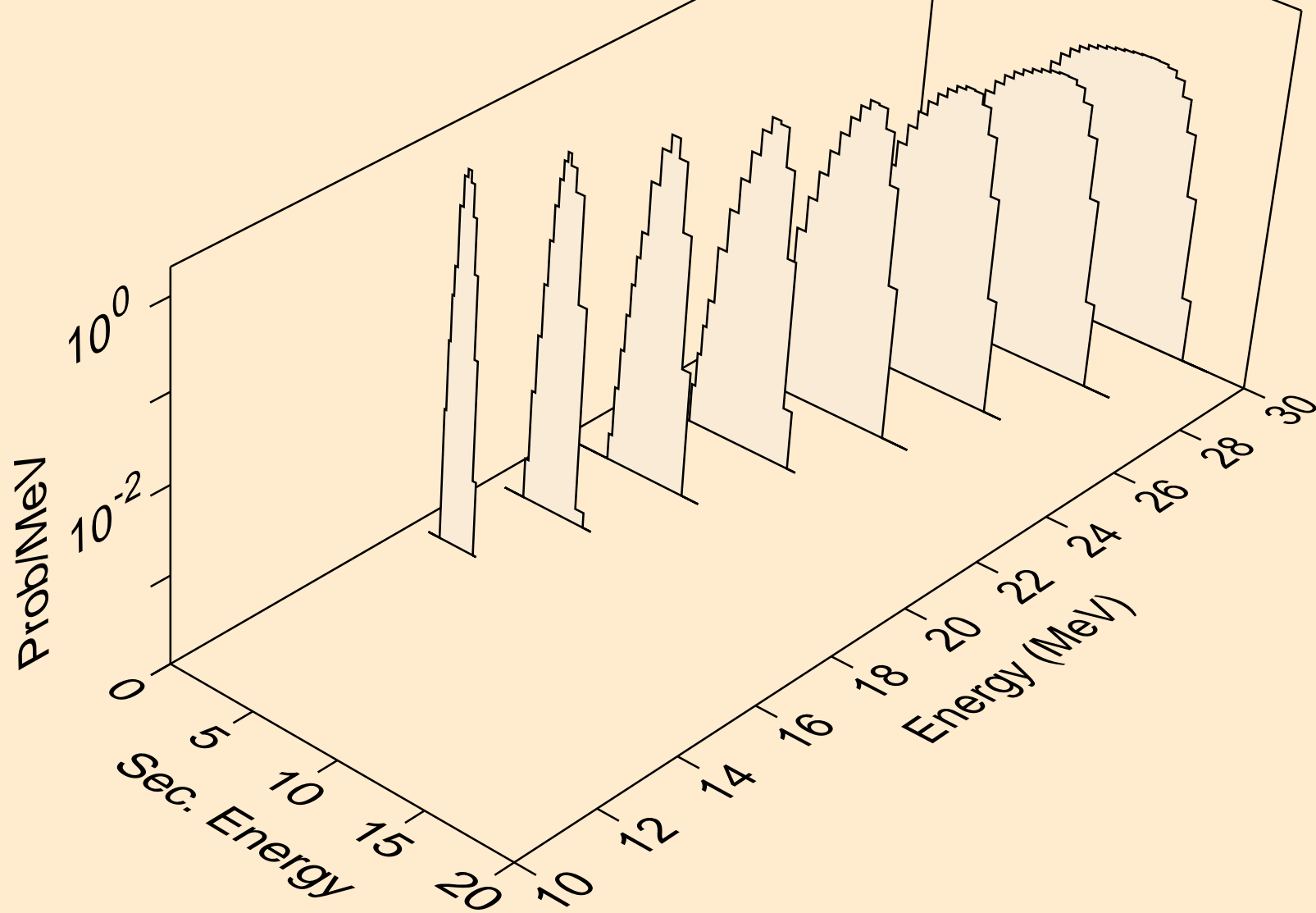

ND127 PHOTON ACER TENDL-2023 LIBRARY; T=0.K
deuterons from (g,da)

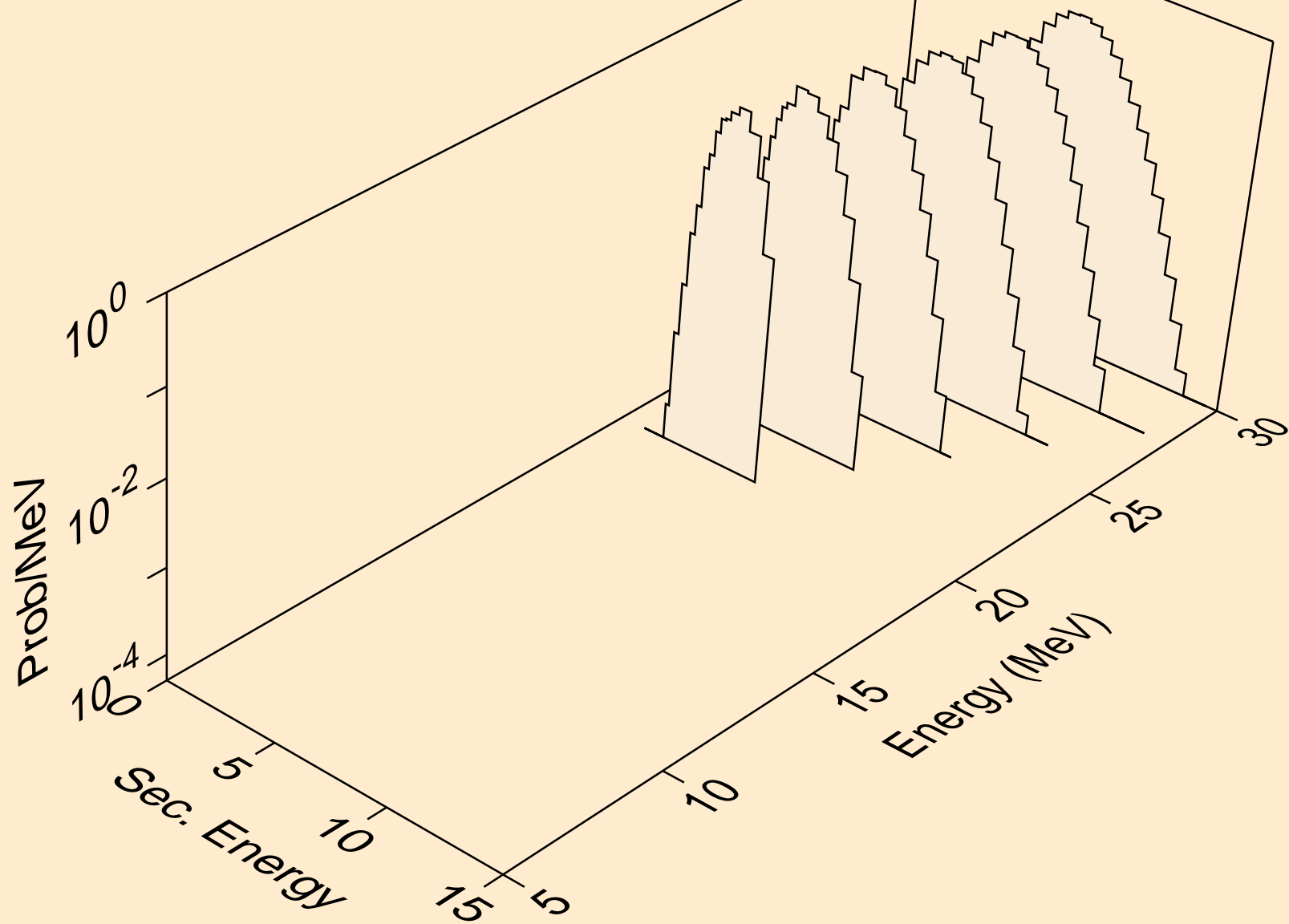

ND127 PHOTON ACER TENDL-2023 LIBRARY; T=0.K
tritons from (g,x)

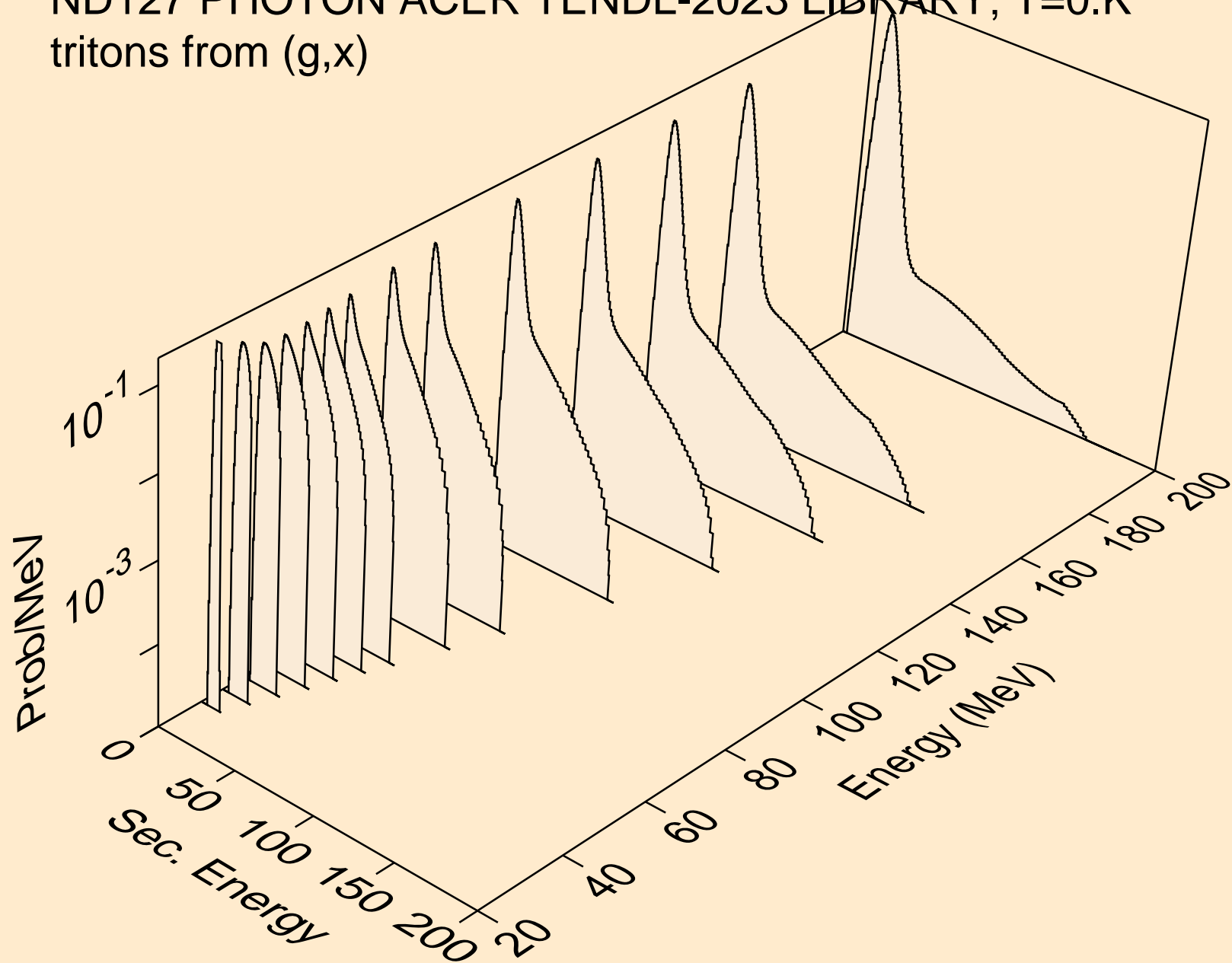

ND127 PHOTON ACER TENDL-2023 LIBRARY; T=0.K
tritons from (g,t)

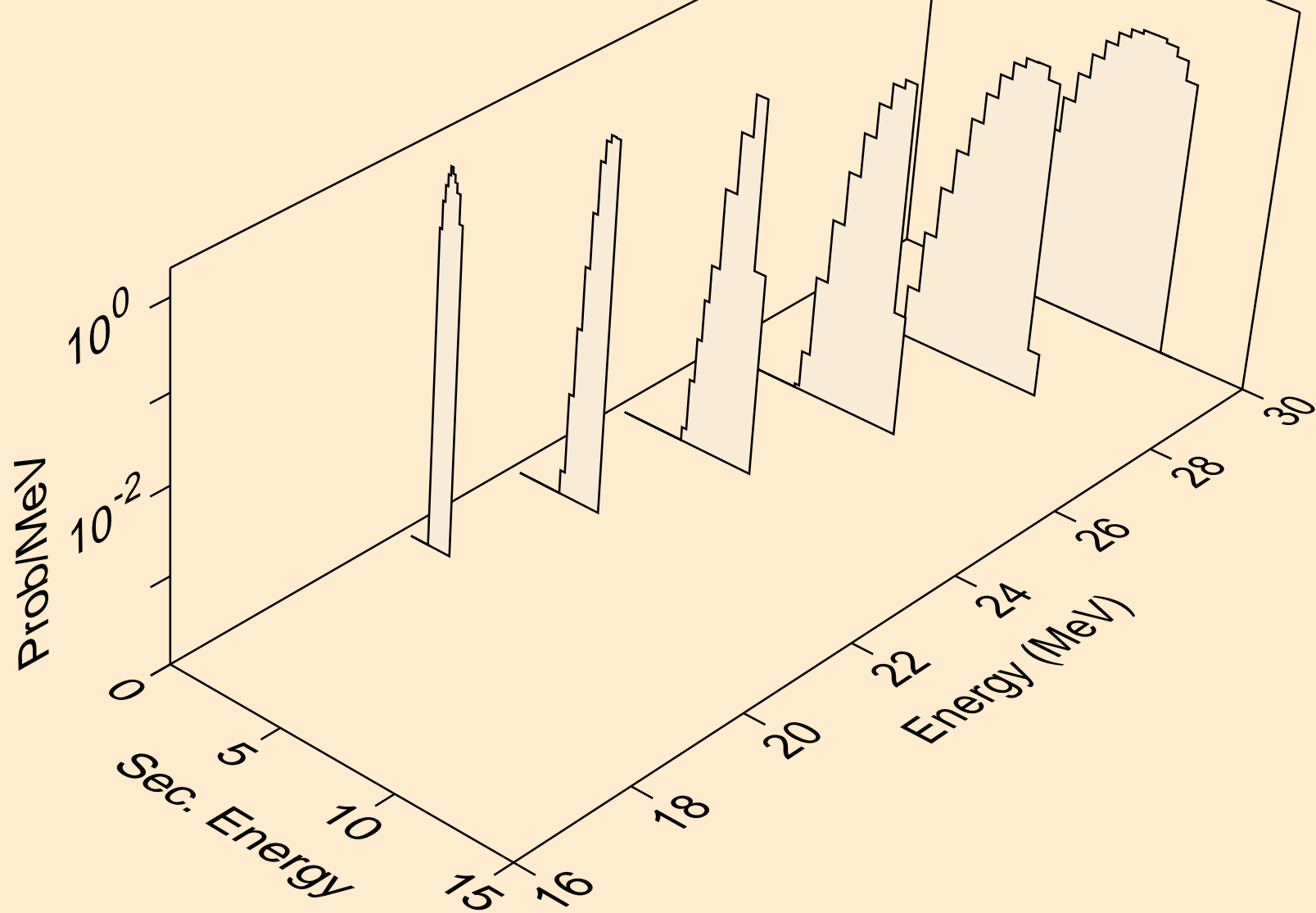

ND127 PHOTON ACER TENDL-2023 LIBRARY; T=0.K
tritons from (g,pt)

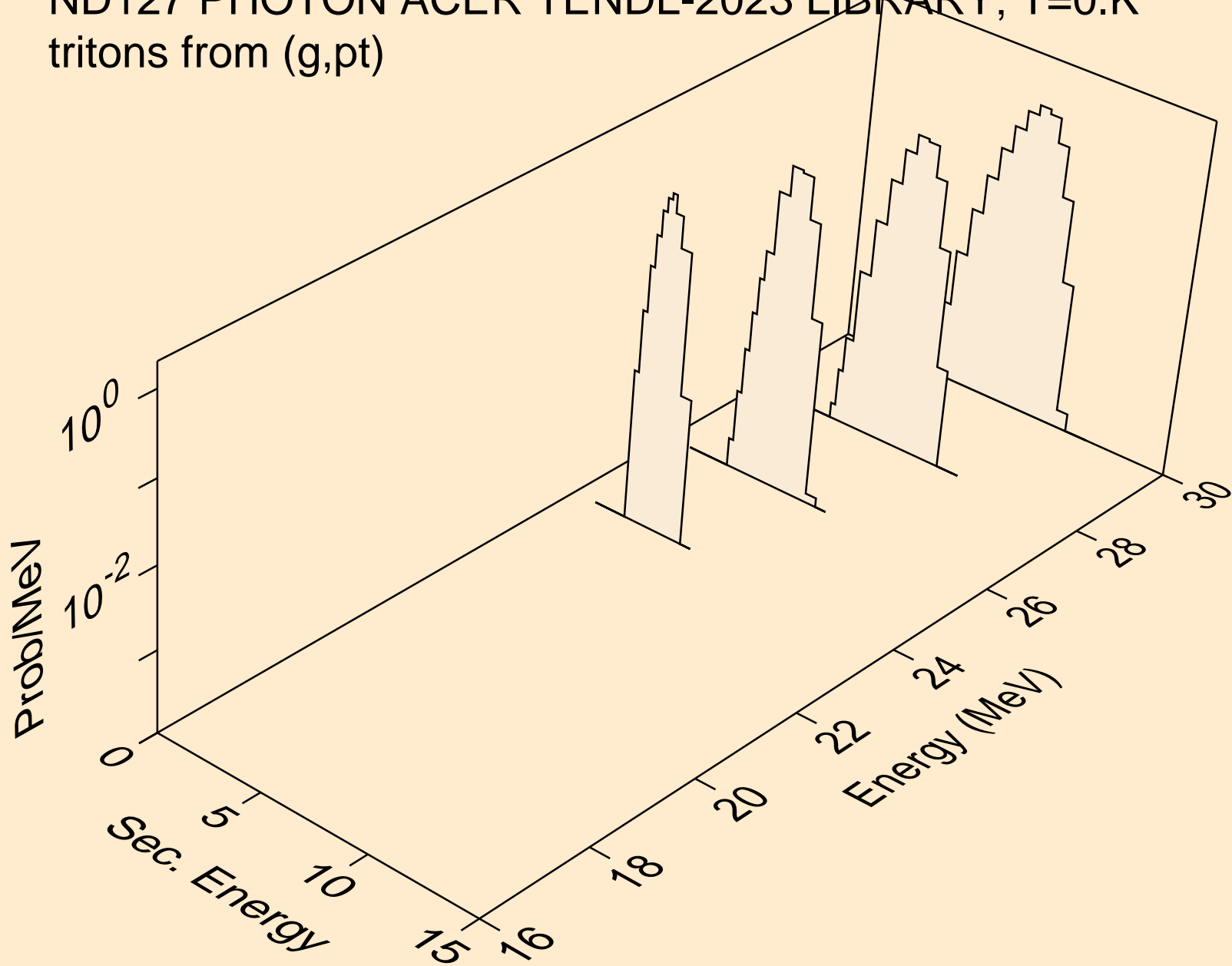

ND127 PHOTON ACER TENDL-2023 LIBRARY; T=0.K
he3s from (g,x)

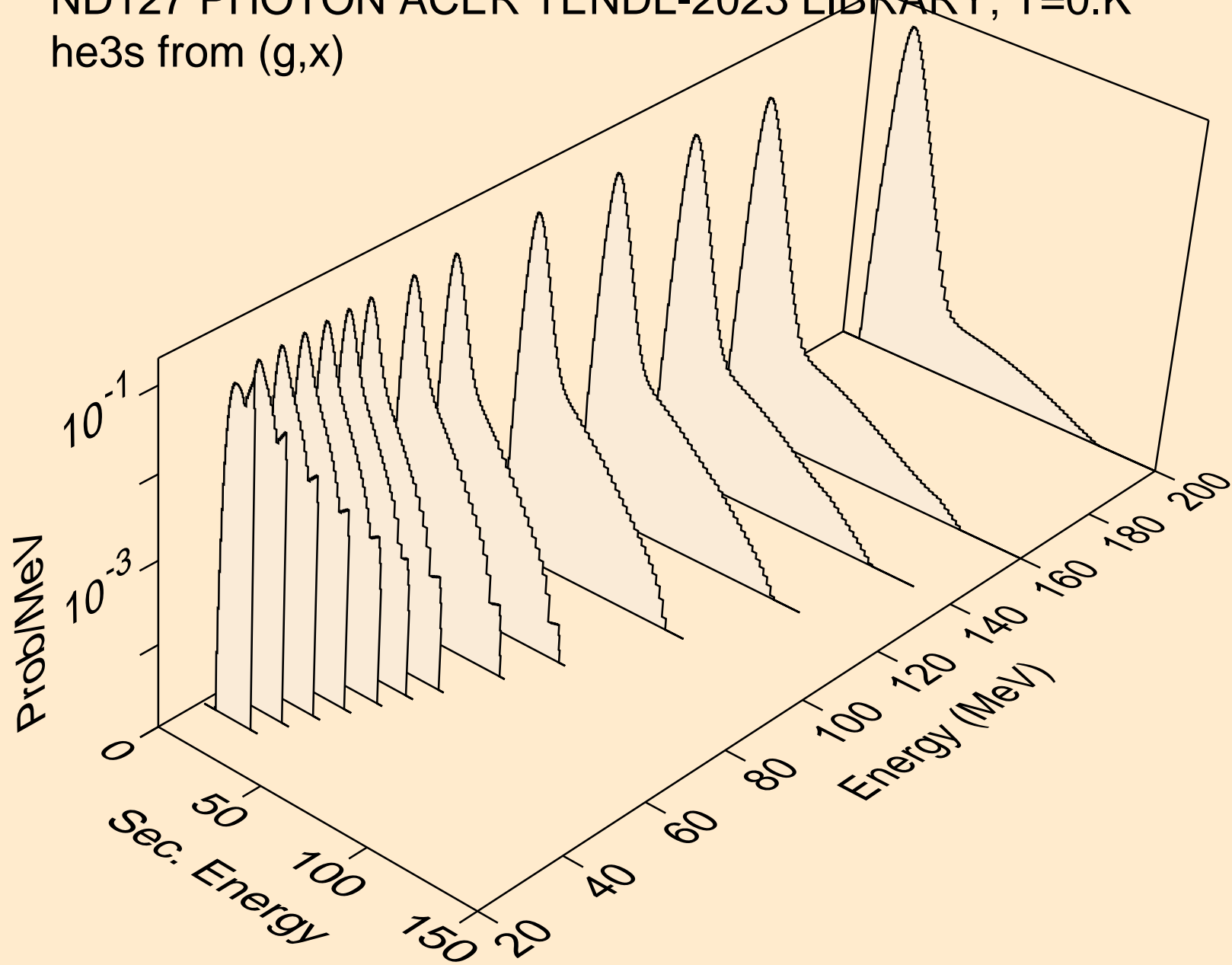

ND127 PHOTON ACER TENDL-2023 LIBRARY; T=0.K
he3s from (g,he3)

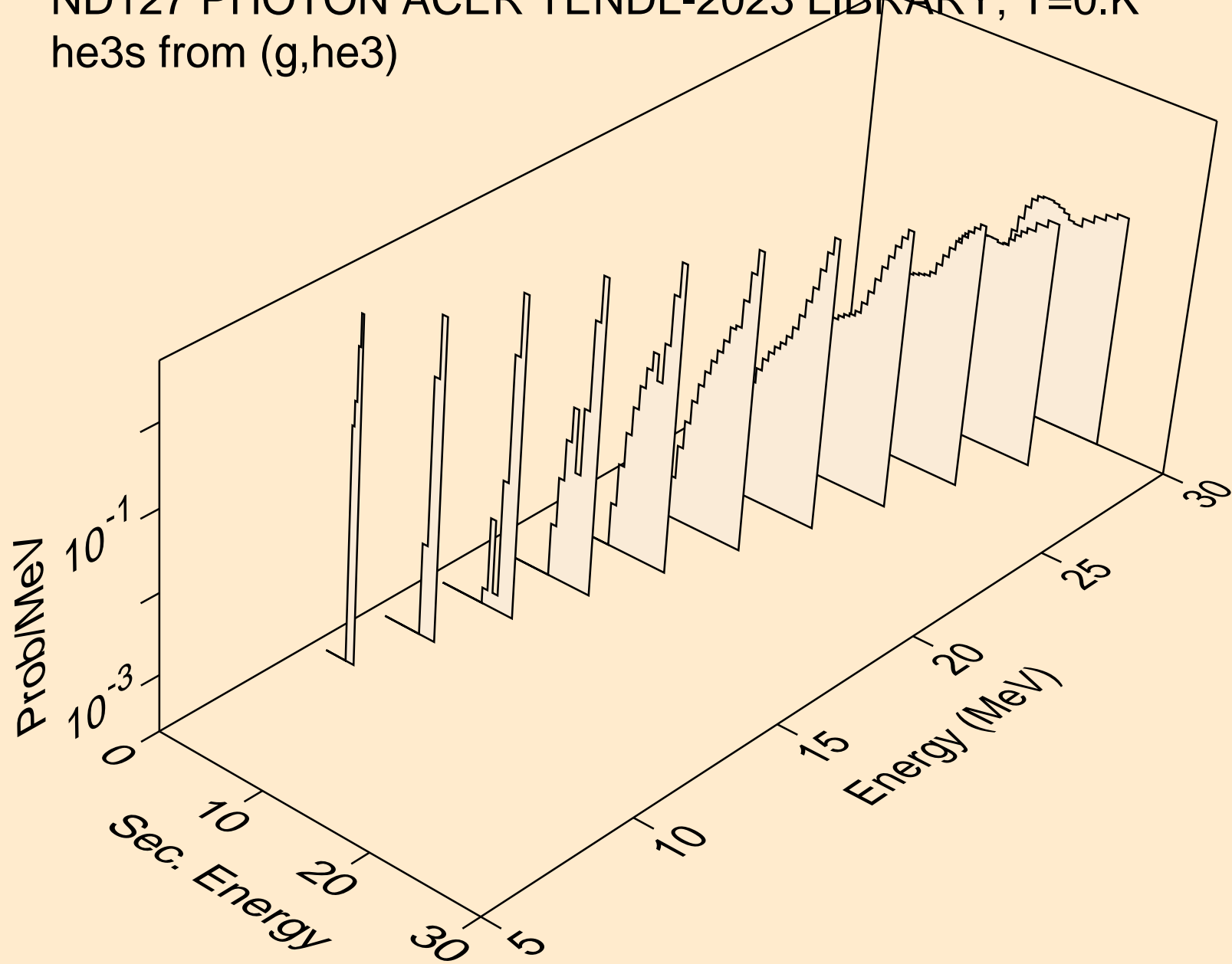

ND127 PHOTON ACER TENDL-2023 LIBRARY; T=0.K
alphas from (g,x)

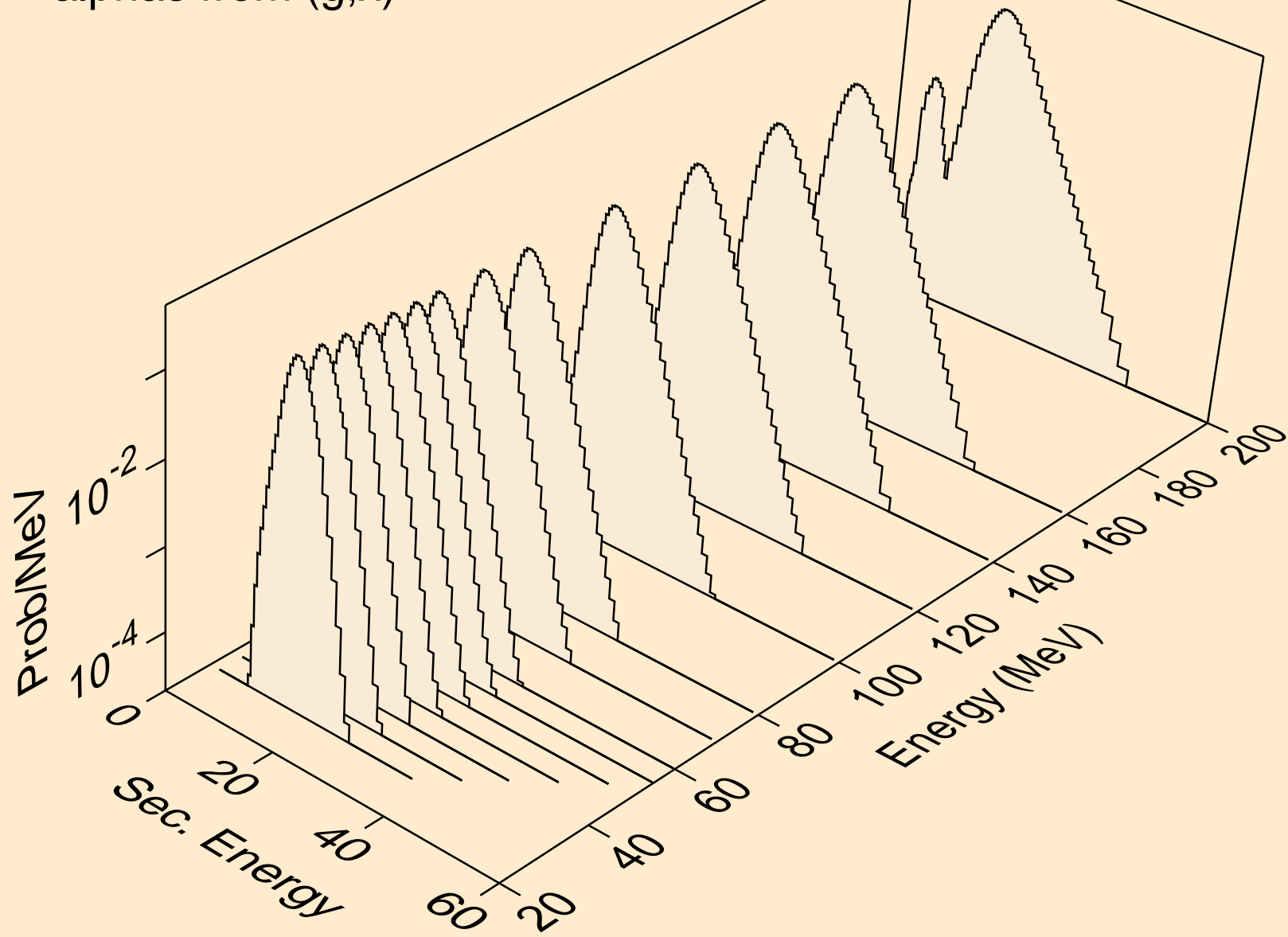

ND127 PHOTON ACER TENDL-2023 LIBRARY; T=0.K
alphas from (g,n*)a

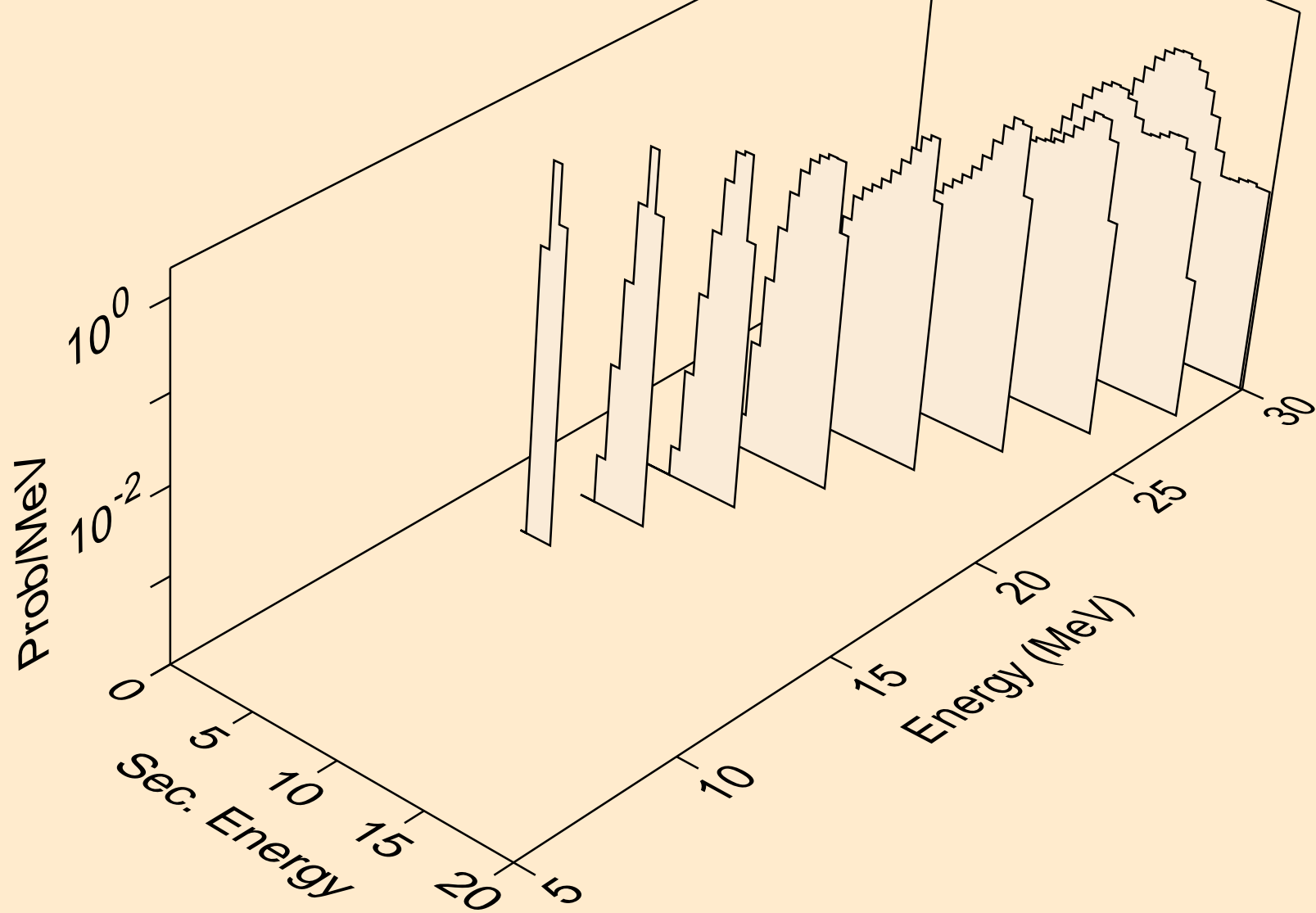

ND127 PHOTON ACER TENDL-2023 LIBRARY; T=0.K
alphas from (g,npa)

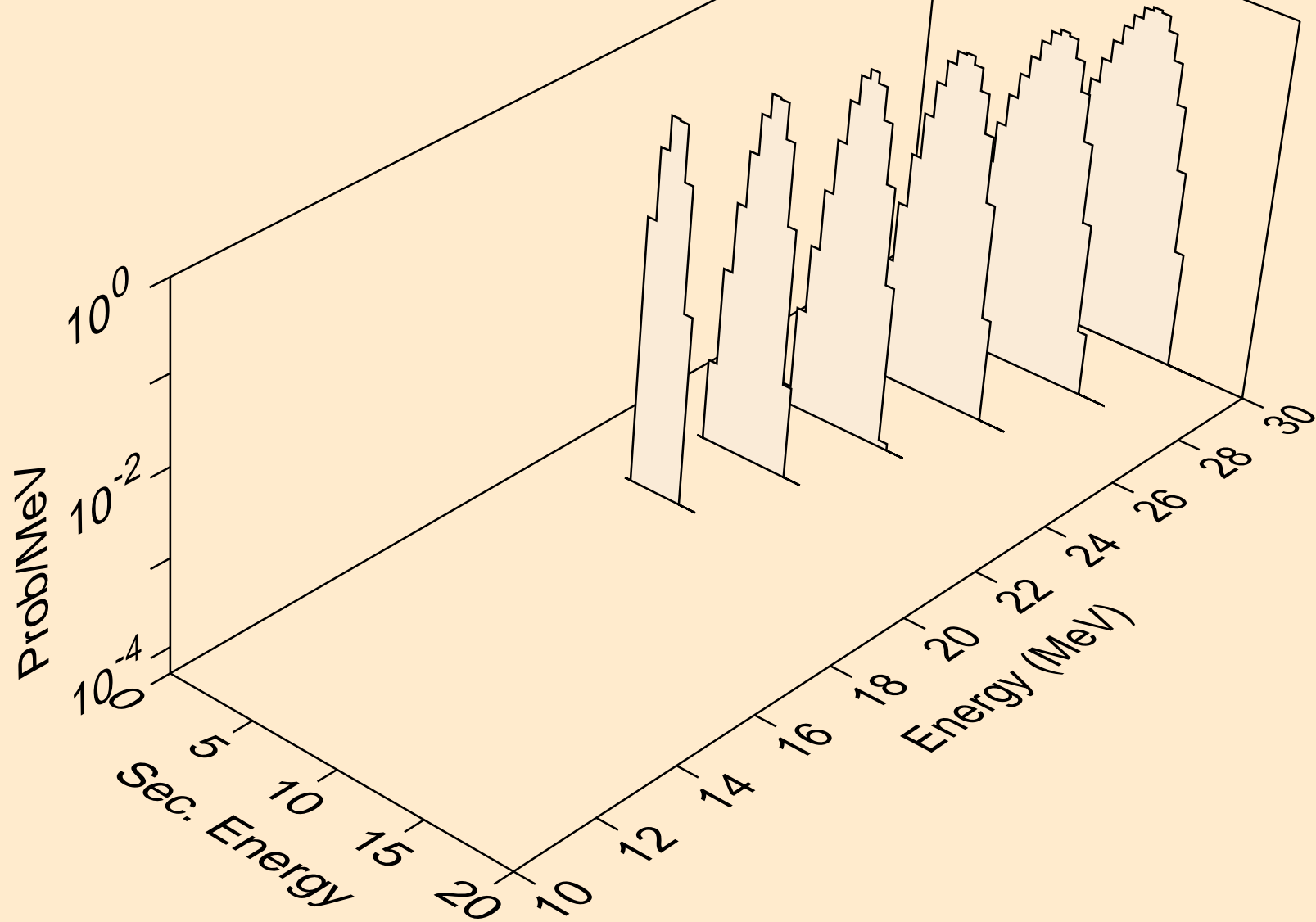

ND127 PHOTON ACER TENDL-2023 LIBRARY; T=0.K
alphas from (g,a)

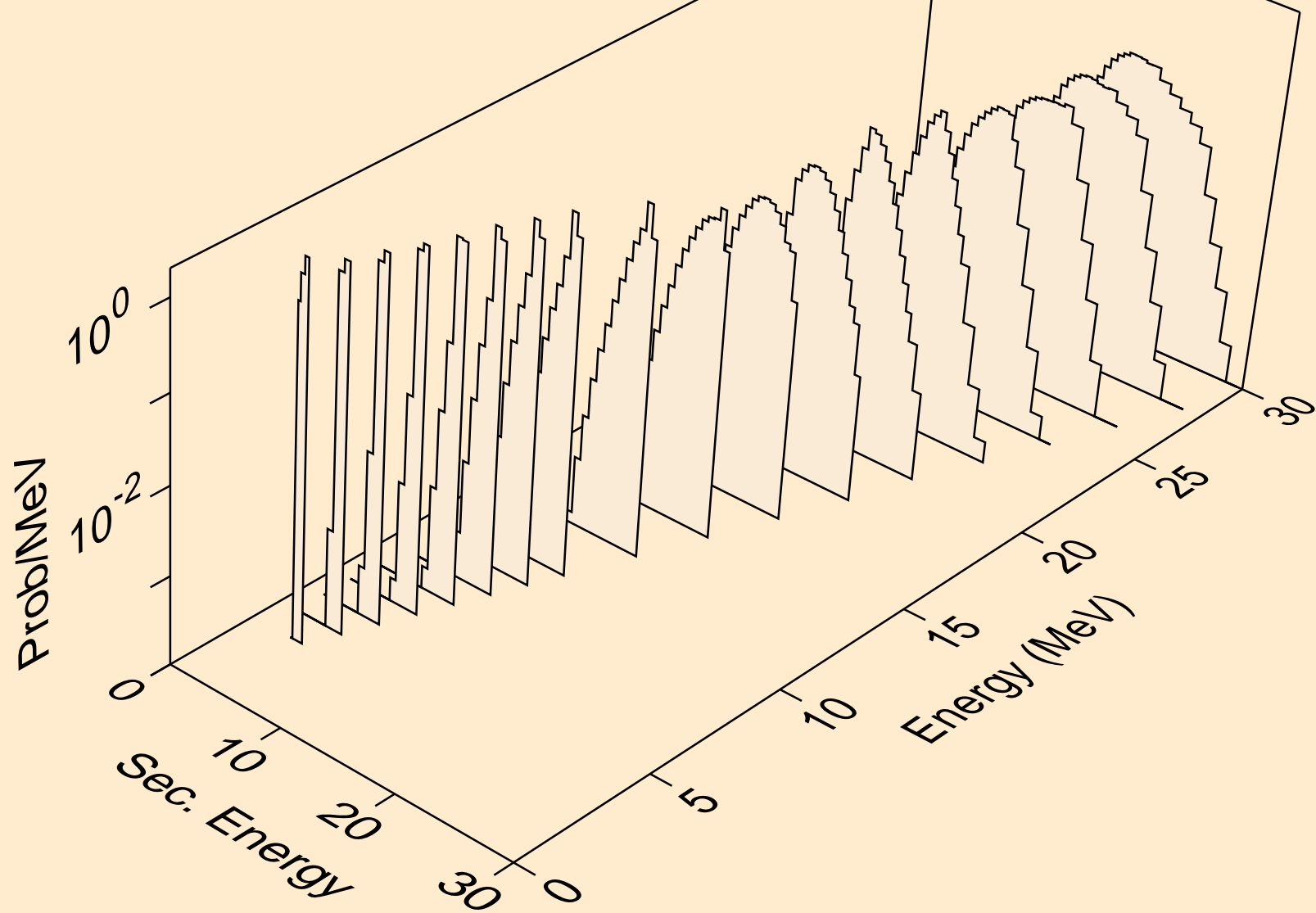

ND127 PHOTON ACER TENDL-2023 LIBRARY; T=0.K
alphas from (g,2a)

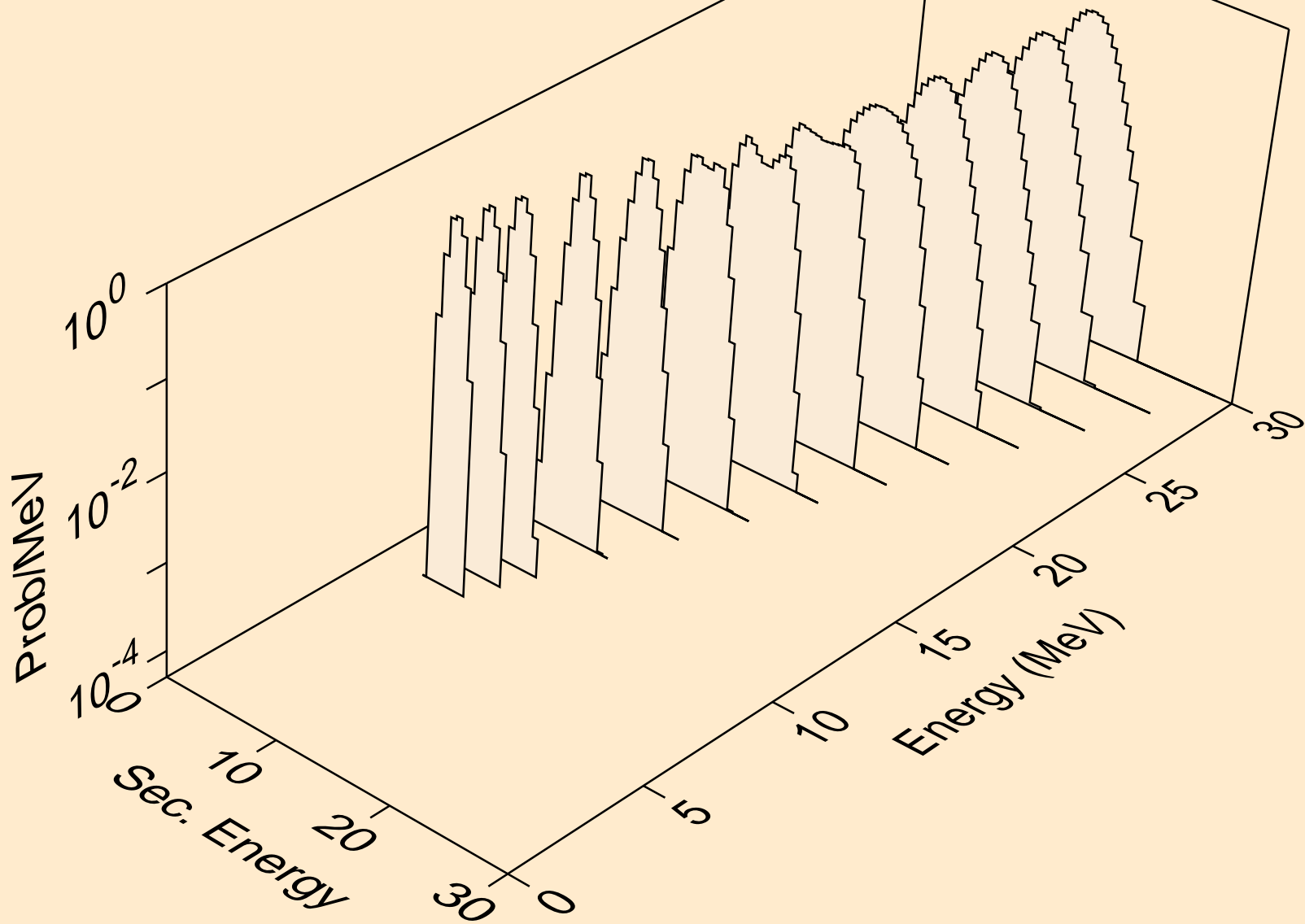

ND127 PHOTON ACER TENDL-2023 LIBRARY; T=0.K
alphas from (g,pa)

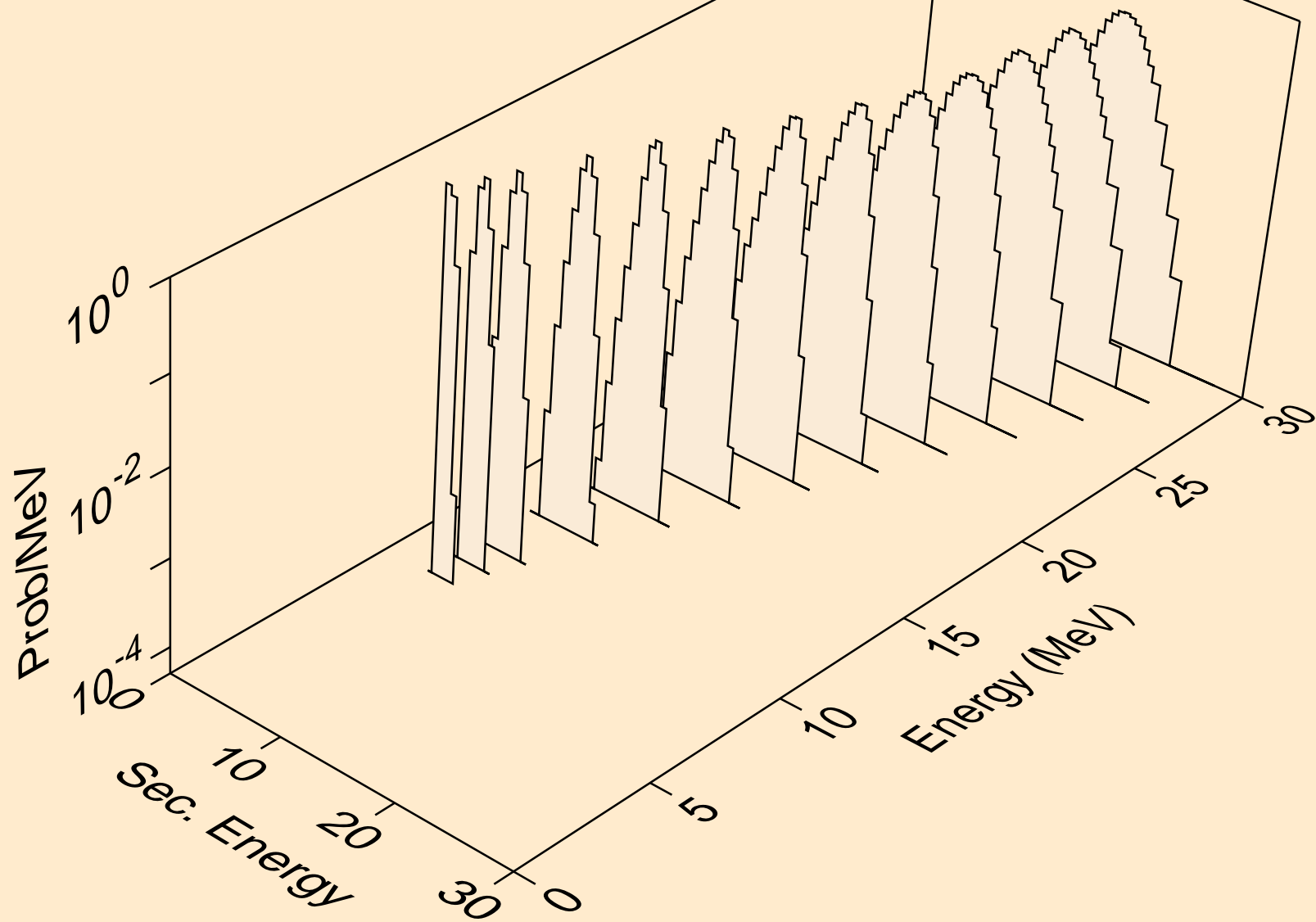

ND127 PHOTON ACER TENDL-2023 LIBRARY; T=0.K
alphas from (g,da)

