

NE022 PHOTON ACER TENDL-2023 LIBRARY; T=0.K
Principal cross sections

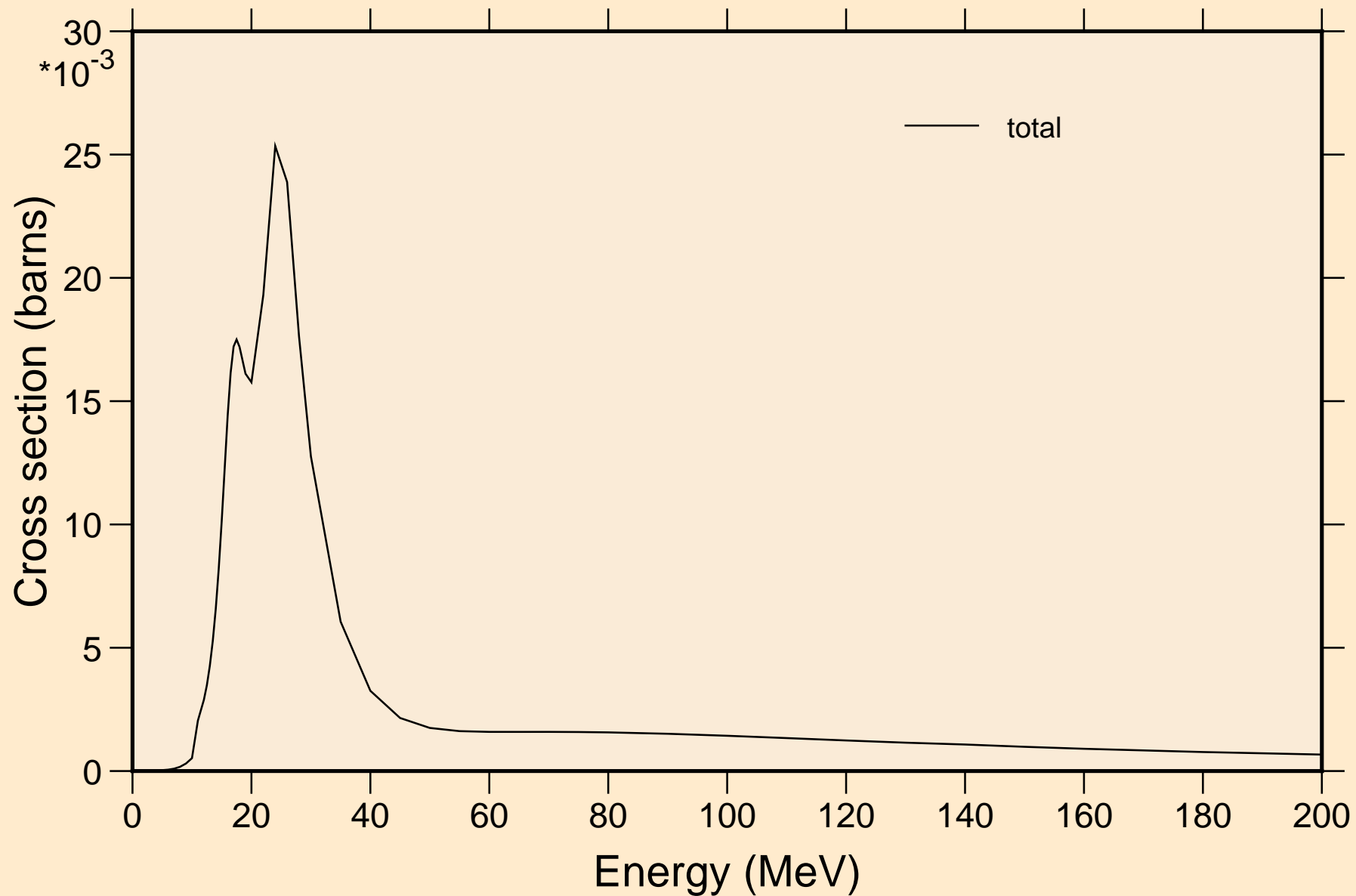

NE022 PHOTON ACER TENDL-2023 LIBRARY; T=0.K

Partial cross sections

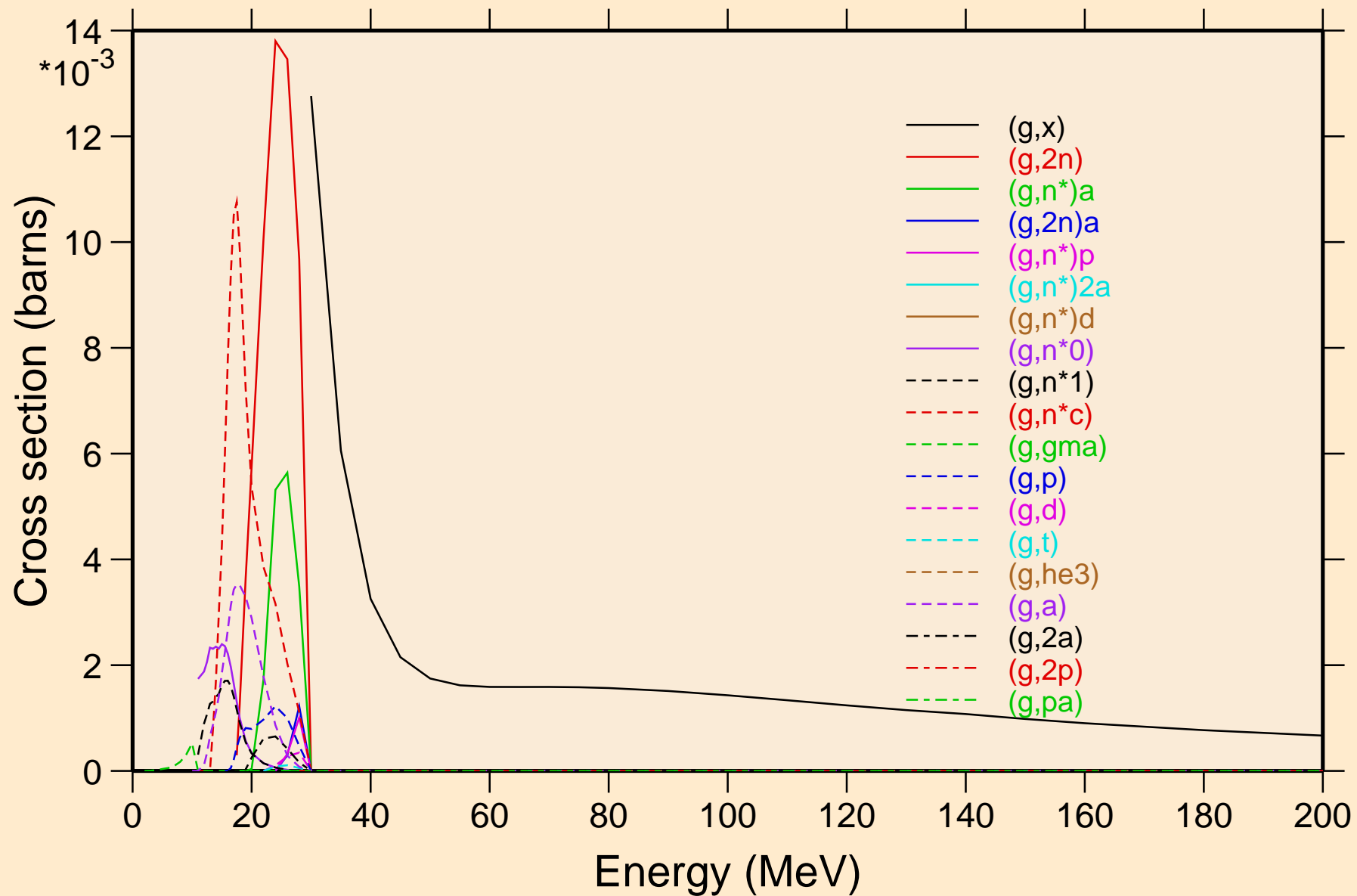

NE022 PHOTON ACER TENDL-2023 LIBRARY; T=0.K
Heating

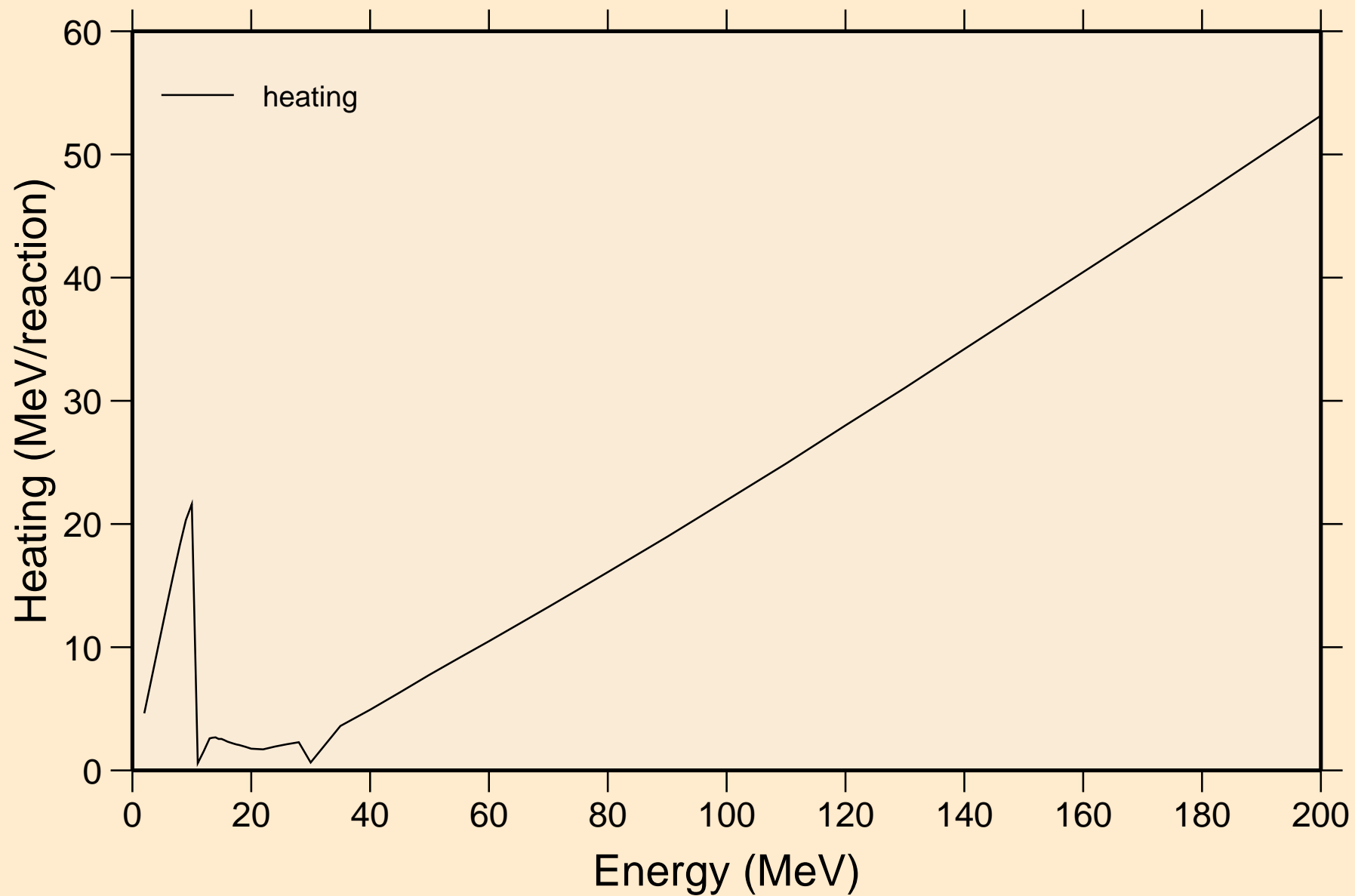

NE022 PHOTON ACER TENDL-2023 LIBRARY; T=0.K

Particle heating contributions

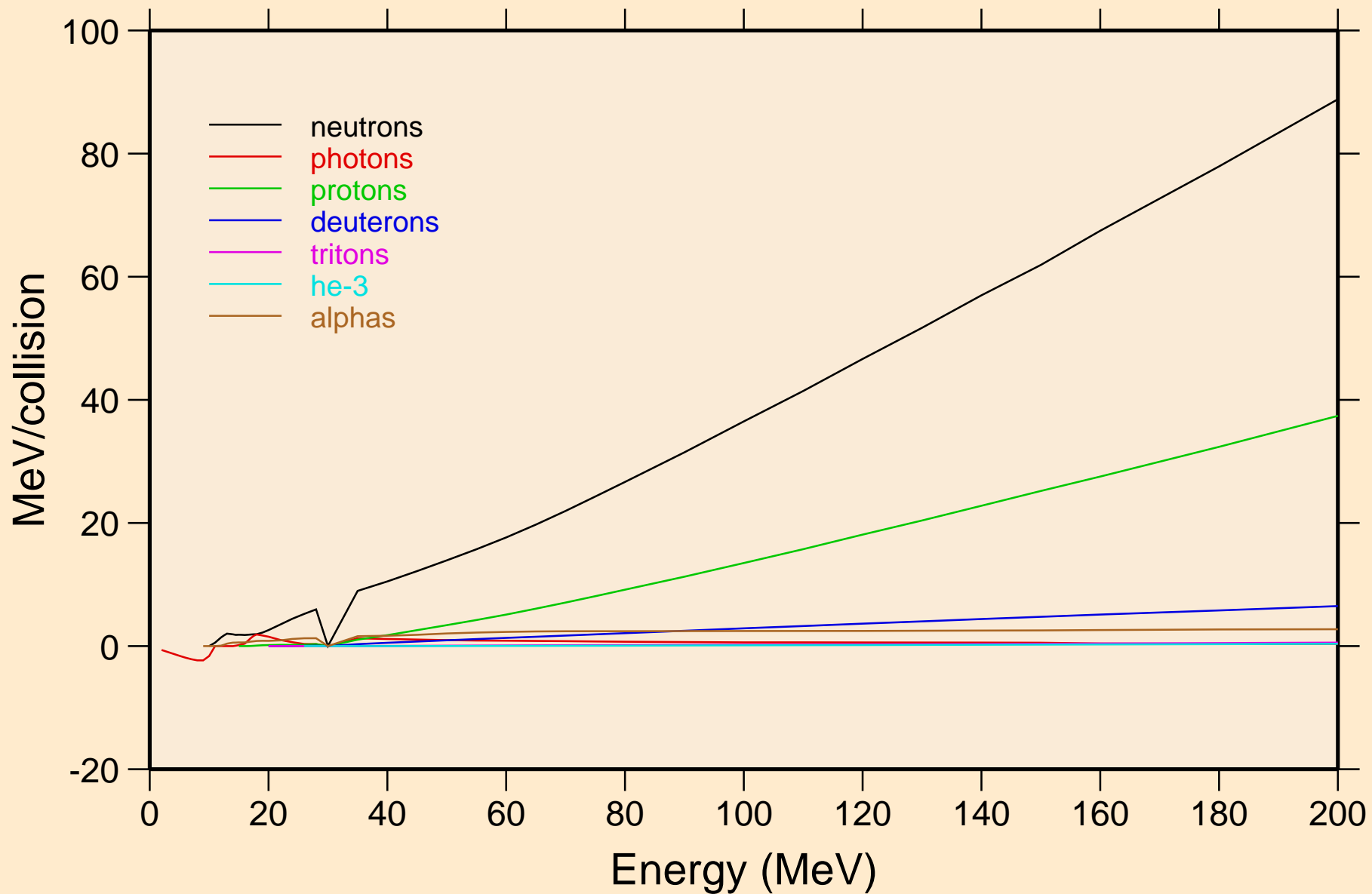

NE022 PHOTON ACER TENDL-2023 LIBRARY; T=0.K

Particle production cross sections

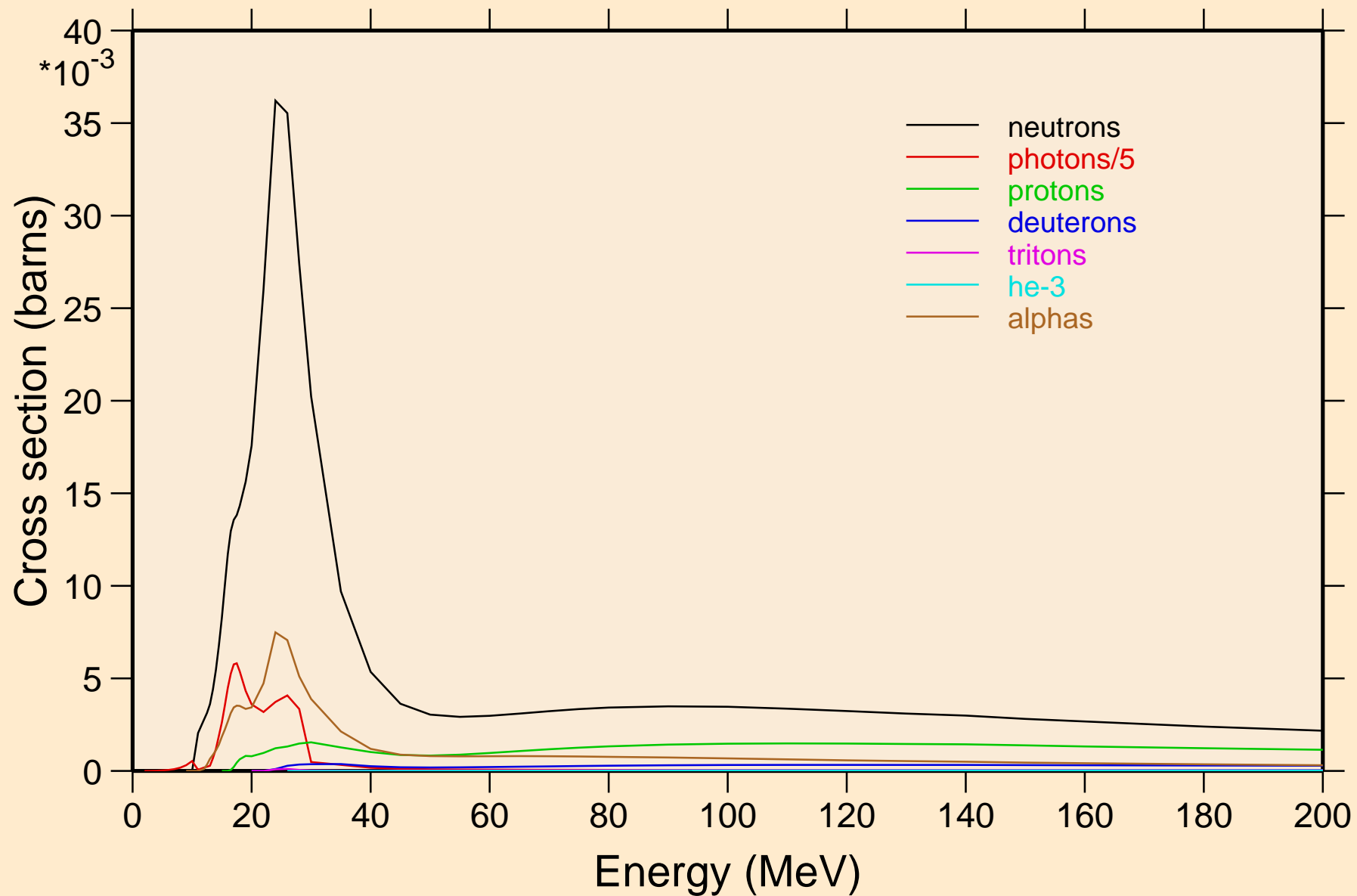

NE022 PHOTON ACER TENDL-2023 LIBRARY; T=0.K
neutrons from (g,x)

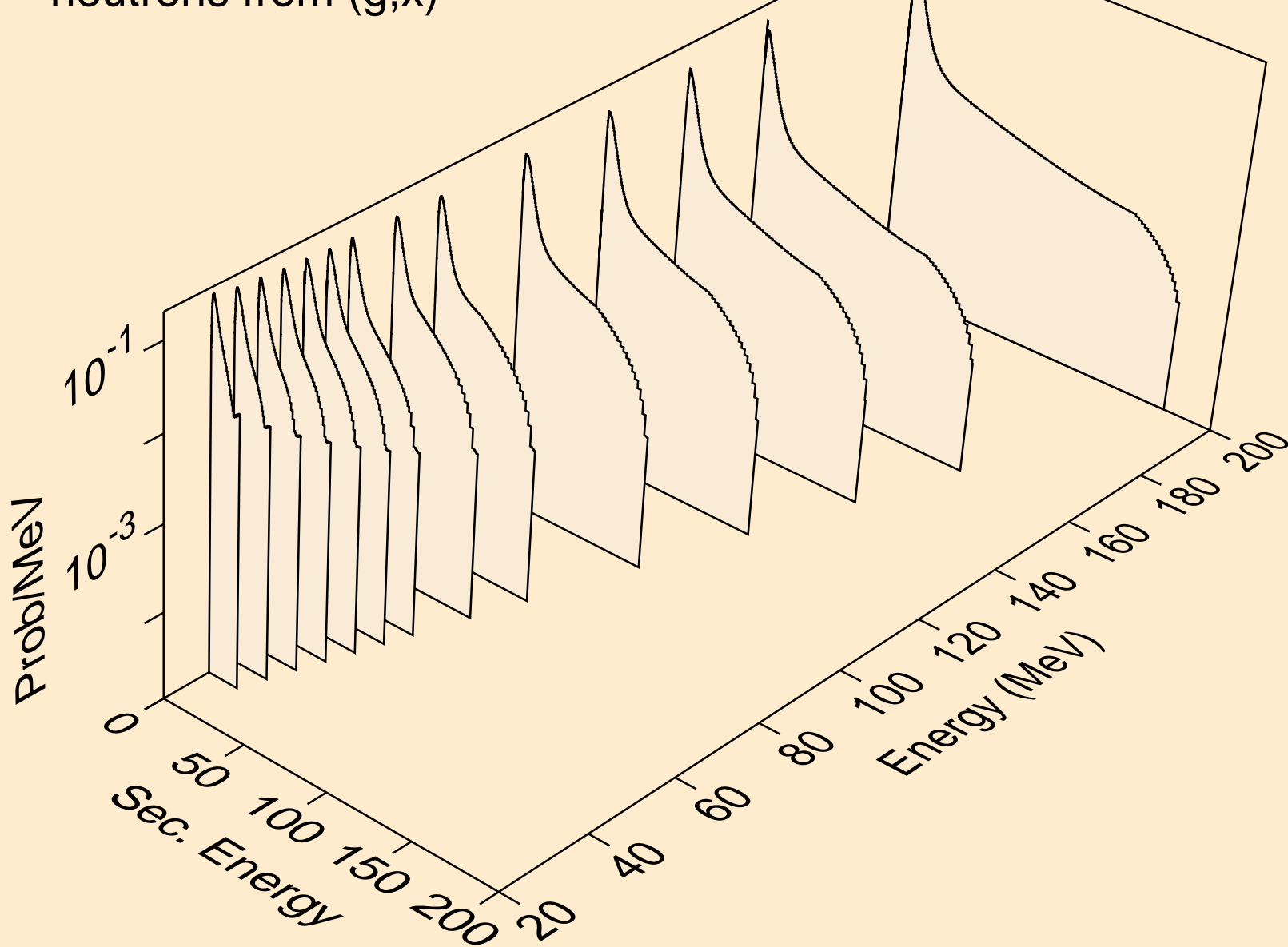

NE022 PHOTON ACER TENDL-2023 LIBRARY; T=0.K
neutrons from (g,2n)

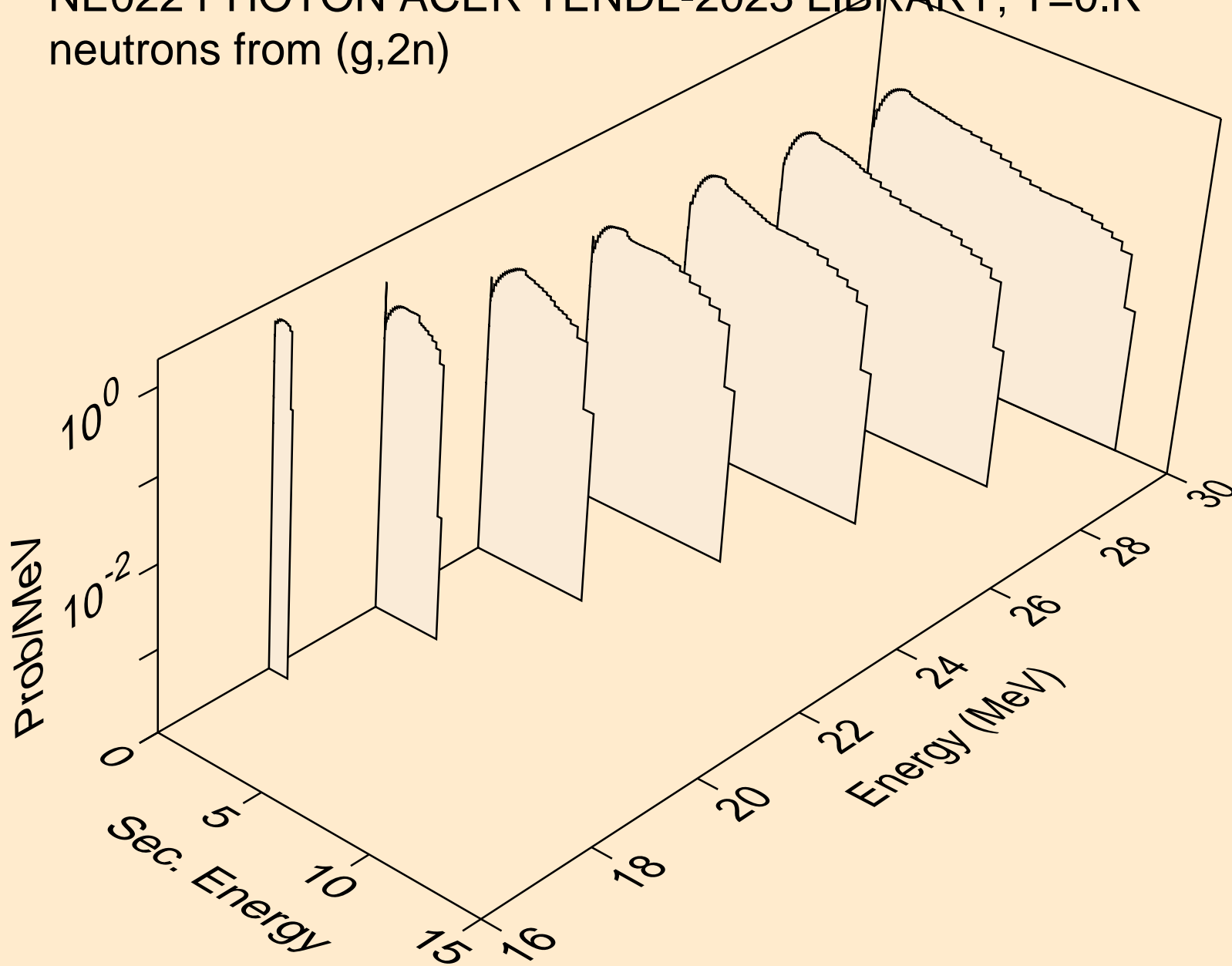

NE022 PHOTON ACER TENDL-2023 LIBRARY; T=0.K
neutrons from (g,n*)a

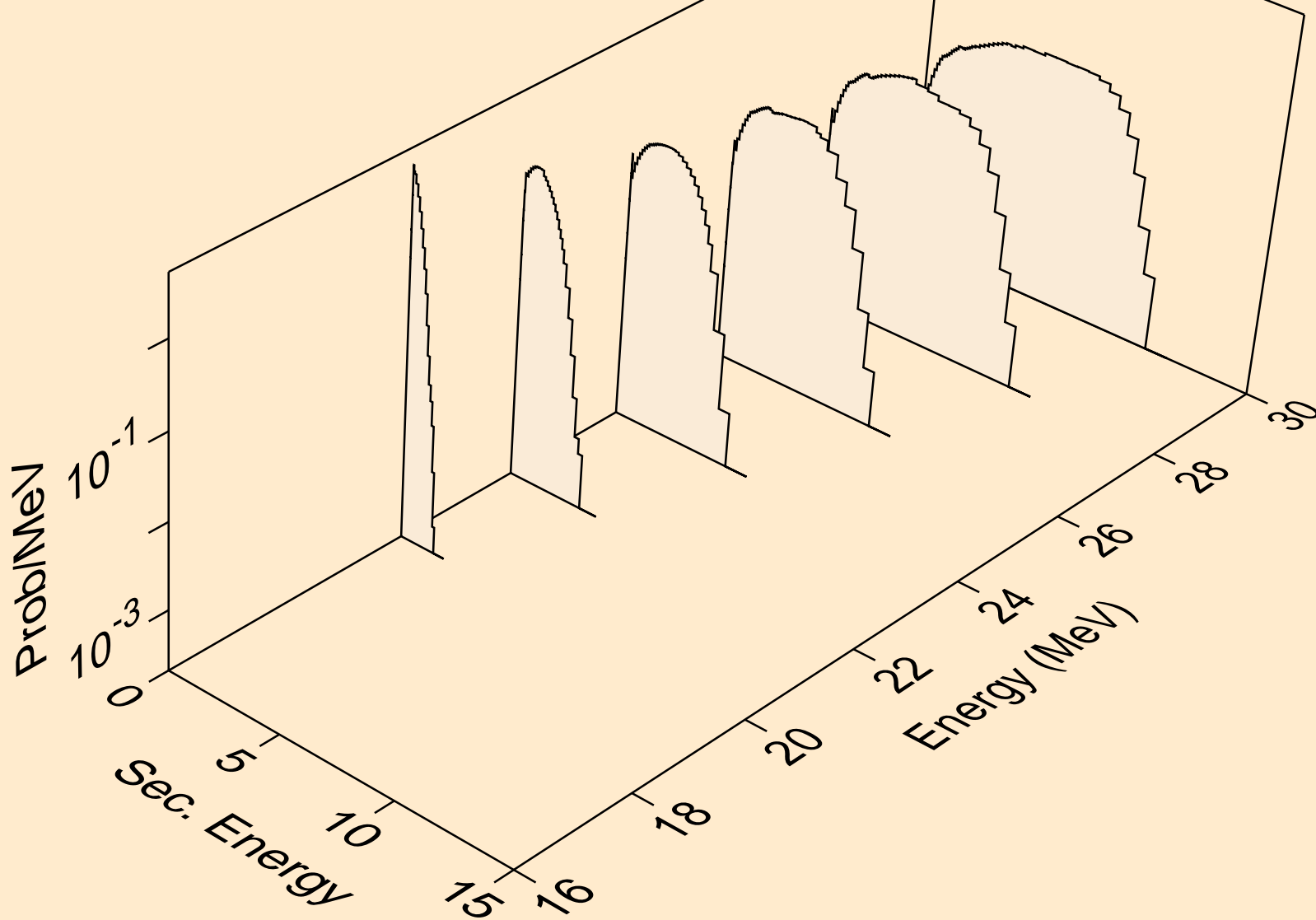

NE022 PHOTON ACER TENDL-2023 LIBRARY; T=0.K
neutrons from (g,2n)a

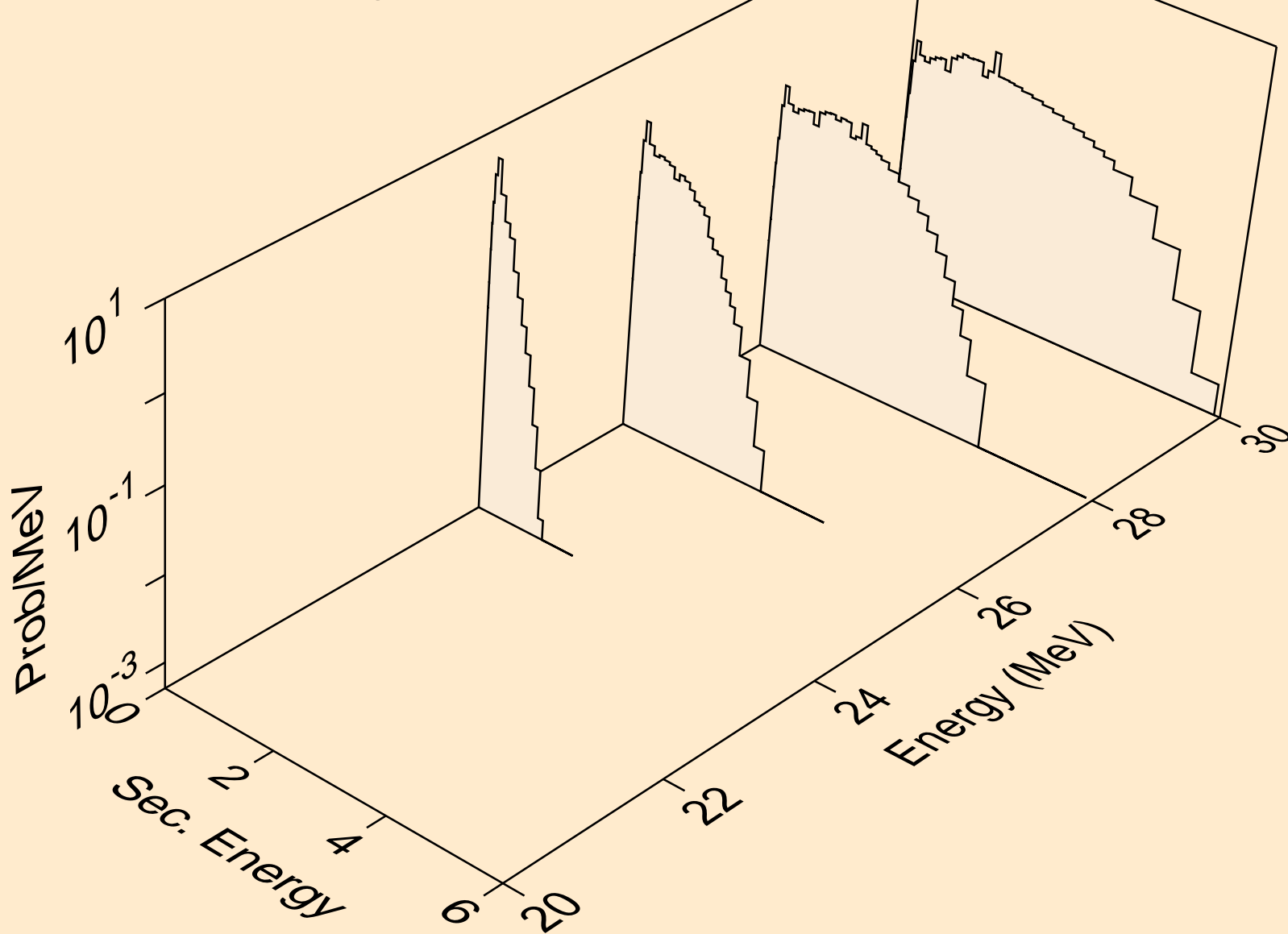

NE022 PHOTON ACER TENDL-2023 LIBRARY; T=0.K
neutrons from (g,n*)p

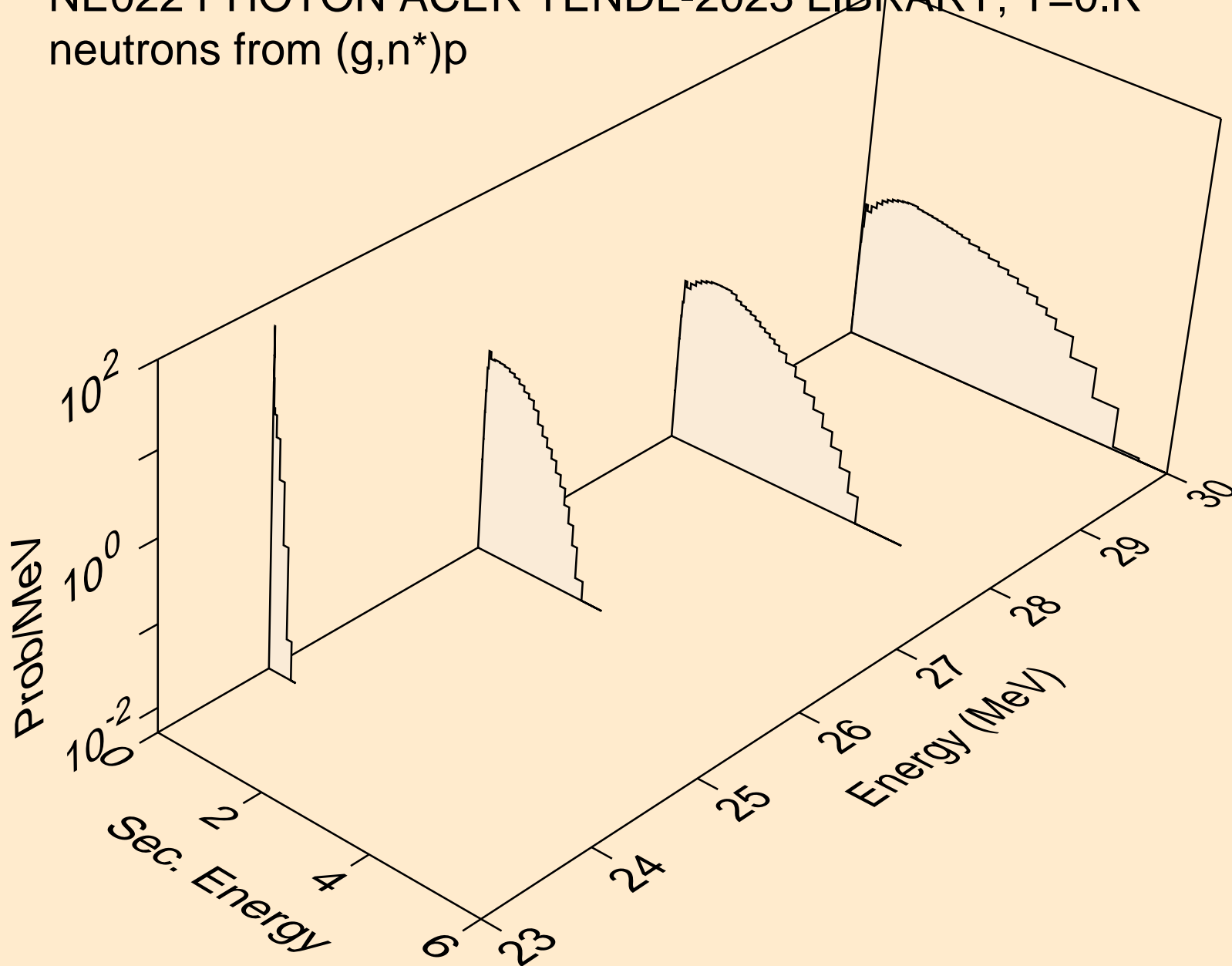

NE022 PHOTON ACER TENDL-2023 LIBRARY; T=0.K
neutrons from (g,n*)2a

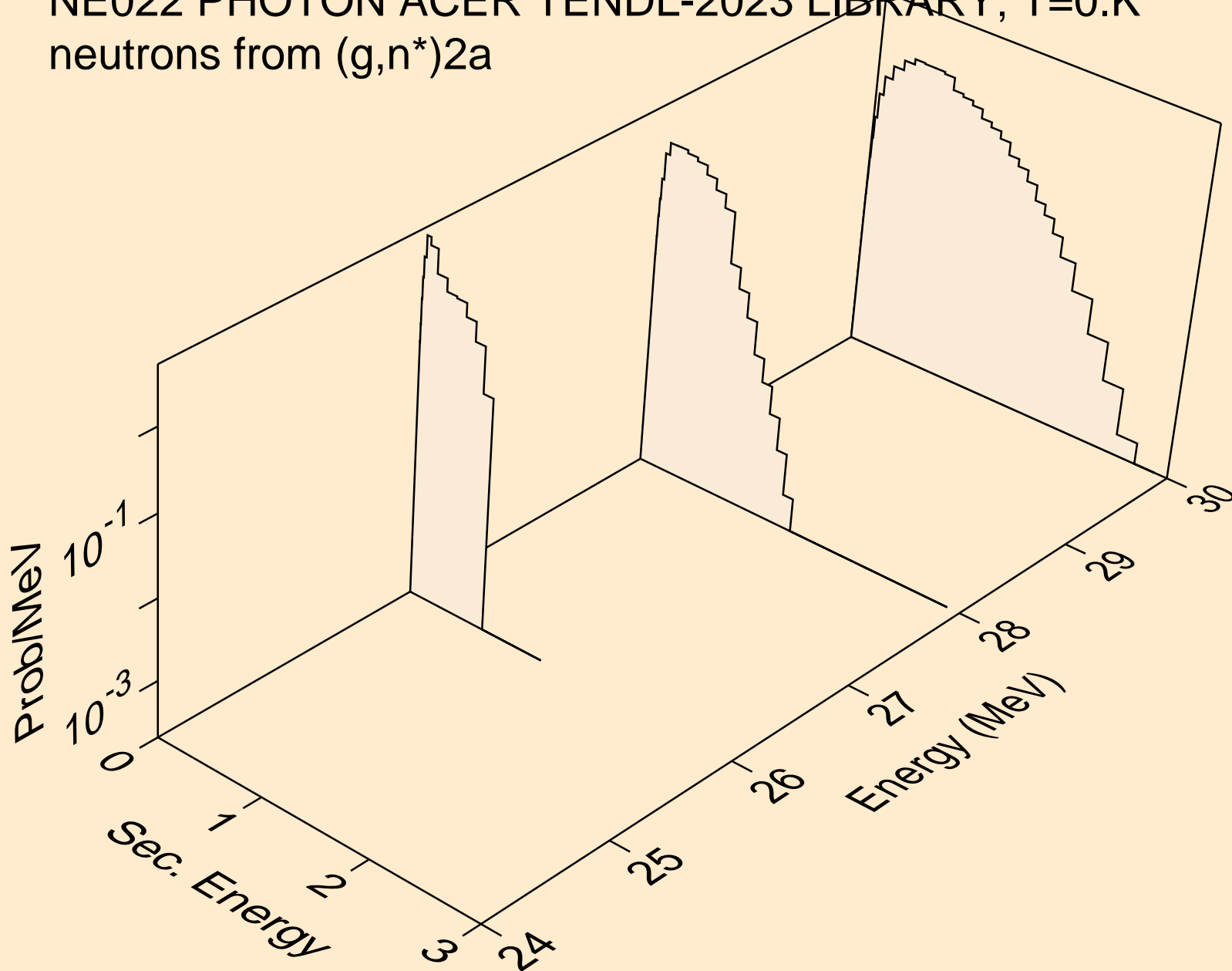

NE022 PHOTON ACER TENDL-2023 LIBRARY; T=0.K
neutrons from (g,n*)d

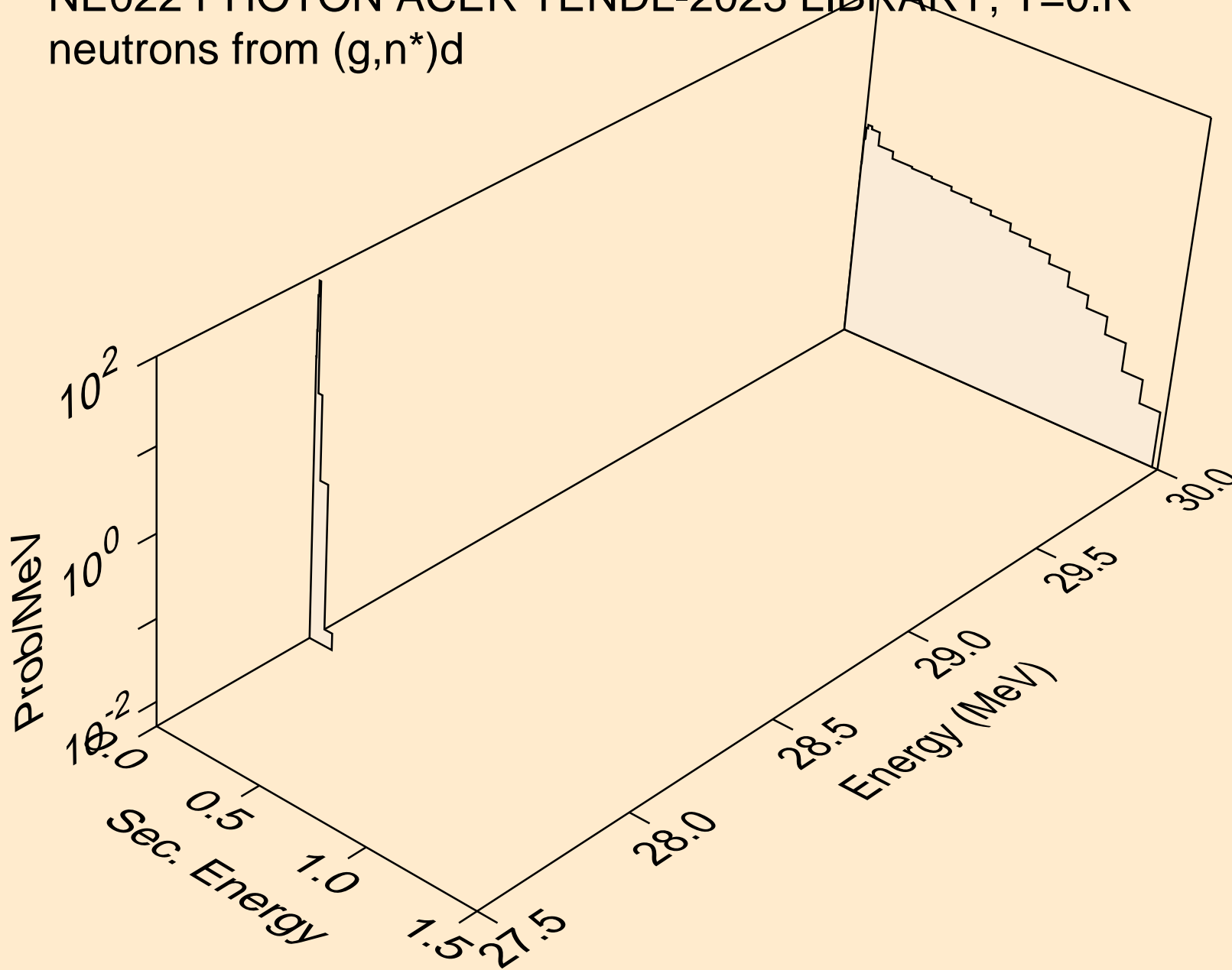

NE022 PHOTON ACER TENDL-2023 LIBRARY; T=0.K
angular distribution for (g,n*0) neutron

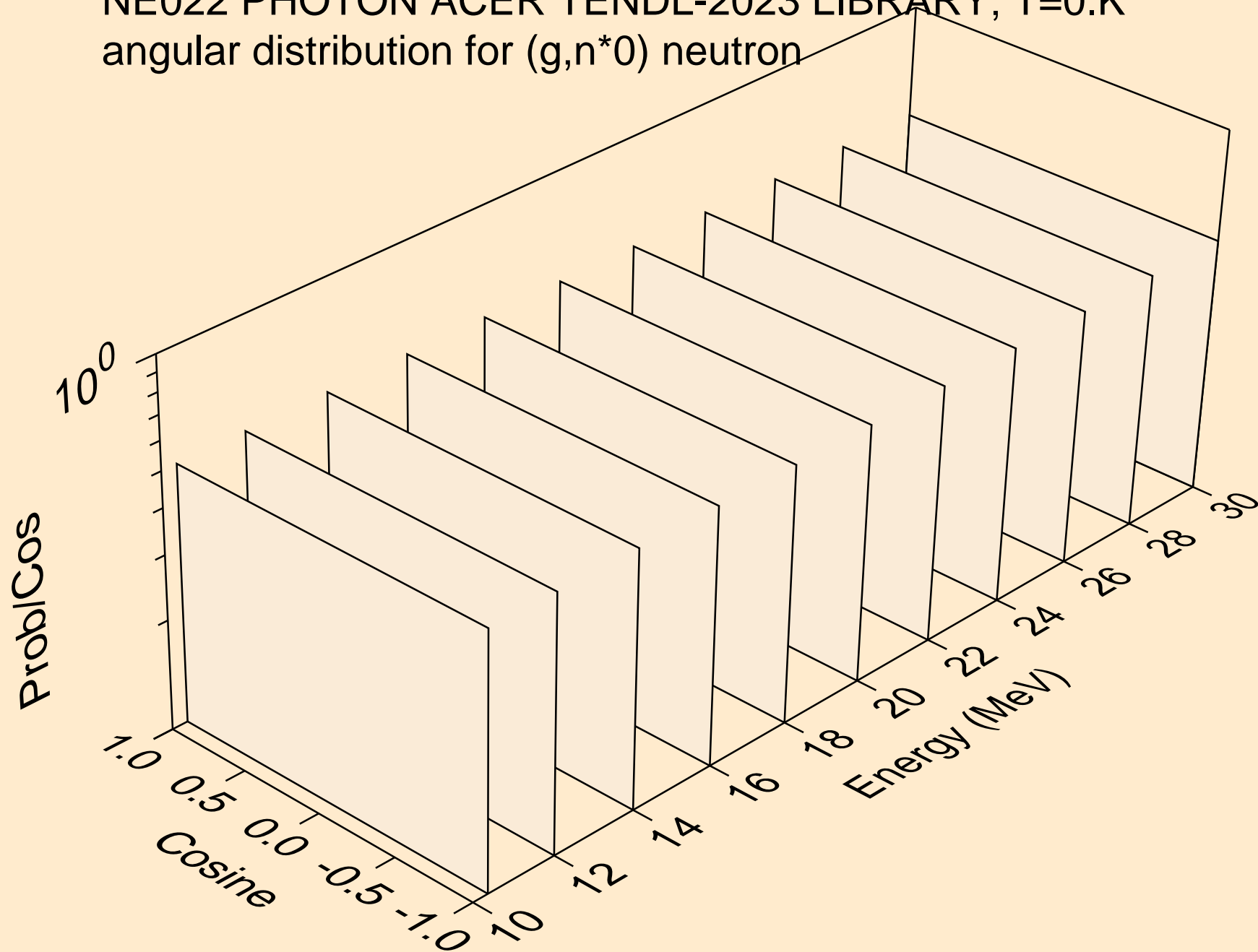

NE022 PHOTON ACER TENDL-2023 LIBRARY; T=0.K
angular distribution for (g,n*1) neutron

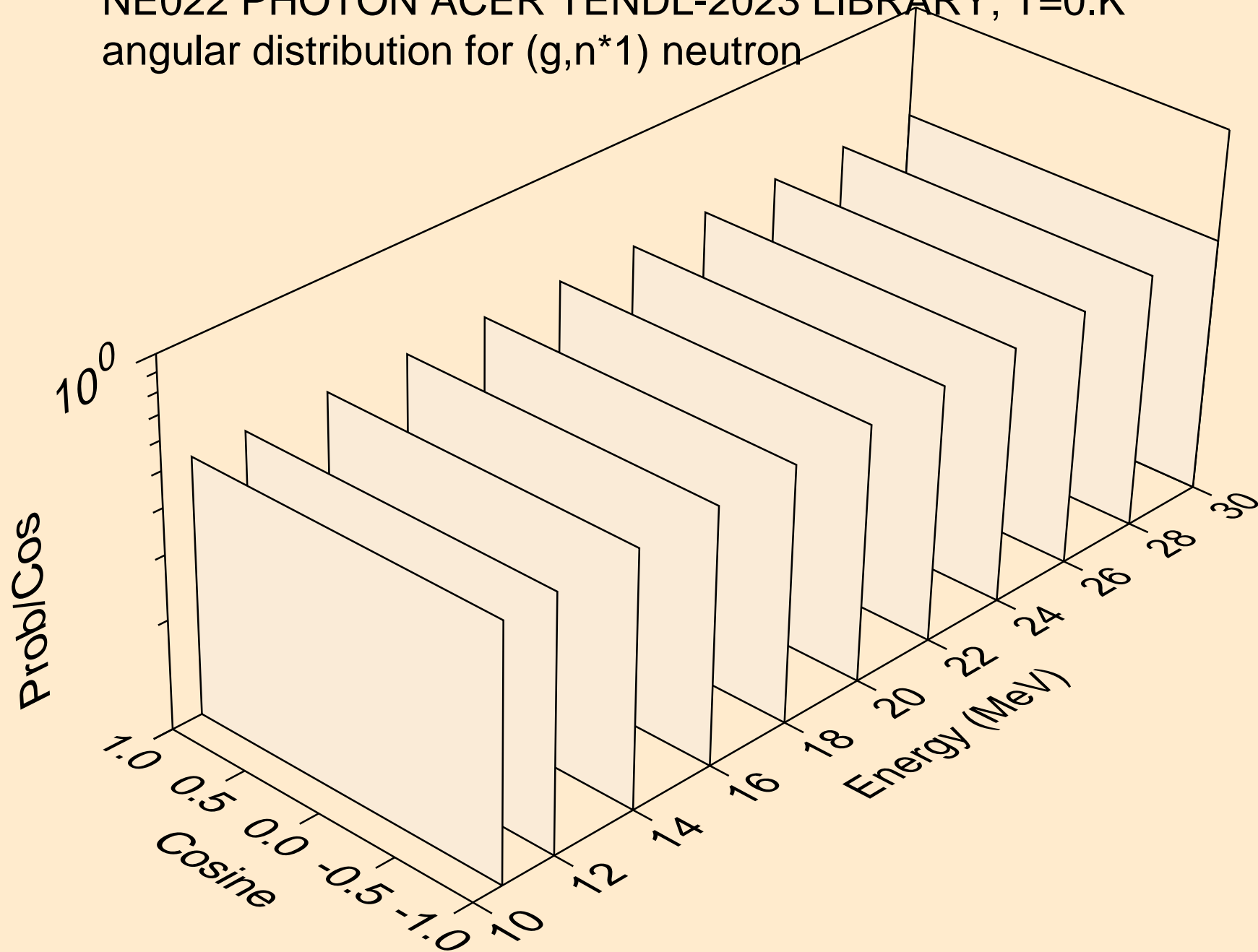

NE022 PHOTON ACER TENDL-2023 LIBRARY; T=0.K
neutrons from (g,n*c)

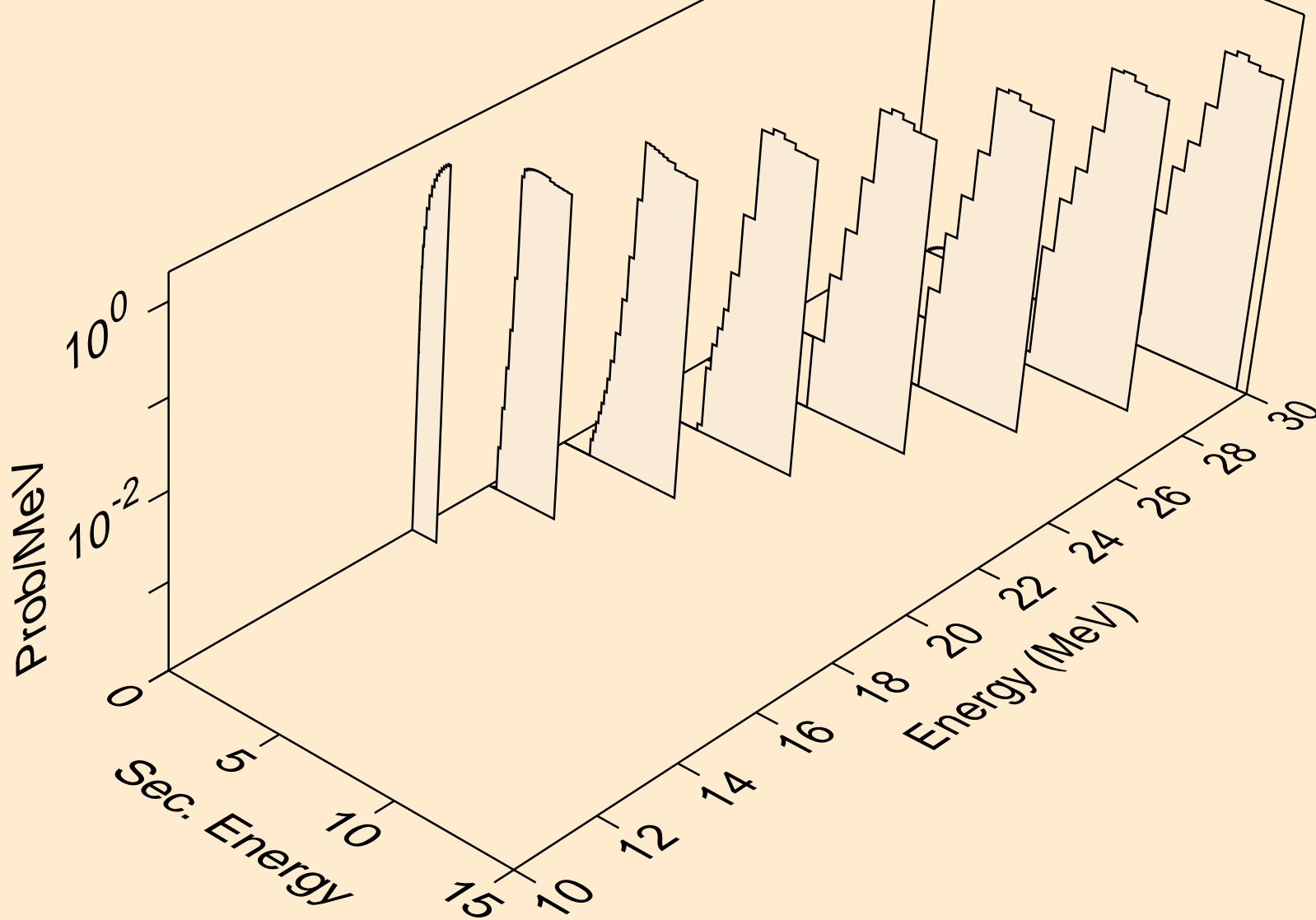

NE022 PHOTON ACER TENDL-2023 LIBRARY; T=0.K
photons from (g,x)

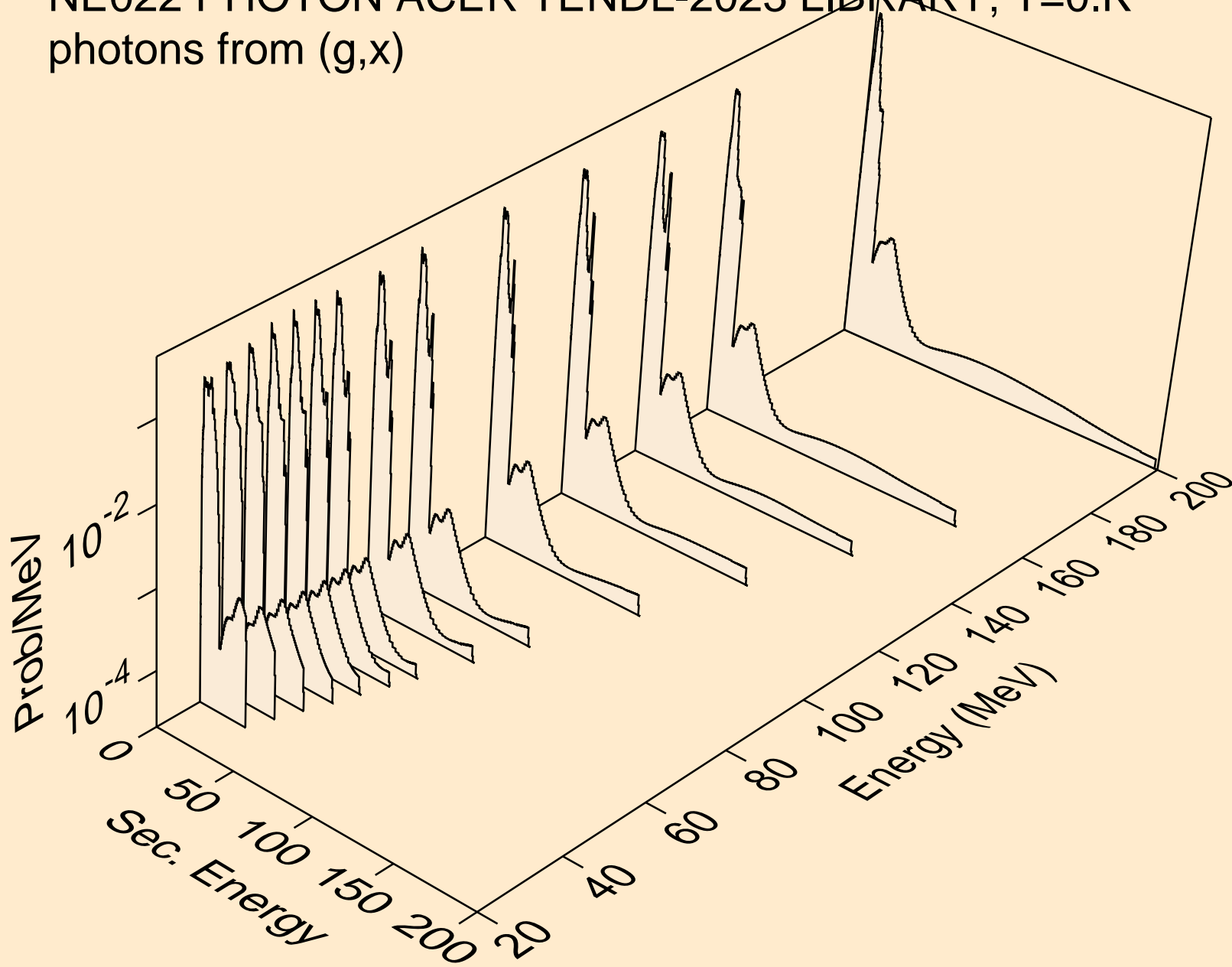

NE022 PHOTON ACER TENDL-2023 LIBRARY; T=0.K
photons from (g,2n)

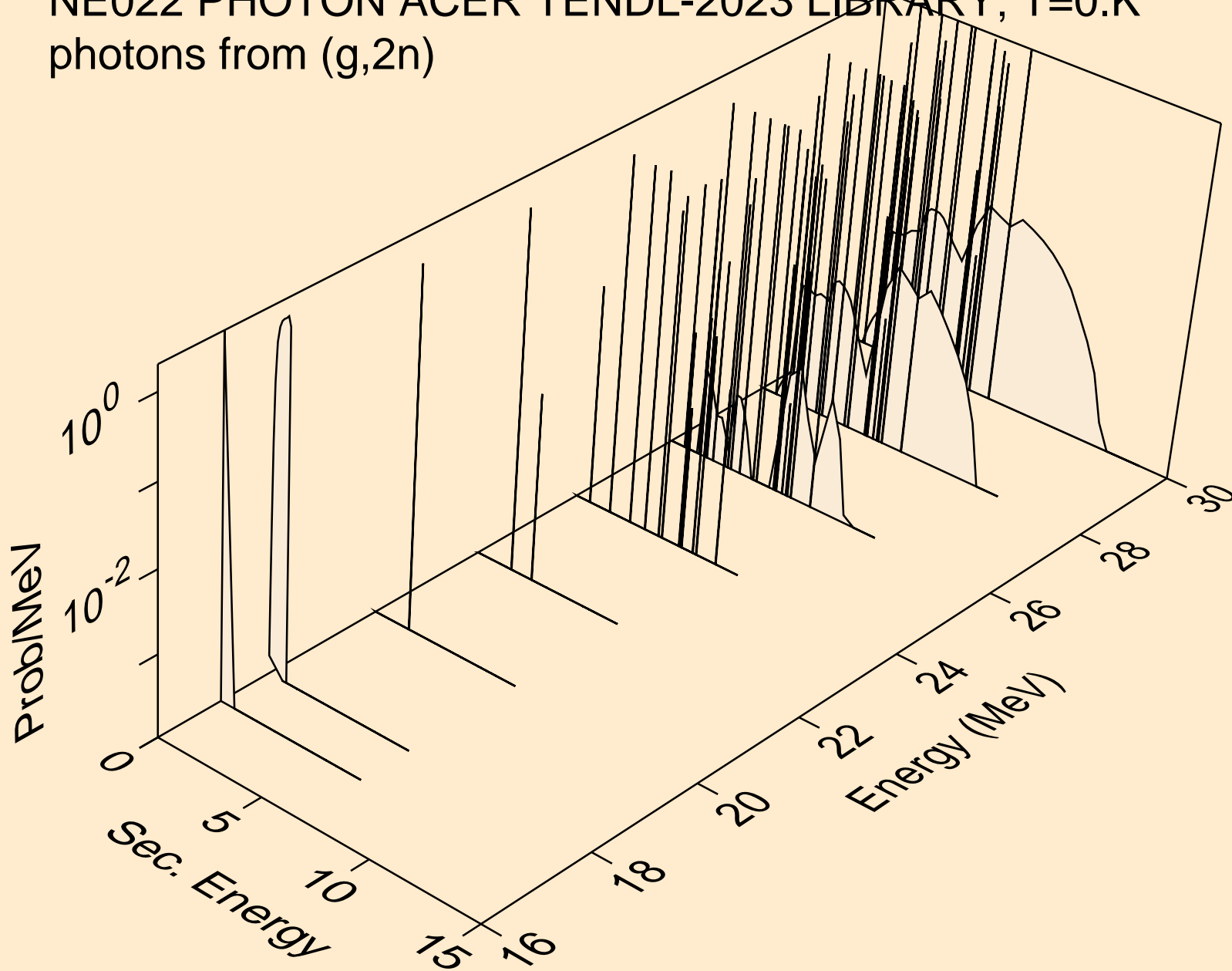

NE022 PHOTON ACER TENDL-2023 LIBRARY; T=0.K
photons from (g,n*)a

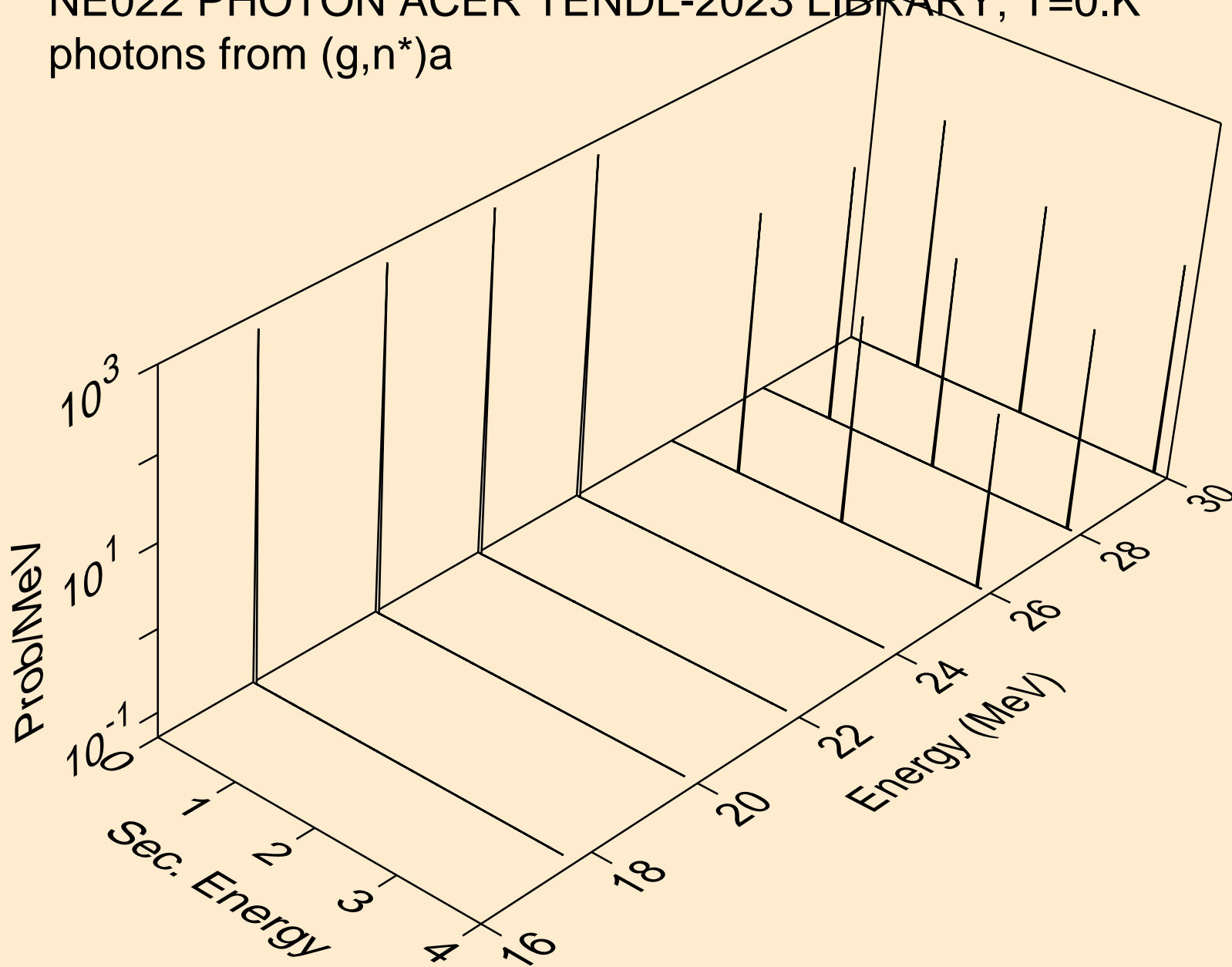

NE022 PHOTON ACER TENDL-2023 LIBRARY; T=0.K
photons from (g,2n)a

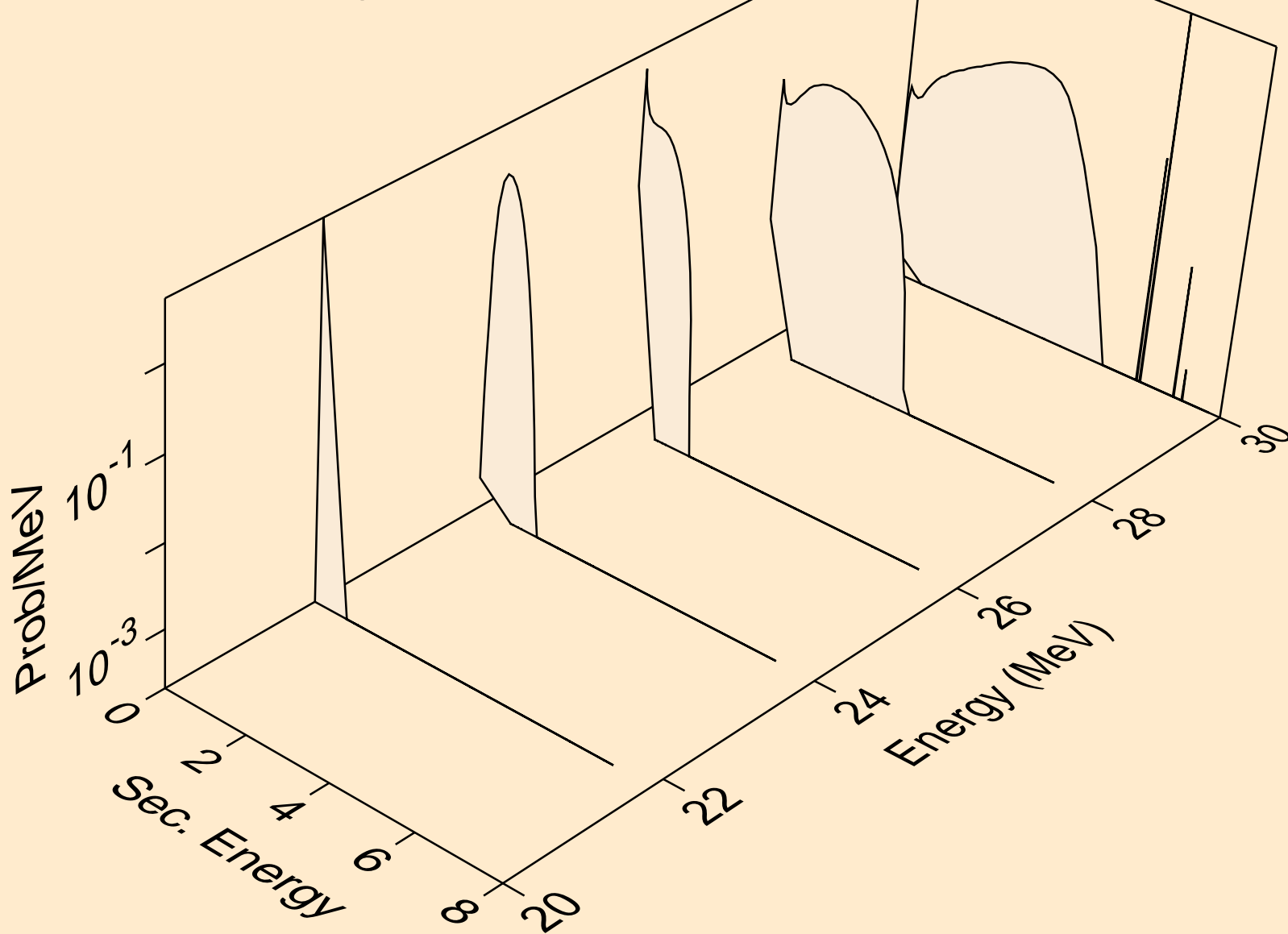

NE022 PHOTON ACER TENDL-2023 LIBRARY; T=0.K
photons from (g,n*)p

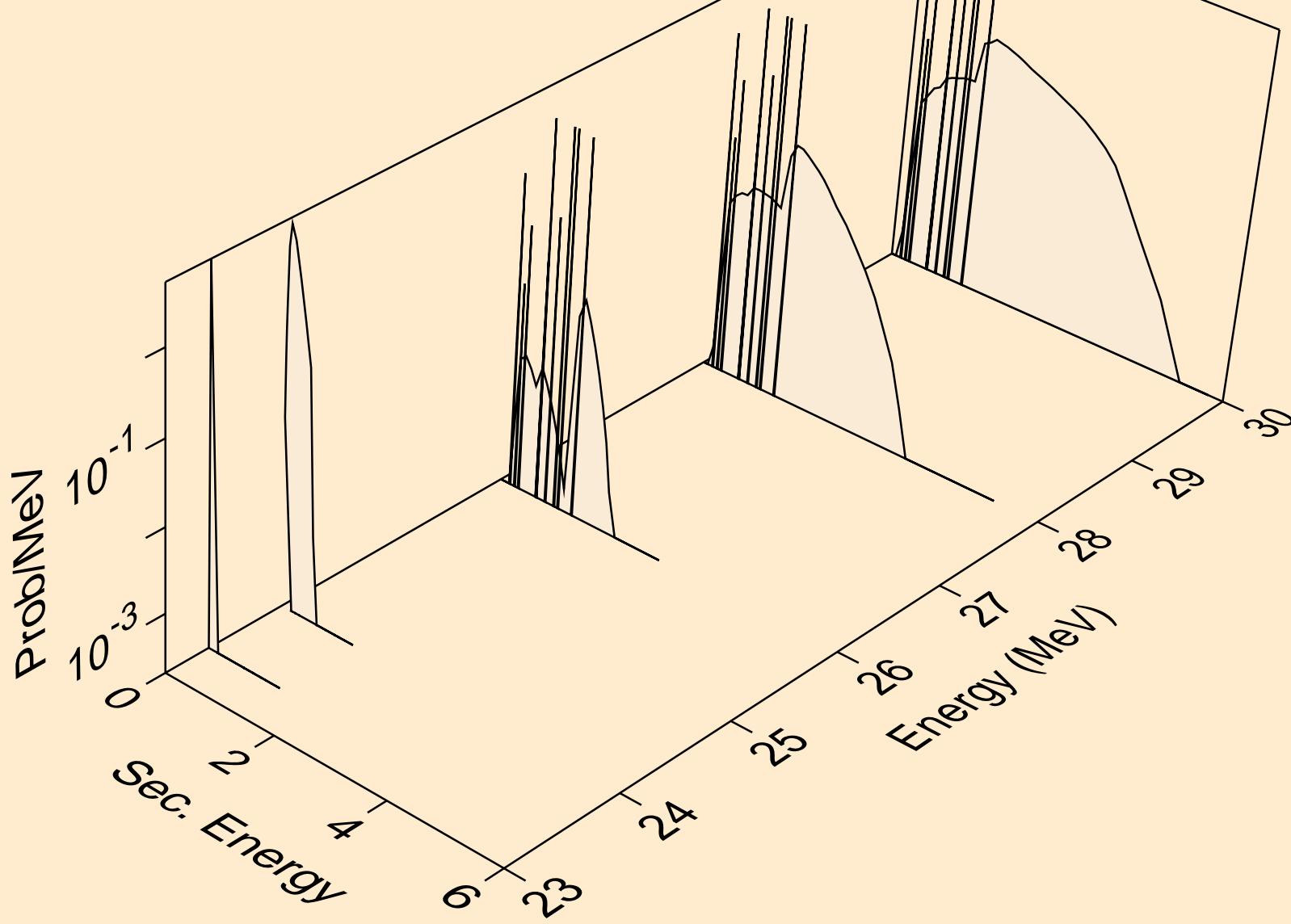

NE022 PHOTON ACER TENDL-2023 LIBRARY; T=0.K
photons from (g,n*)2a

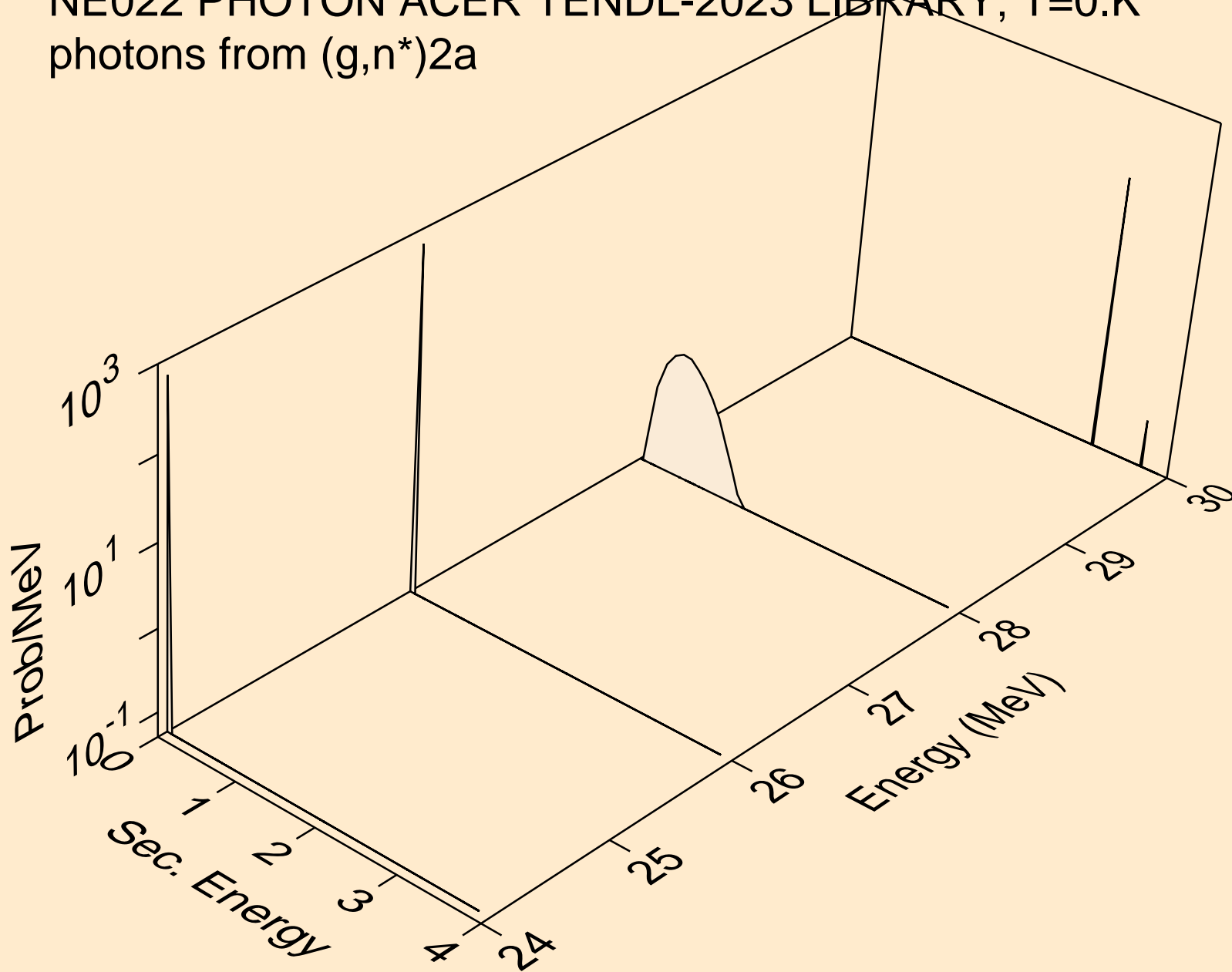

NE022 PHOTON ACER TENDL-2023 LIBRARY; T=0.K
photons from (g,n*)d

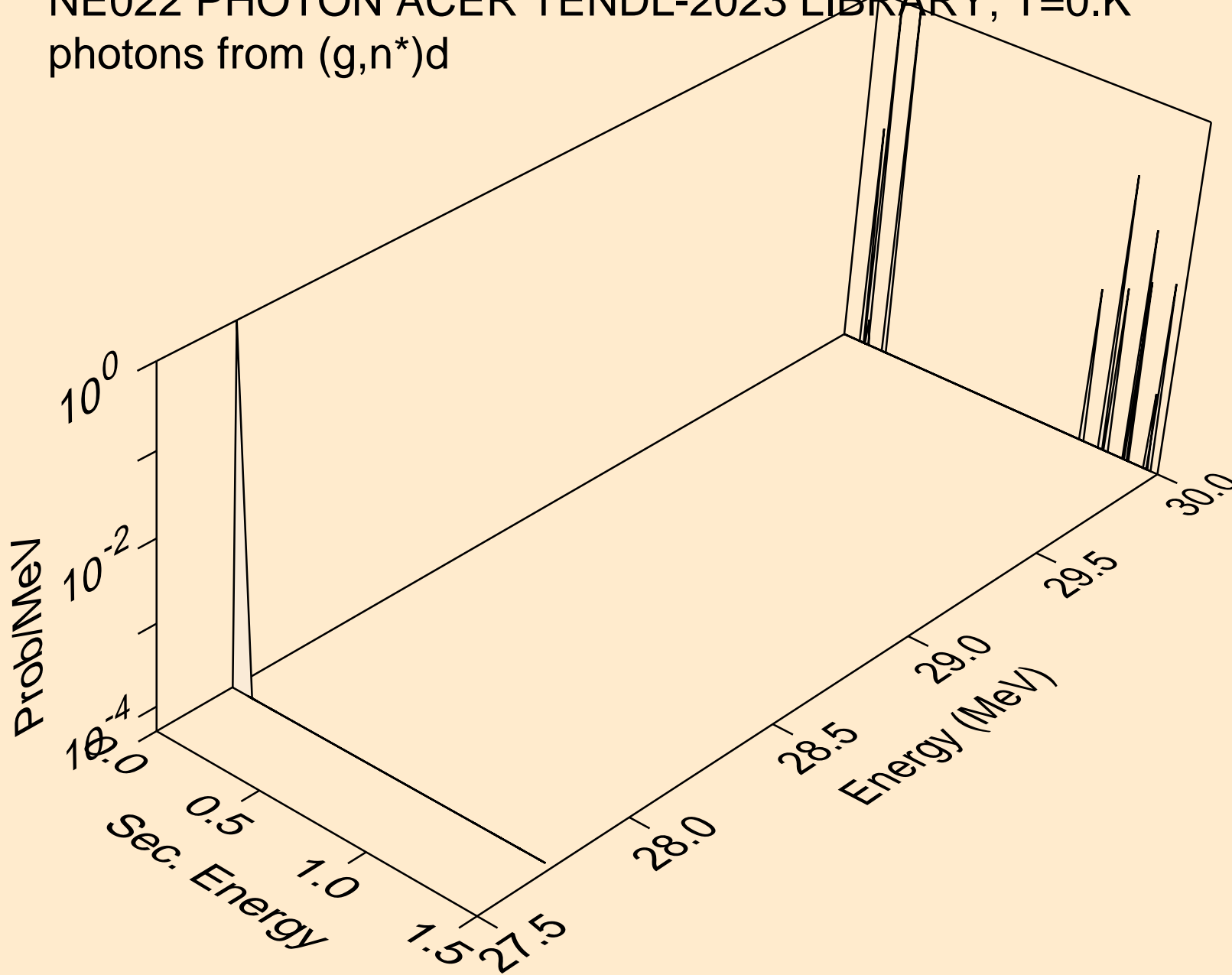

NE022 PHOTON ACER TENDL-2023 LIBRARY; T=0.K
photons from (g,n*c)

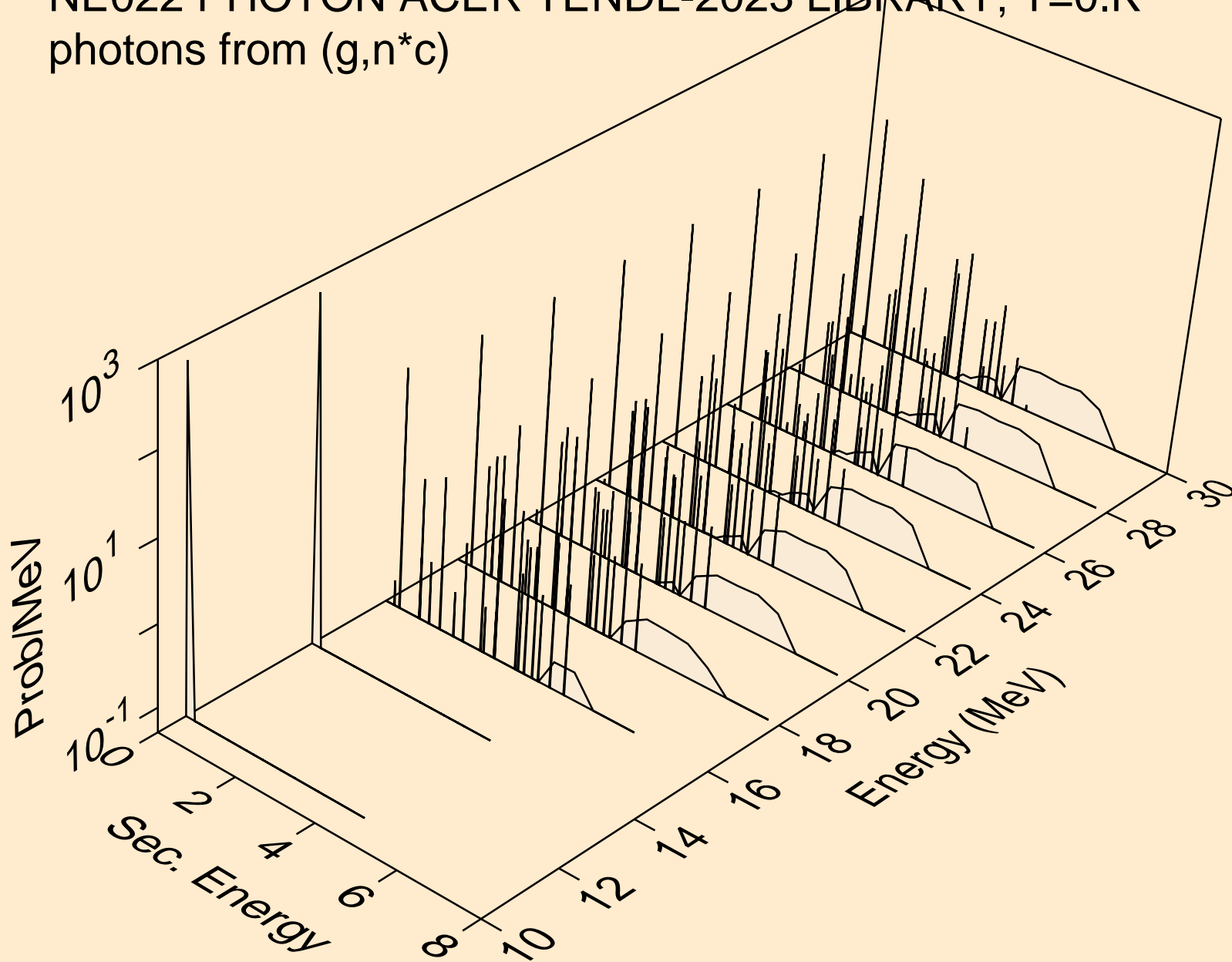

NE022 PHOTON ACER TENDL-2023 LIBRARY; T=0.K
photons from (g,gma)

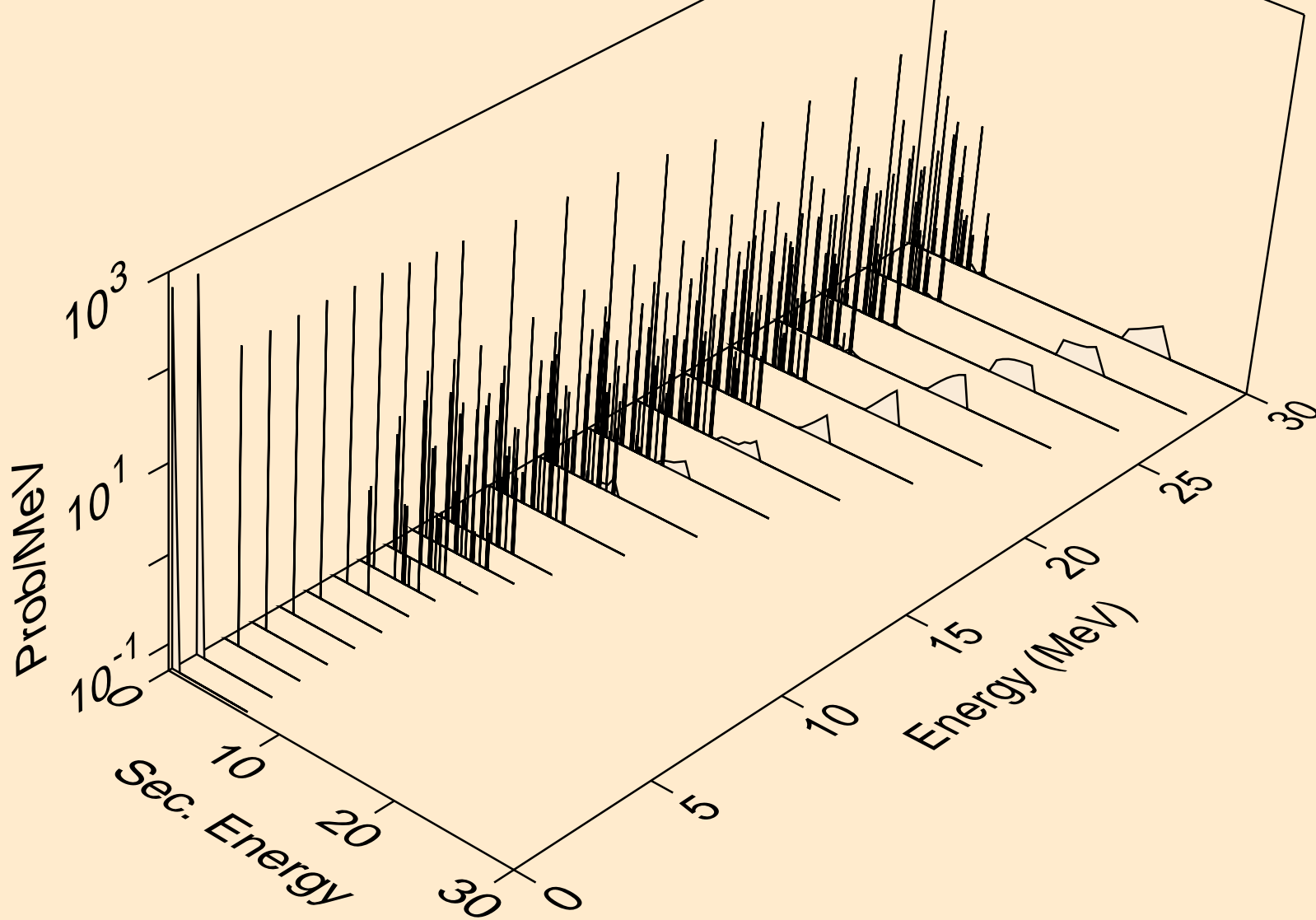

NE022 PHOTON ACER TENDL-2023 LIBRARY; T=0.K
photons from (g,p)

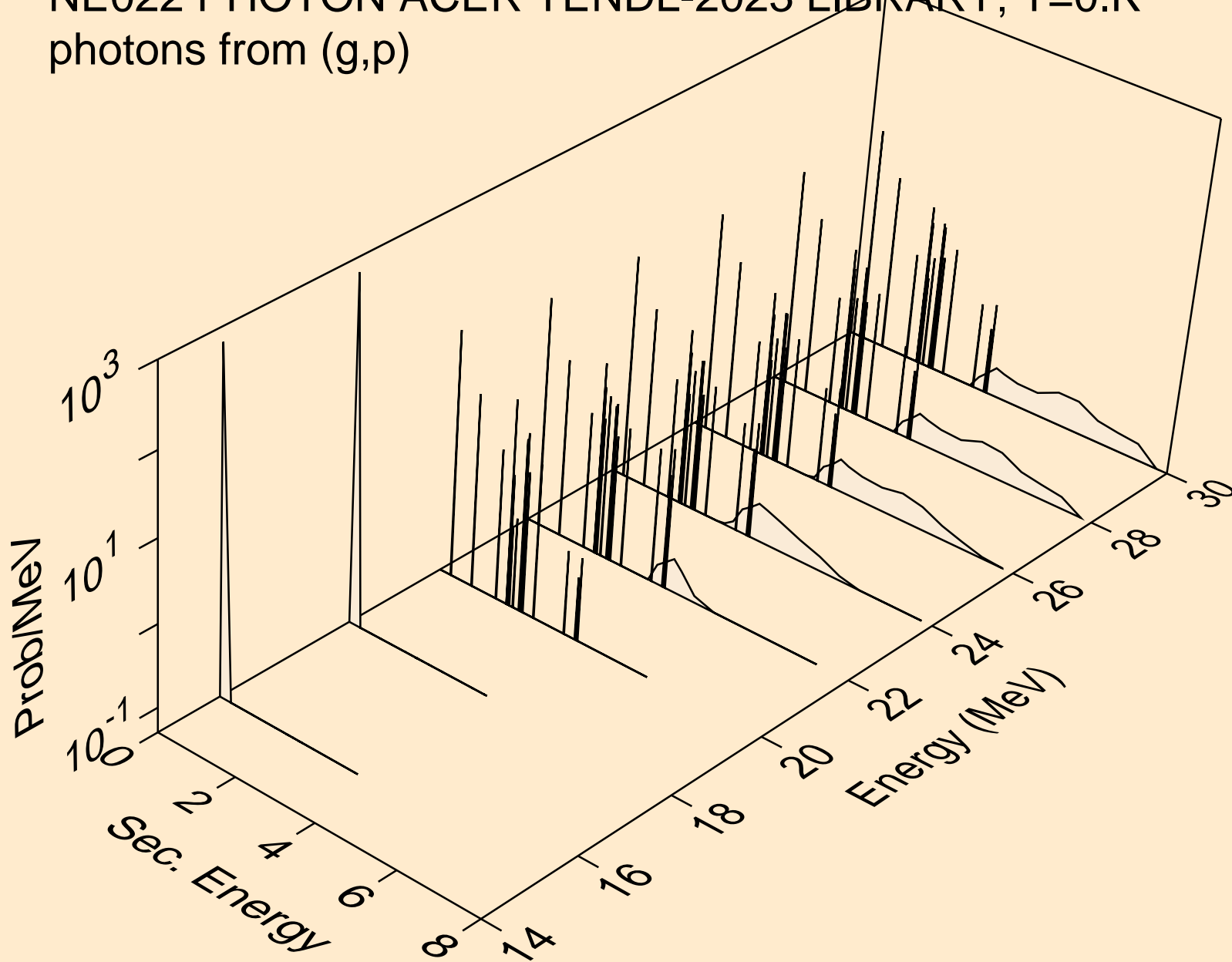

NE022 PHOTON ACER TENDL-2023 LIBRARY; T=0.K
photons from (g,d)

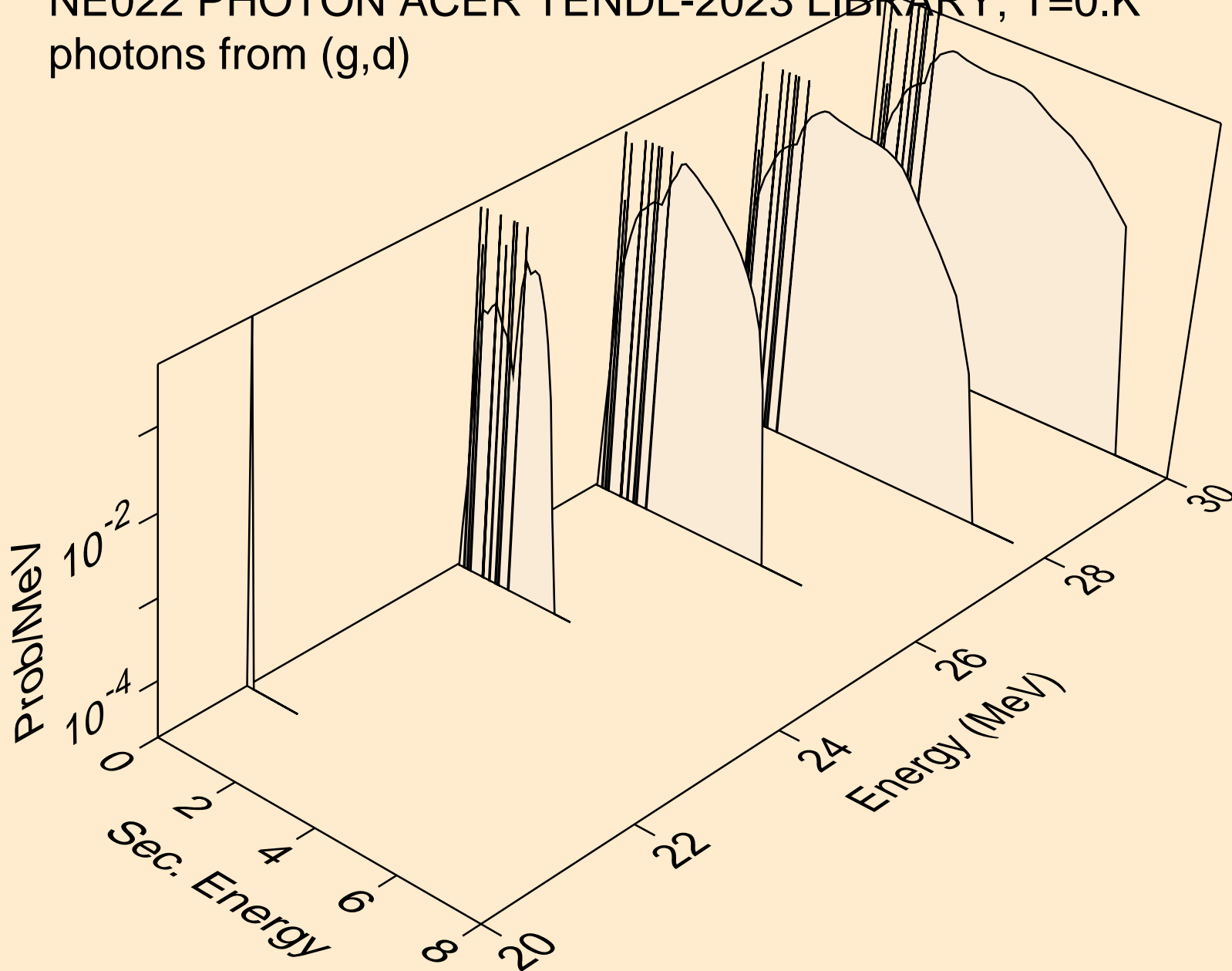

NE022 PHOTON ACER TENDL-2023 LIBRARY; T=0.K
photons from (g,t)

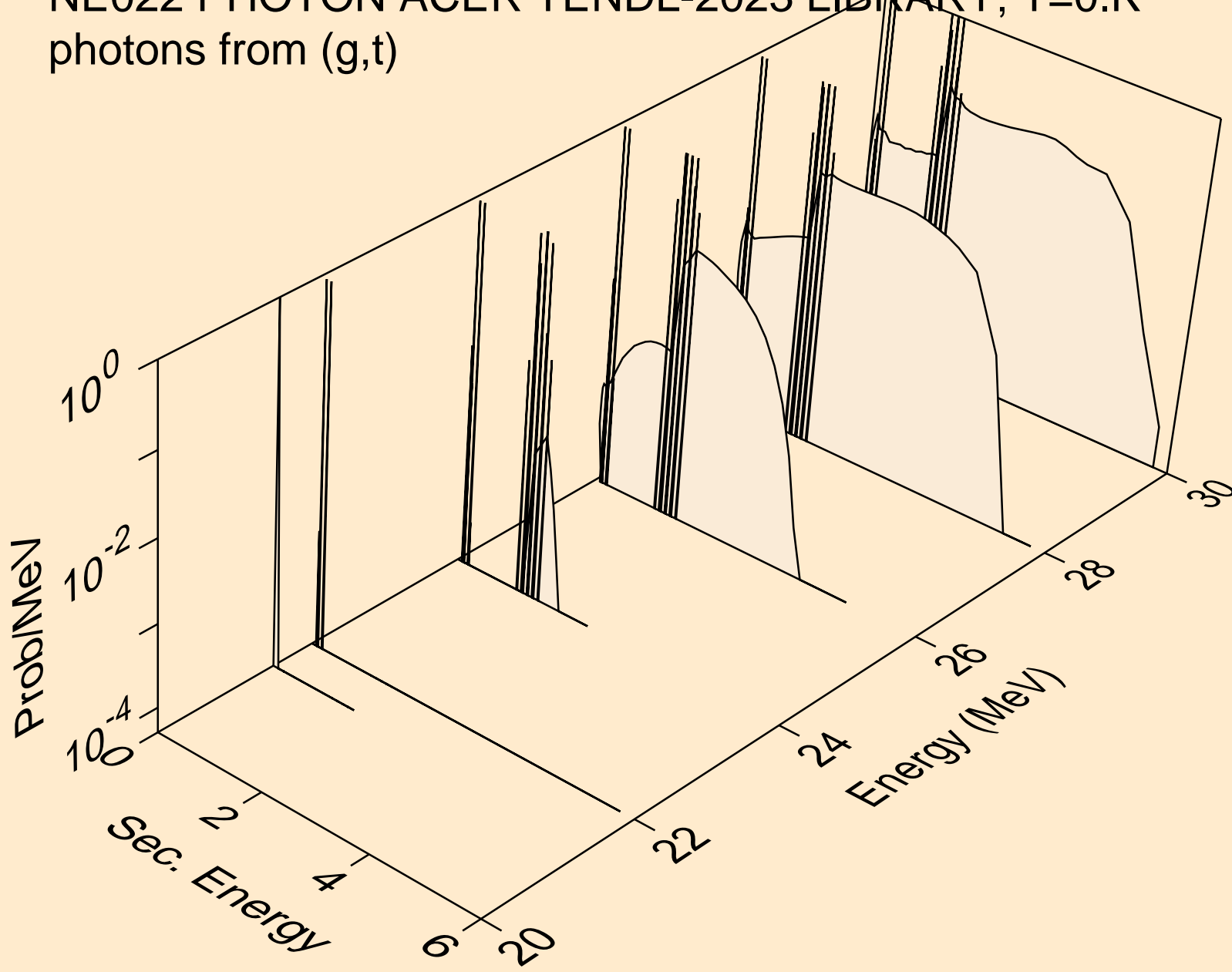

NE022 PHOTON ACER TENDL-2023 LIBRARY; T=0.K
photons from (g,he3)

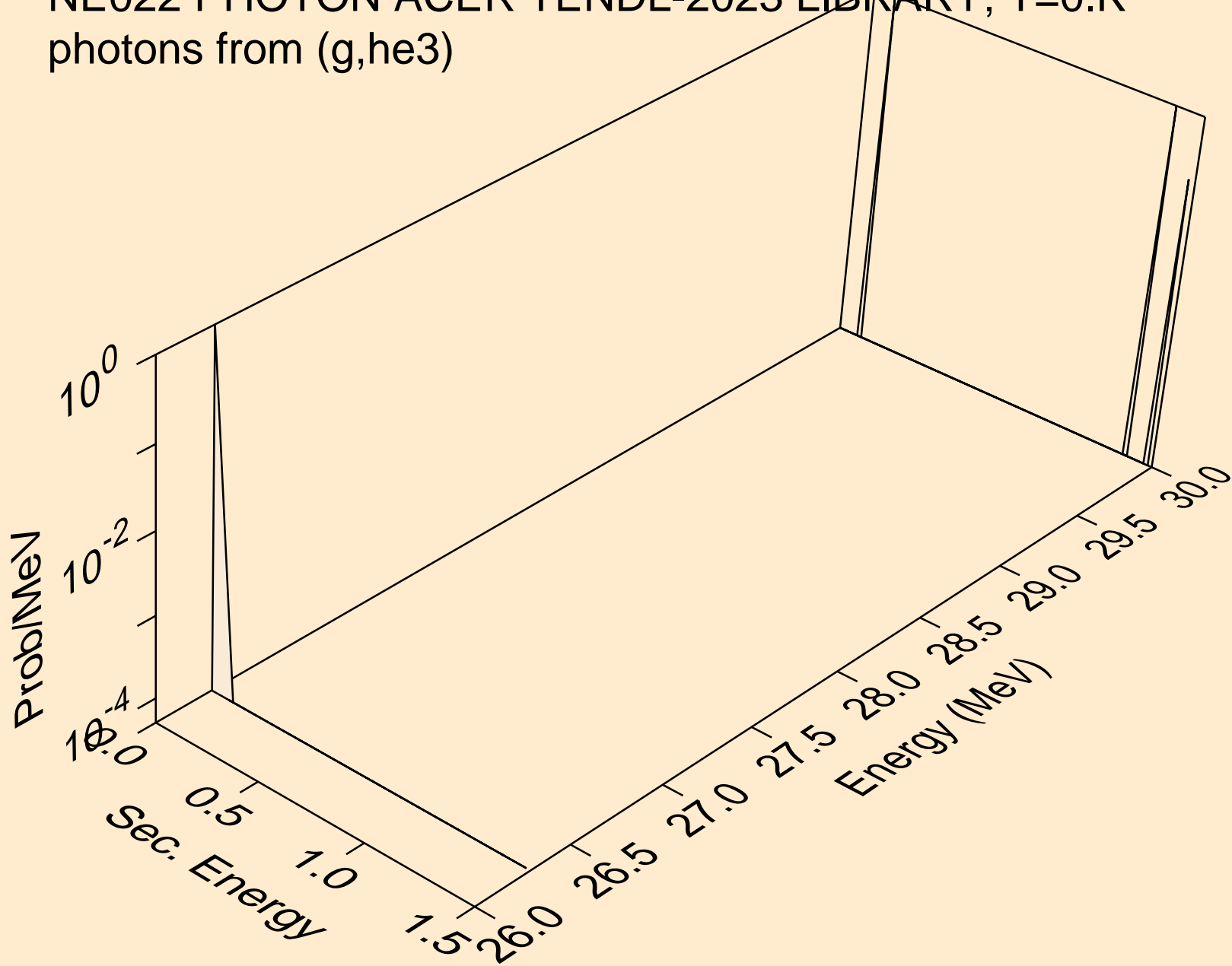

NE022 PHOTON ACER TENDL-2023 LIBRARY; T=0.K
photons from (g,a)

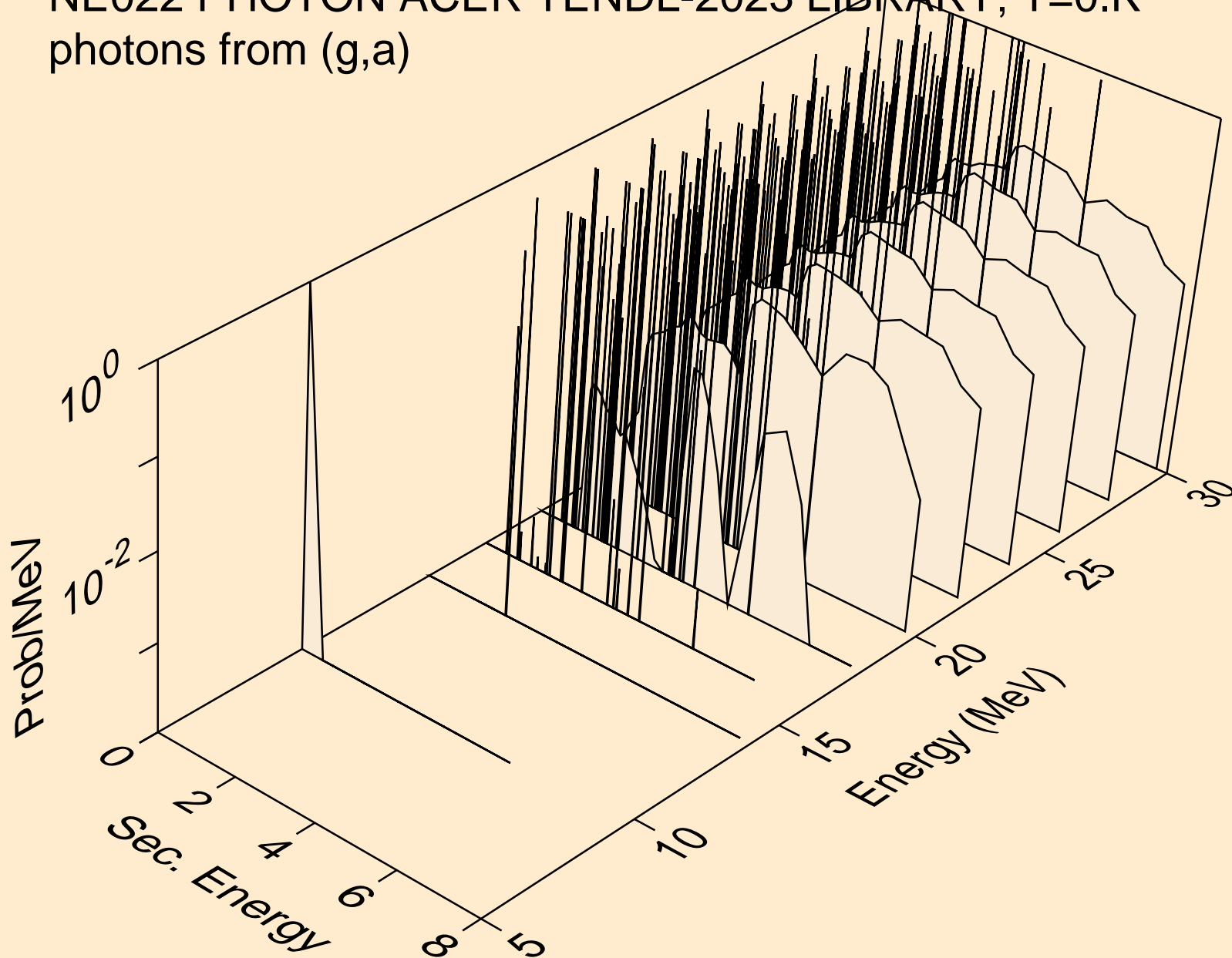

NE022 PHOTON ACER TENDL-2023 LIBRARY; T=0.K
photons from (g,2a)

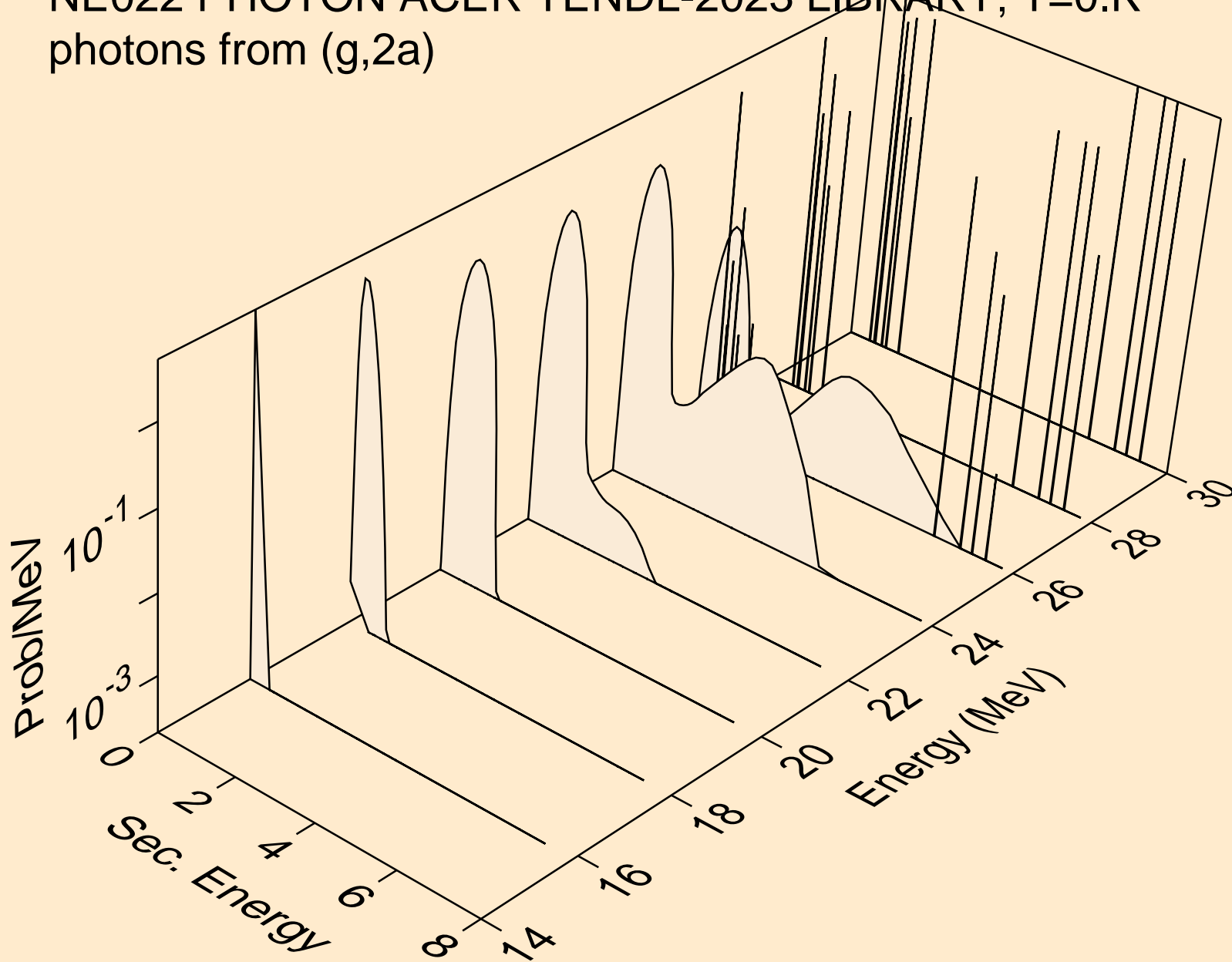

NE022 PHOTON ACER TENDL-2023 LIBRARY; T=0.K
photons from (g,2p)

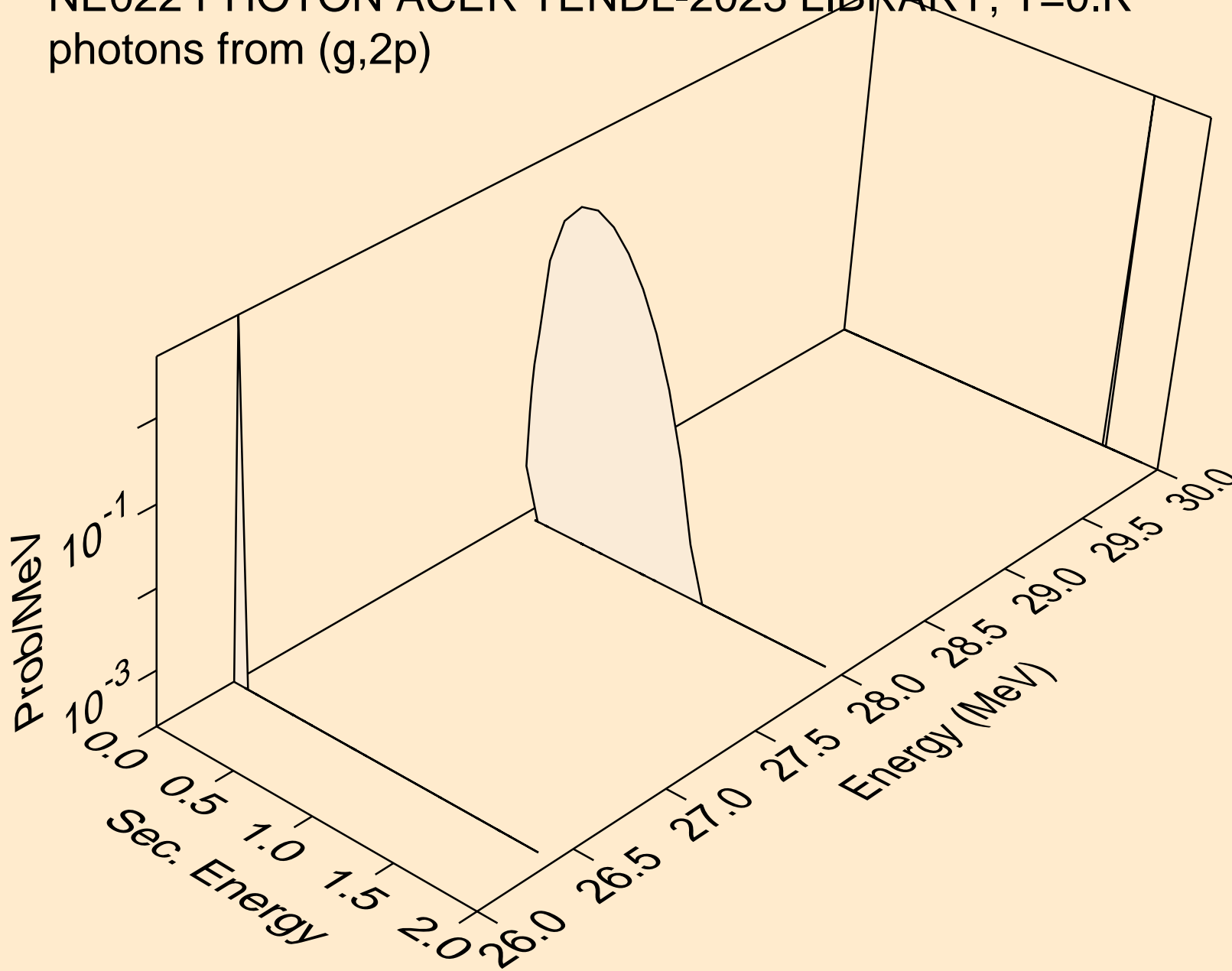

NE022 PHOTON ACER TENDL-2023 LIBRARY; T=0.K
photons from (g,pa)

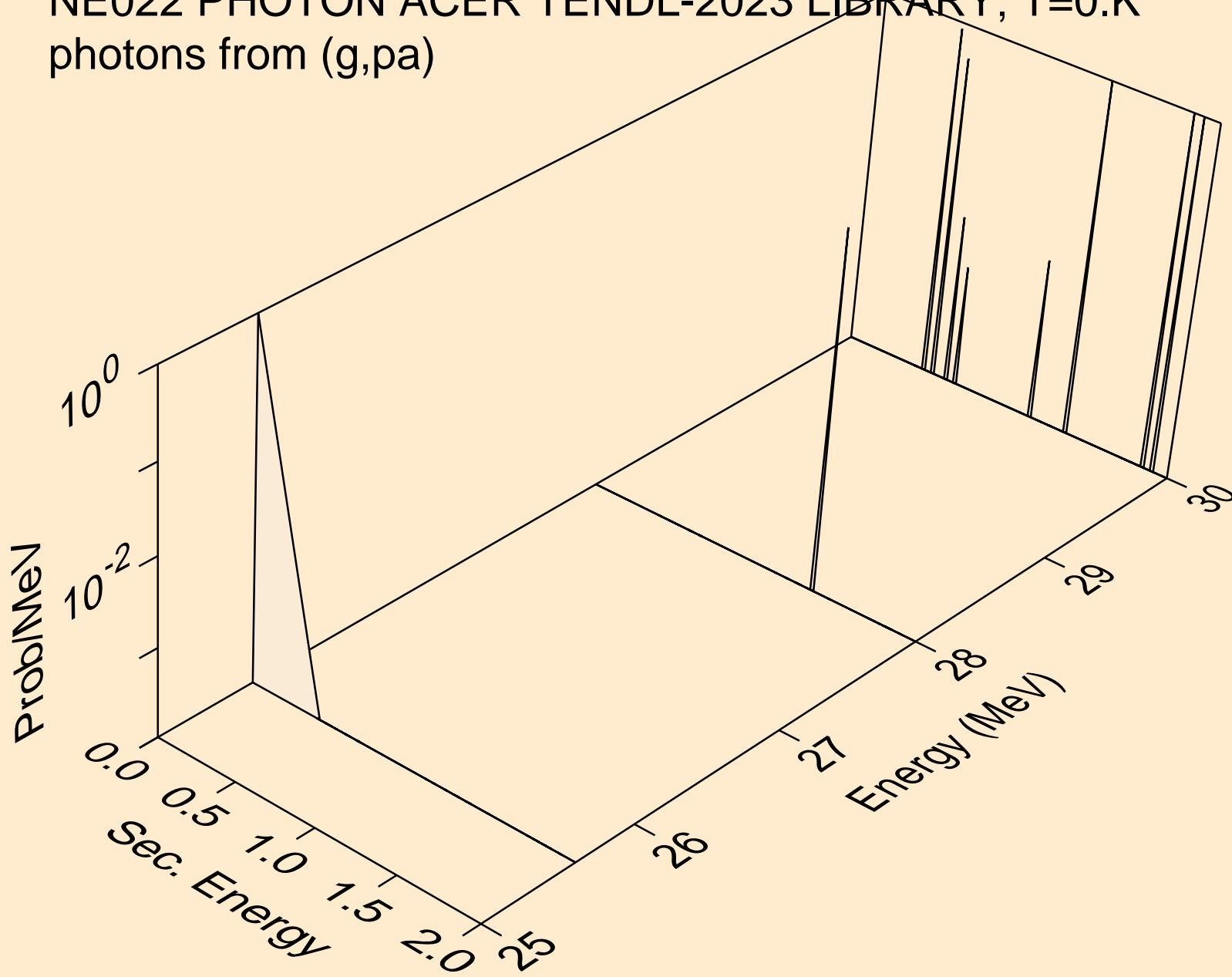

NE022 PHOTON ACER TENDL-2023 LIBRARY; T=0.K
protons from (g,x)

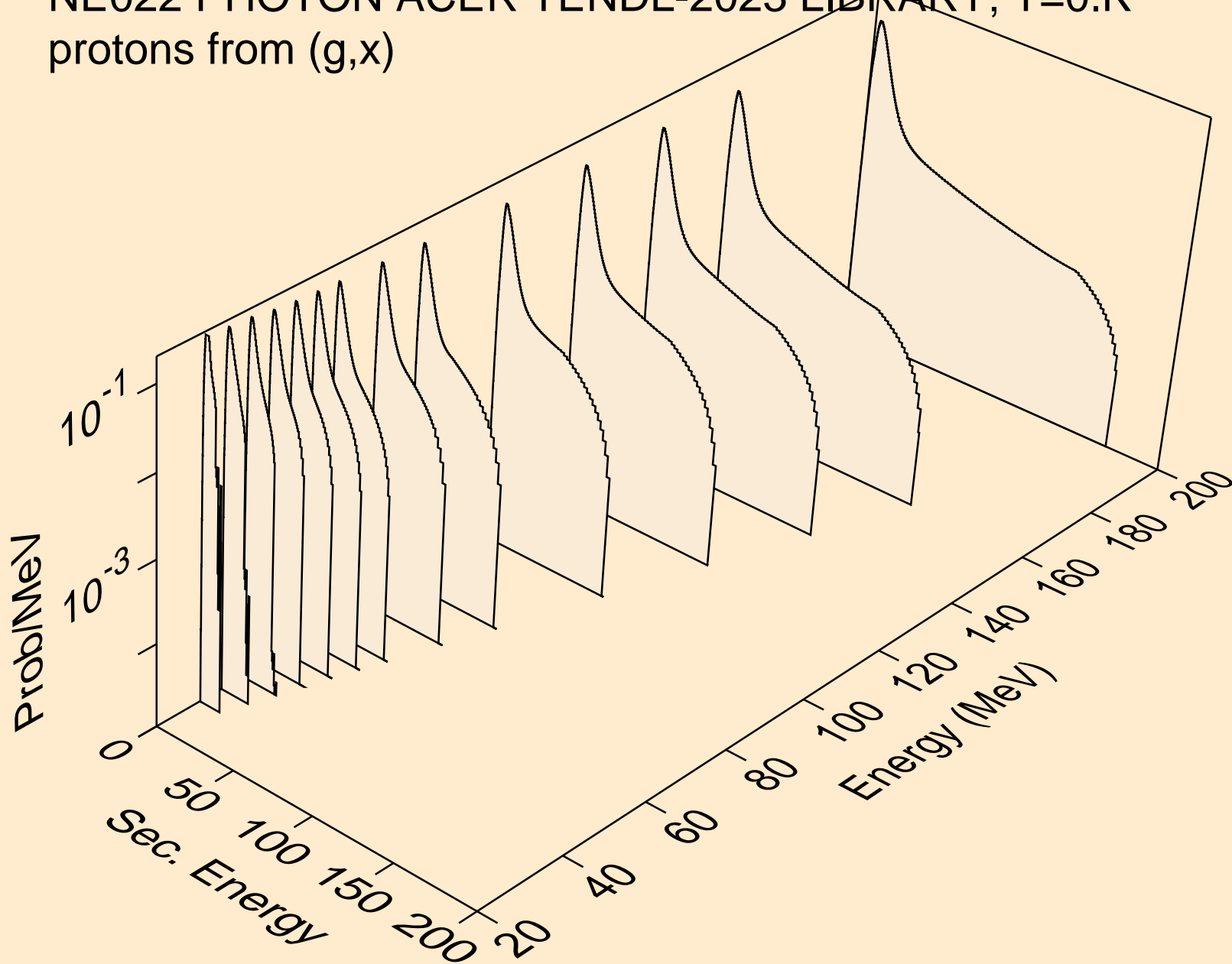

NE022 PHOTON ACER TENDL-2023 LIBRARY; T=0.K
protons from (g,n*)p

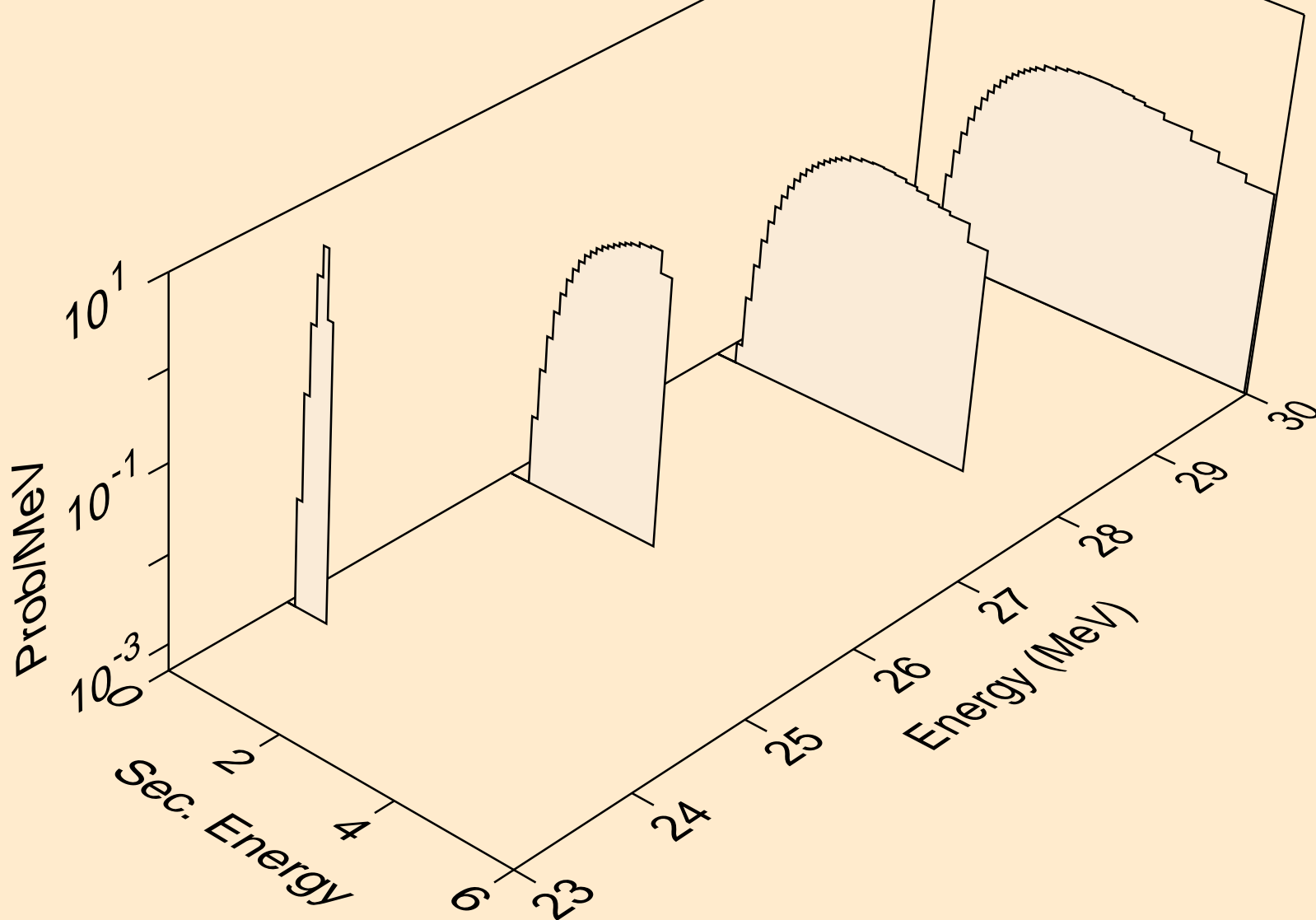

NE022 PHOTON ACER TENDL-2023 LIBRARY; T=0.K
protons from (g,p)

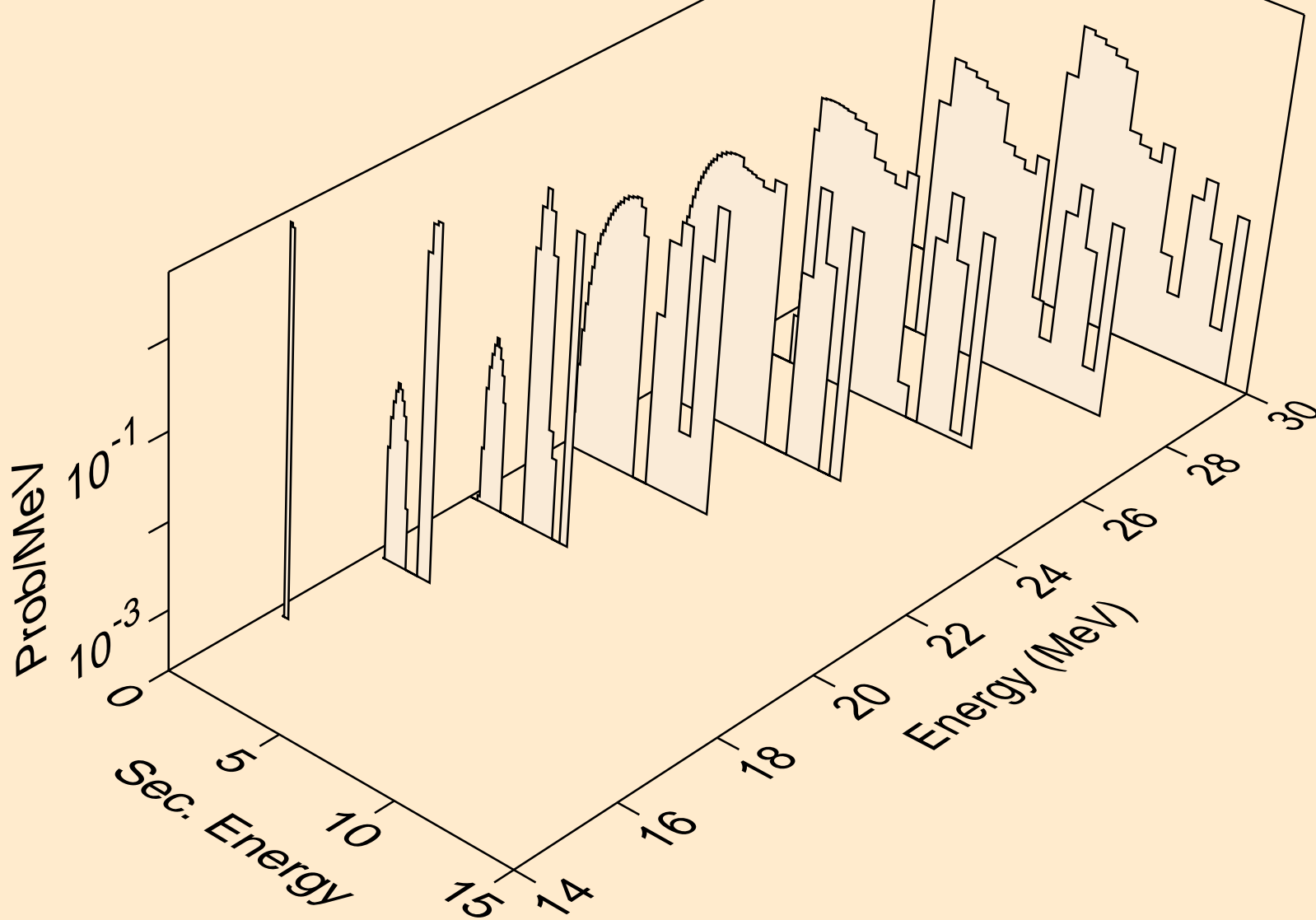

NE022 PHOTON ACER TENDL-2023 LIBRARY; T=0.K
protons from (g,2p)

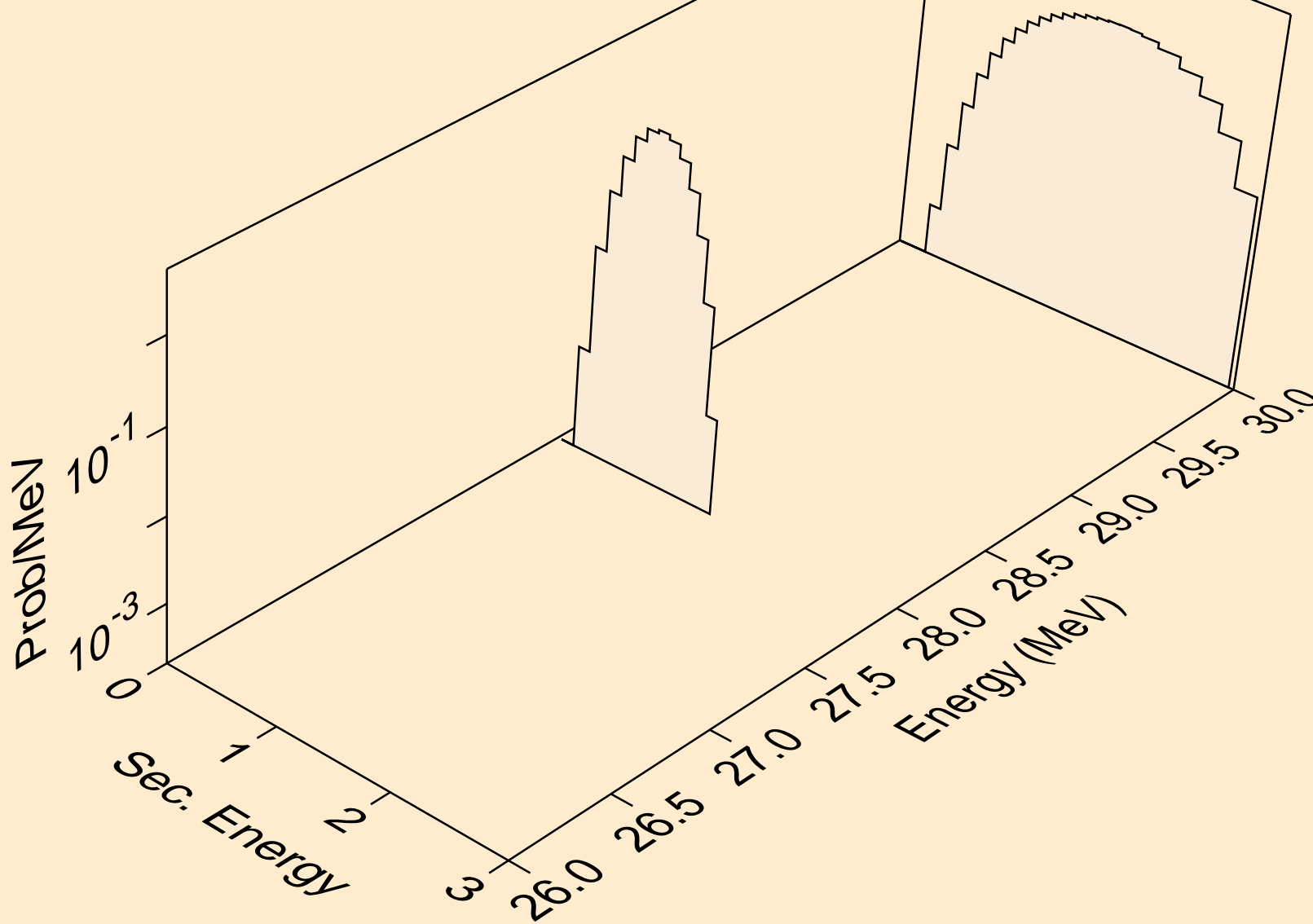

NE022 PHOTON ACER TENDL-2023 LIBRARY; T=0.K
protons from (g,pa)

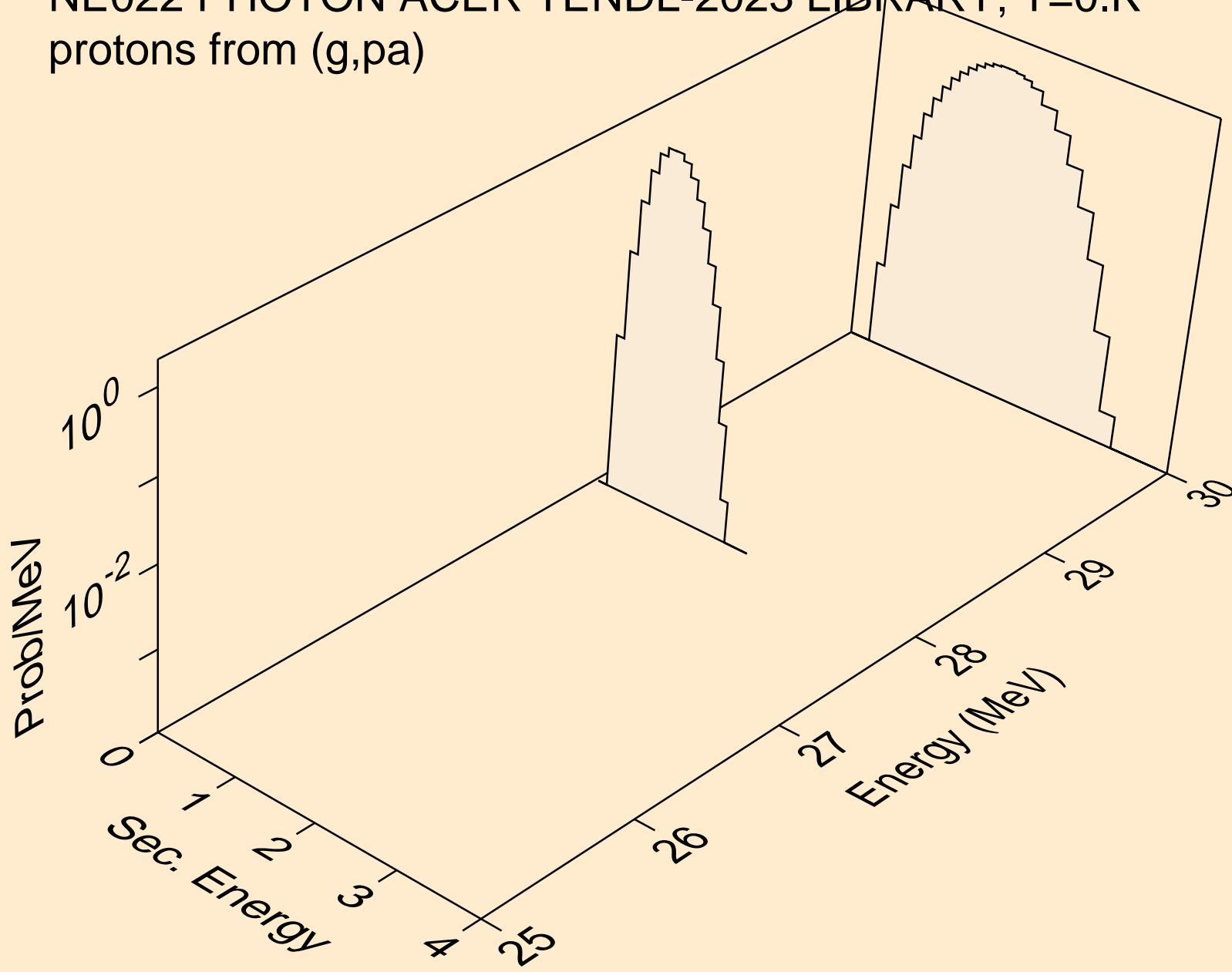

NE022 PHOTON ACER TENDL-2023 LIBRARY; T=0.K
deuterons from (g,x)

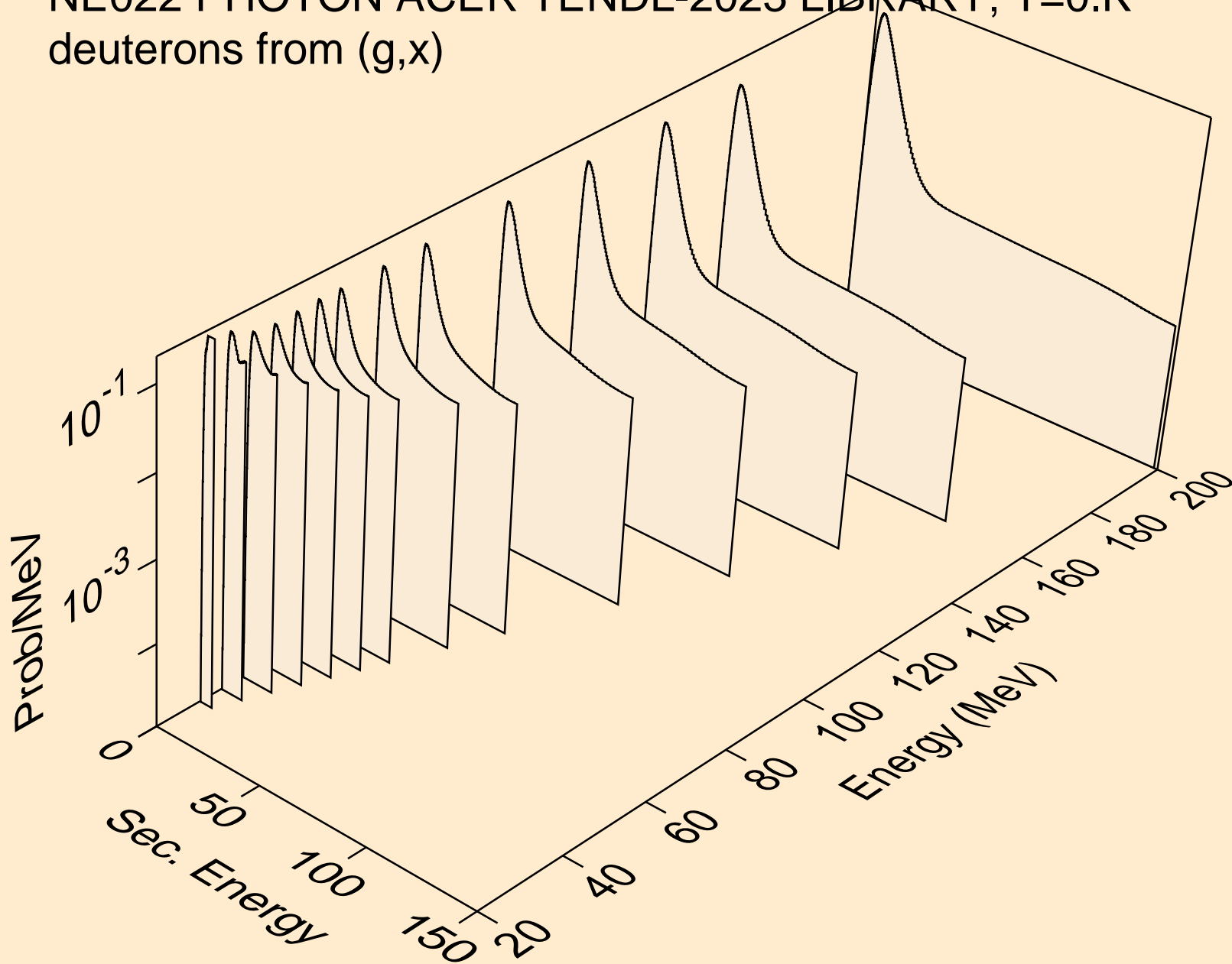

NE022 PHOTON ACER TENDL-2023 LIBRARY; T=0.K
deuterons from (g,n*)d

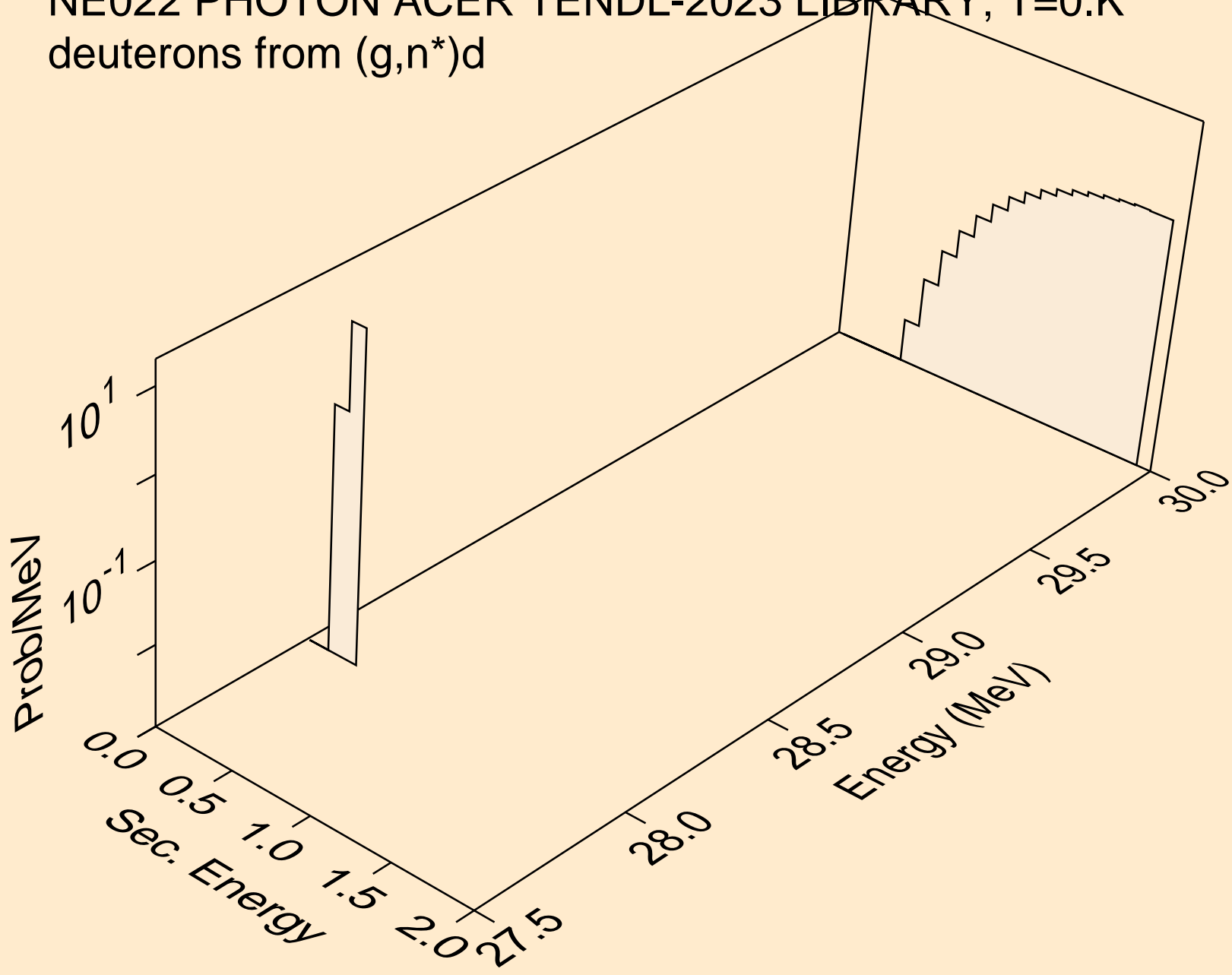

NE022 PHOTON ACER TENDL-2023 LIBRARY; T=0.K
deuterons from (g,d)

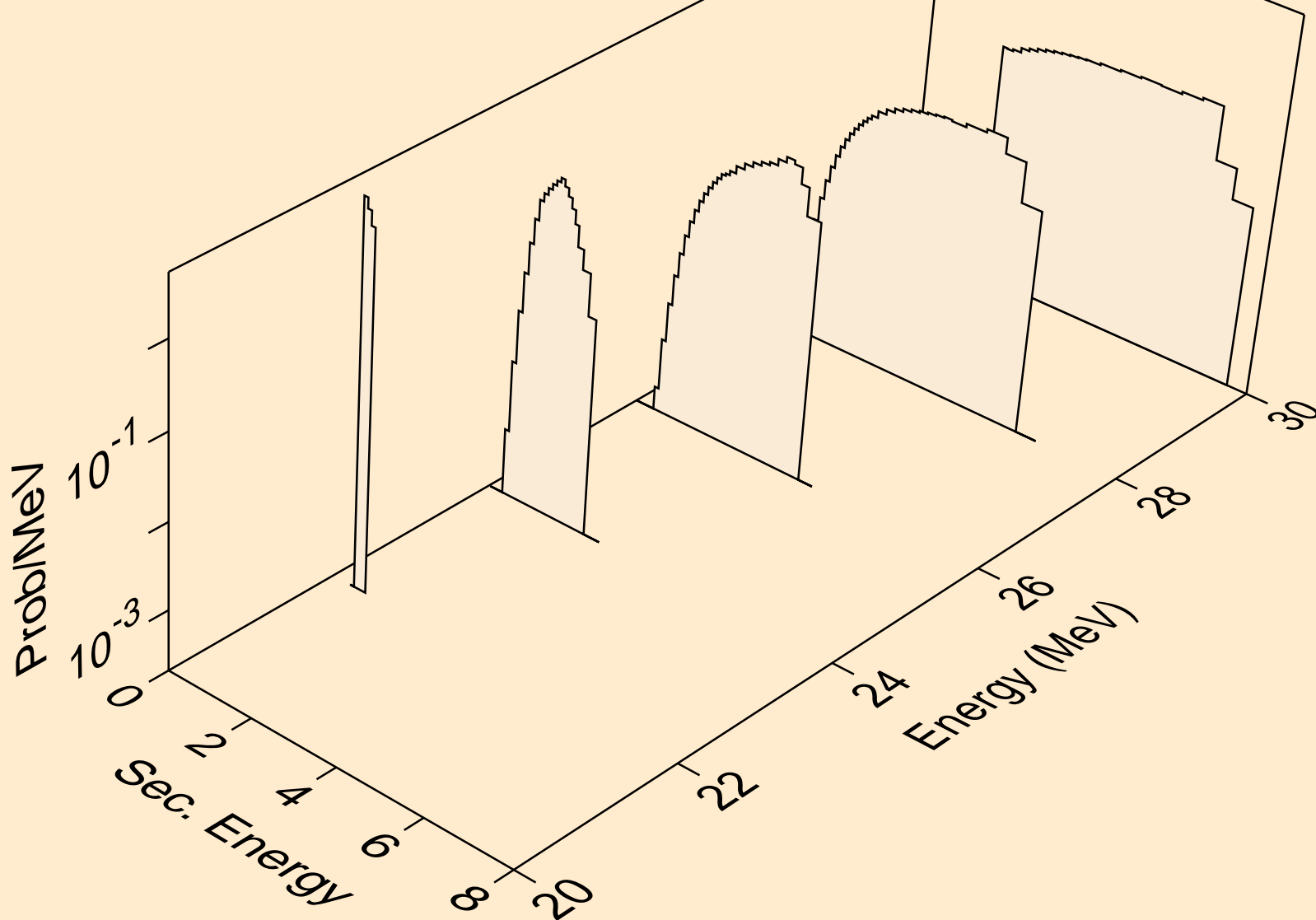

NE022 PHOTON ACER TENDL-2023 LIBRARY; T=0.K
tritons from (g,x)

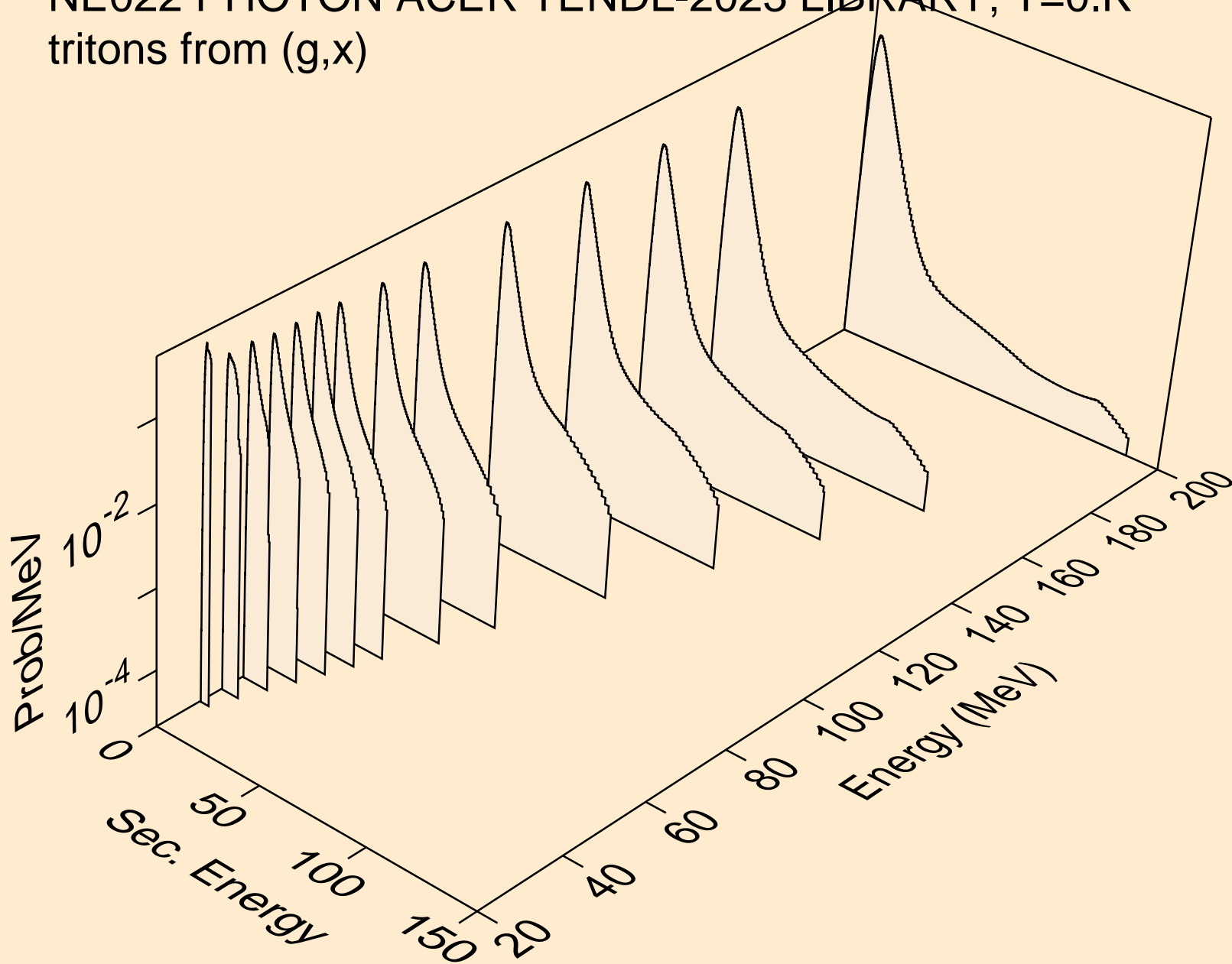

NE022 PHOTON ACER TENDL-2023 LIBRARY; T=0.K
tritons from (g,t)

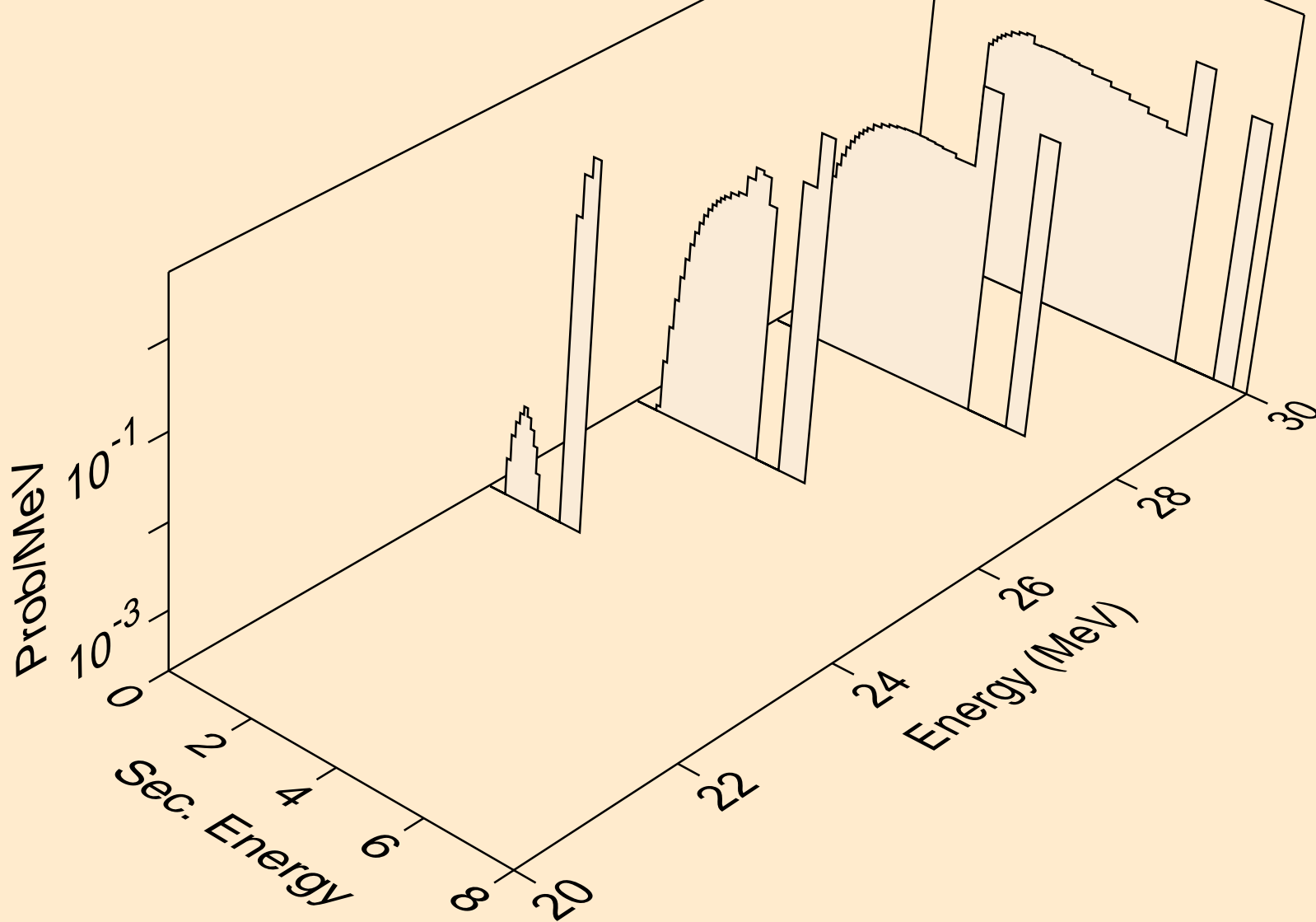

NE022 PHOTON ACER TENDL-2023 LIBRARY; T=0.K
he3s from (g,x)

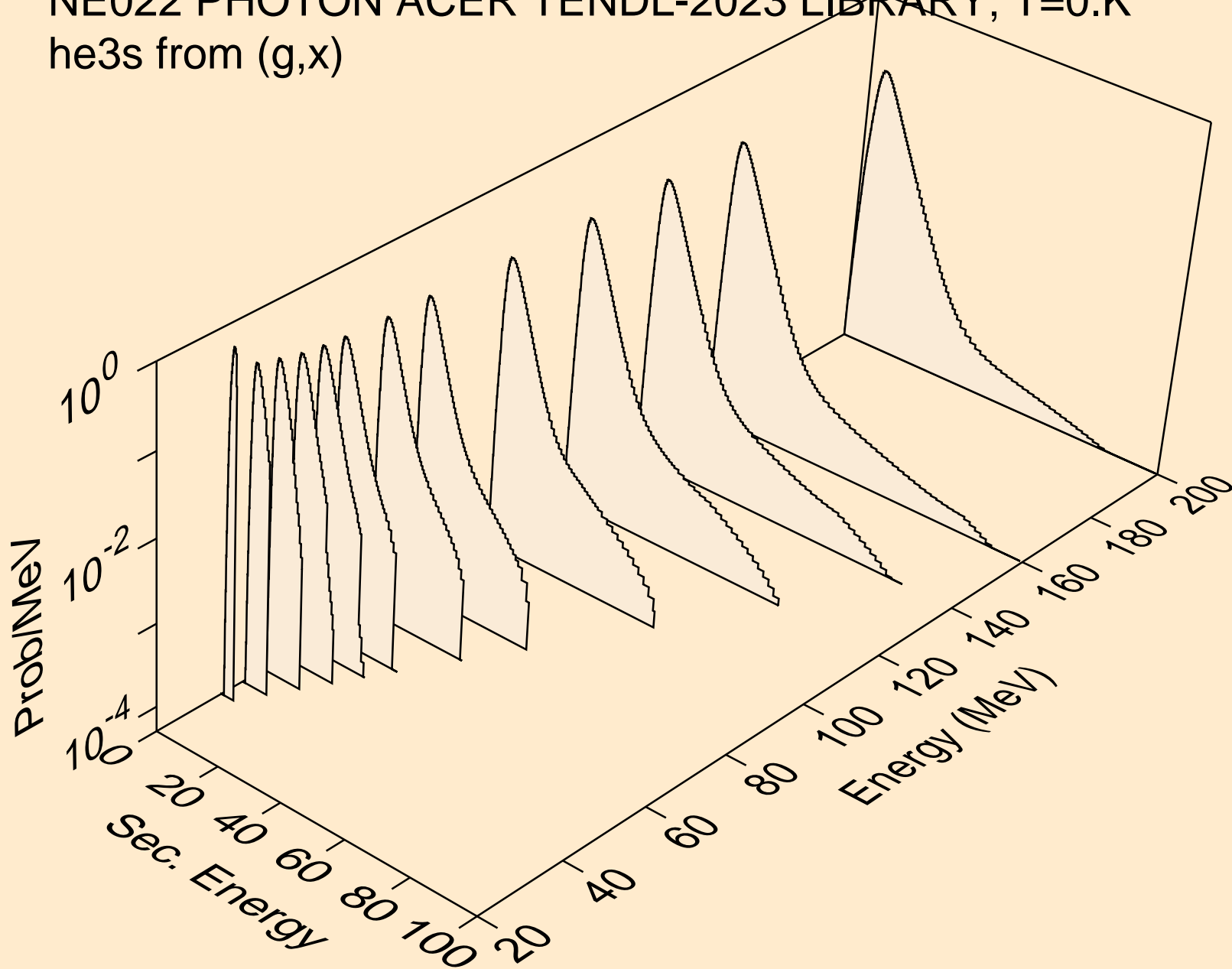

NE022 PHOTON ACER TENDL-2023 LIBRARY; T=0.K
he3s from (g,he3)

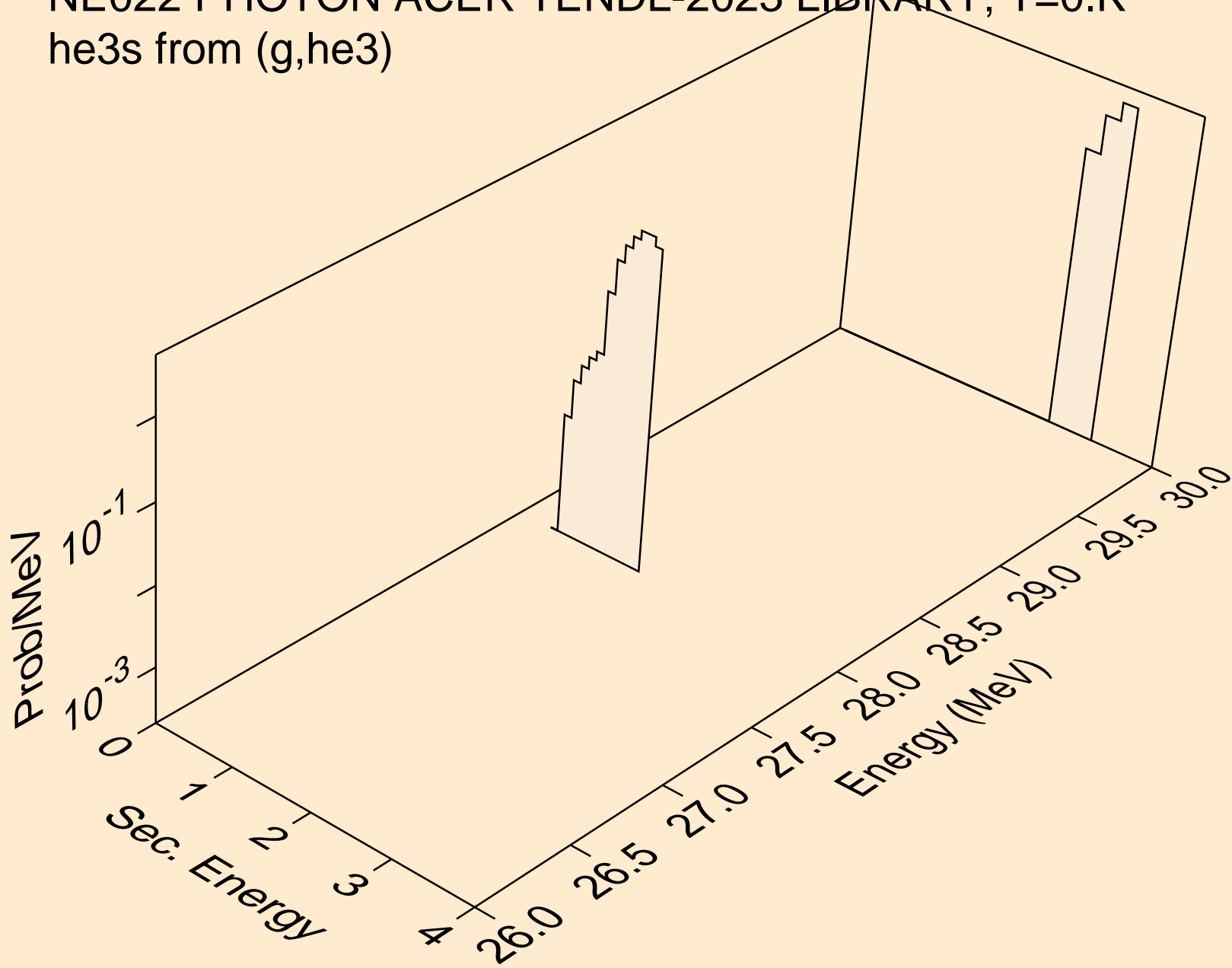

NE022 PHOTON ACER TENDL-2023 LIBRARY; T=0.K
alphas from (g,x)

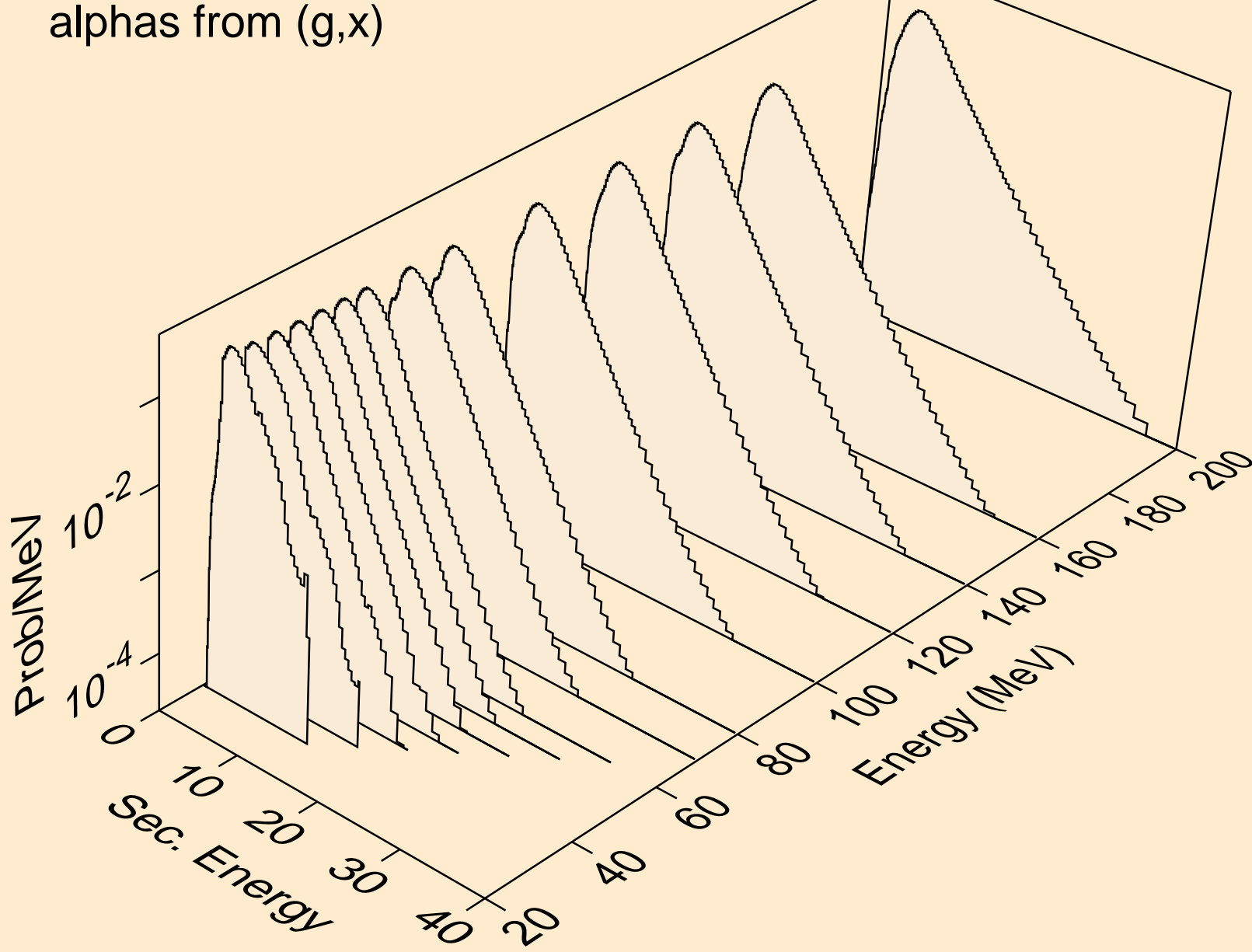

NE022 PHOTON ACER TENDL-2023 LIBRARY; T=0.K
alphas from (g,n*)a

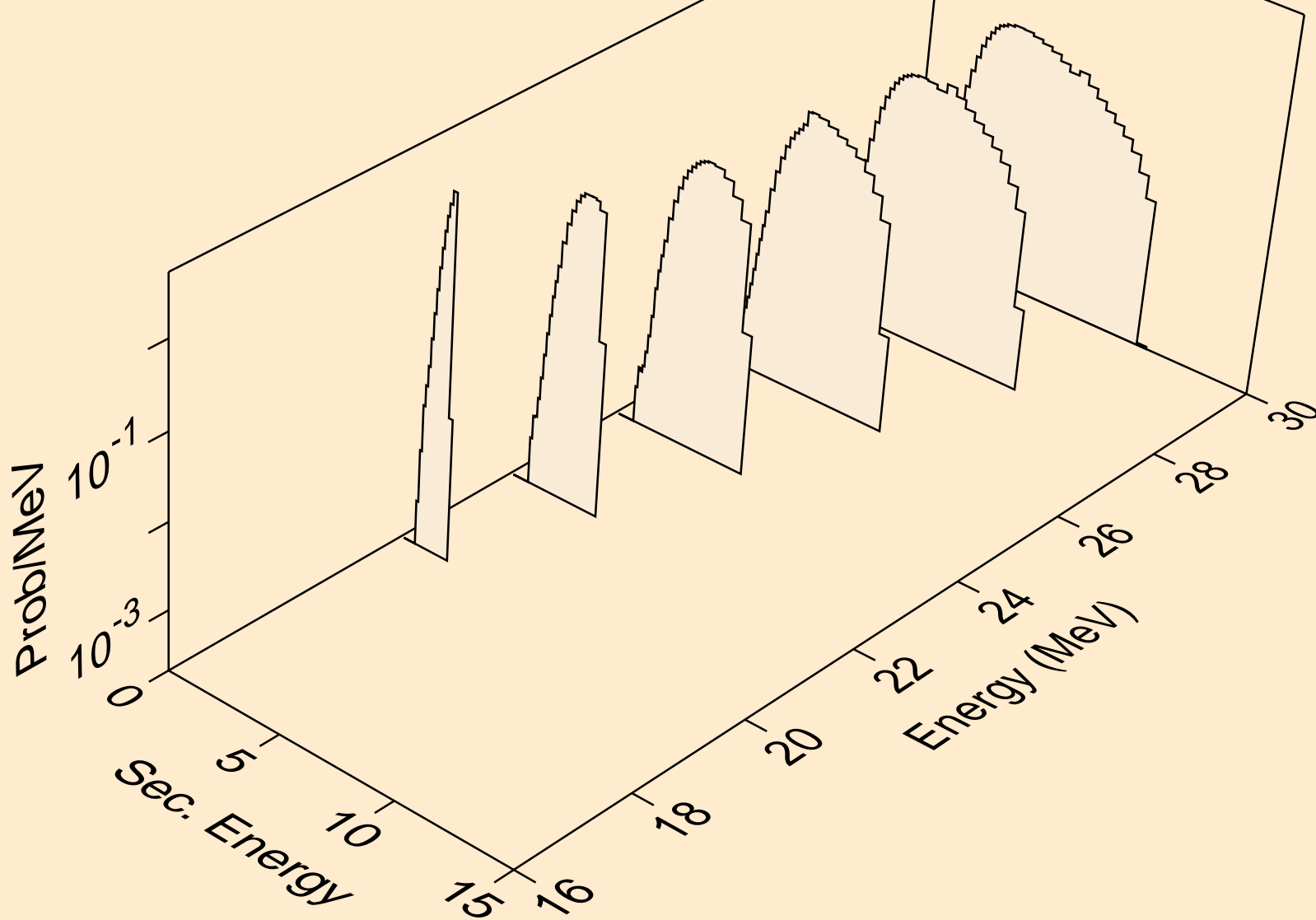

NE022 PHOTON ACER TENDL-2023 LIBRARY; T=0.K
alphas from (g,2n)a

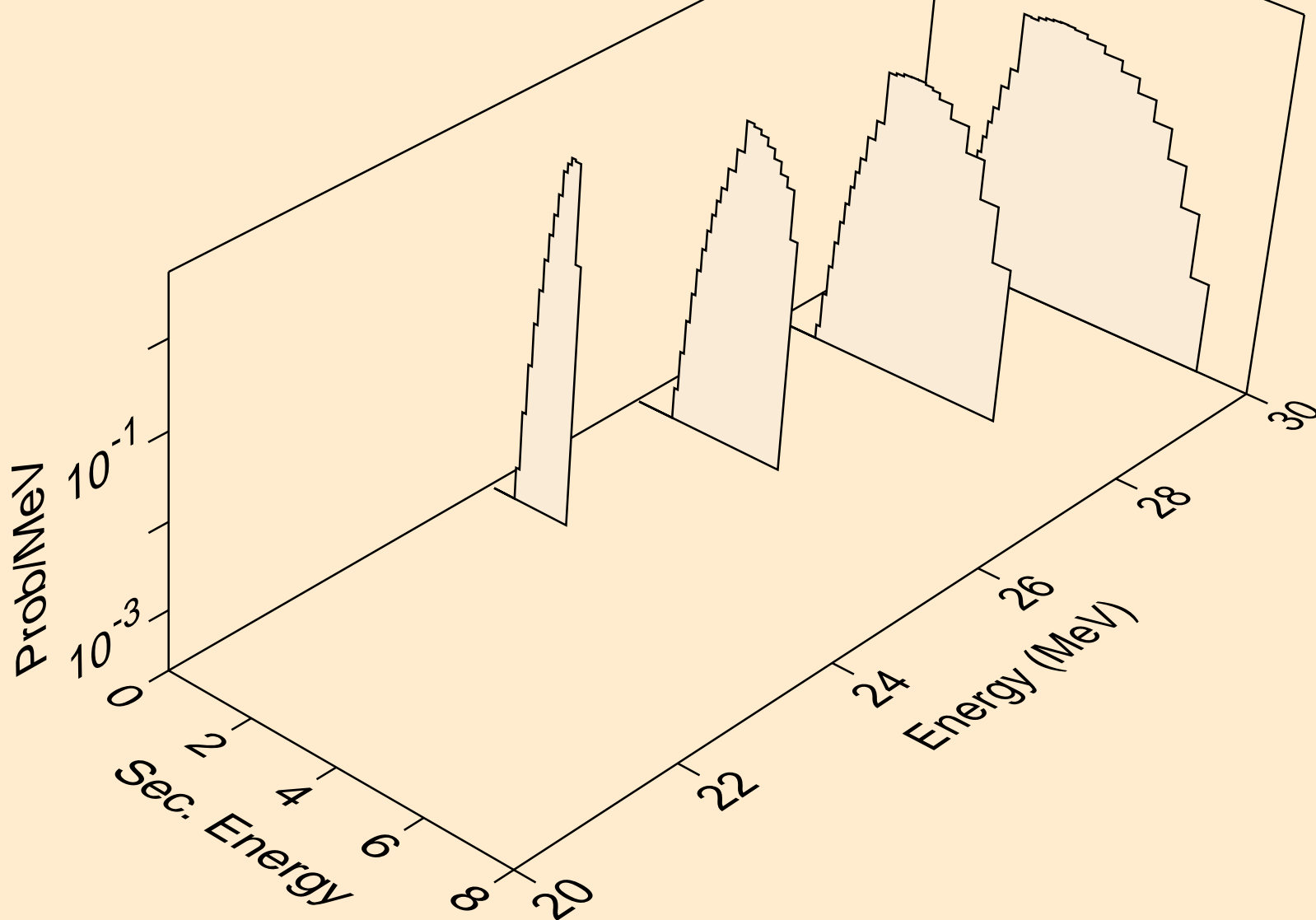

NE022 PHOTON ACER TENDL-2023 LIBRARY; T=0.K
alphas from (g,n*)2a

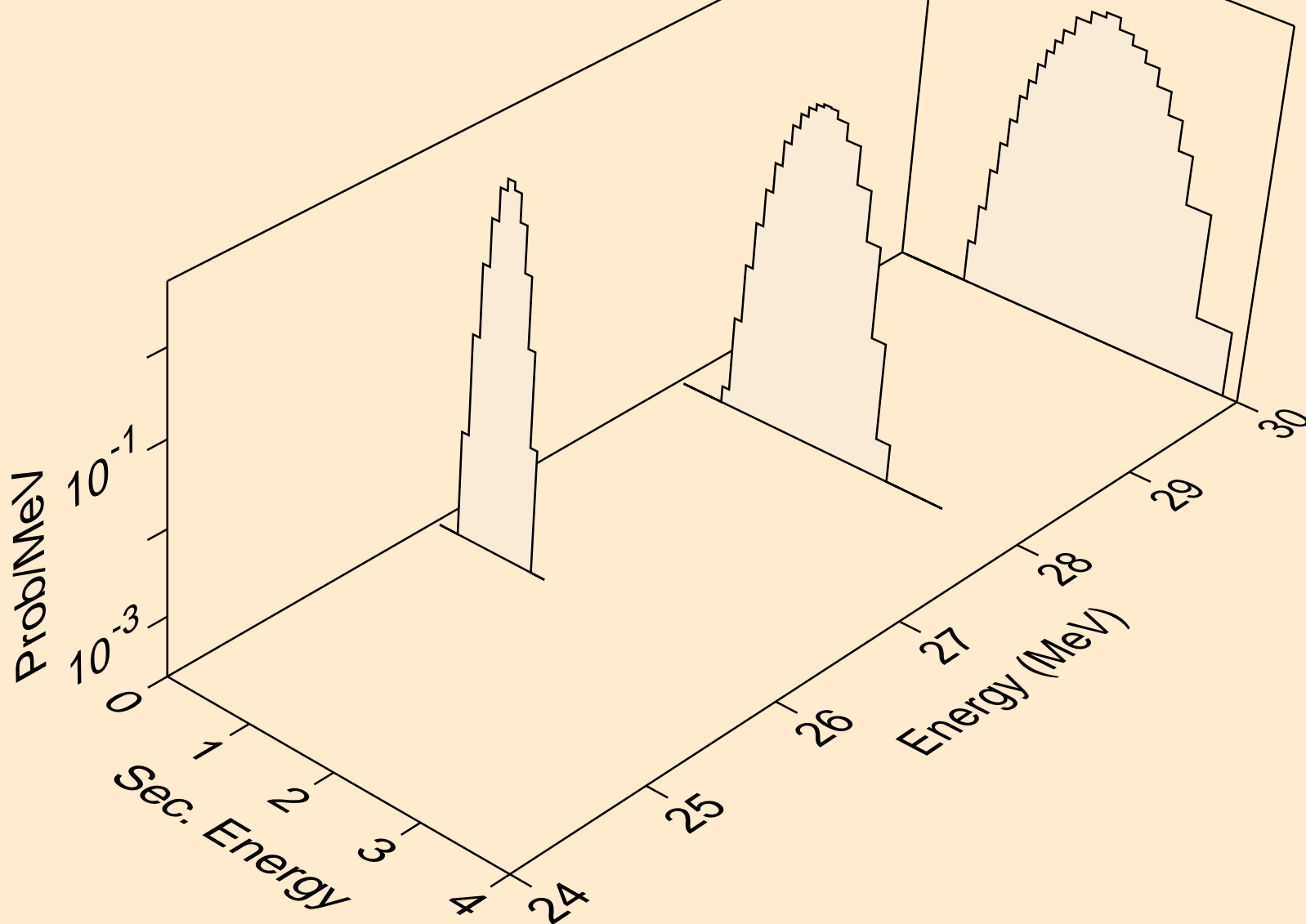

NE022 PHOTON ACER TENDL-2023 LIBRARY; T=0.K
alphas from (g,a)

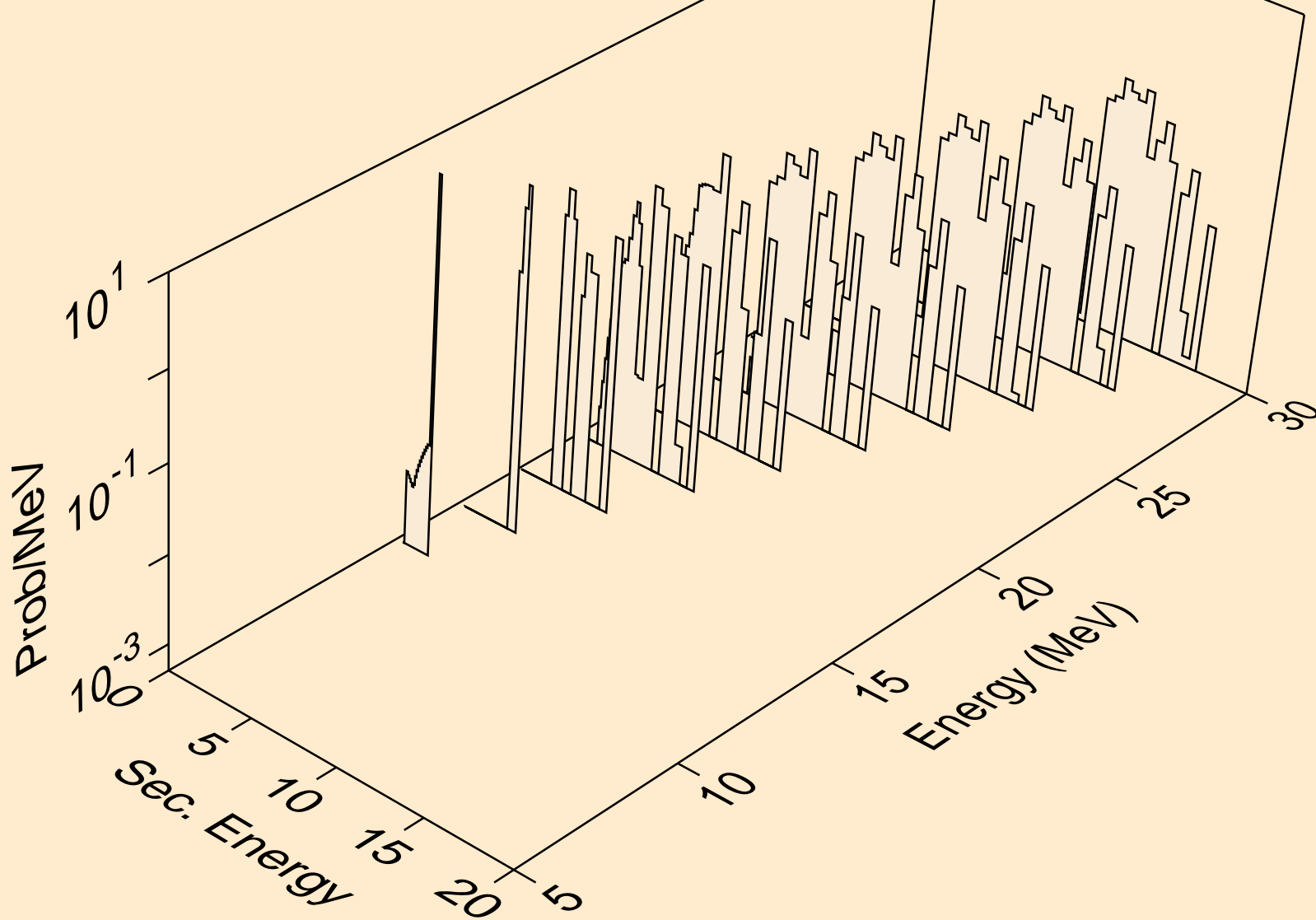

NE022 PHOTON ACER TENDL-2023 LIBRARY; T=0.K
alphas from (g,2a)

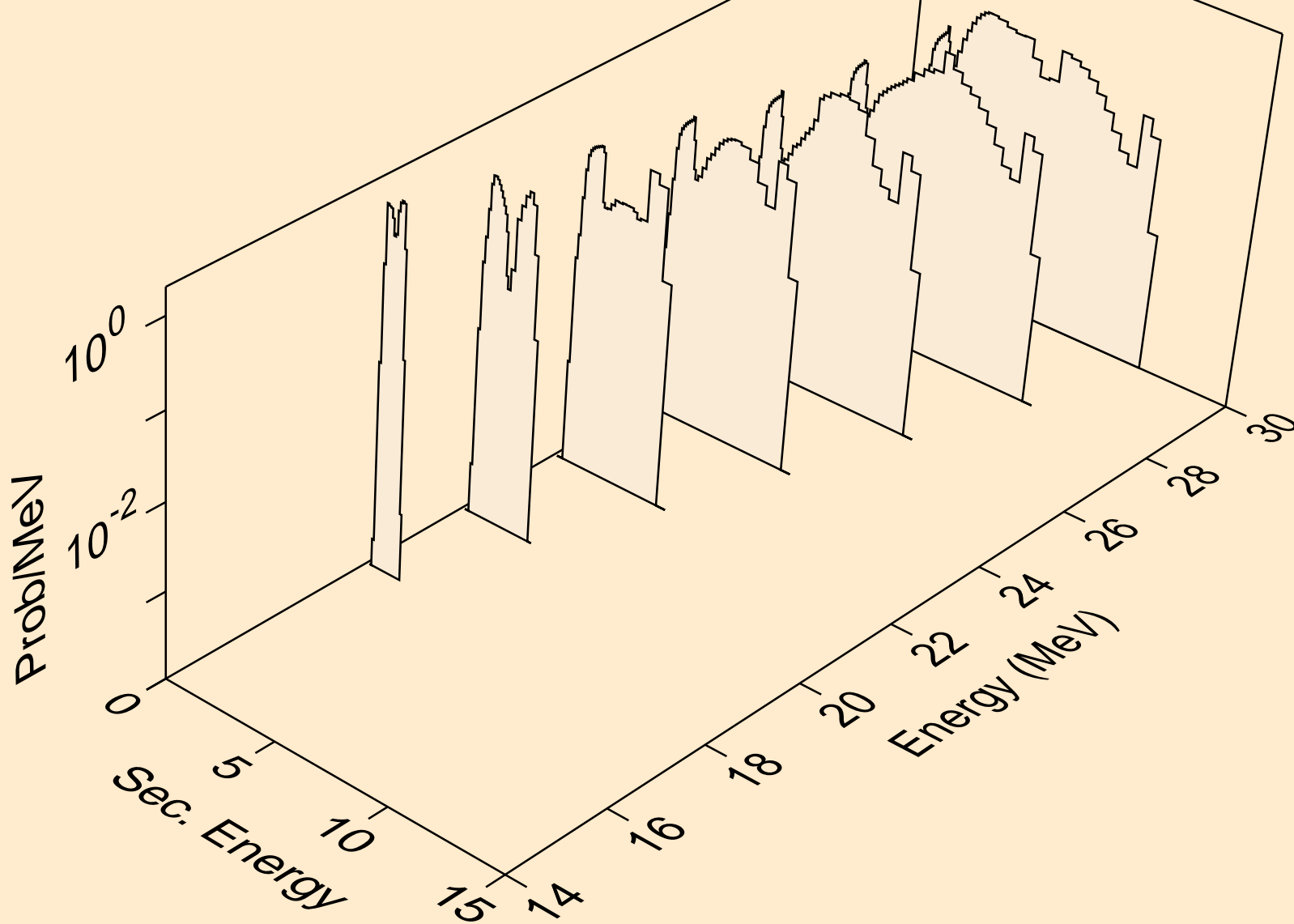

NE022 PHOTON ACER TENDL-2023 LIBRARY; T=0.K
alphas from (g,pa)

