

P033 PHOTON ACER TENDL-2023 LIBRARY; T=0.K

Principal cross sections

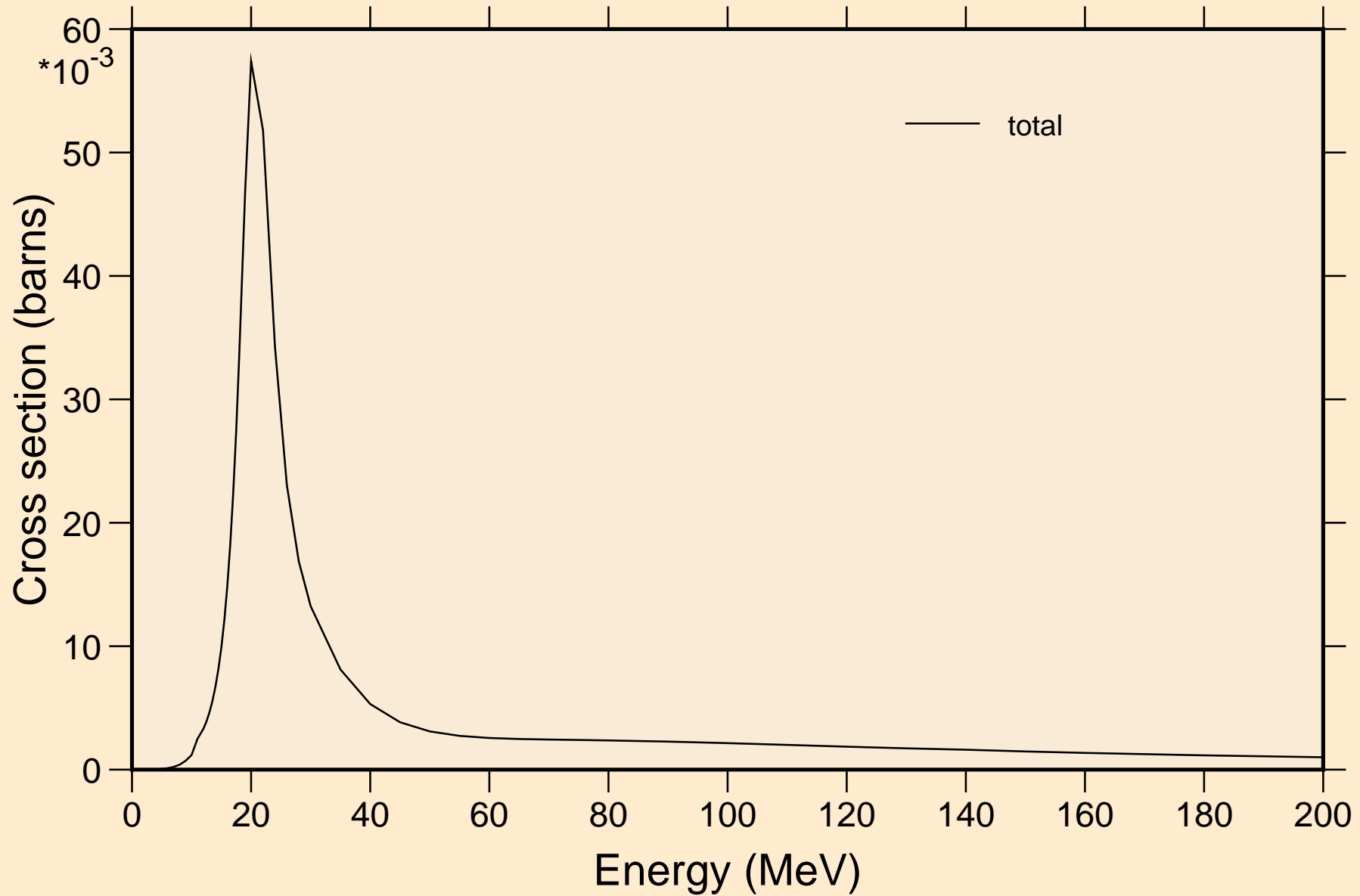

# P033 PHOTON ACER TENDL-2023 LIBRARY; T=0.K

## Partial cross sections

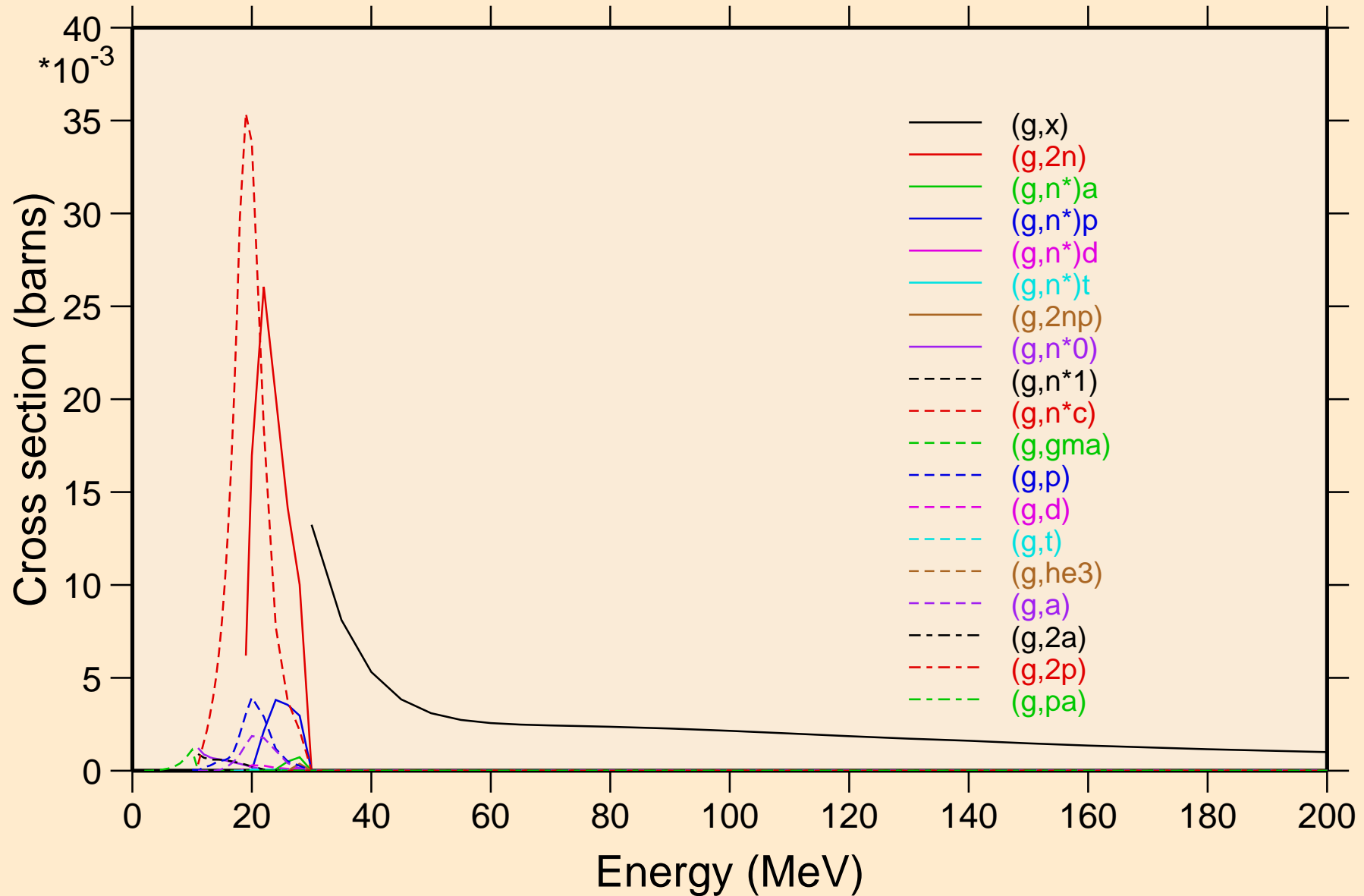

# P033 PHOTON ACER TENDL-2023 LIBRARY; T=0.K

## Heating

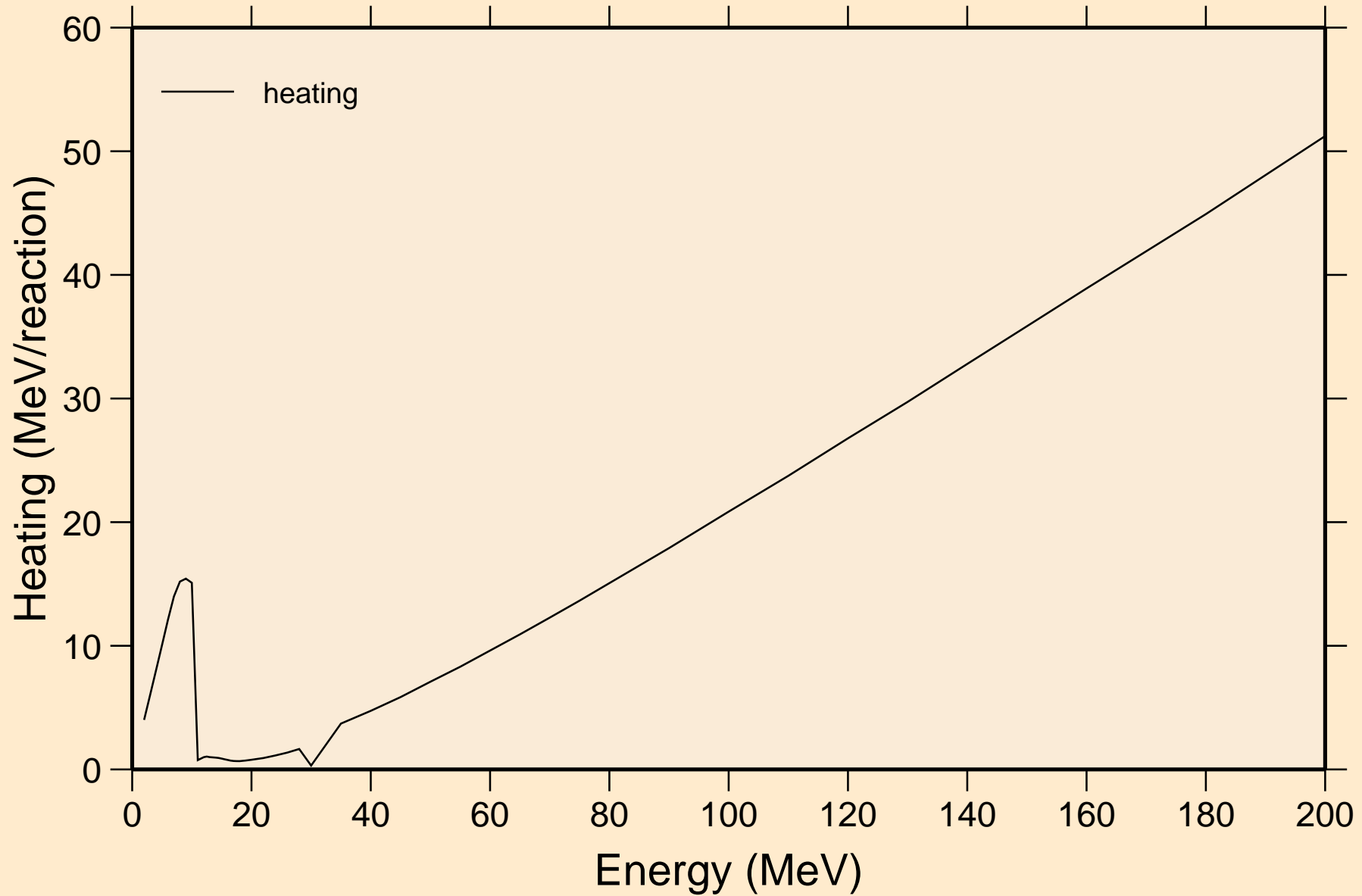

# P033 PHOTON ACER TENDL-2023 LIBRARY; T=0.K

## Particle heating contributions

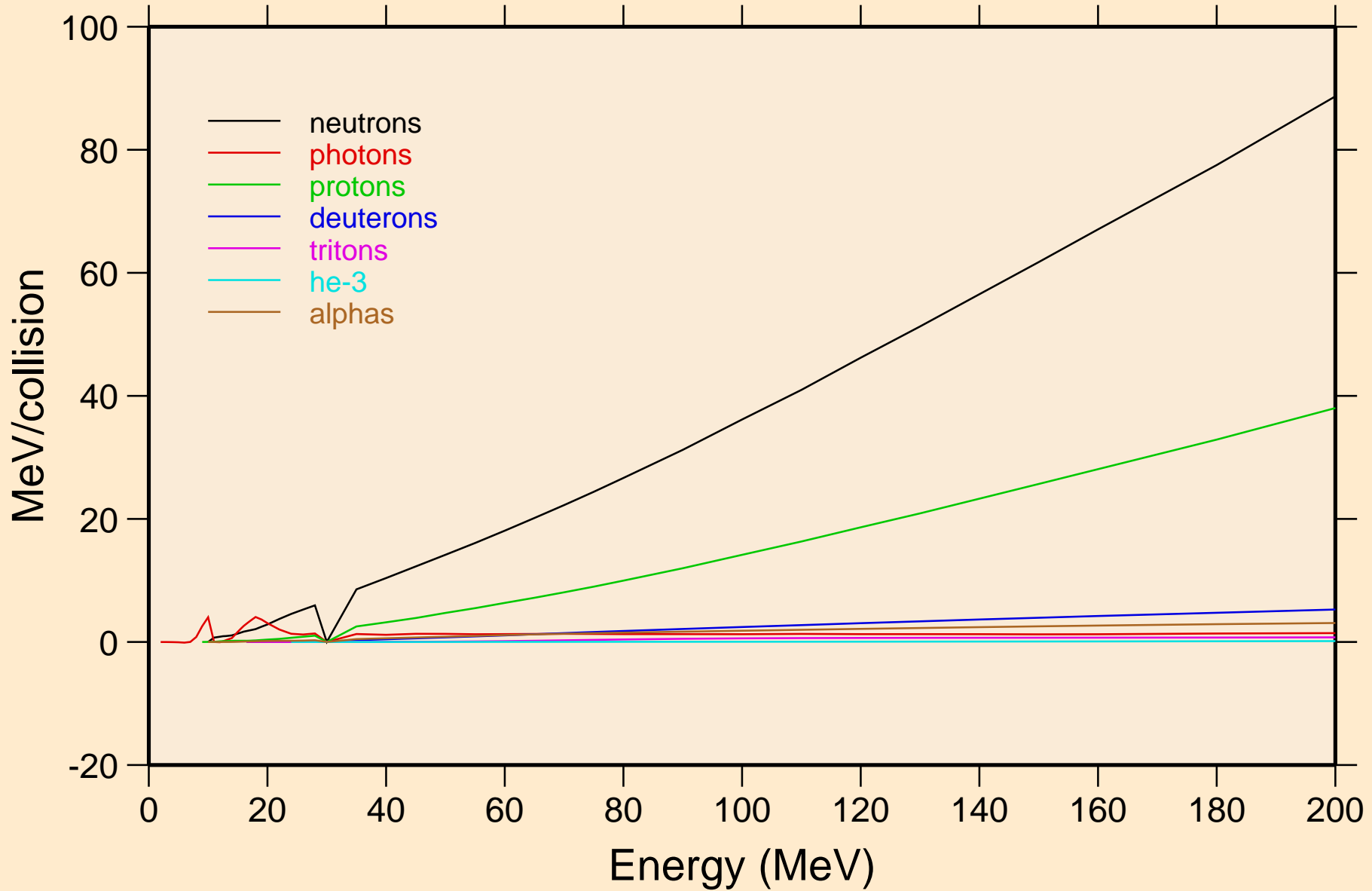

P033 PHOTON ACER TENDL-2023 LIBRARY; T=0.K  
Particle production cross sections

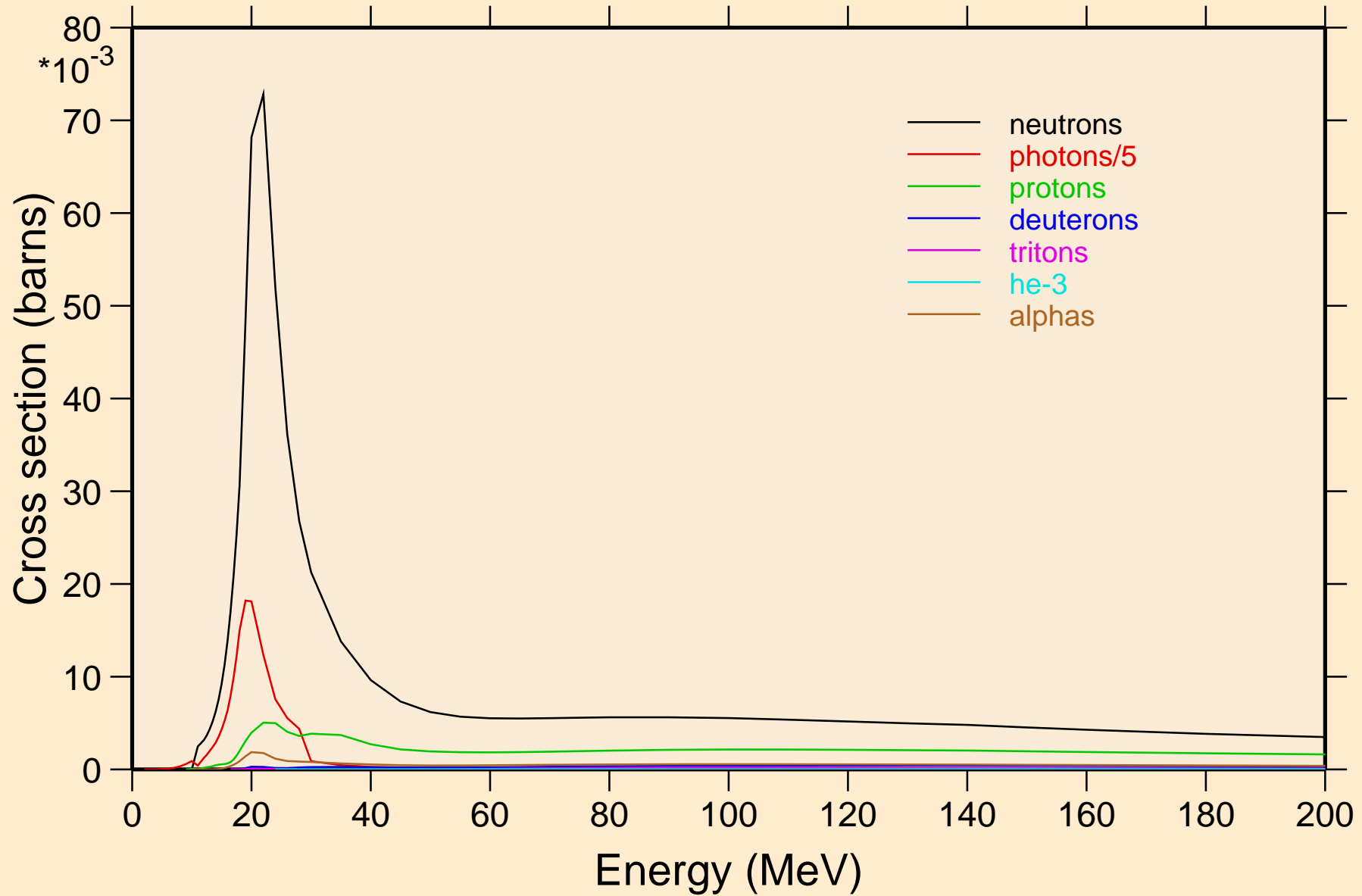

P033 PHOTON ACER TENDL-2023 LIBRARY; T=0.K  
neutrons from (g,x)

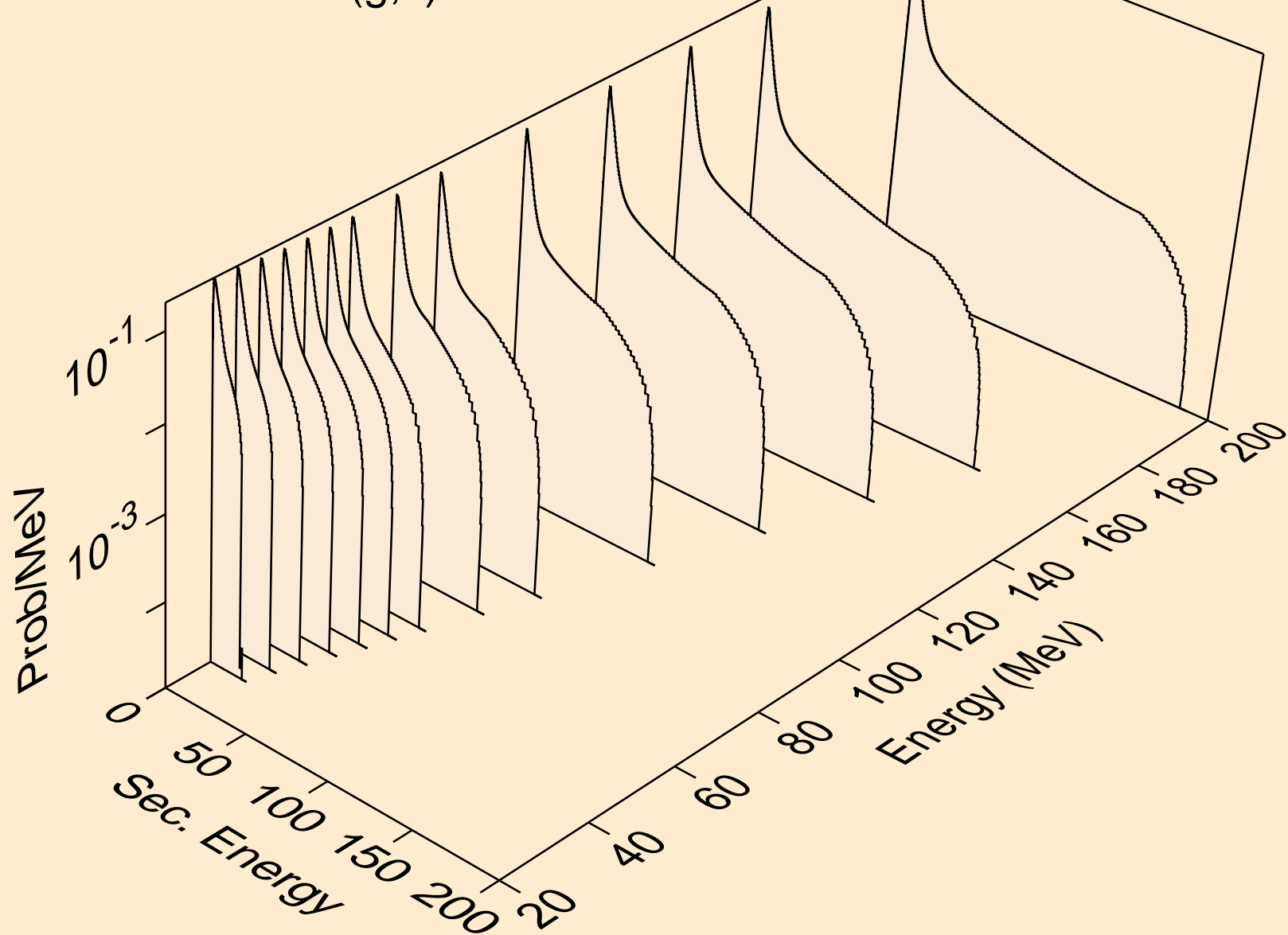

P033 PHOTON ACER TENDL-2023 LIBRARY; T=0.K  
neutrons from (g,2n)

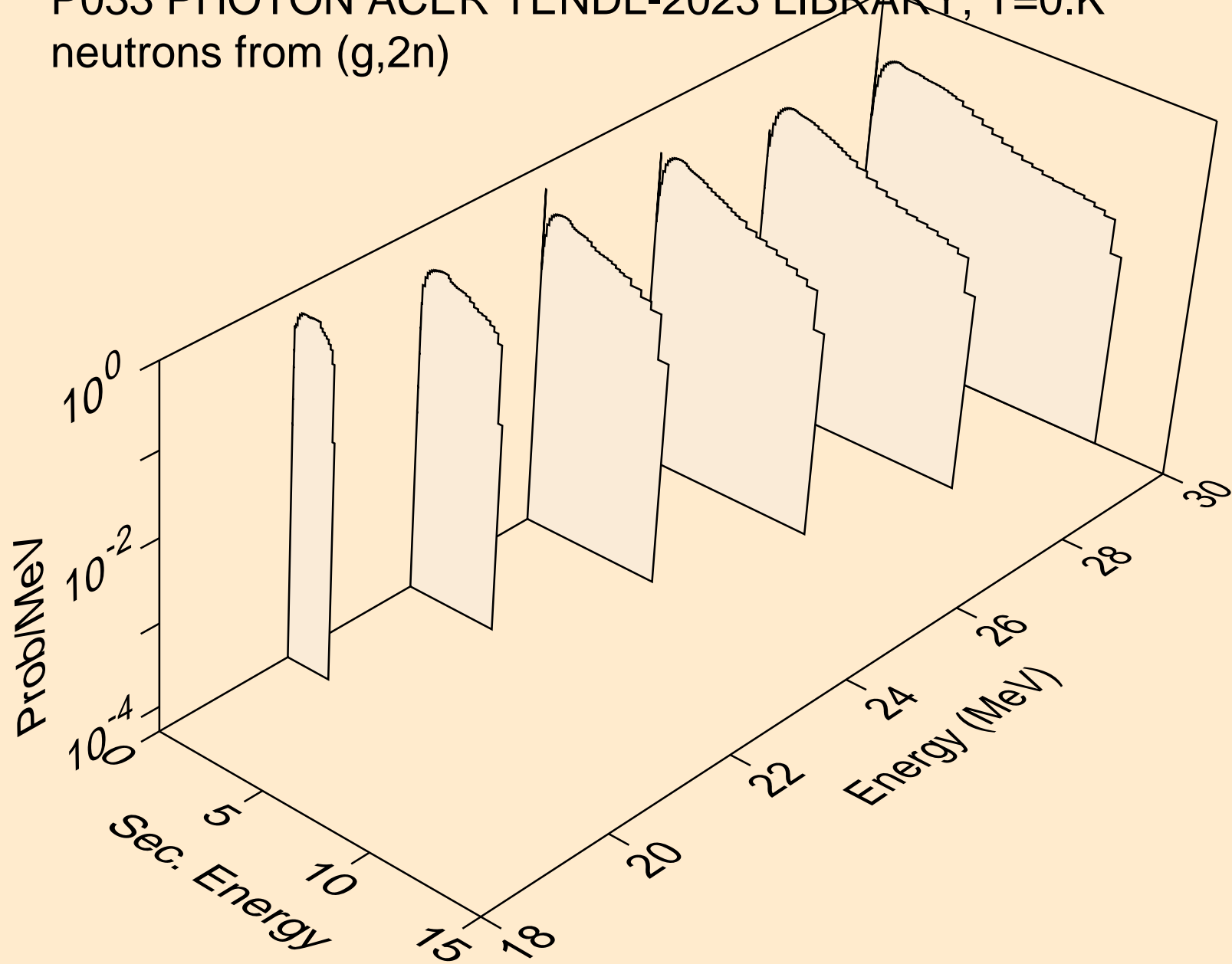

P033 PHOTON ACER TENDL-2023 LIBRARY; T=0.K  
neutrons from (g,n\*)a

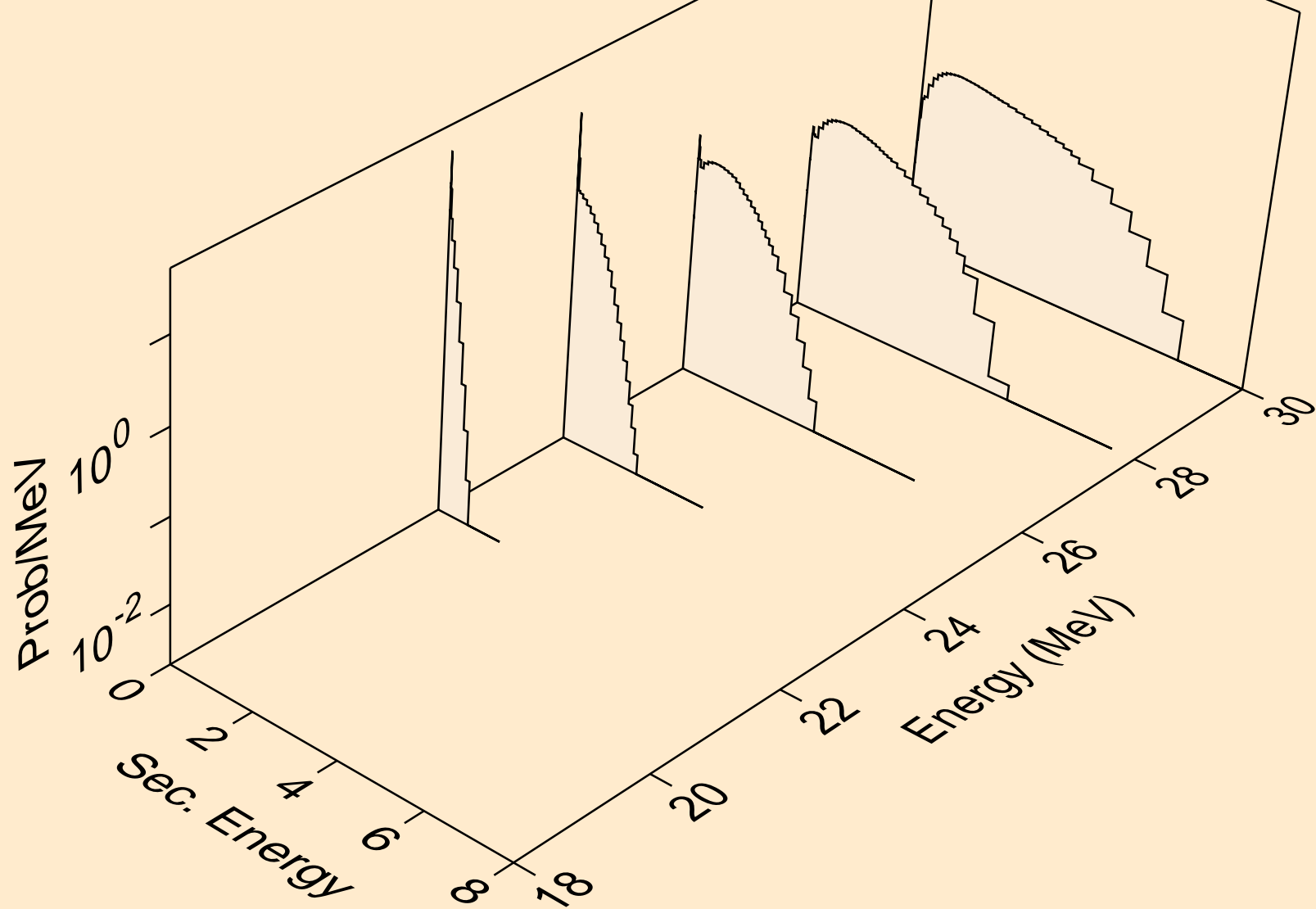



P033 PHOTON ACER TENDL-2023 LIBRARY; T=0.K  
neutrons from (g,n\*)p

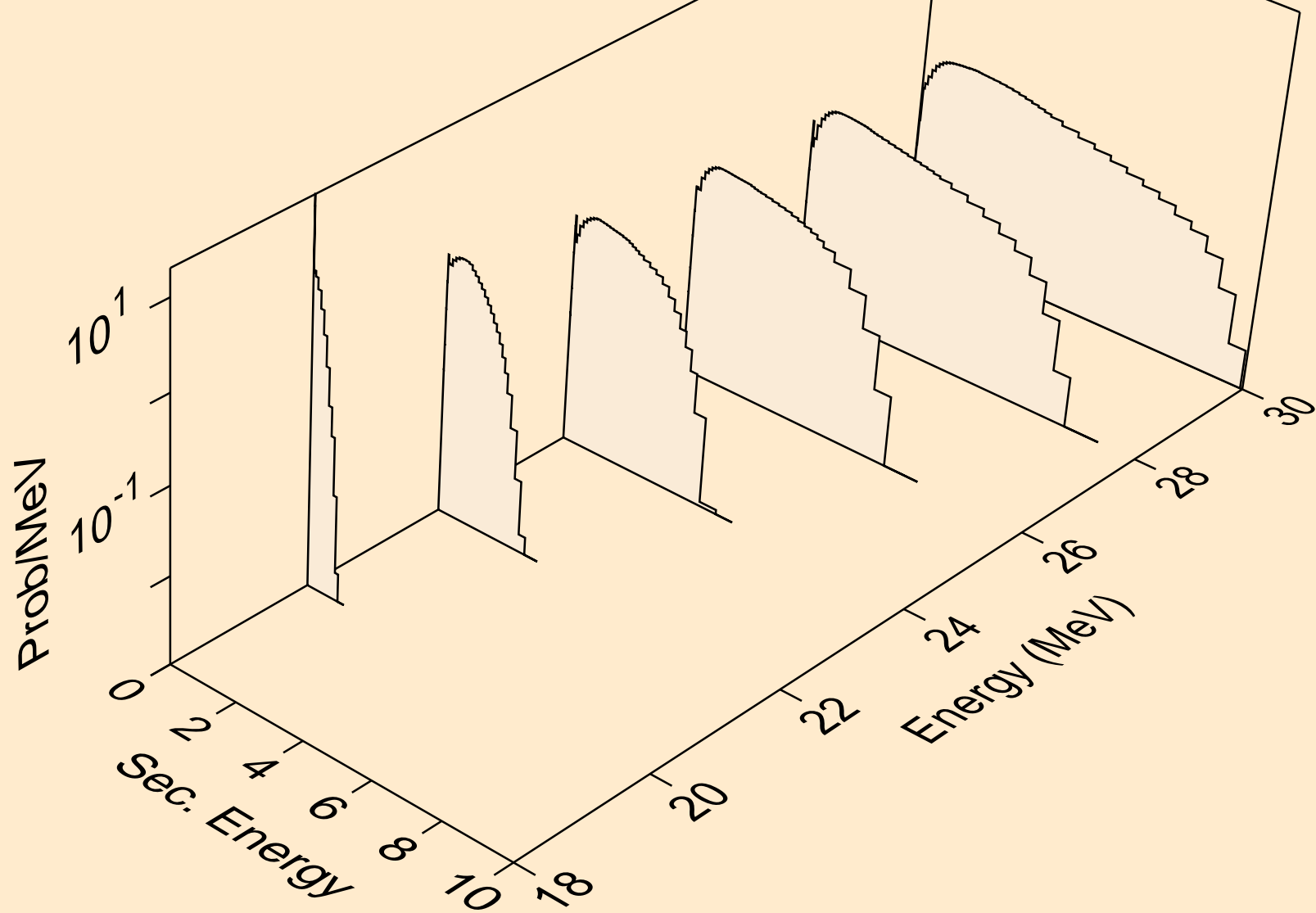

P033 PHOTON ACER TENDL-2023 LIBRARY; T=0.K  
neutrons from (g,n\*)d

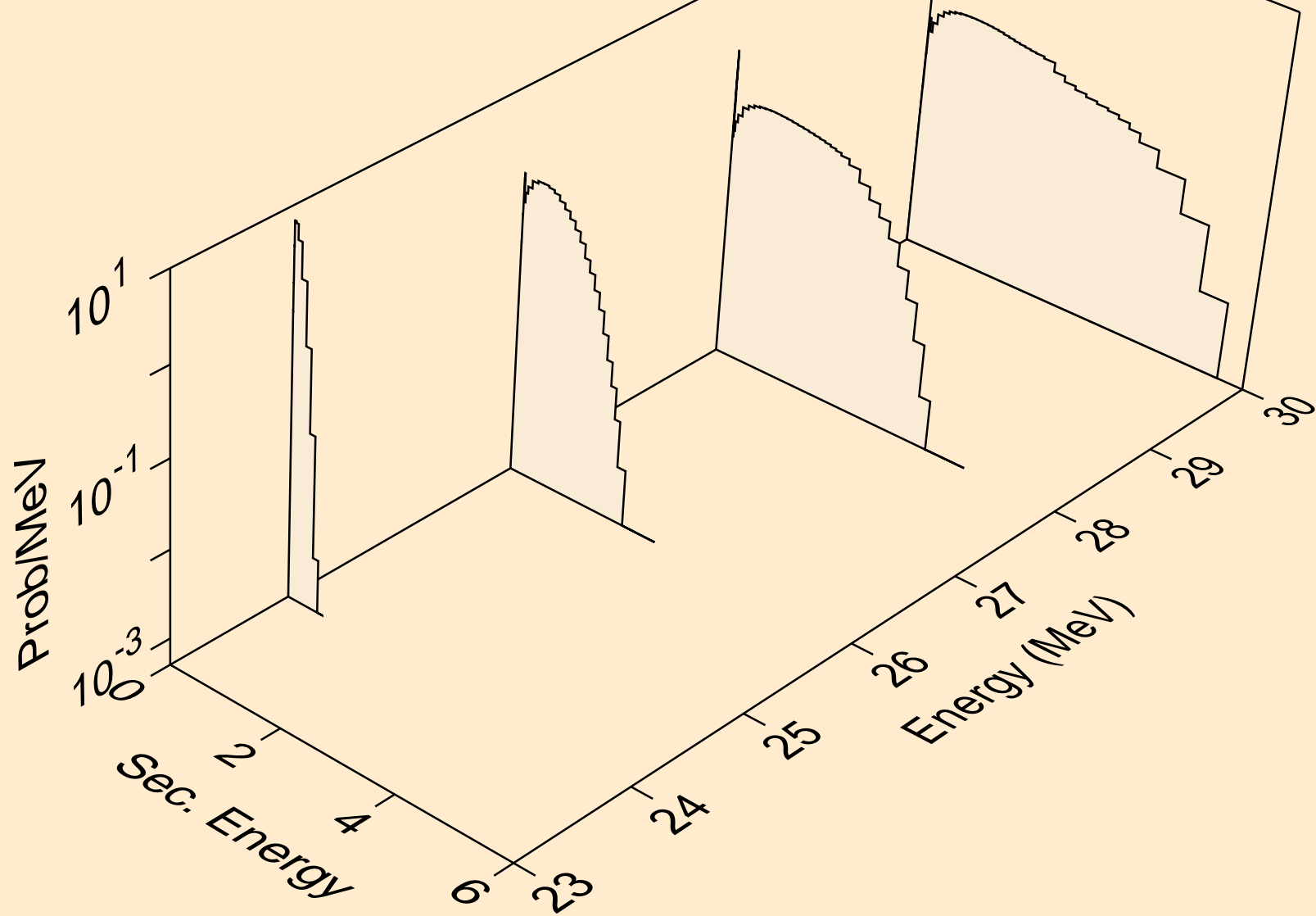

P033 PHOTON ACER TENDL-2023 LIBRARY; T=0.K  
neutrons from (g,n\*)t

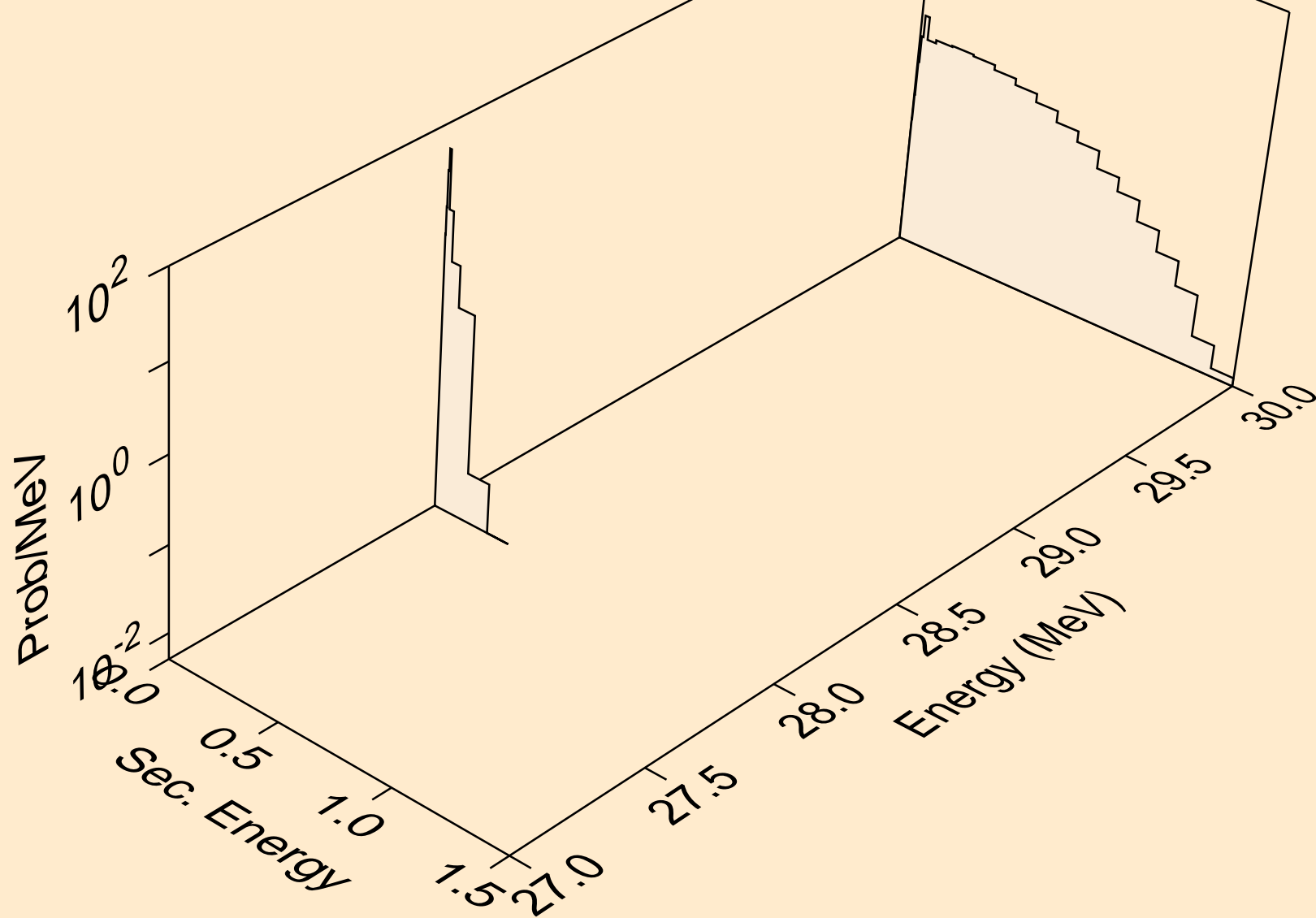

P033 PHOTON ACER TENDL-2023 LIBRARY; T=0.K  
neutrons from (g,2np)

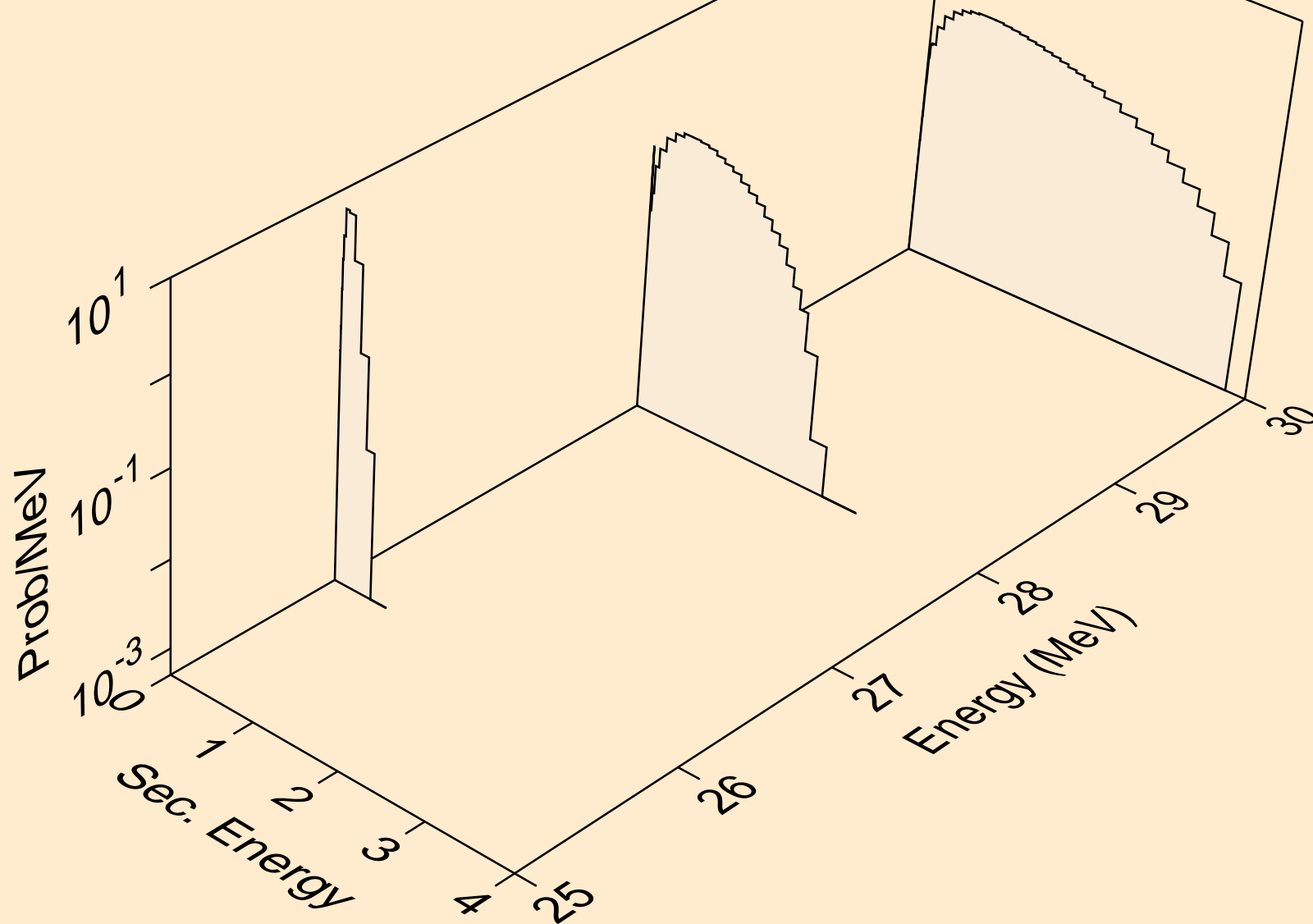

P033 PHOTON ACER TENDL-2023 LIBRARY; T=0.K  
angular distribution for (g,n\*0) neutron

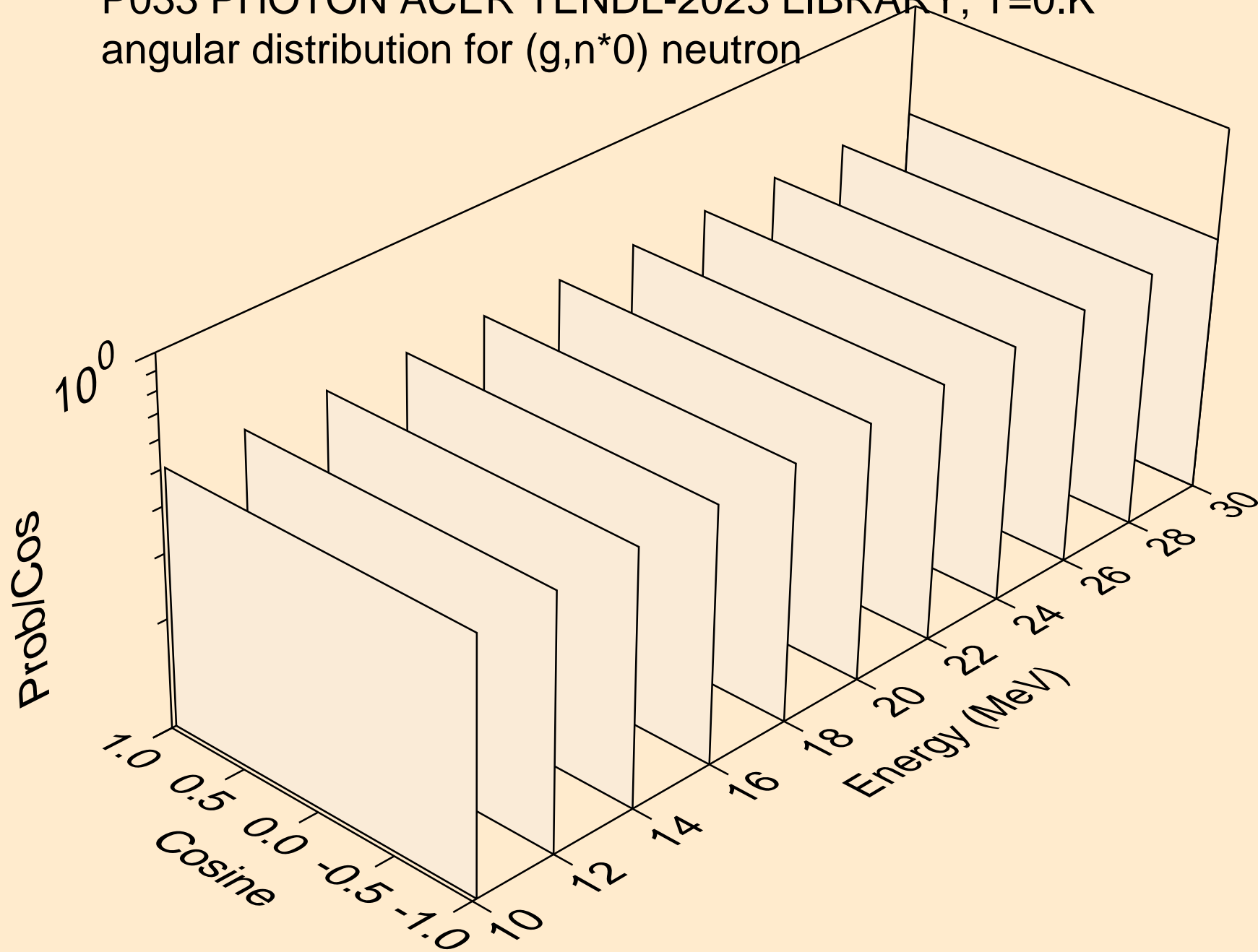

P033 PHOTON ACER TENDL-2023 LIBRARY; T=0.K  
angular distribution for (g,n\*1) neutron

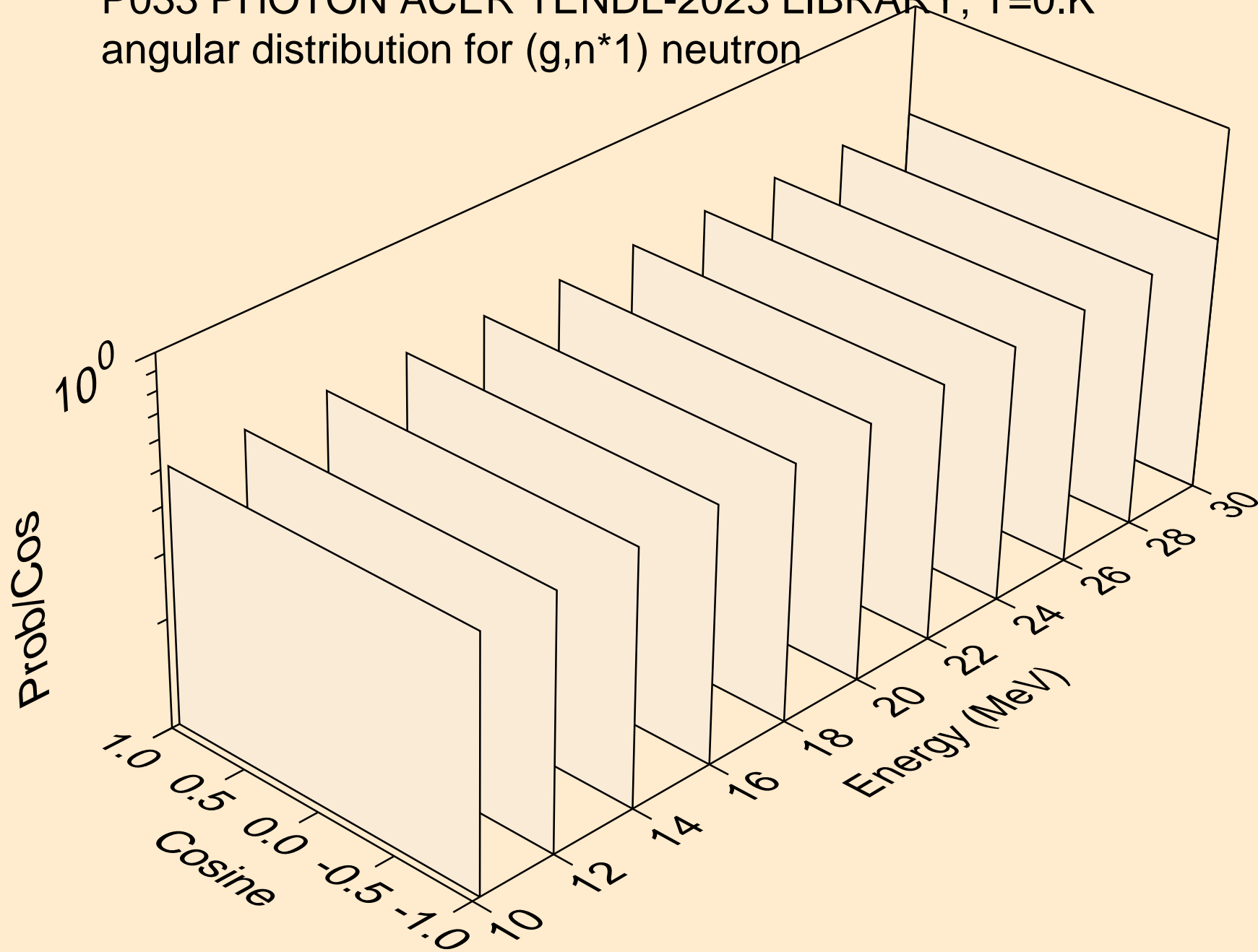

P033 PHOTON ACER TENDL-2023 LIBRARY; T=0.K  
neutrons from (g,n\*c)

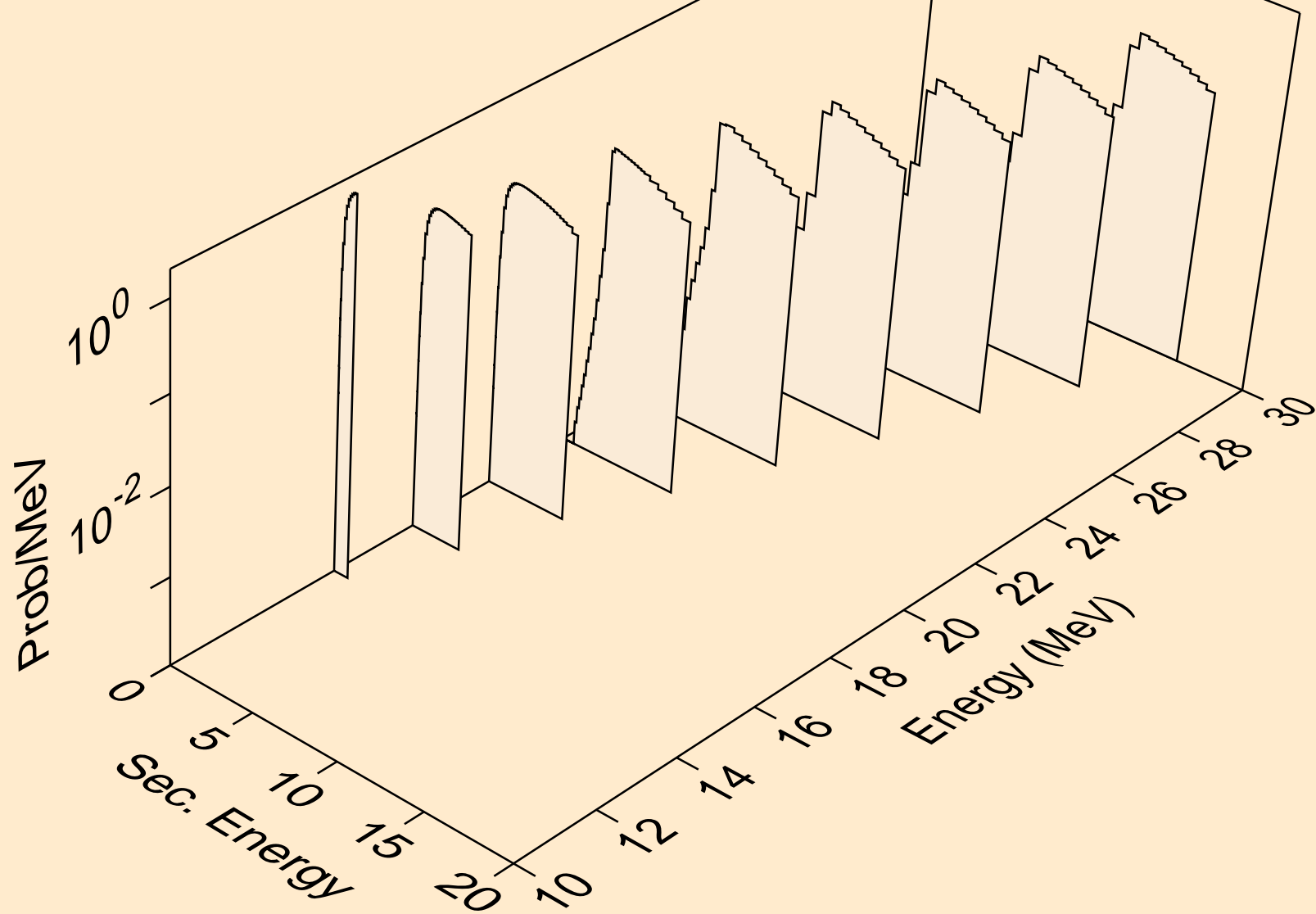

P033 PHOTON ACER TENDL-2023 LIBRARY; T=0.K  
photons from (g,x)

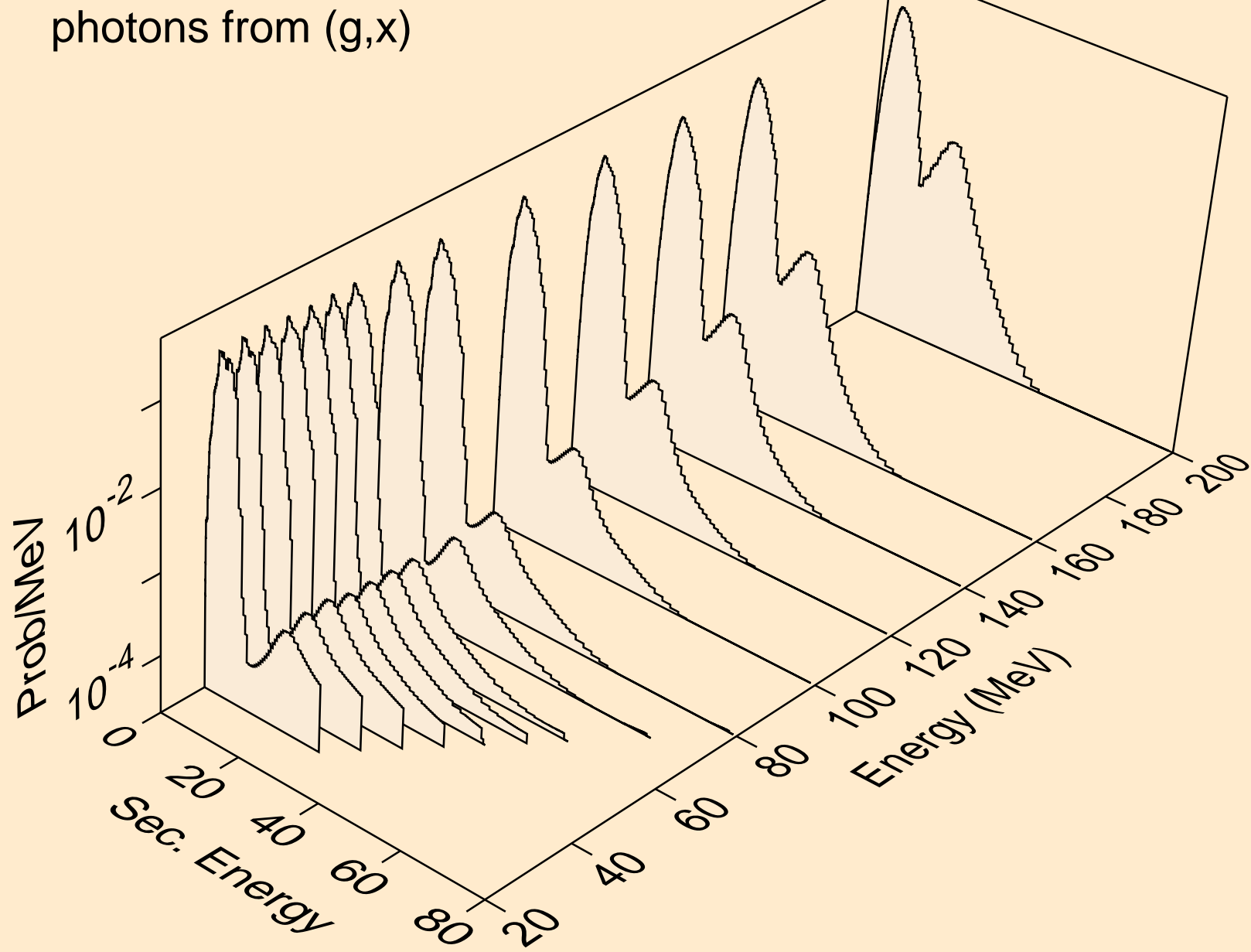



P033 PHOTON ACER TENDL-2023 LIBRARY; T=0.K  
photons from (g,2n)

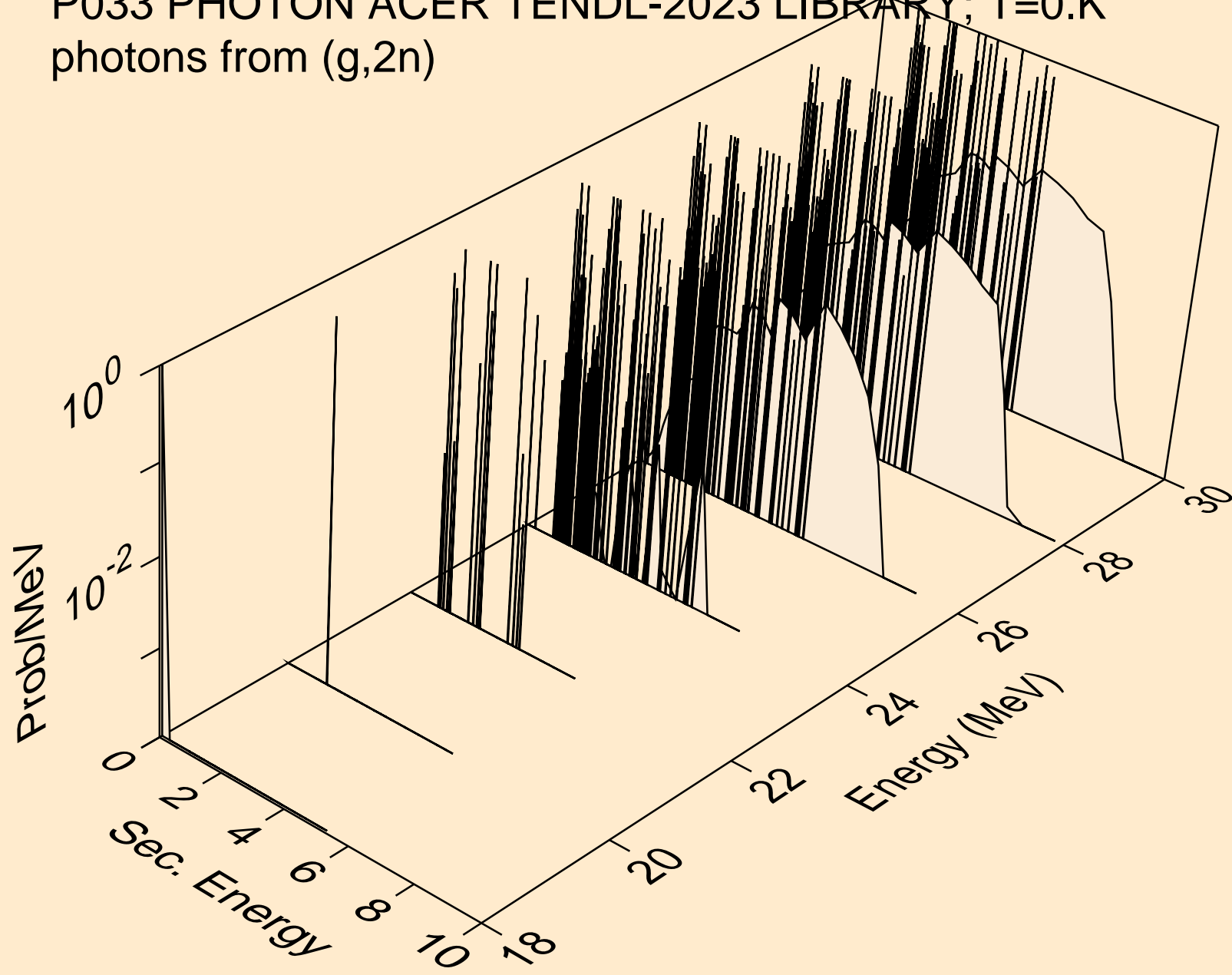

P033 PHOTON ACER TENDL-2023 LIBRARY; T=0.K  
photons from (g,n\*)a

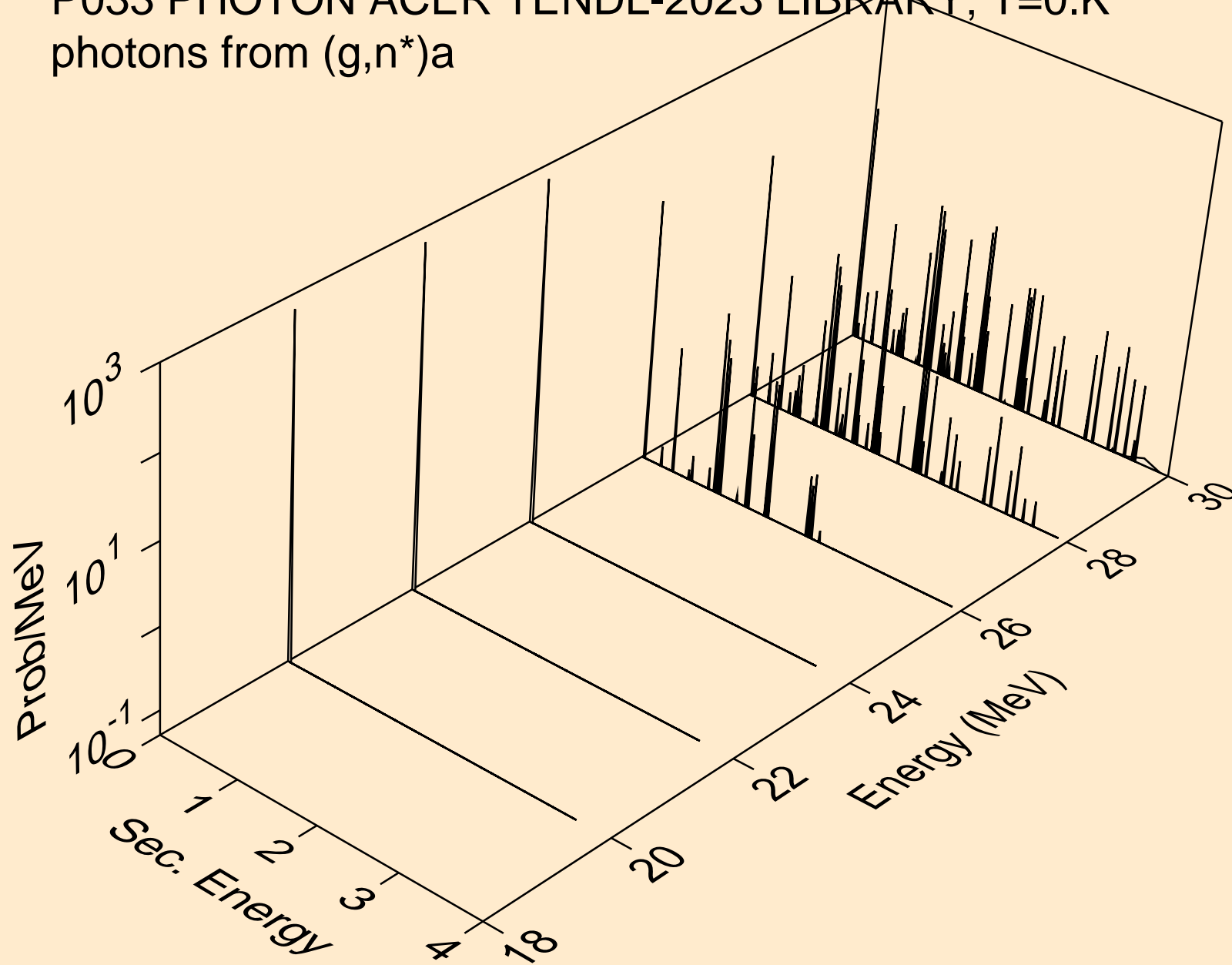

P033 PHOTON ACER TENDL-2023 LIBRARY; T=0.K  
photons from (g,n\*)p

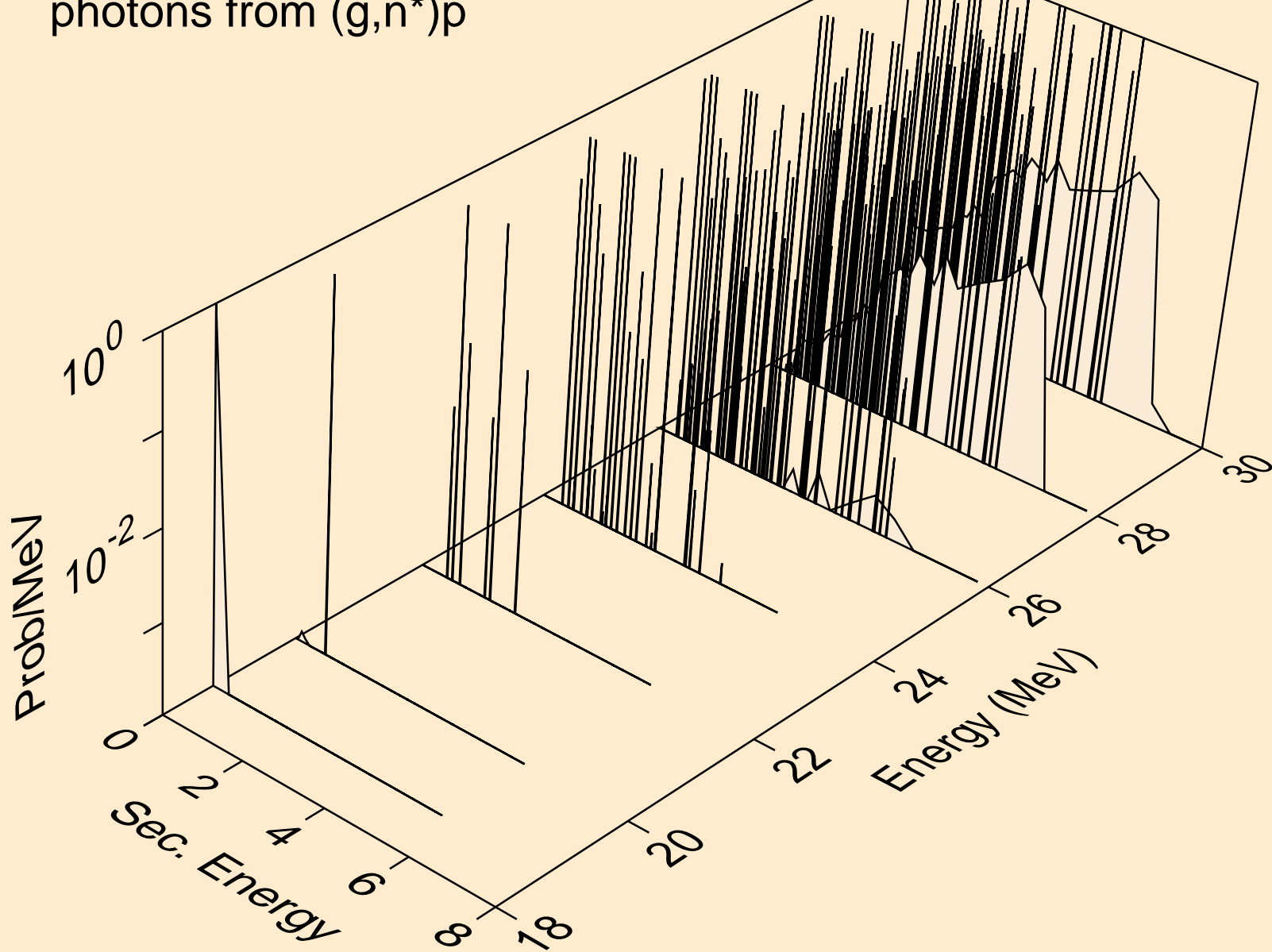

P033 PHOTON ACER TENDL-2023 LIBRARY; T=0.K  
photons from (g,n\*)d

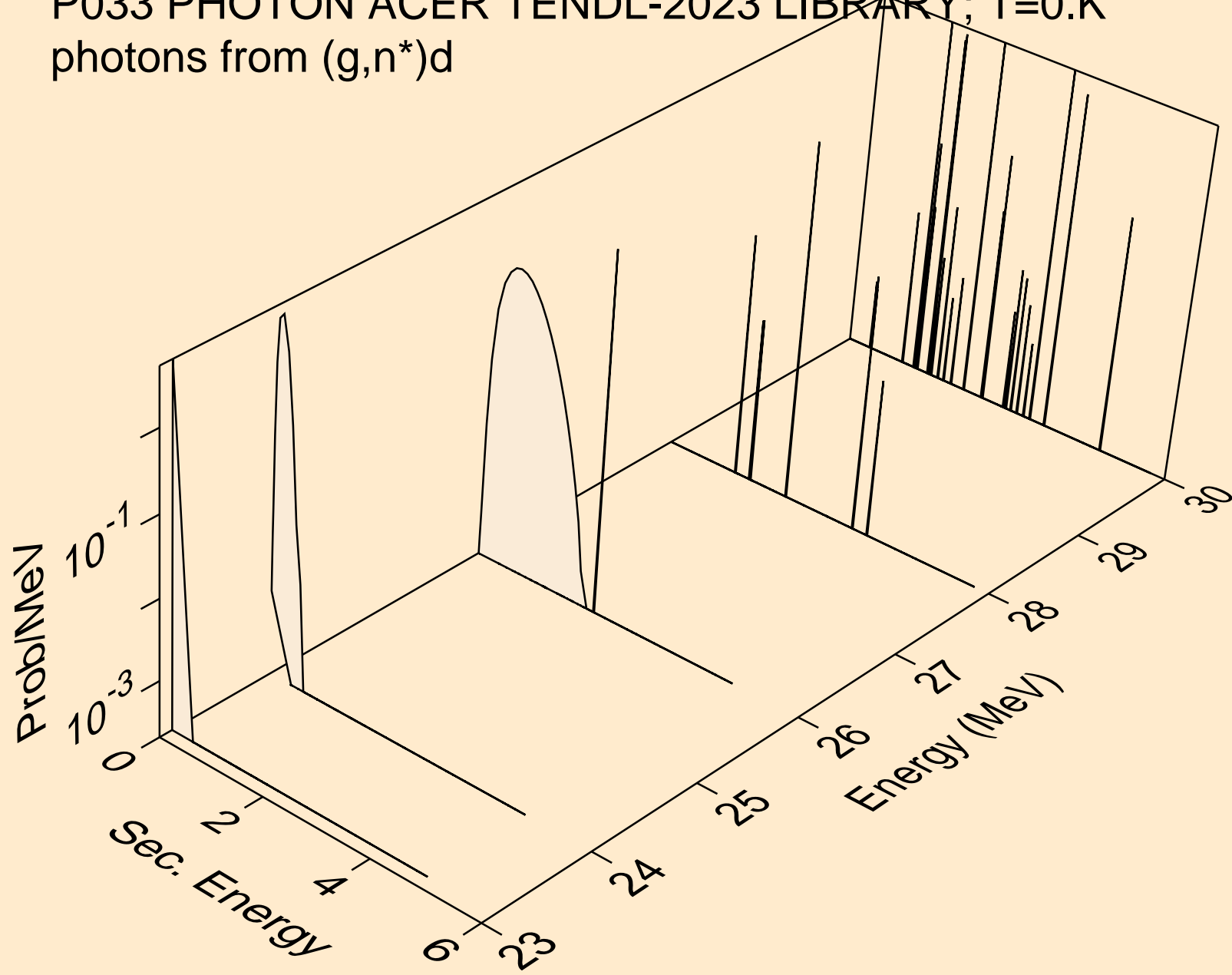

P033 PHOTON ACER TENDL-2023 LIBRARY; T=0.K  
photons from (g,n\*)t

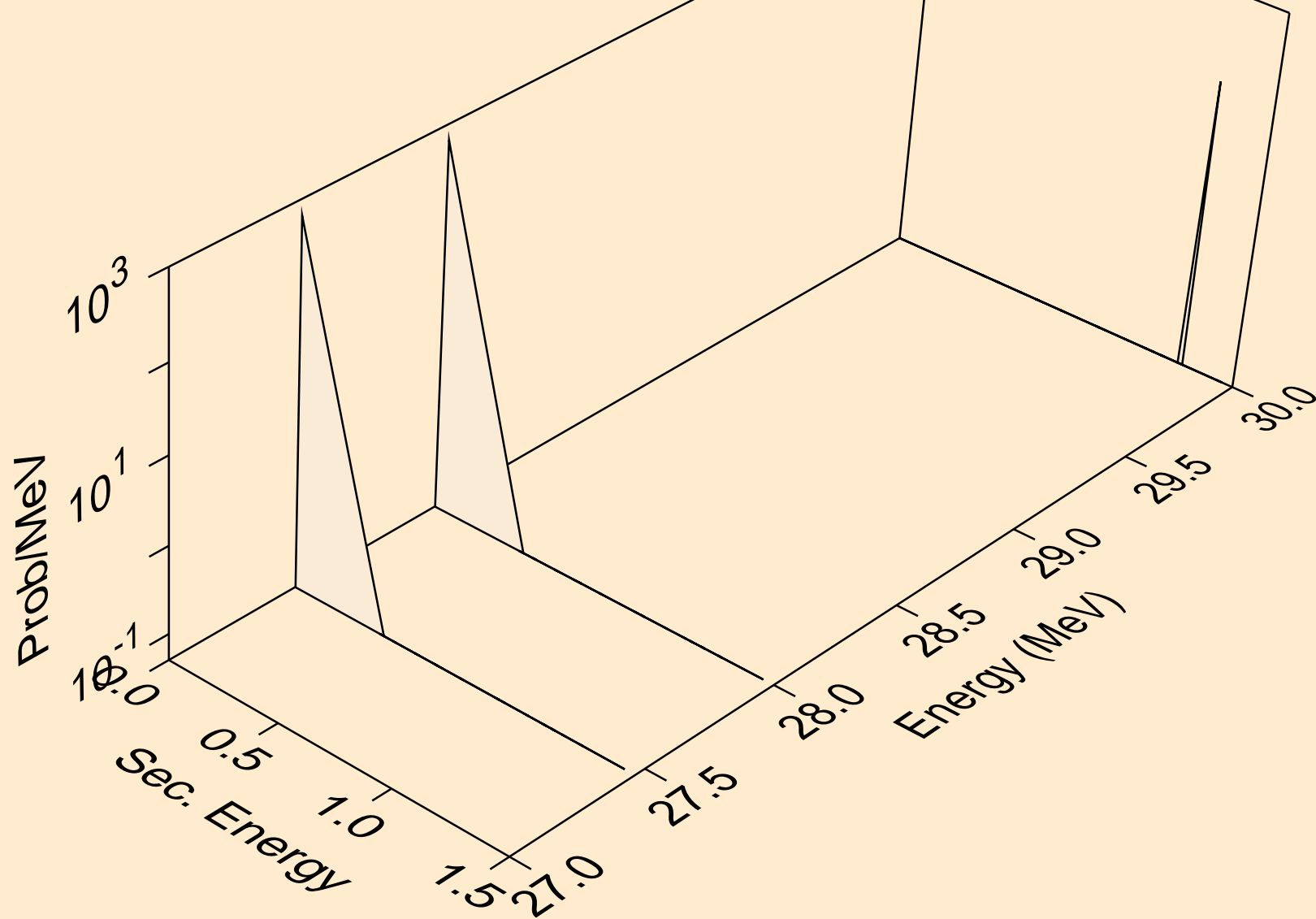

P033 PHOTON ACER TENDL-2023 LIBRARY; T=0.K  
photons from (g,2np)

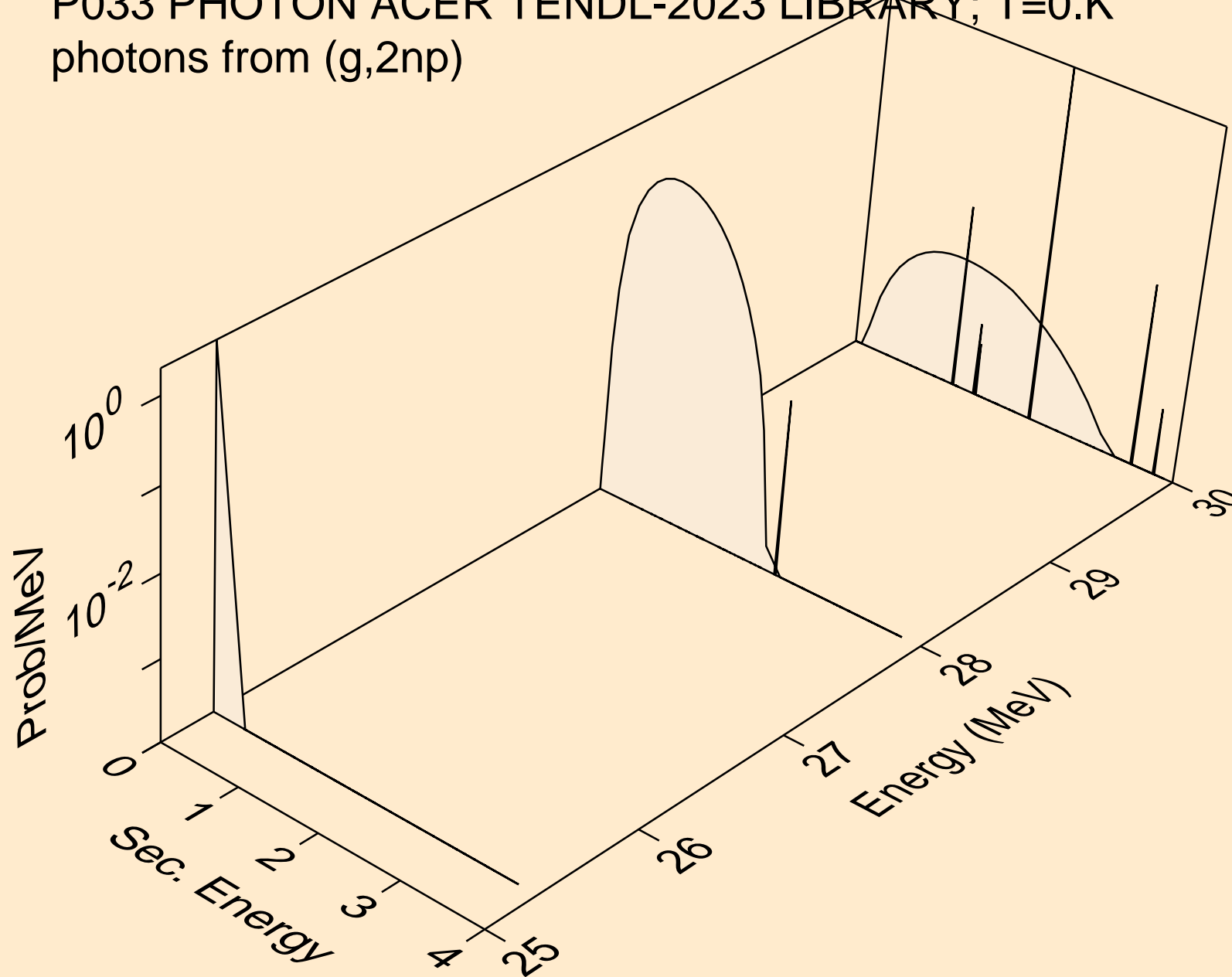

P033 PHOTON ACER TENDL-2023 LIBRARY; T=0.K  
photons from (g,n\*c)

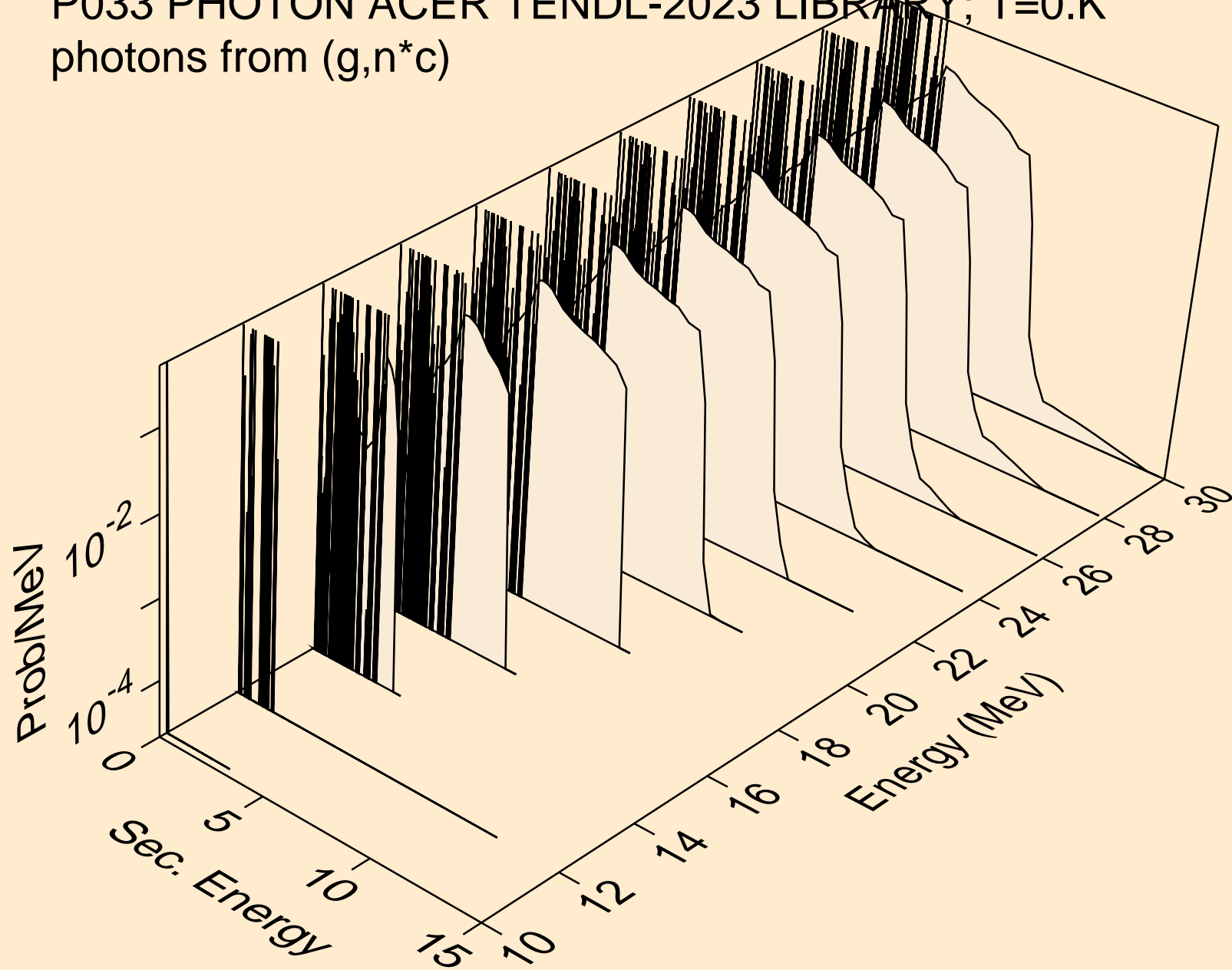

P033 PHOTON ACER TENDL-2023 LIBRARY; T=0.K  
photons from (g,gma)

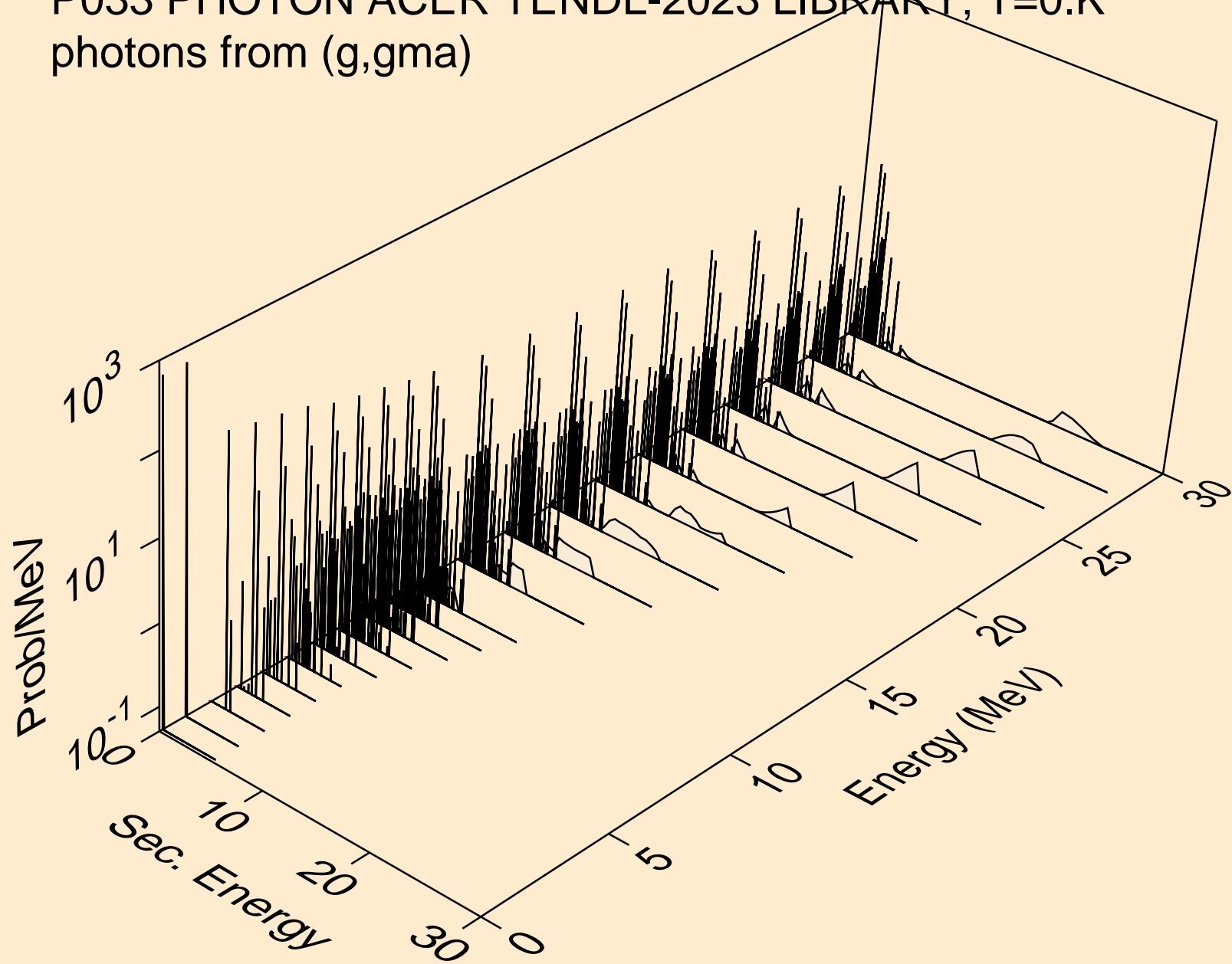



P033 PHOTON ACER TENDL-2023 LIBRARY; T=0.K  
photons from (g,p)

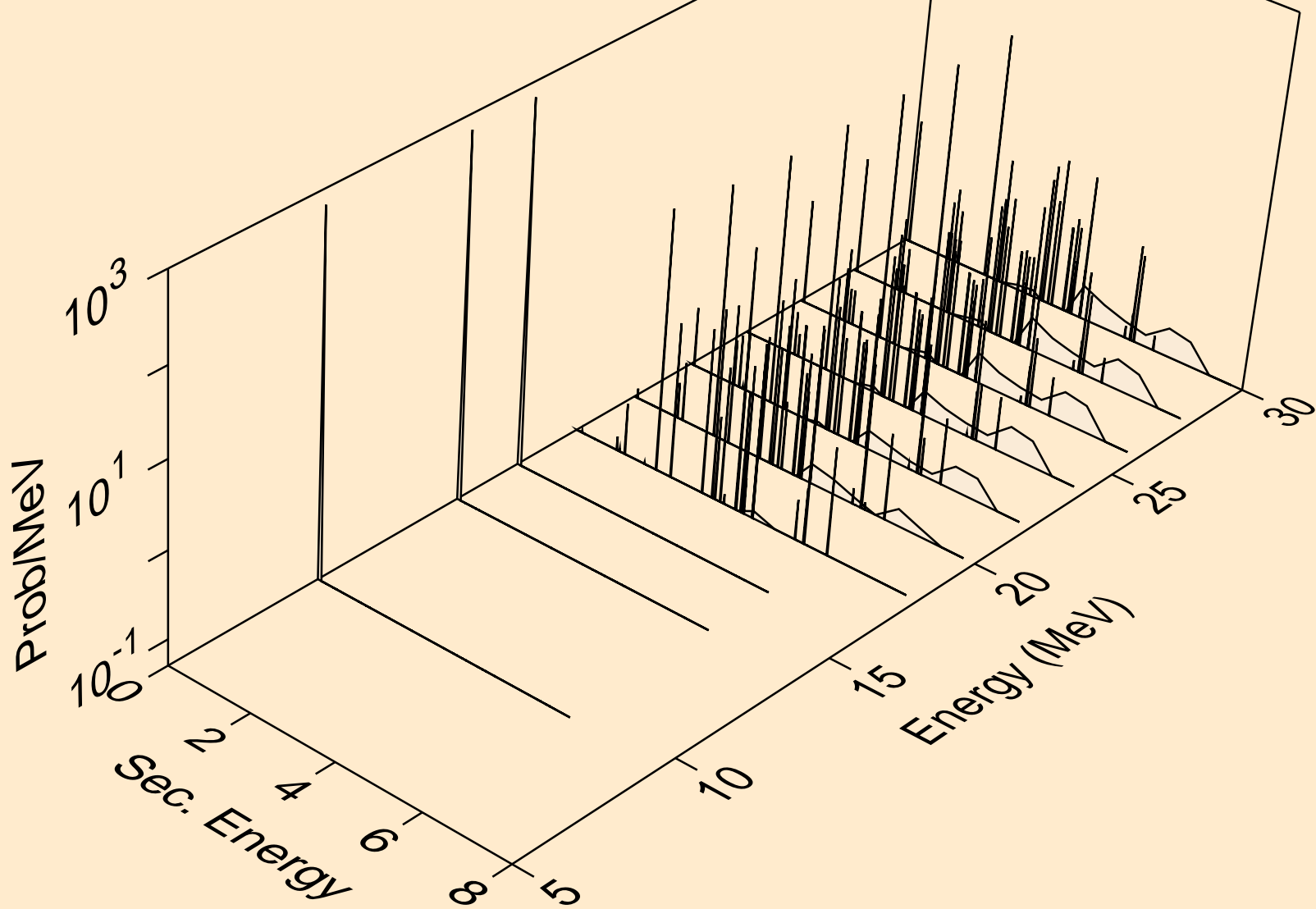

P033 PHOTON ACER TENDL-2023 LIBRARY; T=0.K  
photons from (g,d)

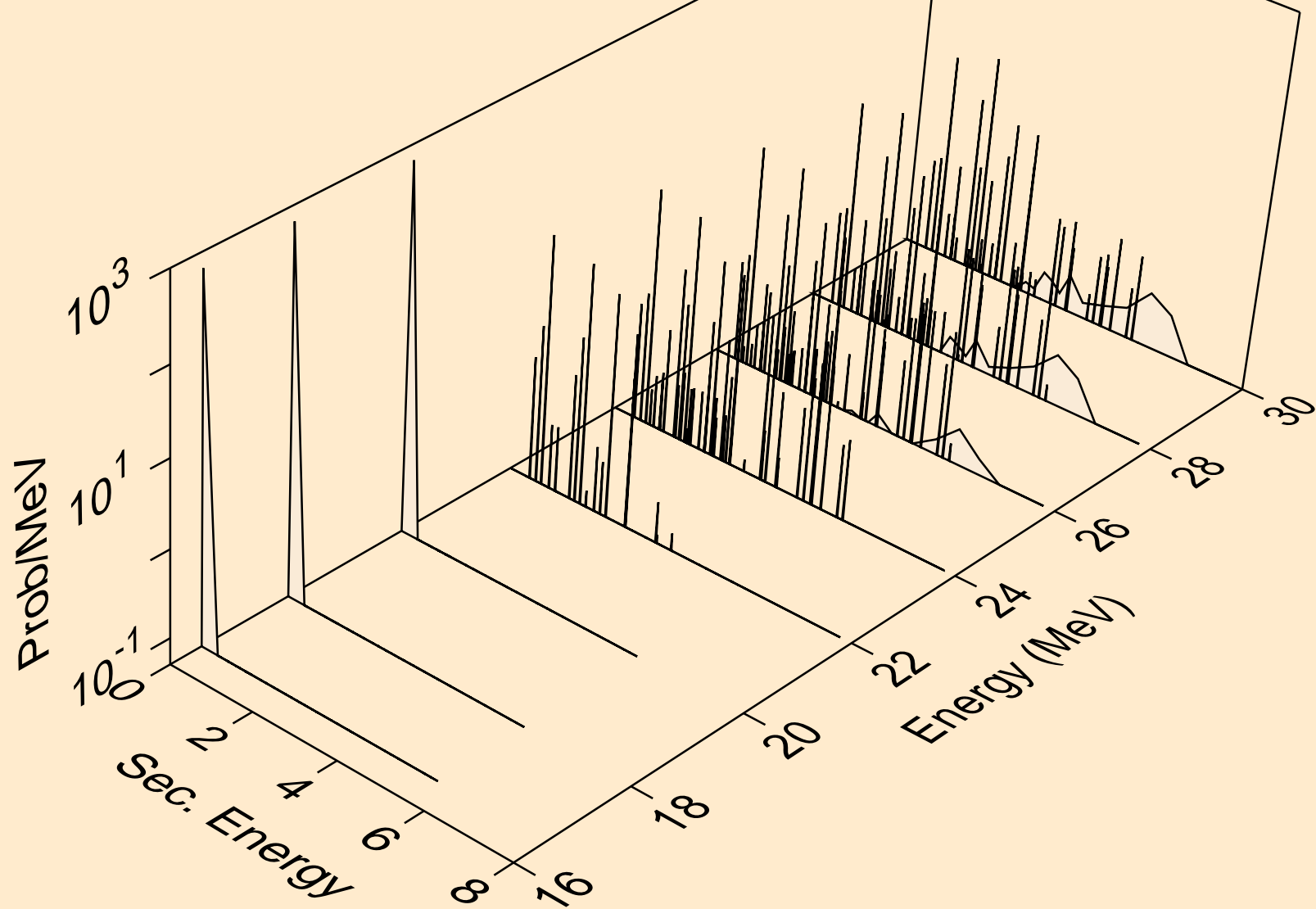

P033 PHOTON ACER TENDL-2023 LIBRARY; T=0.K  
photons from (g,t)

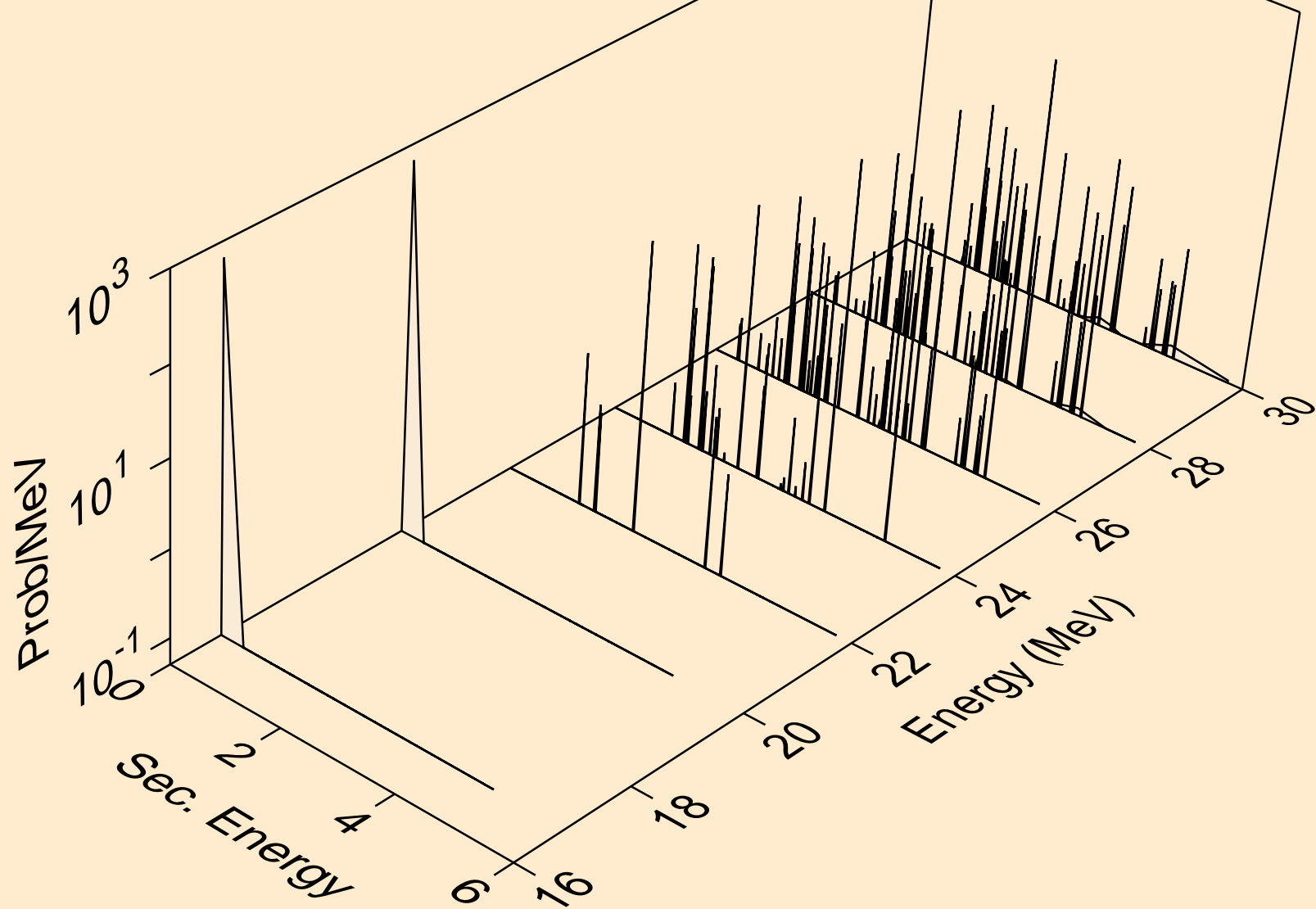

P033 PHOTON ACER TENDL-2023 LIBRARY; T=0.K  
photons from (g,he3)

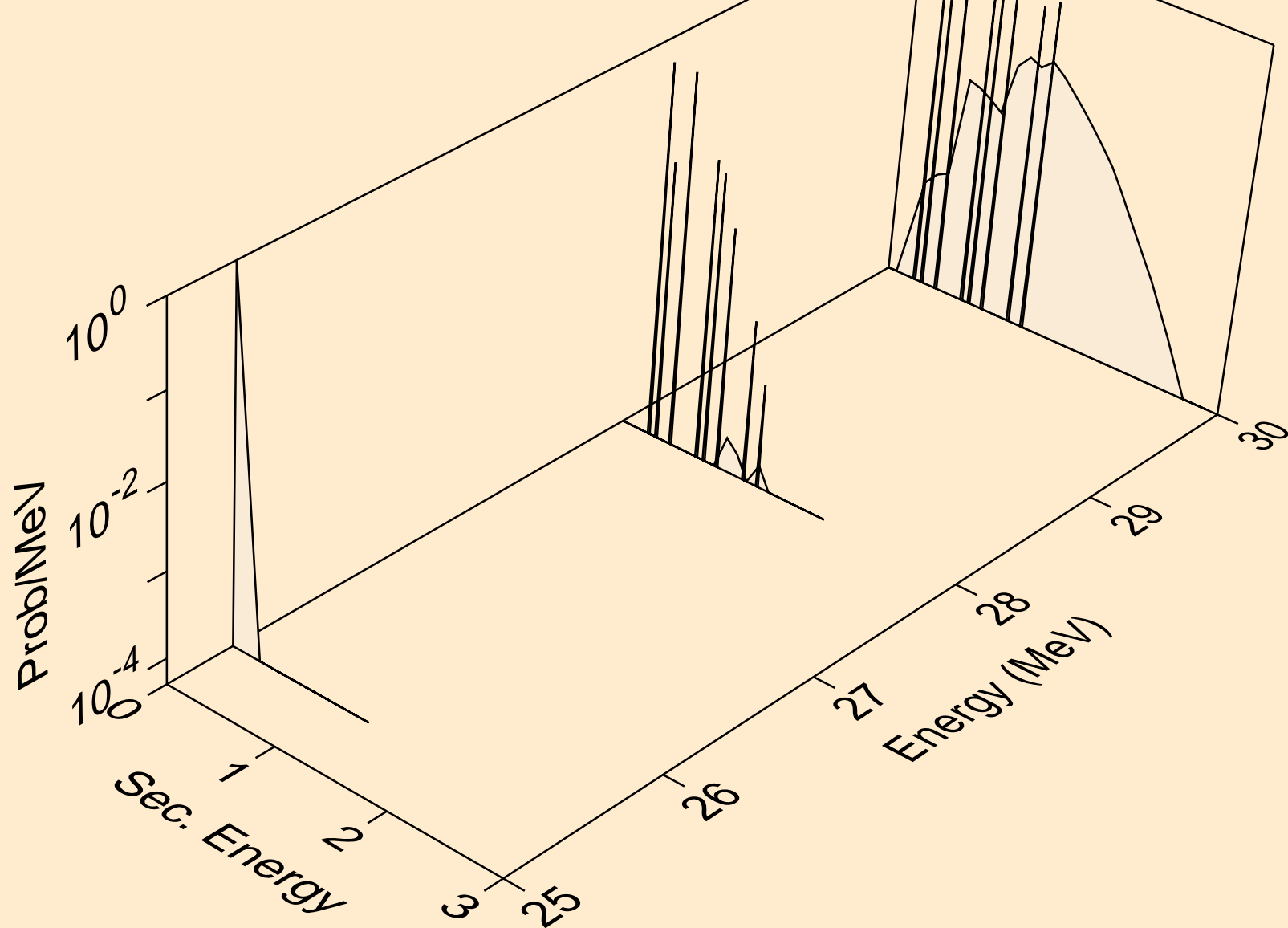

P033 PHOTON ACER TENDL-2023 LIBRARY; T=0.K  
photons from (g,a)

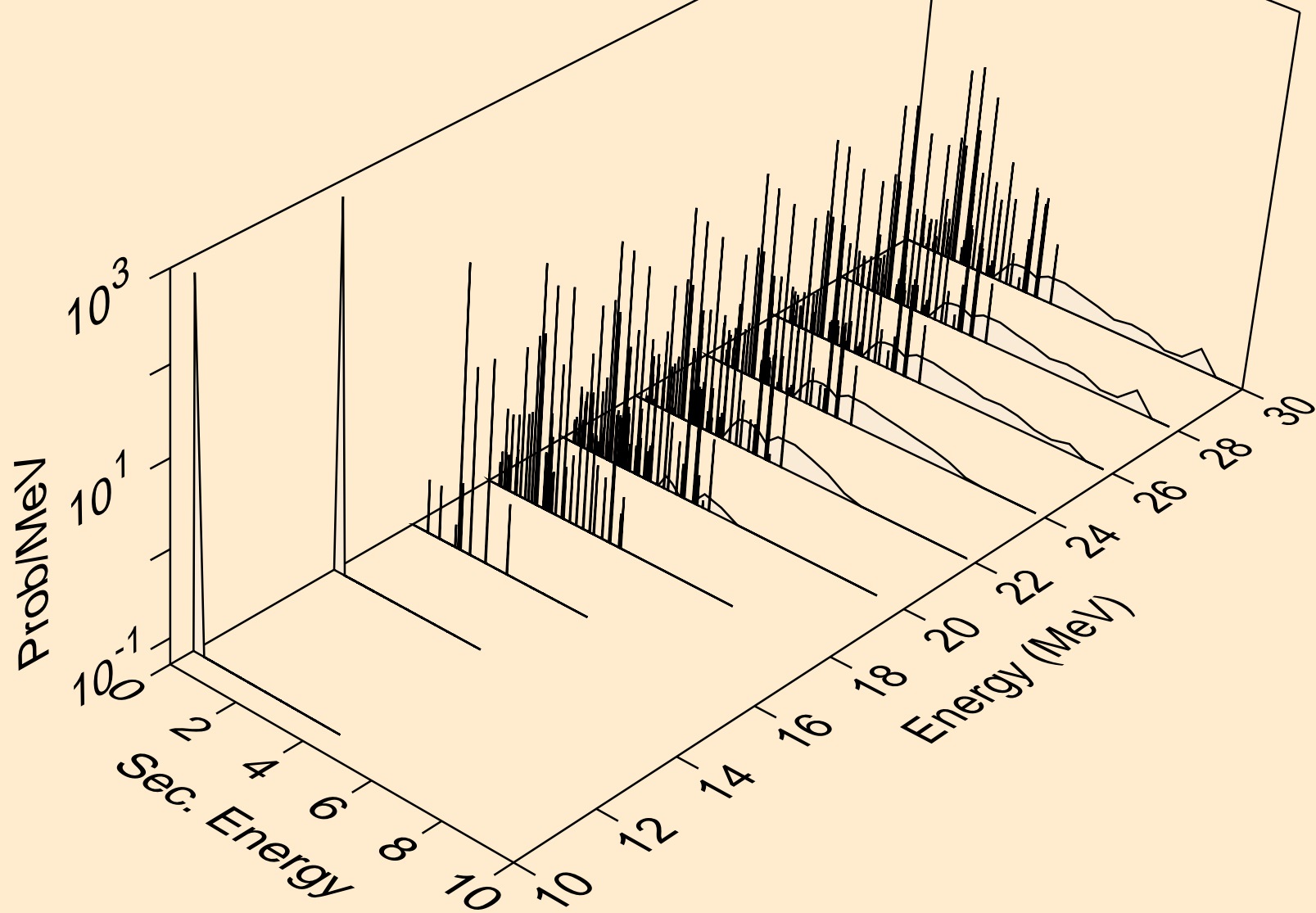

P033 PHOTON ACER TENDL-2023 LIBRARY; T=0.K  
photons from (g,2a)

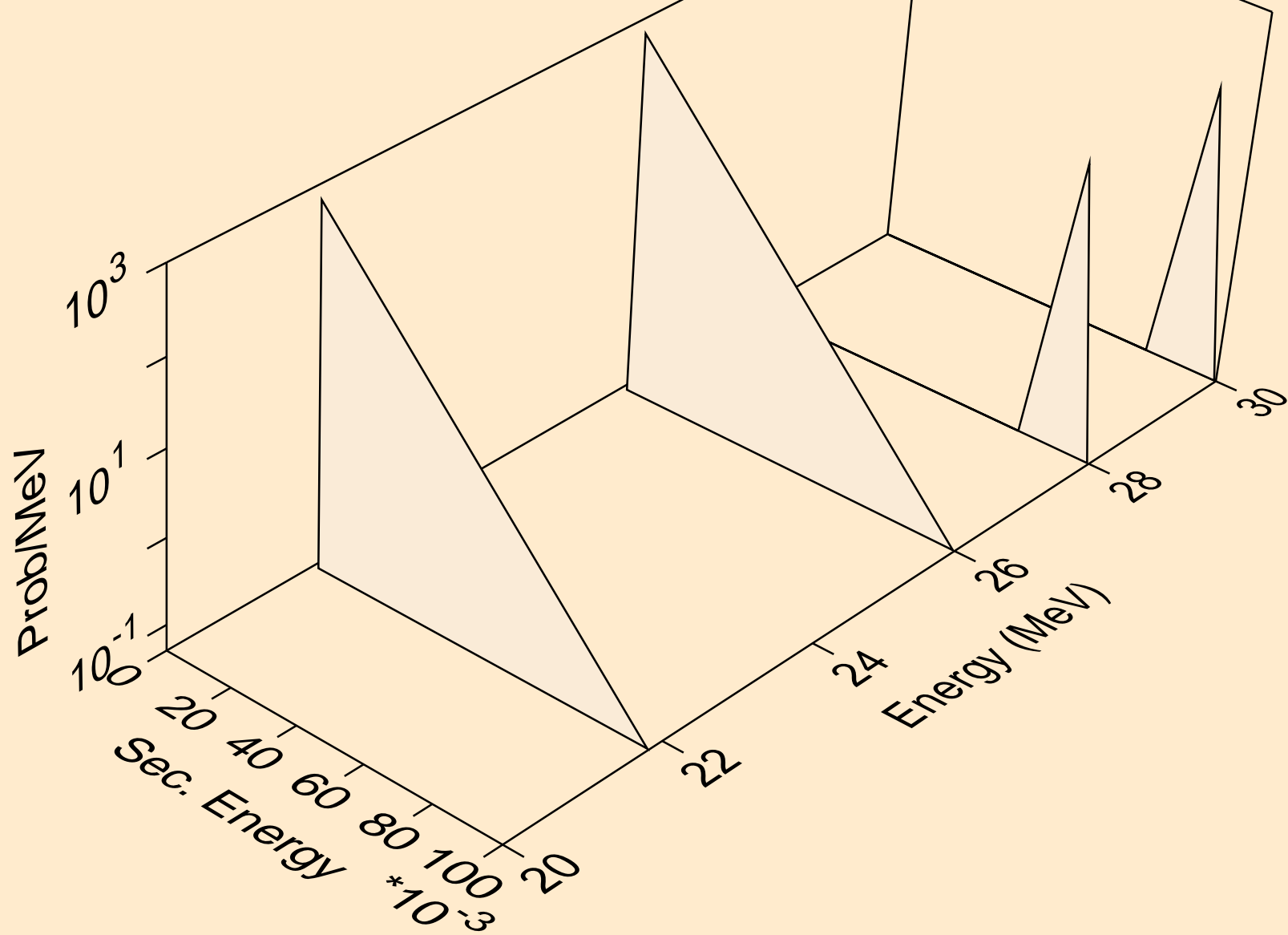

P033 PHOTON ACER TENDL-2023 LIBRARY; T=0.K  
photons from (g,2p)

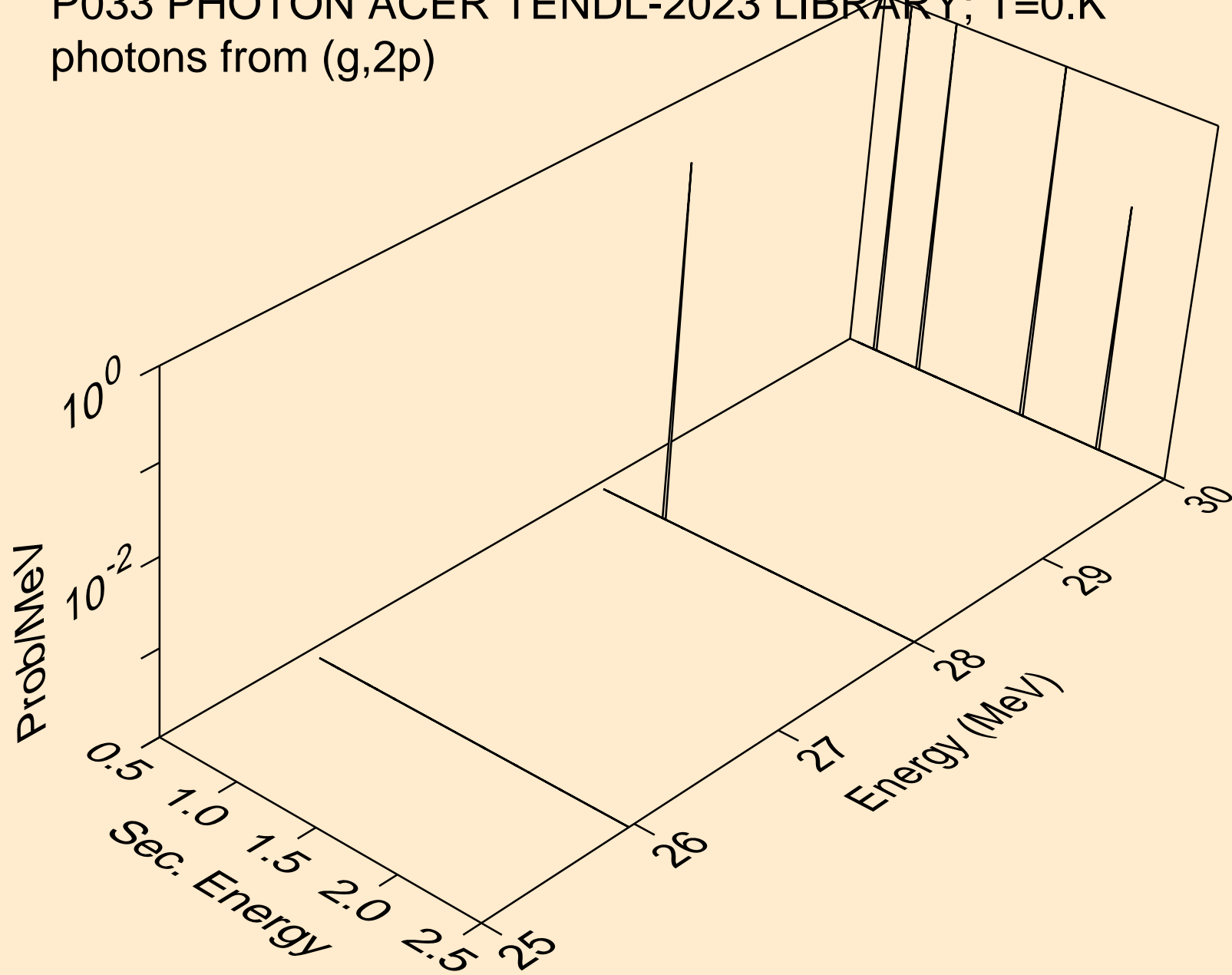

P033 PHOTON ACER TENDL-2023 LIBRARY; T=0.K  
photons from (g,pa)

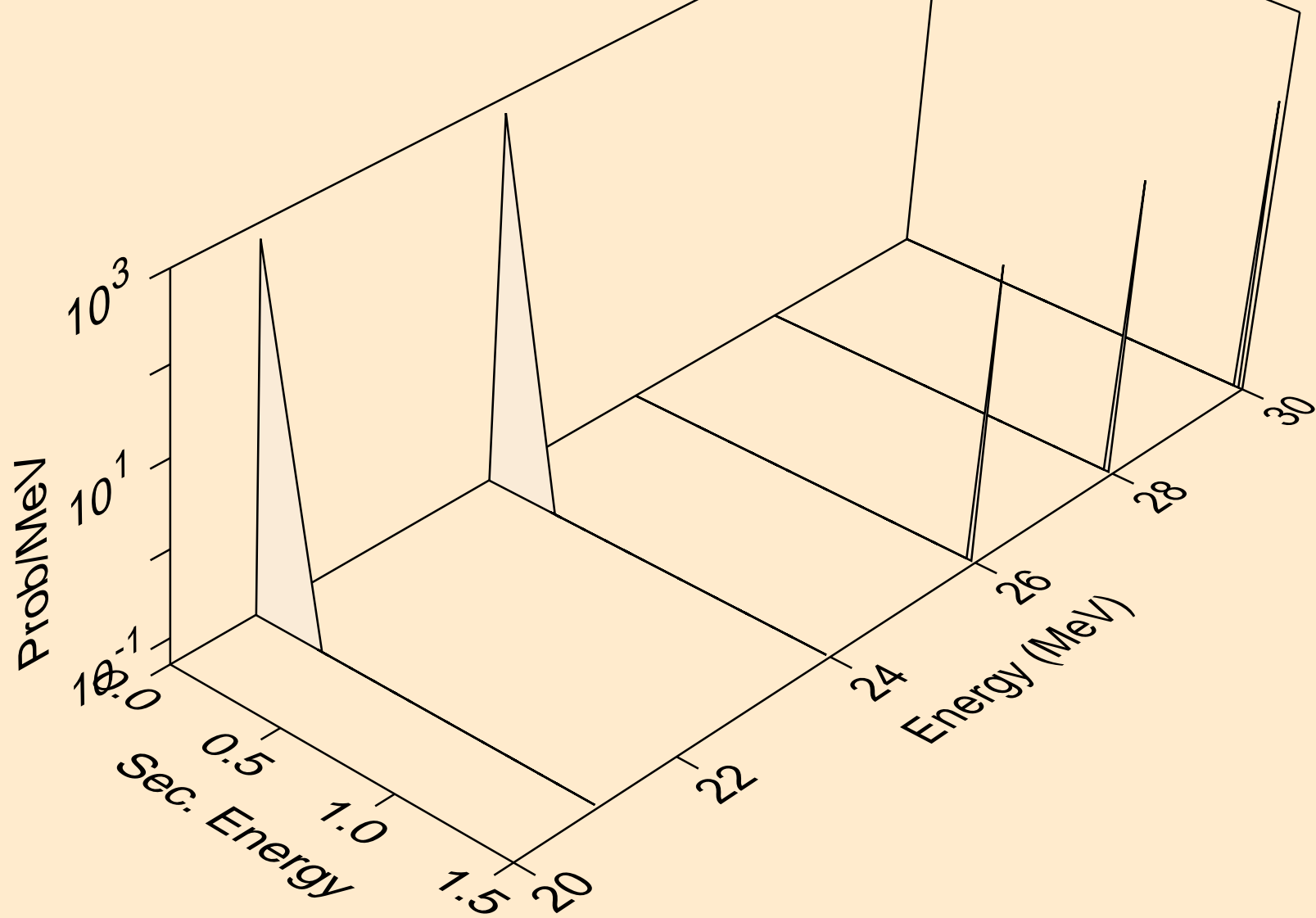



P033 PHOTON ACER TENDL-2023 LIBRARY; T=0.K  
protons from (g,x)

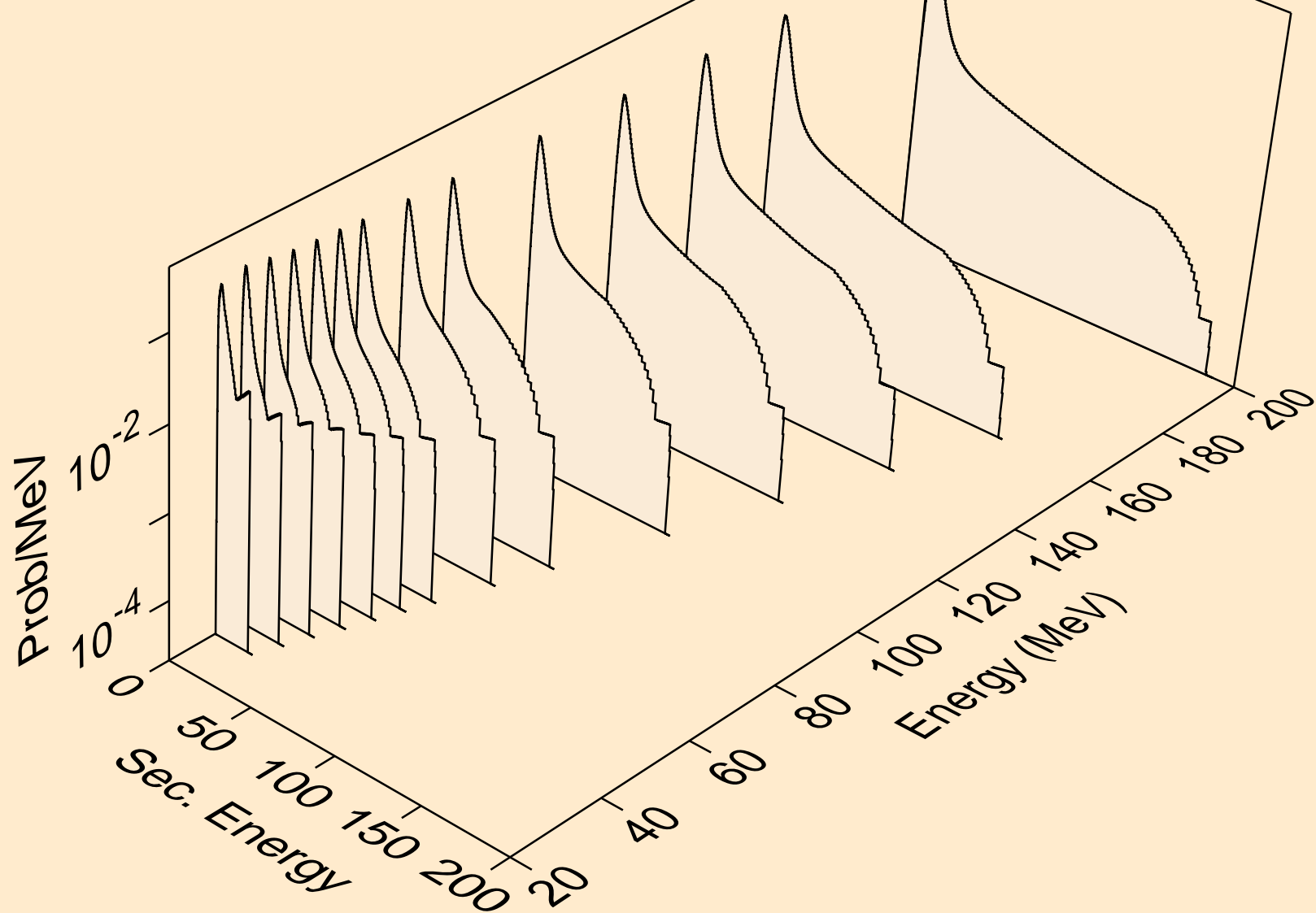

P033 PHOTON ACER TENDL-2023 LIBRARY; T=0.K  
protons from (g,n\*)p

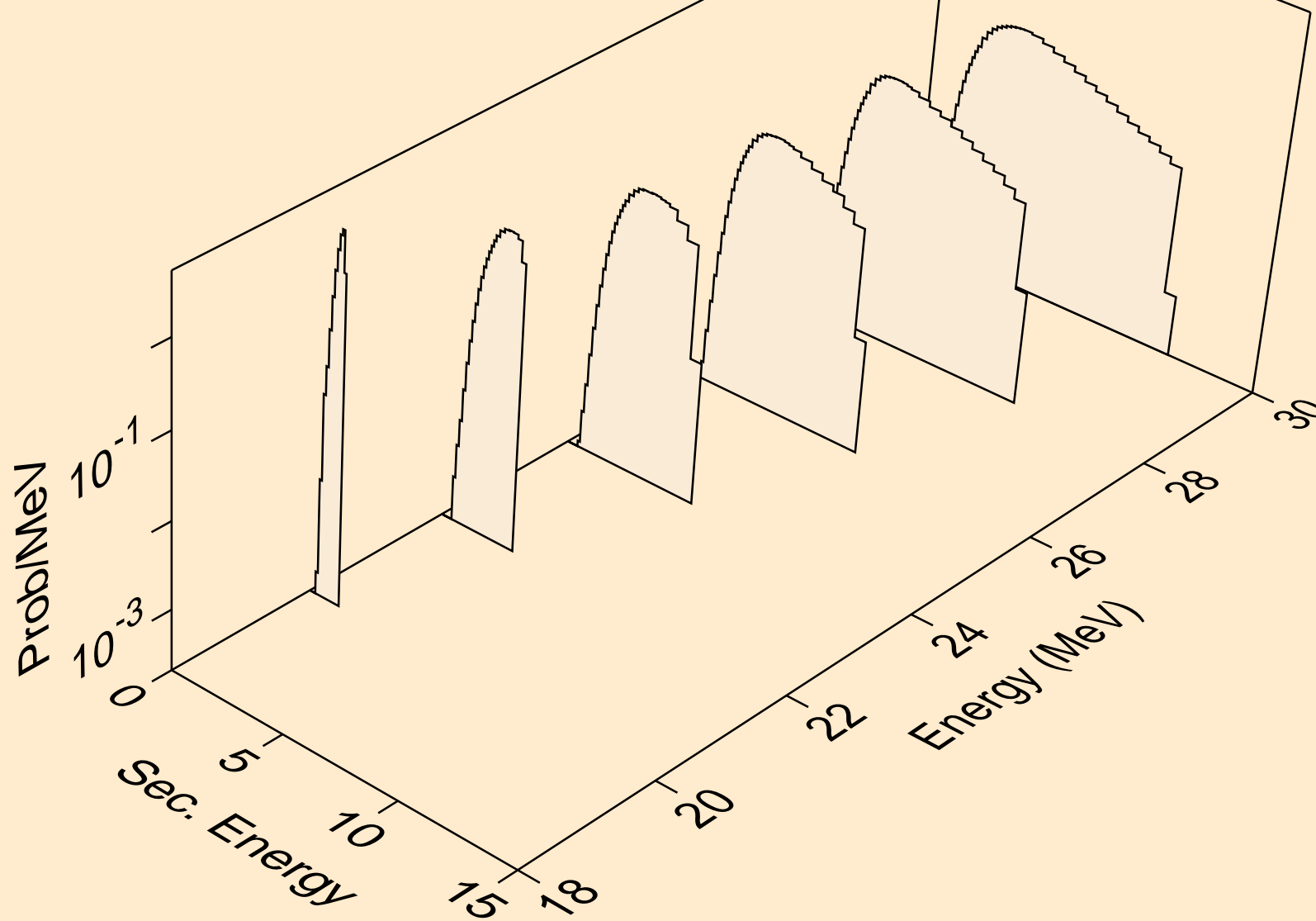

P033 PHOTON ACER TENDL-2023 LIBRARY; T=0.K  
protons from (g,2np)

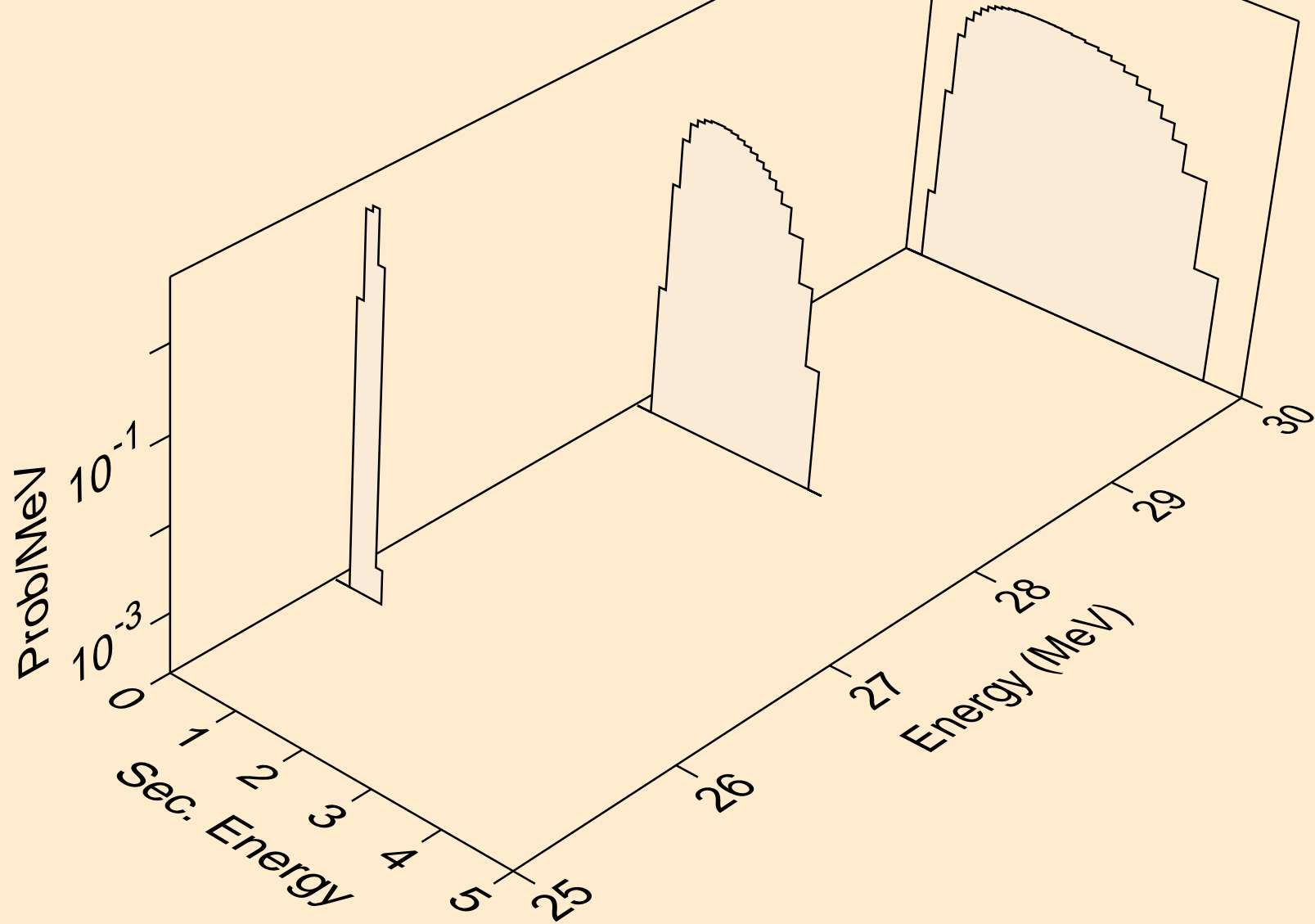

P033 PHOTON ACER TENDL-2023 LIBRARY; T=0.K  
protons from (g,p)

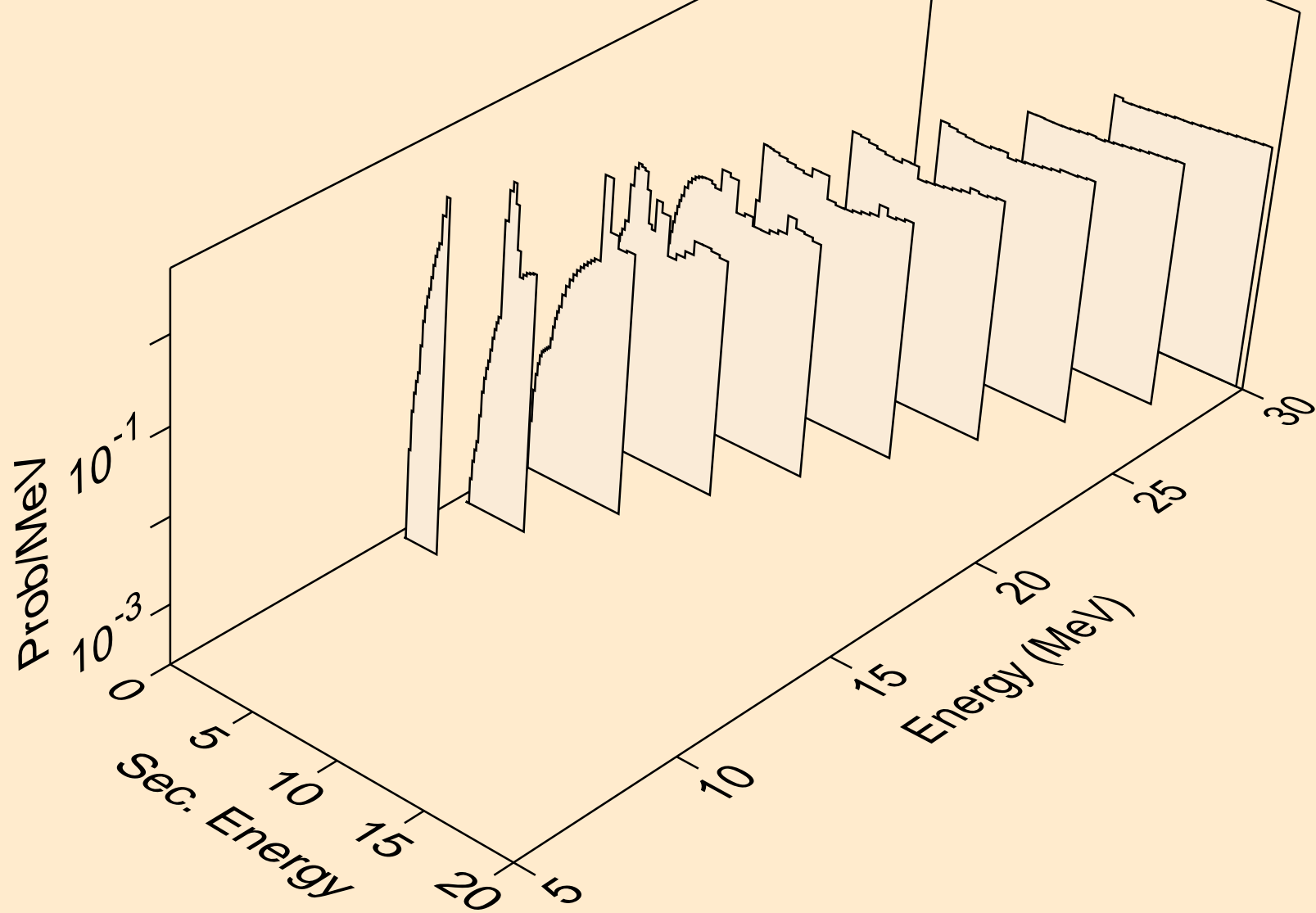

P033 PHOTON ACER TENDL-2023 LIBRARY; T=0.K  
protons from (g,2p)

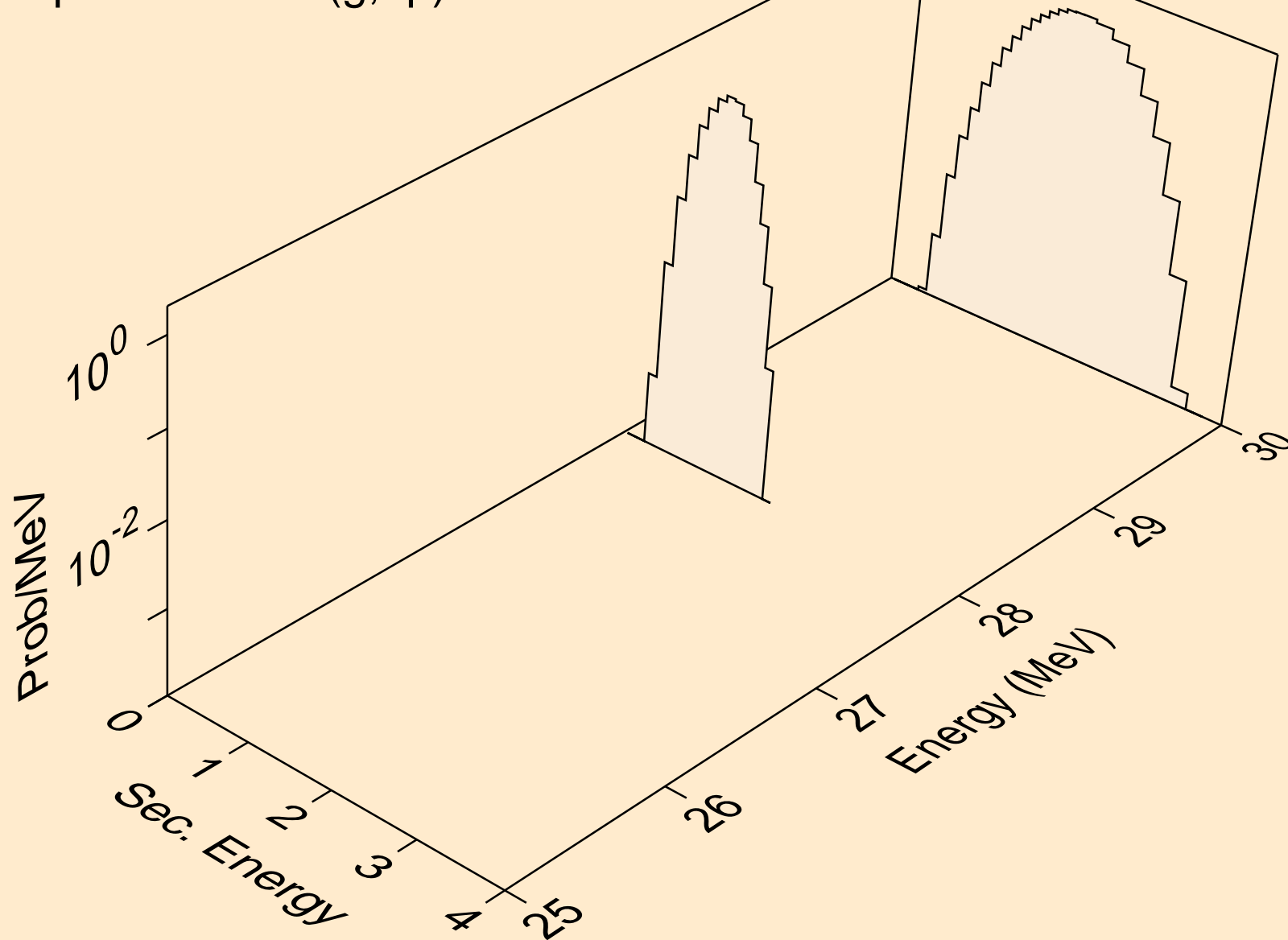

P033 PHOTON ACER TENDL-2023 LIBRARY; T=0.K  
protons from (g,pa)

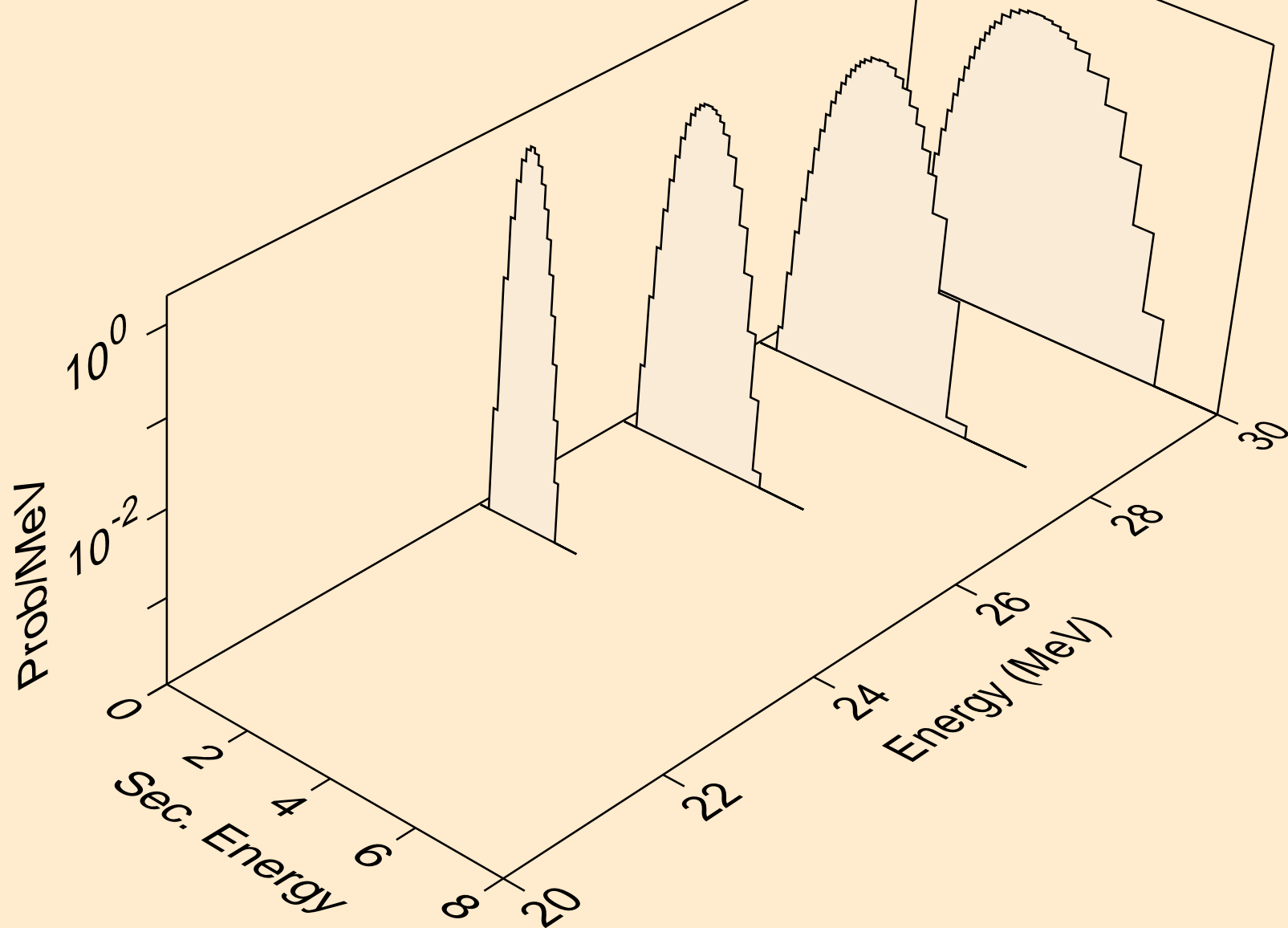

P033 PHOTON ACER TENDL-2023 LIBRARY; T=0.K  
deuterons from (g,x)

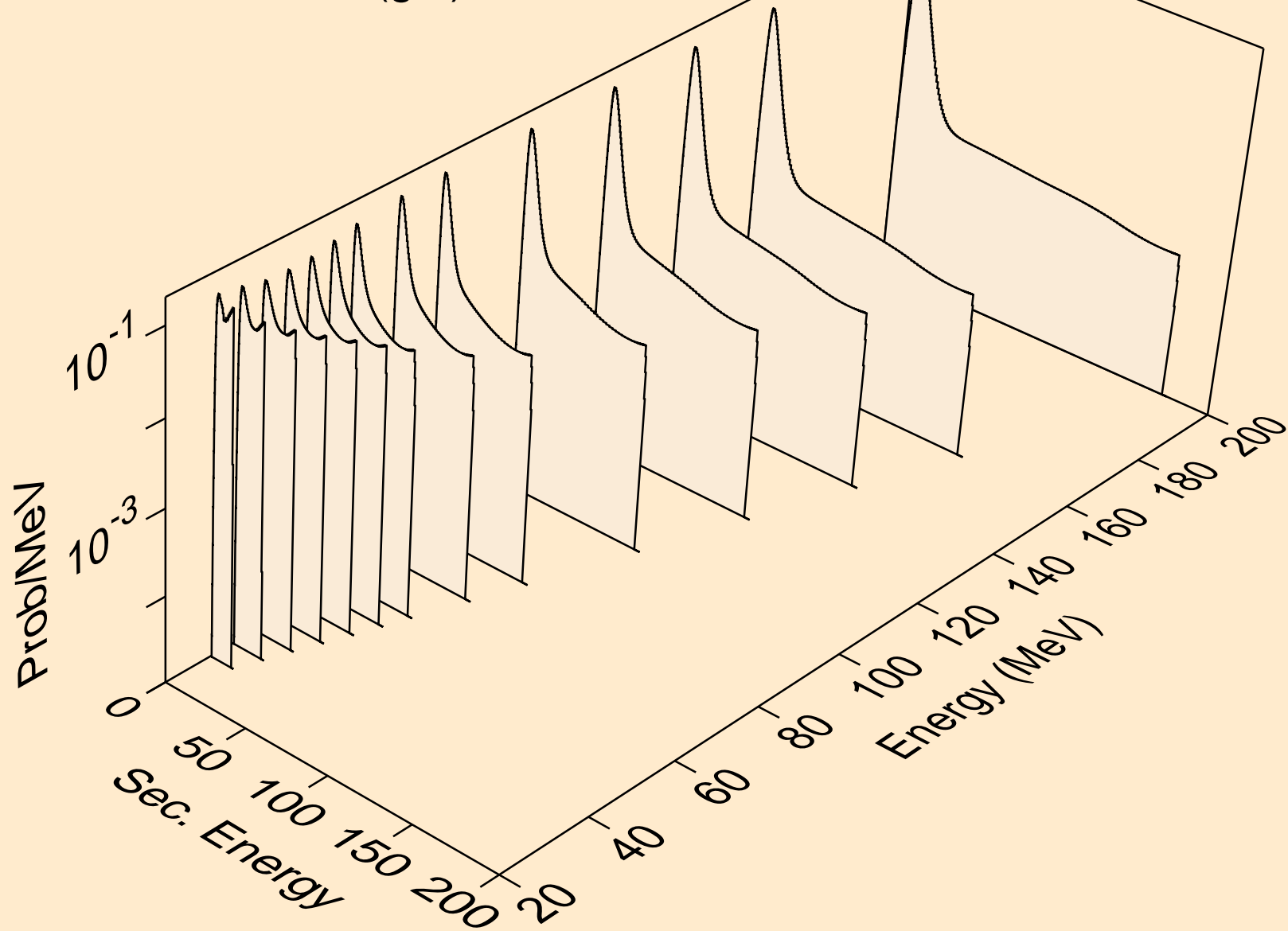

P033 PHOTON ACER TENDL-2023 LIBRARY; T=0.K  
deuterons from (g,n\*)d

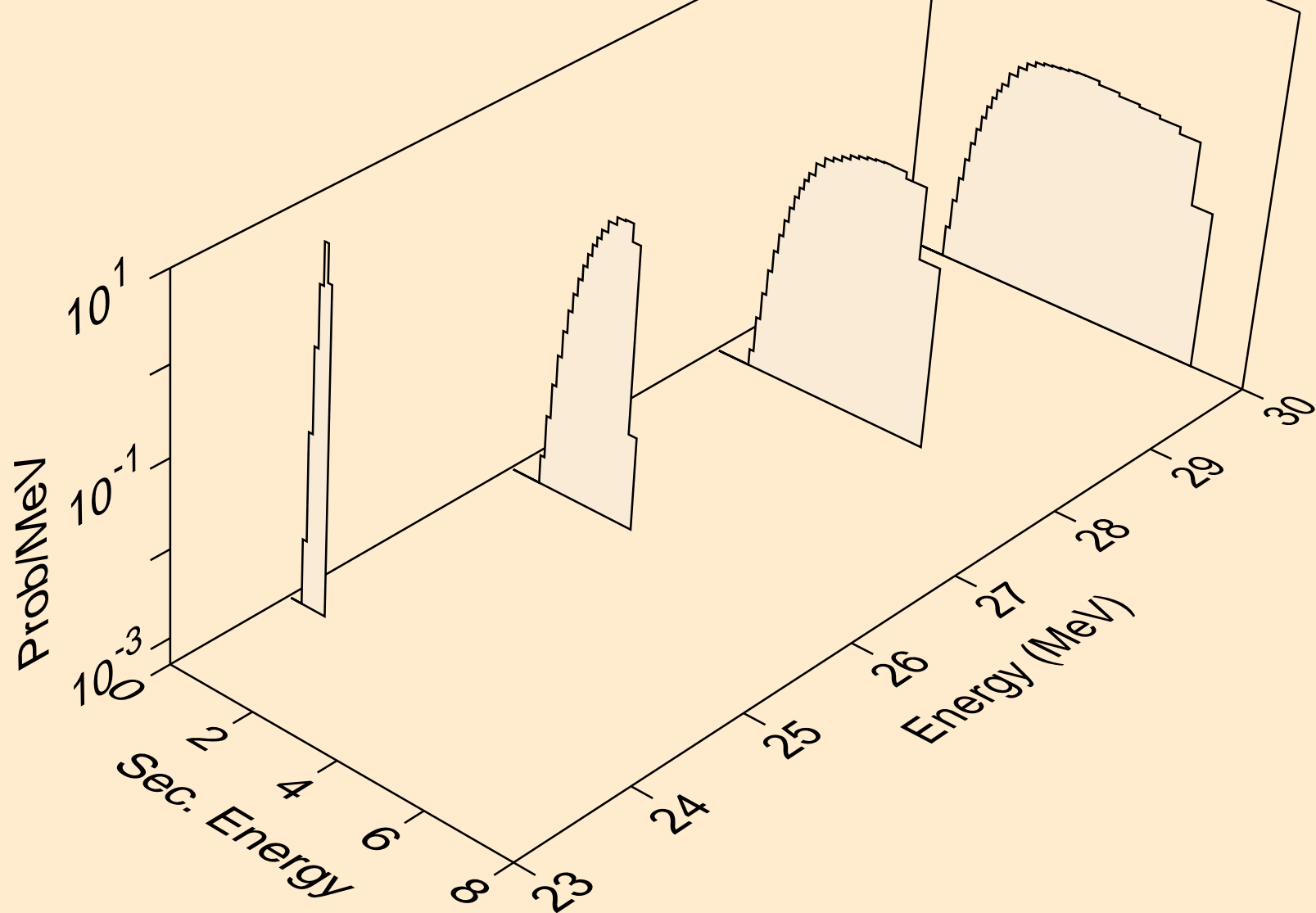



P033 PHOTON ACER TENDL-2023 LIBRARY; T=0.K  
deuterons from (g,d)

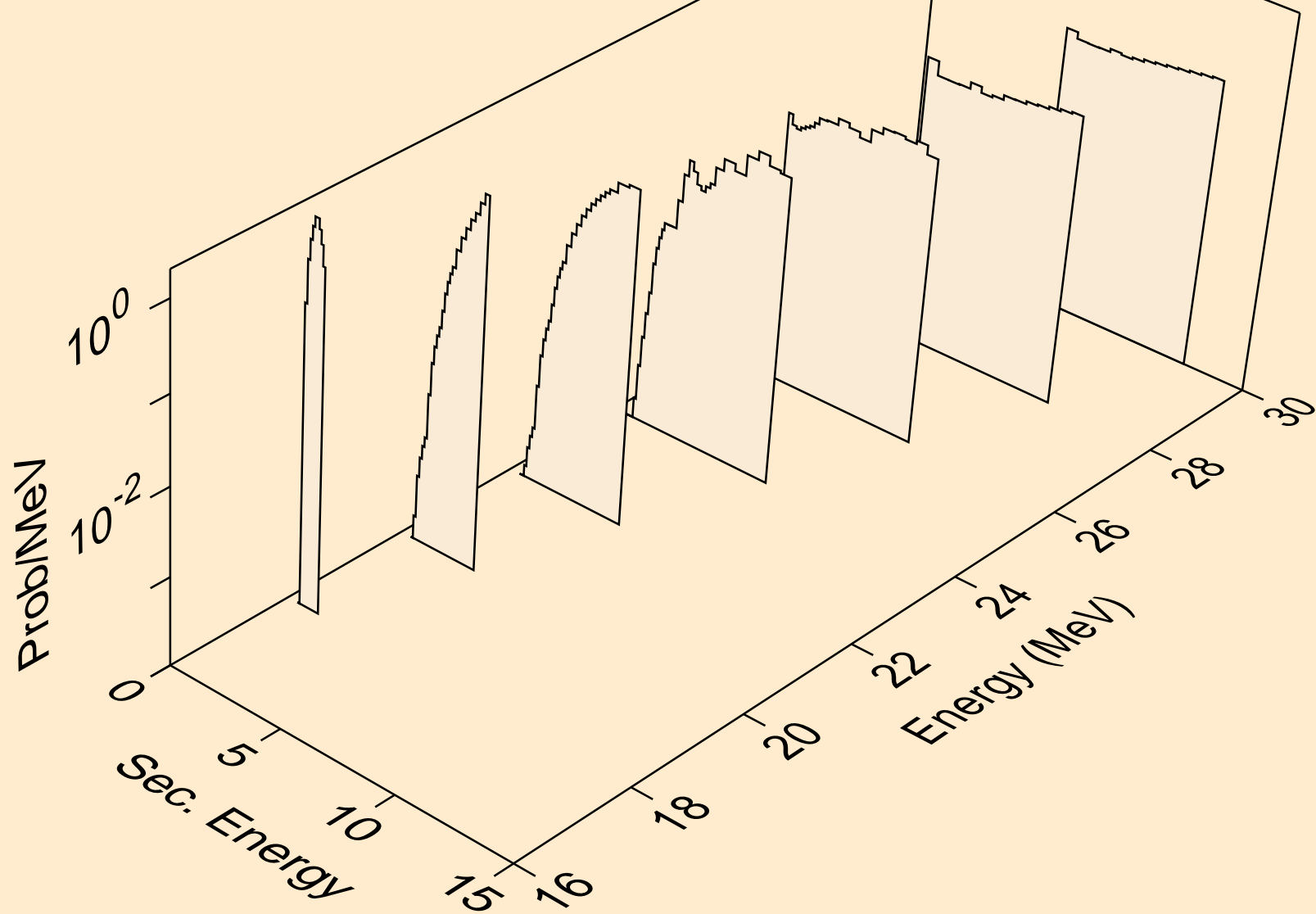

P033 PHOTON ACER TENDL-2023 LIBRARY; T=0.K  
tritons from (g,x)

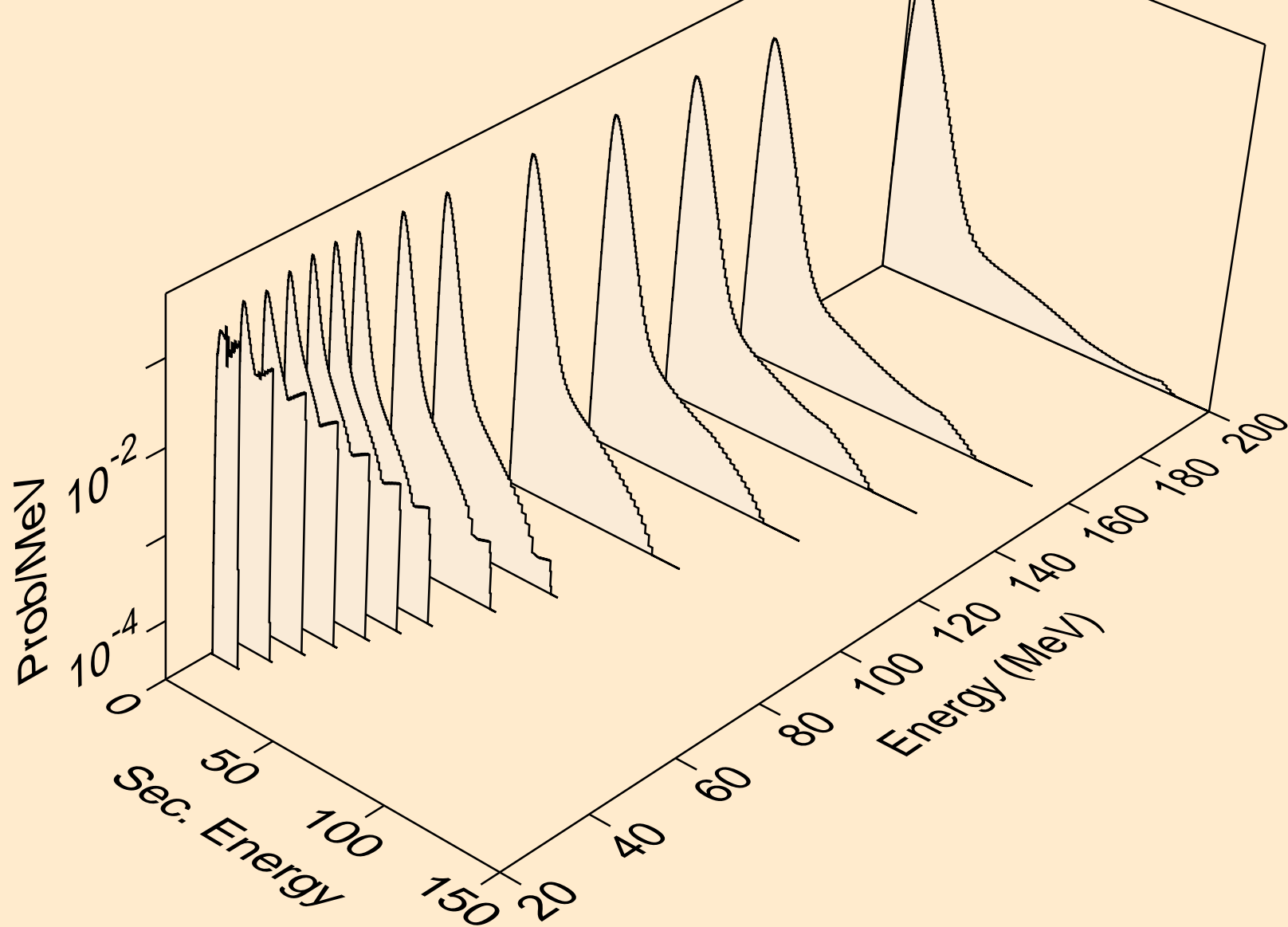

P033 PHOTON ACER TENDL-2023 LIBRARY; T=0.K  
tritons from (g,n\*)t

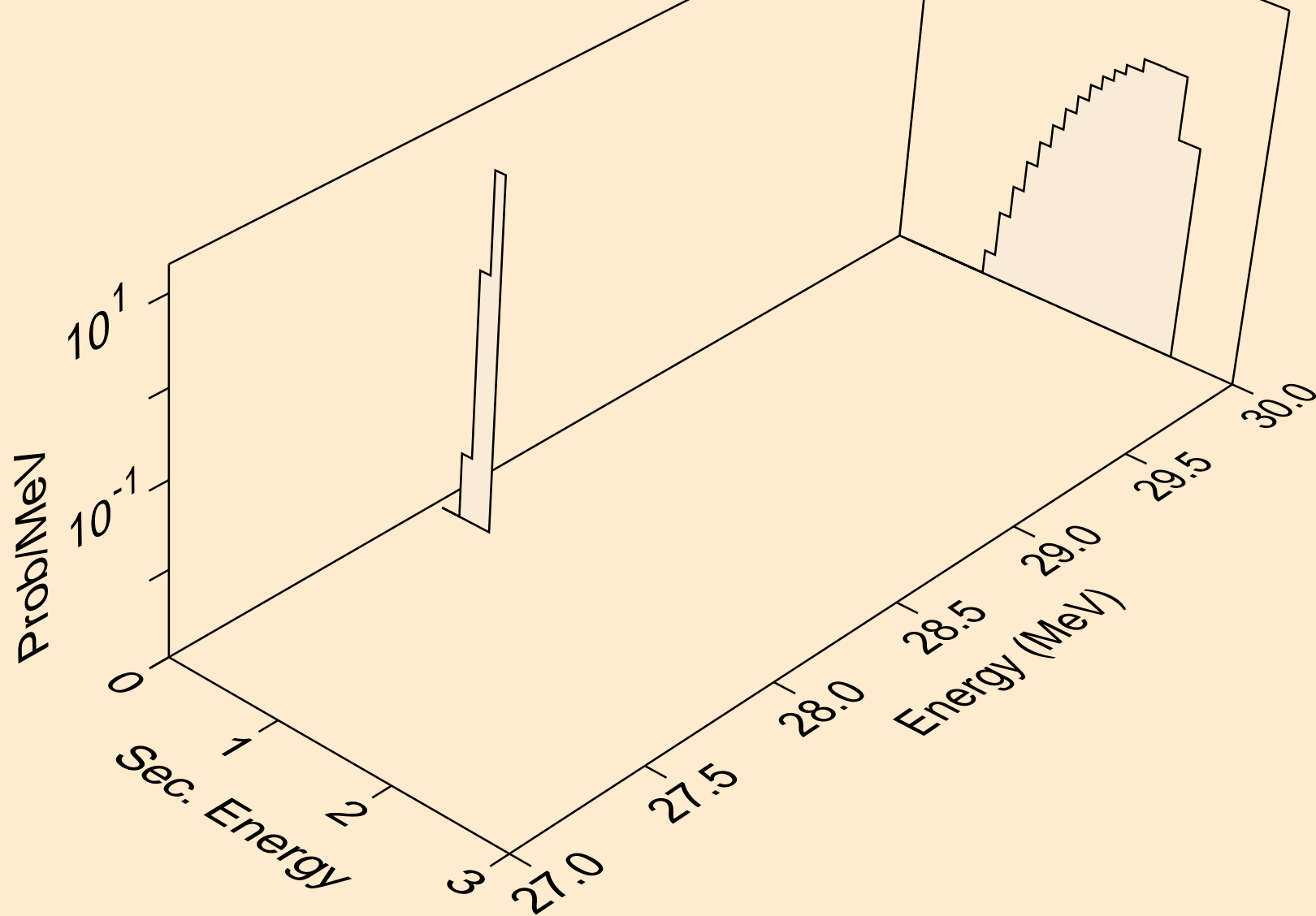

P033 PHOTON ACER TENDL-2023 LIBRARY; T=0.K  
tritons from (g,t)

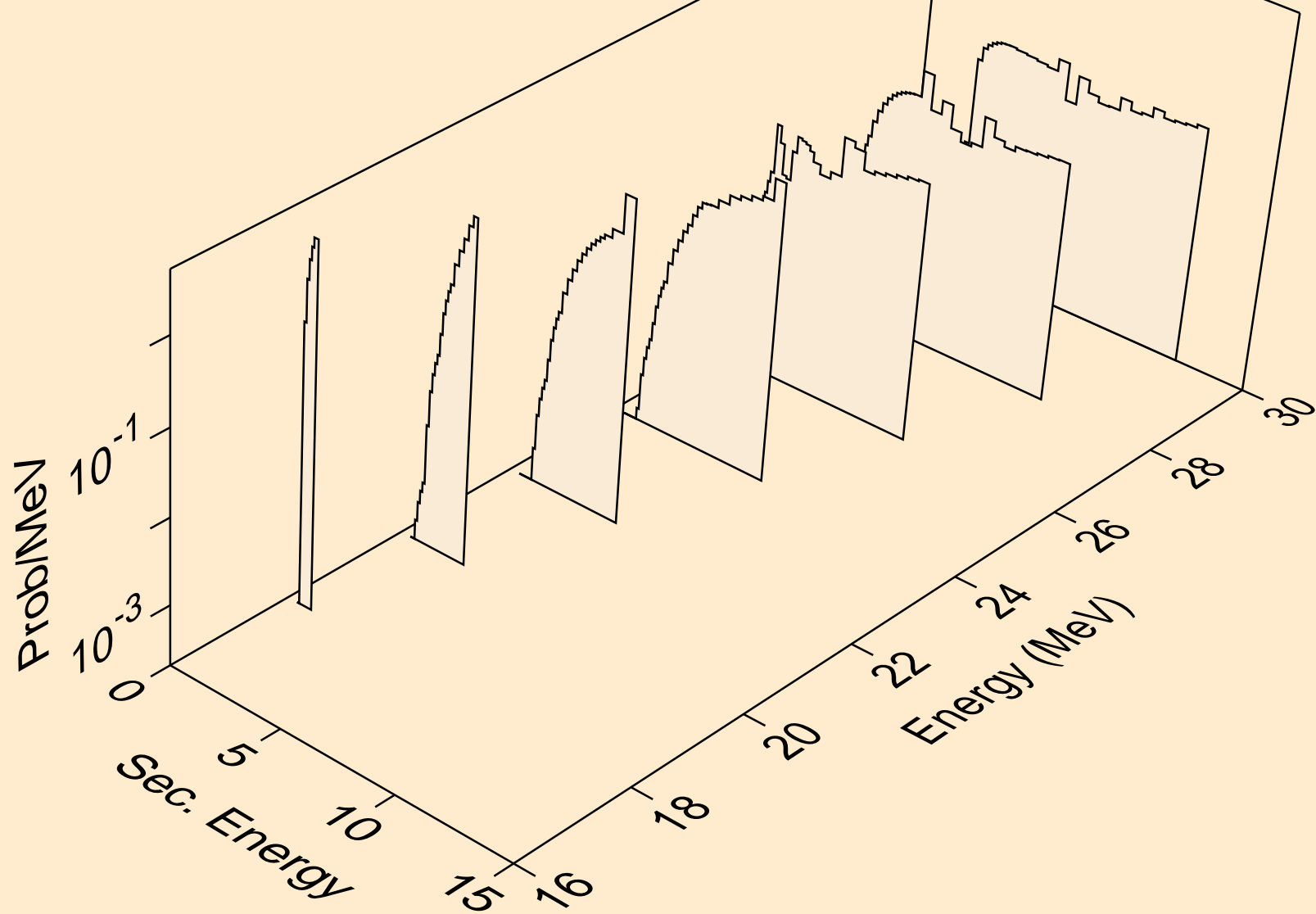

P033 PHOTON ACER TENDL-2023 LIBRARY; T=0.K  
he3s from (g,x)

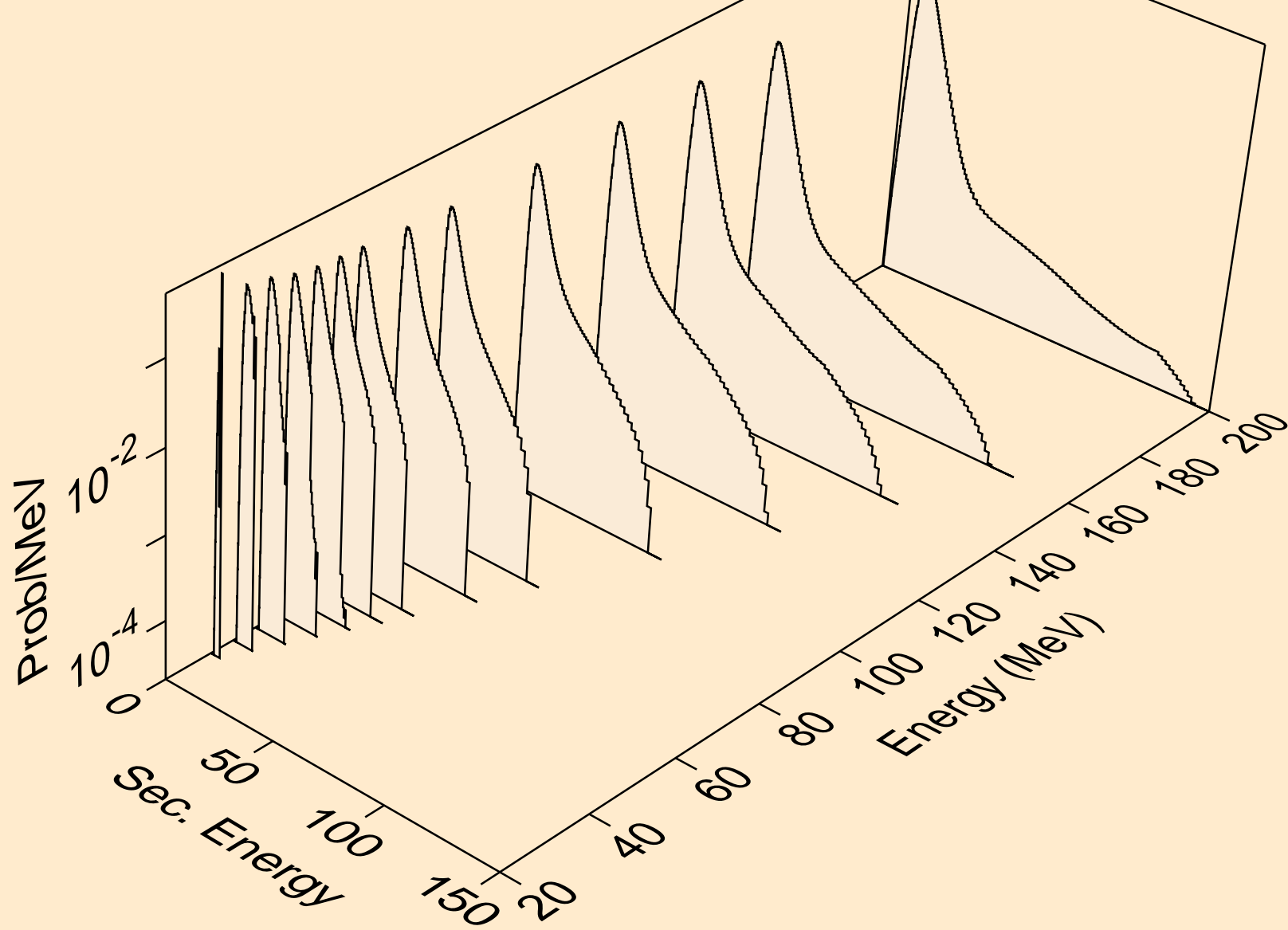

P033 PHOTON ACER TENDL-2023 LIBRARY; T=0.K  
he3s from (g,he3)

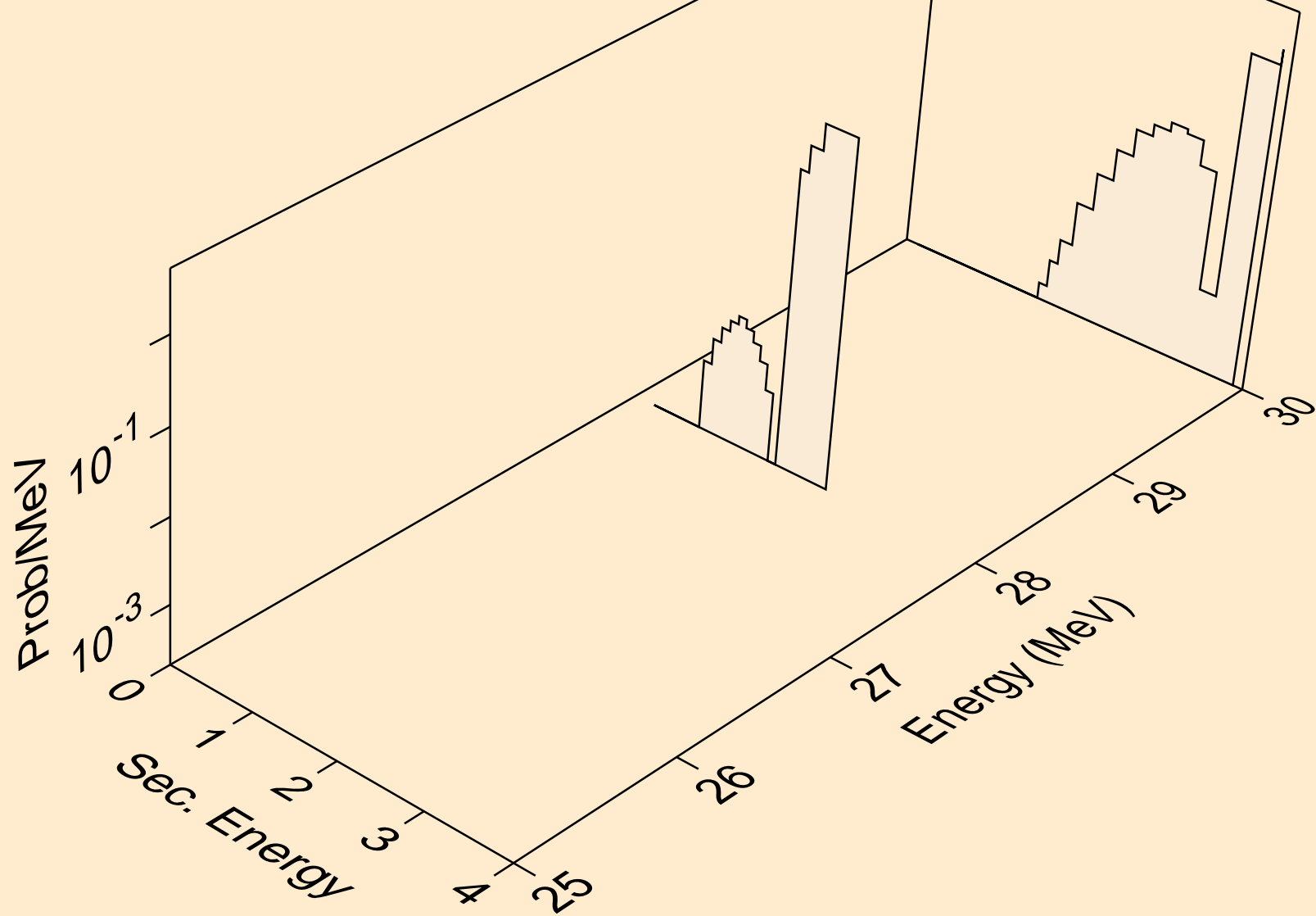

P033 PHOTON ACER TENDL-2023 LIBRARY; T=0.K  
alphas from (g,x)

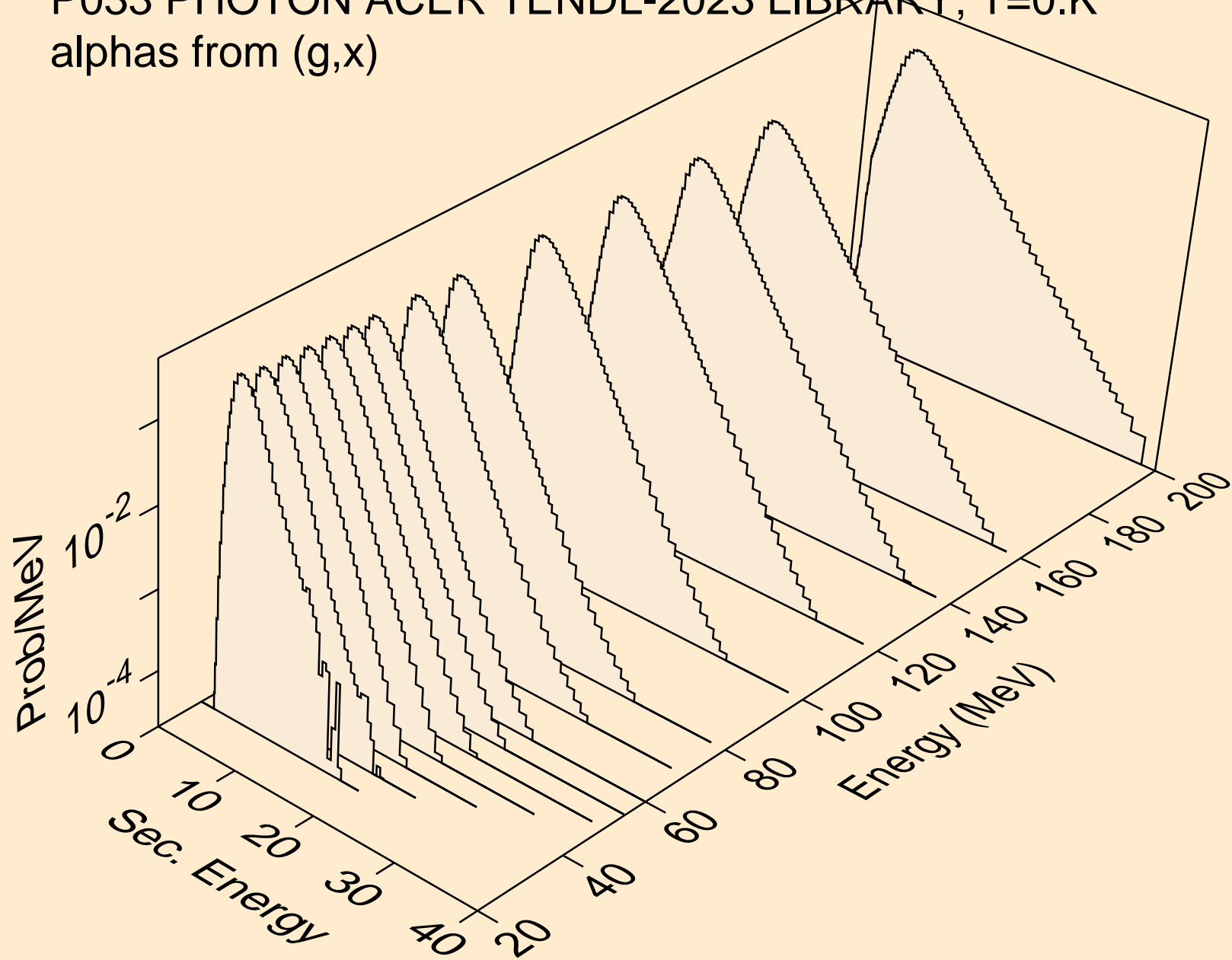

P033 PHOTON ACER TENDL-2023 LIBRARY; T=0.K  
alphas from (g,n\*)a

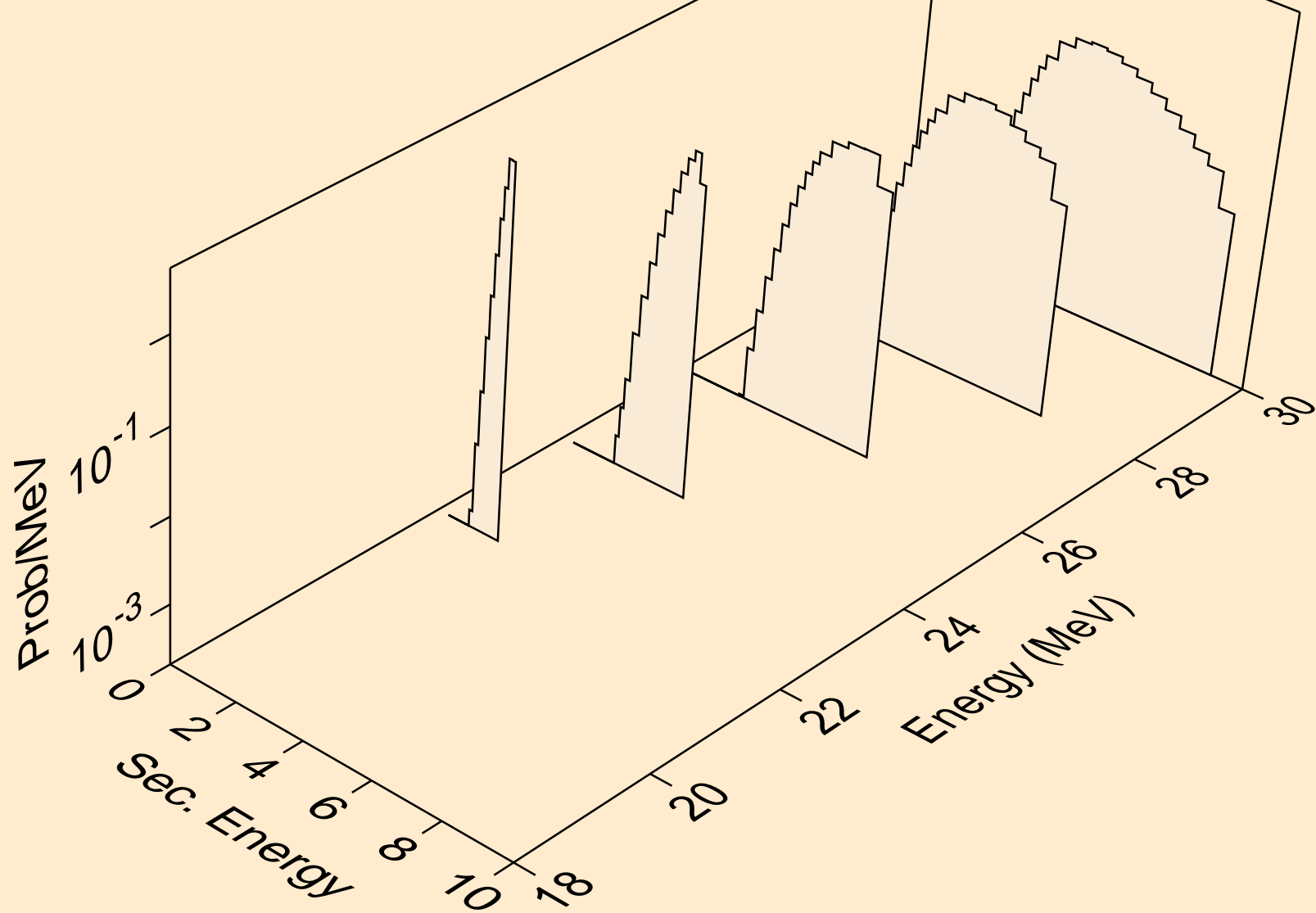



P033 PHOTON ACER TENDL-2023 LIBRARY; T=0.K  
alphas from (g,a)

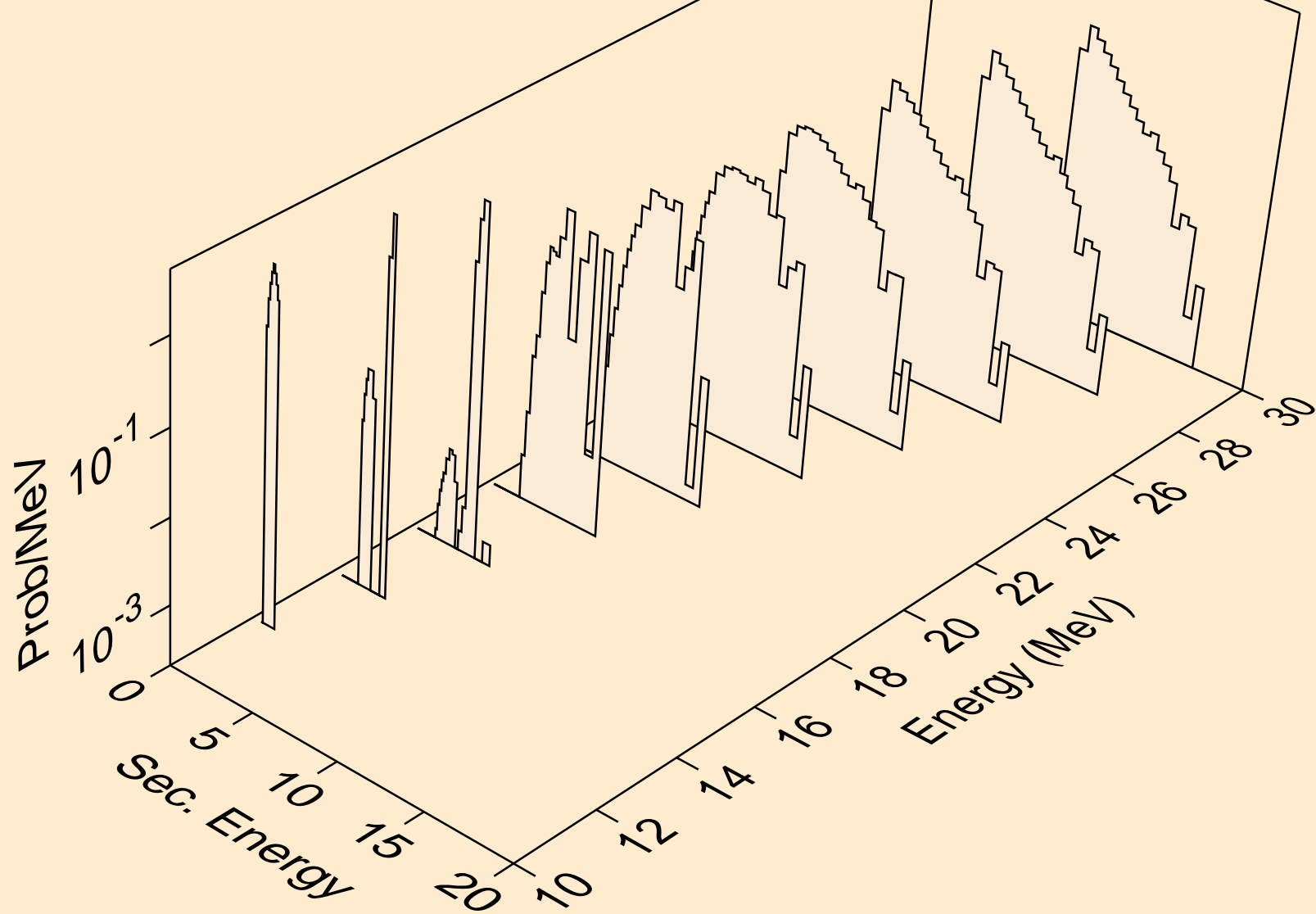

P033 PHOTON ACER TENDL-2023 LIBRARY; T=0.K  
alphas from (g,2a)

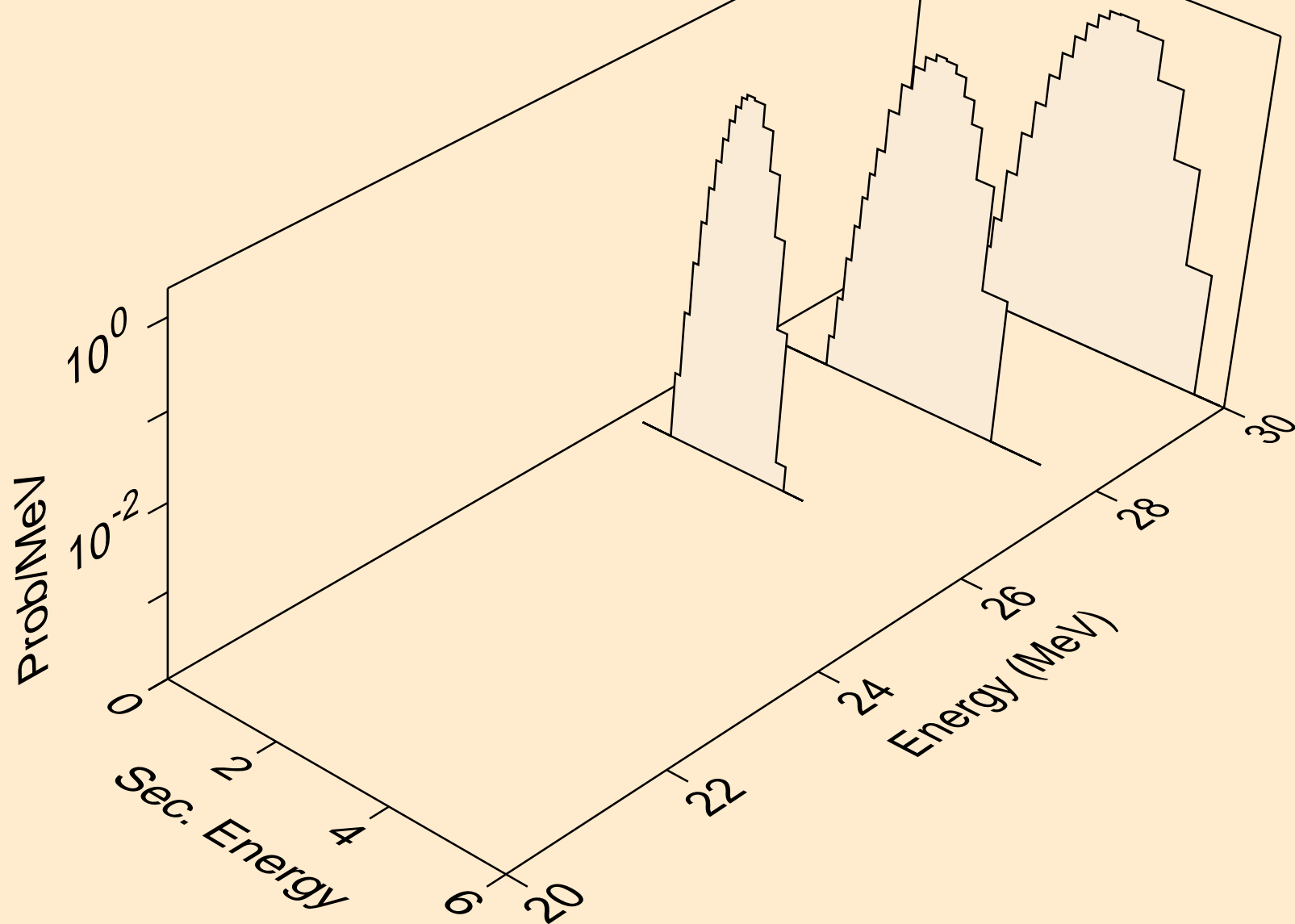

P033 PHOTON ACER TENDL-2023 LIBRARY; T=0.K  
alphas from (g,pa)

