

RA209 PHOTON ACER TENDL-2023 LIBRARY; T=0.K

Principal cross sections

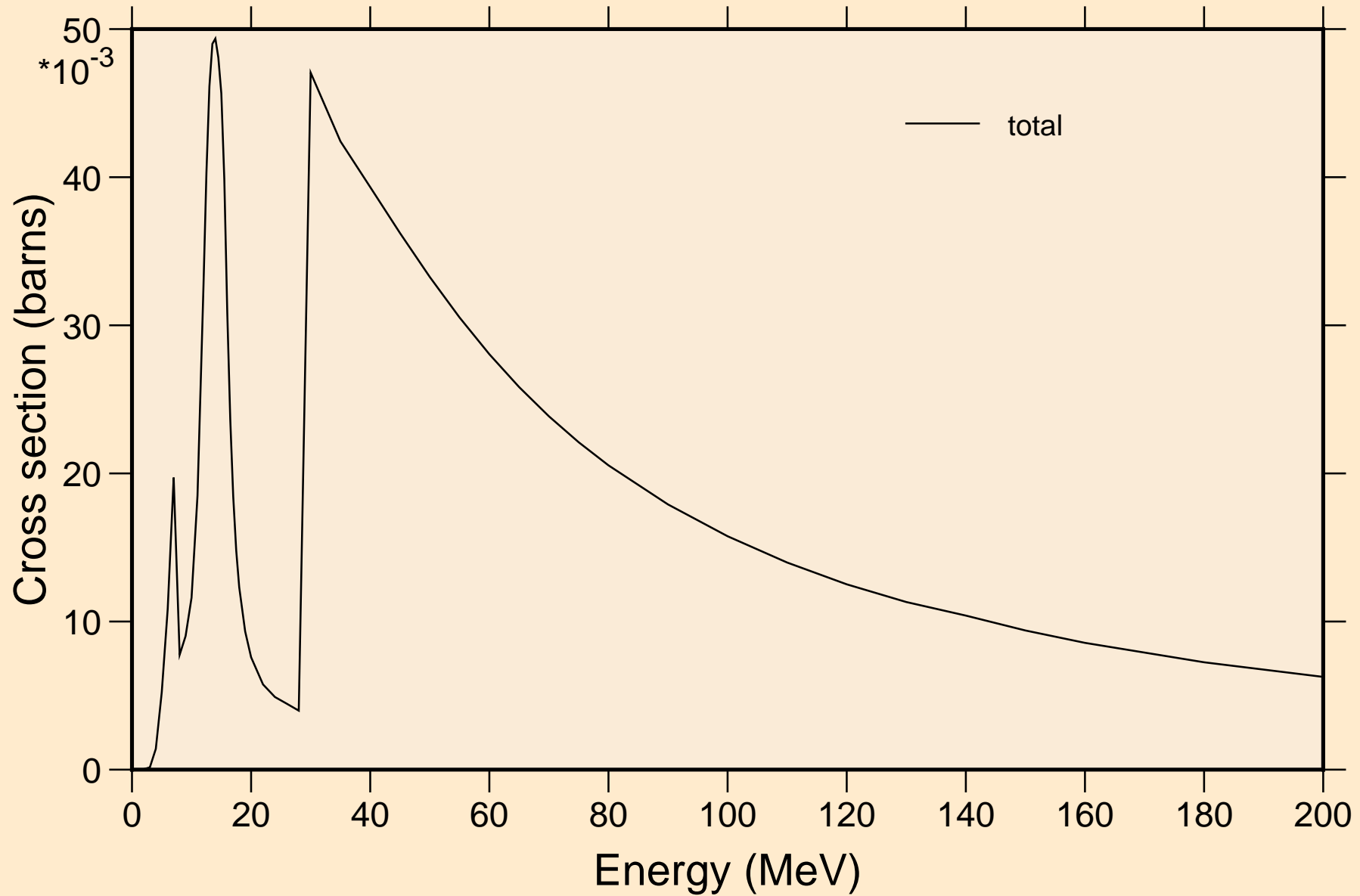

RA209 PHOTON ACER TENDL-2023 LIBRARY; T=0.K
Partial cross sections

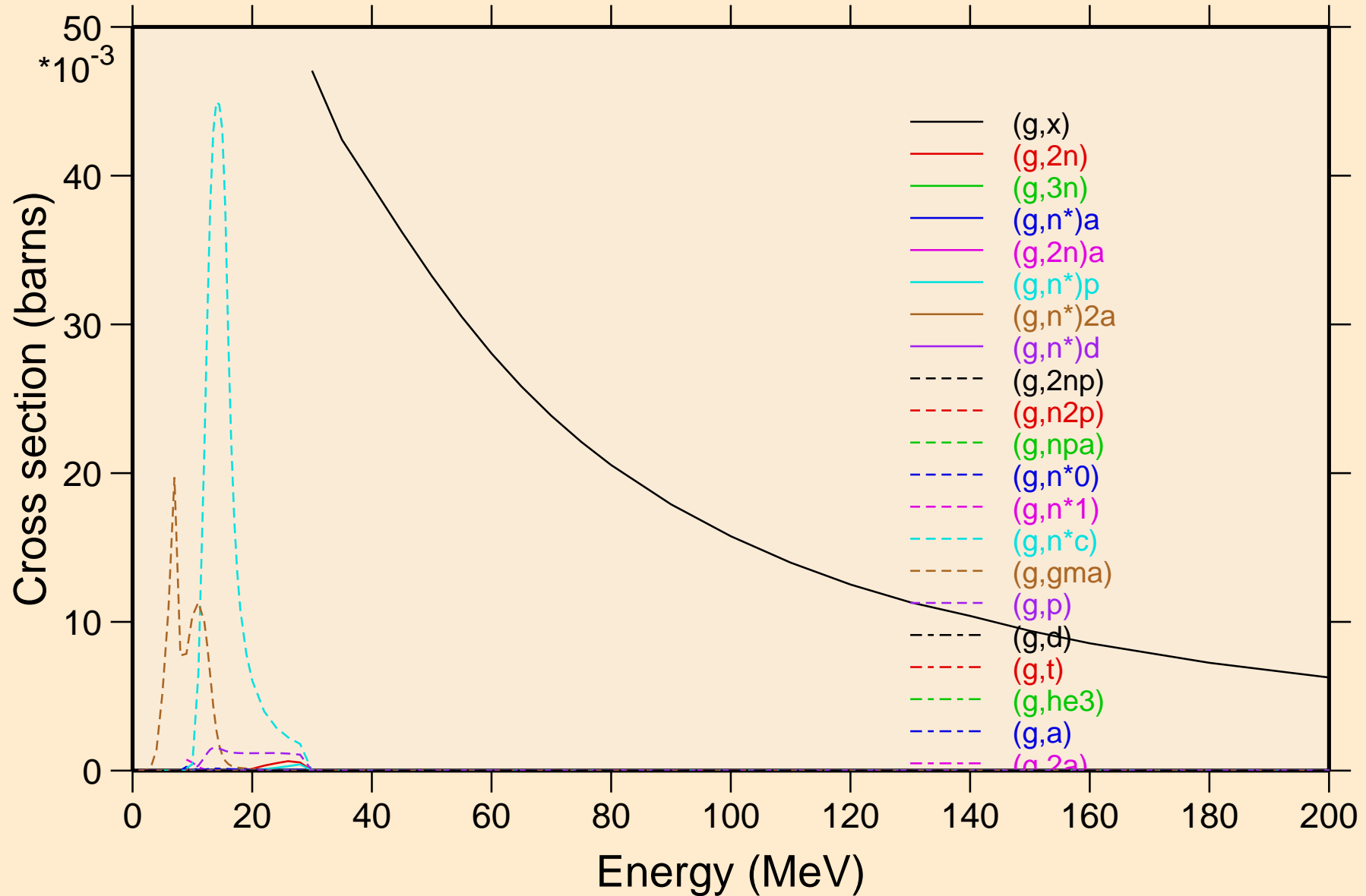

RA209 PHOTON ACER TENDL-2023 LIBRARY; T=0.K

Heating

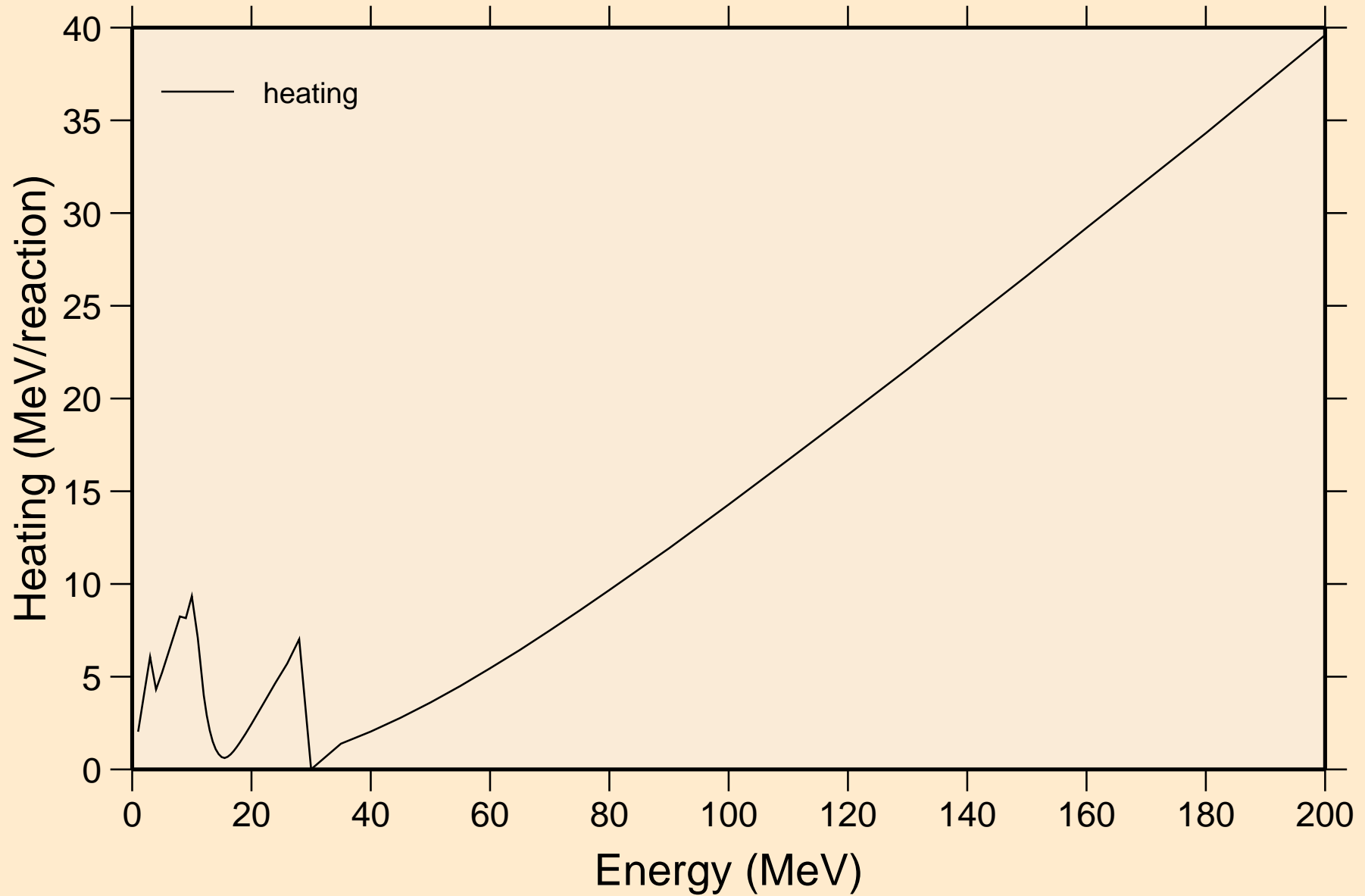

RA209 PHOTON ACER TENDL-2023 LIBRARY; T=0.K

Particle heating contributions

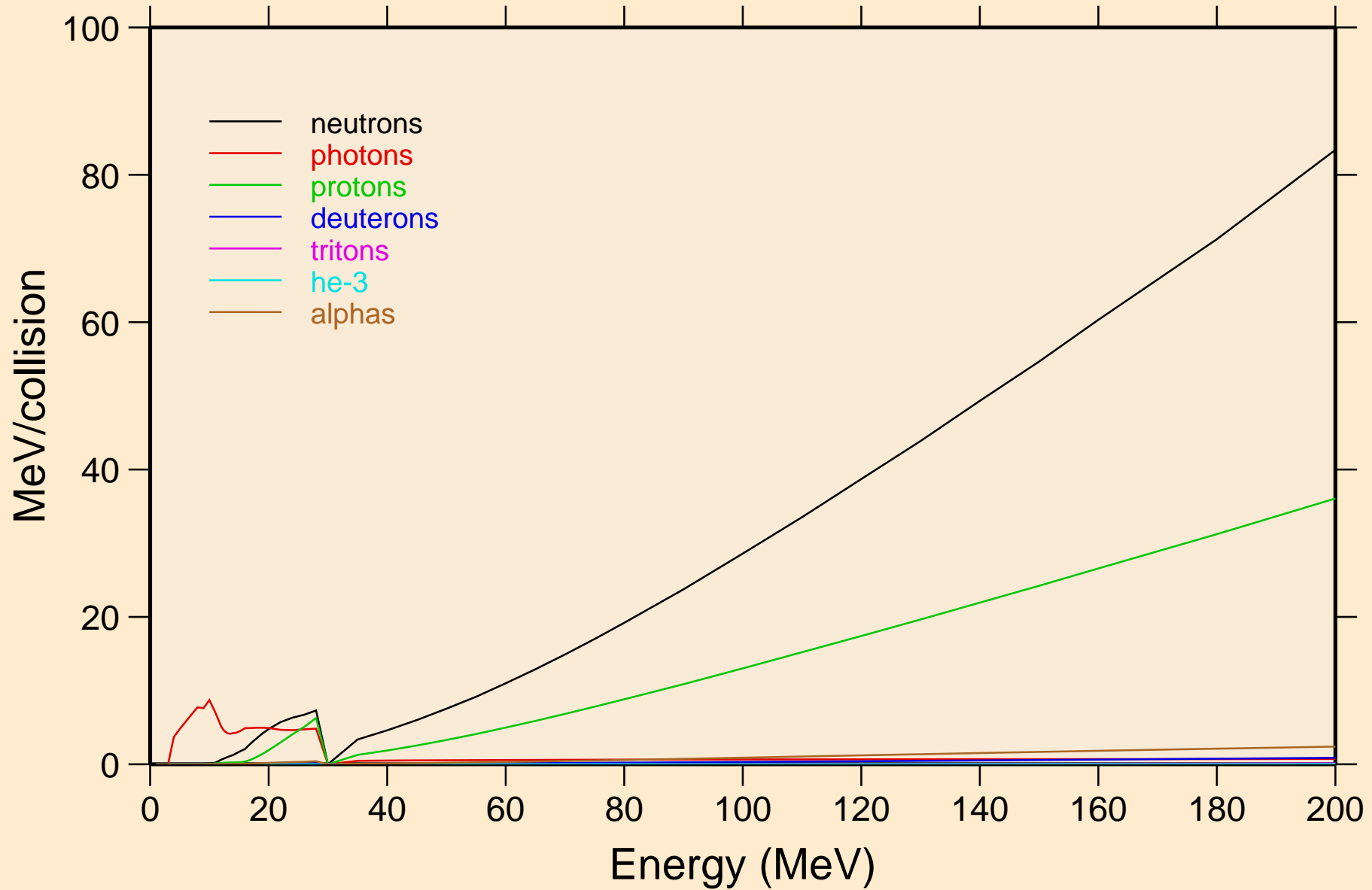

RA209 PHOTON ACER TENDL-2023 LIBRARY; T=0.K
Particle production cross sections

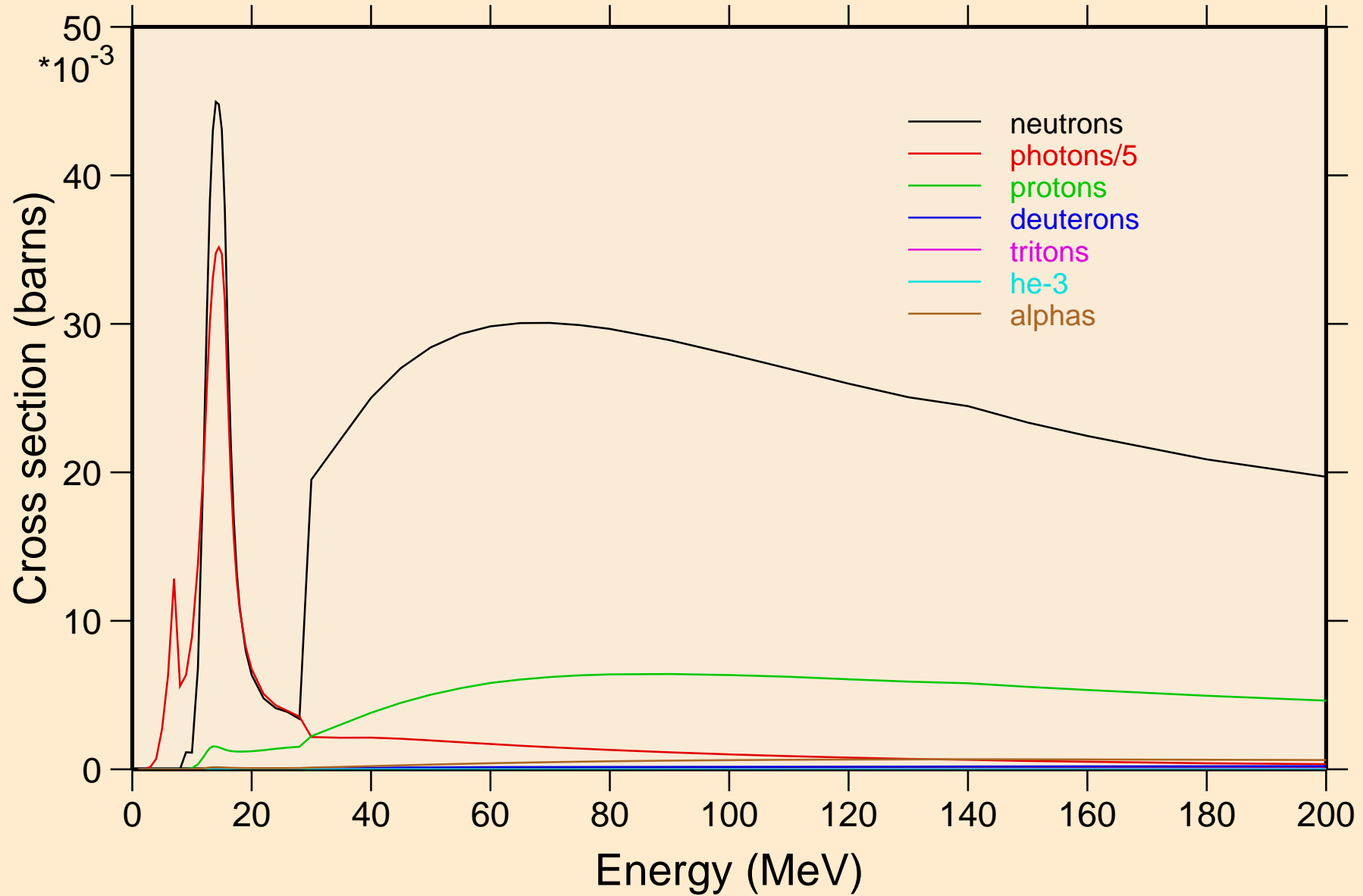

RA209 PHOTON ACER TENDL-2023 LIBRARY; T=0.K
neutrons from (g,x)

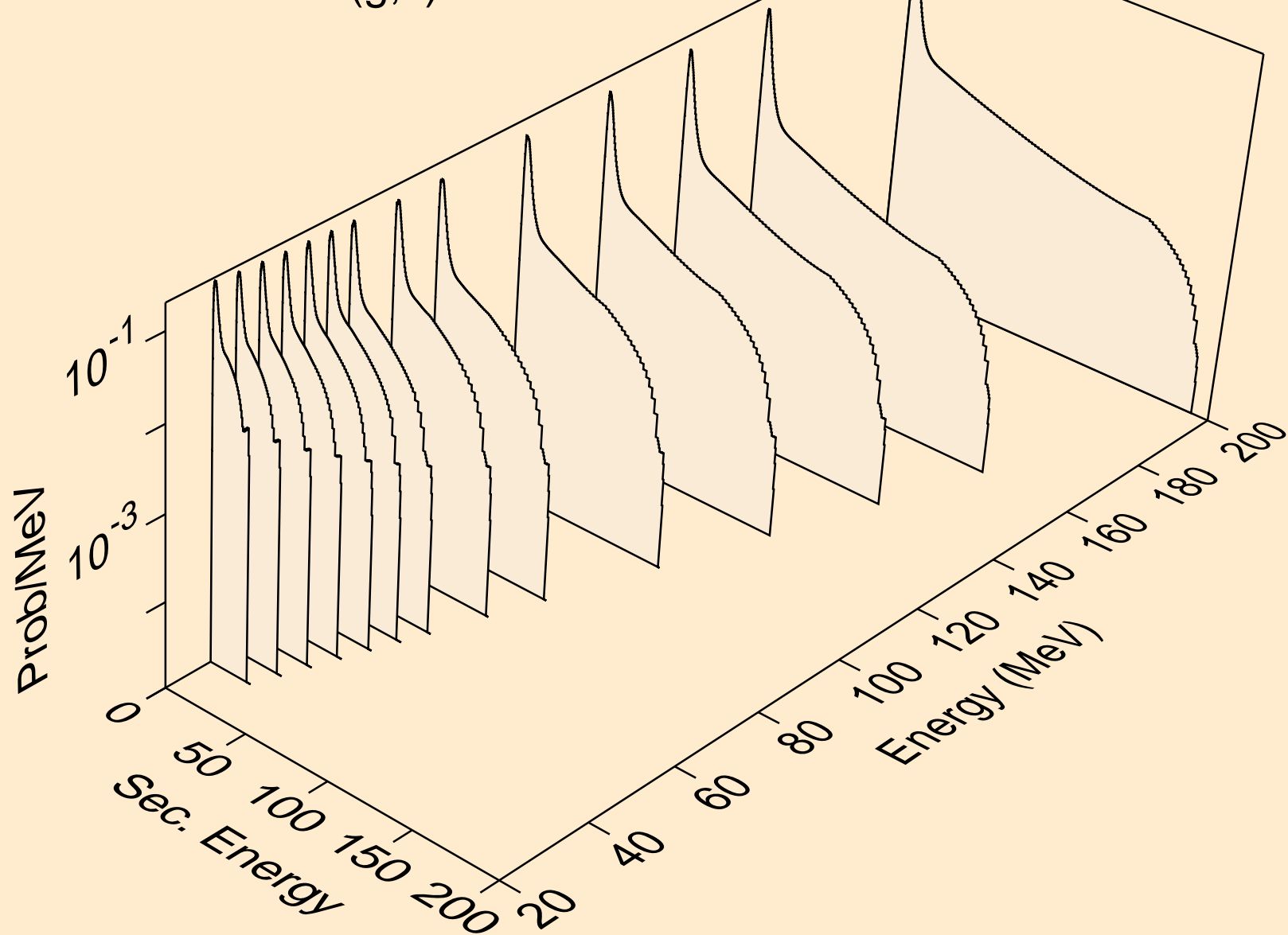

RA209 PHOTON ACER TENDL-2023 LIBRARY; T=0.K
neutrons from (g,2n)

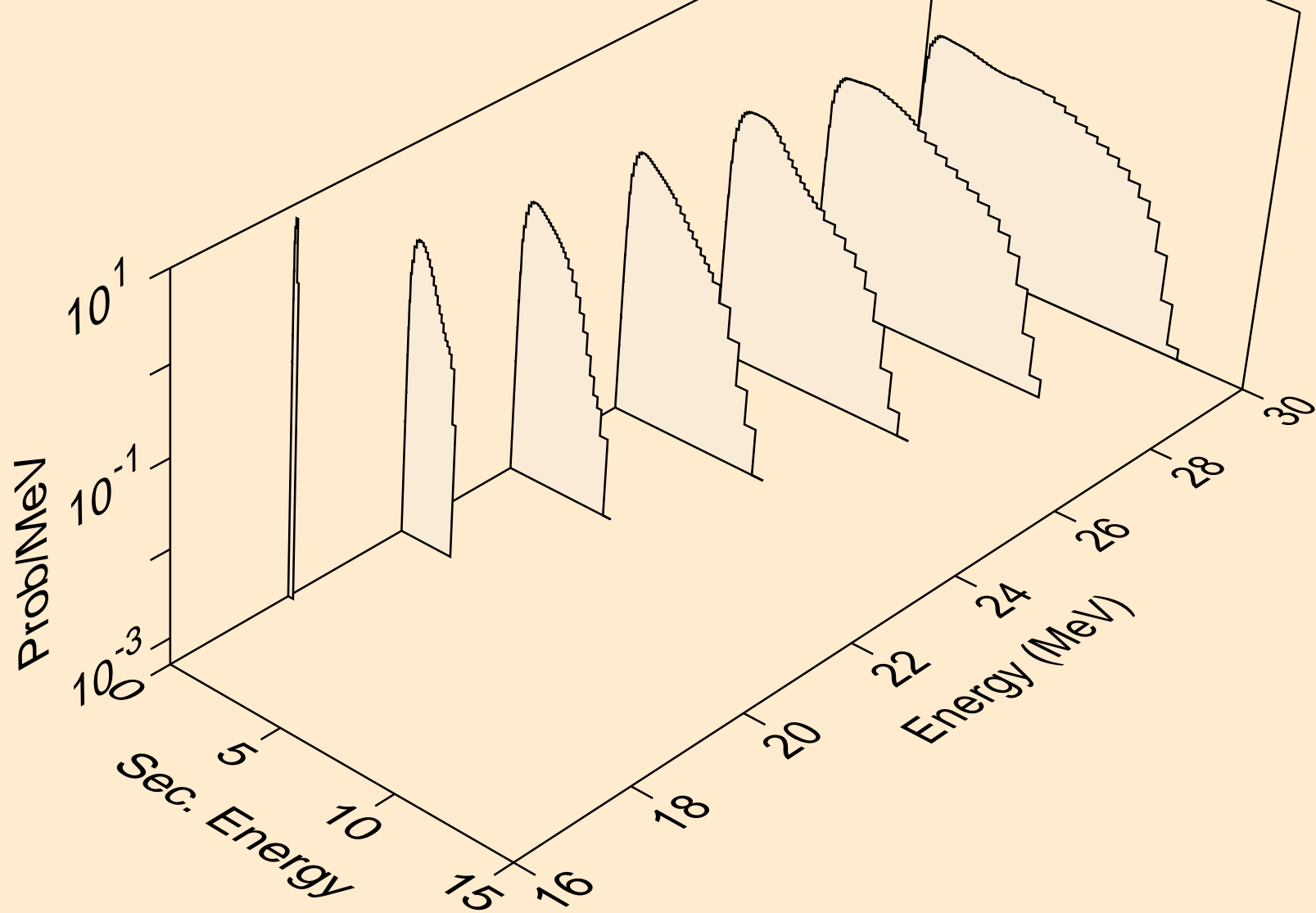

RA209 PHOTON ACER TENDL-2023 LIBRARY; T=0.K
neutrons from (g,3n)

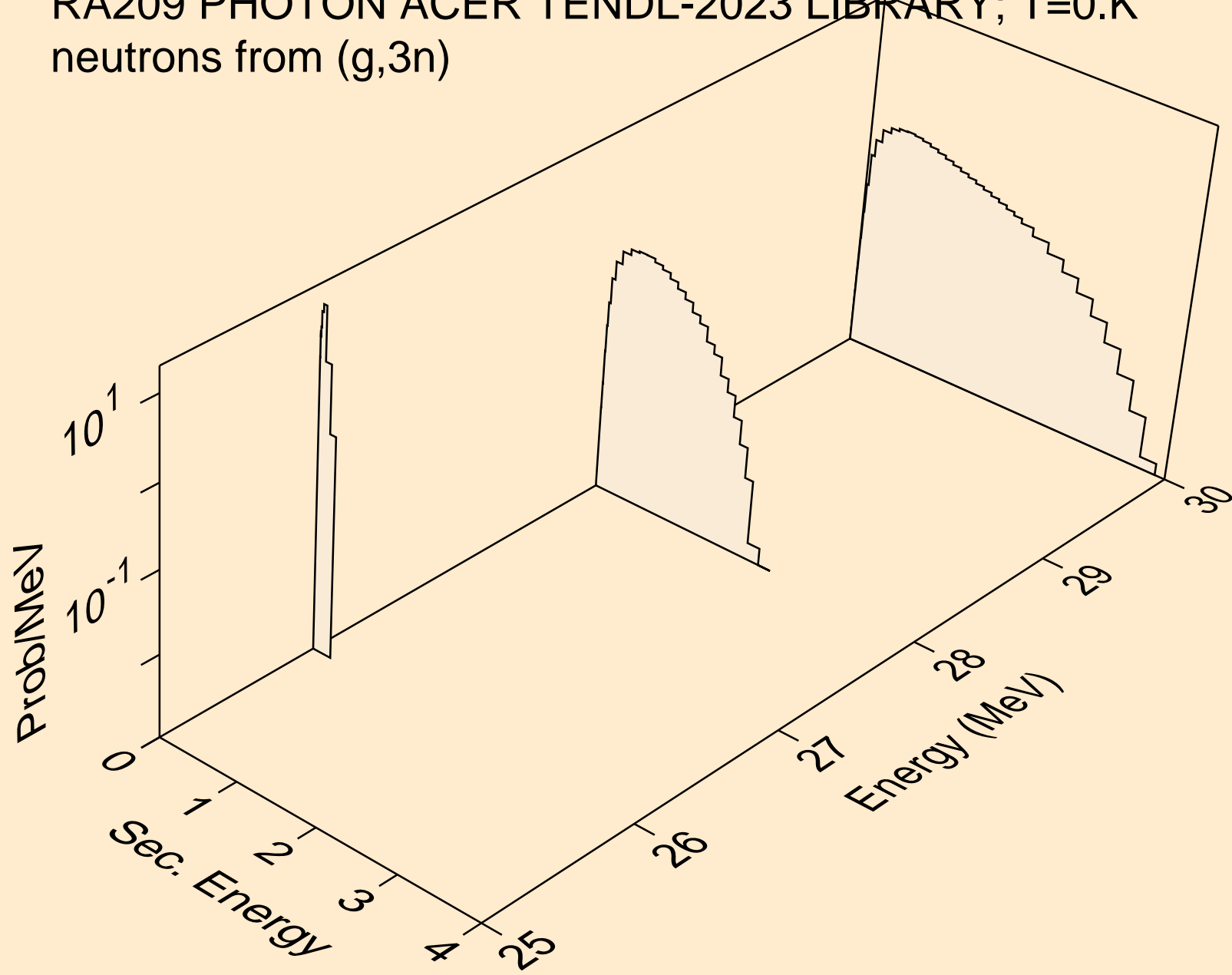

RA209 PHOTON ACER TENDL-2023 LIBRARY; T=0.K
neutrons from (g,n*)a

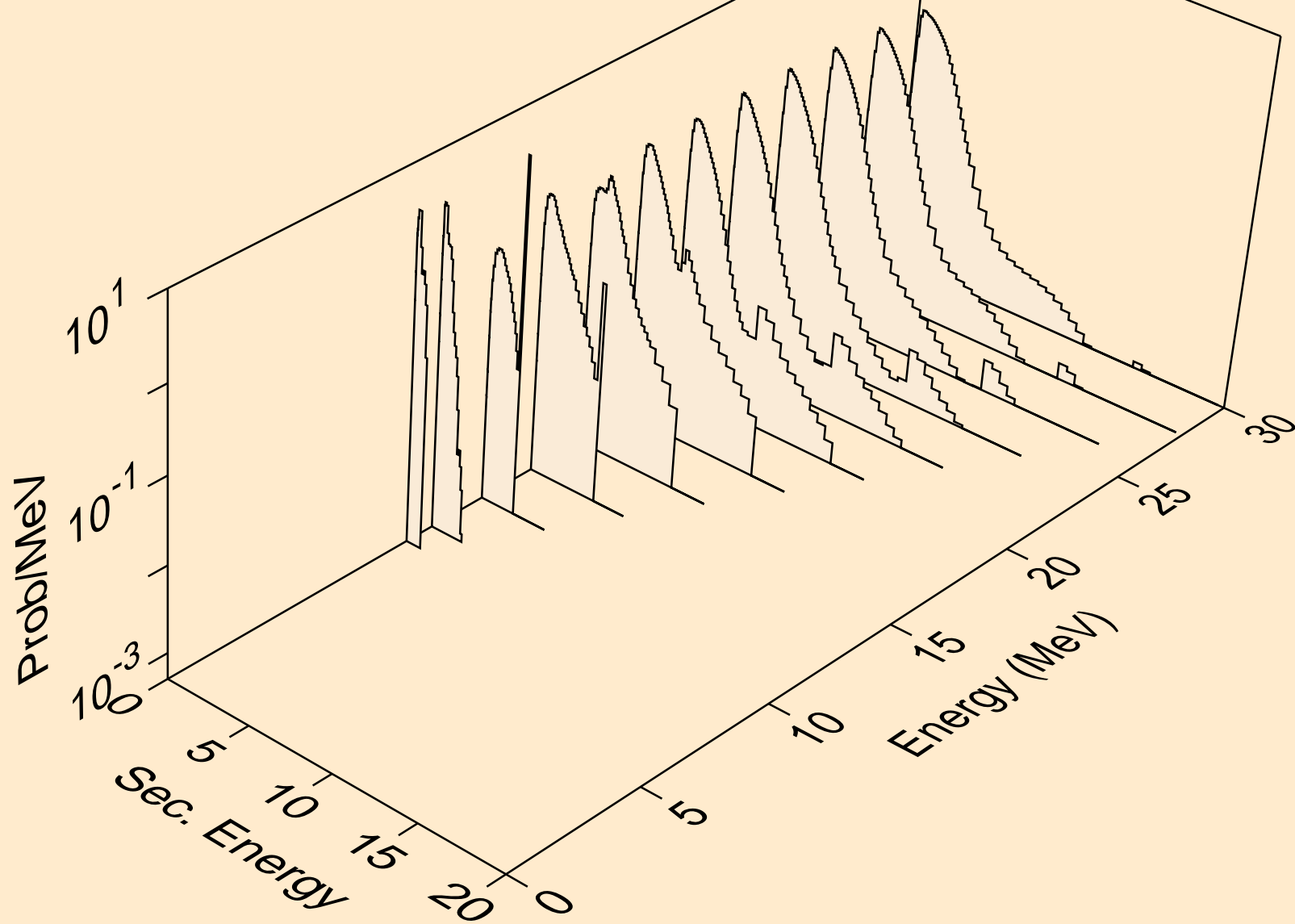

RA209 PHOTON ACER TENDL-2023 LIBRARY; T=0.K
neutrons from (g,2n)a

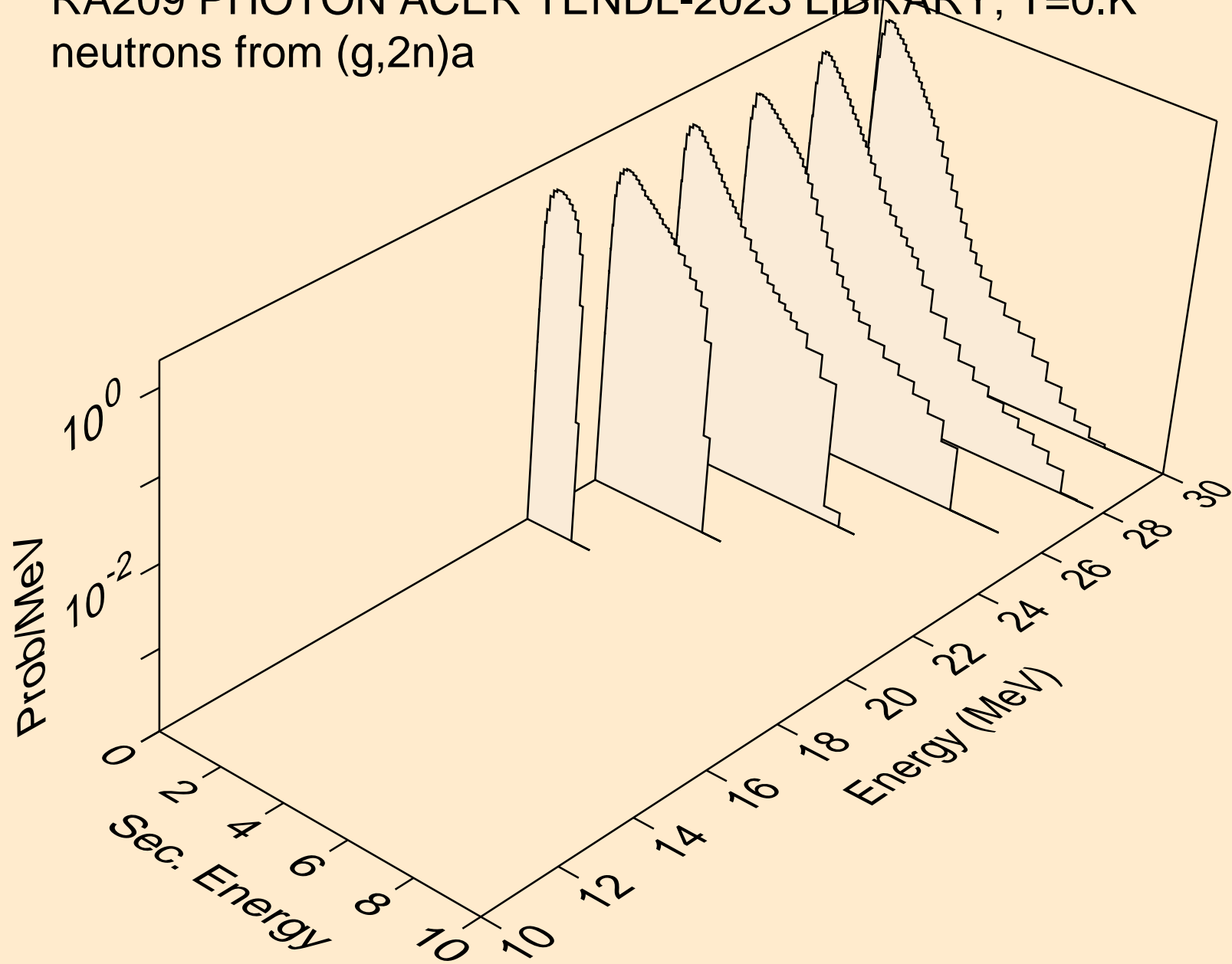

RA209 PHOTON ACER TENDL-2023 LIBRARY; T=0.K
neutrons from (g,n*)p

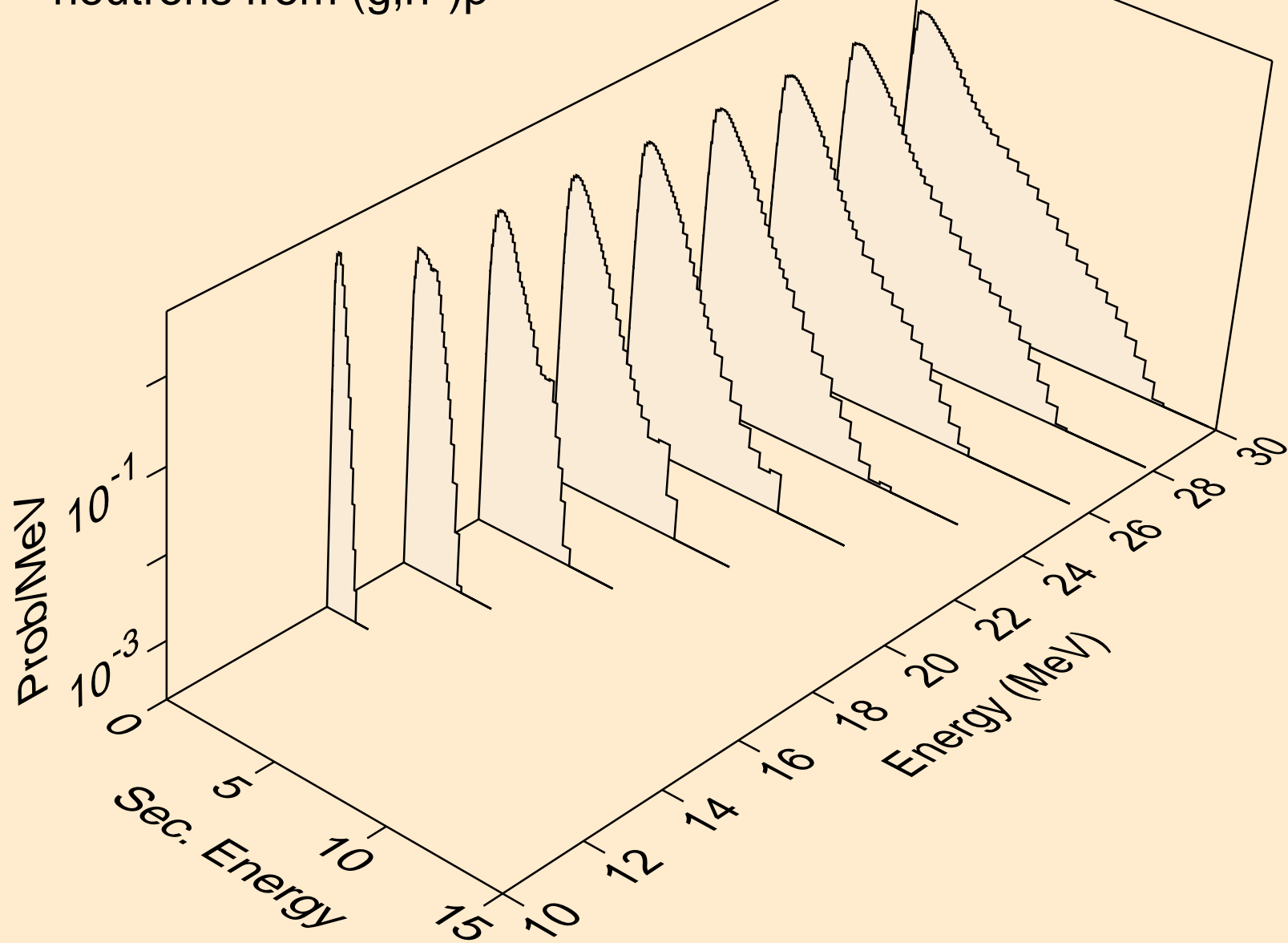

RA209 PHOTON ACER TENDL-2023 LIBRARY; T=0.K
neutrons from (g,n*)2a

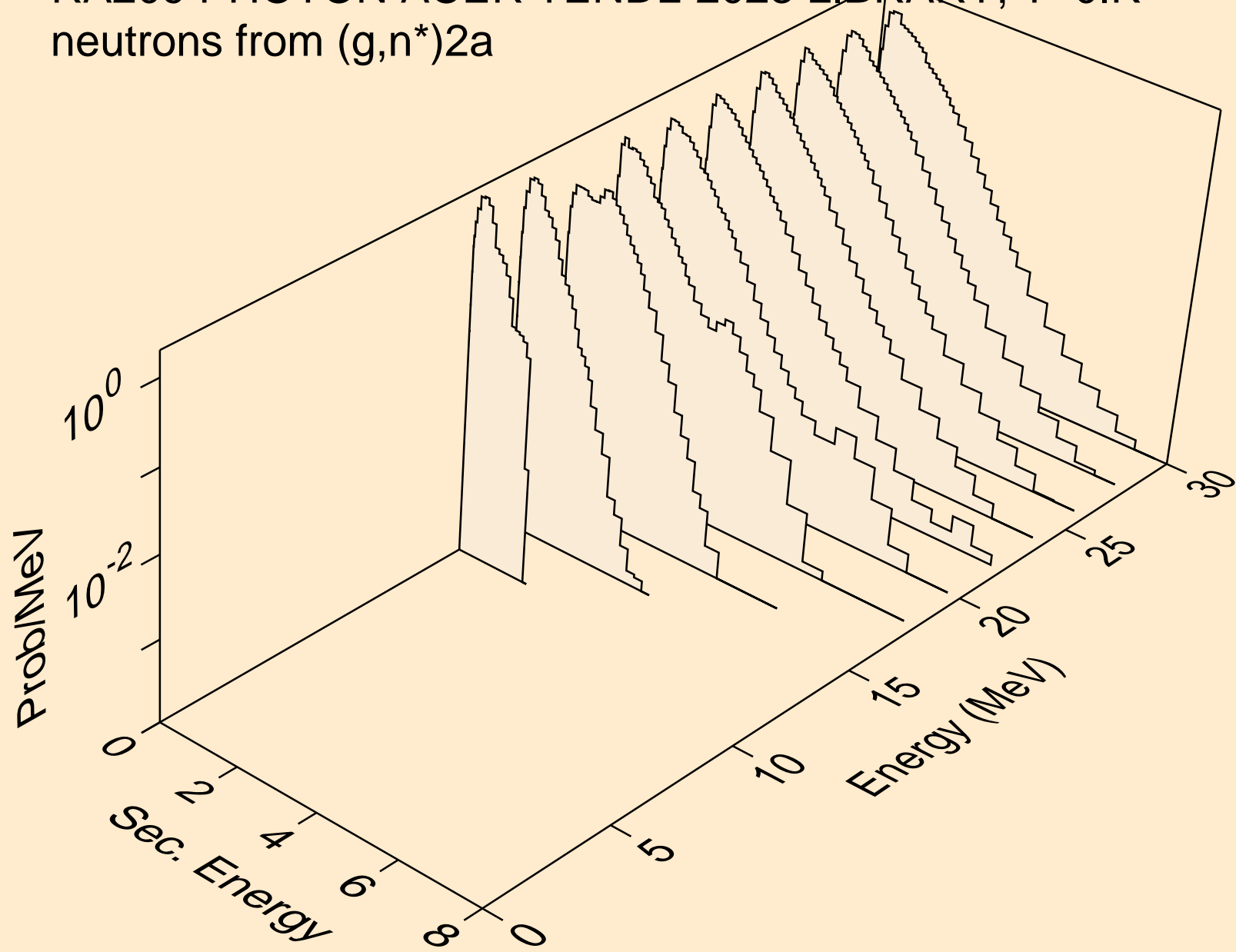

RA209 PHOTON ACER TENDL-2023 LIBRARY; T=0.K
neutrons from (g,n*)d

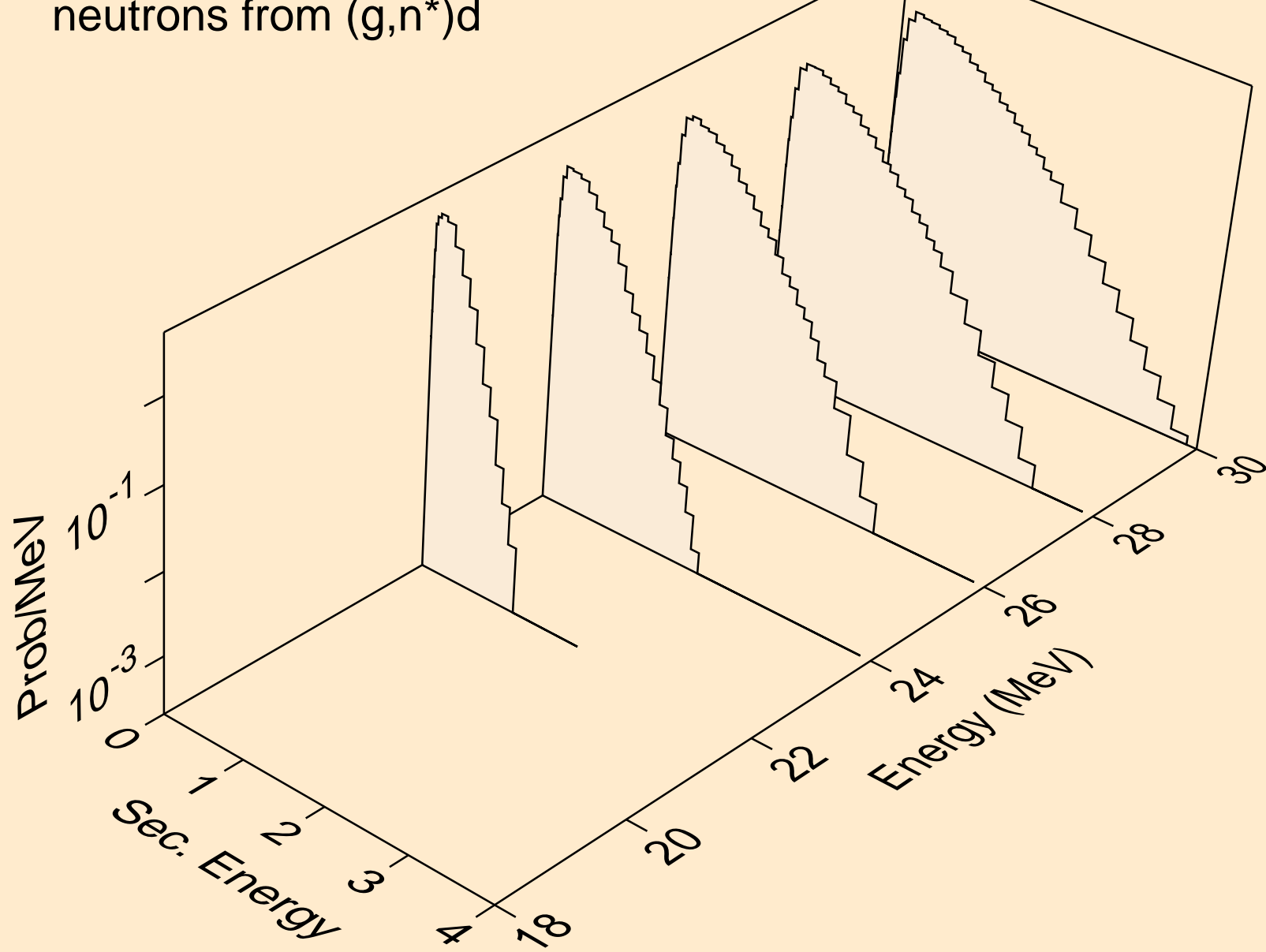

RA209 PHOTON ACER TENDL-2023 LIBRARY; T=0.K
neutrons from (g,2np)

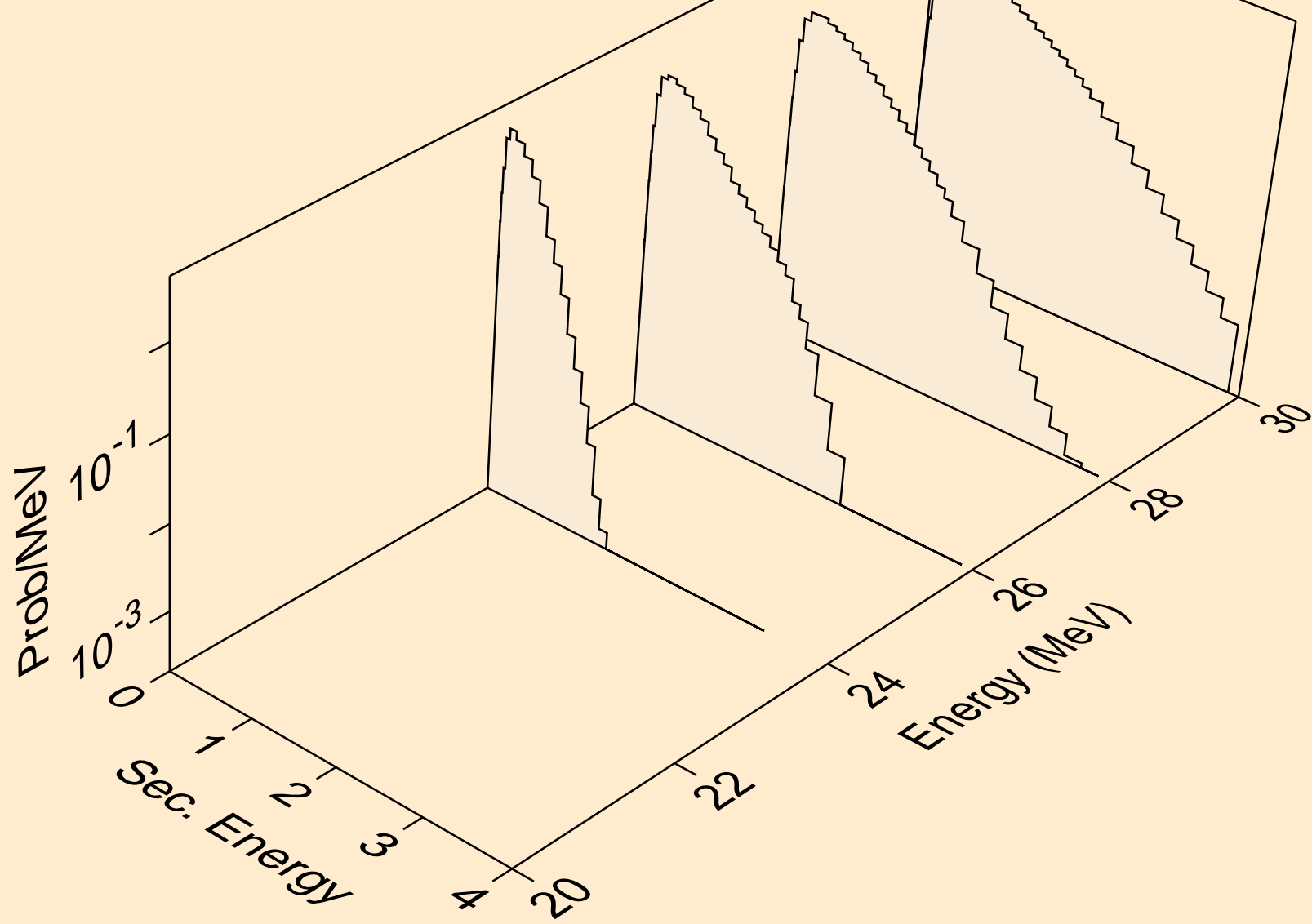

RA209 PHOTON ACER TENDL-2023 LIBRARY; T=0.K
neutrons from (g,n2p)

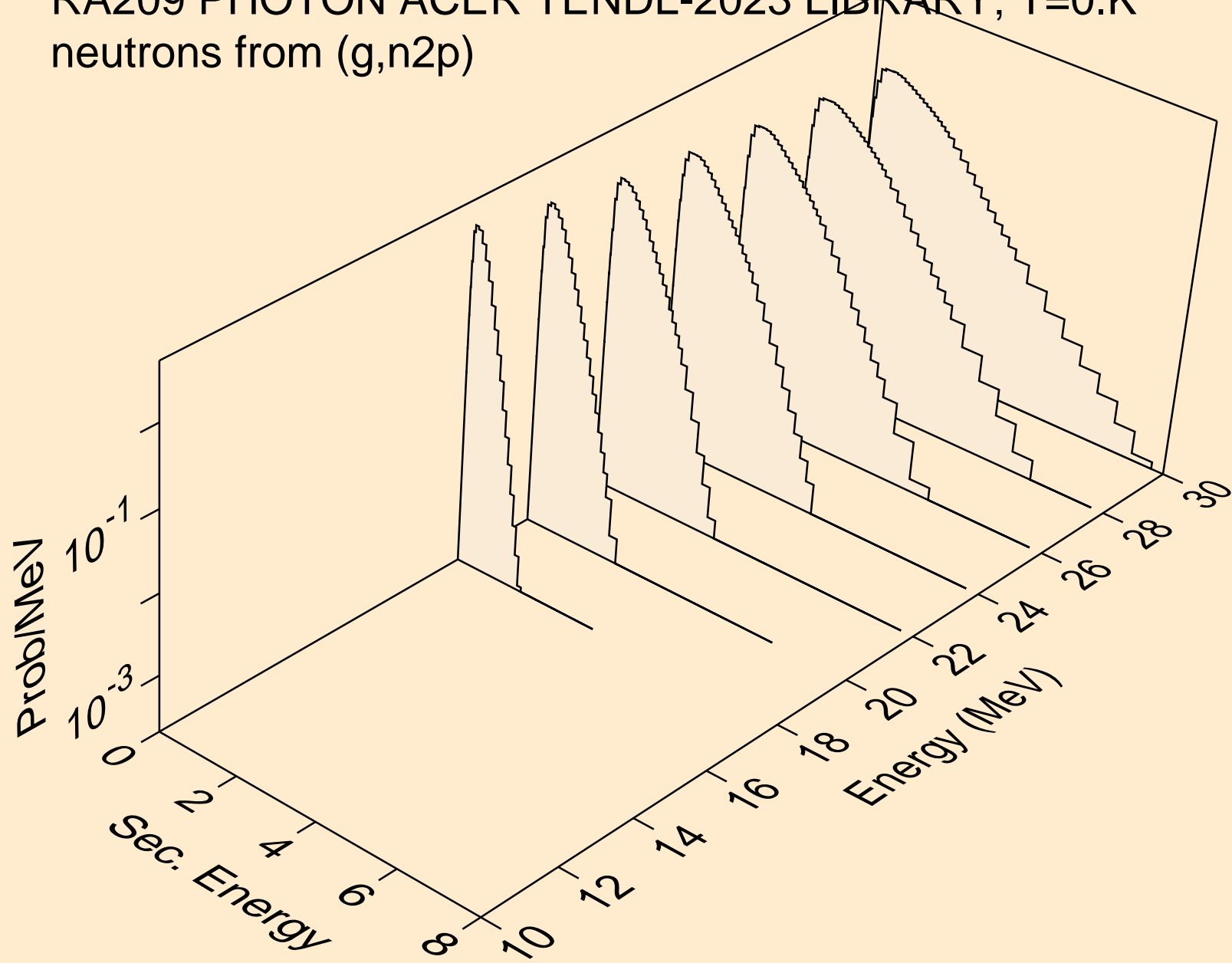

RA209 PHOTON ACER TENDL-2023 LIBRARY; T=0.K
neutrons from (g,npa)

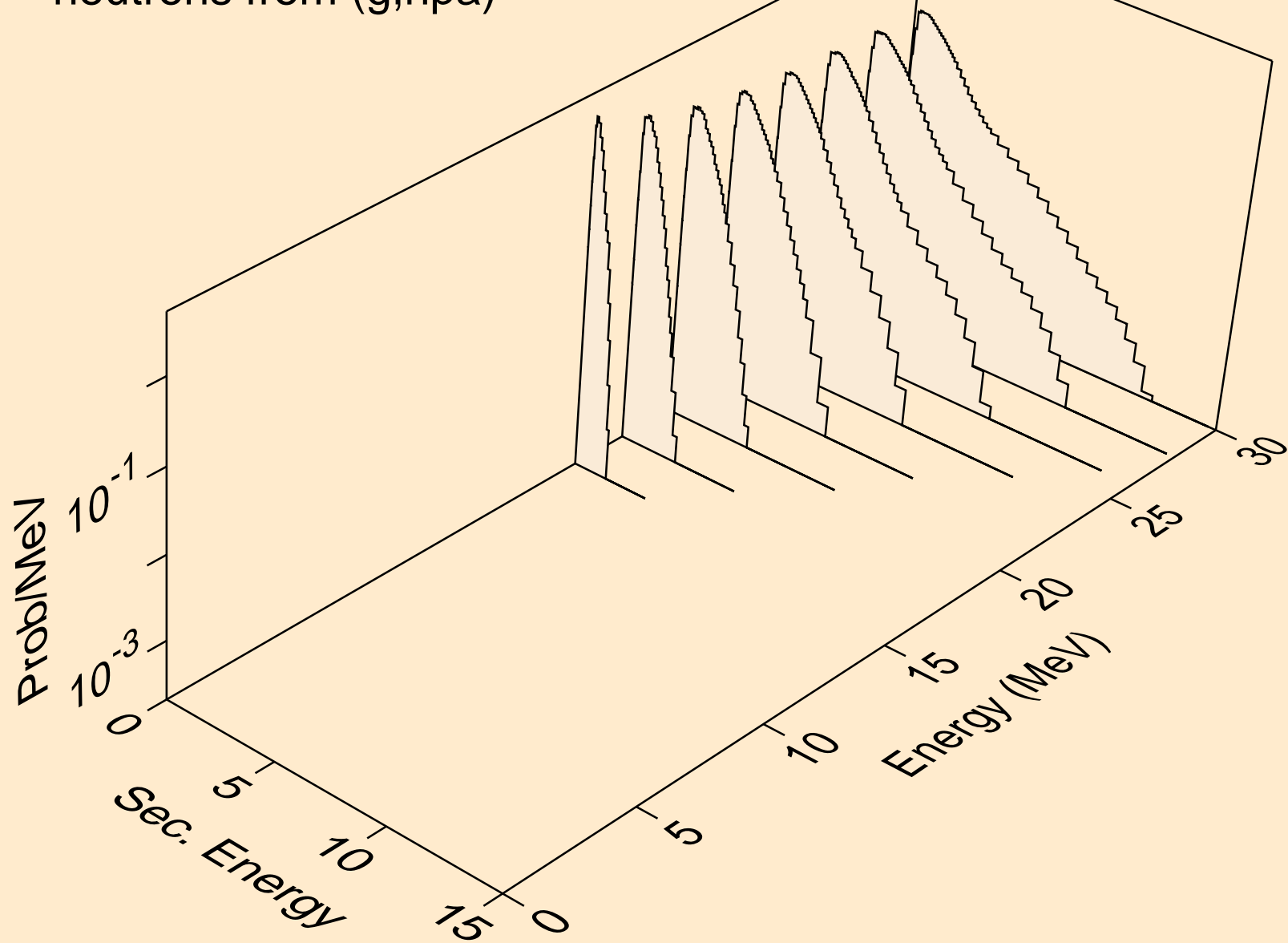

RA209 PHOTON ACER TENDL-2023 LIBRARY; T=0.K
angular distribution for (g,n*0) neutron

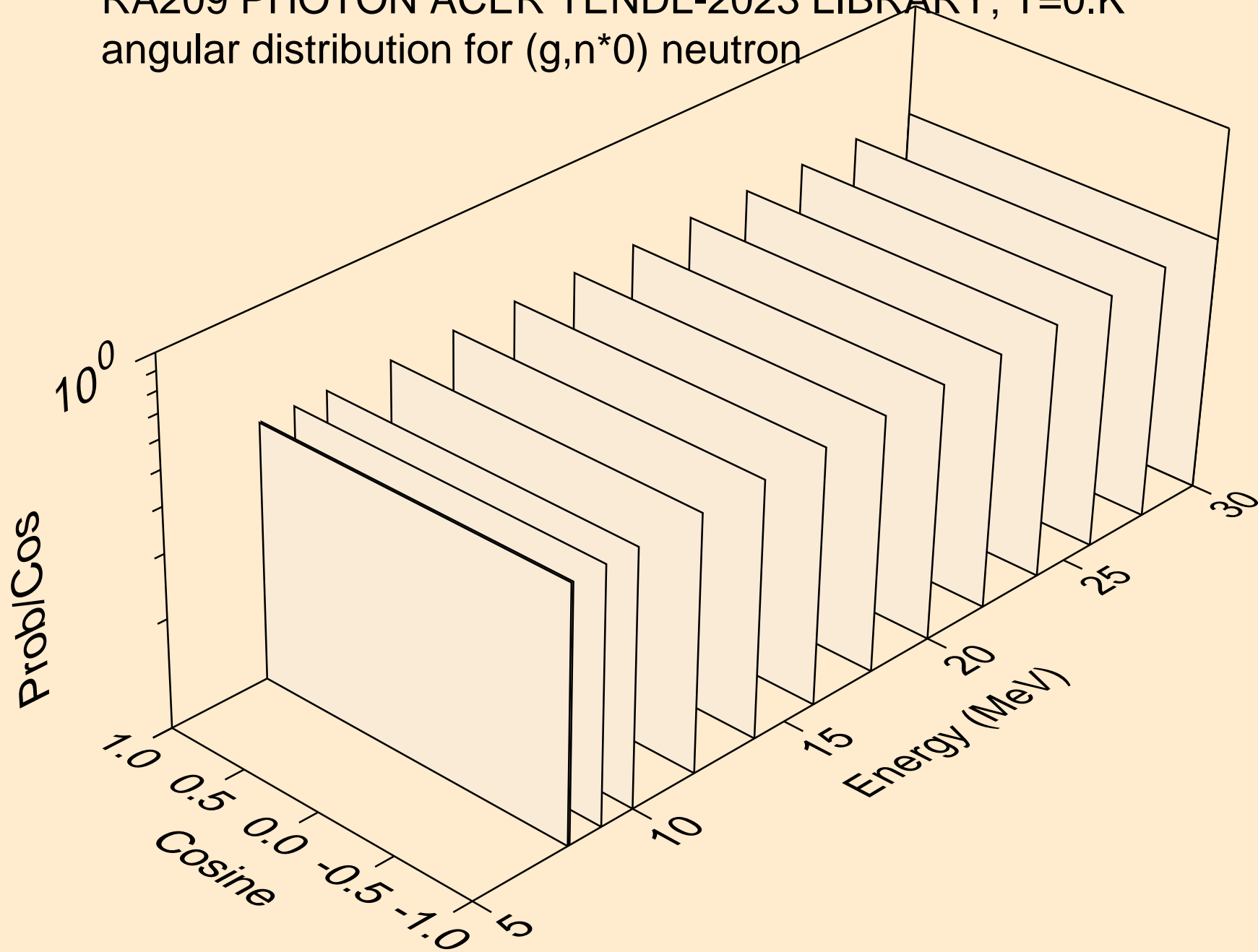

RA209 PHOTON ACER TENDL-2023 LIBRARY; T=0.K
angular distribution for (g,n*1) neutron

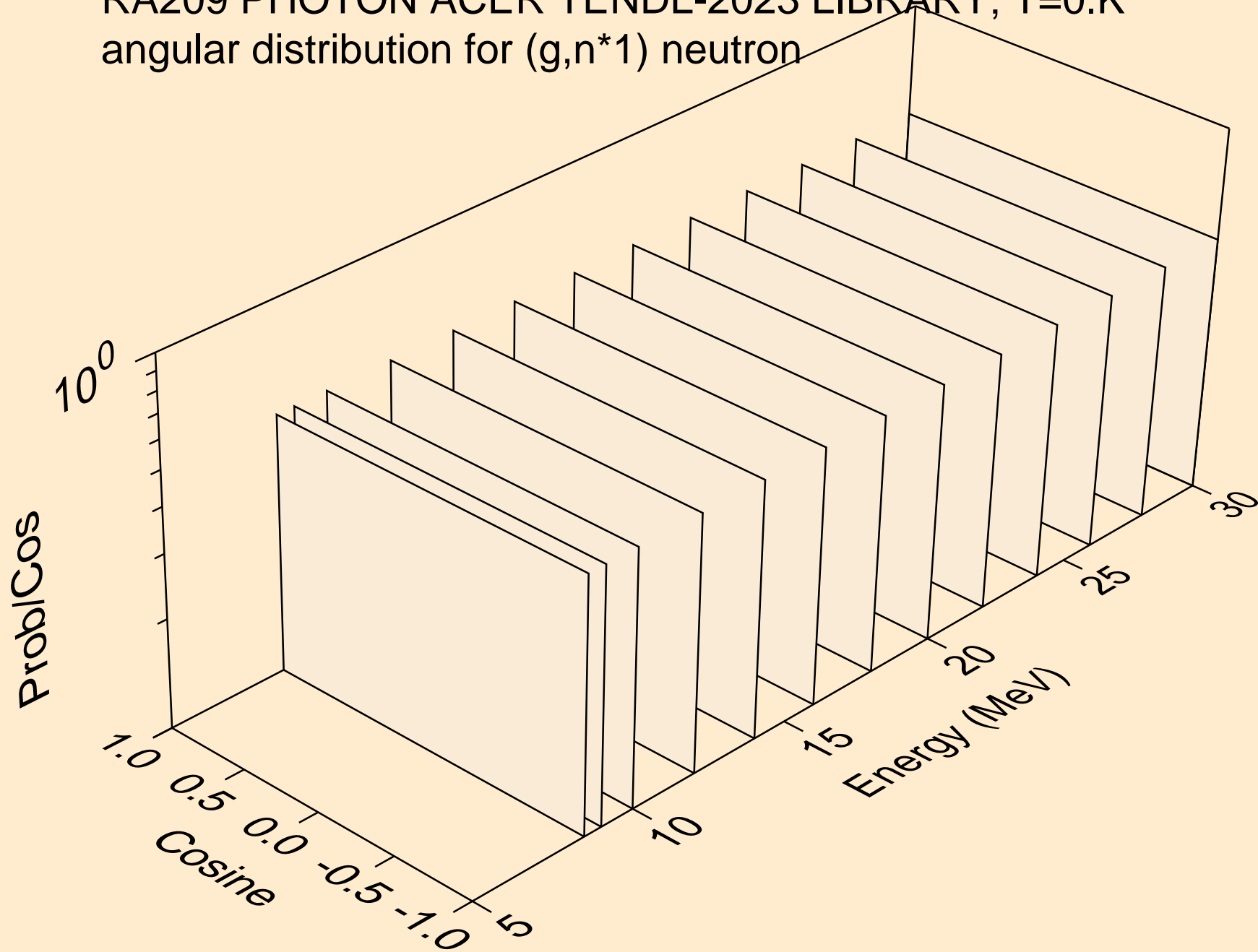

RA209 PHOTON ACER TENDL-2023 LIBRARY; T=0.K
neutrons from (g,n*c)

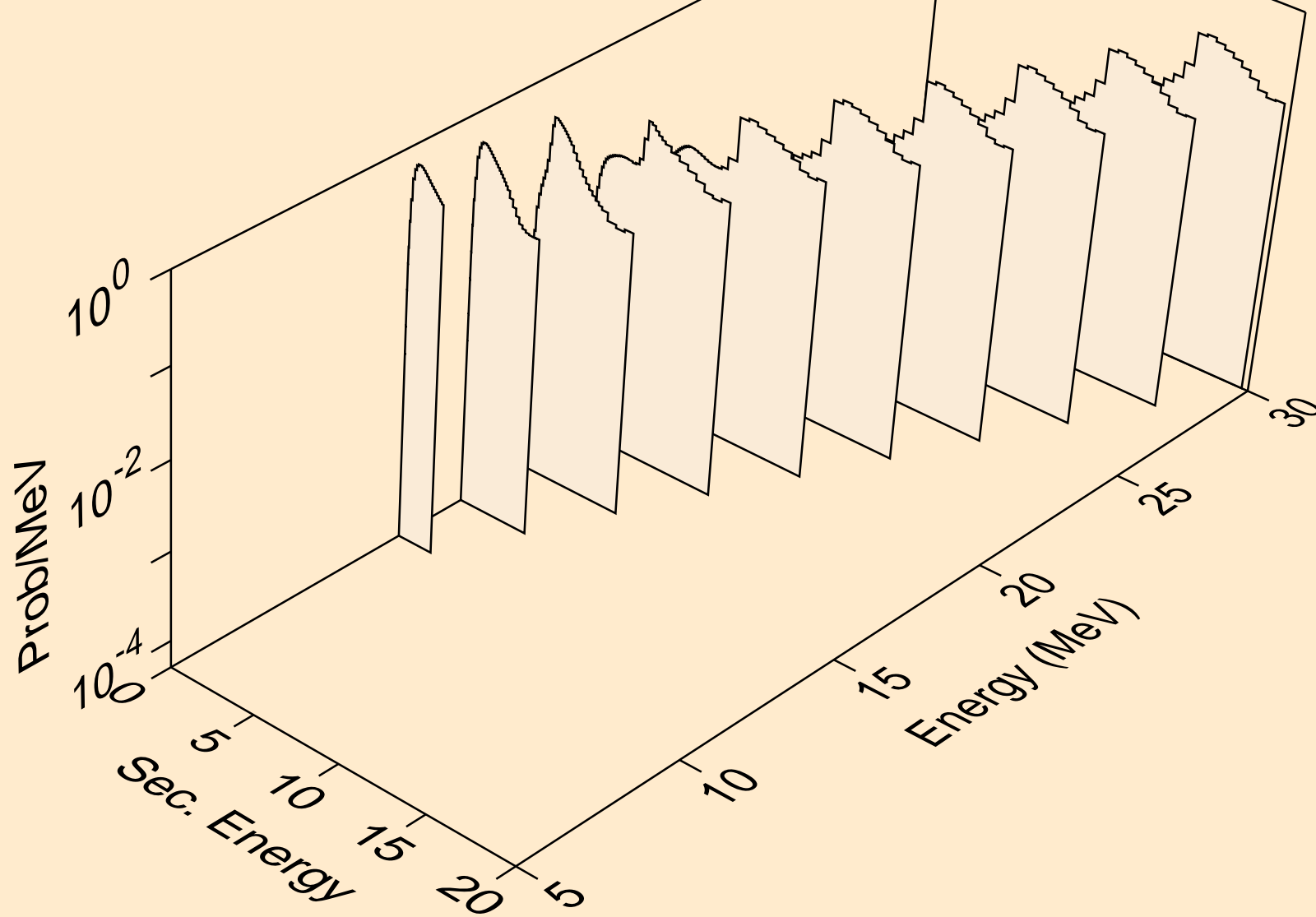

RA209 PHOTON ACER TENDL-2023 LIBRARY; T=0.K
photons from (g,x)

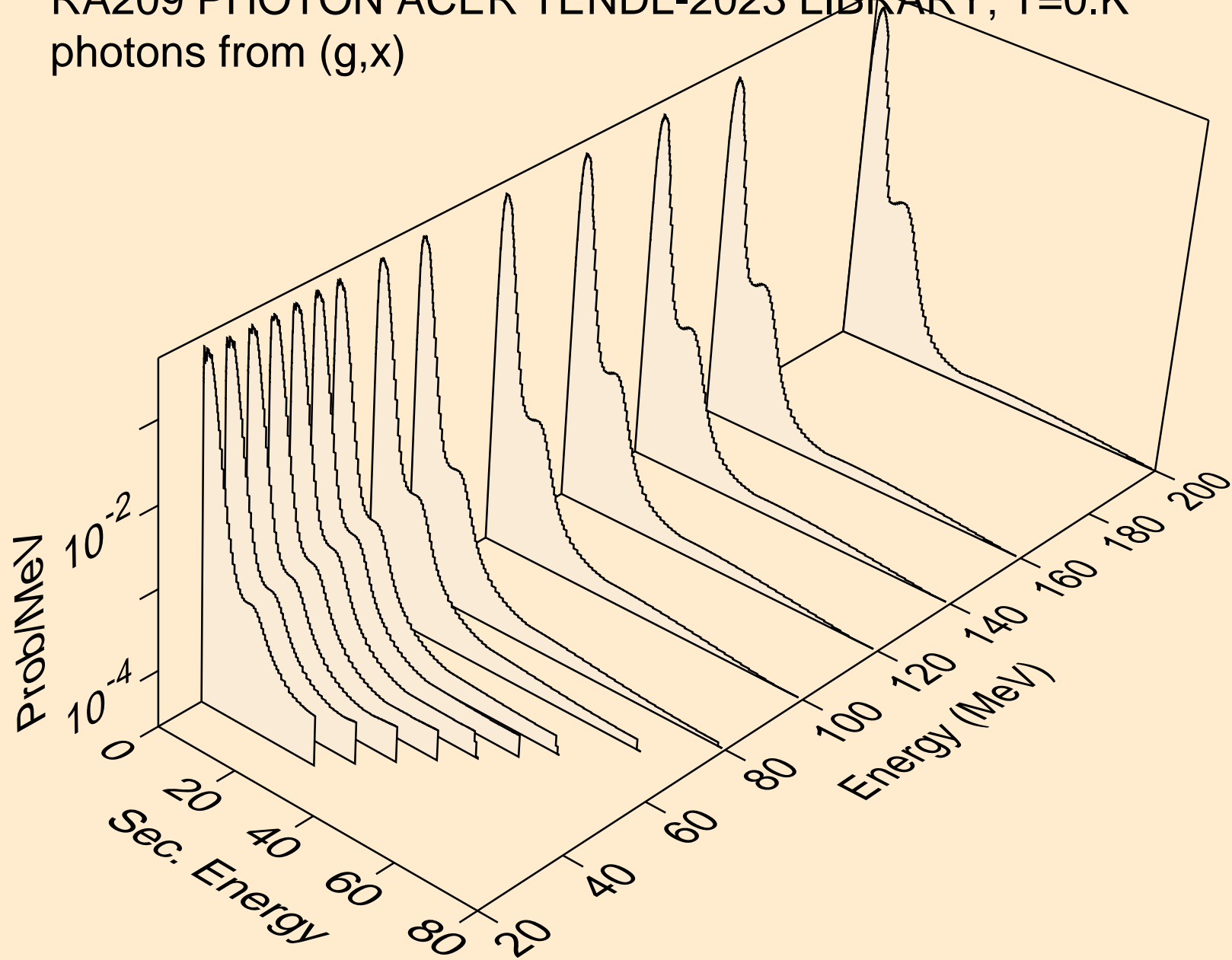

RA209 PHOTON ACER TENDL-2023 LIBRARY; T=0.K
photons from (g,2n)

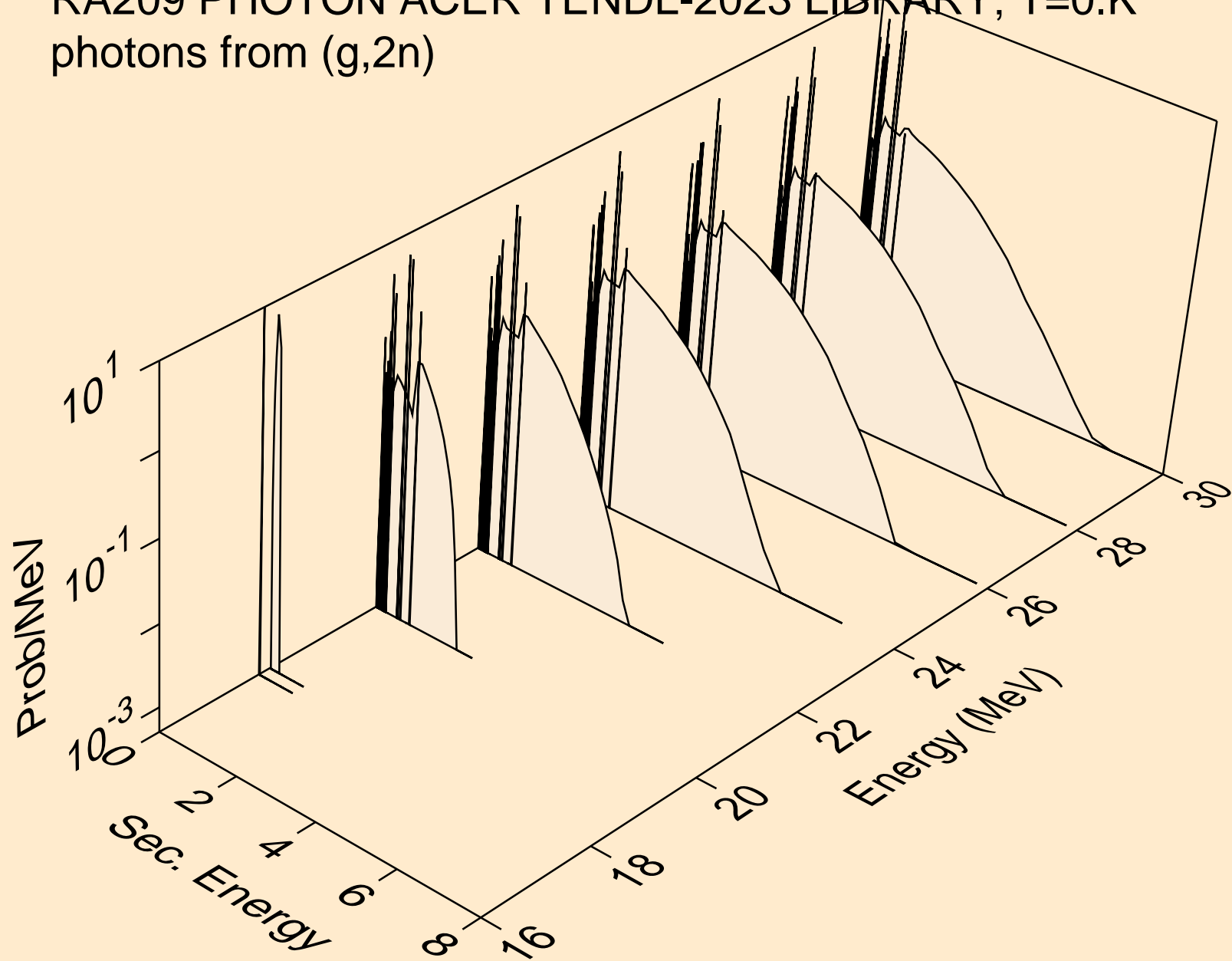

RA209 PHOTON ACER TENDL-2023 LIBRARY; T=0.K
photons from (g,3n)

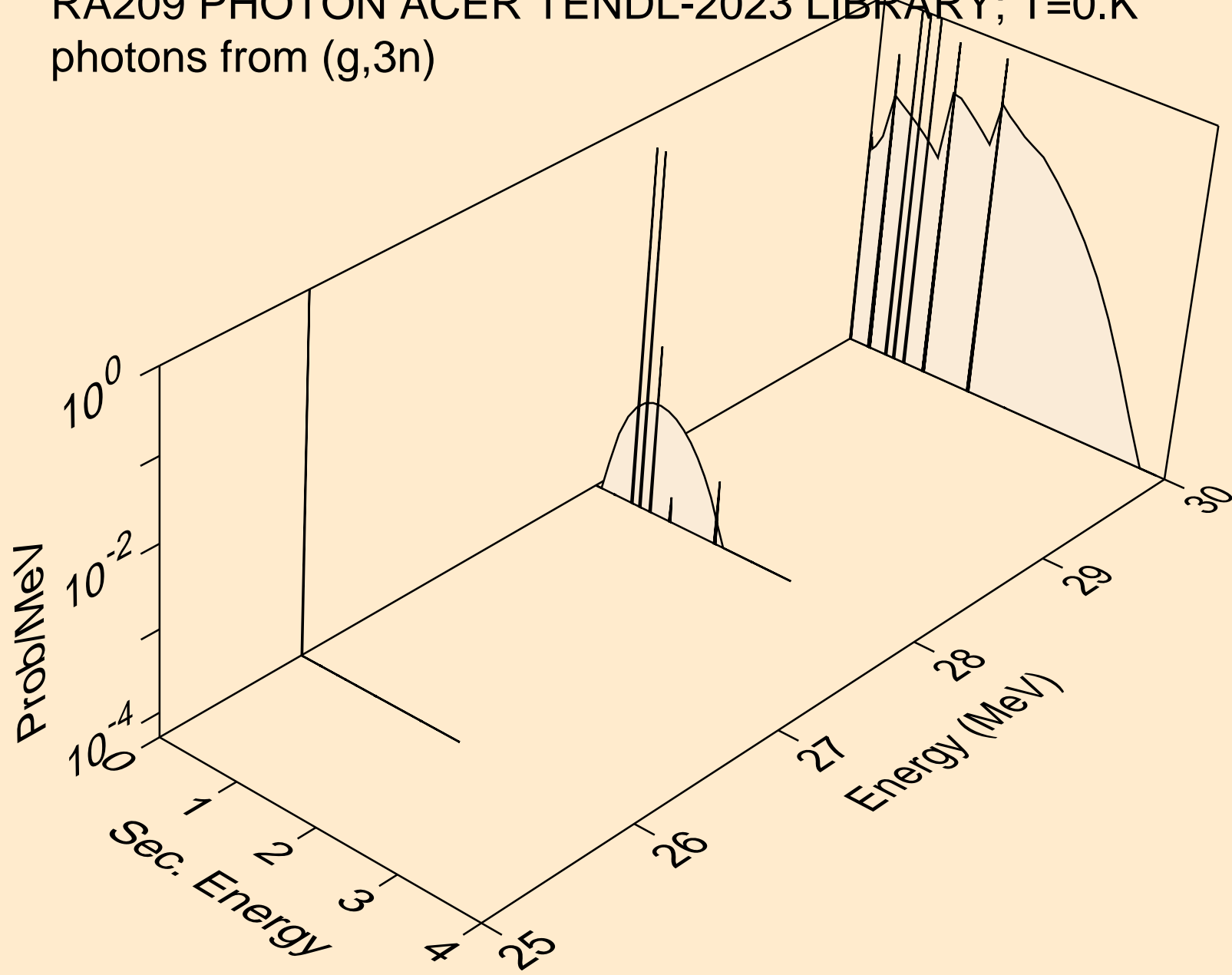

RA209 PHOTON ACER TENDL-2023 LIBRARY; T=0.K
photons from (g,n*)a

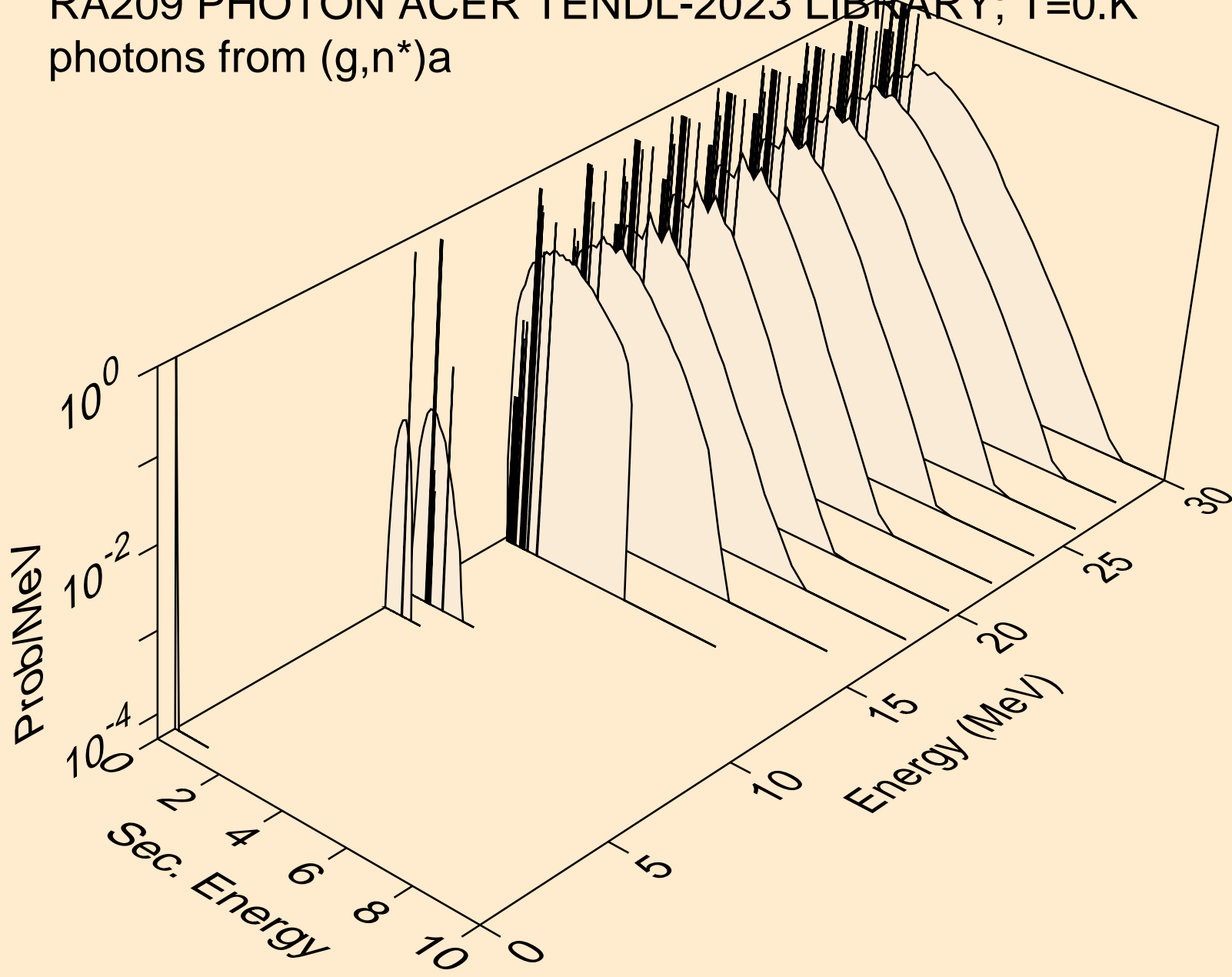

RA209 PHOTON ACER TENDL-2023 LIBRARY; T=0.K
photons from (g,2n)a

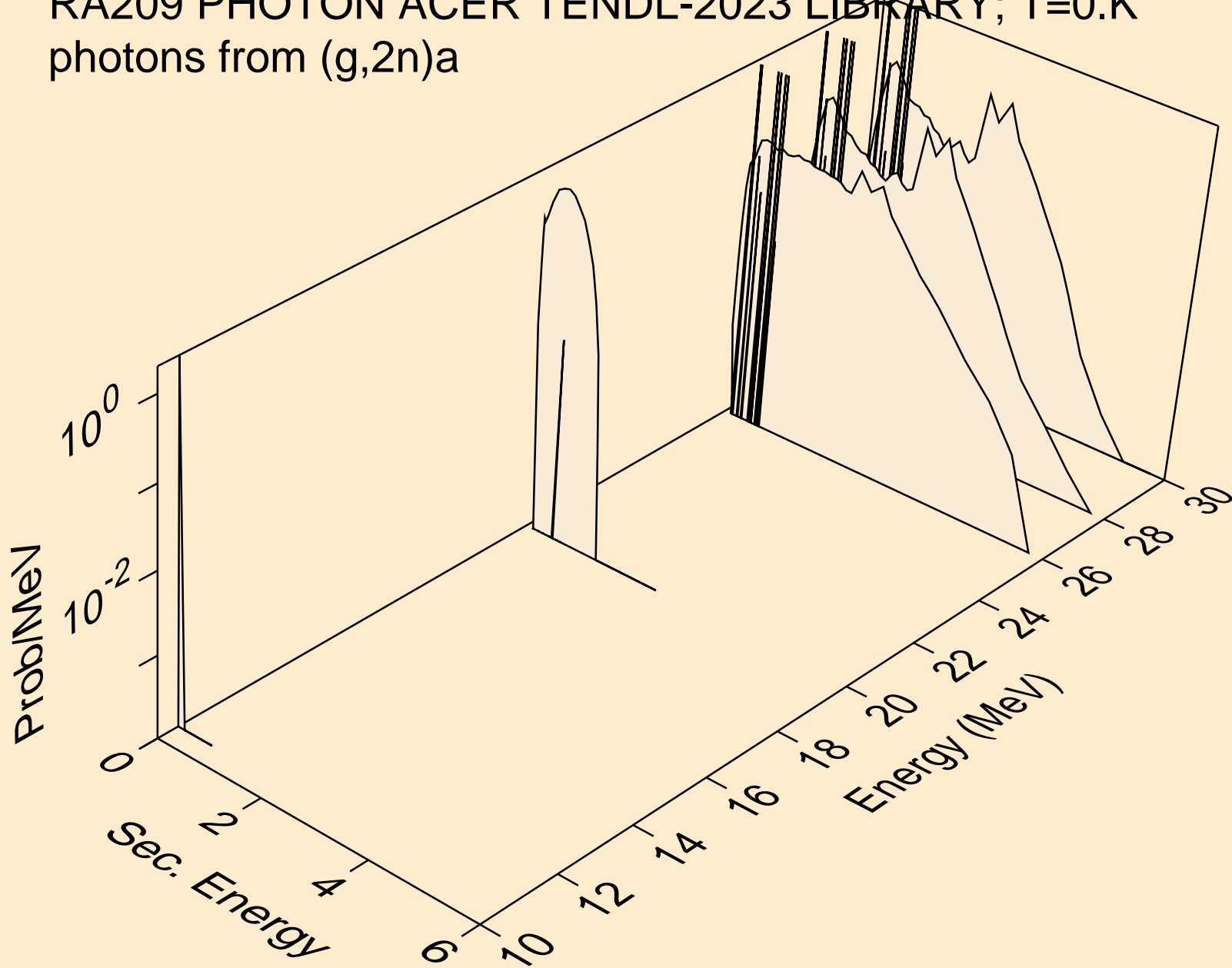

RA209 PHOTON ACER TENDL-2023 LIBRARY; T=0.K
photons from (g,n*)p

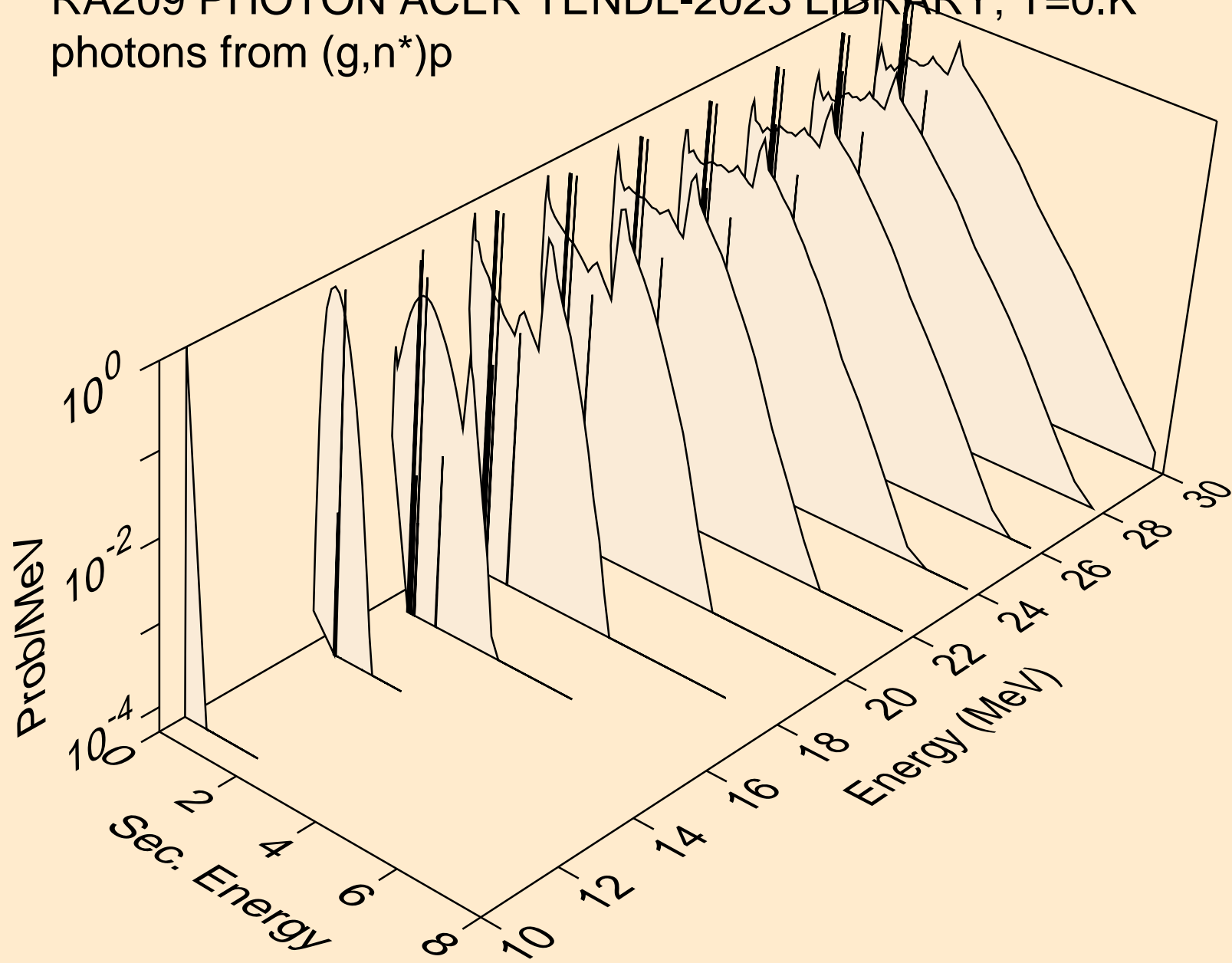

RA209 PHOTON ACER TENDL-2023 LIBRARY; T=0.K
photons from (g,n*)2a

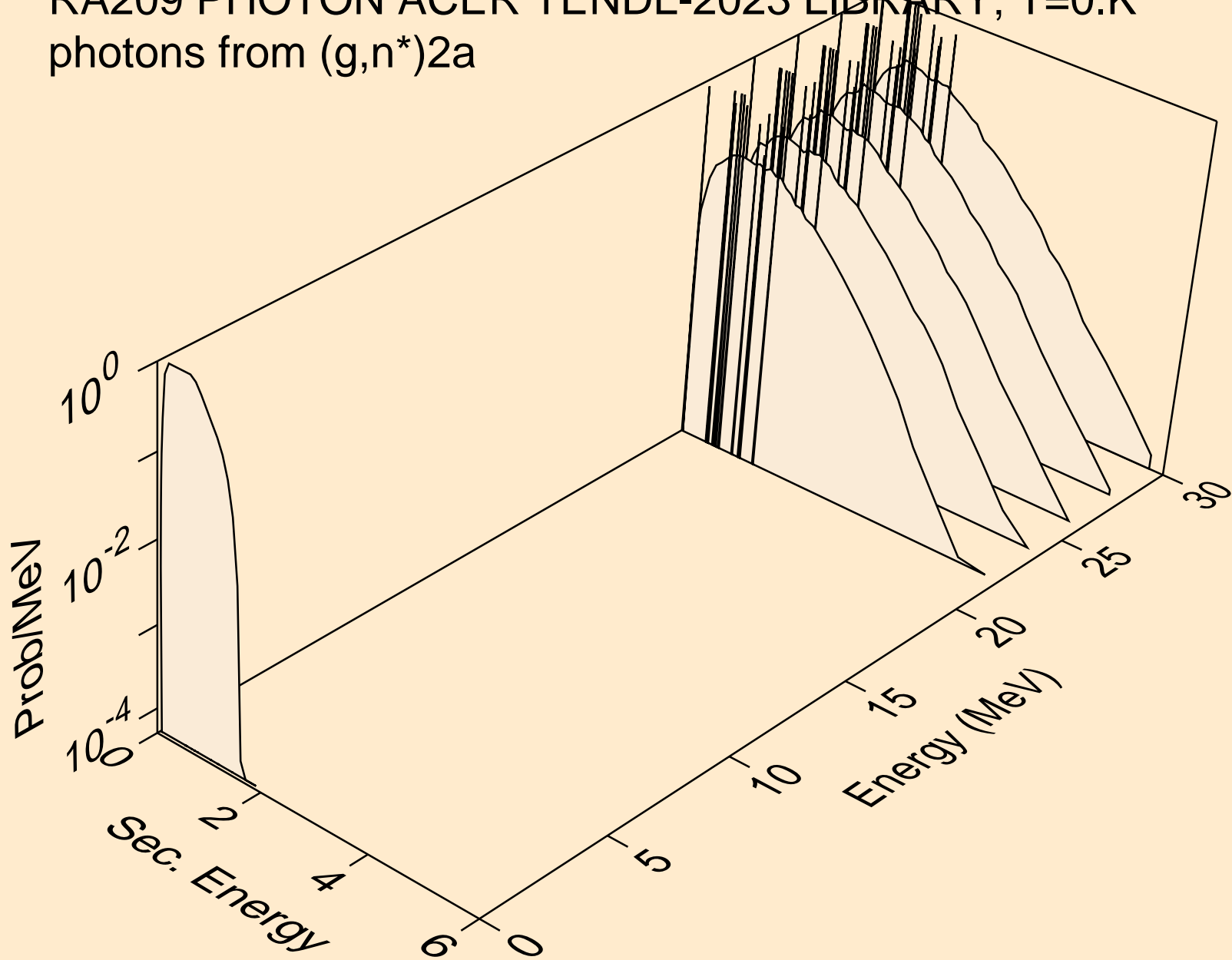

RA209 PHOTON ACER TENDL-2023 LIBRARY; T=0.K
photons from (g,n*)d

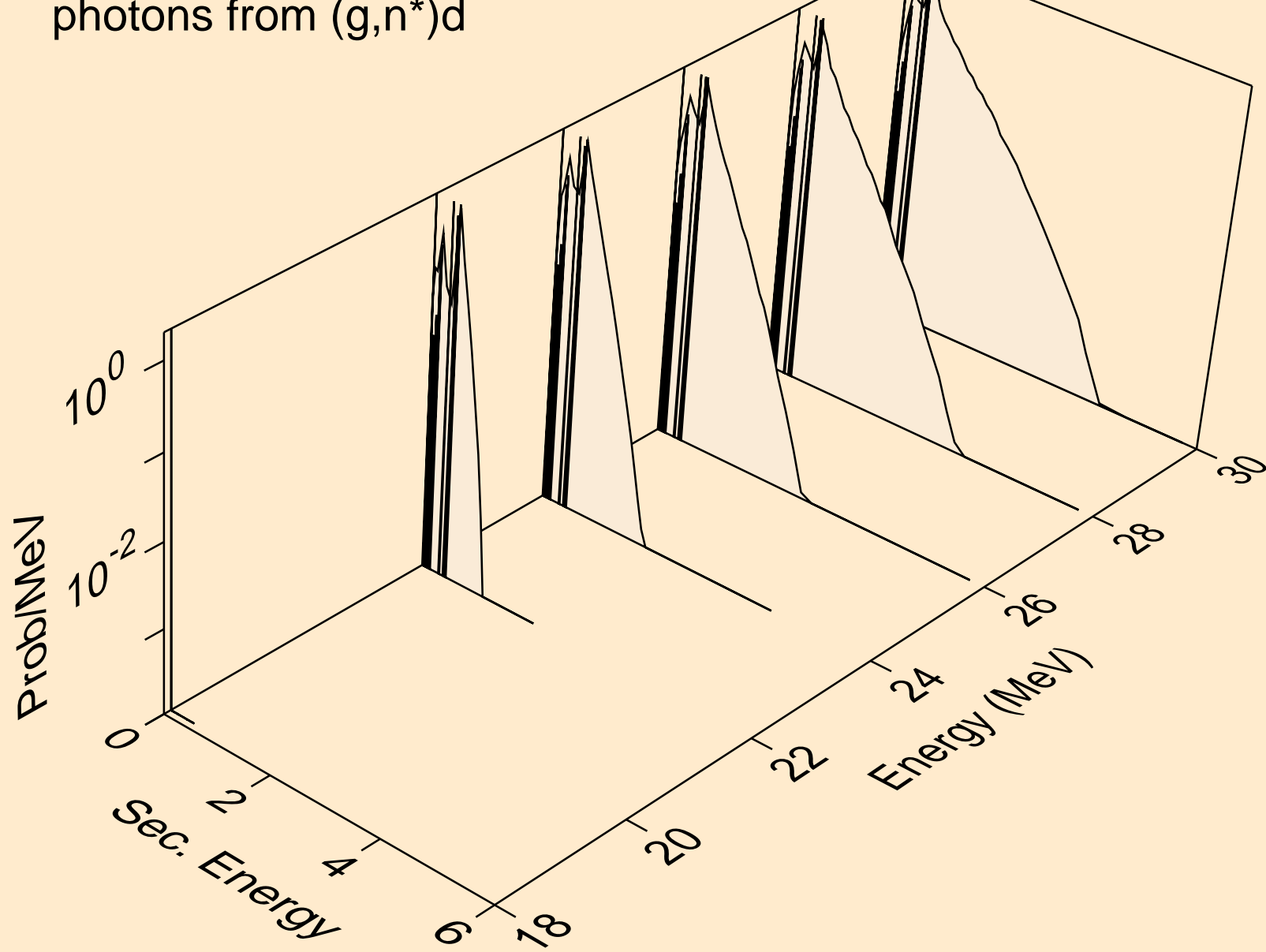

RA209 PHOTON ACER TENDL-2023 LIBRARY; T=0.K
photons from (g,2np)

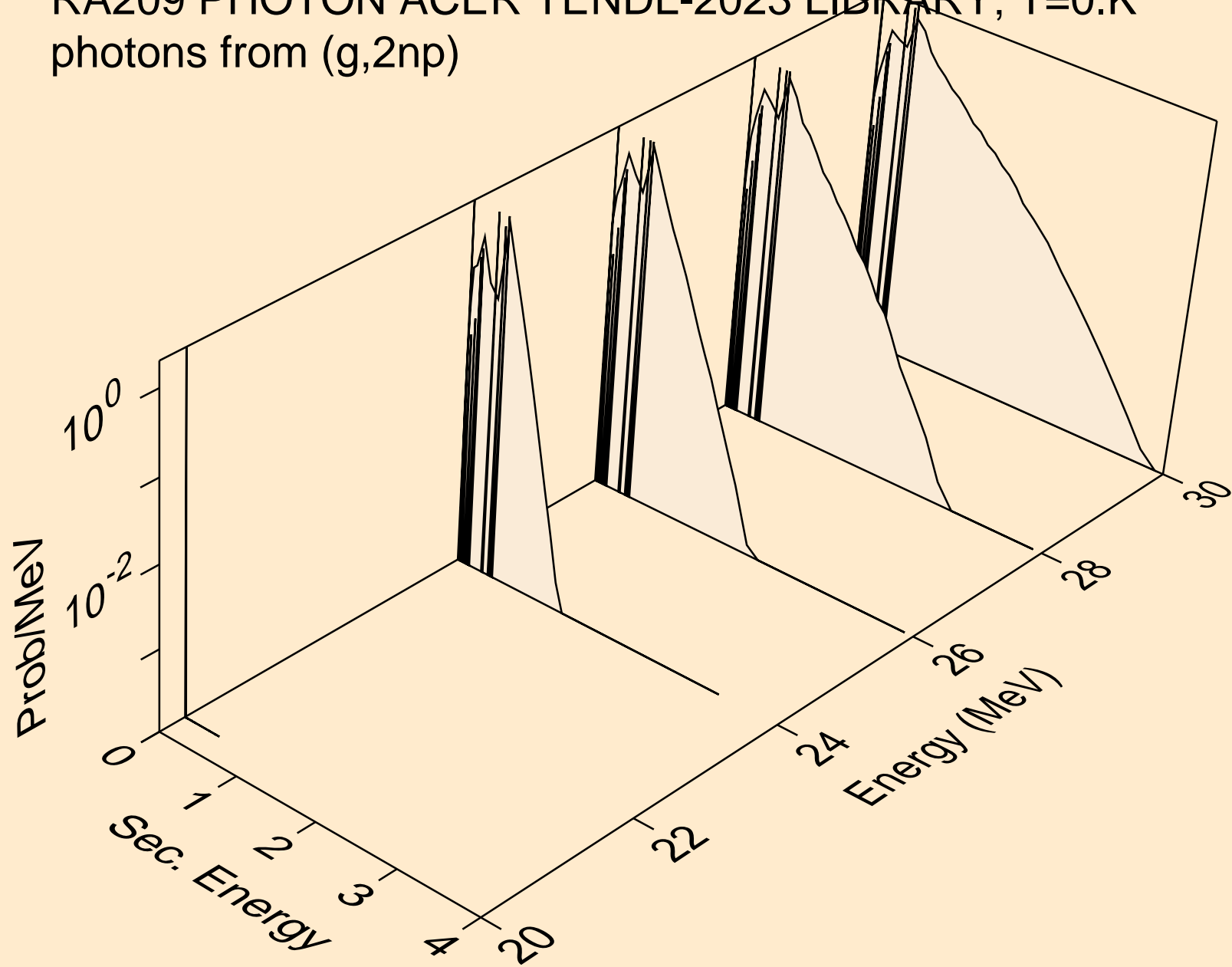

RA209 PHOTON ACER TENDL-2023 LIBRARY; T=0.K
photons from (g,n2p)

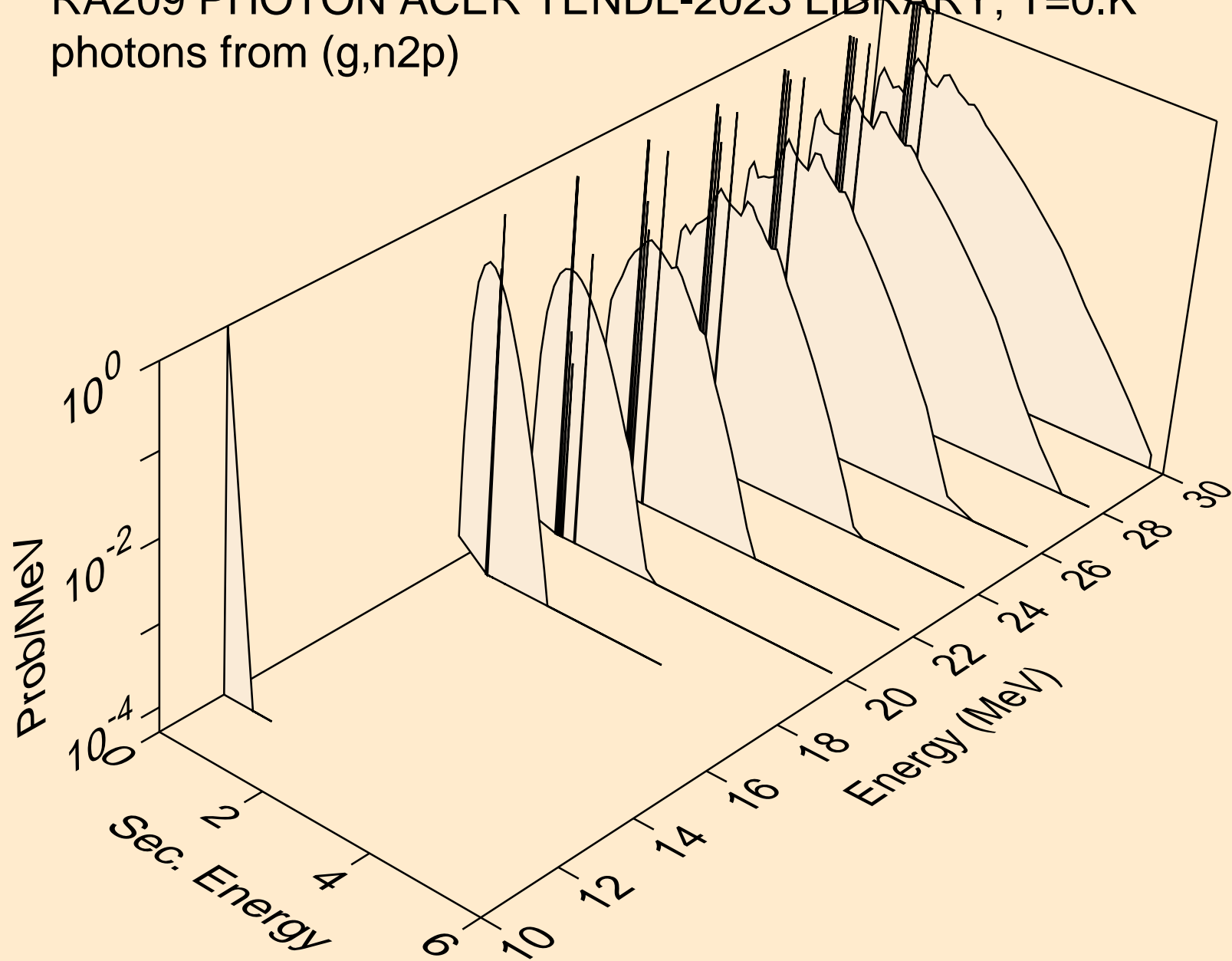

RA209 PHOTON ACER TENDL-2023 LIBRARY; T=0.K
photons from (g,npa)

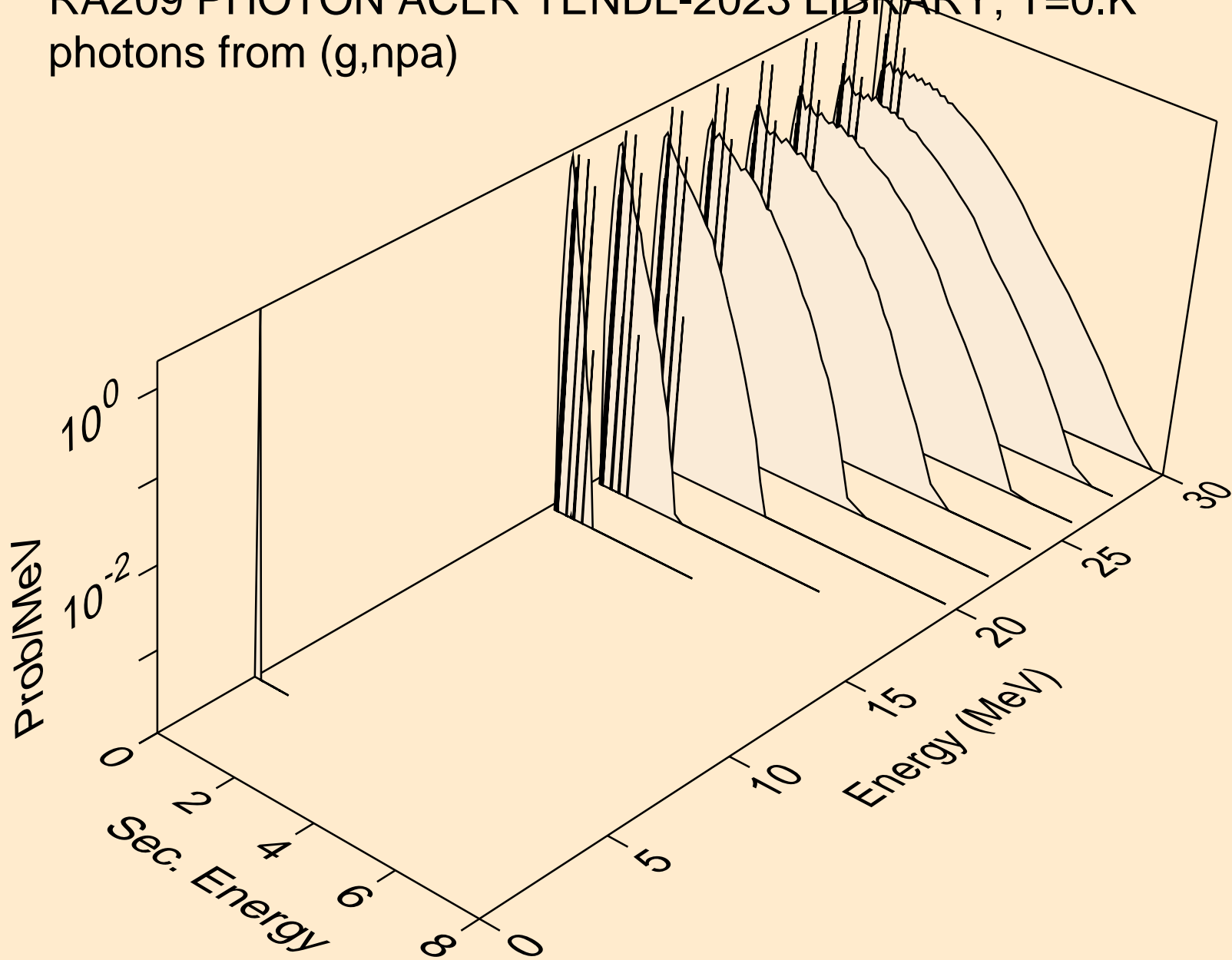

RA209 PHOTON ACER TENDL-2023 LIBRARY; T=0.K
photons from (g,n*c)

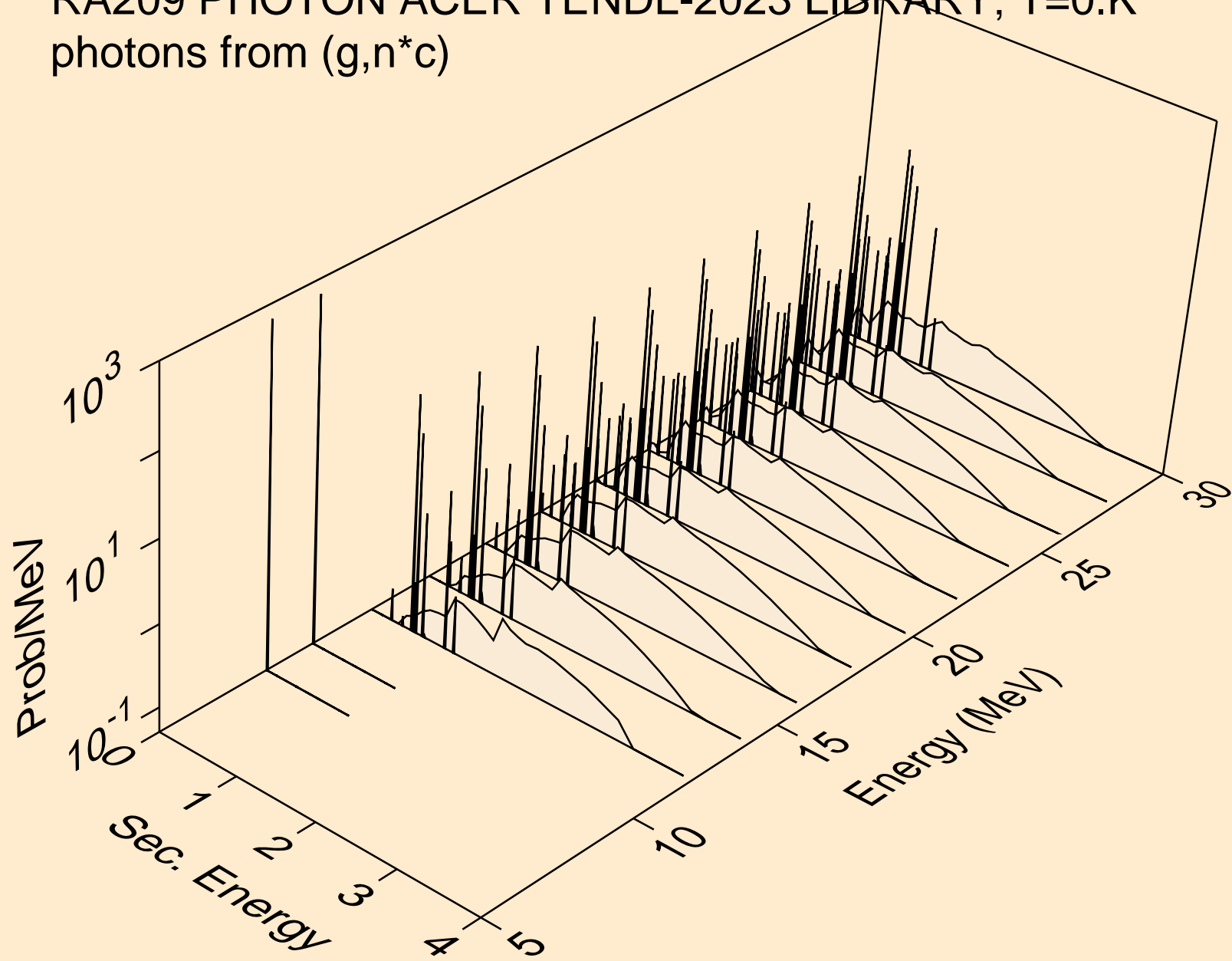

RA209 PHOTON ACER TENDL-2023 LIBRARY; T=0.K
photons from (g,gma)

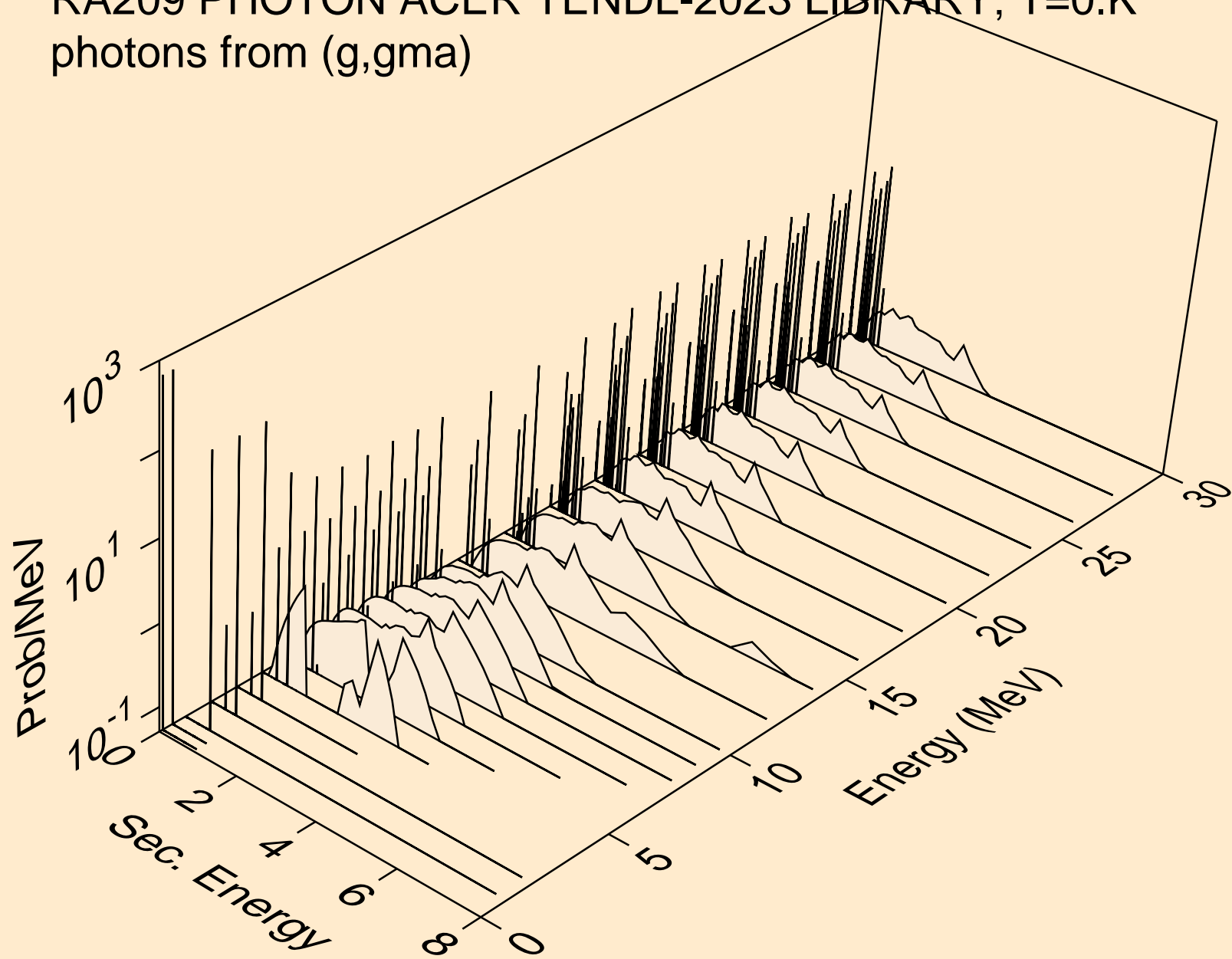

RA209 PHOTON ACER TENDL-2023 LIBRARY; T=0.K
photons from (g,p)

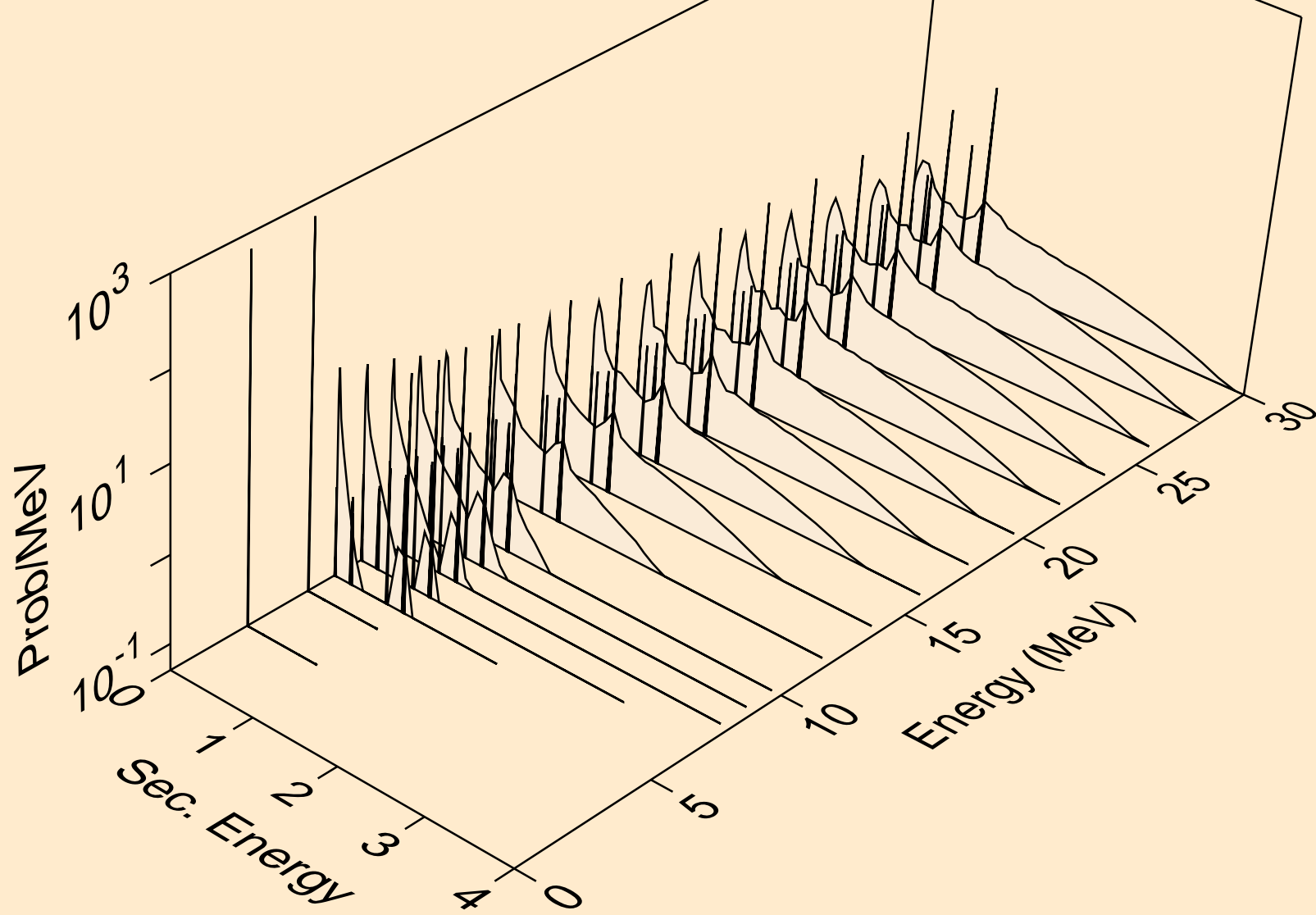

RA209 PHOTON ACER TENDL-2023 LIBRARY; T=0.K
photons from (g,d)

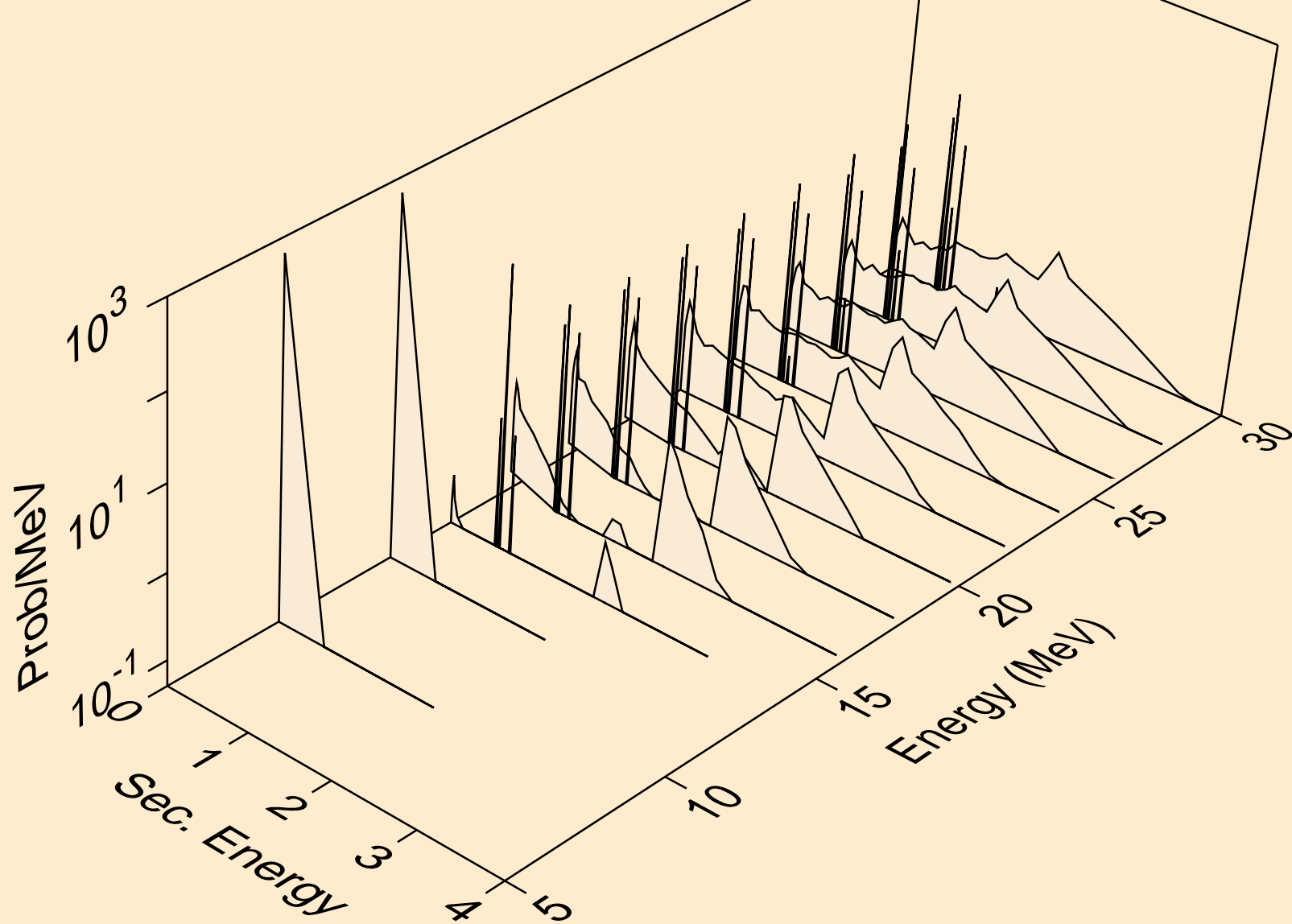

RA209 PHOTON ACER TENDL-2023 LIBRARY; T=0.K
photons from (g,t)

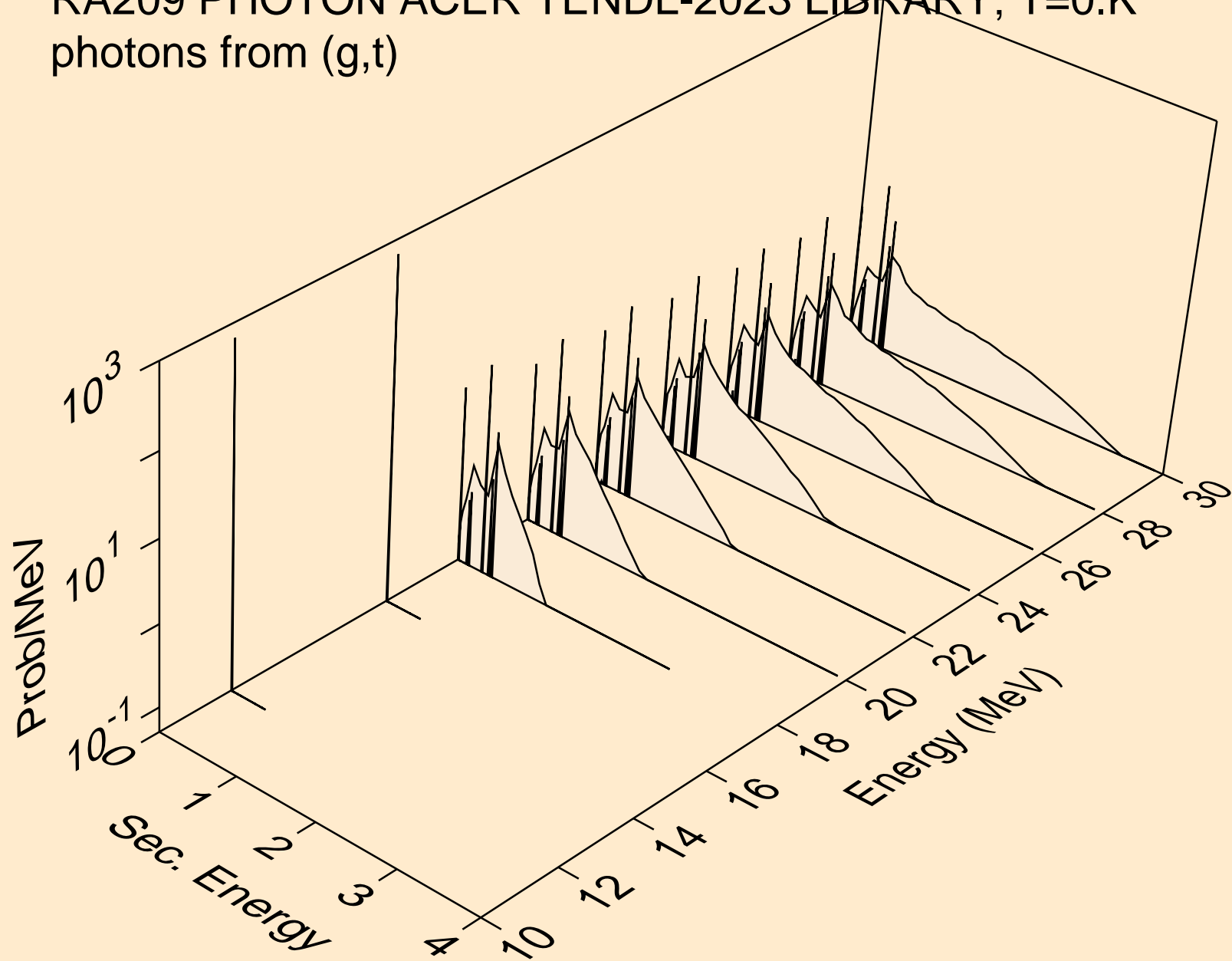

RA209 PHOTON ACER TENDL-2023 LIBRARY; T=0.K
photons from (g,he3)

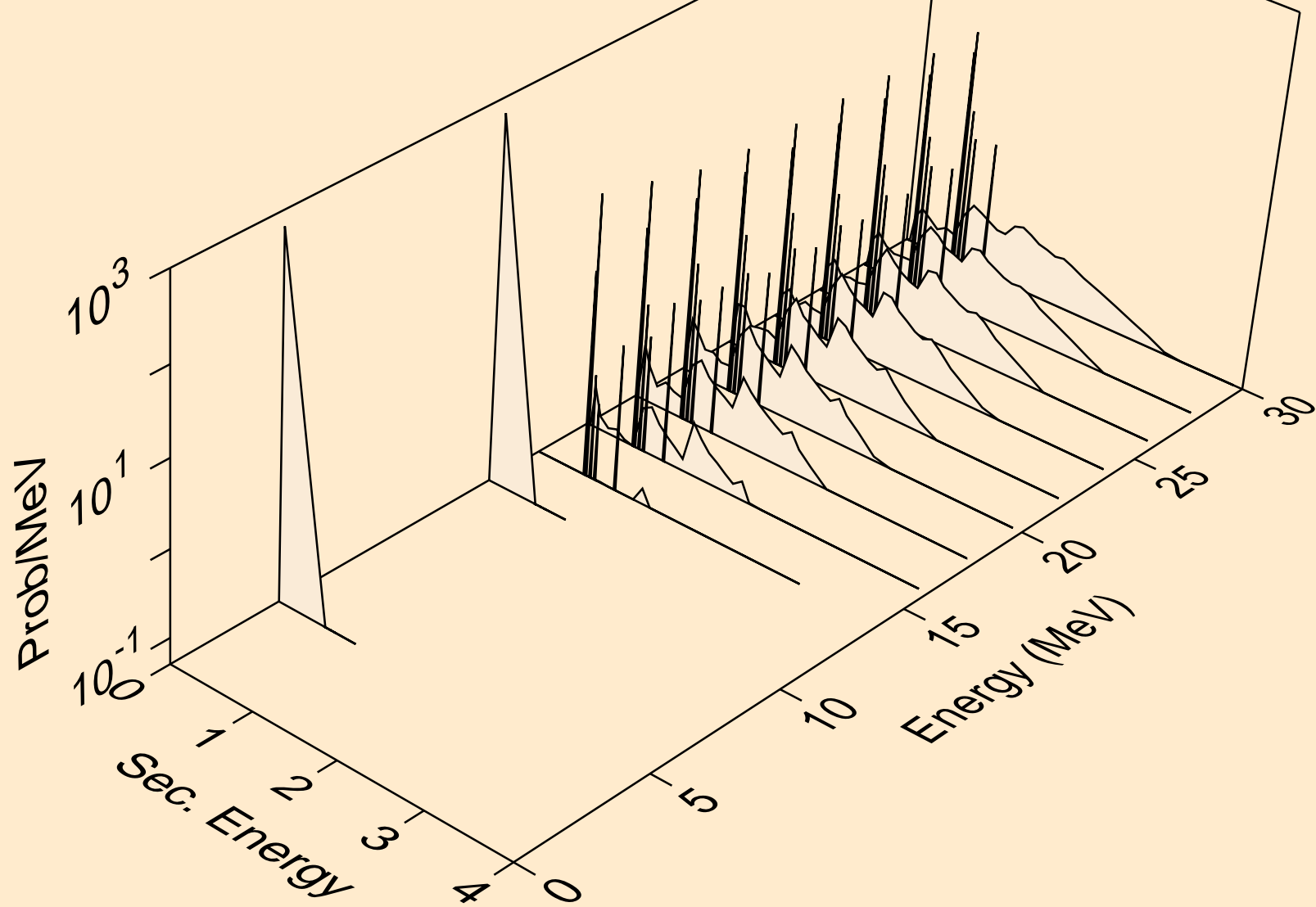

RA209 PHOTON ACER TENDL-2023 LIBRARY; T=0.K
photons from (g,a)

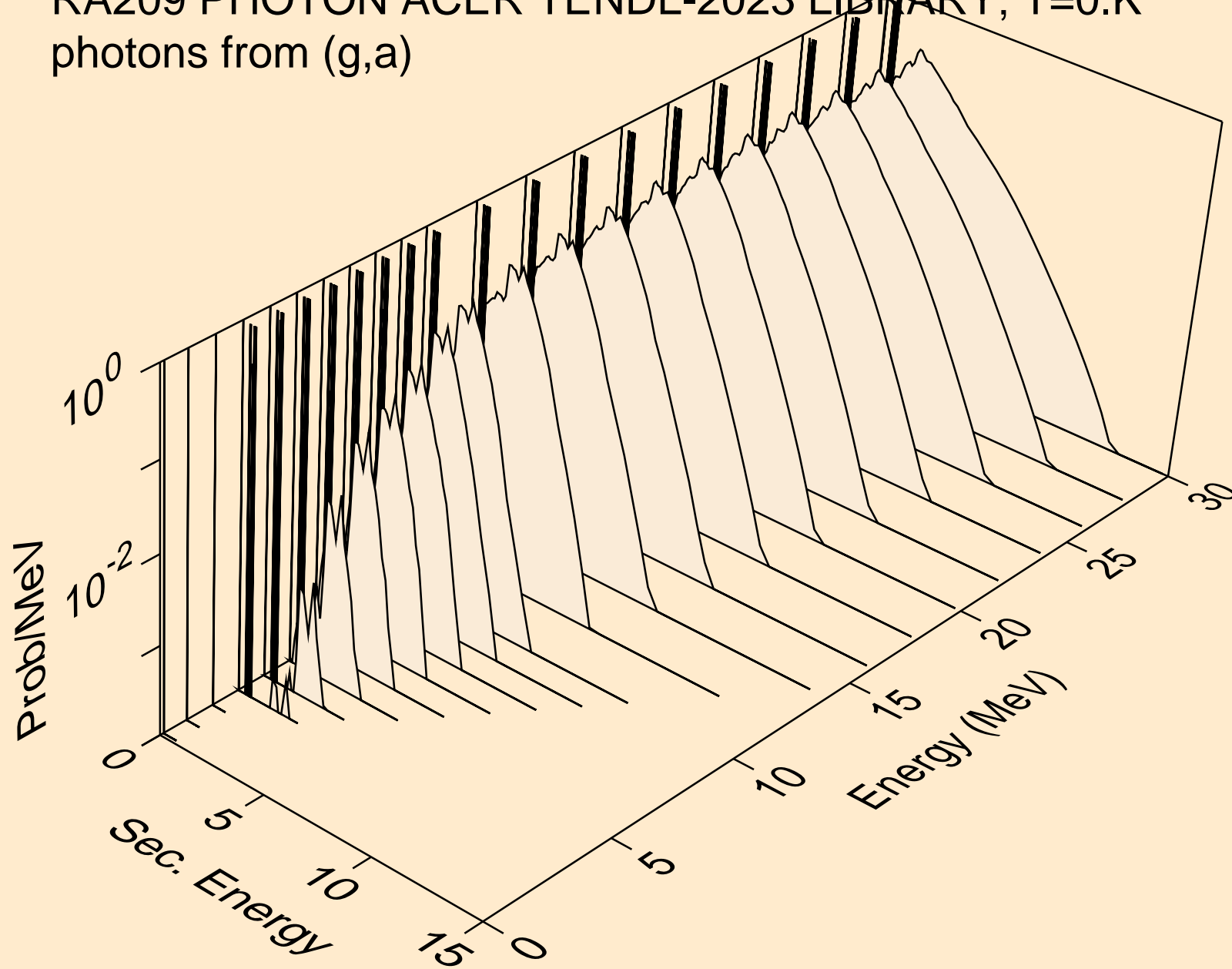

RA209 PHOTON ACER TENDL-2023 LIBRARY; T=0.K
photons from (g,2a)

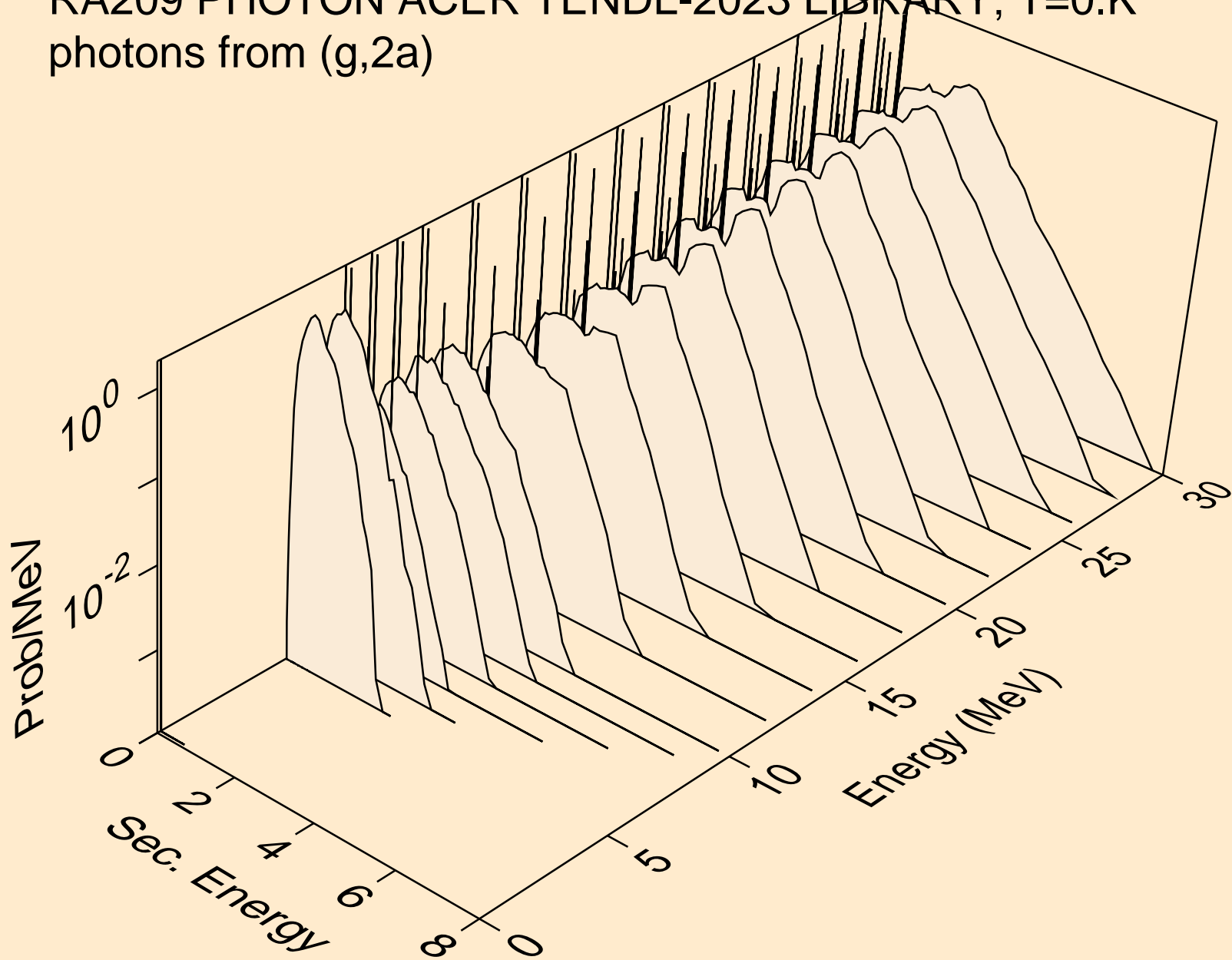

RA209 PHOTON ACER TENDL-2023 LIBRARY; T=0.K
photons from (g,2p)

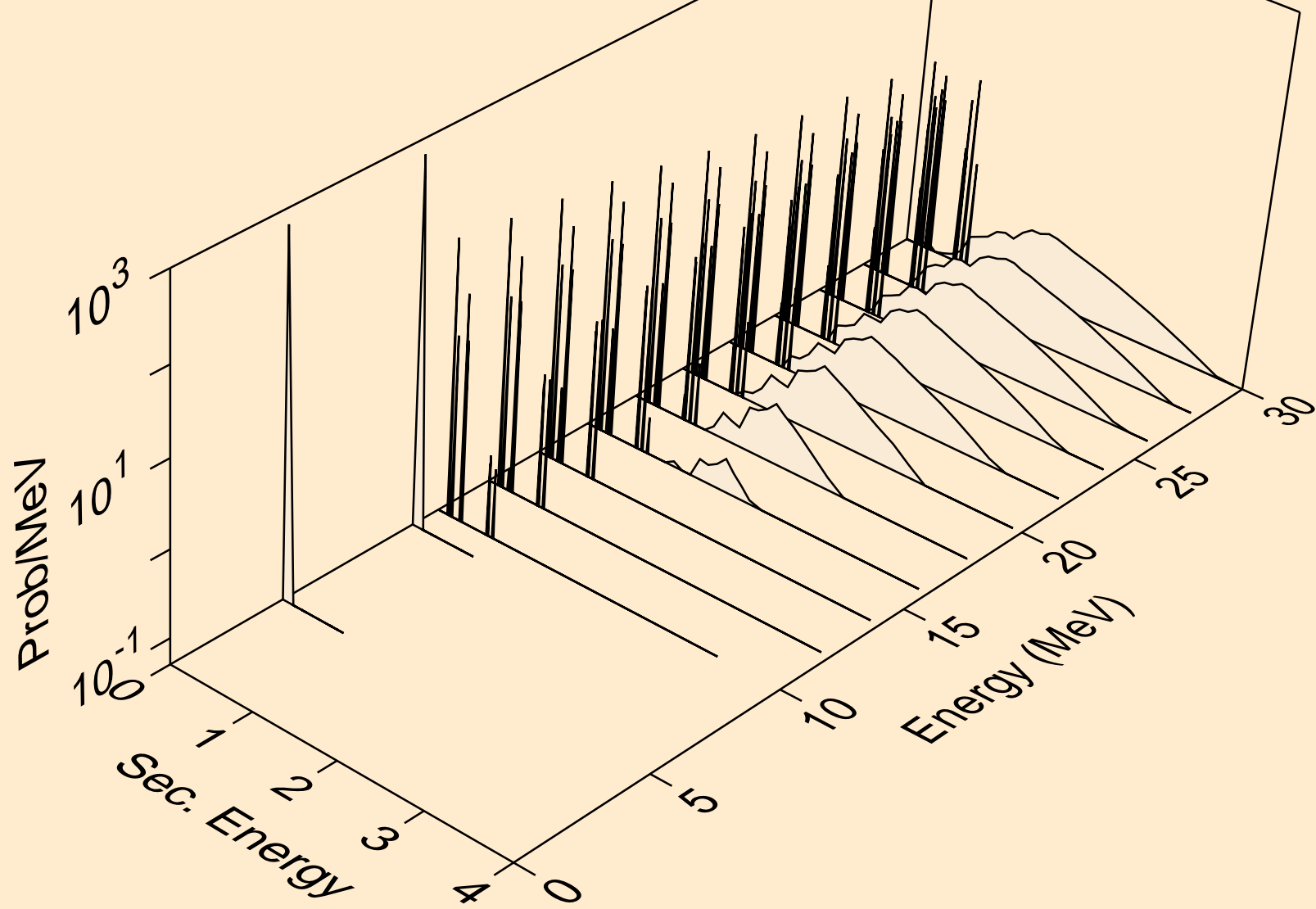

RA209 PHOTON ACER TENDL-2023 LIBRARY; T=0.K
photons from (g,pa)

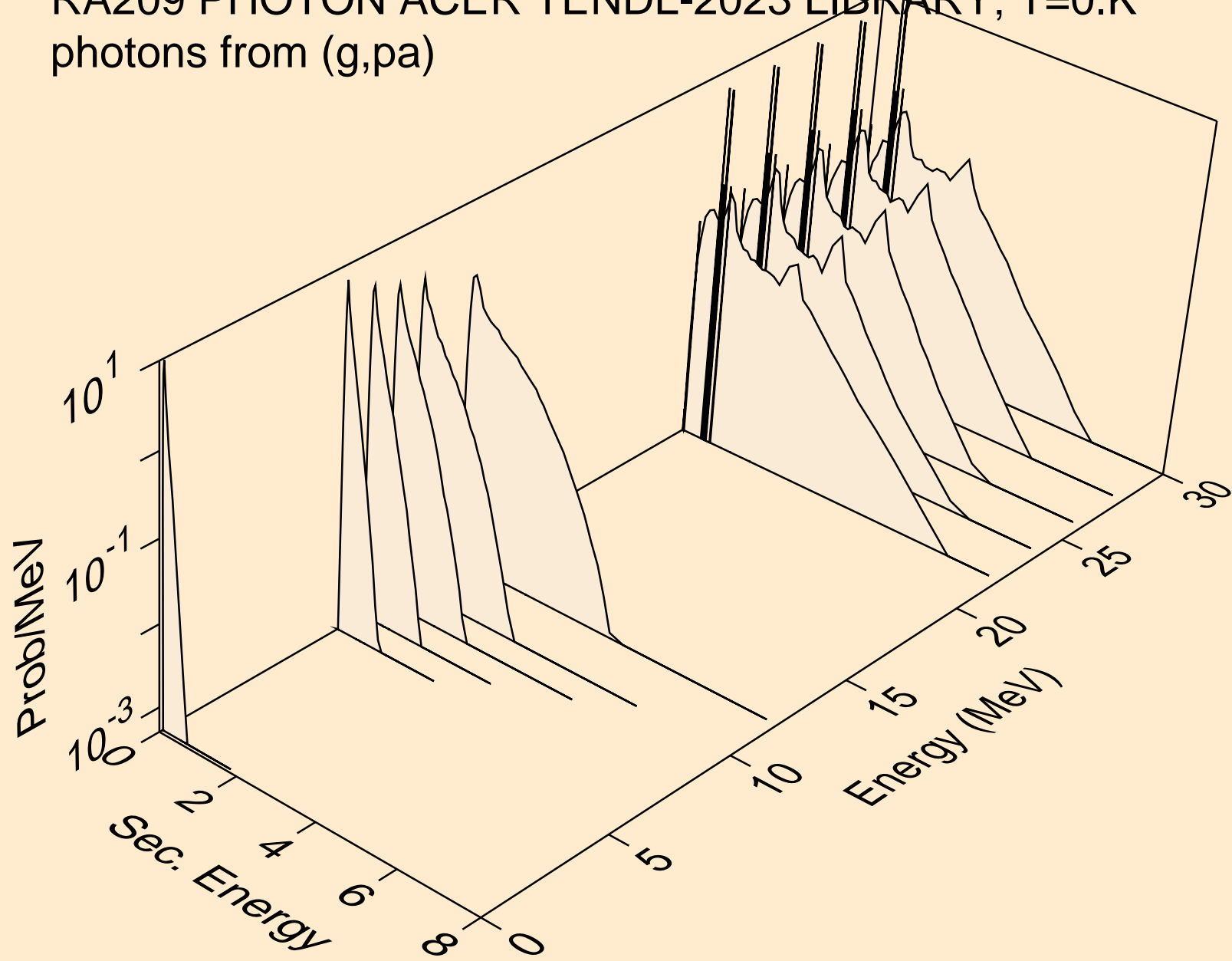

RA209 PHOTON ACER TENDL-2023 LIBRARY; T=0.K
photons from (g,pd)

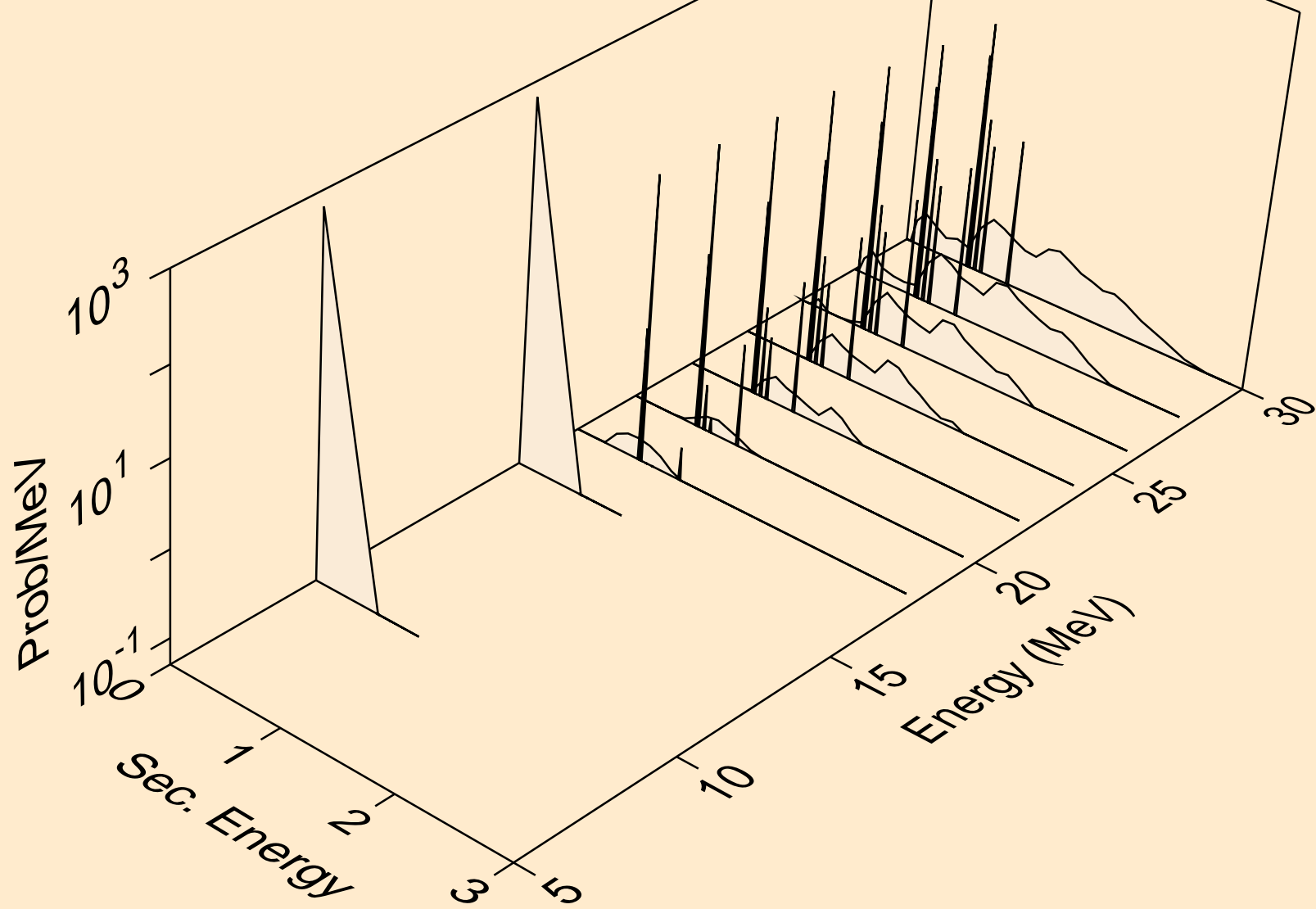

RA209 PHOTON ACER TENDL-2023 LIBRARY; T=0.K
photons from (g,da)

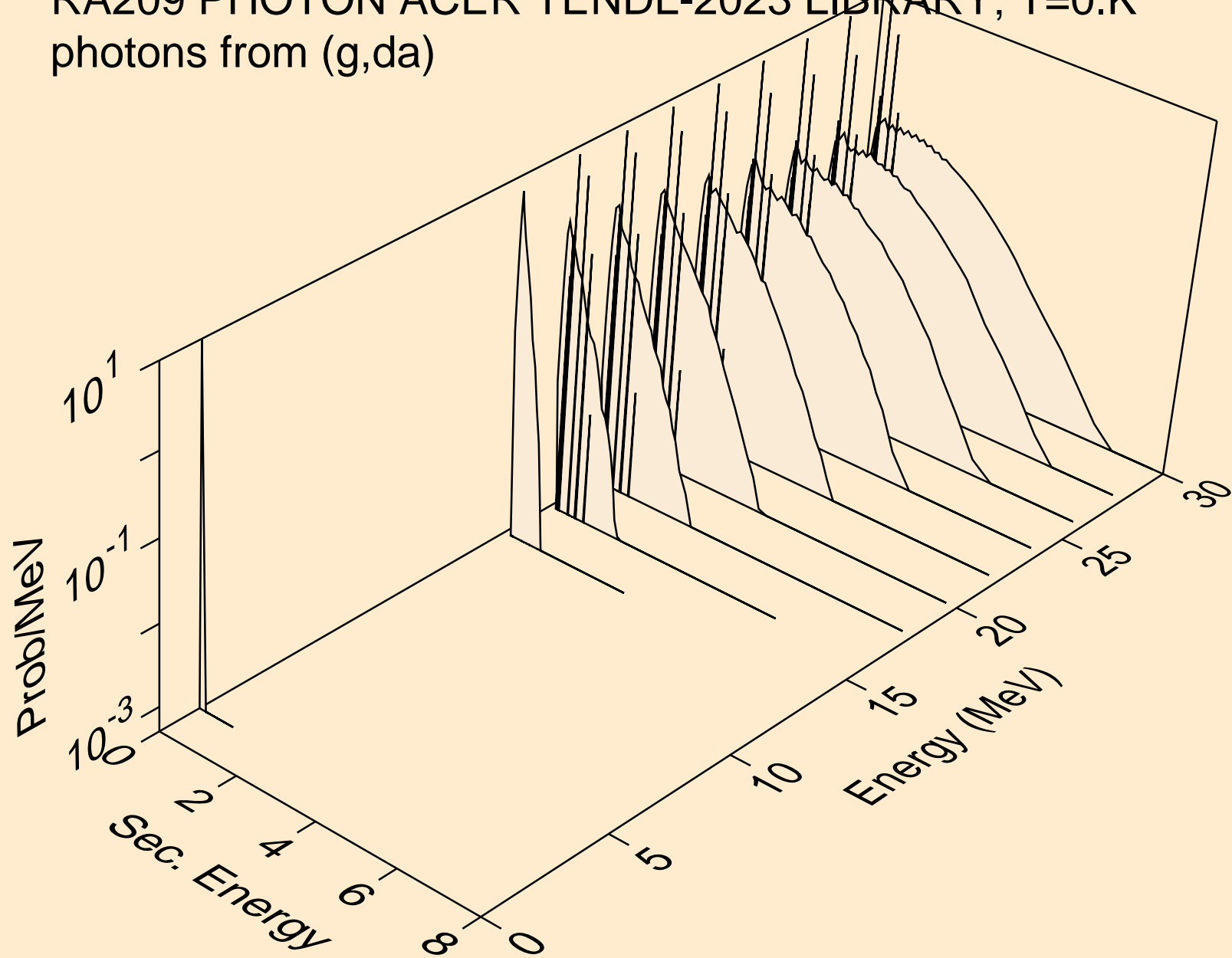

RA209 PHOTON ACER TENDL-2023 LIBRARY; T=0.K
protons from (g,x)

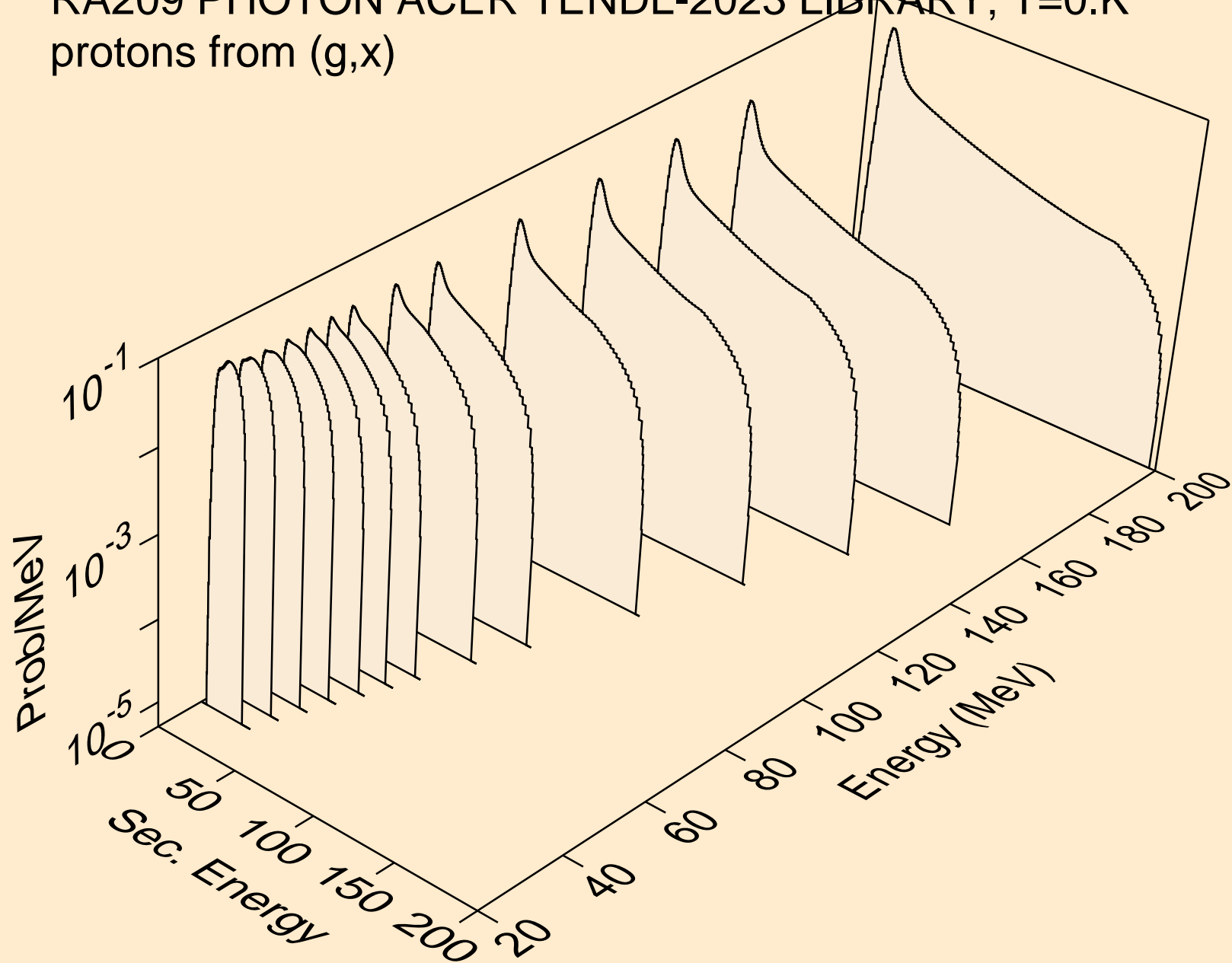

RA209 PHOTON ACER TENDL-2023 LIBRARY; T=0.K
protons from (g,n*)p

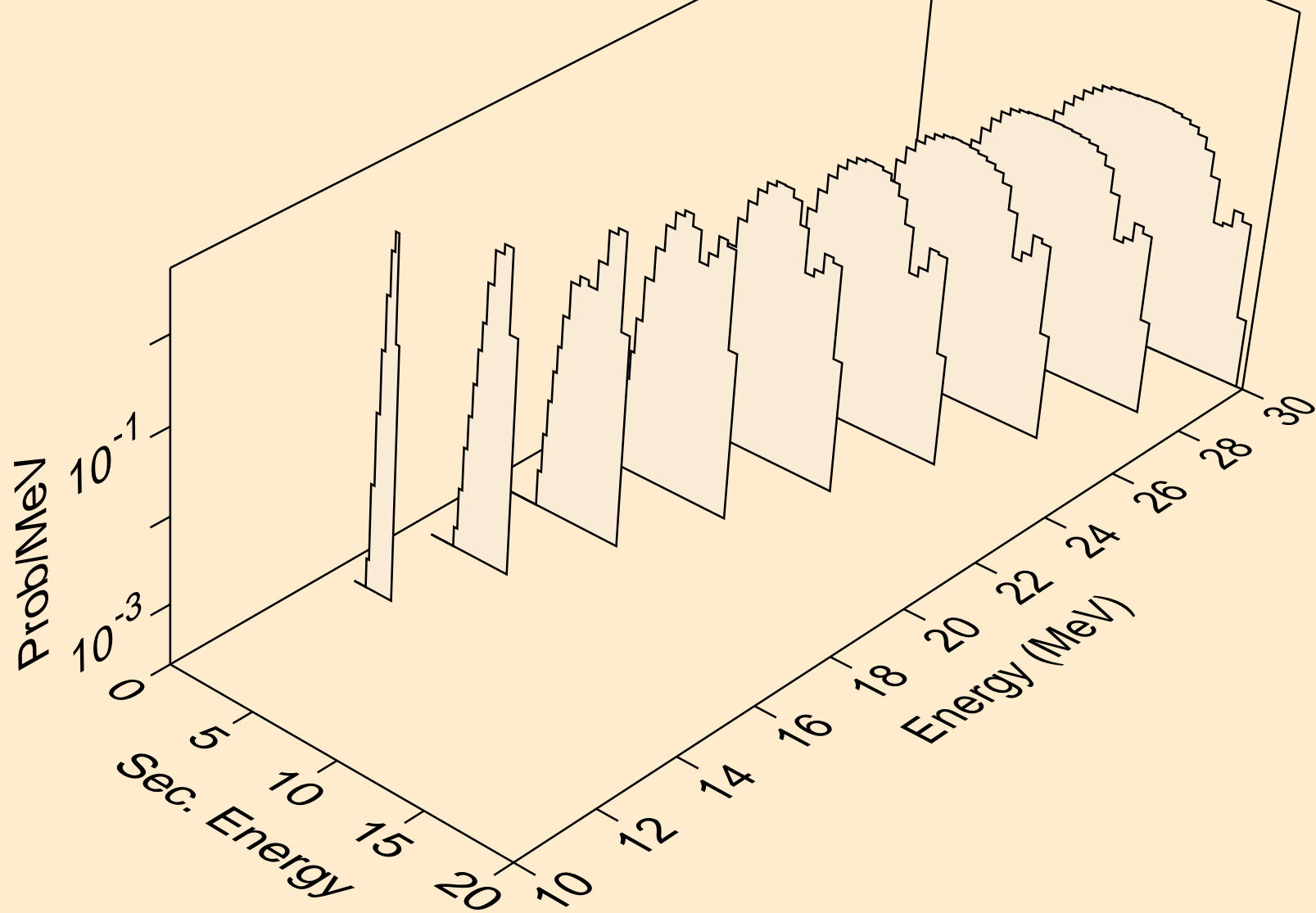

RA209 PHOTON ACER TENDL-2023 LIBRARY; T=0.K
protons from (g,2np)

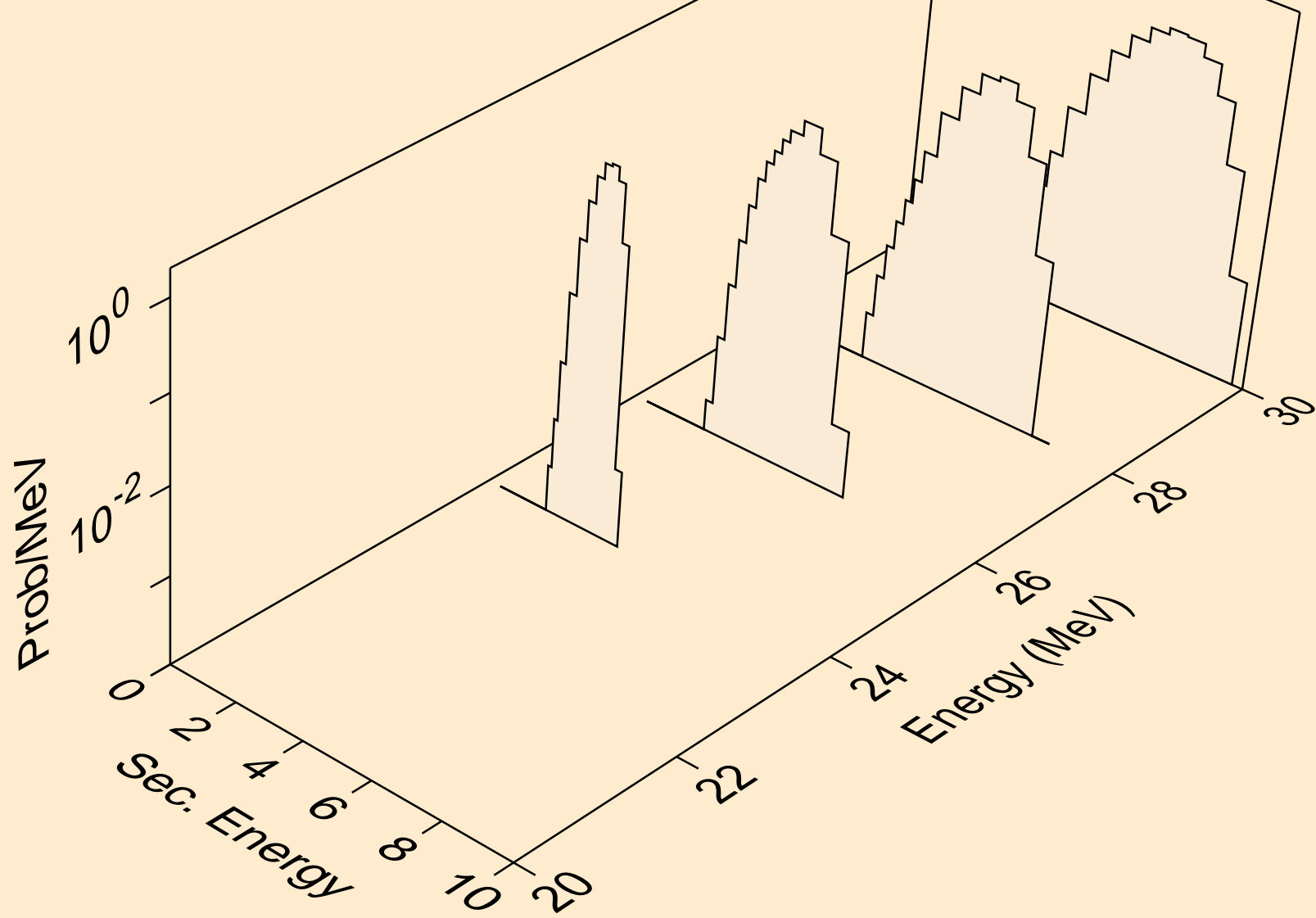

RA209 PHOTON ACER TENDL-2023 LIBRARY; T=0.K
protons from (g,n2p)

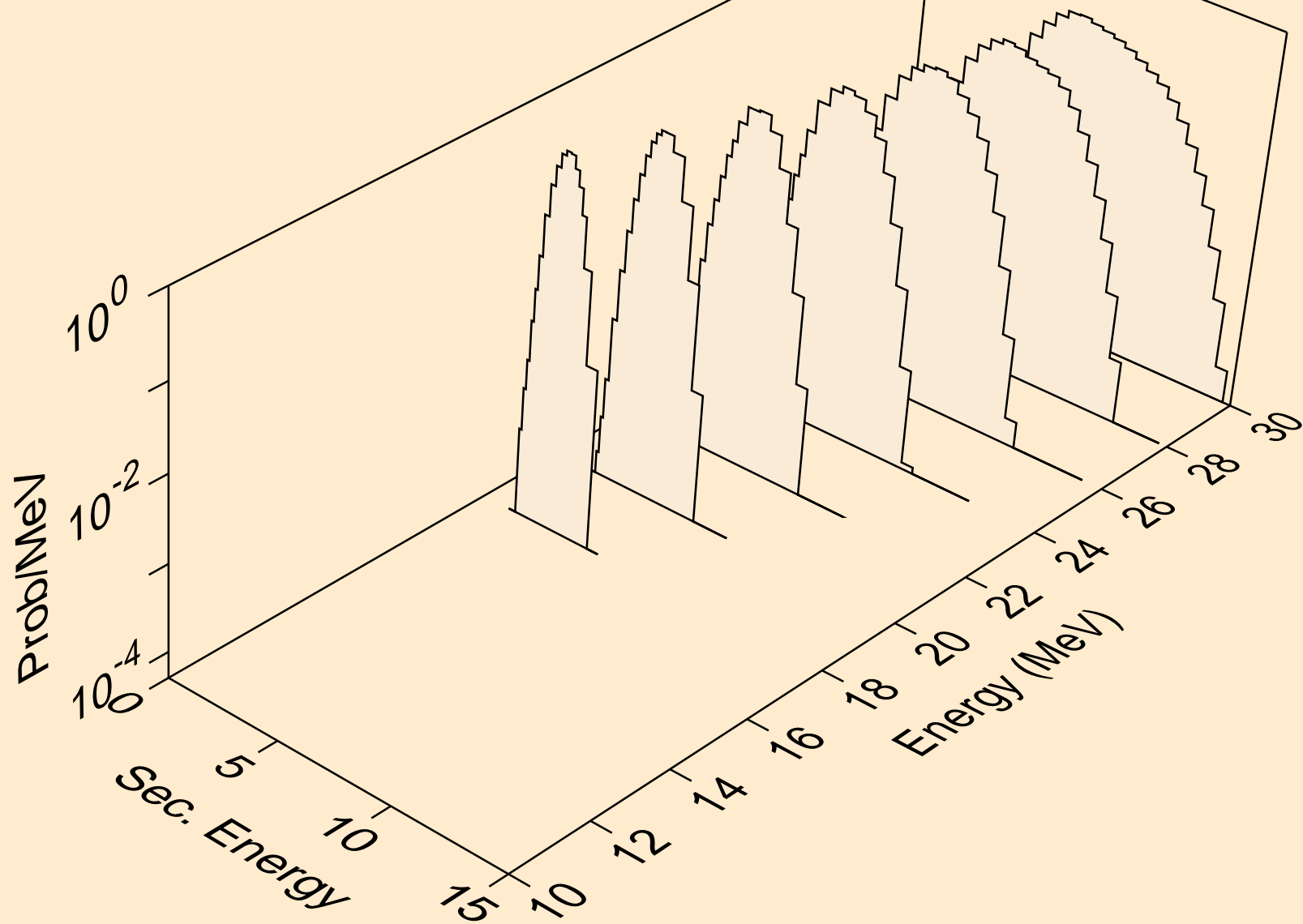

RA209 PHOTON ACER TENDL-2023 LIBRARY; T=0.K
protons from (g,npa)

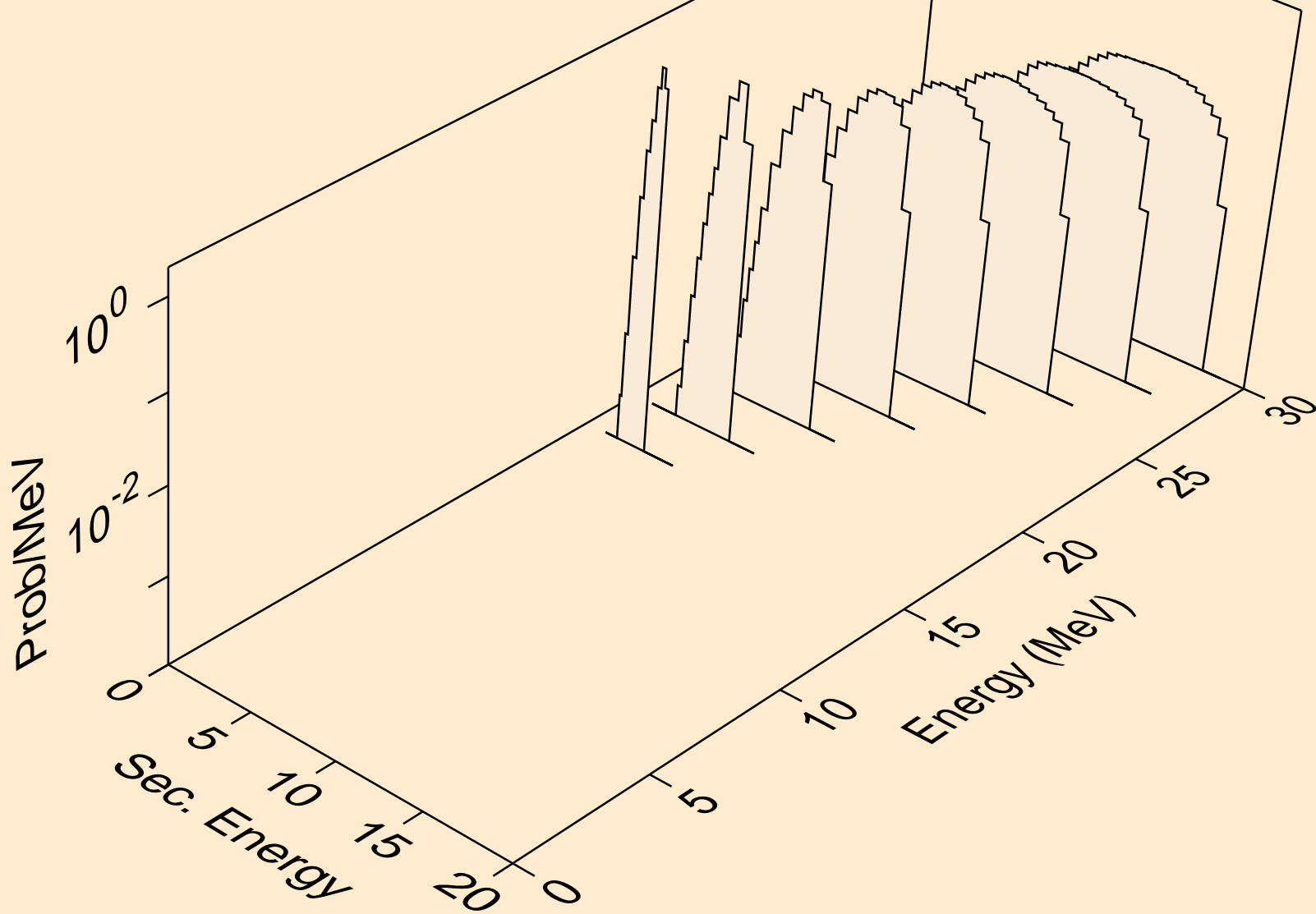

RA209 PHOTON ACER TENDL-2023 LIBRARY; T=0.K
protons from (g,p)

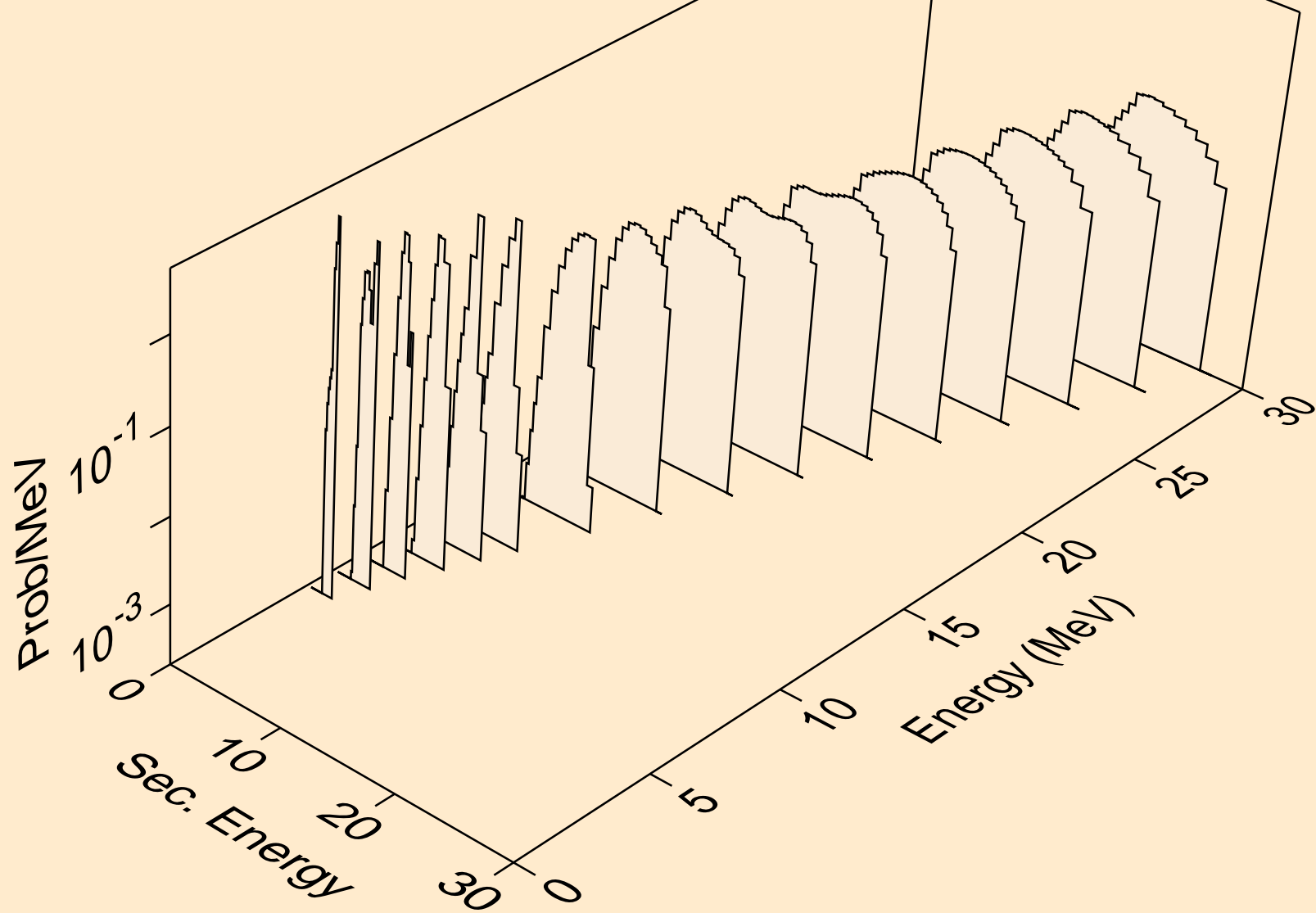

RA209 PHOTON ACER TENDL-2023 LIBRARY; T=0.K
protons from (g,2p)

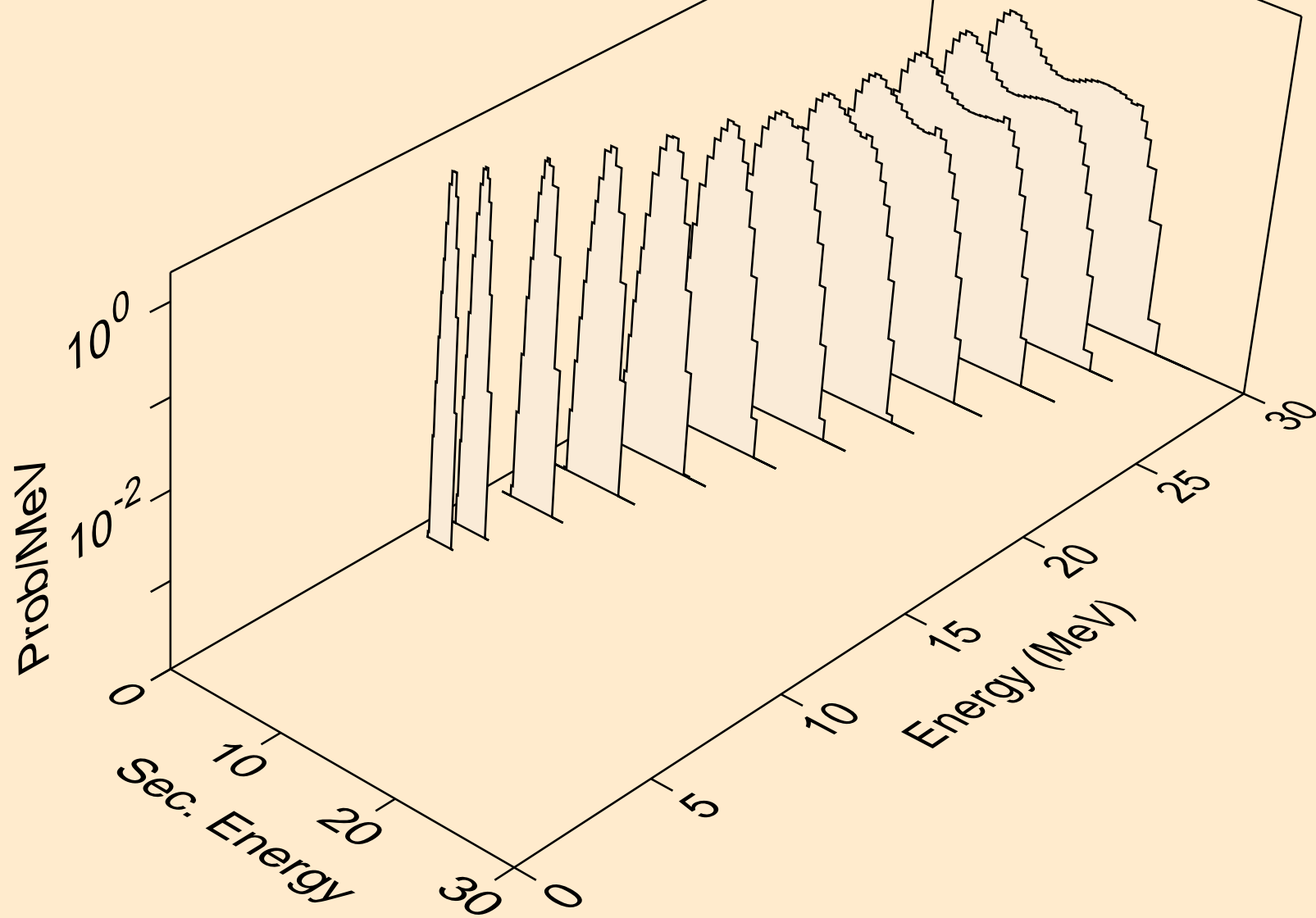

RA209 PHOTON ACER TENDL-2023 LIBRARY; T=0.K
protons from (g,pa)

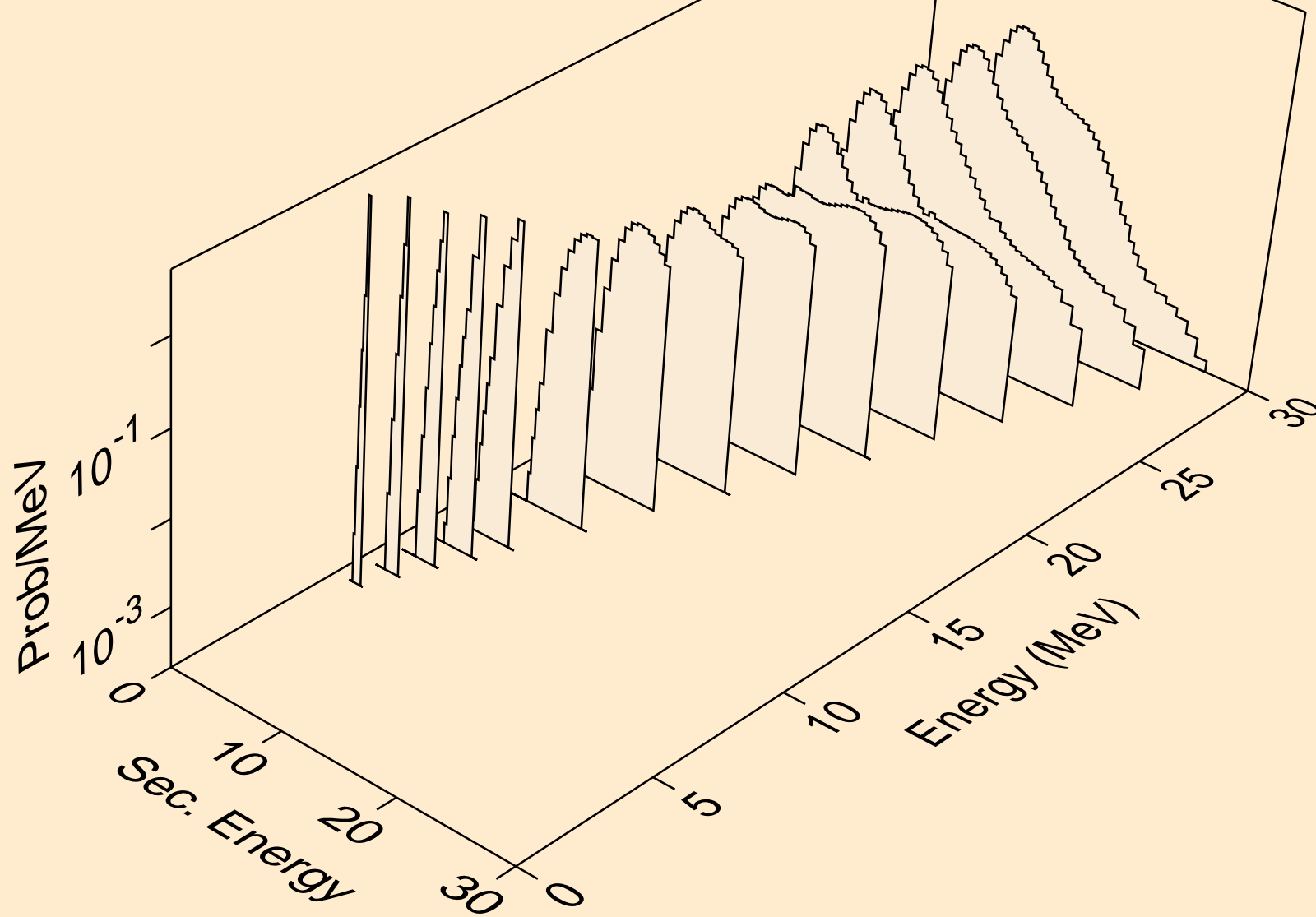

RA209 PHOTON ACER TENDL-2023 LIBRARY; T=0.K
protons from (g,pd)

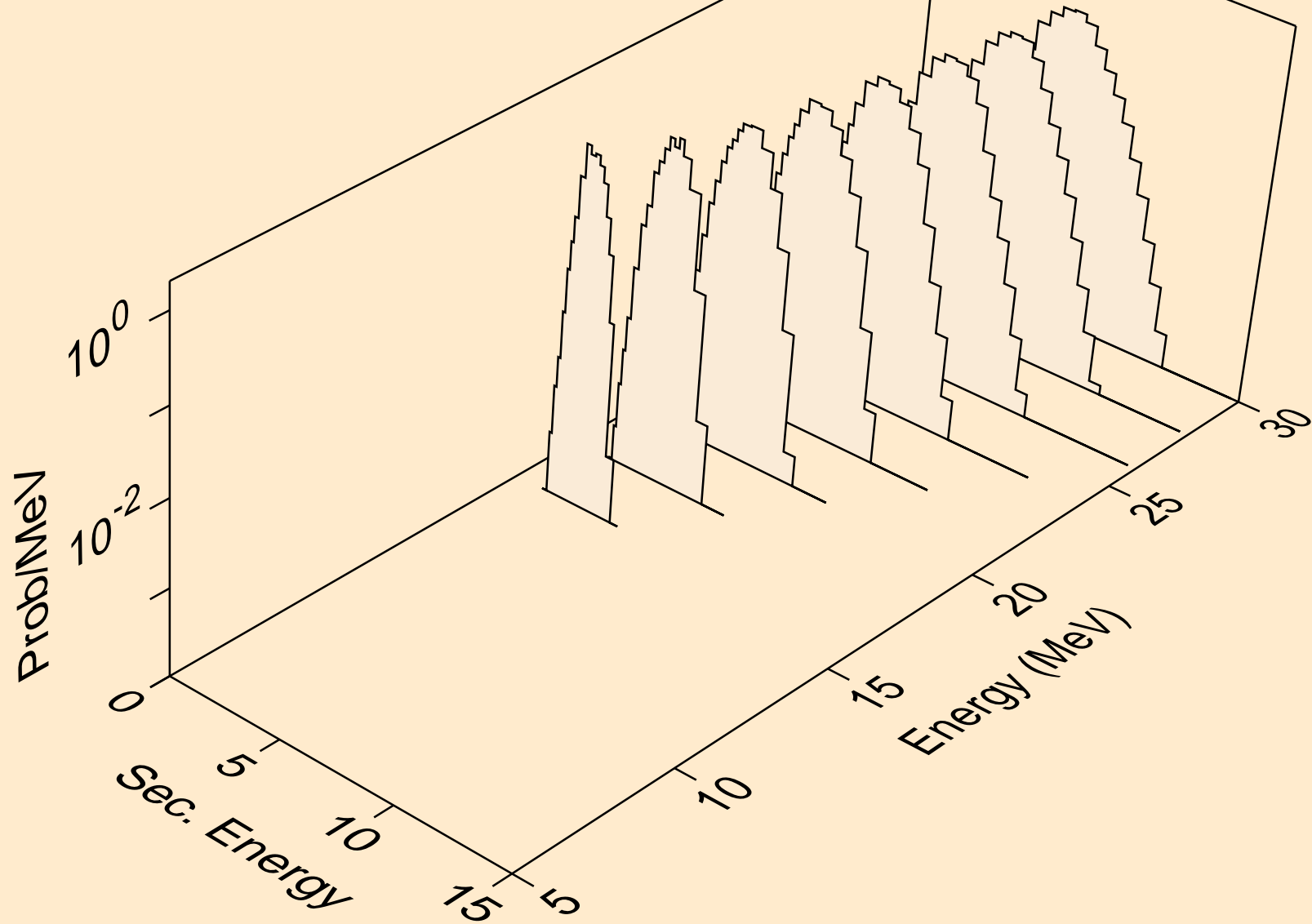

RA209 PHOTON ACER TENDL-2023 LIBRARY; T=0.K
deuterons from (g,x)

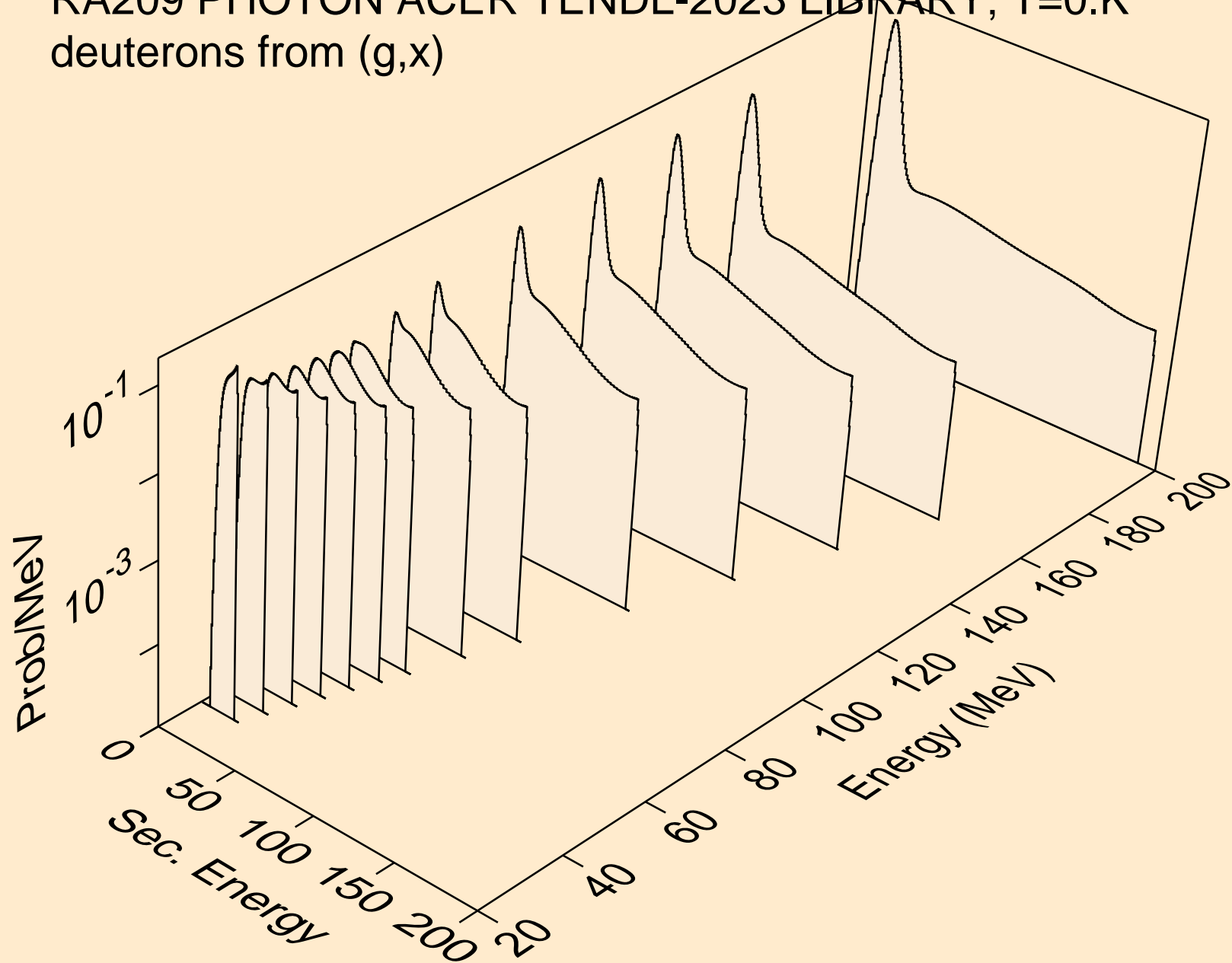

RA209 PHOTON ACER TENDL-2023 LIBRARY; T=0.K
deuterons from (g,n*)d

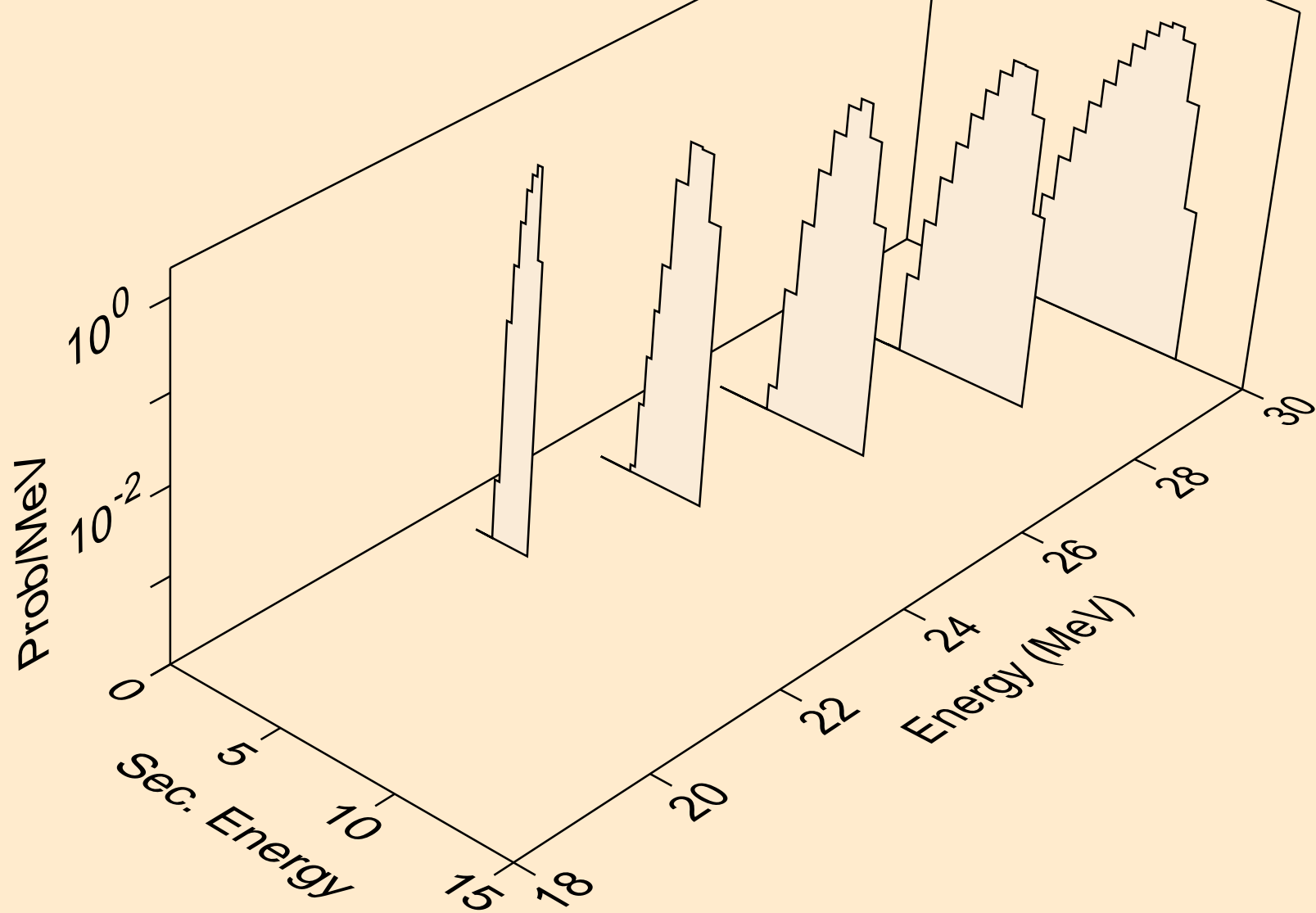

RA209 PHOTON ACER TENDL-2023 LIBRARY; T=0.K
deuterons from (g,d)

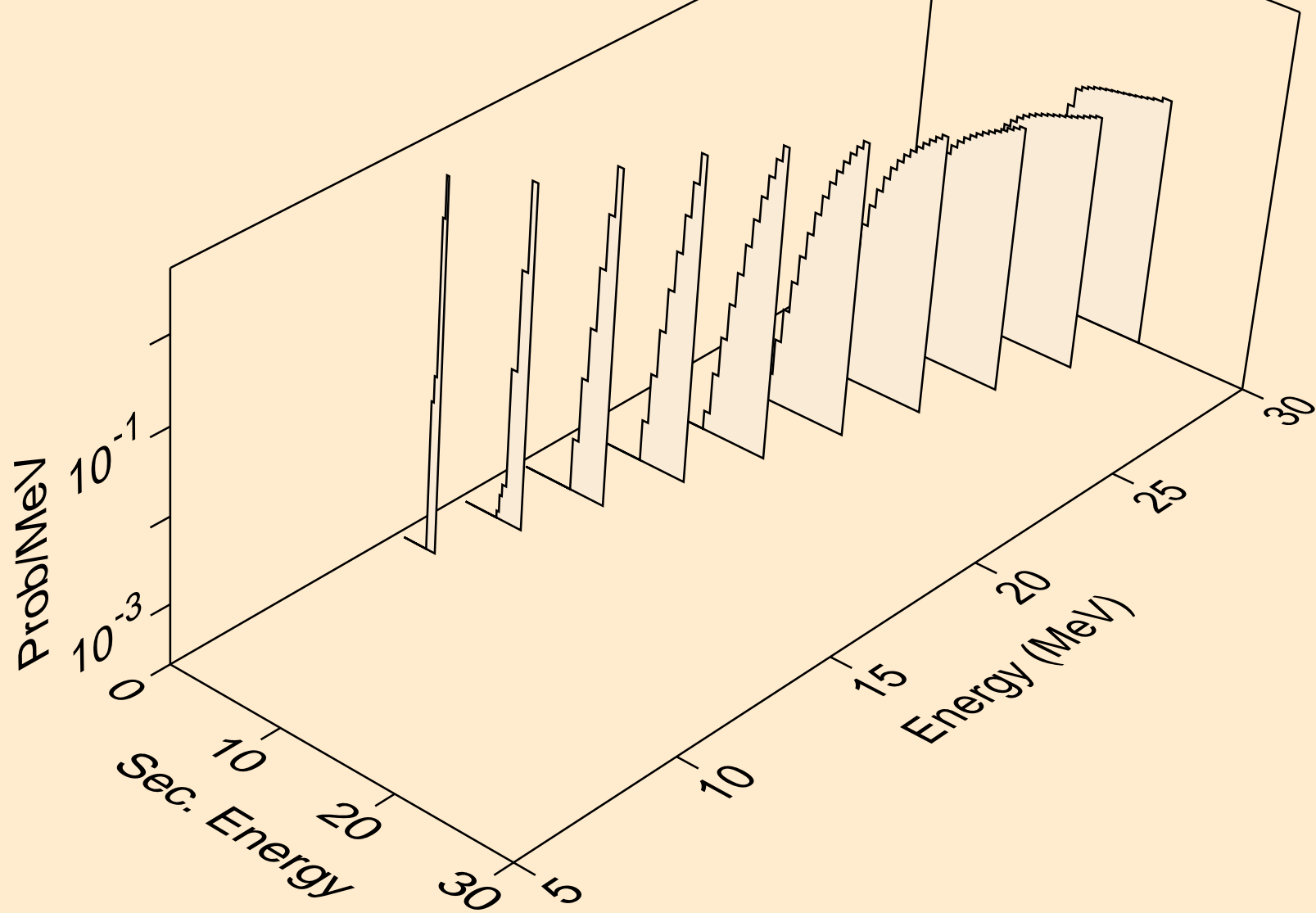

RA209 PHOTON ACER TENDL-2023 LIBRARY; T=0.K
deuterons from (g,pd)

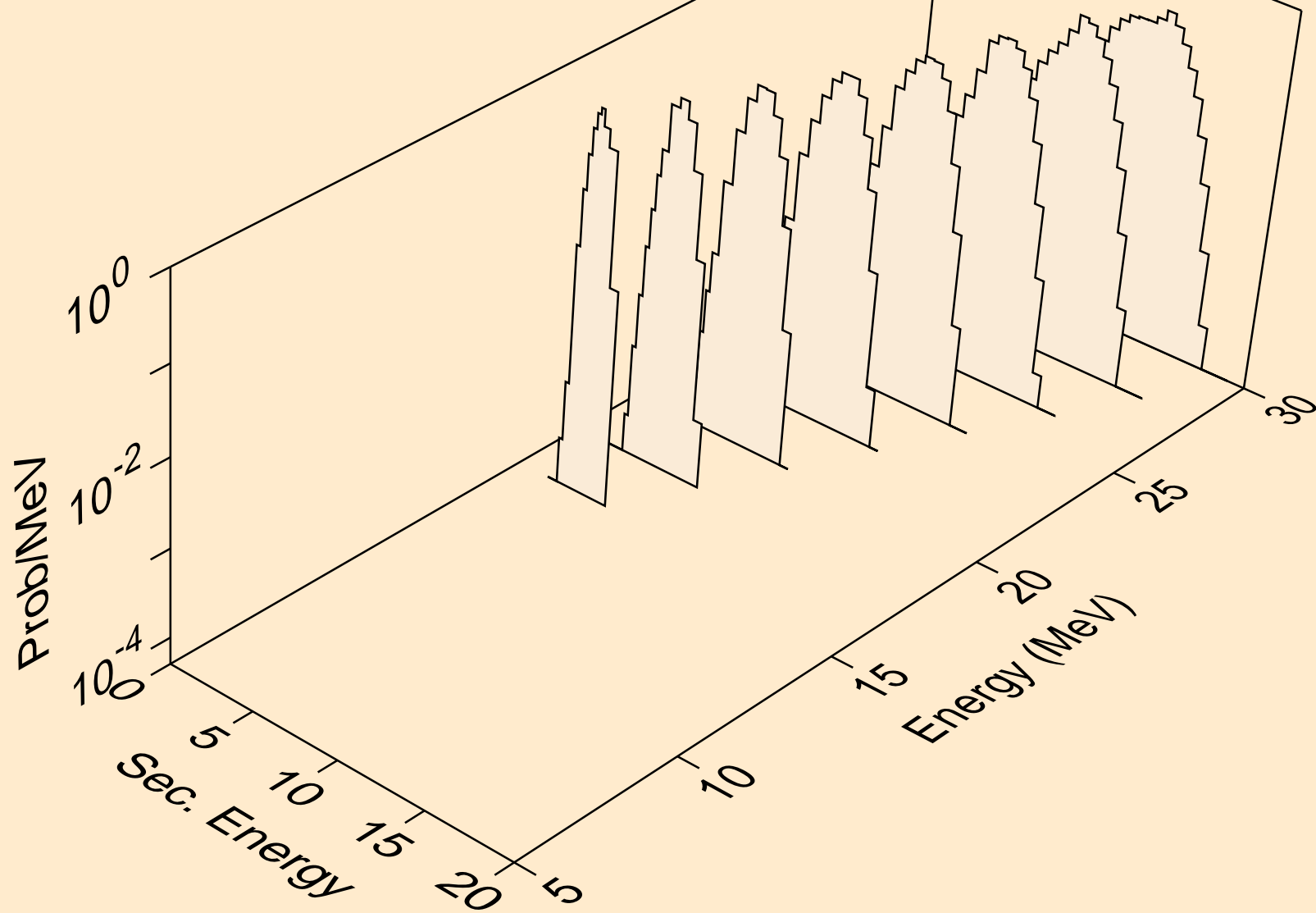

RA209 PHOTON ACER TENDL-2023 LIBRARY; T=0.K
deuterons from (g,da)

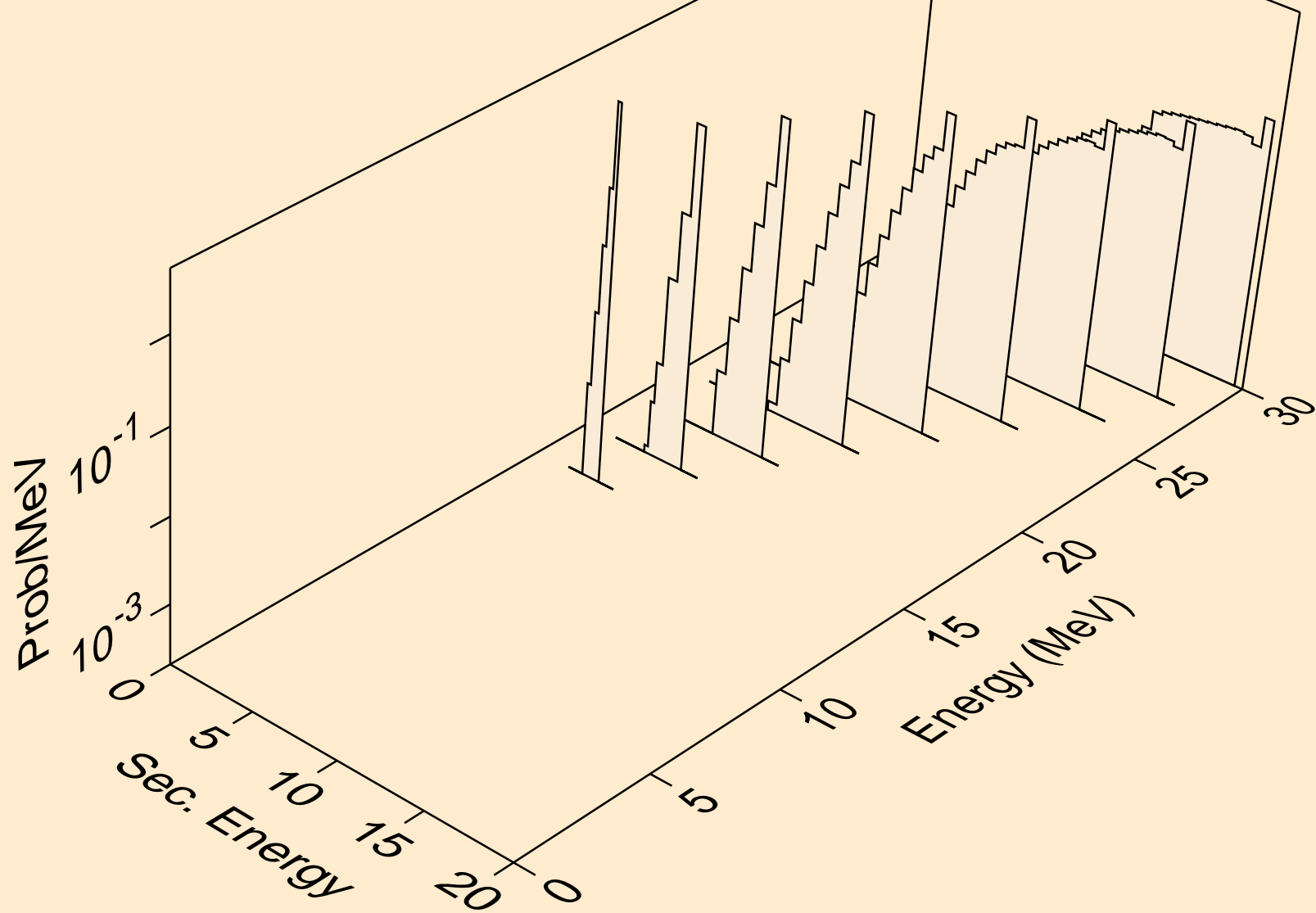

RA209 PHOTON ACER TENDL-2023 LIBRARY; T=0.K
tritons from (g,x)

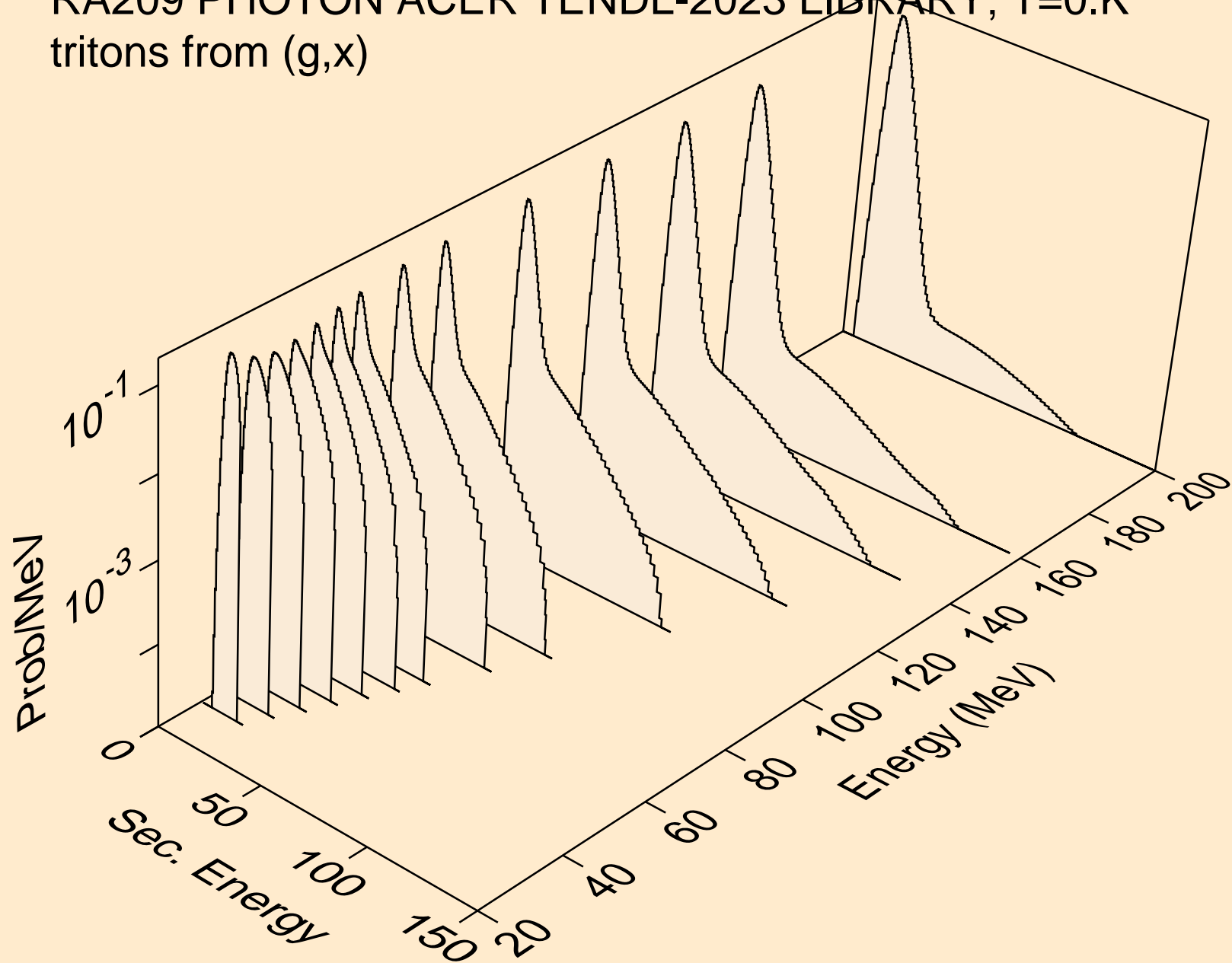

RA209 PHOTON ACER TENDL-2023 LIBRARY; T=0.K
tritons from (g,t)

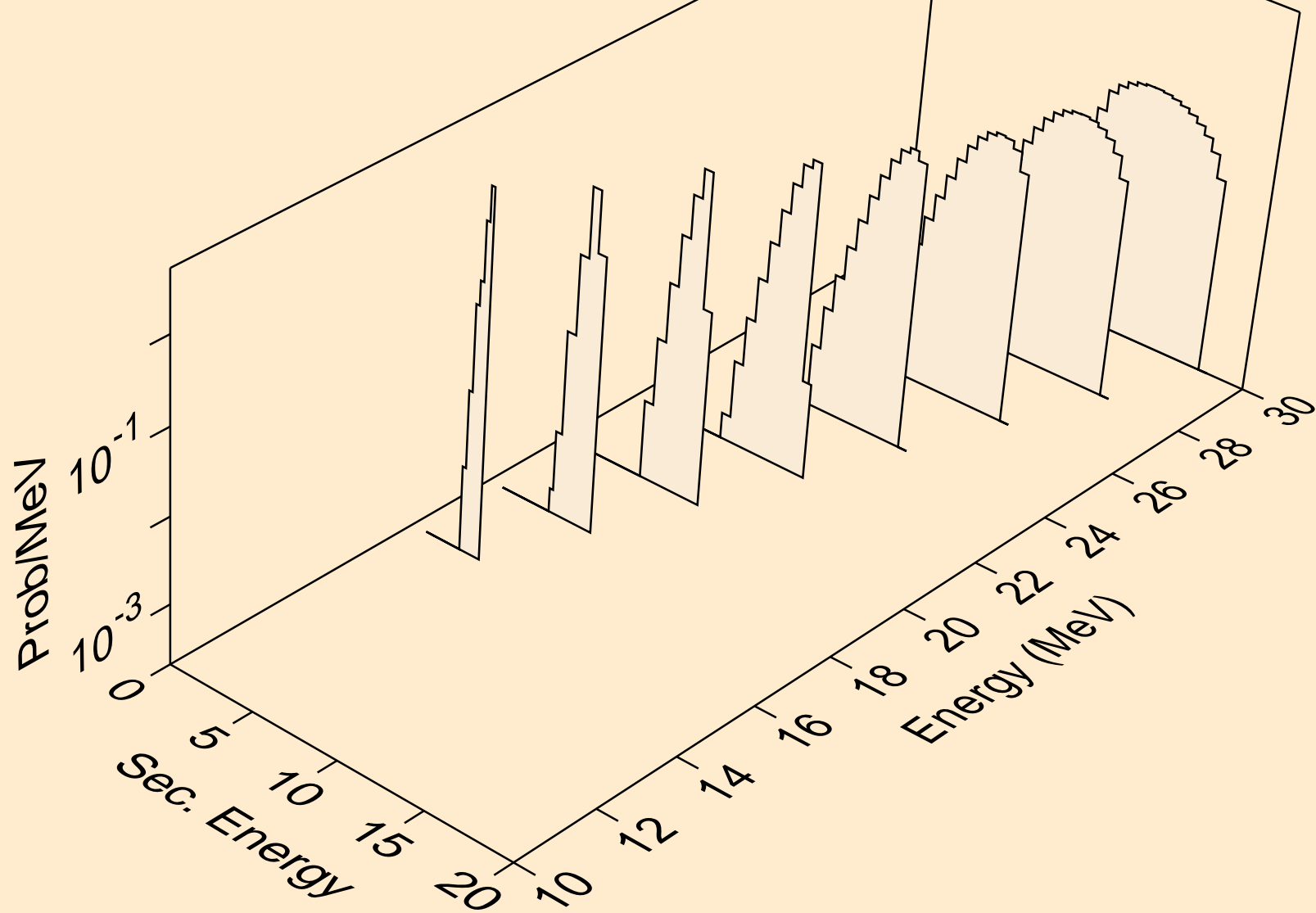

RA209 PHOTON ACER TENDL-2023 LIBRARY; T=0.K
he3s from (g,x)

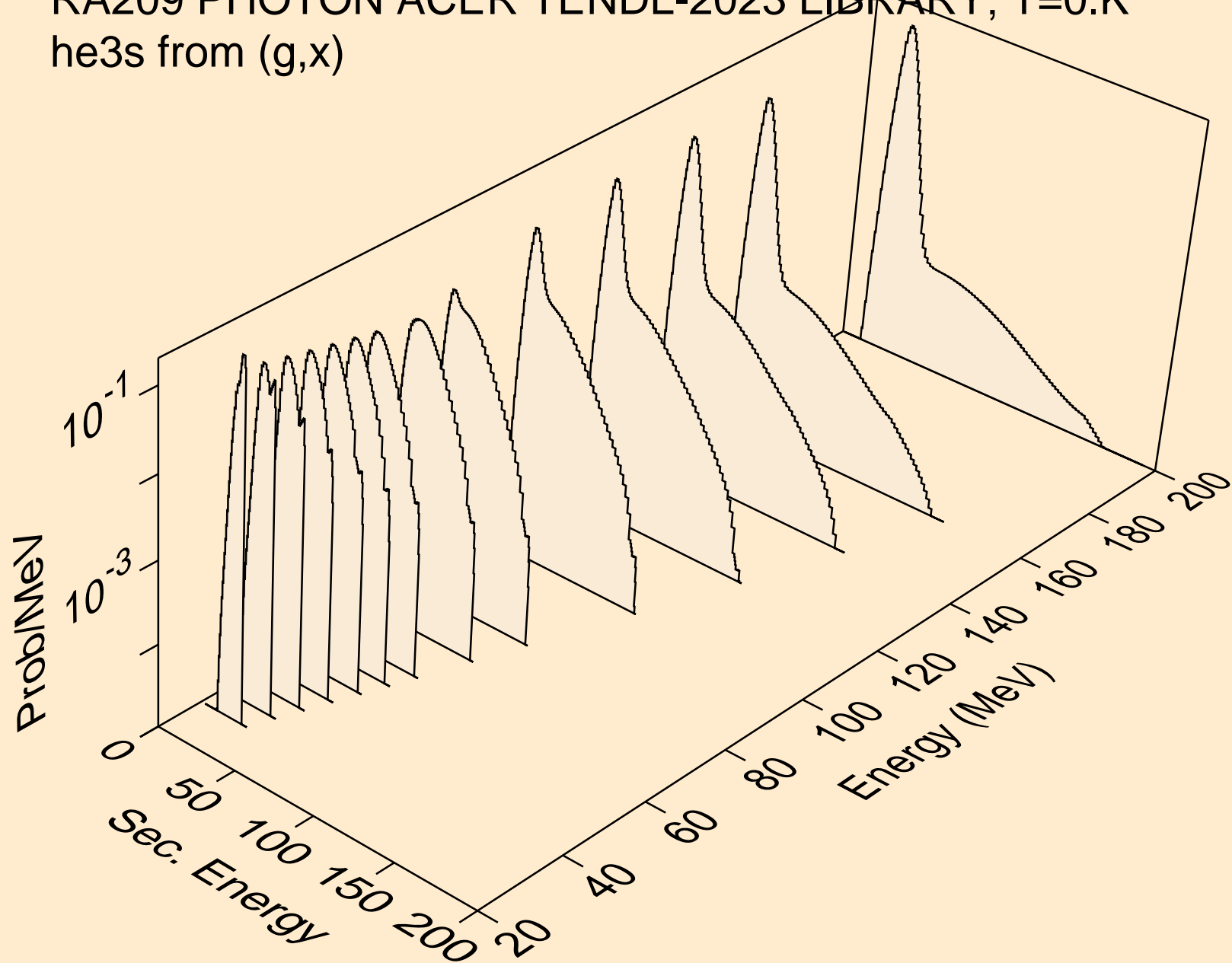

RA209 PHOTON ACER TENDL-2023 LIBRARY; T=0.K
he3s from (g,he3)

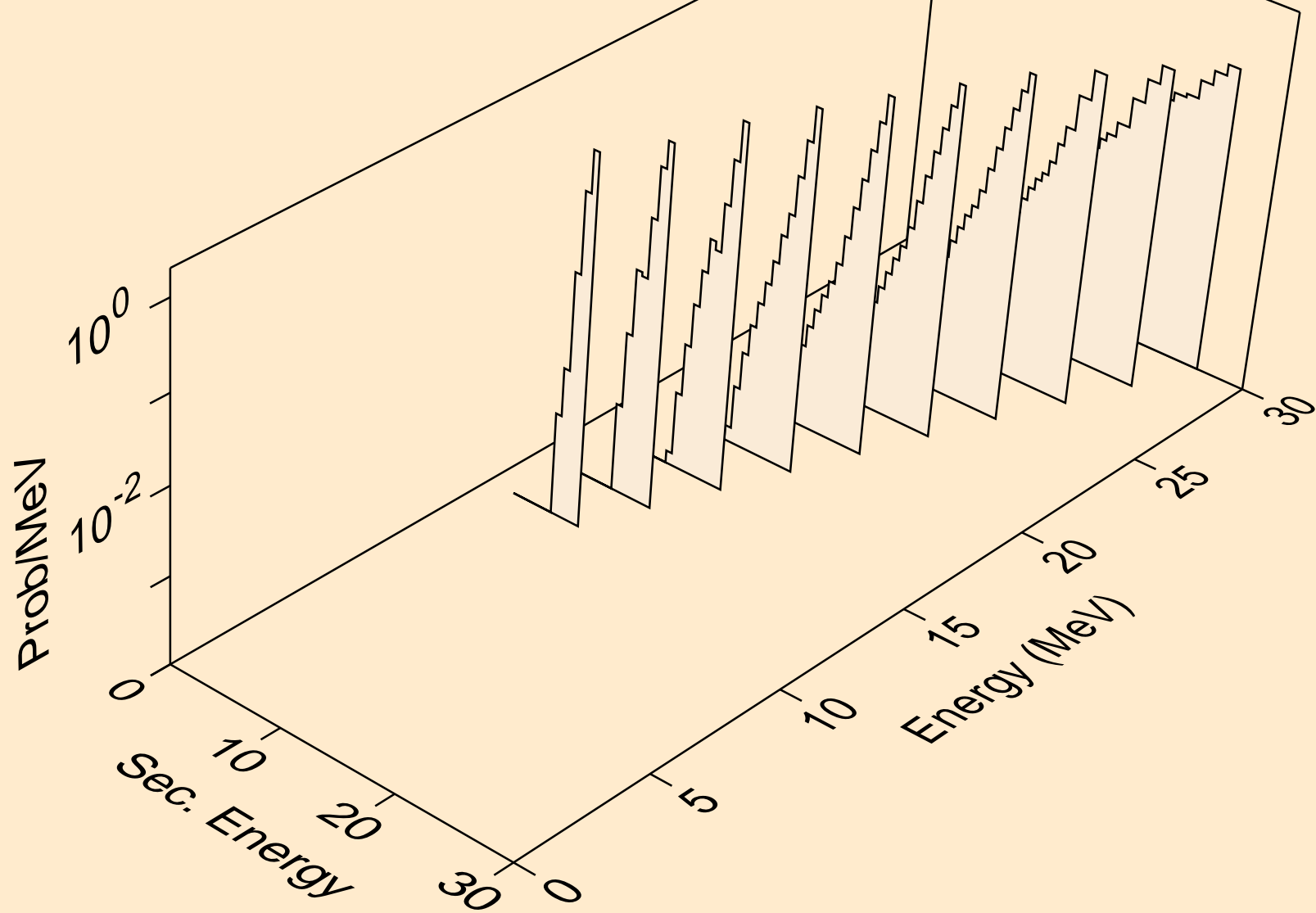

RA209 PHOTON ACER TENDL-2023 LIBRARY; T=0.K
alphas from (g,x)

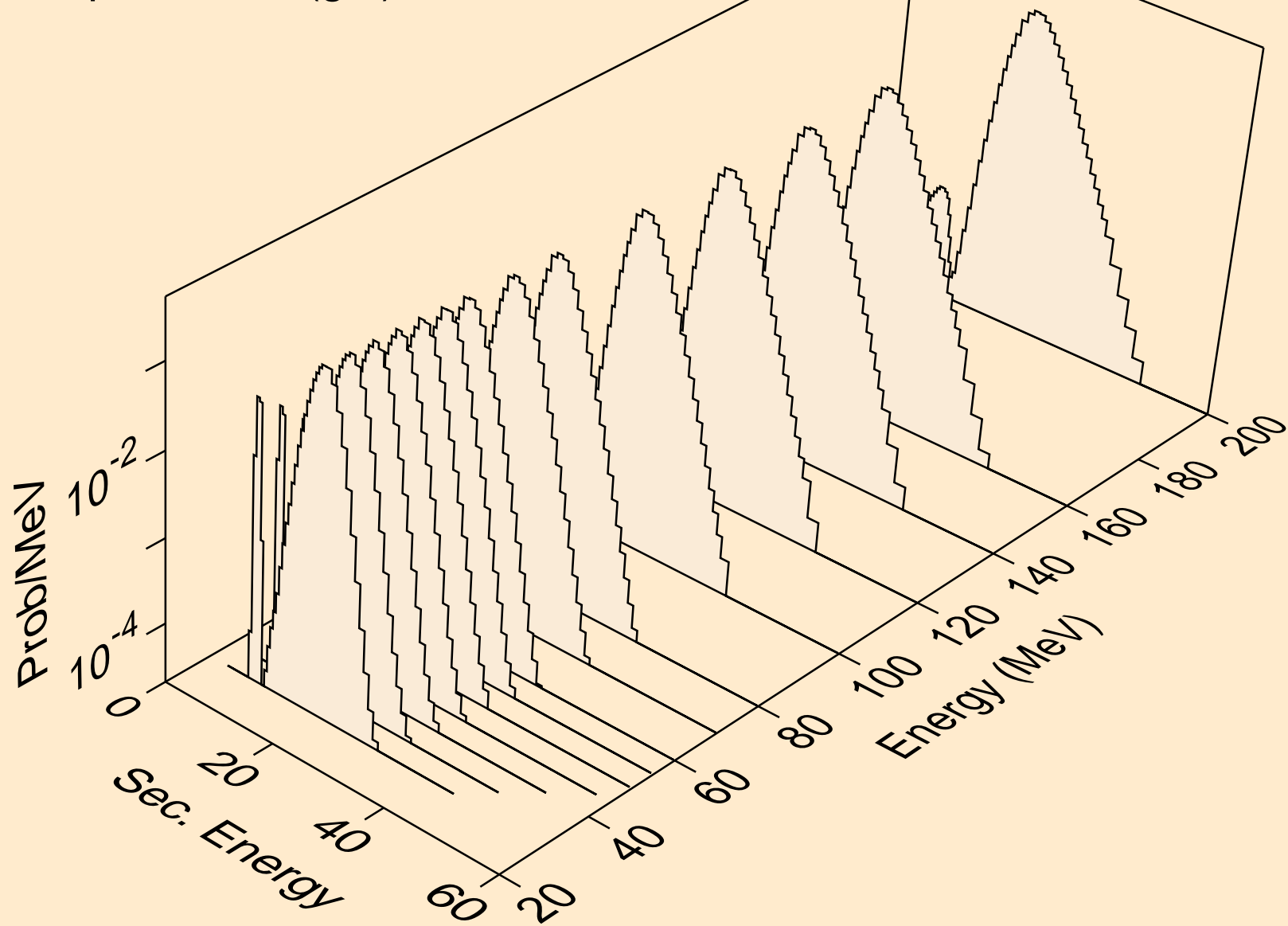

RA209 PHOTON ACER TENDL-2023 LIBRARY; T=0.K
alphas from (g,n*)a

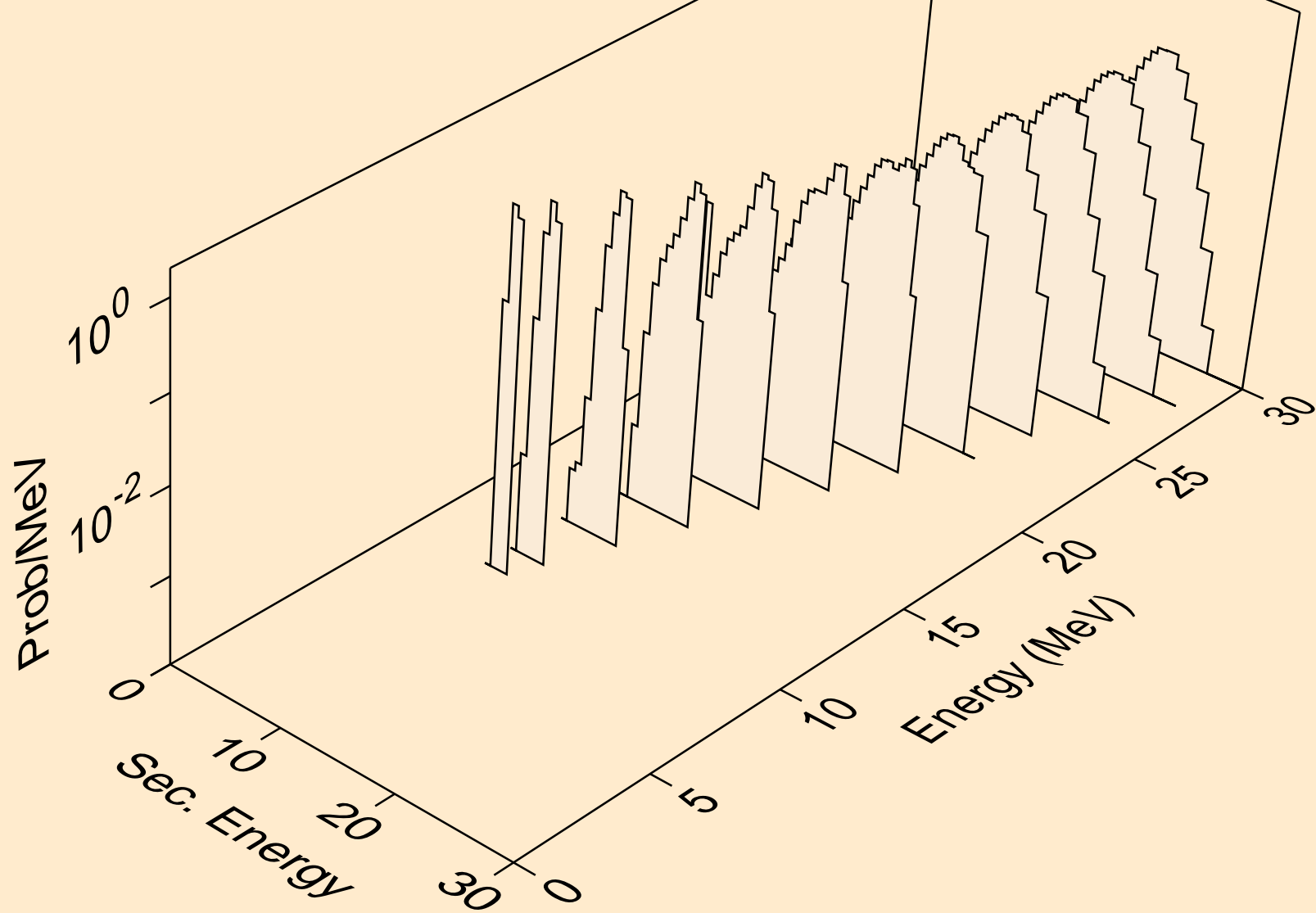

RA209 PHOTON ACER TENDL-2023 LIBRARY; T=0.K
alphas from (g,2n)a

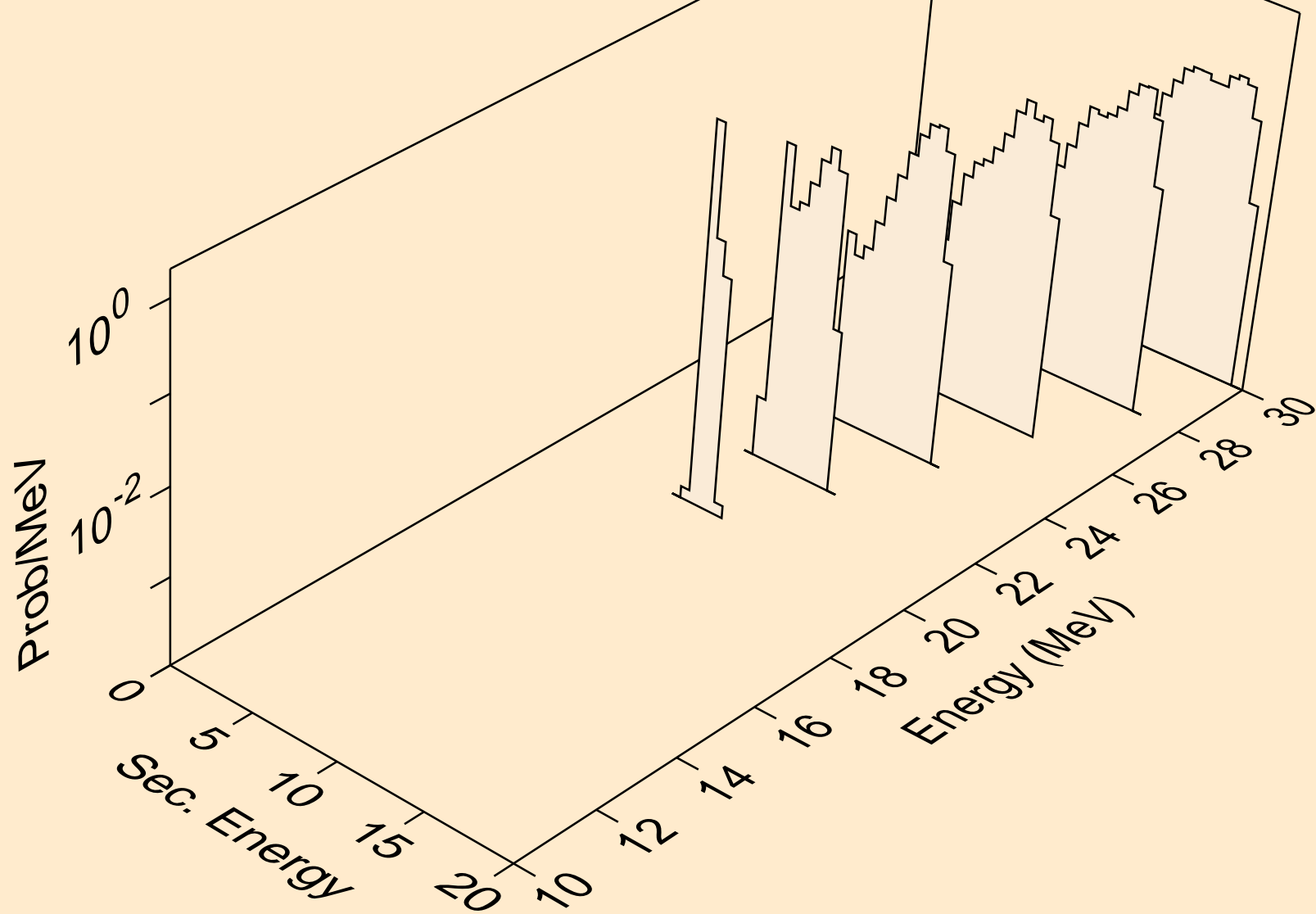

RA209 PHOTON ACER TENDL-2023 LIBRARY; T=0.K
alphas from (g,n*)2a

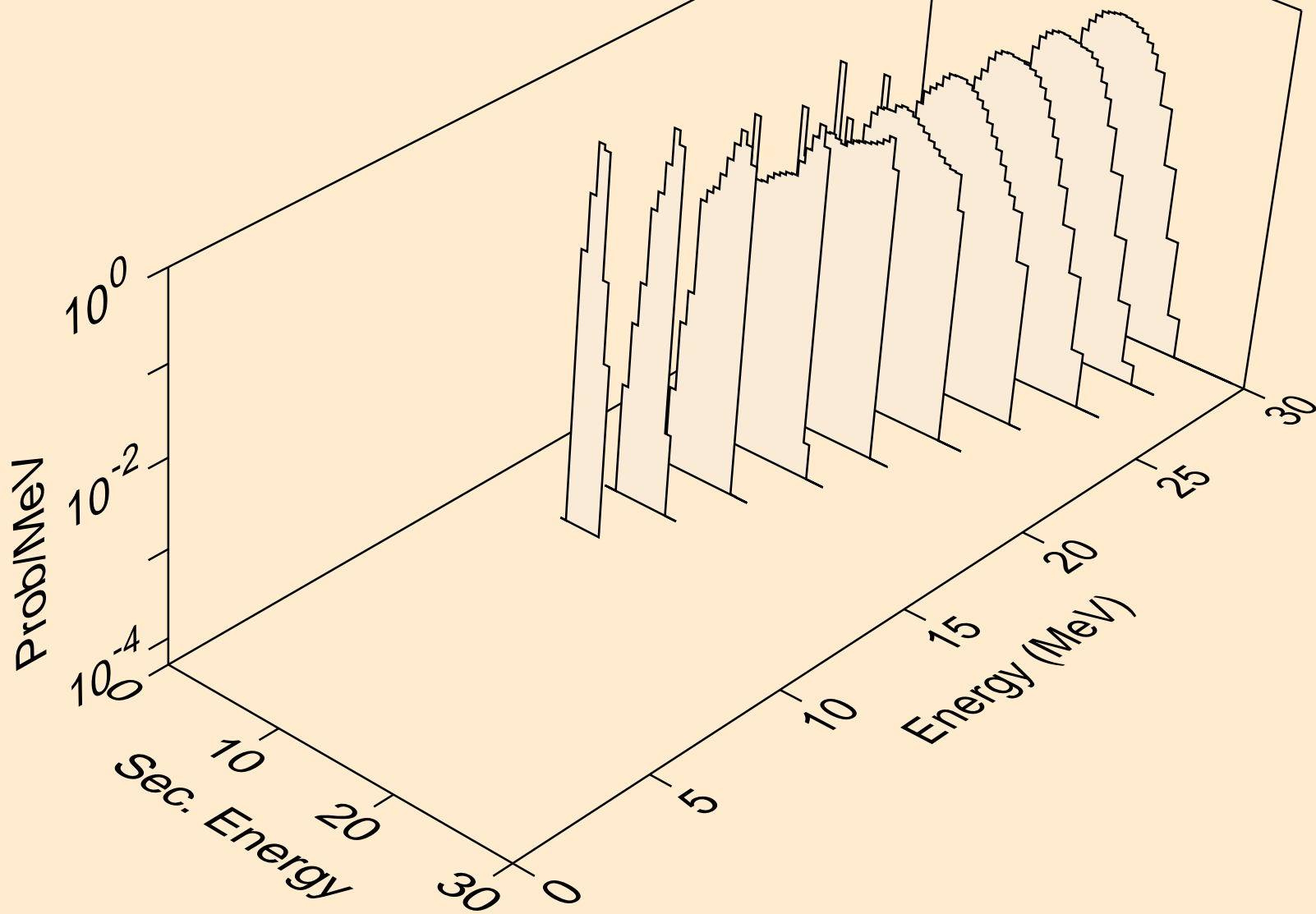

RA209 PHOTON ACER TENDL-2023 LIBRARY; T=0.K
alphas from (g,npa)

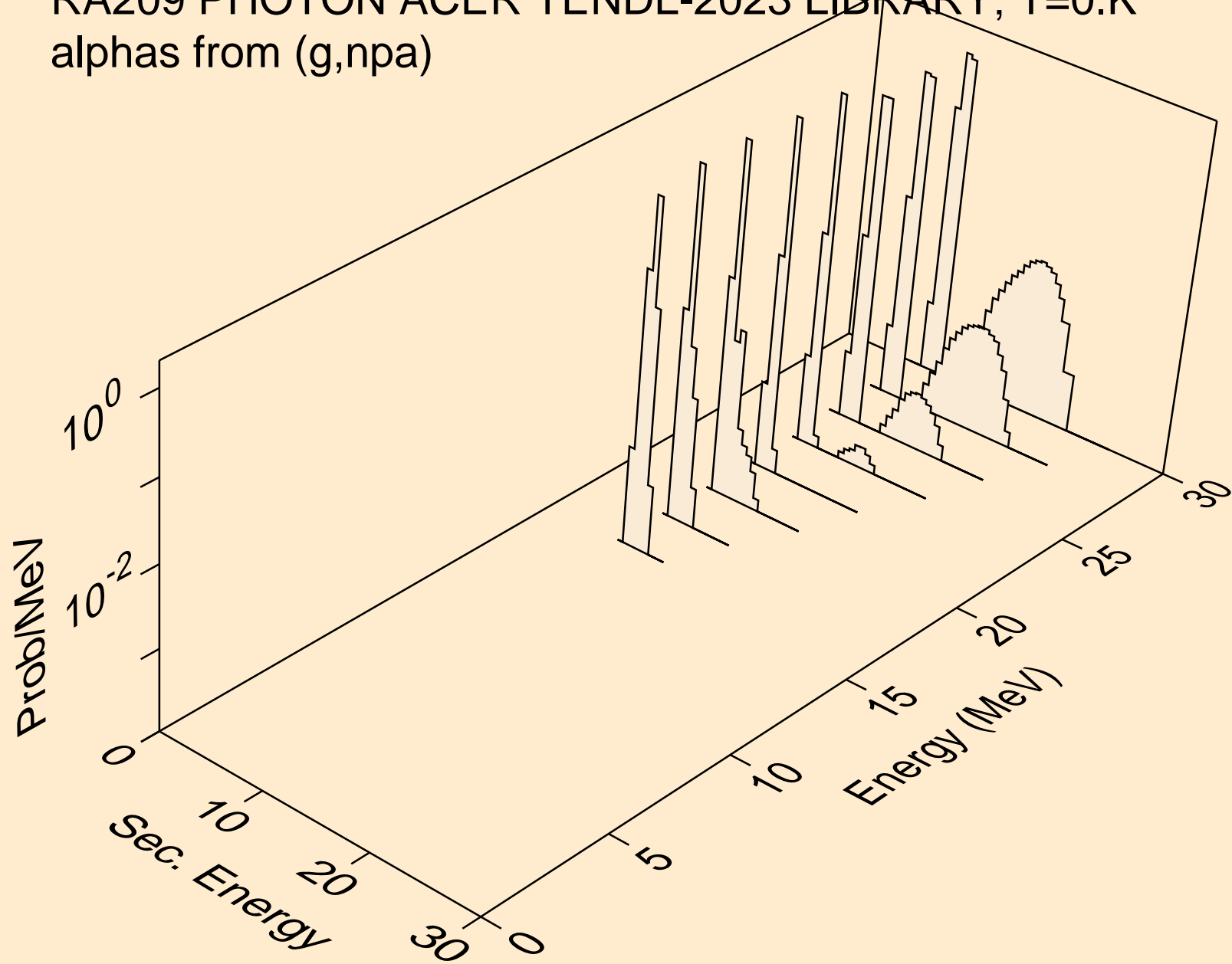

RA209 PHOTON ACER TENDL-2023 LIBRARY; T=0.K
alphas from (g,a)

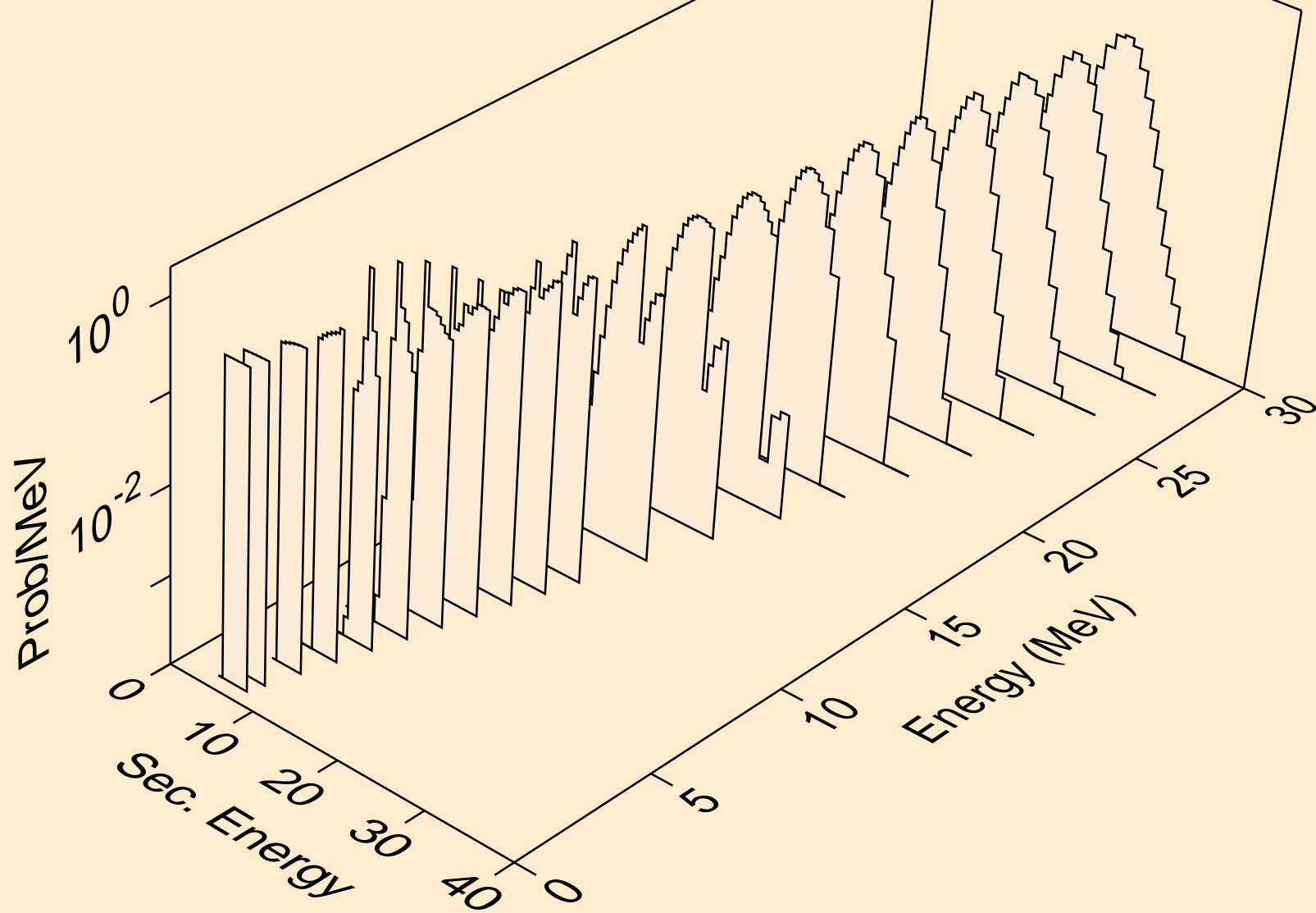

RA209 PHOTON ACER TENDL-2023 LIBRARY; T=0.K
alphas from (g,2a)

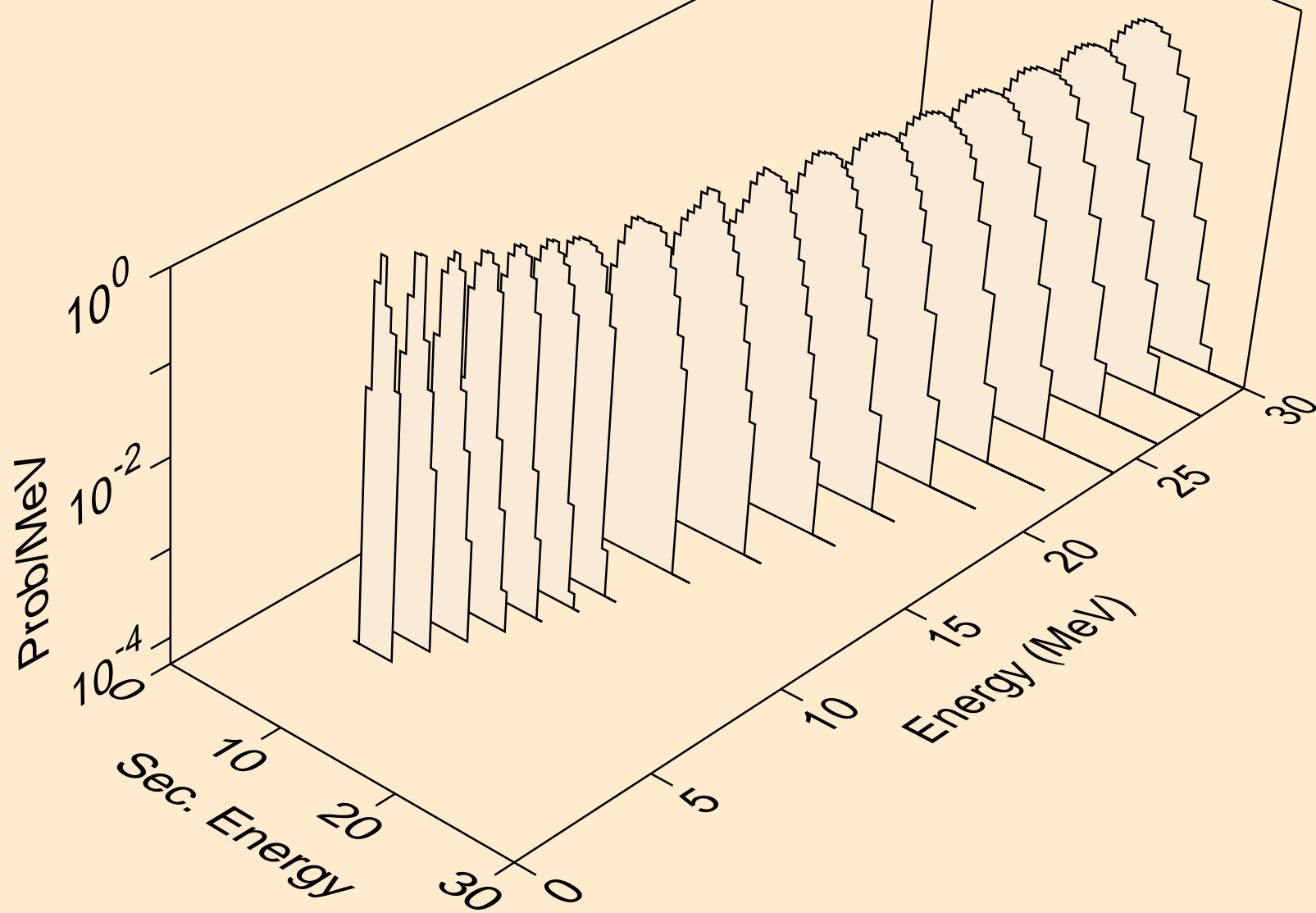

RA209 PHOTON ACER TENDL-2023 LIBRARY; T=0.K
alphas from (g,pa)

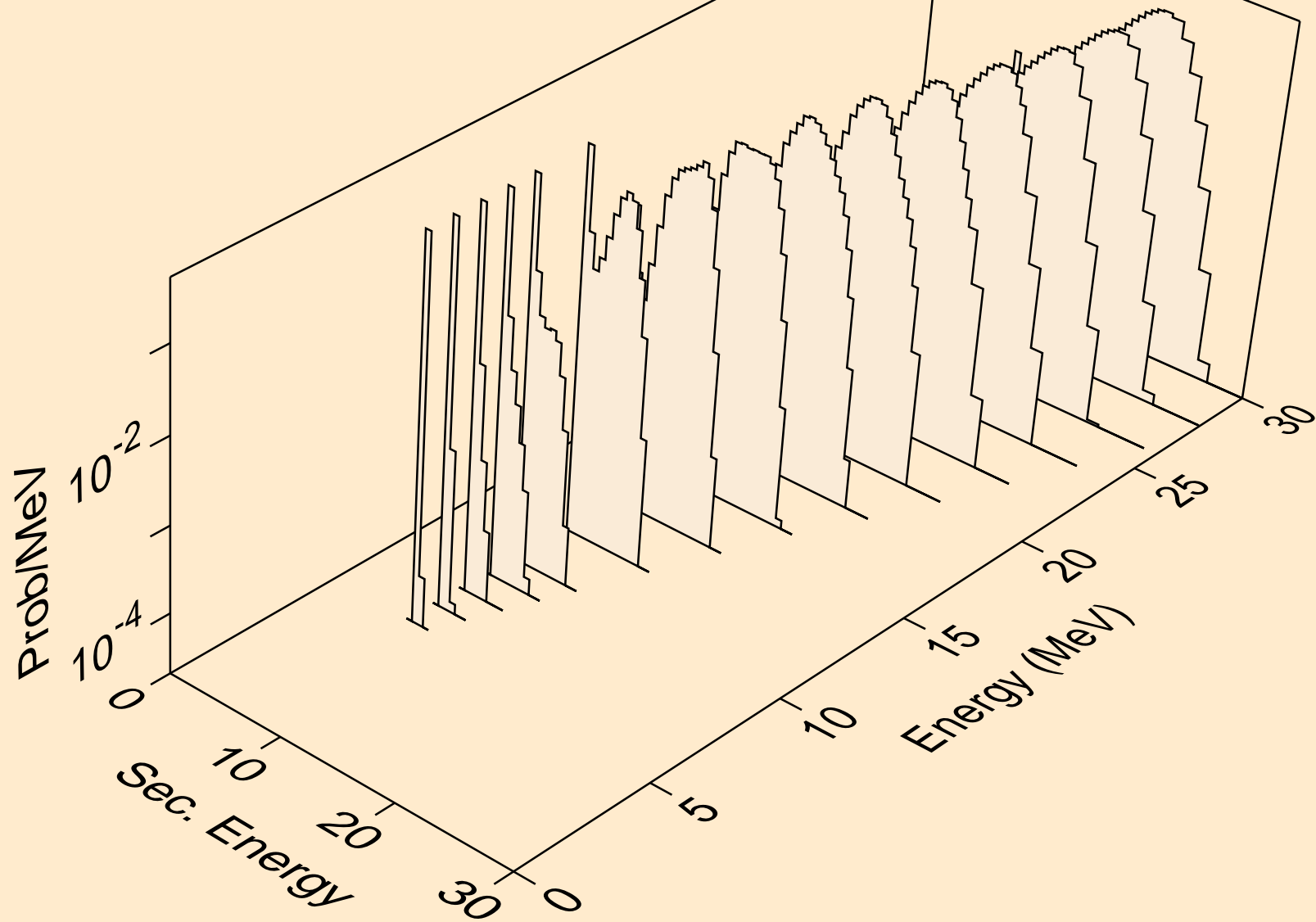

RA209 PHOTON ACER TENDL-2023 LIBRARY; T=0.K
alphas from (g,da)

