

SN112 PHOTON ACER TENDL-2023 LIBRARY; T=0.K
Principal cross sections

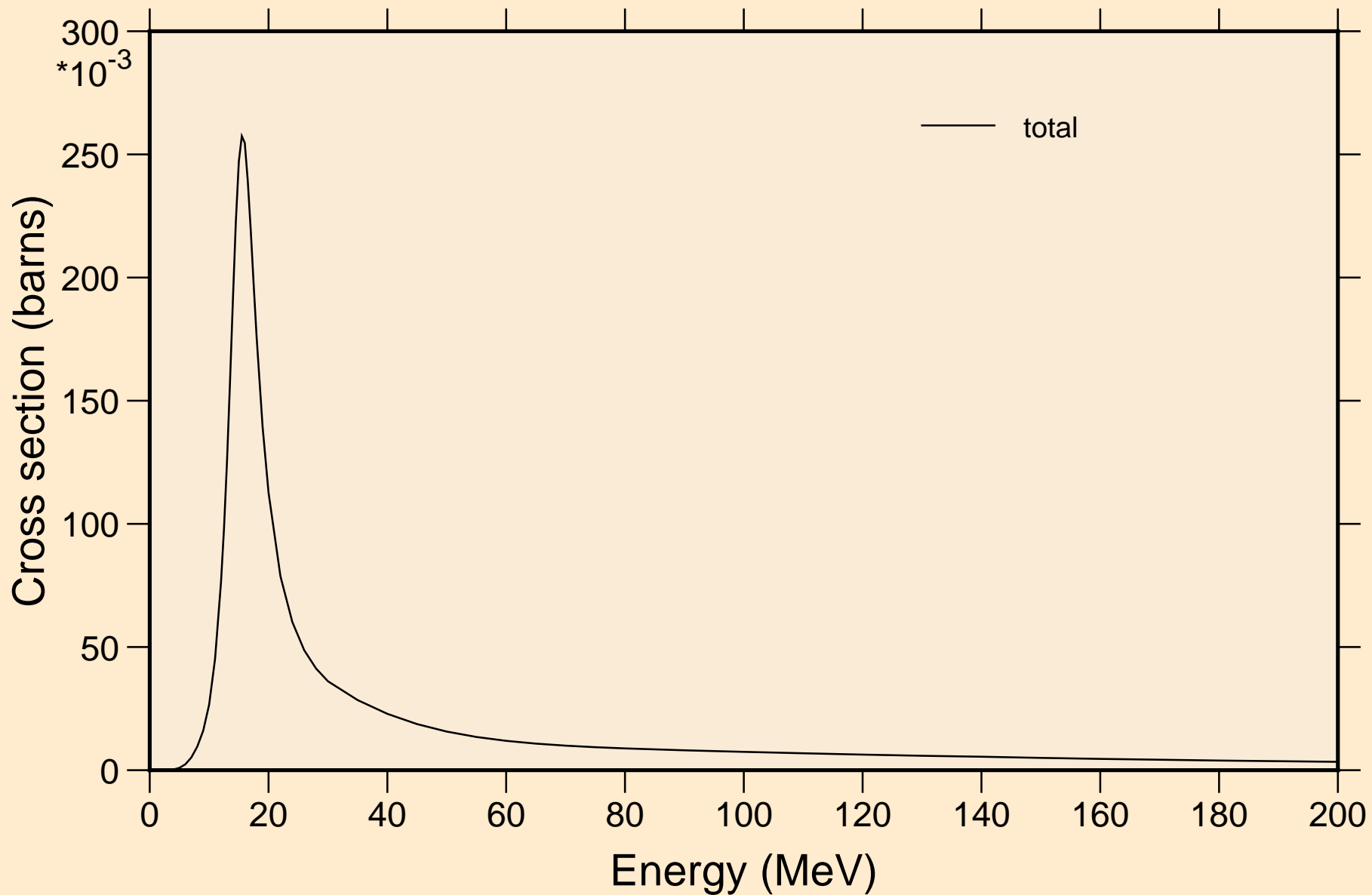

SN112 PHOTON ACER TENDL-2023 LIBRARY; T=0.K

Partial cross sections

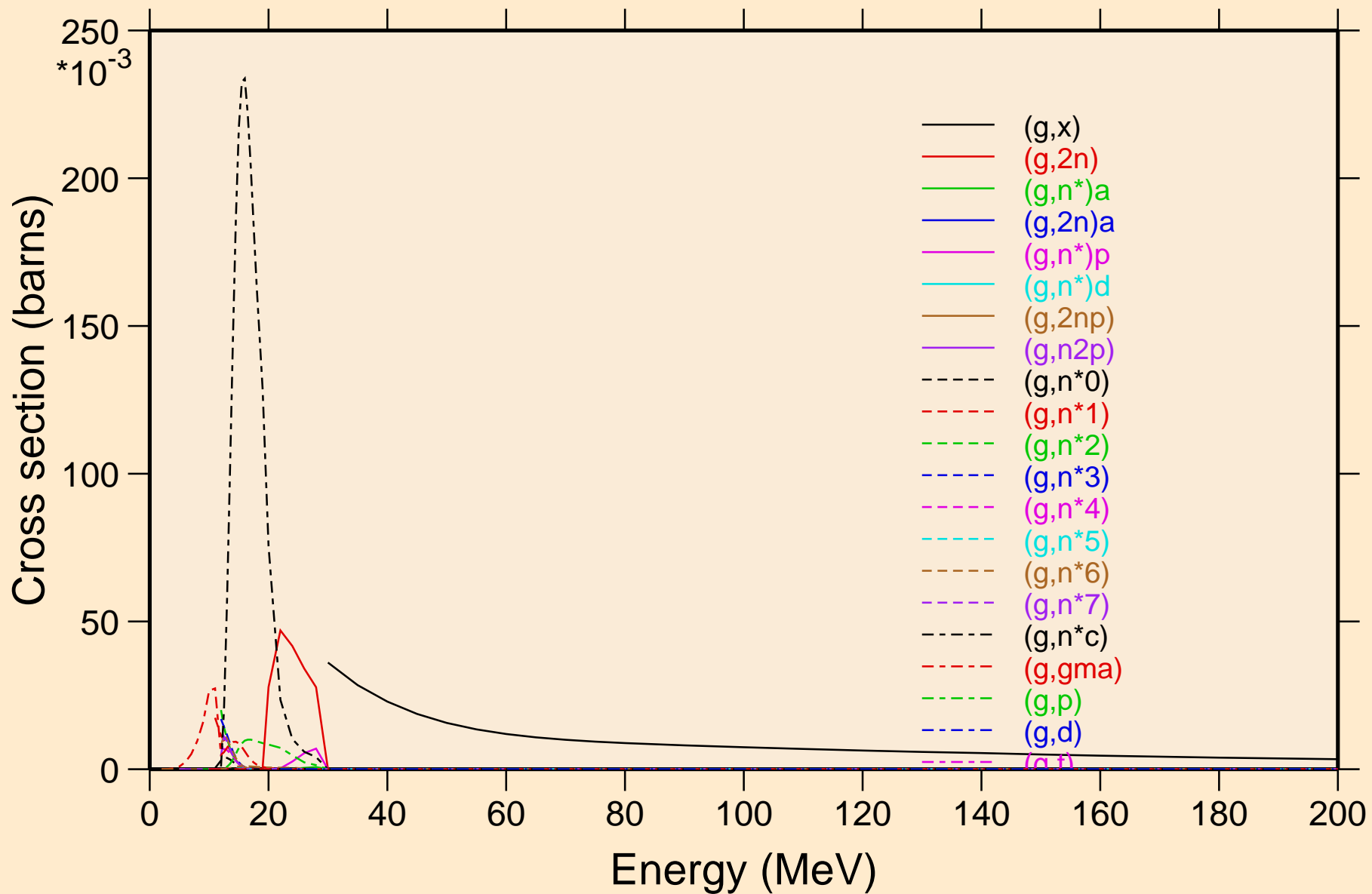

SN112 PHOTON ACER TENDL-2023 LIBRARY; T=0.K

Heating

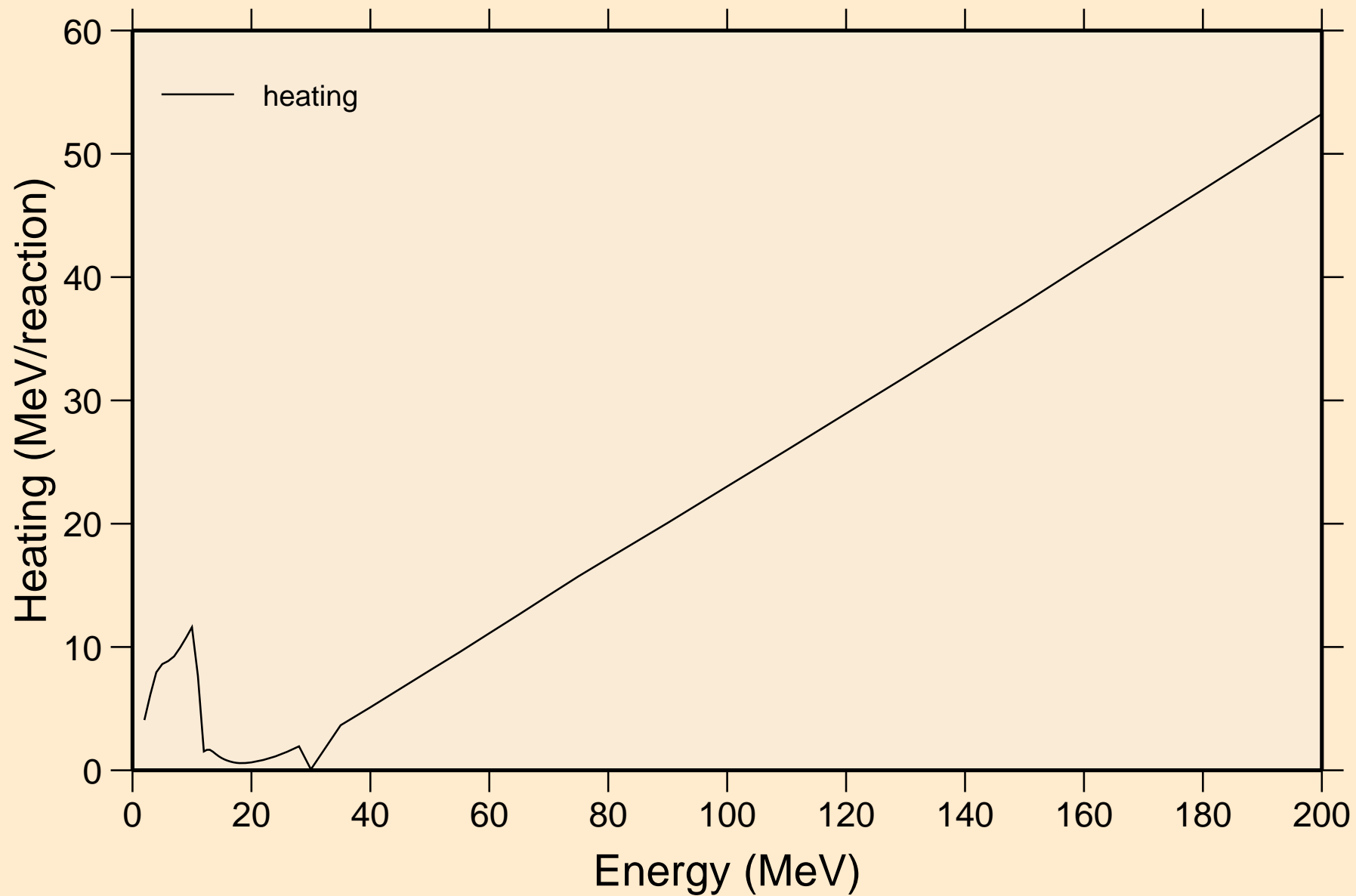

SN112 PHOTON ACER TENDL-2023 LIBRARY; T=0.K

Particle heating contributions

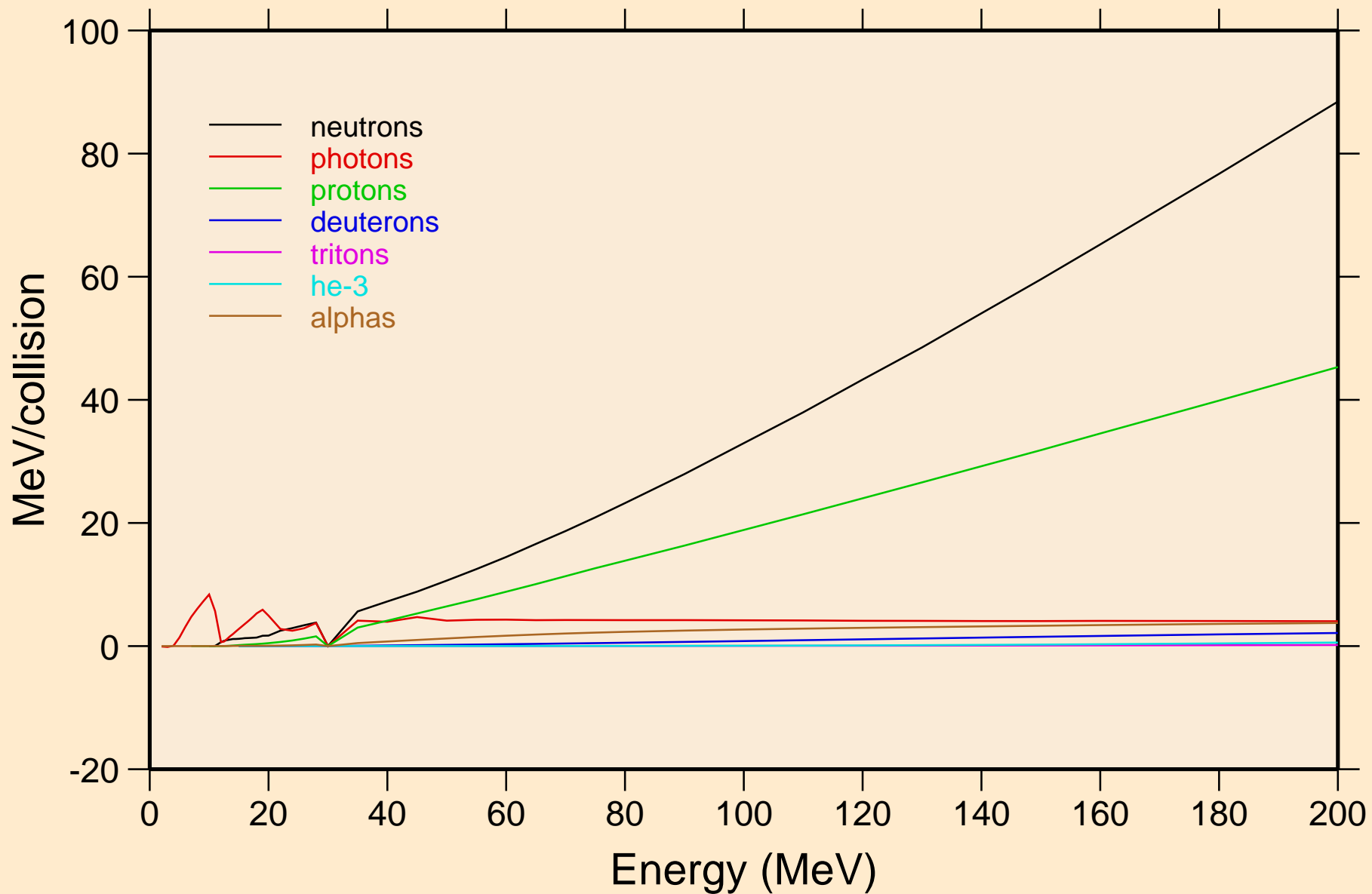

SN112 PHOTON ACER TENDL-2023 LIBRARY; T=0.K

Particle production cross sections

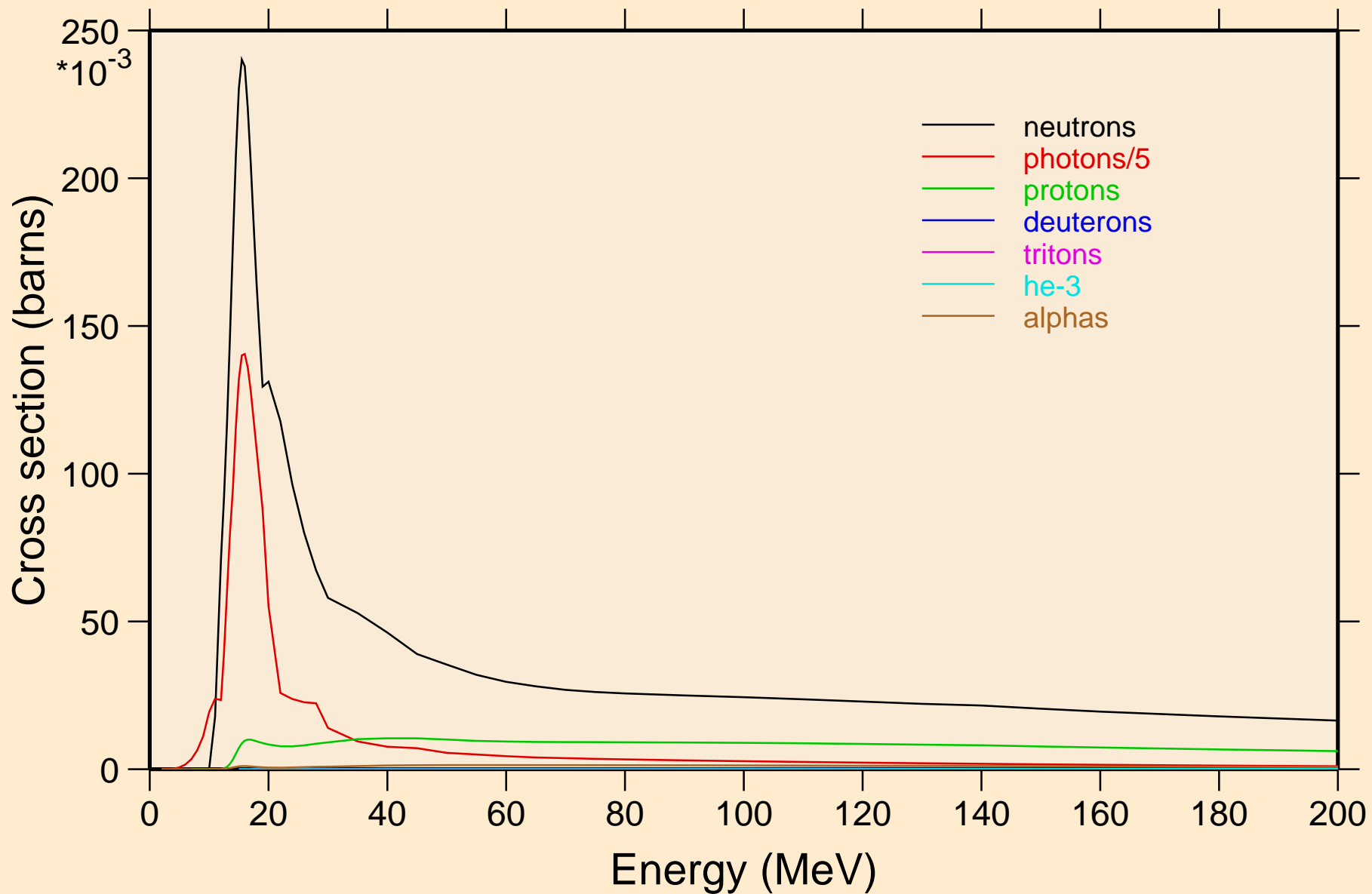

SN112 PHOTON ACER TENDL-2023 LIBRARY; T=0.K
neutrons from (g,x)

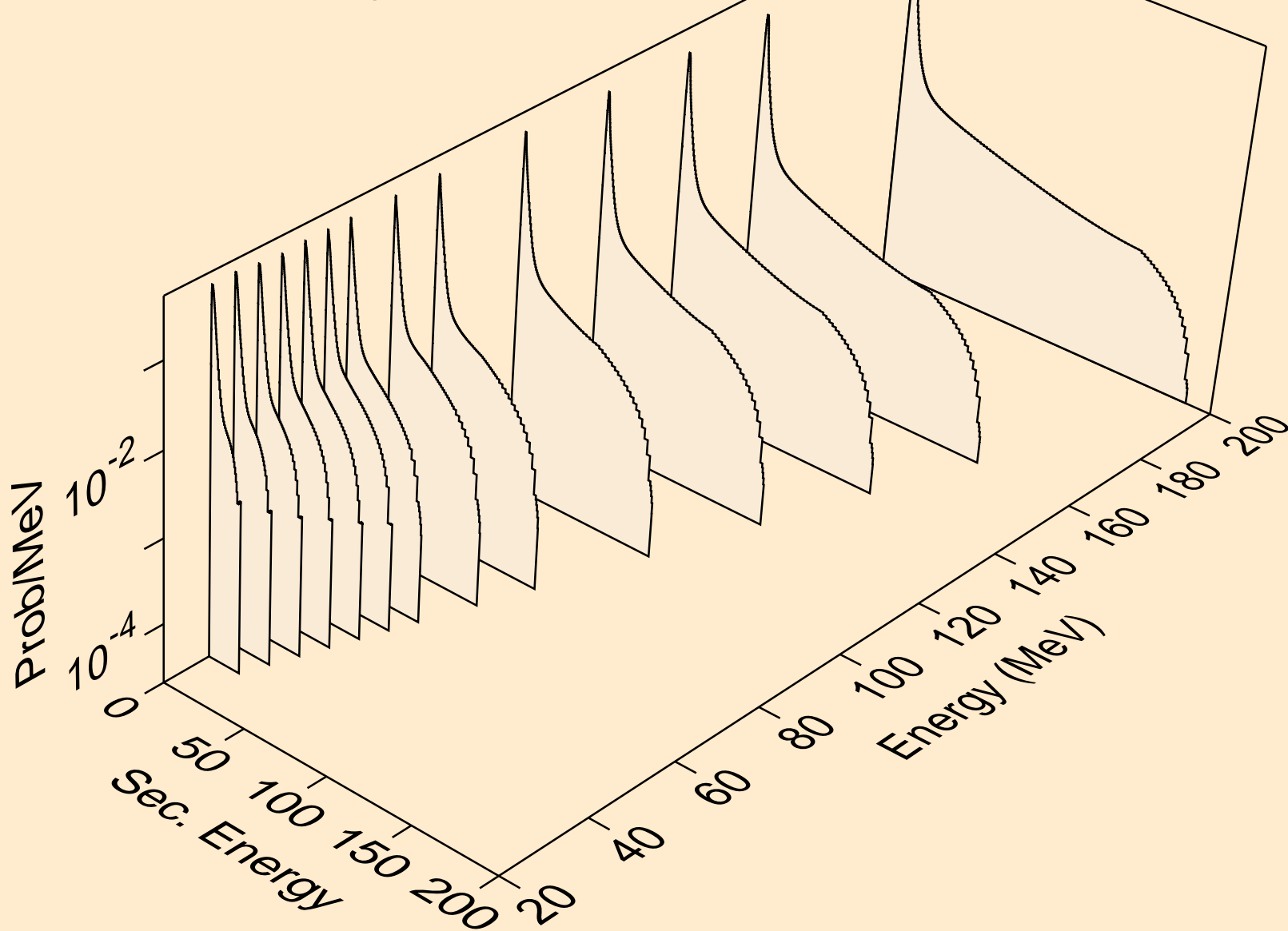

SN112 PHOTON ACER TENDL-2023 LIBRARY; T=0.K
neutrons from (g,2n)

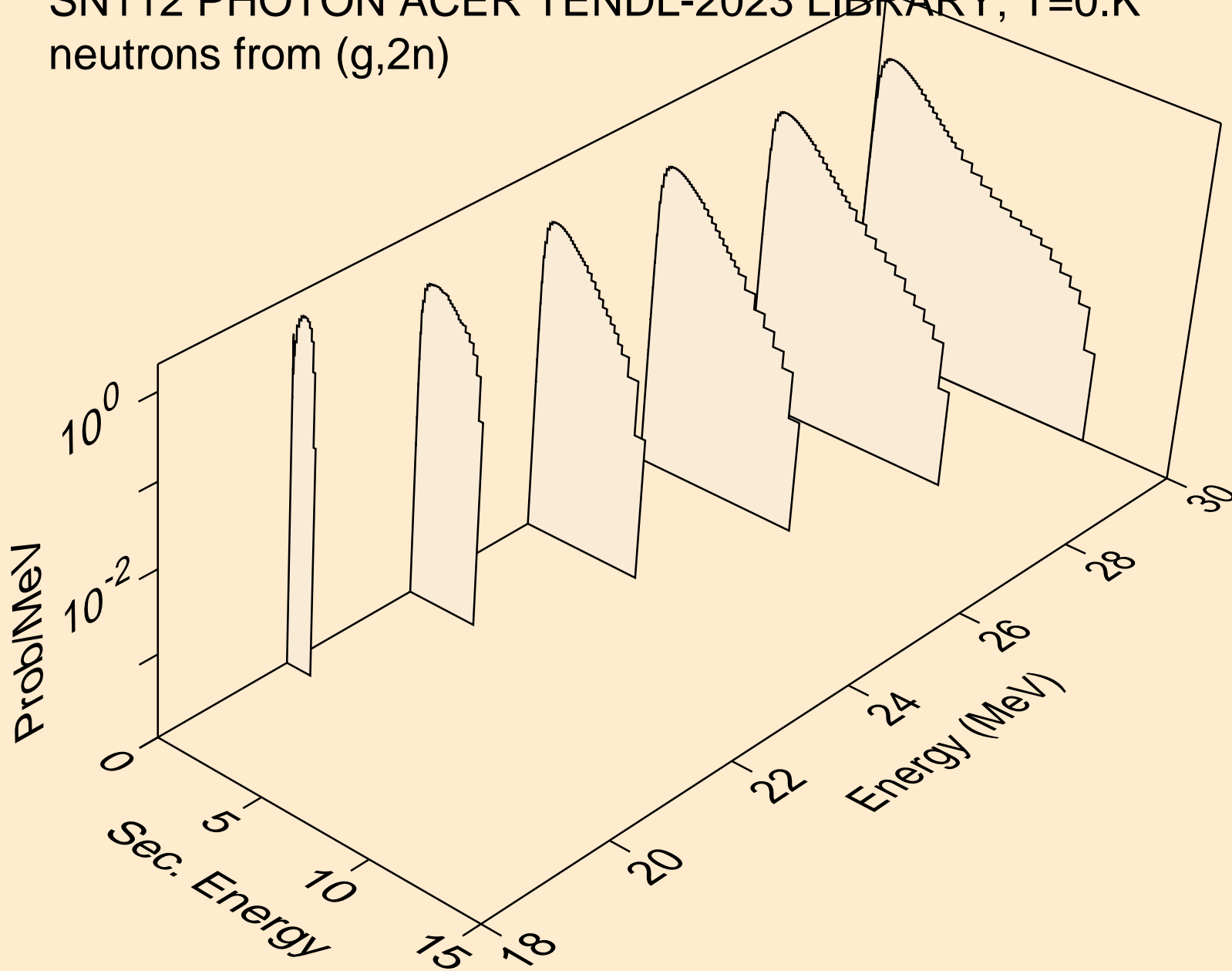

SN112 PHOTON ACER TENDL-2023 LIBRARY; T=0.K
neutrons from (g,n*)a

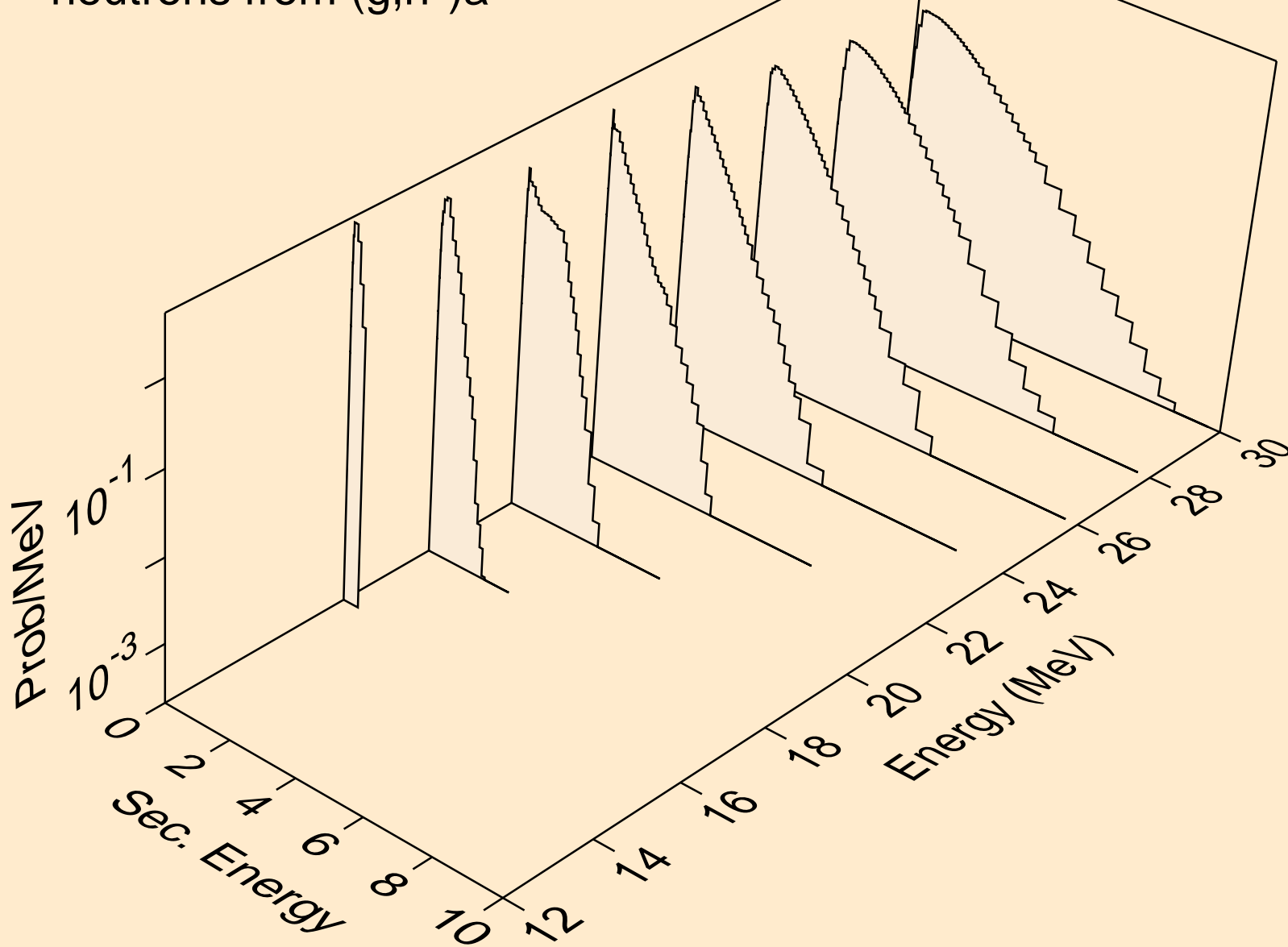

SN112 PHOTON ACER TENDL-2023 LIBRARY; T=0.K
neutrons from (g,2n)a

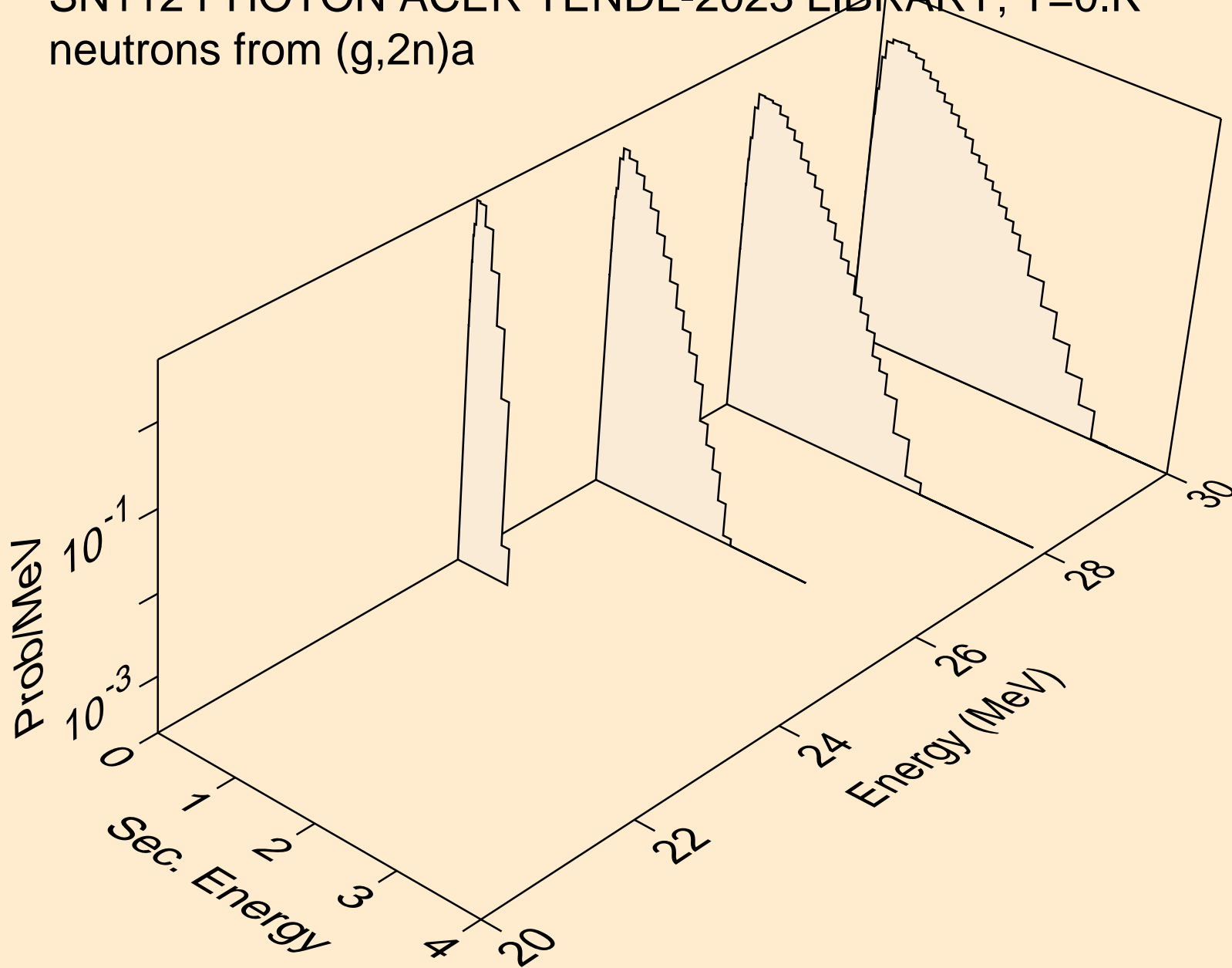

SN112 PHOTON ACER TENDL-2023 LIBRARY; T=0.K
neutrons from (g,n*)p

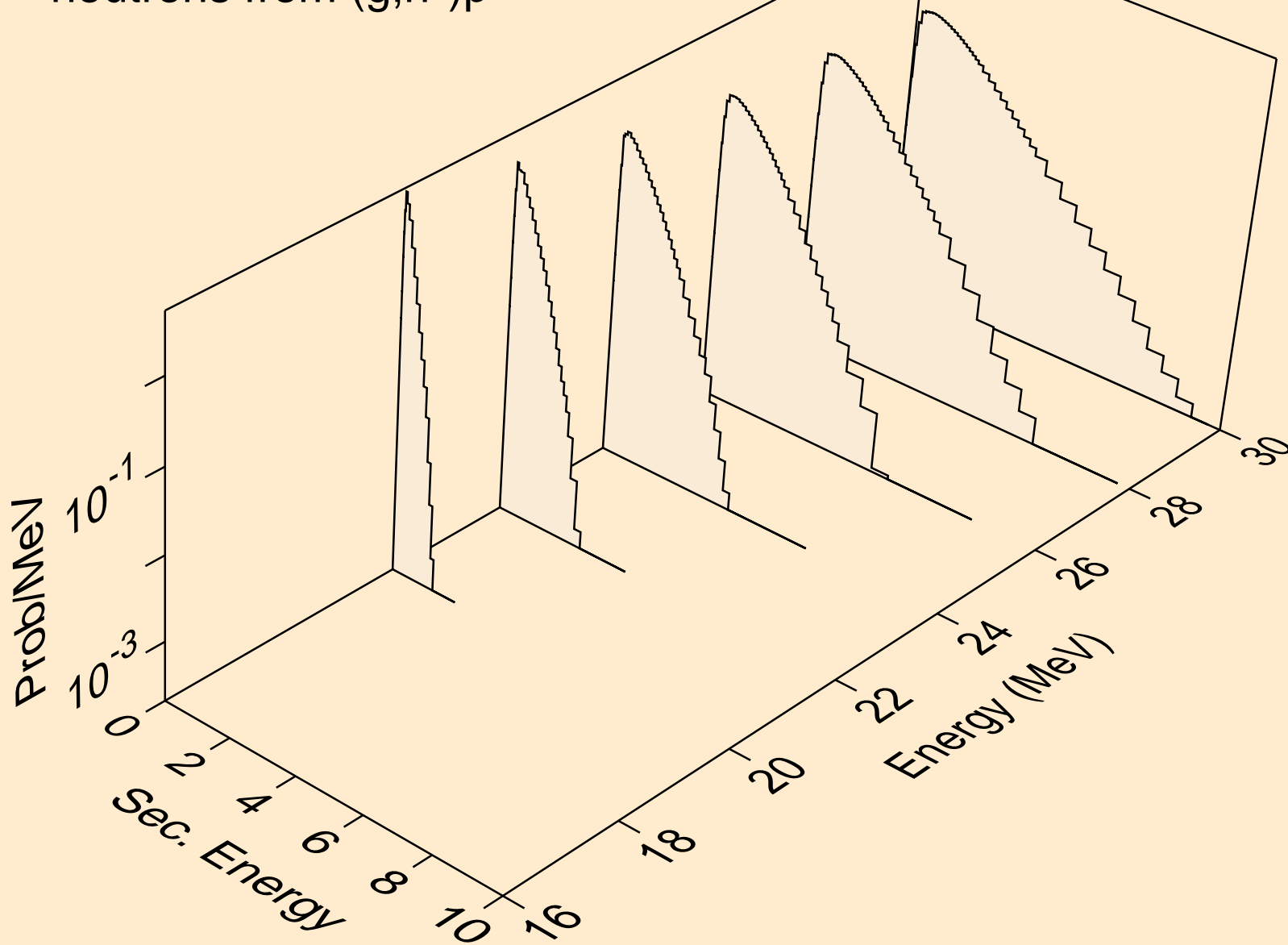

SN112 PHOTON ACER TENDL-2023 LIBRARY; T=0.K
neutrons from (g,n*)d

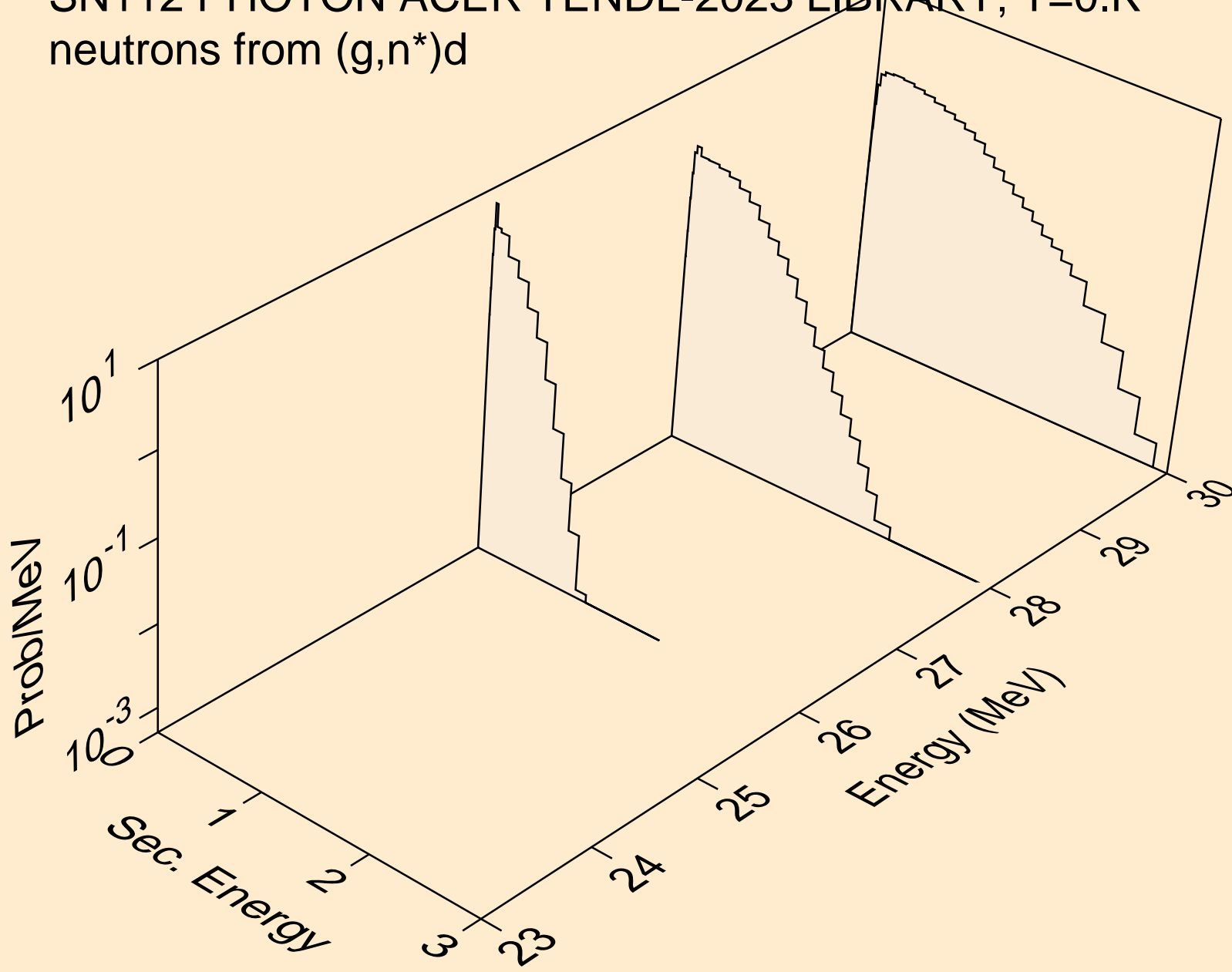

SN112 PHOTON ACER TENDL-2023 LIBRARY; T=0.K
neutrons from (g,2np)

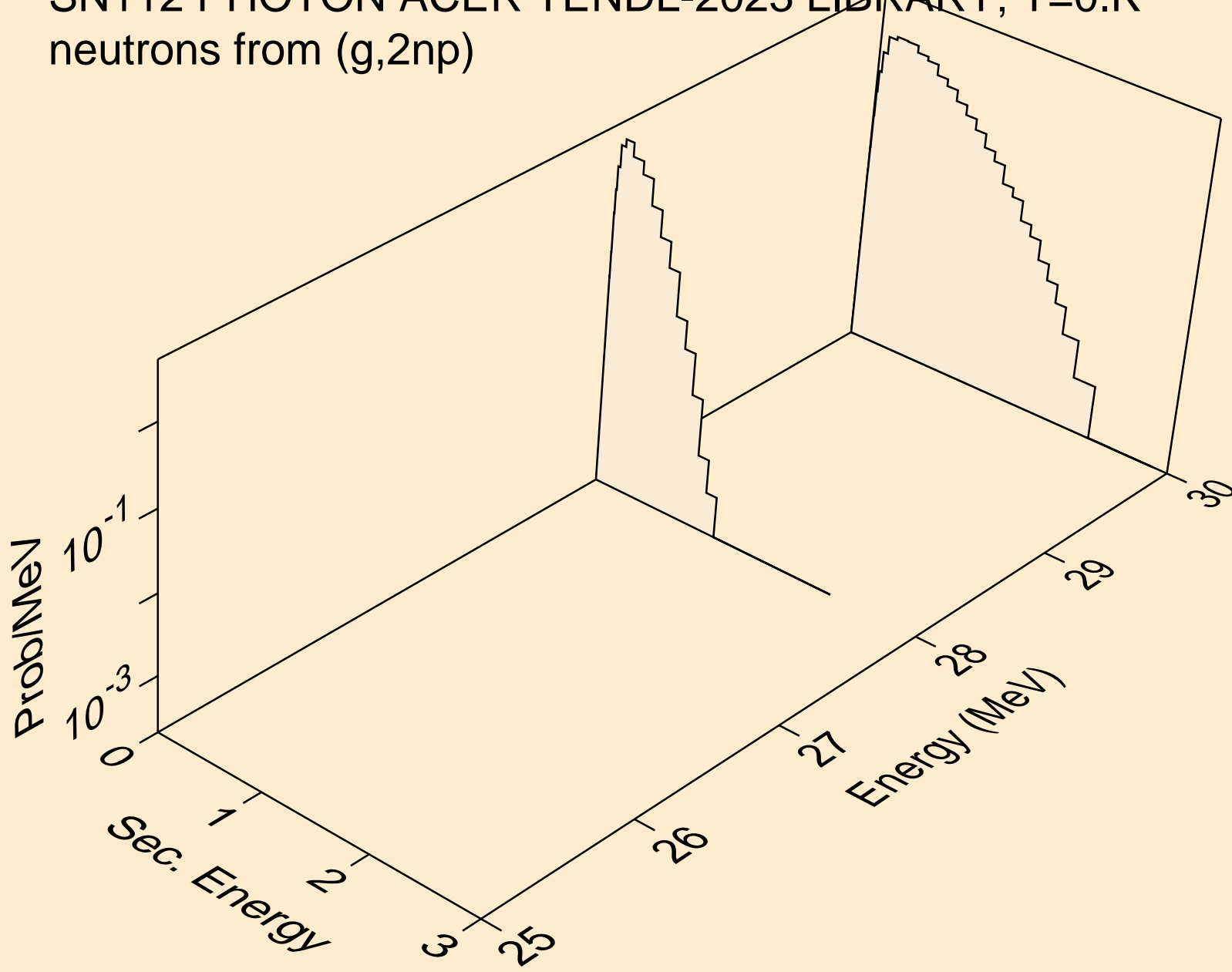

SN112 PHOTON ACER TENDL-2023 LIBRARY; T=0.K
neutrons from (g,n2p)

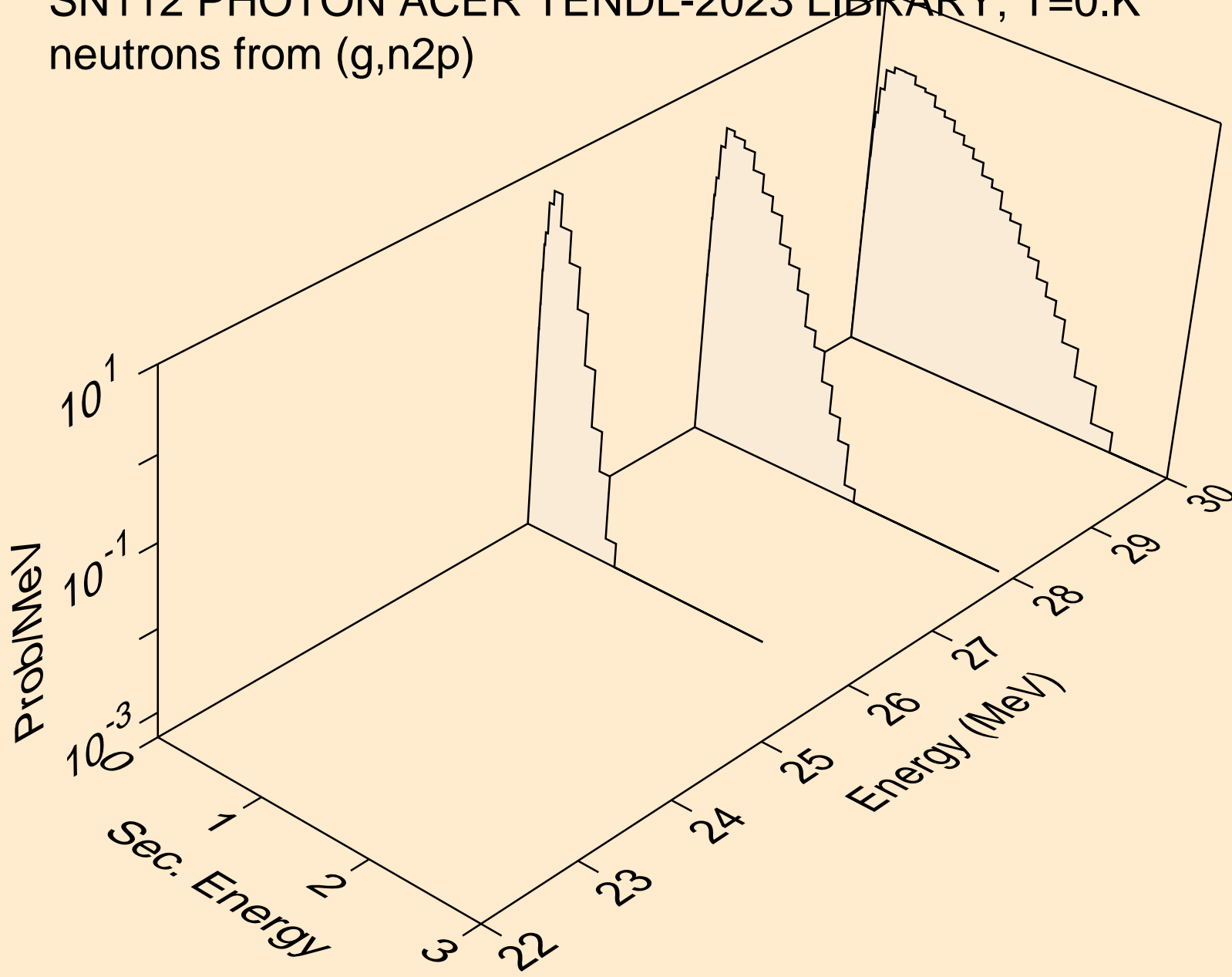

SN112 PHOTON ACER TENDL-2023 LIBRARY; T=0.K
angular distribution for (g,n*0) neutron

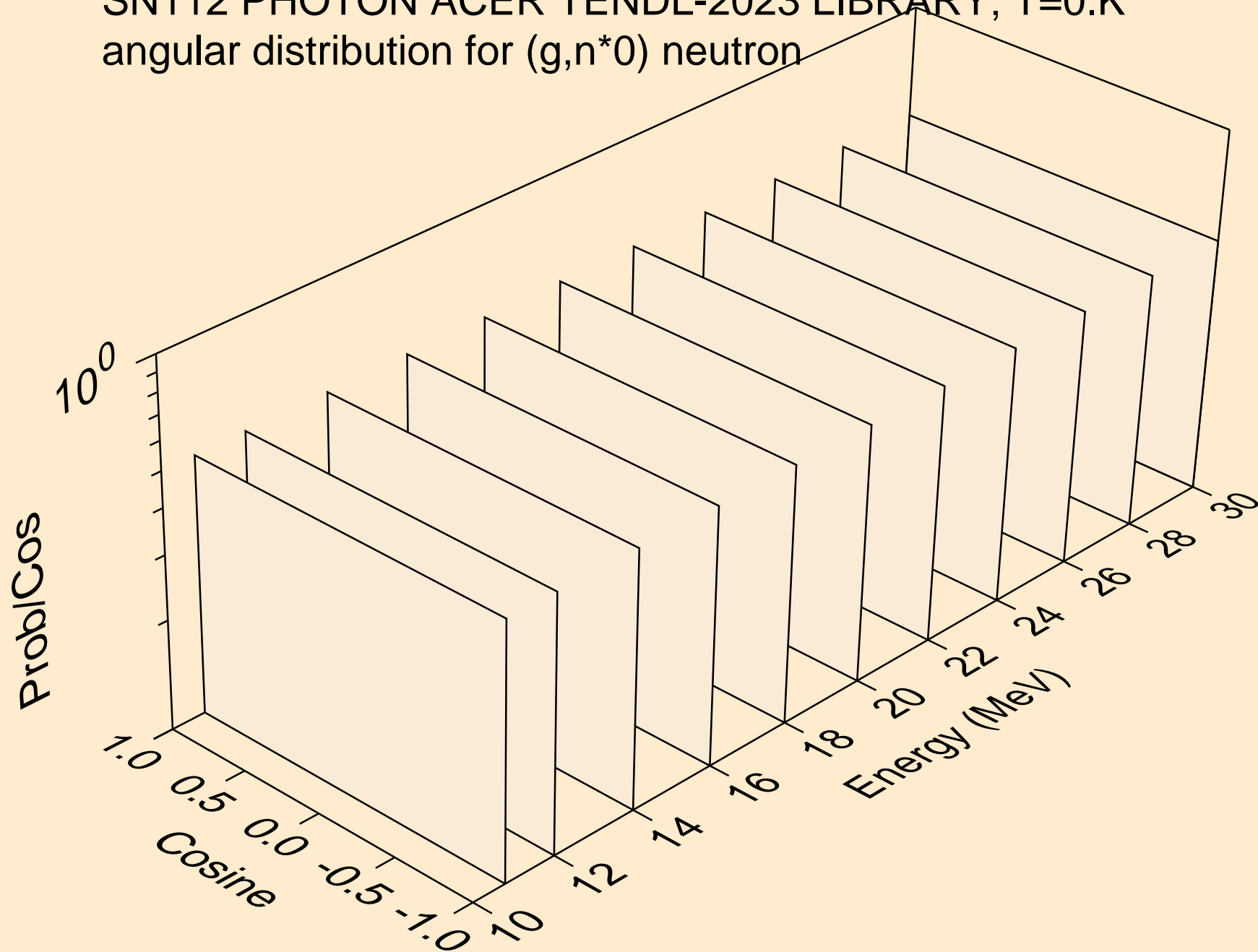

SN112 PHOTON ACER TENDL-2023 LIBRARY; T=0.K
angular distribution for (g,n*1) neutron

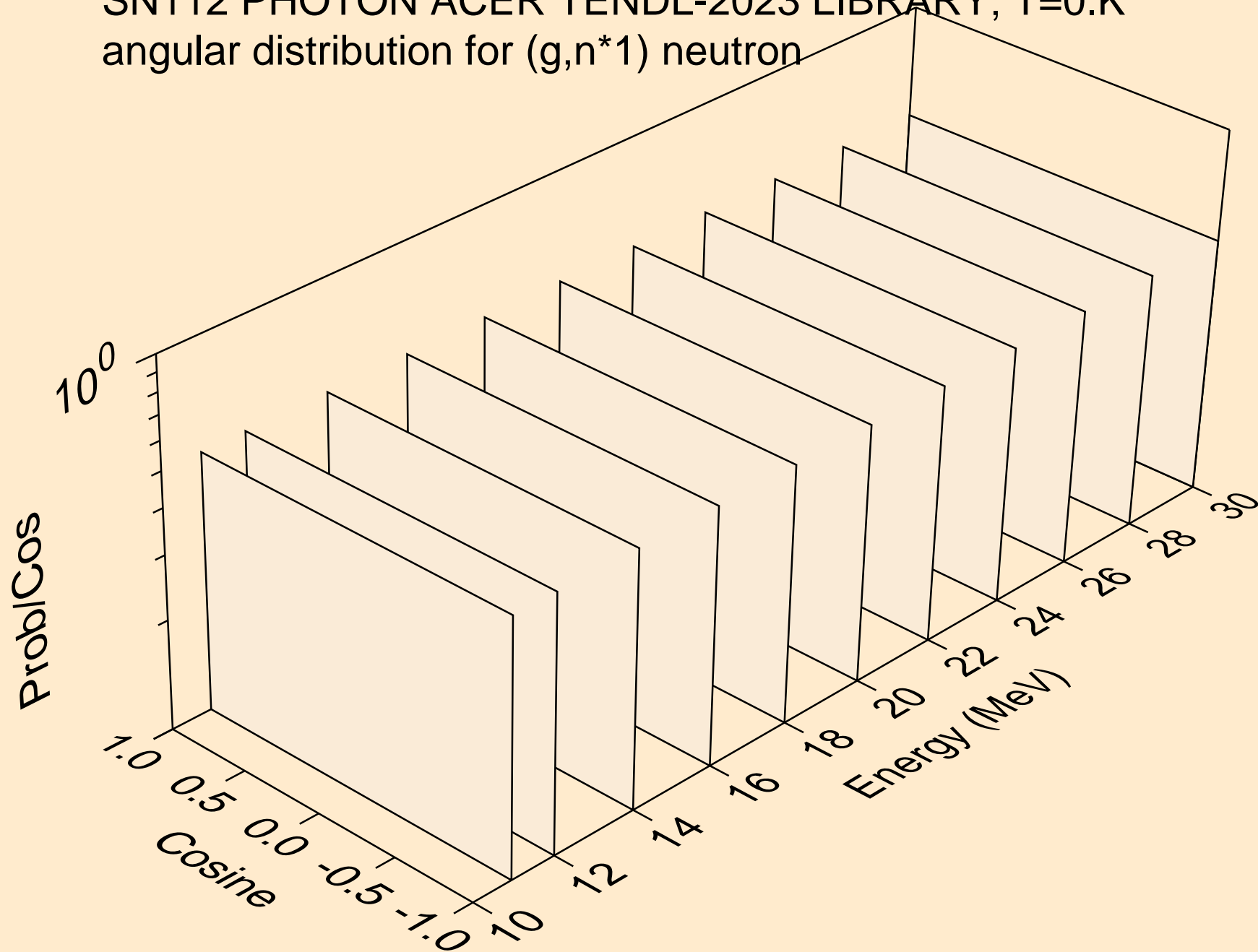

SN112 PHOTON ACER TENDL-2023 LIBRARY; T=0.K
angular distribution for (g,n*2) neutron

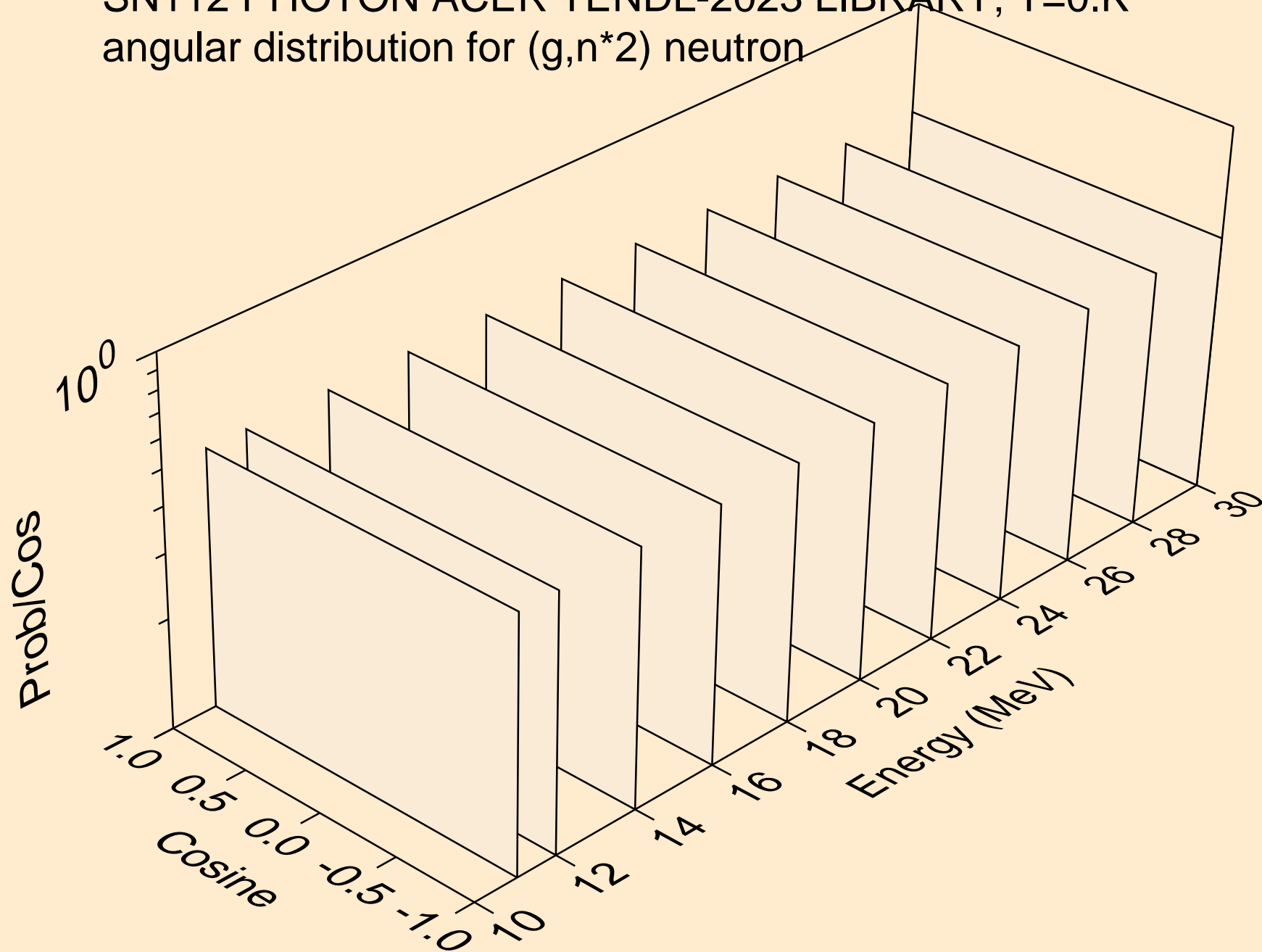

SN112 PHOTON ACER TENDL-2023 LIBRARY; T=0.K
angular distribution for (g,n*3) neutron

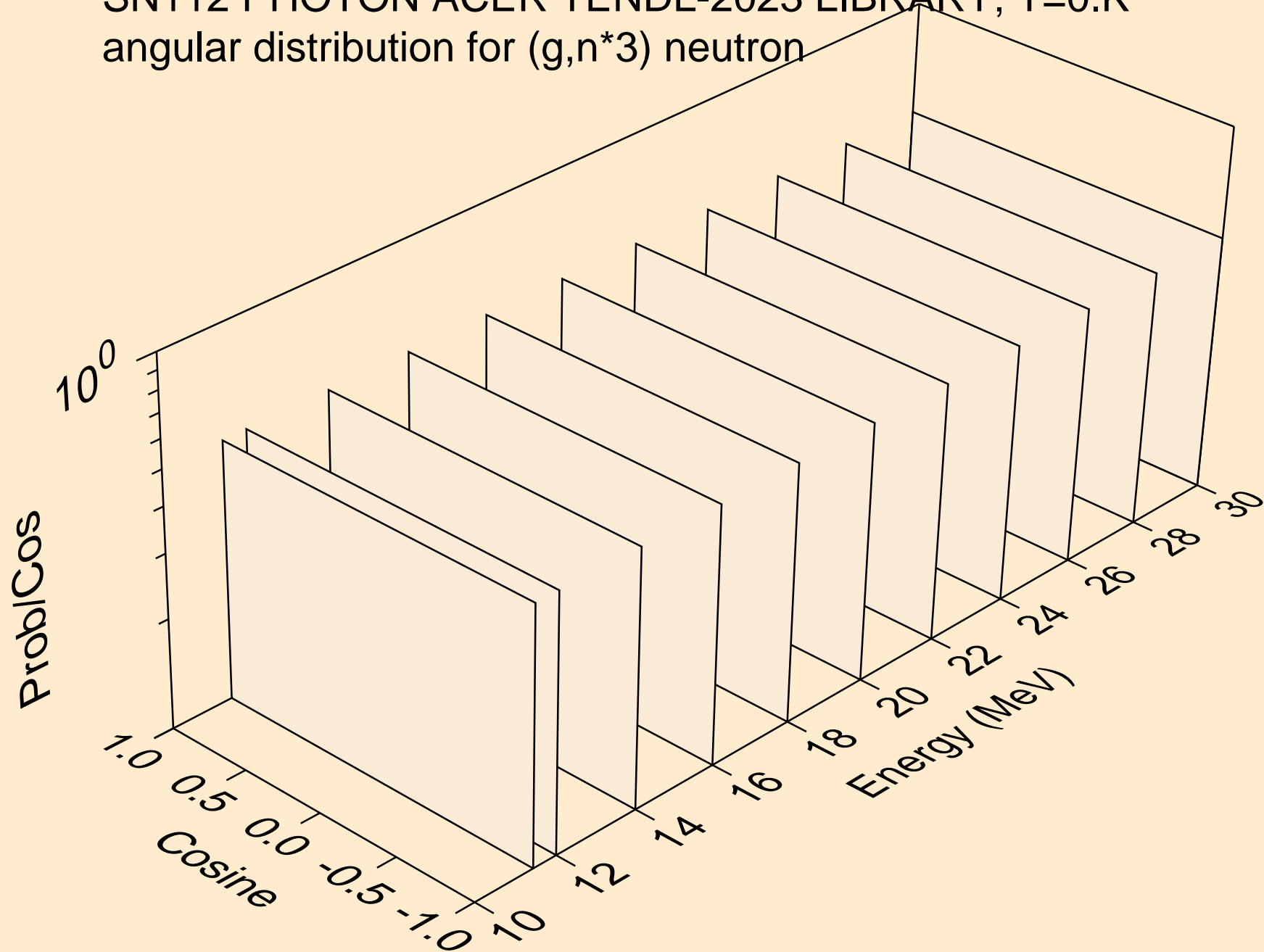

SN112 PHOTON ACER TENDL-2023 LIBRARY; T=0.K
angular distribution for (g,n*4) neutron

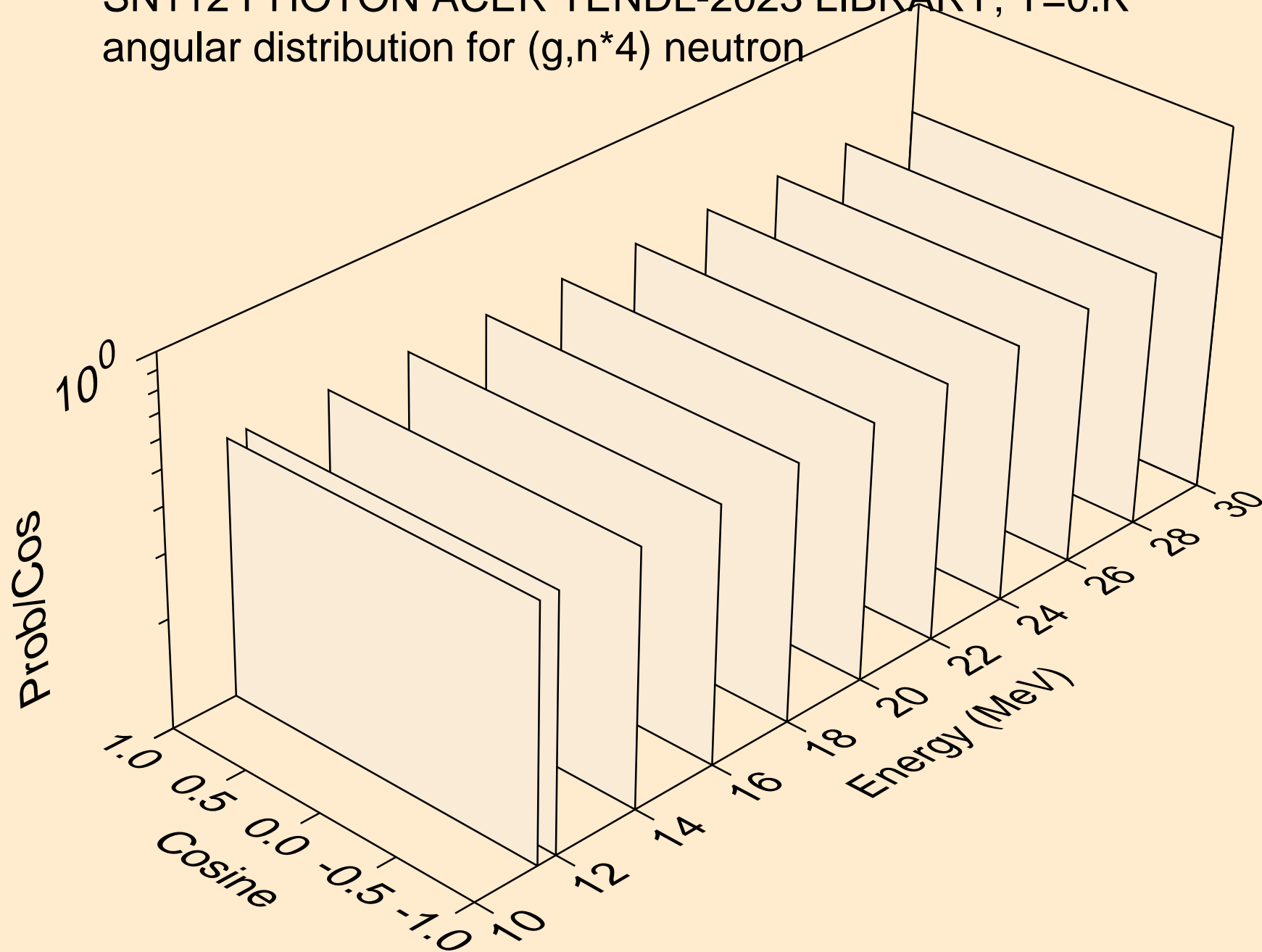

SN112 PHOTON ACER TENDL-2023 LIBRARY; T=0.K
angular distribution for (g,n*5) neutron

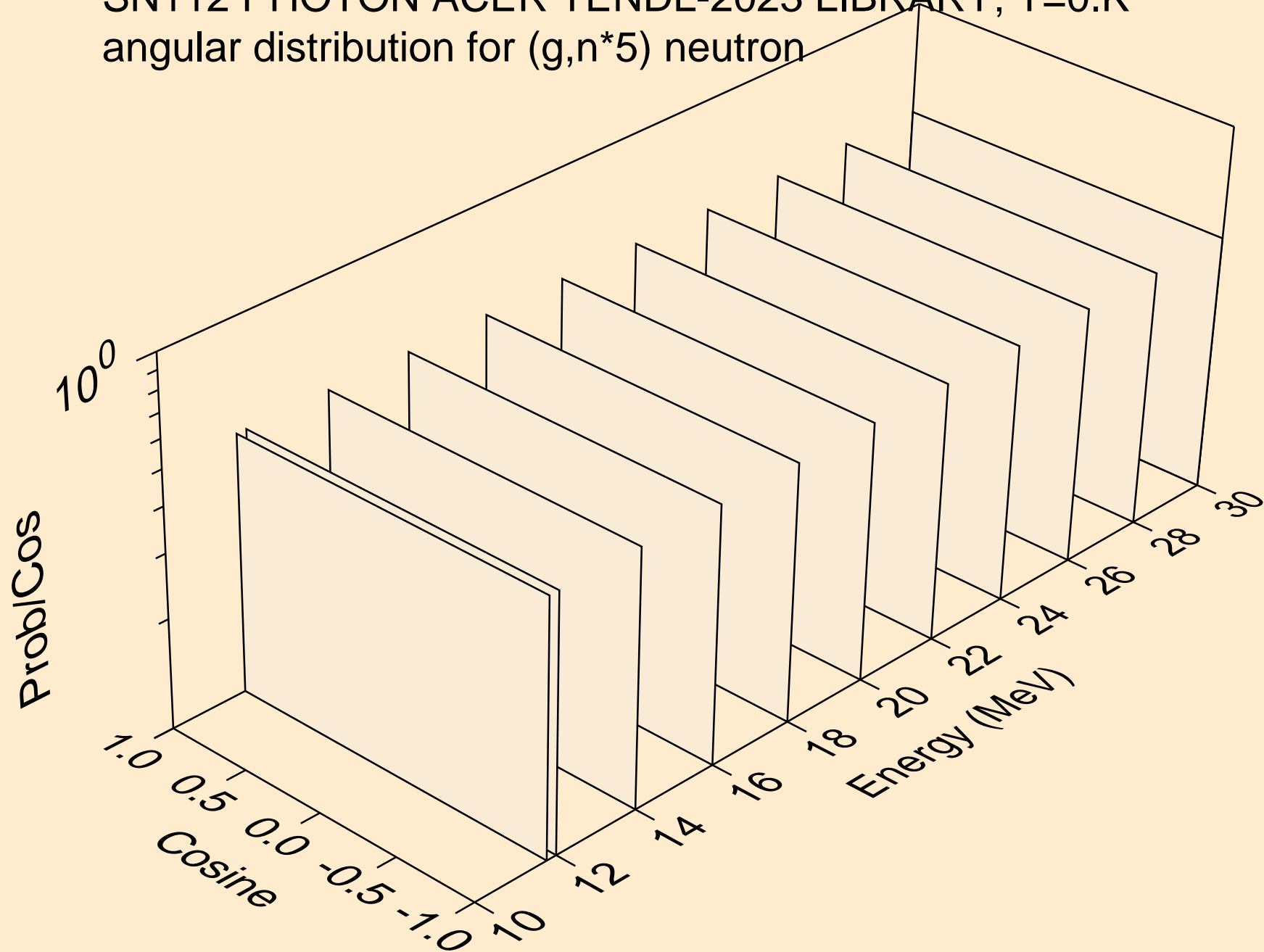

SN112 PHOTON ACER TENDL-2023 LIBRARY; T=0.K
angular distribution for (g,n*6) neutron

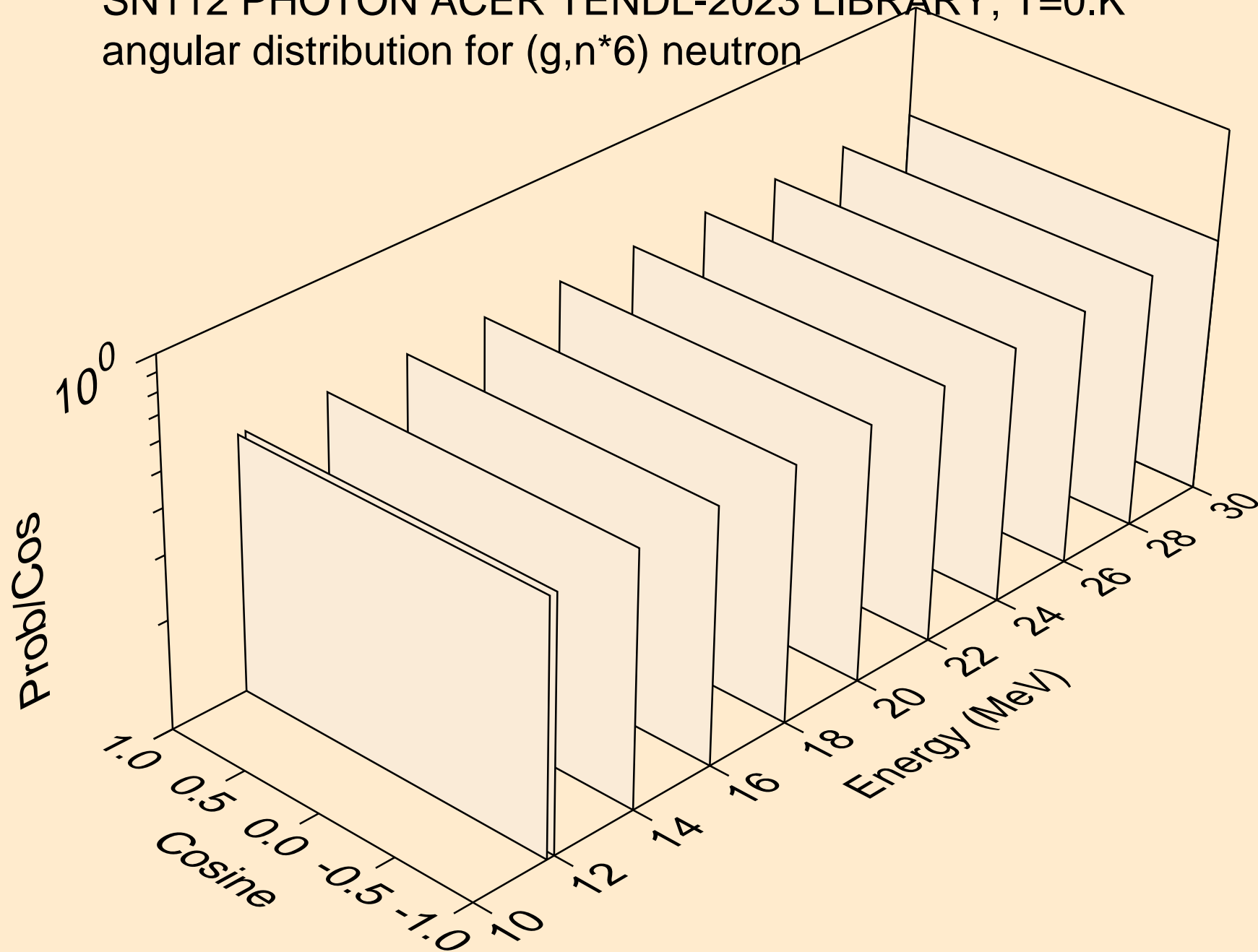

SN112 PHOTON ACER TENDL-2023 LIBRARY; T=0.K
angular distribution for (g,n*7) neutron

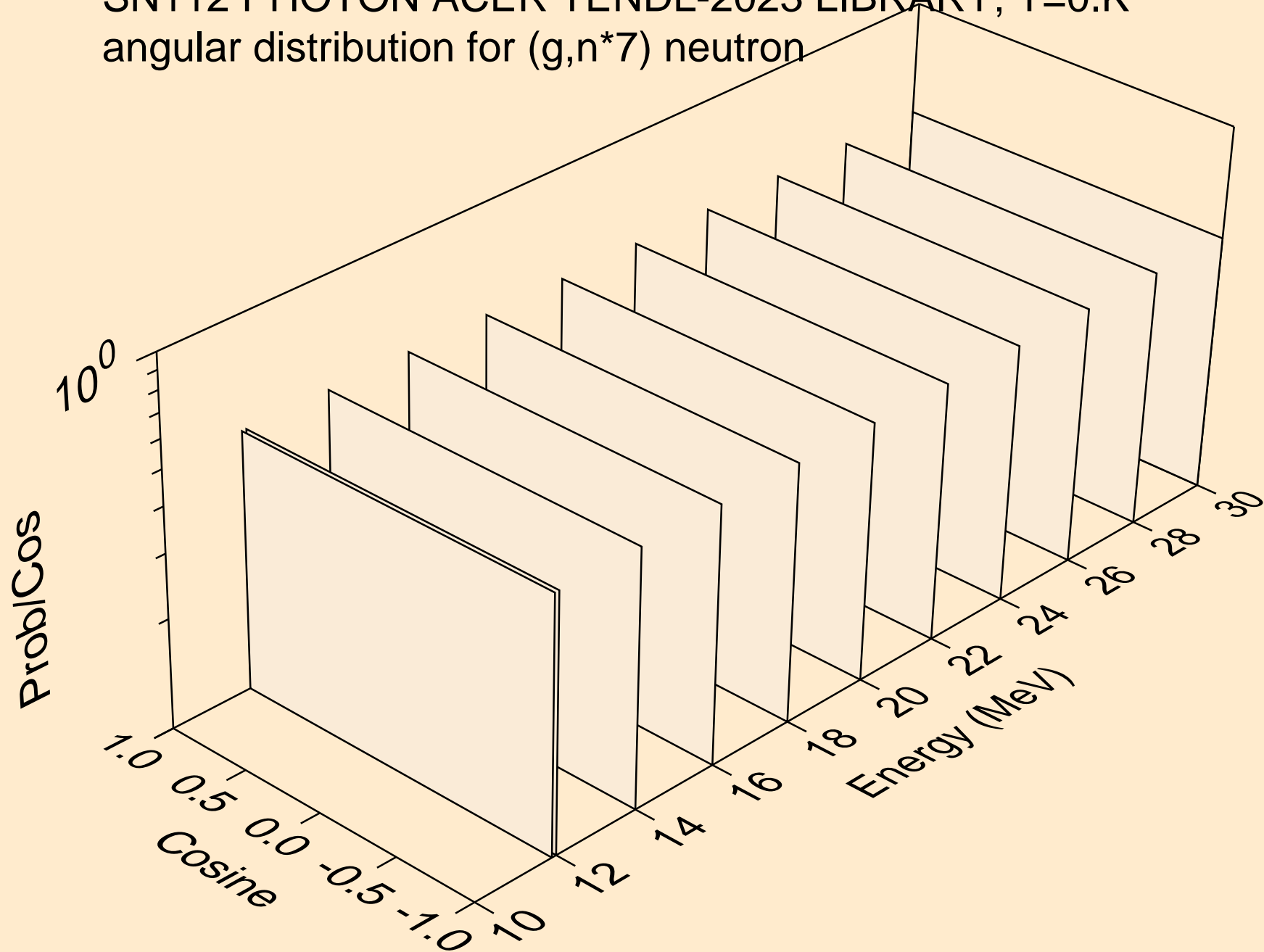

SN112 PHOTON ACER TENDL-2023 LIBRARY; T=0.K
neutrons from (g,n*c)

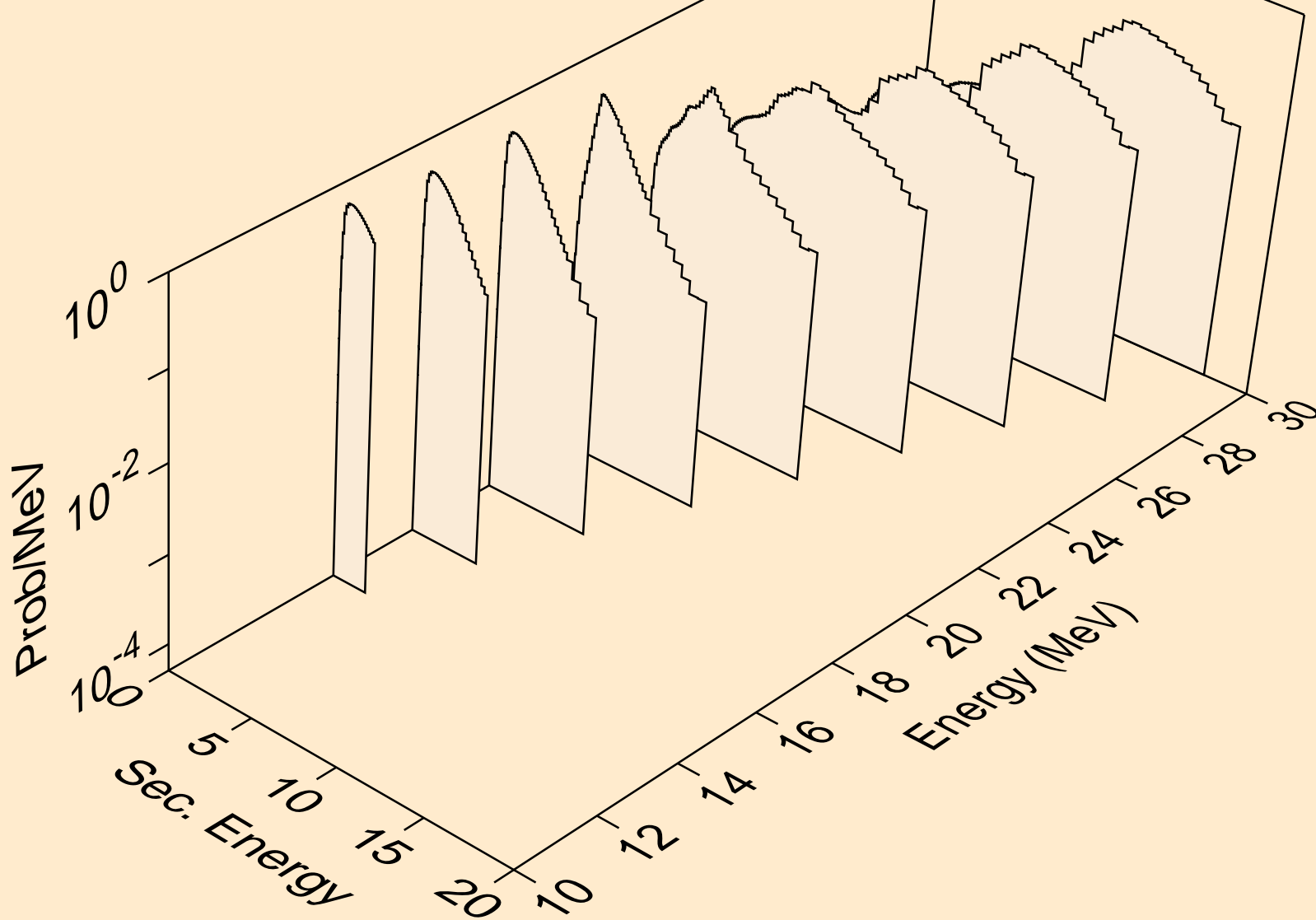

SN112 PHOTON ACER TENDL-2023 LIBRARY; T=0.K
photons from (g,x)

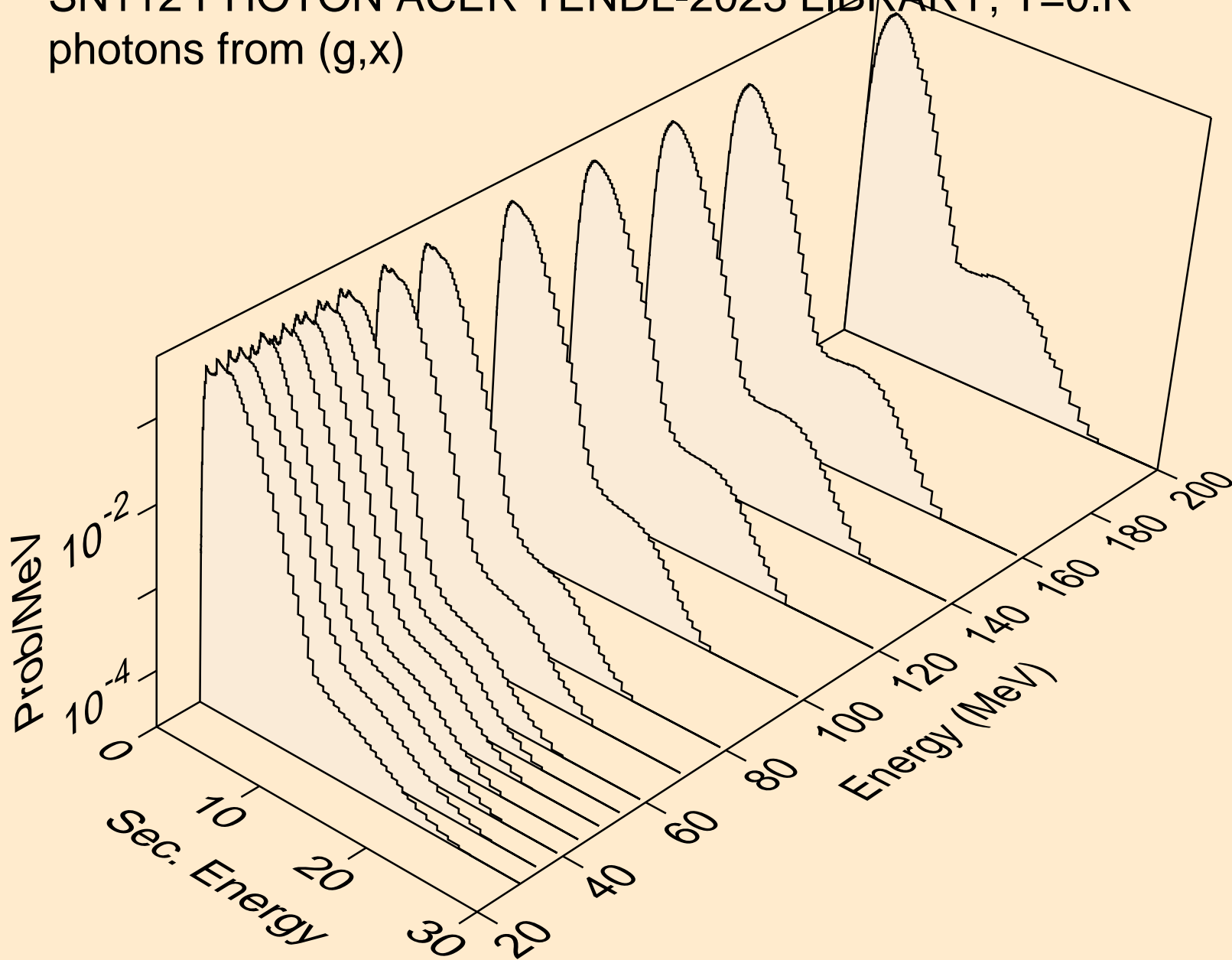

SN112 PHOTON ACER TENDL-2023 LIBRARY; T=0.K
photons from (g,2n)

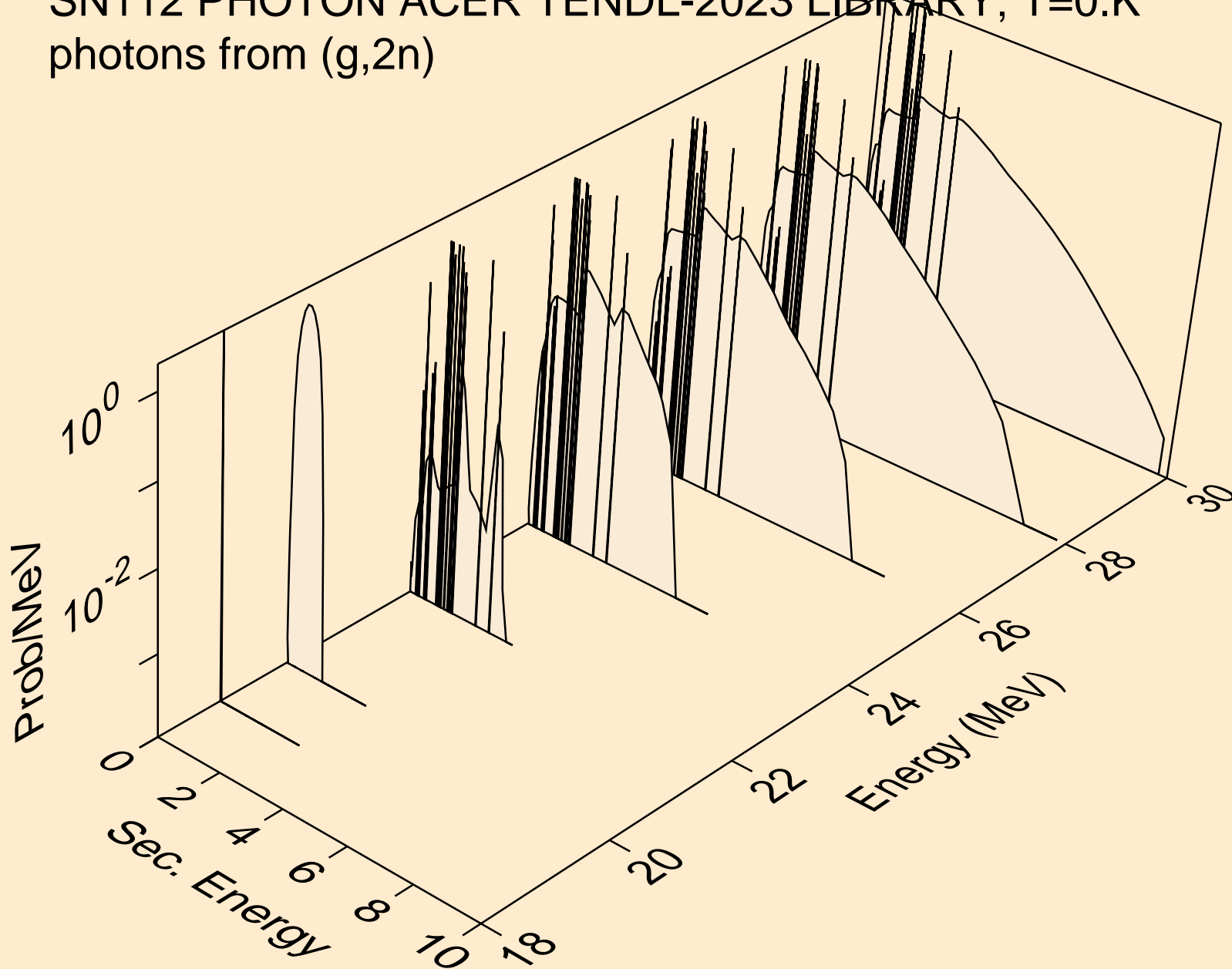

SN112 PHOTON ACER TENDL-2023 LIBRARY; T=0.K
photons from (g,n*)a

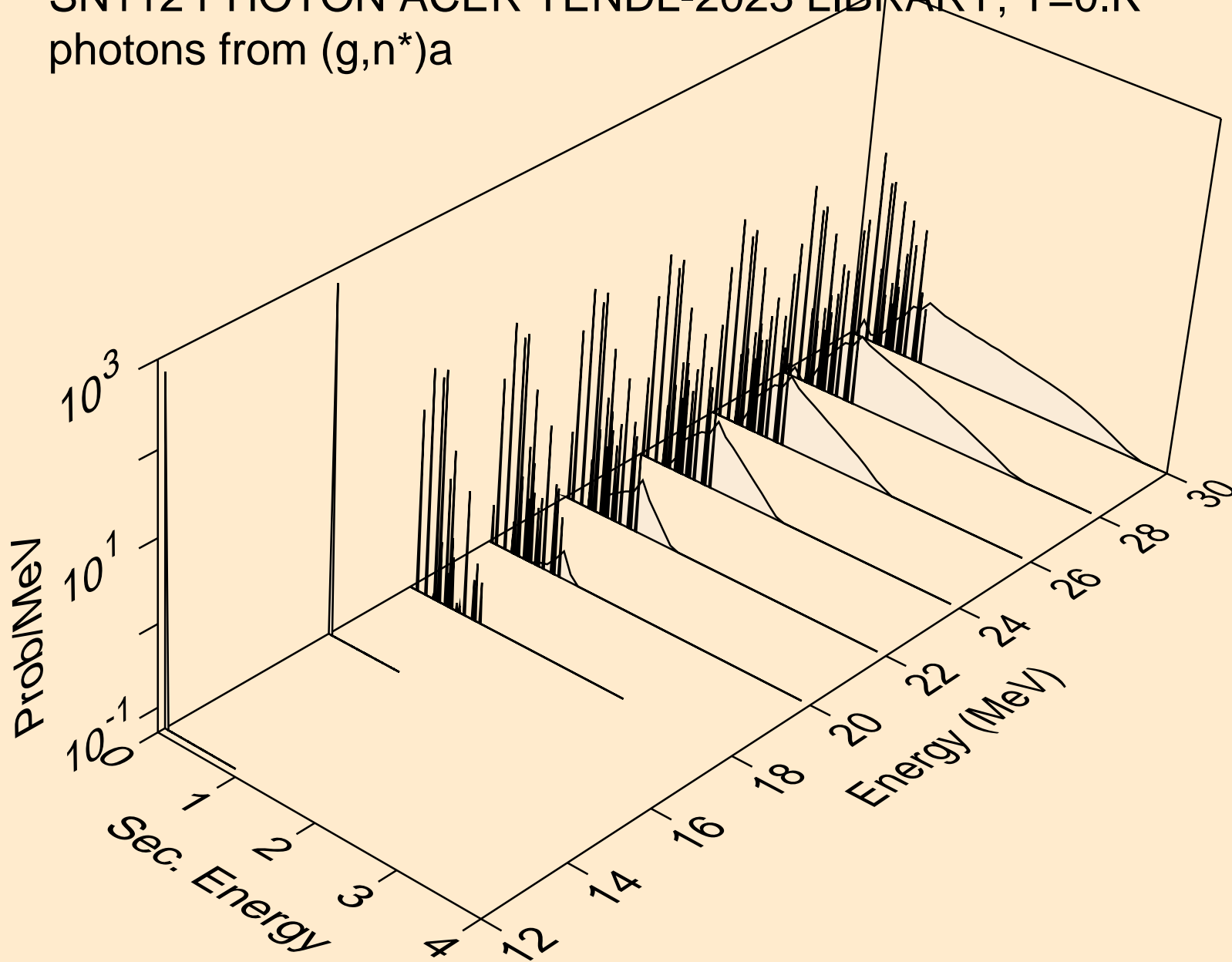

SN112 PHOTON ACER TENDL-2023 LIBRARY; T=0.K
photons from (g,2n)a

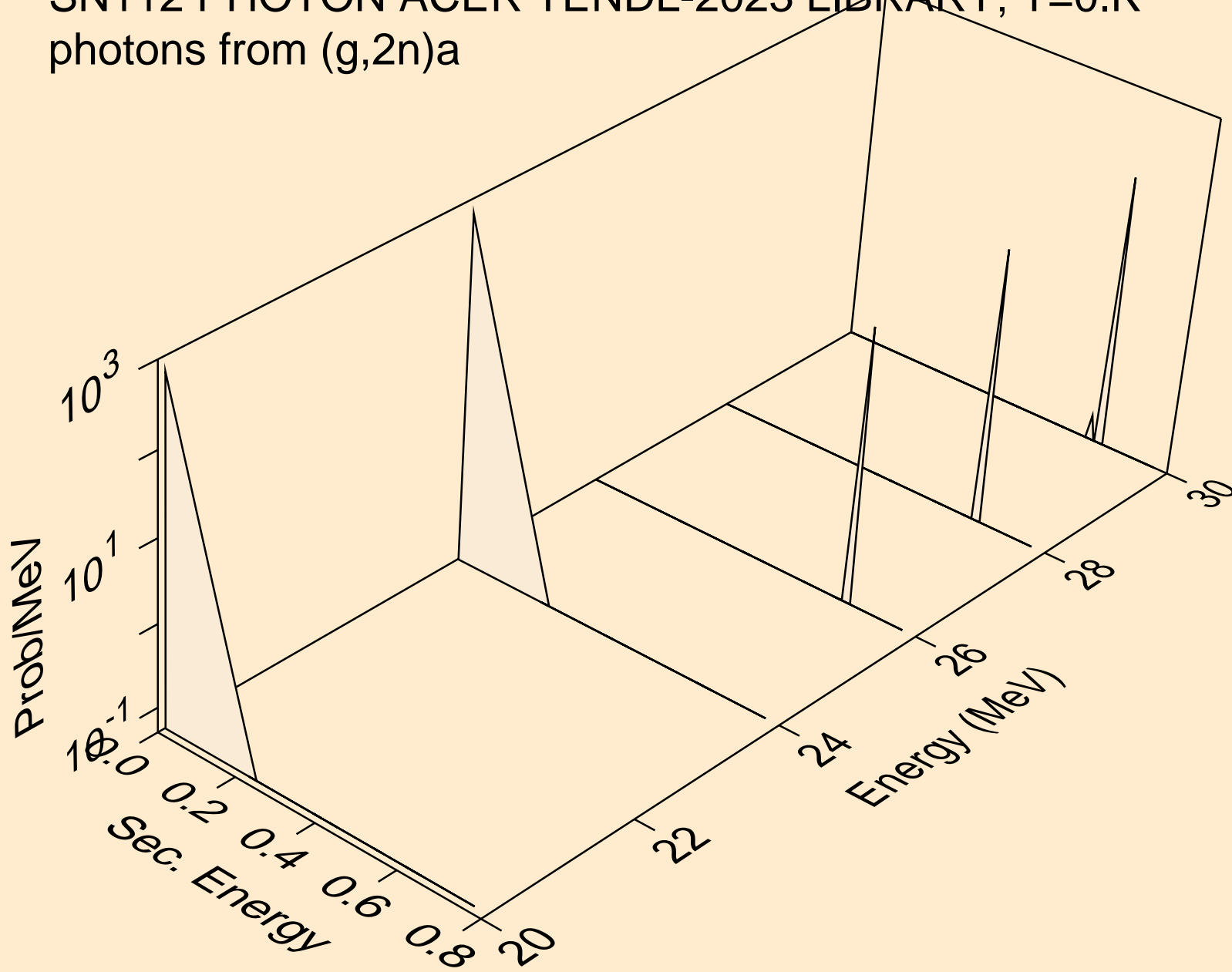

SN112 PHOTON ACER TENDL-2023 LIBRARY; T=0.K
photons from (g,n*)p

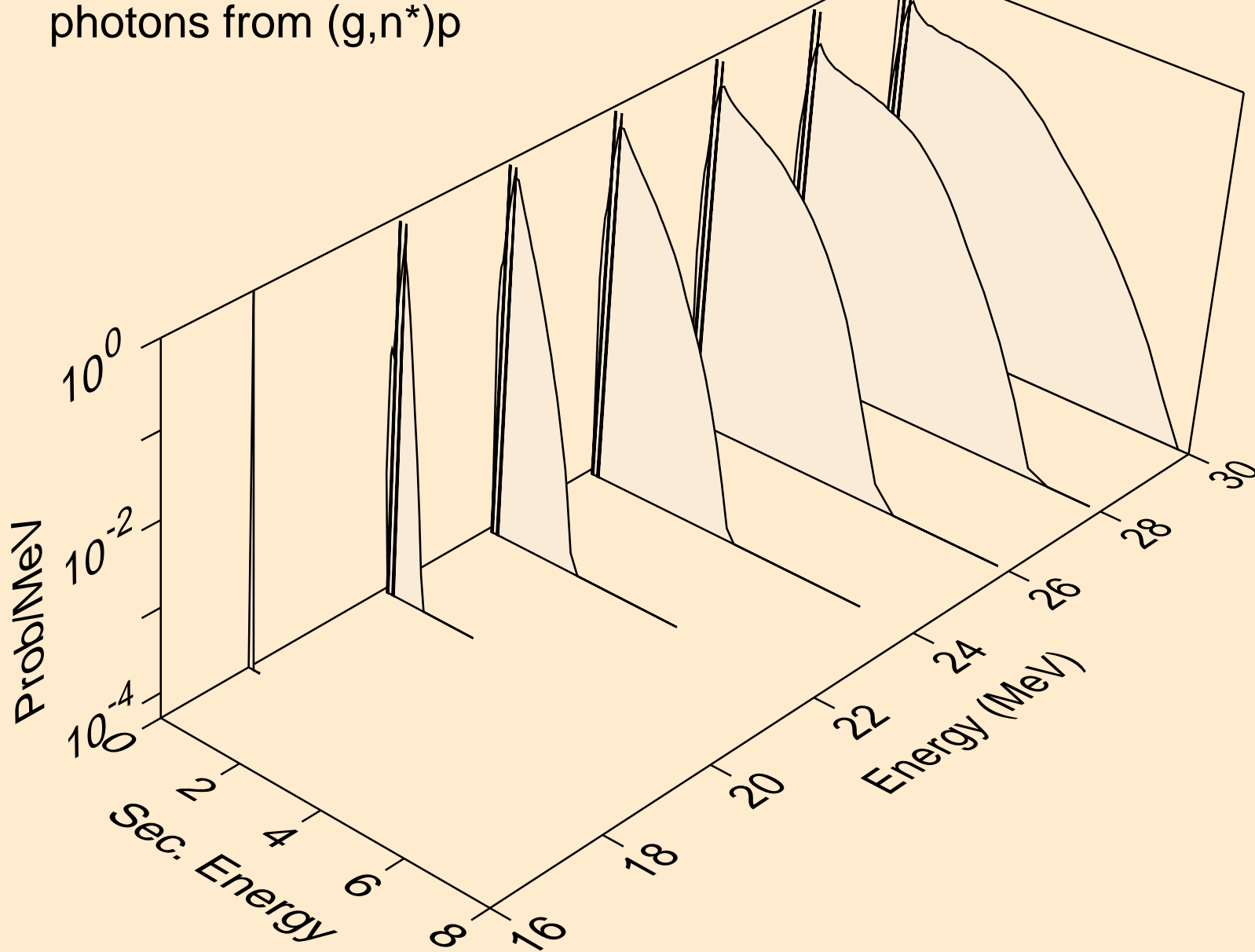

SN112 PHOTON ACER TENDL-2023 LIBRARY; T=0.K
photons from (g,n*)d

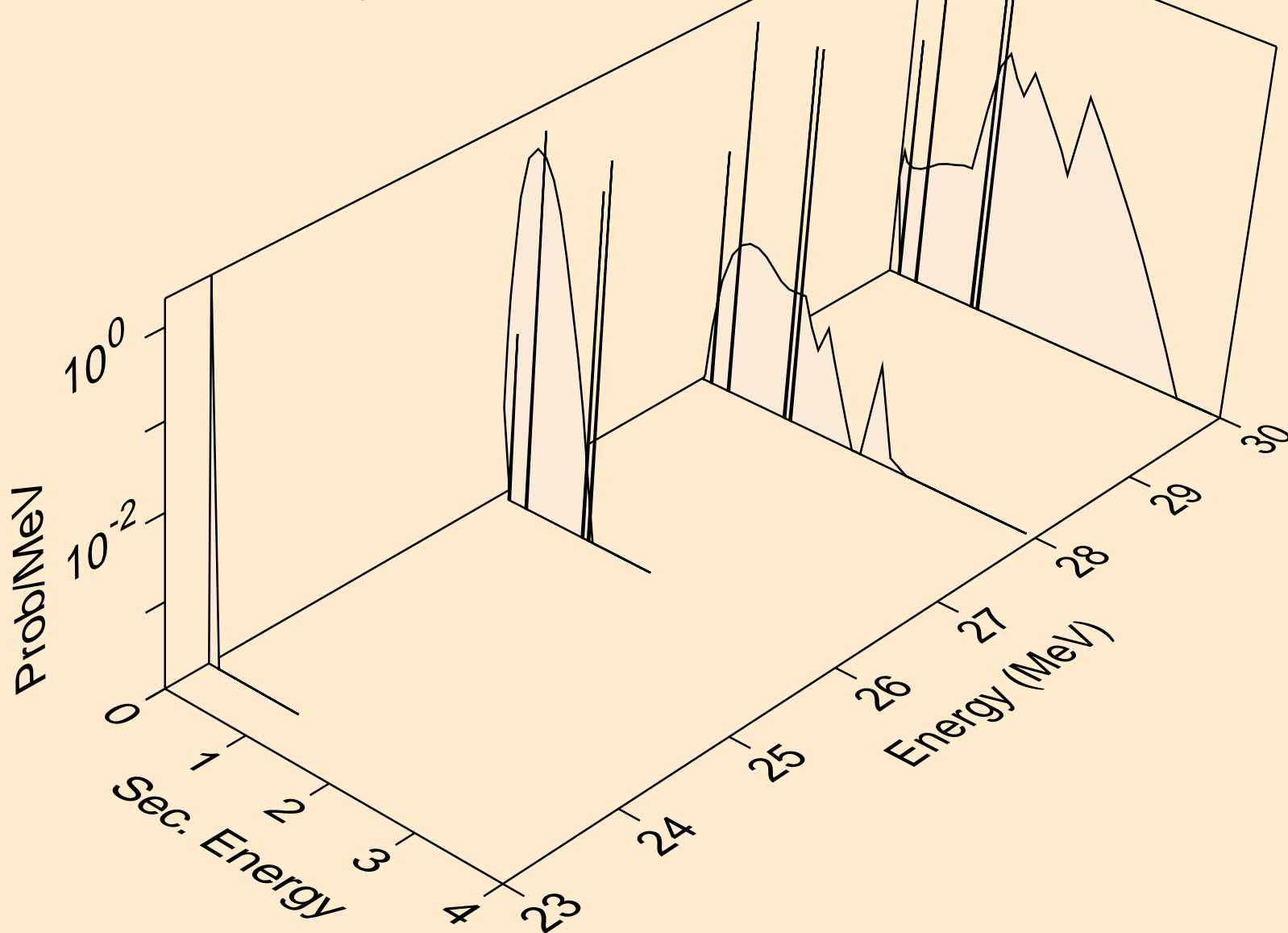

SN112 PHOTON ACER TENDL-2023 LIBRARY; T=0.K
photons from (g,2np)

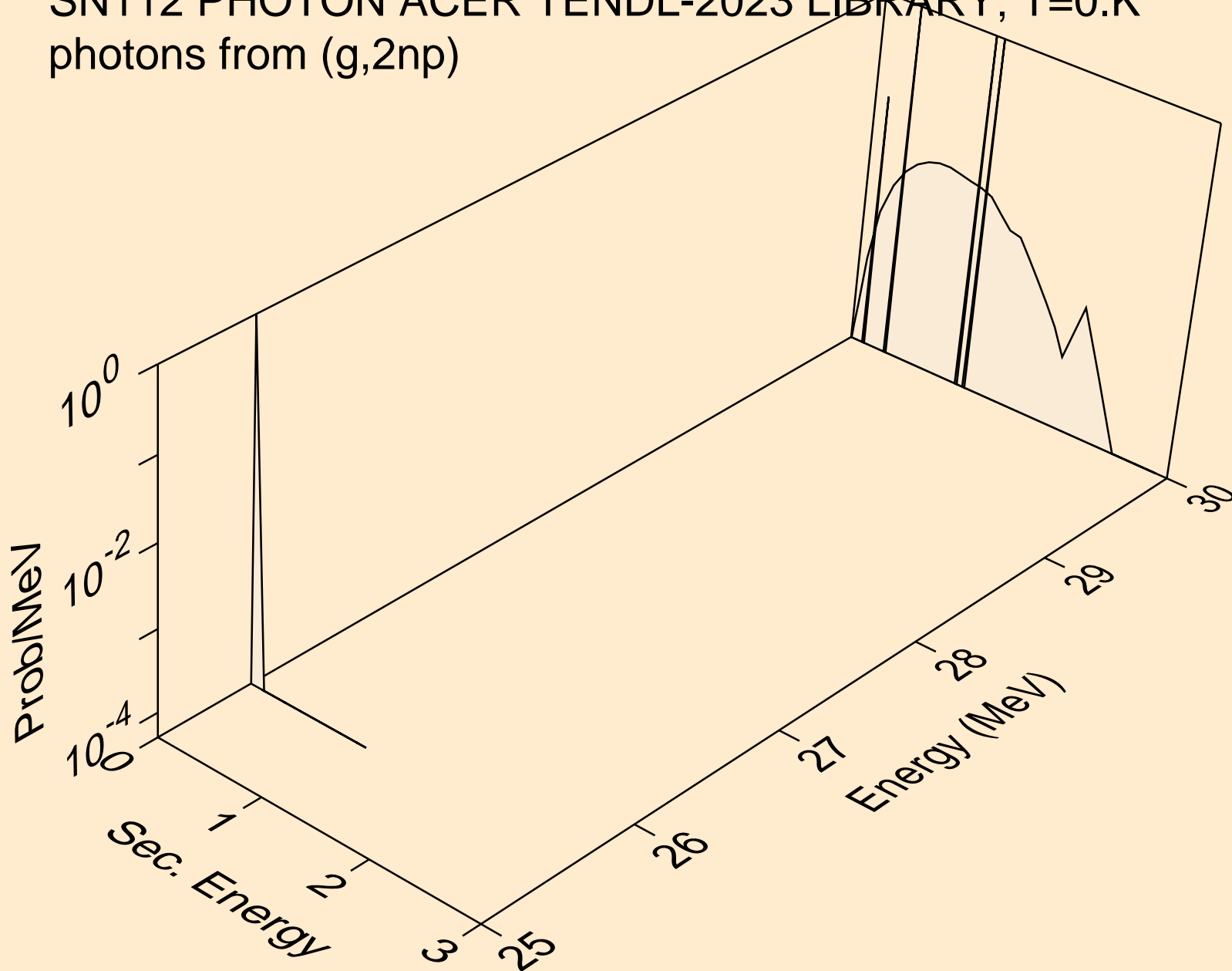

SN112 PHOTON ACER TENDL-2023 LIBRARY; T=0.K
photons from (g,n2p)

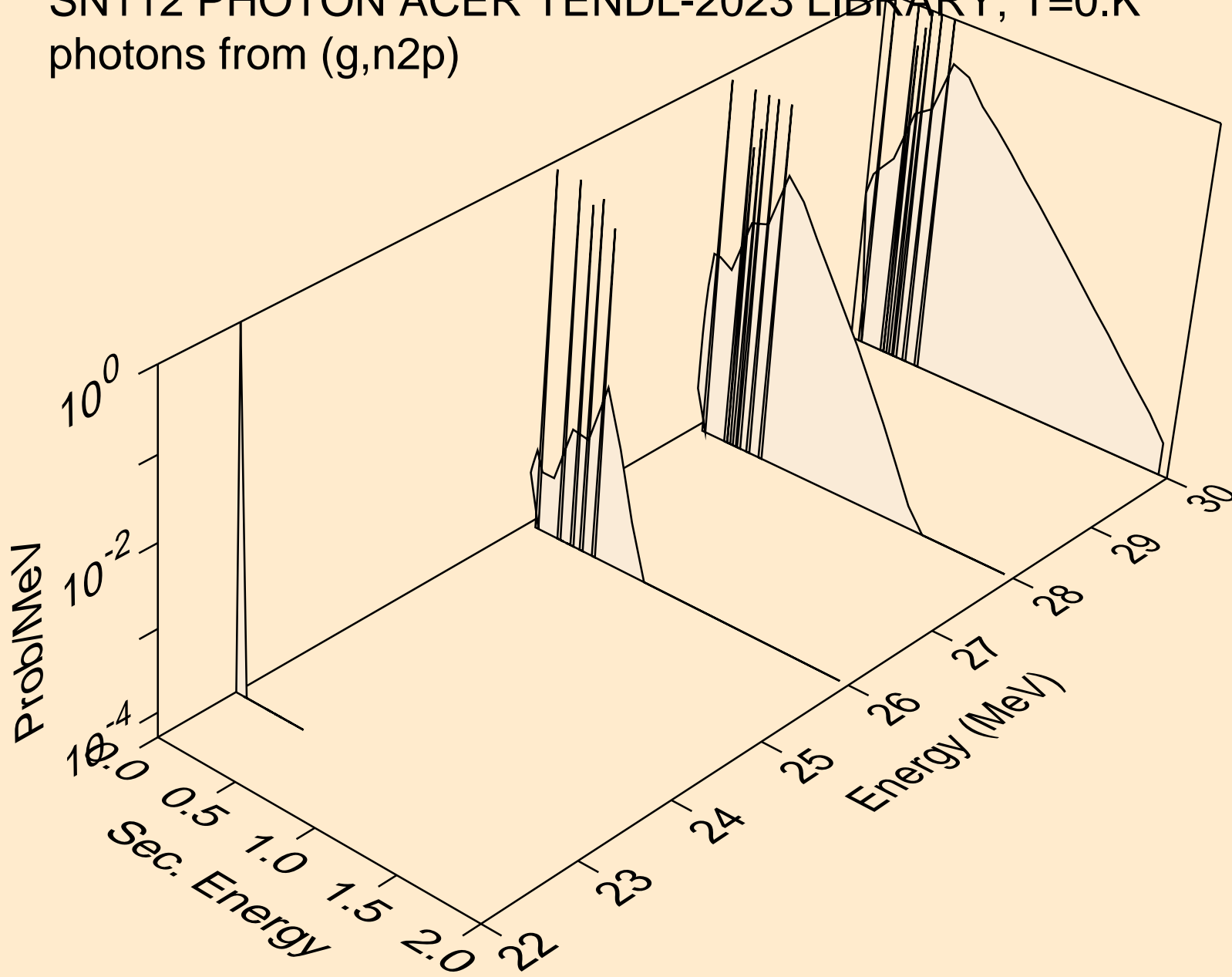

SN112 PHOTON ACER TENDL-2023 LIBRARY; T=0.K
photons from (g,n*c)

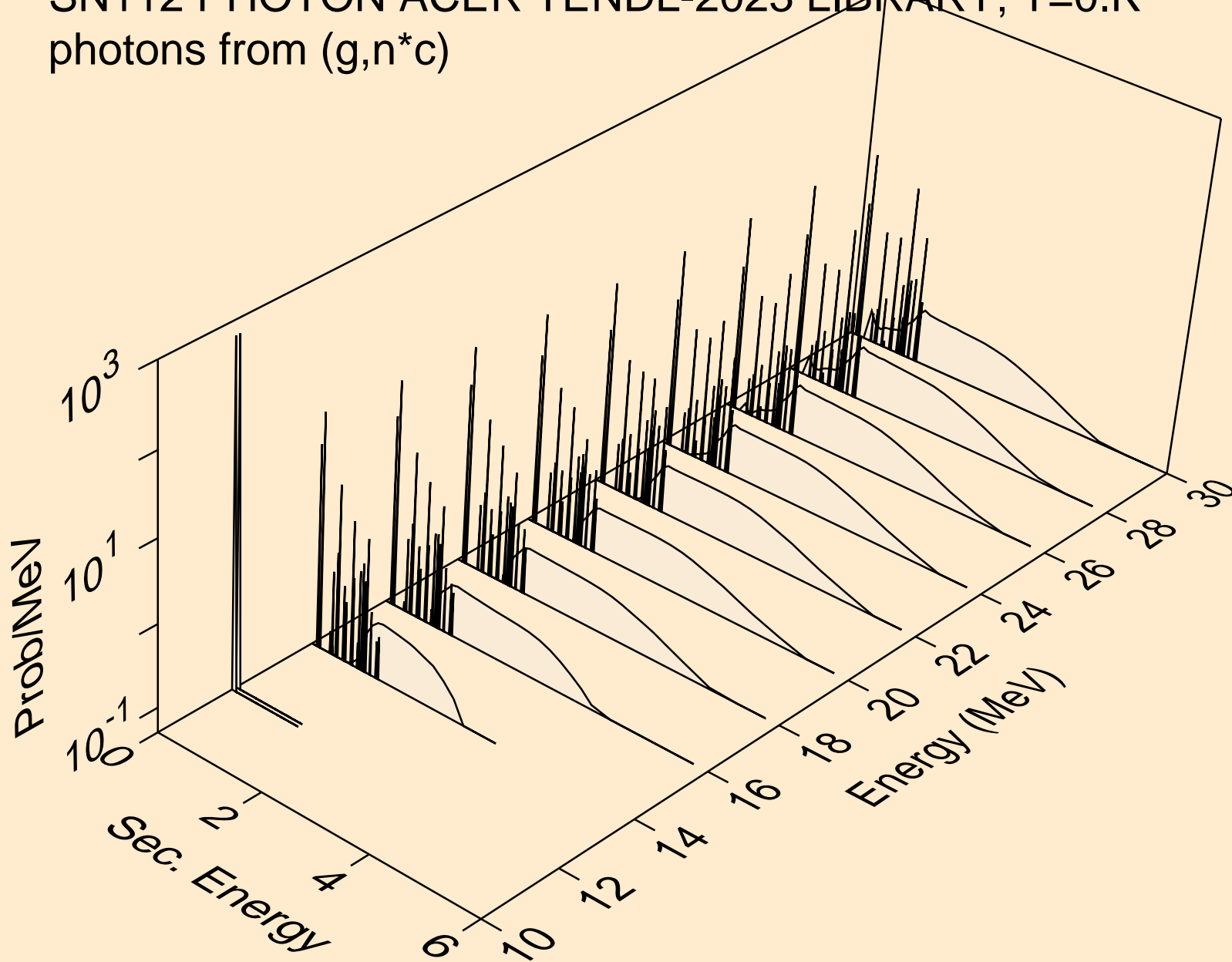

SN112 PHOTON ACER TENDL-2023 LIBRARY; T=0.K
photons from (g,gma)

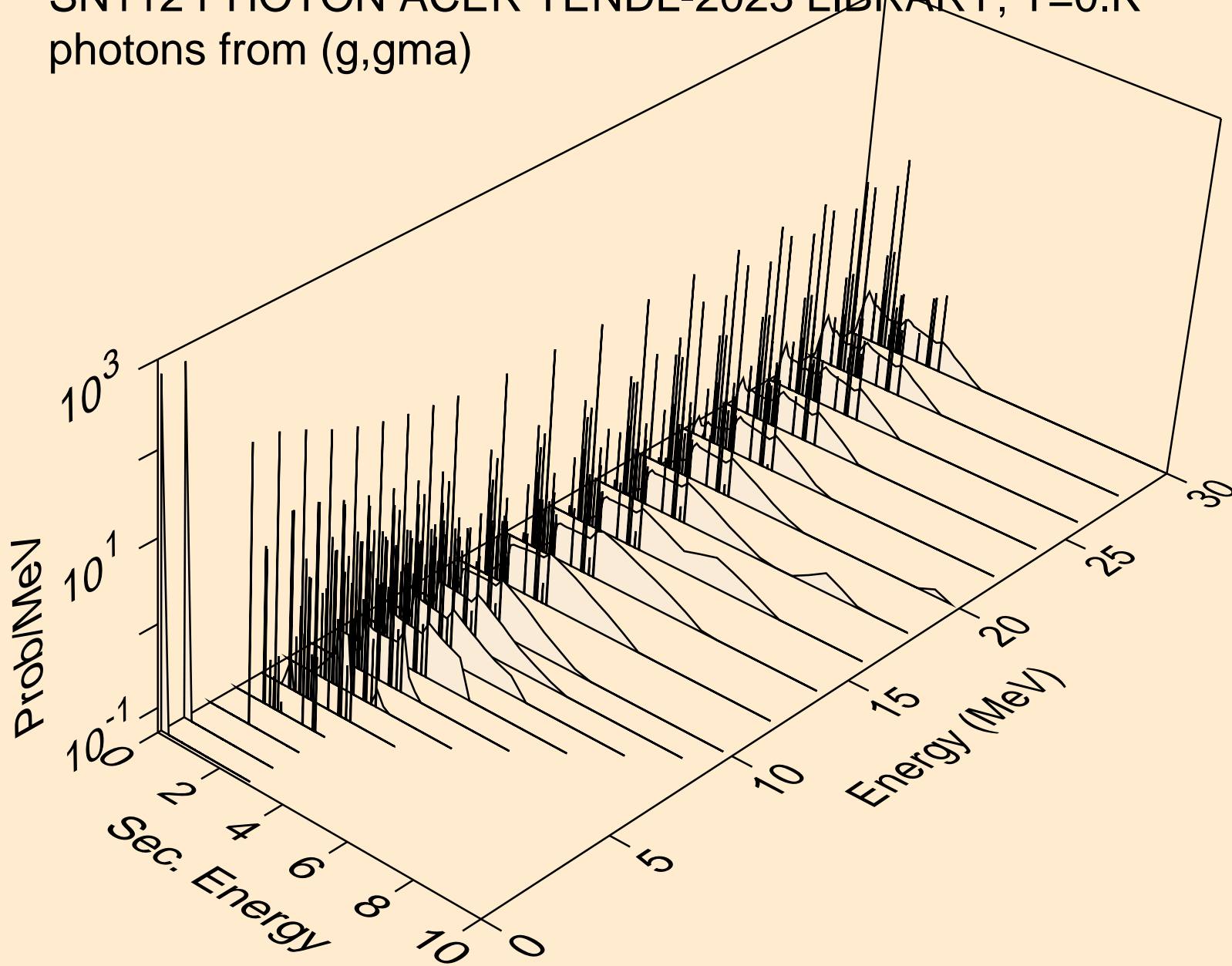

SN112 PHOTON ACER TENDL-2023 LIBRARY; T=0.K
photons from (g,p)

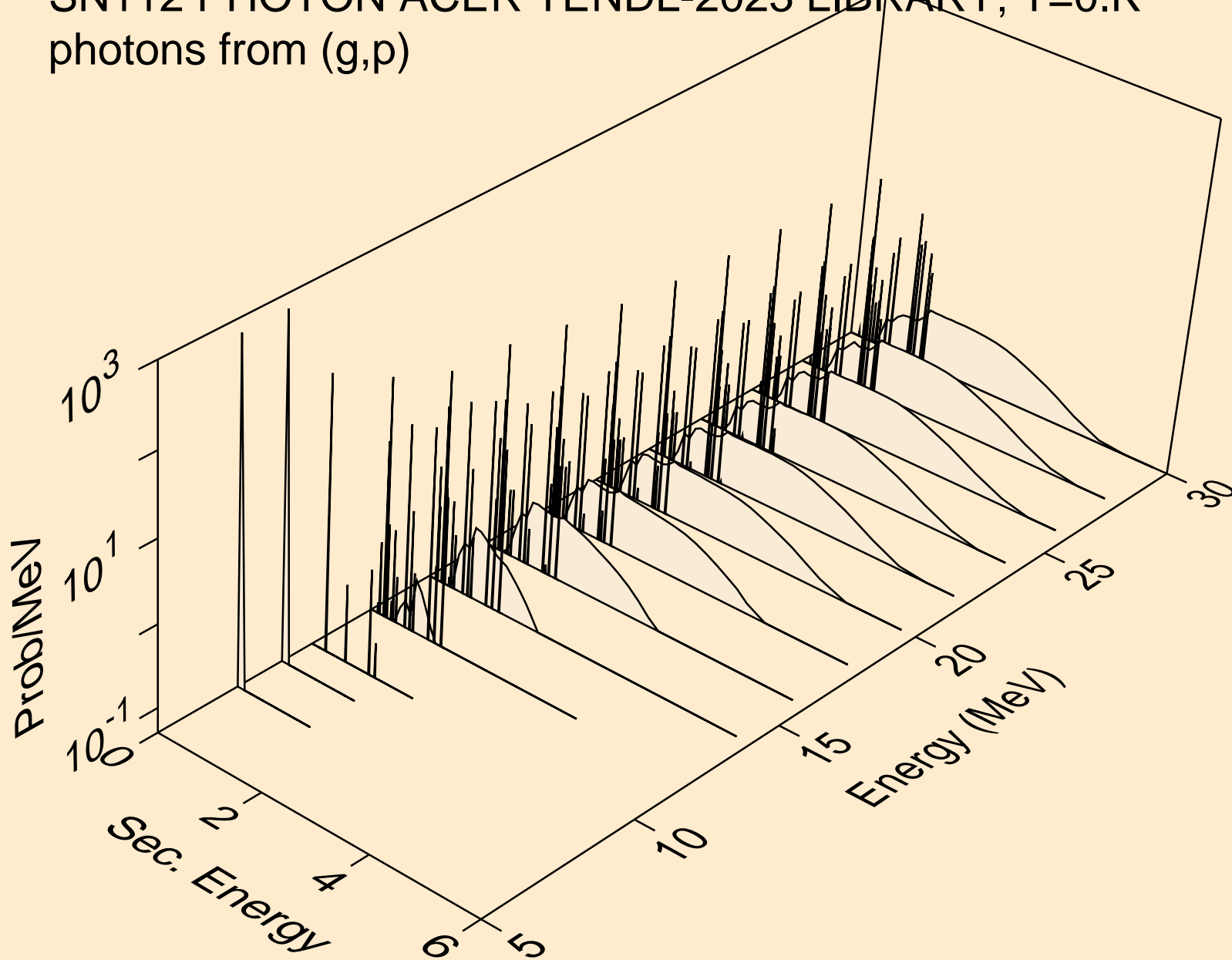

SN112 PHOTON ACER TENDL-2023 LIBRARY; T=0.K
photons from (g,d)

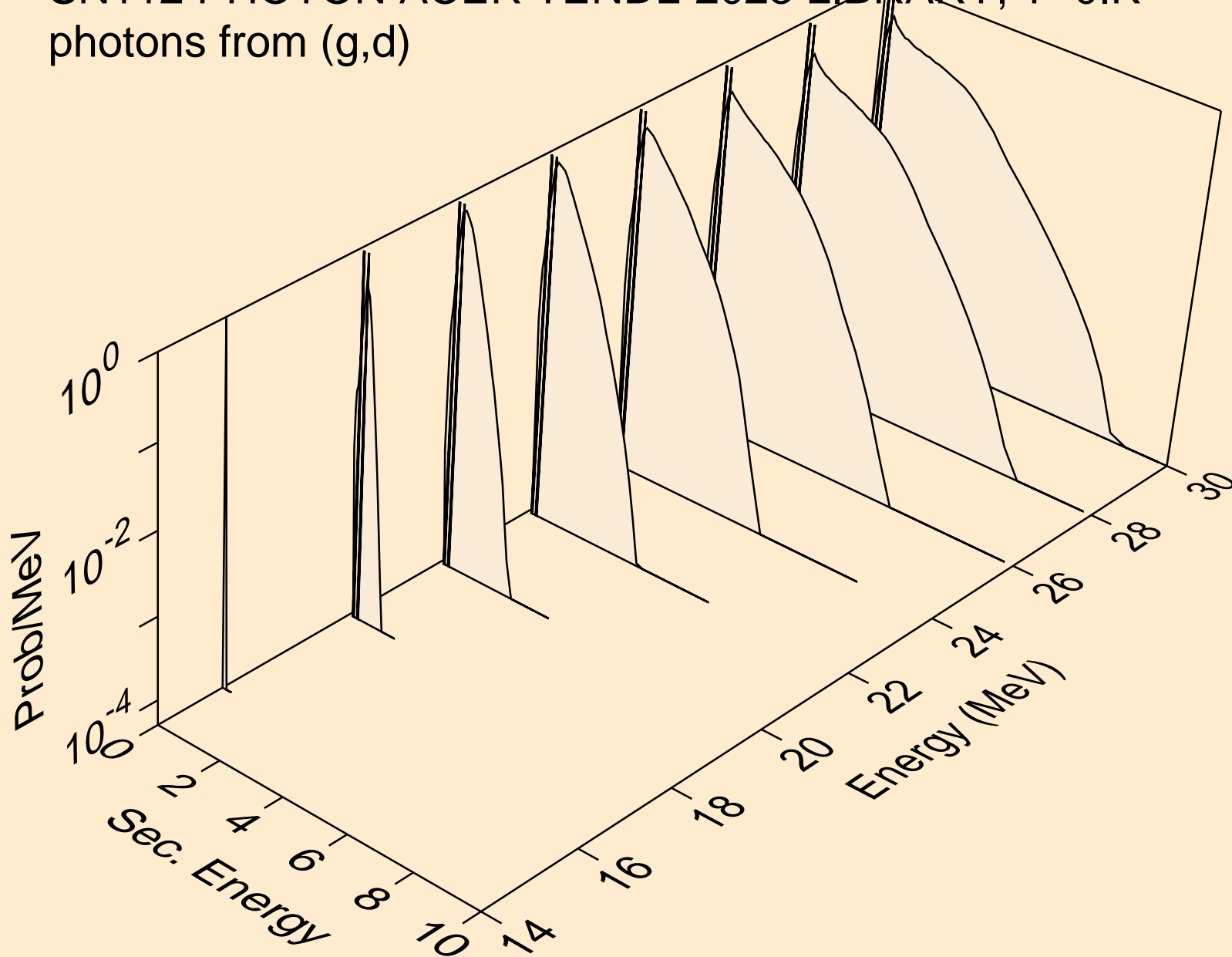

SN112 PHOTON ACER TENDL-2023 LIBRARY; T=0.K
photons from (g,t)

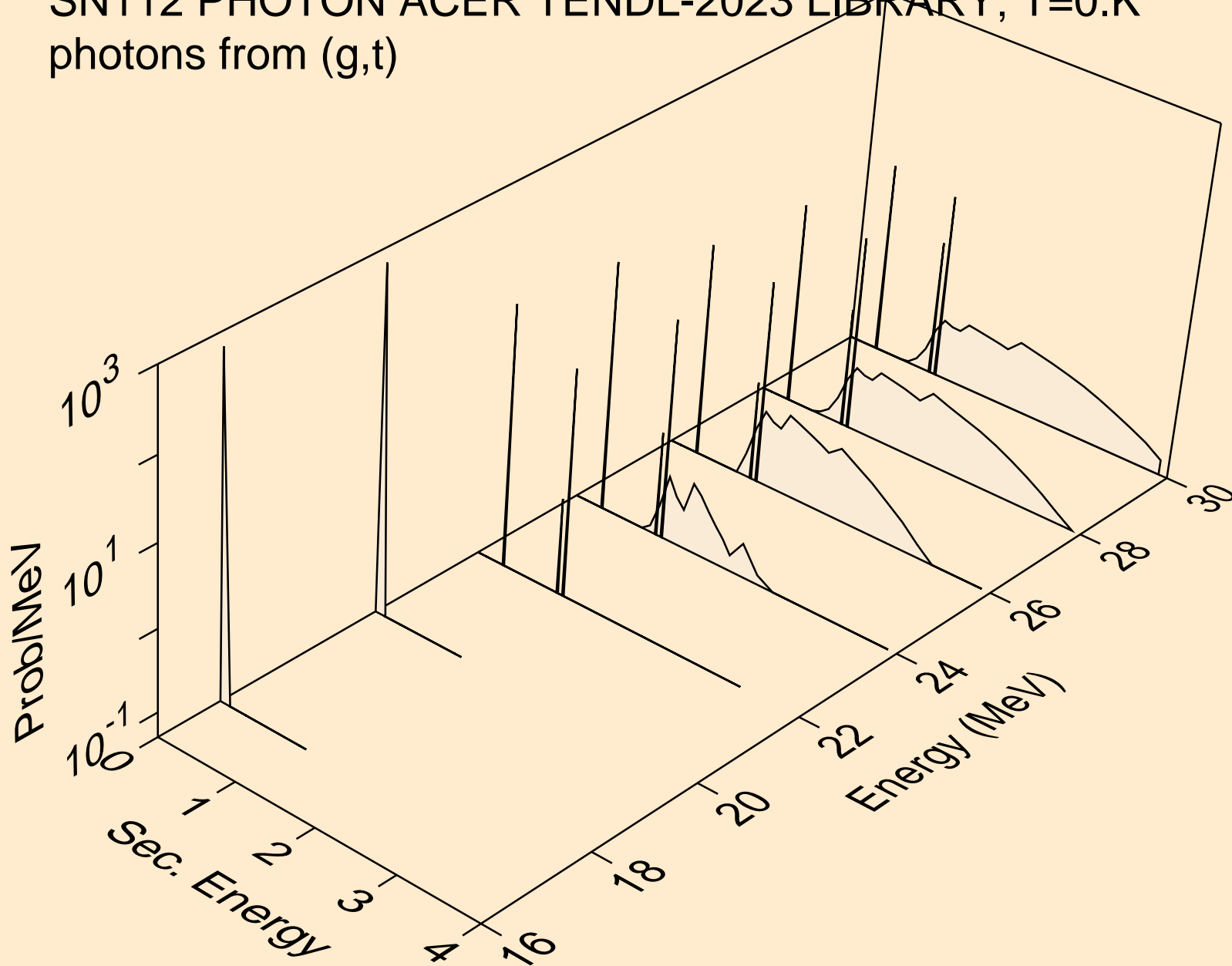

SN112 PHOTON ACER TENDL-2023 LIBRARY; T=0.K
photons from (g,he3)

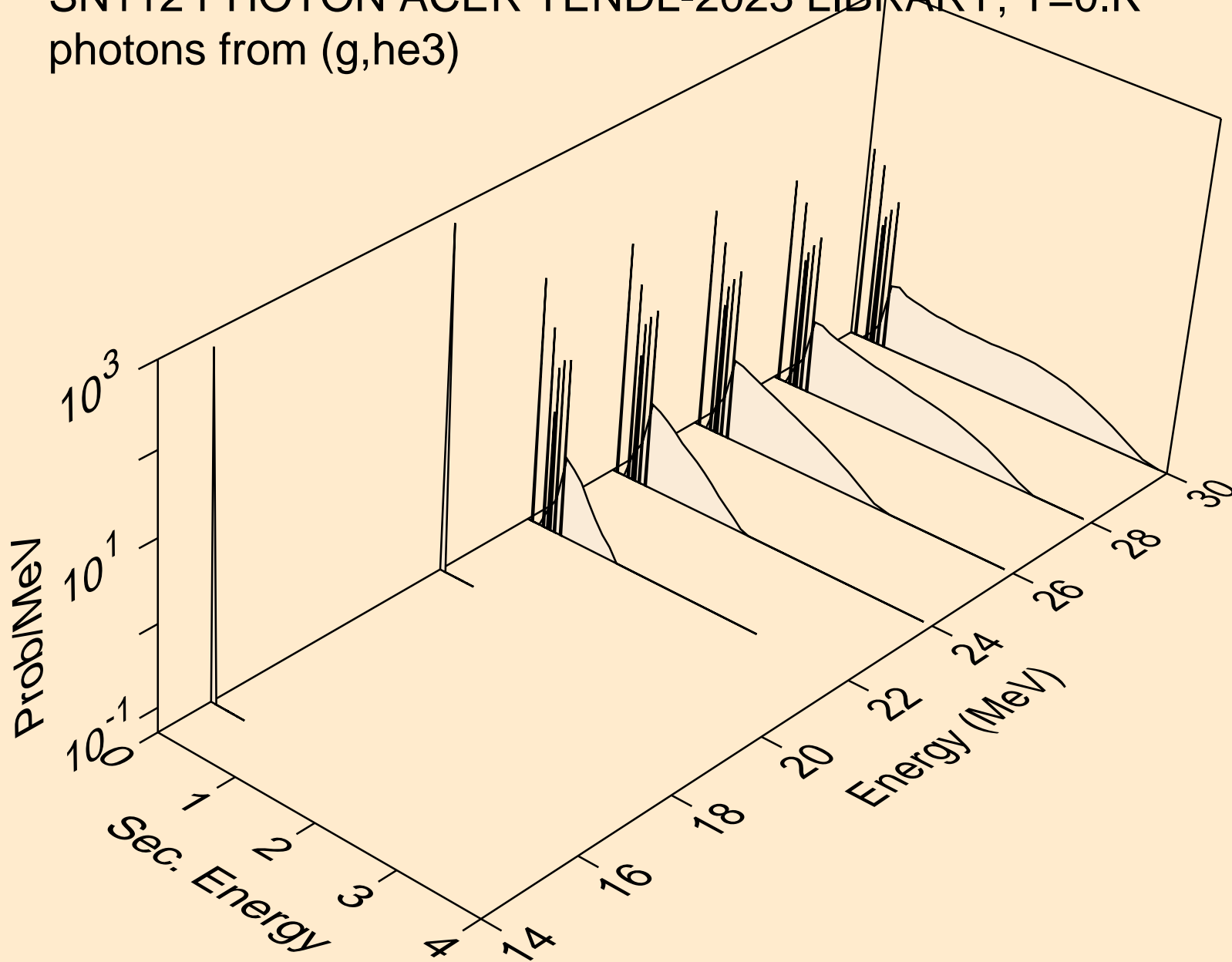

SN112 PHOTON ACER TENDL-2023 LIBRARY; T=0.K
photons from (g,a)

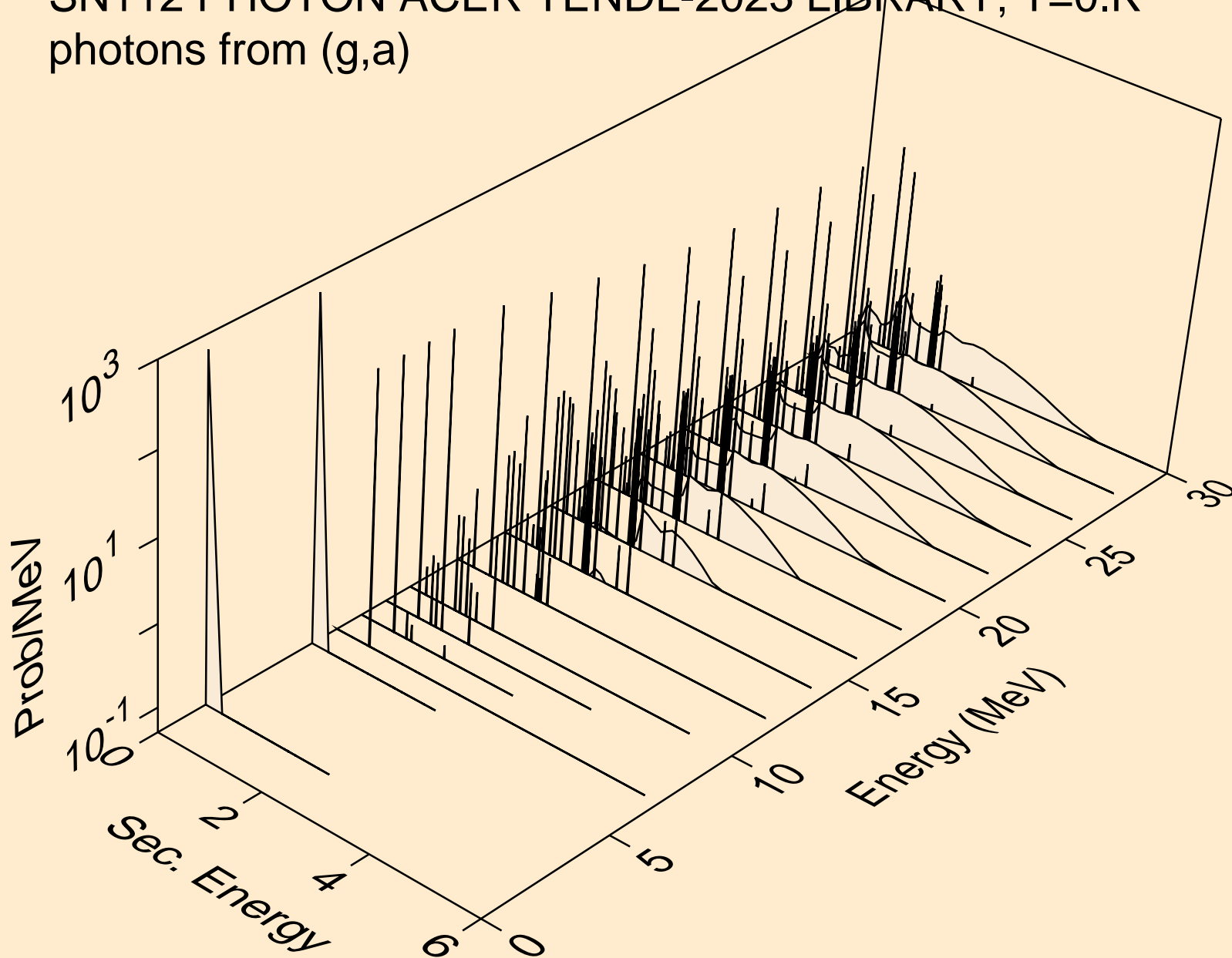

SN112 PHOTON ACER TENDL-2023 LIBRARY; T=0.K
photons from (g,2a)

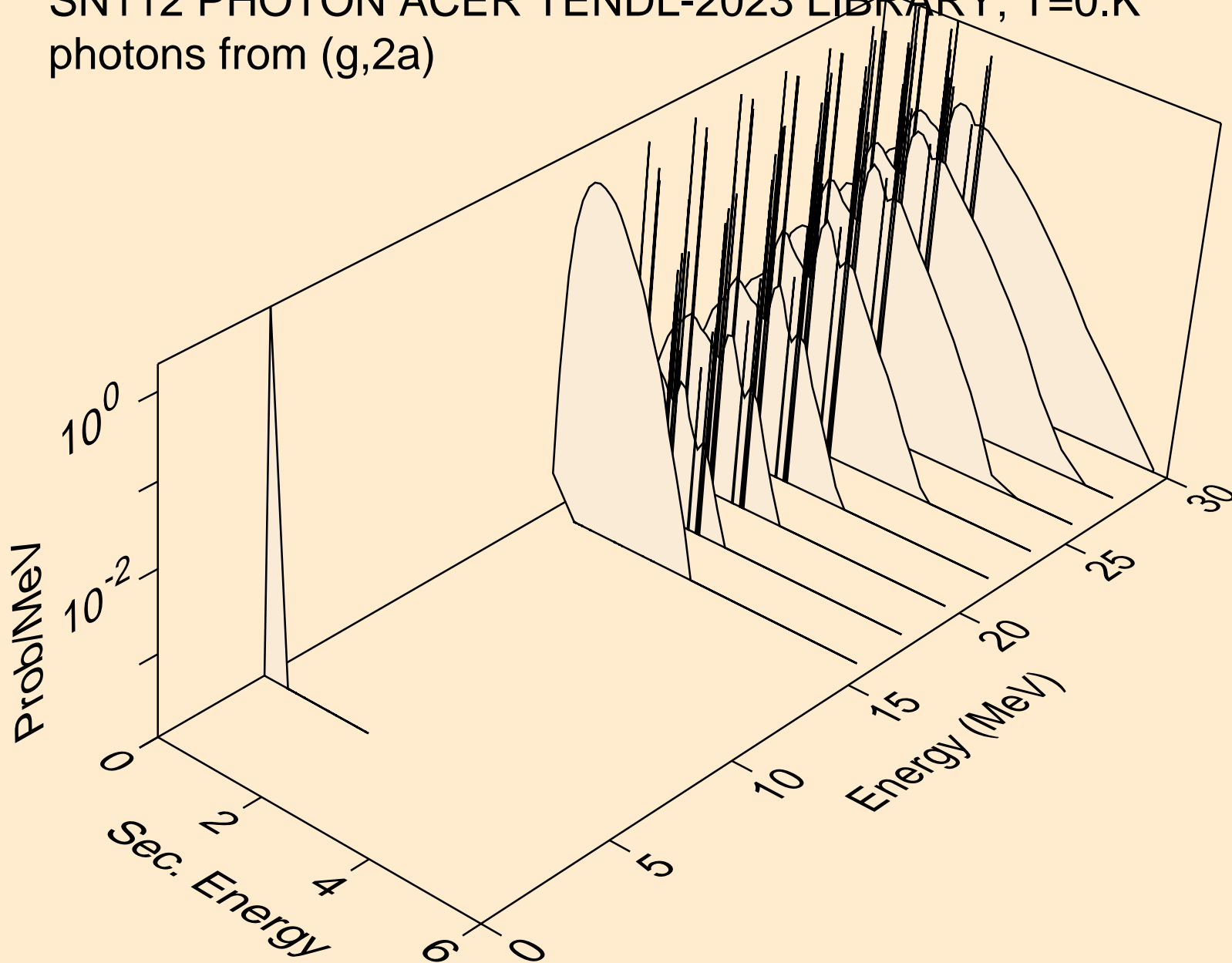

SN112 PHOTON ACER TENDL-2023 LIBRARY; T=0.K
photons from (g,2p)

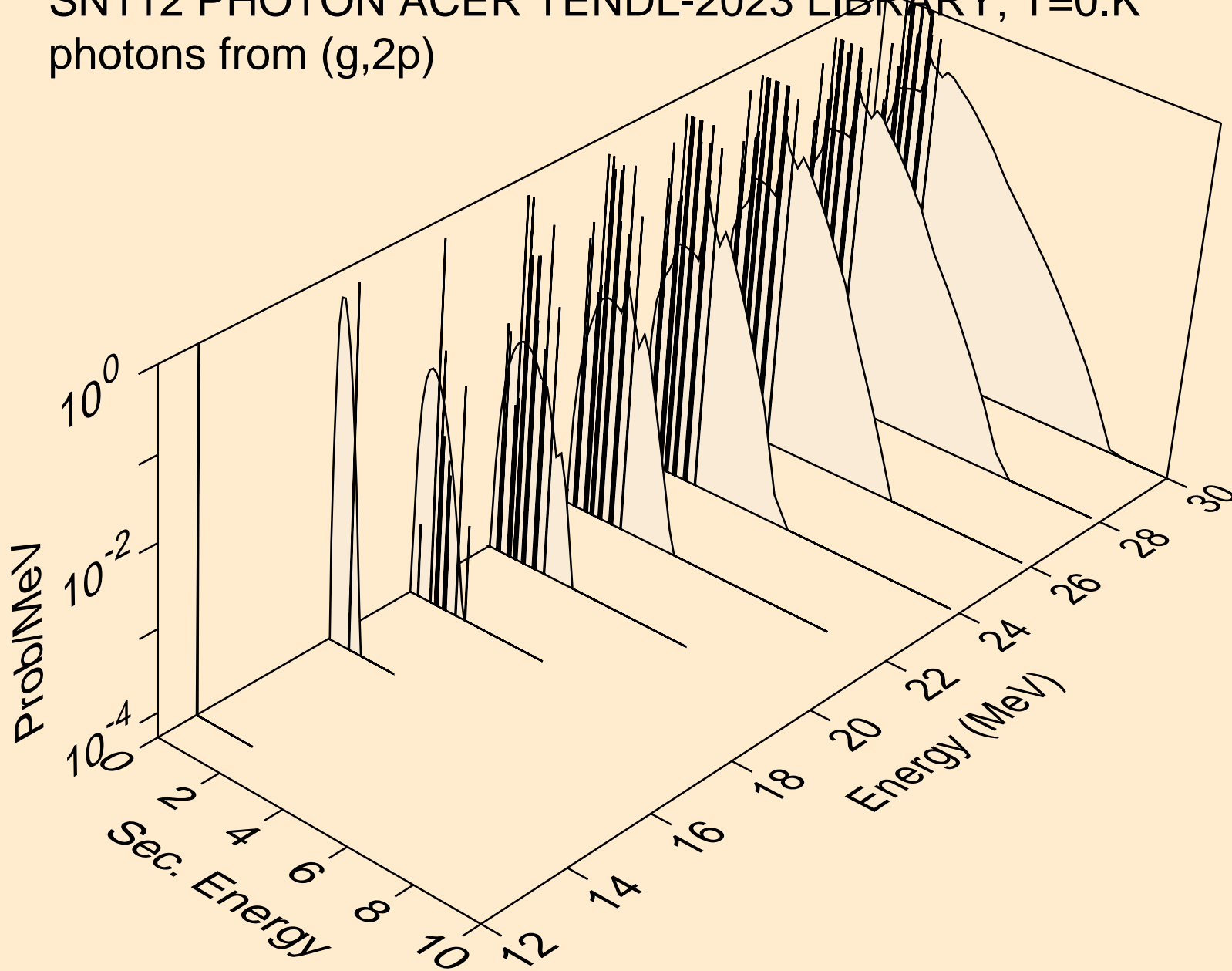

SN112 PHOTON ACER TENDL-2023 LIBRARY; T=0.K
photons from (g,pa)

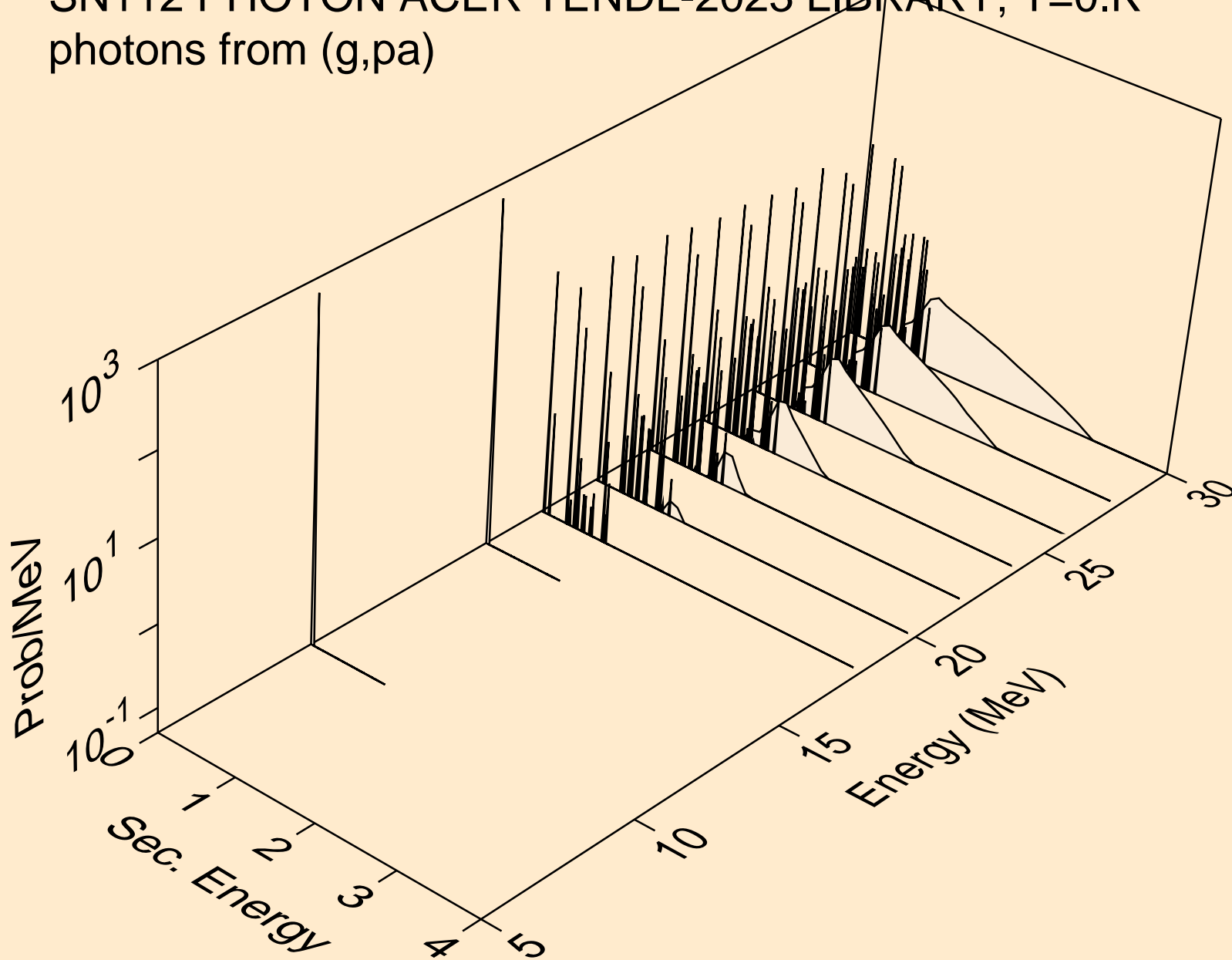

SN112 PHOTON ACER TENDL-2023 LIBRARY; T=0.K
photons from (g,pd)

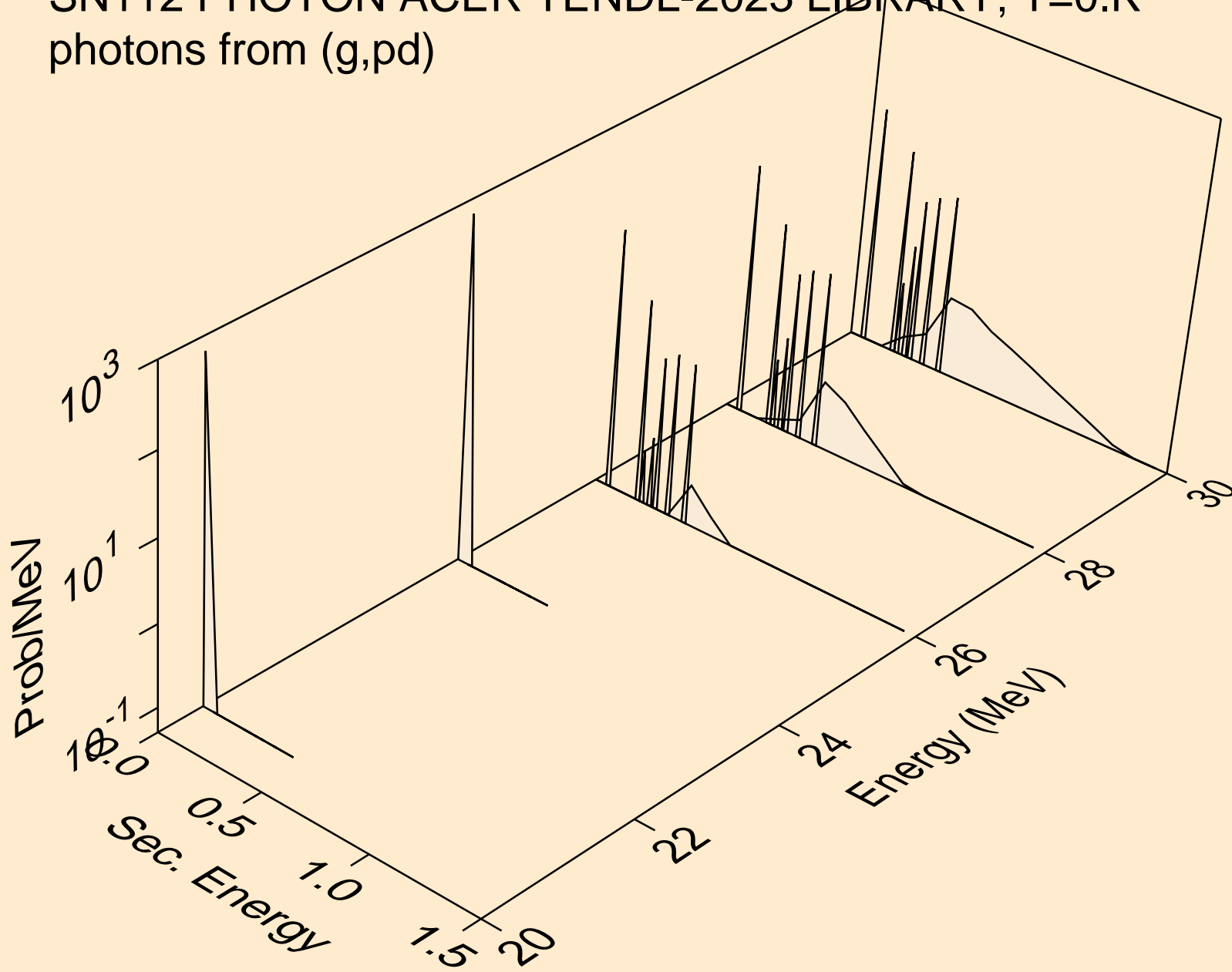

SN112 PHOTON ACER TENDL-2023 LIBRARY; T=0.K
photons from (g,pt)

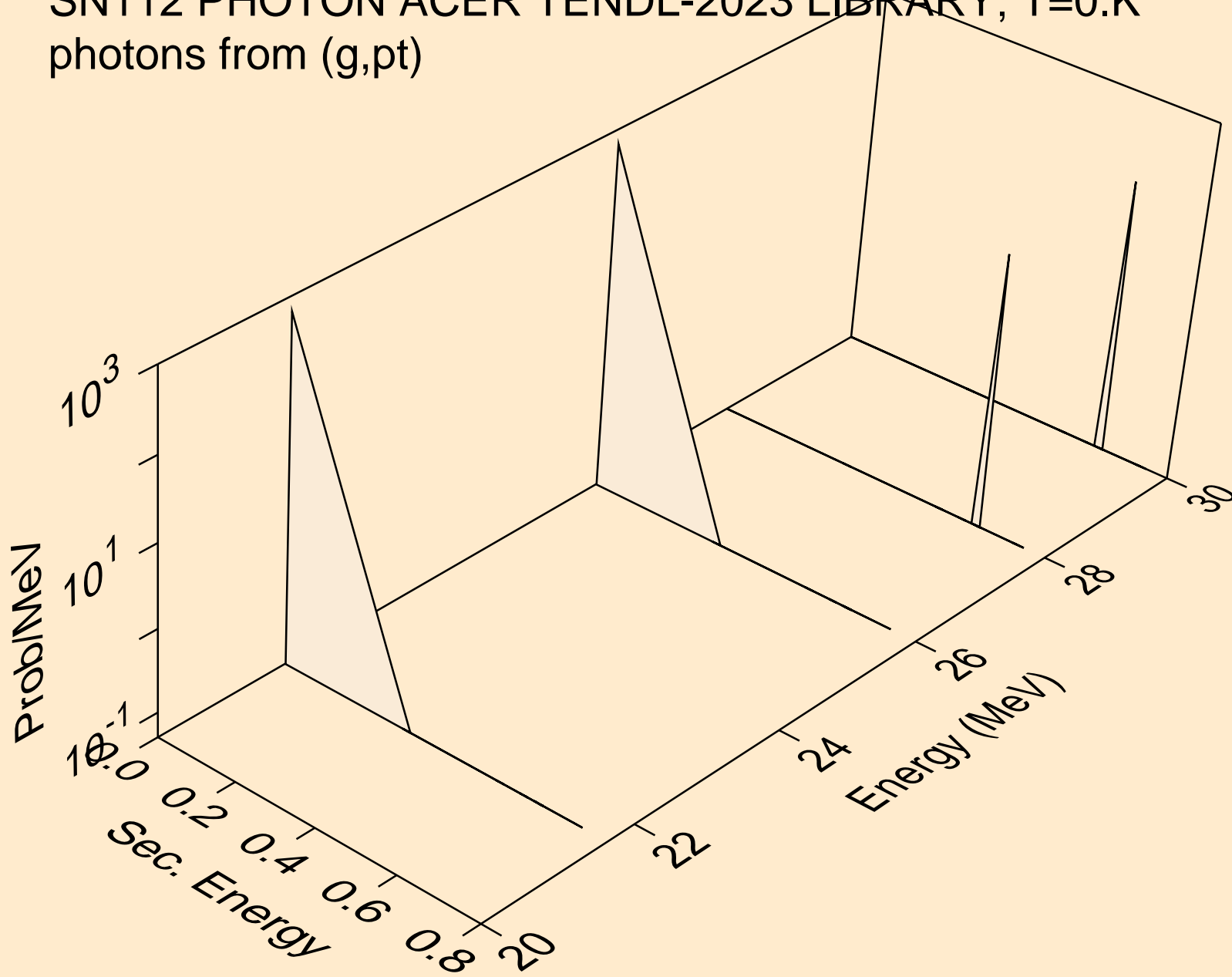

SN112 PHOTON ACER TENDL-2023 LIBRARY; T=0.K
protons from (g,x)

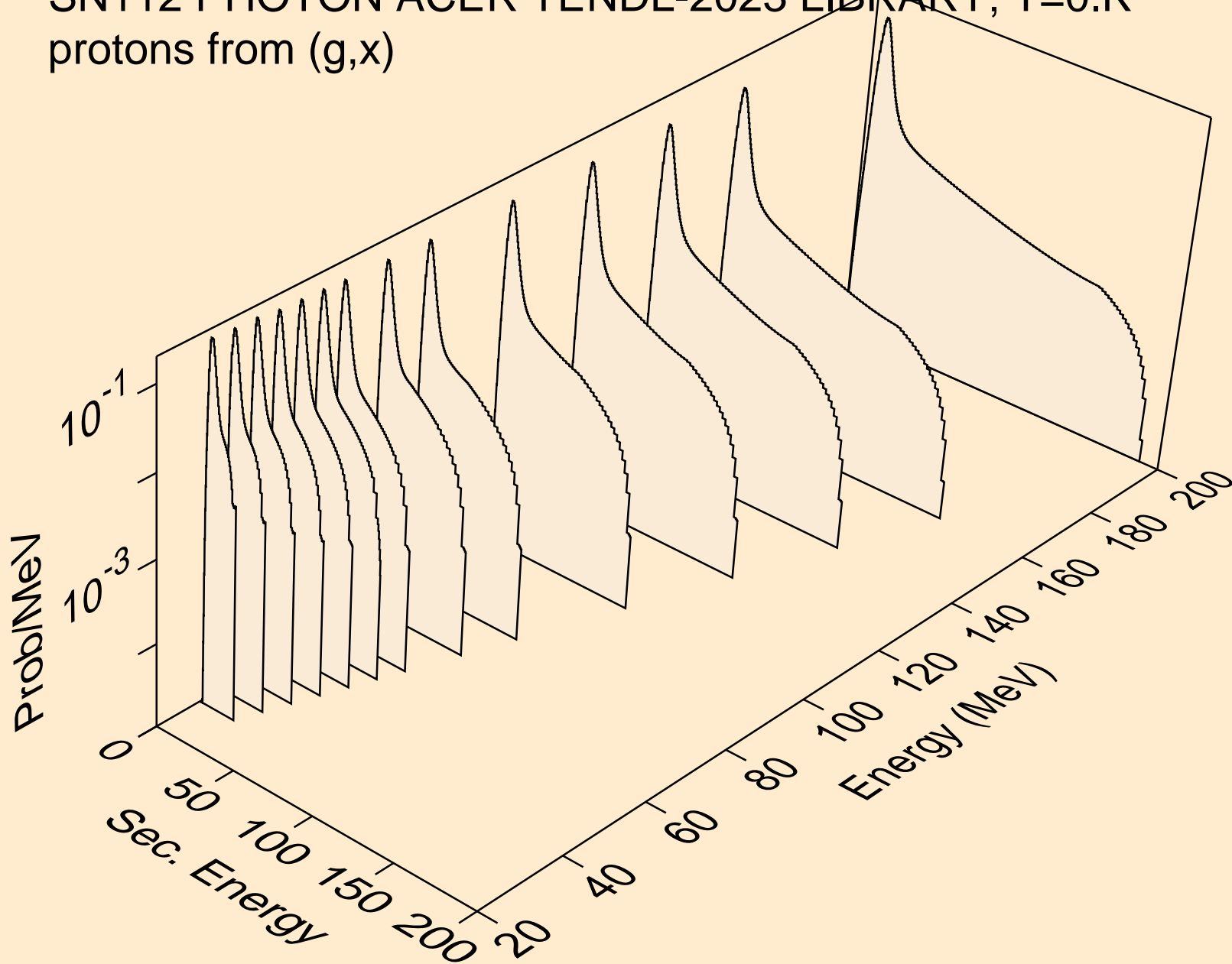

SN112 PHOTON ACER TENDL-2023 LIBRARY; T=0.K
protons from (g,n*)p

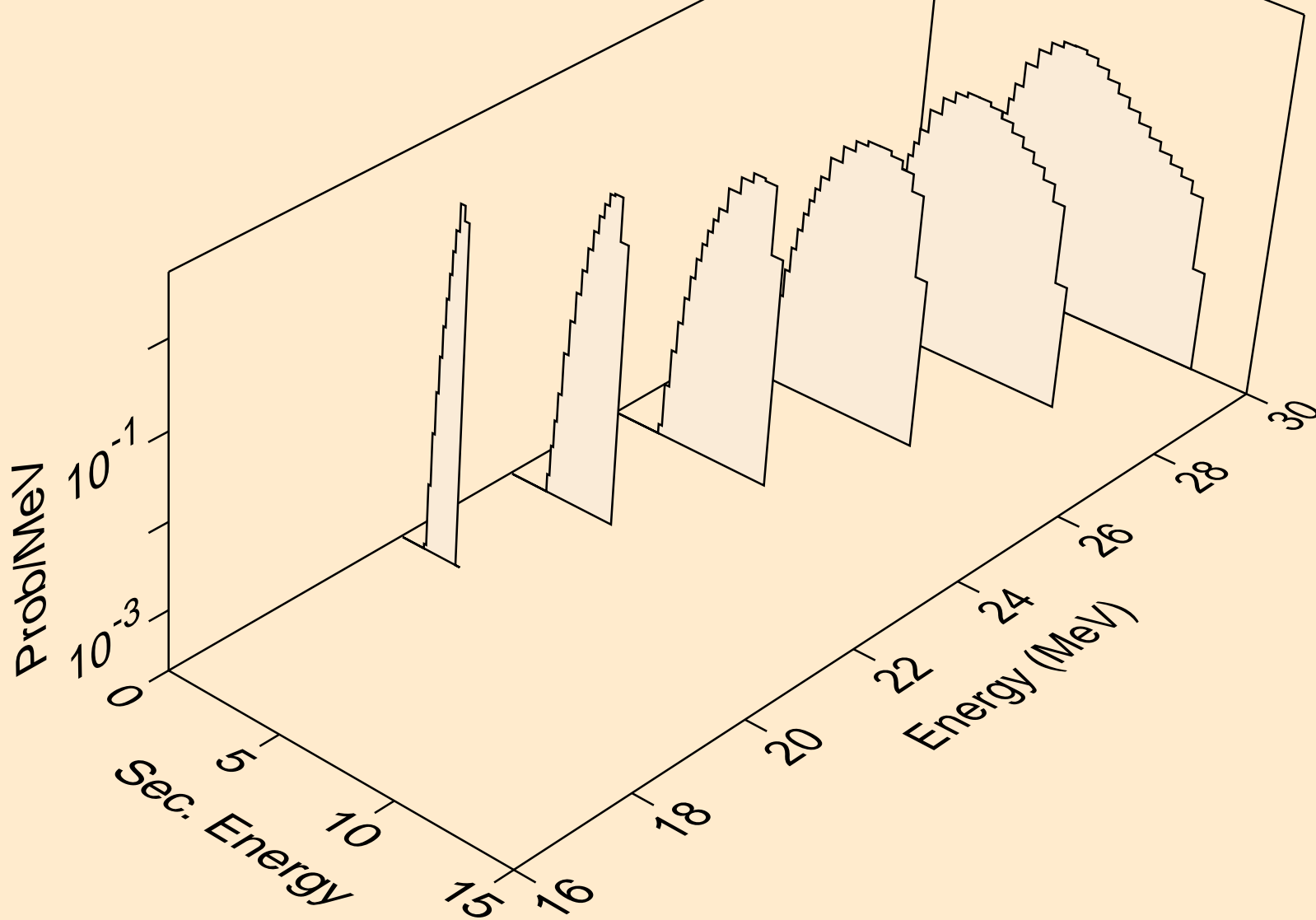

SN112 PHOTON ACER TENDL-2023 LIBRARY; T=0.K
protons from (g,2np)

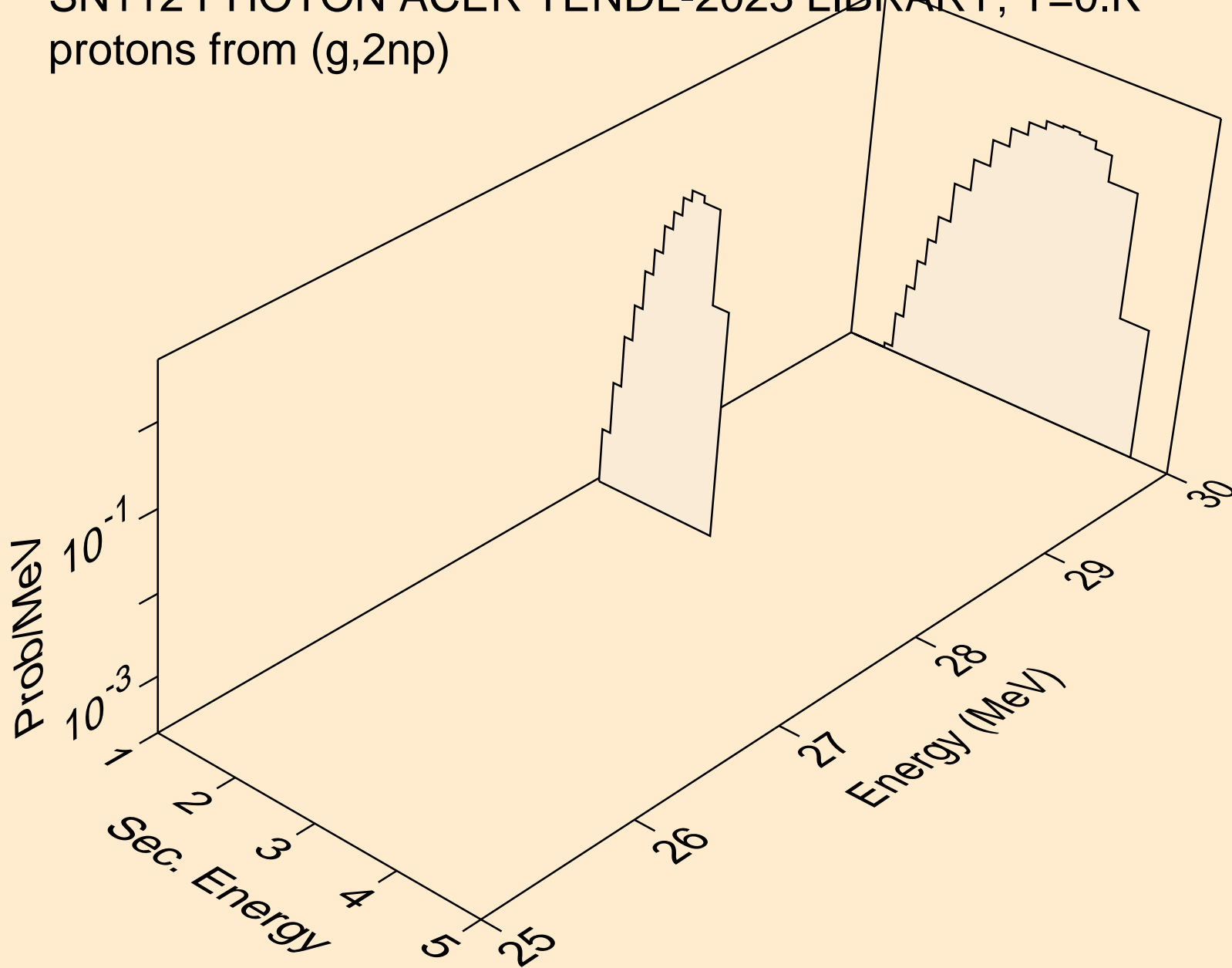

SN112 PHOTON ACER TENDL-2023 LIBRARY; T=0.K
protons from (g,n2p)

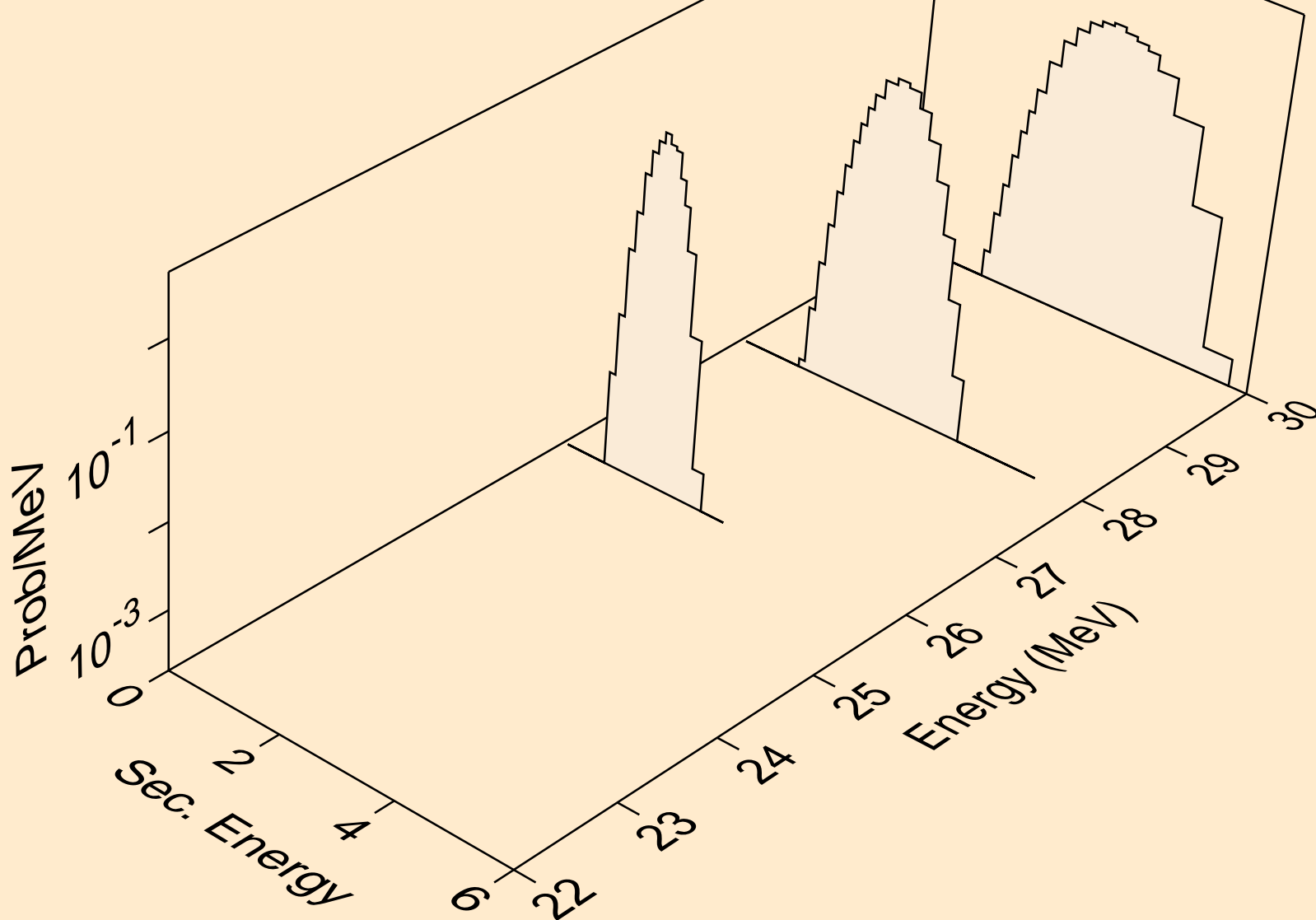

SN112 PHOTON ACER TENDL-2023 LIBRARY; T=0.K
protons from (g,p)

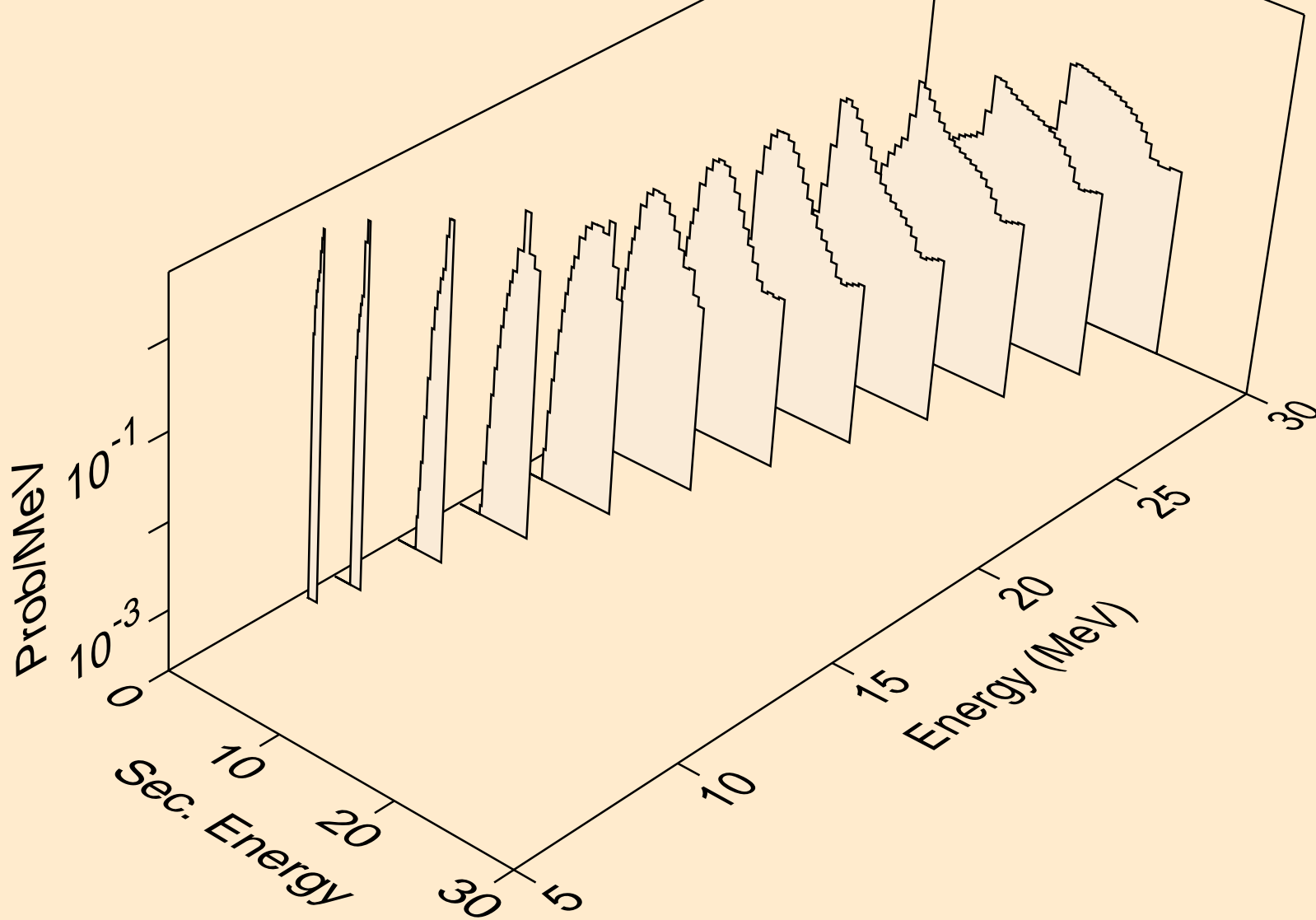

SN112 PHOTON ACER TENDL-2023 LIBRARY; T=0.K
protons from (g,2p)

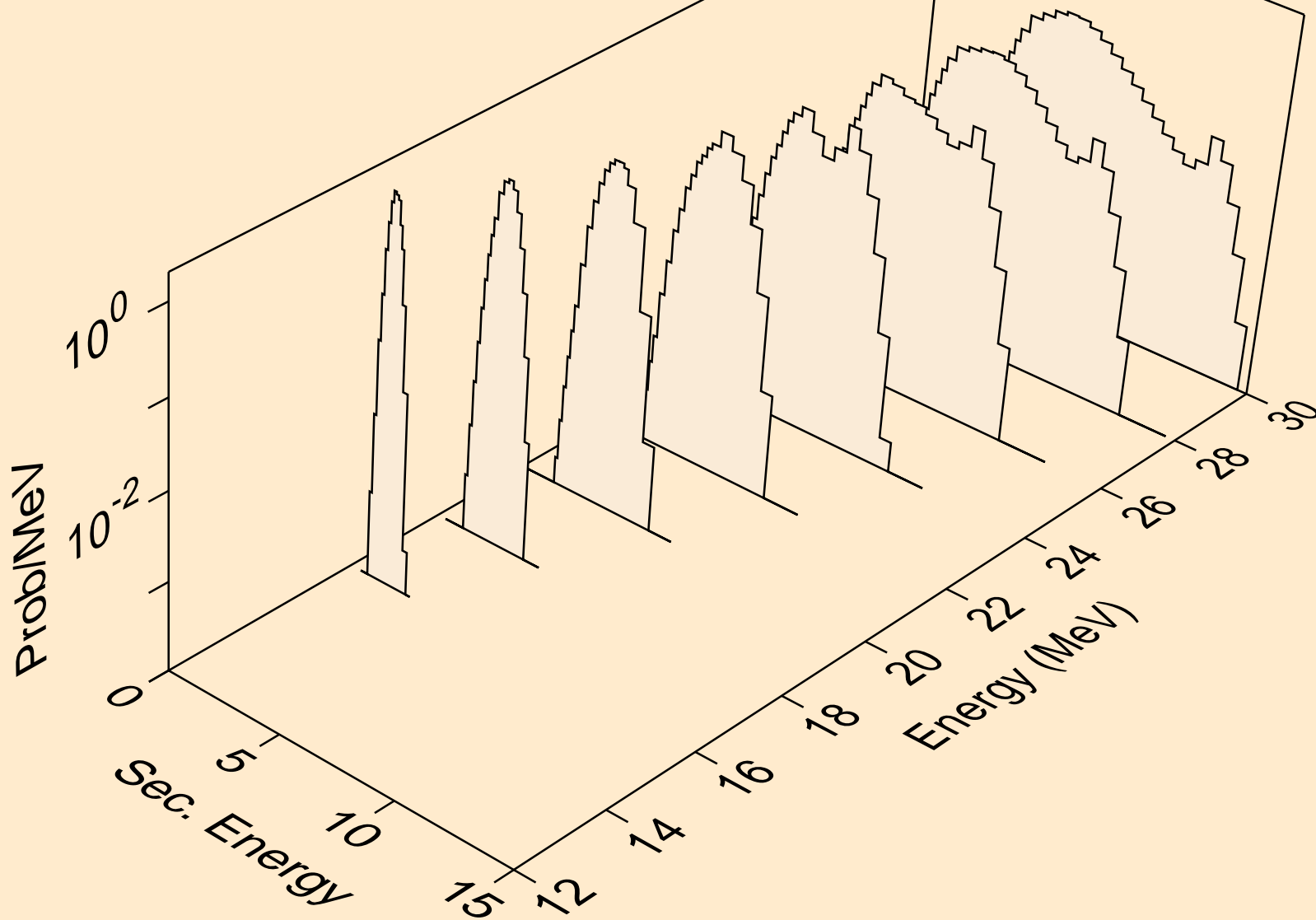

SN112 PHOTON ACER TENDL-2023 LIBRARY; T=0.K
protons from (g,pa)

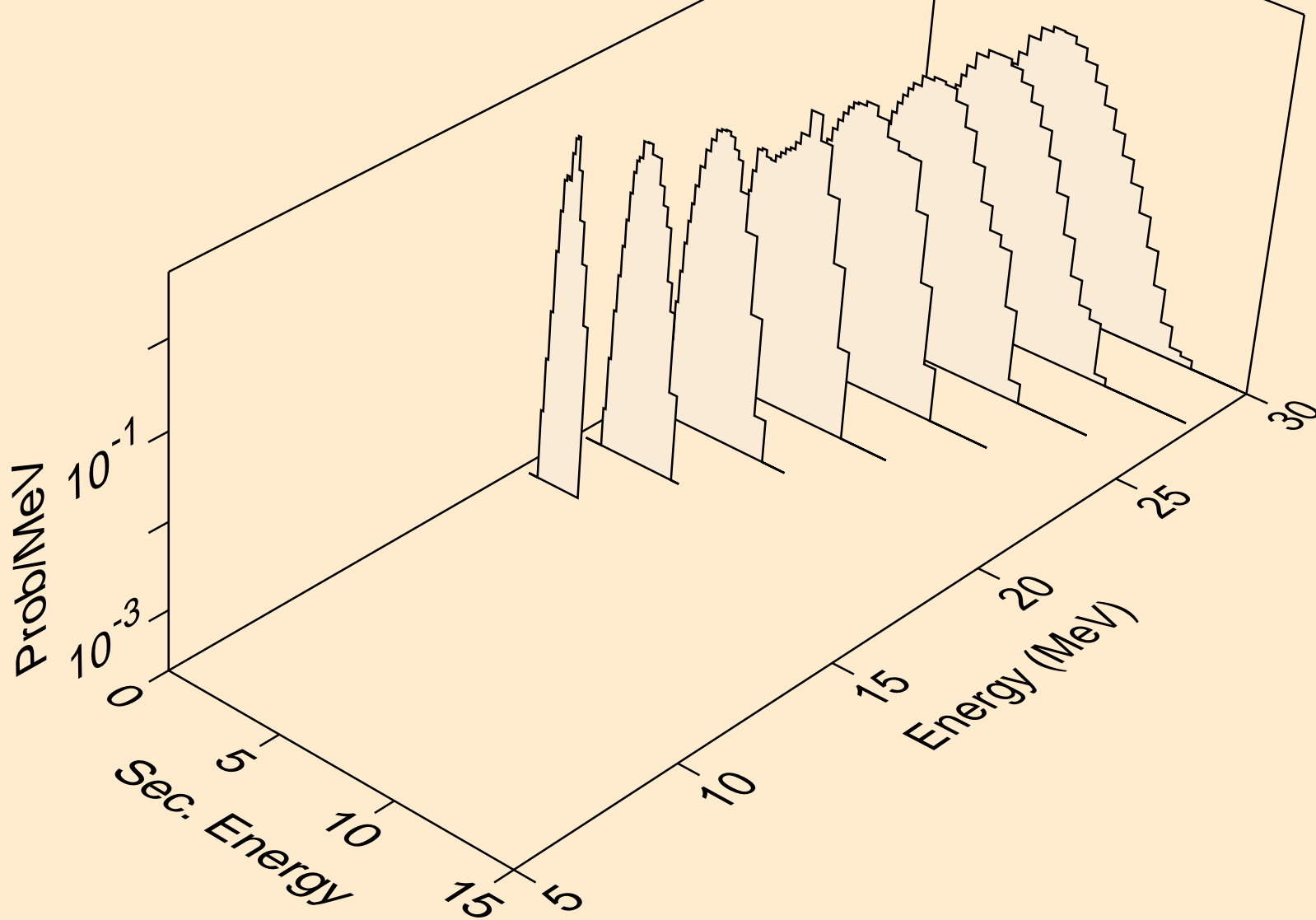

SN112 PHOTON ACER TENDL-2023 LIBRARY; T=0.K
protons from (g,pd)

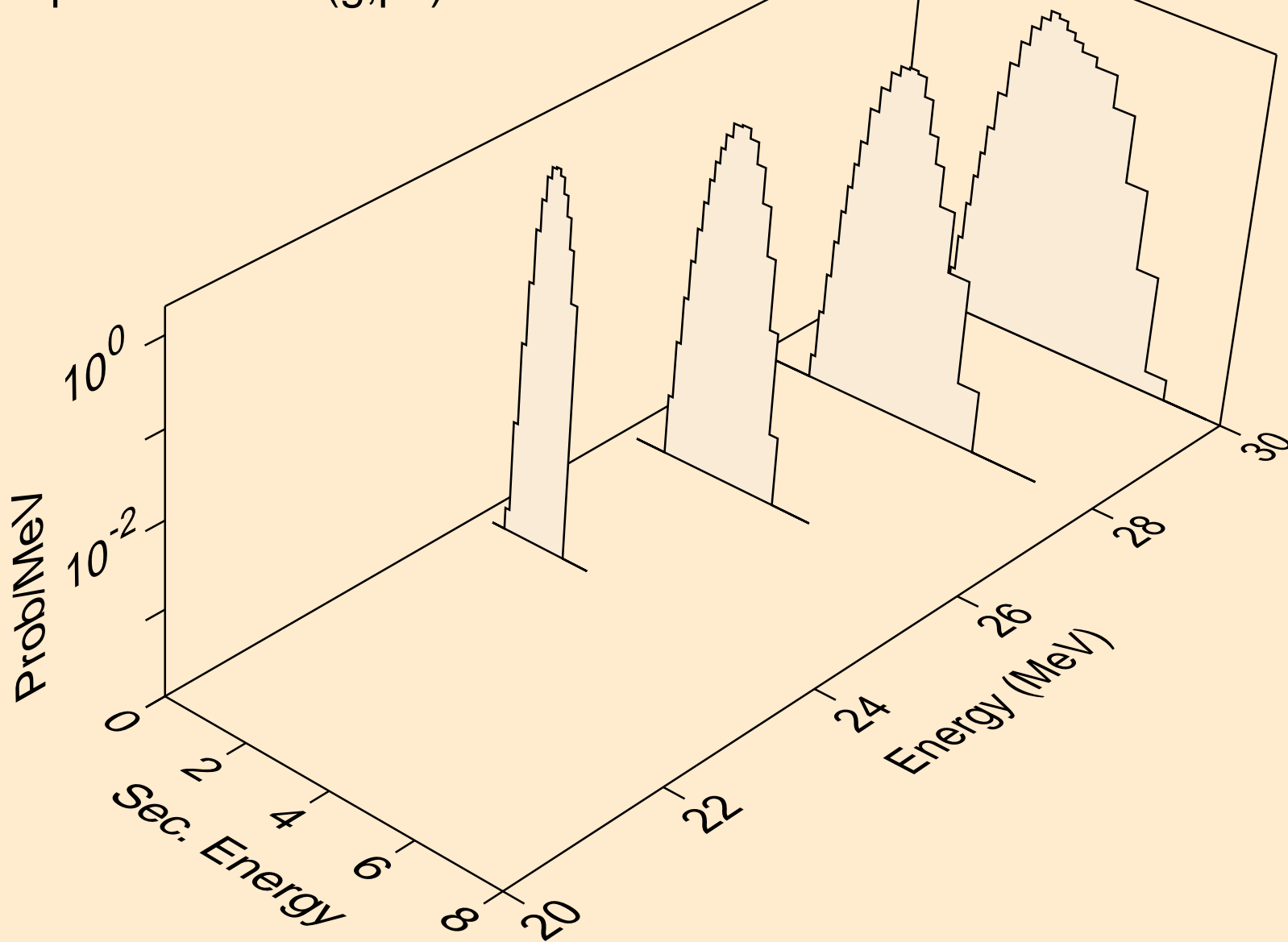

SN112 PHOTON ACER TENDL-2023 LIBRARY; T=0.K
protons from (g,pt)

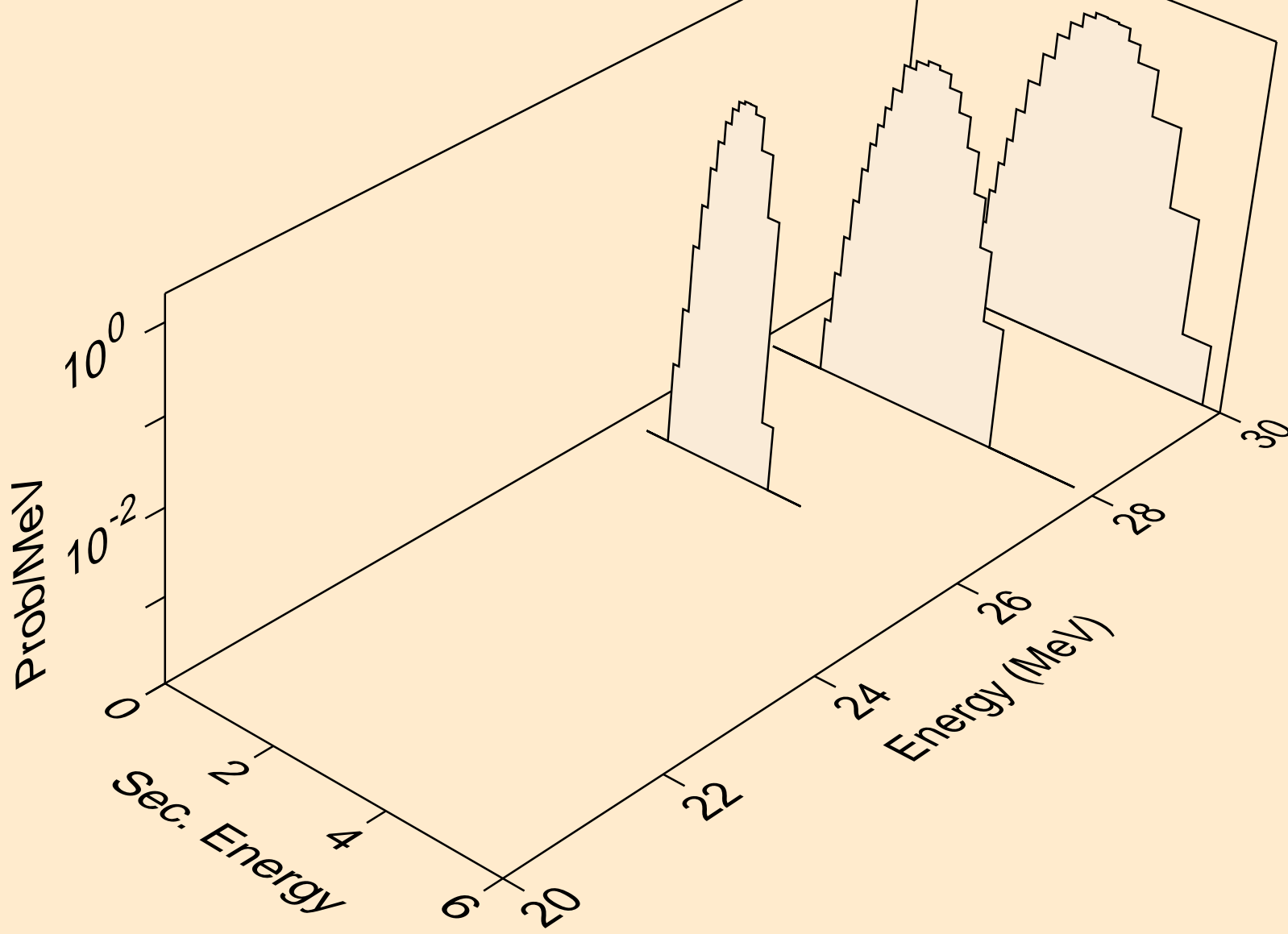

SN112 PHOTON ACER TENDL-2023 LIBRARY; T=0.K
deuterons from (g,x)

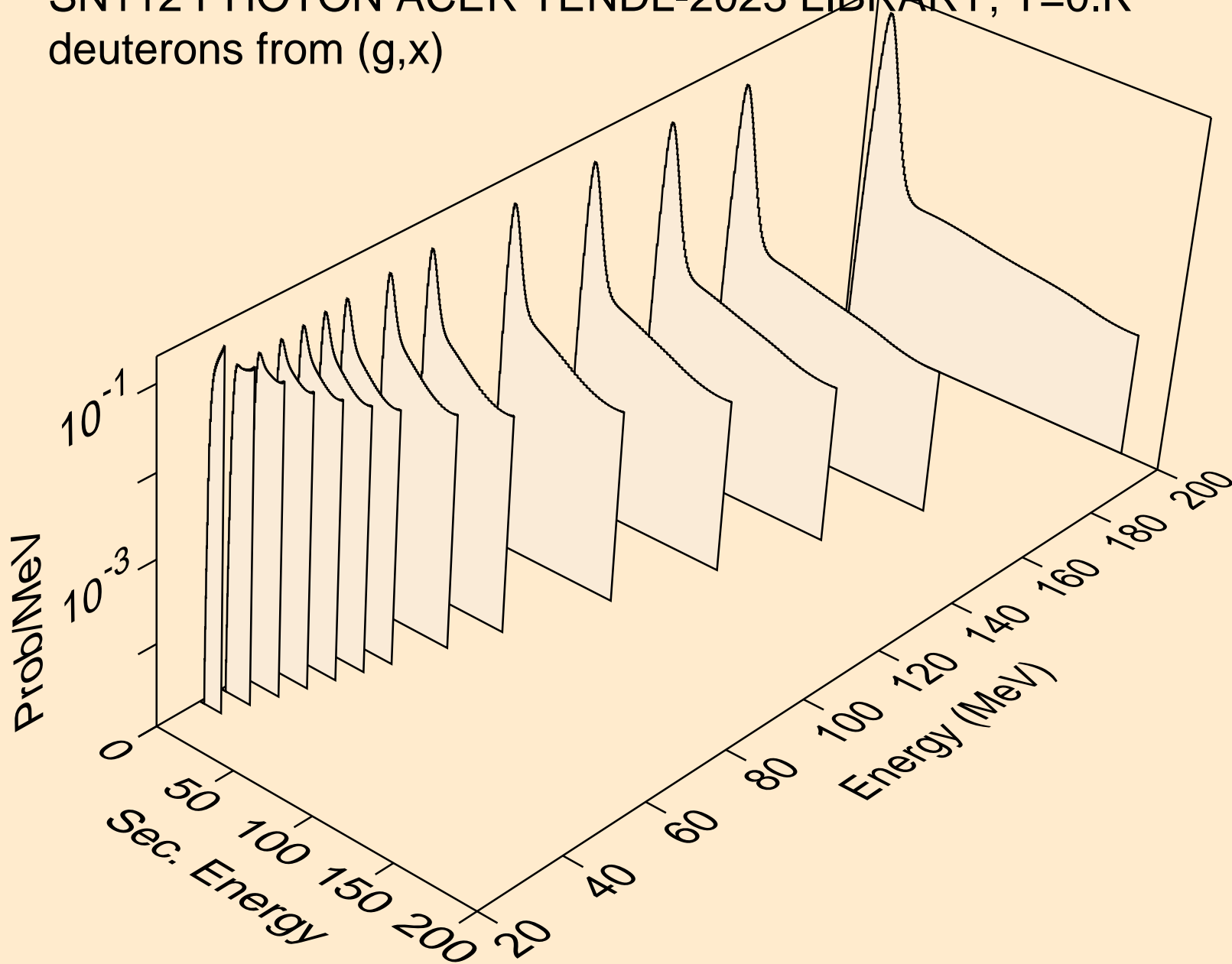

SN112 PHOTON ACER TENDL-2023 LIBRARY; T=0.K
deuterons from (g,n*)d

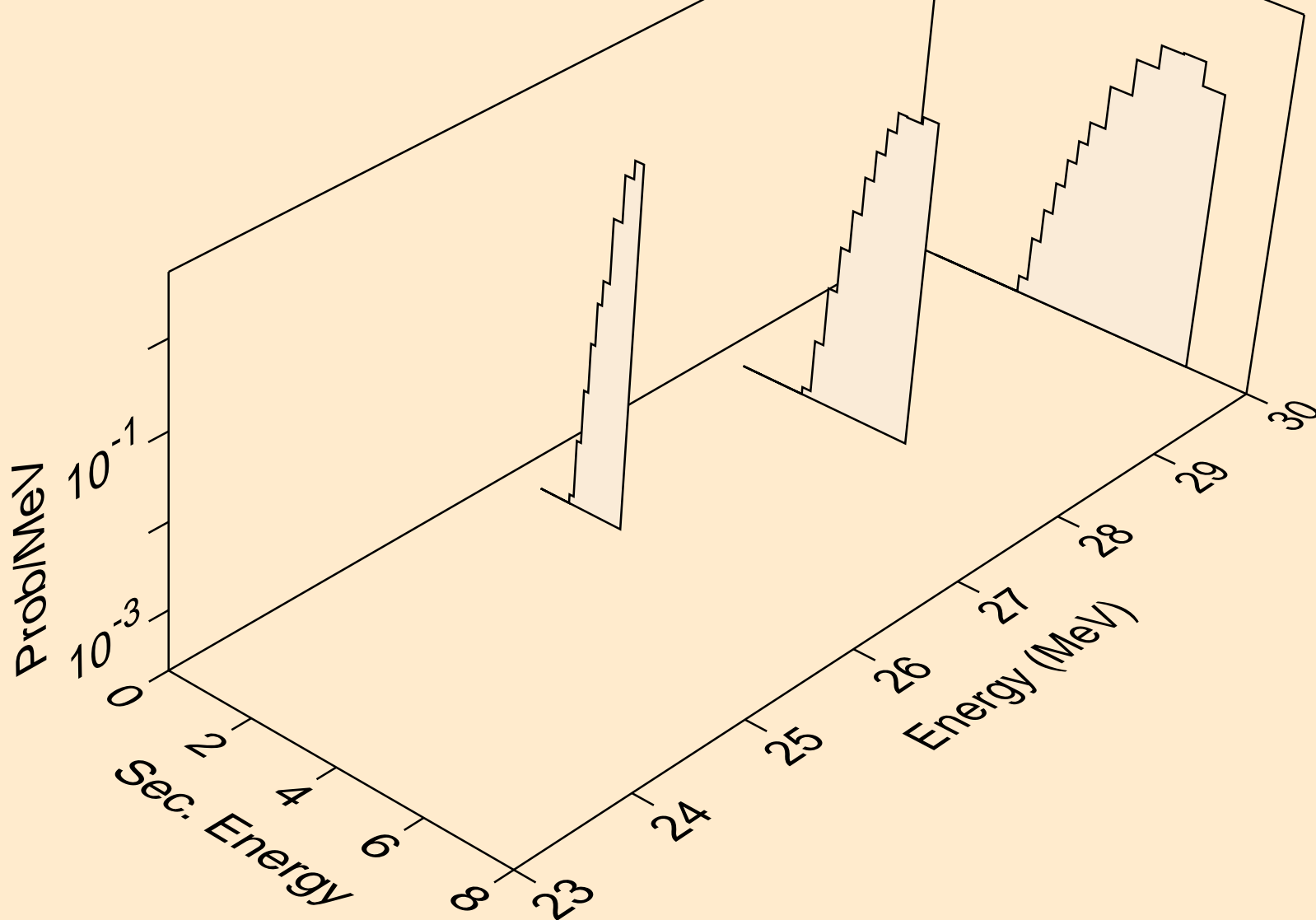

SN112 PHOTON ACER TENDL-2023 LIBRARY; T=0.K
deuterons from (g,d)

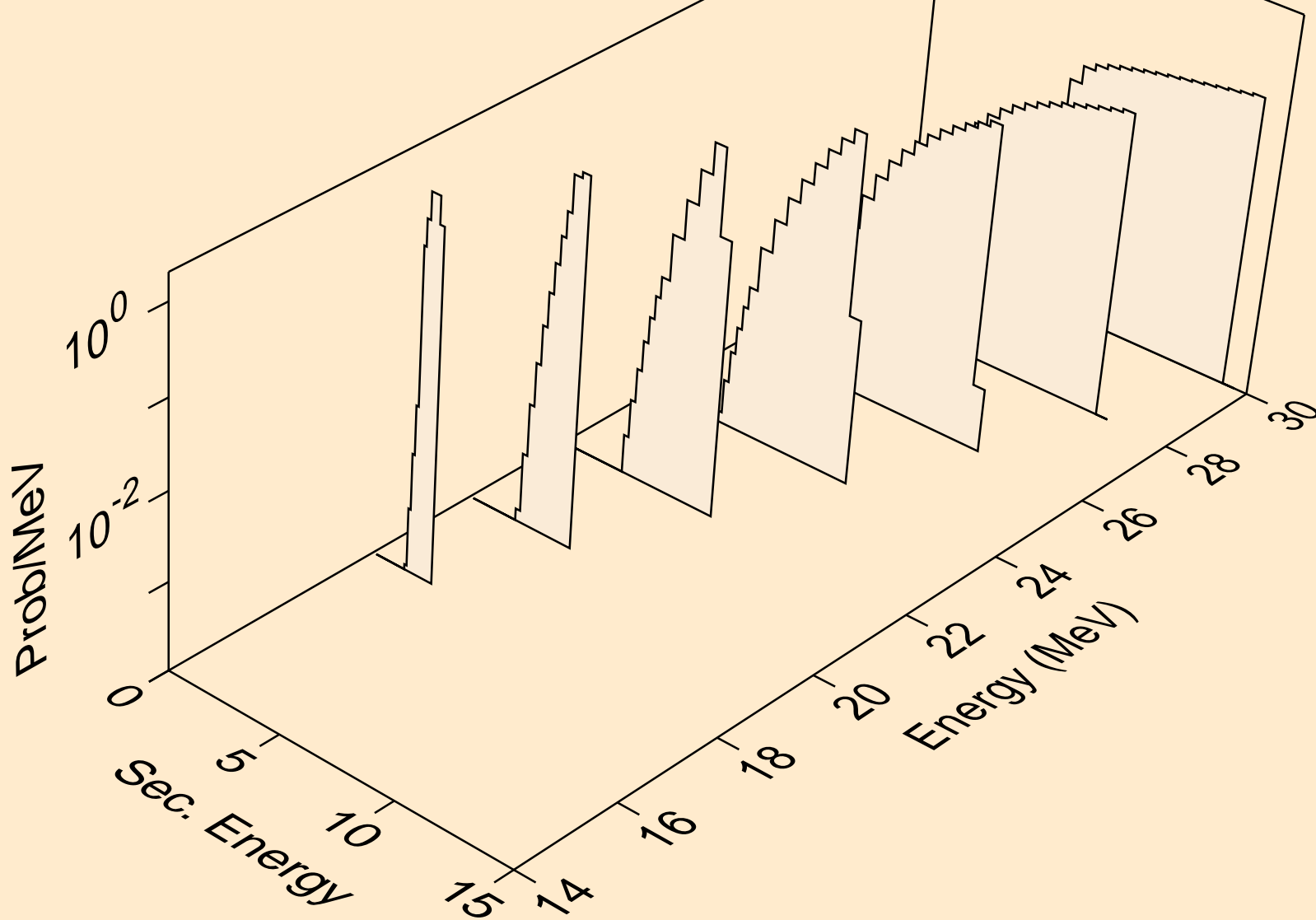

SN112 PHOTON ACER TENDL-2023 LIBRARY; T=0.K
deuterons from (g,pd)

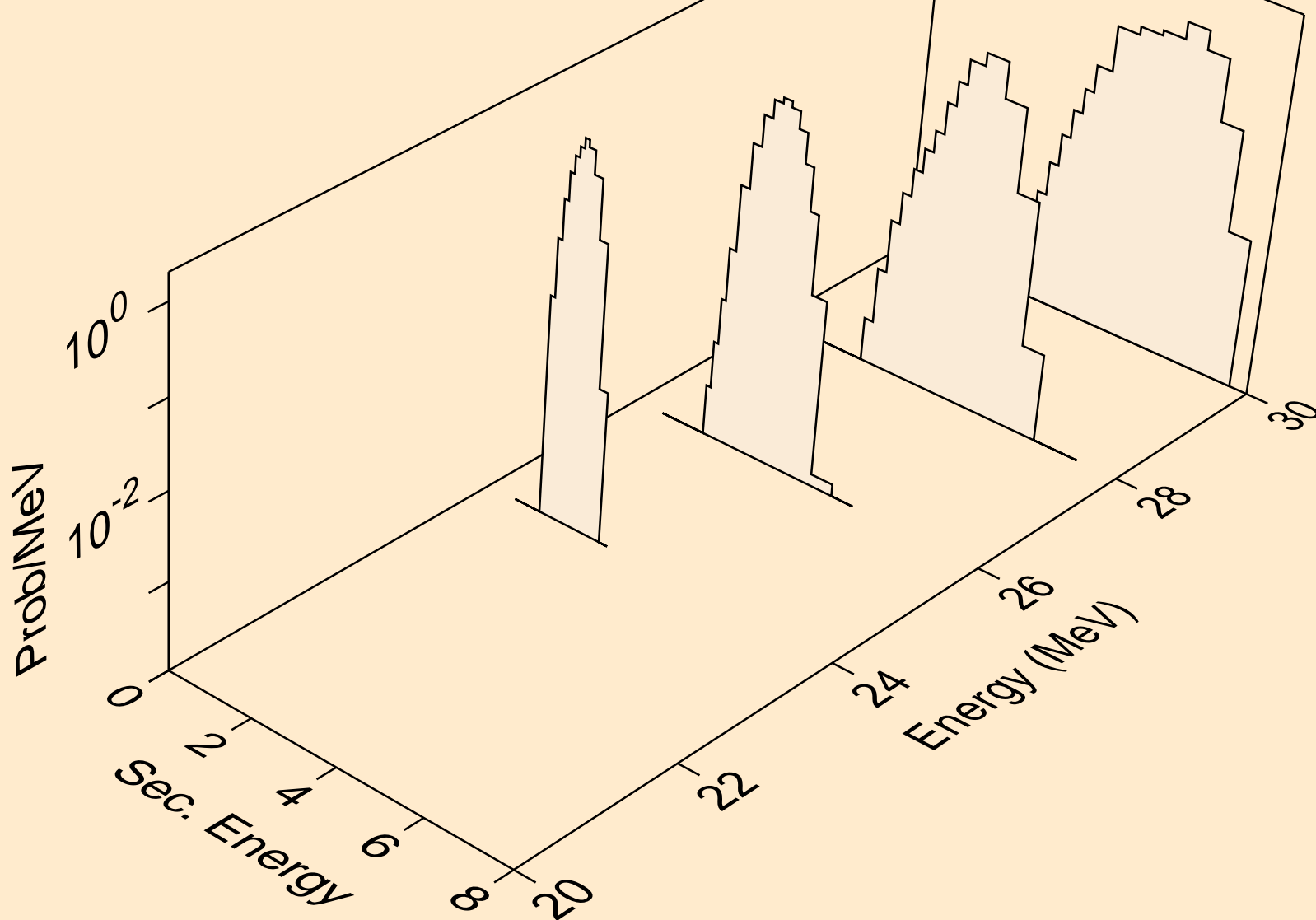

SN112 PHOTON ACER TENDL-2023 LIBRARY; T=0.K
tritons from (g,x)

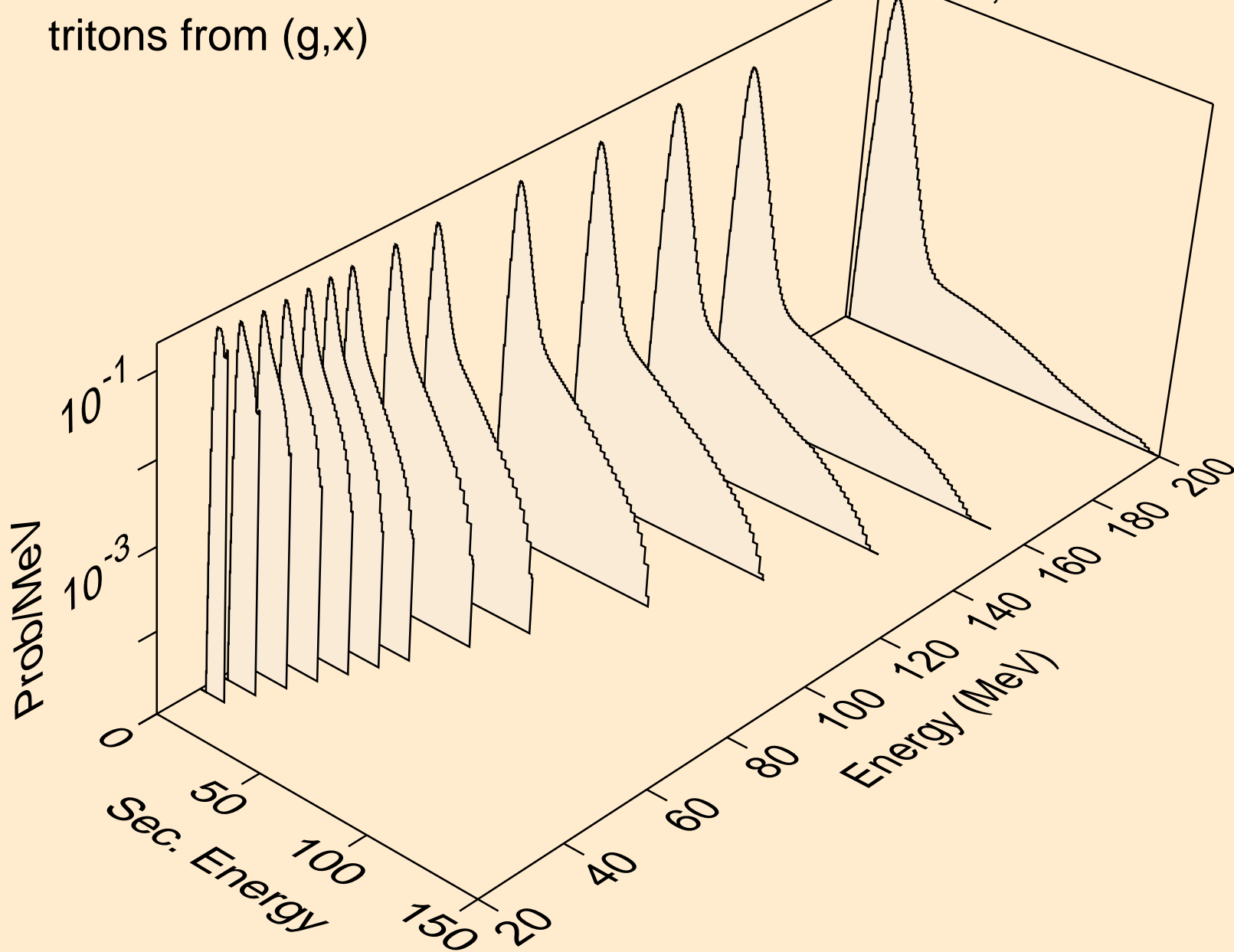

SN112 PHOTON ACER TENDL-2023 LIBRARY; T=0.K
tritons from (g,t)

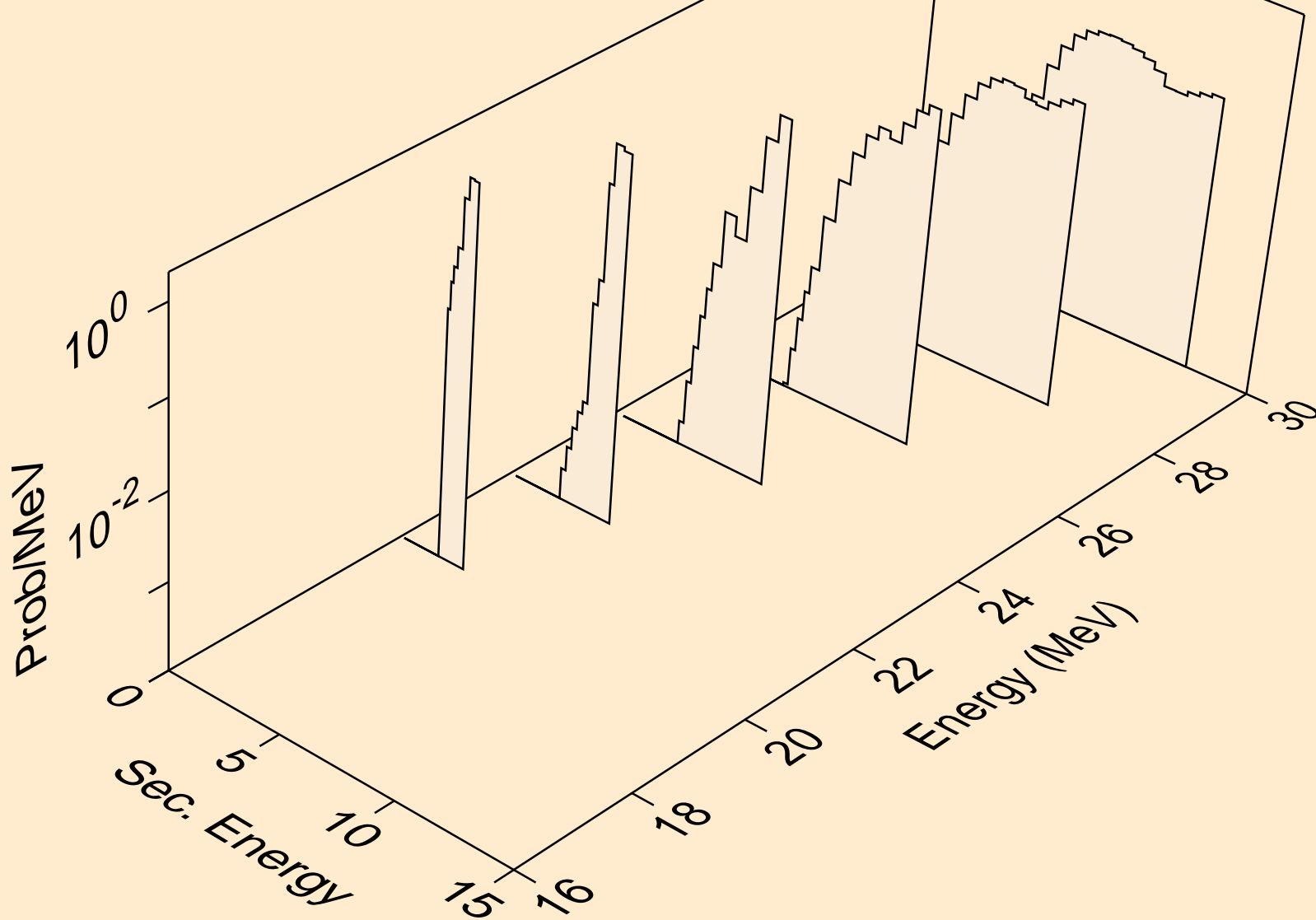

SN112 PHOTON ACER TENDL-2023 LIBRARY; T=0.K
tritons from (g,pt)

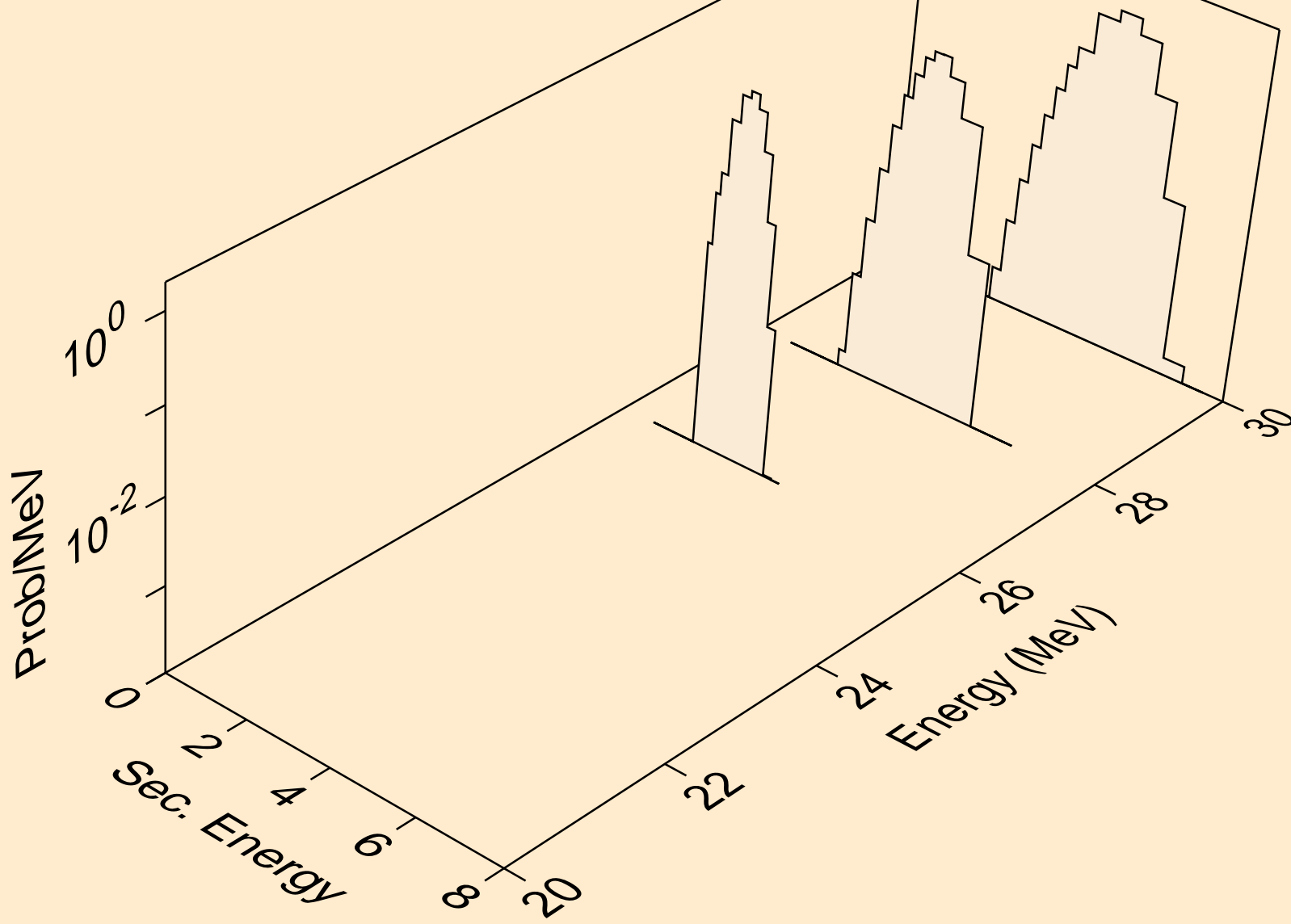

SN112 PHOTON ACER TENDL-2023 LIBRARY; T=0.K
he3s from (g,x)

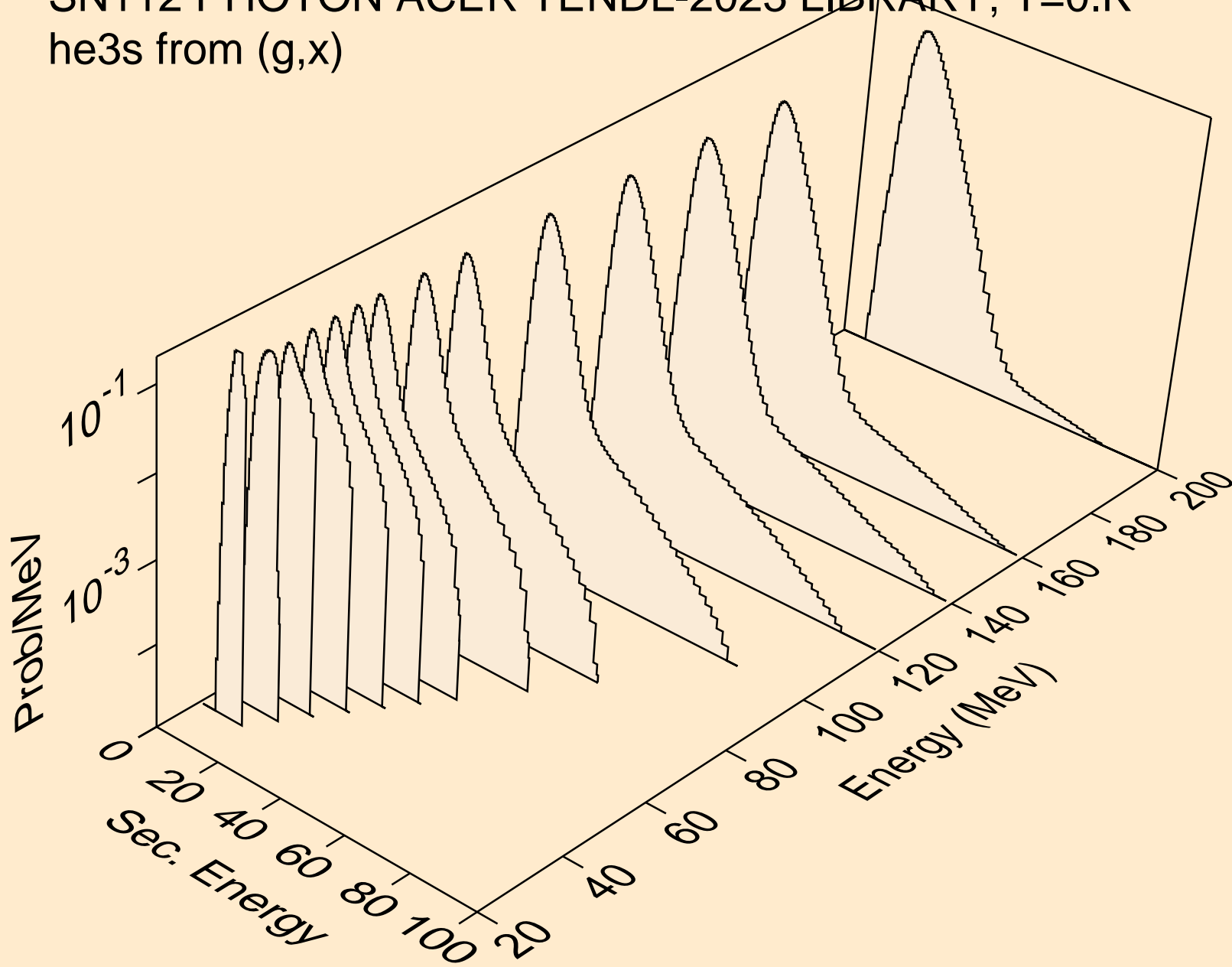

SN112 PHOTON ACER TENDL-2023 LIBRARY; T=0.K
he3s from (g,he3)

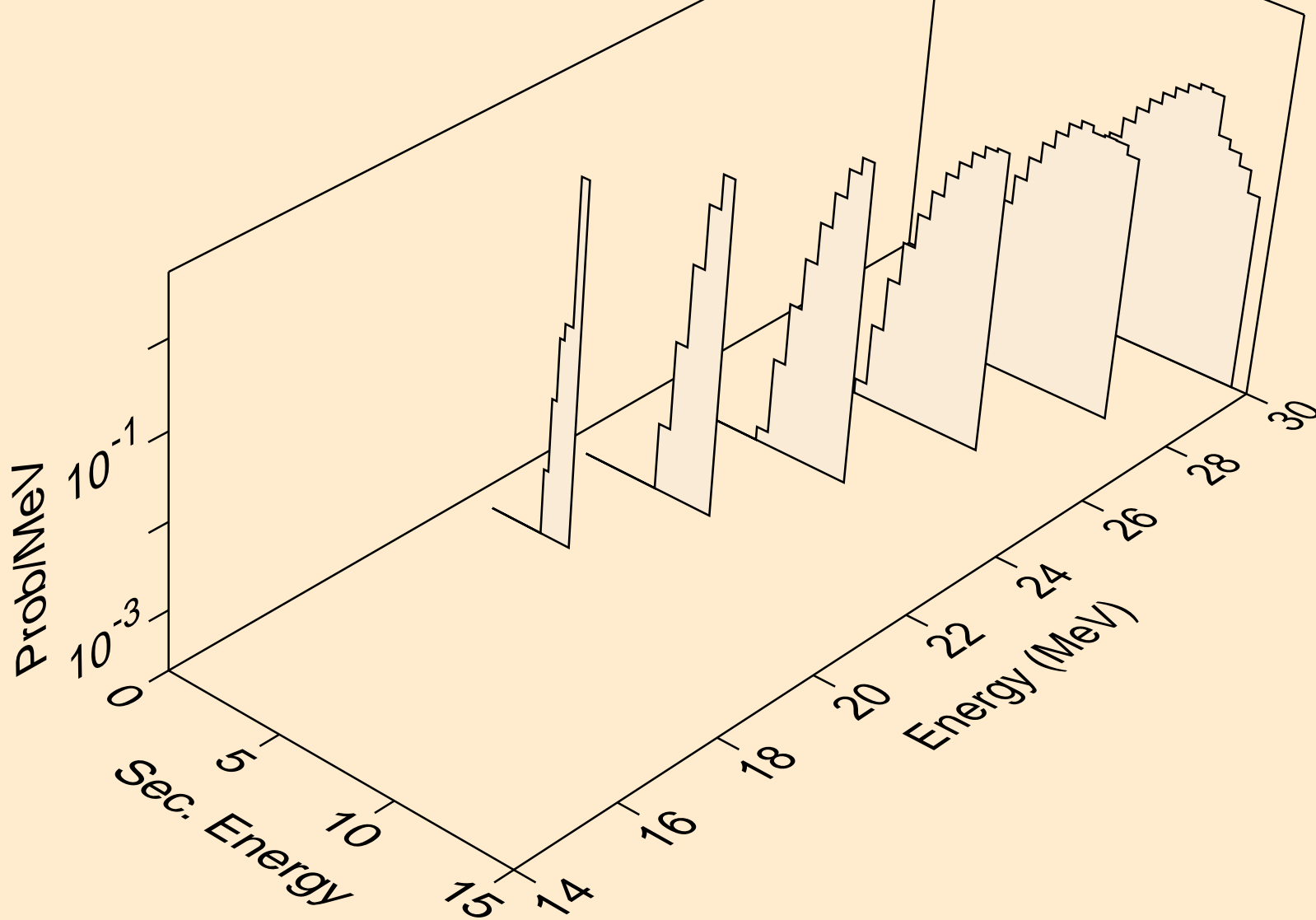

SN112 PHOTON ACER TENDL-2023 LIBRARY; T=0.K
alphas from (g,x)

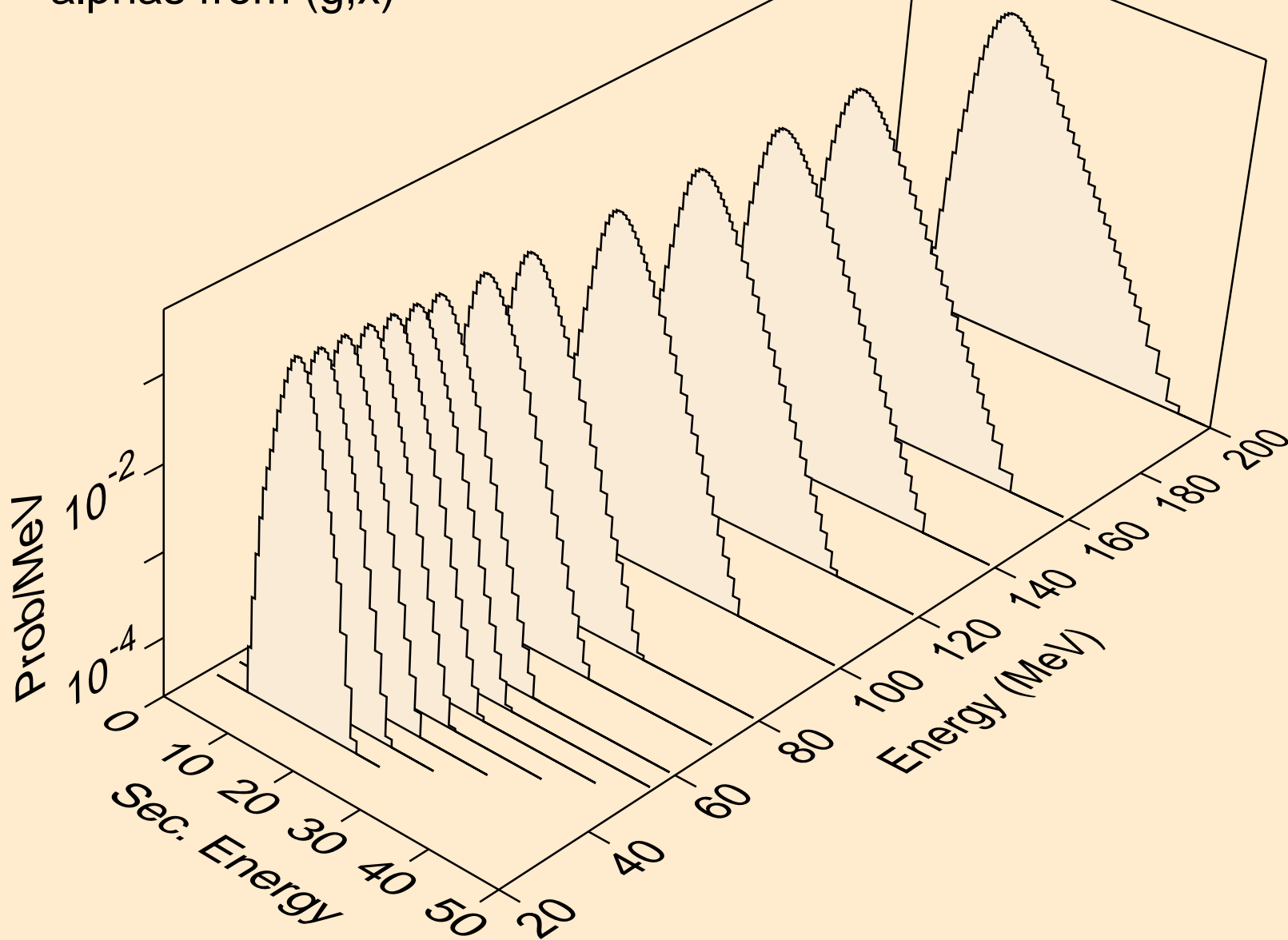

SN112 PHOTON ACER TENDL-2023 LIBRARY; T=0.K
alphas from (g,n*)a

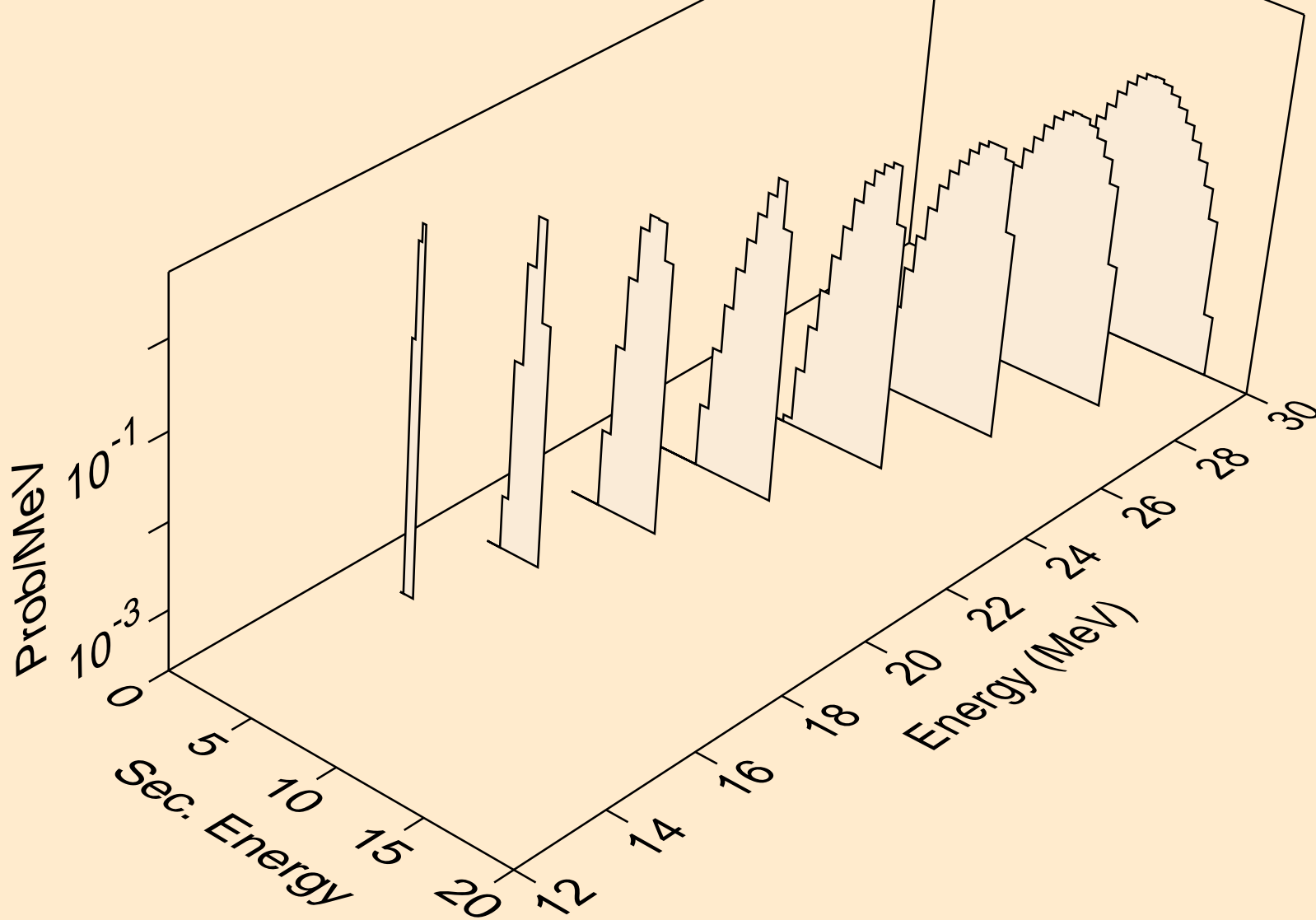

SN112 PHOTON ACER TENDL-2023 LIBRARY; T=0.K
alphas from (g,2n)a

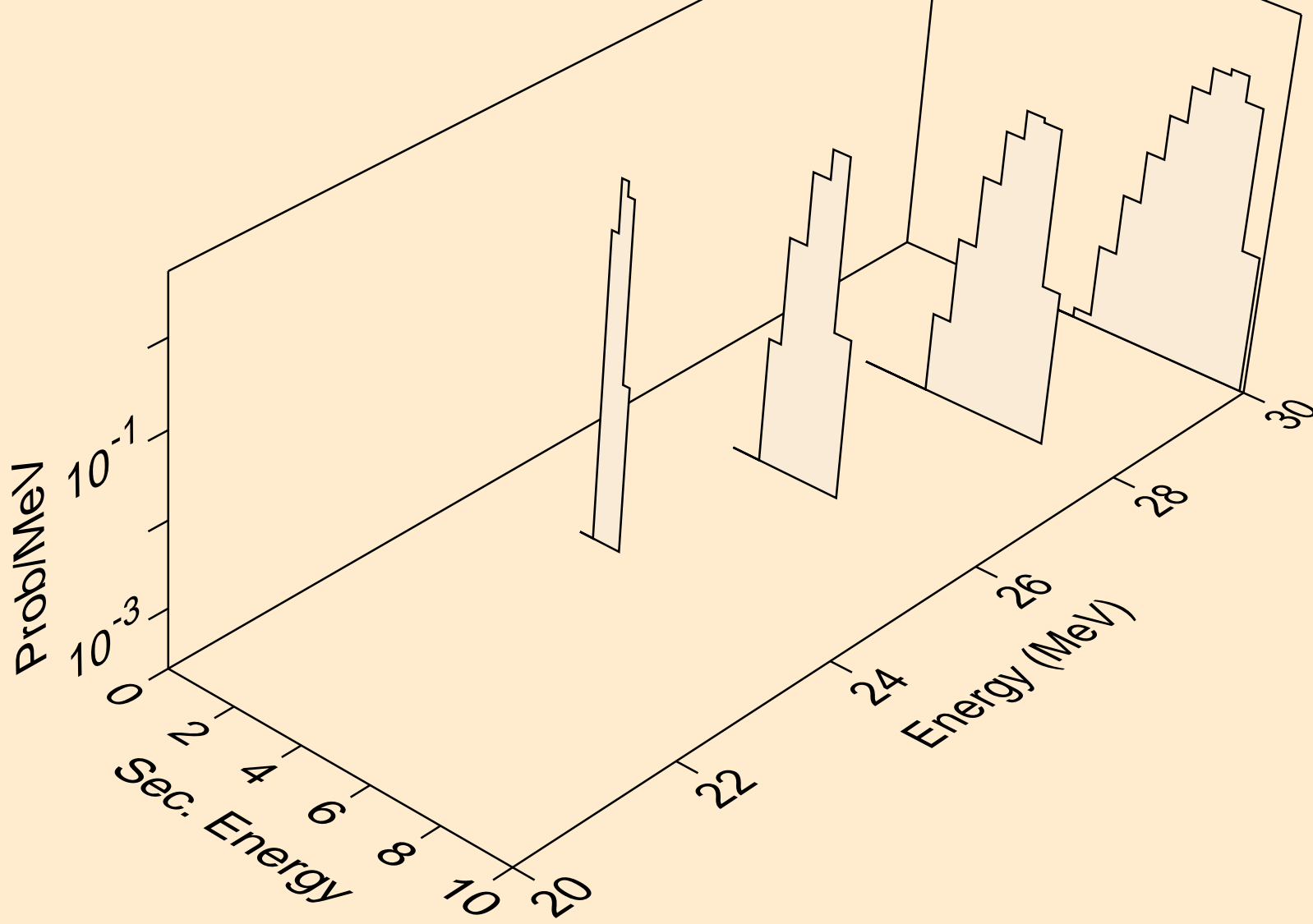

SN112 PHOTON ACER TENDL-2023 LIBRARY; T=0.K
alphas from (g,a)

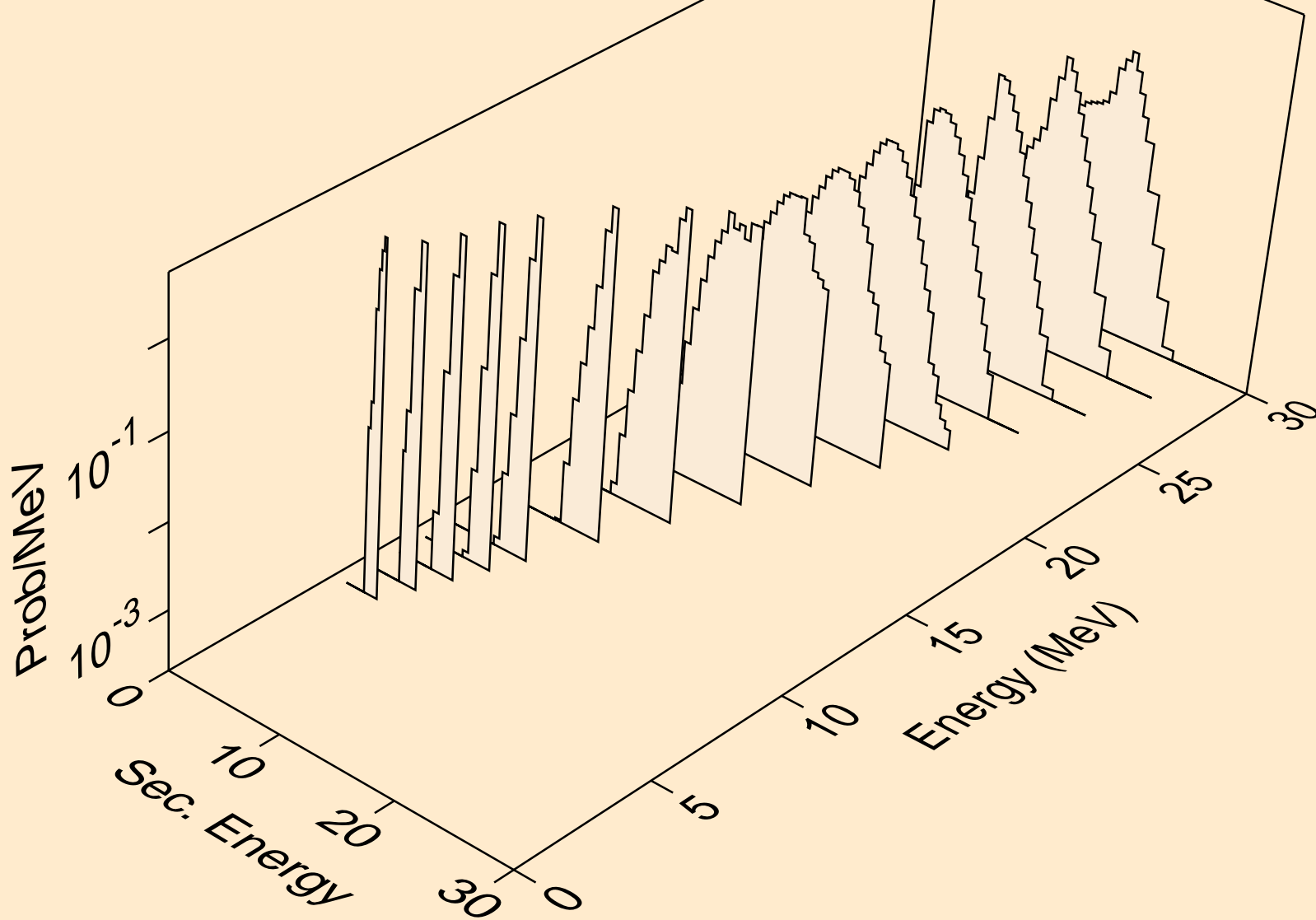

SN112 PHOTON ACER TENDL-2023 LIBRARY; T=0.K
alphas from (g,2a)

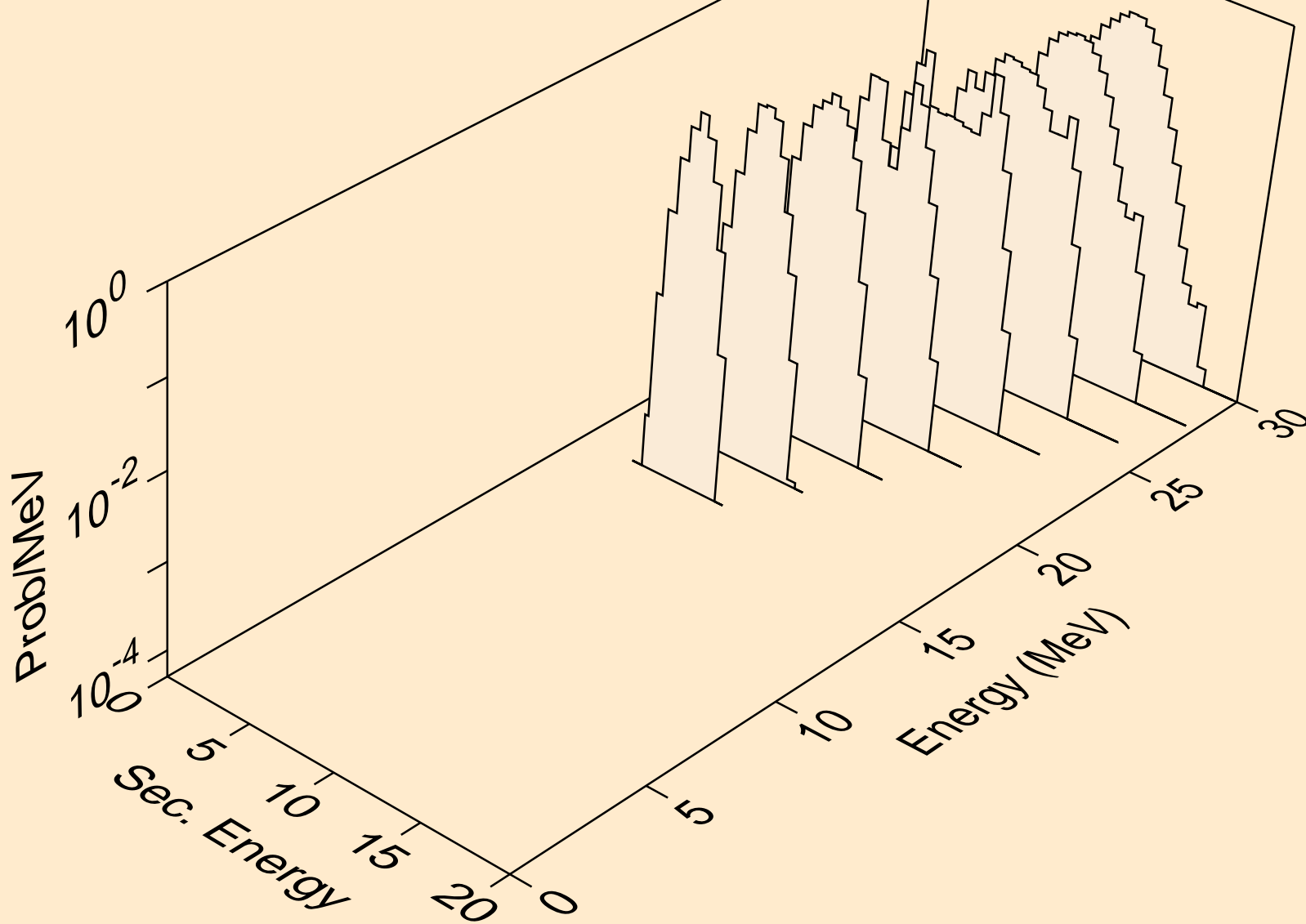

SN112 PHOTON ACER TENDL-2023 LIBRARY; T=0.K
alphas from (g,pa)

