

TC089M PHOTON ACER TENDL-2023 LIBRARY; T=0.K

Principal cross sections

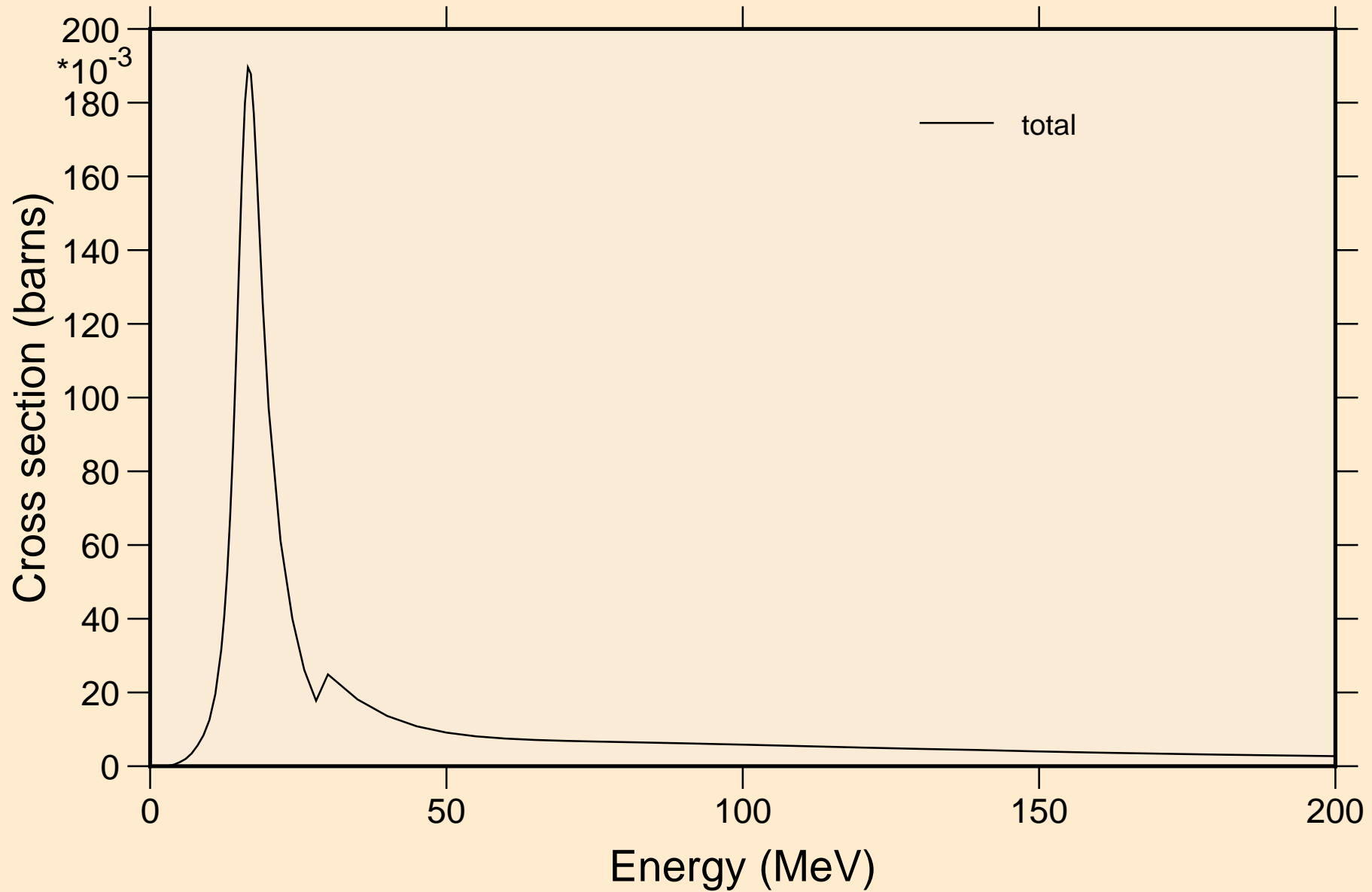

TC089M PHOTON ACER TENDL-2023 LIBRARY; T=0.K
Partial cross sections

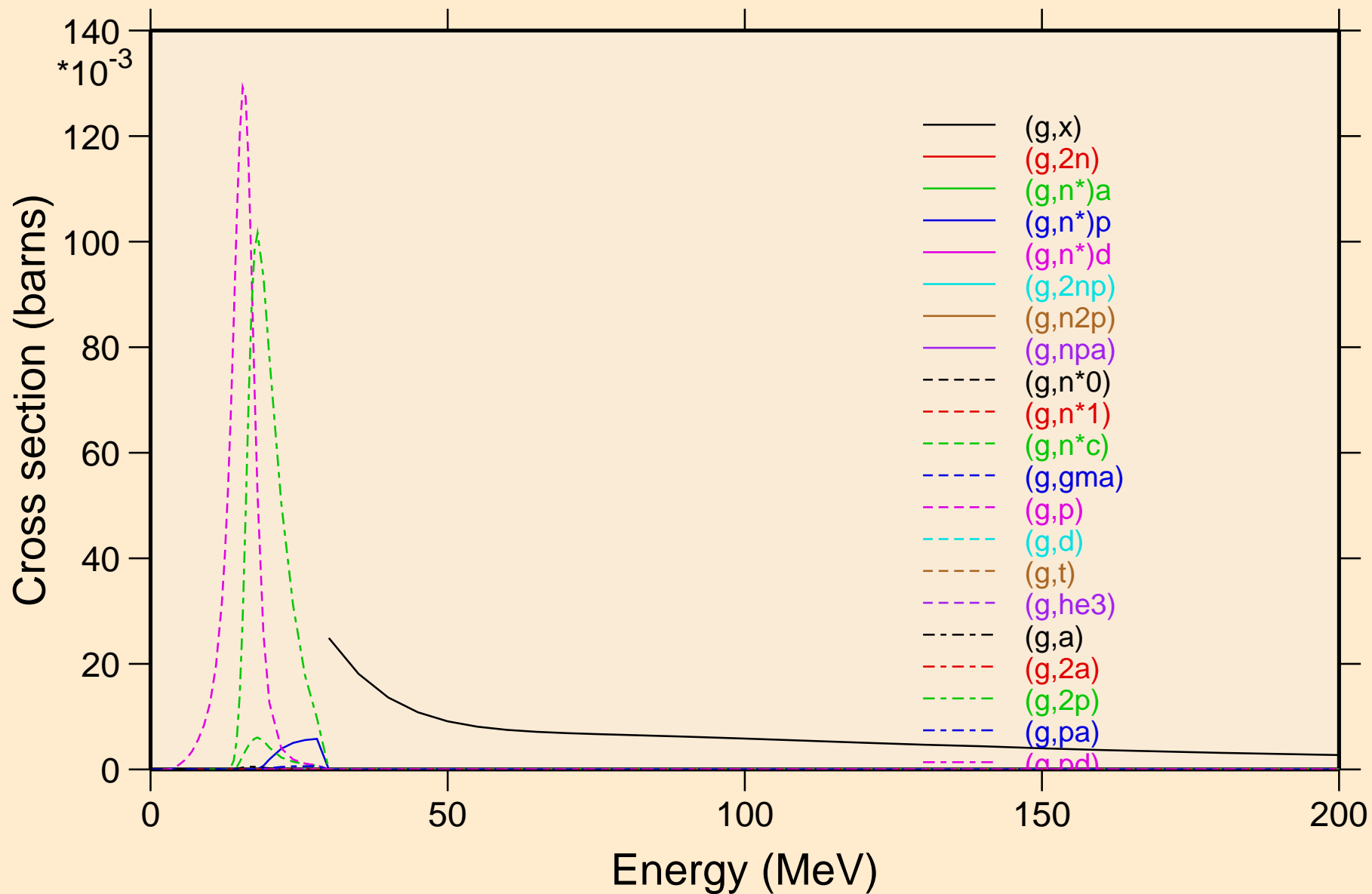

TC089M PHOTON ACER TENDL-2023 LIBRARY; T=0.K

Heating

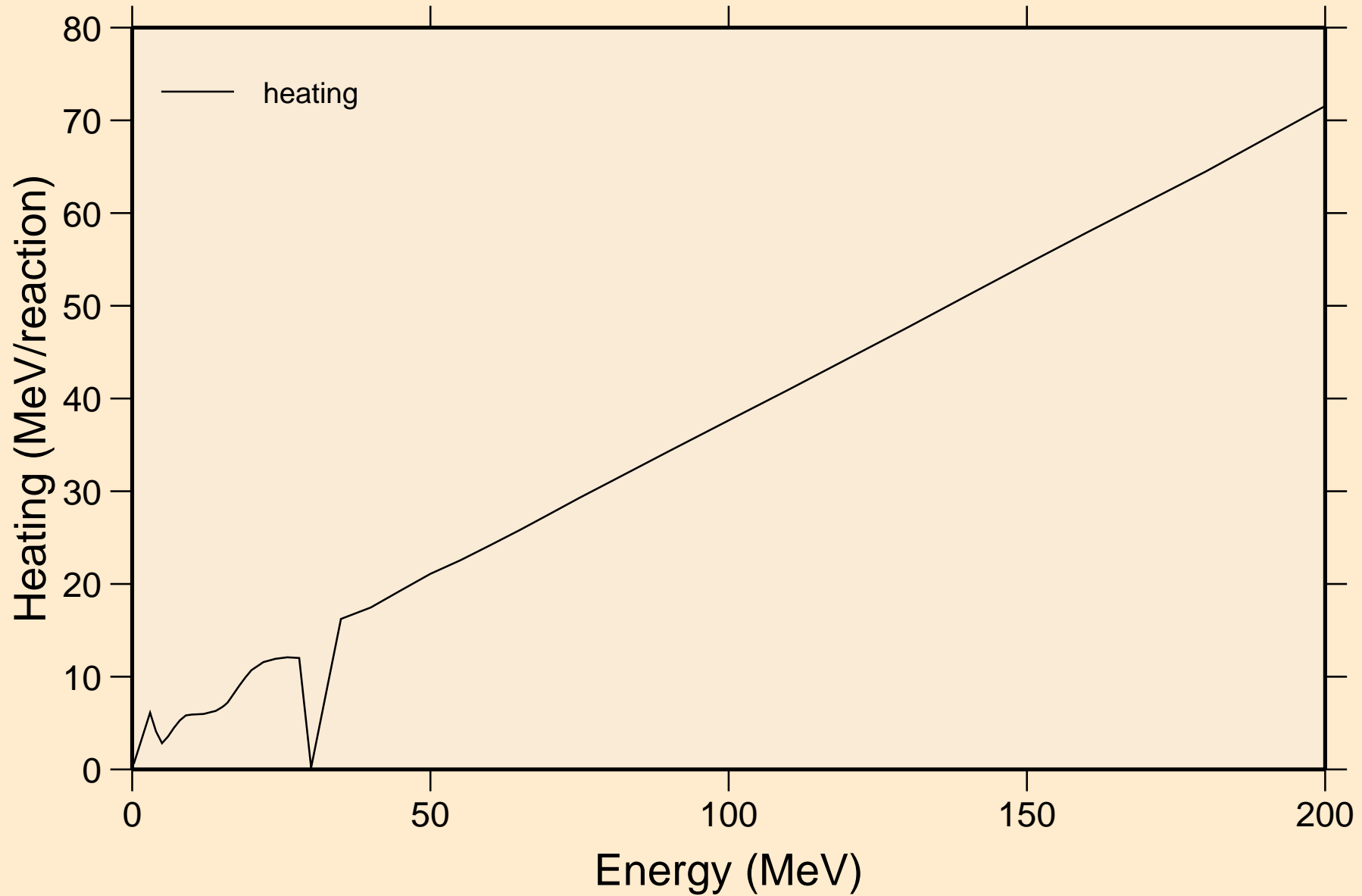

TC089M PHOTON ACER TENDL-2023 LIBRARY; T=0.K
Particle heating contributions

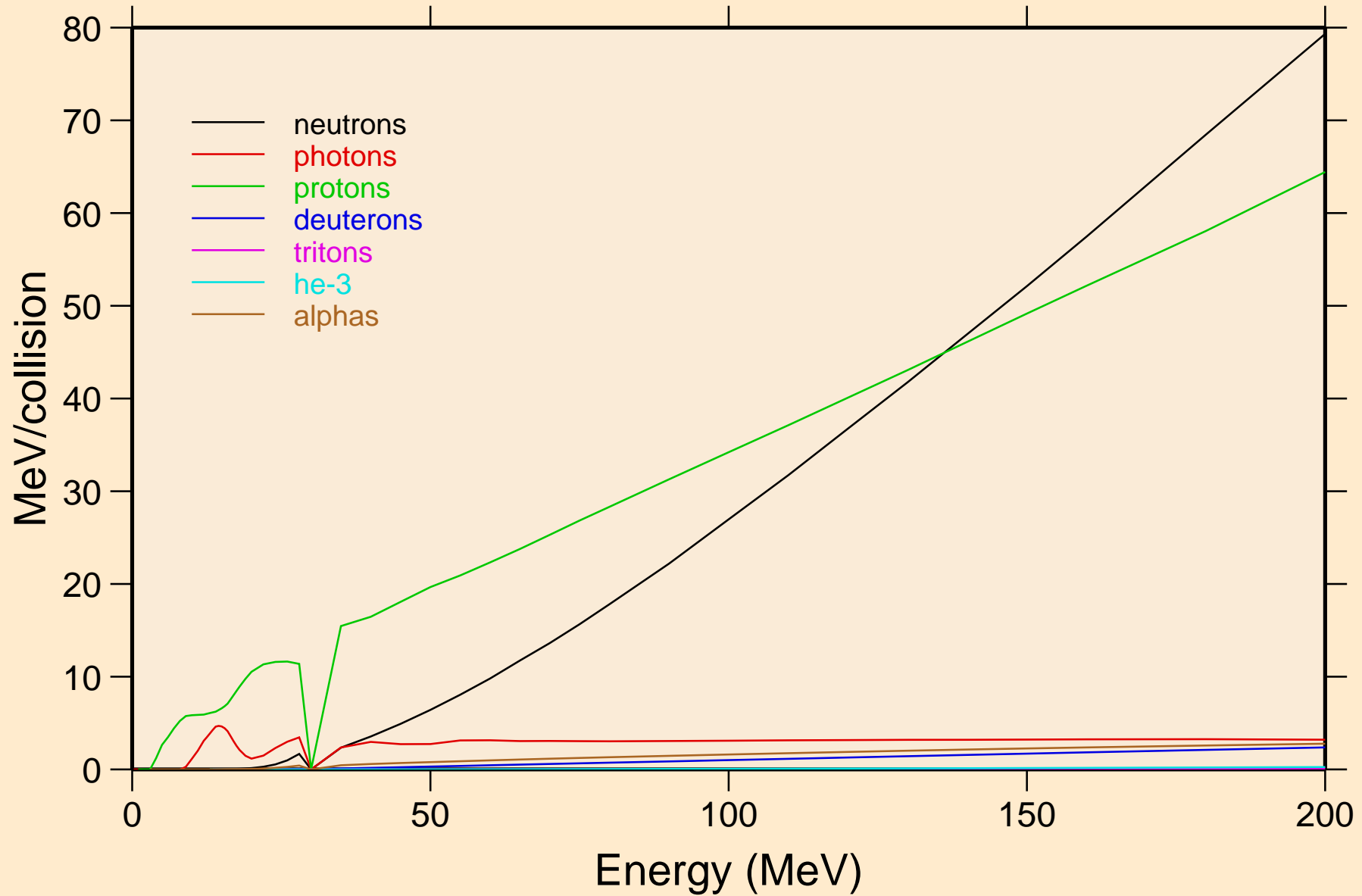

TC089M PHOTON ACER TENDL-2023 LIBRARY; T=0.K
Particle production cross sections

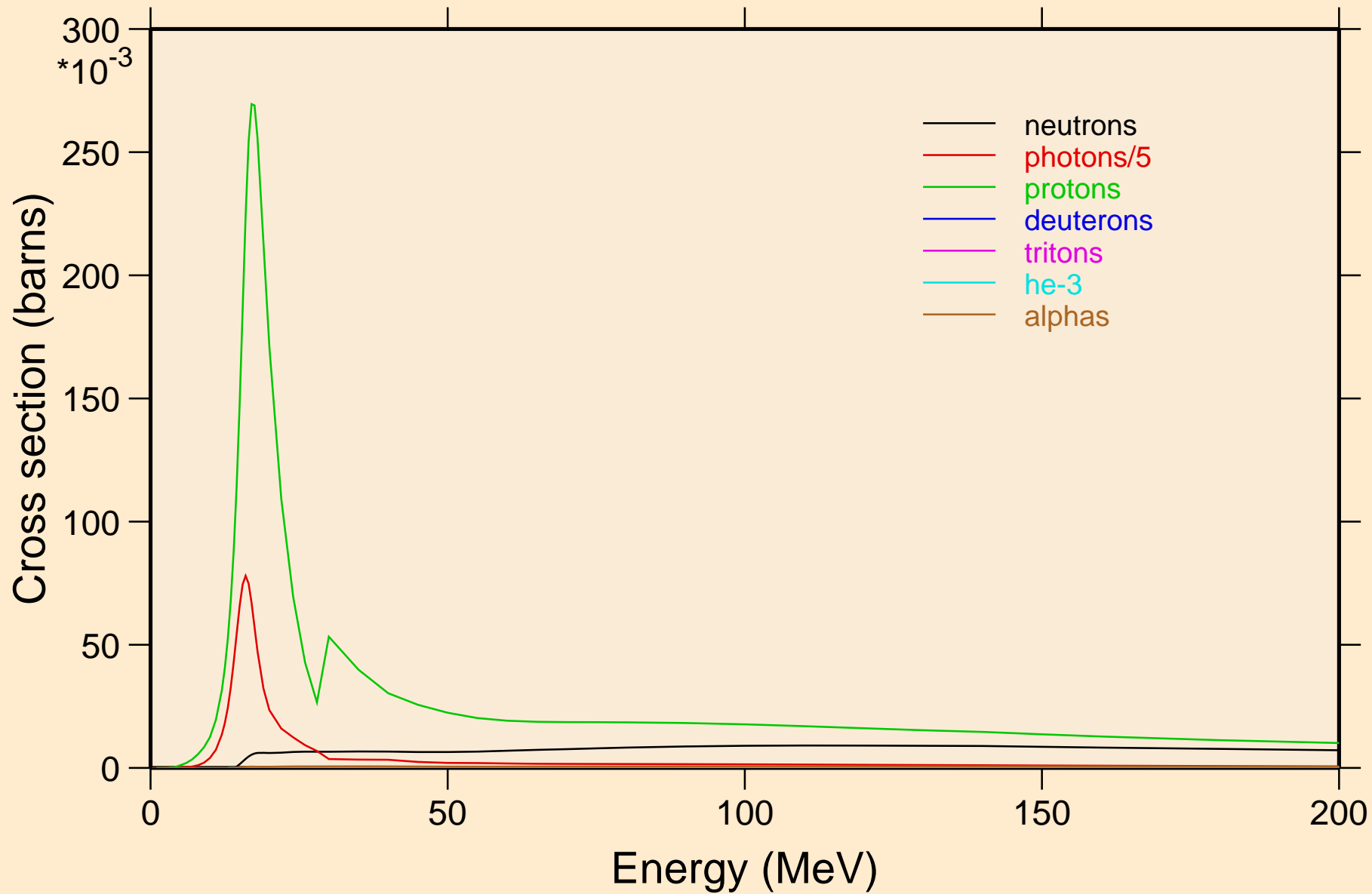

TC089M PHOTON ACER TENDL-2023 LIBRARY; T=0.K
neutrons from (g,x)

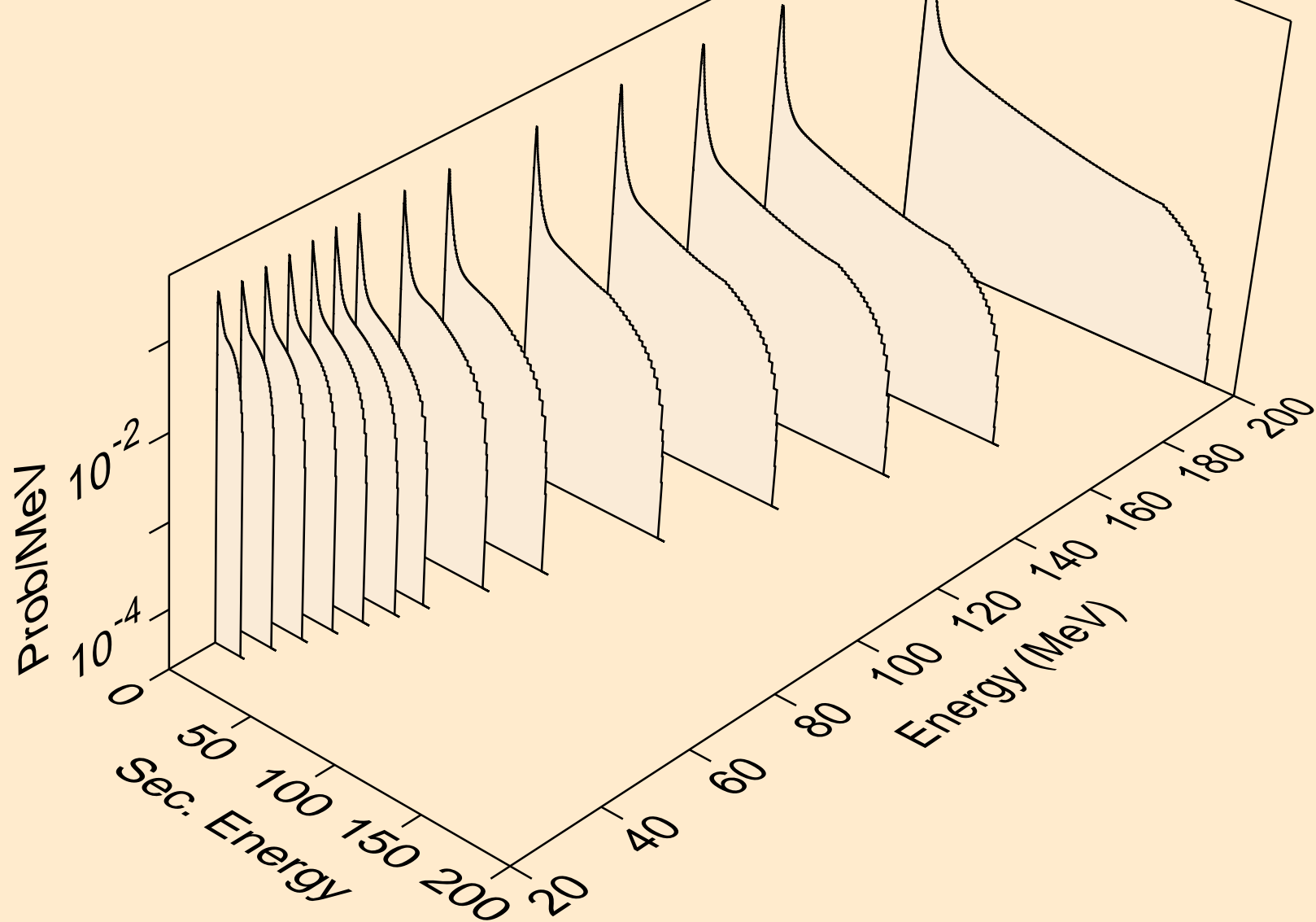

TC089M PHOTON ACER TENDL-2023 LIBRARY; T=0.K
neutrons from (g,2n)

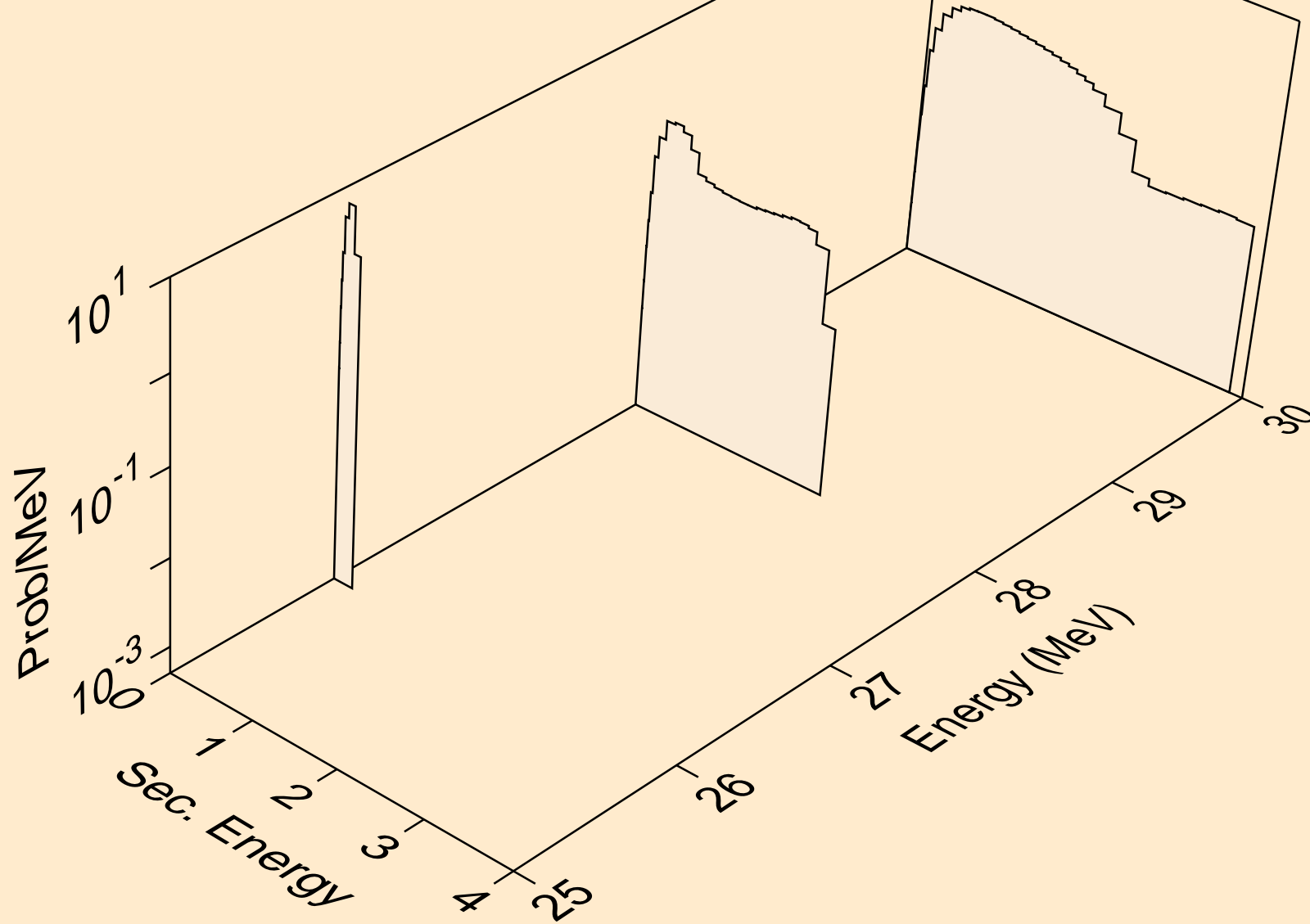

TC089M PHOTON ACER TENDL-2023 LIBRARY; T=0.K
neutrons from (g,n*)a

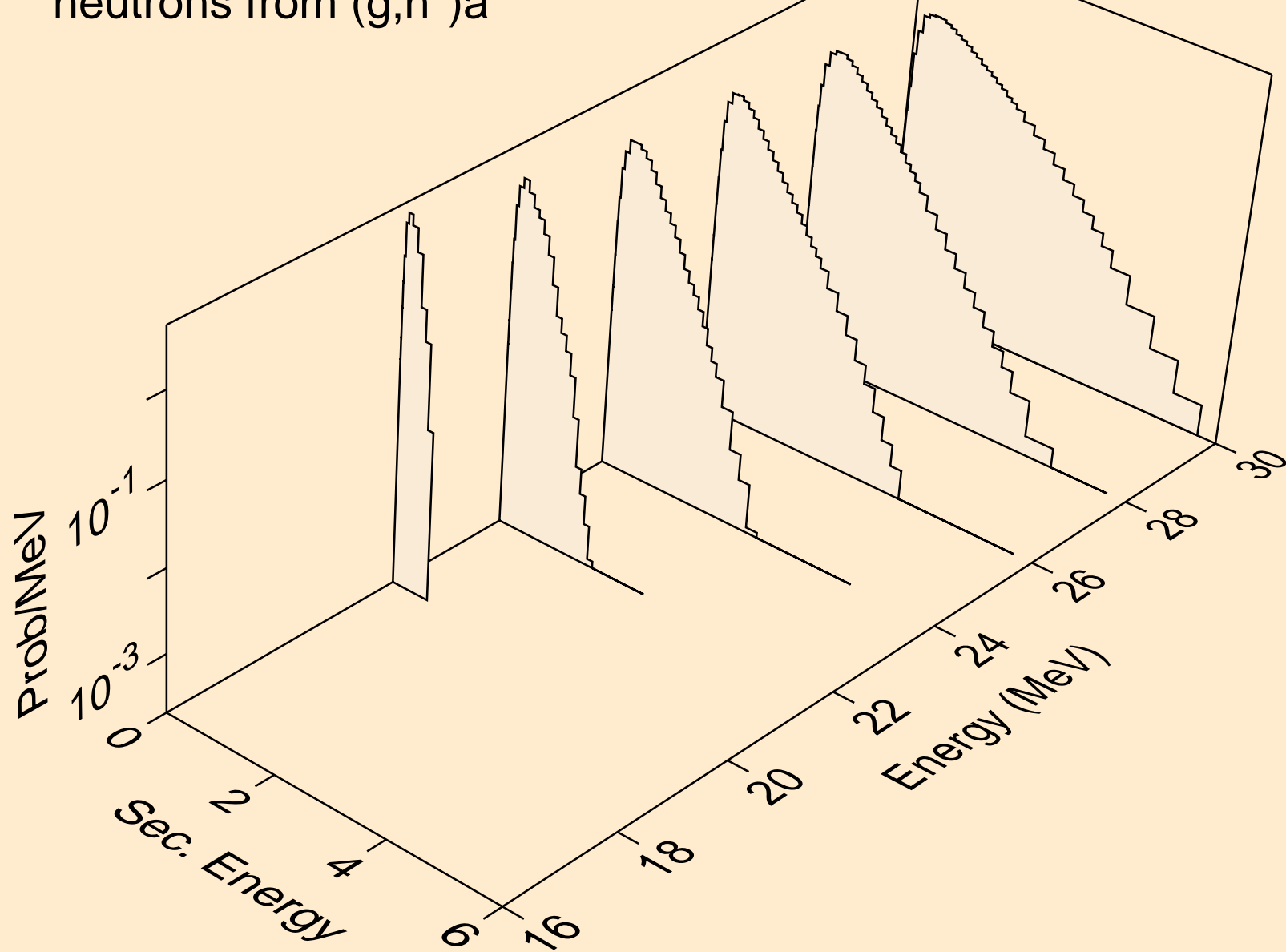

TC089M PHOTON ACER TENDL-2023 LIBRARY; T=0.K
neutrons from (g,n*)p

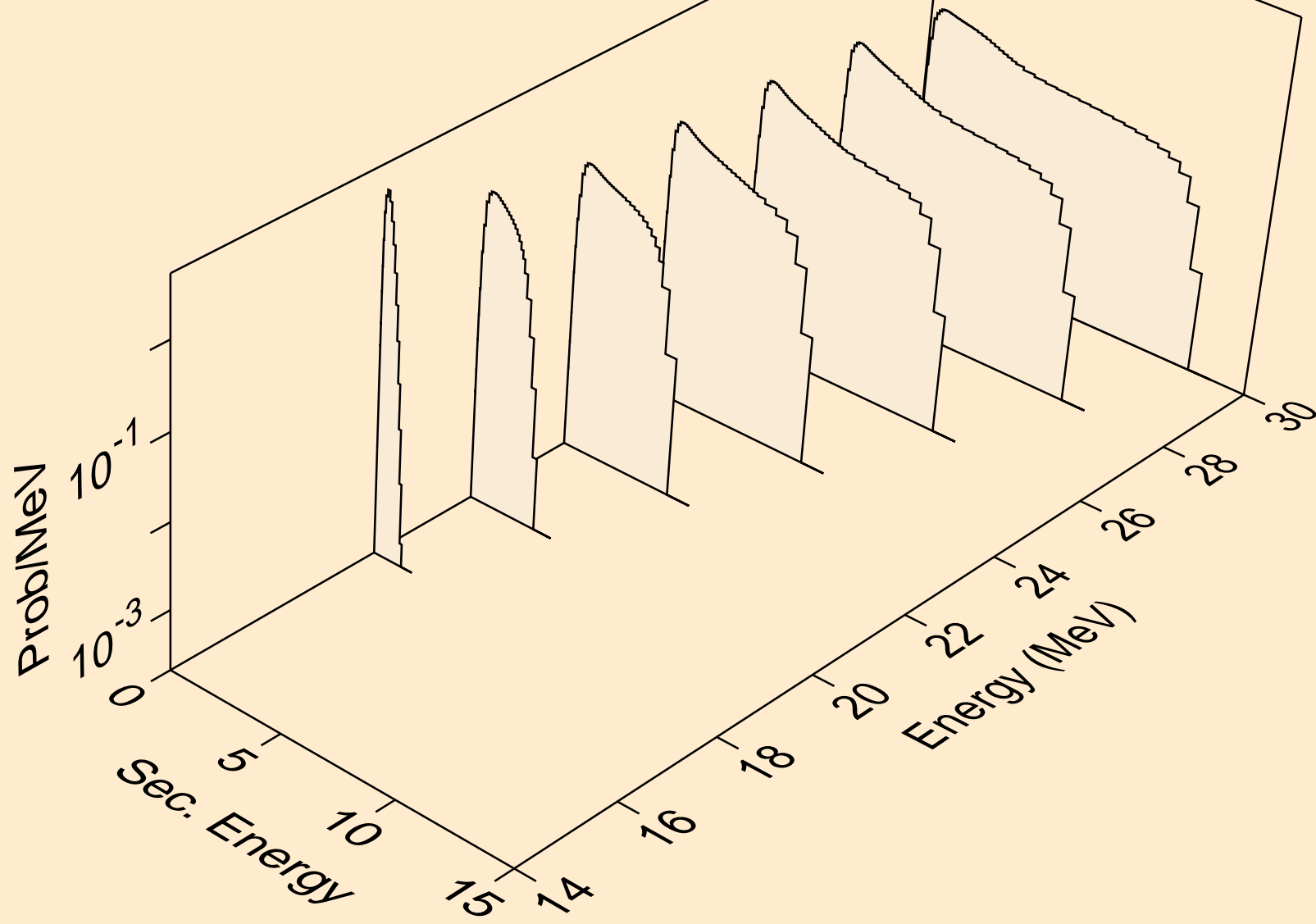

TC089M PHOTON ACER TENDL-2023 LIBRARY; T=0.K
neutrons from (g,n*)d

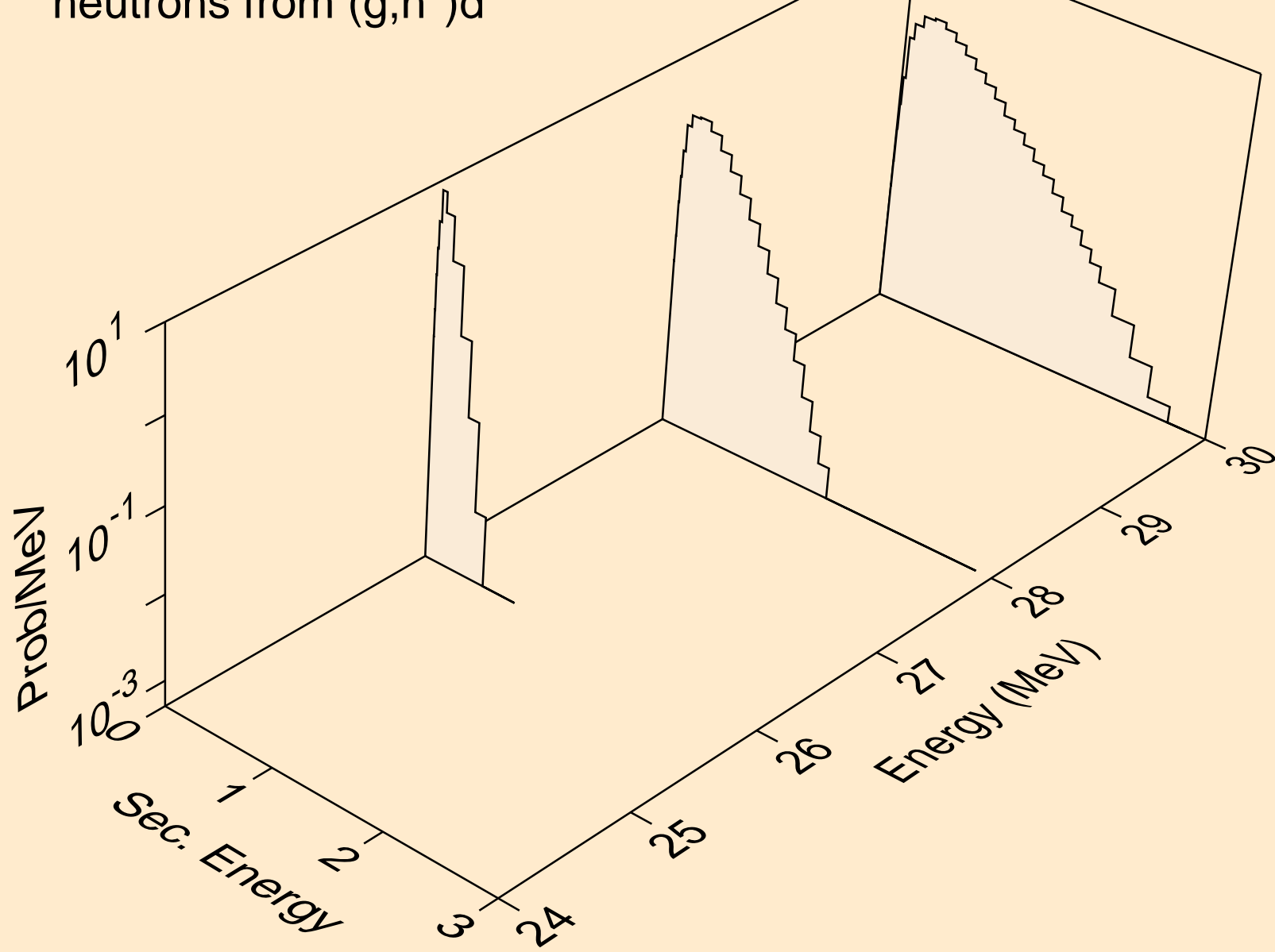

TC089M PHOTON ACER TENDL-2023 LIBRARY; T=0.K
neutrons from (g,2np)

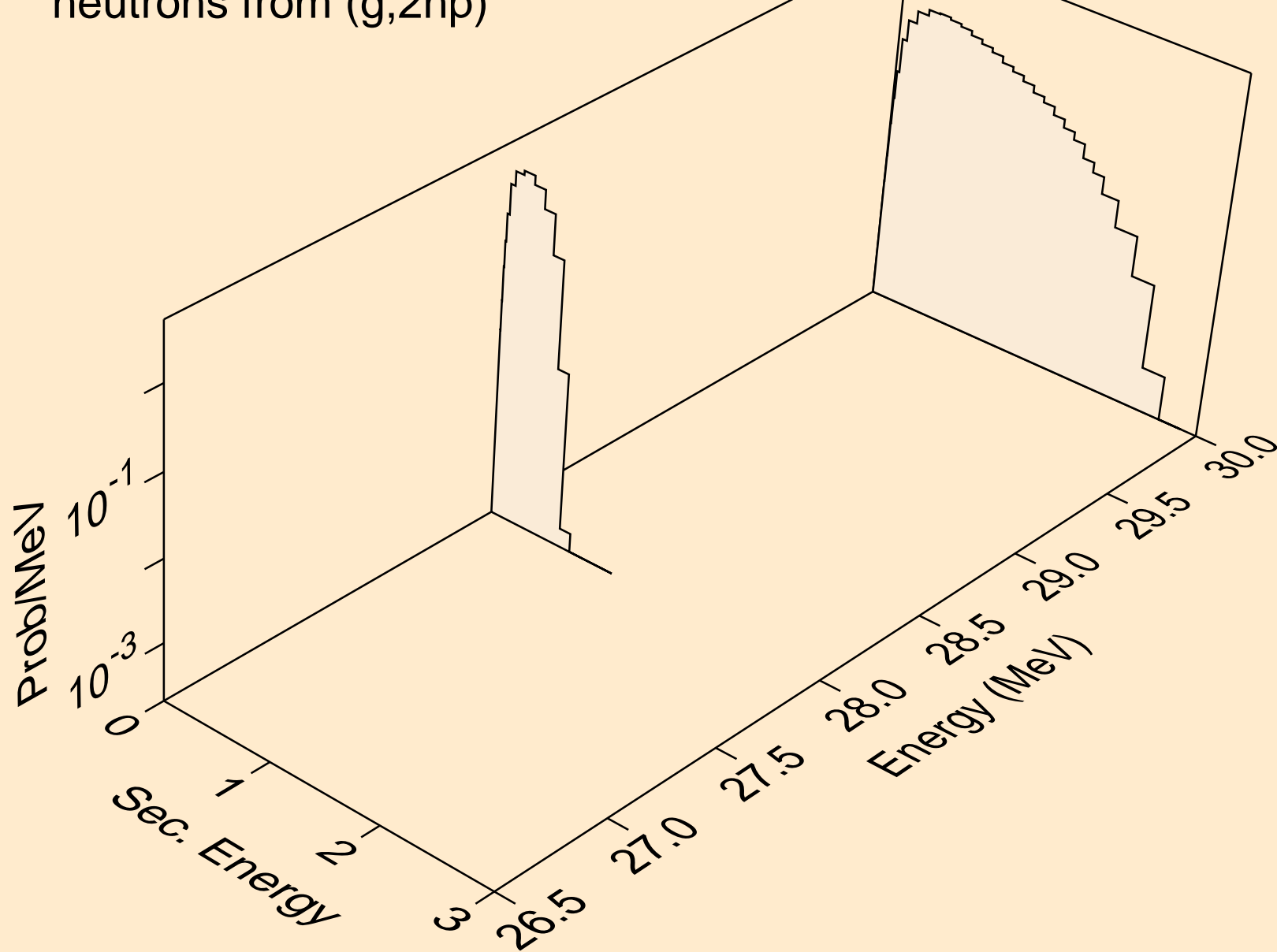

TC089M PHOTON ACER TENDL-2023 LIBRARY; T=0.K
neutrons from (g,n2p)

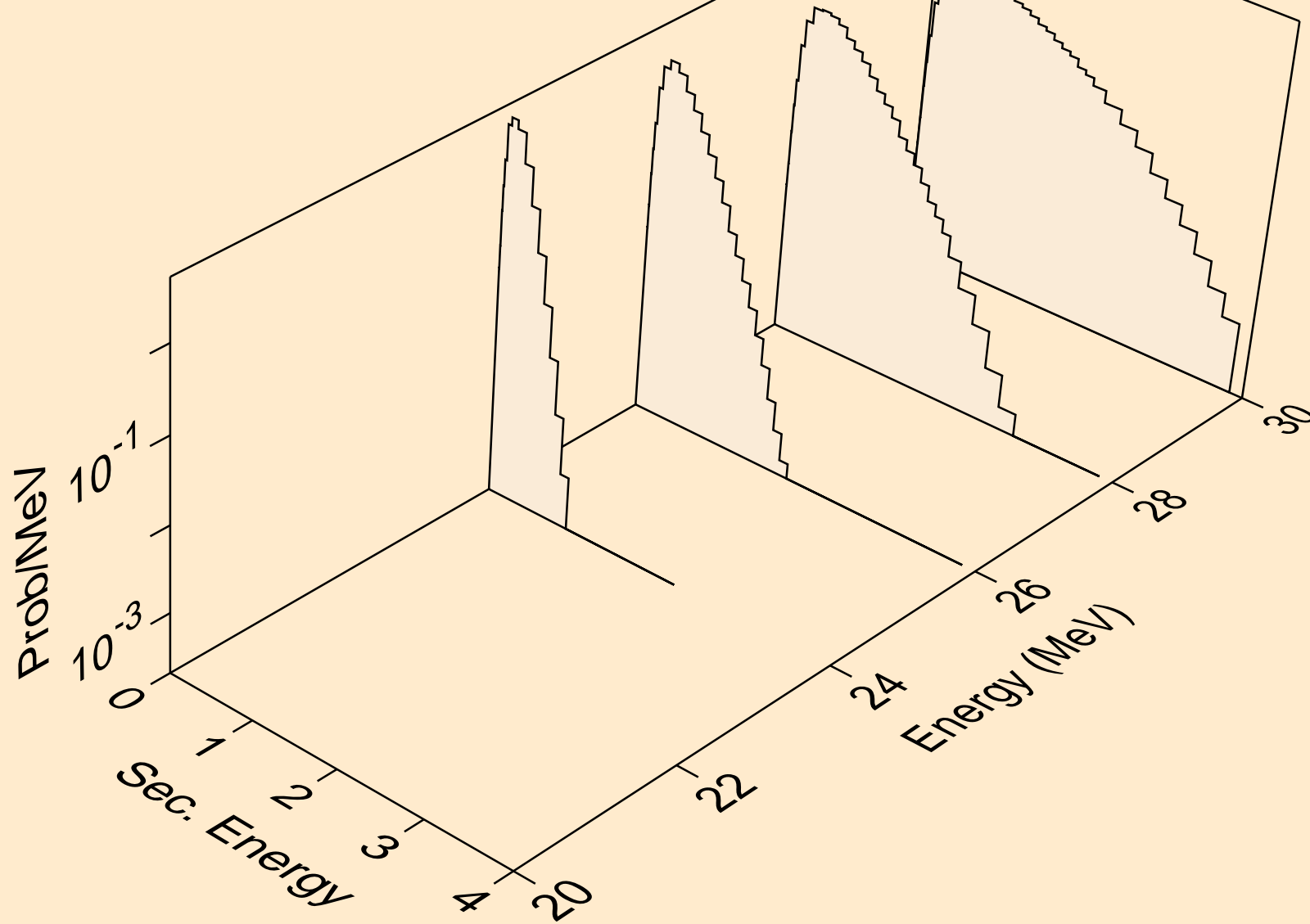

TC089M PHOTON ACER TENDL-2023 LIBRARY; T=0.K
neutrons from (g,npa)

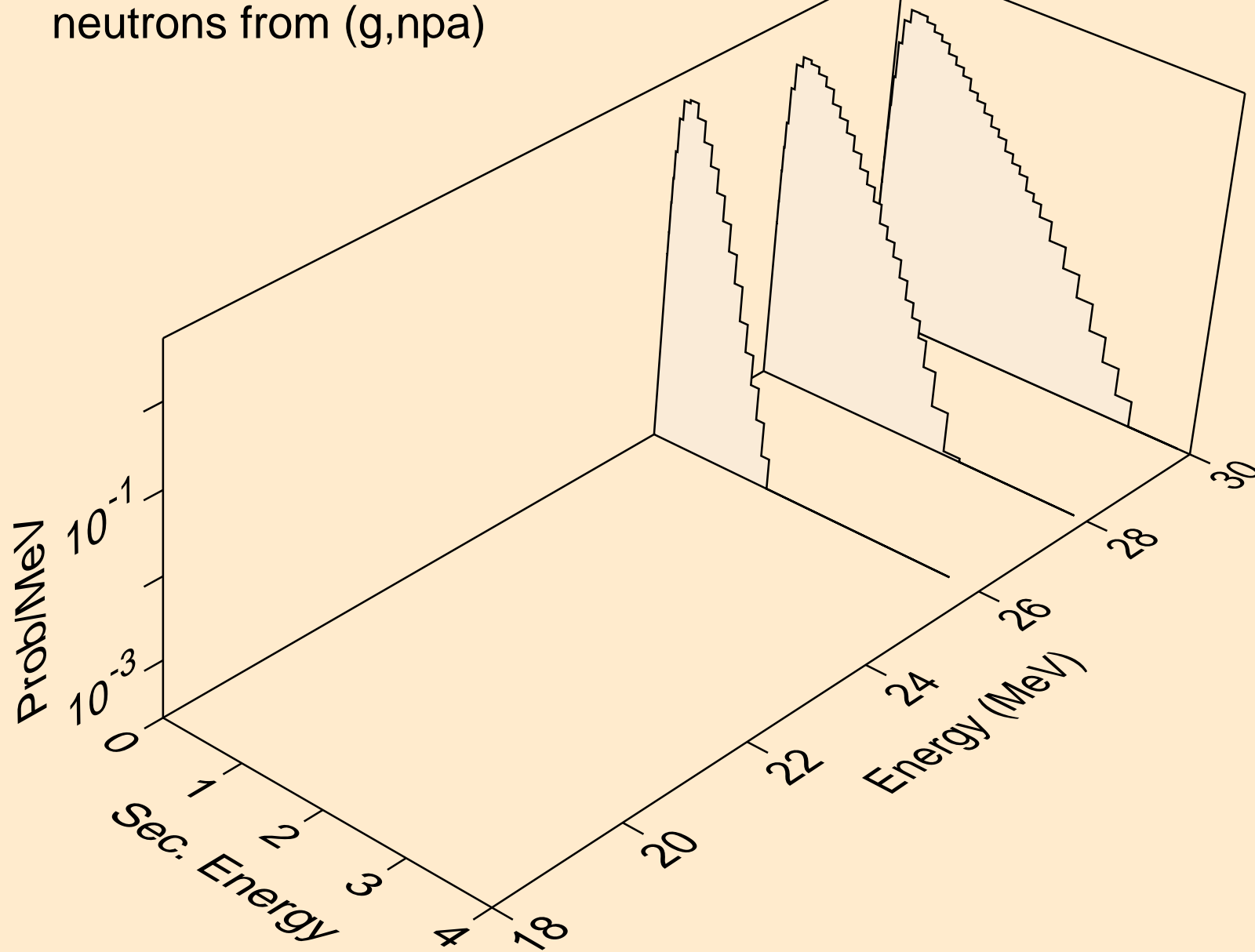

TC089M PHOTON ACER TENDL-2023 LIBRARY; T=0.K
angular distribution for (g,n*0) neutron

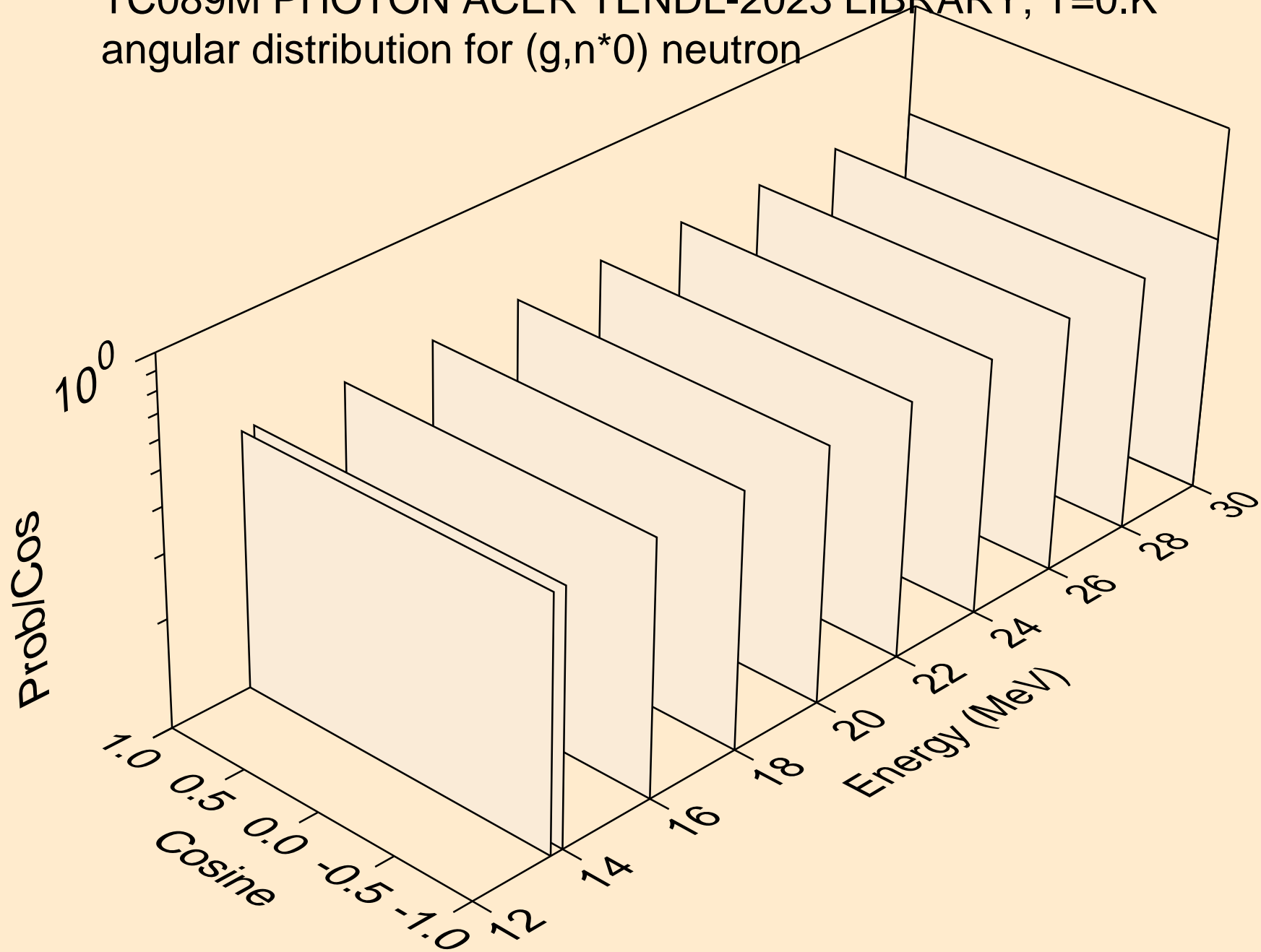

TC089M PHOTON ACER TENDL-2023 LIBRARY; T=0.K
angular distribution for (g,n*1) neutron

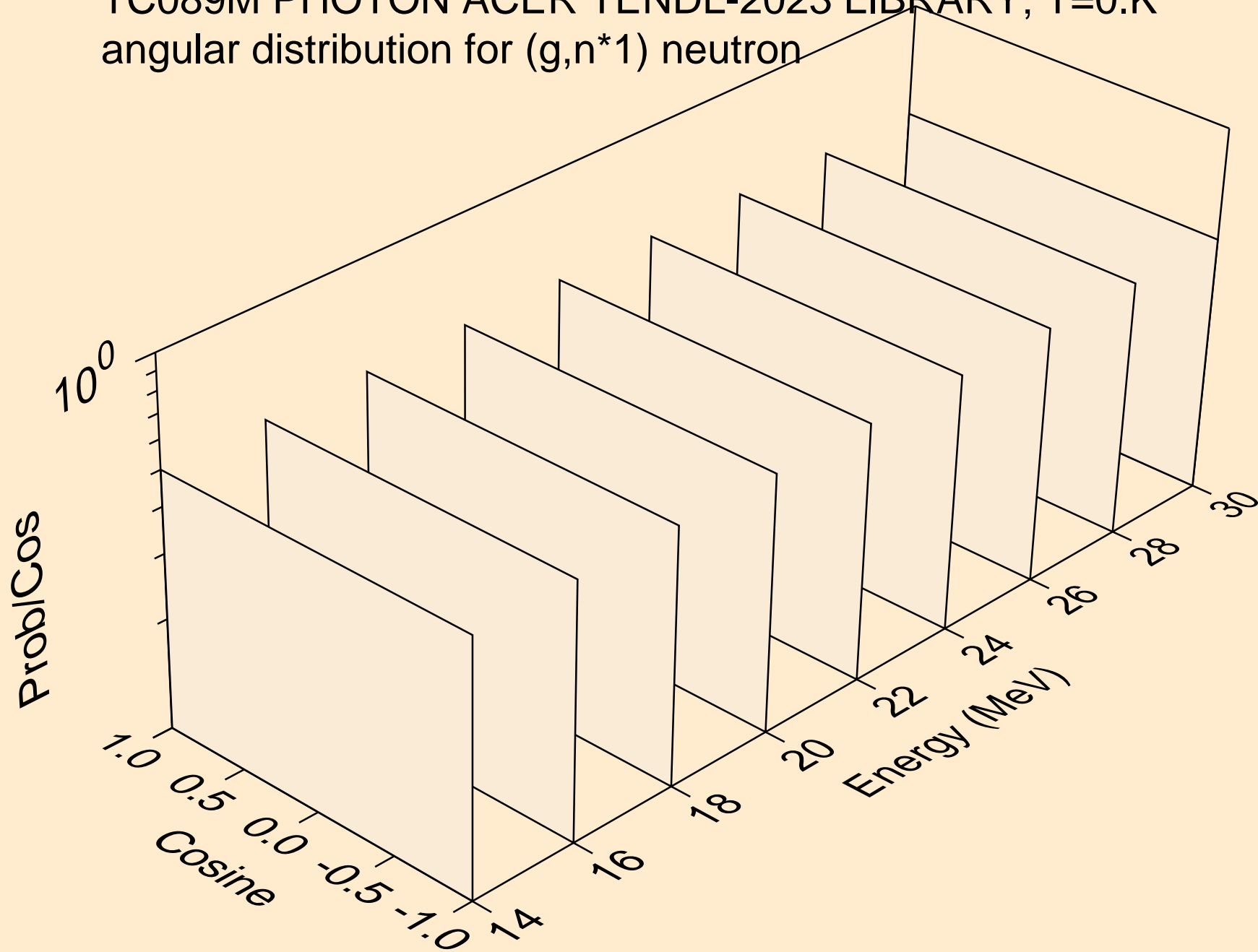

TC089M PHOTON ACER TENDL-2023 LIBRARY; T=0.K
neutrons from (g,n*c)

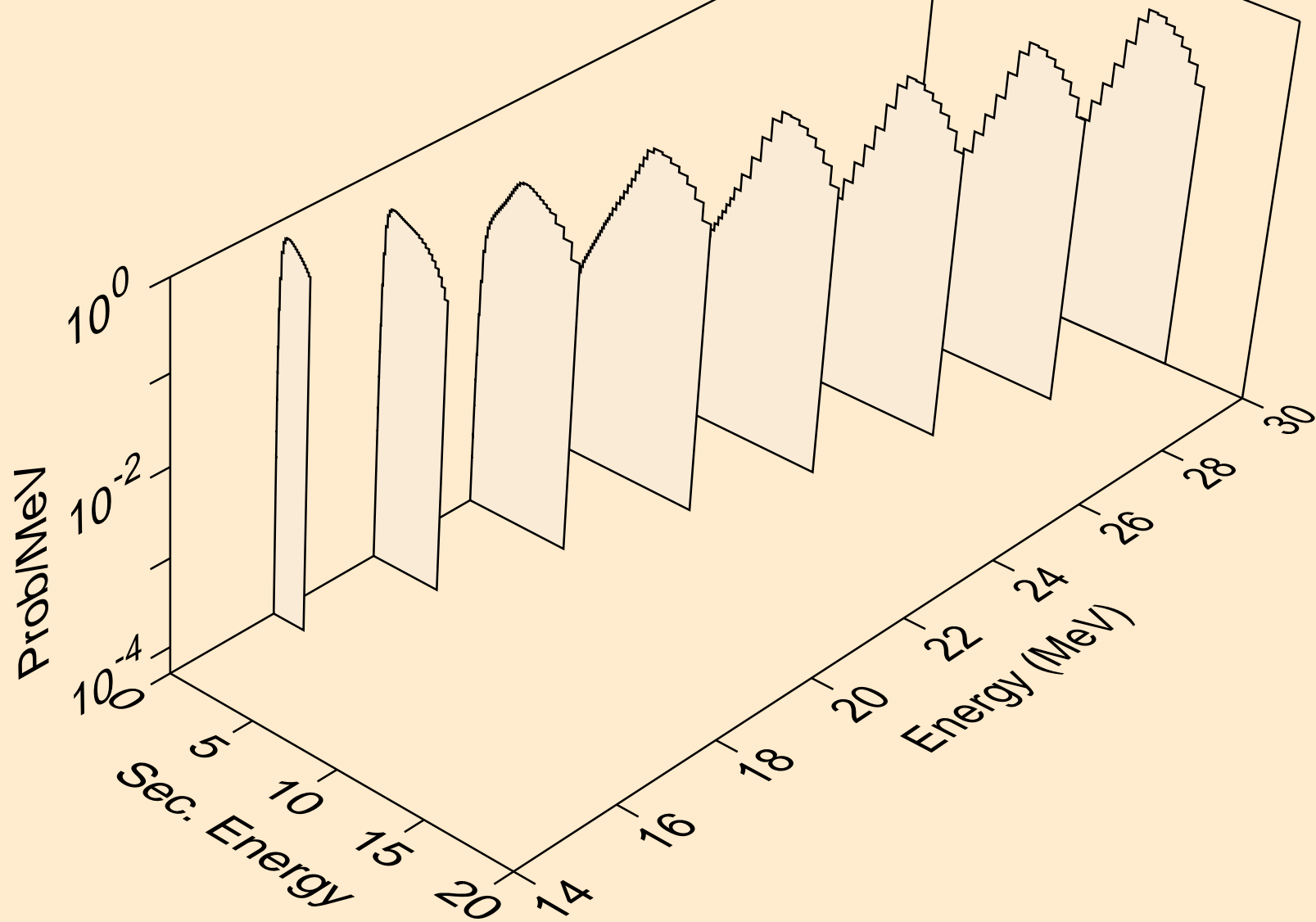

TC089M PHOTON ACER TENDL-2023 LIBRARY; T=0.K
photons from (g,x)

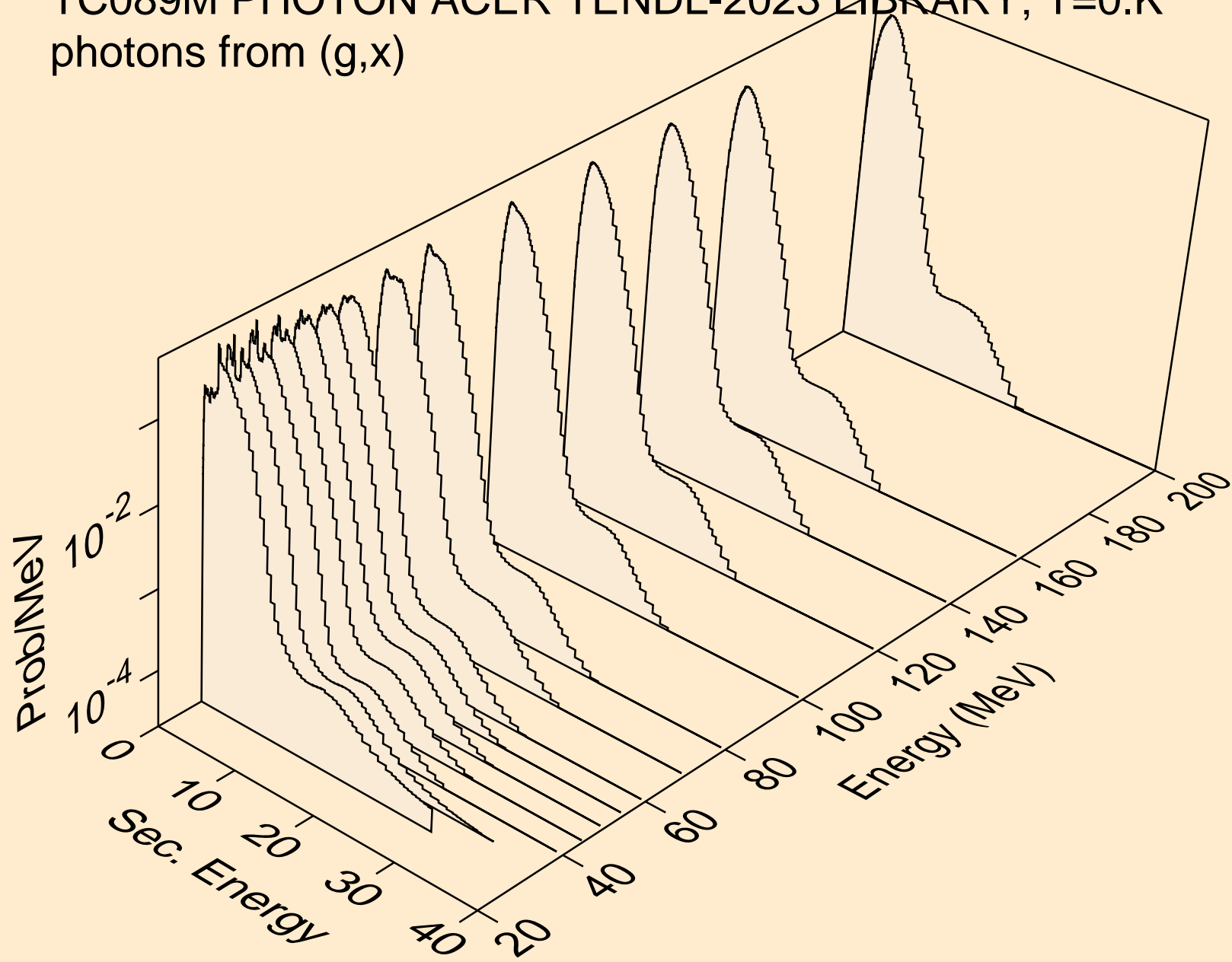

TC089M PHOTON ACER TENDL-2023 LIBRARY; T=0.K
photons from (g,2n)

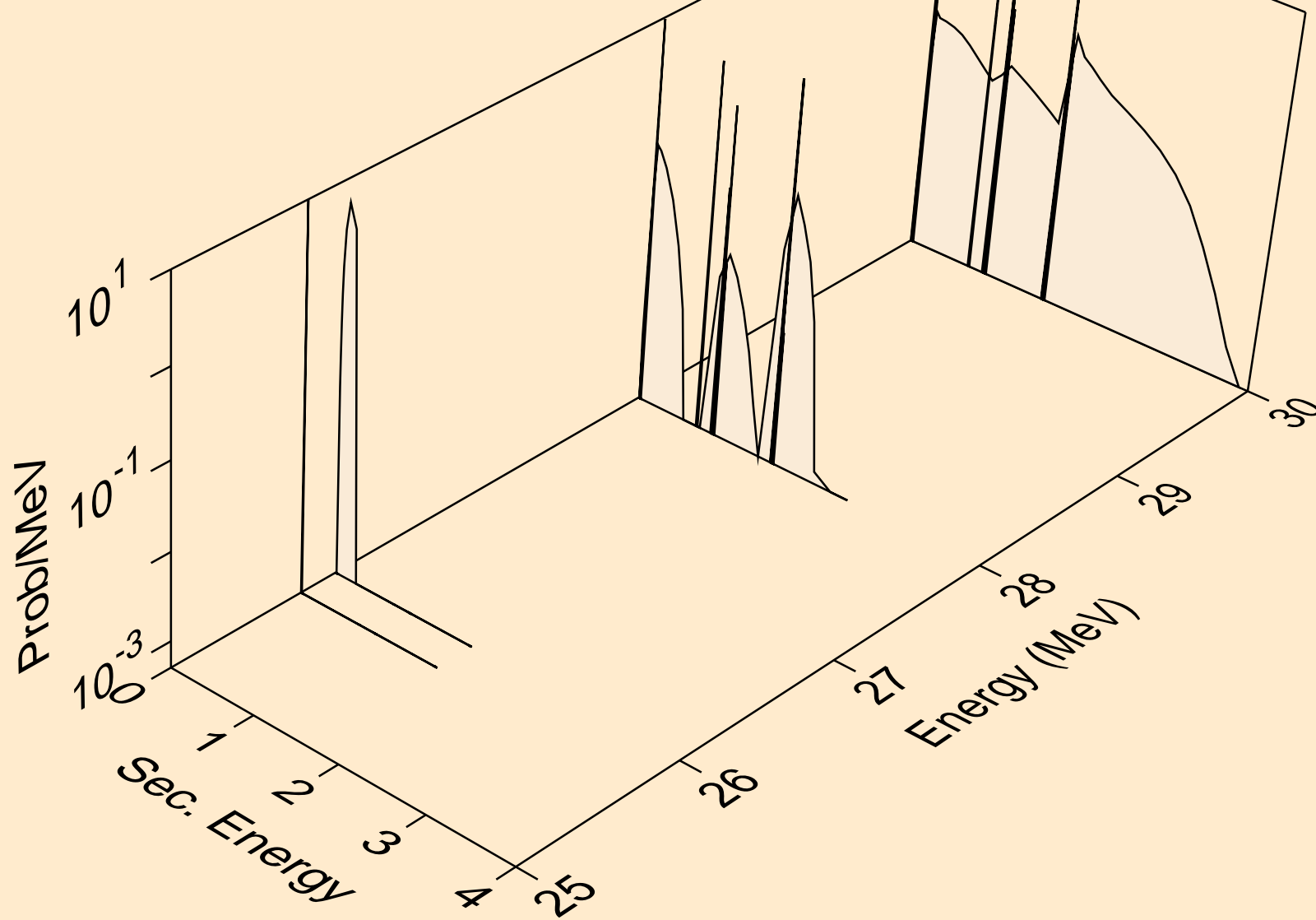

TC089M PHOTON ACER TENDL-2023 LIBRARY; T=0.K
photons from (g,n*)a

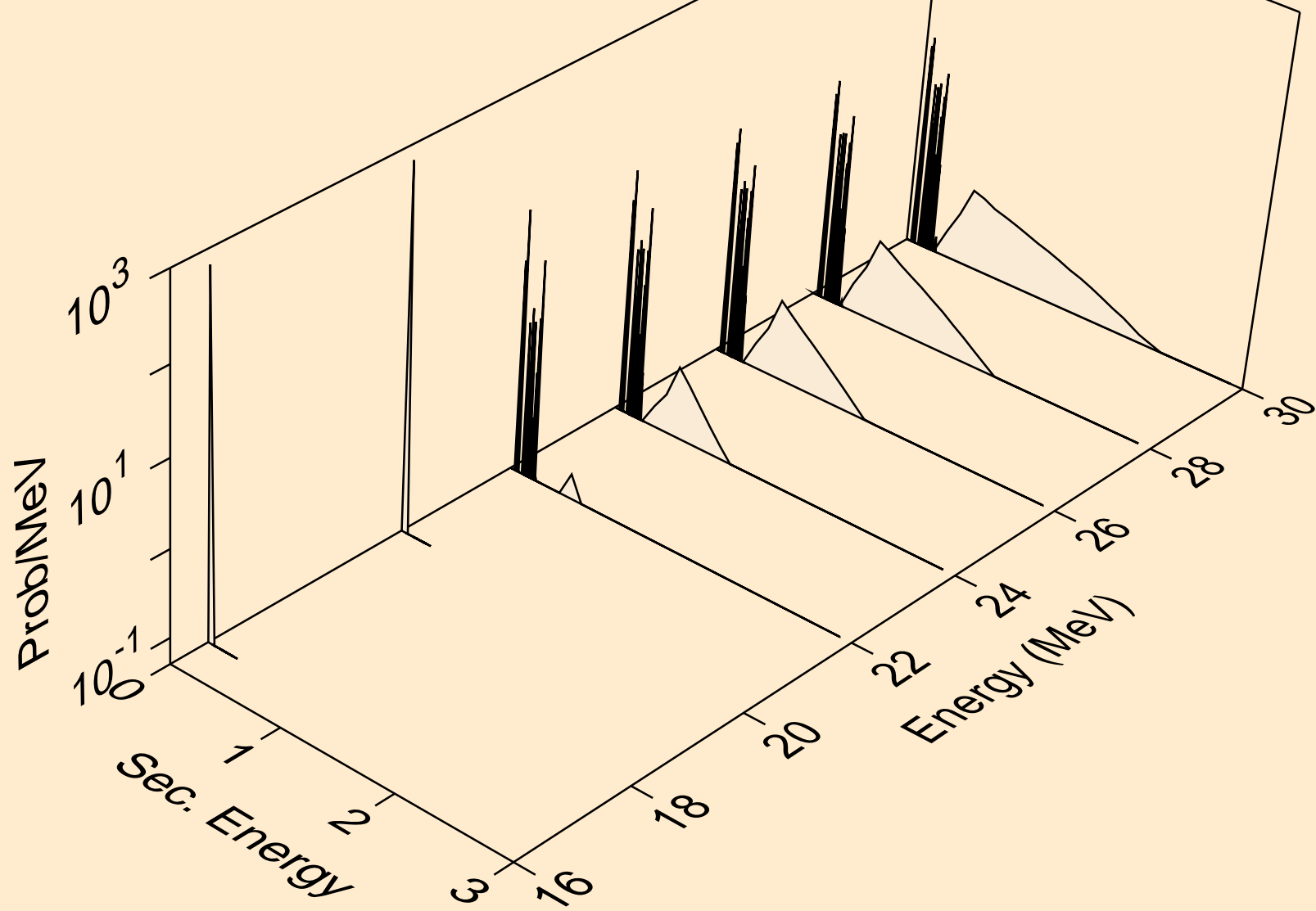

TC089M PHOTON ACER TENDL-2023 LIBRARY; T=0.K
photons from (g,n*)p

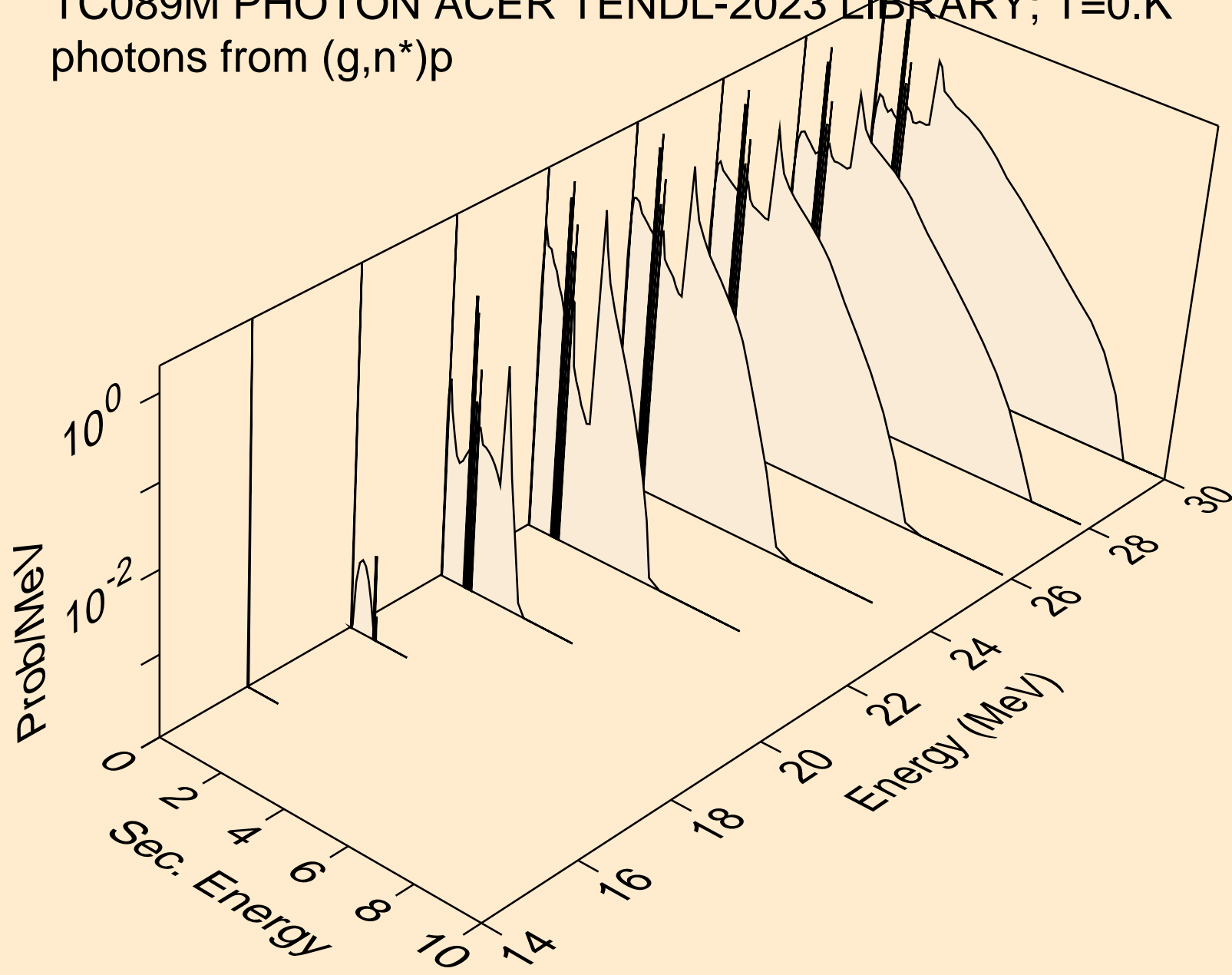

TC089M PHOTON ACER TENDL-2023 LIBRARY; T=0.K
photons from (g,n*)d

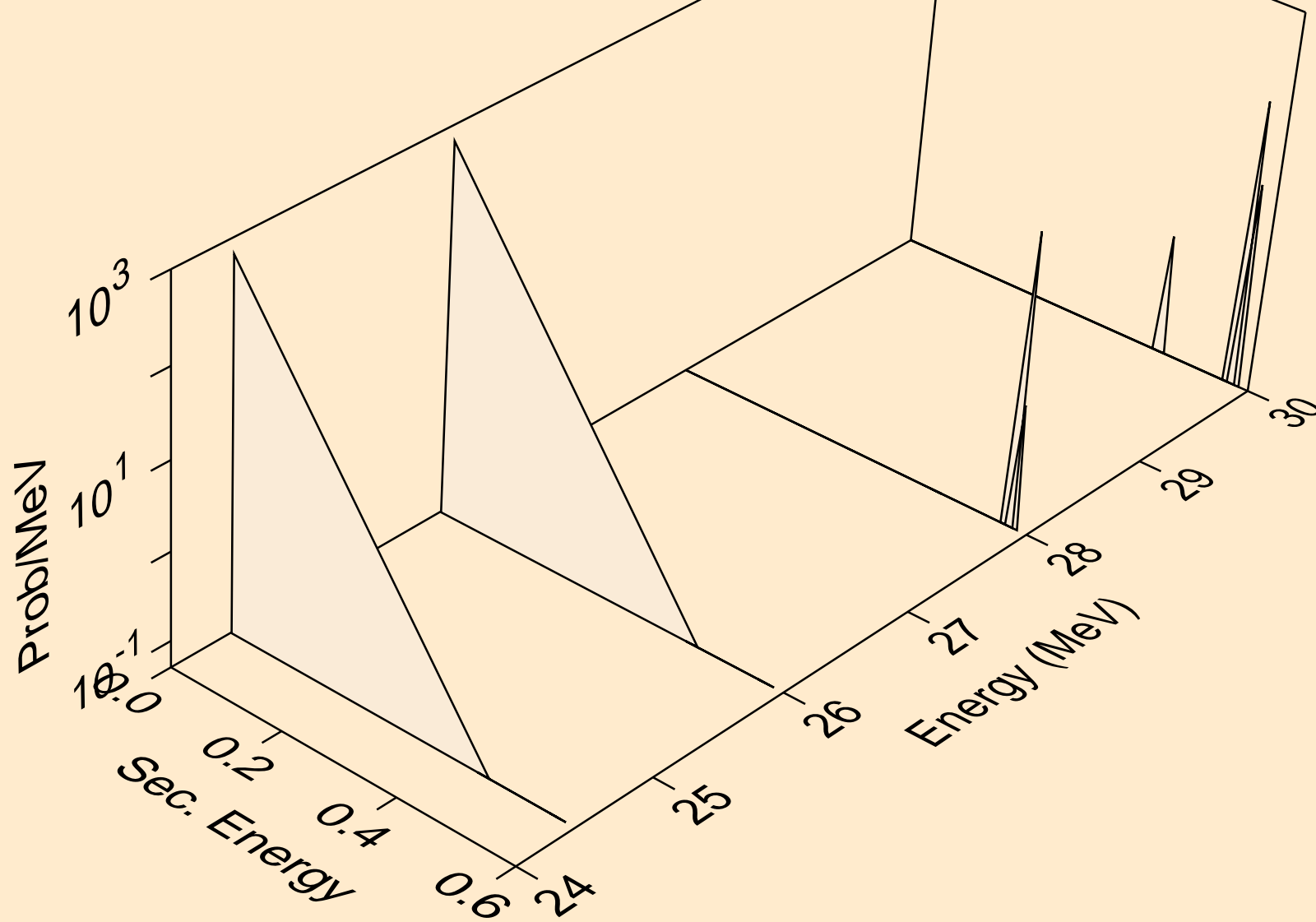

TC089M PHOTON ACER TENDL-2023 LIBRARY; T=0.K
photons from (g,2np)

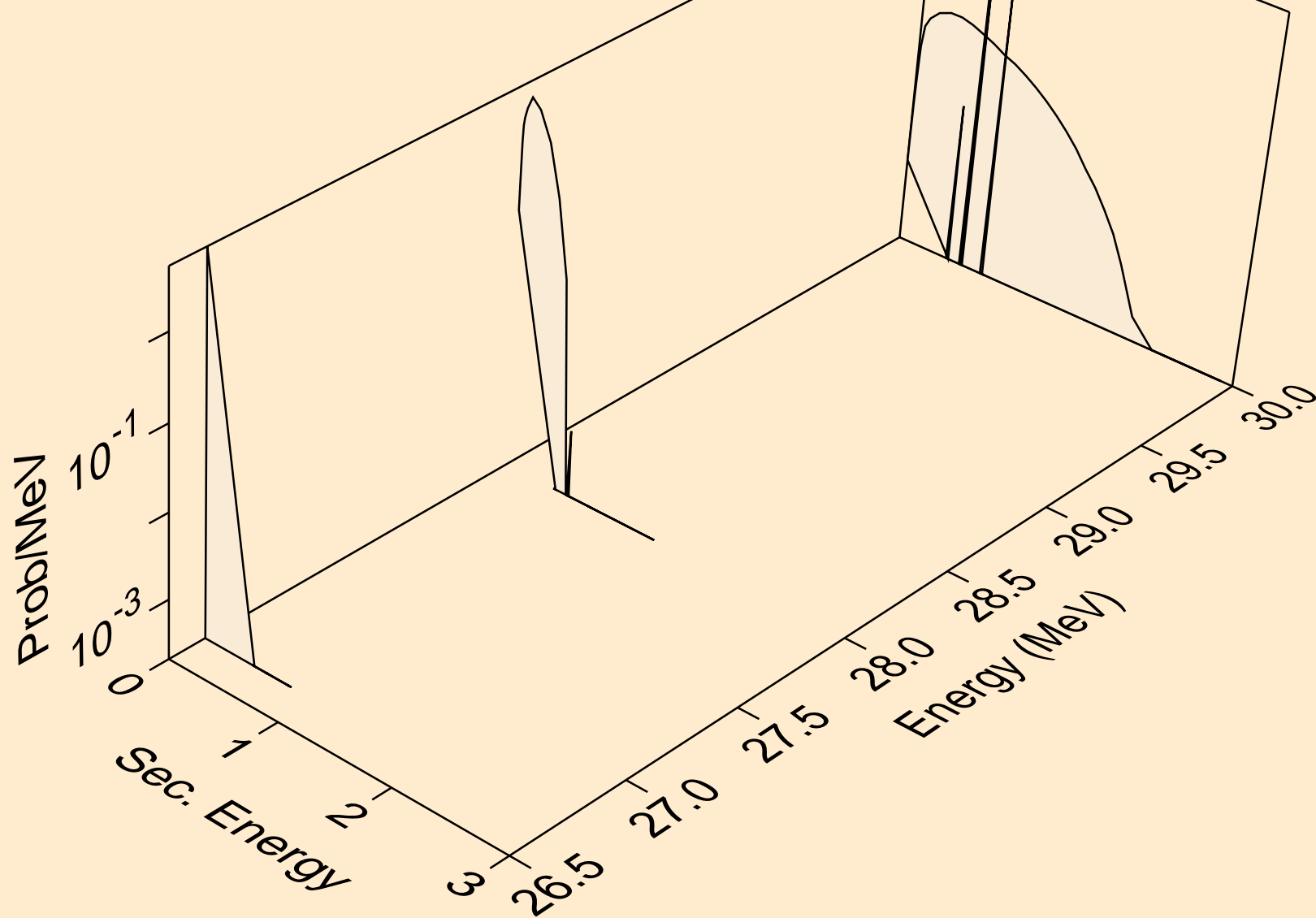

TC089M PHOTON ACER TENDL-2023 LIBRARY; T=0.K
photons from (g,n2p)

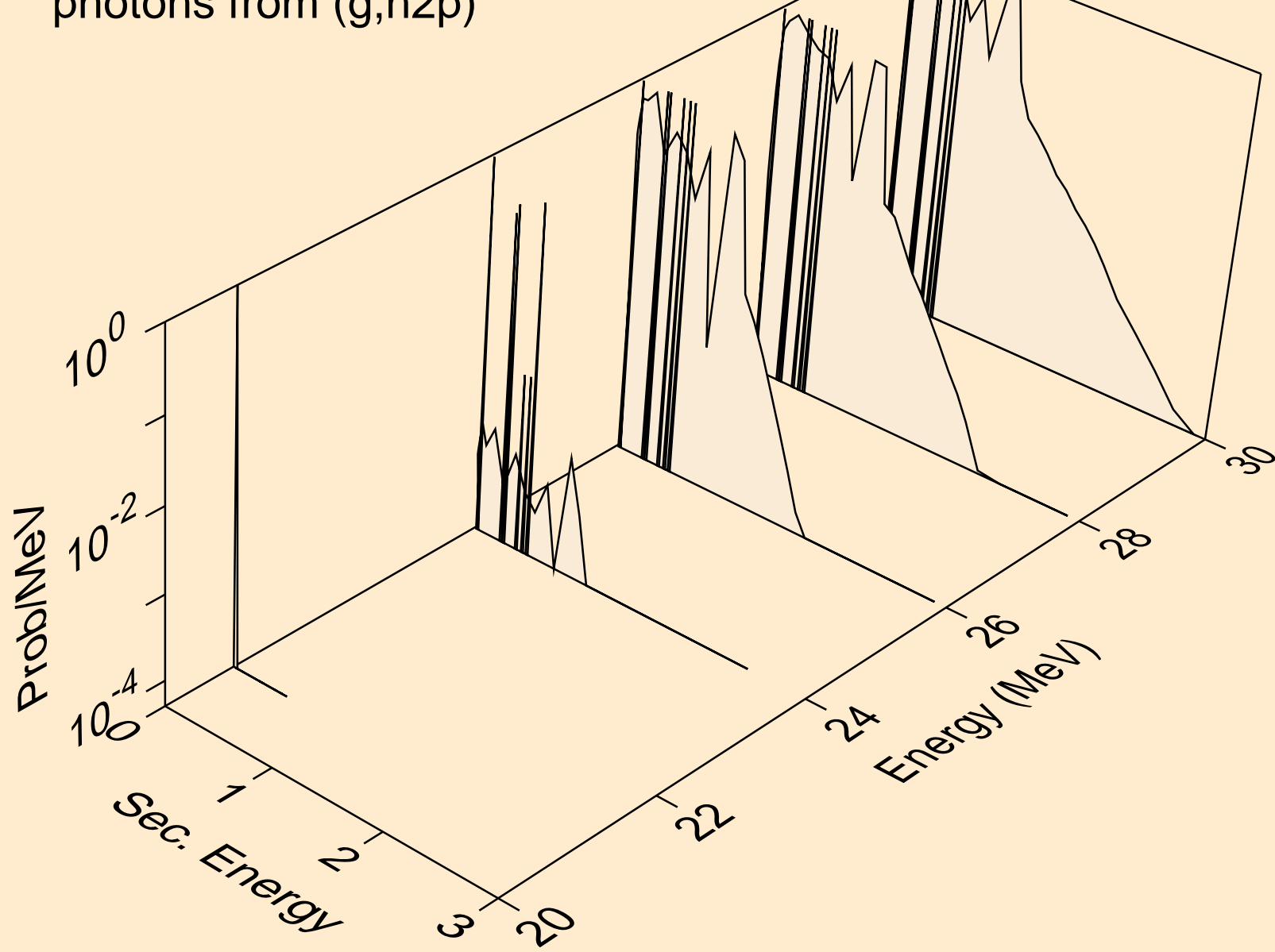

TC089M PHOTON ACER TENDL-2023 LIBRARY; T=0.K
photons from (g,npa)

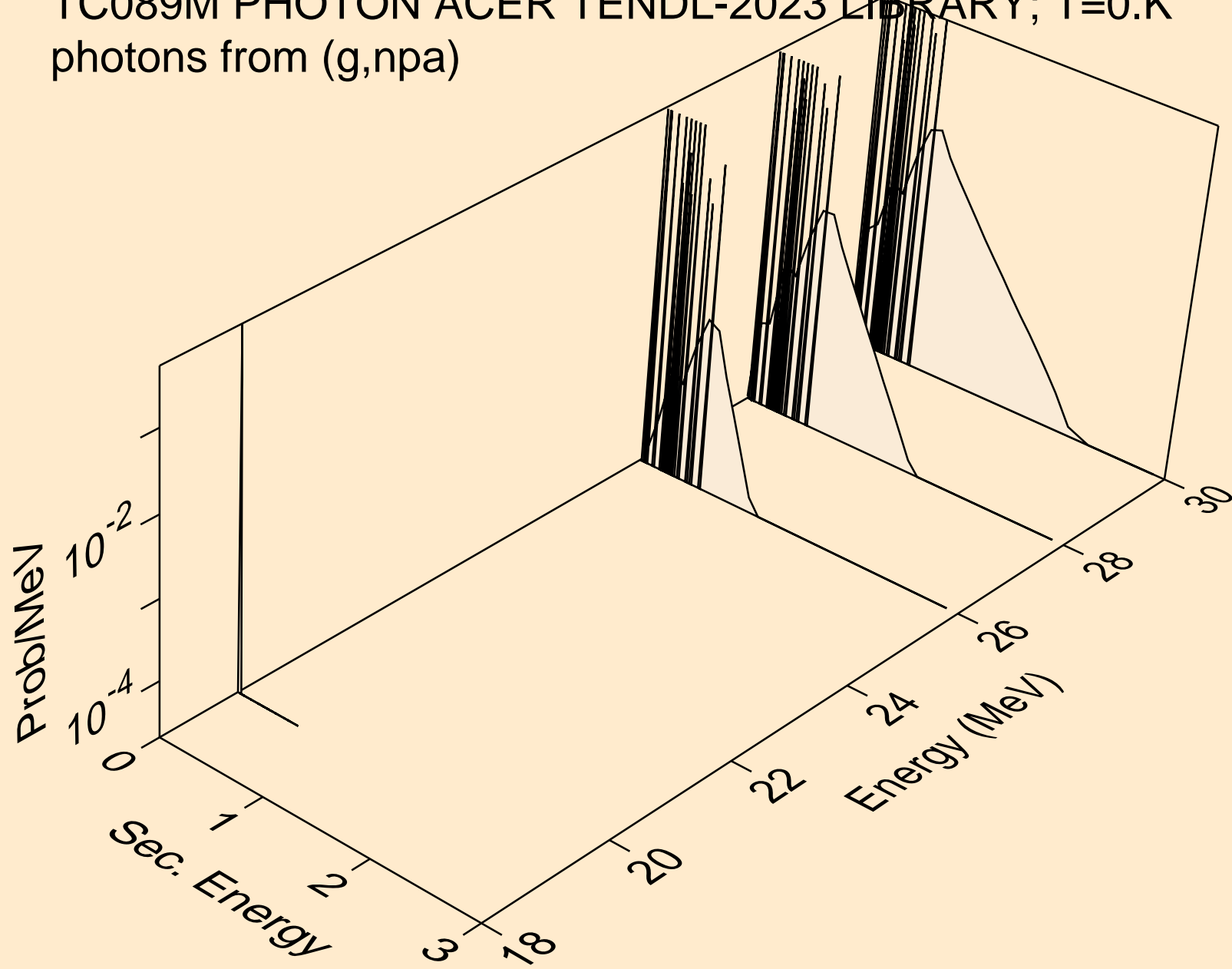

TC089M PHOTON ACER TENDL-2023 LIBRARY; T=0.K
photons from (g,n*c)

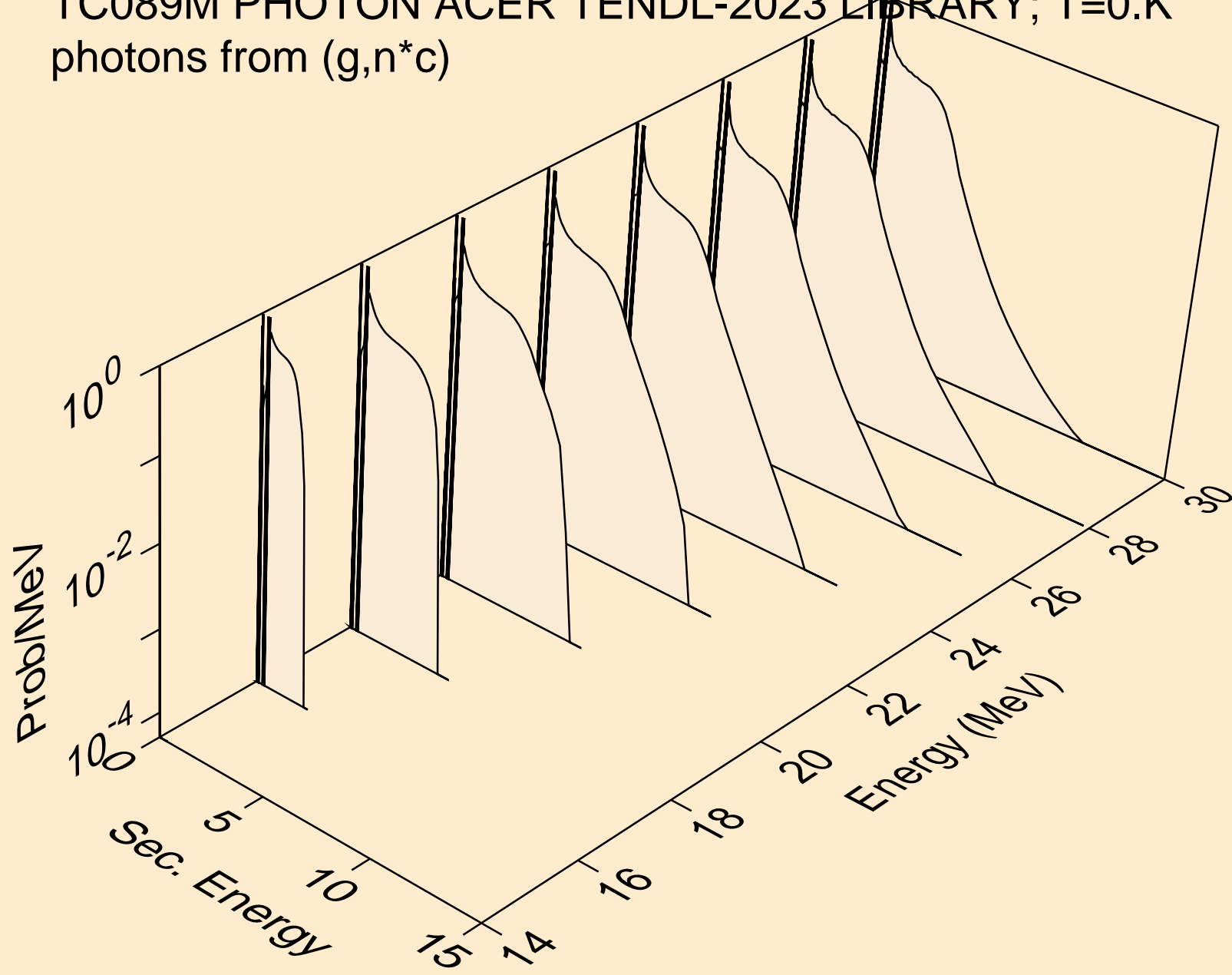

TC089M PHOTON ACER TENDL-2023 LIBRARY; T=0.K
photons from (g,gma)

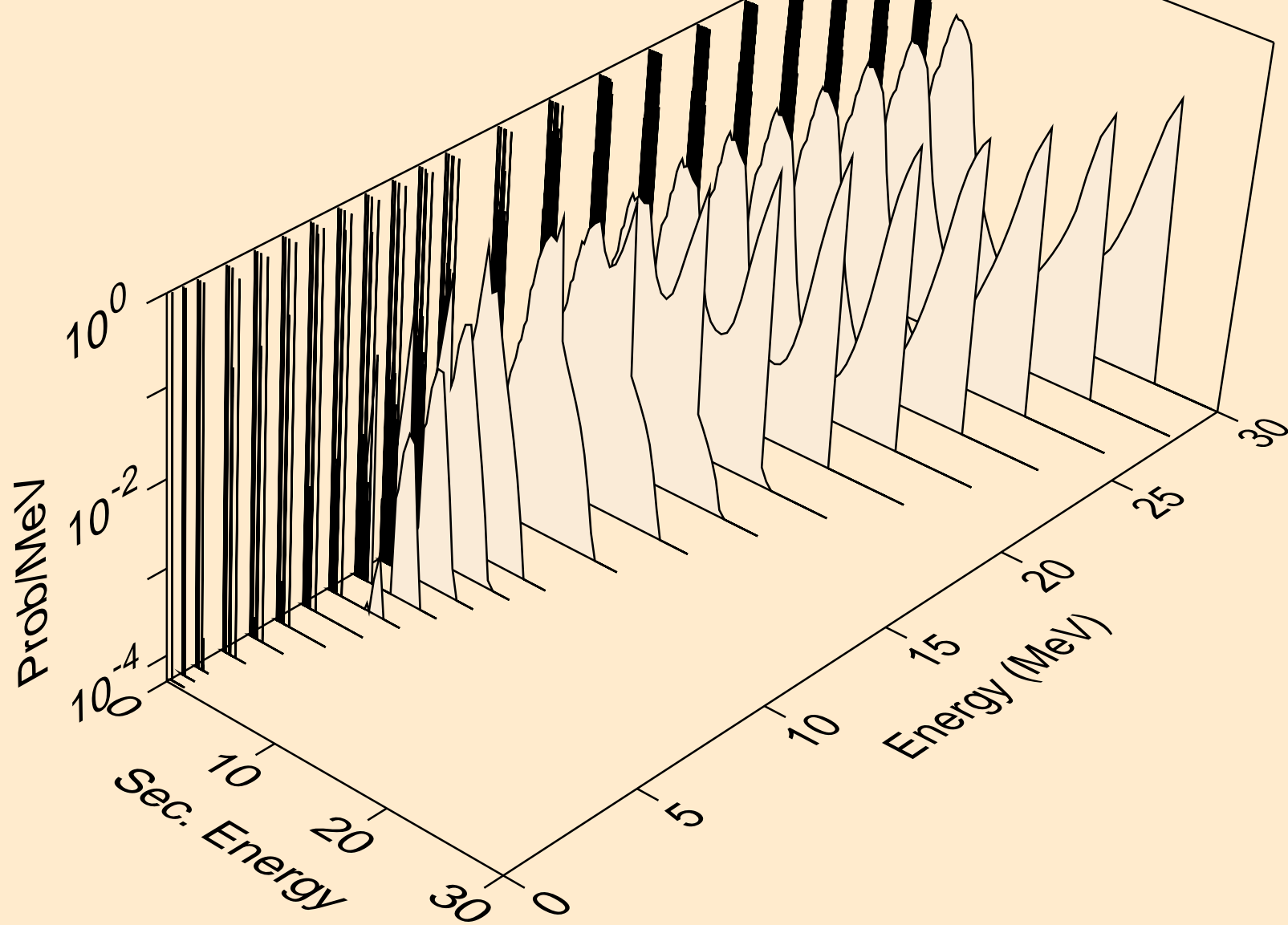

TC089M PHOTON ACER TENDL-2023 LIBRARY; T=0.K
photons from (g,p)

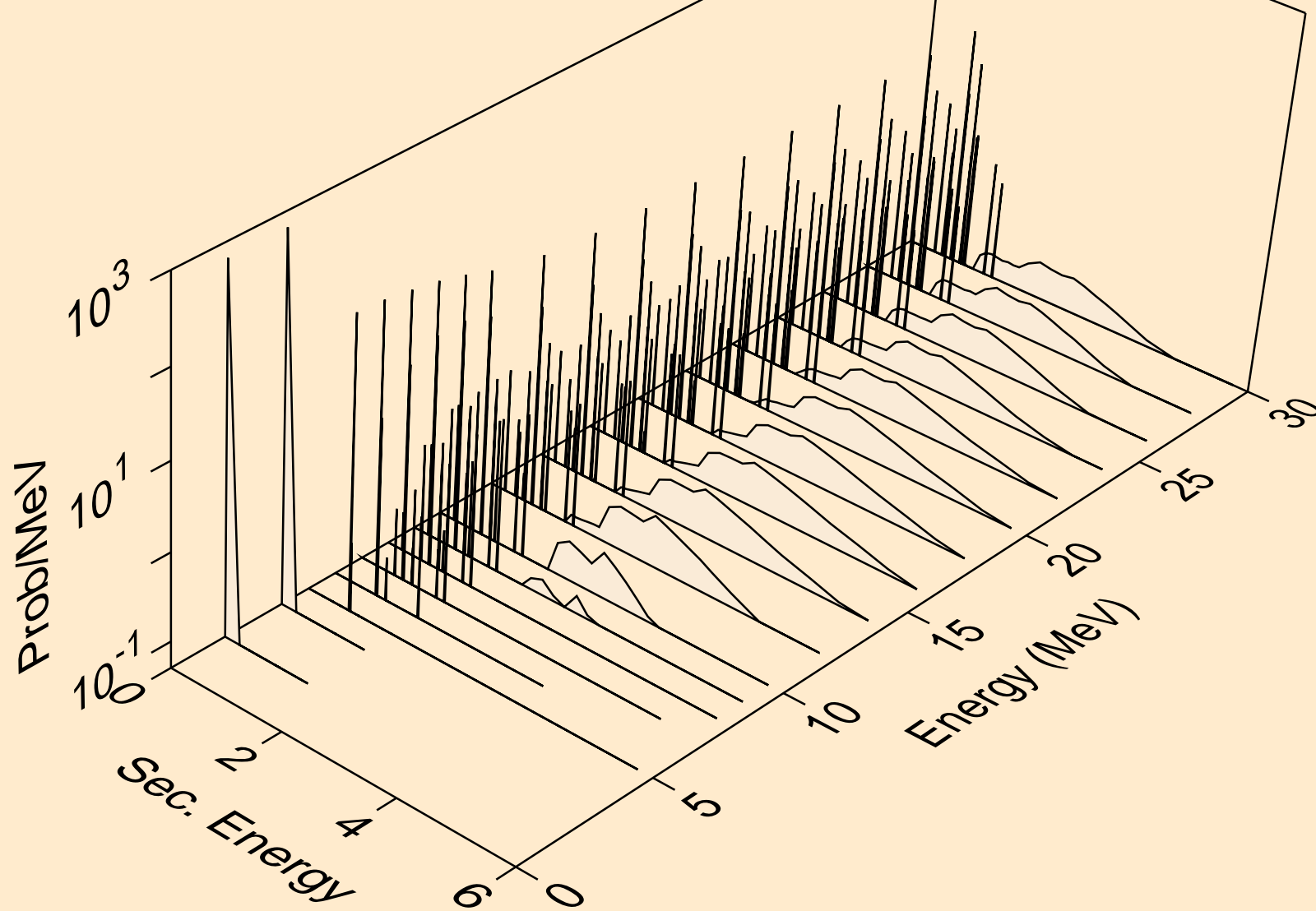

TC089M PHOTON ACER TENDL-2023 LIBRARY; T=0.K
photons from (g,d)

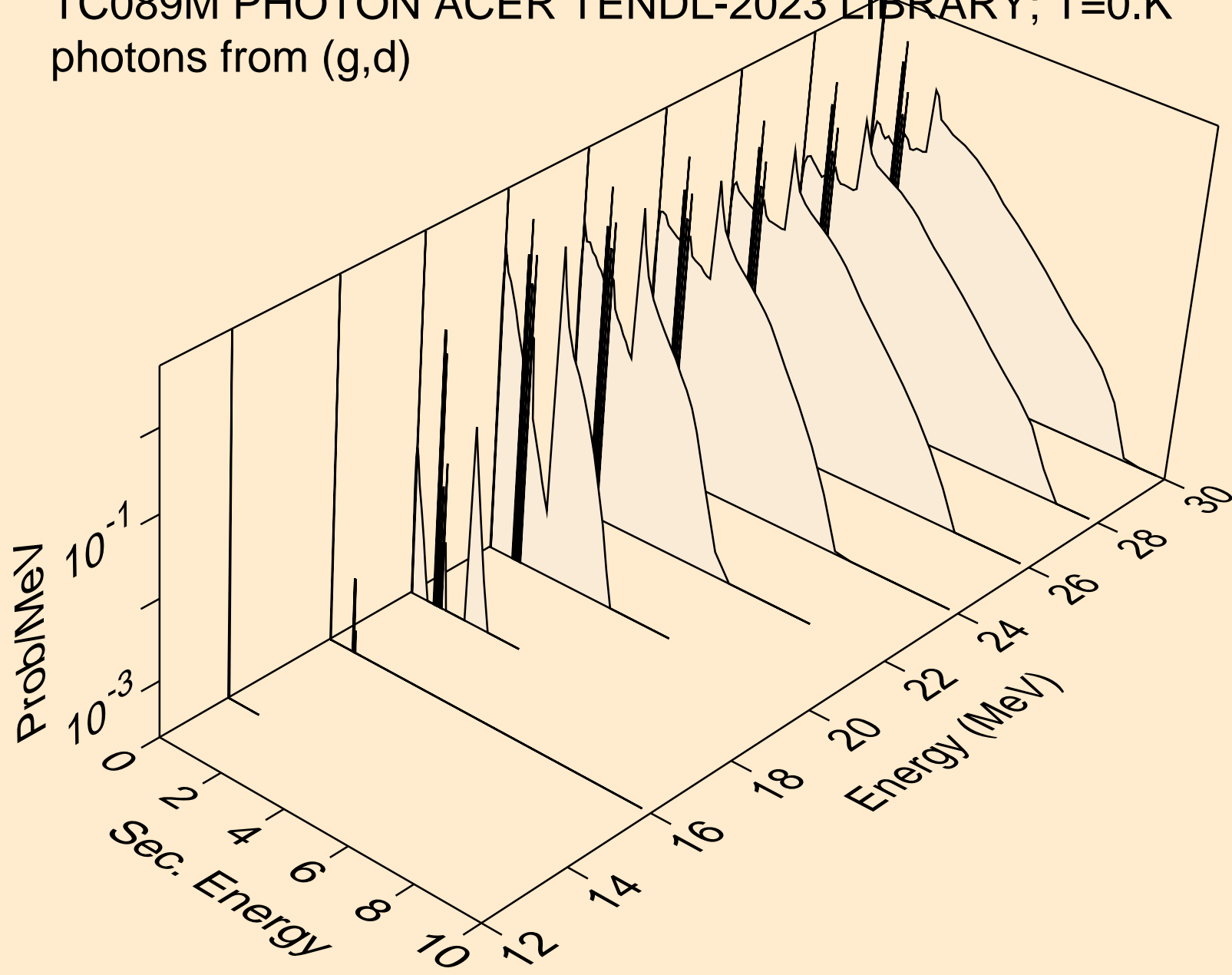

TC089M PHOTON ACER TENDL-2023 LIBRARY; T=0.K
photons from (g,t)

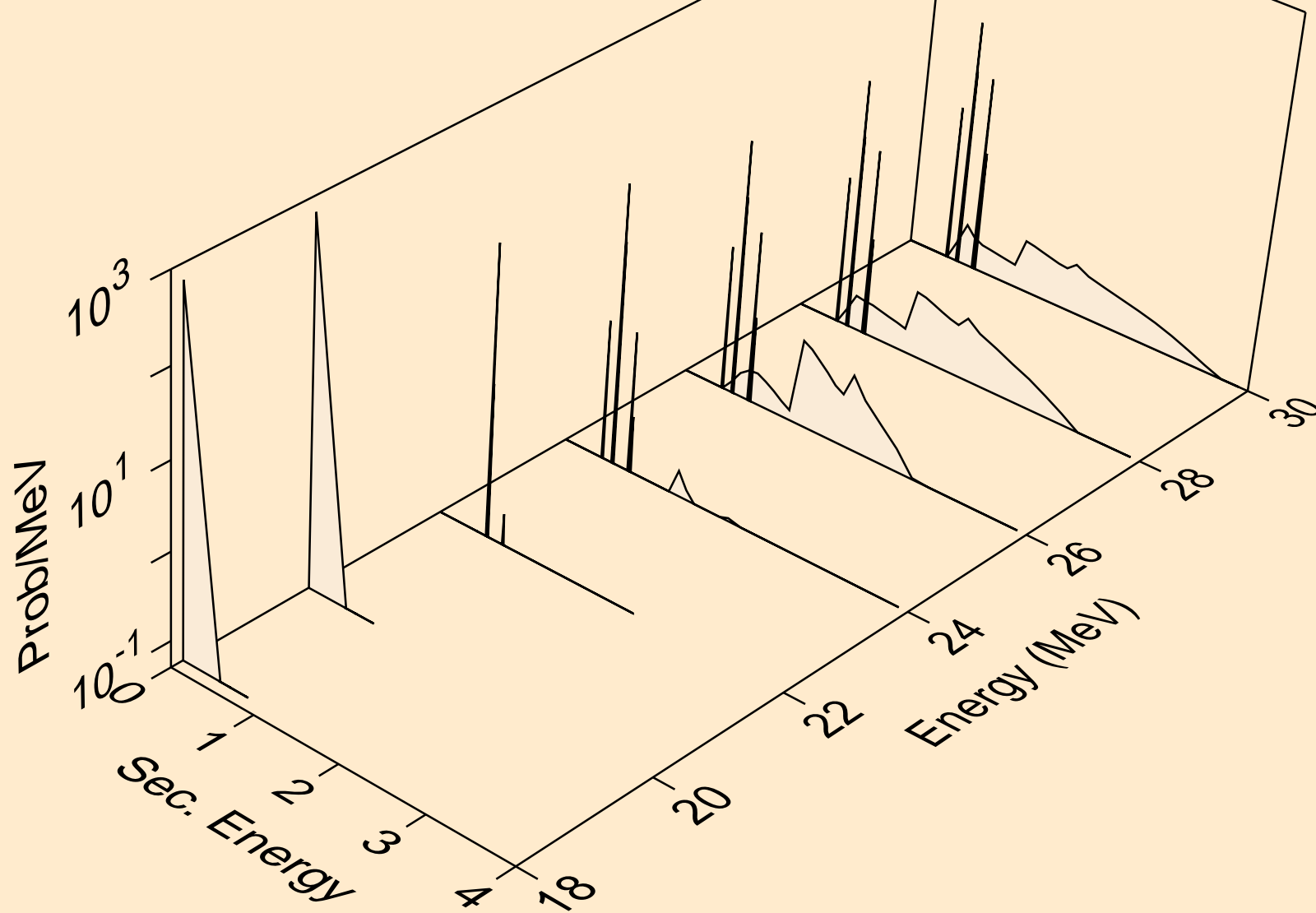

TC089M PHOTON ACER TENDL-2023 LIBRARY; T=0.K
photons from (g,he3)

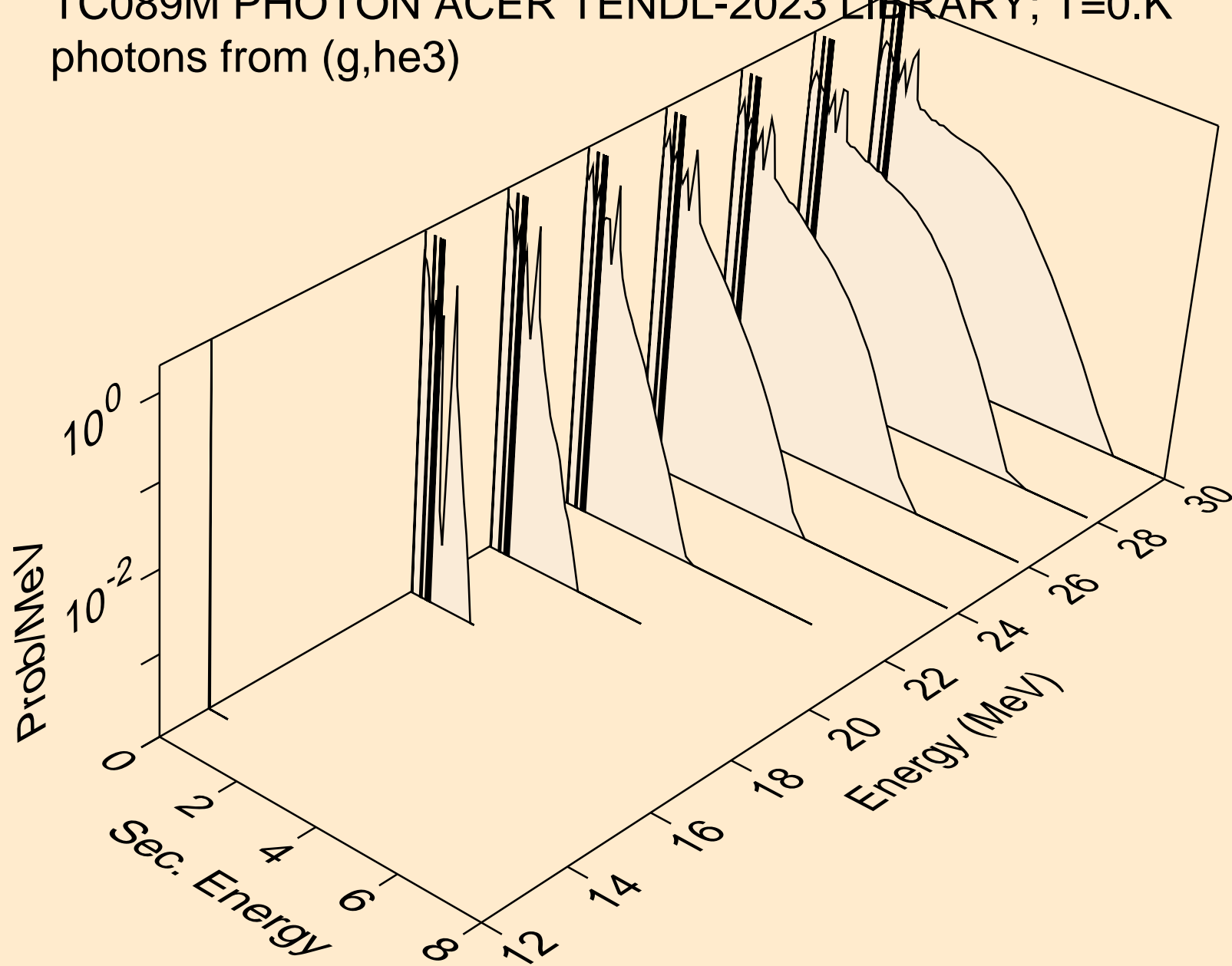

TC089M PHOTON ACER TENDL-2023 LIBRARY; T=0.K
photons from (g,a)

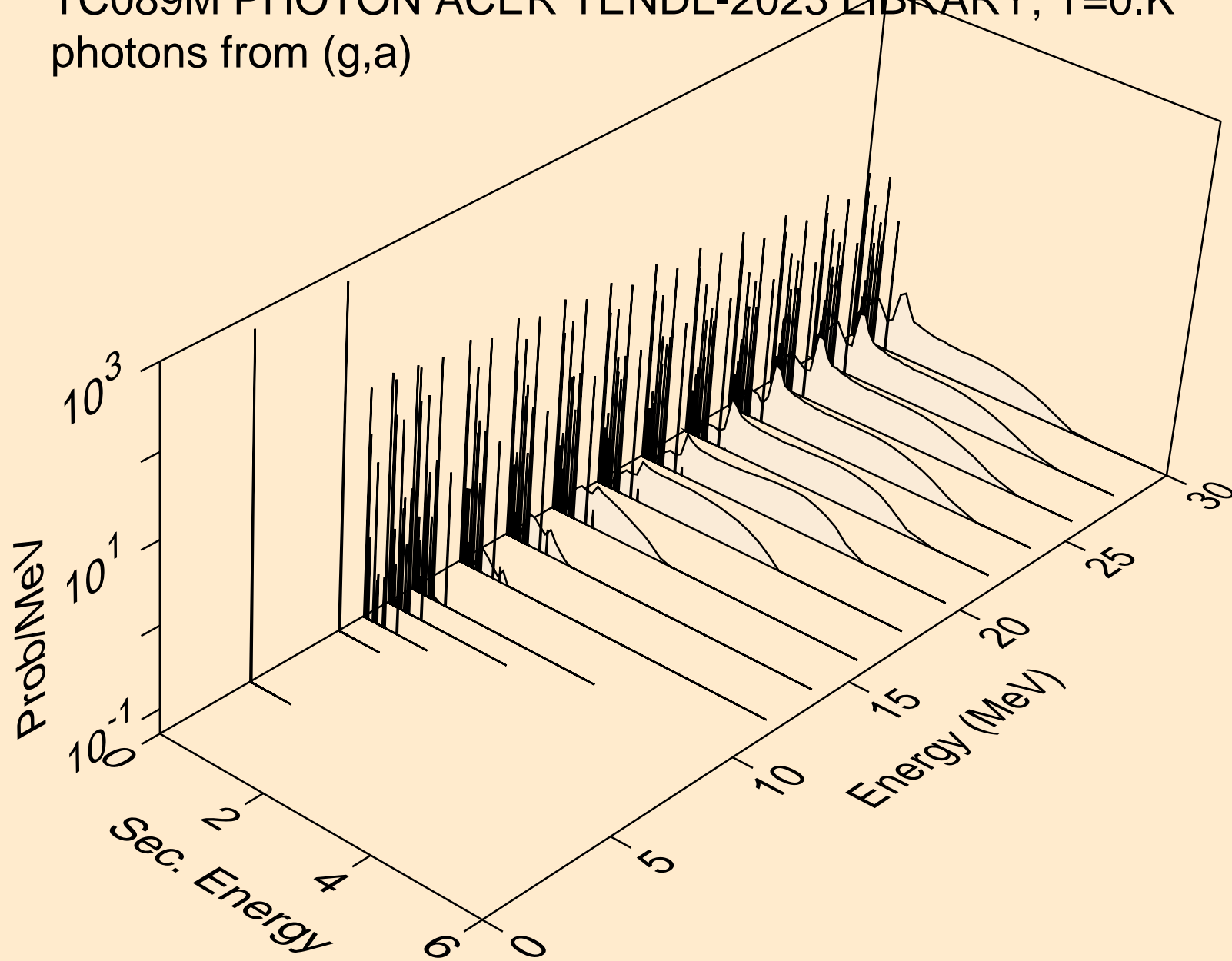

TC089M PHOTON ACER TENDL-2023 LIBRARY; T=0.K
photons from (g,2a)

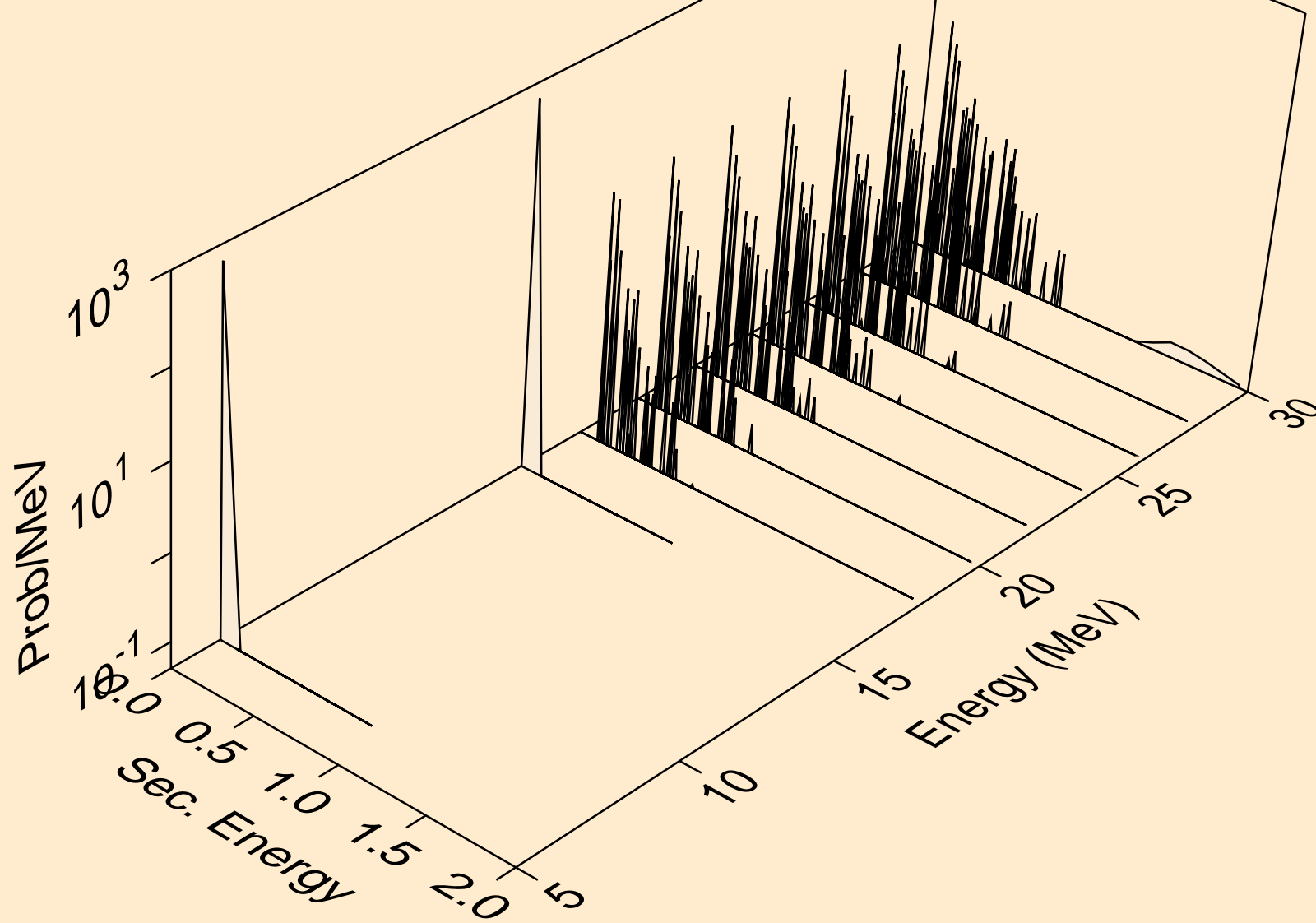

TC089M PHOTON ACER TENDL-2023 LIBRARY; T=0.K
photons from (g,2p)

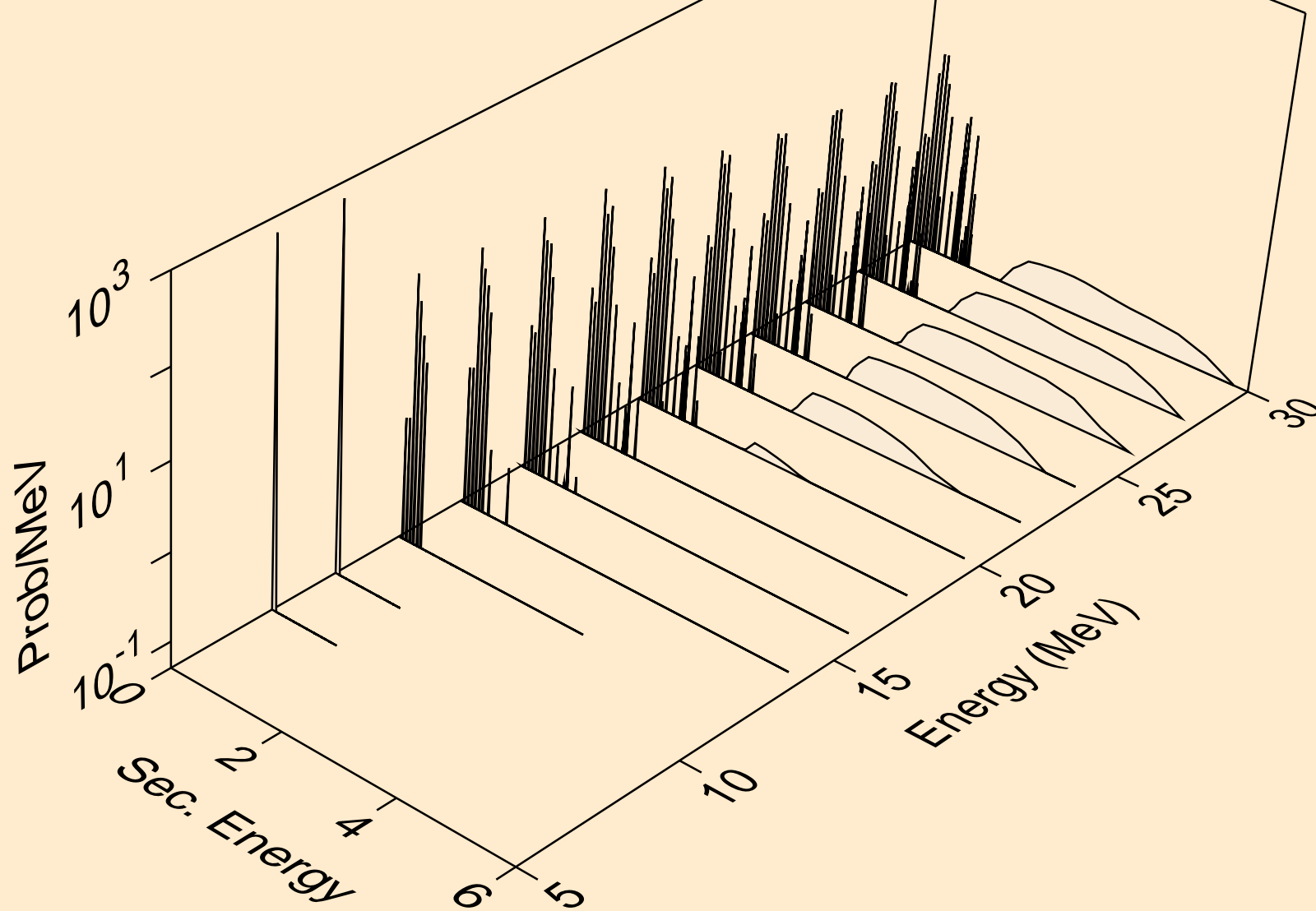

TC089M PHOTON ACER TENDL-2023 LIBRARY; T=0.K
photons from (g,pa)

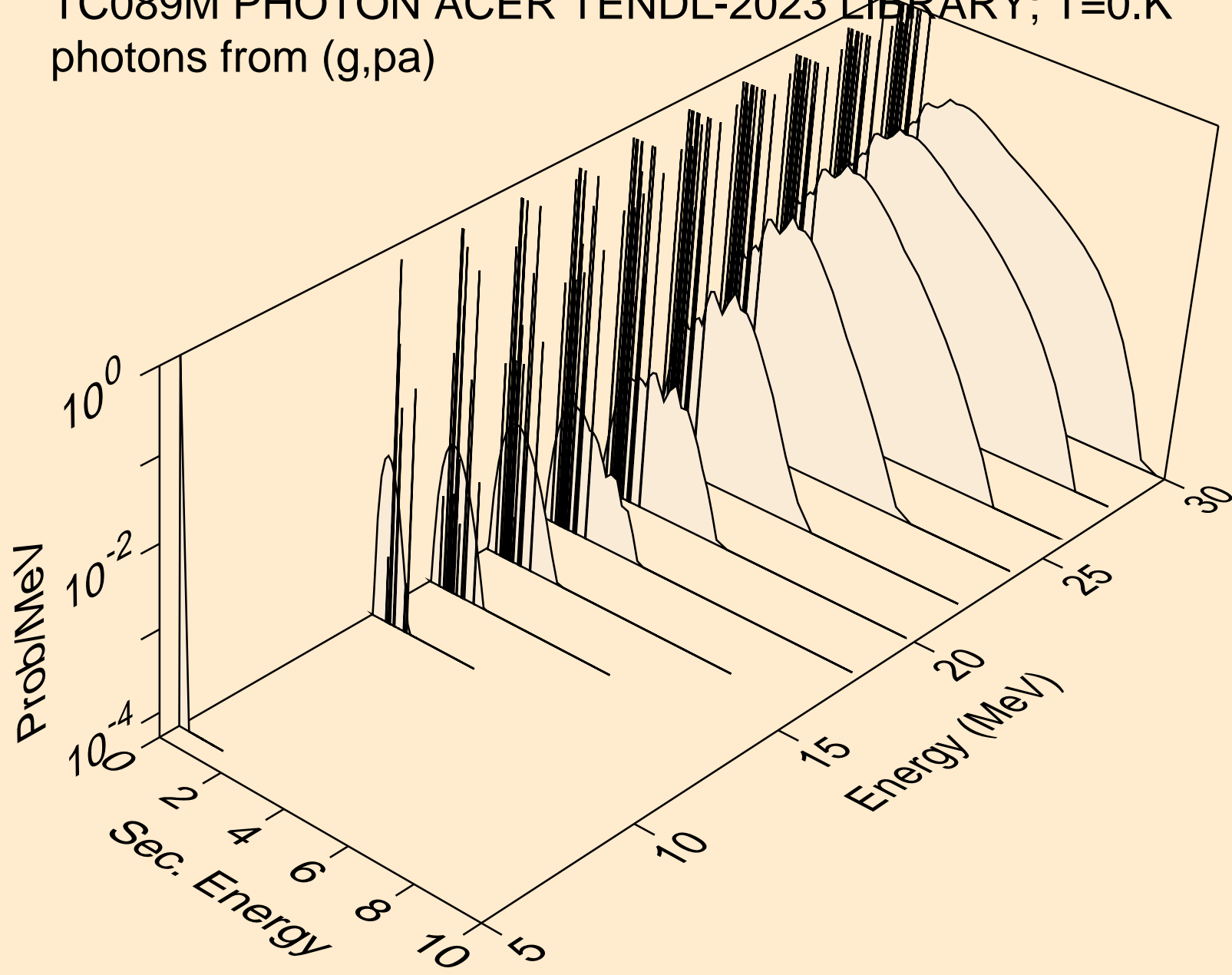

TC089M PHOTON ACER TENDL-2023 LIBRARY; T=0.K
photons from (g,pd)

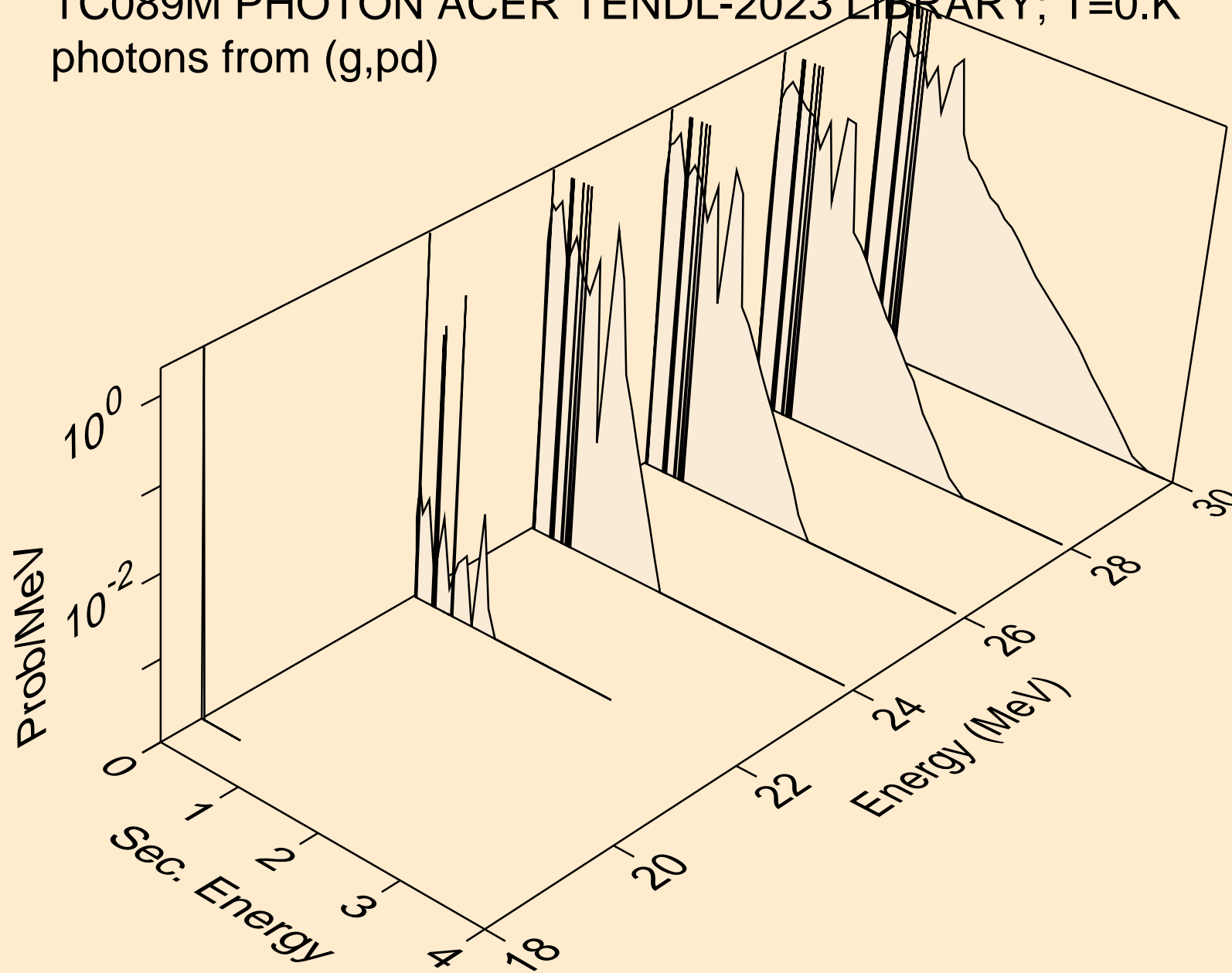

TC089M PHOTON ACER TENDL-2023 LIBRARY; T=0.K
protons from (g,x)

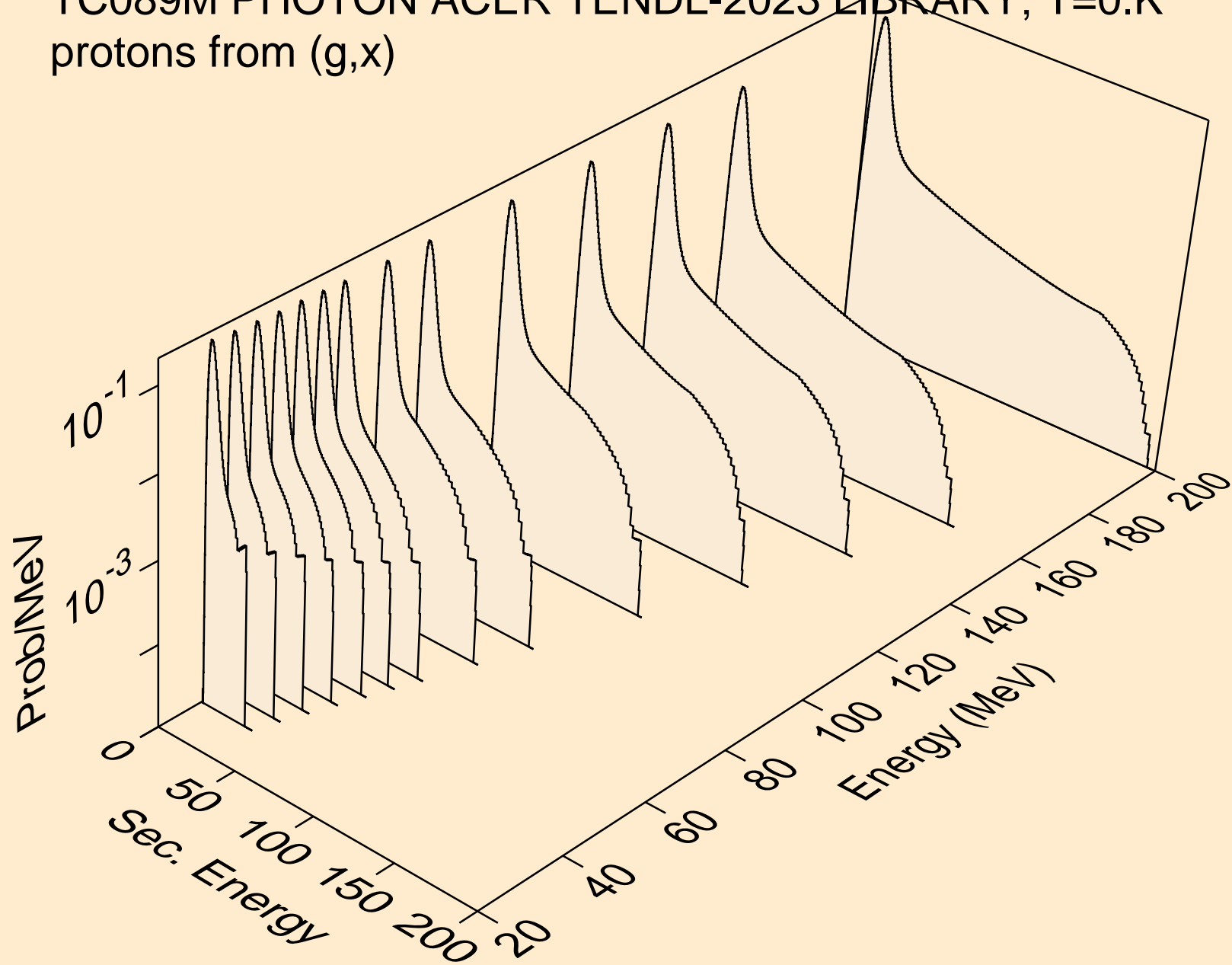

TC089M PHOTON ACER TENDL-2023 LIBRARY; T=0.K
protons from (g,n*)p

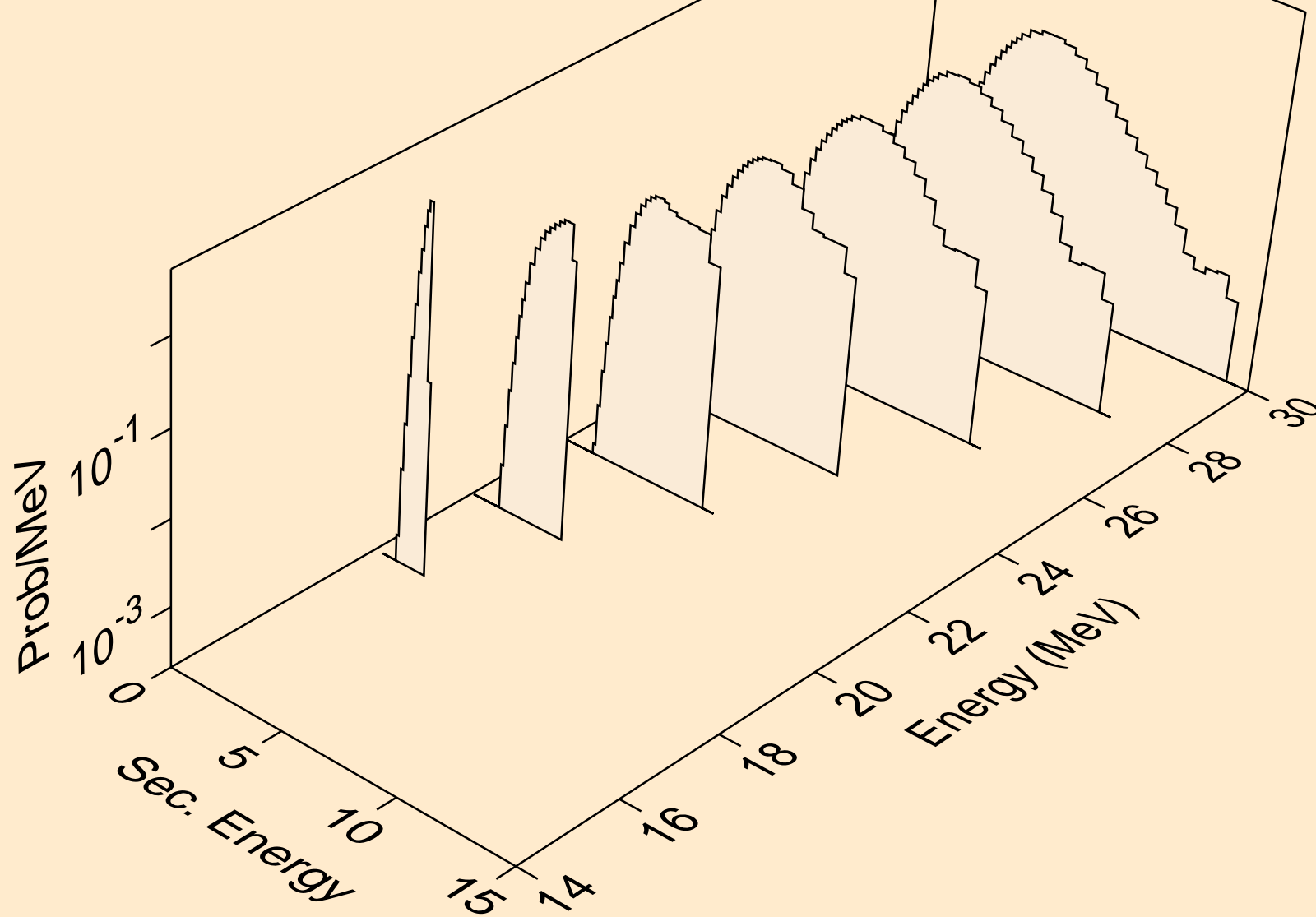

TC089M PHOTON ACER TENDL-2023 LIBRARY; T=0.K
protons from (g,2np)

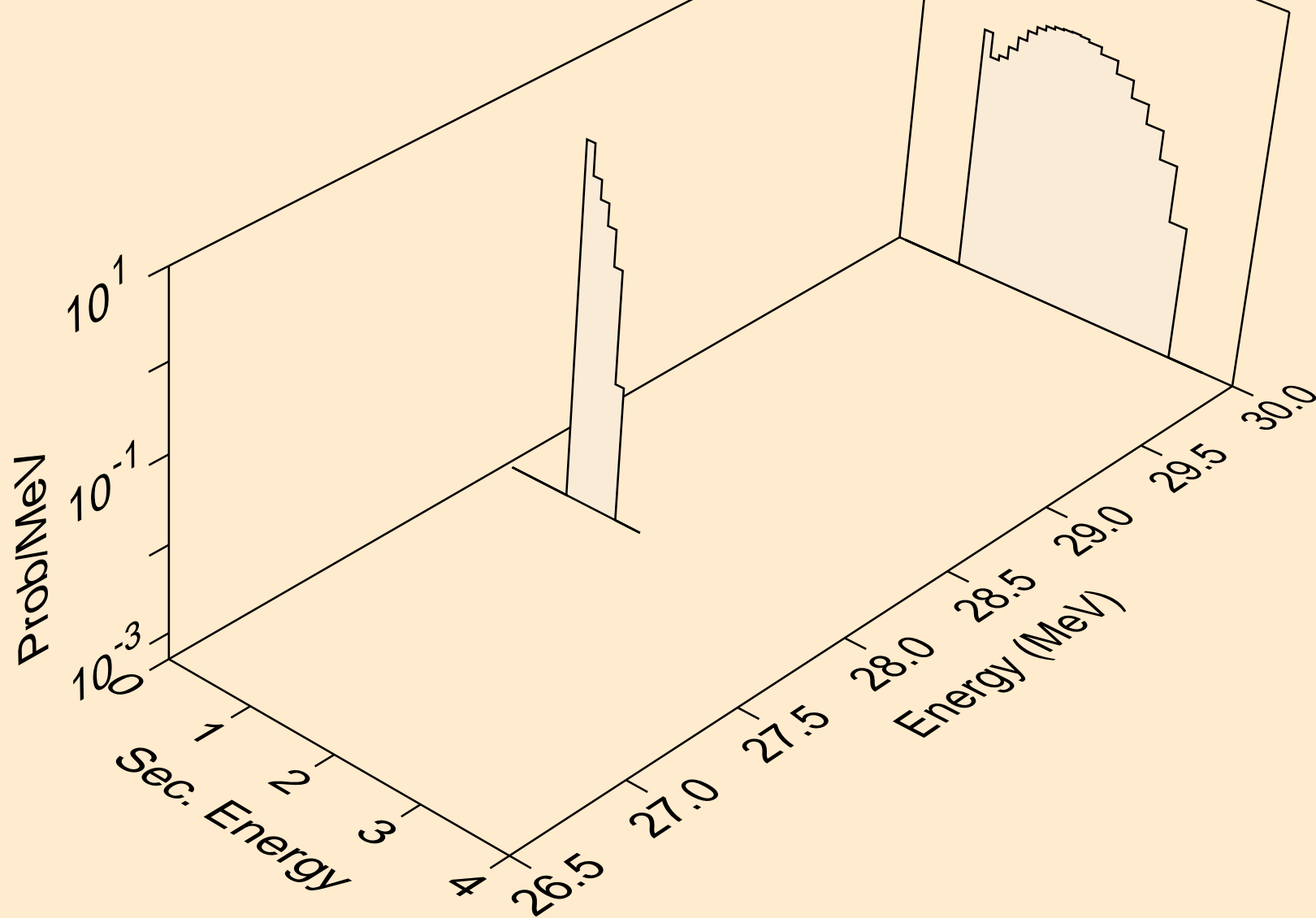

TC089M PHOTON ACER TENDL-2023 LIBRARY; T=0.K
protons from (g,n2p)

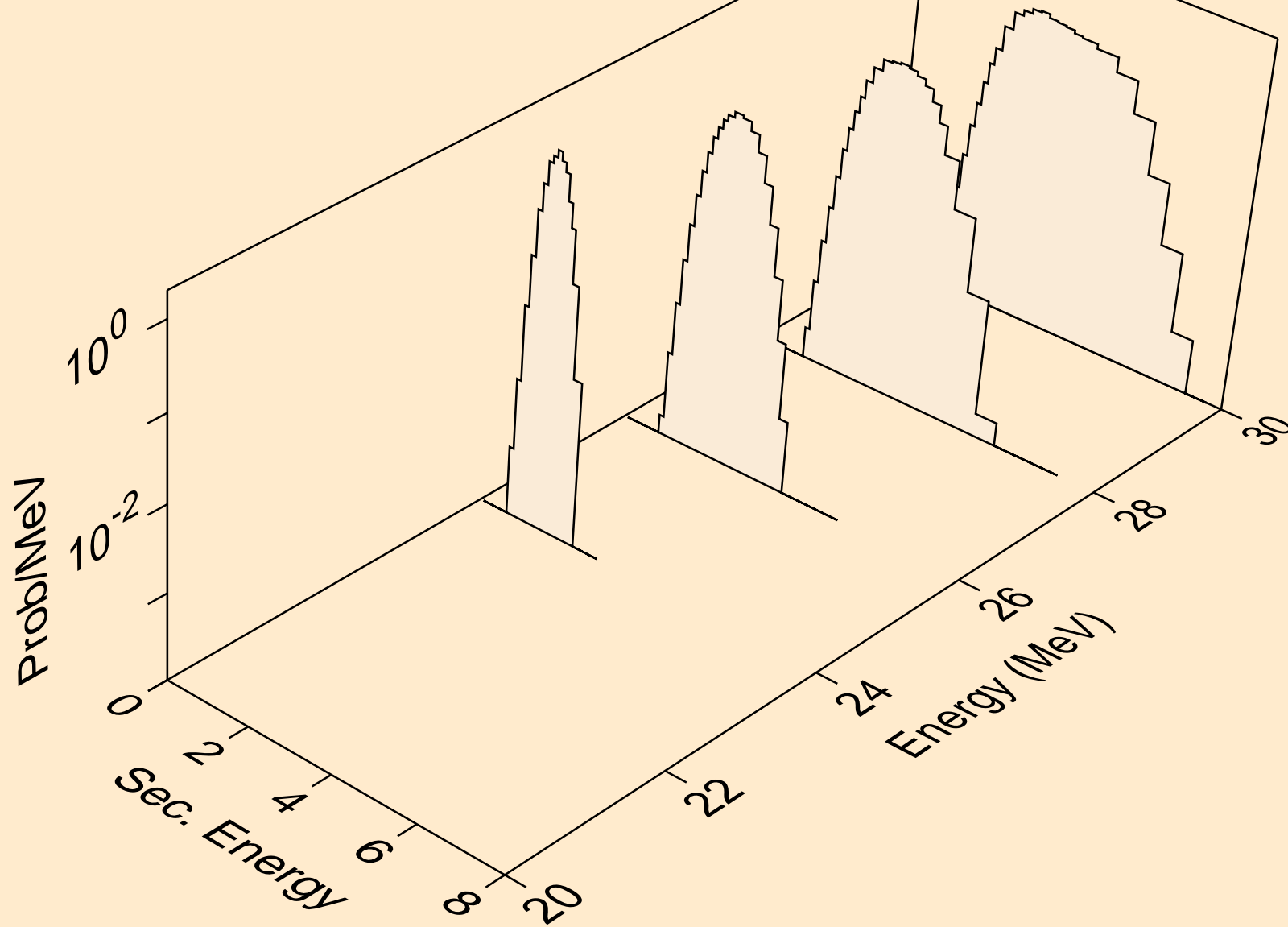

TC089M PHOTON ACER TENDL-2023 LIBRARY; T=0.K
protons from (g,npa)

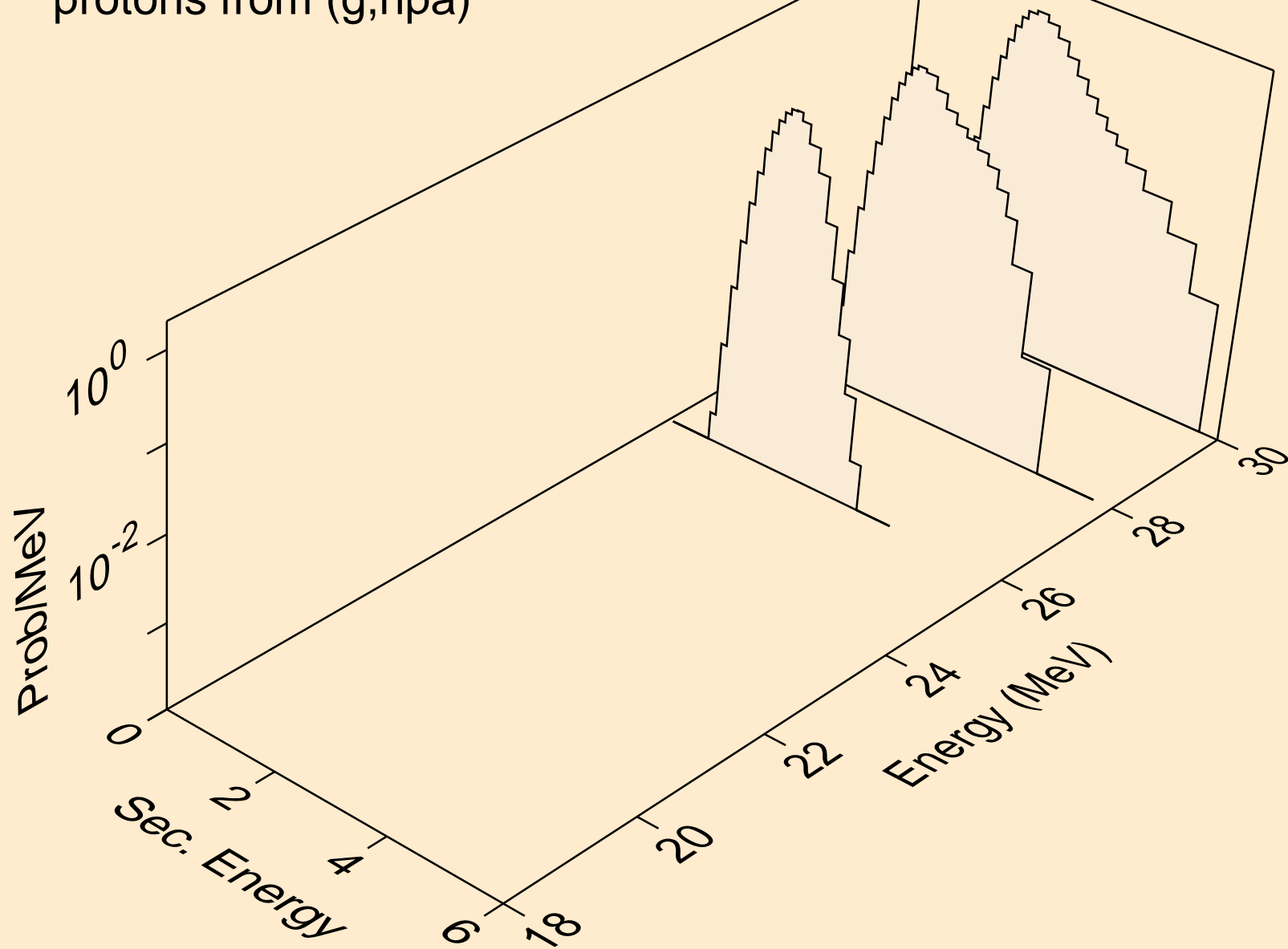

TC089M PHOTON ACER TENDL-2023 LIBRARY; T=0.K
protons from (g,p)

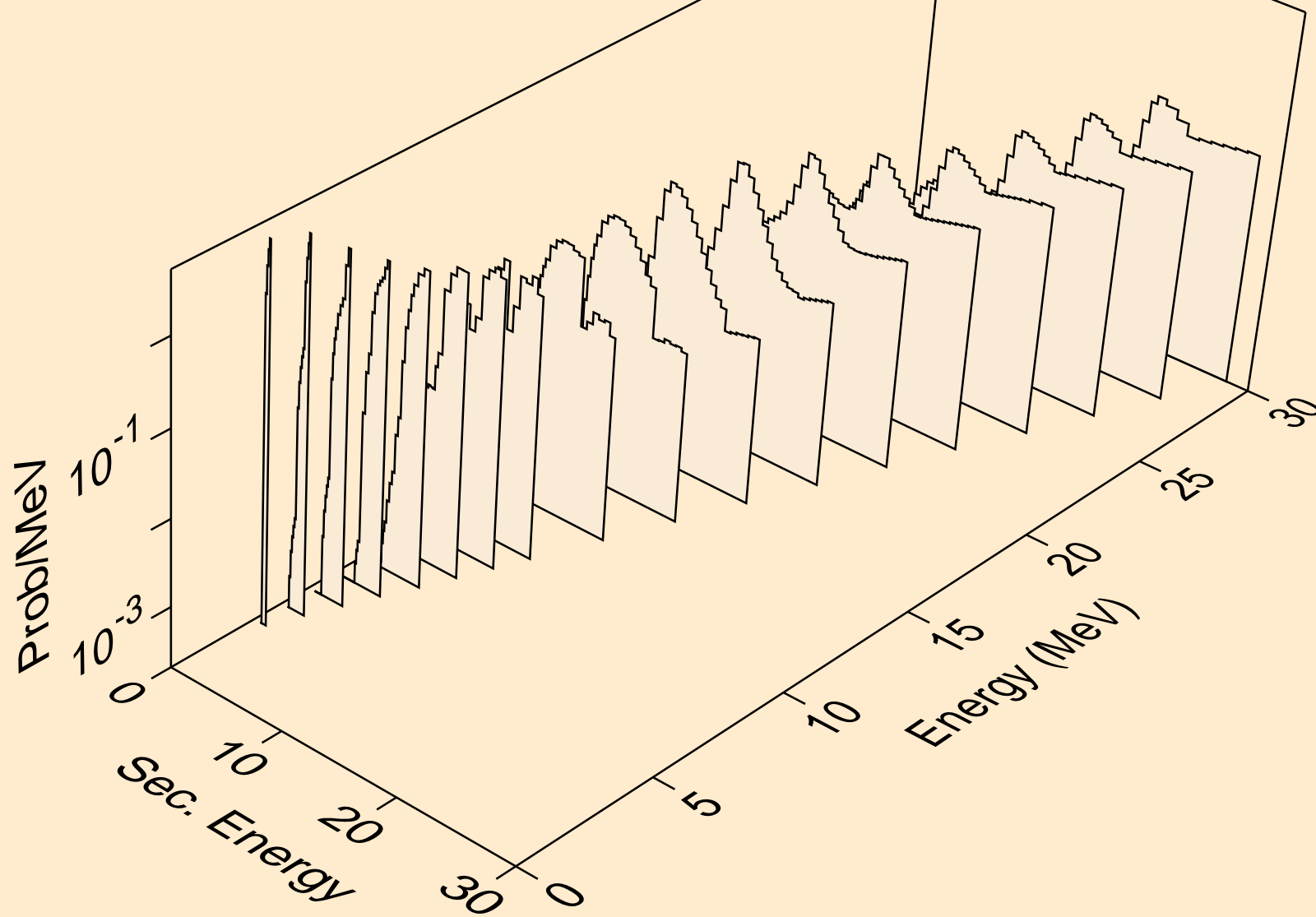

TC089M PHOTON ACER TENDL-2023 LIBRARY; T=0.K
protons from (g,2p)

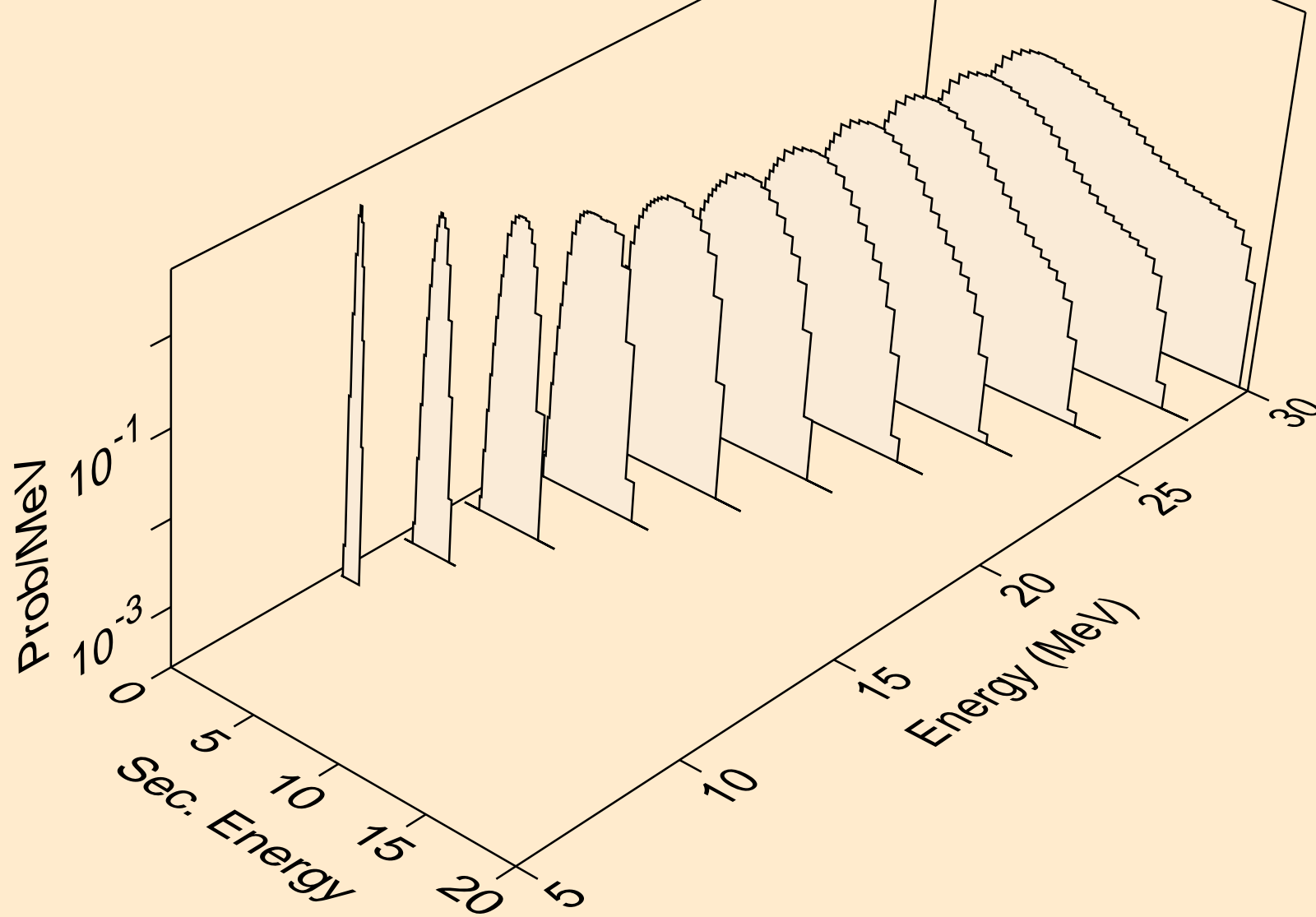

TC089M PHOTON ACER TENDL-2023 LIBRARY; T=0.K
protons from (g,pa)

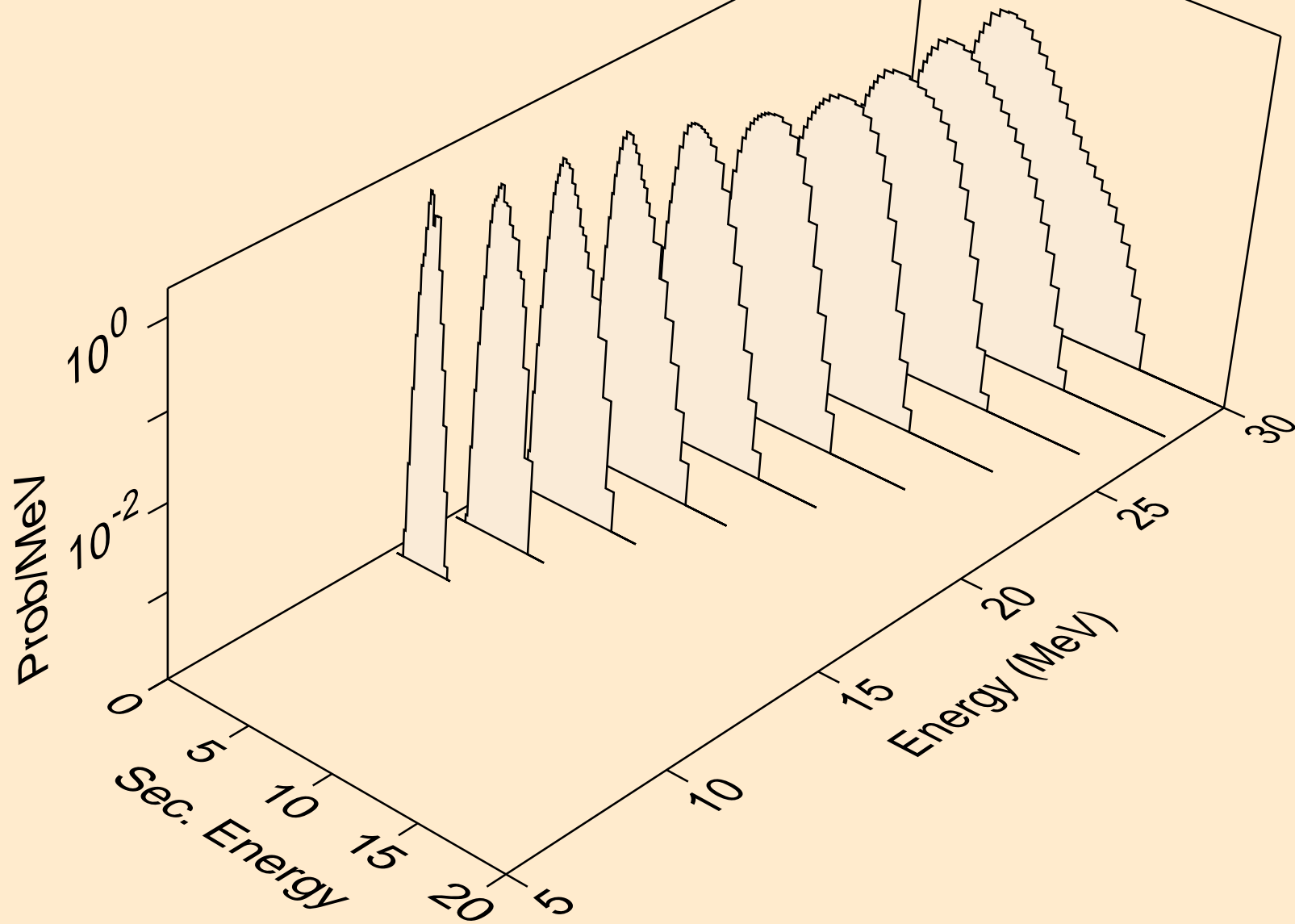

TC089M PHOTON ACER TENDL-2023 LIBRARY; T=0.K
protons from (g,pd)

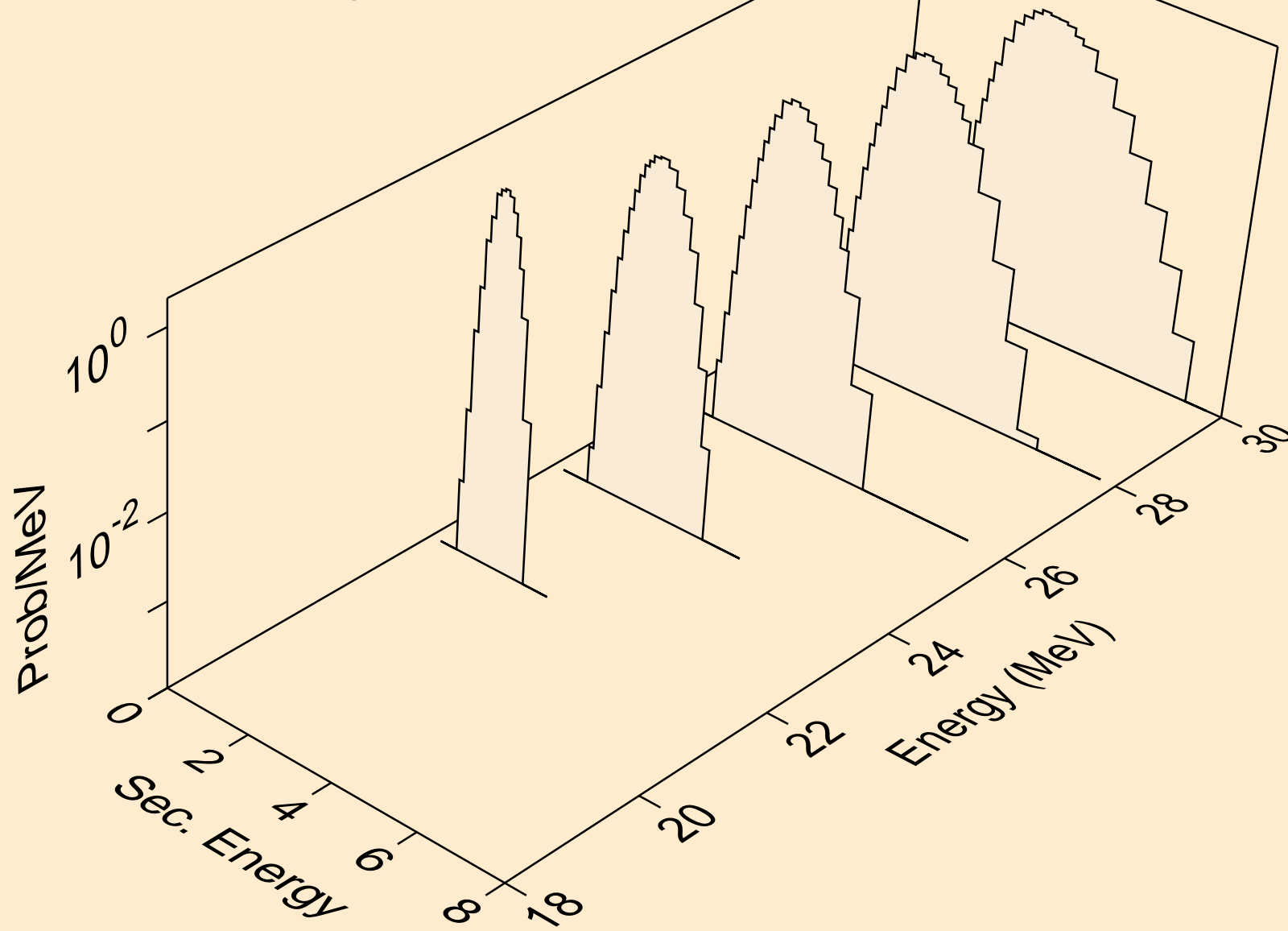

TC089M PHOTON ACER TENDL-2023 LIBRARY; T=0.K
deuterons from (g,x)

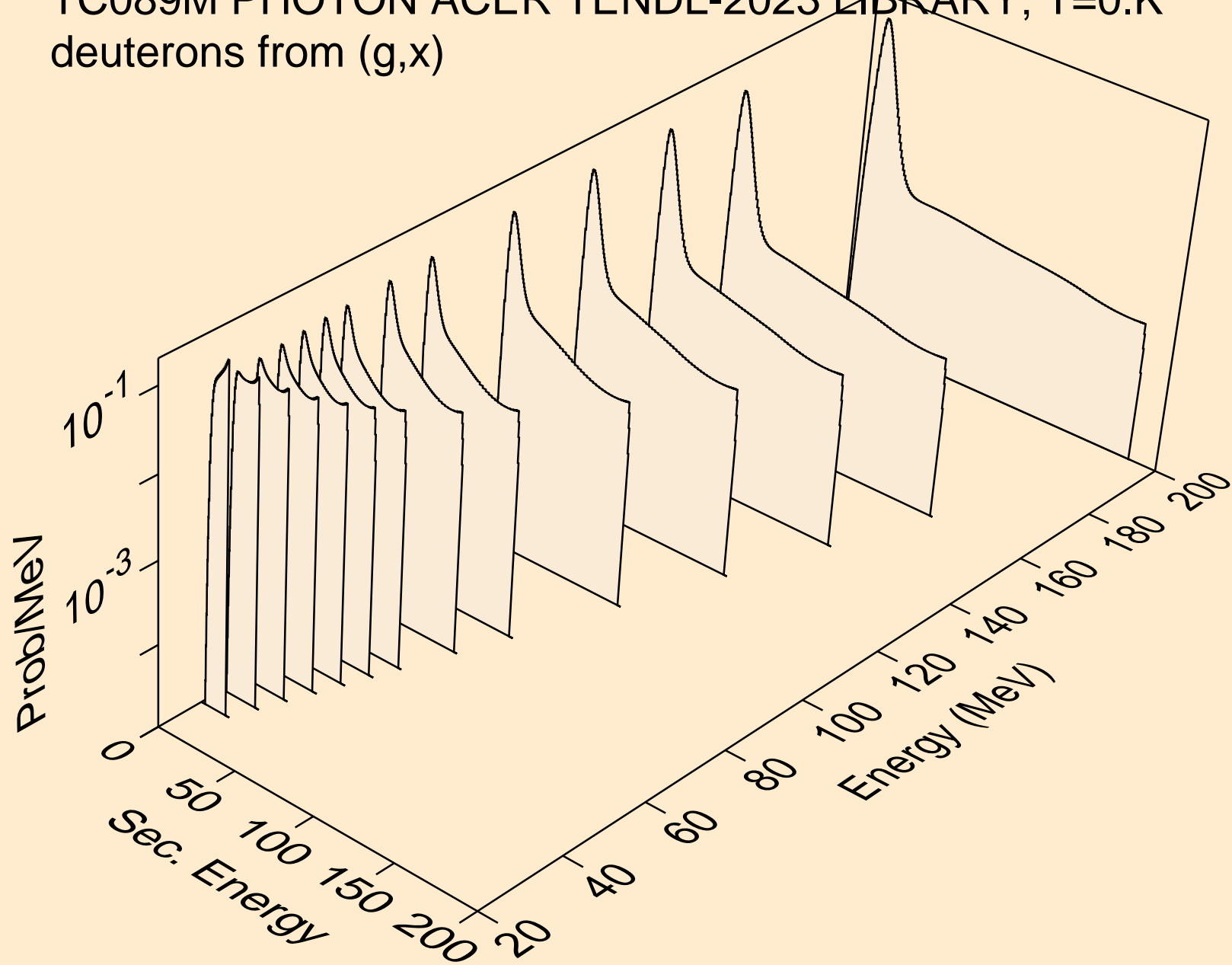

TC089M PHOTON ACER TENDL-2023 LIBRARY; T=0.K
deuterons from (g,n*)d

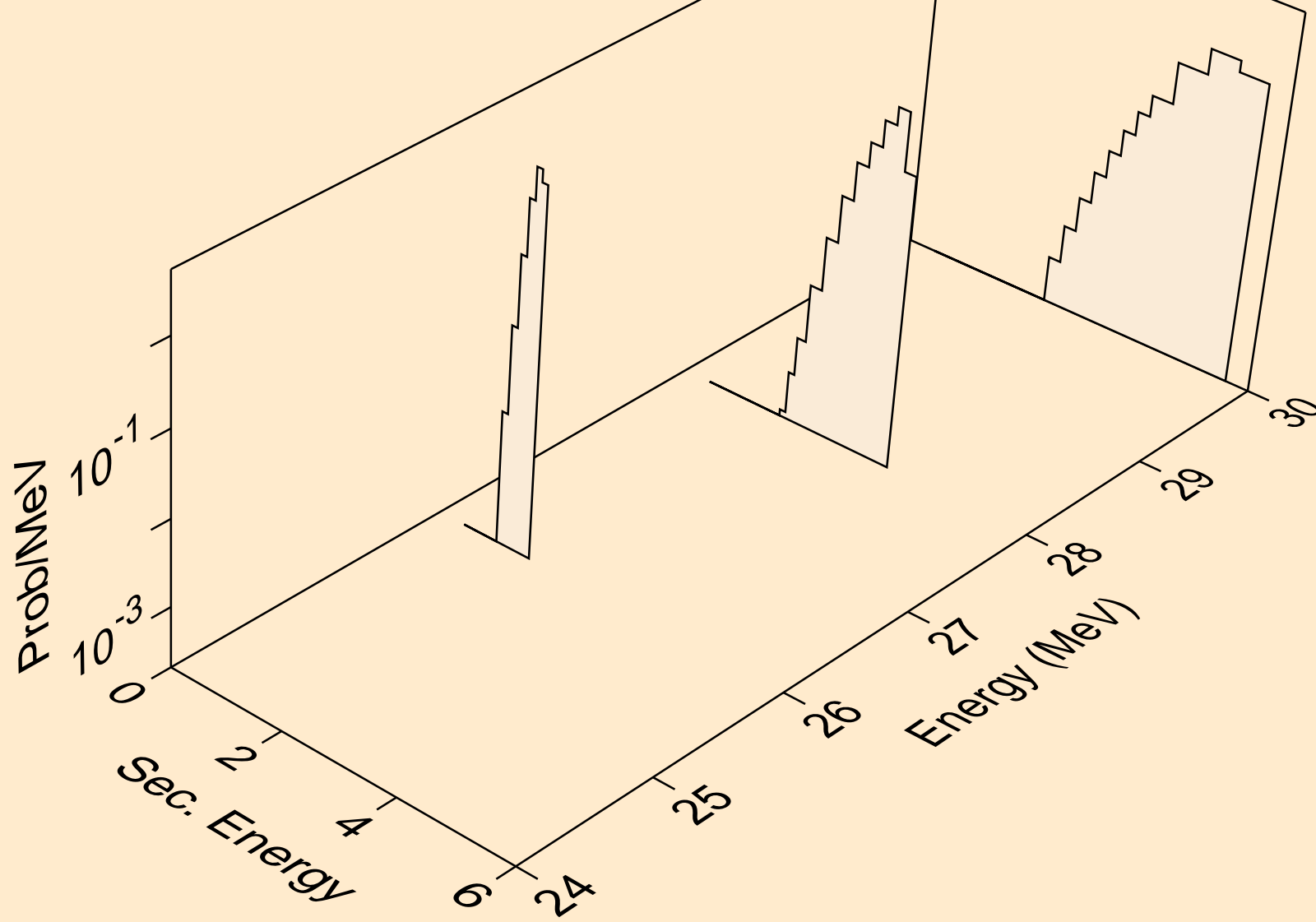

TC089M PHOTON ACER TENDL-2023 LIBRARY; T=0.K
deuterons from (g,d)

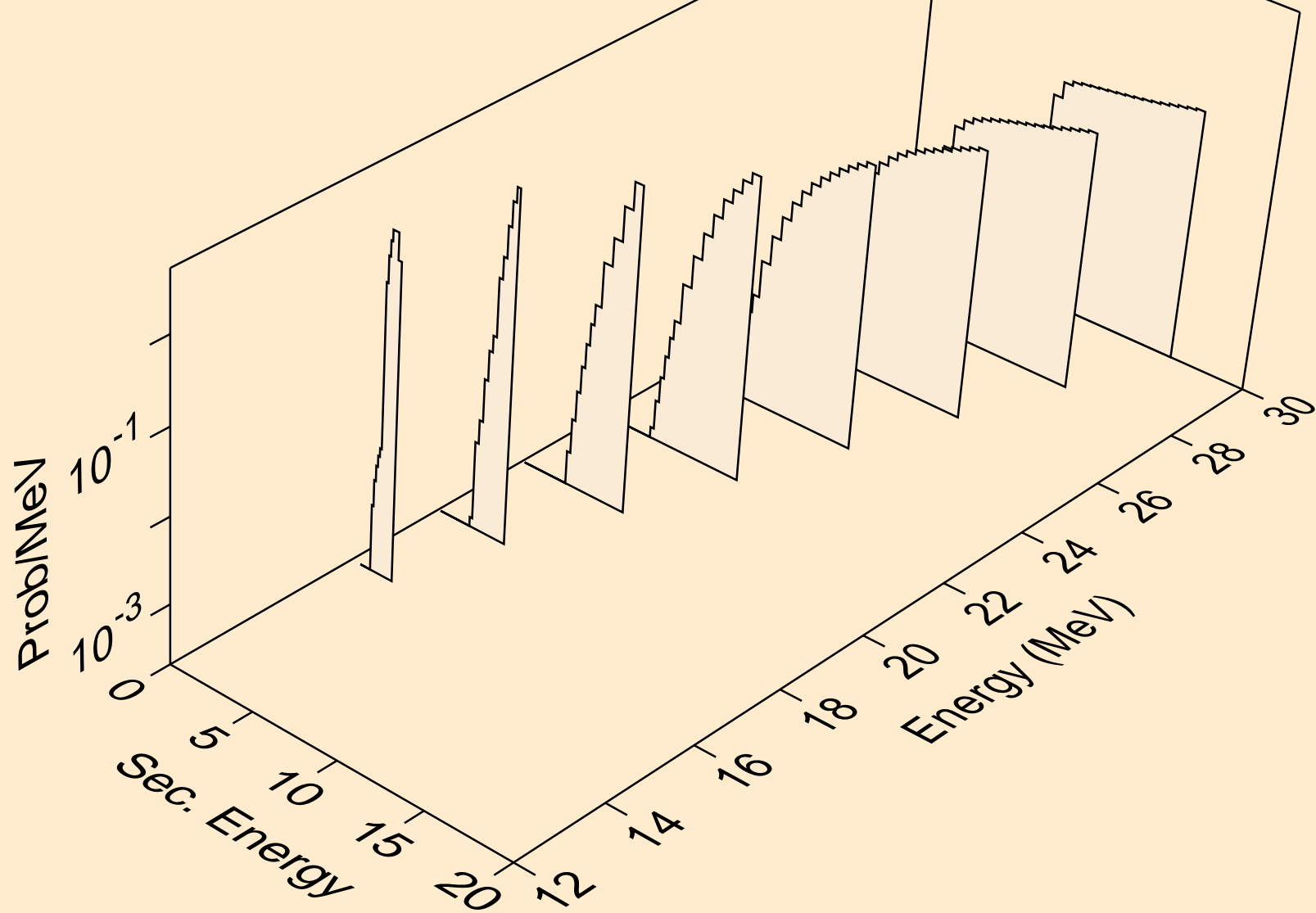

TC089M PHOTON ACER TENDL-2023 LIBRARY; T=0.K
deuterons from (g,pd)

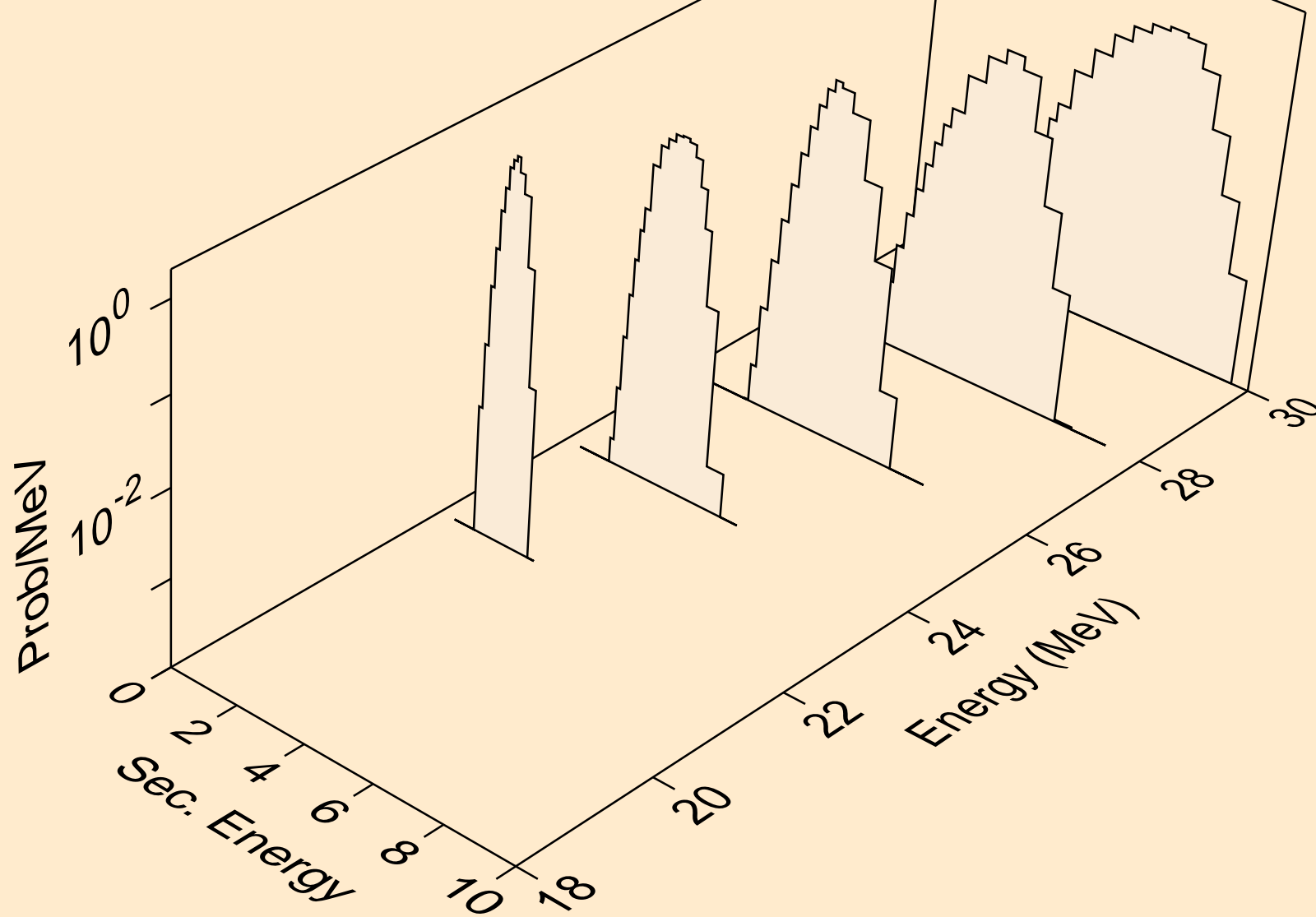

TC089M PHOTON ACER TENDL-2023 LIBRARY; T=0.K
tritons from (g,x)

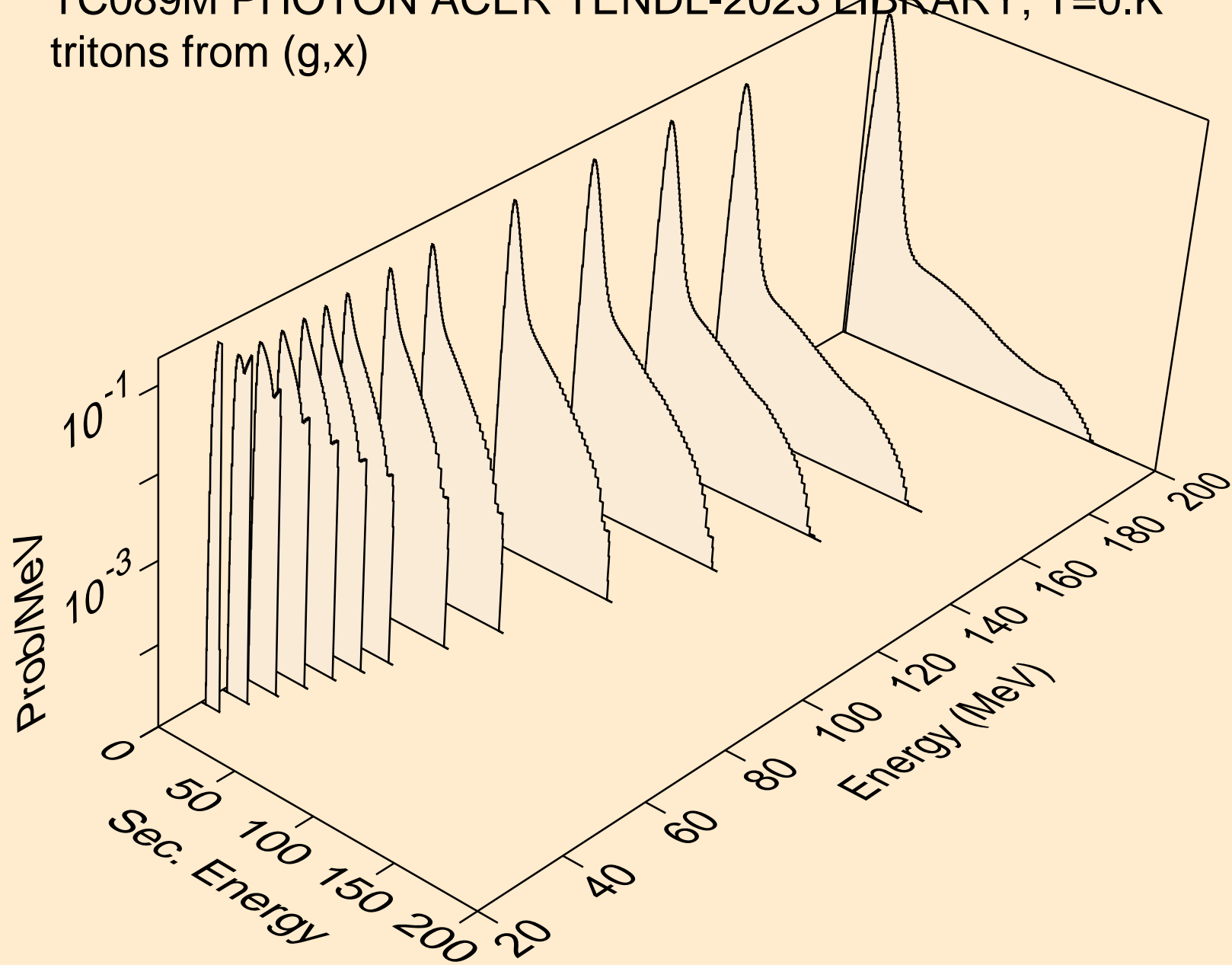

TC089M PHOTON ACER TENDL-2023 LIBRARY; T=0.K
tritons from (g,t)

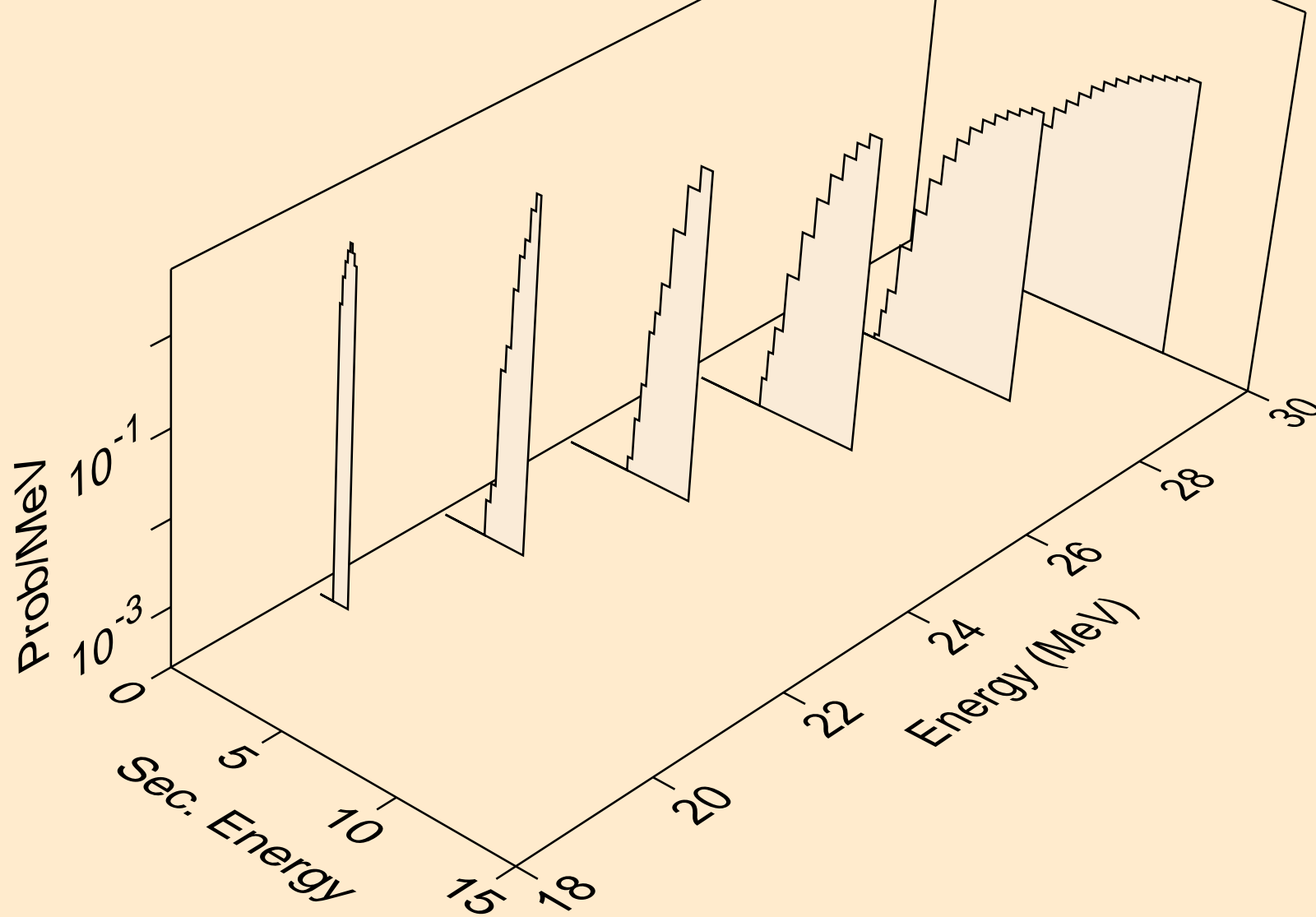

TC089M PHOTON ACER TENDL-2023 LIBRARY; T=0.K
he3s from (g,x)

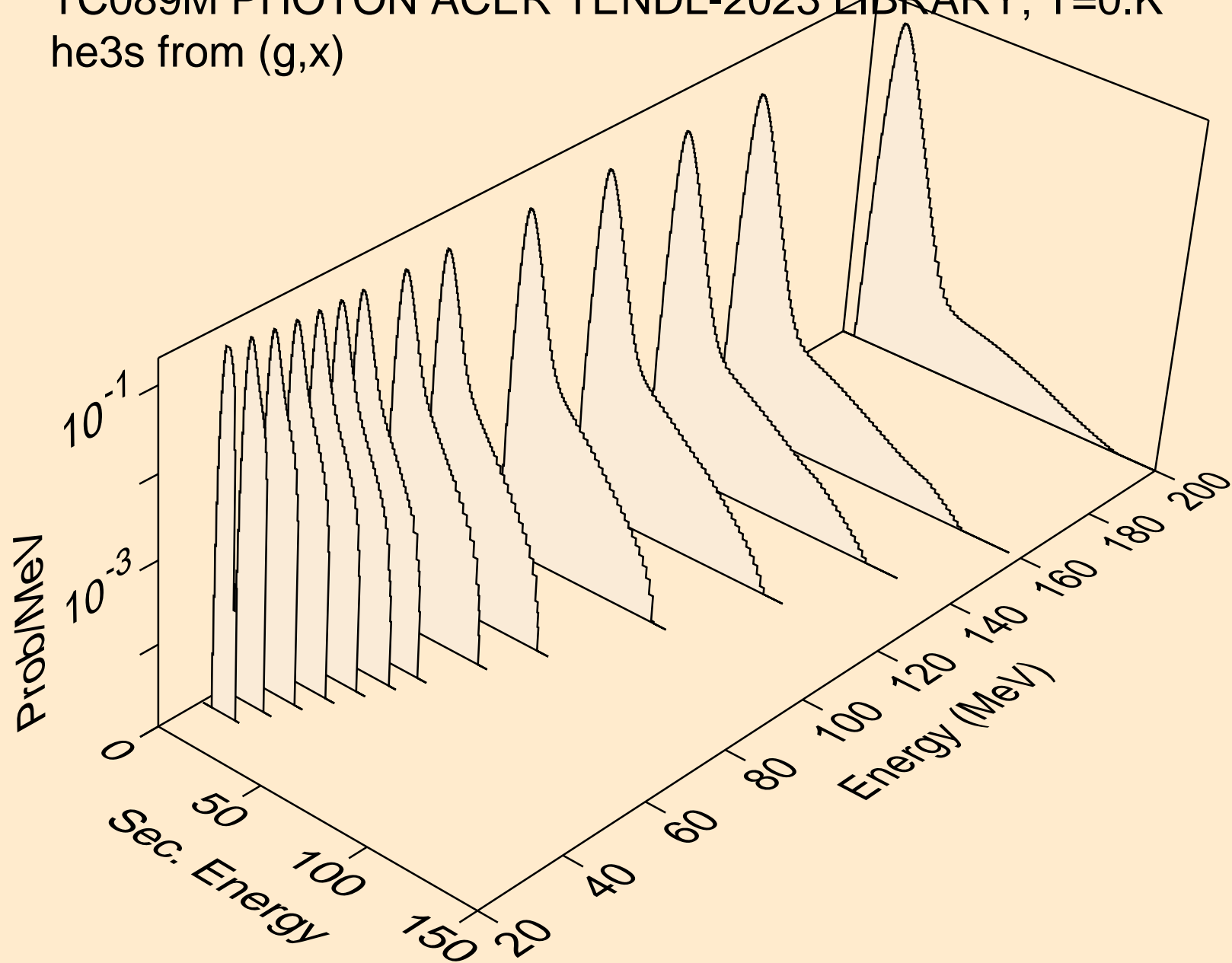

TC089M PHOTON ACER TENDL-2023 LIBRARY; T=0.K
he3s from (g,he3)

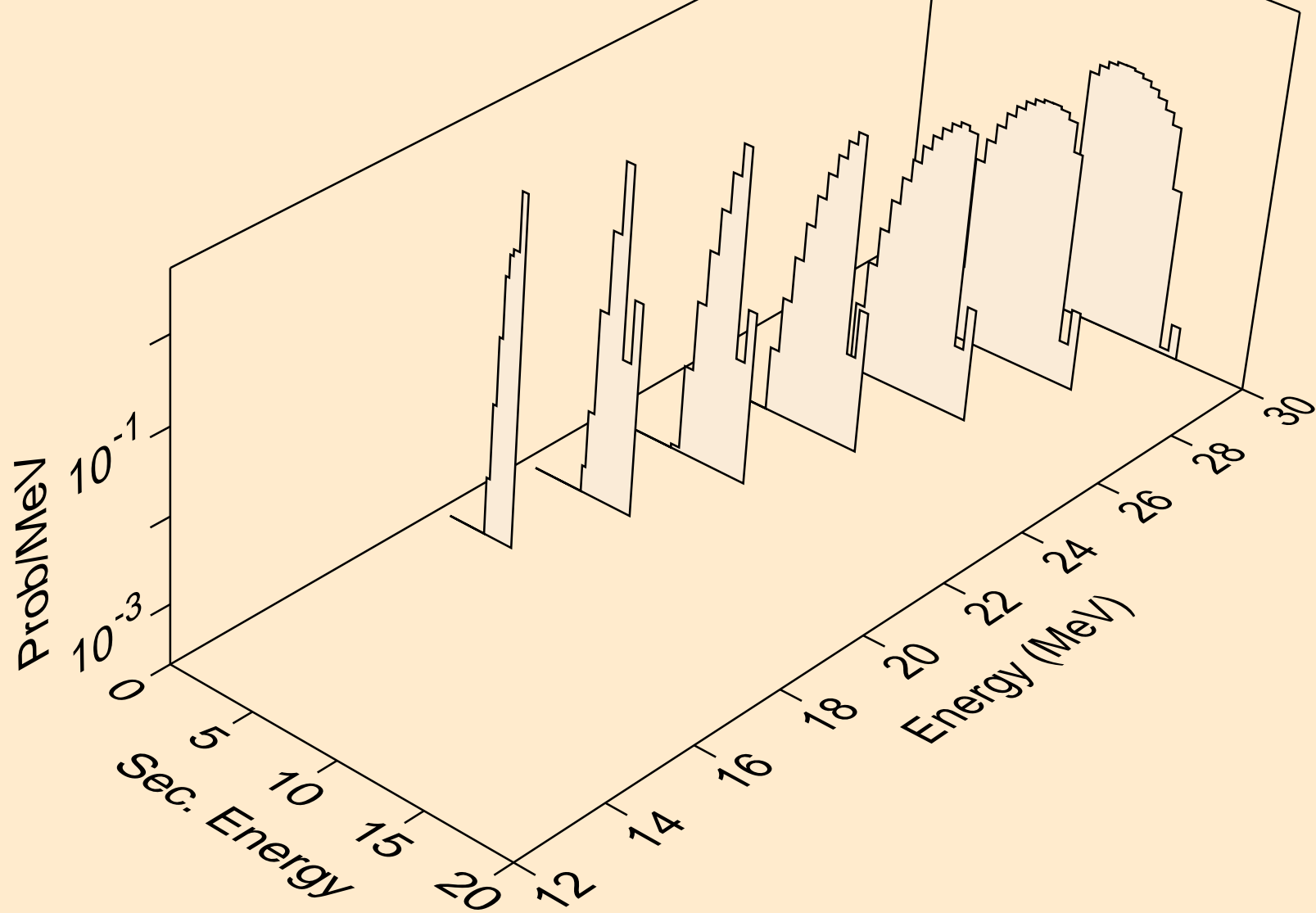

TC089M PHOTON ACER TENDL-2023 LIBRARY; T=0.K
alphas from (g,x)

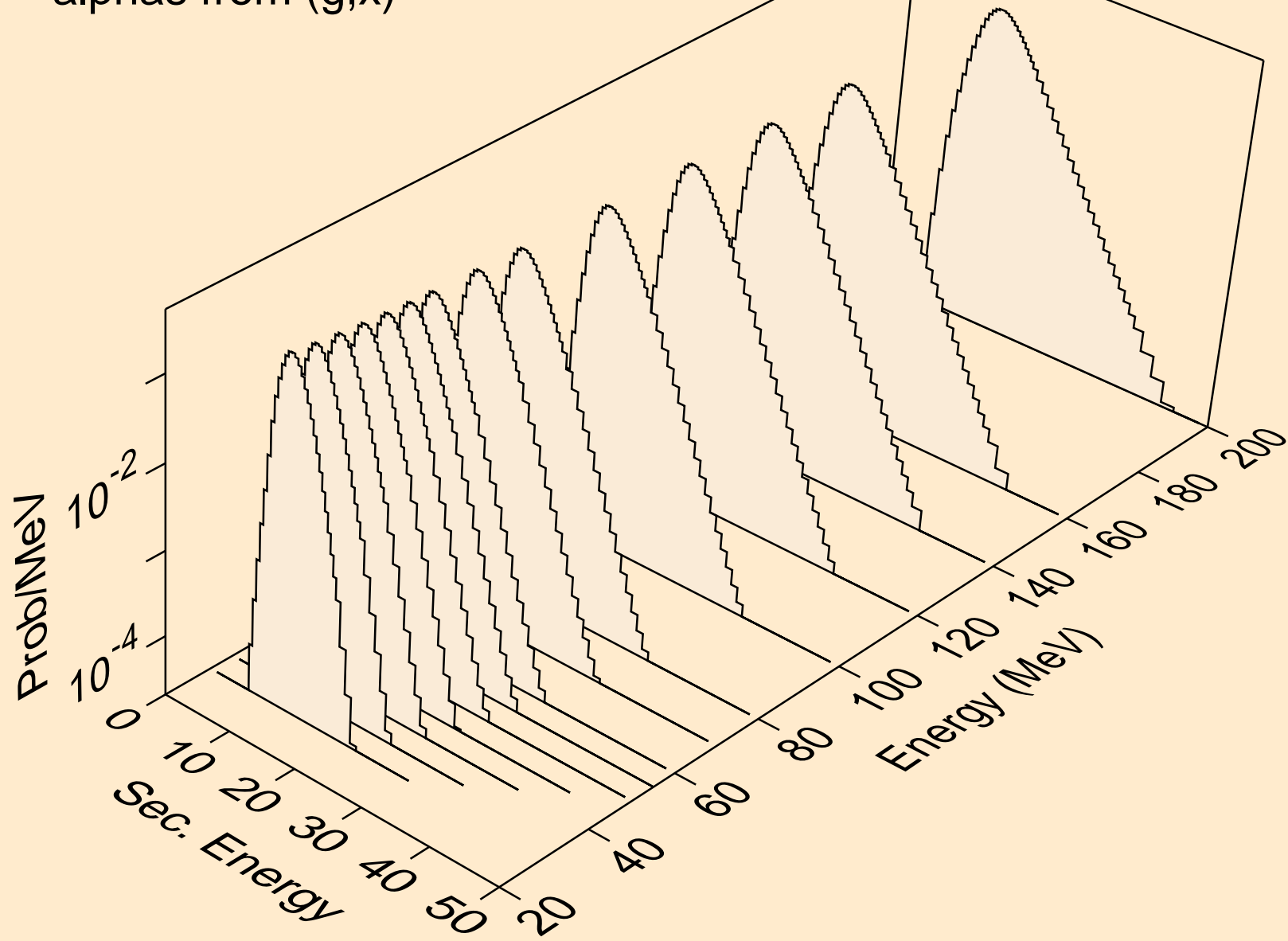

TC089M PHOTON ACER TENDL-2023 LIBRARY; T=0.K
alphas from (g,n*)a

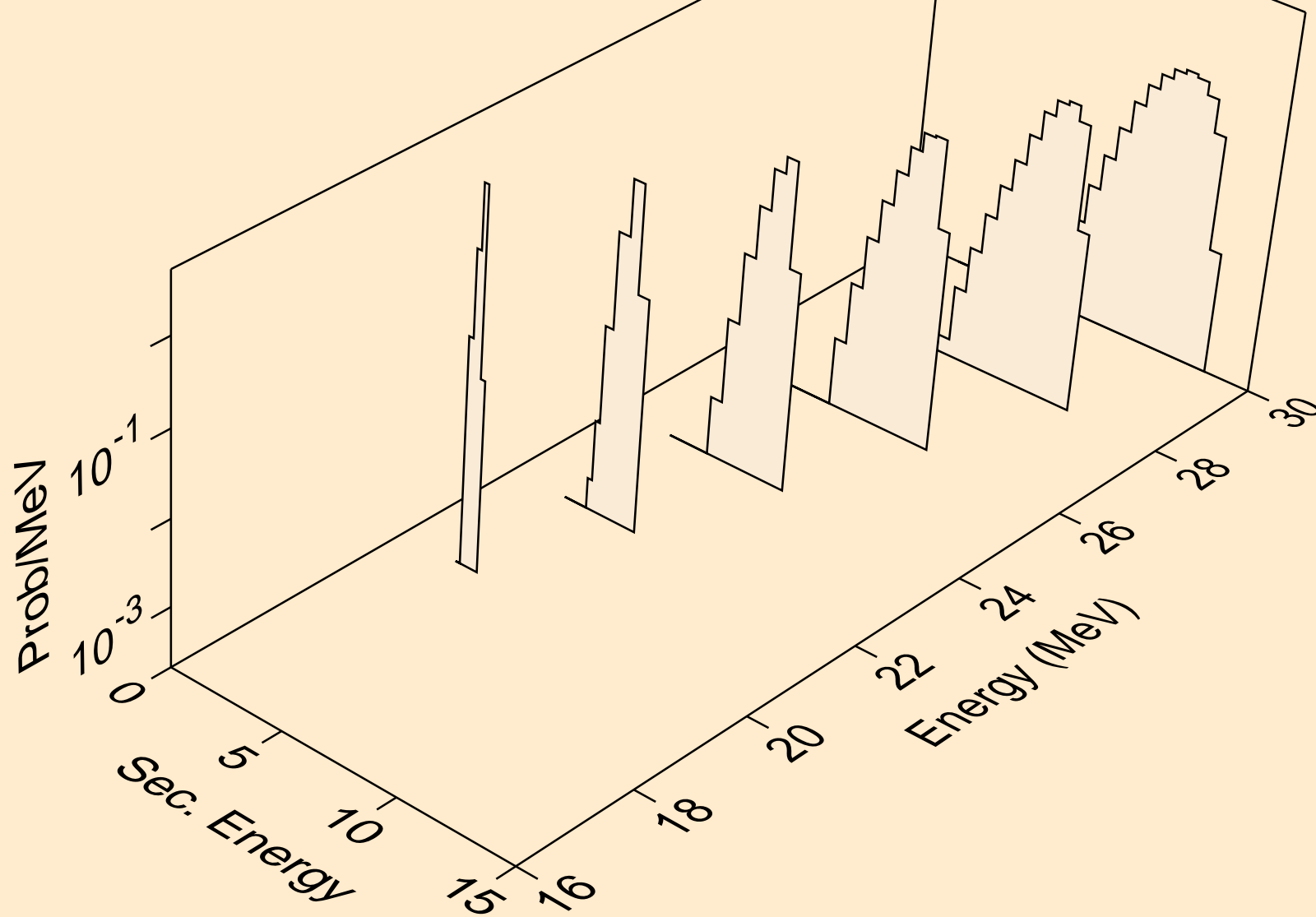

TC089M PHOTON ACER TENDL-2023 LIBRARY; T=0.K
alphas from (g,npa)

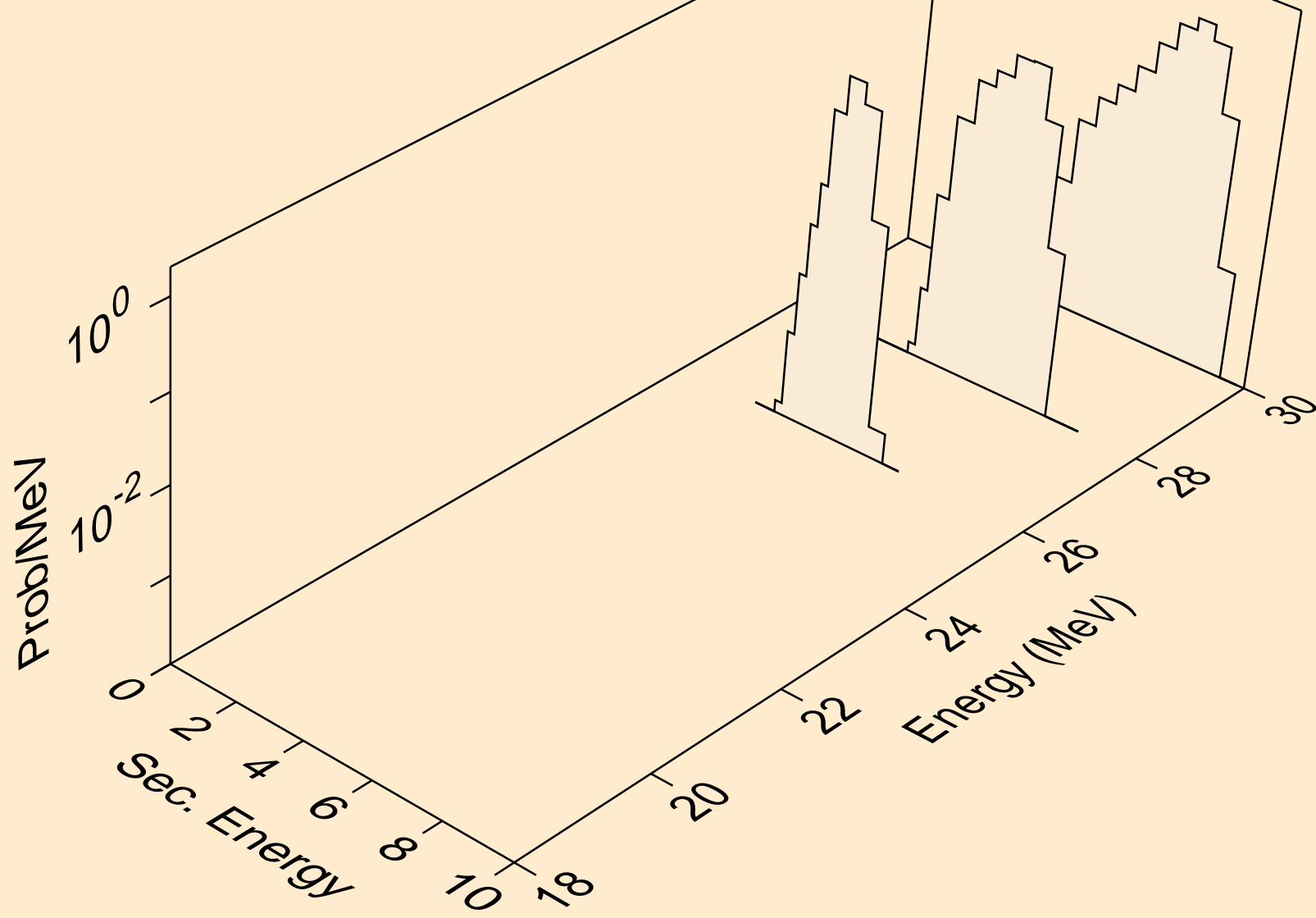

TC089M PHOTON ACER TENDL-2023 LIBRARY; T=0.K
alphas from (g,a)

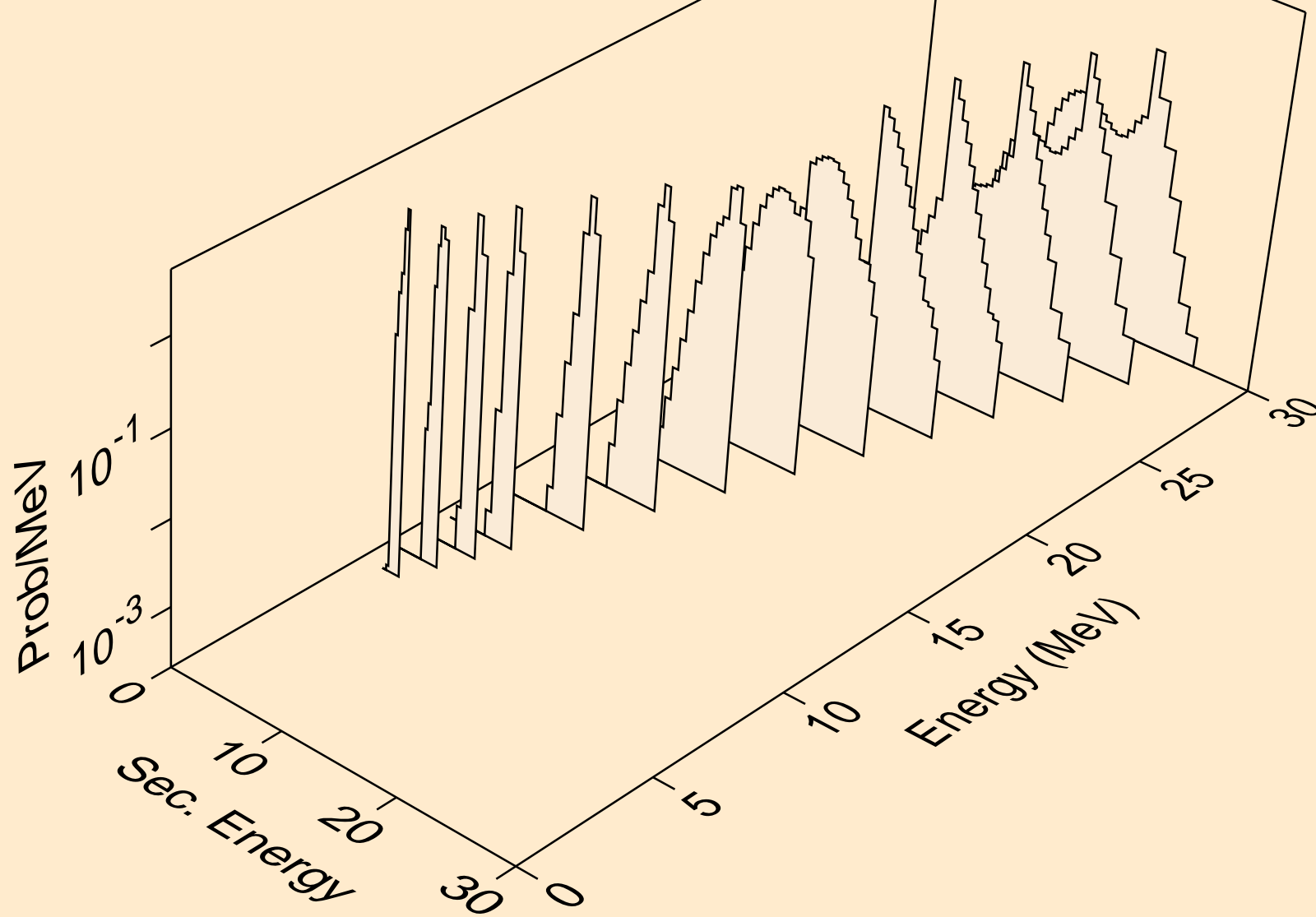

TC089M PHOTON ACER TENDL-2023 LIBRARY; T=0.K
alphas from (g,2a)

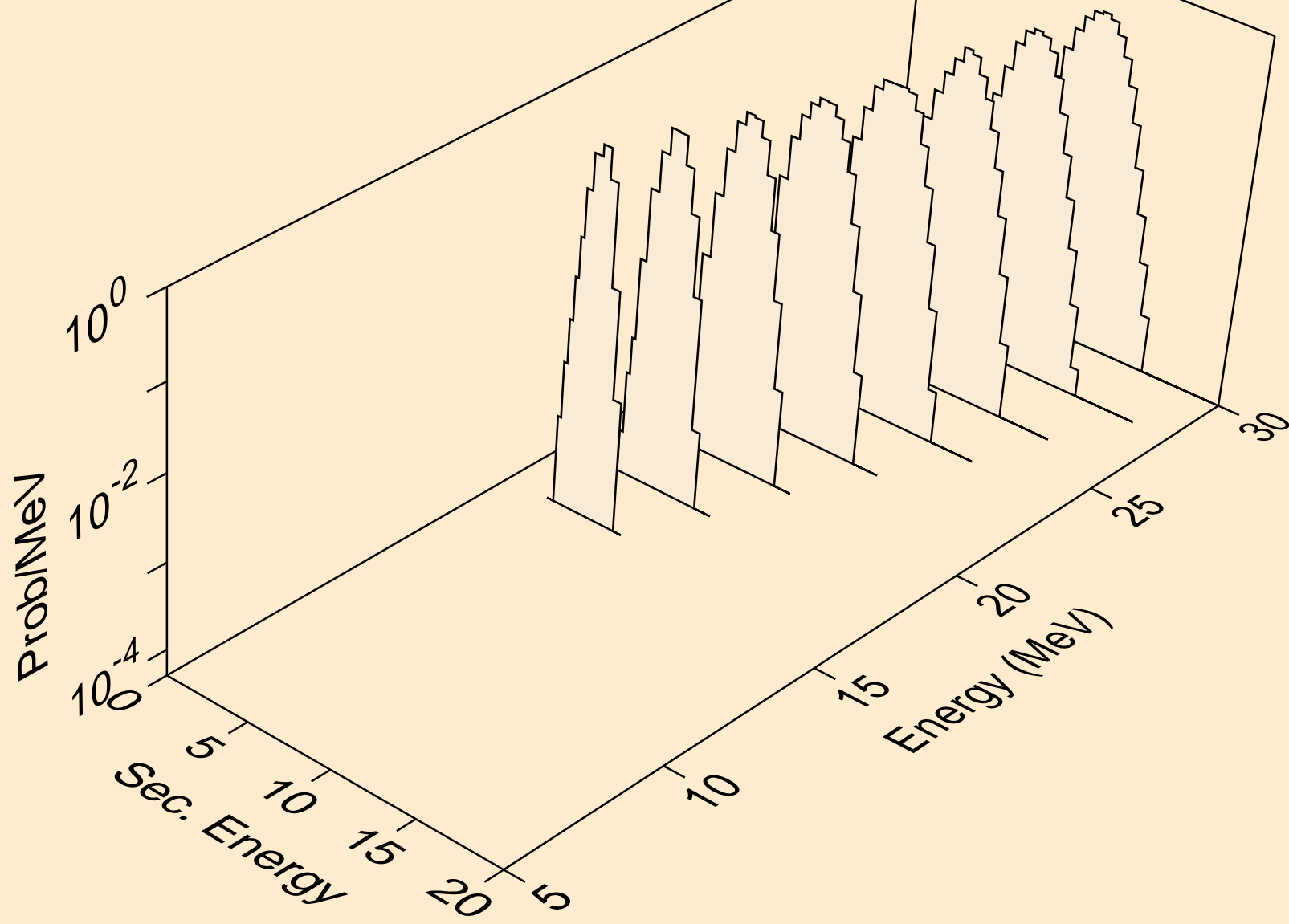

TC089M PHOTON ACER TENDL-2023 LIBRARY; T=0.K
alphas from (g,pa)

