

BK252 HELION ACER TENDL-2023 LIBRARY; T=0.K
Principal cross sections

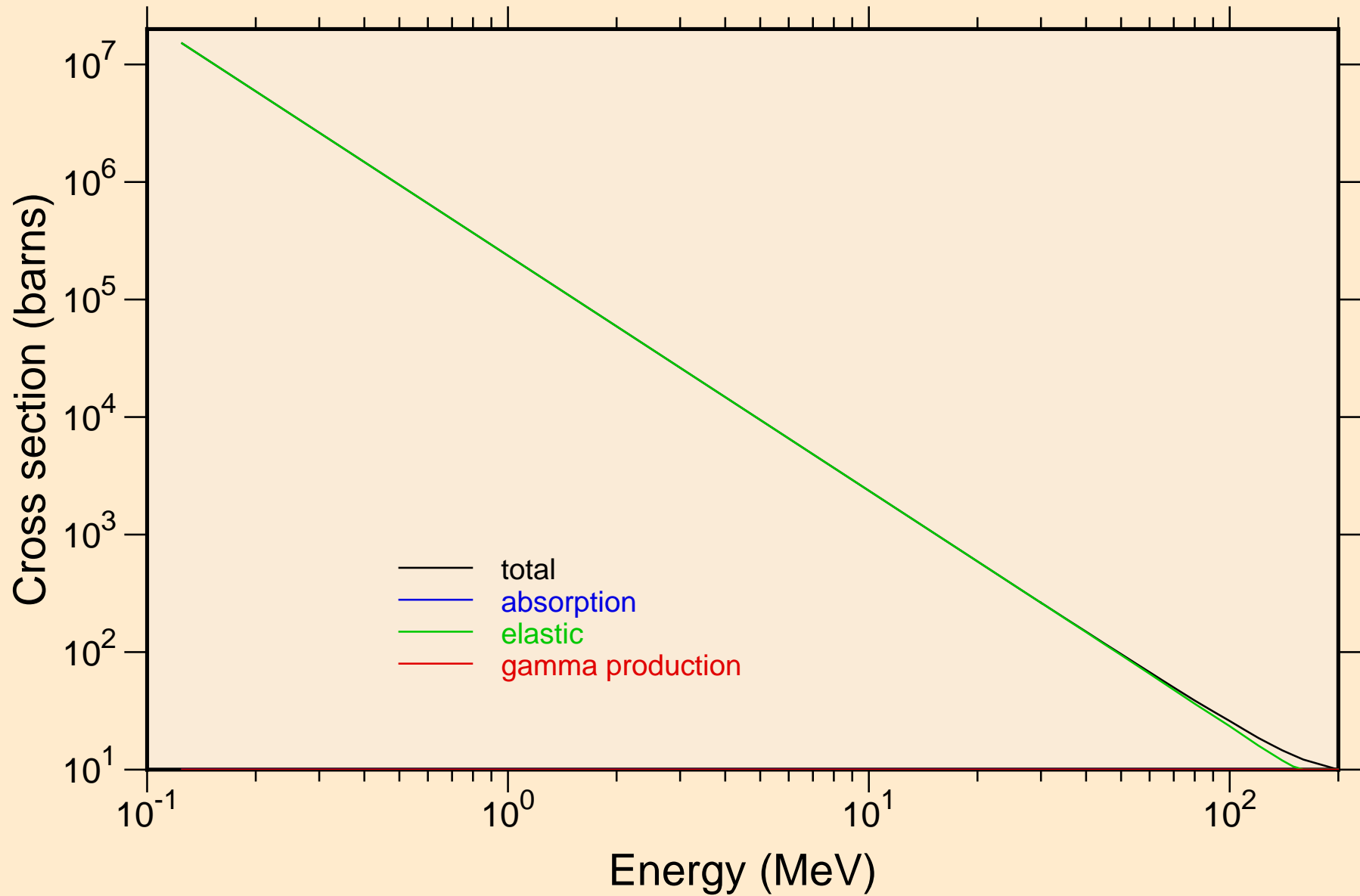

BK252 HELION ACER TENDL-2023 LIBRARY; T=0.K

Heating

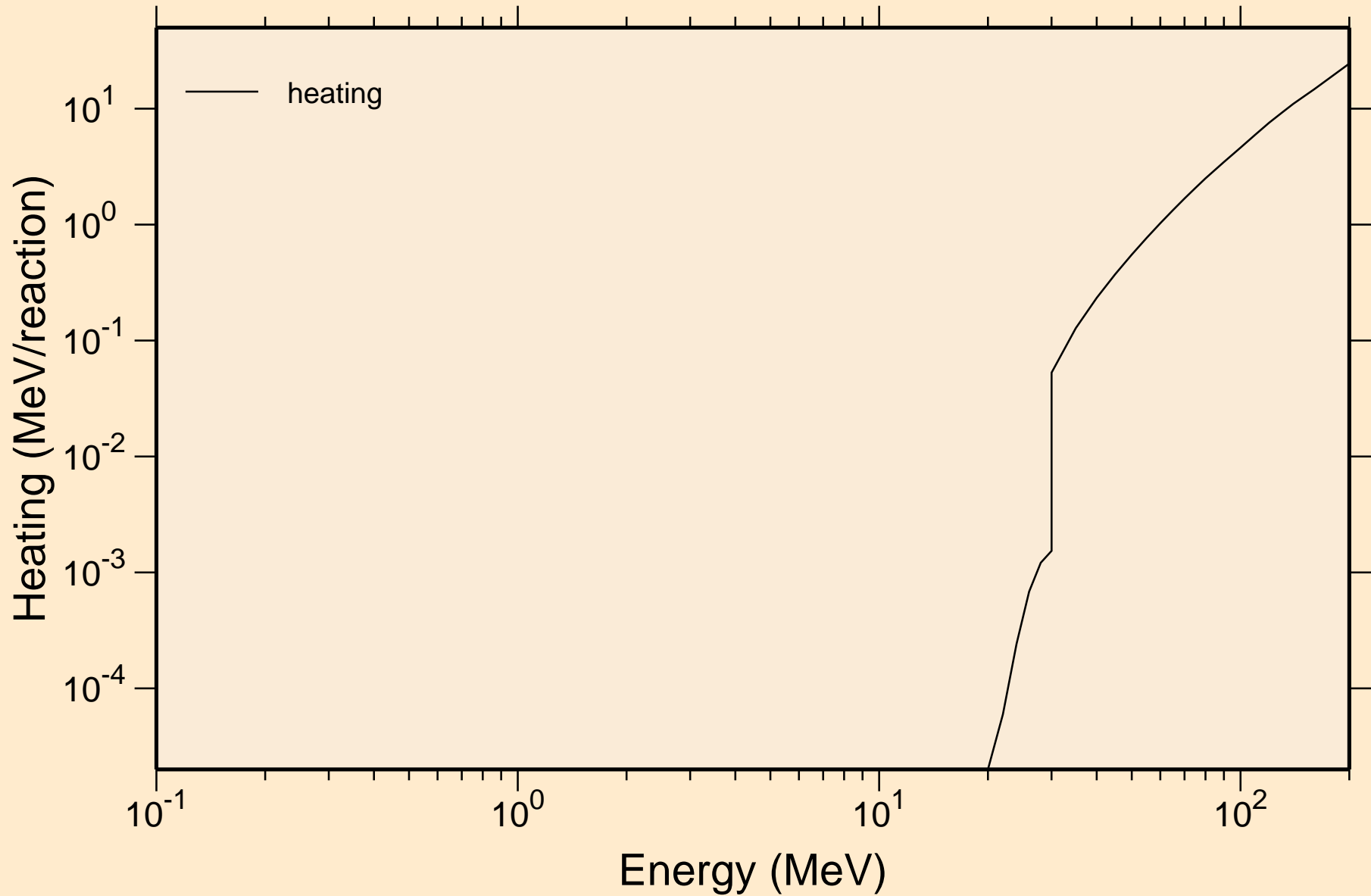

BK252 HELION ACER TENDL-2023 LIBRARY; T=0.K

Principal cross sections

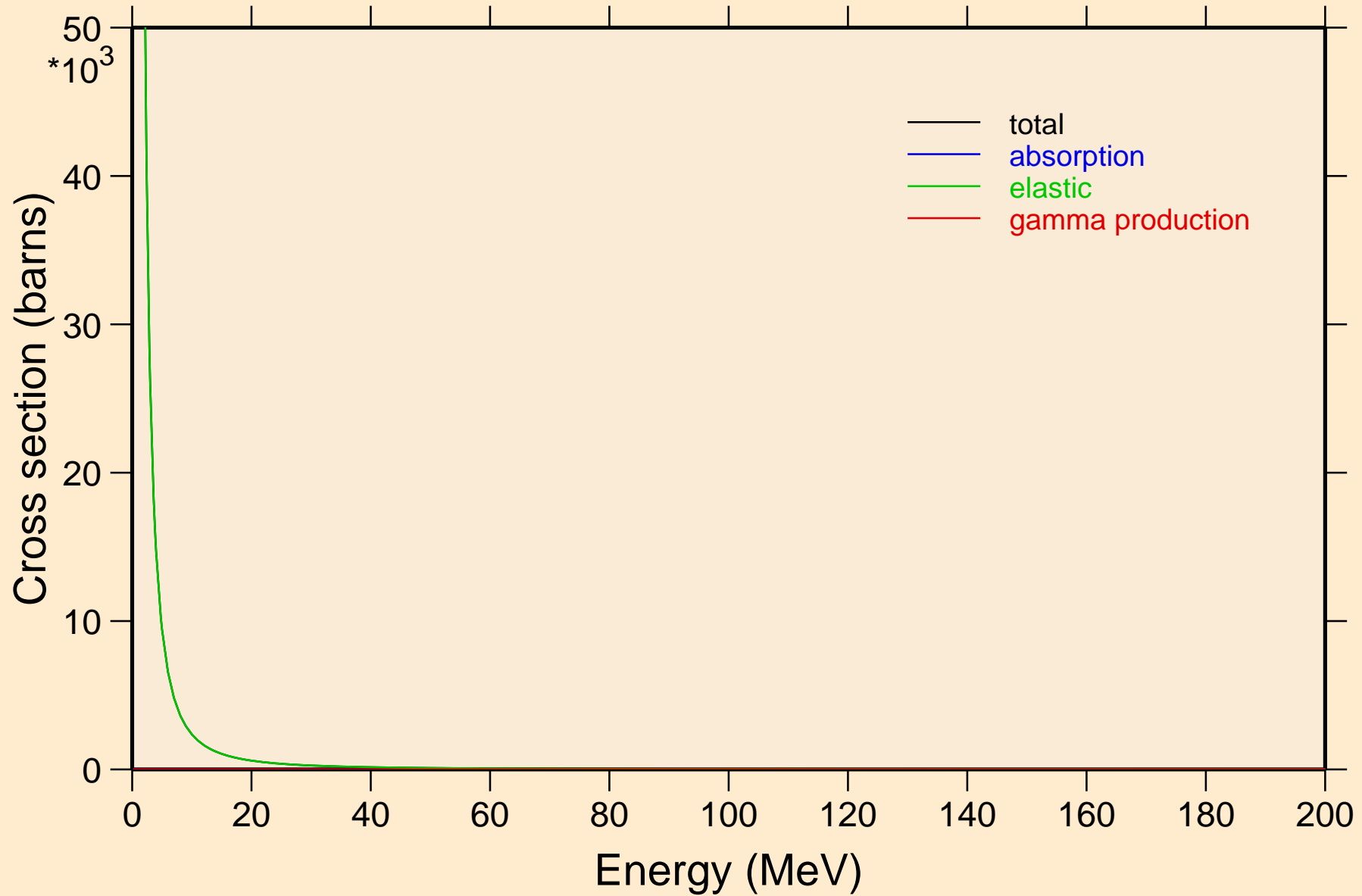

BK252 HELION ACER TENDL-2023 LIBRARY; T=0.K

Heating

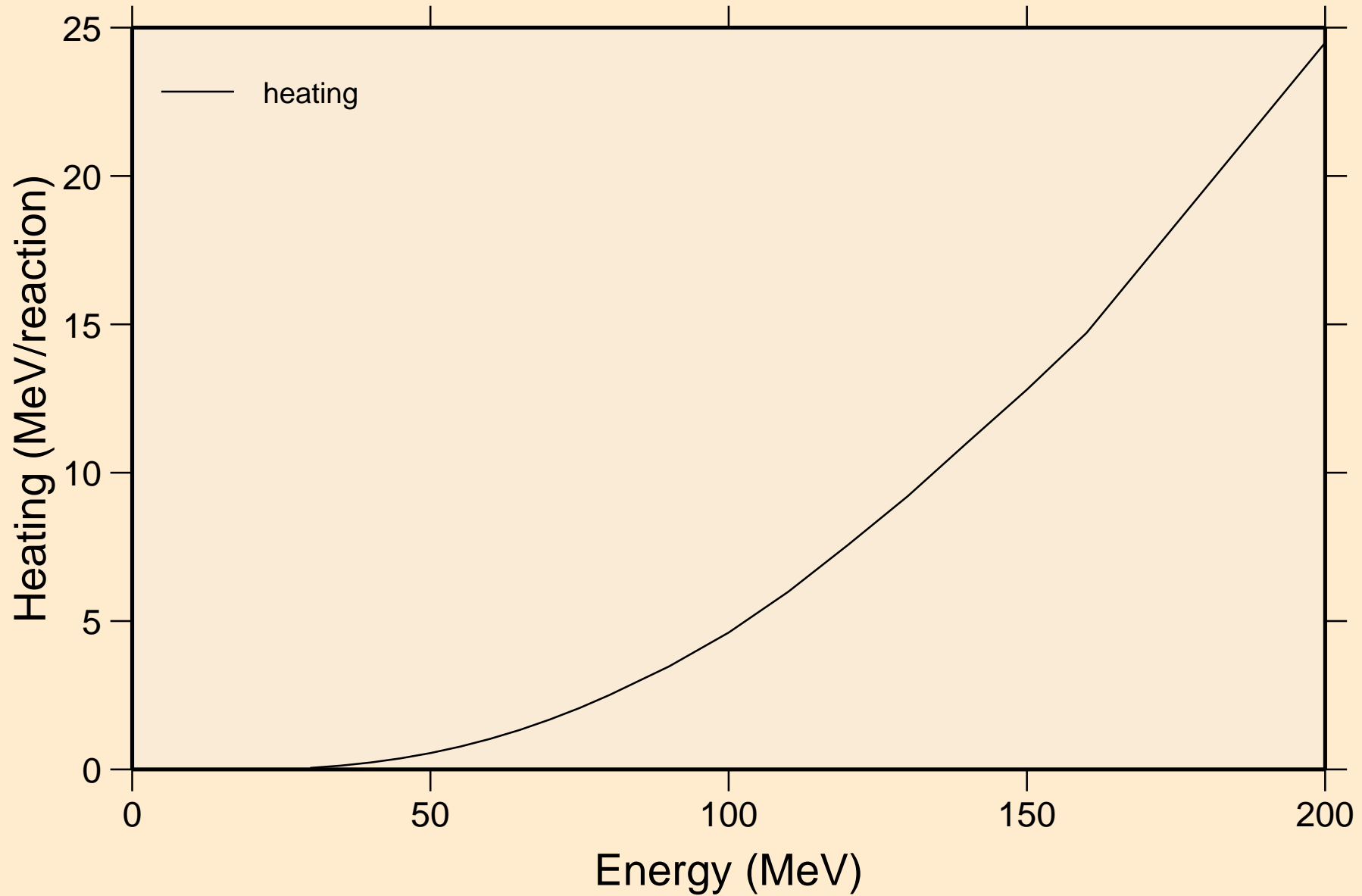

BK252 HELION ACER TENDL-2023 LIBRARY; T=0.K
Threshold reactions

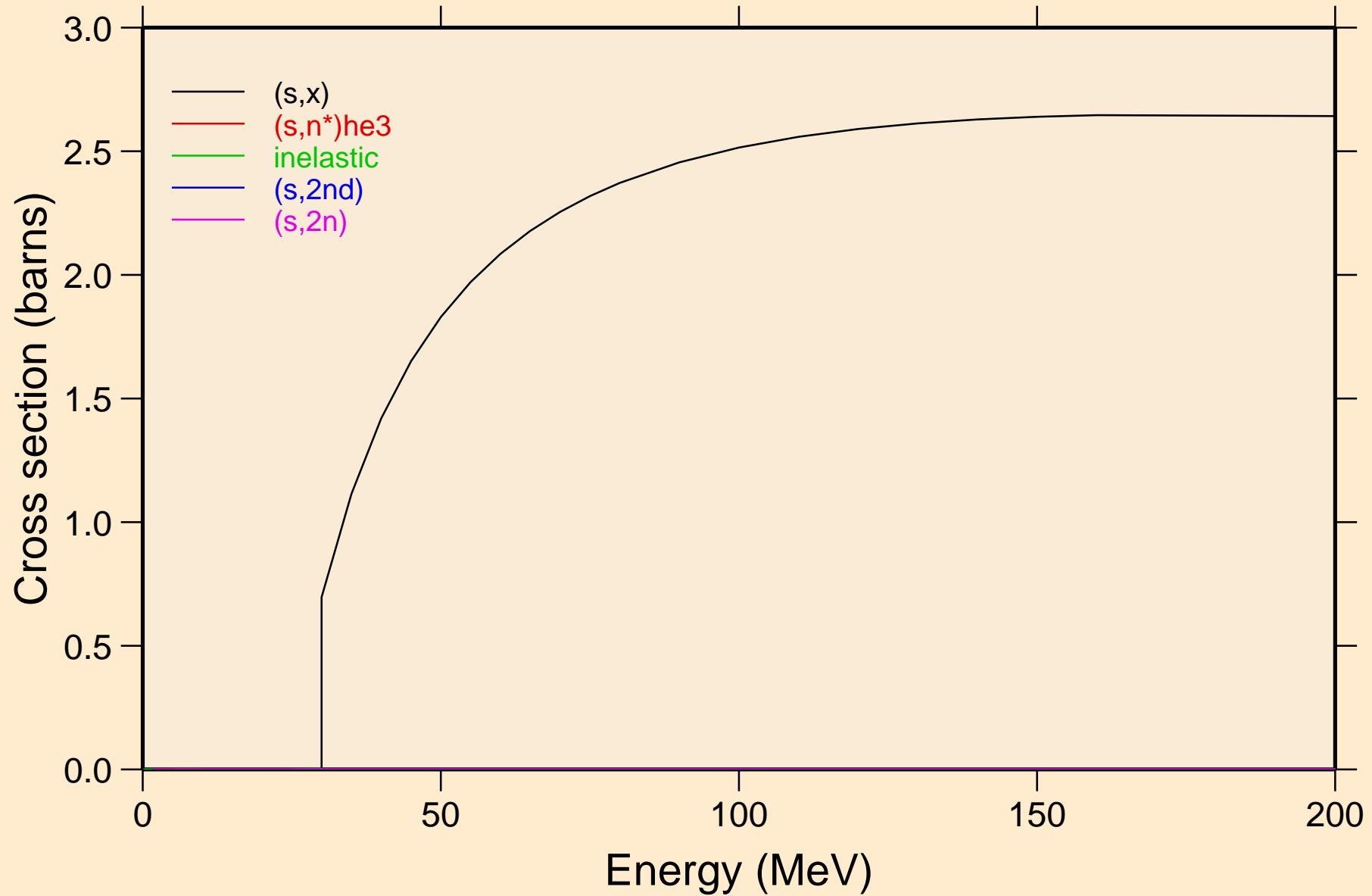

BK252 HELION ACER TENDL-2023 LIBRARY; T=0.K
Threshold reactions

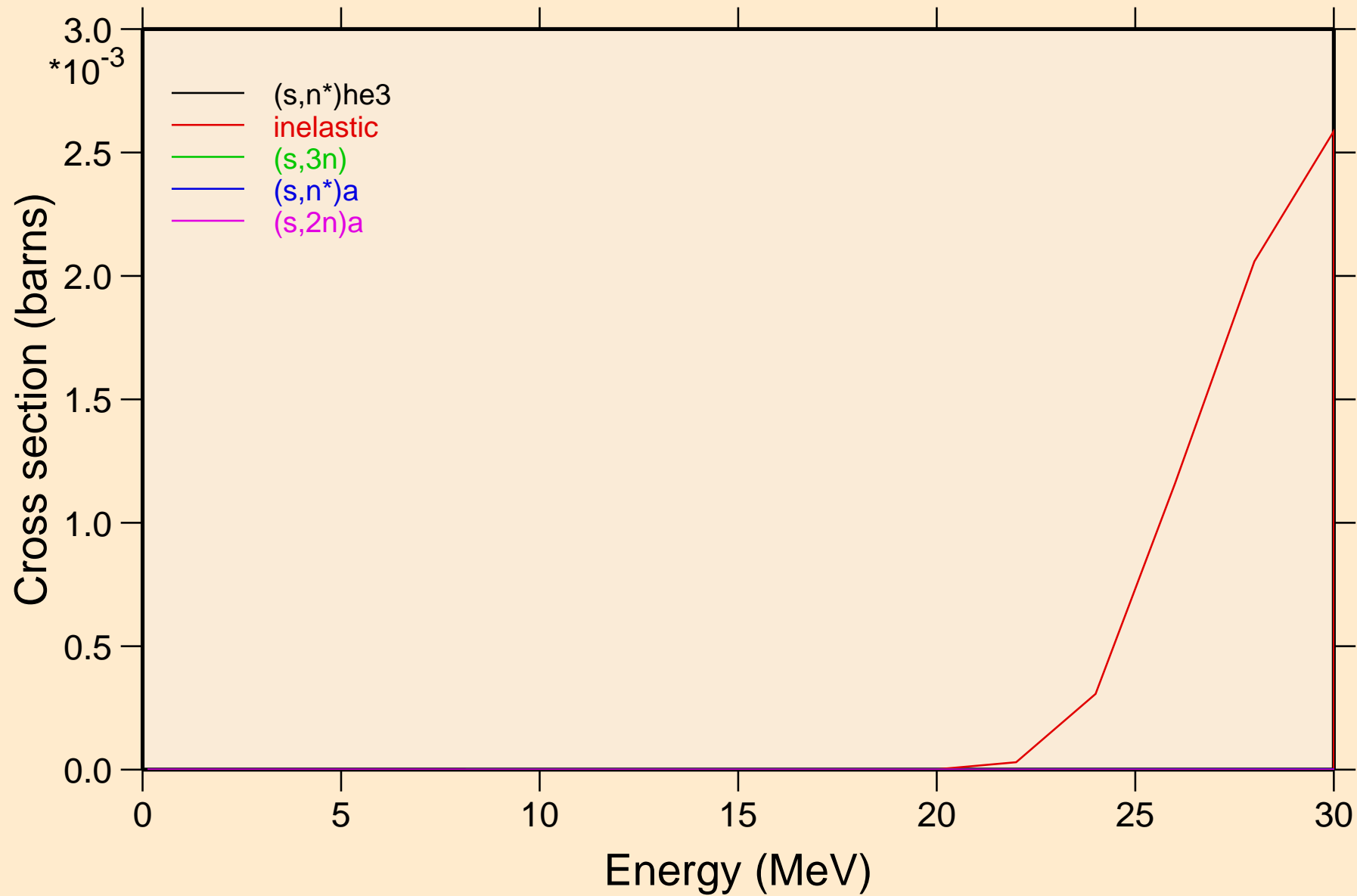

BK252 HELION ACER TENDL-2023 LIBRARY; T=0.K
Threshold reactions

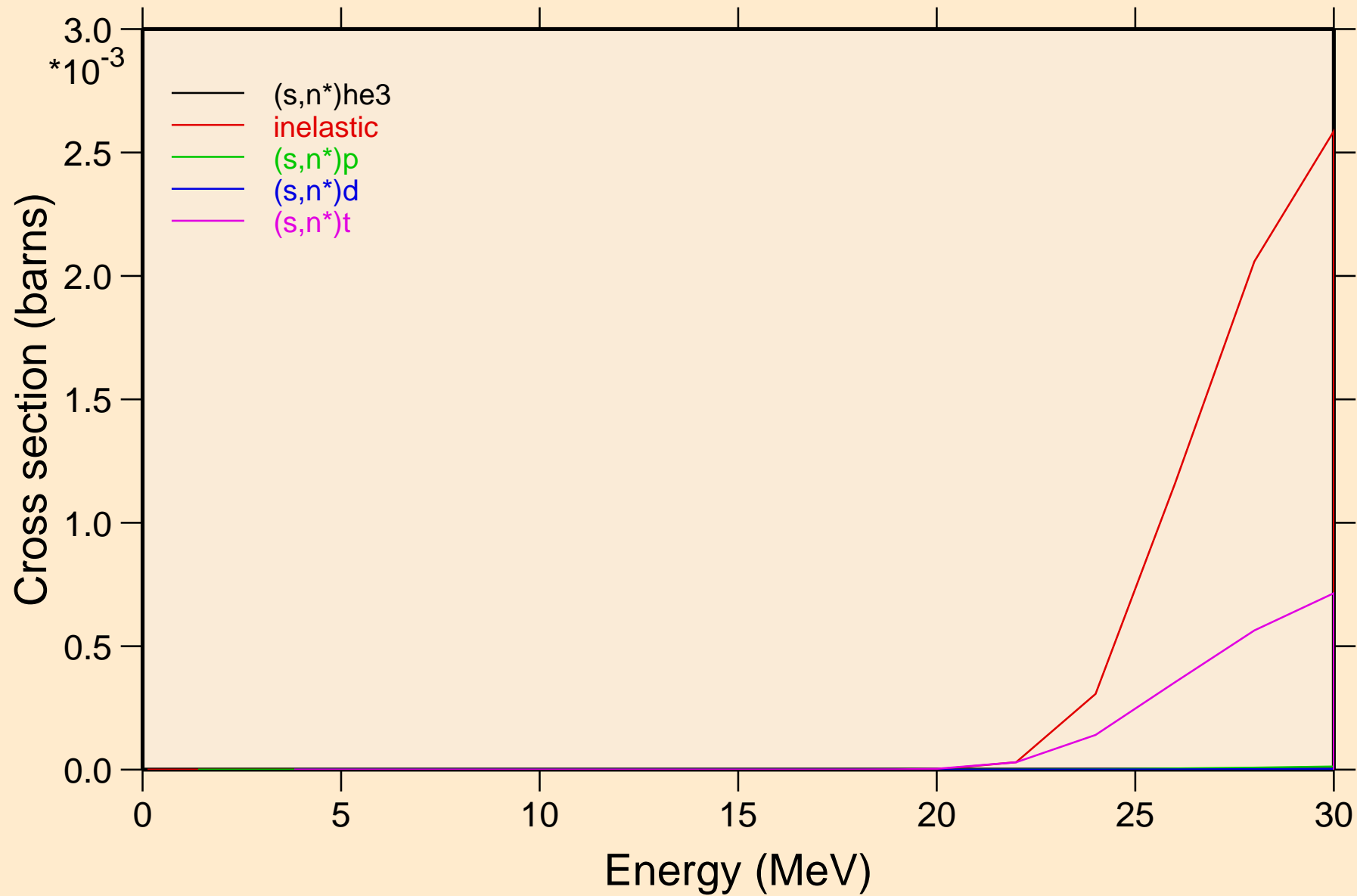

BK252 HELION ACER TENDL-2023 LIBRARY; T=0.K
Threshold reactions

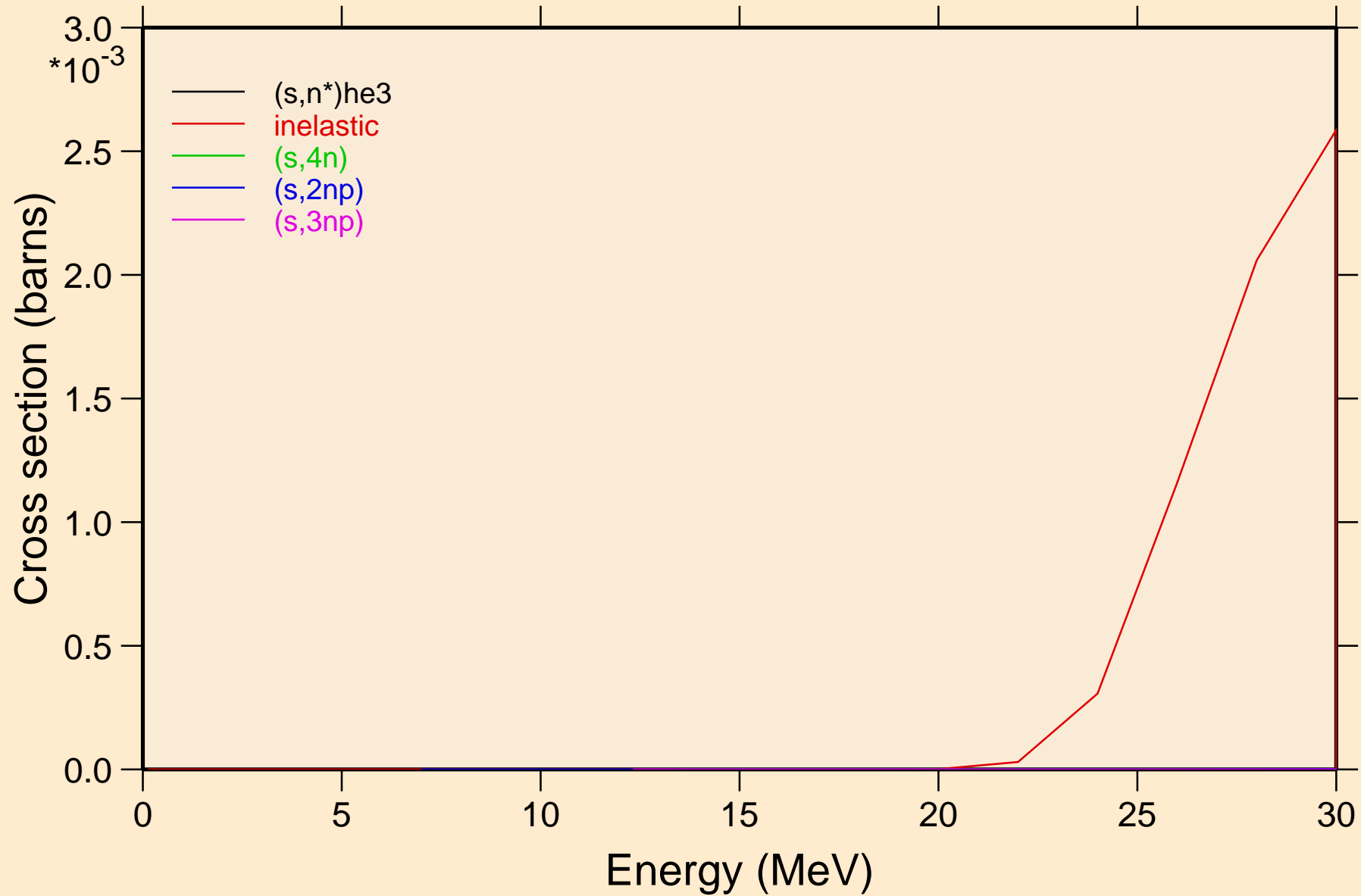

BK252 HELION ACER TENDL-2023 LIBRARY; T=0.K
Threshold reactions

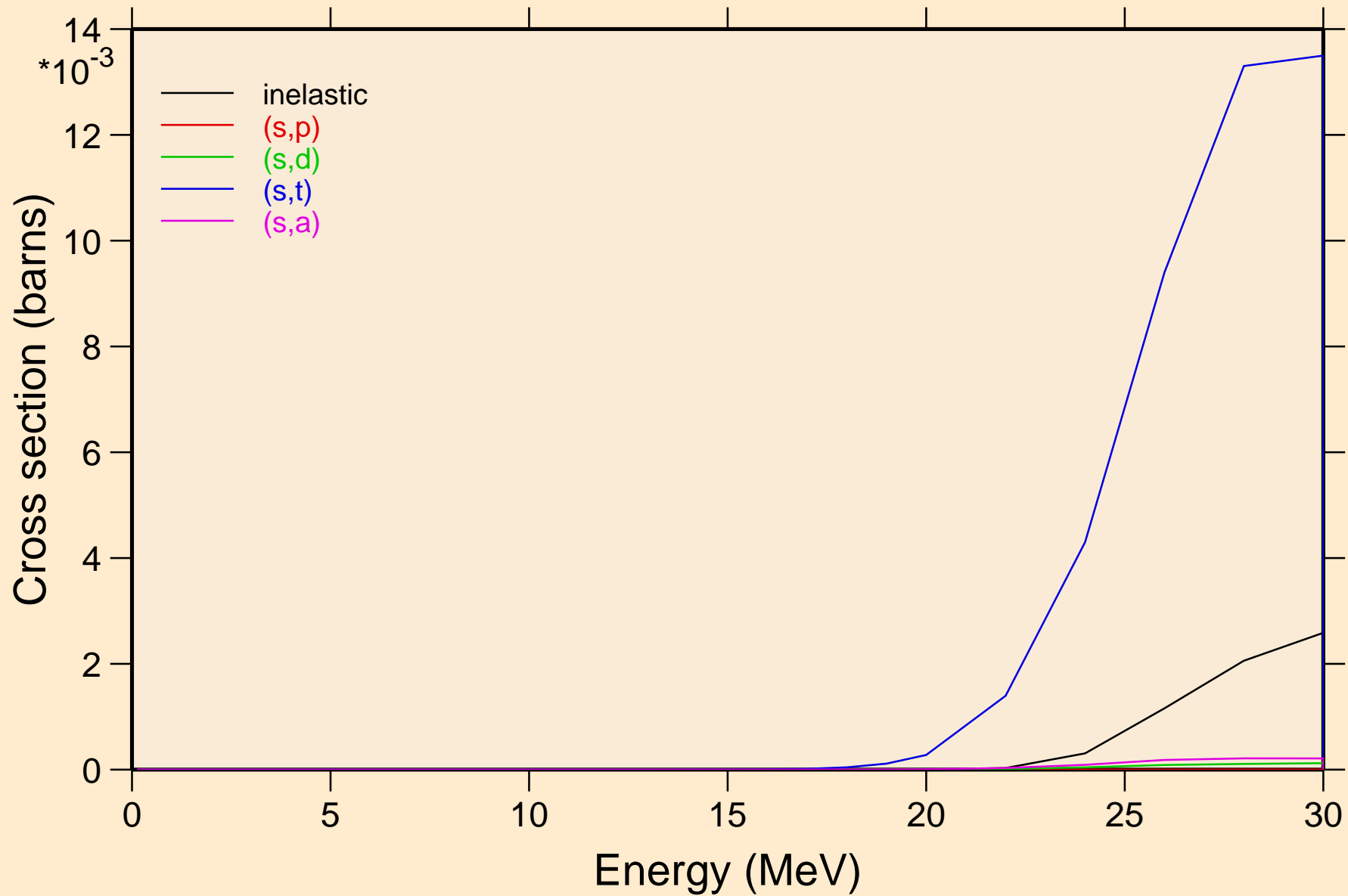

BK252 HELION ACER TENDL-2023 LIBRARY; T=0.K
Threshold reactions

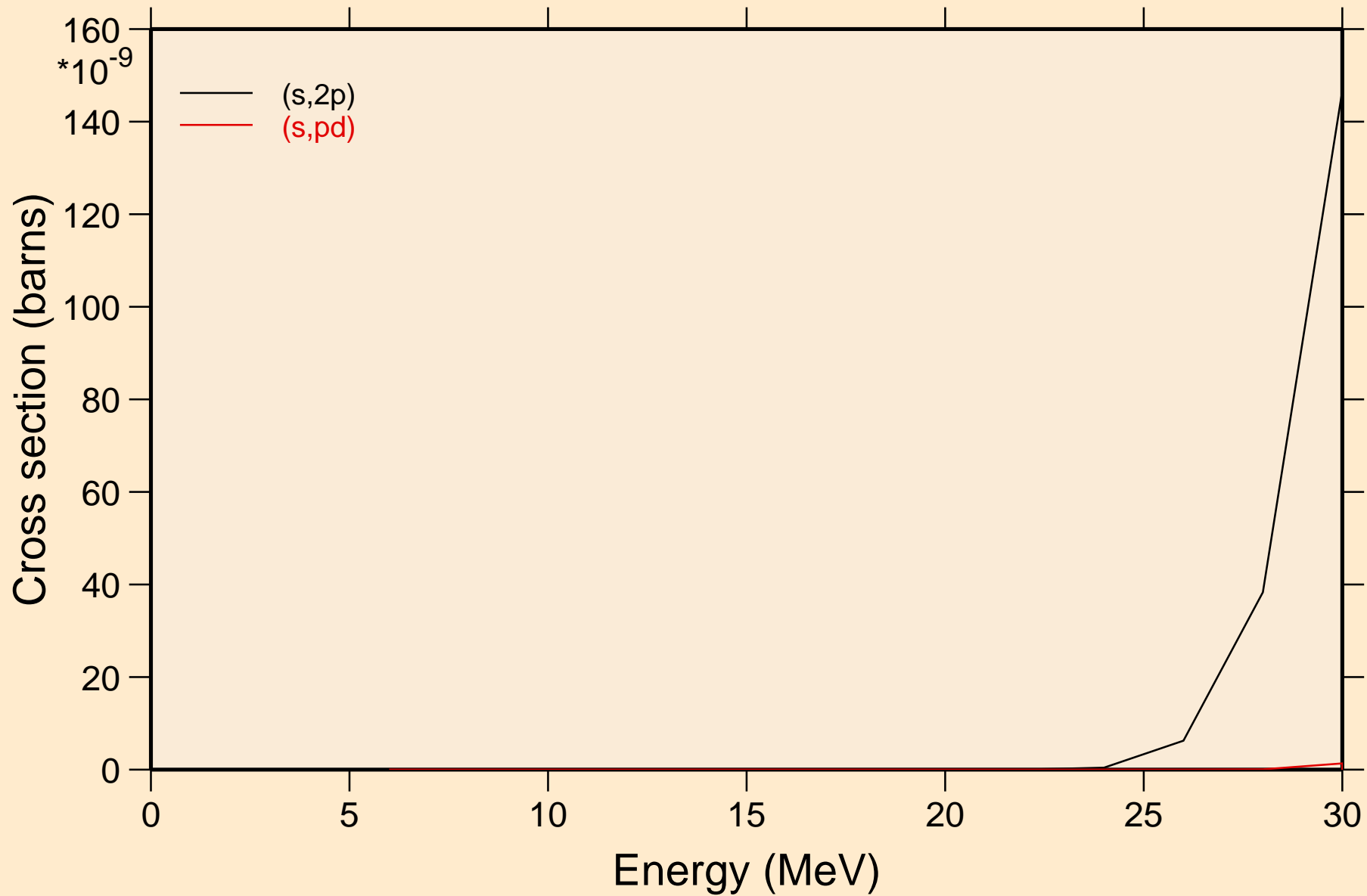

BK252 HELION ACER TENDL-2023 LIBRARY; T=0.K
angular distribution for elastic

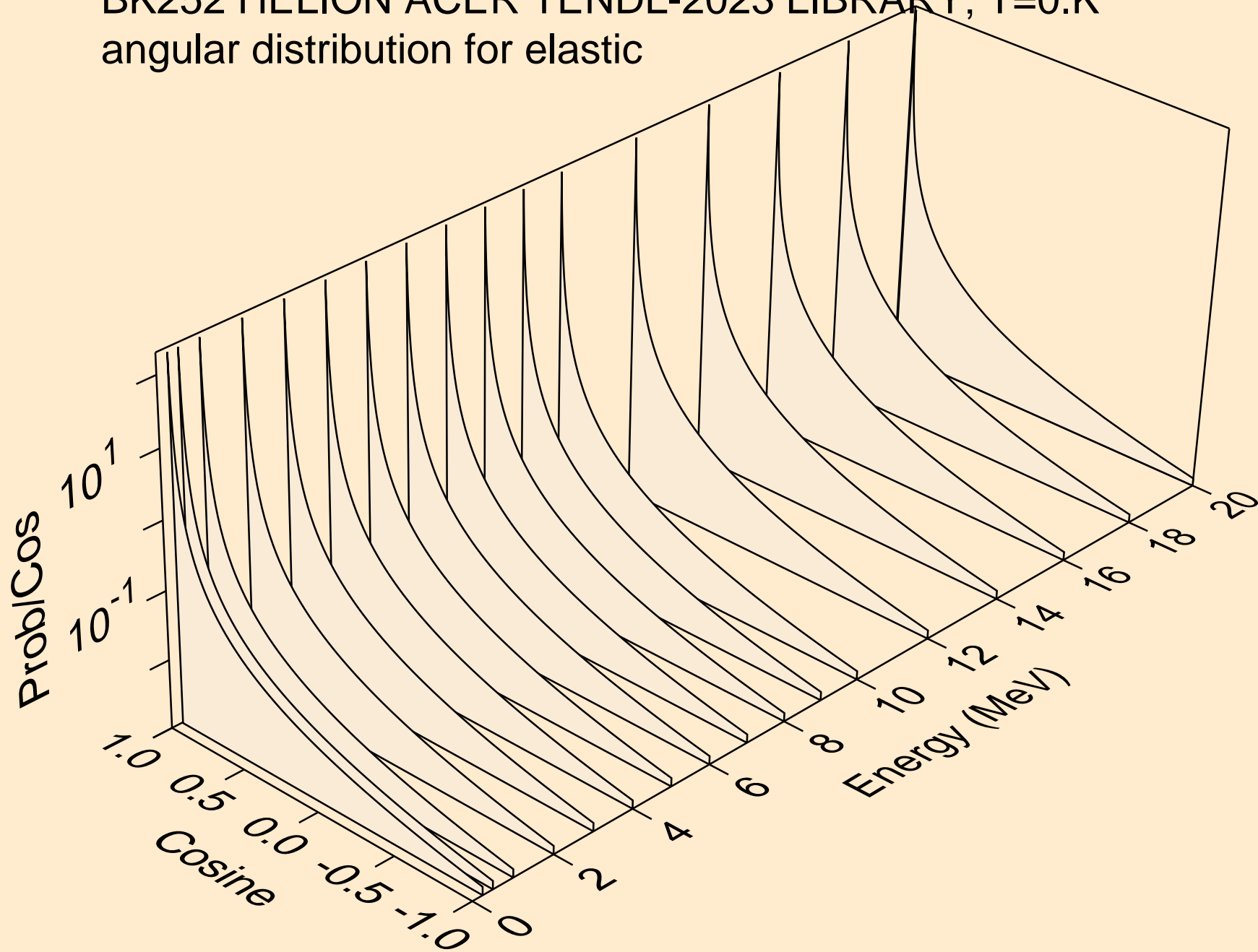

BK252 HELION ACER TENDL-2023 LIBRARY; T=0.K
angular distribution for elastic

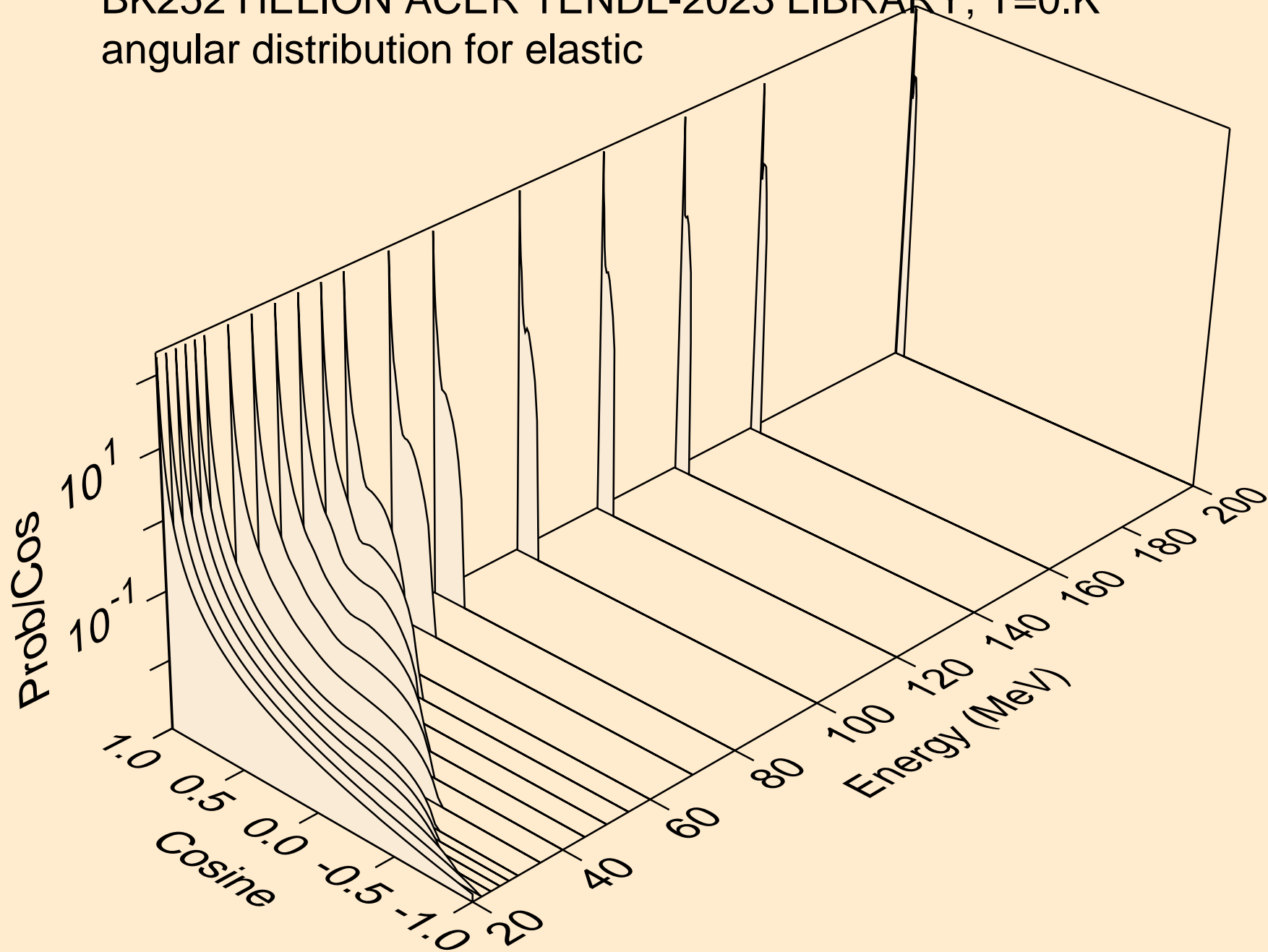

BK252 HELION ACER TENDL-2023 LIBRARY; T=0.K
He-3 emission for (s,x)

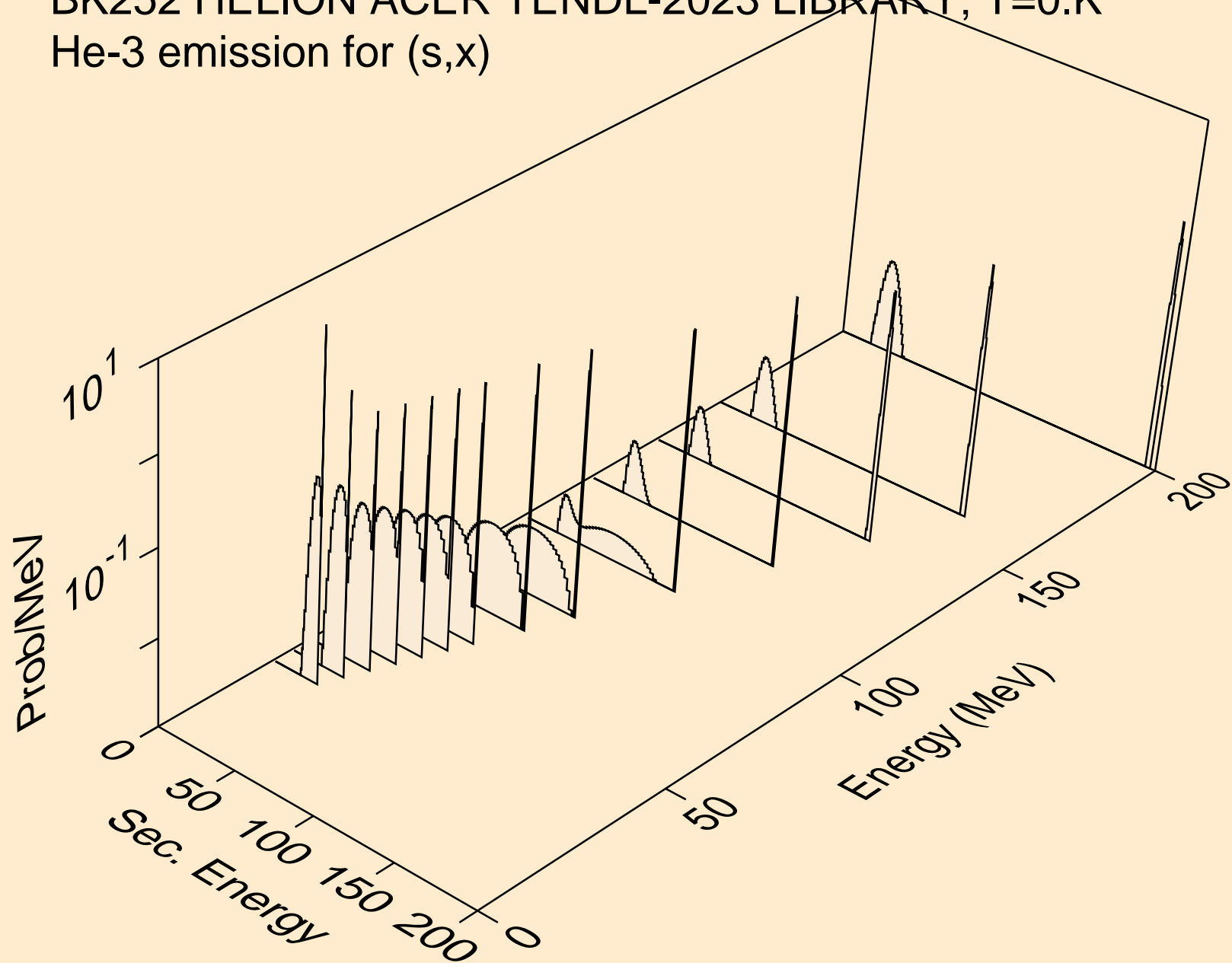

BK252 HELION ACER TENDL-2023 LIBRARY; T=0.K
He-3 emission for (s,n*)he3

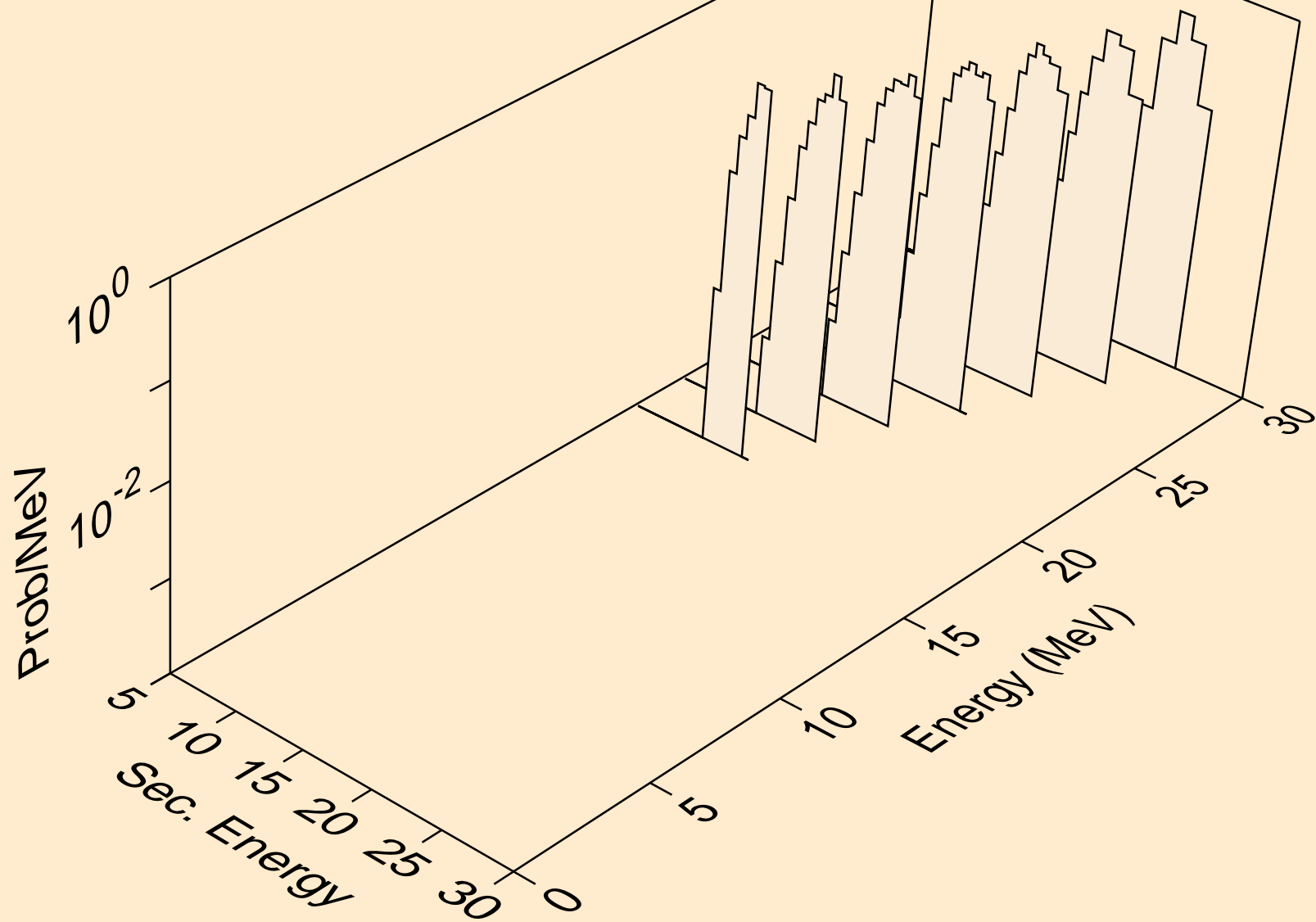

BK252 HELION ACER TENDL-2023 LIBRARY; T=0.K
He-3 emission for inelastic

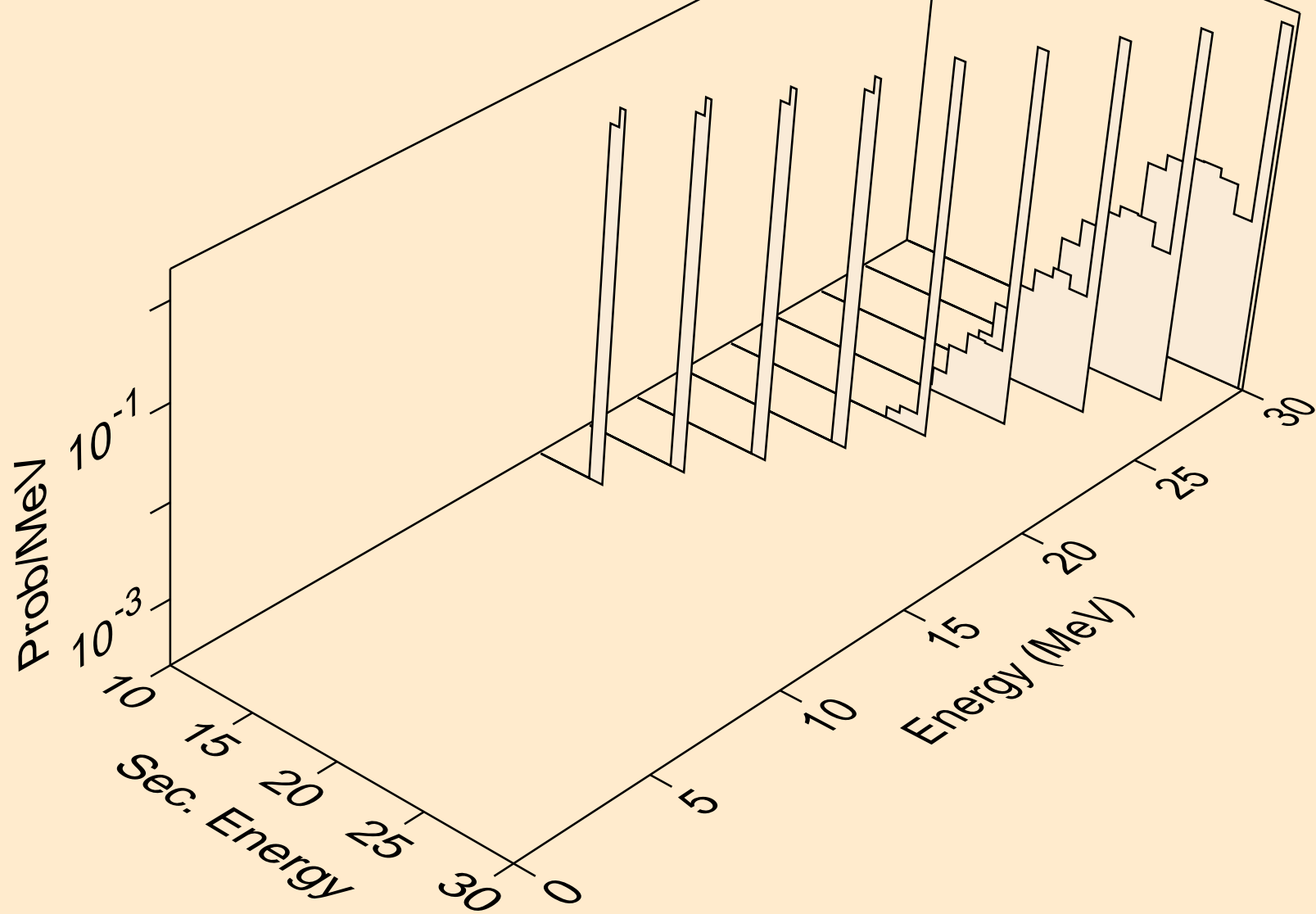

BK252 HELION ACER TENDL-2023 LIBRARY; T=0.K
Photon emission for (z,n)

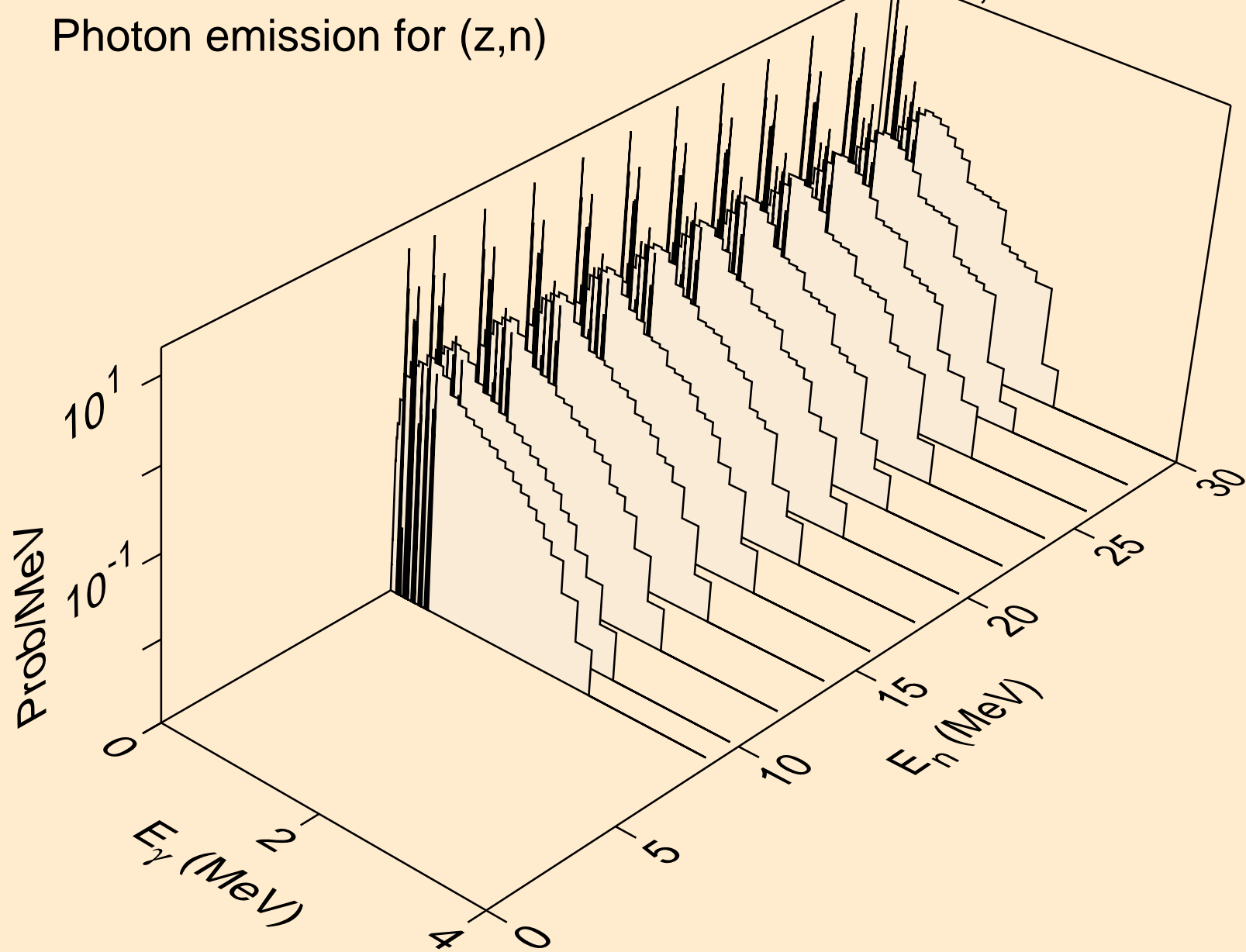

BK252 HELION ACER TENDL-2023 LIBRARY; T=0.K
Photon emission for (z,x)

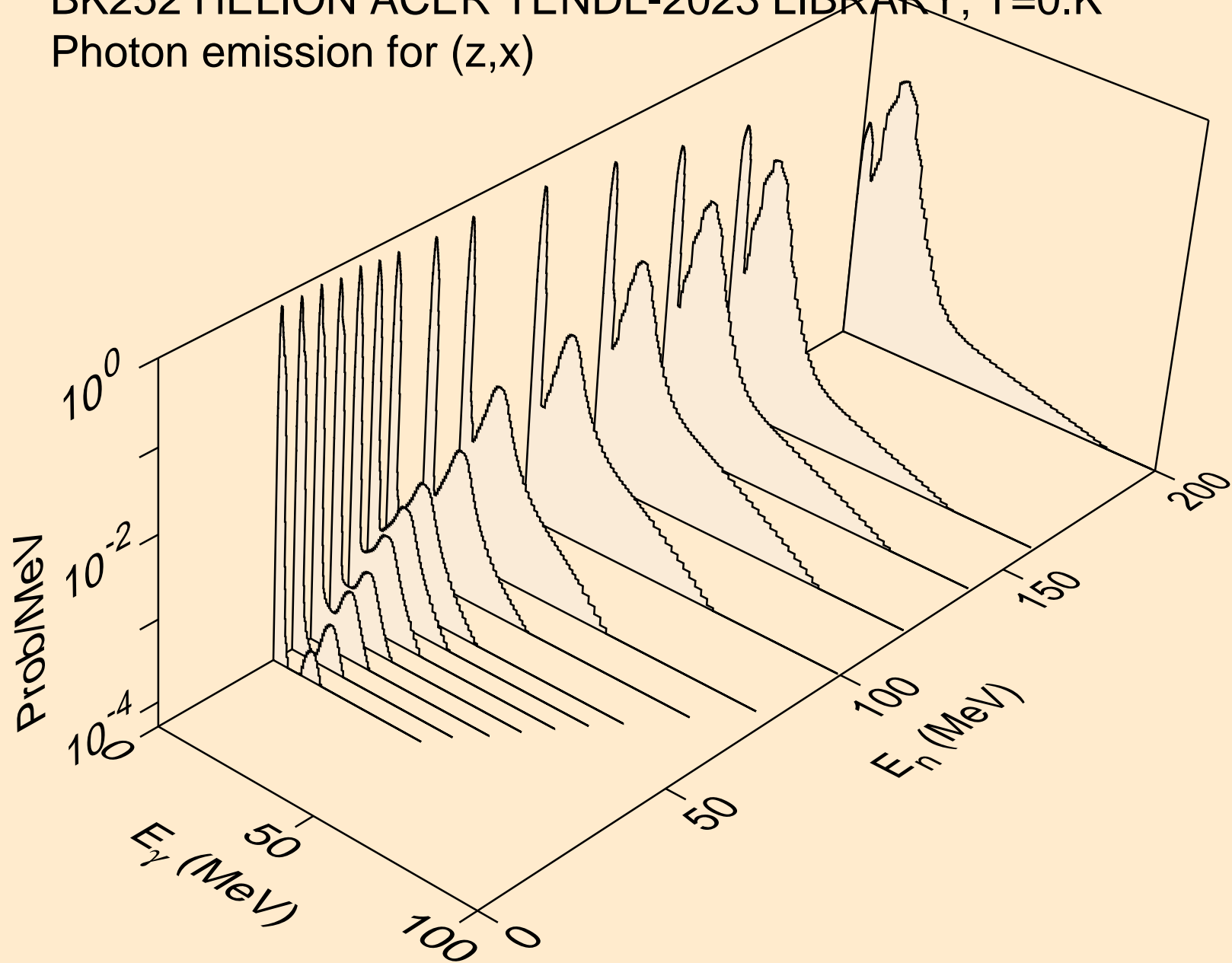

BK252 HELION ACER TENDL-2023 LIBRARY; T=0.K
Photon emission for (n,2nd)

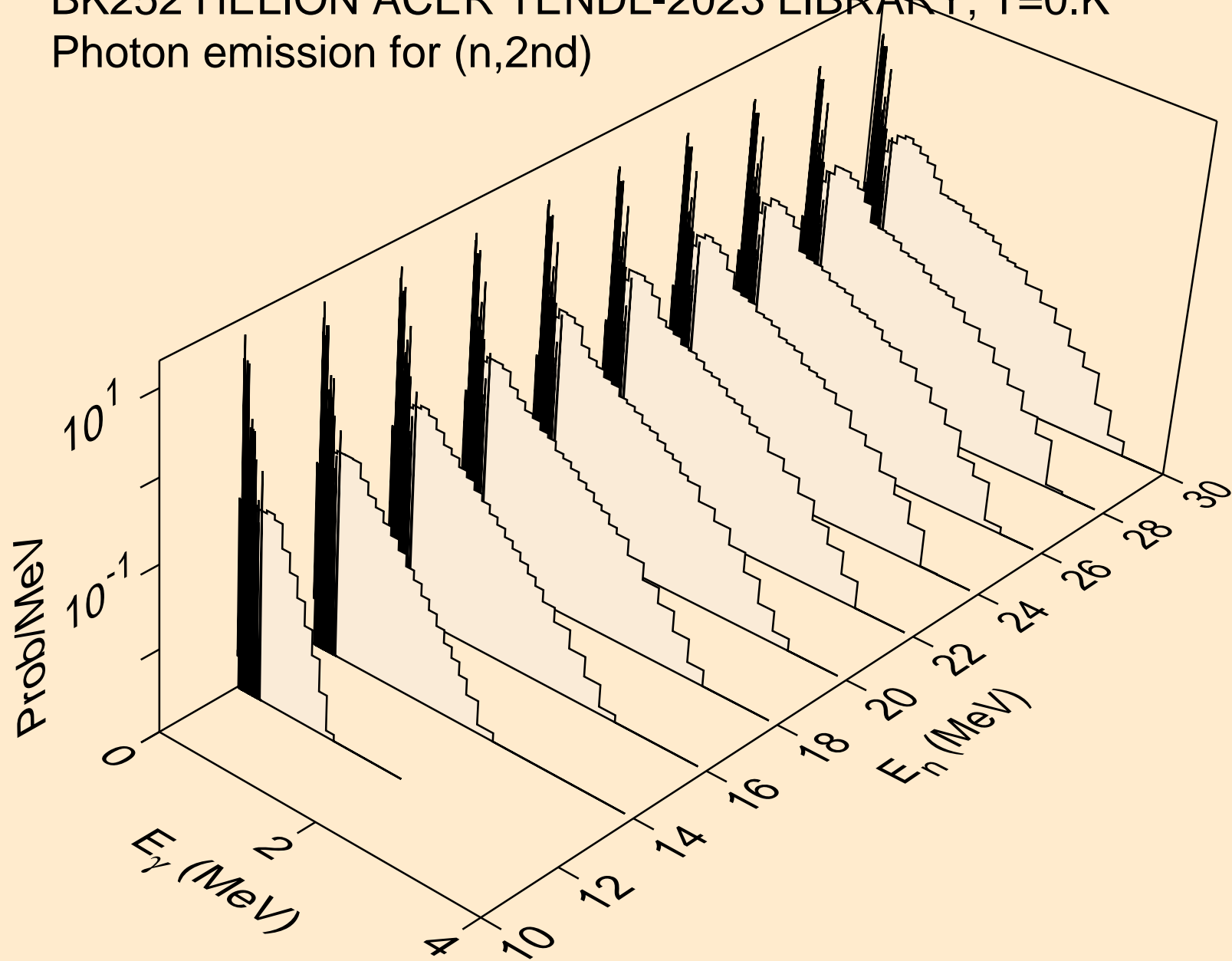

BK252 HELION ACER TENDL-2023 LIBRARY; T=0.K
Photon emission for (n,2n)

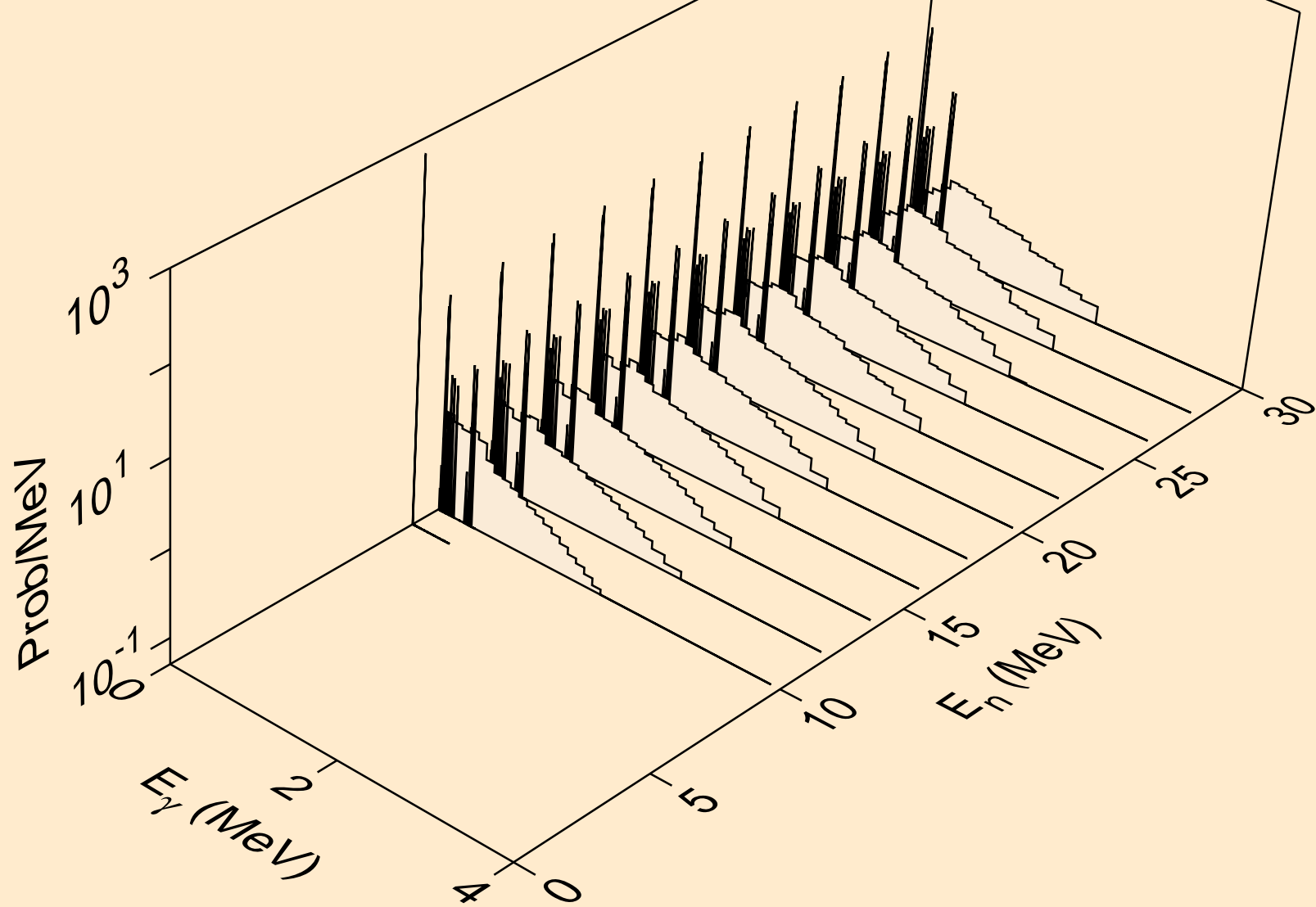

BK252 HELION ACER TENDL-2023 LIBRARY; T=0.K
Photon emission for (n,3n)

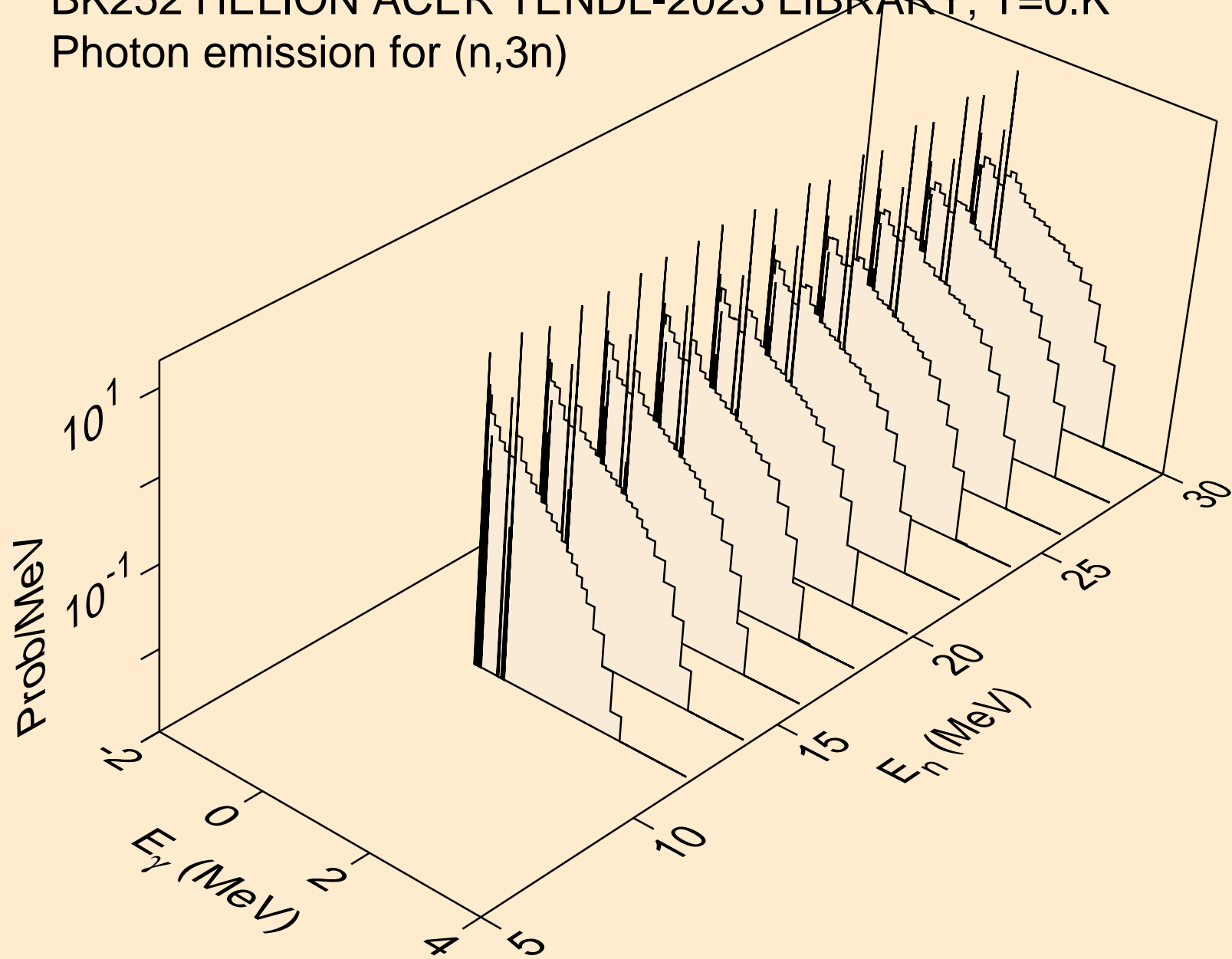

BK252 HELION ACER TENDL-2023 LIBRARY; T=0.K
Photon emission for (n,n*)a

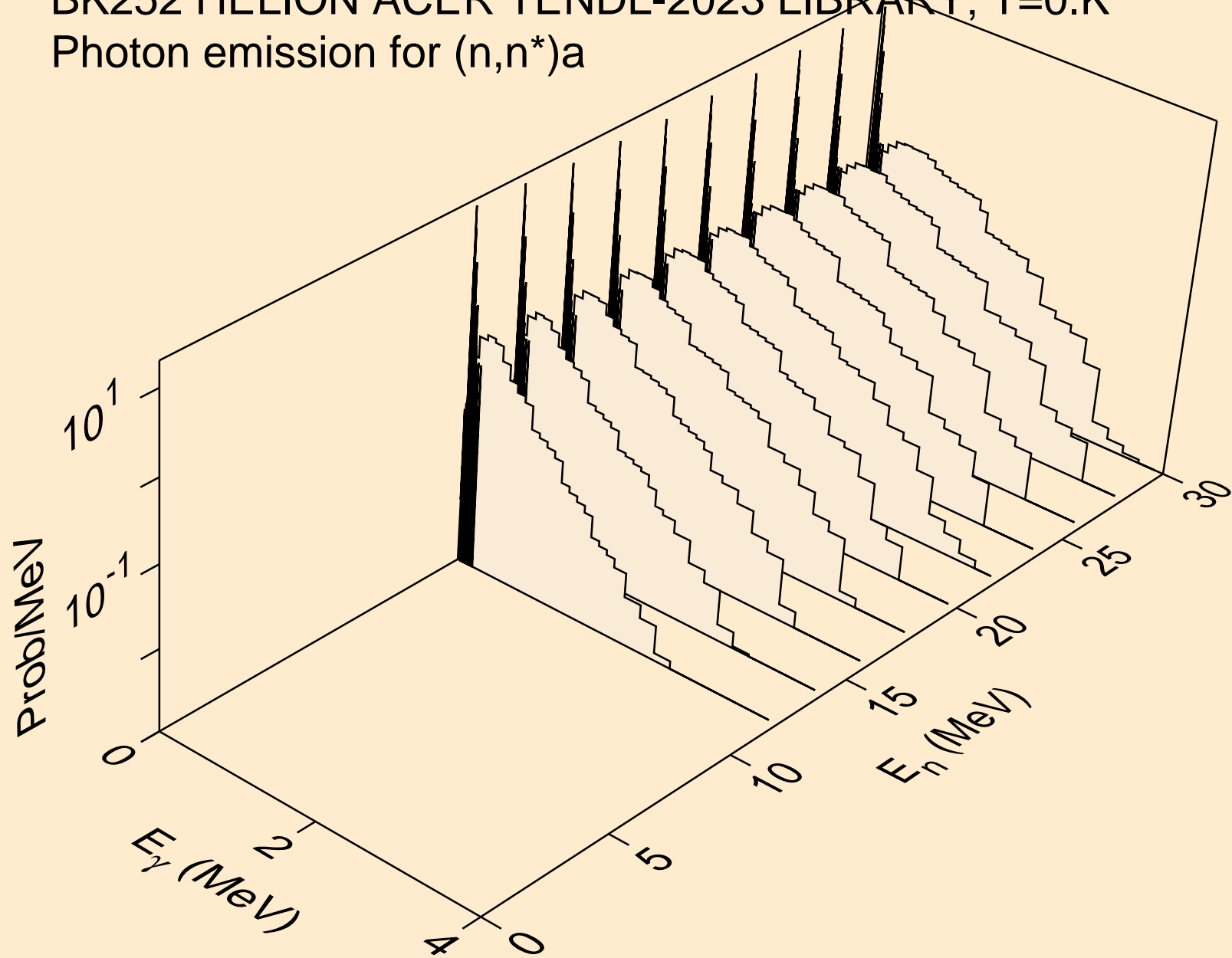

BK252 HELION ACER TENDL-2023 LIBRARY; T=0.K
Photon emission for (n,2n)a

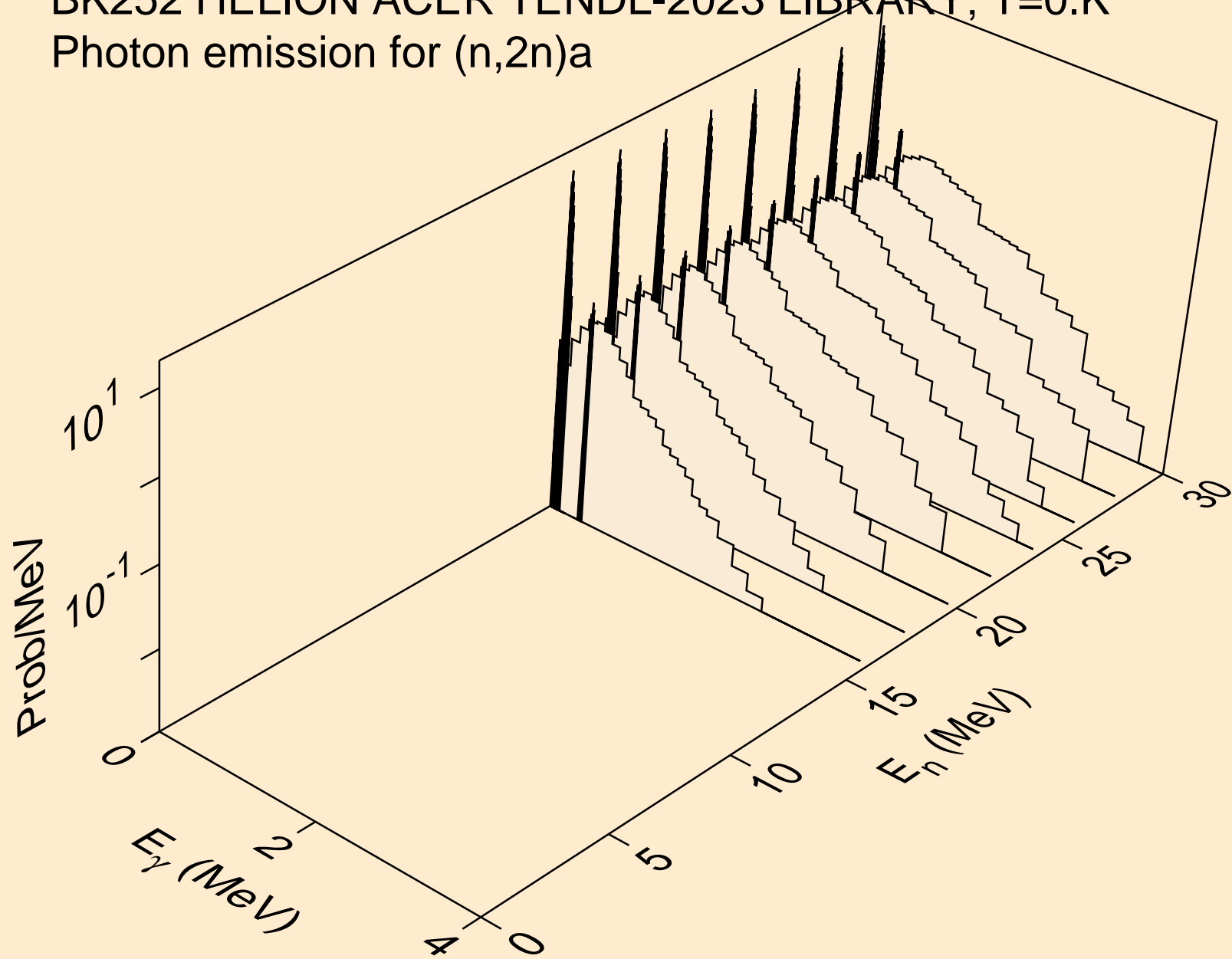

BK252 HELION ACER TENDL-2023 LIBRARY; T=0.K
Photon emission for (n,n*)p

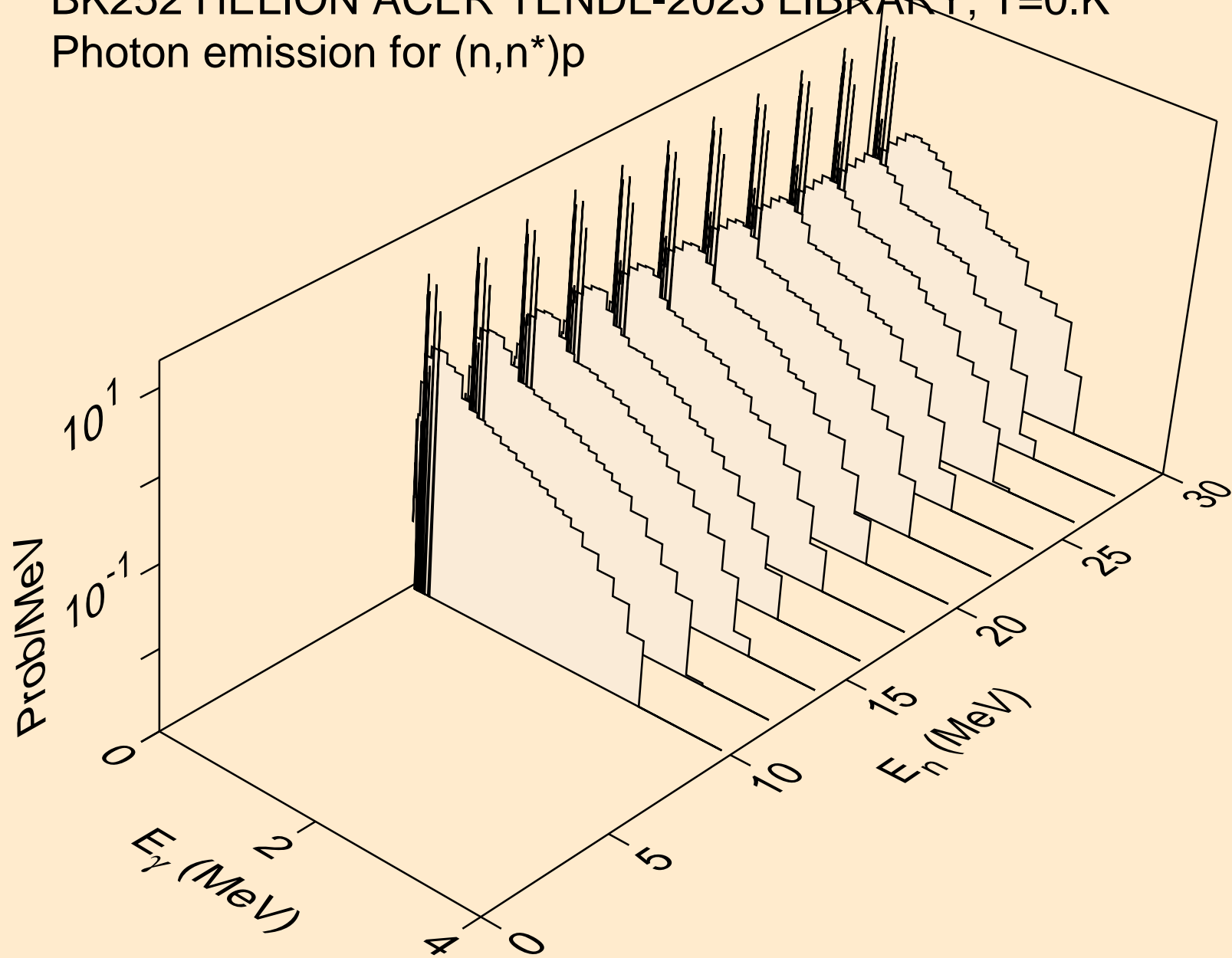

BK252 HELION ACER TENDL-2023 LIBRARY; T=0.K
Photon emission for (n,n*)d

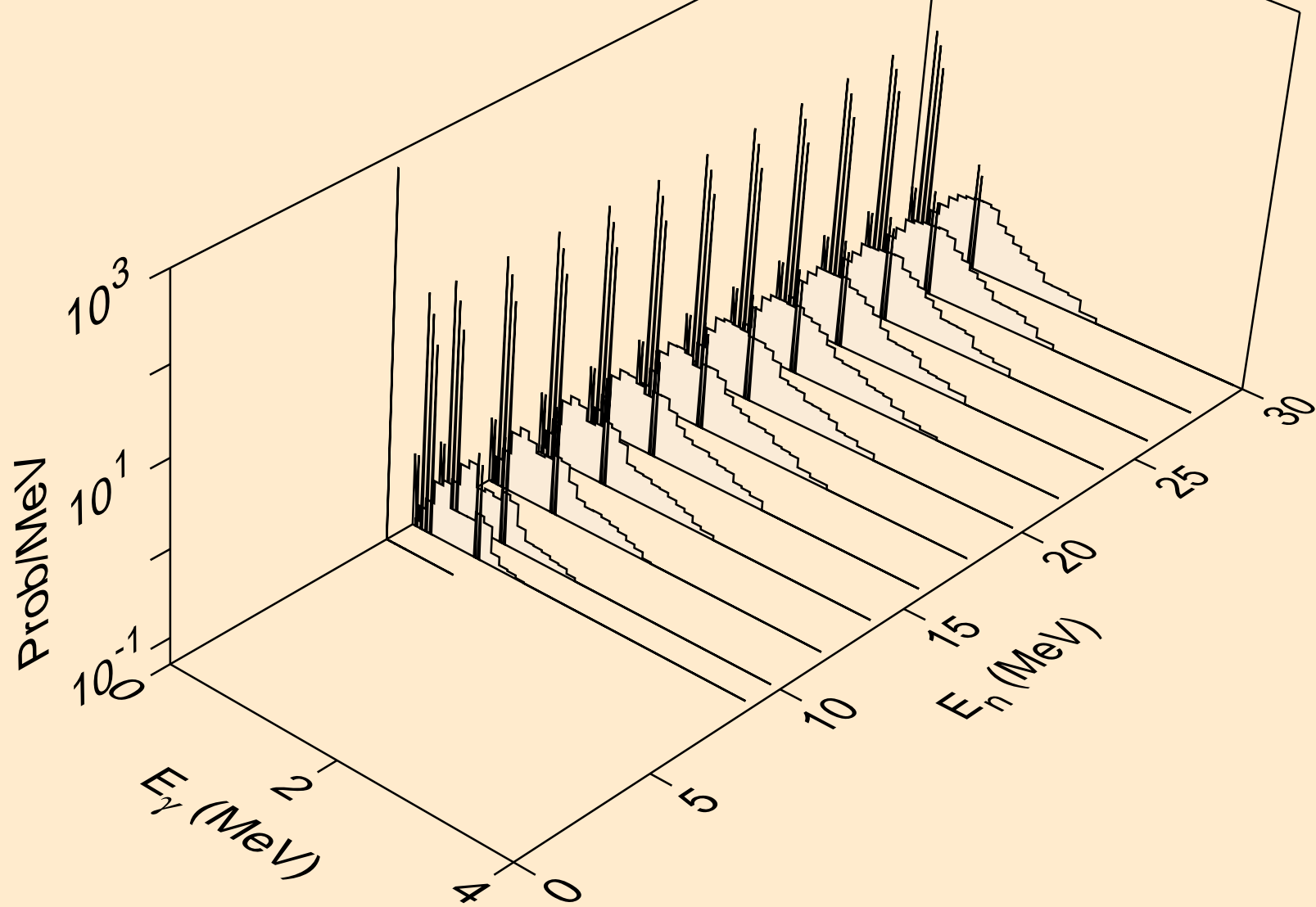

BK252 HELION ACER TENDL-2023 LIBRARY; T=0.K
Photon emission for (n,n*)t

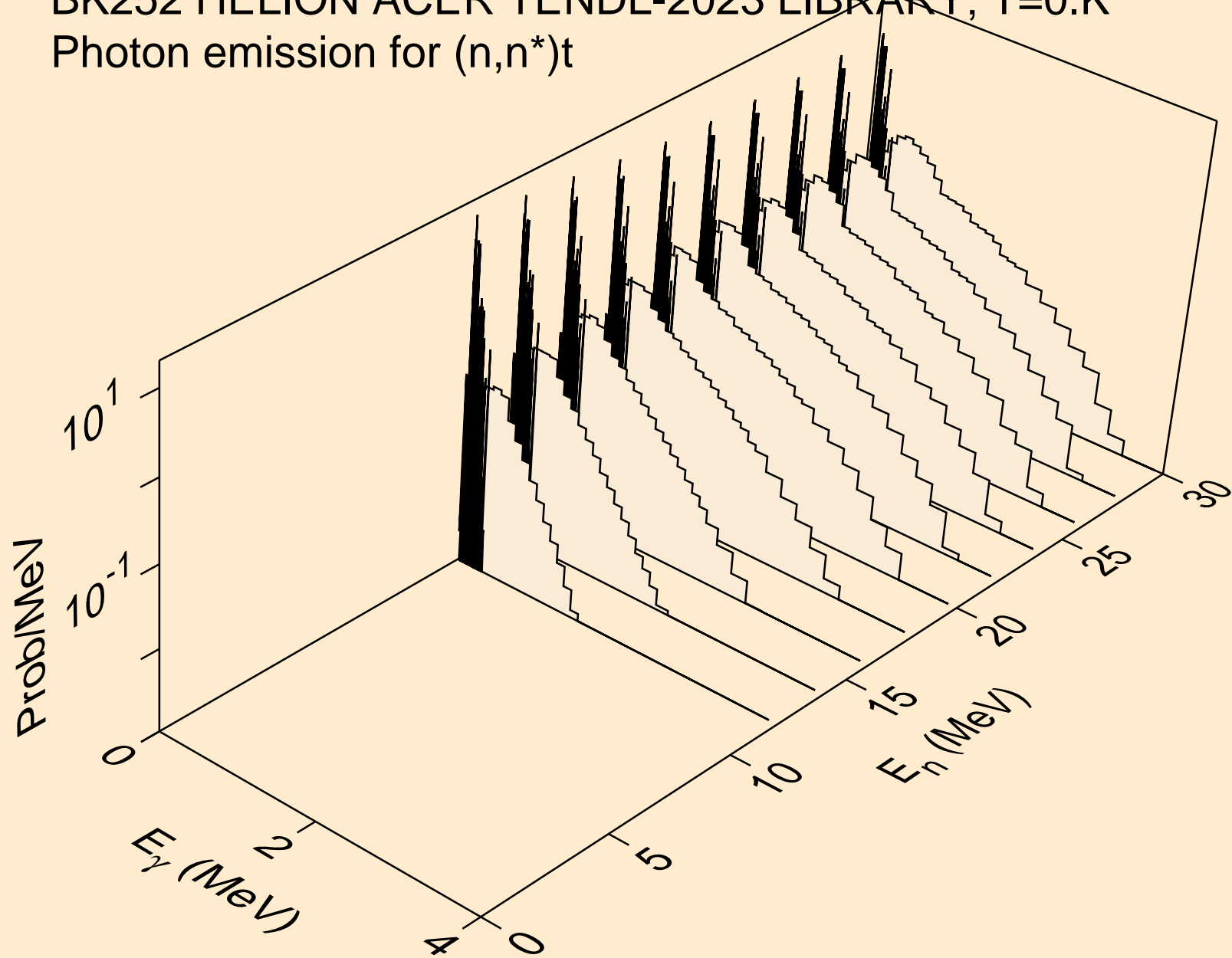

BK252 HELION ACER TENDL-2023 LIBRARY; T=0.K
Photon emission for (n,n*)he3

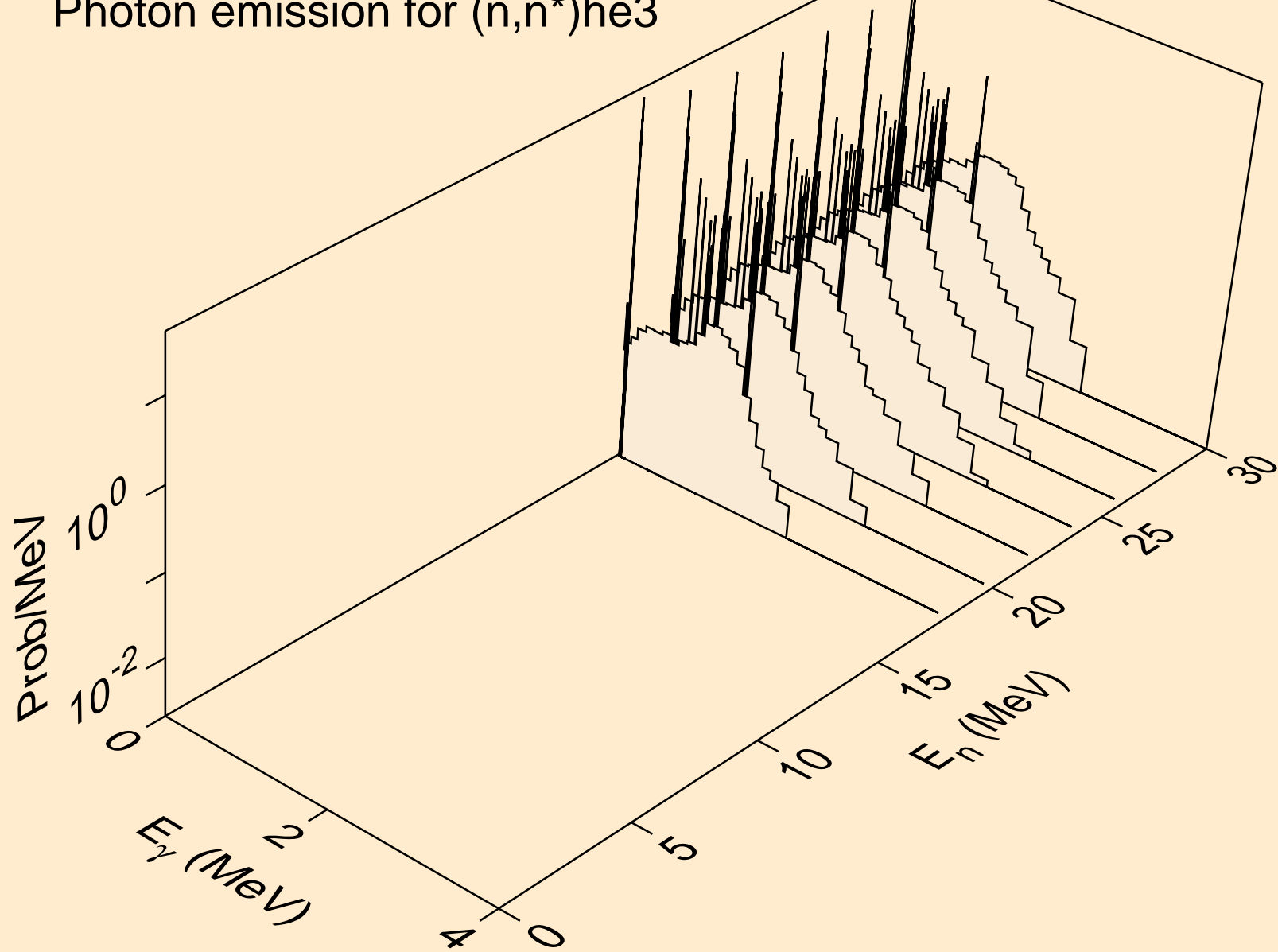

BK252 HELION ACER TENDL-2023 LIBRARY; T=0.K
Photon emission for (n,4n)

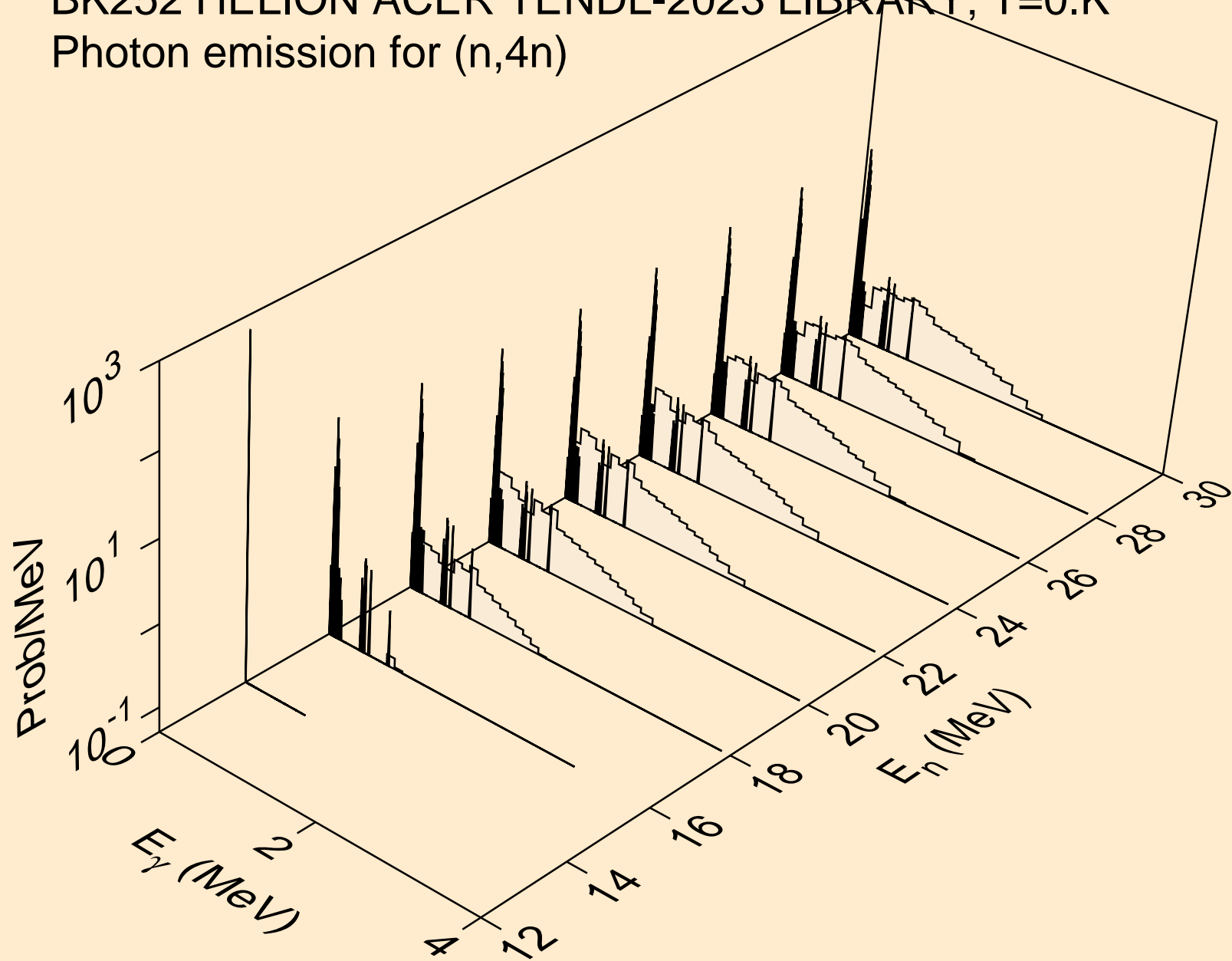

BK252 HELION ACER TENDL-2023 LIBRARY; T=0.K
Photon emission for (n,2np)

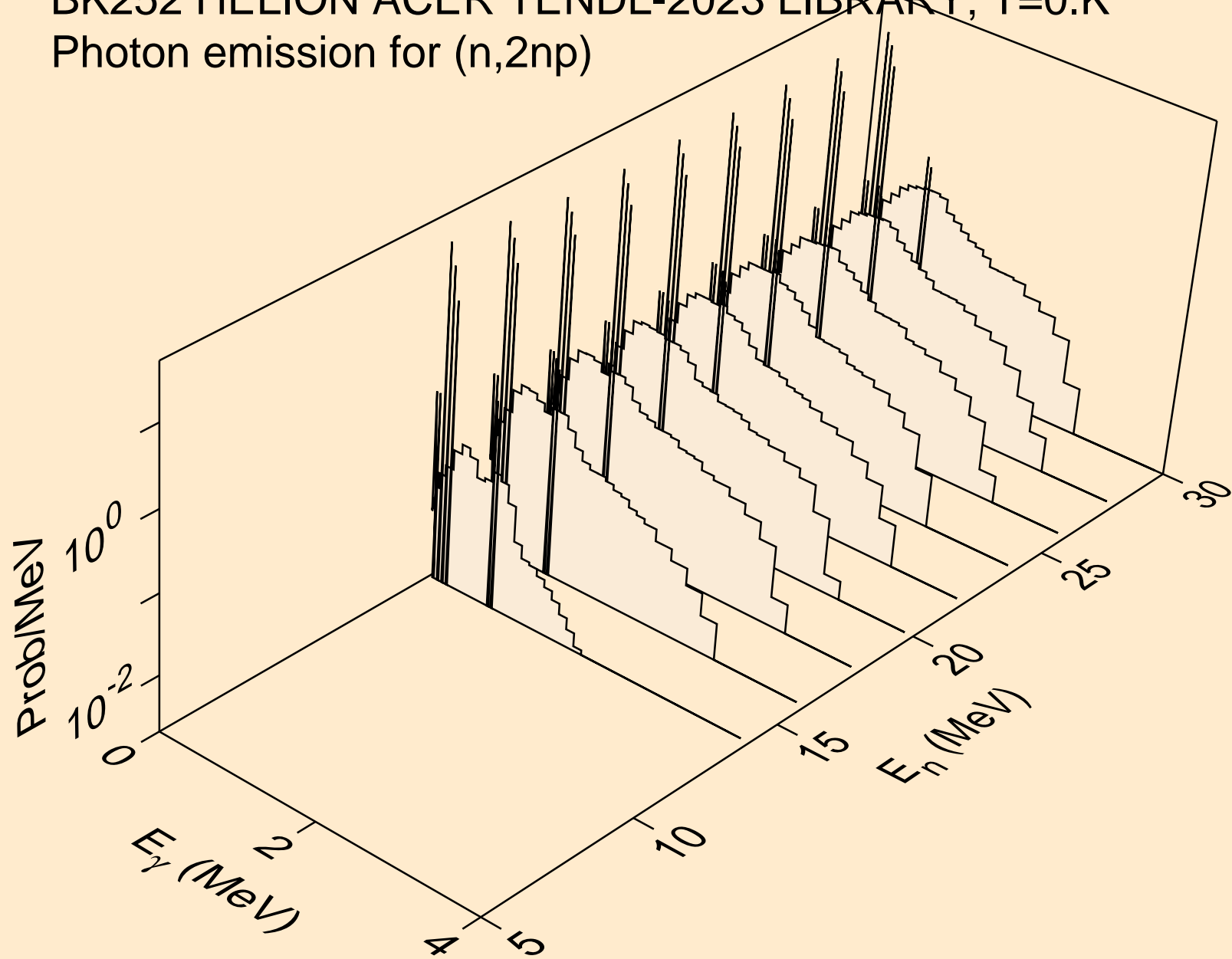

BK252 HELION ACER TENDL-2023 LIBRARY; T=0.K
Photon emission for (n,3np)

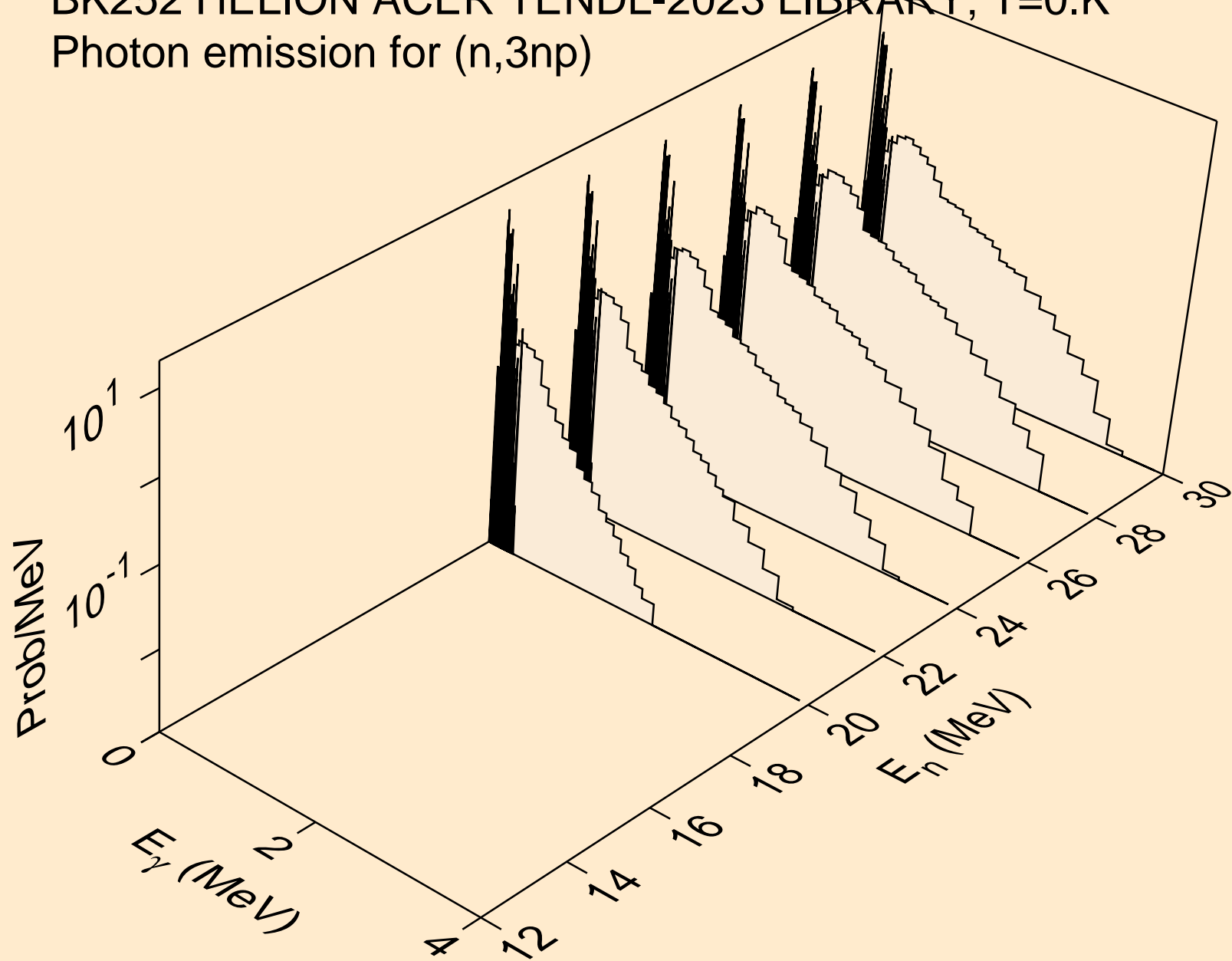

BK252 HELION ACER TENDL-2023 LIBRARY; T=0.K
Photon emission for (n,p)

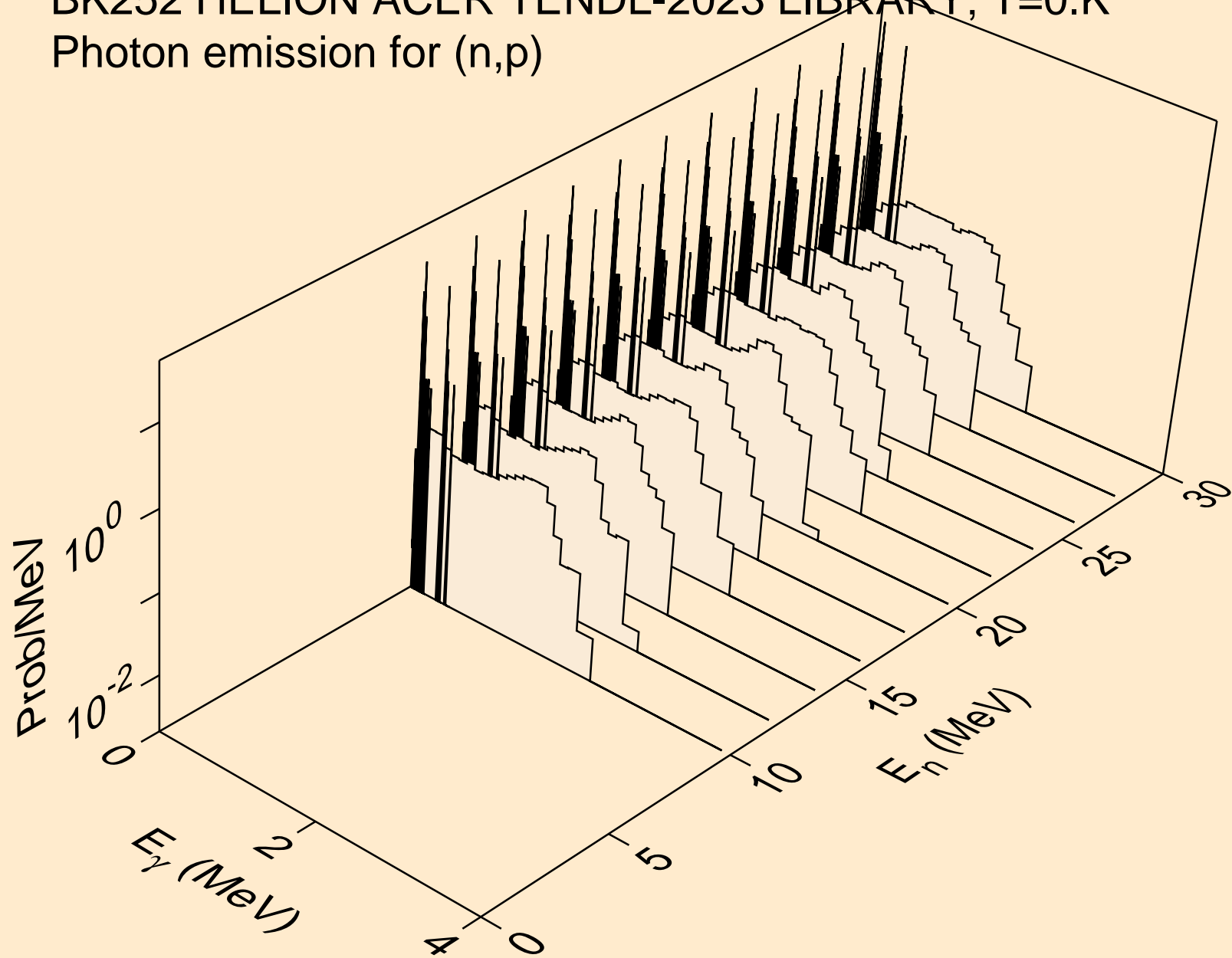

BK252 HELION ACER TENDL-2023 LIBRARY; T=0.K
Photon emission for (n,d)

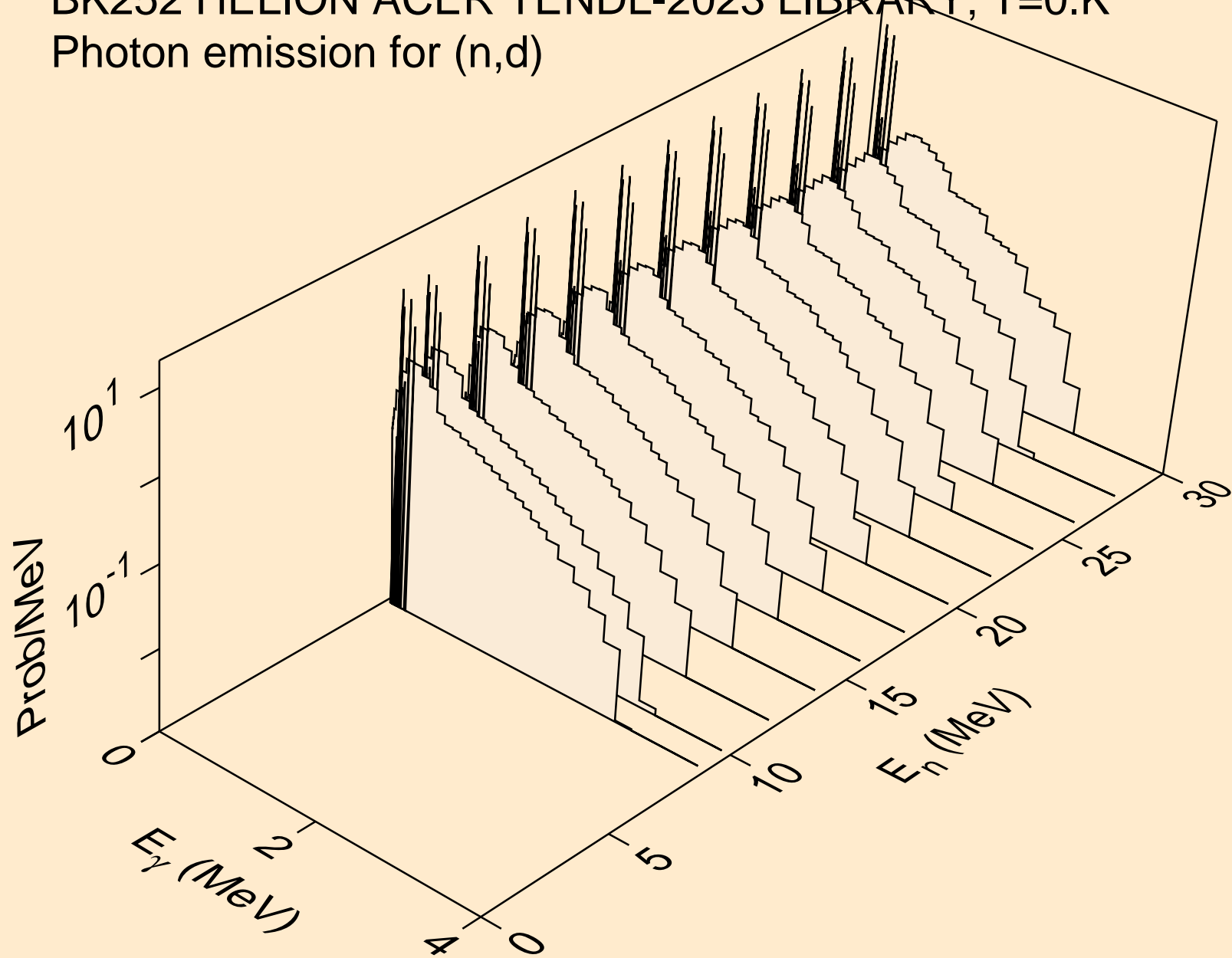

BK252 HELION ACER TENDL-2023 LIBRARY; T=0.K
Photon emission for (n,t)

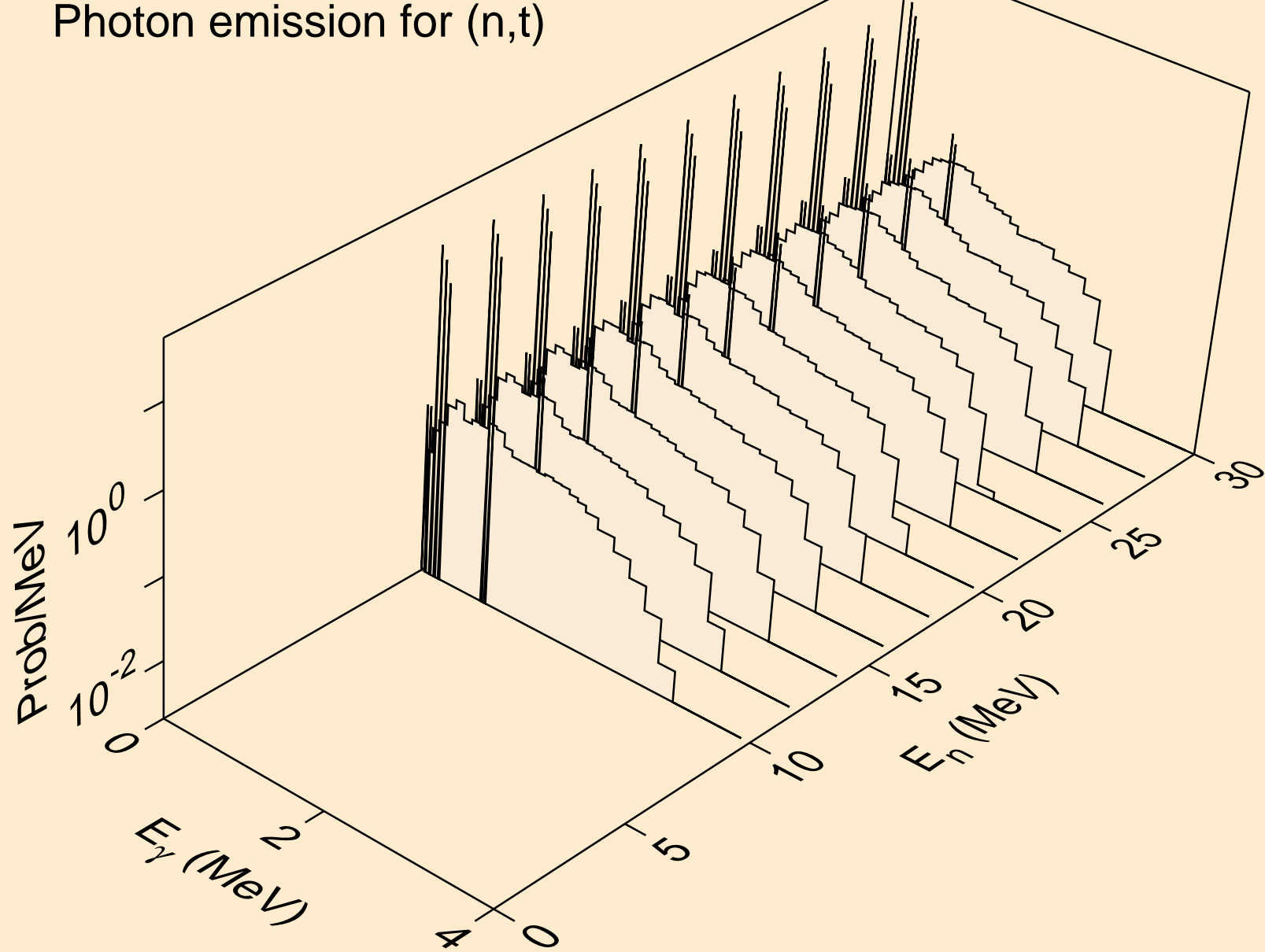

BK252 HELION ACER TENDL-2023 LIBRARY; T=0.K
Photon emission for inelastic

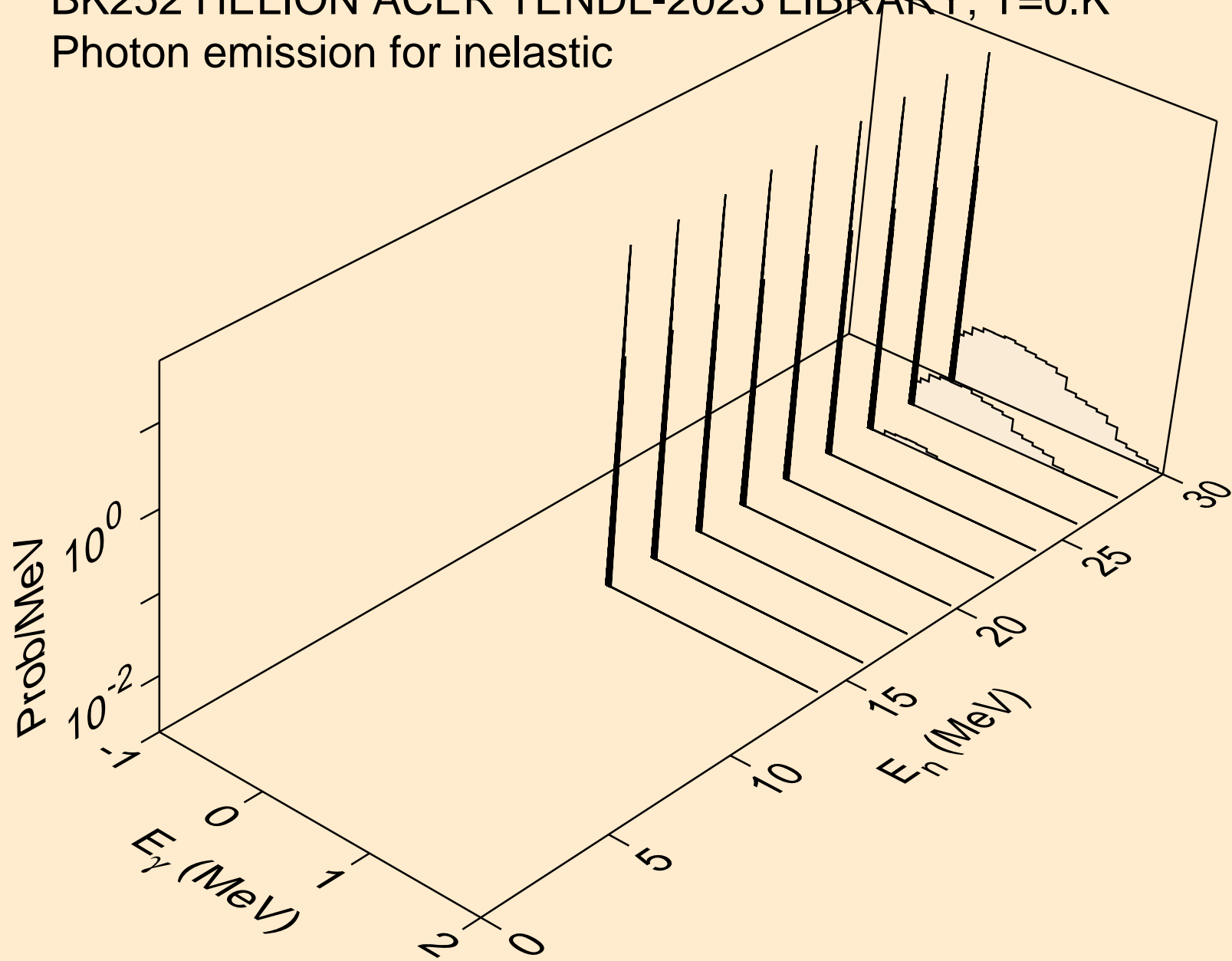

BK252 HELION ACER TENDL-2023 LIBRARY; T=0.K
Photon emission for (n,a)

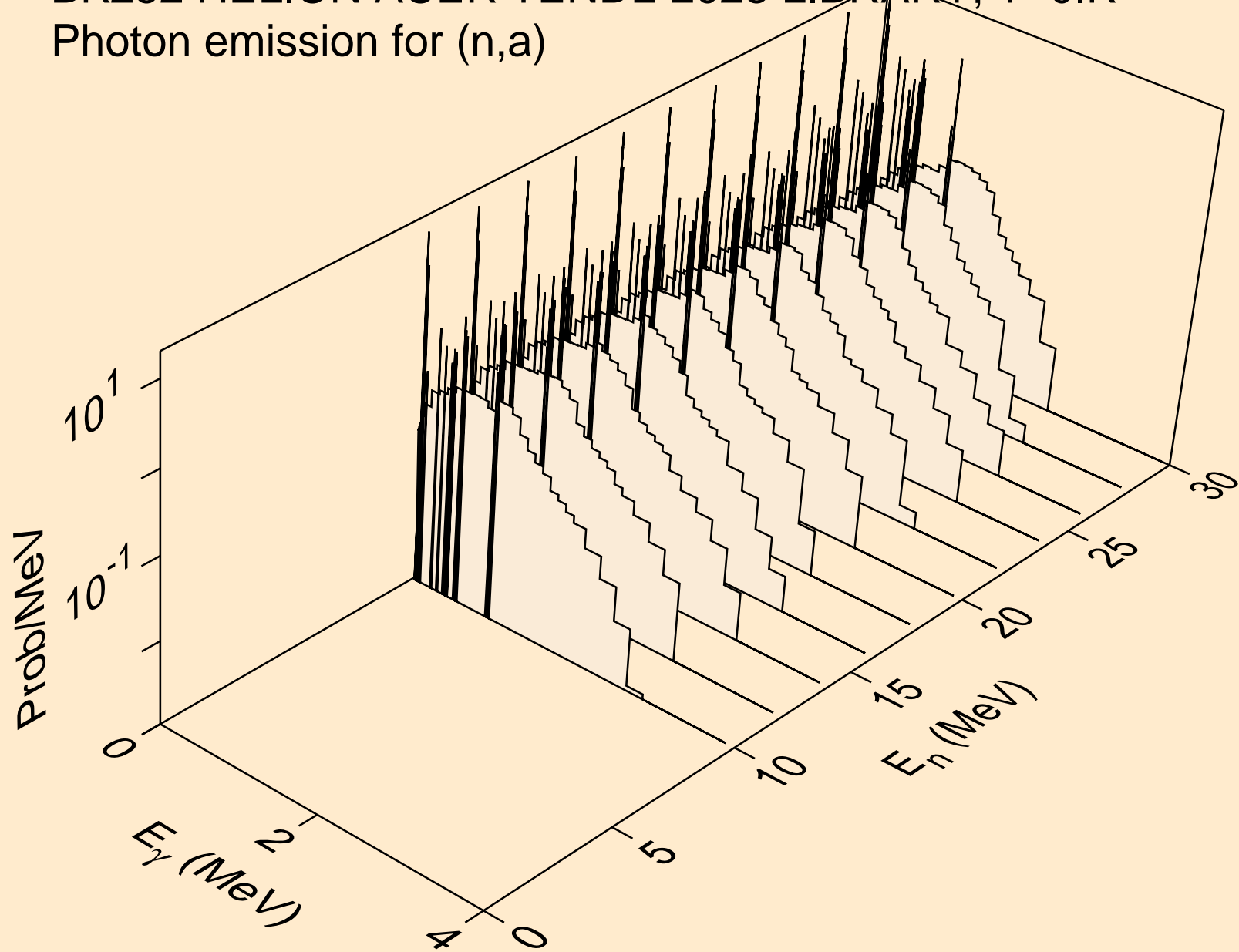

BK252 HELION ACER TENDL-2023 LIBRARY; T=0.K
Photon emission for (n,2p)

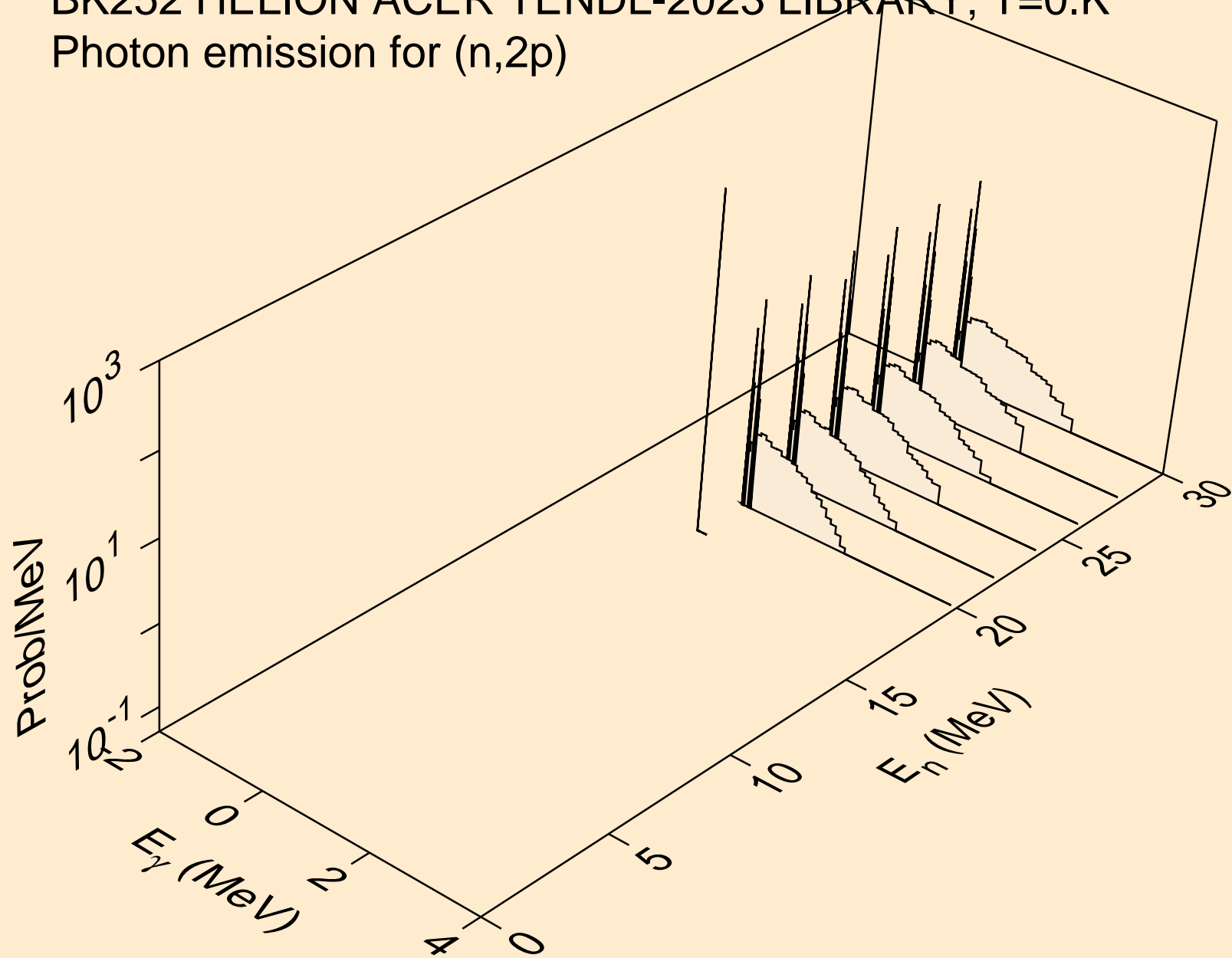

BK252 HELION ACER TENDL-2023 LIBRARY; T=0.K
Photon emission for (n,pd)

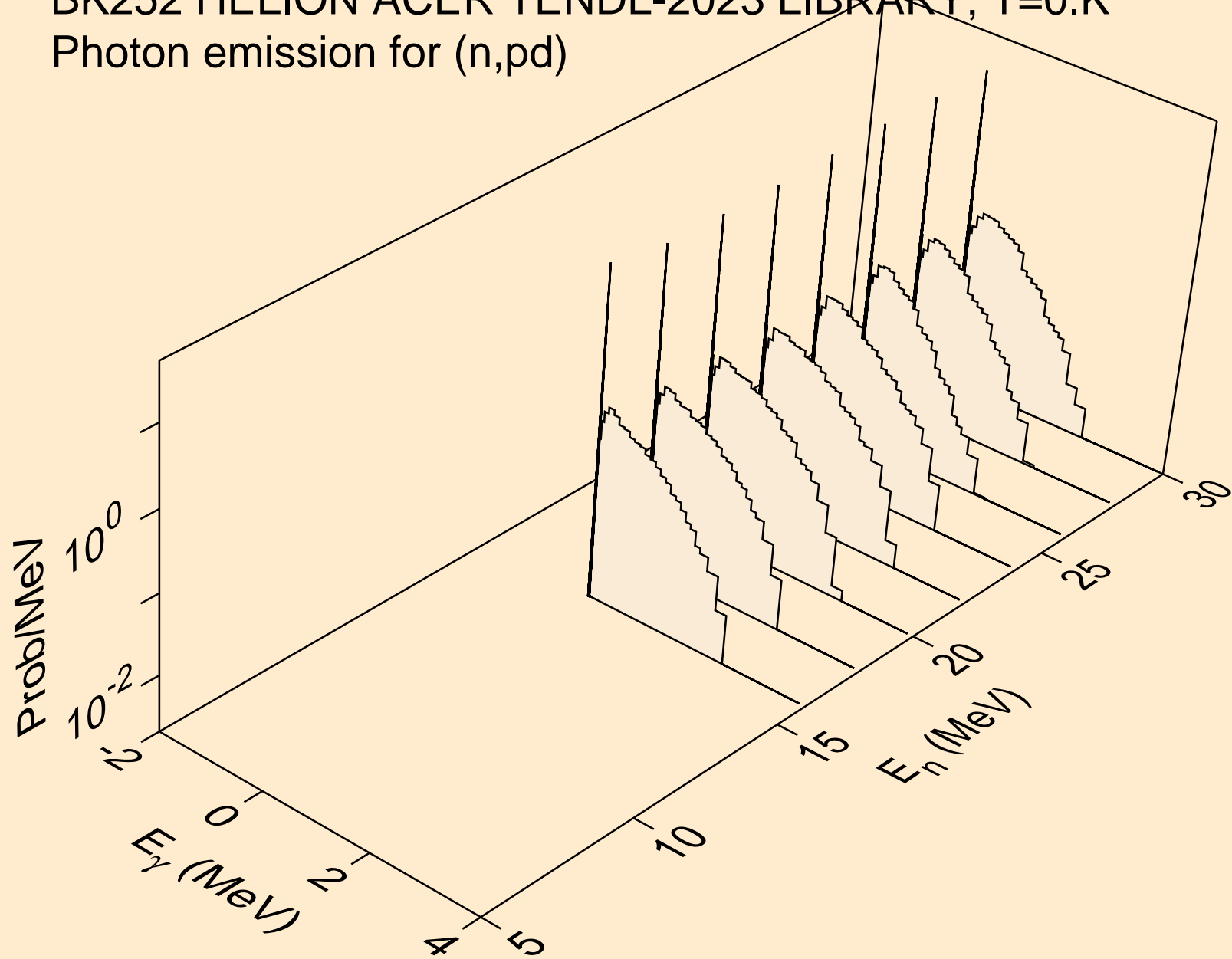

BK252 HELION ACER TENDL-2023 LIBRARY; T=0.K
Particle heating contributions

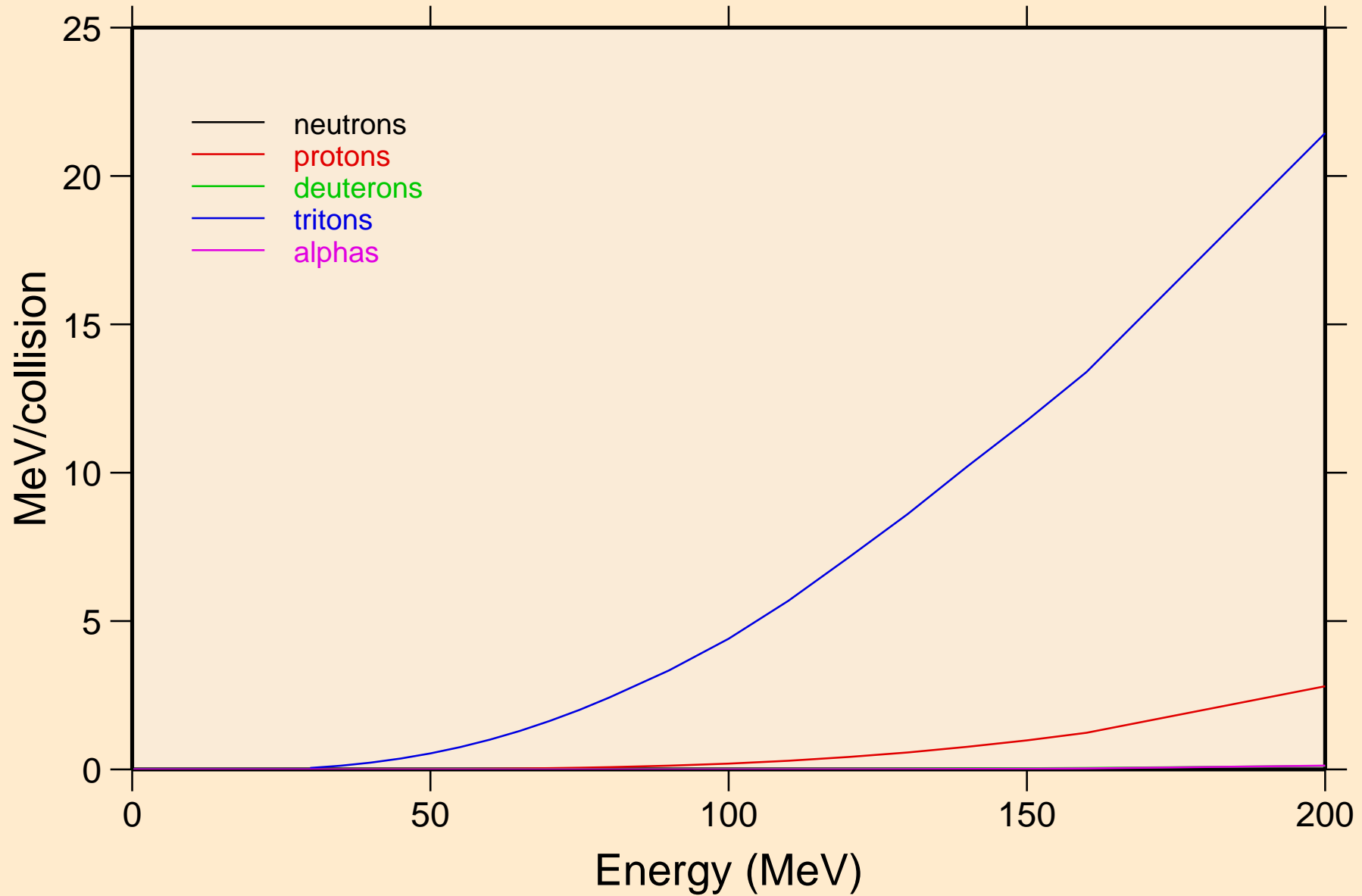

BK252 HELION ACER TENDL-2023 LIBRARY; T=0.K
Recoil Heating

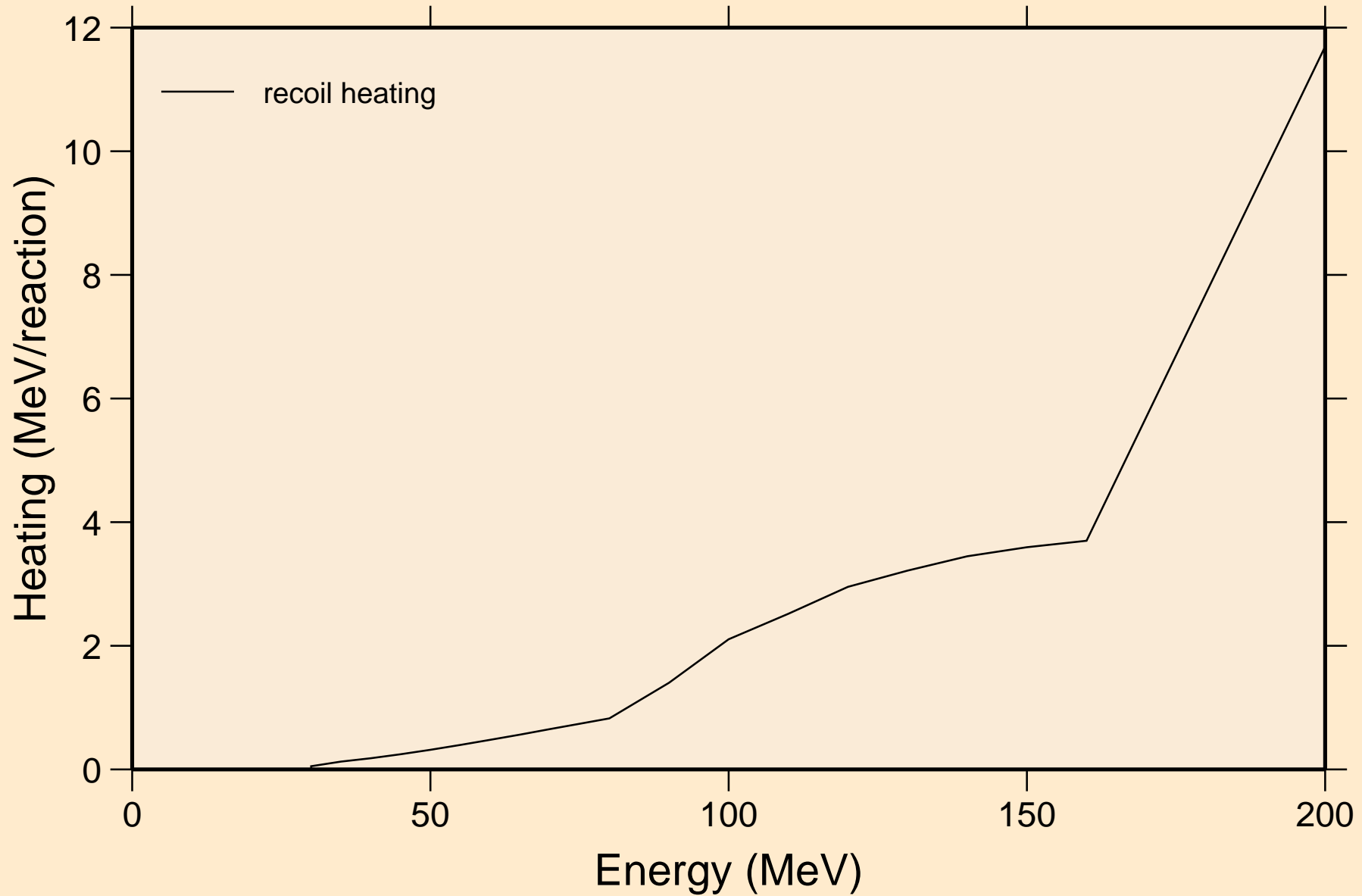

BK252 HELION ACER TENDL-2023 LIBRARY; T=0.K
Particle production cross sections

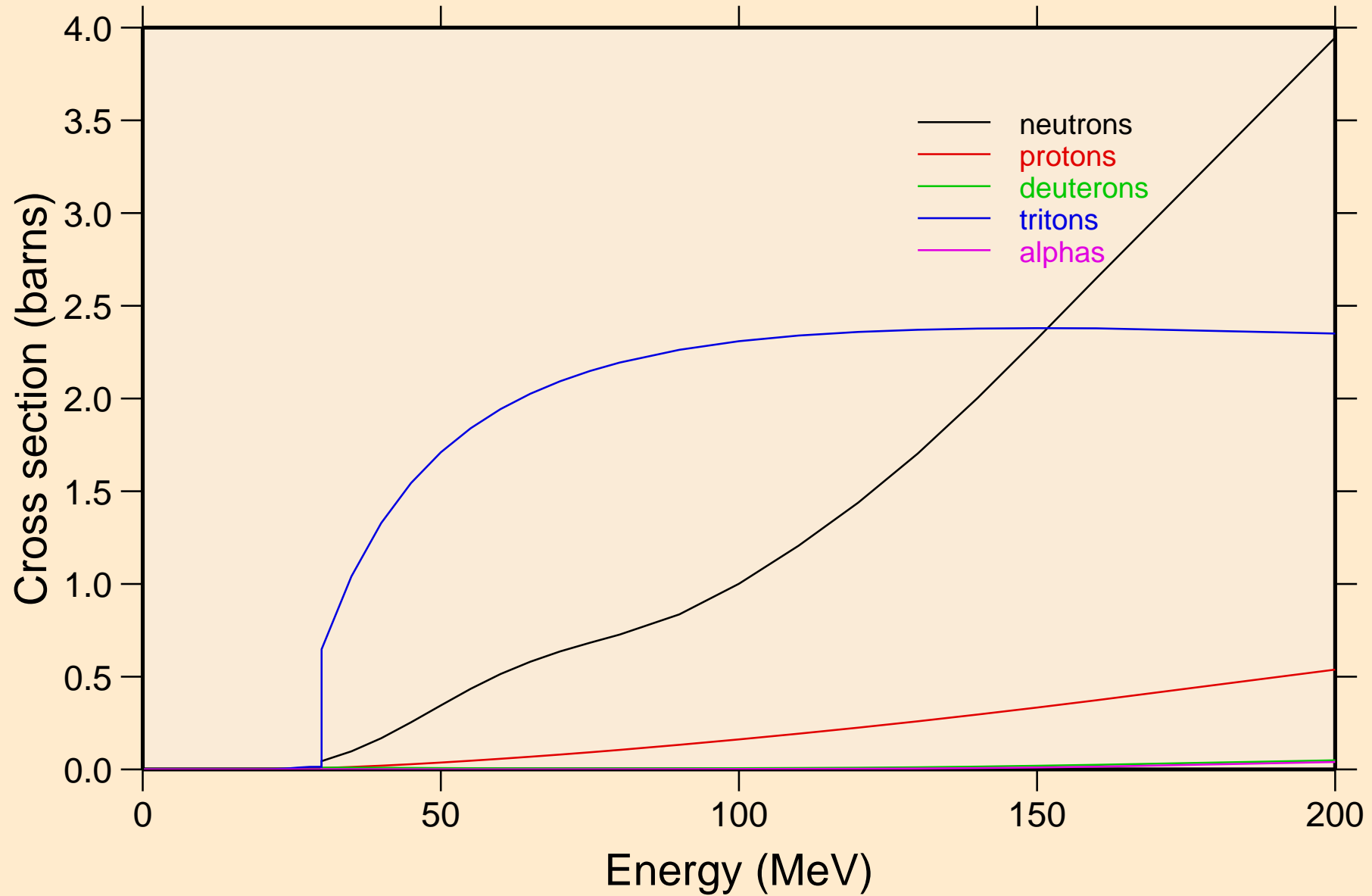

BK252 HELION ACER TENDL-2023 LIBRARY; T=0.K
neutrons from (s,n)

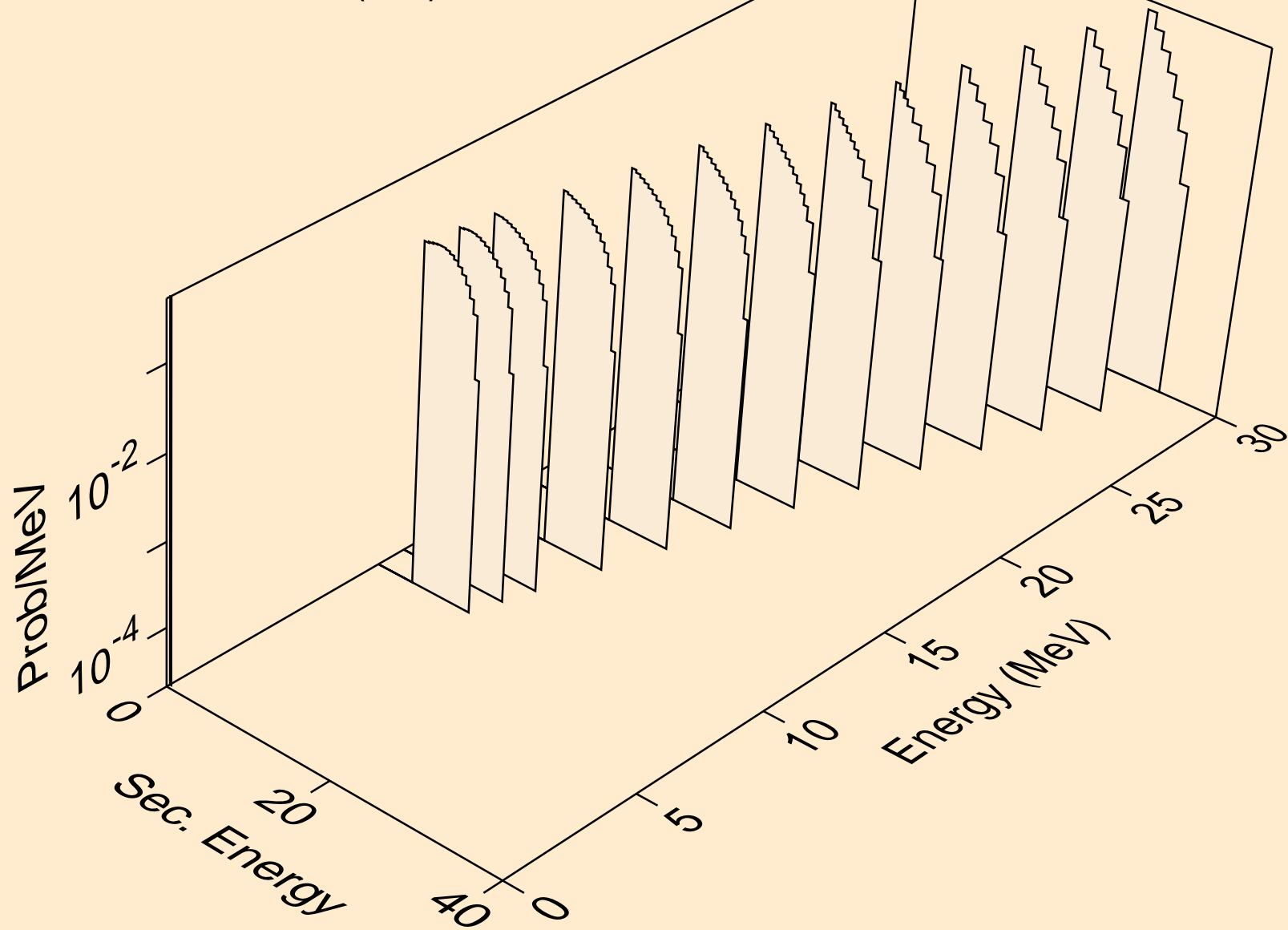

BK252 HELION ACER TENDL-2023 LIBRARY; T=0.K
neutrons from (s,x)

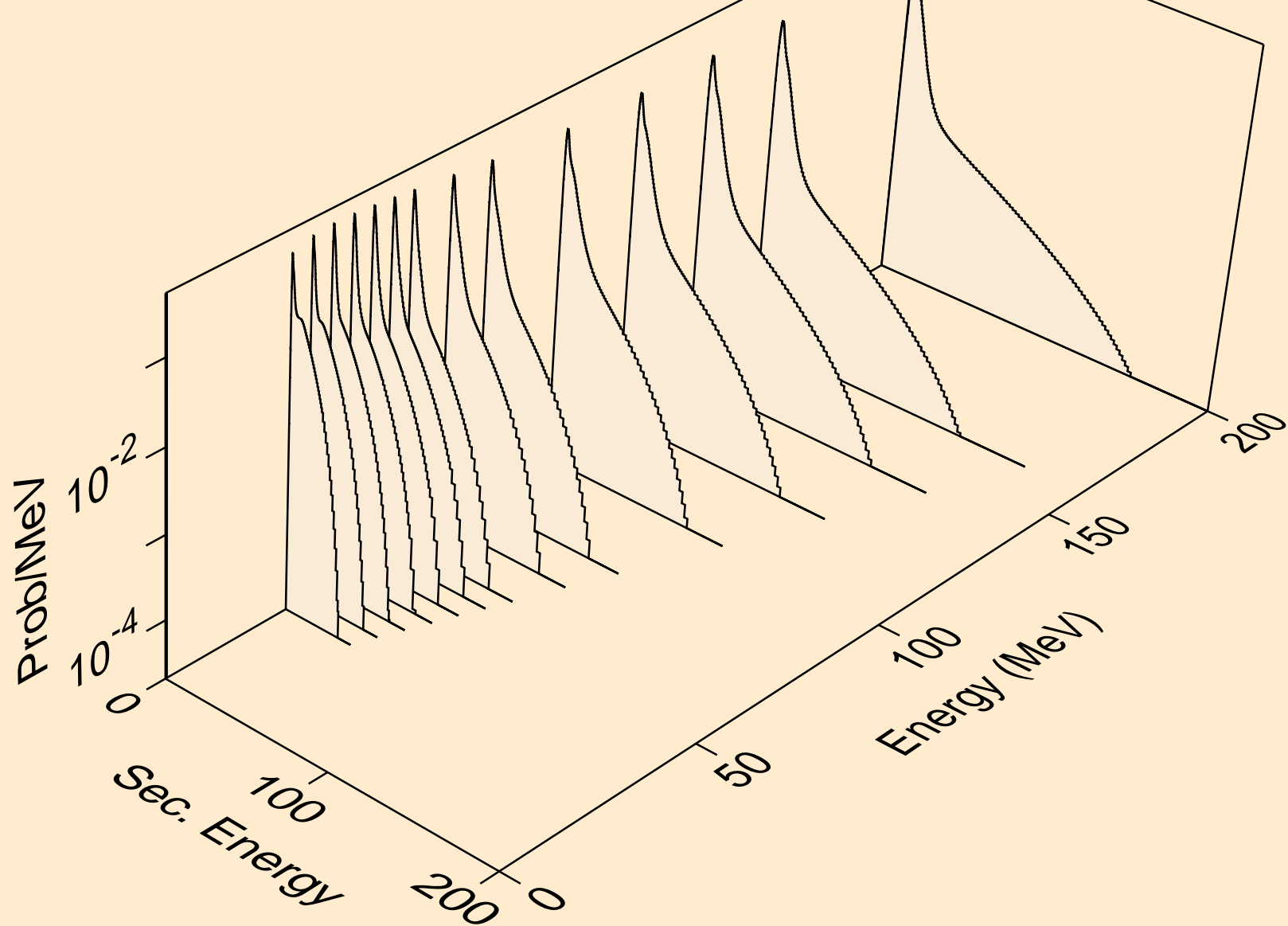

BK252 HELION ACER TENDL-2023 LIBRARY; T=0.K
neutrons from (s,2nd)

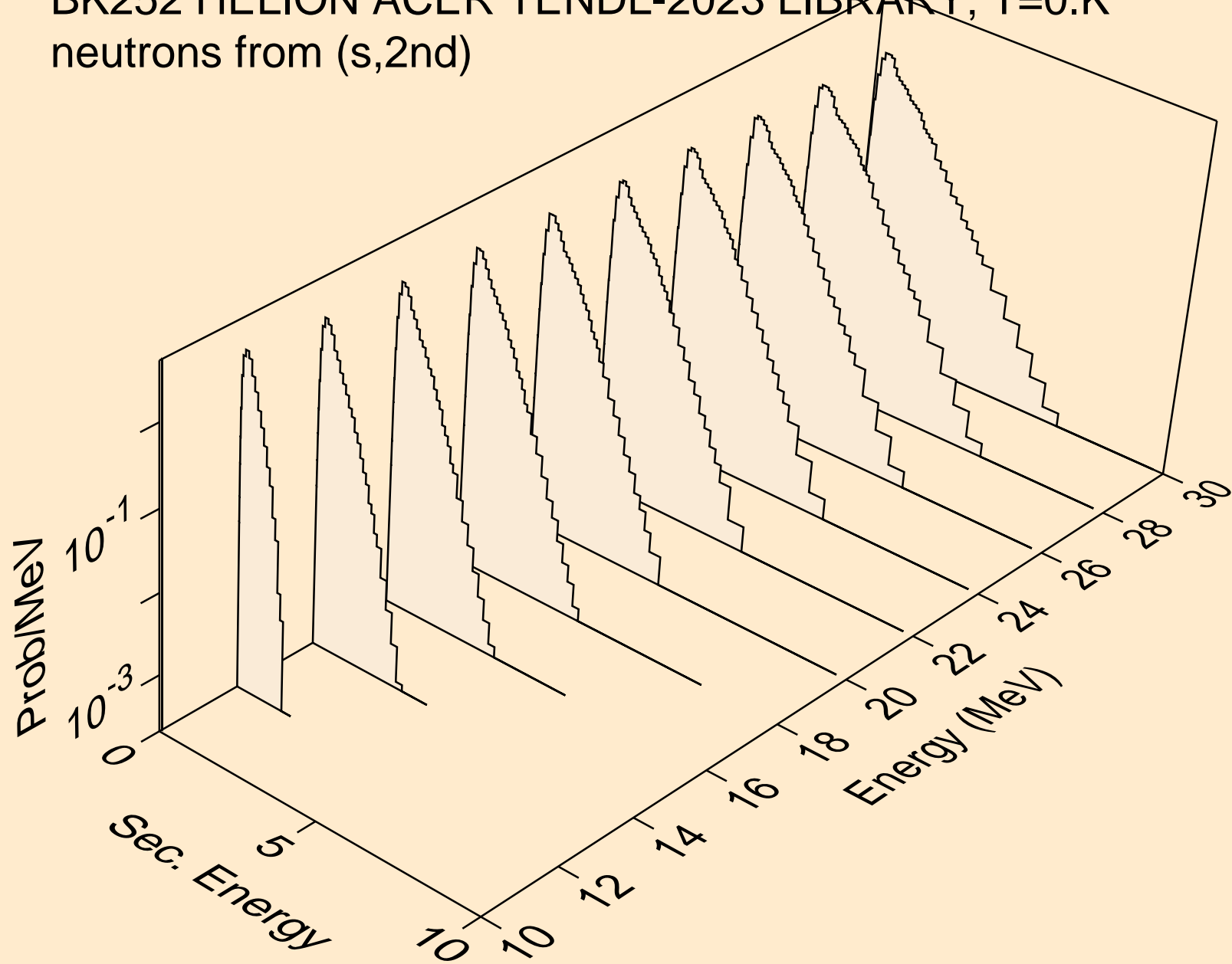

BK252 HELION ACER TENDL-2023 LIBRARY; T=0.K
neutrons from (s,2n)

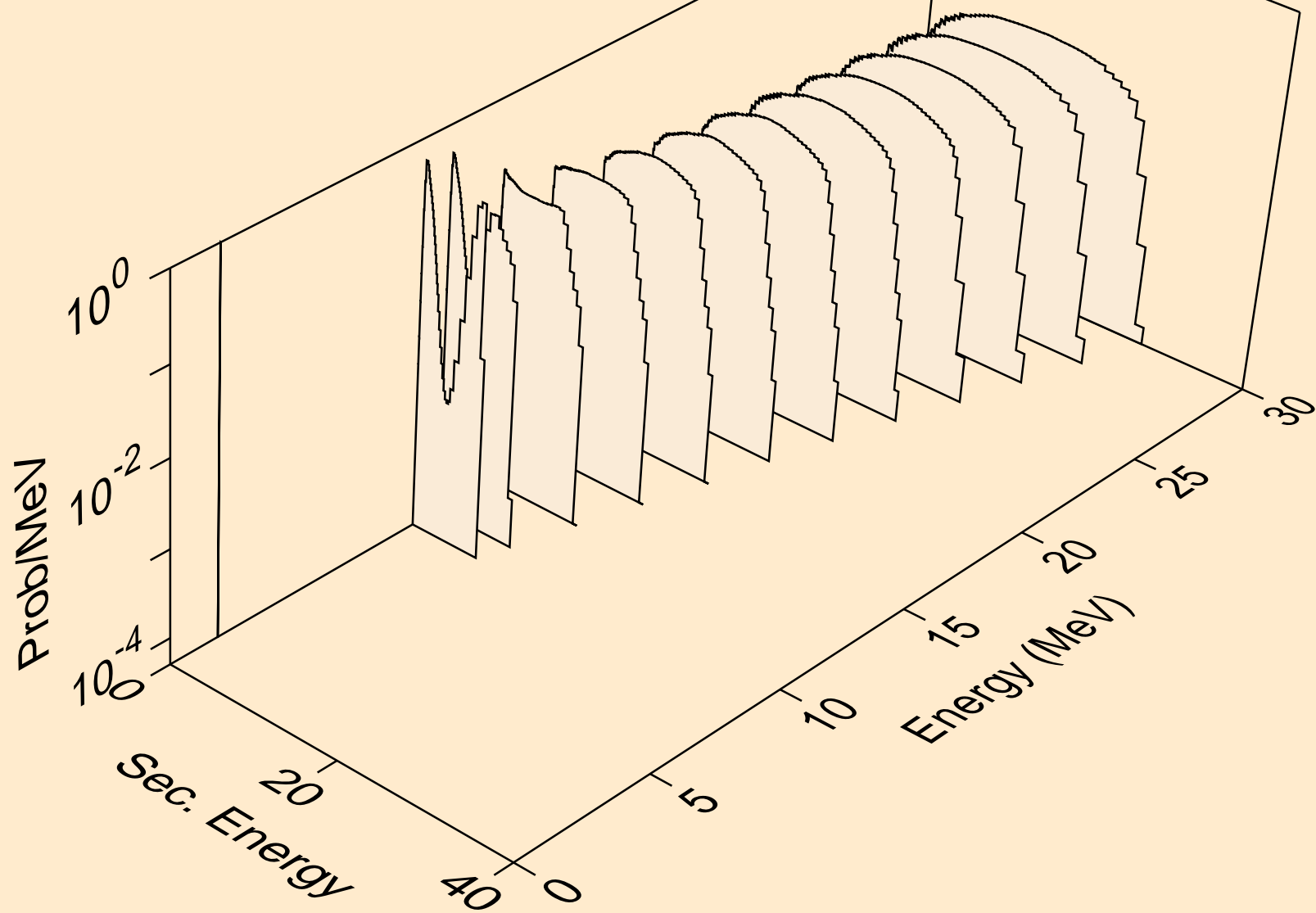

BK252 HELION ACER TENDL-2023 LIBRARY; T=0.K
neutrons from (s,3n)

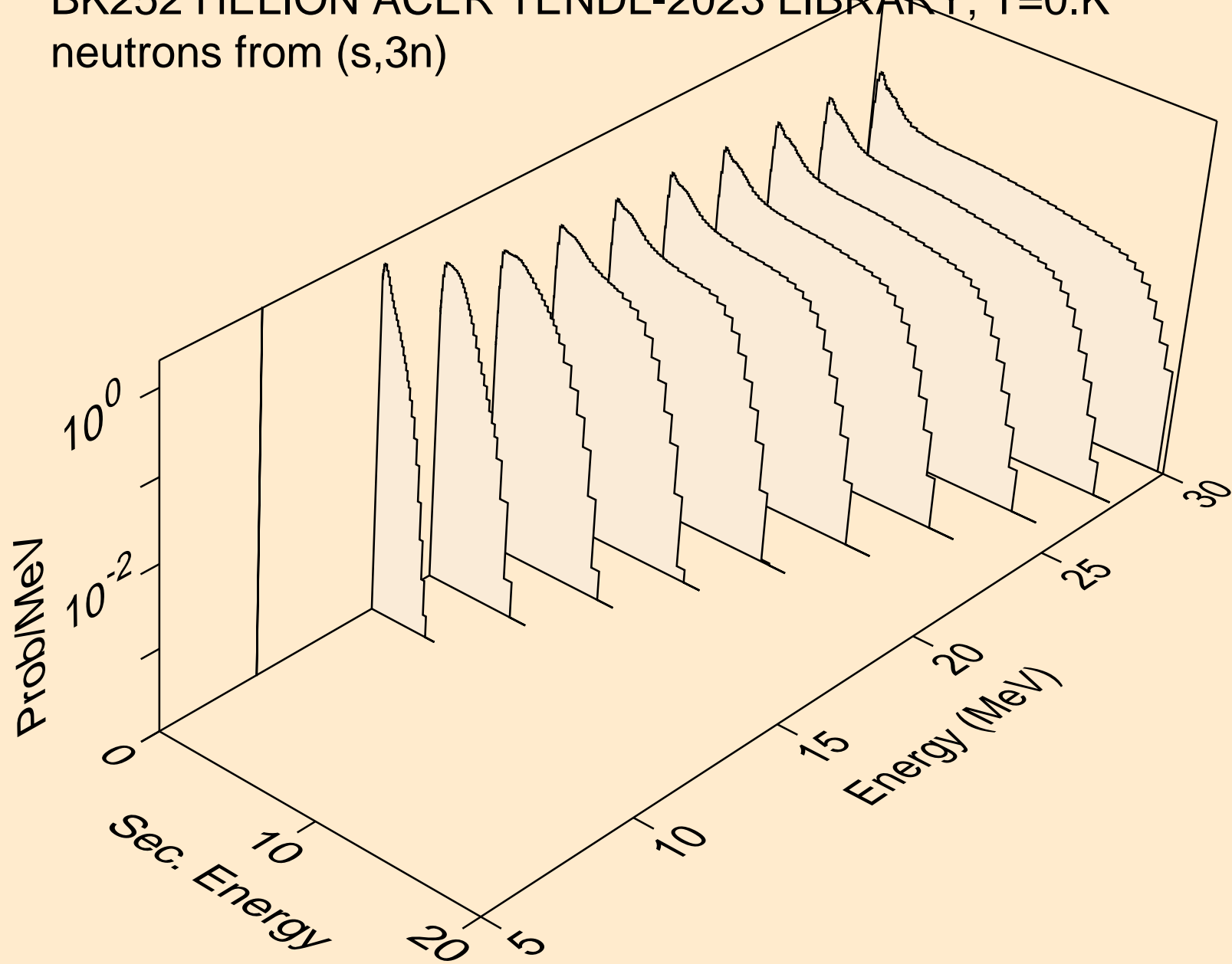

BK252 HELION ACER TENDL-2023 LIBRARY; T=0.K
neutrons from (s,n*)a

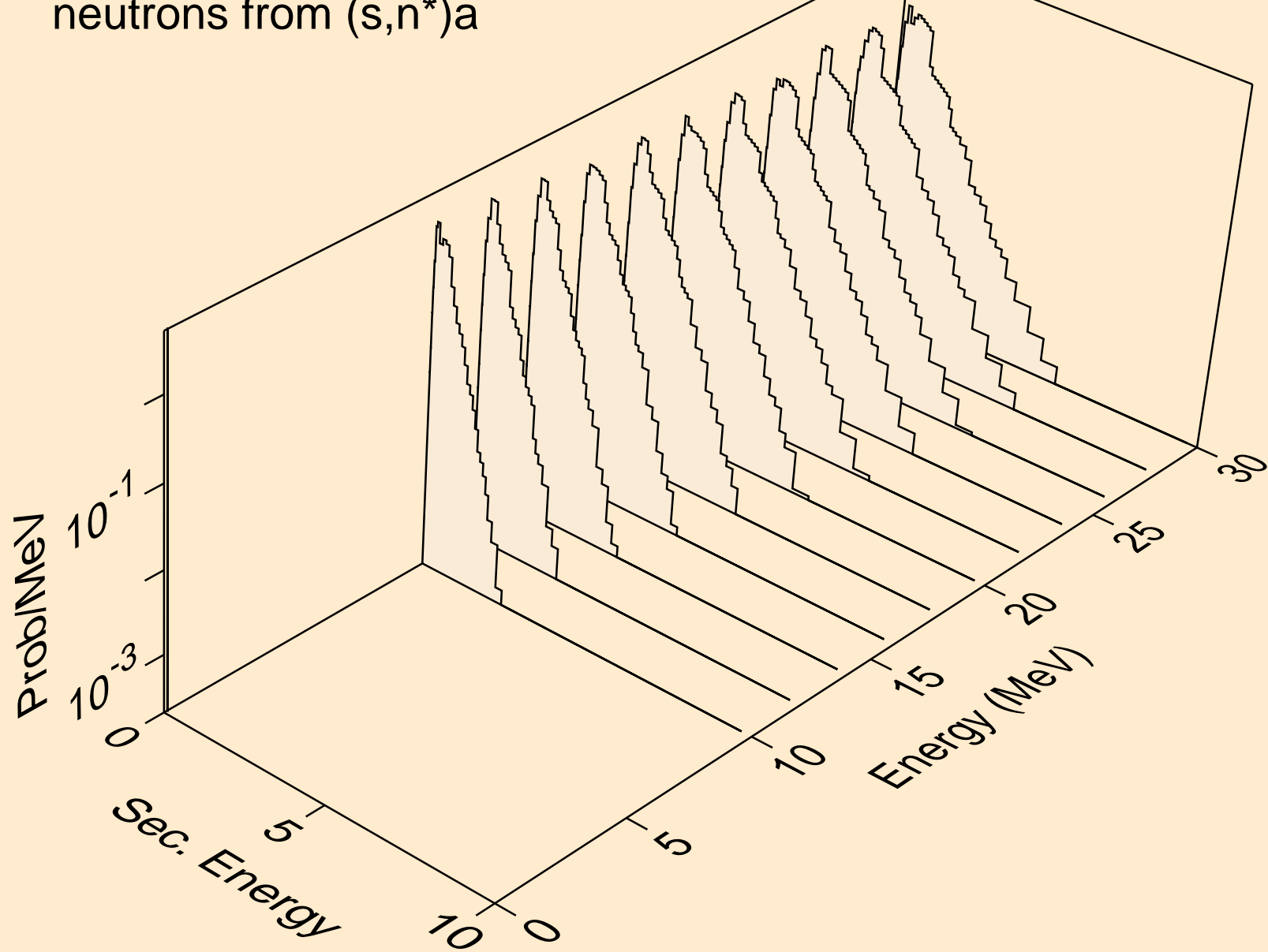

BK252 HELION ACER TENDL-2023 LIBRARY; T=0.K
neutrons from (s,2n)a

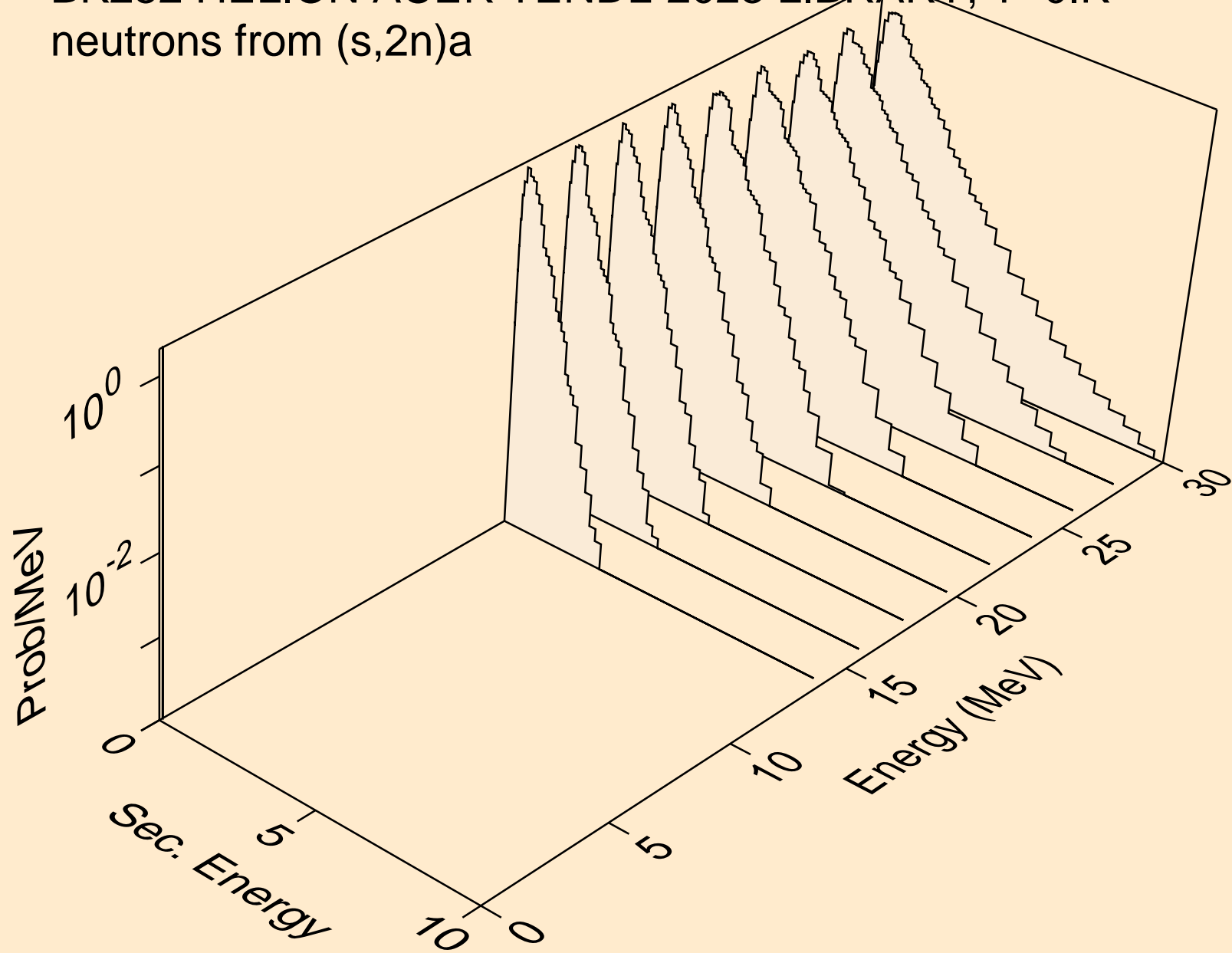

BK252 HELION ACER TENDL-2023 LIBRARY; T=0.K
neutrons from (s,n*)p

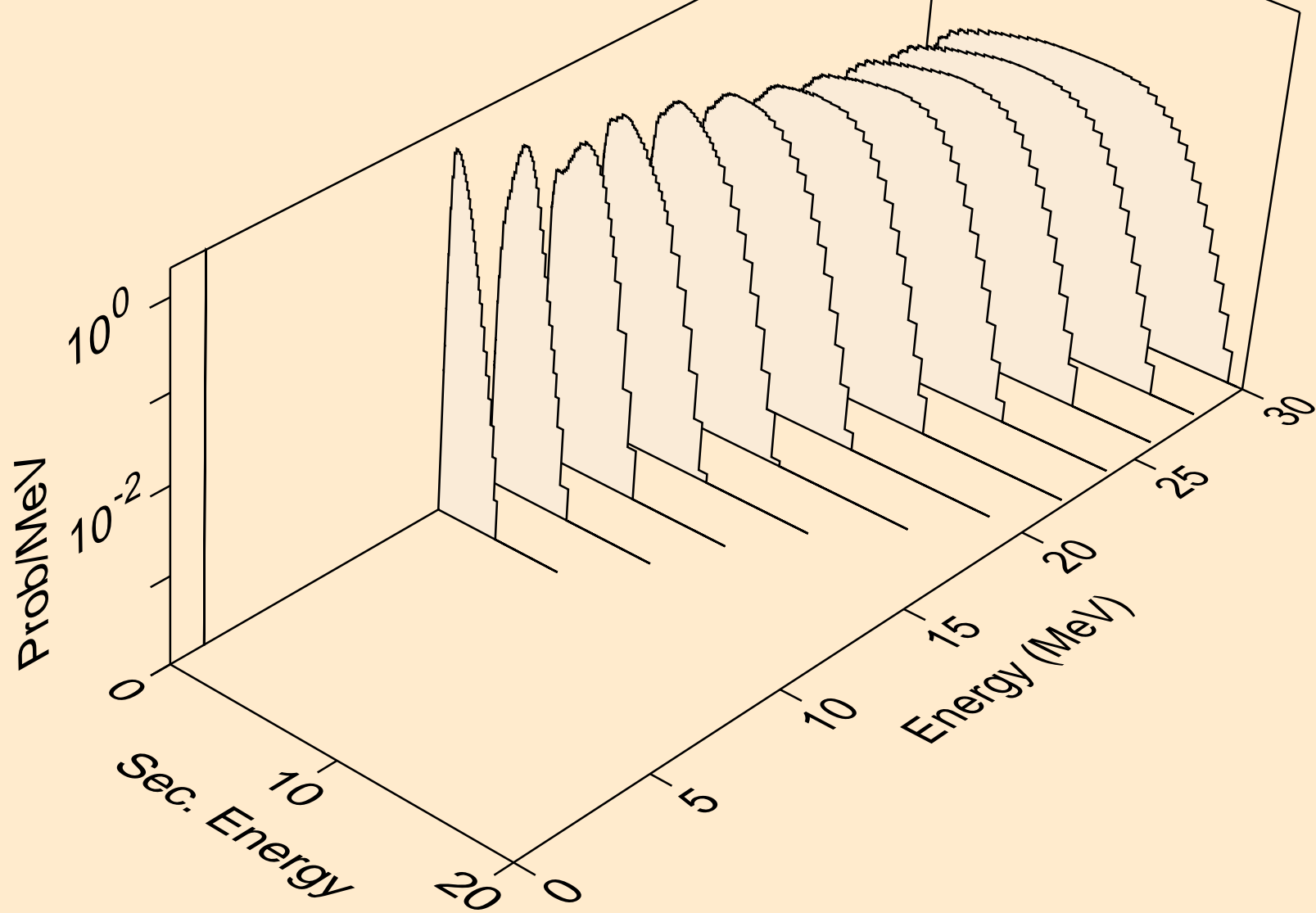

BK252 HELION ACER TENDL-2023 LIBRARY; T=0.K
neutrons from (s,n*)d

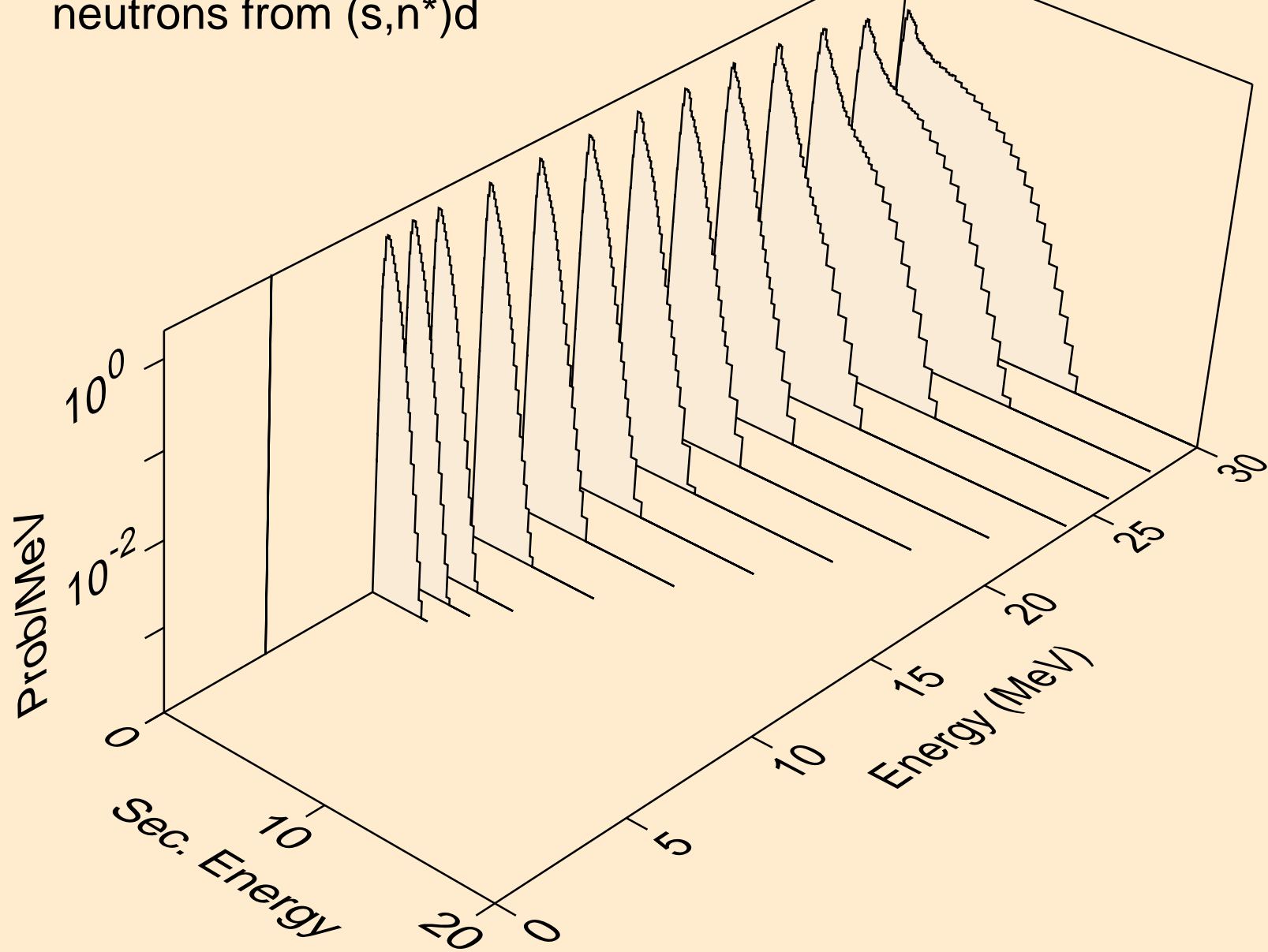

BK252 HELION ACER TENDL-2023 LIBRARY; T=0.K
neutrons from (s,n*)t

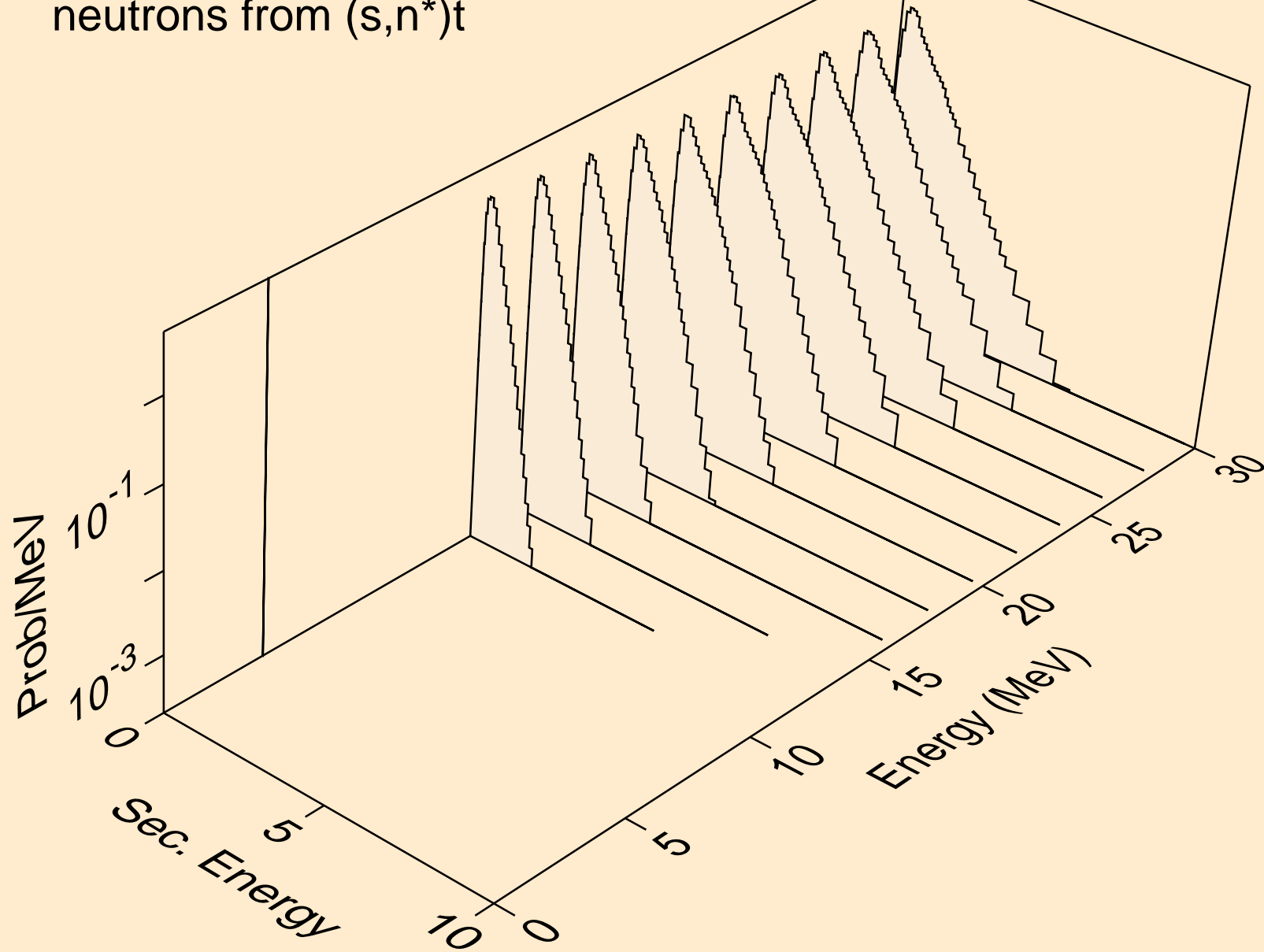

BK252 HELION ACER TENDL-2023 LIBRARY; T=0.K
neutrons from (s,n*)he3

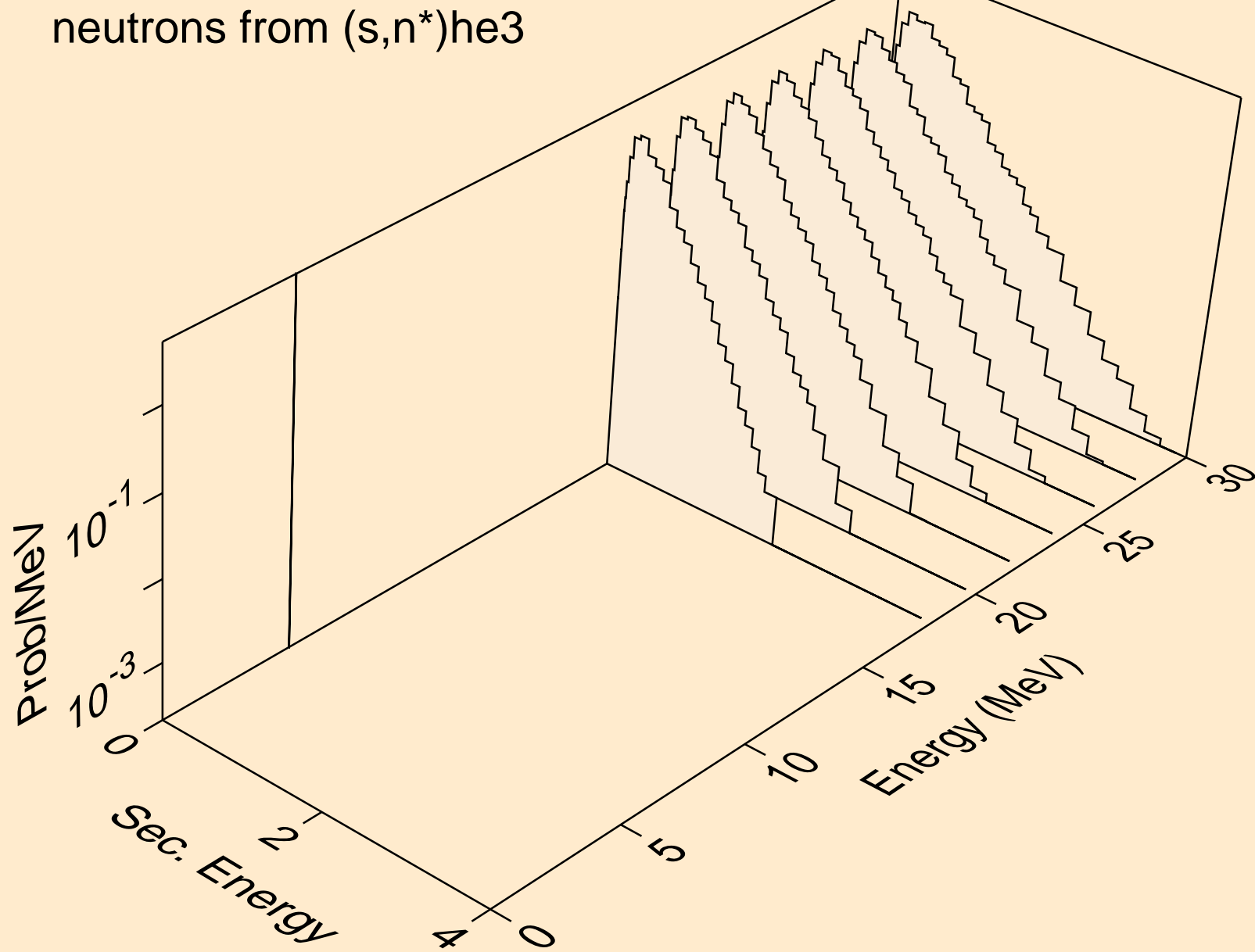

BK252 HELION ACER TENDL-2023 LIBRARY; T=0.K
neutrons from (s,4n)

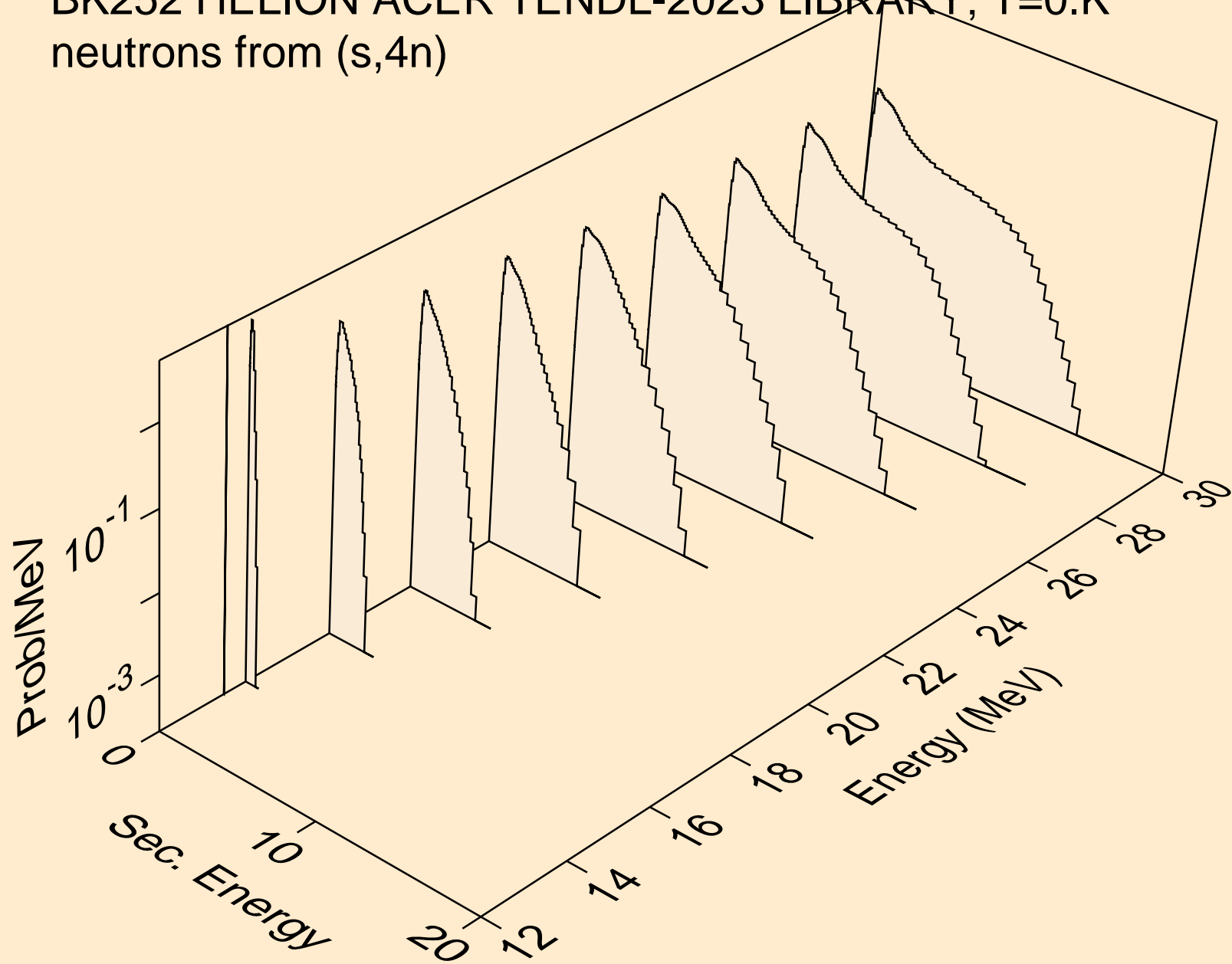

BK252 HELION ACER TENDL-2023 LIBRARY; T=0.K
neutrons from (s,2np)

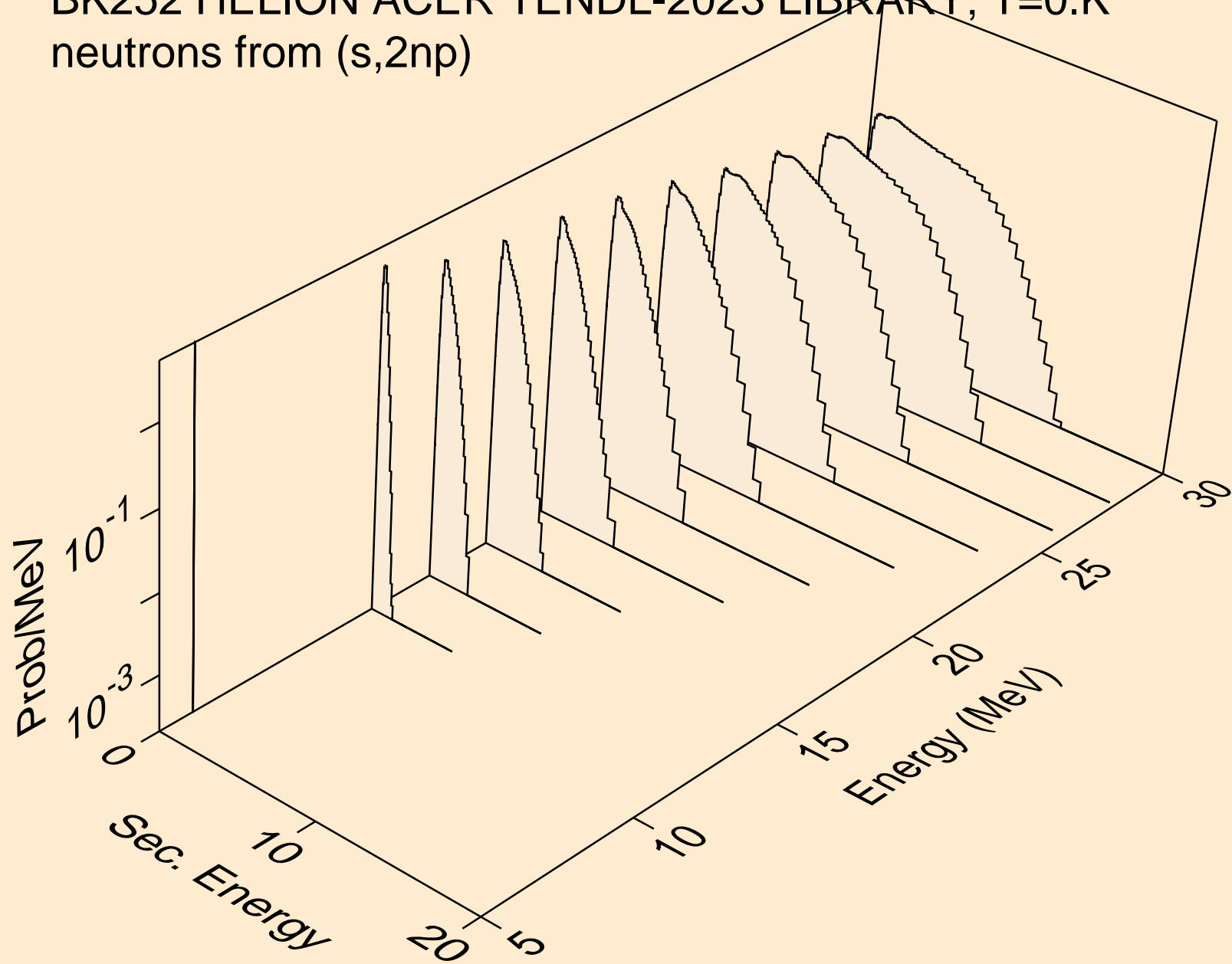

BK252 HELION ACER TENDL-2023 LIBRARY; T=0.K
neutrons from (s,3np)

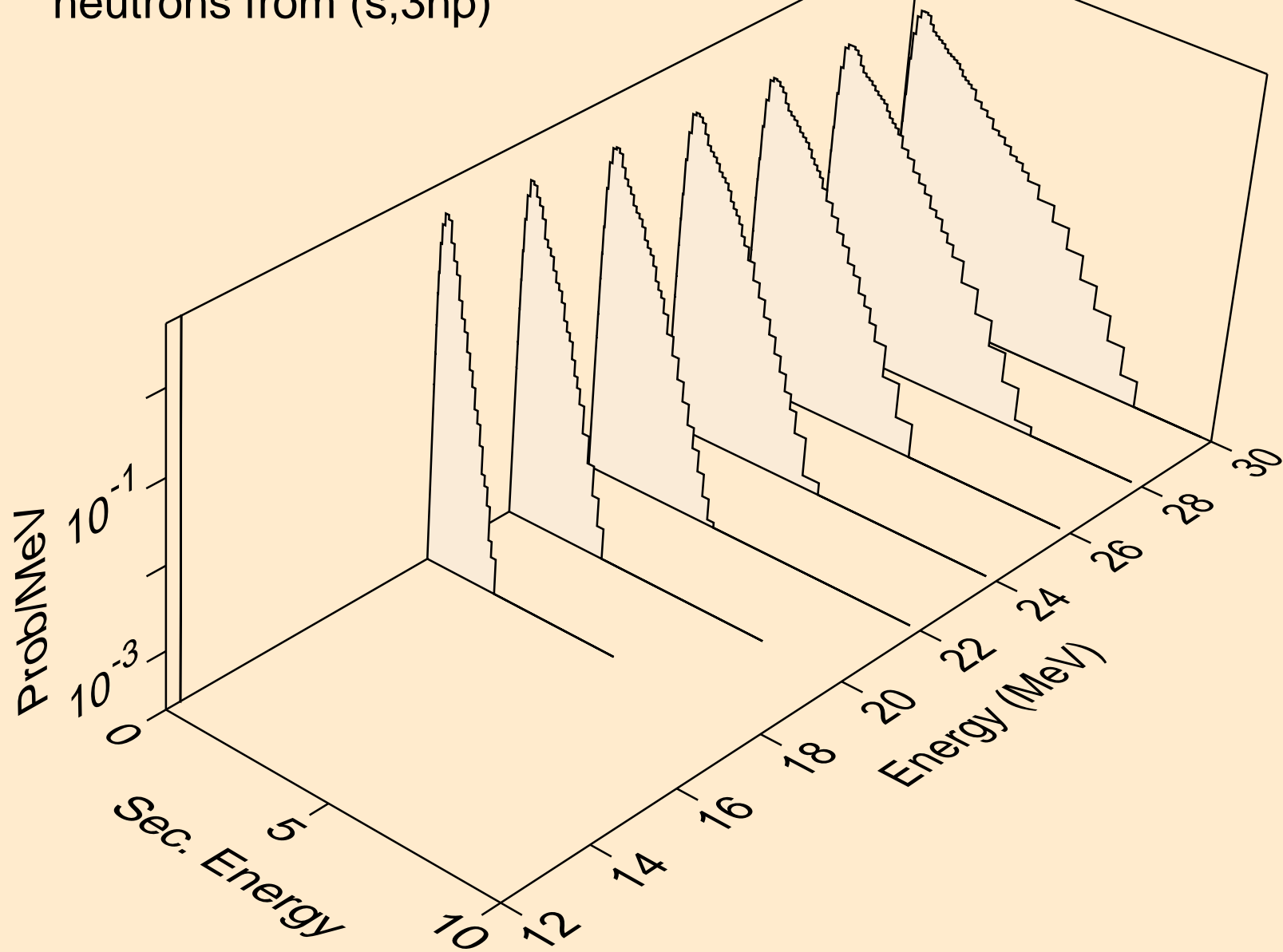

BK252 HELION ACER TENDL-2023 LIBRARY; T=0.K
protons from (s,x)

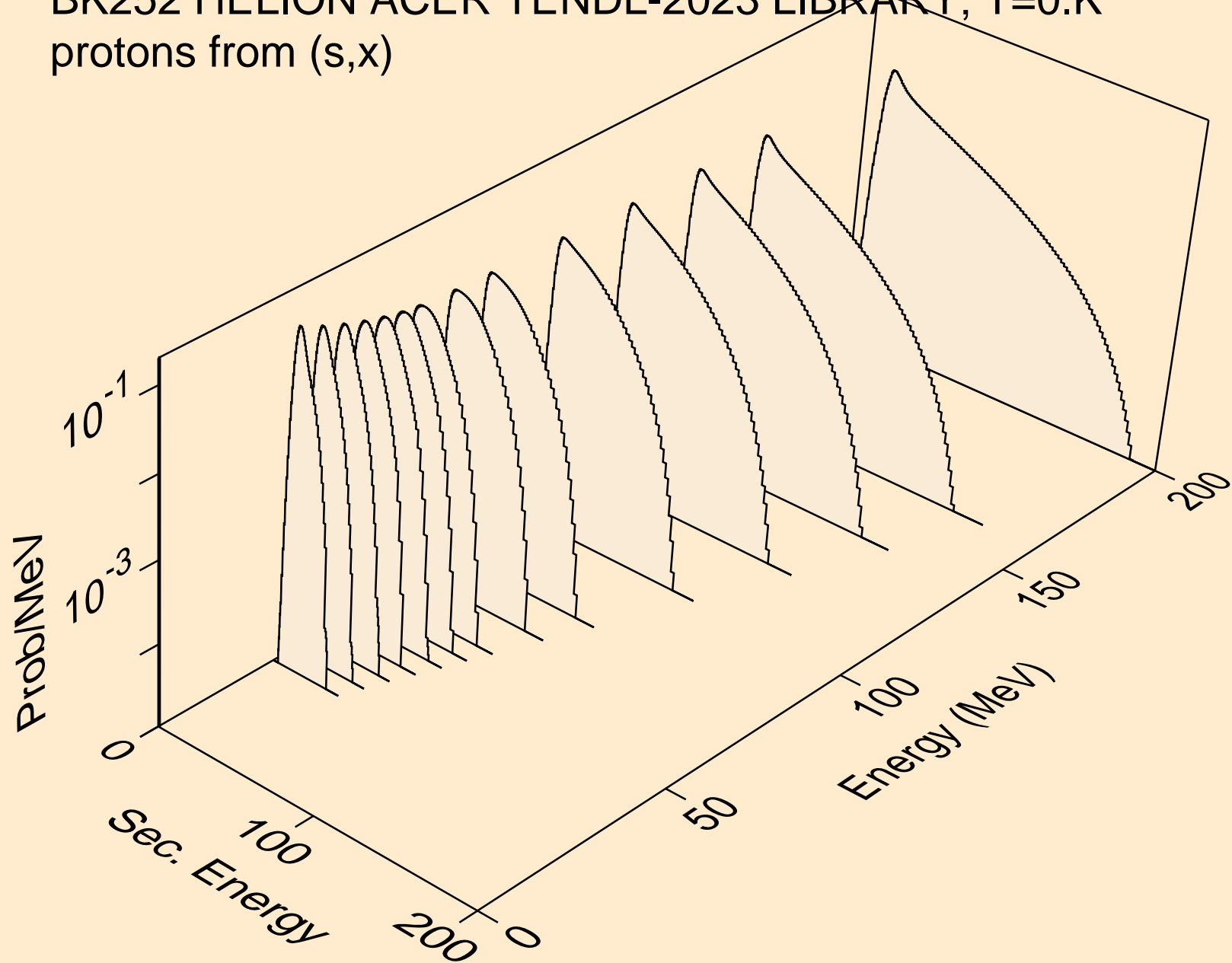

BK252 HELION ACER TENDL-2023 LIBRARY; T=0.K
protons from (s,n*)p

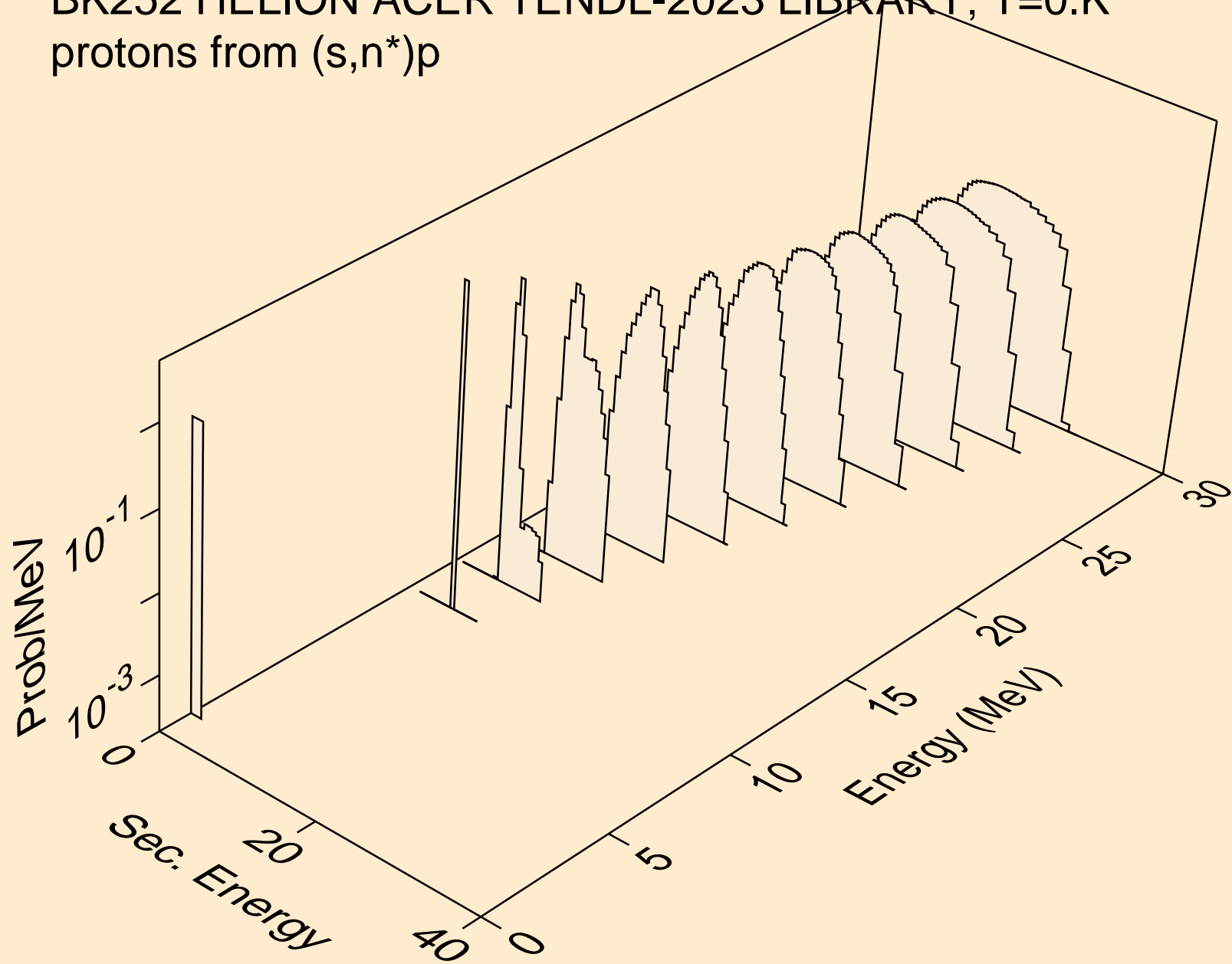

BK252 HELION ACER TENDL-2023 LIBRARY; T=0.K
protons from (s,2np)

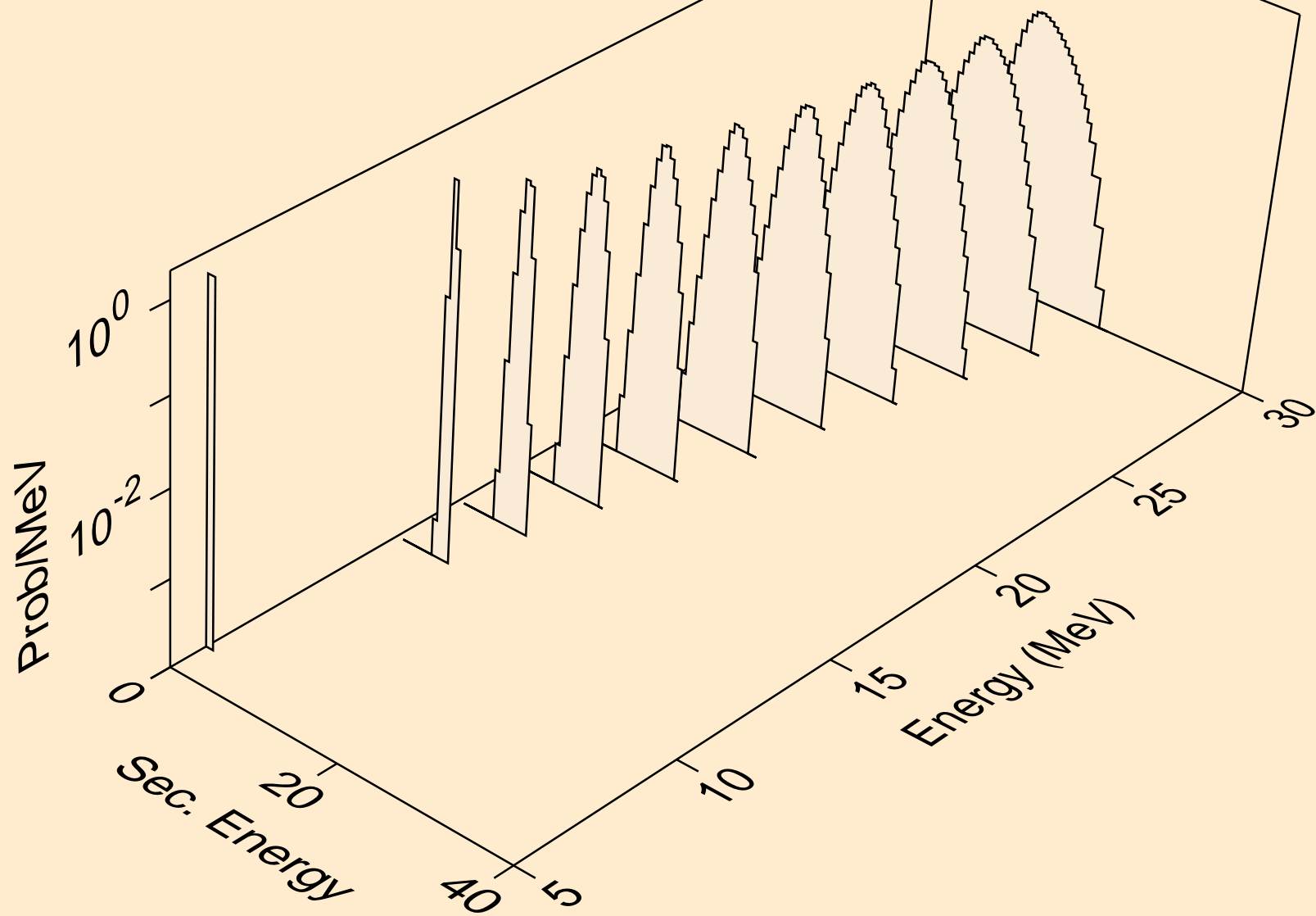

BK252 HELION ACER TENDL-2023 LIBRARY; T=0.K
protons from (s,3np)

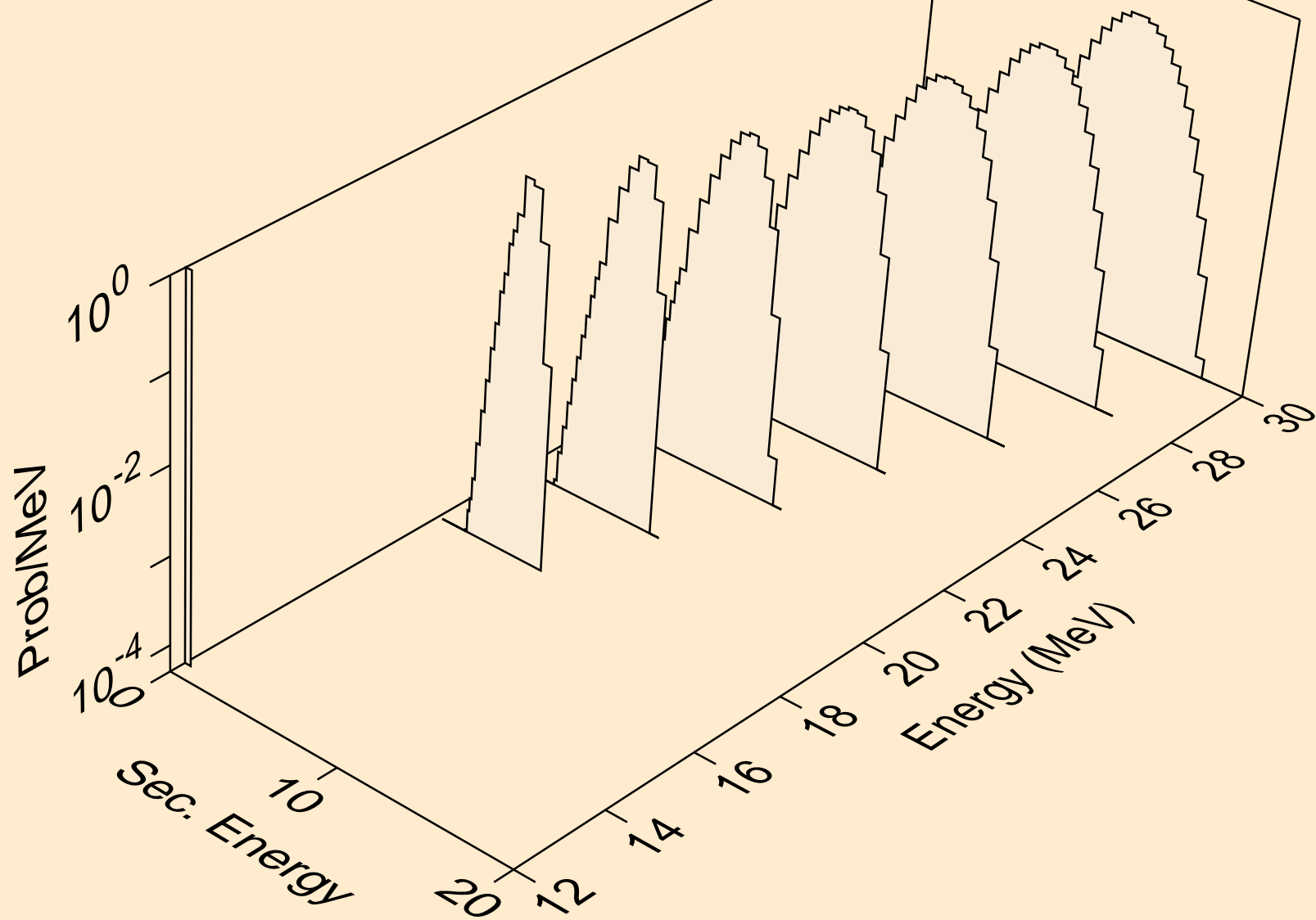

BK252 HELION ACER TENDL-2023 LIBRARY; T=0.K
protons from (s,p)

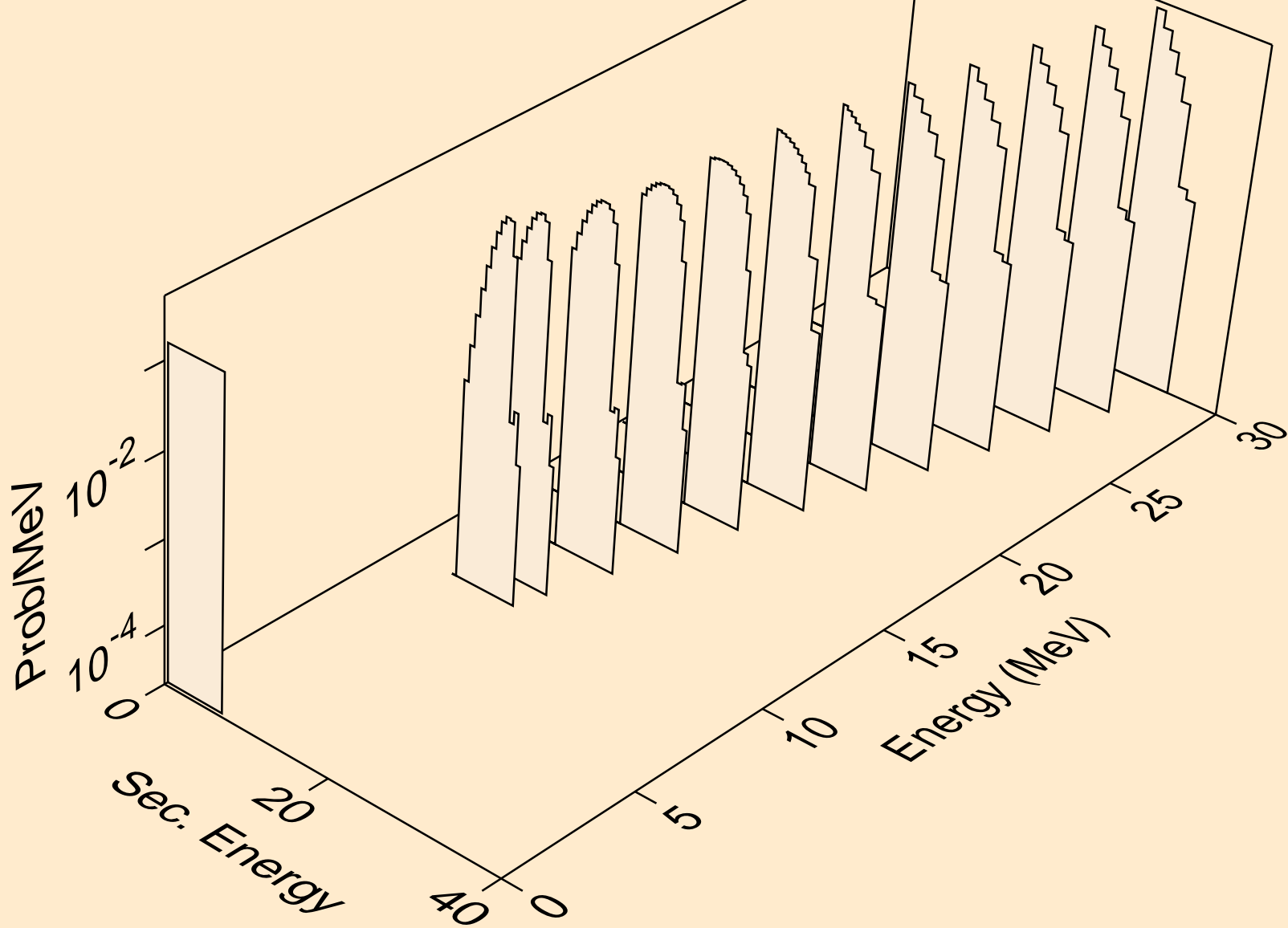

BK252 HELION ACER TENDL-2023 LIBRARY; T=0.K
protons from (s,2p)

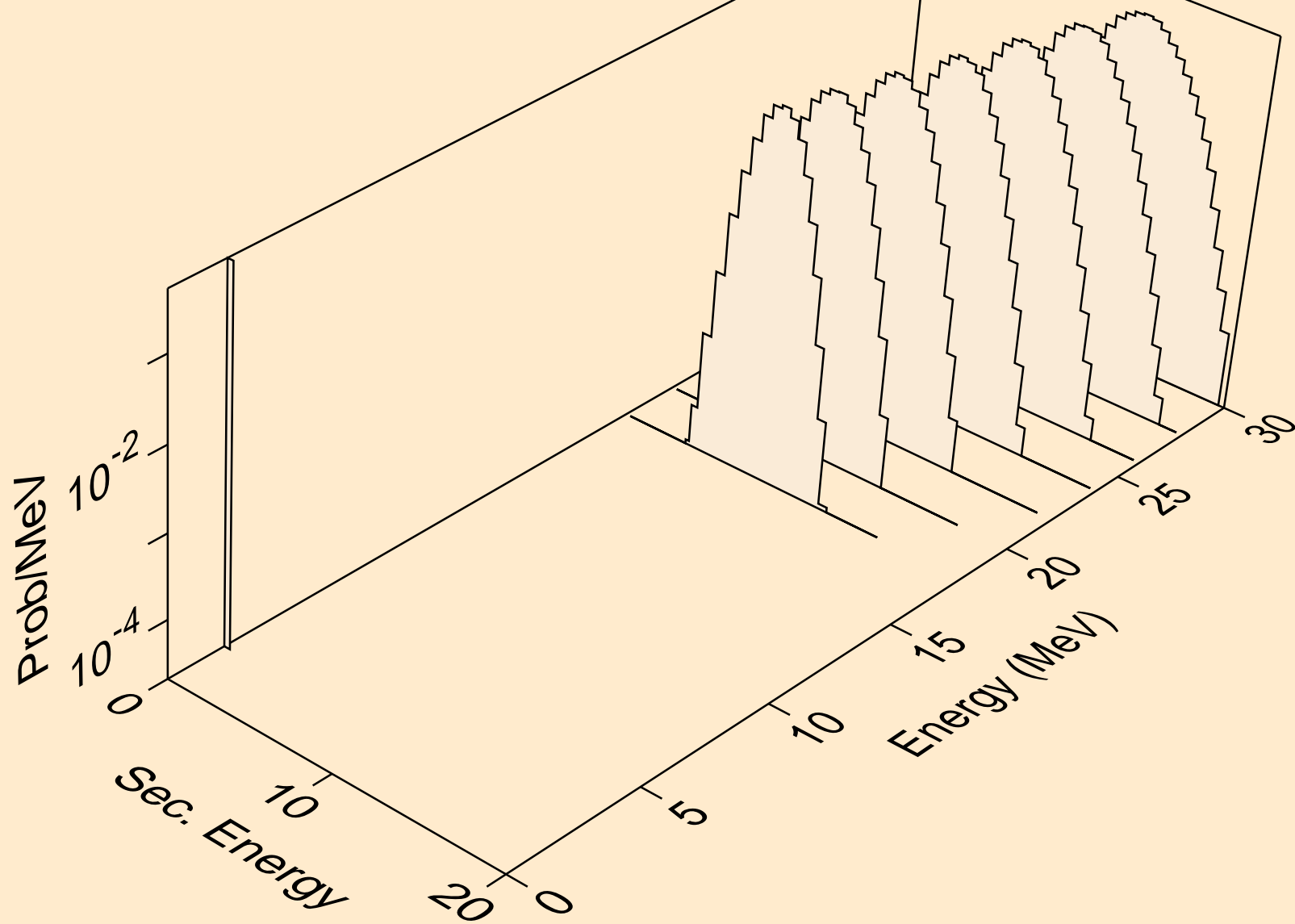

BK252 HELION ACER TENDL-2023 LIBRARY; T=0.K
protons from (s,pd)

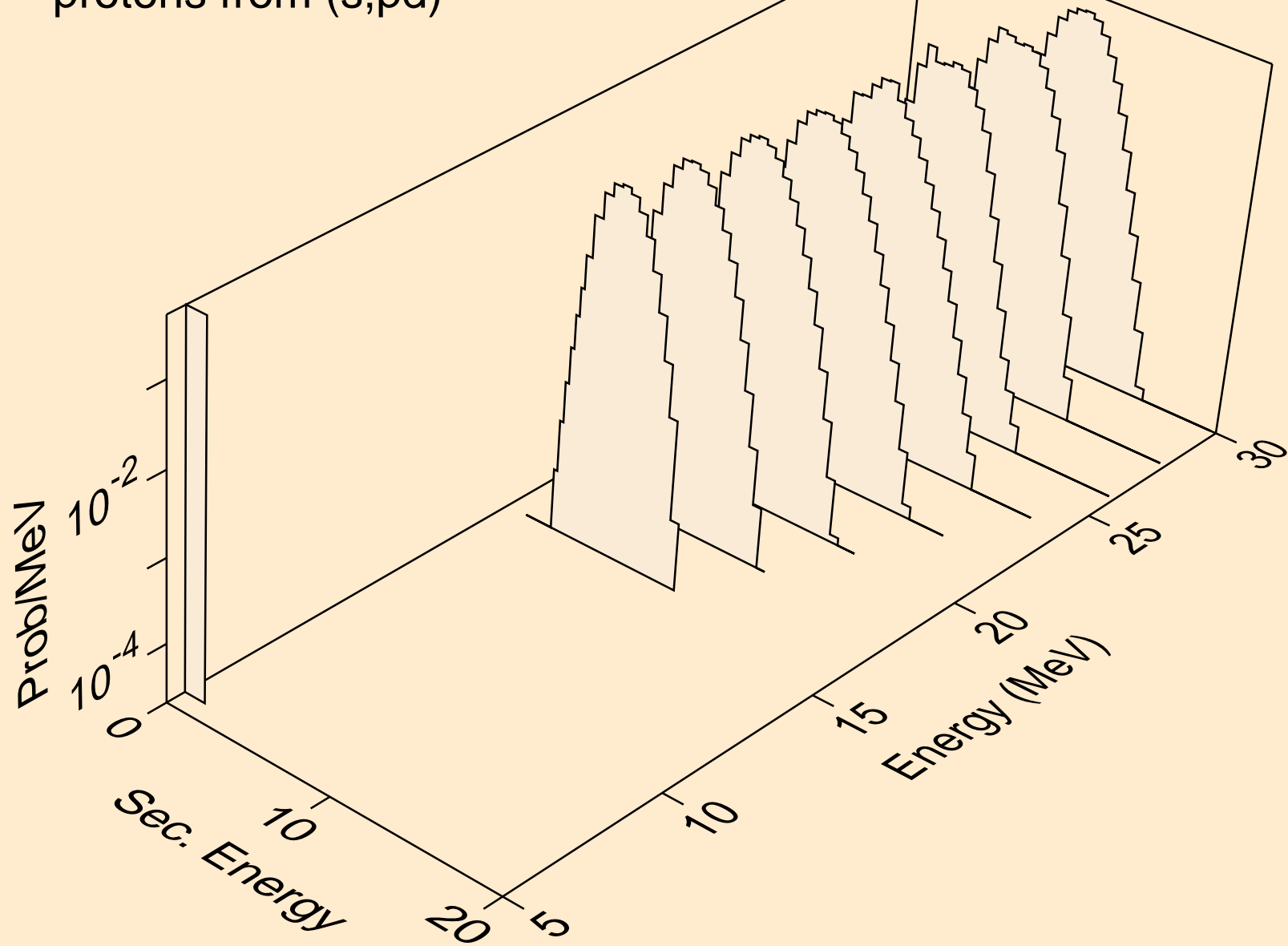

BK252 HELION ACER TENDL-2023 LIBRARY; T=0.K
deuterons from (s,x)

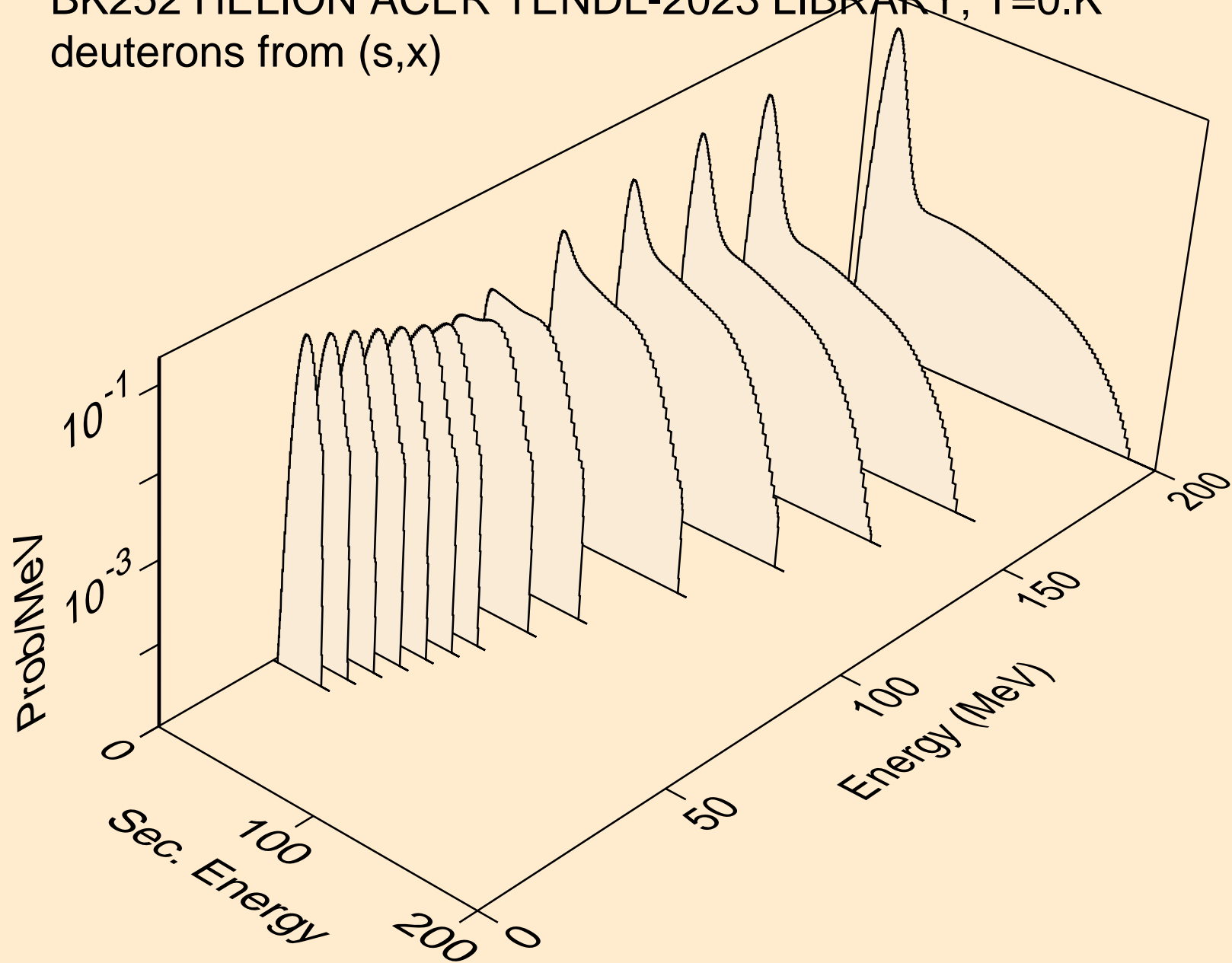

BK252 HELION ACER TENDL-2023 LIBRARY; T=0.K
deuterons from (s,2nd)

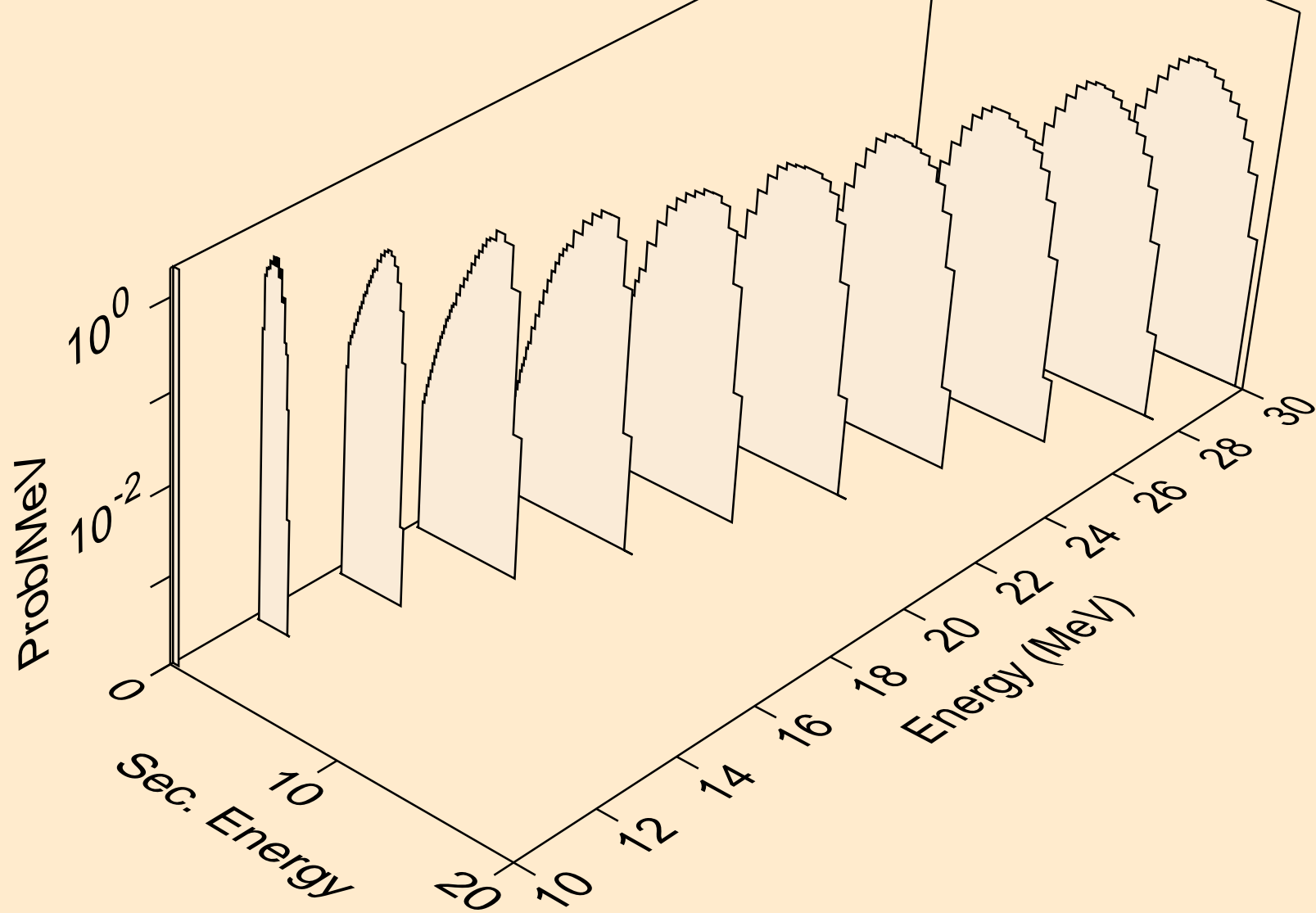

BK252 HELION ACER TENDL-2023 LIBRARY; T=0.K
deuterons from (s,n*)d

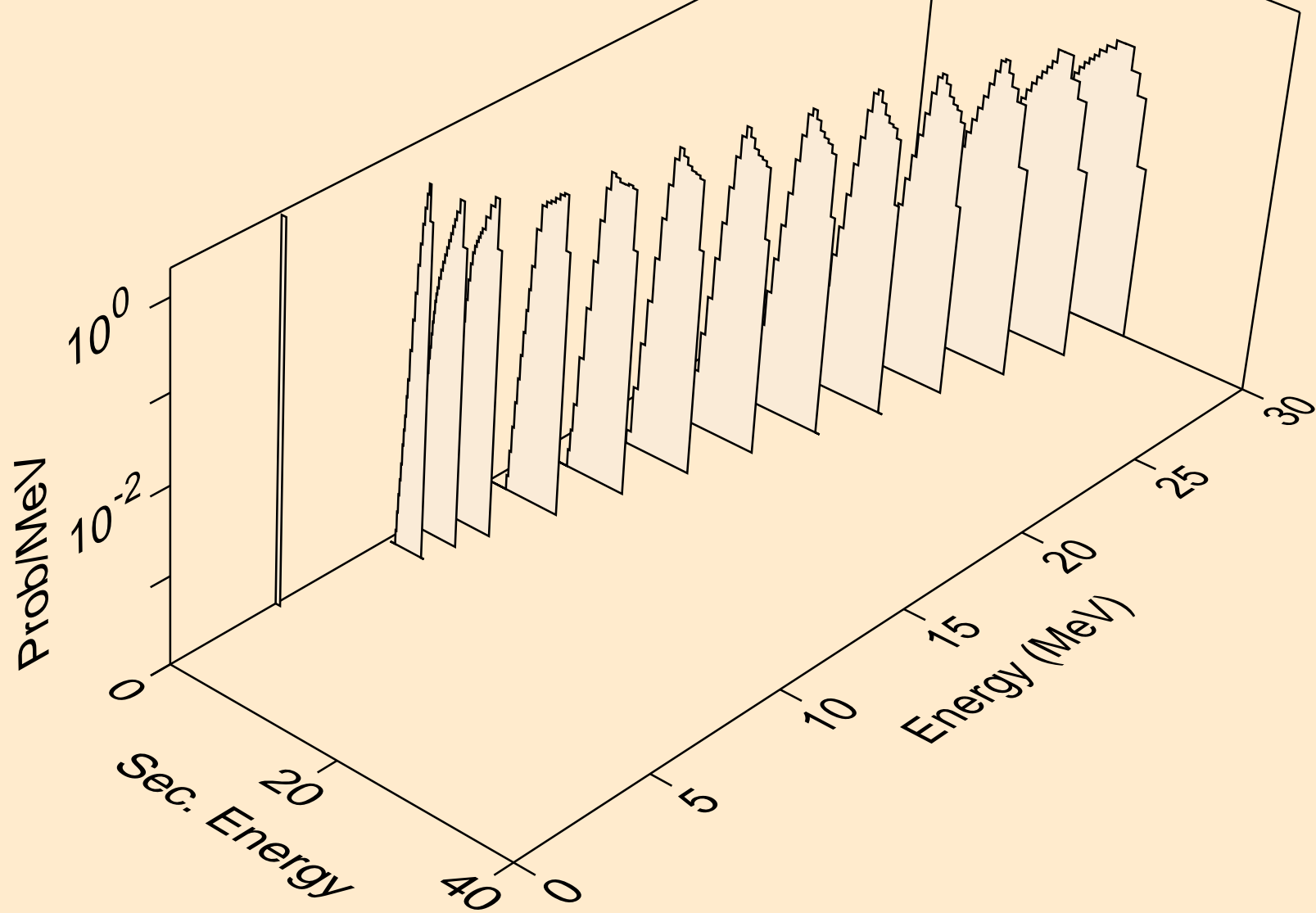

BK252 HELION ACER TENDL-2023 LIBRARY; T=0.K
deuterons from (s,d)

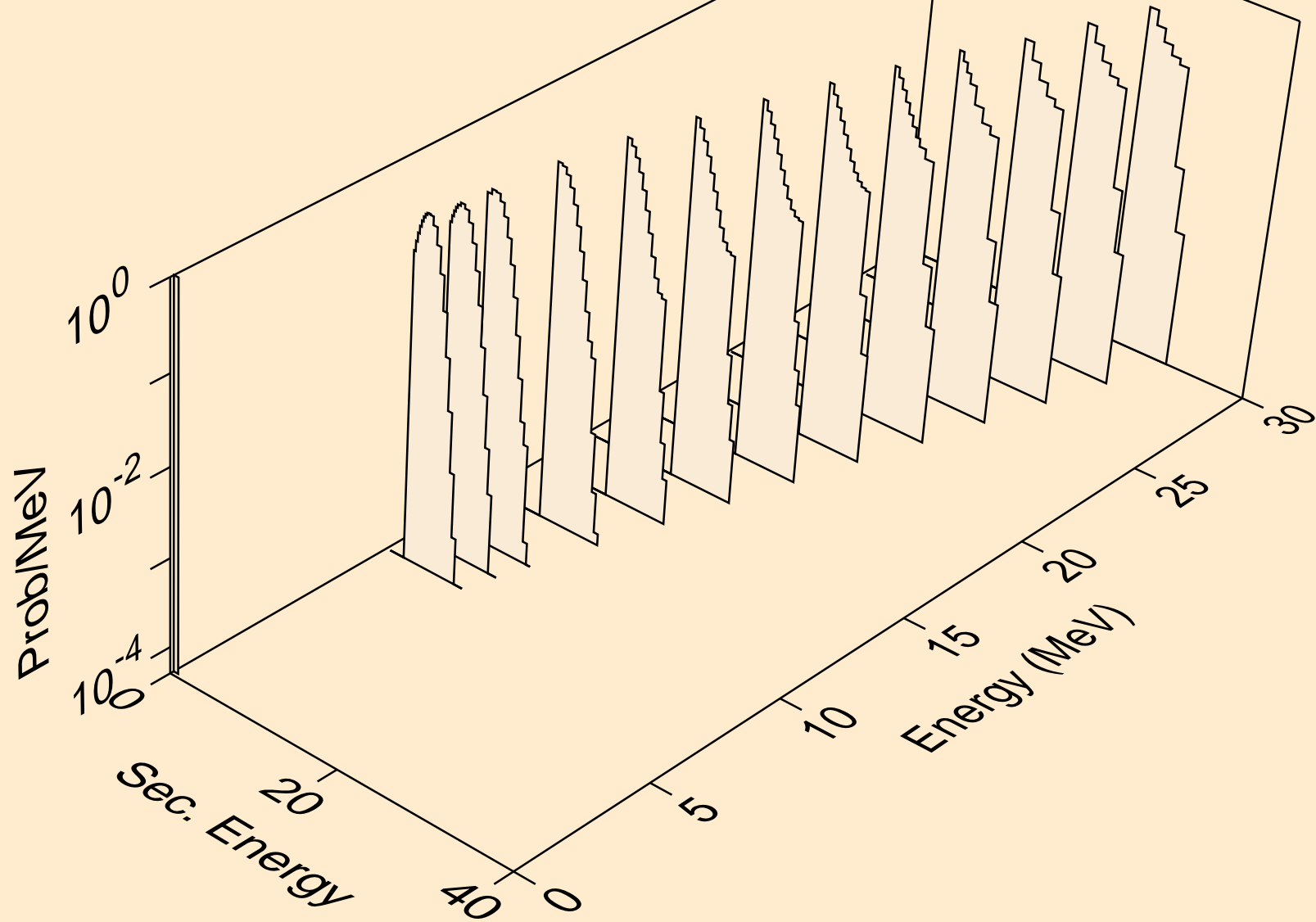

BK252 HELION ACER TENDL-2023 LIBRARY; T=0.K
deuterons from (s,pd)

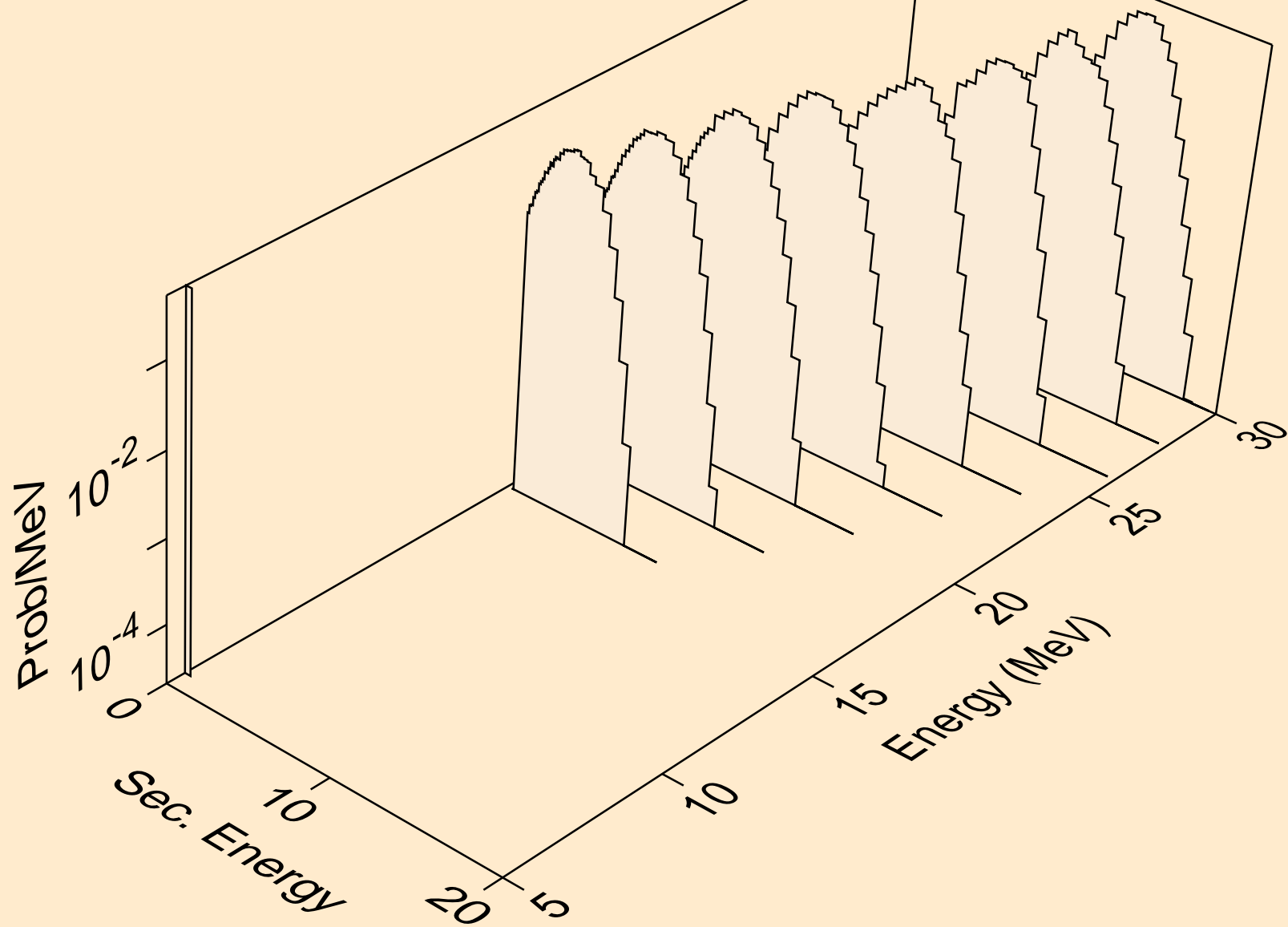

BK252 HELION ACER TENDL-2023 LIBRARY; T=0.K
tritons from (s,x)

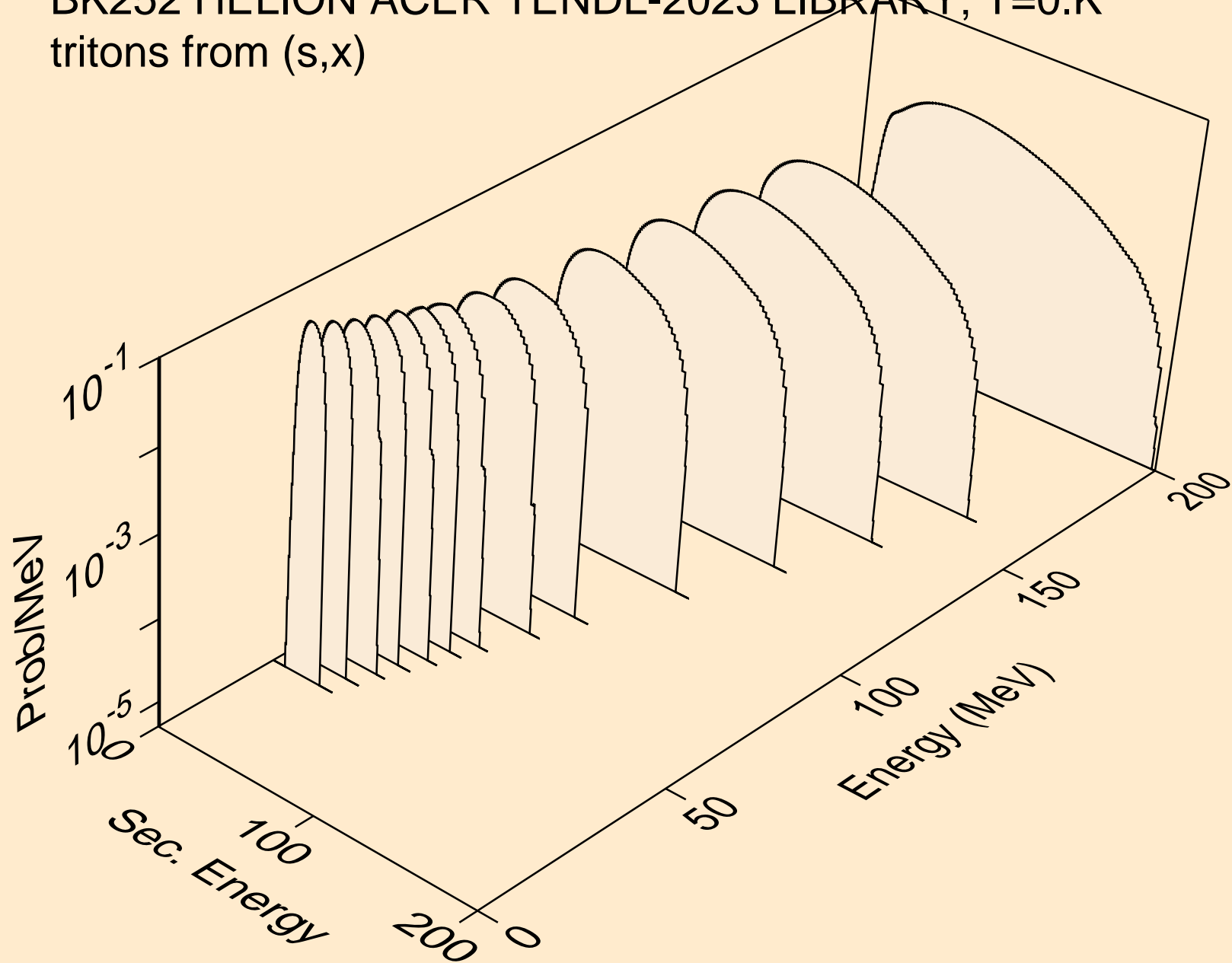

BK252 HELION ACER TENDL-2023 LIBRARY; T=0.K
tritons from (s,n*)t

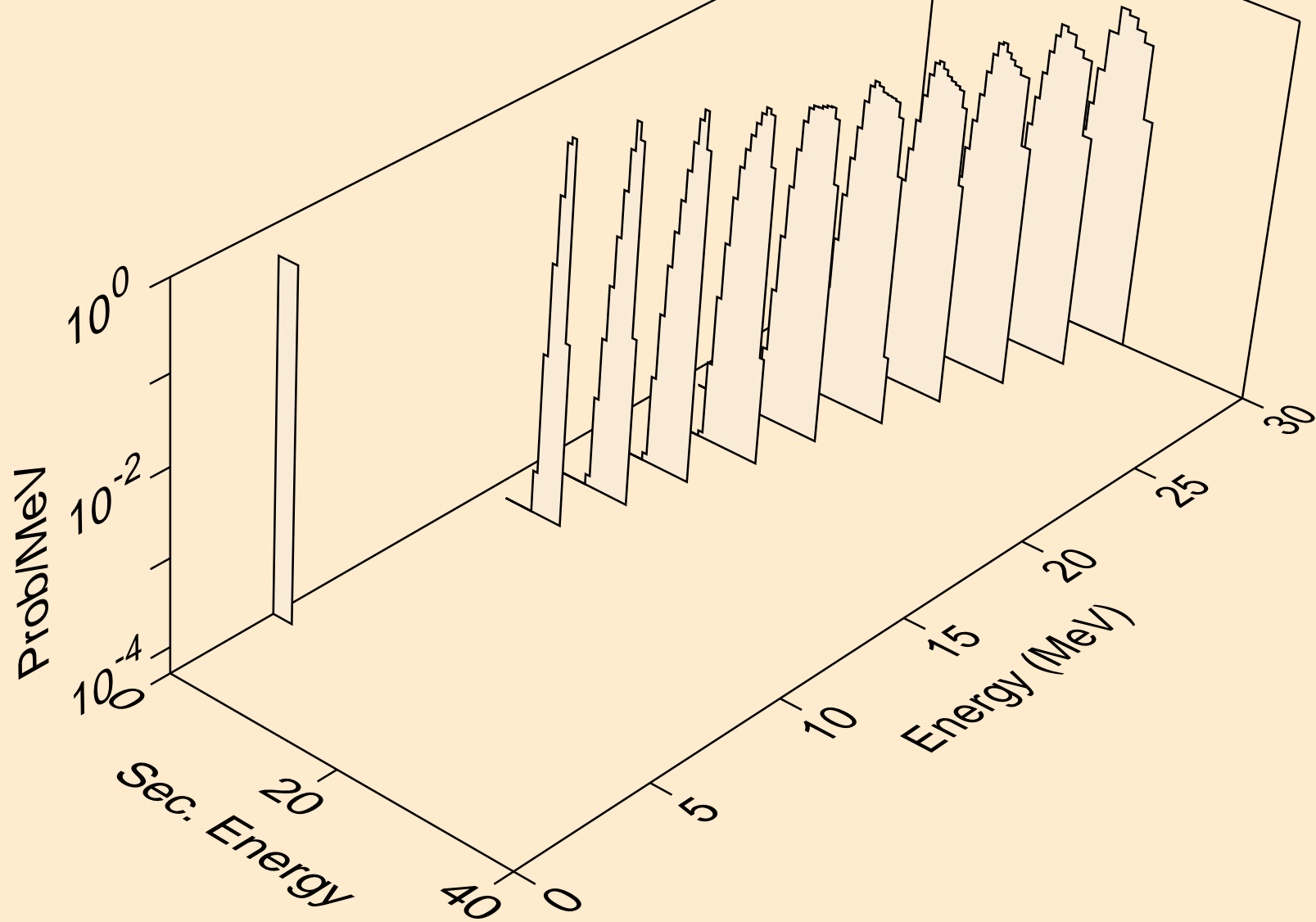

BK252 HELION ACER TENDL-2023 LIBRARY; T=0.K
tritons from (s,t)

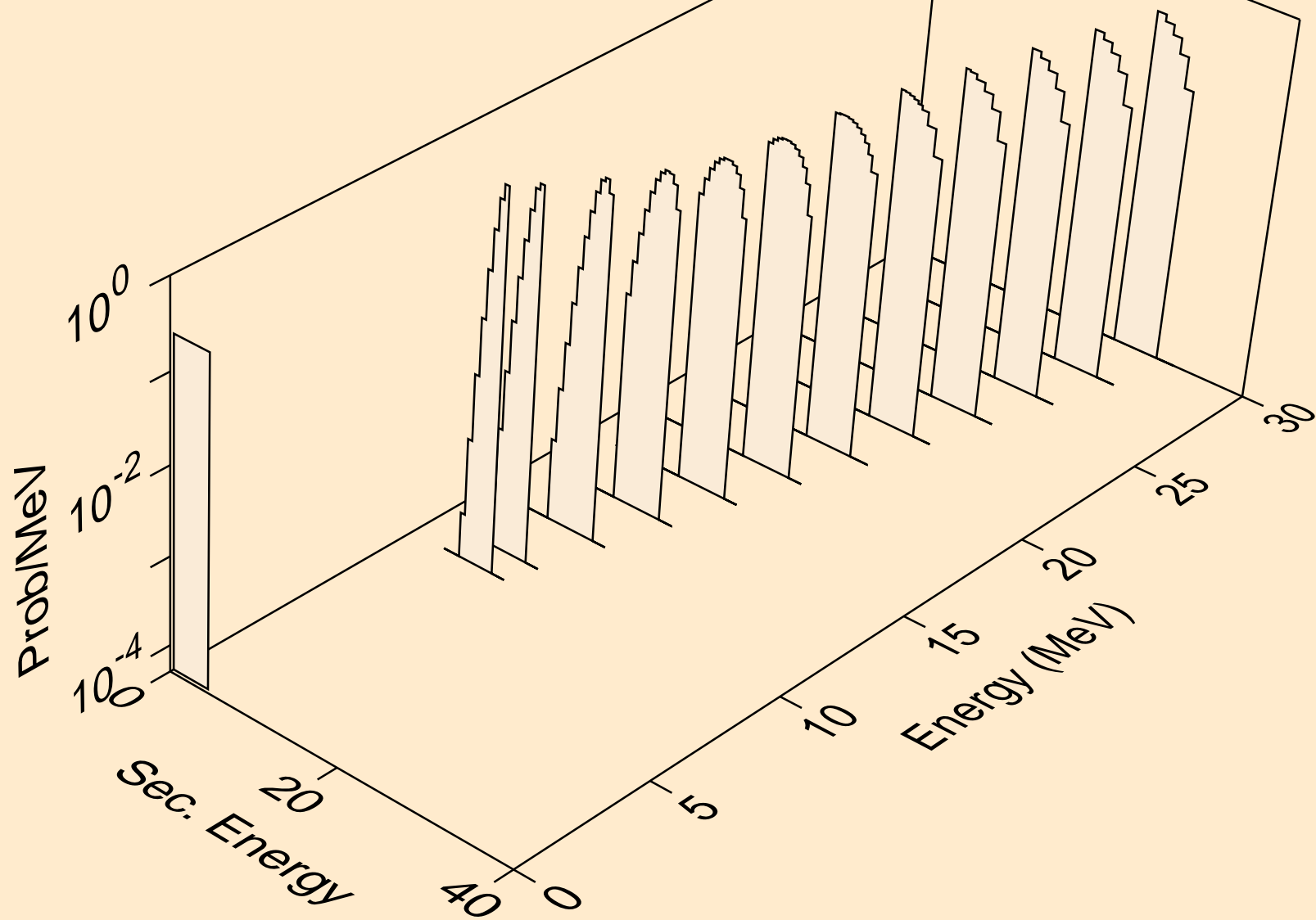

BK252 HELION ACER TENDL-2023 LIBRARY; T=0.K
alphas from (s,x)

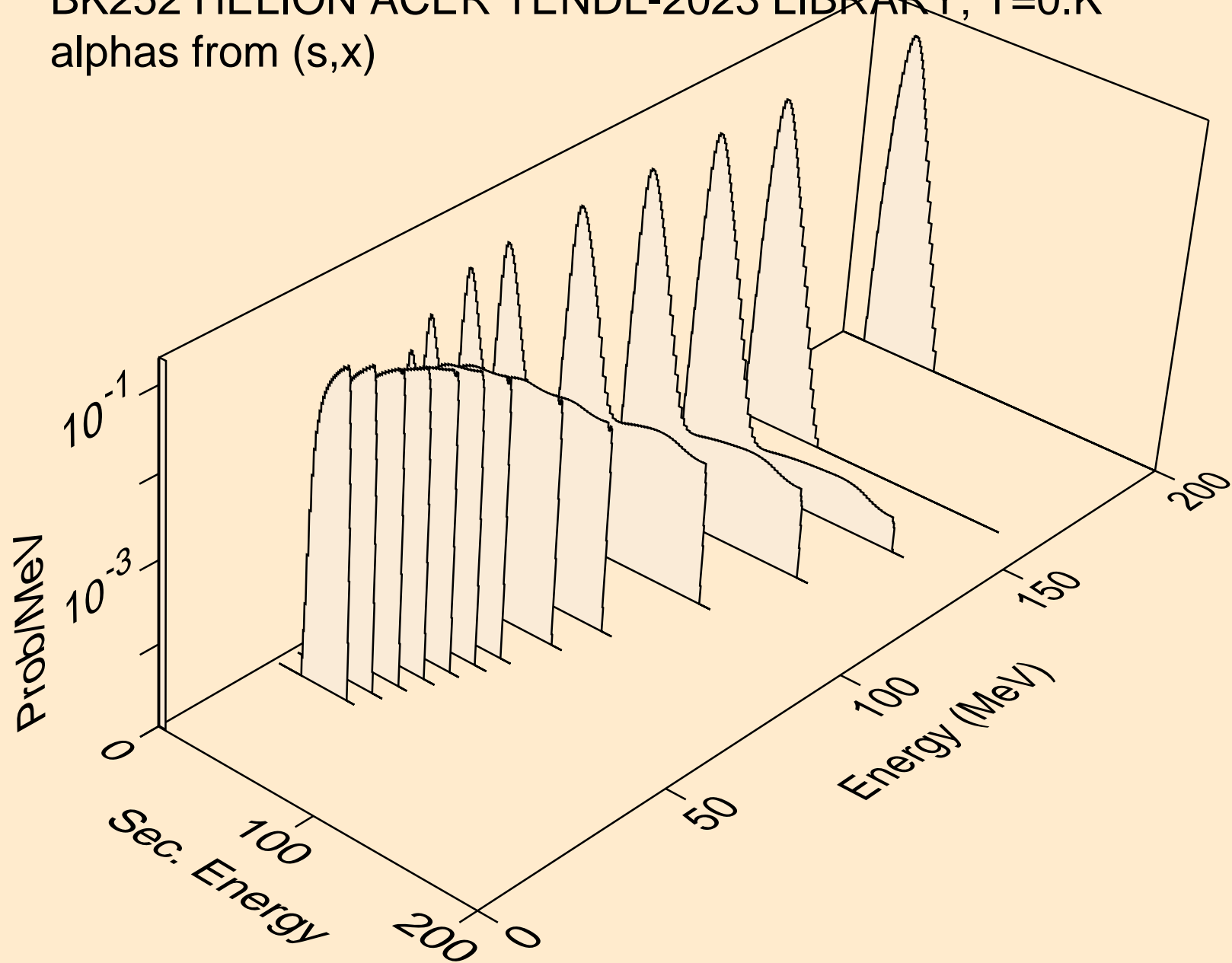

BK252 HELION ACER TENDL-2023 LIBRARY; T=0.K
alphas from (s,n*)a

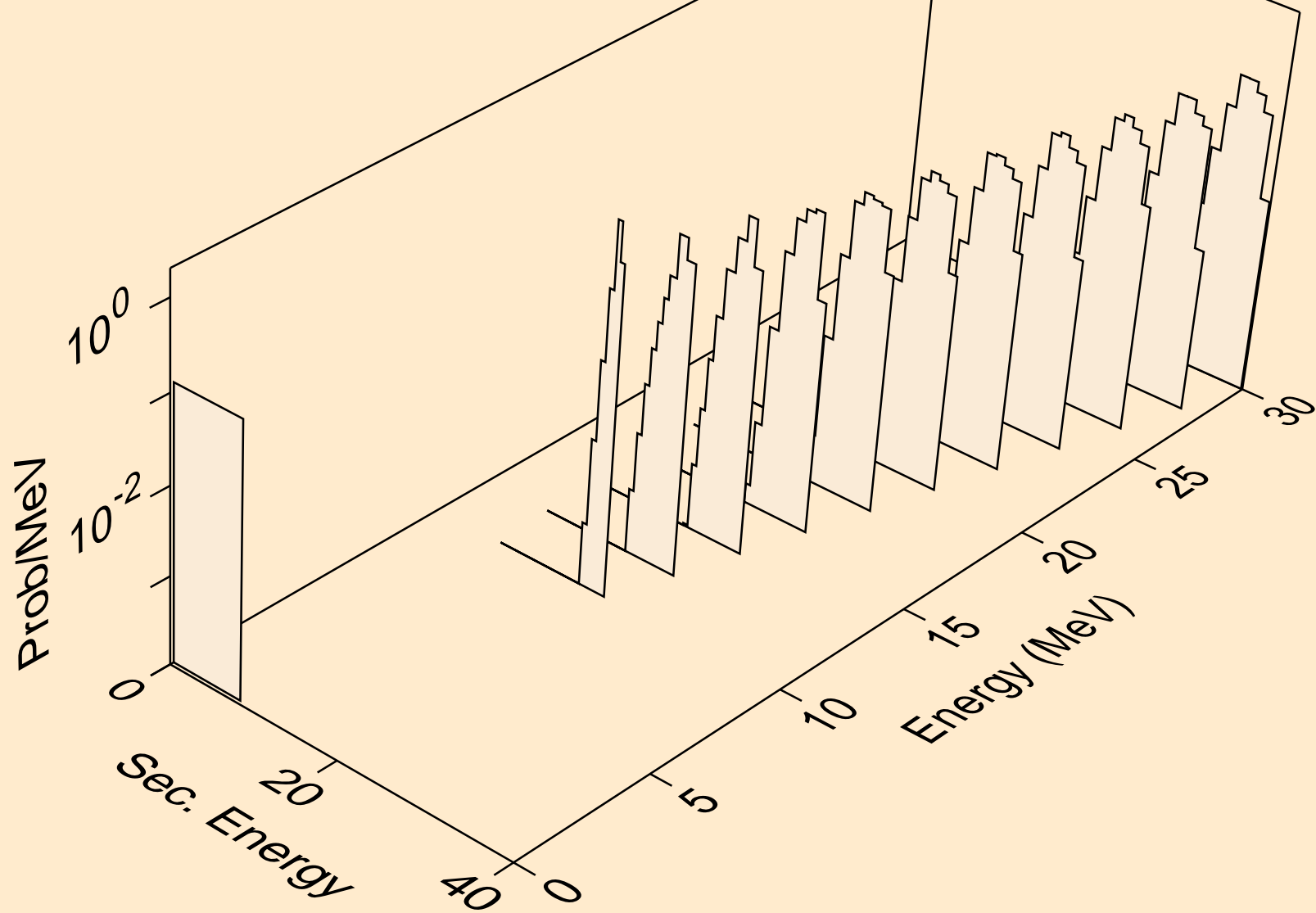

BK252 HELION ACER TENDL-2023 LIBRARY; T=0.K
alphas from (s,2n)a

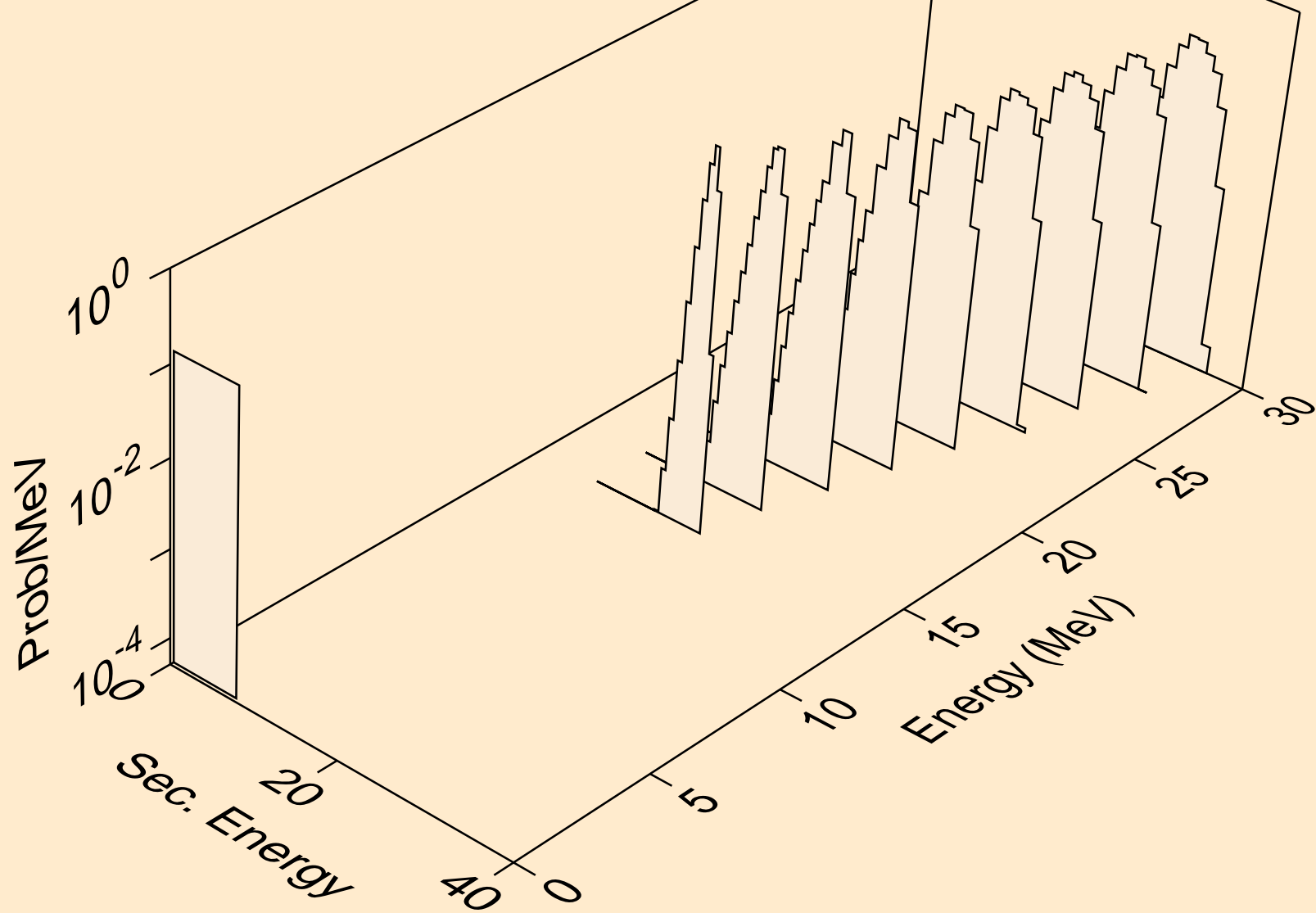

BK252 HELION ACER TENDL-2023 LIBRARY; T=0.K
alphas from (s,a)

