

ES251 HELION ACER TENDL-2023 LIBRARY; T=0.K
Principal cross sections

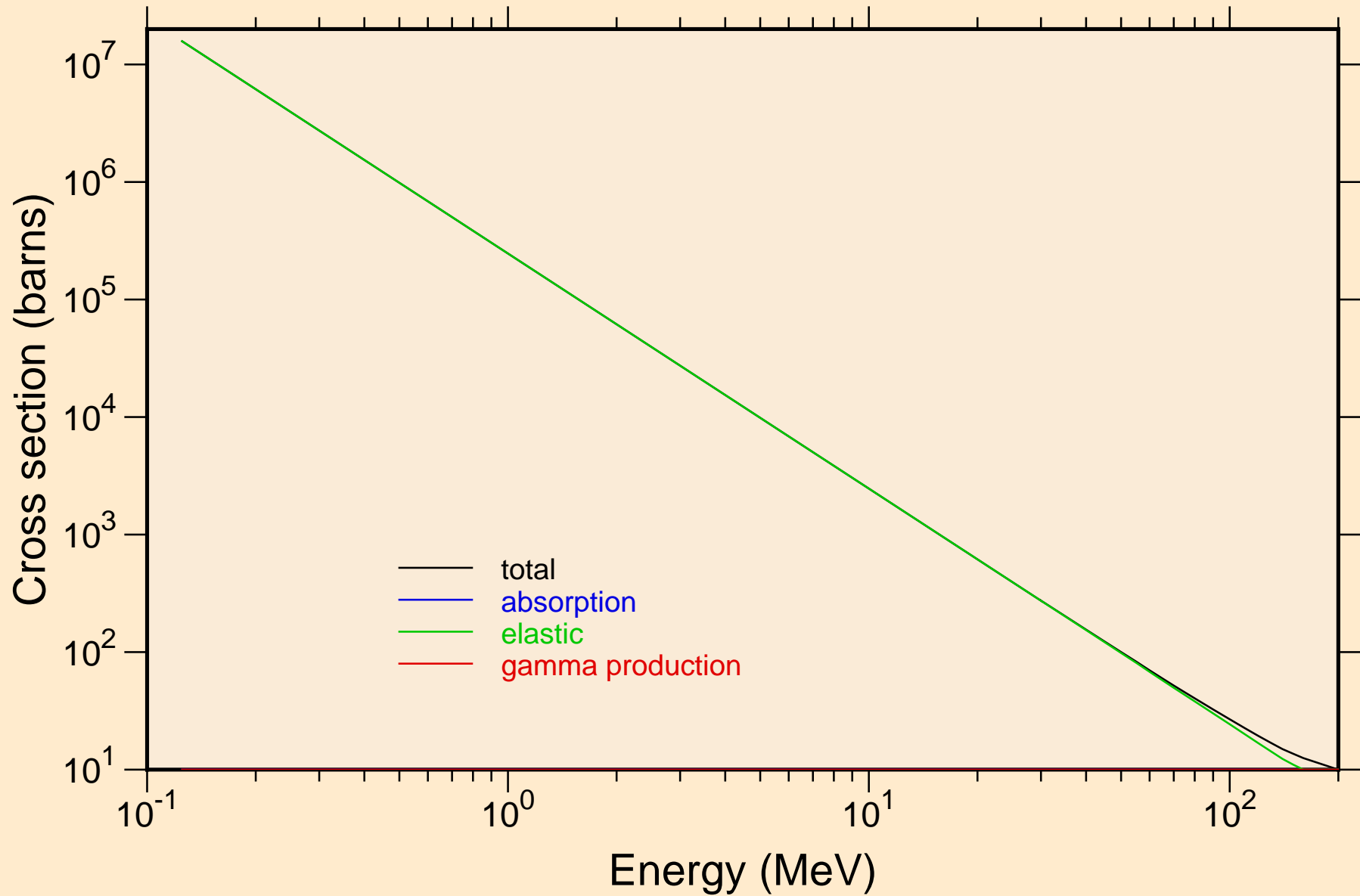

ES251 HELION ACER TENDL-2023 LIBRARY; T=0.K

Heating

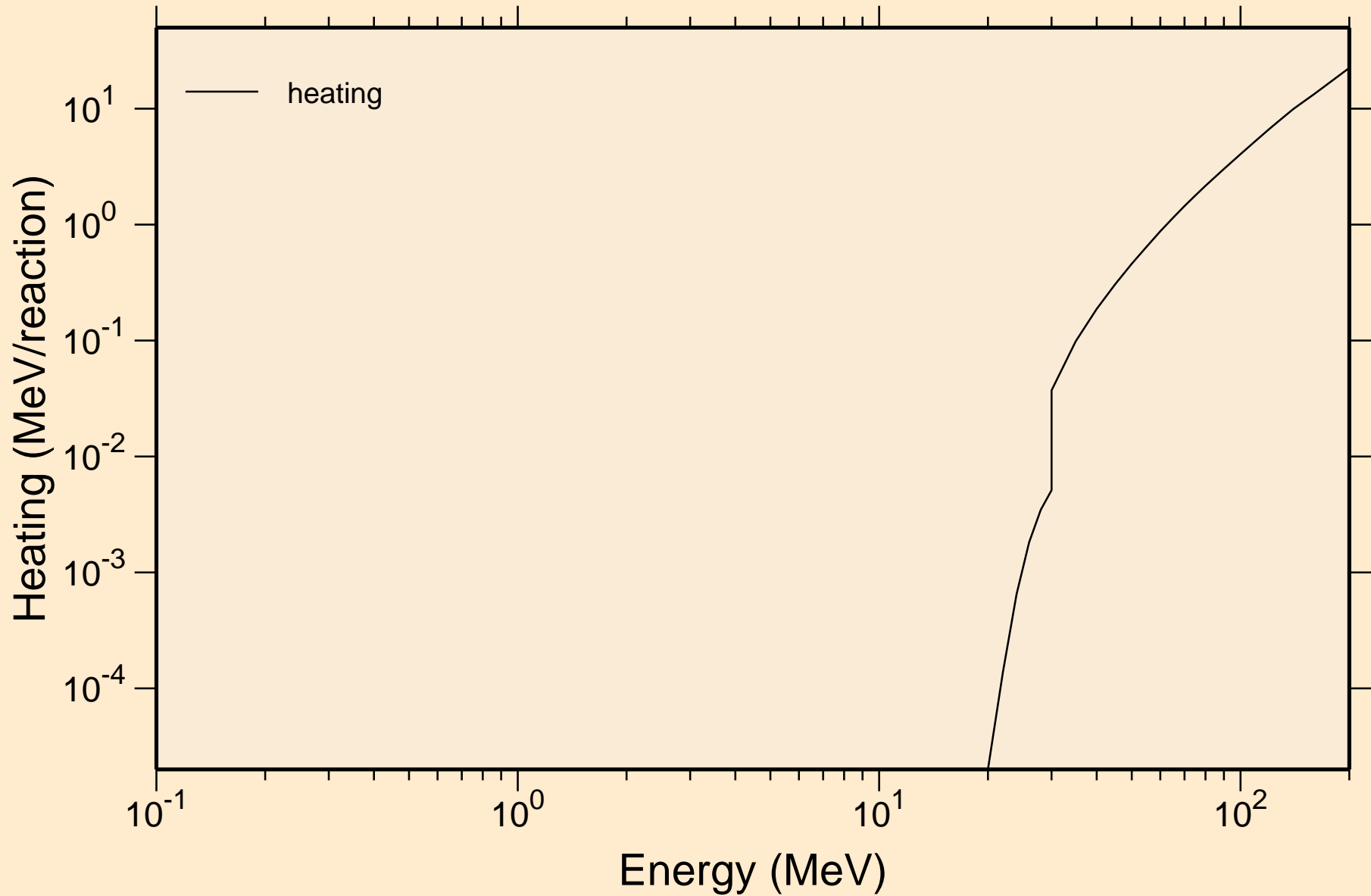

ES251 HELION ACER TENDL-2023 LIBRARY; T=0.K

Principal cross sections

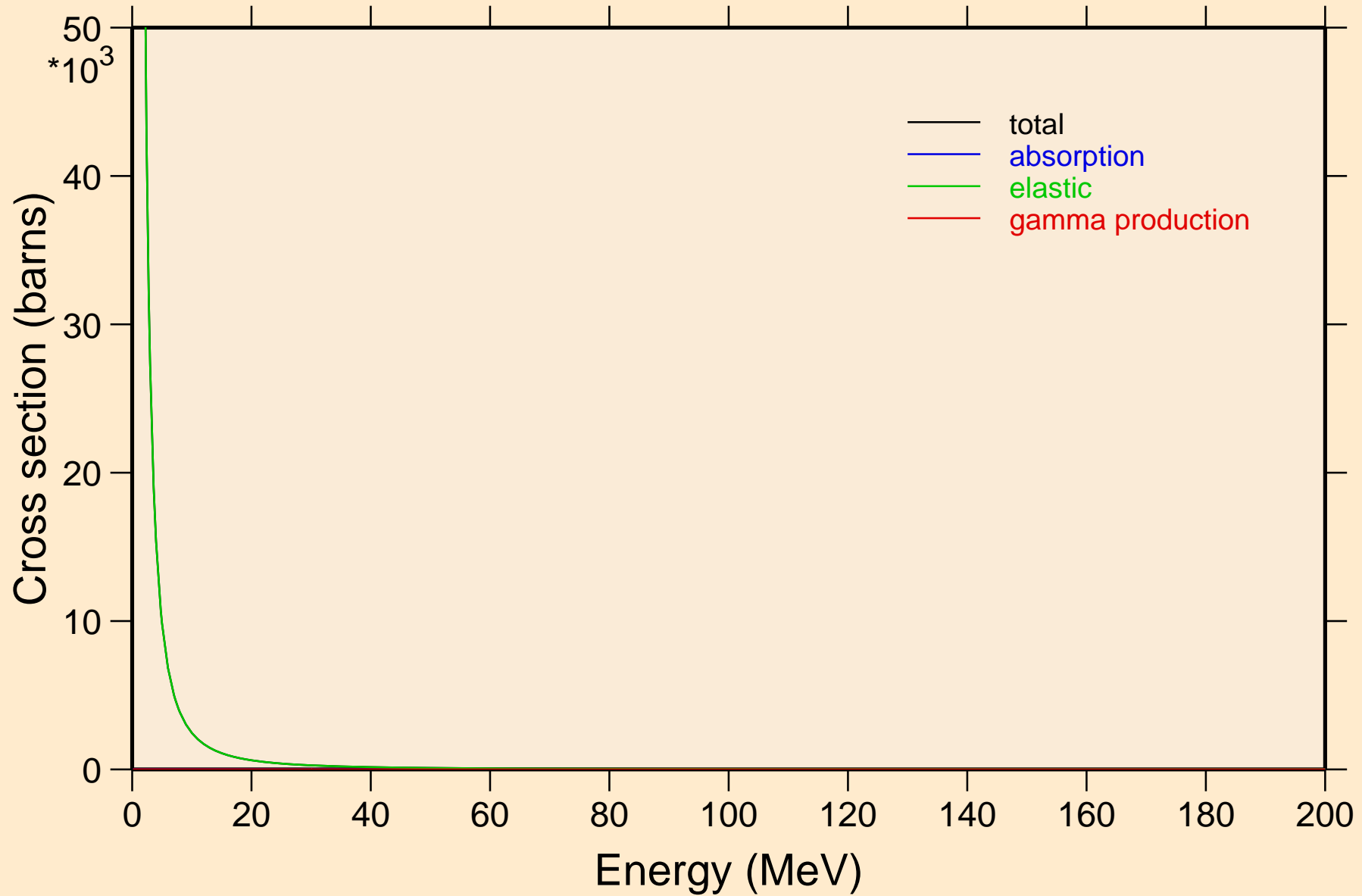

ES251 HELION ACER TENDL-2023 LIBRARY; T=0.K

Heating

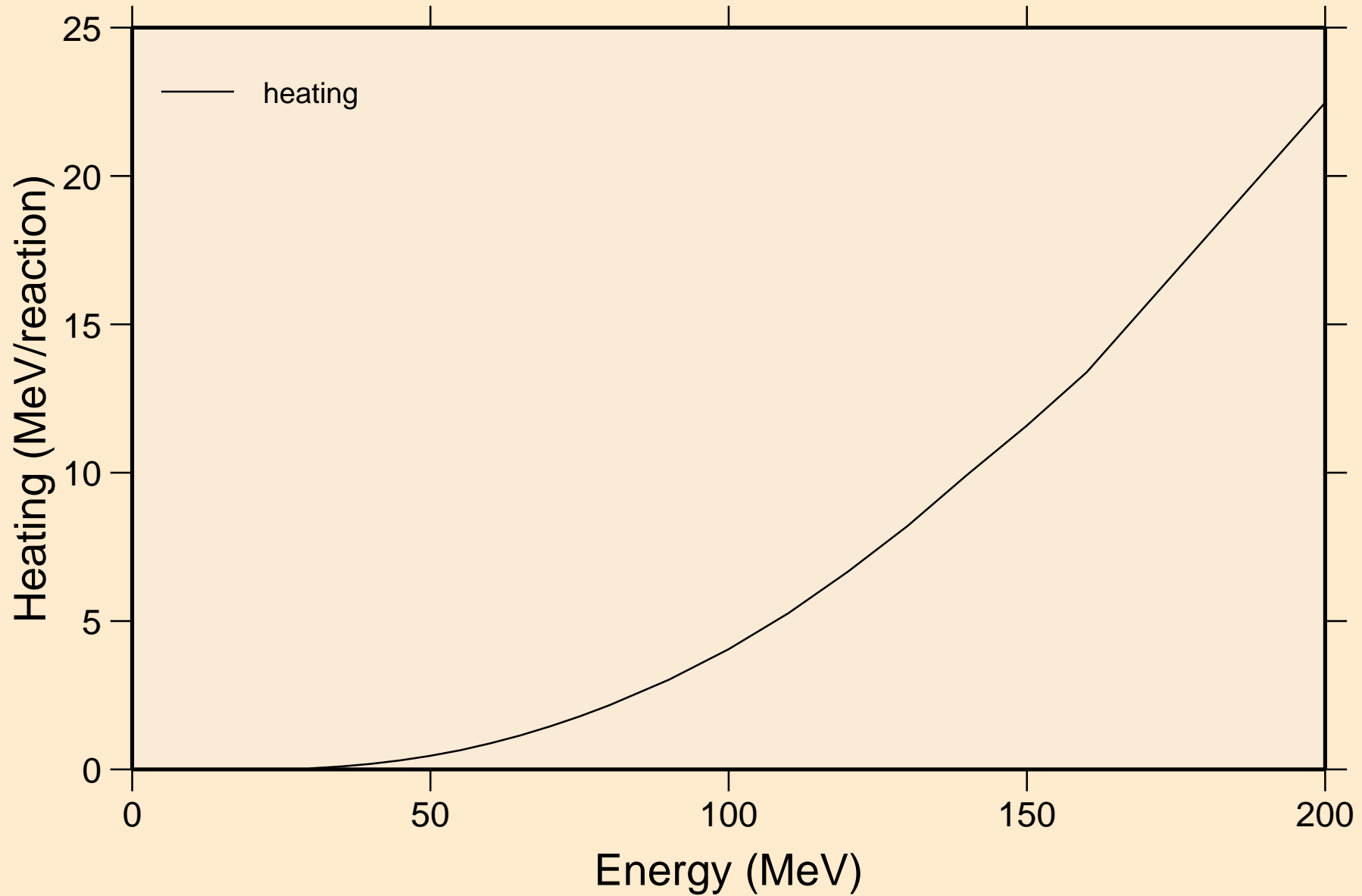

ES251 HELION ACER TENDL-2023 LIBRARY; T=0.K
Threshold reactions

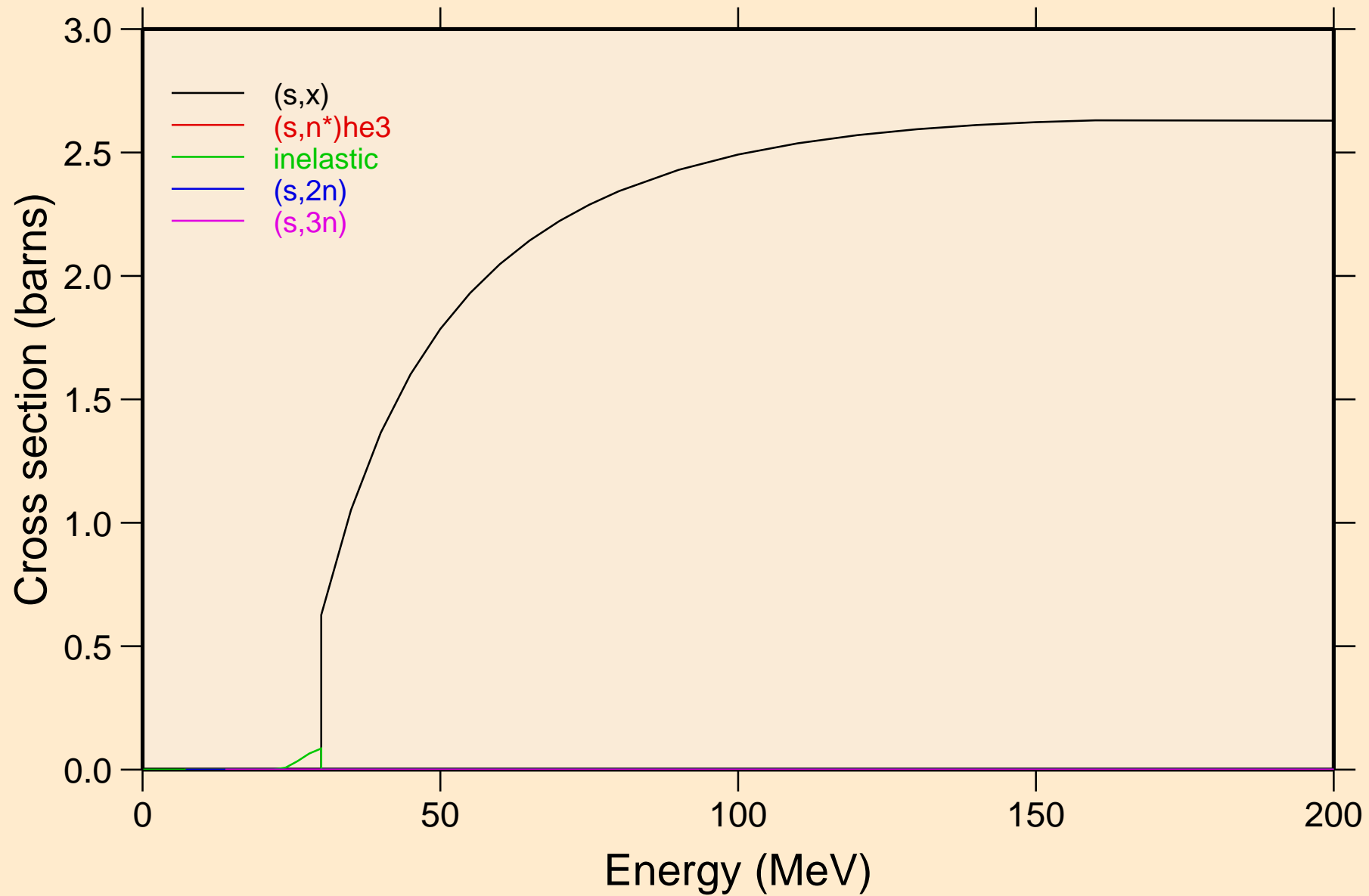

ES251 HELION ACER TENDL-2023 LIBRARY; T=0.K
Threshold reactions

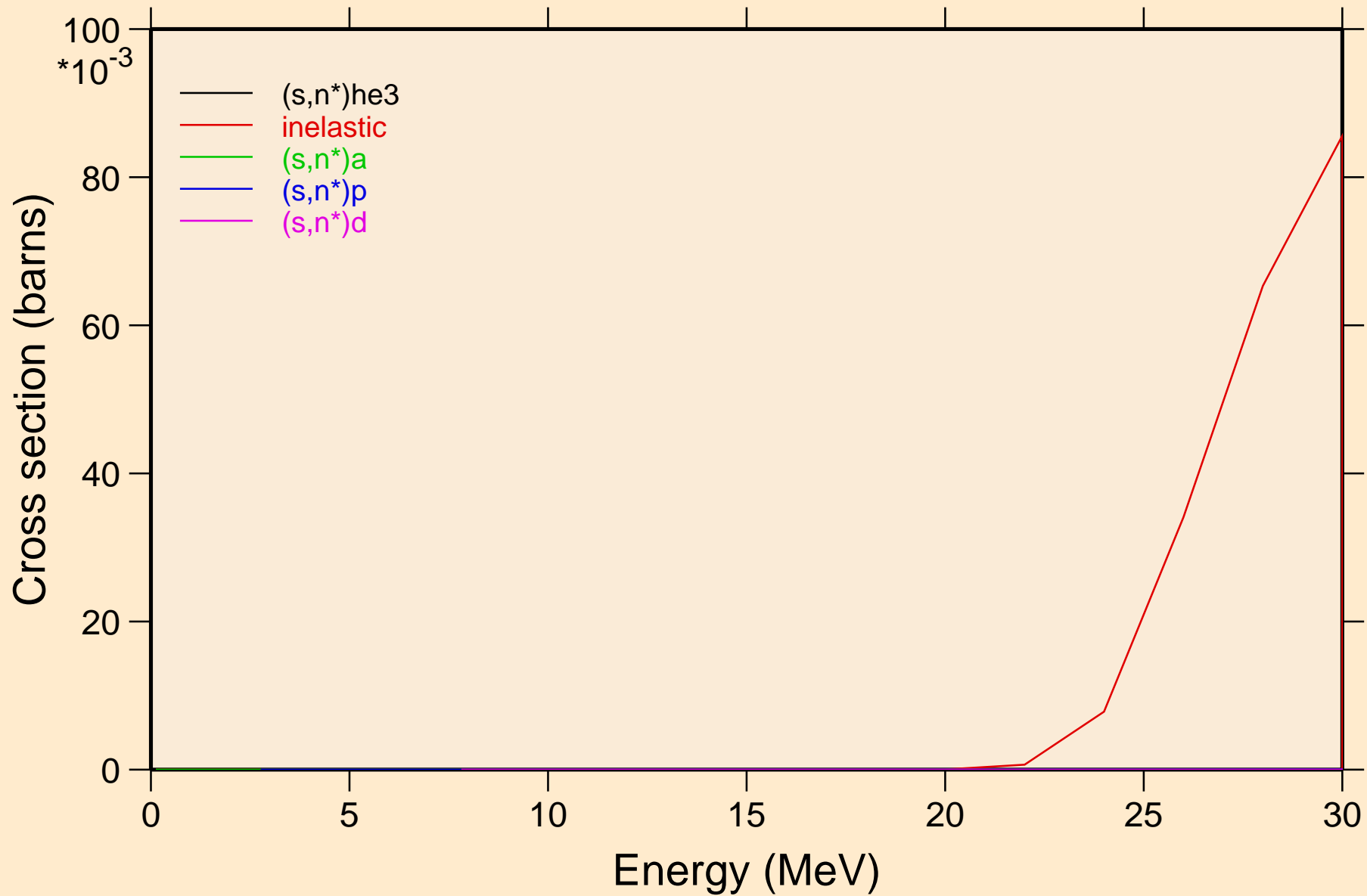

ES251 HELION ACER TENDL-2023 LIBRARY; T=0.K
Threshold reactions

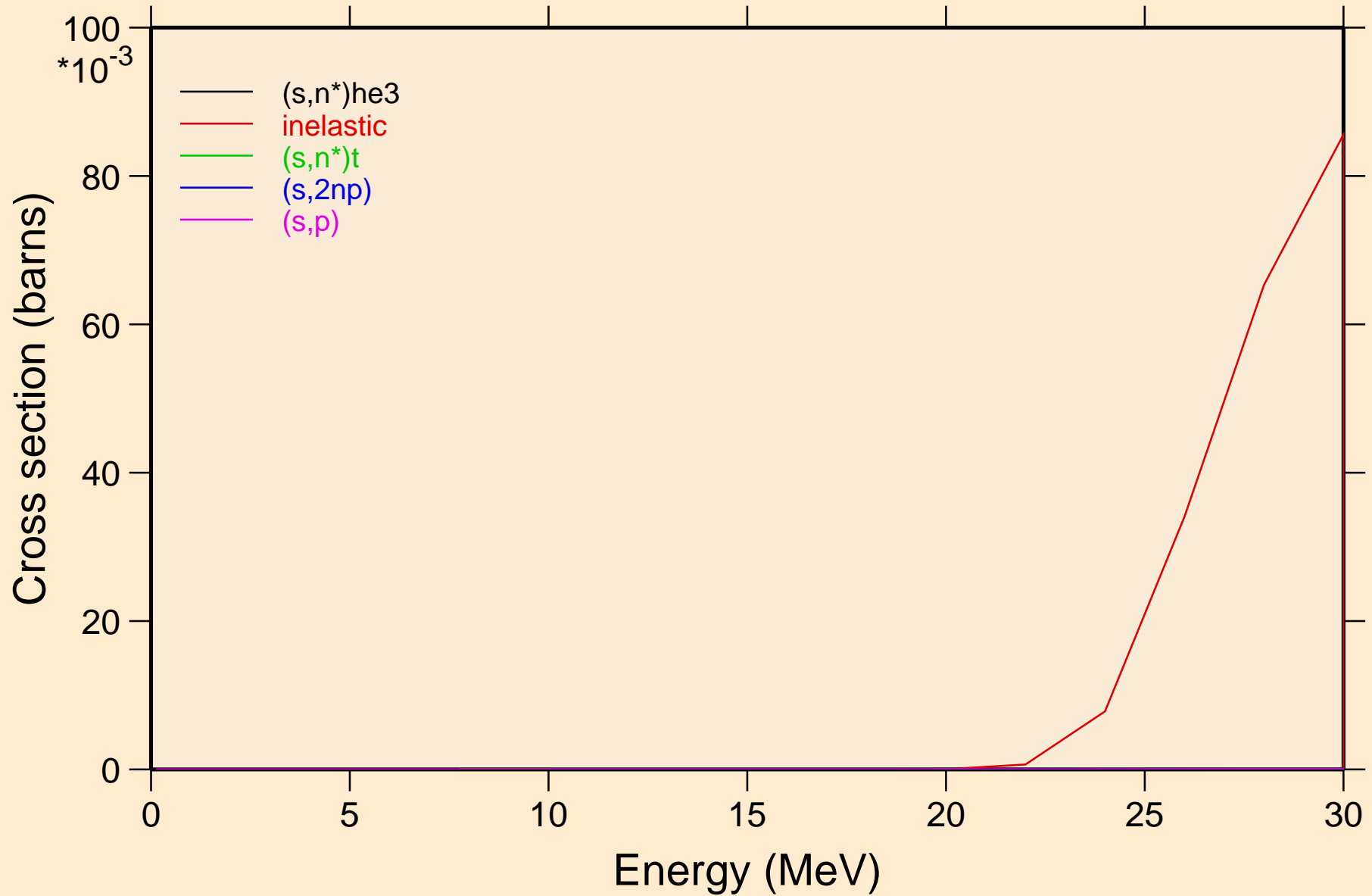

ES251 HELION ACER TENDL-2023 LIBRARY; T=0.K

Threshold reactions

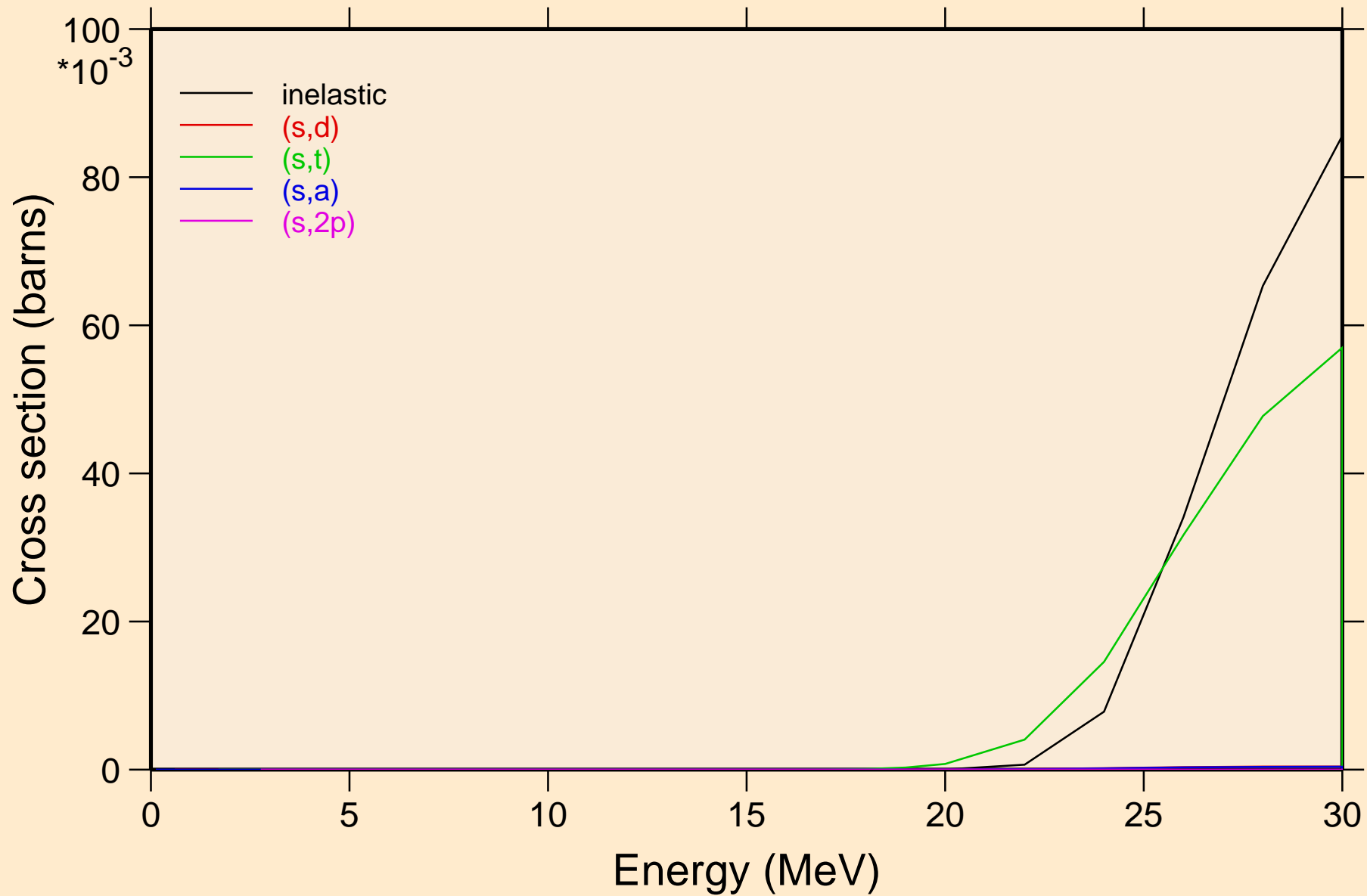

ES251 HELION ACER TENDL-2023 LIBRARY; T=0.K
angular distribution for elastic

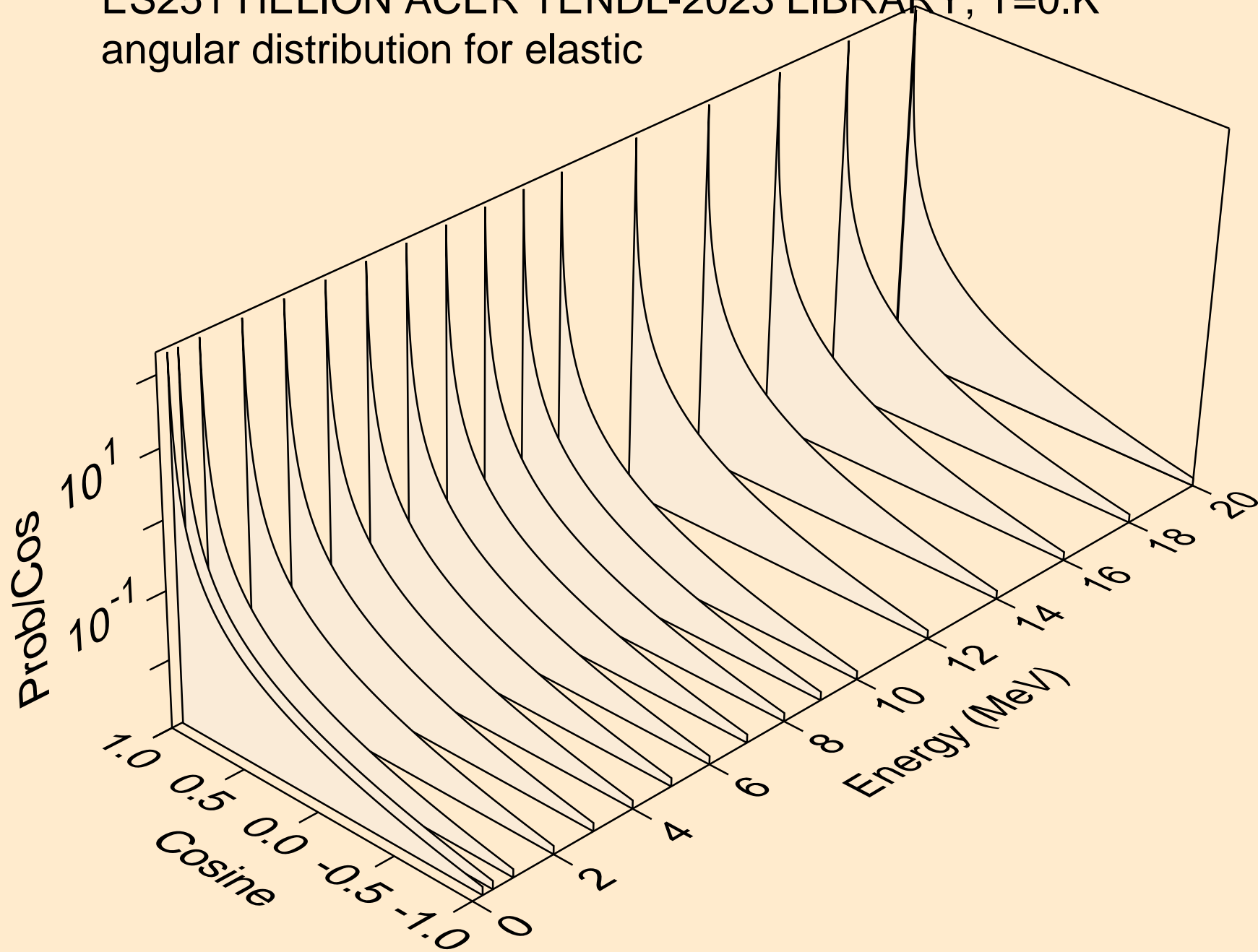

ES251 HELION ACER TENDL-2023 LIBRARY; T=0.K
angular distribution for elastic

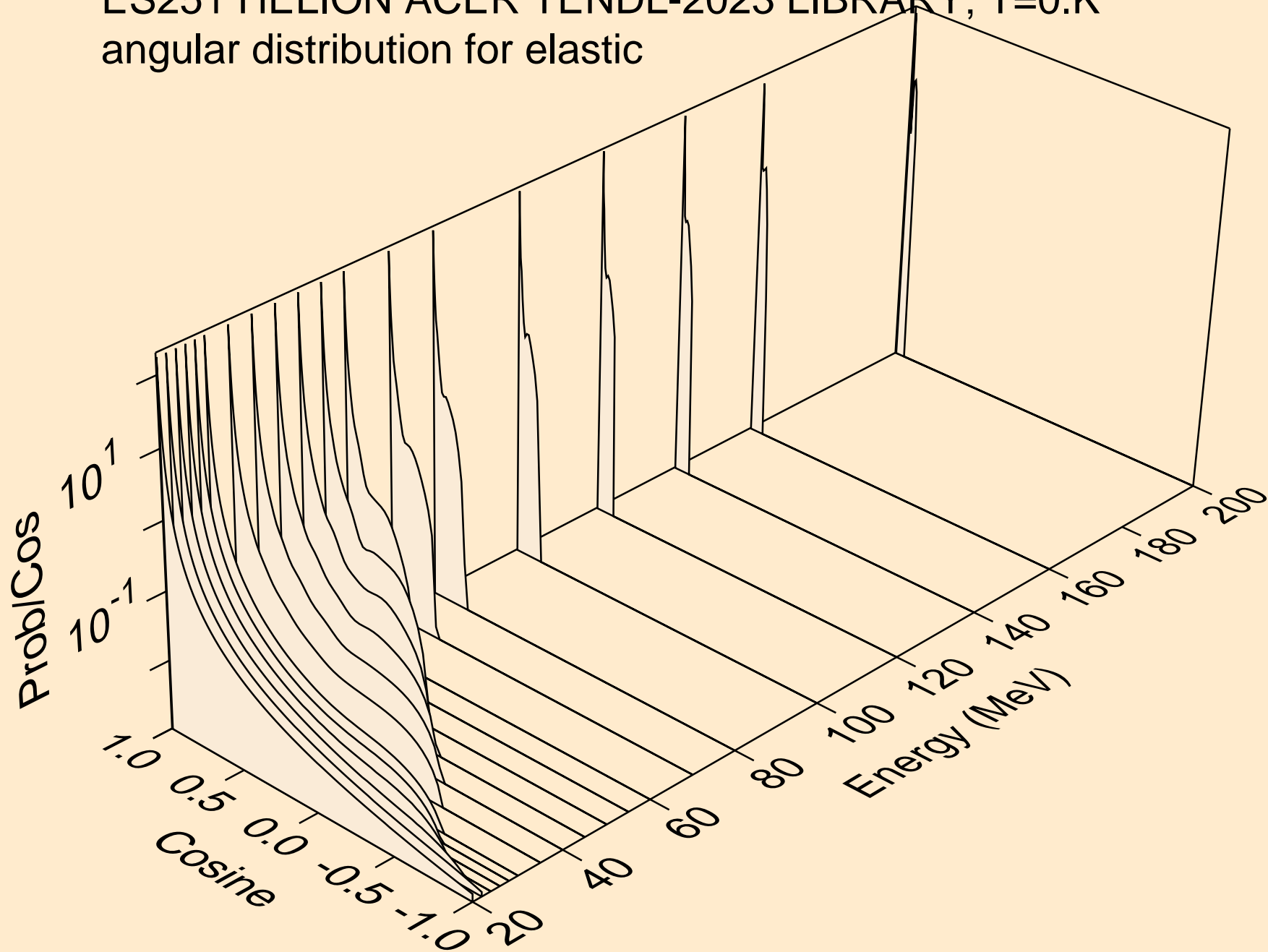

ES251 HELION ACER TENDL-2023 LIBRARY; T=0.K
He-3 emission for (s,x)

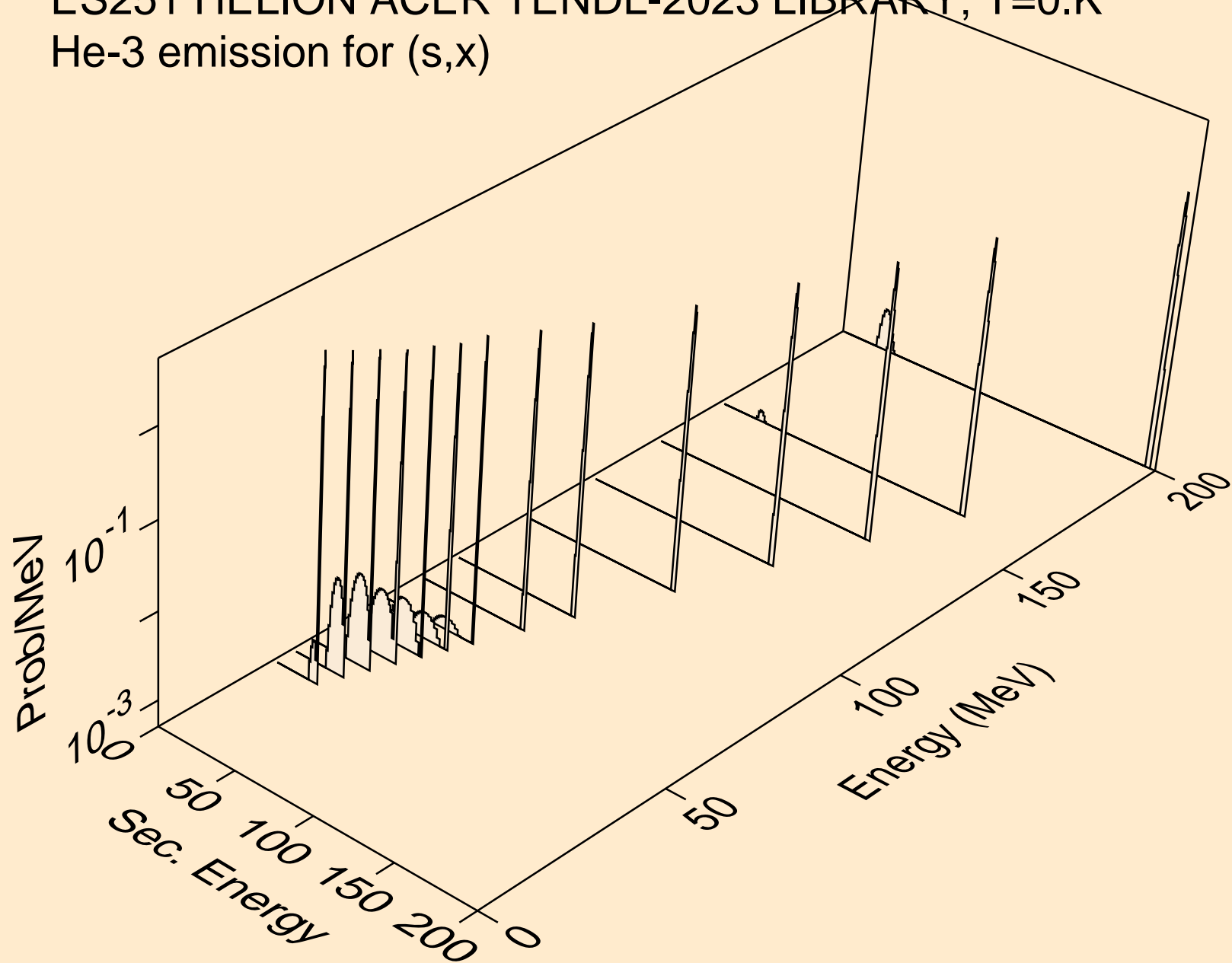

ES251 HELION ACER TENDL-2023 LIBRARY; T=0.K
He-3 emission for (s,n*)he3

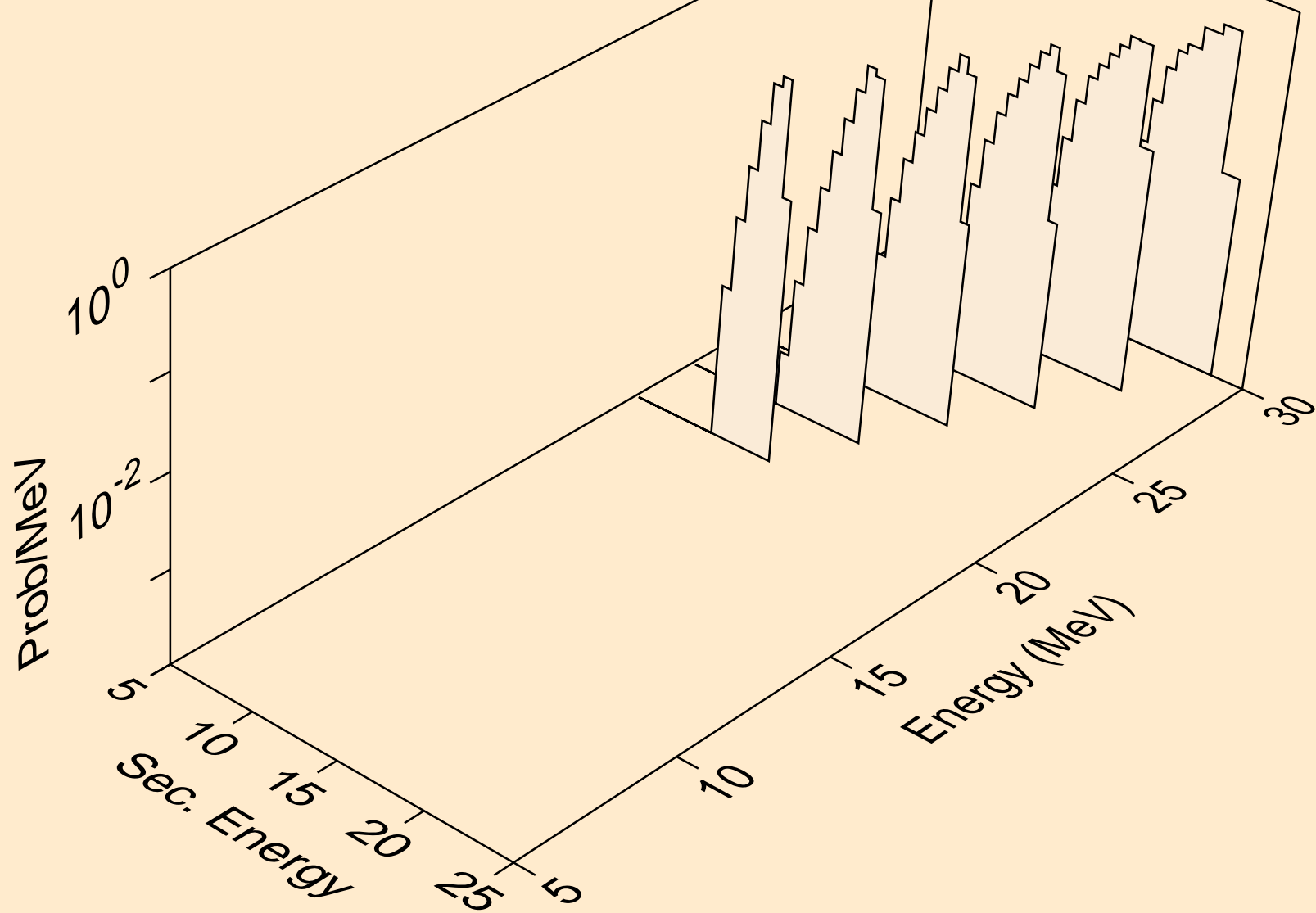

ES251 HELION ACER TENDL-2023 LIBRARY; T=0.K
He-3 emission for inelastic

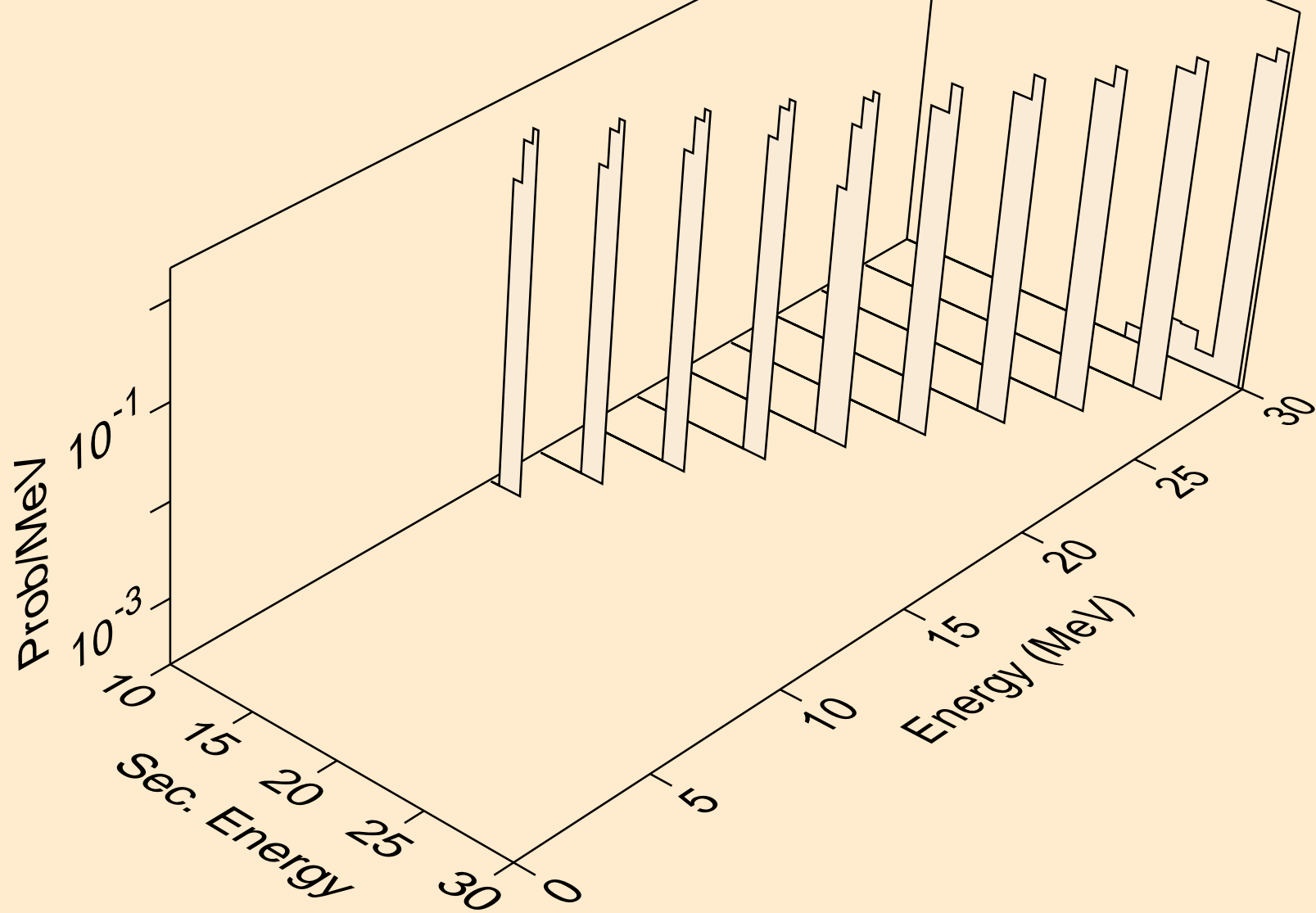

ES251 HELION ACER TENDL-2023 LIBRARY; T=0.K
Photon emission for (z,n)

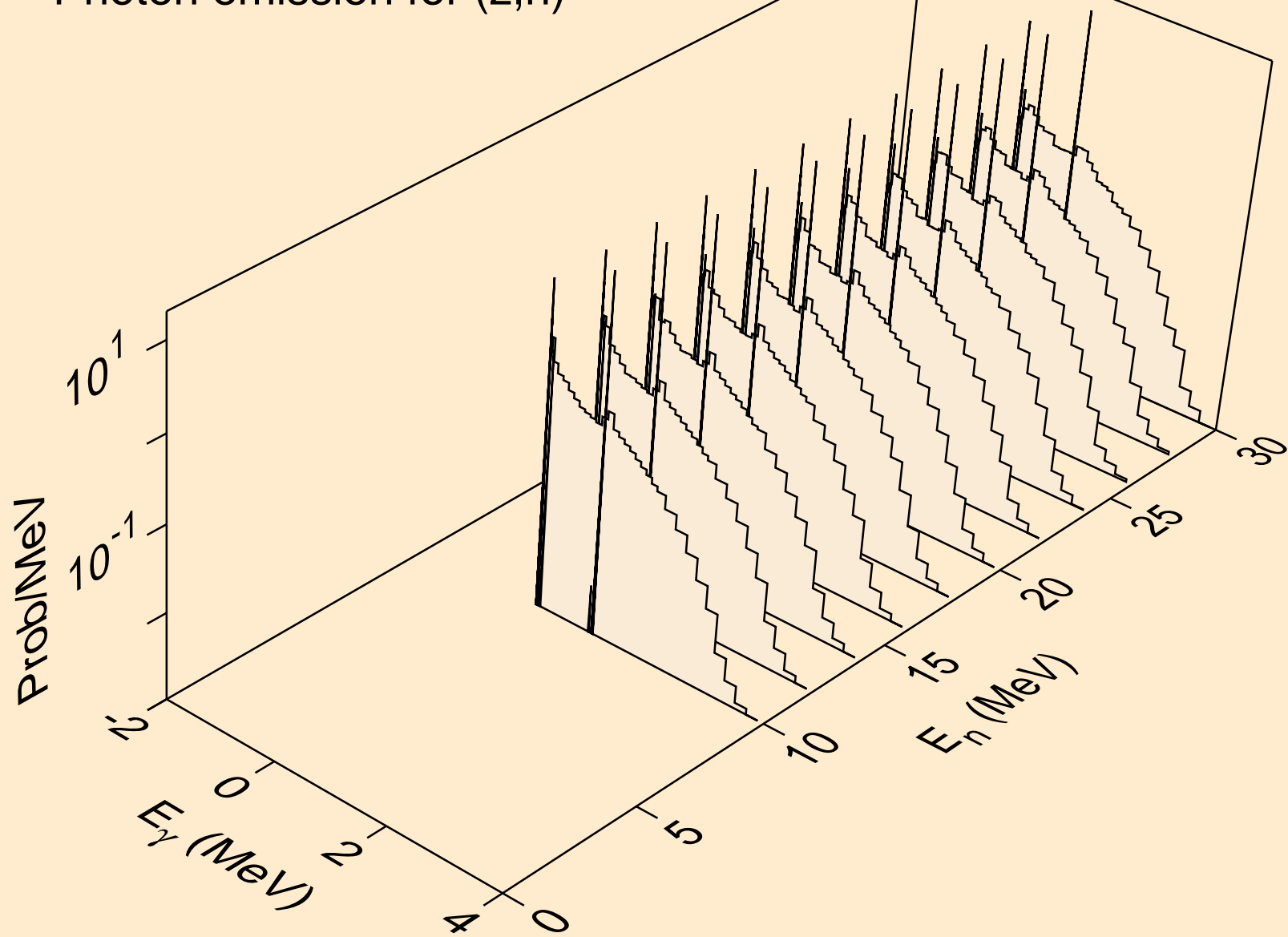

ES251 HELION ACER TENDL-2023 LIBRARY; T=0.K
Photon emission for (z,x)

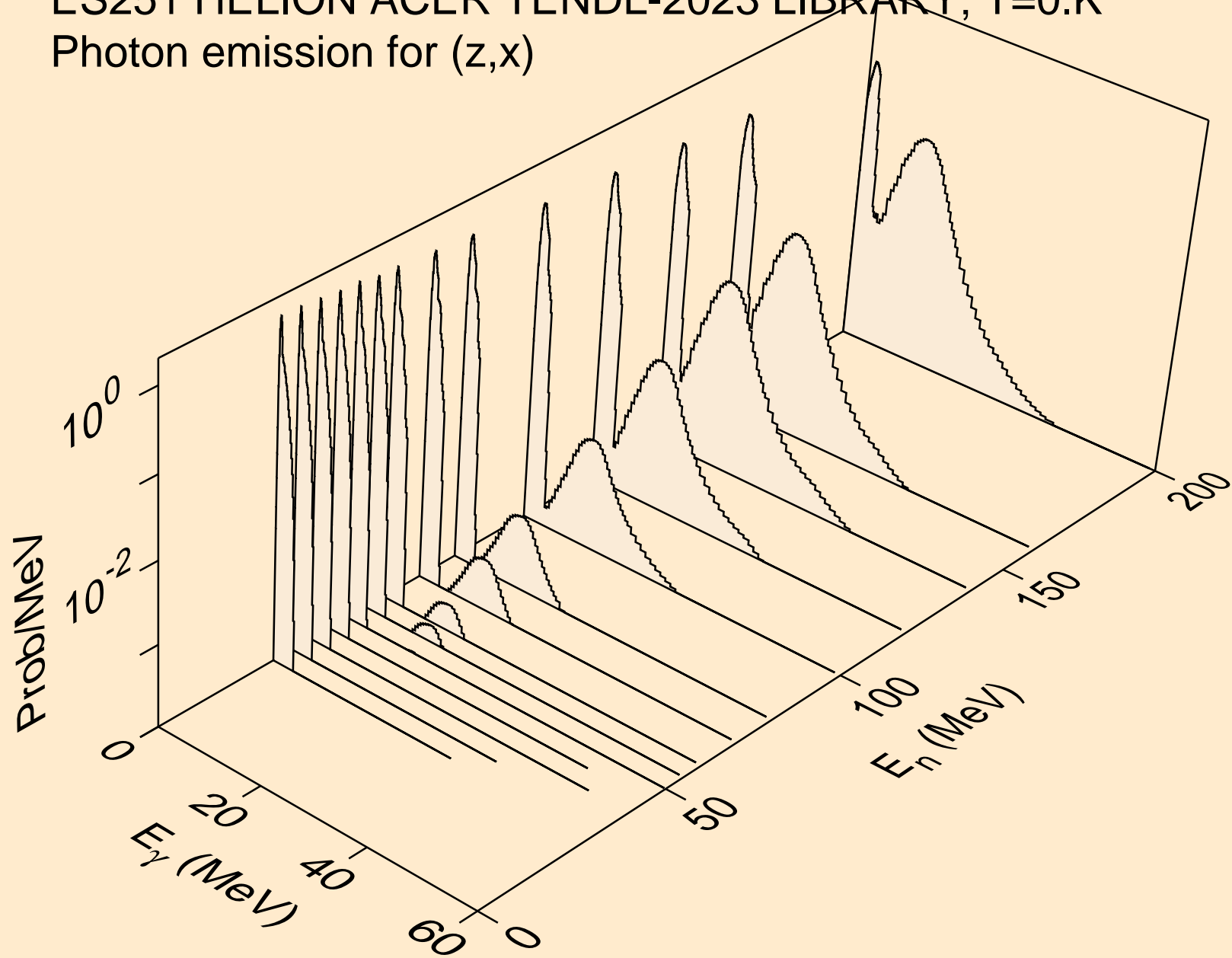

ES251 HELION ACER TENDL-2023 LIBRARY; T=0.K
Photon emission for (n,2n)

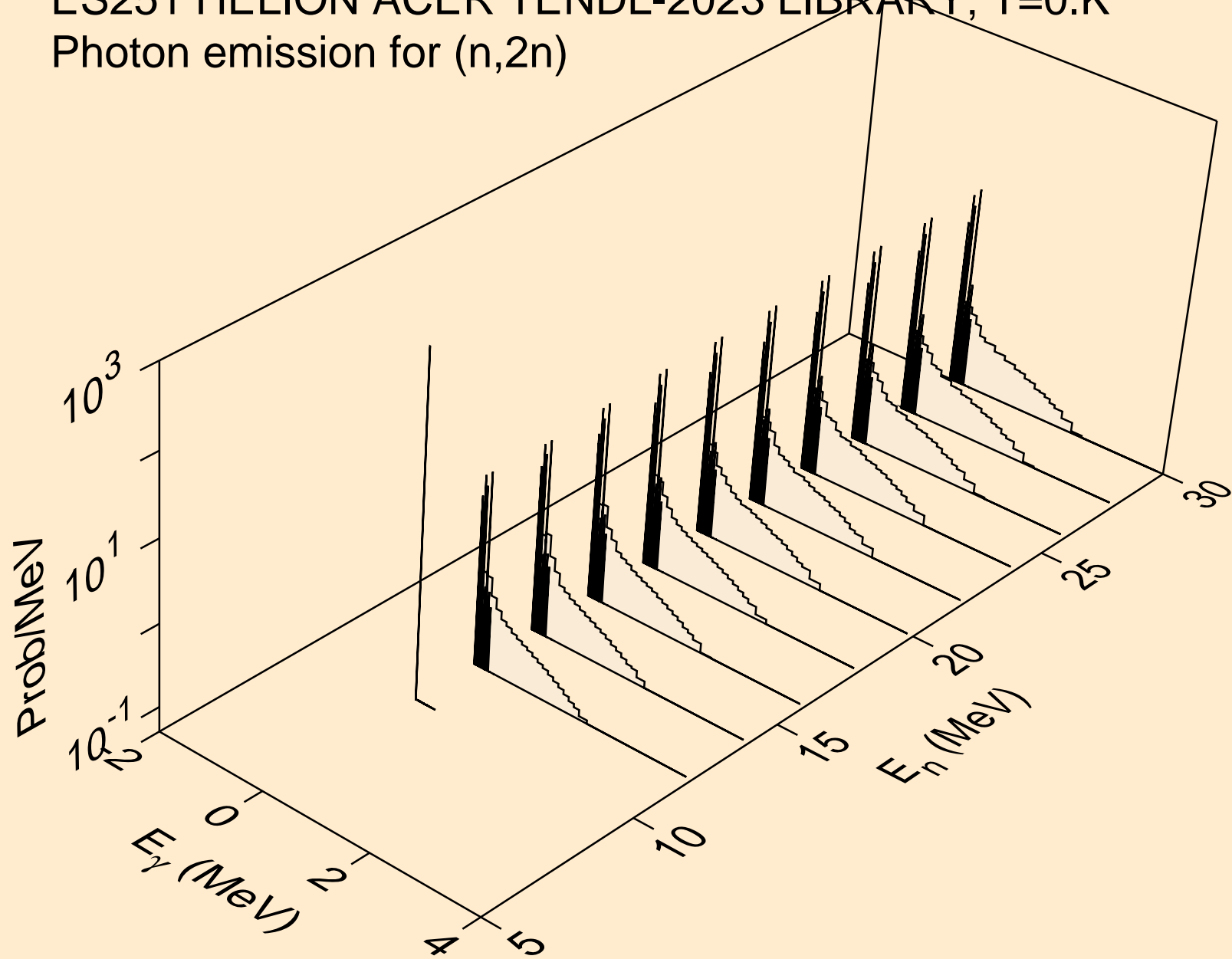

ES251 HELION ACER TENDL-2023 LIBRARY; T=0.K
Photon emission for (n,3n)

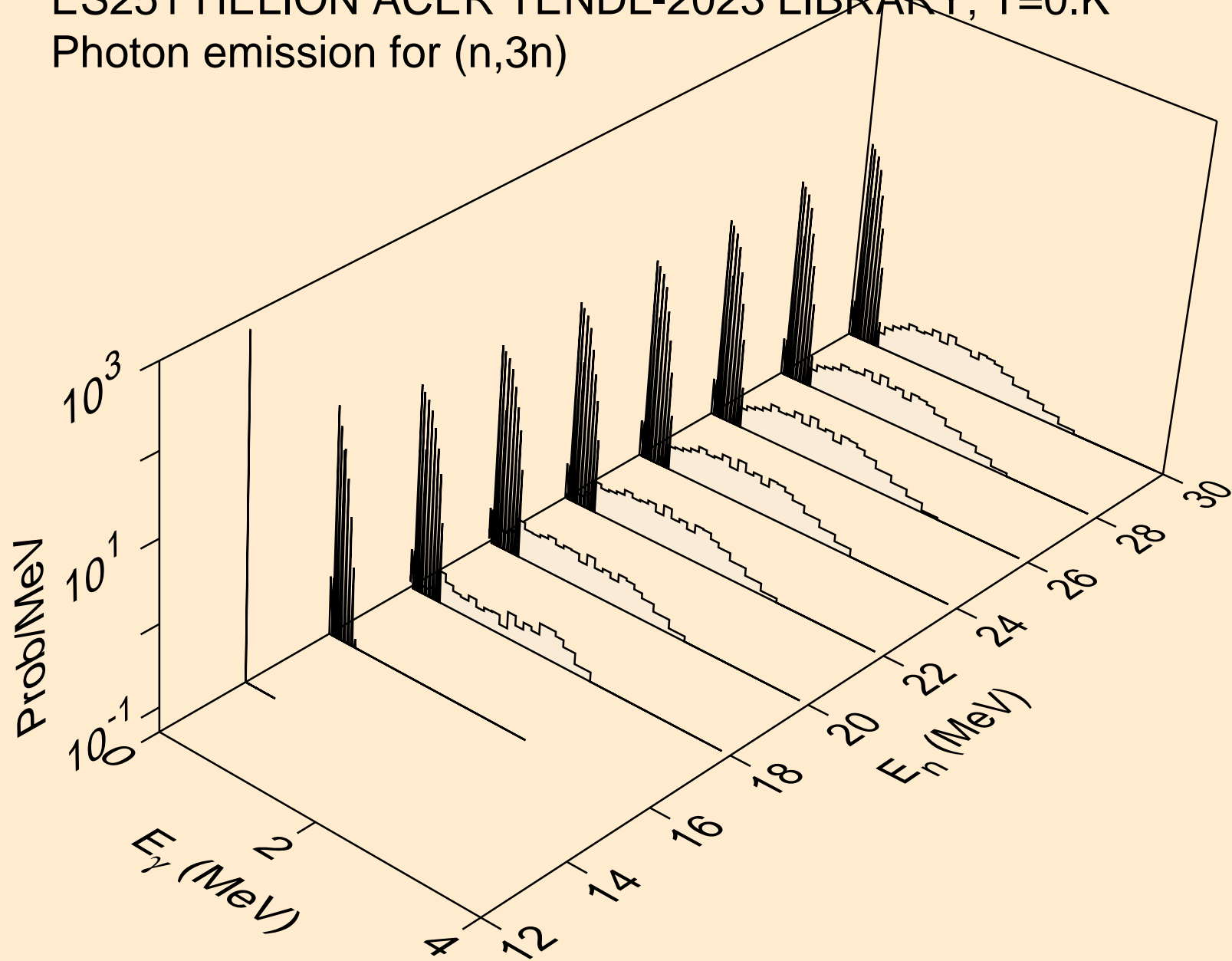

ES251 HELION ACER TENDL-2023 LIBRARY; T=0.K
Photon emission for (n,n*)a

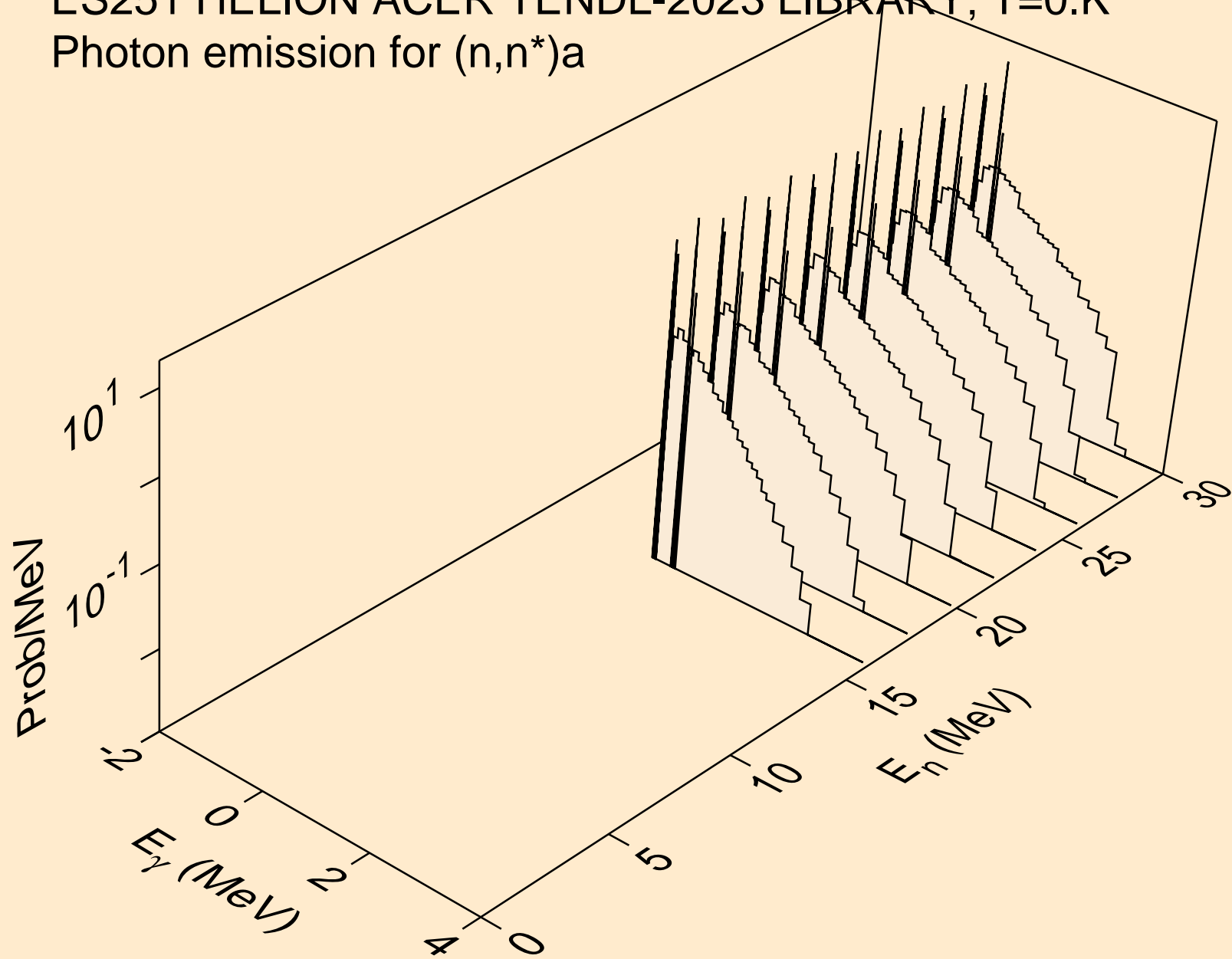

ES251 HELION ACER TENDL-2023 LIBRARY; T=0.K
Photon emission for (n,n*)p

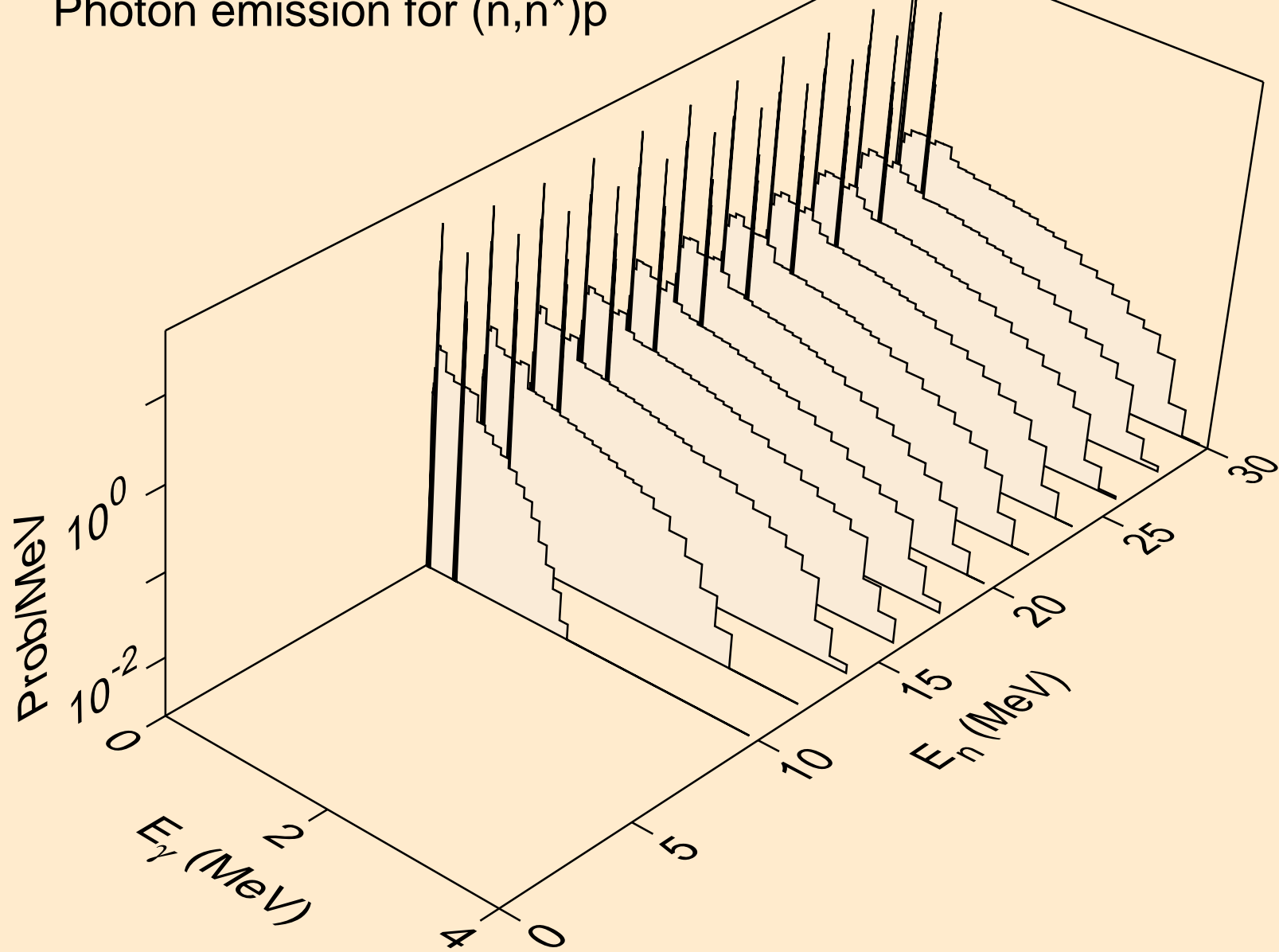

ES251 HELION ACER TENDL-2023 LIBRARY; T=0.K
Photon emission for (n,n*)d

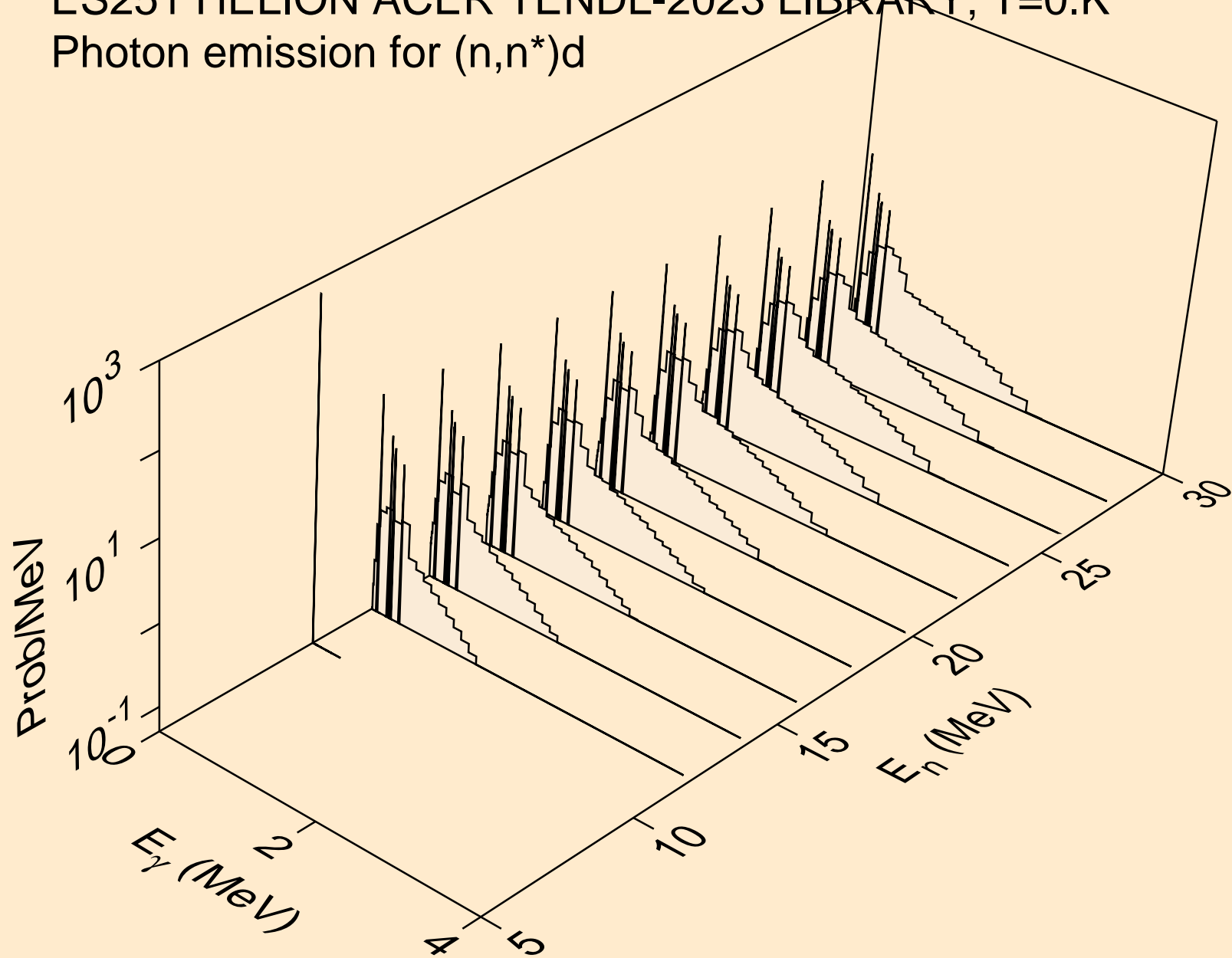

ES251 HELION ACER TENDL-2023 LIBRARY; T=0.K
Photon emission for (n,n*)t

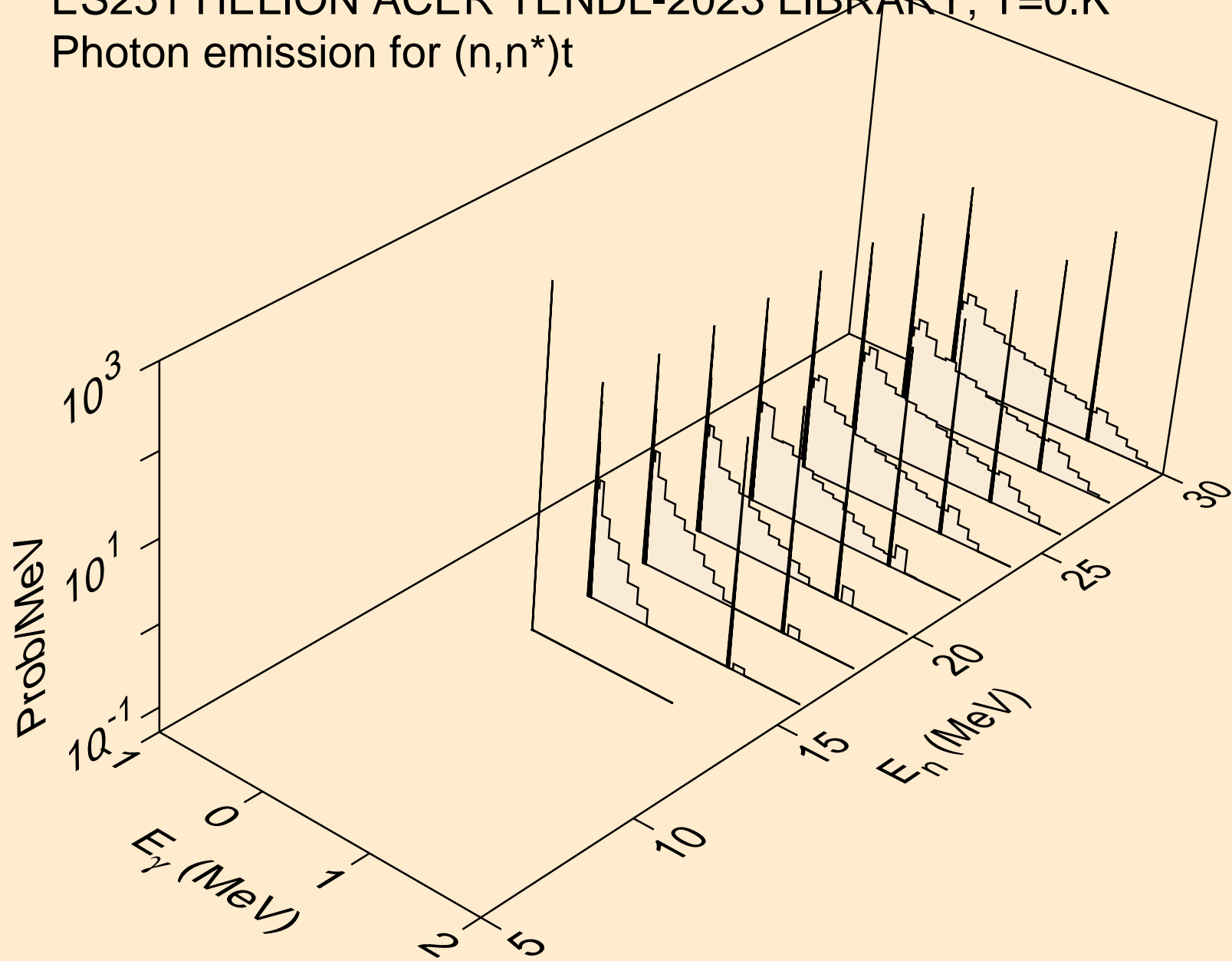

ES251 HELION ACER TENDL-2023 LIBRARY; T=0.K
Photon emission for (n,n*)he3

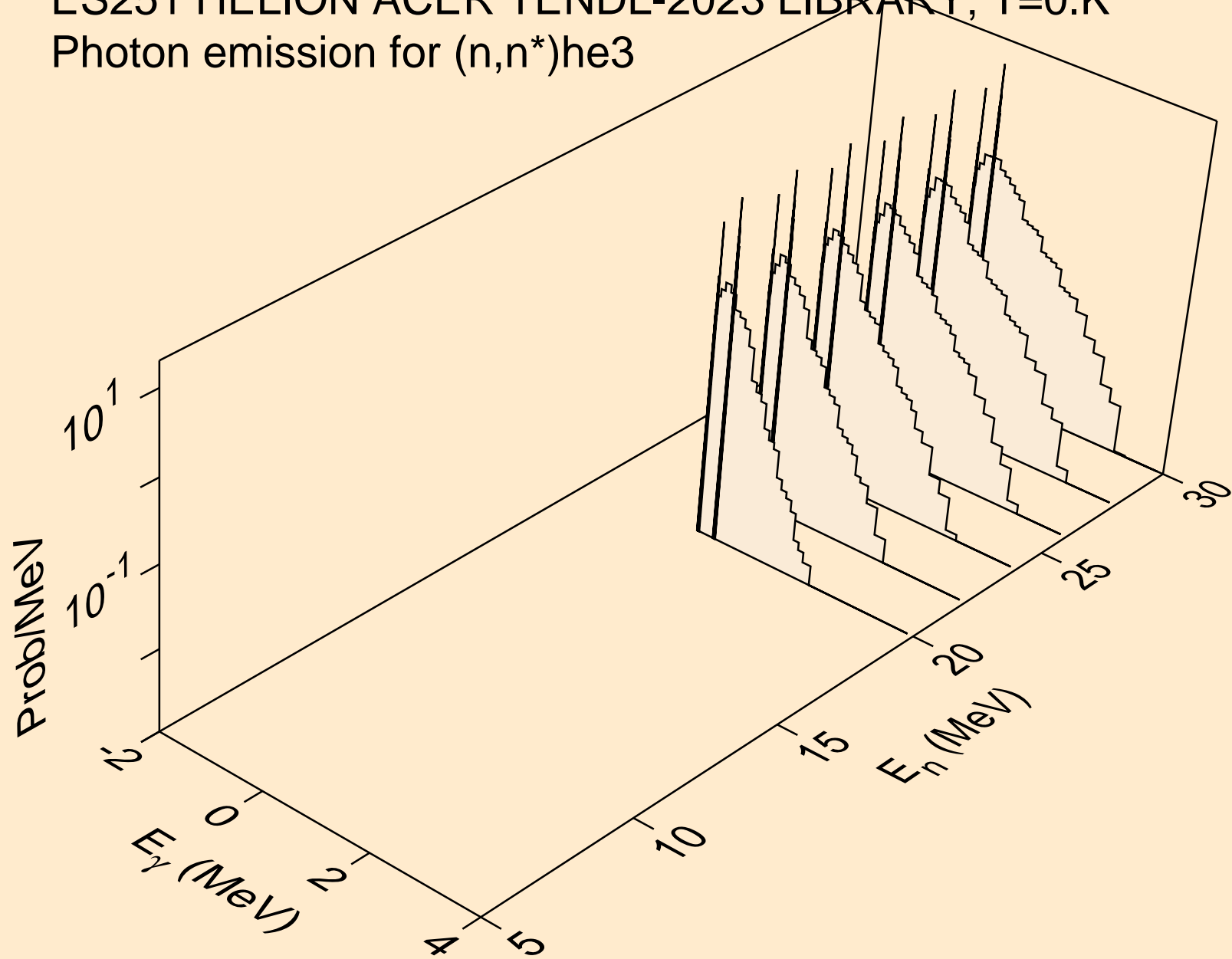

ES251 HELION ACER TENDL-2023 LIBRARY; T=0.K
Photon emission for (n,2np)

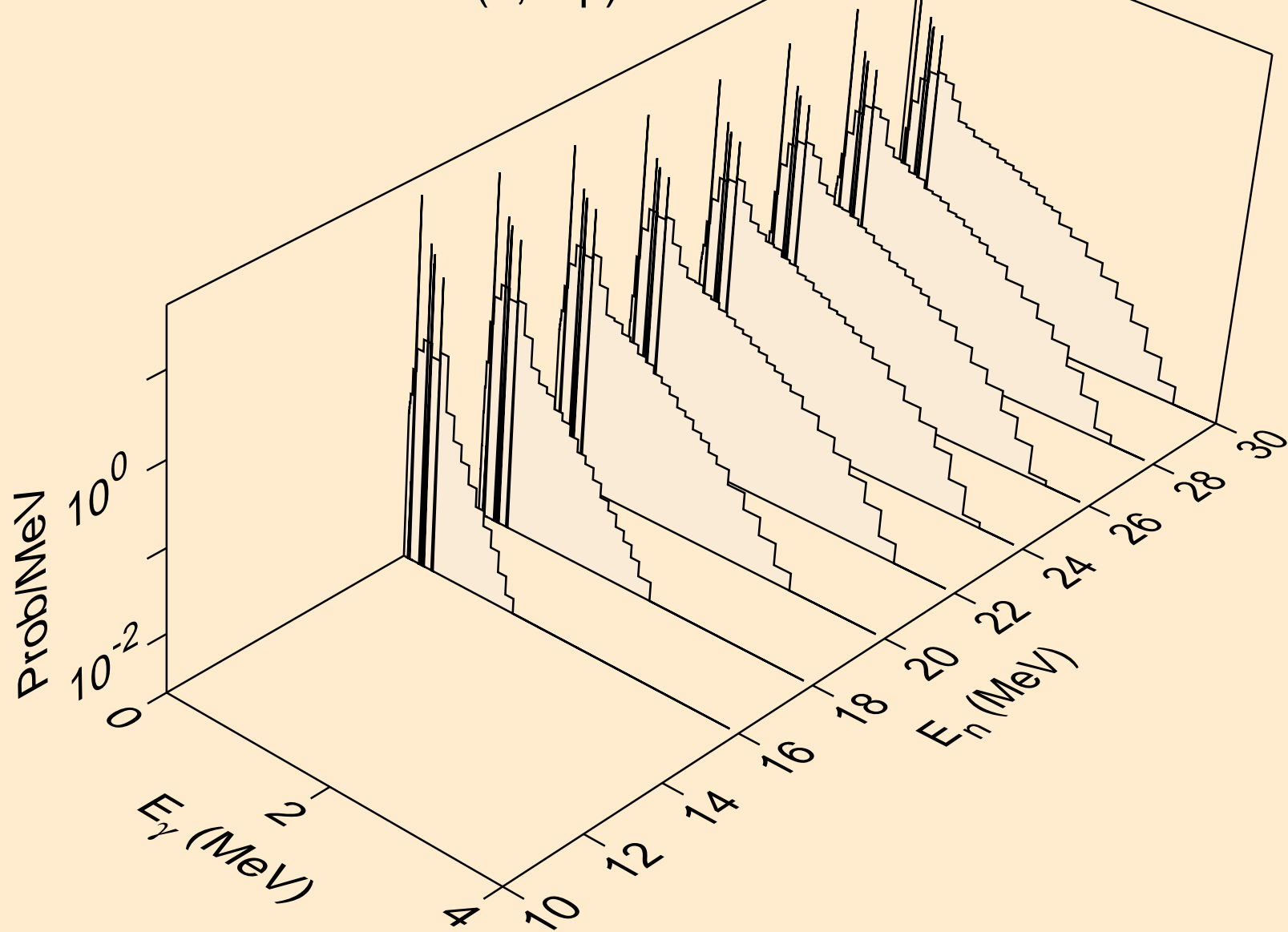

ES251 HELION ACER TENDL-2023 LIBRARY; T=0.K
Photon emission for (n,p)

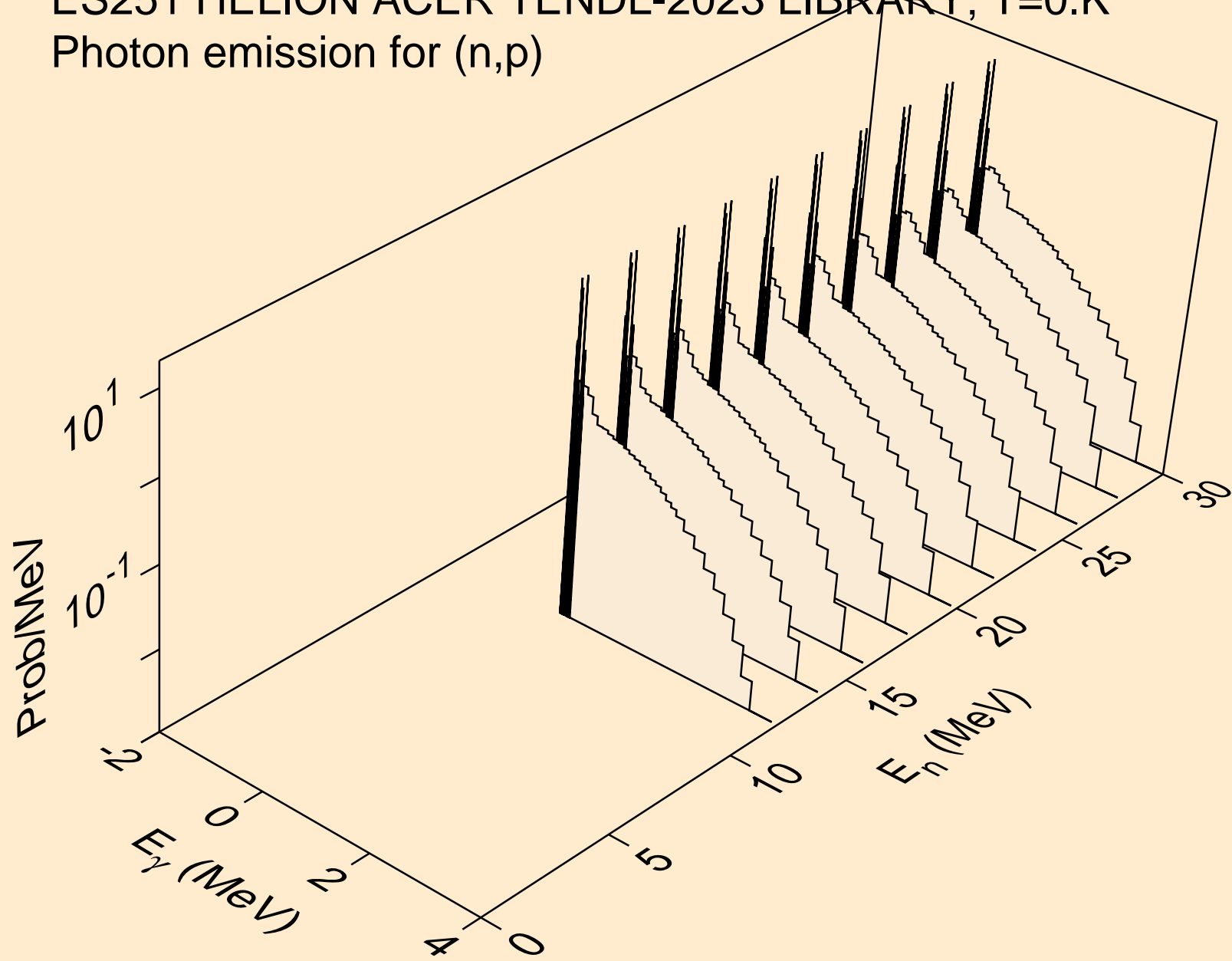

ES251 HELION ACER TENDL-2023 LIBRARY; T=0.K
Photon emission for (n,d)

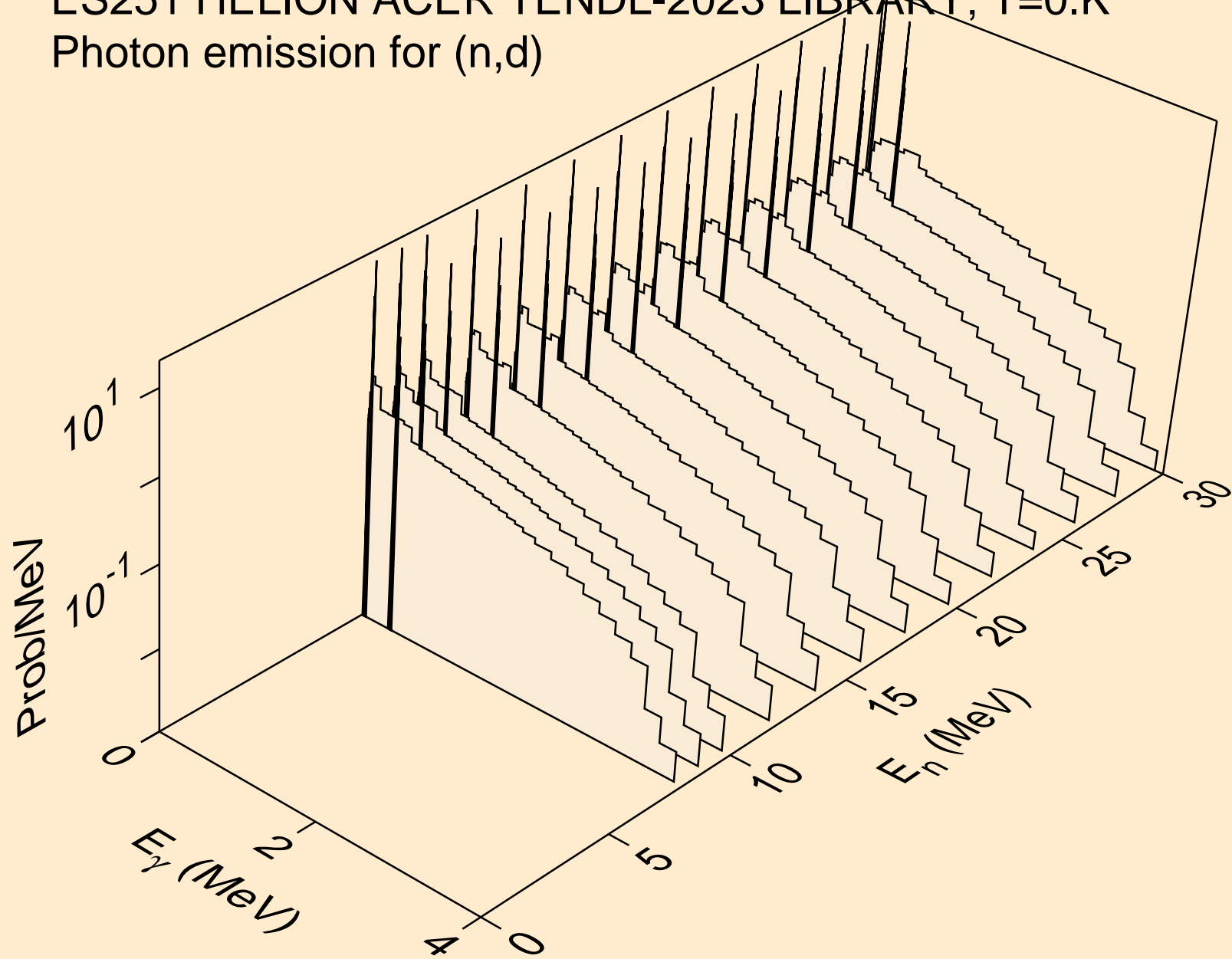

ES251 HELION ACER TENDL-2023 LIBRARY; T=0.K
Photon emission for (n,t)

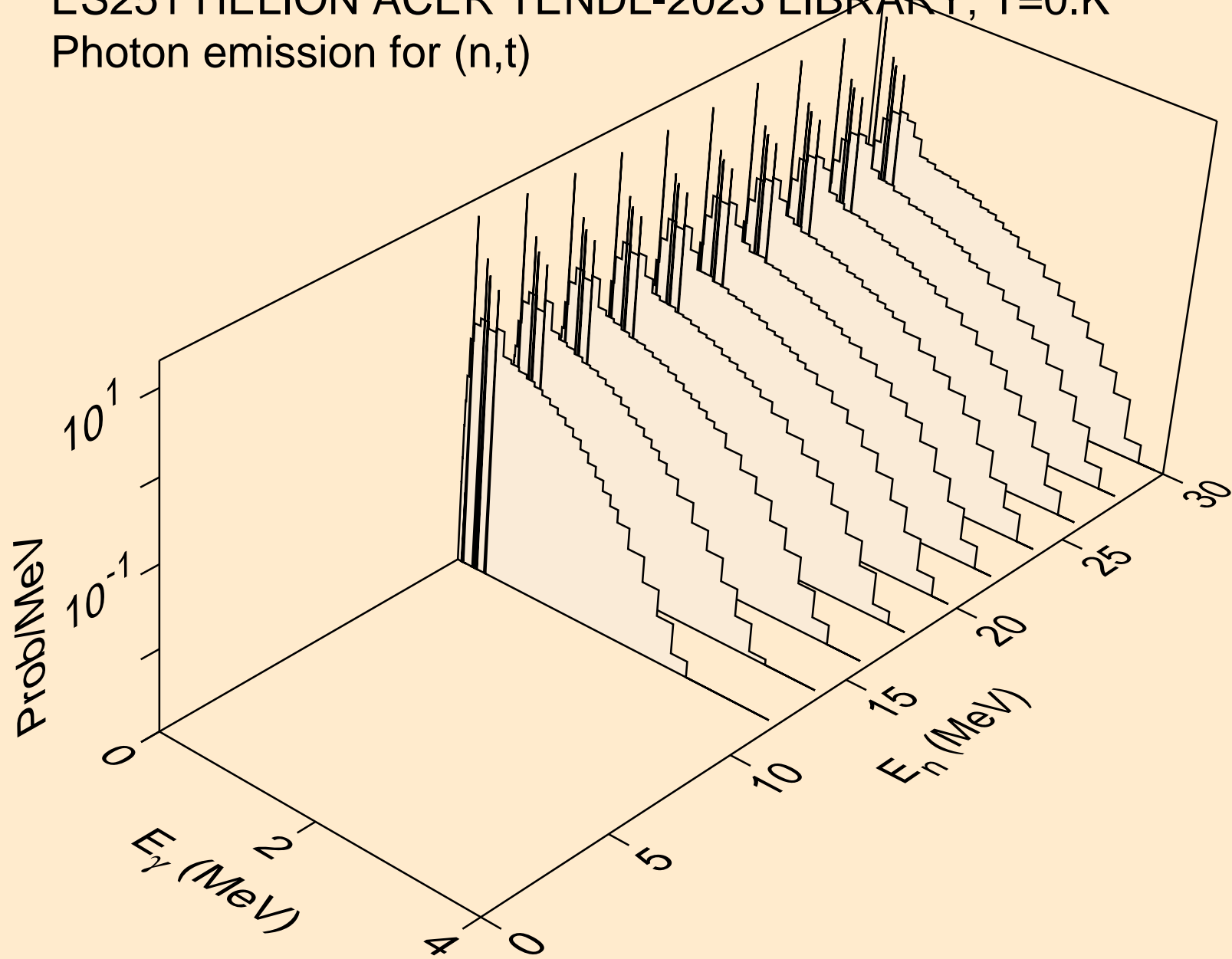

ES251 HELION ACER TENDL-2023 LIBRARY; T=0.K
Photon emission for inelastic

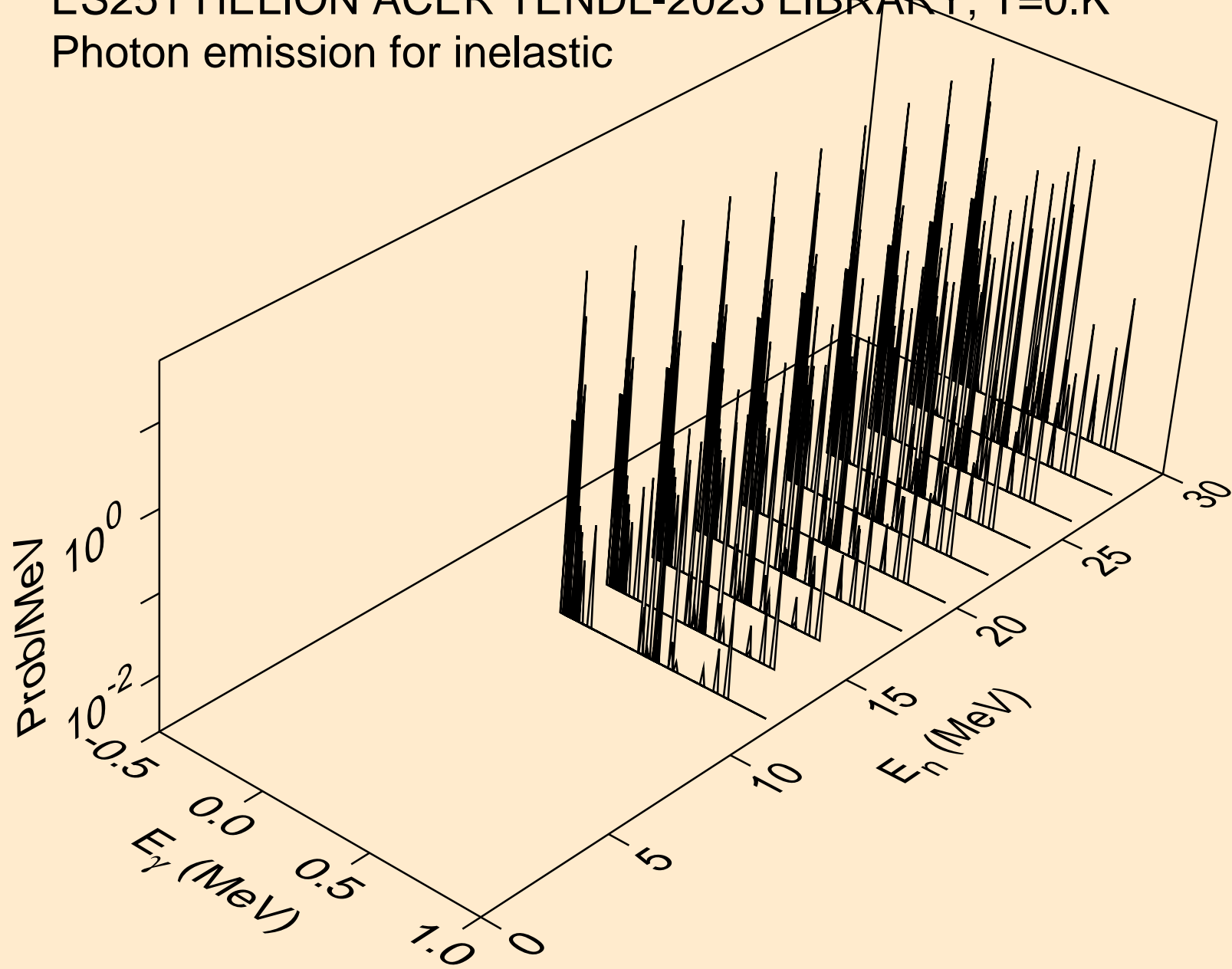

ES251 HELION ACER TENDL-2023 LIBRARY; T=0.K
Photon emission for (n,a)

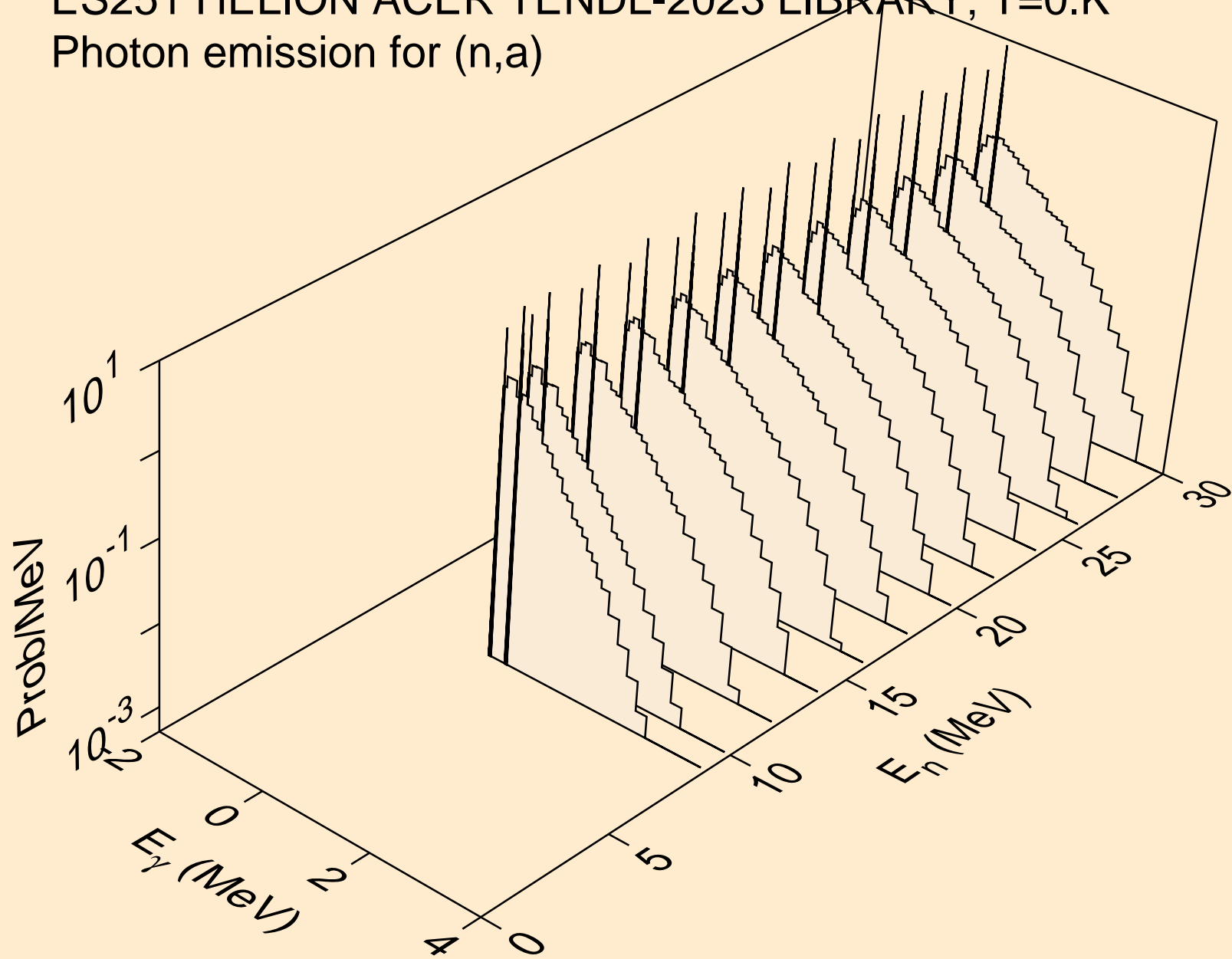

ES251 HELION ACER TENDL-2023 LIBRARY; T=0.K
Photon emission for (n,2p)

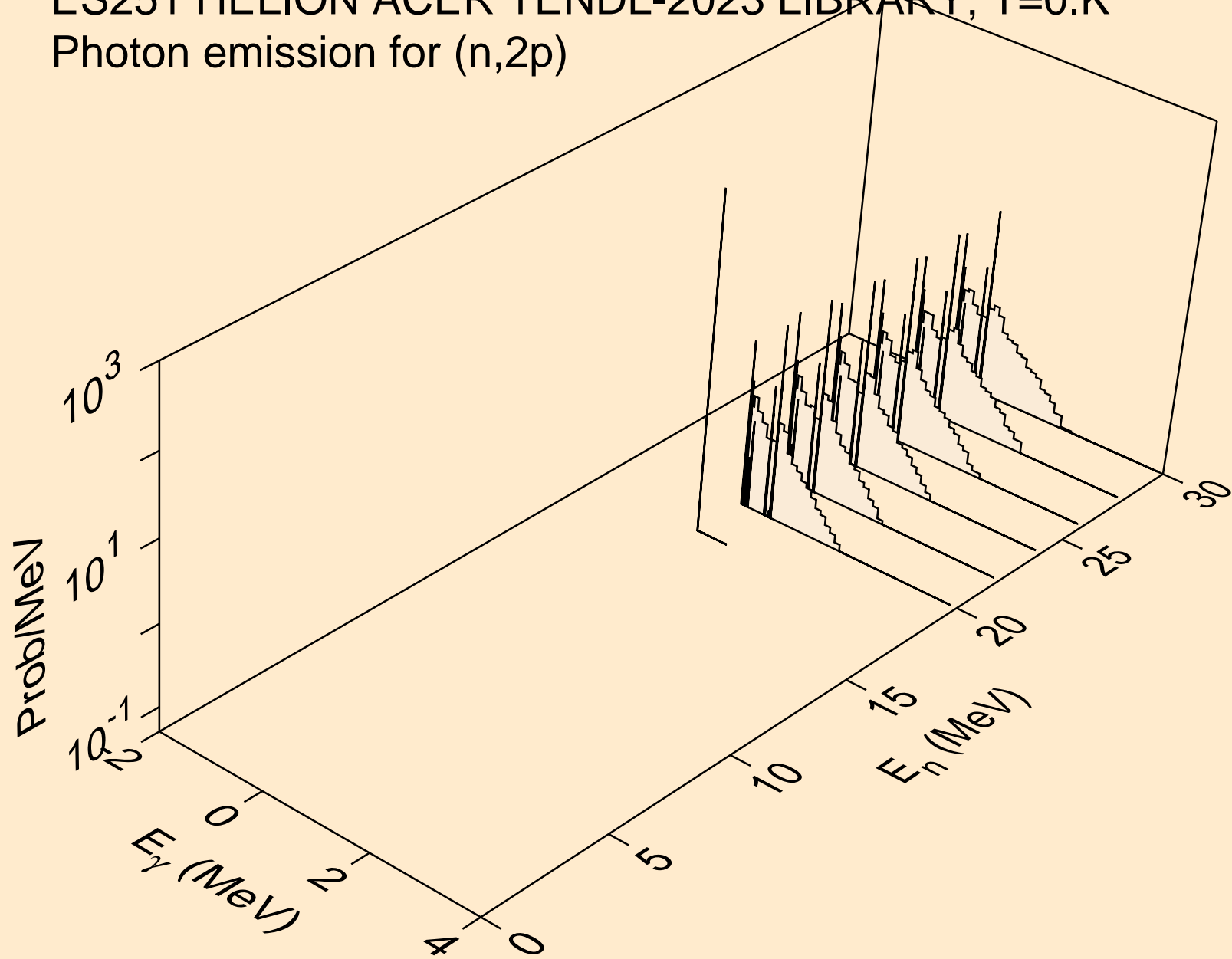

ES251 HELION ACER TENDL-2023 LIBRARY; T=0.K
Particle heating contributions

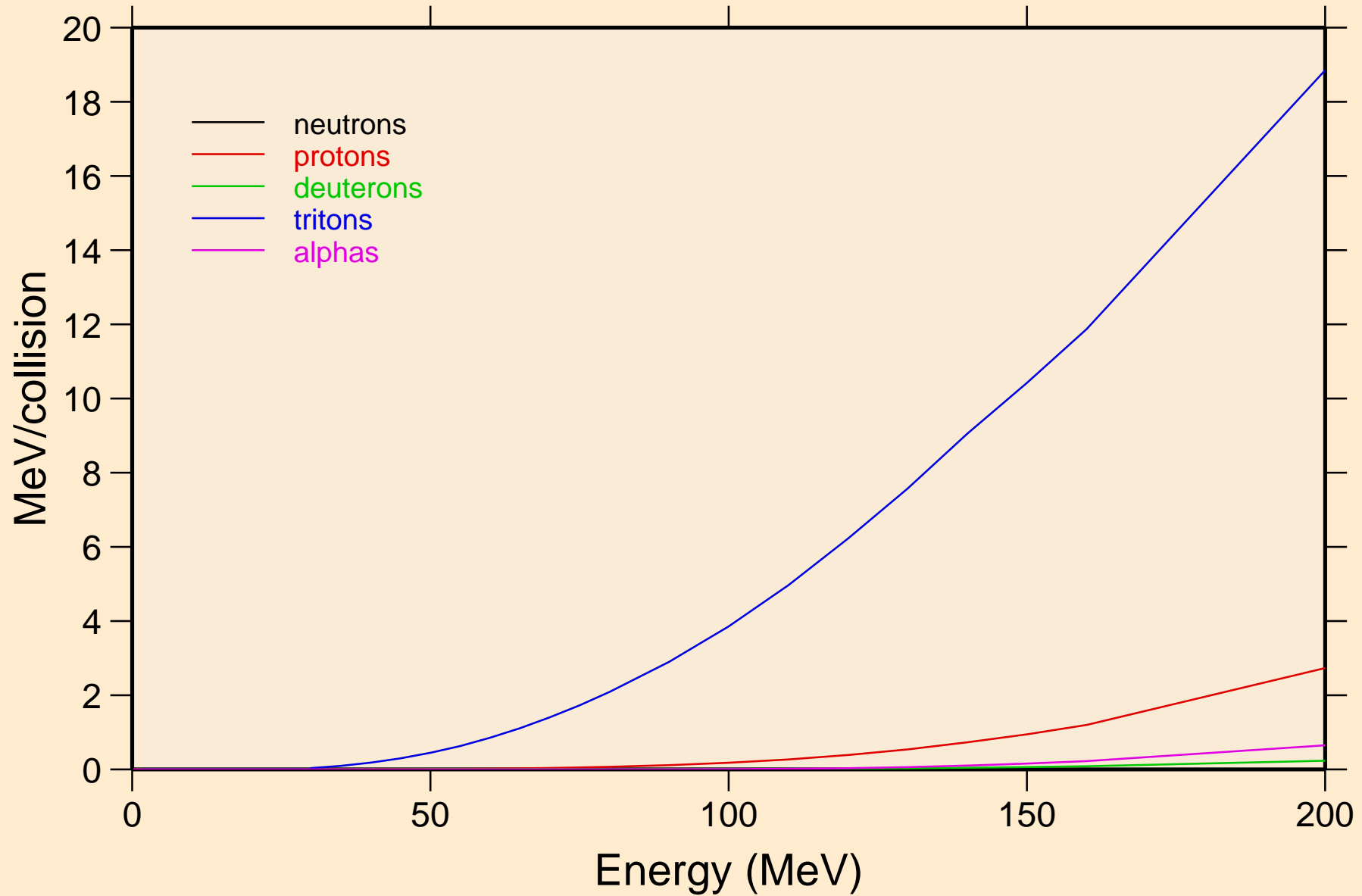

ES251 HELION ACER TENDL-2023 LIBRARY; T=0.K
Recoil Heating

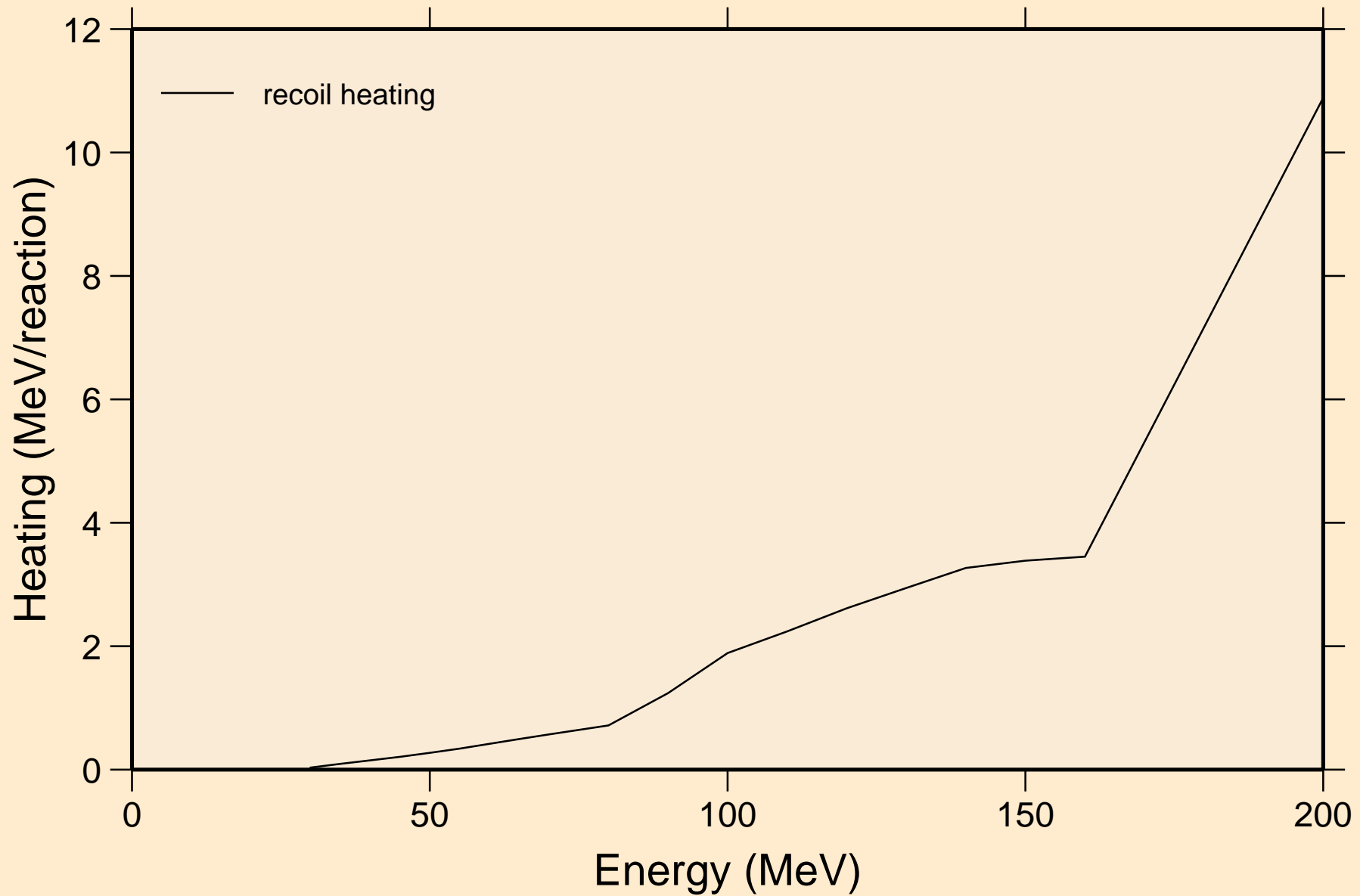

ES251 HELION ACER TENDL-2023 LIBRARY; T=0.K
Particle production cross sections

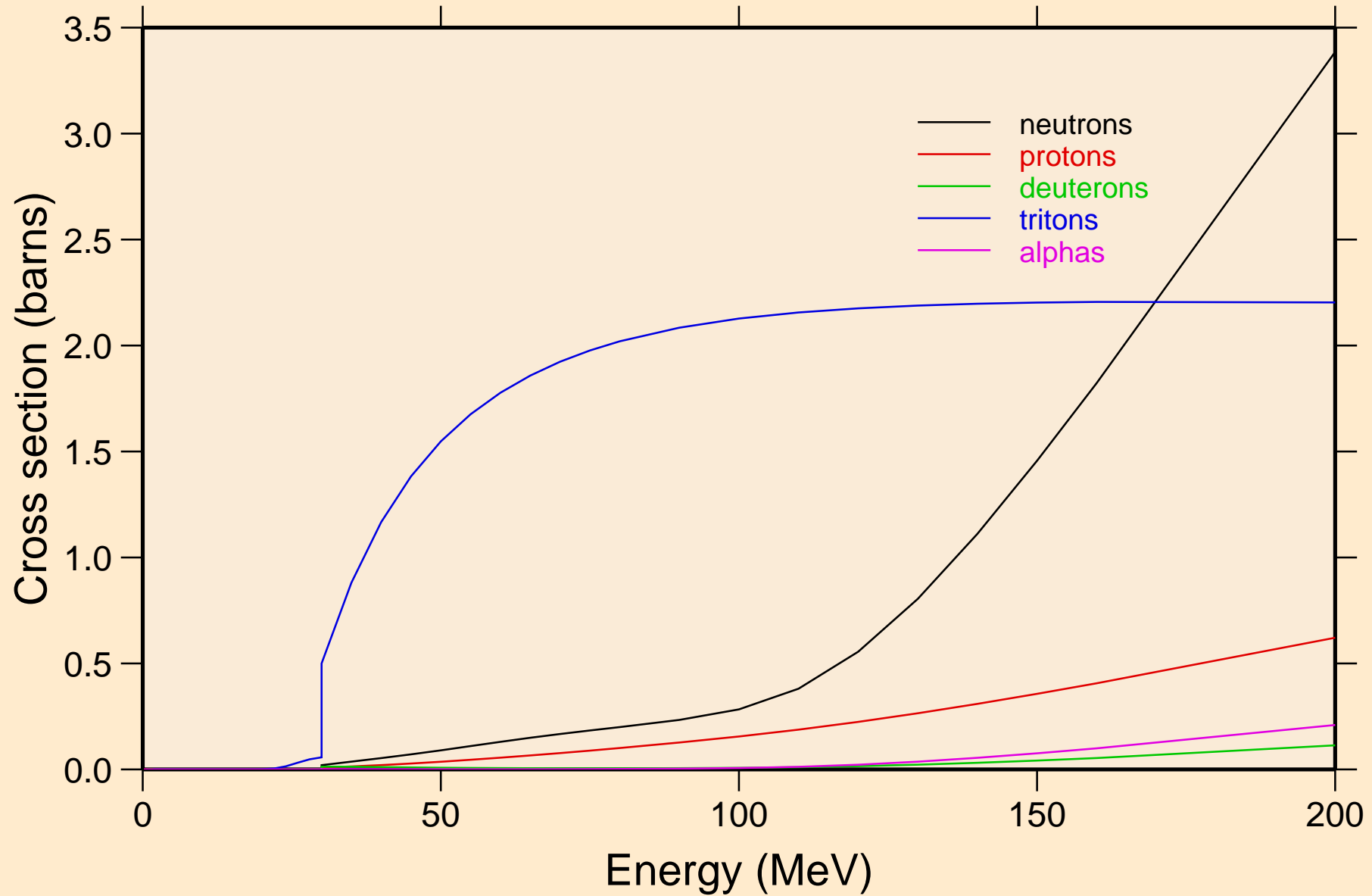

ES251 HELION ACER TENDL-2023 LIBRARY; T=0.K
neutrons from (s,n)

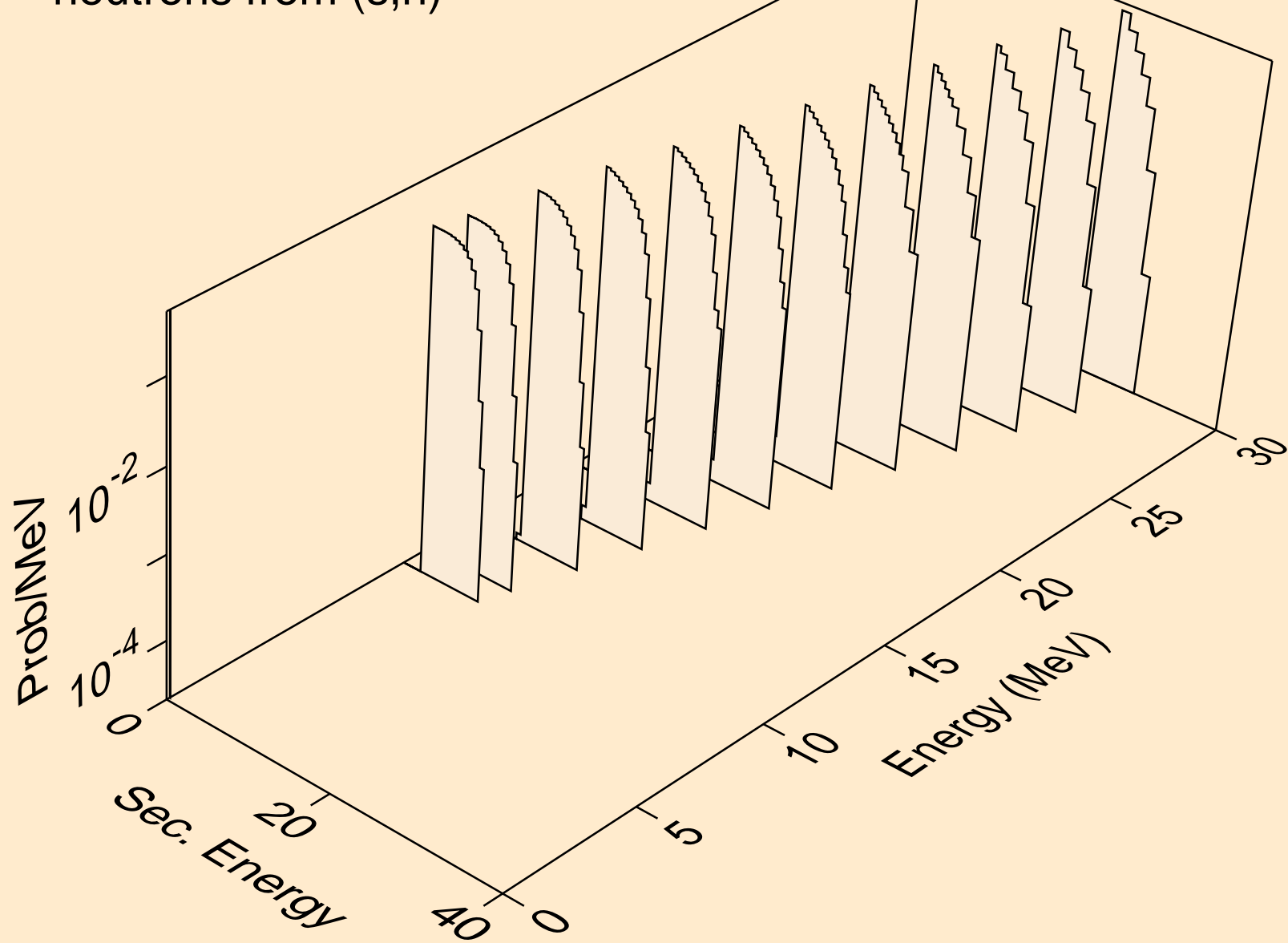

ES251 HELION ACER TENDL-2023 LIBRARY; T=0.K
neutrons from (s,x)

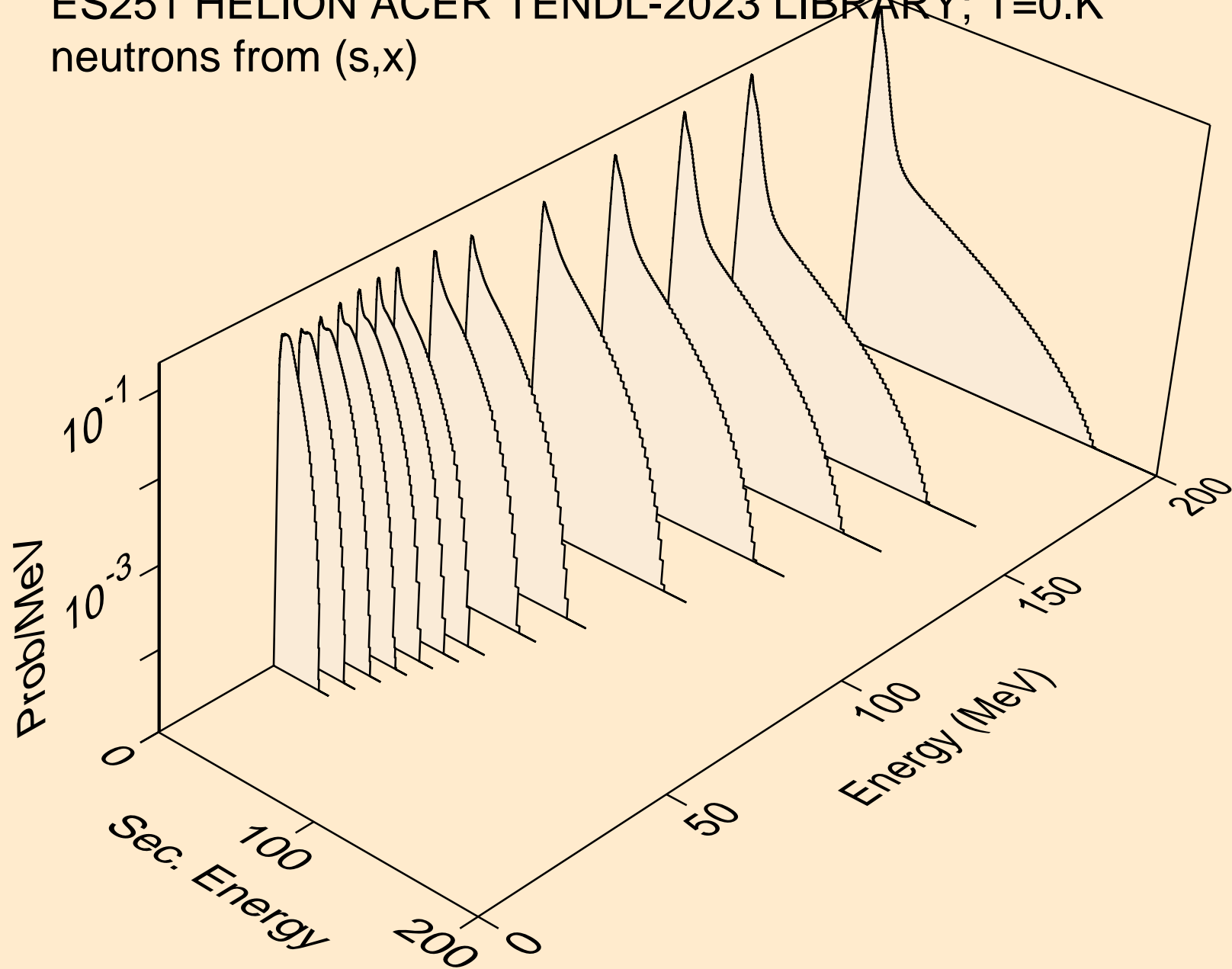

ES251 HELION ACER TENDL-2023 LIBRARY; T=0.K
neutrons from (s,2n)

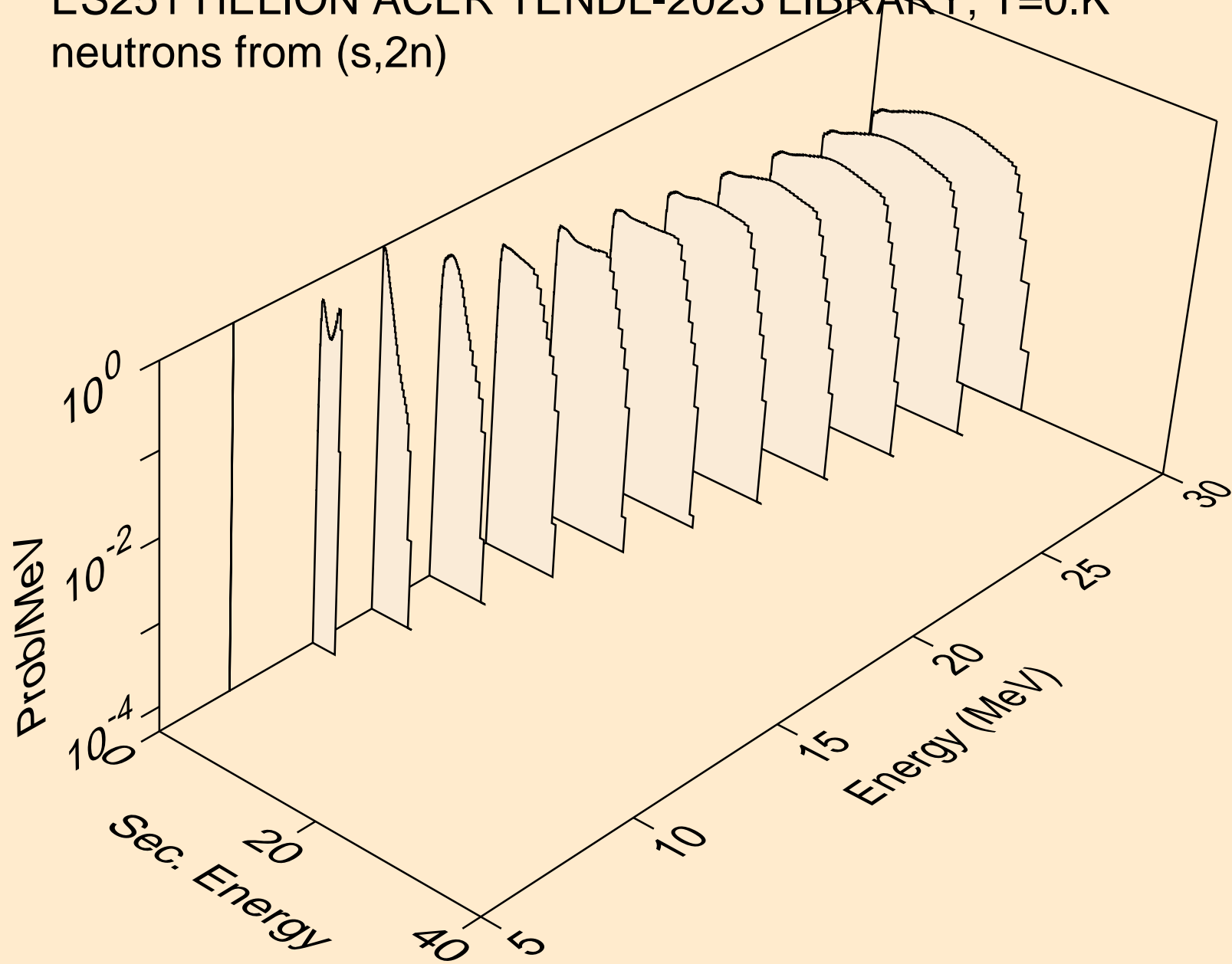

ES251 HELION ACER TENDL-2023 LIBRARY; T=0.K
neutrons from (s,3n)

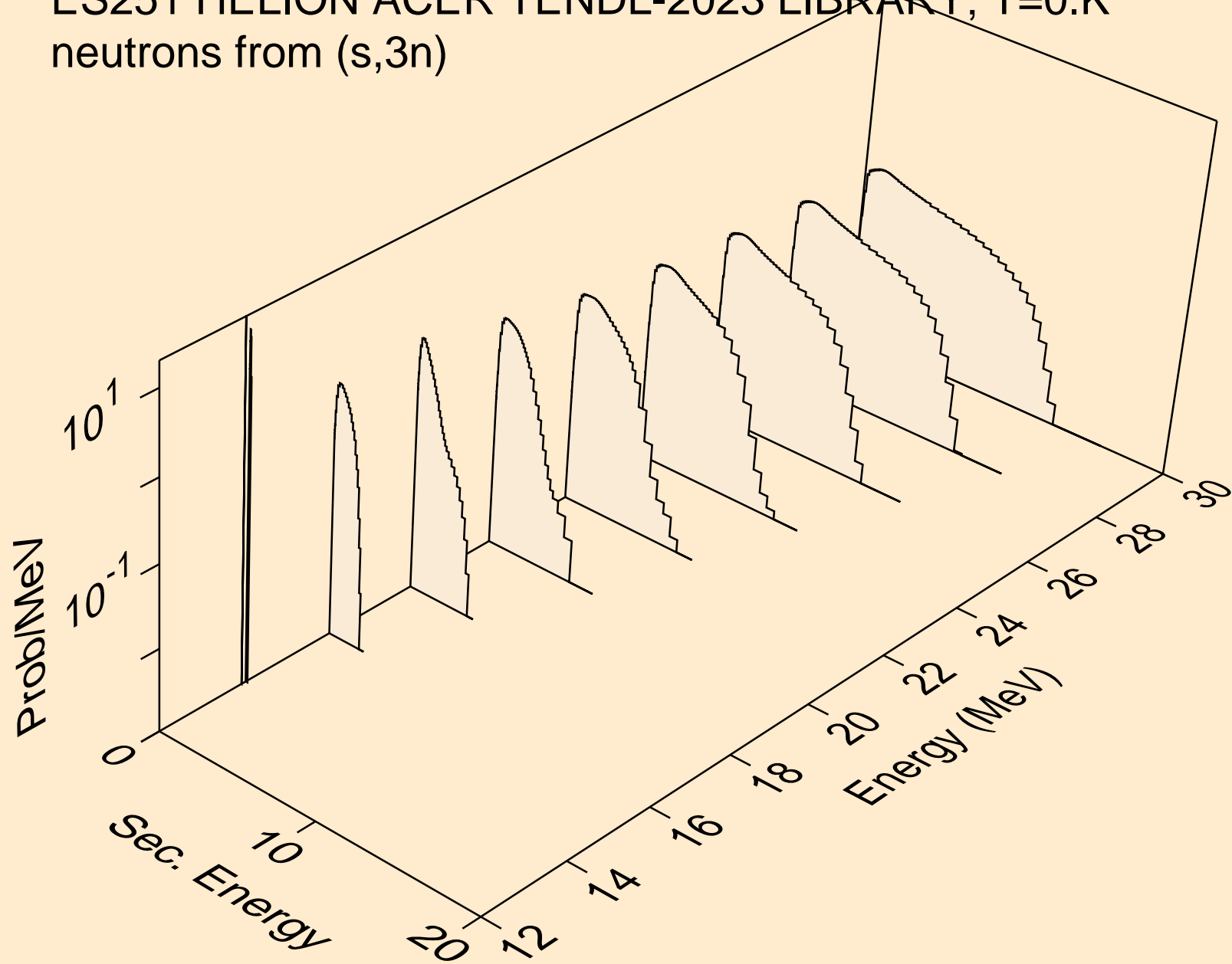

ES251 HELION ACER TENDL-2023 LIBRARY; T=0.K
neutrons from (s,n*)a

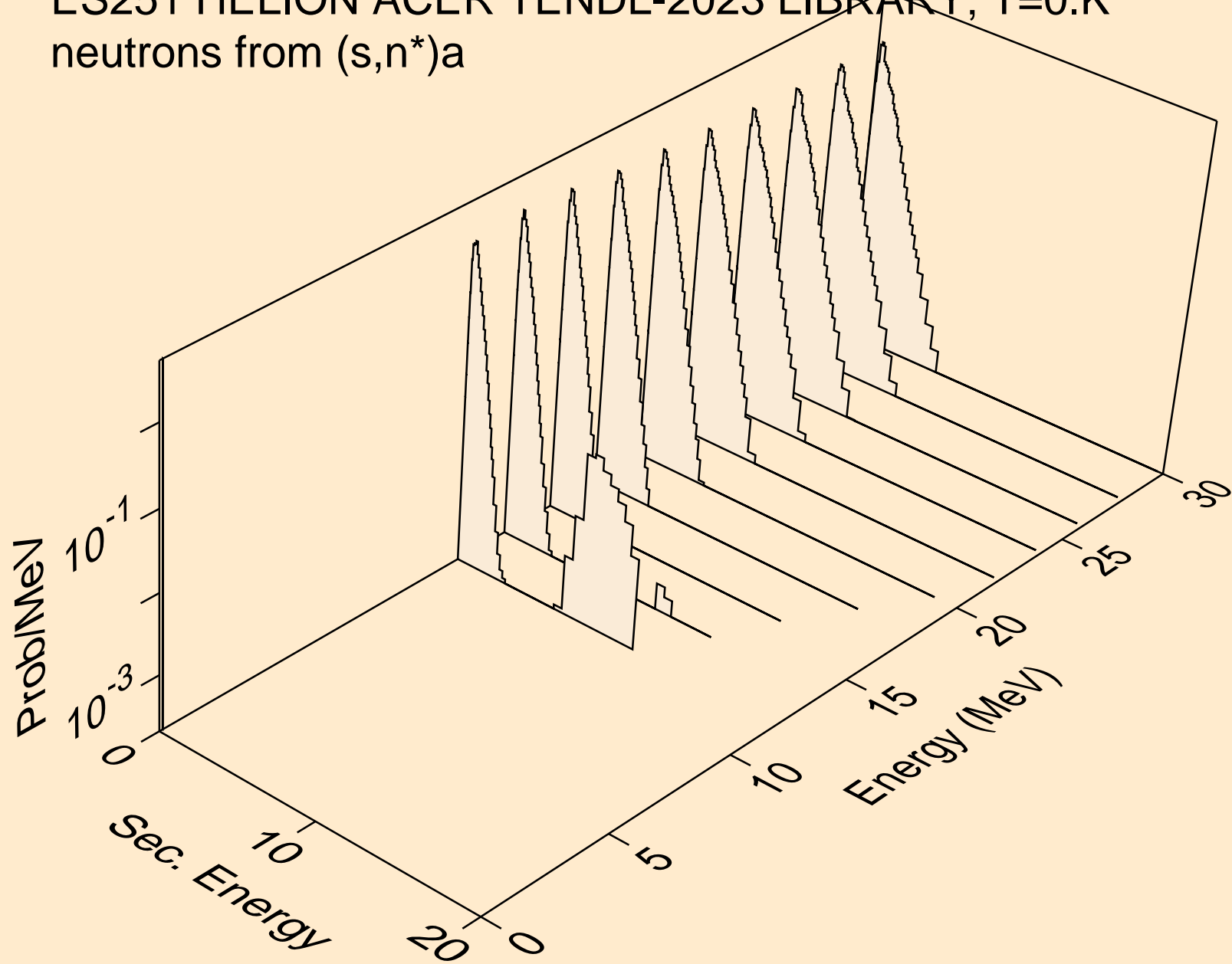

ES251 HELION ACER TENDL-2023 LIBRARY; T=0.K
neutrons from (s,n*)p

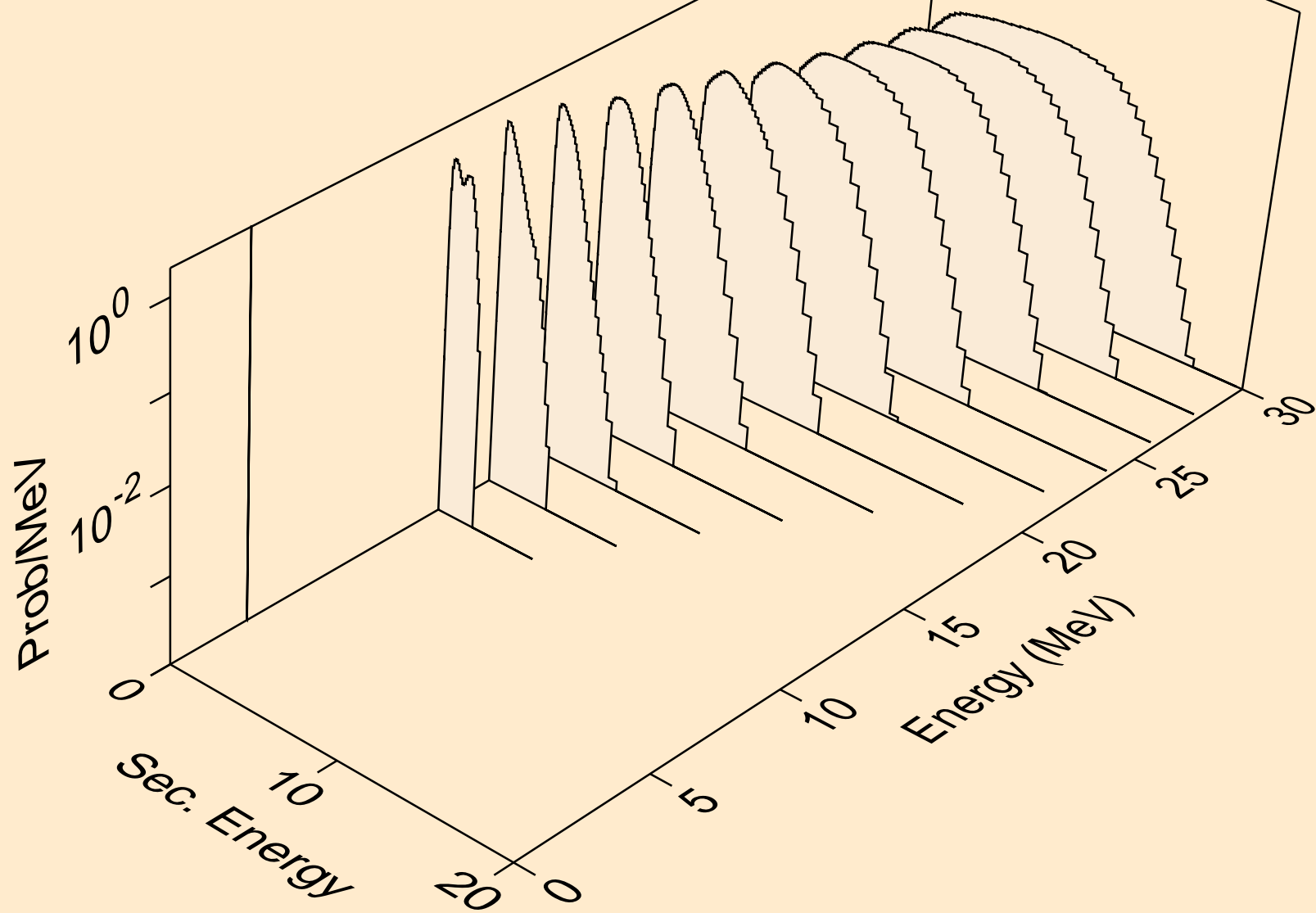

ES251 HELION ACER TENDL-2023 LIBRARY; T=0.K
neutrons from (s,n*)d

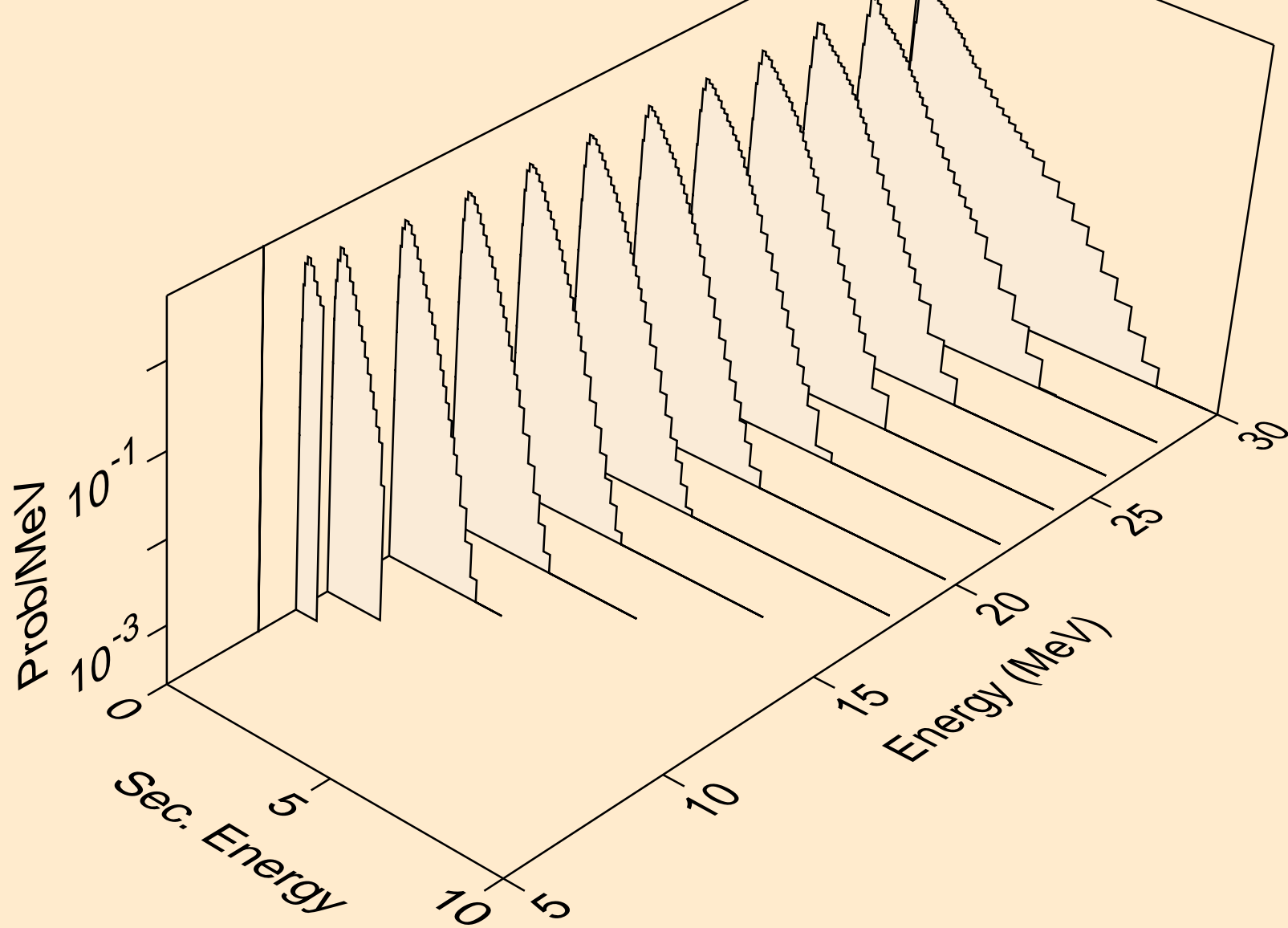

ES251 HELION ACER TENDL-2023 LIBRARY; T=0.K
neutrons from (s,n*)t

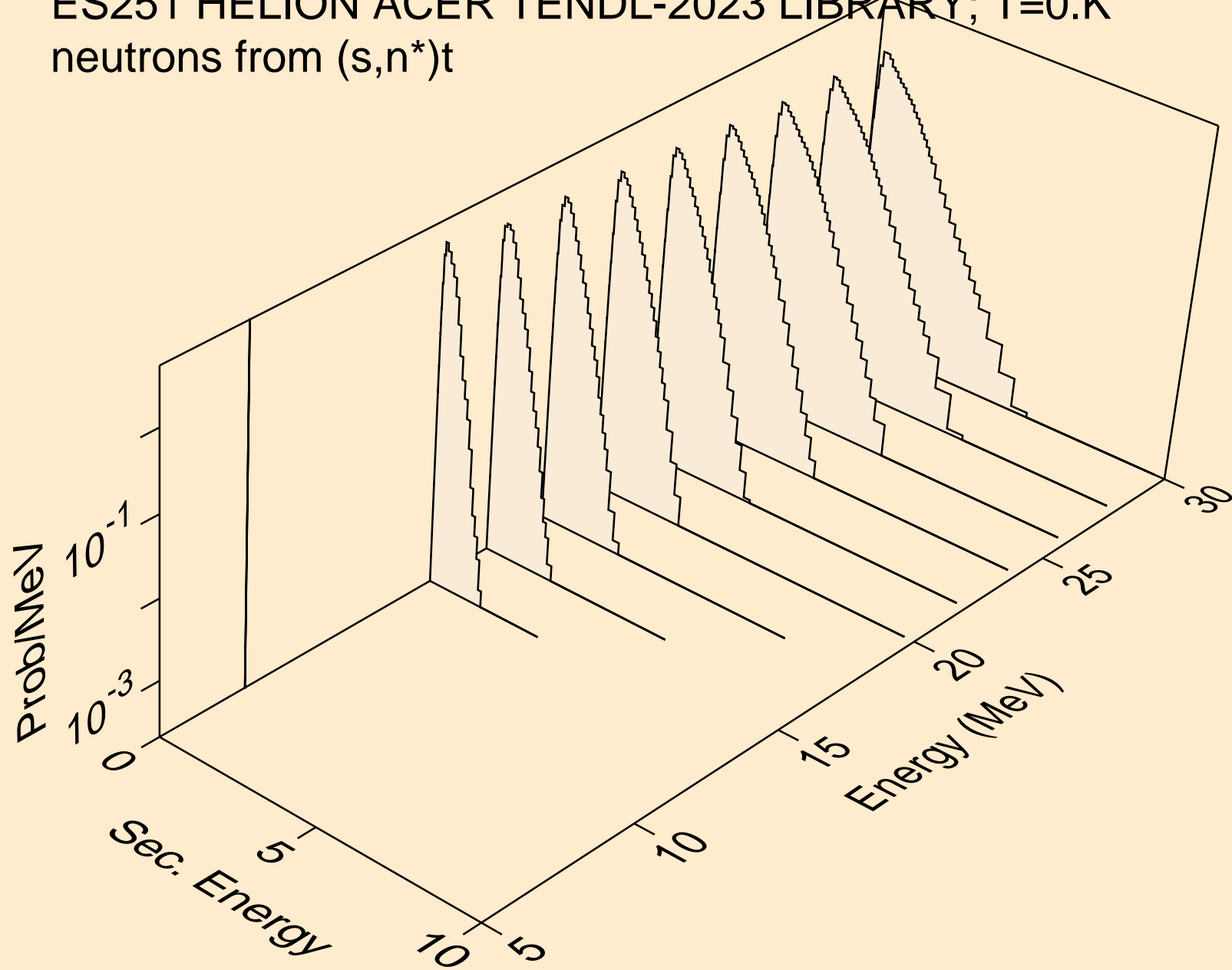

ES251 HELION ACER TENDL-2023 LIBRARY; T=0.K
neutrons from (s,n*)he3

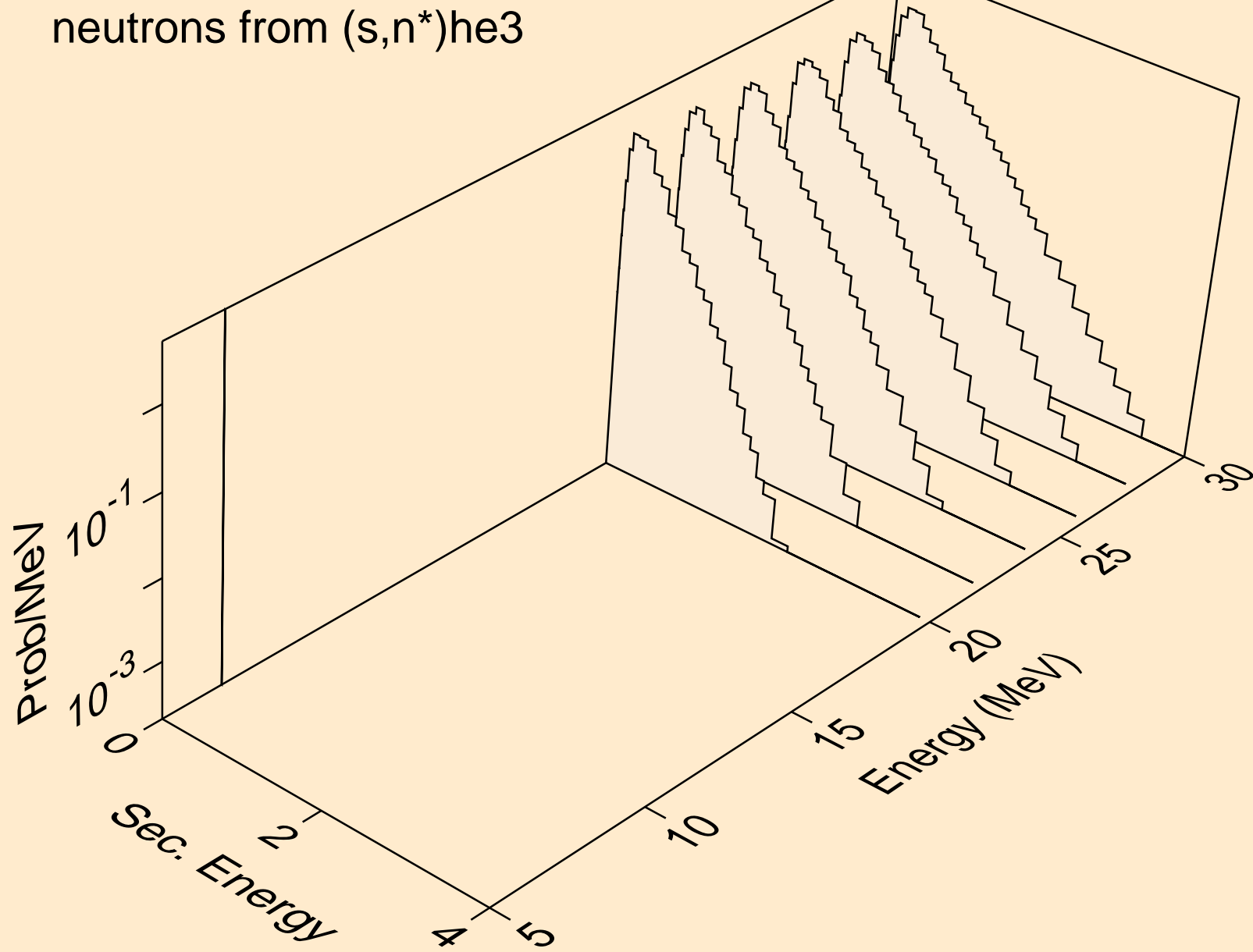

ES251 HELION ACER TENDL-2023 LIBRARY; T=0.K
neutrons from (s,2np)

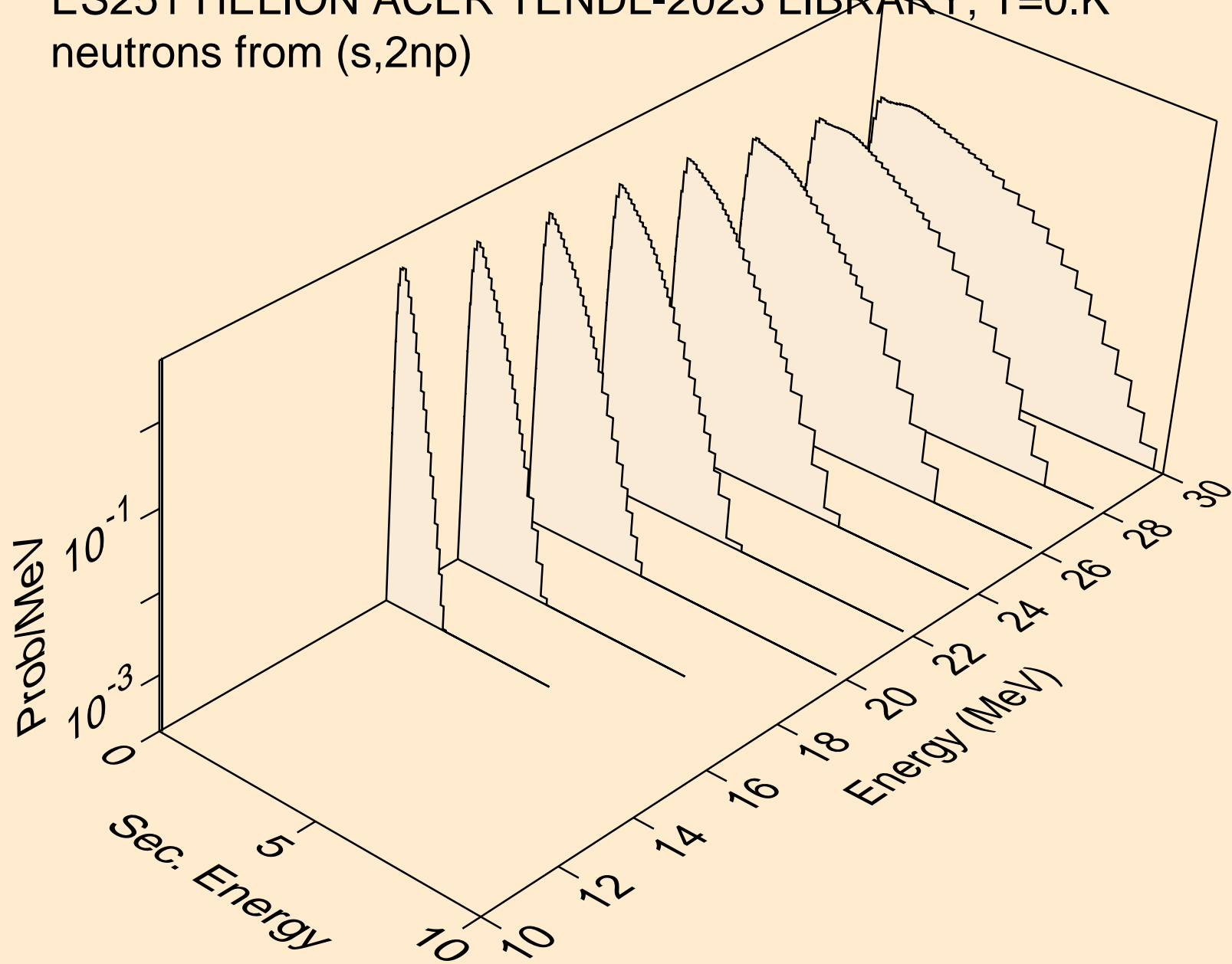

ES251 HELION ACER TENDL-2023 LIBRARY; T=0.K
protons from (s,x)

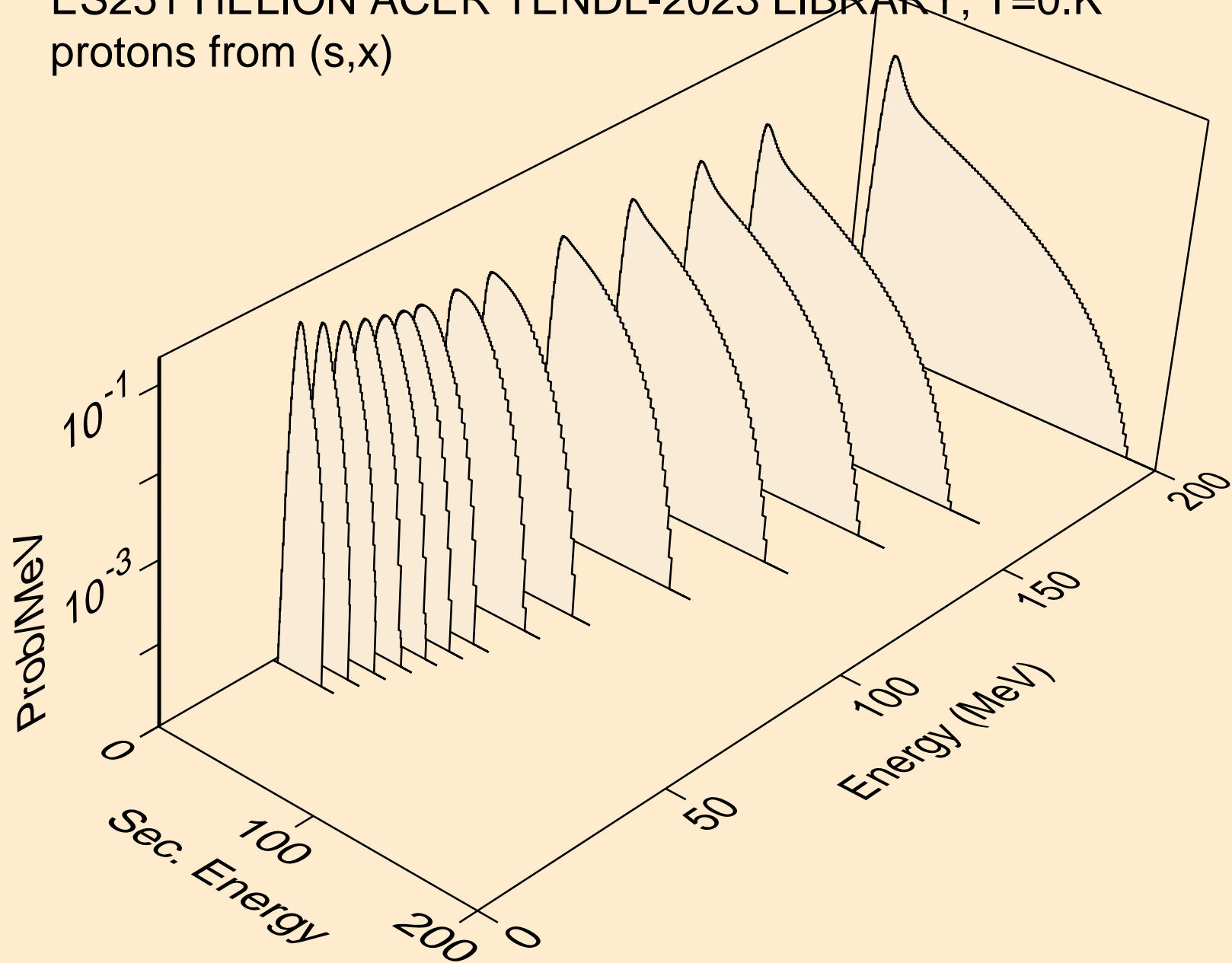

ES251 HELION ACER TENDL-2023 LIBRARY; T=0.K
protons from (s,n*)p

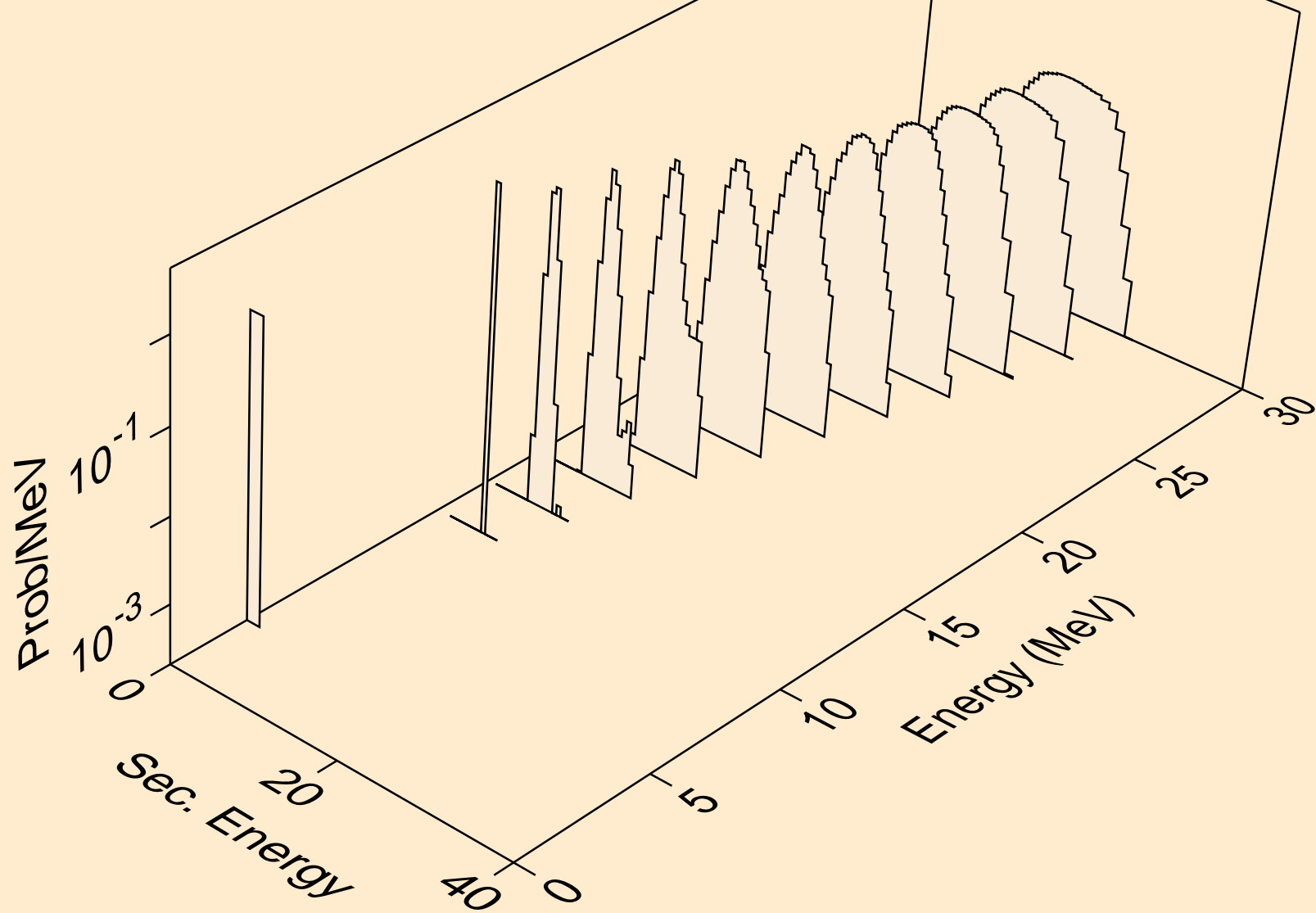

ES251 HELION ACER TENDL-2023 LIBRARY; T=0.K
protons from (s,2np)

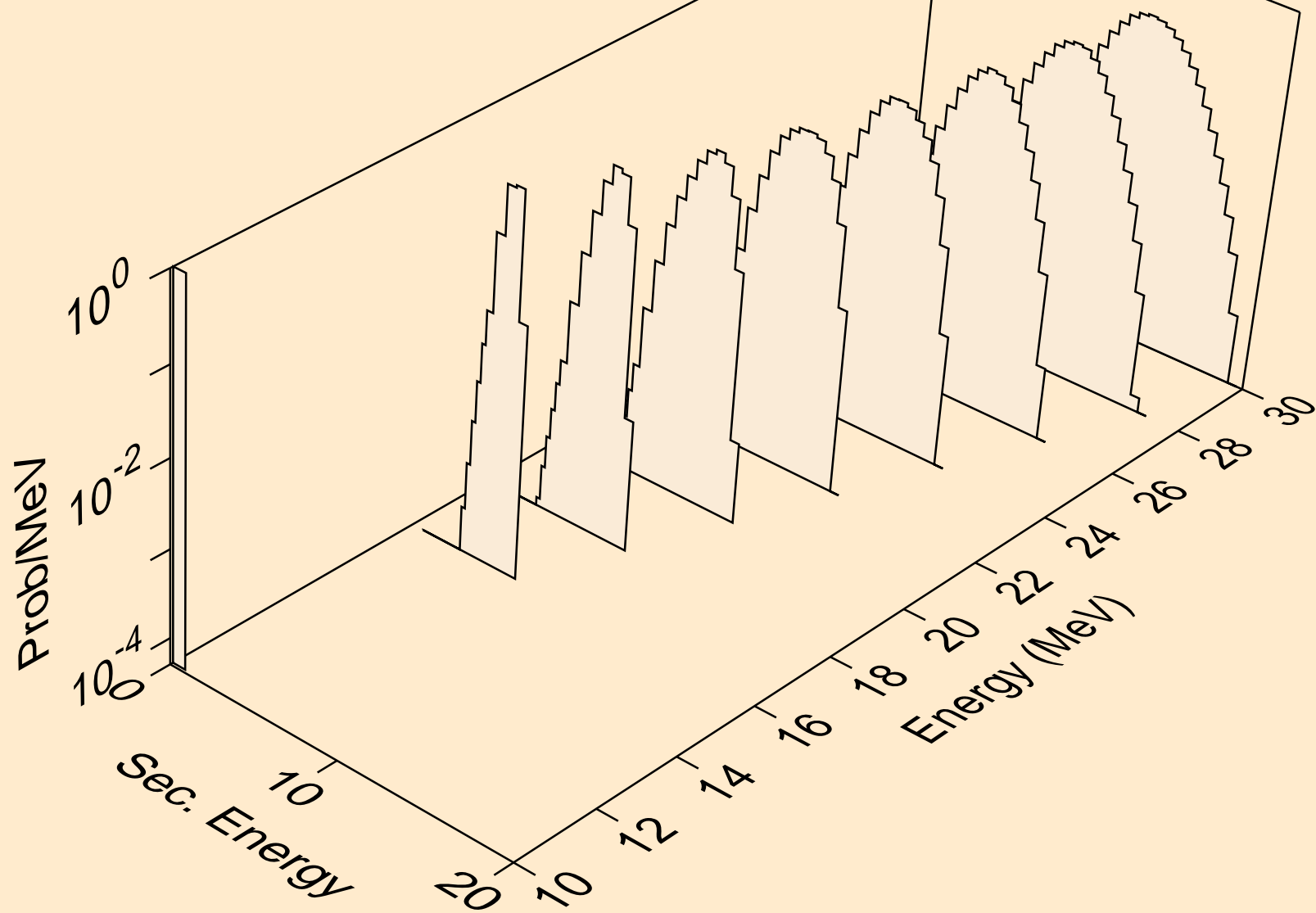

ES251 HELION ACER TENDL-2023 LIBRARY; T=0.K
protons from (s,p)

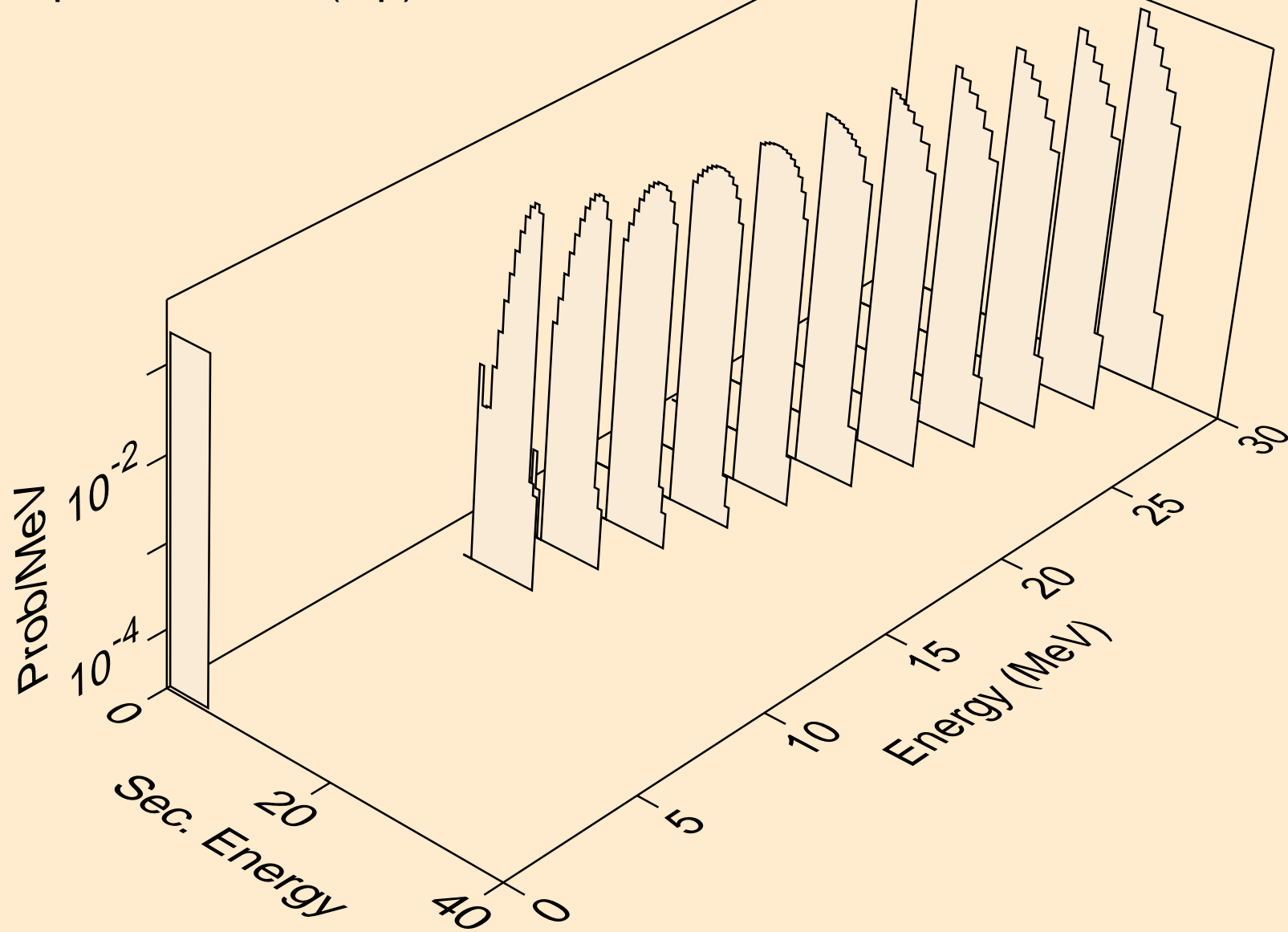

ES251 HELION ACER TENDL-2023 LIBRARY; T=0.K
protons from (s,2p)

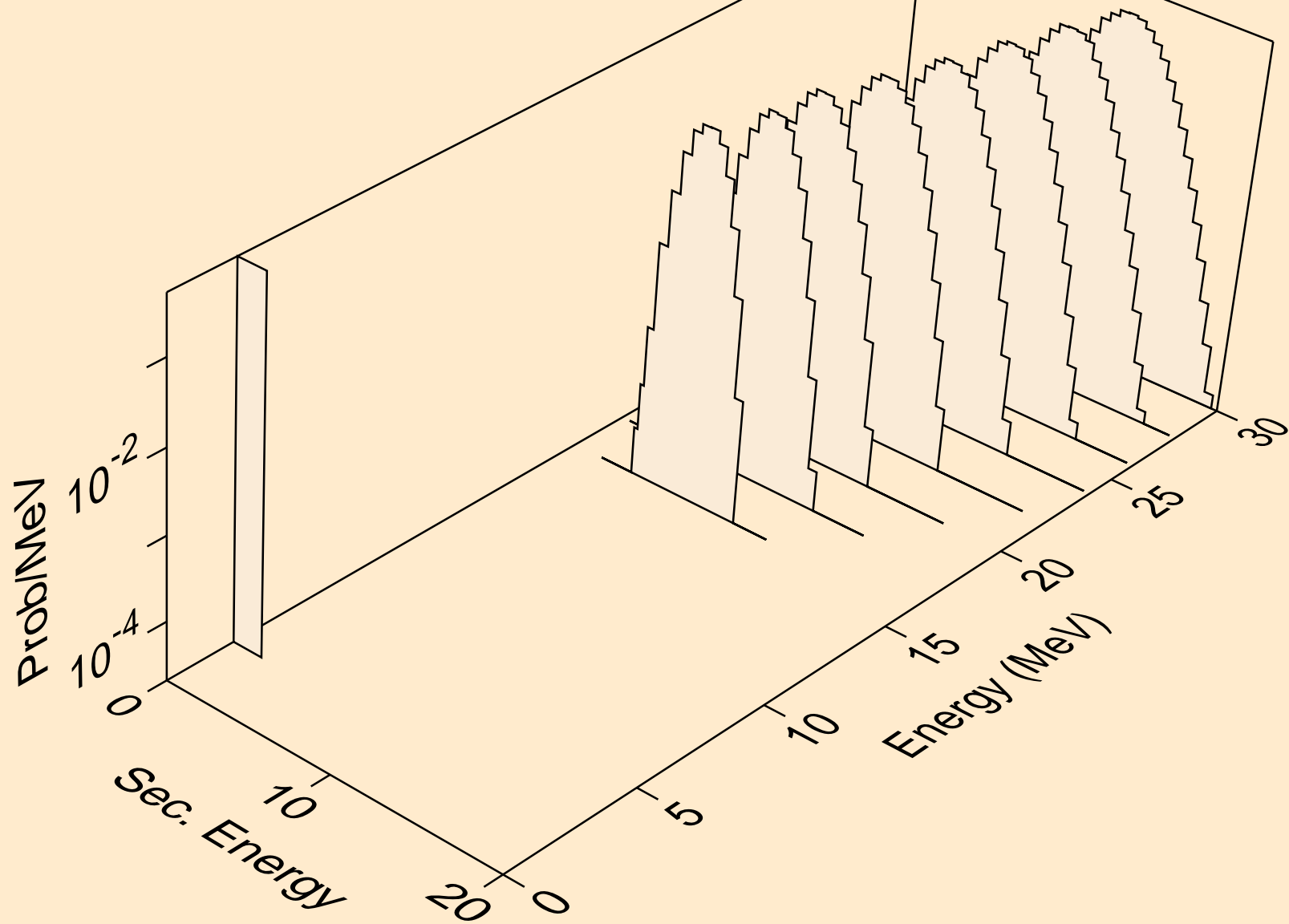

ES251 HELION ACER TENDL-2023 LIBRARY; T=0.K
deuterons from (s,x)

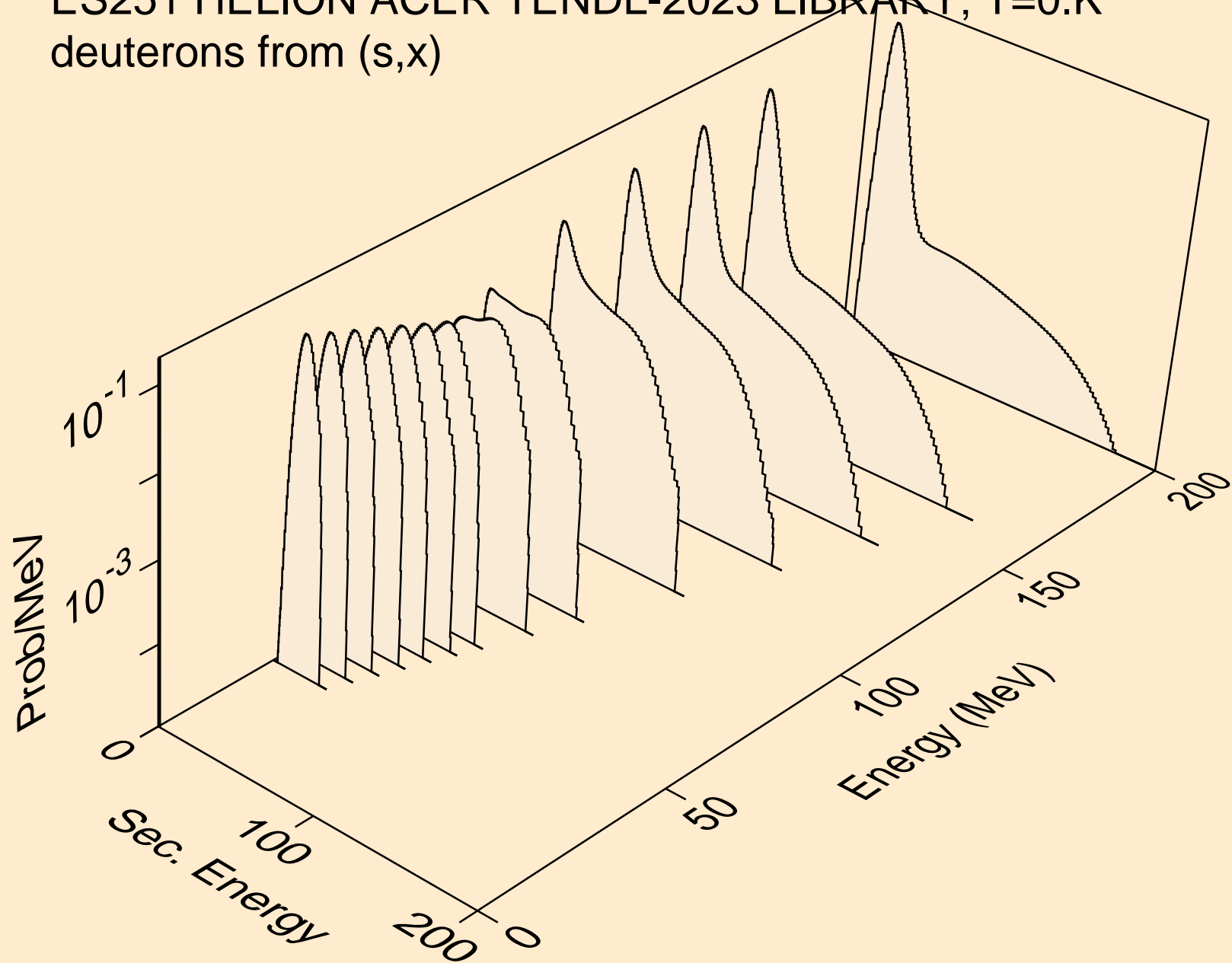

ES251 HELION ACER TENDL-2023 LIBRARY; T=0.K
deuterons from (s,n*)d

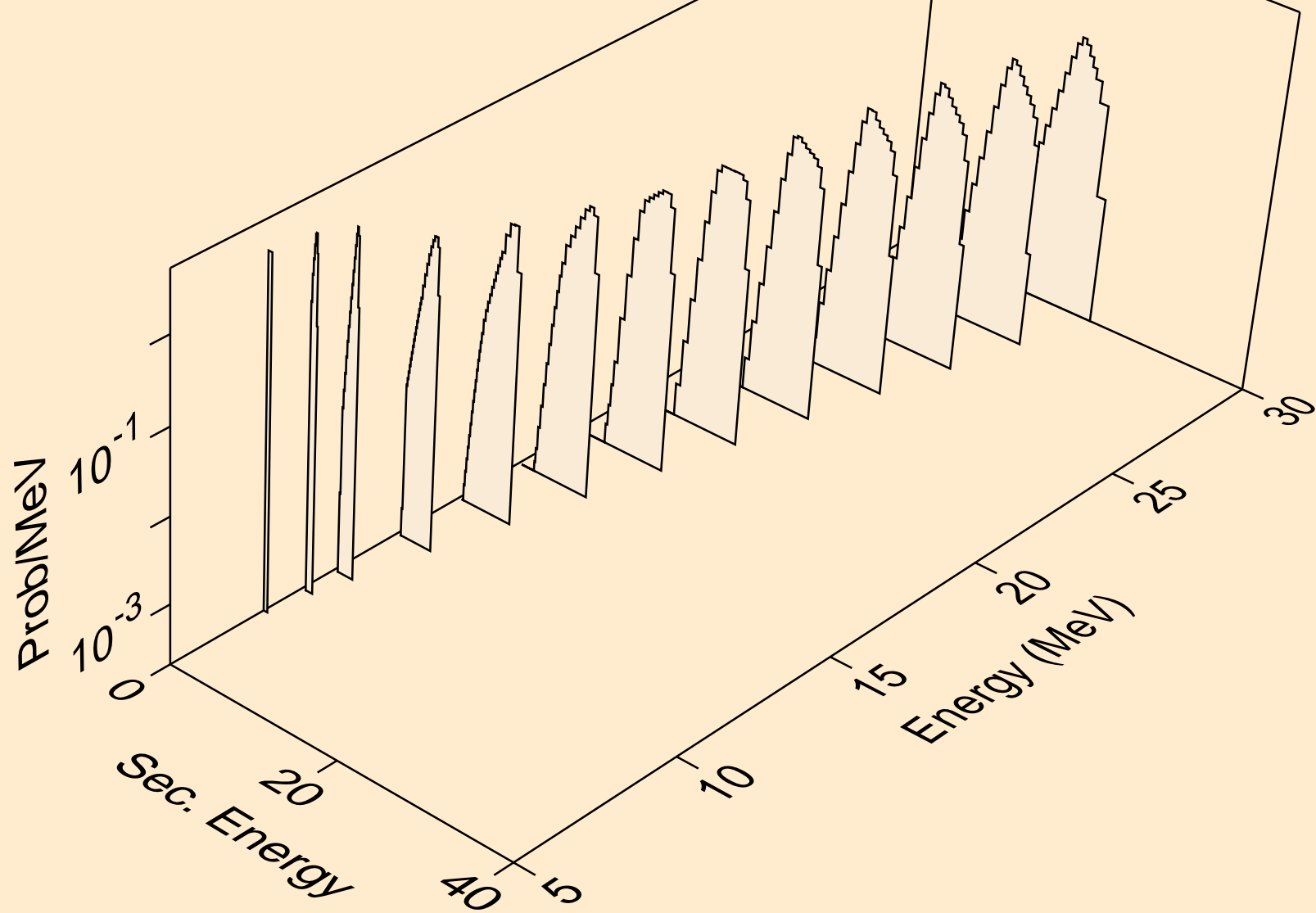

ES251 HELION ACER TENDL-2023 LIBRARY; T=0.K
deuterons from (s,d)

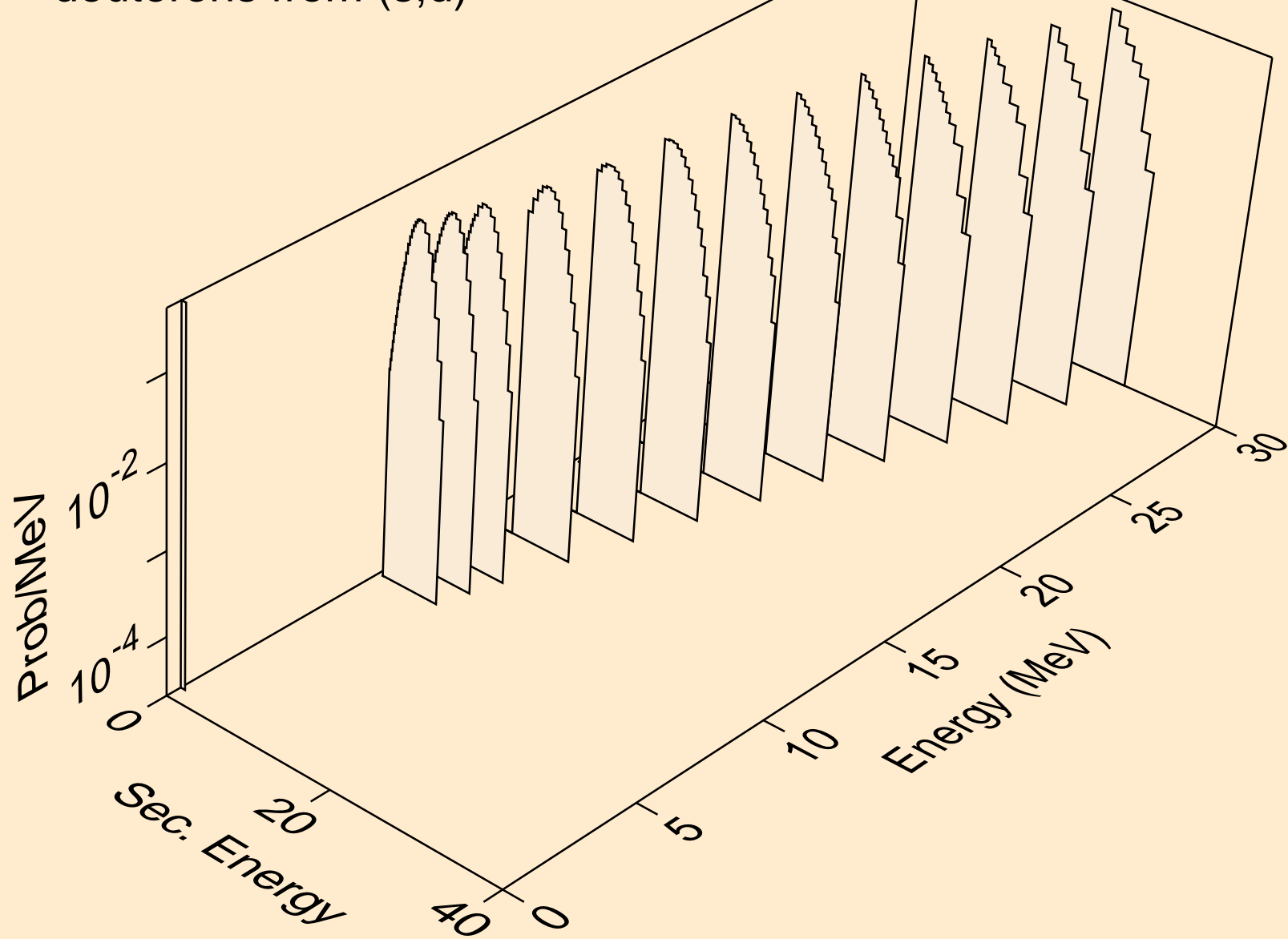

ES251 HELION ACER TENDL-2023 LIBRARY; T=0.K
tritons from (s,x)

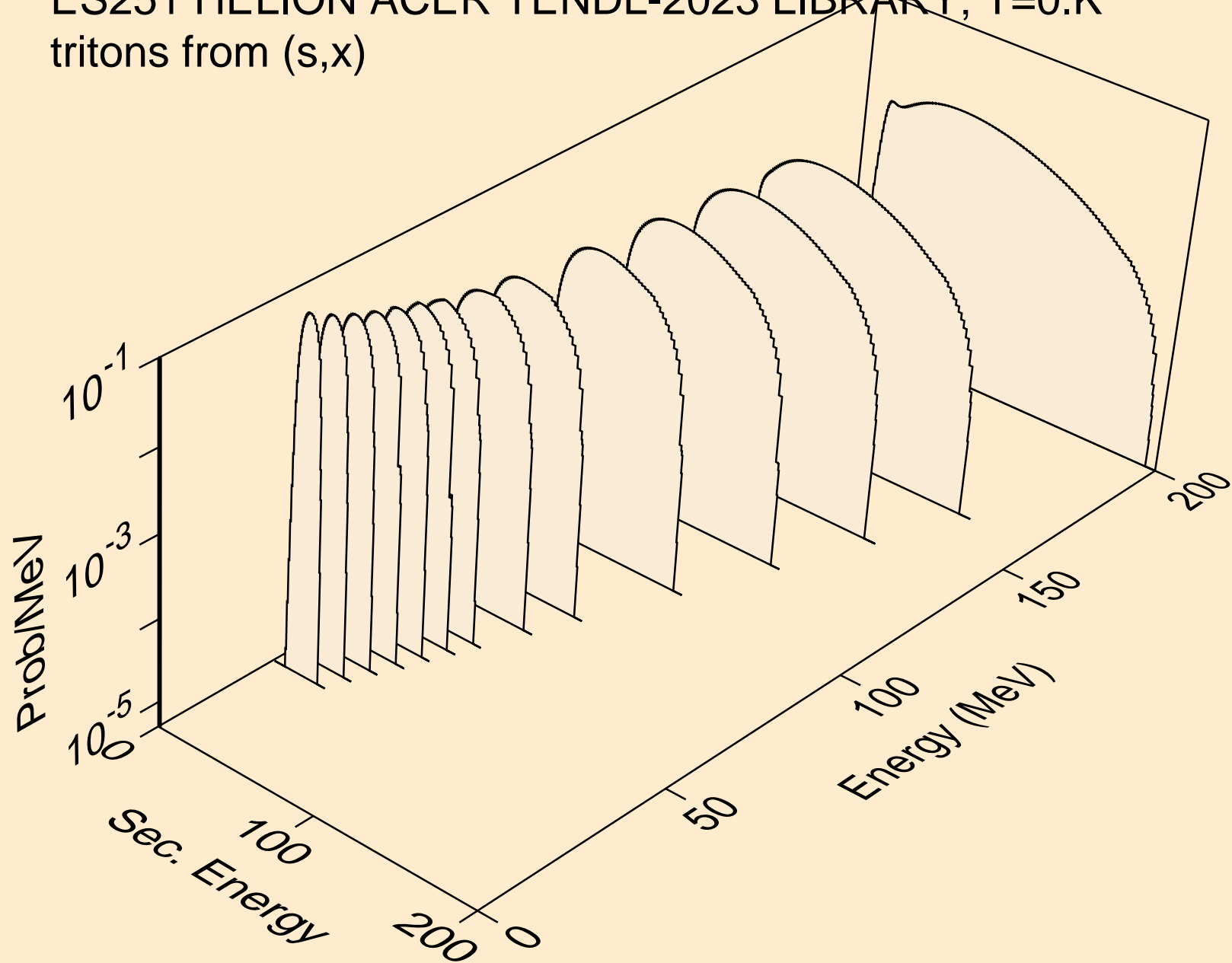

ES251 HELION ACER TENDL-2023 LIBRARY; T=0.K
tritons from (s,n*)t

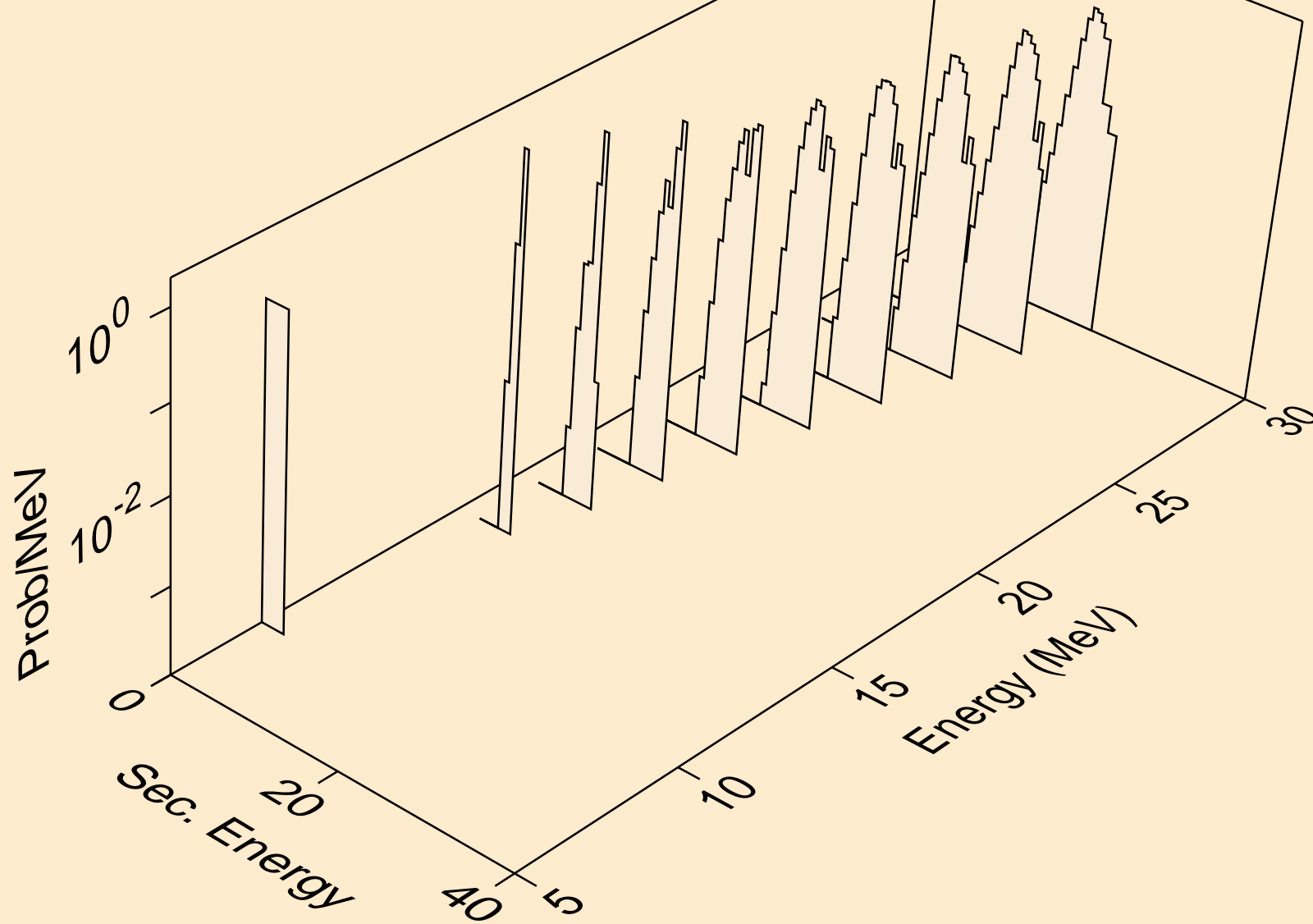

ES251 HELION ACER TENDL-2023 LIBRARY; T=0.K
tritons from (s,t)

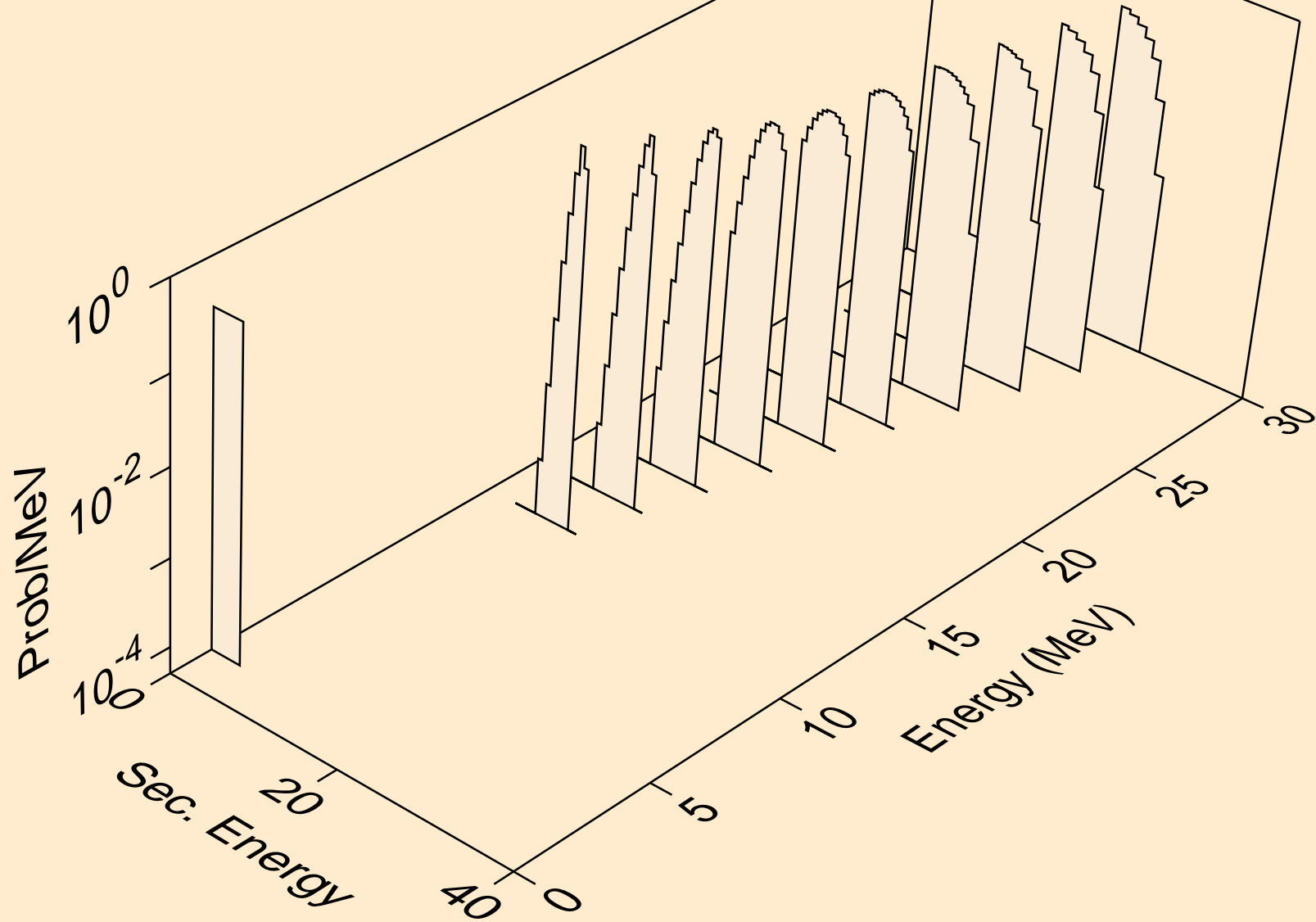

ES251 HELION ACER TENDL-2023 LIBRARY; T=0.K
alphas from (s,x)

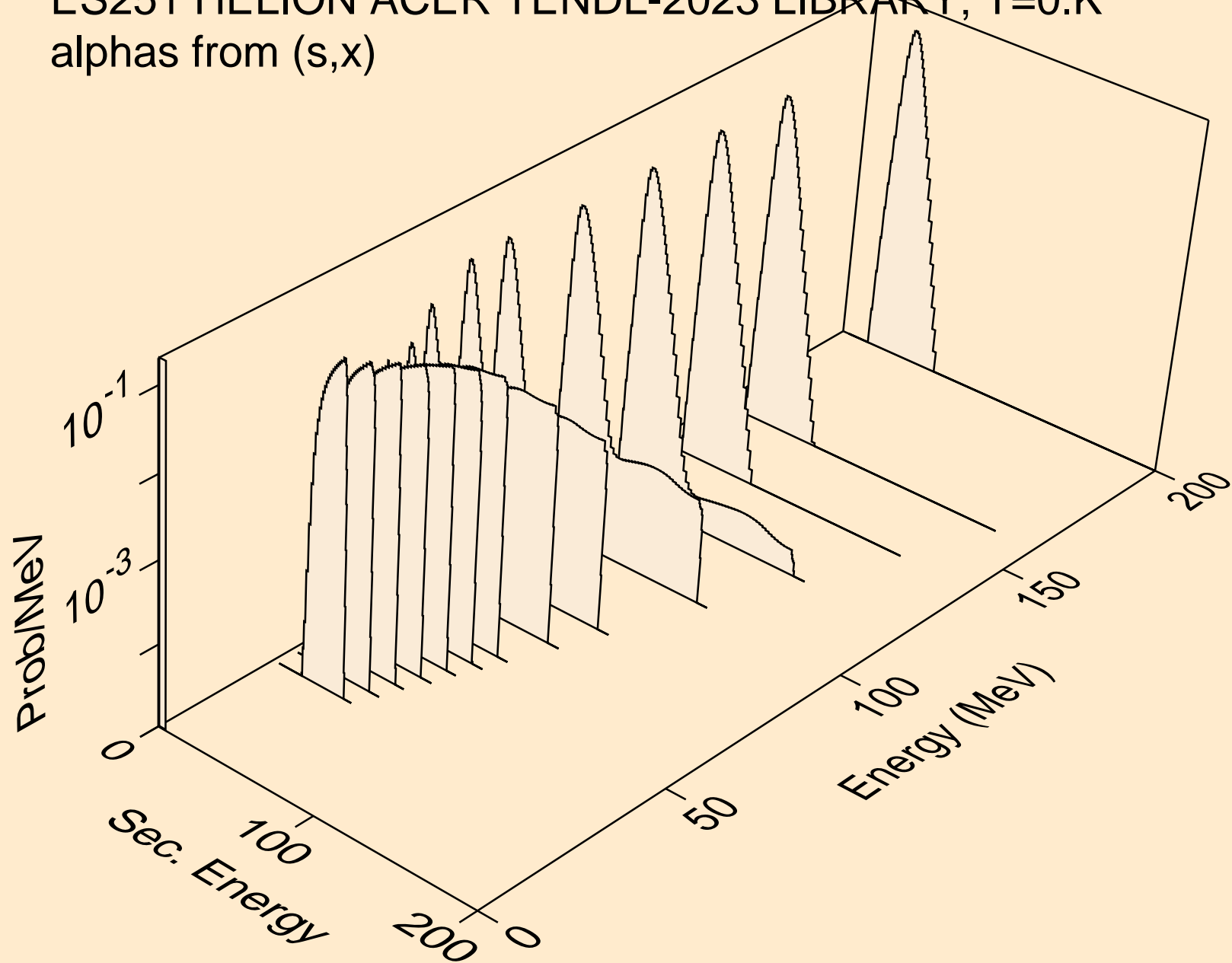

ES251 HELION ACER TENDL-2023 LIBRARY; T=0.K
alphas from (s,n*)a

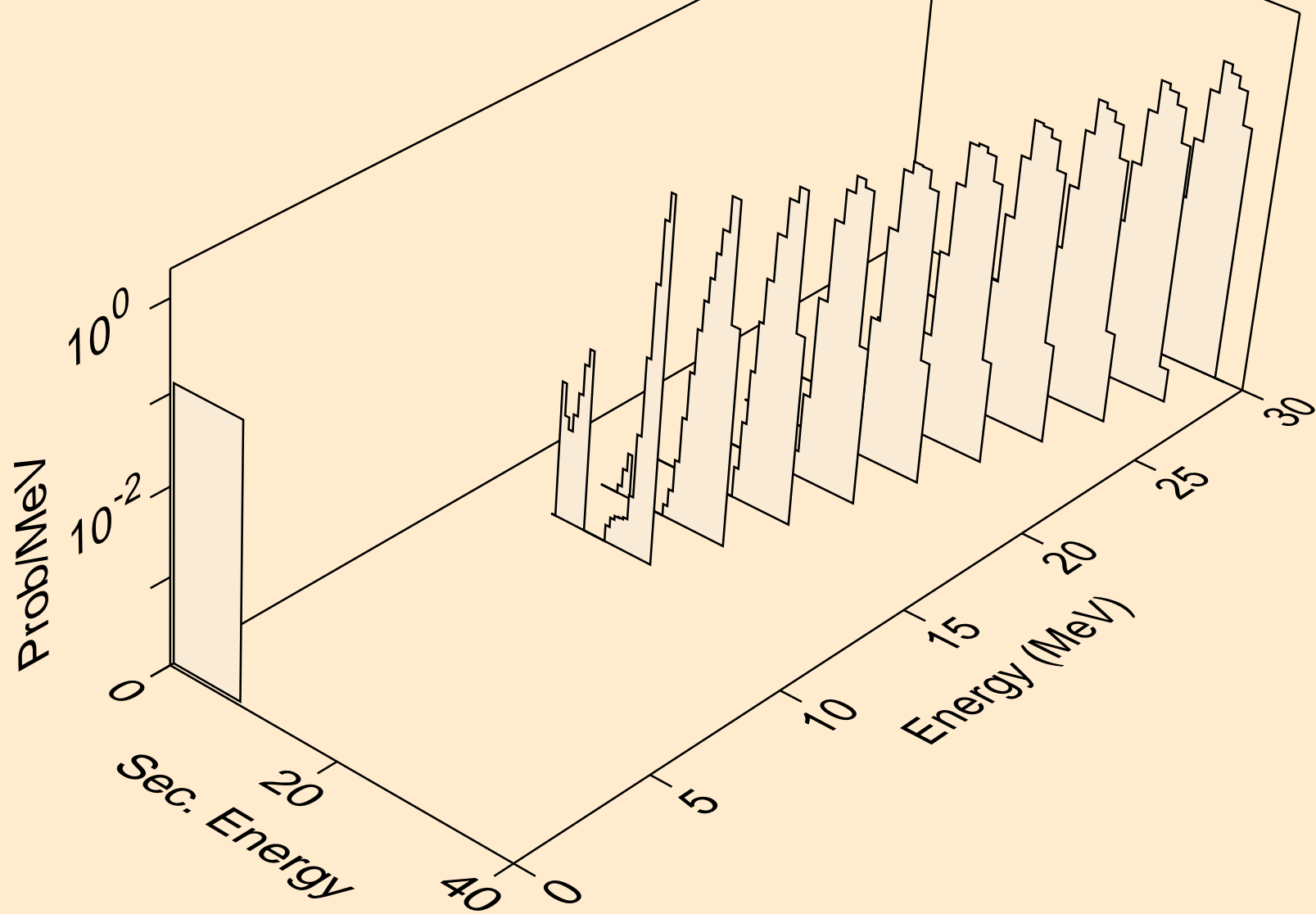

ES251 HELION ACER TENDL-2023 LIBRARY; T=0.K
alphas from (s,a)

