

FE055 HELION ACER TENDL-2023 LIBRARY; T=0.K  
Principal cross sections

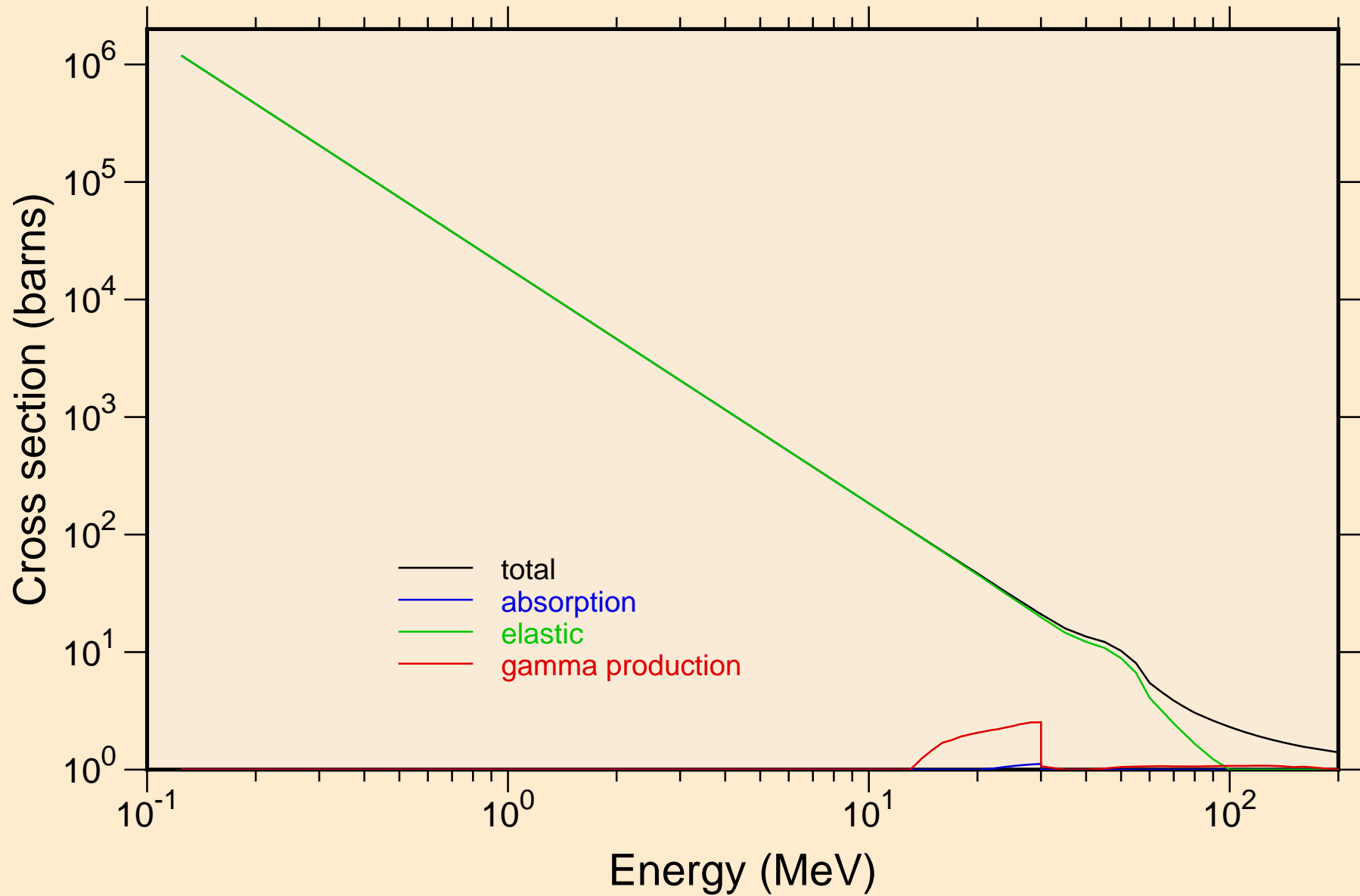

# FE055 HELION ACER TENDL-2023 LIBRARY; T=0.K

## Heating

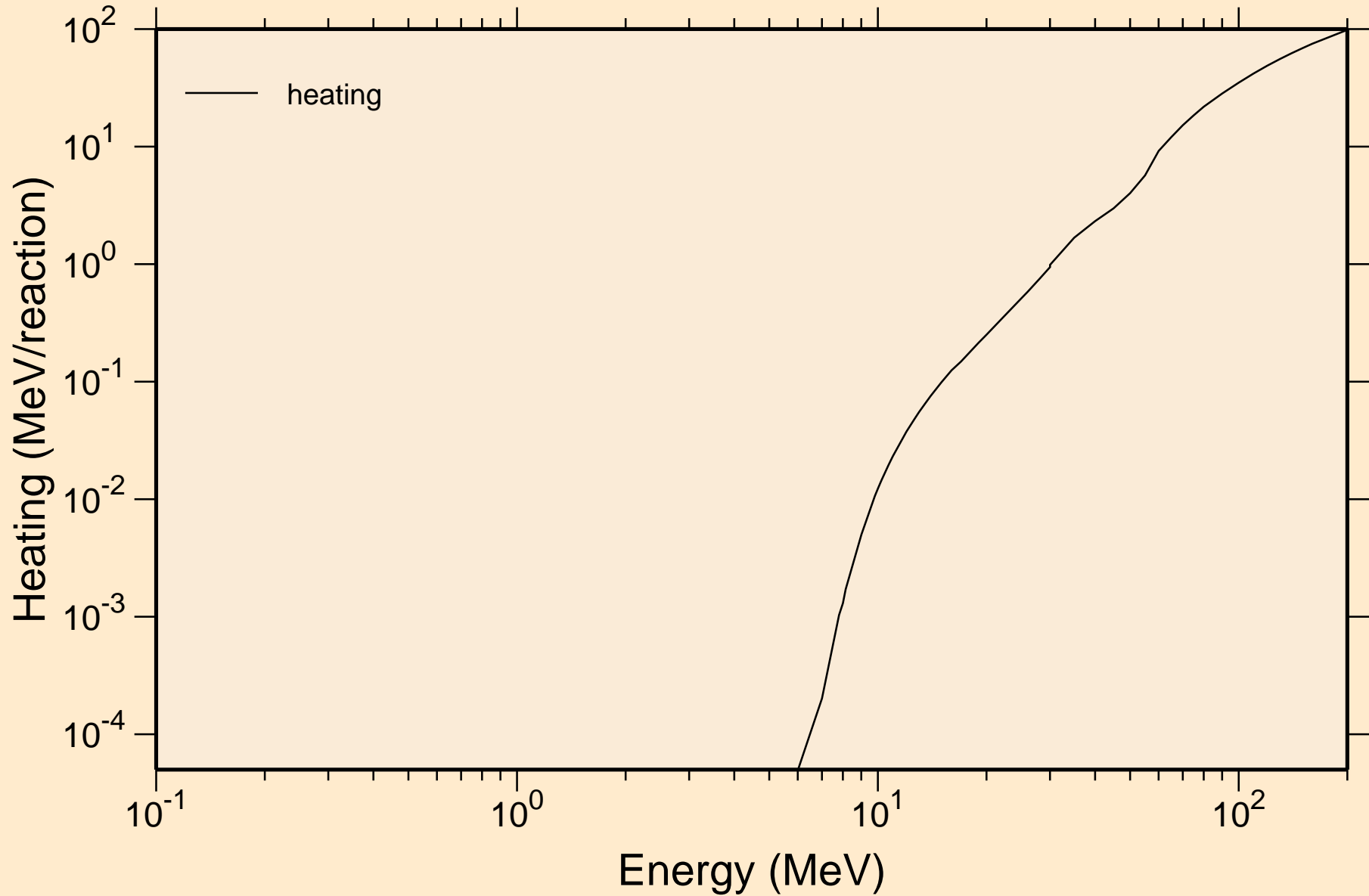

# FE055 HELION ACER TENDL-2023 LIBRARY; T=0.K

## Principal cross sections

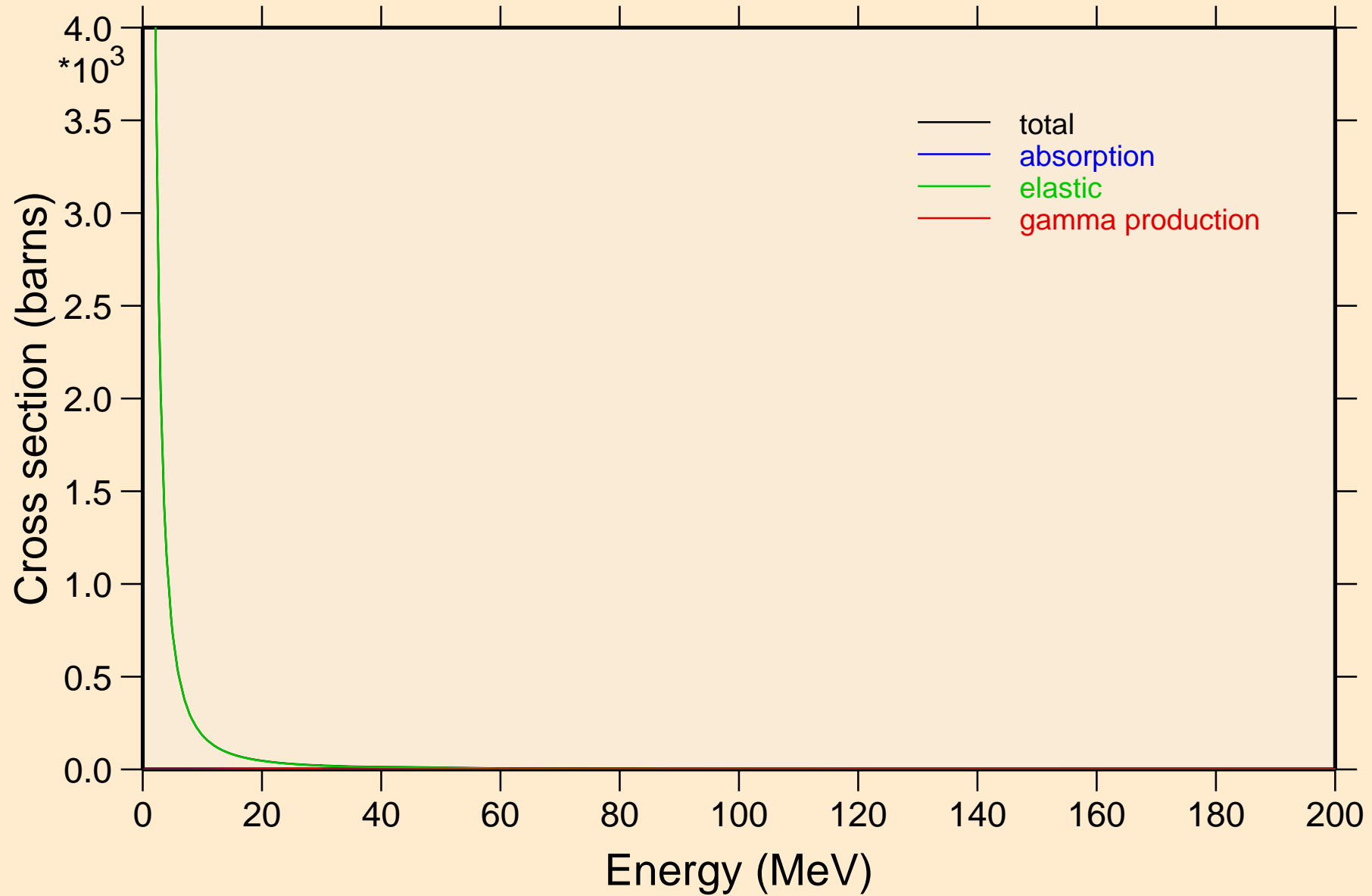

FE055 HELION ACER TENDL-2023 LIBRARY; T=0.K

Heating

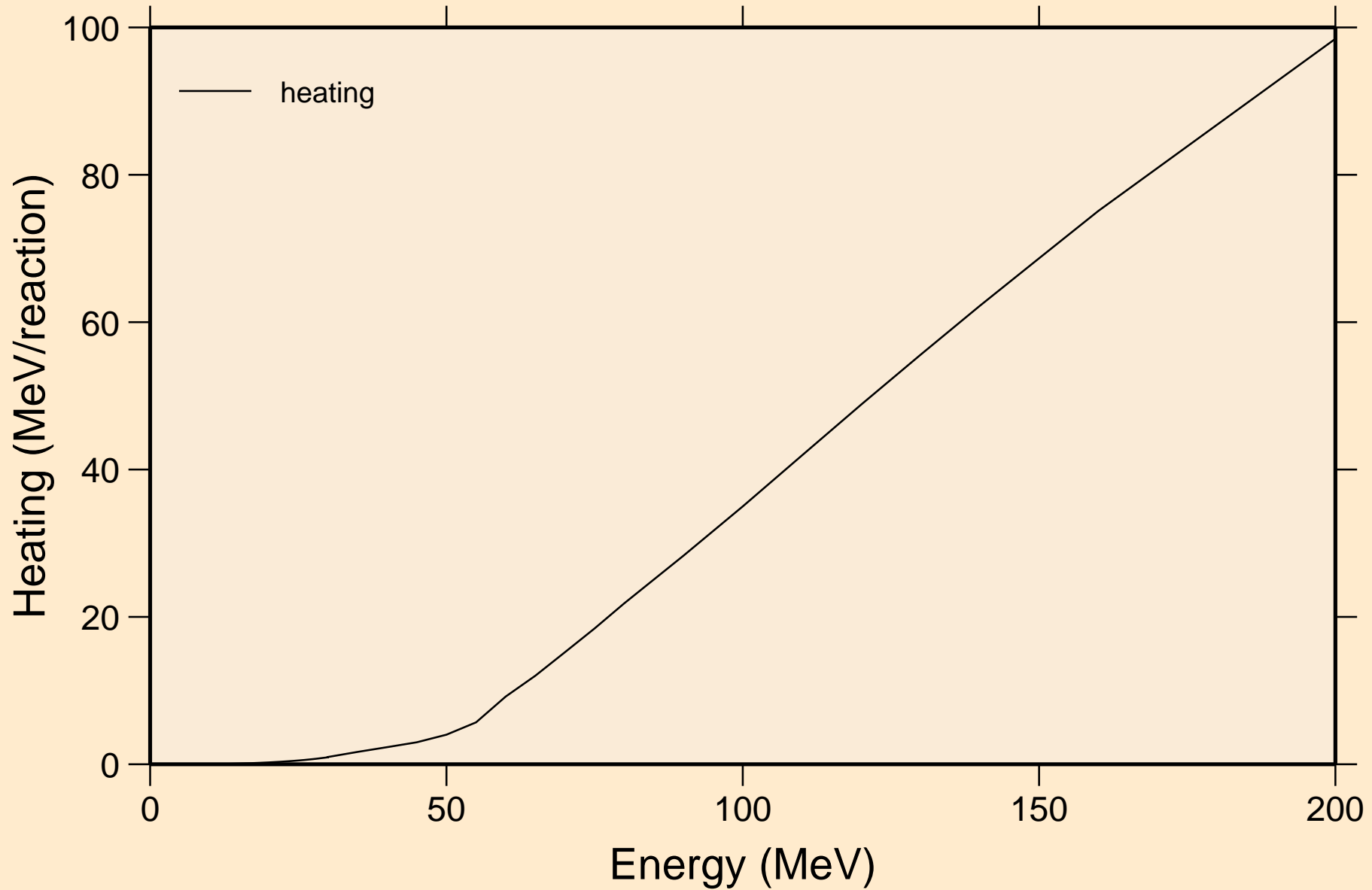

FE055 HELION ACER TENDL-2023 LIBRARY; T=0.K  
Threshold reactions

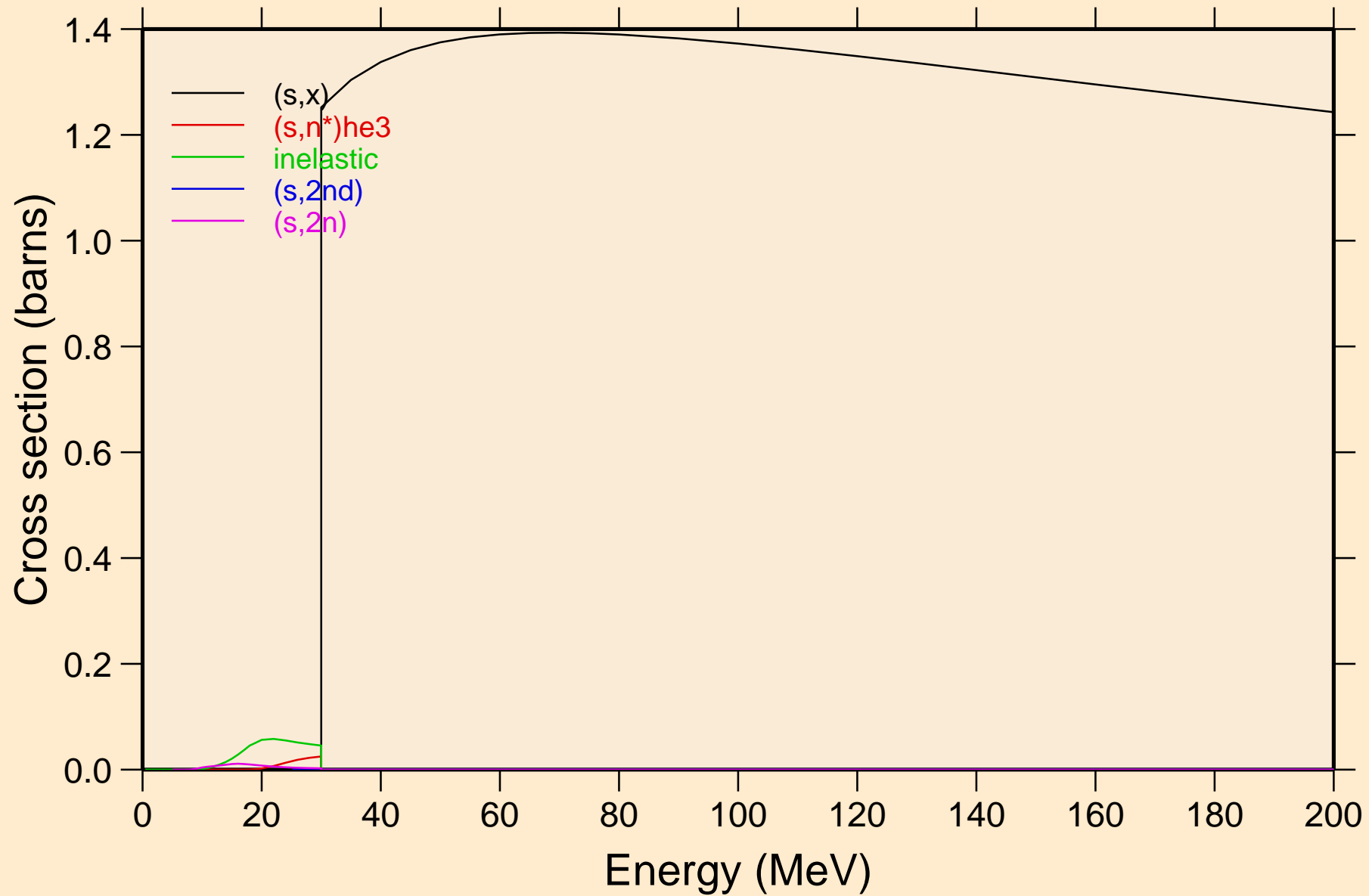

FE055 HELION ACER TENDL-2023 LIBRARY; T=0.K  
Threshold reactions

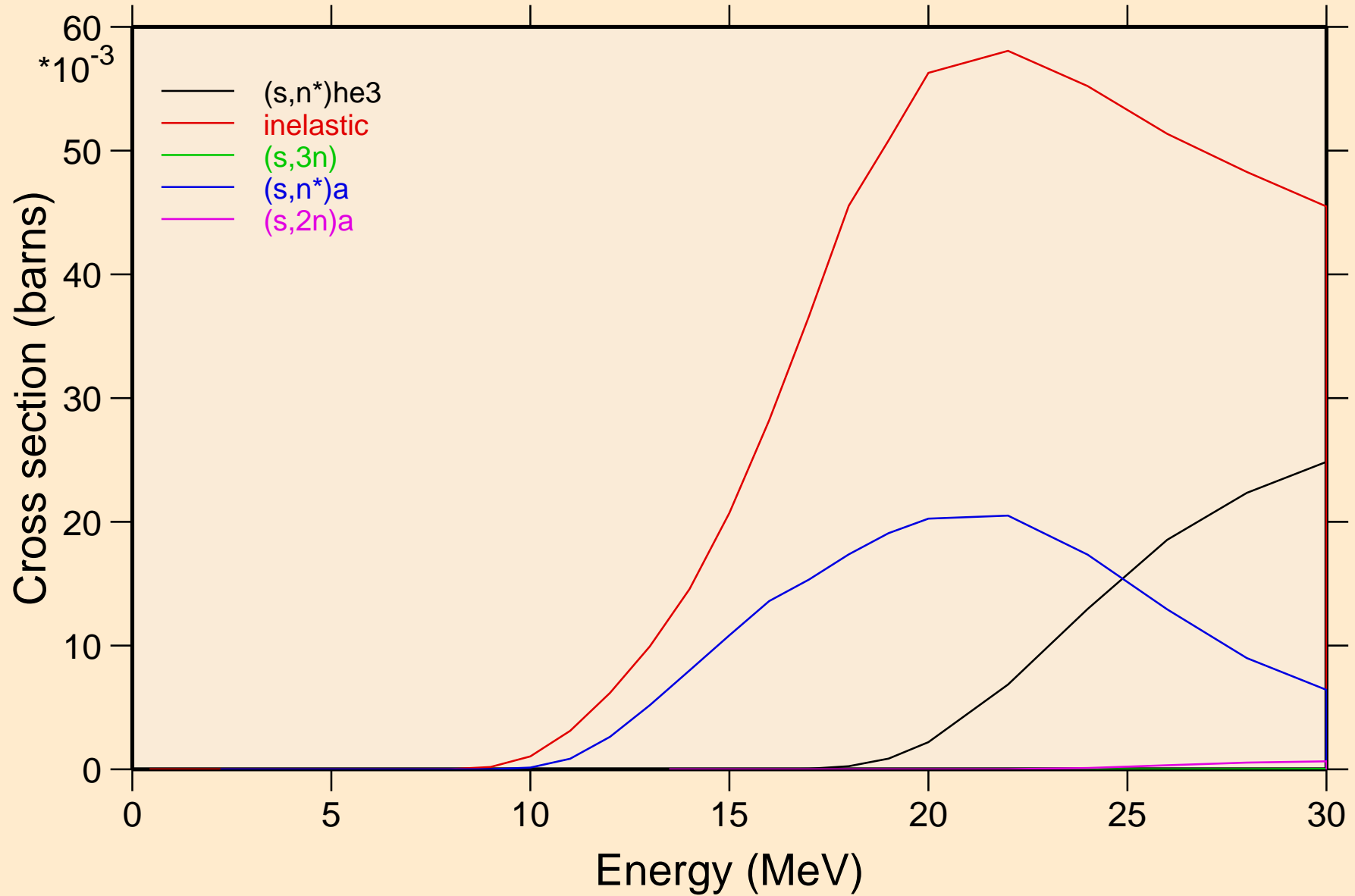

# FE055 HELION ACER TENDL-2023 LIBRARY; T=0.K

## Threshold reactions

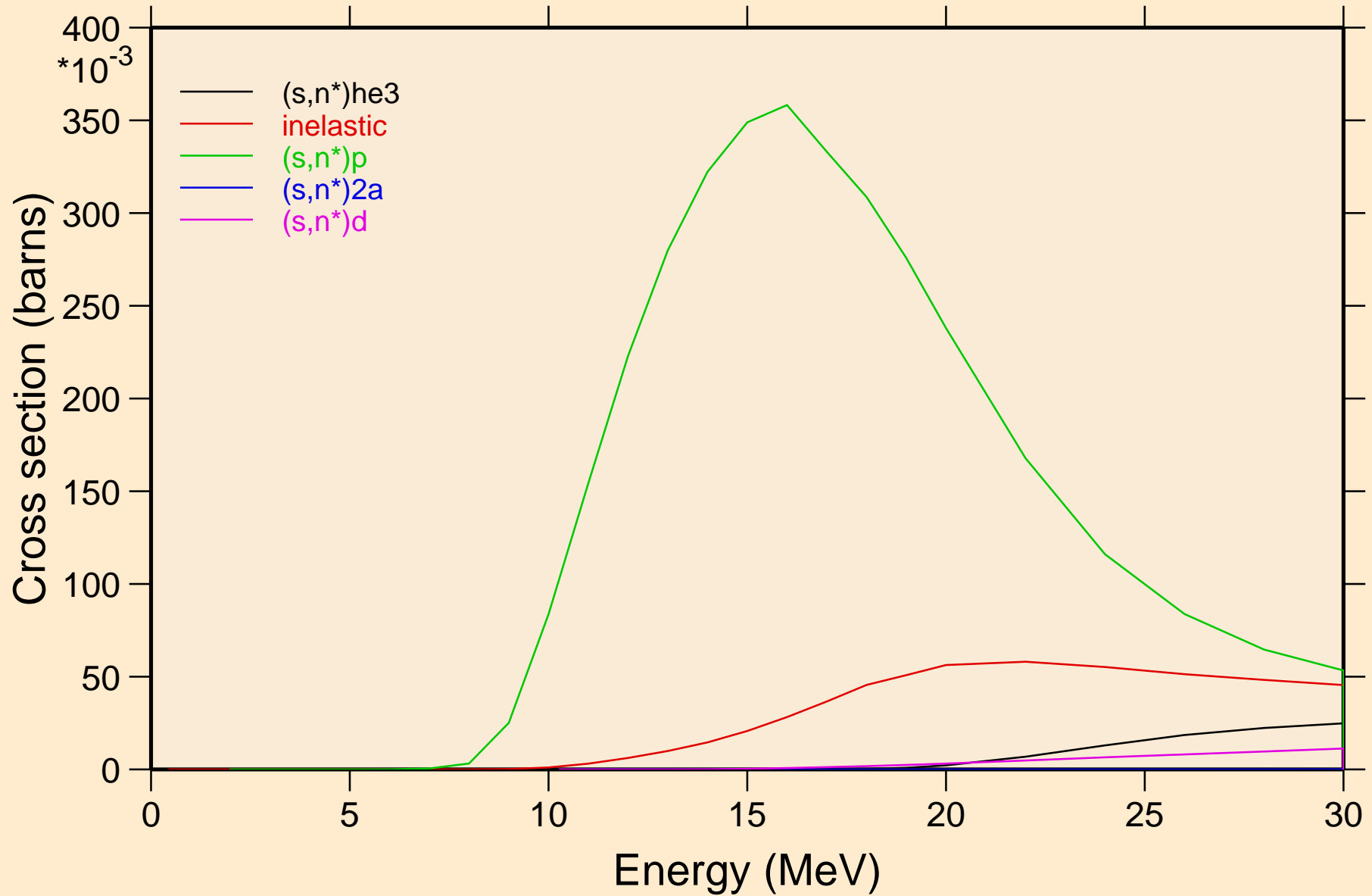

FE055 HELION ACER TENDL-2023 LIBRARY; T=0.K  
Threshold reactions

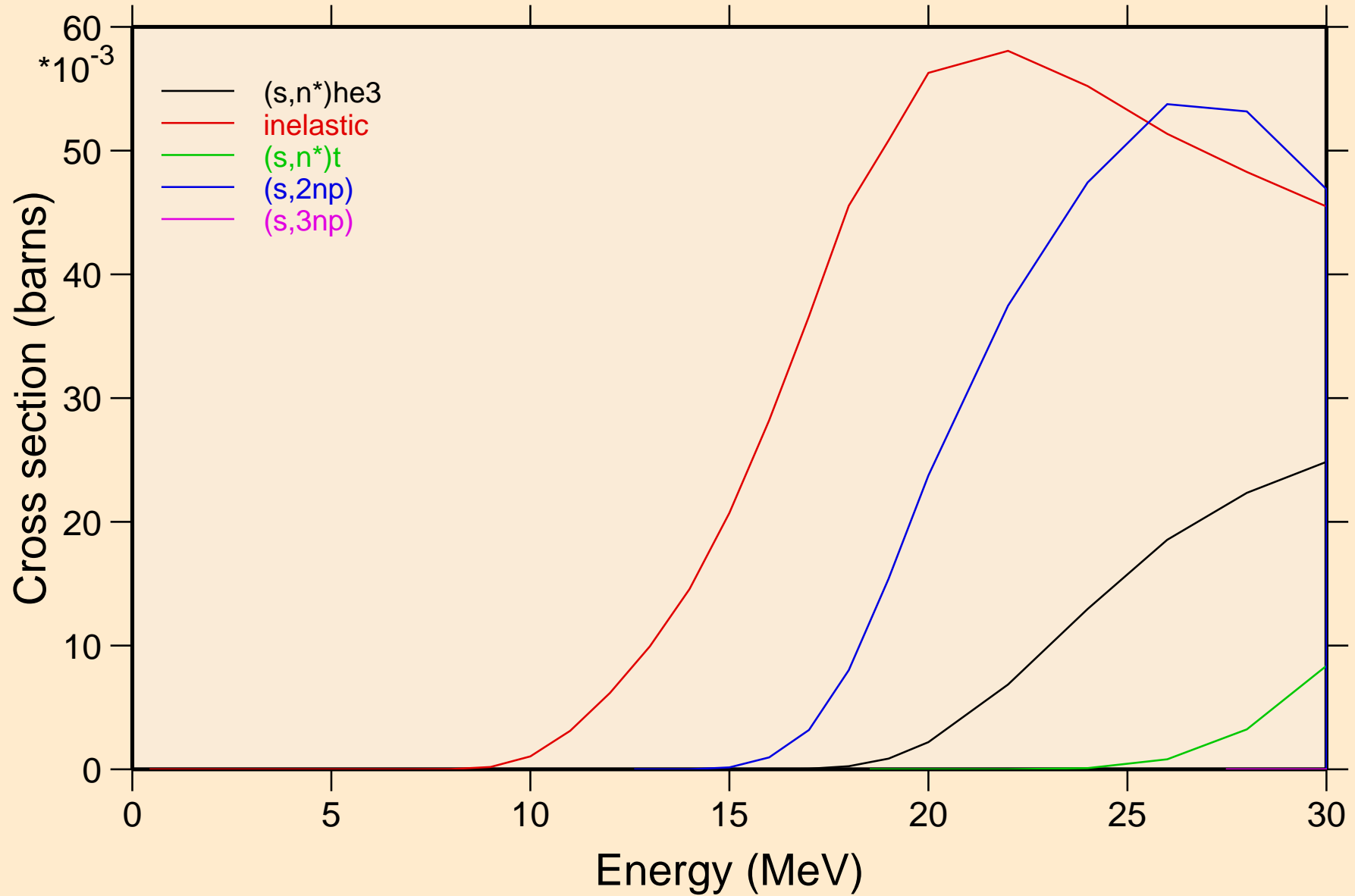



# FE055 HELION ACER TENDL-2023 LIBRARY; T=0.K

## Threshold reactions

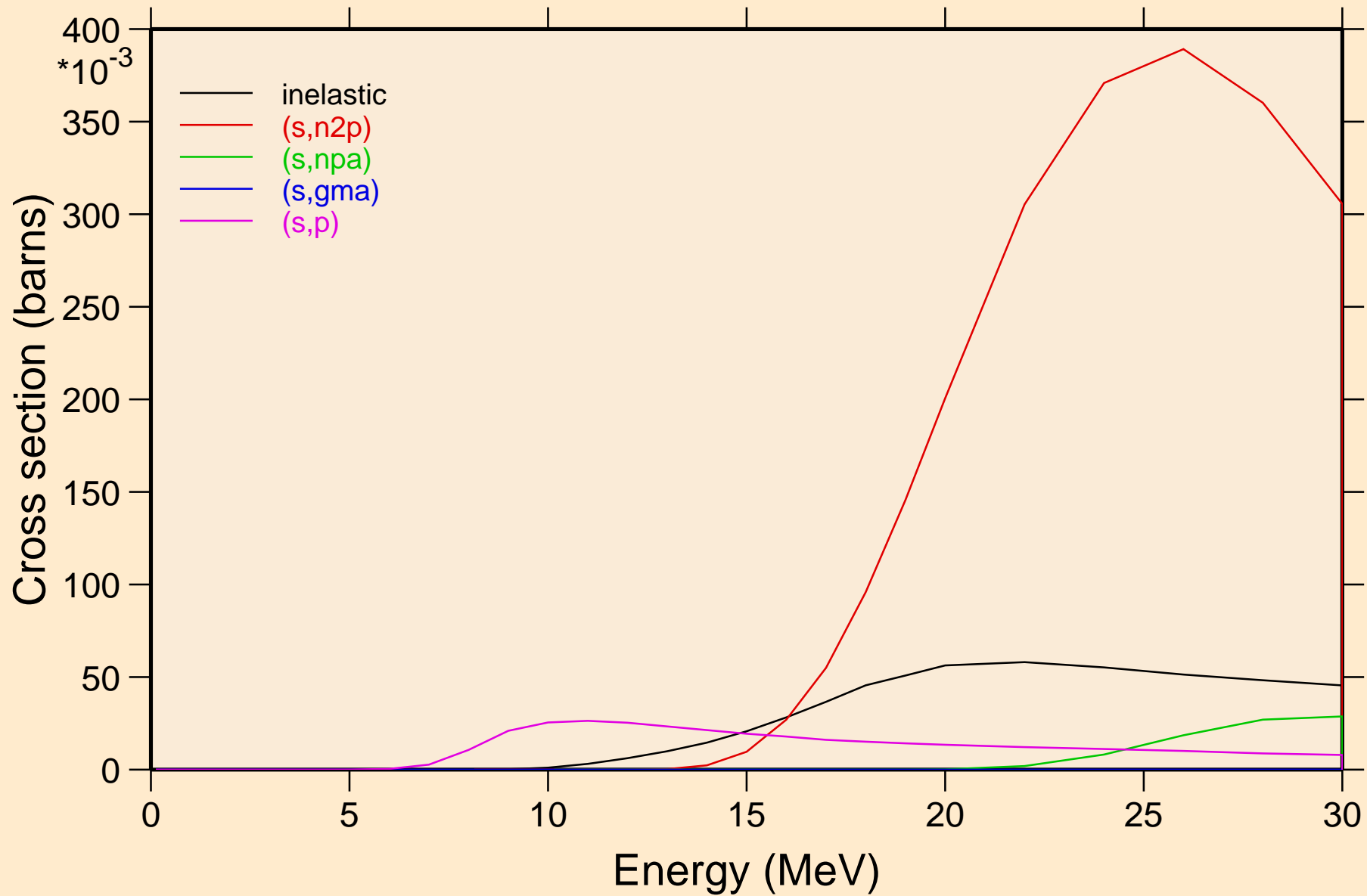

FE055 HELION ACER TENDL-2023 LIBRARY; T=0.K  
Threshold reactions

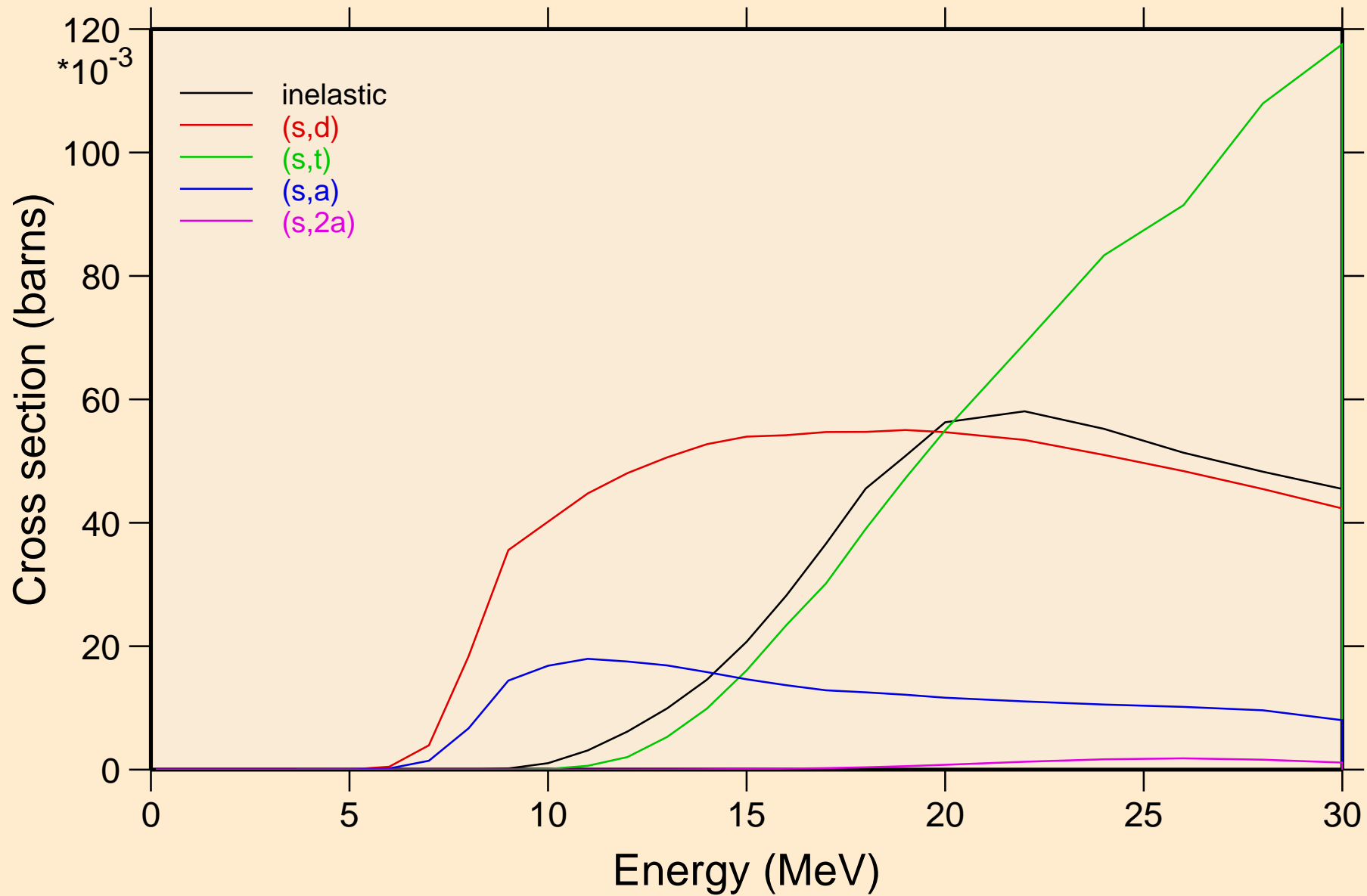

FE055 HELION ACER TENDL-2023 LIBRARY; T=0.K  
Threshold reactions

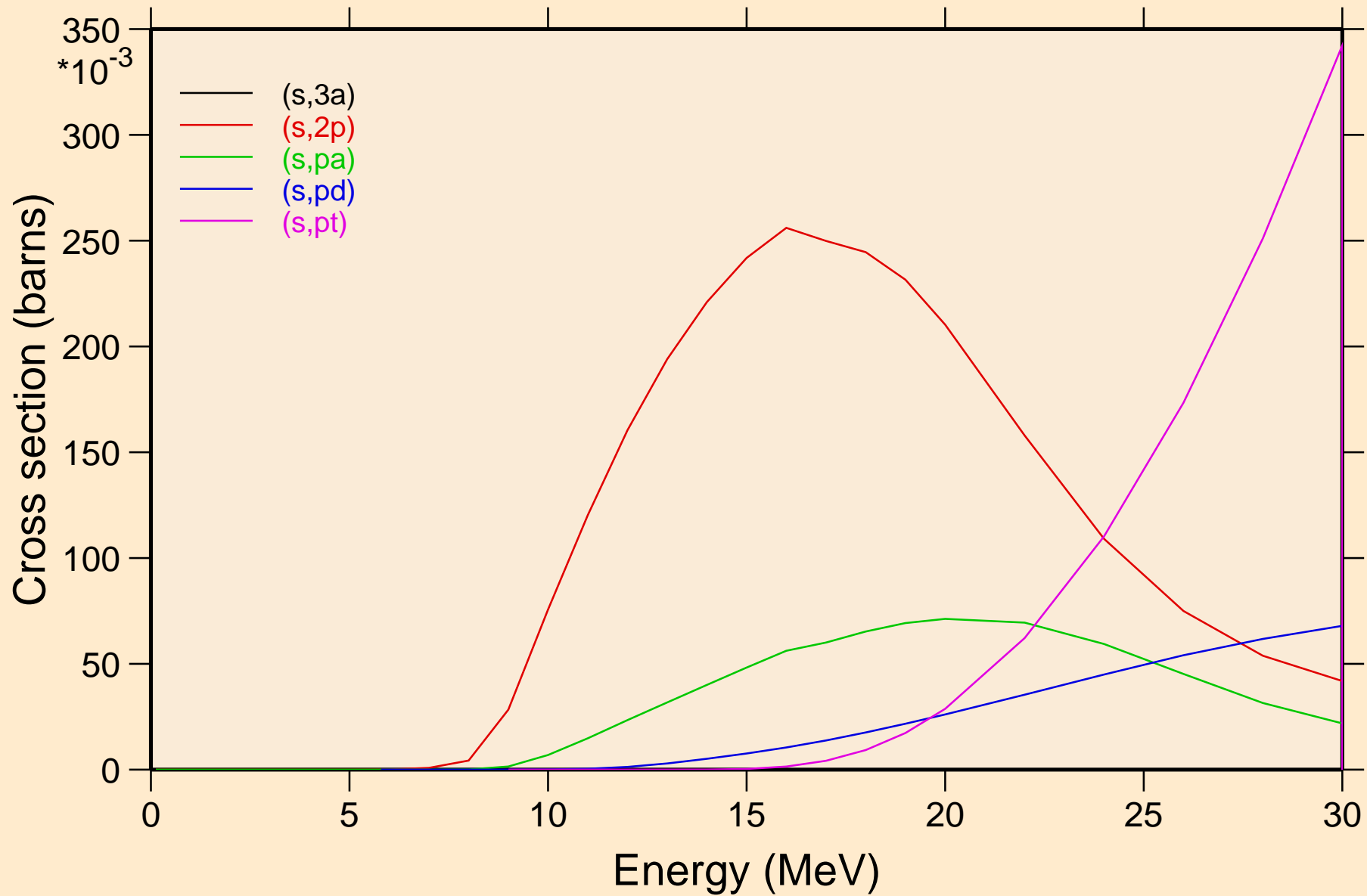

FE055 HELION ACER TENDL-2023 LIBRARY; T=0.K  
Threshold reactions

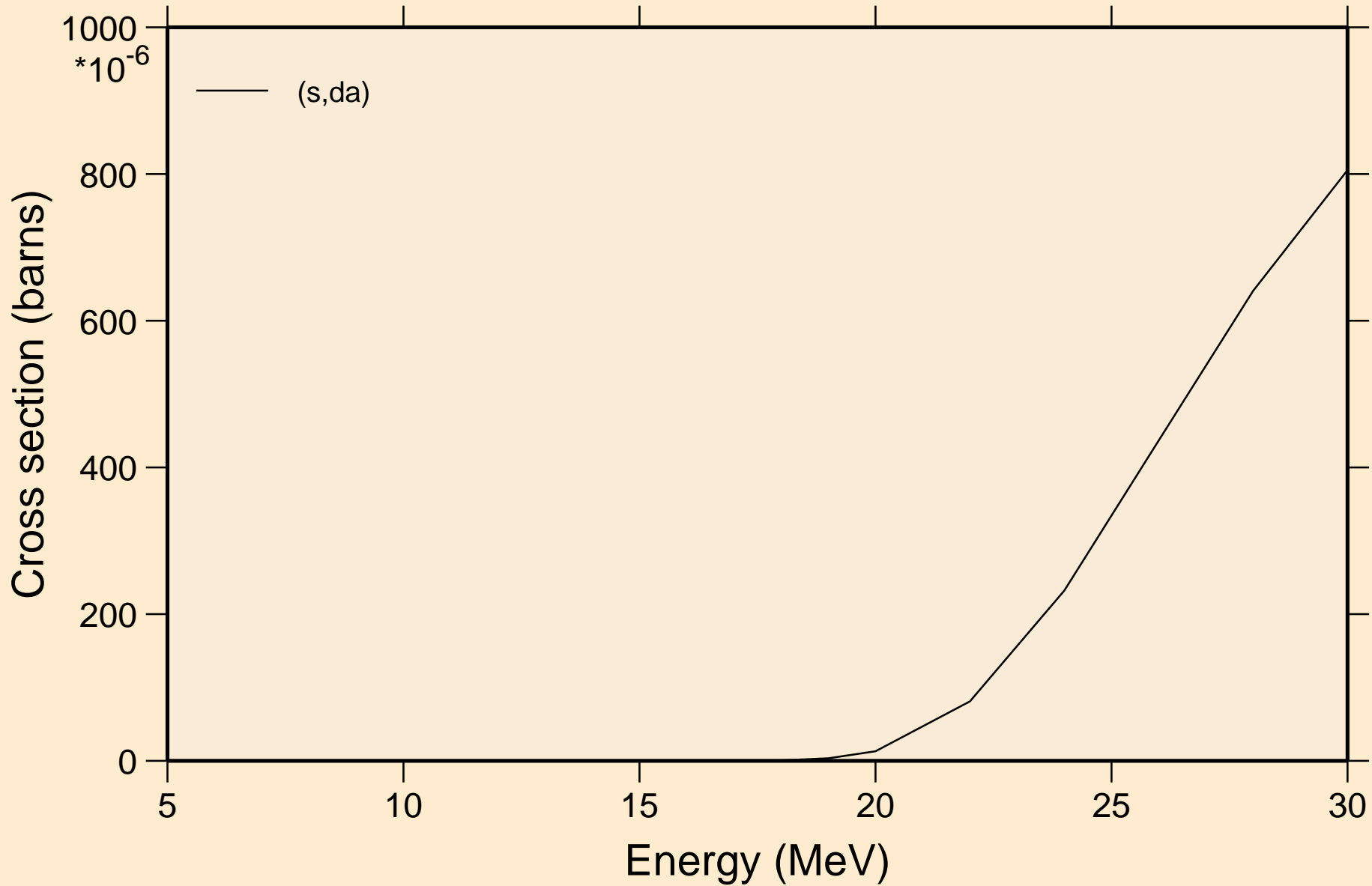

FE055 HELION ACER TENDL-2023 LIBRARY; T=0.K  
angular distribution for elastic

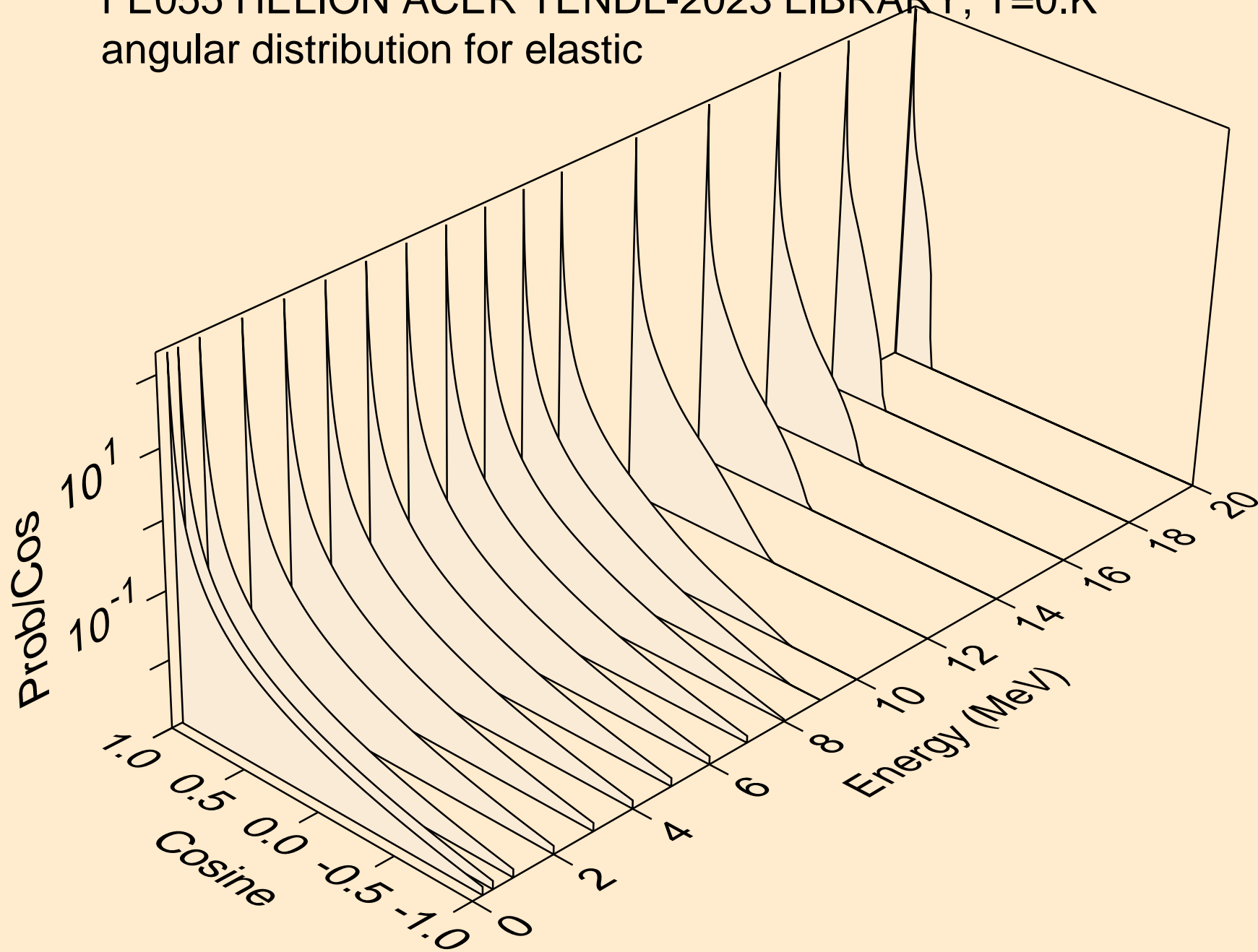

FE055 HELION ACER TENDL-2023 LIBRARY; T=0.K  
angular distribution for elastic

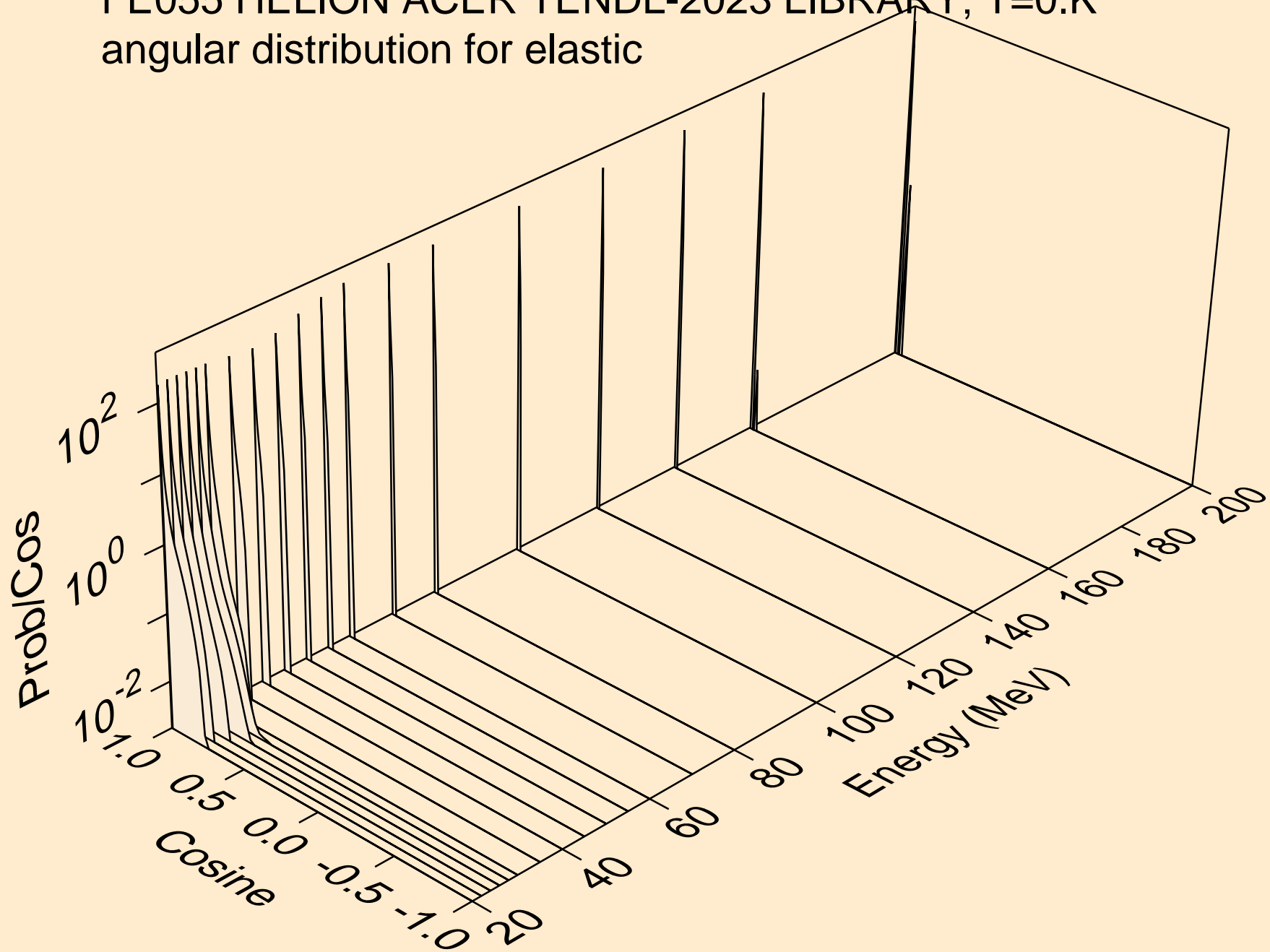

FE055 HELION ACER TENDL-2023 LIBRARY; T=0.K  
He-3 emission for (s,x)

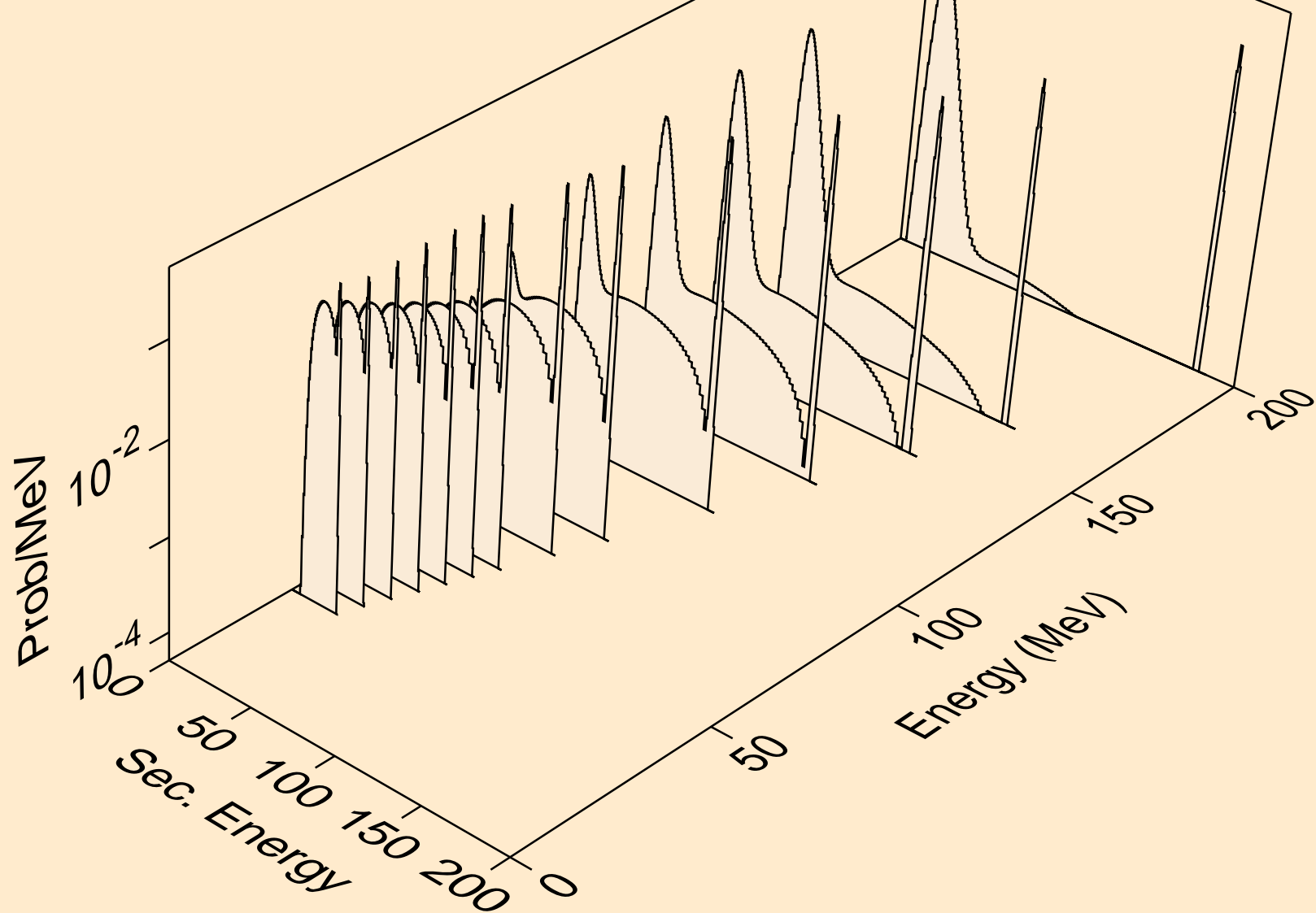

FE055 HELION ACER TENDL-2023 LIBRARY; T=0.K  
He-3 emission for (s,n\*)he3

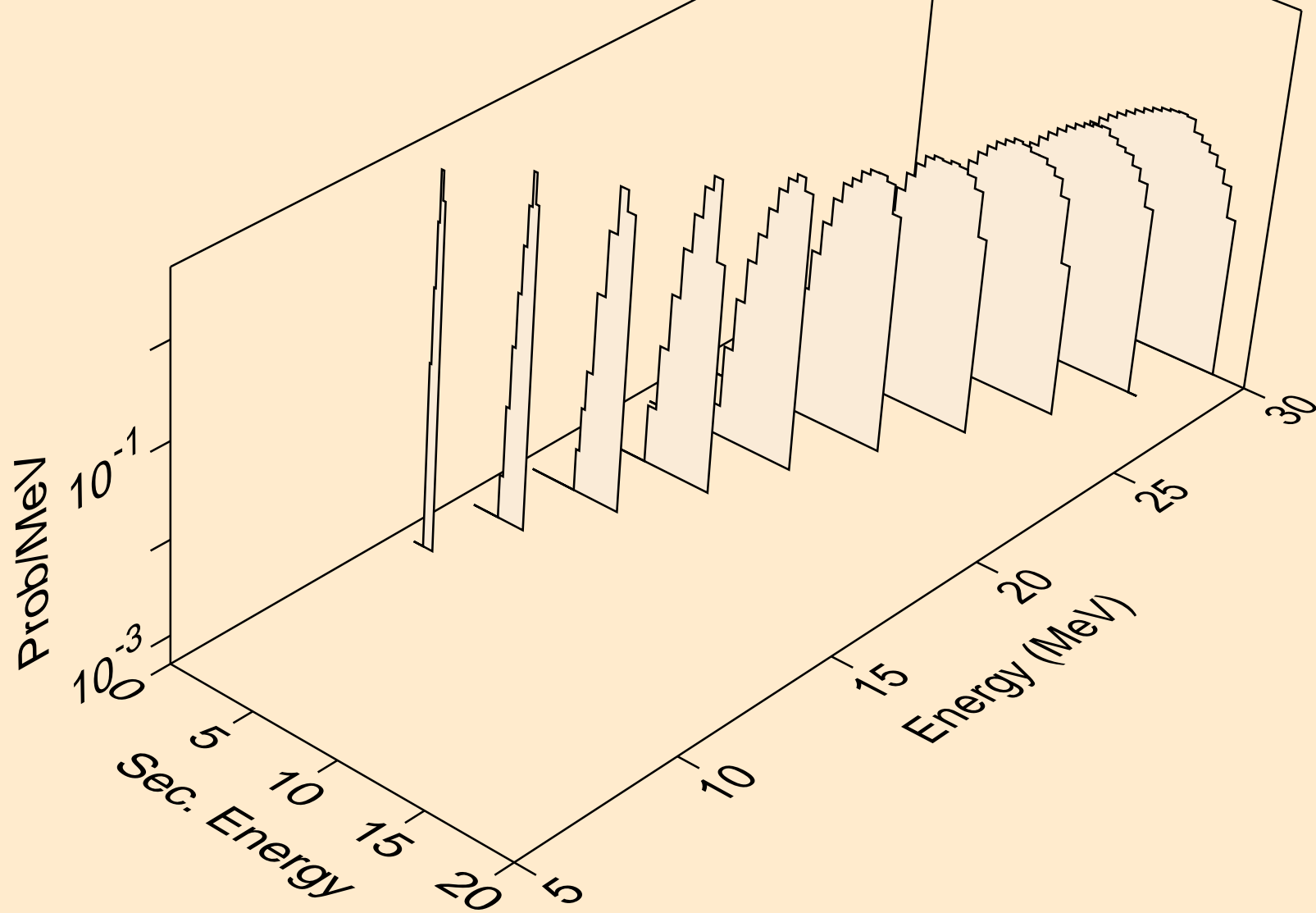



FE055 HELION ACER TENDL-2023 LIBRARY; T=0.K  
He-3 emission for inelastic

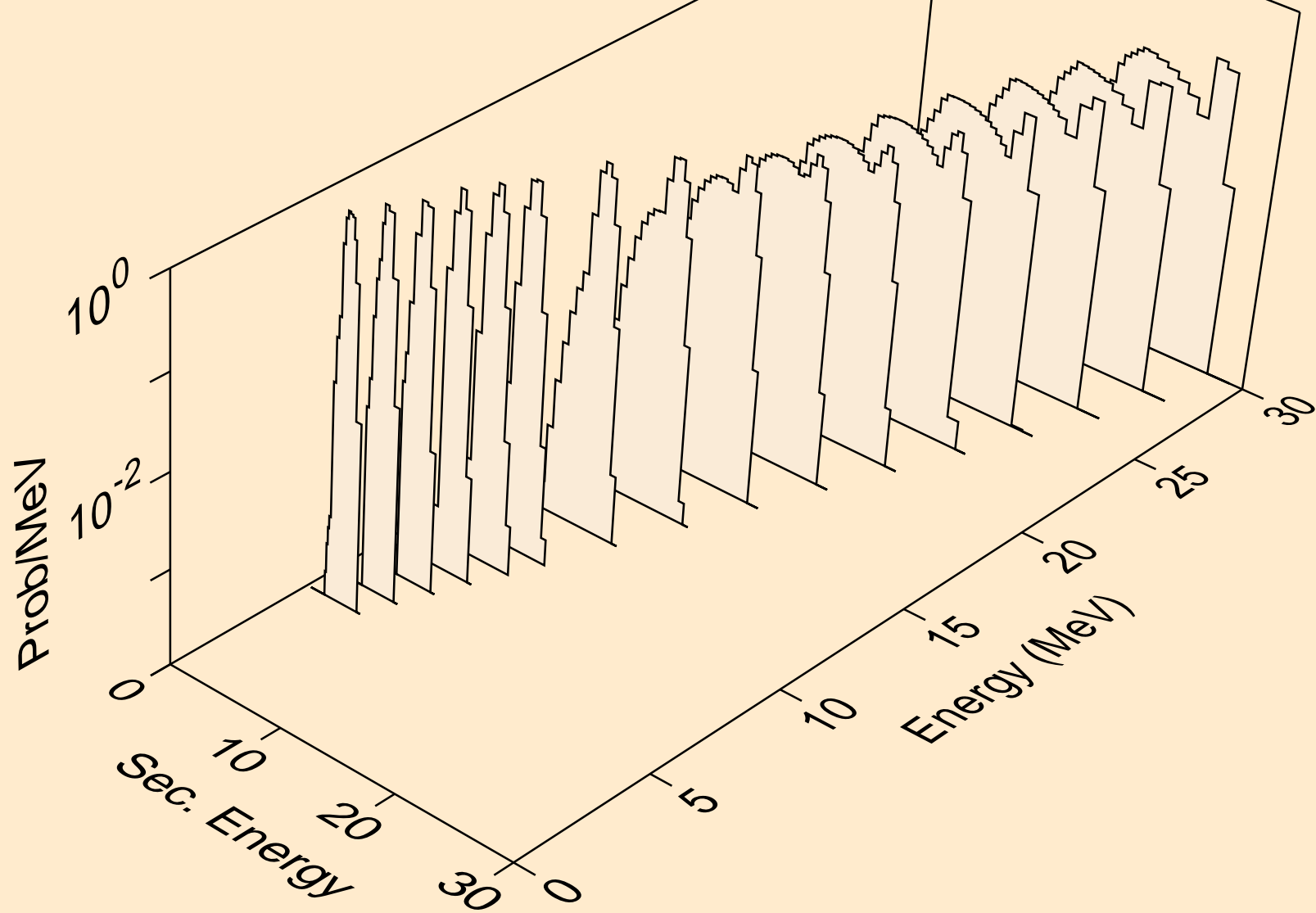

FE055 HELION ACER TENDL-2023 LIBRARY; T=0.K  
Photon emission for (z,n)

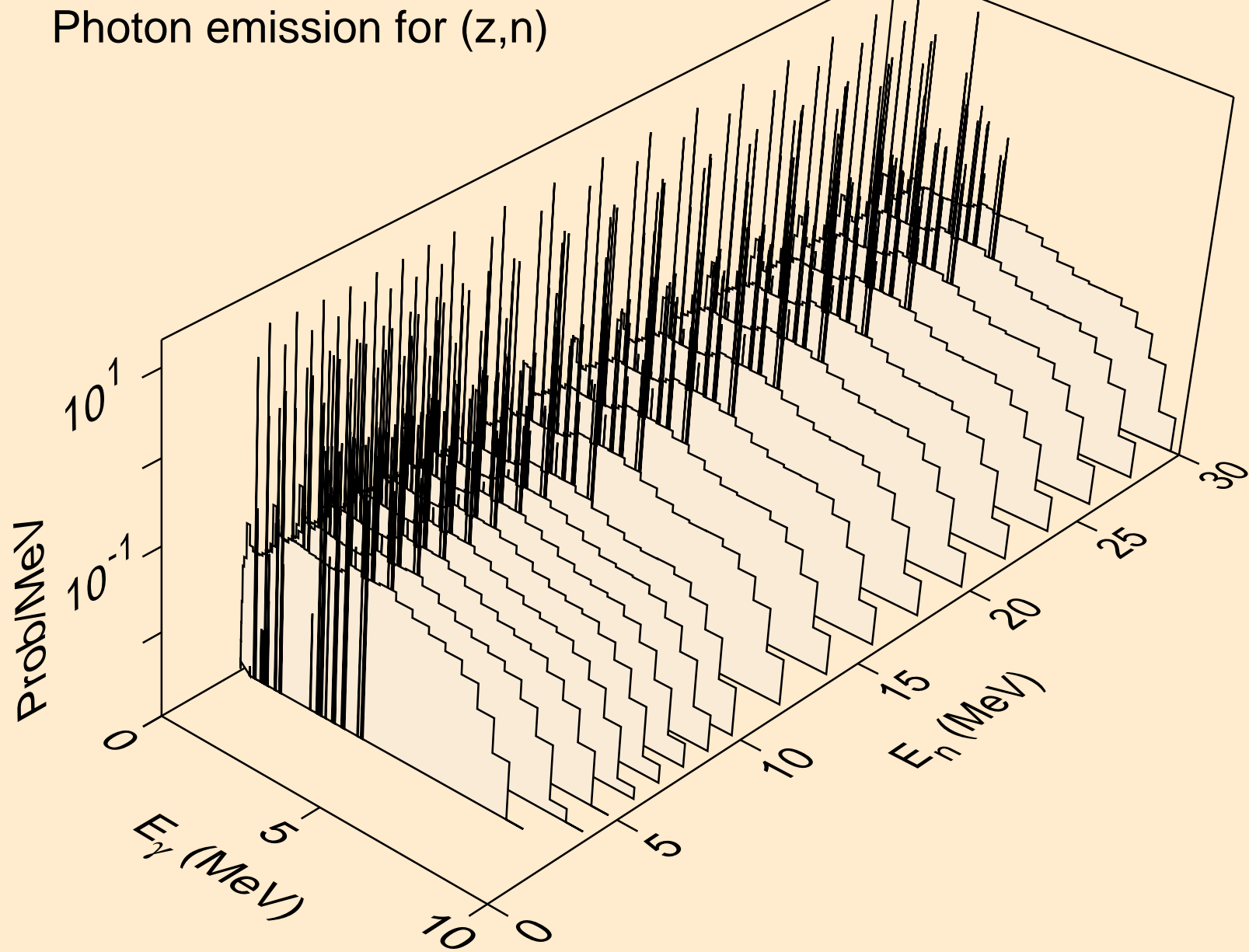

FE055 HELION ACER TENDL-2023 LIBRARY; T=0.K  
Photon emission for (z,x)

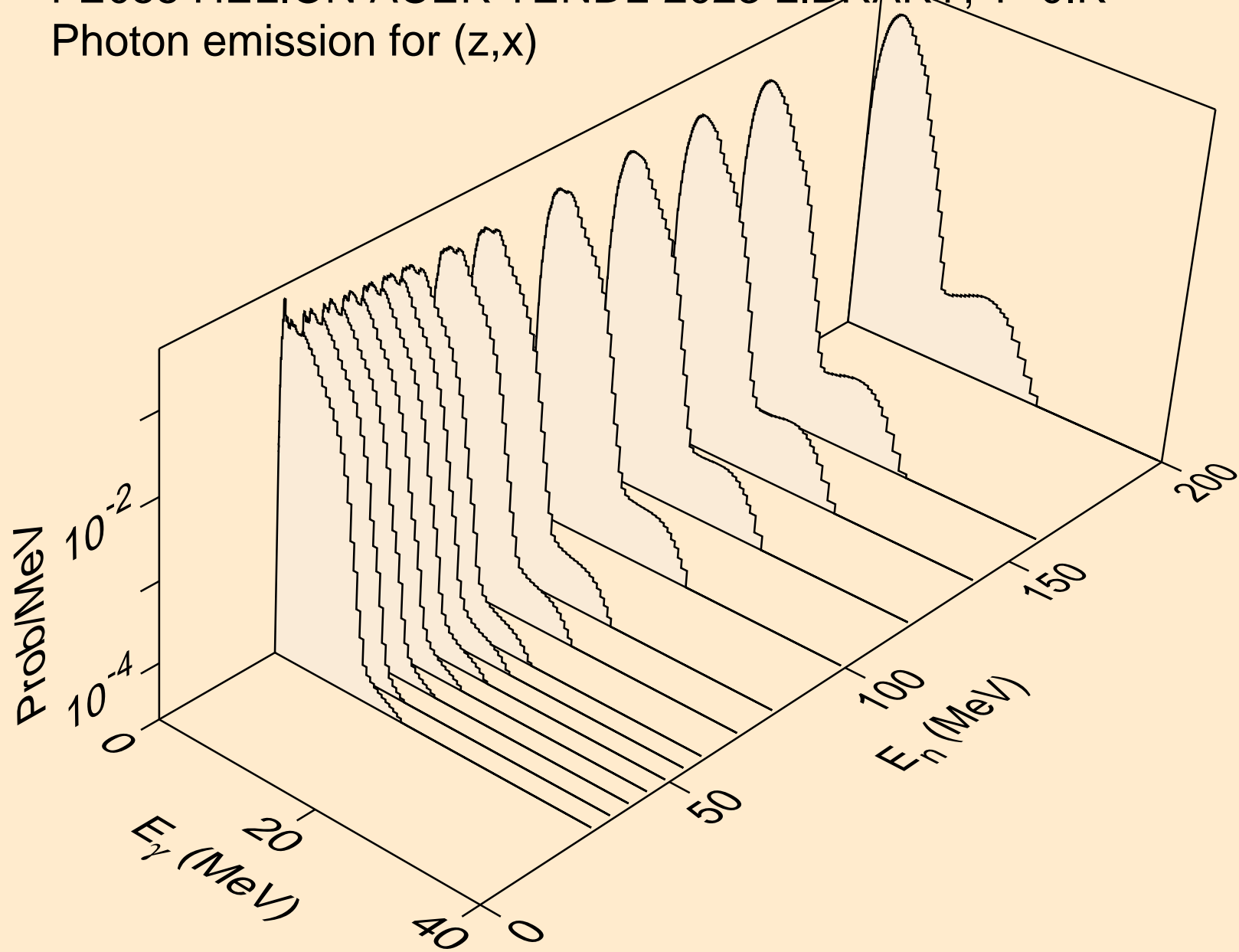

FE055 HELION ACER TENDL-2023 LIBRARY; T=0.K  
Photon emission for (n,2nd)

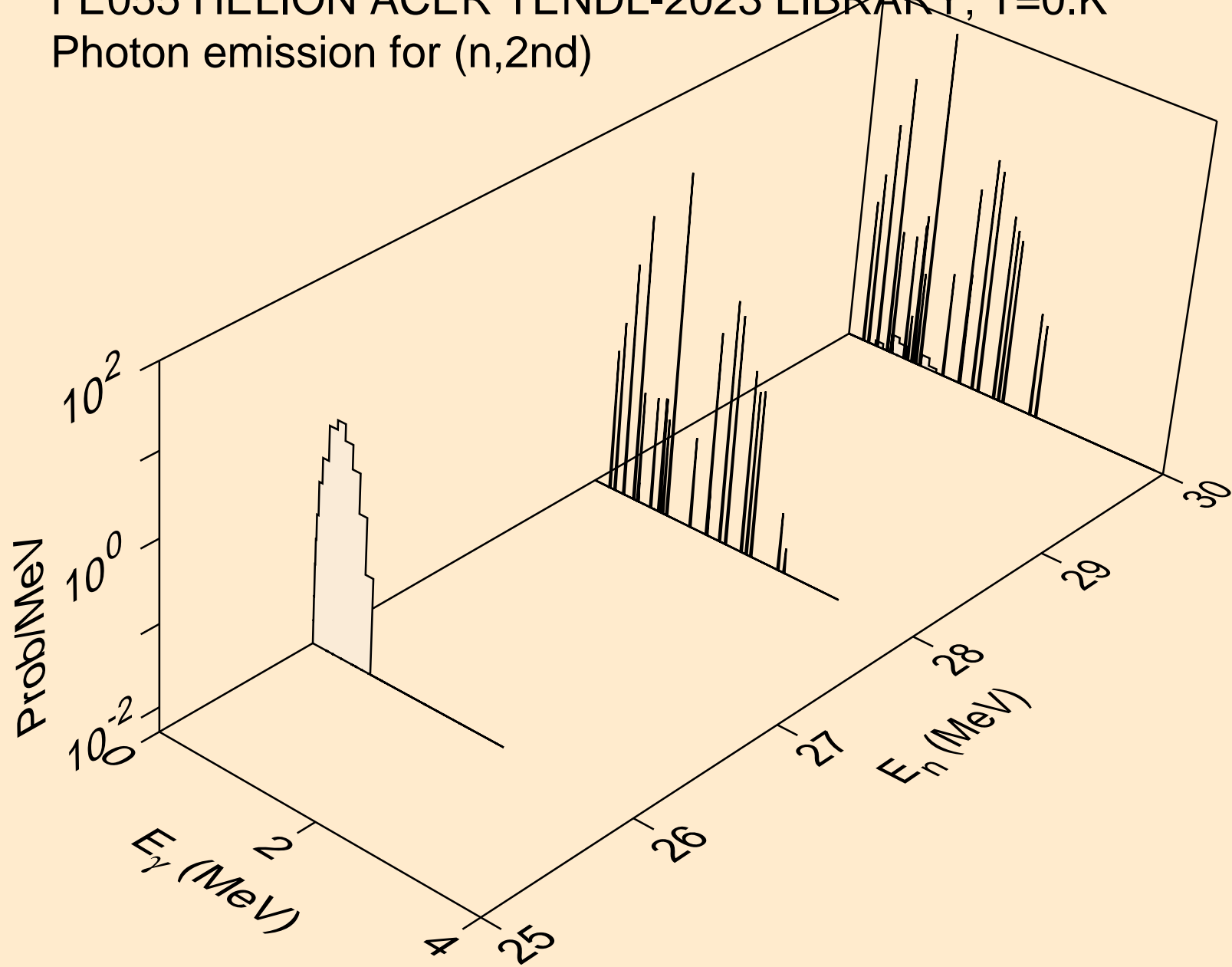

FE055 HELION ACER TENDL-2023 LIBRARY; T=0.K  
Photon emission for (n,2n)

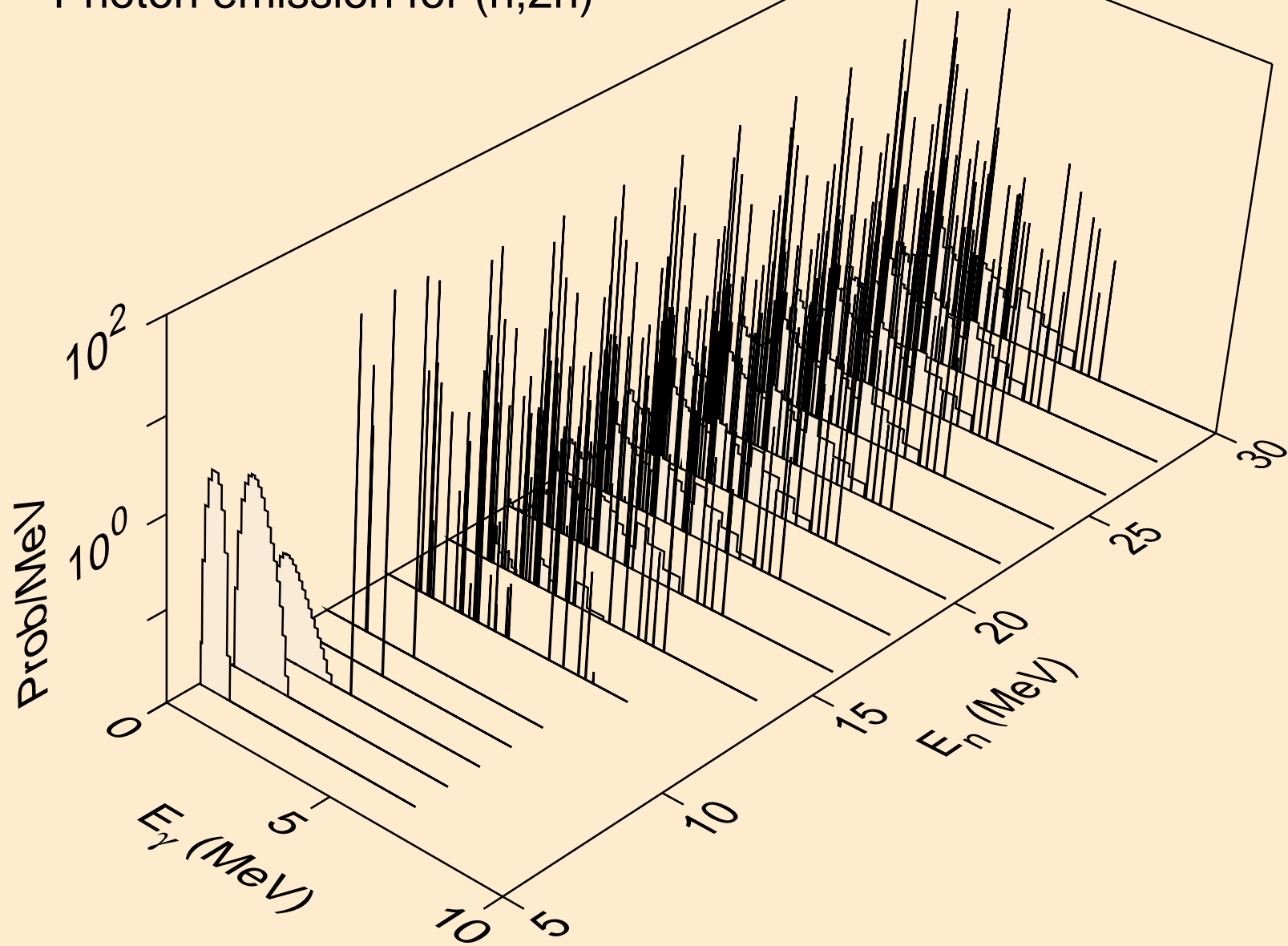

FE055 HELION ACER TENDL-2023 LIBRARY; T=0.K  
Photon emission for (n,3n)

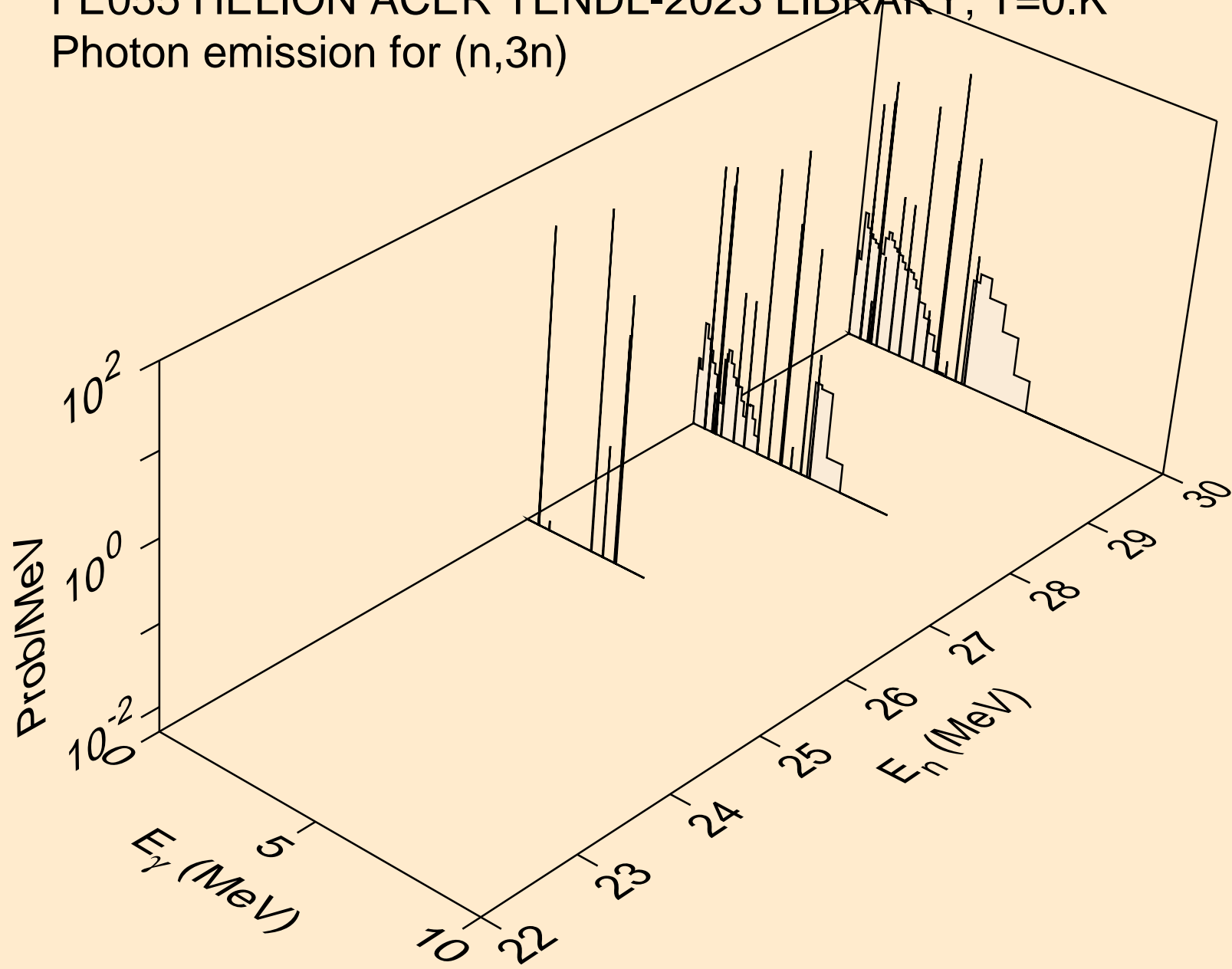

FE055 HELION ACER TENDL-2023 LIBRARY; T=0.K  
Photon emission for (n,n\*)a

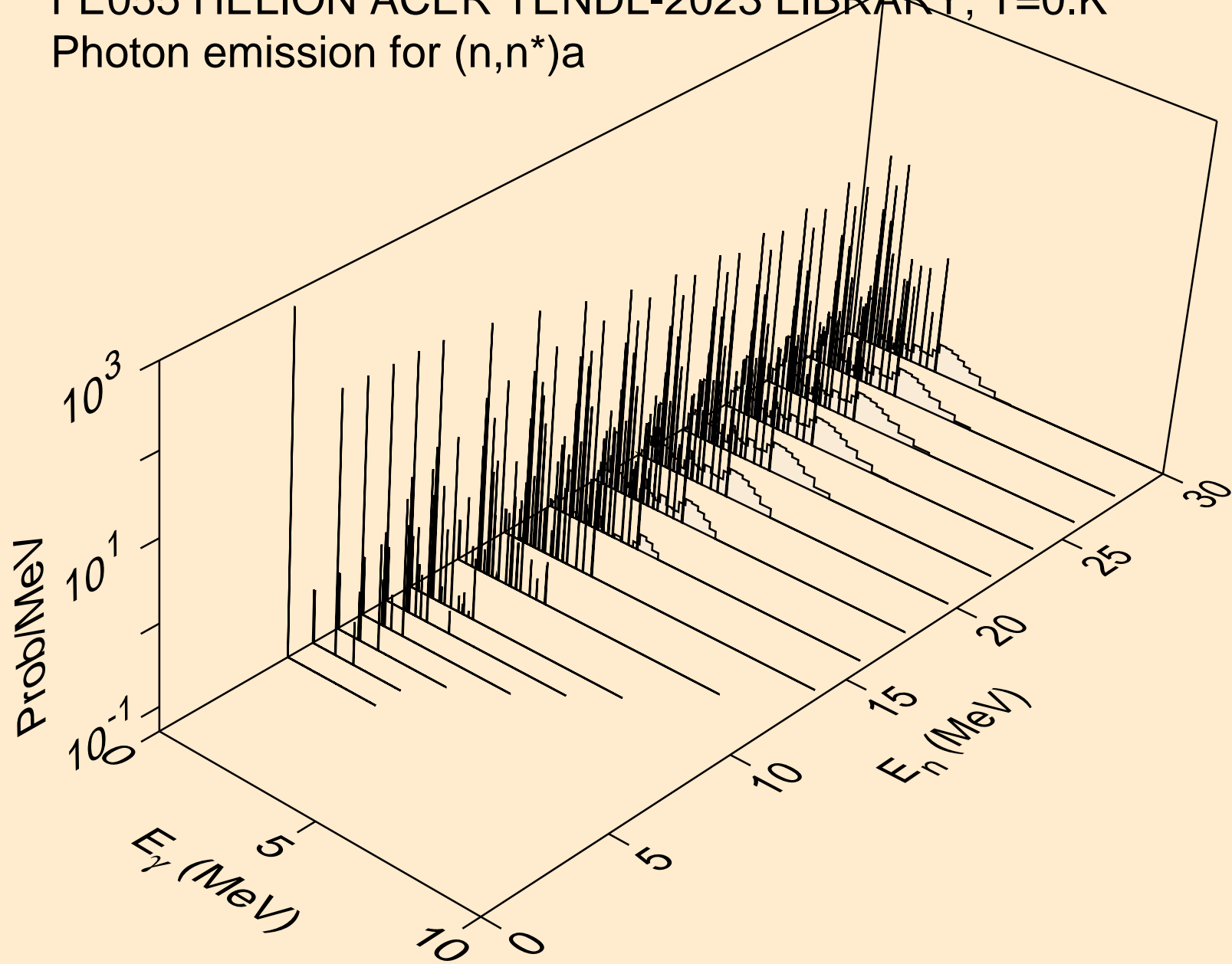

FE055 HELION ACER TENDL-2023 LIBRARY; T=0.K  
Photon emission for (n,2n)a

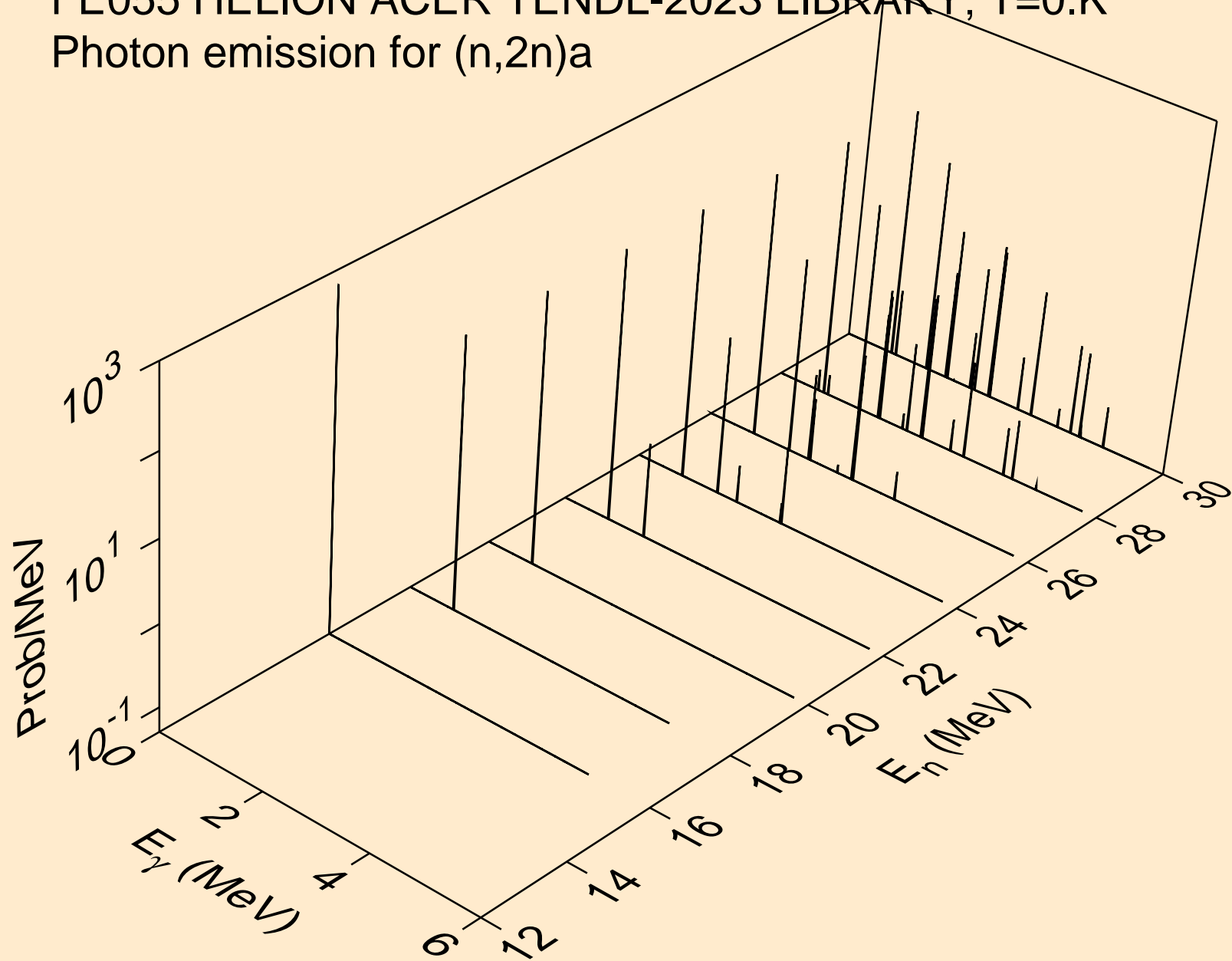



FE055 HELION ACER TENDL-2023 LIBRARY; T=0.K  
Photon emission for (n,n\*)p

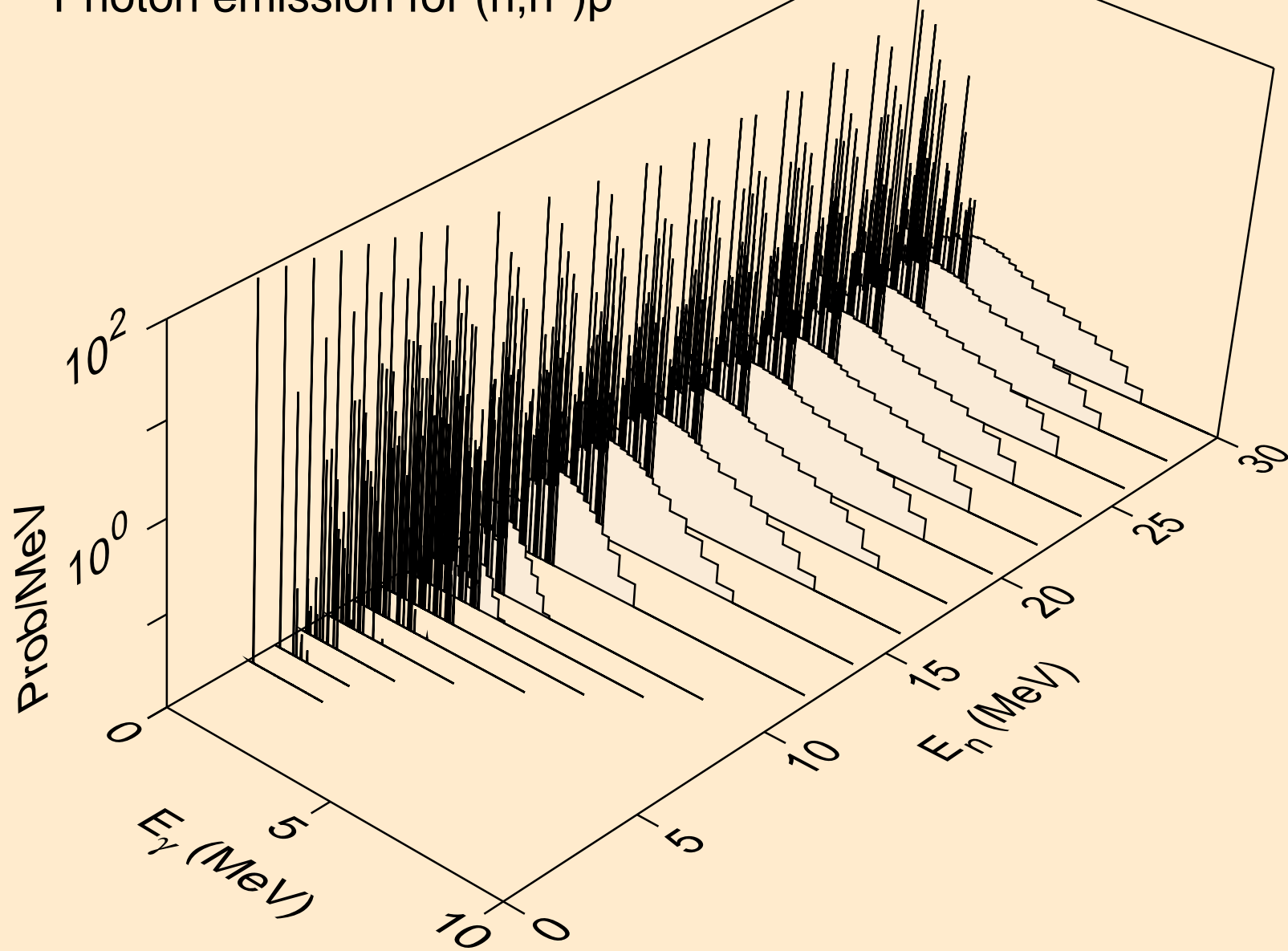

FE055 HELION ACER TENDL-2023 LIBRARY; T=0.K  
Photon emission for (n,n\*)2a

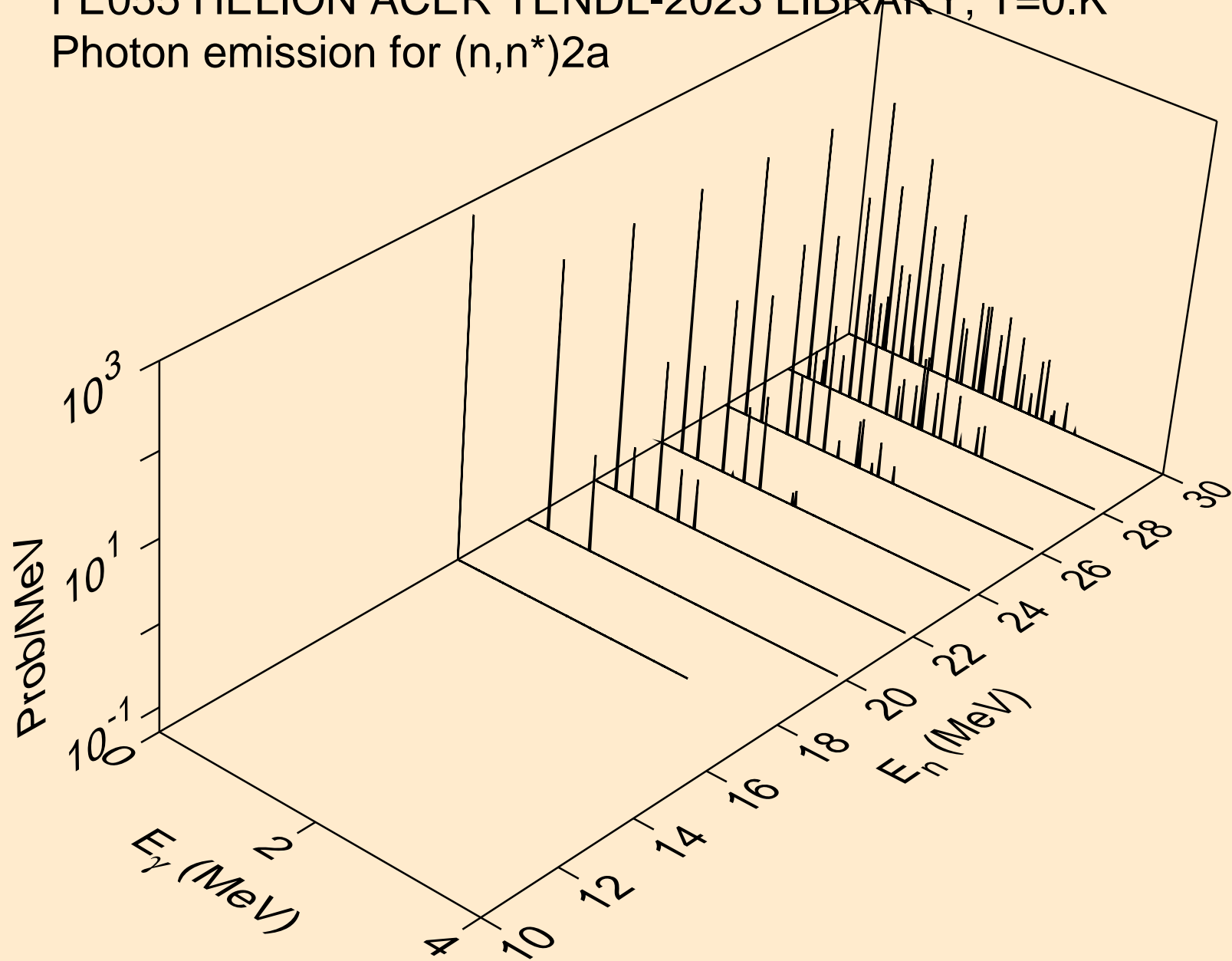

FE055 HELION ACER TENDL-2023 LIBRARY; T=0.K  
Photon emission for (n,n\*)d

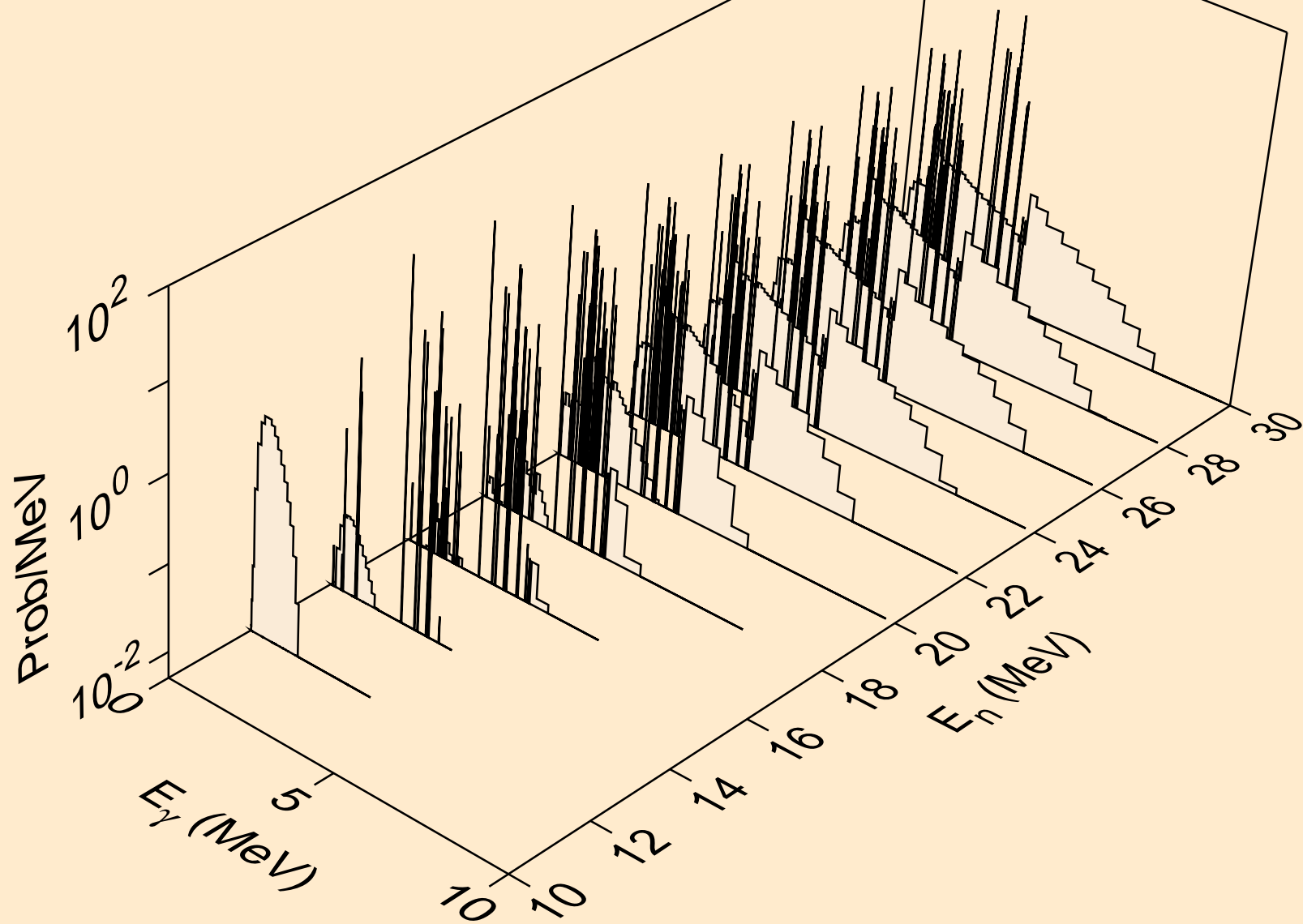

FE055 HELION ACER TENDL-2023 LIBRARY; T=0.K  
Photon emission for (n,n\*)t

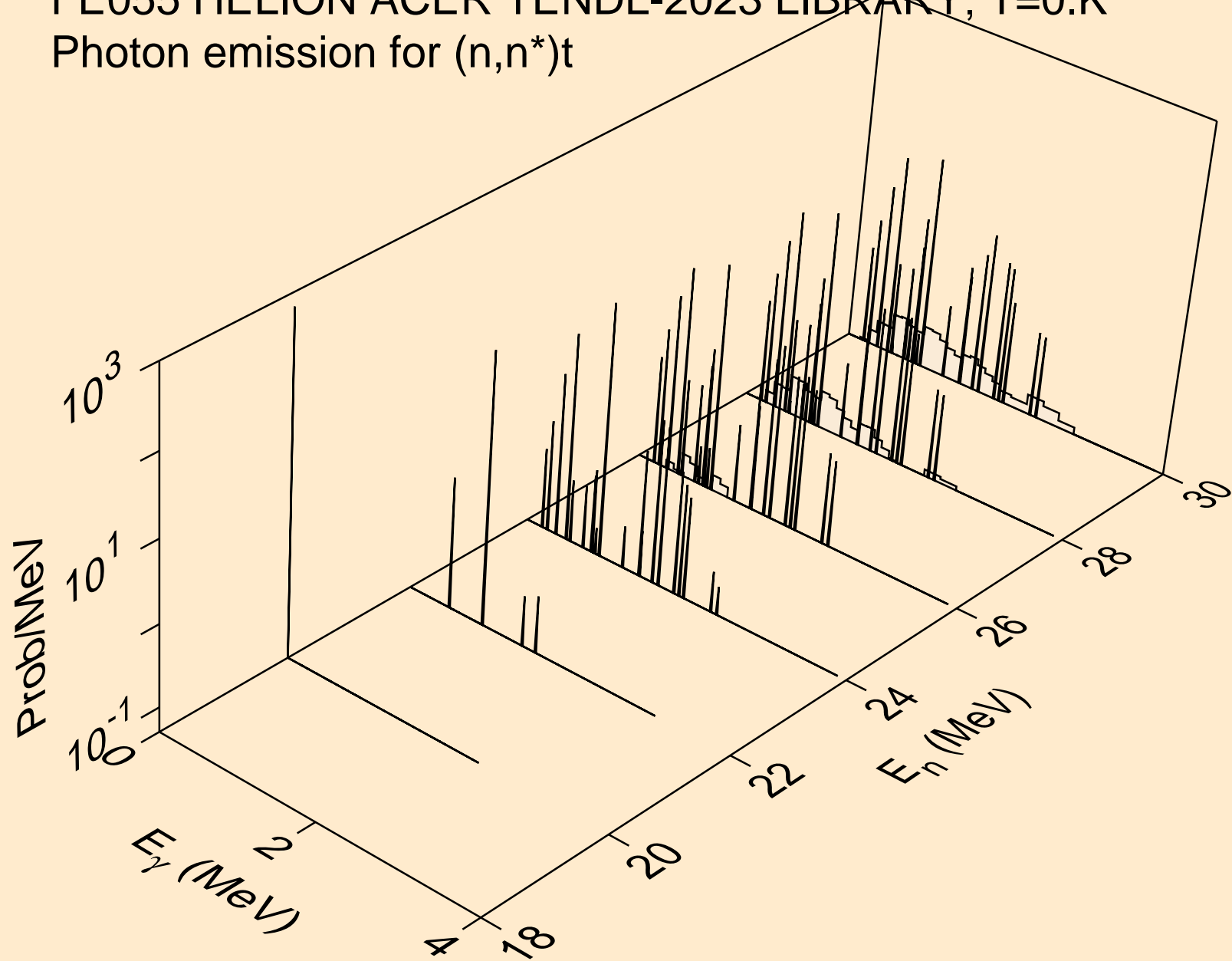

FE055 HELION ACER TENDL-2023 LIBRARY; T=0.K  
Photon emission for (n,n\*)he3

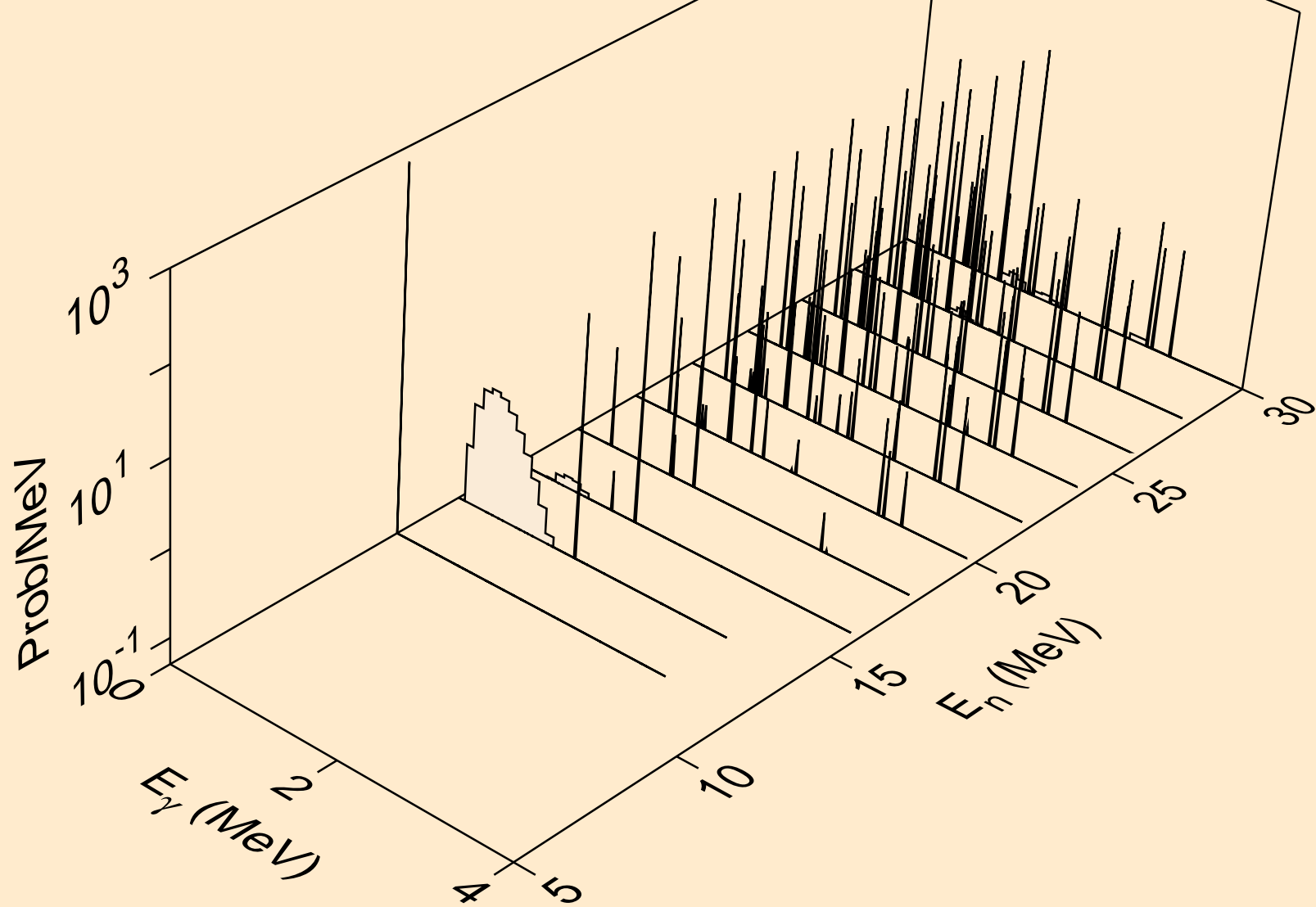

FE055 HELION ACER TENDL-2023 LIBRARY; T=0.K  
Photon emission for (n,2np)

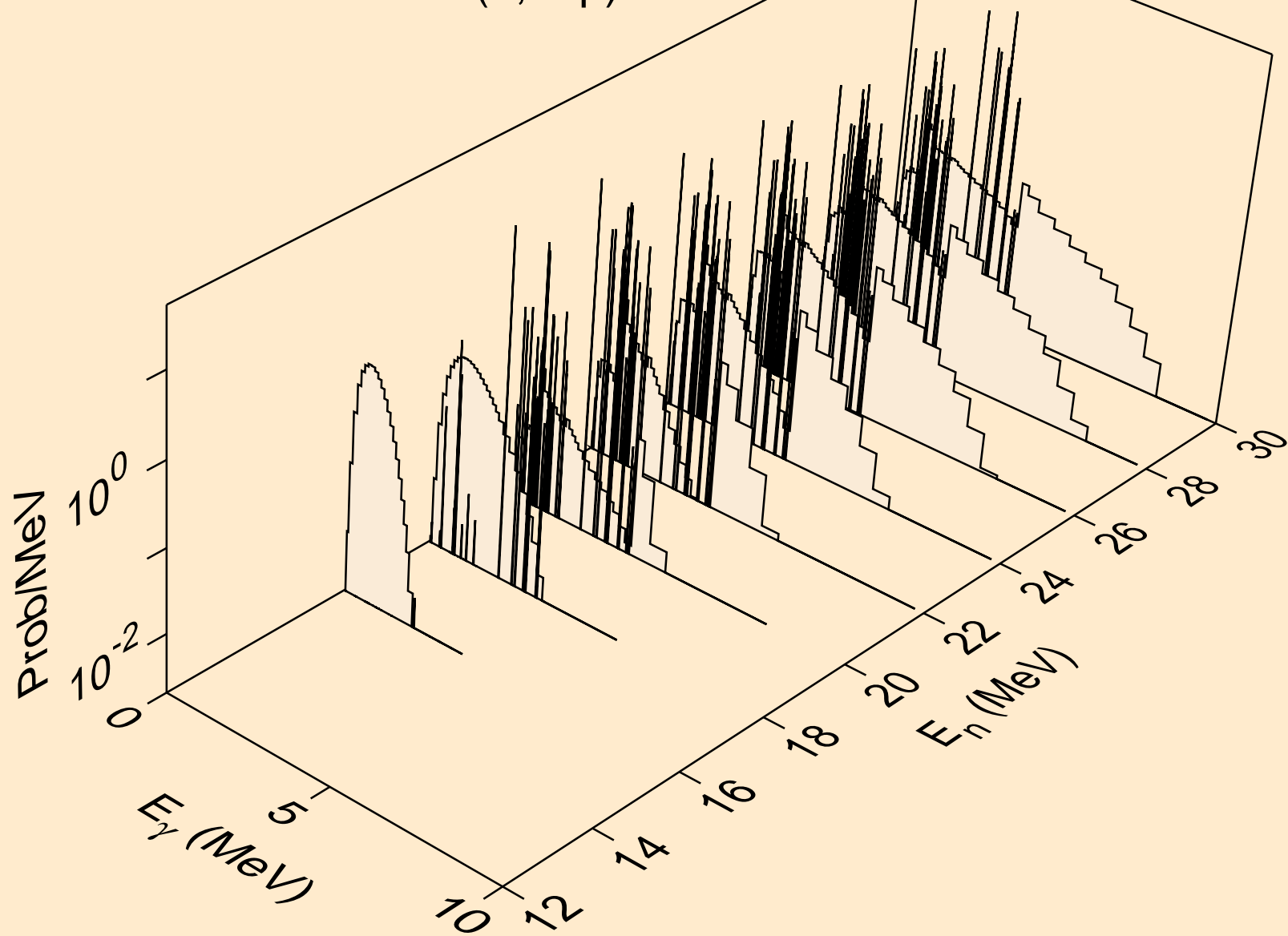

FE055 HELION ACER TENDL-2023 LIBRARY; T=0.K  
Photon emission for (n,3np)

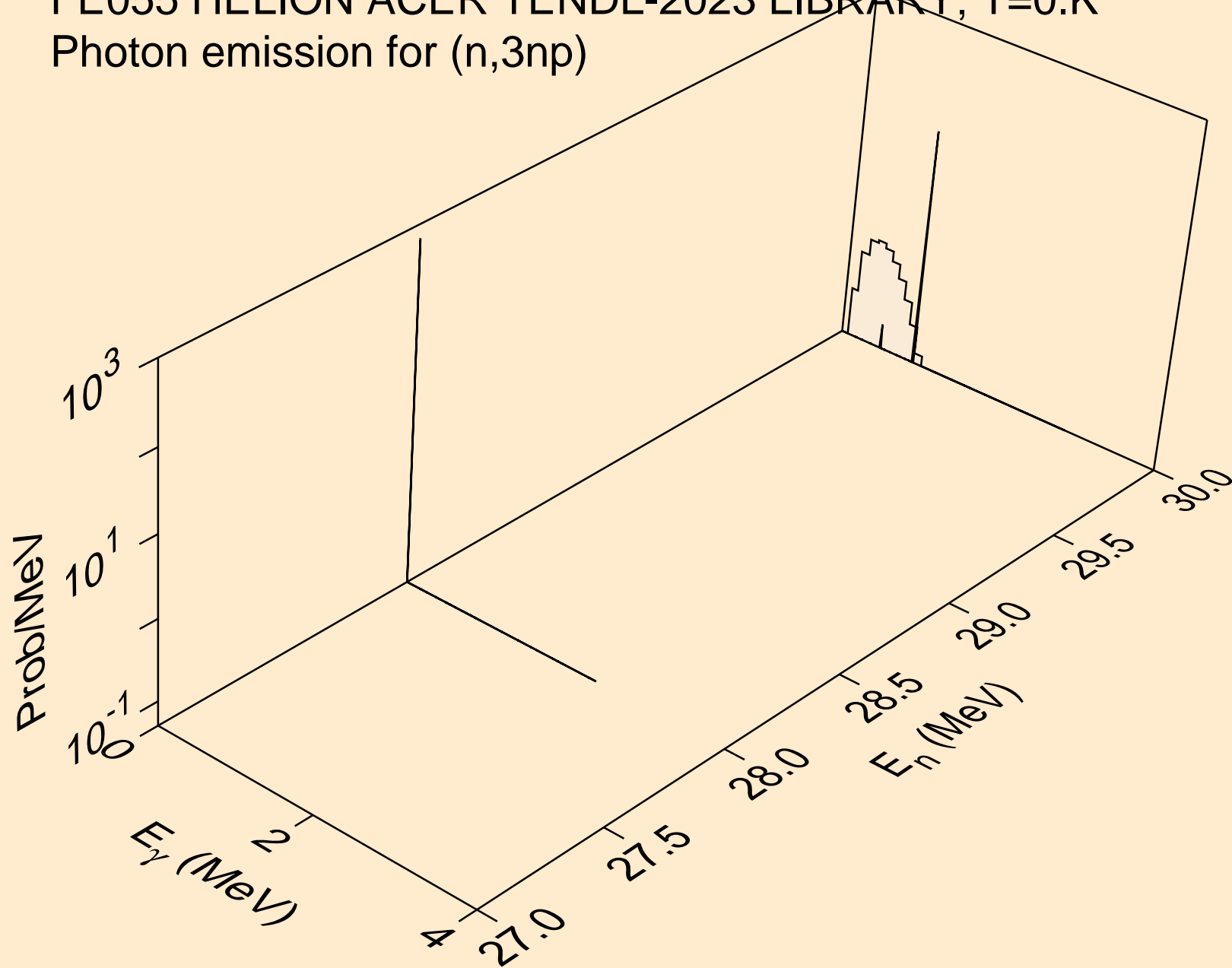

FE055 HELION ACER TENDL-2023 LIBRARY; T=0.K  
Photon emission for (n,n2p)

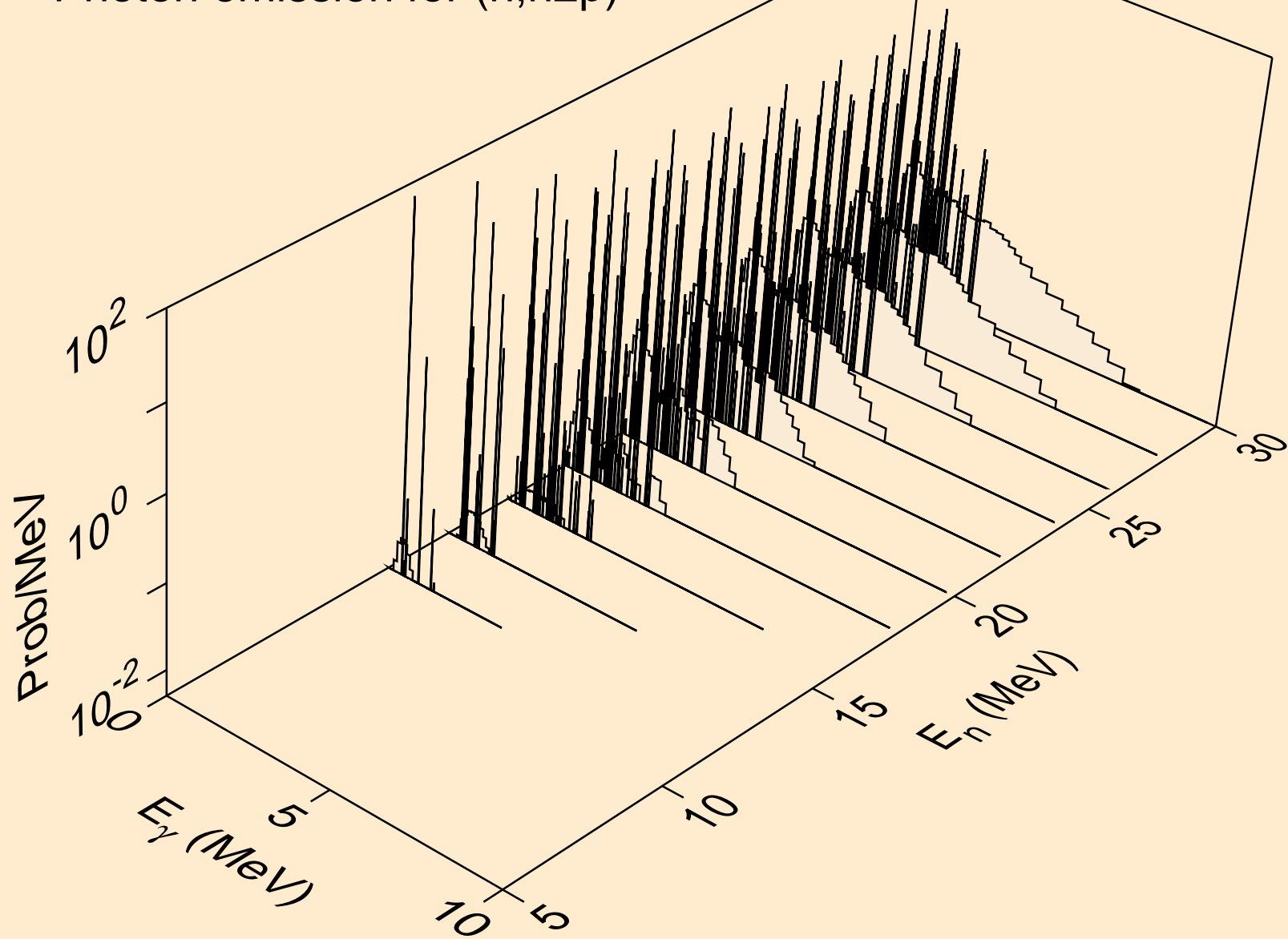



FE055 HELION ACER TENDL-2023 LIBRARY; T=0.K  
Photon emission for (n,npa)

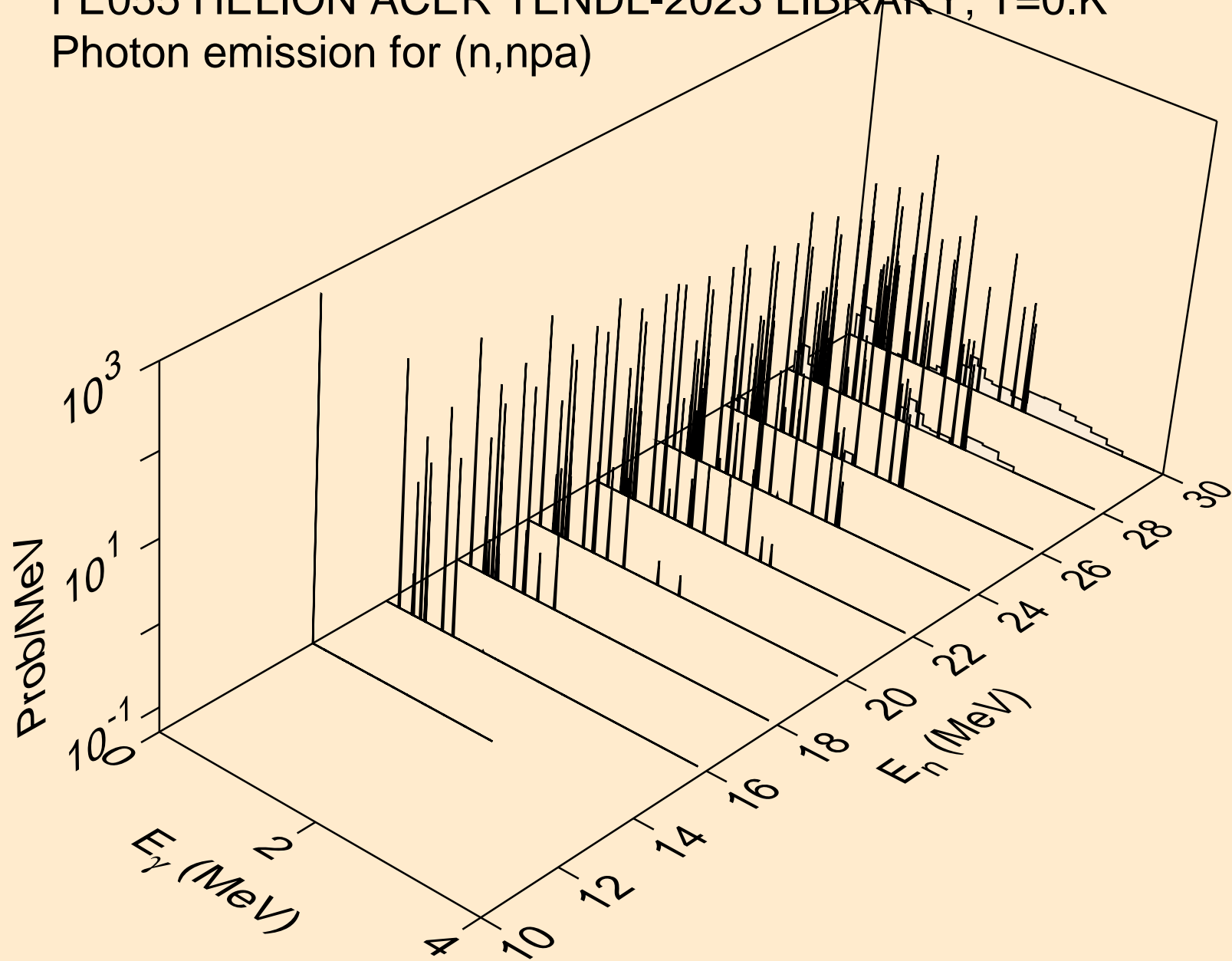

FE055 HELION ACER TENDL-2023 LIBRARY; T=0.K  
Photon emission for (n,gma)

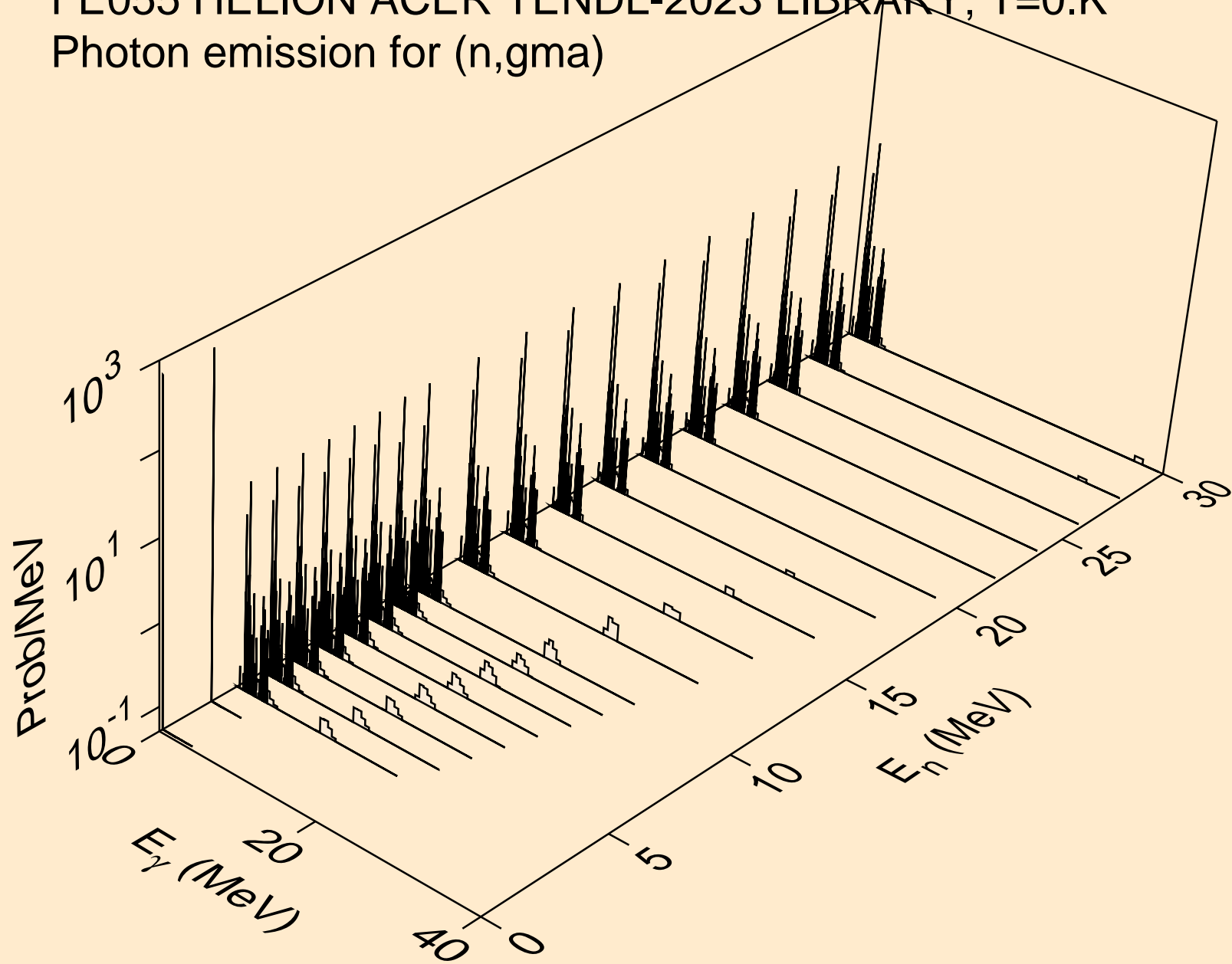

FE055 HELION ACER TENDL-2023 LIBRARY; T=0.K  
Photon emission for (n,p)

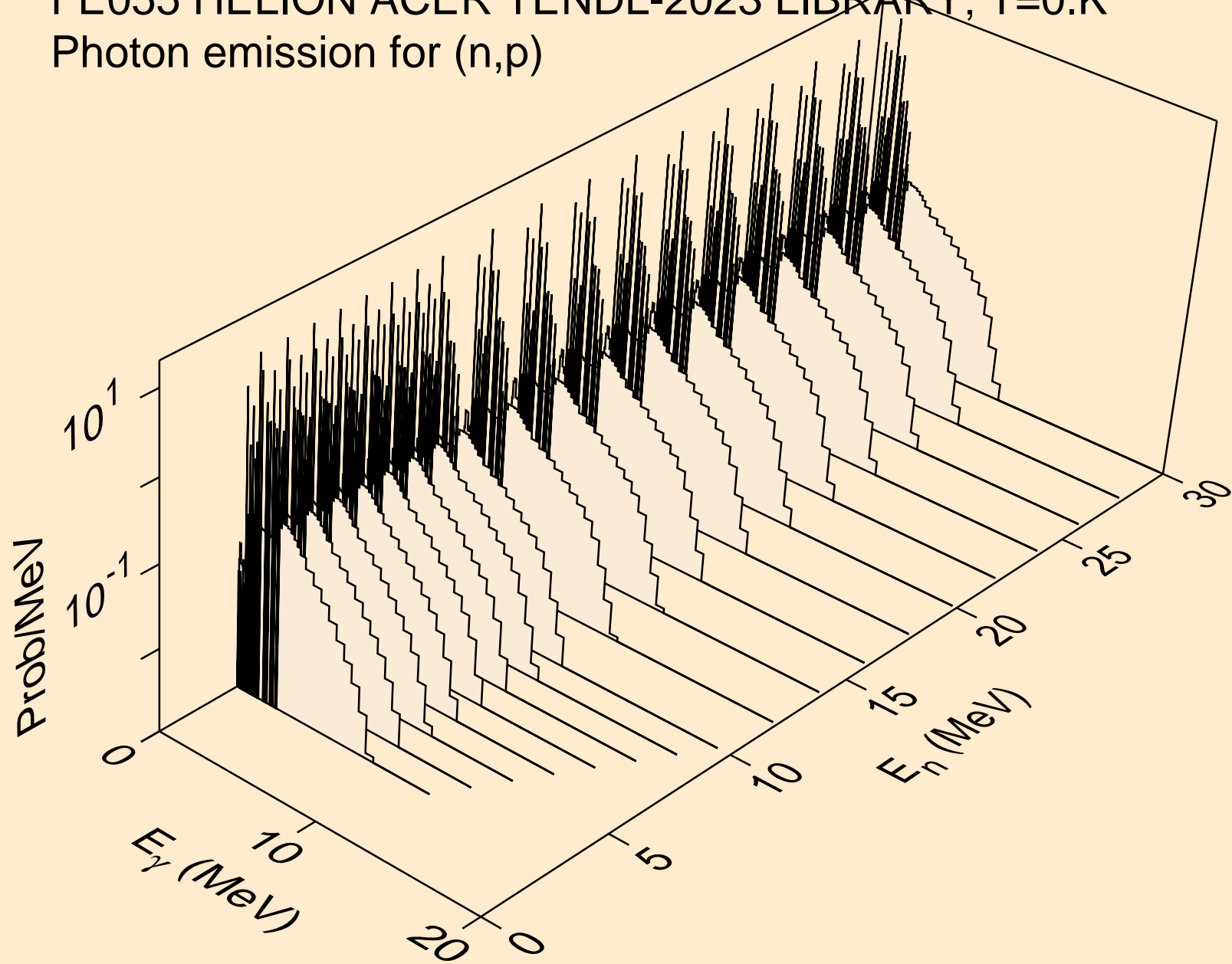

FE055 HELION ACER TENDL-2023 LIBRARY; T=0.K  
Photon emission for (n,d)

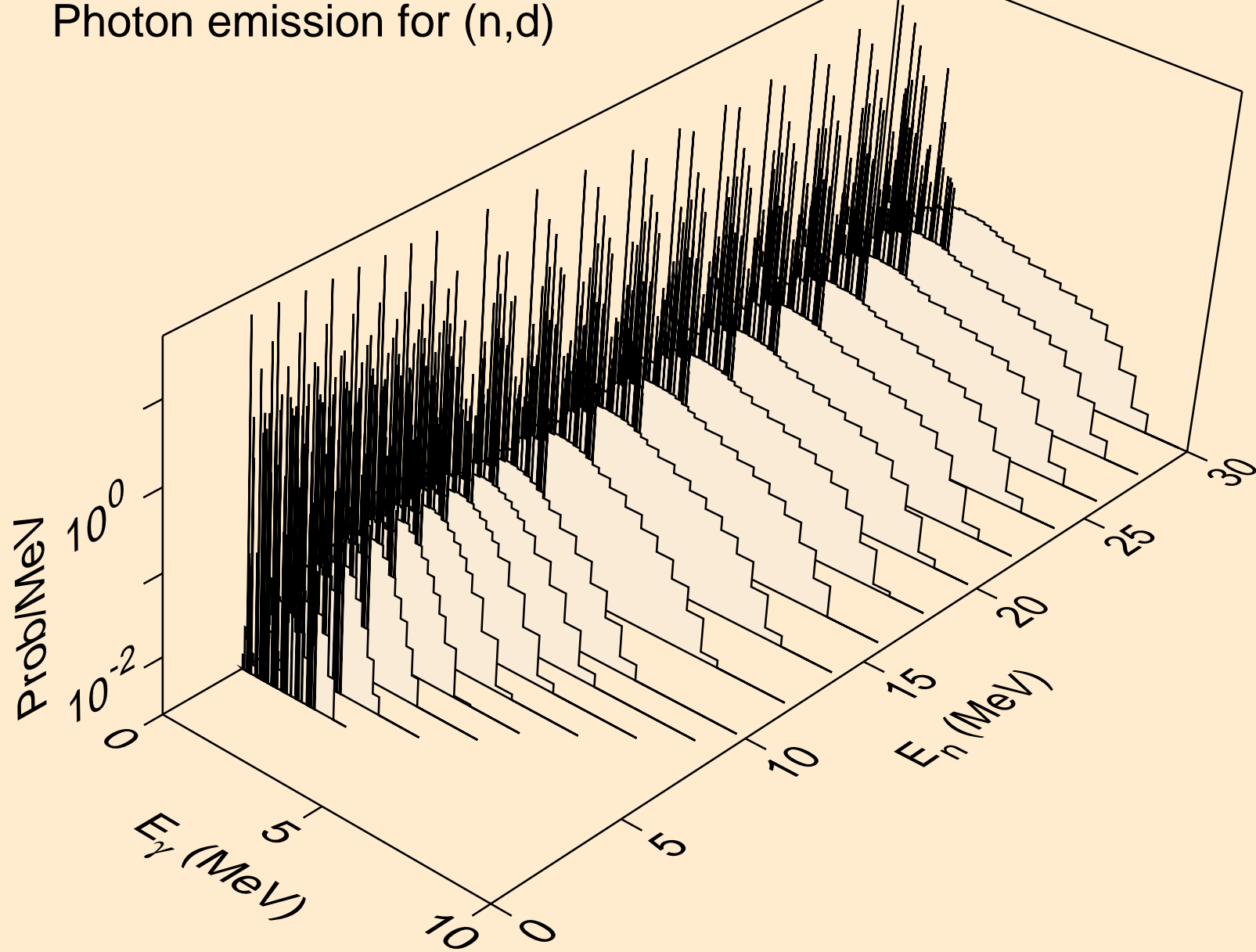

FE055 HELION ACER TENDL-2023 LIBRARY; T=0.K  
Photon emission for (n,t)

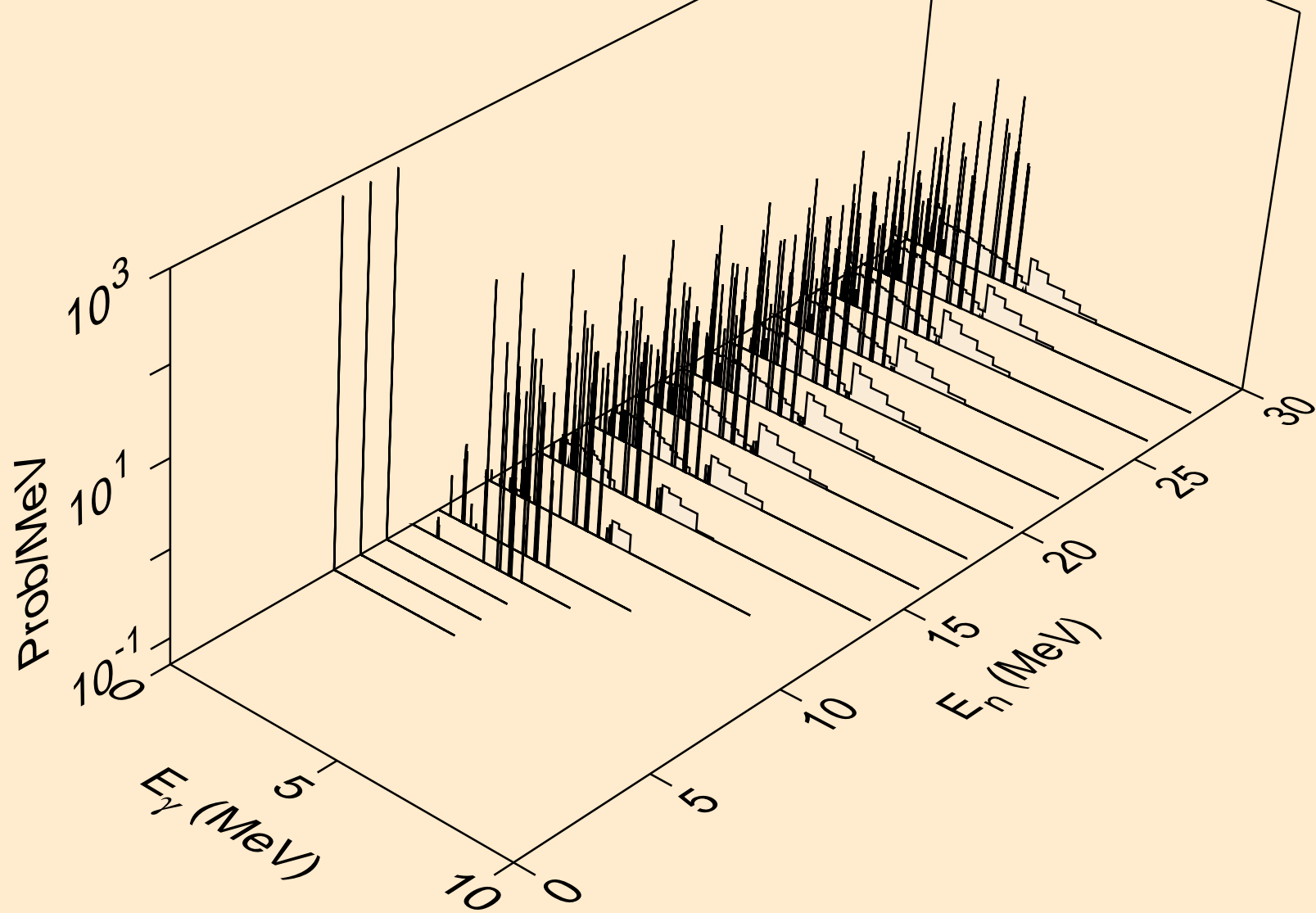

FE055 HELION ACER TENDL-2023 LIBRARY; T=0.K  
Photon emission for inelastic

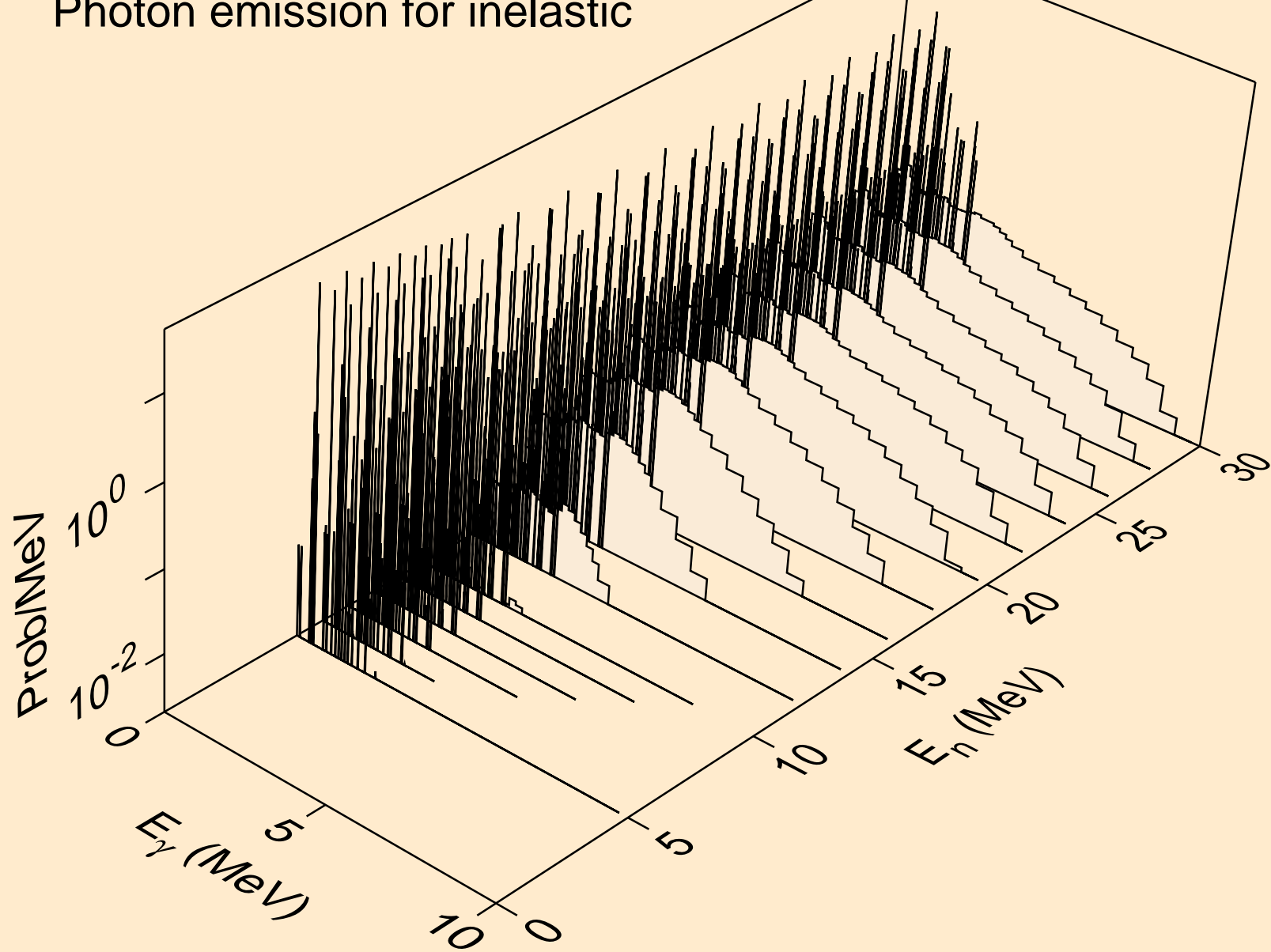

FE055 HELION ACER TENDL-2023 LIBRARY; T=0.K  
Photon emission for (n,a)

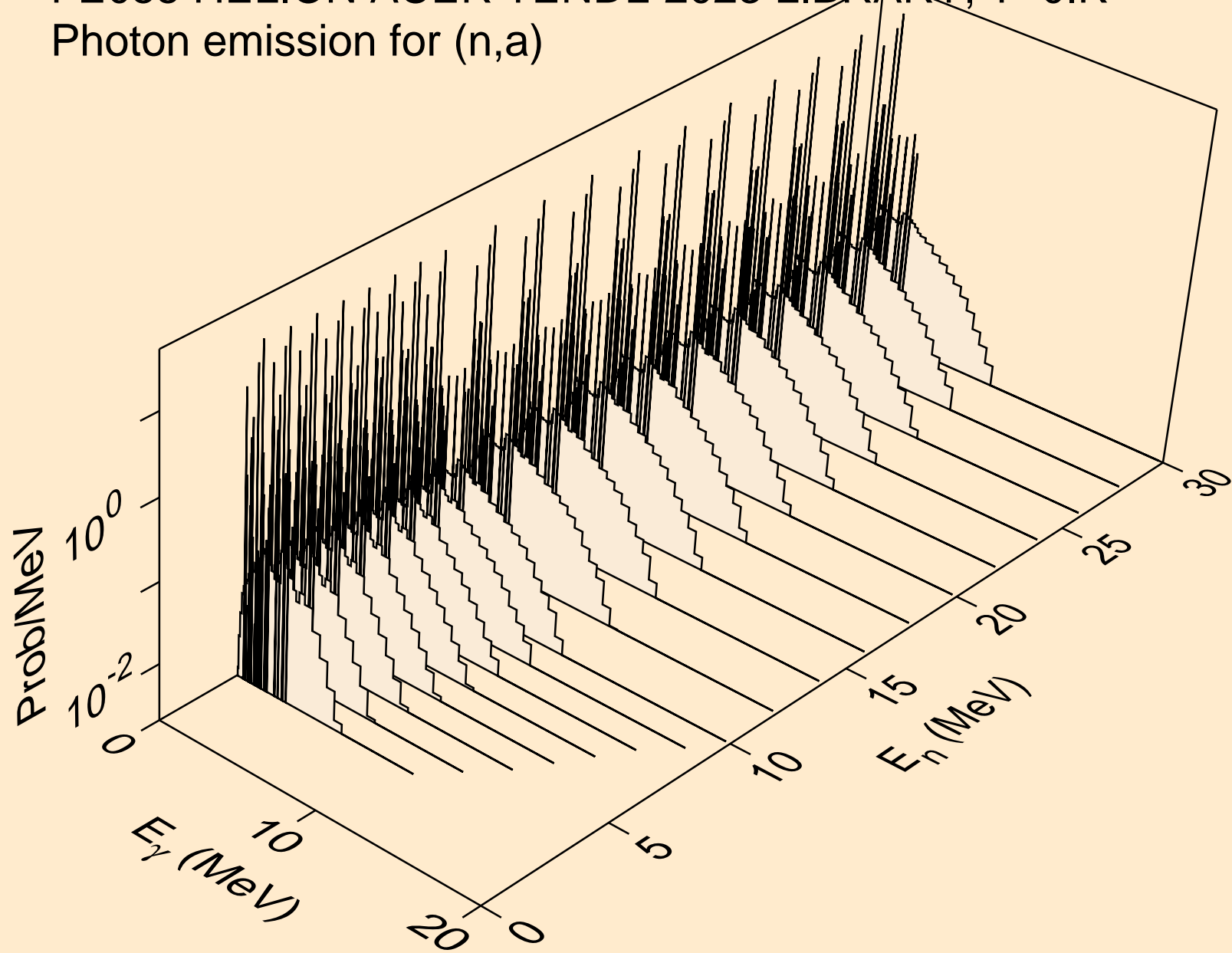

FE055 HELION ACER TENDL-2023 LIBRARY; T=0.K  
Photon emission for (n,2a)

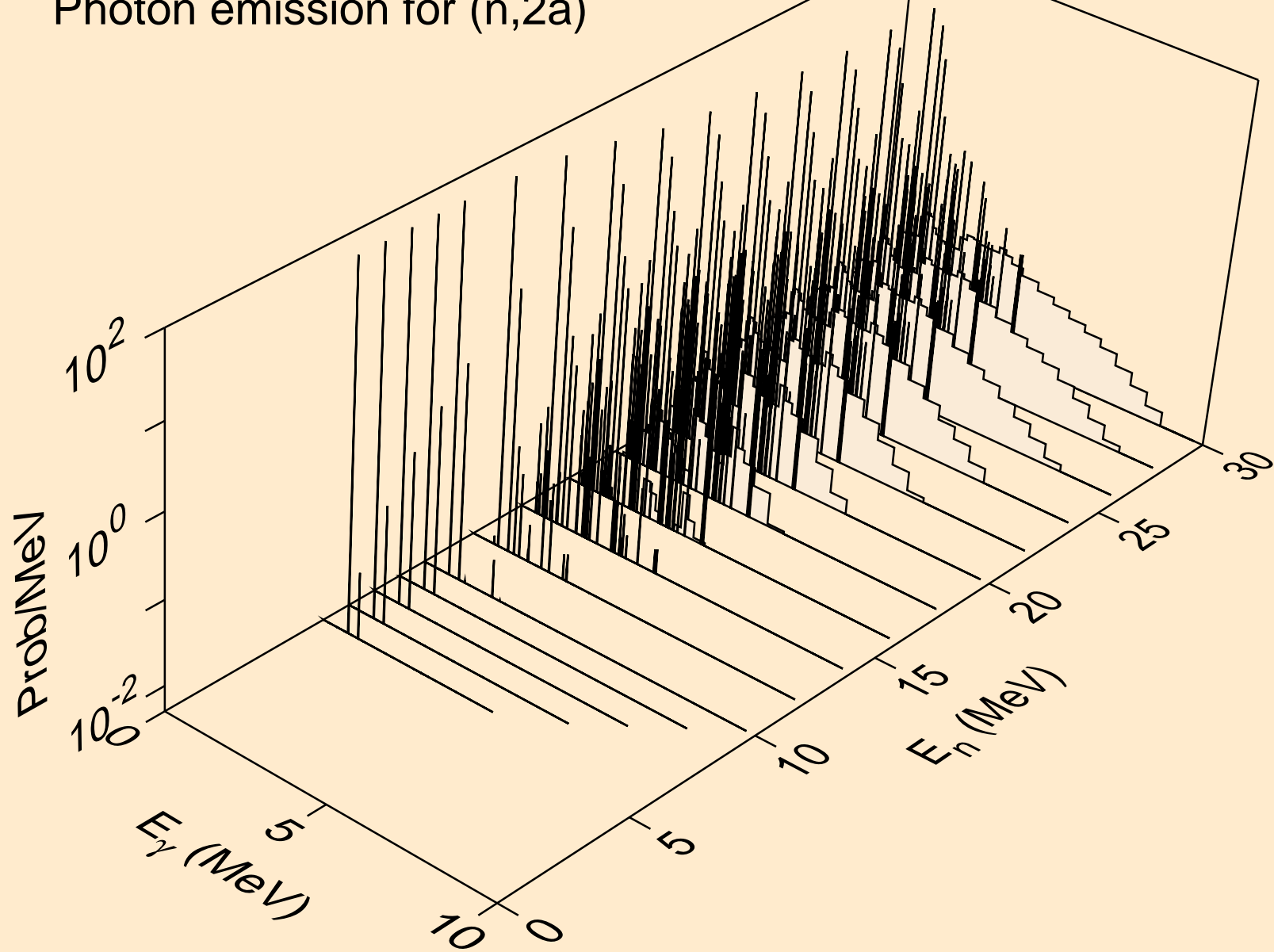



FE055 HELION ACER TENDL-2023 LIBRARY; T=0.K  
Photon emission for (n,3a)

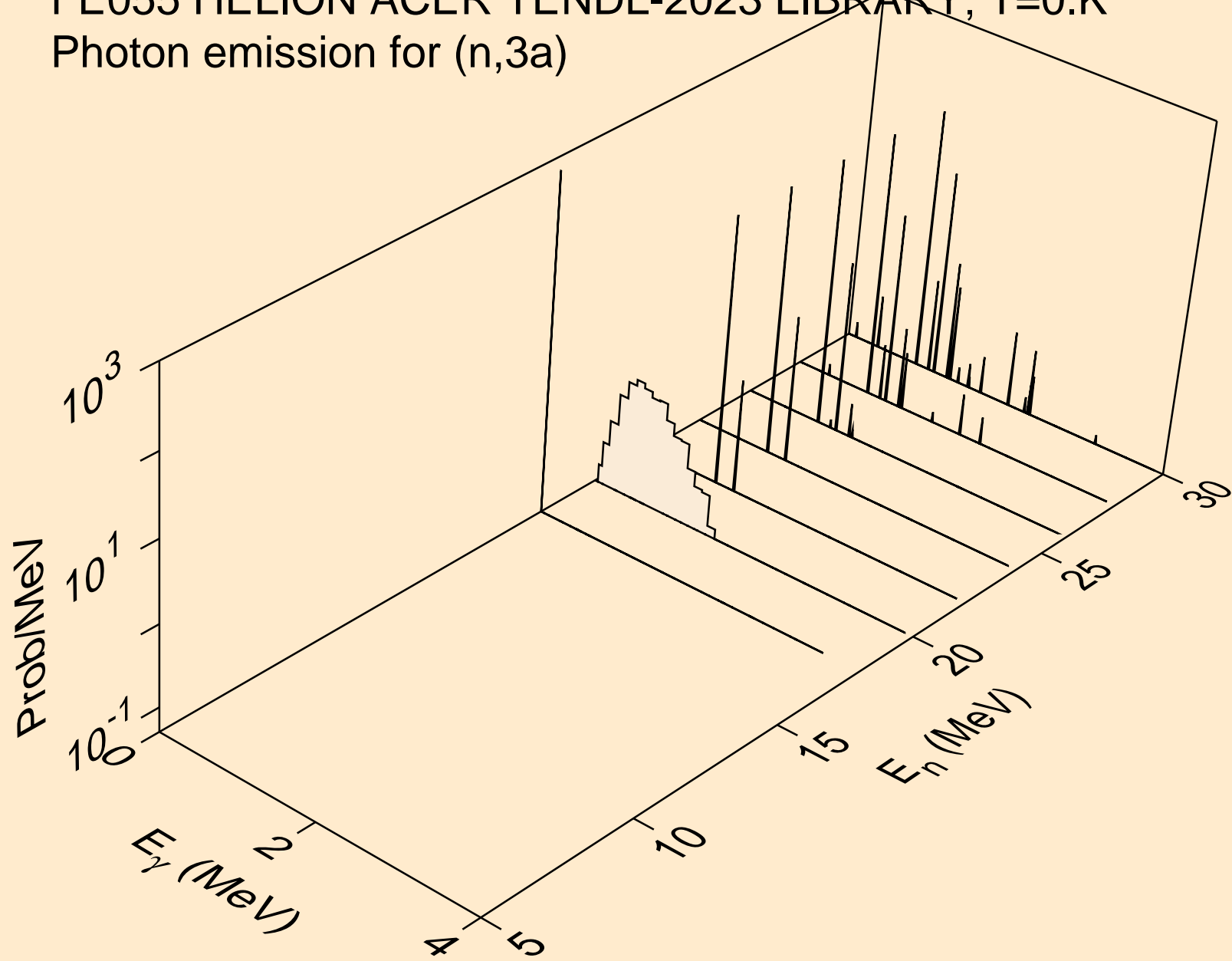

FE055 HELION ACER TENDL-2023 LIBRARY; T=0.K  
Photon emission for (n,2p)

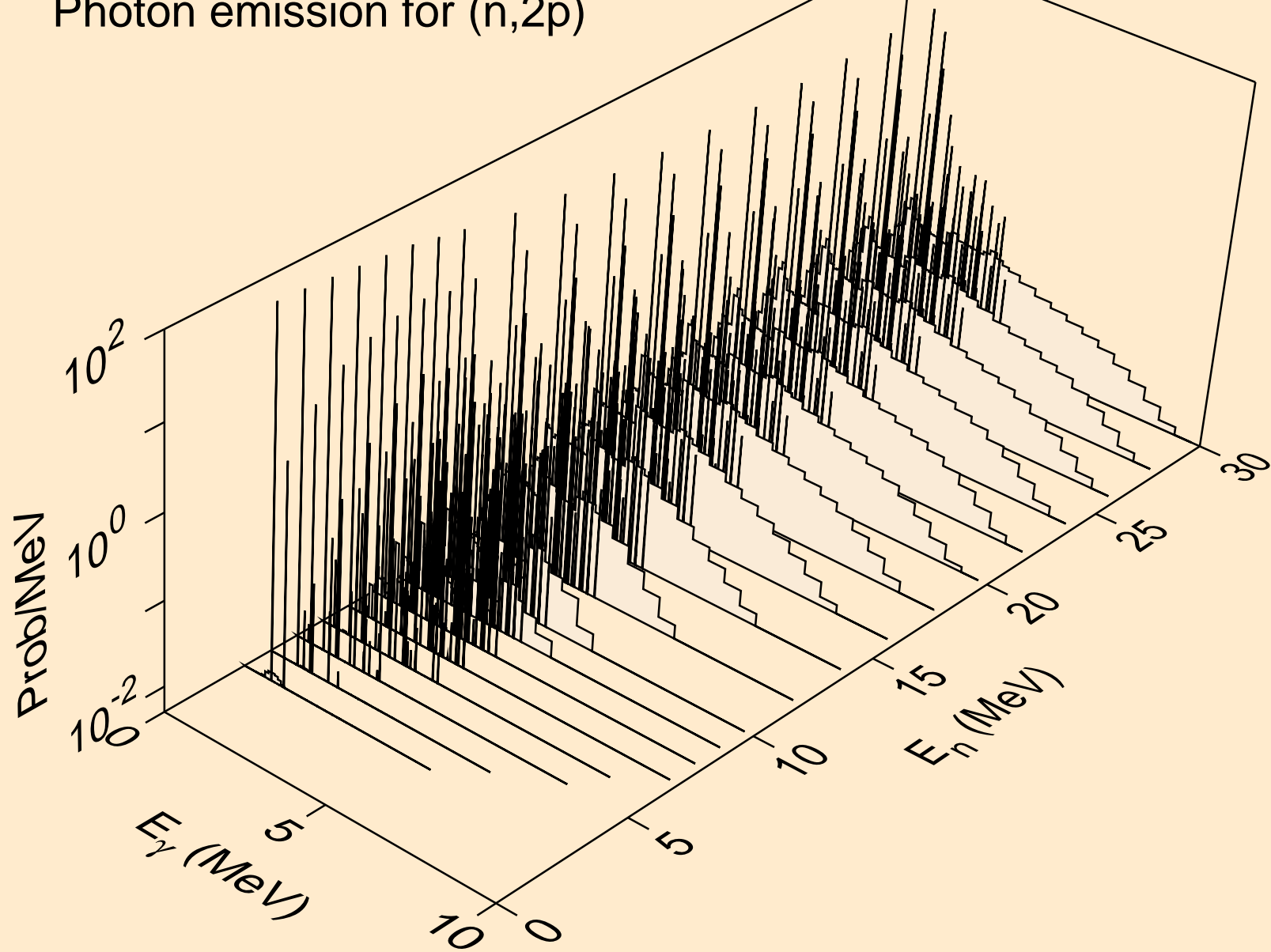

FE055 HELION ACER TENDL-2023 LIBRARY; T=0.K  
Photon emission for (n,pa)

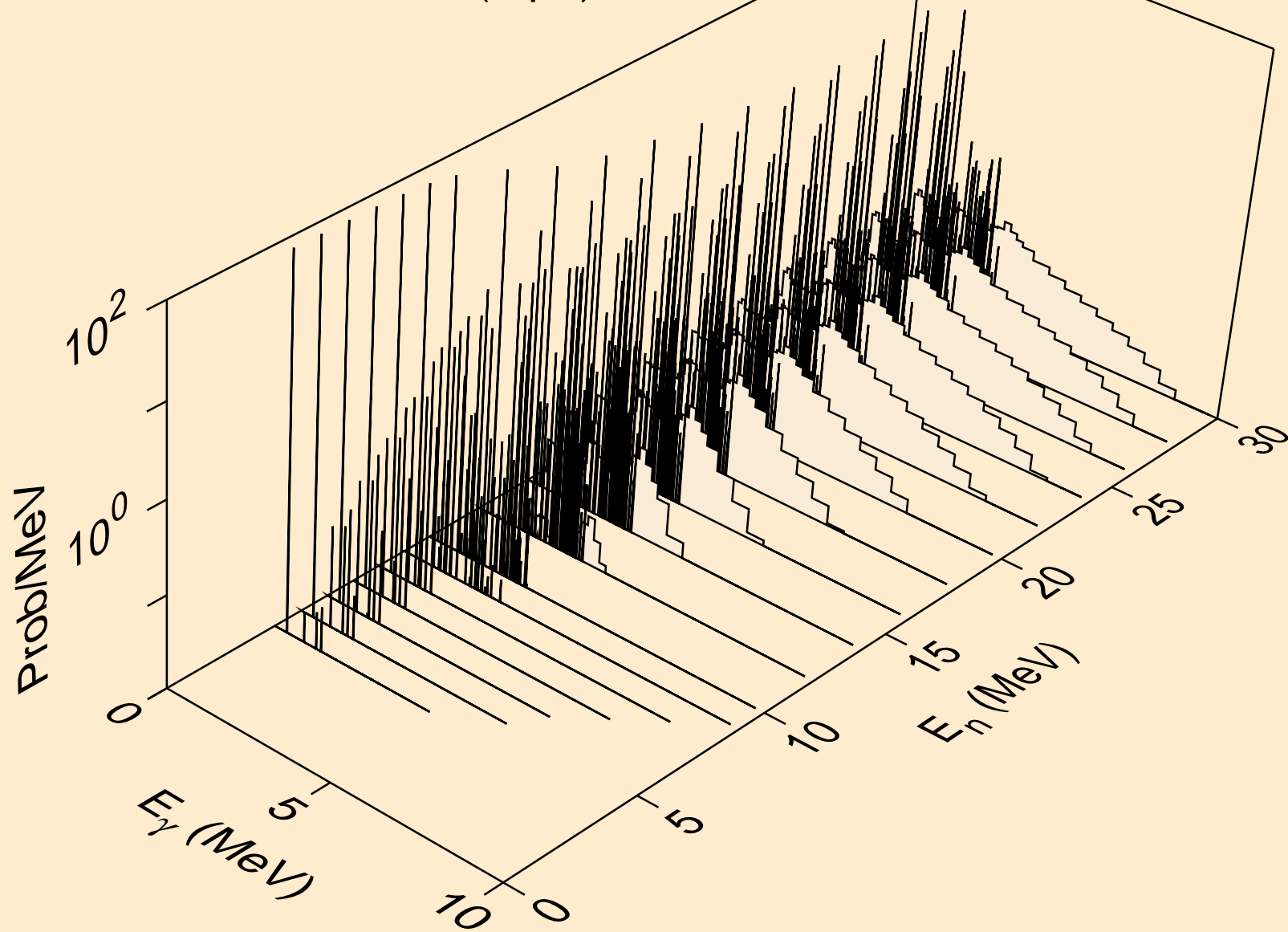

FE055 HELION ACER TENDL-2023 LIBRARY; T=0.K  
Photon emission for (n,pd)

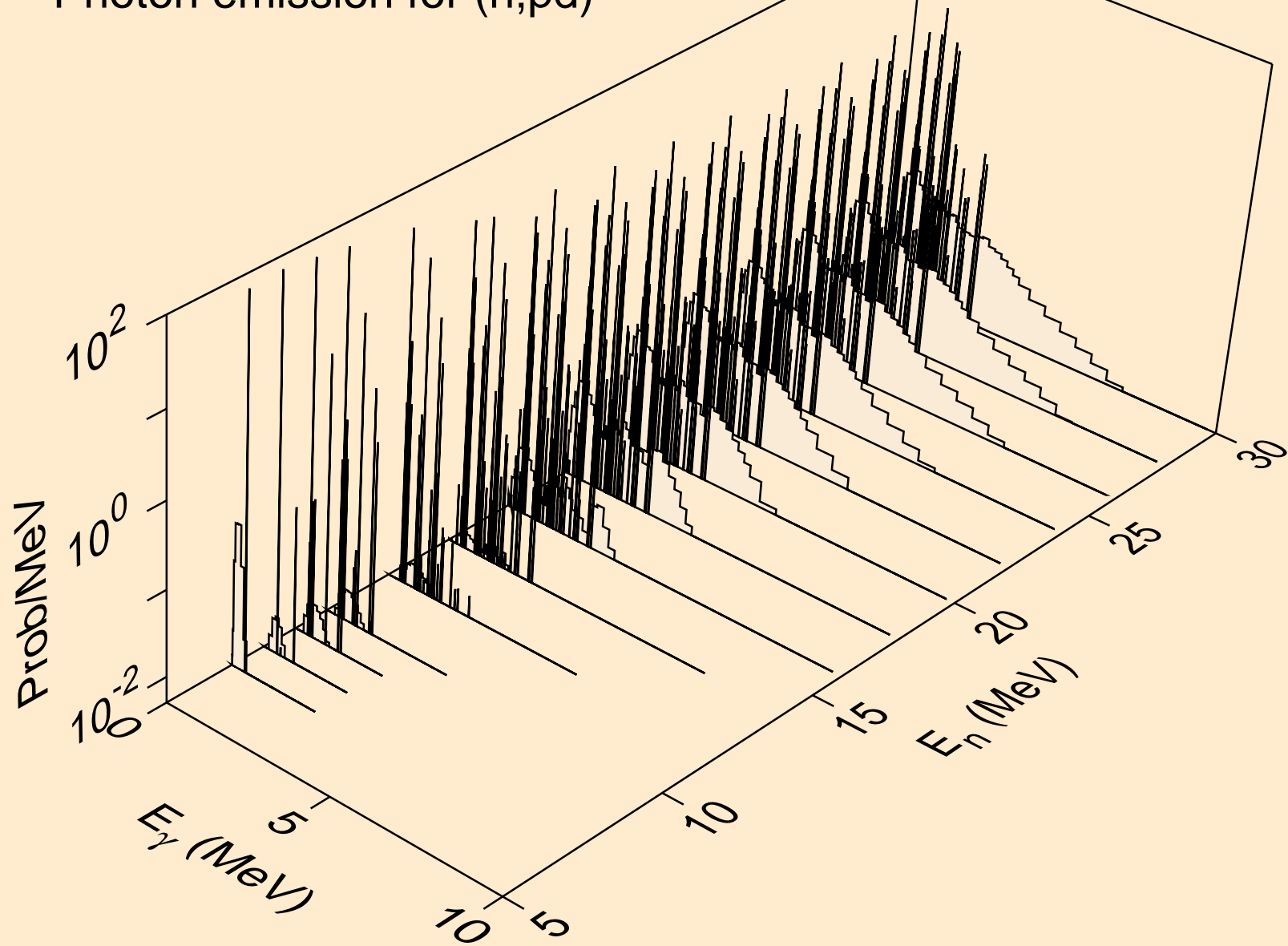

FE055 HELION ACER TENDL-2023 LIBRARY; T=0.K  
Photon emission for (n,pt)

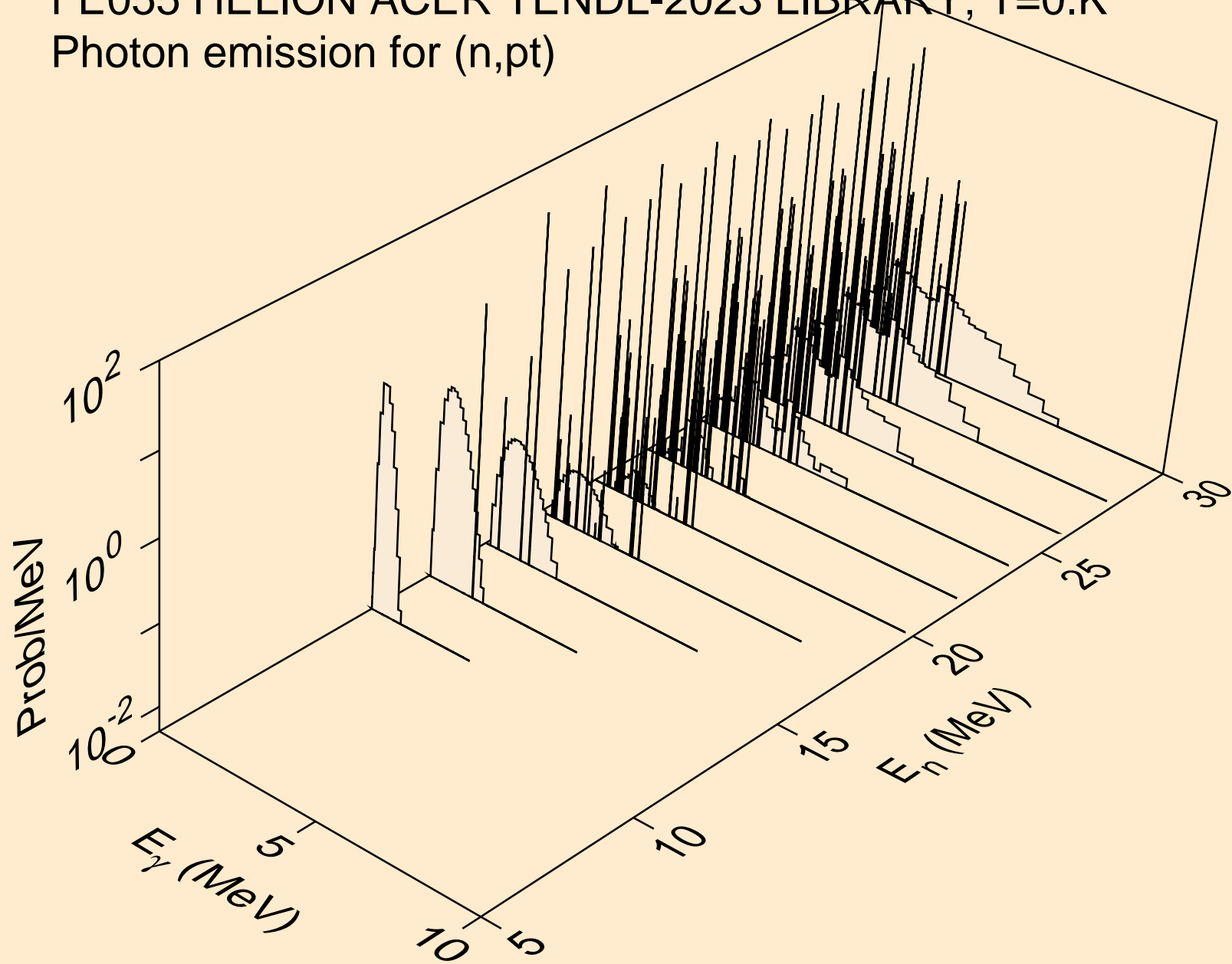

FE055 HELION ACER TENDL-2023 LIBRARY; T=0.K  
Photon emission for (n,da)

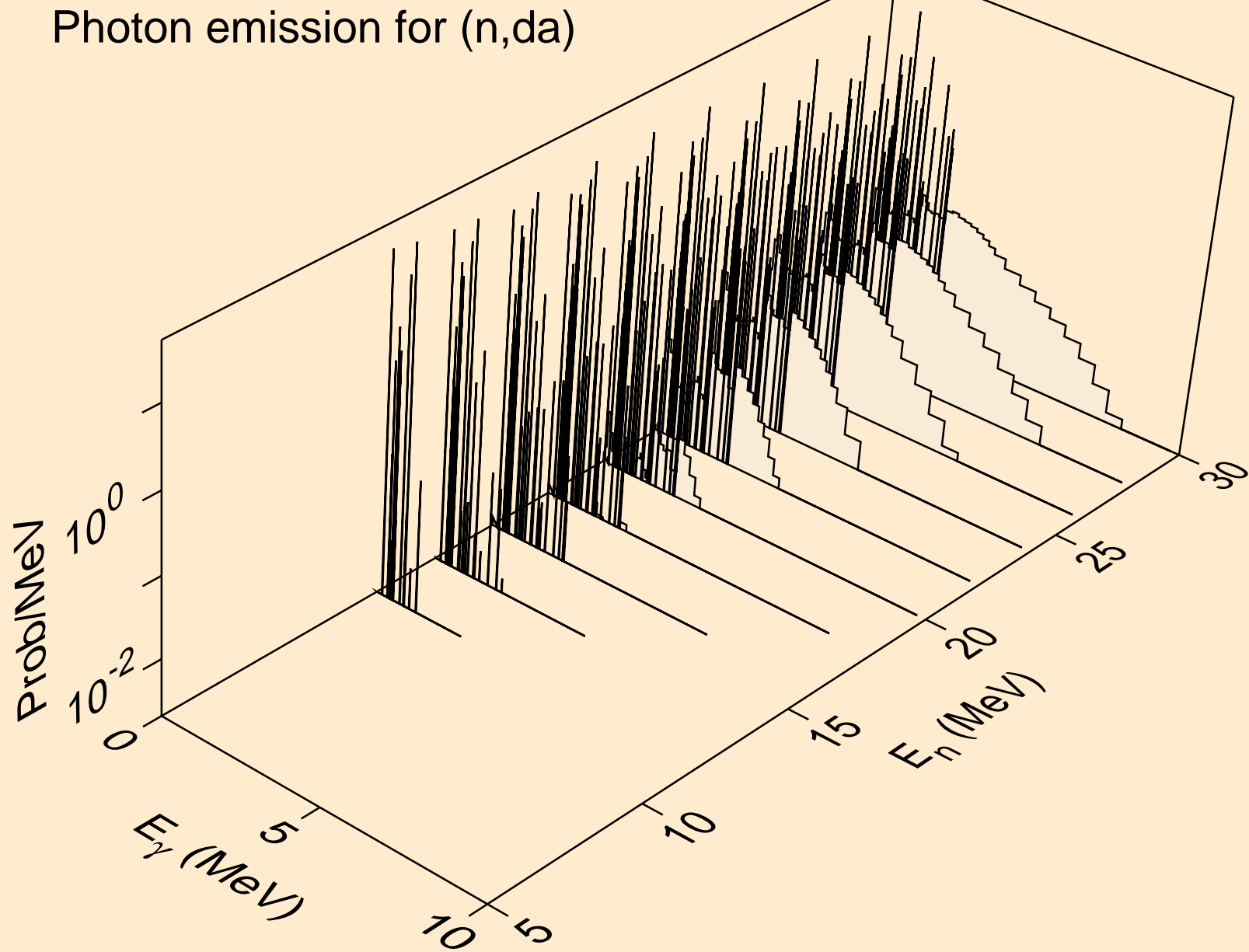

FE055 HELION ACER TENDL-2023 LIBRARY; T=0.K  
Particle heating contributions

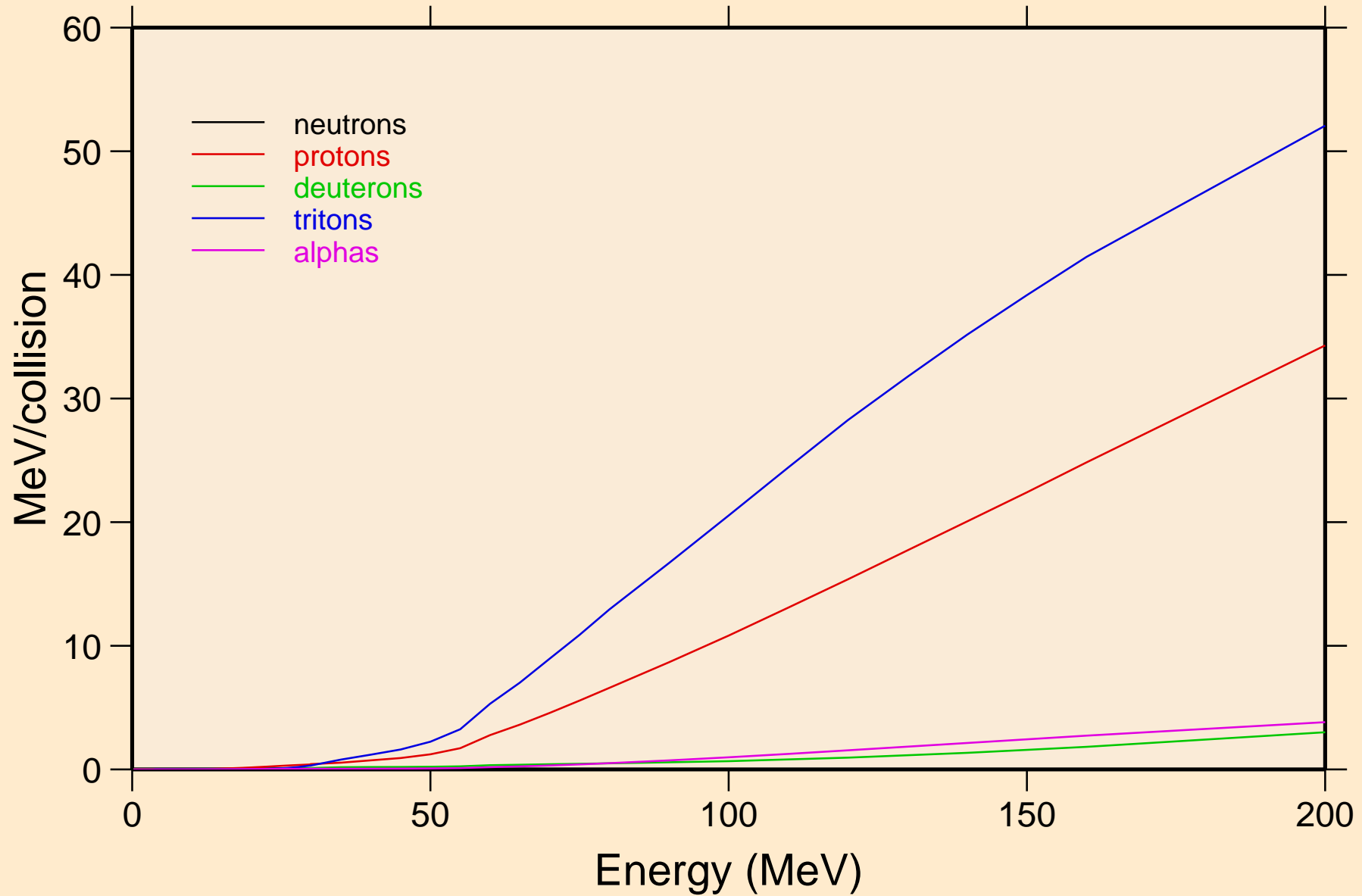

FE055 HELION ACER TENDL-2023 LIBRARY; T=0.K  
Recoil Heating

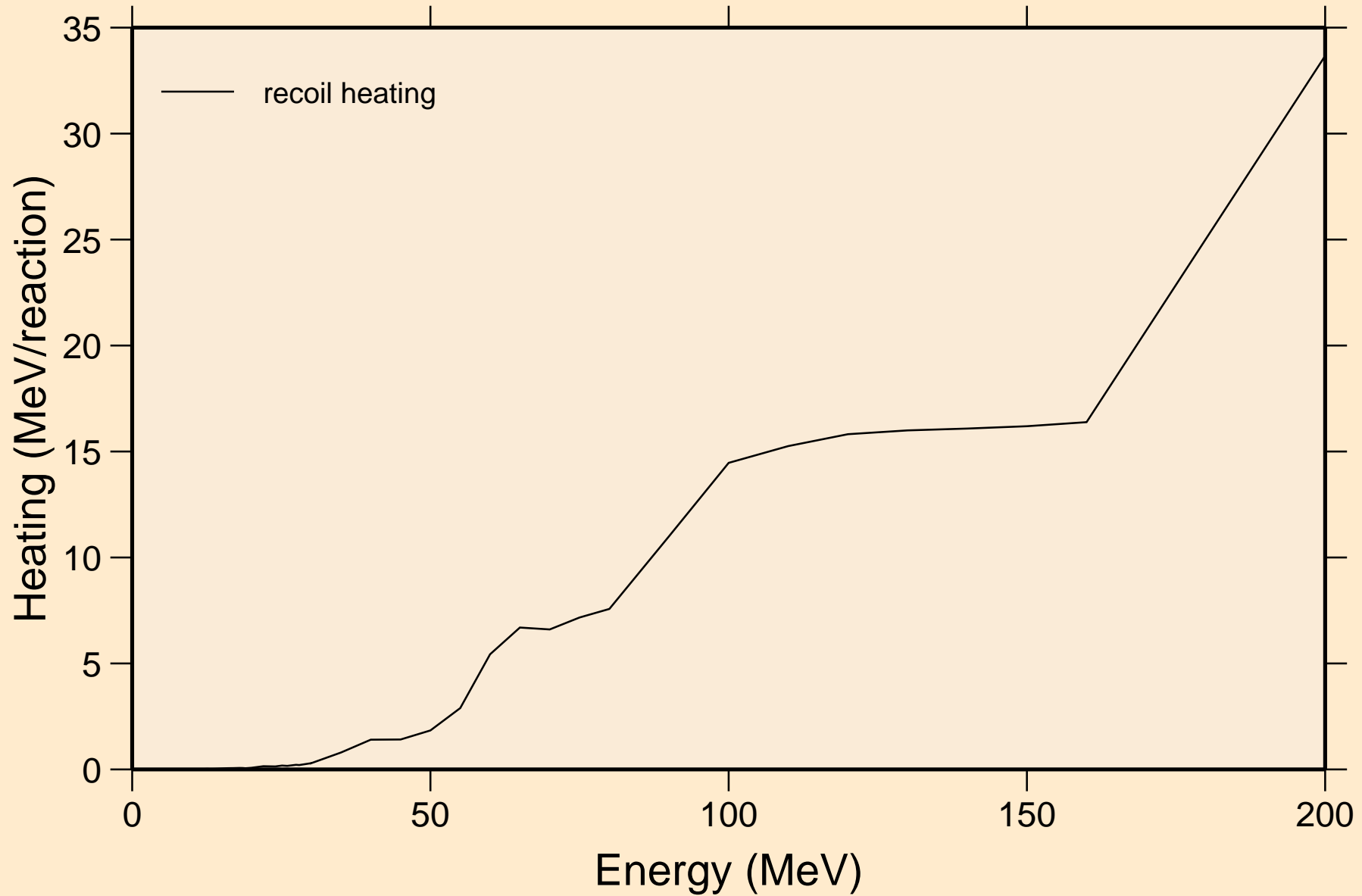



FE055 HELION ACER TENDL-2023 LIBRARY; T=0.K  
Particle production cross sections

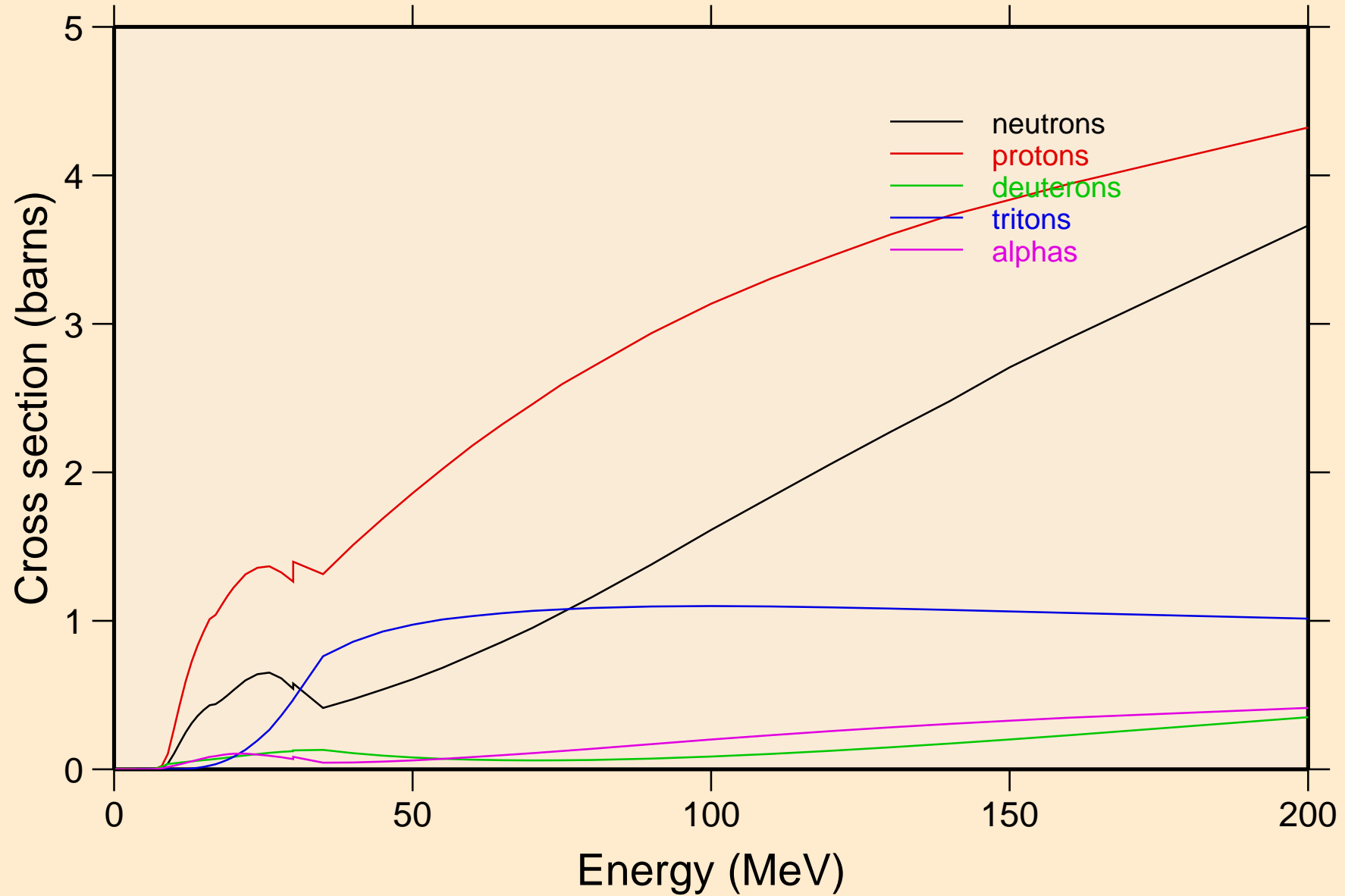

FE055 HELION ACER TENDL-2023 LIBRARY; T=0.K  
neutrons from (s,n)

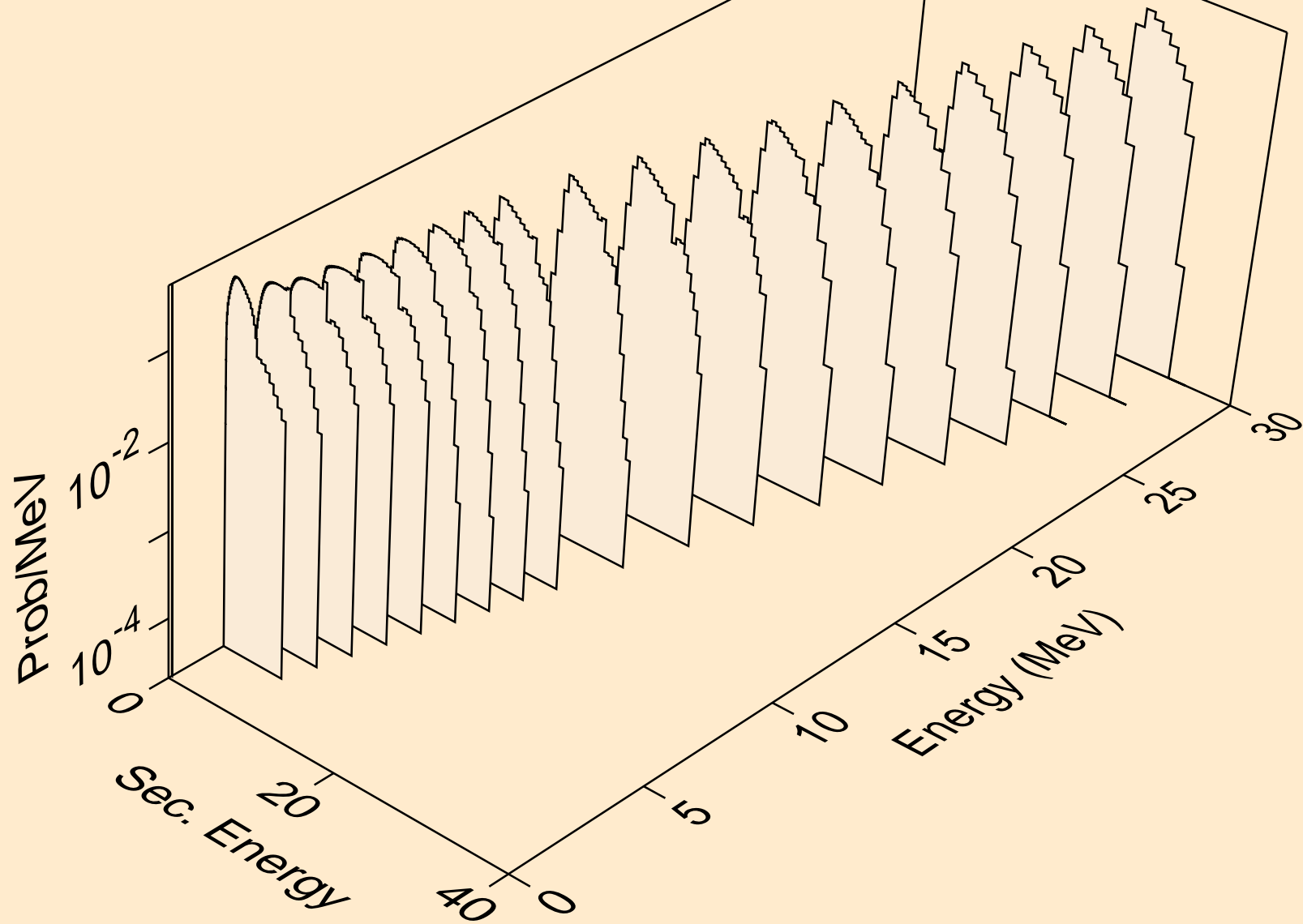

FE055 HELION ACER TENDL-2023 LIBRARY; T=0.K  
neutrons from (s,x)

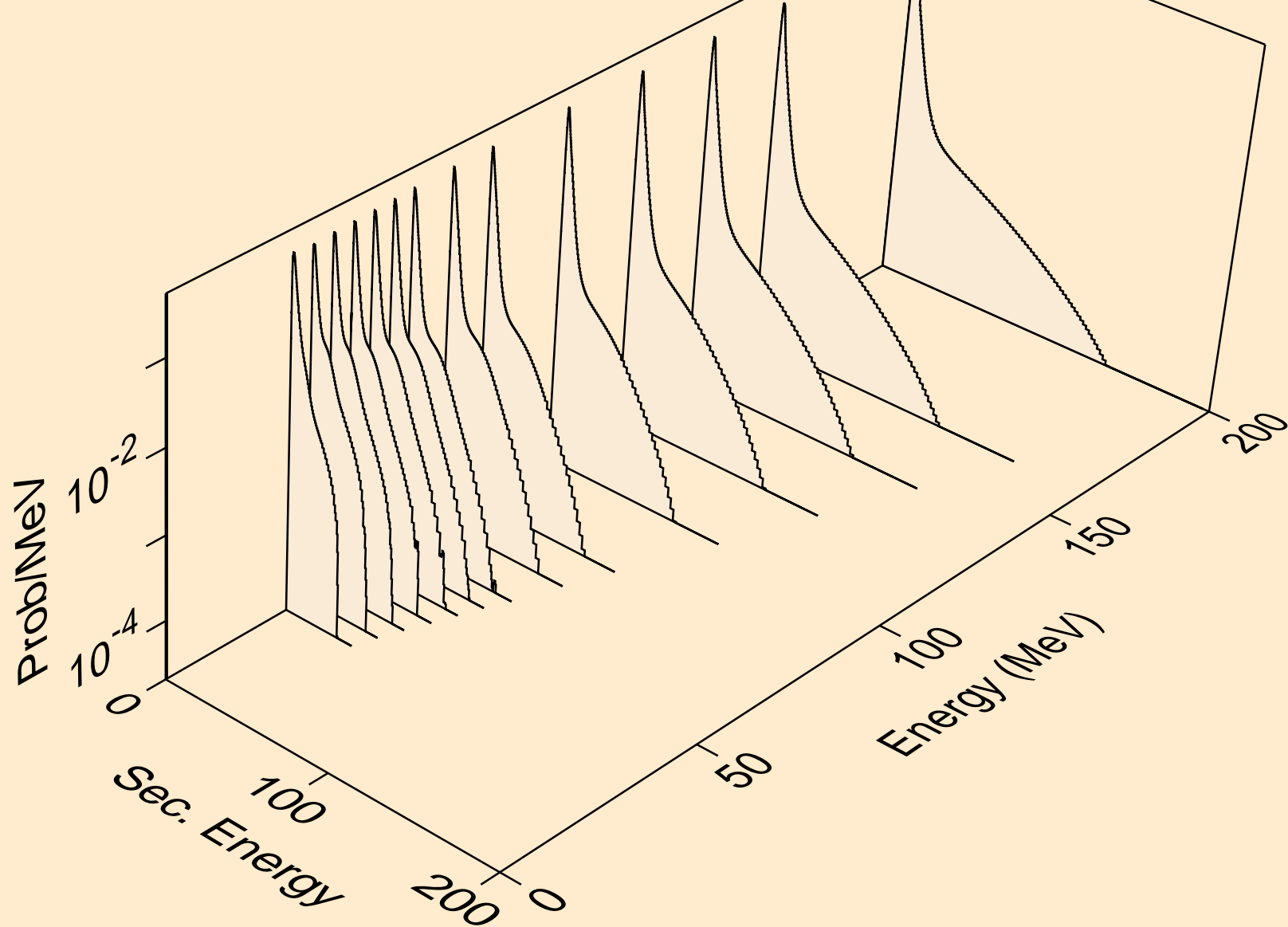

FE055 HELION ACER TENDL-2023 LIBRARY; T=0.K  
neutrons from (s,2nd)

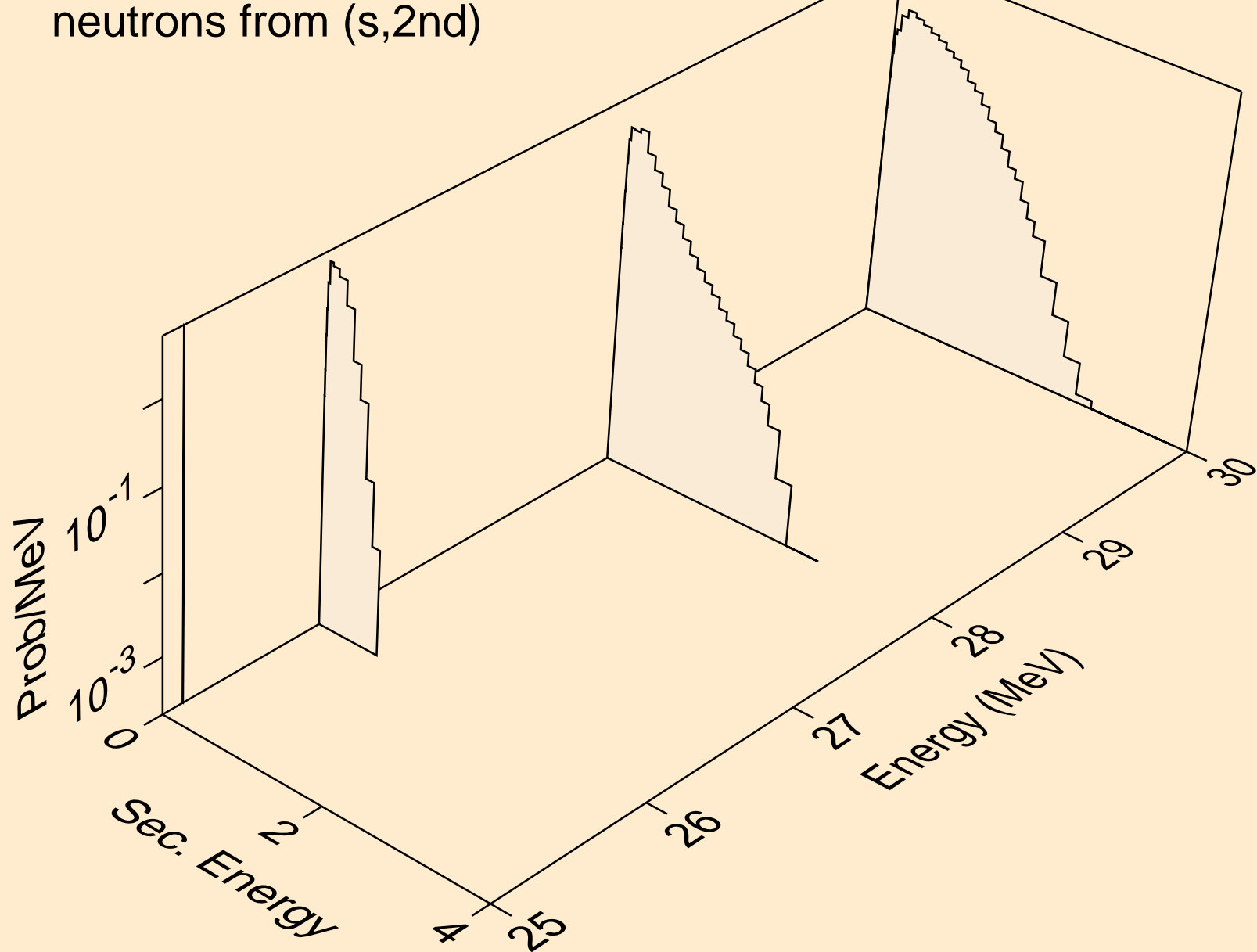

FE055 HELION ACER TENDL-2023 LIBRARY; T=0.K  
neutrons from (s,2n)

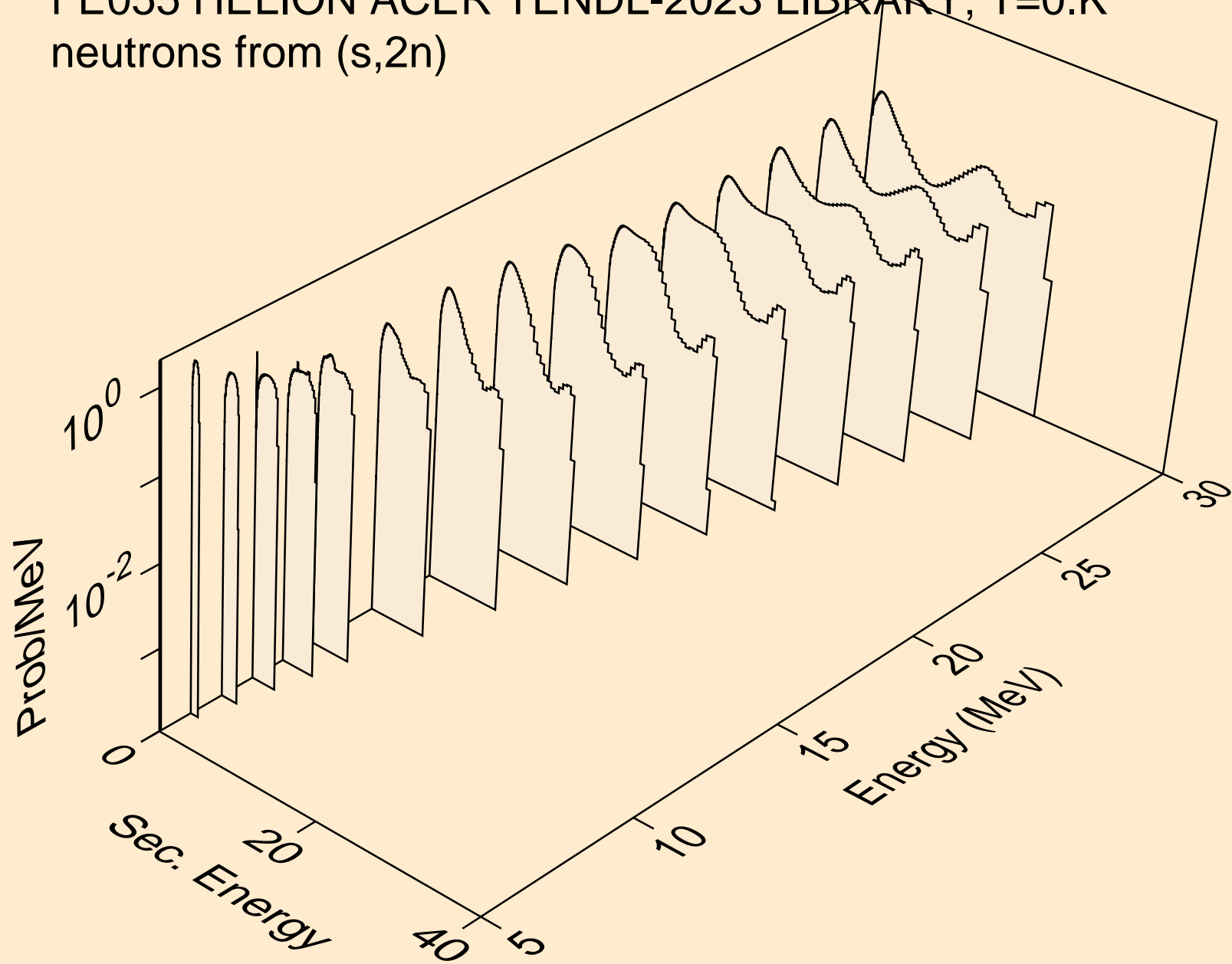

FE055 HELION ACER TENDL-2023 LIBRARY; T=0.K  
neutrons from (s,3n)

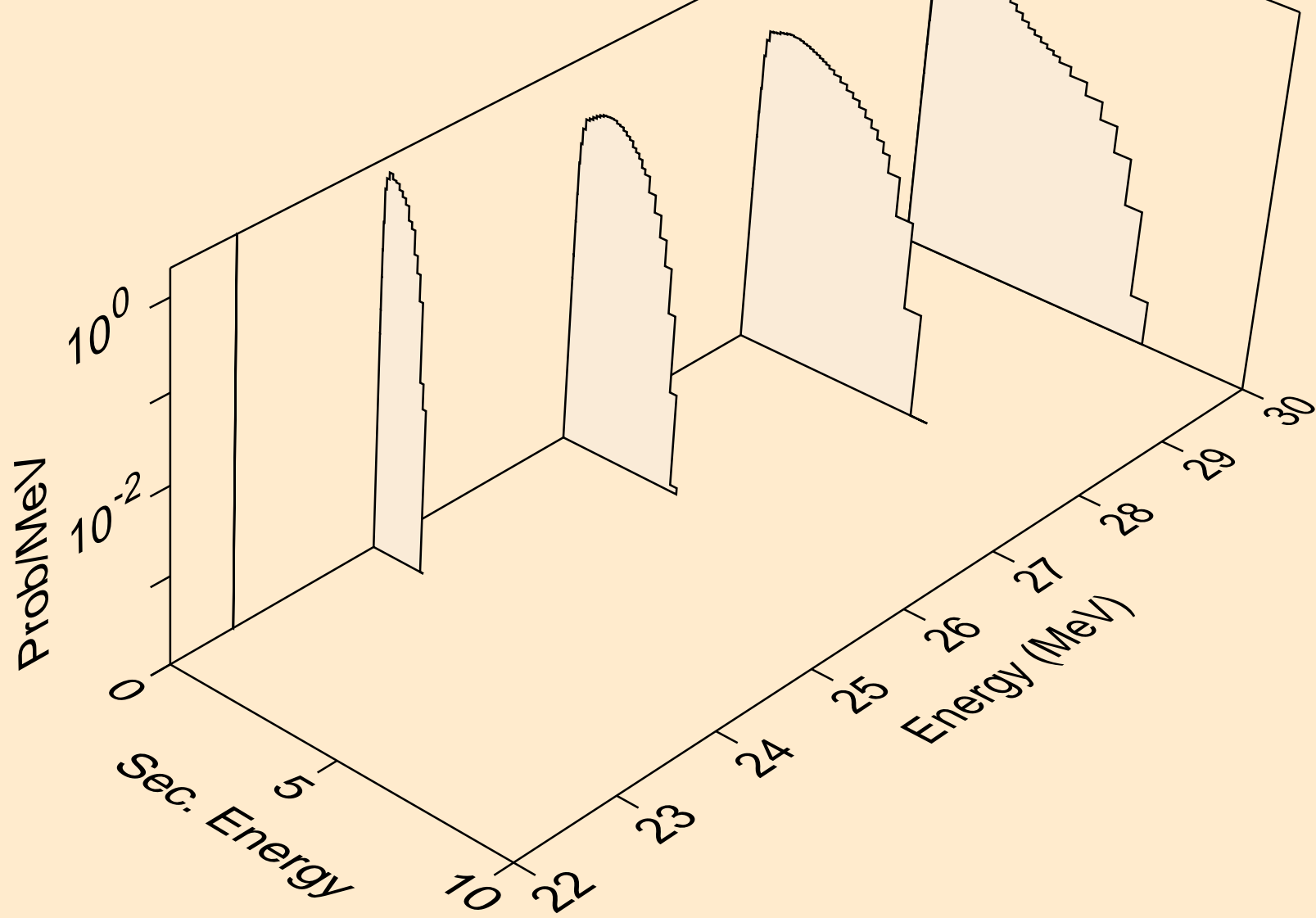

FE055 HELION ACER TENDL-2023 LIBRARY; T=0.K  
neutrons from (s,n\*)a

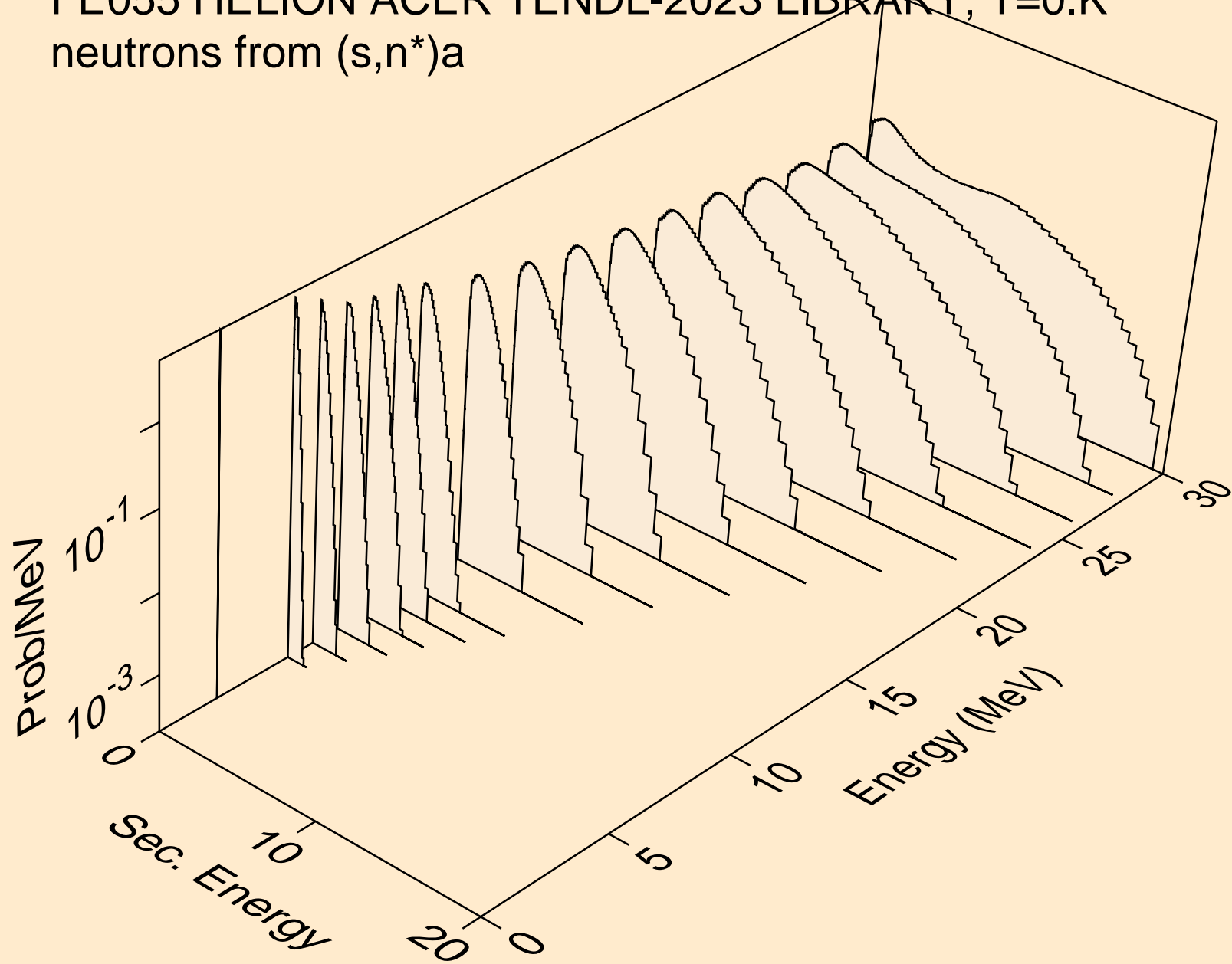

FE055 HELION ACER TENDL-2023 LIBRARY; T=0.K  
neutrons from (s,2n)a

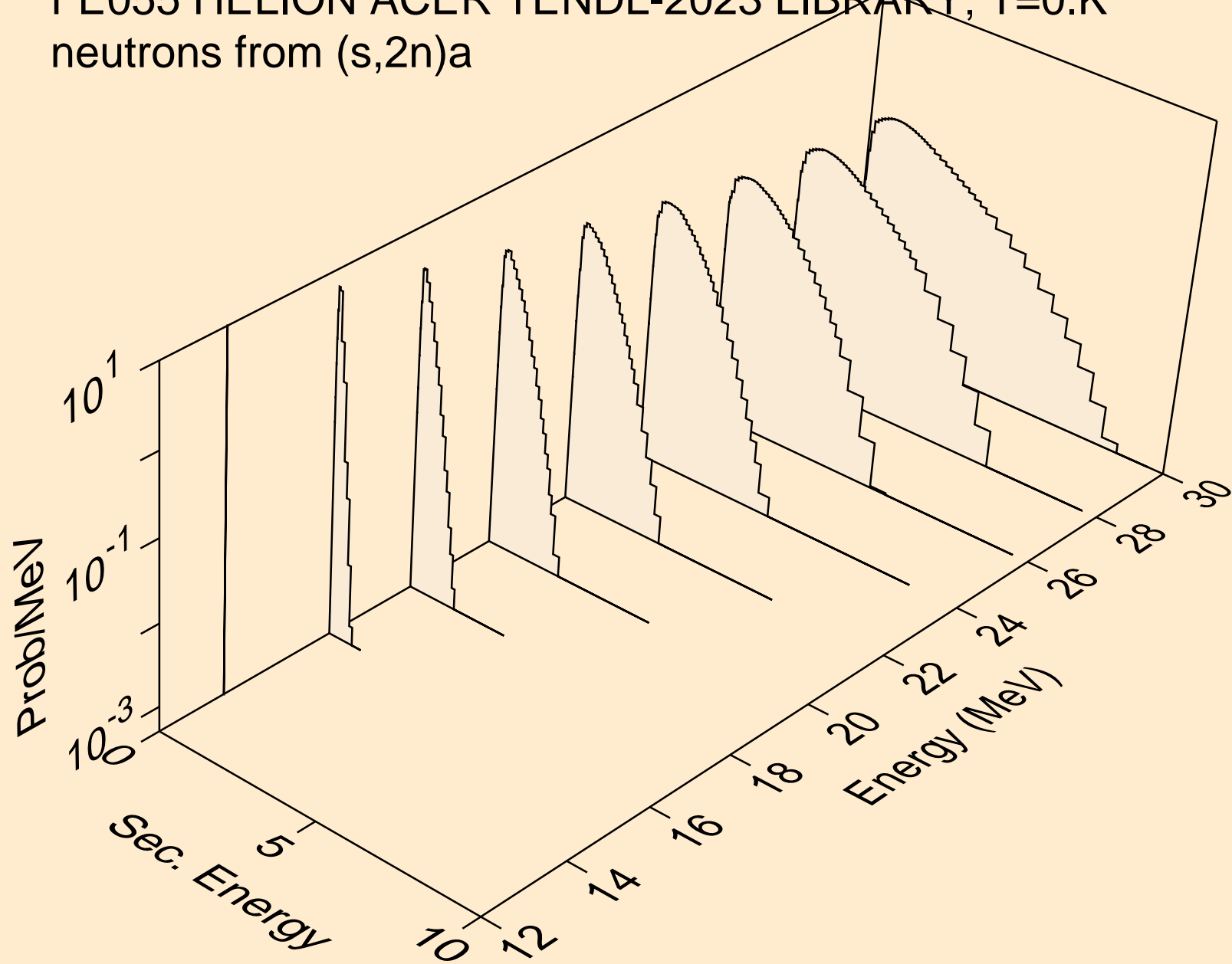



FE055 HELION ACER TENDL-2023 LIBRARY; T=0.K  
neutrons from (s,n\*)p

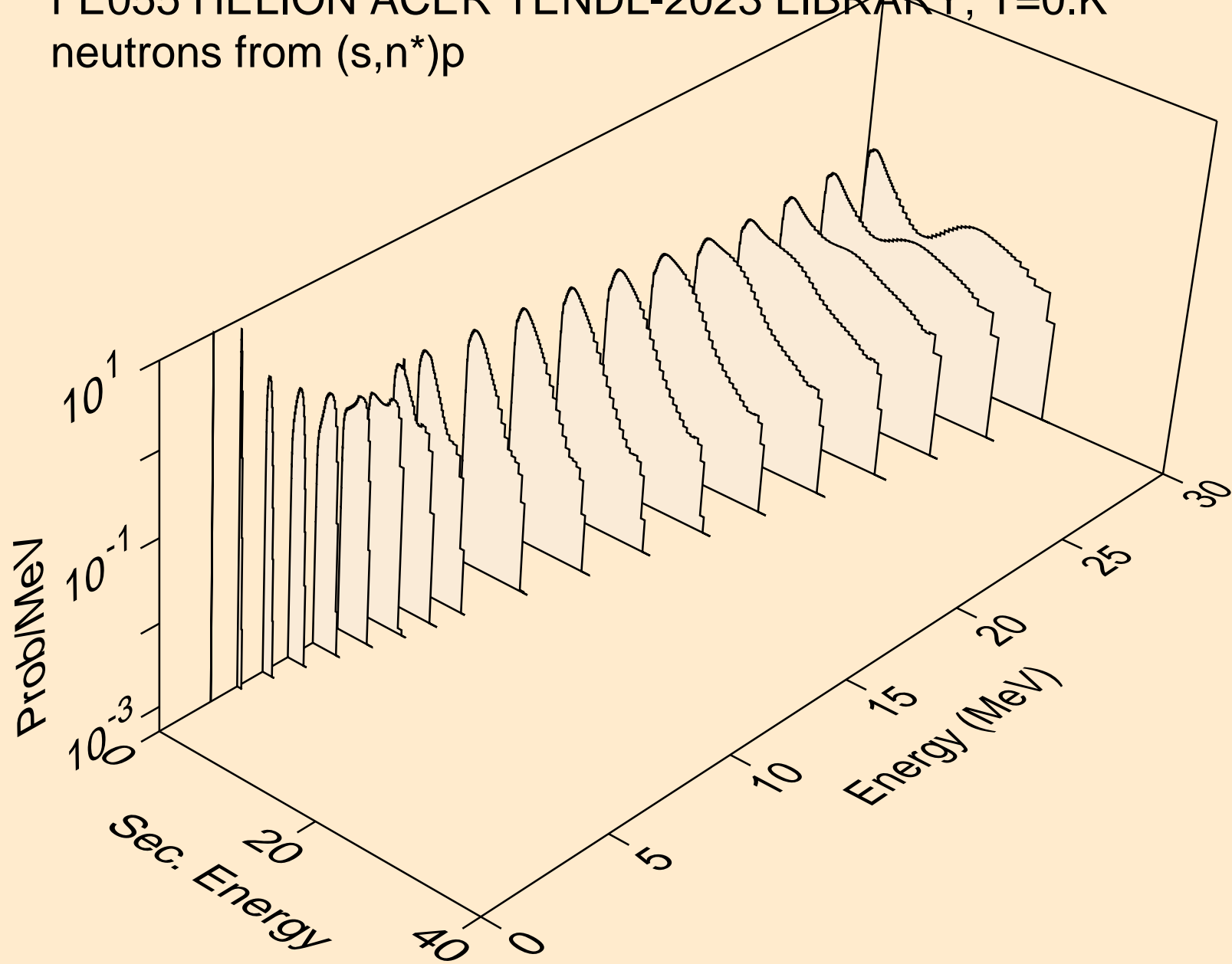

FE055 HELION ACER TENDL-2023 LIBRARY; T=0.K  
neutrons from (s,n\*)2a

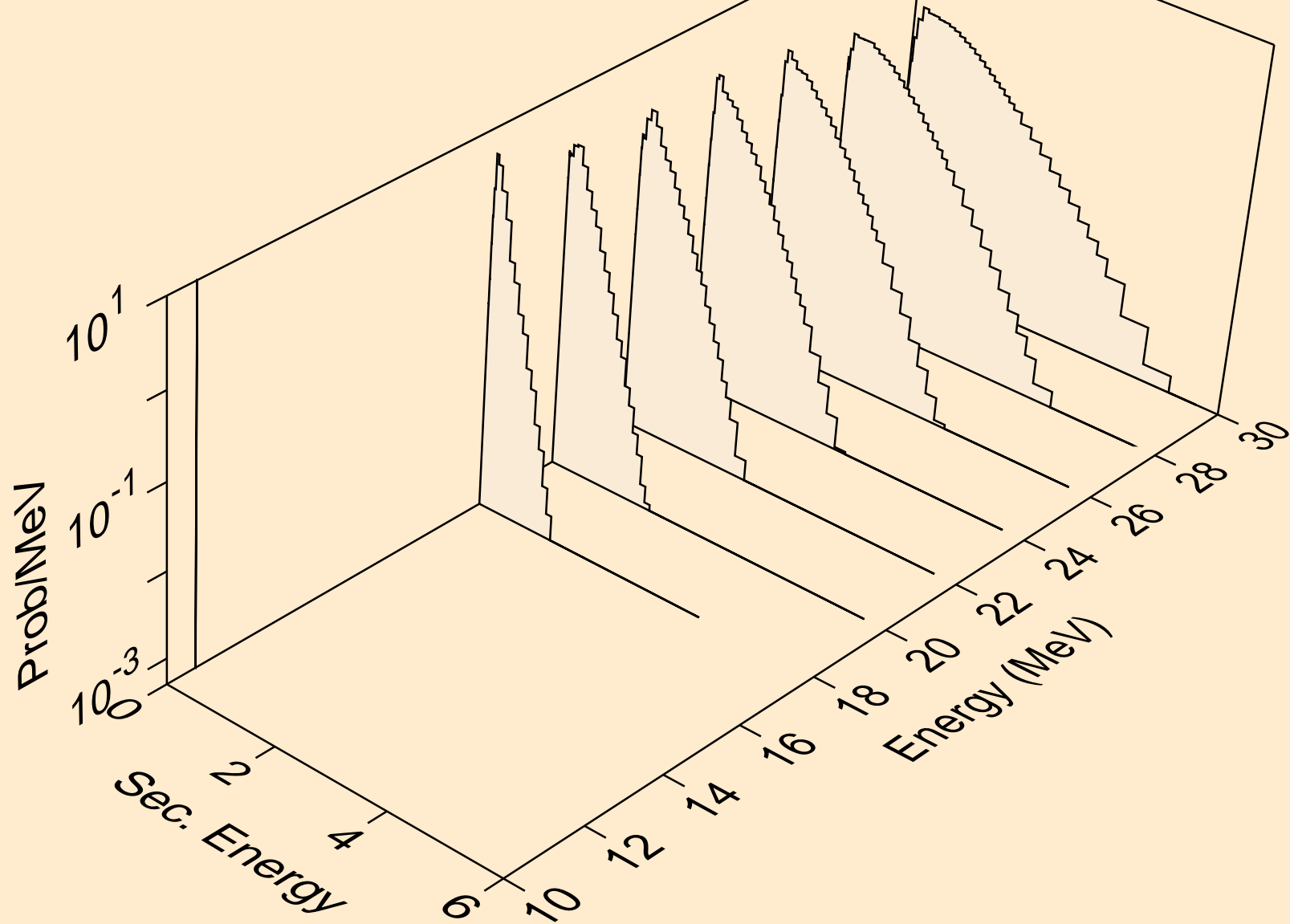

FE055 HELION ACER TENDL-2023 LIBRARY; T=0.K  
neutrons from (s,n\*)d

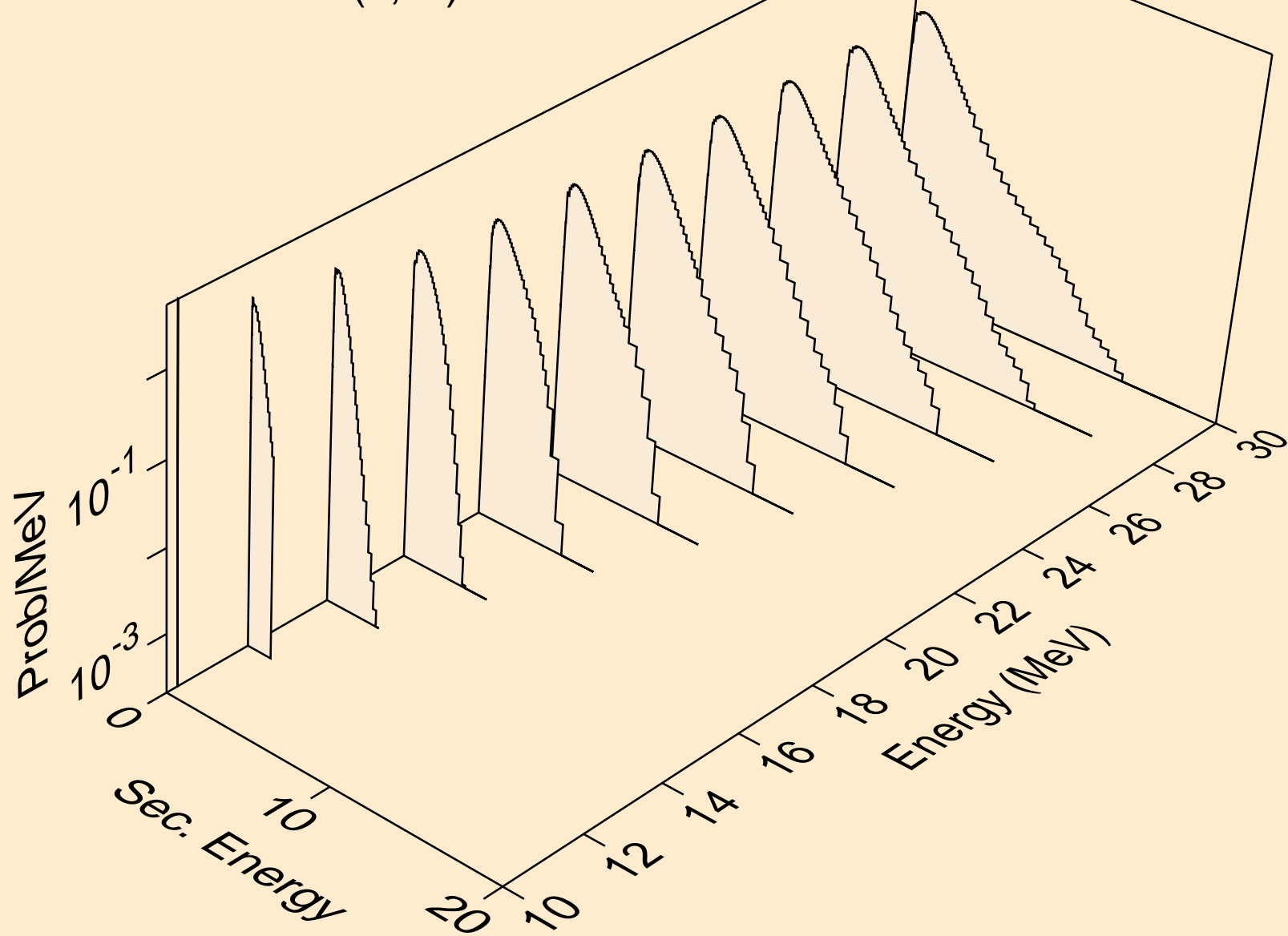

FE055 HELION ACER TENDL-2023 LIBRARY; T=0.K  
neutrons from (s,n\*)t

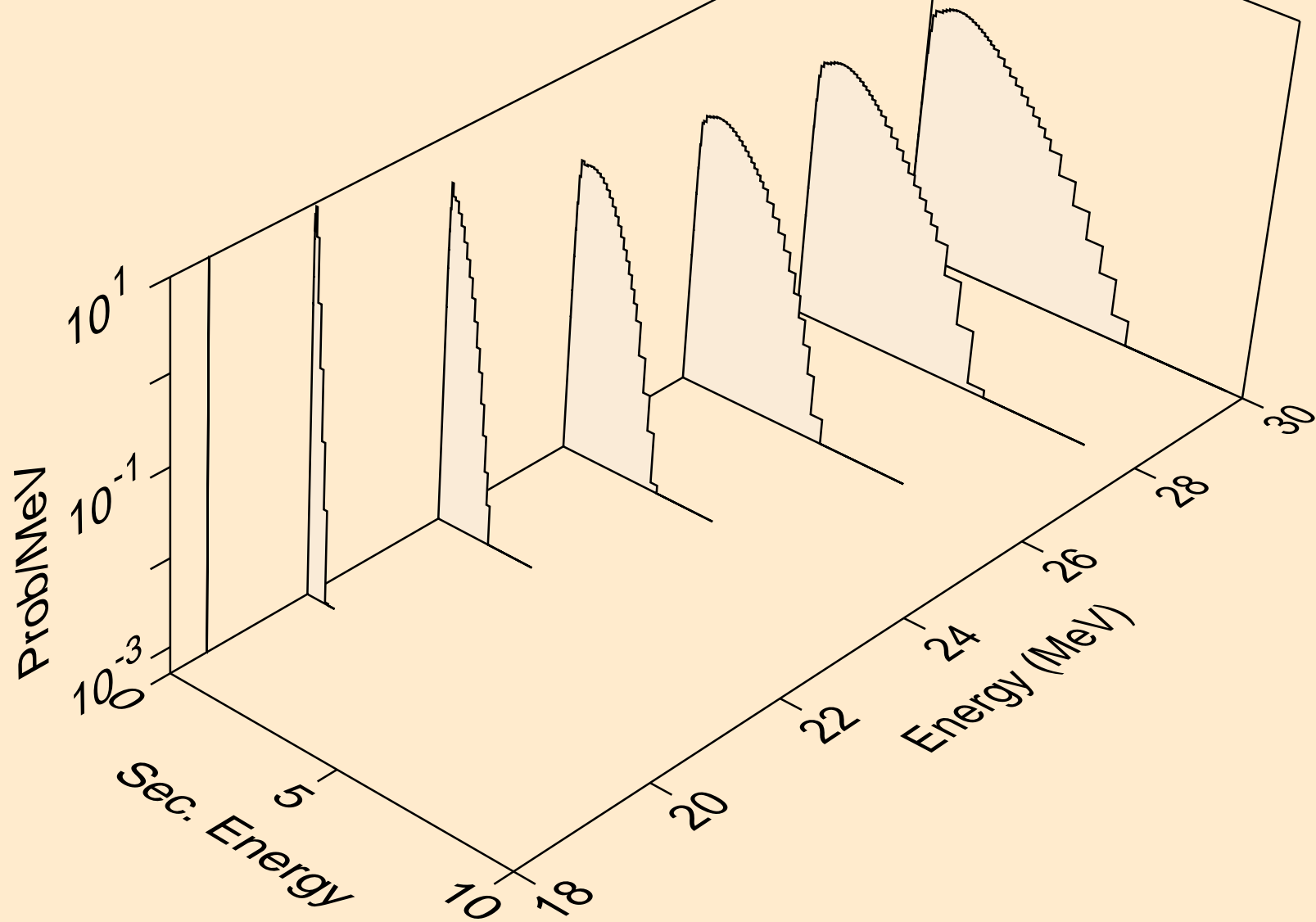

FE055 HELION ACER TENDL-2023 LIBRARY; T=0.K  
neutrons from (s,n\*)he3

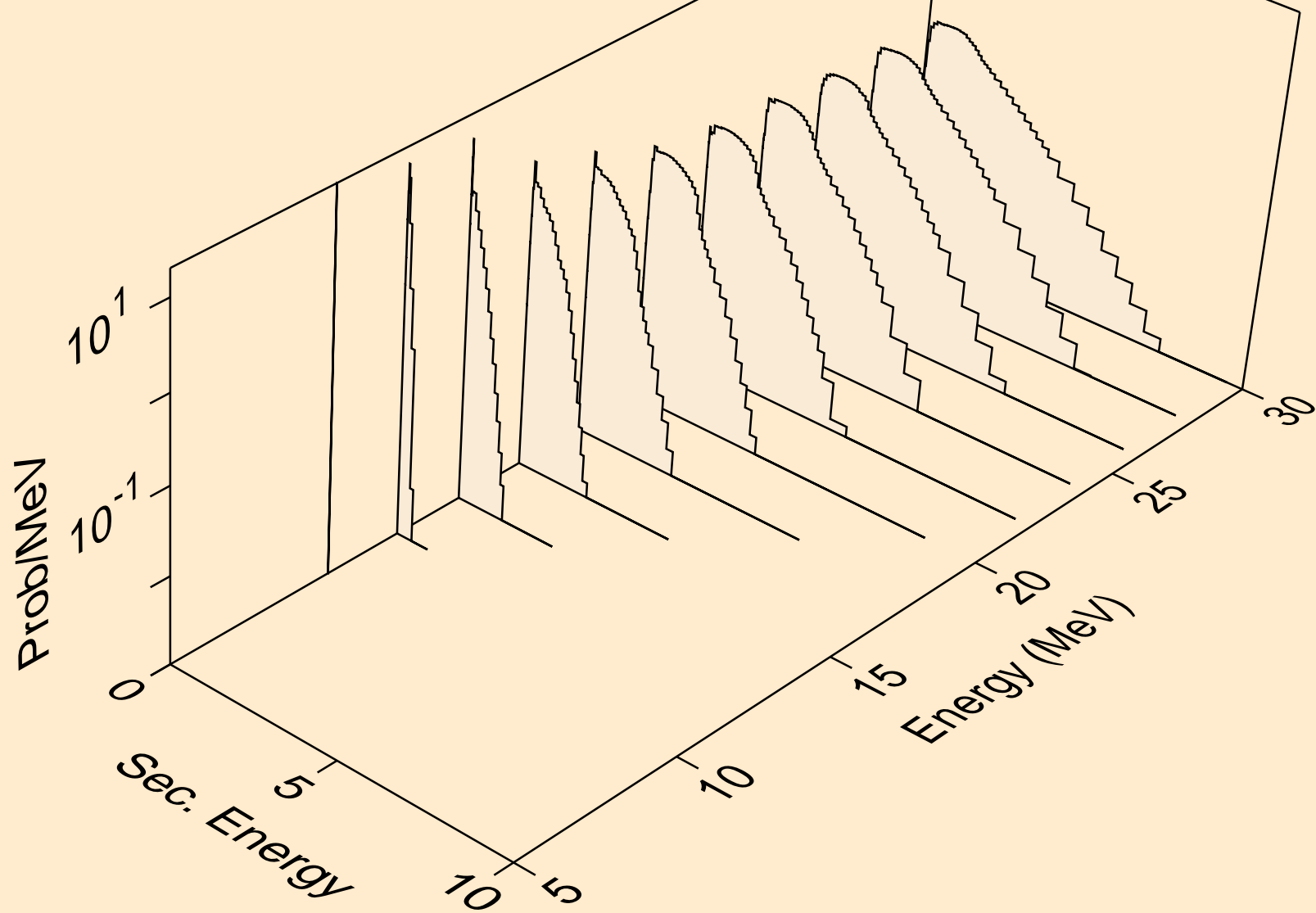

FE055 HELION ACER TENDL-2023 LIBRARY; T=0.K  
neutrons from (s,2np)

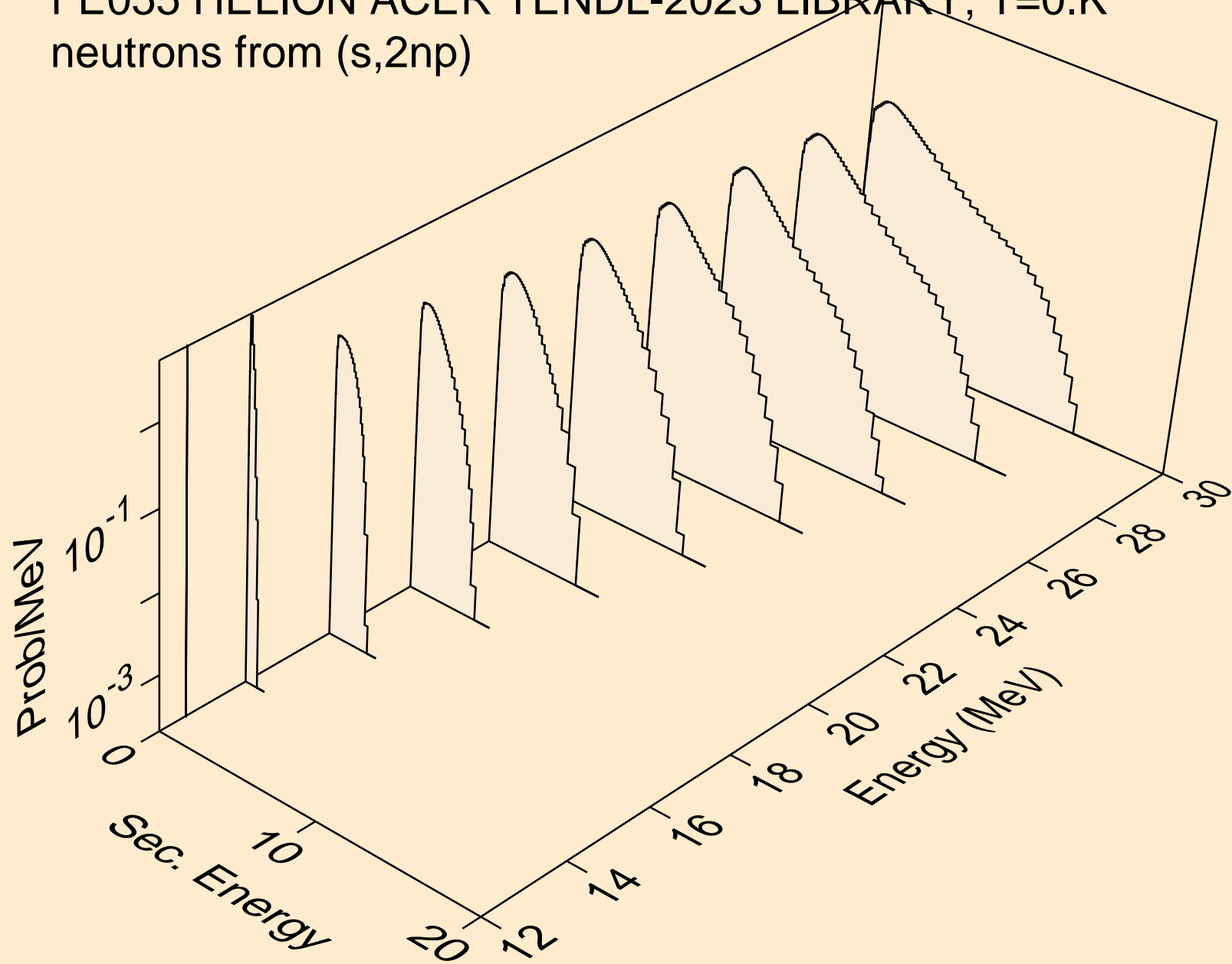

FE055 HELION ACER TENDL-2023 LIBRARY; T=0.K  
neutrons from (s,3np)

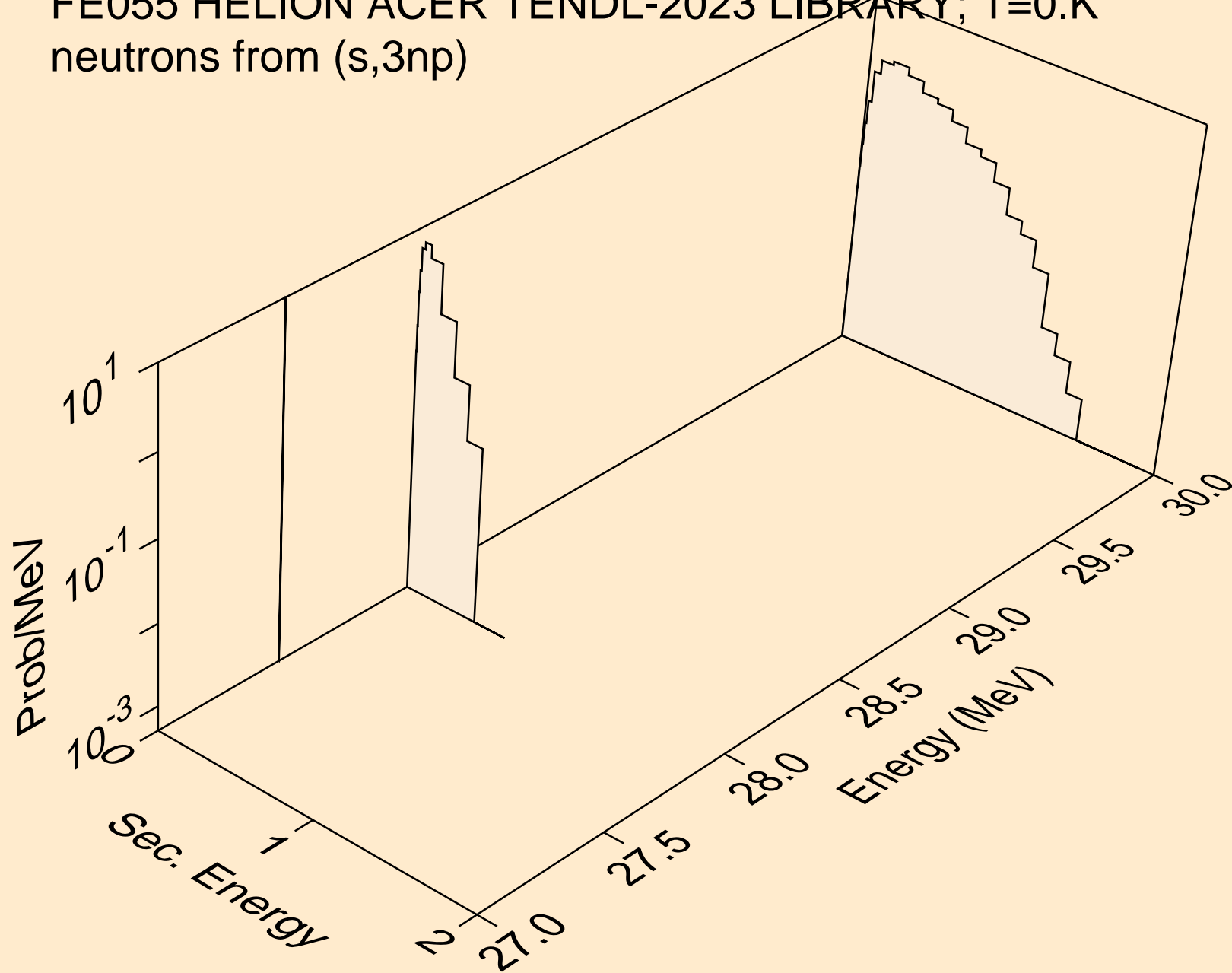

FE055 HELION ACER TENDL-2023 LIBRARY; T=0.K  
neutrons from (s,n2p)

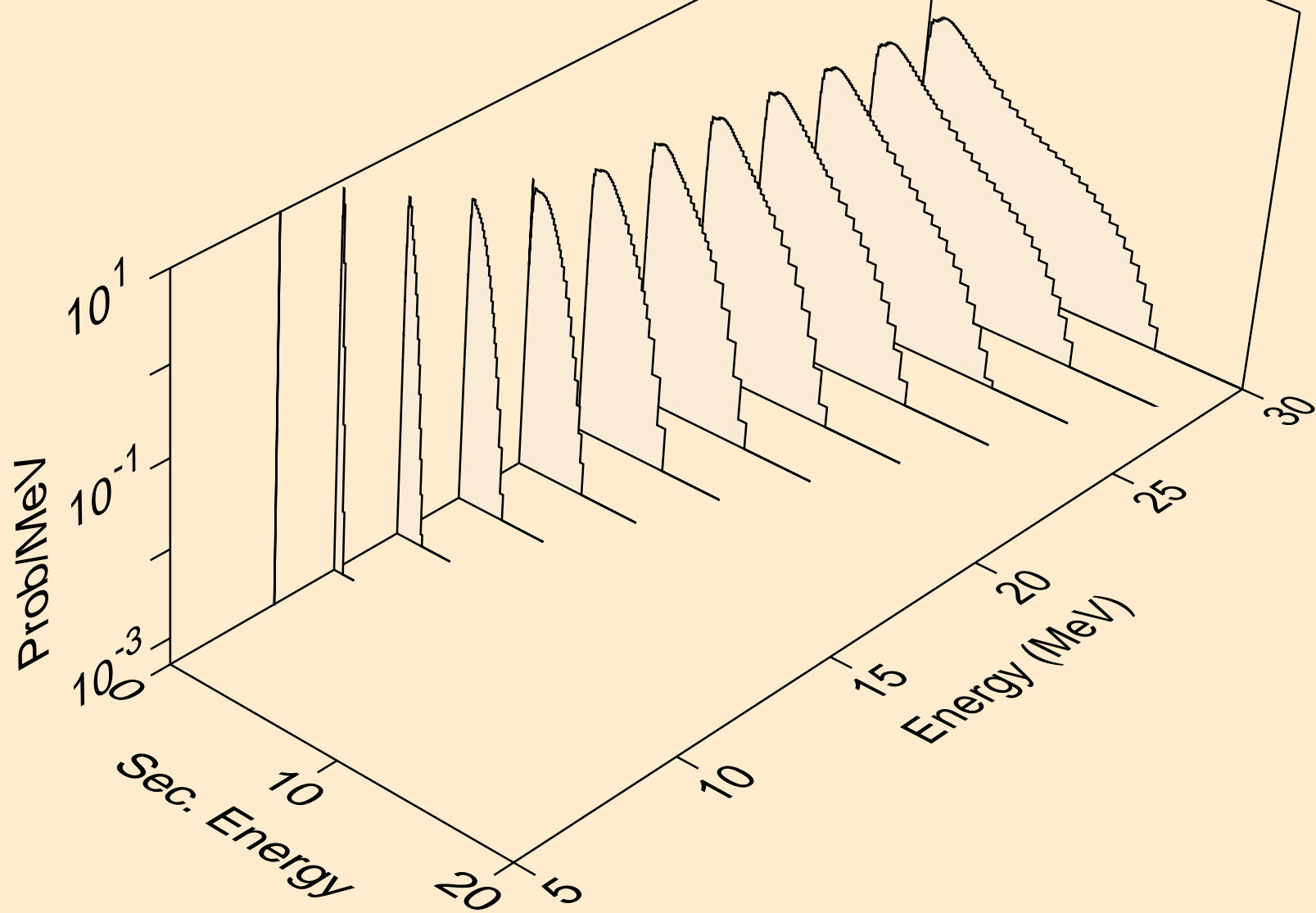



FE055 HELION ACER TENDL-2023 LIBRARY; T=0.K  
neutrons from (s,npa)

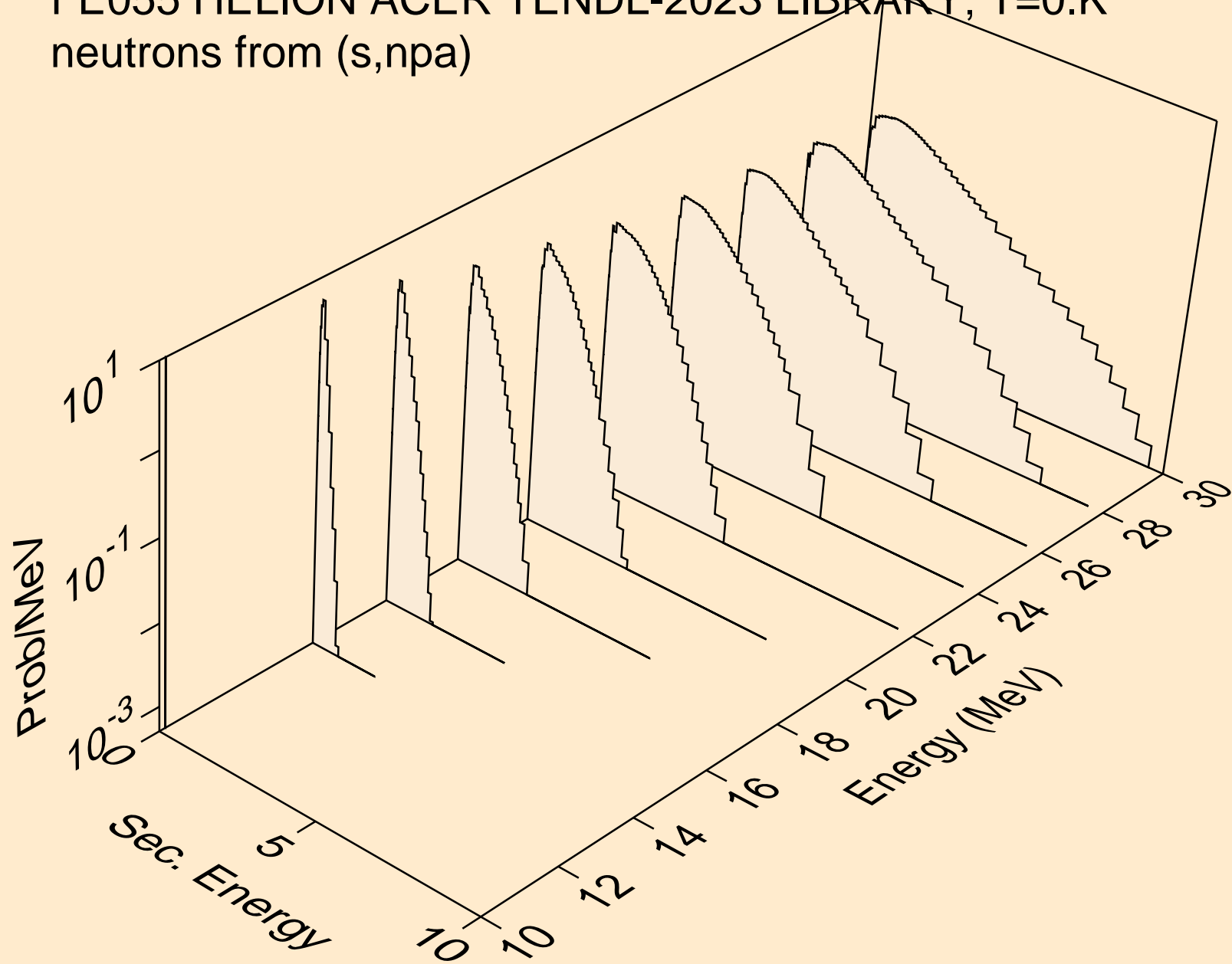

FE055 HELION ACER TENDL-2023 LIBRARY; T=0.K  
protons from (s,x)

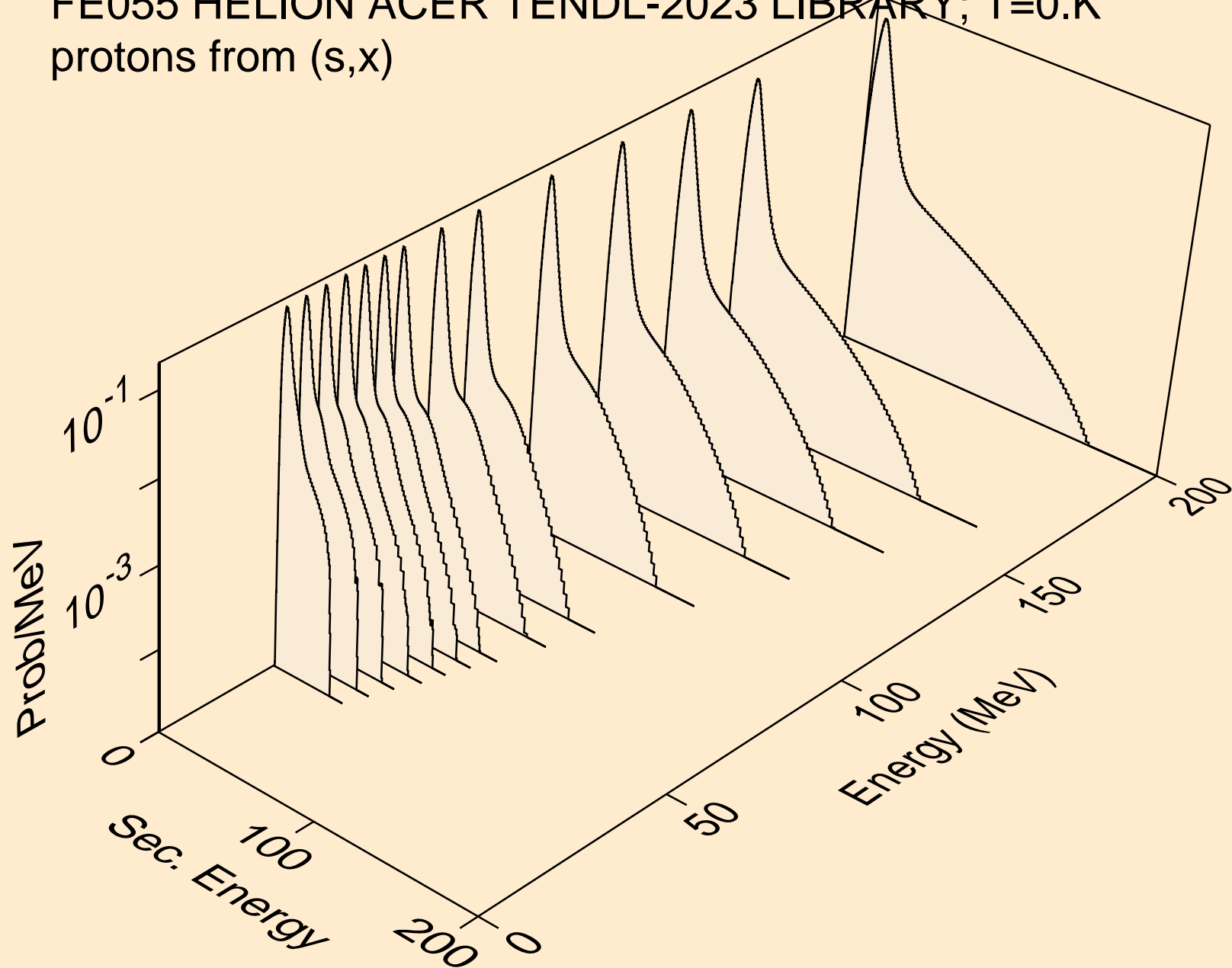

FE055 HELION ACER TENDL-2023 LIBRARY; T=0.K  
protons from (s,n\*)p

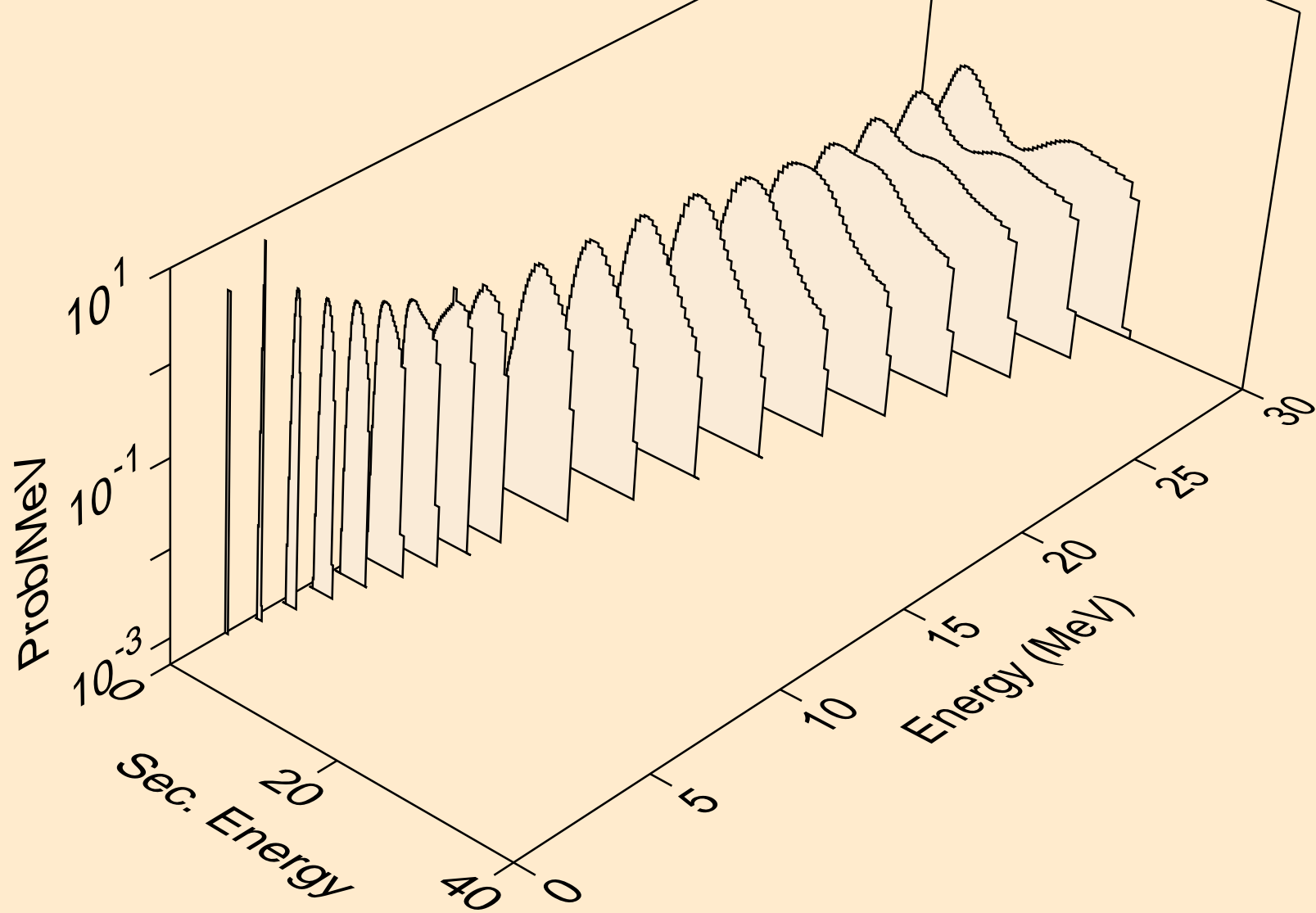

FE055 HELION ACER TENDL-2023 LIBRARY; T=0.K  
protons from (s,2np)

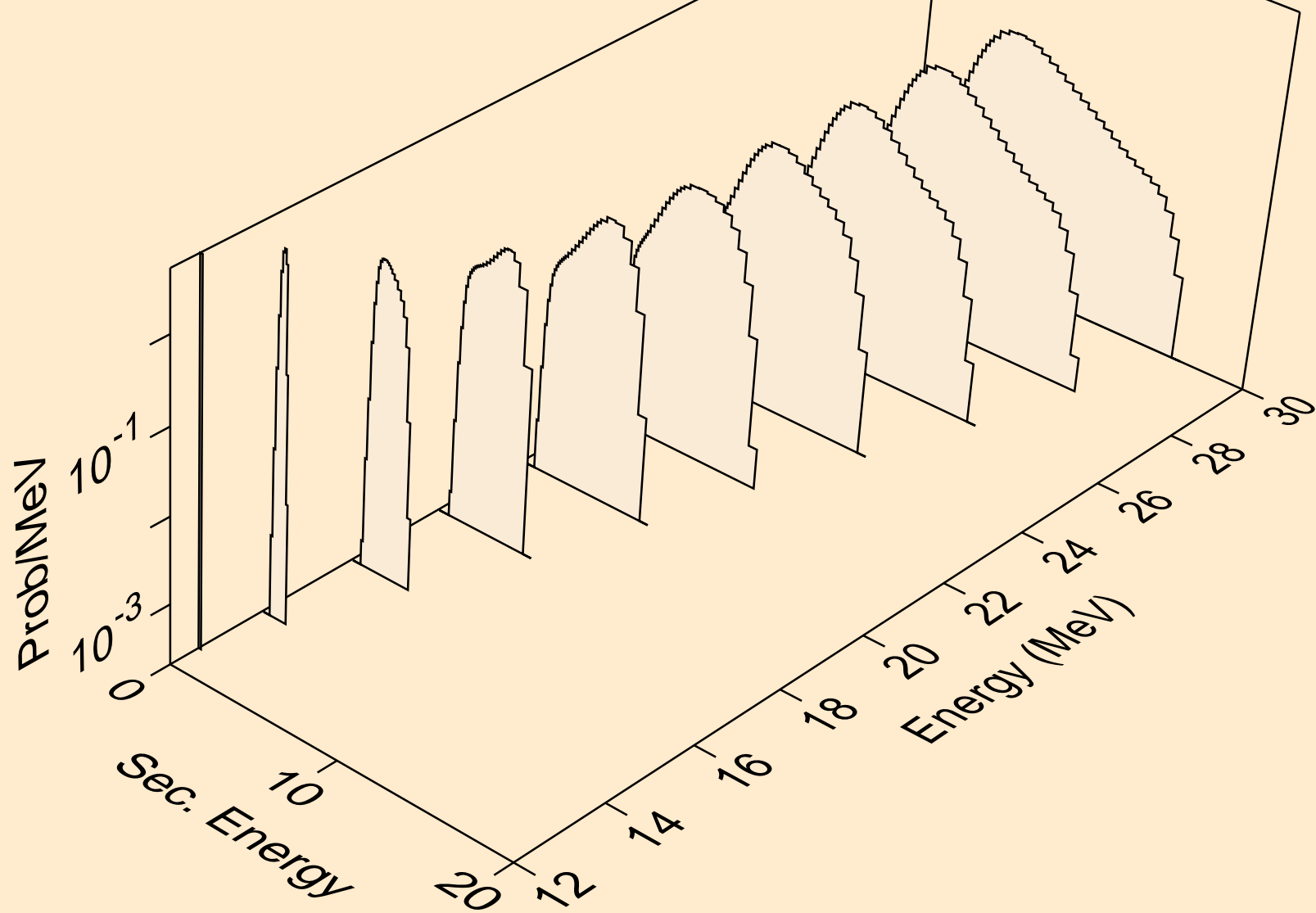

FE055 HELION ACER TENDL-2023 LIBRARY; T=0.K  
protons from (s,3np)

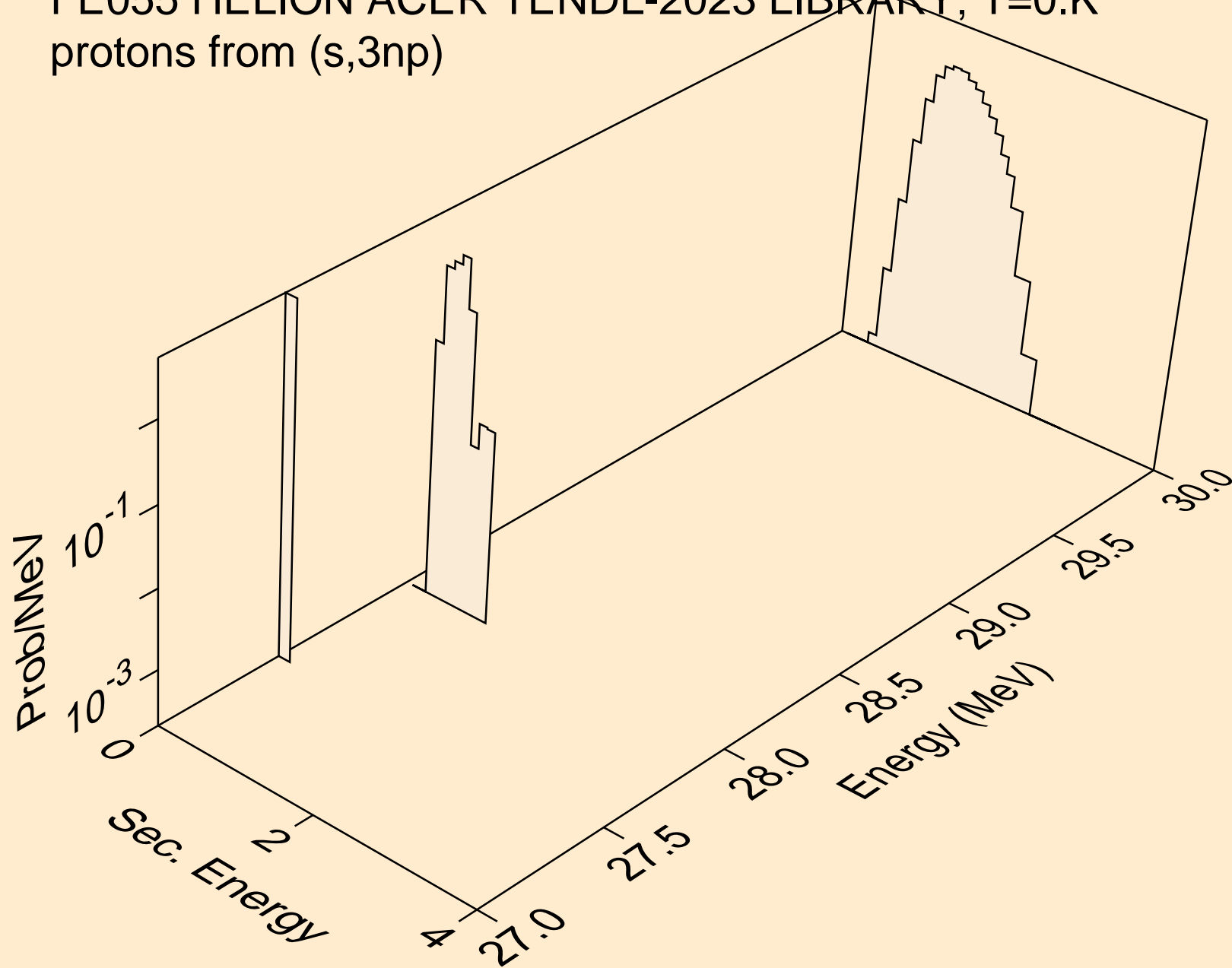

FE055 HELION ACER TENDL-2023 LIBRARY; T=0.K  
protons from (s,n2p)

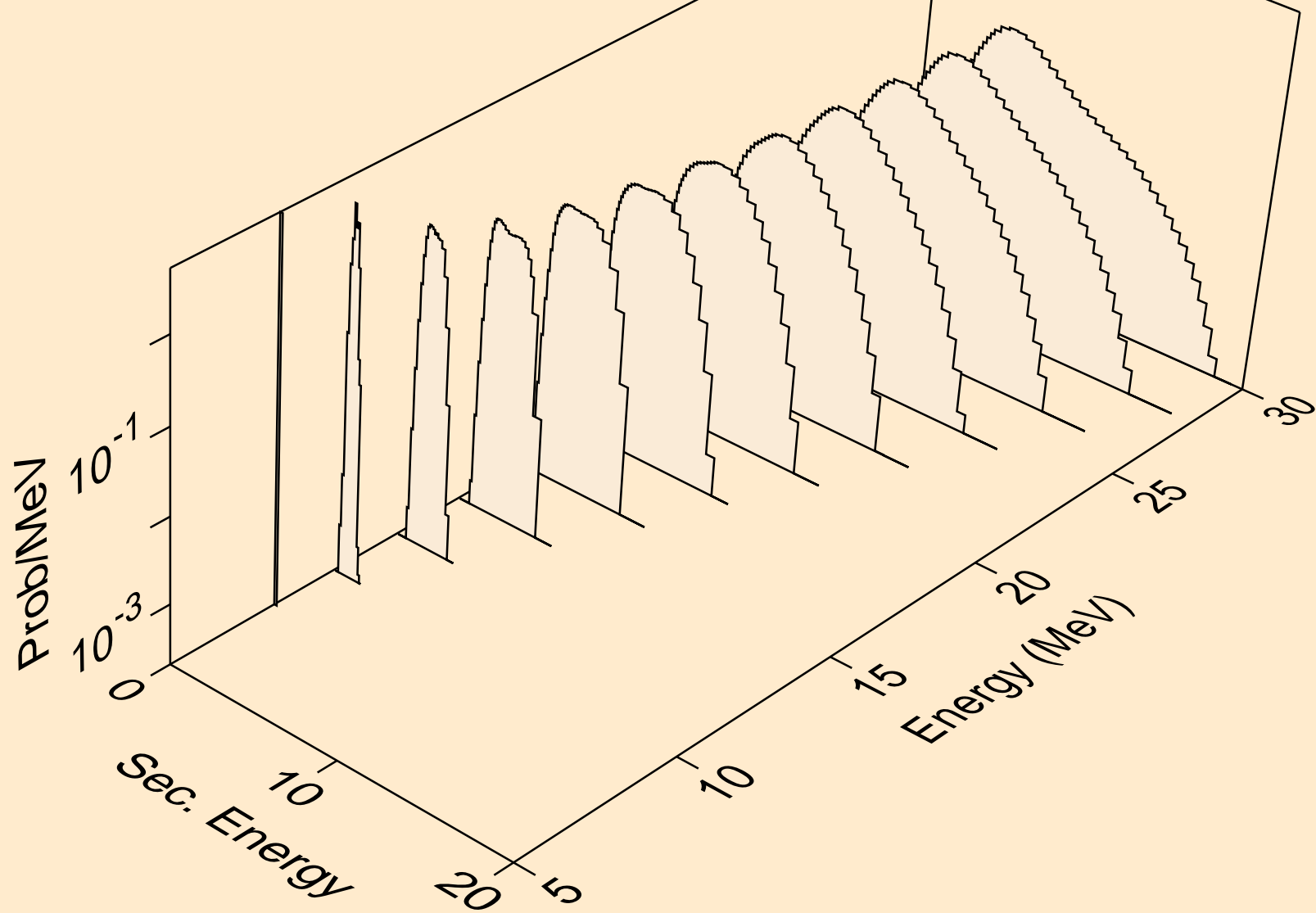

FE055 HELION ACER TENDL-2023 LIBRARY; T=0.K  
protons from (s,npa)

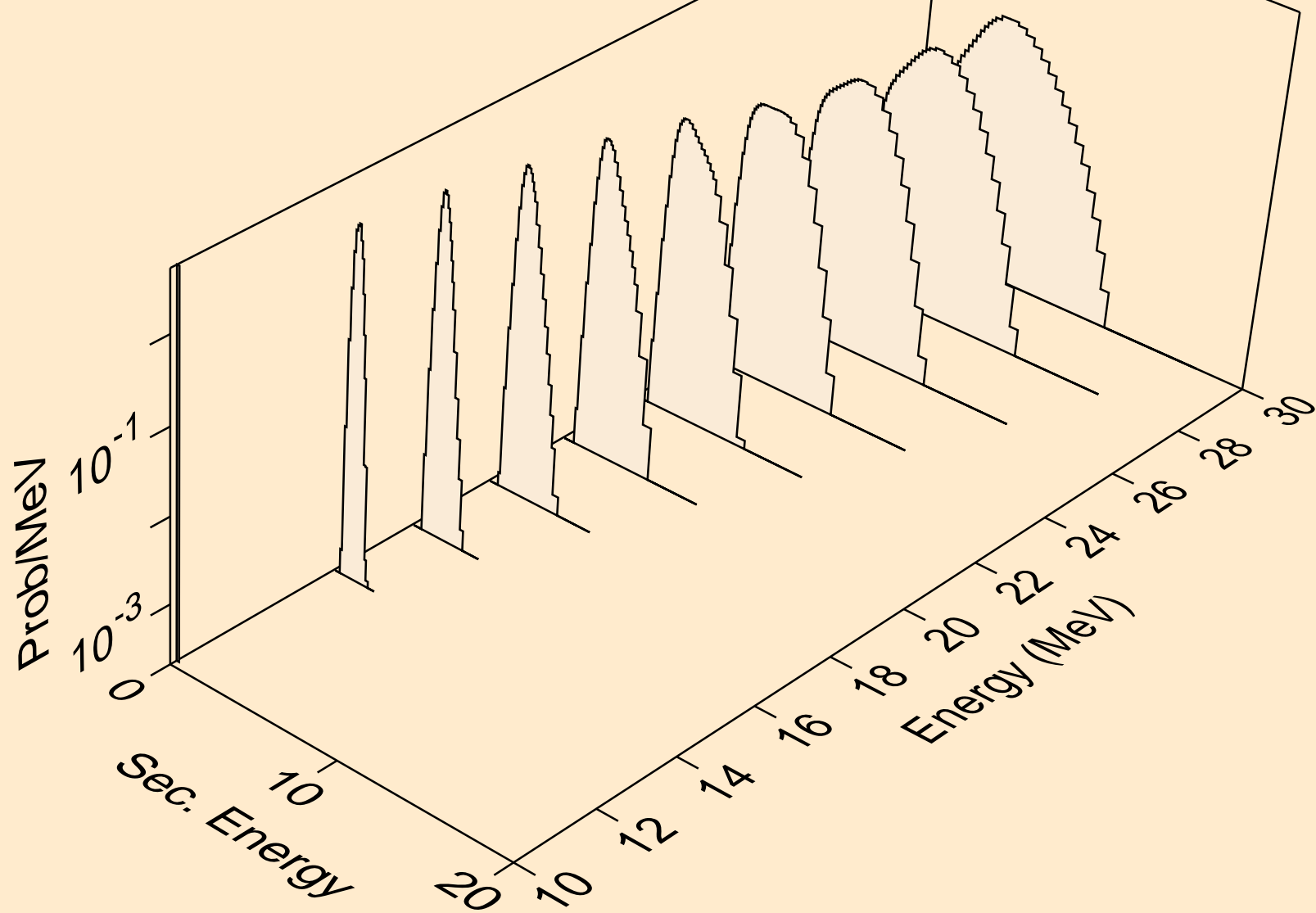

FE055 HELION ACER TENDL-2023 LIBRARY; T=0.K  
protons from (s,p)

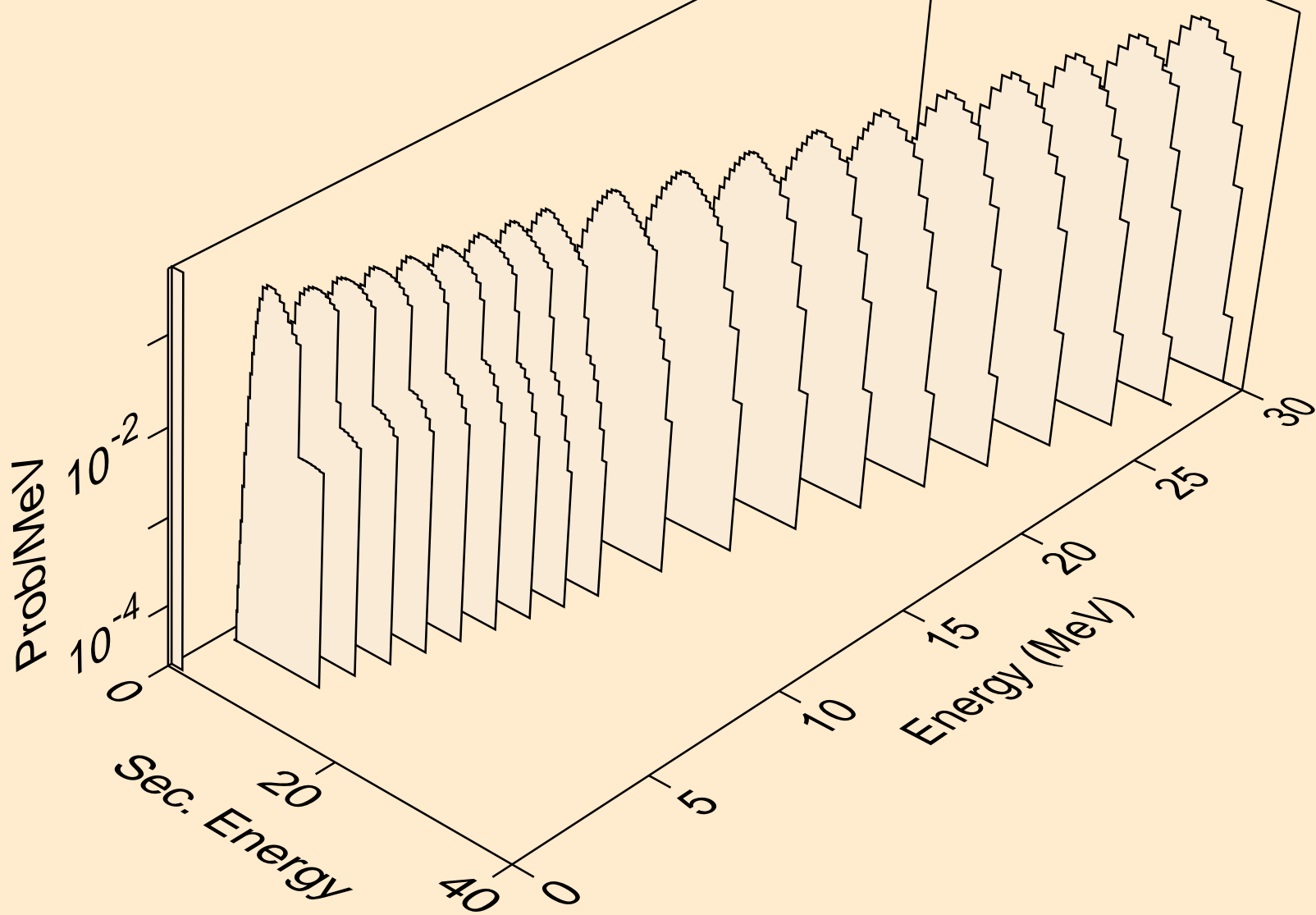



FE055 HELION ACER TENDL-2023 LIBRARY; T=0.K  
protons from (s,2p)

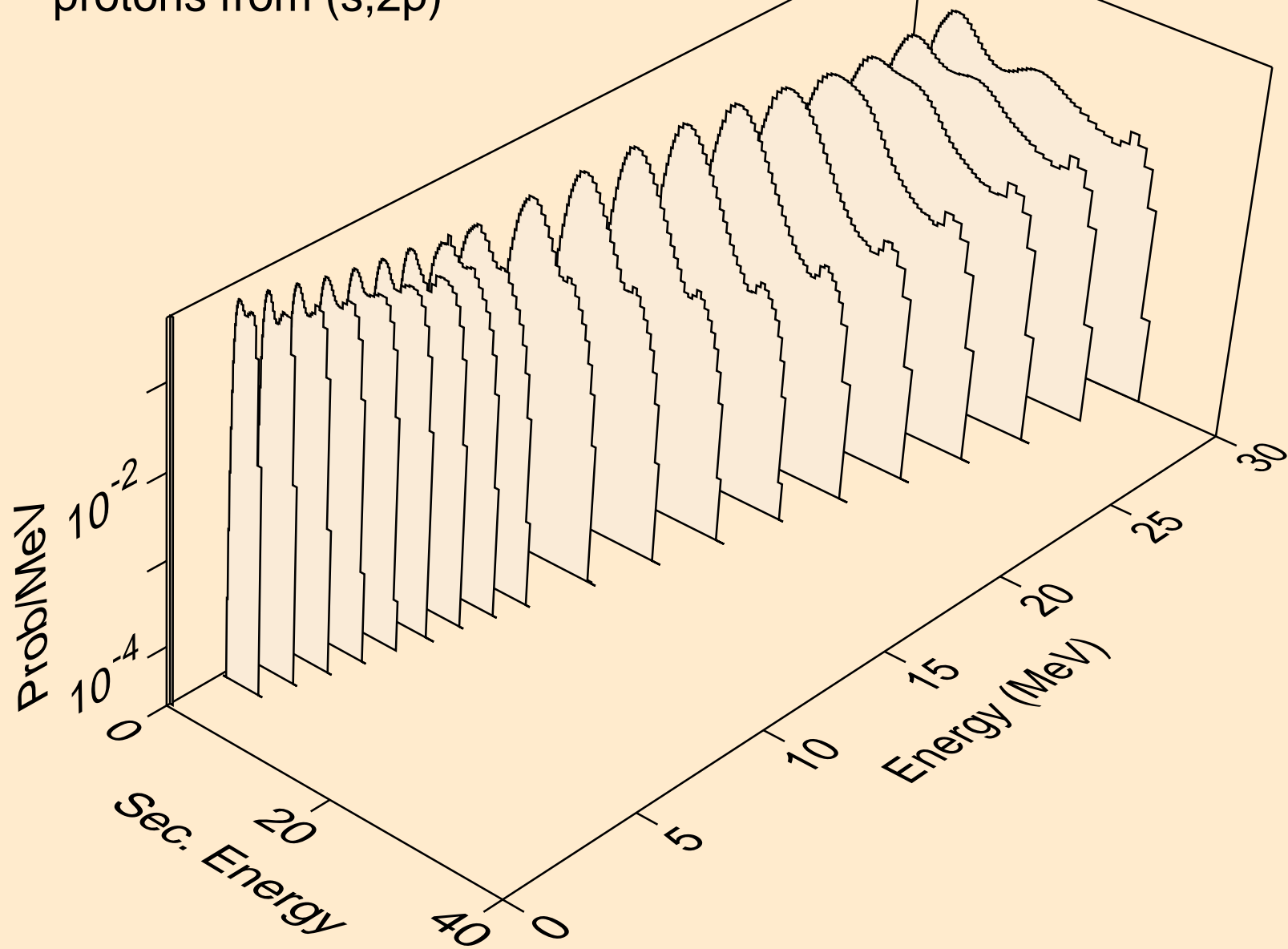

FE055 HELION ACER TENDL-2023 LIBRARY; T=0.K  
protons from (s,pa)

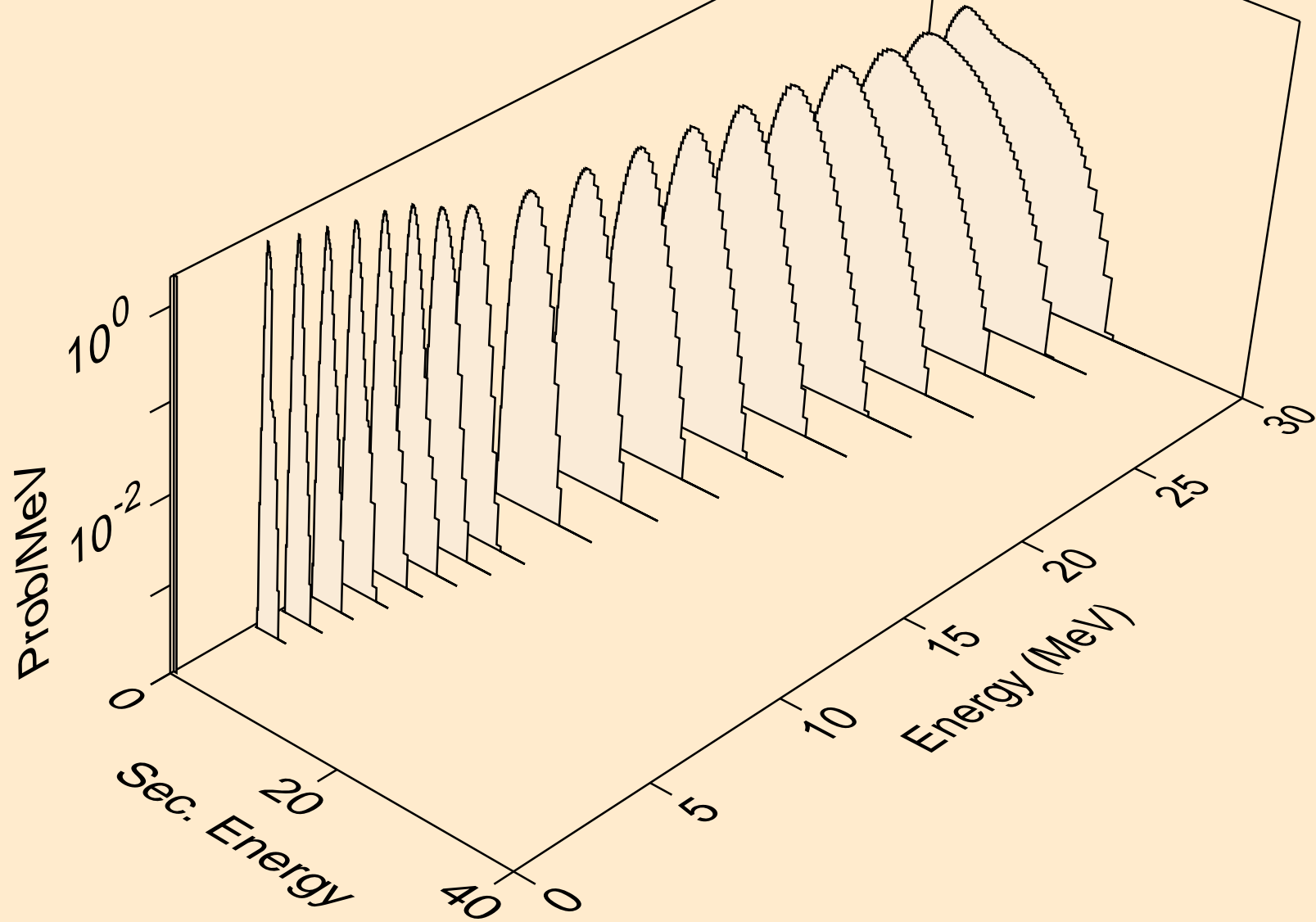

FE055 HELION ACER TENDL-2023 LIBRARY; T=0.K  
protons from (s,pd)

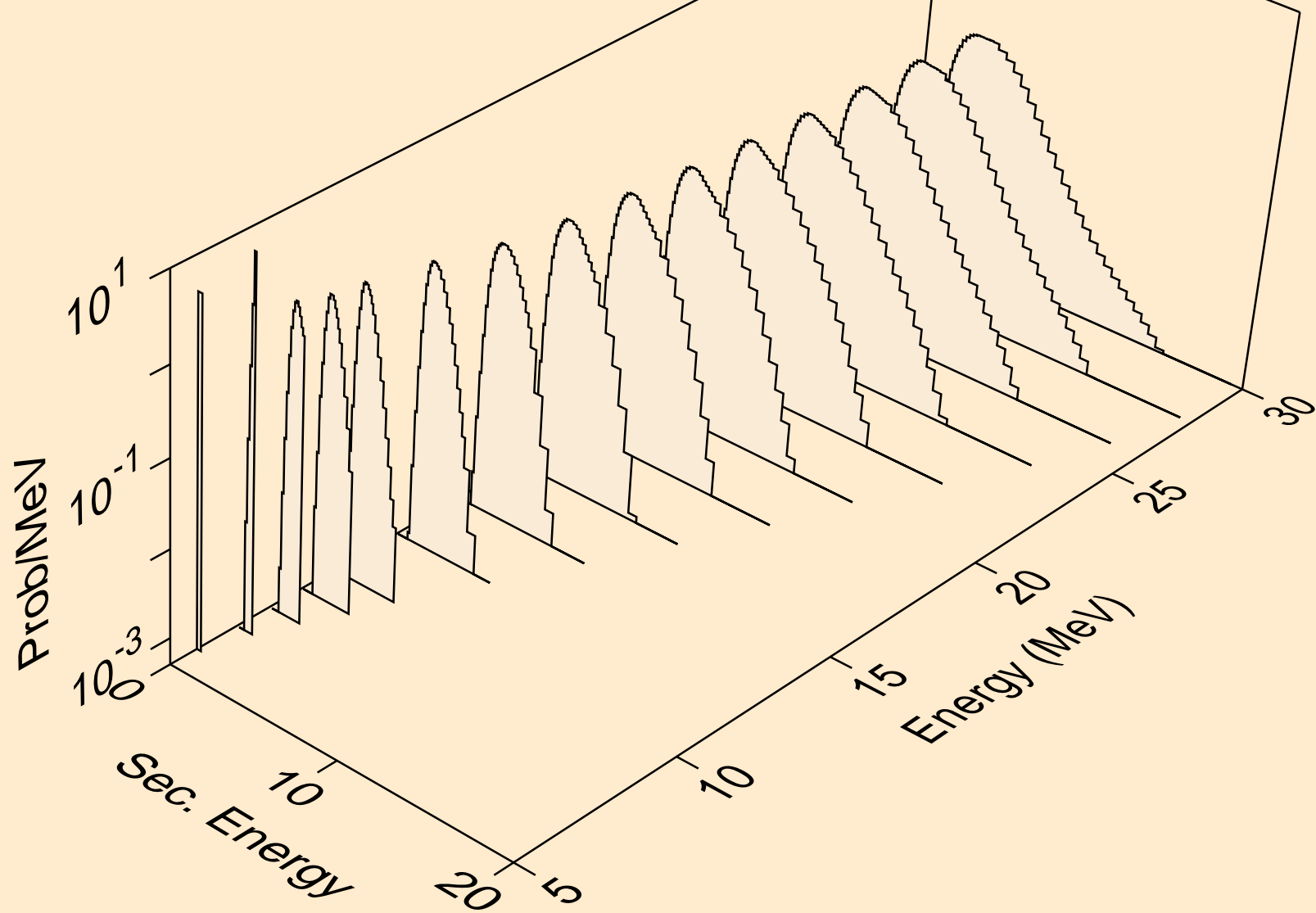

FE055 HELION ACER TENDL-2023 LIBRARY; T=0.K  
protons from (s,pt)

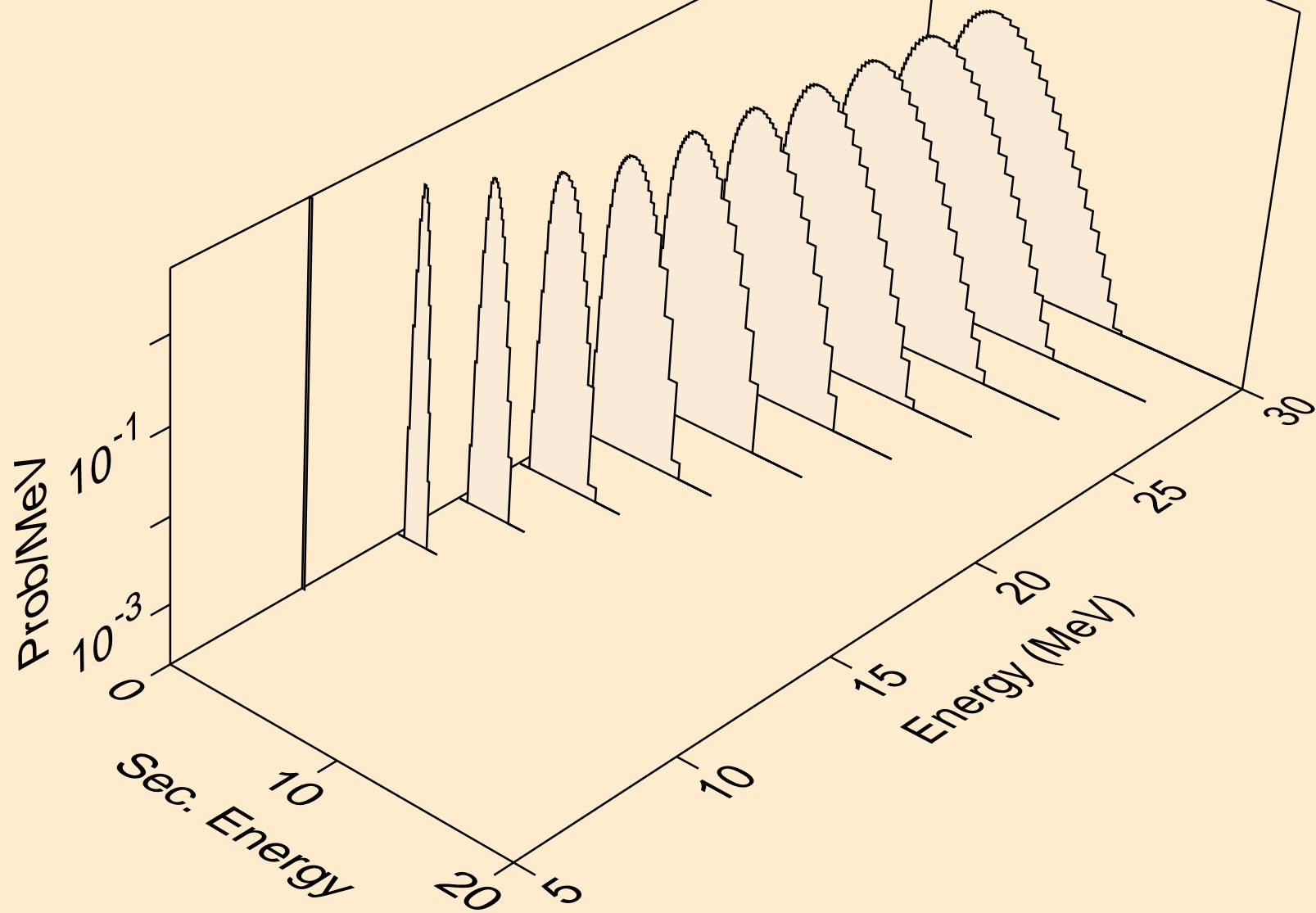

FE055 HELION ACER TENDL-2023 LIBRARY; T=0.K  
deuterons from (s,x)

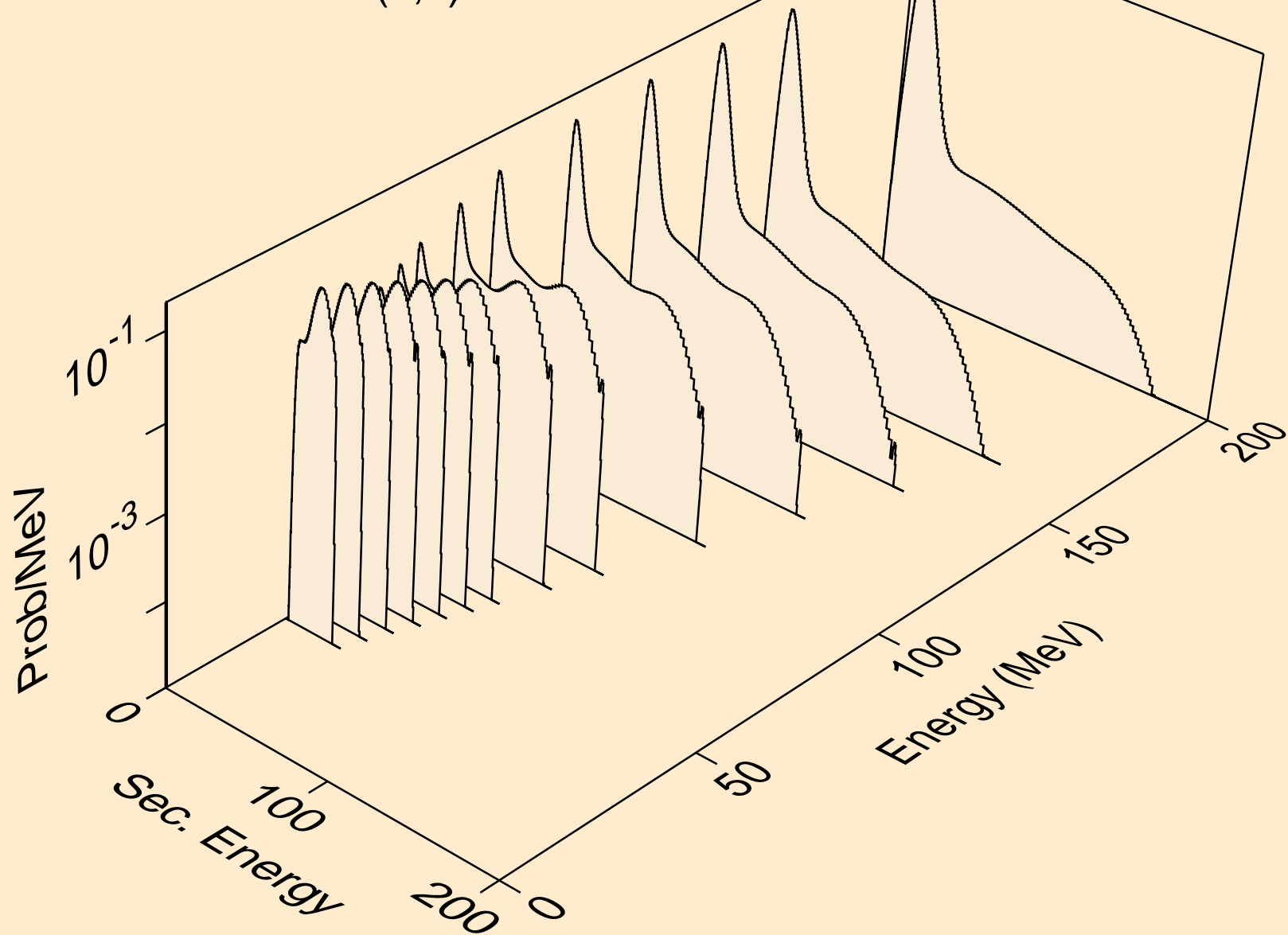

FE055 HELION ACER TENDL-2023 LIBRARY; T=0.K  
deuterons from (s,2nd)

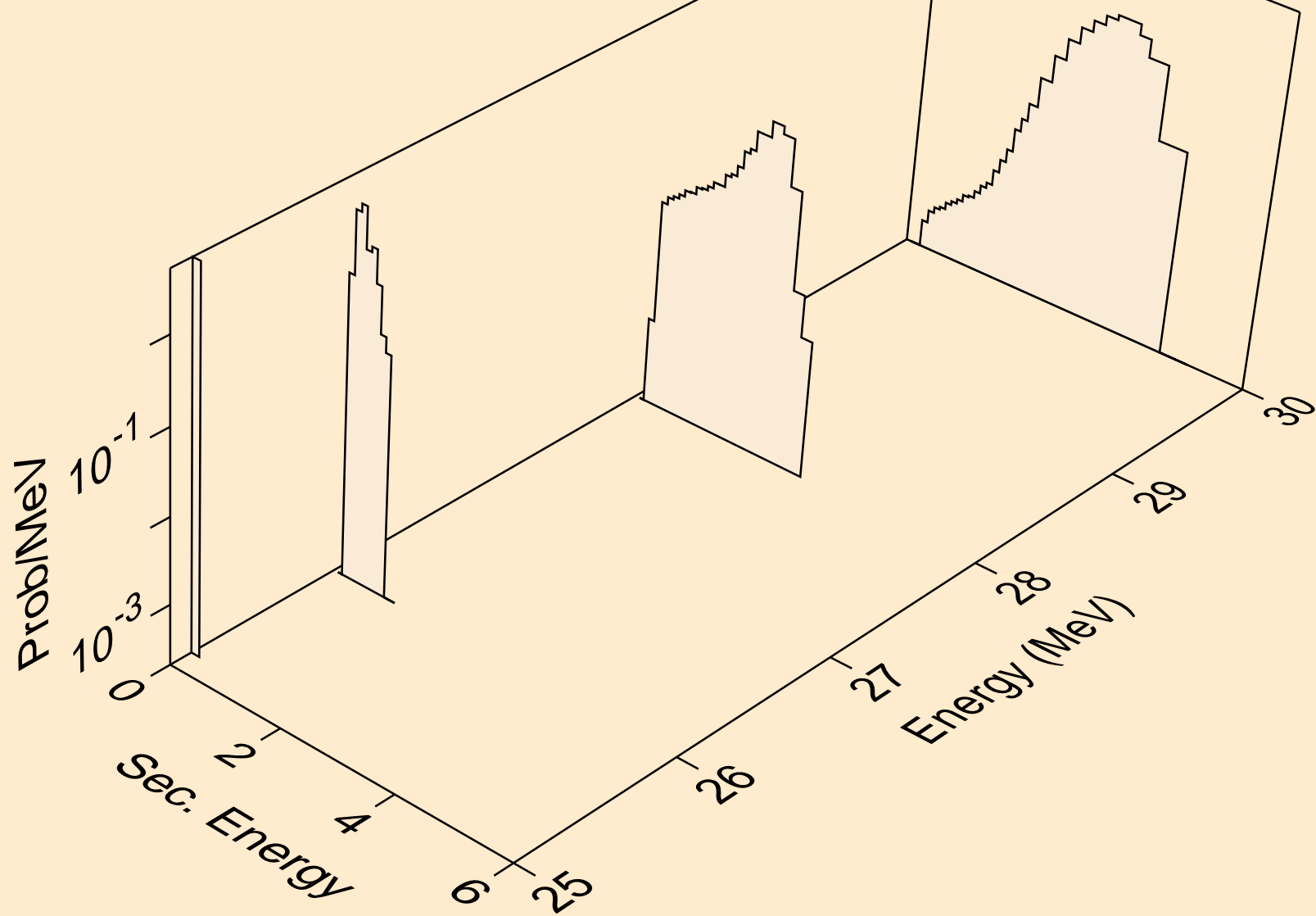

FE055 HELION ACER TENDL-2023 LIBRARY; T=0.K  
deuterons from (s,n\*)d

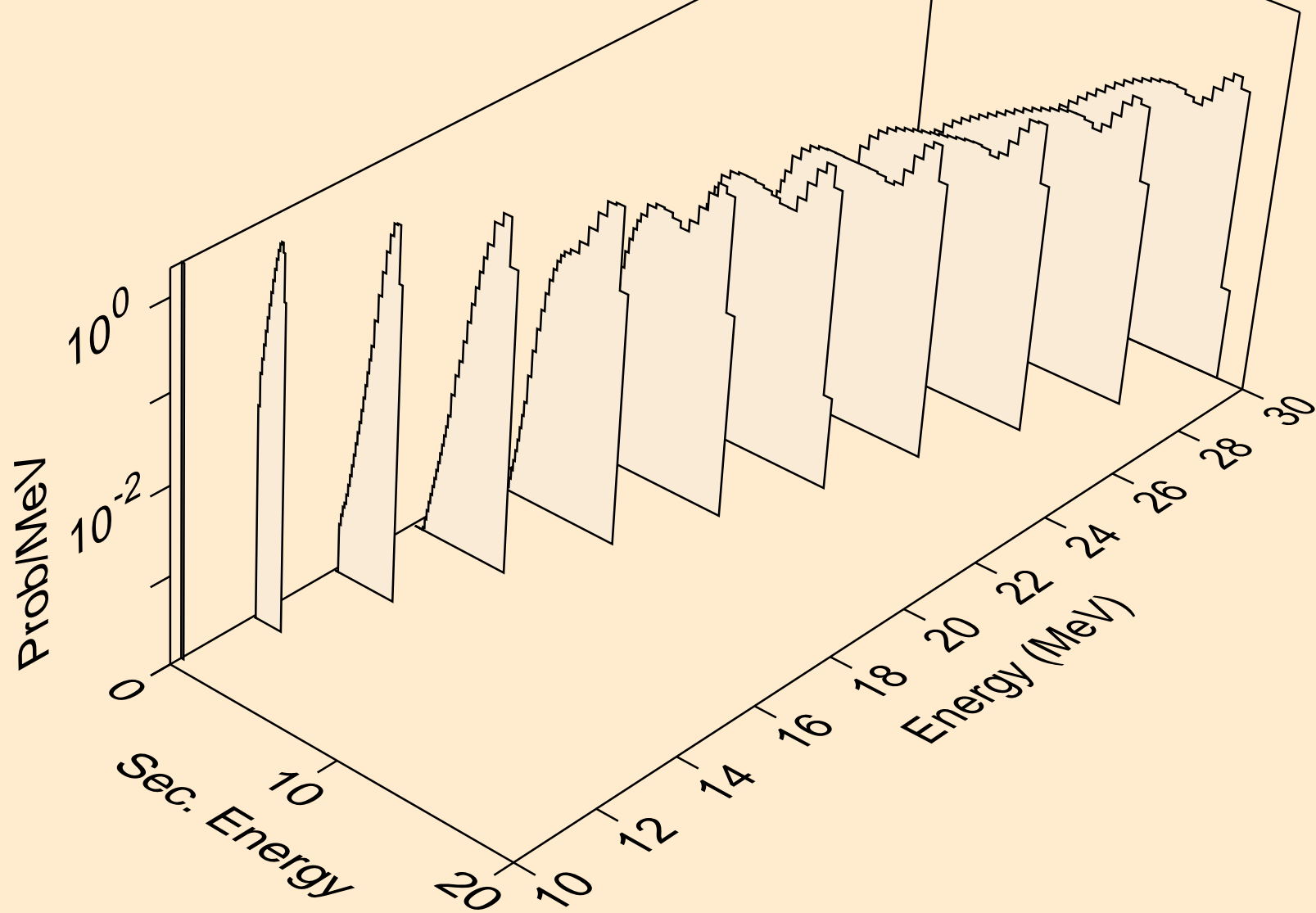

FE055 HELION ACER TENDL-2023 LIBRARY; T=0.K  
deuterons from (s,d)

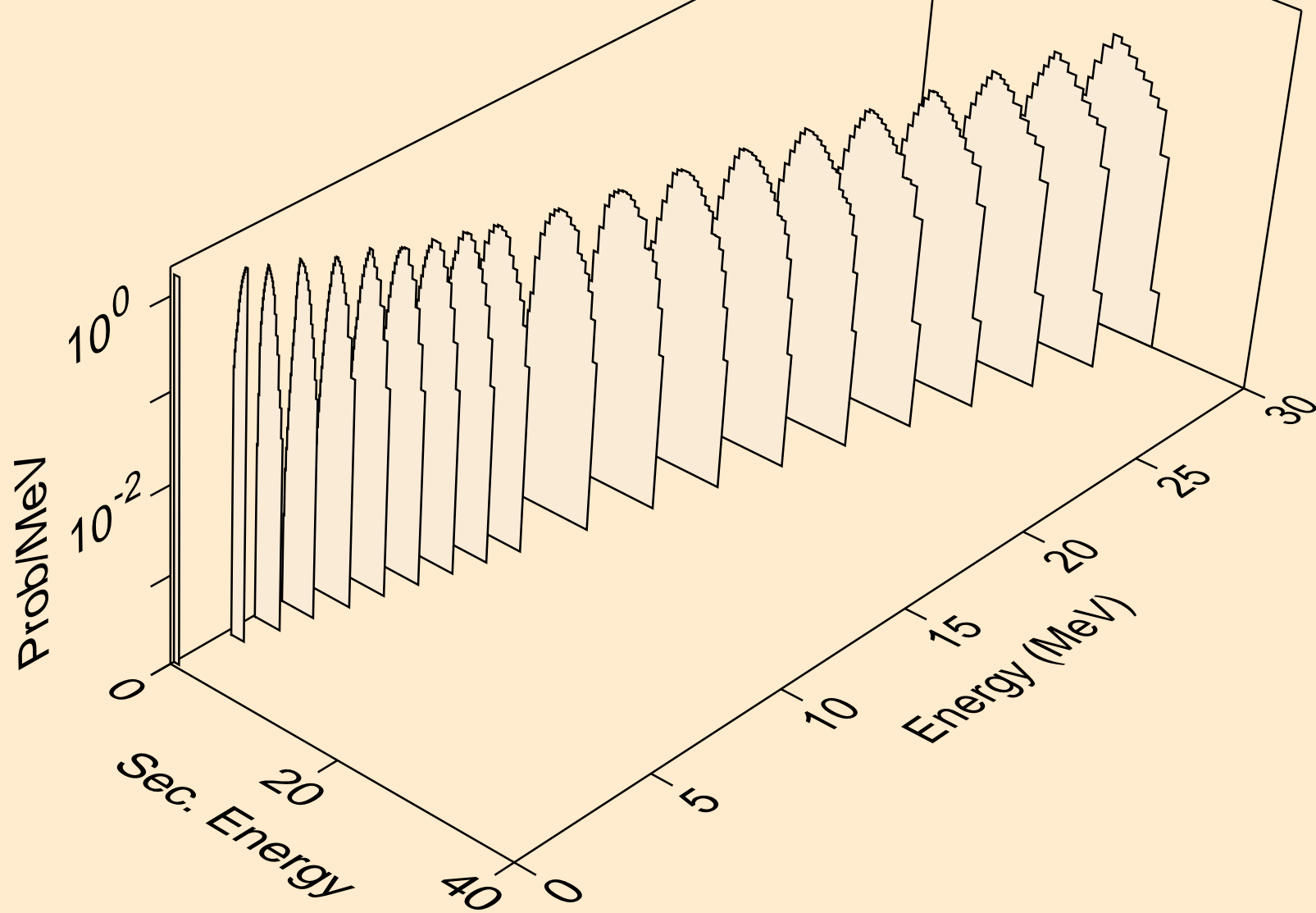



FE055 HELION ACER TENDL-2023 LIBRARY; T=0.K  
deuterons from (s,pd)

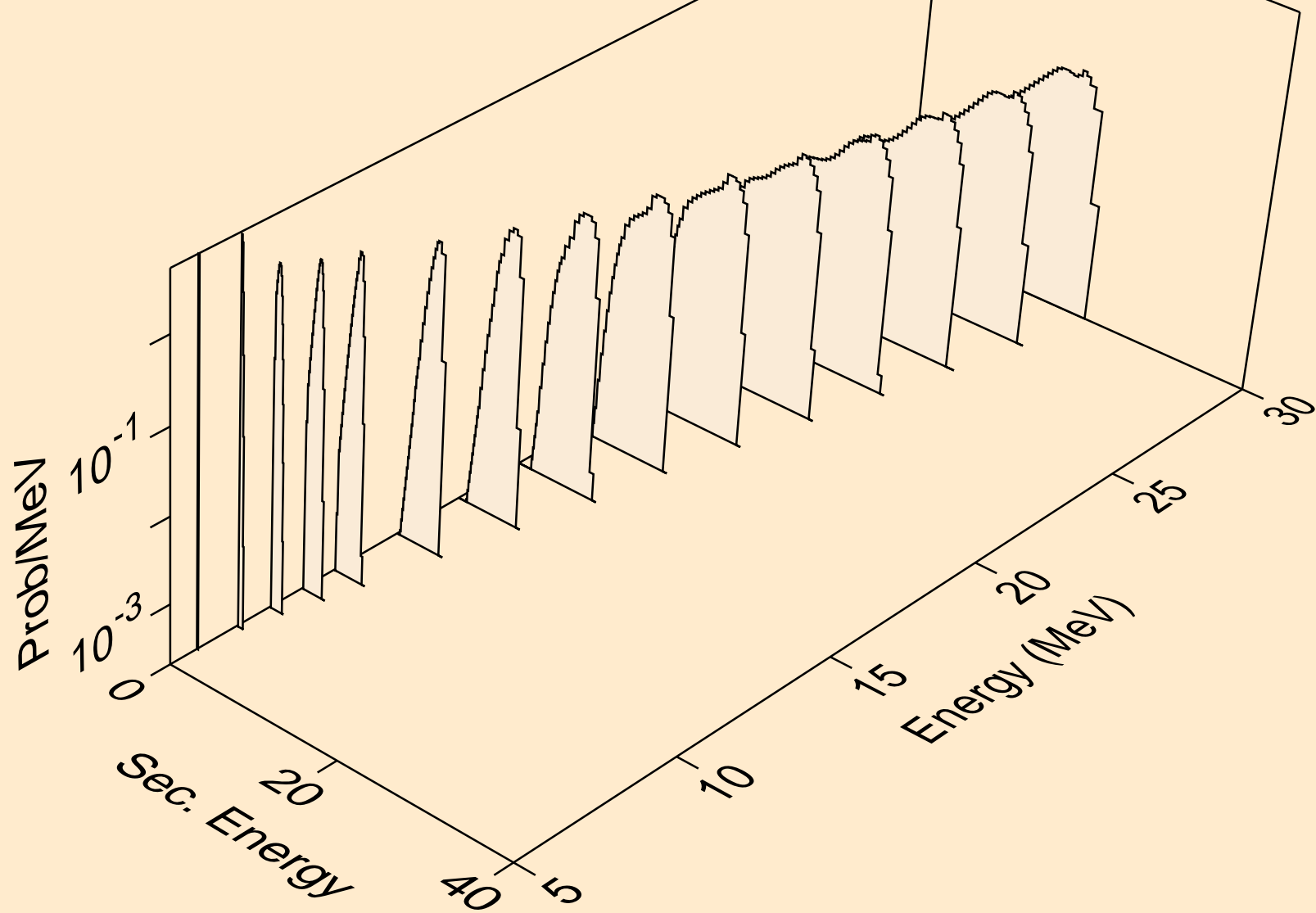

FE055 HELION ACER TENDL-2023 LIBRARY; T=0.K  
deuterons from (s,da)

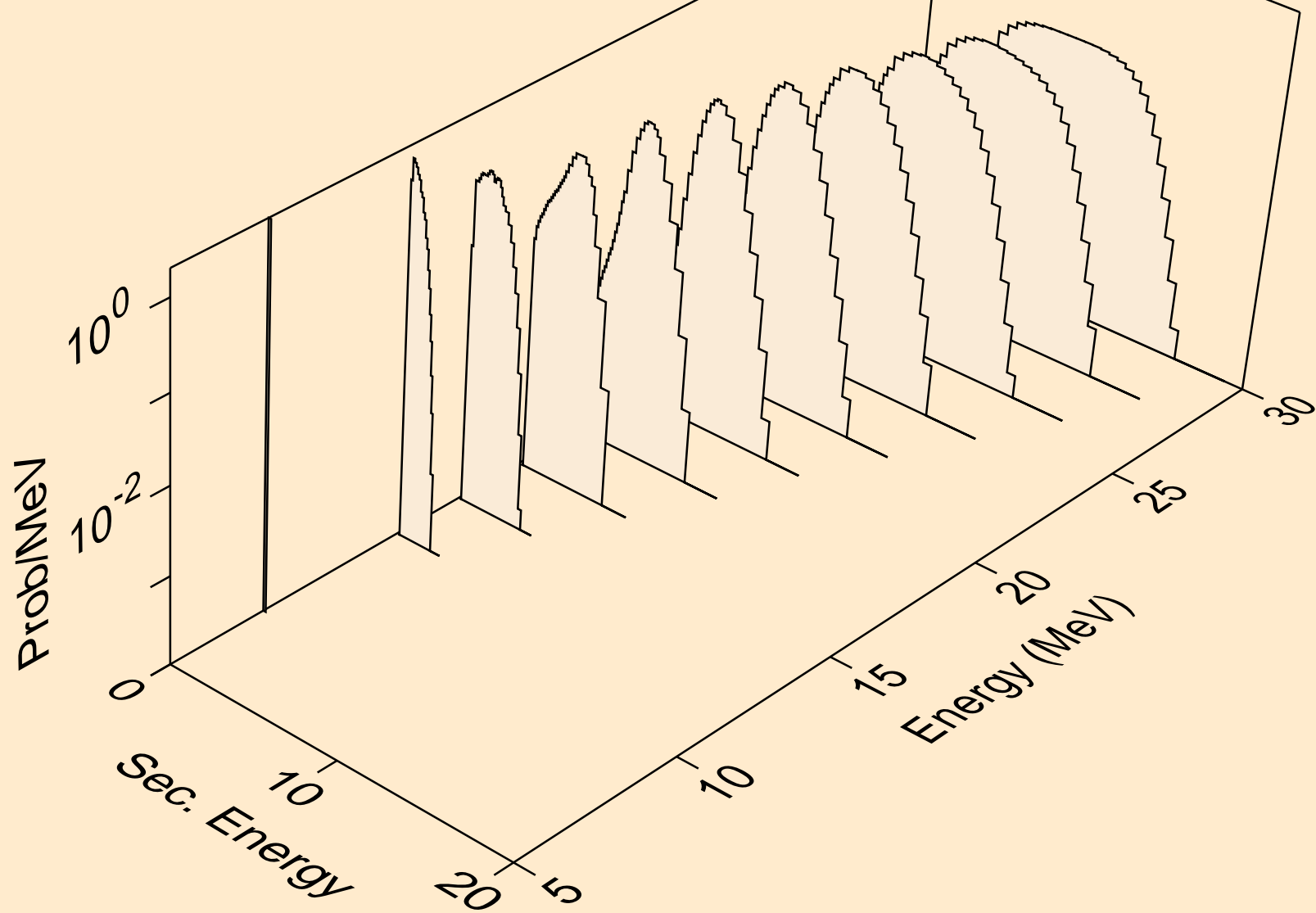

FE055 HELION ACER TENDL-2023 LIBRARY; T=0.K  
tritons from (s,x)

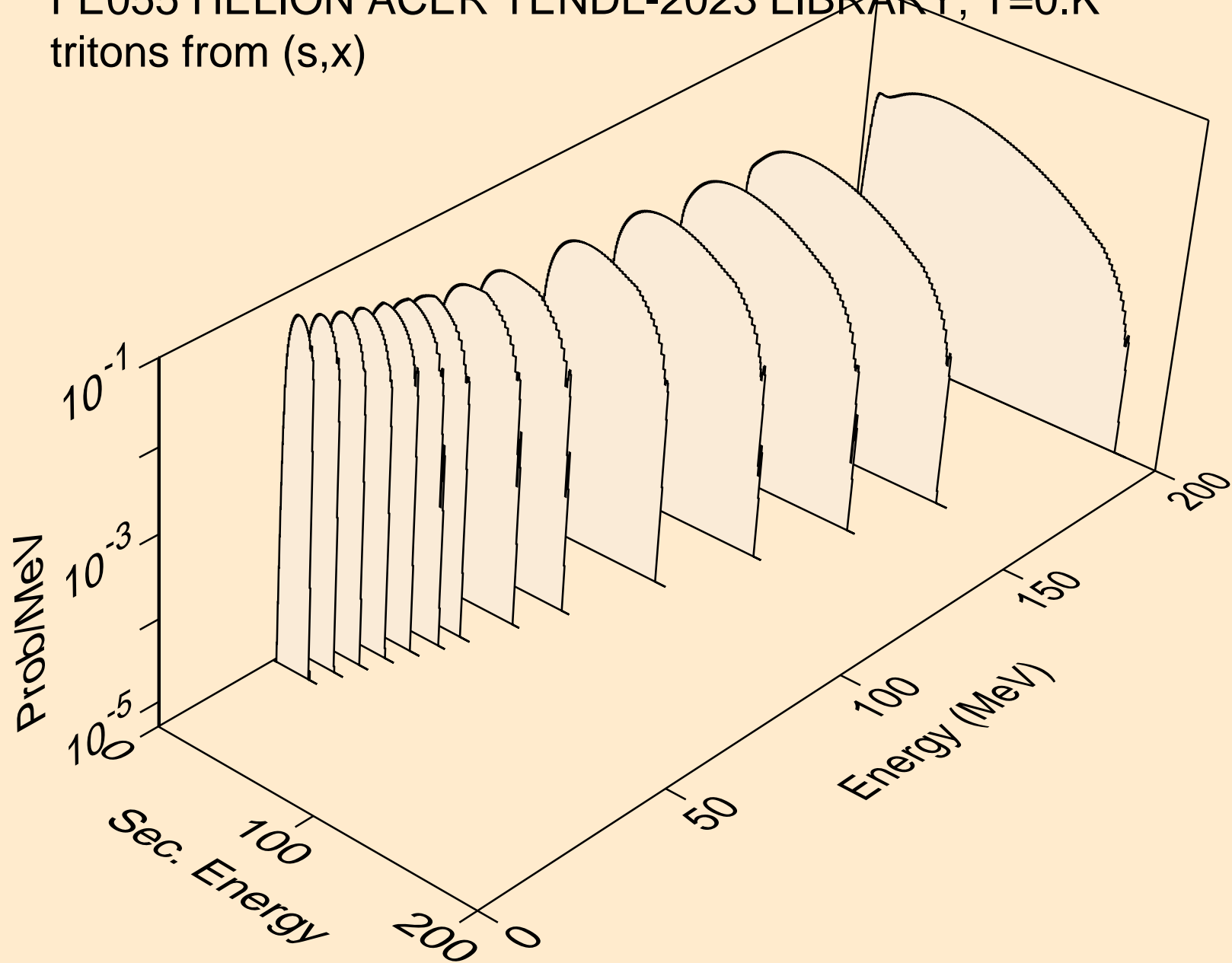

FE055 HELION ACER TENDL-2023 LIBRARY; T=0.K  
tritons from (s,n\*)t

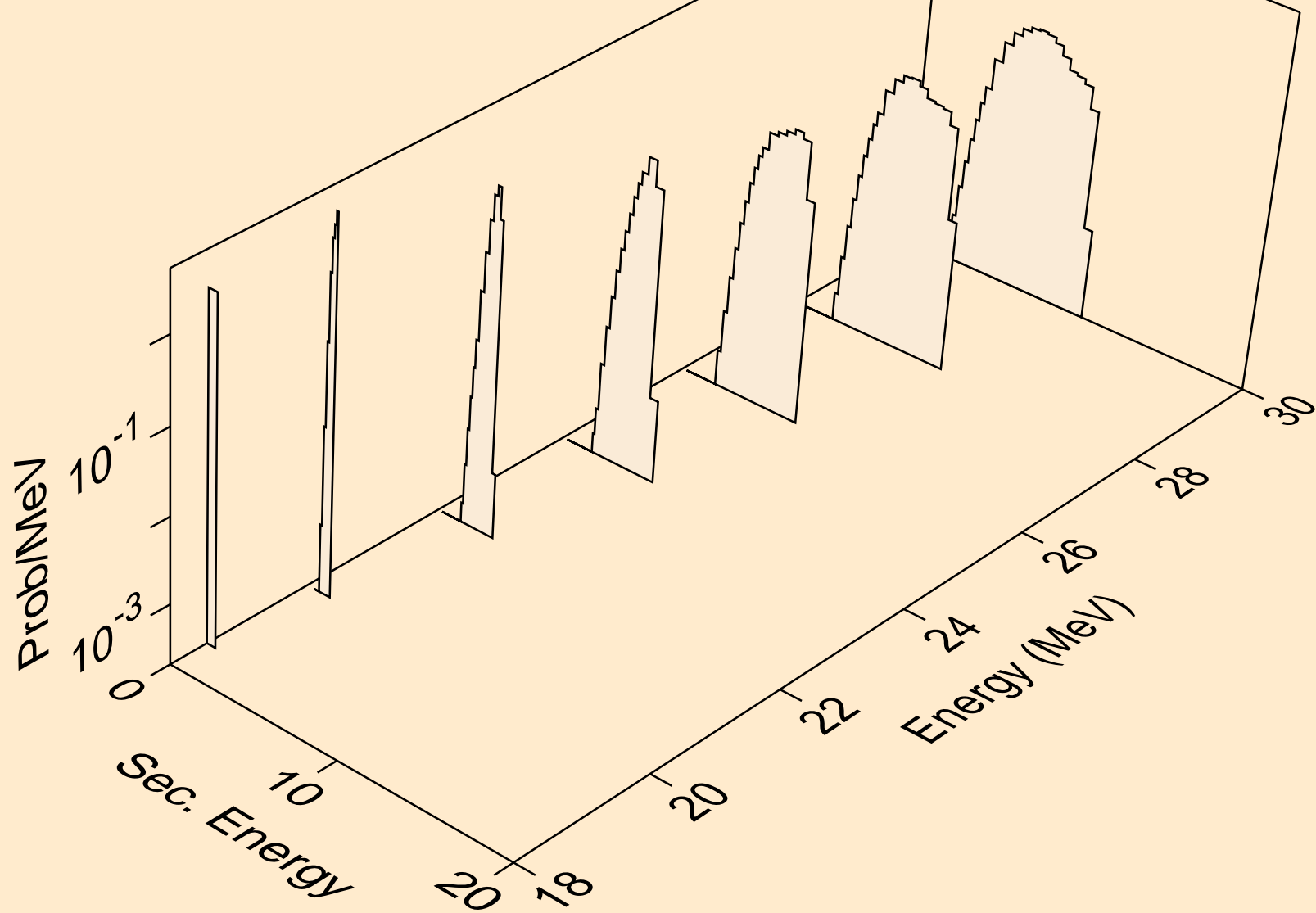

FE055 HELION ACER TENDL-2023 LIBRARY; T=0.K  
tritons from (s,t)

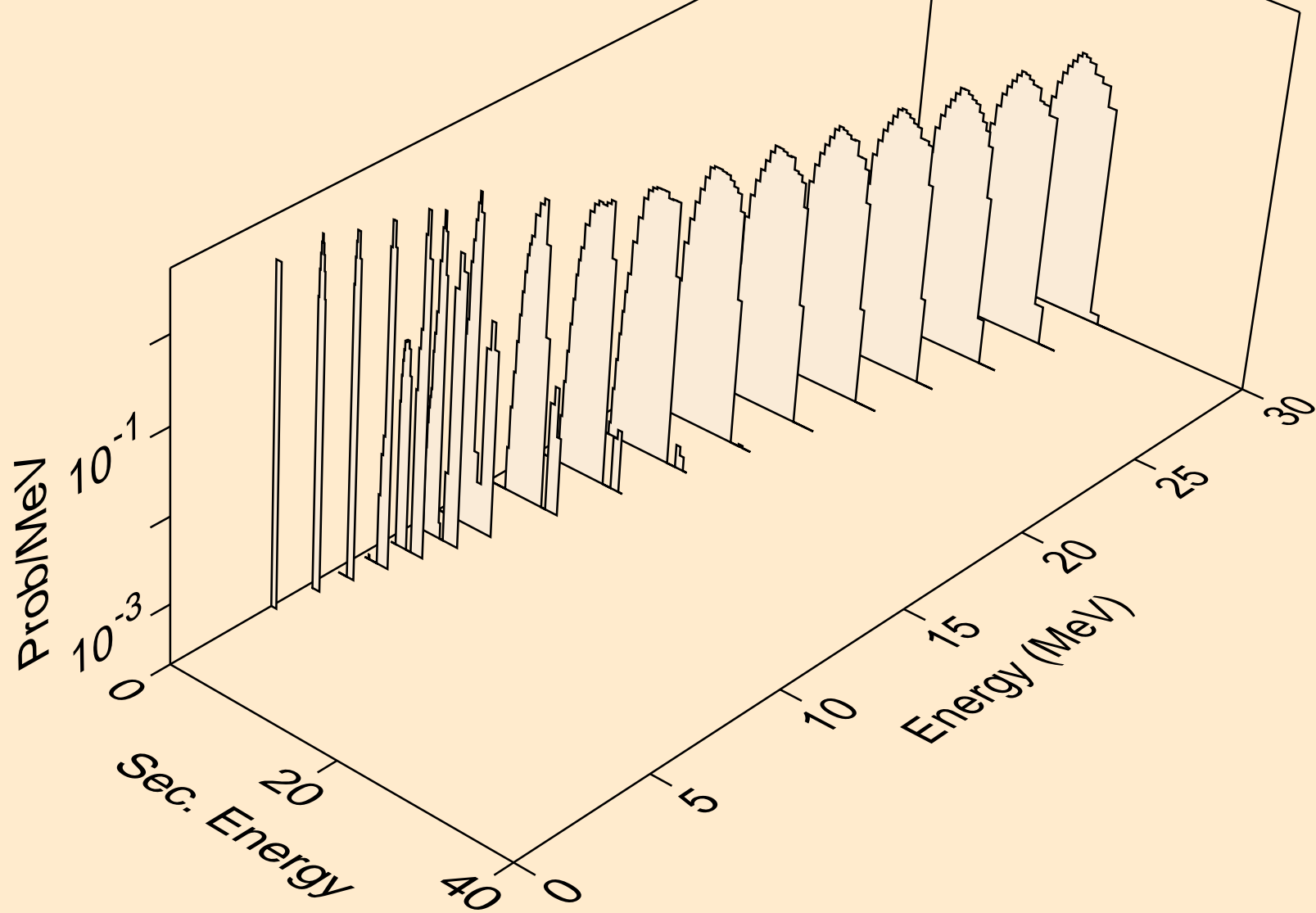

FE055 HELION ACER TENDL-2023 LIBRARY; T=0.K  
tritons from (s,pt)

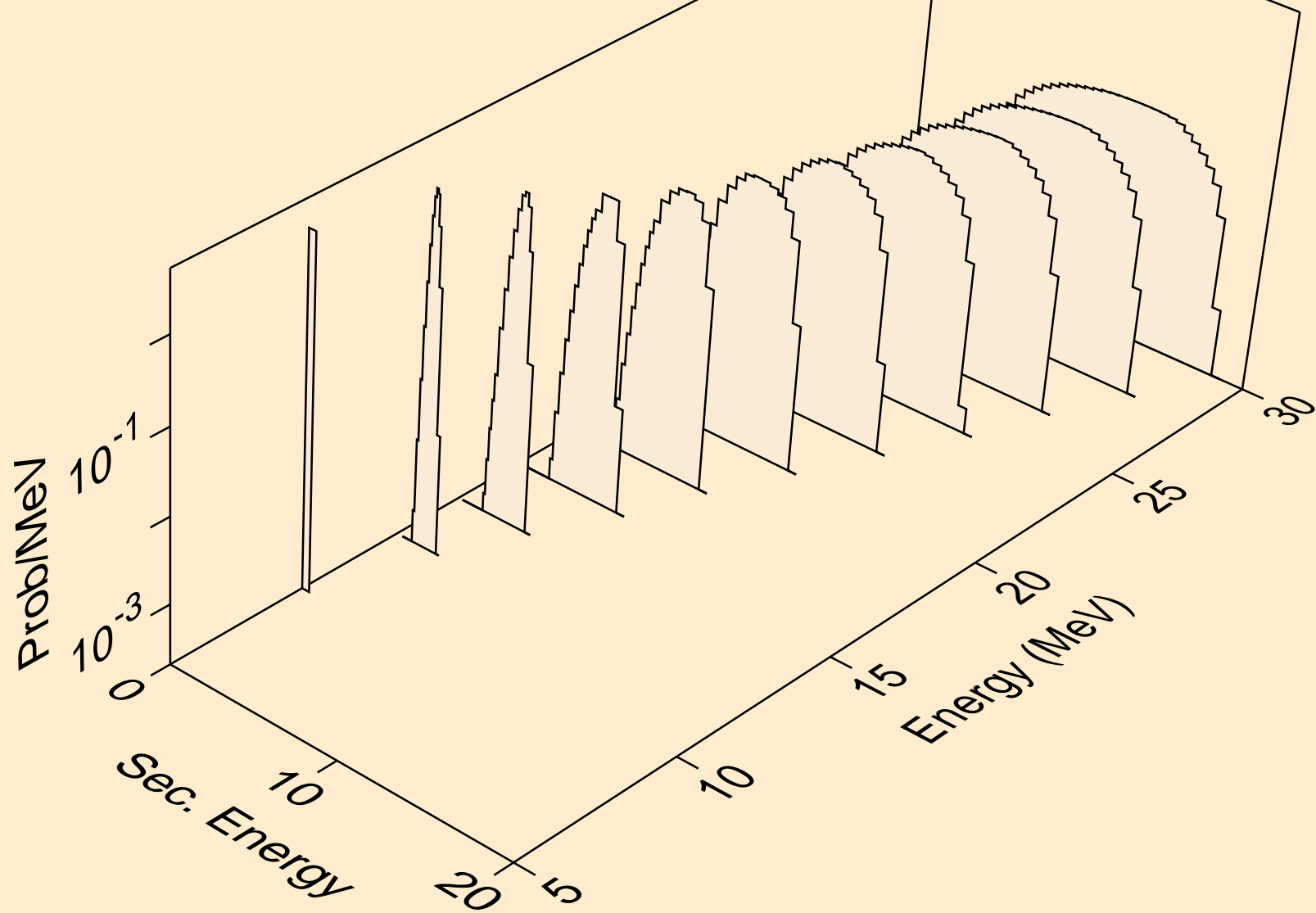

FE055 HELION ACER TENDL-2023 LIBRARY; T=0.K  
alphas from (s,x)

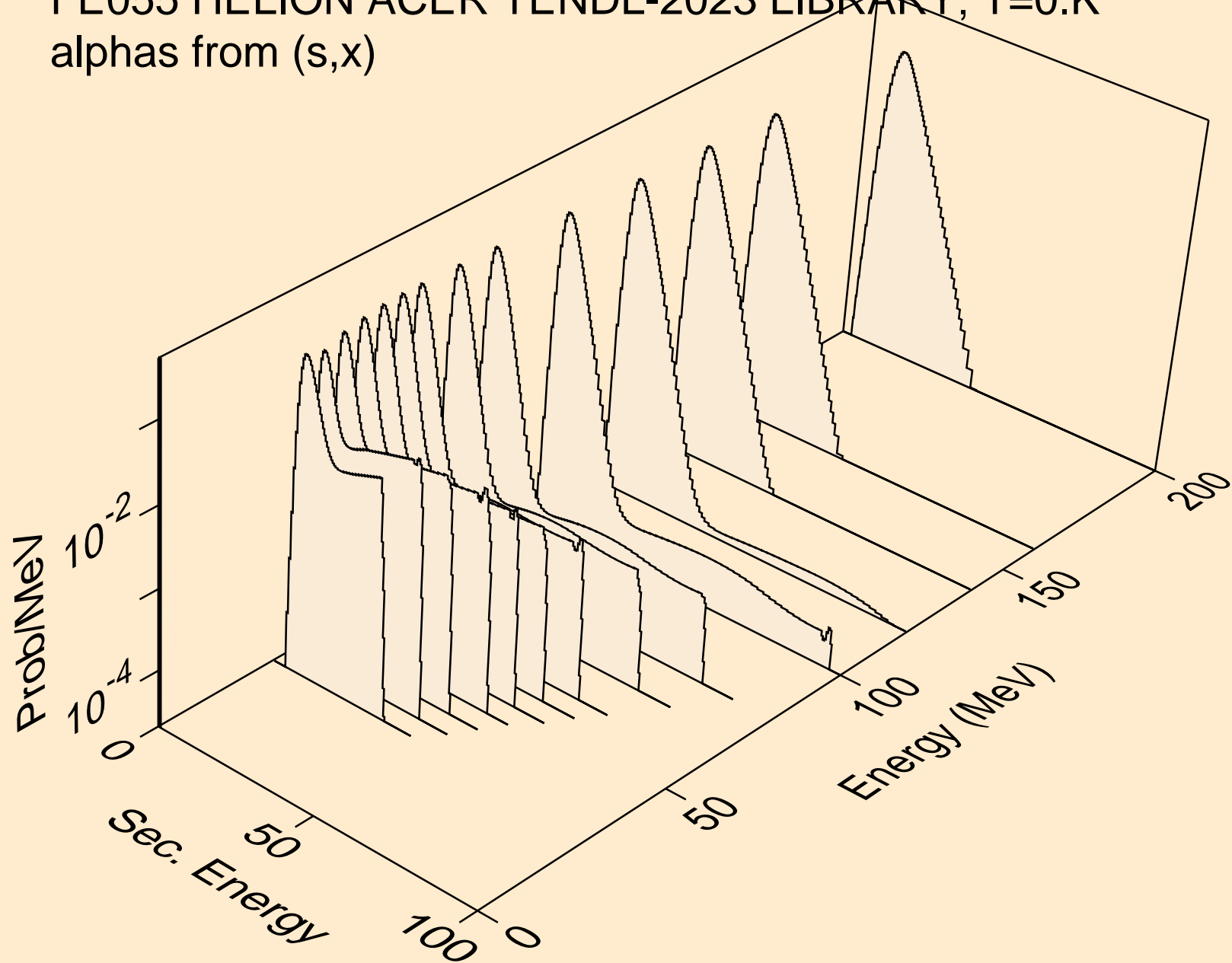

FE055 HELION ACER TENDL-2023 LIBRARY; T=0.K  
alphas from (s,n\*)a

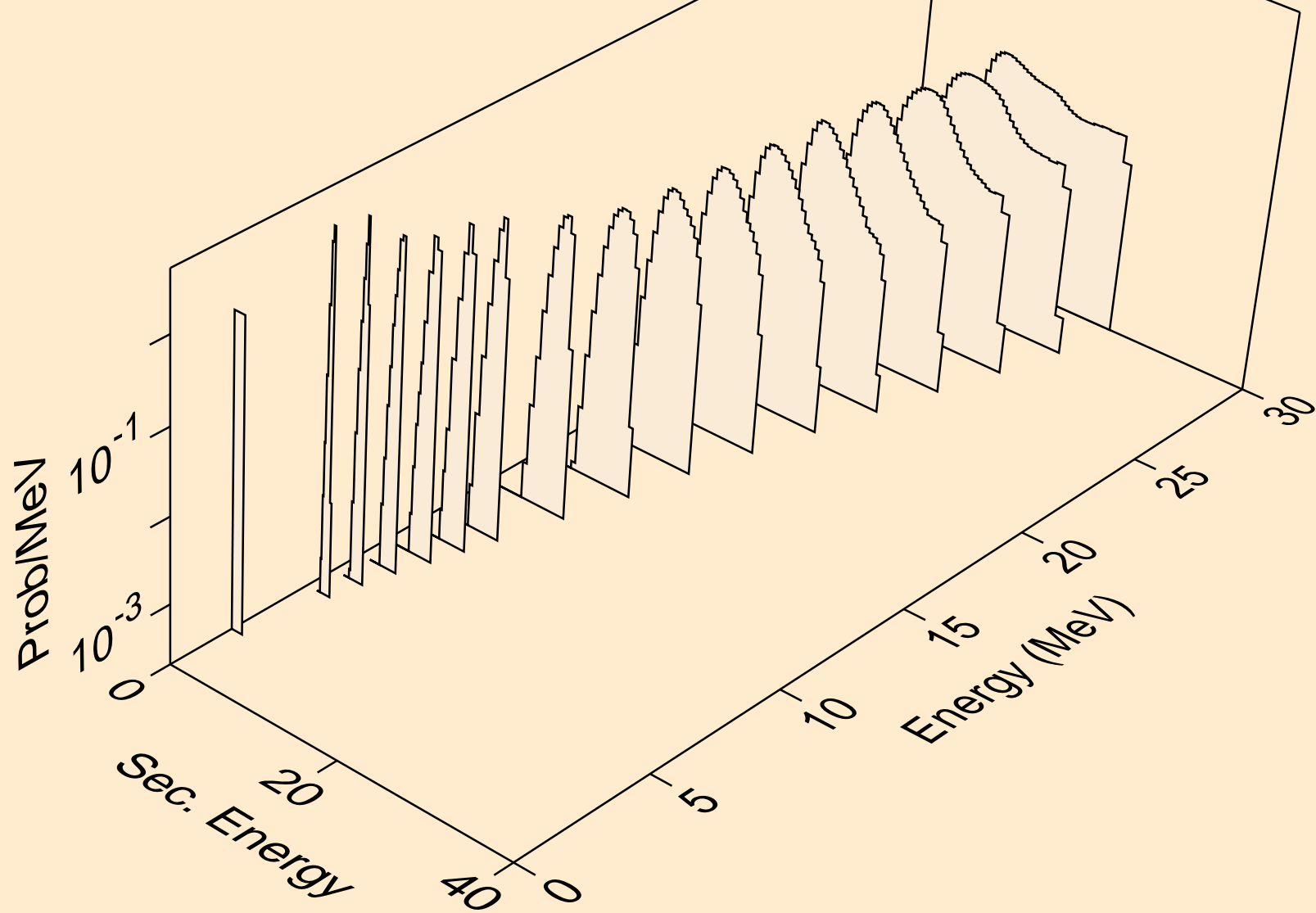



FE055 HELION ACER TENDL-2023 LIBRARY; T=0.K  
alphas from (s,2n)a

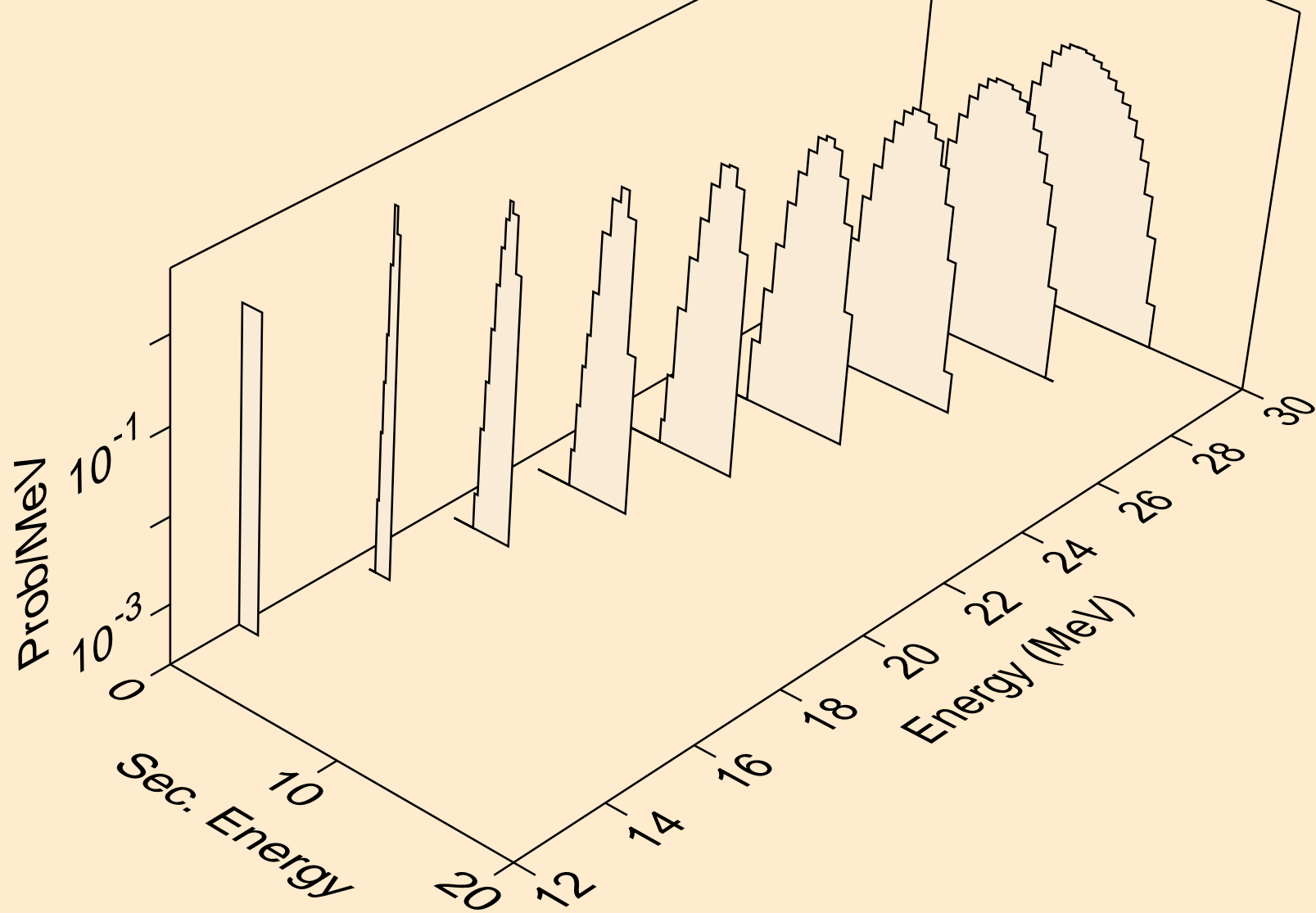

FE055 HELION ACER TENDL-2023 LIBRARY; T=0.K  
alphas from (s,n\*)2a

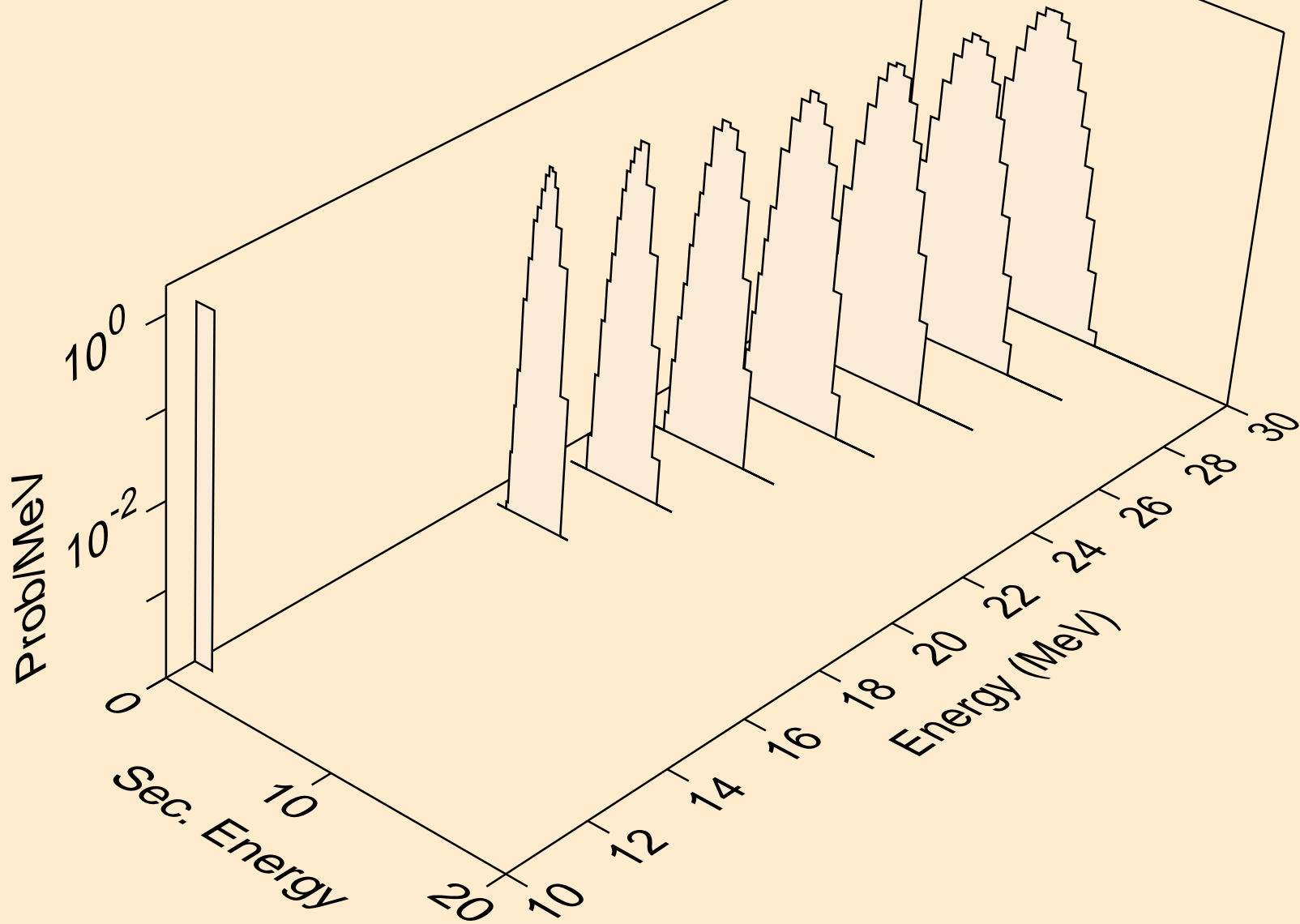

FE055 HELION ACER TENDL-2023 LIBRARY; T=0.K  
alphas from (s,npa)

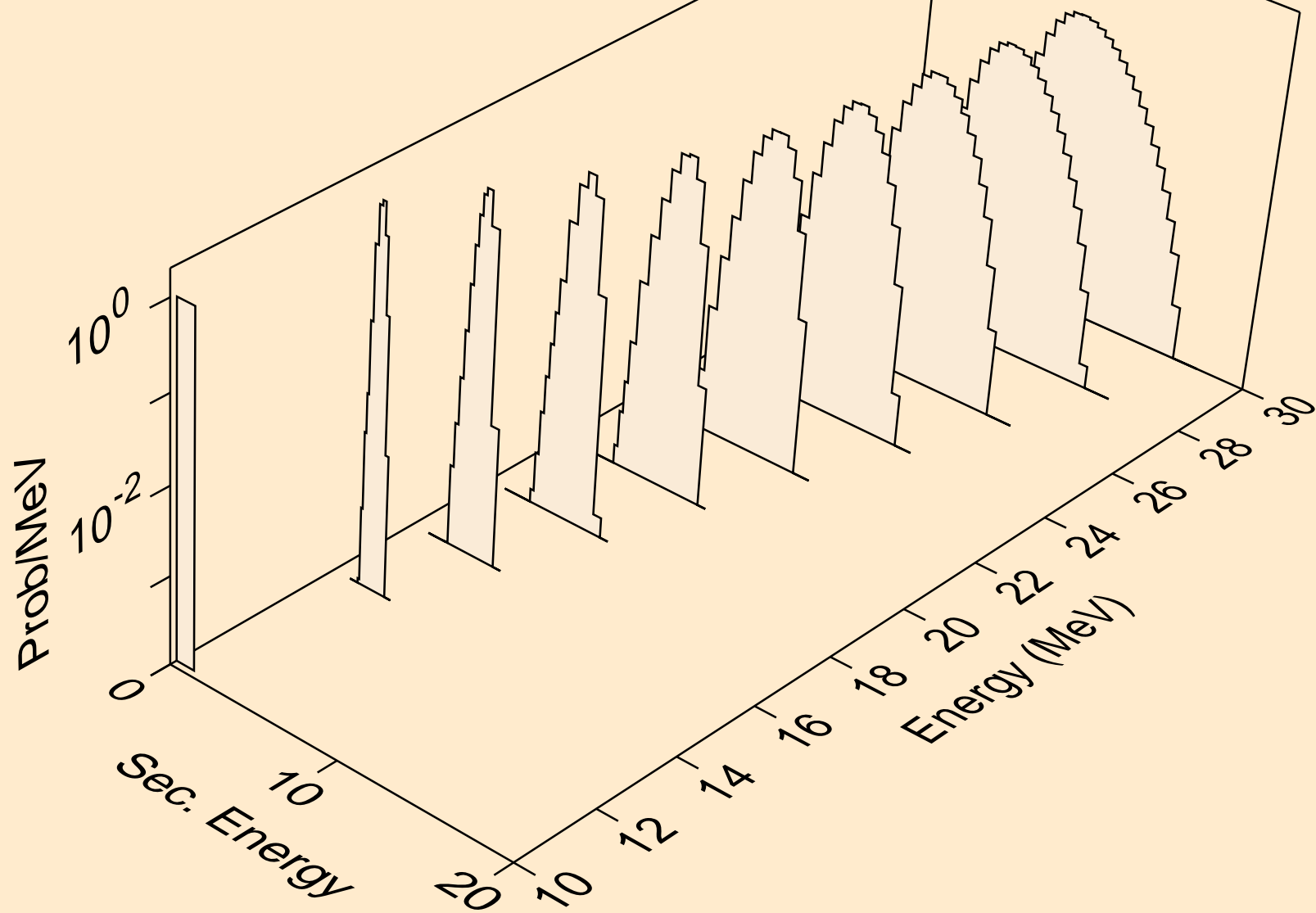

FE055 HELION ACER TENDL-2023 LIBRARY; T=0.K  
alphas from (s,a)

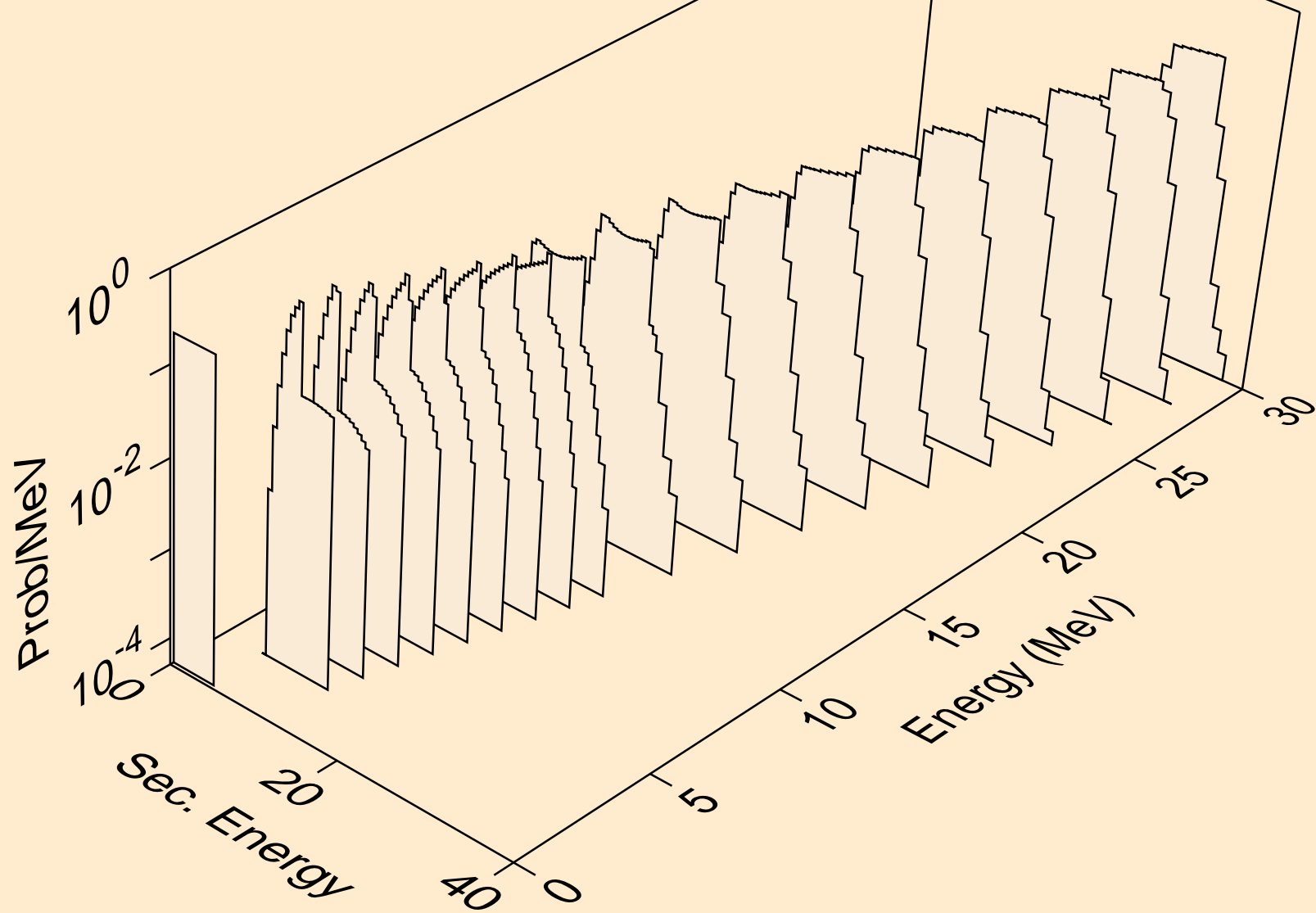

FE055 HELION ACER TENDL-2023 LIBRARY; T=0.K  
alphas from (s,2a)

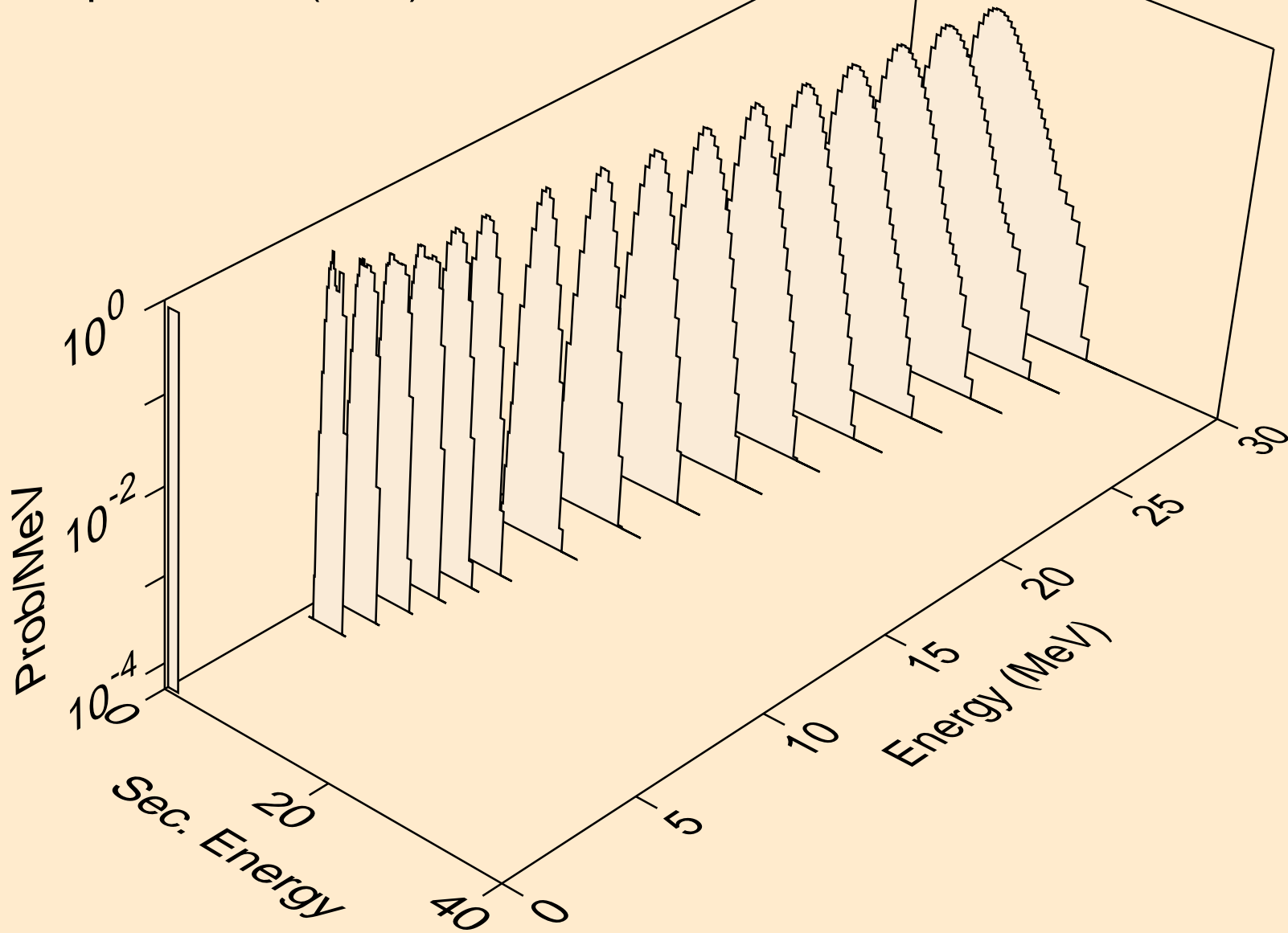

FE055 HELION ACER TENDL-2023 LIBRARY; T=0.K  
alphas from (s,3a)

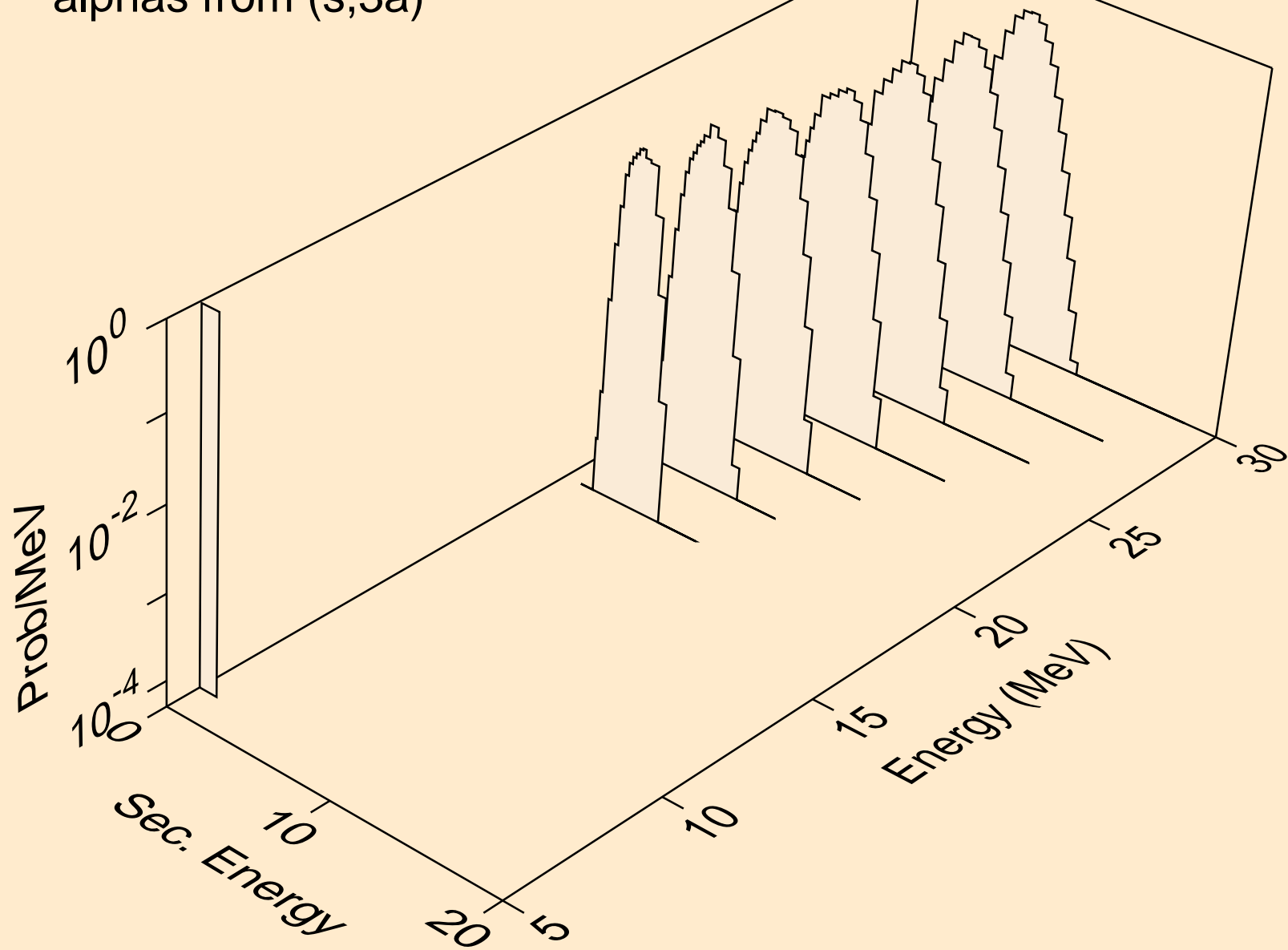

FE055 HELION ACER TENDL-2023 LIBRARY; T=0.K  
alphas from (s,pa)

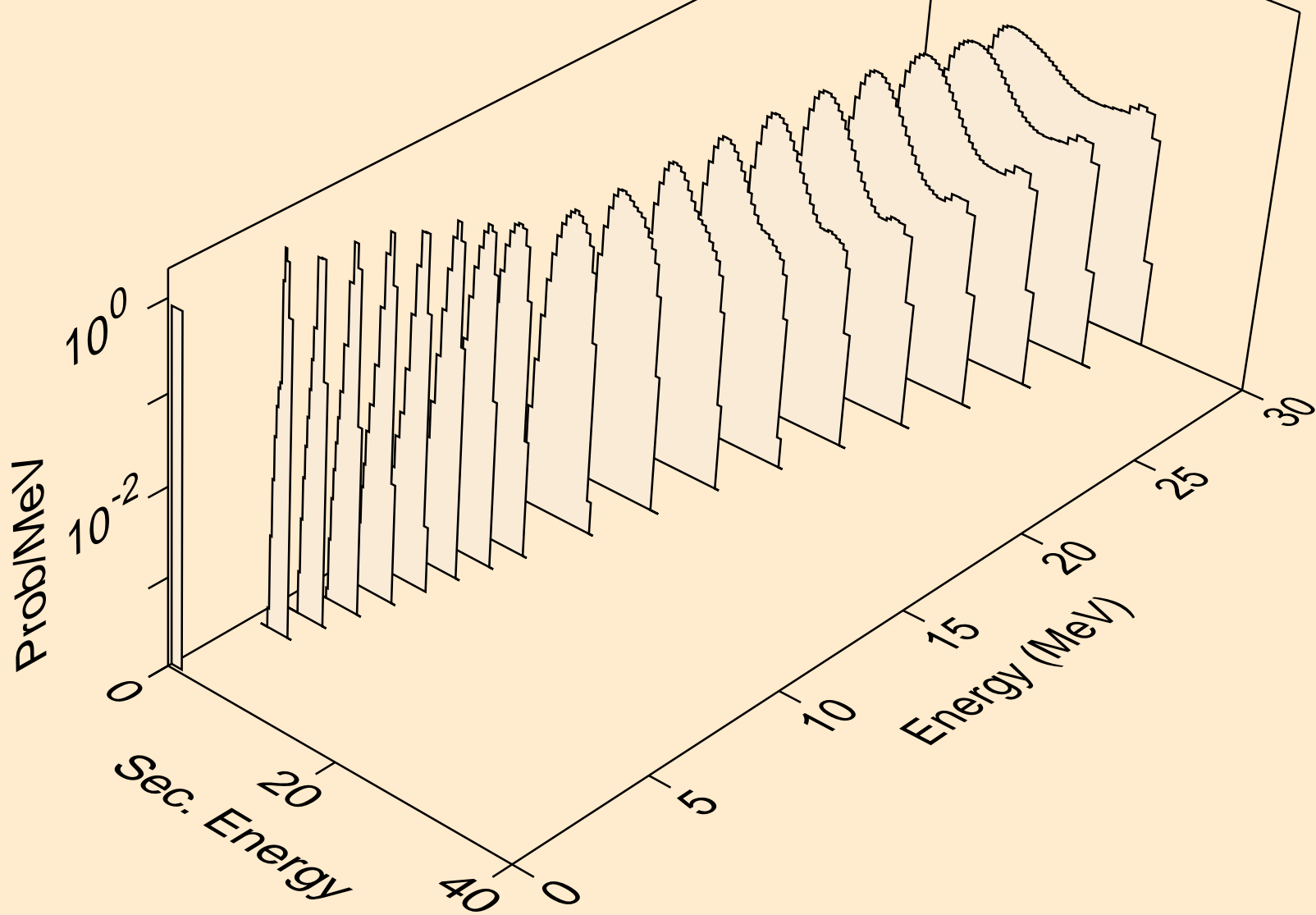

FE055 HELION ACER TENDL-2023 LIBRARY; T=0.K  
alphas from (s,da)

