

HF154 HELION ACER TENDL-2023 LIBRARY; T=0.K

Principal cross sections

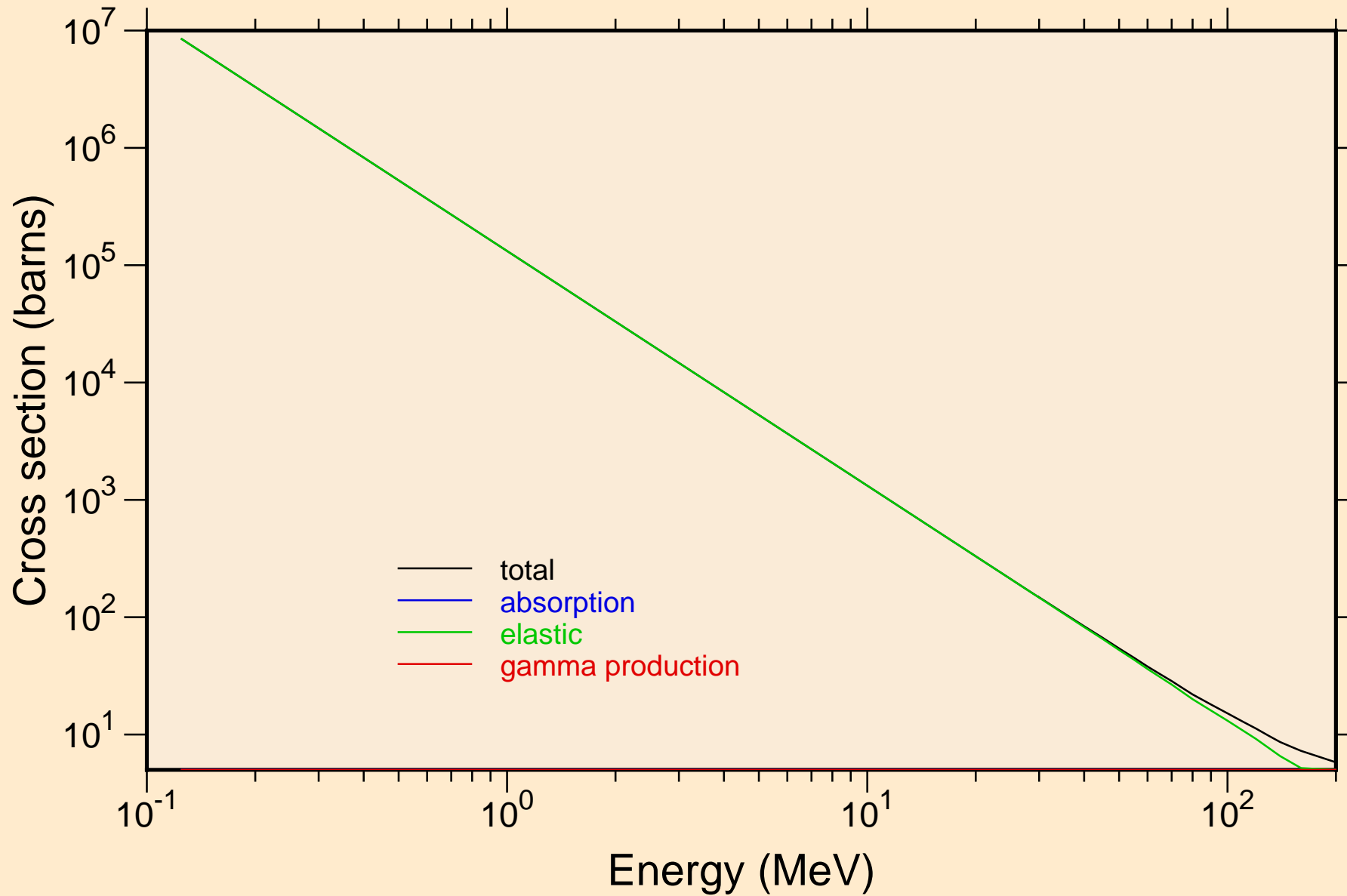

HF154 HELION ACER TENDL-2023 LIBRARY; T=0.K

Heating

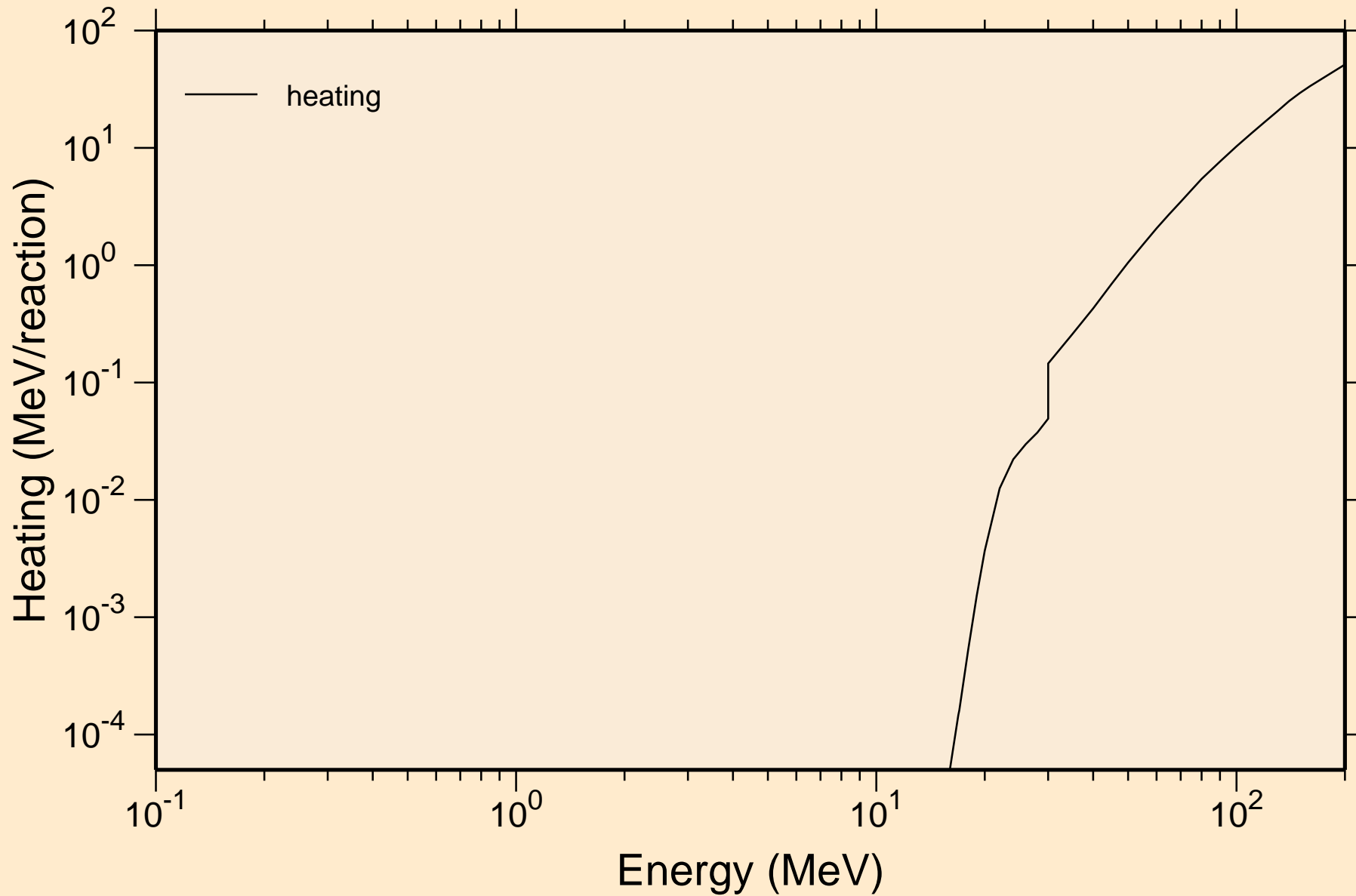

HF154 HELION ACER TENDL-2023 LIBRARY; T=0.K

Principal cross sections

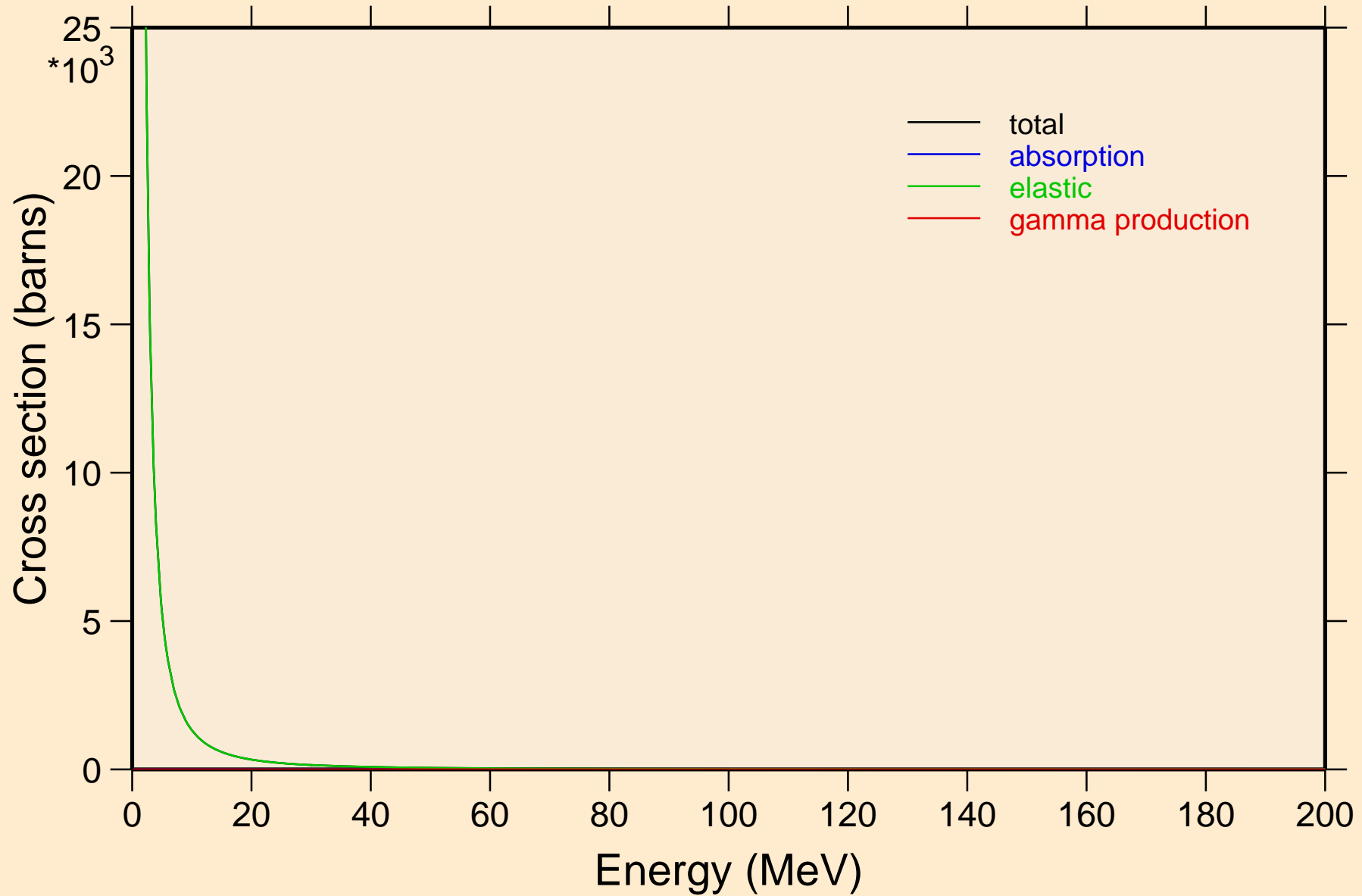

HF154 HELION ACER TENDL-2023 LIBRARY; T=0.K

Heating

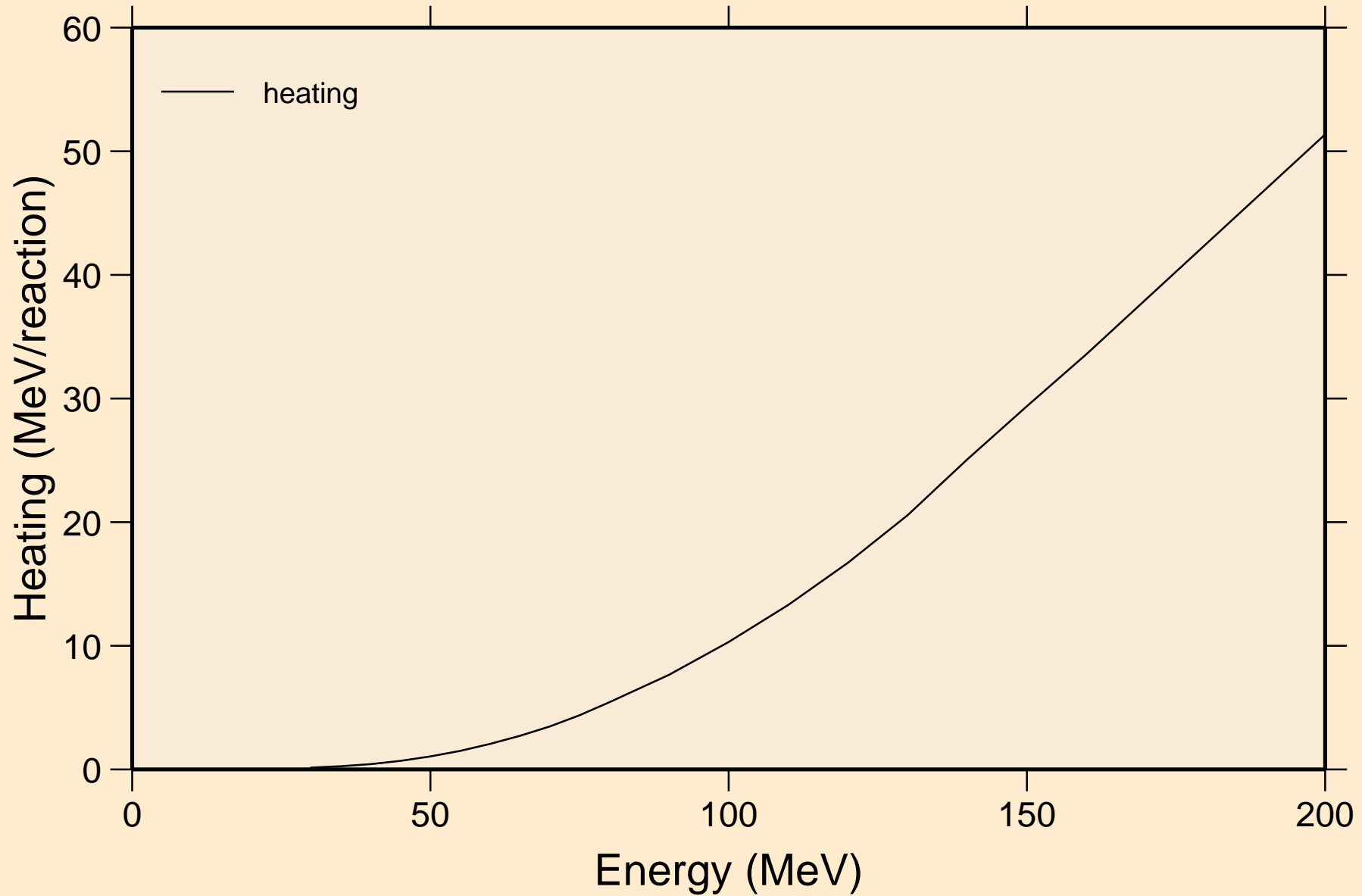

HF154 HELION ACER TENDL-2023 LIBRARY; T=0.K
Threshold reactions

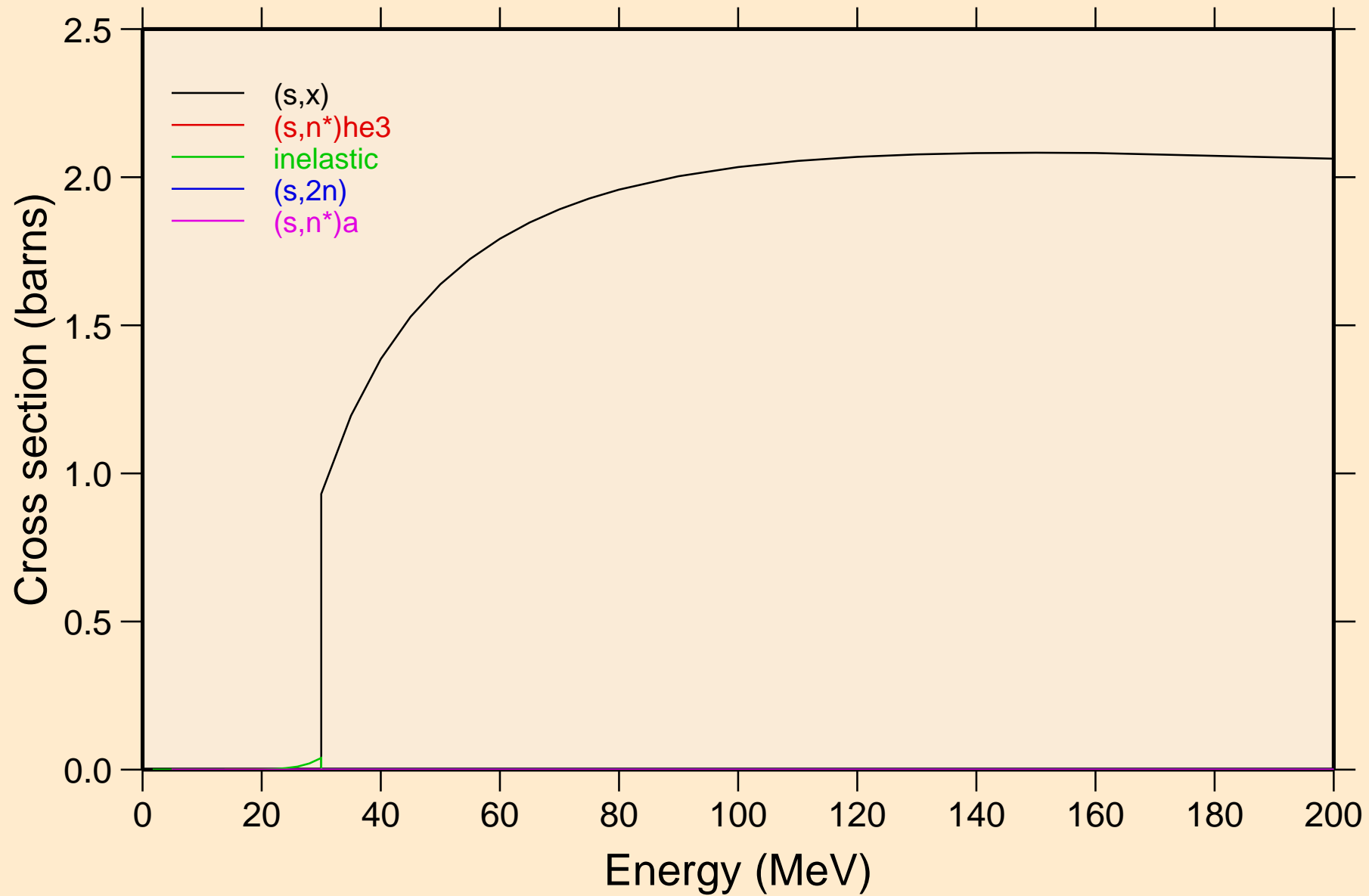

HF154 HELION ACER TENDL-2023 LIBRARY; T=0.K
Threshold reactions

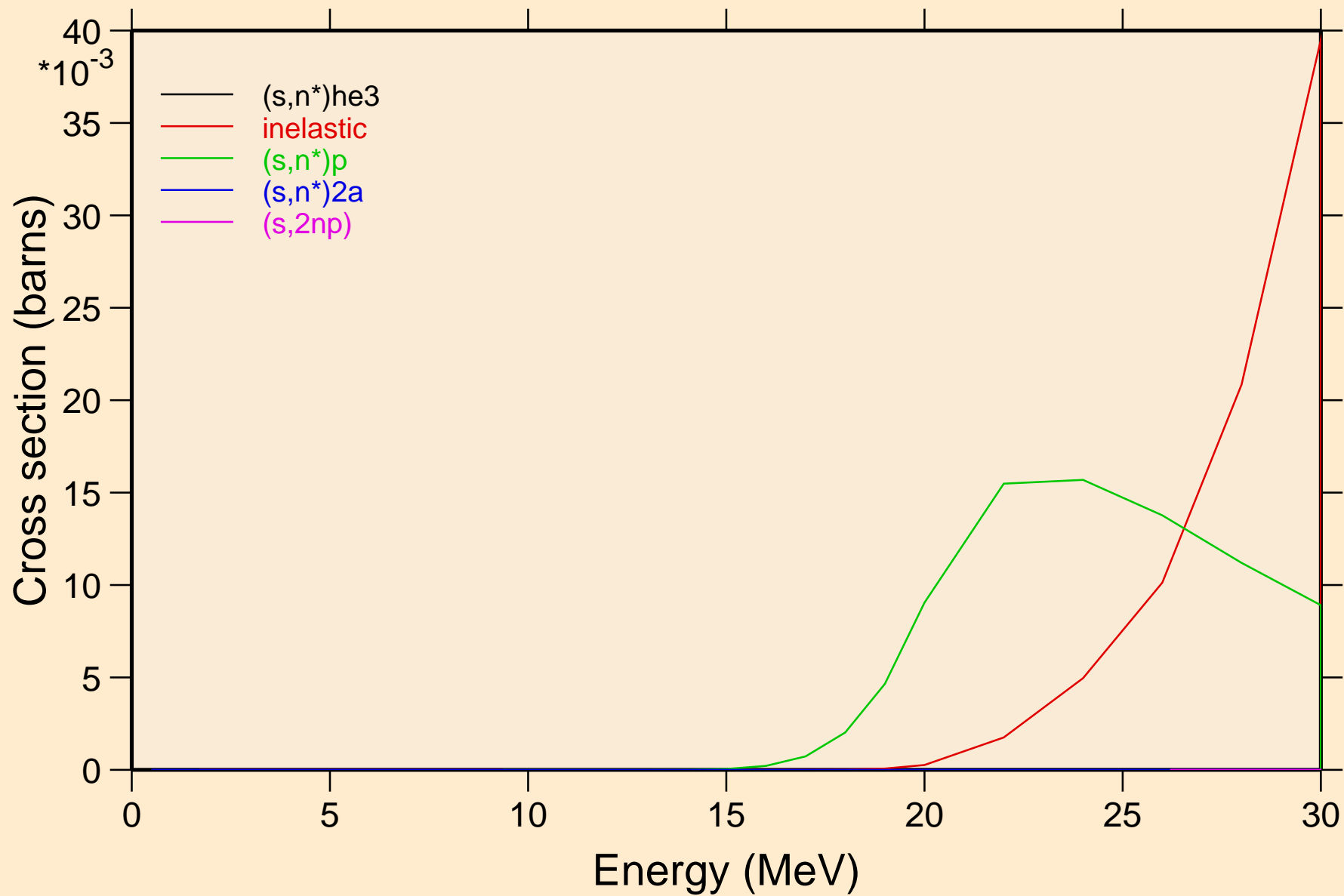

HF154 HELION ACER TENDL-2023 LIBRARY; T=0.K
Threshold reactions

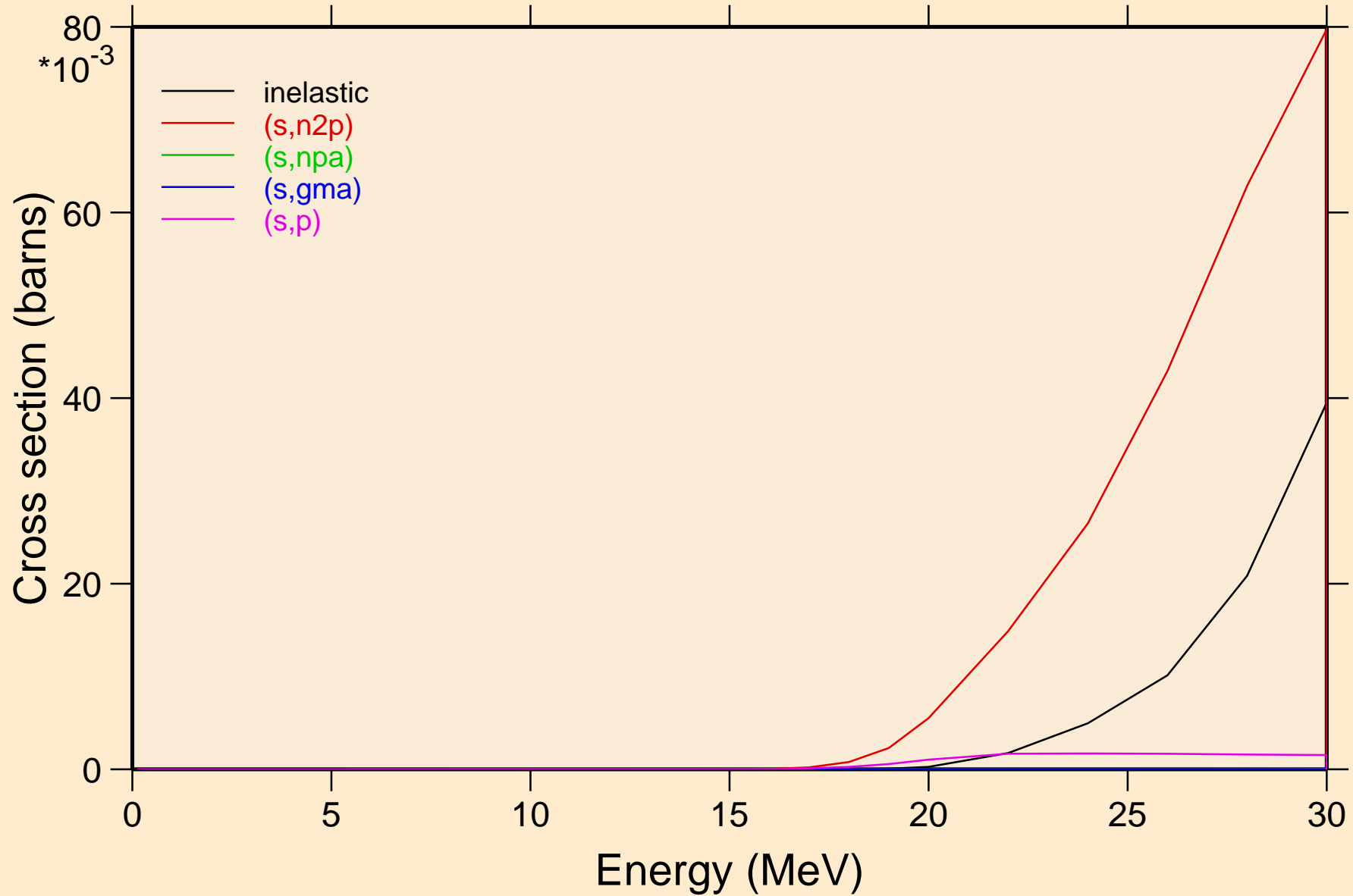

HF154 HELION ACER TENDL-2023 LIBRARY; T=0.K
Threshold reactions

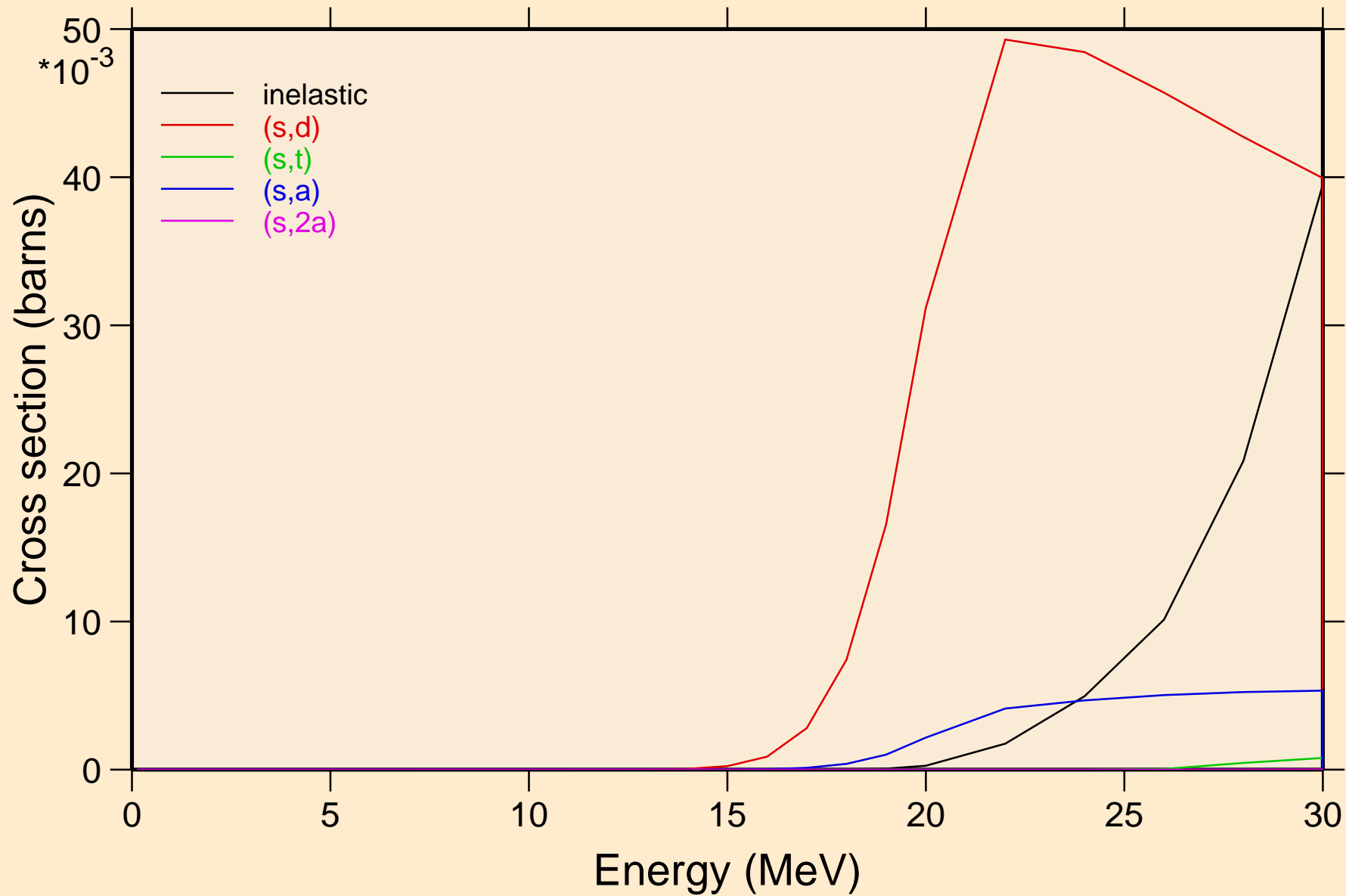

HF154 HELION ACER TENDL-2023 LIBRARY; T=0.K
Threshold reactions

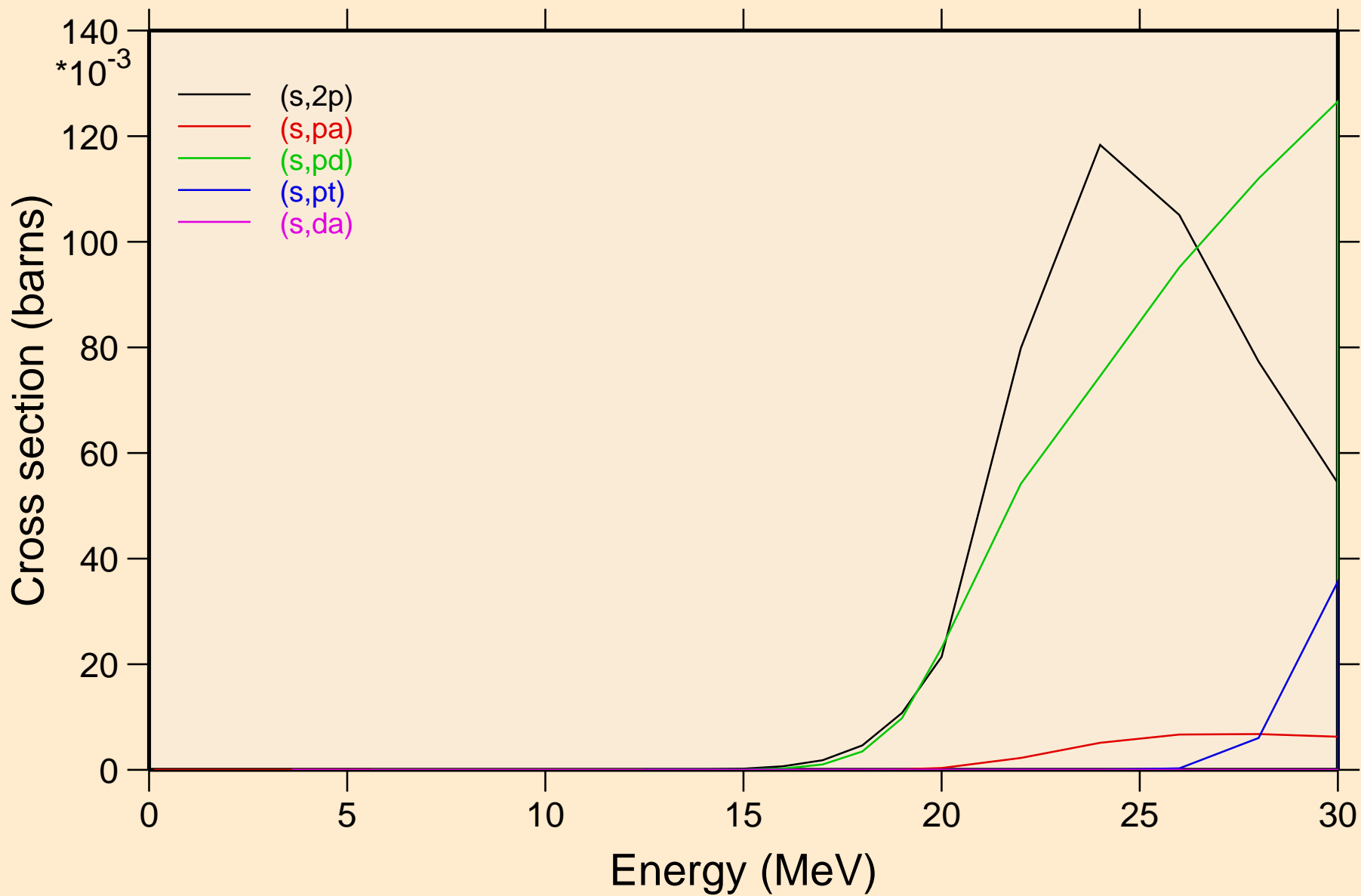

HF154 HELION ACER TENDL-2023 LIBRARY; T=0.K
angular distribution for elastic

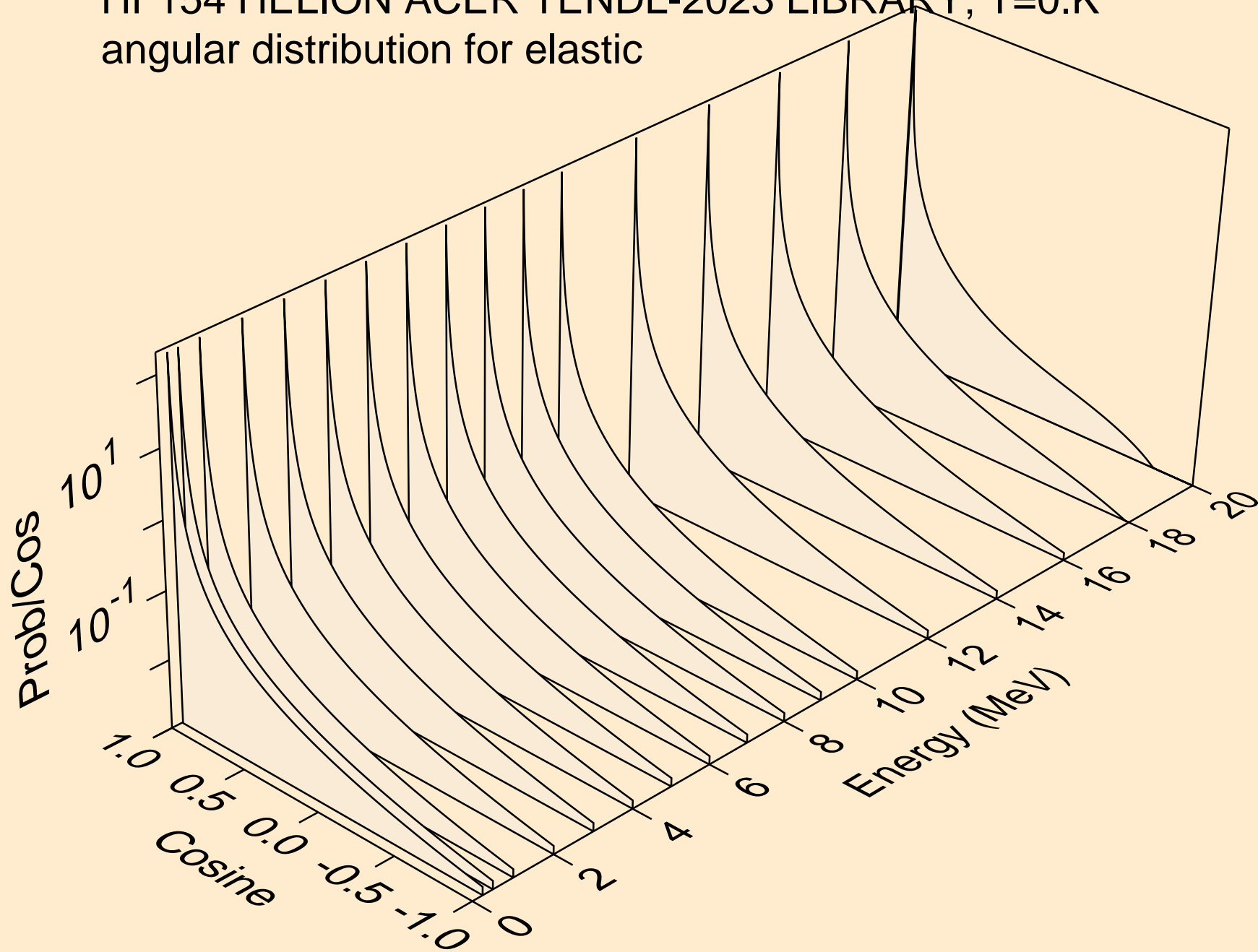

HF154 HELION ACER TENDL-2023 LIBRARY; T=0.K
angular distribution for elastic

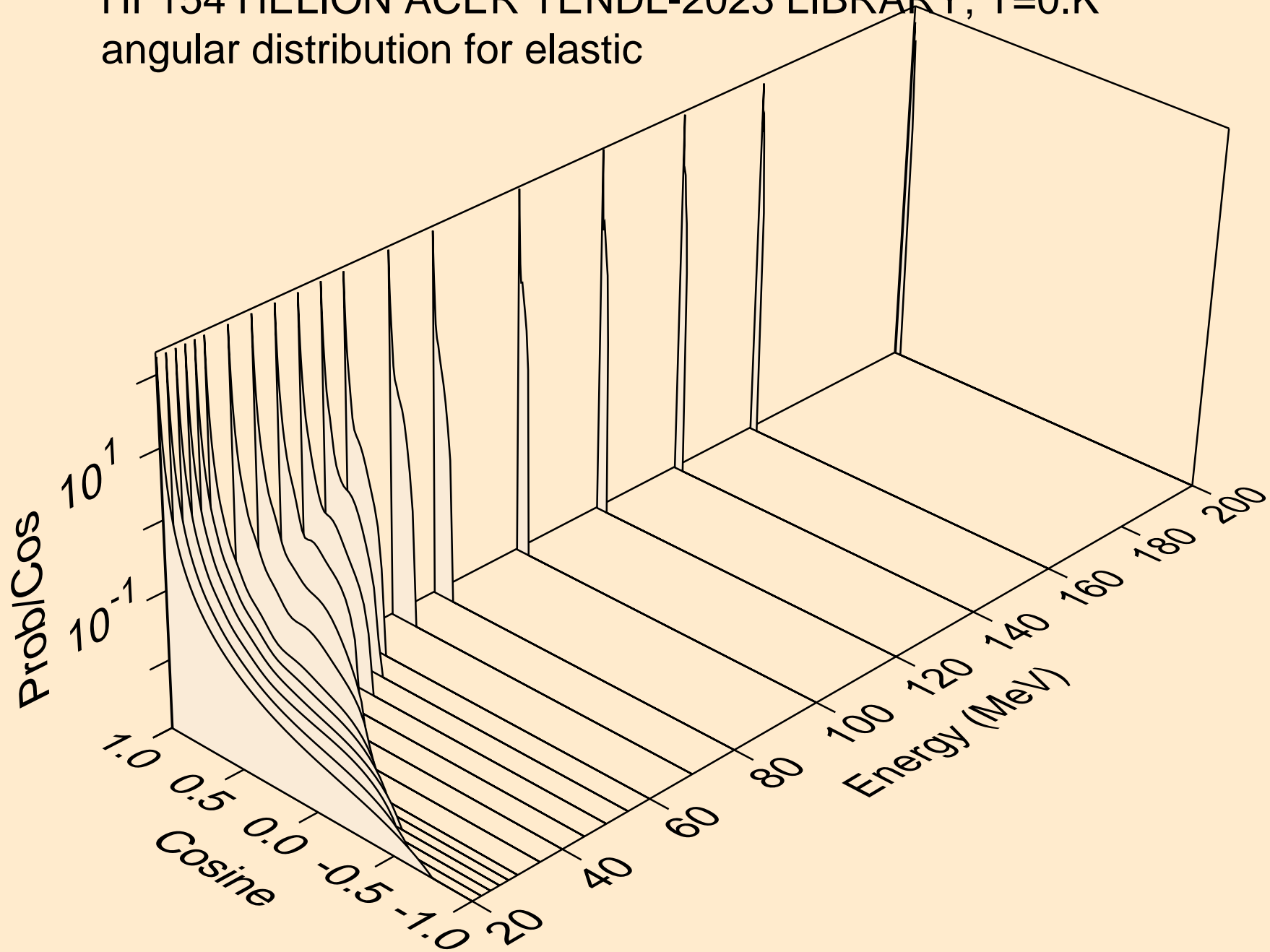

HF154 HELION ACER TENDL-2023 LIBRARY; T=0.K
He-3 emission for (s,x)

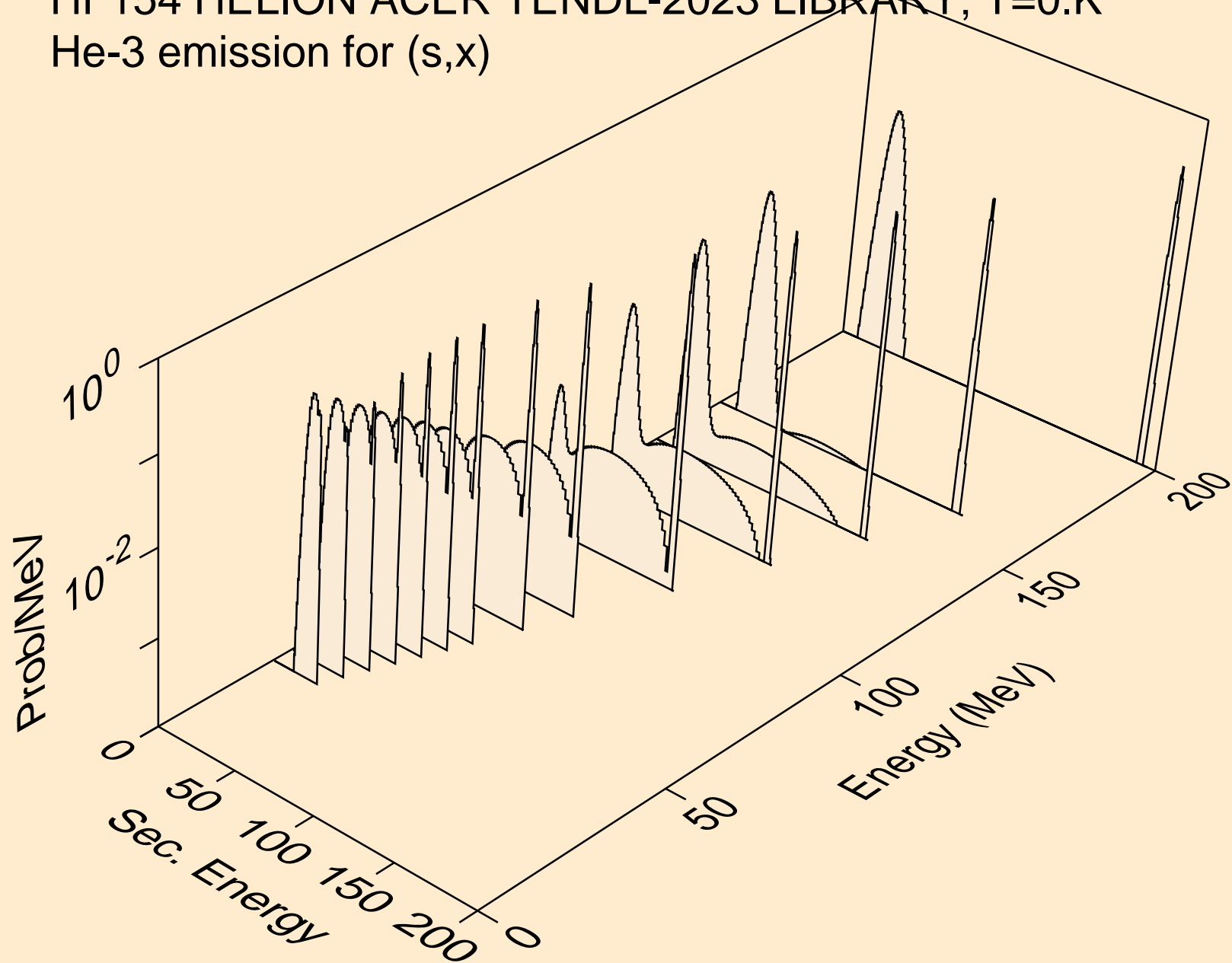

HF154 HELION ACER TENDL-2023 LIBRARY; T=0.K
He-3 emission for (s,n*)he3

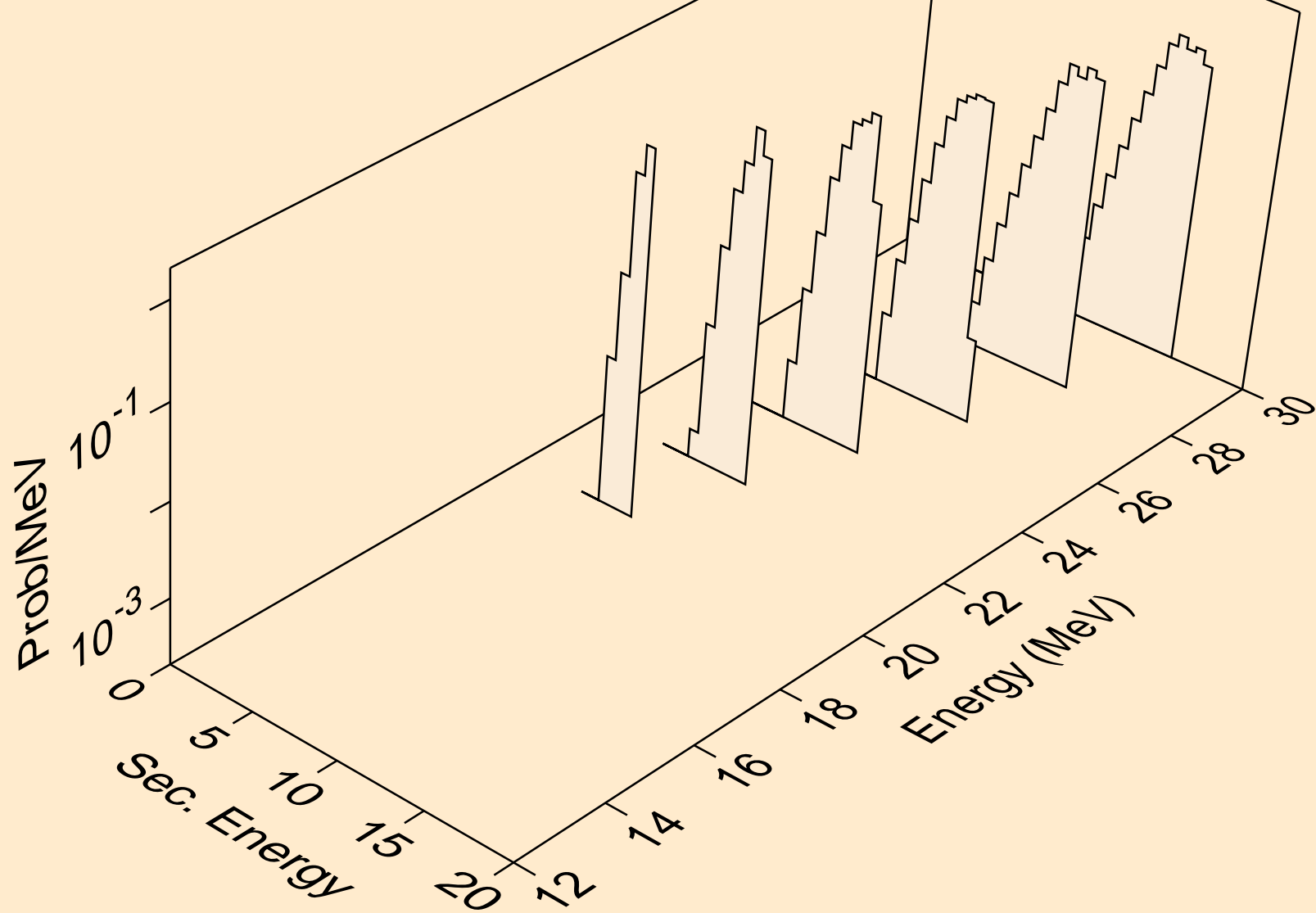

HF154 HELION ACER TENDL-2023 LIBRARY; T=0.K
He-3 emission for inelastic

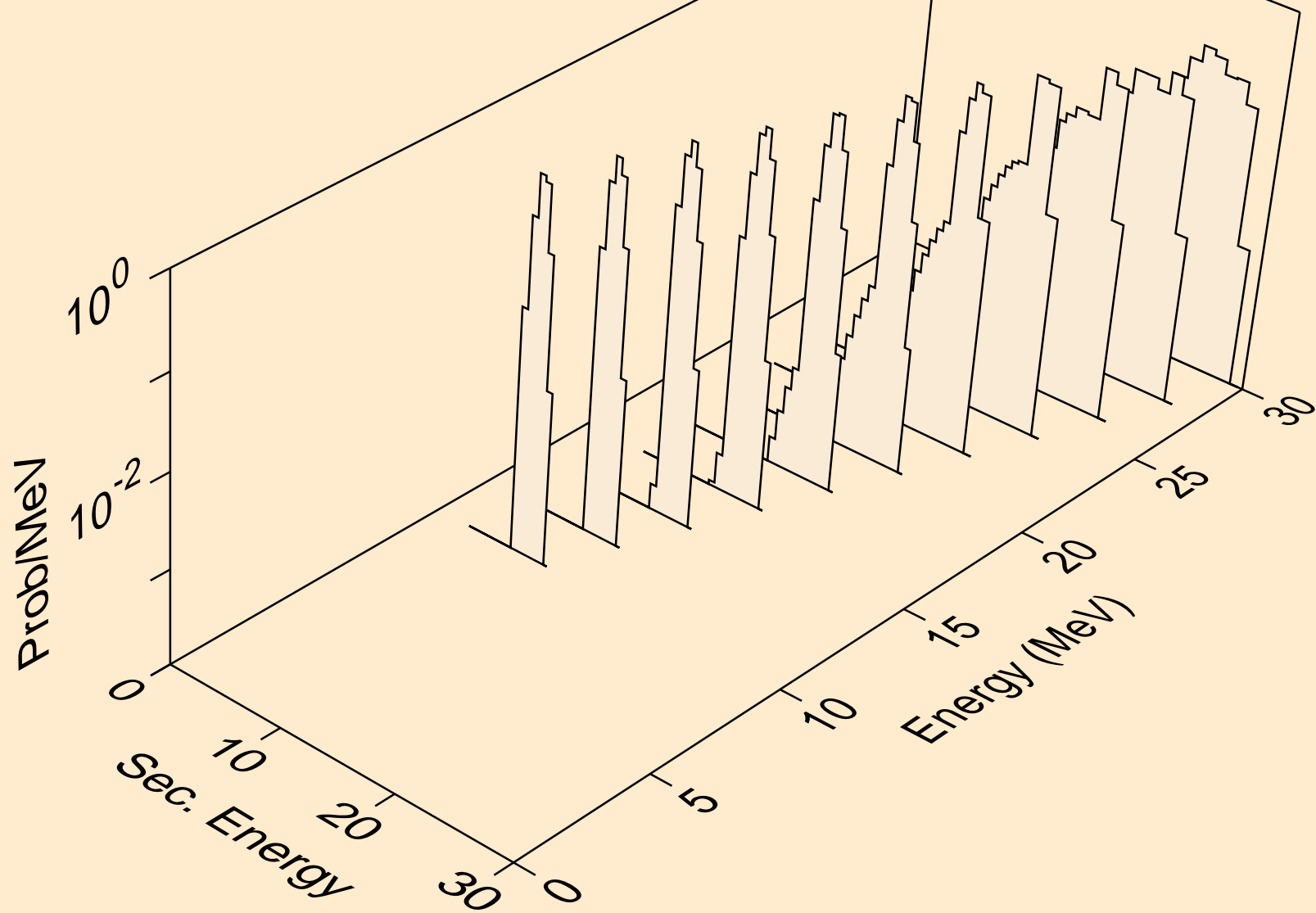

HF154 HELION ACER TENDL-2023 LIBRARY; T=0.K
Photon emission for (z,n)

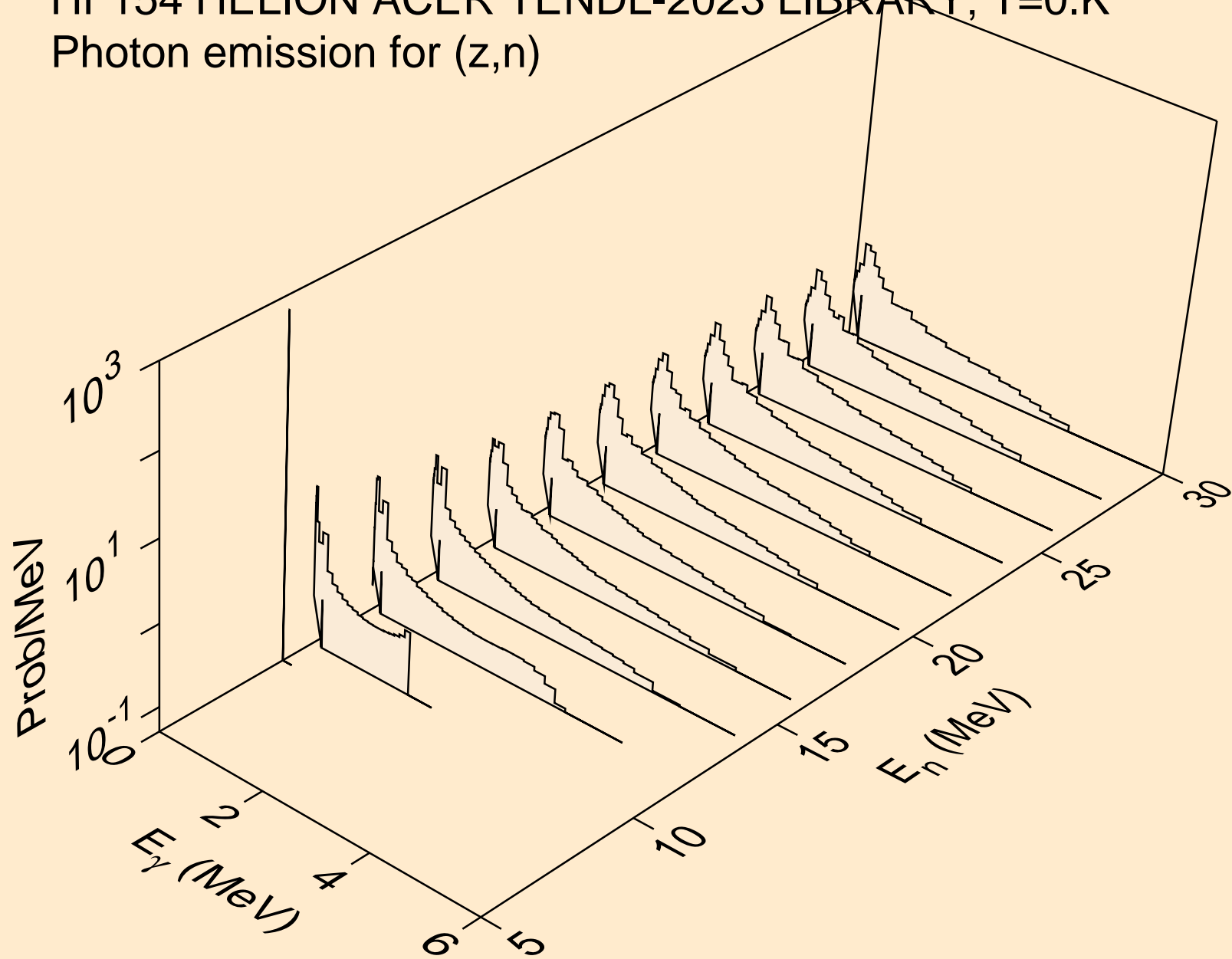

HF154 HELION ACER TENDL-2023 LIBRARY; T=0.K
Photon emission for (z,x)

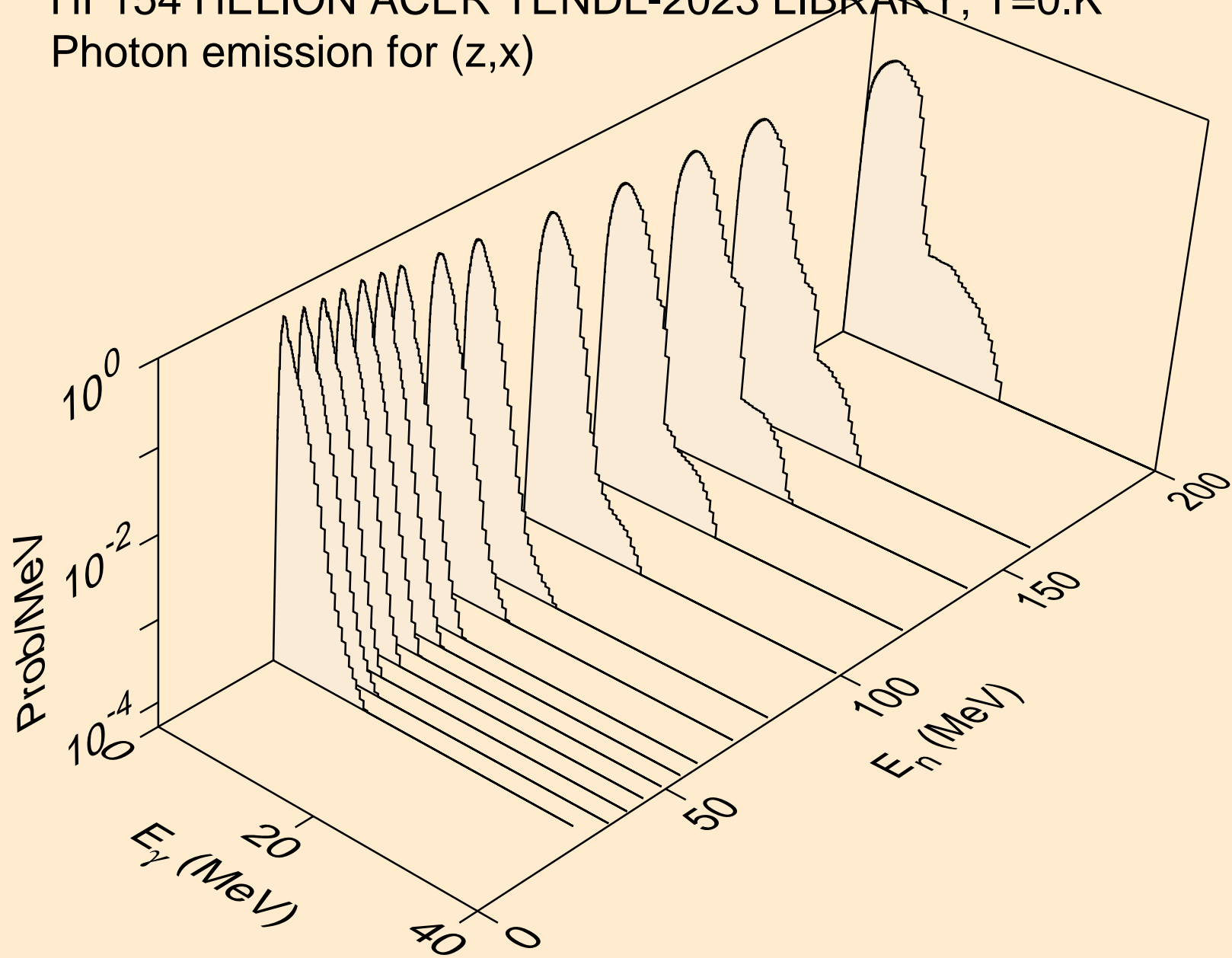

HF154 HELION ACER TENDL-2023 LIBRARY; T=0.K
Photon emission for (n,2n)

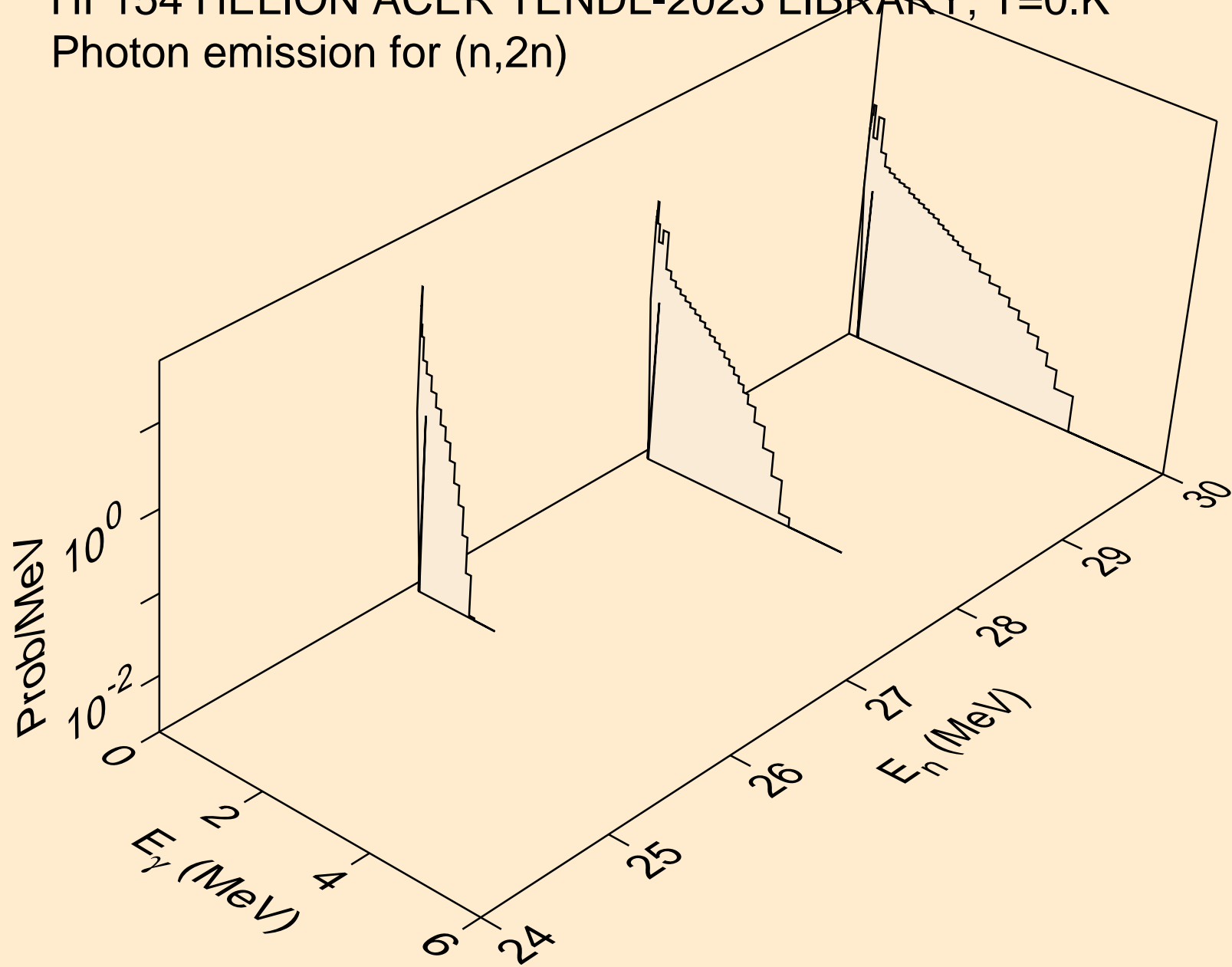

HF154 HELION ACER TENDL-2023 LIBRARY; T=0.K
Photon emission for (n,n*)a

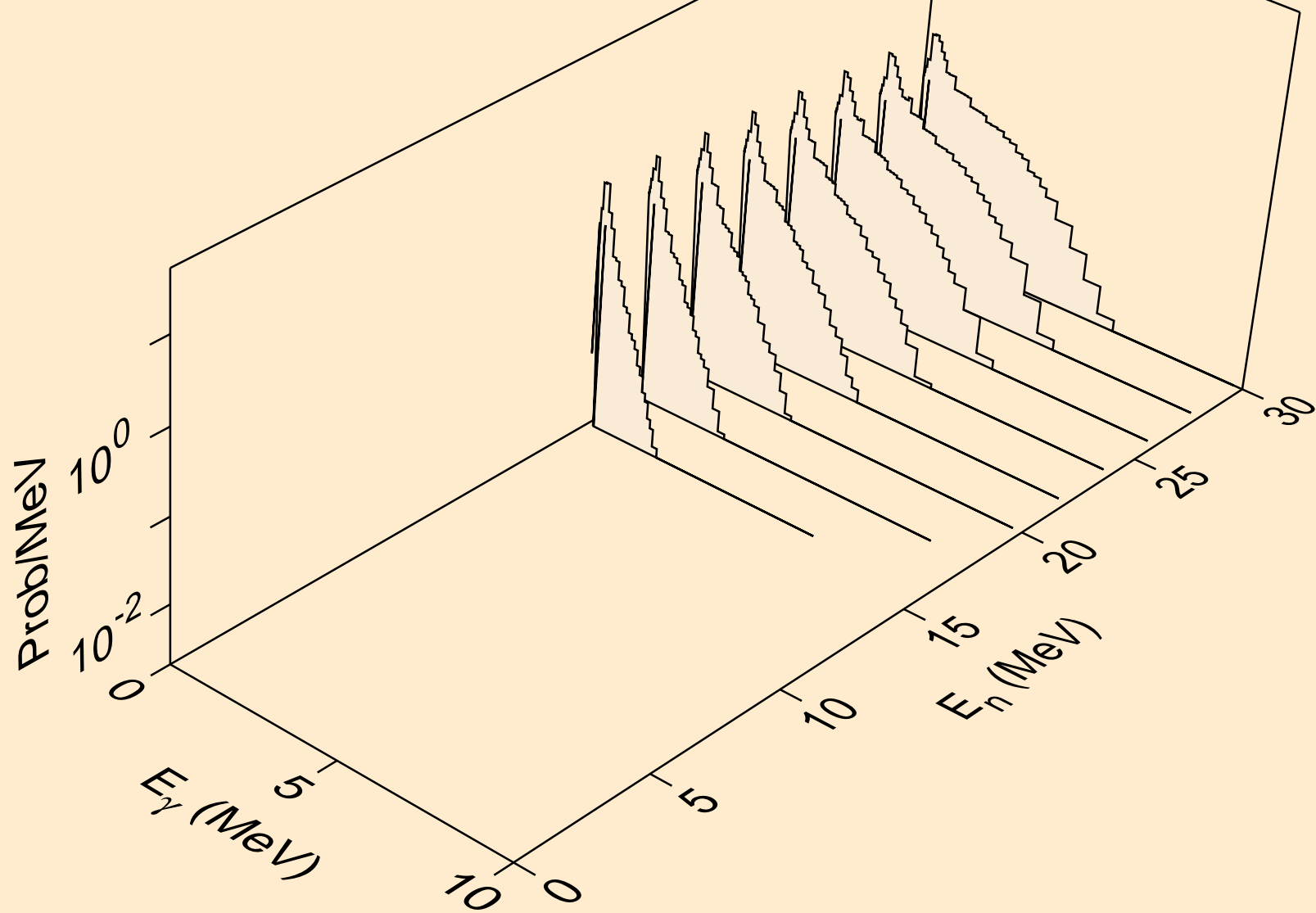

HF154 HELION ACER TENDL-2023 LIBRARY; T=0.K
Photon emission for (n,n*)p

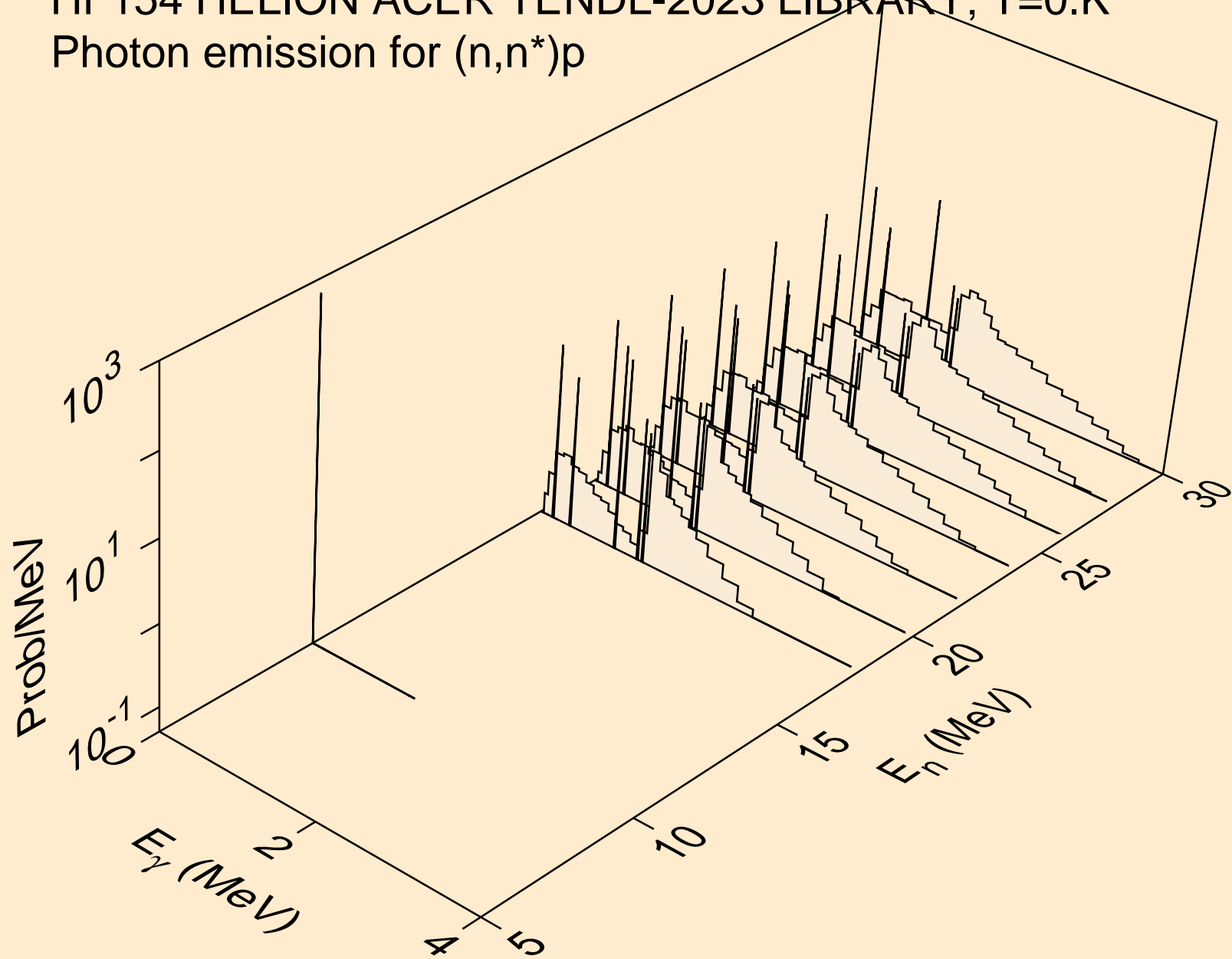

HF154 HELION ACER TENDL-2023 LIBRARY; T=0.K
Photon emission for (n,n*)2a

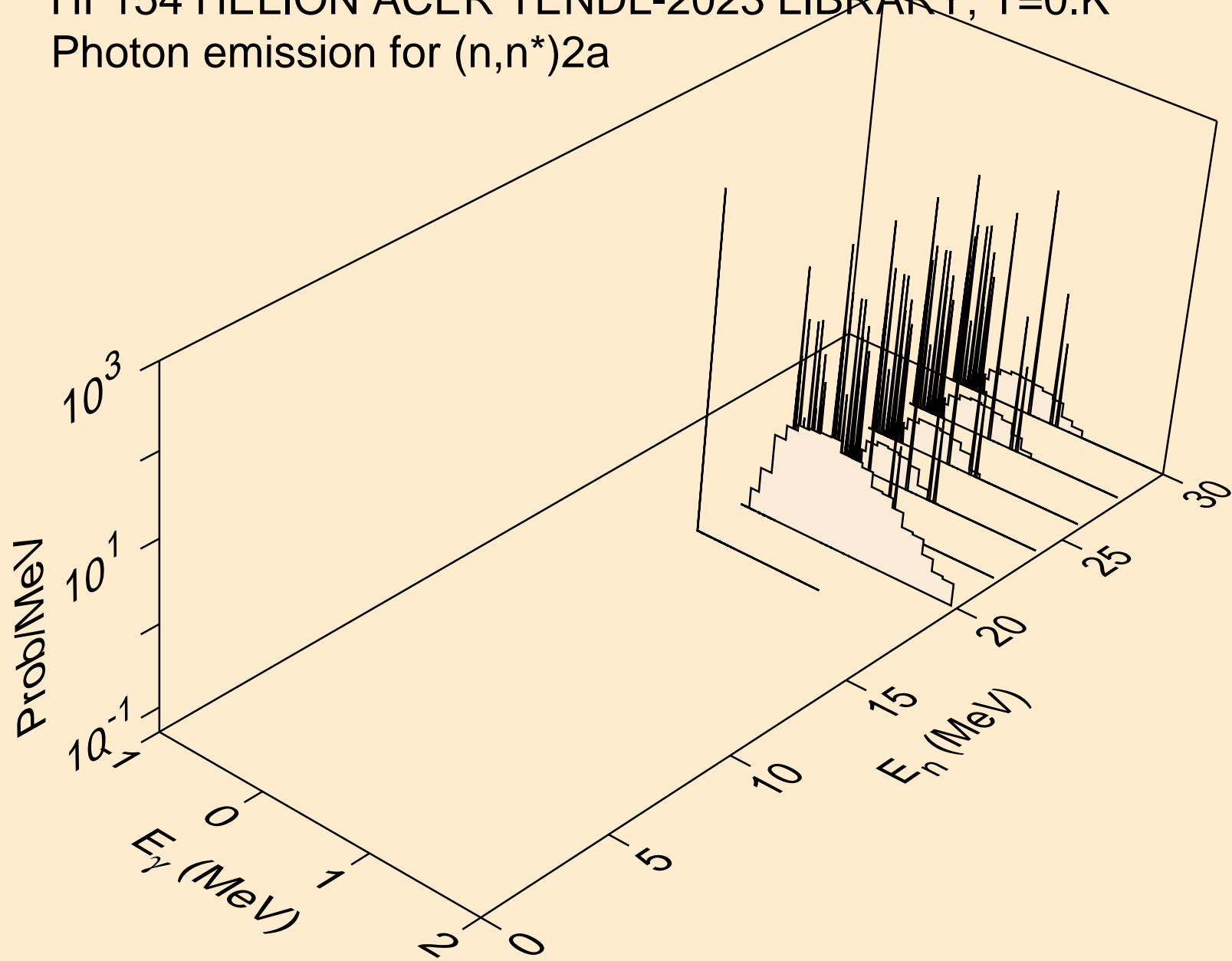

HF154 HELION ACER TENDL-2023 LIBRARY; T=0.K
Photon emission for (n,n*)he3

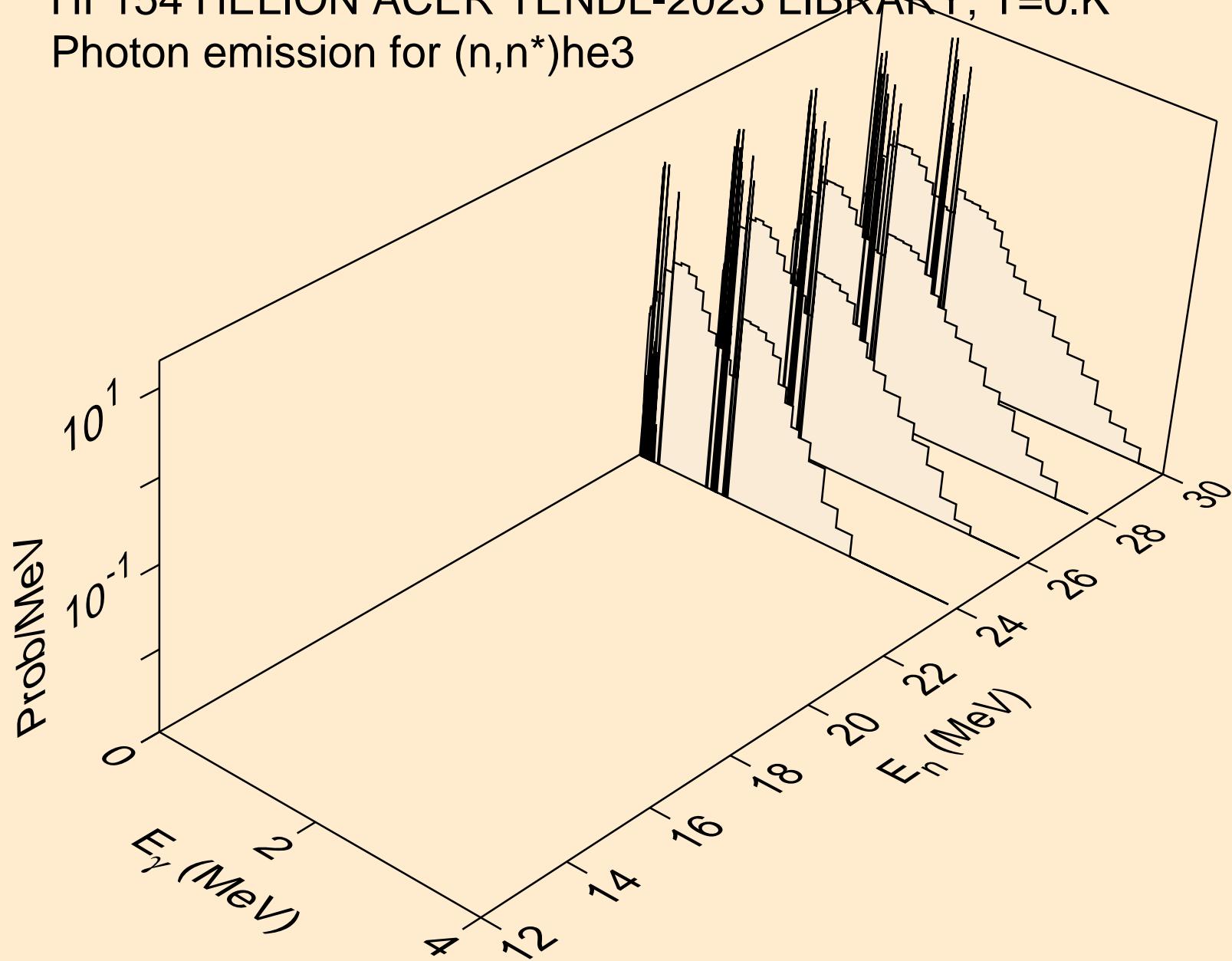

HF154 HELION ACER TENDL-2023 LIBRARY; T=0.K
Photon emission for (n,2np)

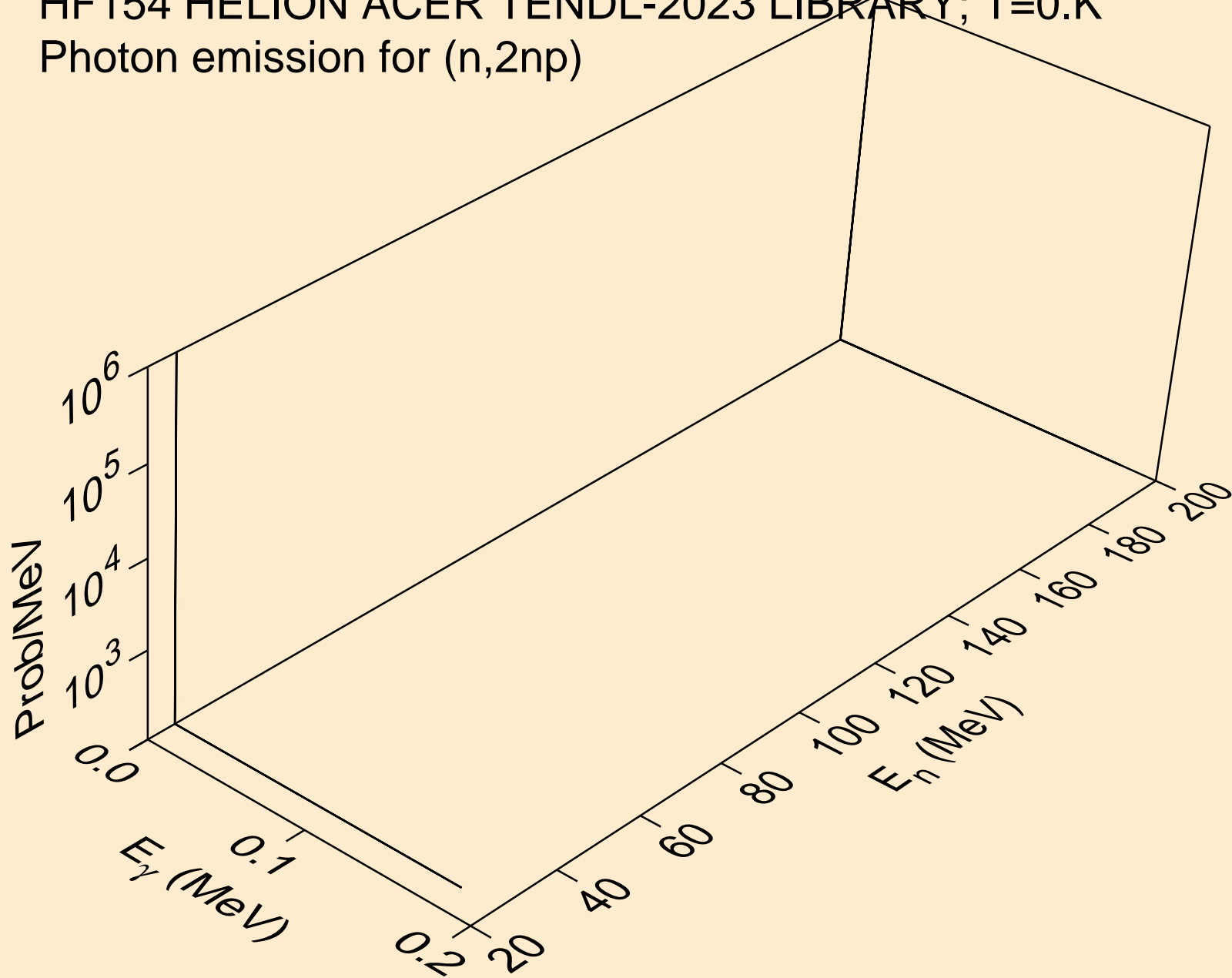

HF154 HELION ACER TENDL-2023 LIBRARY; T=0.K
Photon emission for (n,n2p)

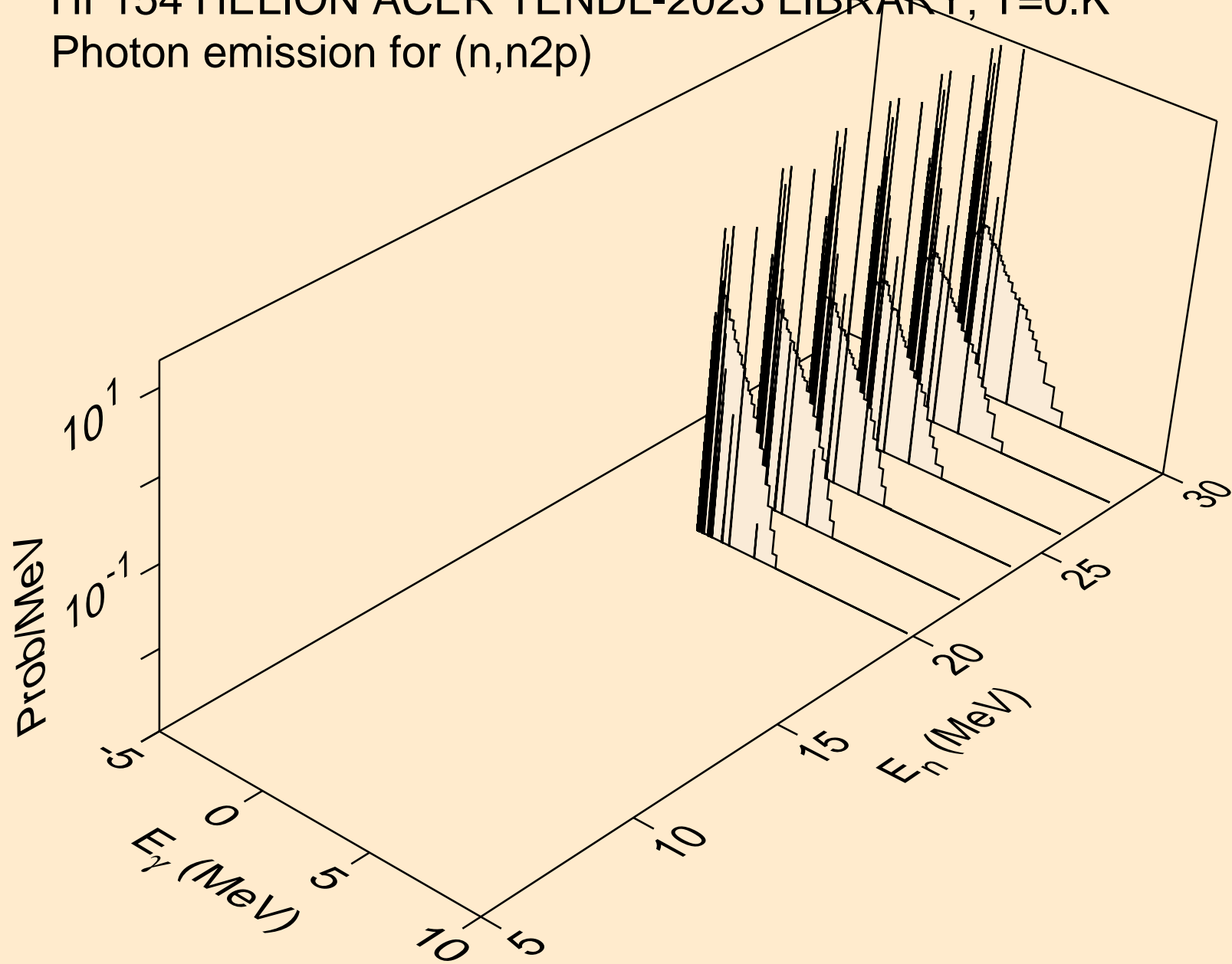

HF154 HELION ACER TENDL-2023 LIBRARY; T=0.K
Photon emission for (n,npa)

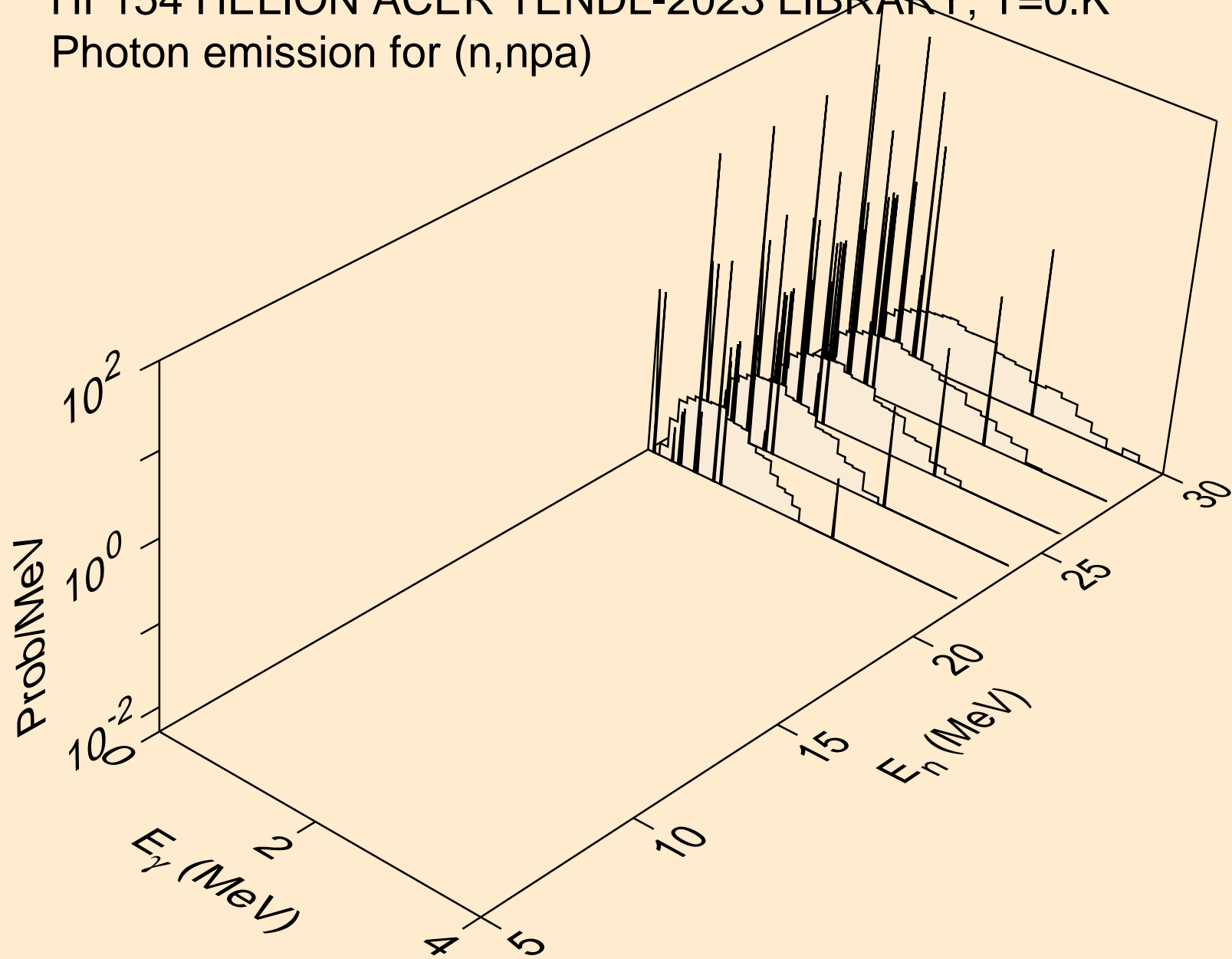

HF154 HELION ACER TENDL-2023 LIBRARY; T=0.K
Photon emission for (n,gma)

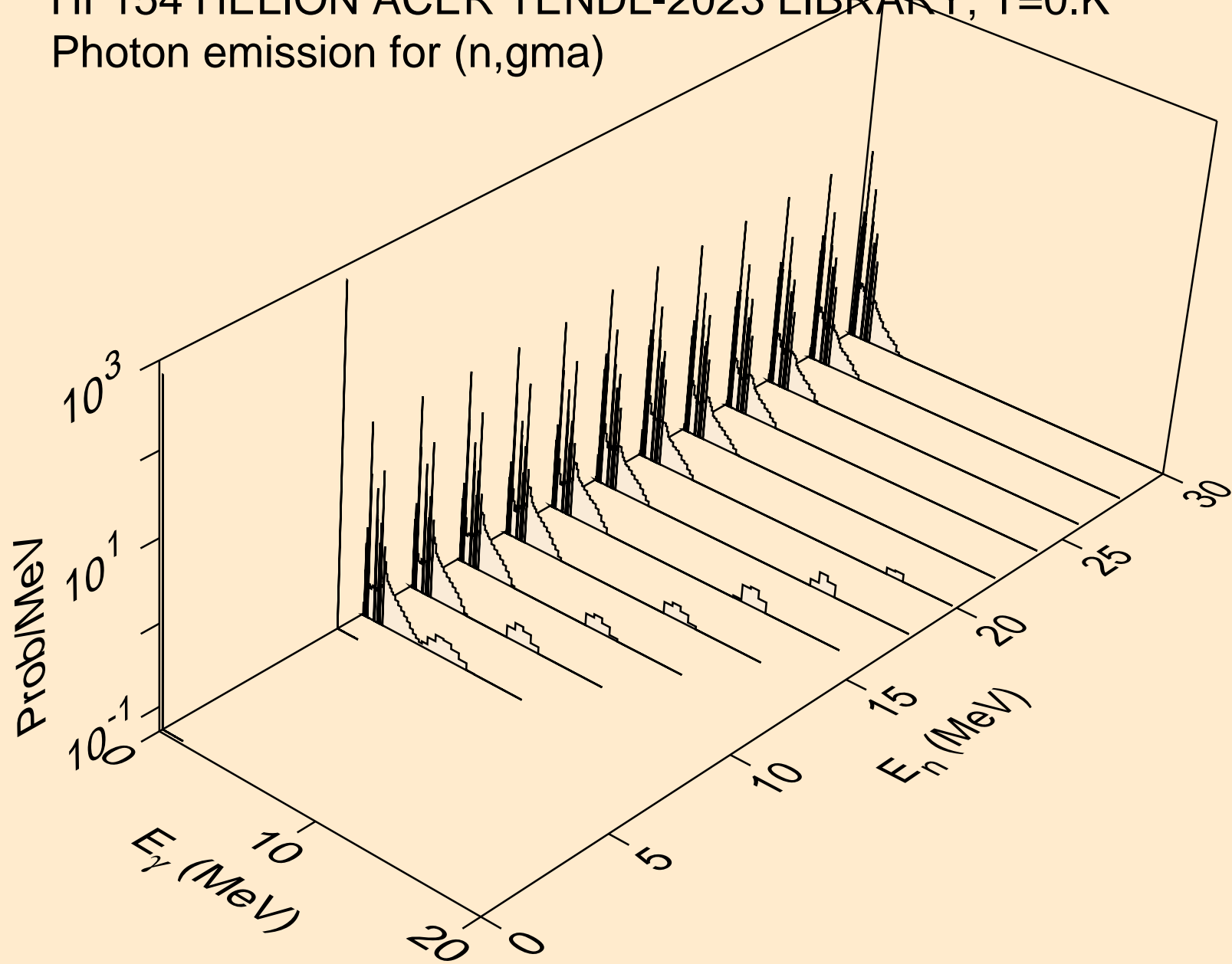

HF154 HELION ACER TENDL-2023 LIBRARY; T=0.K
Photon emission for (n,p)

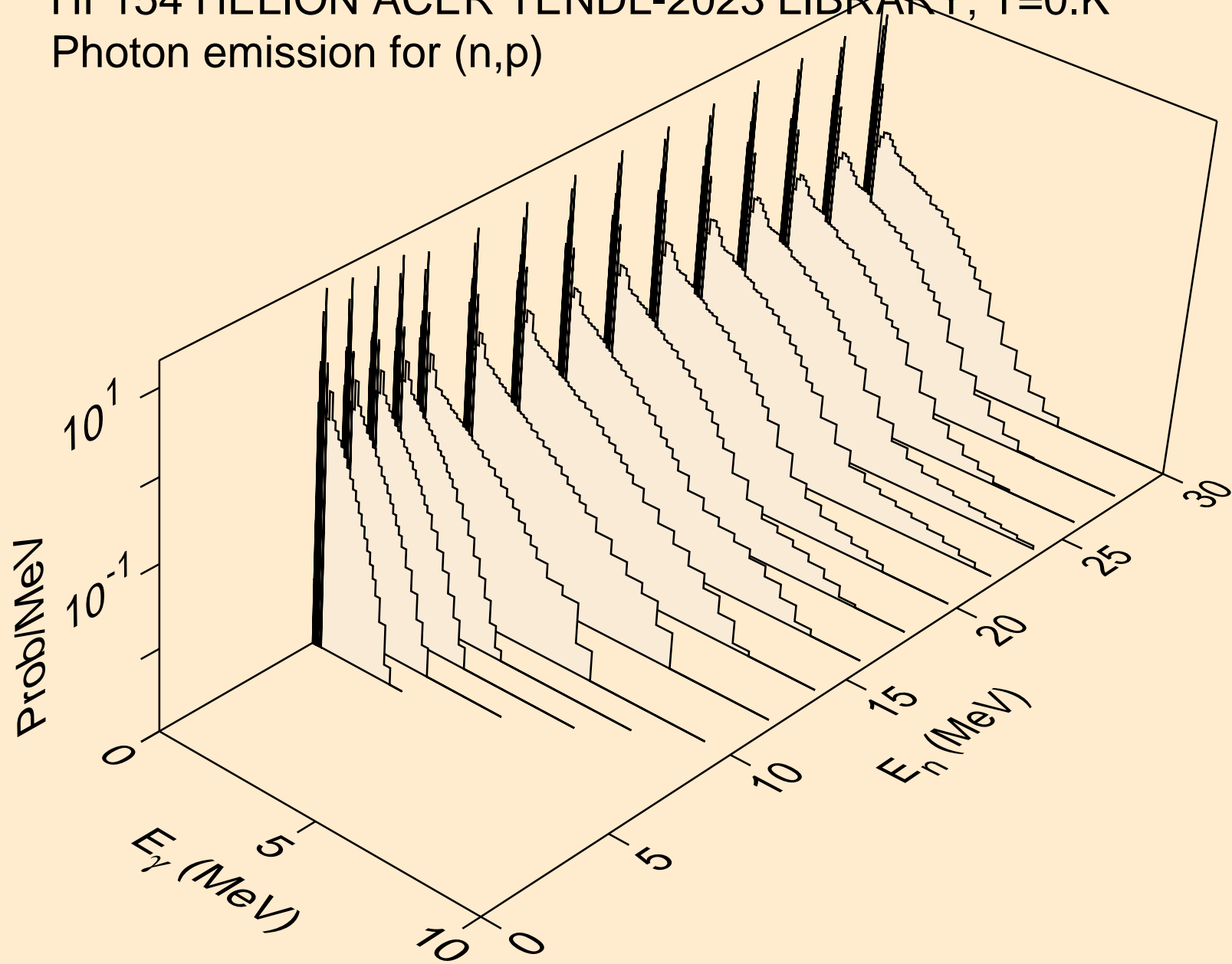

HF154 HELION ACER TENDL-2023 LIBRARY; T=0.K
Photon emission for (n,d)

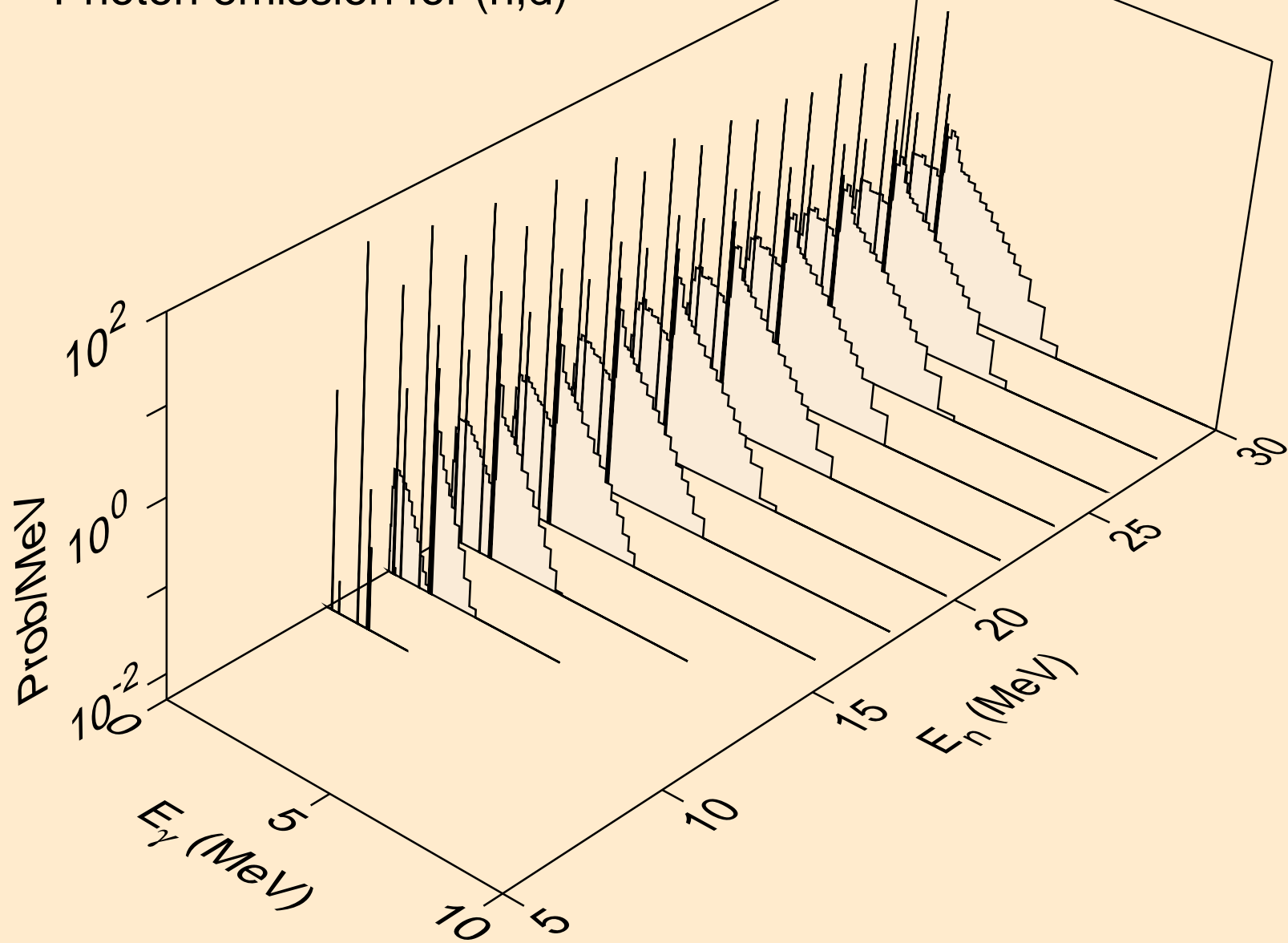

HF154 HELION ACER TENDL-2023 LIBRARY; T=0.K
Photon emission for (n,t)

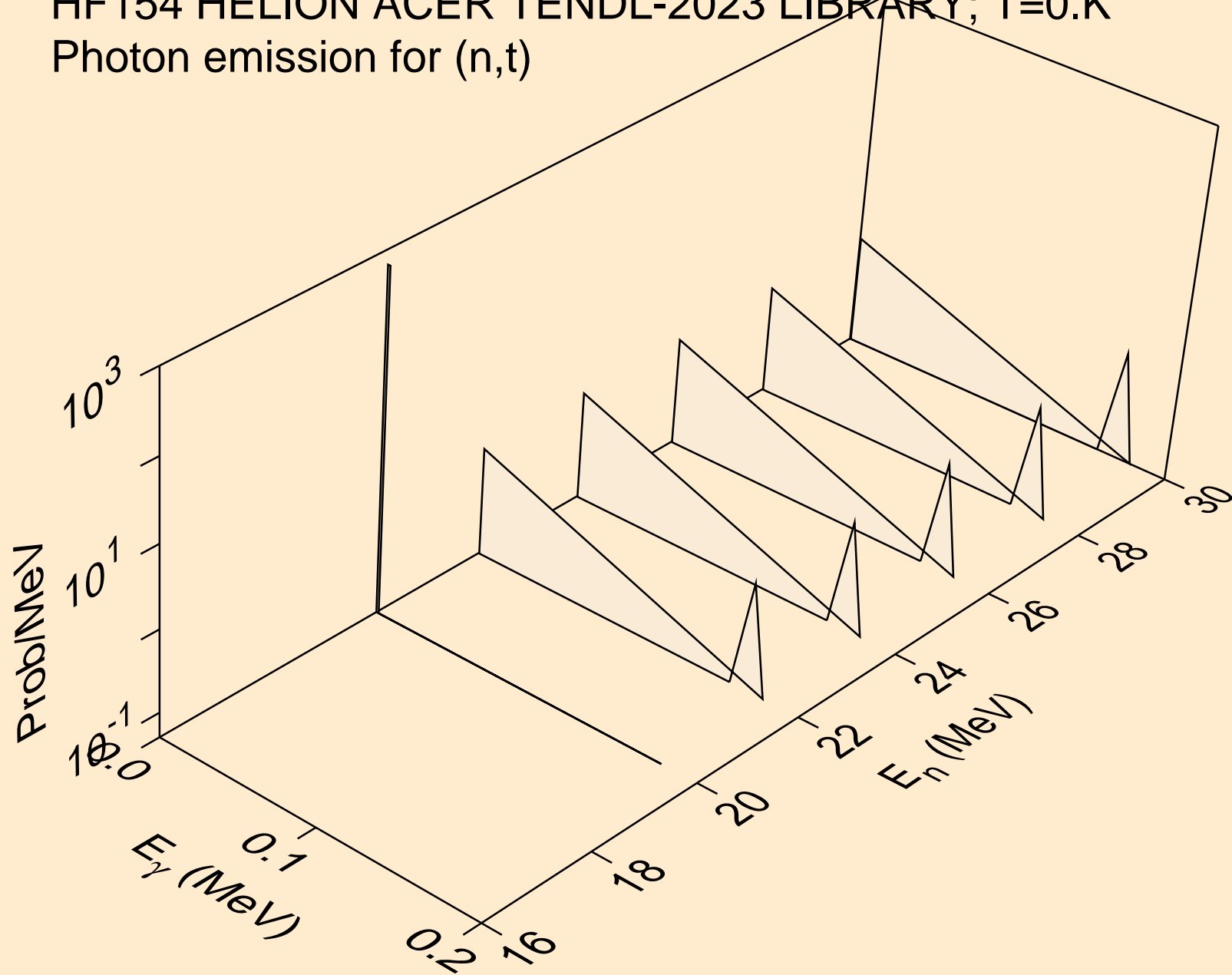

HF154 HELION ACER TENDL-2023 LIBRARY; T=0.K
Photon emission for inelastic

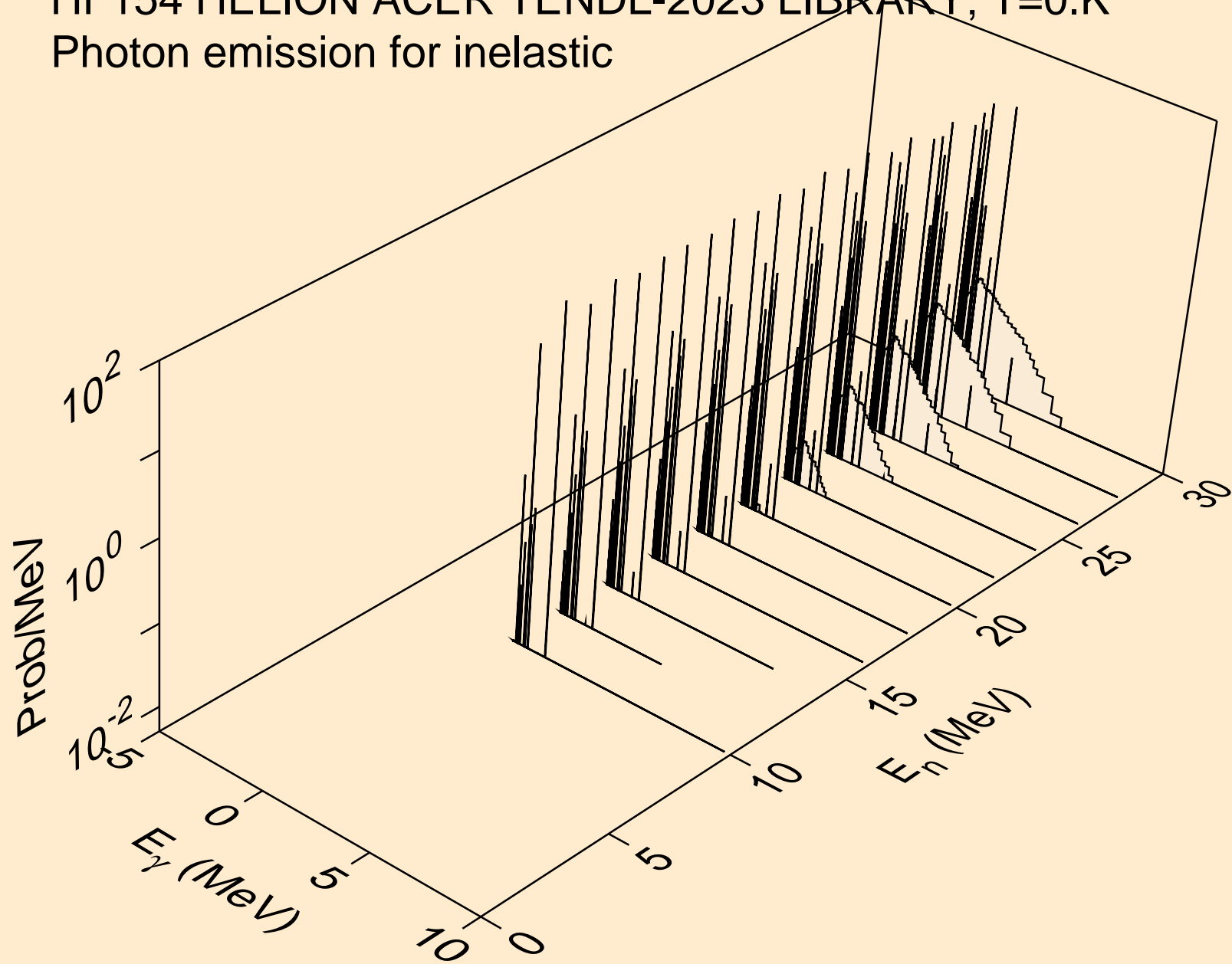

HF154 HELION ACER TENDL-2023 LIBRARY; T=0.K
Photon emission for (n,a)

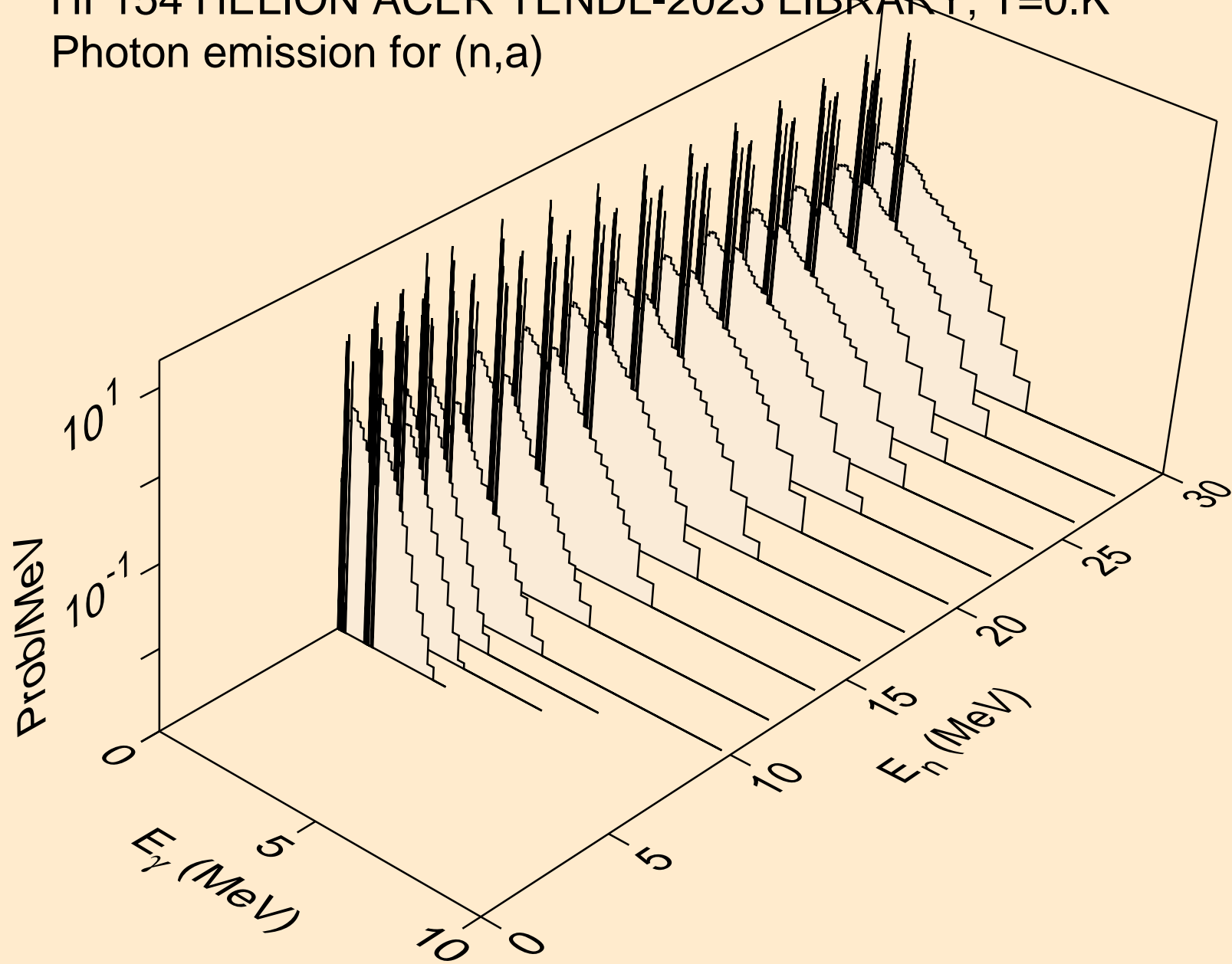

HF154 HELION ACER TENDL-2023 LIBRARY; T=0.K
Photon emission for (n,2a)

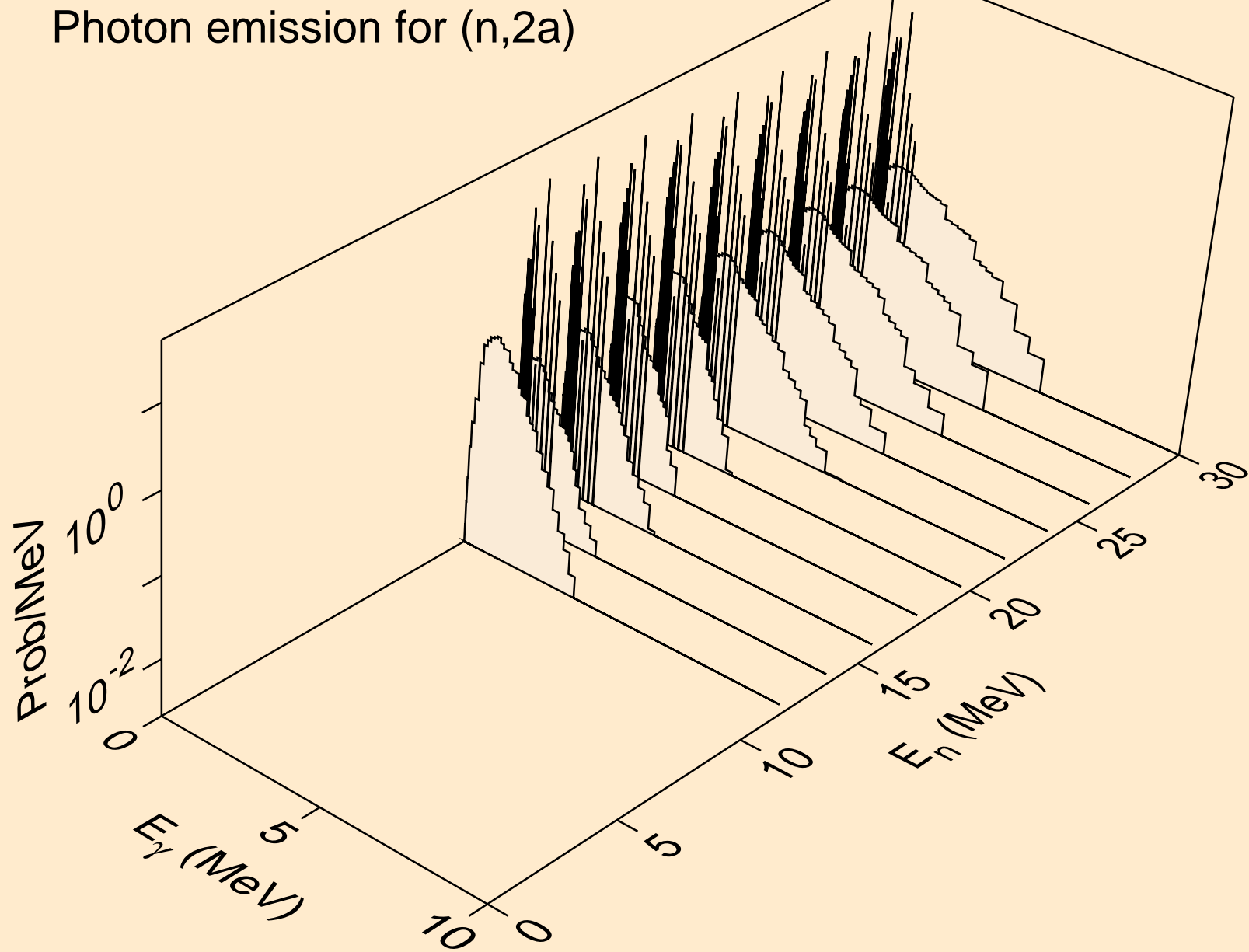

HF154 HELION ACER TENDL-2023 LIBRARY; T=0.K
Photon emission for (n,2p)

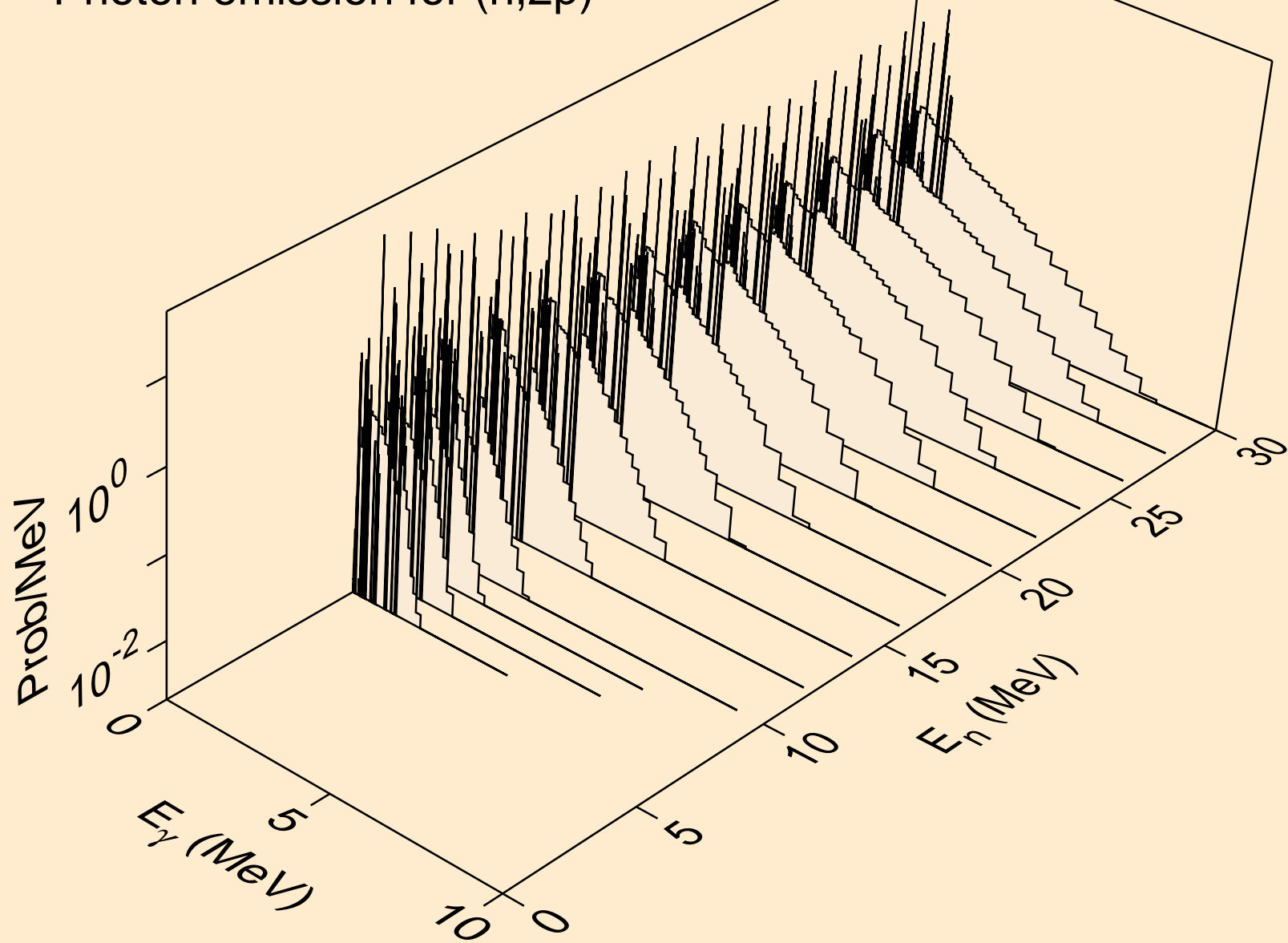

HF154 HELION ACER TENDL-2023 LIBRARY; T=0.K
Photon emission for (n,pa)

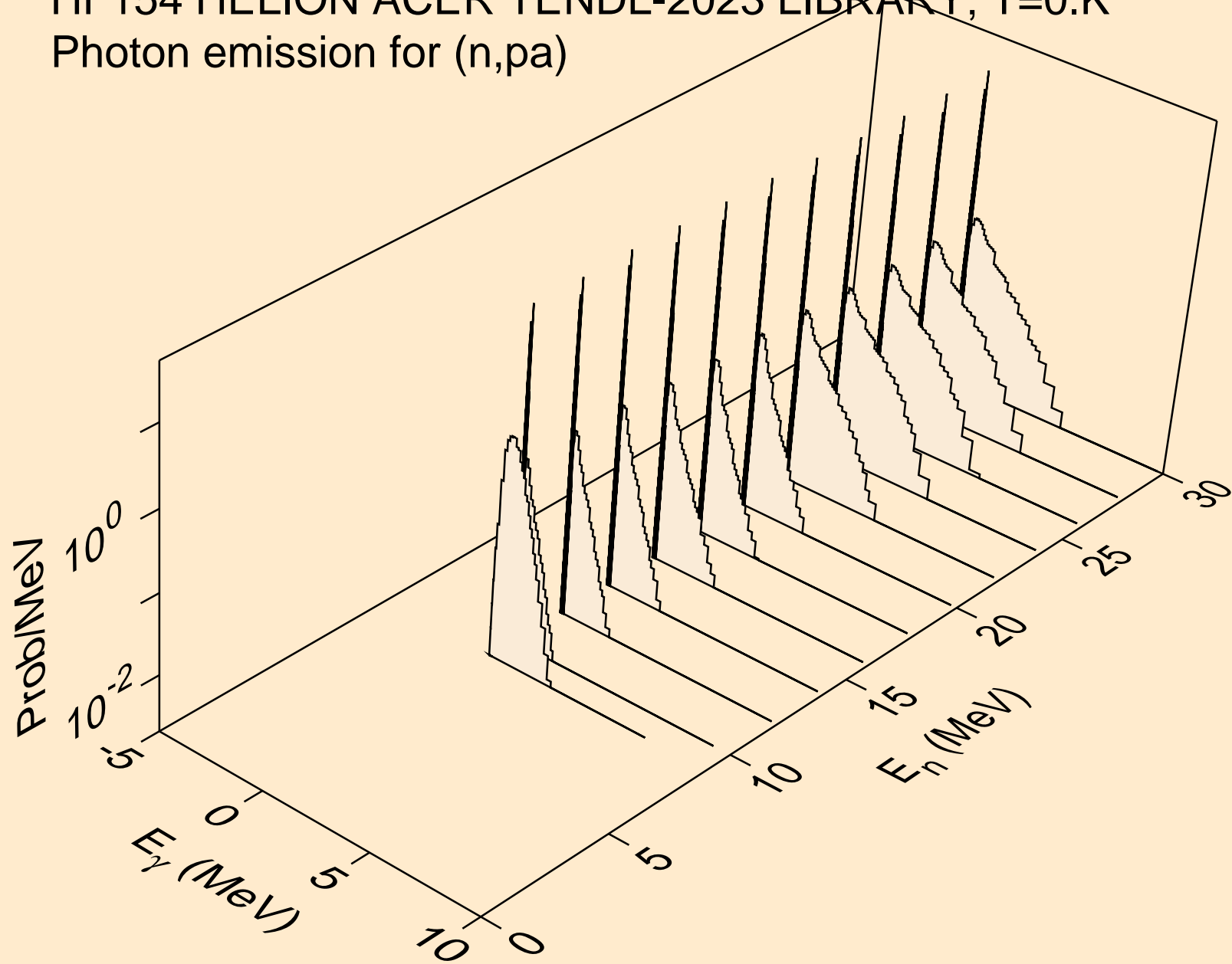

HF154 HELION ACER TENDL-2023 LIBRARY; T=0.K
Photon emission for (n,pd)

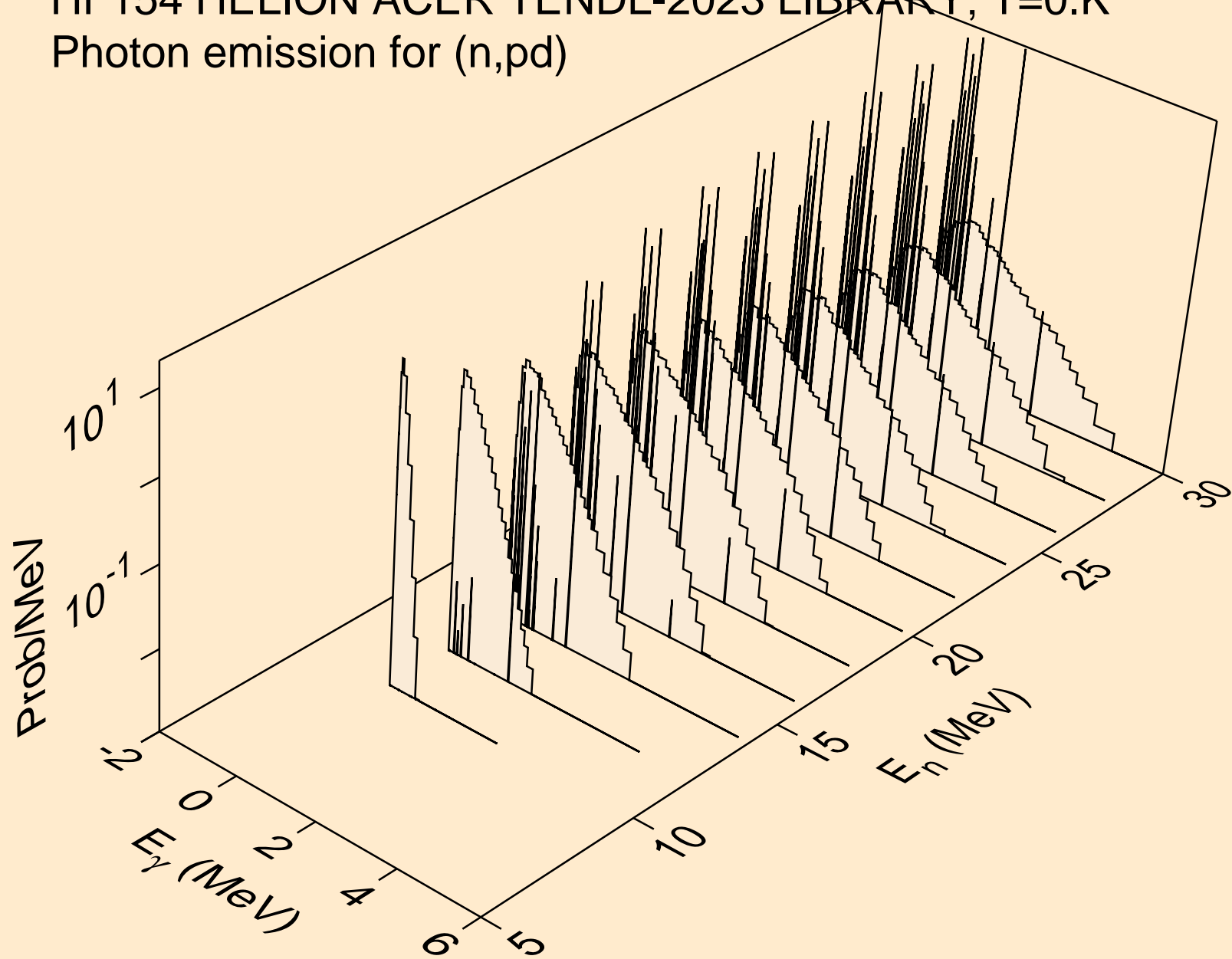

HF154 HELION ACER TENDL-2023 LIBRARY; T=0.K
Photon emission for (n,pt)

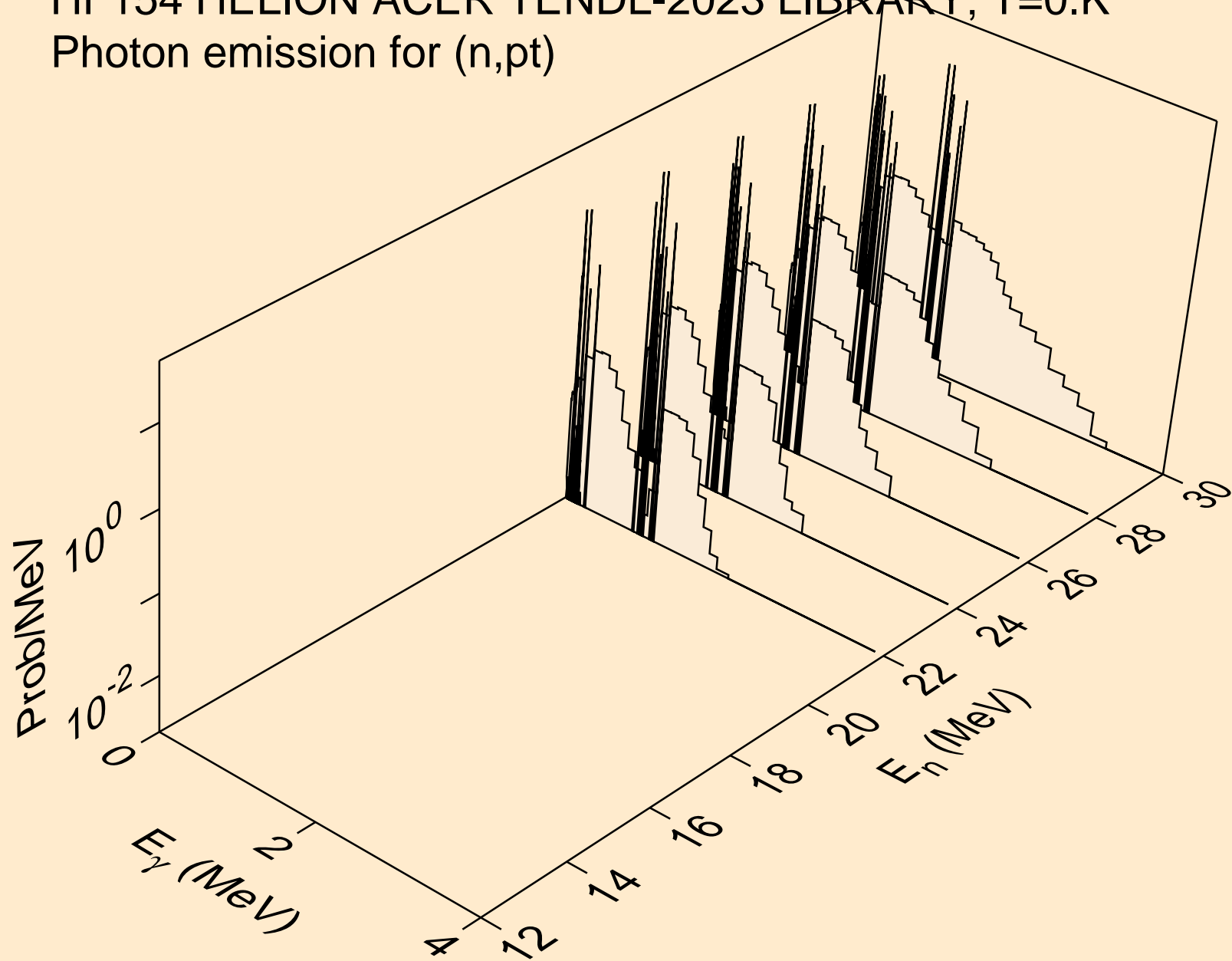

HF154 HELION ACER TENDL-2023 LIBRARY; T=0.K
Photon emission for (n,da)

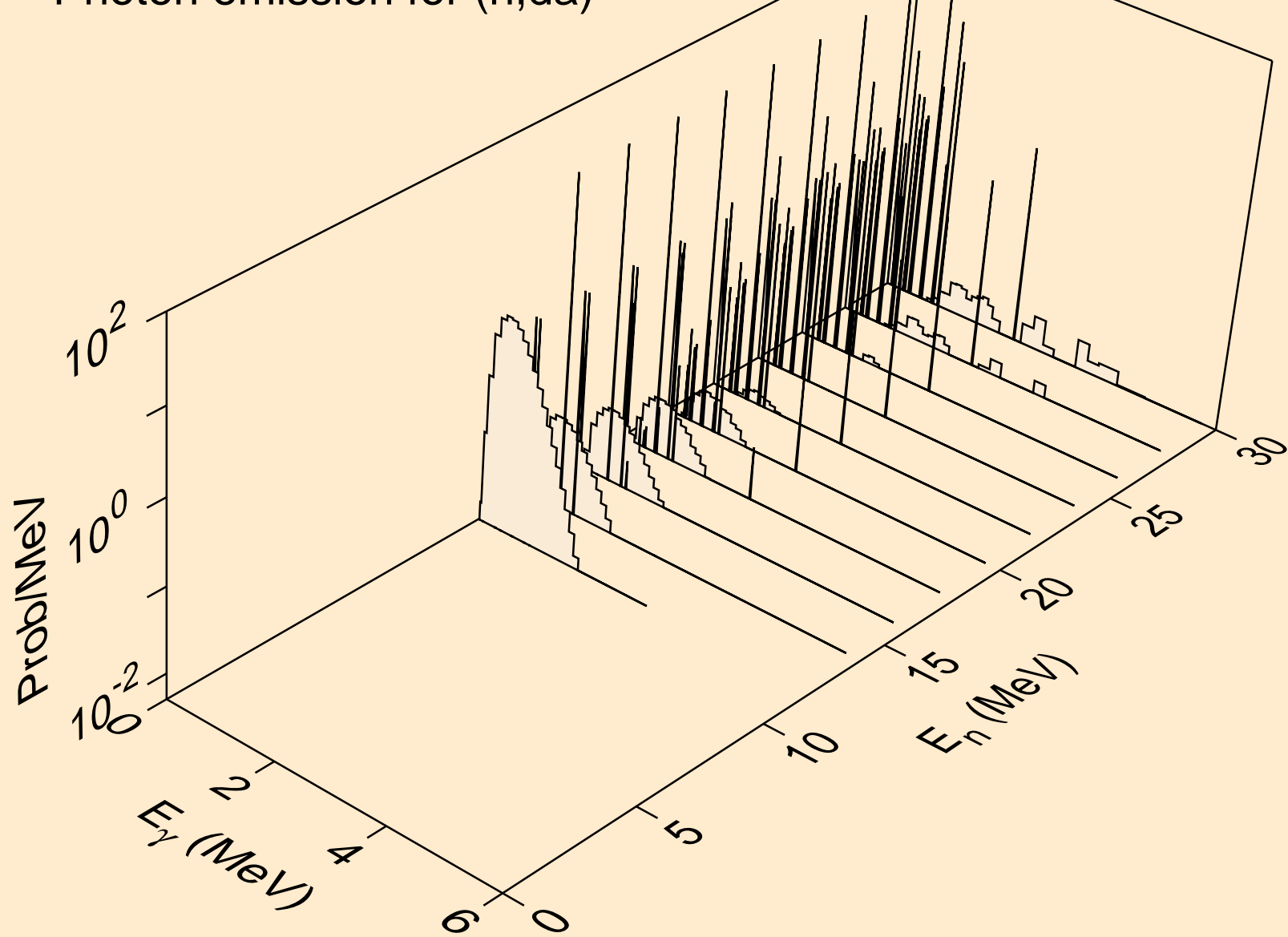

HF154 HELION ACER TENDL-2023 LIBRARY; T=0.K
Particle heating contributions

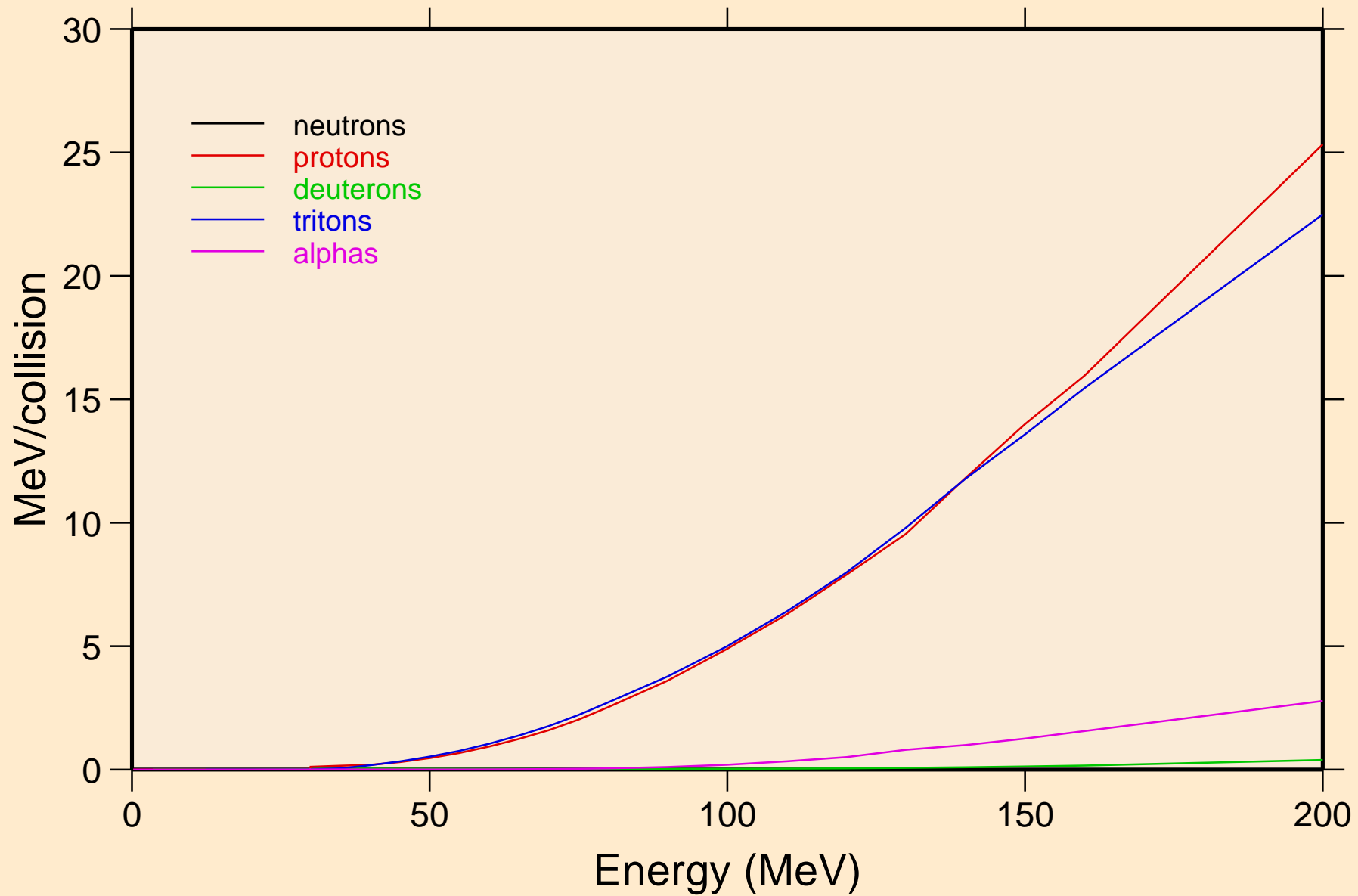

HF154 HELION ACER TENDL-2023 LIBRARY; T=0.K
Recoil Heating

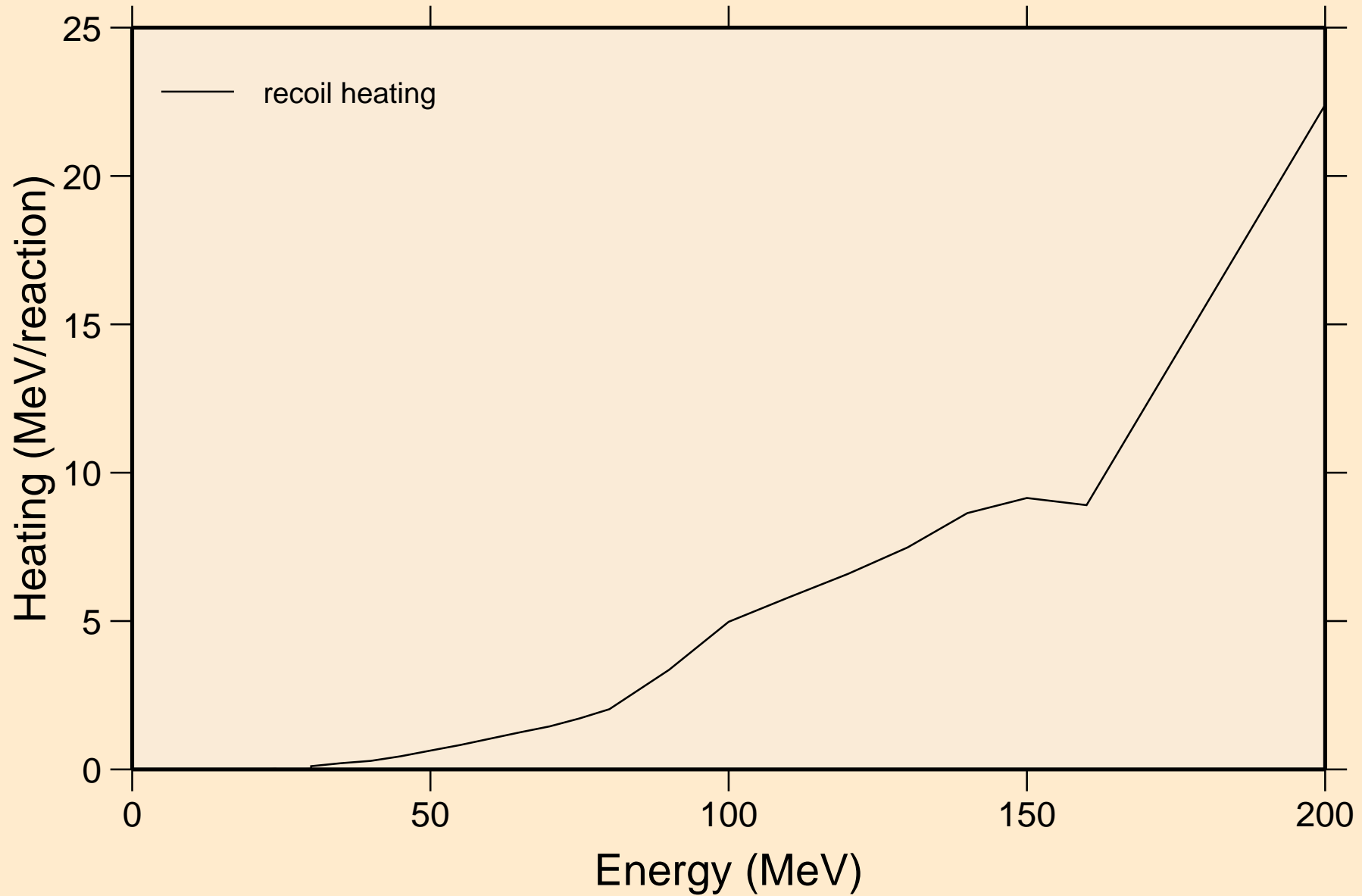

HF154 HELION ACER TENDL-2023 LIBRARY; T=0.K
Particle production cross sections

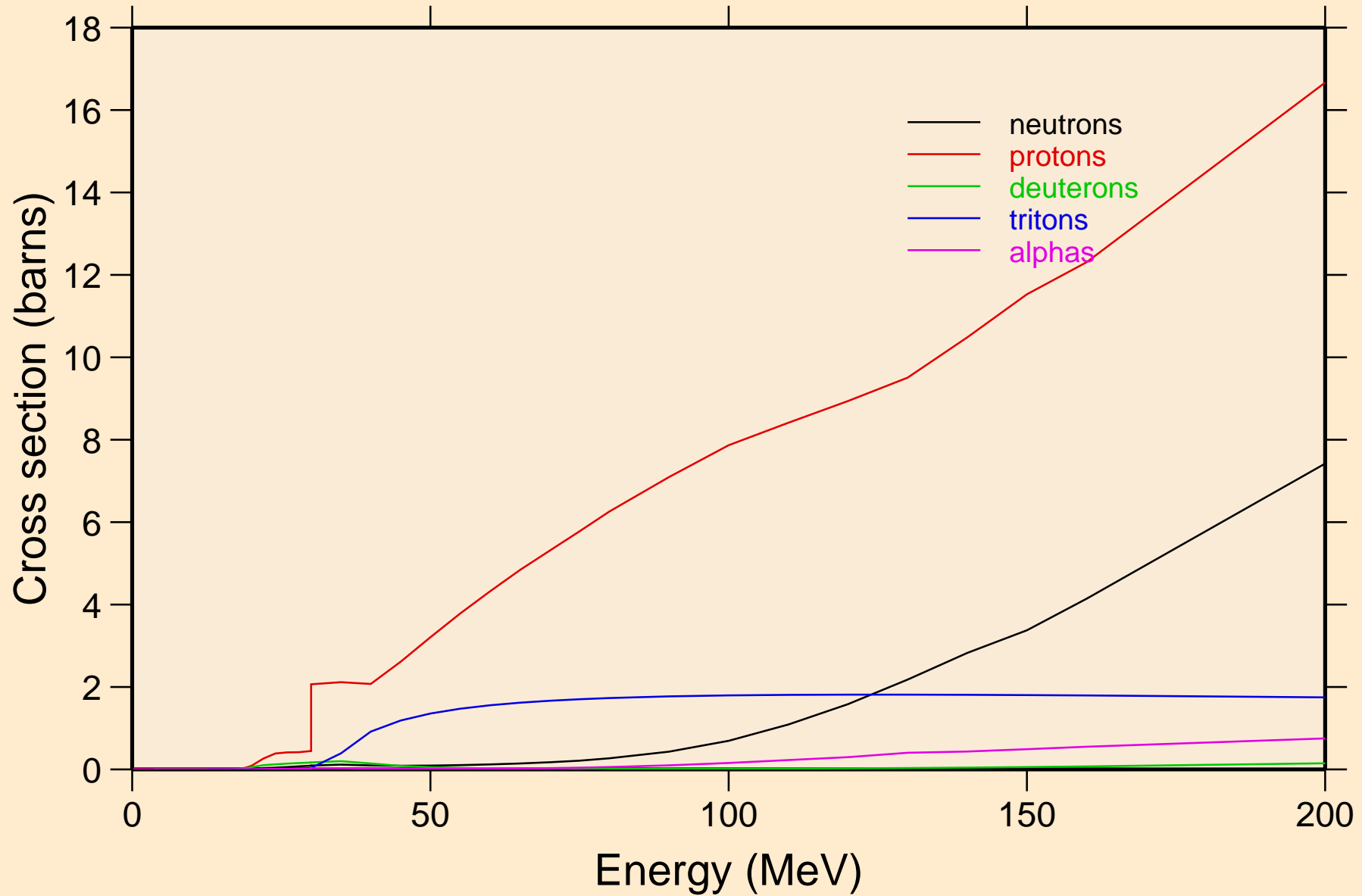

HF154 HELION ACER TENDL-2023 LIBRARY; T=0.K
neutrons from (s,n)

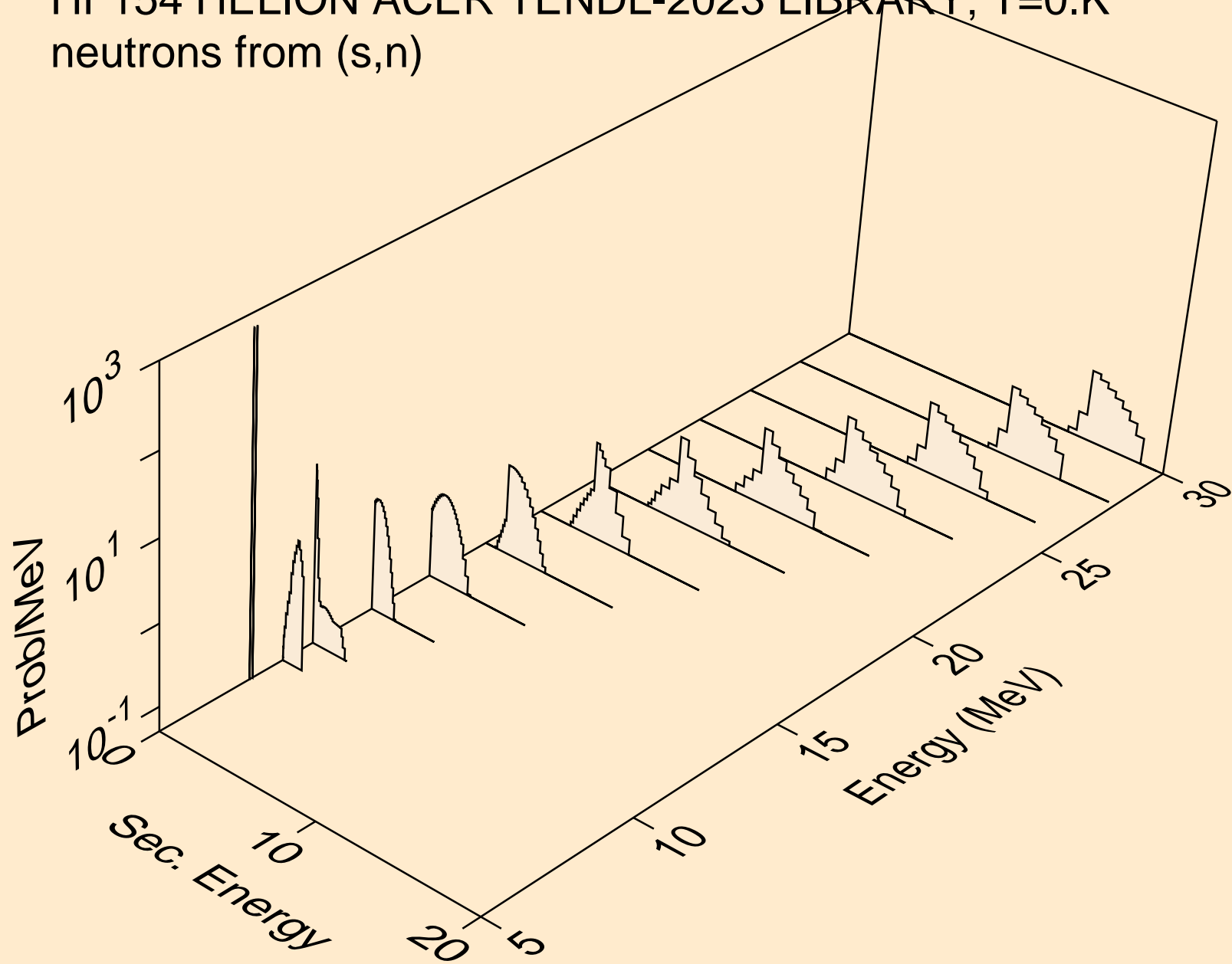

HF154 HELION ACER TENDL-2023 LIBRARY; T=0.K
neutrons from (s,x)

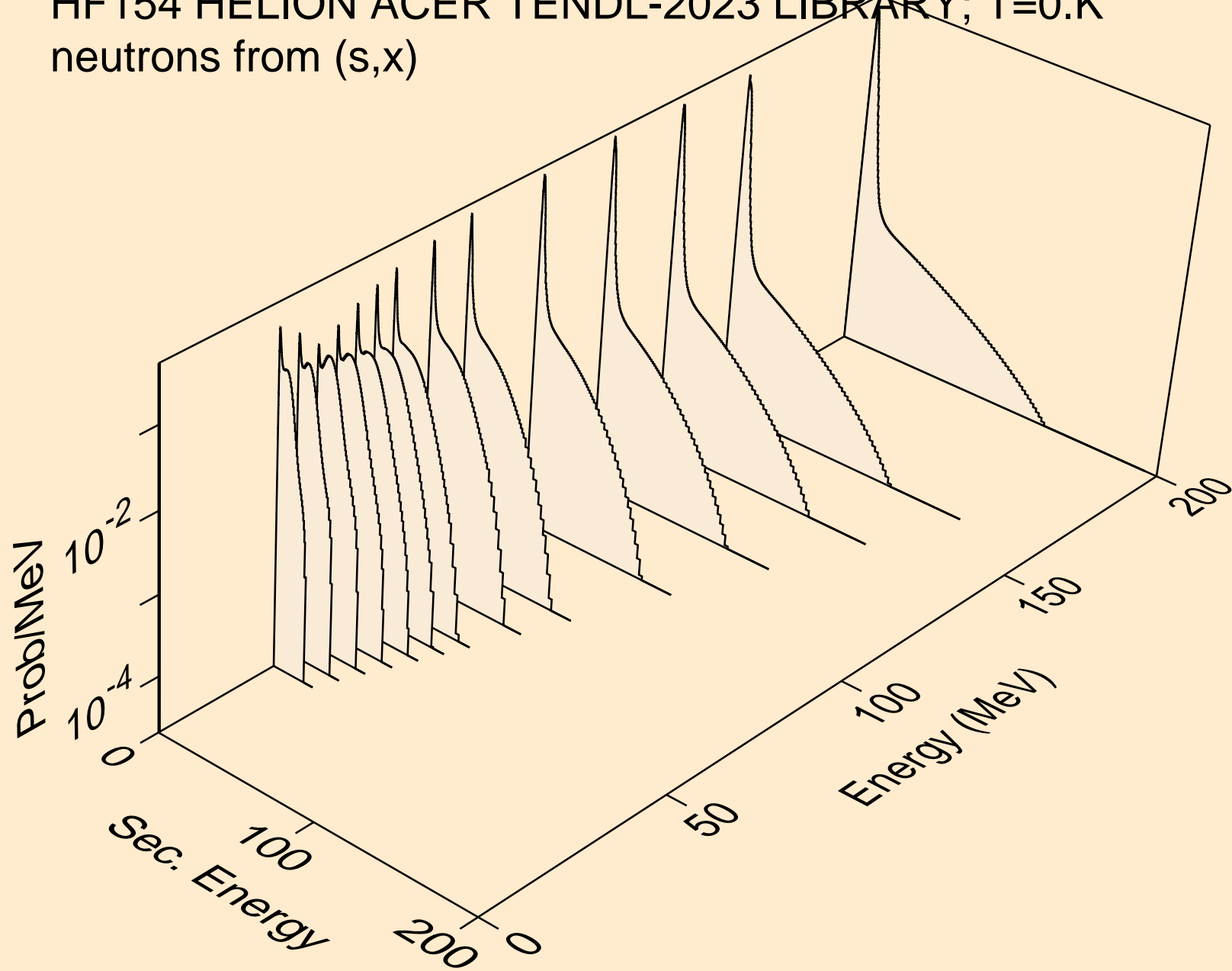

HF154 HELION ACER TENDL-2023 LIBRARY; T=0.K
neutrons from (s,2n)

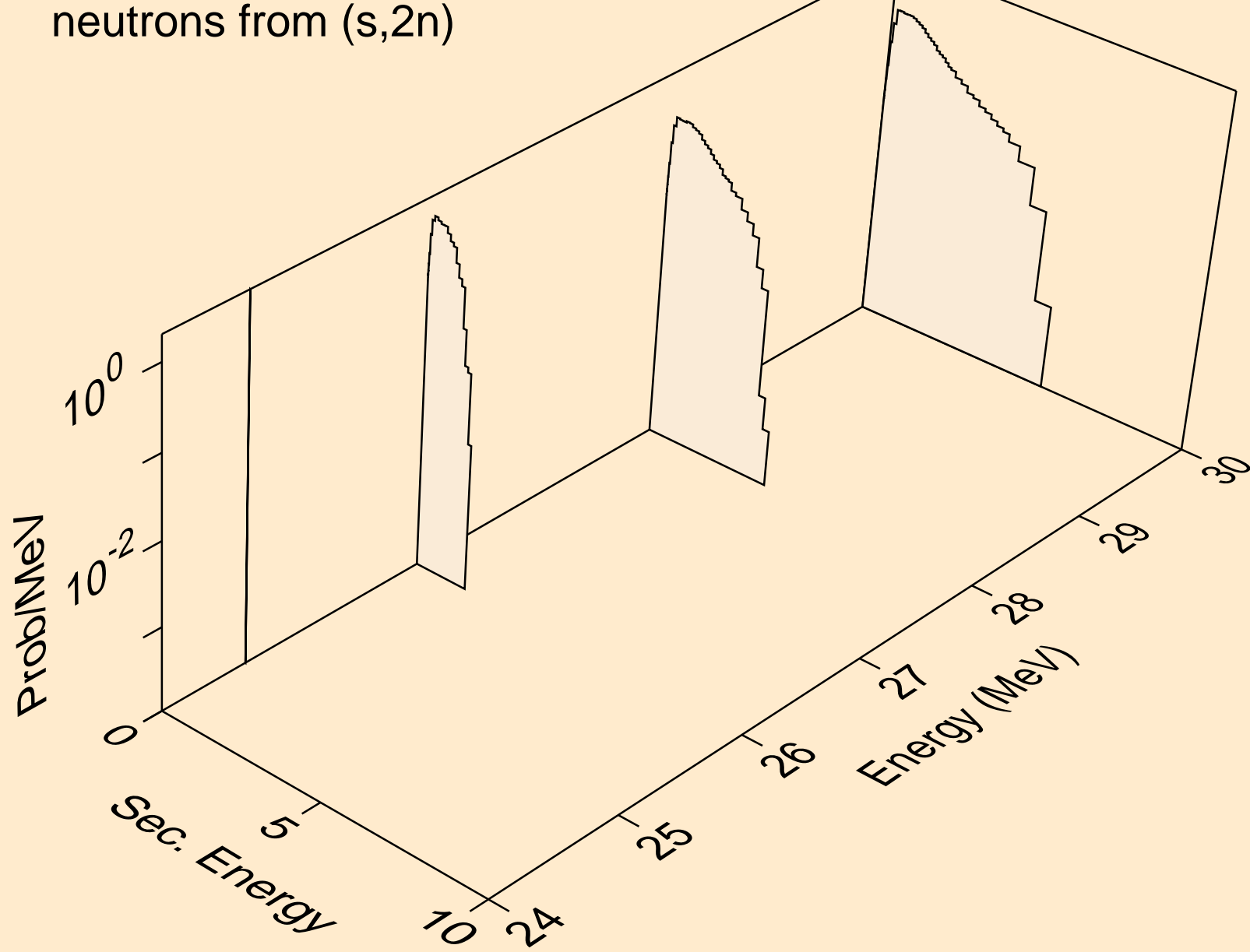

HF154 HELION ACER TENDL-2023 LIBRARY; T=0.K
neutrons from (s,n*)a

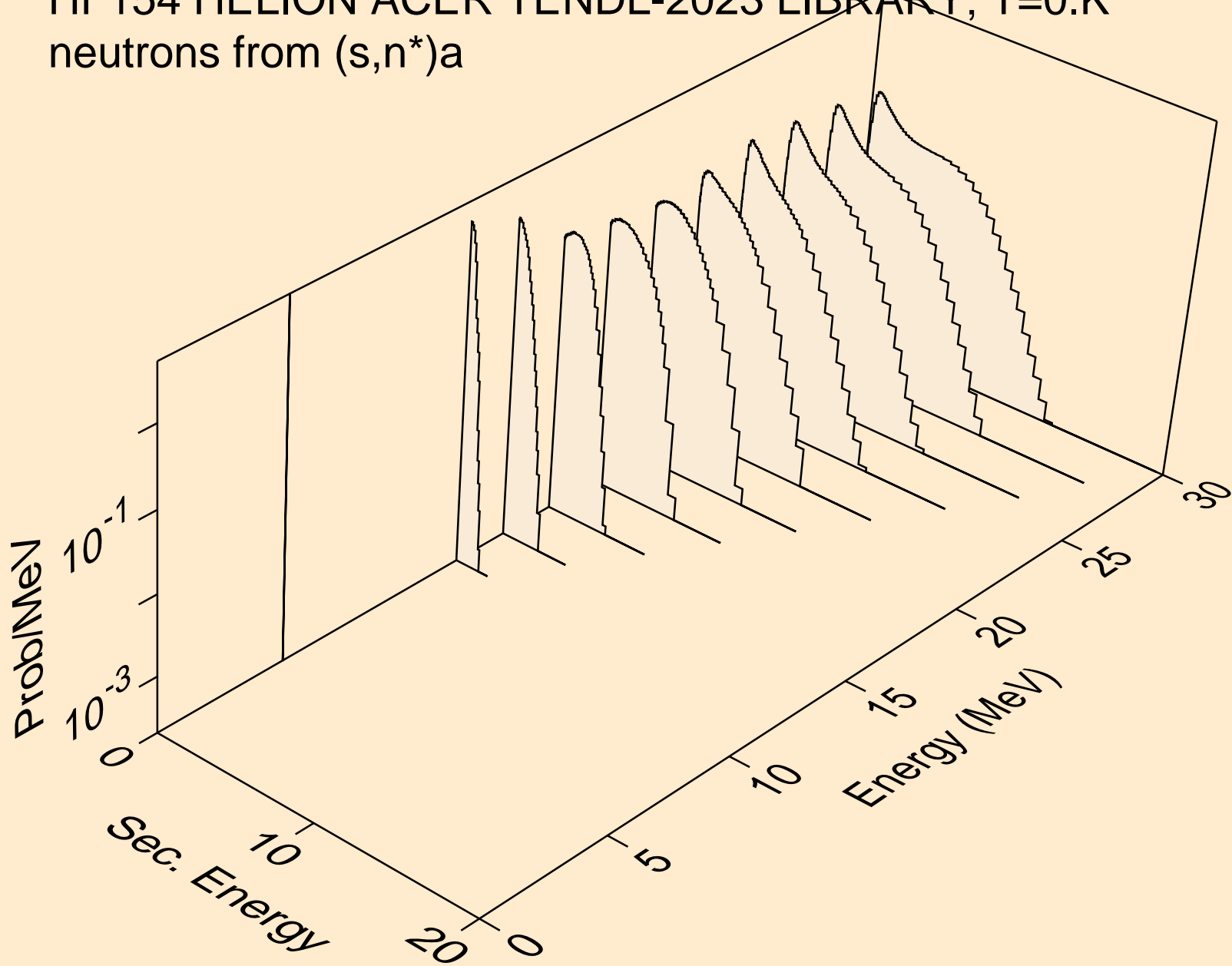

HF154 HELION ACER TENDL-2023 LIBRARY; T=0.K
neutrons from (s,n*)p

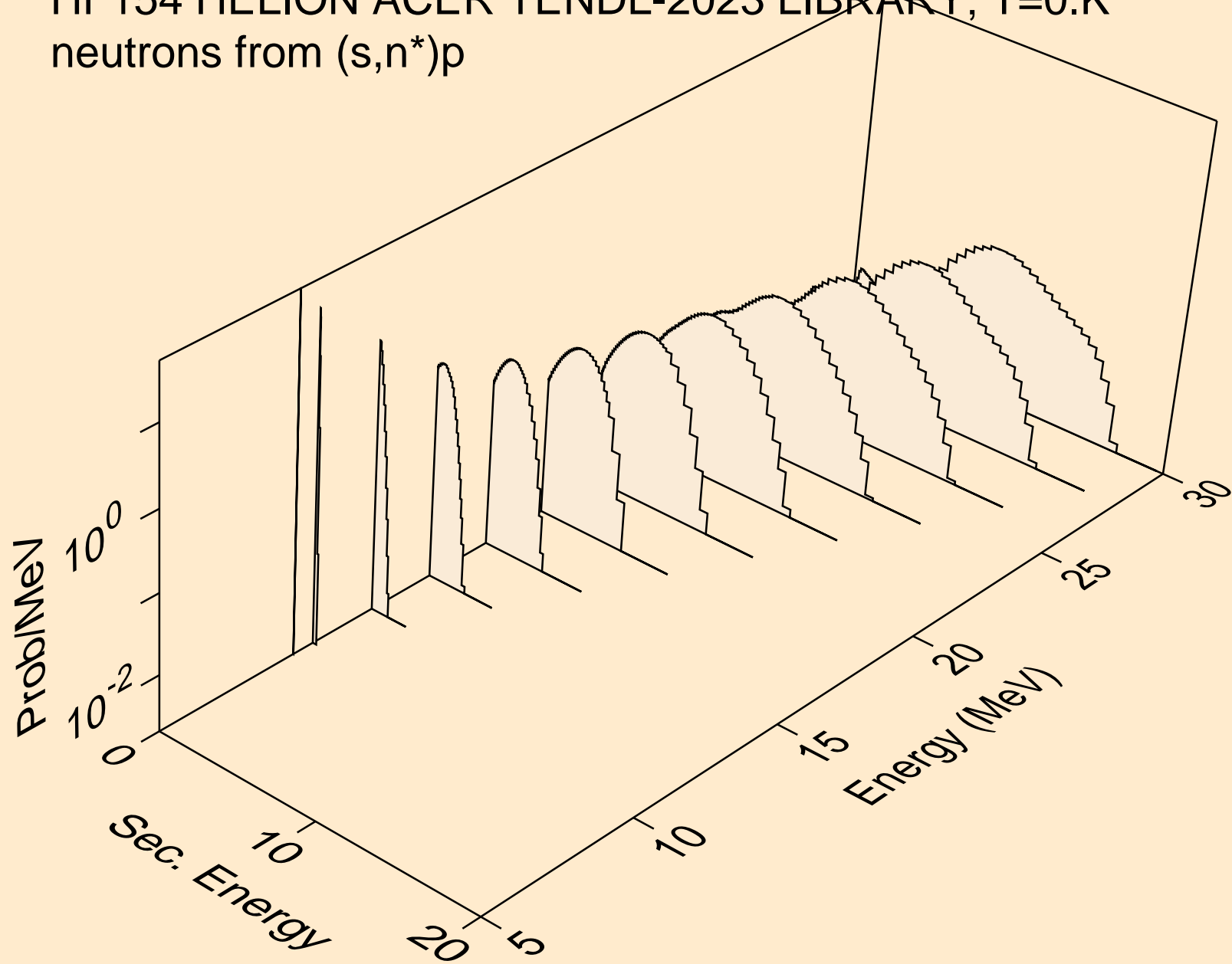

HF154 HELION ACER TENDL-2023 LIBRARY; T=0.K
neutrons from (s,n*)2a

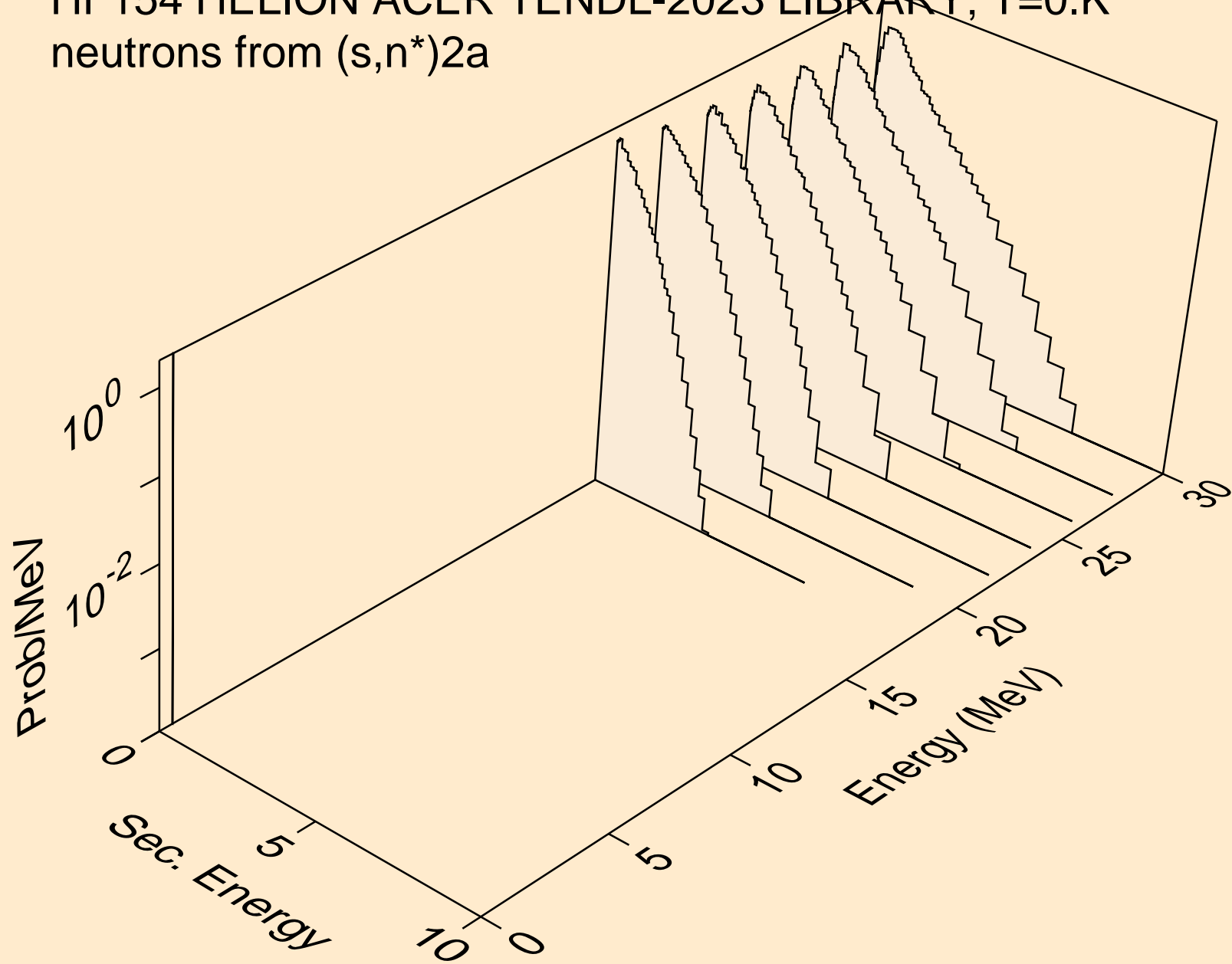

HF154 HELION ACER TENDL-2023 LIBRARY; T=0.K
neutrons from (s,n*)he3

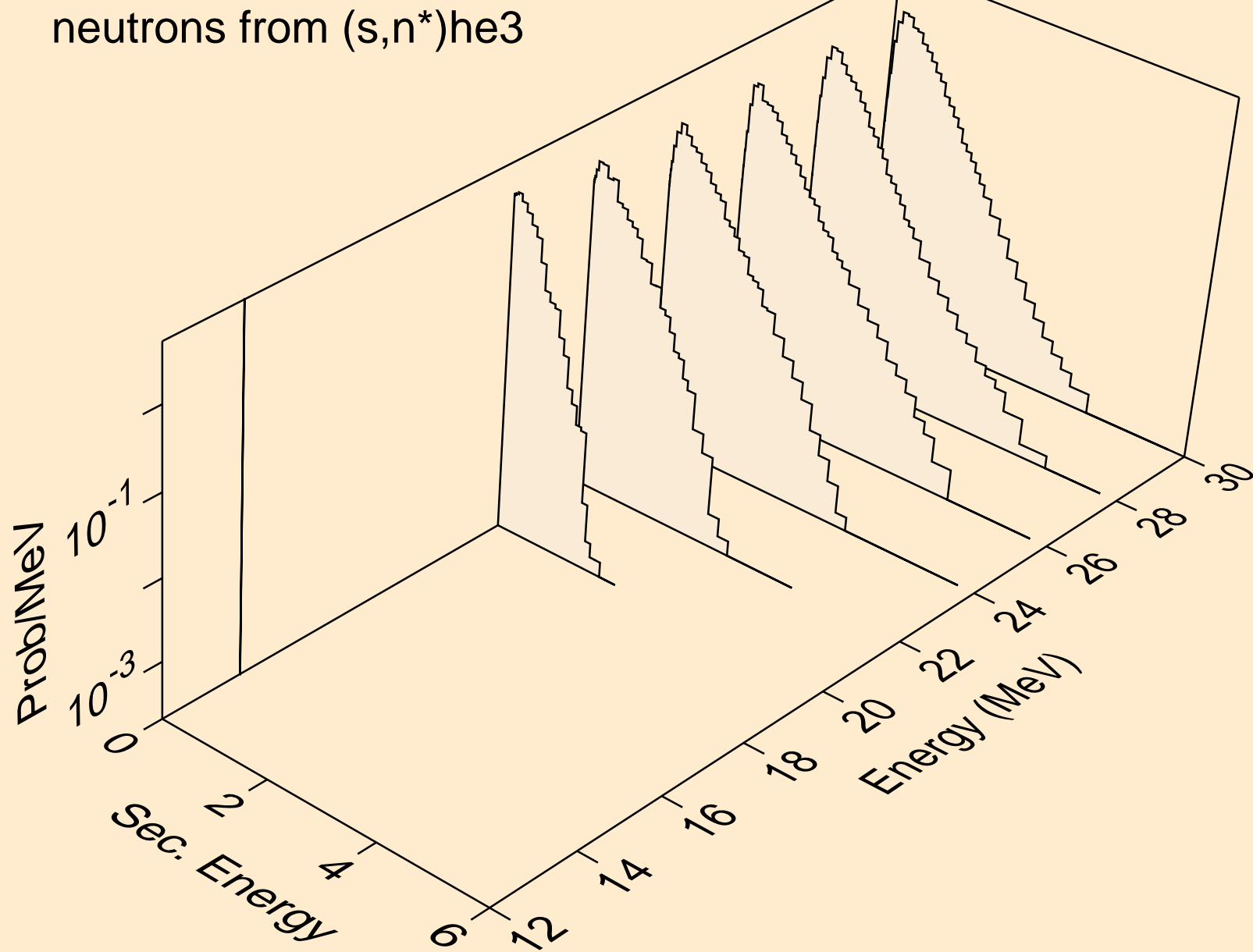

HF154 HELION ACER TENDL-2023 LIBRARY; T=0.K
neutrons from (s,2np)

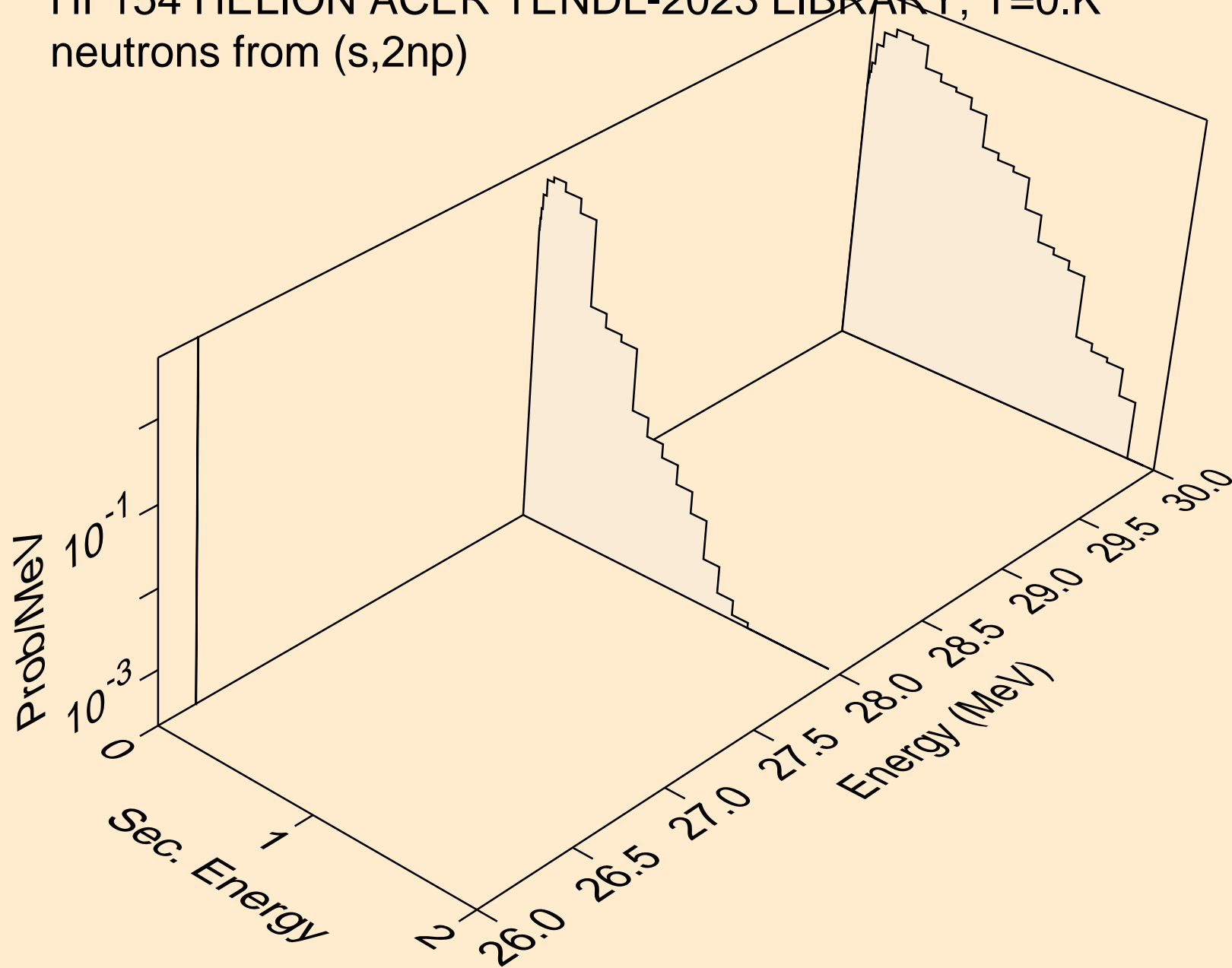

HF154 HELION ACER TENDL-2023 LIBRARY; T=0.K
neutrons from (s,n2p)

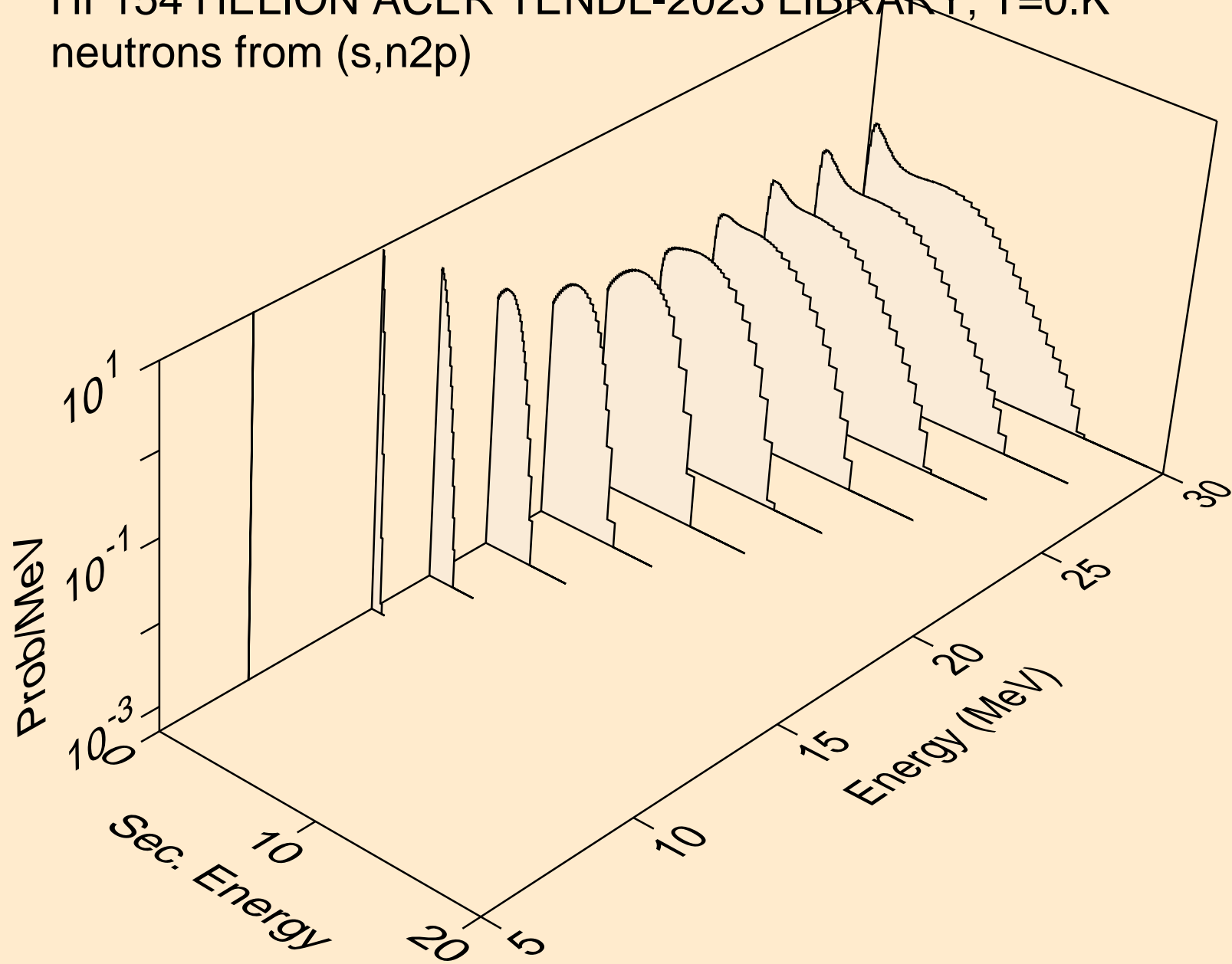

HF154 HELION ACER TENDL-2023 LIBRARY; T=0.K
neutrons from (s,npa)

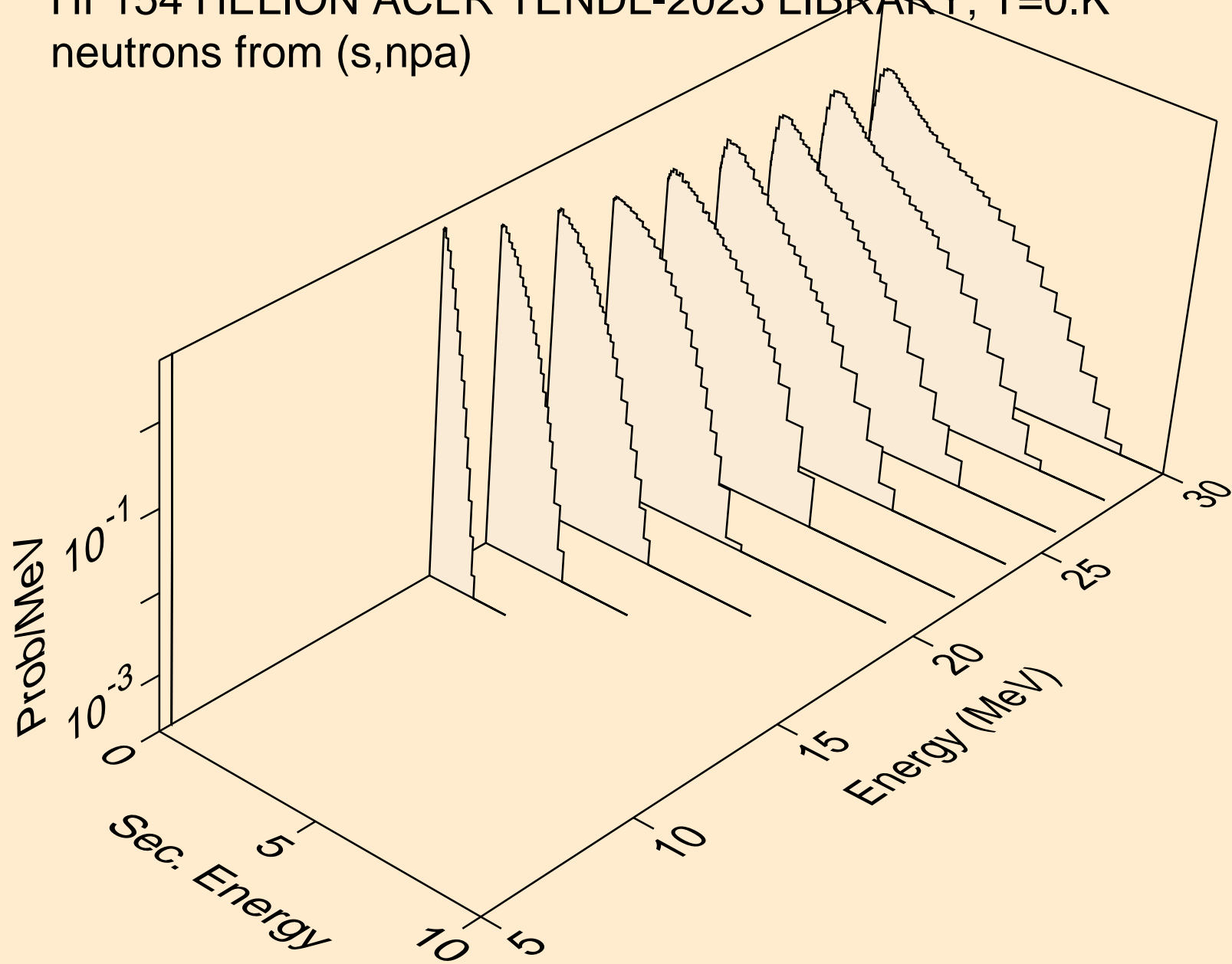

HF154 HELION ACER TENDL-2023 LIBRARY; T=0.K
protons from (s,x)

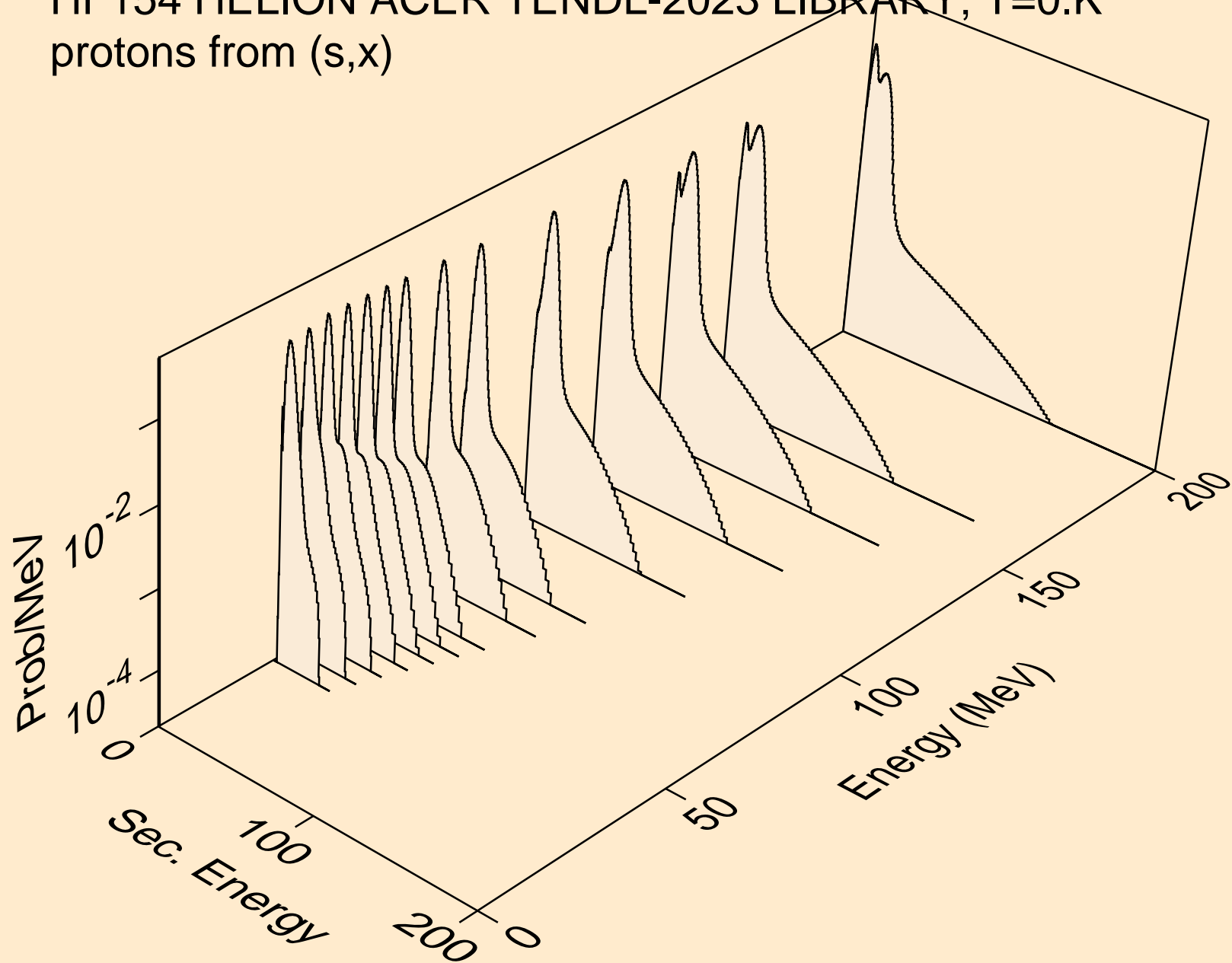

HF154 HELION ACER TENDL-2023 LIBRARY; T=0.K
protons from (s,n*)p

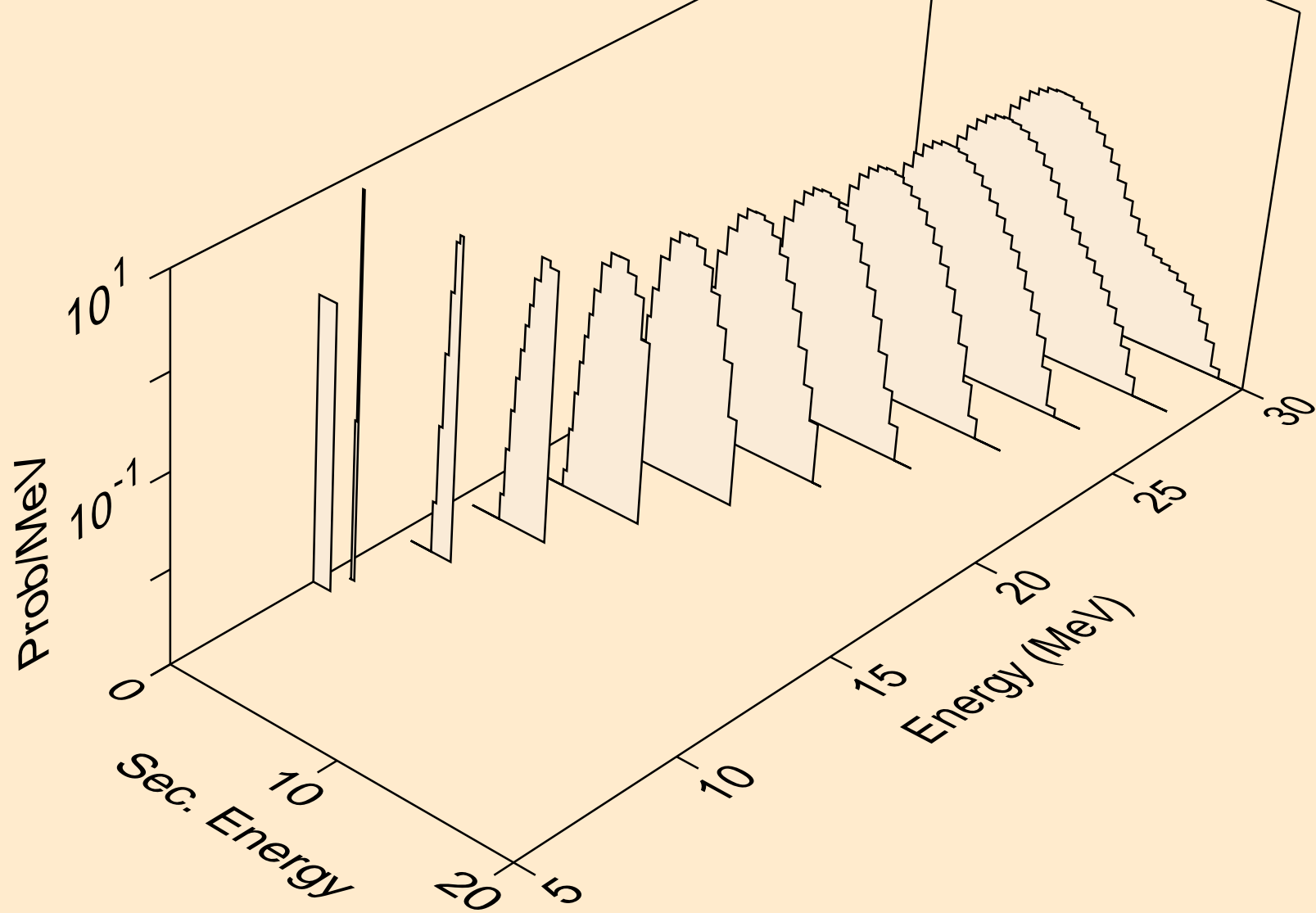

HF154 HELION ACER TENDL-2023 LIBRARY; T=0.K
protons from (s,2np)

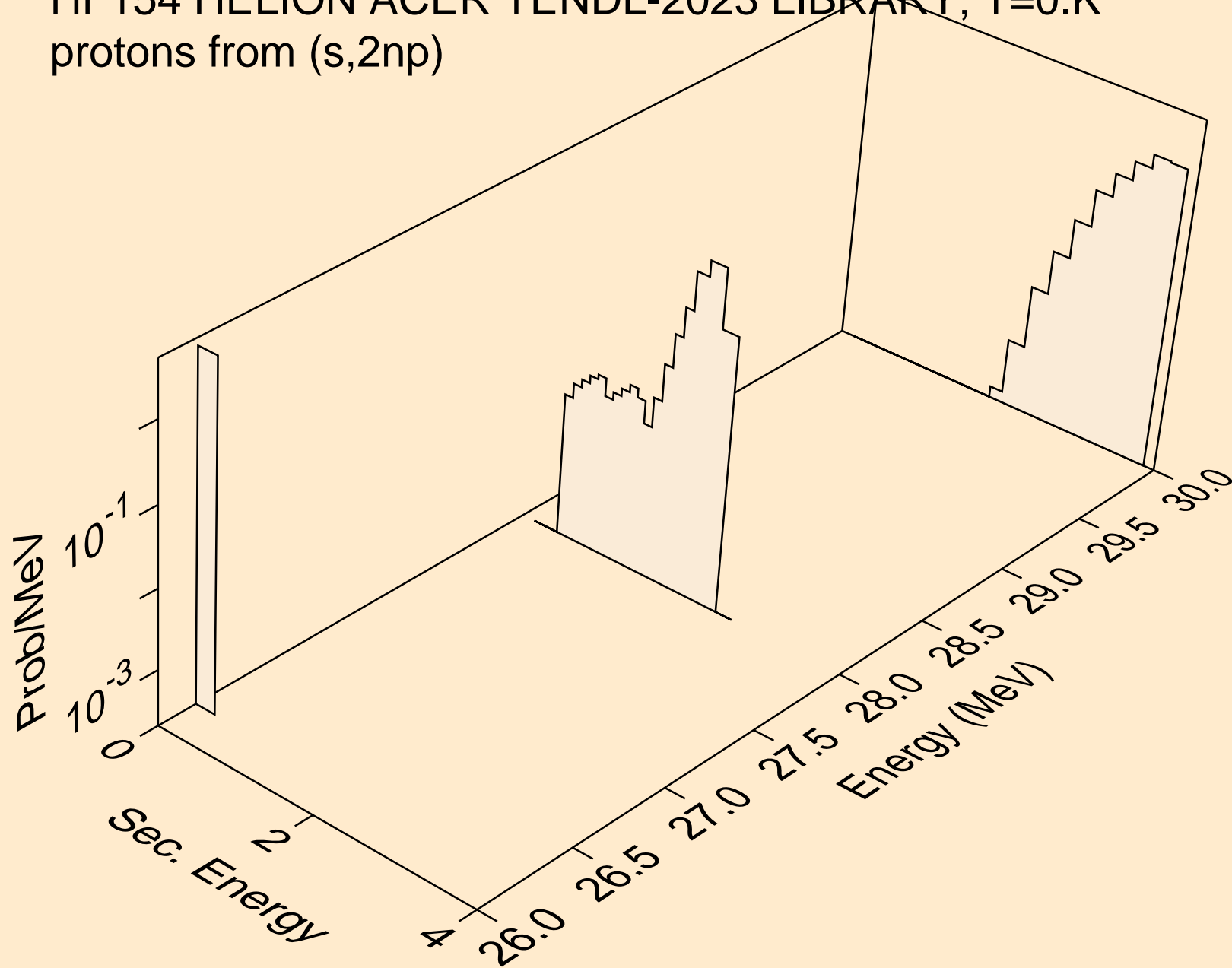

HF154 HELION ACER TENDL-2023 LIBRARY; T=0.K
protons from (s,n2p)

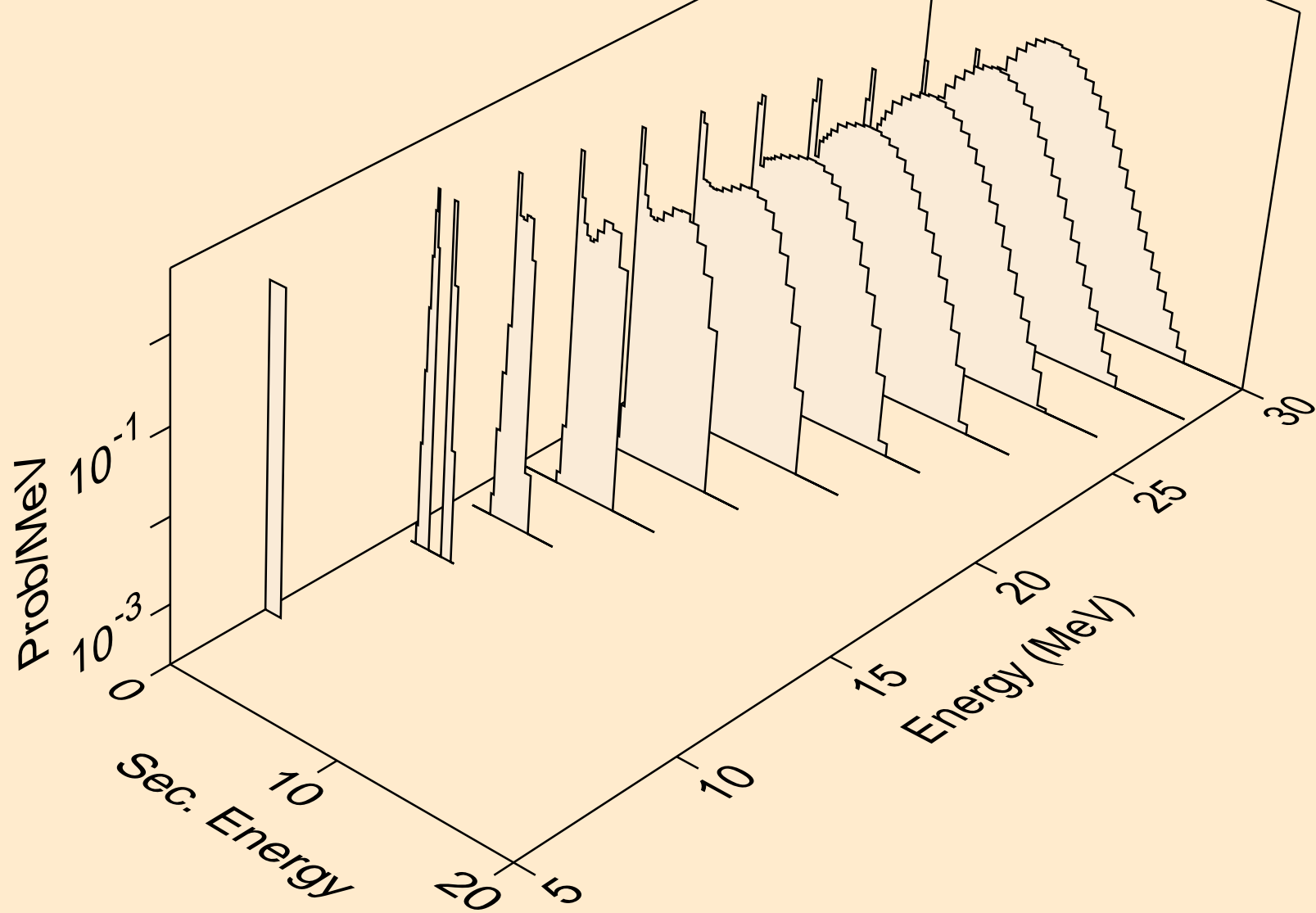

HF154 HELION ACER TENDL-2023 LIBRARY; T=0.K
protons from (s,npa)

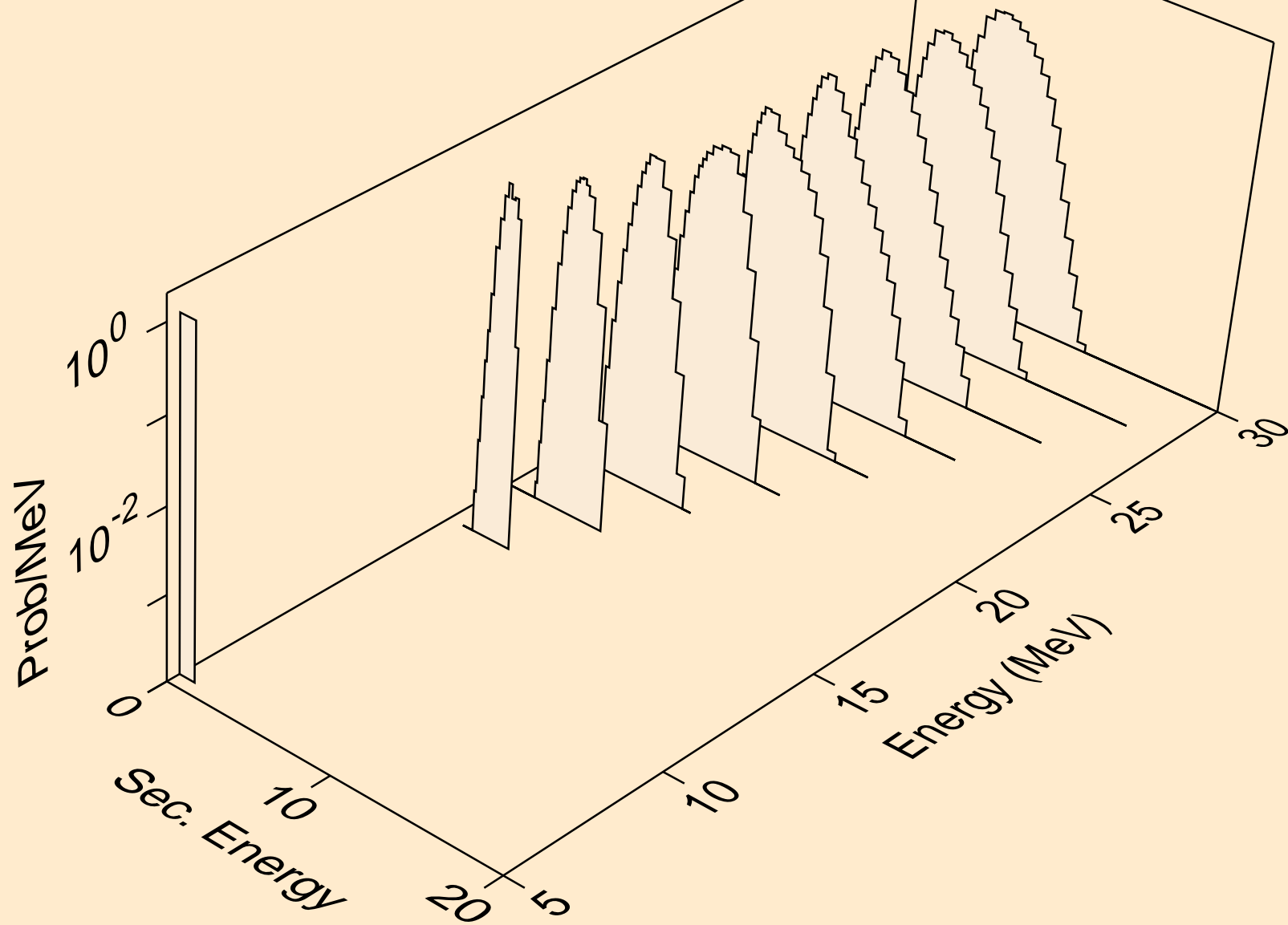

HF154 HELION ACER TENDL-2023 LIBRARY; T=0.K
protons from (s,p)

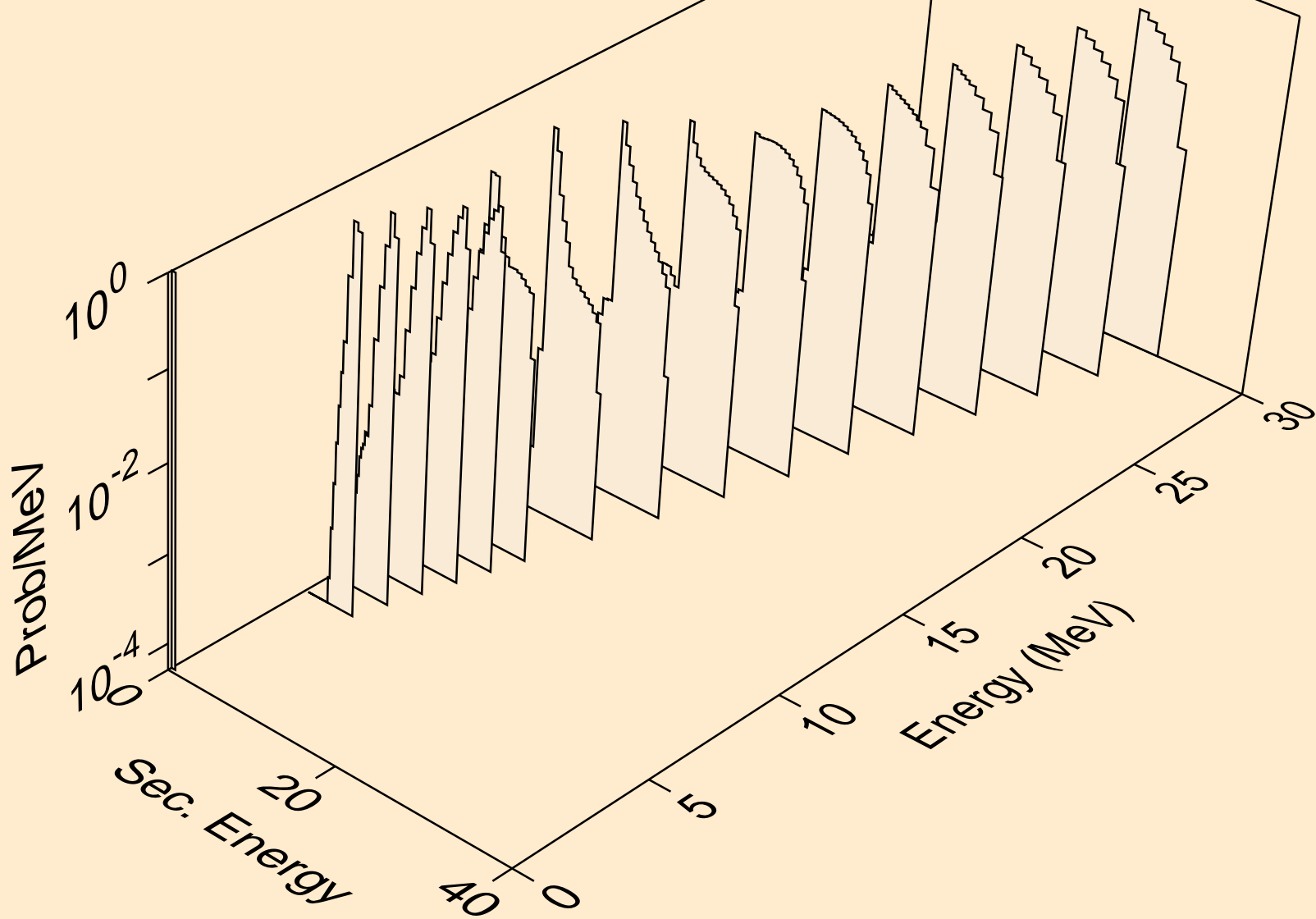

HF154 HELION ACER TENDL-2023 LIBRARY; T=0.K
protons from (s,2p)

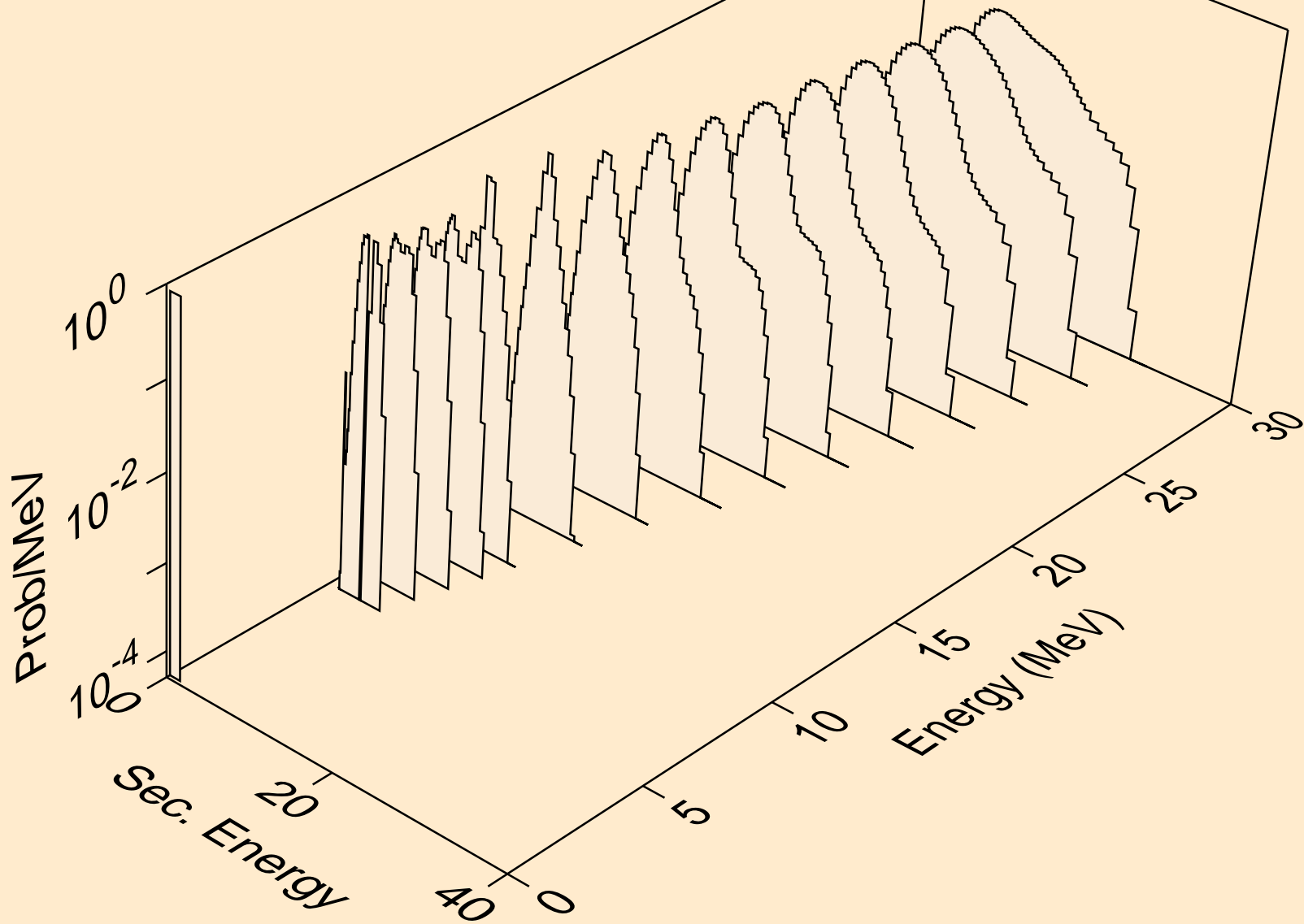

HF154 HELION ACER TENDL-2023 LIBRARY; T=0.K
protons from (s,pa)

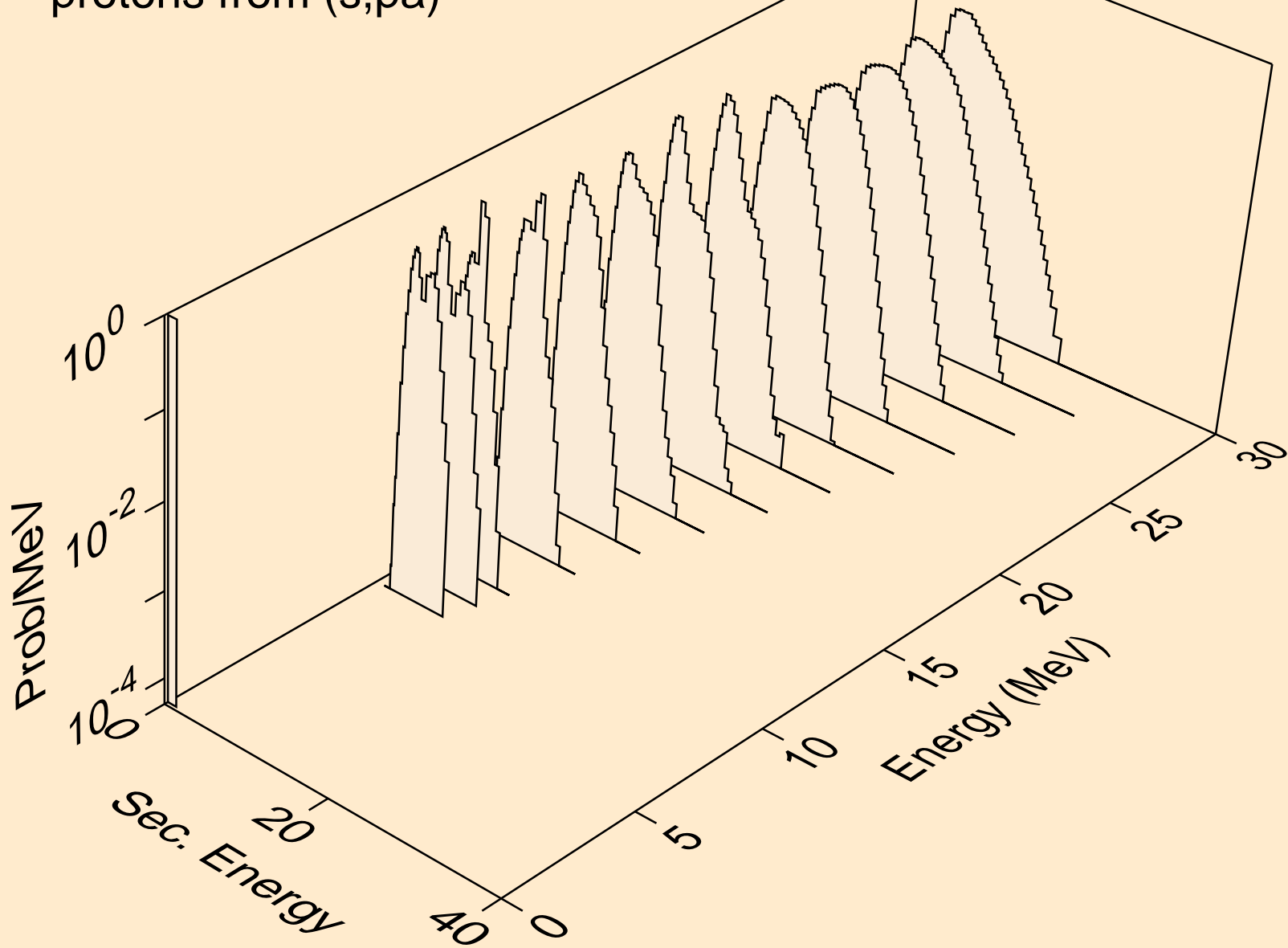

HF154 HELION ACER TENDL-2023 LIBRARY; T=0.K
protons from (s,pd)

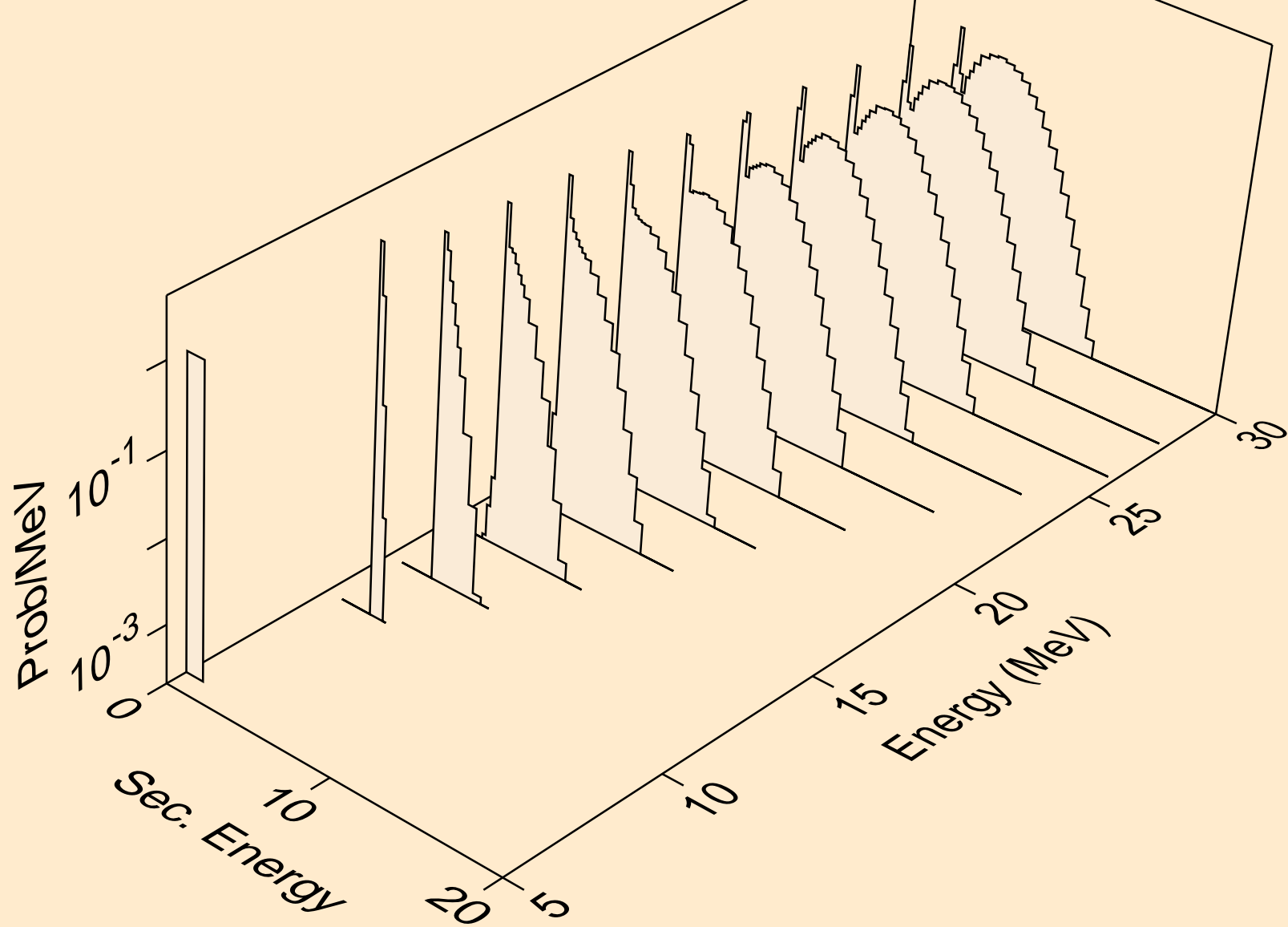

HF154 HELION ACER TENDL-2023 LIBRARY; T=0.K
protons from (s,pt)

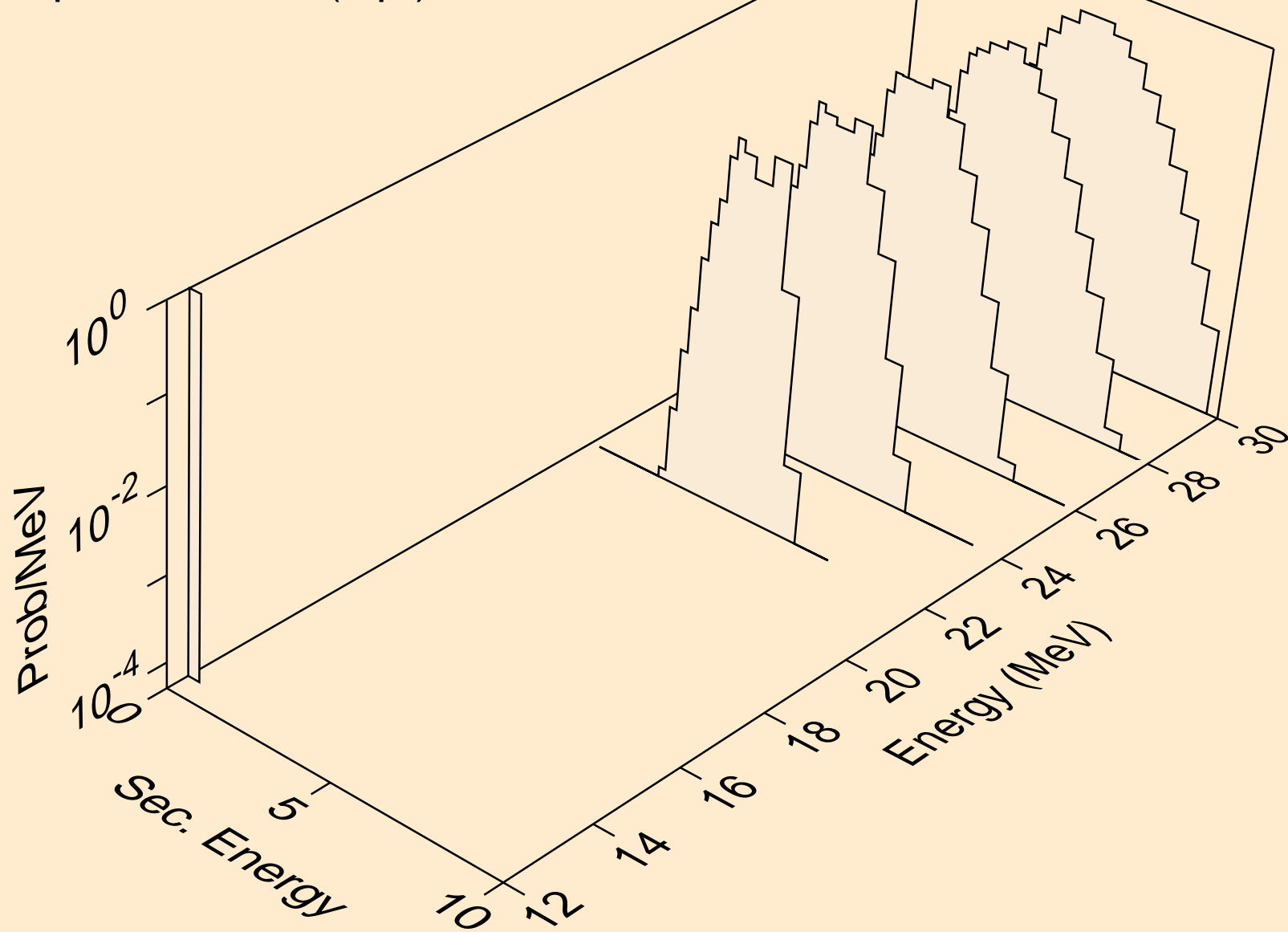

HF154 HELION ACER TENDL-2023 LIBRARY; T=0.K
deuterons from (s,x)

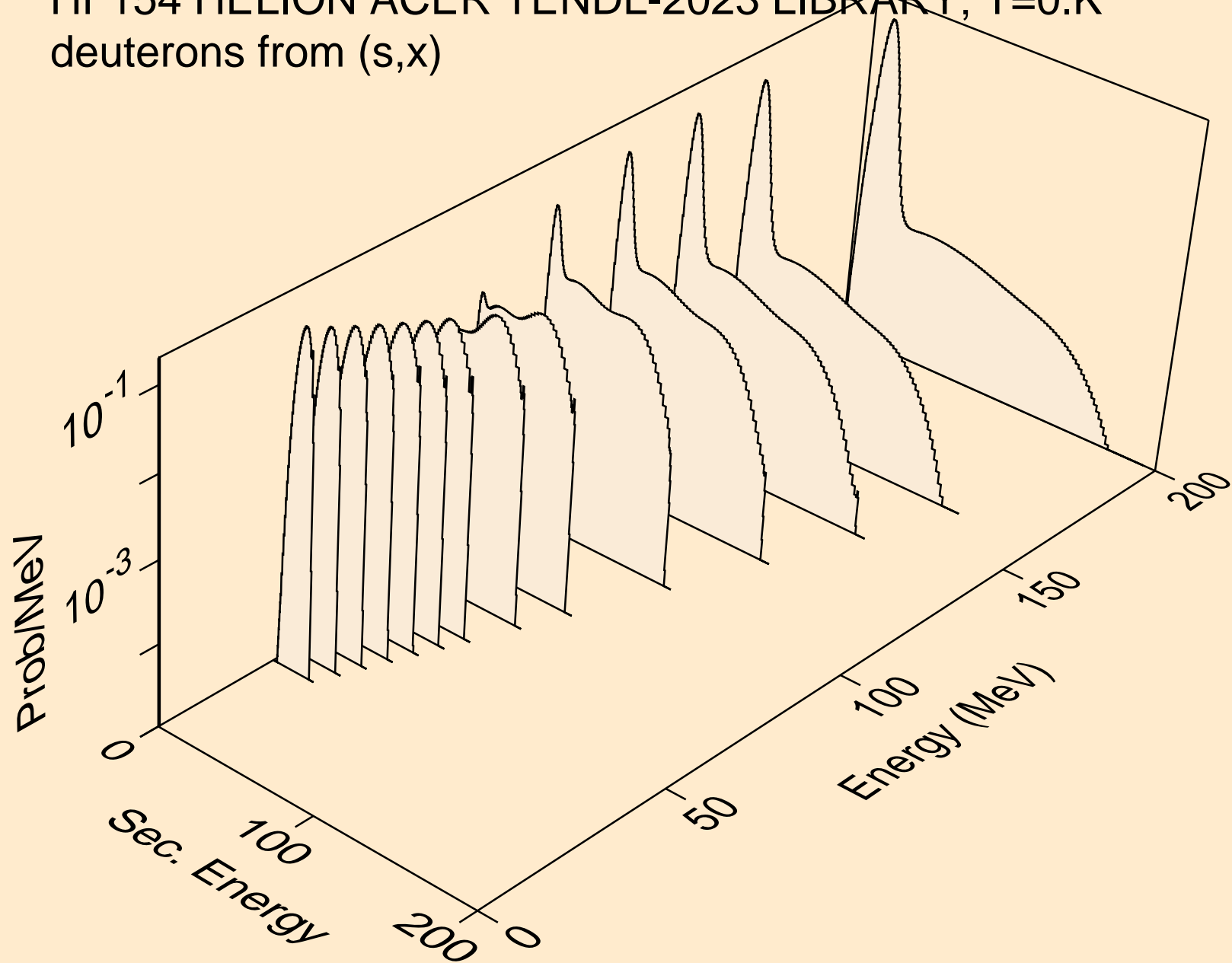

HF154 HELION ACER TENDL-2023 LIBRARY; T=0.K
deuterons from (s,d)

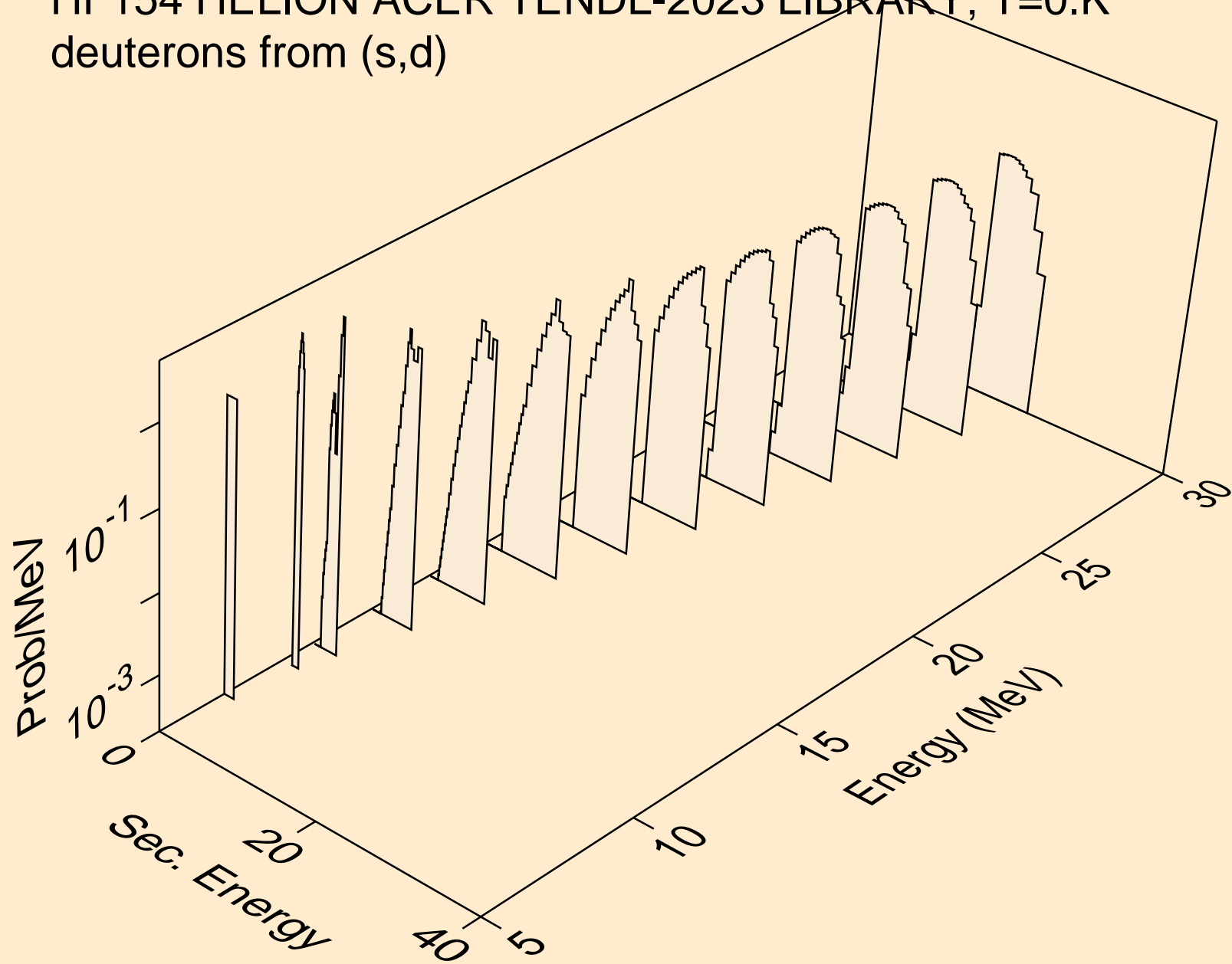

HF154 HELION ACER TENDL-2023 LIBRARY; T=0.K
deuterons from (s,pd)

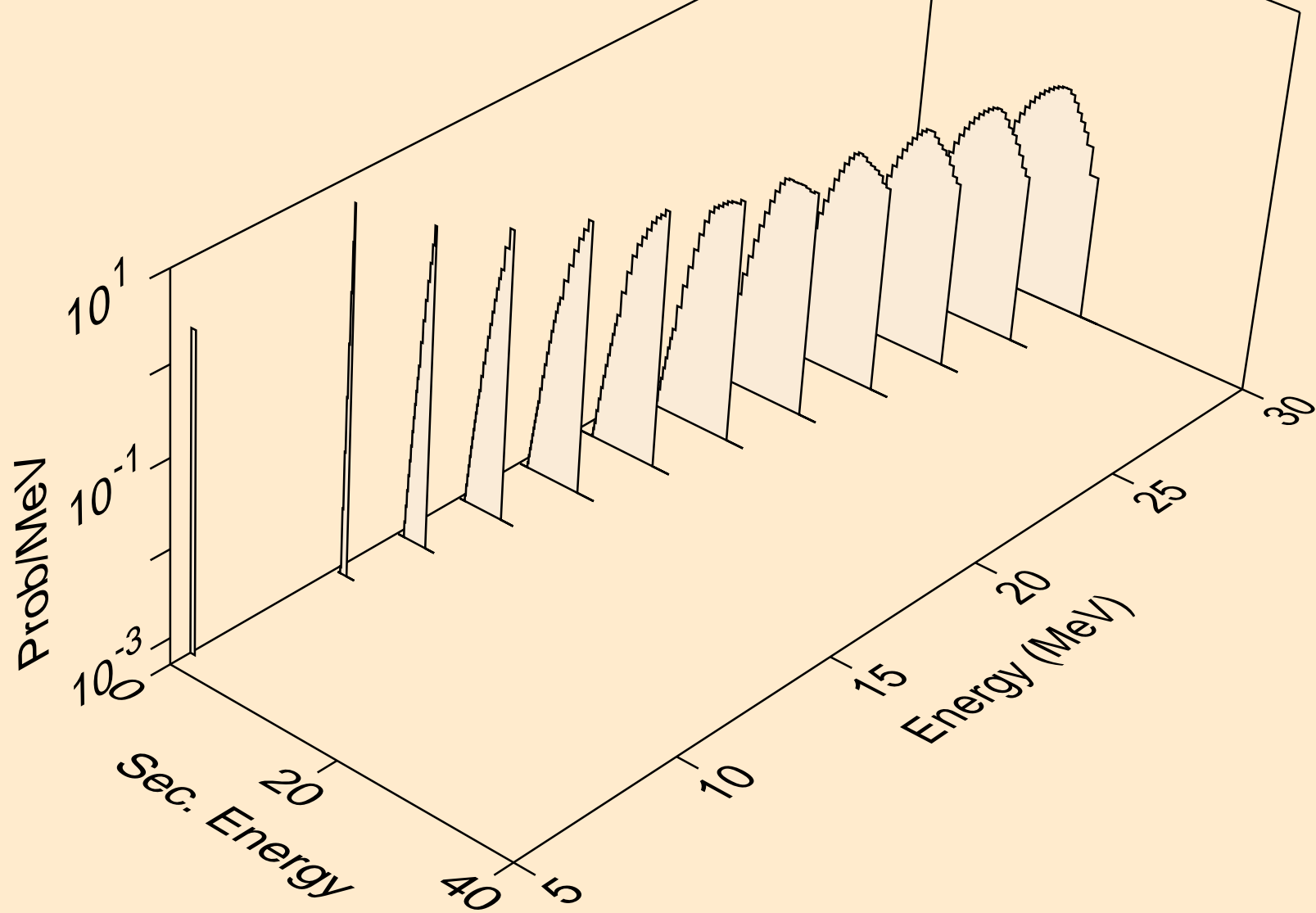

HF154 HELION ACER TENDL-2023 LIBRARY; T=0.K
deuterons from (s,da)

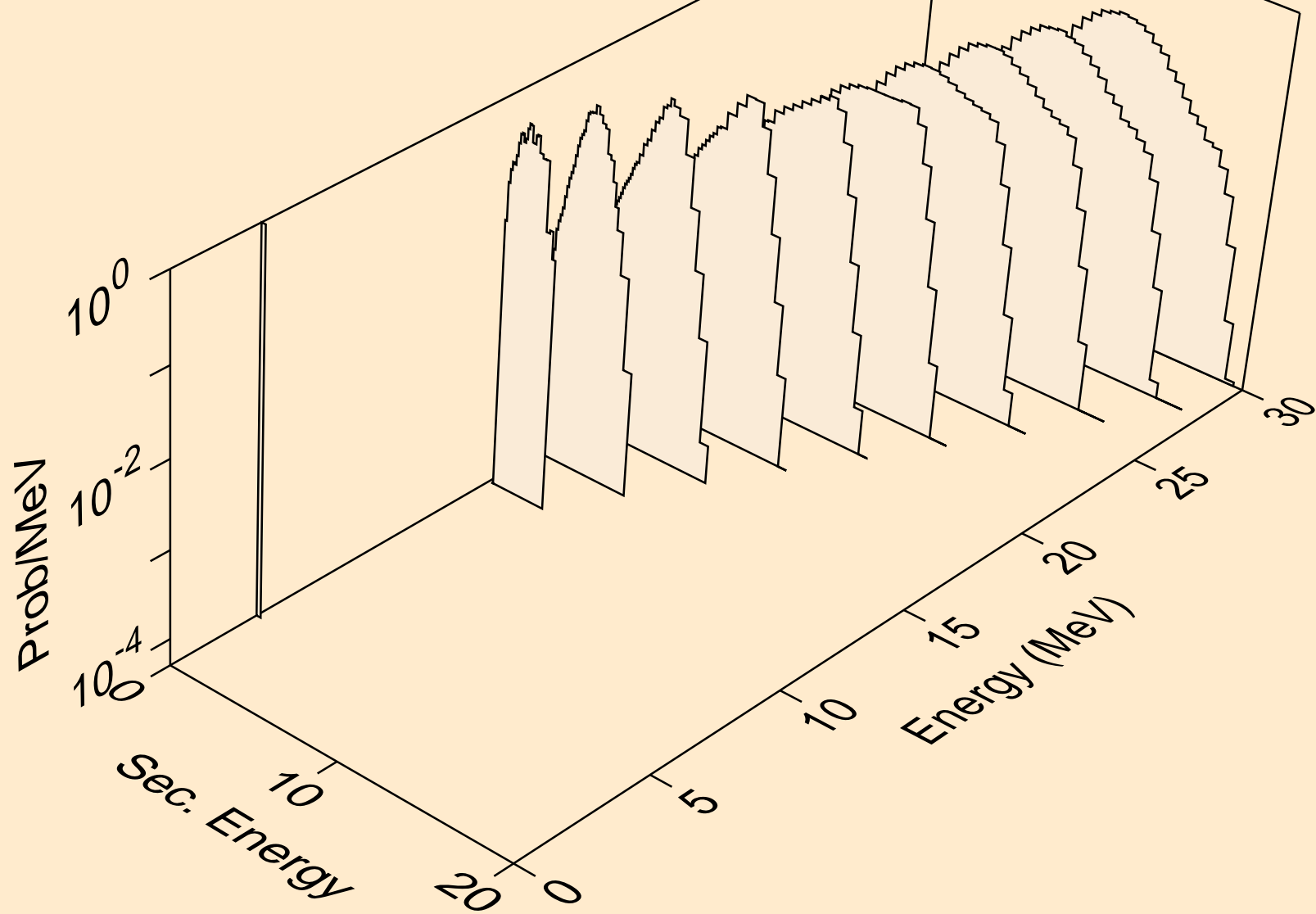

HF154 HELION ACER TENDL-2023 LIBRARY; T=0.K
tritons from (s,x)

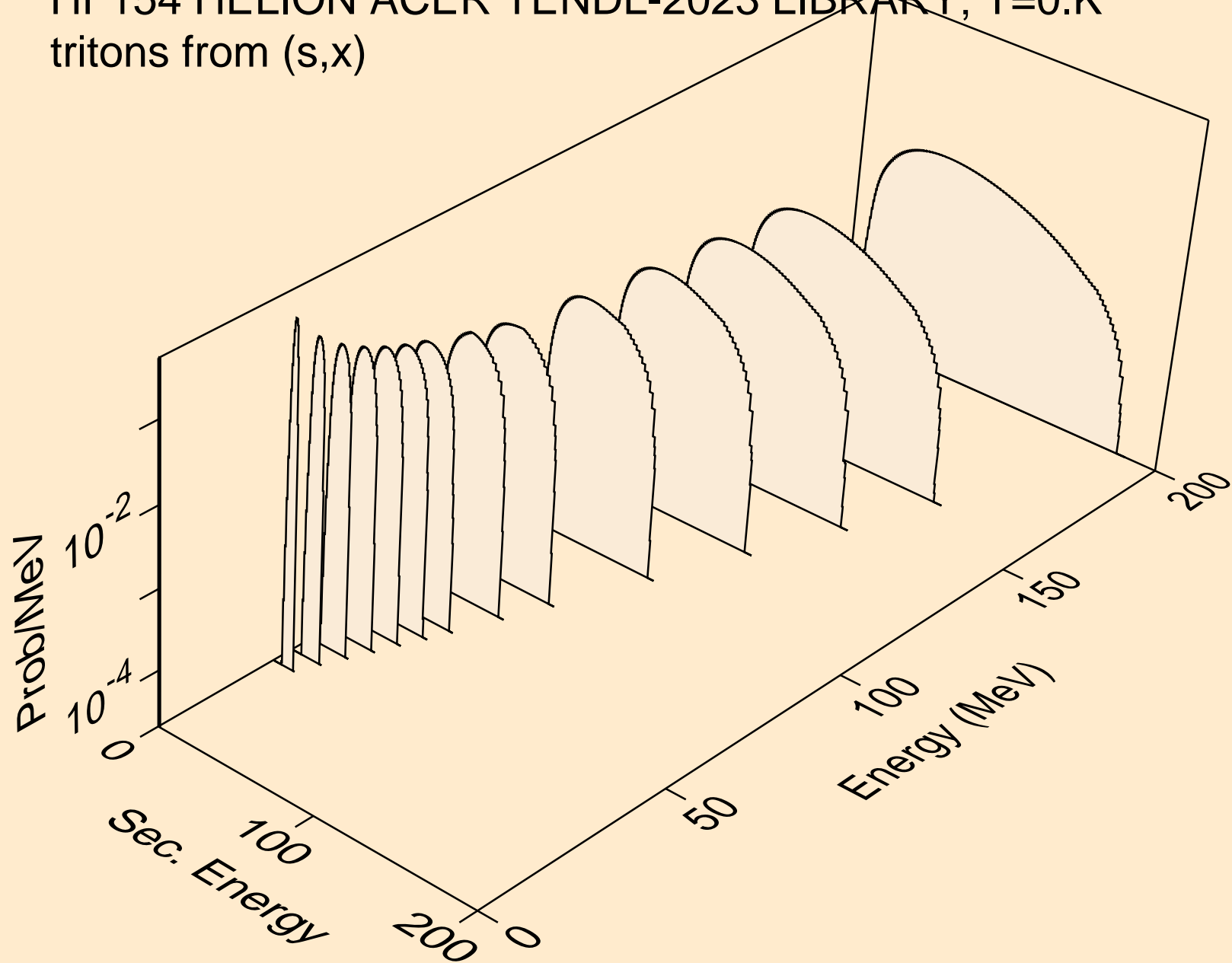

HF154 HELION ACER TENDL-2023 LIBRARY; T=0.K
tritons from (s,t)

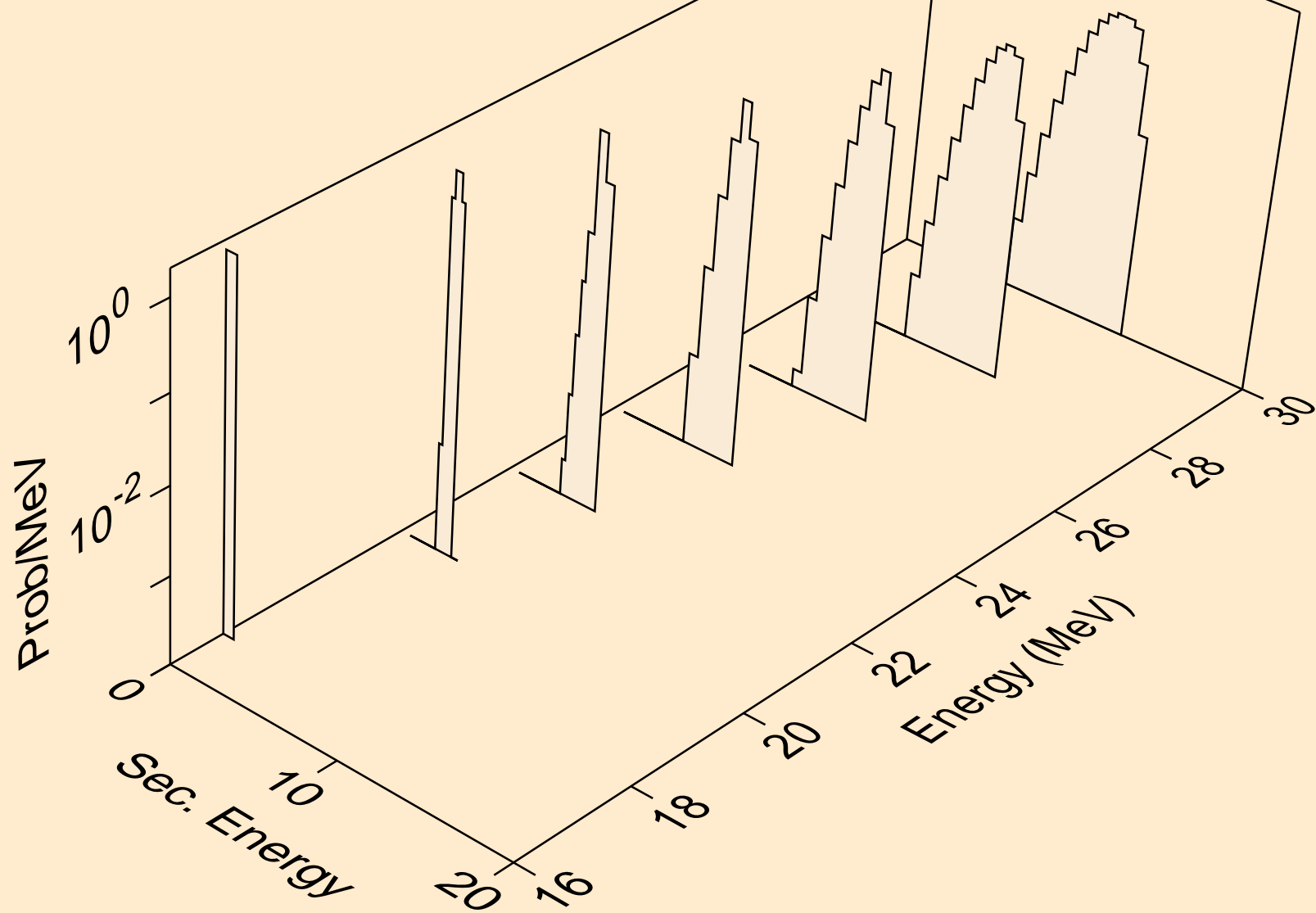

HF154 HELION ACER TENDL-2023 LIBRARY; T=0.K
tritons from (s,pt)

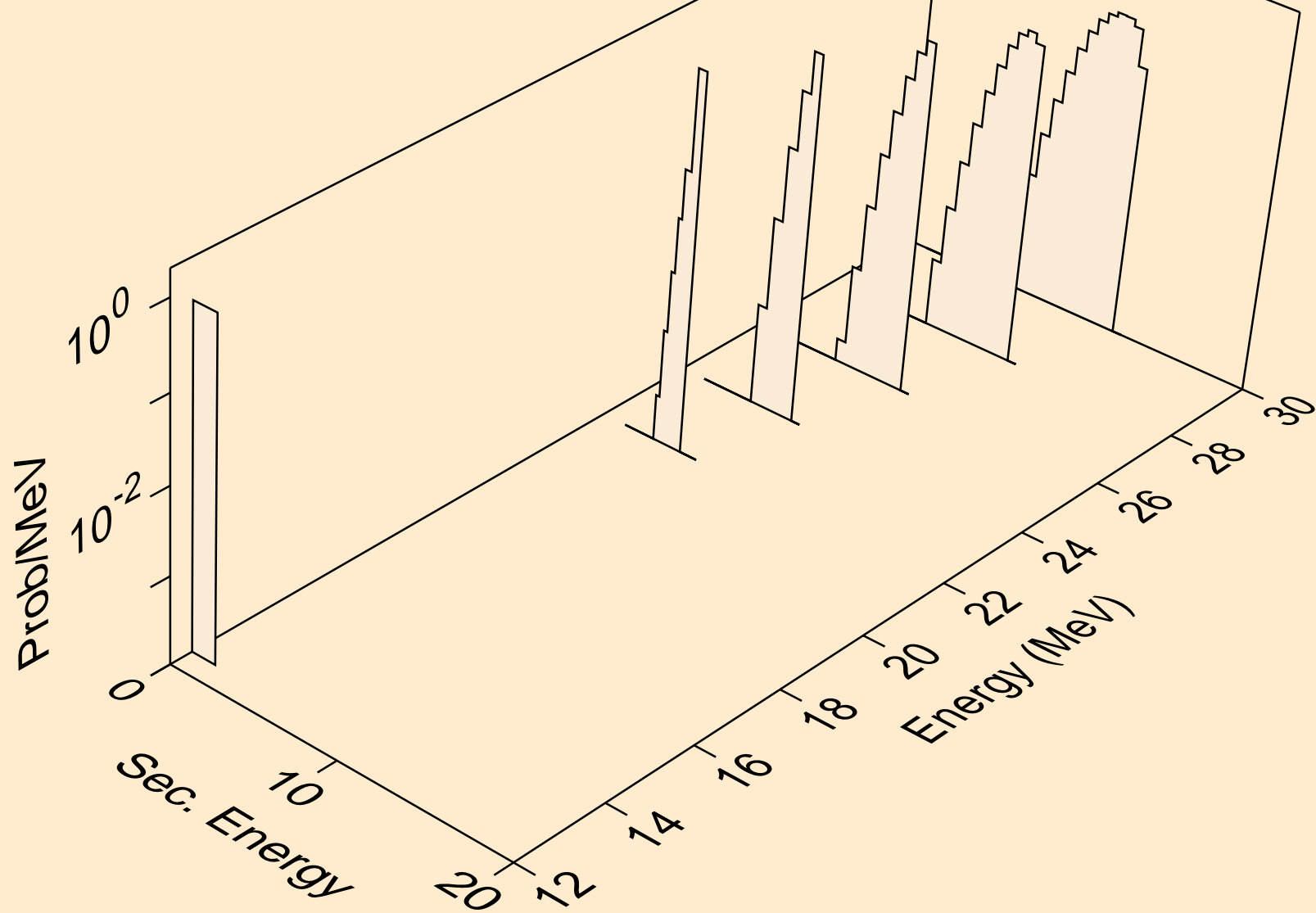

HF154 HELION ACER TENDL-2023 LIBRARY; T=0.K
alphas from (s,x)

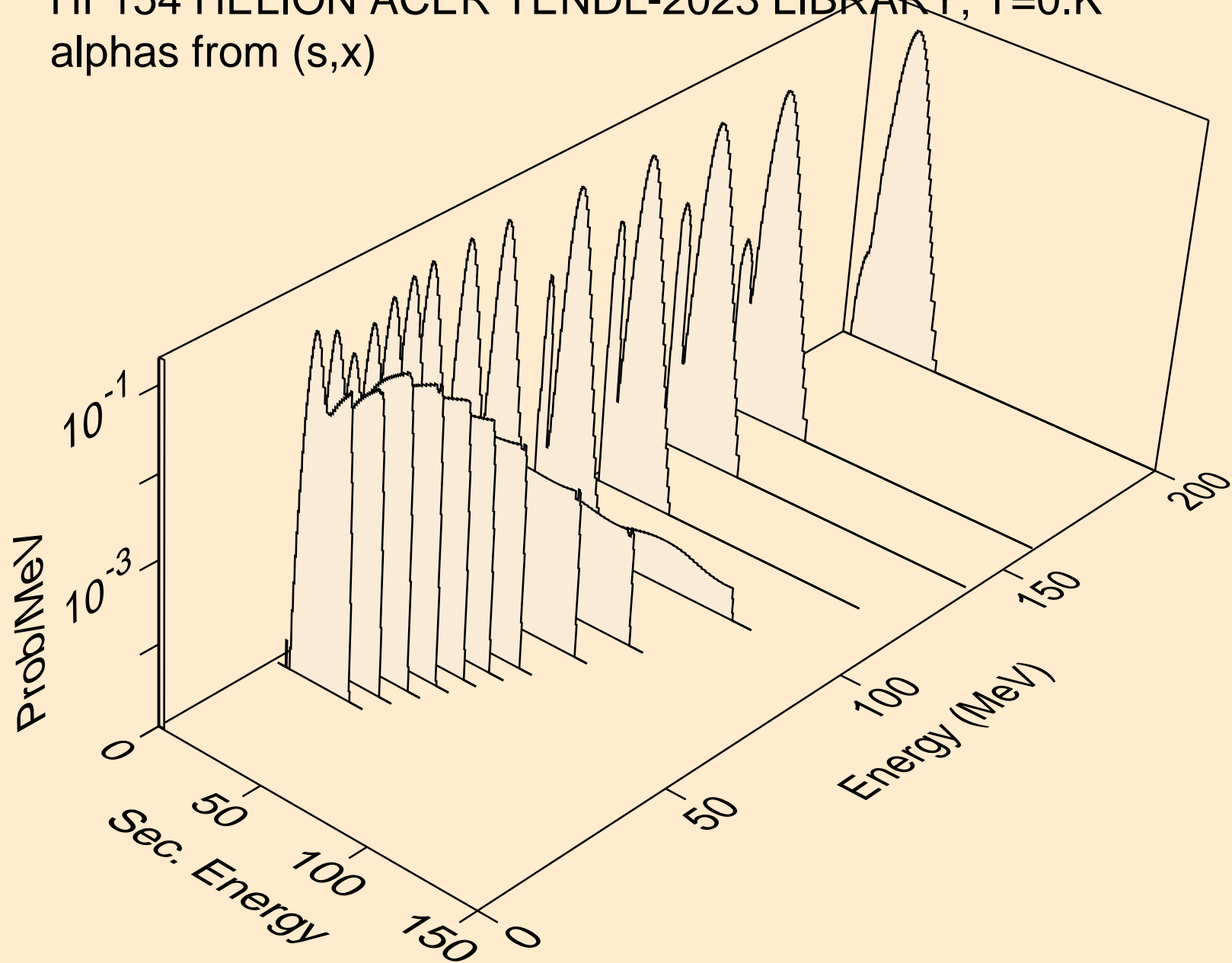

HF154 HELION ACER TENDL-2023 LIBRARY; T=0.K
alphas from (s,n*)a

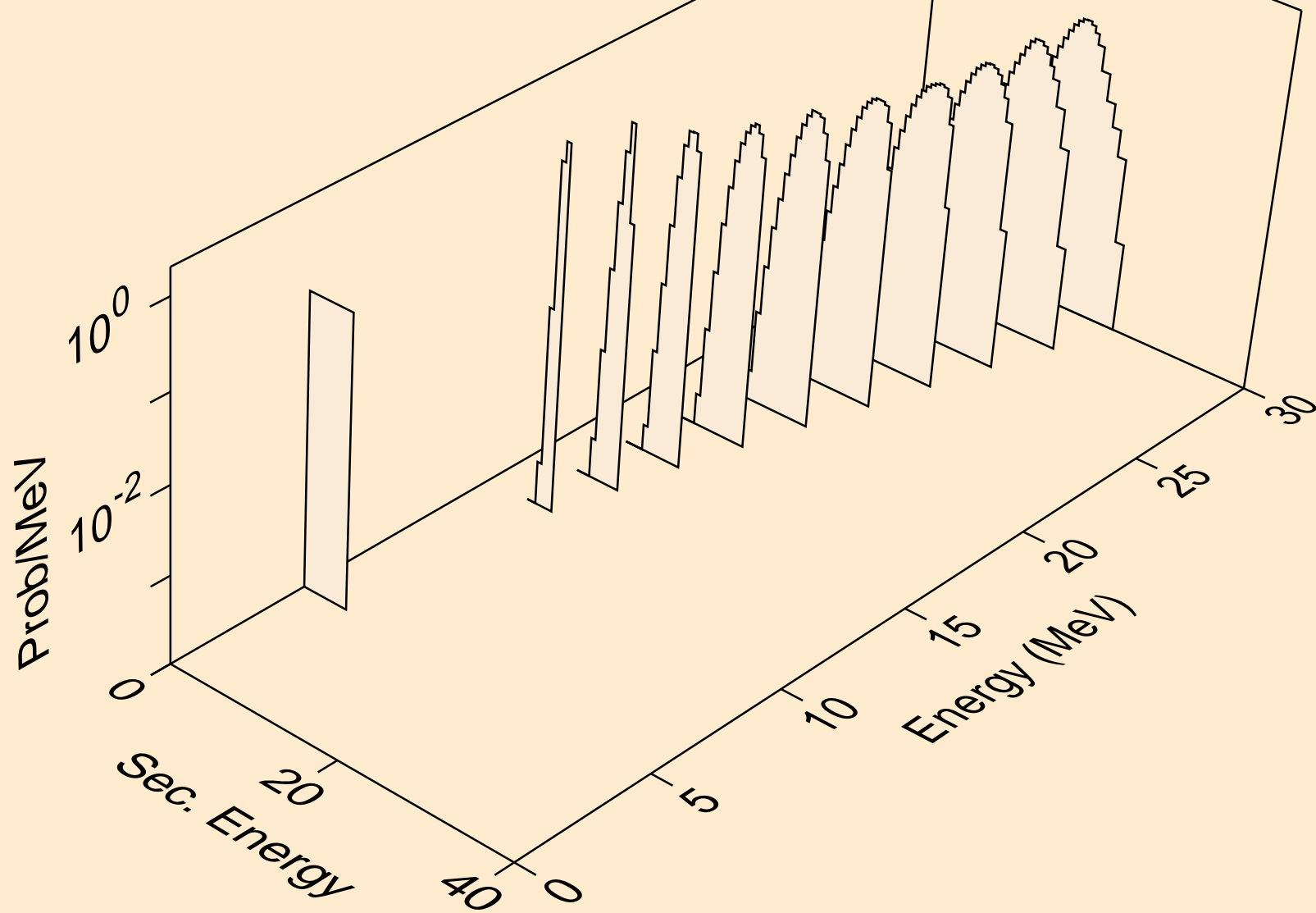

HF154 HELION ACER TENDL-2023 LIBRARY; T=0.K
alphas from (s,n*)2a

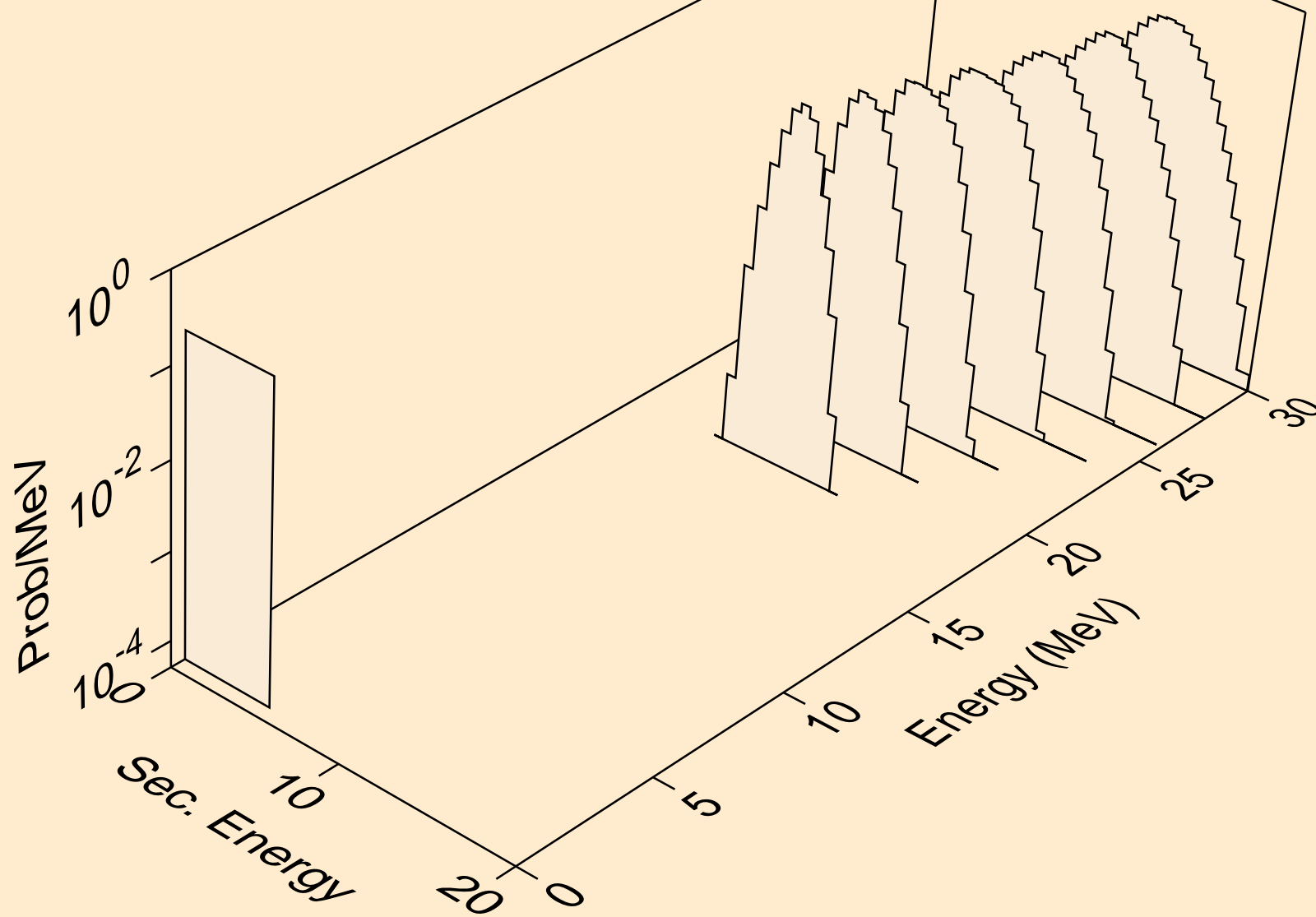

HF154 HELION ACER TENDL-2023 LIBRARY; T=0.K
alphas from (s,npa)

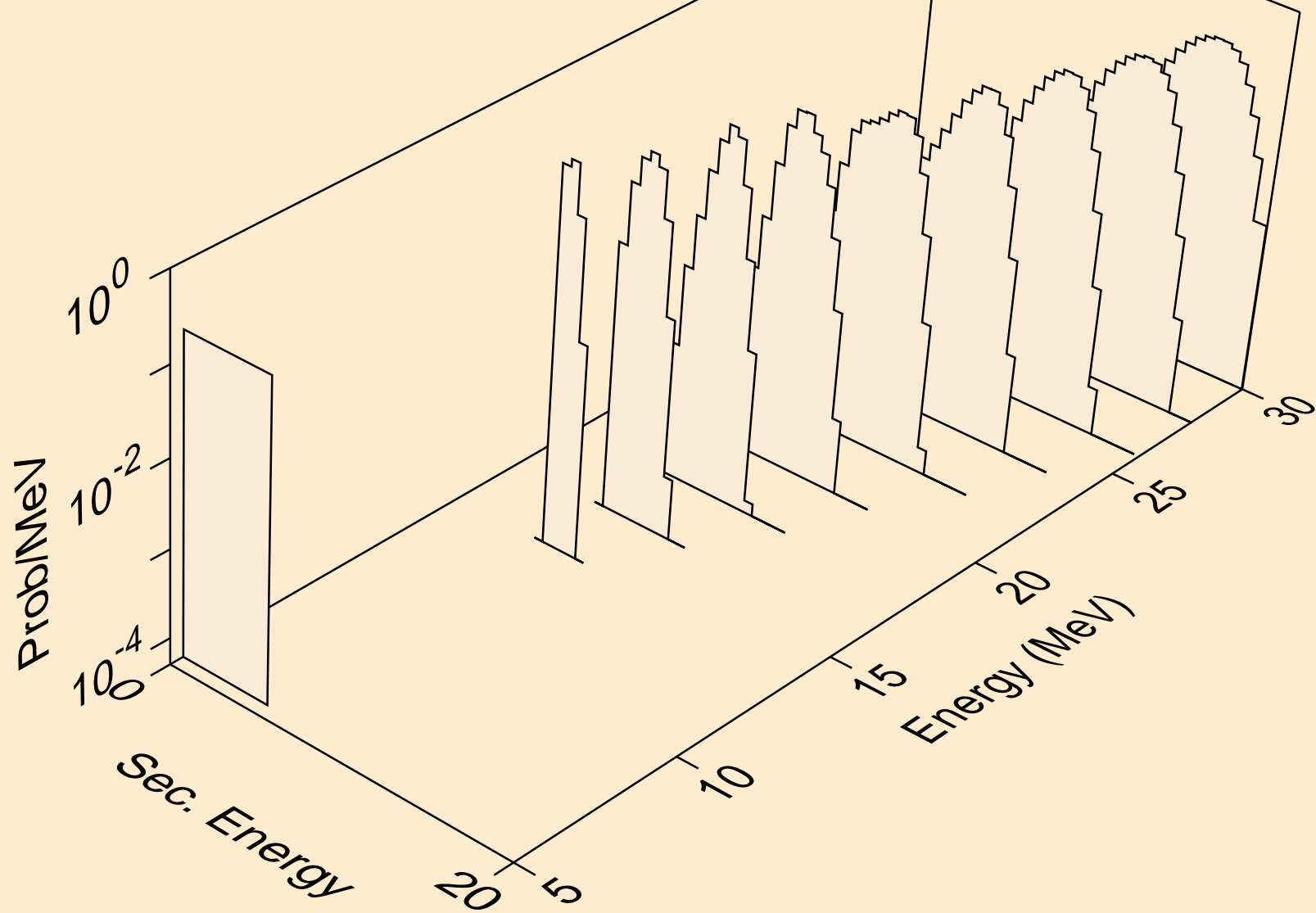

HF154 HELION ACER TENDL-2023 LIBRARY; T=0.K
alphas from (s,a)

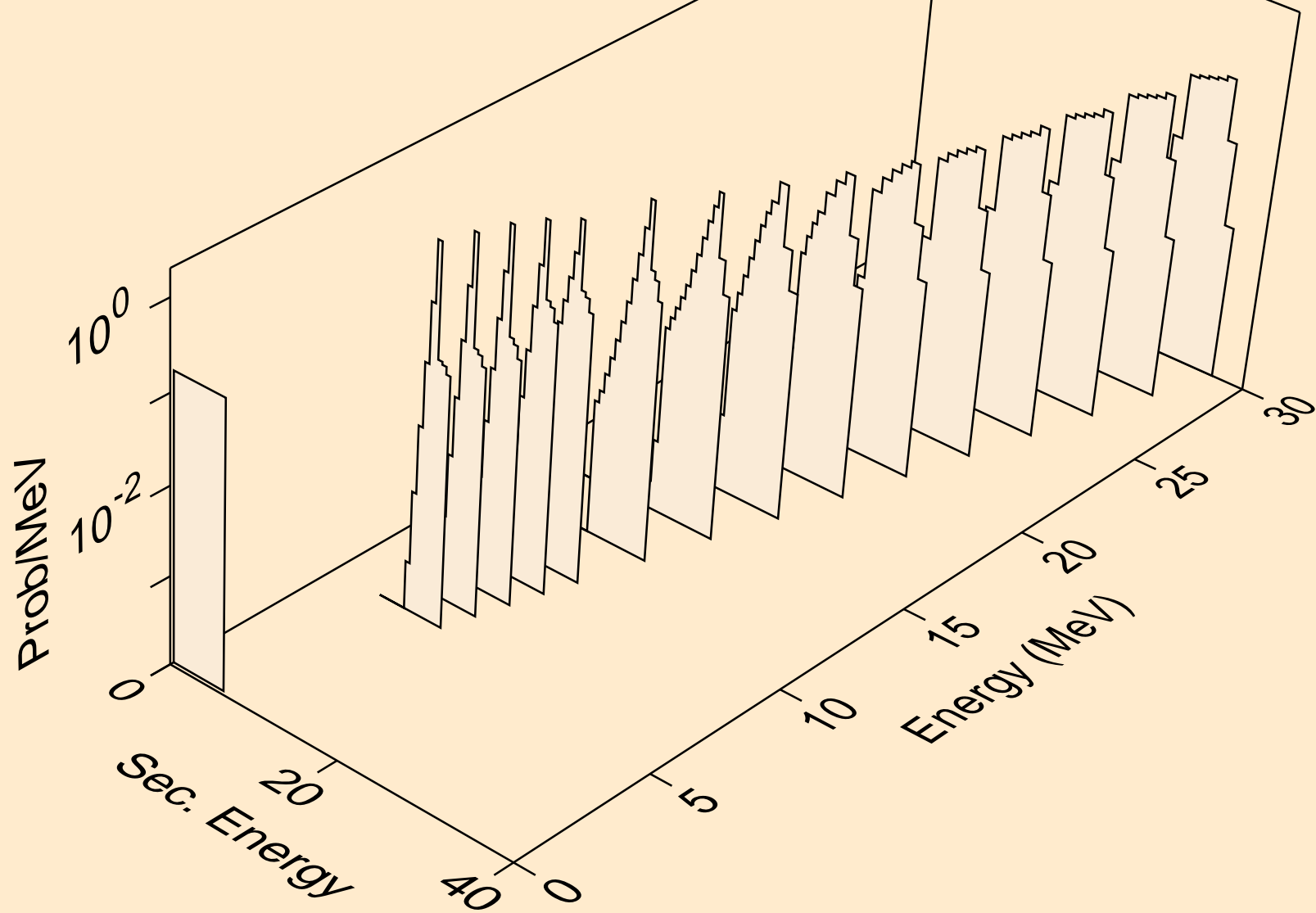

HF154 HELION ACER TENDL-2023 LIBRARY; T=0.K
alphas from (s,2a)

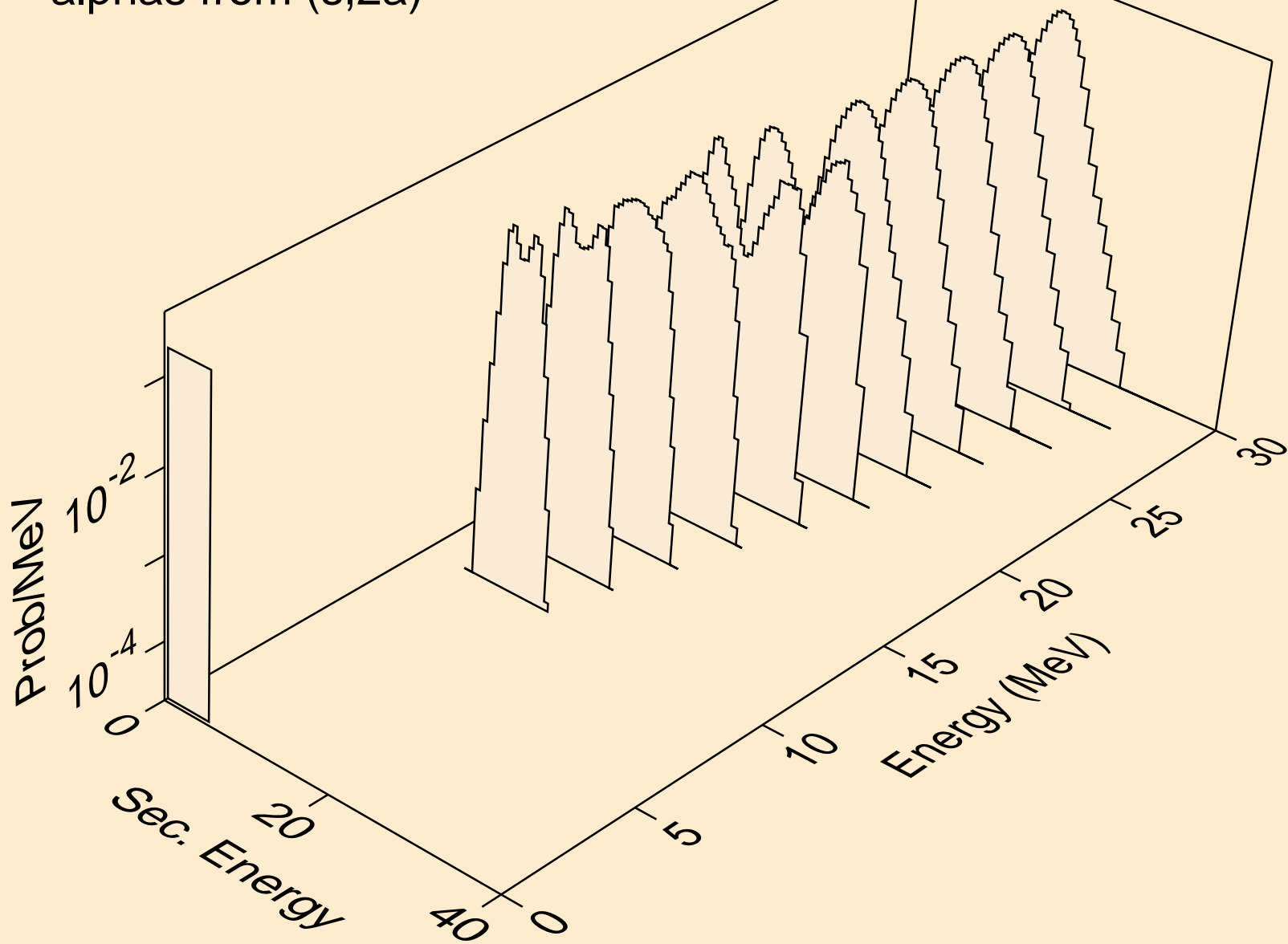

HF154 HELION ACER TENDL-2023 LIBRARY; T=0.K
alphas from (s,pa)

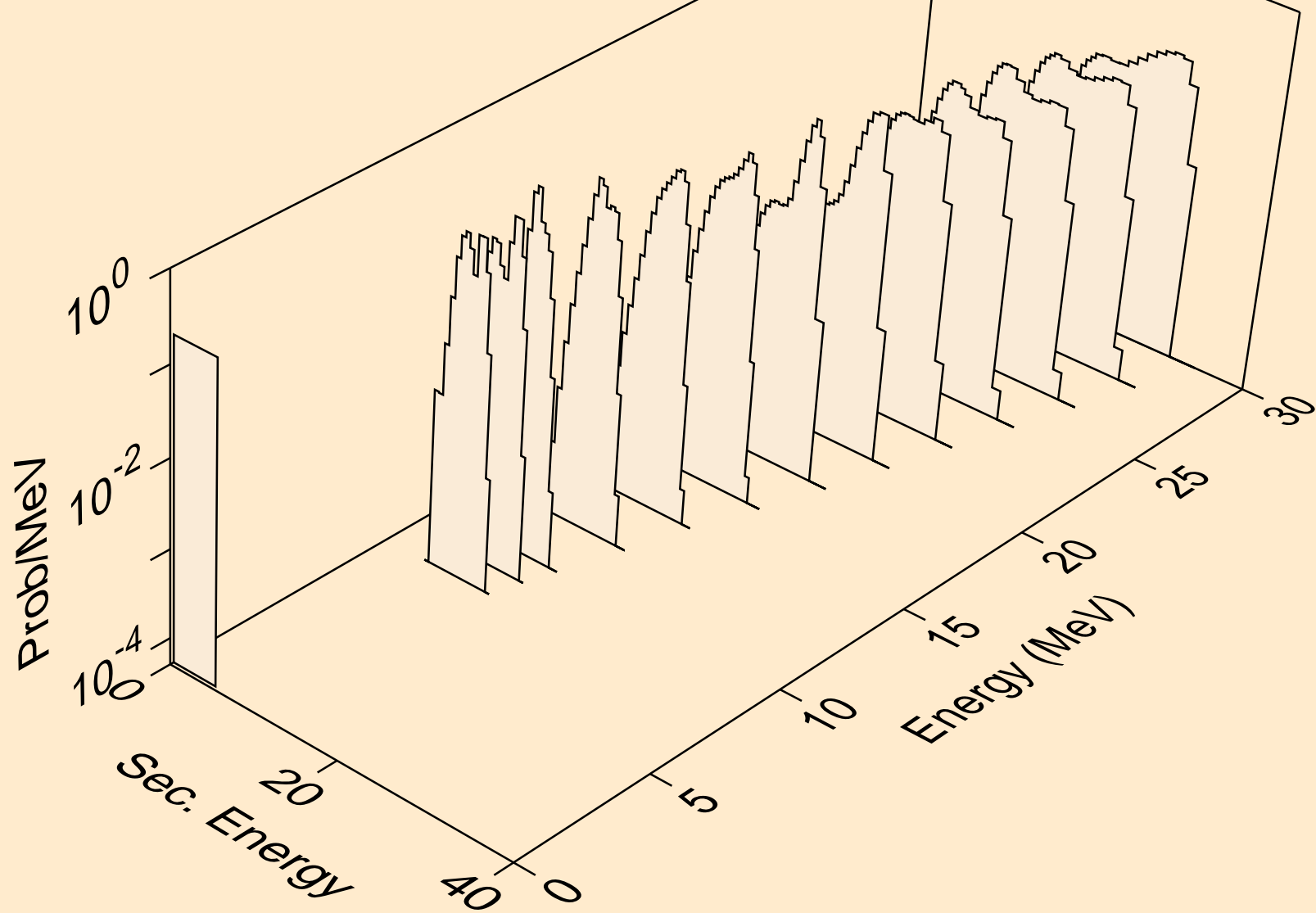

HF154 HELION ACER TENDL-2023 LIBRARY; T=0.K
alphas from (s,da)

