

PO201M HELION ACER TENDL-2023 LIBRARY; T=0.K  
Principal cross sections

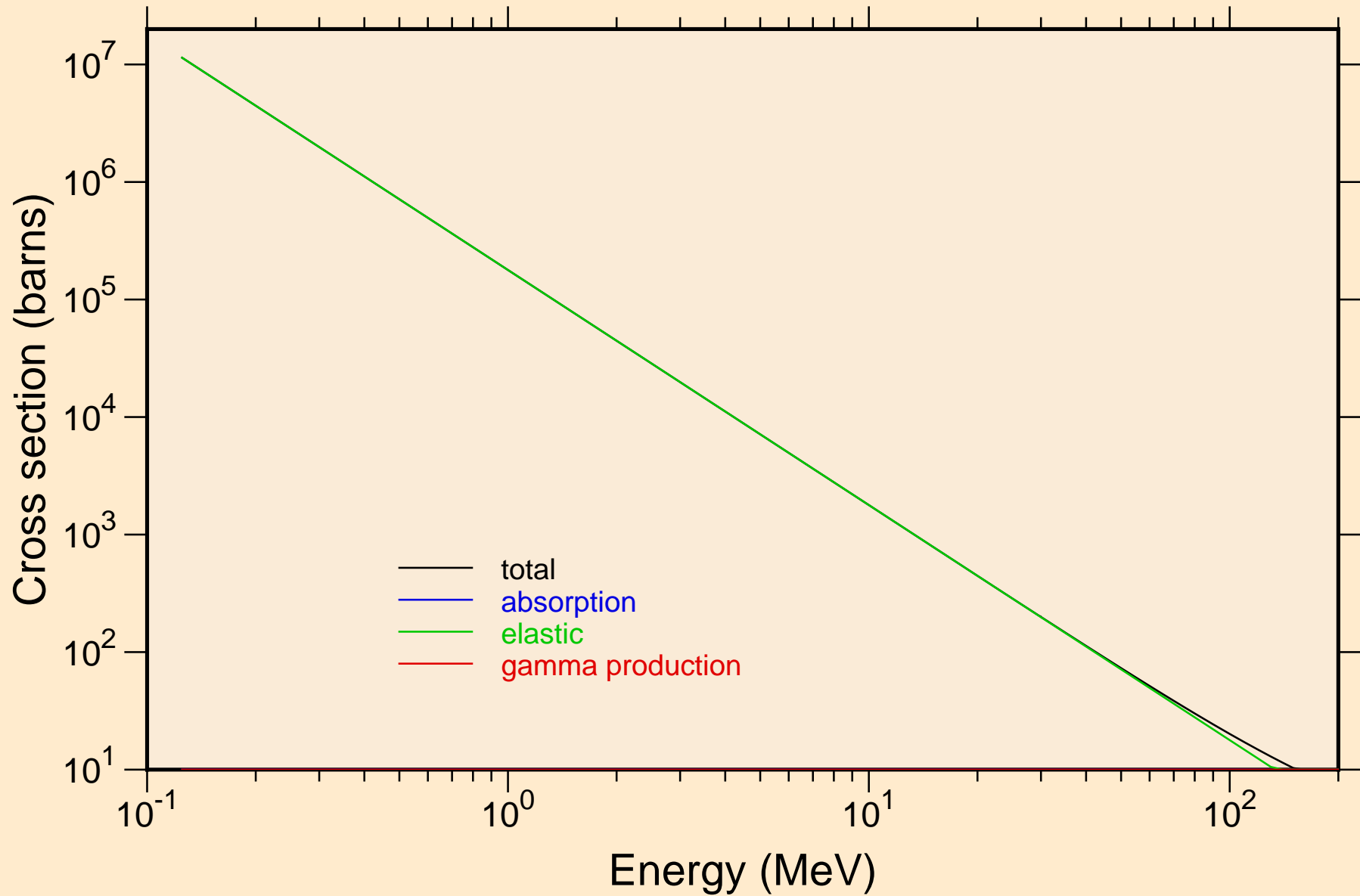

PO201M HELION ACER TENDL-2023 LIBRARY; T=0.K

Heating

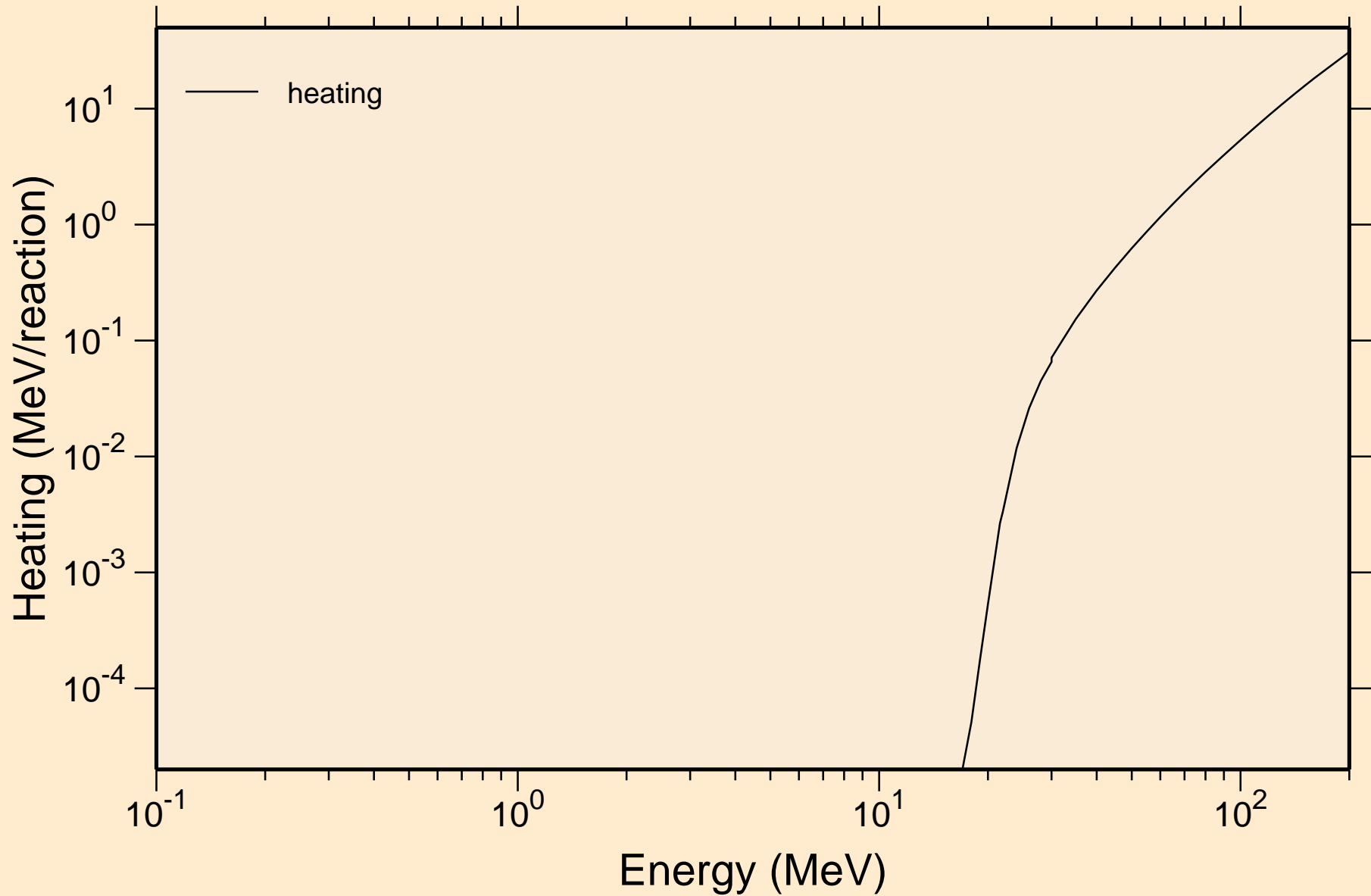

PO201M HELION ACER TENDL-2023 LIBRARY; T=0.K

Principal cross sections

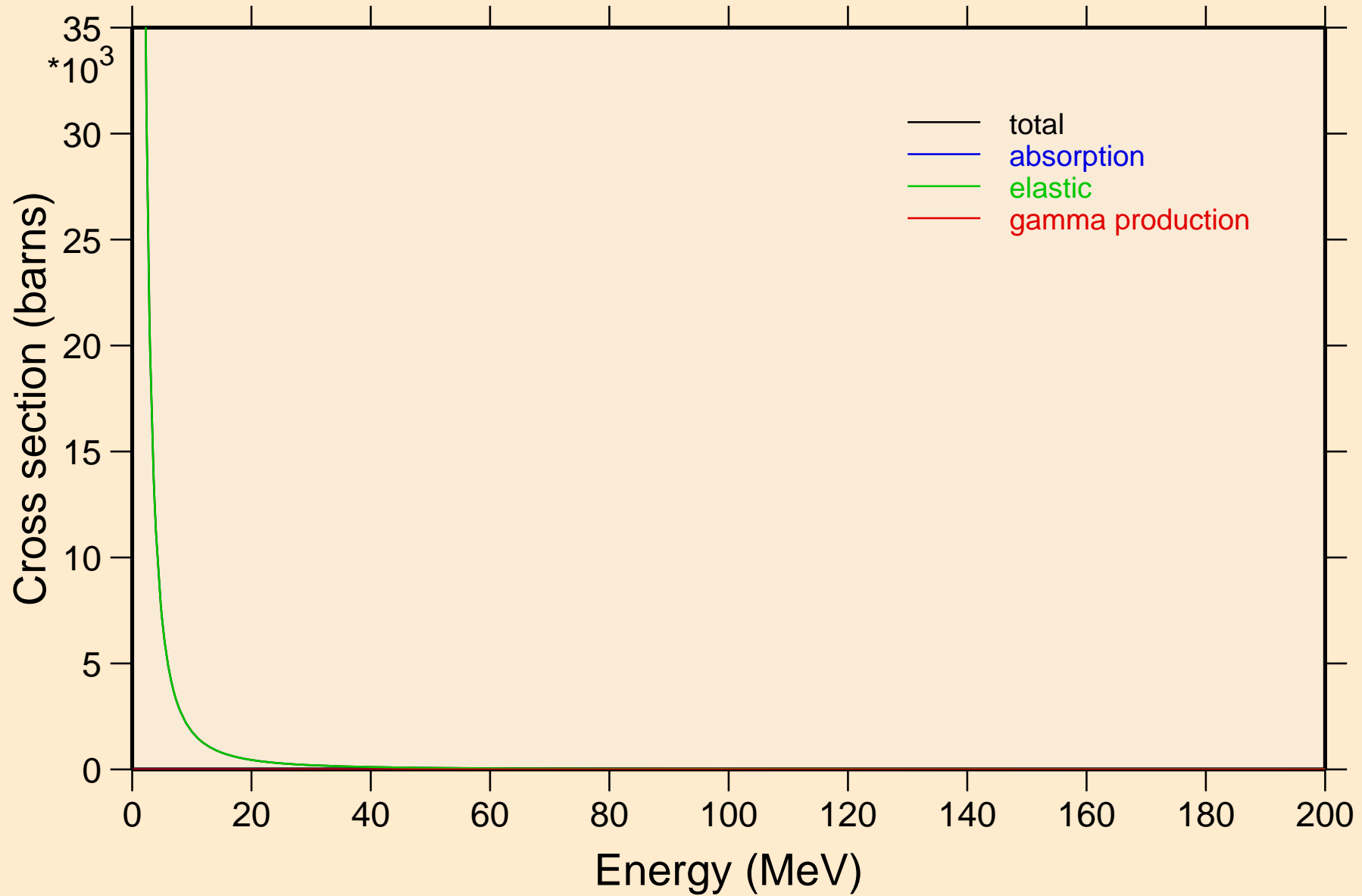

PO201M HELION ACER TENDL-2023 LIBRARY; T=0.K

Heating

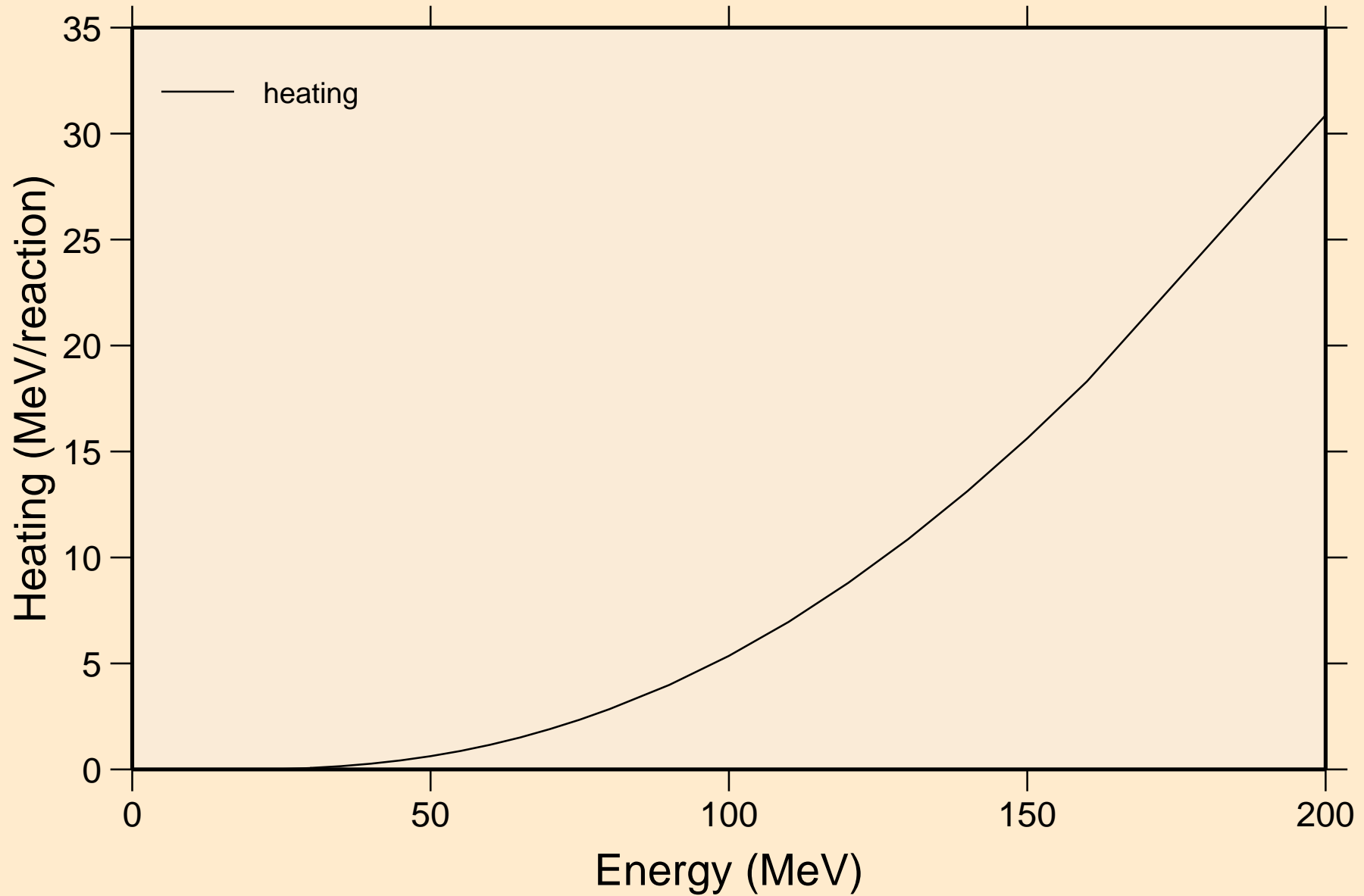

PO201M HELION ACER TENDL-2023 LIBRARY; T=0.K  
Threshold reactions

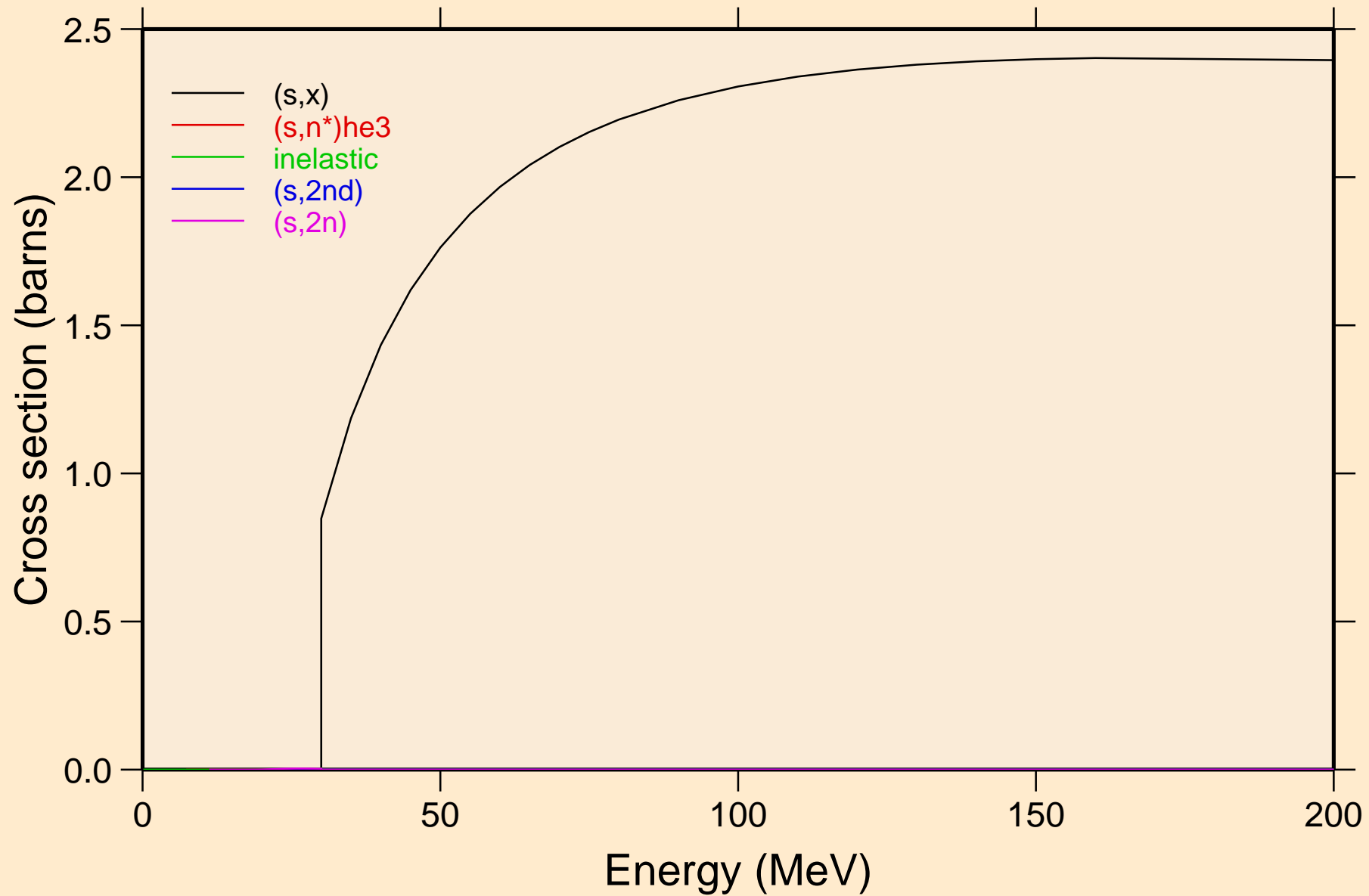

PO201M HELION ACER TENDL-2023 LIBRARY; T=0.K  
Threshold reactions

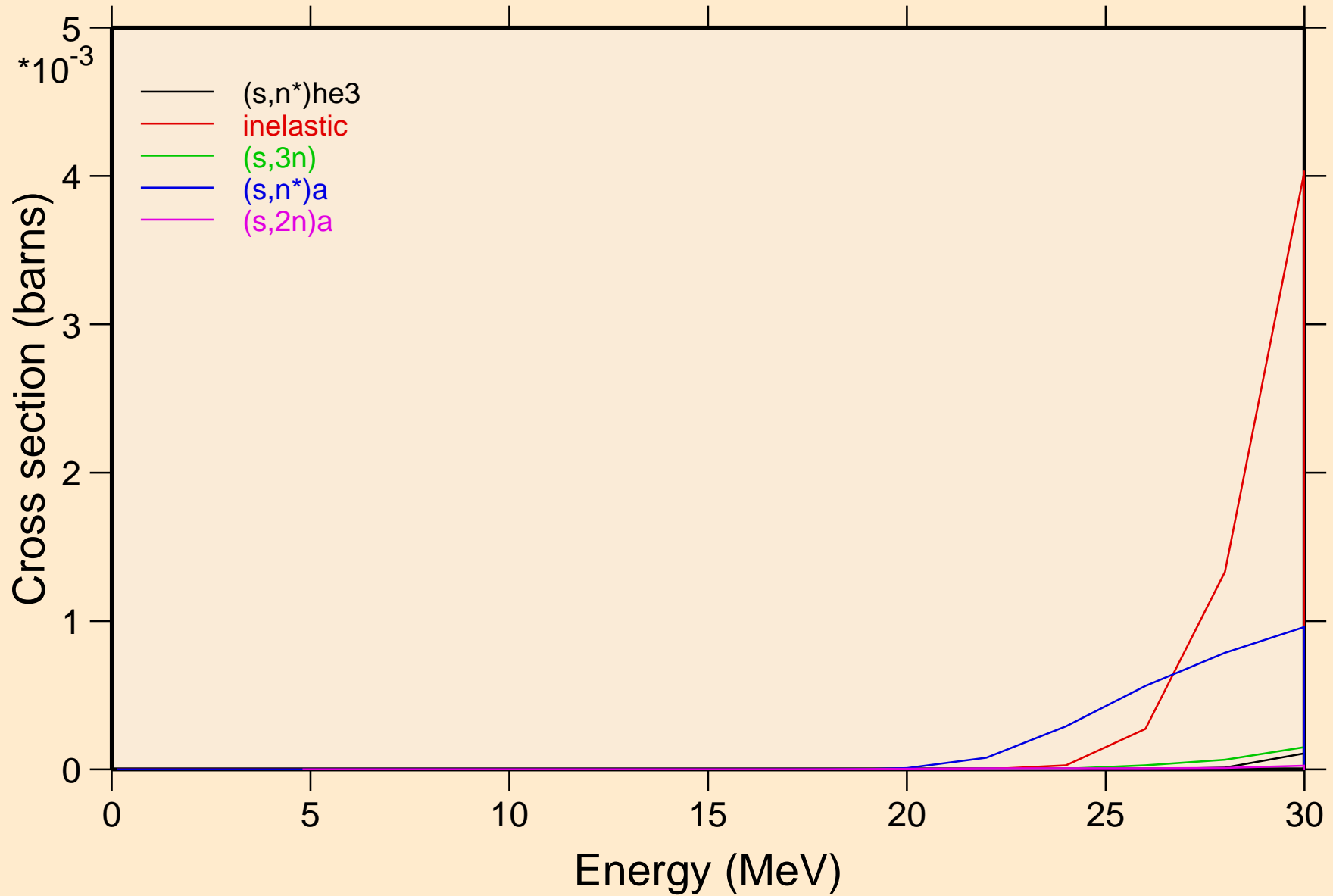

PO201M HELION ACER TENDL-2023 LIBRARY; T=0.K  
Threshold reactions

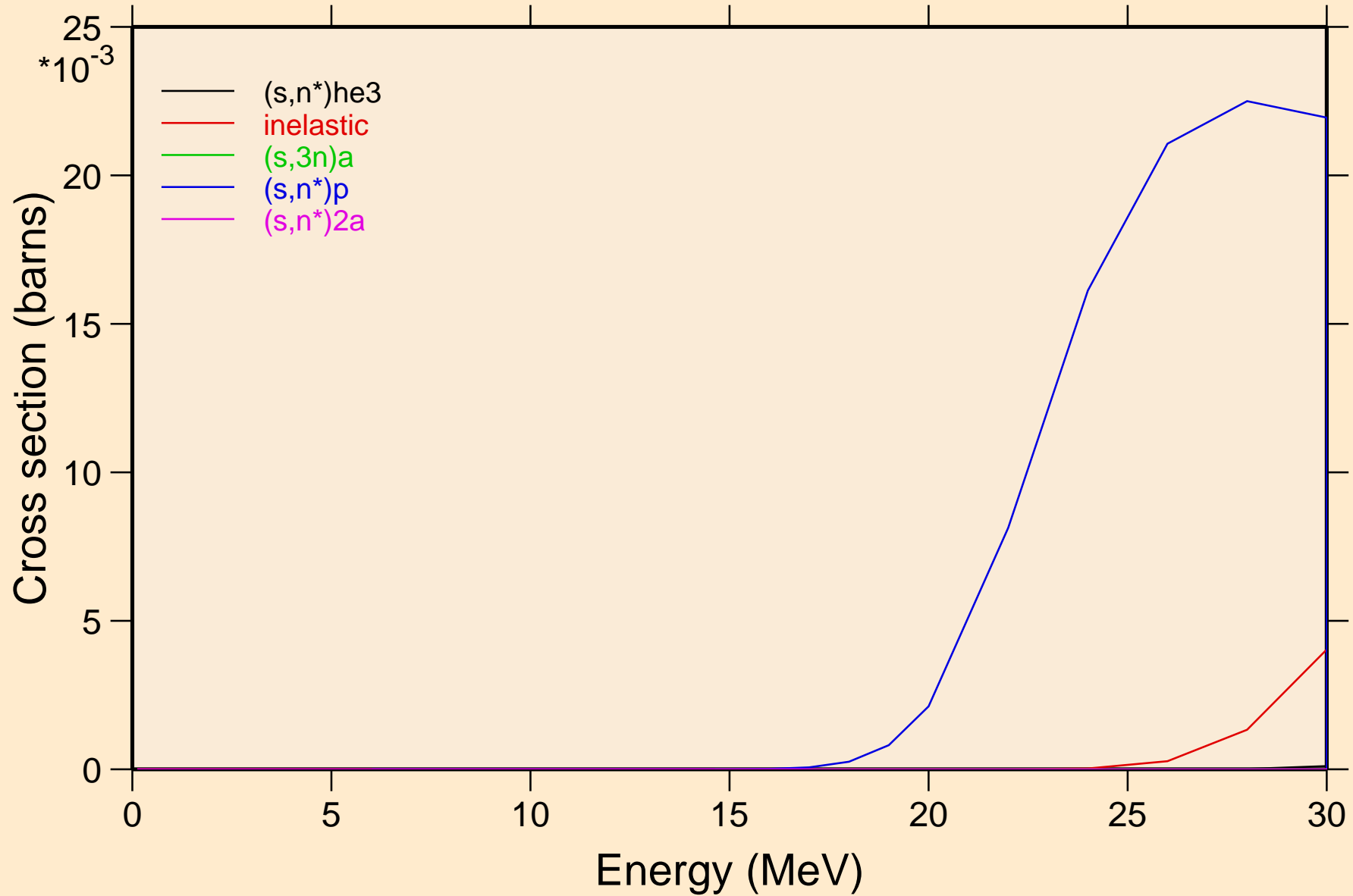

PO201M HELION ACER TENDL-2023 LIBRARY; T=0.K  
Threshold reactions

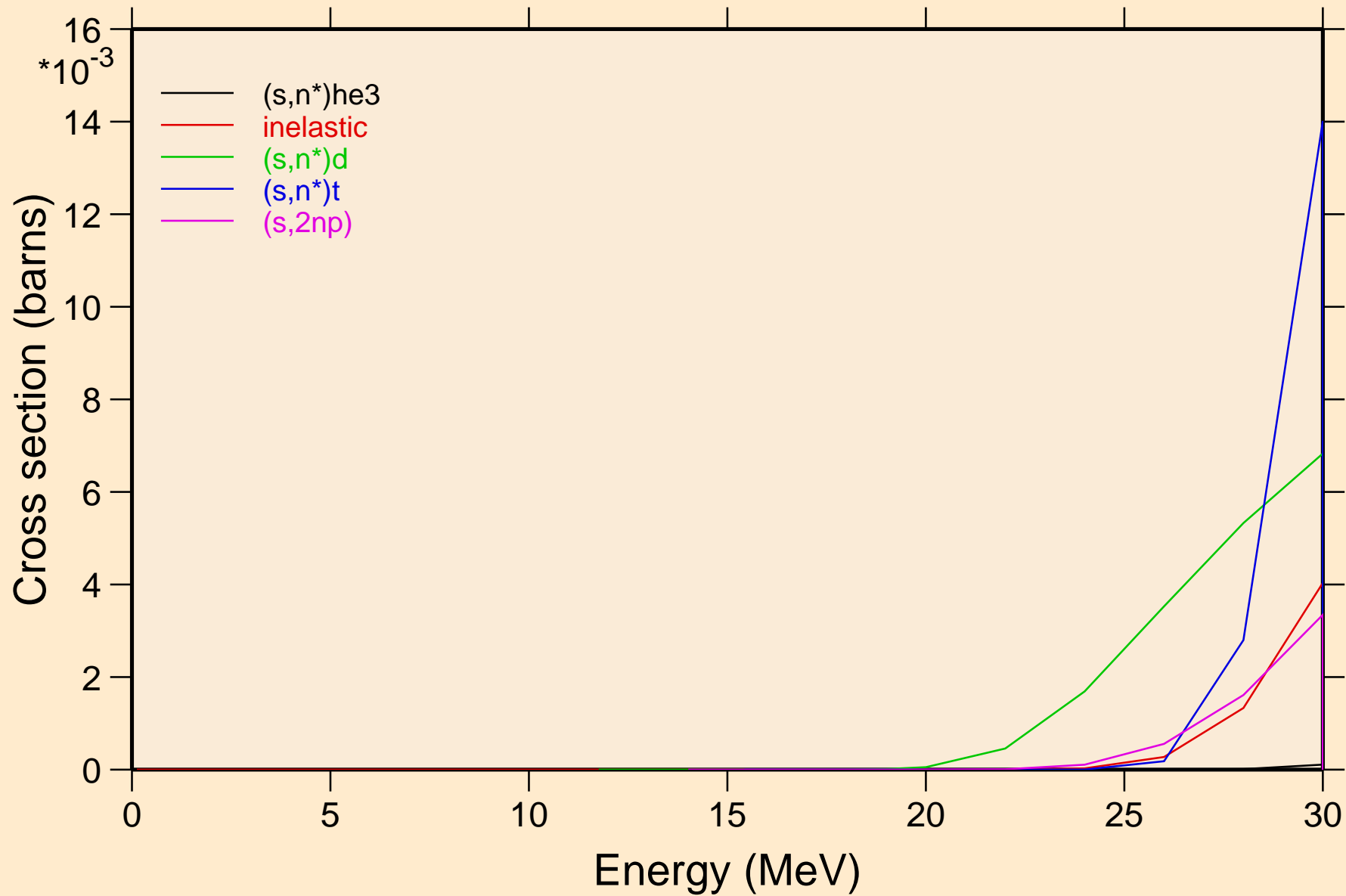



PO201M HELION ACER TENDL-2023 LIBRARY; T=0.K  
Threshold reactions

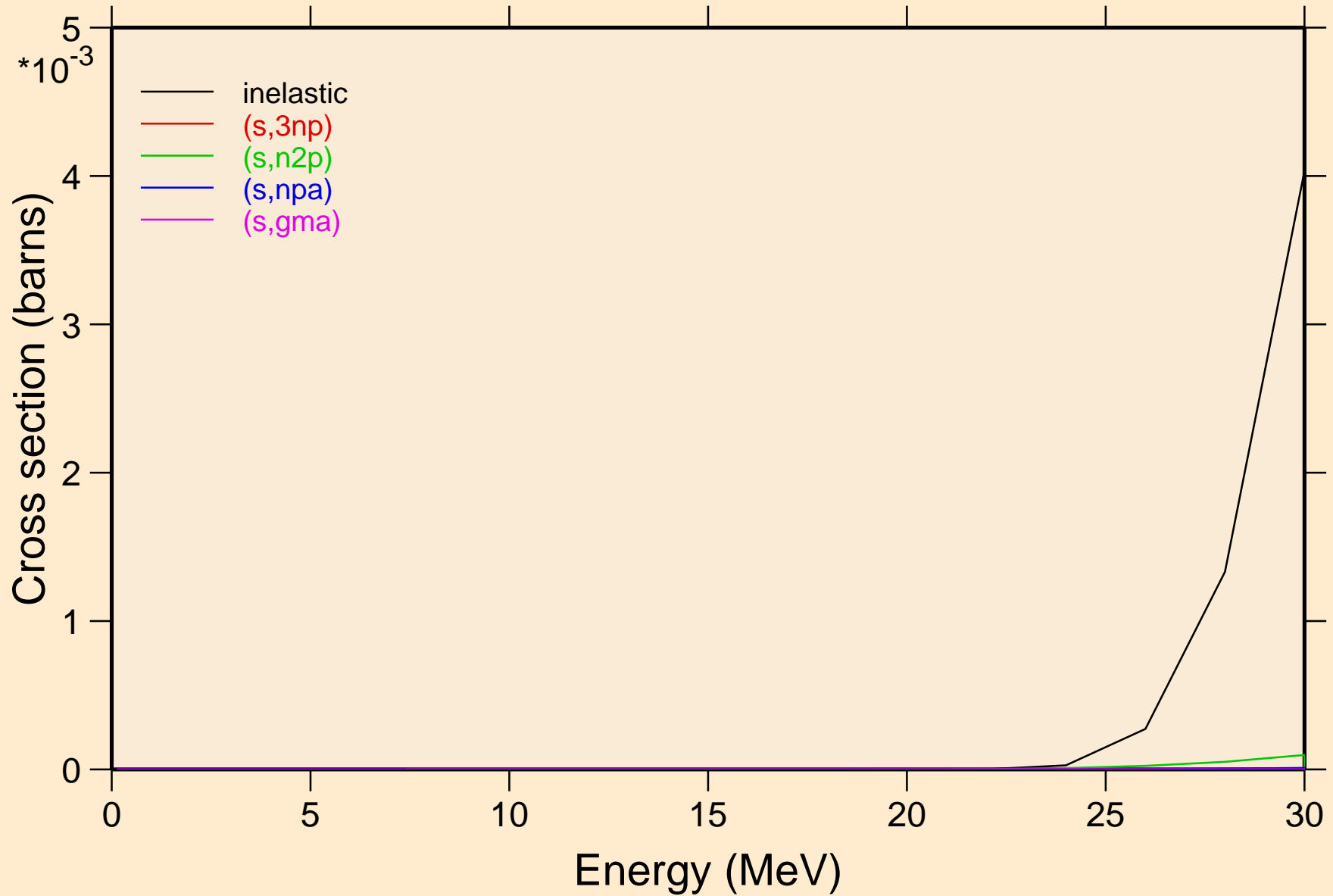

PO201M HELION ACER TENDL-2023 LIBRARY; T=0.K  
Threshold reactions

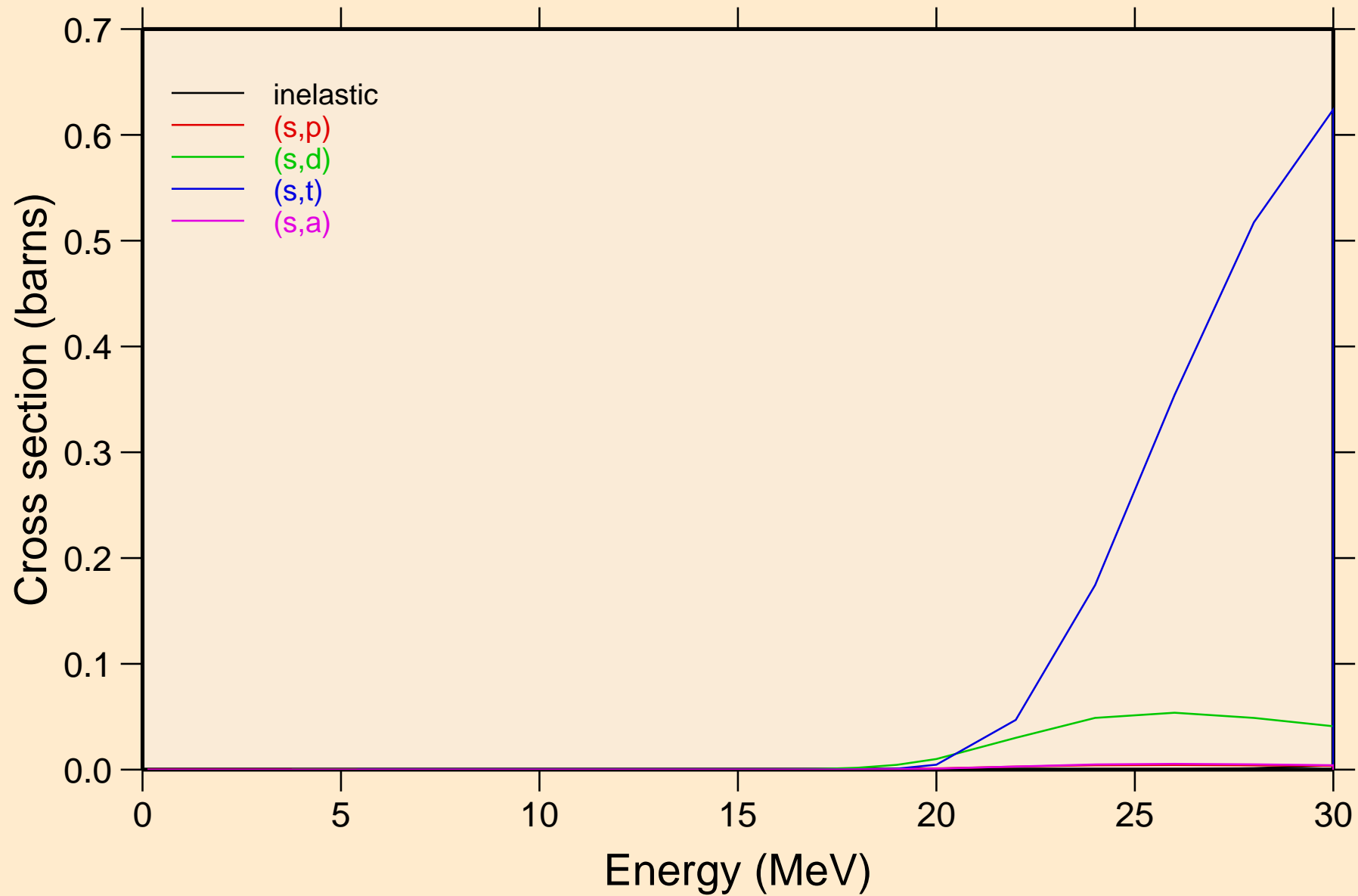

PO201M HELION ACER TENDL-2023 LIBRARY; T=0.K  
Threshold reactions

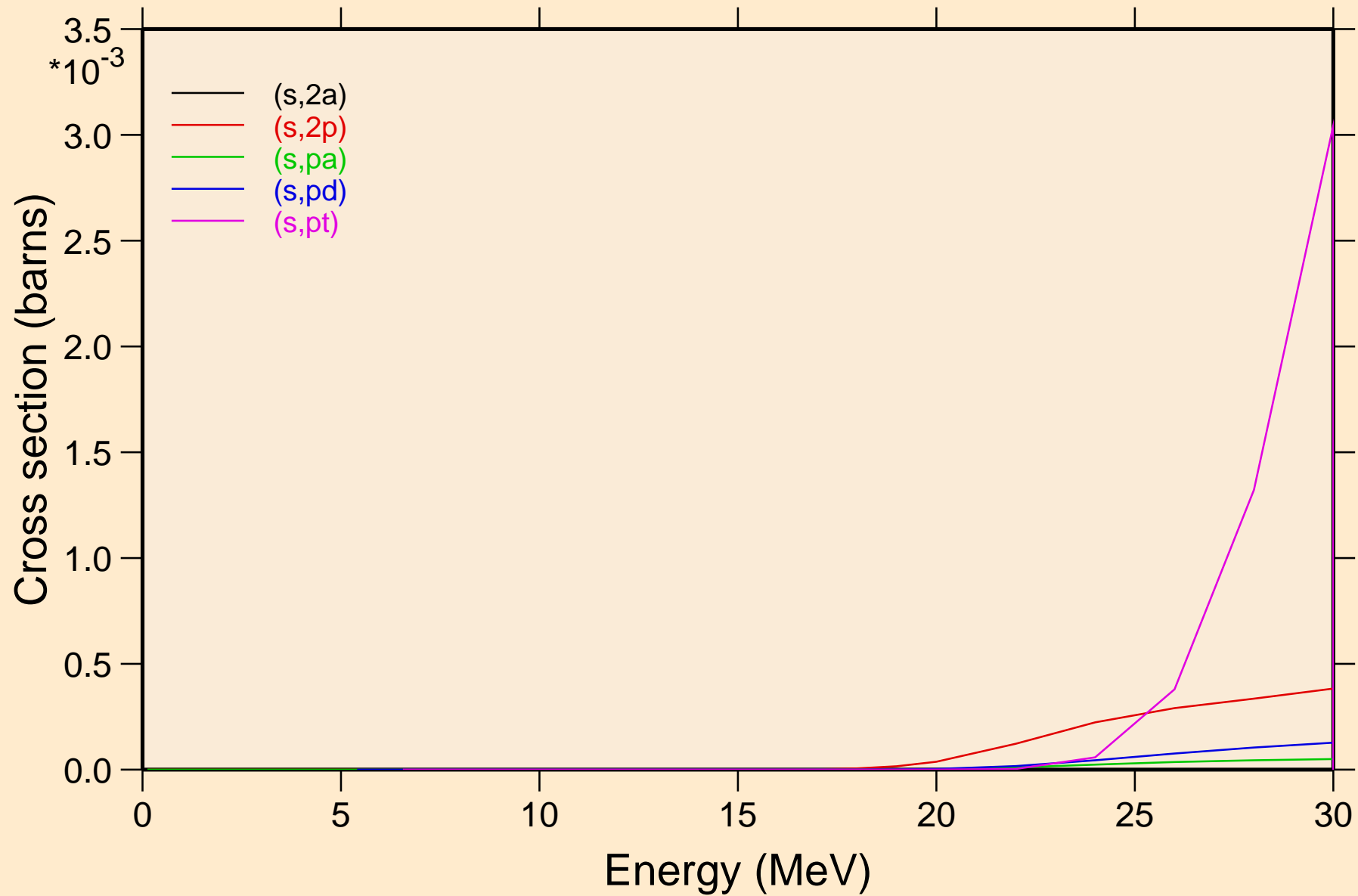

PO201M HELION ACER TENDL-2023 LIBRARY; T=0.K  
Threshold reactions

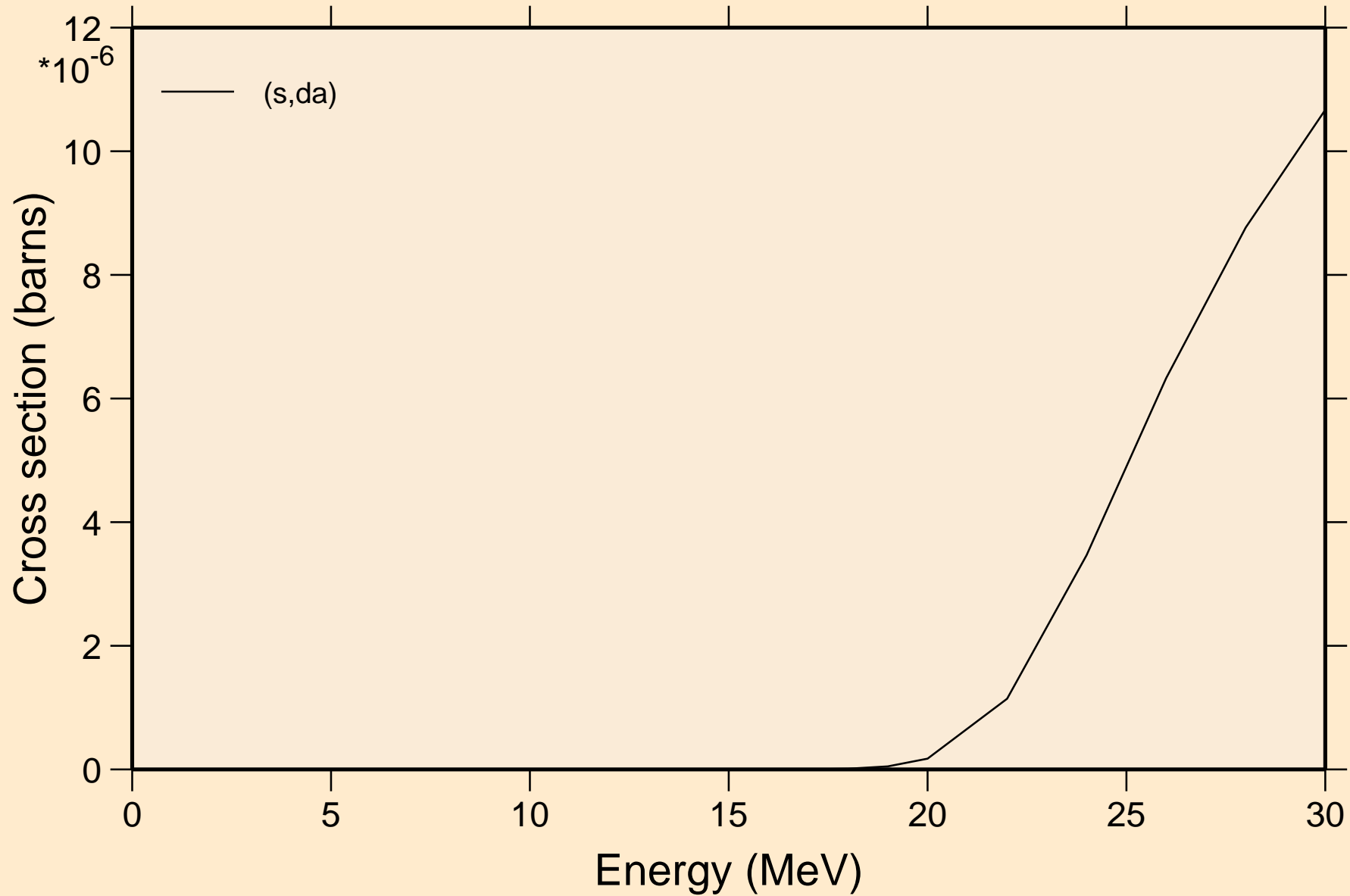

PO201M HELION ACER TENDL-2023 LIBRARY; T=0.K  
angular distribution for elastic

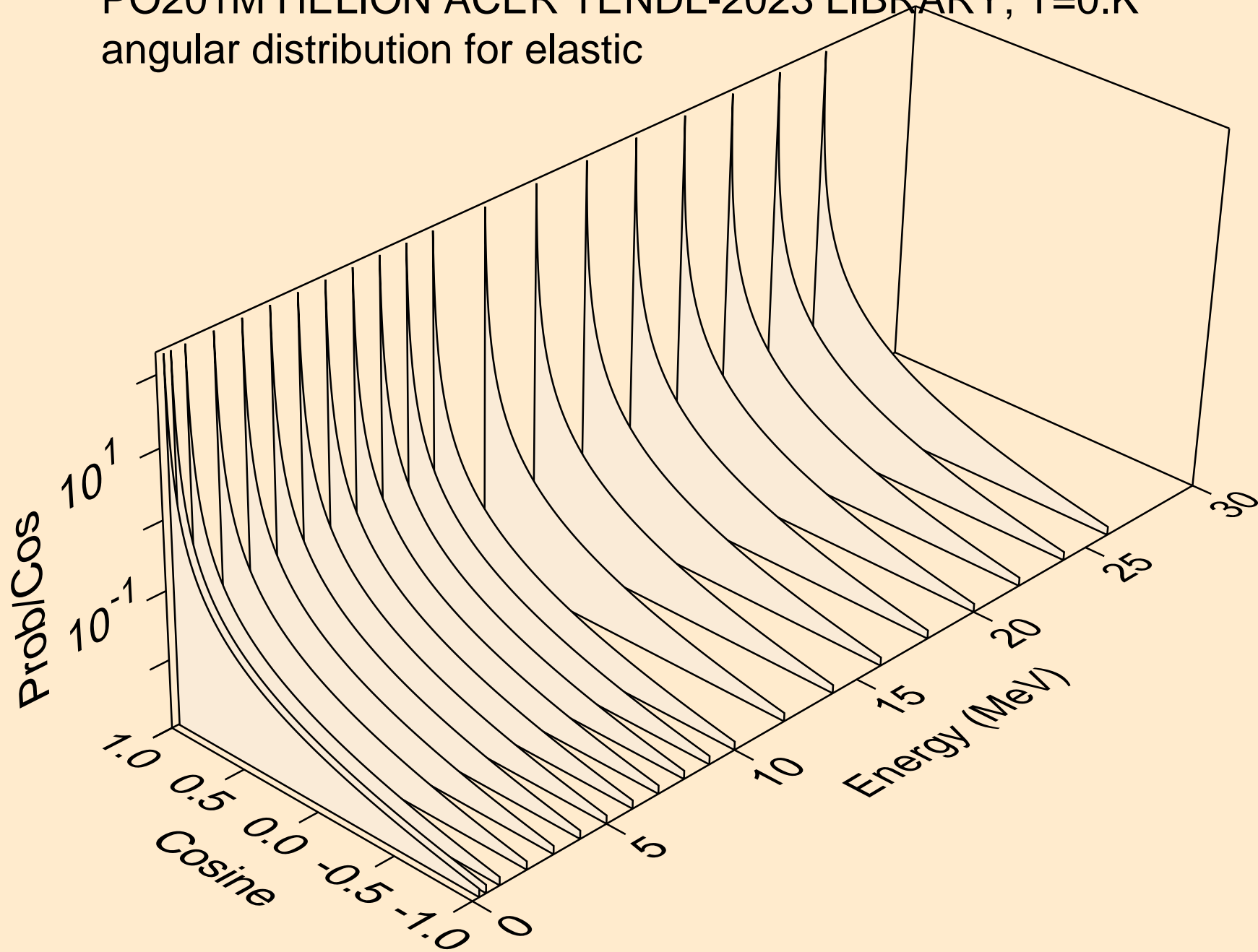

PO201M HELION ACER TENDL-2023 LIBRARY; T=0.K  
He-3 emission for (s,x)

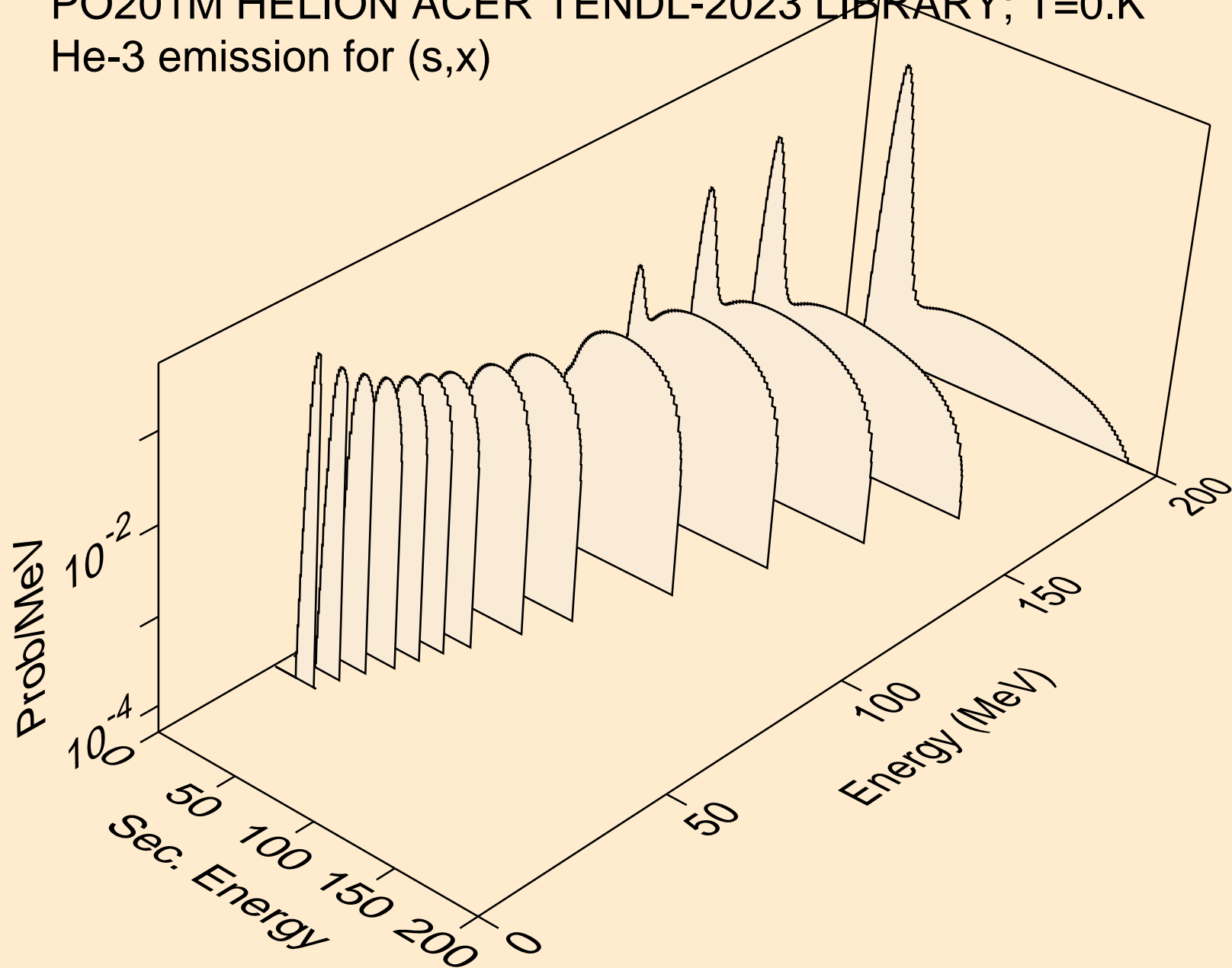

PO201M HELION ACER TENDL-2023 LIBRARY; T=0.K  
He-3 emission for (s,n\*)he3

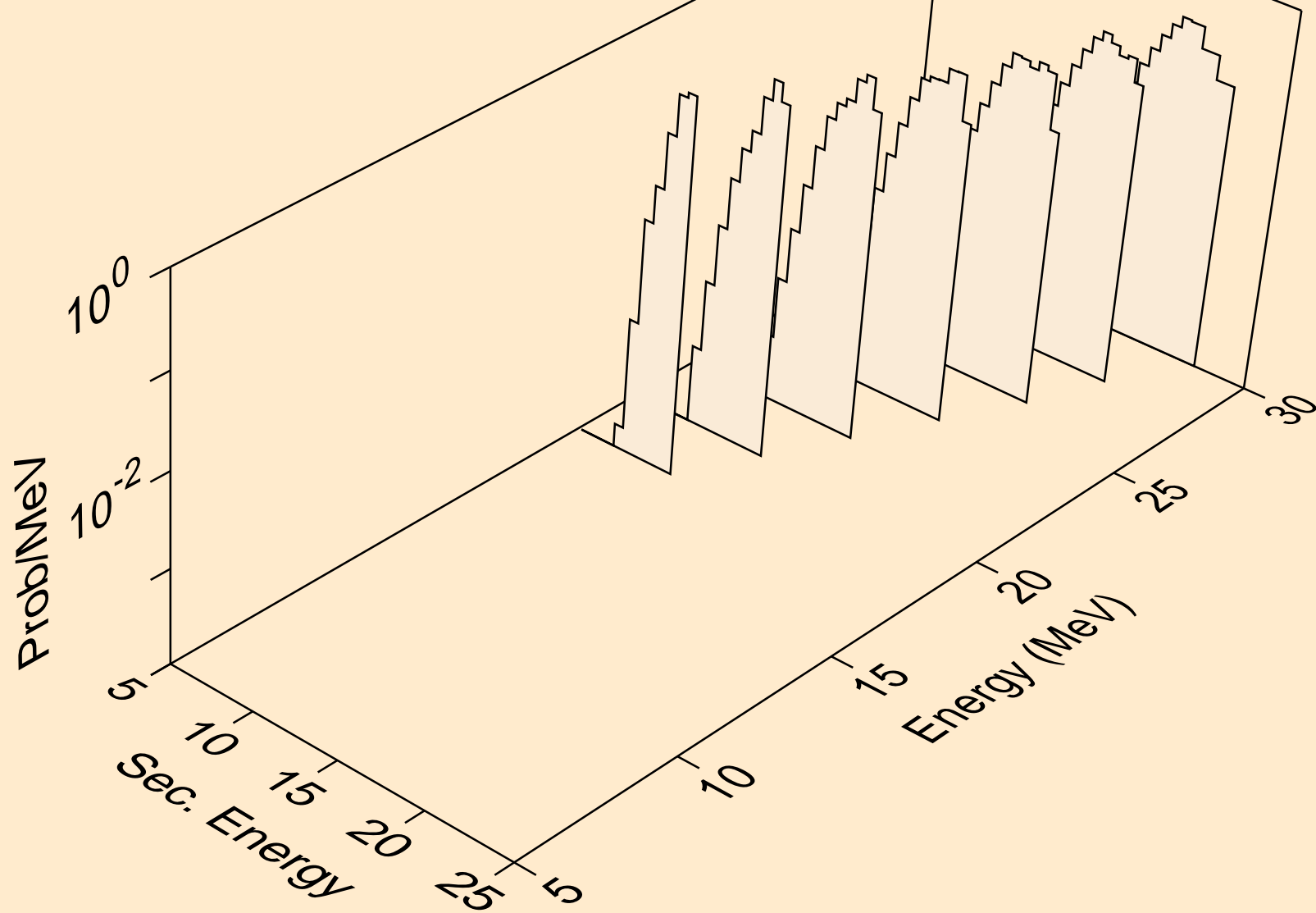

PO201M HELION ACER TENDL-2023 LIBRARY; T=0.K  
He-3 emission for inelastic

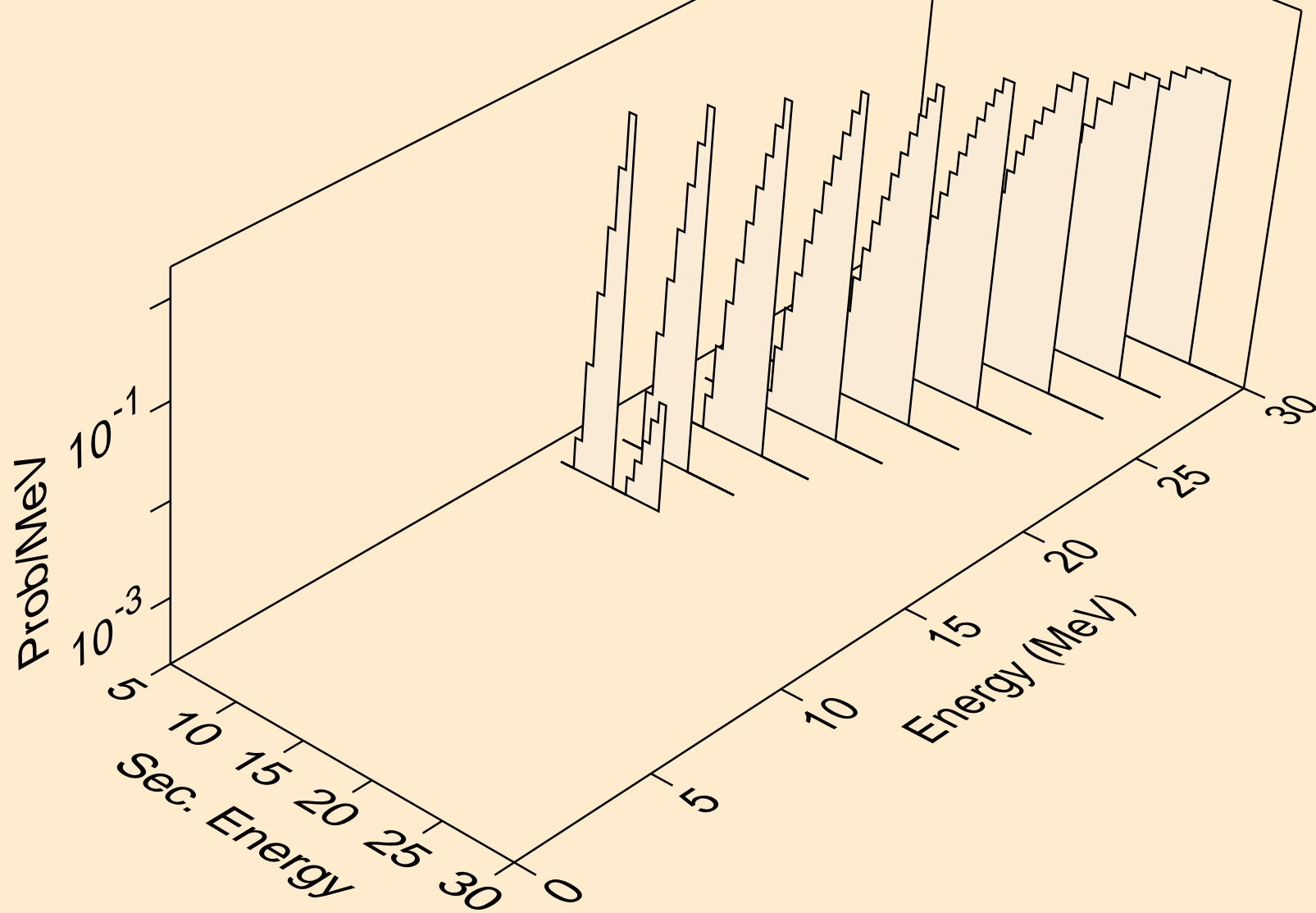



PO201M HELION ACER TENDL-2023 LIBRARY; T=0.K  
Photon emission for (z,n)

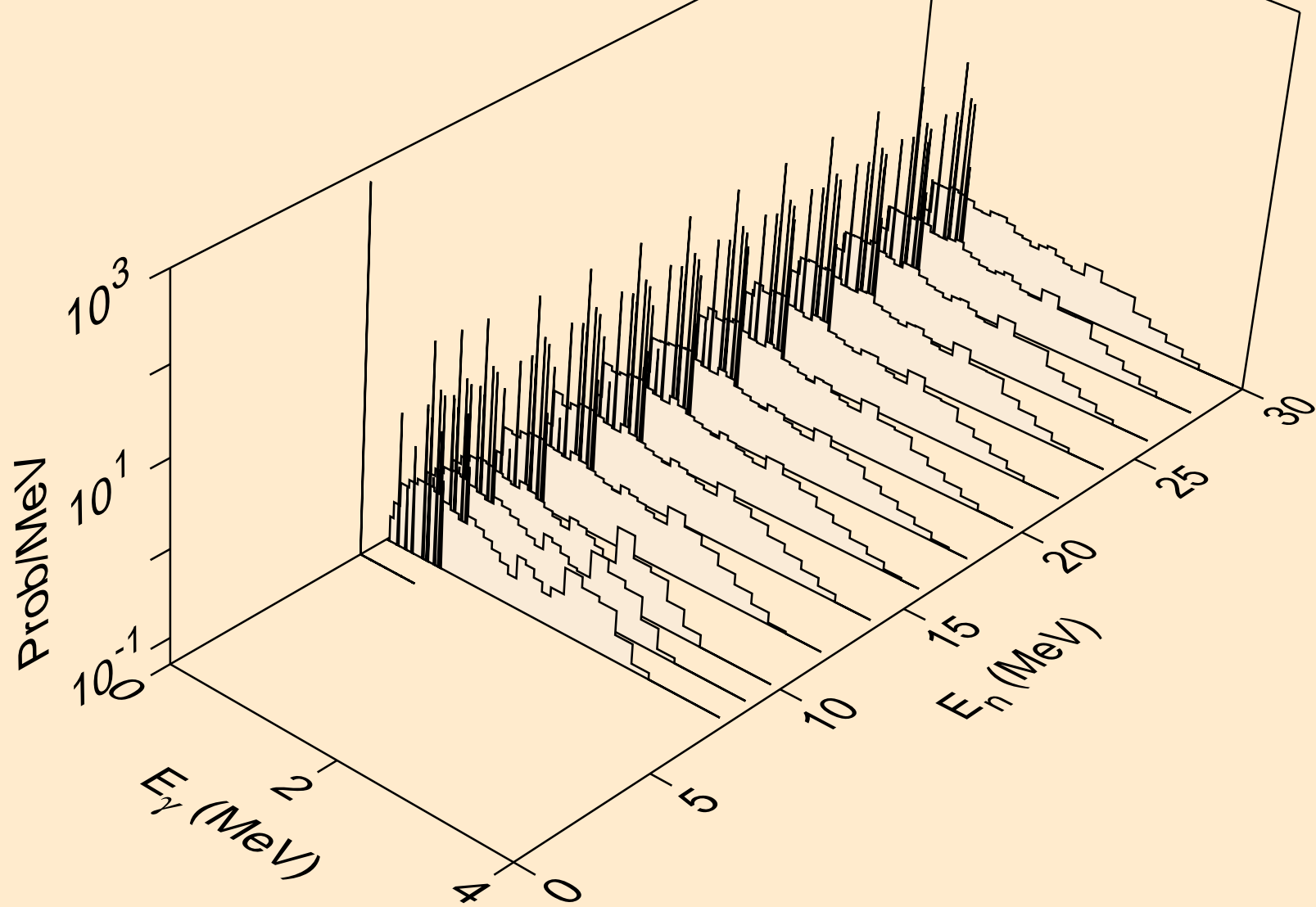

PO201M HELION ACER TENDL-2023 LIBRARY; T=0.K  
Photon emission for (z,x)

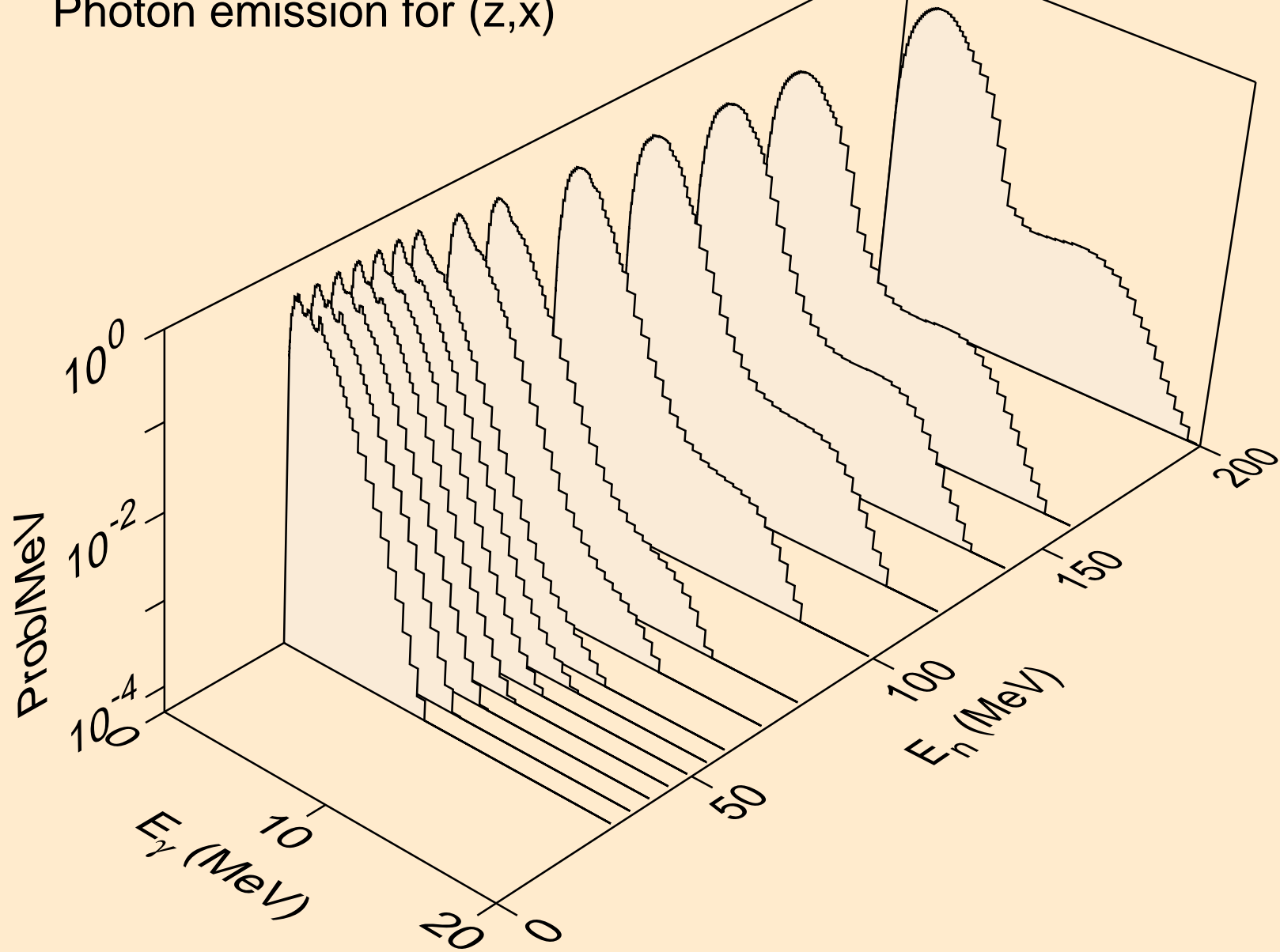

PO201M HELION ACER TENDL-2023 LIBRARY; T=0.K  
Photon emission for (n,2nd)

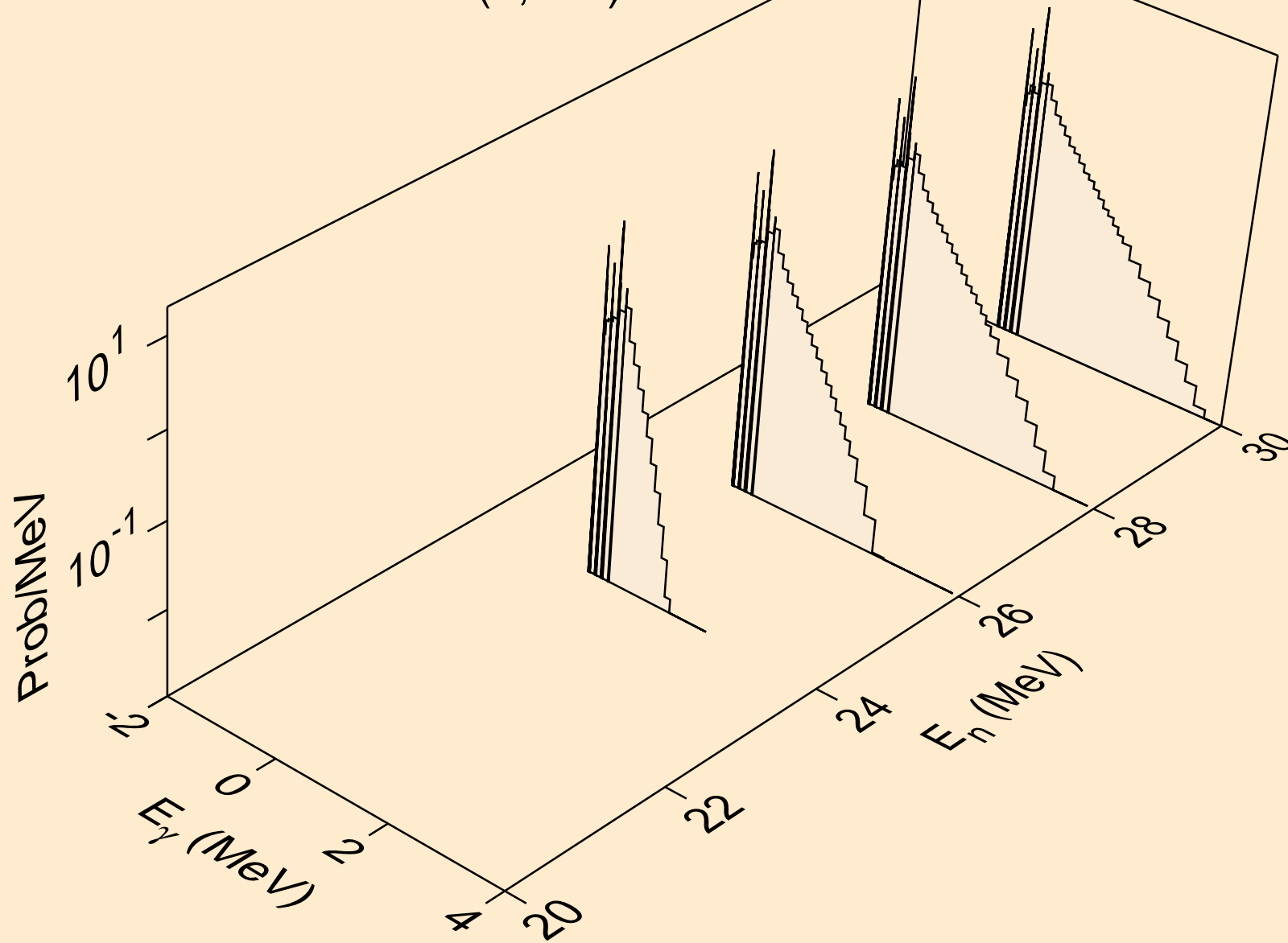

PO201M HELION ACER TENDL-2023 LIBRARY; T=0.K  
Photon emission for (n,2n)

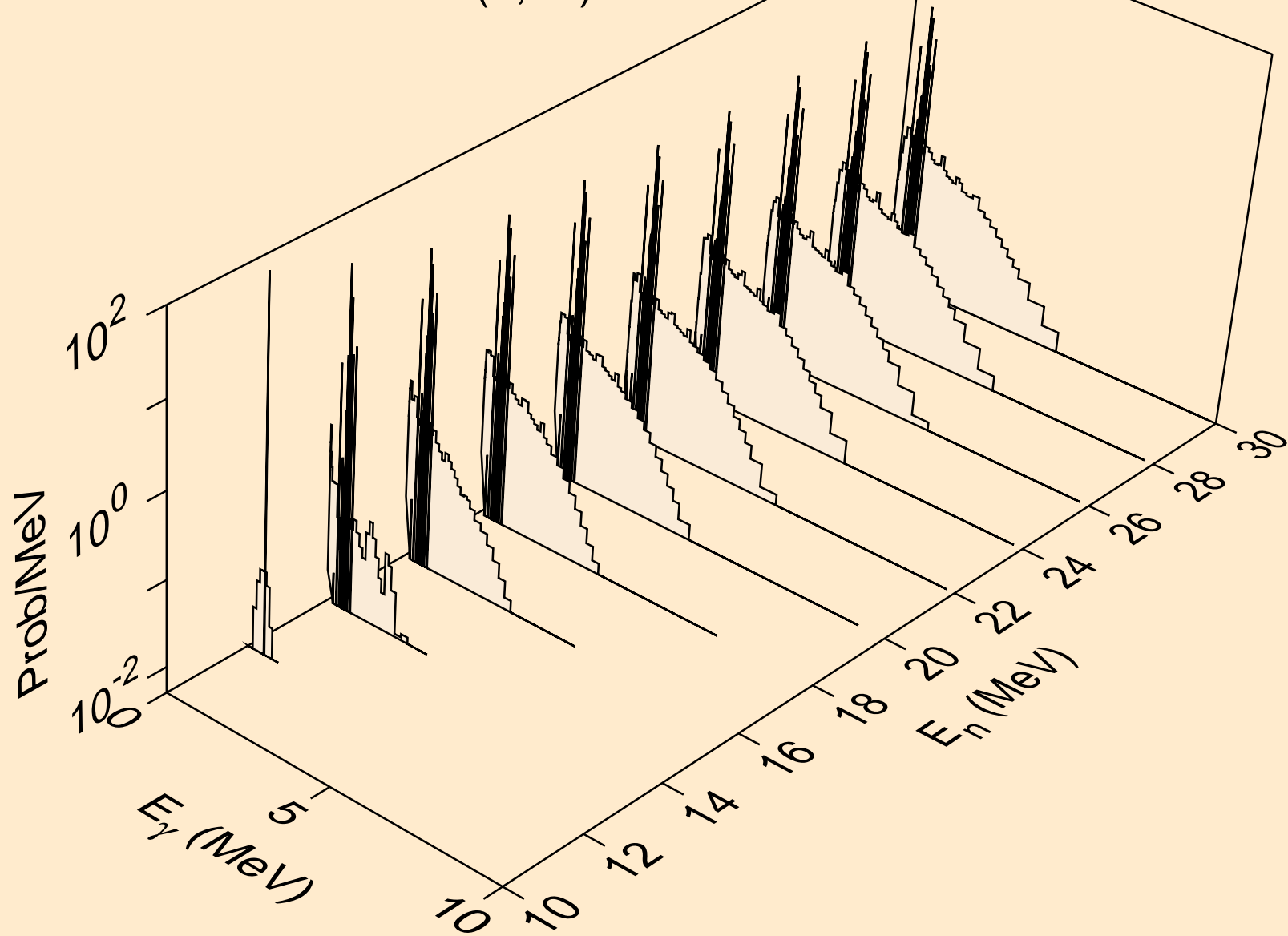

PO201M HELION ACER TENDL-2023 LIBRARY; T=0.K  
Photon emission for (n,3n)

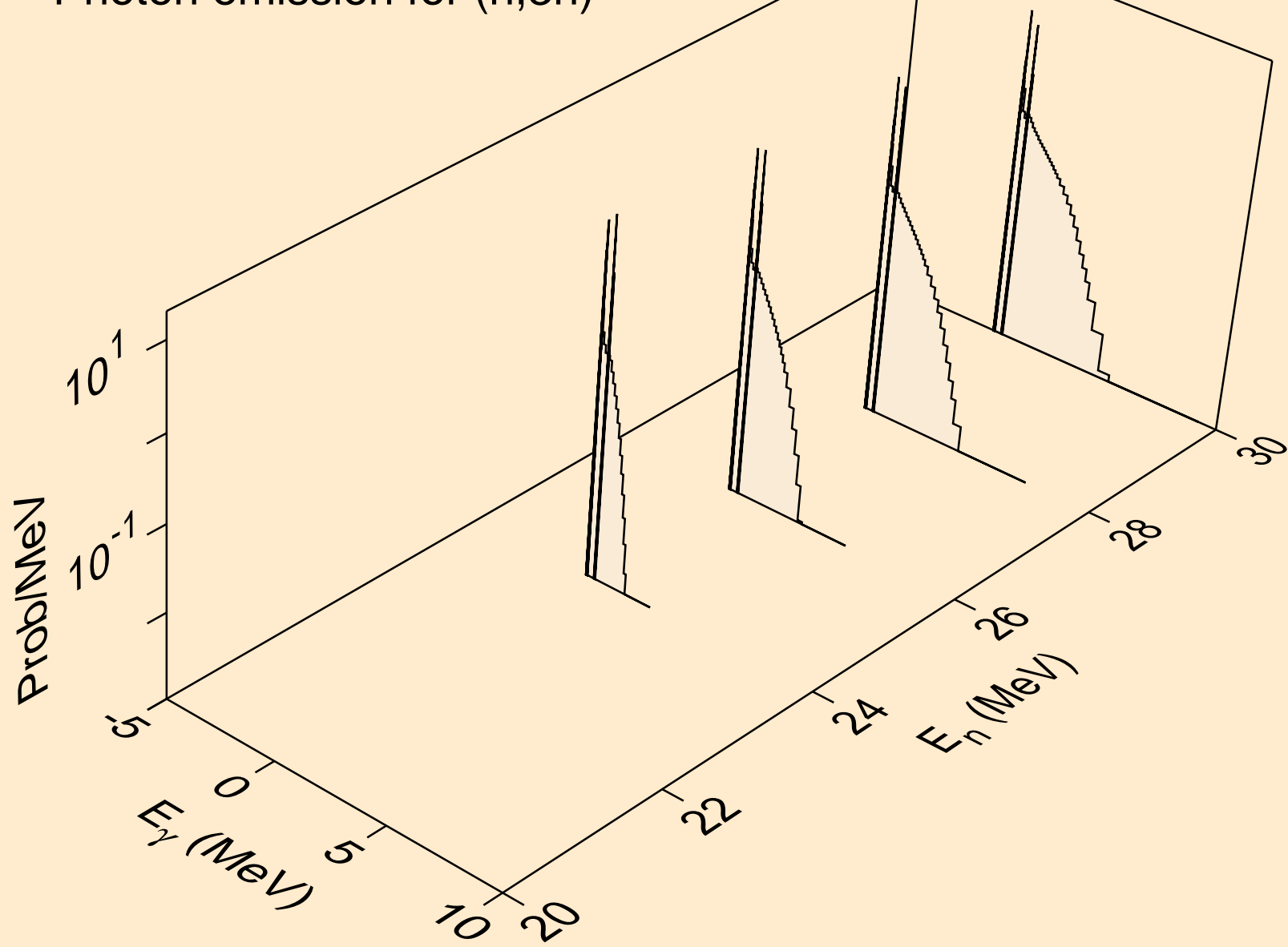

PO201M HELION ACER TENDL-2023 LIBRARY; T=0.K  
Photon emission for (n,n\*)a

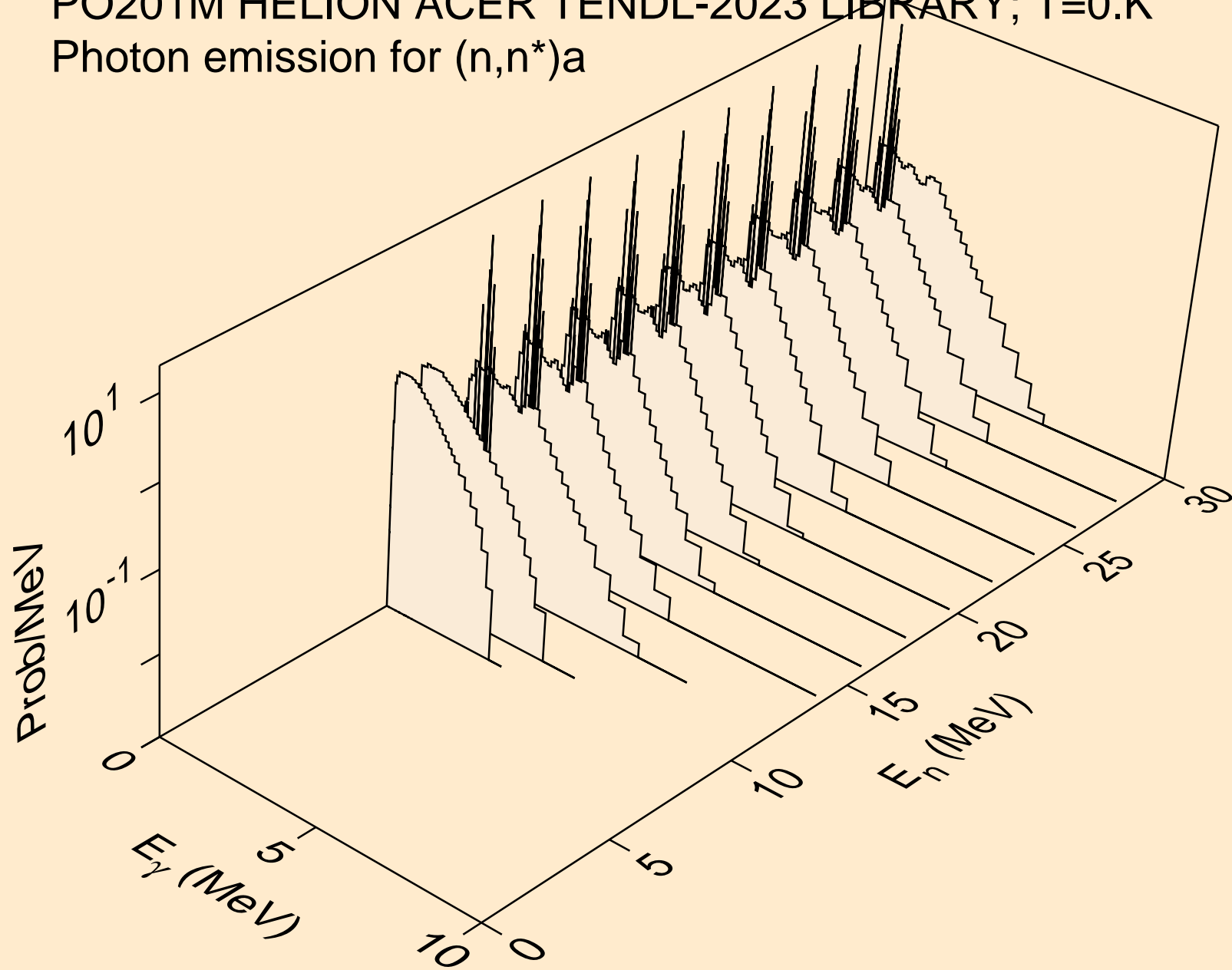

PO201M HELION ACER TENDL-2023 LIBRARY; T=0.K  
Photon emission for (n,2n)a

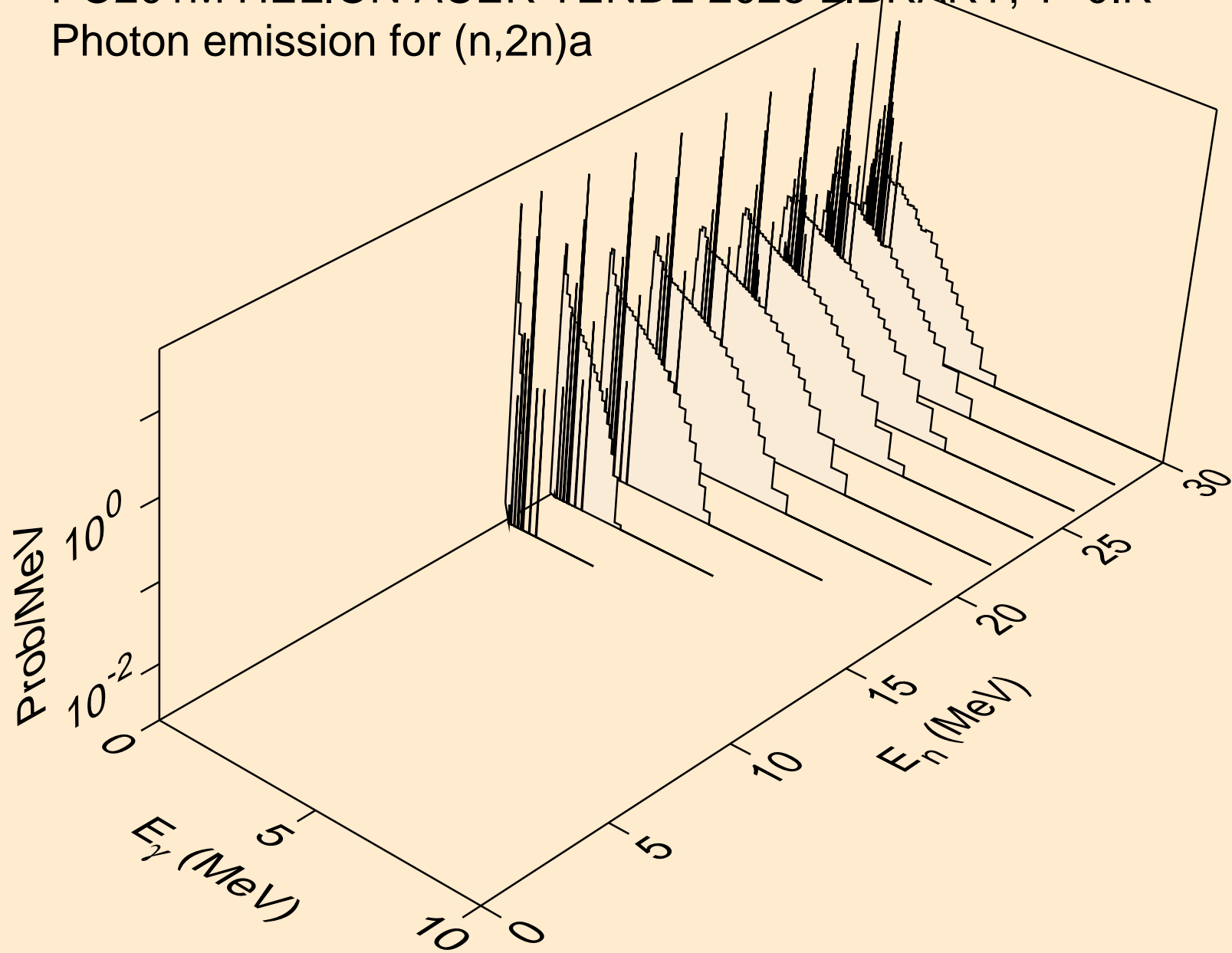

PO201M HELION ACER TENDL-2023 LIBRARY; T=0.K  
Photon emission for (n,3n)a

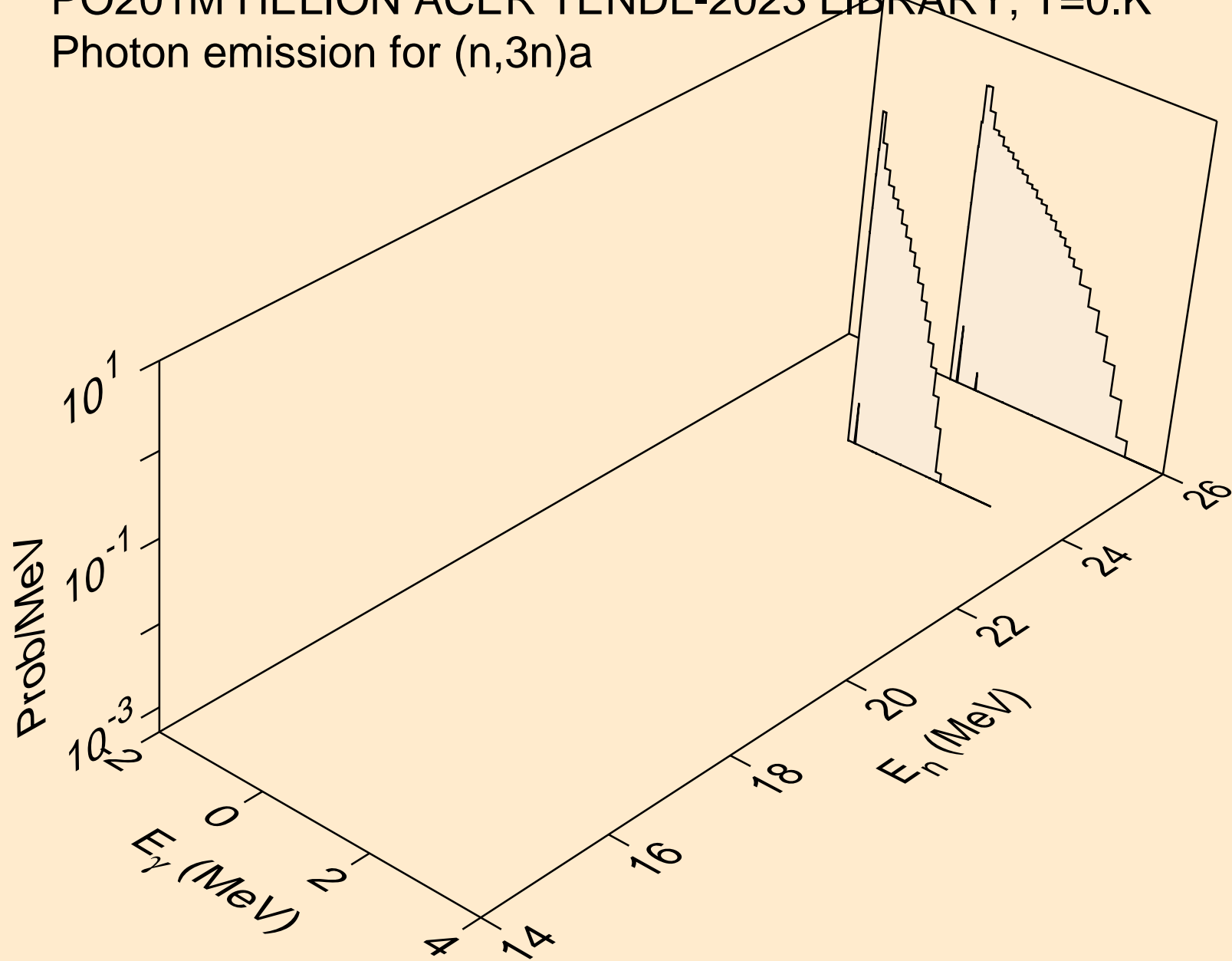



PO201M HELION ACER TENDL-2023 LIBRARY; T=0.K  
Photon emission for (n,n\*)p

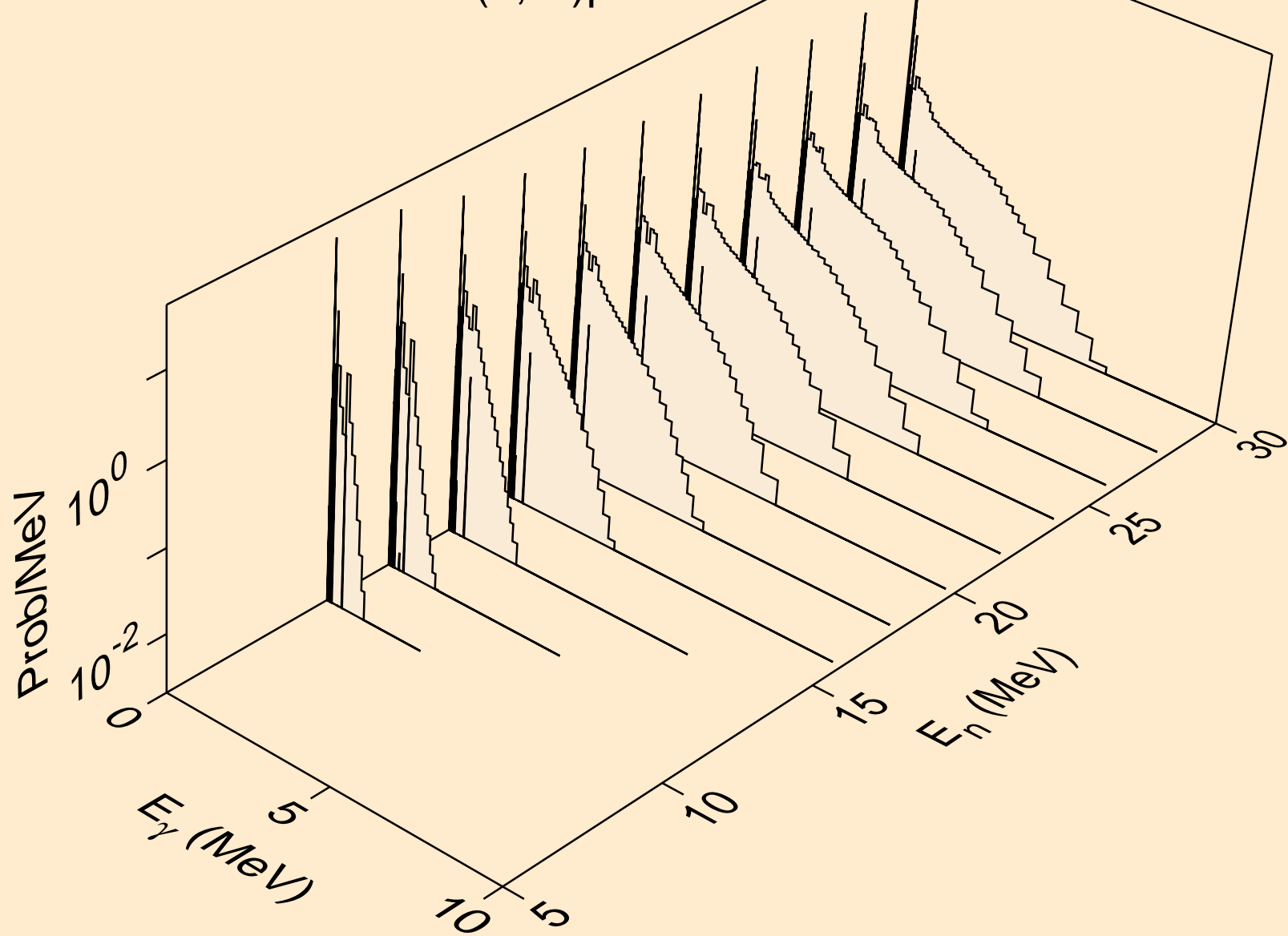

PO201M HELION ACER TENDL-2023 LIBRARY; T=0.K  
Photon emission for (n,n\*)2a

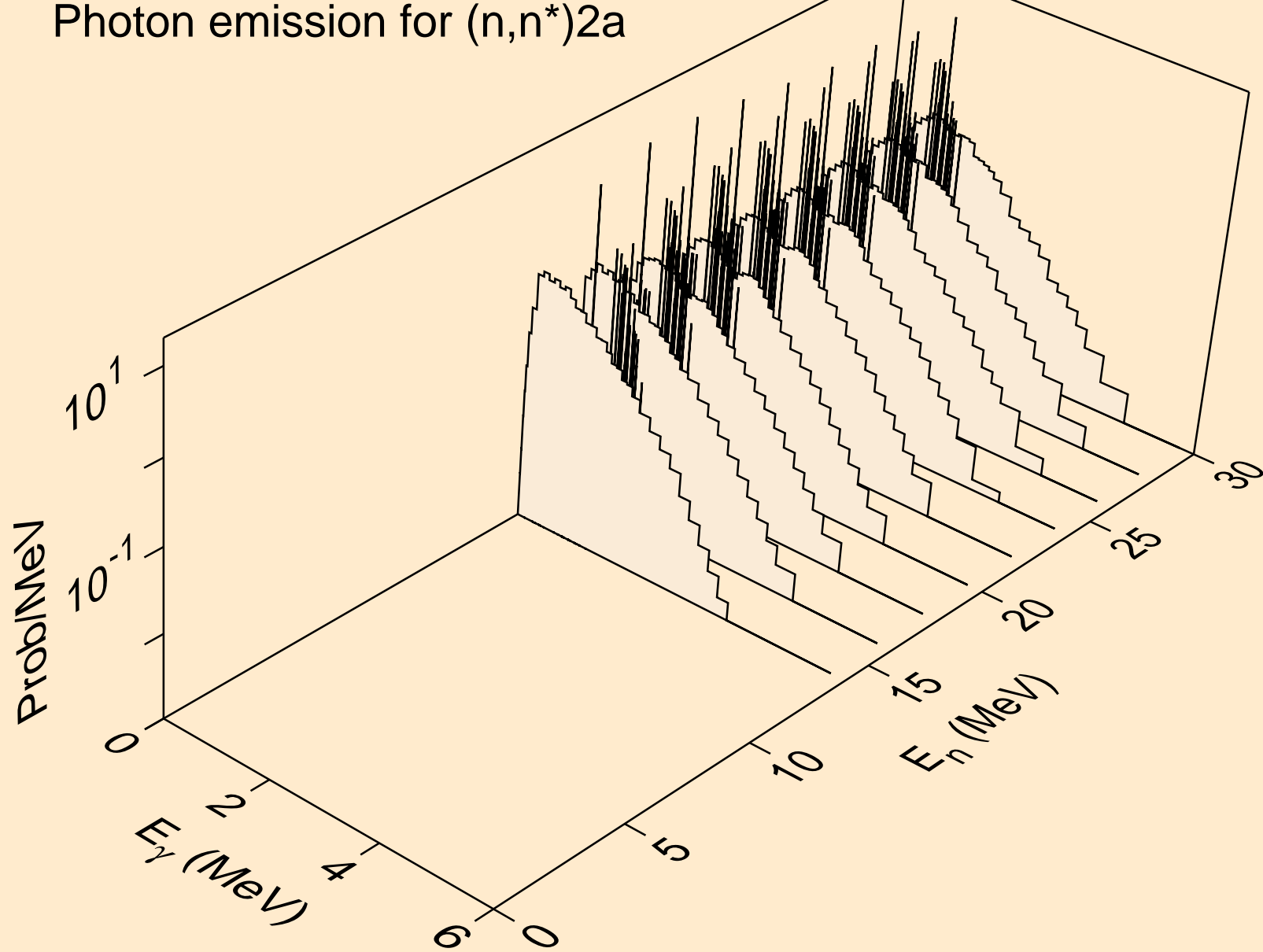

PO201M HELION ACER TENDL-2023 LIBRARY; T=0.K  
Photon emission for (n,n\*)d

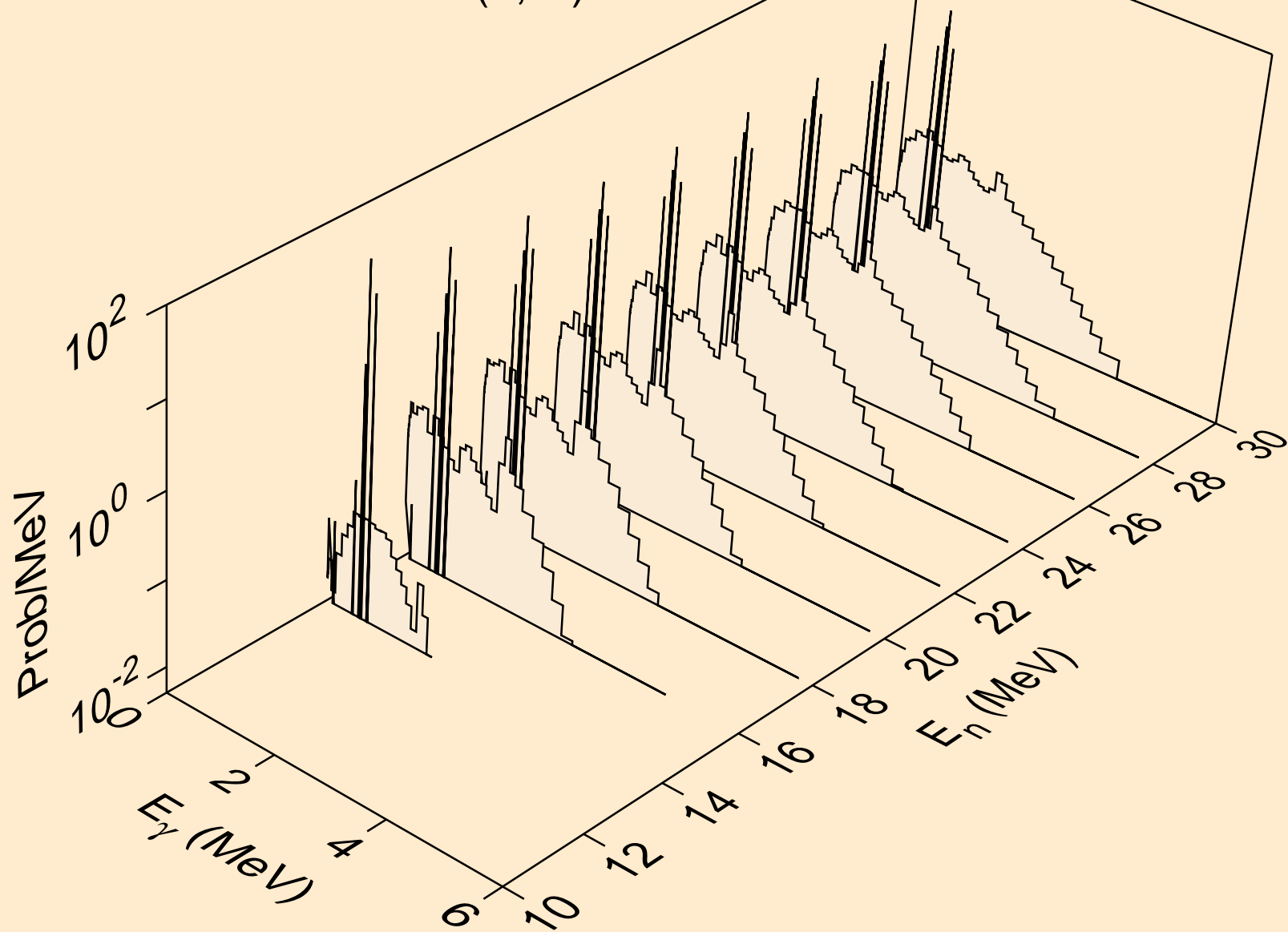

PO201M HELION ACER TENDL-2023 LIBRARY; T=0.K  
Photon emission for (n,n\*)t

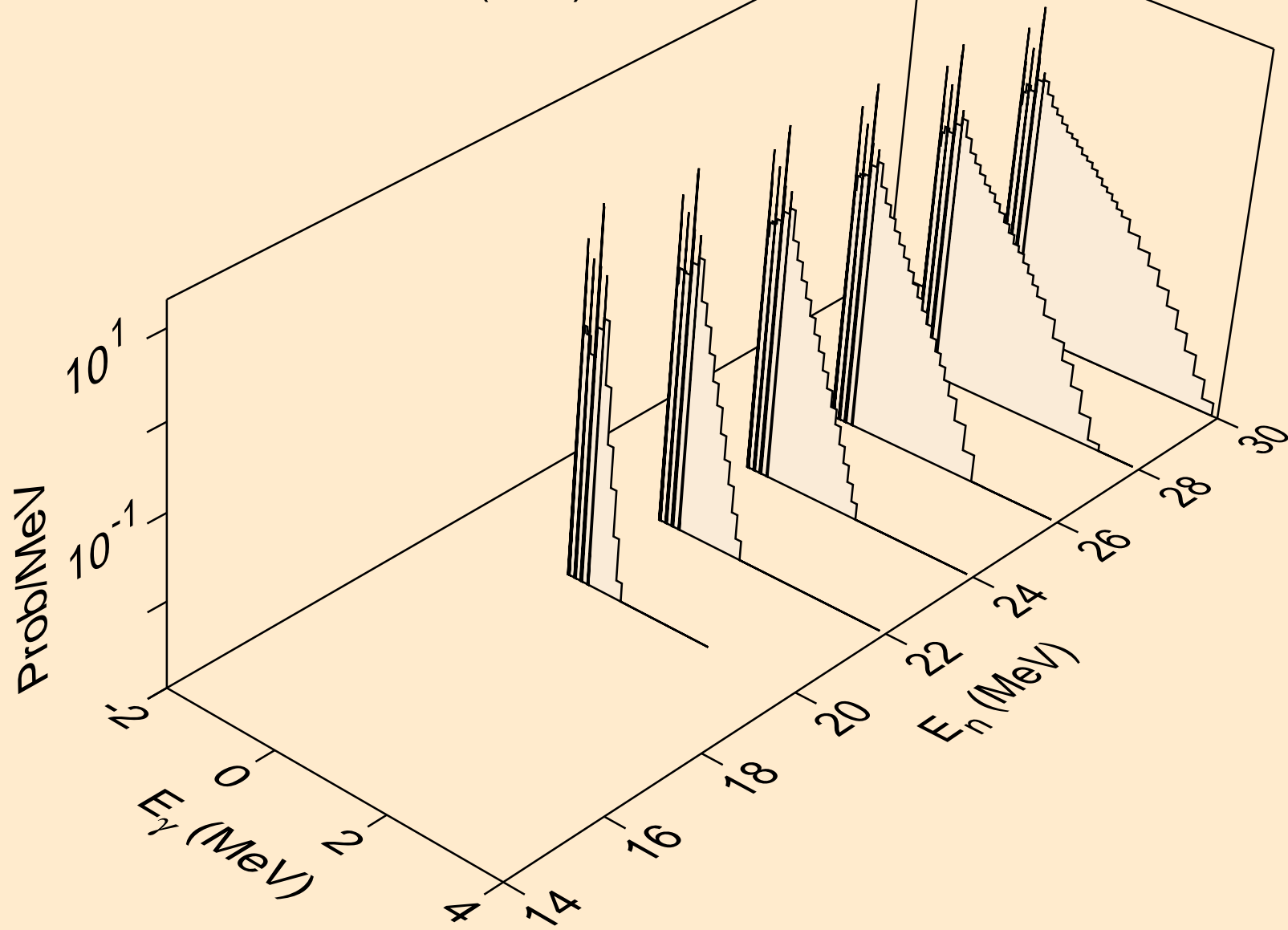

PO201M HELION ACER TENDL-2023 LIBRARY; T=0.K  
Photon emission for (n,n\*)he3

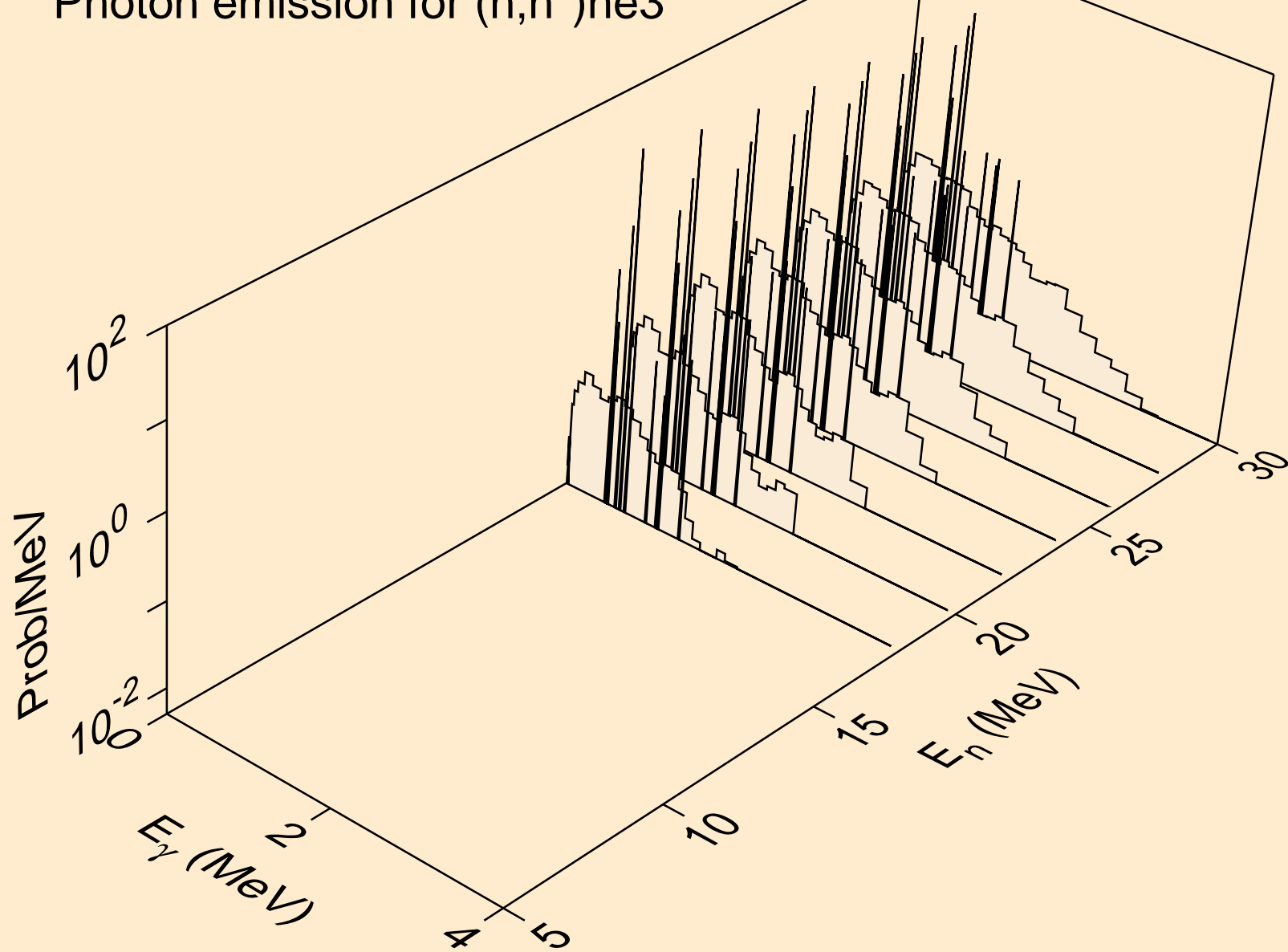

PO201M HELION ACER TENDL-2023 LIBRARY; T=0.K  
Photon emission for (n,2np)

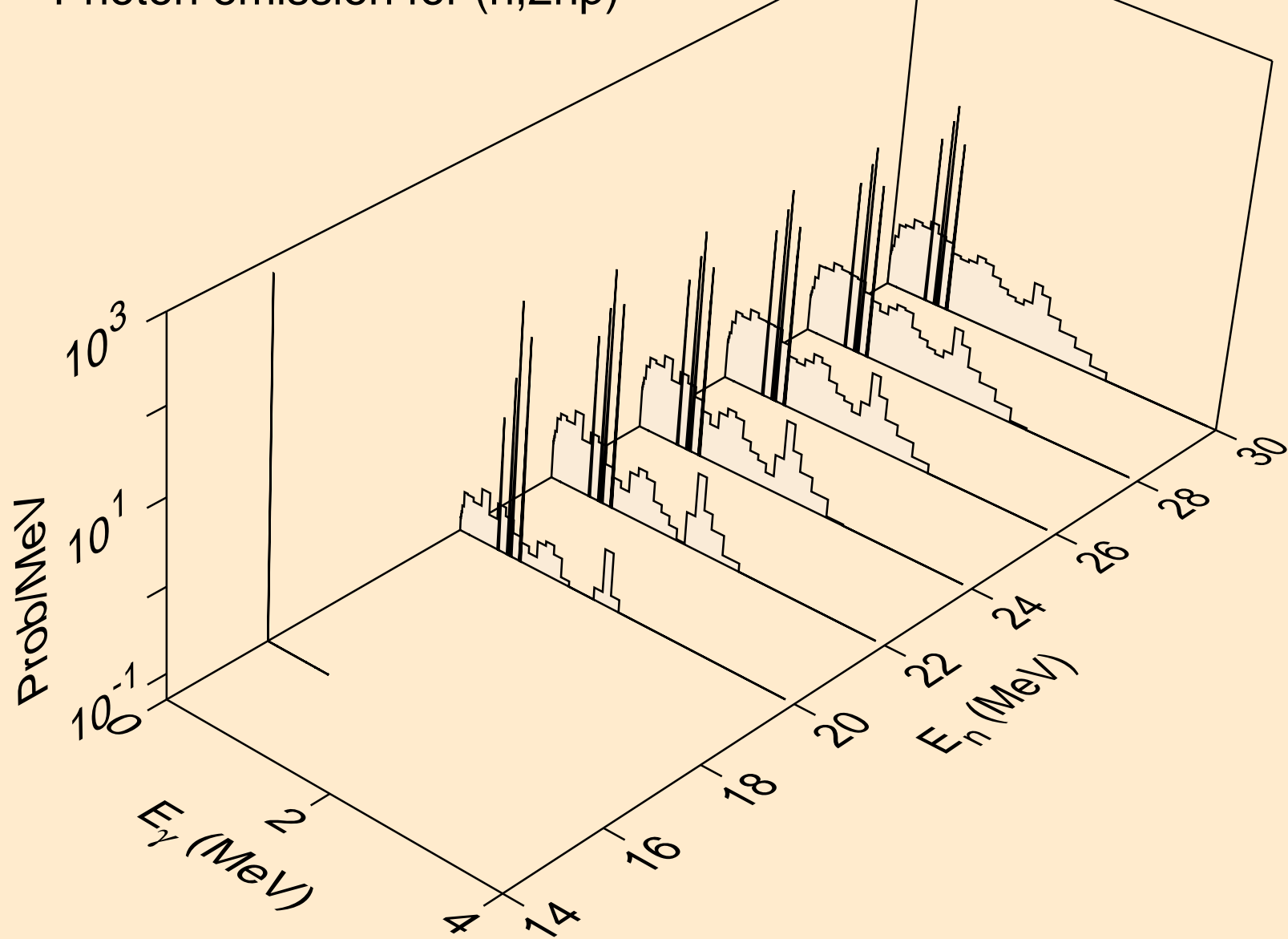

PO201M HELION ACER TENDL-2023 LIBRARY; T=0.K  
Photon emission for (n,3np)

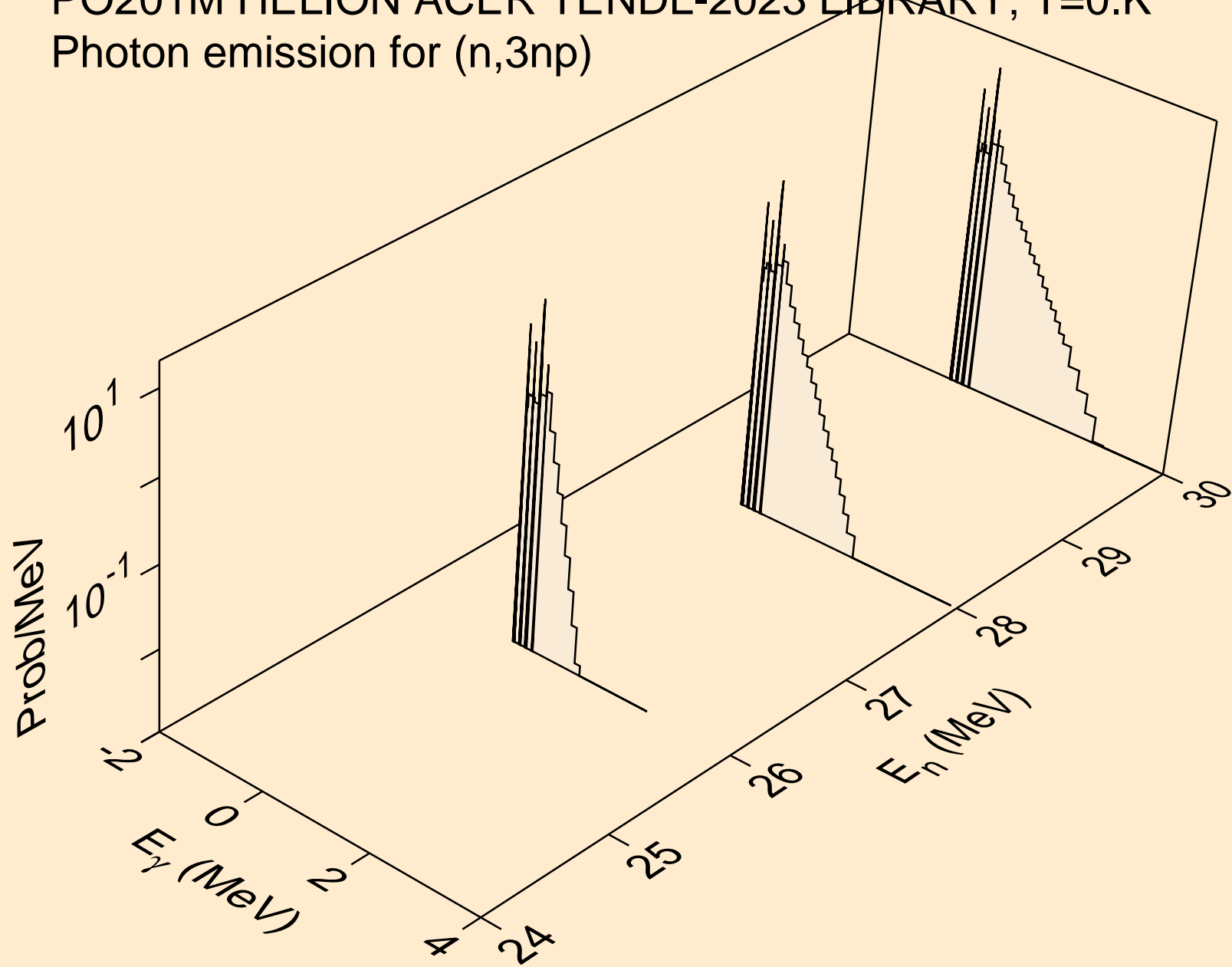

PO201M HELION ACER TENDL-2023 LIBRARY; T=0.K  
Photon emission for (n,n2p)

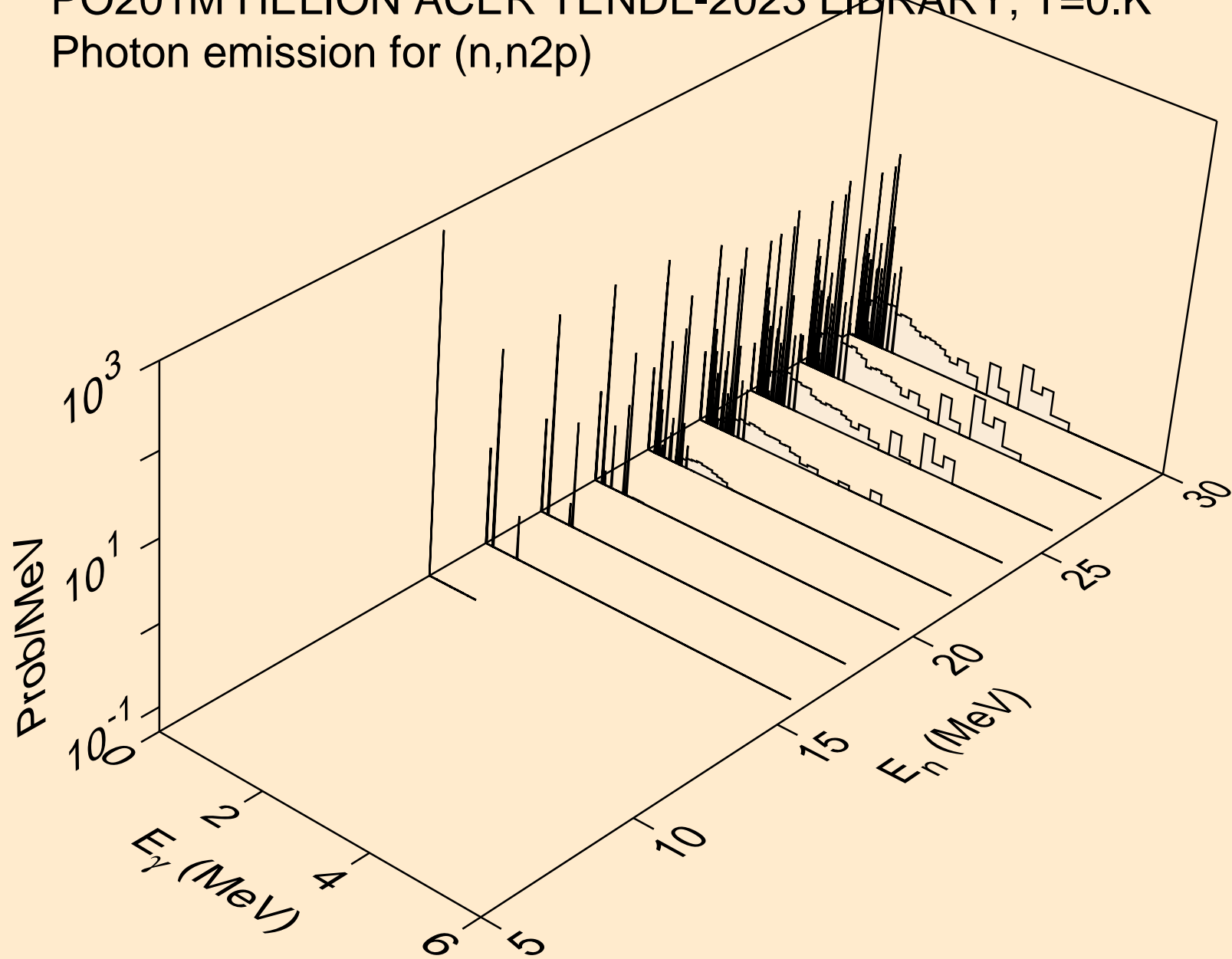



PO201M HELION ACER TENDL-2023 LIBRARY; T=0.K  
Photon emission for (n,npa)

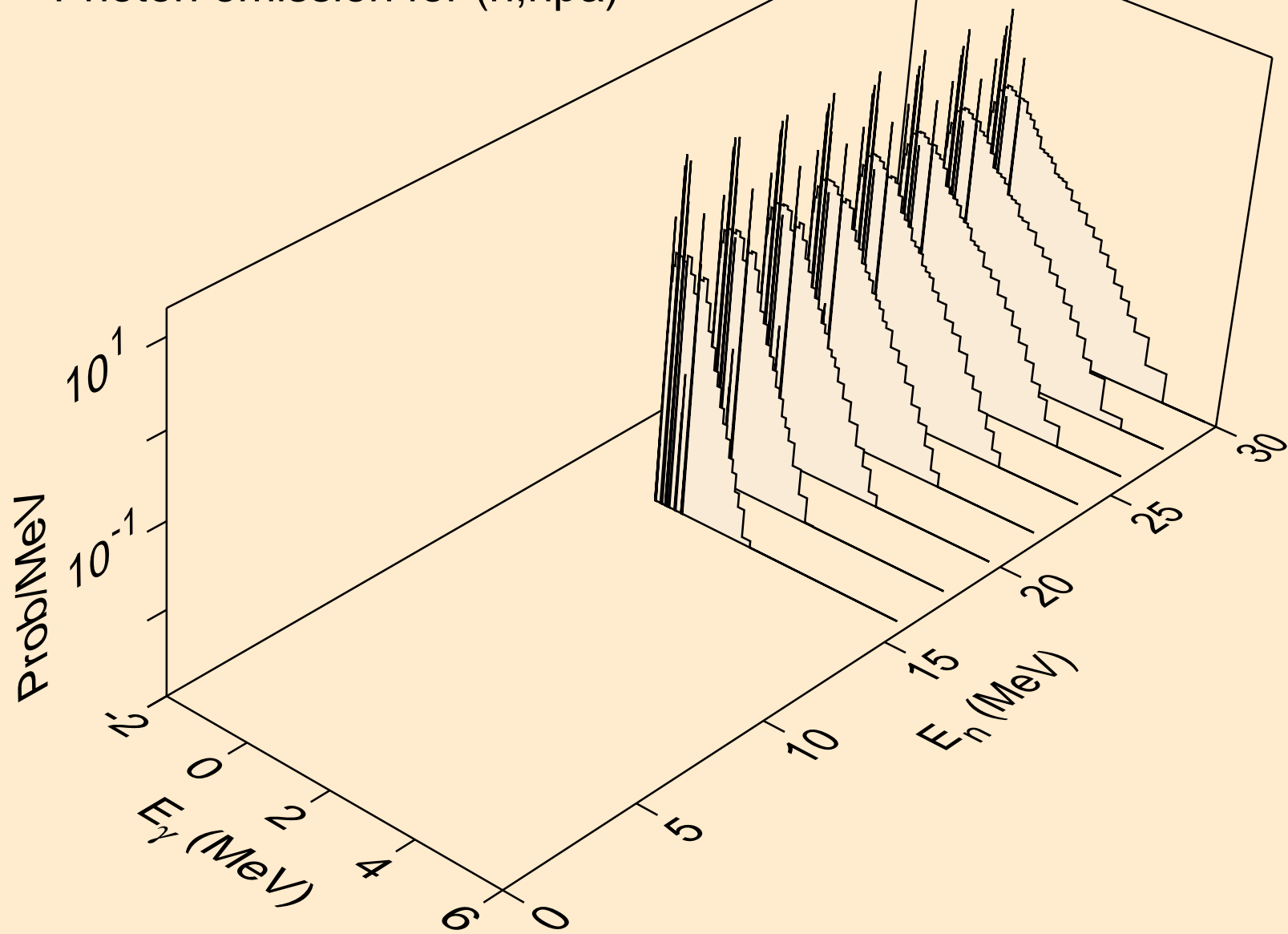

PO201M HELION ACER TENDL-2023 LIBRARY; T=0.K  
Photon emission for (n,gma)

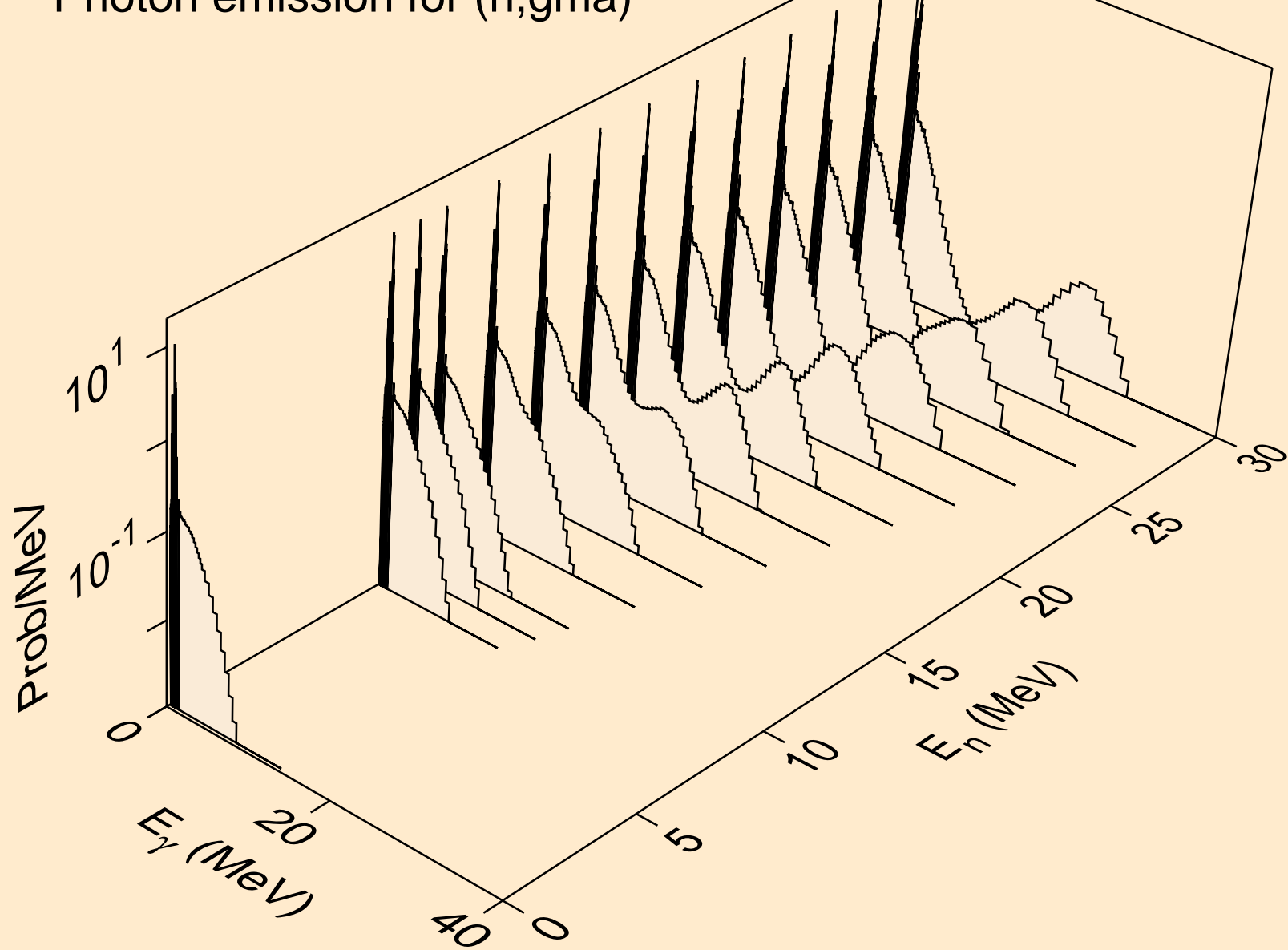

PO201M HELION ACER TENDL-2023 LIBRARY; T=0.K  
Photon emission for (n,p)

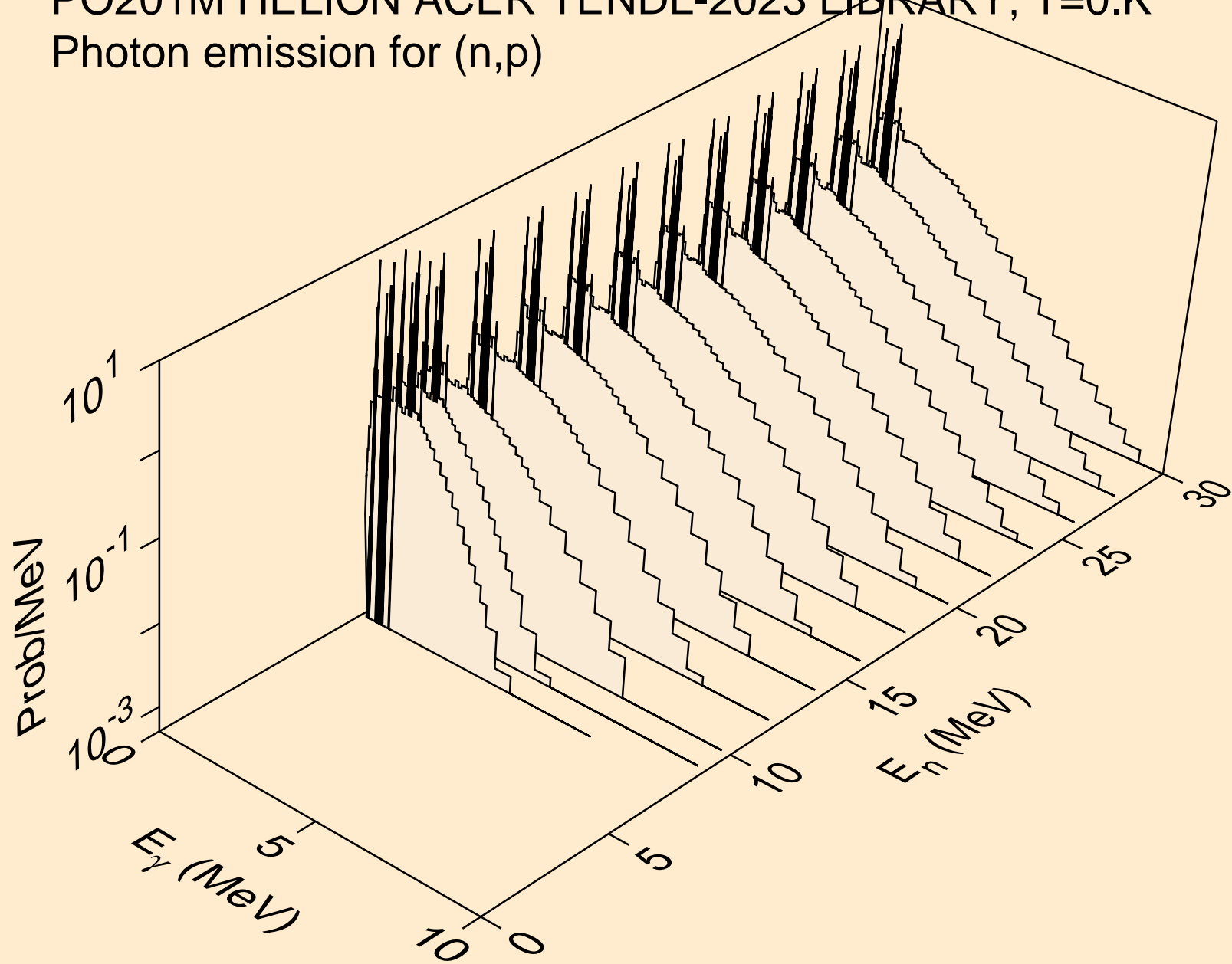

PO201M HELION ACER TENDL-2023 LIBRARY; T=0.K  
Photon emission for (n,d)

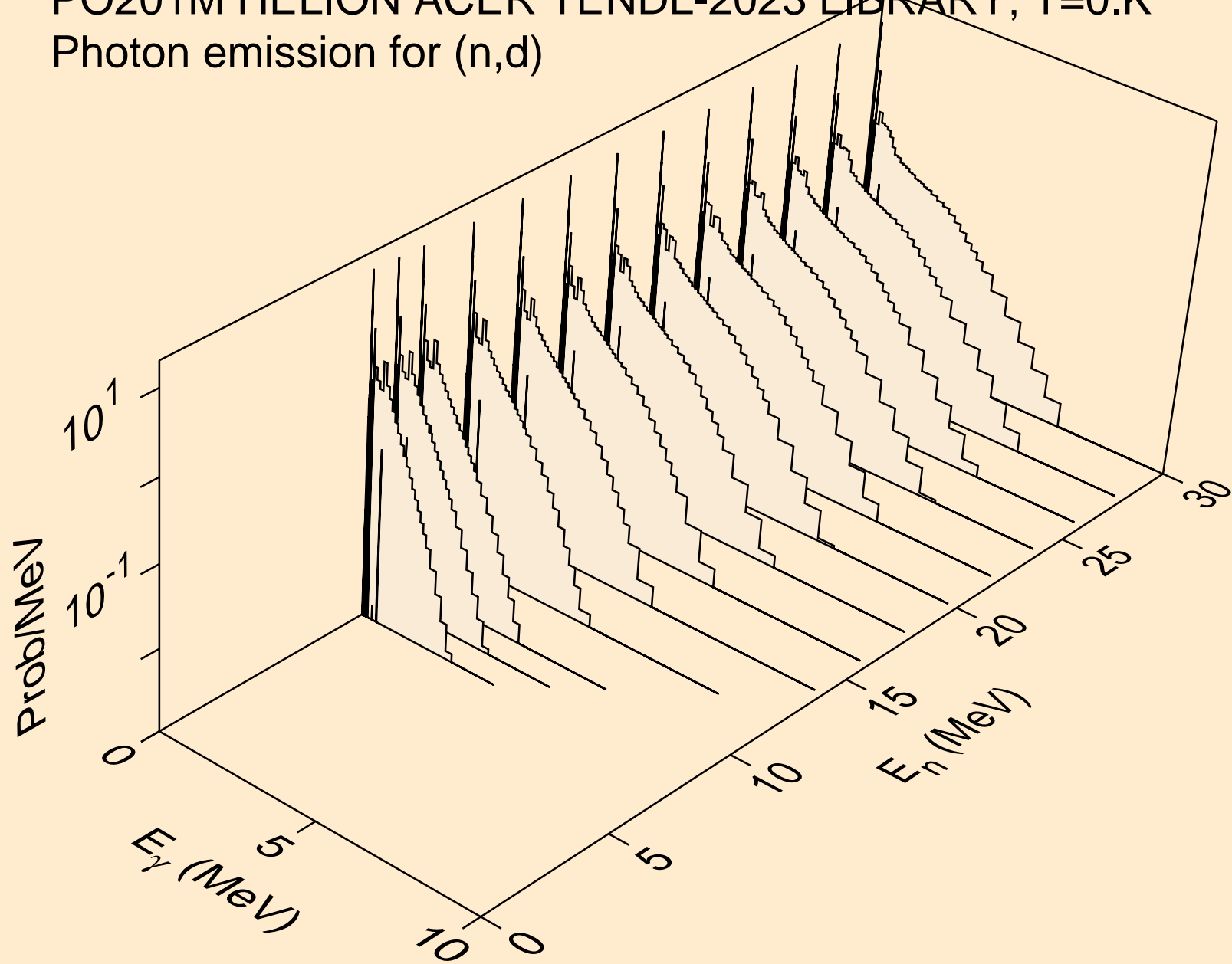

PO201M HELION ACER TENDL-2023 LIBRARY; T=0.K  
Photon emission for (n,t)

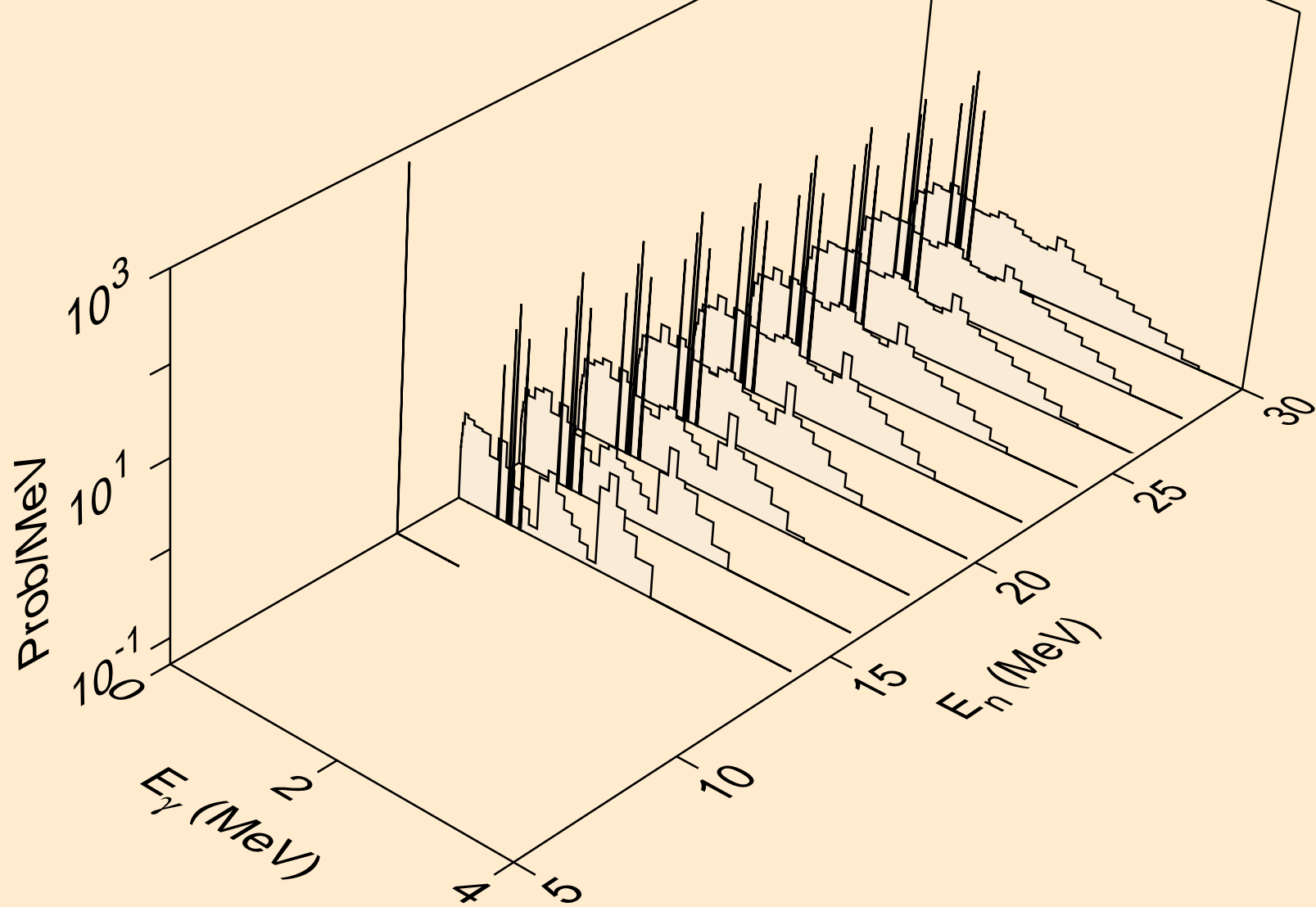

PO201M HELION ACER TENDL-2023 LIBRARY; T=0.K  
Photon emission for inelastic

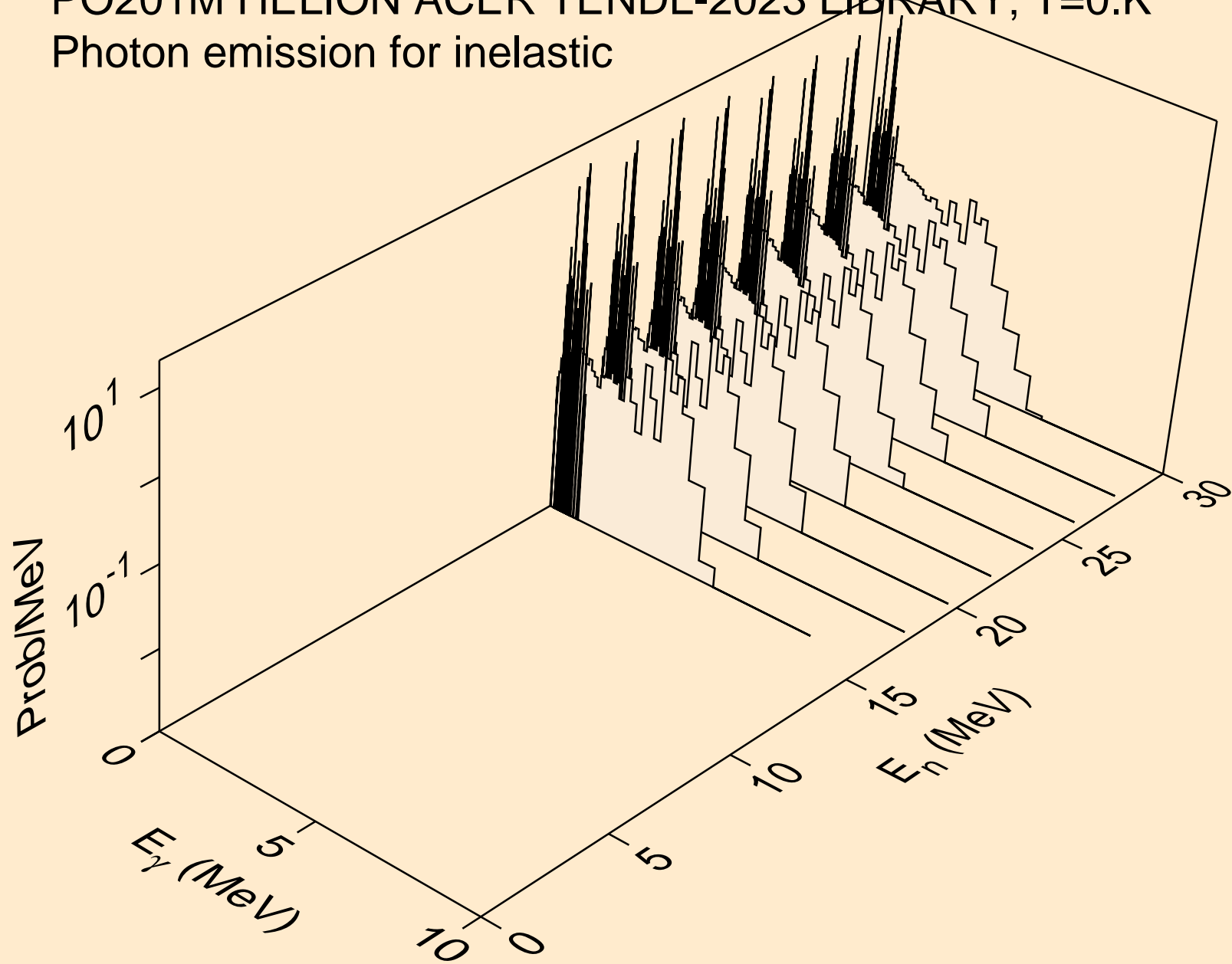

PO201M HELION ACER TENDL-2023 LIBRARY; T=0.K  
Photon emission for (n,a)

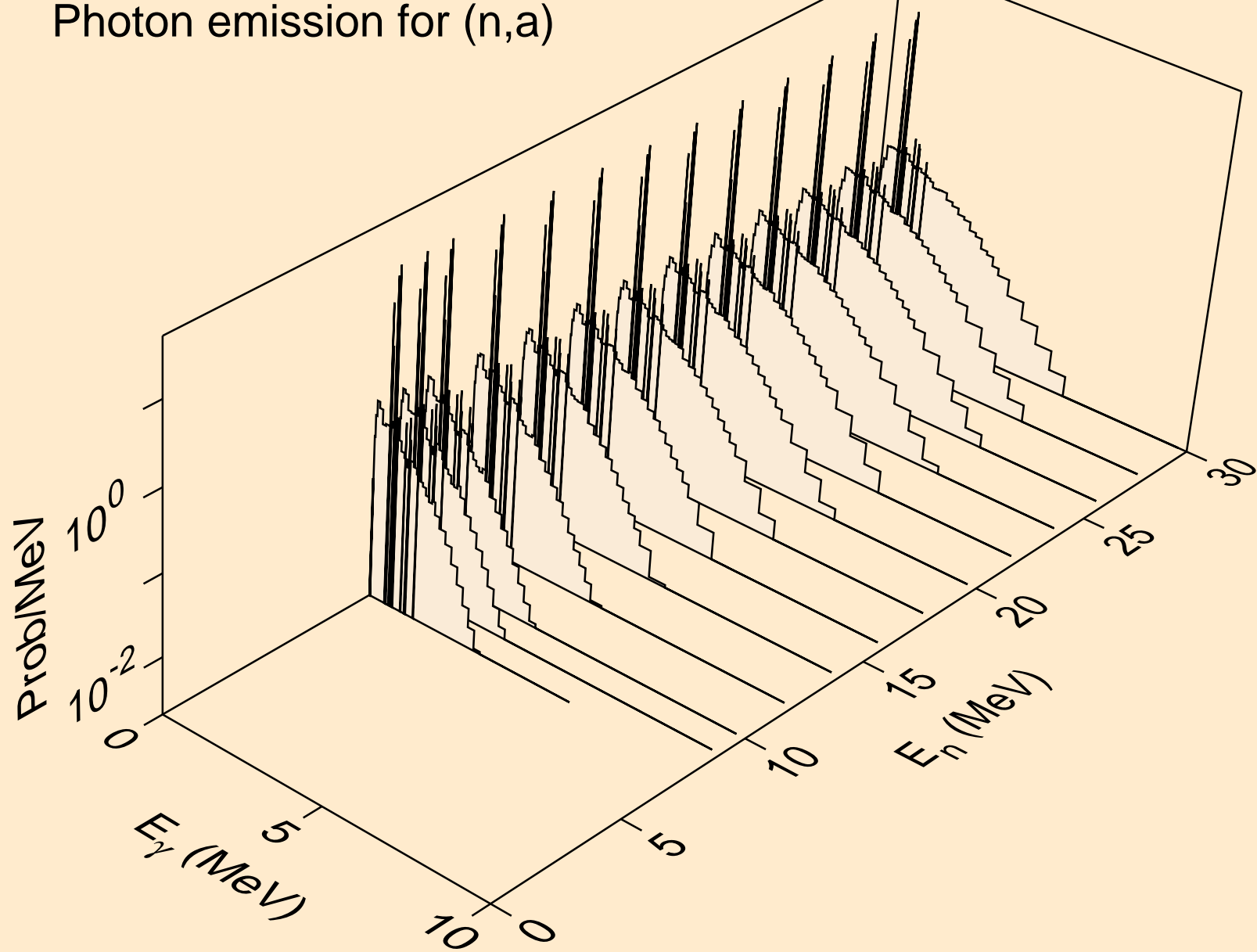

PO201M HELION ACER TENDL-2023 LIBRARY; T=0.K  
Photon emission for (n,2a)

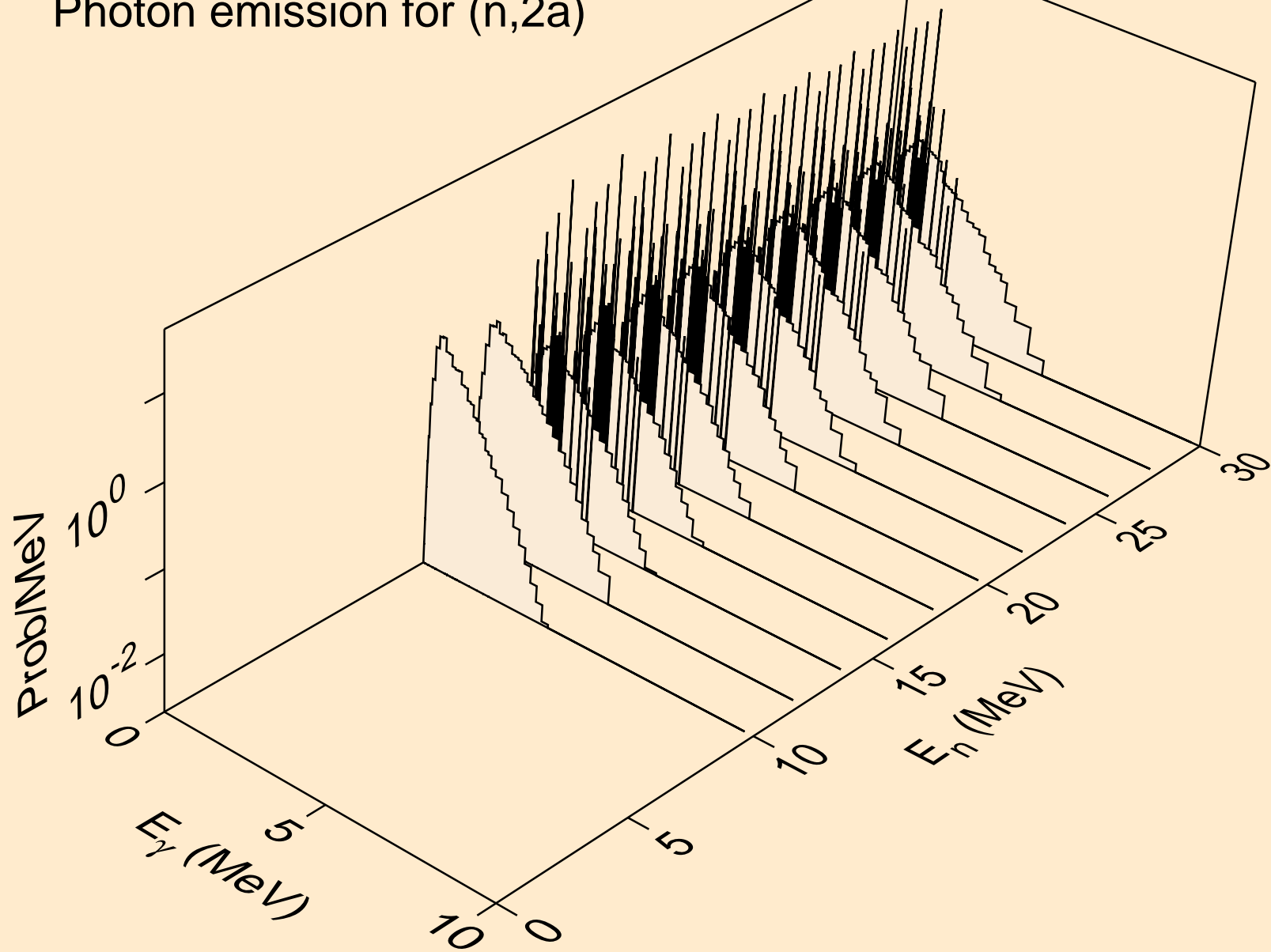



PO201M HELION ACER TENDL-2023 LIBRARY; T=0.K  
Photon emission for (n,2p)

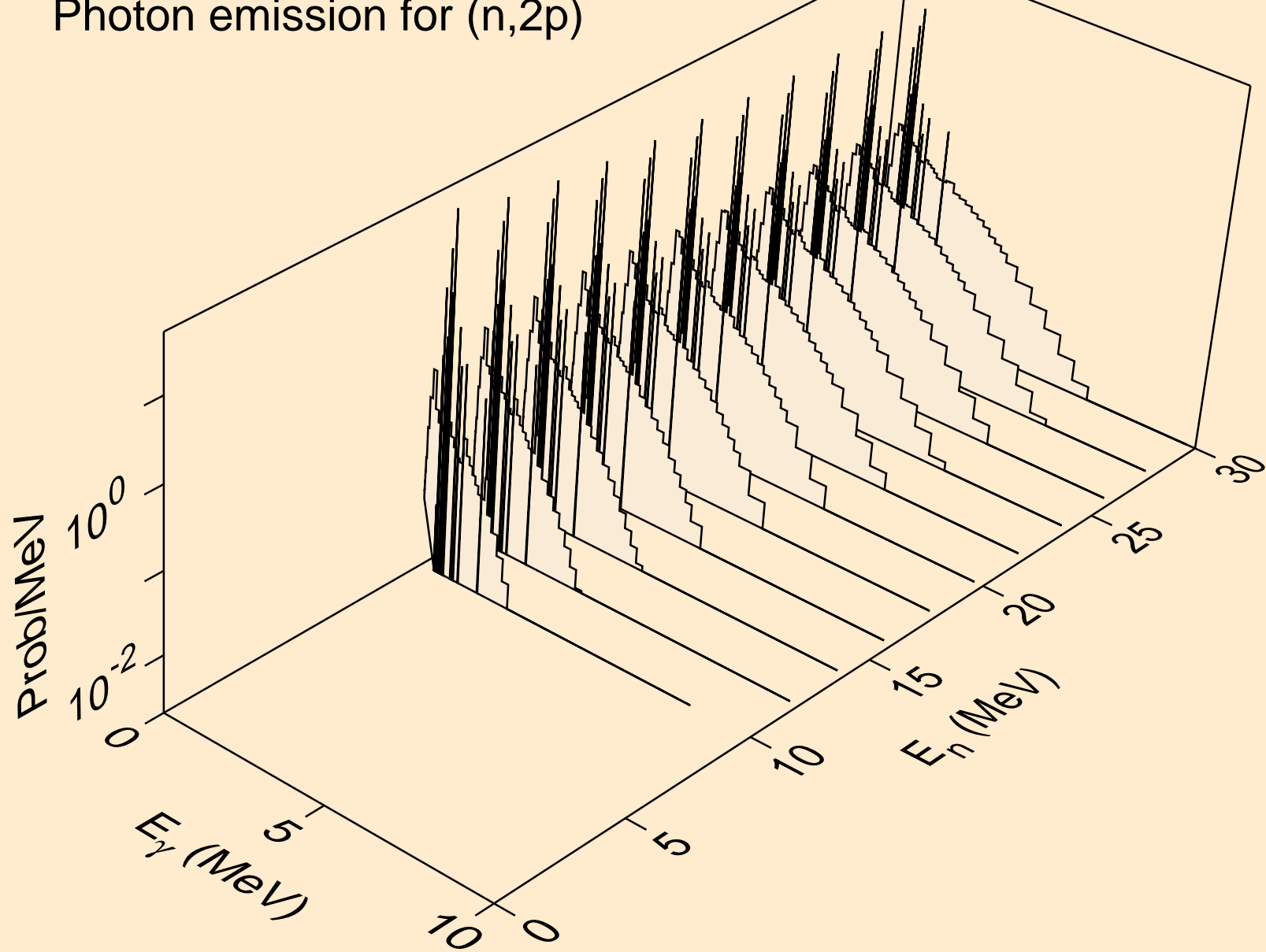

PO201M HELION ACER TENDL-2023 LIBRARY; T=0.K  
Photon emission for (n,pa)

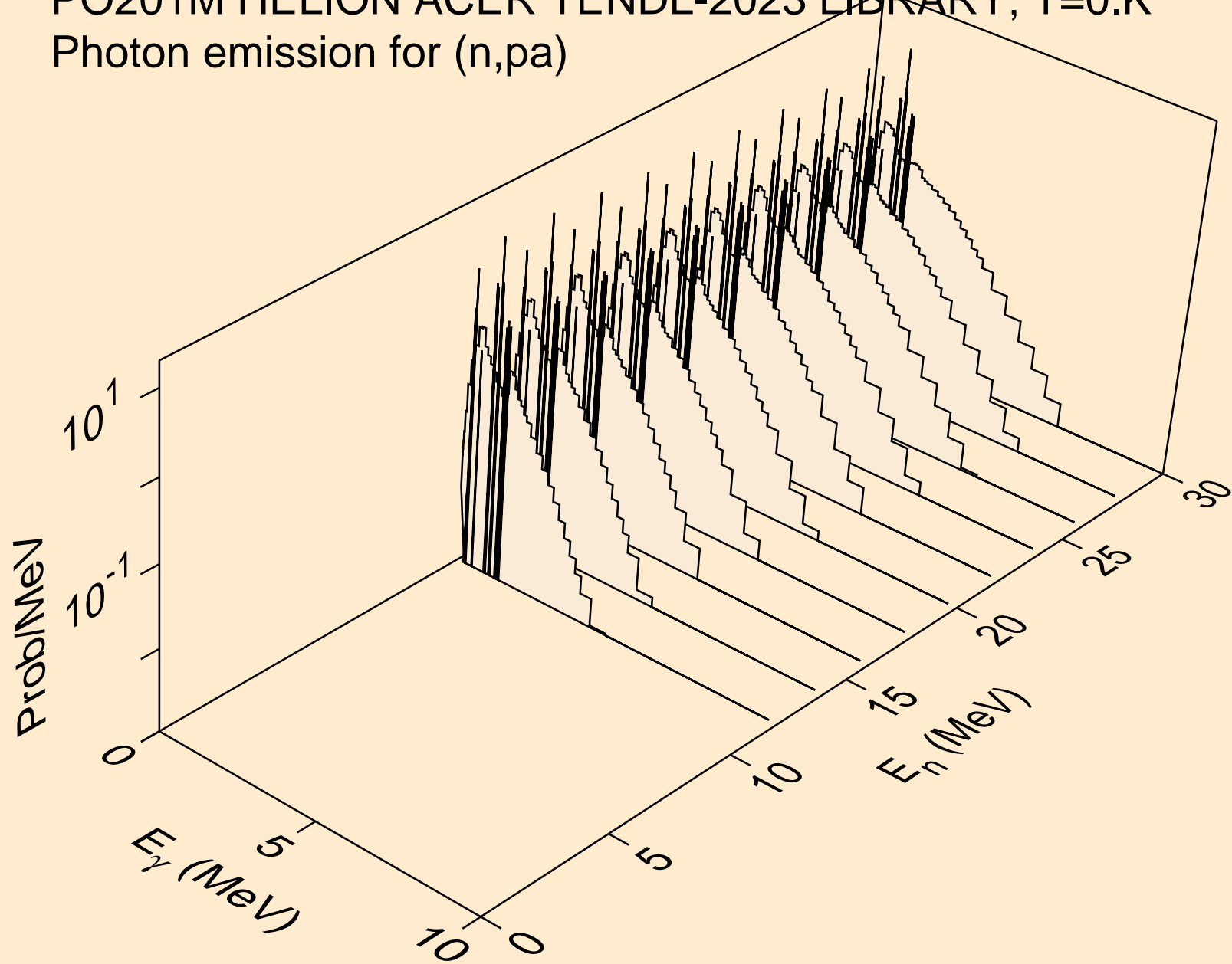

PO201M HELION ACER TENDL-2023 LIBRARY; T=0.K  
Photon emission for (n,pd)

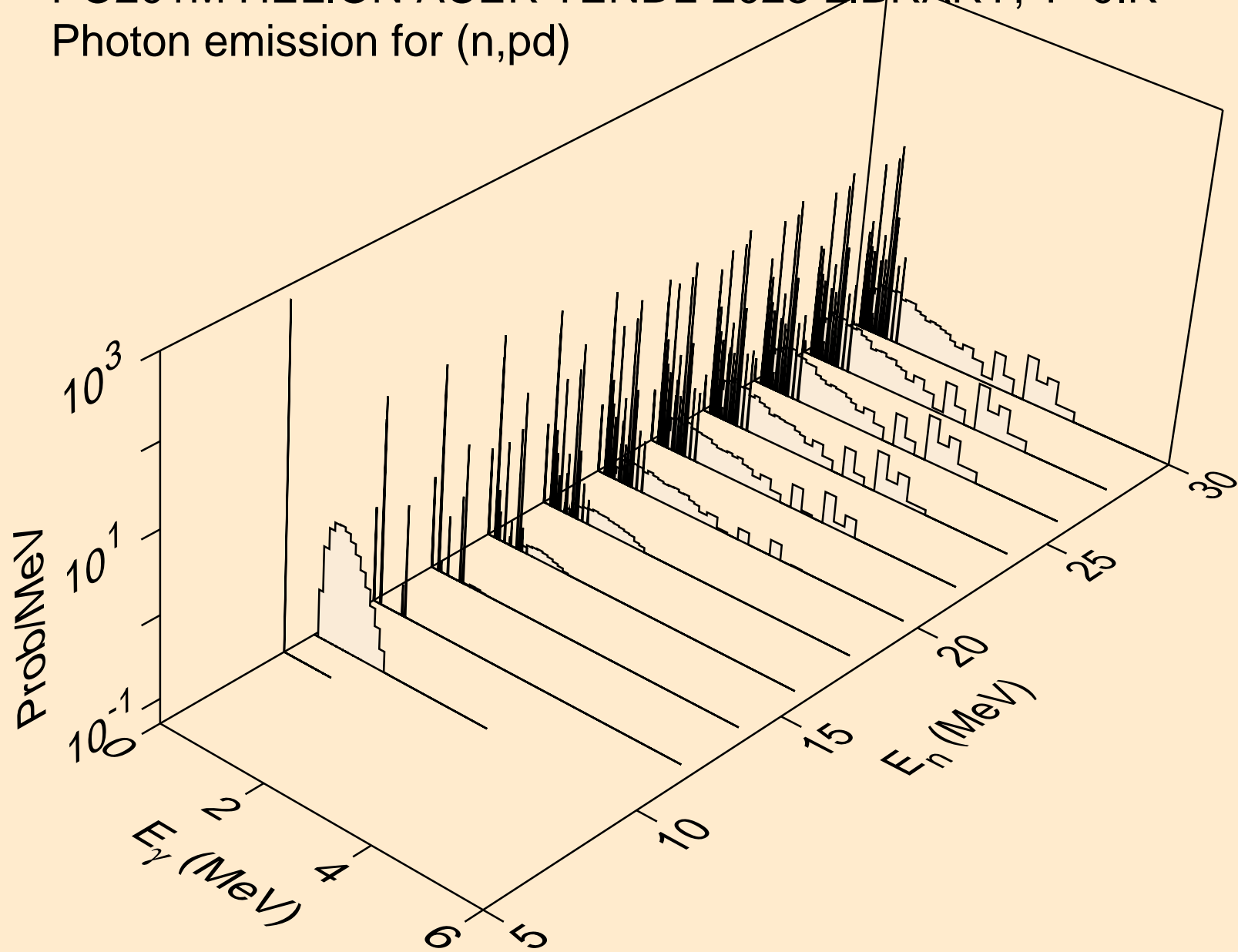

PO201M HELION ACER TENDL-2023 LIBRARY; T=0.K  
Photon emission for (n,pt)

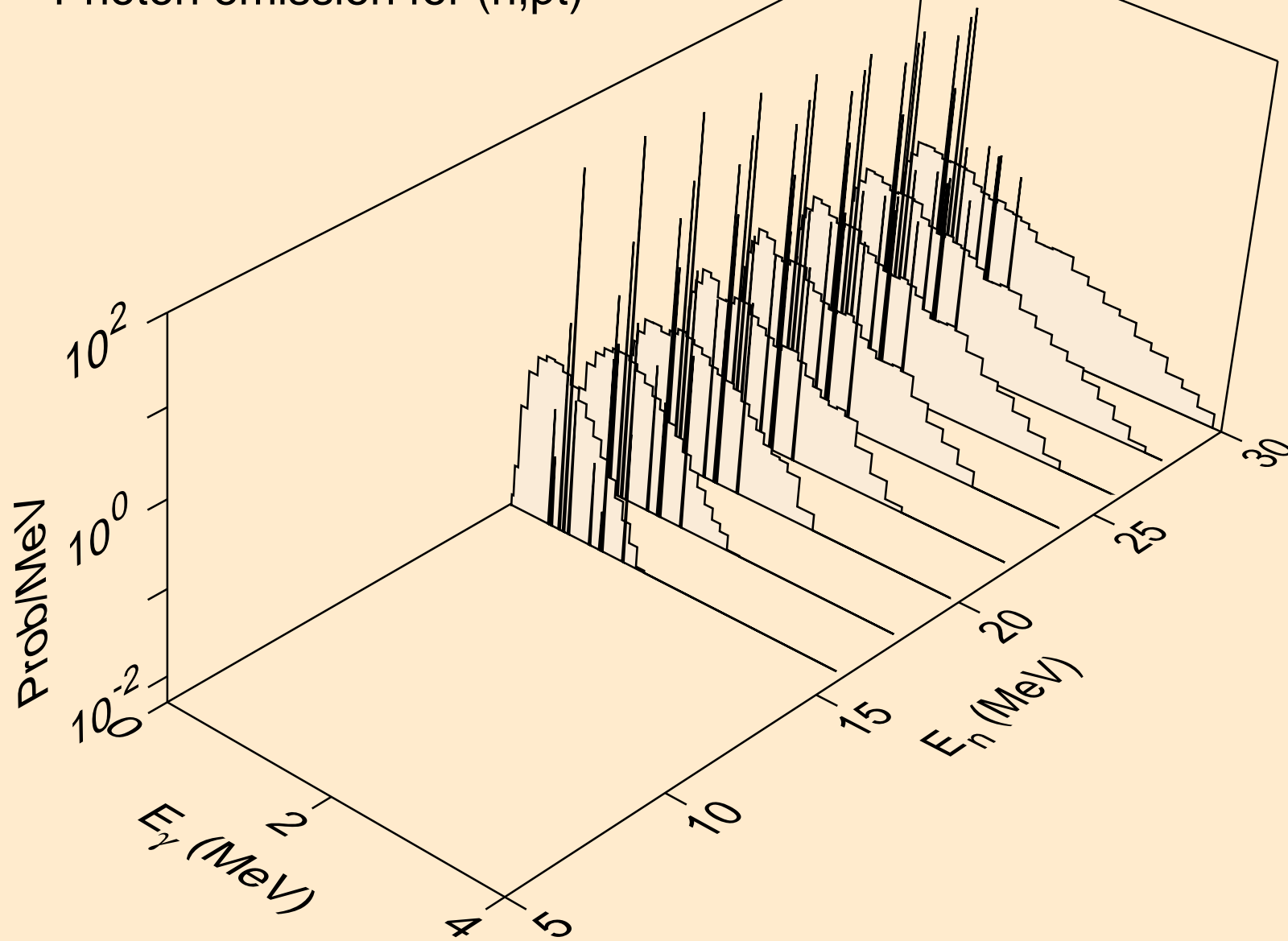

PO201M HELION ACER TENDL-2023 LIBRARY; T=0.K  
Photon emission for (n,da)

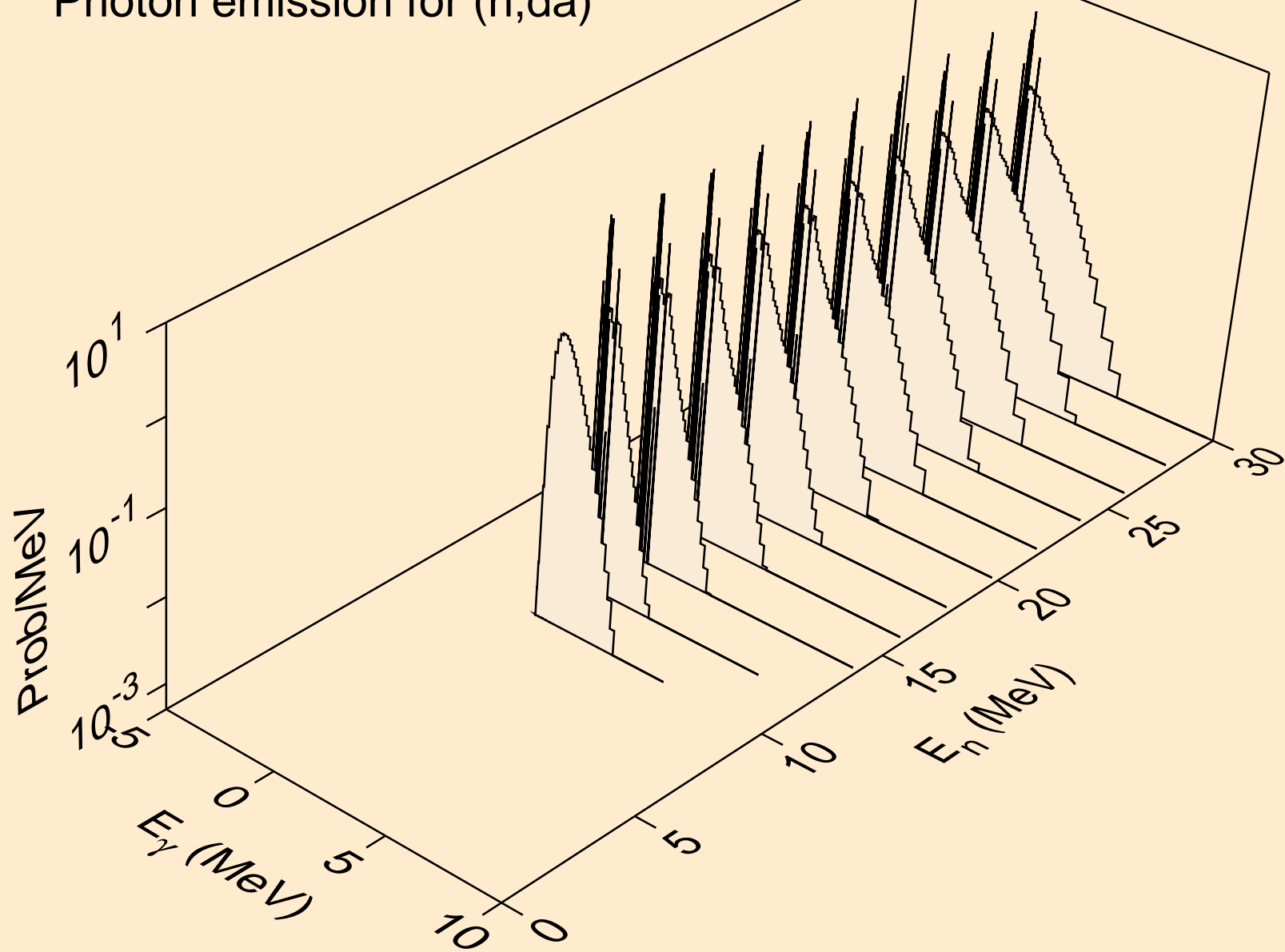

PO201M HELION ACER TENDL-2023 LIBRARY; T=0.K  
Particle heating contributions

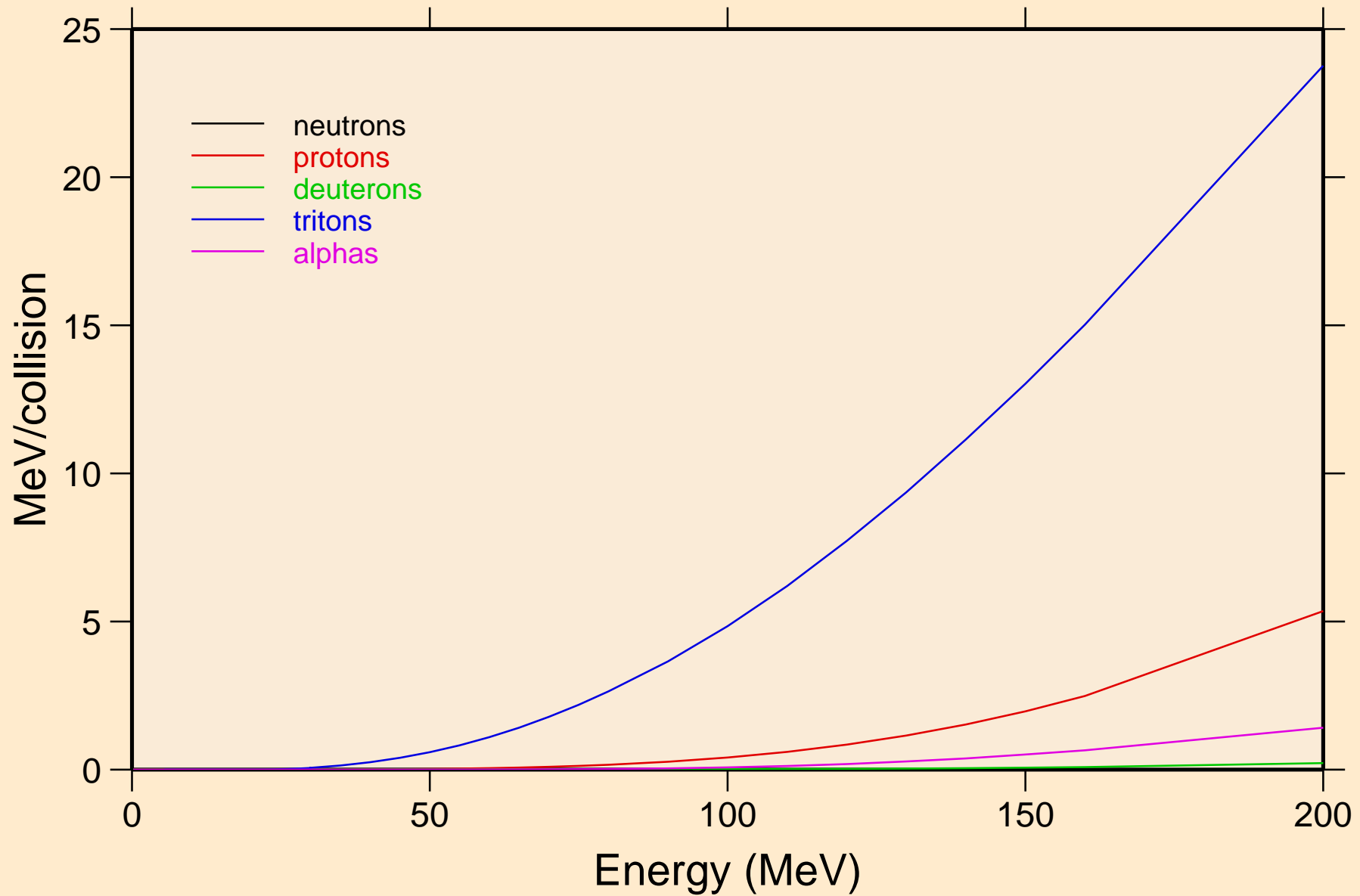

PO201M HELION ACER TENDL-2023 LIBRARY; T=0.K  
Recoil Heating

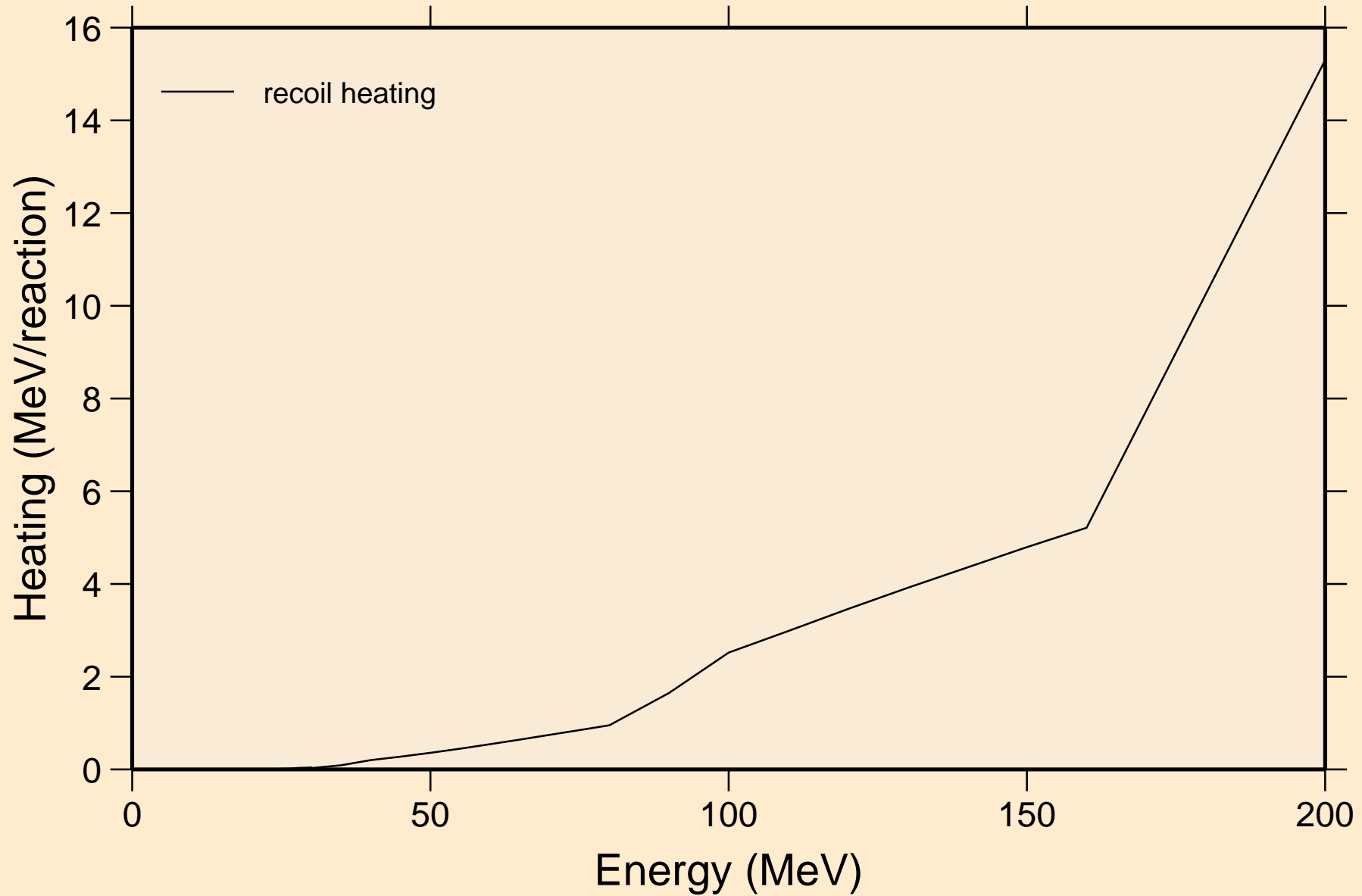

PO201M HELION ACER TENDL-2023 LIBRARY; T=0.K  
Particle production cross sections

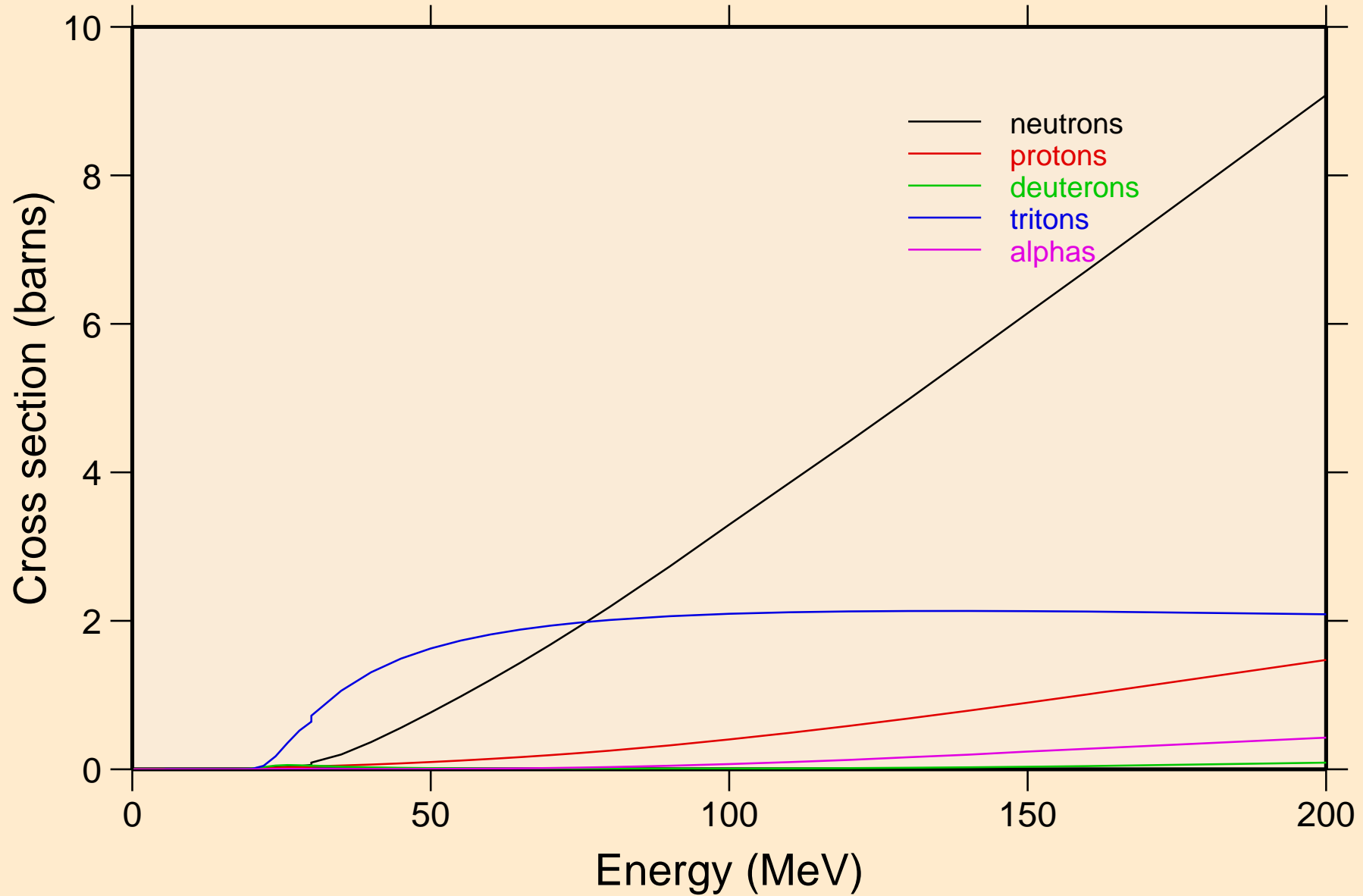



PO201M HELION ACER TENDL-2023 LIBRARY; T=0.K  
neutrons from (s,n)

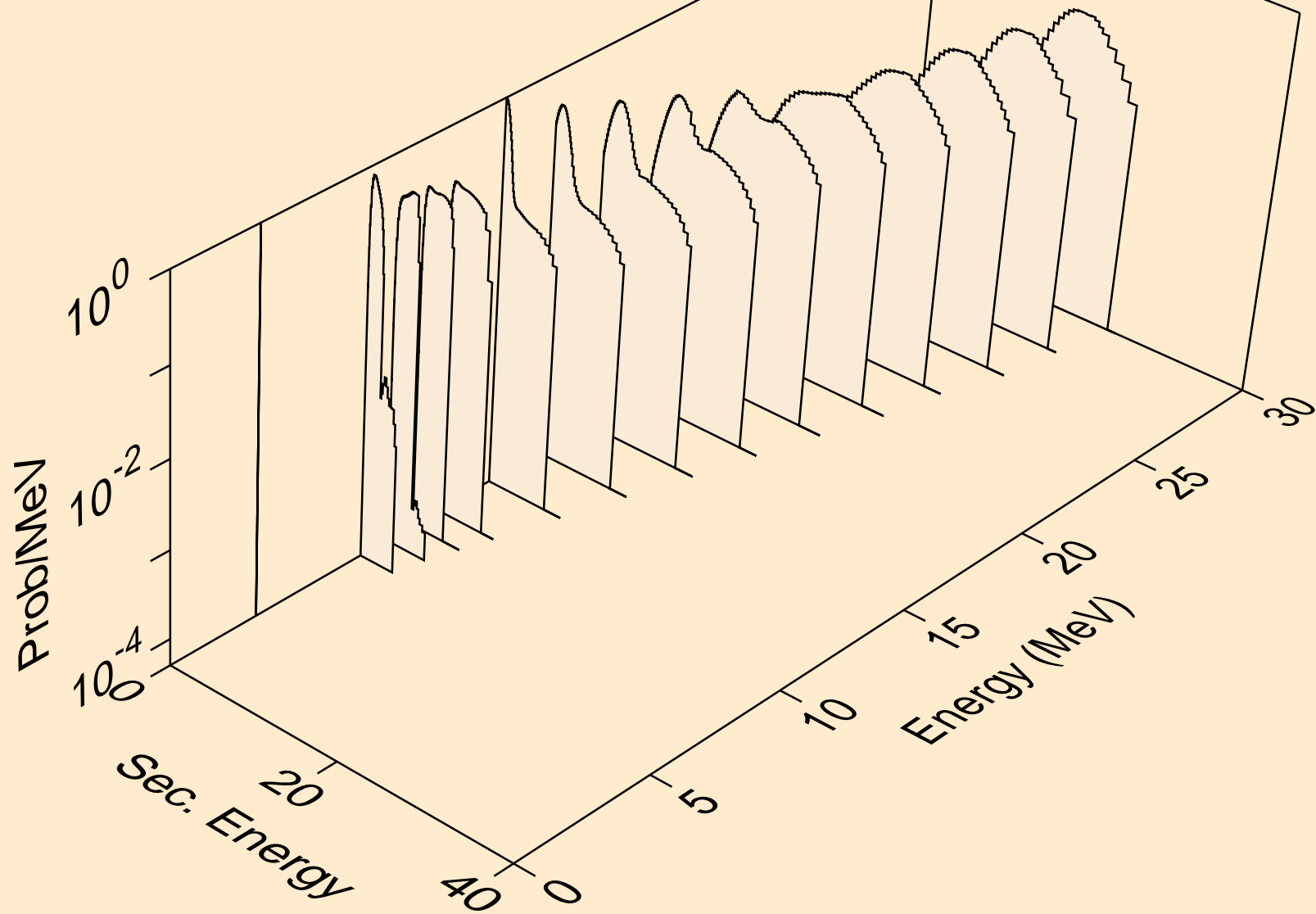

PO201M HELION ACER TENDL-2023 LIBRARY; T=0.K  
neutrons from (s,x)

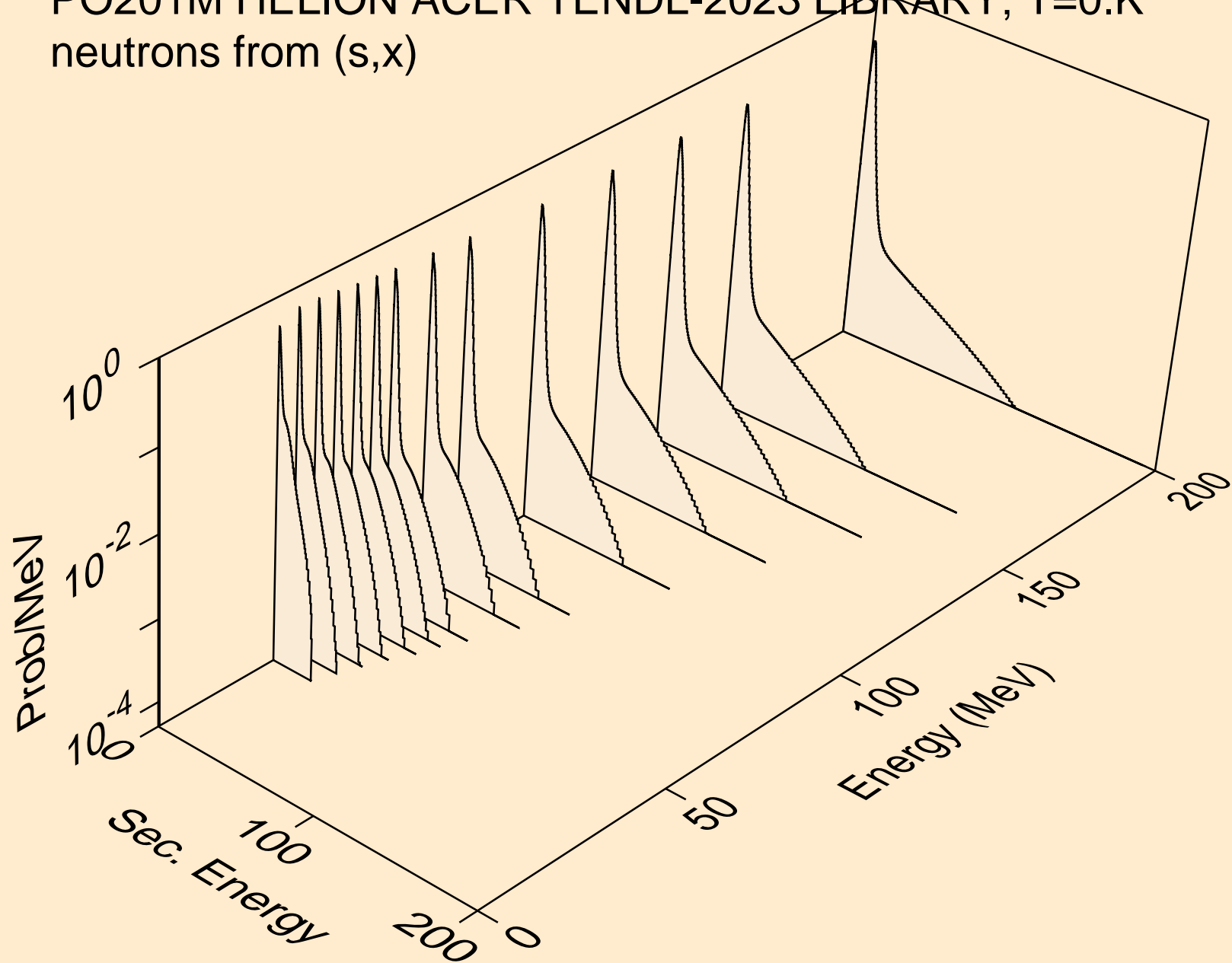

PO201M HELION ACER TENDL-2023 LIBRARY; T=0.K  
neutrons from (s,2nd)

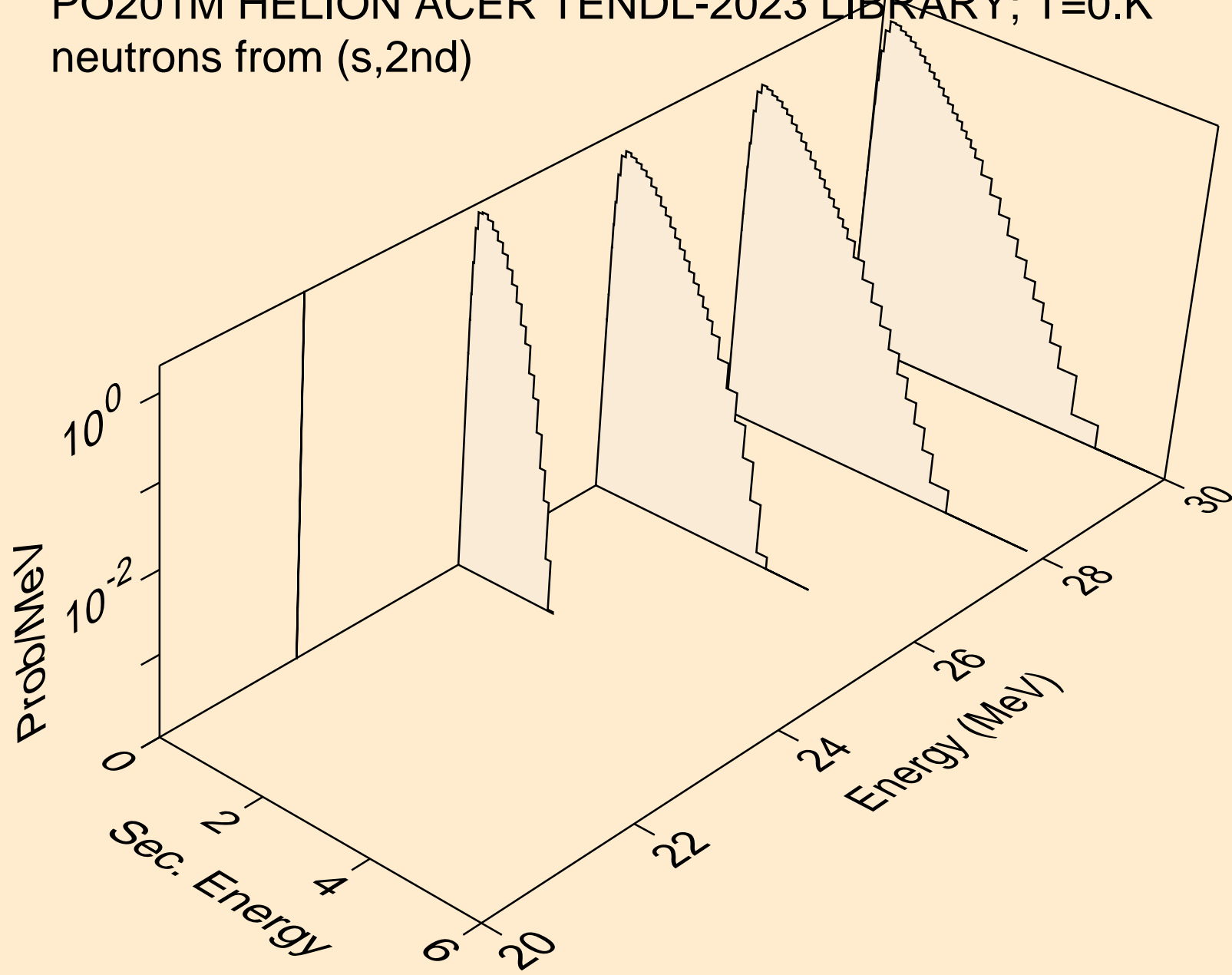

PO201M HELION ACER TENDL-2023 LIBRARY; T=0.K  
neutrons from (s,2n)

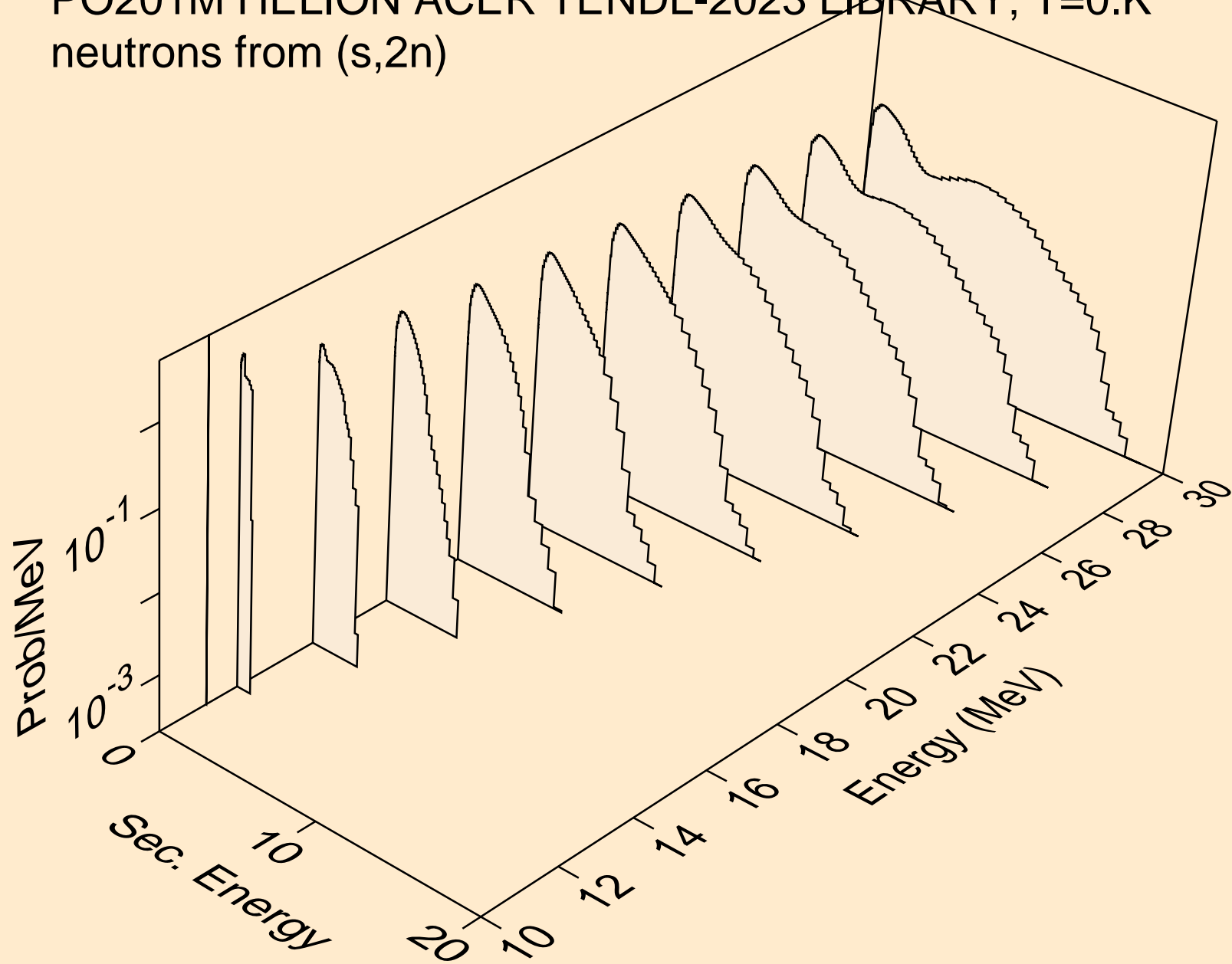

PO201M HELION ACER TENDL-2023 LIBRARY; T=0.K  
neutrons from (s,3n)

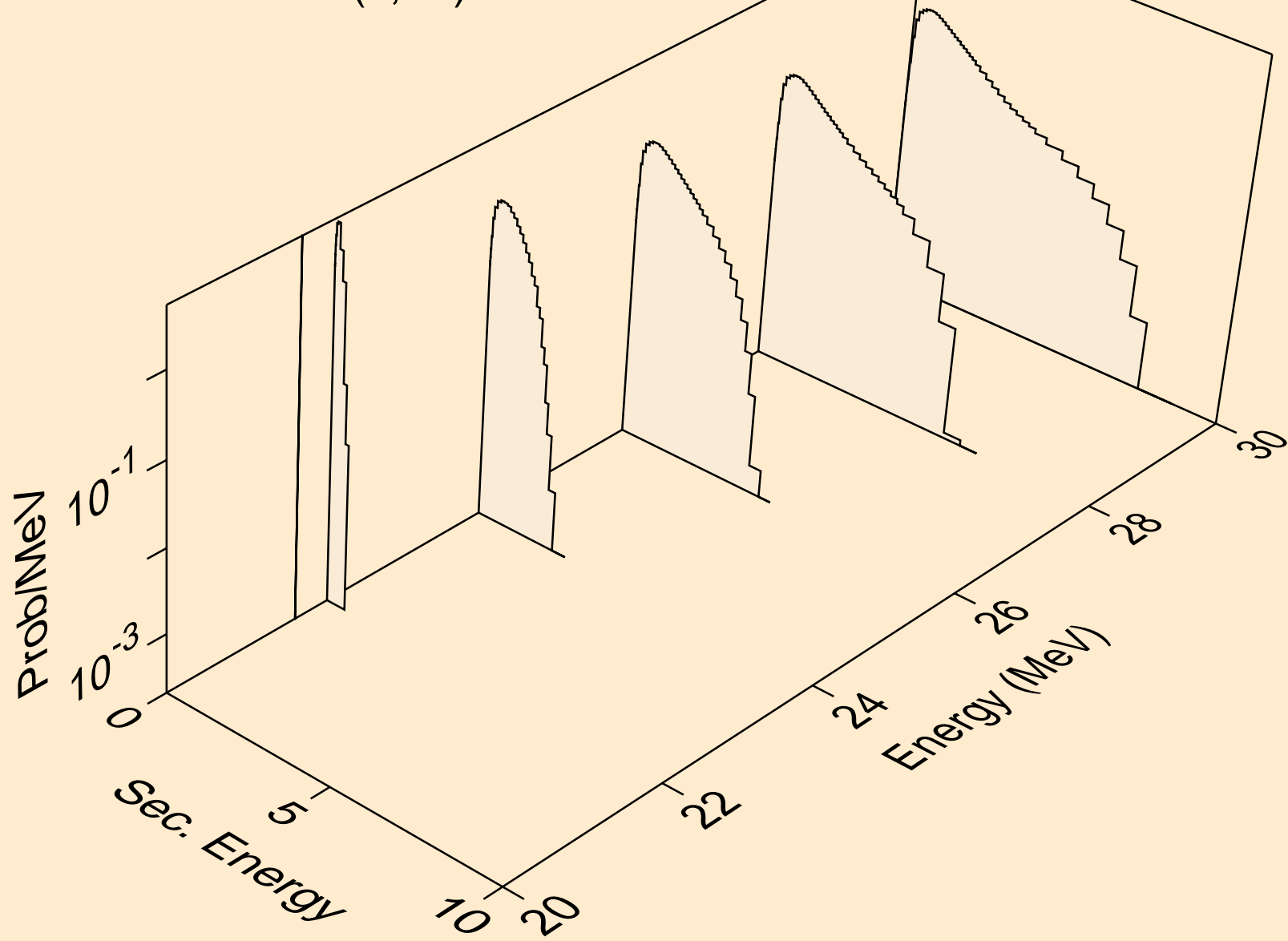

PO201M HELION ACER TENDL-2023 LIBRARY; T=0.K  
neutrons from (s,n\*)a

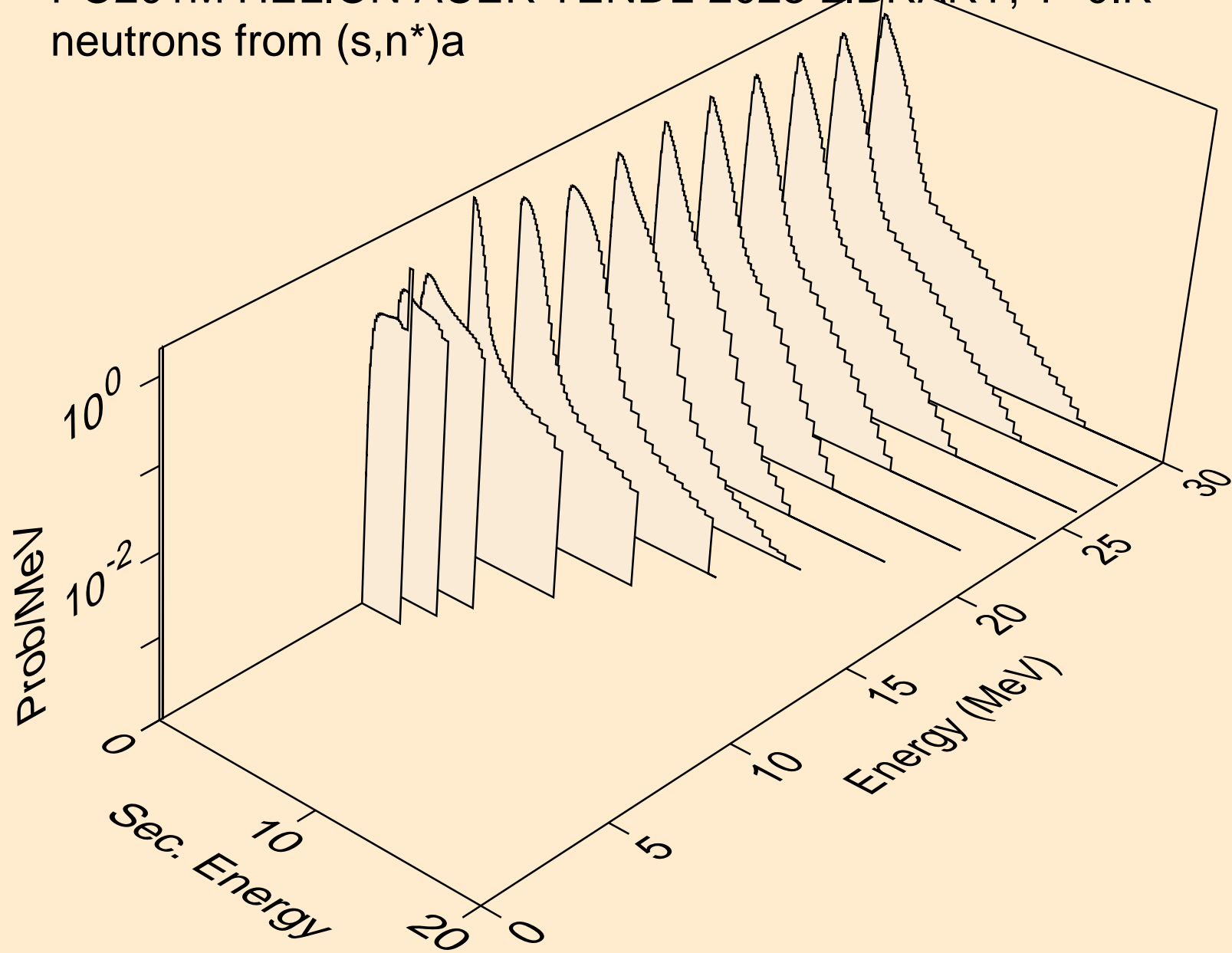

PO201M HELION ACER TENDL-2023 LIBRARY; T=0.K  
neutrons from (s,2n)a

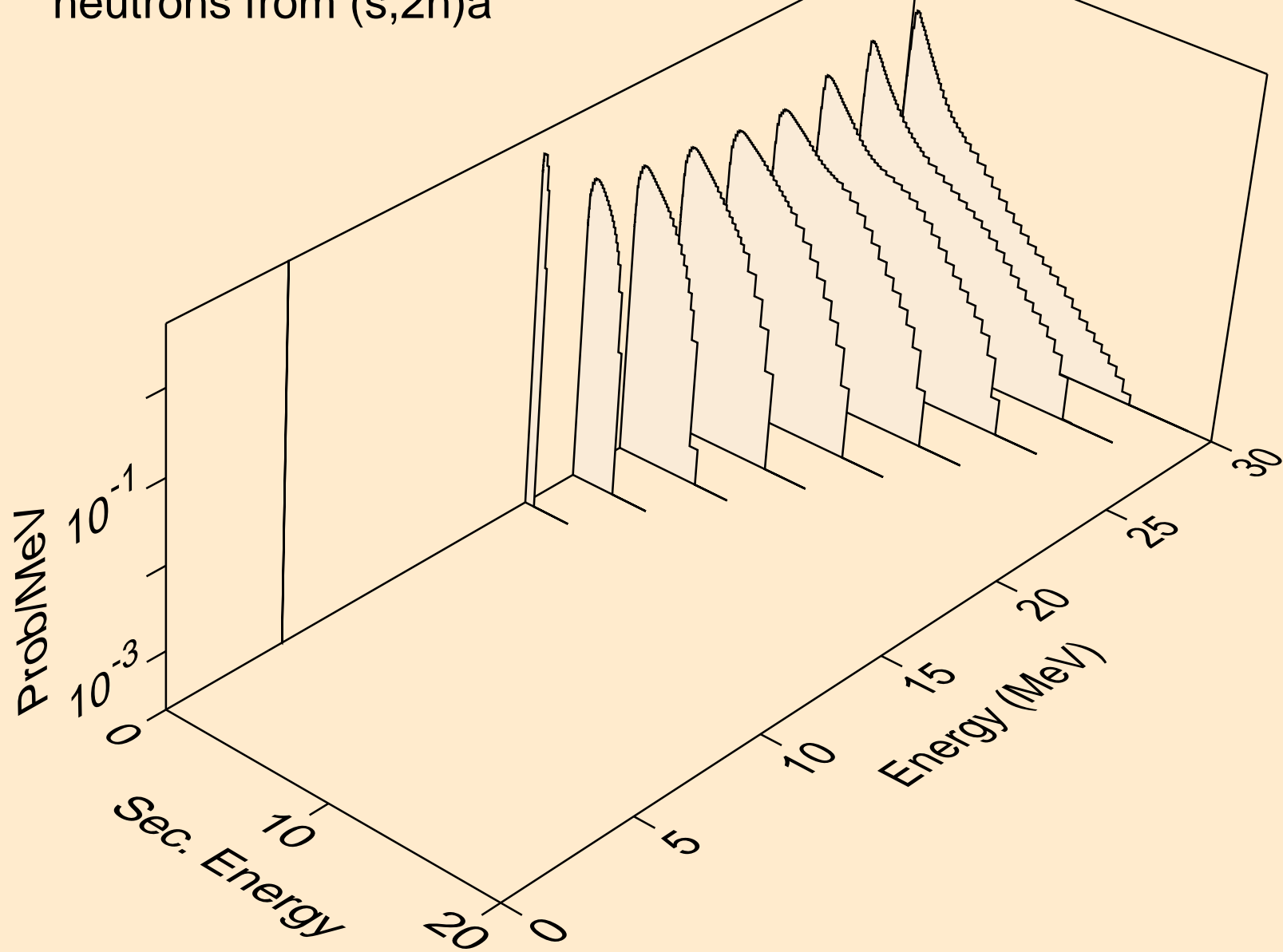

PO201M HELION ACER TENDL-2023 LIBRARY; T=0.K  
neutrons from (s,3n)a

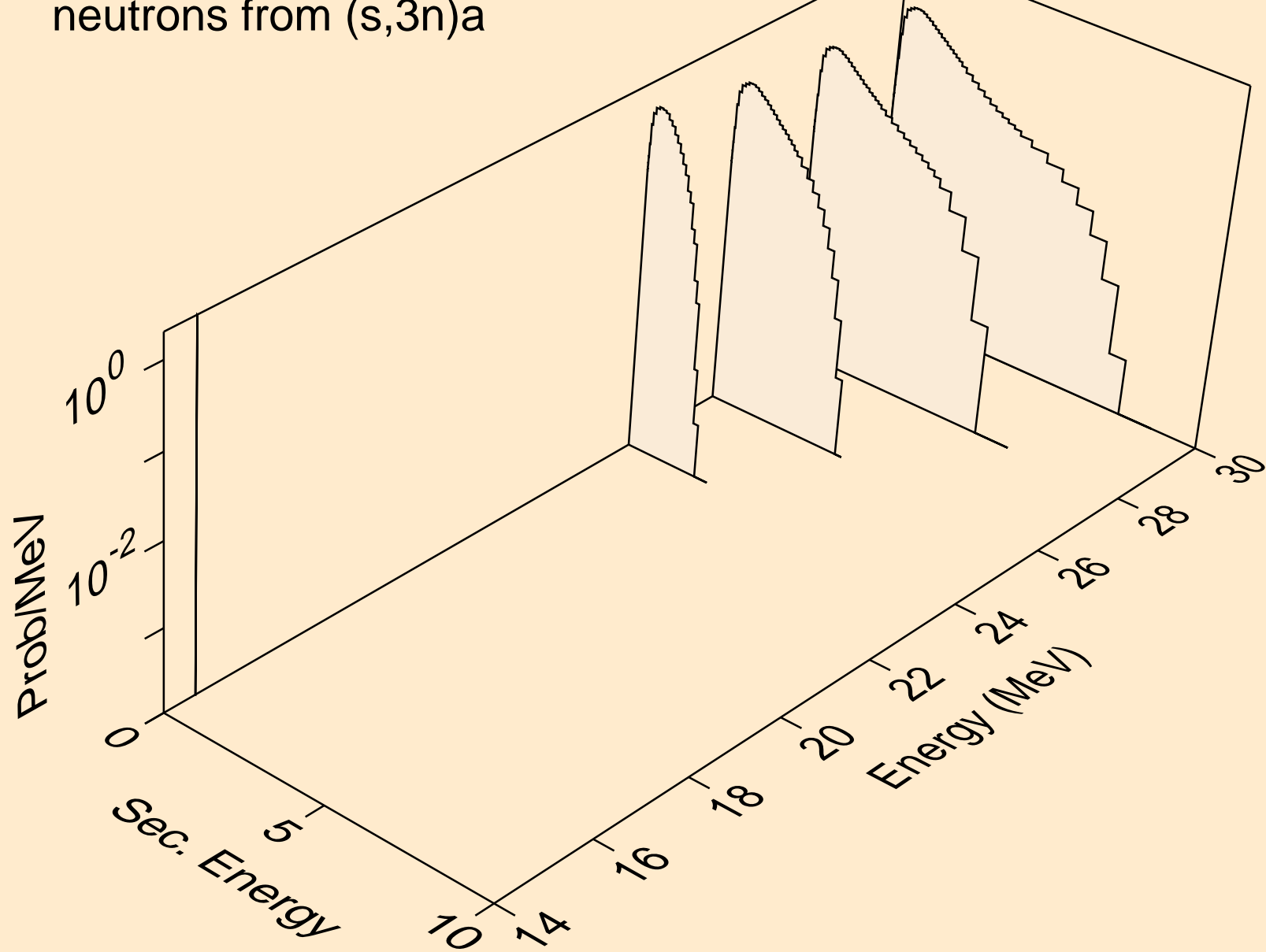



PO201M HELION ACER TENDL-2023 LIBRARY; T=0.K  
neutrons from (s,n\*)p

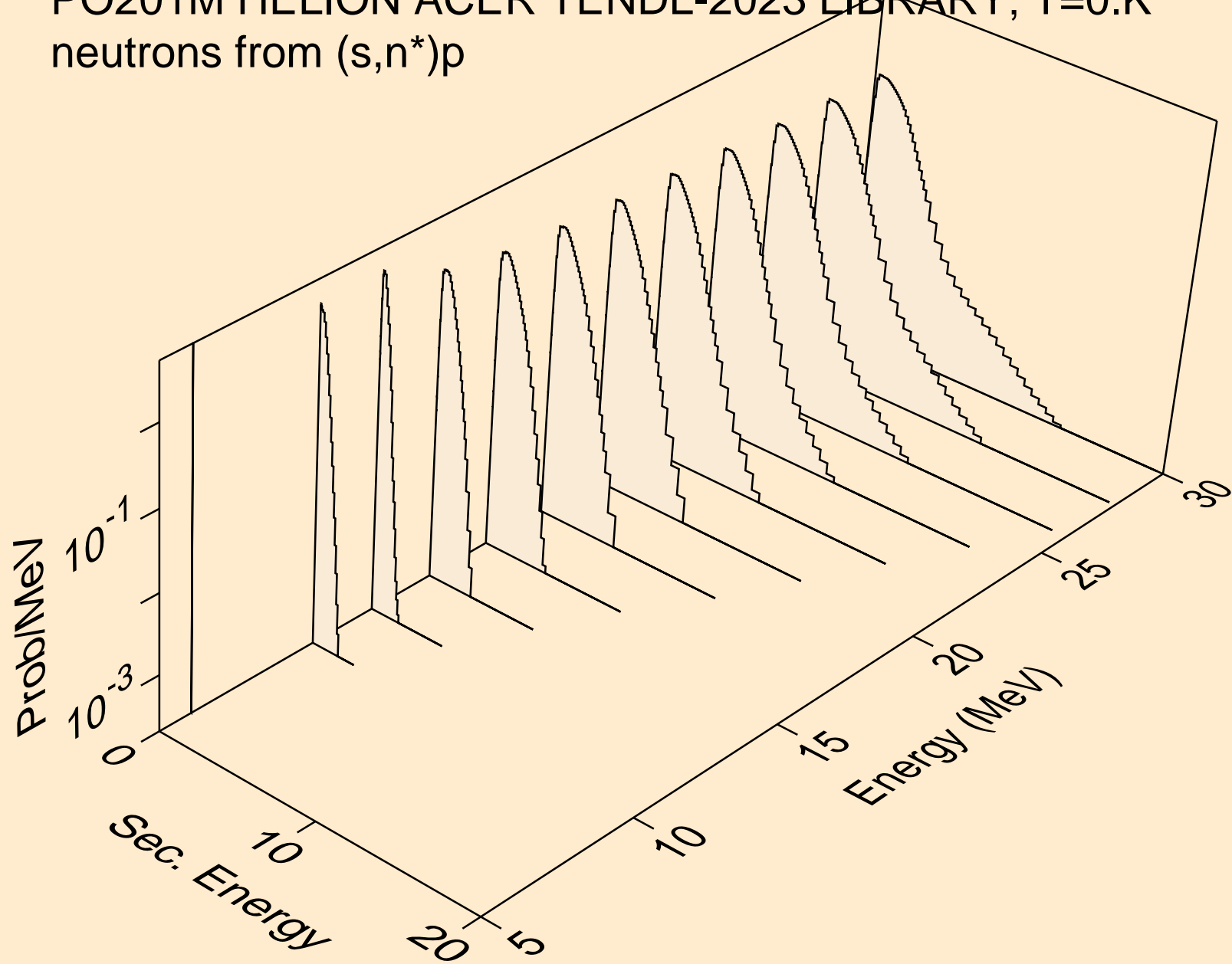

PO201M HELION ACER TENDL-2023 LIBRARY; T=0.K  
neutrons from (s,n\*)2a

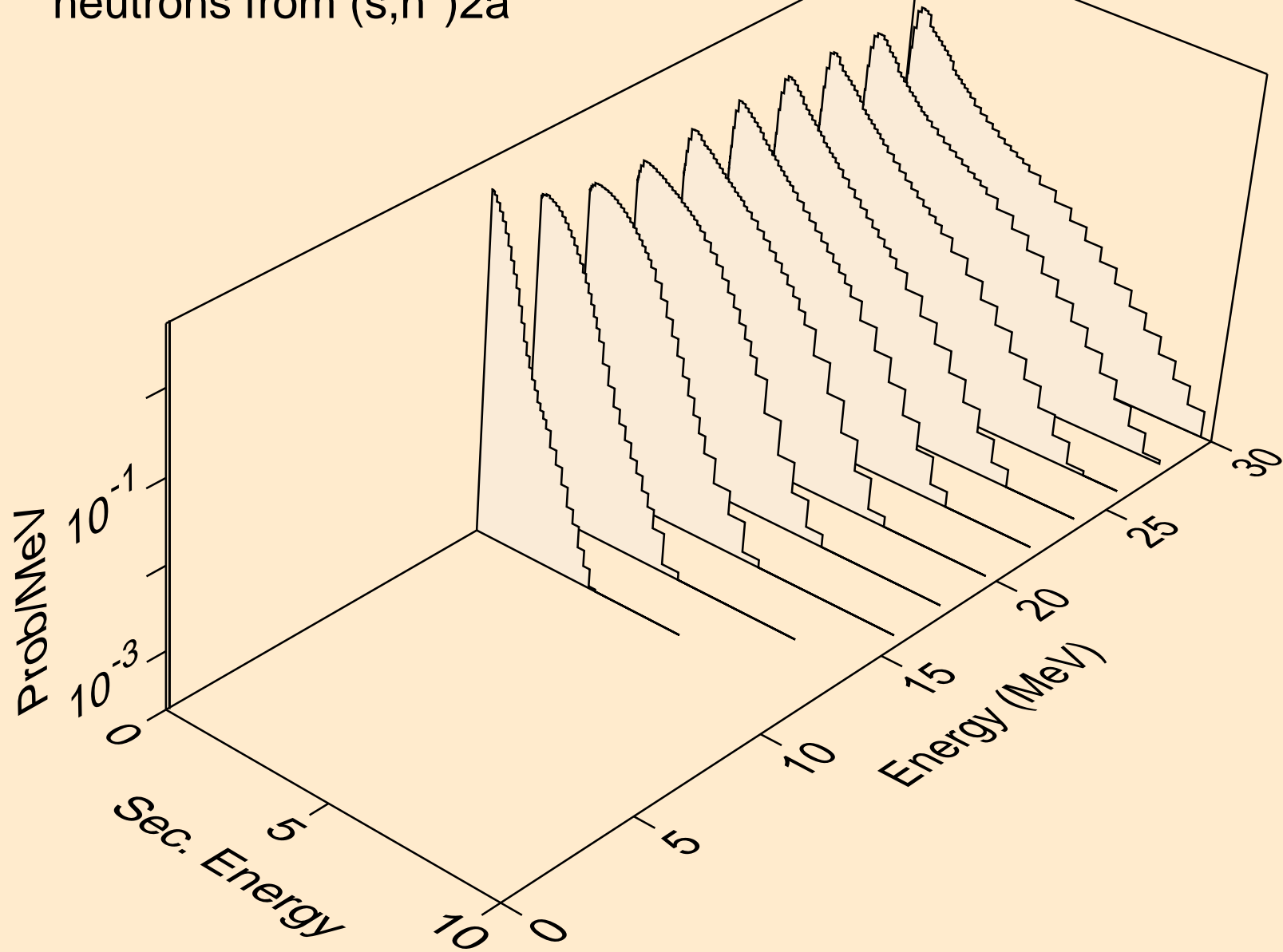

PO201M HELION ACER TENDL-2023 LIBRARY; T=0.K  
neutrons from (s,n\*)d

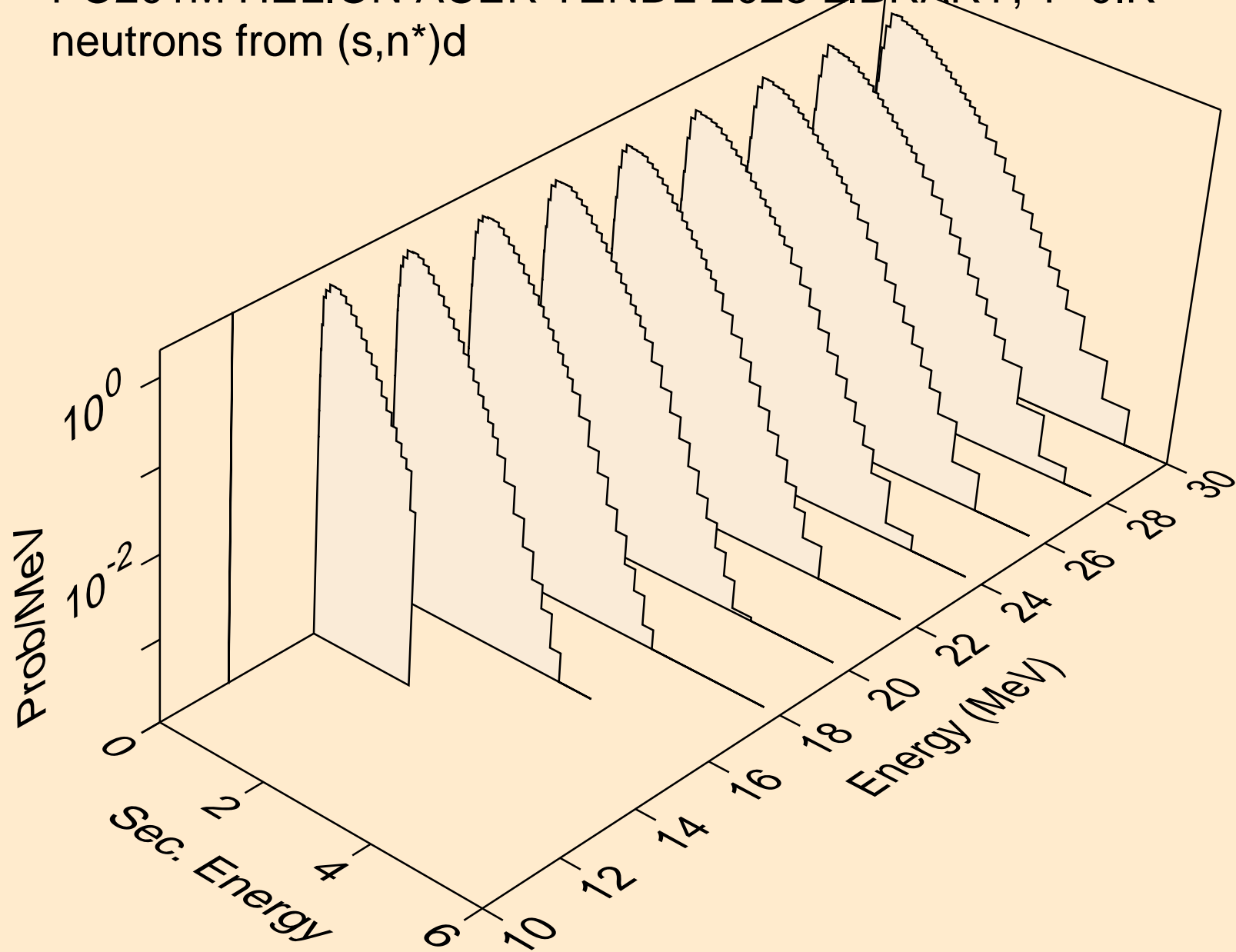

PO201M HELION ACER TENDL-2023 LIBRARY; T=0.K  
neutrons from (s,n\*)t

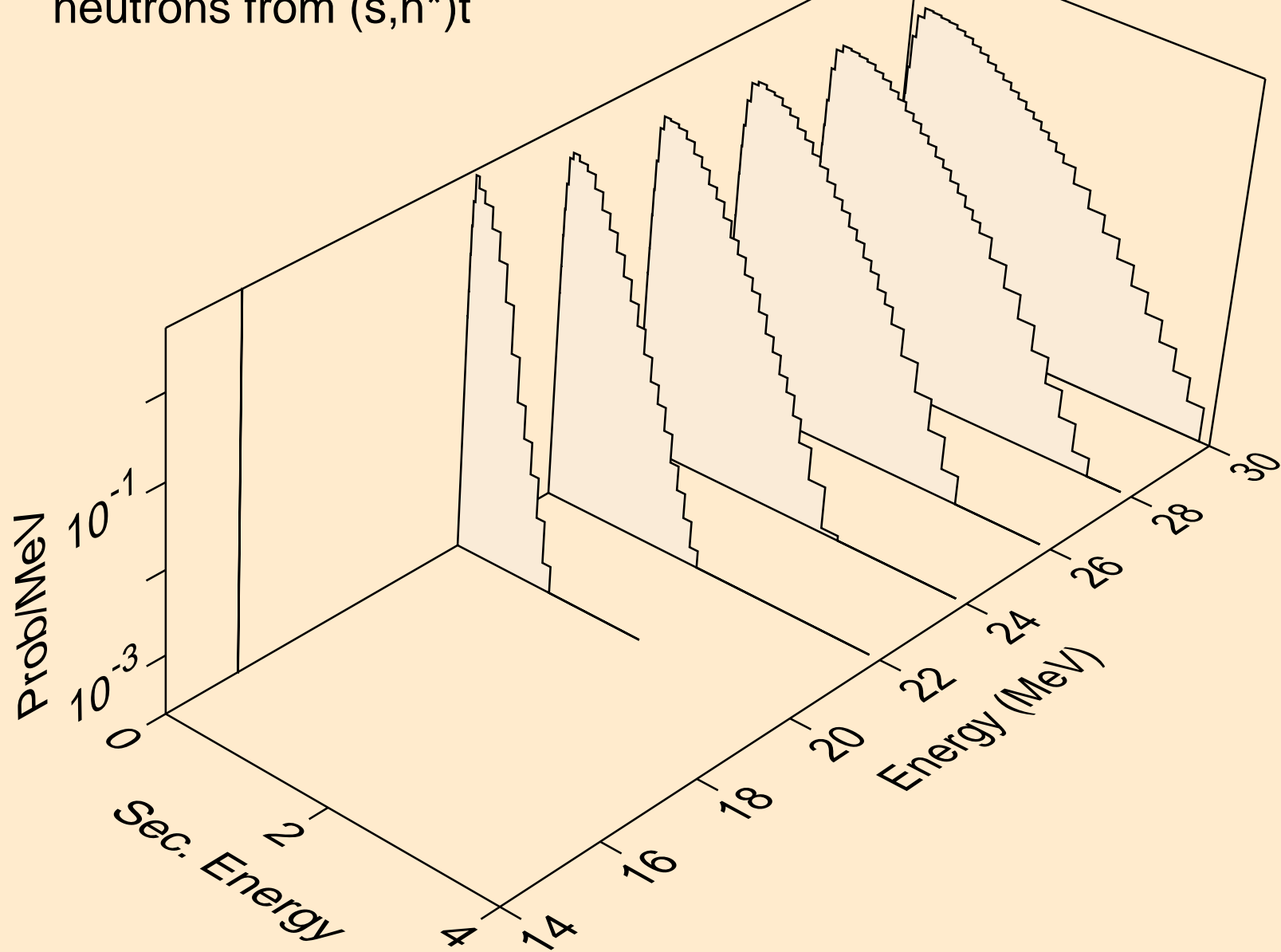

PO201M HELION ACER TENDL-2023 LIBRARY; T=0.K  
neutrons from (s,n\*)he3

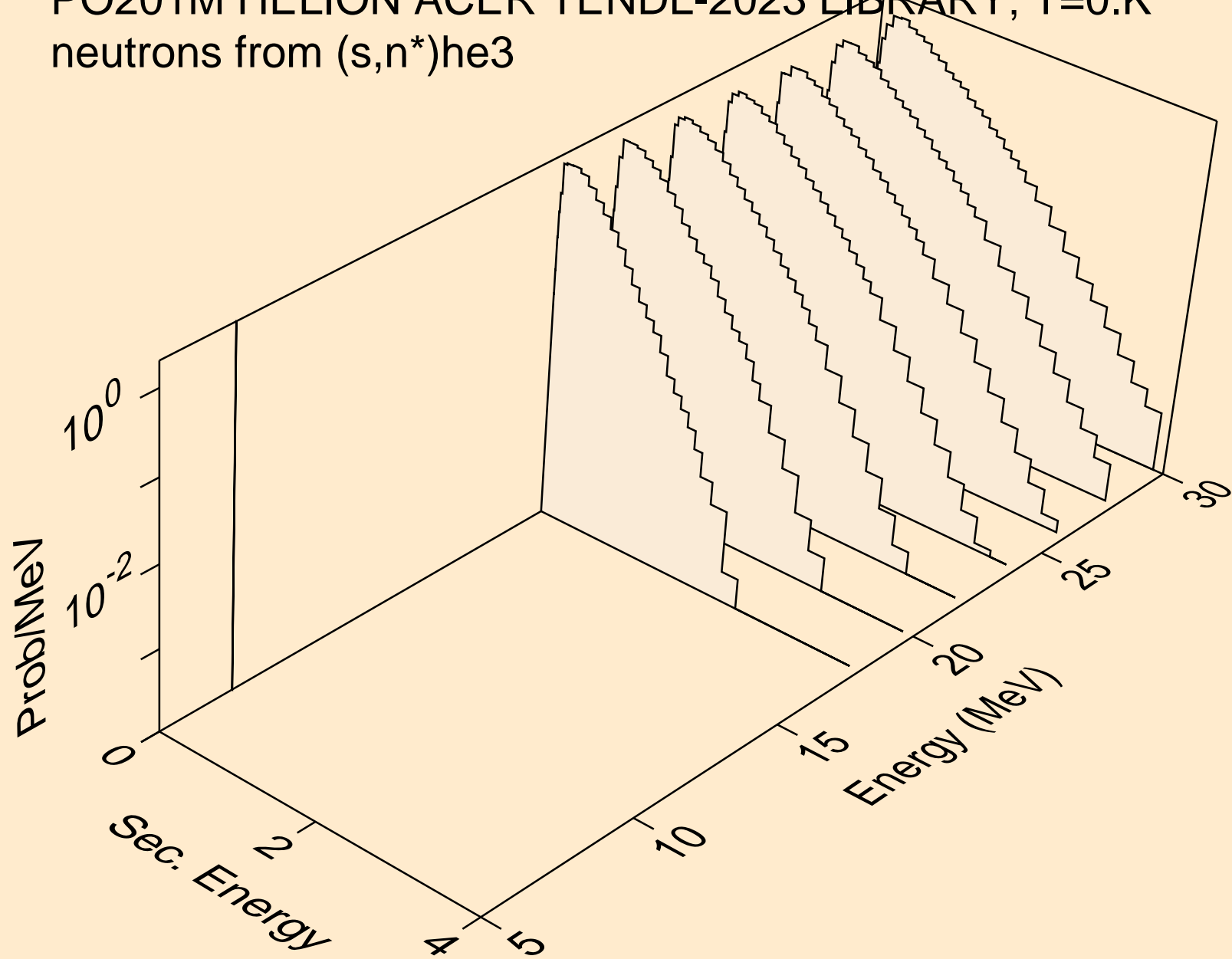

PO201M HELION ACER TENDL-2023 LIBRARY; T=0.K  
neutrons from (s,2np)

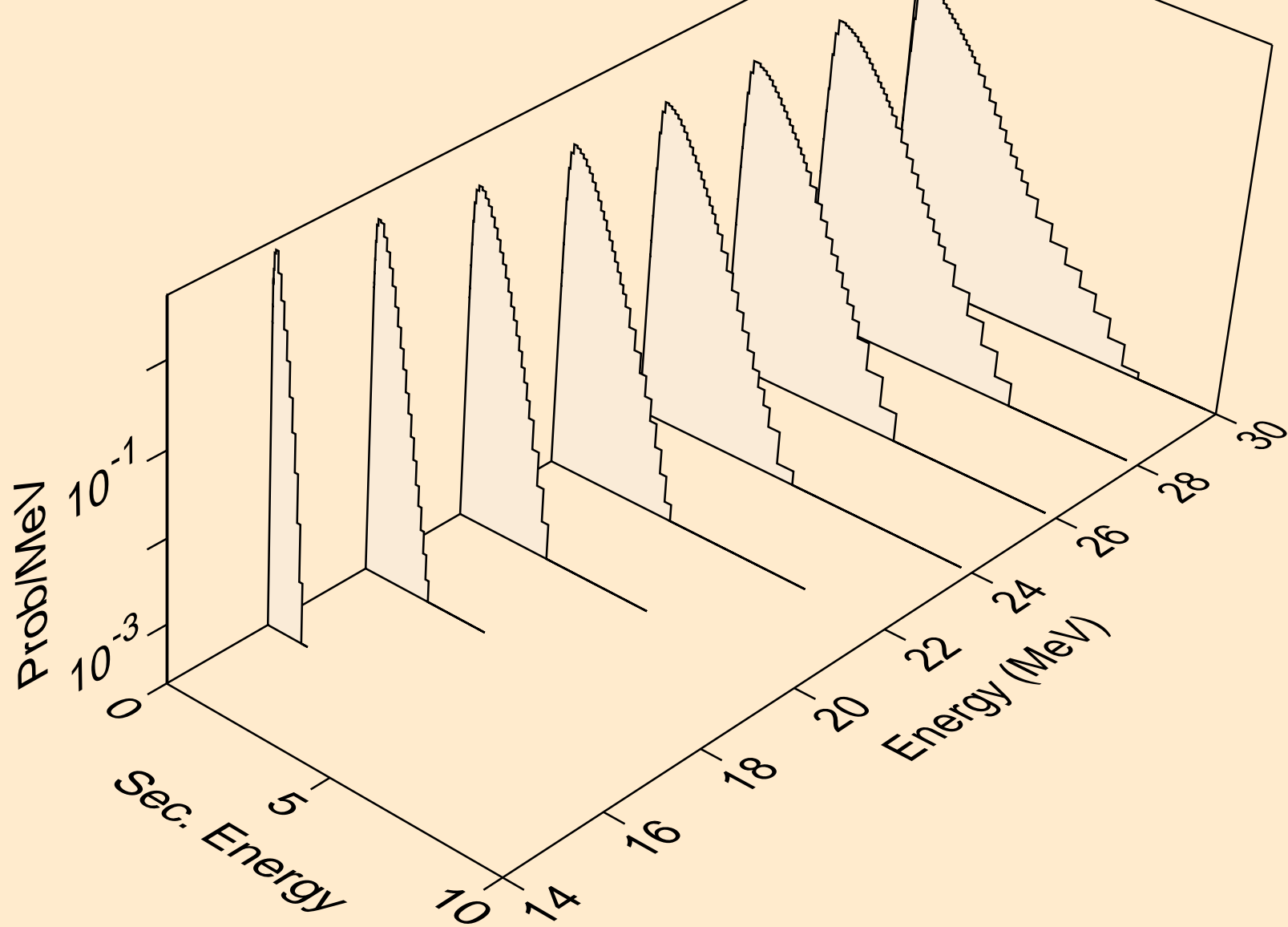

PO201M HELION ACER TENDL-2023 LIBRARY; T=0.K  
neutrons from (s,3np)

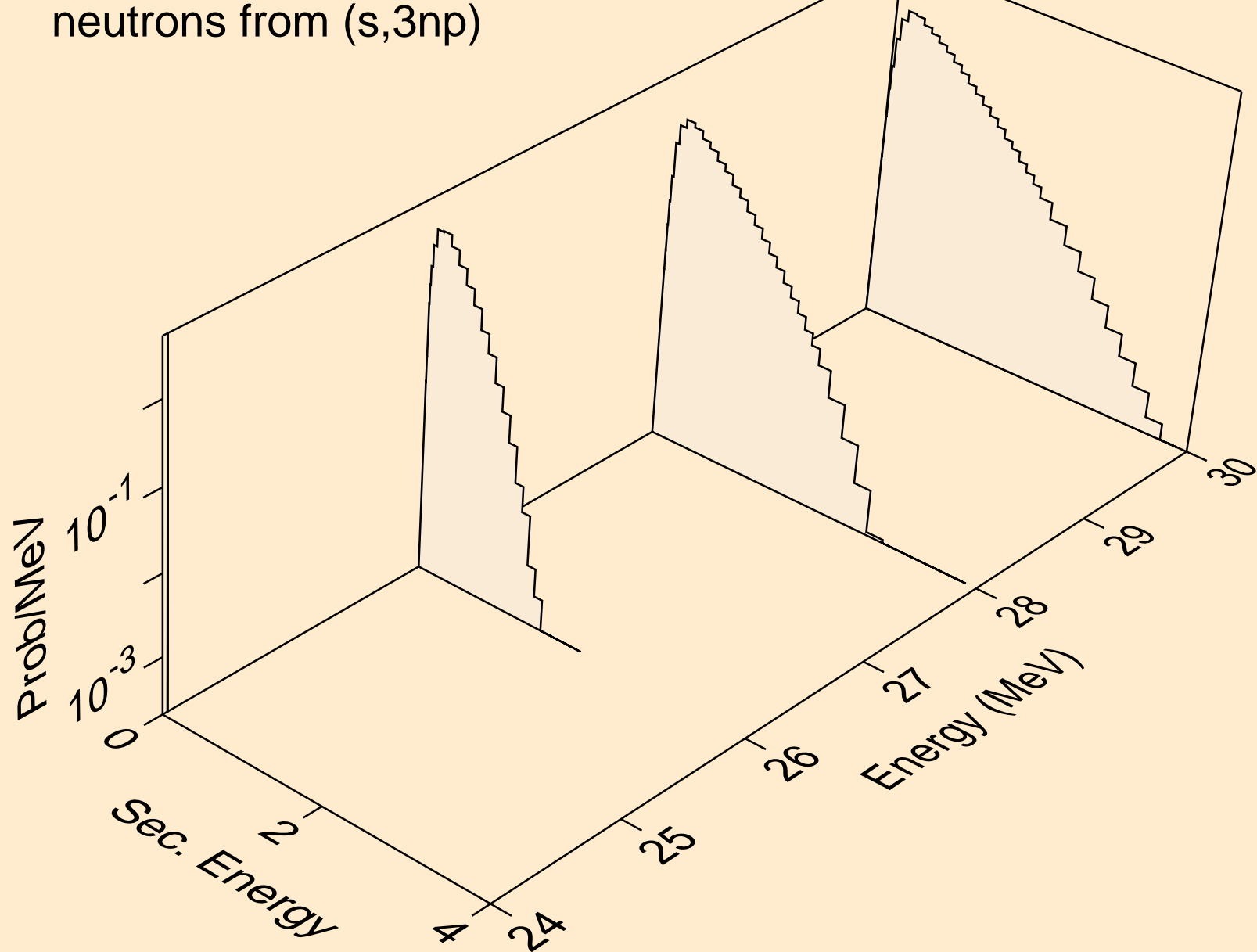

PO201M HELION ACER TENDL-2023 LIBRARY; T=0.K  
neutrons from (s,n2p)

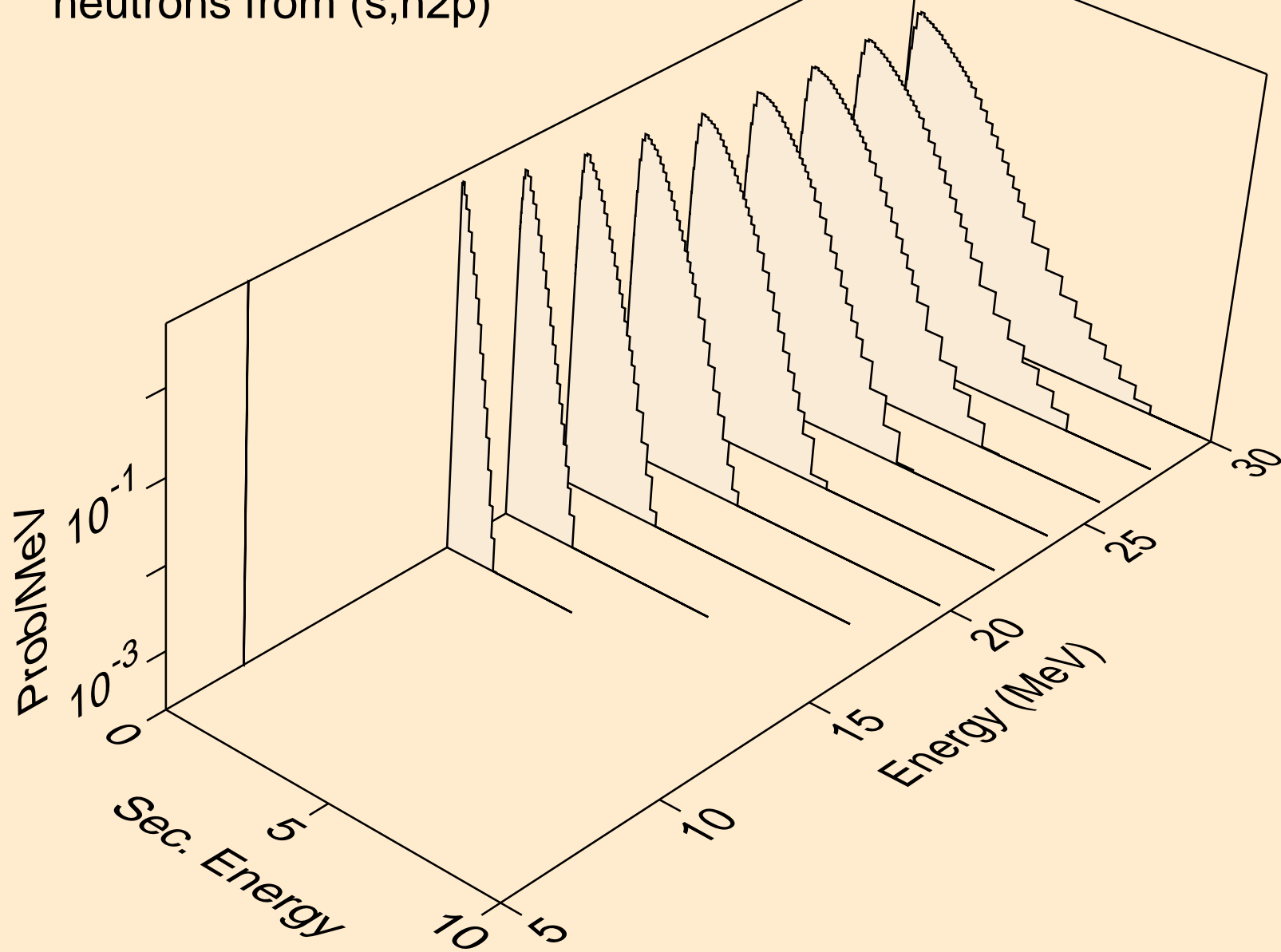



PO201M HELION ACER TENDL-2023 LIBRARY; T=0.K  
neutrons from (s,npa)

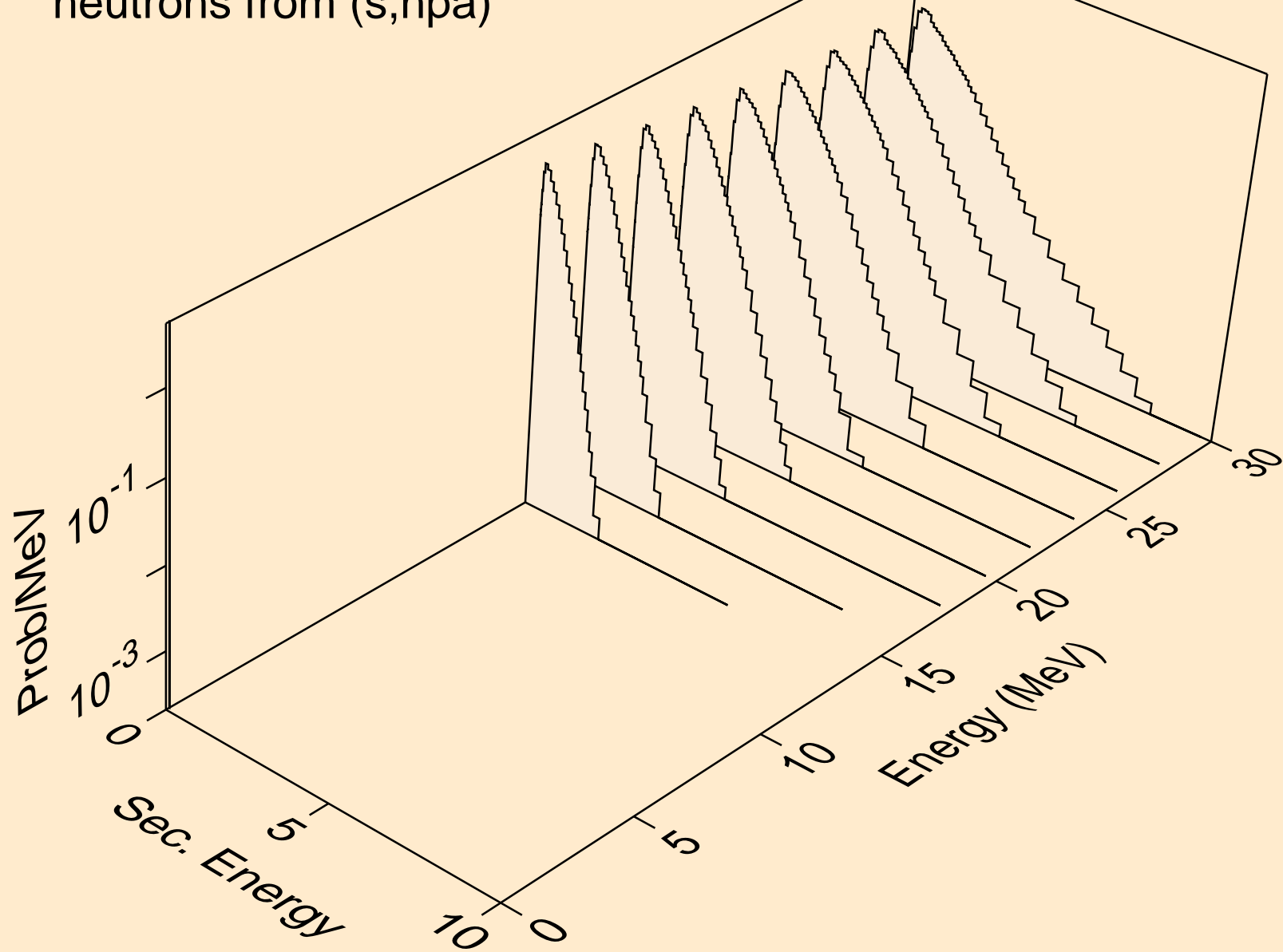

PO201M HELION ACER TENDL-2023 LIBRARY; T=0.K  
protons from (s,x)

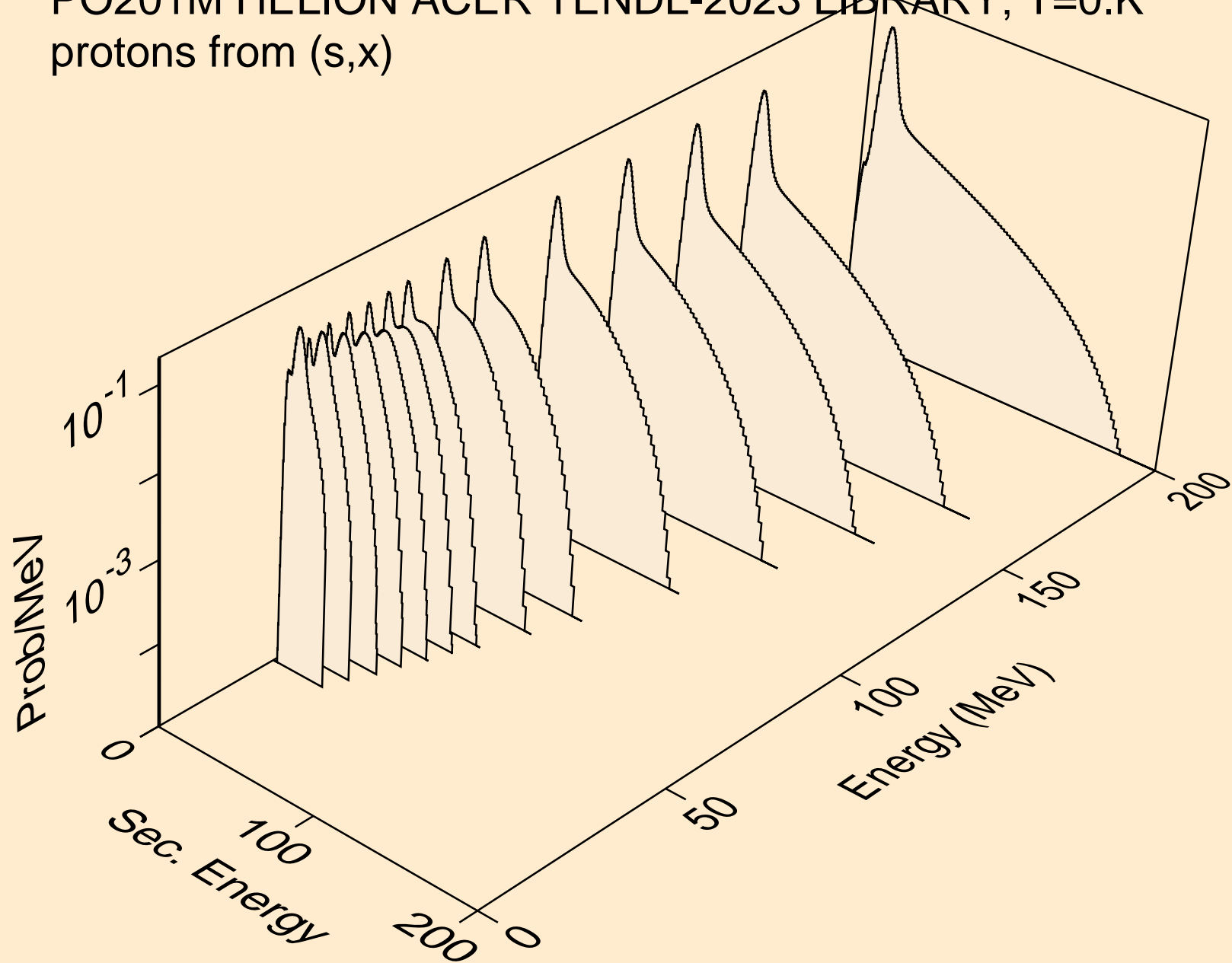

PO201M HELION ACER TENDL-2023 LIBRARY; T=0.K  
protons from (s,n\*)p

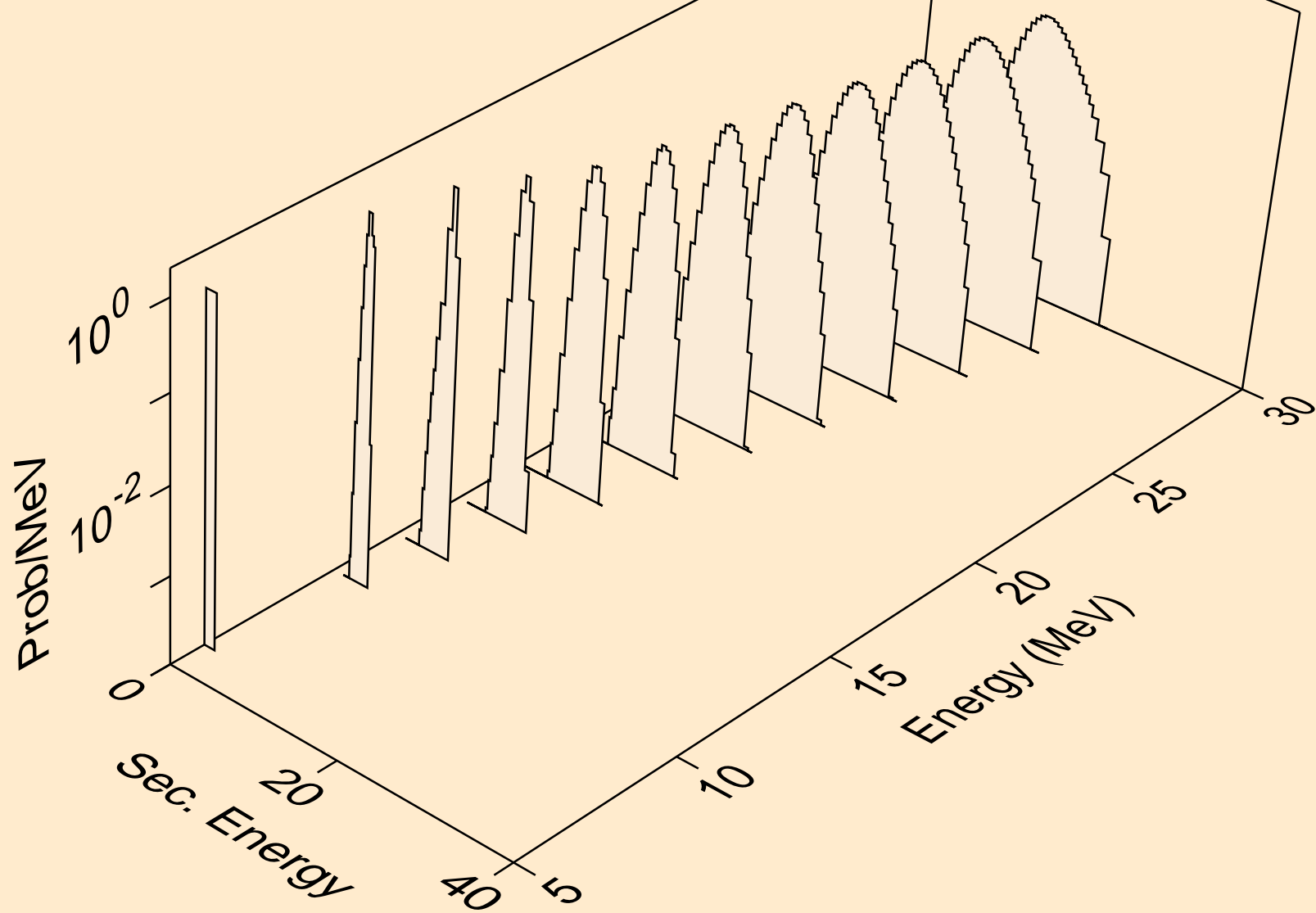

PO201M HELION ACER TENDL-2023 LIBRARY; T=0.K  
protons from (s,2np)

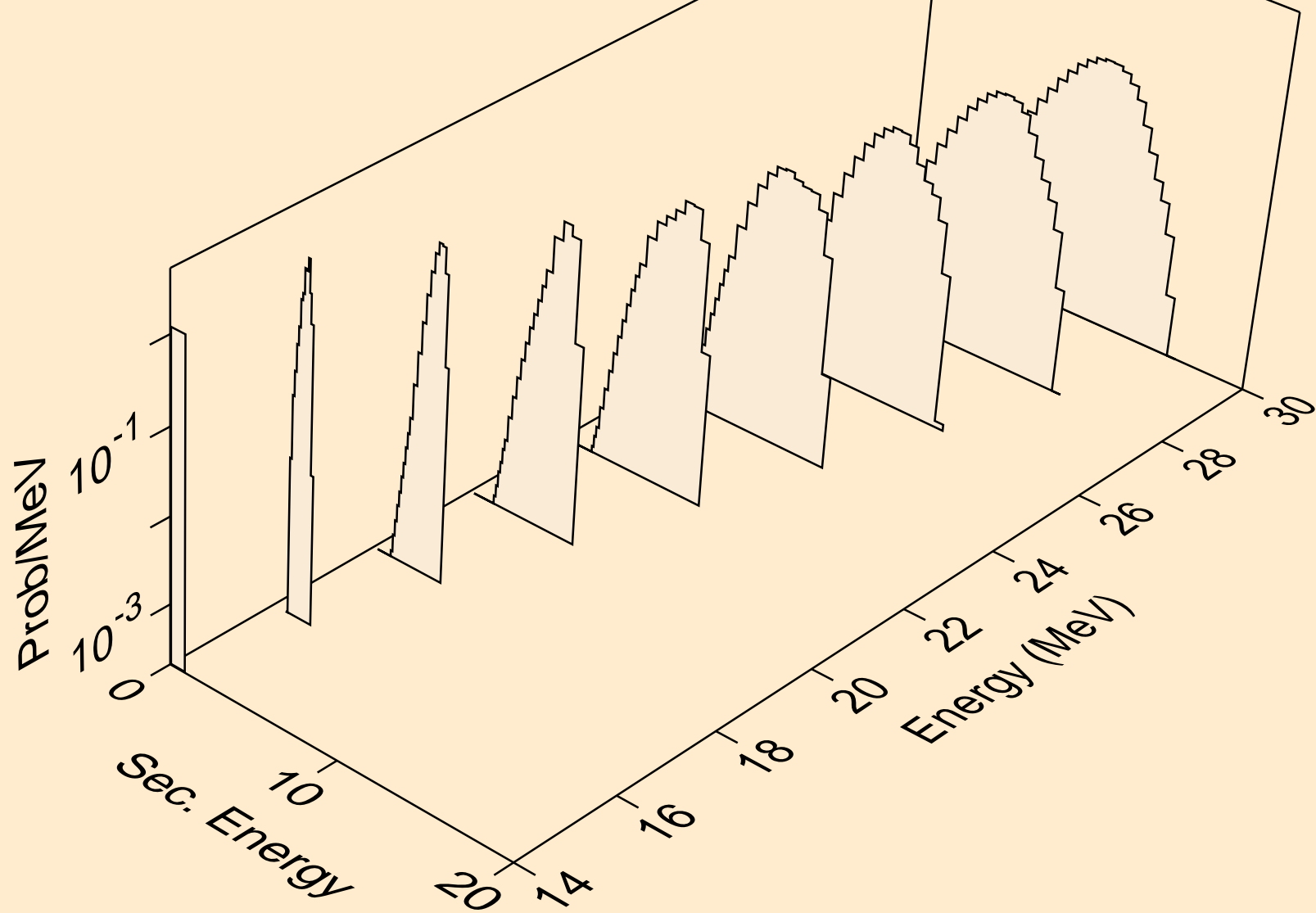

PO201M HELION ACER TENDL-2023 LIBRARY; T=0.K  
protons from (s,3np)

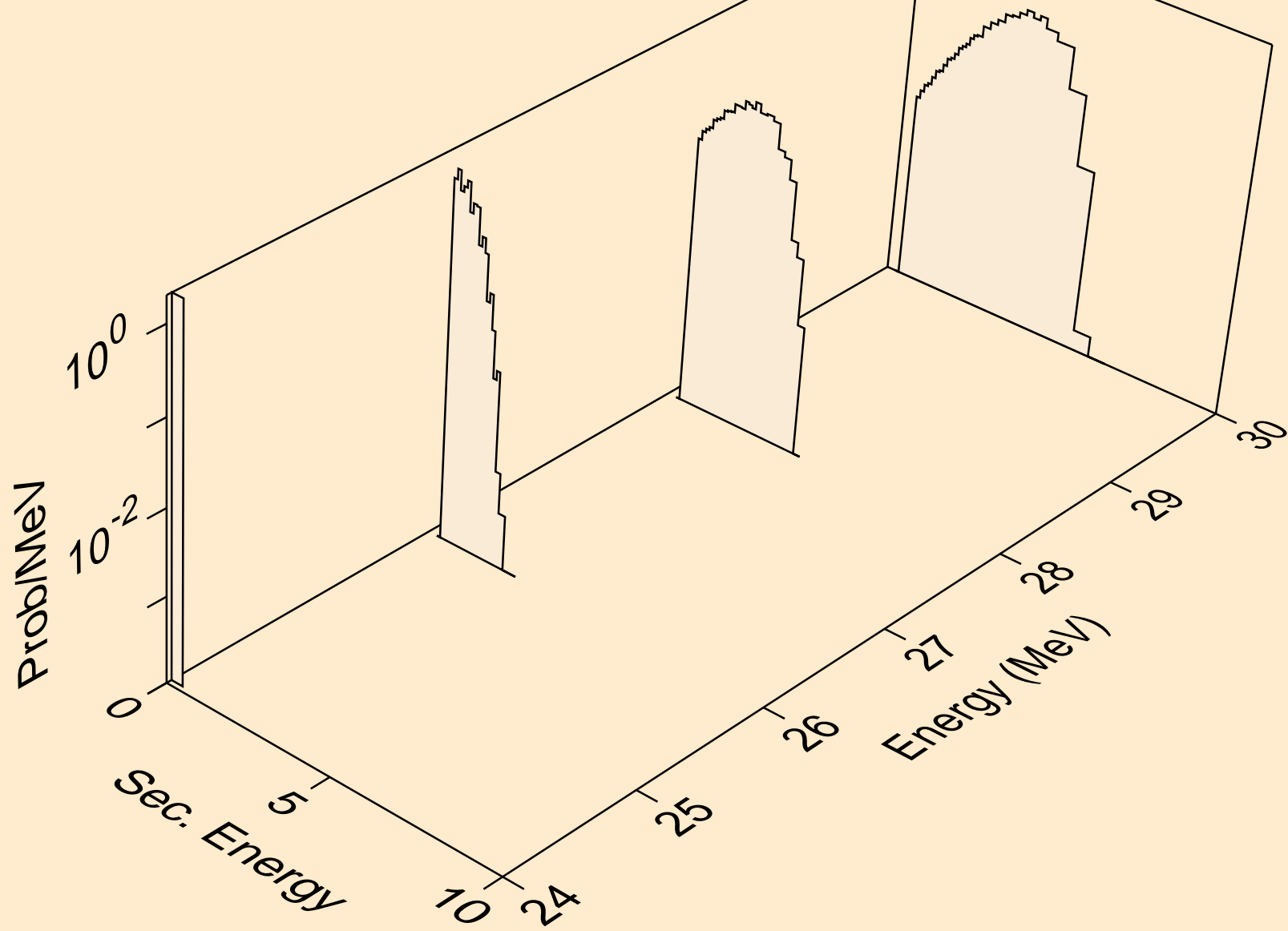

PO201M HELION ACER TENDL-2023 LIBRARY; T=0.K  
protons from (s,n2p)

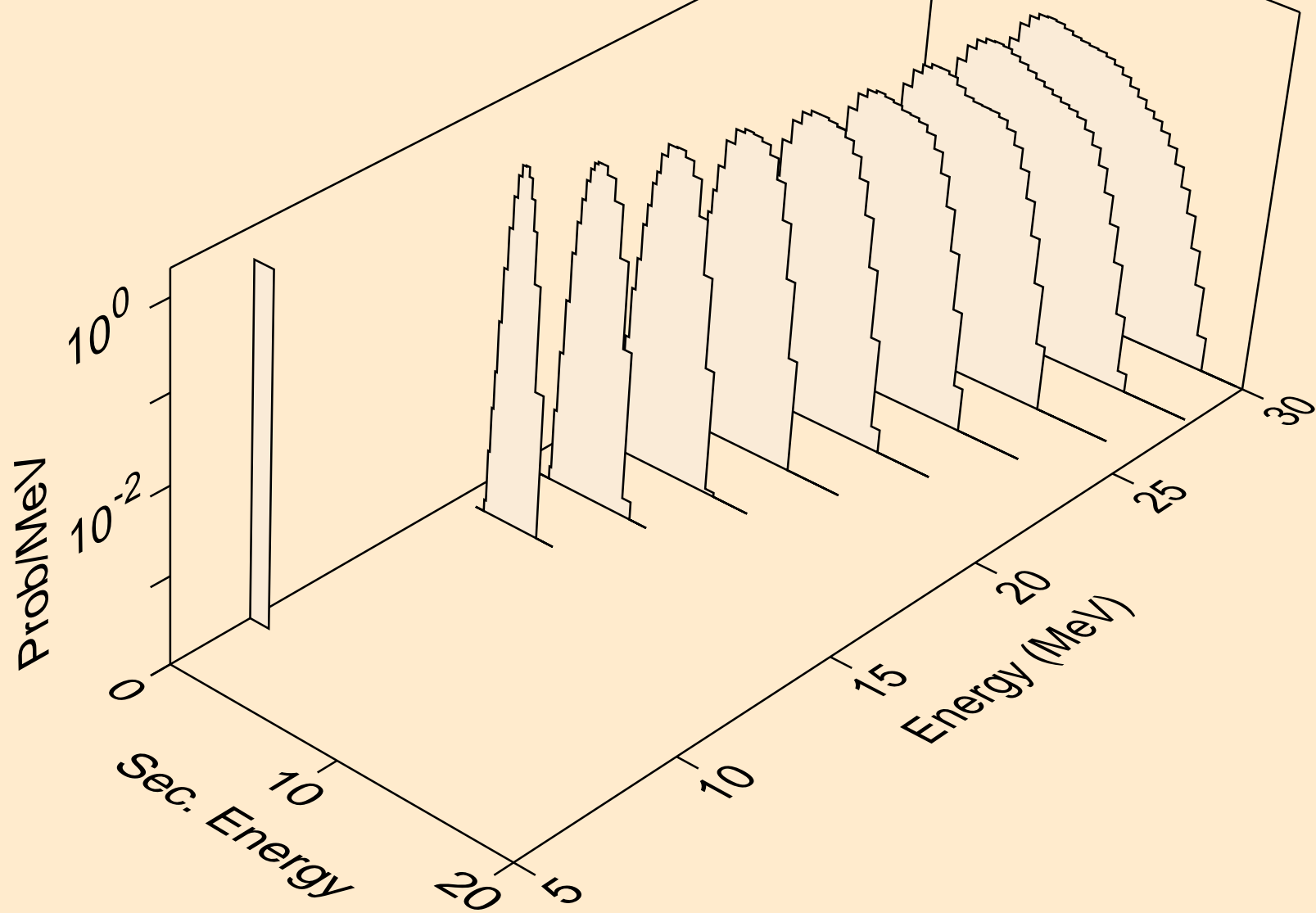

PO201M HELION ACER TENDL-2023 LIBRARY; T=0.K  
protons from (s,npa)

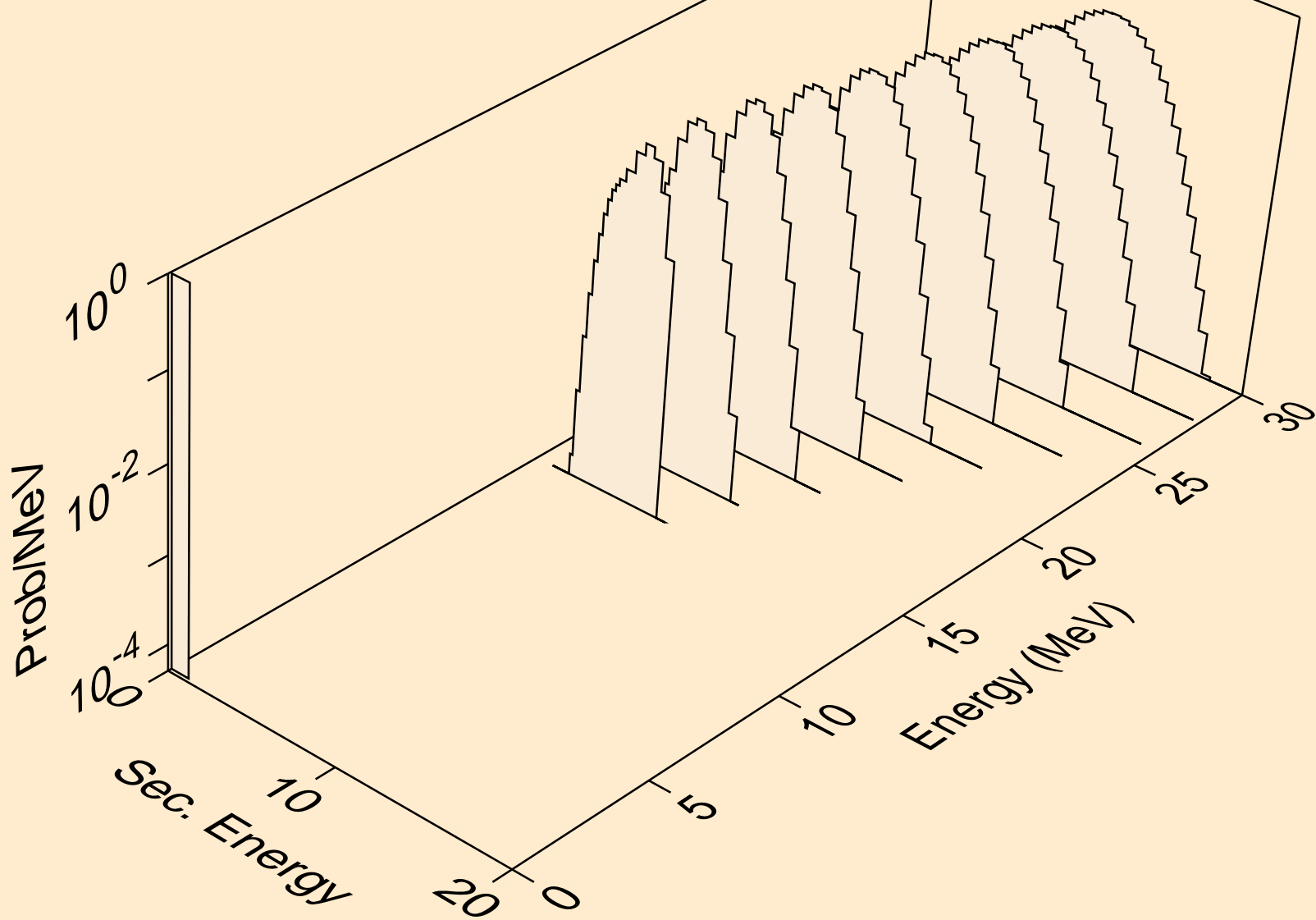

PO201M HELION ACER TENDL-2023 LIBRARY; T=0.K  
protons from (s,p)

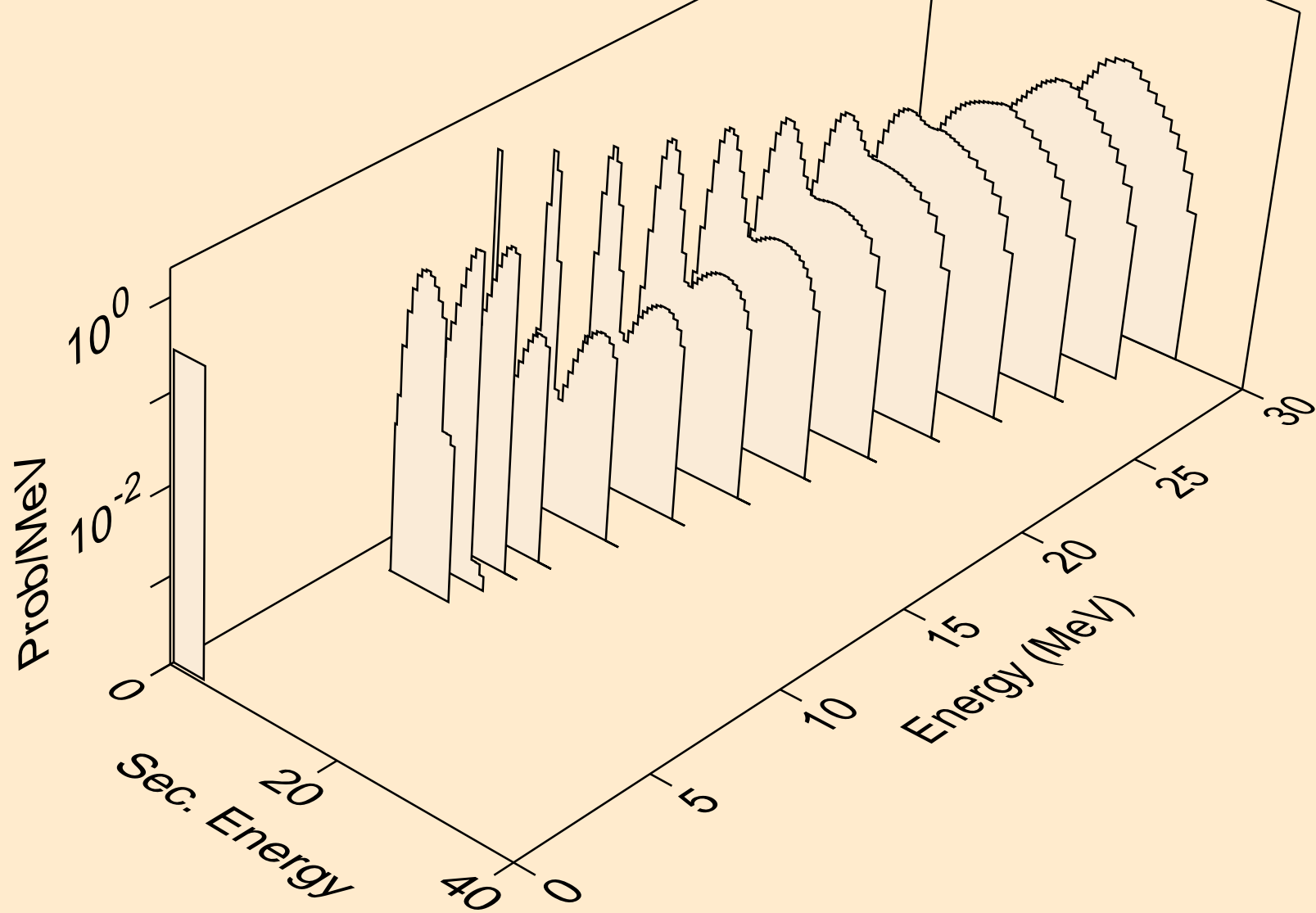



PO201M HELION ACER TENDL-2023 LIBRARY; T=0.K  
protons from (s,2p)

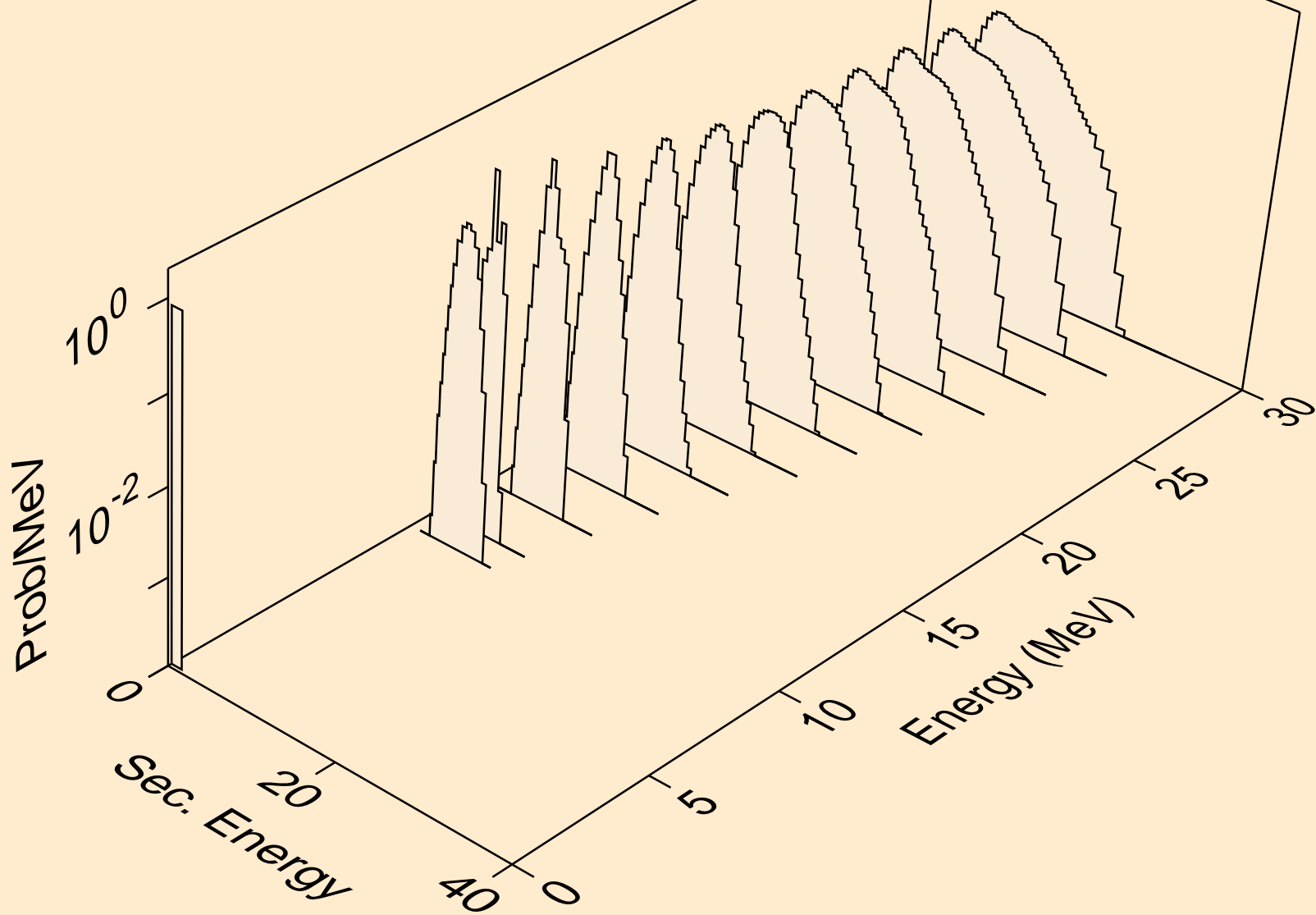

PO201M HELION ACER TENDL-2023 LIBRARY; T=0.K  
protons from (s,pa)

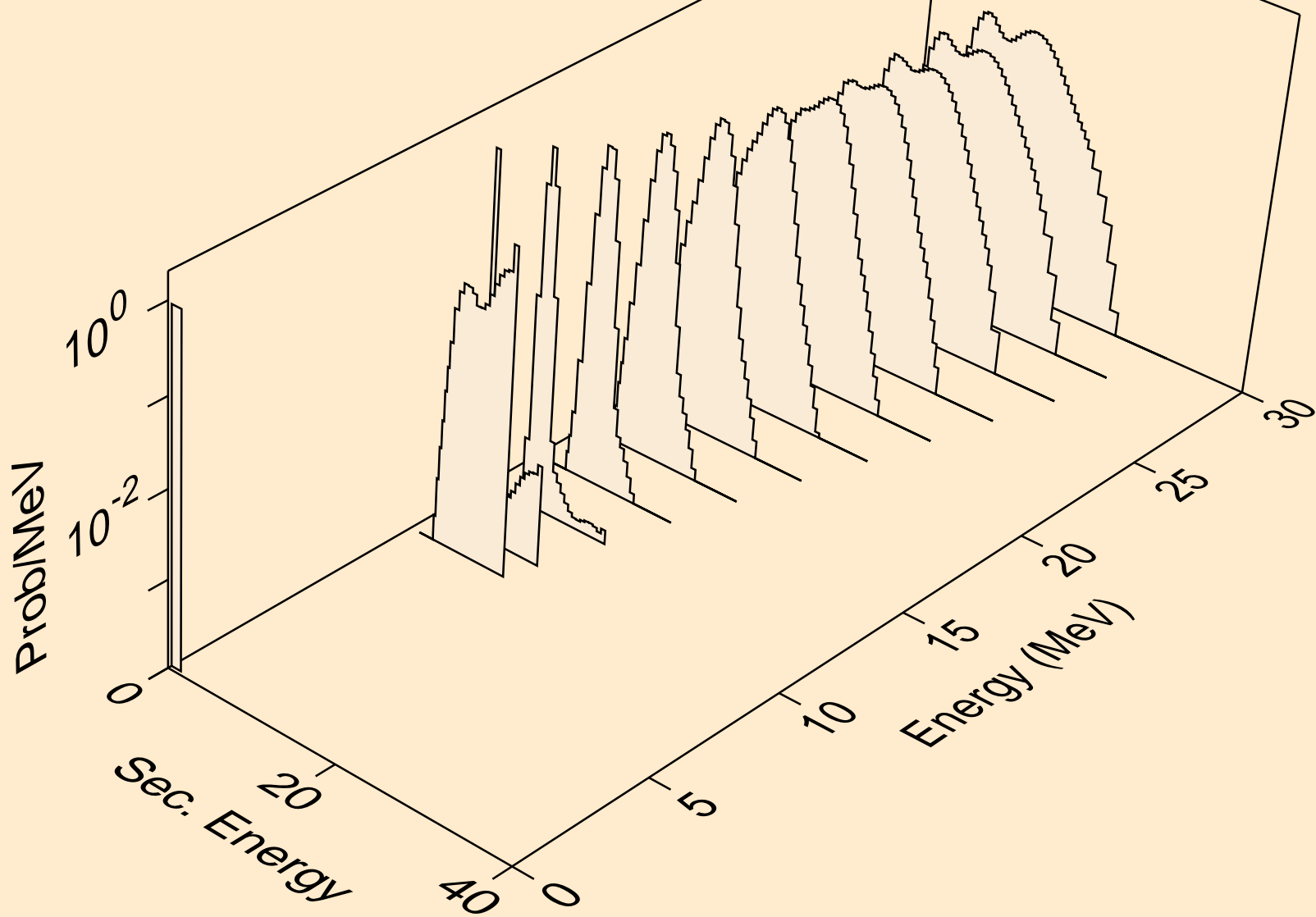

PO201M HELION ACER TENDL-2023 LIBRARY; T=0.K  
protons from (s,pd)

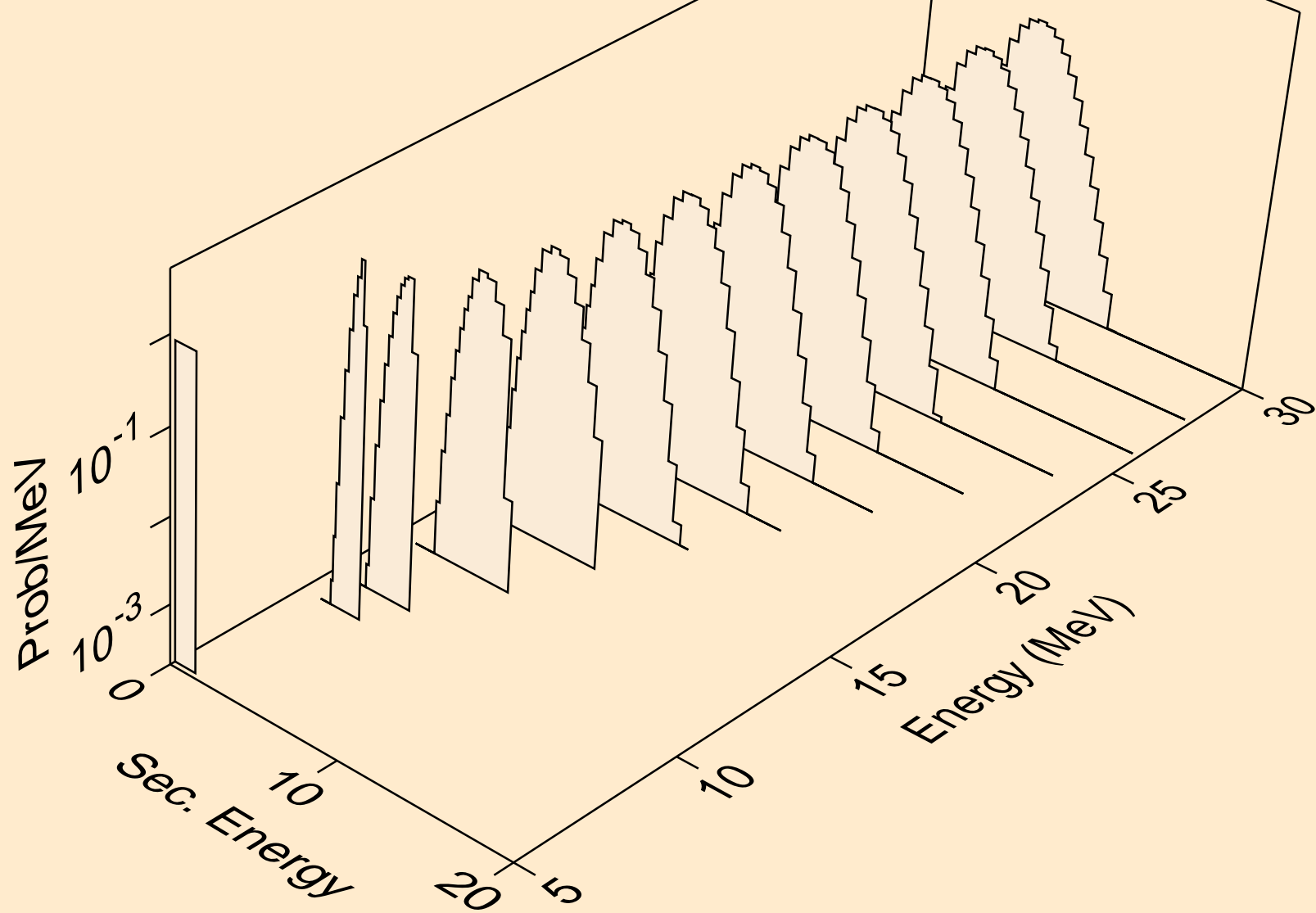

PO201M HELION ACER TENDL-2023 LIBRARY; T=0.K  
protons from (s,pt)

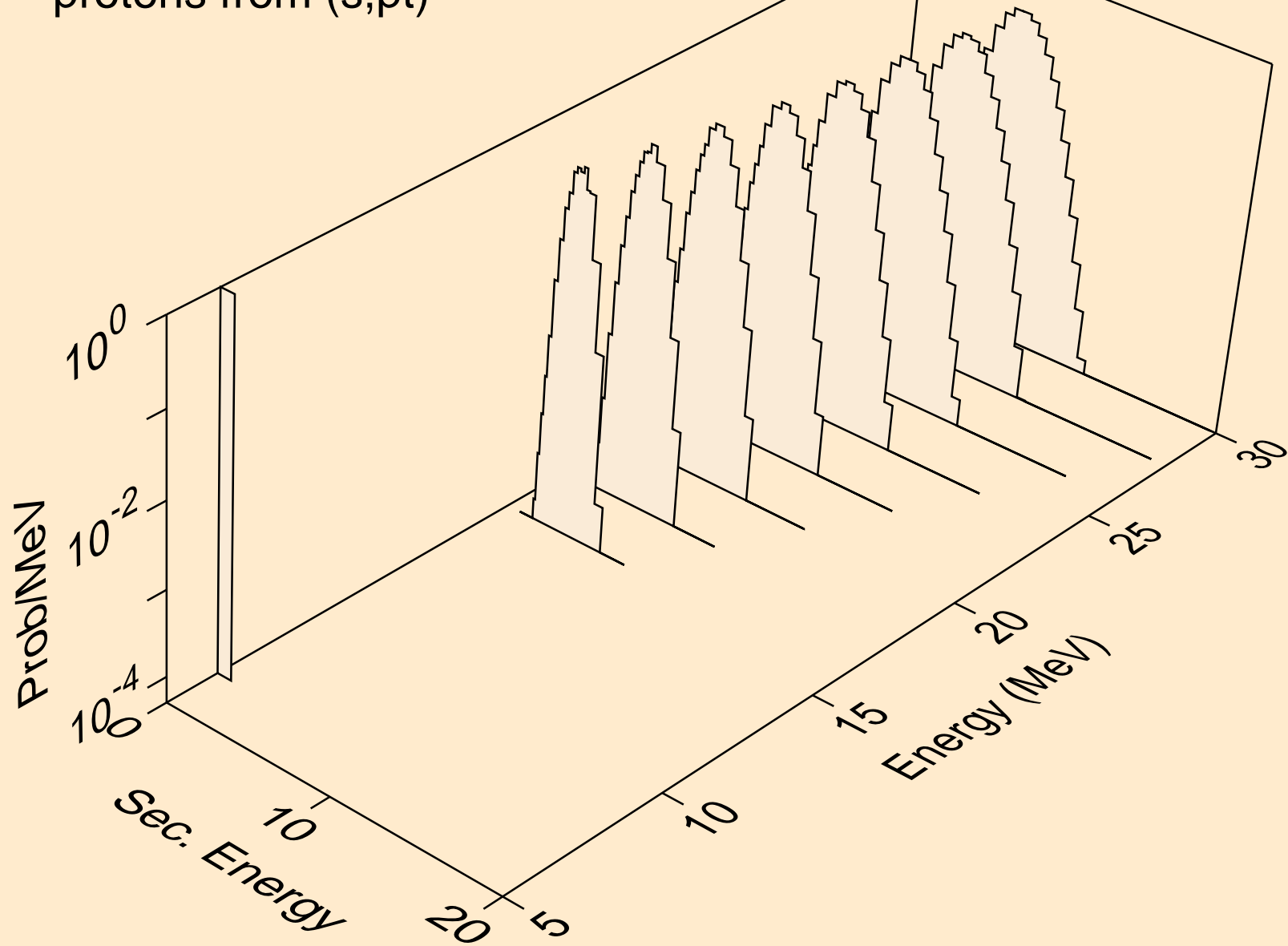

PO201M HELION ACER TENDL-2023 LIBRARY; T=0.K  
deuterons from (s,x)

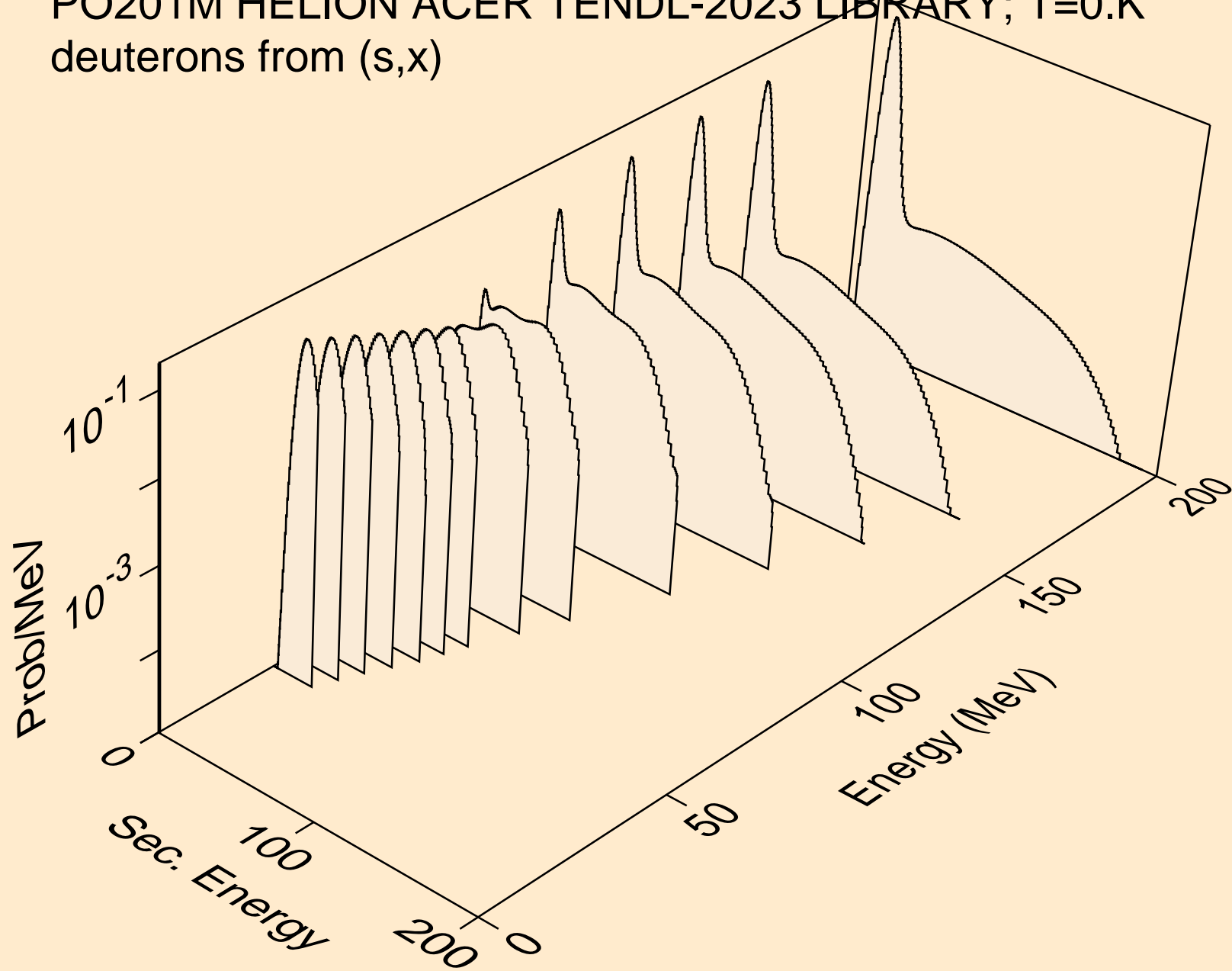

PO201M HELION ACER TENDL-2023 LIBRARY; T=0.K  
deuterons from (s,2nd)

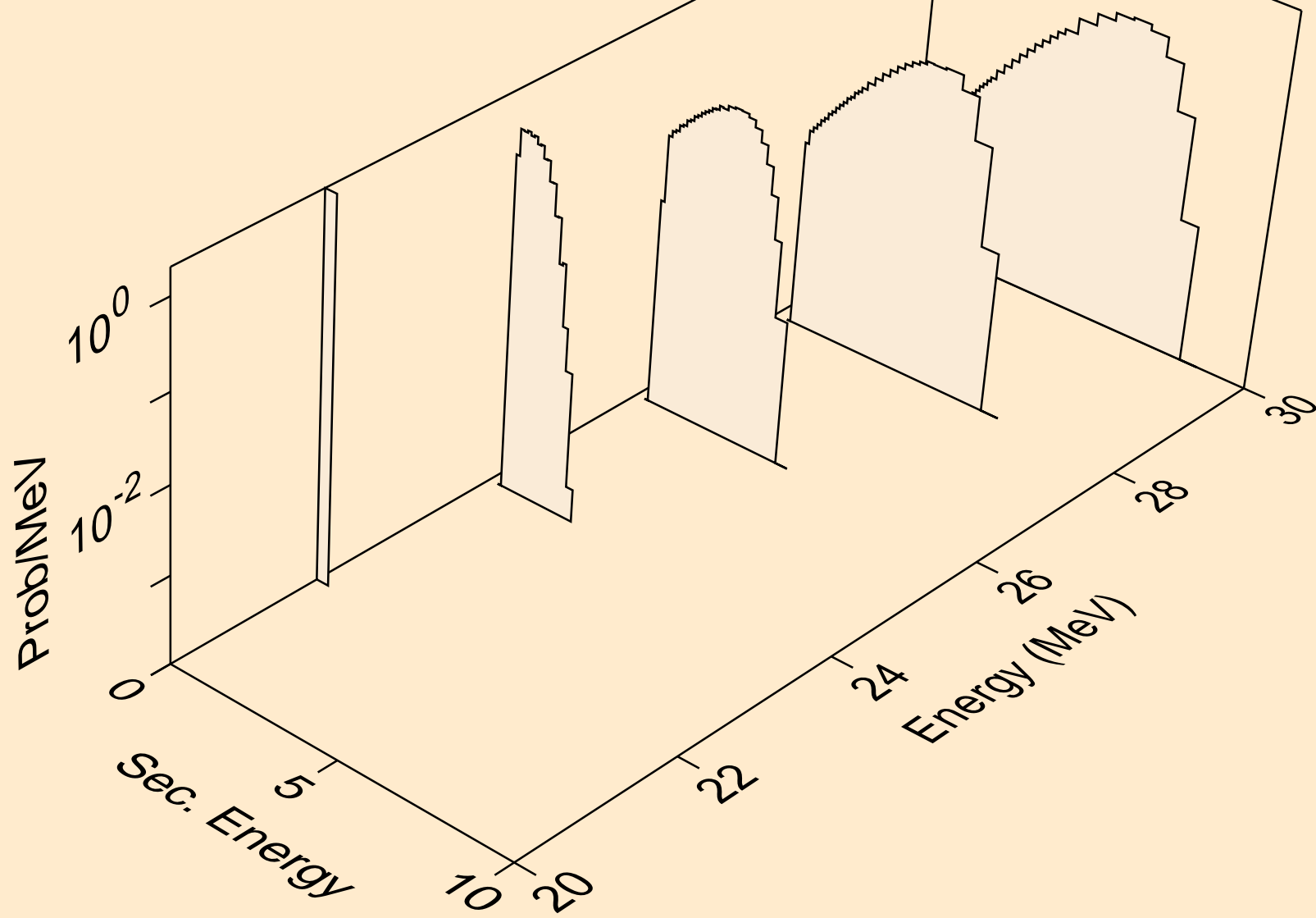

PO201M HELION ACER TENDL-2023 LIBRARY; T=0.K  
deuterons from (s,n\*)d

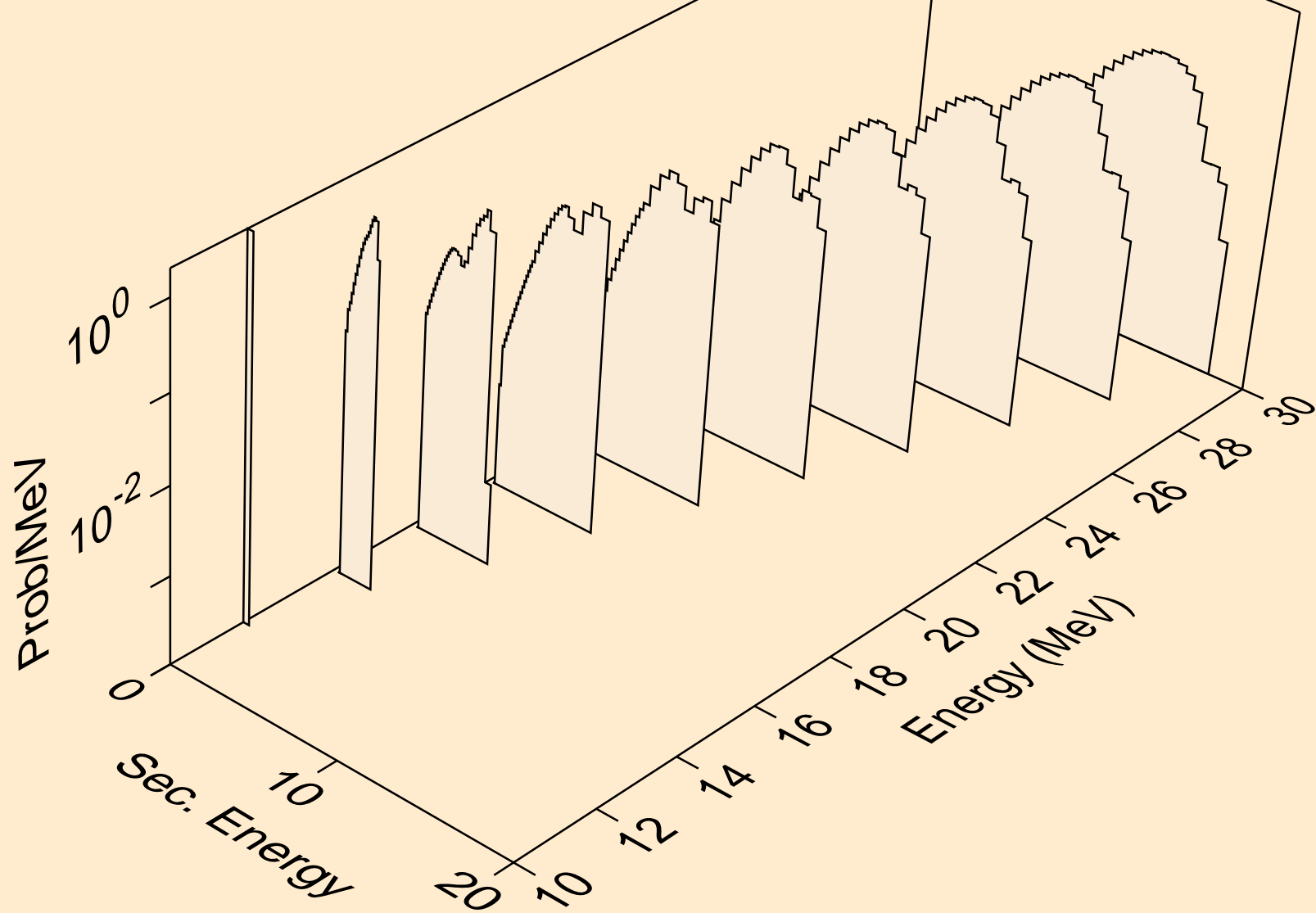

PO201M HELION ACER TENDL-2023 LIBRARY; T=0.K  
deuterons from (s,d)

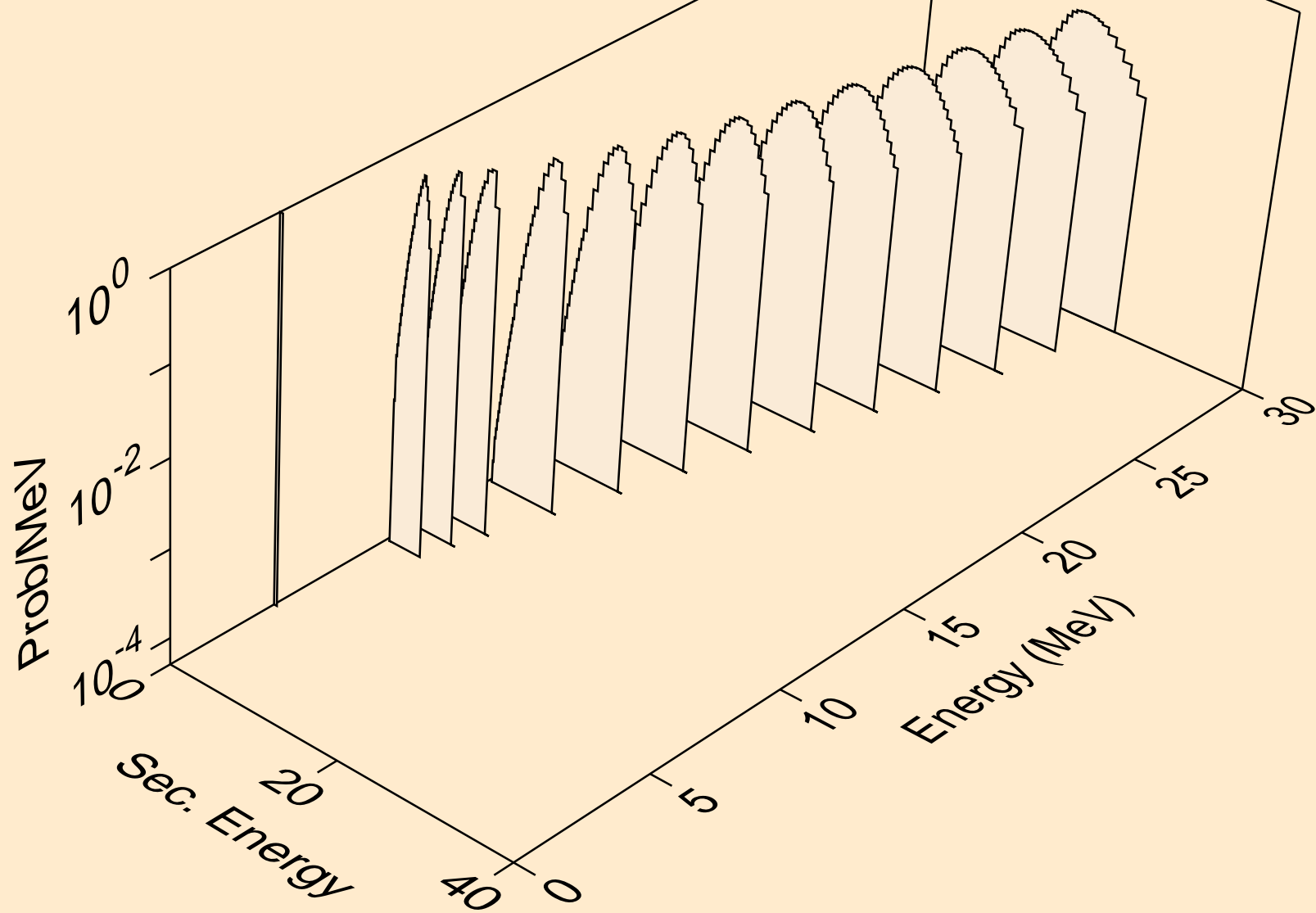



PO201M HELION ACER TENDL-2023 LIBRARY; T=0.K  
deuterons from (s,pd)

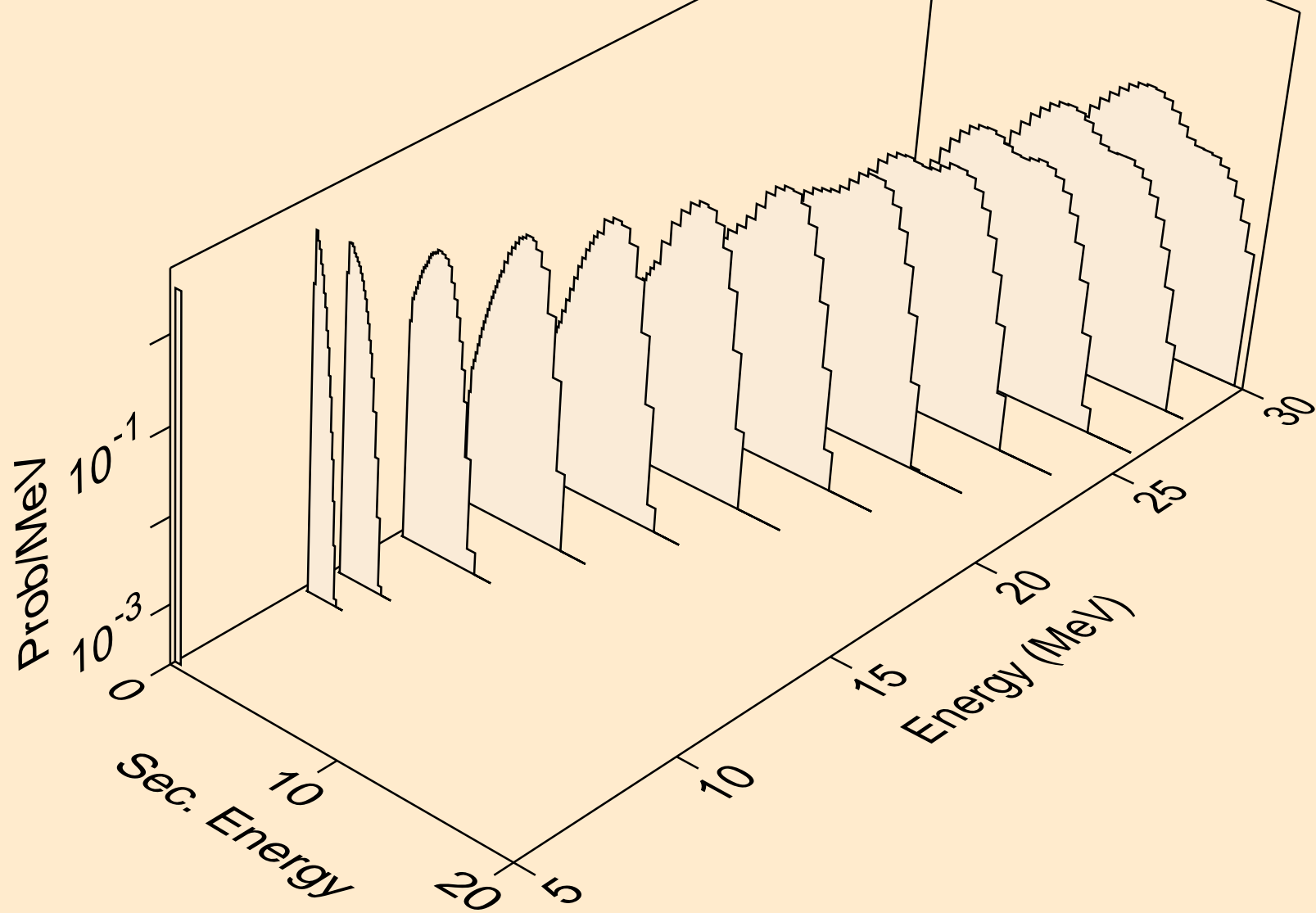

PO201M HELION ACER TENDL-2023 LIBRARY; T=0.K  
deuterons from (s,da)

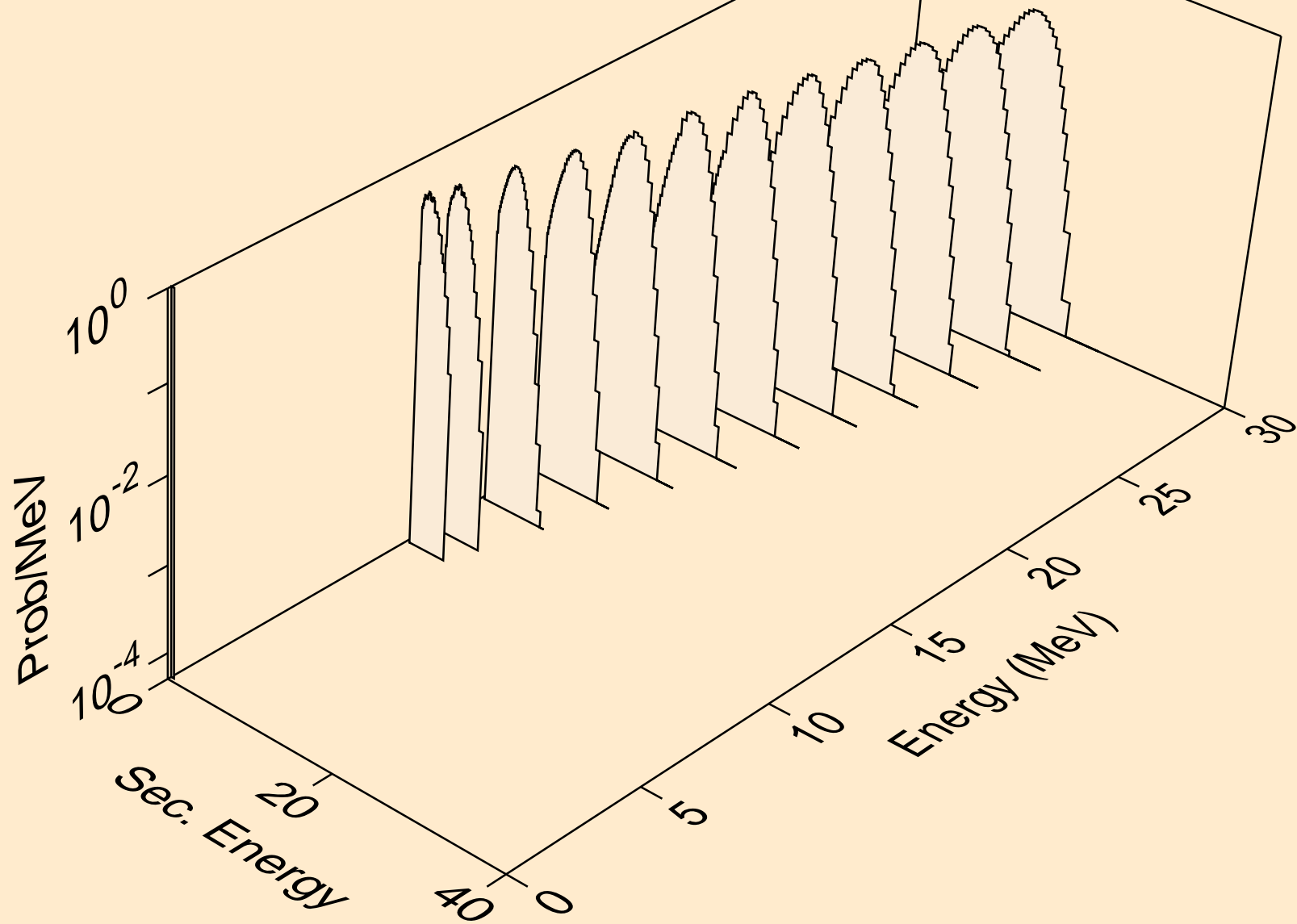

PO201M HELION ACER TENDL-2023 LIBRARY; T=0.K  
tritons from (s,x)

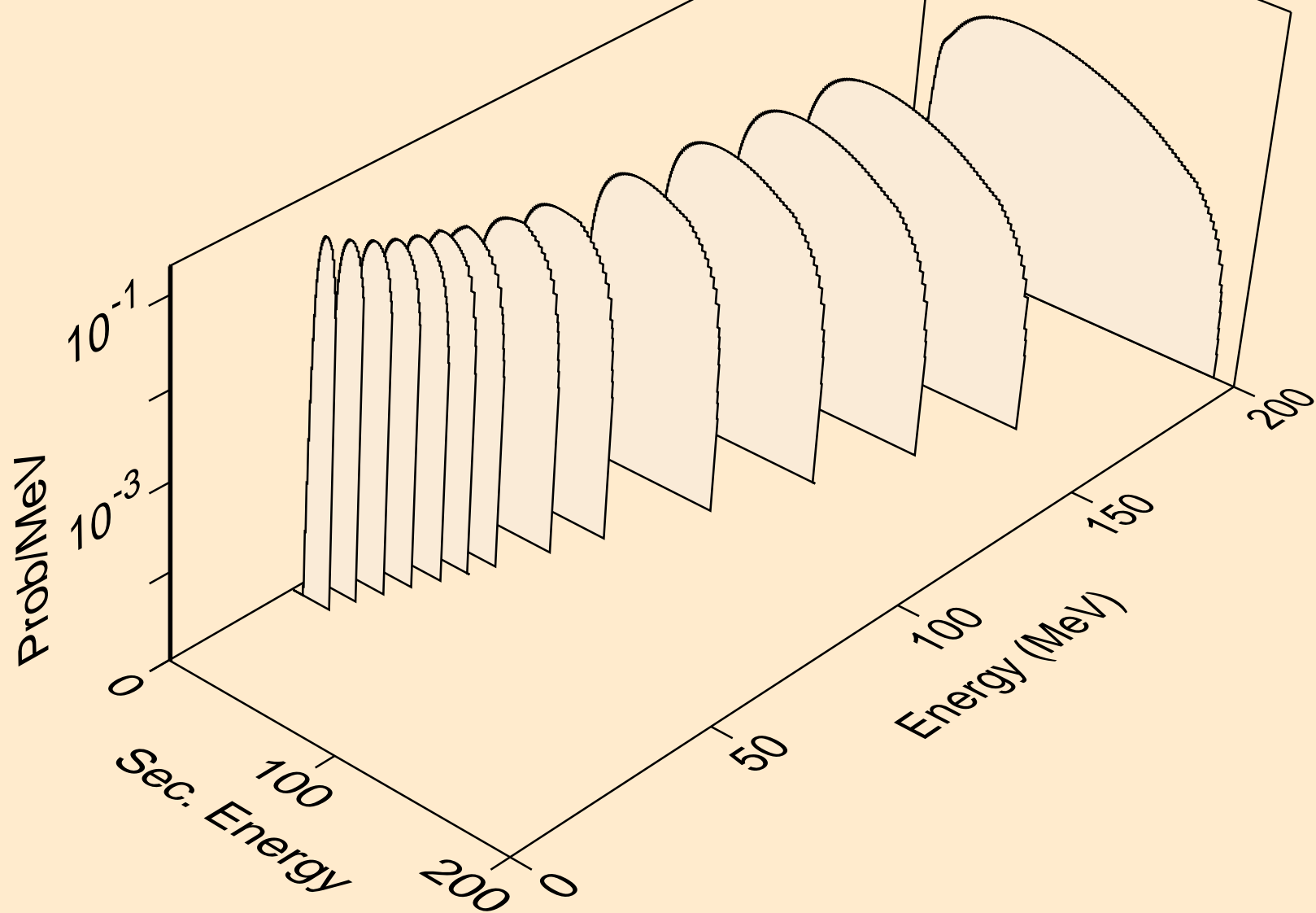

PO201M HELION ACER TENDL-2023 LIBRARY; T=0.K  
tritons from (s,n\*)t

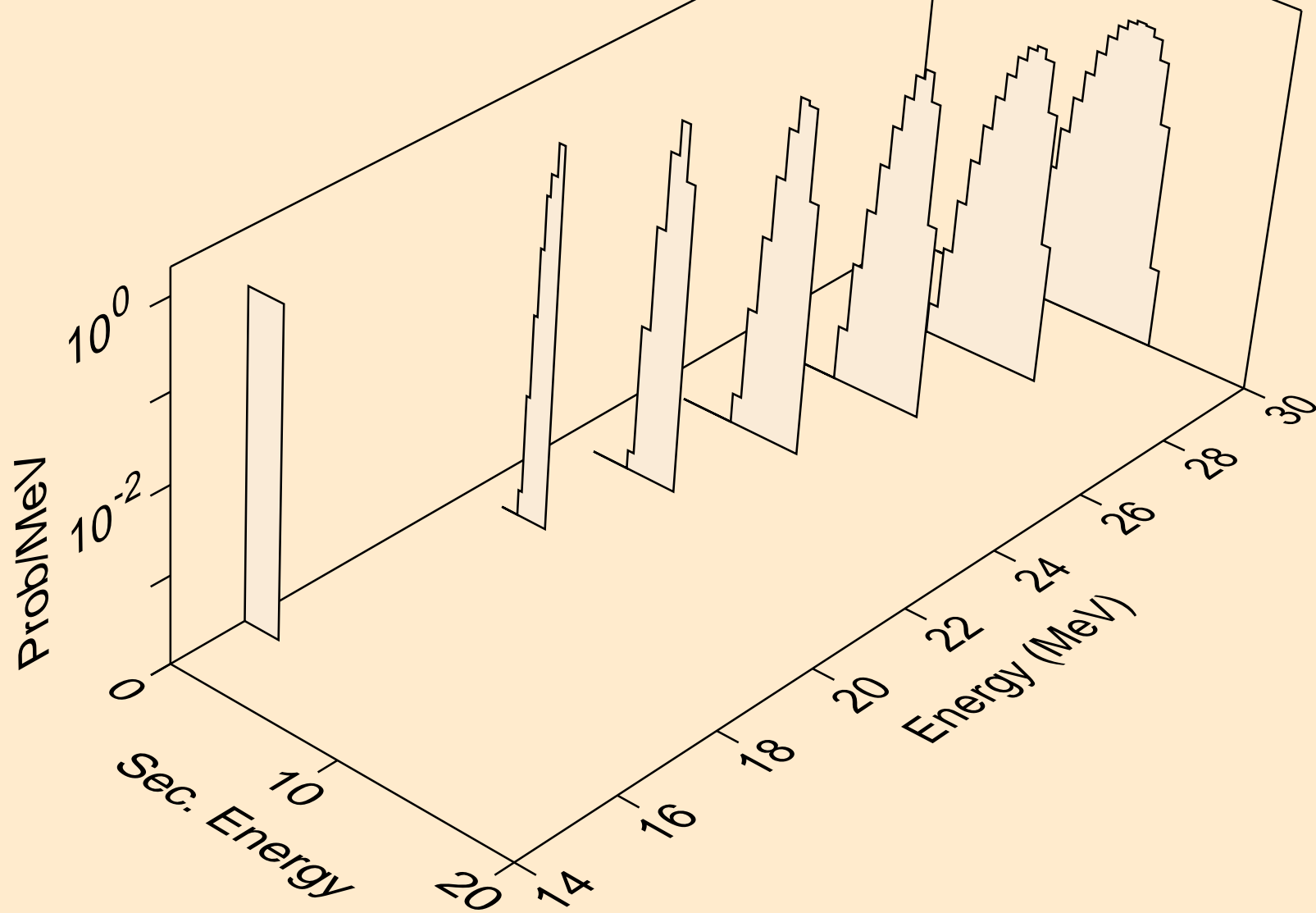

PO201M HELION ACER TENDL-2023 LIBRARY; T=0.K  
tritons from (s,t)

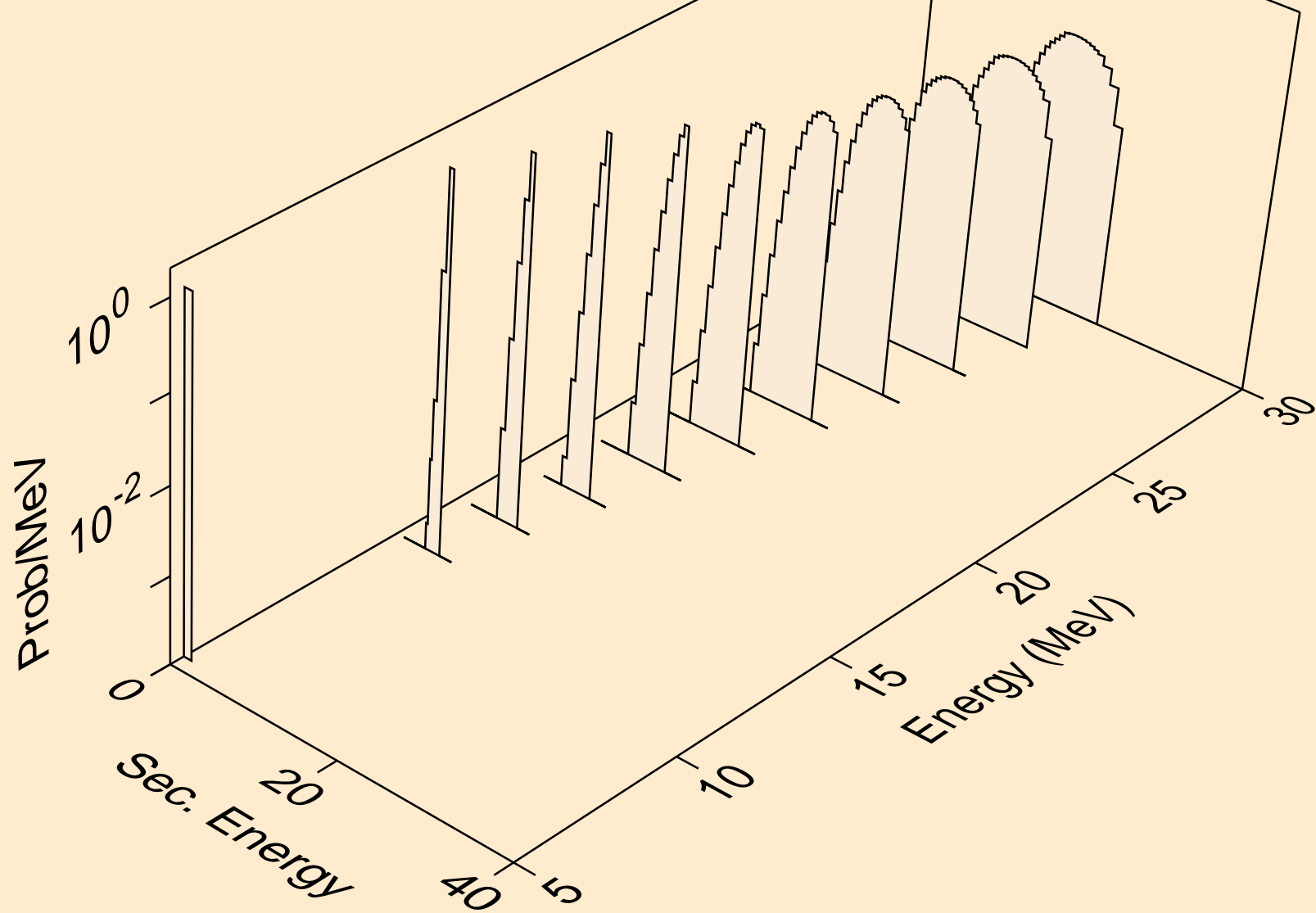

PO201M HELION ACER TENDL-2023 LIBRARY; T=0.K  
tritons from (s,pt)

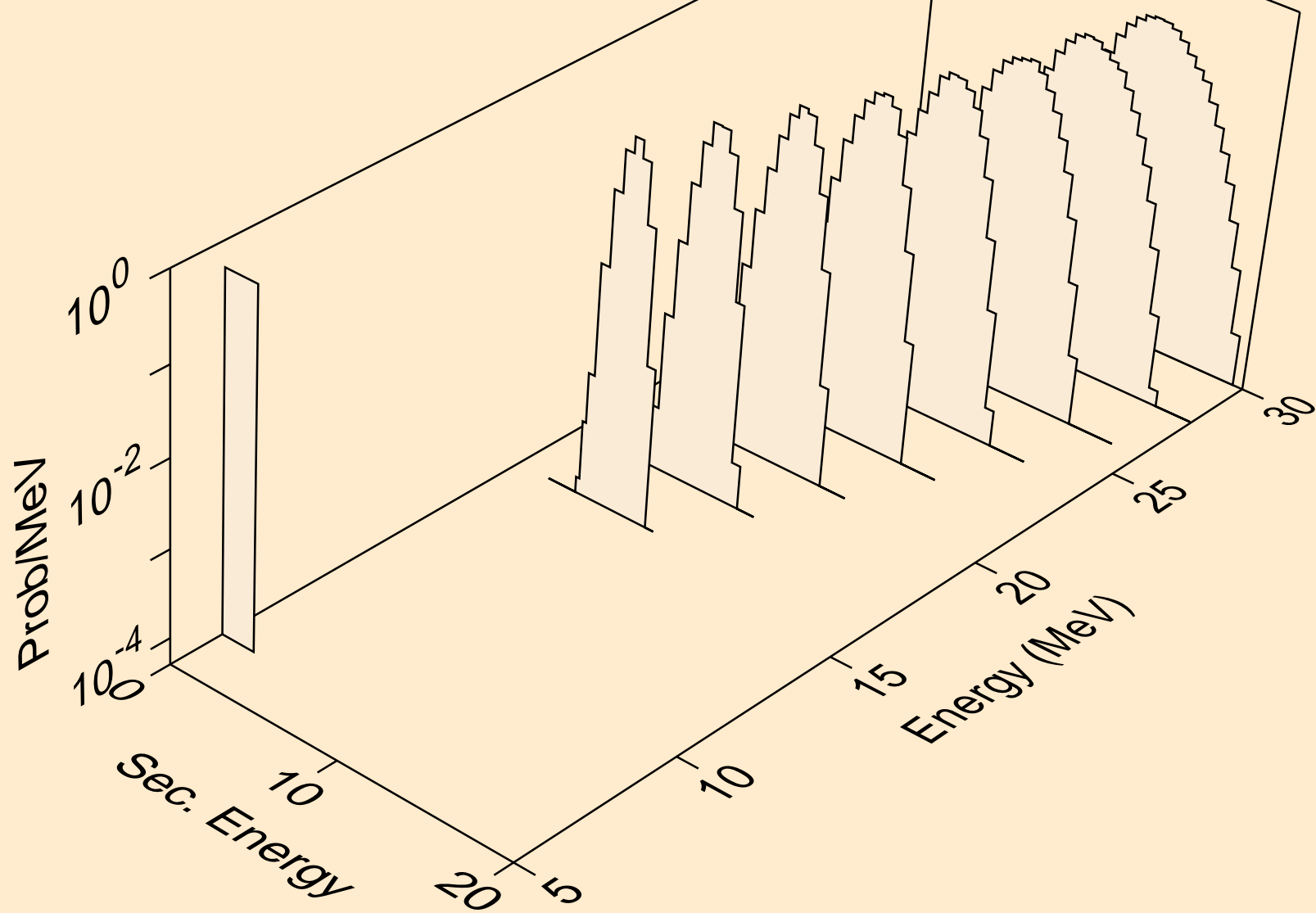

PO201M HELION ACER TENDL-2023 LIBRARY; T=0.K  
alphas from (s,x)

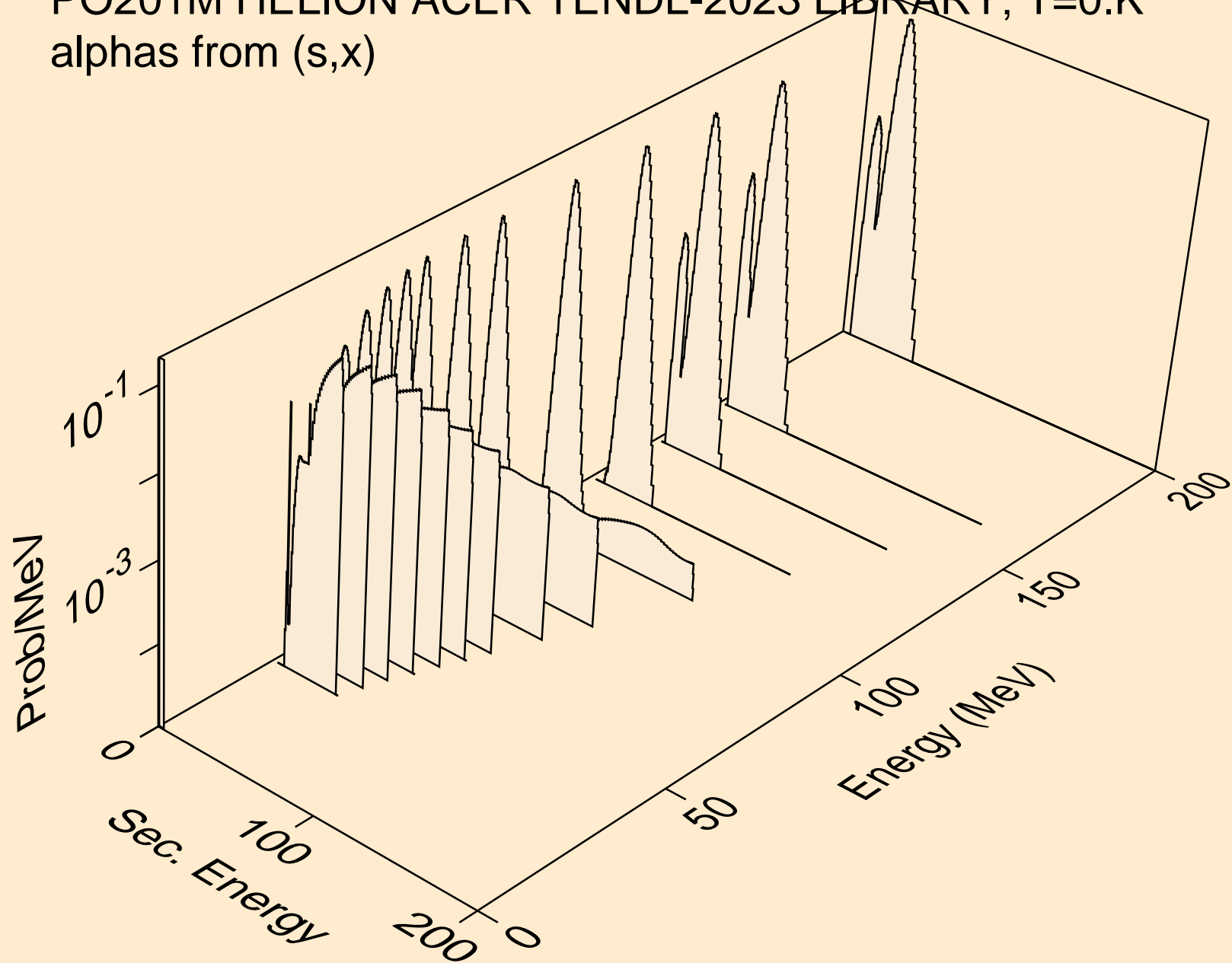

PO201M HELION ACER TENDL-2023 LIBRARY; T=0.K  
alphas from (s,n\*)a

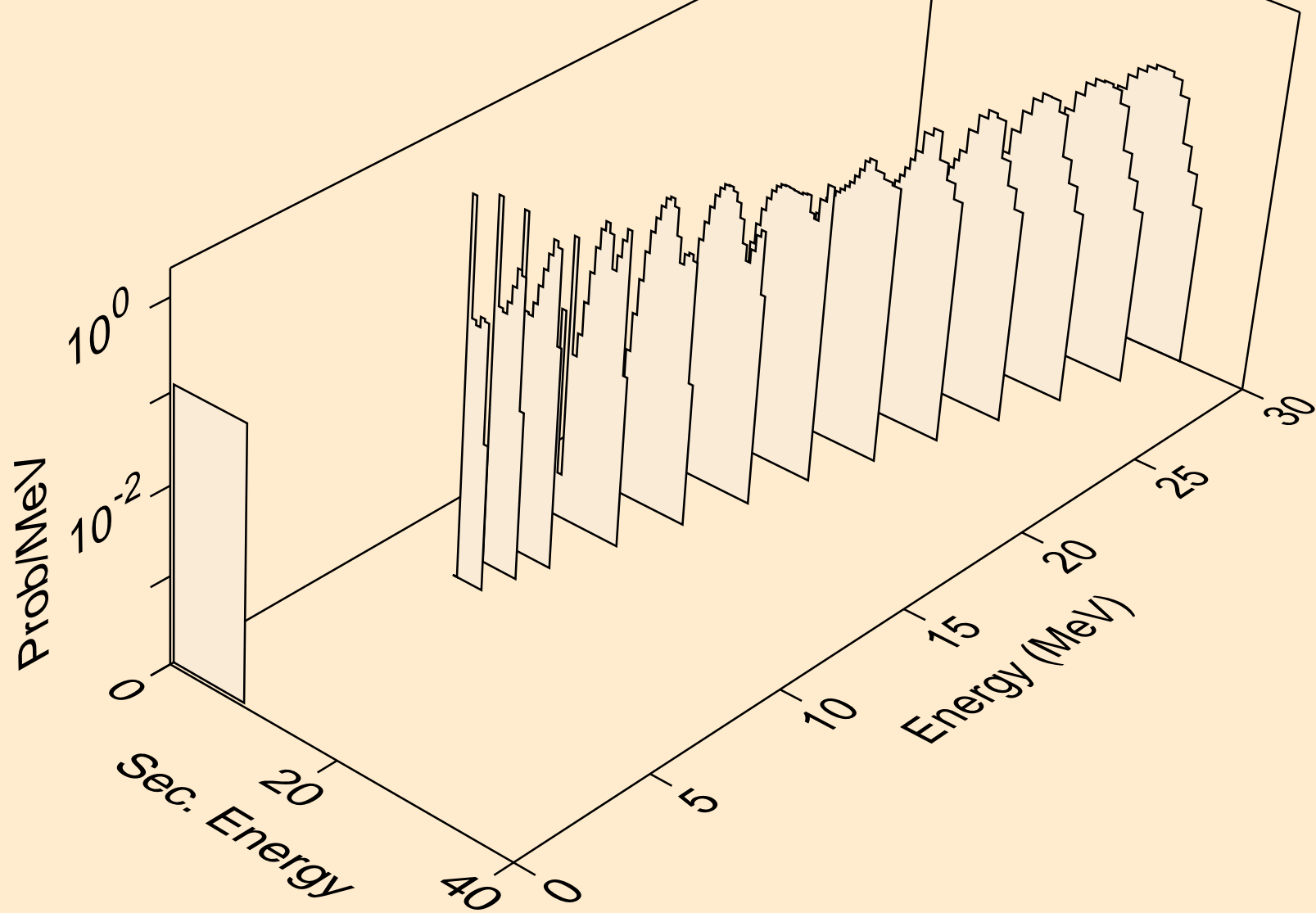



PO201M HELION ACER TENDL-2023 LIBRARY; T=0.K  
alphas from (s,2n)a

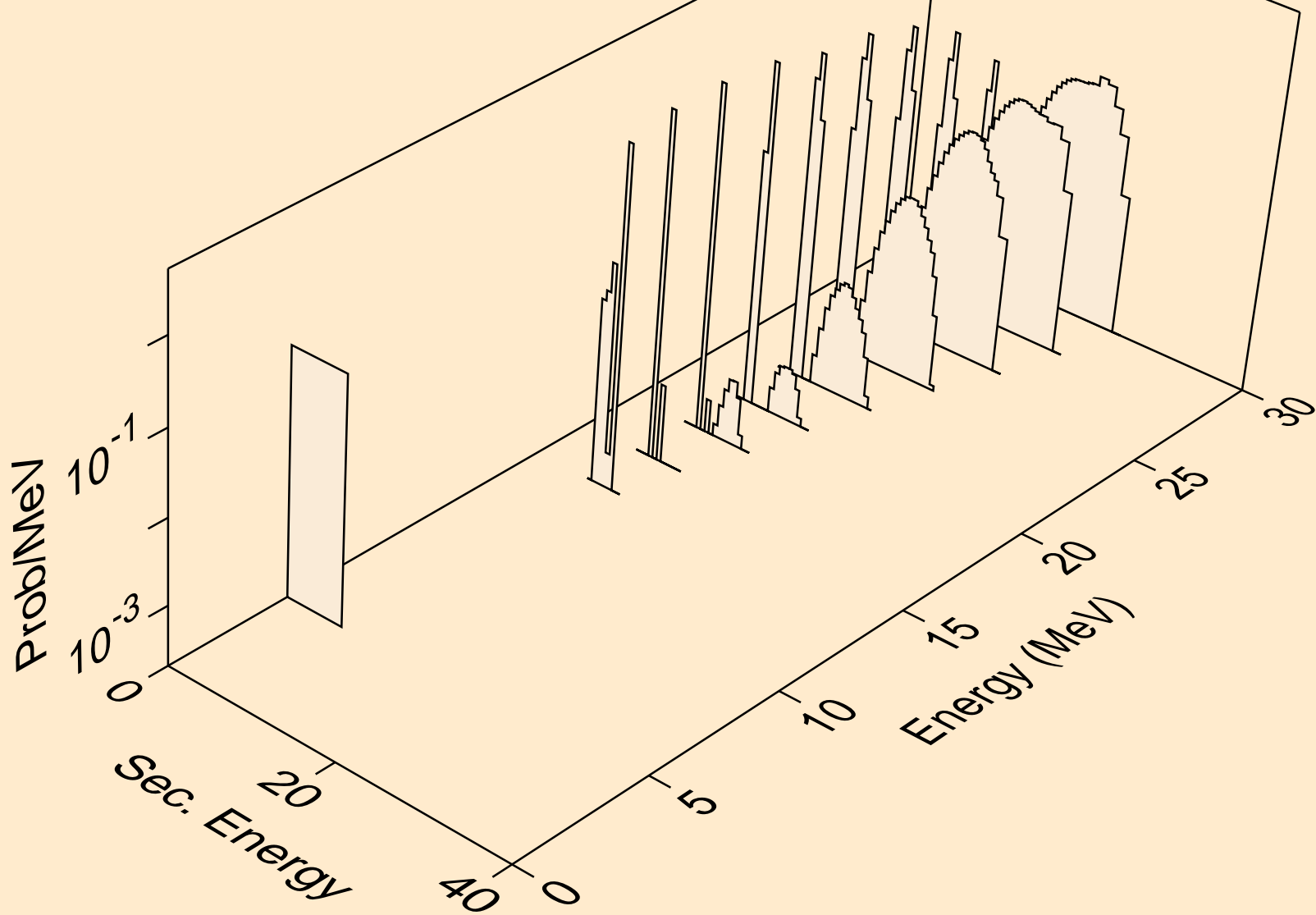

PO201M HELION ACER TENDL-2023 LIBRARY; T=0.K  
alphas from (s,3n)a

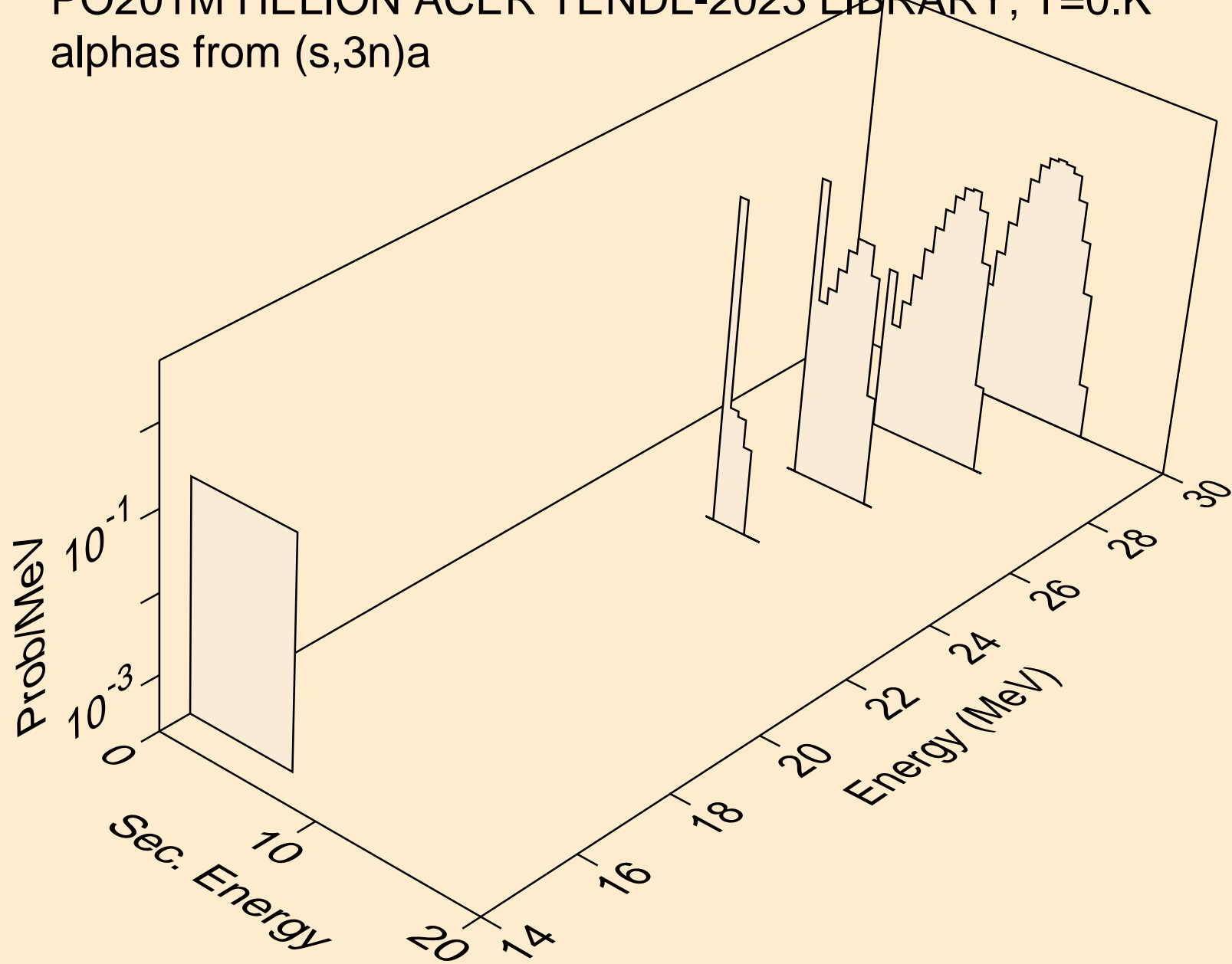

PO201M HELION ACER TENDL-2023 LIBRARY; T=0.K  
alphas from (s,n\*)2a

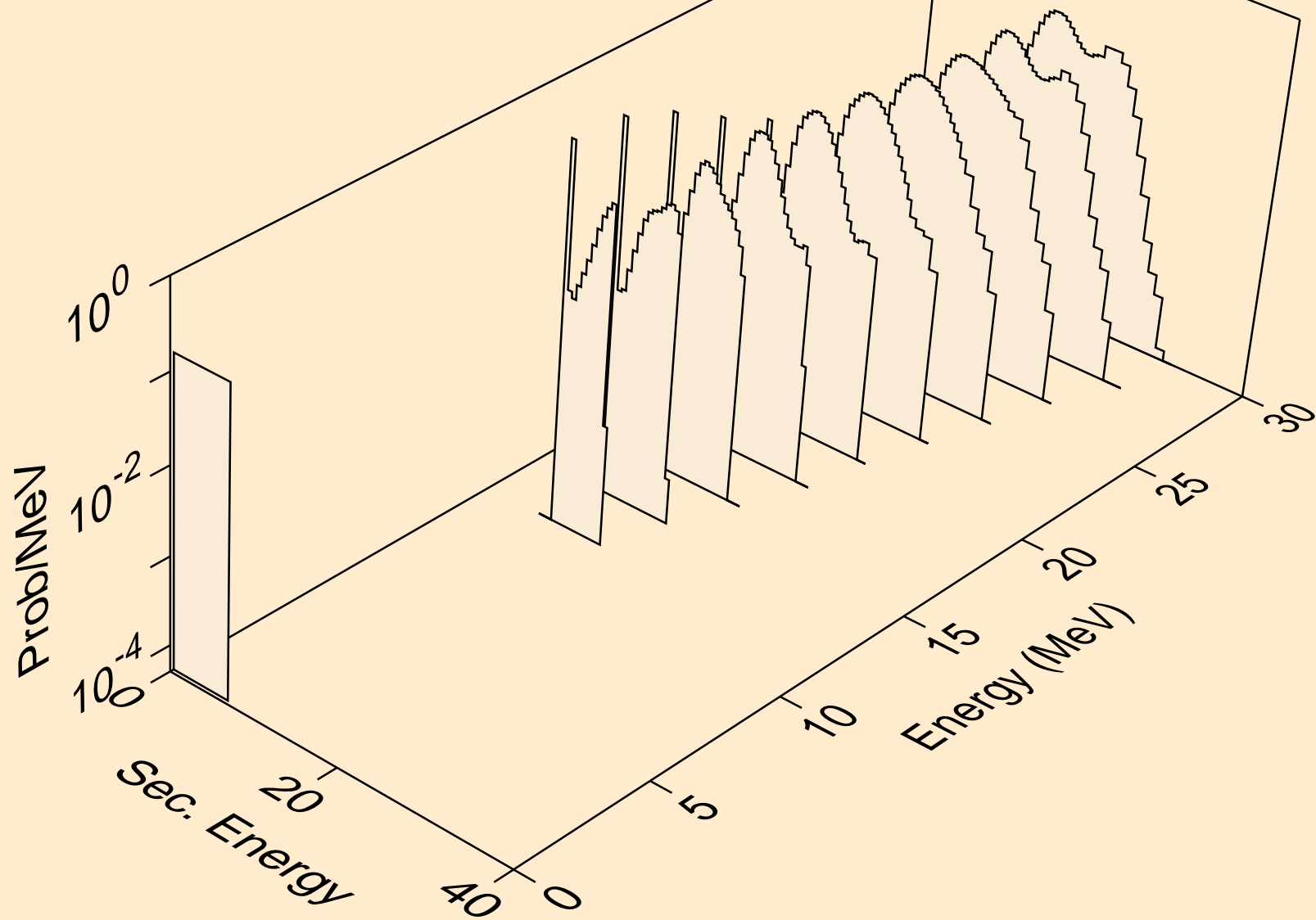

PO201M HELION ACER TENDL-2023 LIBRARY; T=0.K  
alphas from (s,npa)

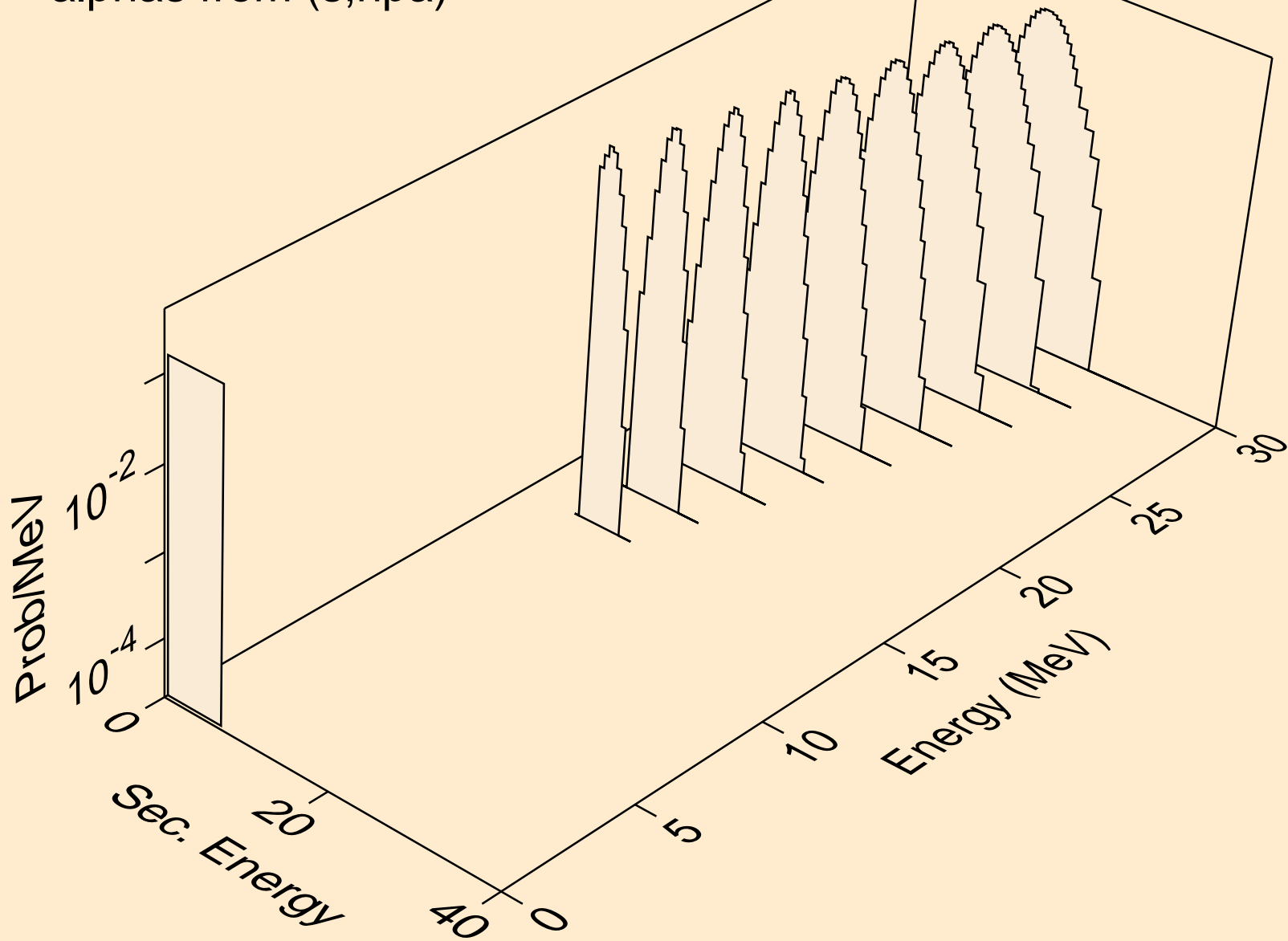

PO201M HELION ACER TENDL-2023 LIBRARY; T=0.K  
alphas from (s,a)

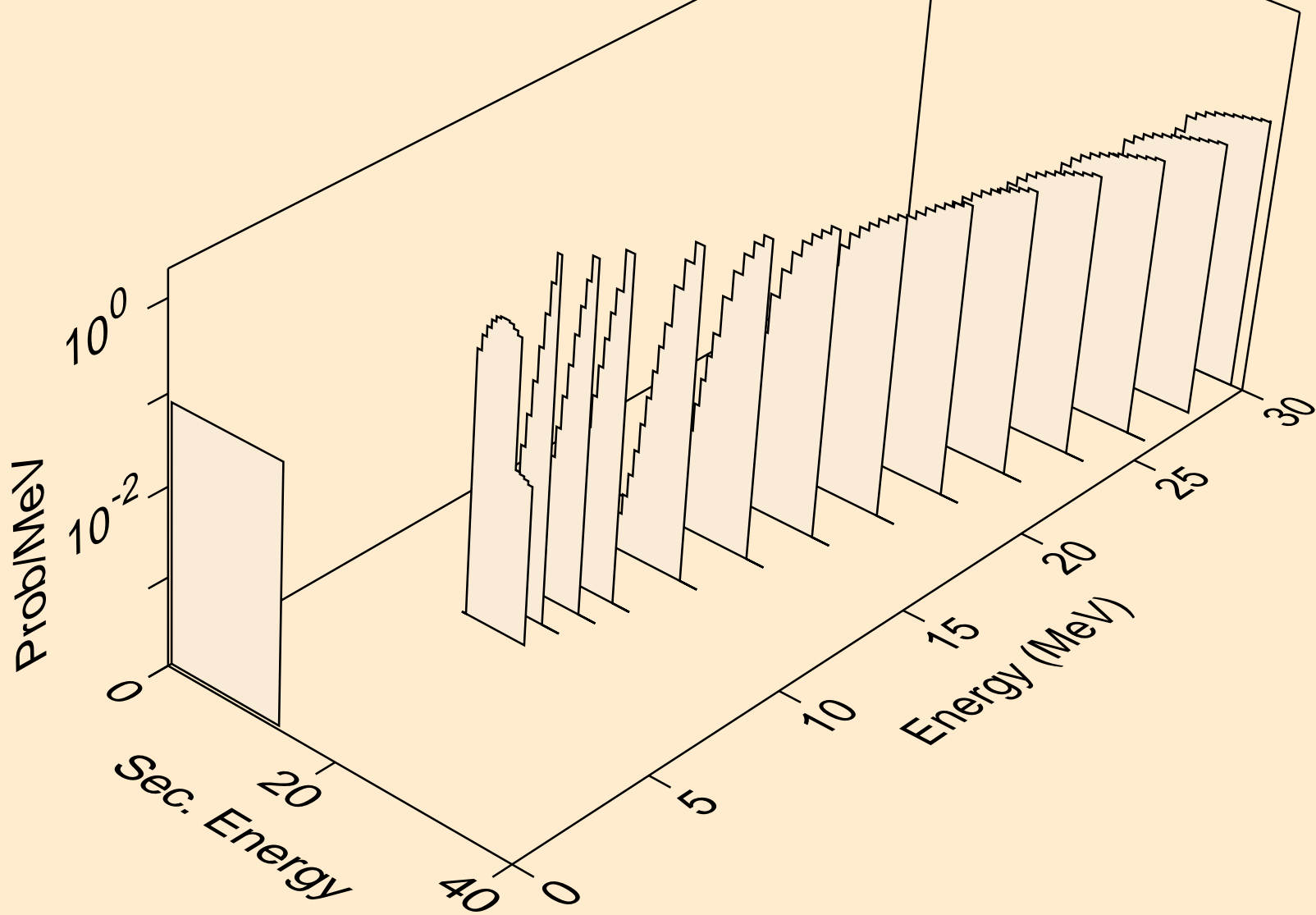

PO201M HELION ACER TENDL-2023 LIBRARY; T=0.K  
alphas from (s,2a)

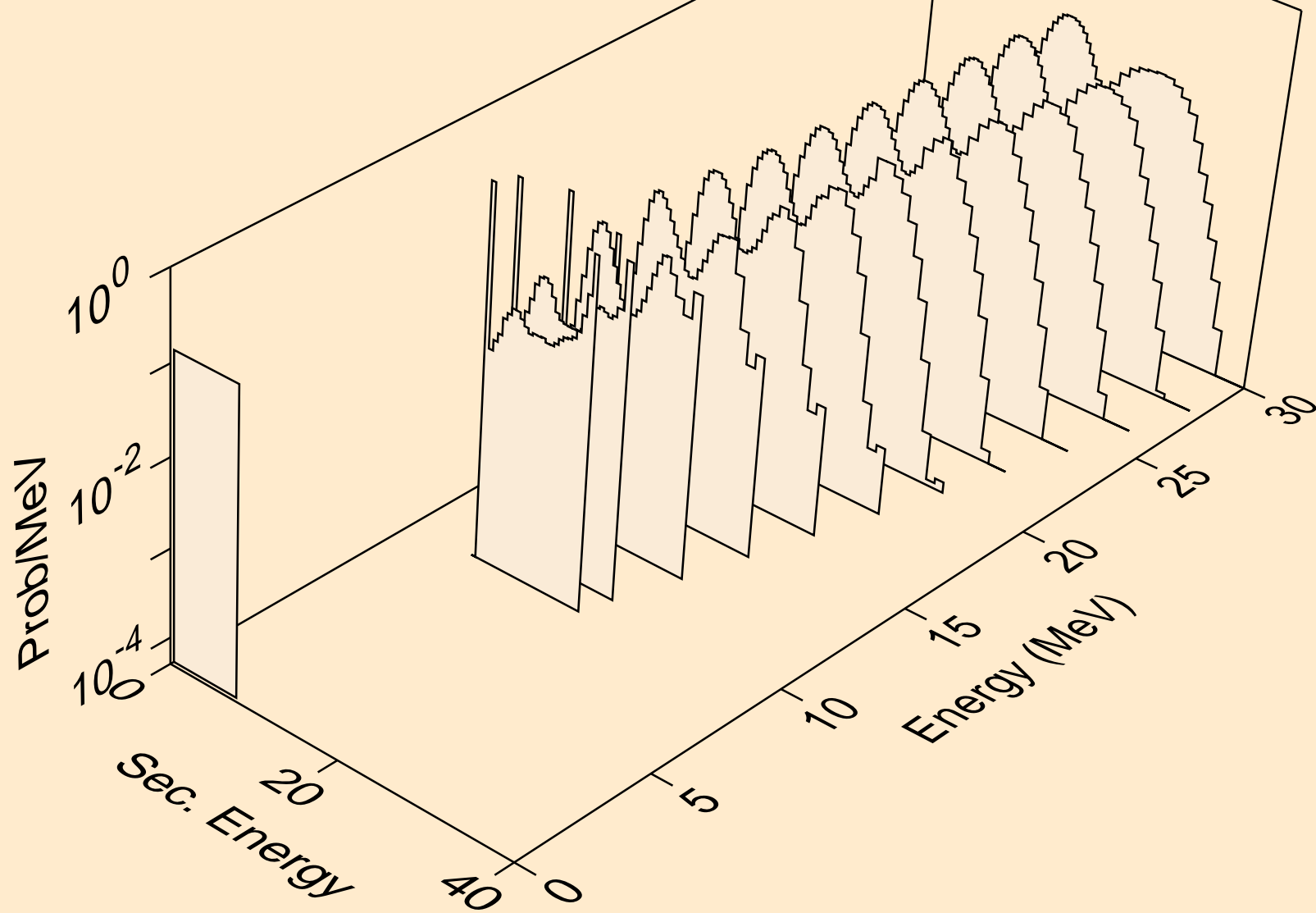

PO201M HELION ACER TENDL-2023 LIBRARY; T=0.K  
alphas from (s,pa)

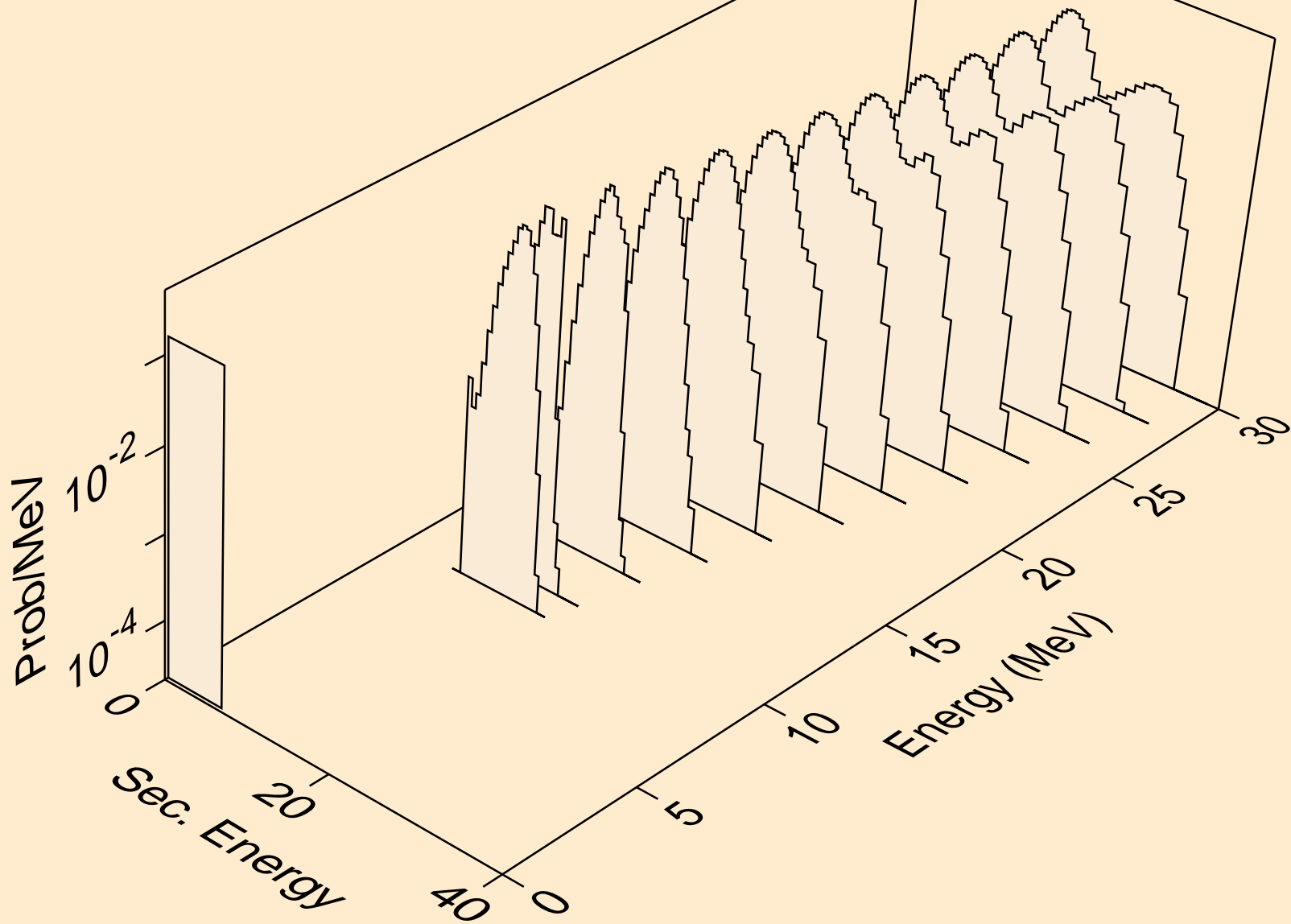

PO201M HELION ACER TENDL-2023 LIBRARY; T=0.K  
alphas from (s,da)

