

RF255 HELION ACER TENDL-2023 LIBRARY; T=0.K
Principal cross sections

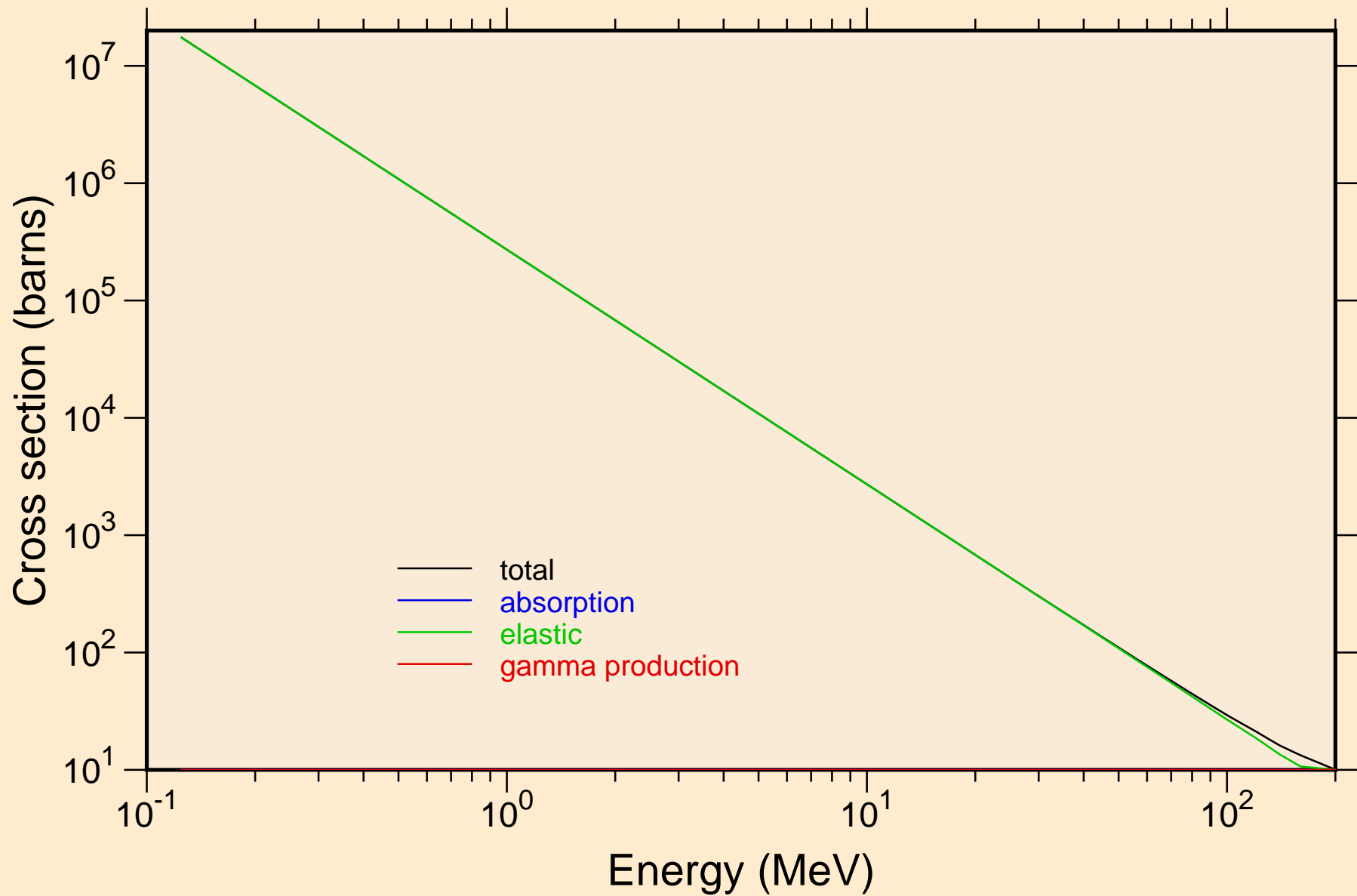

RF255 HELION ACER TENDL-2023 LIBRARY; T=0.K

Heating

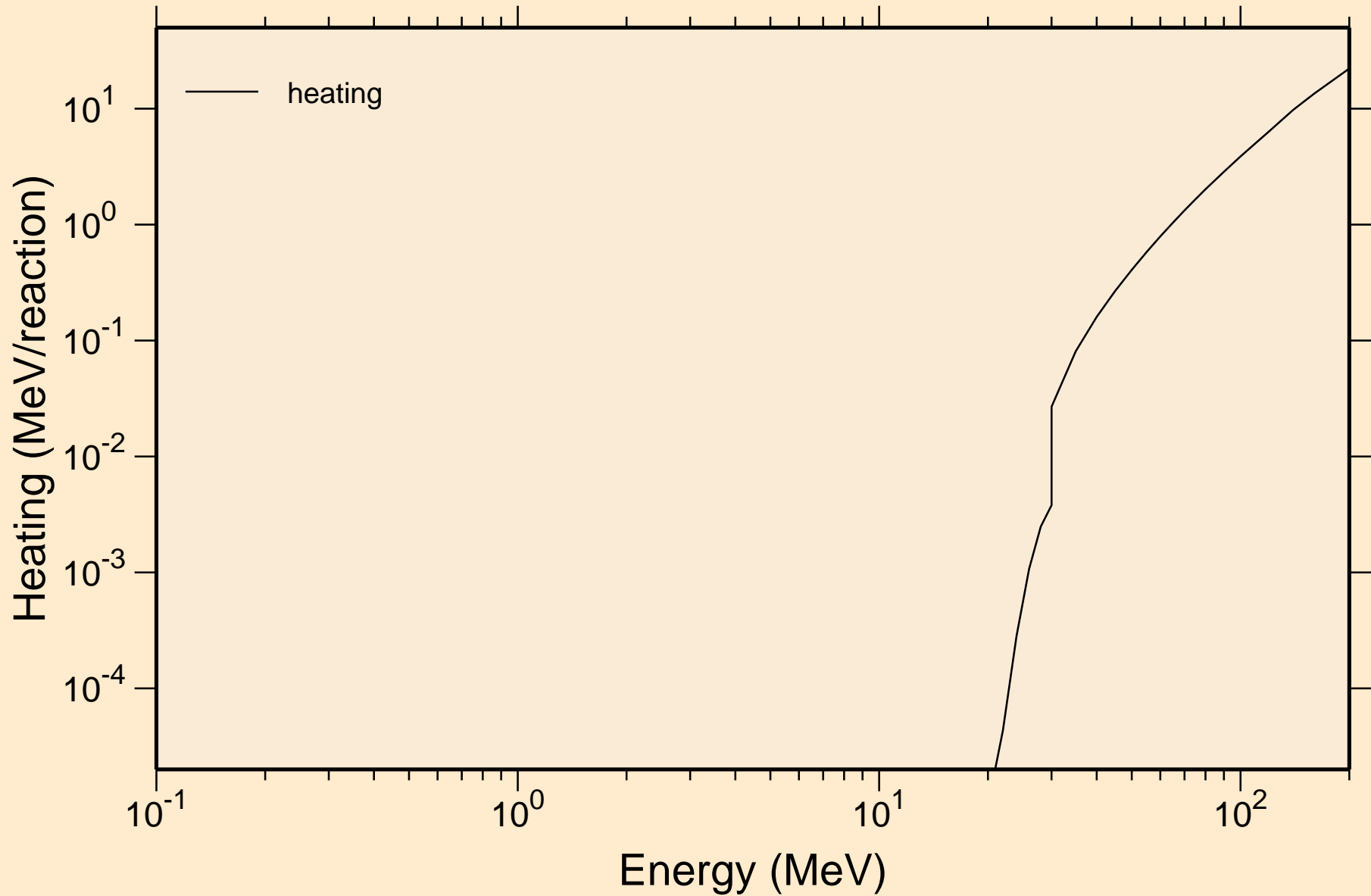

RF255 HELION ACER TENDL-2023 LIBRARY; T=0.K

Principal cross sections

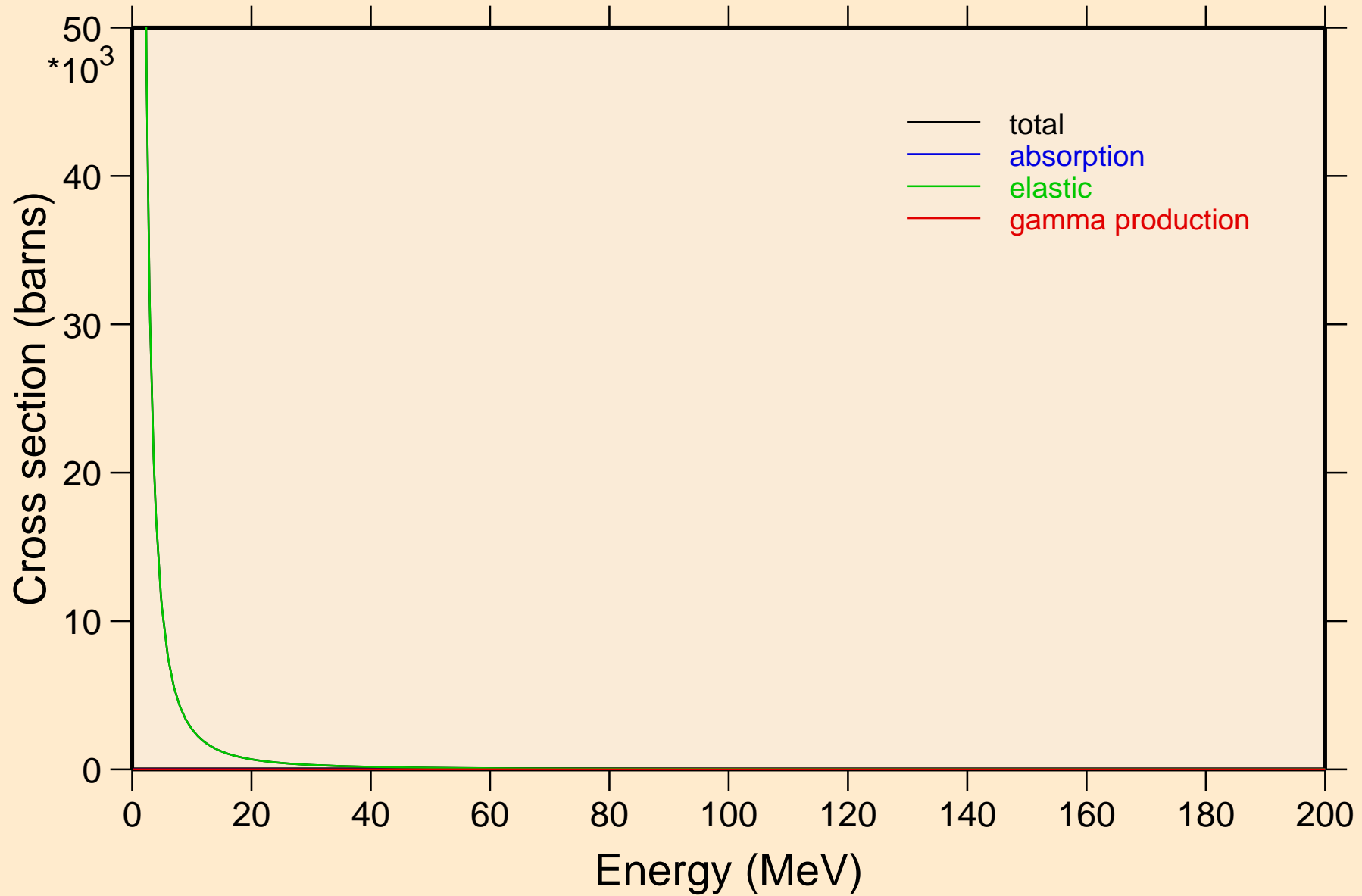

RF255 HELION ACER TENDL-2023 LIBRARY; T=0.K

Heating

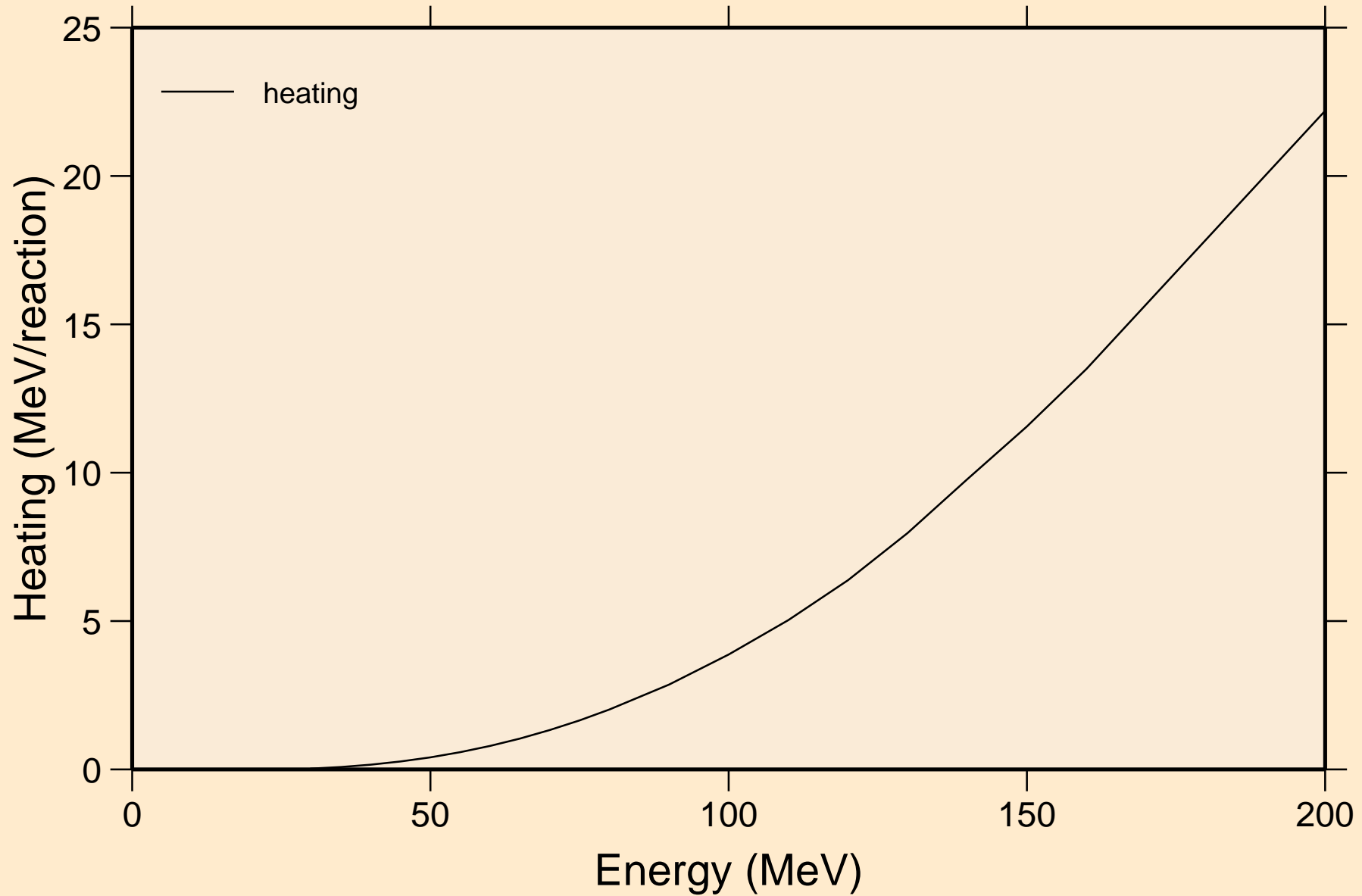

RF255 HELION ACER TENDL-2023 LIBRARY; T=0.K
Threshold reactions

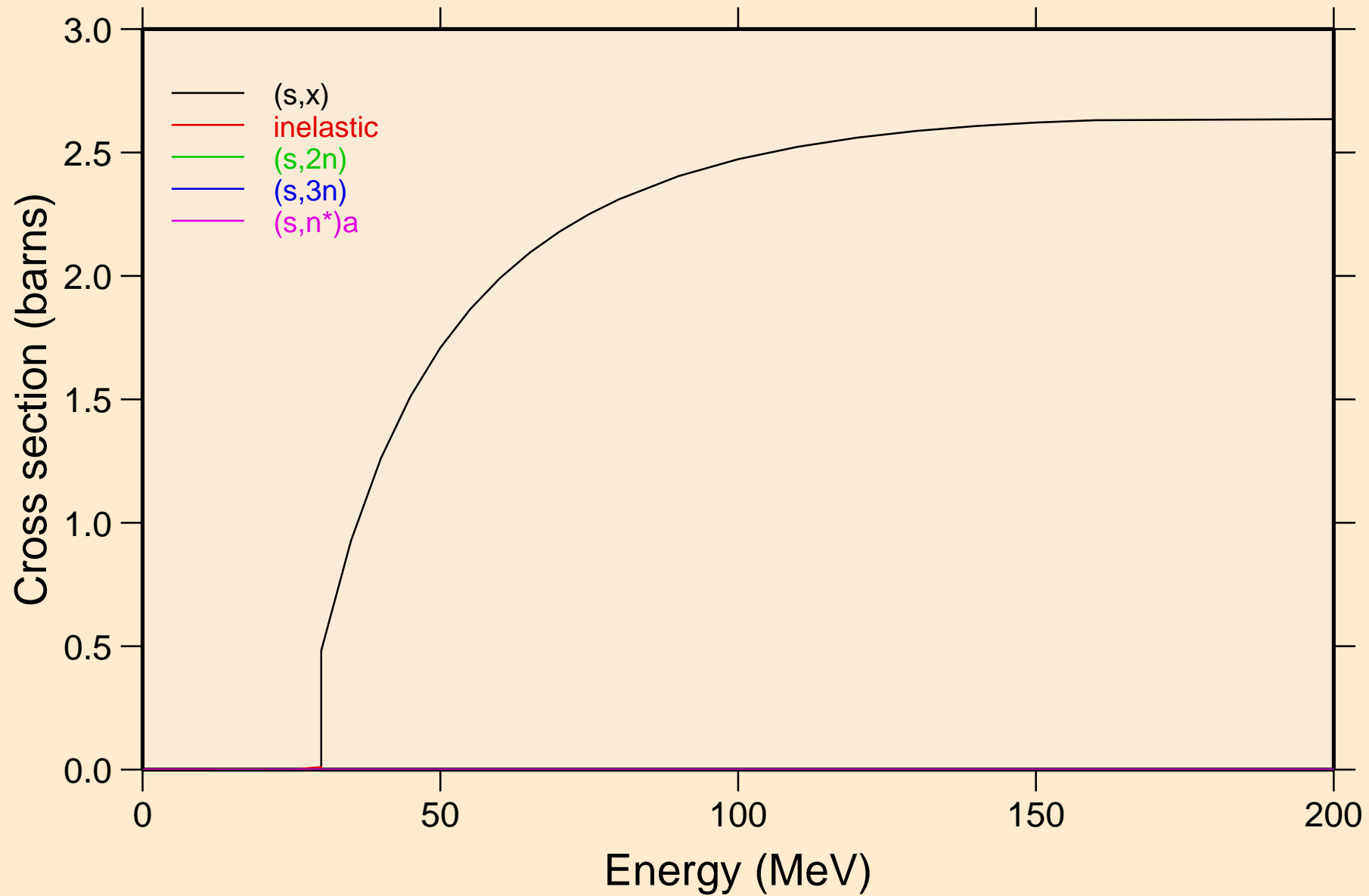

RF255 HELION ACER TENDL-2023 LIBRARY; T=0.K
Threshold reactions

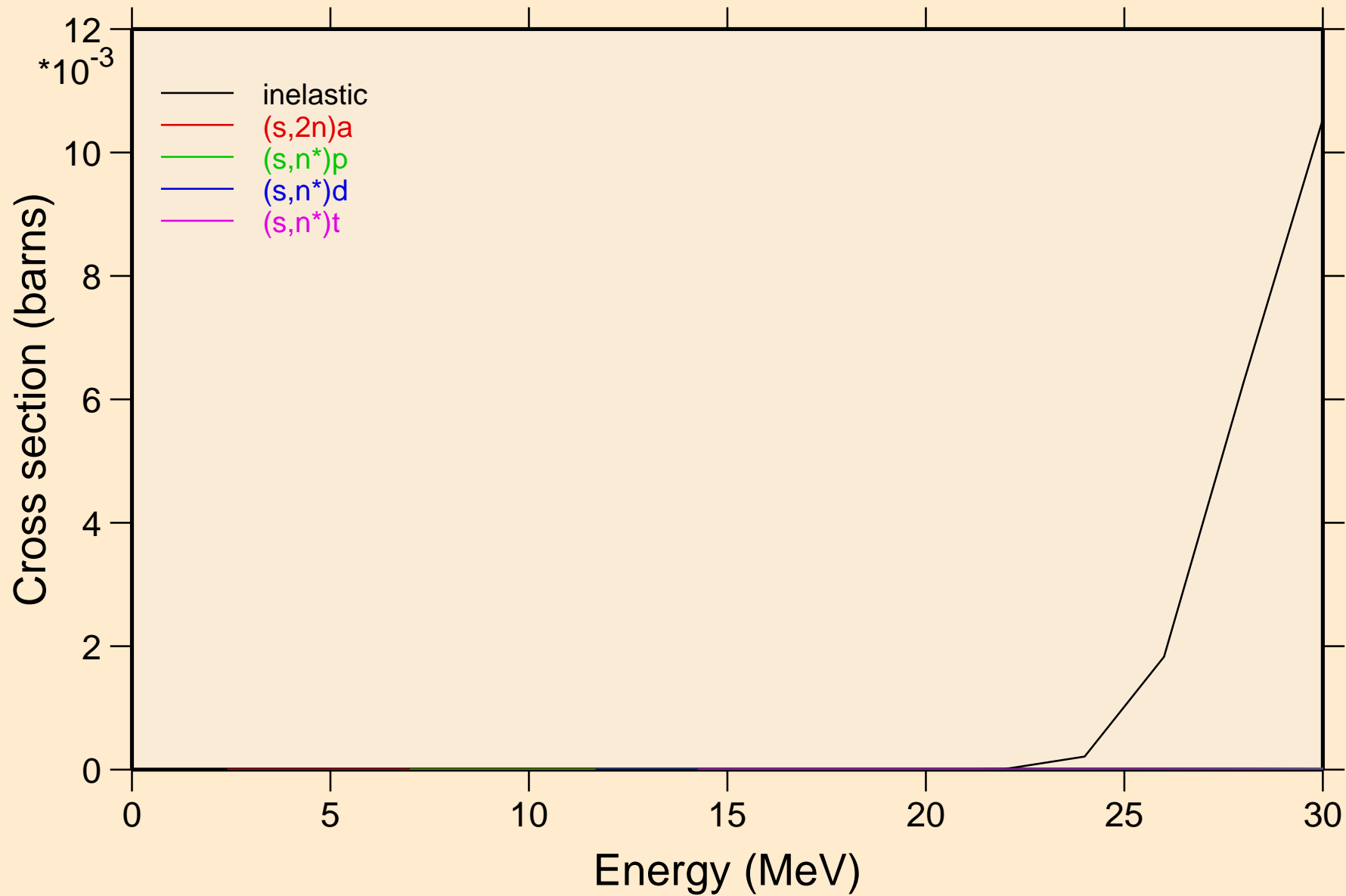

RF255 HELION ACER TENDL-2023 LIBRARY; T=0.K
Threshold reactions

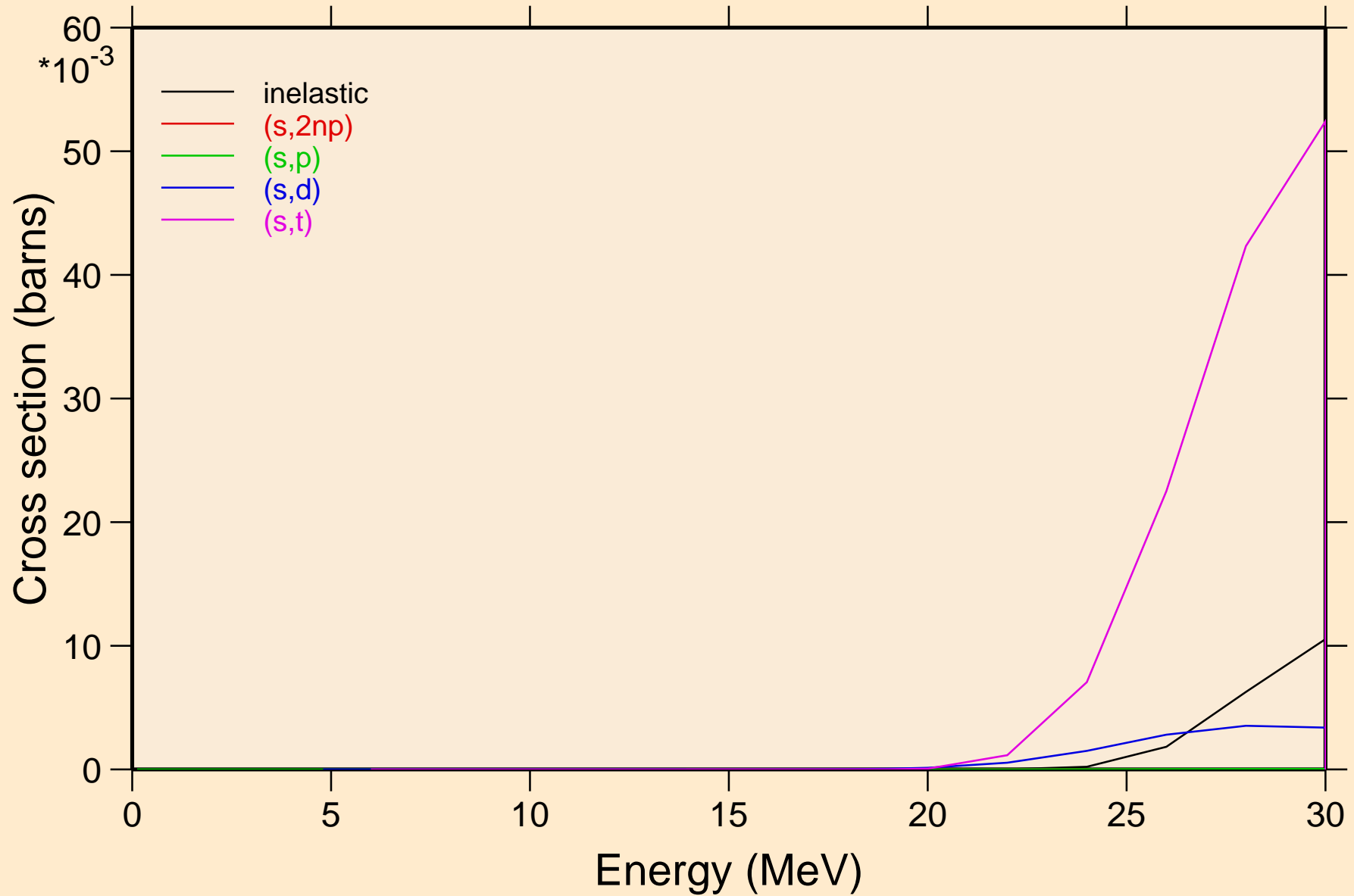

RF255 HELION ACER TENDL-2023 LIBRARY; T=0.K
Threshold reactions

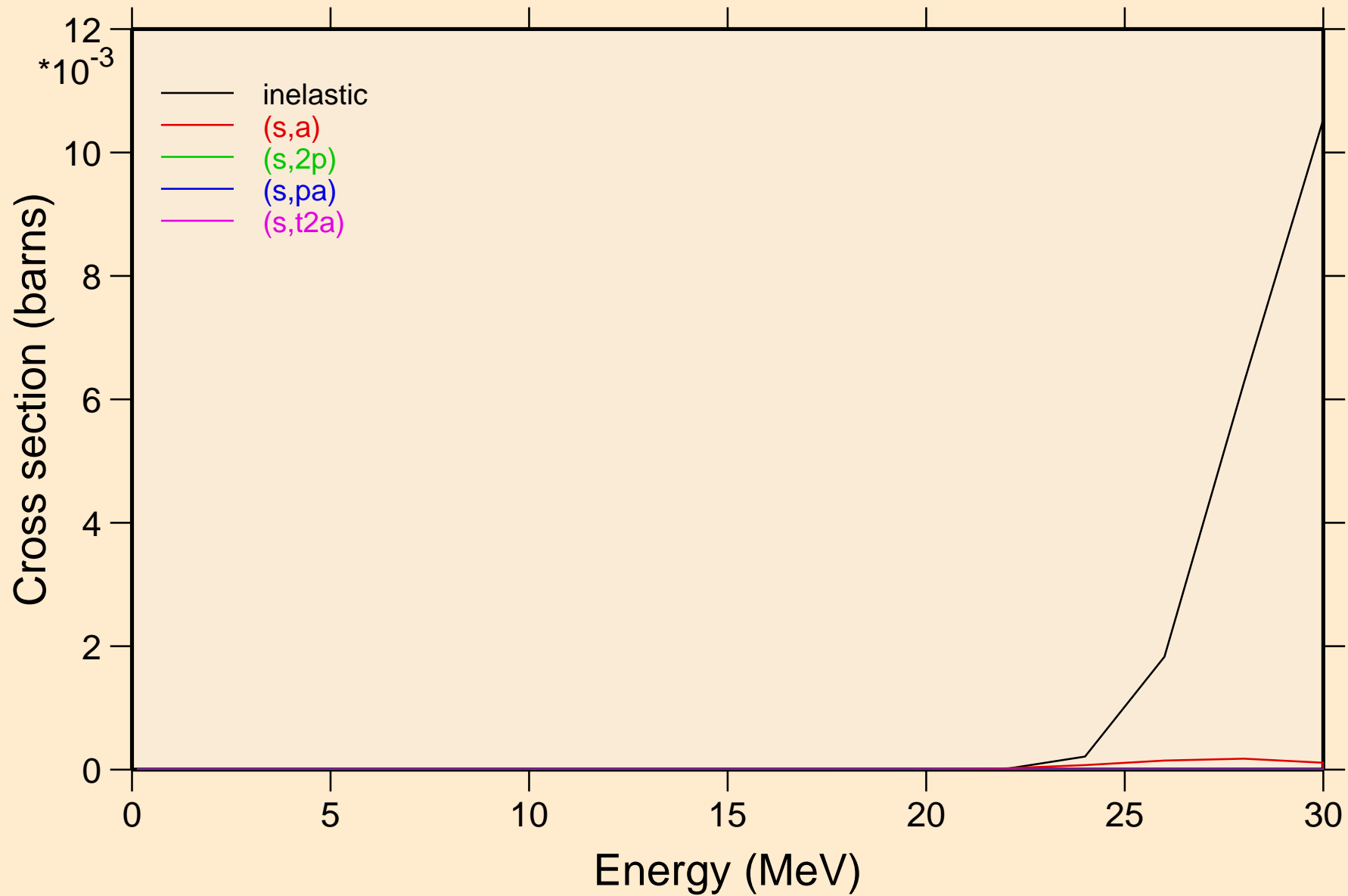

RF255 HELION ACER TENDL-2023 LIBRARY; T=0.K
Threshold reactions

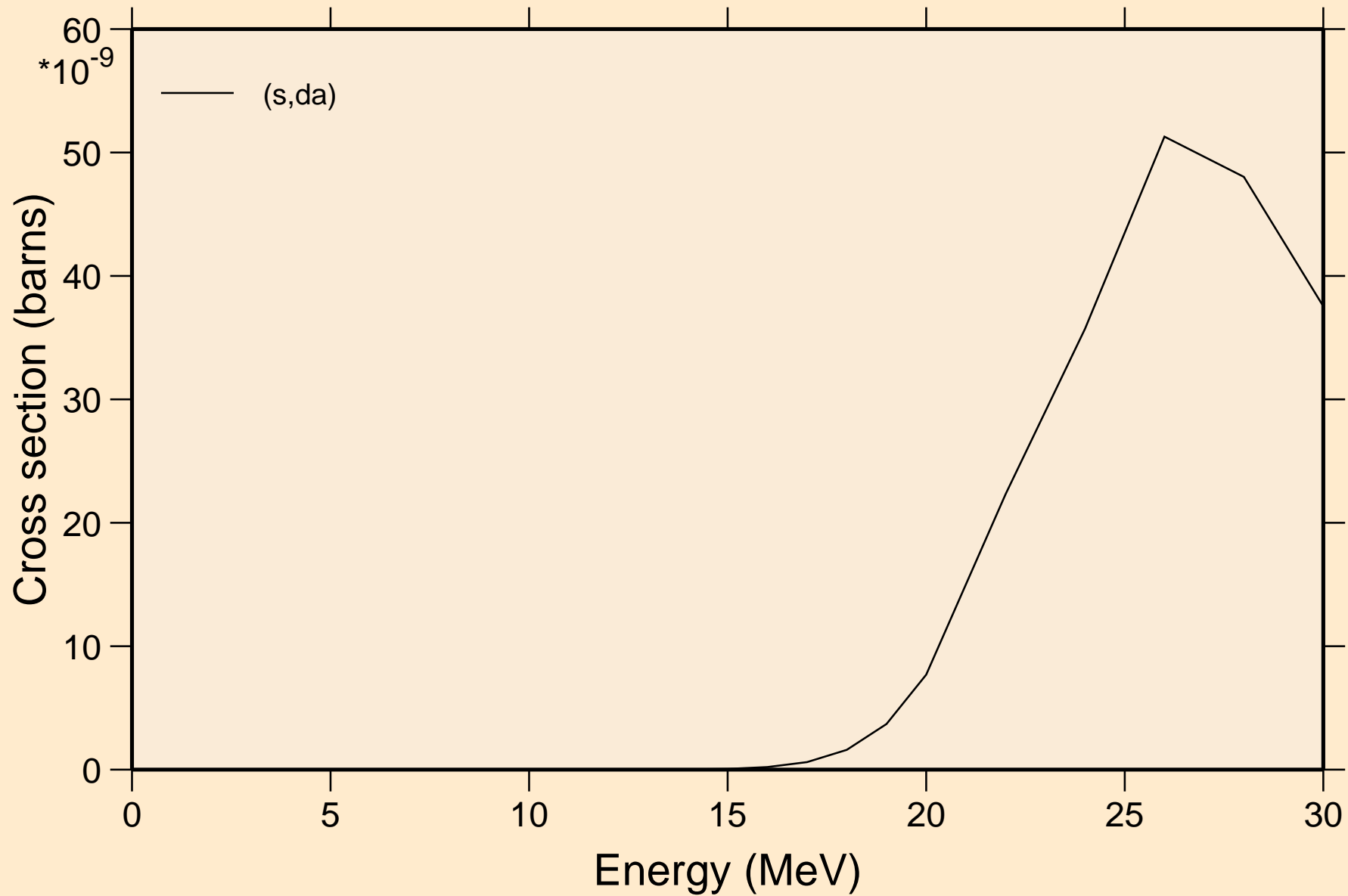

RF255 HELION ACER TENDL-2023 LIBRARY; T=0.K
angular distribution for elastic

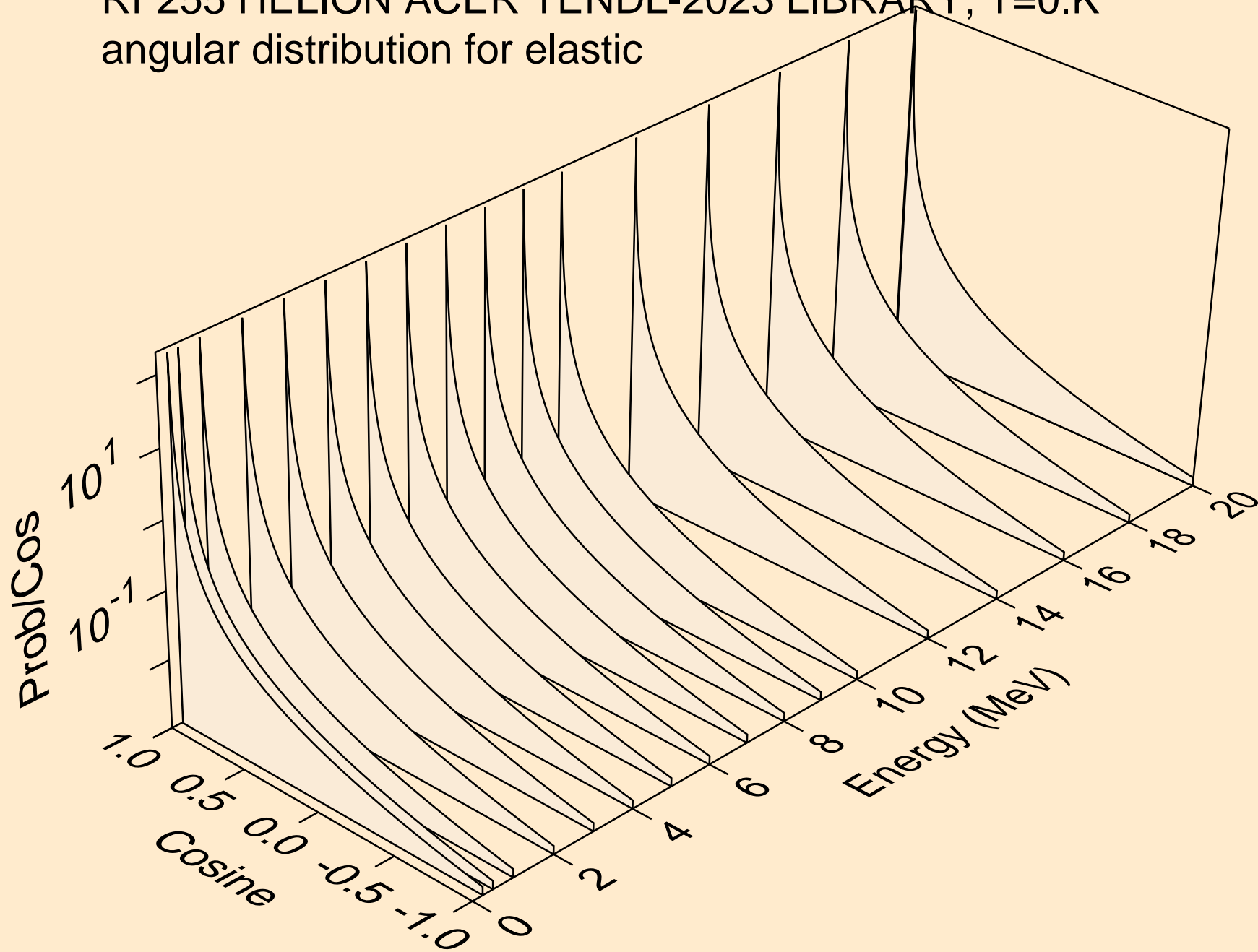

RF255 HELION ACER TENDL-2023 LIBRARY; T=0.K
angular distribution for elastic

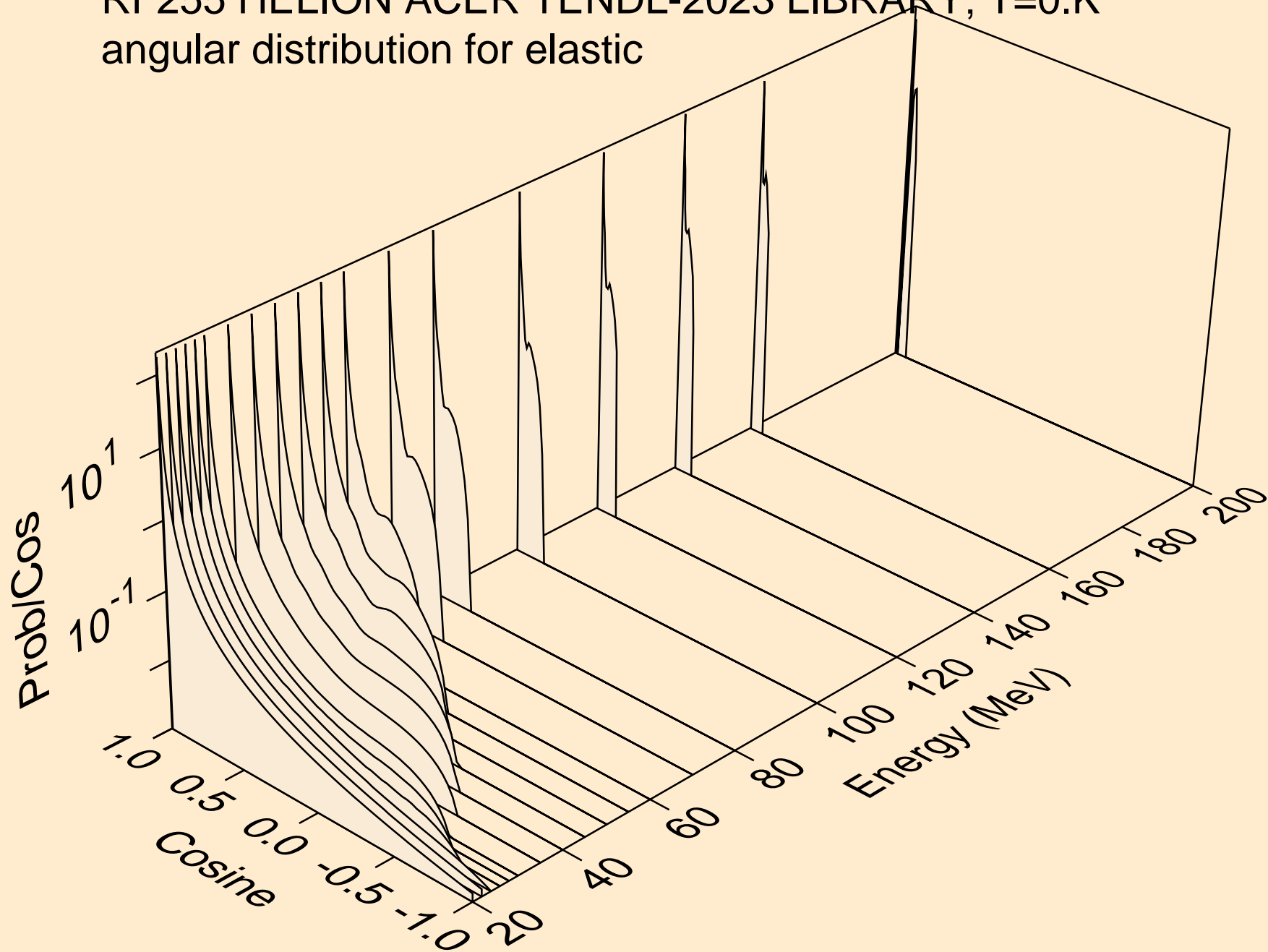

RF255 HELION ACER TENDL-2023 LIBRARY; T=0.K
He-3 emission for (s,x)

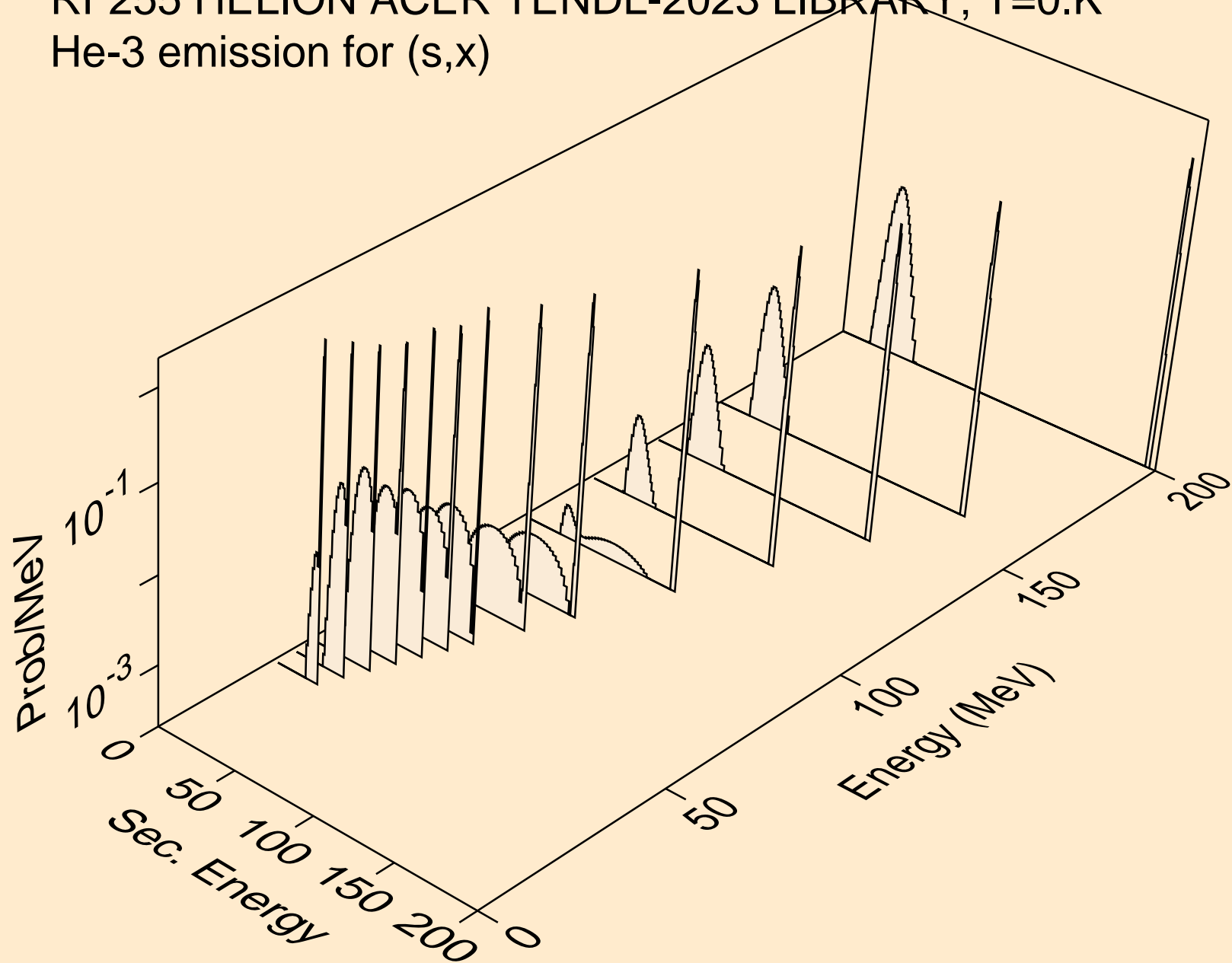

RF255 HELION ACER TENDL-2023 LIBRARY; T=0.K
He-3 emission for inelastic

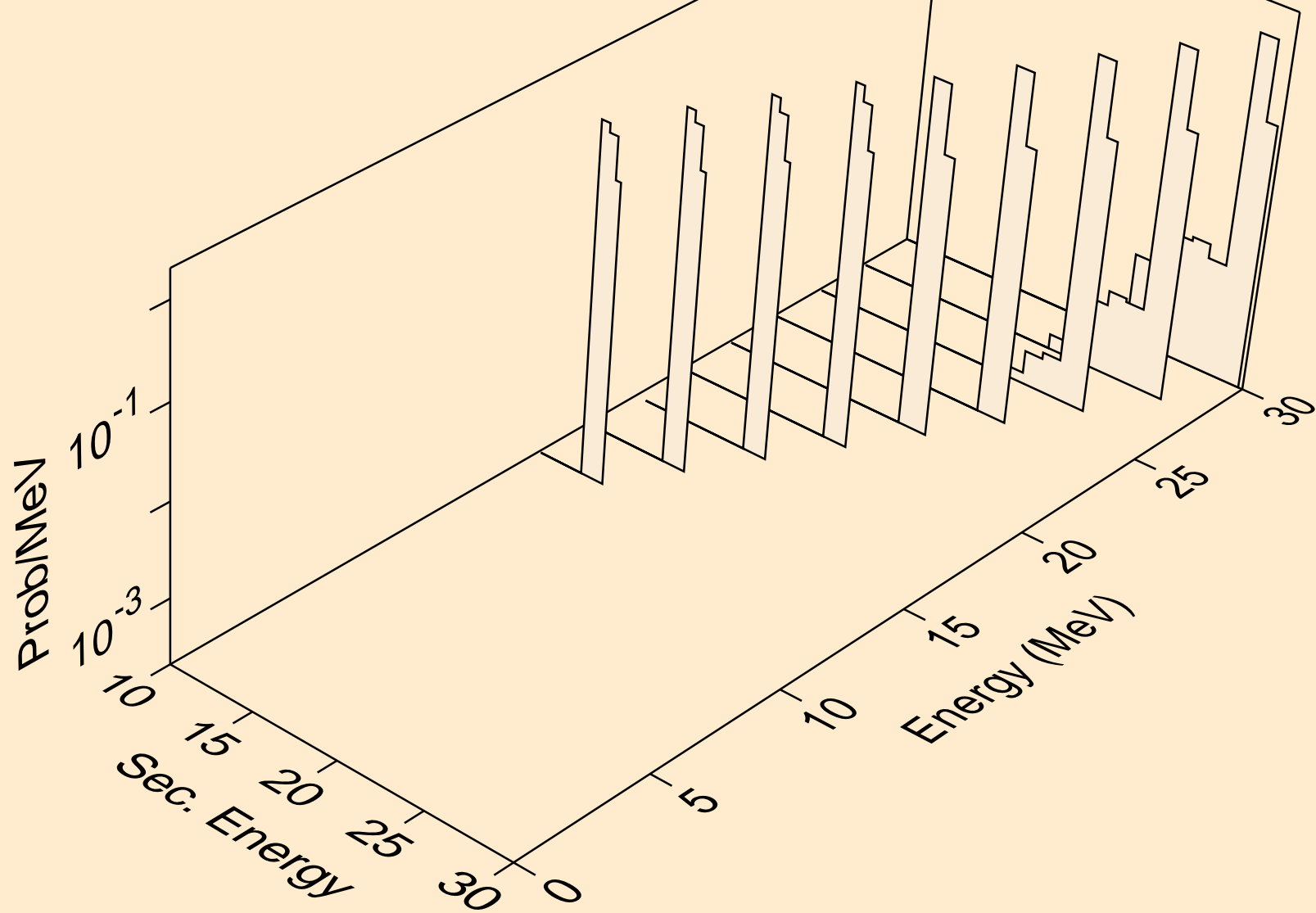

RF255 HELION ACER TENDL-2023 LIBRARY; T=0.K
Photon emission for (z,n)

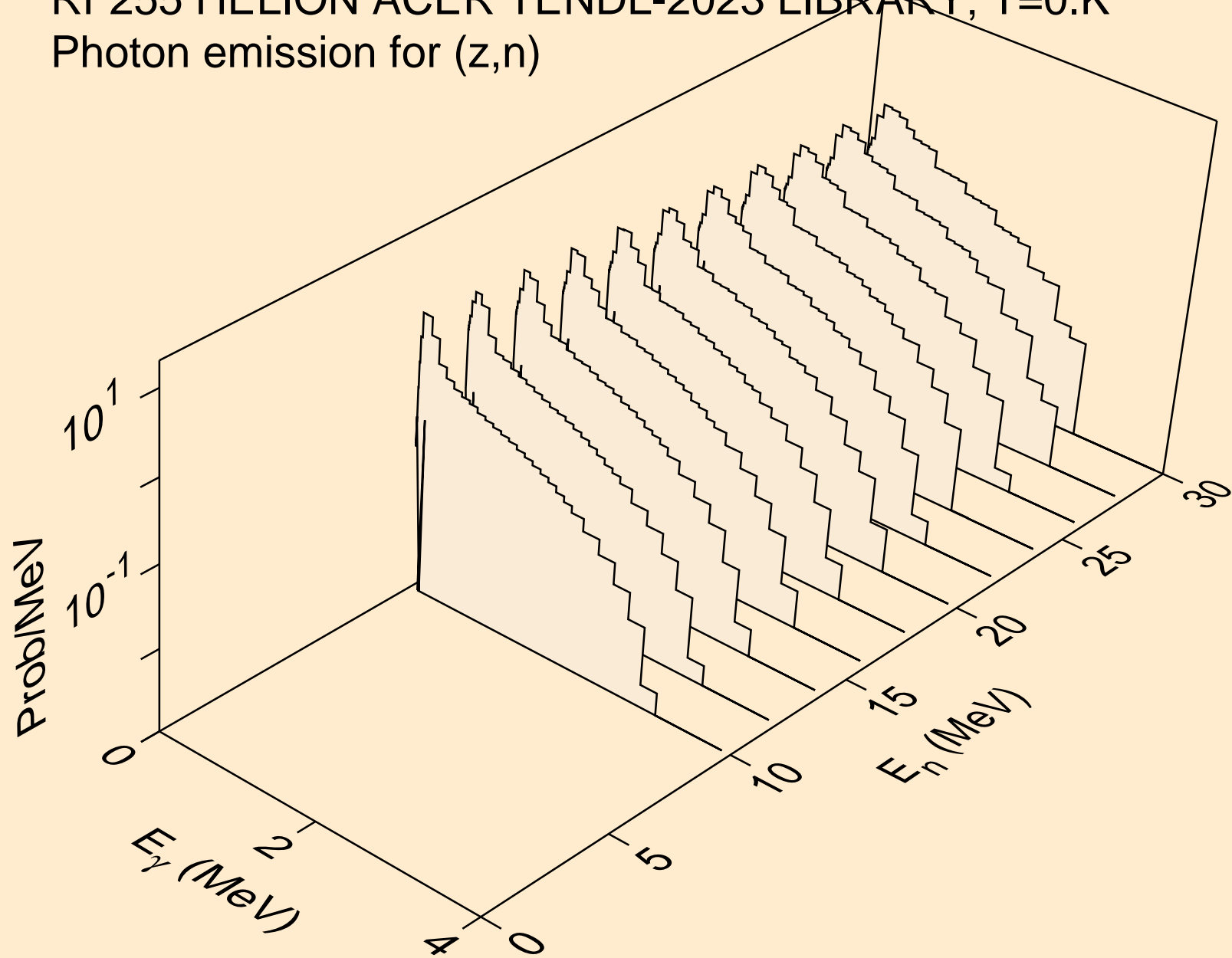

RF255 HELION ACER TENDL-2023 LIBRARY; T=0.K
Photon emission for (z,x)

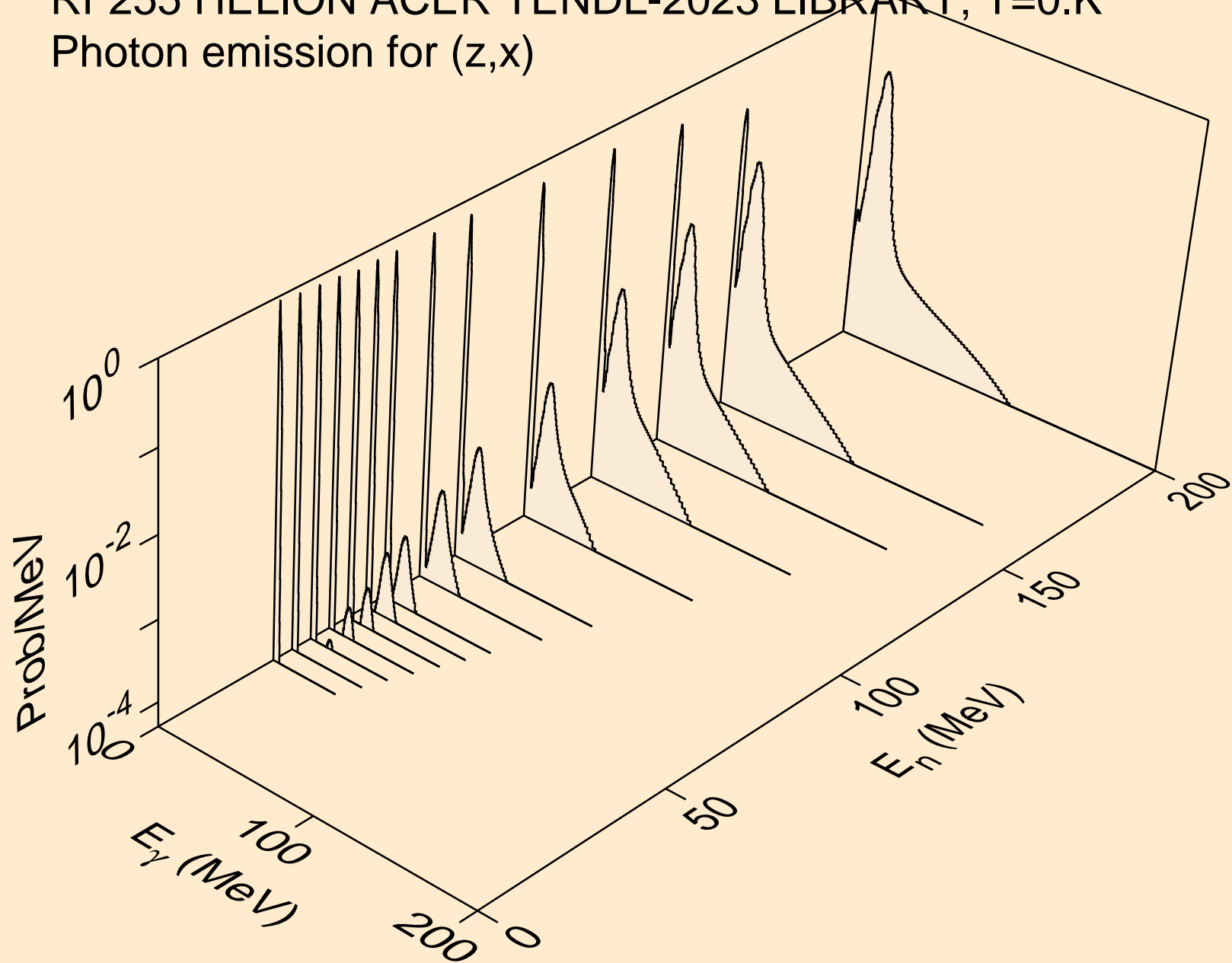

RF255 HELION ACER TENDL-2023 LIBRARY; T=0.K
Photon emission for (n,2n)

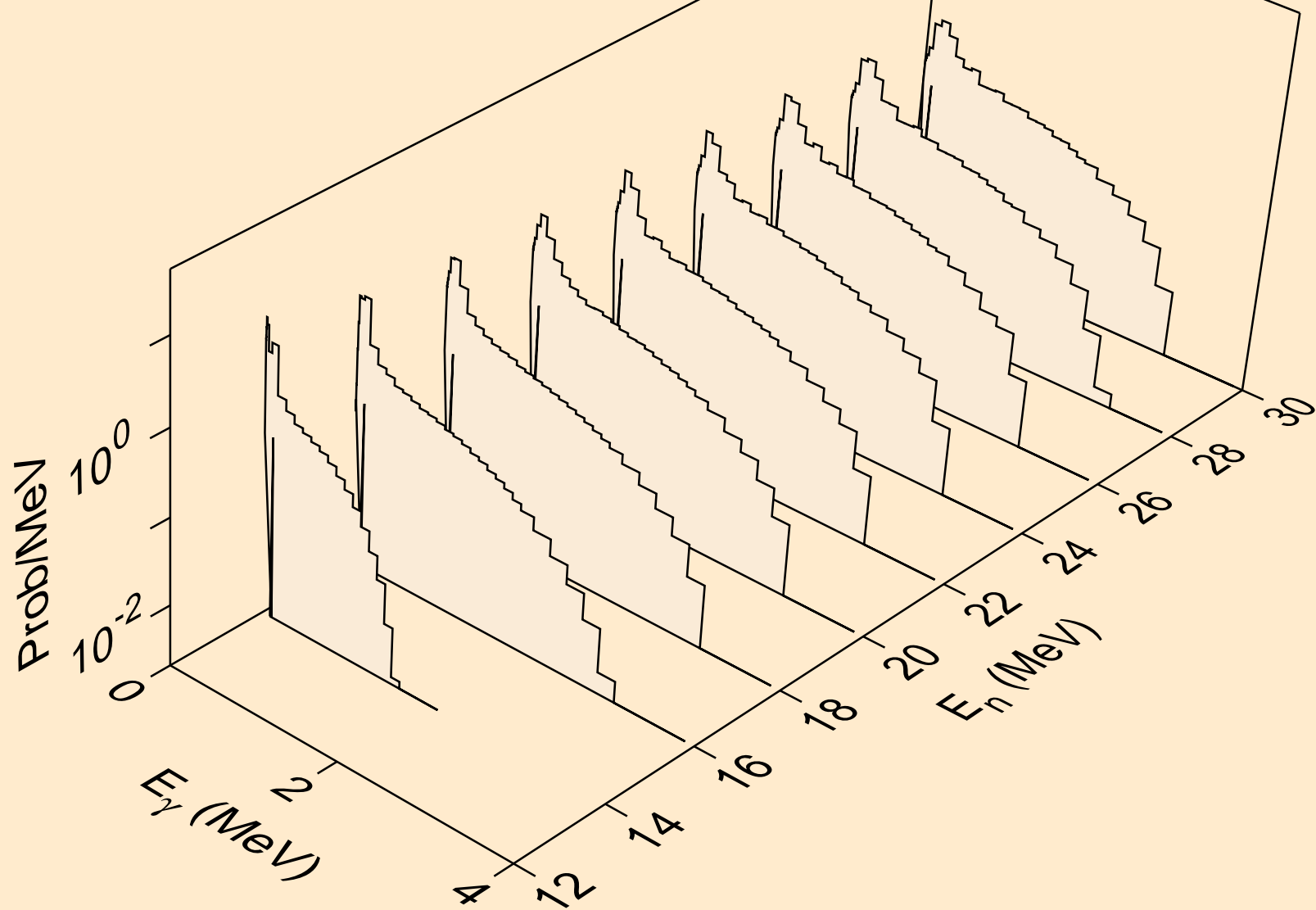

RF255 HELION ACER TENDL-2023 LIBRARY; T=0.K
Photon emission for (n,3n)

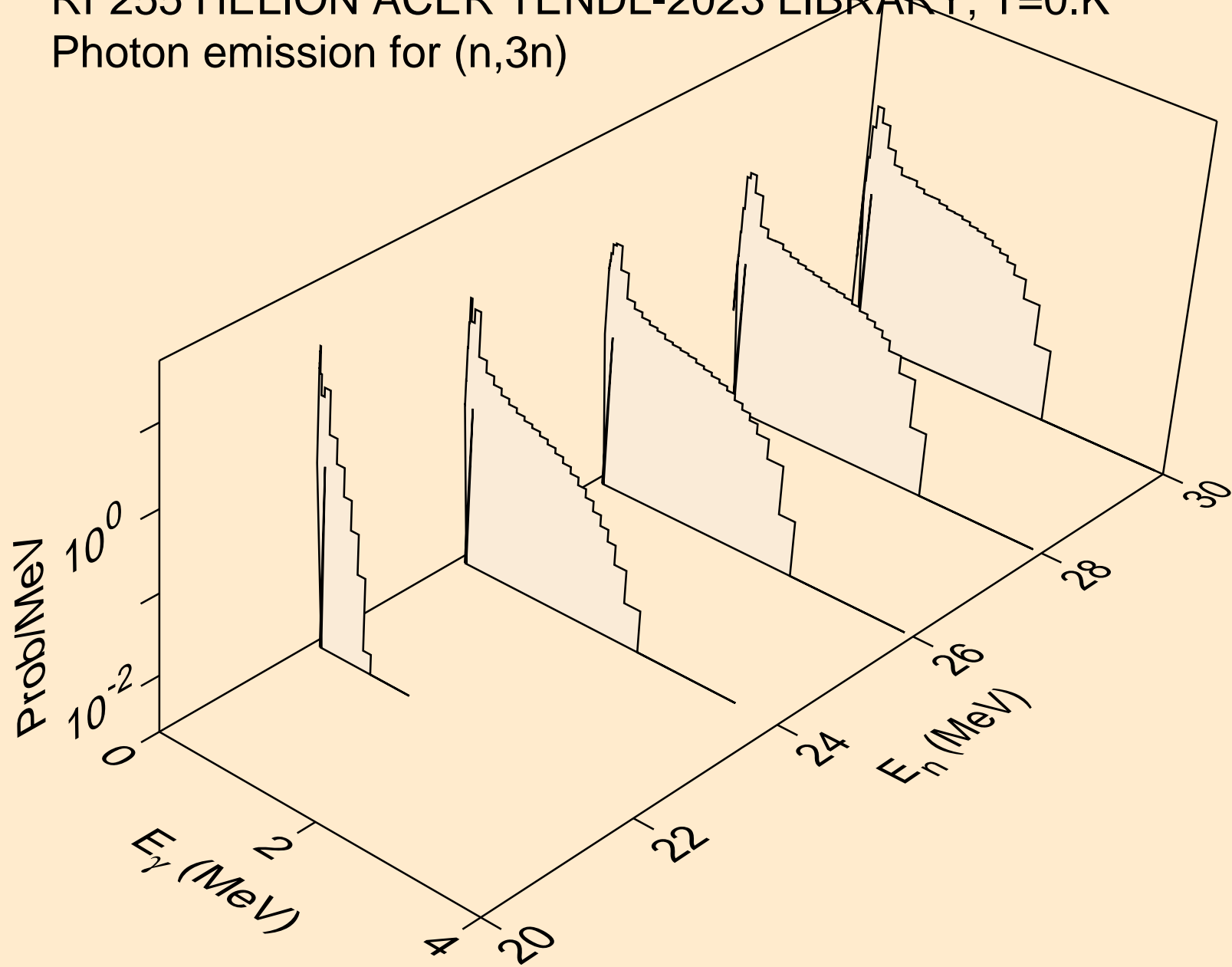

RF255 HELION ACER TENDL-2023 LIBRARY; T=0.K
Photon emission for (n,n*)a

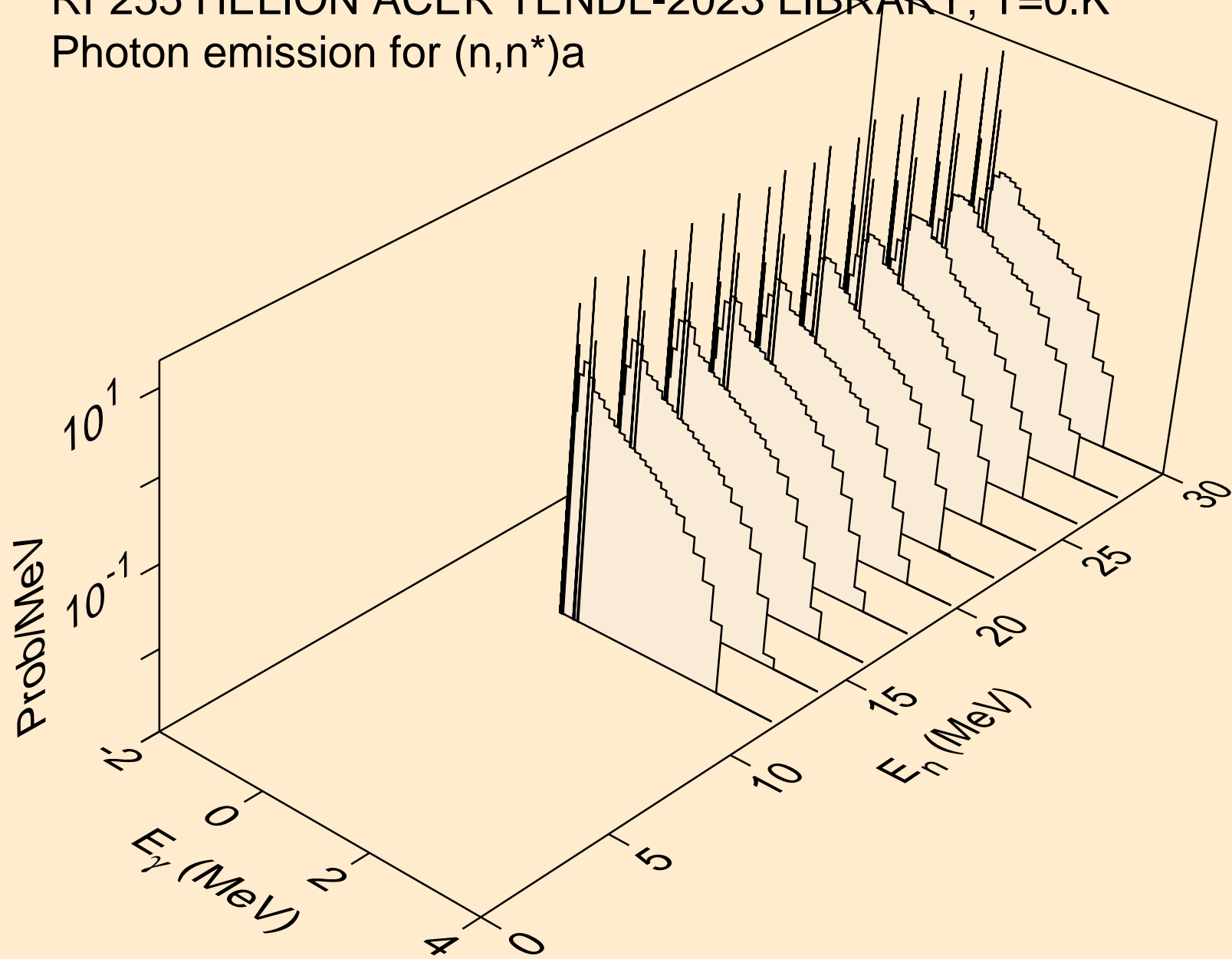

RF255 HELION ACER TENDL-2023 LIBRARY; T=0.K
Photon emission for (n,2n)a

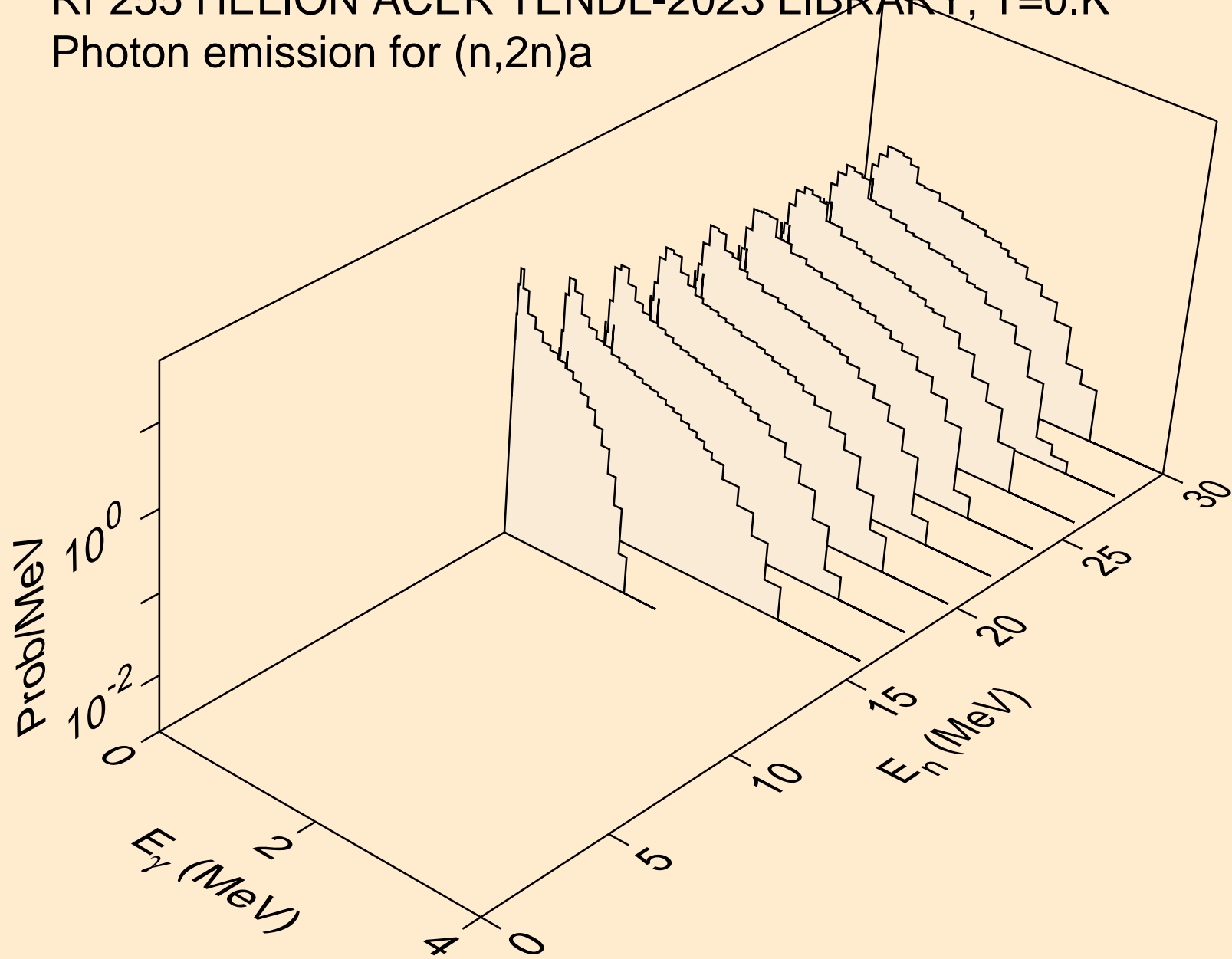

RF255 HELION ACER TENDL-2023 LIBRARY; T=0.K
Photon emission for (n,n*)p

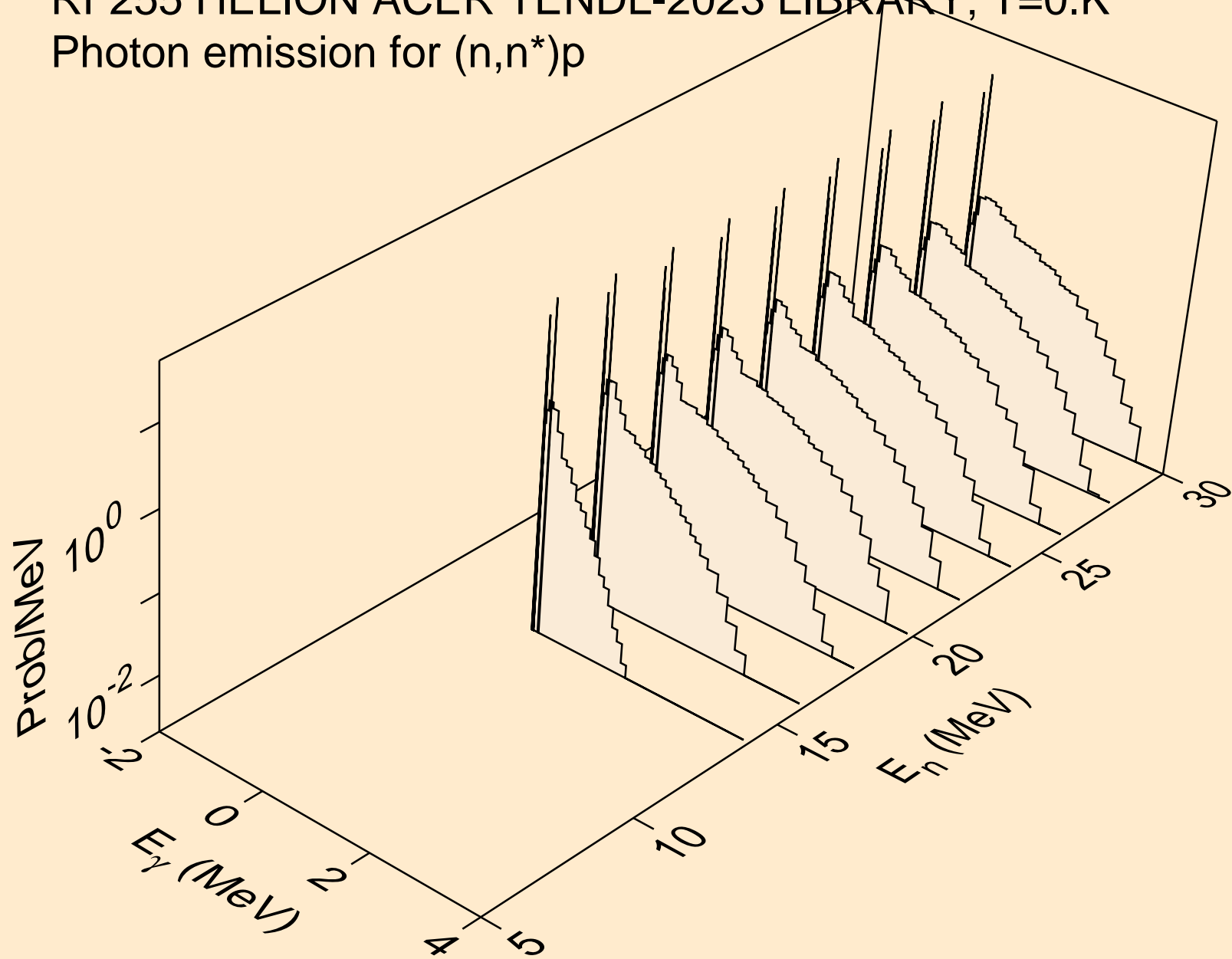

RF255 HELION ACER TENDL-2023 LIBRARY; T=0.K
Photon emission for (n,n*)d

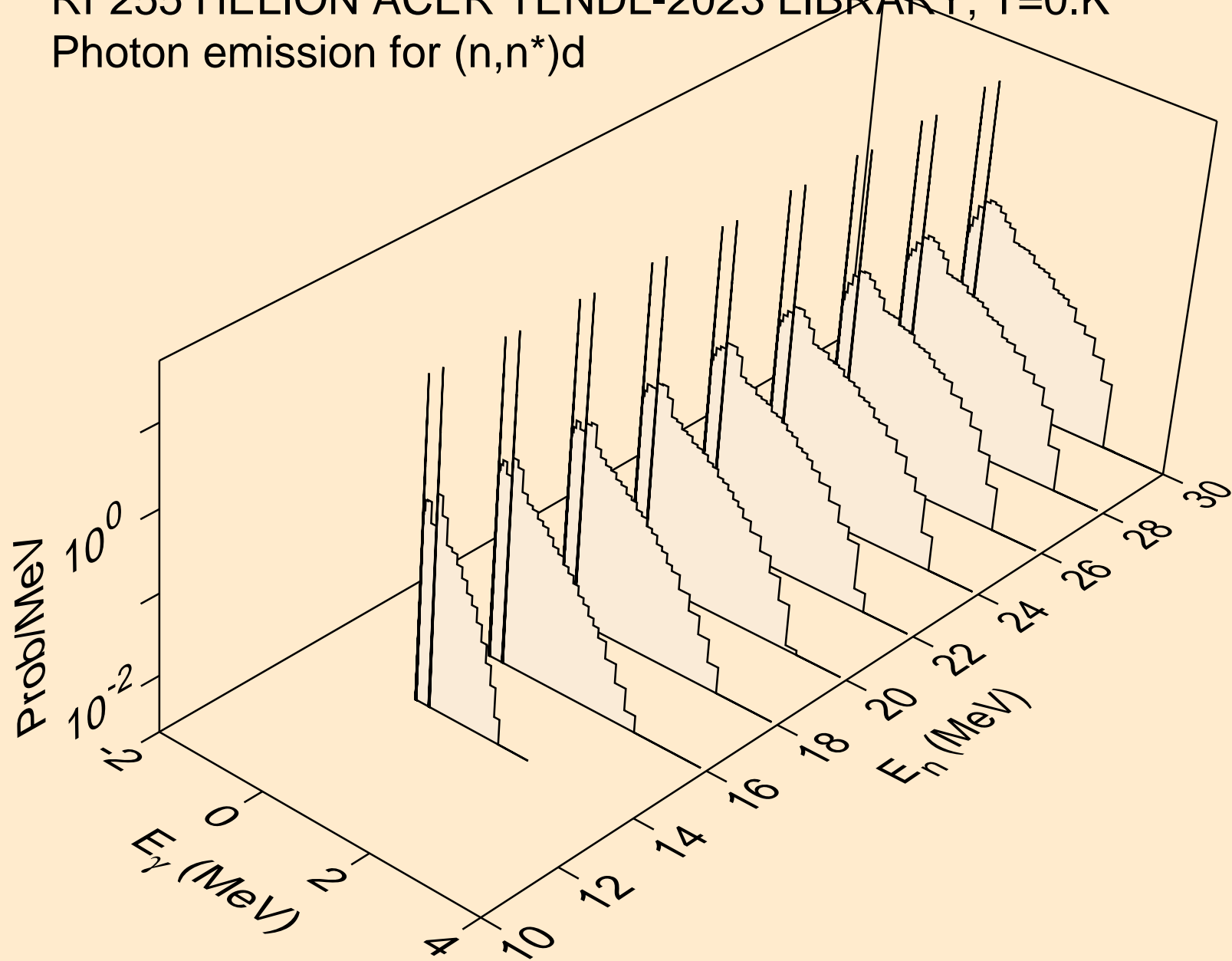

RF255 HELION ACER TENDL-2023 LIBRARY; T=0.K
Photon emission for (n,n*)t

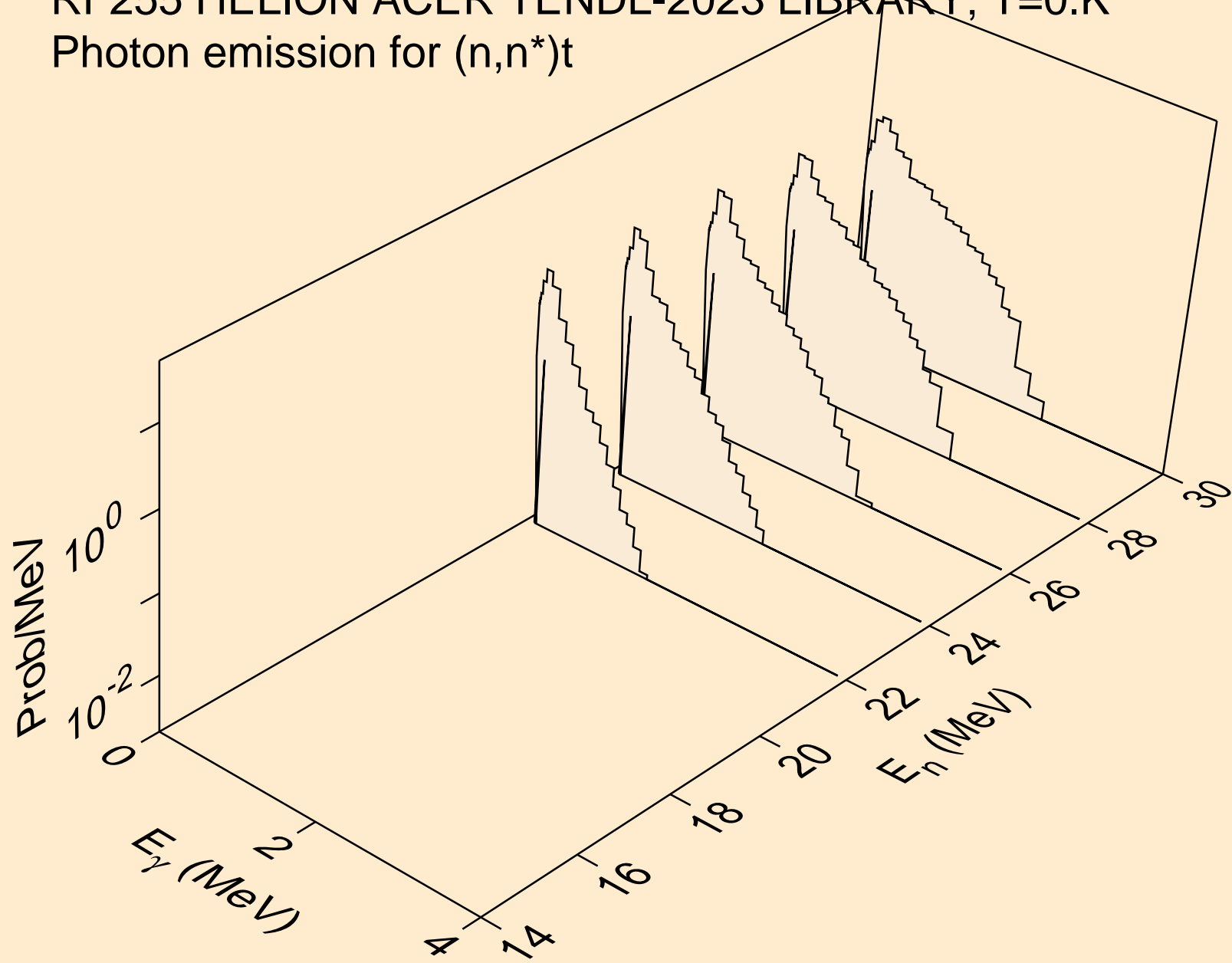

RF255 HELION ACER TENDL-2023 LIBRARY; T=0.K
Photon emission for (n,2np)

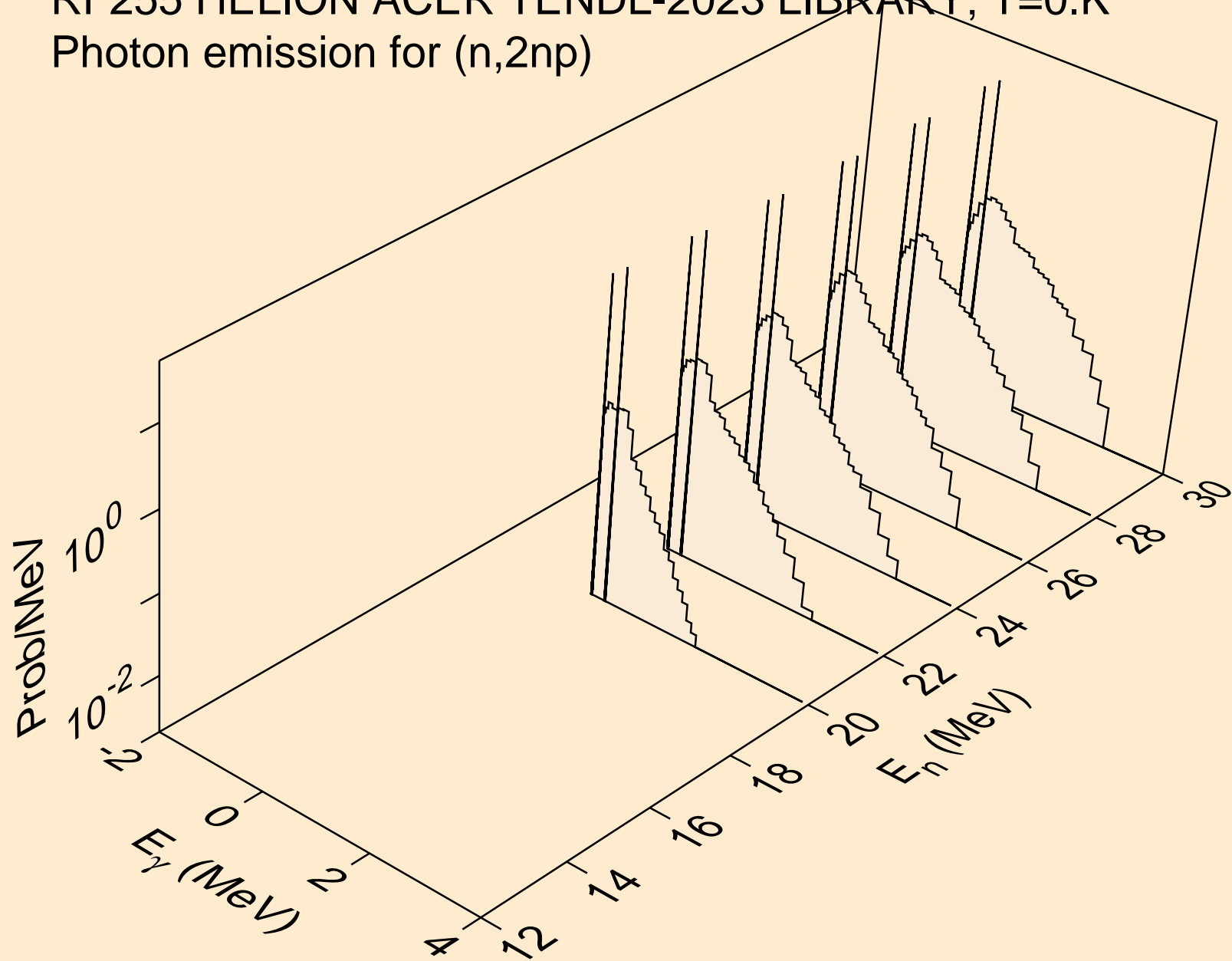

RF255 HELION ACER TENDL-2023 LIBRARY; T=0.K
Photon emission for (n,p)

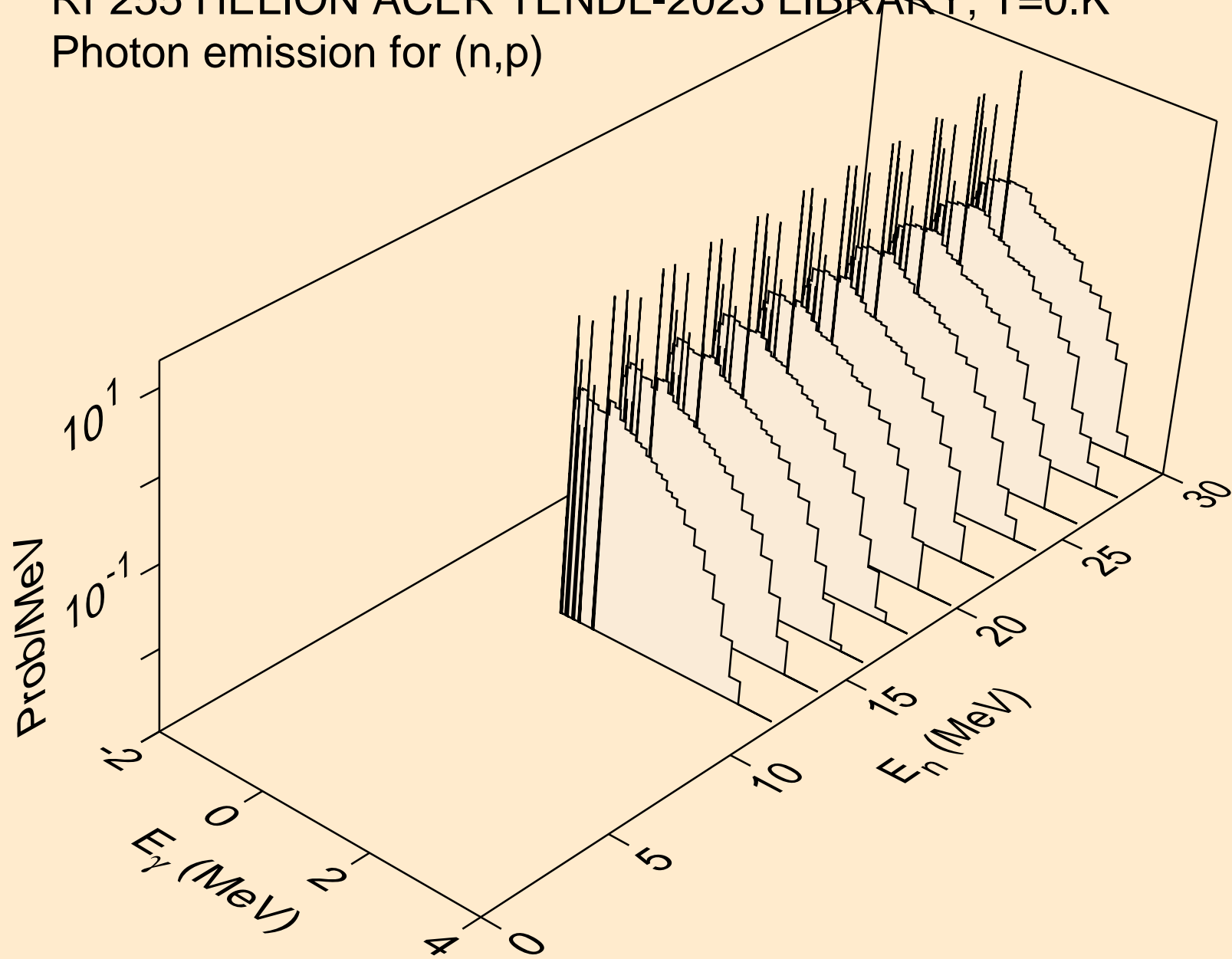

RF255 HELION ACER TENDL-2023 LIBRARY; T=0.K
Photon emission for (n,d)

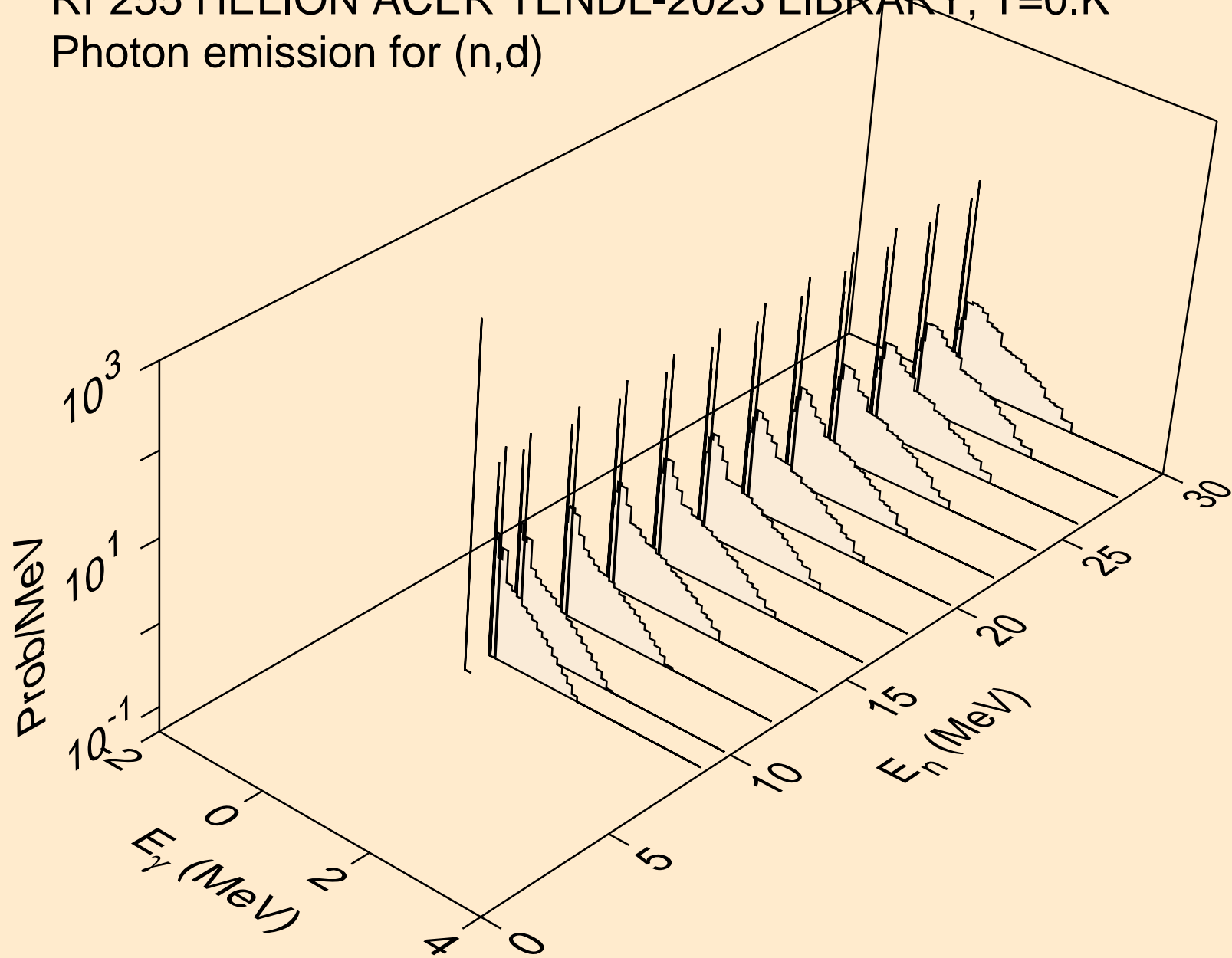

RF255 HELION ACER TENDL-2023 LIBRARY; T=0.K
Photon emission for (n,t)

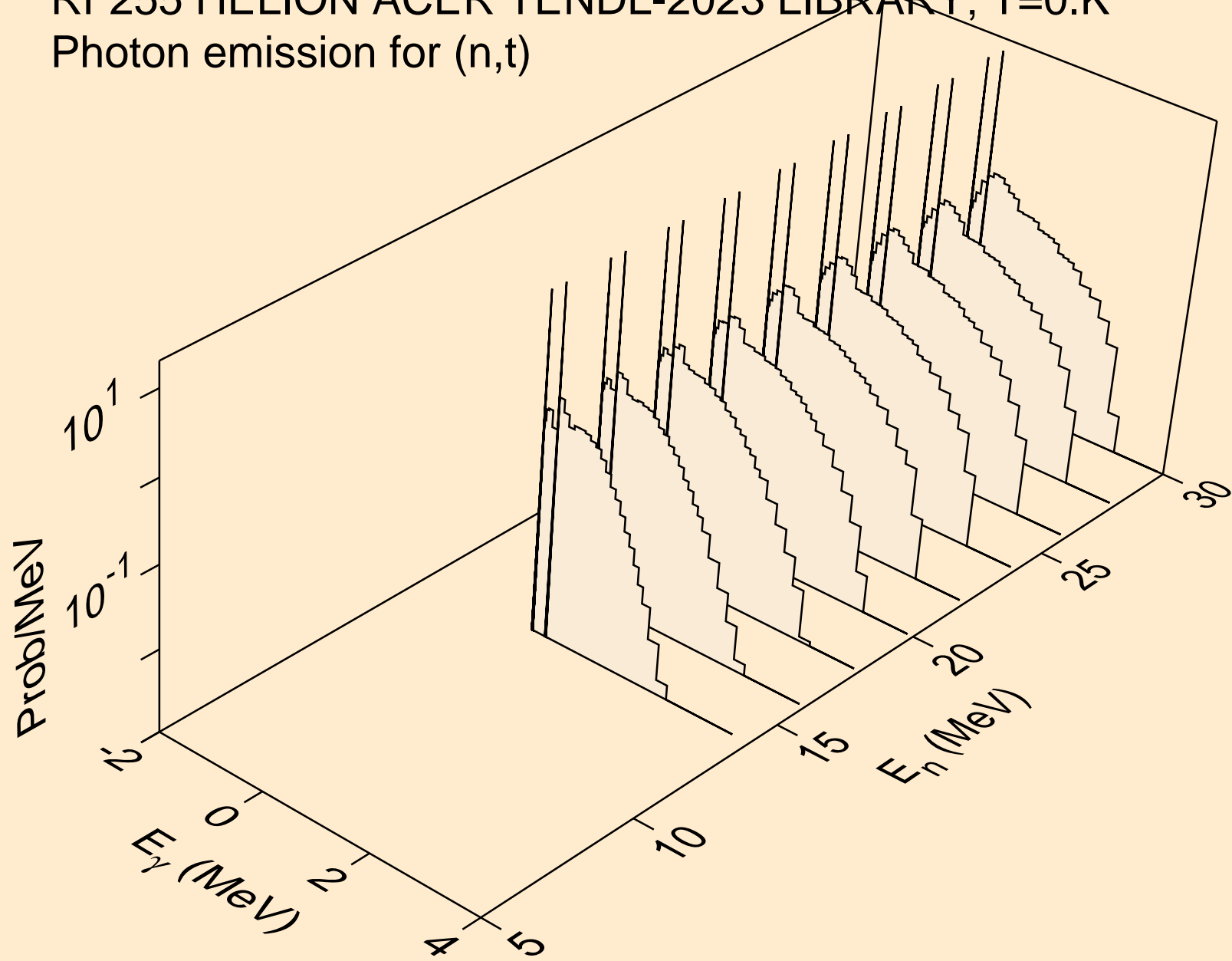

RF255 HELION ACER TENDL-2023 LIBRARY; T=0.K
Photon emission for inelastic

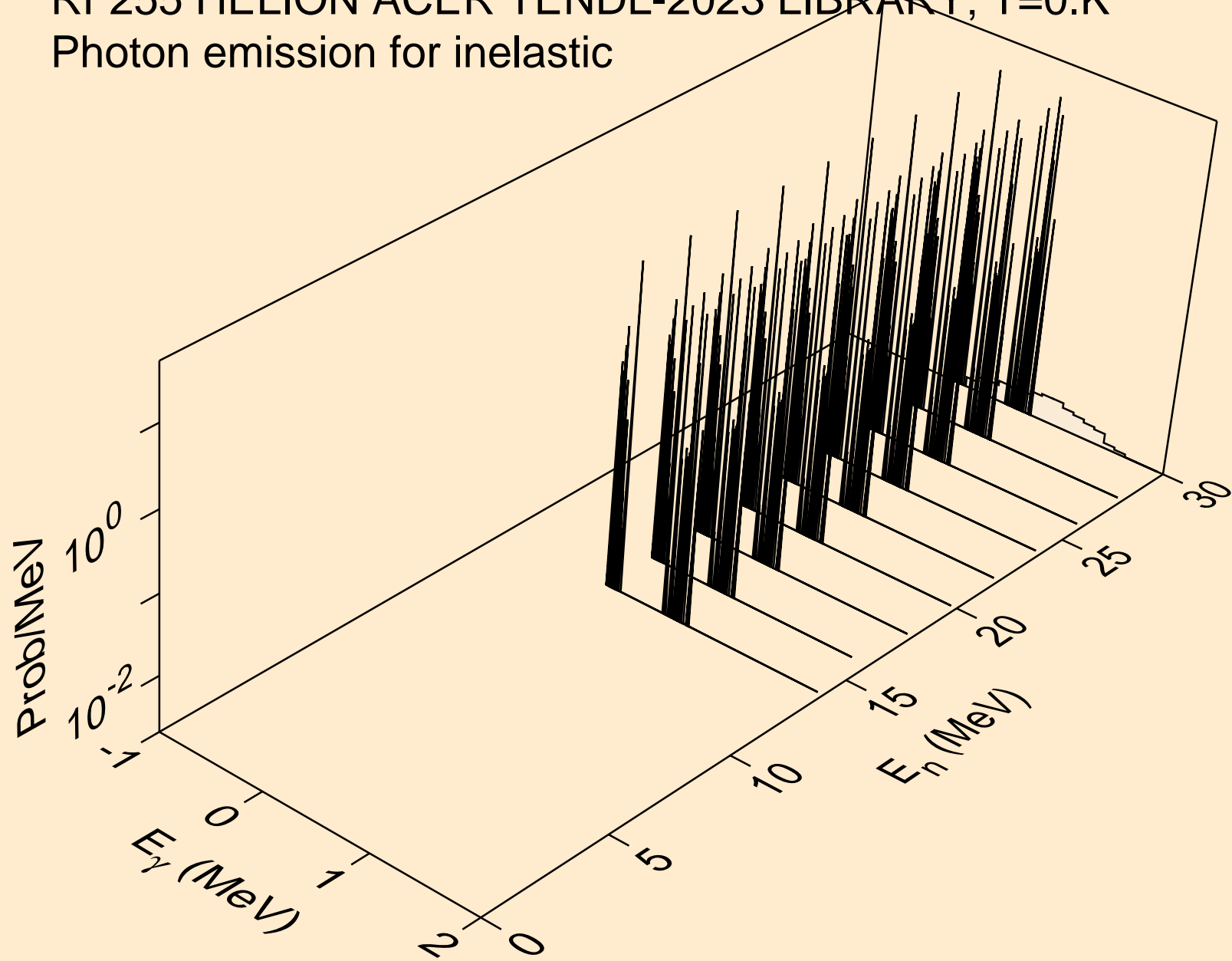

RF255 HELION ACER TENDL-2023 LIBRARY; T=0.K
Photon emission for (n,a)

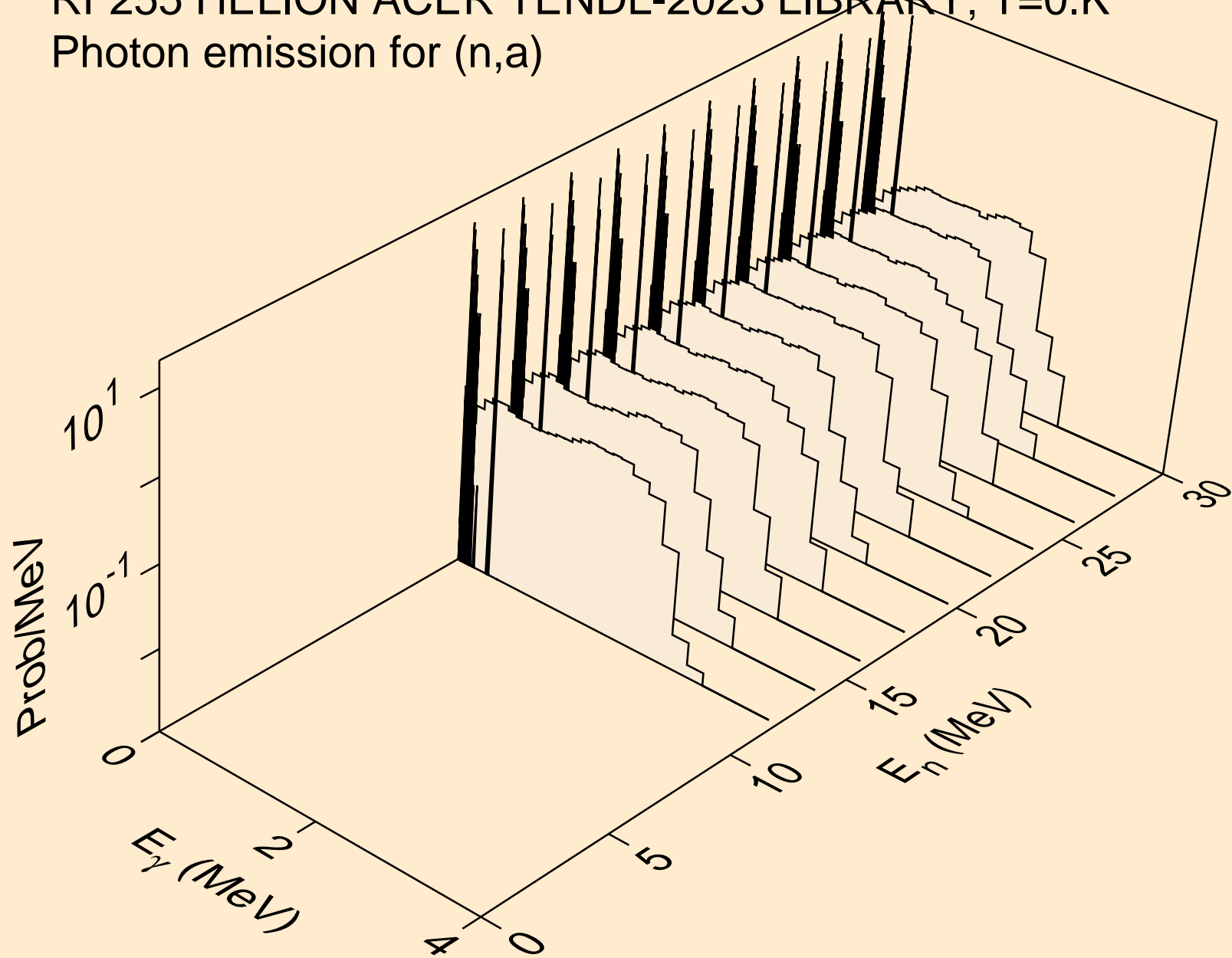

RF255 HELION ACER TENDL-2023 LIBRARY; T=0.K
Photon emission for (n,2p)

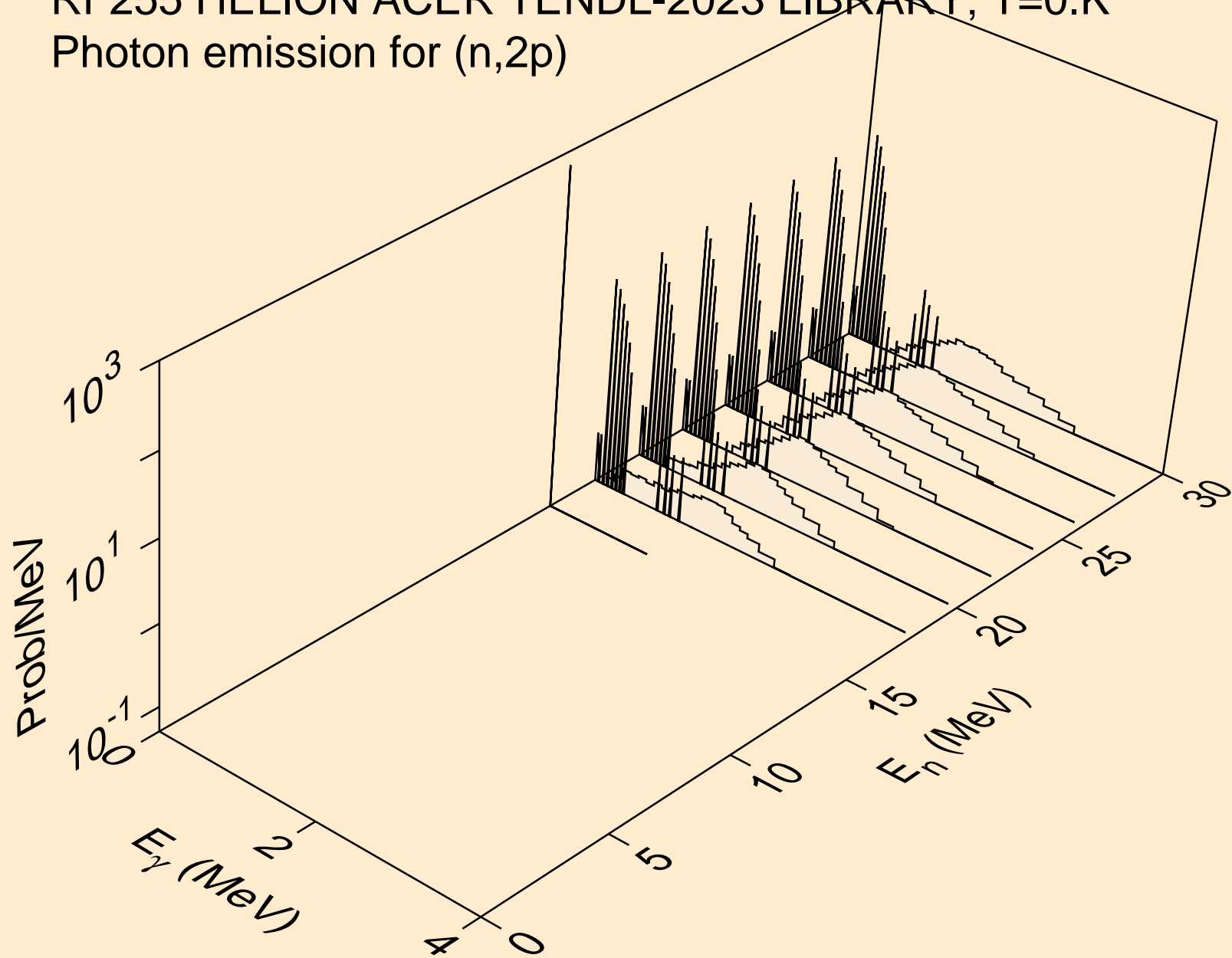

RF255 HELION ACER TENDL-2023 LIBRARY; T=0.K
Photon emission for (n,pa)

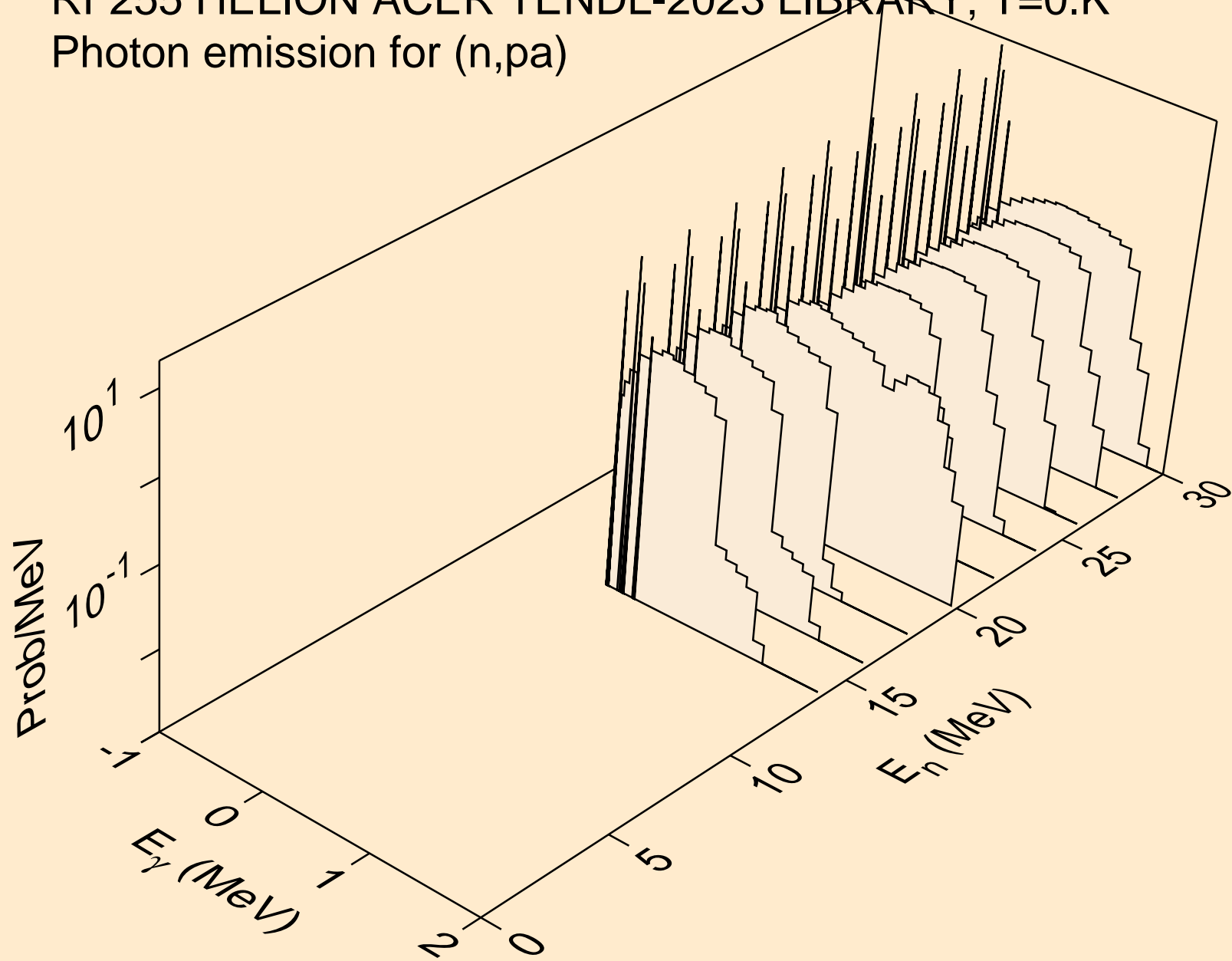

RF255 HELION ACER TENDL-2023 LIBRARY; T=0.K
Photon emission for (n,t2a)

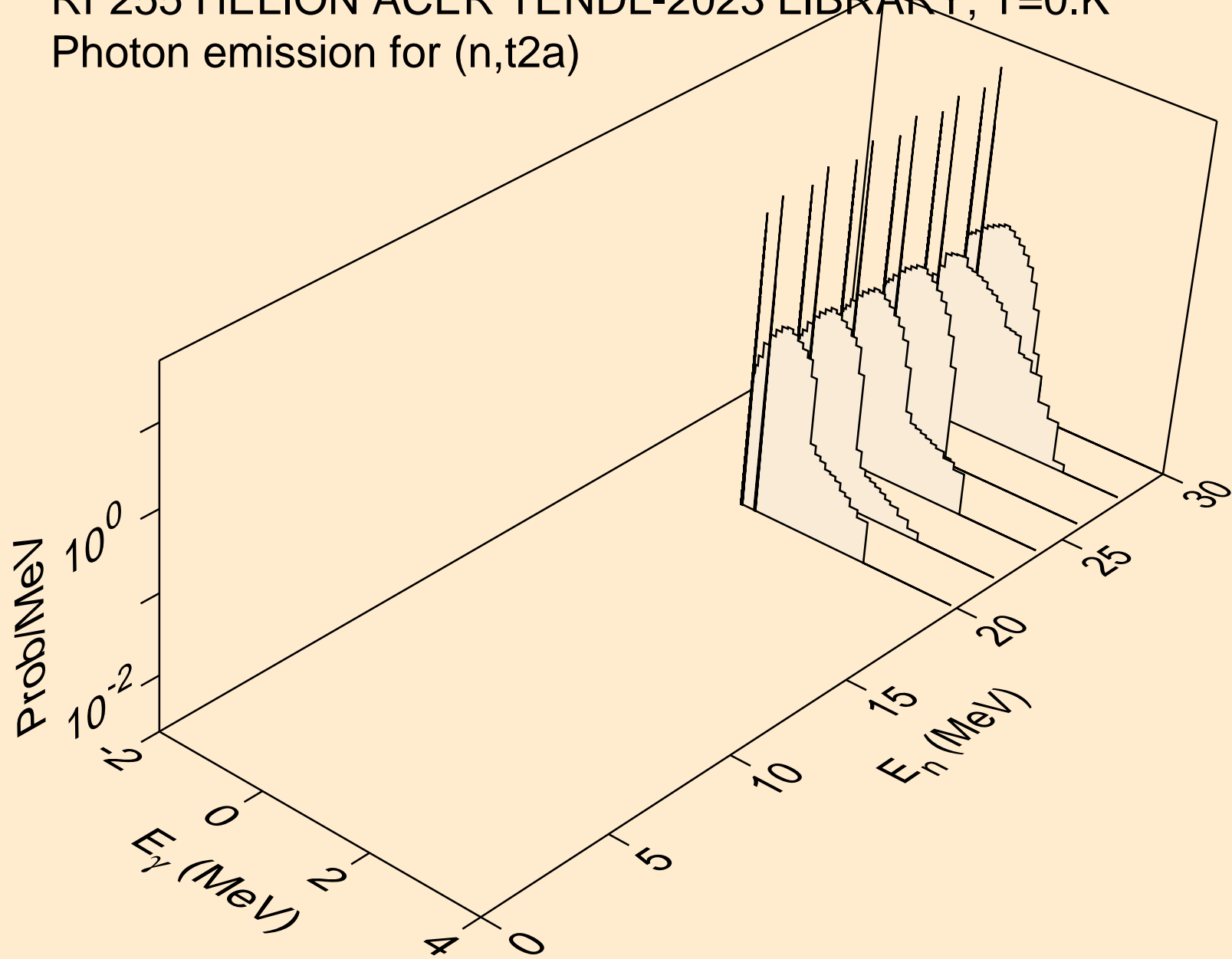

RF255 HELION ACER TENDL-2023 LIBRARY; T=0.K
Photon emission for (n,da)

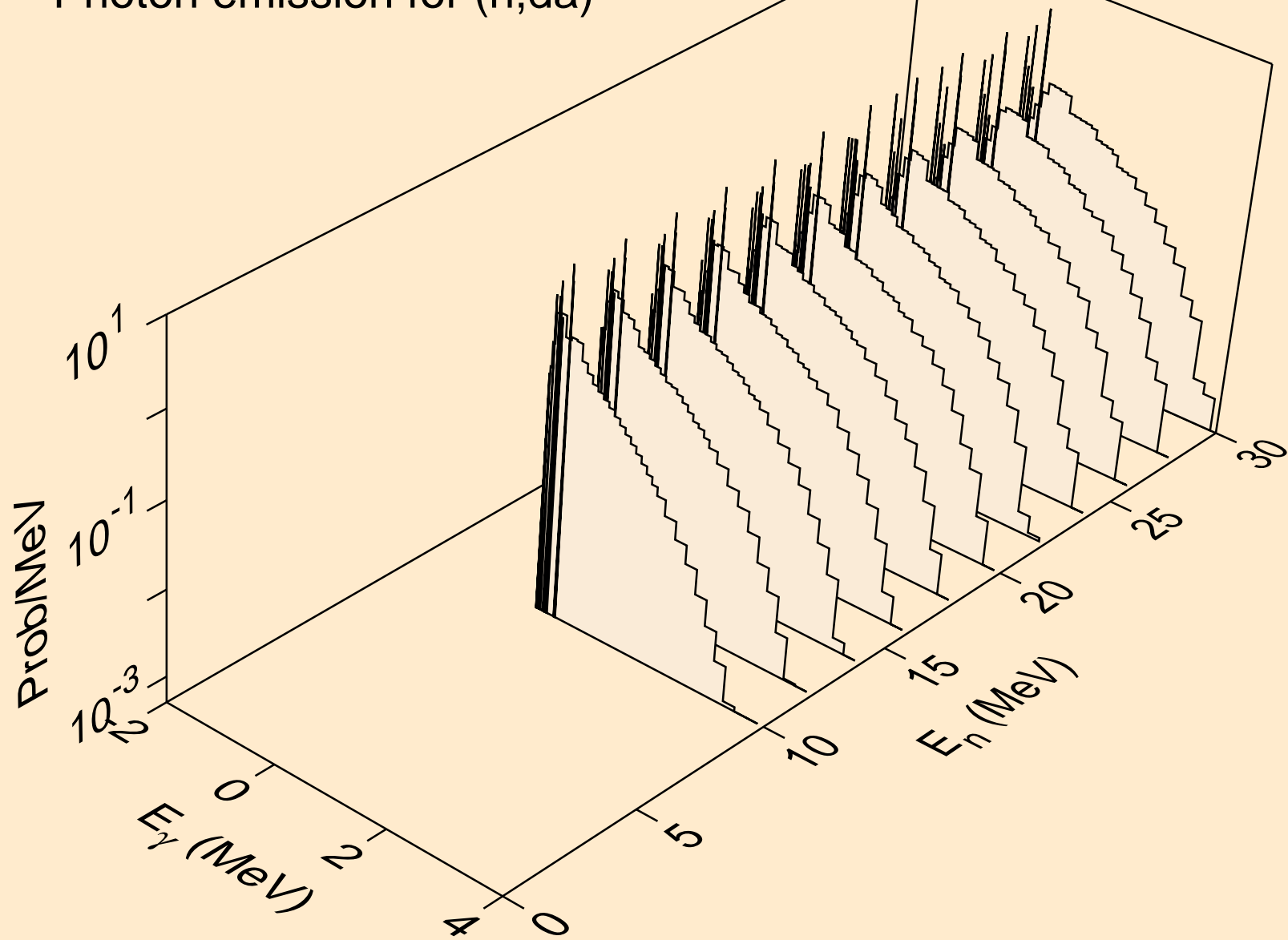

RF255 HELION ACER TENDL-2023 LIBRARY; T=0.K
Particle heating contributions

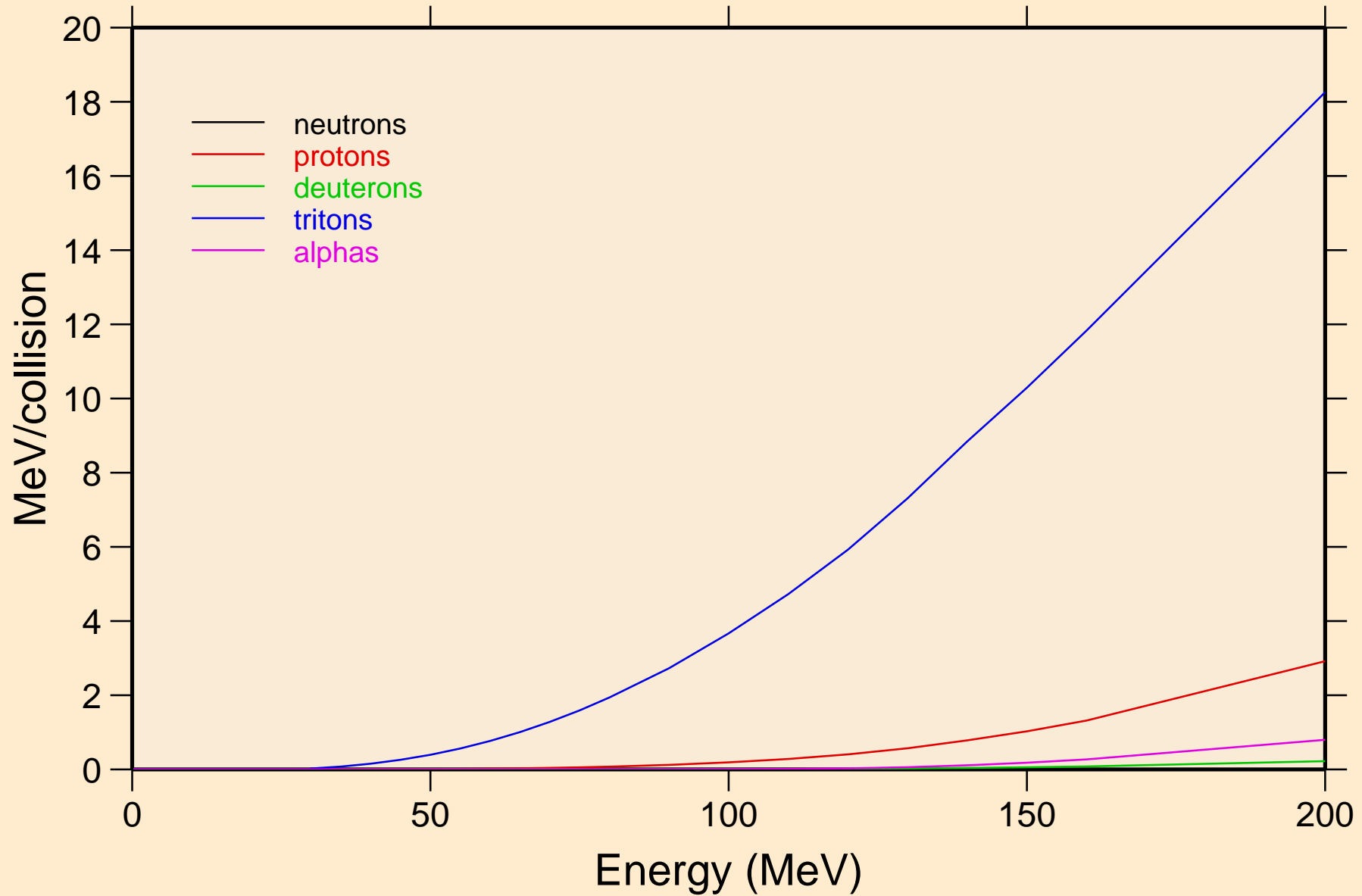

RF255 HELION ACER TENDL-2023 LIBRARY; T=0.K
Recoil Heating

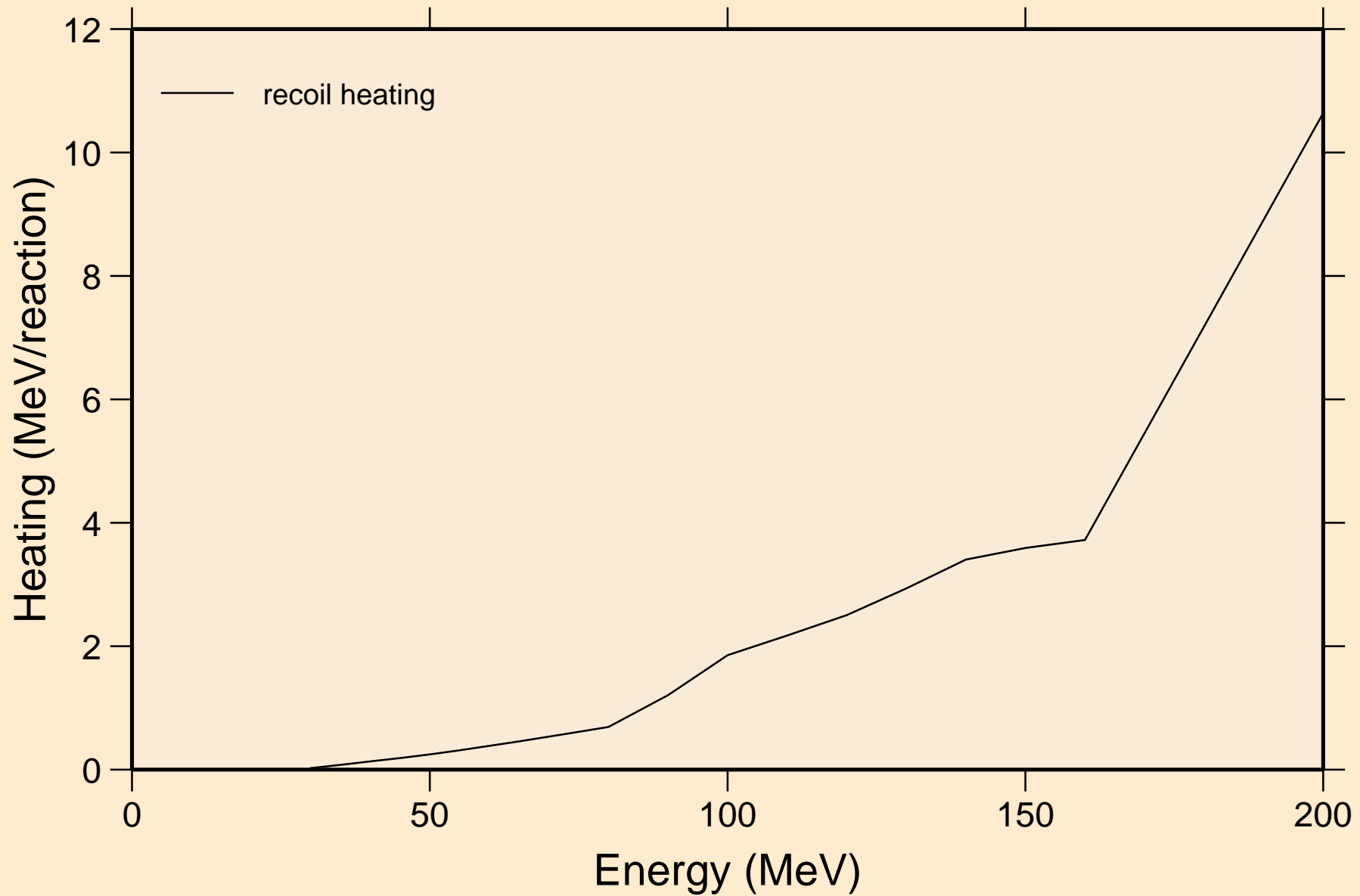

RF255 HELION ACER TENDL-2023 LIBRARY; T=0.K
Particle production cross sections

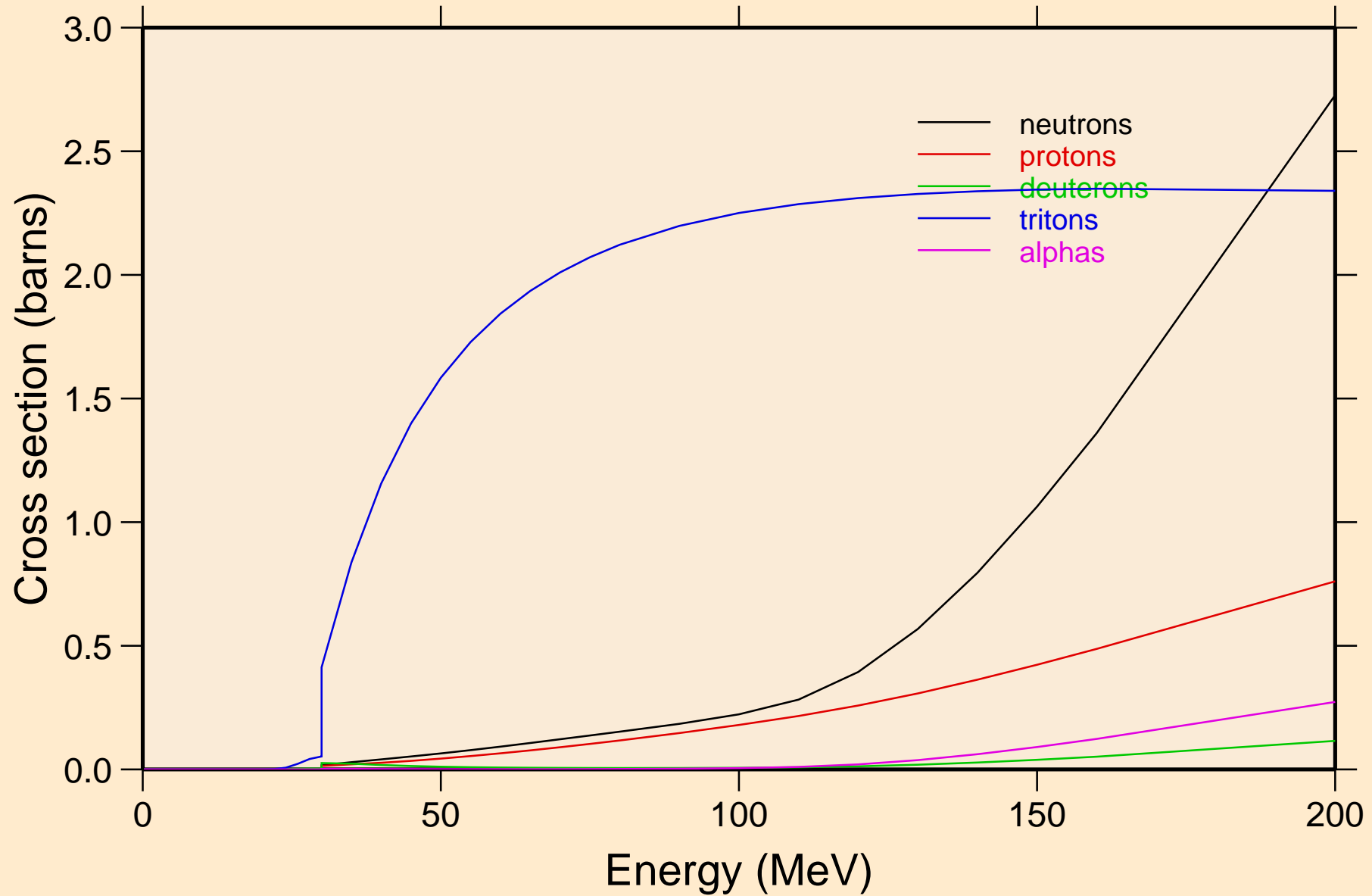

RF255 HELION ACER TENDL-2023 LIBRARY; T=0.K
neutrons from (s,n)

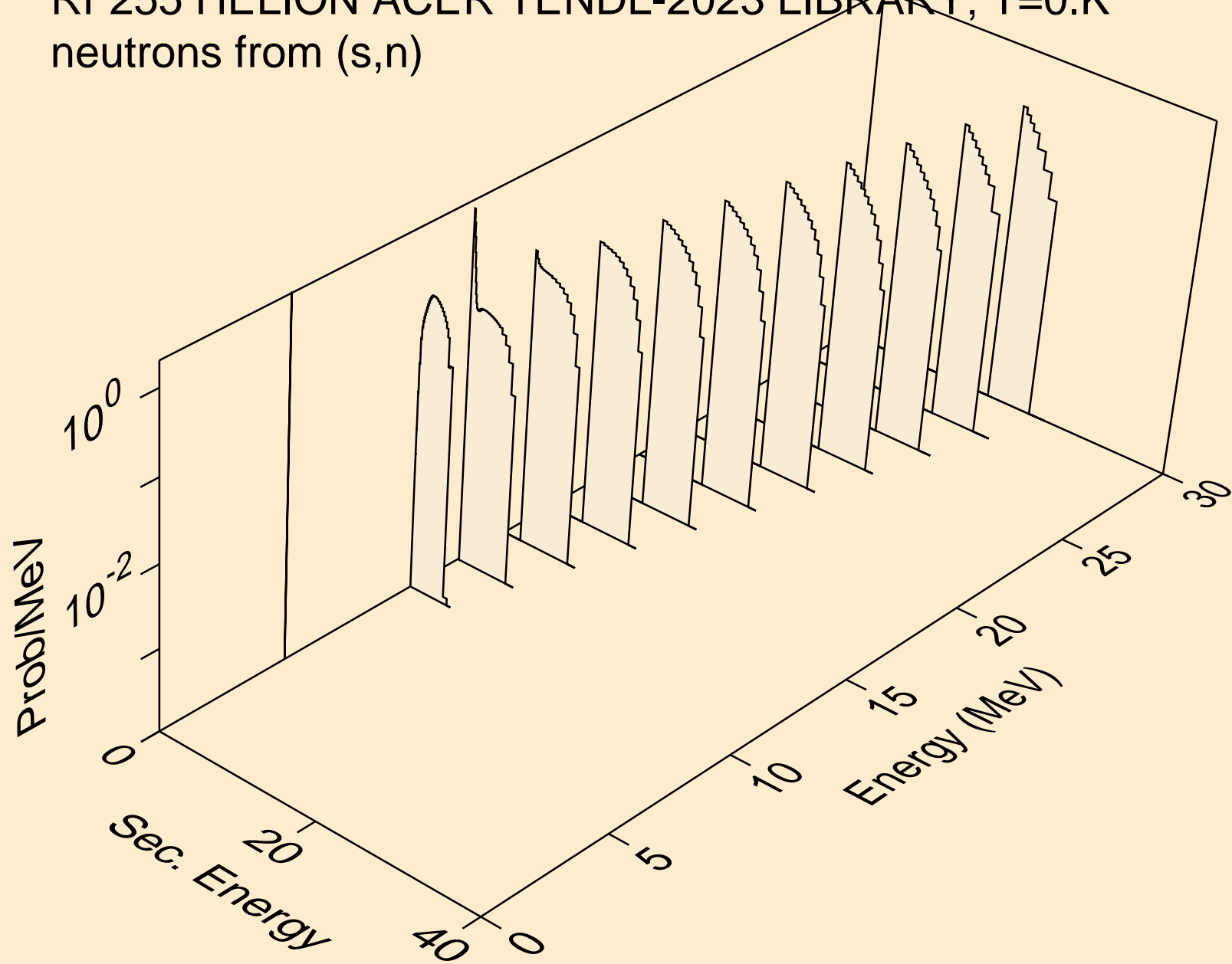

RF255 HELION ACER TENDL-2023 LIBRARY; T=0.K
neutrons from (s,x)

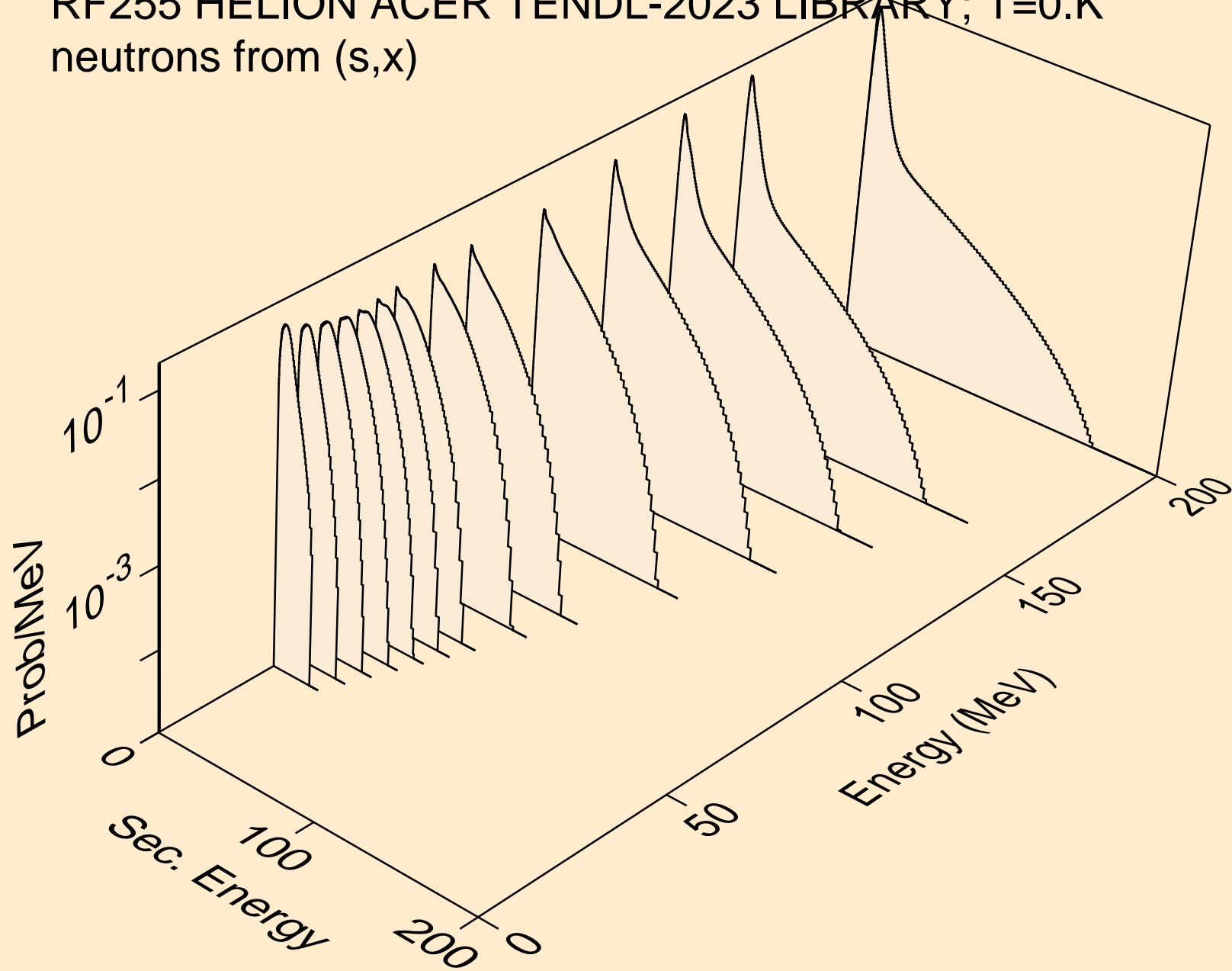

RF255 HELION ACER TENDL-2023 LIBRARY; T=0.K
neutrons from (s,2n)

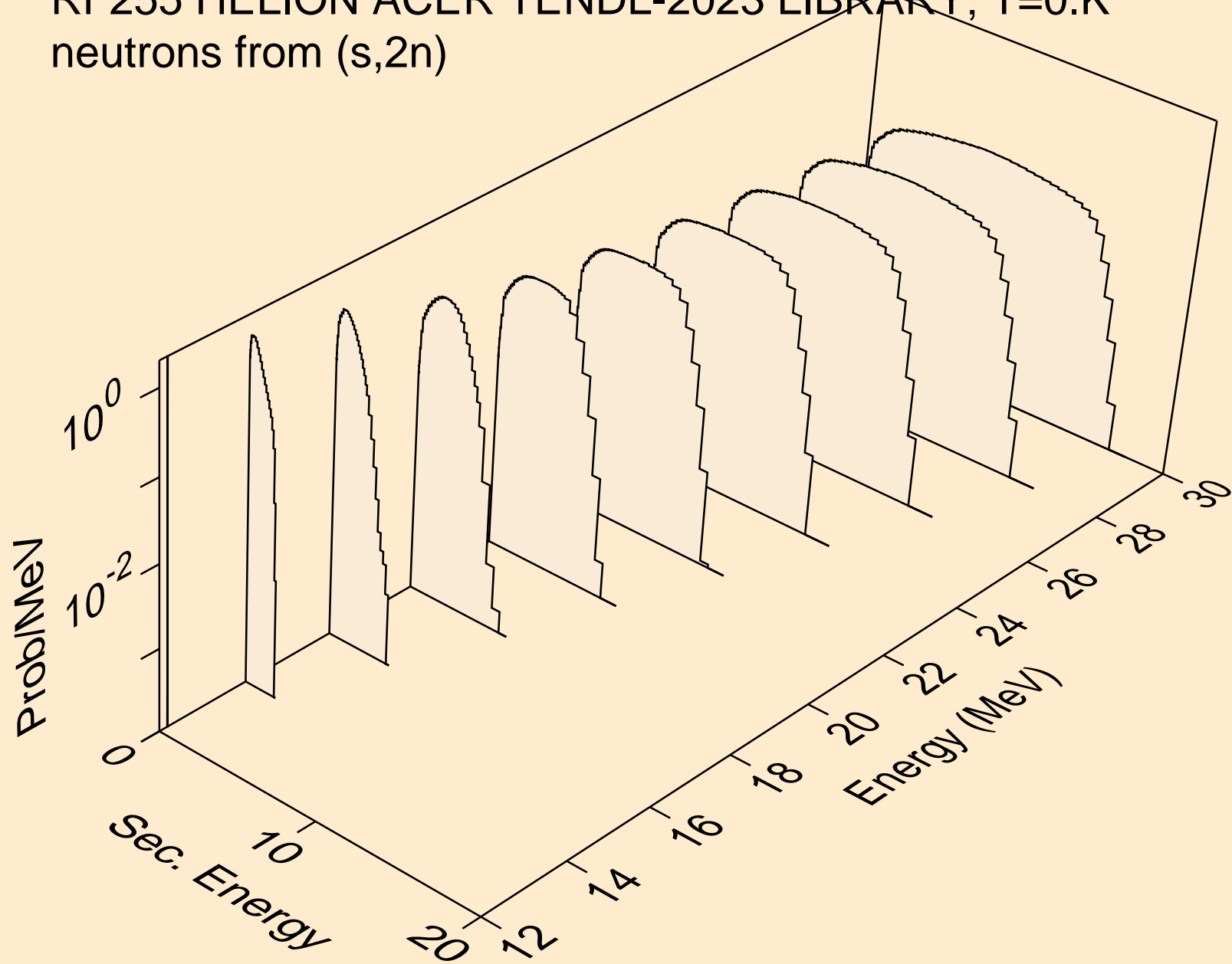

RF255 HELION ACER TENDL-2023 LIBRARY; T=0.K
neutrons from (s,3n)

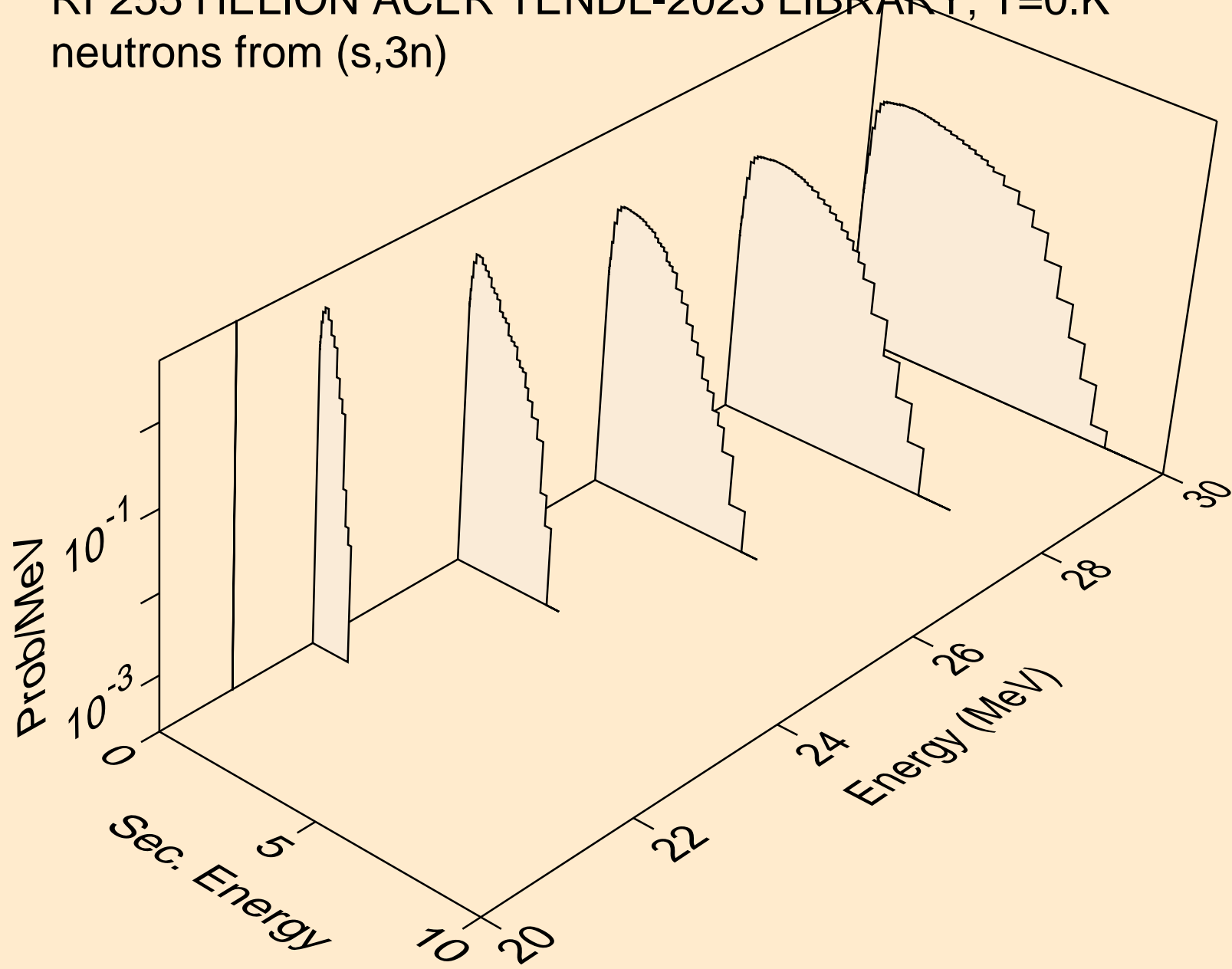

RF255 HELION ACER TENDL-2023 LIBRARY; T=0.K
neutrons from (s,n*)a

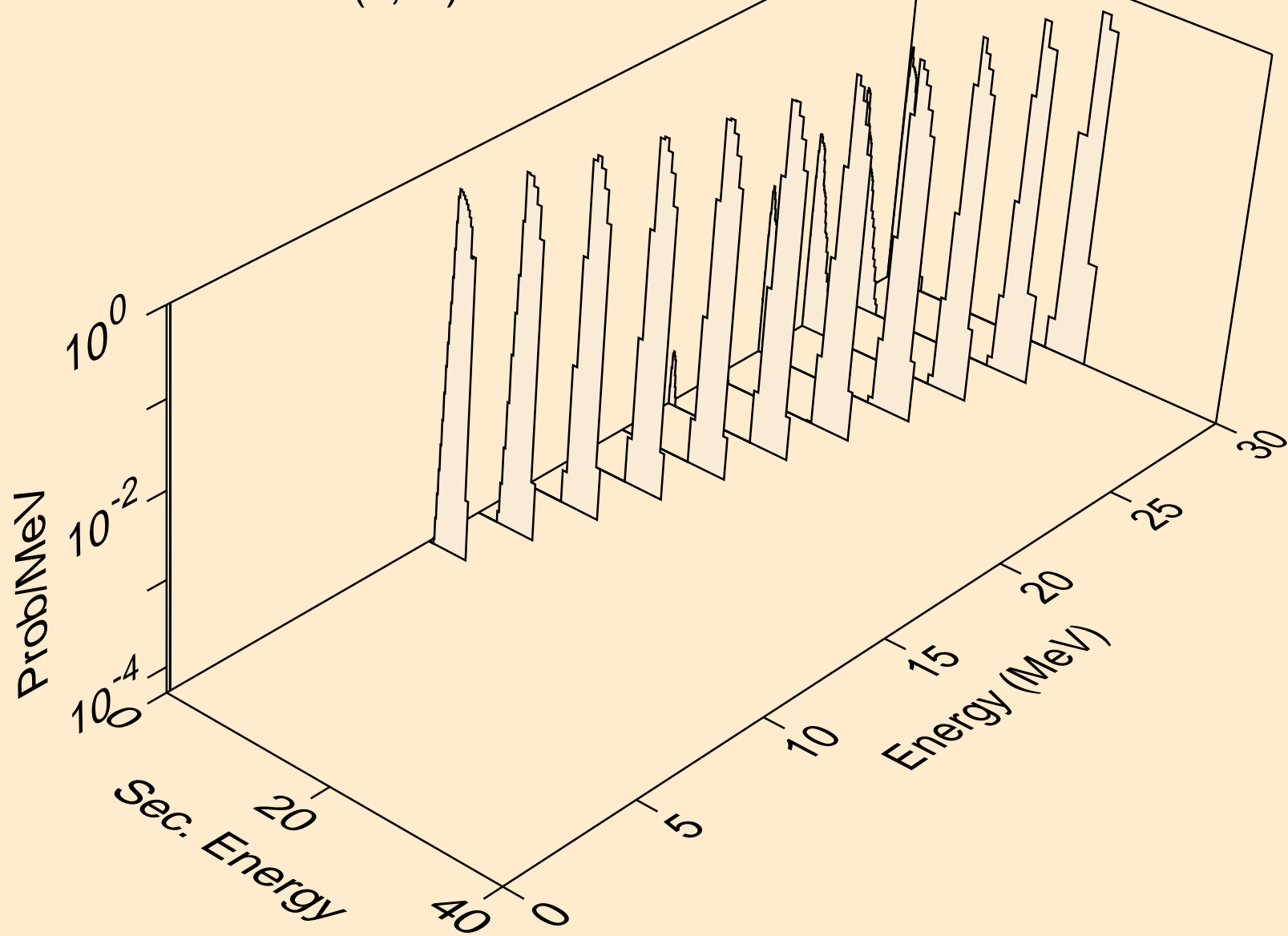

RF255 HELION ACER TENDL-2023 LIBRARY; T=0.K
neutrons from (s,2n)a

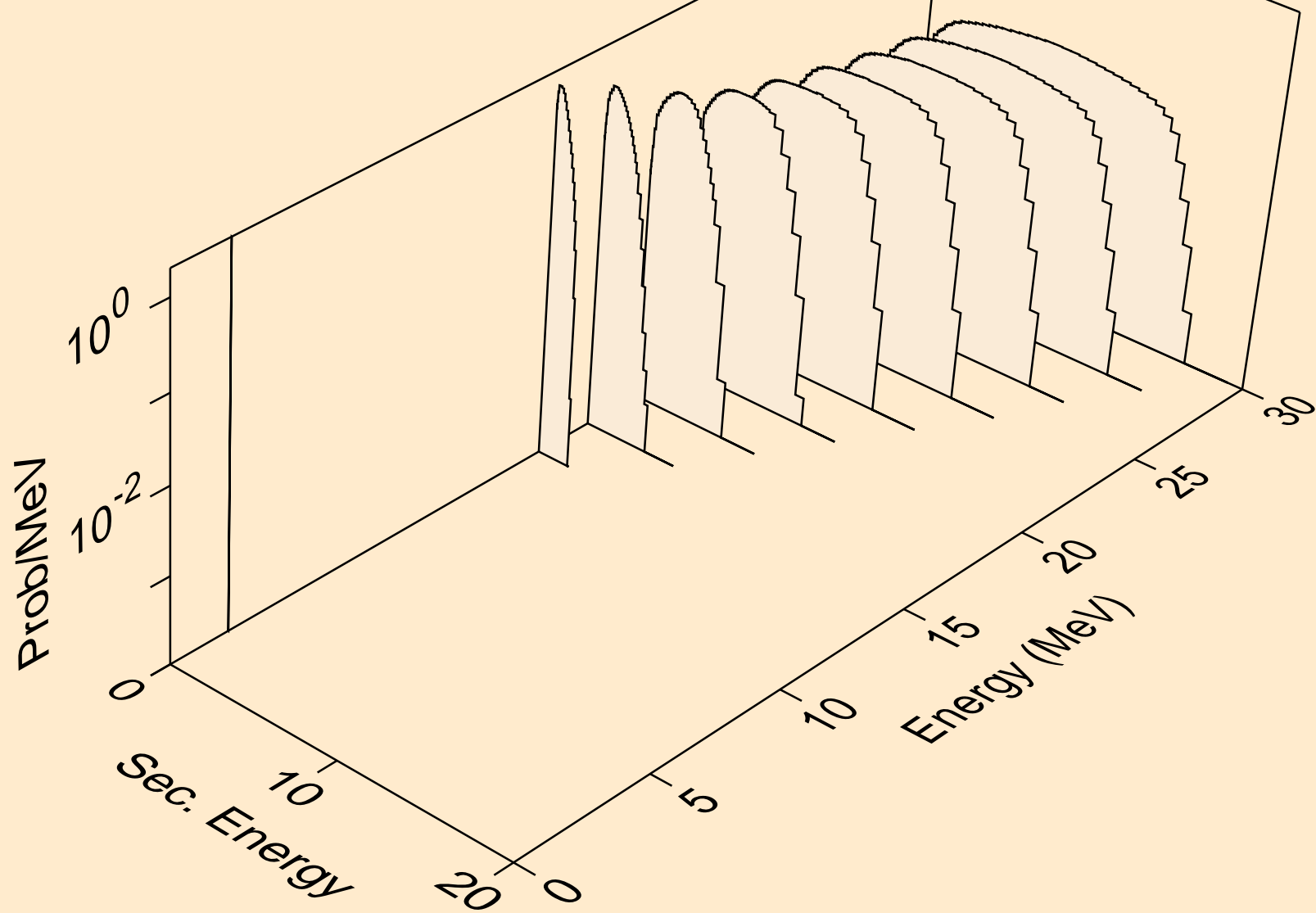

RF255 HELION ACER TENDL-2023 LIBRARY; T=0.K
neutrons from (s,n*)p

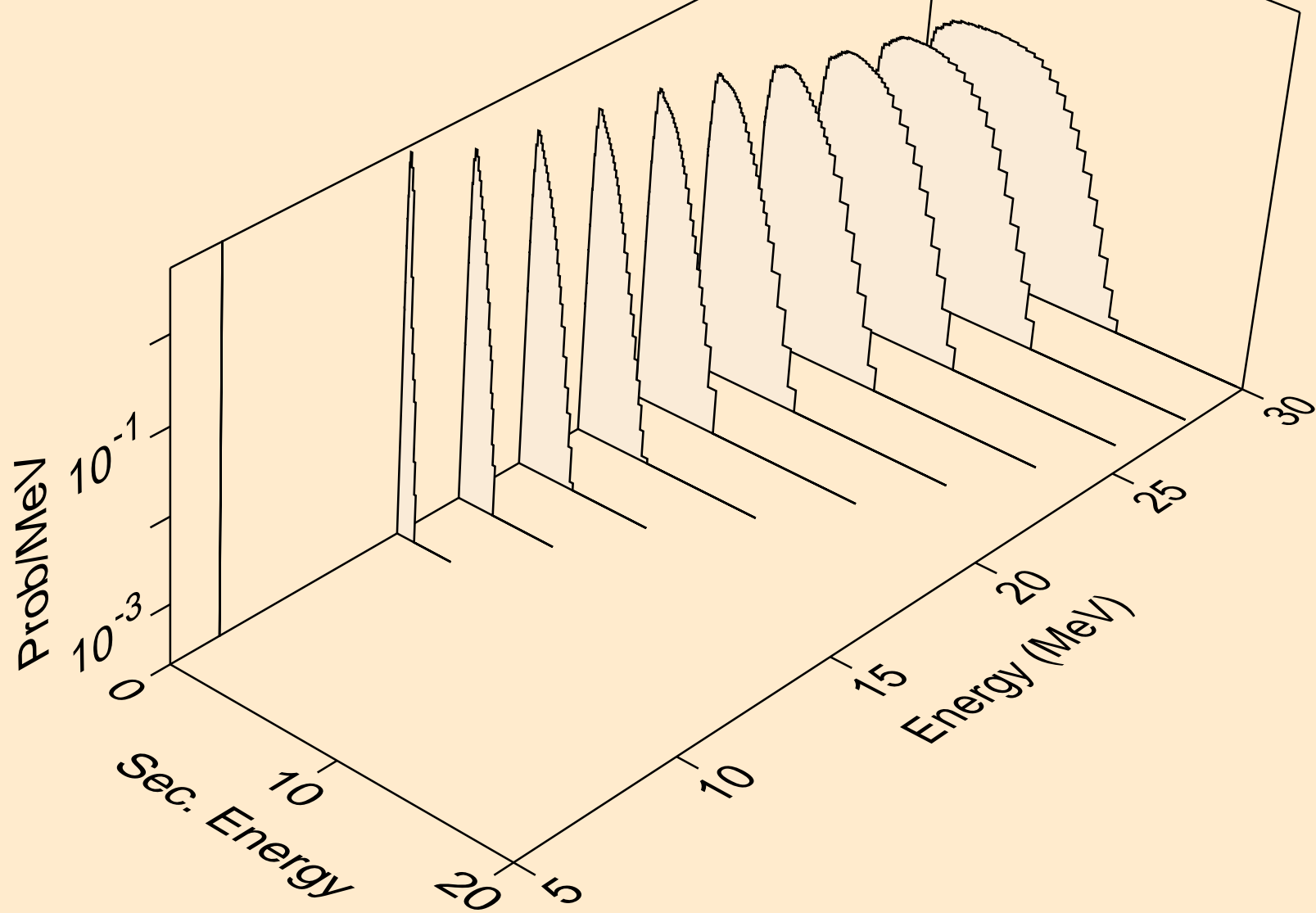

RF255 HELION ACER TENDL-2023 LIBRARY; T=0.K
neutrons from (s,n*)d

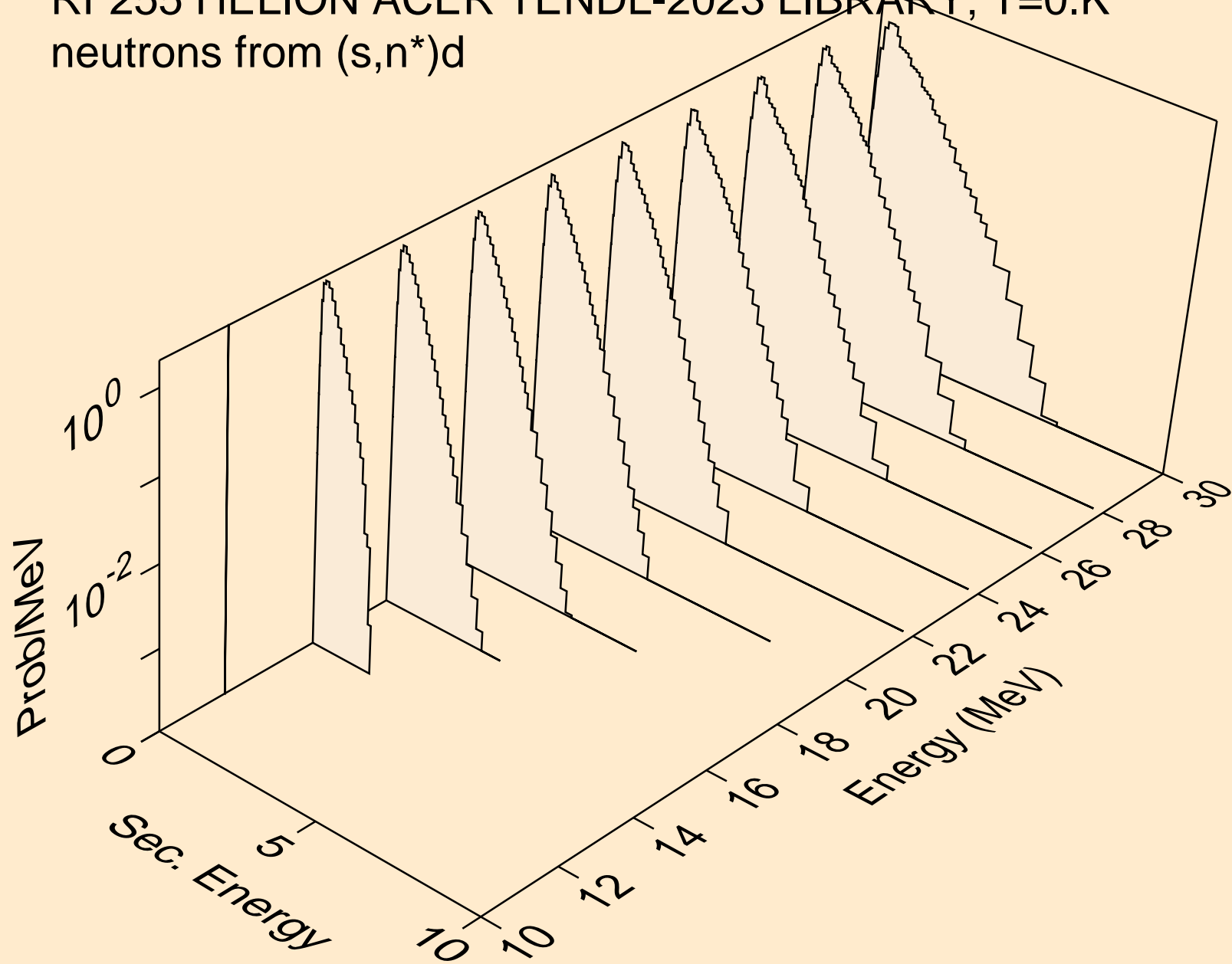

RF255 HELION ACER TENDL-2023 LIBRARY; T=0.K
neutrons from (s,n*)t

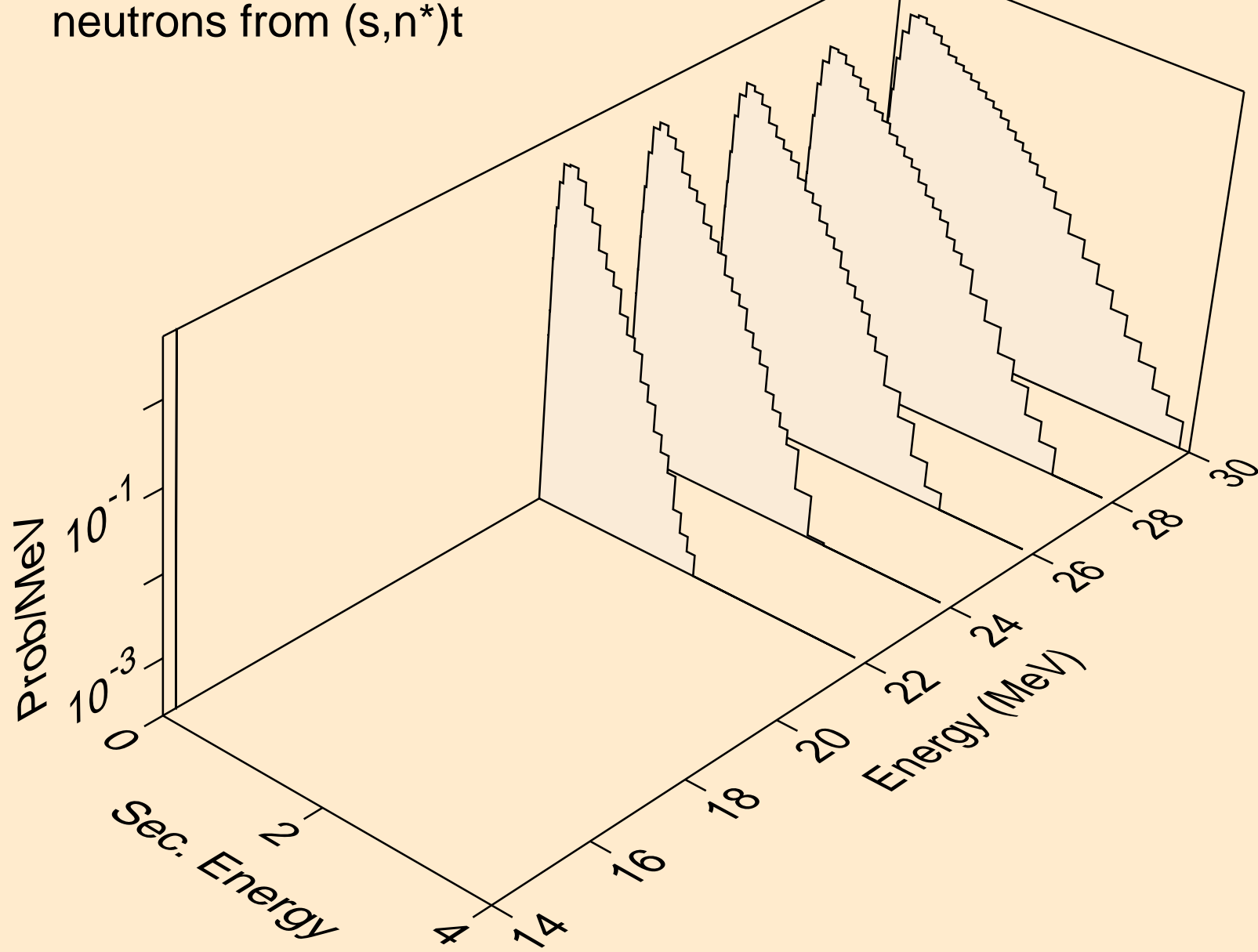

RF255 HELION ACER TENDL-2023 LIBRARY; T=0.K
neutrons from (s,2np)

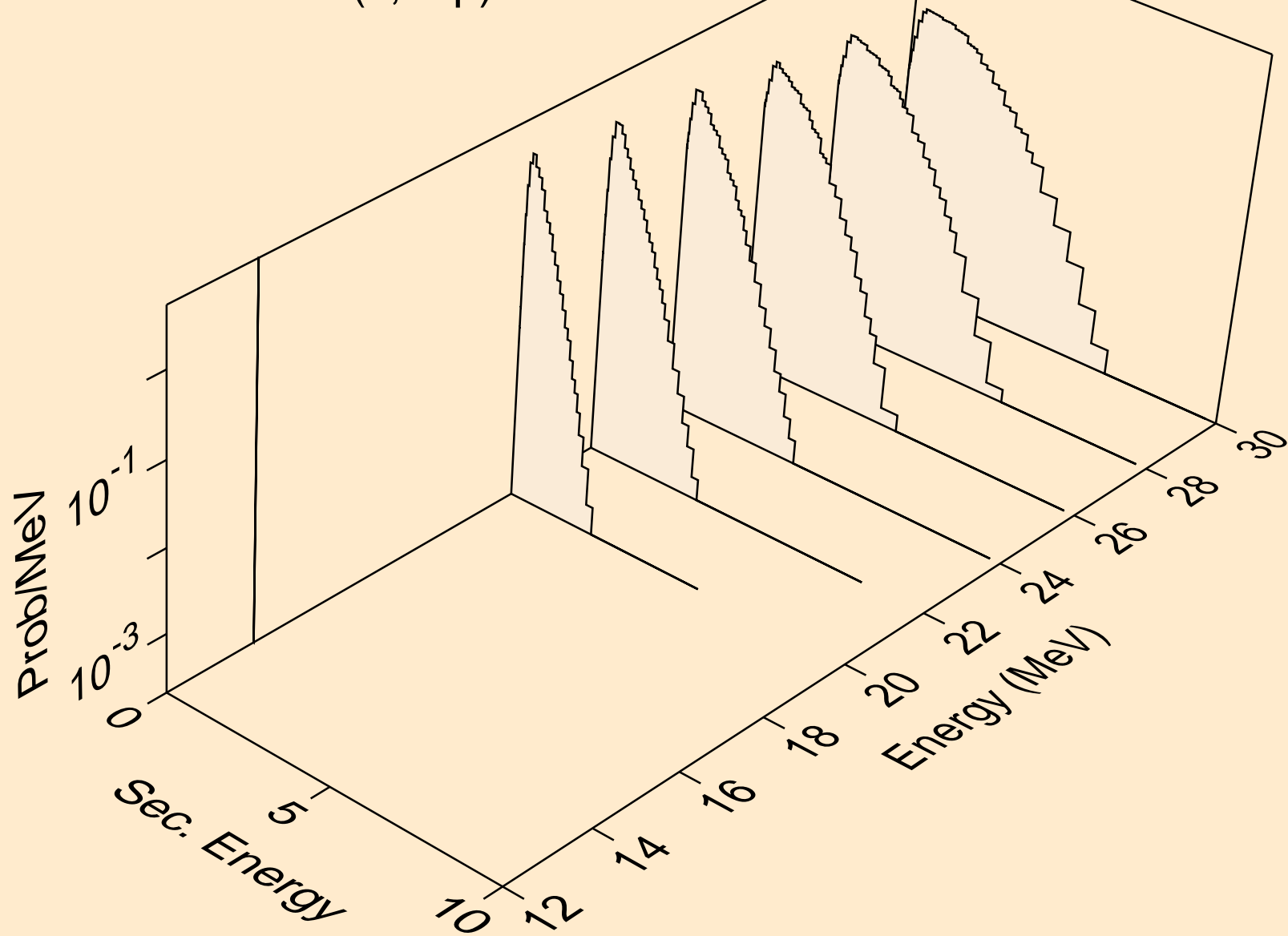

RF255 HELION ACER TENDL-2023 LIBRARY; T=0.K
protons from (s,x)

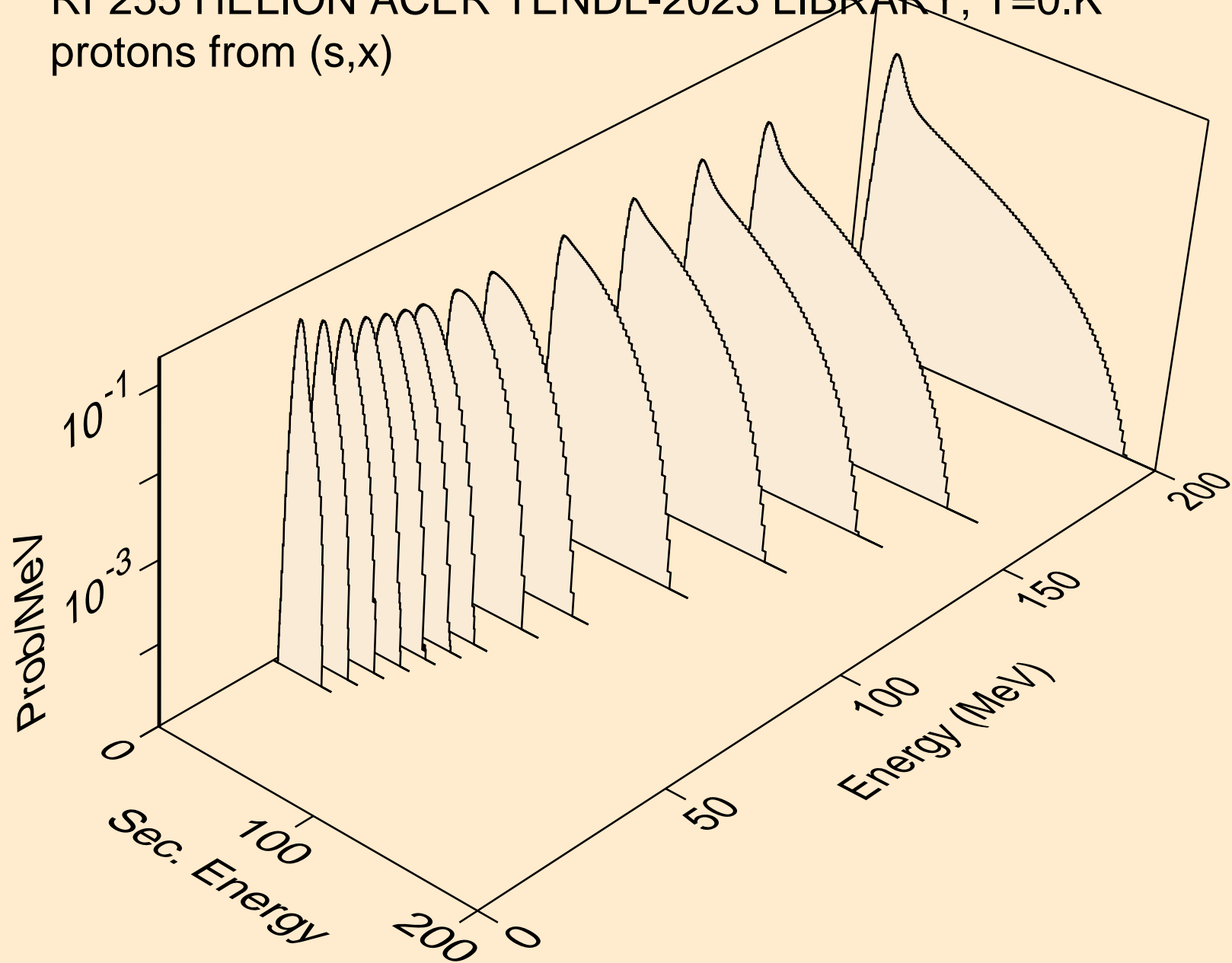

RF255 HELION ACER TENDL-2023 LIBRARY; T=0.K
protons from (s,n*)p

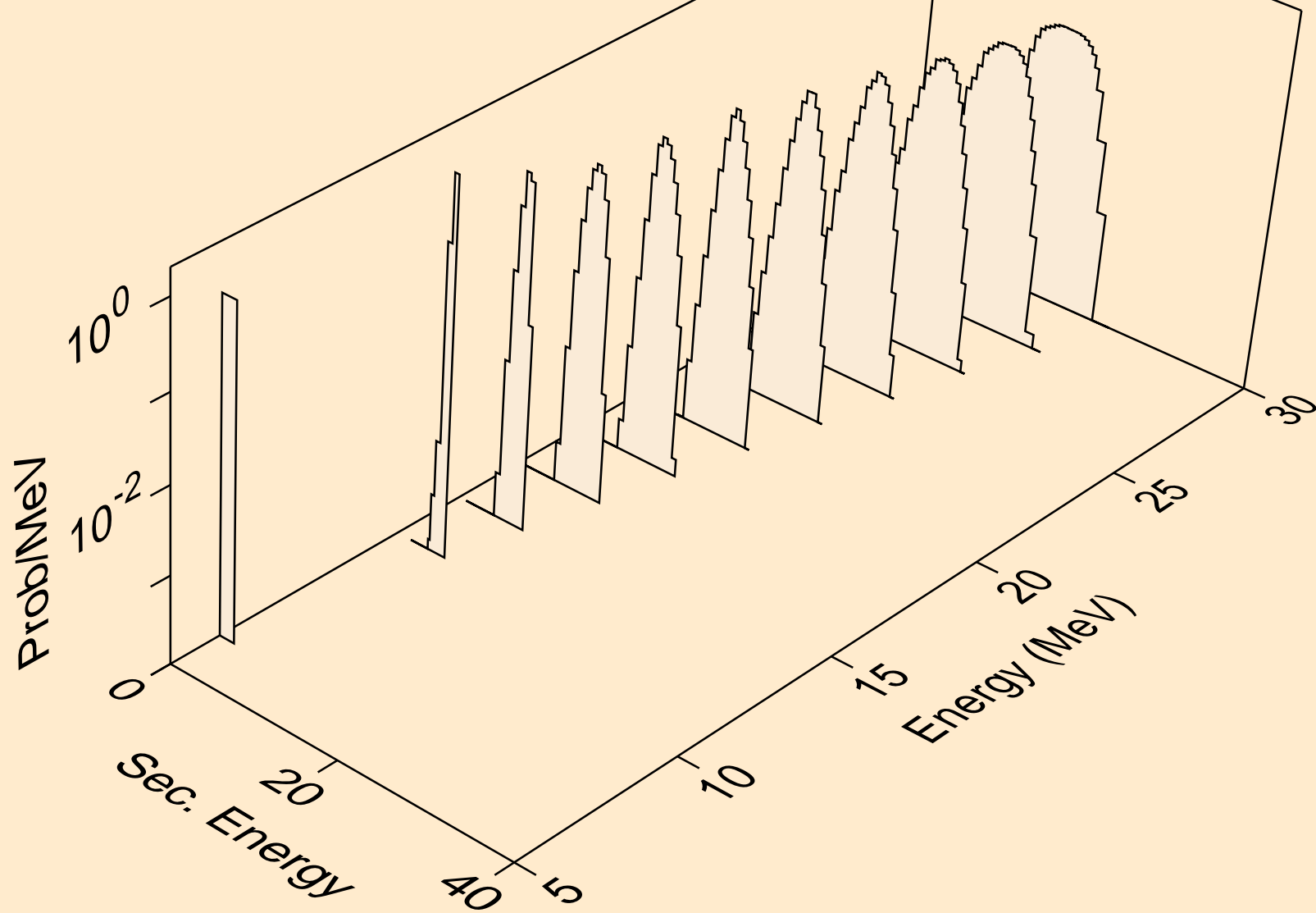

RF255 HELION ACER TENDL-2023 LIBRARY; T=0.K
protons from (s,2np)

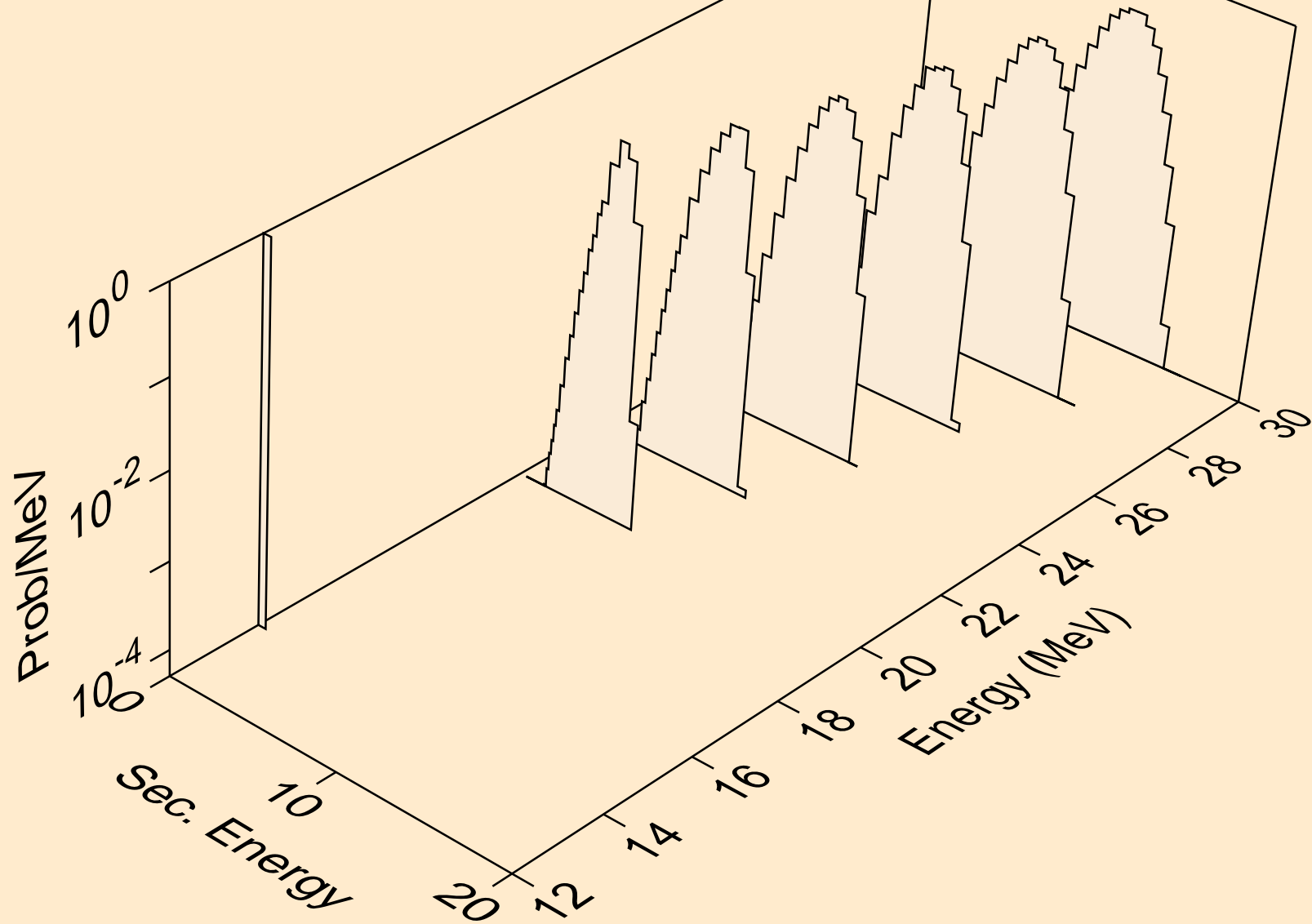

RF255 HELION ACER TENDL-2023 LIBRARY; T=0.K
protons from (s,p)

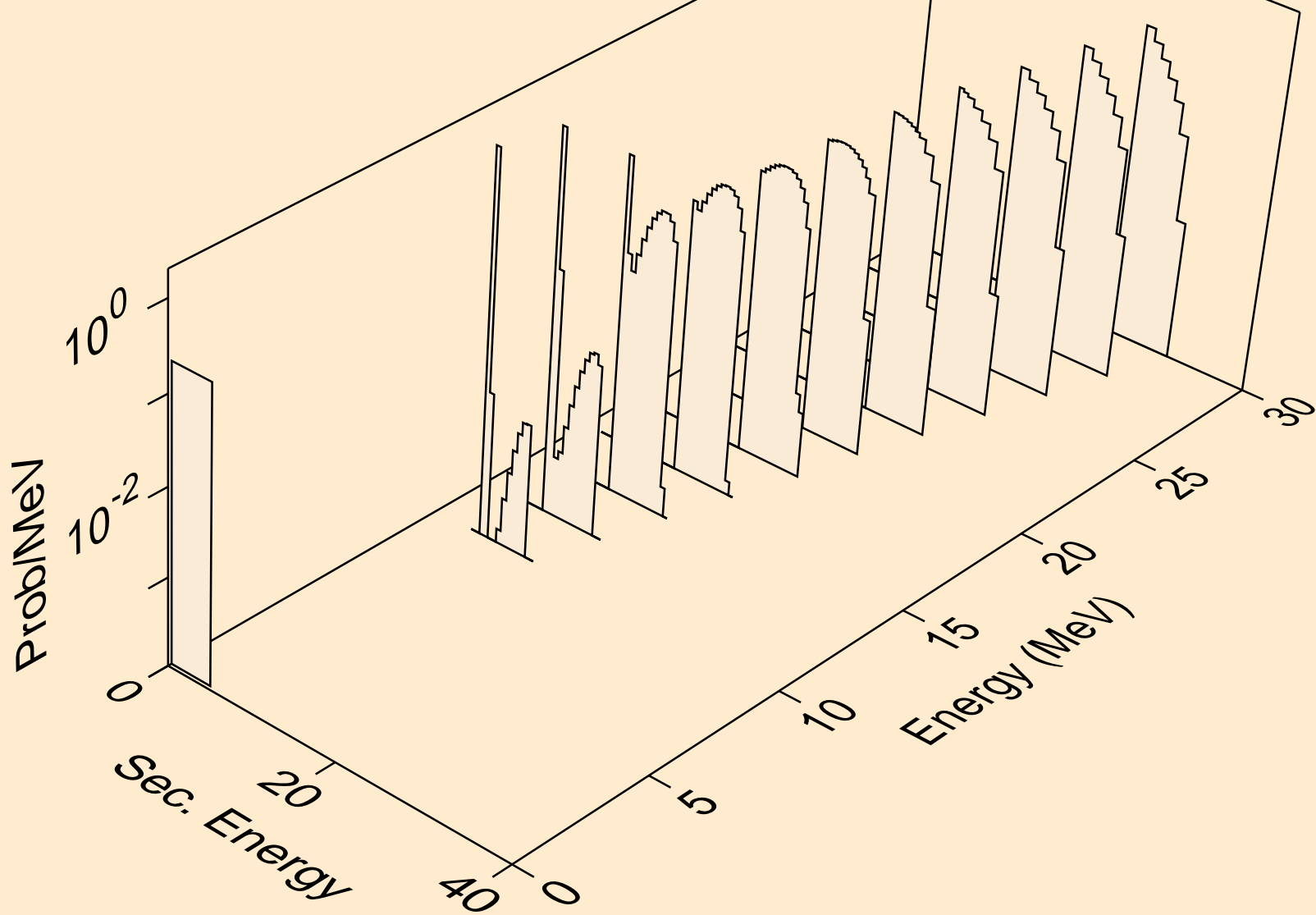

RF255 HELION ACER TENDL-2023 LIBRARY; T=0.K
protons from (s,2p)

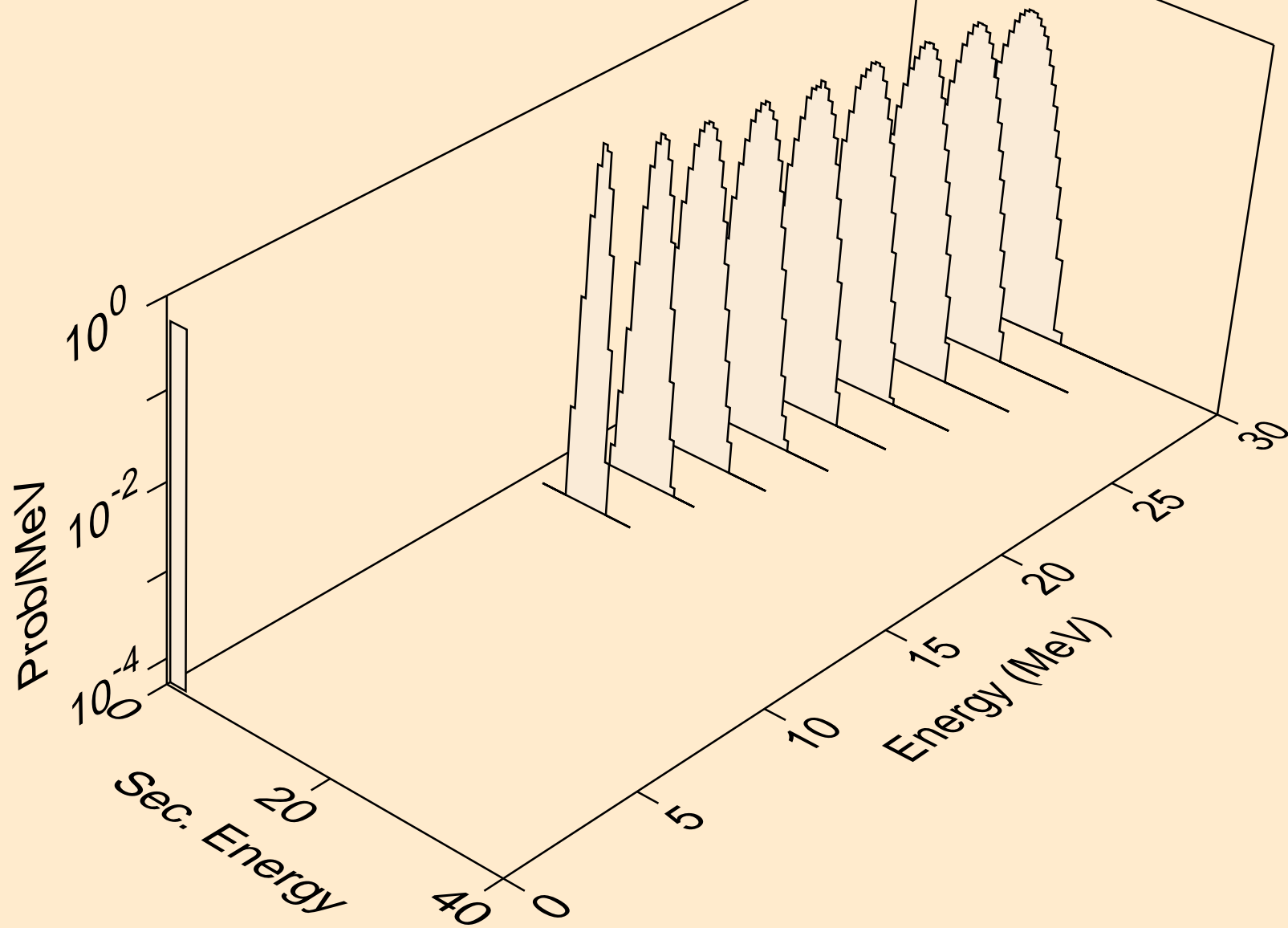

RF255 HELION ACER TENDL-2023 LIBRARY; T=0.K
protons from (s,pa)

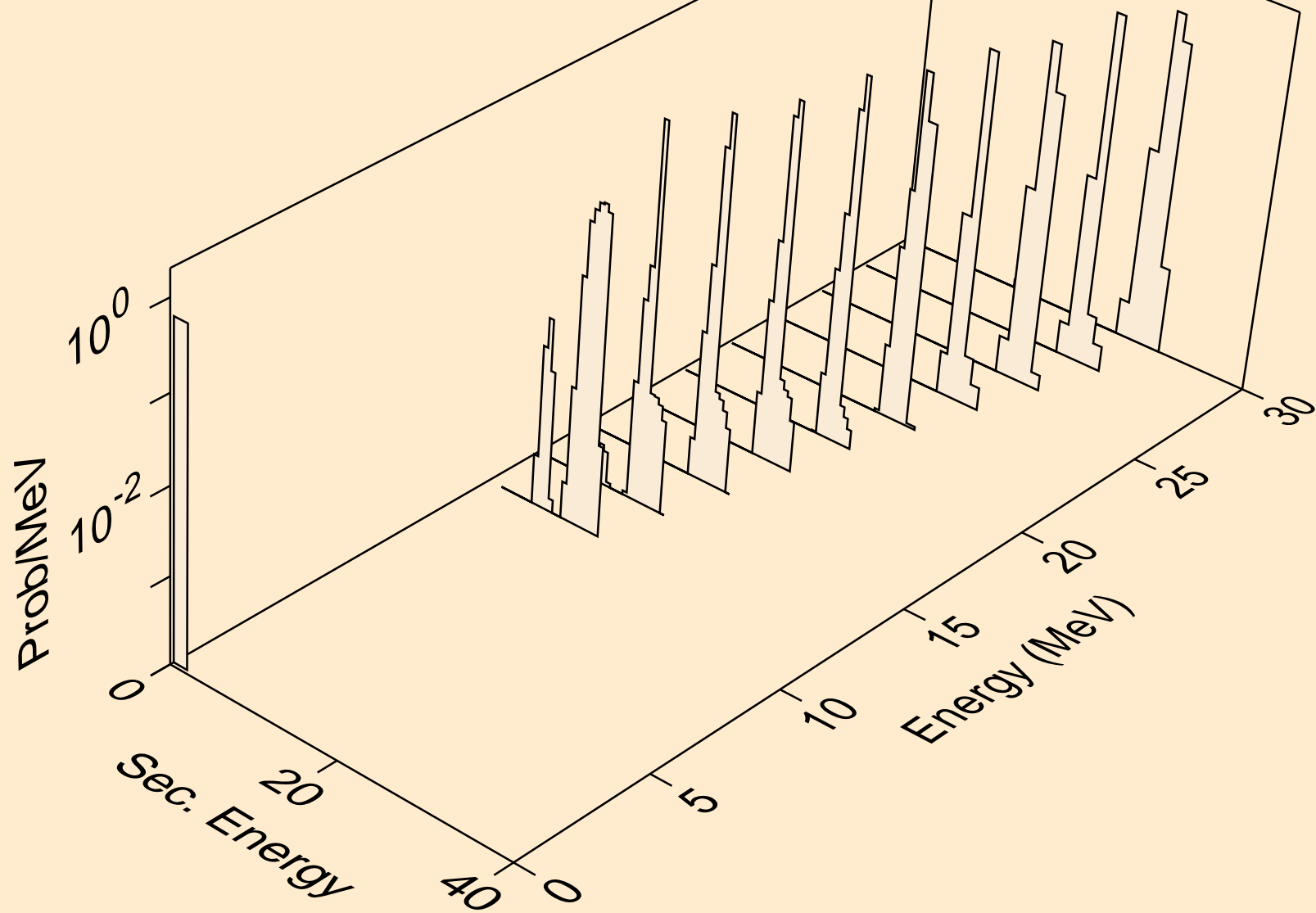

RF255 HELION ACER TENDL-2023 LIBRARY; T=0.K
deuterons from (s,x)

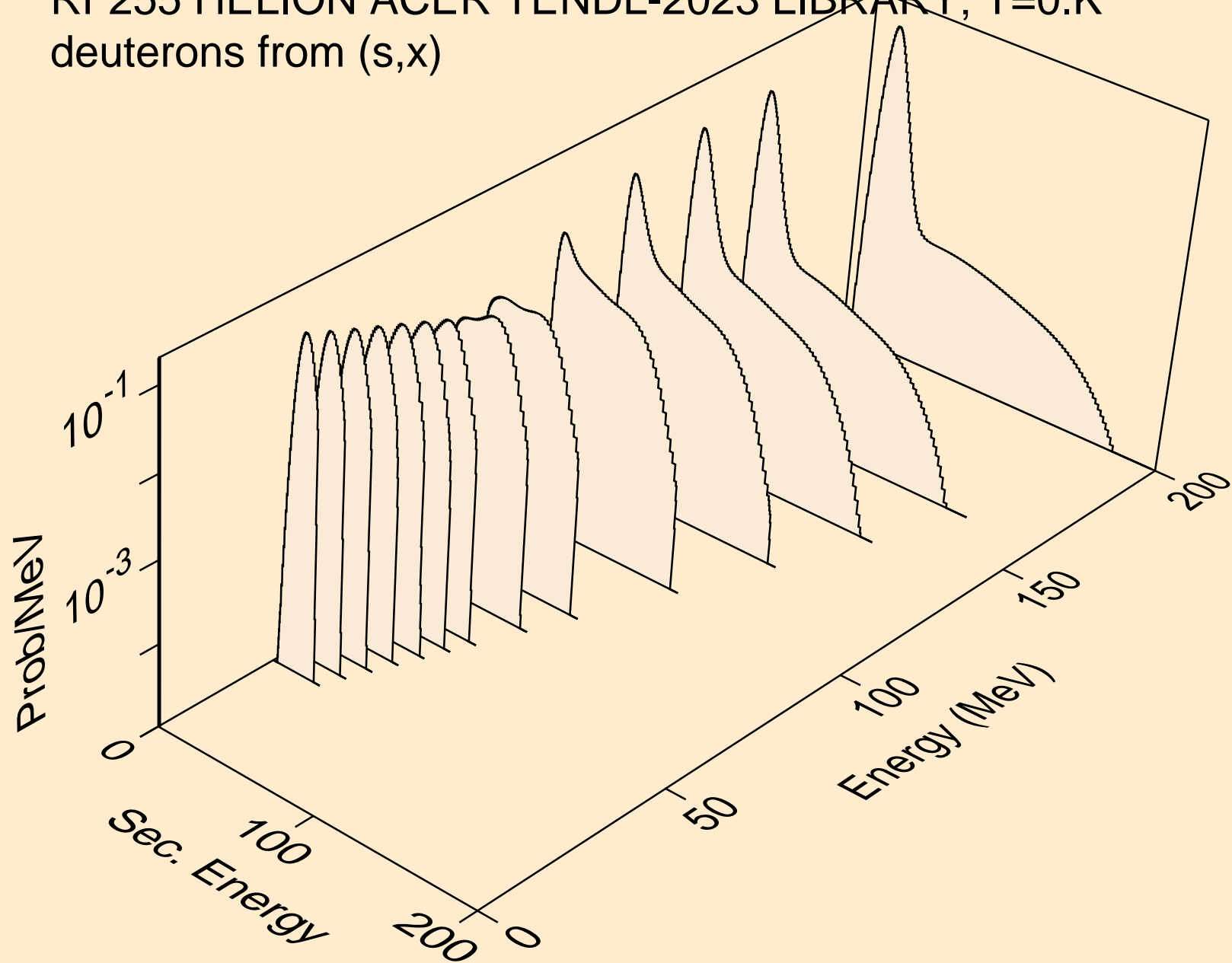

RF255 HELION ACER TENDL-2023 LIBRARY; T=0.K
deuterons from (s,n*)d

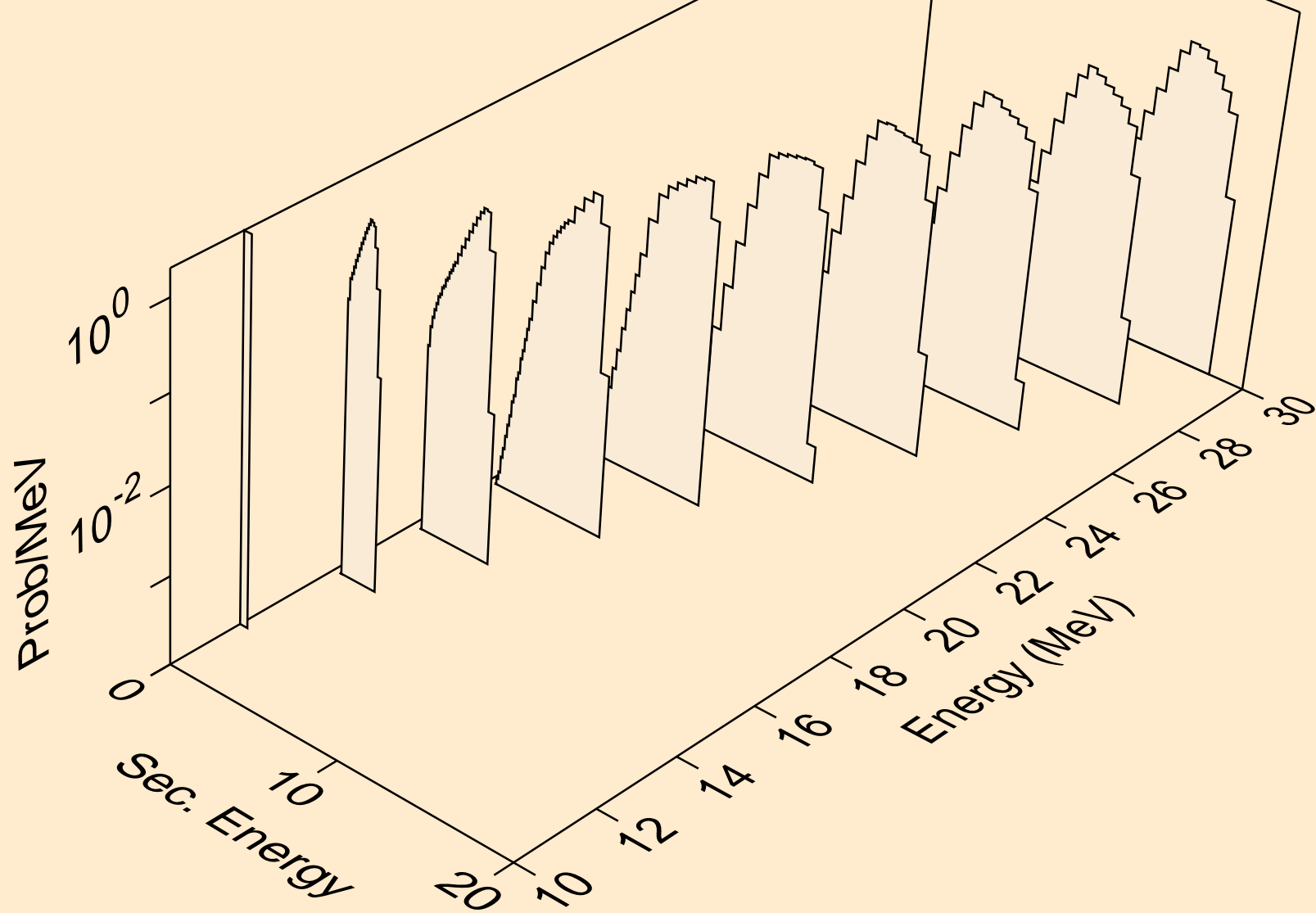

RF255 HELION ACER TENDL-2023 LIBRARY; T=0.K
deuterons from (s,d)

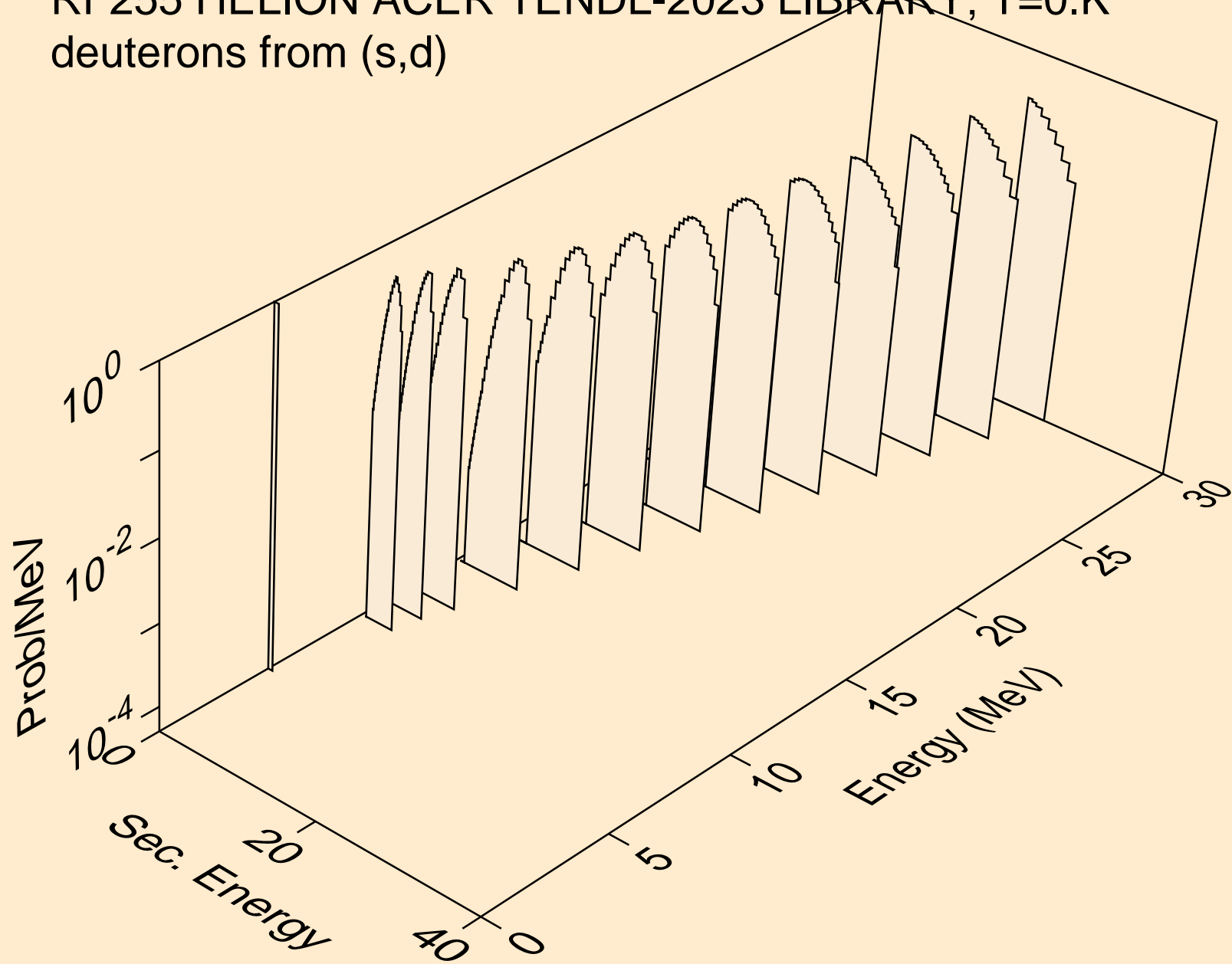

RF255 HELION ACER TENDL-2023 LIBRARY; T=0.K
deuterons from (s,da)

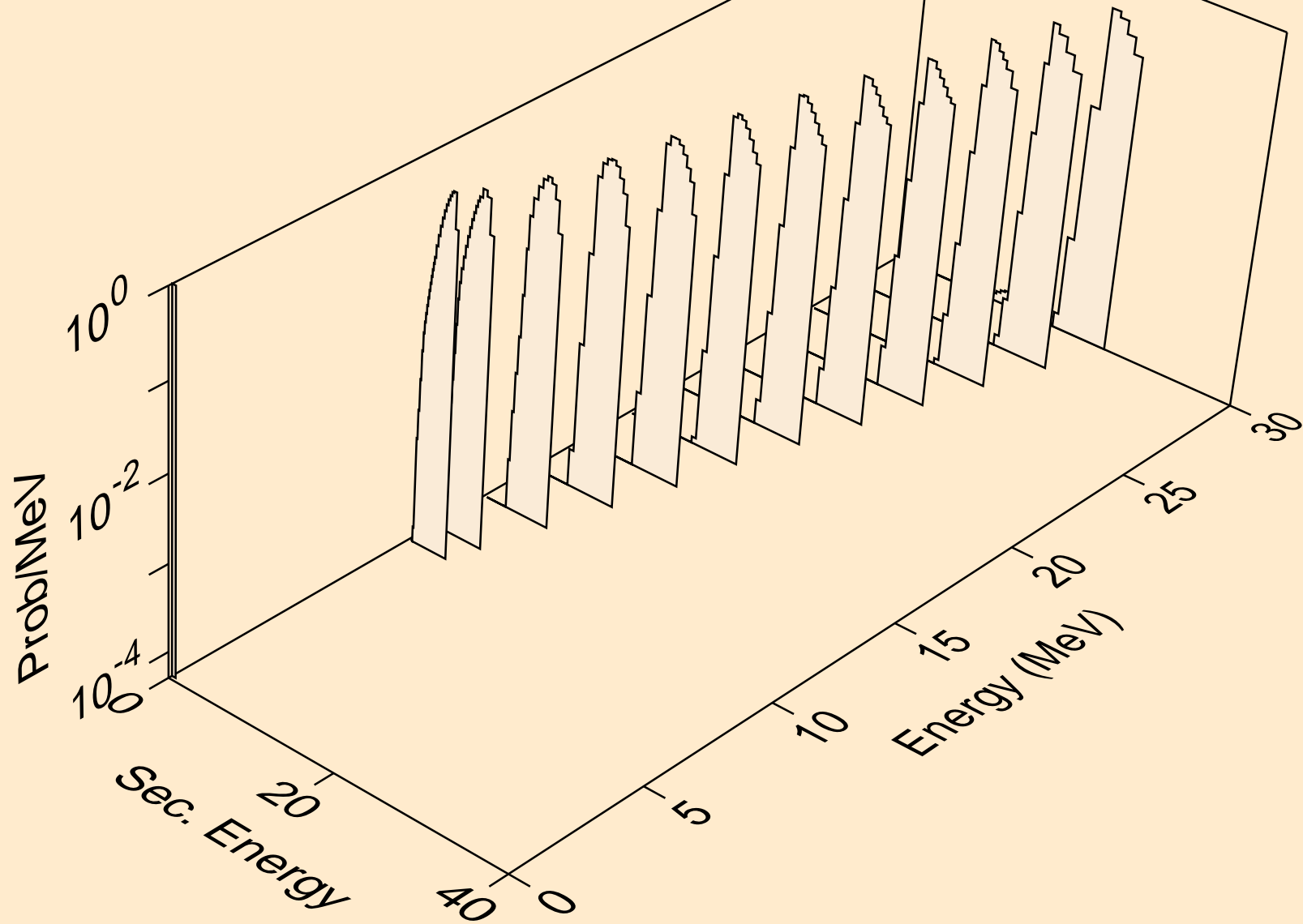

RF255 HELION ACER TENDL-2023 LIBRARY; T=0.K
tritons from (s,x)

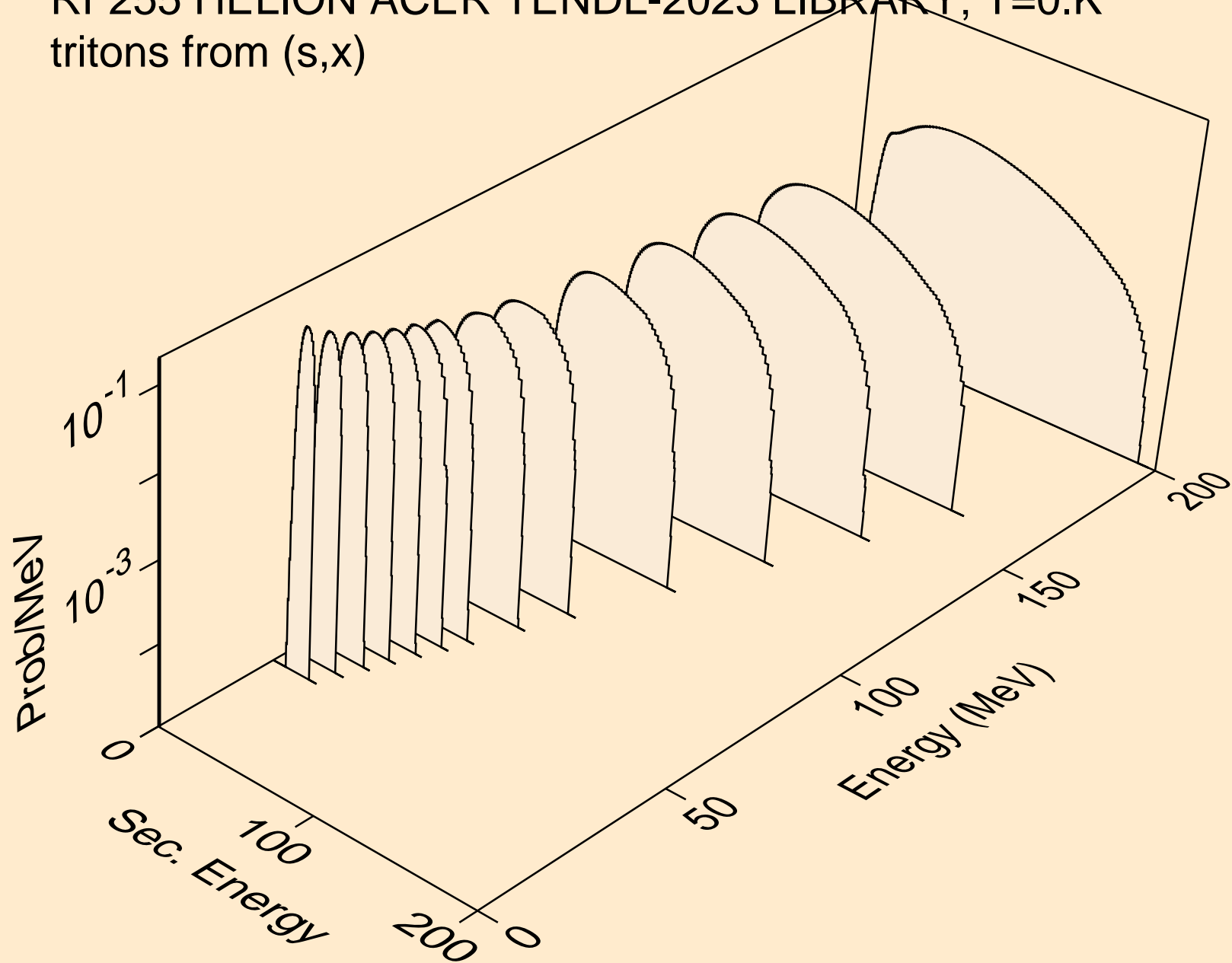

RF255 HELION ACER TENDL-2023 LIBRARY; T=0.K
tritons from (s,n*)t

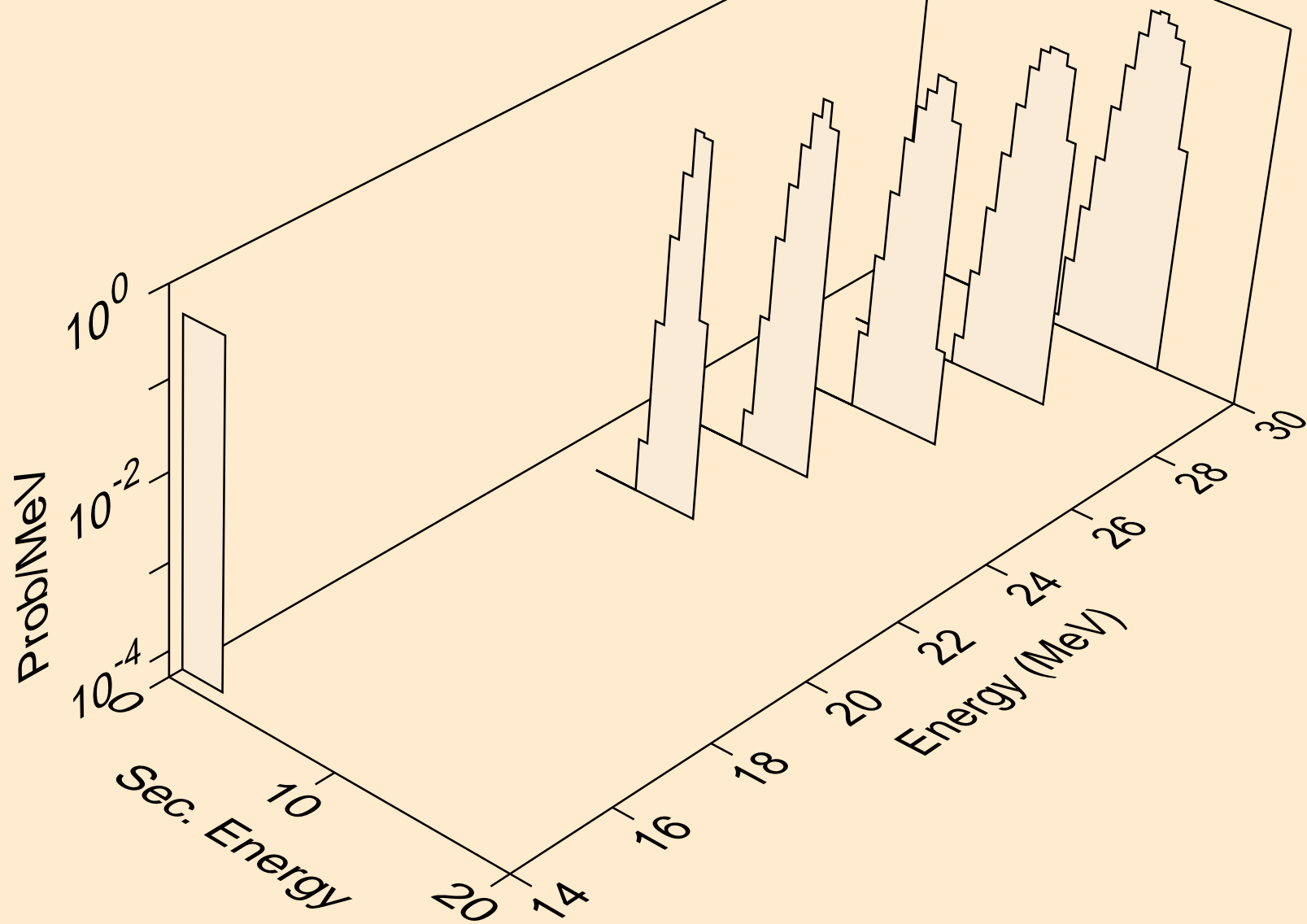

RF255 HELION ACER TENDL-2023 LIBRARY; T=0.K
tritons from (s,t)

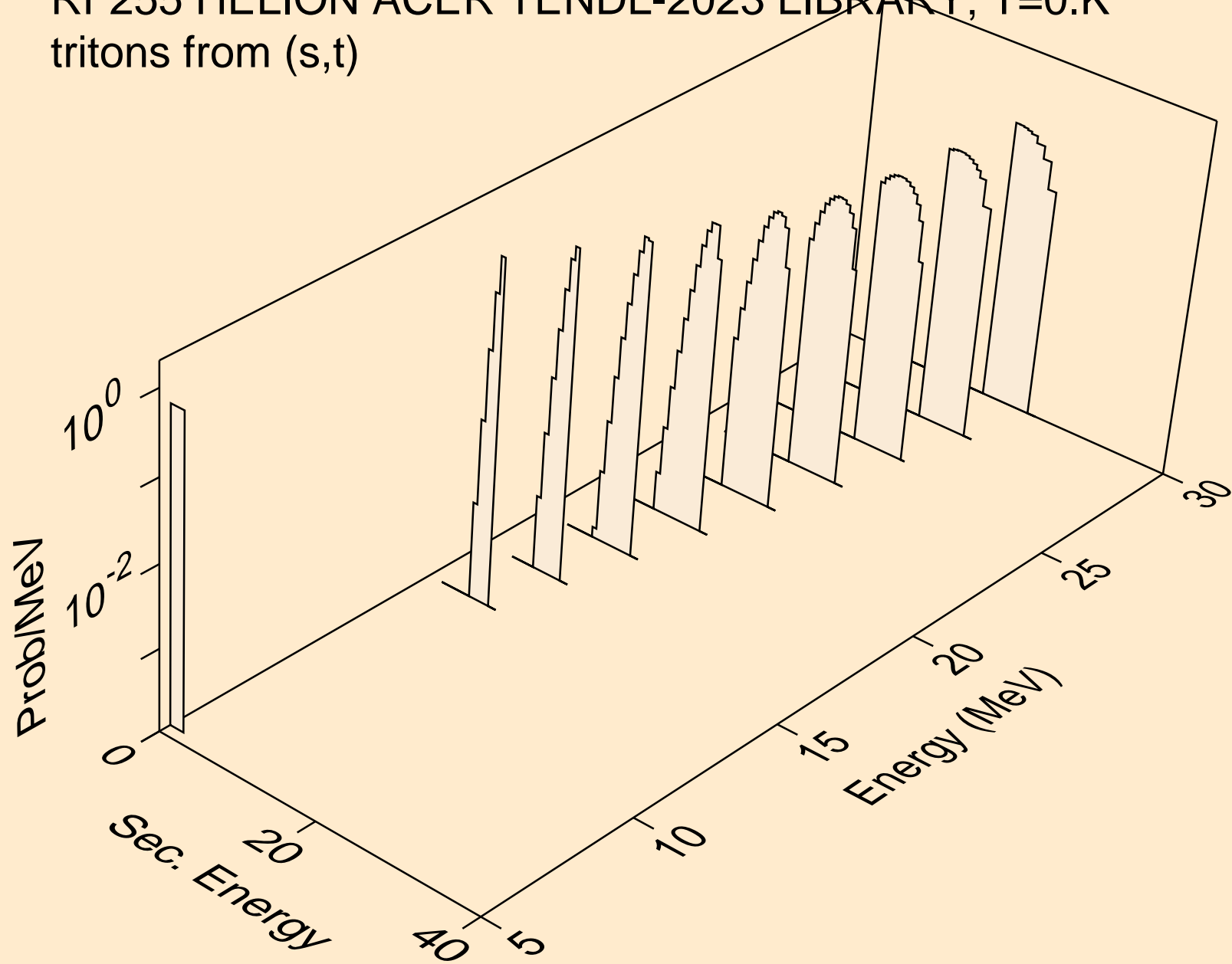

RF255 HELION ACER TENDL-2023 LIBRARY; T=0.K
tritons from (s,t2a)

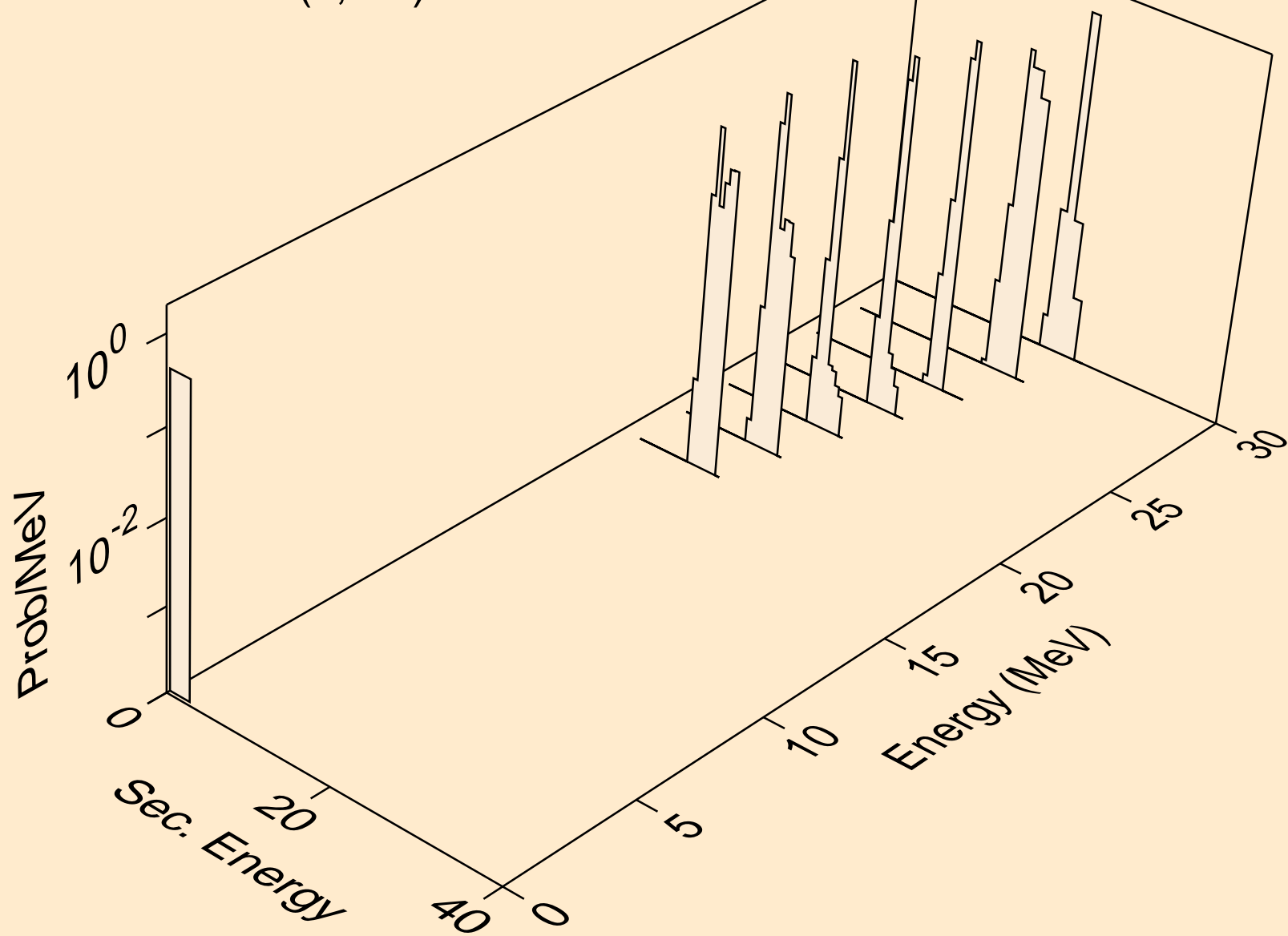

RF255 HELION ACER TENDL-2023 LIBRARY; T=0.K
alphas from (s,x)

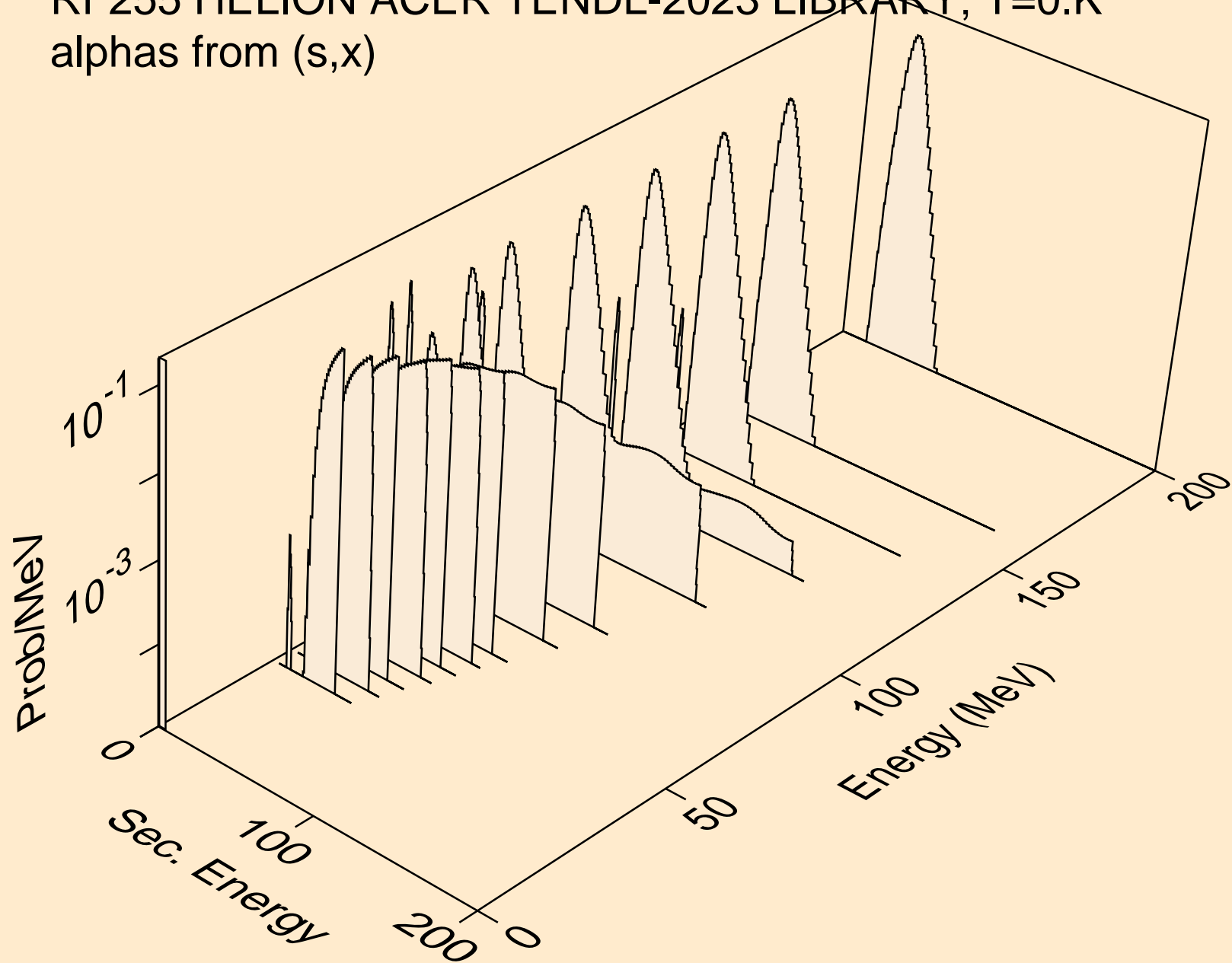

RF255 HELION ACER TENDL-2023 LIBRARY; T=0.K
alphas from (s,n*)a

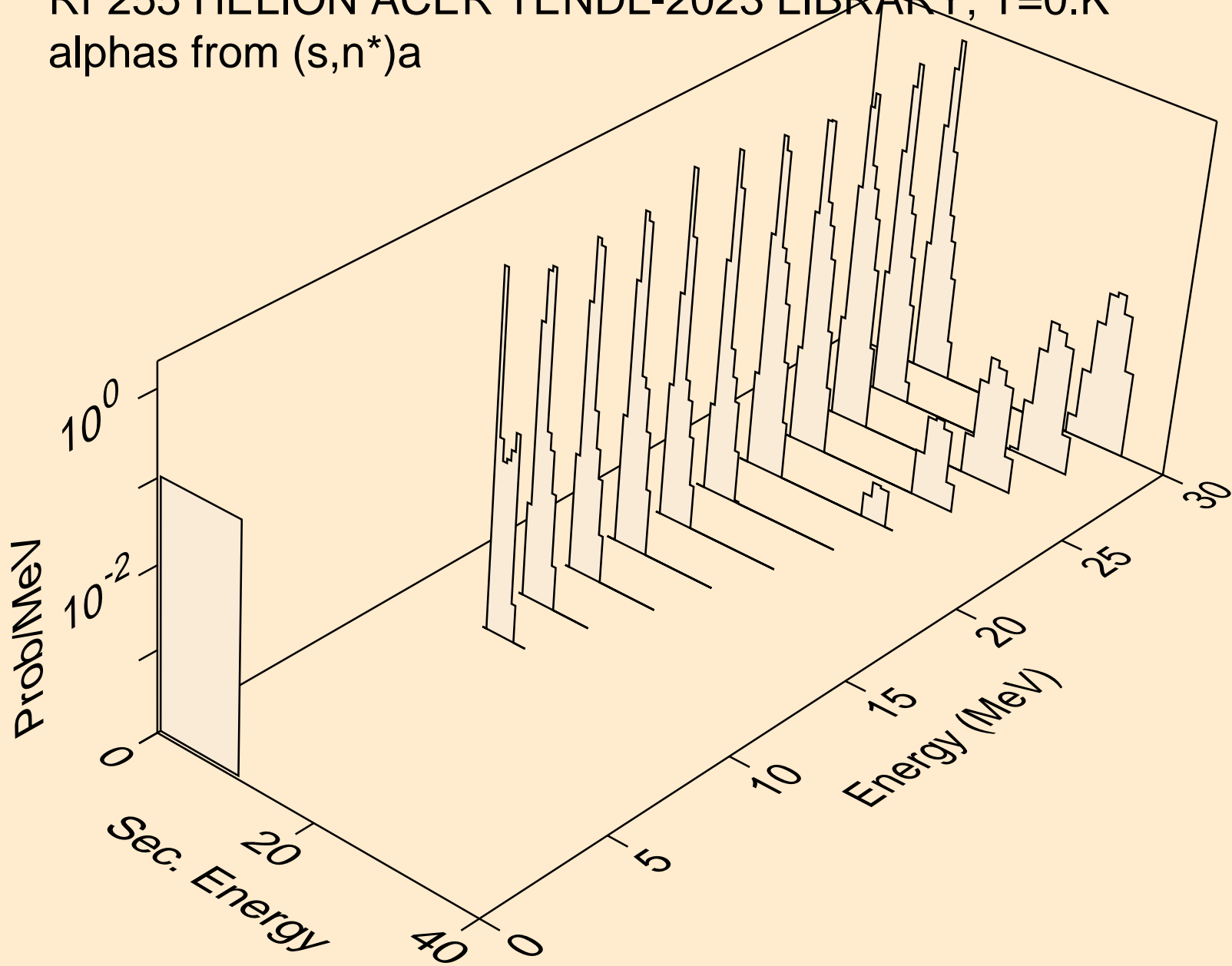

RF255 HELION ACER TENDL-2023 LIBRARY; T=0.K
alphas from (s,2n)a

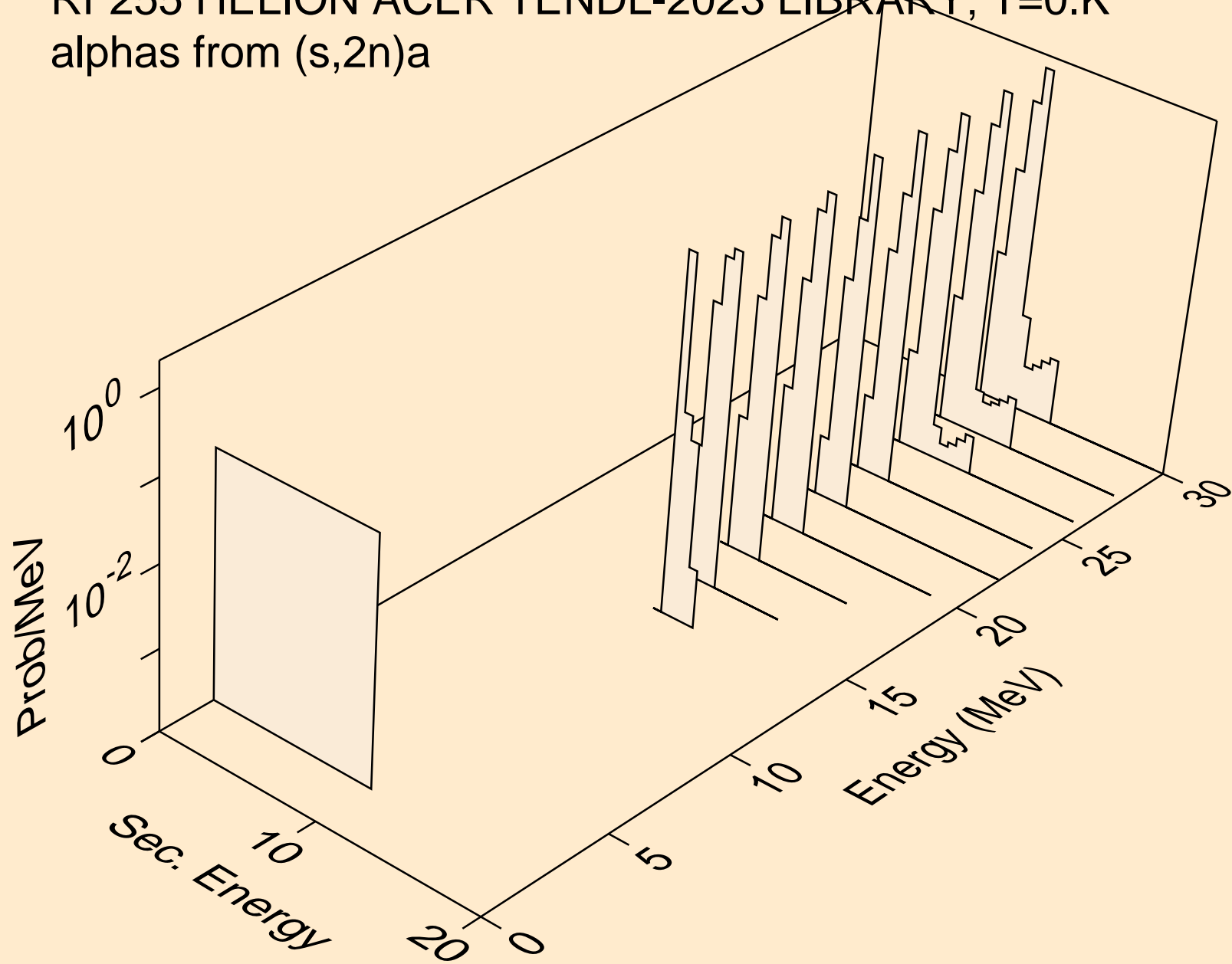

RF255 HELION ACER TENDL-2023 LIBRARY; T=0.K
alphas from (s,a)

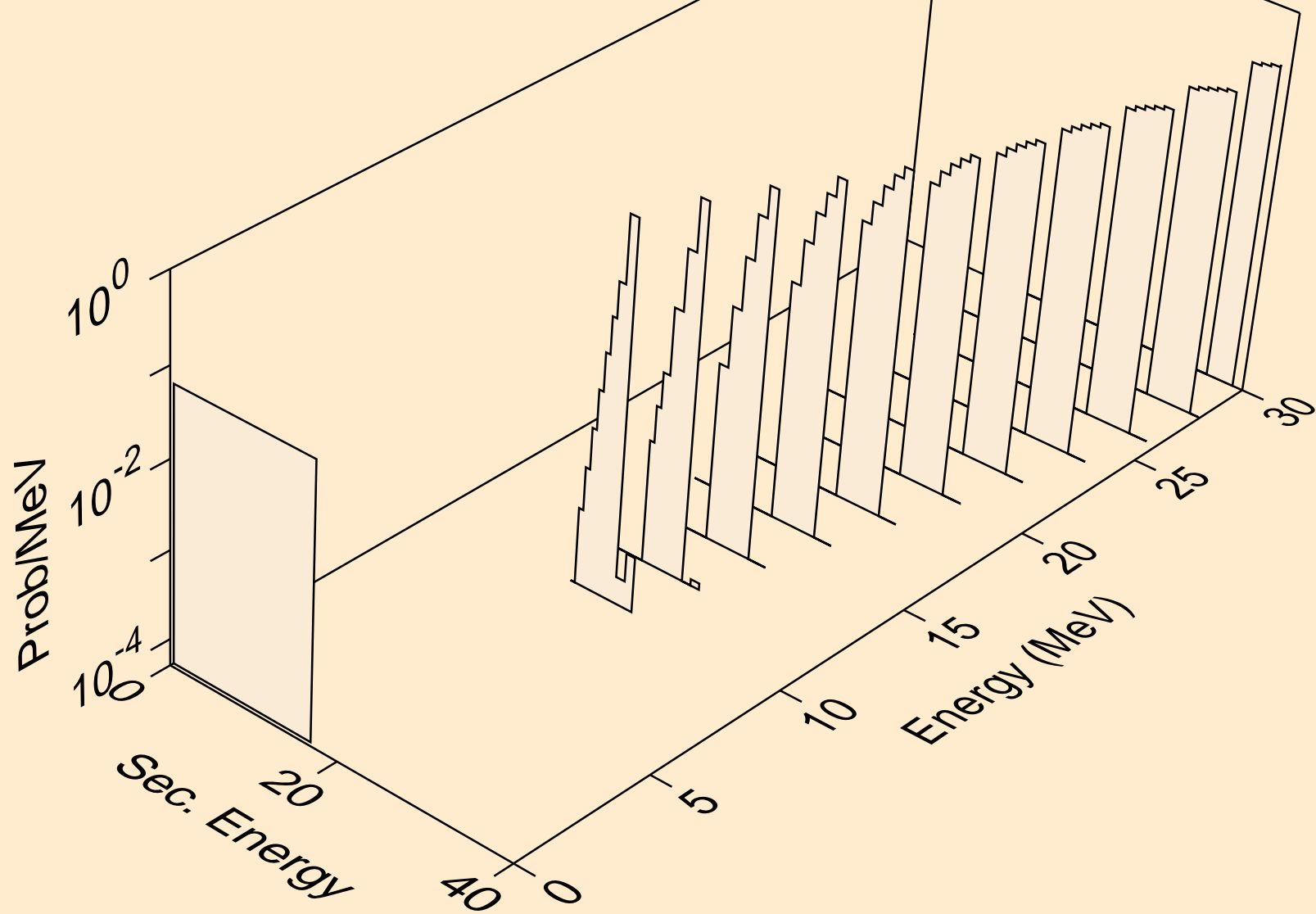

RF255 HELION ACER TENDL-2023 LIBRARY; T=0.K
alphas from (s,pa)

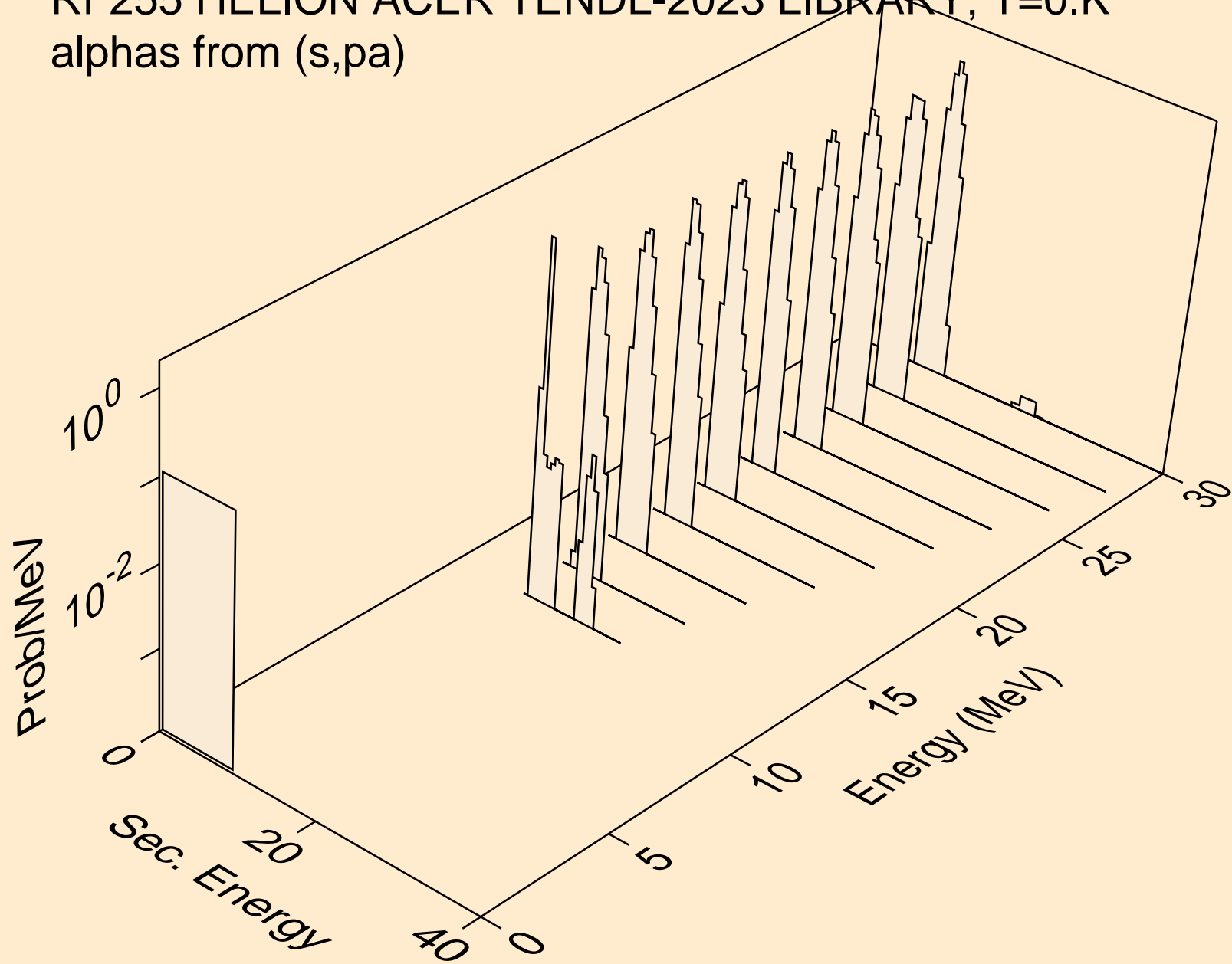

RF255 HELION ACER TENDL-2023 LIBRARY; T=0.K
alphas from (s,t2a)

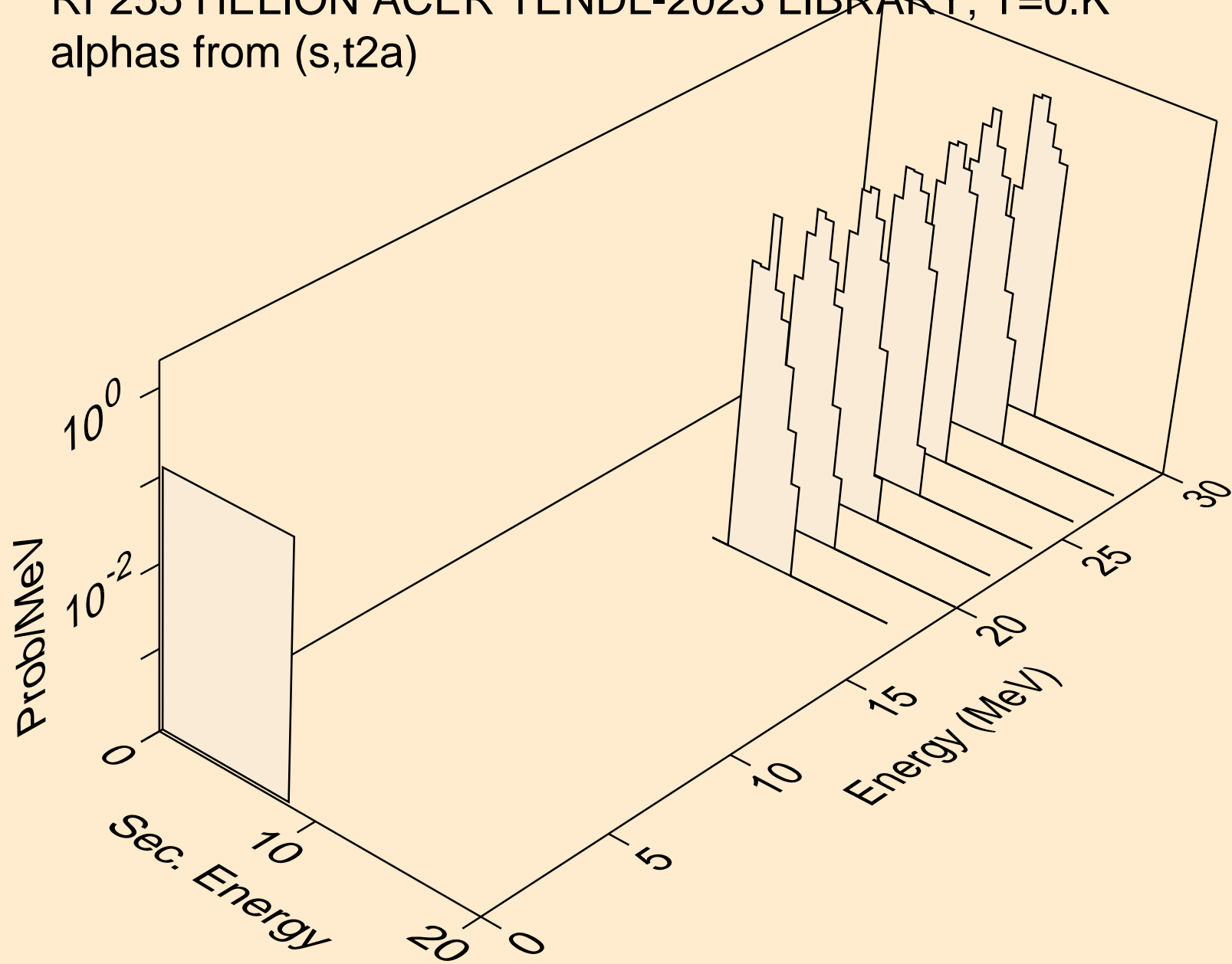

RF255 HELION ACER TENDL-2023 LIBRARY; T=0.K
alphas from (s,da)

