

# SM160 HELION ACER TENDL-2023 LIBRARY; T=0.K

## Principal cross sections

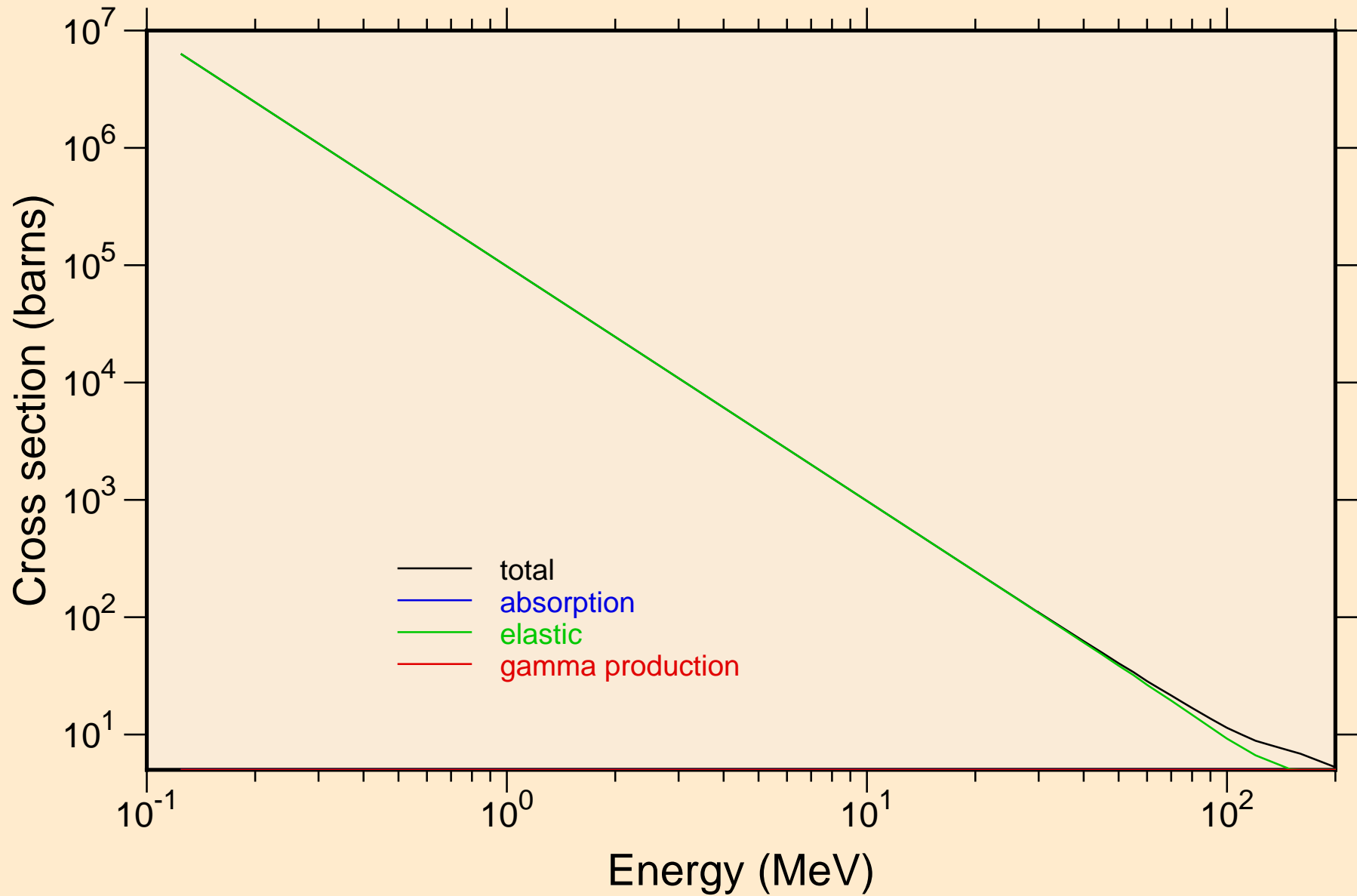

# SM160 HELION ACER TENDL-2023 LIBRARY; T=0.K

## Heating

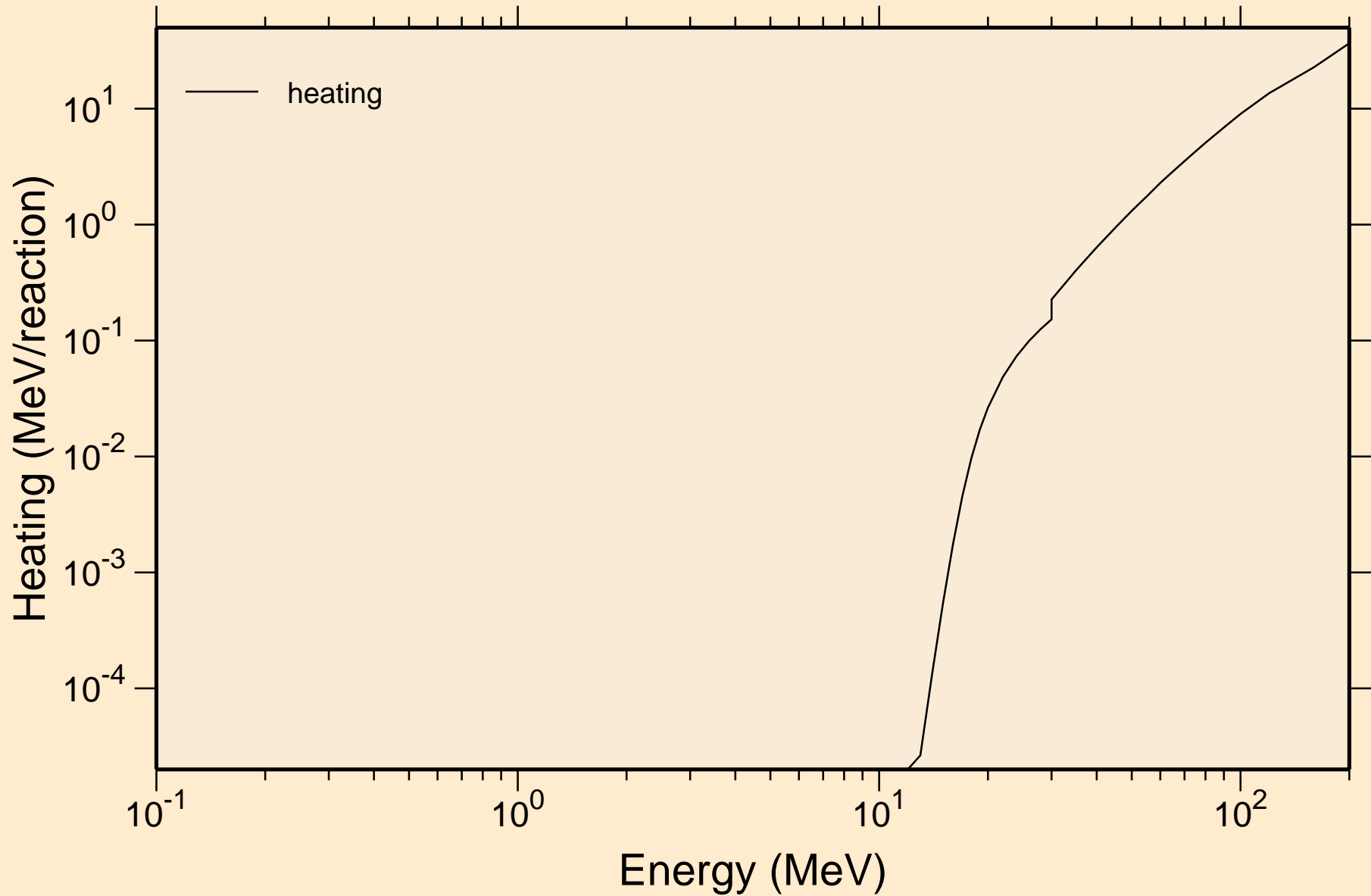

# SM160 HELION ACER TENDL-2023 LIBRARY; T=0.K

## Principal cross sections

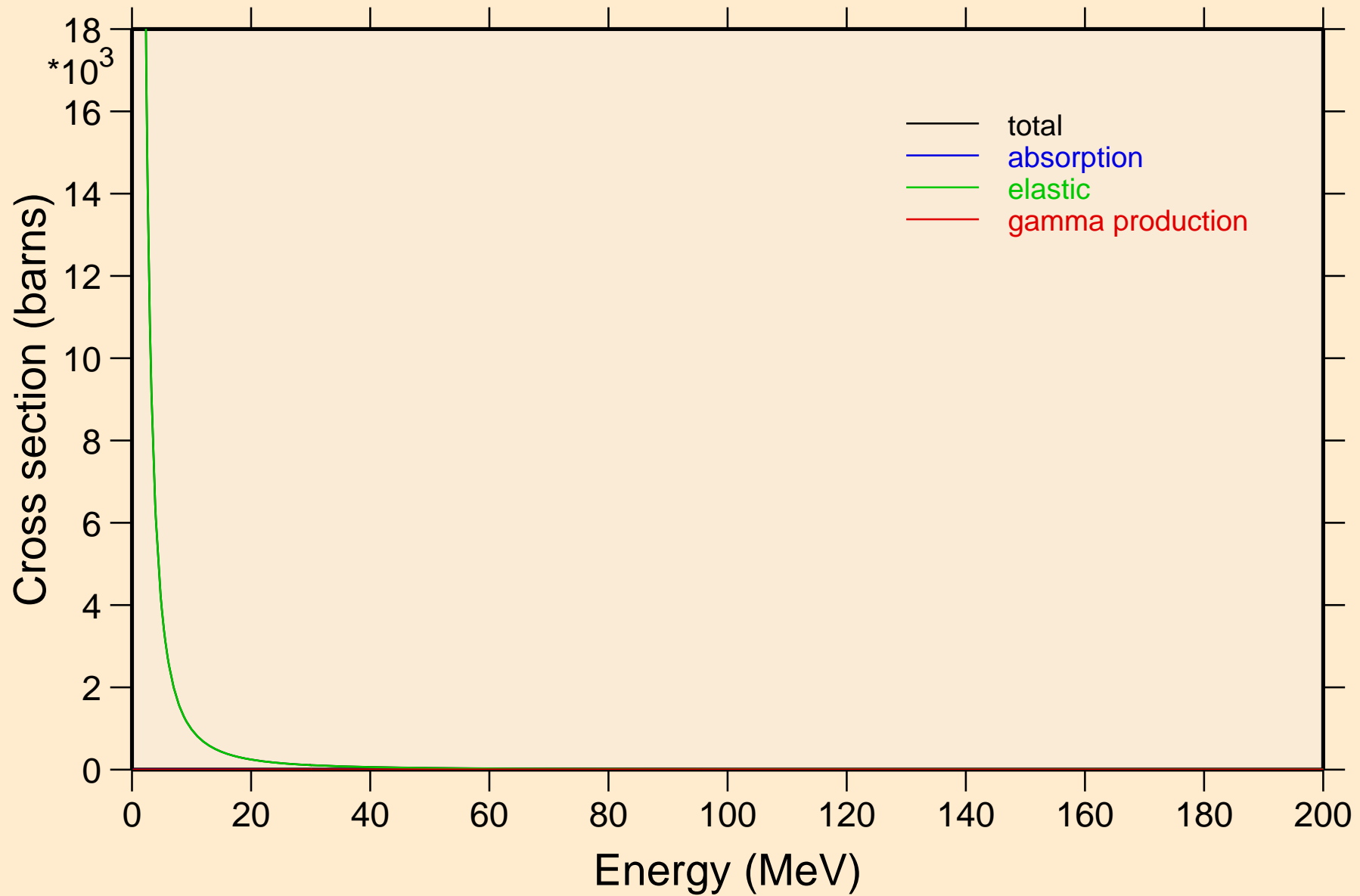

# SM160 HELION ACER TENDL-2023 LIBRARY; T=0.K

## Heating

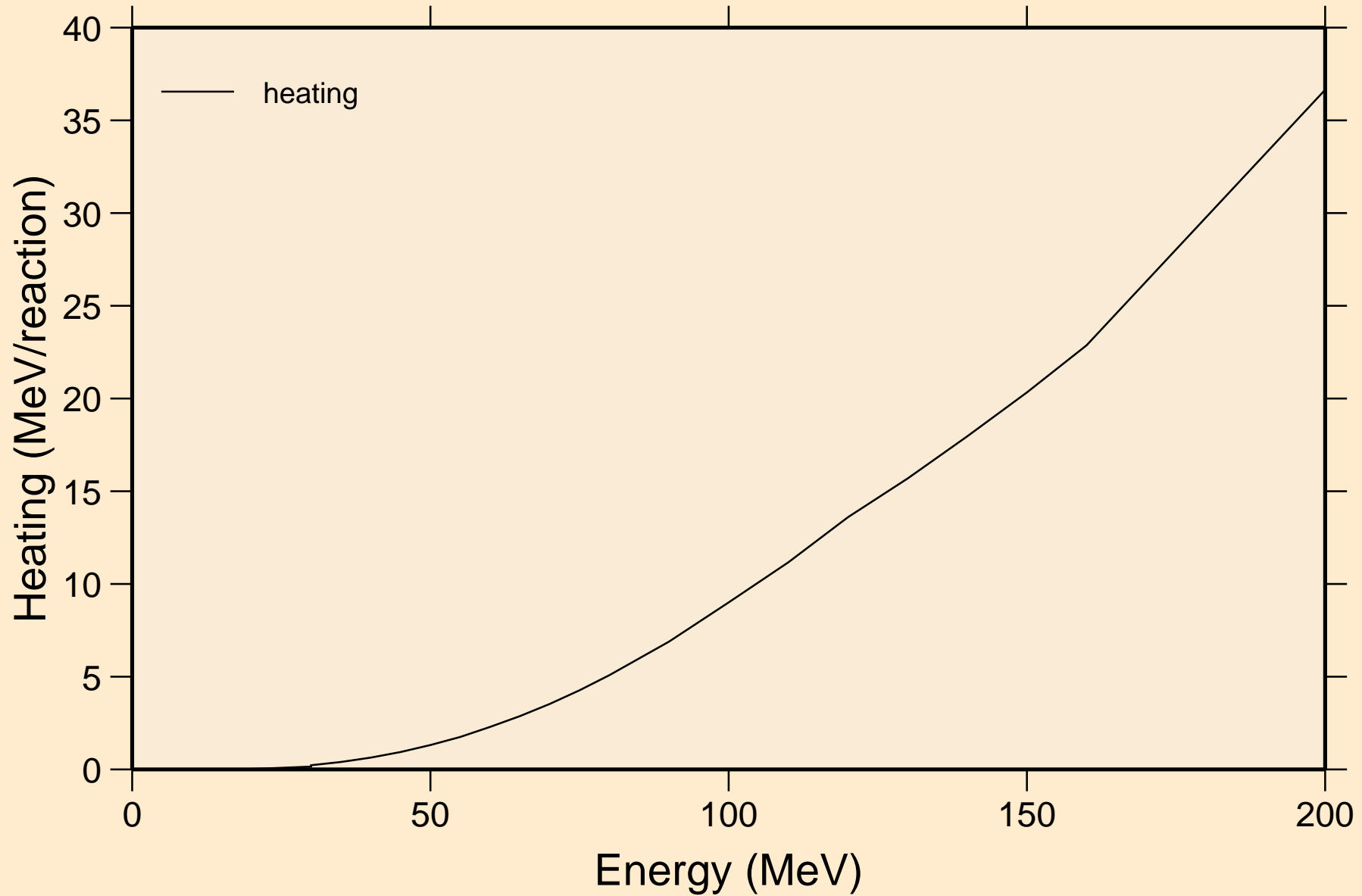

SM160 HELION ACER TENDL-2023 LIBRARY; T=0.K  
Threshold reactions

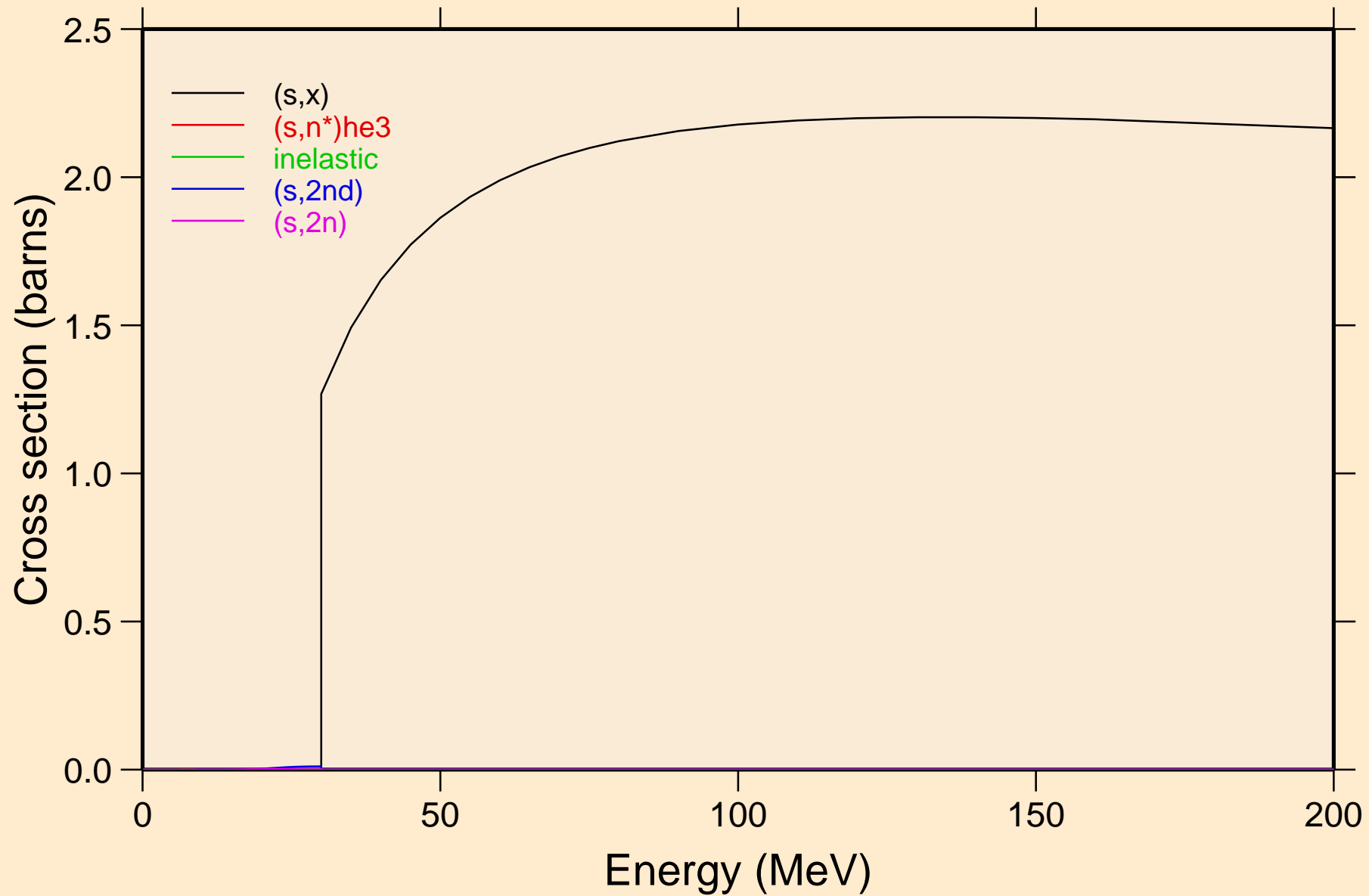

SM160 HELION ACER TENDL-2023 LIBRARY; T=0.K  
Threshold reactions

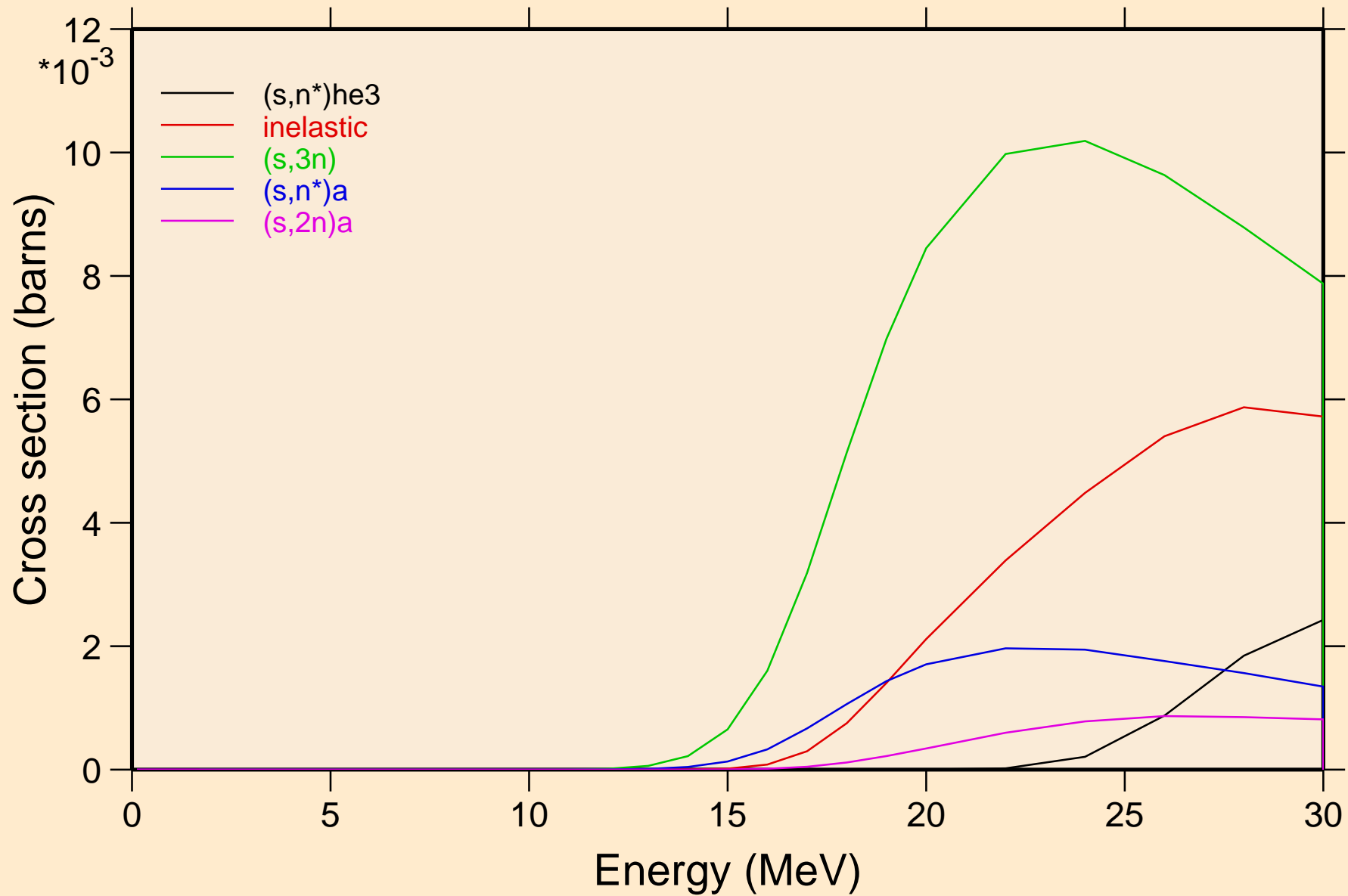

SM160 HELION ACER TENDL-2023 LIBRARY; T=0.K  
Threshold reactions

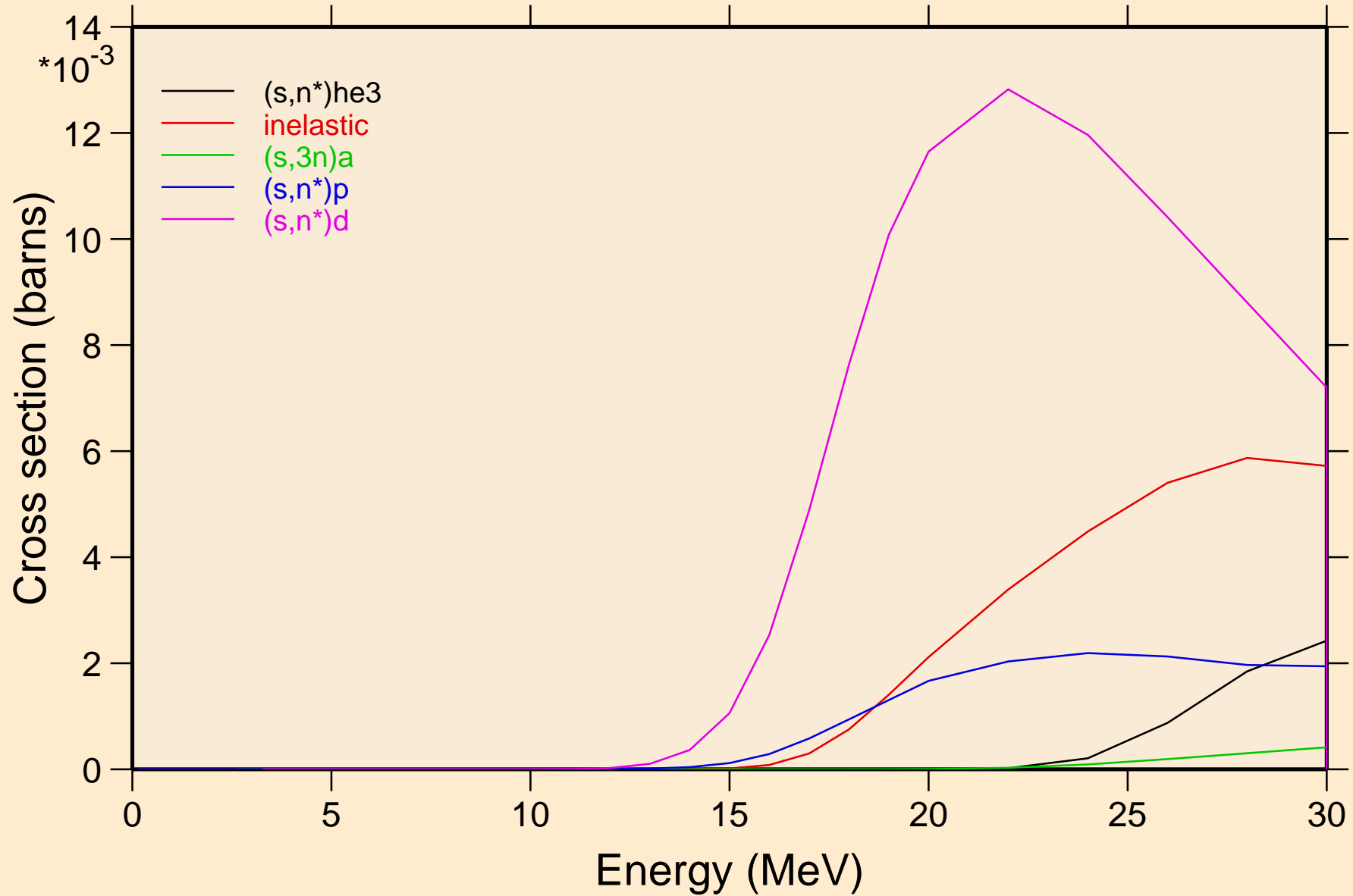

SM160 HELION ACER TENDL-2023 LIBRARY; T=0.K  
Threshold reactions

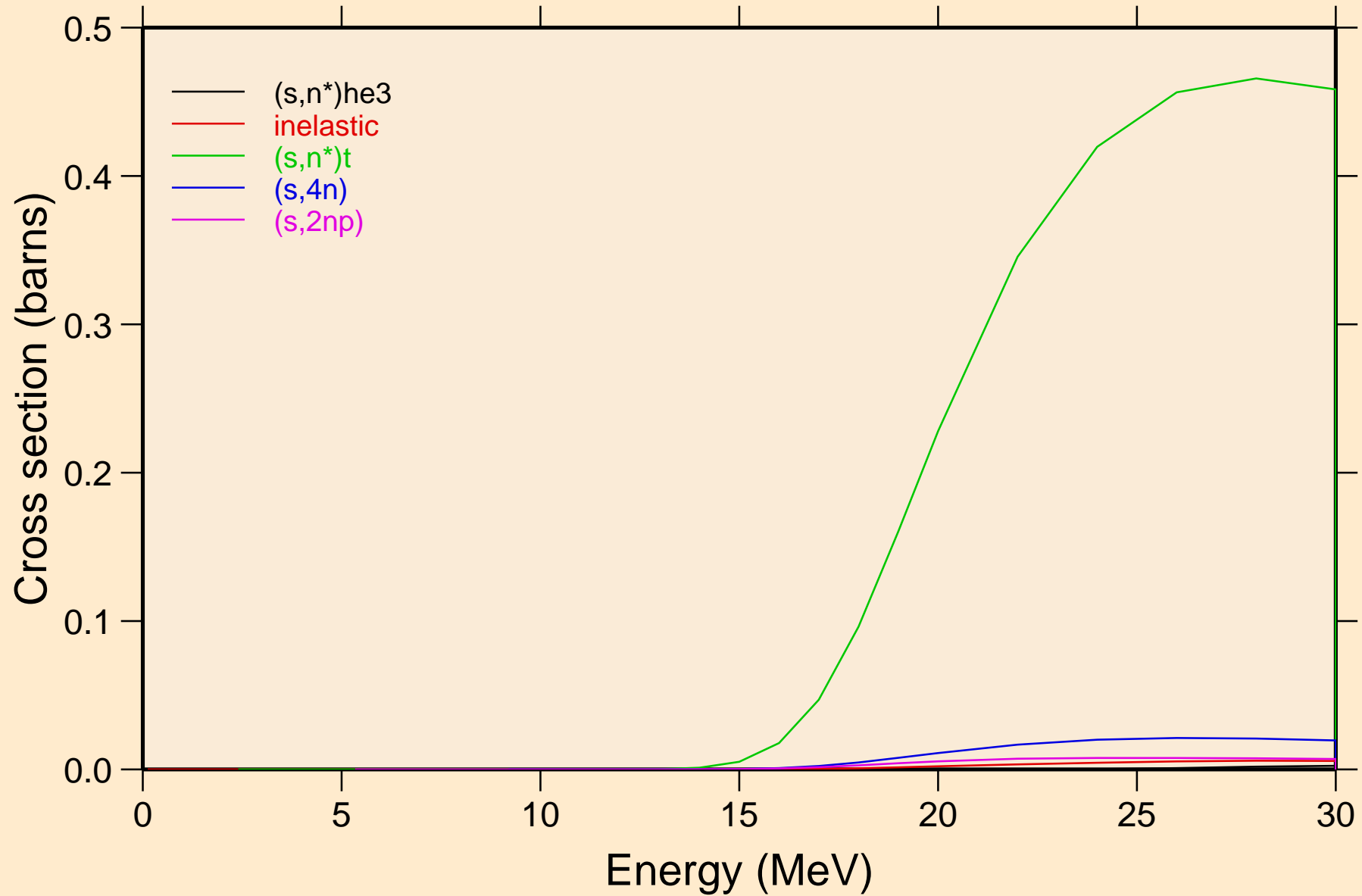



SM160 HELION ACER TENDL-2023 LIBRARY; T=0.K  
Threshold reactions

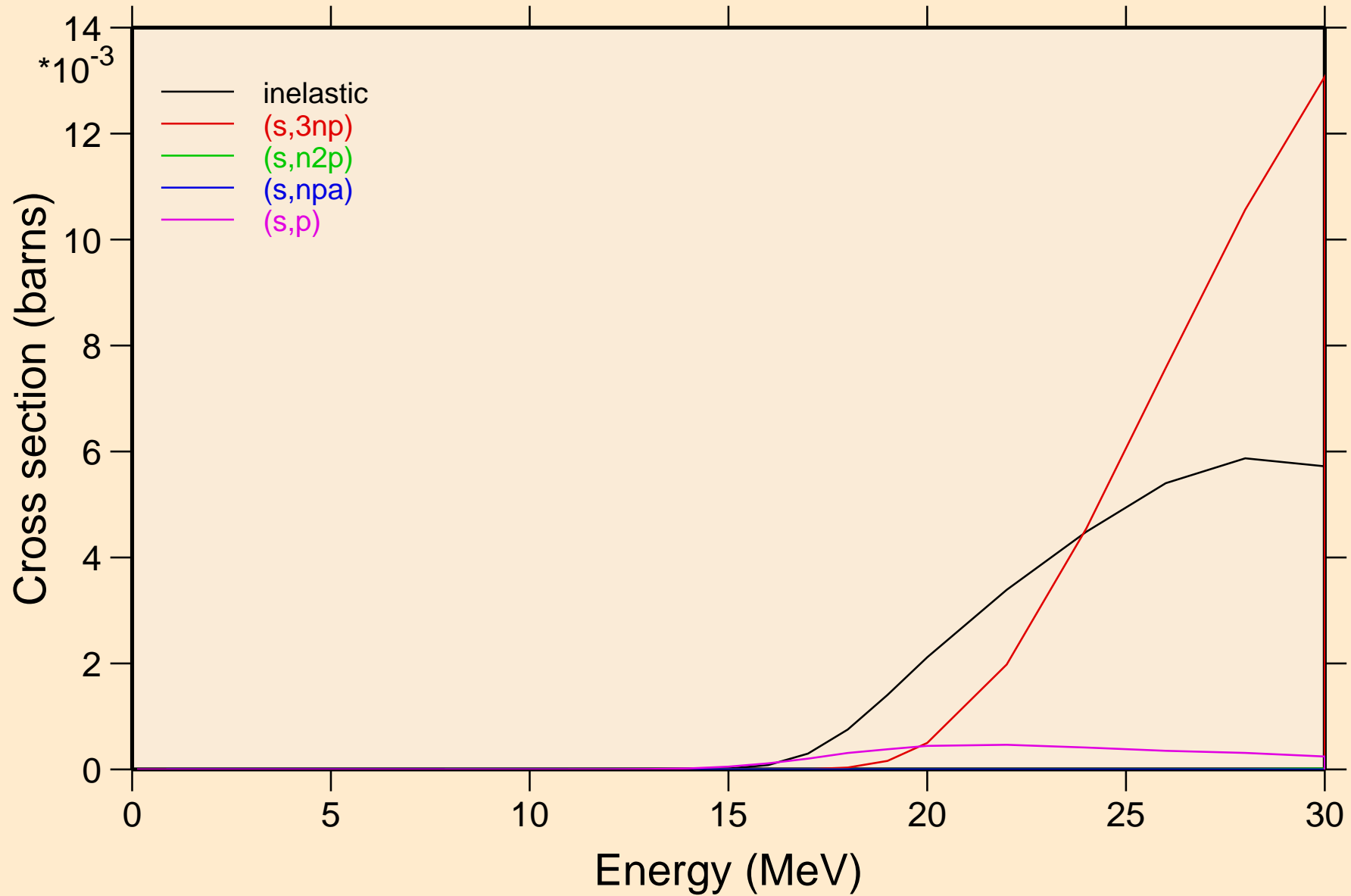

SM160 HELION ACER TENDL-2023 LIBRARY; T=0.K  
Threshold reactions

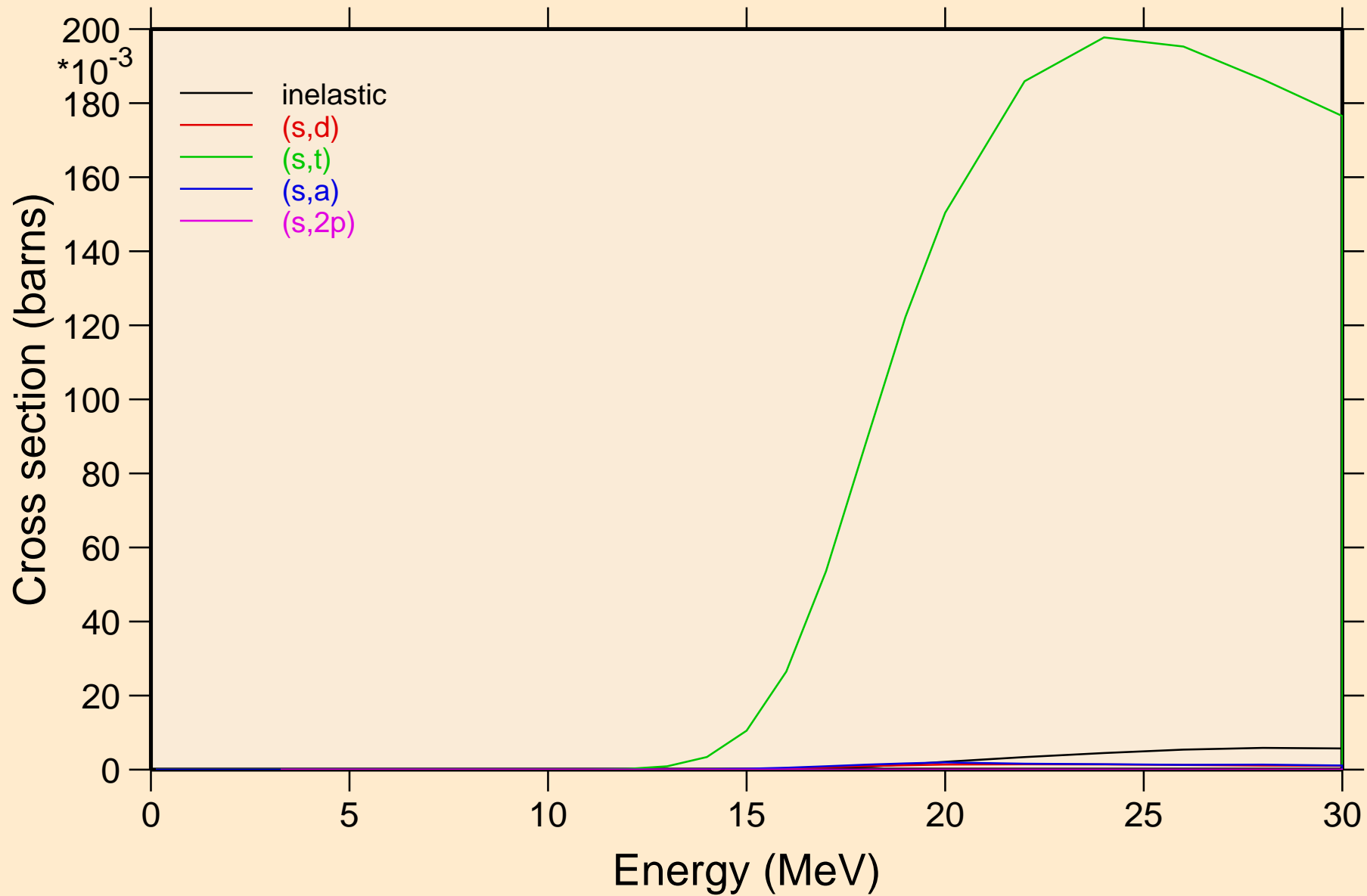

SM160 HELION ACER TENDL-2023 LIBRARY; T=0.K  
Threshold reactions

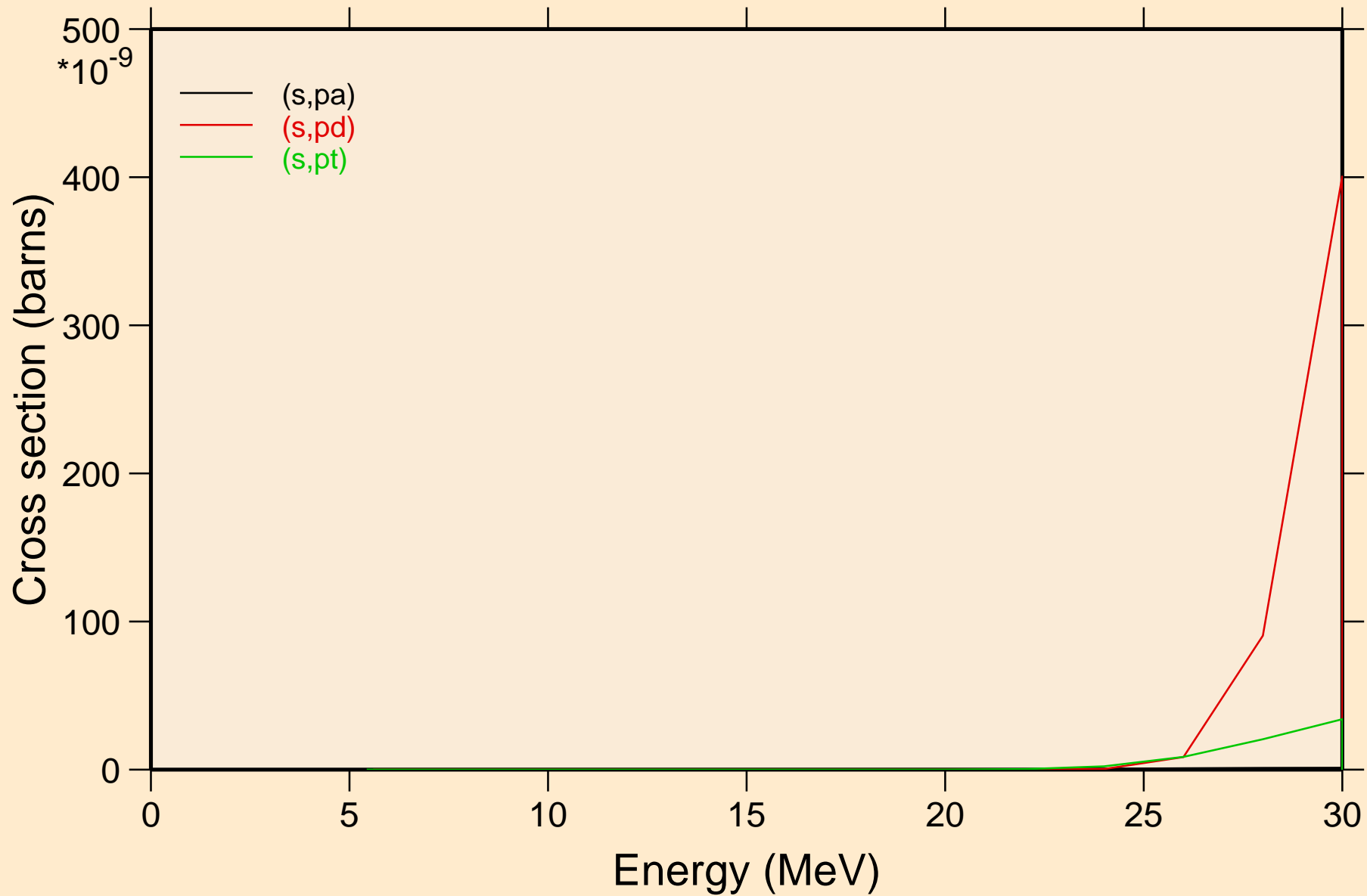

SM160 HELION ACER TENDL-2023 LIBRARY; T=0.K  
angular distribution for elastic

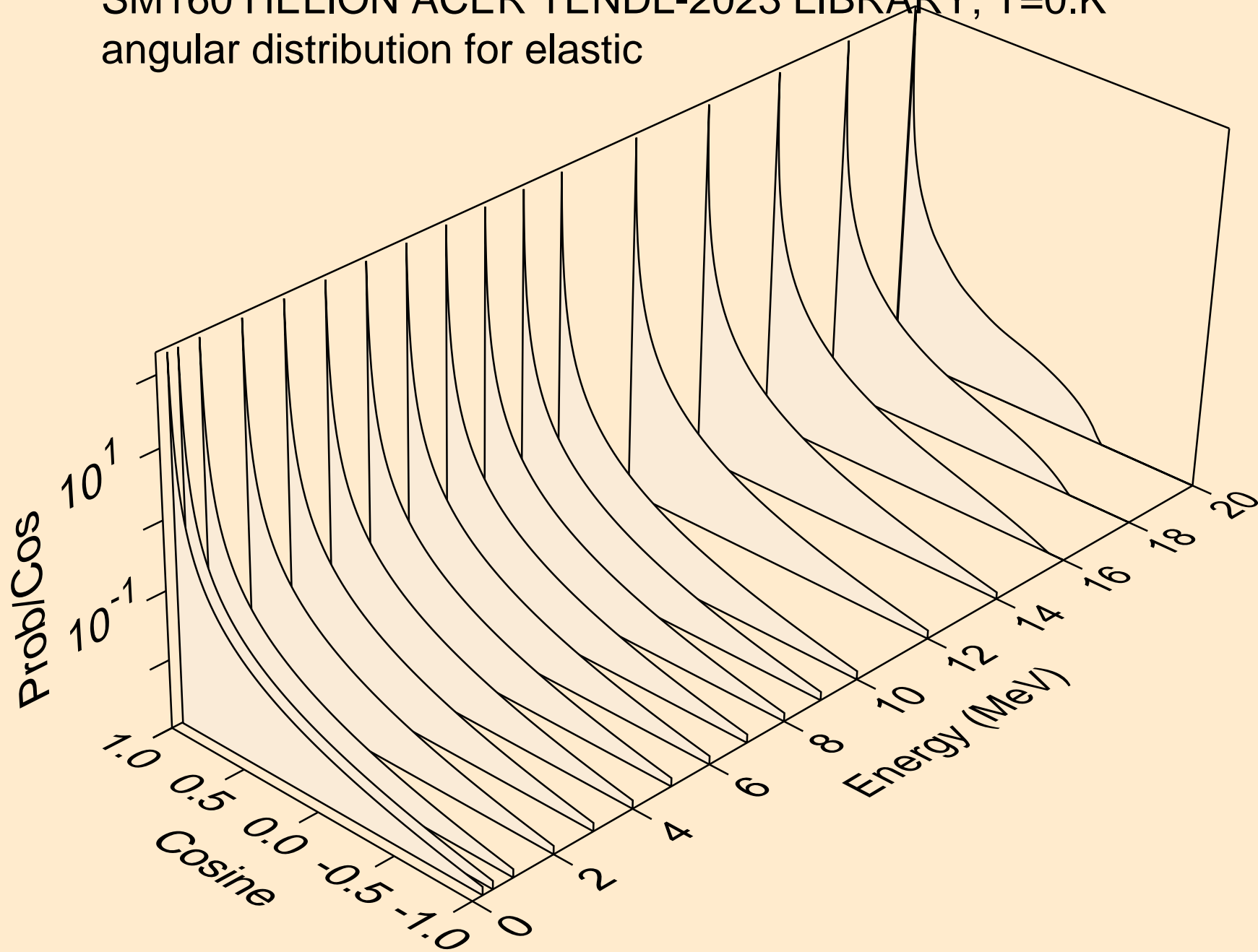

SM160 HELION ACER TENDL-2023 LIBRARY; T=0.K  
angular distribution for elastic

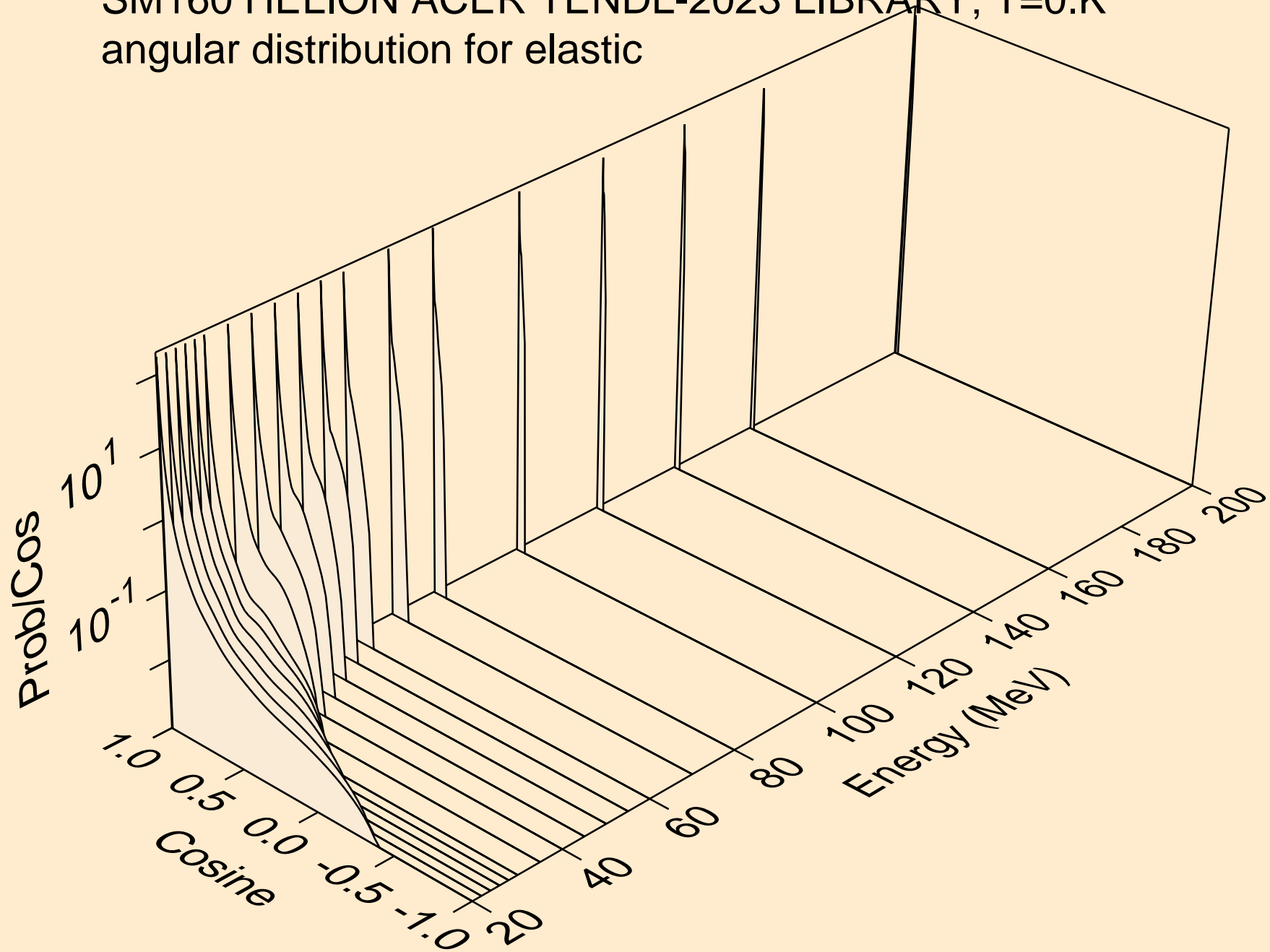

SM160 HELION ACER TENDL-2023 LIBRARY; T=0.K  
He-3 emission for (s,x)

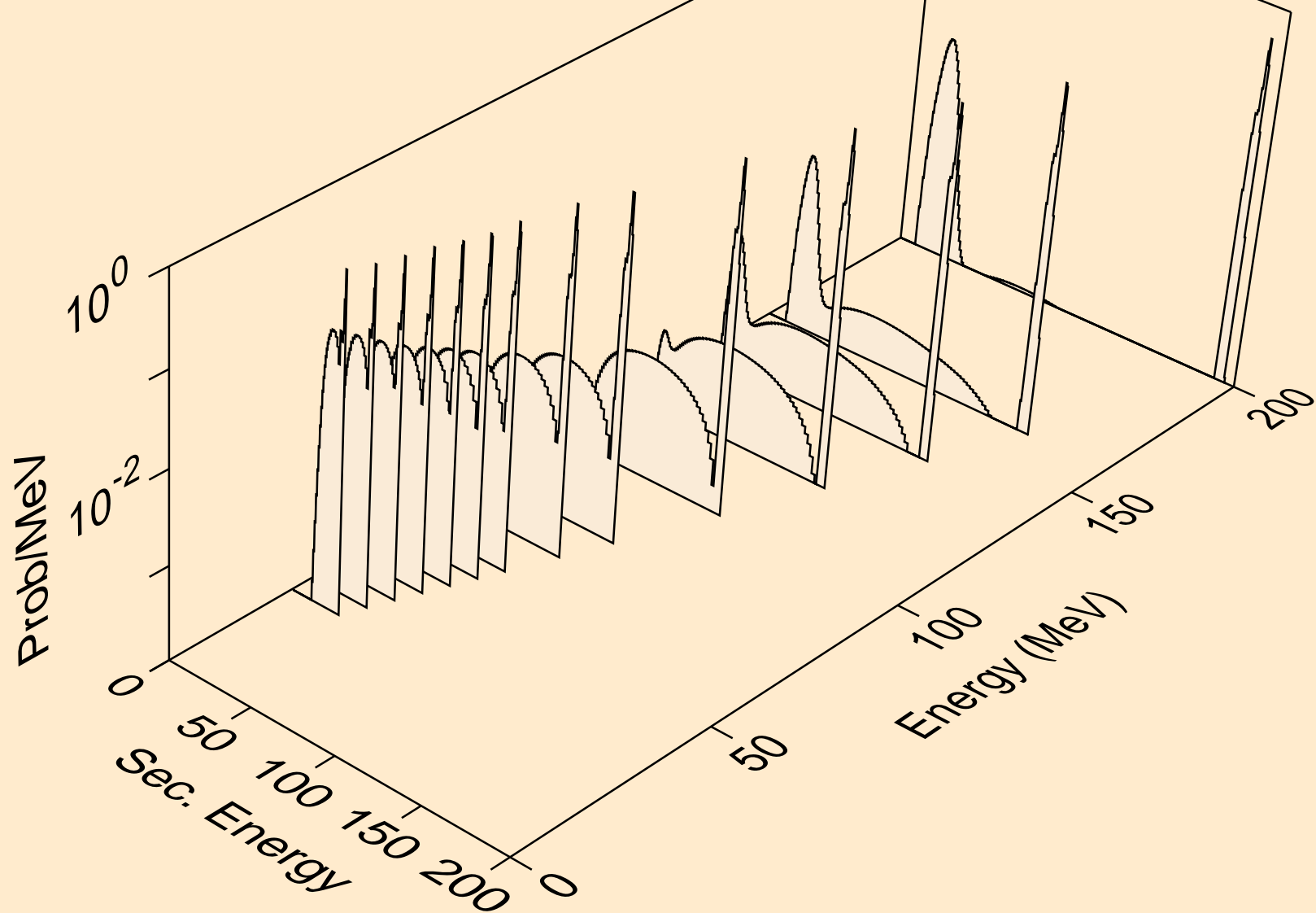

SM160 HELION ACER TENDL-2023 LIBRARY; T=0.K  
He-3 emission for (s,n\*)he3

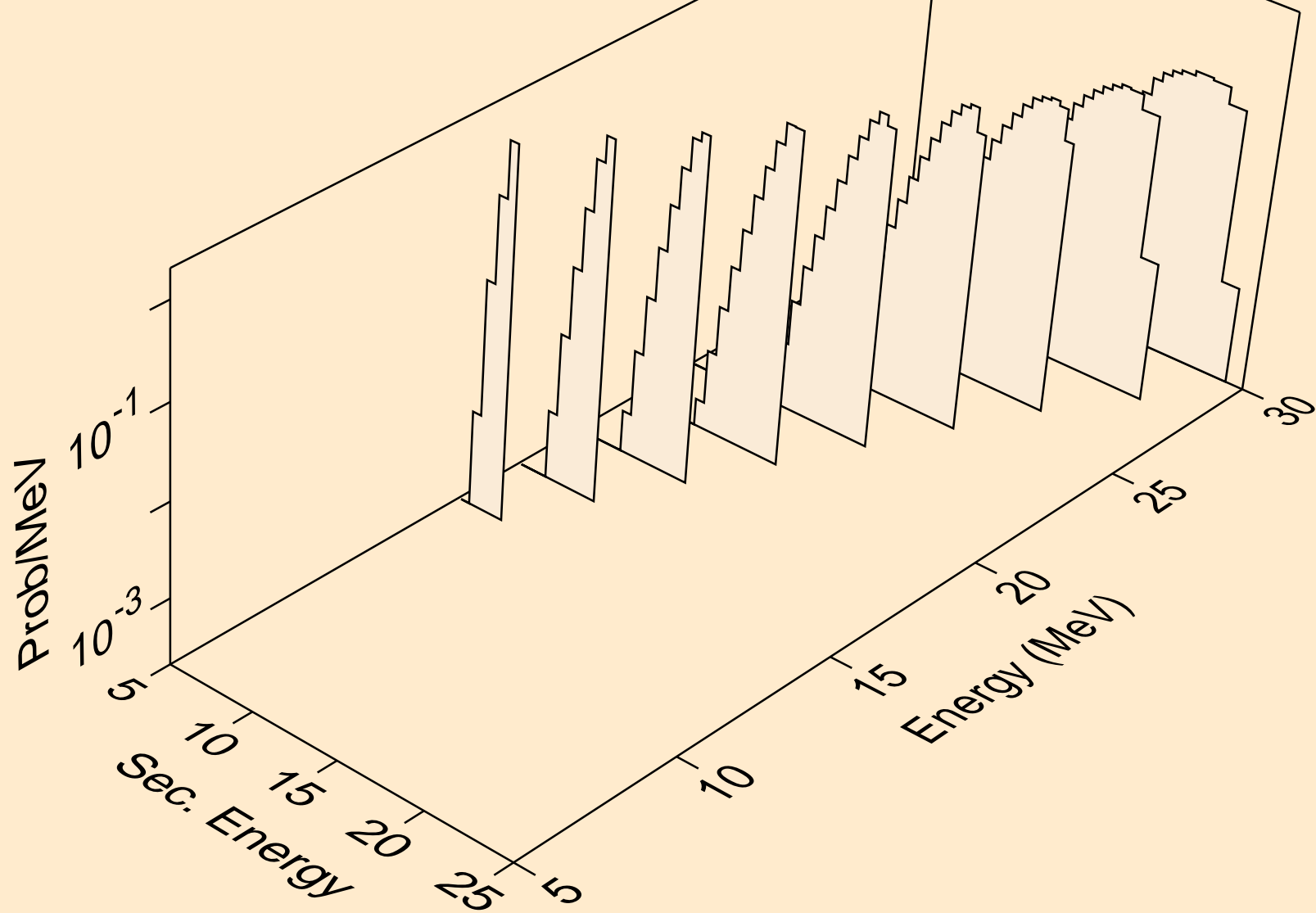

SM160 HELION ACER TENDL-2023 LIBRARY; T=0.K  
He-3 emission for inelastic

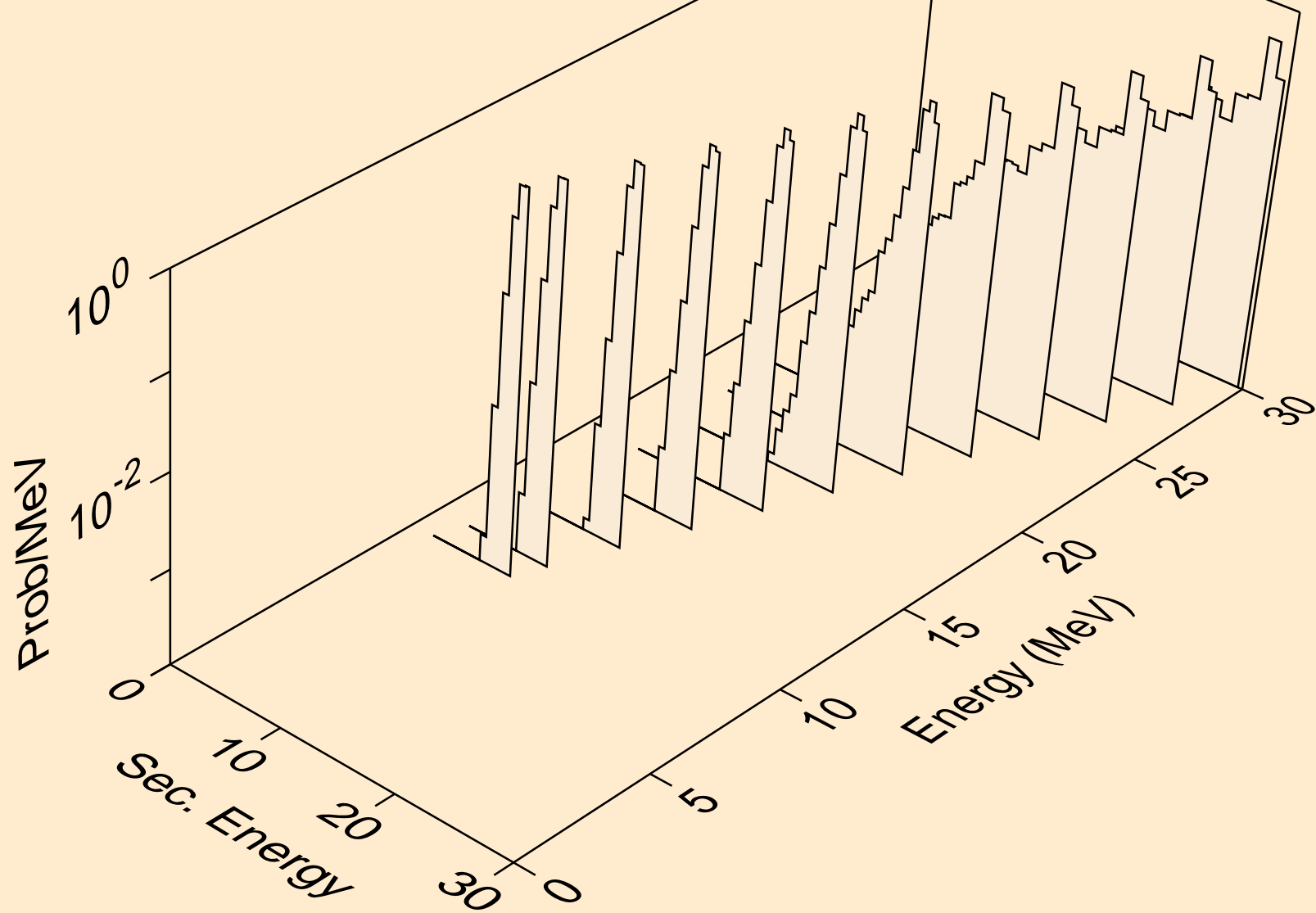



SM160 HELION ACER TENDL-2023 LIBRARY; T=0.K  
Photon emission for (z,n)

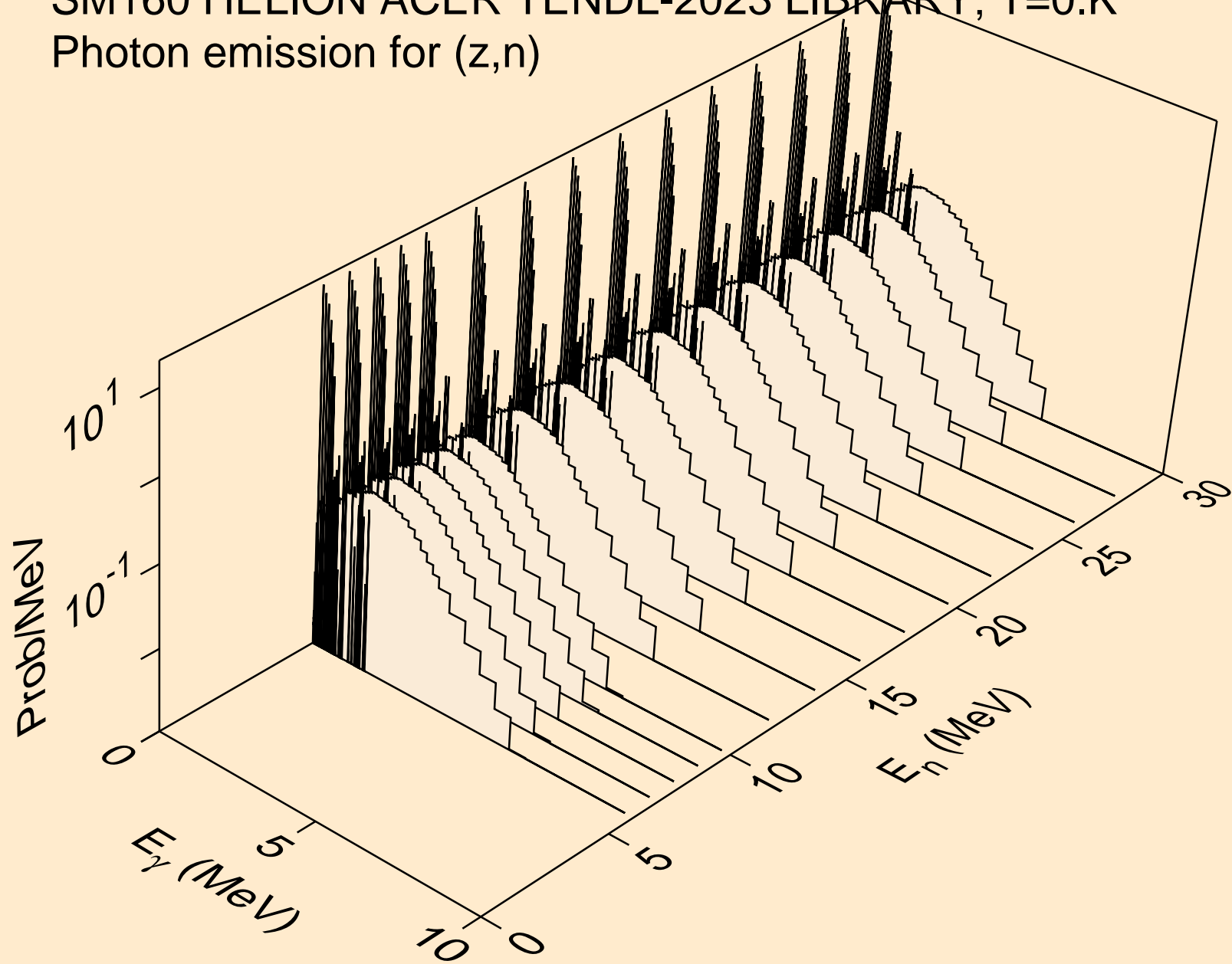

SM160 HELION ACER TENDL-2023 LIBRARY; T=0.K  
Photon emission for (z,x)

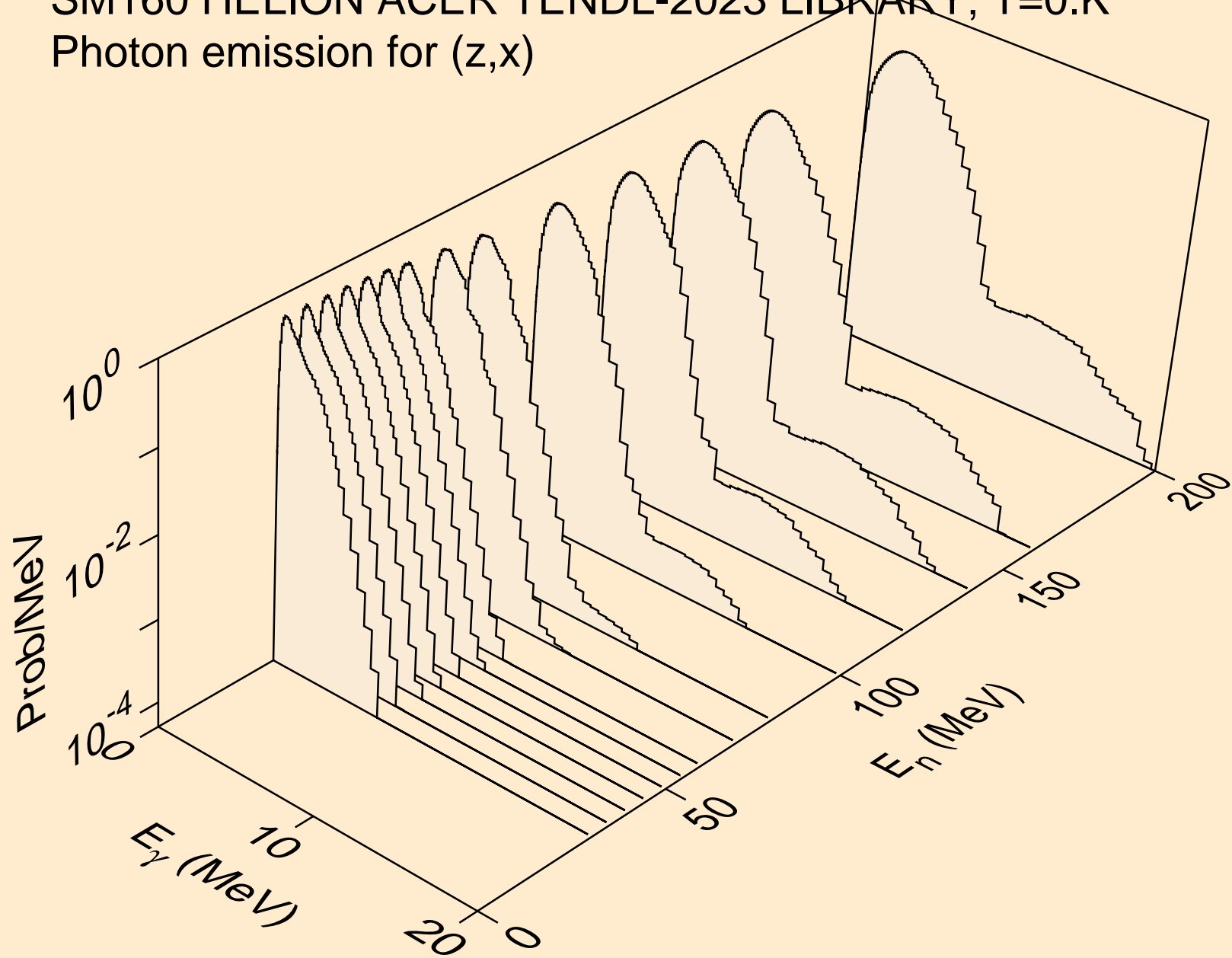

SM160 HELION ACER TENDL-2023 LIBRARY; T=0.K  
Photon emission for (n,2nd)

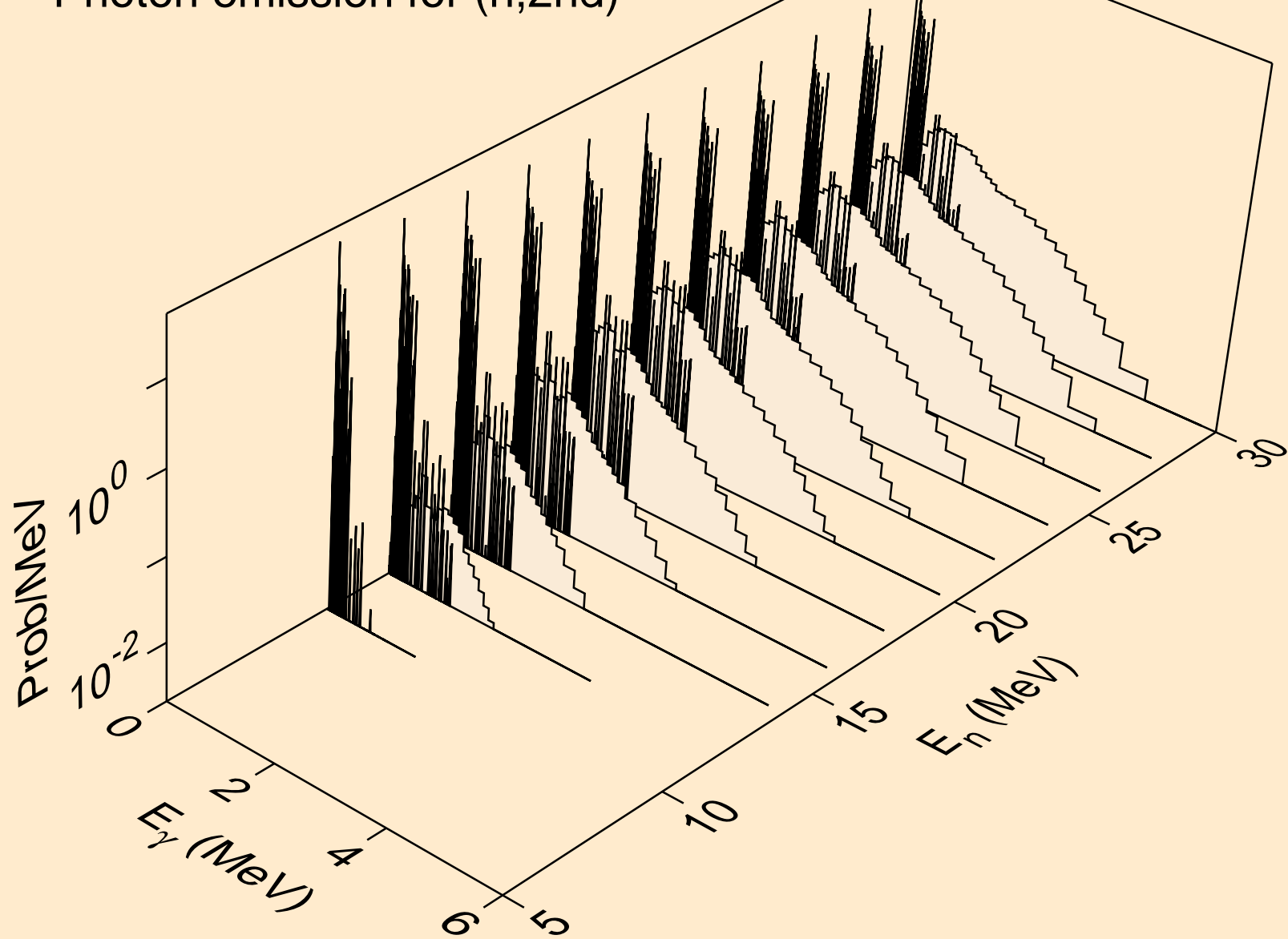

SM160 HELION ACER TENDL-2023 LIBRARY; T=0.K  
Photon emission for (n,2n)

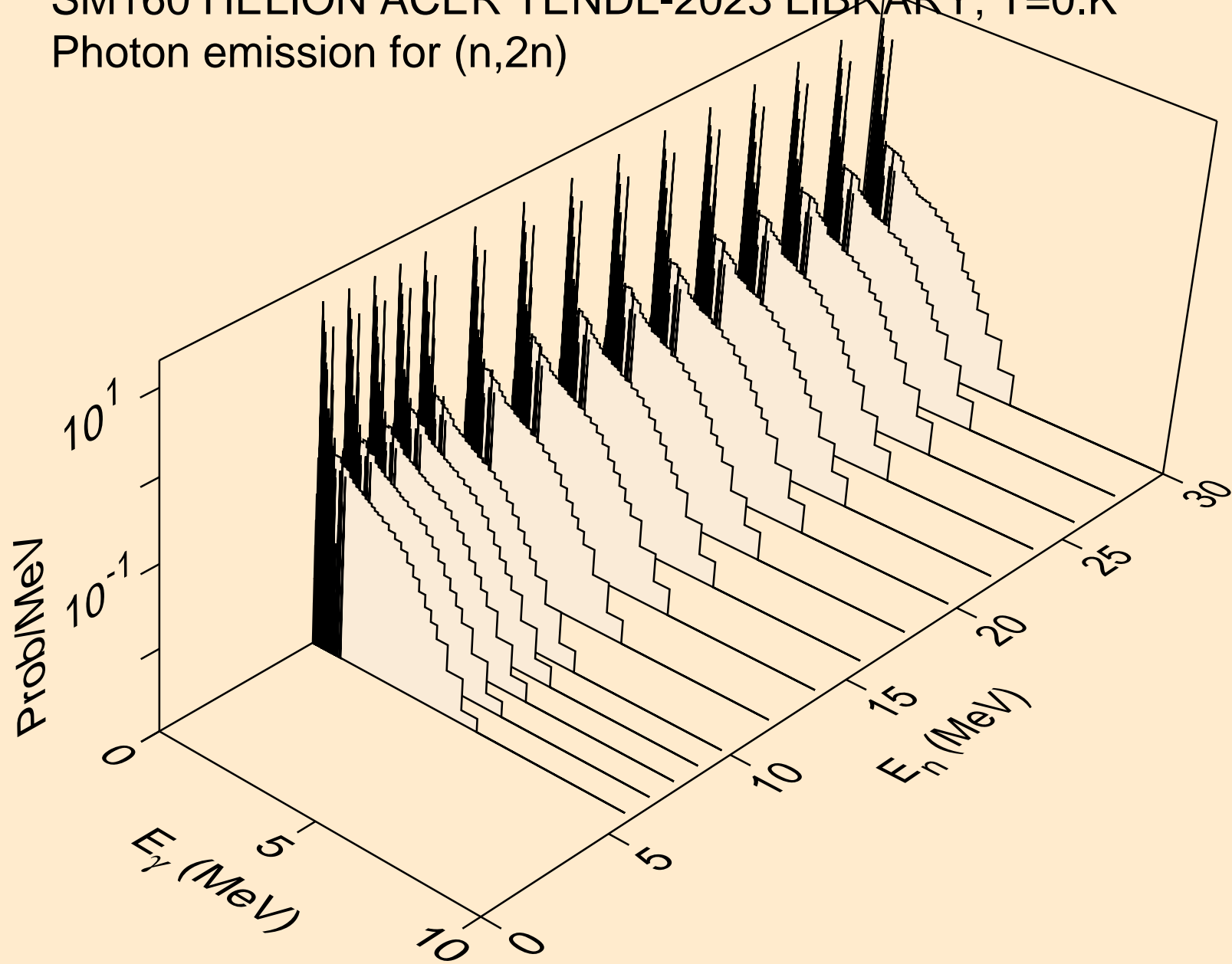

SM160 HELION ACER TENDL-2023 LIBRARY; T=0.K  
Photon emission for (n,3n)

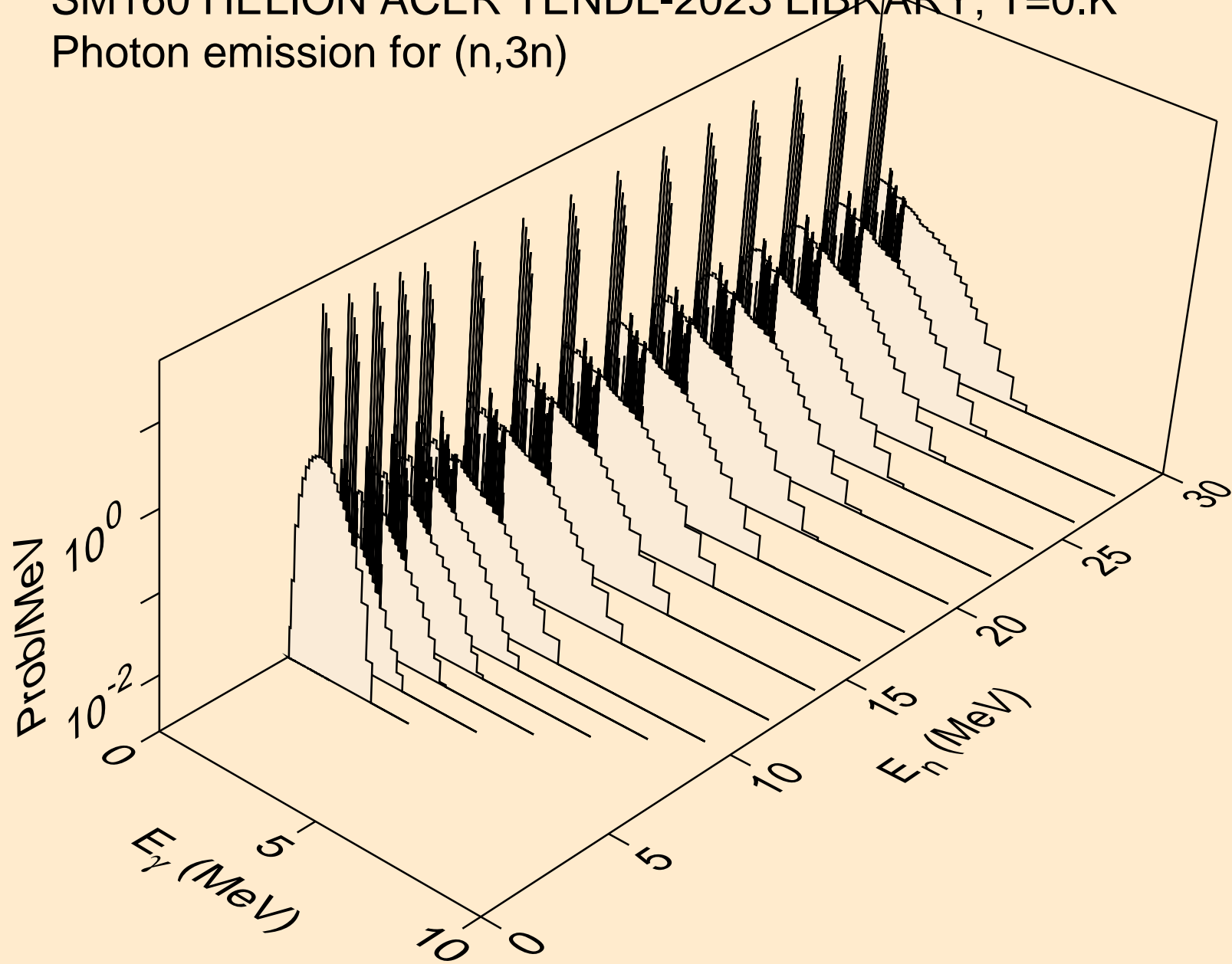

SM160 HELION ACER TENDL-2023 LIBRARY; T=0.K  
Photon emission for (n,n\*)a

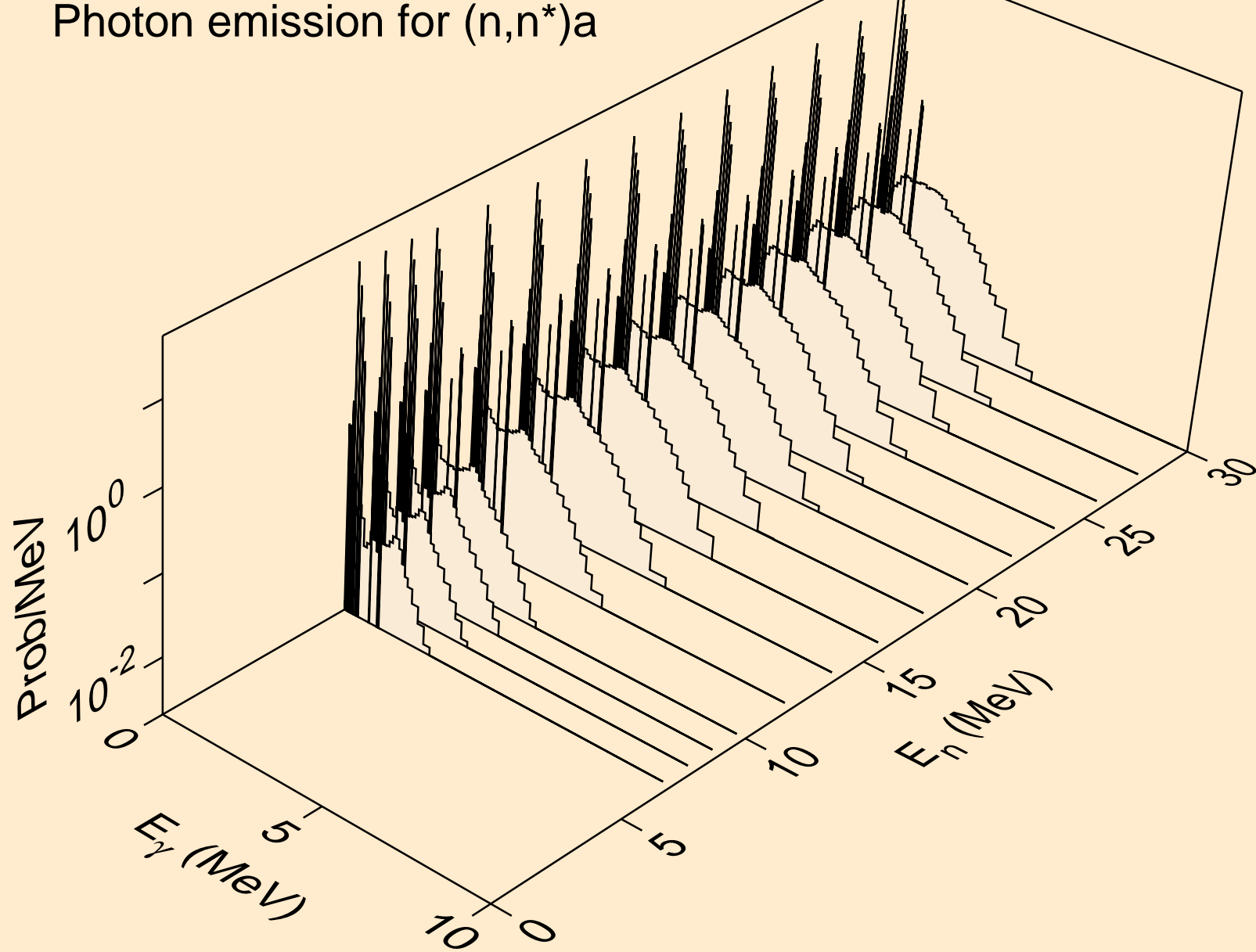

SM160 HELION ACER TENDL-2023 LIBRARY; T=0.K  
Photon emission for (n,2n)a

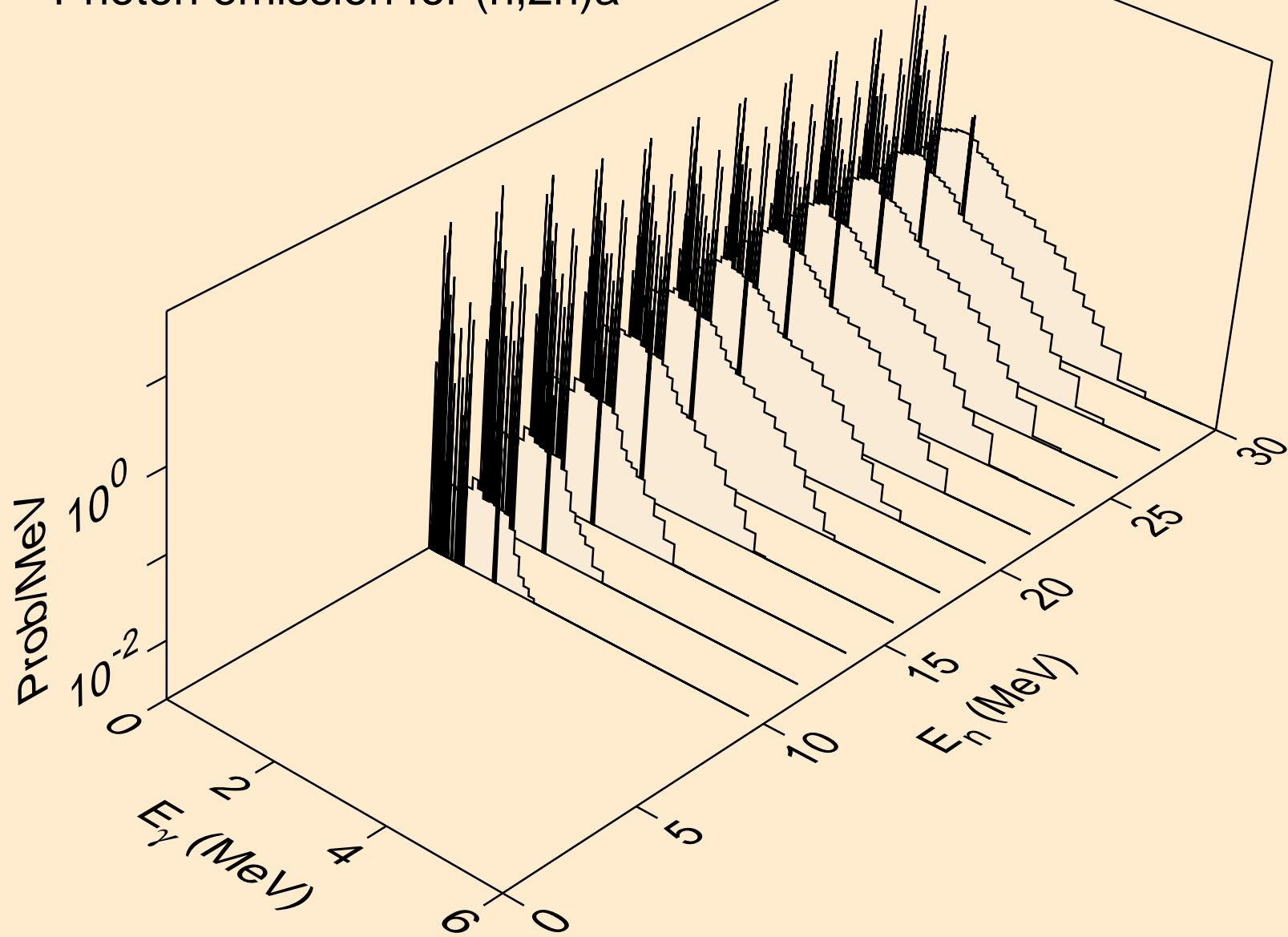

SM160 HELION ACER TENDL-2023 LIBRARY; T=0.K  
Photon emission for (n,3n)a

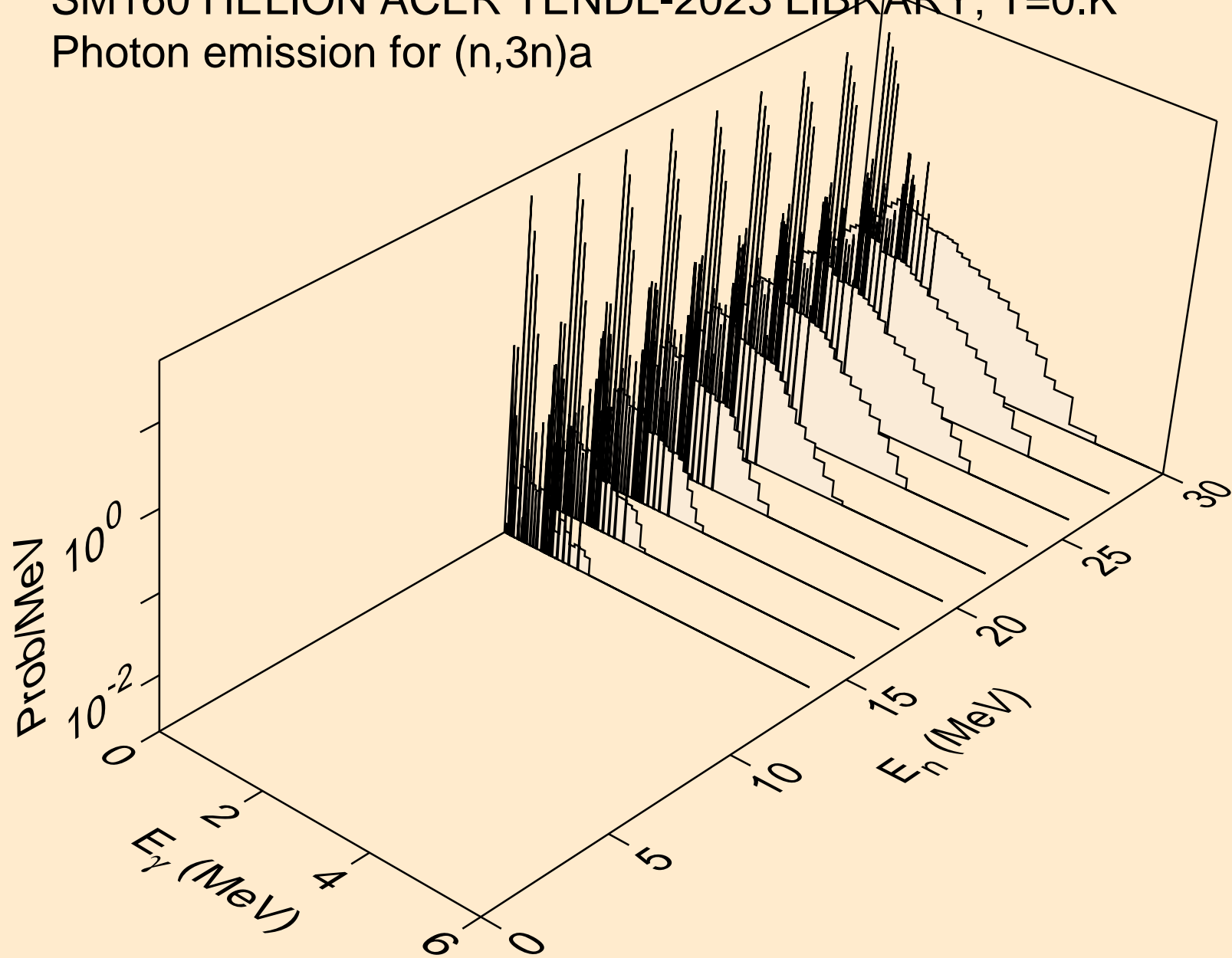



SM160 HELION ACER TENDL-2023 LIBRARY; T=0.K  
Photon emission for (n,n\*)p

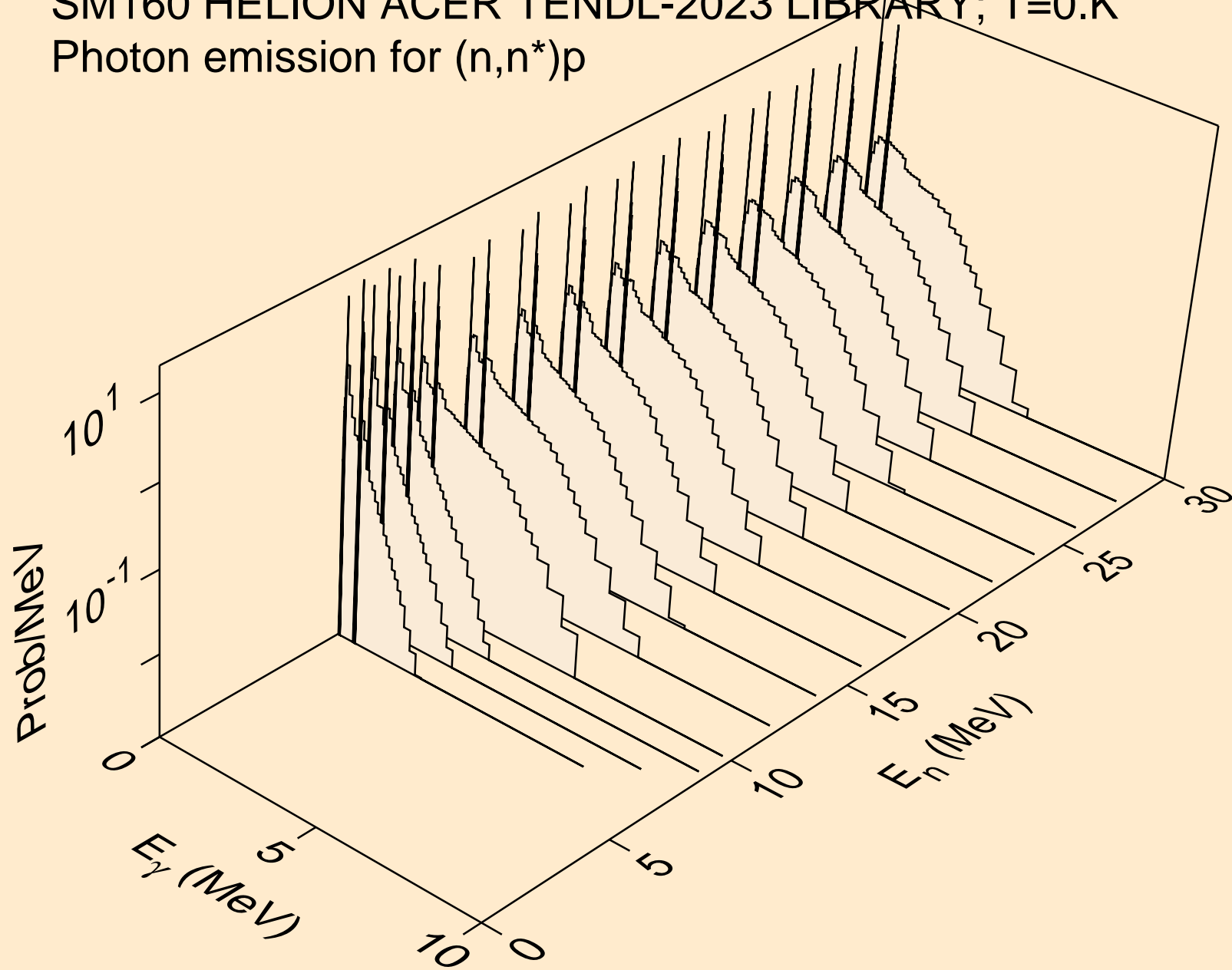

SM160 HELION ACER TENDL-2023 LIBRARY; T=0.K  
Photon emission for (n,n\*)d

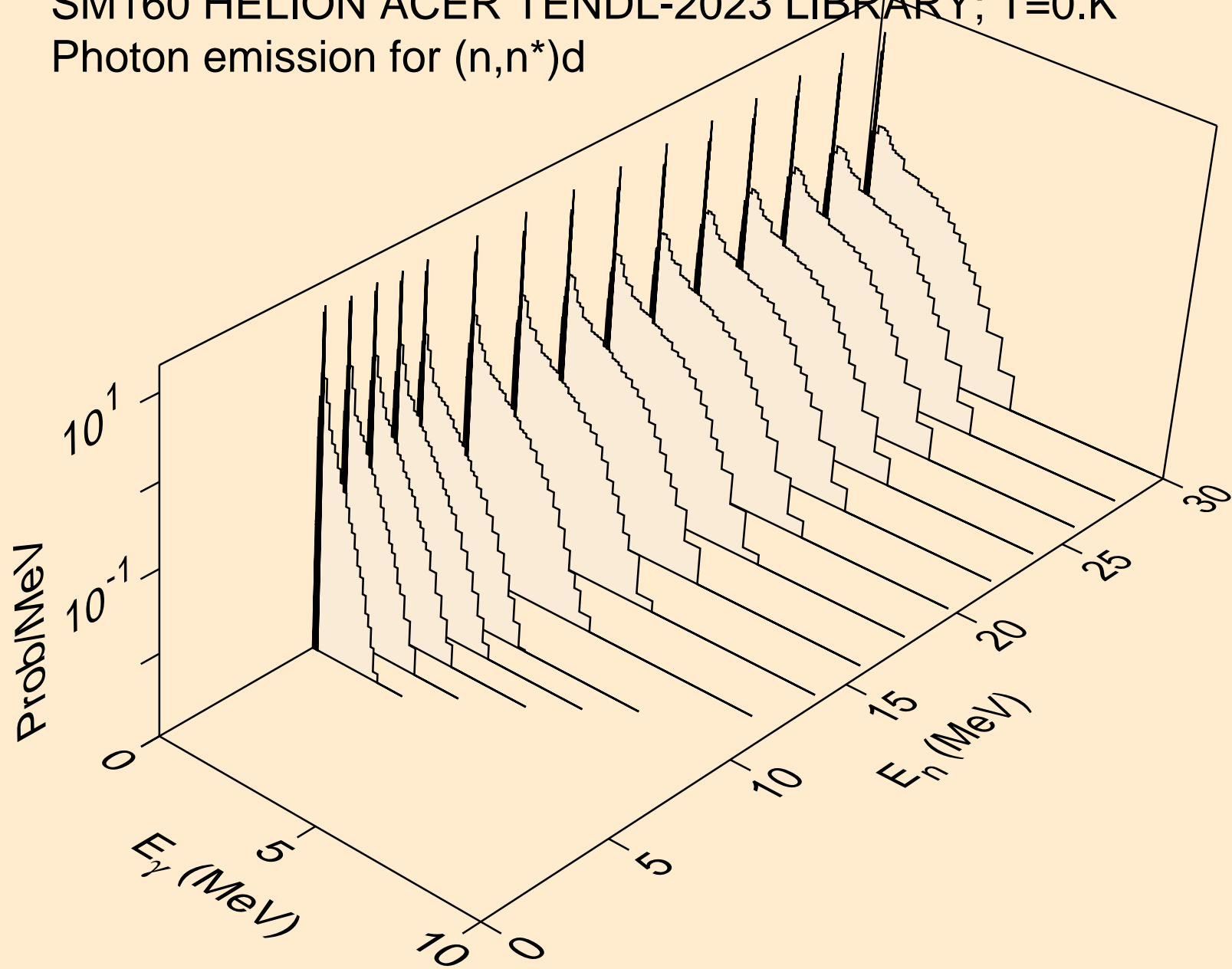

SM160 HELION ACER TENDL-2023 LIBRARY; T=0.K  
Photon emission for (n,n\*)t

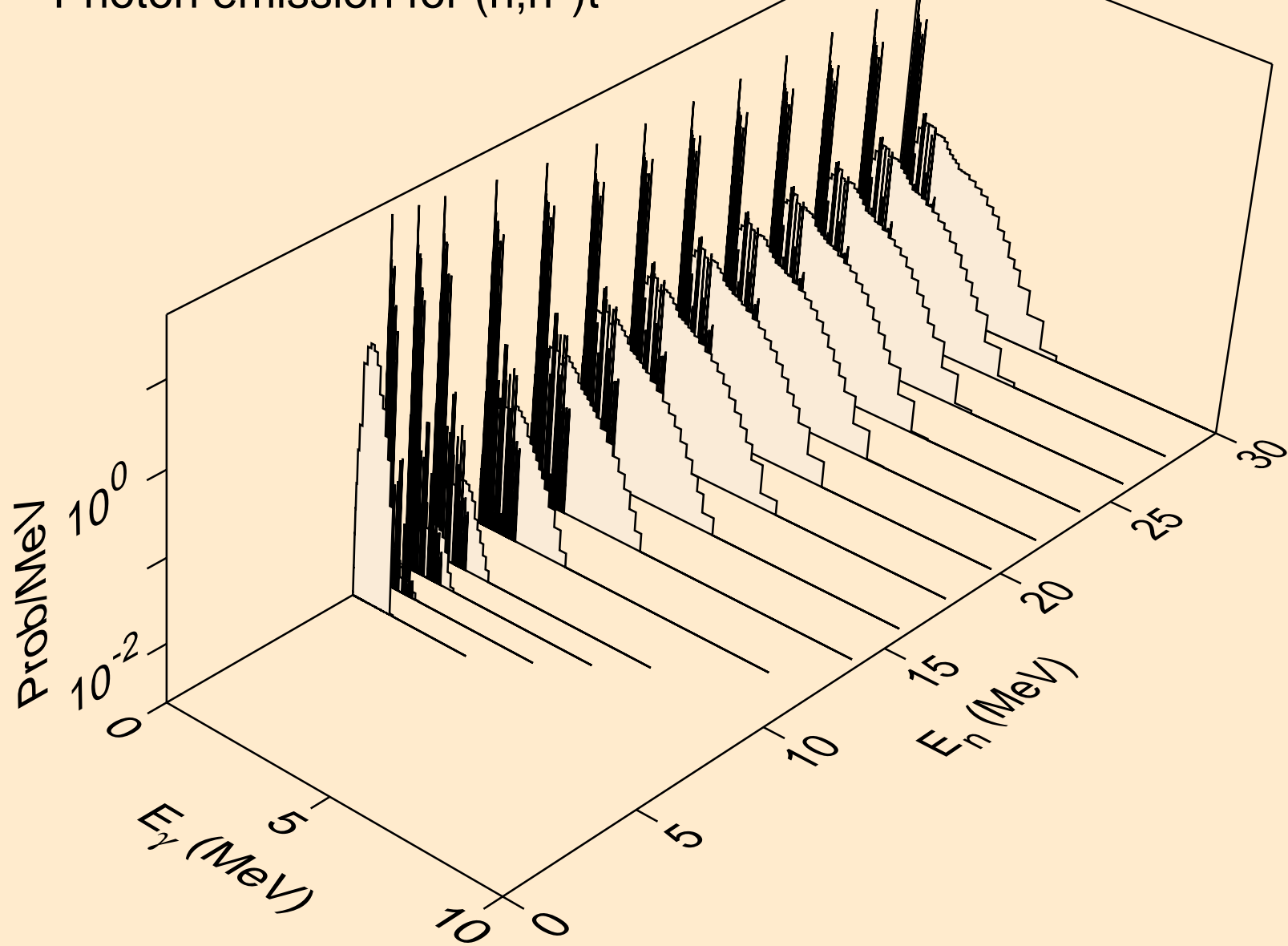

SM160 HELION ACER TENDL-2023 LIBRARY; T=0.K  
Photon emission for (n,n\*)he3

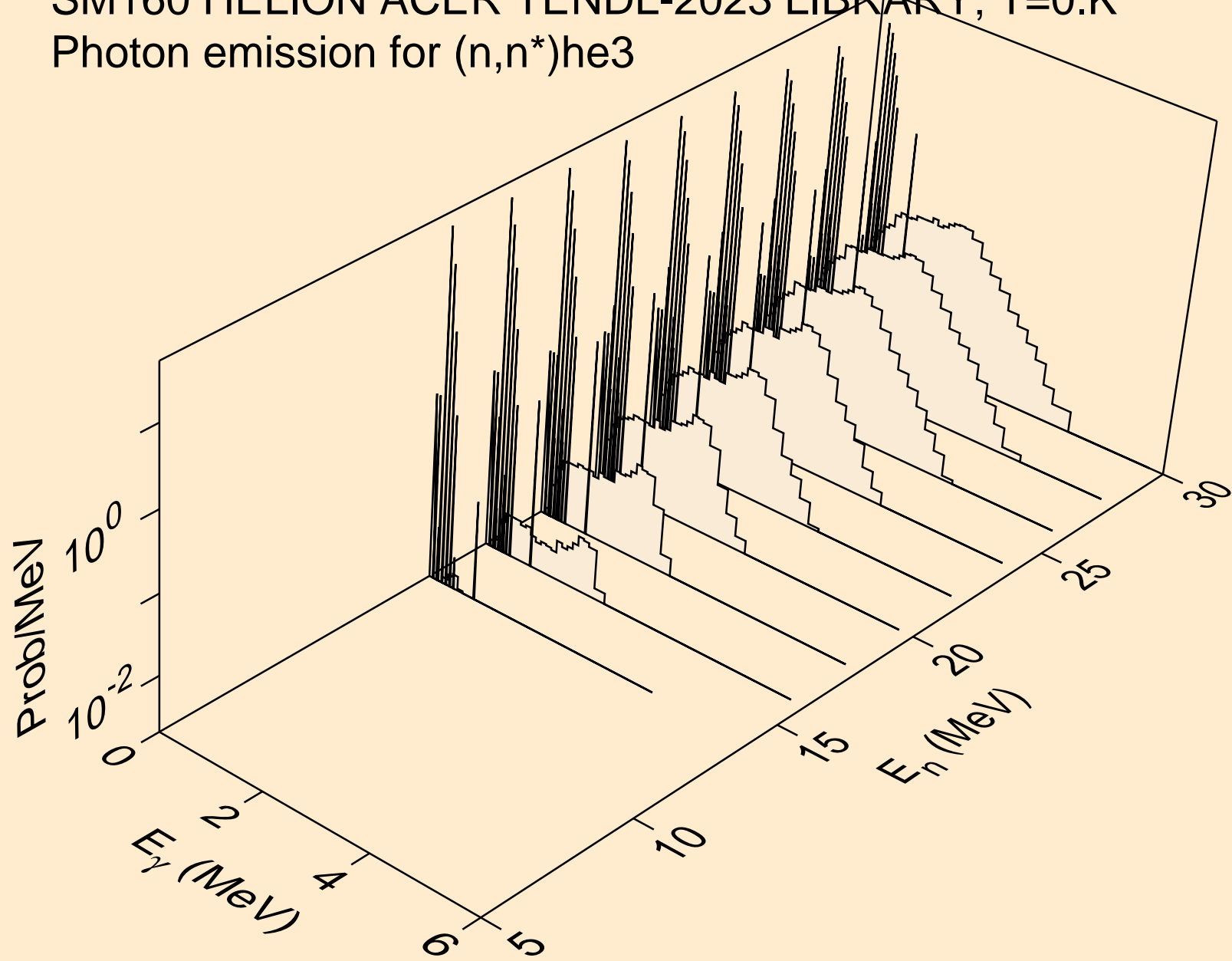

SM160 HELION ACER TENDL-2023 LIBRARY; T=0.K  
Photon emission for (n,4n)

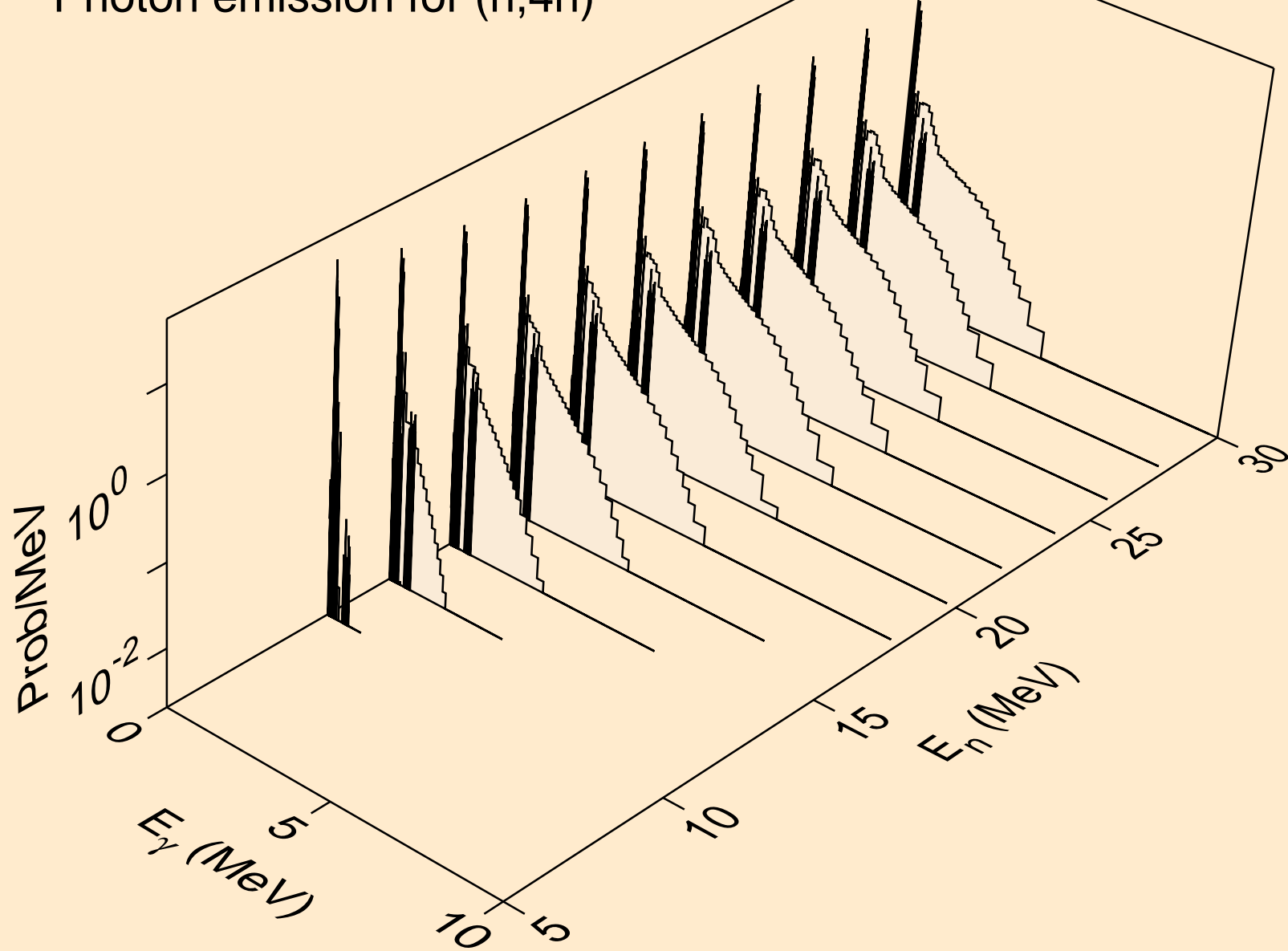

SM160 HELION ACER TENDL-2023 LIBRARY; T=0.K  
Photon emission for (n,2np)

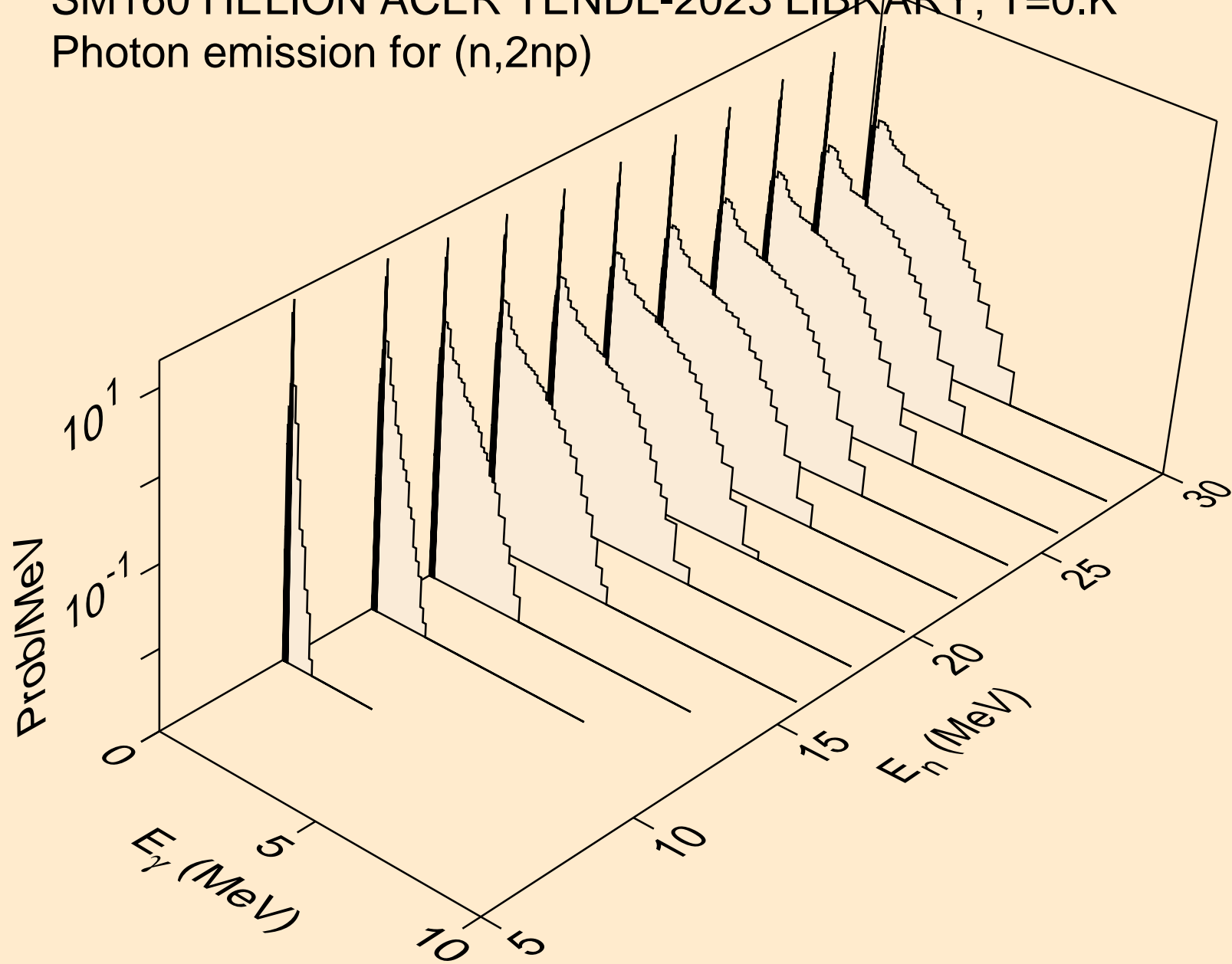

SM160 HELION ACER TENDL-2023 LIBRARY; T=0.K  
Photon emission for (n,3np)

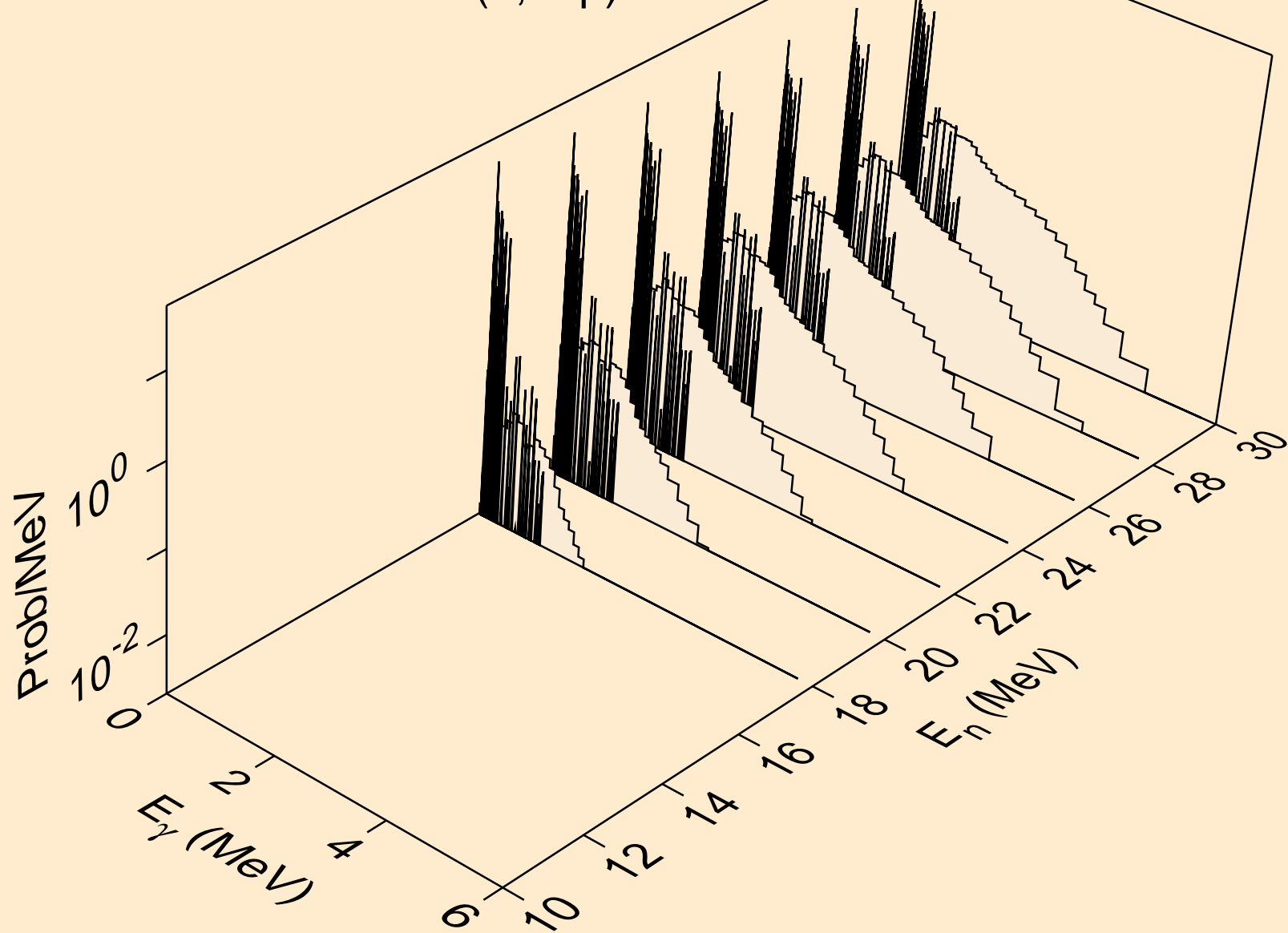

SM160 HELION ACER TENDL-2023 LIBRARY; T=0.K  
Photon emission for (n,n2p)

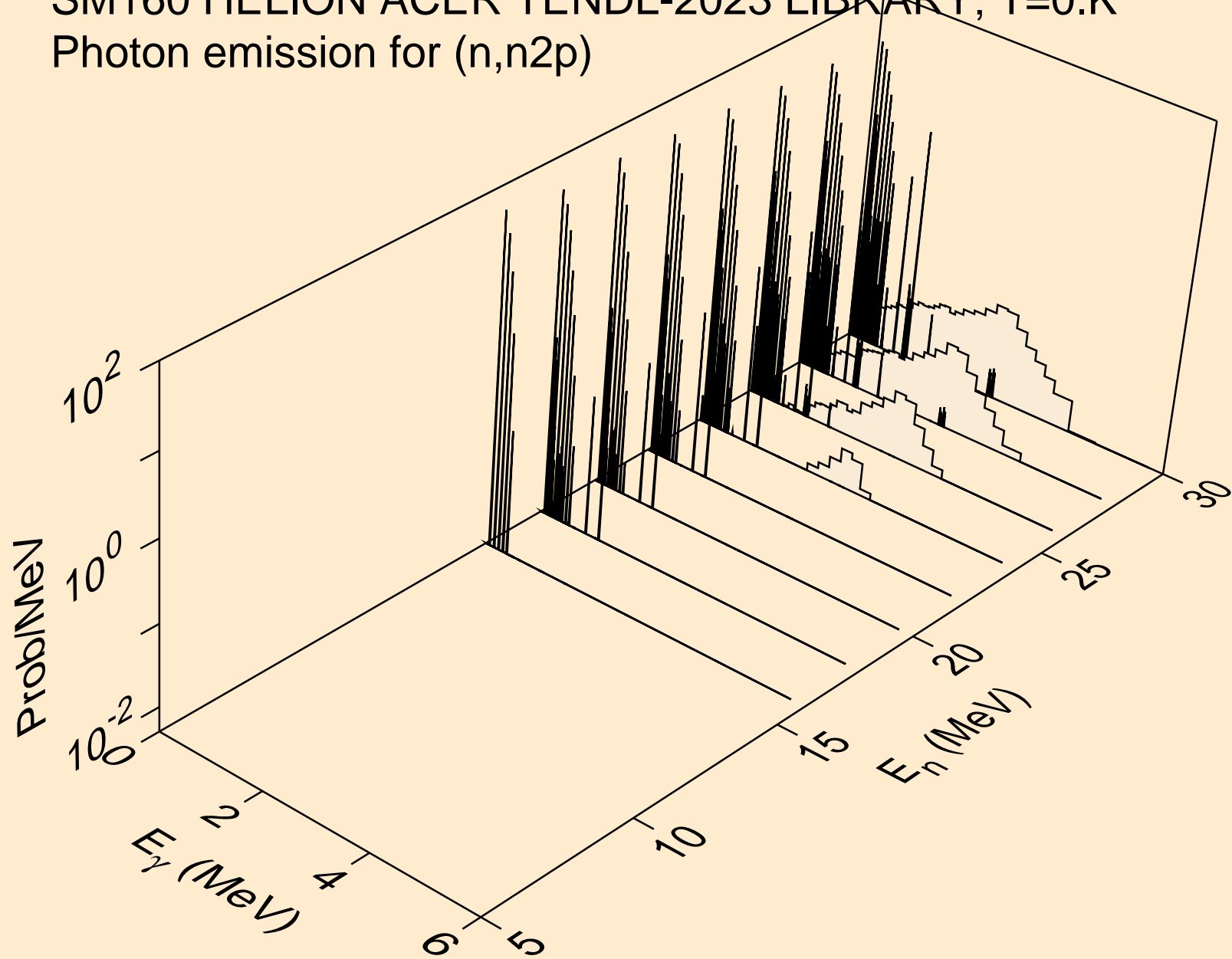



SM160 HELION ACER TENDL-2023 LIBRARY; T=0.K  
Photon emission for (n,npa)

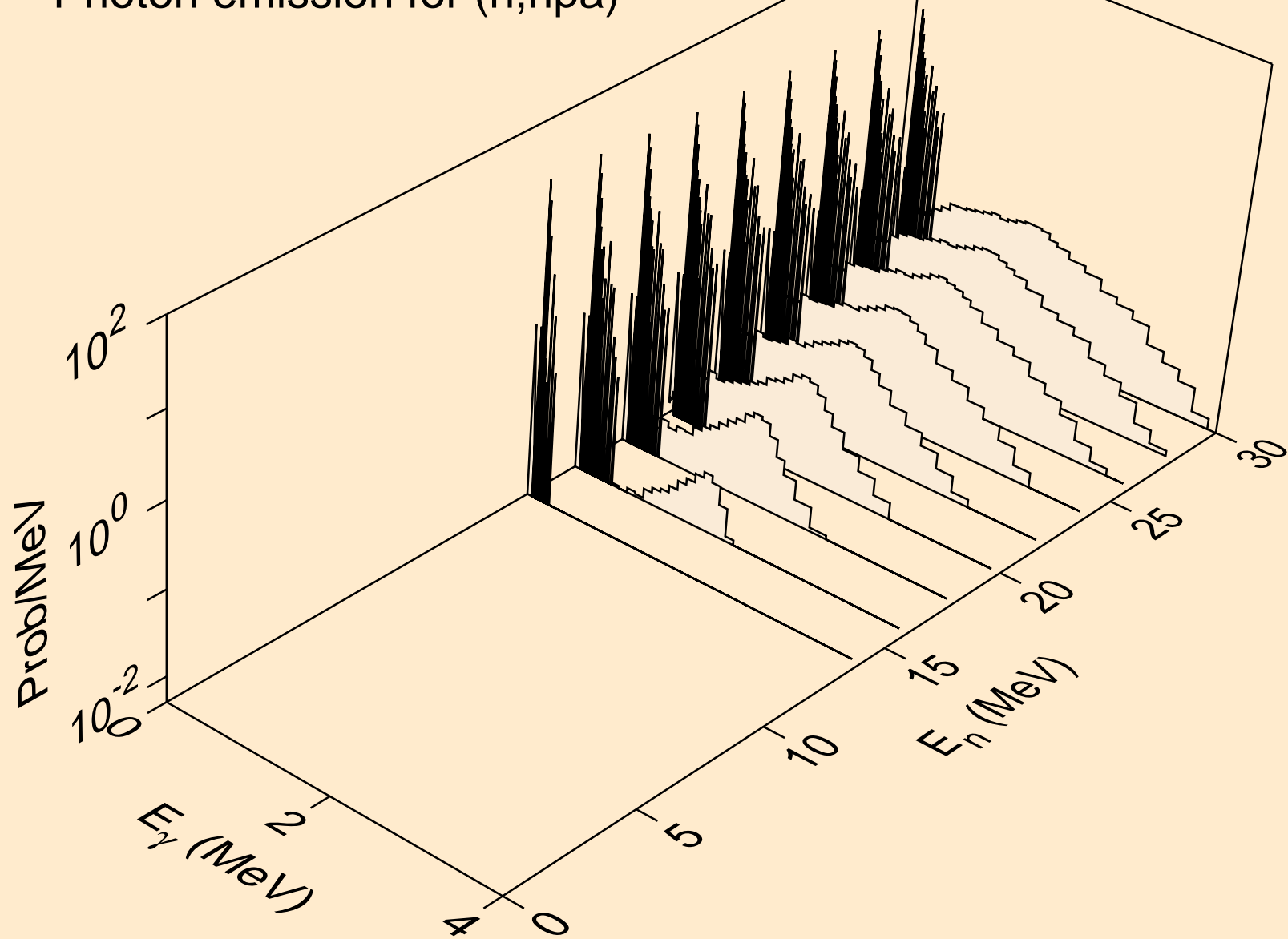

SM160 HELION ACER TENDL-2023 LIBRARY; T=0.K  
Photon emission for (n,p)

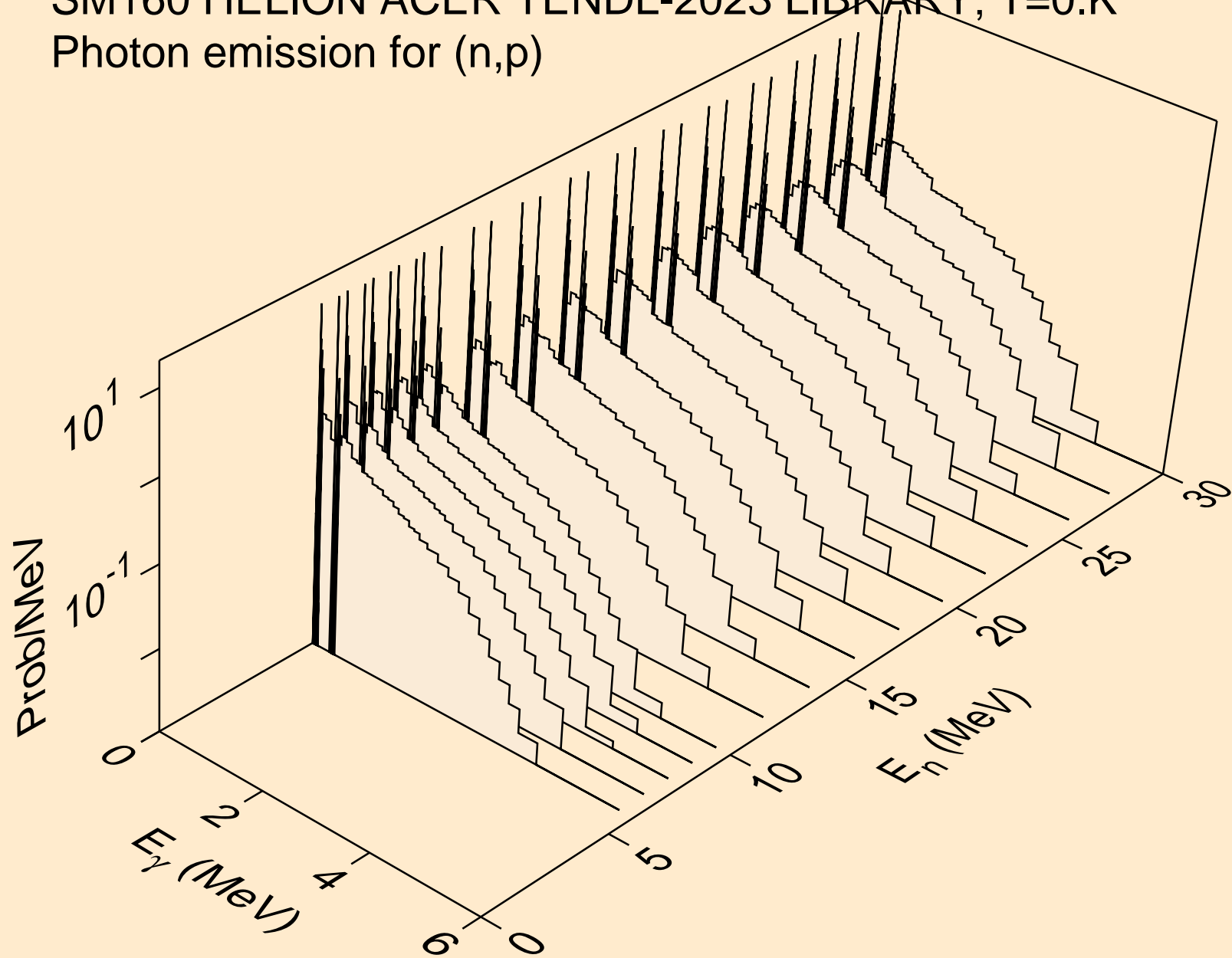

SM160 HELION ACER TENDL-2023 LIBRARY; T=0.K  
Photon emission for (n,d)

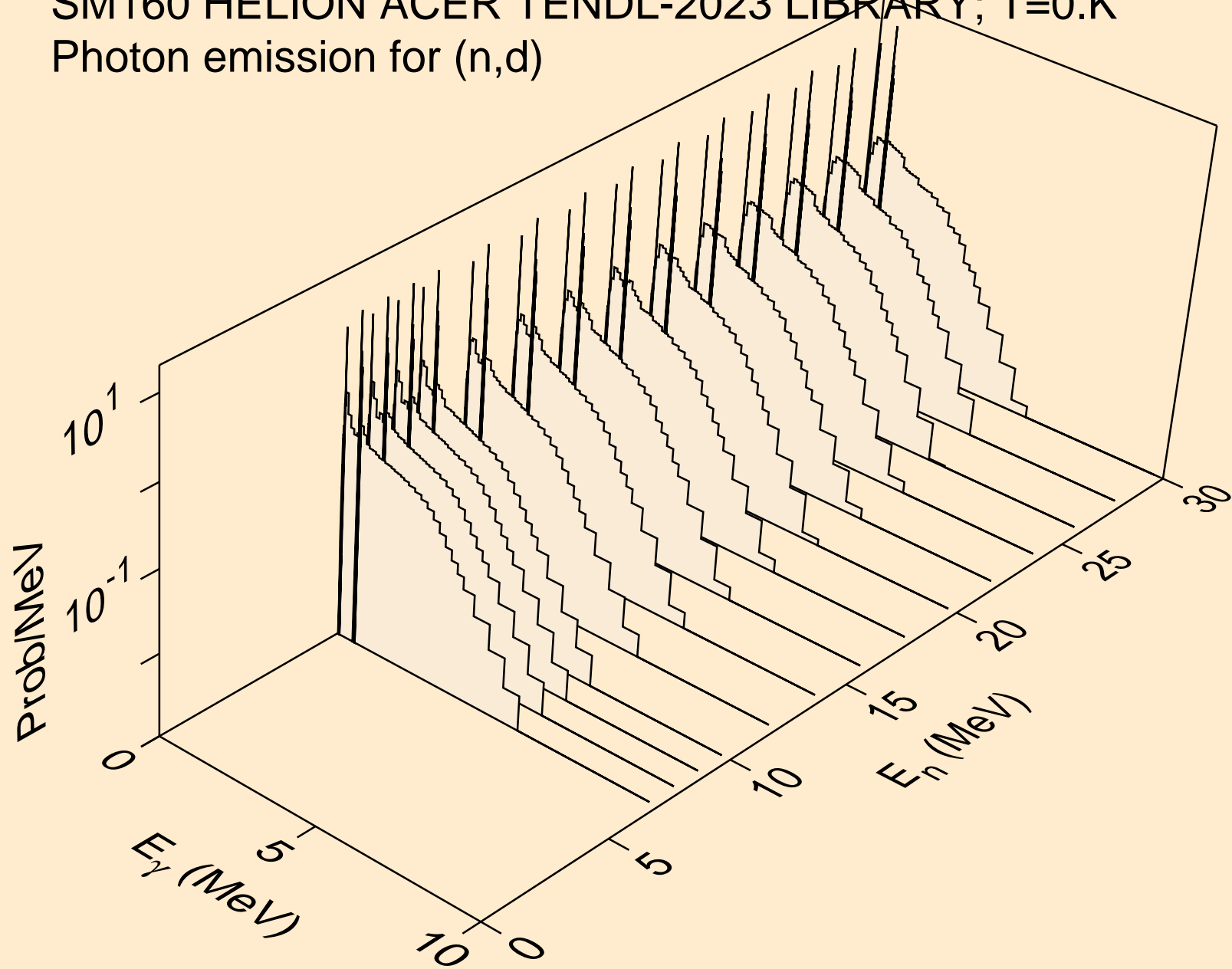

SM160 HELION ACER TENDL-2023 LIBRARY; T=0.K  
Photon emission for (n,t)

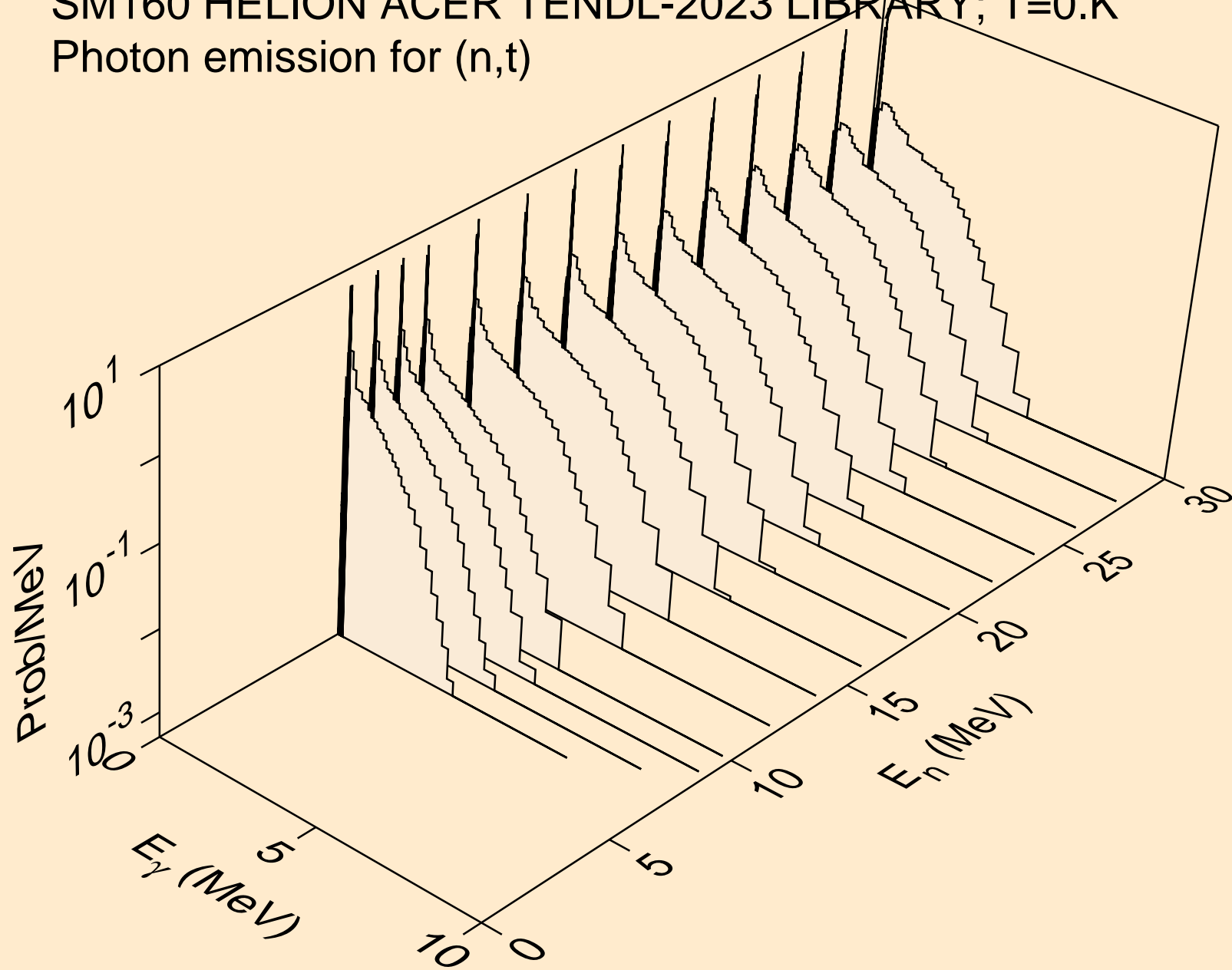

SM160 HELION ACER TENDL-2023 LIBRARY; T=0.K  
Photon emission for inelastic

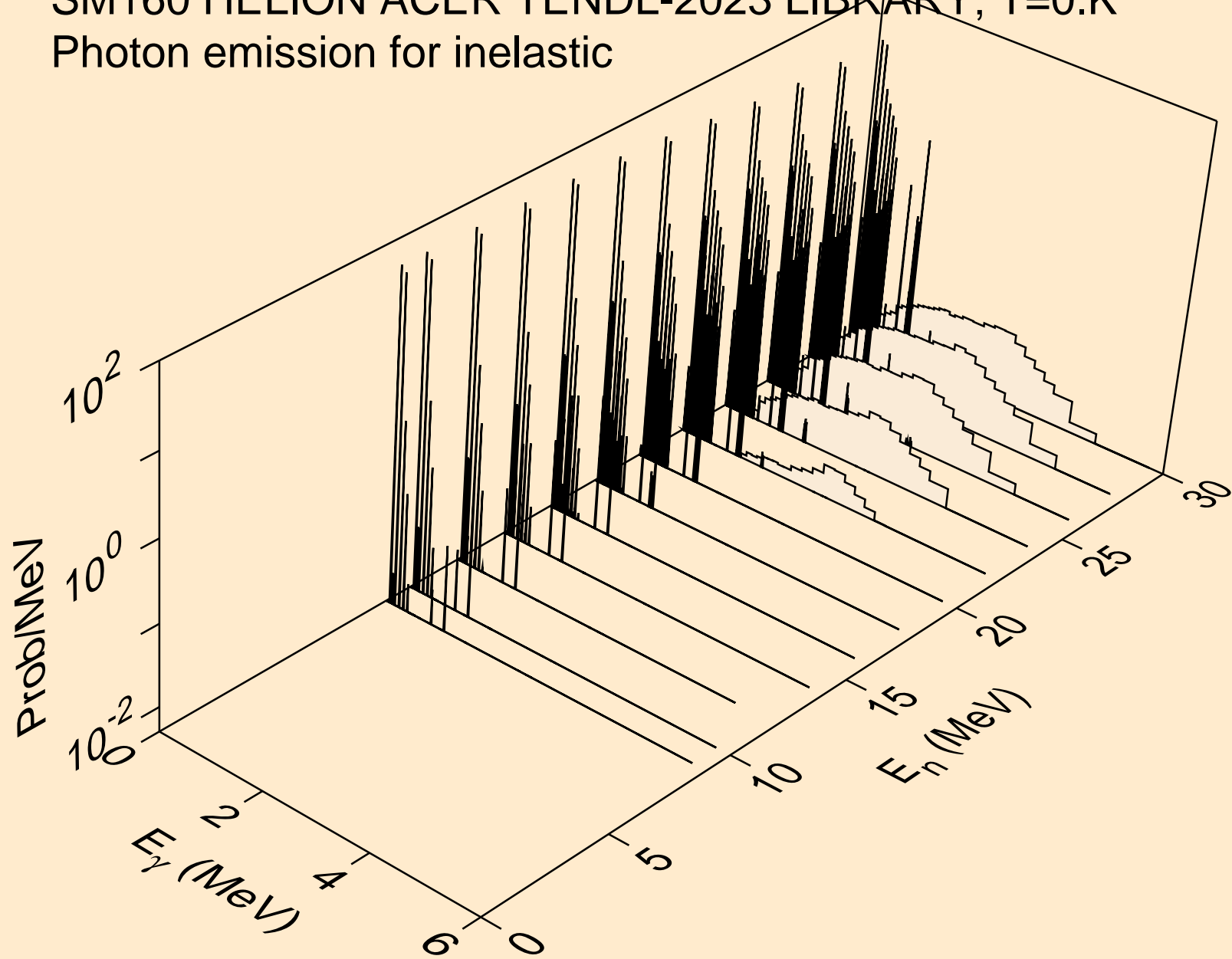

SM160 HELION ACER TENDL-2023 LIBRARY; T=0.K  
Photon emission for (n,a)

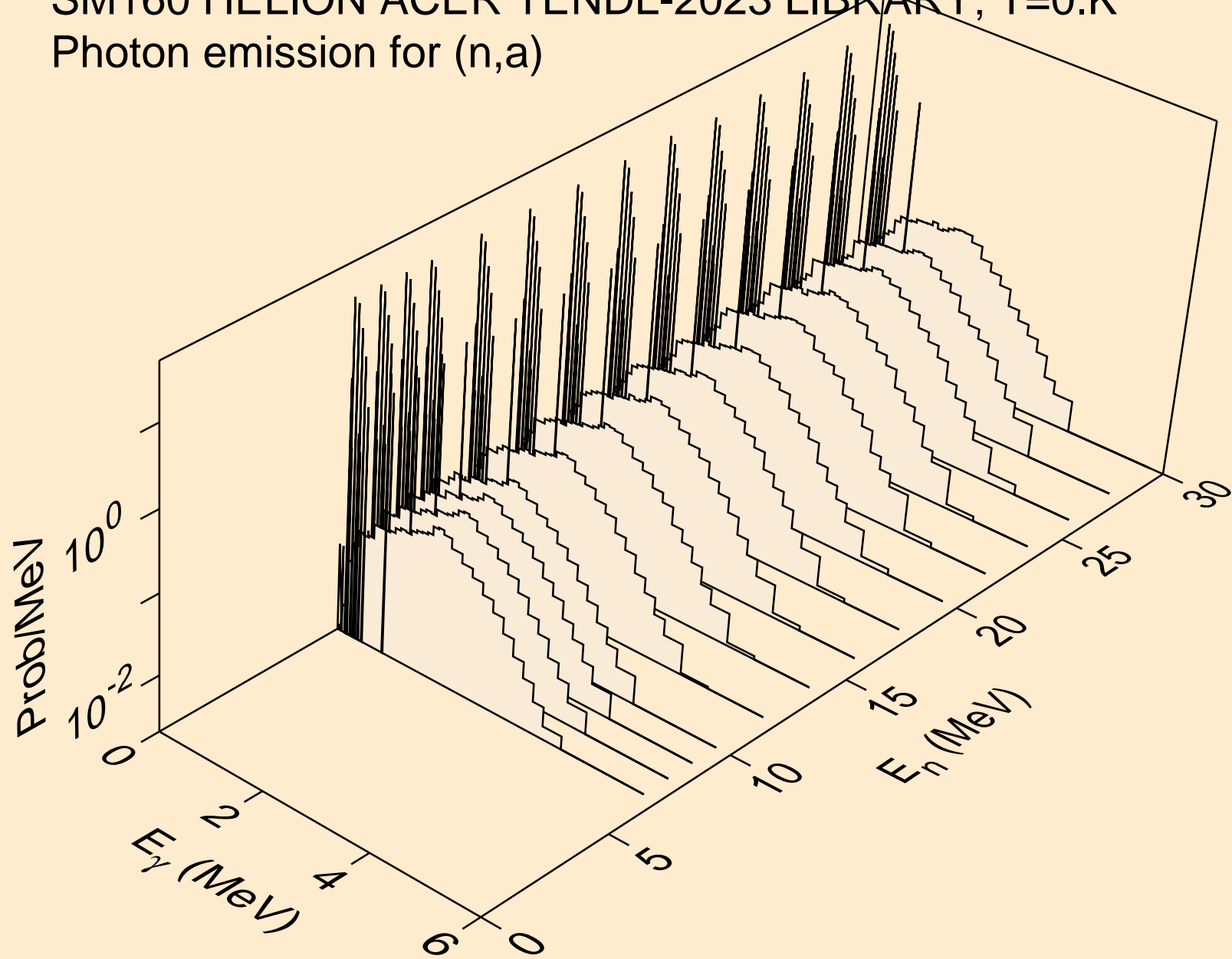

SM160 HELION ACER TENDL-2023 LIBRARY; T=0.K  
Photon emission for (n,2p)

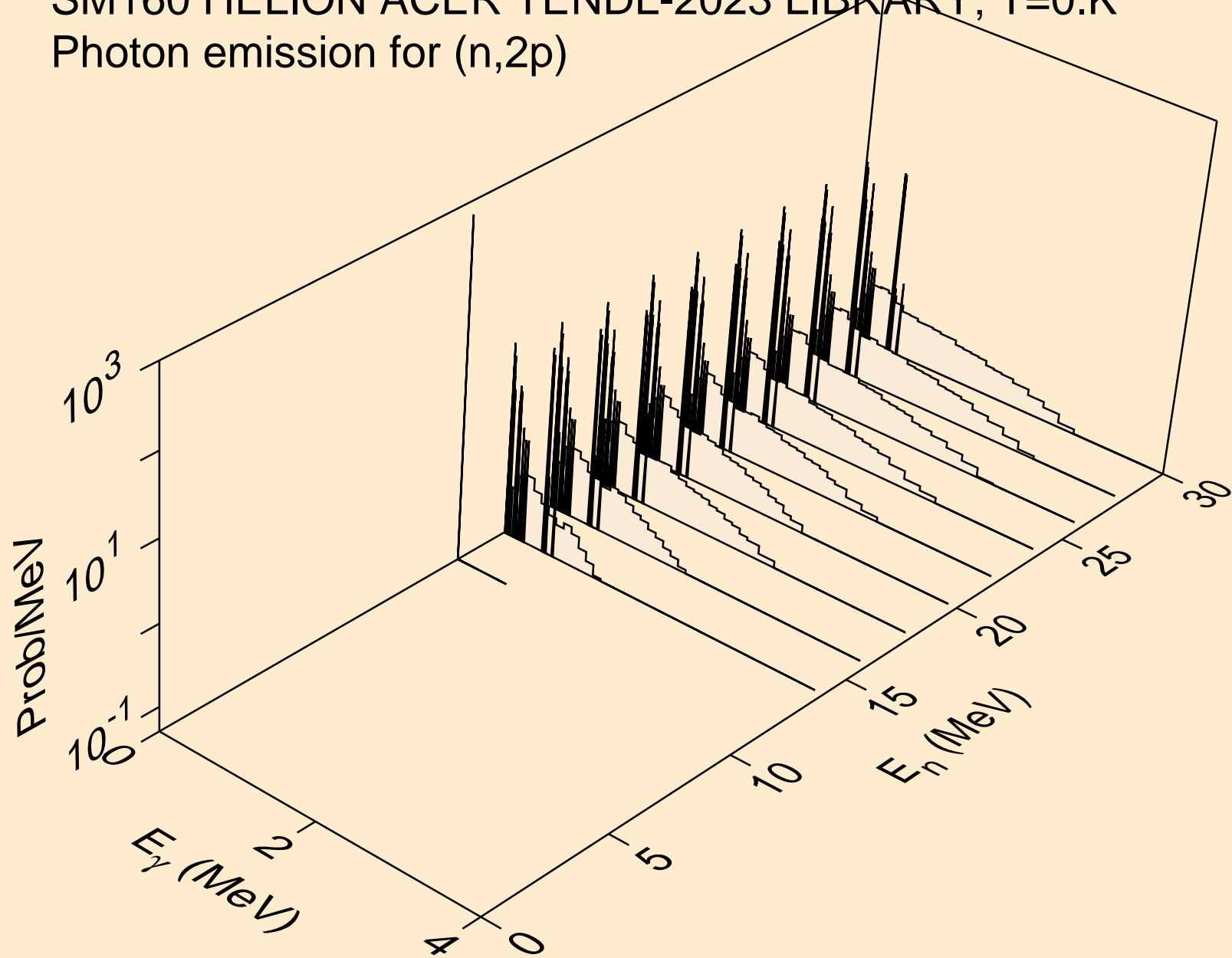

SM160 HELION ACER TENDL-2023 LIBRARY; T=0.K  
Photon emission for (n,pa)

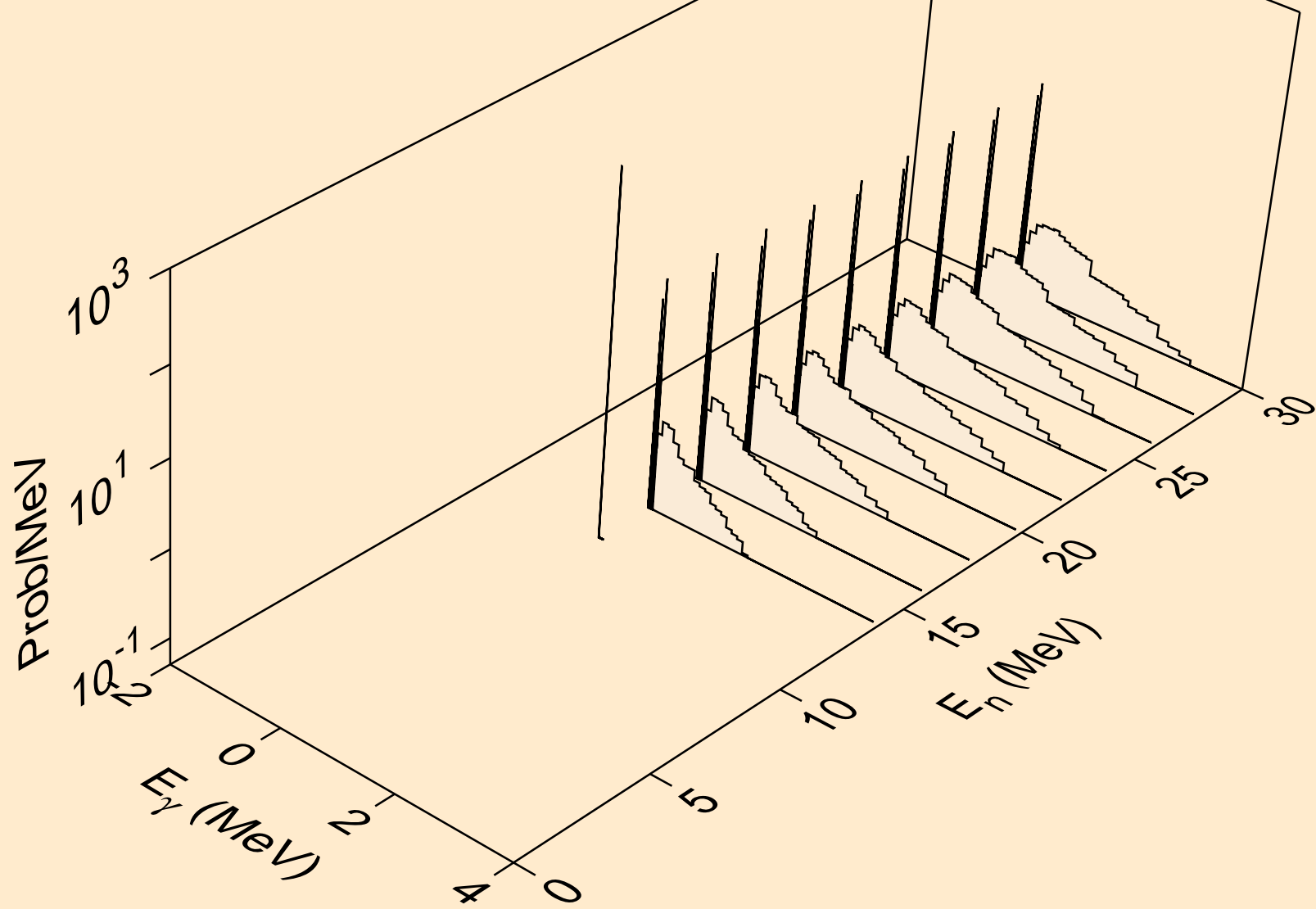



SM160 HELION ACER TENDL-2023 LIBRARY; T=0.K  
Photon emission for (n,pd)

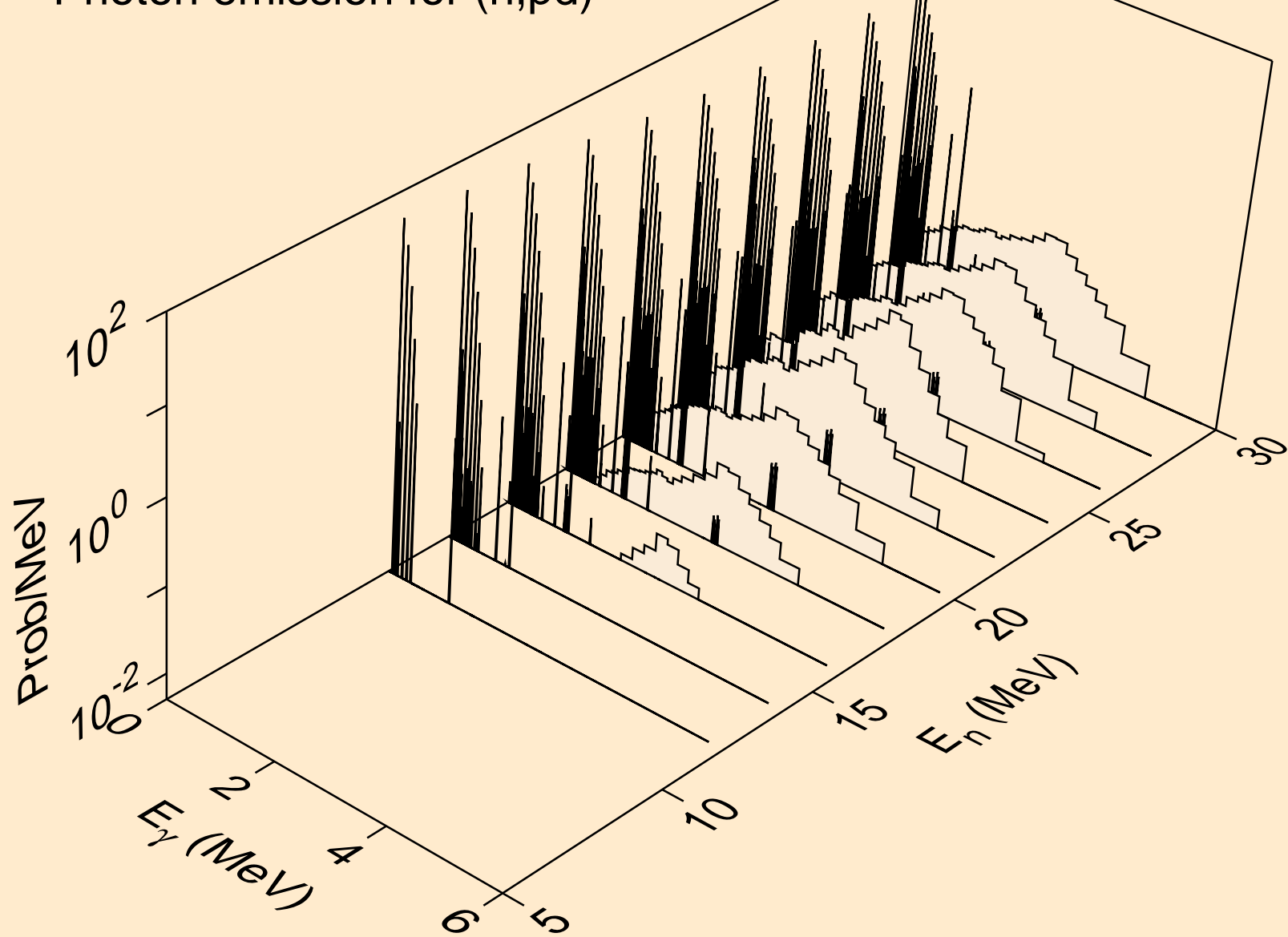

SM160 HELION ACER TENDL-2023 LIBRARY; T=0.K  
Photon emission for (n,pt)

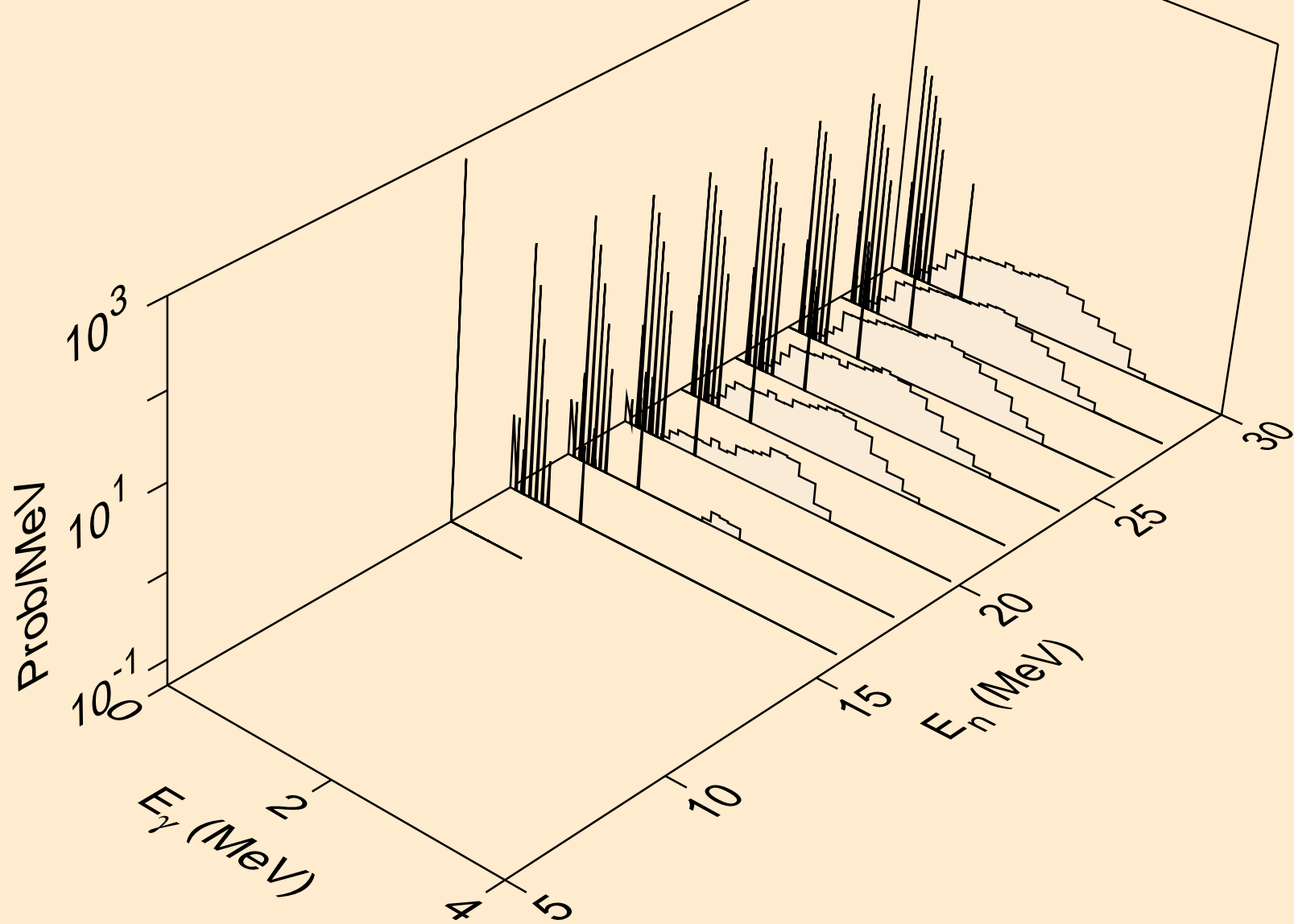

# SM160 HELION ACER TENDL-2023 LIBRARY; T=0.K

## Particle heating contributions

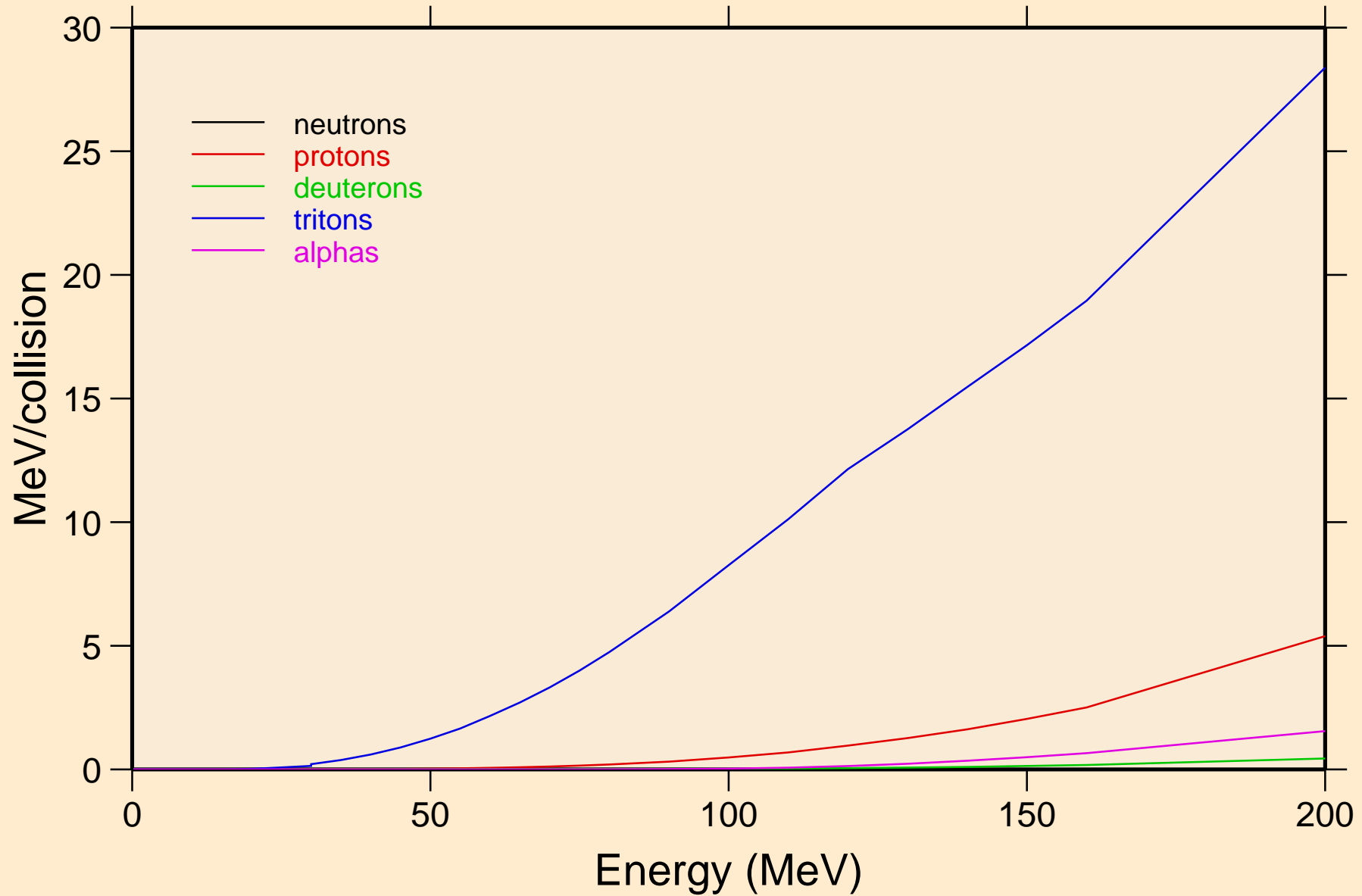

SM160 HELION ACER TENDL-2023 LIBRARY; T=0.K  
Recoil Heating

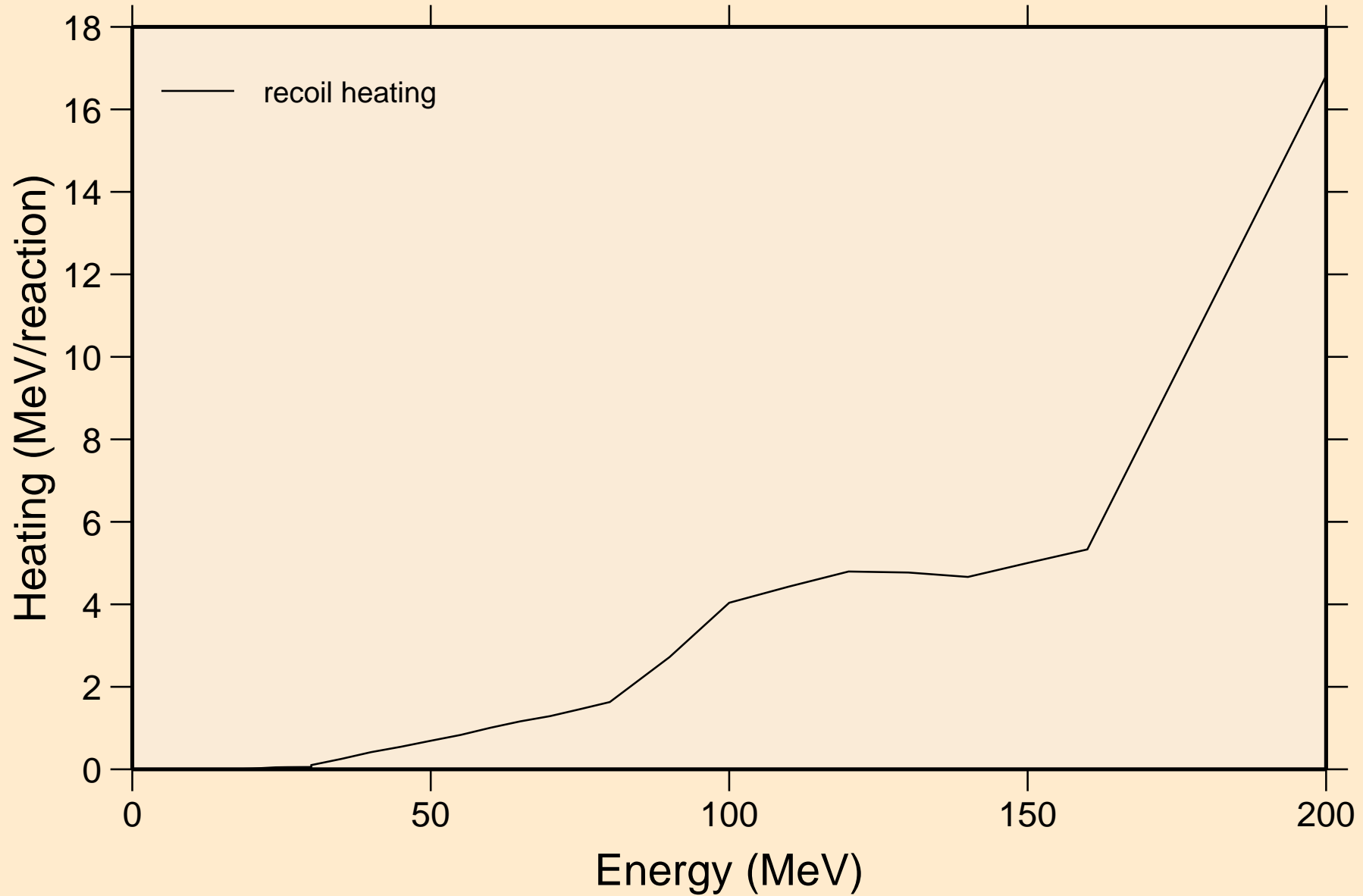

SM160 HELION ACER TENDL-2023 LIBRARY; T=0.K  
Particle production cross sections

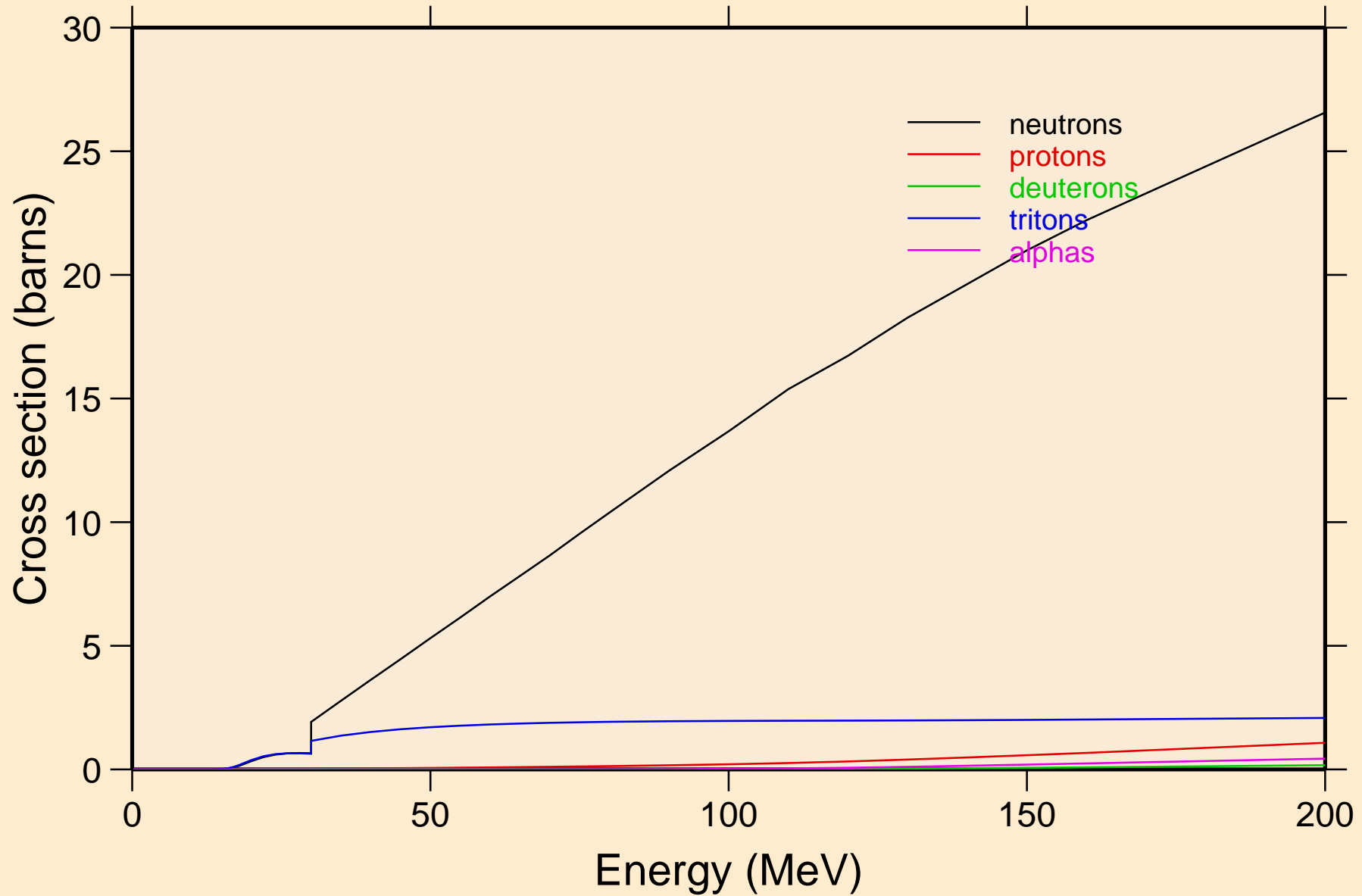

SM160 HELION ACER TENDL-2023 LIBRARY; T=0.K  
neutrons from (s,n)

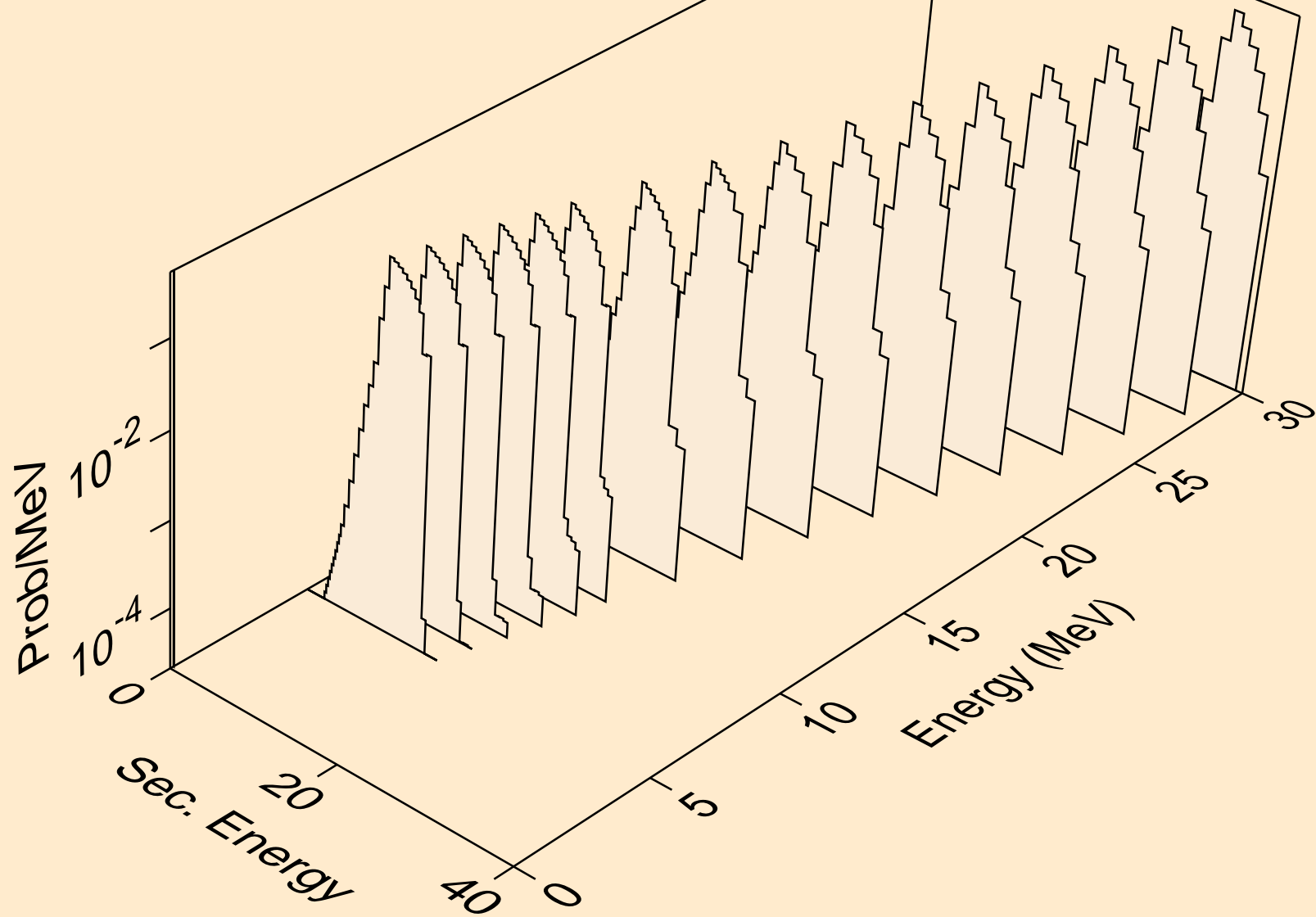

SM160 HELION ACER TENDL-2023 LIBRARY; T=0.K  
neutrons from (s,x)

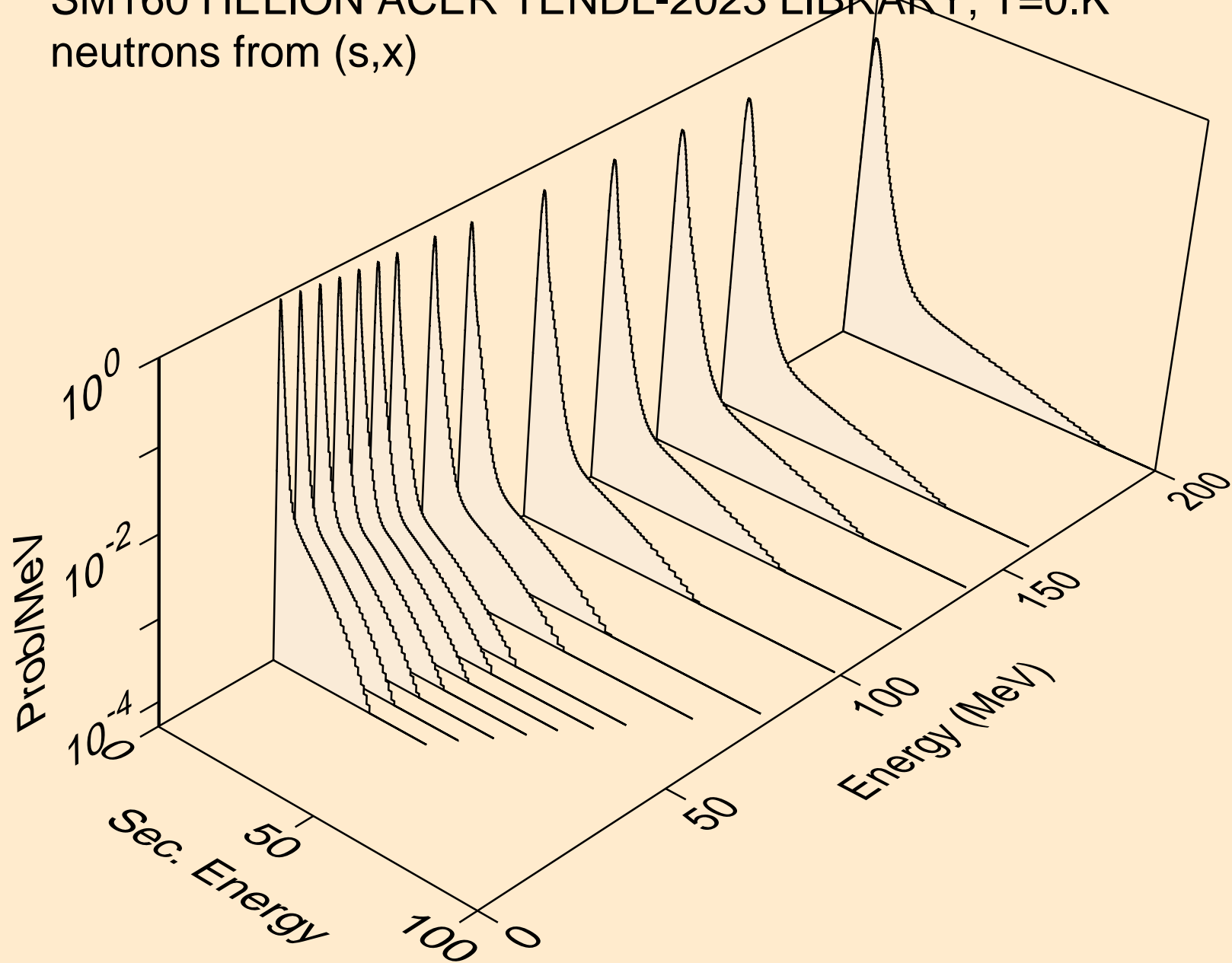

SM160 HELION ACER TENDL-2023 LIBRARY; T=0.K  
neutrons from (s,2nd)

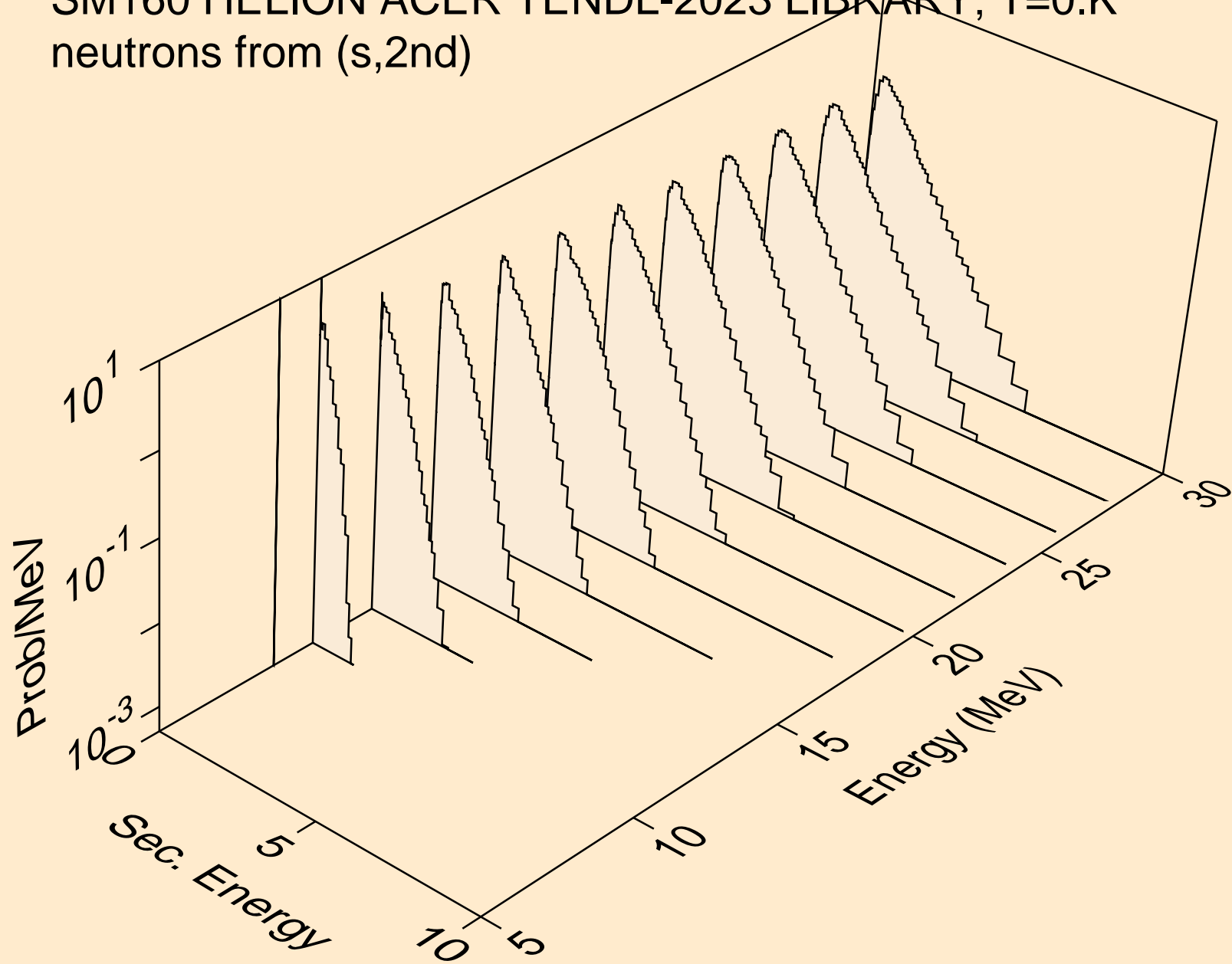



SM160 HELION ACER TENDL-2023 LIBRARY; T=0.K  
neutrons from (s,2n)

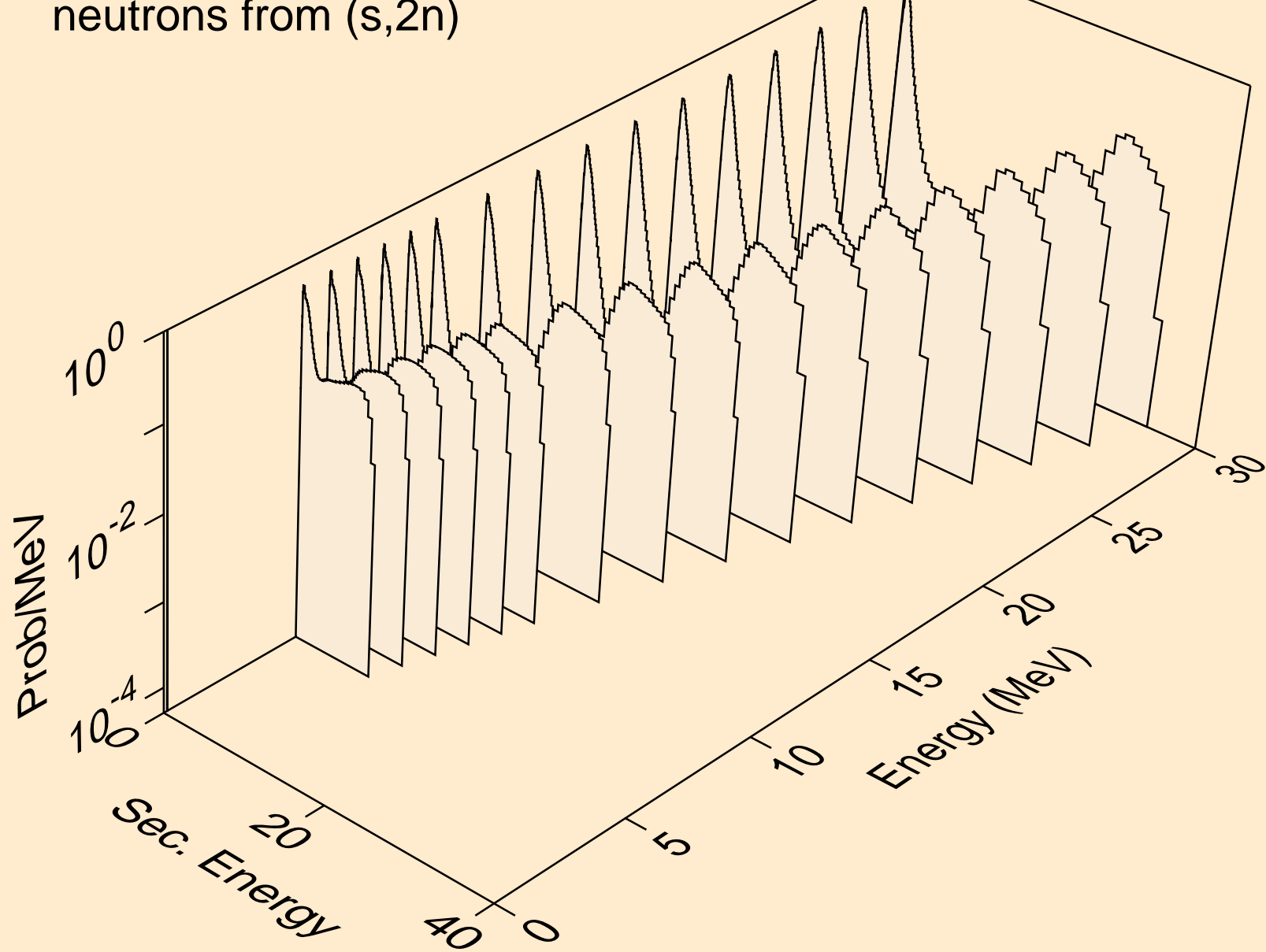

SM160 HELION ACER TENDL-2023 LIBRARY; T=0.K  
neutrons from (s,3n)

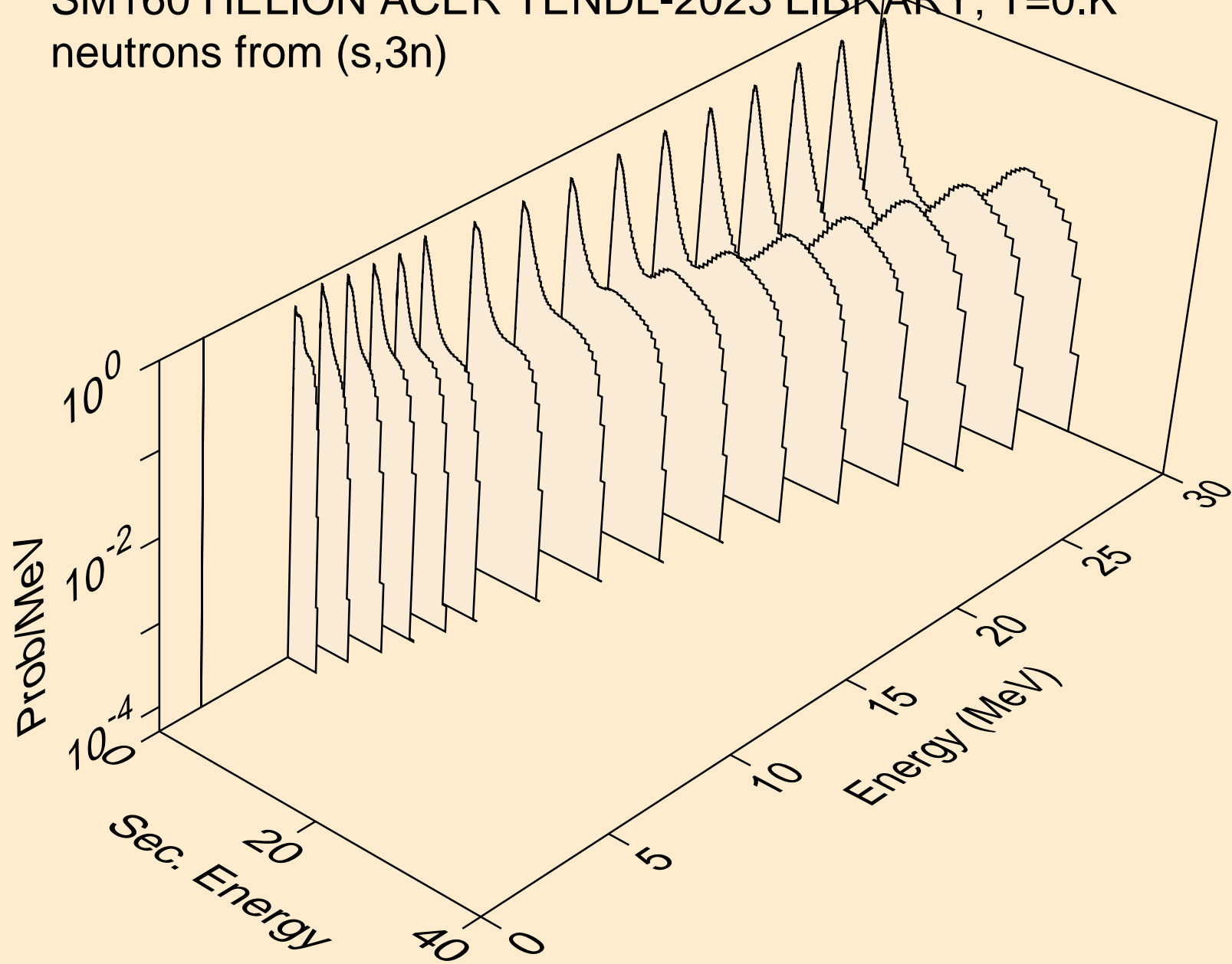

SM160 HELION ACER TENDL-2023 LIBRARY; T=0.K  
neutrons from (s,n\*)a

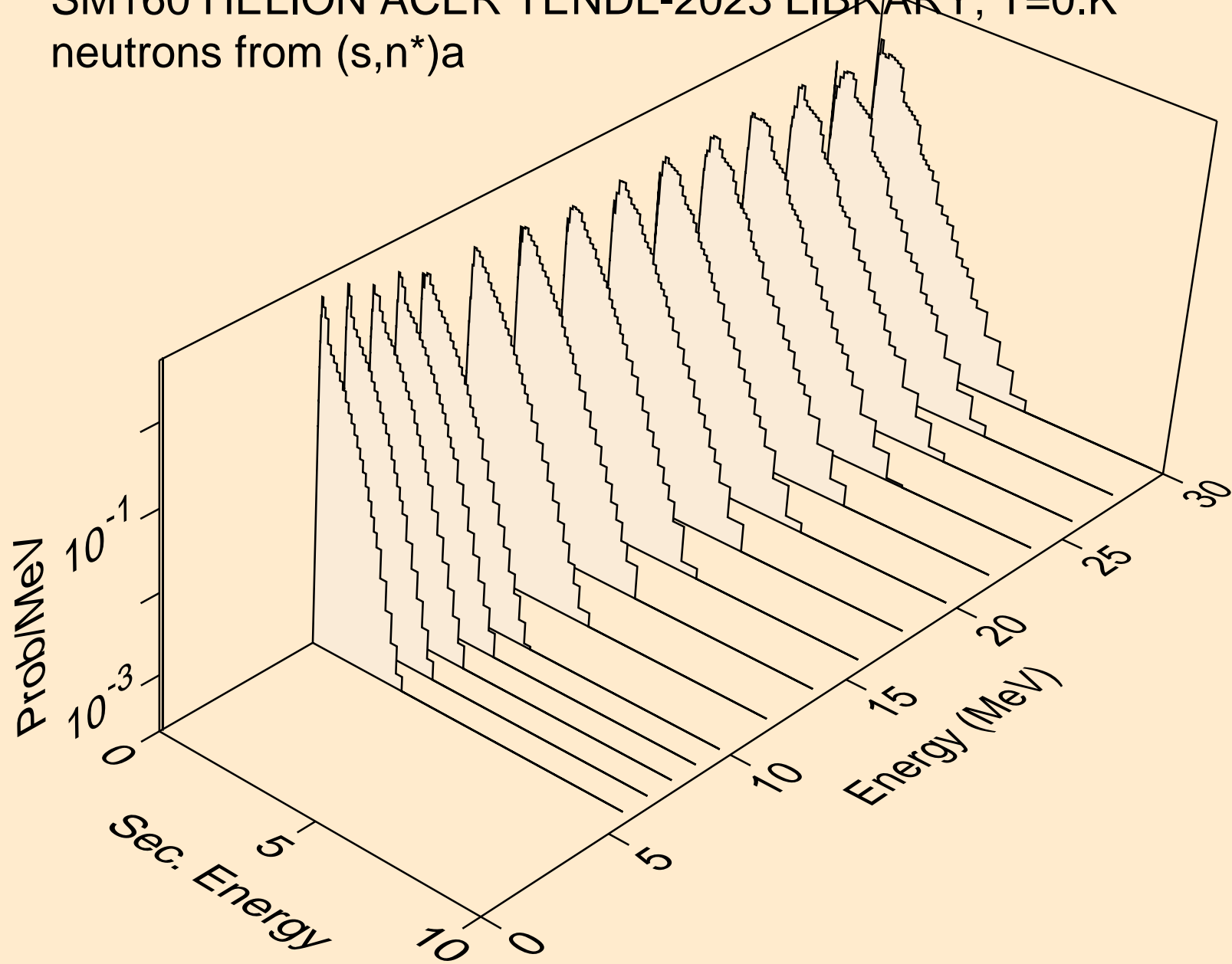

SM160 HELION ACER TENDL-2023 LIBRARY; T=0.K  
neutrons from (s,2n)a

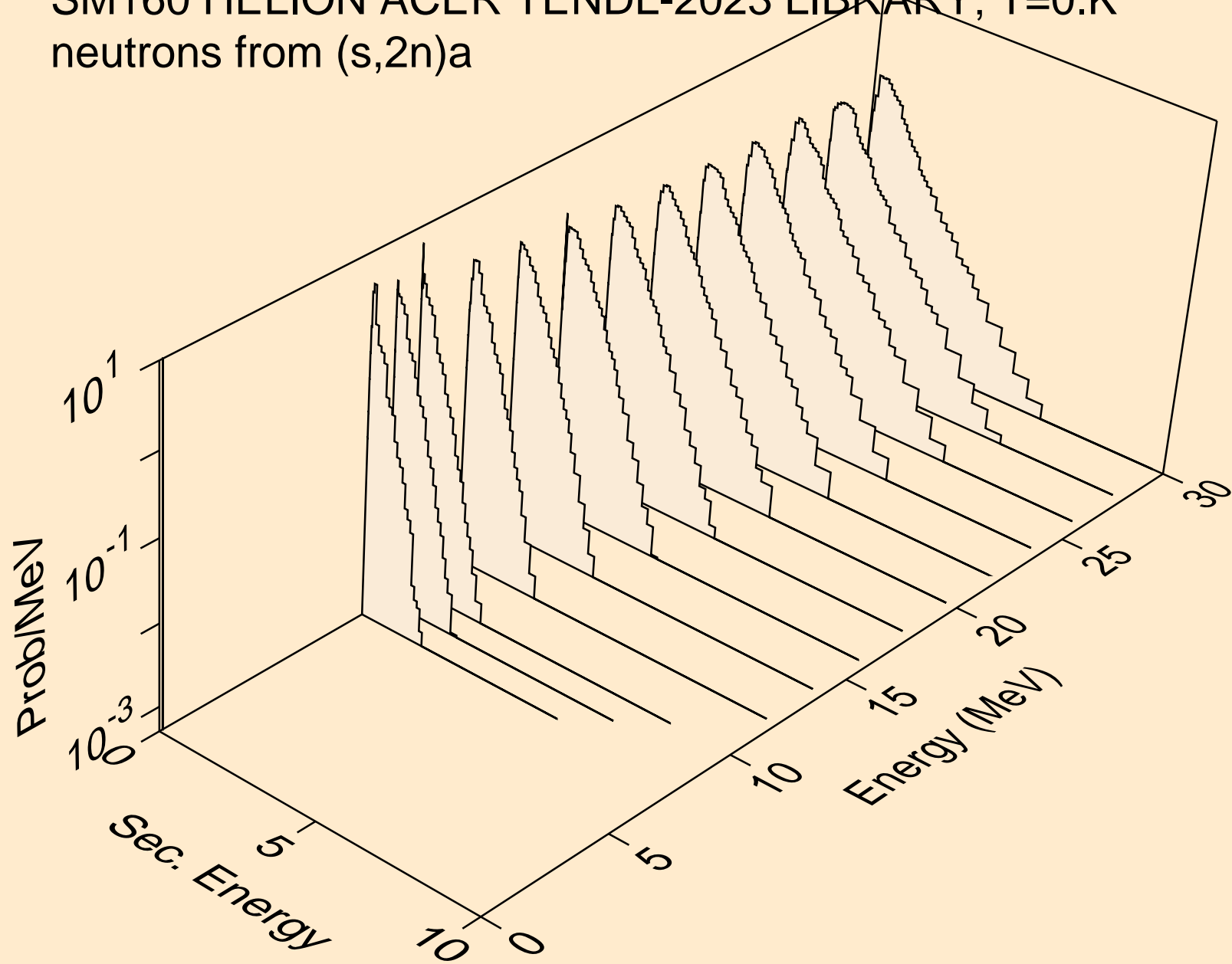

SM160 HELION ACER TENDL-2023 LIBRARY; T=0.K  
neutrons from (s,3n)a

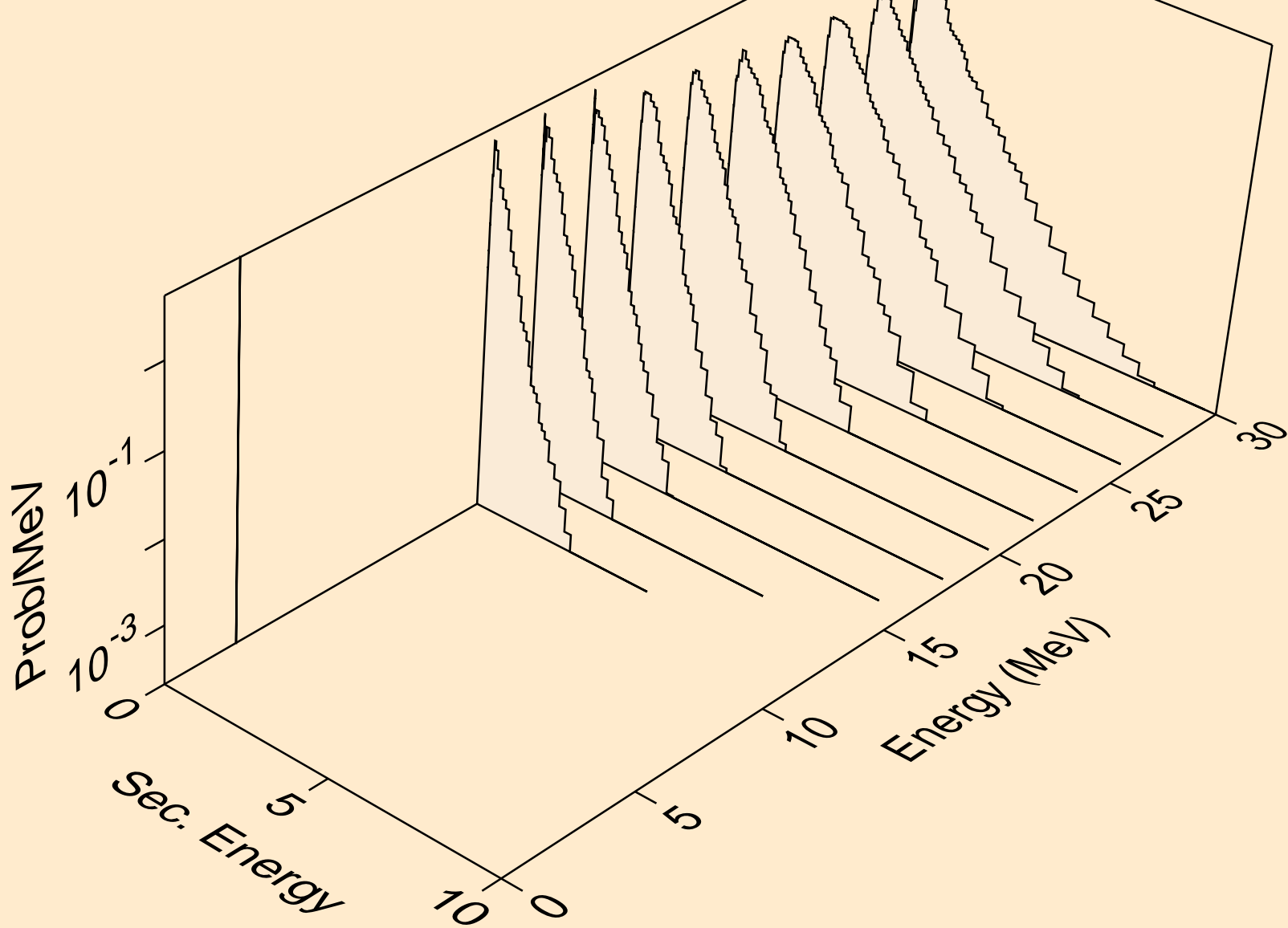

SM160 HELION ACER TENDL-2023 LIBRARY; T=0.K  
neutrons from (s,n\*)p

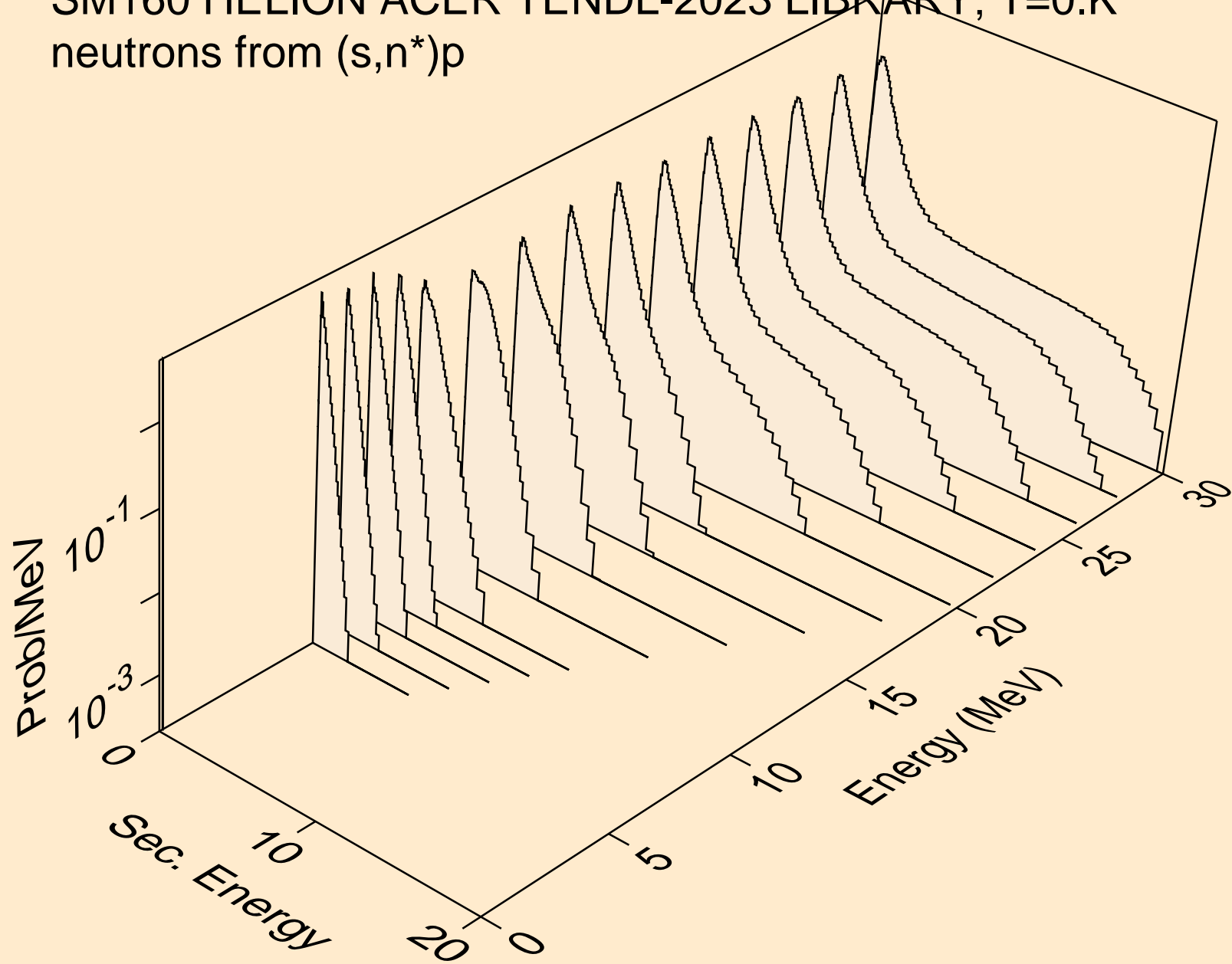

SM160 HELION ACER TENDL-2023 LIBRARY; T=0.K  
neutrons from (s,n\*)d

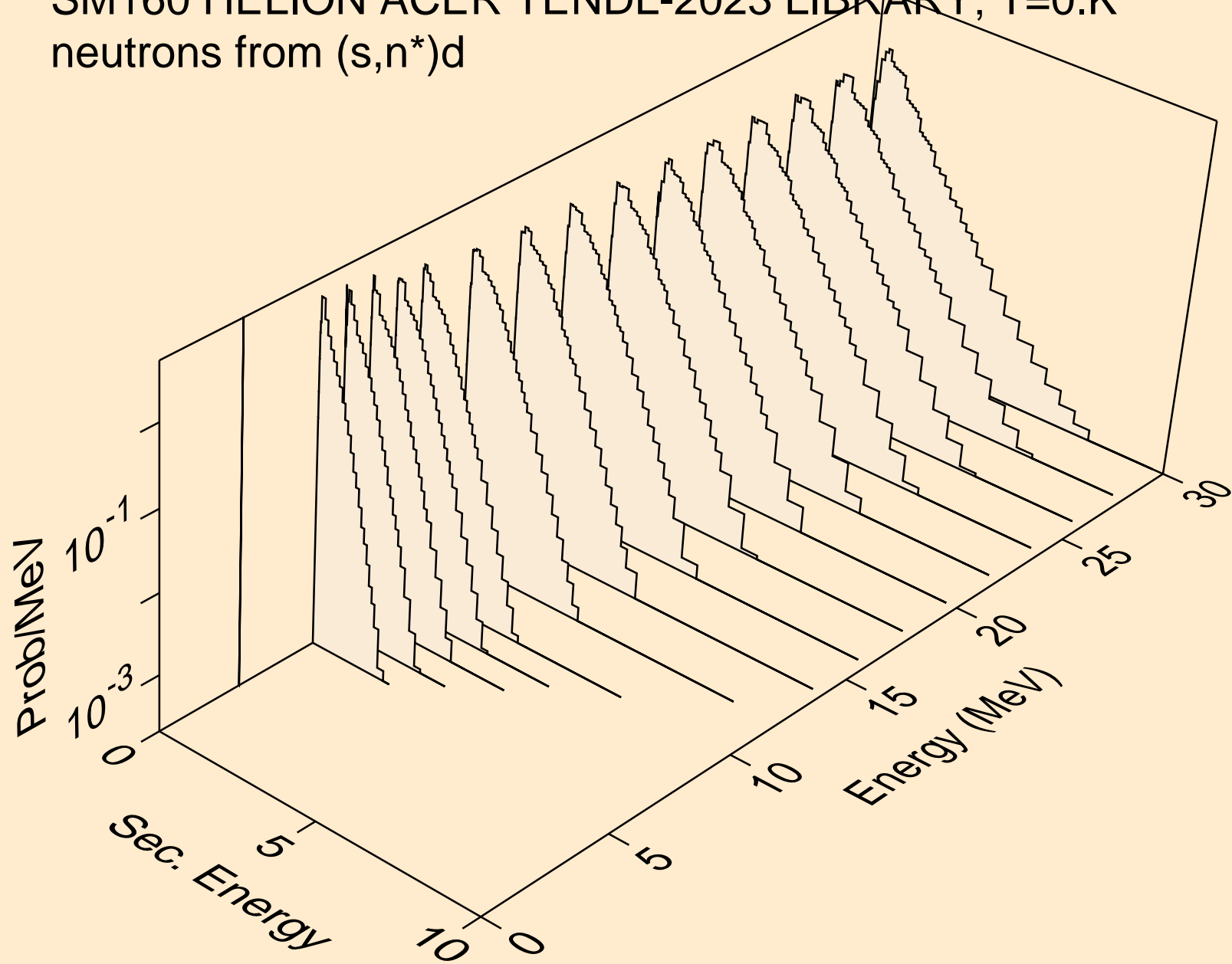

SM160 HELION ACER TENDL-2023 LIBRARY; T=0.K  
neutrons from (s,n\*)t

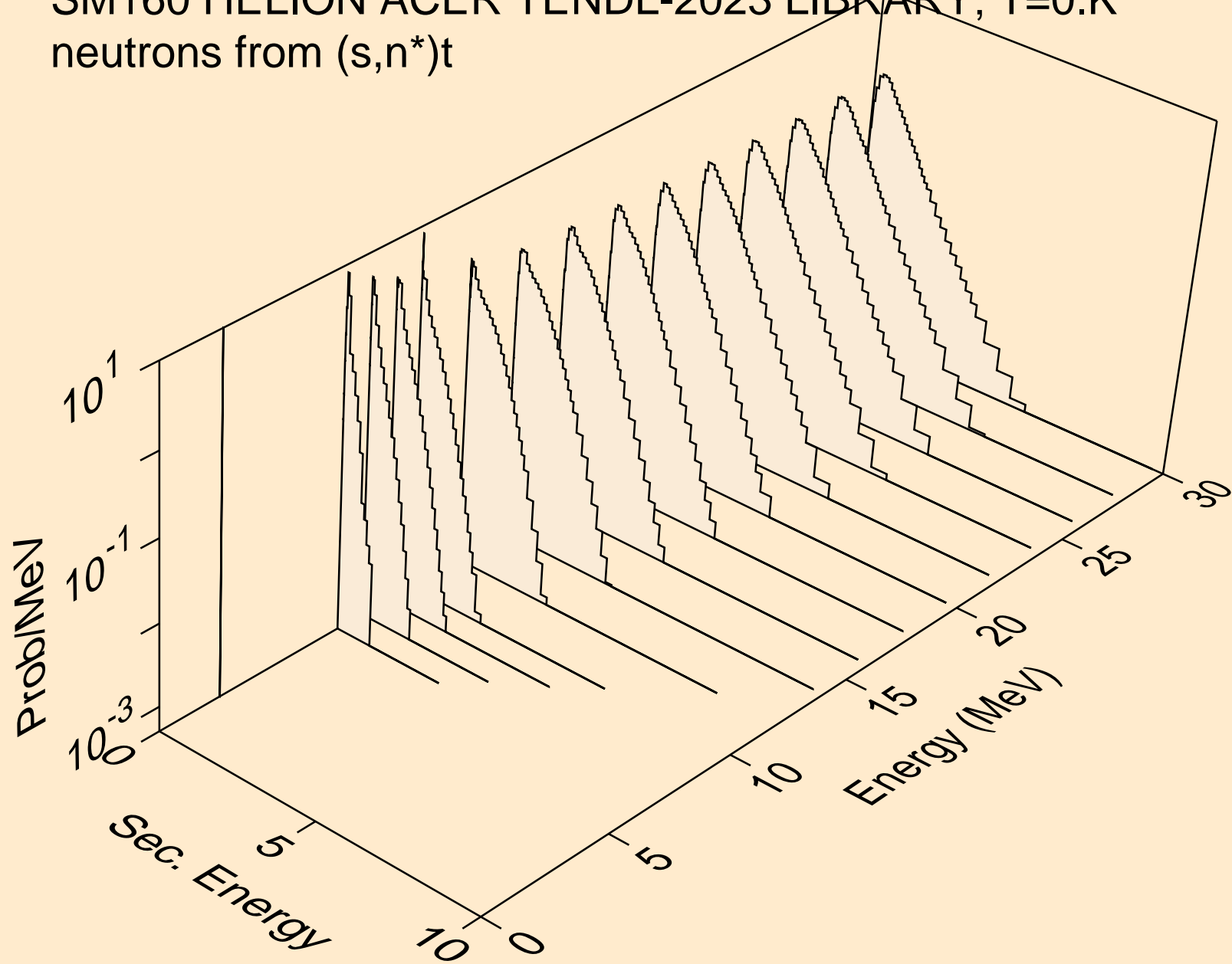



SM160 HELION ACER TENDL-2023 LIBRARY; T=0.K  
neutrons from (s,n\*)he3

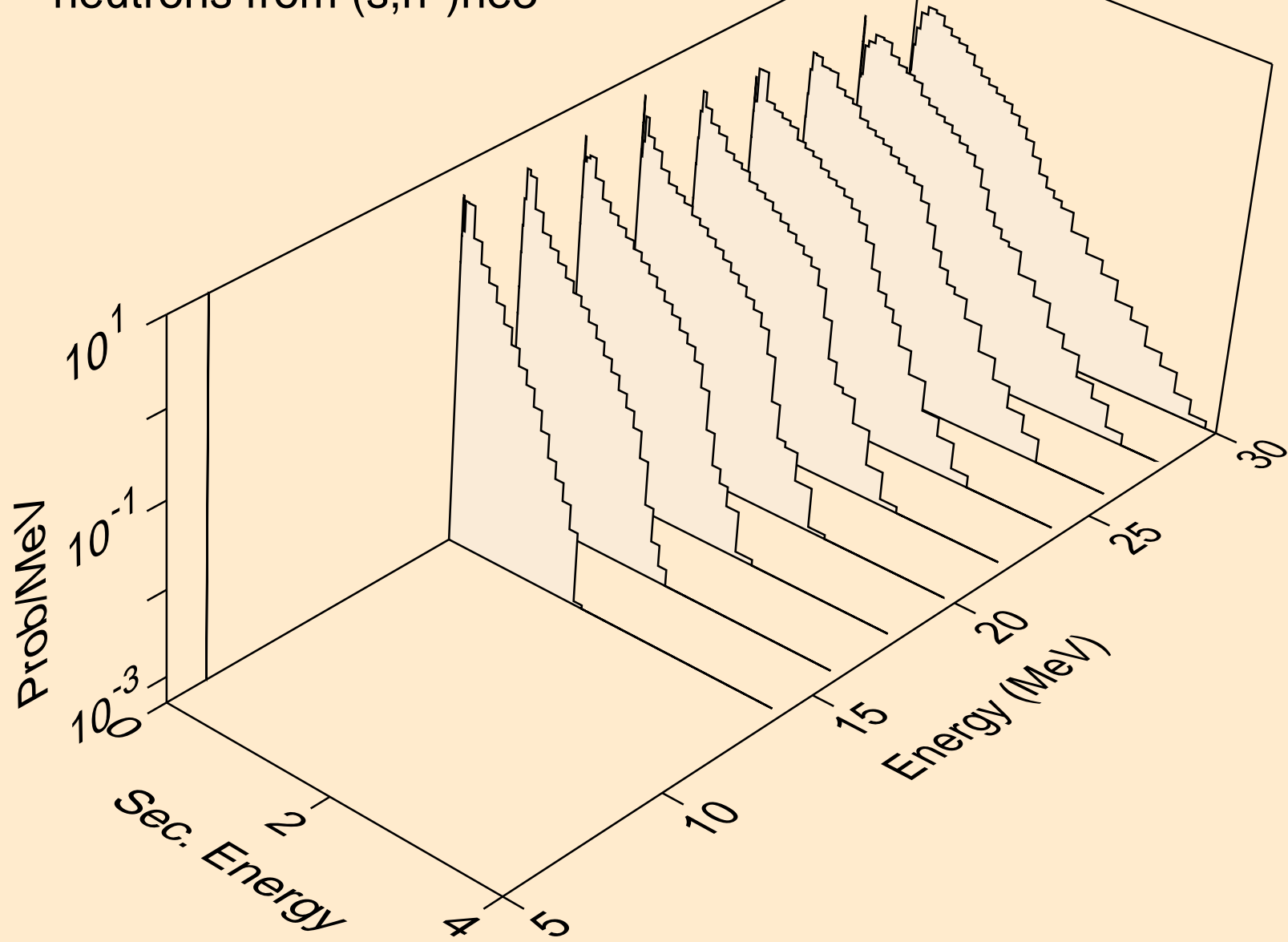

SM160 HELION ACER TENDL-2023 LIBRARY; T=0.K  
neutrons from (s,4n)

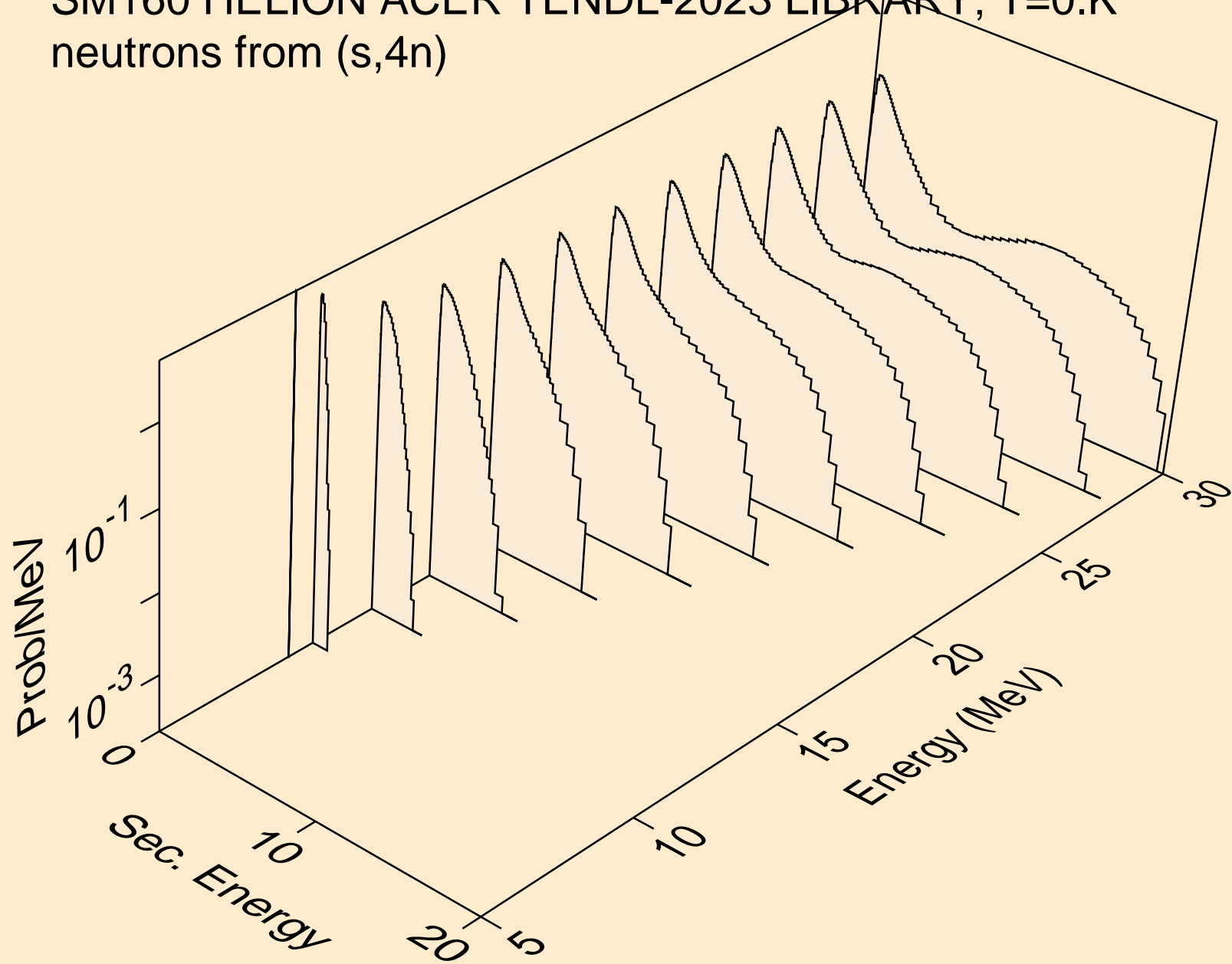

SM160 HELION ACER TENDL-2023 LIBRARY; T=0.K  
neutrons from (s,2np)

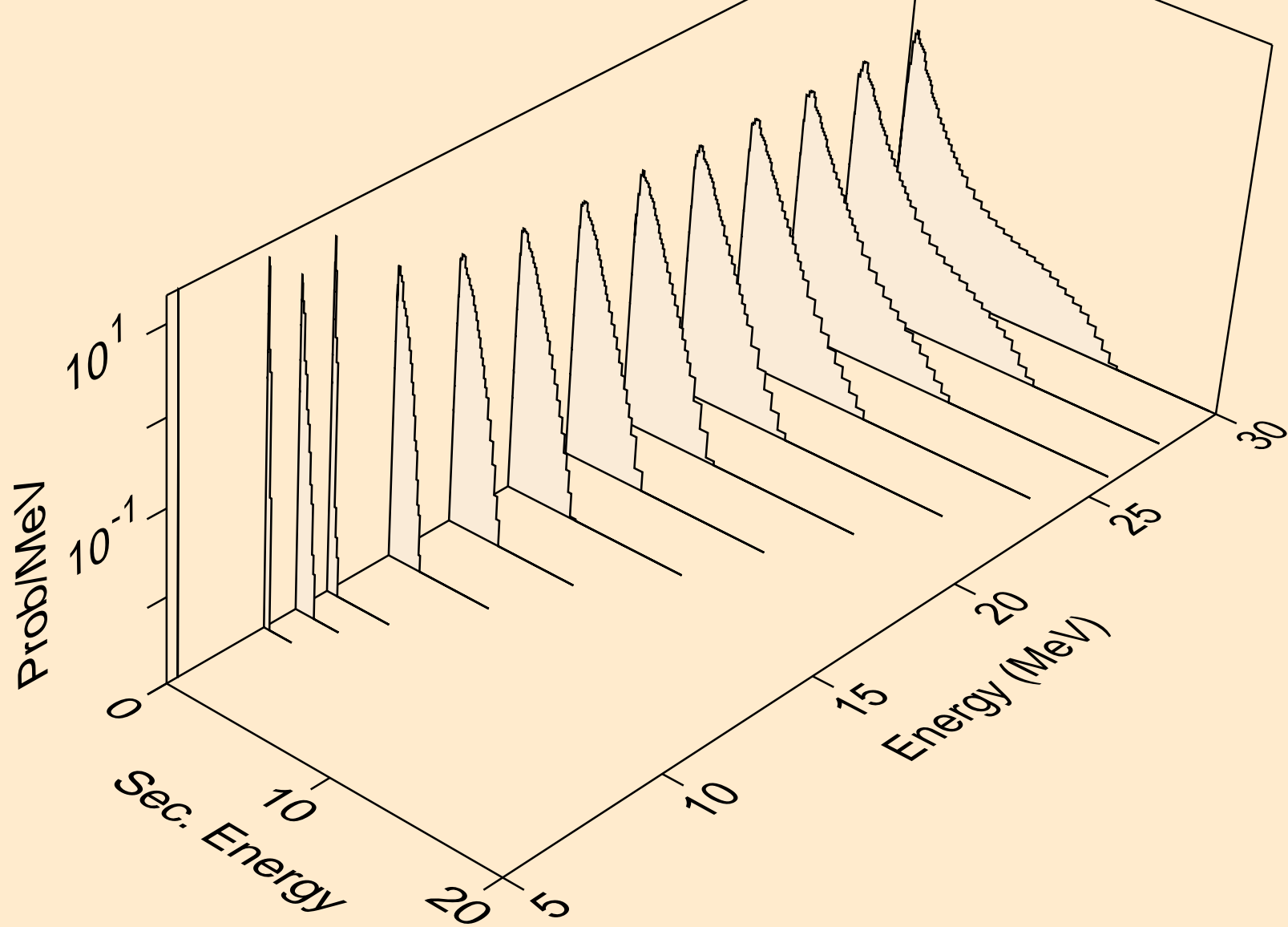

SM160 HELION ACER TENDL-2023 LIBRARY; T=0.K  
neutrons from (s,3np)

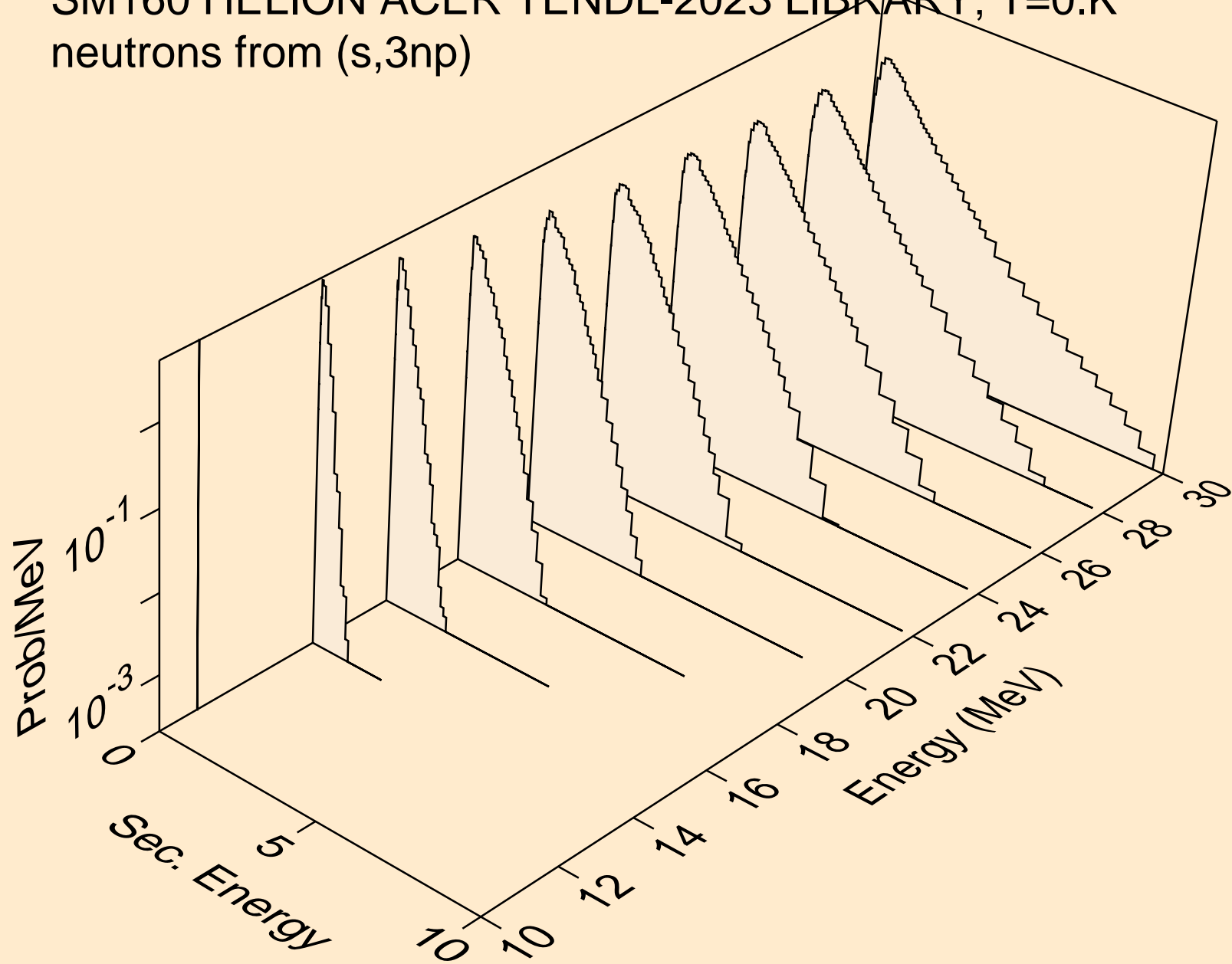

SM160 HELION ACER TENDL-2023 LIBRARY; T=0.K  
neutrons from (s,n2p)

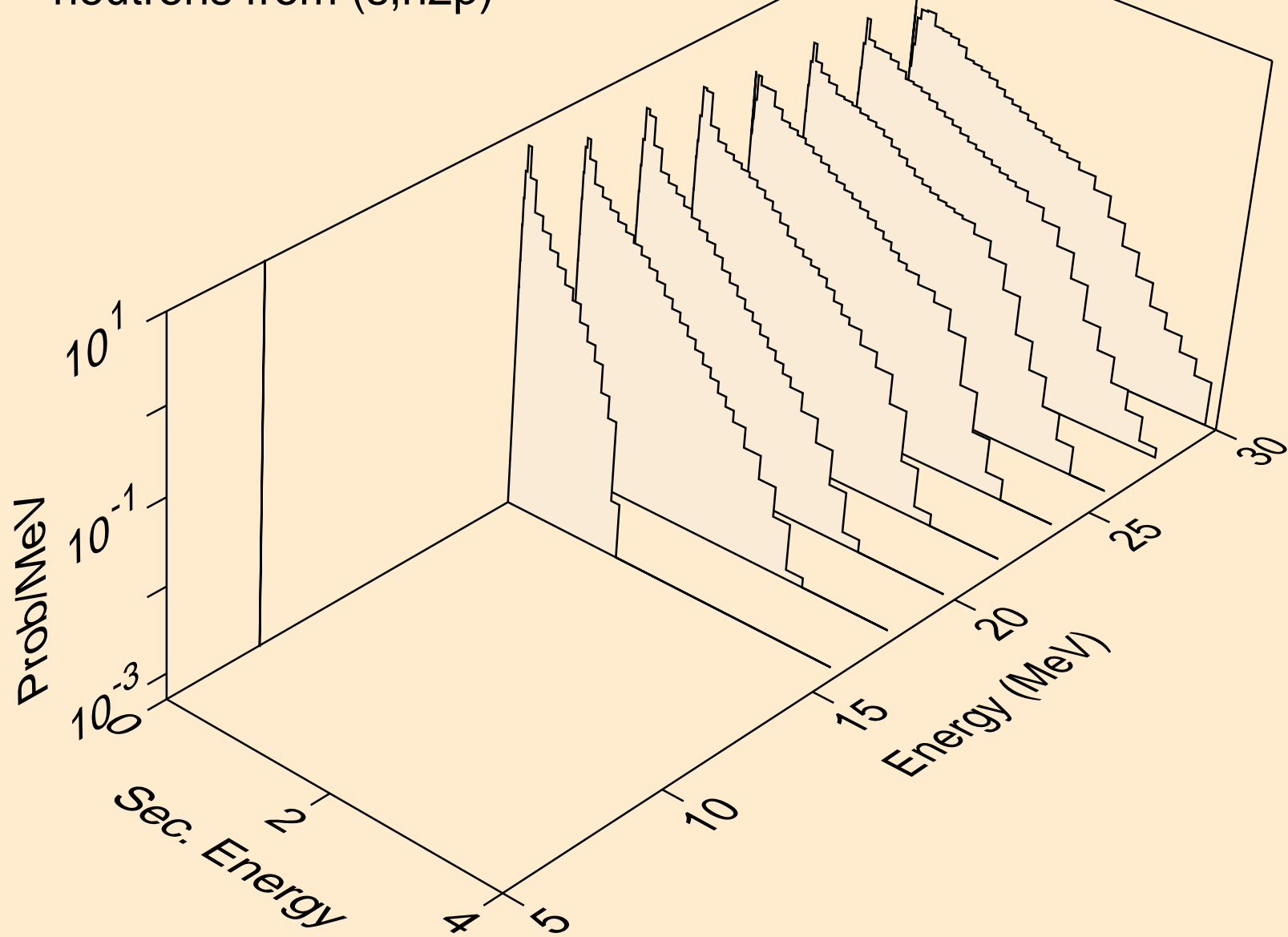

SM160 HELION ACER TENDL-2023 LIBRARY; T=0.K  
neutrons from (s,npa)

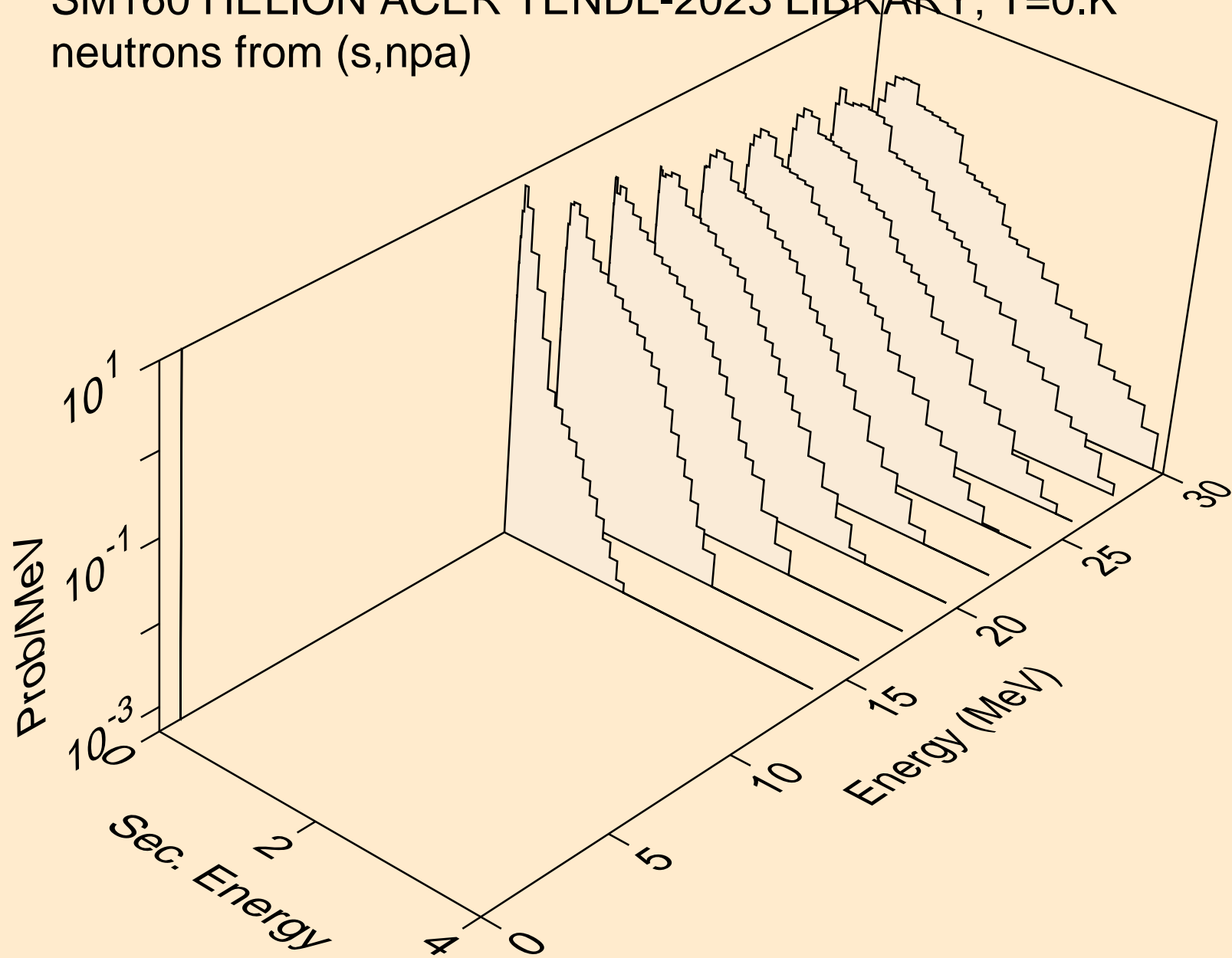

SM160 HELION ACER TENDL-2023 LIBRARY; T=0.K  
protons from (s,x)

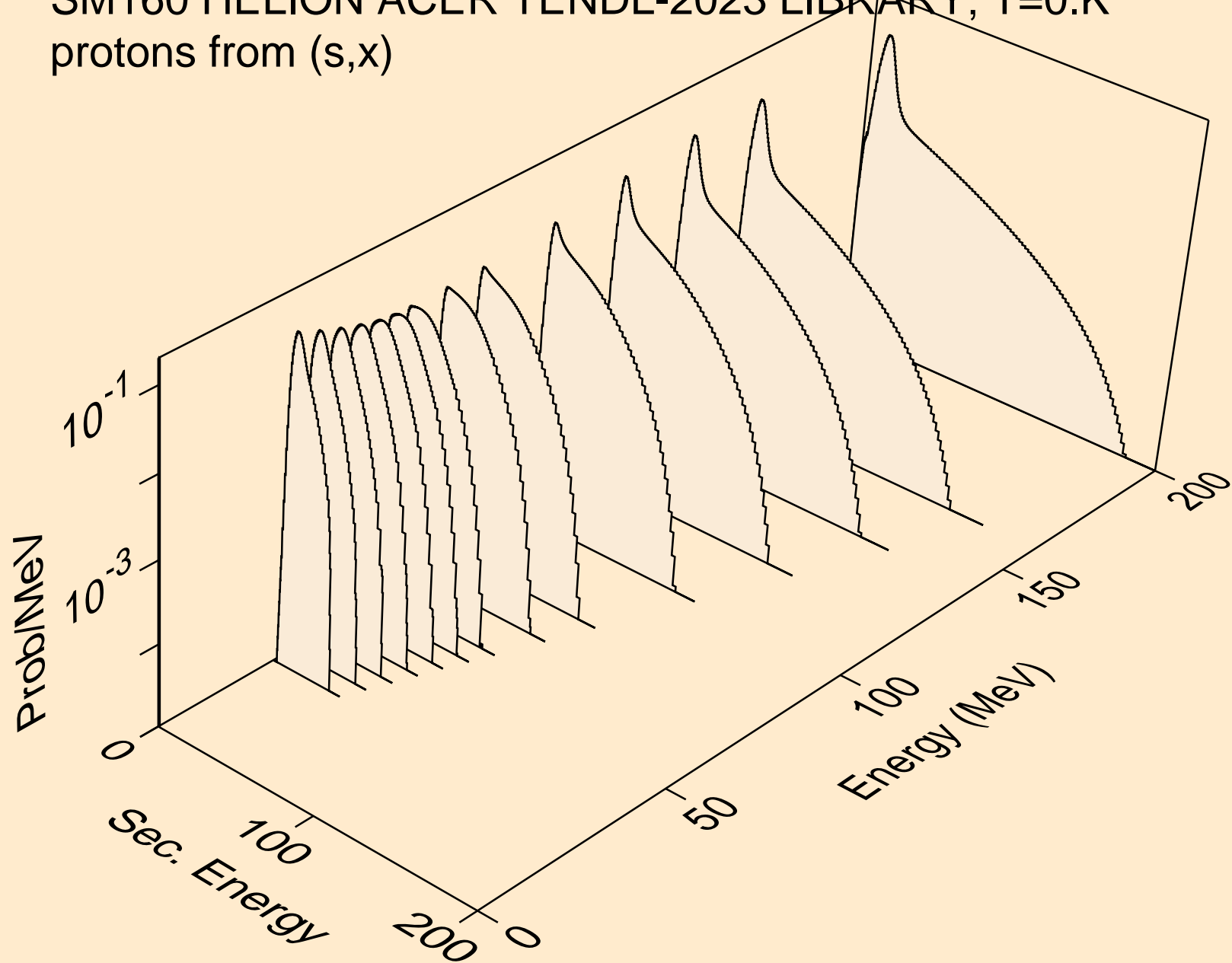

SM160 HELION ACER TENDL-2023 LIBRARY; T=0.K  
protons from (s,n\*)p

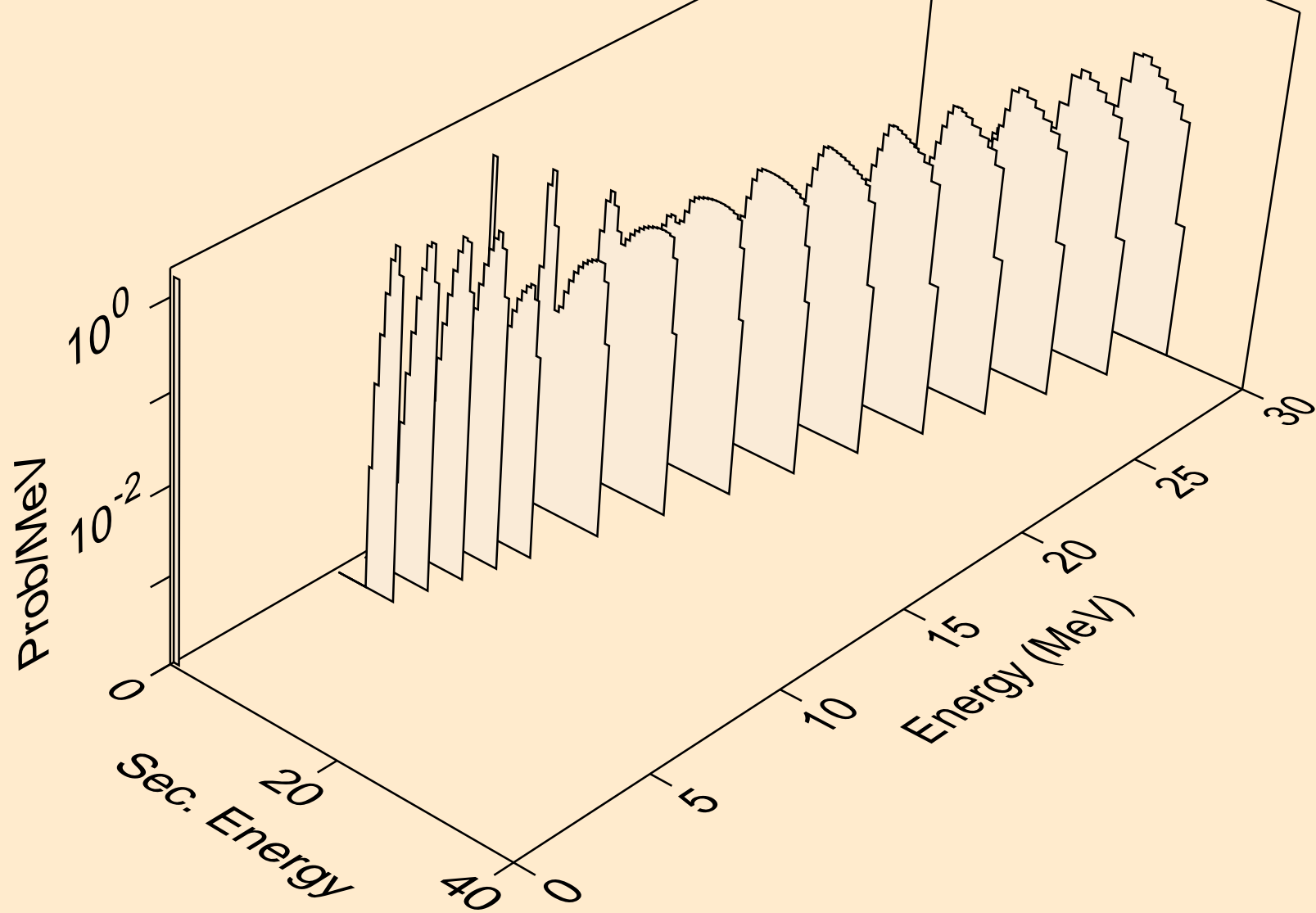



SM160 HELION ACER TENDL-2023 LIBRARY; T=0.K  
protons from (s,2np)

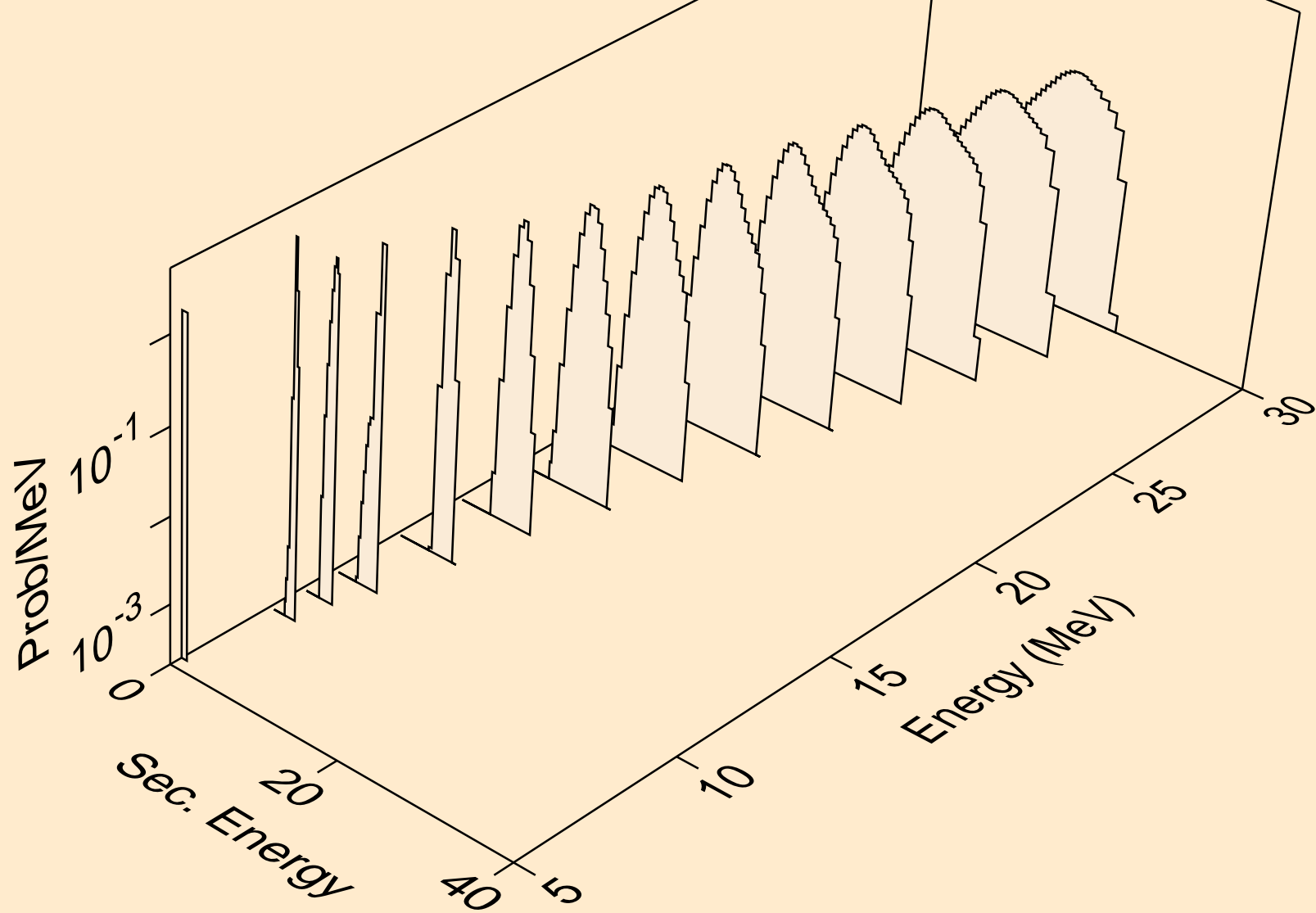

SM160 HELION ACER TENDL-2023 LIBRARY; T=0.K  
protons from (s,3np)

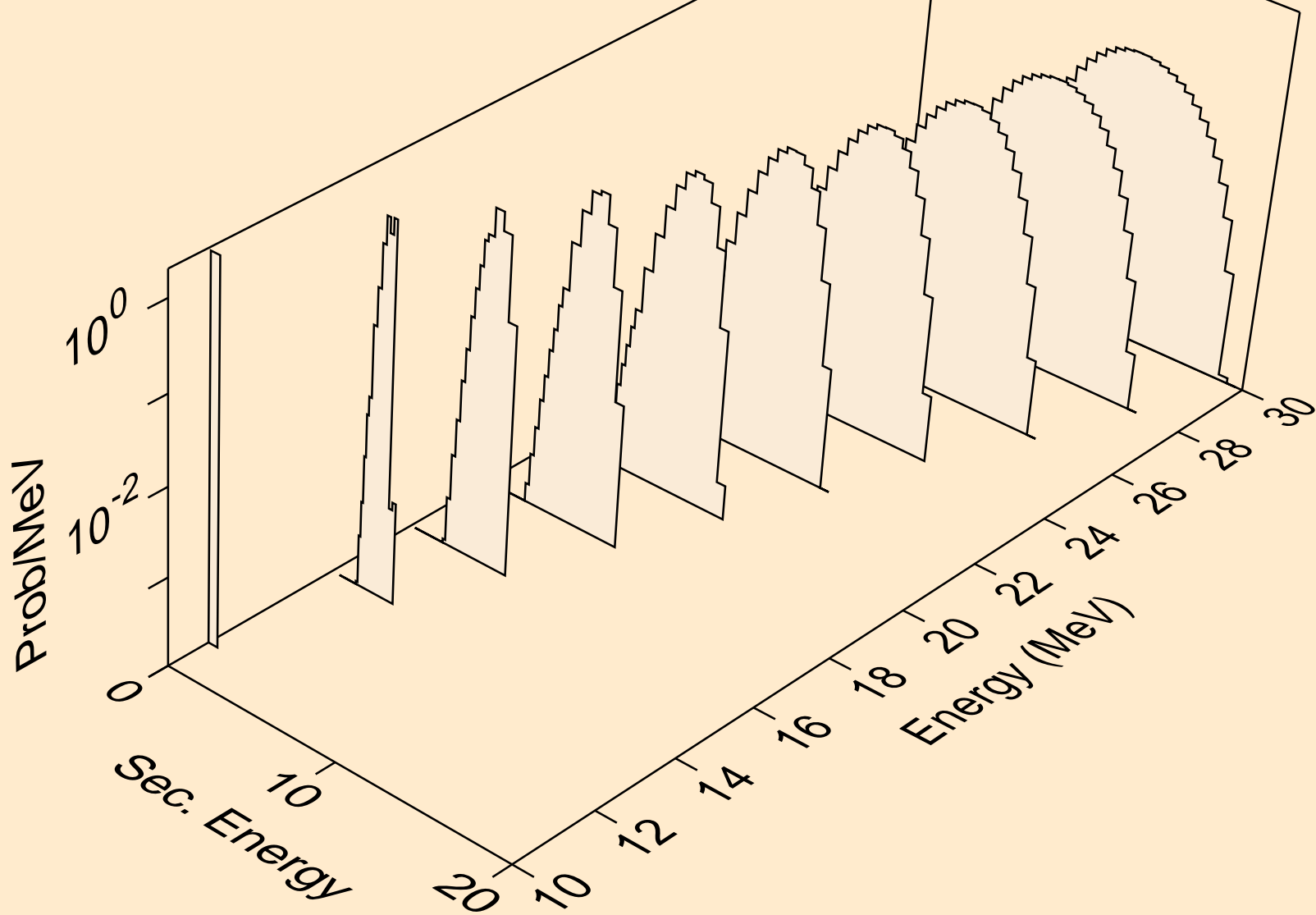

SM160 HELION ACER TENDL-2023 LIBRARY; T=0.K  
protons from (s,n2p)

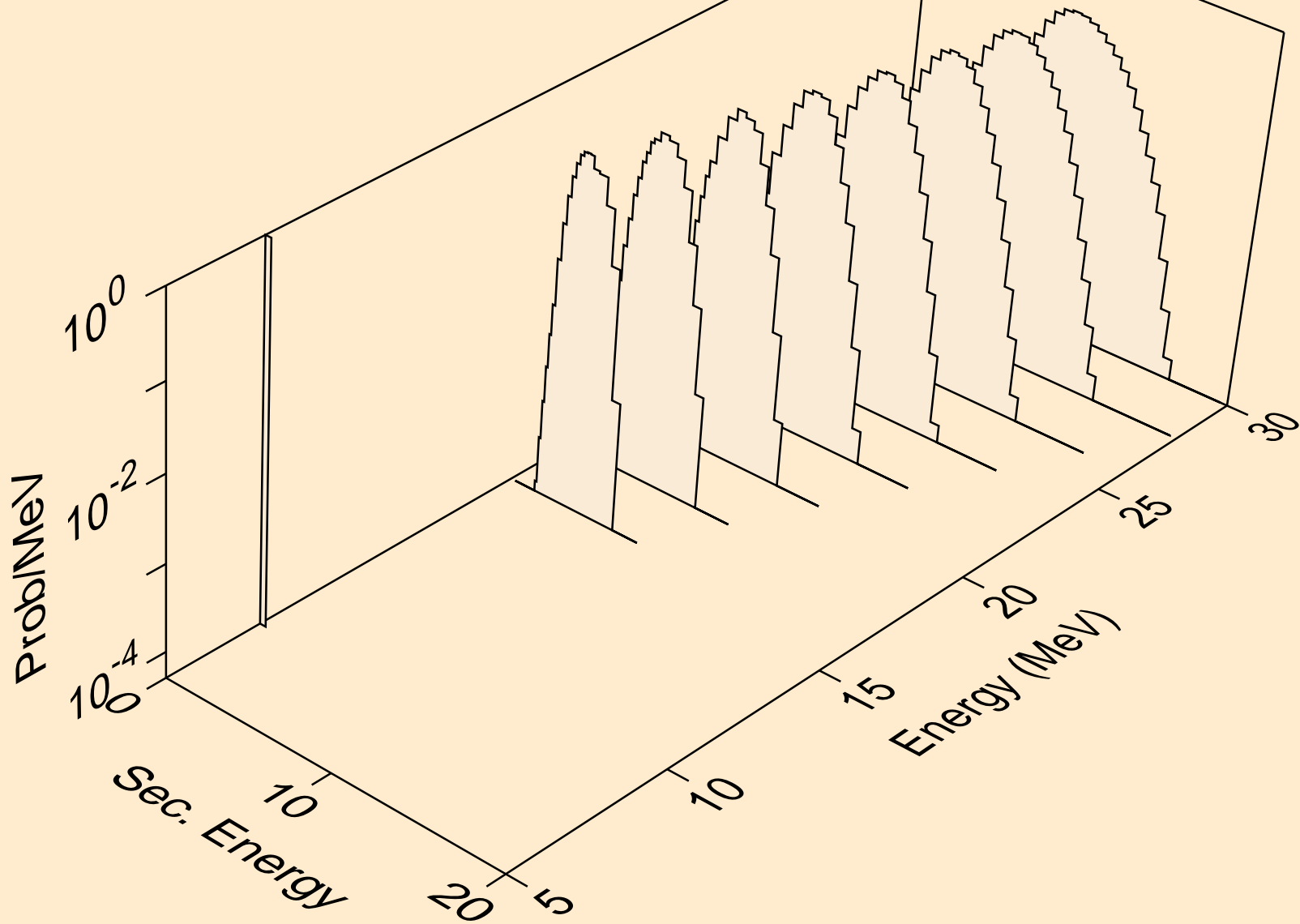

SM160 HELION ACER TENDL-2023 LIBRARY; T=0.K  
protons from (s,npa)

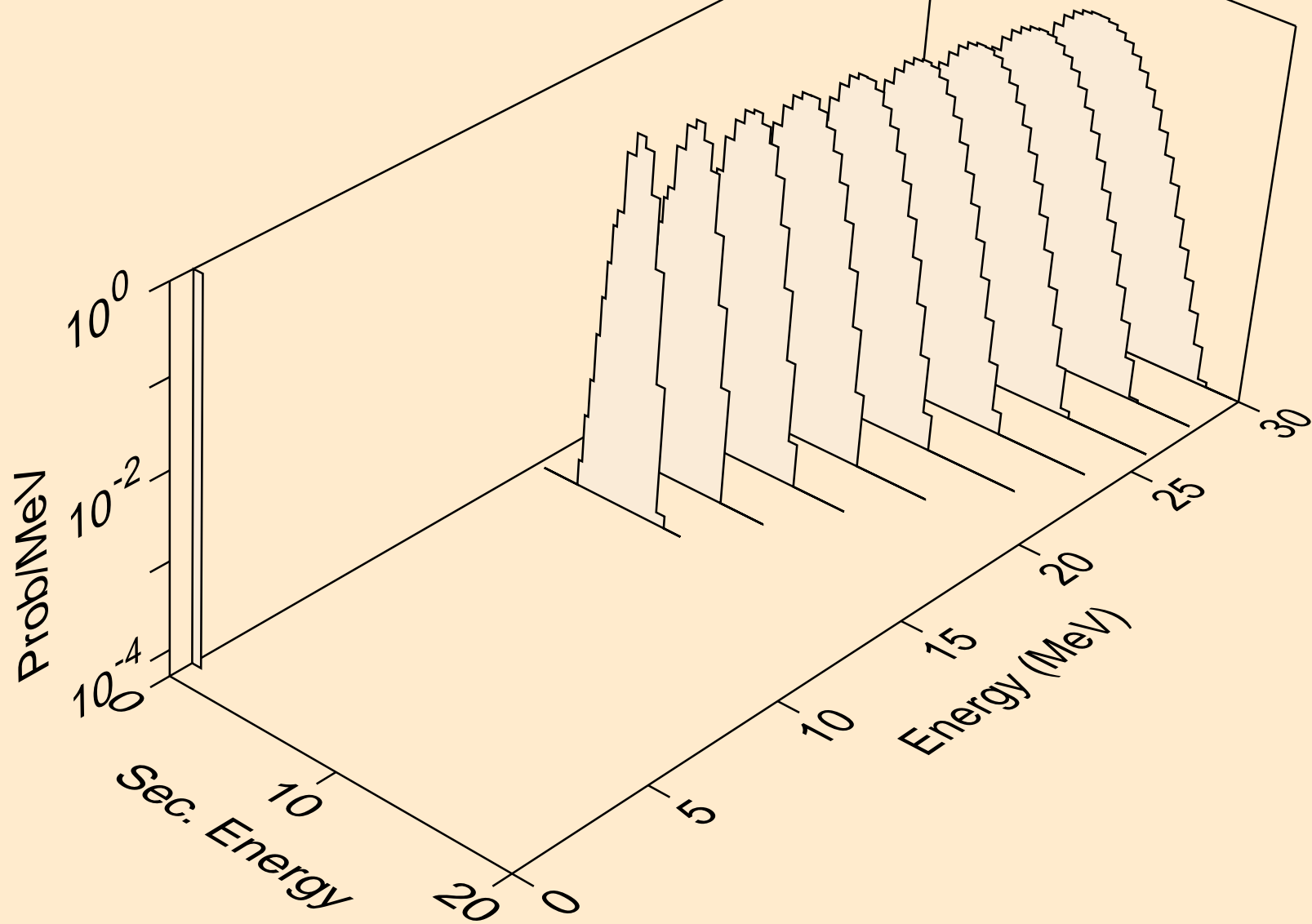

SM160 HELION ACER TENDL-2023 LIBRARY; T=0.K  
protons from (s,p)

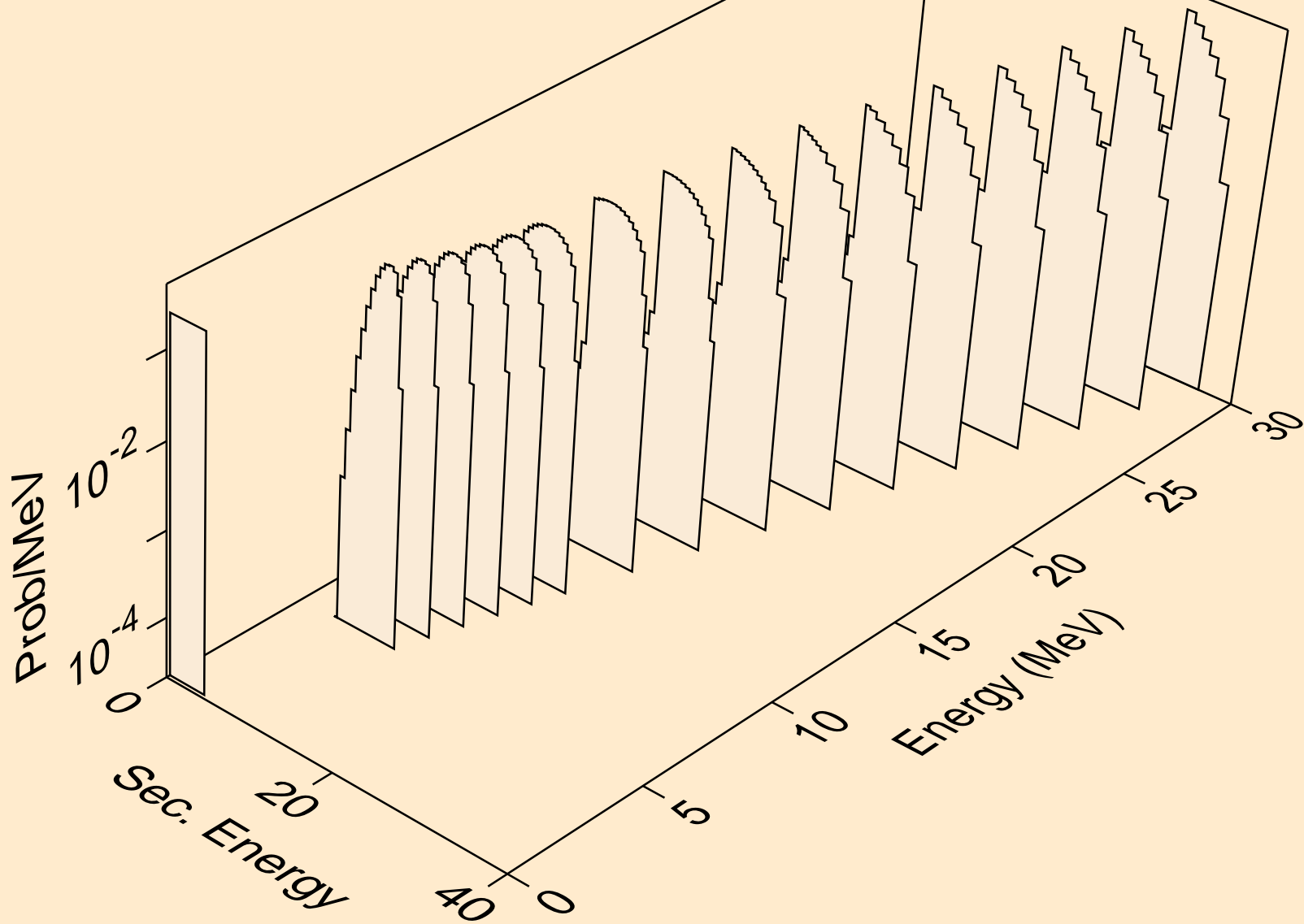

SM160 HELION ACER TENDL-2023 LIBRARY; T=0.K  
protons from (s,2p)

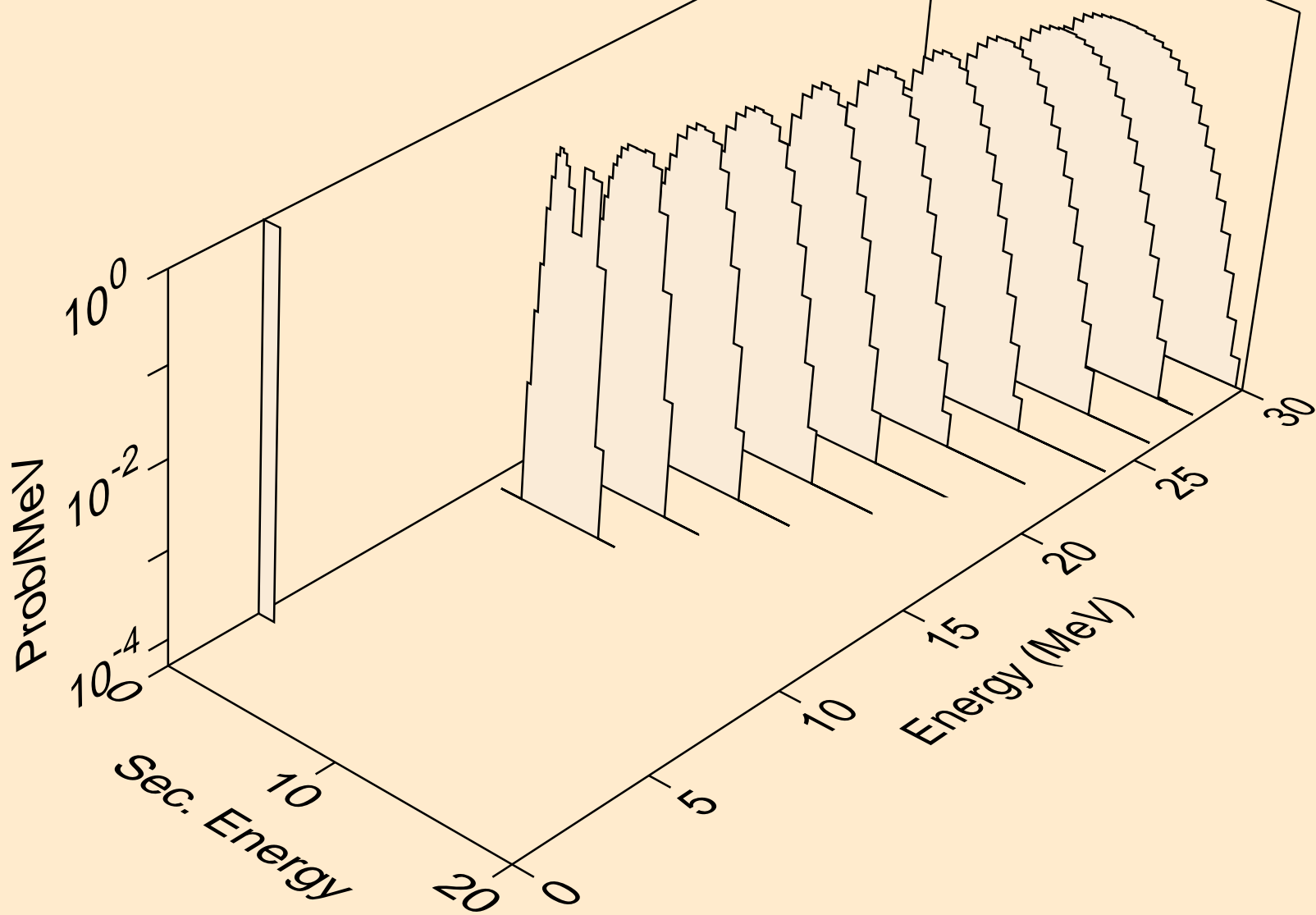

SM160 HELION ACER TENDL-2023 LIBRARY; T=0.K  
protons from (s,pa)

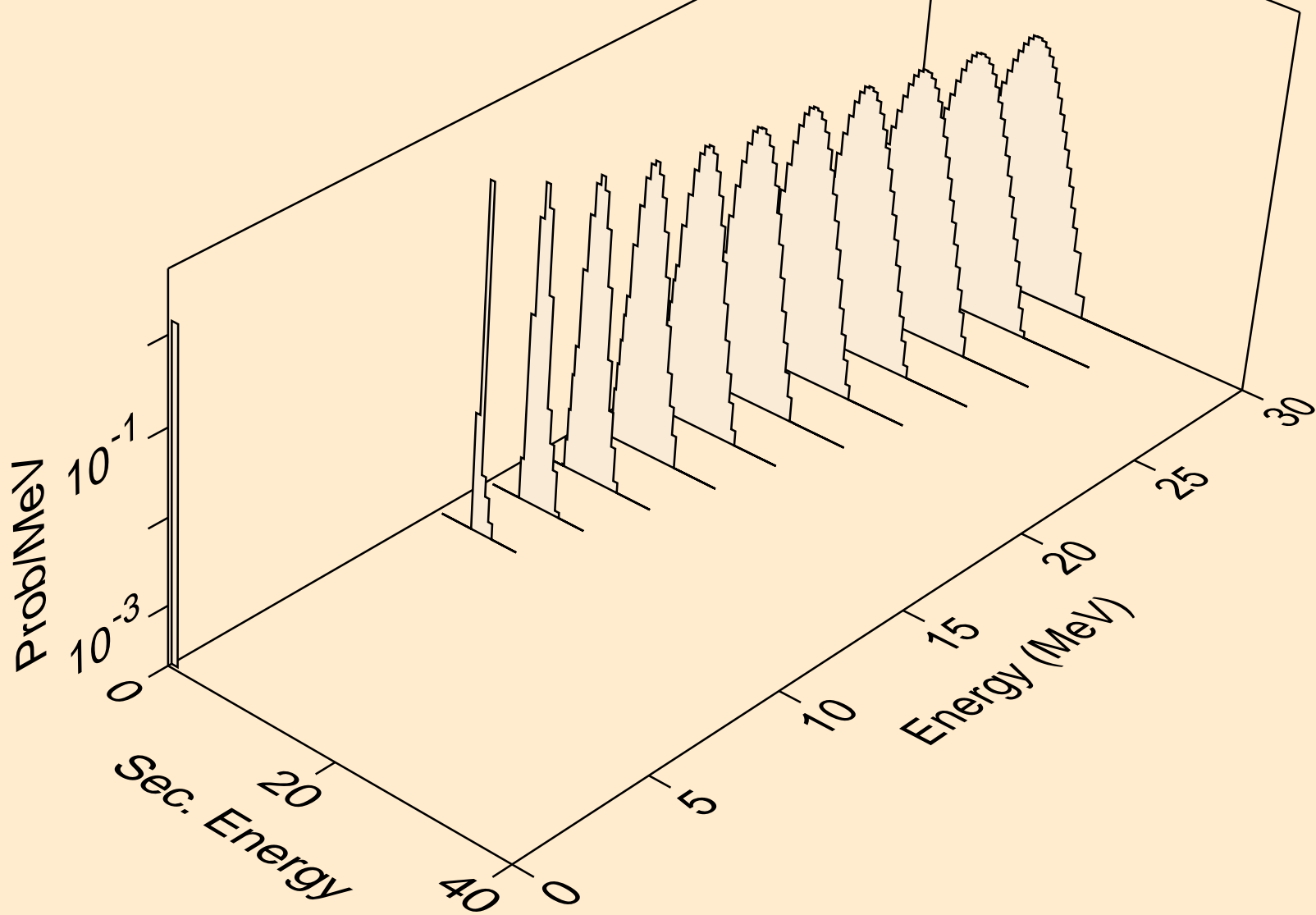

SM160 HELION ACER TENDL-2023 LIBRARY; T=0.K  
protons from (s,pd)

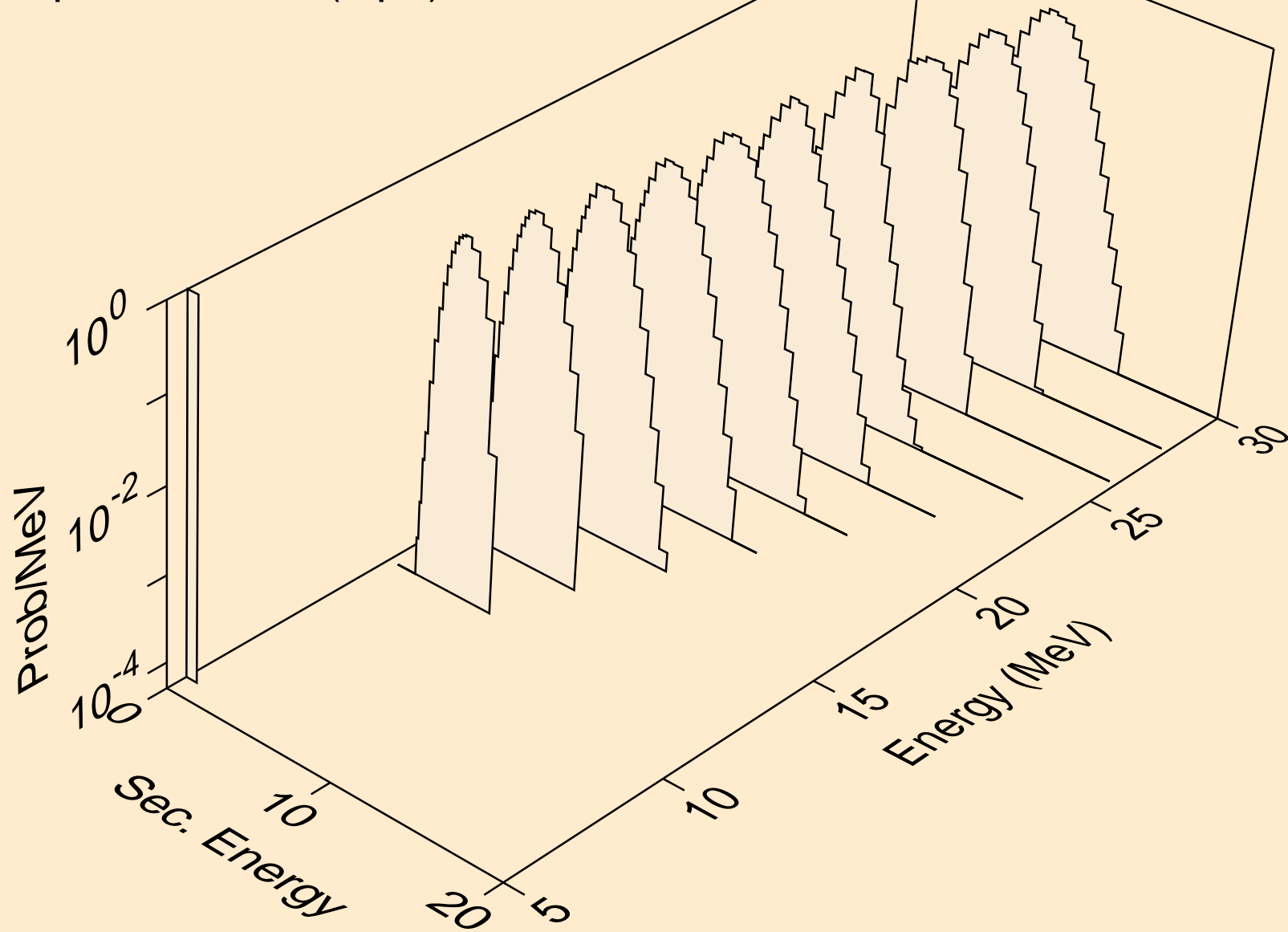



SM160 HELION ACER TENDL-2023 LIBRARY; T=0.K  
protons from (s,pt)

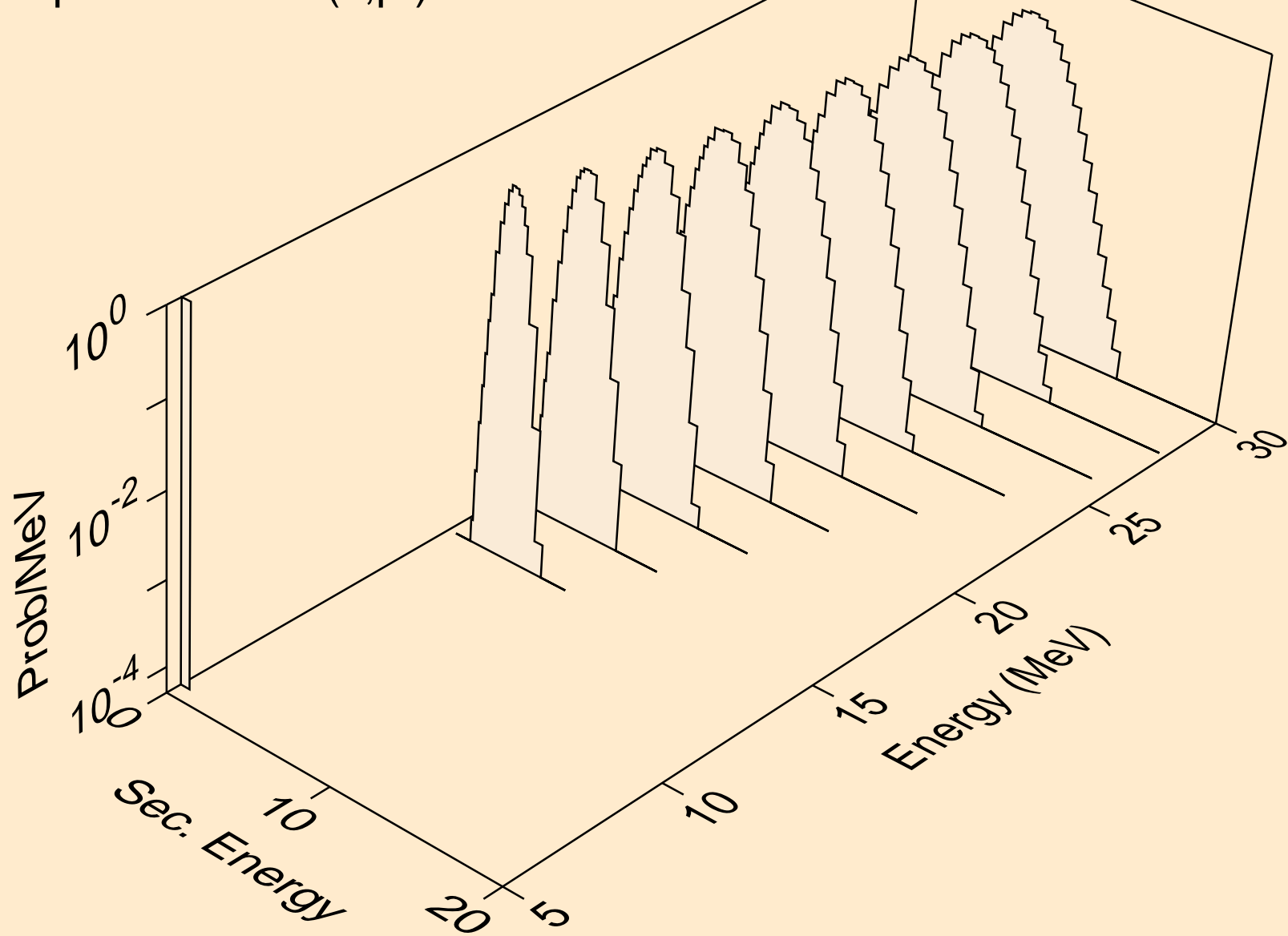

SM160 HELION ACER TENDL-2023 LIBRARY; T=0.K  
deuterons from (s,x)

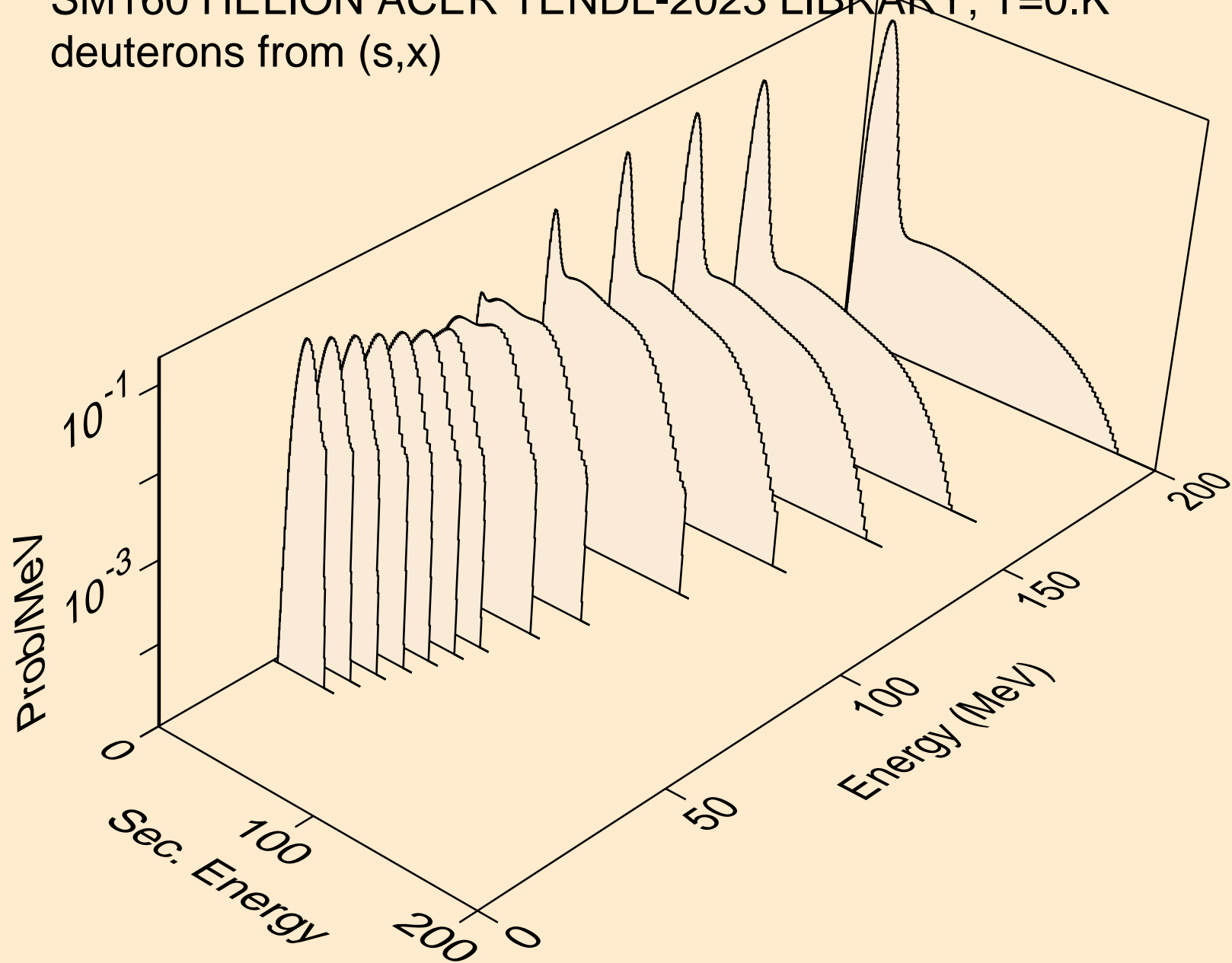

SM160 HELION ACER TENDL-2023 LIBRARY; T=0.K  
deuterons from (s,2nd)

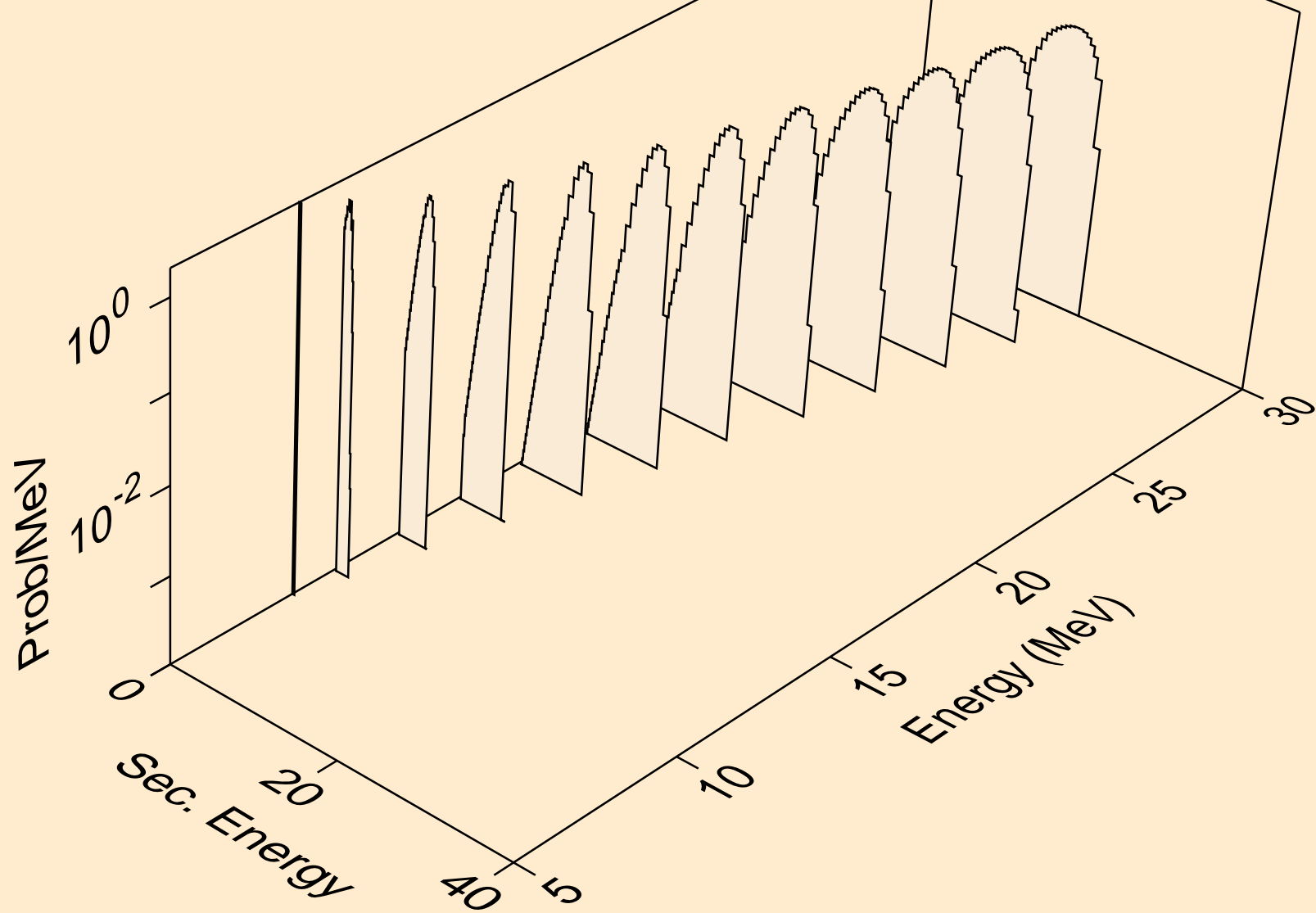

SM160 HELION ACER TENDL-2023 LIBRARY; T=0.K  
deuterons from (s,n\*)d

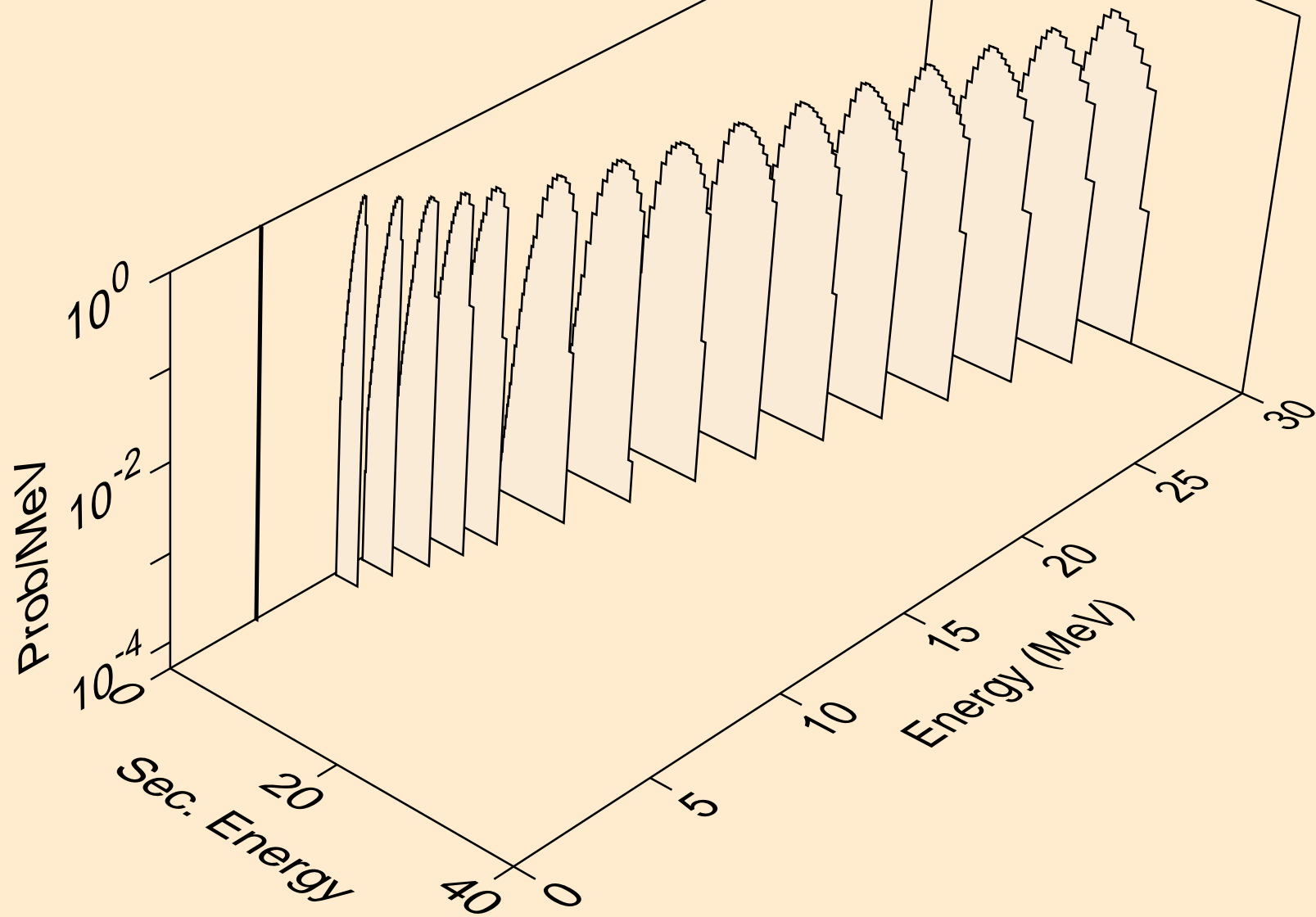

SM160 HELION ACER TENDL-2023 LIBRARY; T=0.K  
deuterons from (s,d)

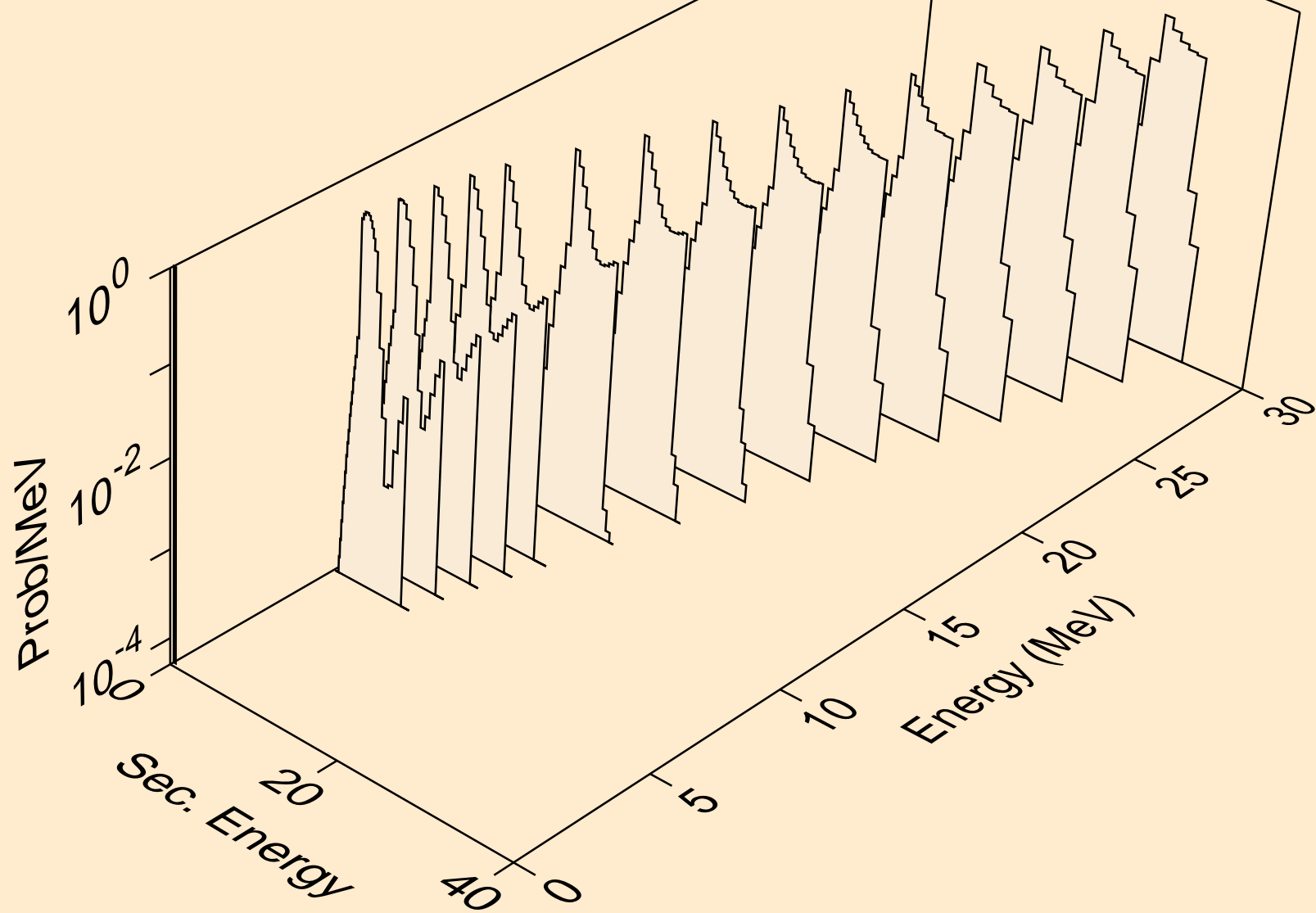

SM160 HELION ACER TENDL-2023 LIBRARY; T=0.K  
deuterons from (s,pd)

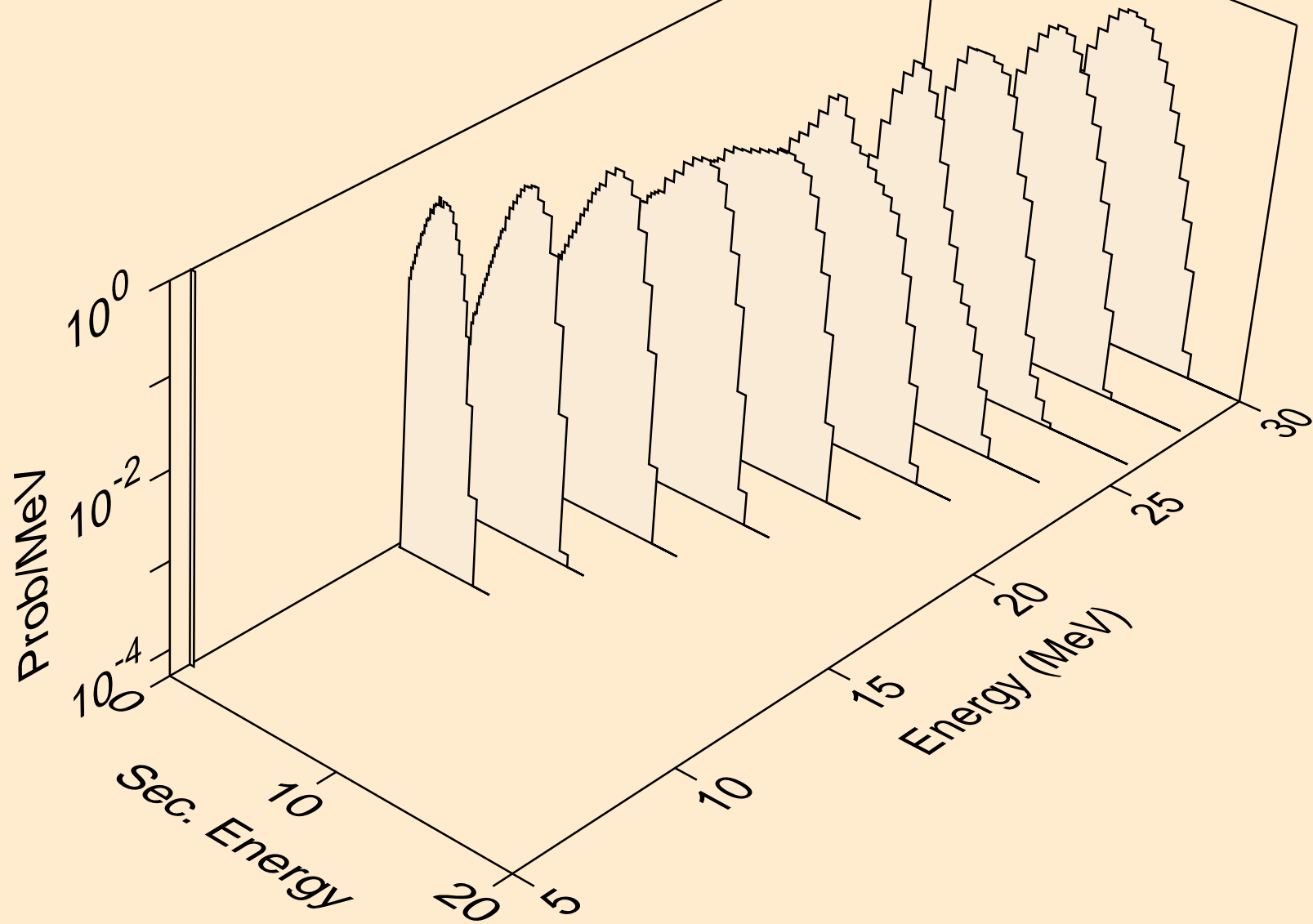

SM160 HELION ACER TENDL-2023 LIBRARY; T=0.K  
tritons from (s,x)

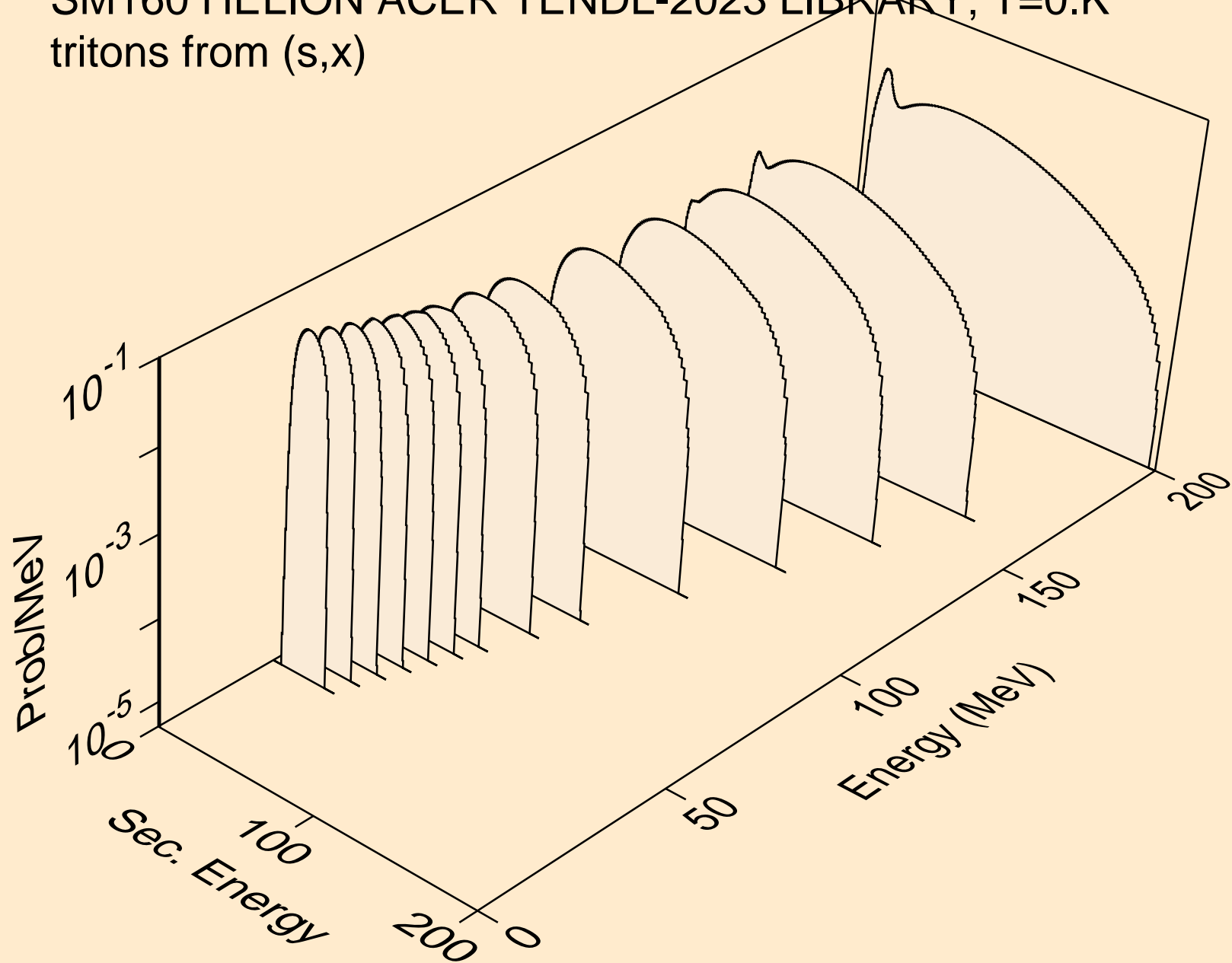

SM160 HELION ACER TENDL-2023 LIBRARY; T=0.K  
tritons from (s,n\*)t

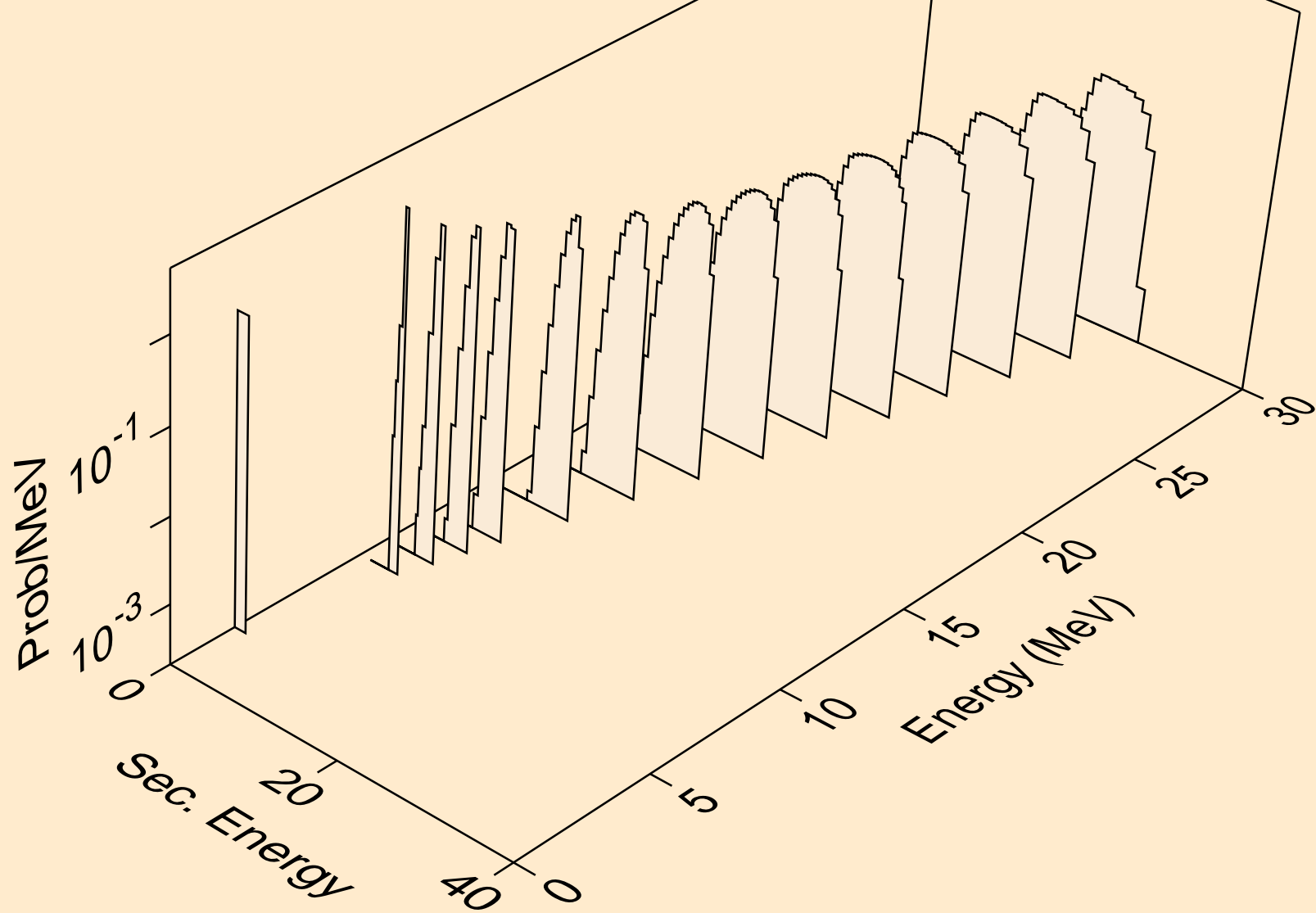



SM160 HELION ACER TENDL-2023 LIBRARY; T=0.K  
tritons from (s,t)

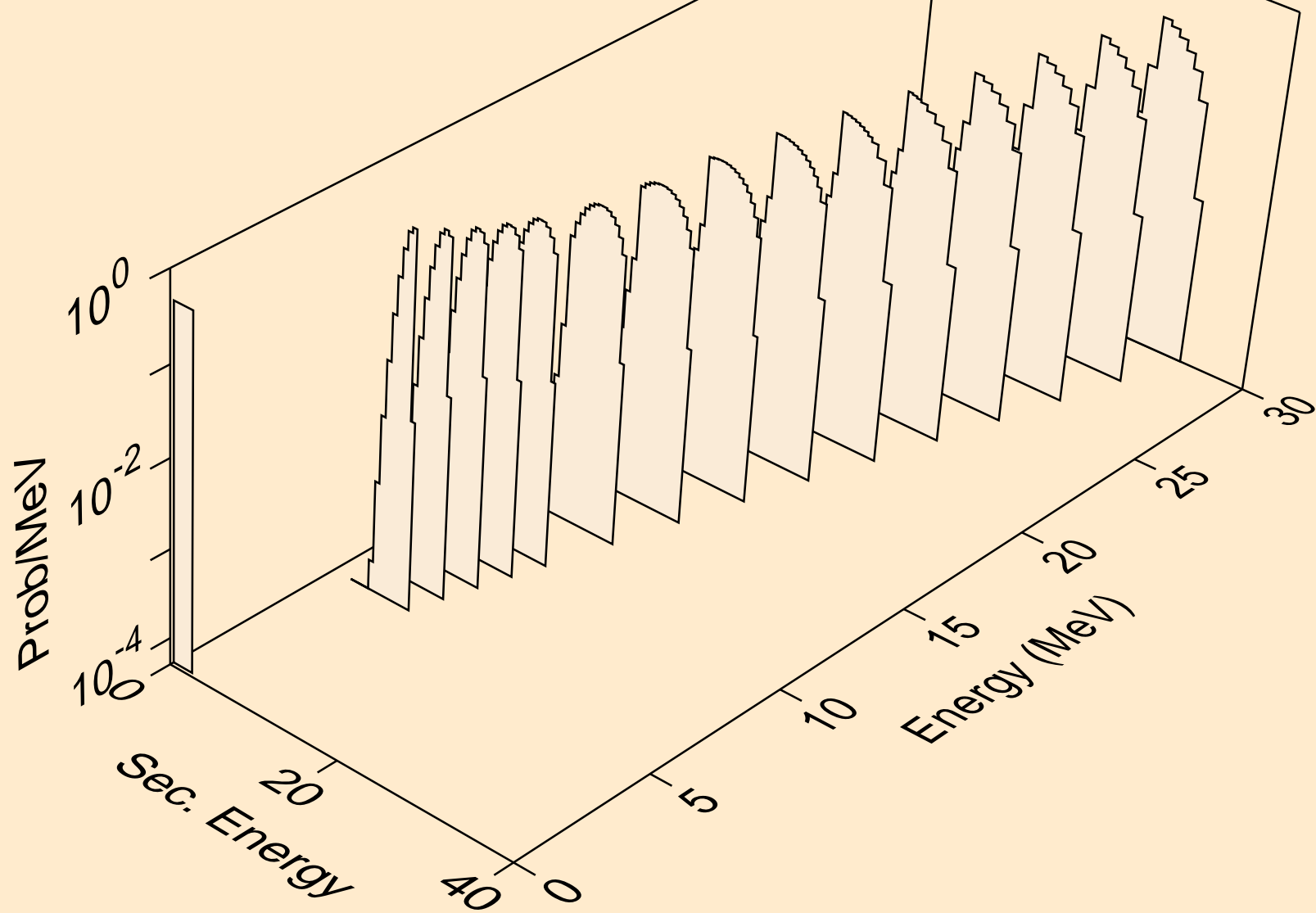

SM160 HELION ACER TENDL-2023 LIBRARY; T=0.K  
tritons from (s,pt)

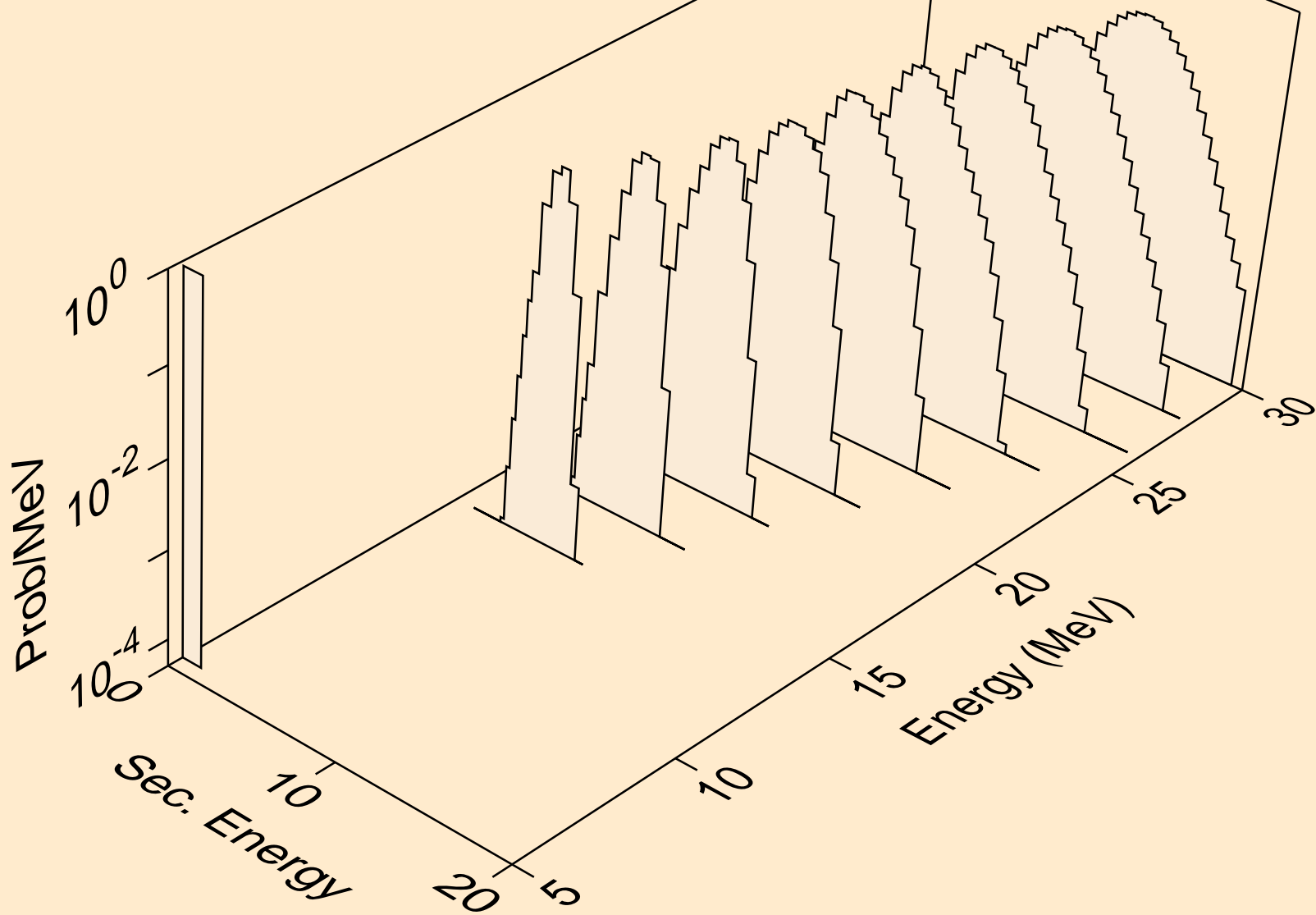

SM160 HELION ACER TENDL-2023 LIBRARY; T=0.K  
alphas from (s,x)

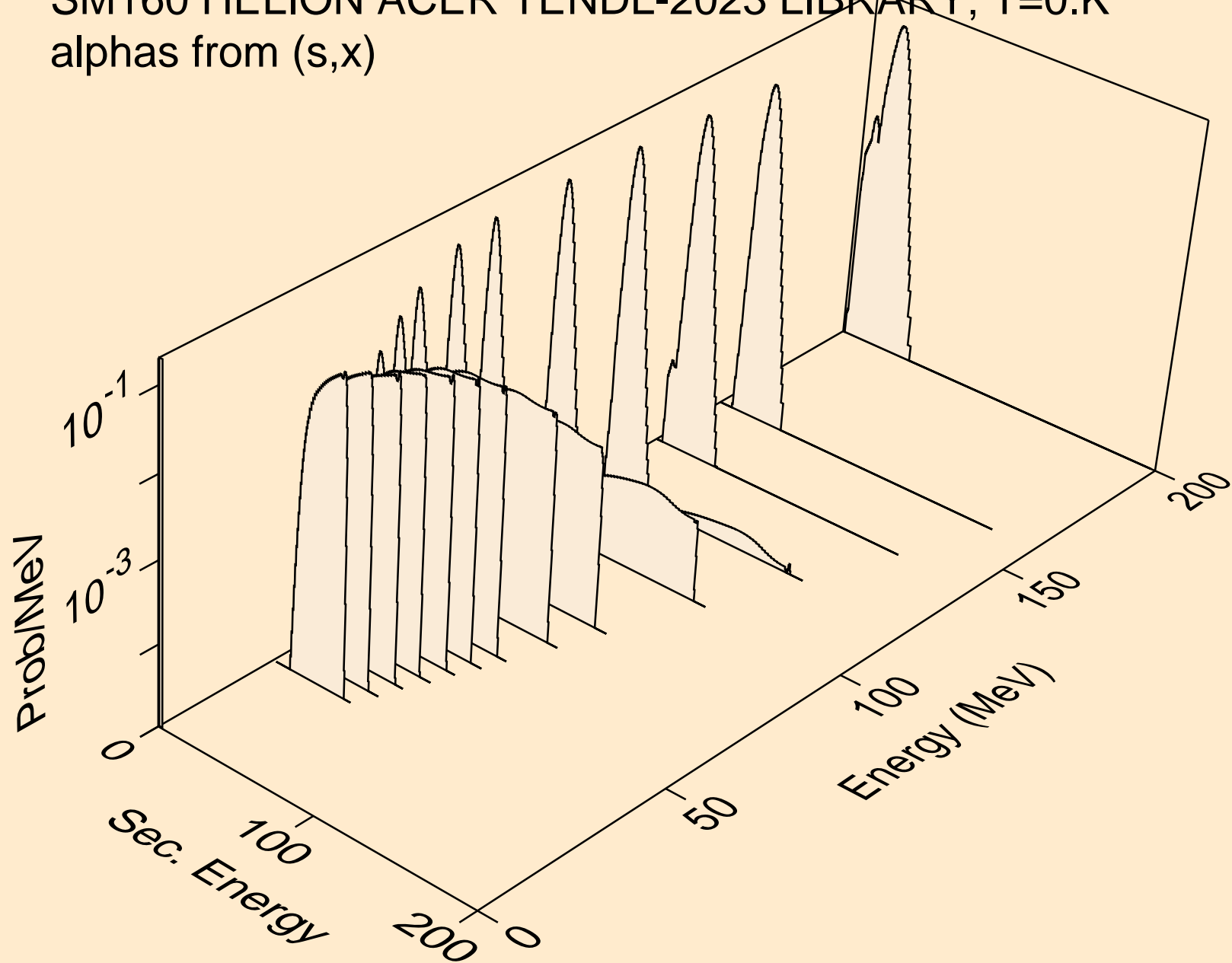

SM160 HELION ACER TENDL-2023 LIBRARY; T=0.K  
alphas from (s,n\*)a

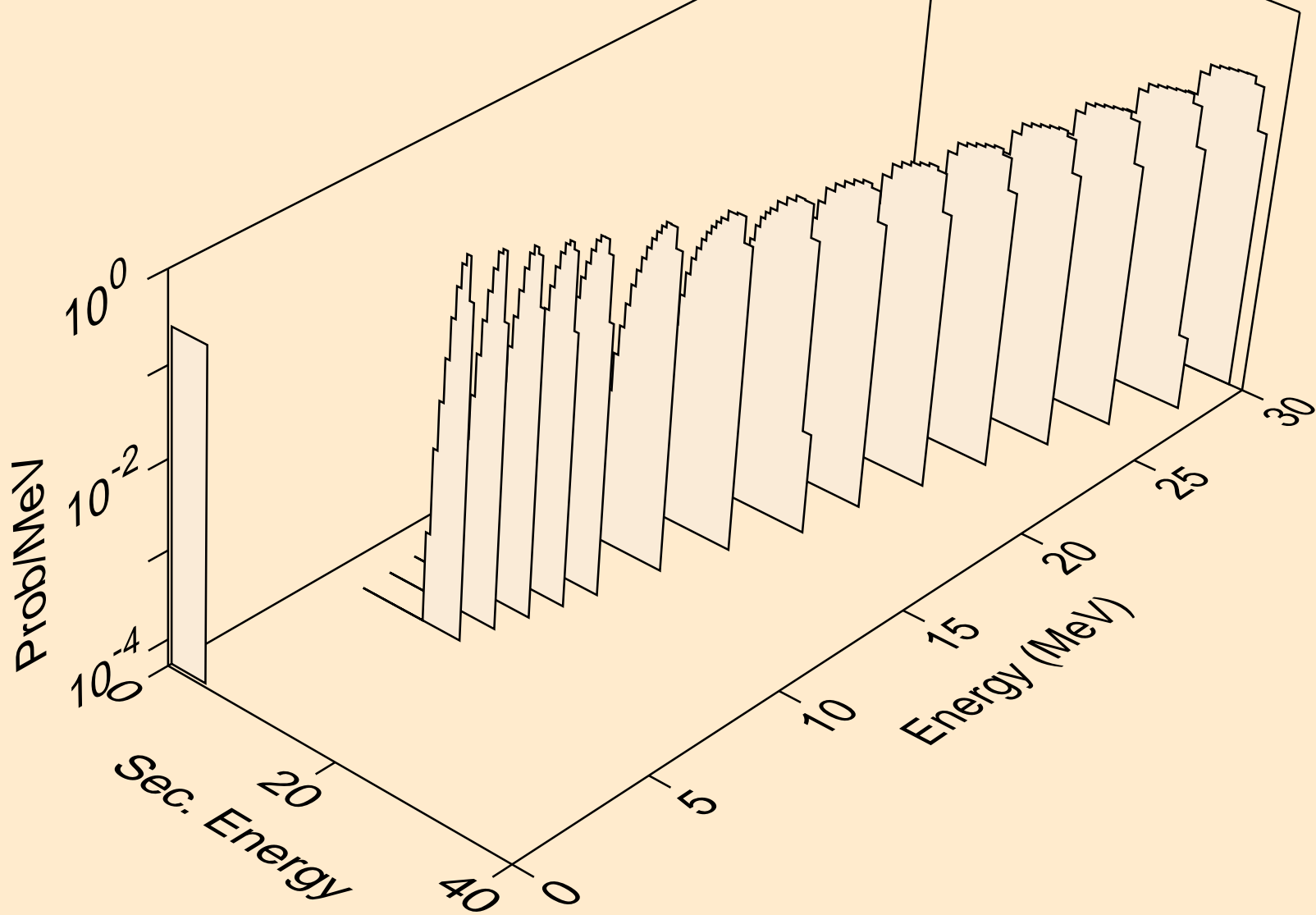

SM160 HELION ACER TENDL-2023 LIBRARY; T=0.K  
alphas from (s,2n)a

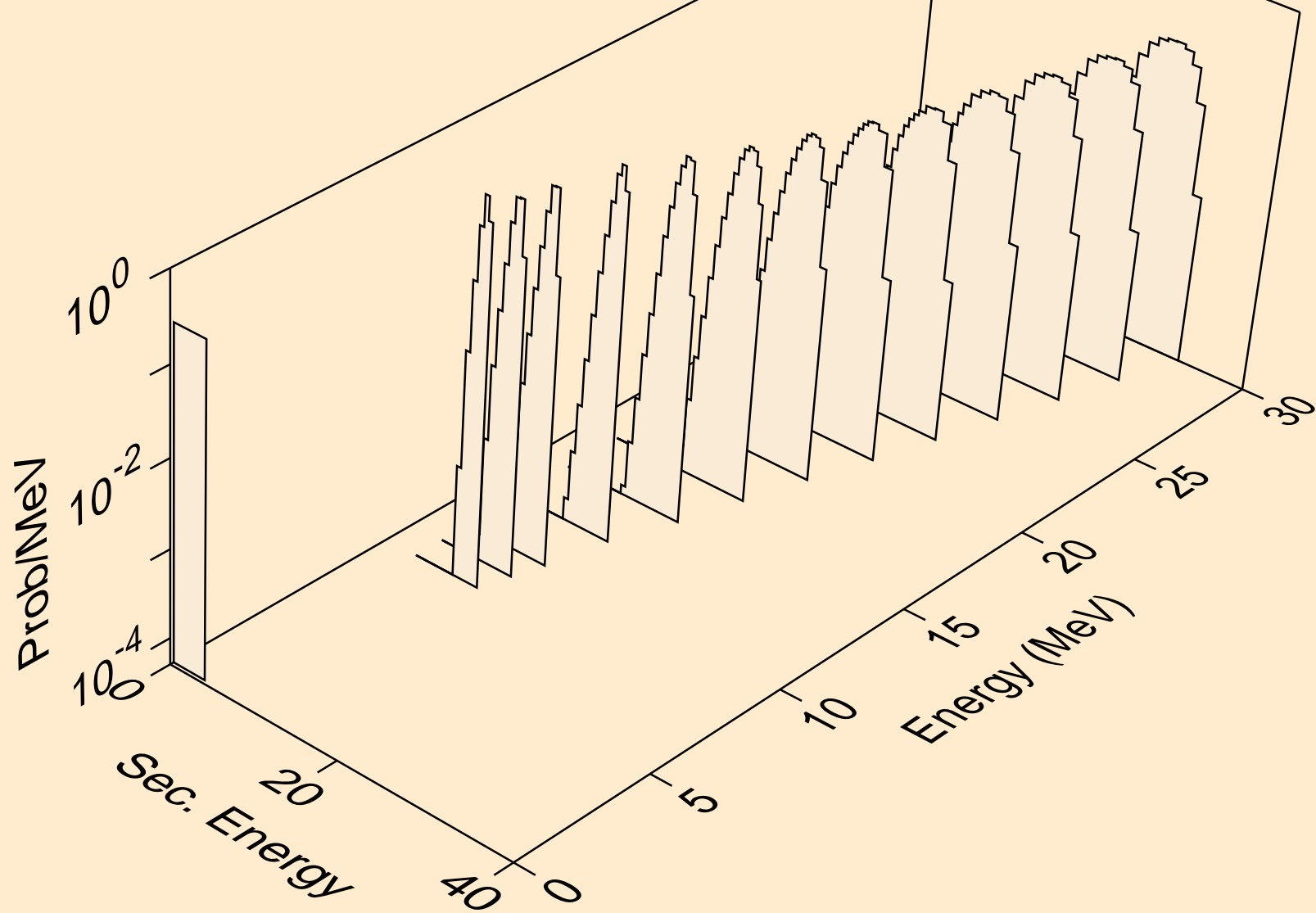

SM160 HELION ACER TENDL-2023 LIBRARY; T=0.K  
alphas from (s,3n)a

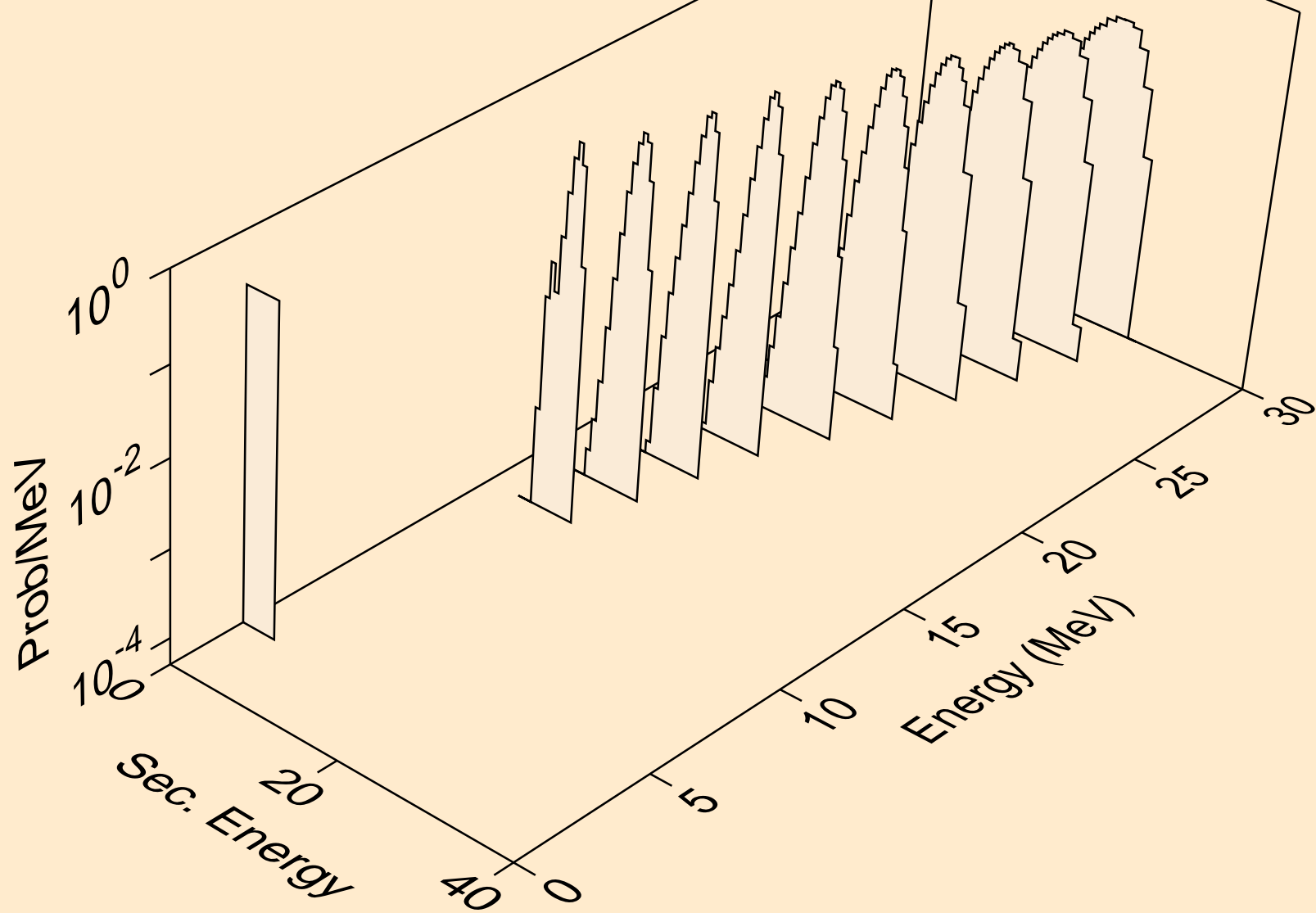

SM160 HELION ACER TENDL-2023 LIBRARY; T=0.K  
alphas from (s,npa)

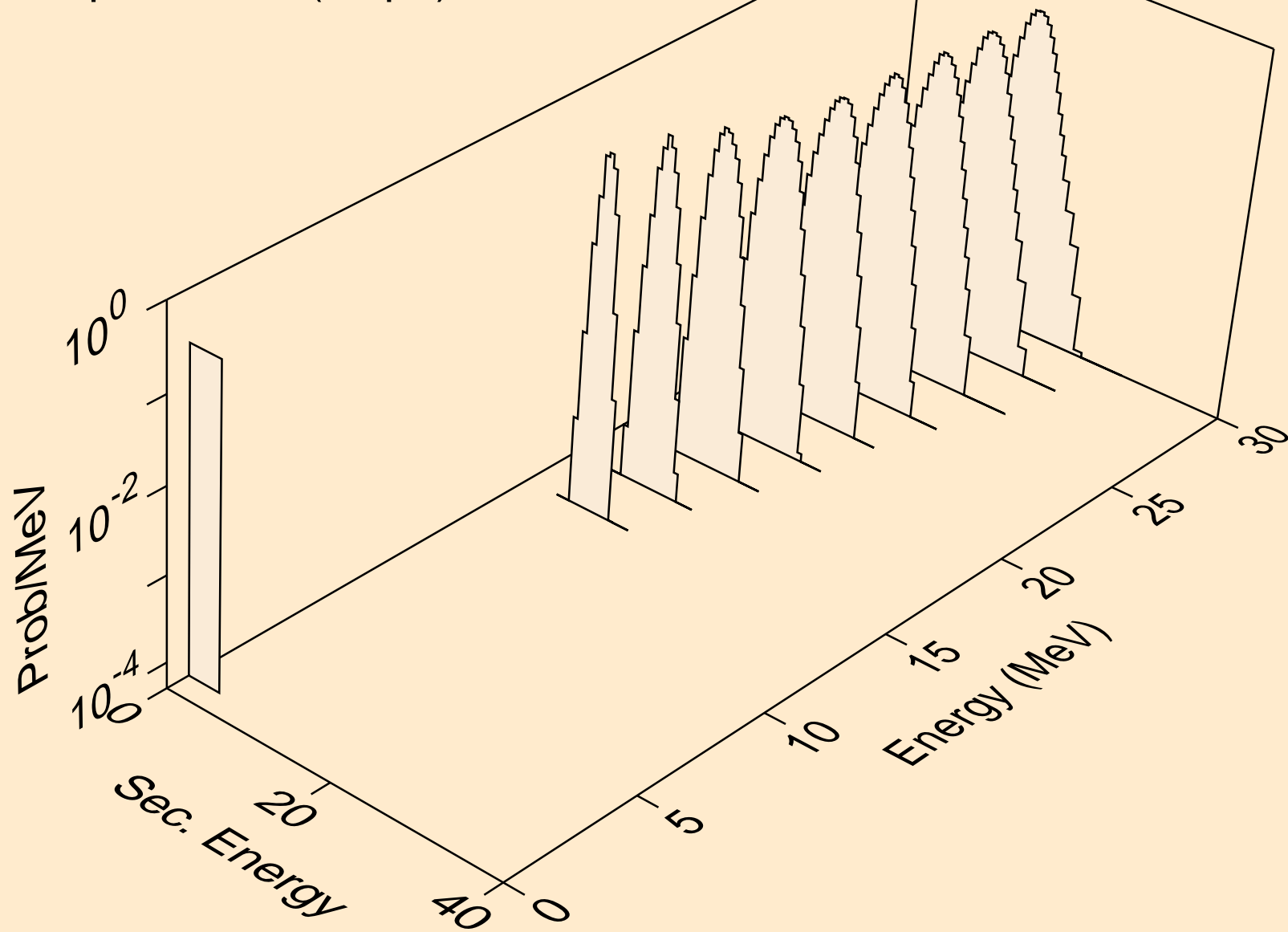

SM160 HELION ACER TENDL-2023 LIBRARY; T=0.K  
alphas from (s,a)

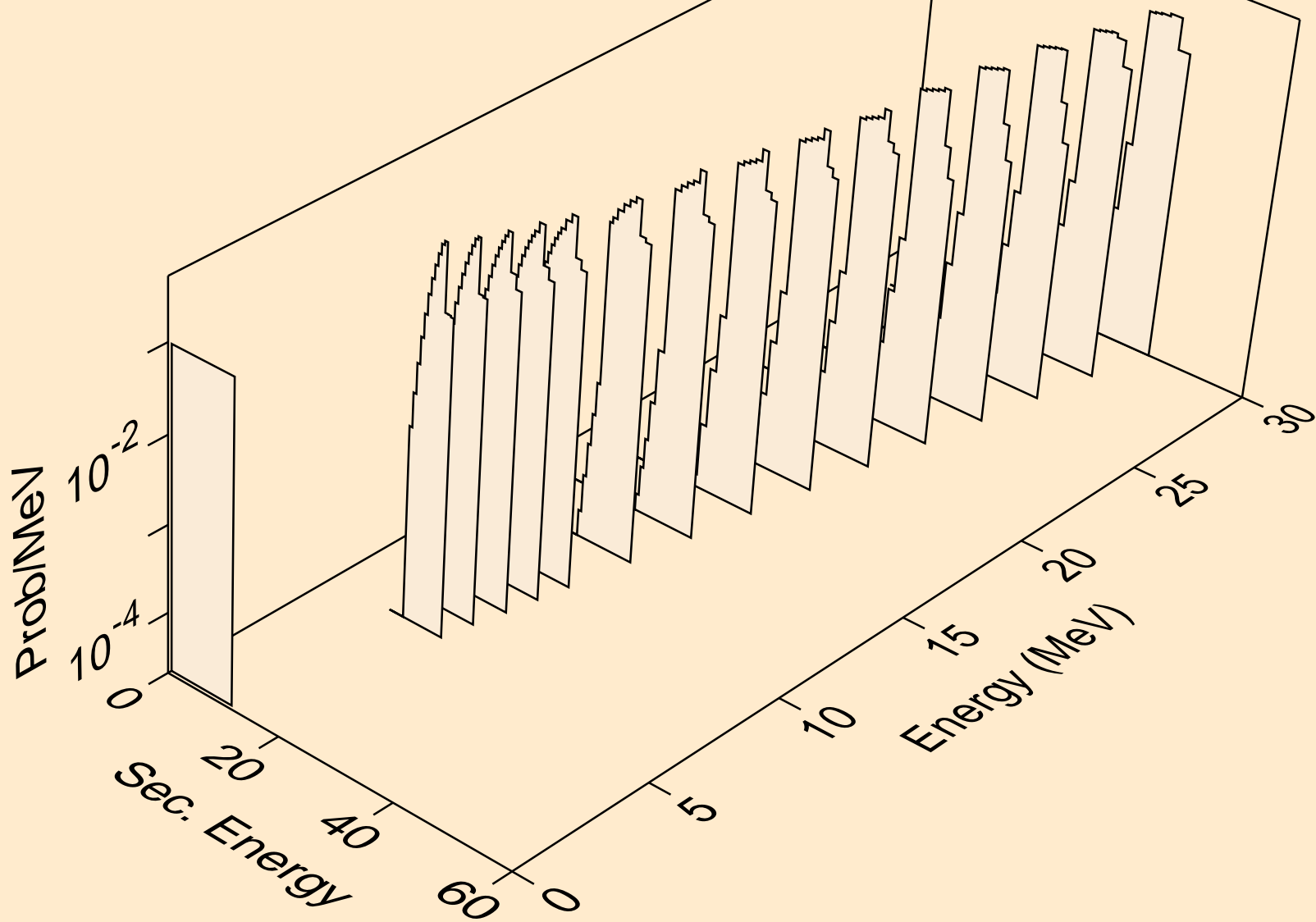



SM160 HELION ACER TENDL-2023 LIBRARY; T=0.K  
alphas from (s,pa)

