

# TH229 HELION ACER TENDL-2023 LIBRARY; T=0.K

## Principal cross sections

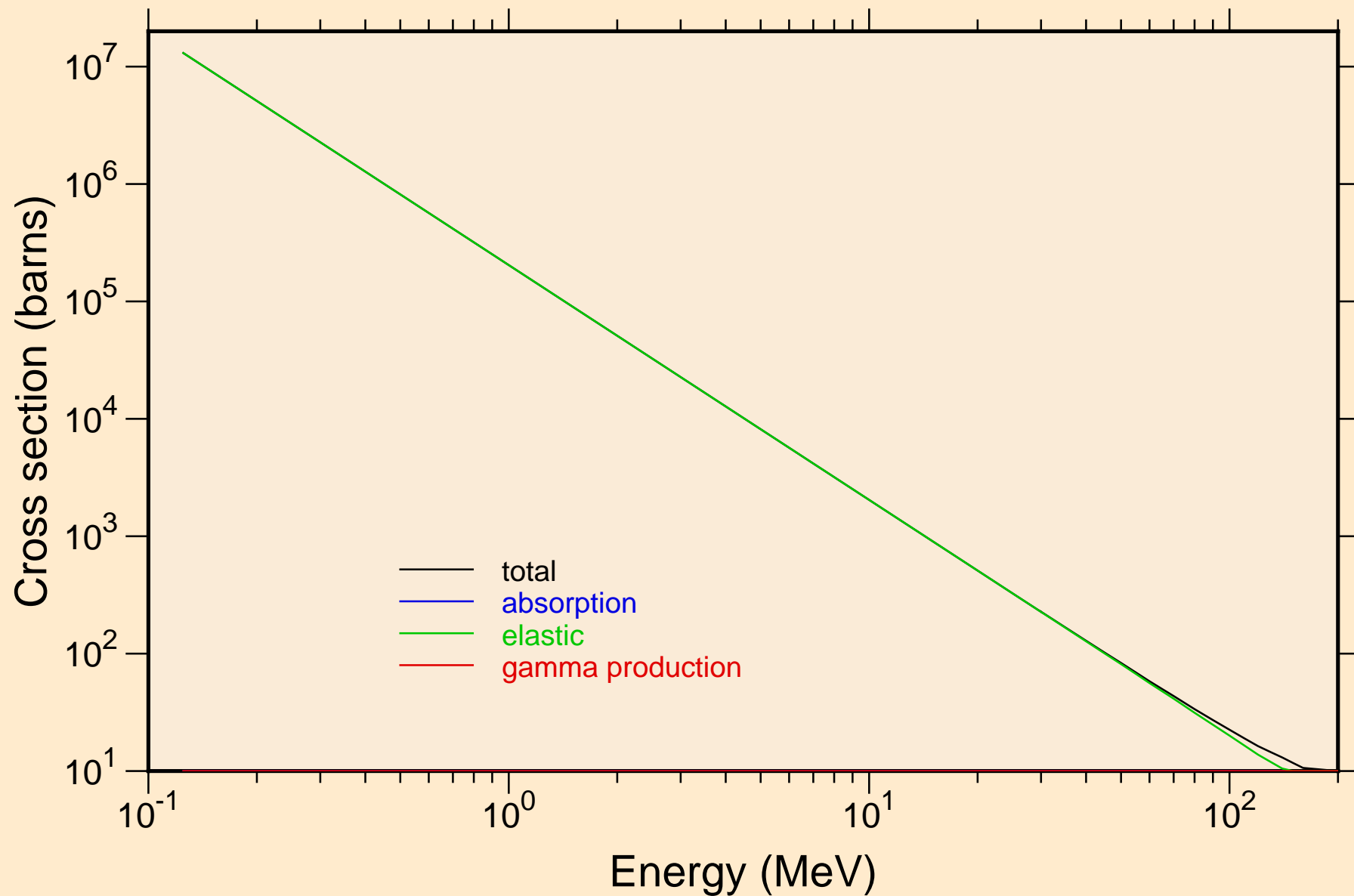

TH229 HELION ACER TENDL-2023 LIBRARY; T=0.K  
Heating

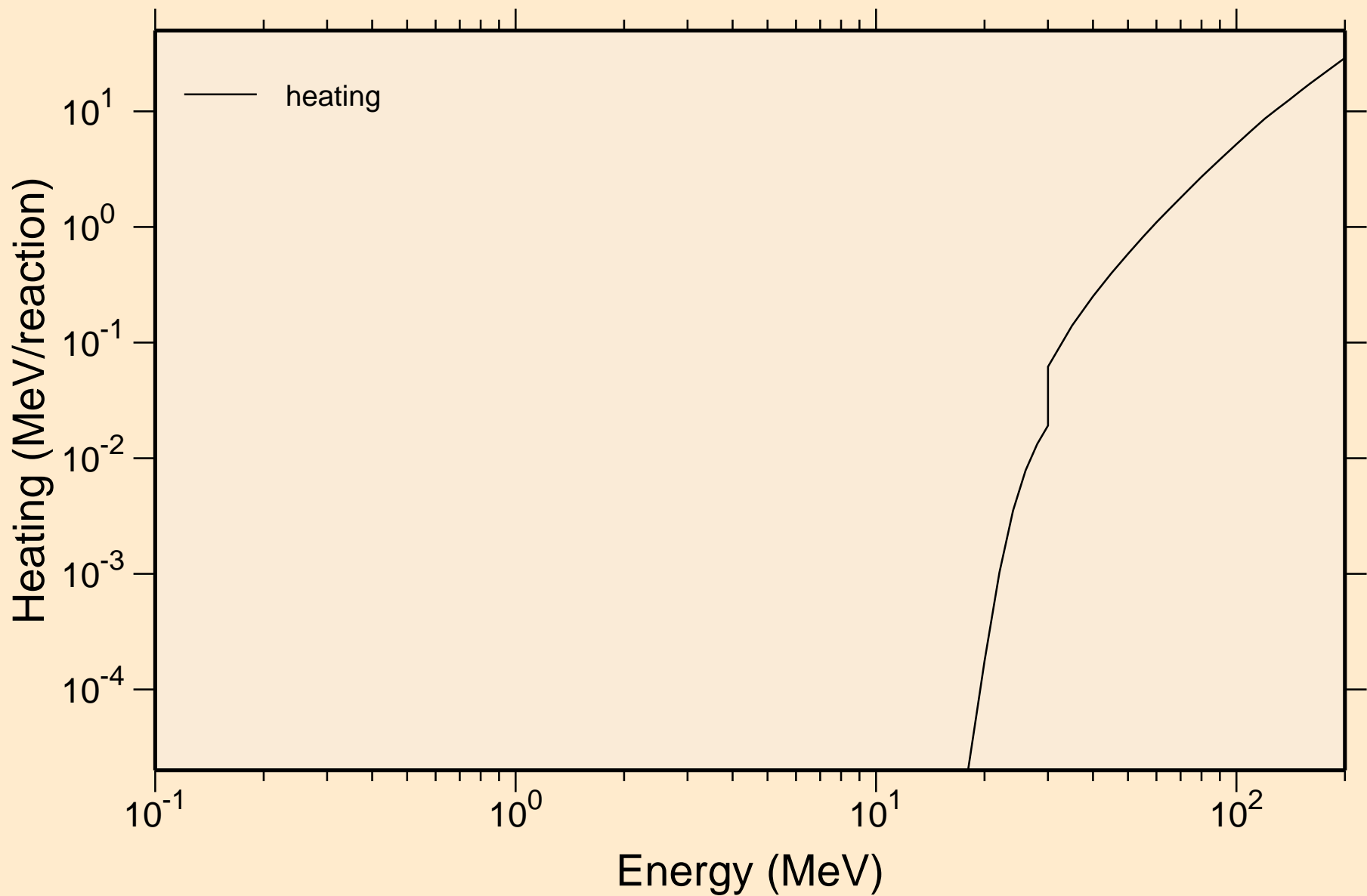

# TH229 HELION ACER TENDL-2023 LIBRARY; T=0.K

## Principal cross sections

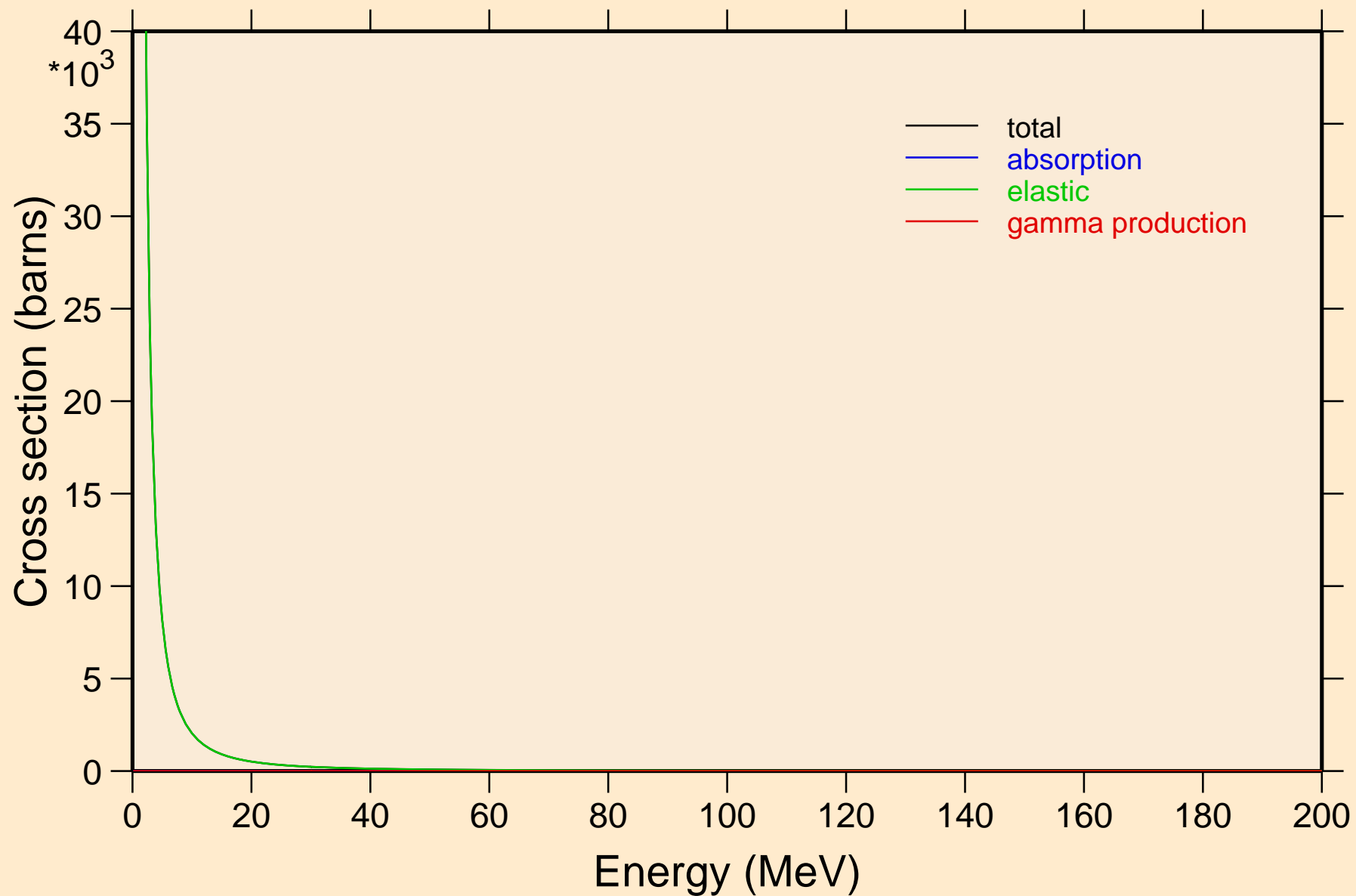

TH229 HELION ACER TENDL-2023 LIBRARY; T=0.K

Heating

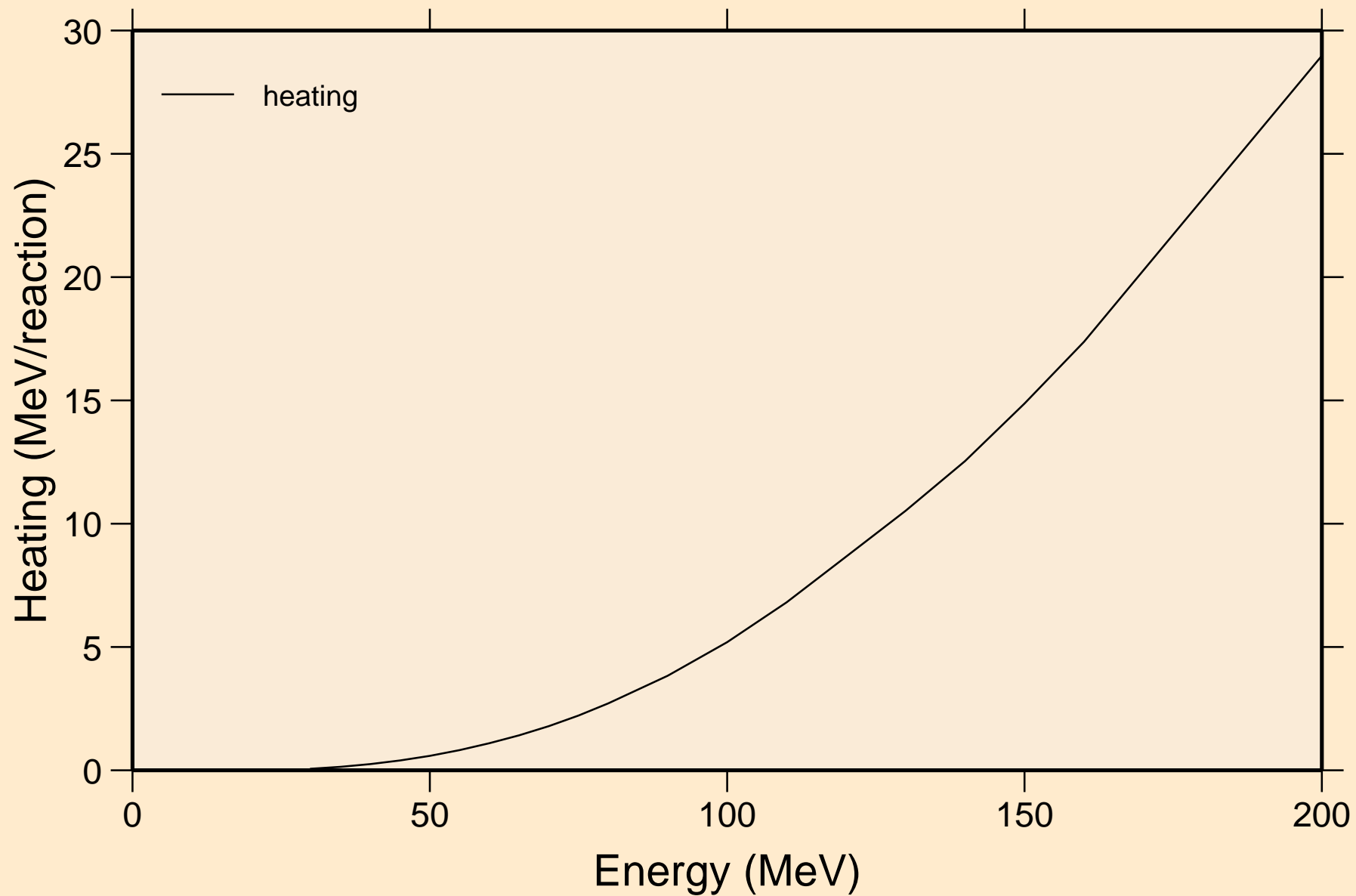

# TH229 HELION ACER TENDL-2023 LIBRARY; T=0.K

## Threshold reactions

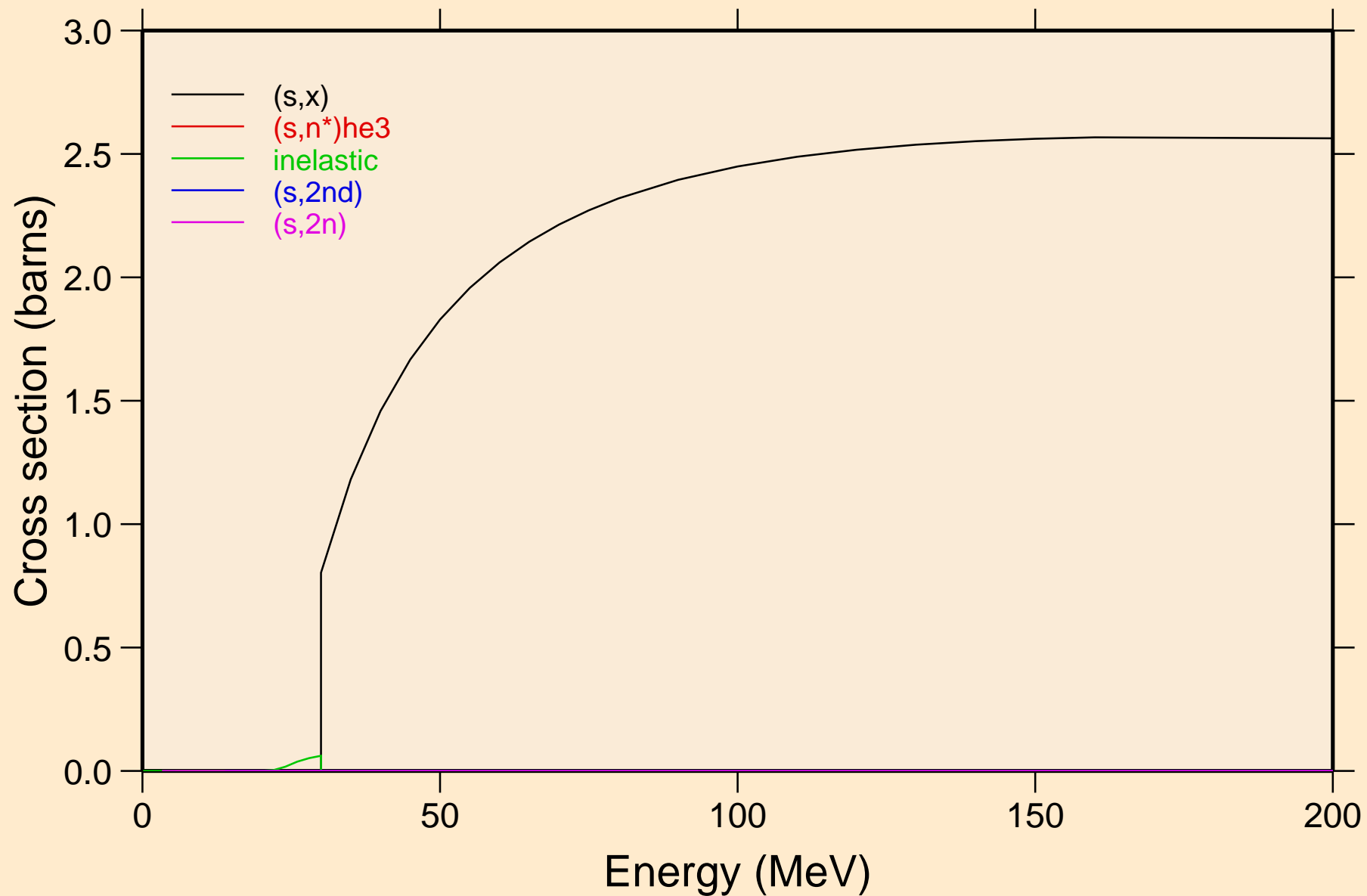

TH229 HELION ACER TENDL-2023 LIBRARY; T=0.K  
Threshold reactions

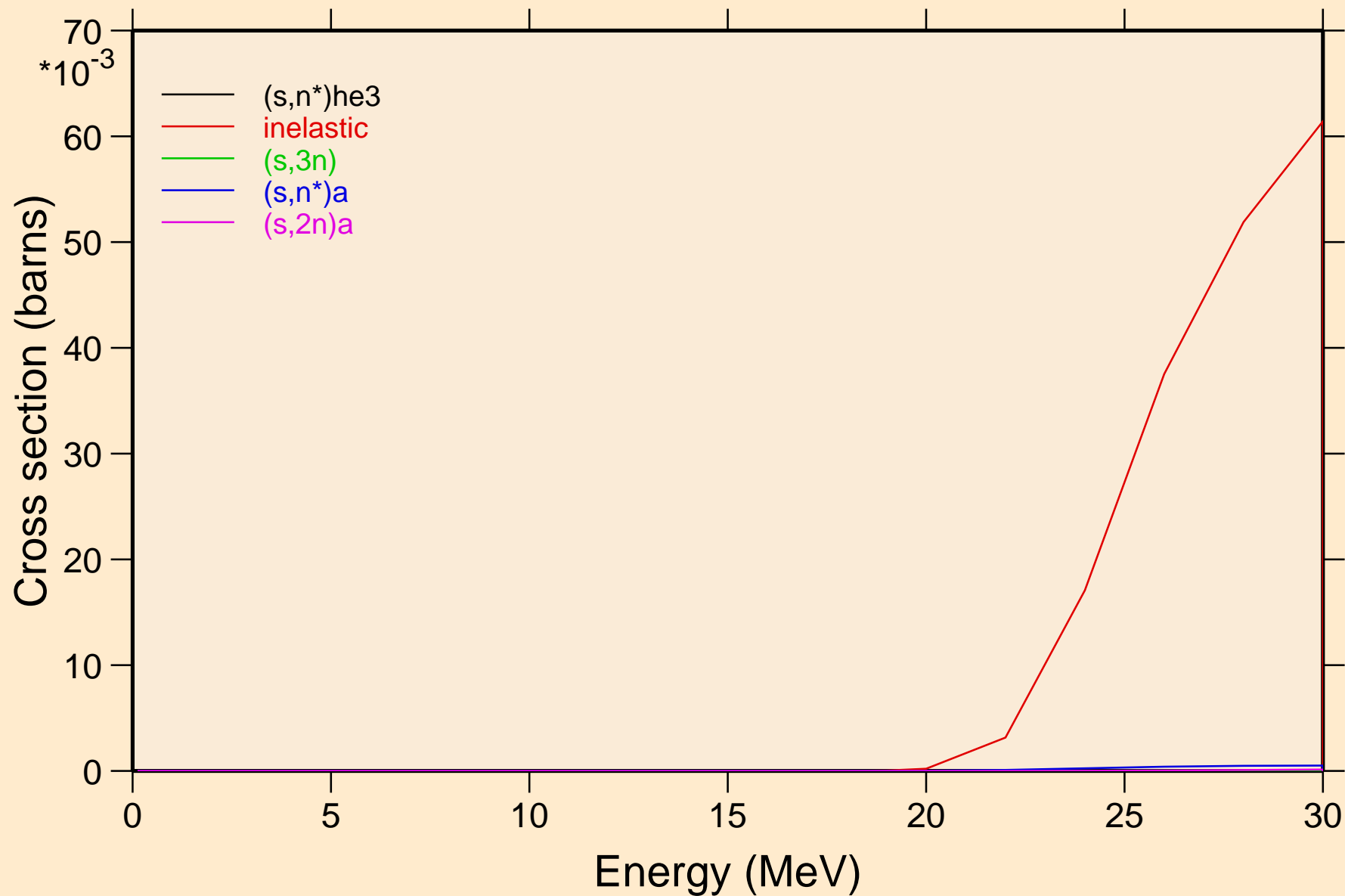

TH229 HELION ACER TENDL-2023 LIBRARY; T=0.K  
Threshold reactions

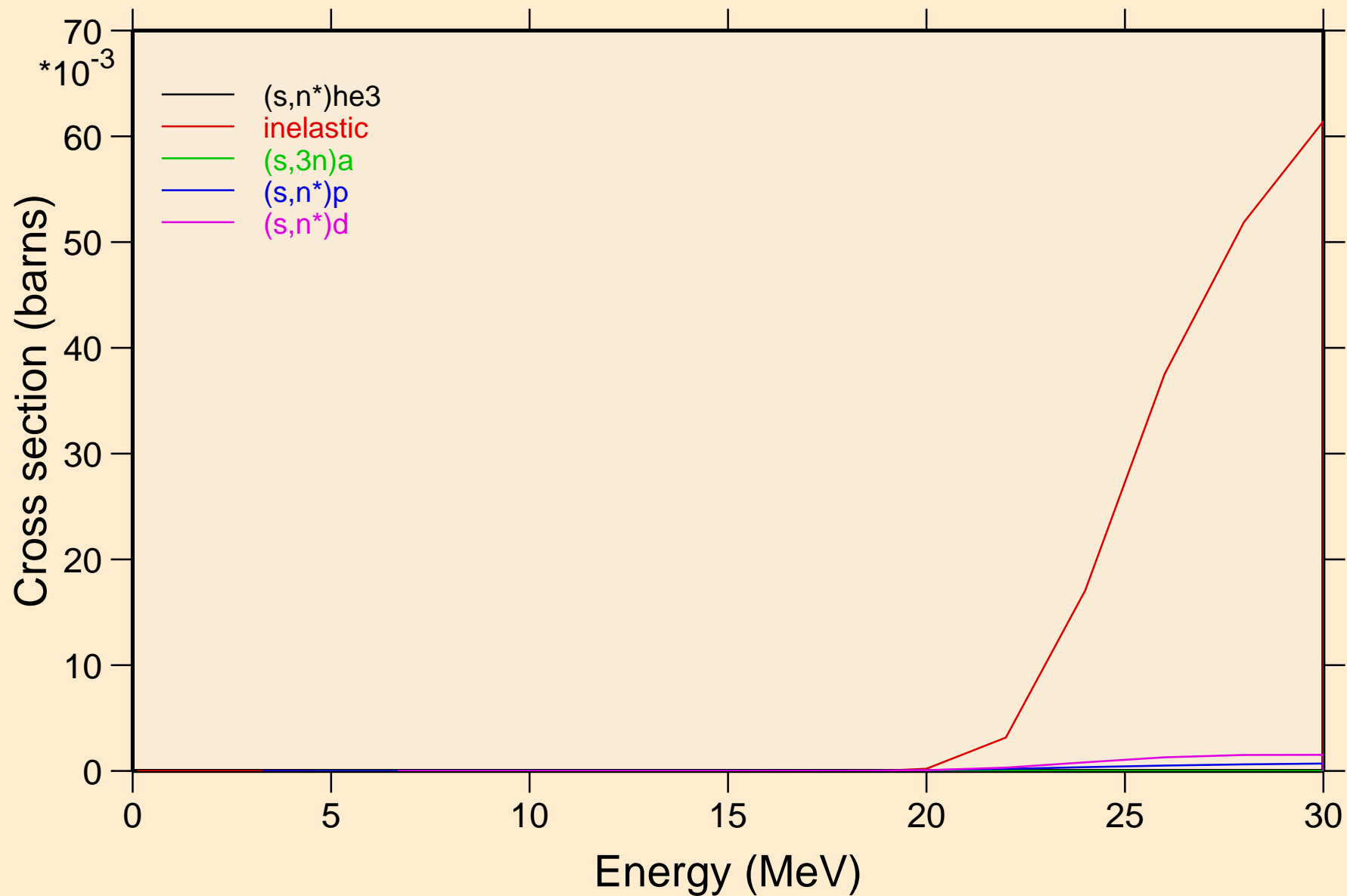

TH229 HELION ACER TENDL-2023 LIBRARY; T=0.K  
Threshold reactions

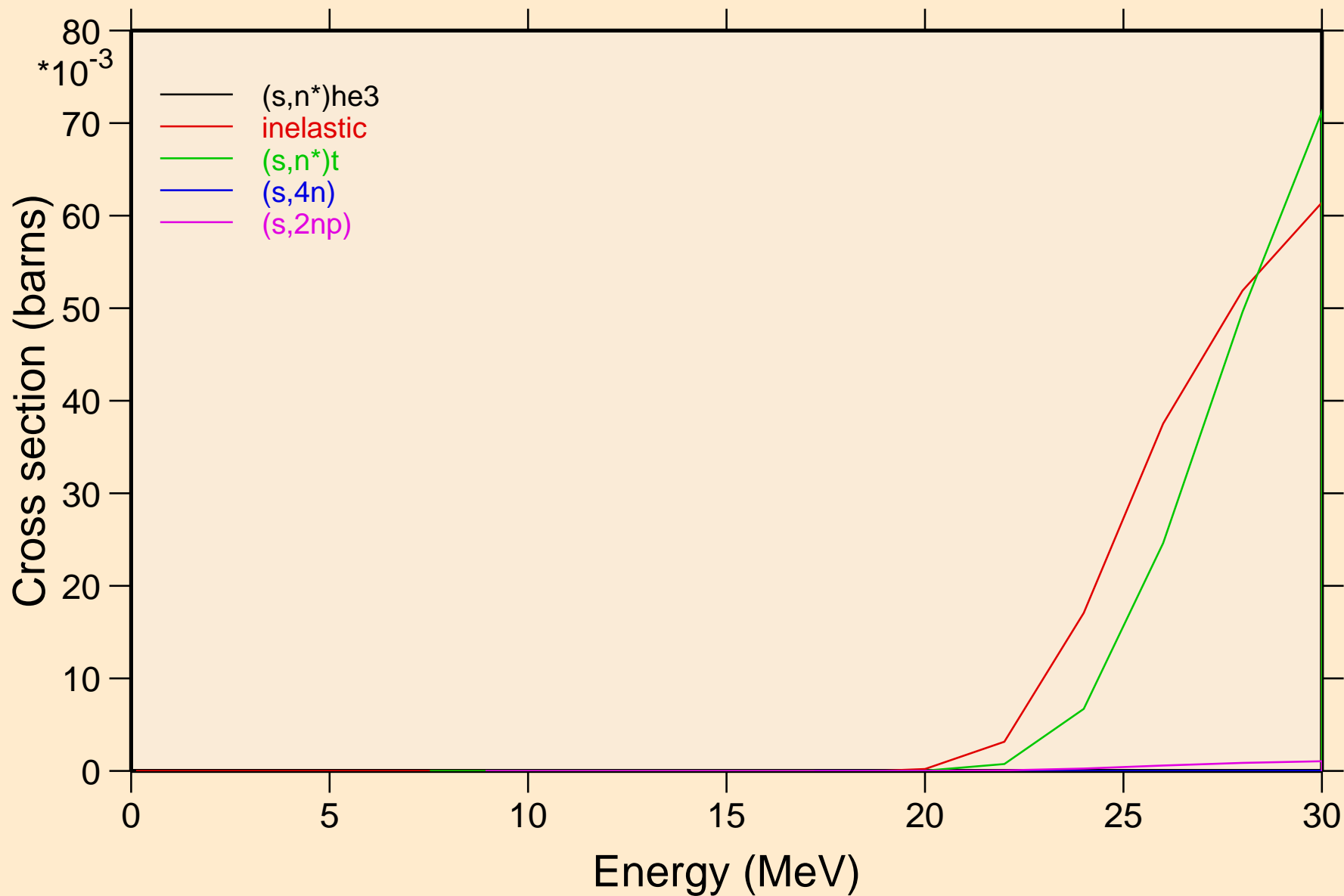



TH229 HELION ACER TENDL-2023 LIBRARY; T=0.K  
Threshold reactions

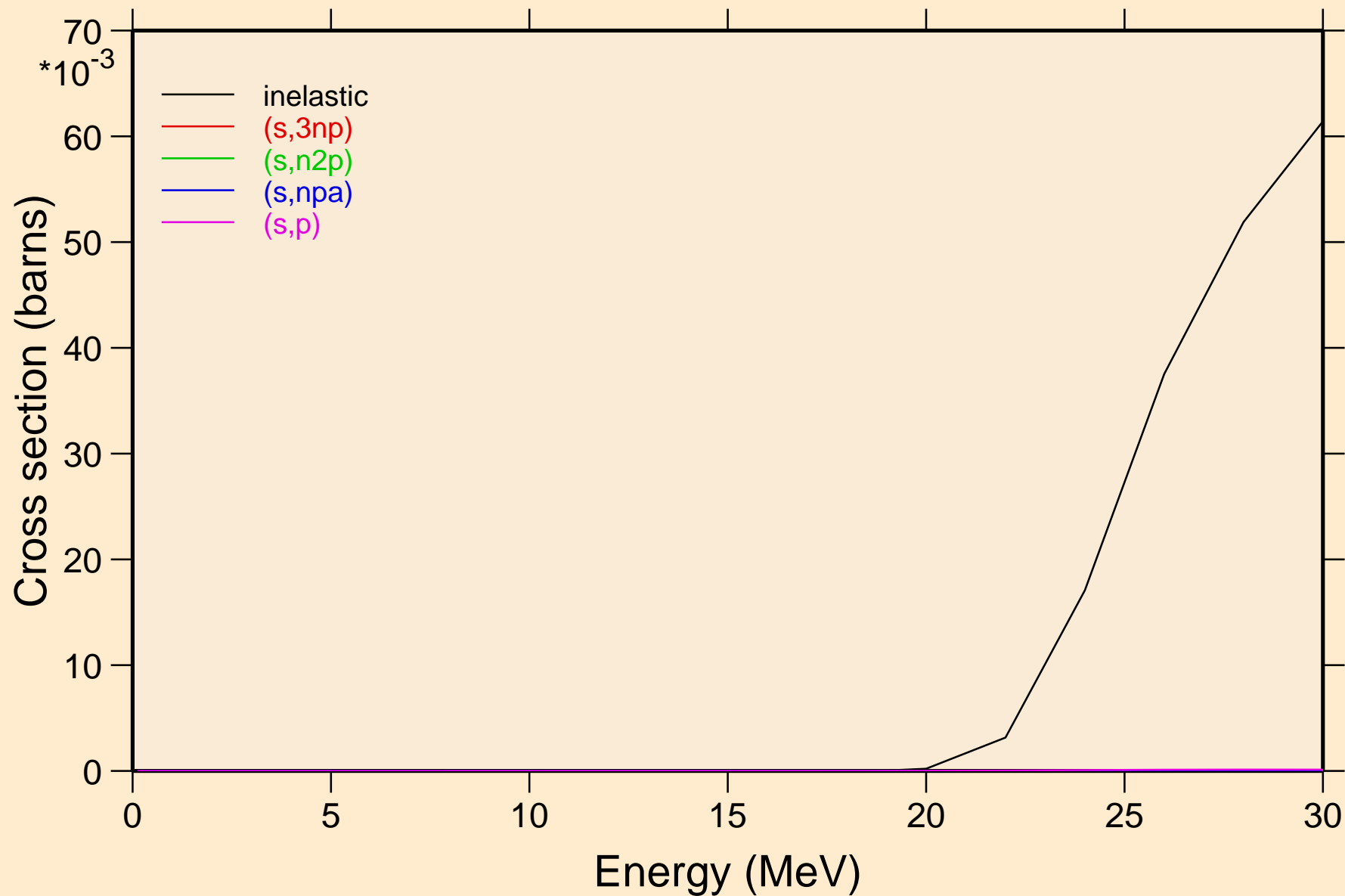

TH229 HELION ACER TENDL-2023 LIBRARY; T=0.K  
Threshold reactions

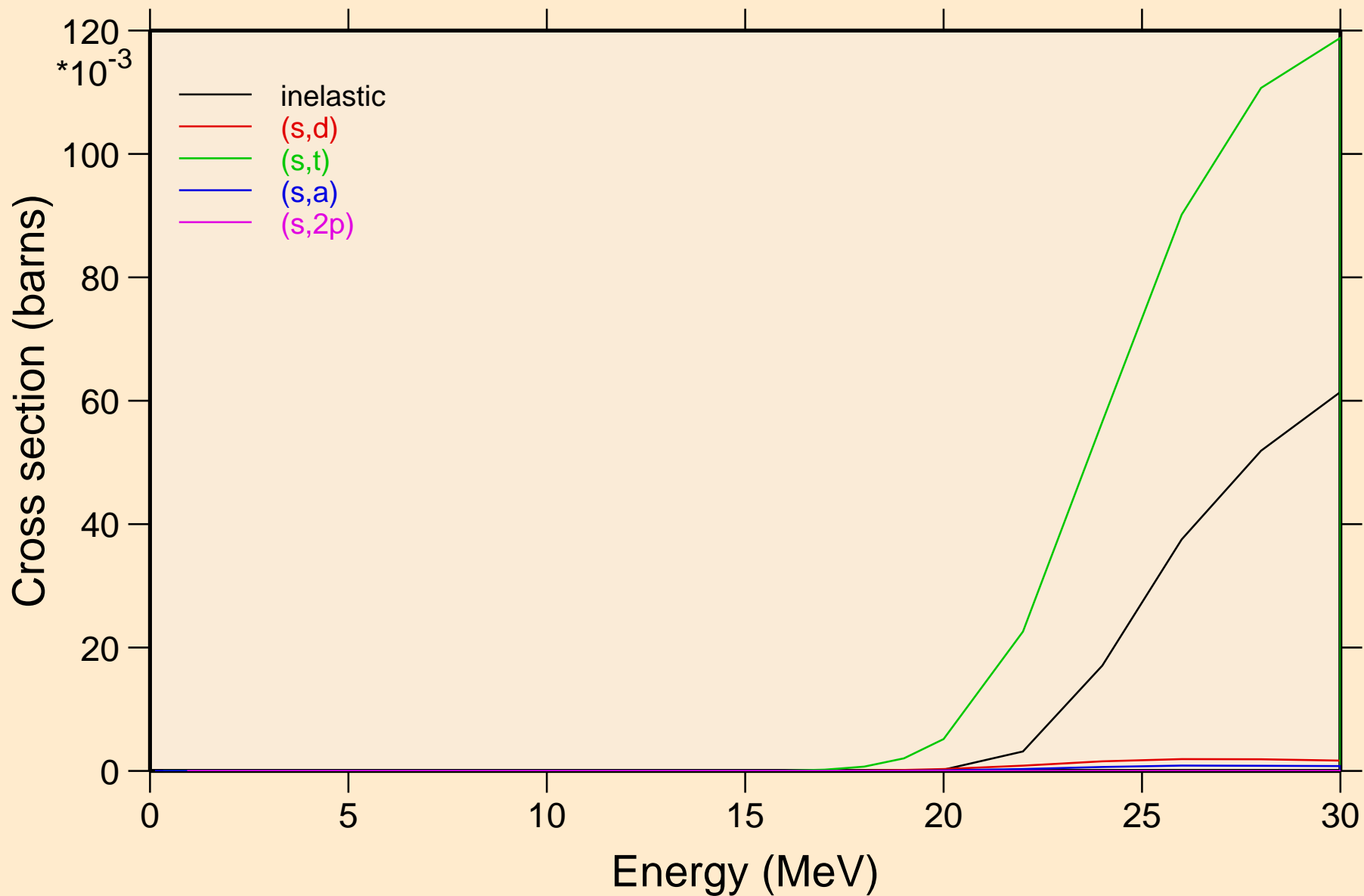

TH229 HELION ACER TENDL-2023 LIBRARY; T=0.K  
Threshold reactions

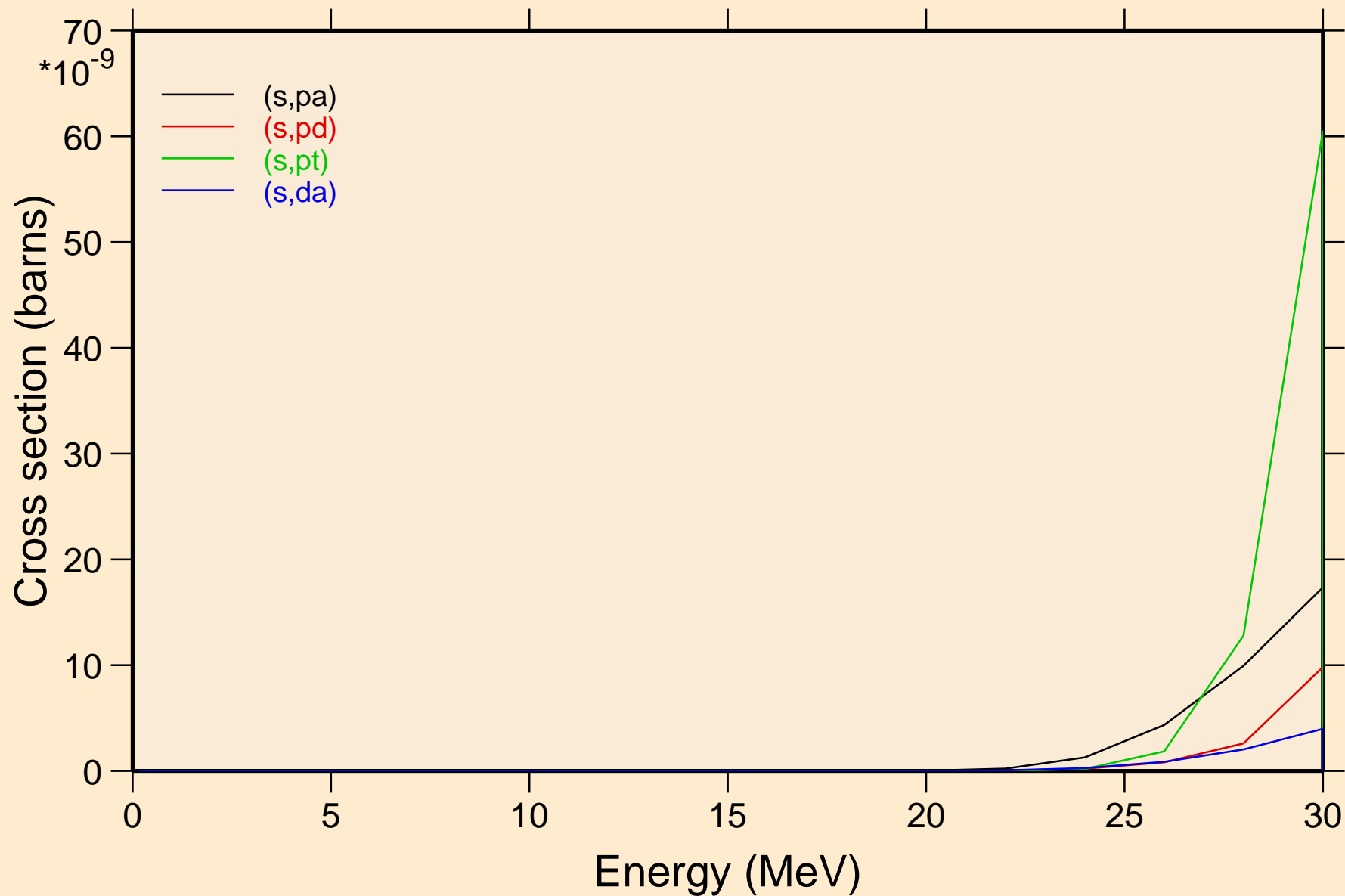

TH229 HELION ACER TENDL-2023 LIBRARY; T=0.K  
angular distribution for elastic

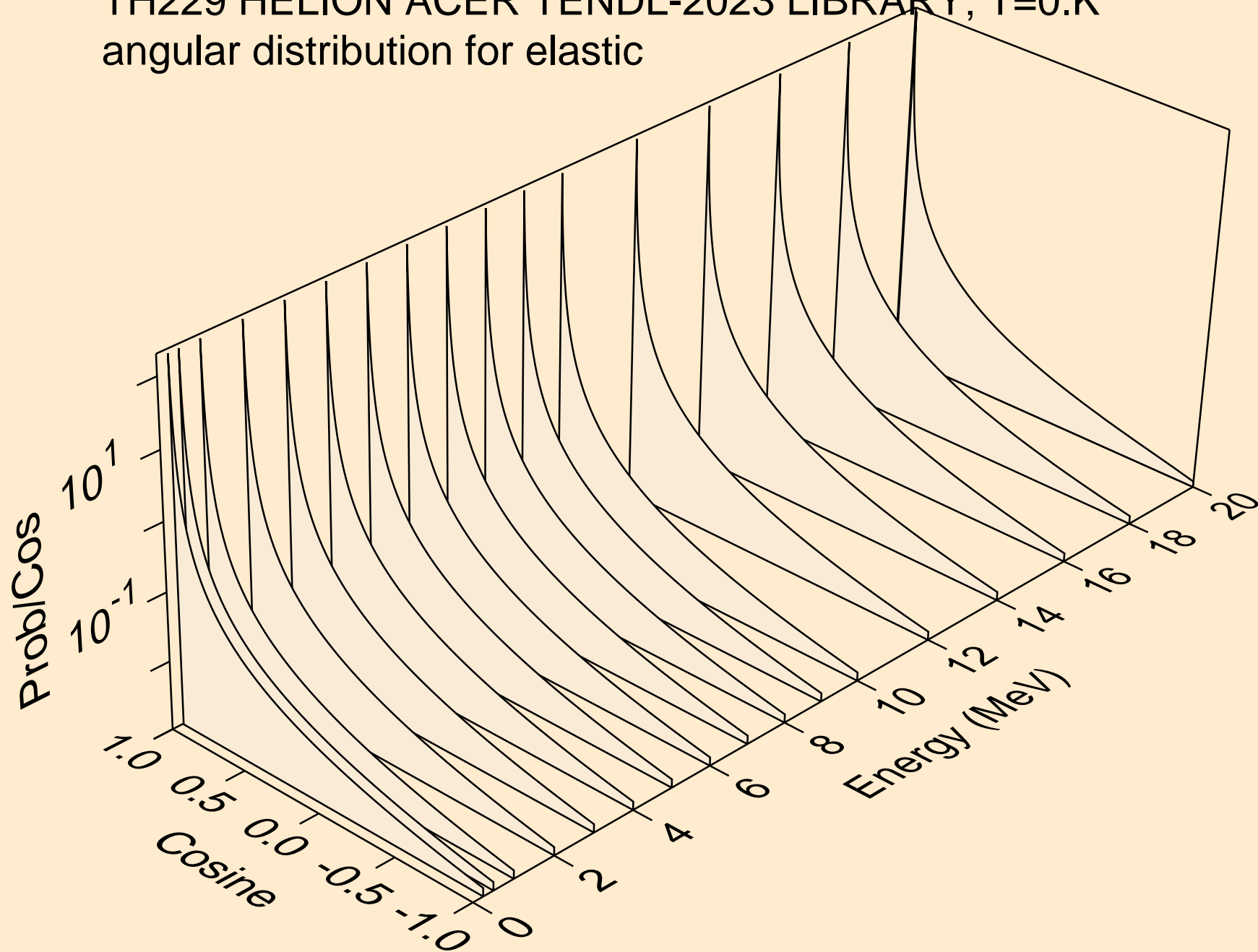

TH229 HELION ACER TENDL-2023 LIBRARY; T=0.K  
angular distribution for elastic

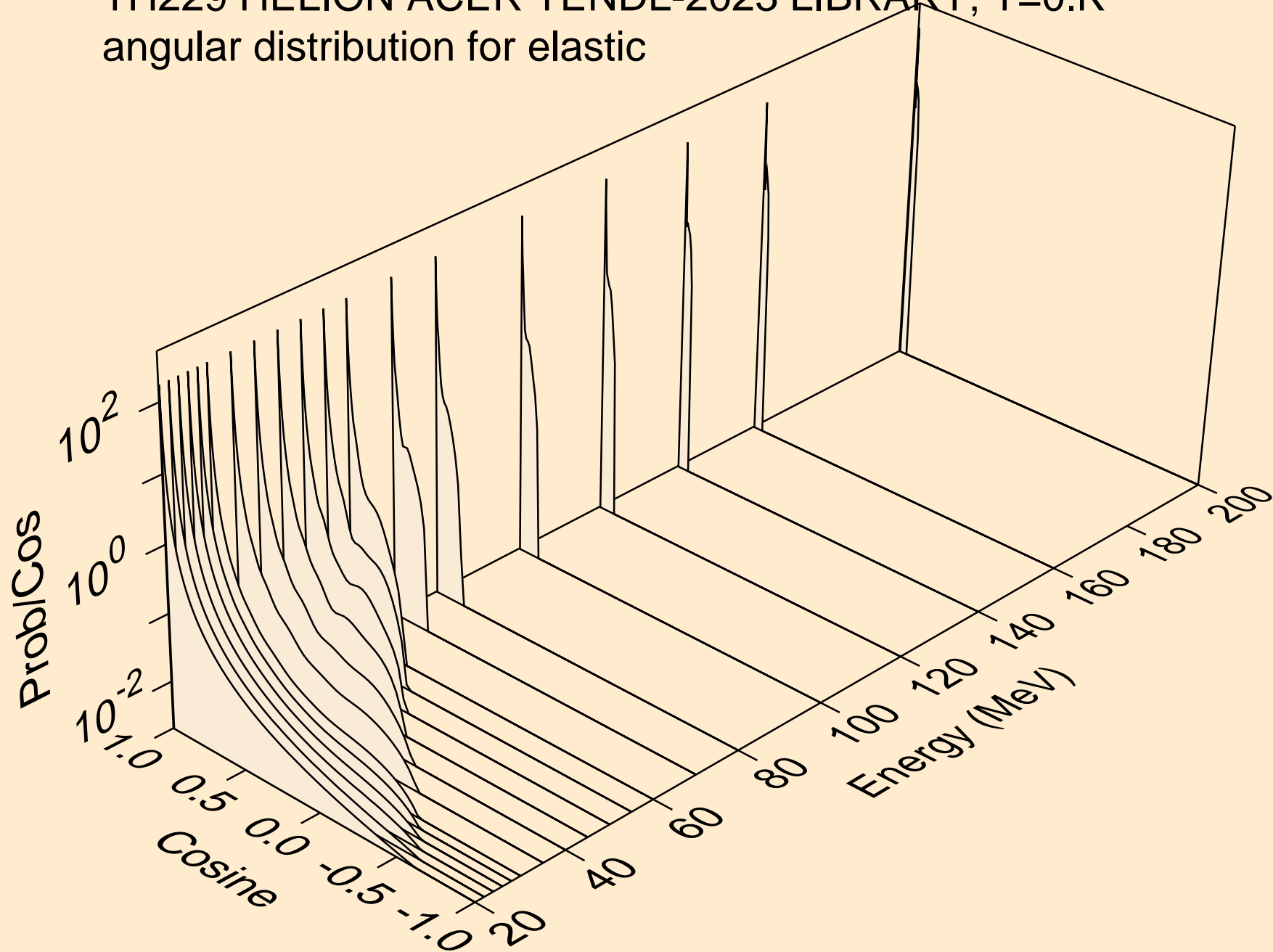

TH229 HELION ACER TENDL-2023 LIBRARY; T=0.K  
He-3 emission for (s,x)

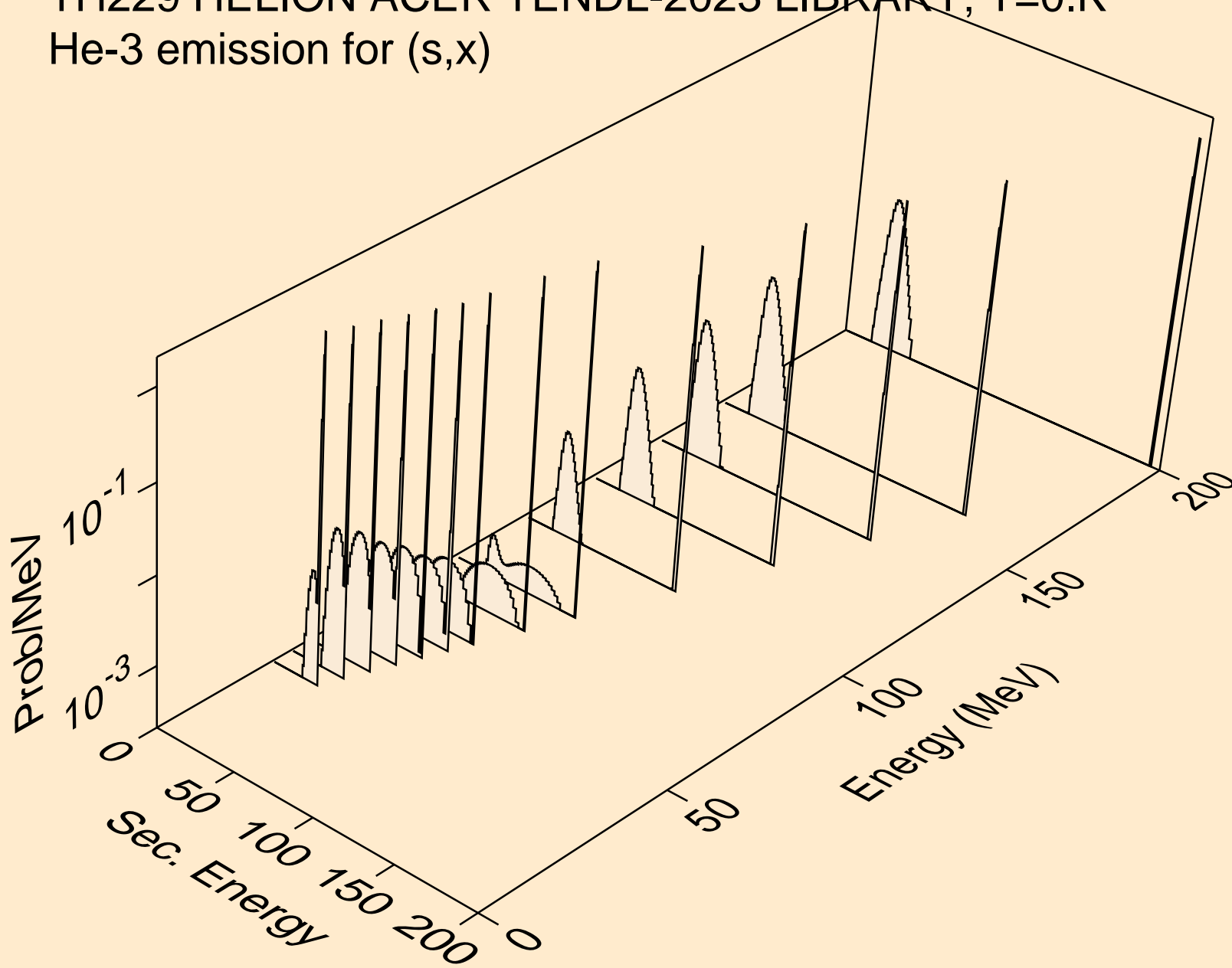

TH229 HELION ACER TENDL-2023 LIBRARY; T=0.K  
He-3 emission for (s,n\*)he3

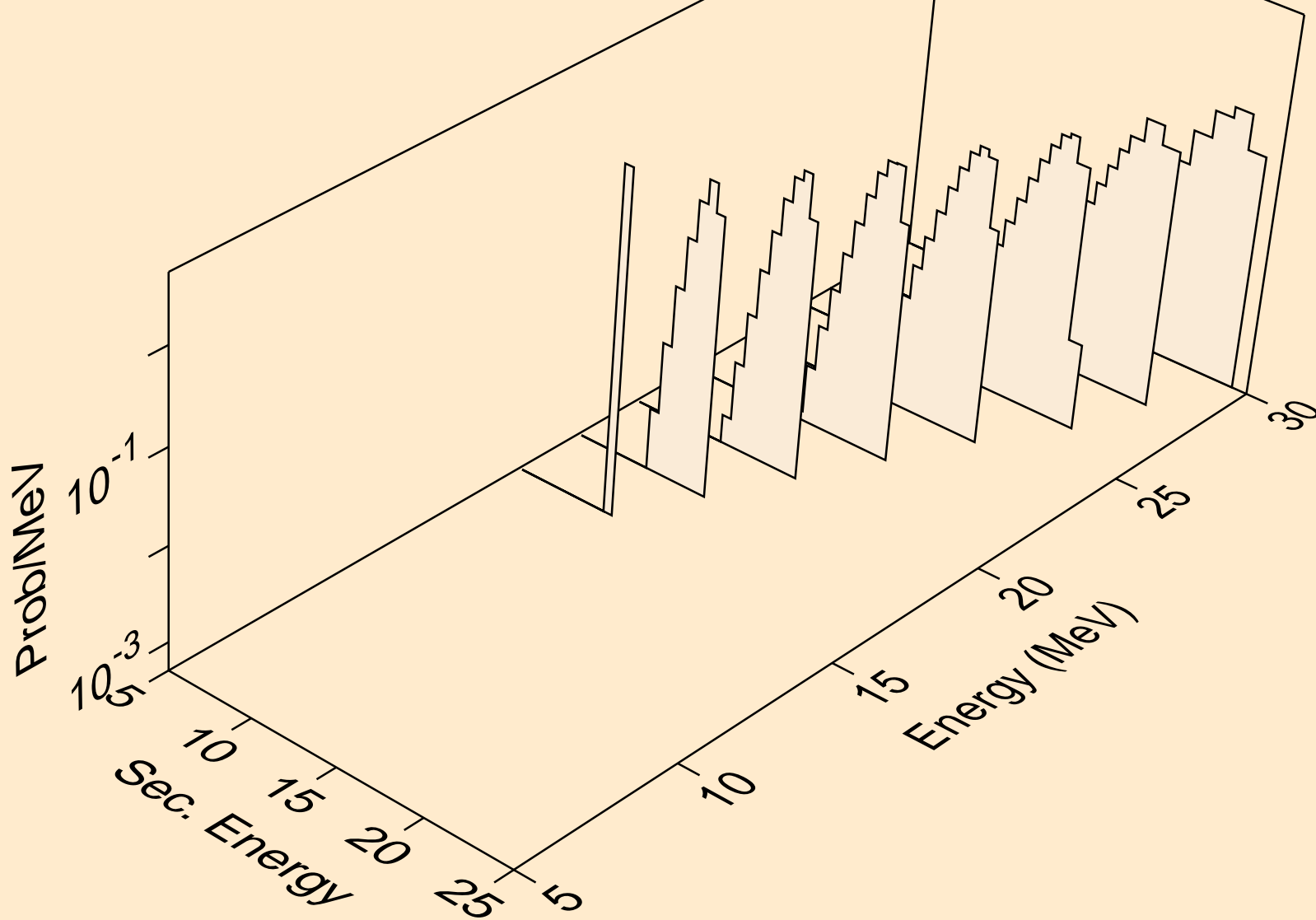

TH229 HELION ACER TENDL-2023 LIBRARY; T=0.K  
He-3 emission for inelastic

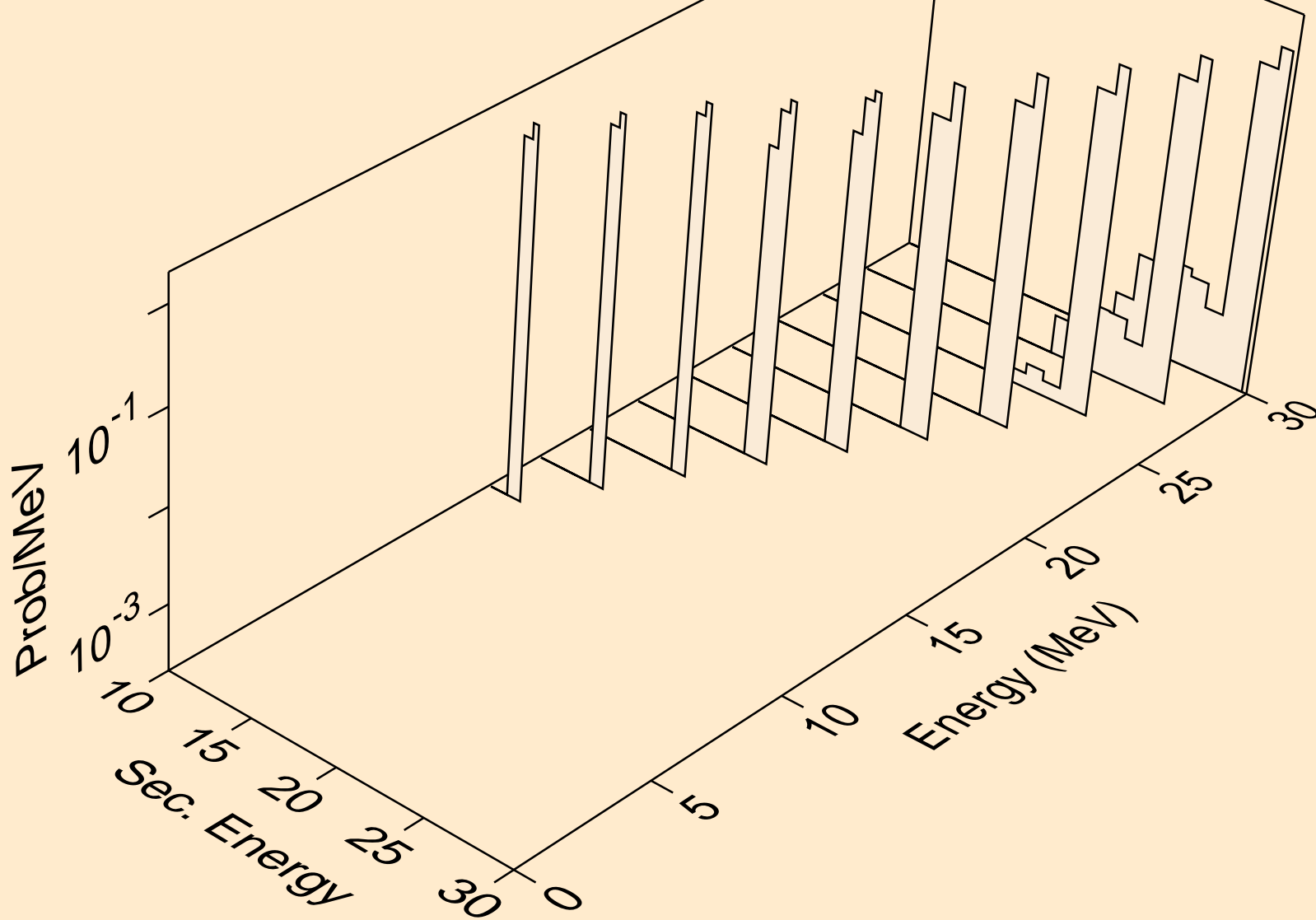



TH229 HELION ACER TENDL-2023 LIBRARY; T=0.K  
Photon emission for (z,n)

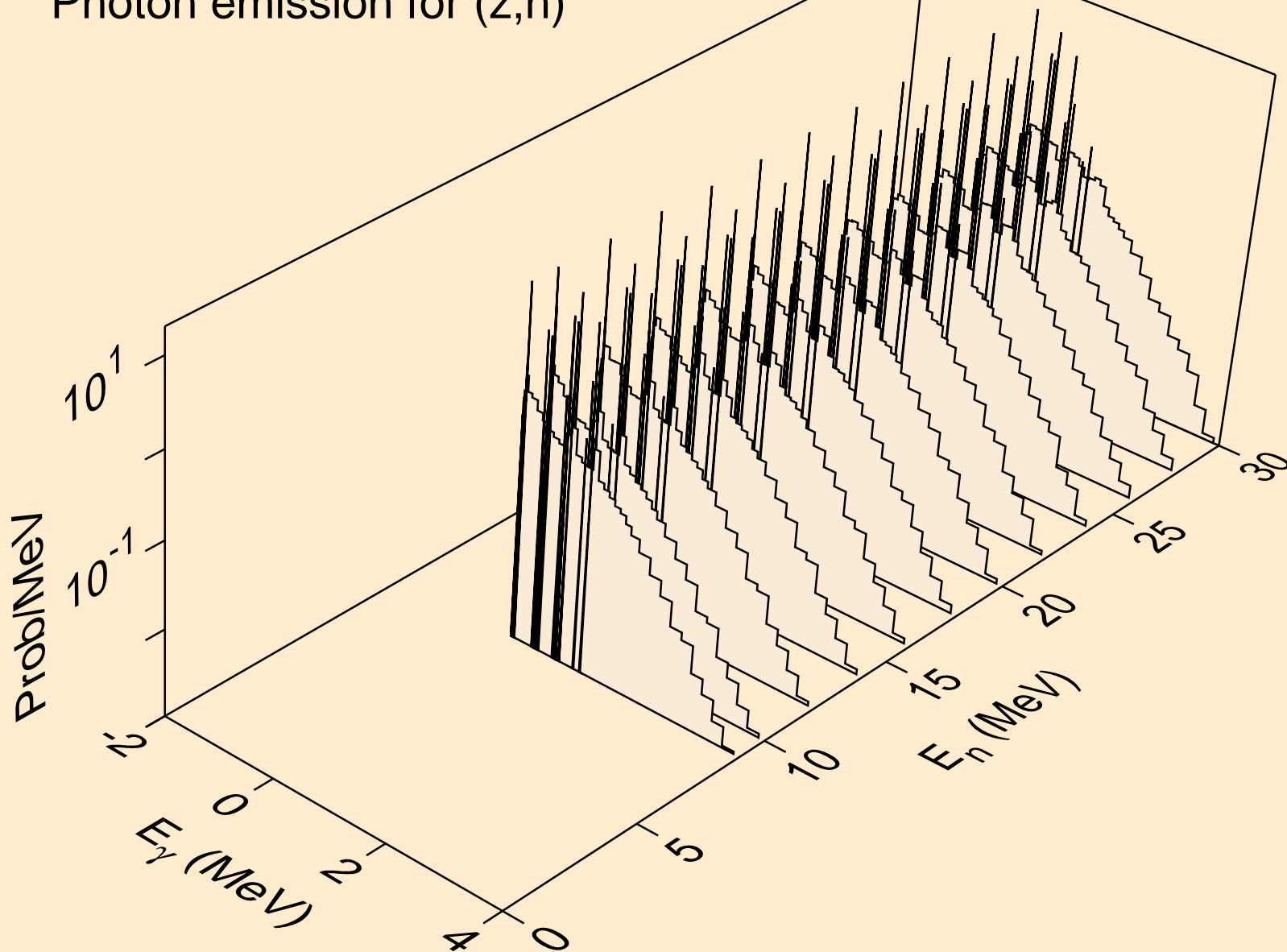

TH229 HELION ACER TENDL-2023 LIBRARY; T=0.K  
Photon emission for (z,x)

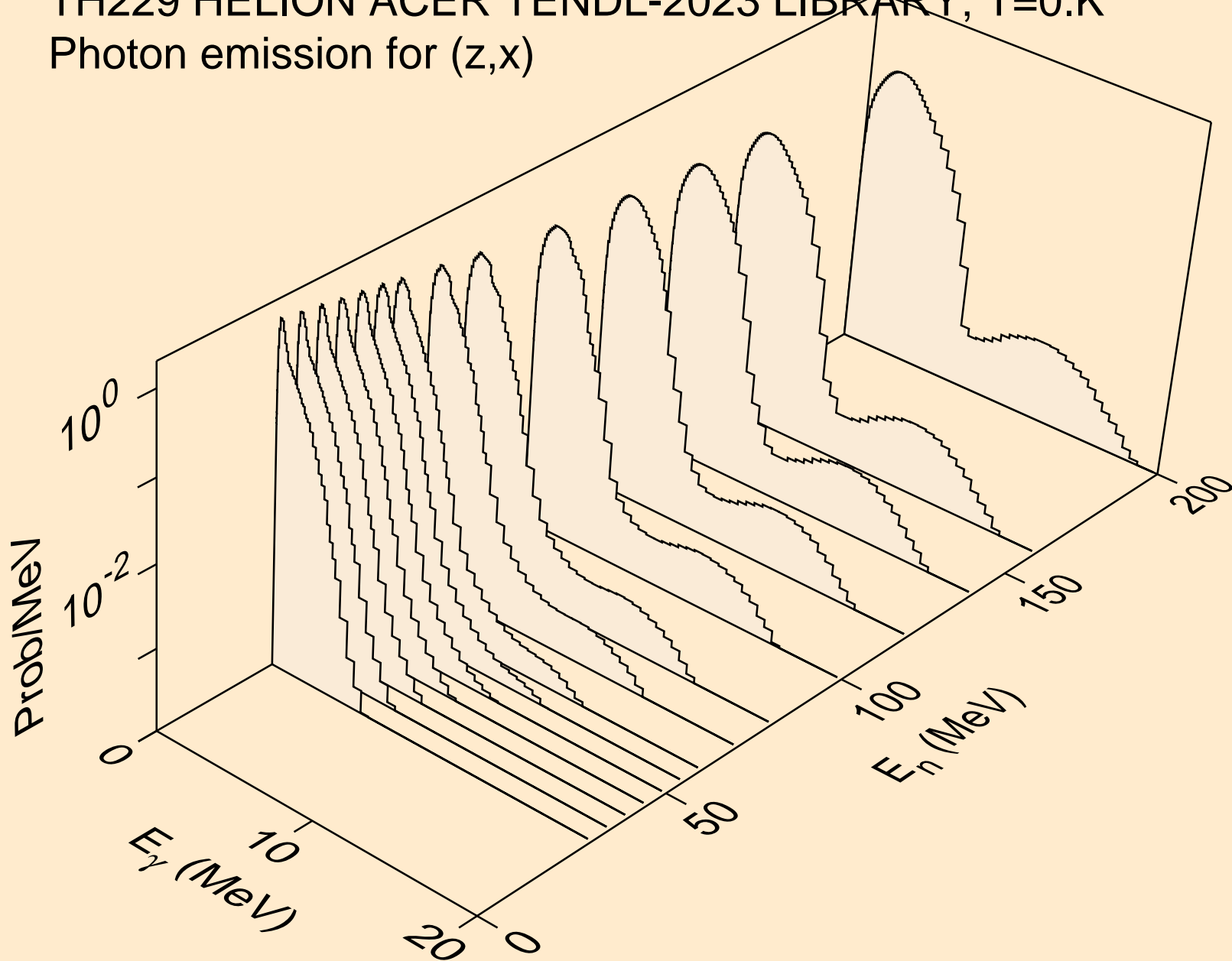

TH229 HELION ACER TENDL-2023 LIBRARY; T=0.K  
Photon emission for (n,2nd)

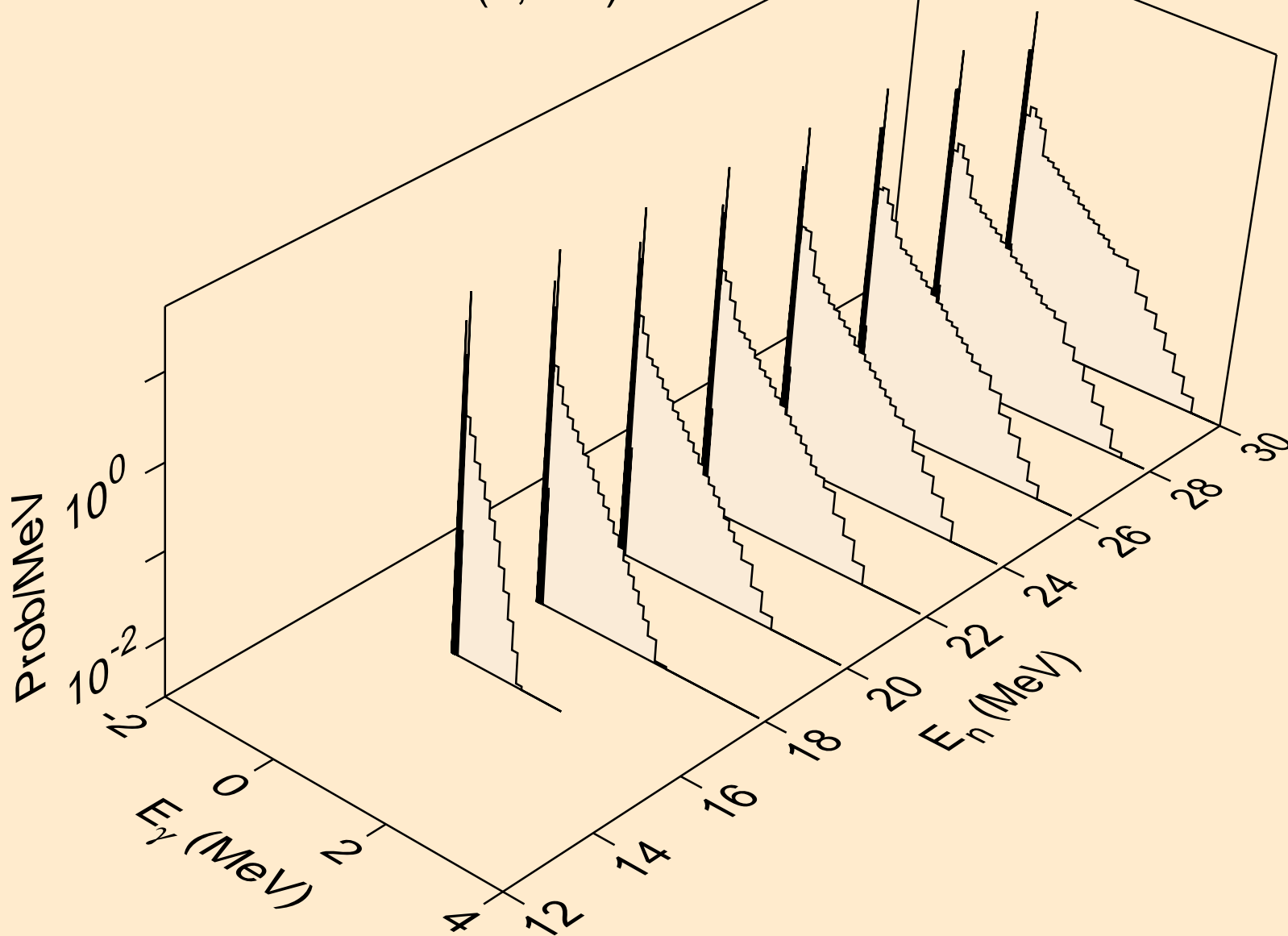

TH229 HELION ACER TENDL-2023 LIBRARY; T=0.K  
Photon emission for (n,2n)

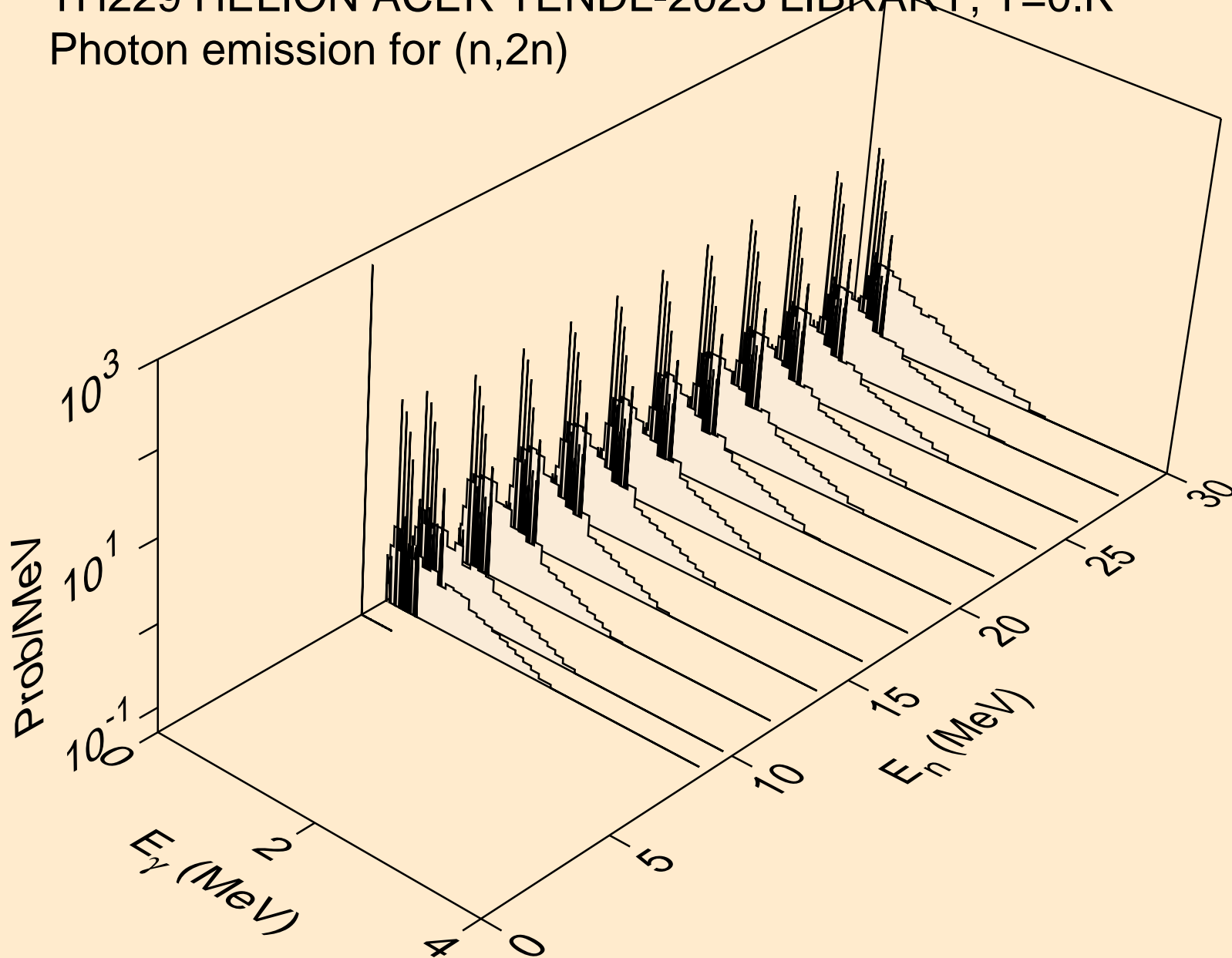

TH229 HELION ACER TENDL-2023 LIBRARY; T=0.K  
Photon emission for (n,3n)

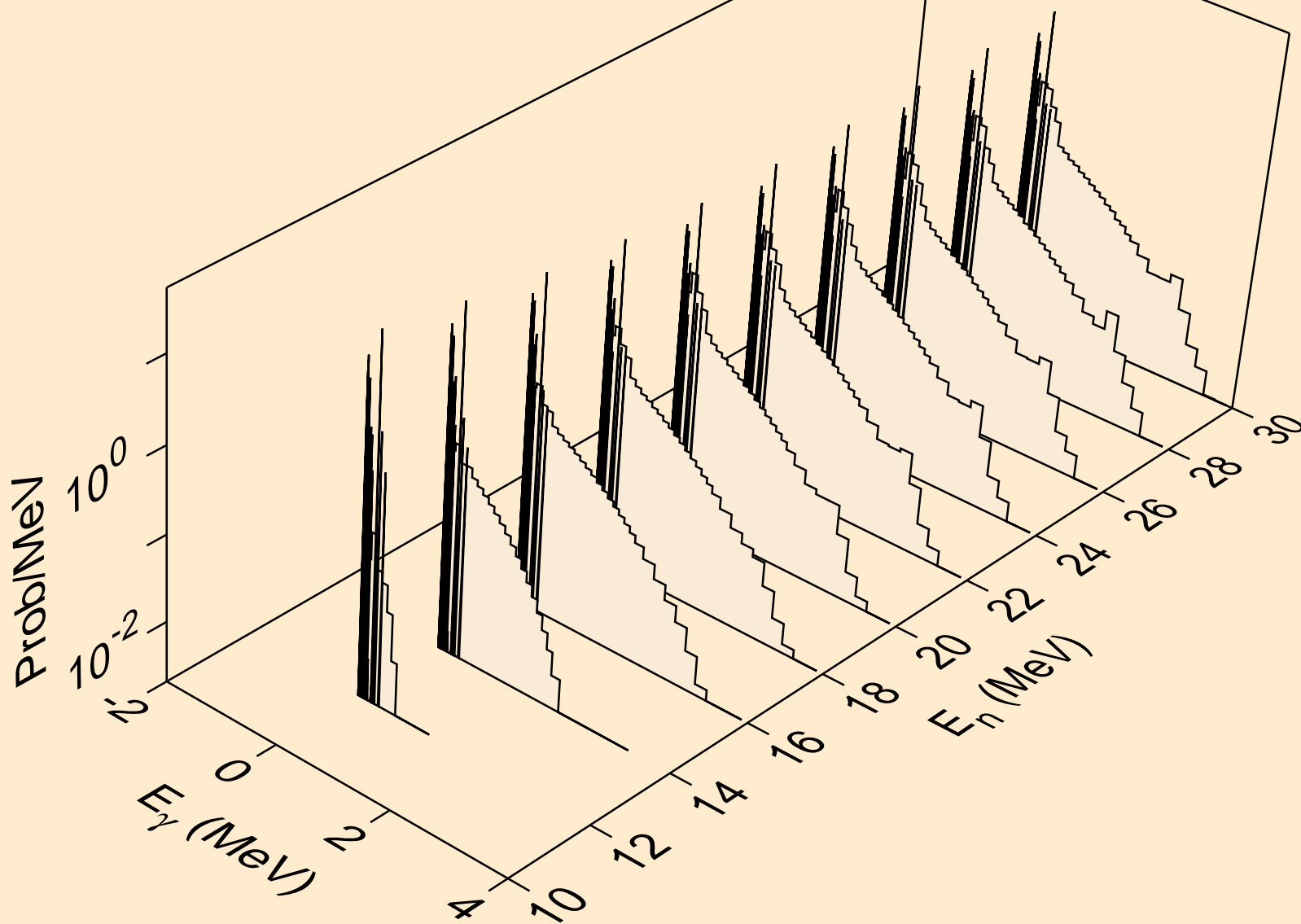

TH229 HELION ACER TENDL-2023 LIBRARY; T=0.K  
Photon emission for (n,n\*)a

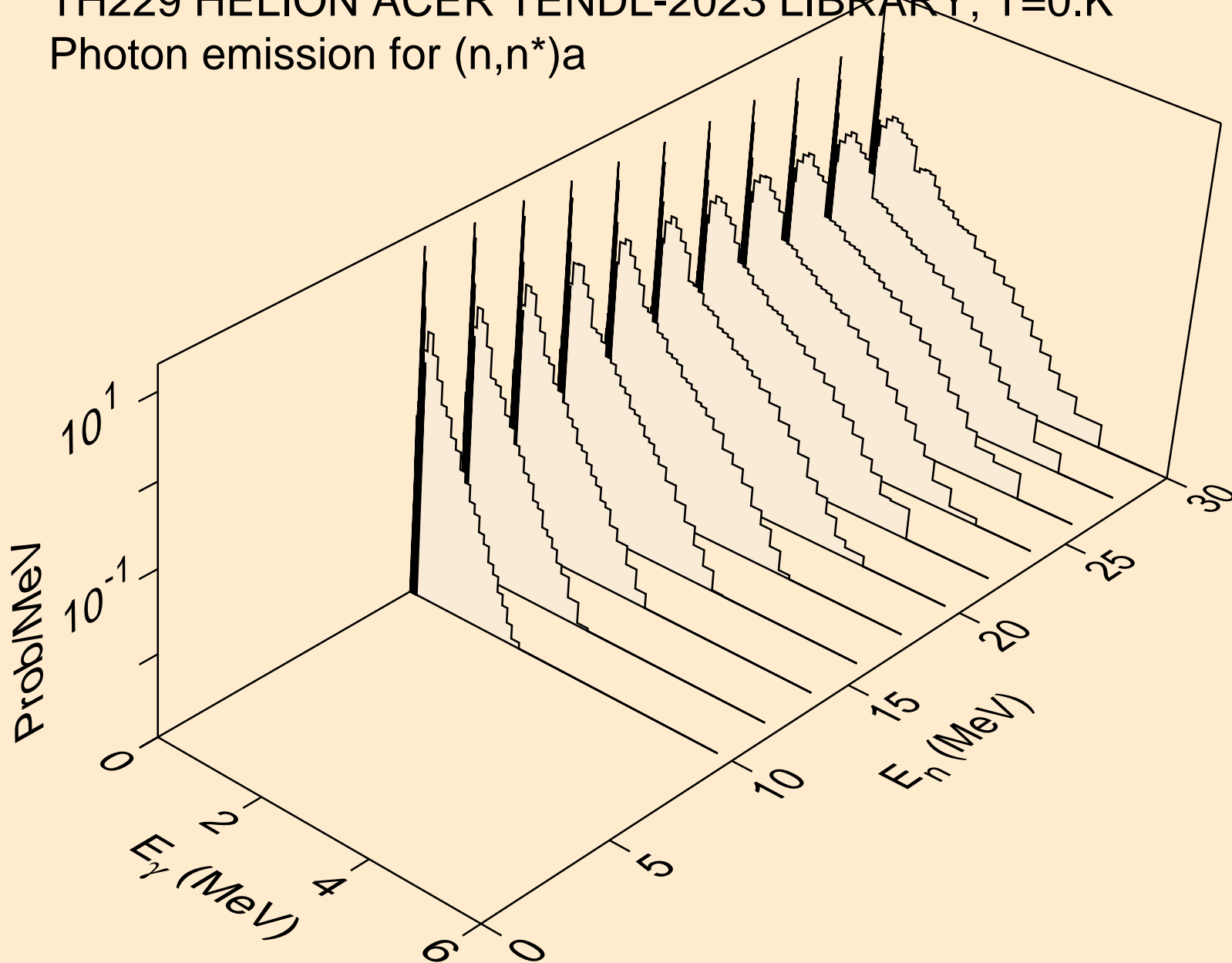

TH229 HELION ACER TENDL-2023 LIBRARY; T=0.K  
Photon emission for (n,2n)a

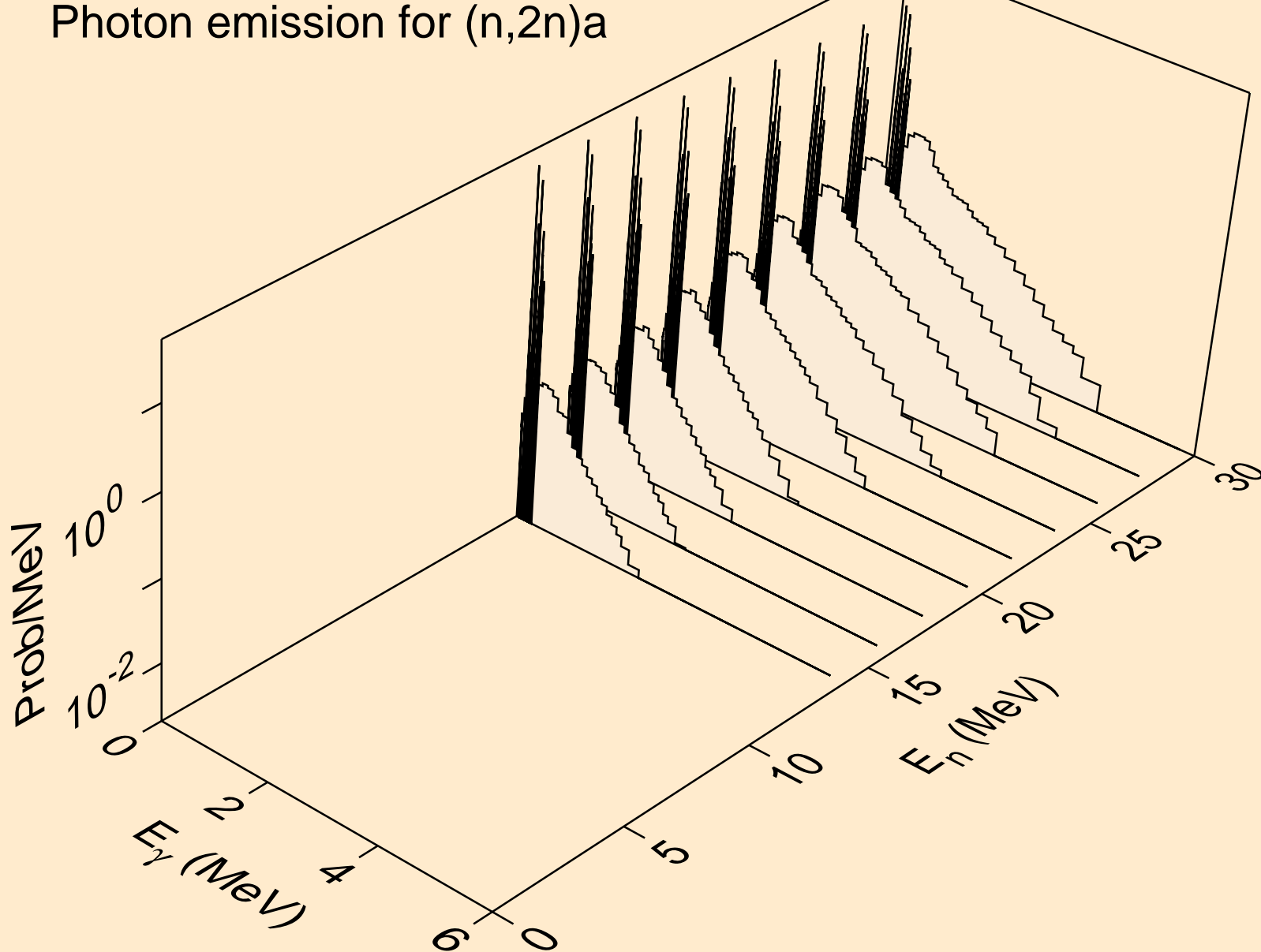

TH229 HELION ACER TENDL-2023 LIBRARY; T=0.K  
Photon emission for (n,3n)a

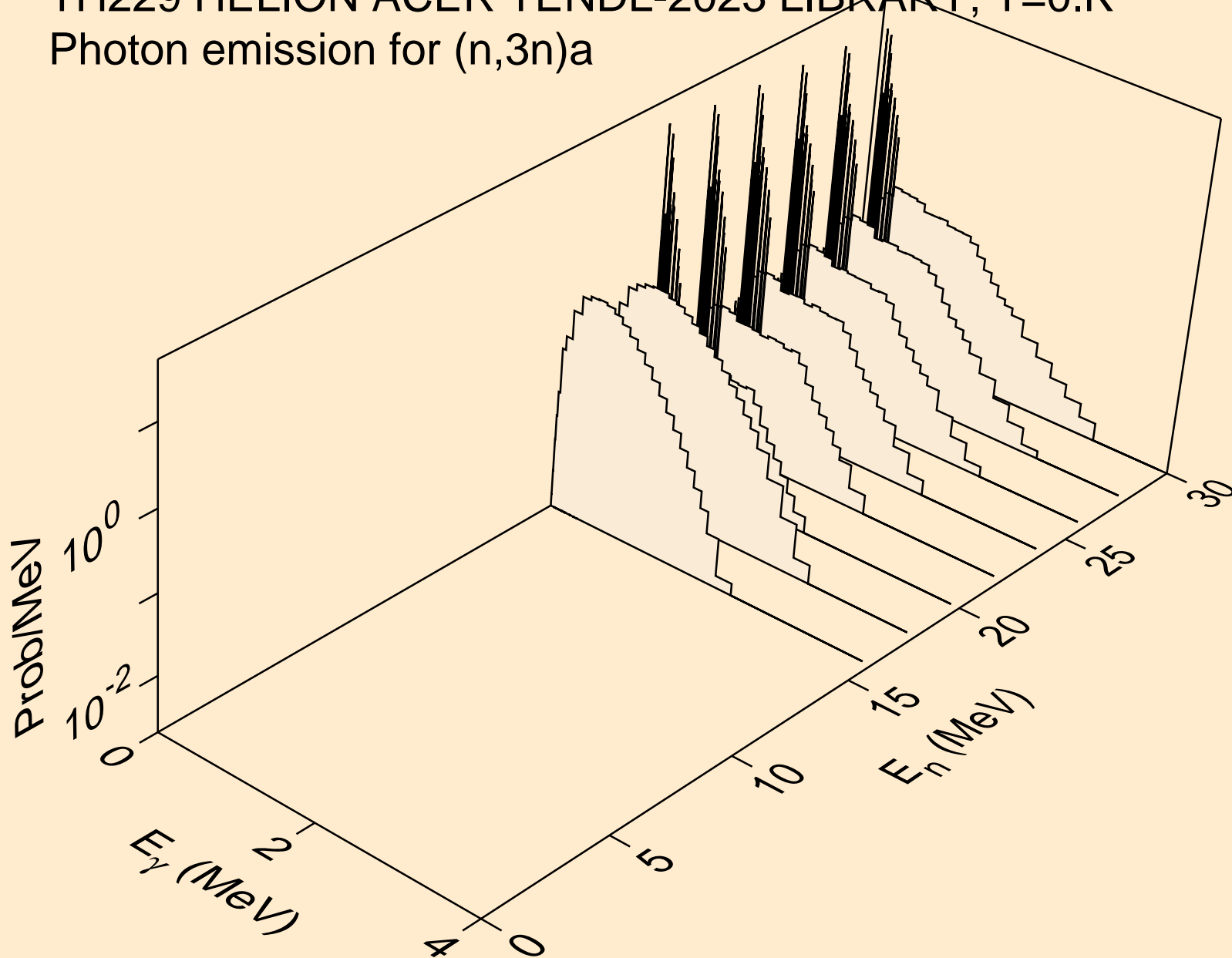



TH229 HELION ACER TENDL-2023 LIBRARY; T=0.K  
Photon emission for (n,n\*)p

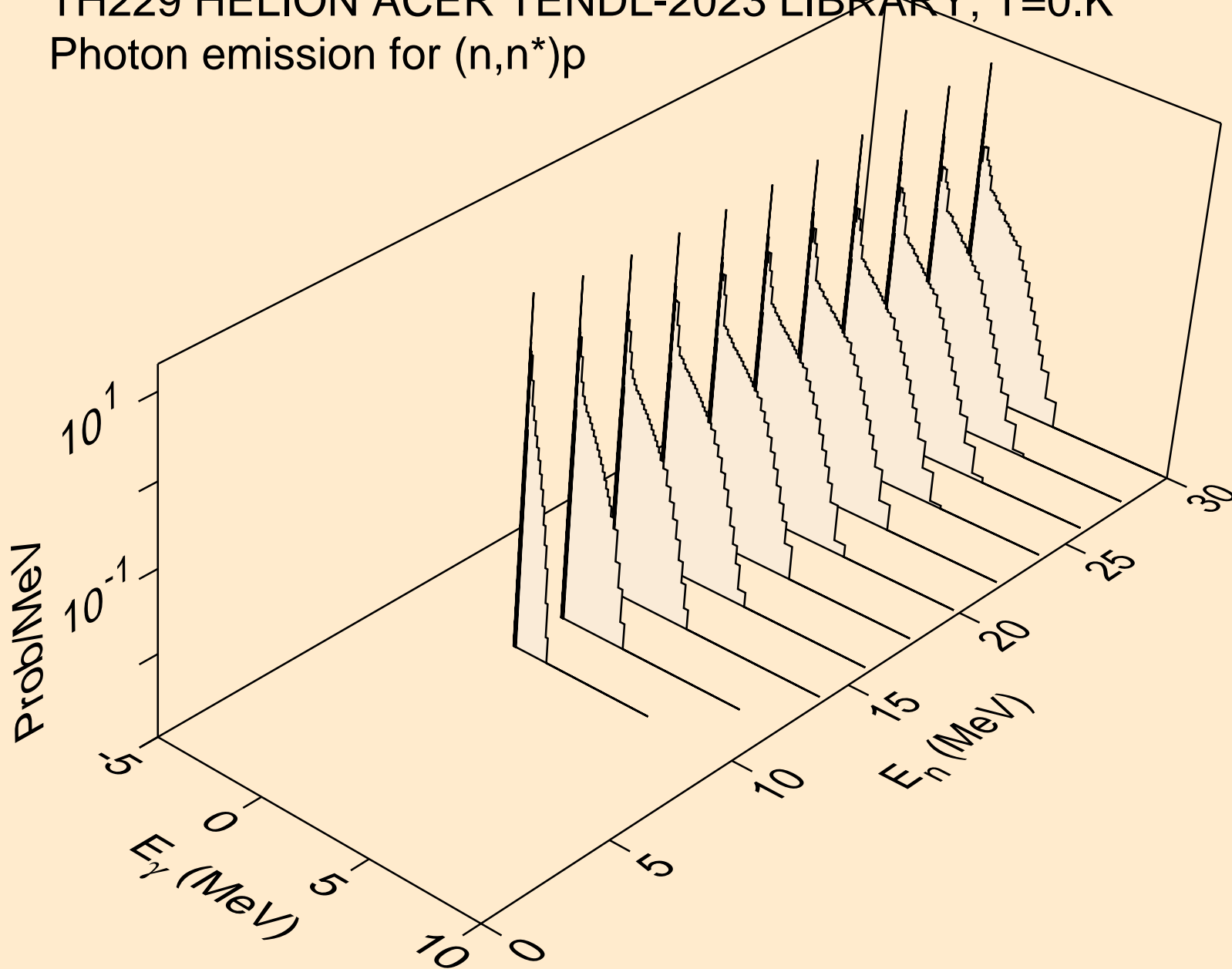

TH229 HELION ACER TENDL-2023 LIBRARY; T=0.K  
Photon emission for (n,n\*)d

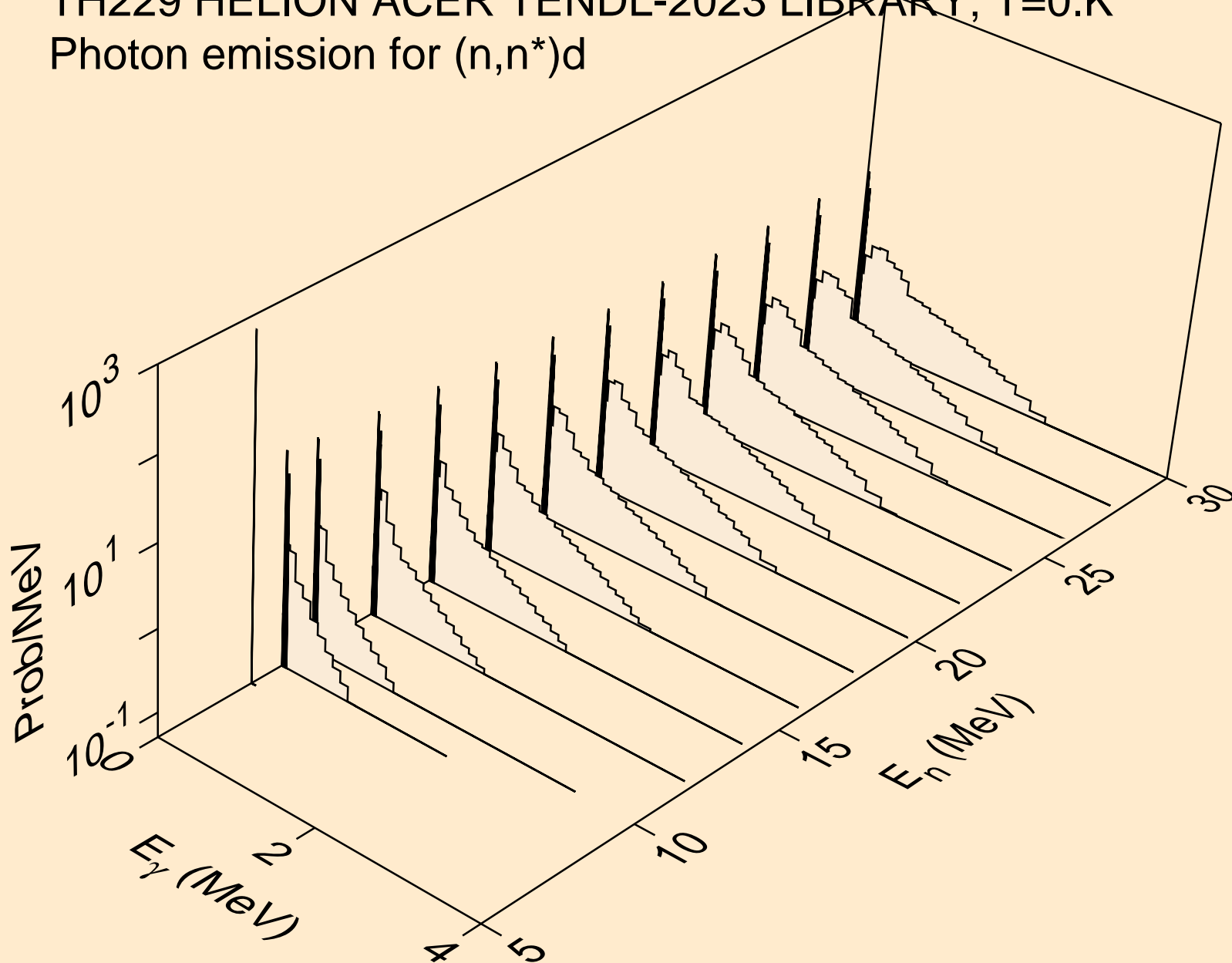

TH229 HELION ACER TENDL-2023 LIBRARY; T=0.K  
Photon emission for (n,n\*)t

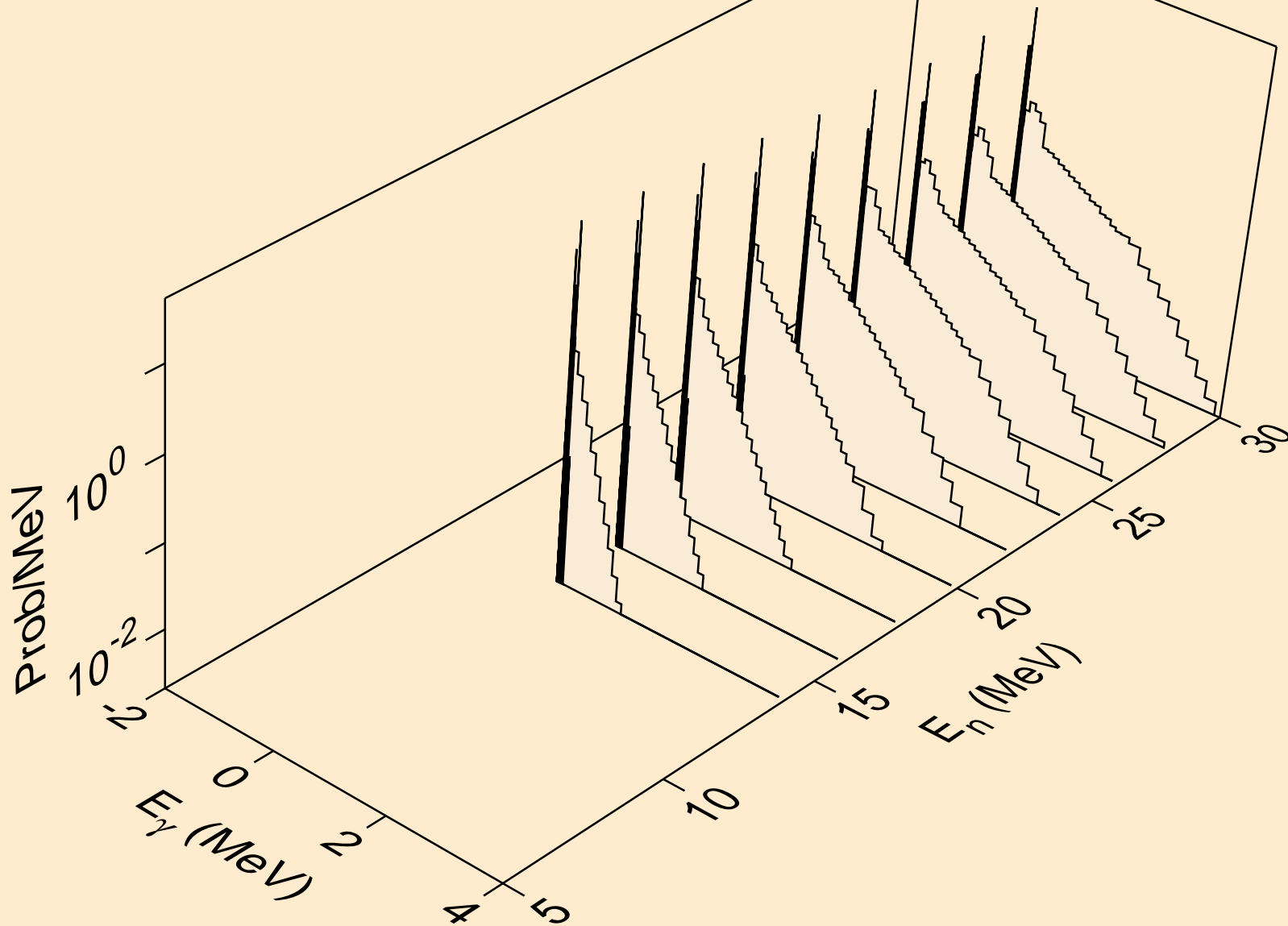

TH229 HELION ACER TENDL-2023 LIBRARY; T=0.K  
Photon emission for (n,n\*)he3

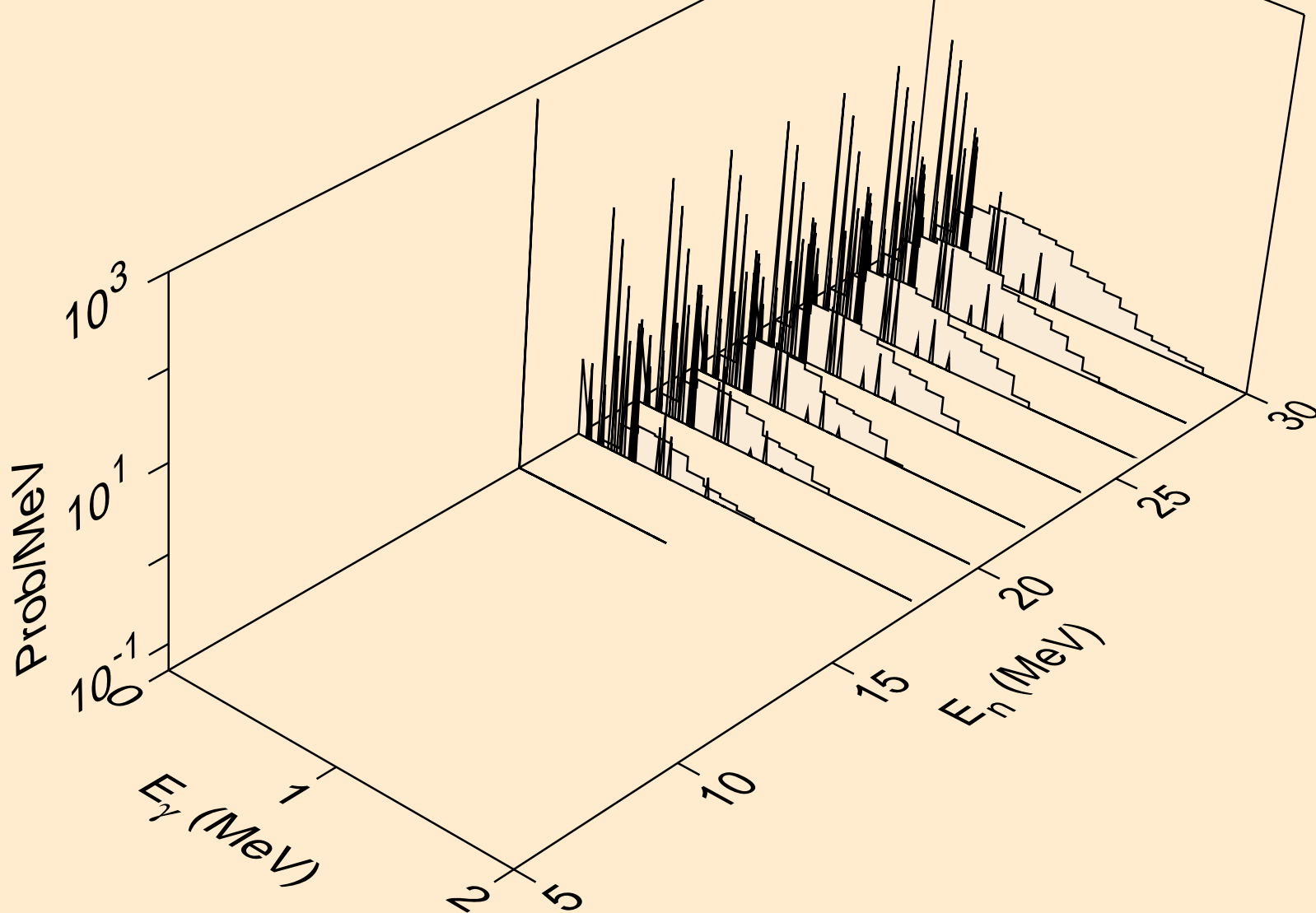

TH229 HELION ACER TENDL-2023 LIBRARY; T=0.K  
Photon emission for (n,4n)

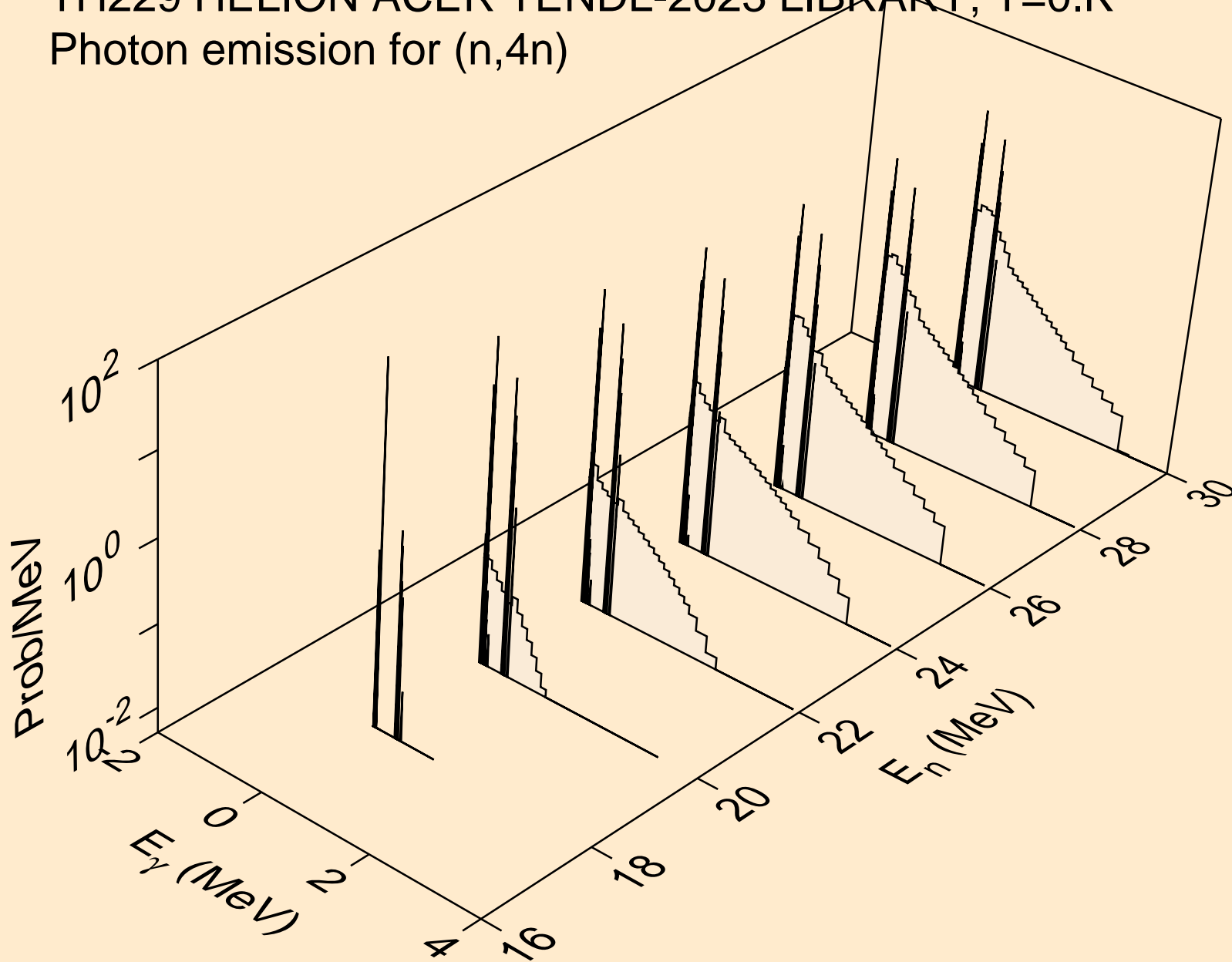

TH229 HELION ACER TENDL-2023 LIBRARY; T=0.K  
Photon emission for (n,2np)

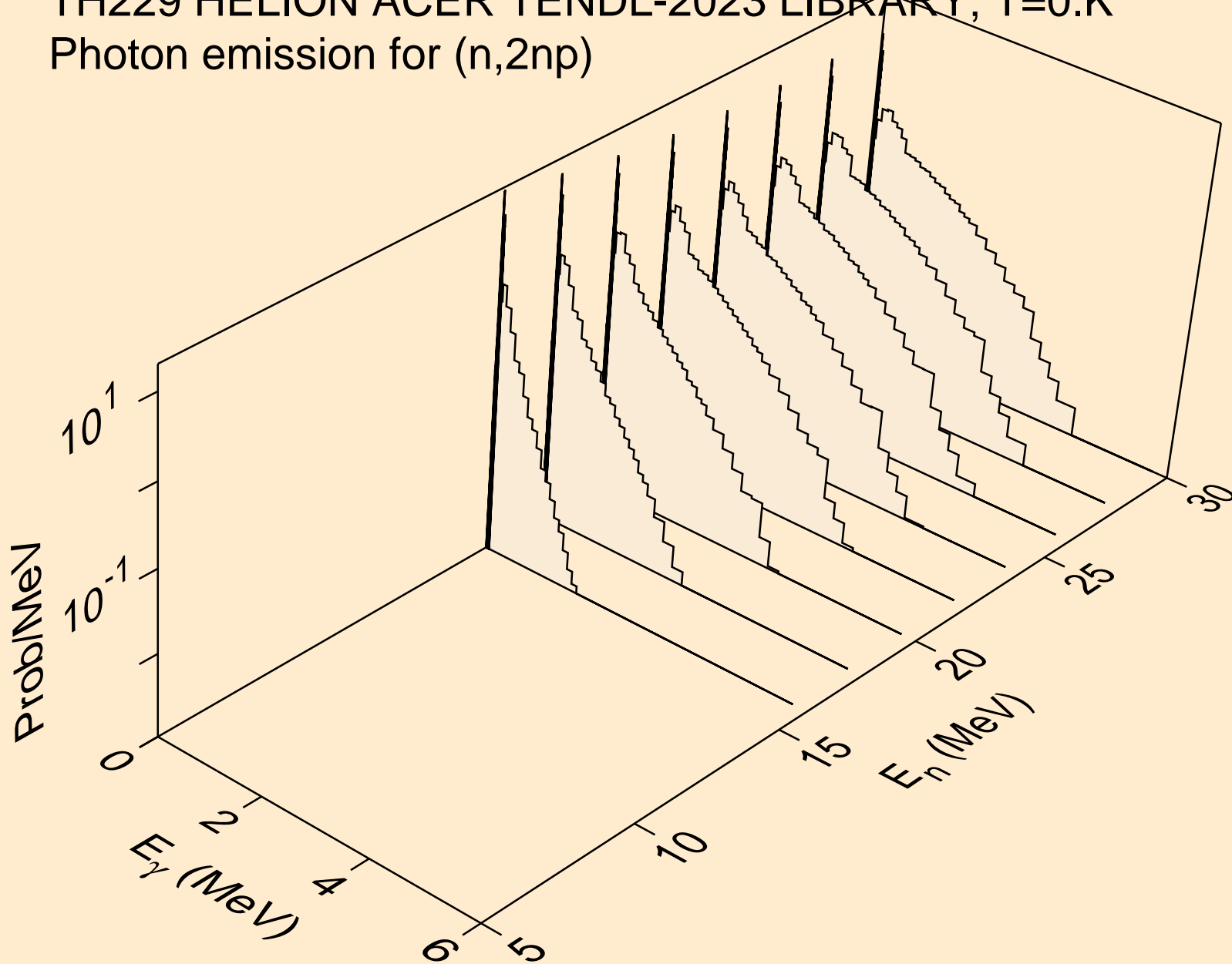

TH229 HELION ACER TENDL-2023 LIBRARY; T=0.K  
Photon emission for (n,3np)

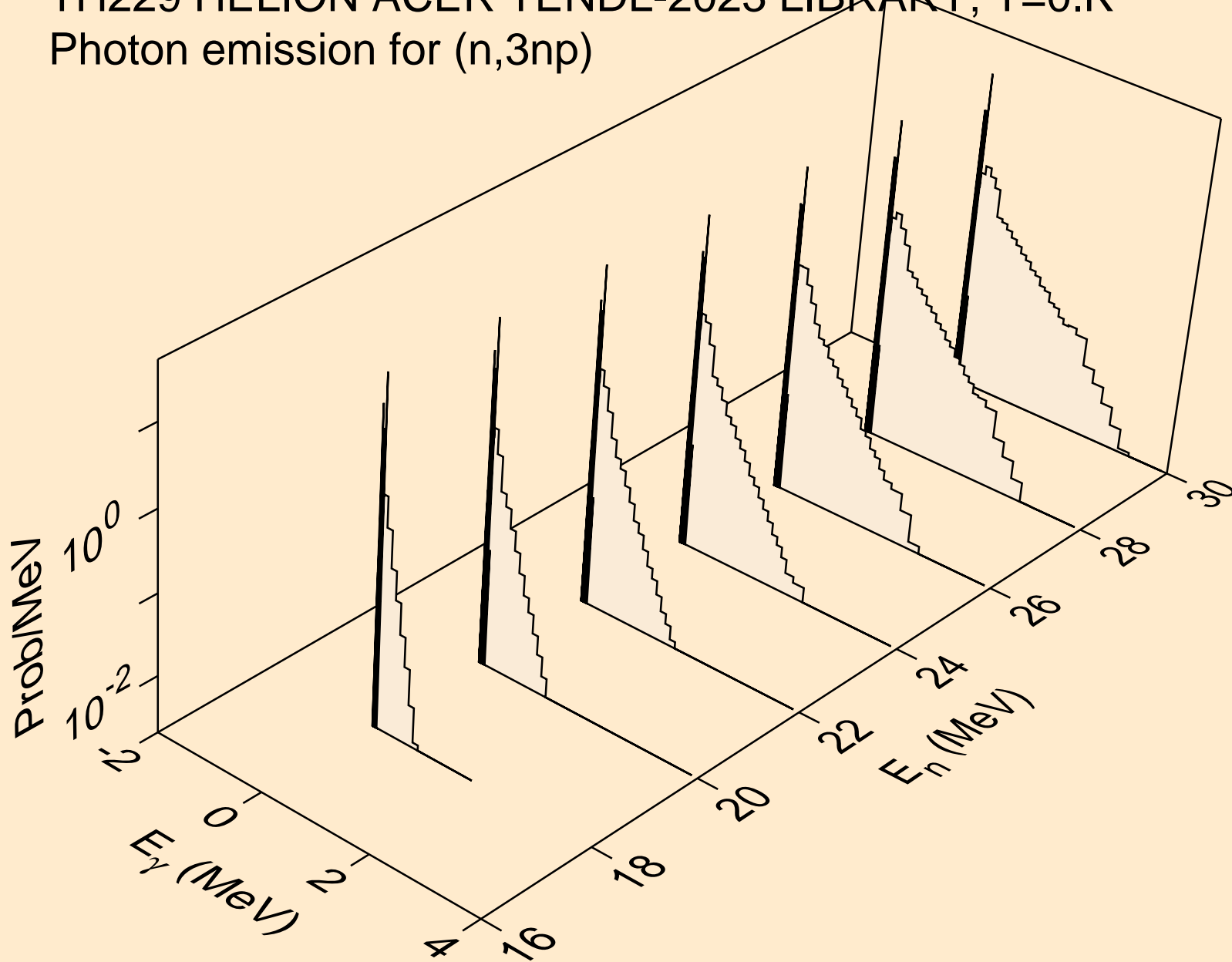

TH229 HELION ACER TENDL-2023 LIBRARY; T=0.K  
Photon emission for (n,n2p)

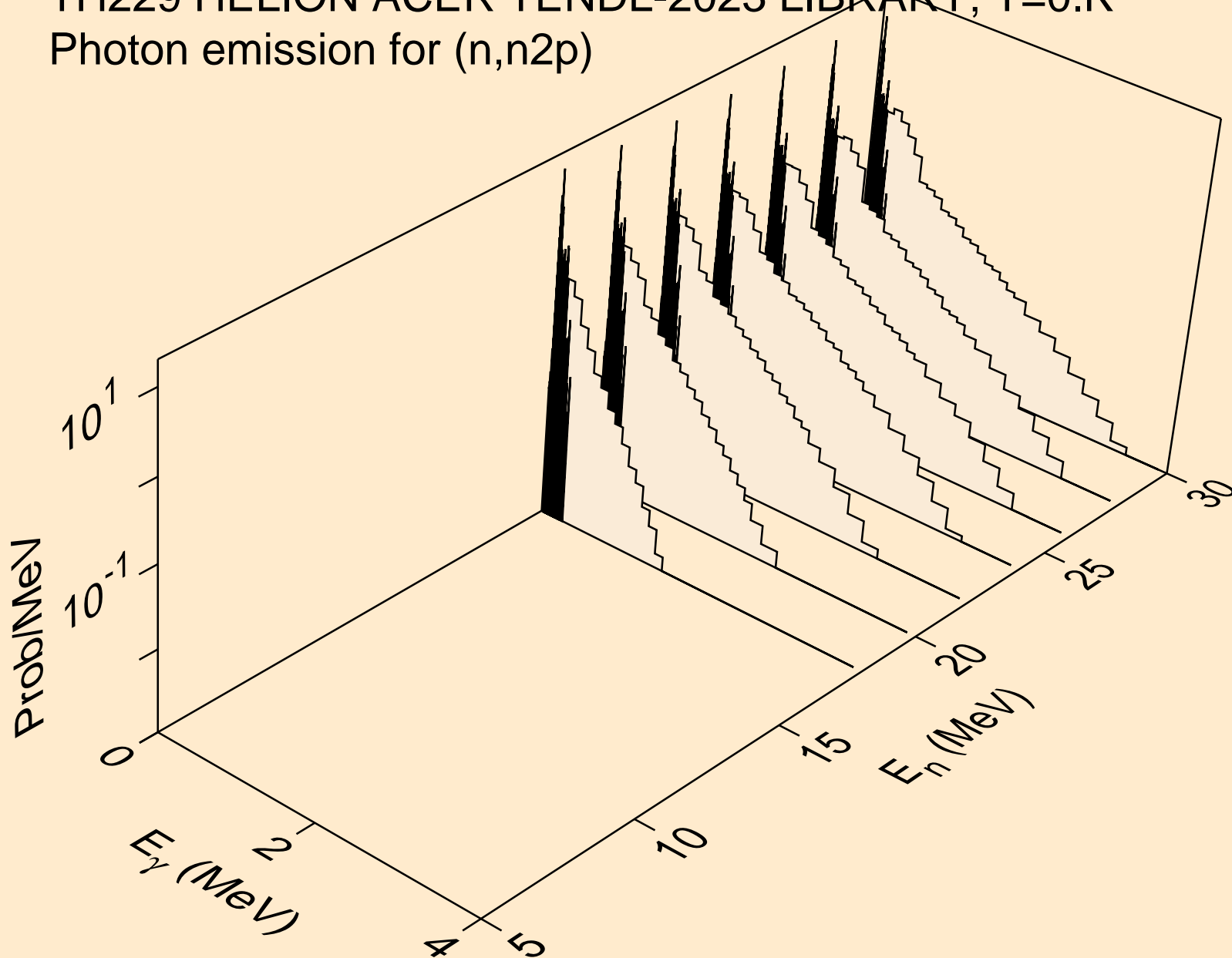



TH229 HELION ACER TENDL-2023 LIBRARY; T=0.K  
Photon emission for (n,npa)

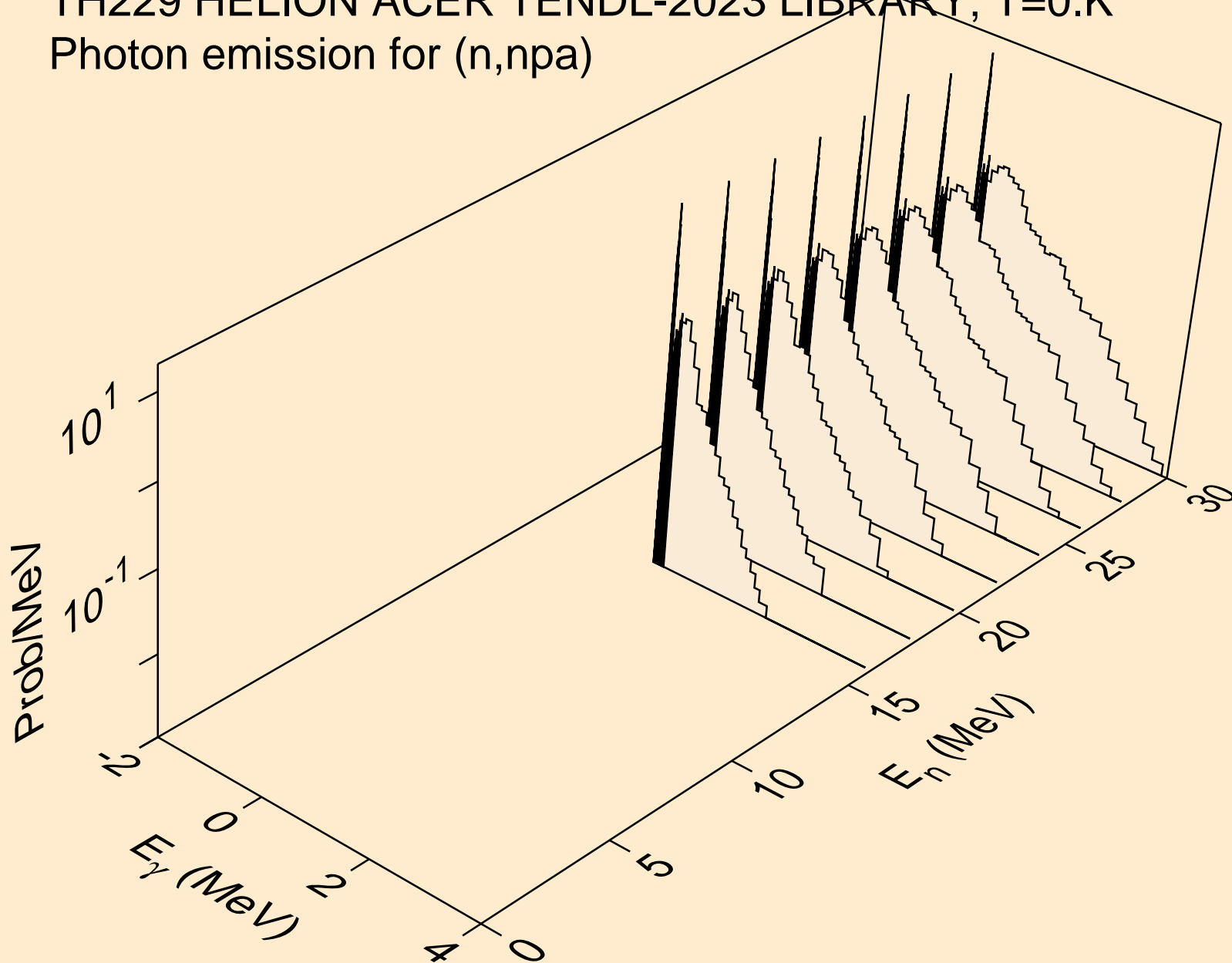

TH229 HELION ACER TENDL-2023 LIBRARY; T=0.K  
Photon emission for (n,p)

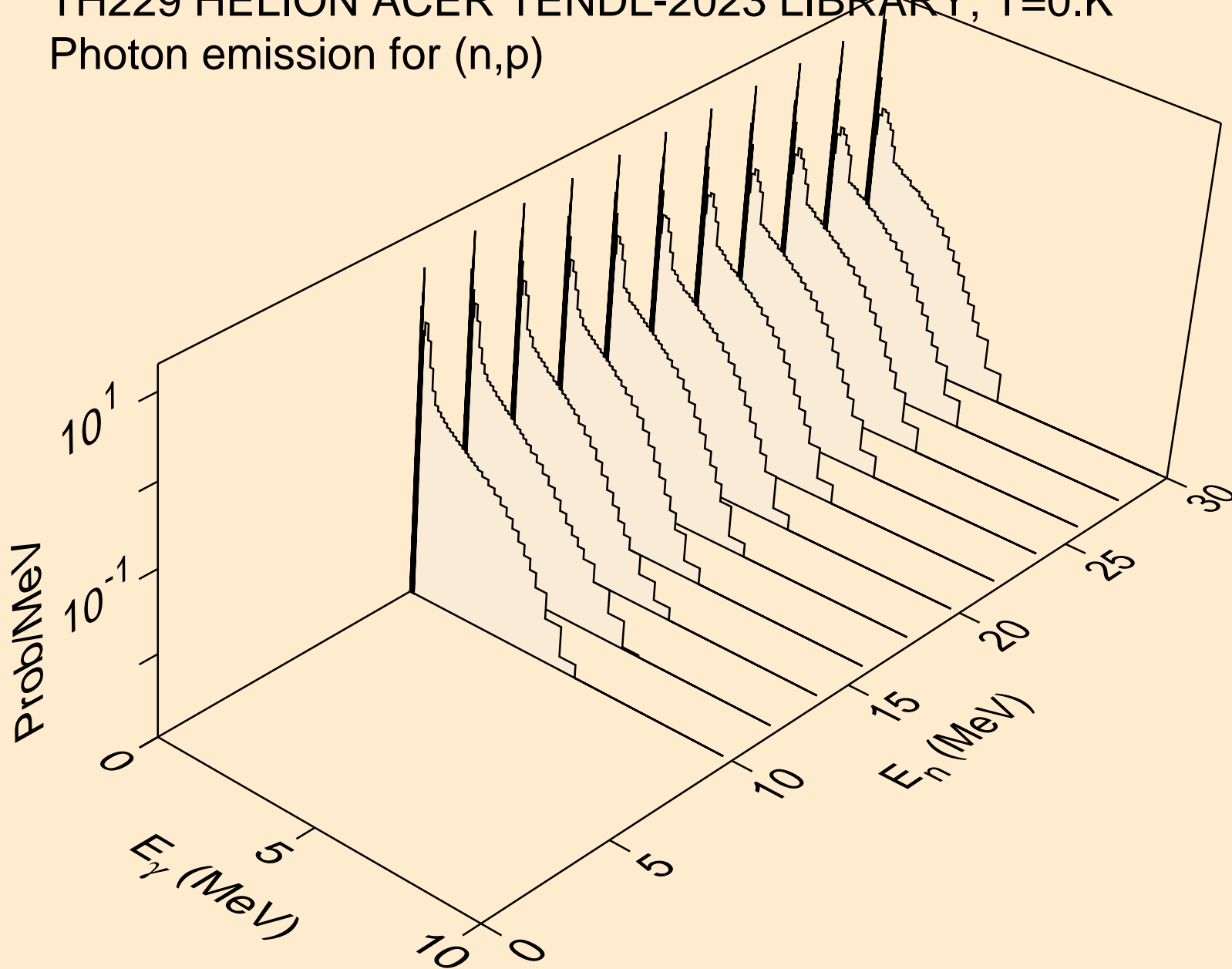

TH229 HELION ACER TENDL-2023 LIBRARY; T=0.K  
Photon emission for (n,d)

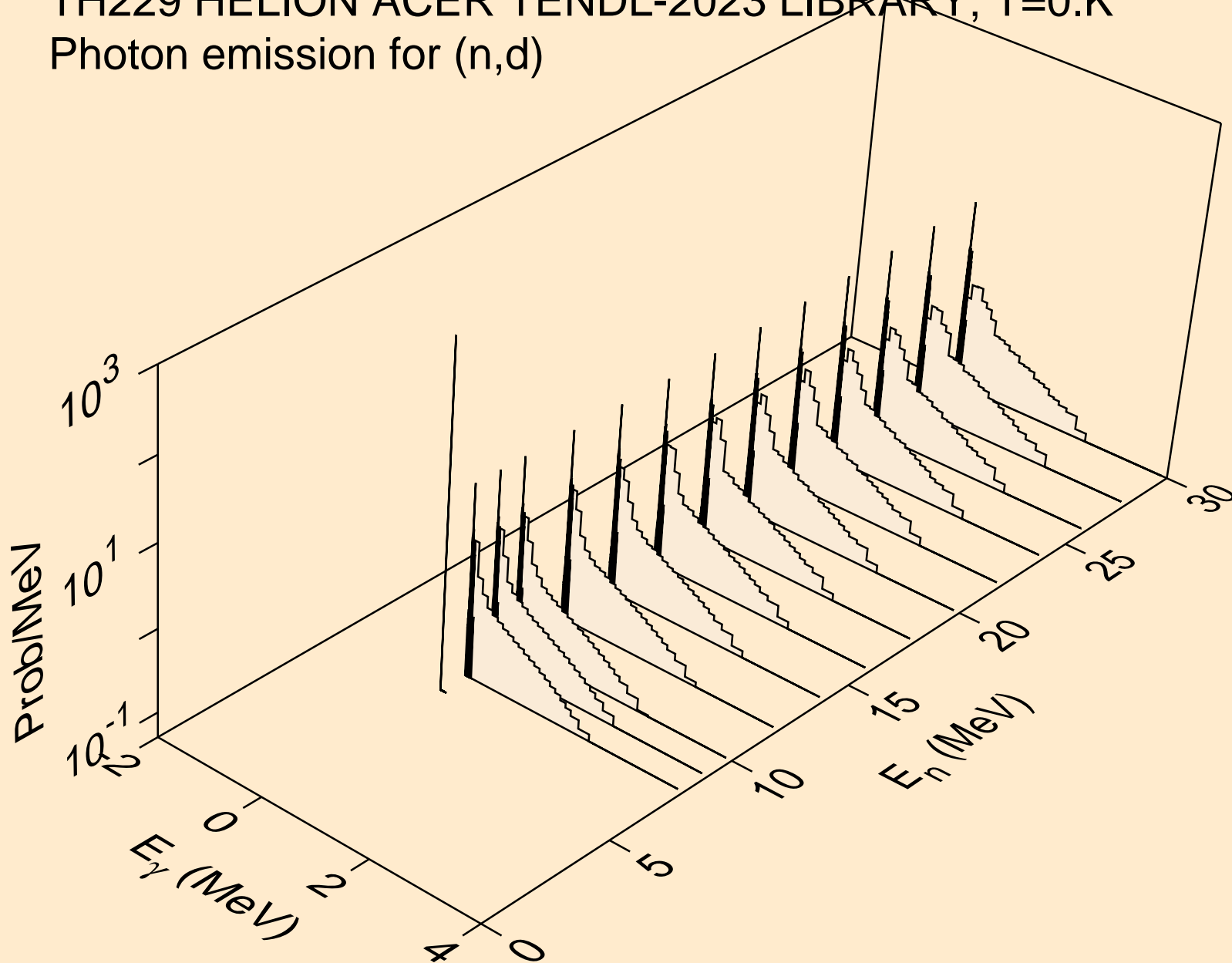

TH229 HELION ACER TENDL-2023 LIBRARY; T=0.K  
Photon emission for (n,t)

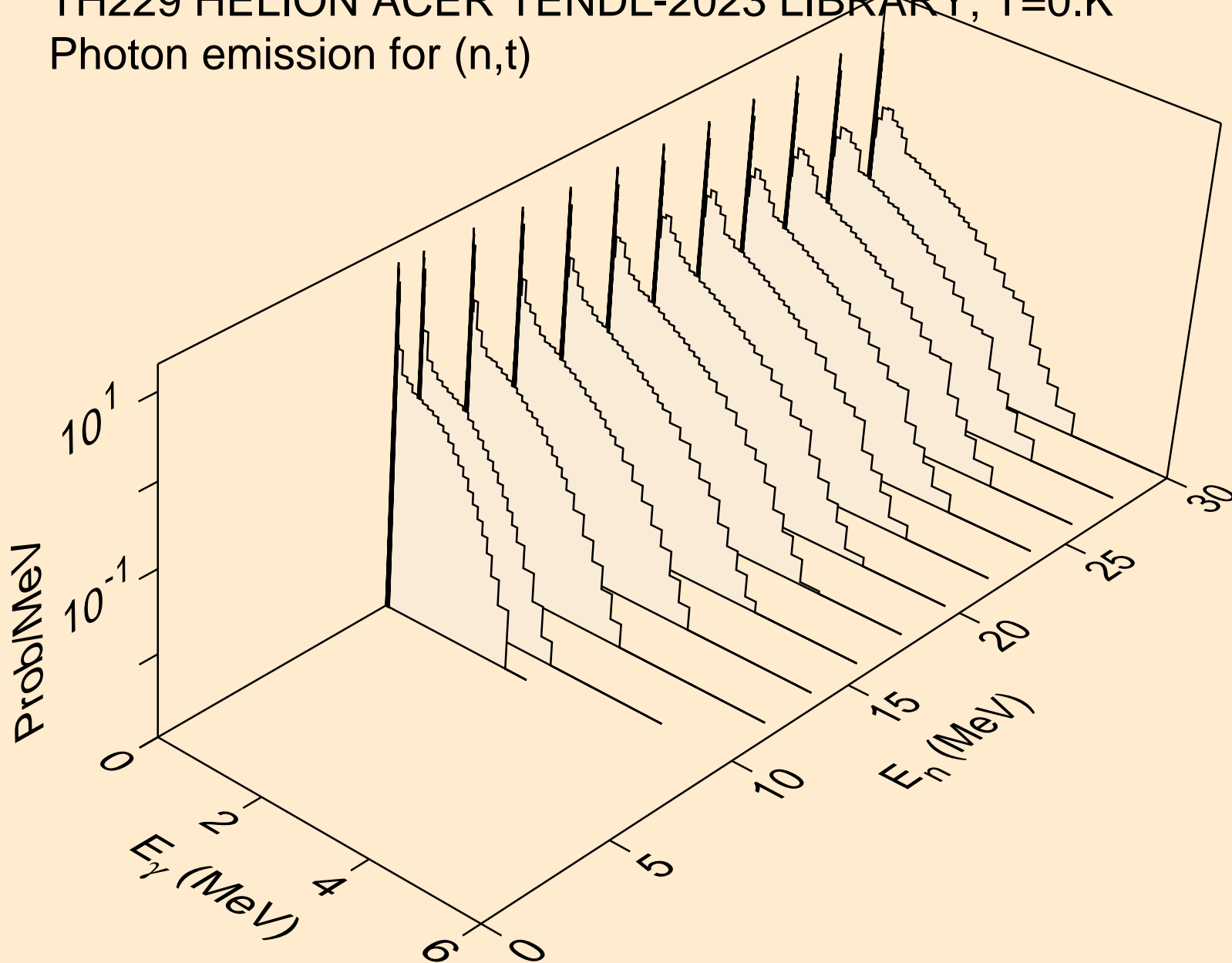

TH229 HELION ACER TENDL-2023 LIBRARY; T=0.K  
Photon emission for inelastic

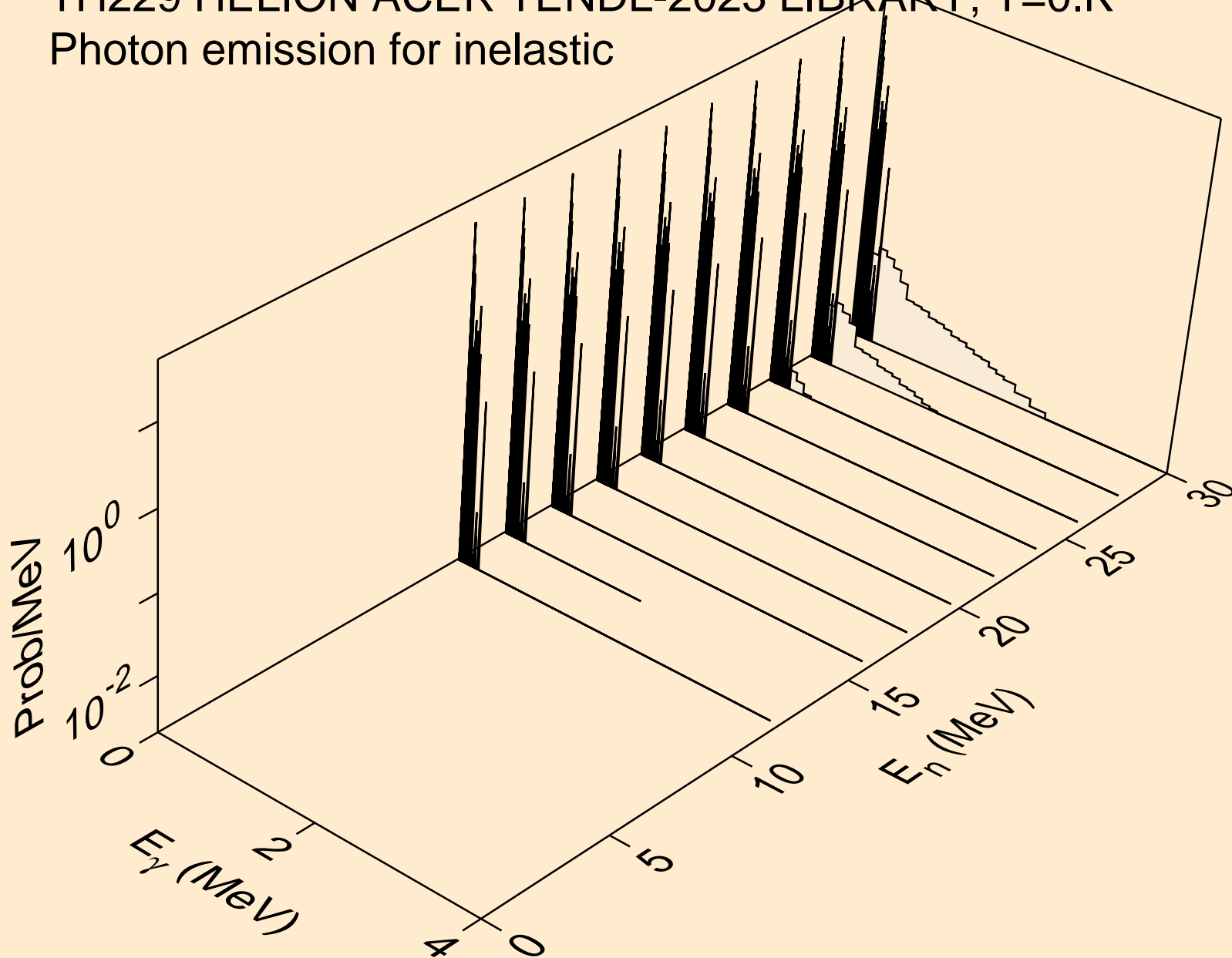

TH229 HELION ACER TENDL-2023 LIBRARY; T=0.K  
Photon emission for (n,a)

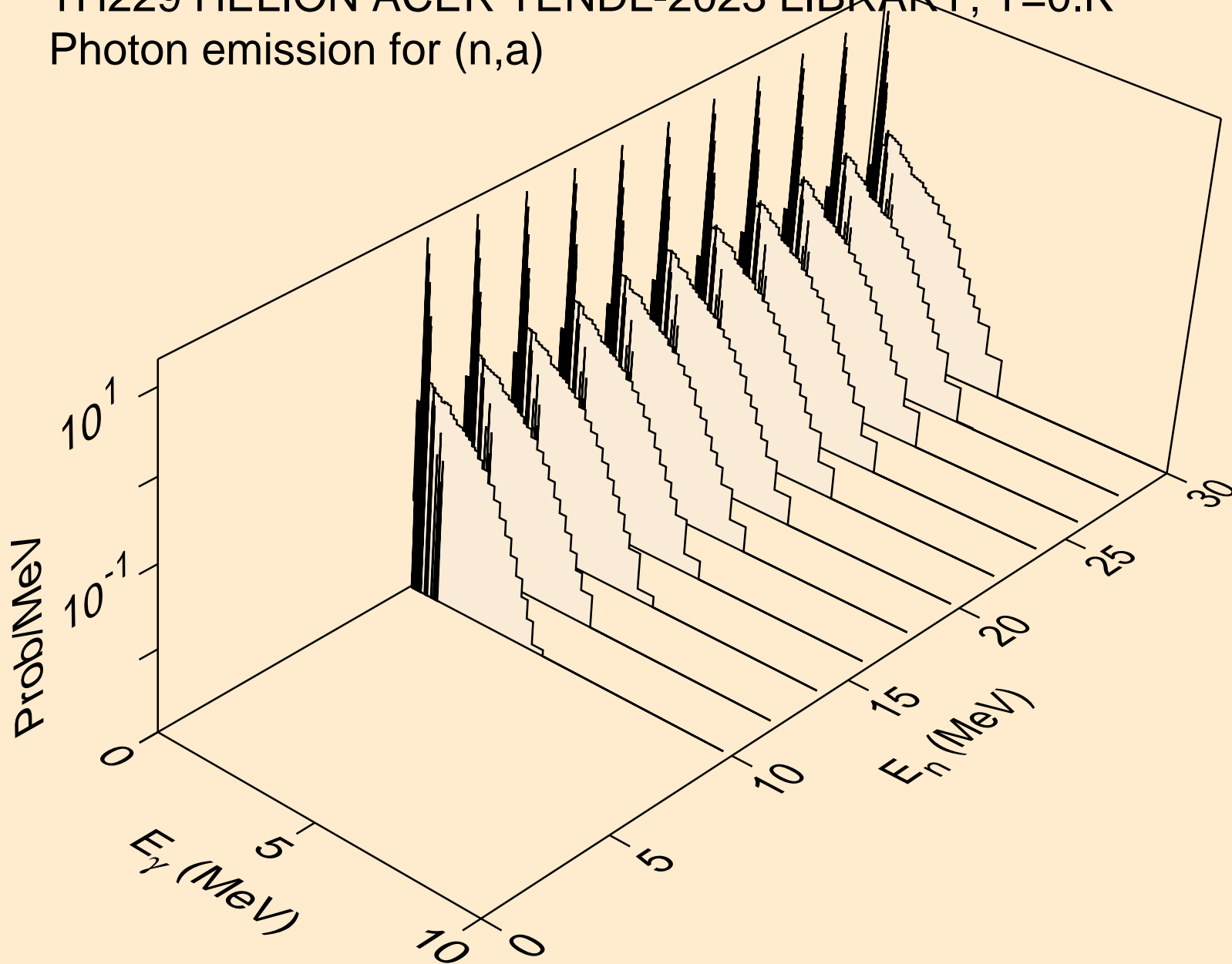

TH229 HELION ACER TENDL-2023 LIBRARY; T=0.K  
Photon emission for (n,2p)

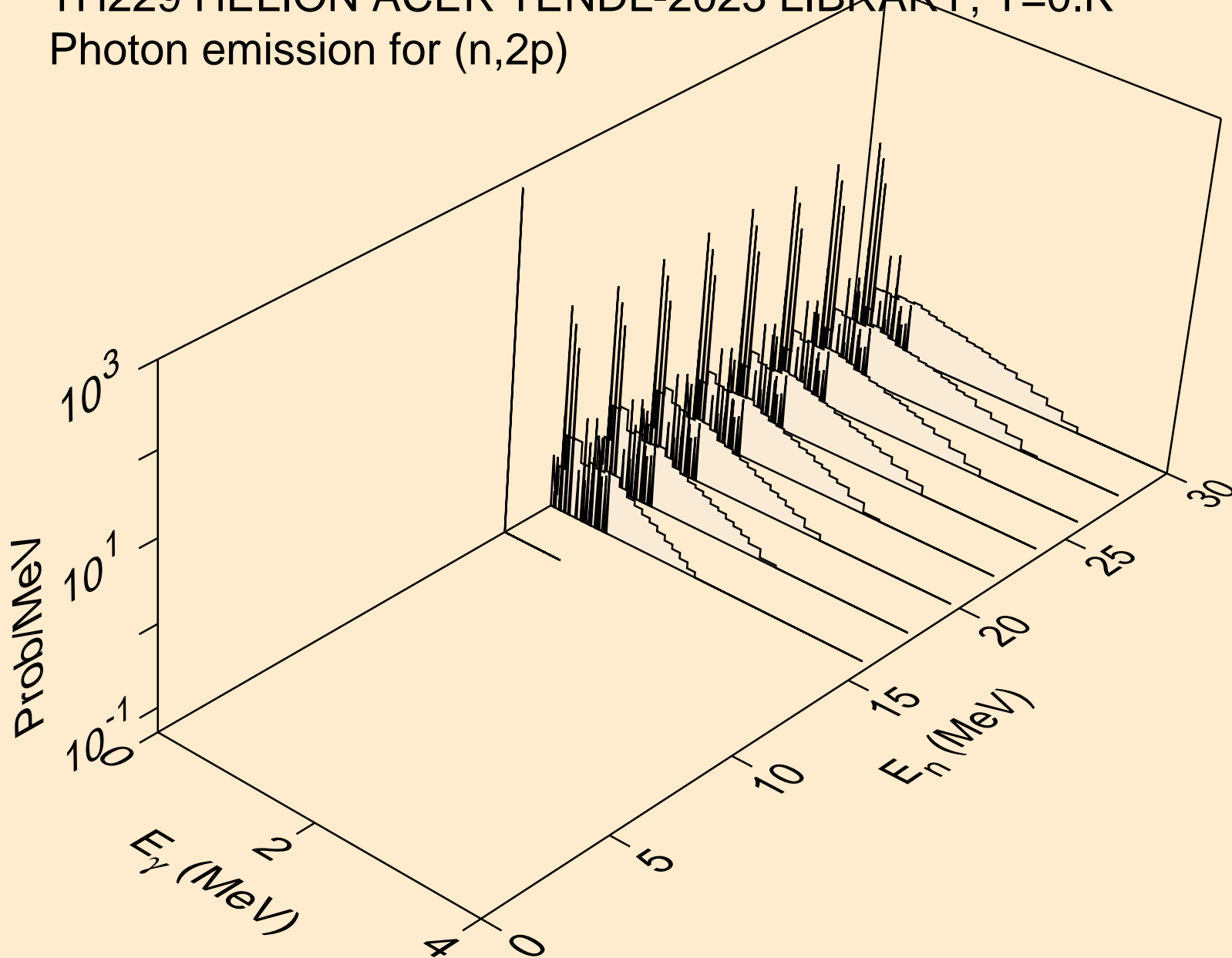

TH229 HELION ACER TENDL-2023 LIBRARY; T=0.K  
Photon emission for (n,pa)

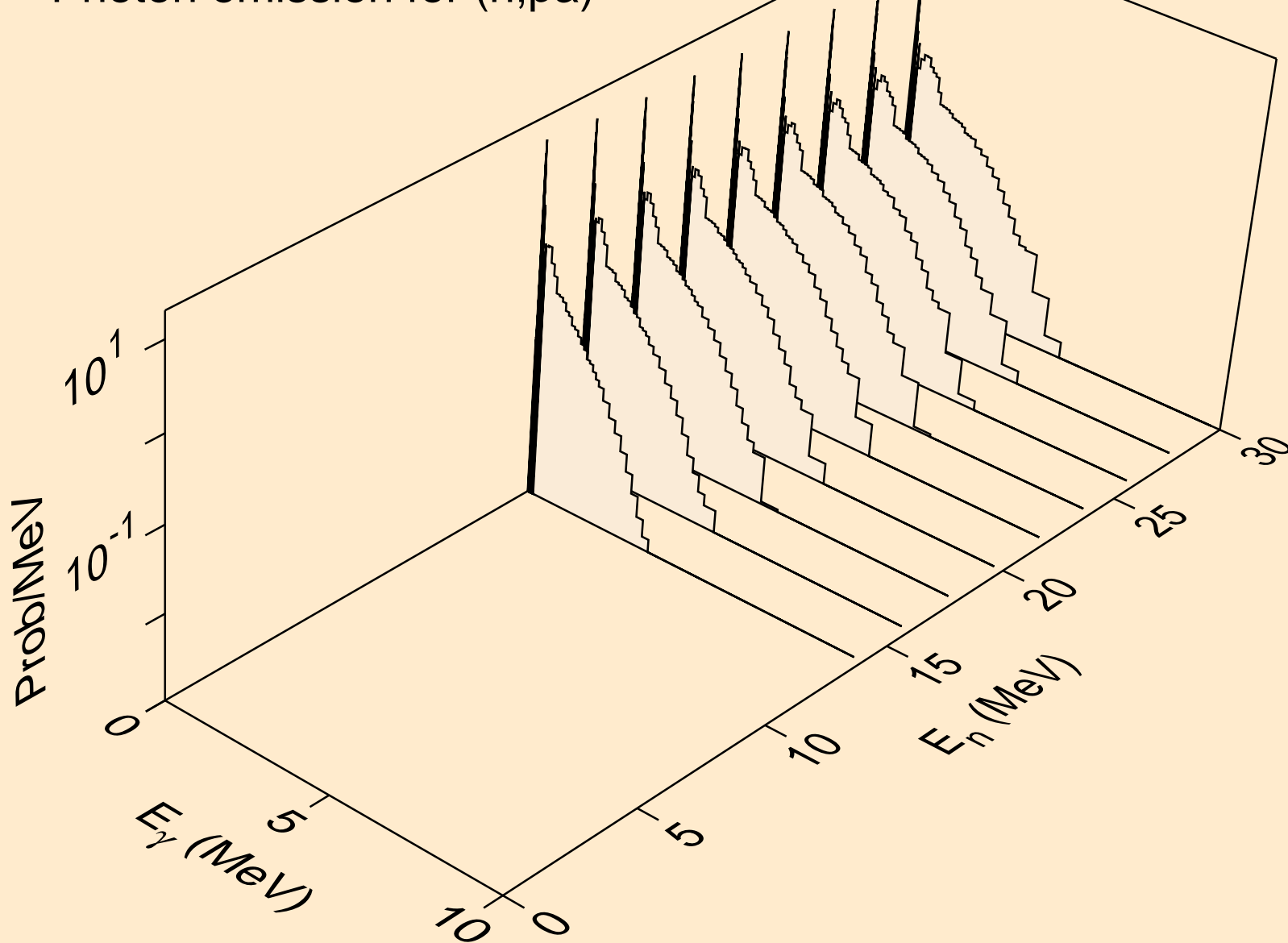



TH229 HELION ACER TENDL-2023 LIBRARY; T=0.K  
Photon emission for (n,pd)

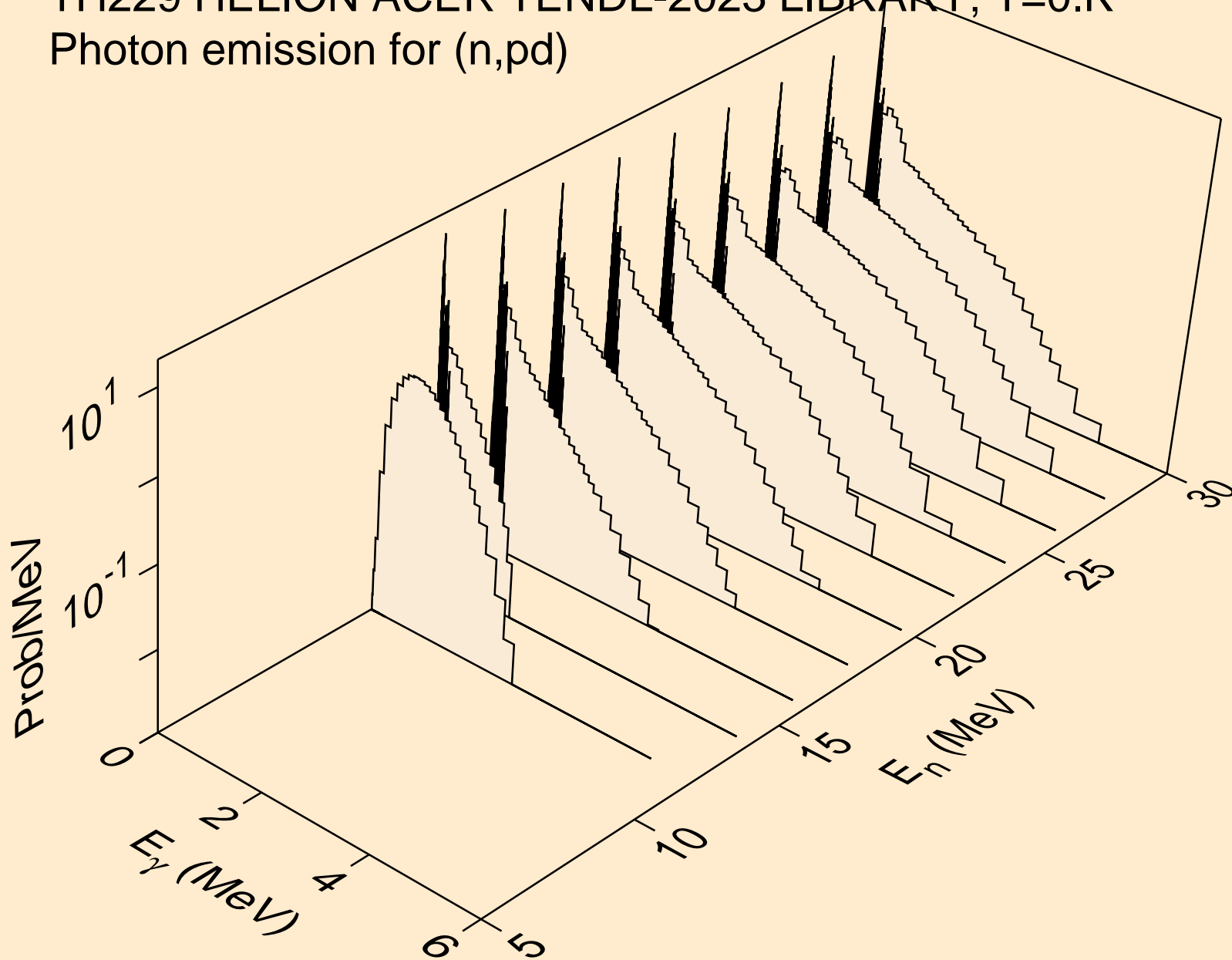

TH229 HELION ACER TENDL-2023 LIBRARY; T=0.K  
Photon emission for (n,pt)

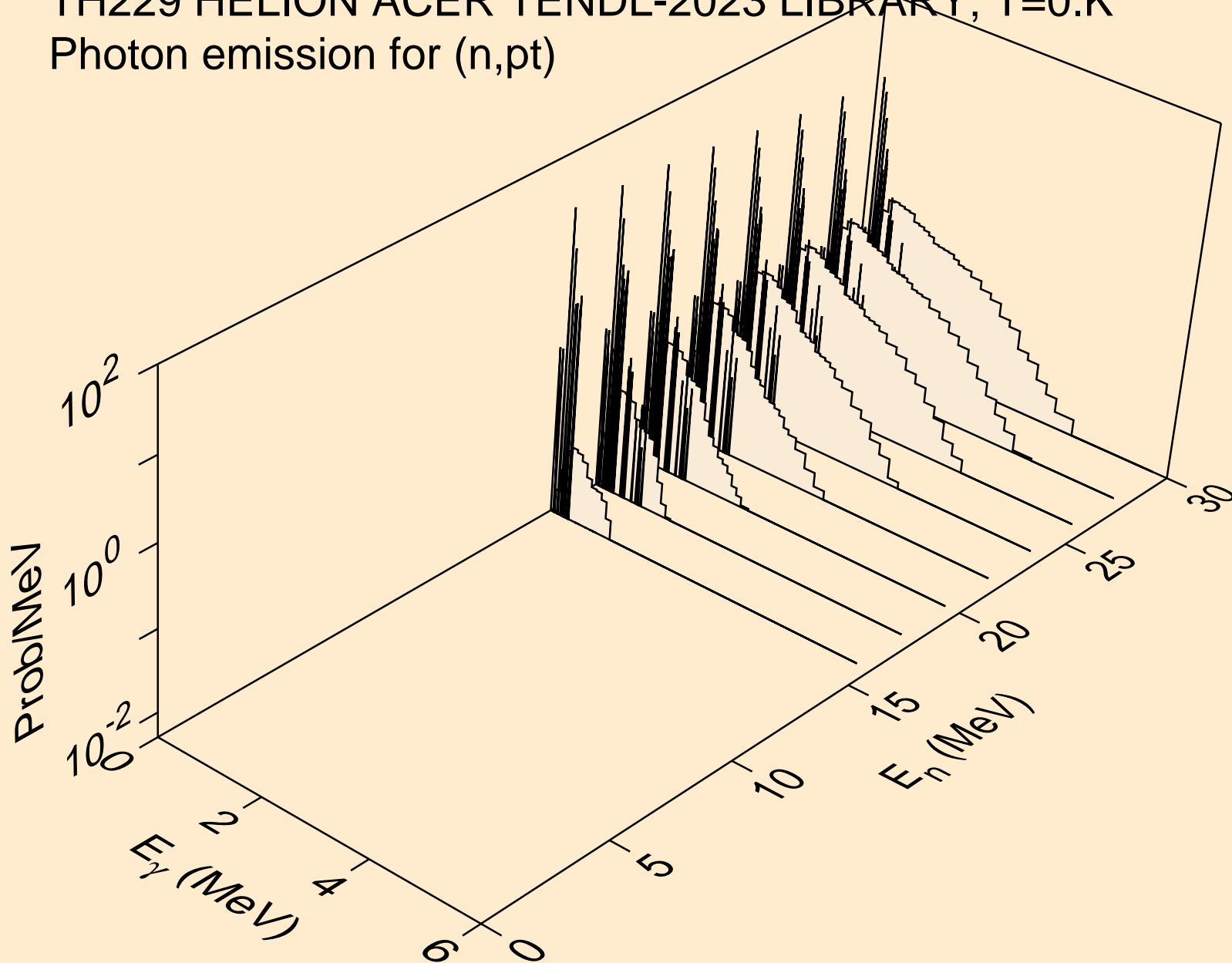

TH229 HELION ACER TENDL-2023 LIBRARY; T=0.K  
Photon emission for (n,da)

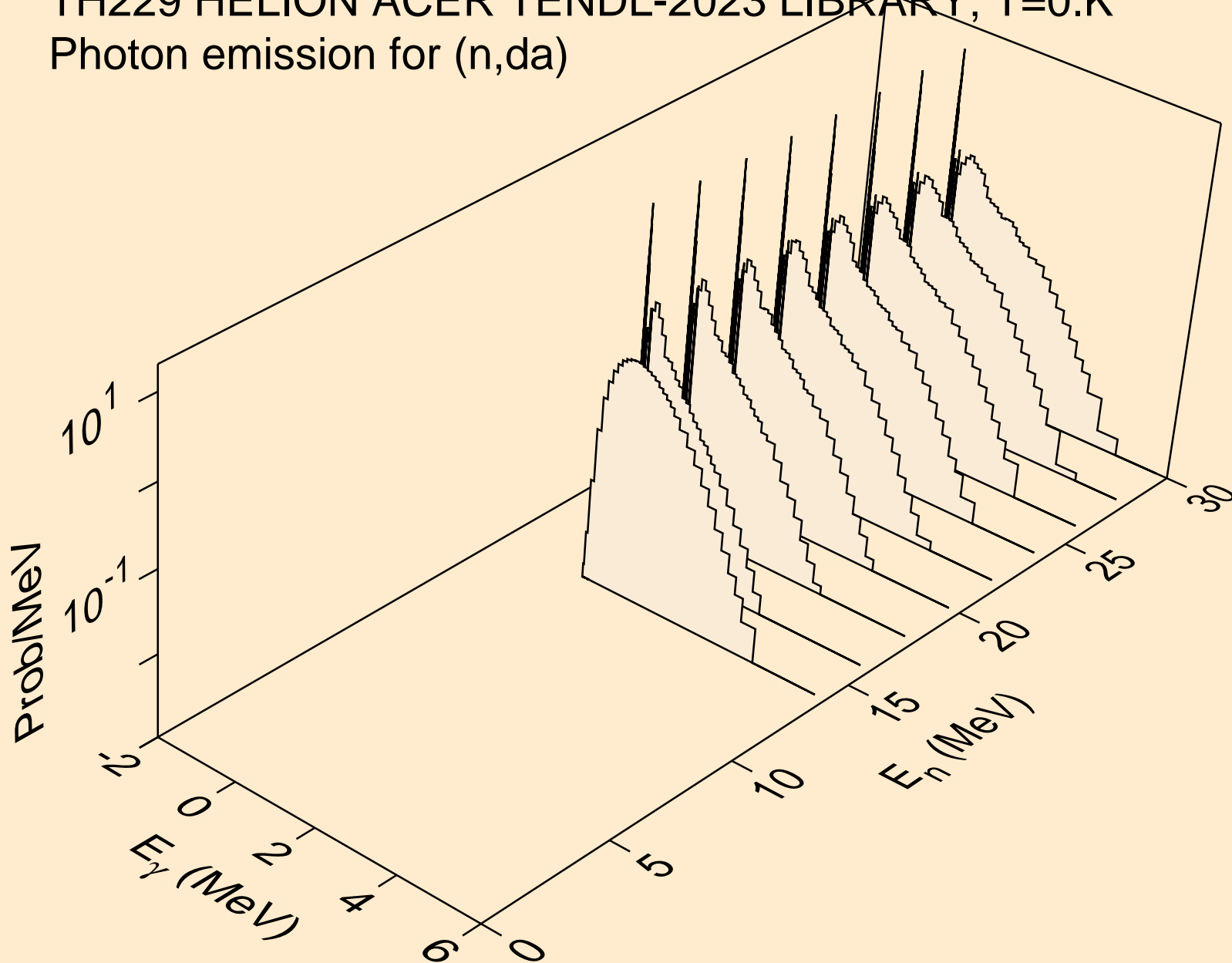

TH229 HELION ACER TENDL-2023 LIBRARY; T=0.K  
Particle heating contributions

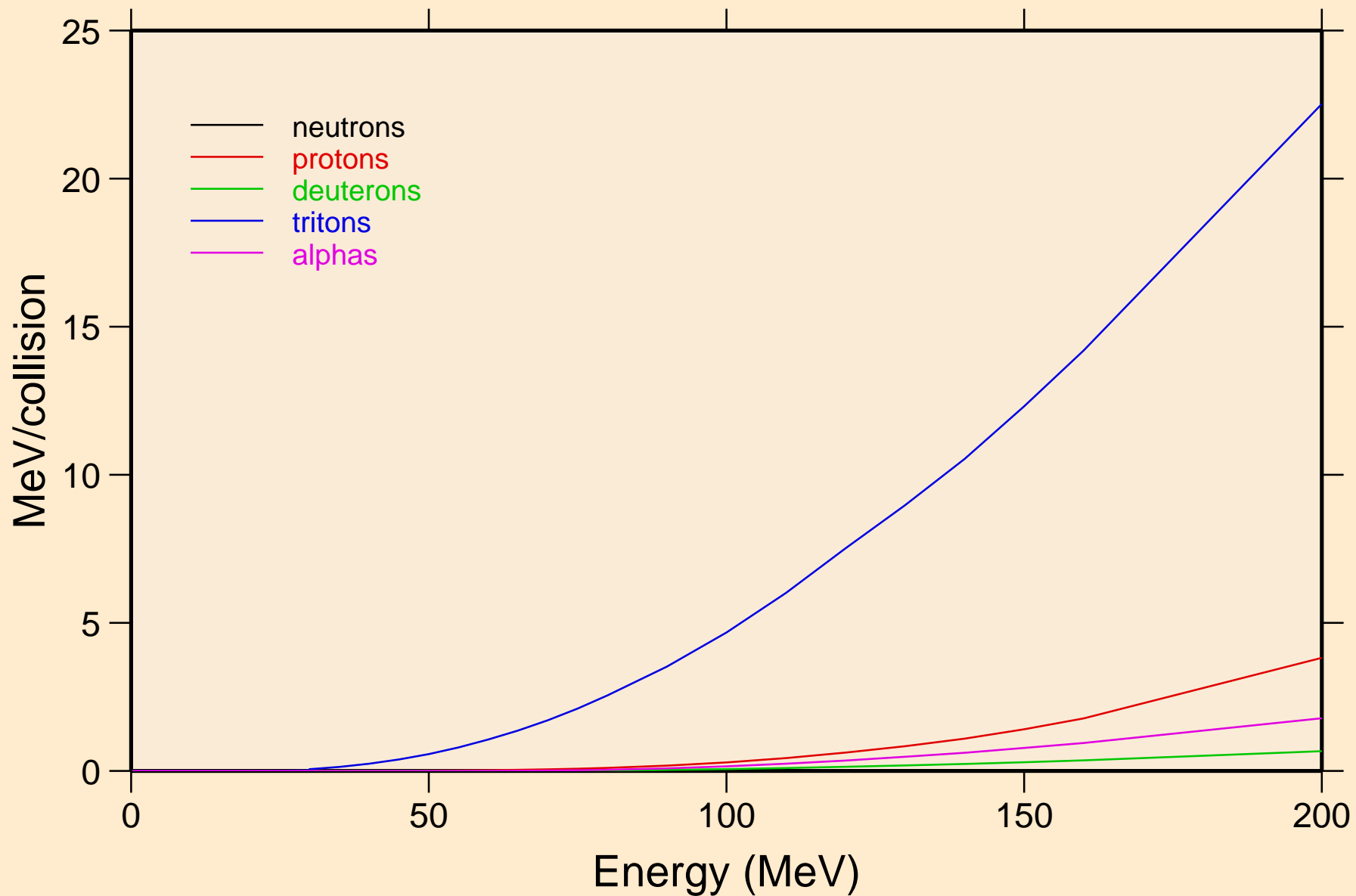

TH229 HELION ACER TENDL-2023 LIBRARY; T=0.K  
Recoil Heating

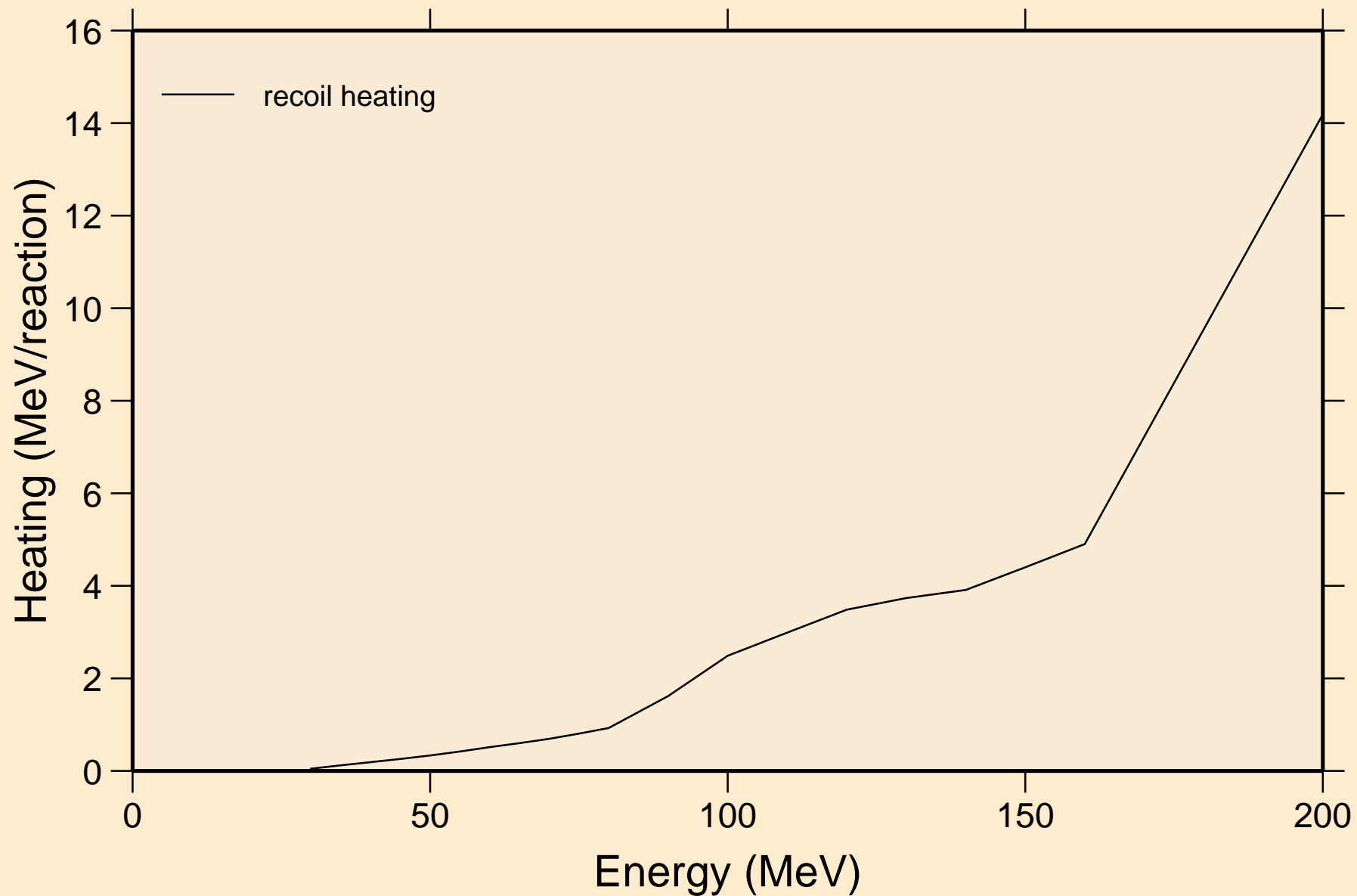

# TH229 HELION ACER TENDL-2023 LIBRARY; T=0.K

## Particle production cross sections

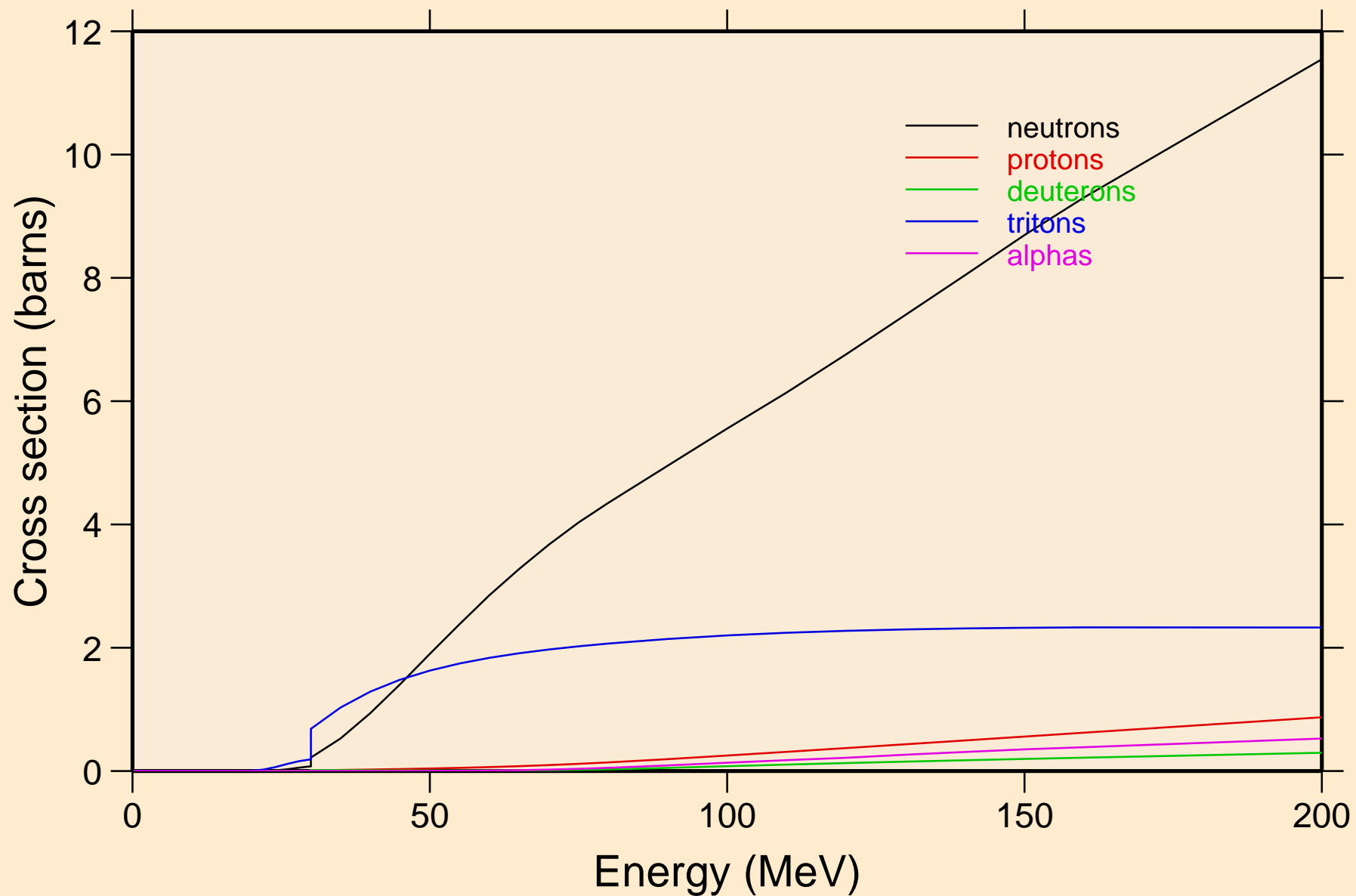

TH229 HELION ACER TENDL-2023 LIBRARY; T=0.K  
neutrons from (s,n)

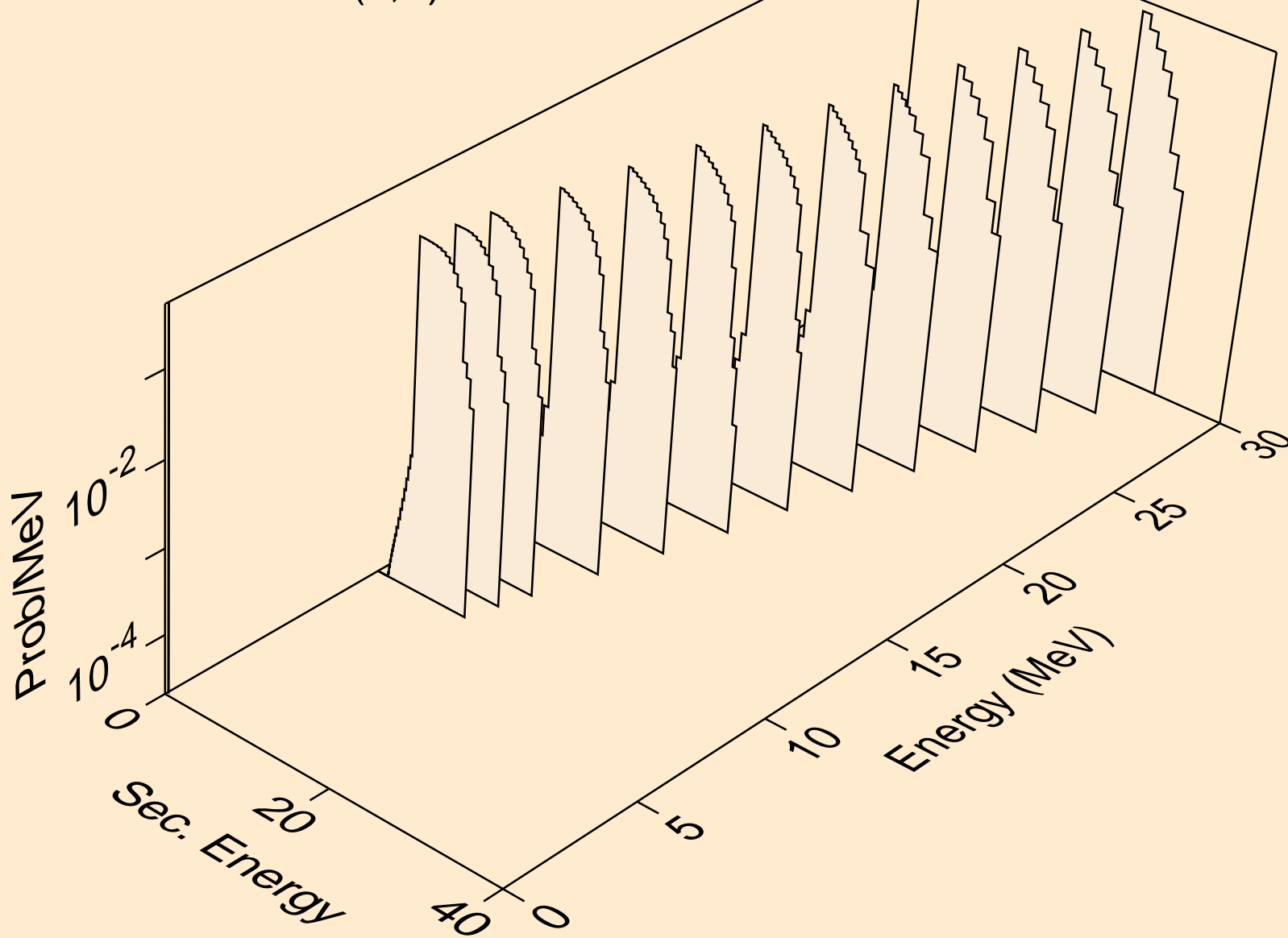

TH229 HELION ACER TENDL-2023 LIBRARY; T=0.K  
neutrons from (s,x)

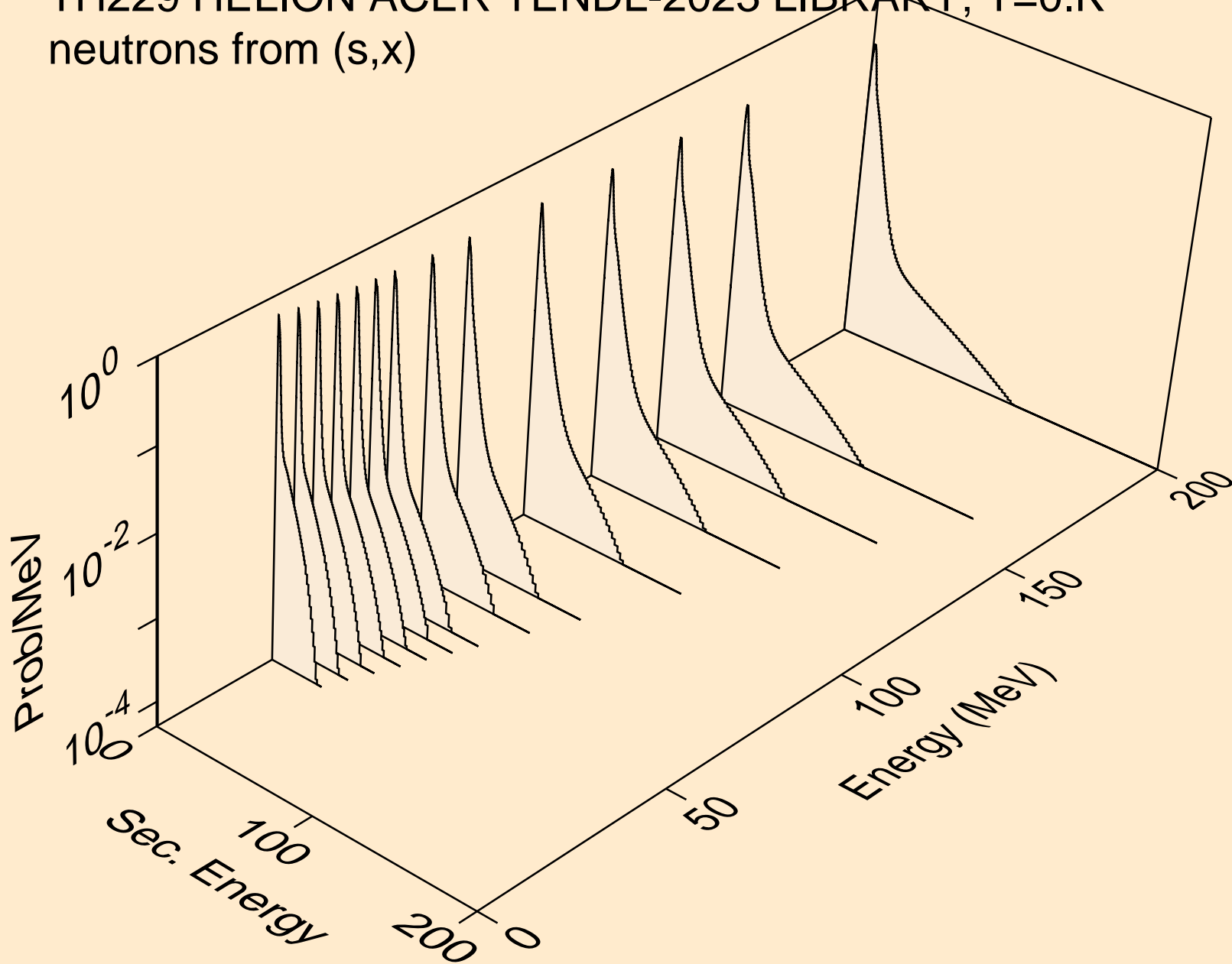



TH229 HELION ACER TENDL-2023 LIBRARY; T=0.K  
neutrons from (s,2nd)

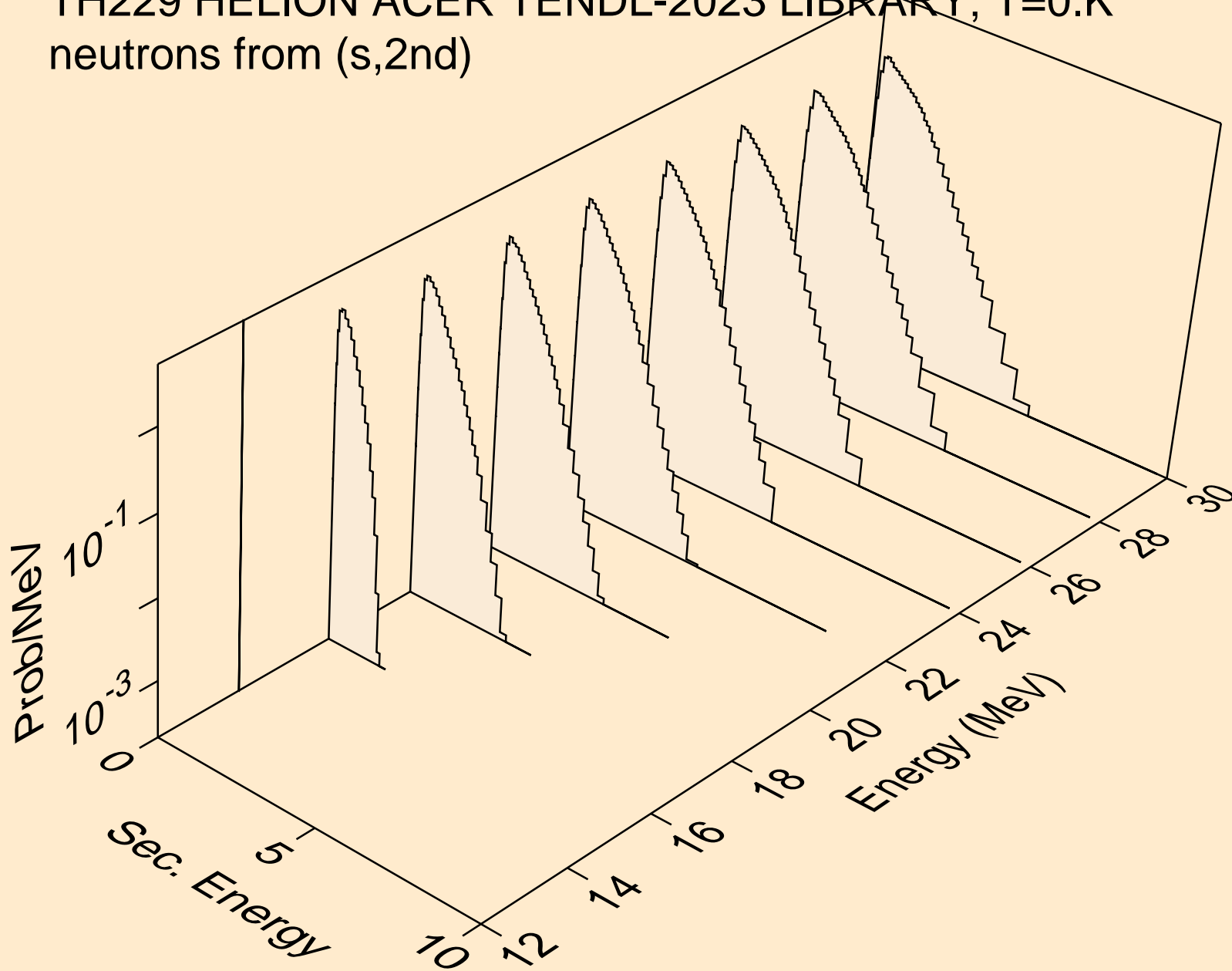

TH229 HELION ACER TENDL-2023 LIBRARY; T=0.K  
neutrons from (s,2n)

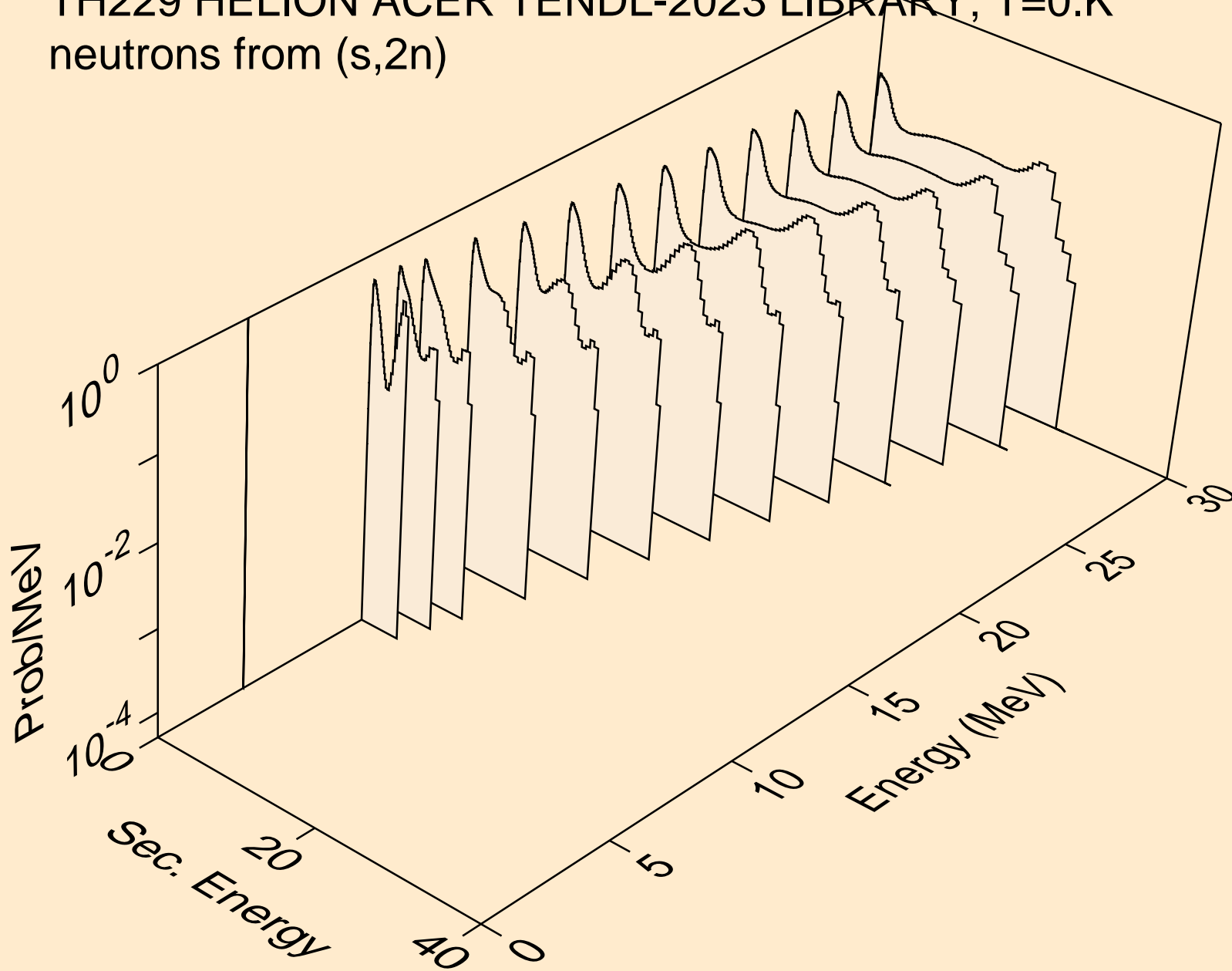

TH229 HELION ACER TENDL-2023 LIBRARY; T=0.K  
neutrons from (s,3n)

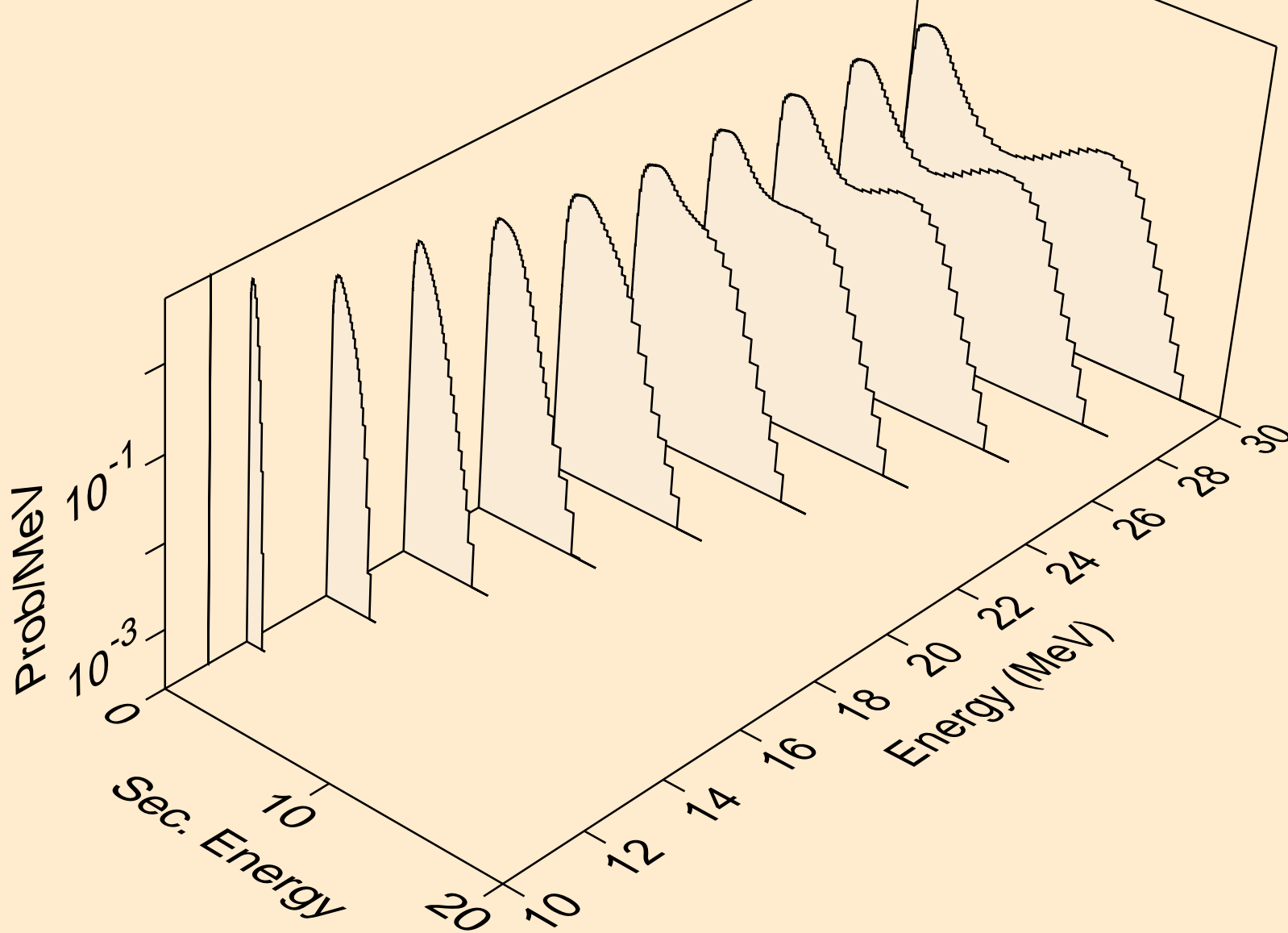

TH229 HELION ACER TENDL-2023 LIBRARY; T=0.K  
neutrons from (s,n\*)a

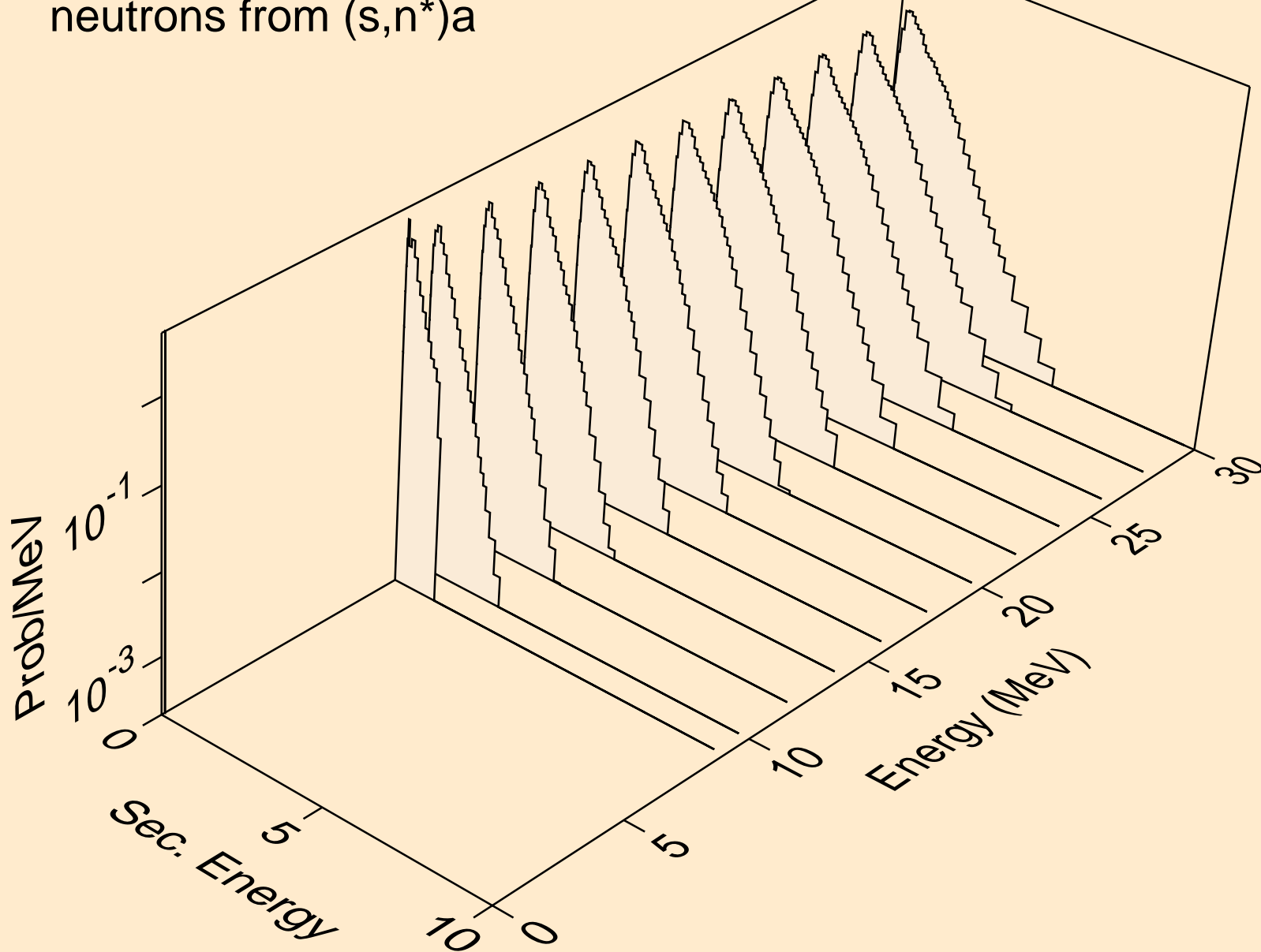

TH229 HELION ACER TENDL-2023 LIBRARY; T=0.K  
neutrons from (s,2n)a

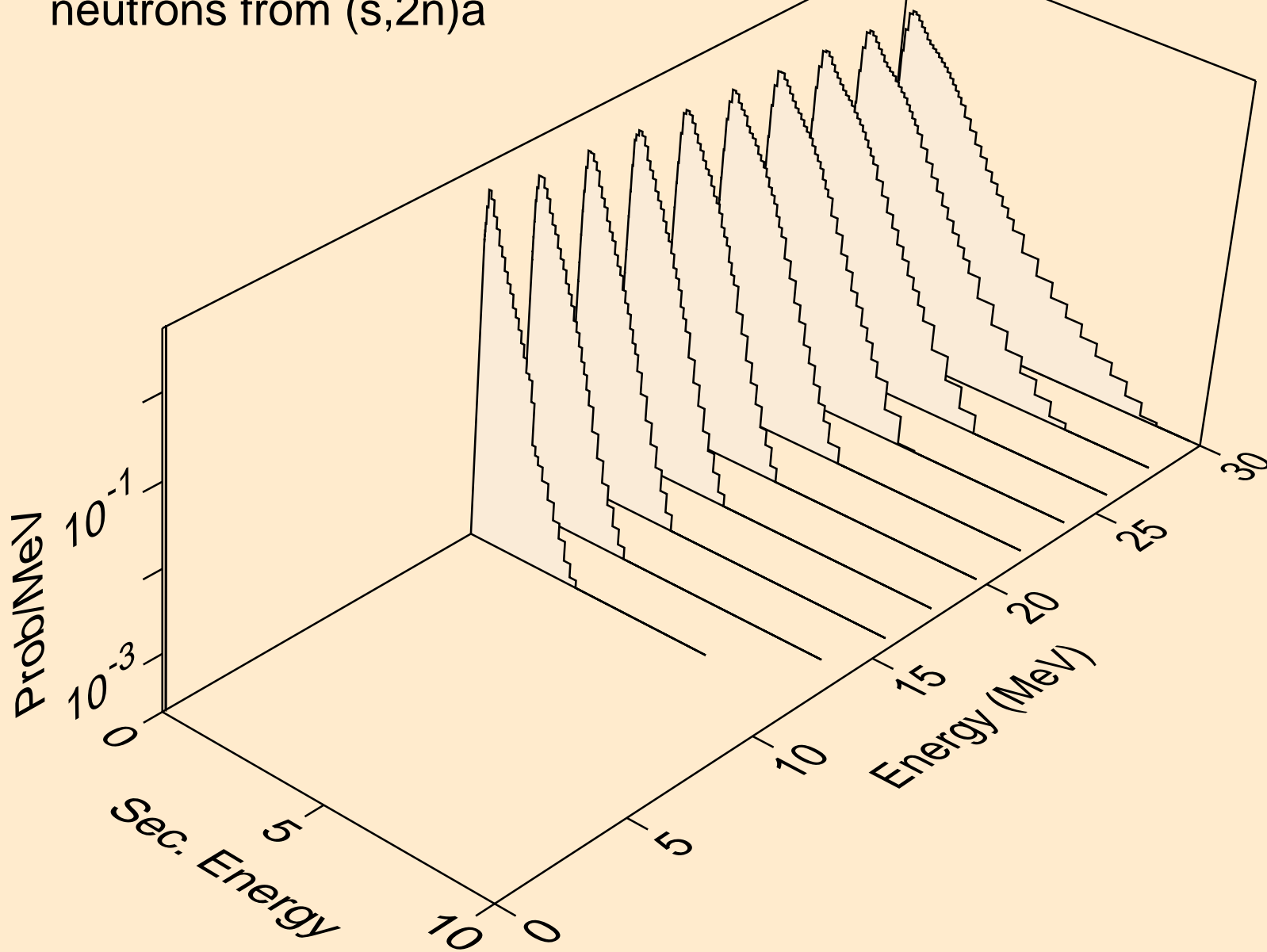

TH229 HELION ACER TENDL-2023 LIBRARY; T=0.K  
neutrons from (s,3n)a

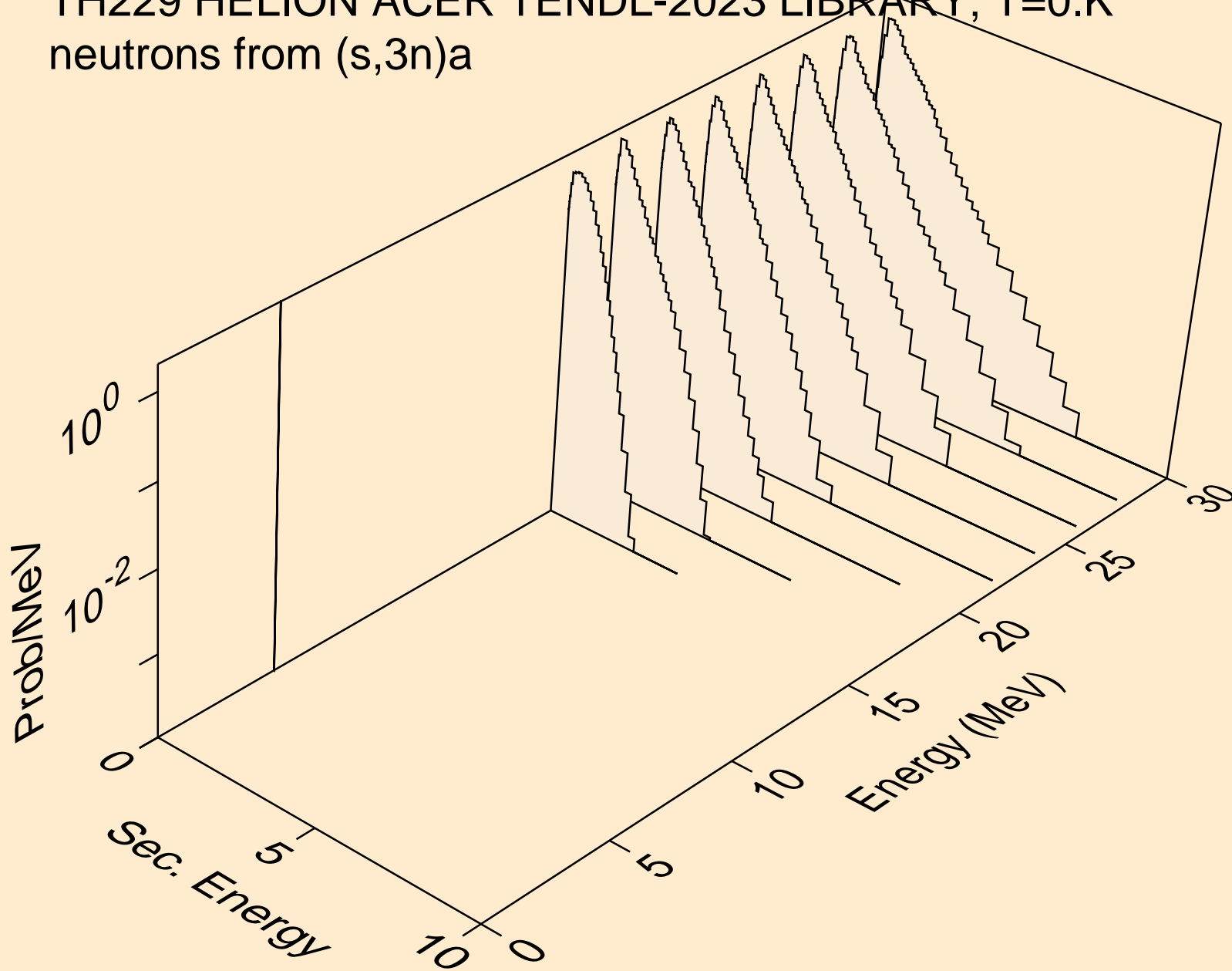

TH229 HELION ACER TENDL-2023 LIBRARY; T=0.K  
neutrons from (s,n\*)p

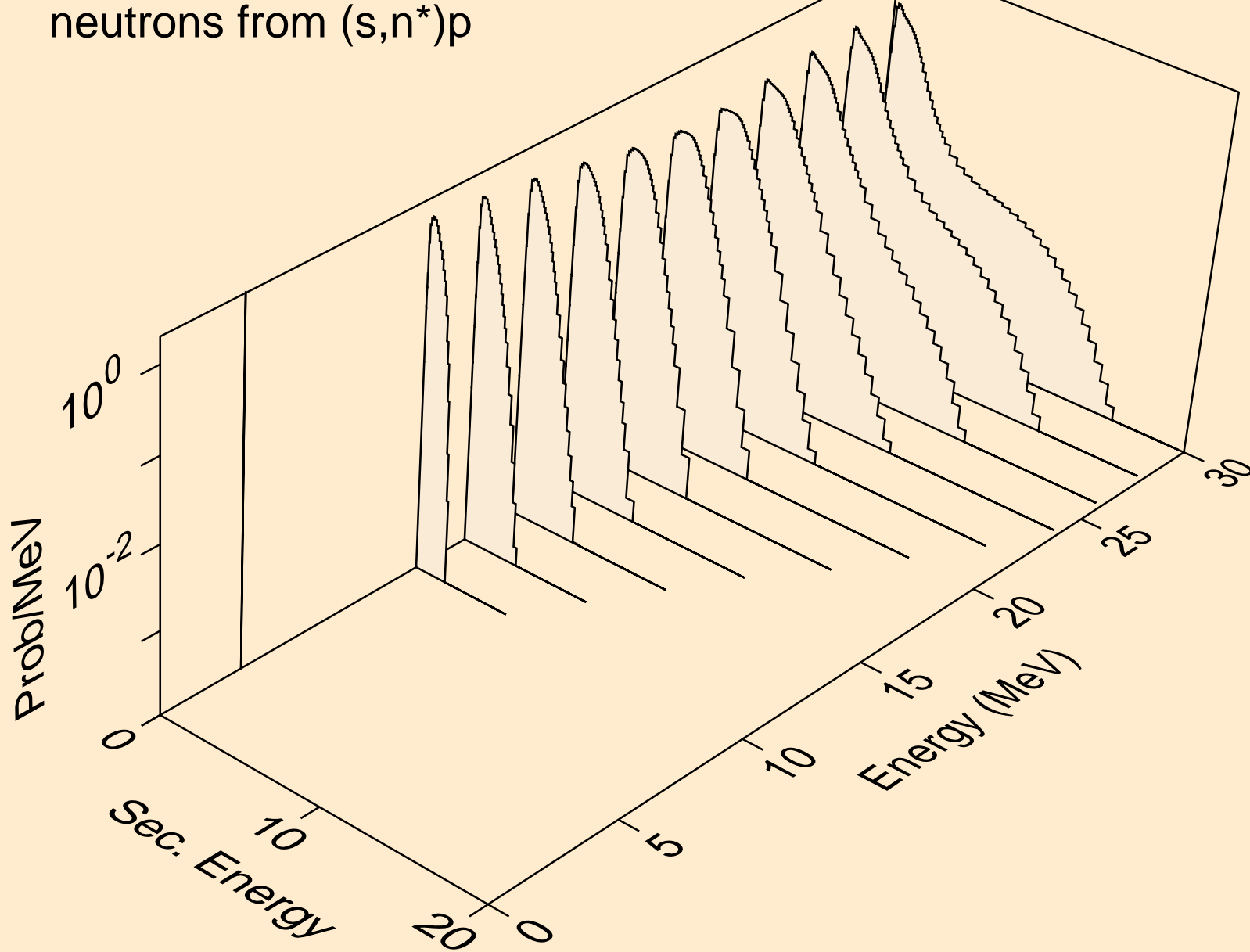

TH229 HELION ACER TENDL-2023 LIBRARY; T=0.K  
neutrons from (s,n\*)d

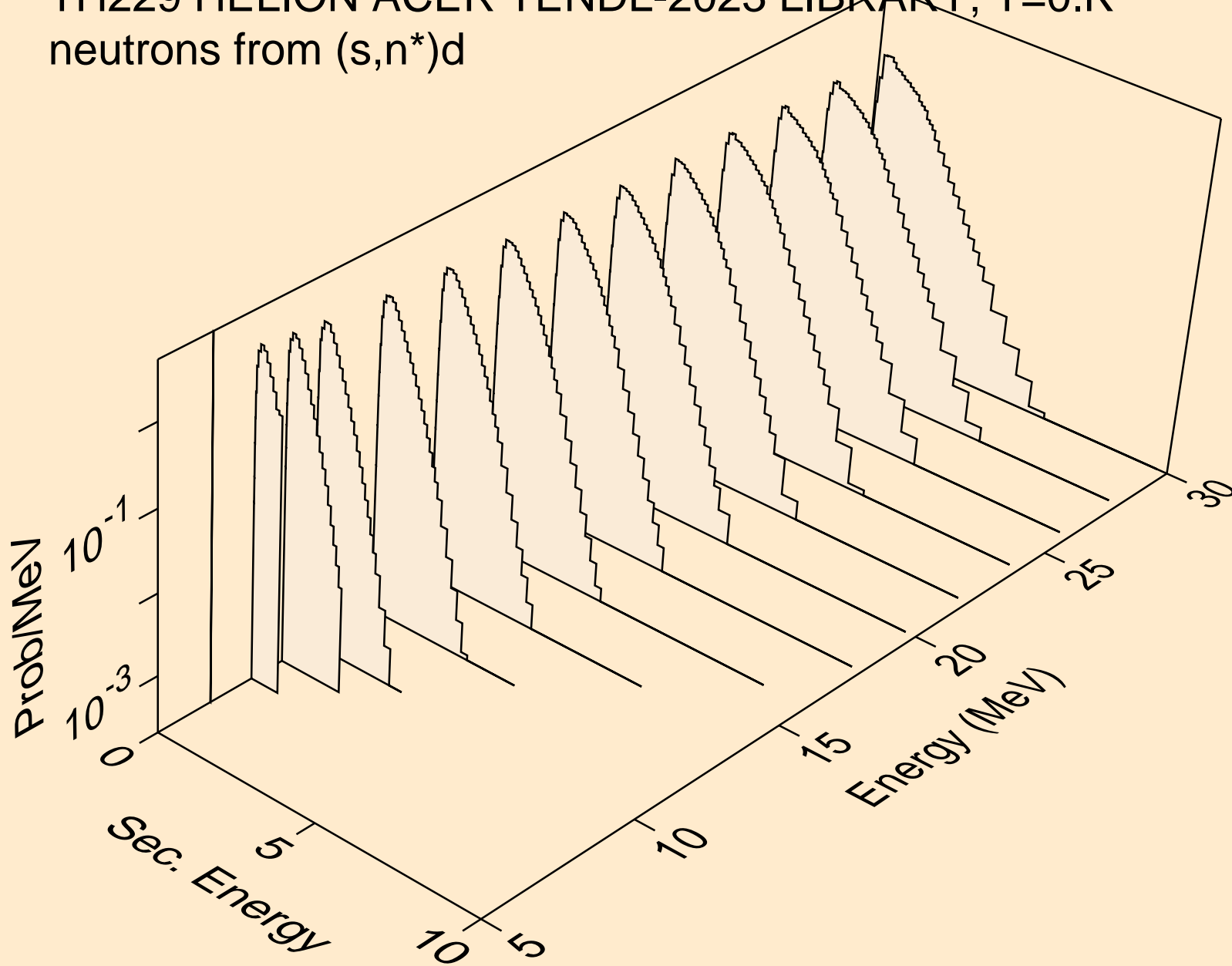



TH229 HELION ACER TENDL-2023 LIBRARY; T=0.K  
neutrons from (s,n\*)t

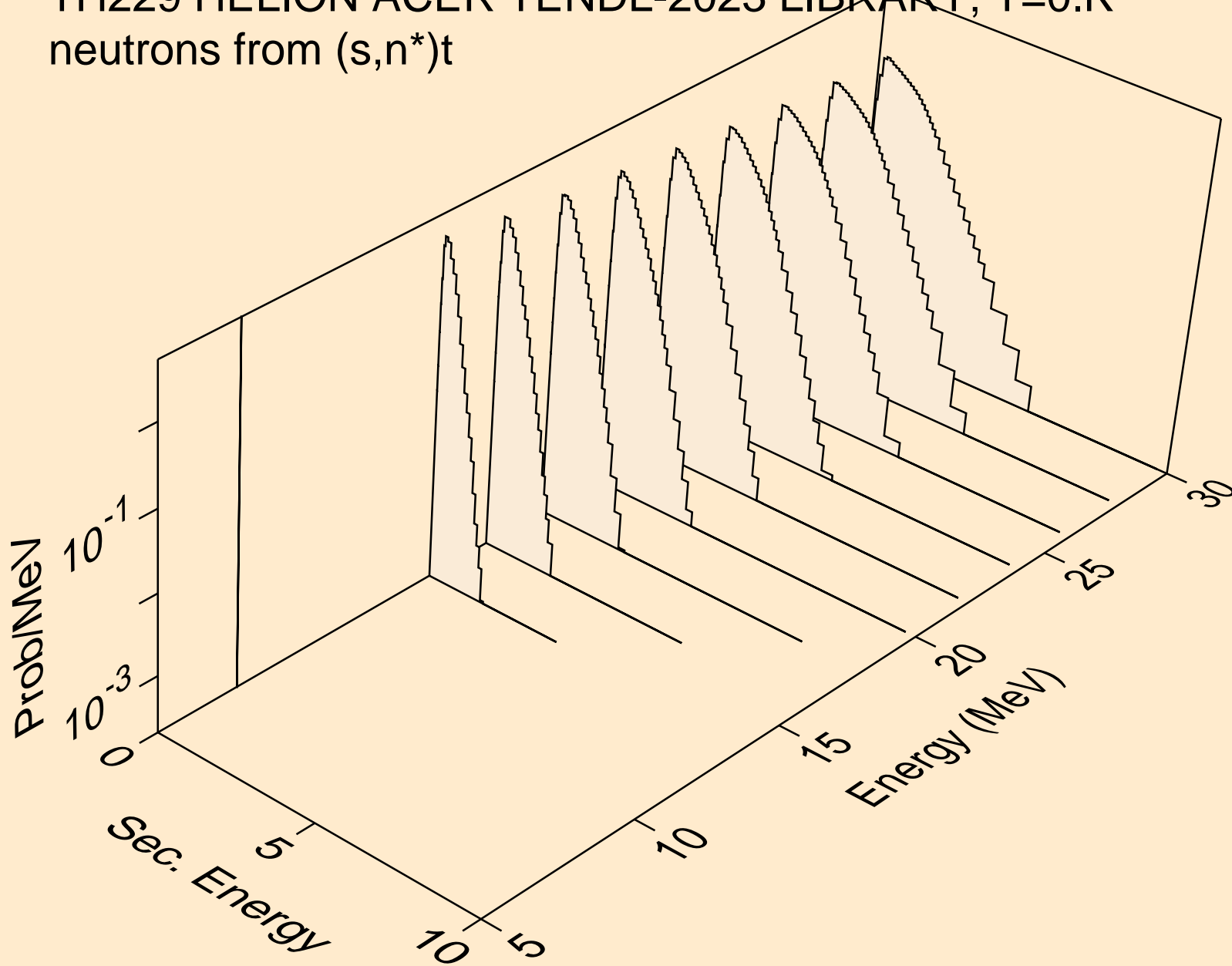

TH229 HELION ACER TENDL-2023 LIBRARY; T=0.K  
neutrons from (s,n\*)he3

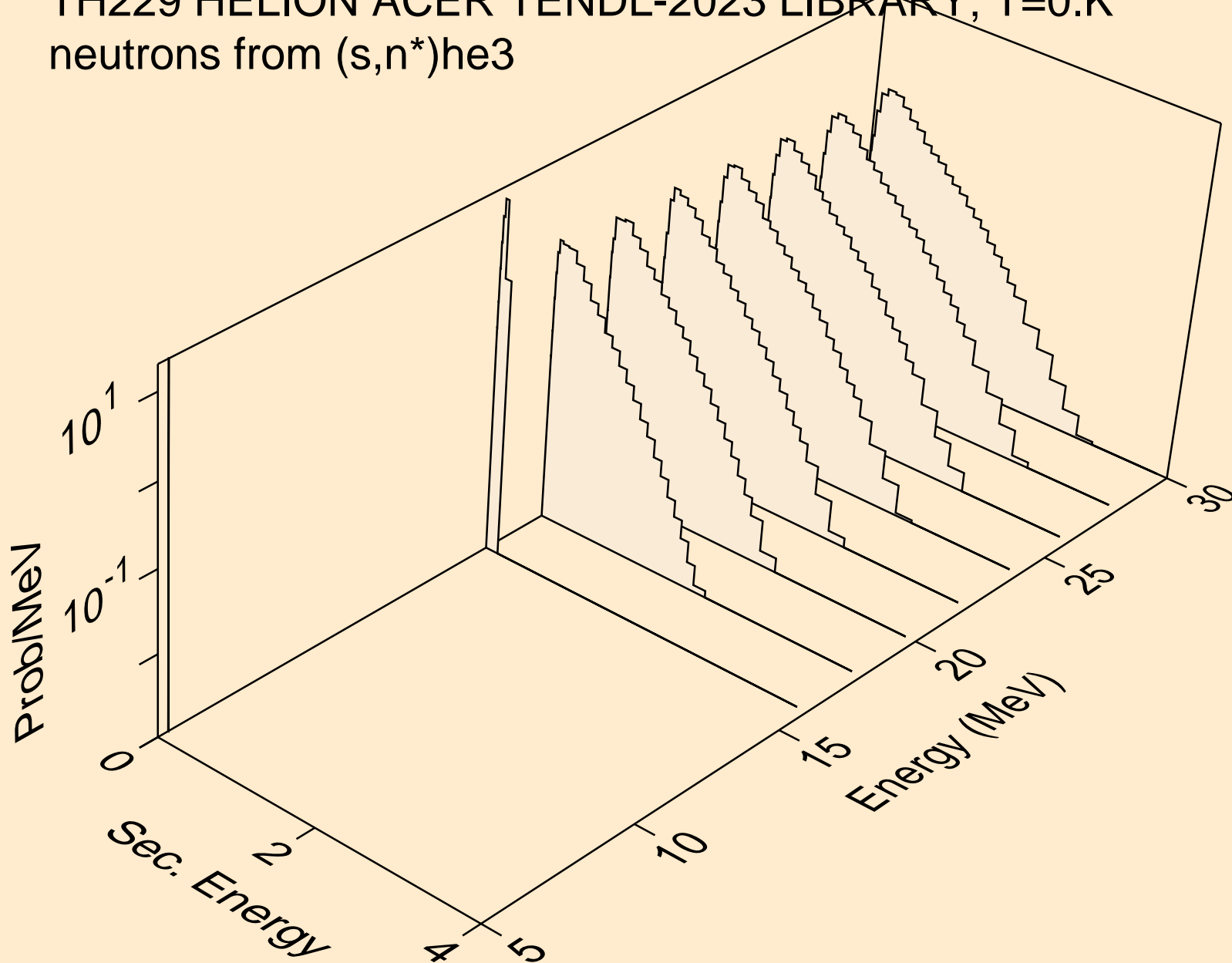

TH229 HELION ACER TENDL-2023 LIBRARY; T=0.K  
neutrons from (s,4n)

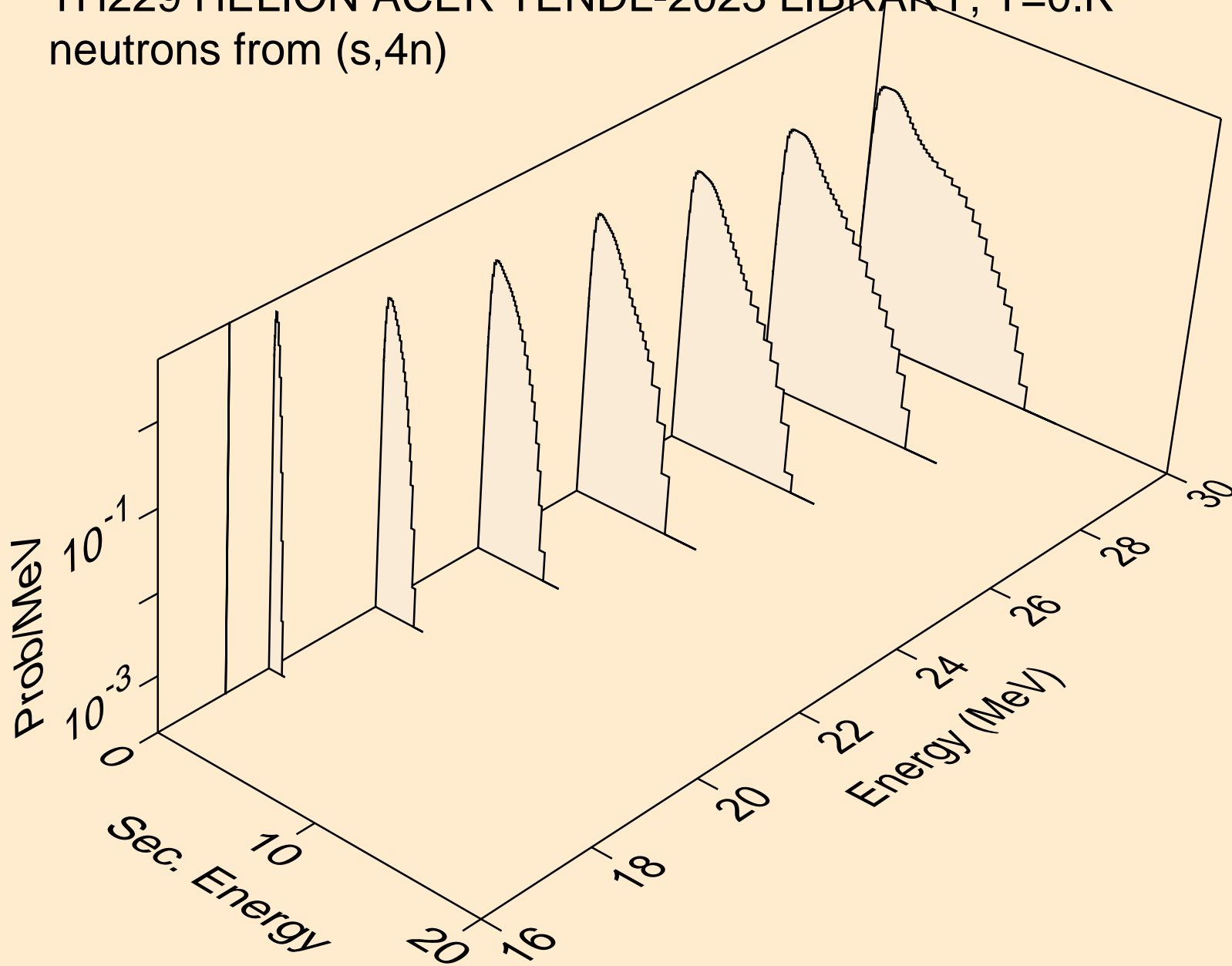

TH229 HELION ACER TENDL-2023 LIBRARY; T=0.K  
neutrons from (s,2np)

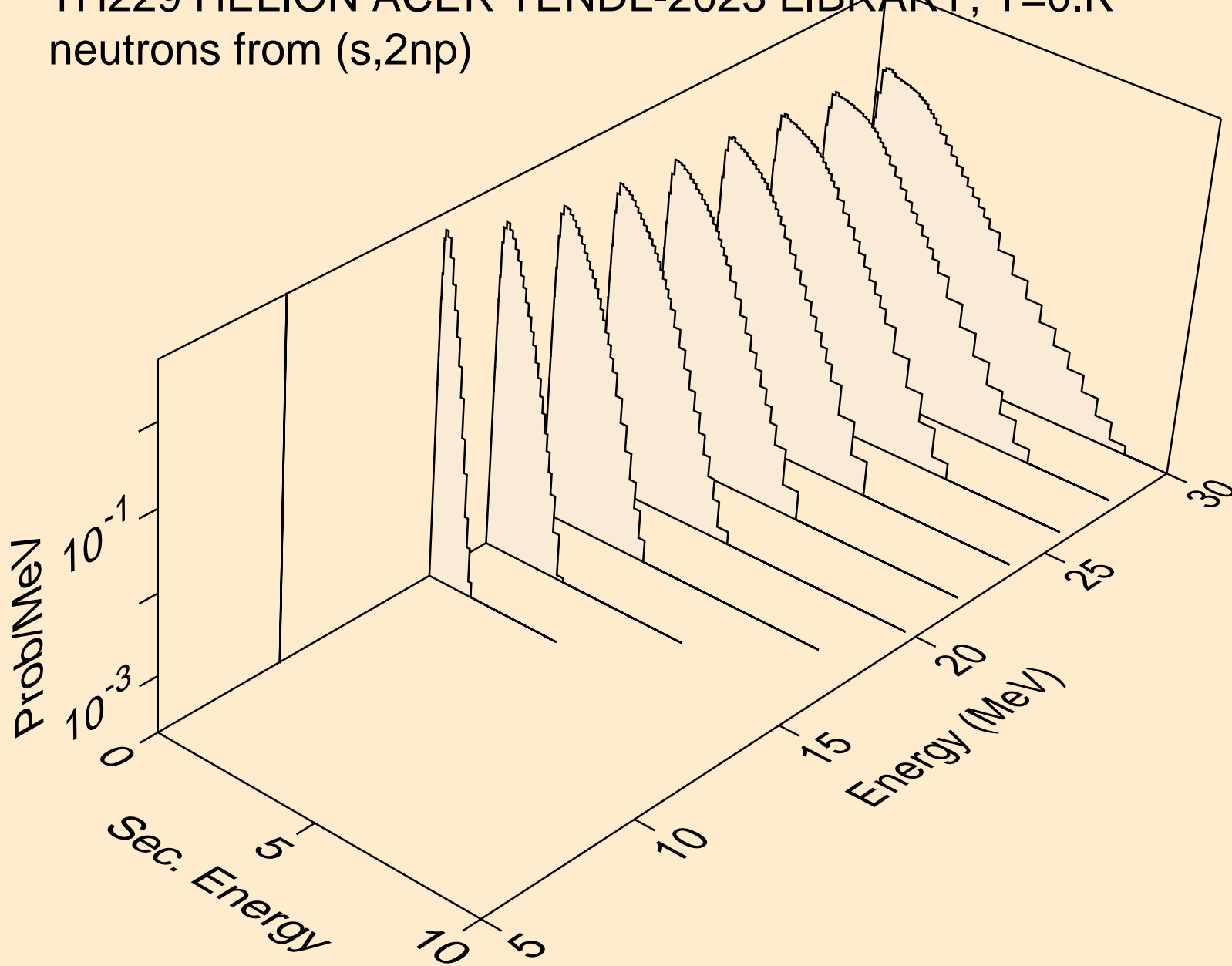

TH229 HELION ACER TENDL-2023 LIBRARY; T=0.K  
neutrons from (s,3np)

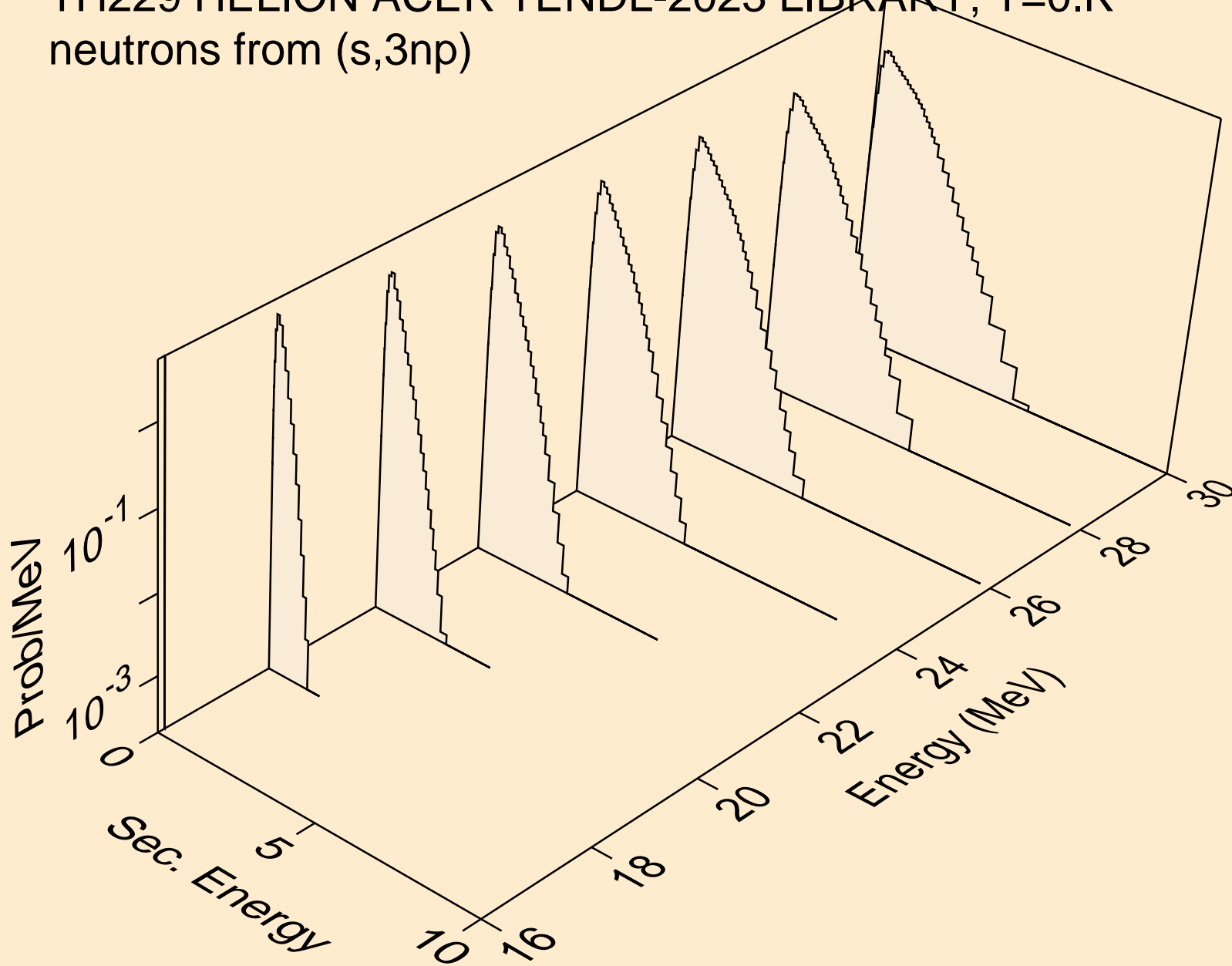

TH229 HELION ACER TENDL-2023 LIBRARY; T=0.K  
neutrons from (s,n2p)

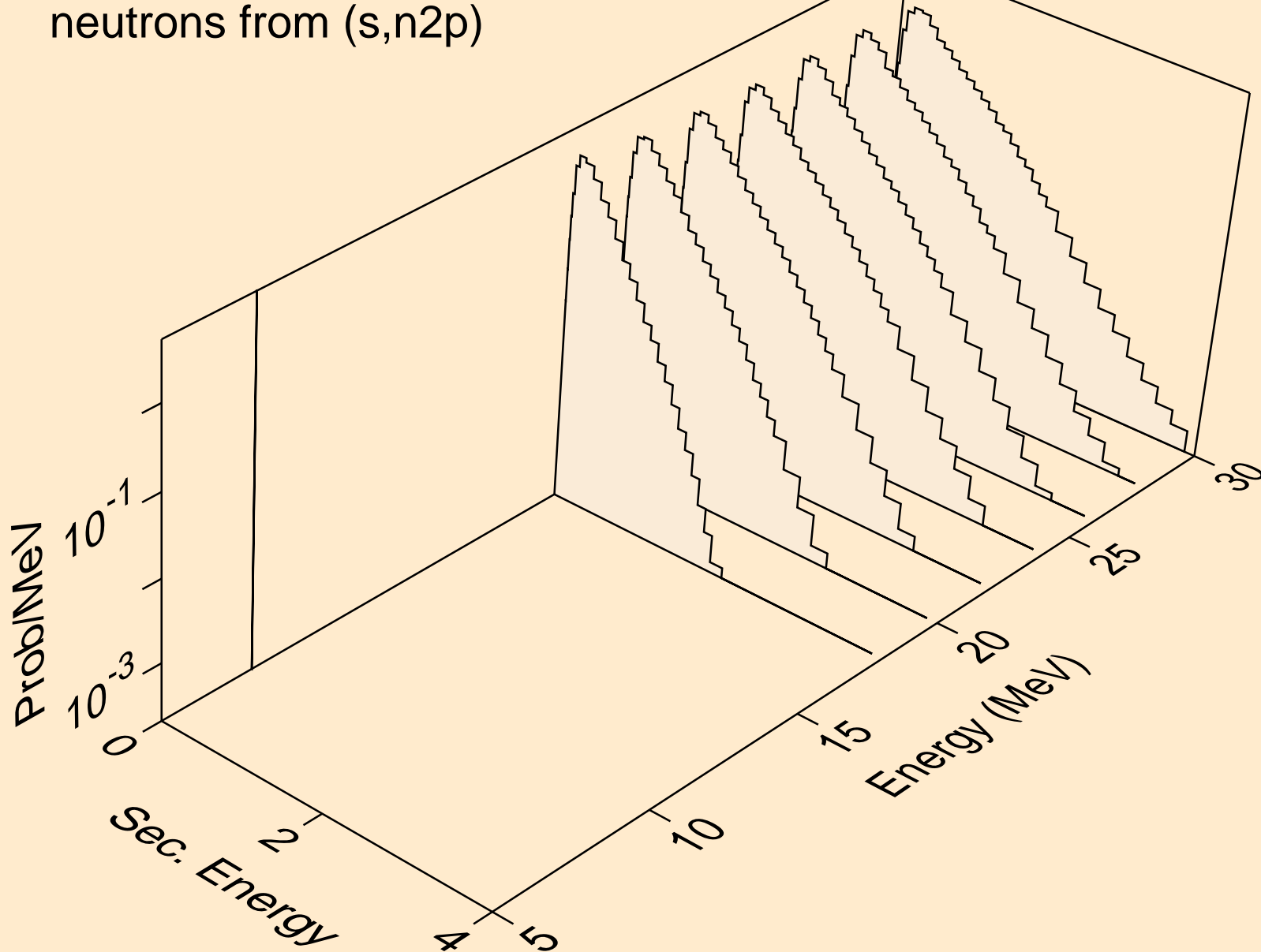

TH229 HELION ACER TENDL-2023 LIBRARY; T=0.K  
neutrons from (s,npa)

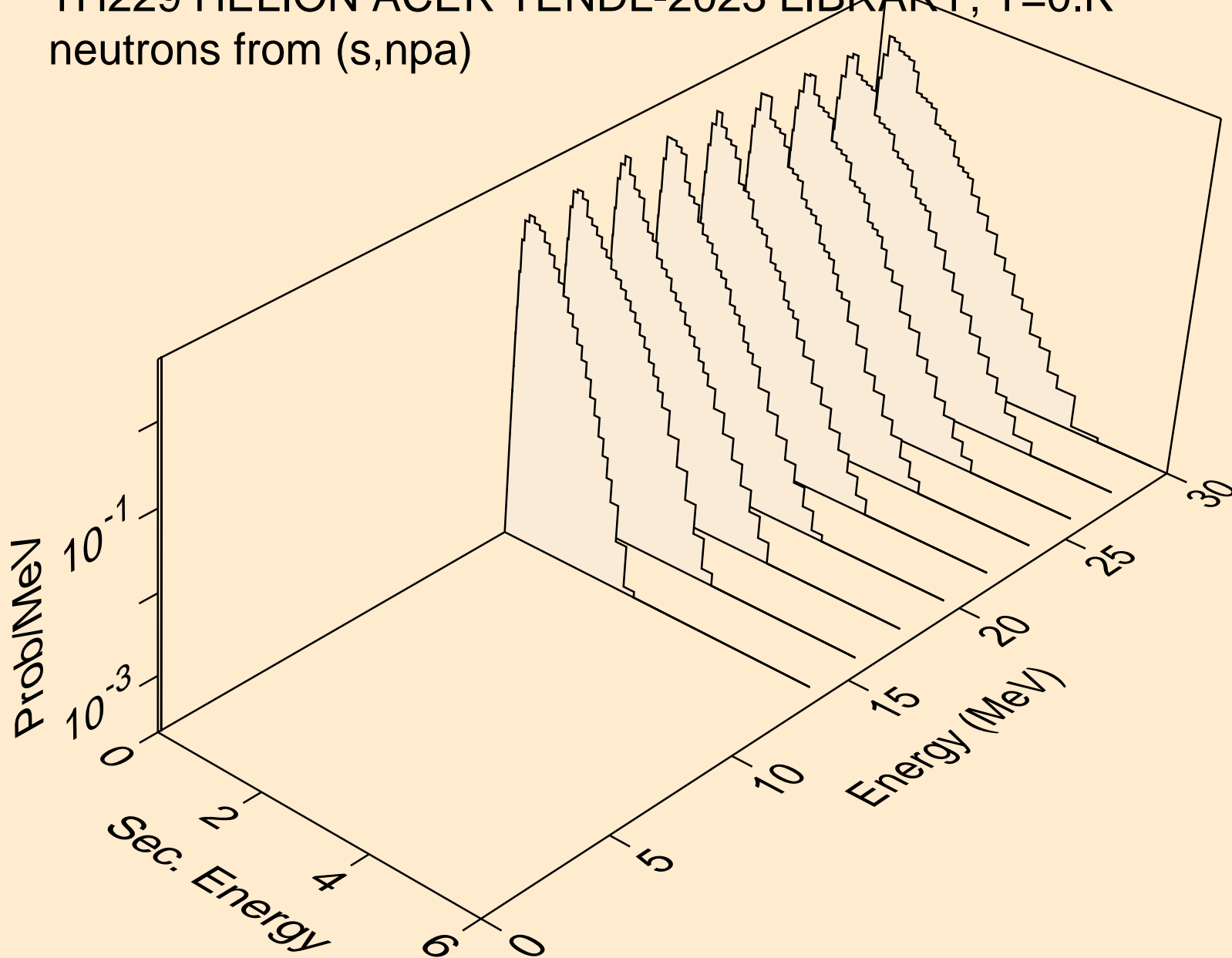

TH229 HELION ACER TENDL-2023 LIBRARY; T=0.K  
protons from (s,x)

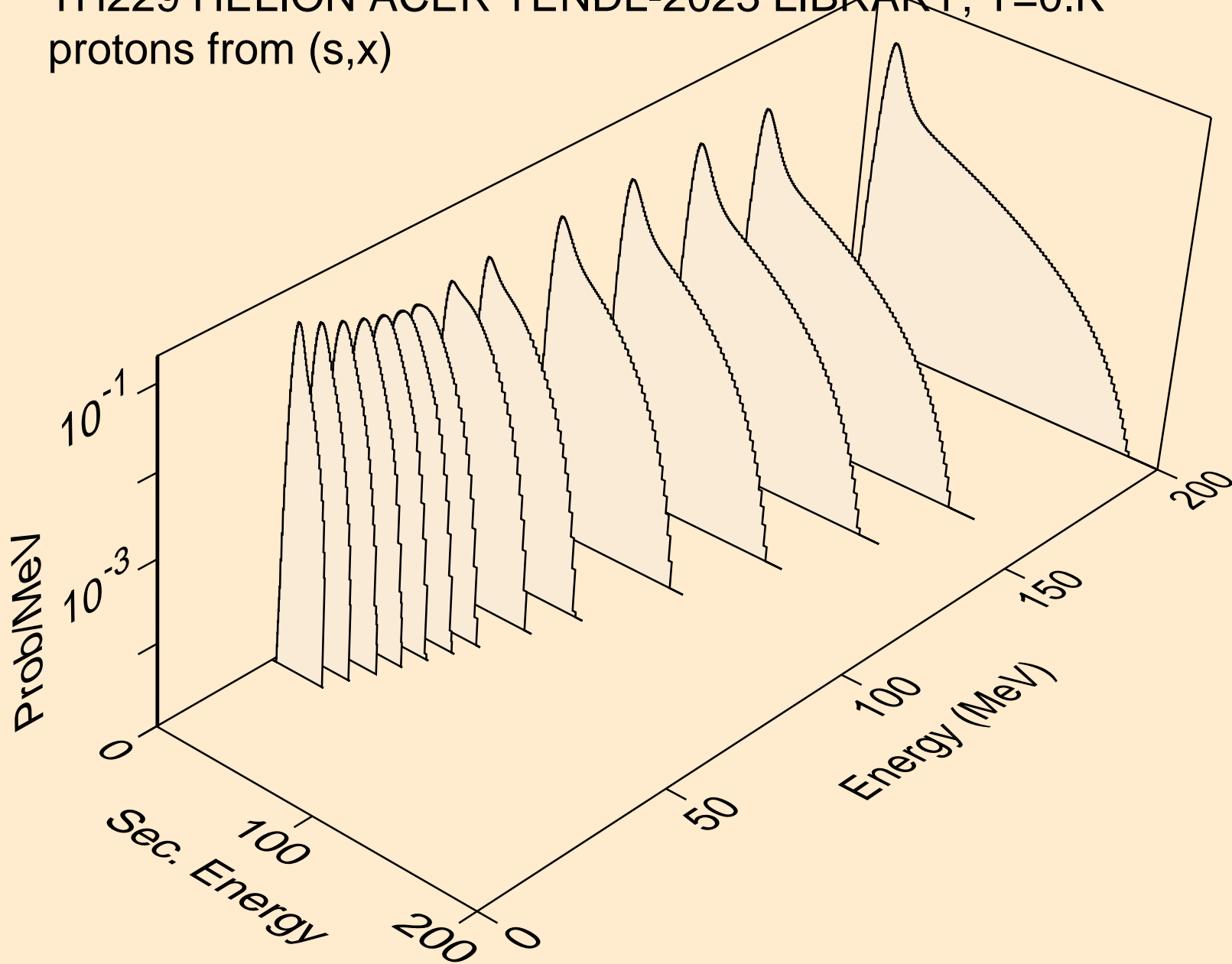



TH229 HELION ACER TENDL-2023 LIBRARY; T=0.K  
protons from (s,n\*)p

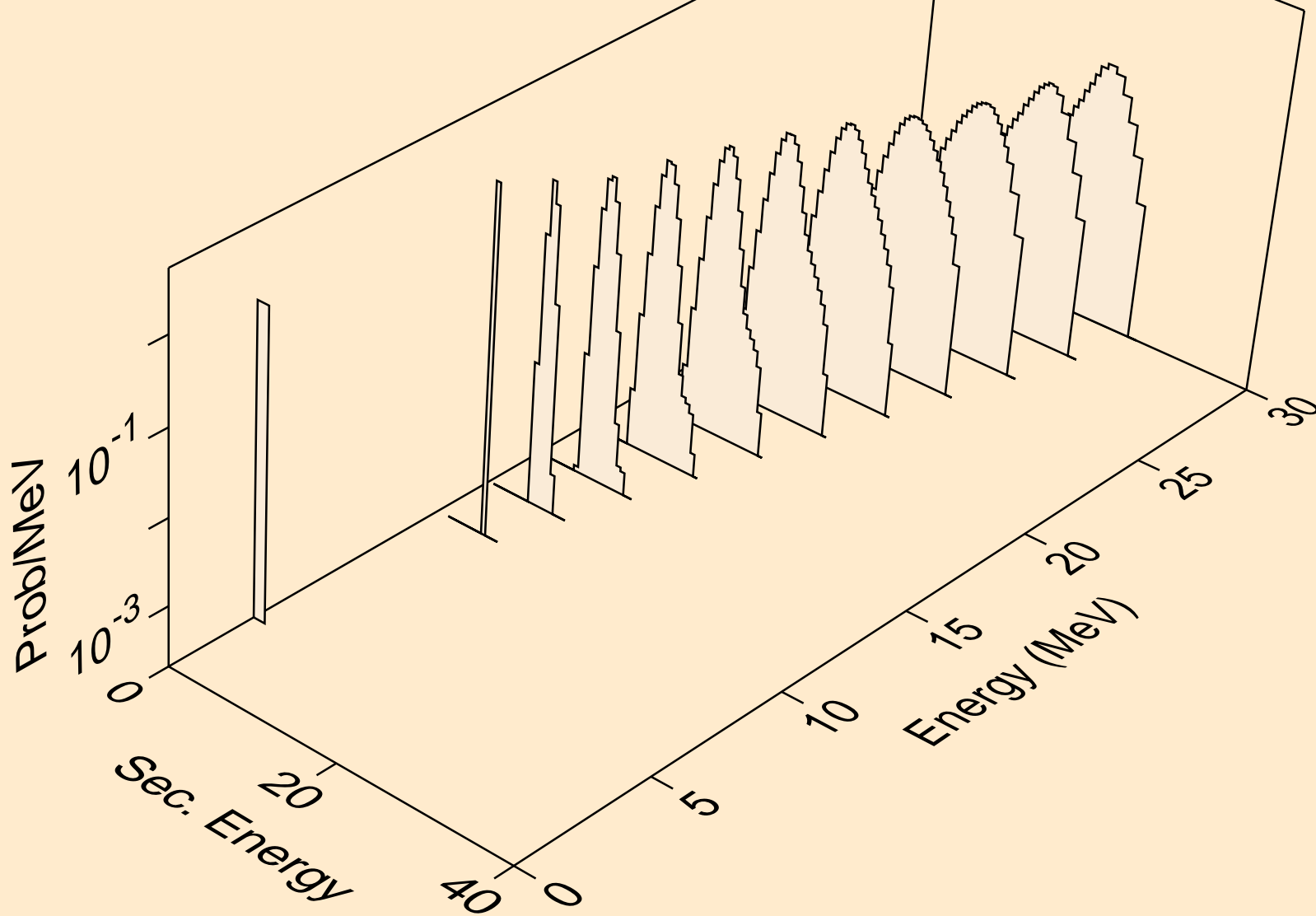

TH229 HELION ACER TENDL-2023 LIBRARY; T=0.K  
protons from (s,2np)

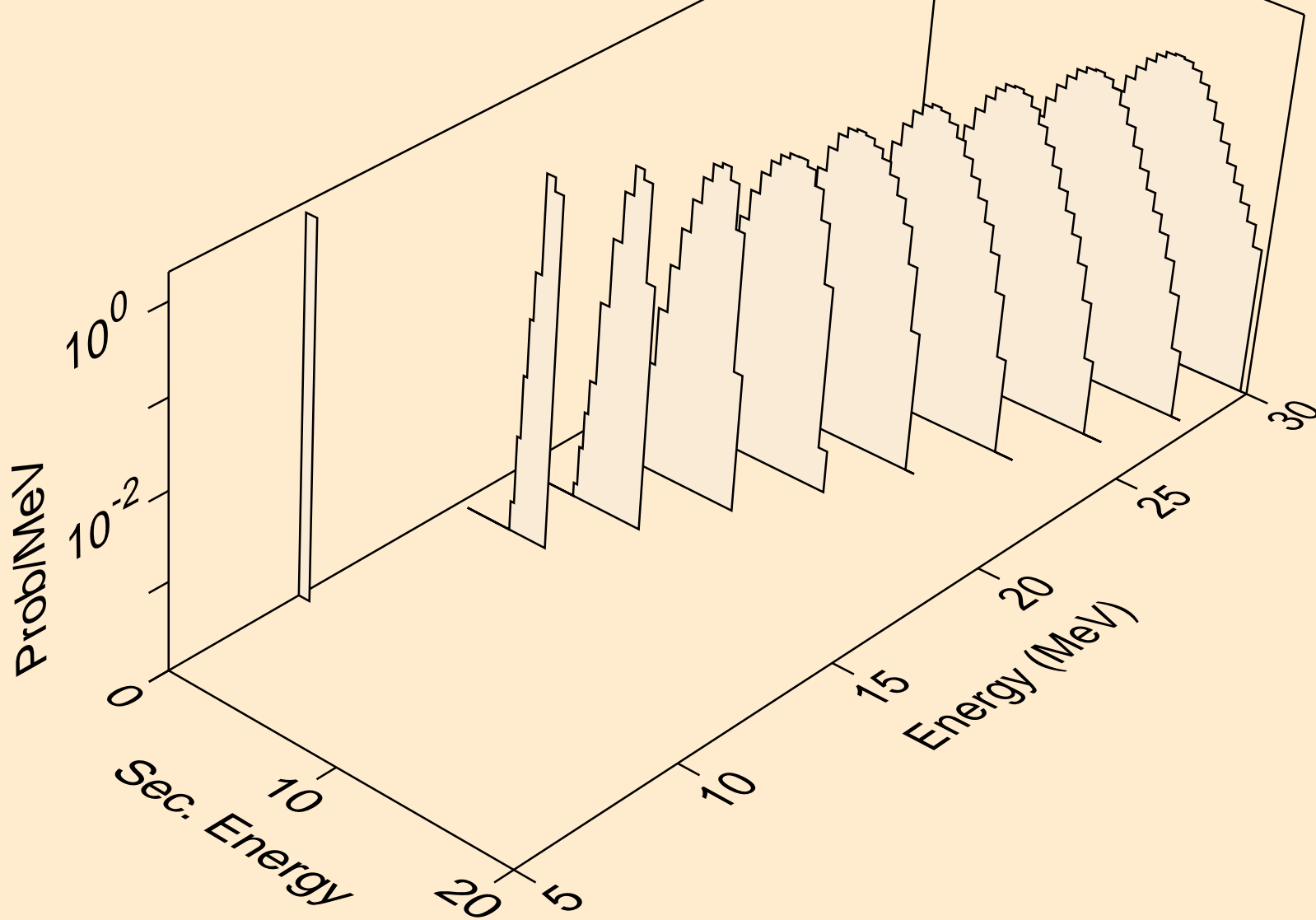

TH229 HELION ACER TENDL-2023 LIBRARY; T=0.K  
protons from (s,3np)

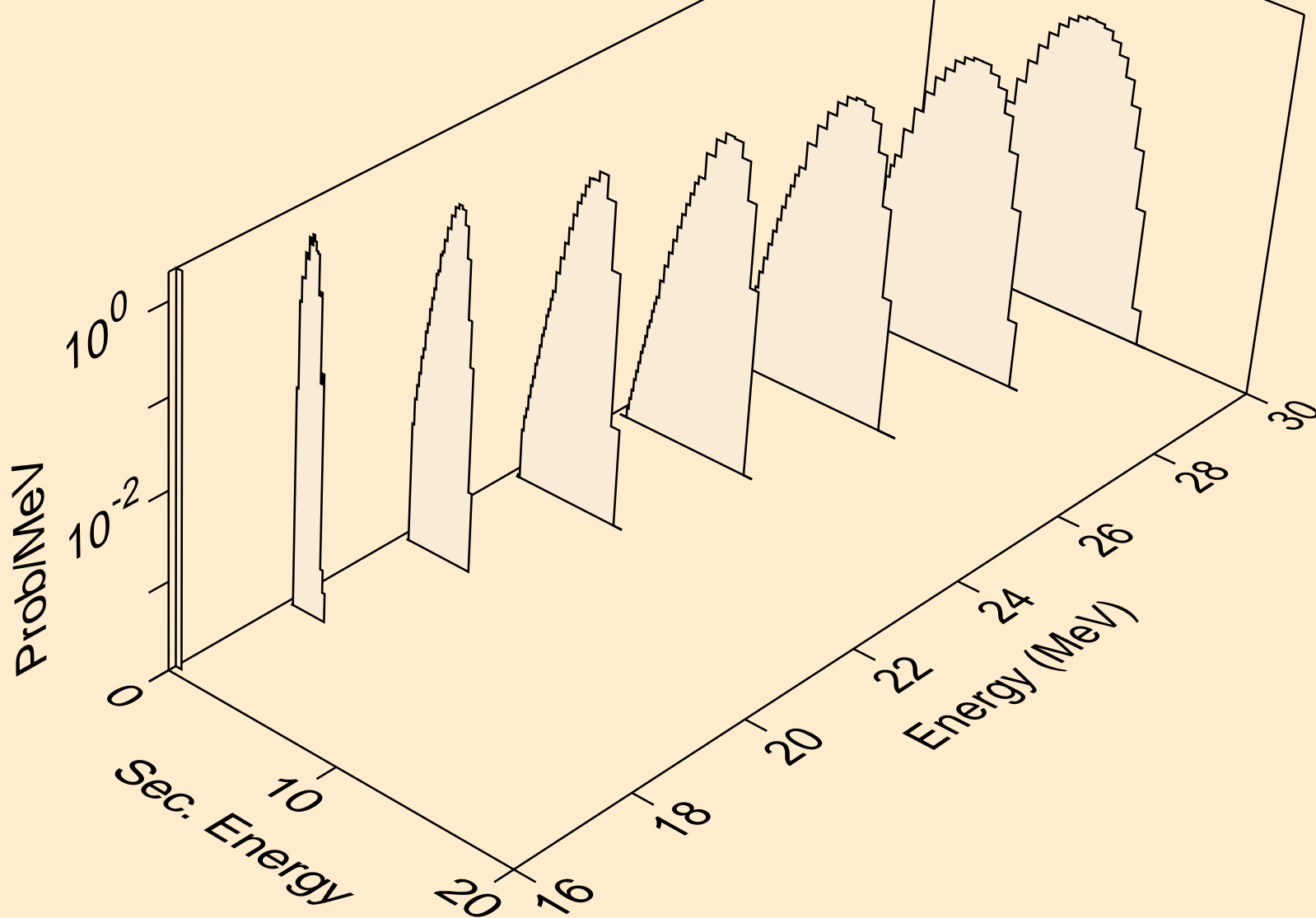

TH229 HELION ACER TENDL-2023 LIBRARY; T=0.K  
protons from (s,n2p)

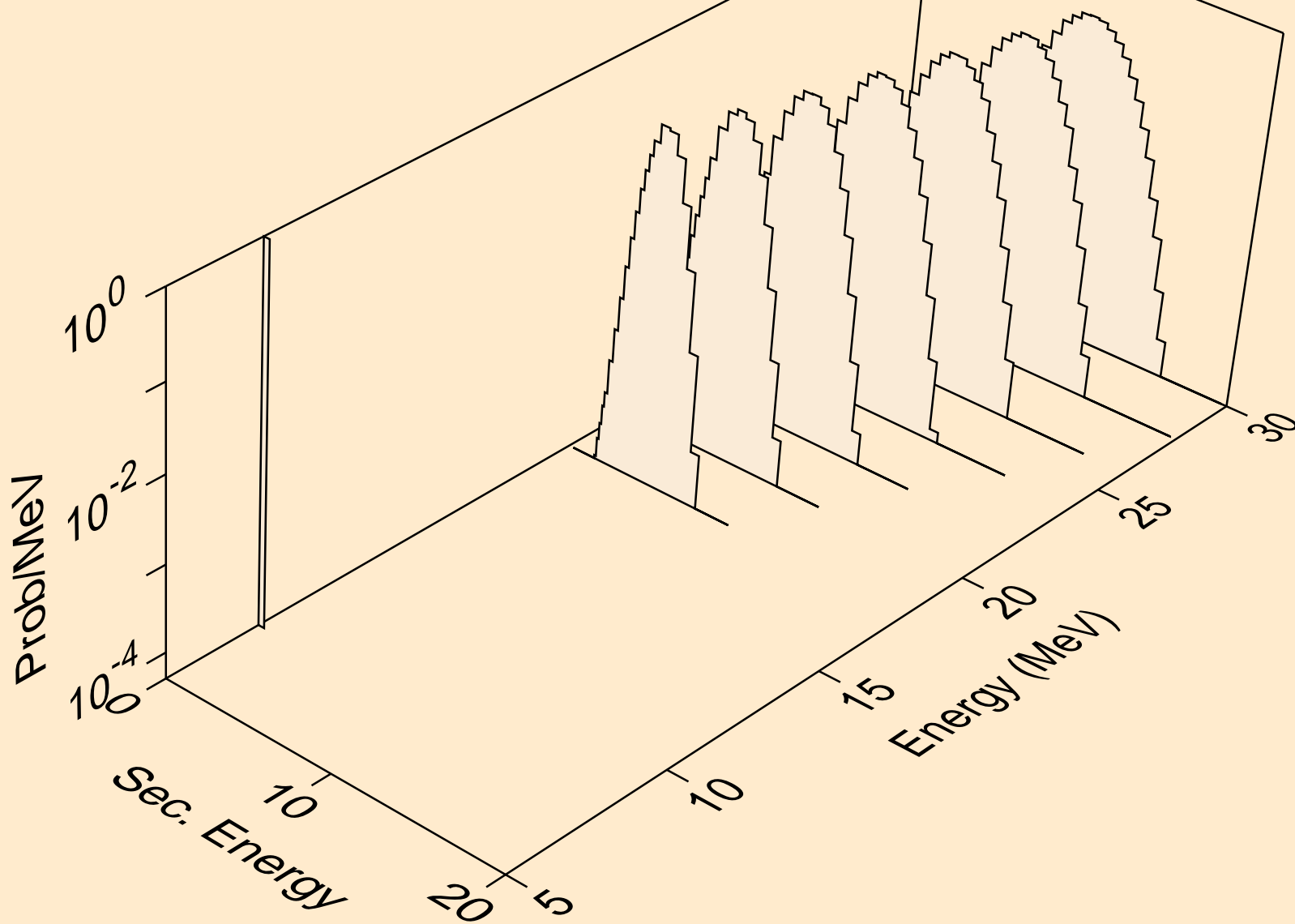

TH229 HELION ACER TENDL-2023 LIBRARY; T=0.K  
protons from (s,npa)

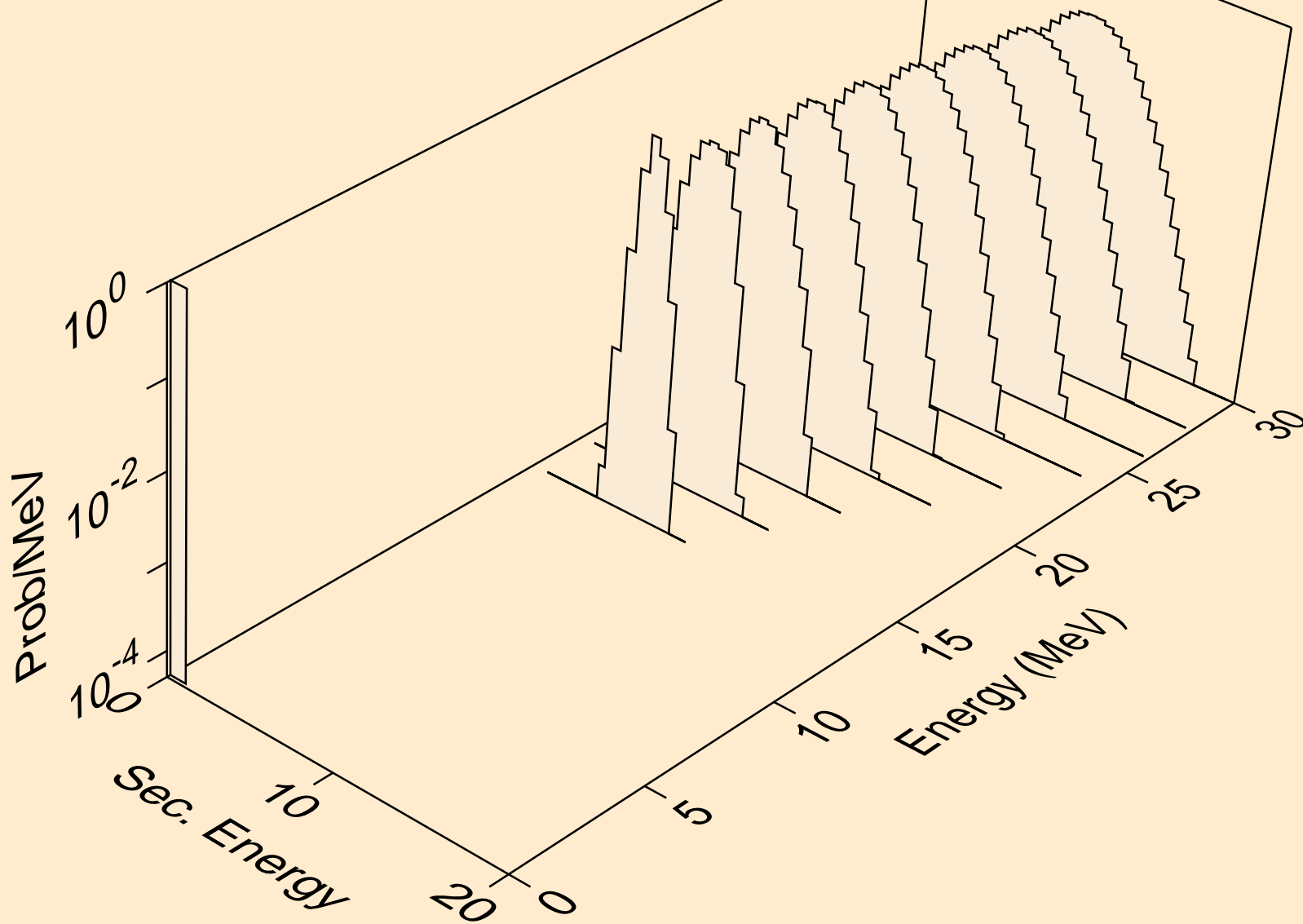

TH229 HELION ACER TENDL-2023 LIBRARY; T=0.K  
protons from (s,p)

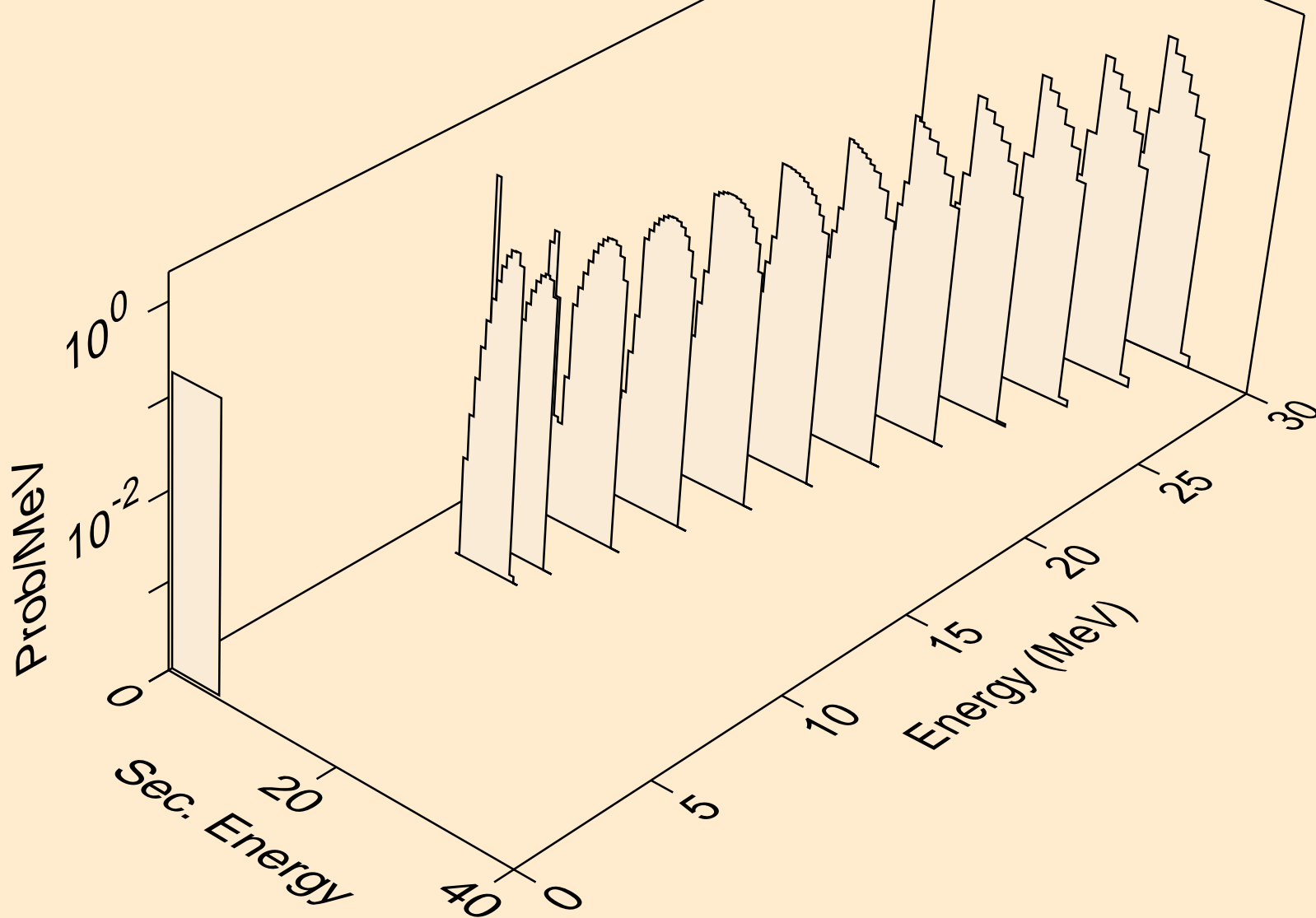

TH229 HELION ACER TENDL-2023 LIBRARY; T=0.K  
protons from (s,2p)

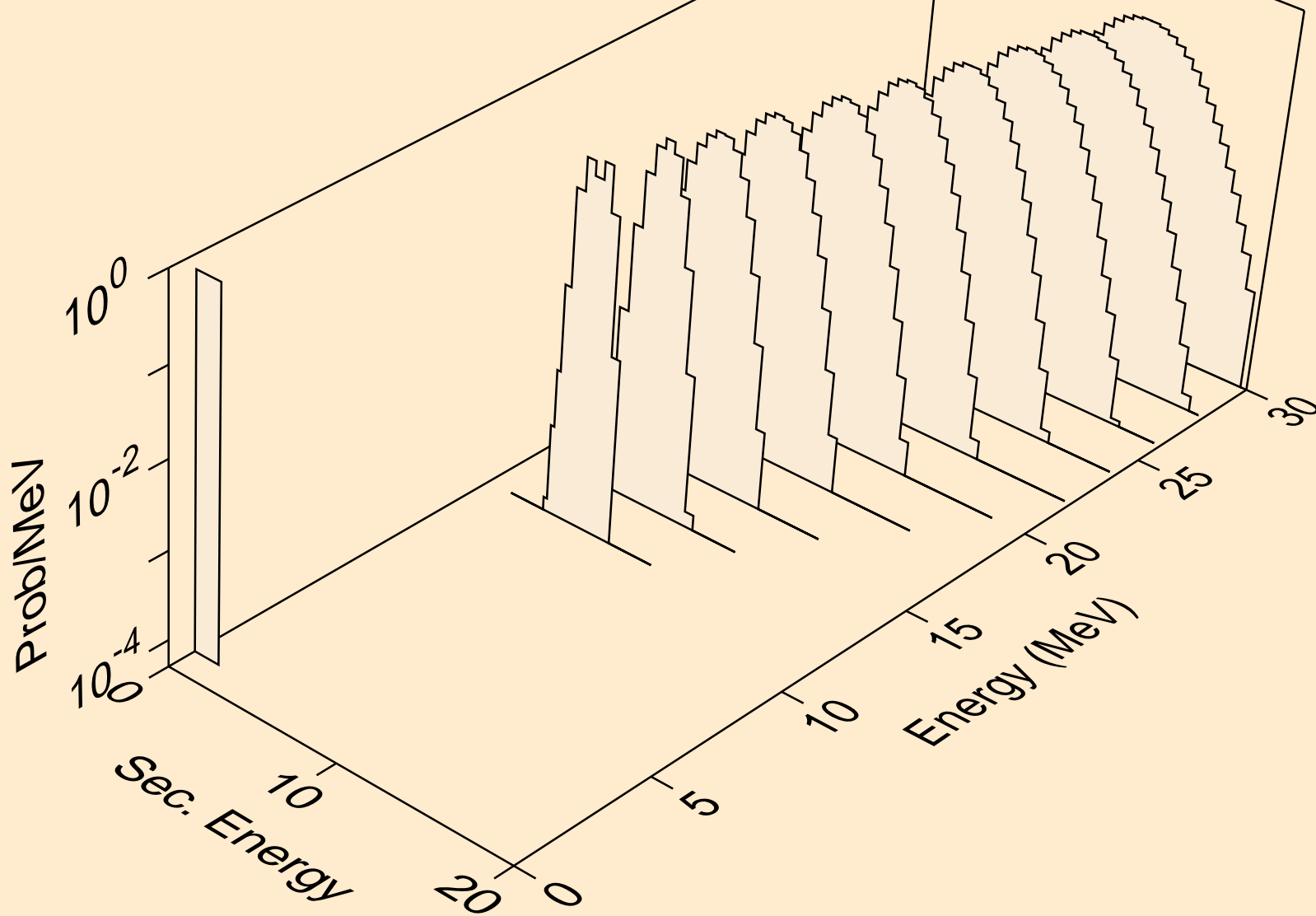

TH229 HELION ACER TENDL-2023 LIBRARY; T=0.K  
protons from (s,pa)

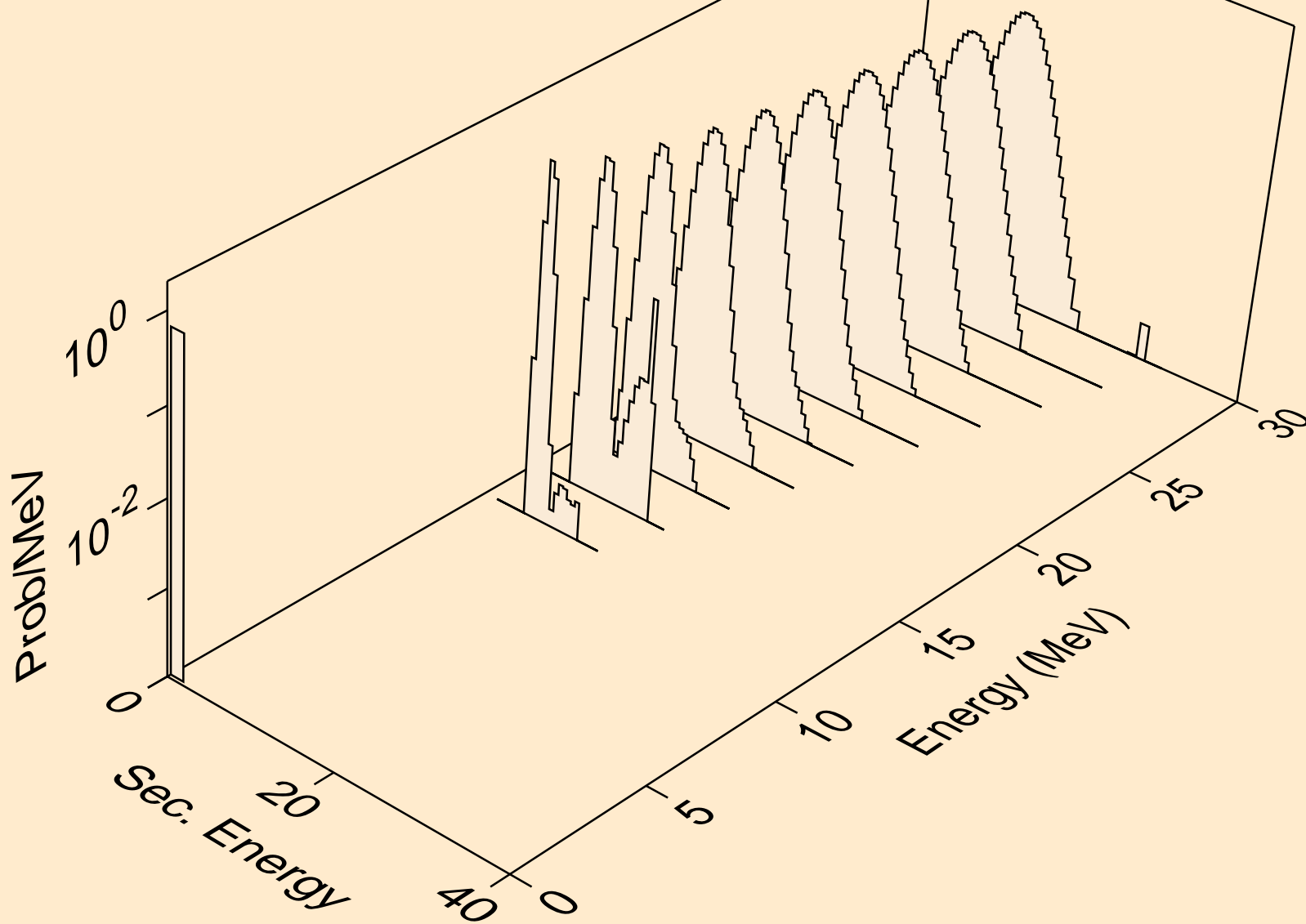



TH229 HELION ACER TENDL-2023 LIBRARY; T=0.K  
protons from (s,pd)

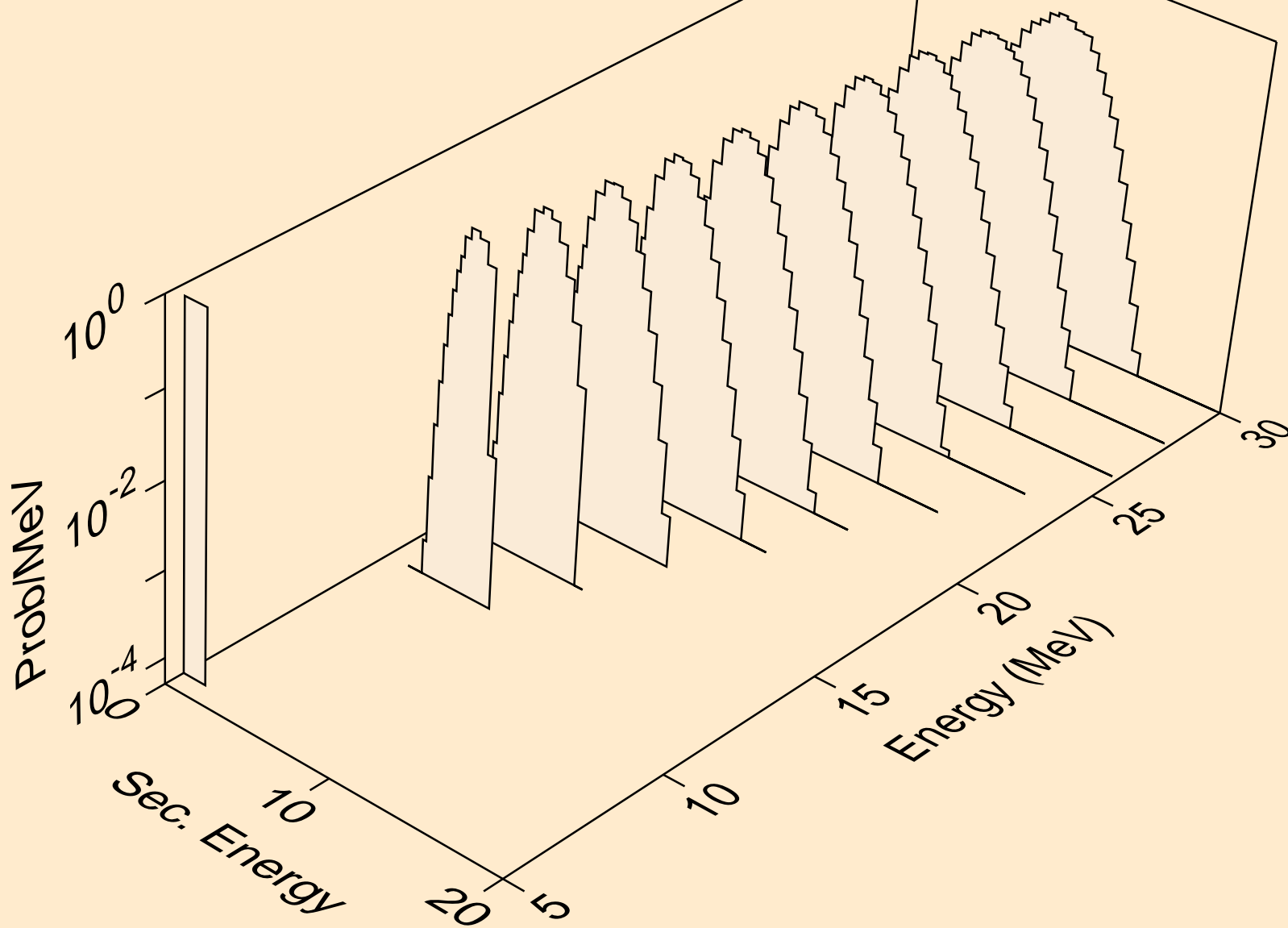

TH229 HELION ACER TENDL-2023 LIBRARY; T=0.K  
protons from (s,pt)

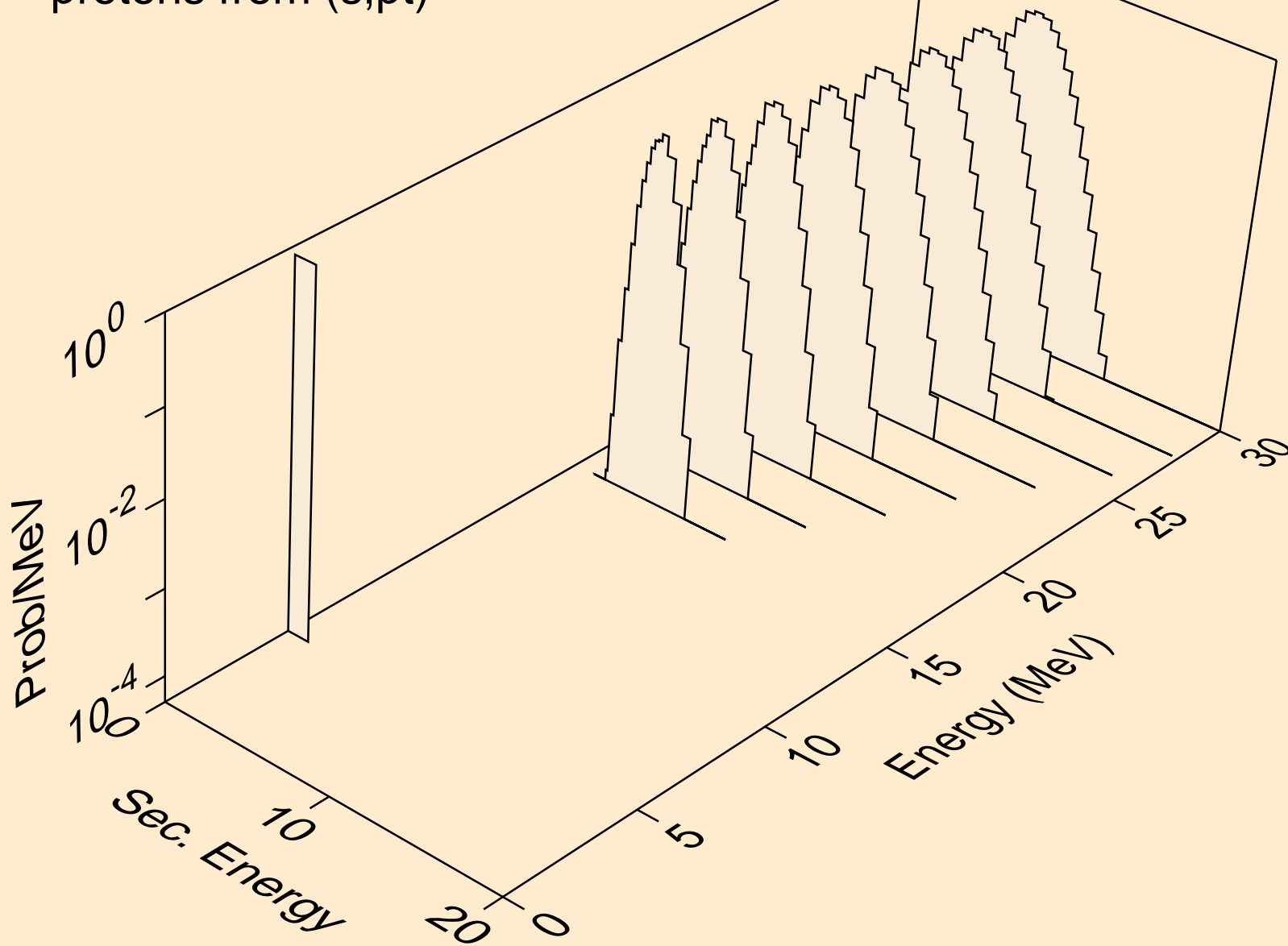

TH229 HELION ACER TENDL-2023 LIBRARY; T=0.K  
deuterons from (s,x)

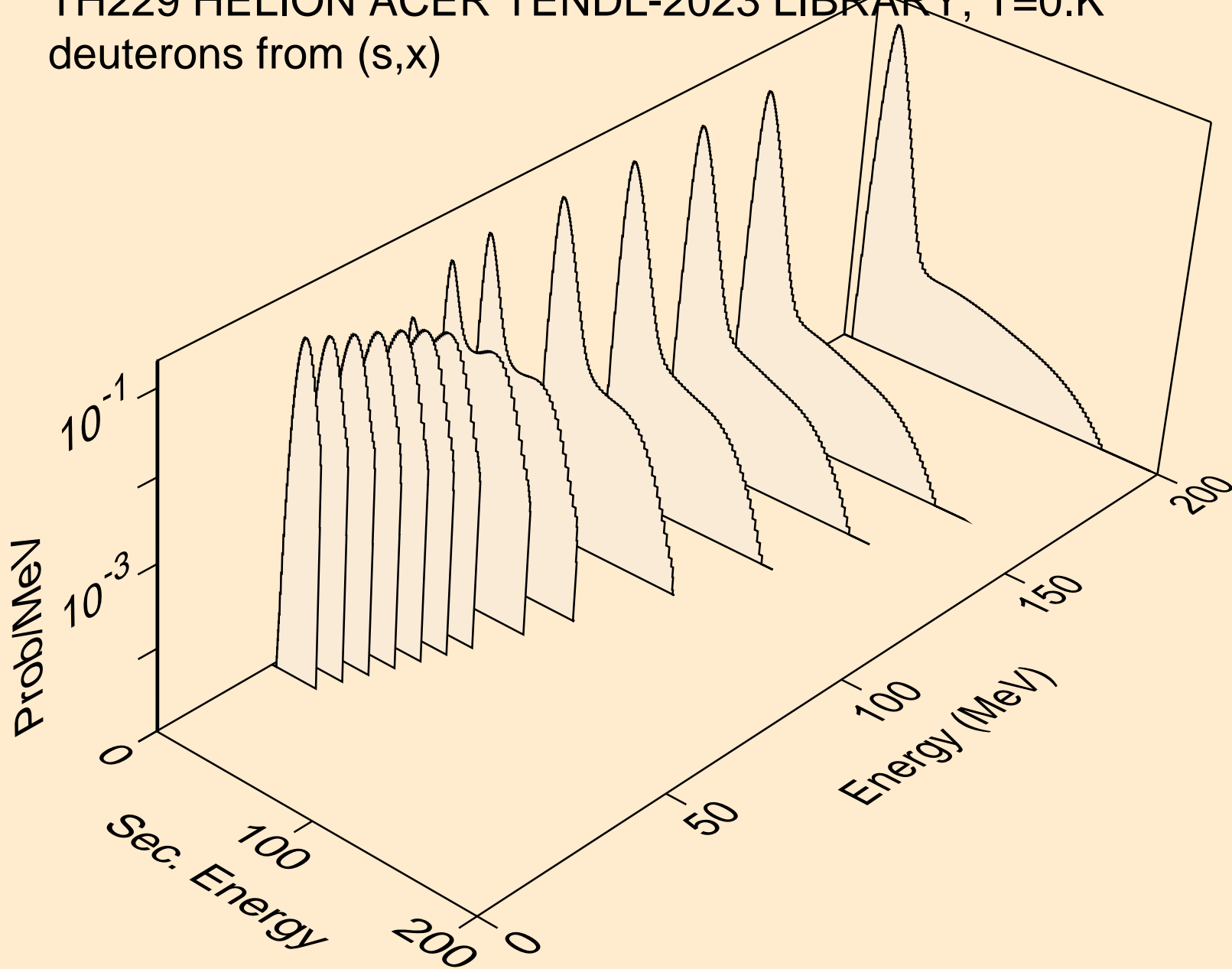

TH229 HELION ACER TENDL-2023 LIBRARY; T=0.K  
deuterons from (s,2nd)

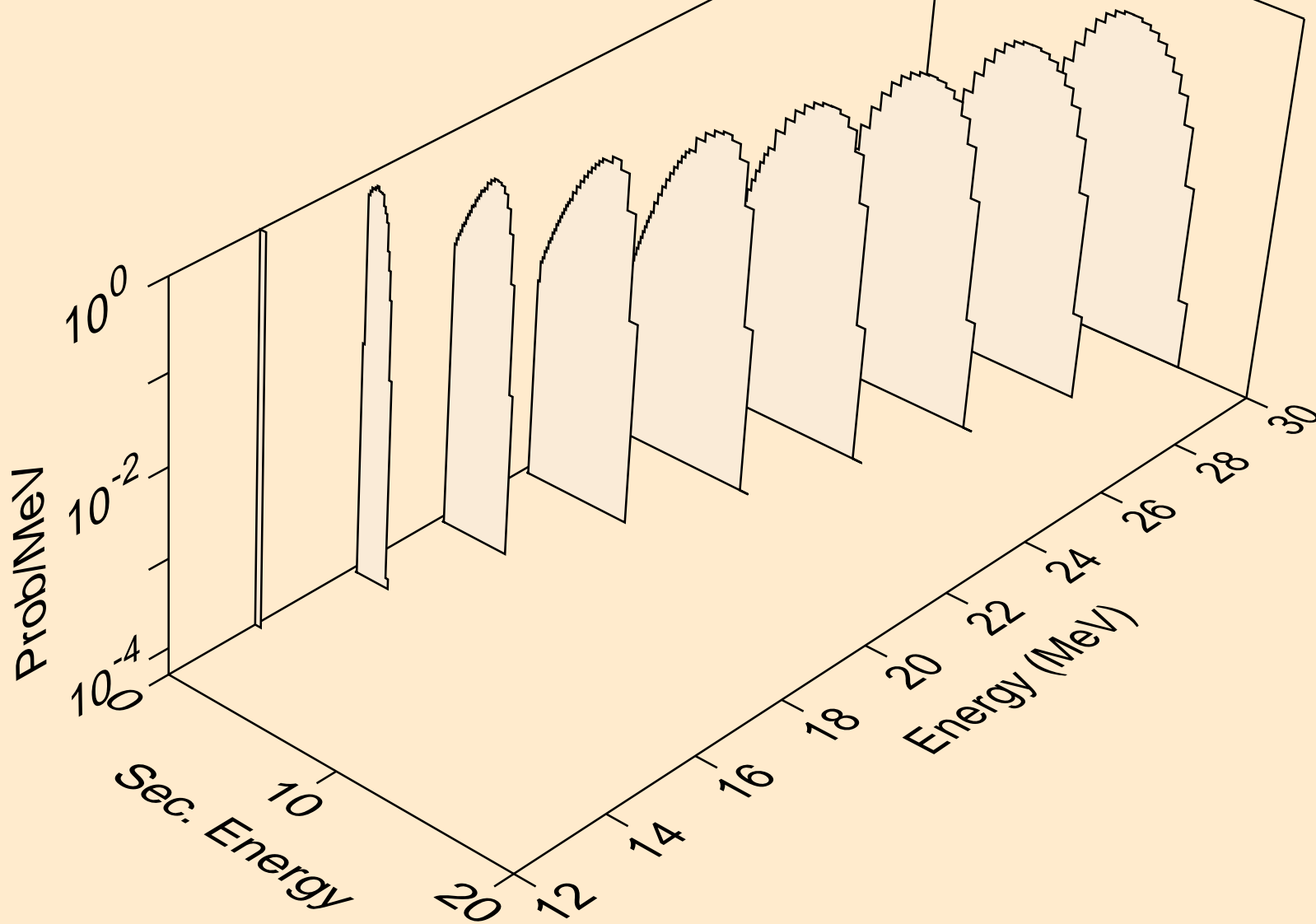

TH229 HELION ACER TENDL-2023 LIBRARY; T=0.K  
deuterons from (s,n\*)d

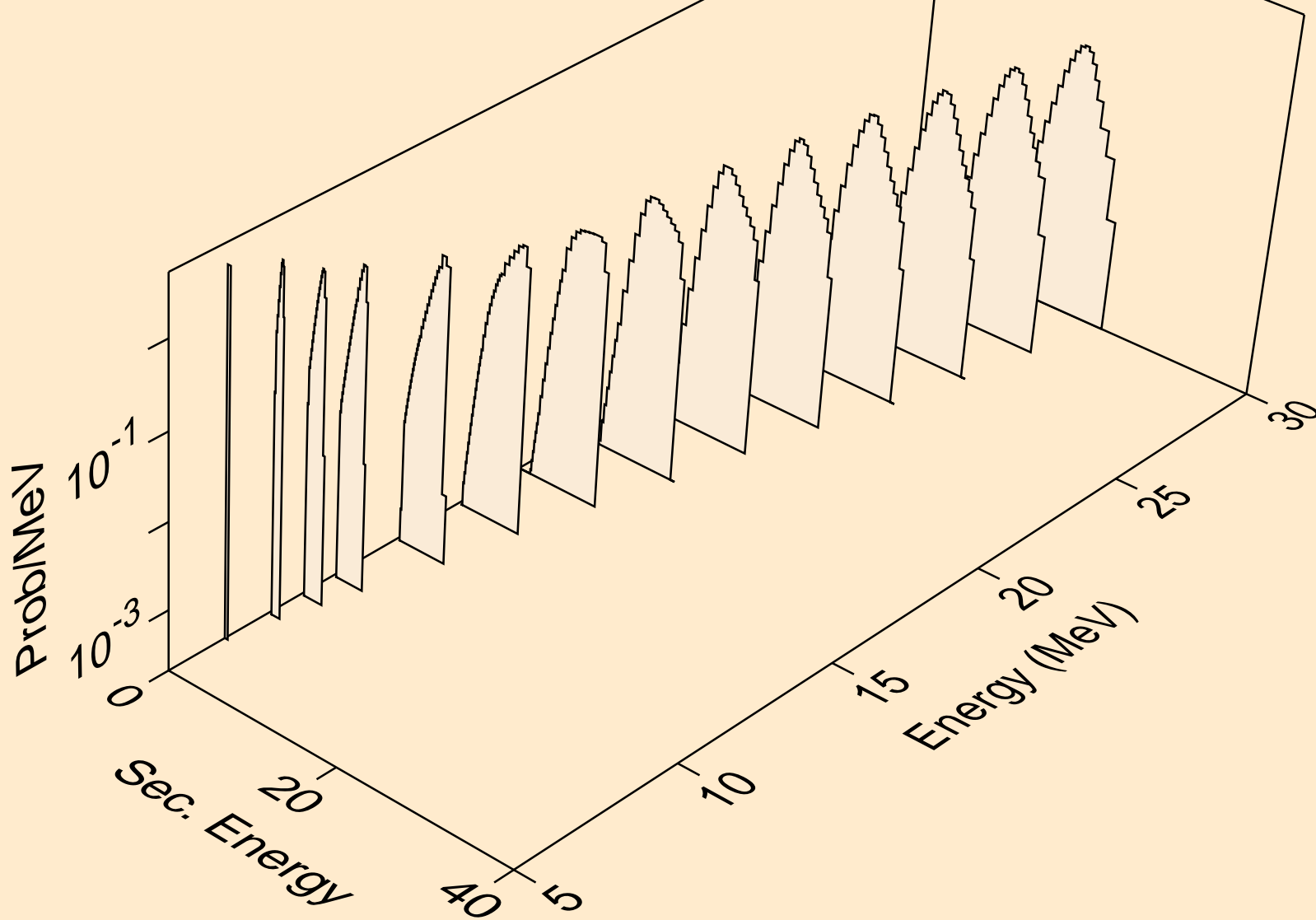

TH229 HELION ACER TENDL-2023 LIBRARY; T=0.K  
deuterons from (s,d)

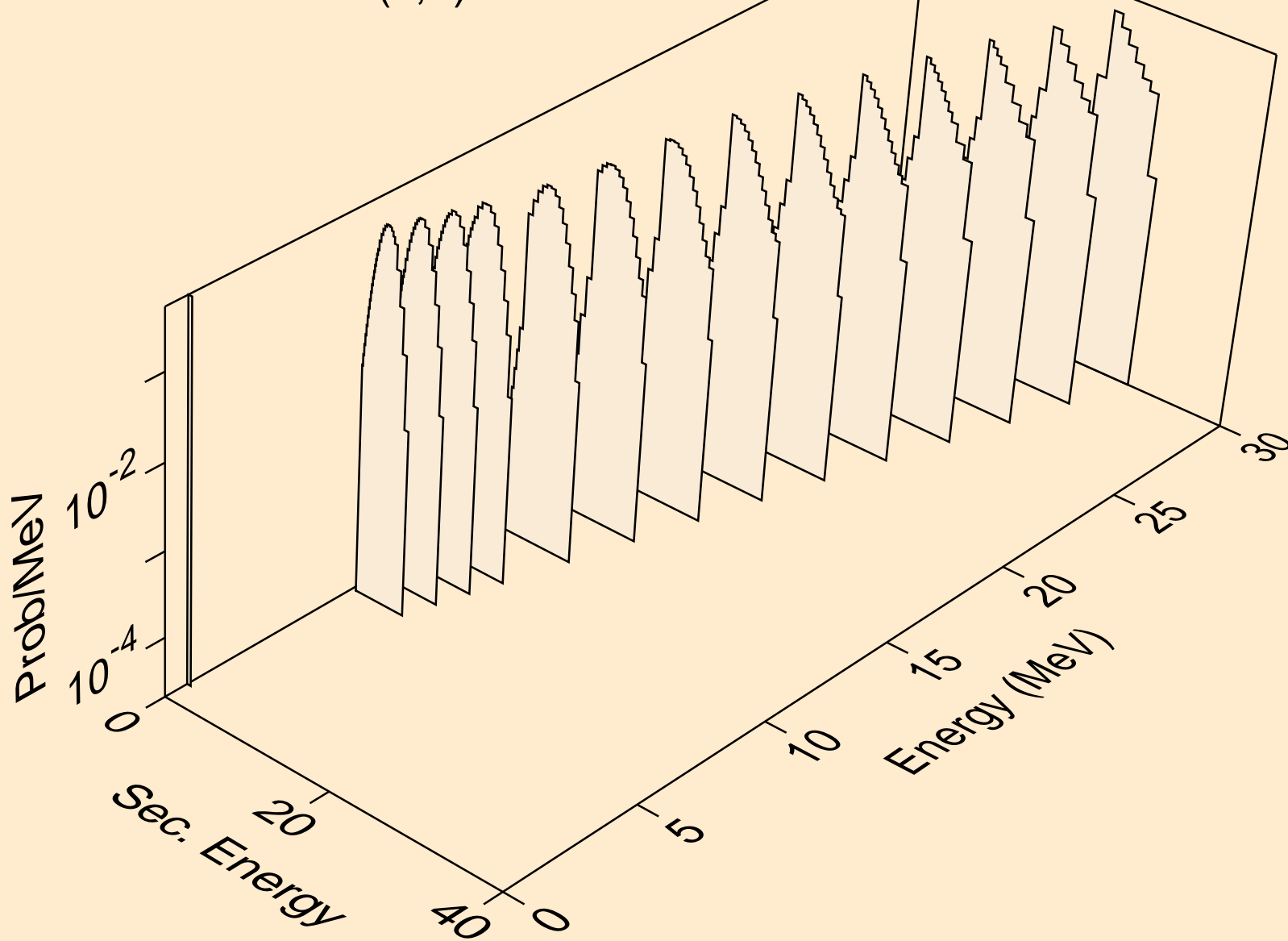

TH229 HELION ACER TENDL-2023 LIBRARY; T=0.K  
deuterons from (s,pd)

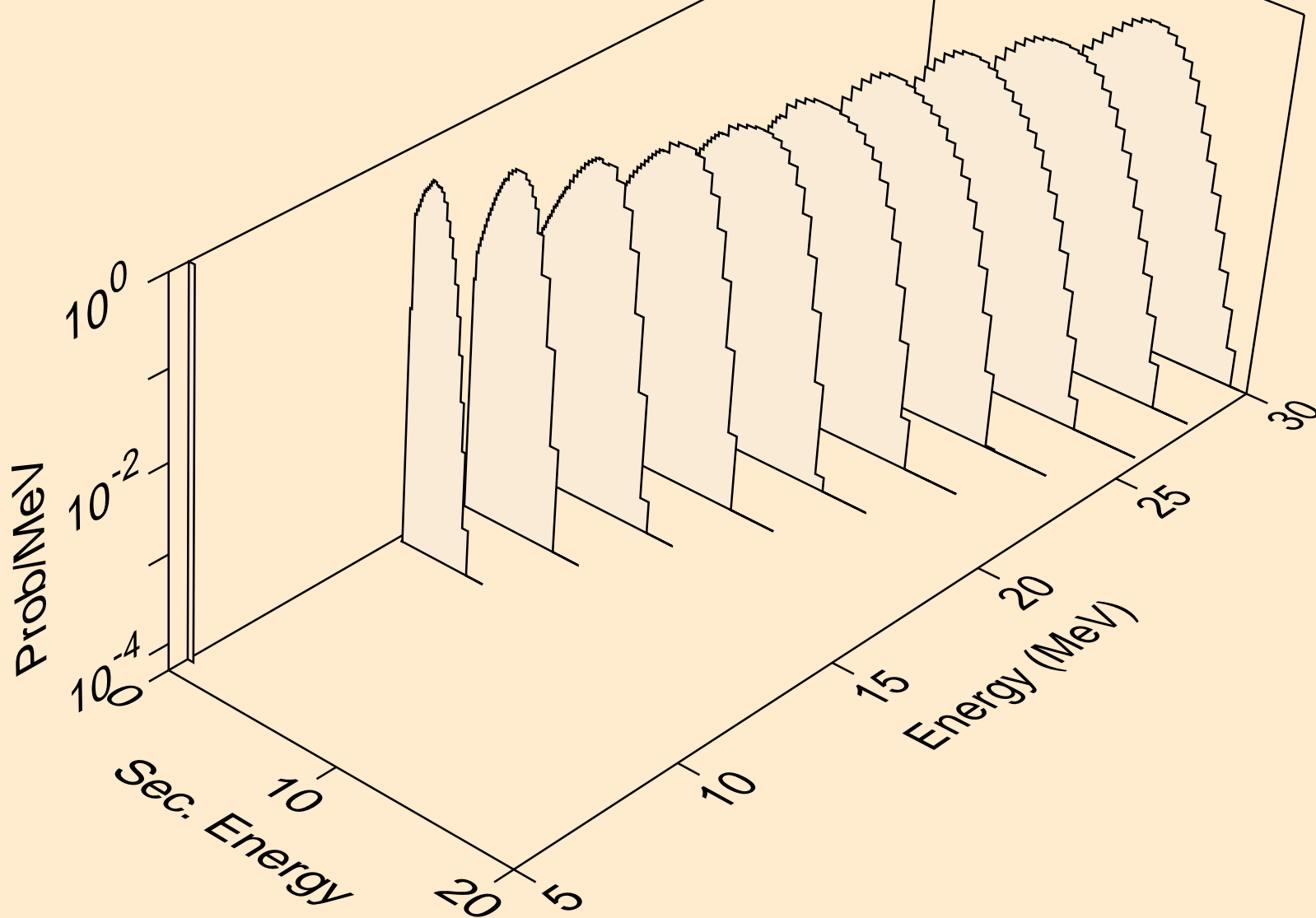

TH229 HELION ACER TENDL-2023 LIBRARY; T=0.K  
deuterons from (s,da)

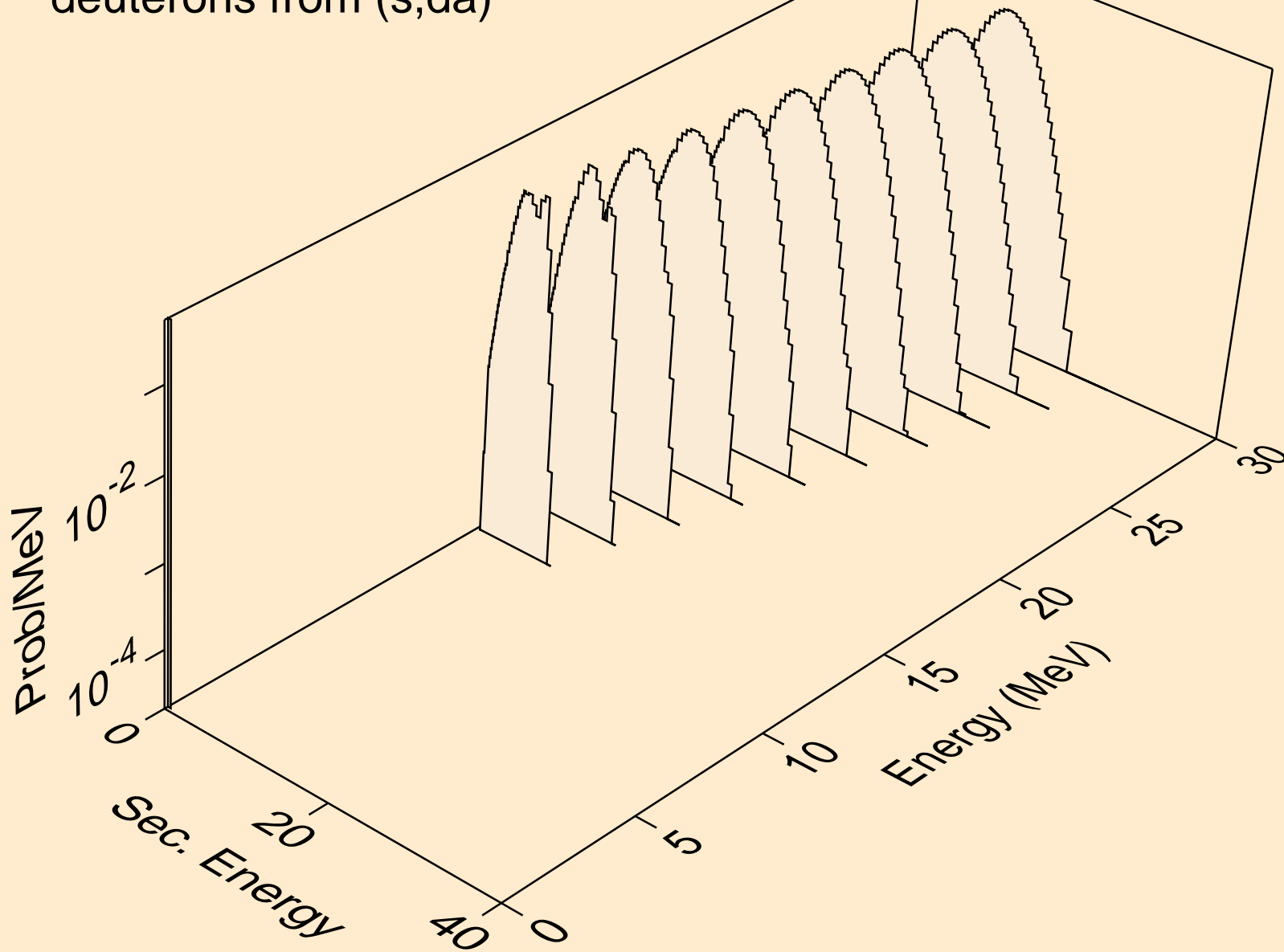



TH229 HELION ACER TENDL-2023 LIBRARY; T=0.K  
tritons from (s,x)

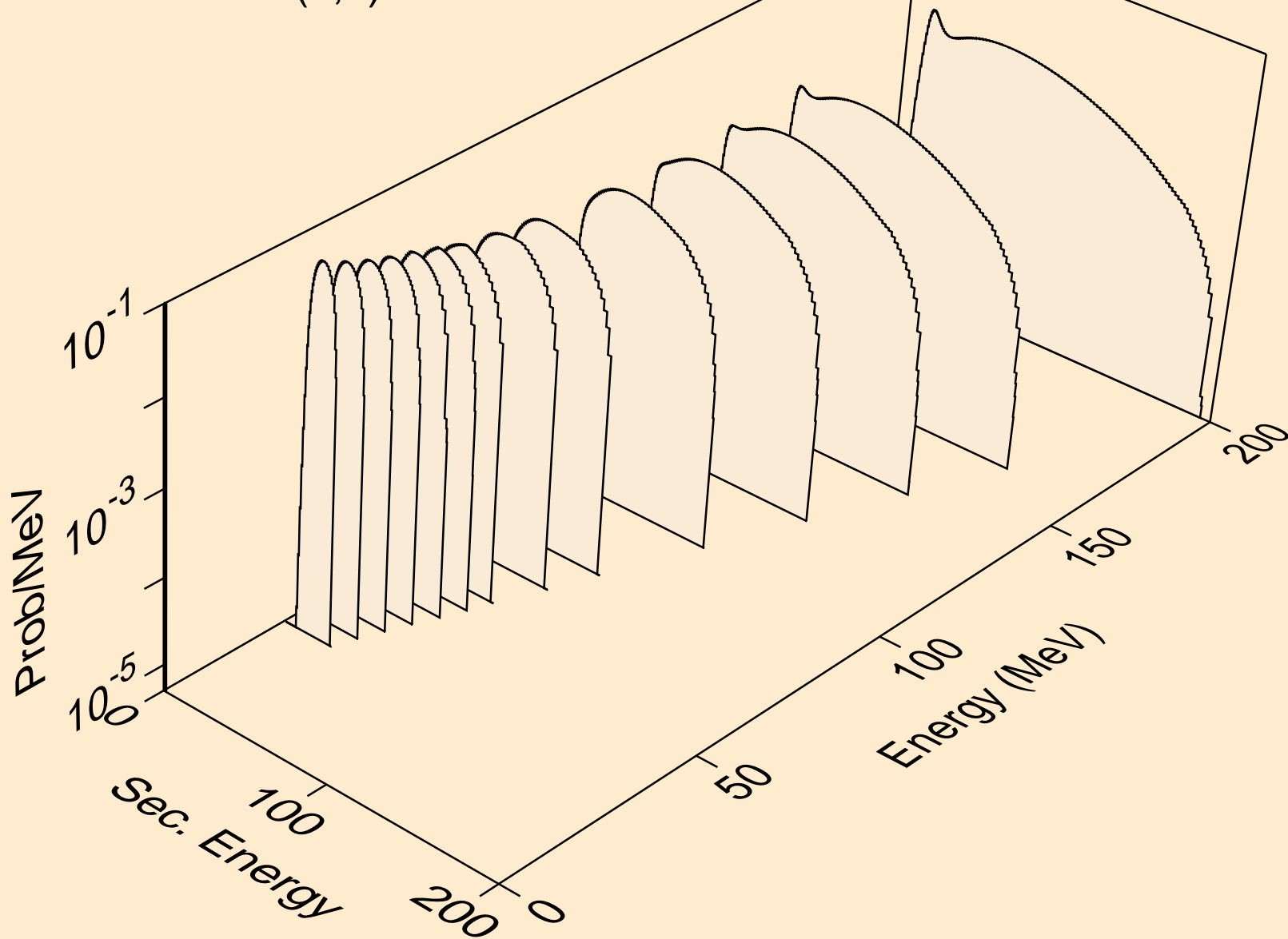

TH229 HELION ACER TENDL-2023 LIBRARY; T=0.K  
tritons from (s,n\*)t

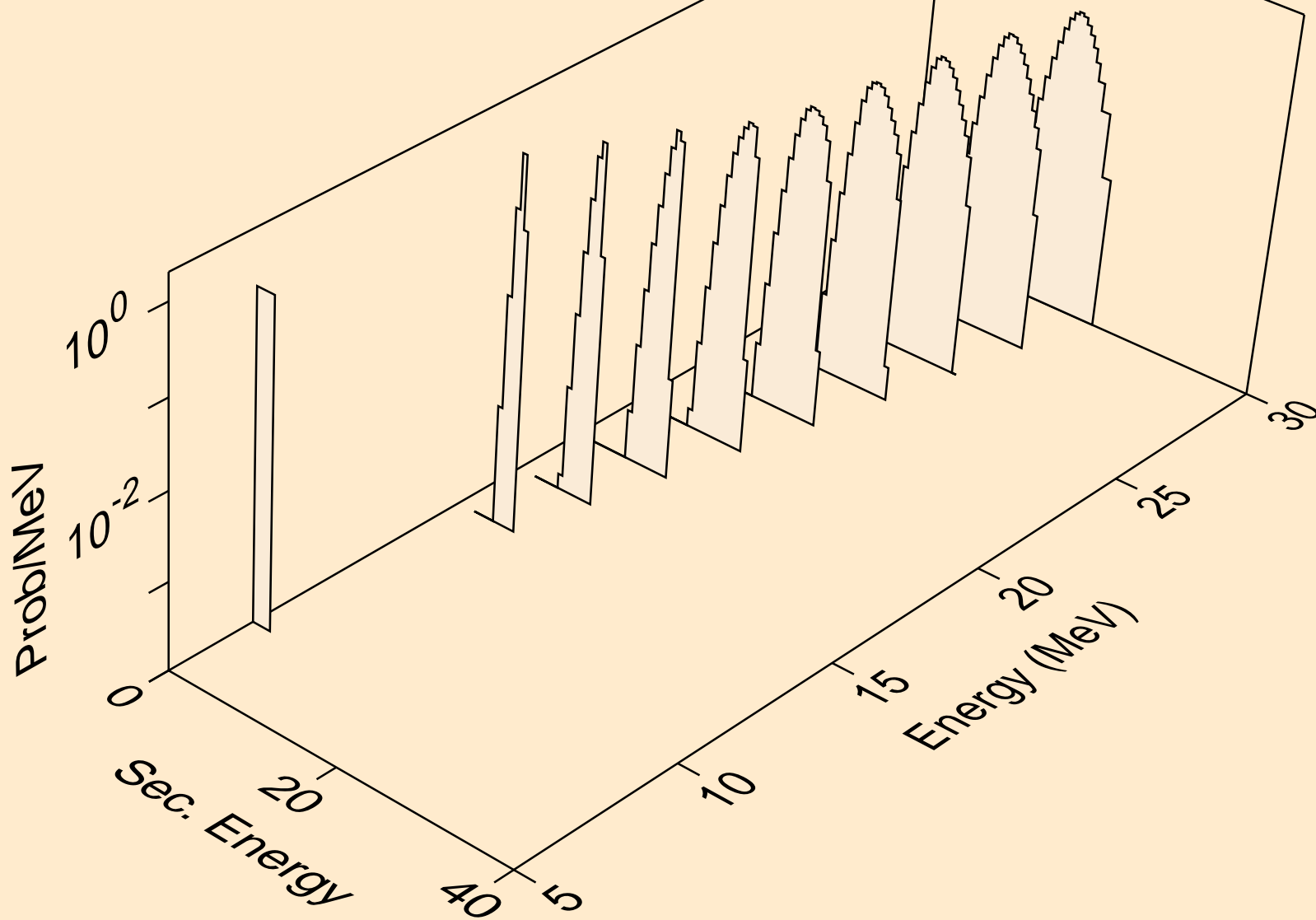

TH229 HELION ACER TENDL-2023 LIBRARY; T=0.K  
tritons from (s,t)

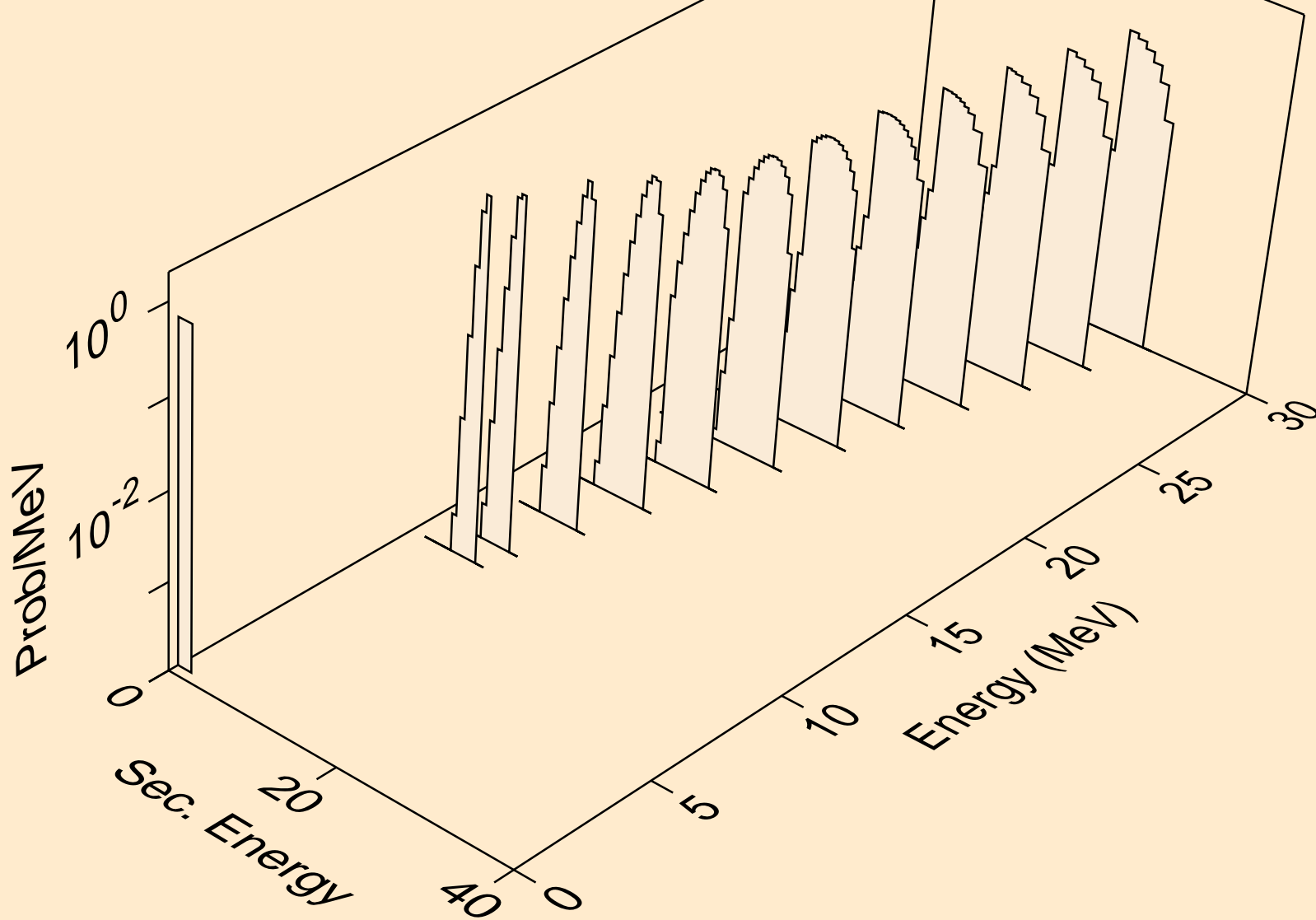

TH229 HELION ACER TENDL-2023 LIBRARY; T=0.K  
tritons from (s,pt)

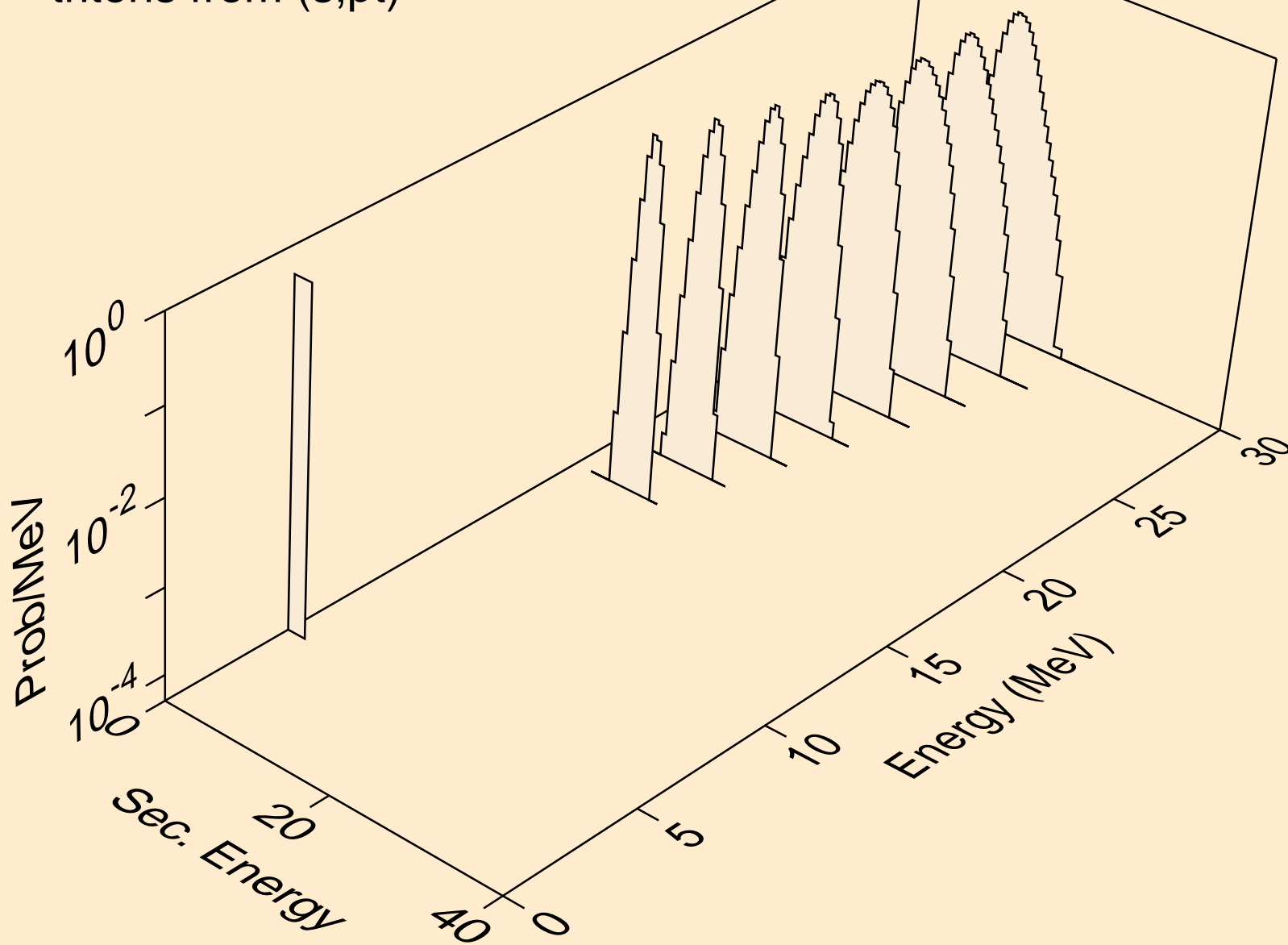

TH229 HELION ACER TENDL-2023 LIBRARY; T=0.K  
alphas from (s,x)

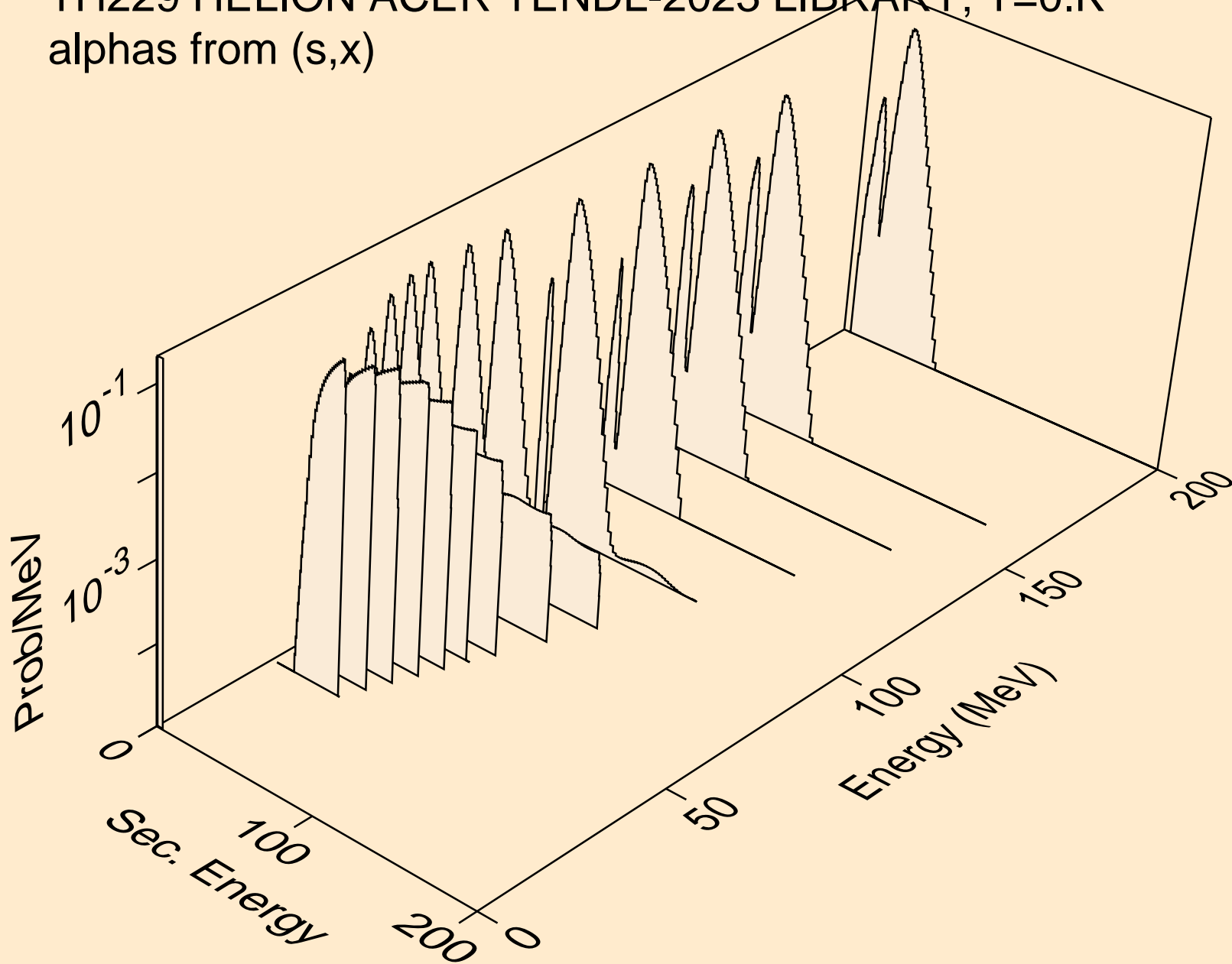

TH229 HELION ACER TENDL-2023 LIBRARY; T=0.K  
alphas from (s,n\*)a

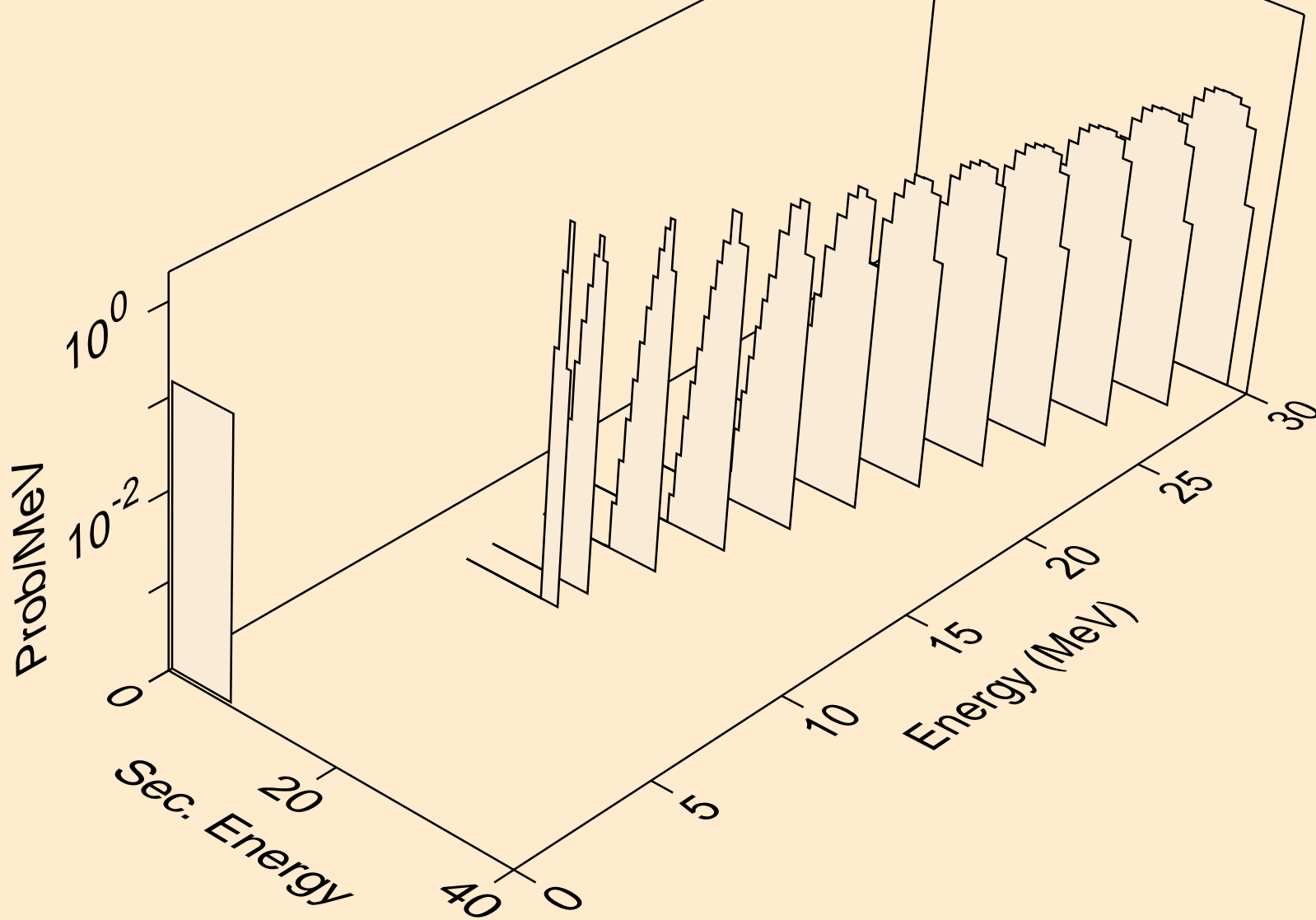

TH229 HELION ACER TENDL-2023 LIBRARY; T=0.K  
alphas from (s,2n)a

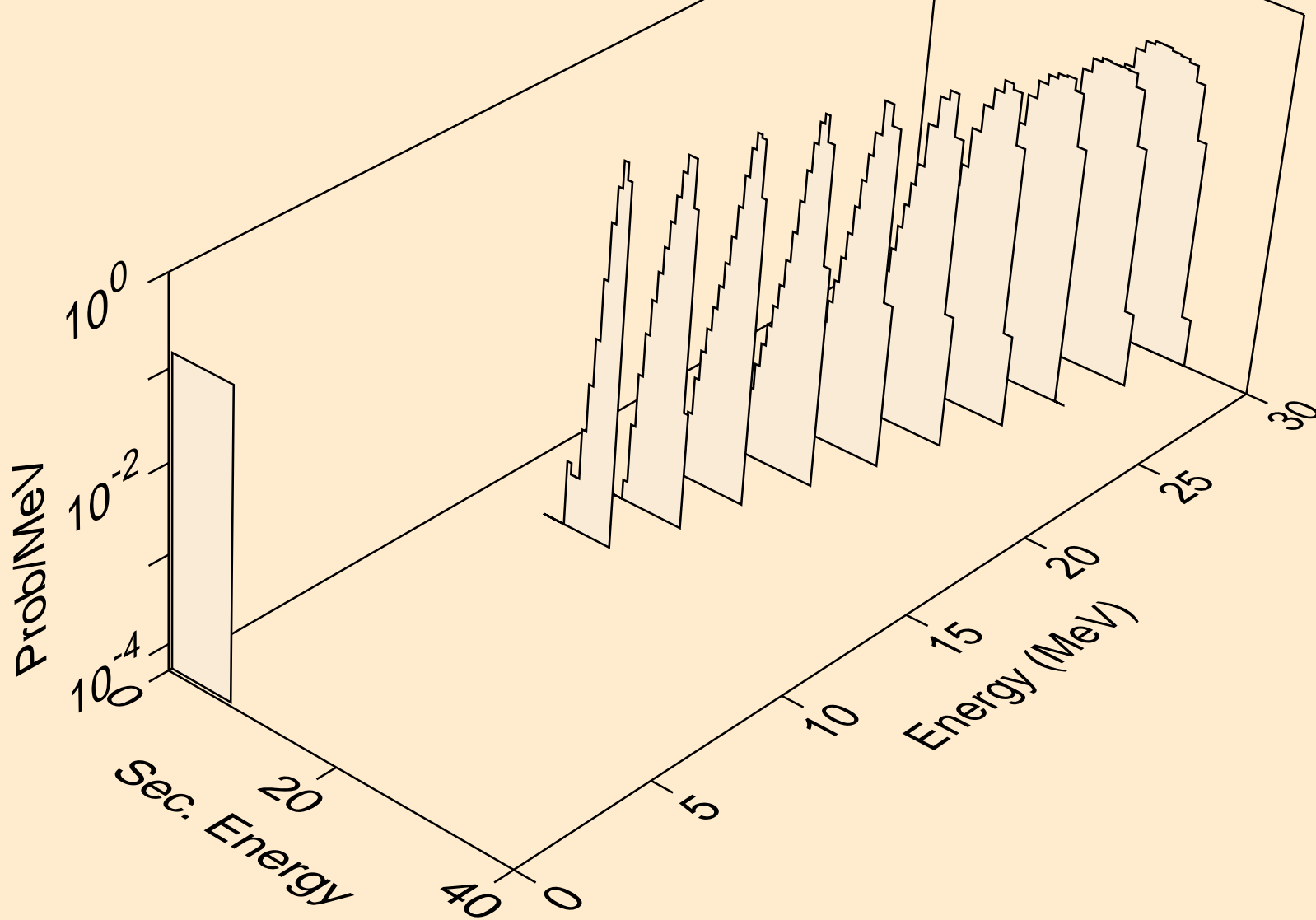

TH229 HELION ACER TENDL-2023 LIBRARY; T=0.K  
alphas from (s,3n)a

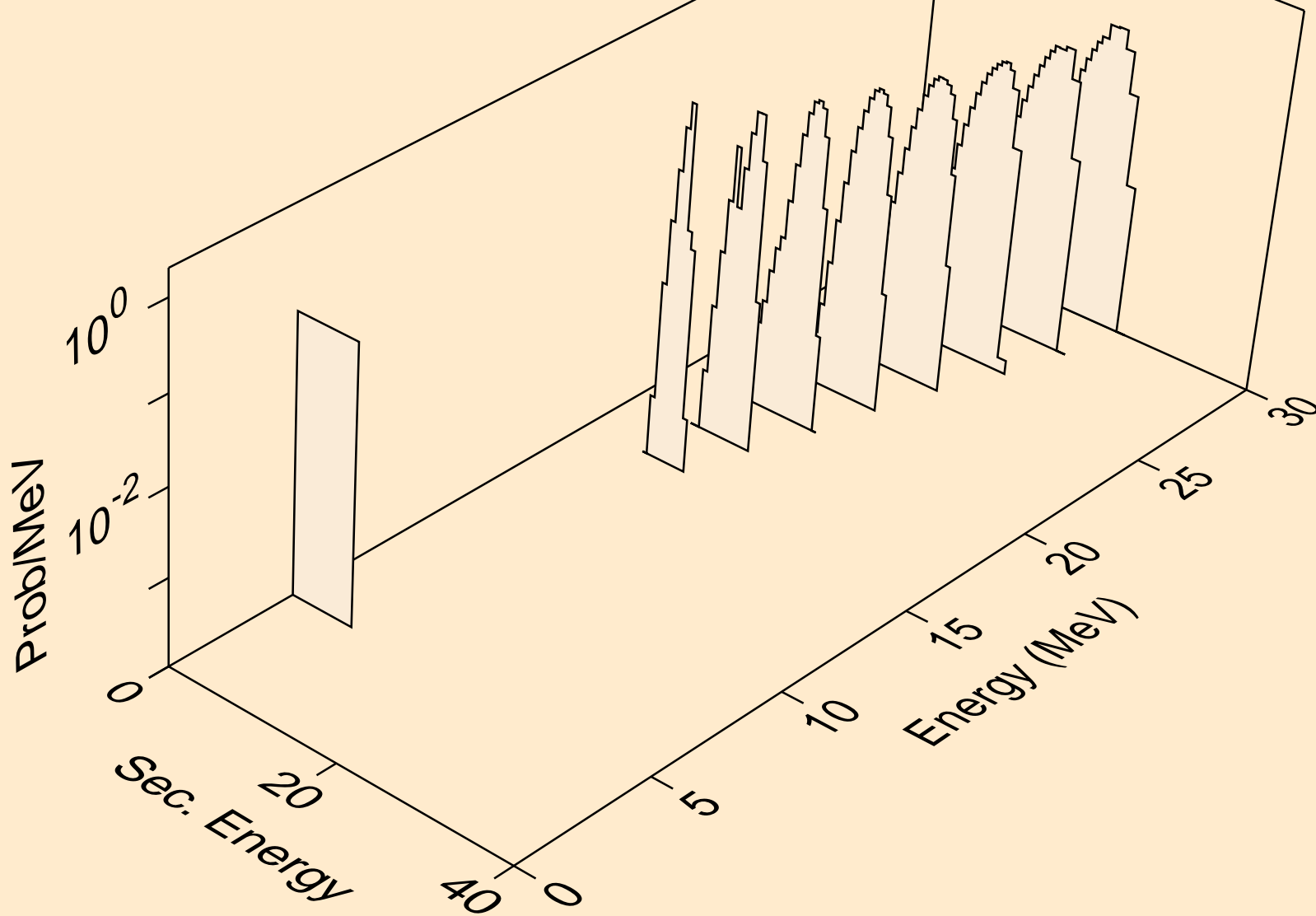



TH229 HELION ACER TENDL-2023 LIBRARY; T=0.K  
alphas from (s,npa)

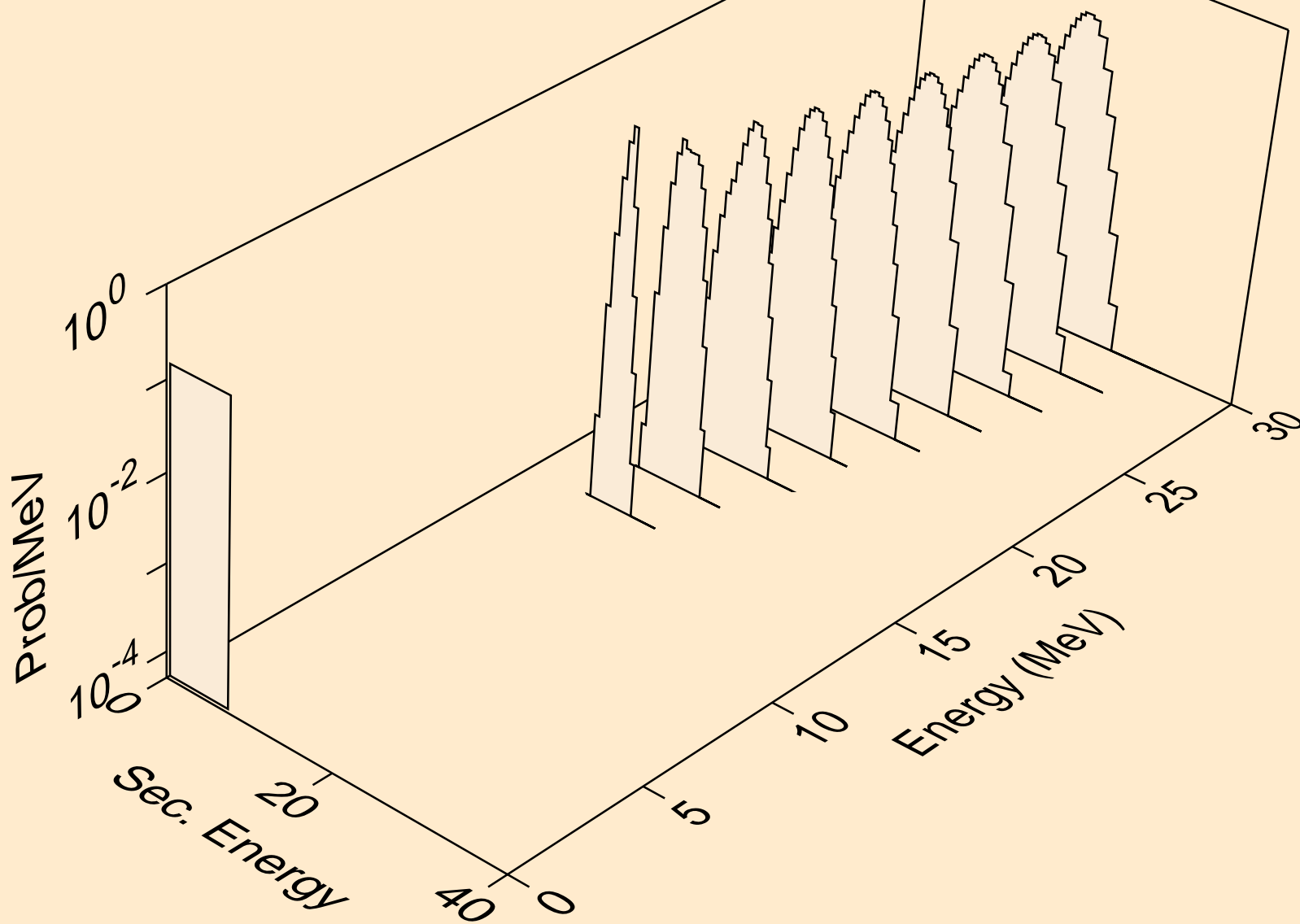

TH229 HELION ACER TENDL-2023 LIBRARY; T=0.K  
alphas from (s,a)

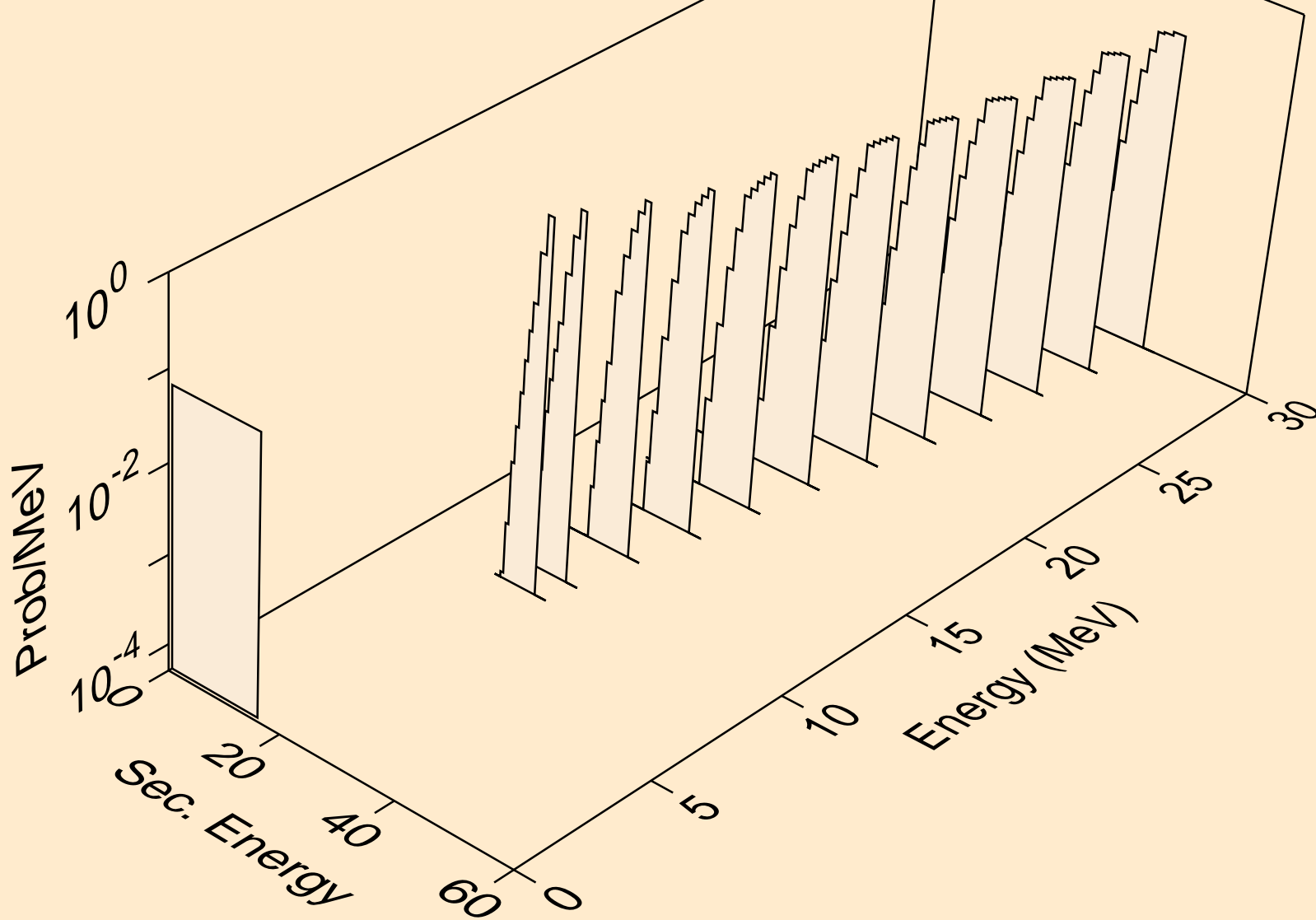

TH229 HELION ACER TENDL-2023 LIBRARY; T=0.K  
alphas from (s,pa)

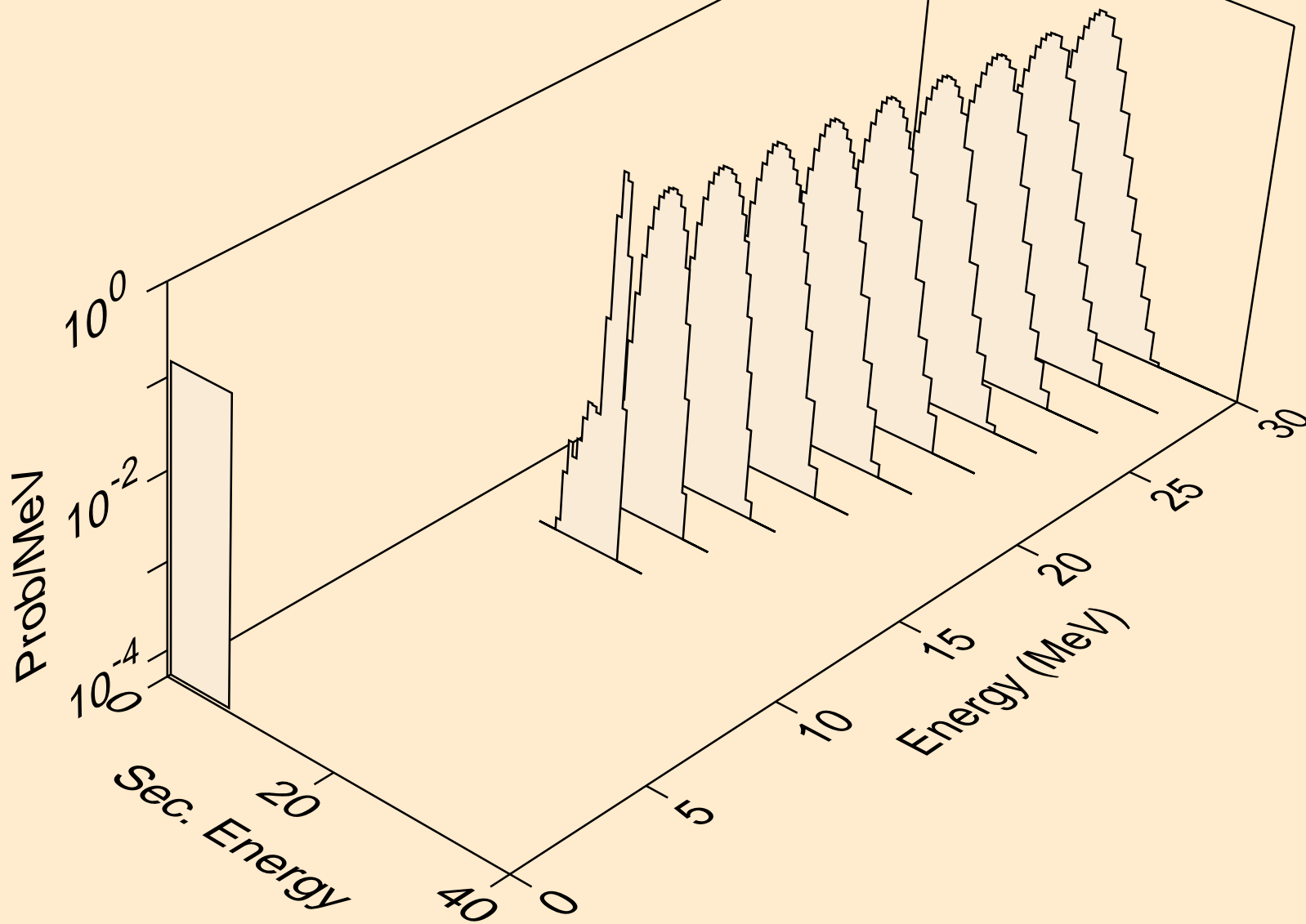

TH229 HELION ACER TENDL-2023 LIBRARY; T=0.K  
alphas from (s,da)

