

AR042 NEUTRON ACER TENDL-2023 LIBRARY; T=0.K

Principal cross sections

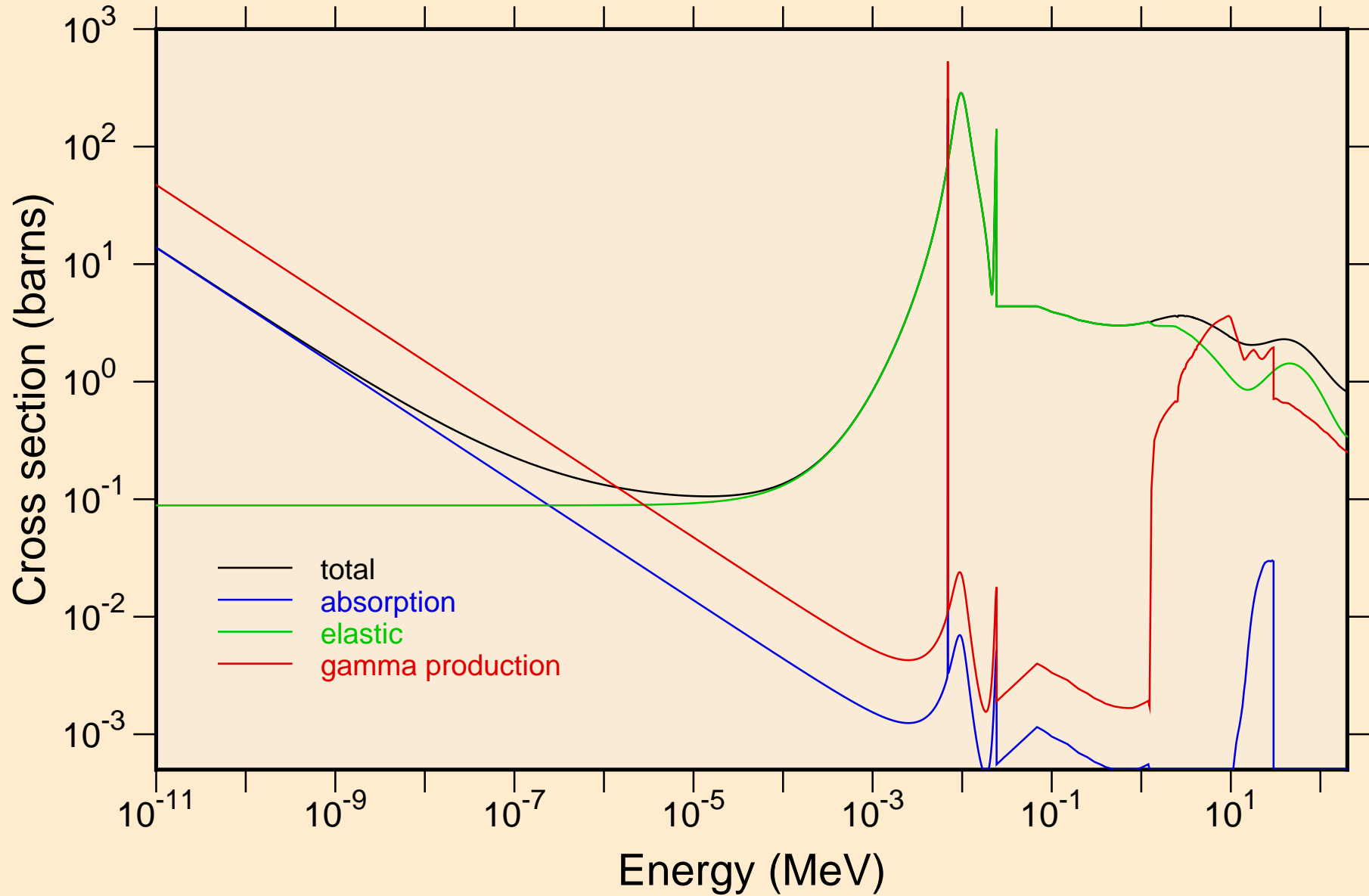

AR042 NEUTRON ACER TENDL-2023 LIBRARY; T=0.K
Heating

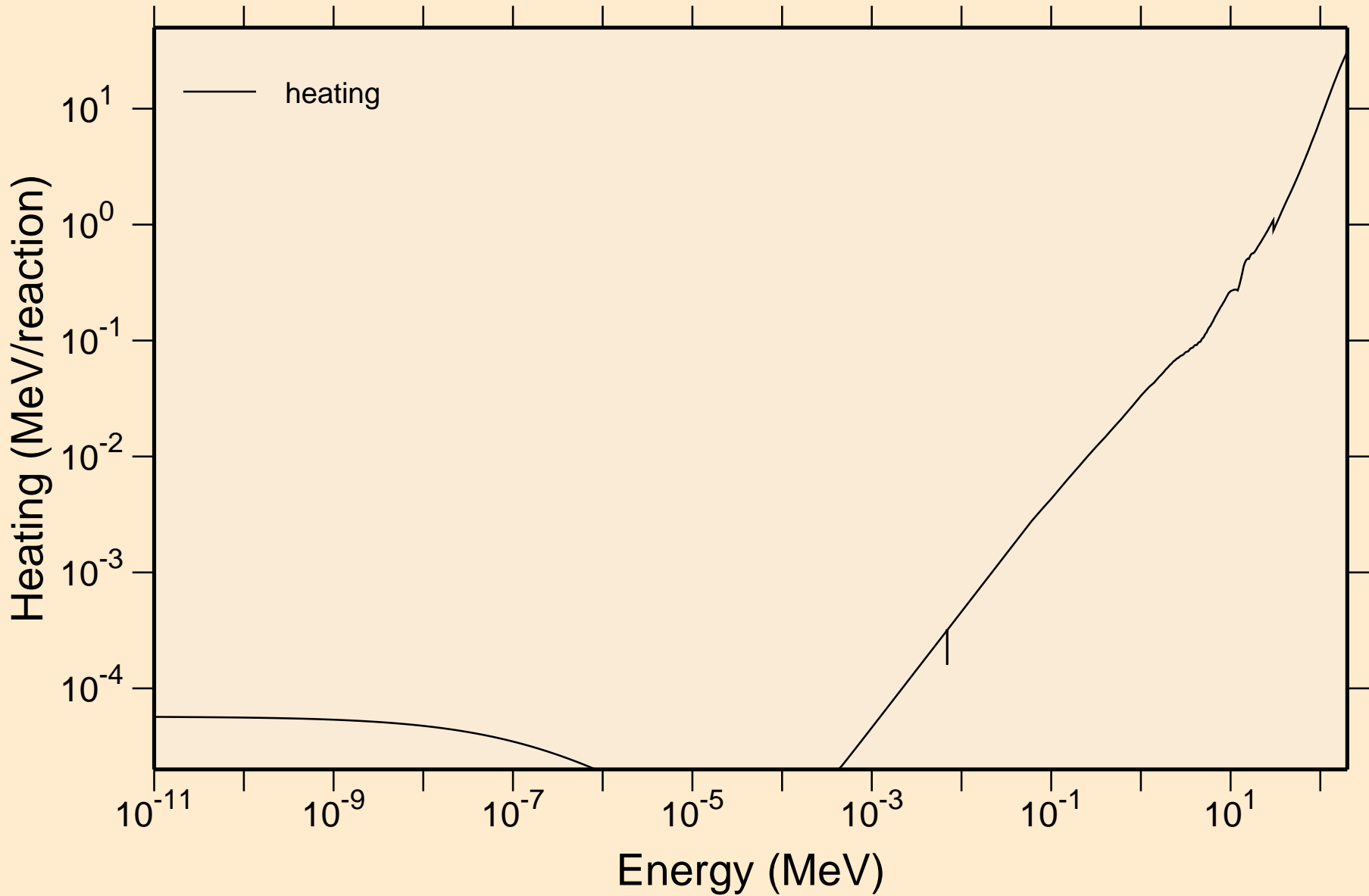

AR042 NEUTRON ACER TENDL-2023 LIBRARY; T=0.K
Damage

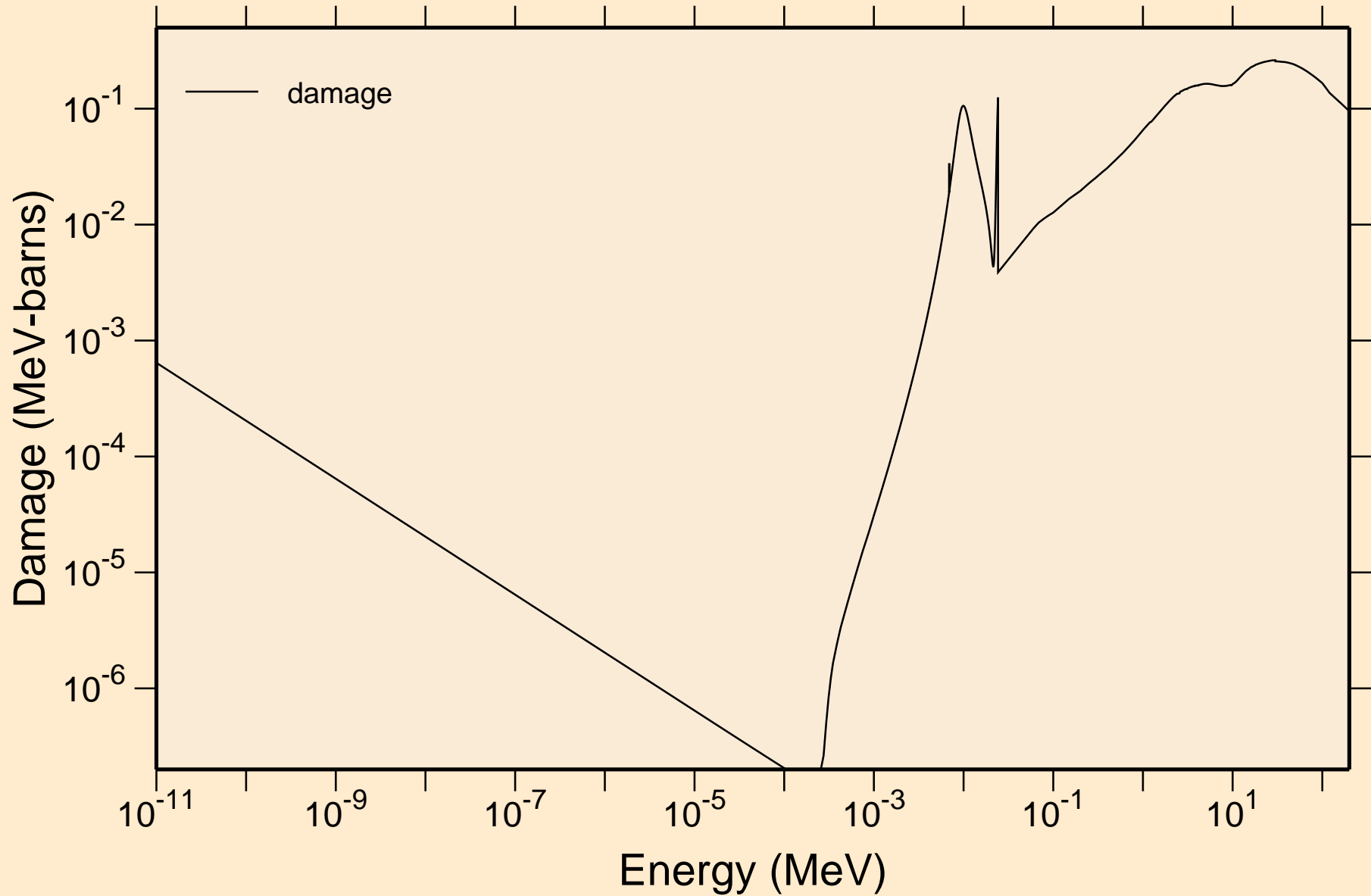

AR042 NEUTRON ACER TENDL-2023 LIBRARY; T=0.K
Non-threshold reactions

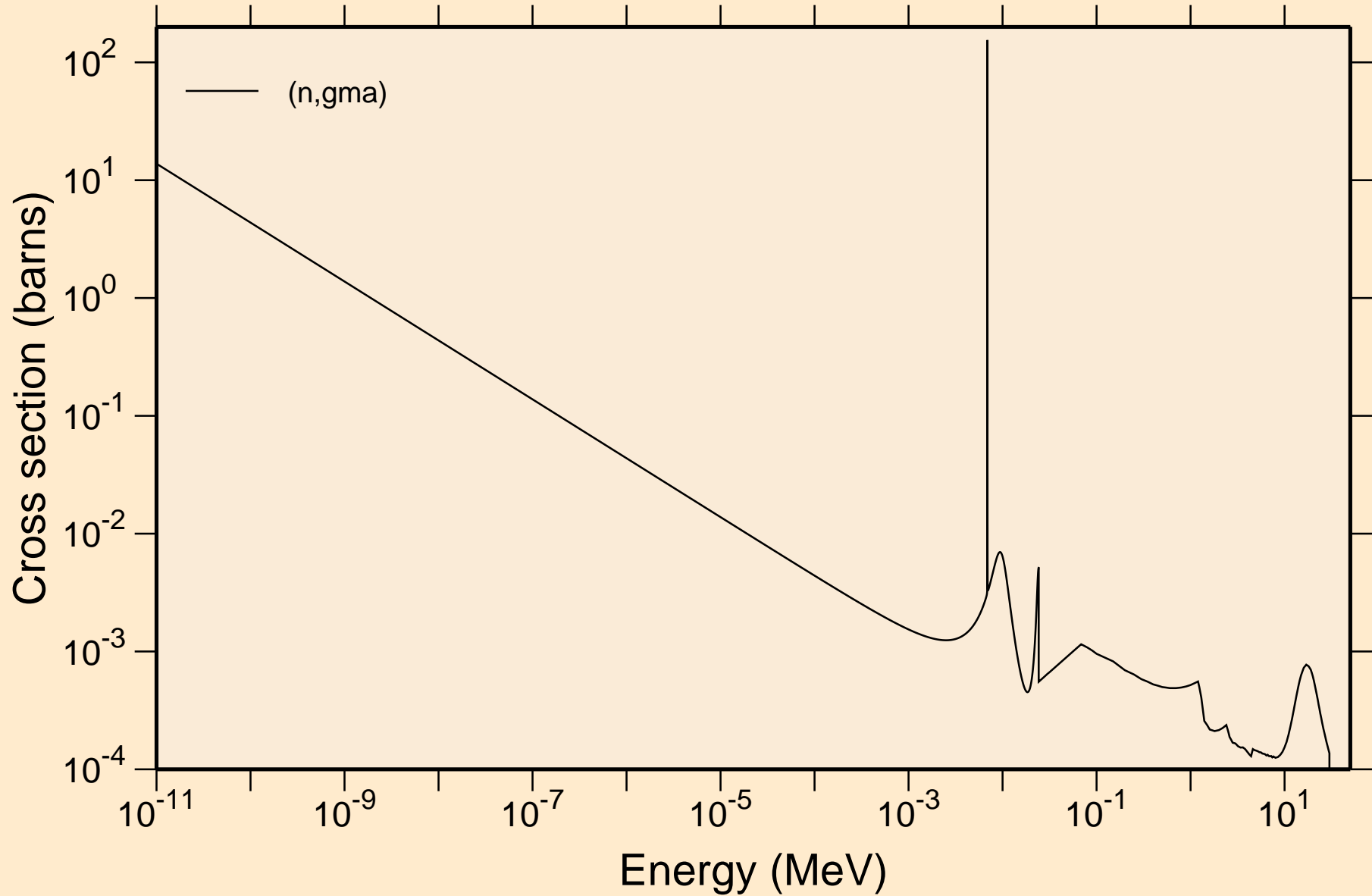

AR042 NEUTRON ACER TENDL-2023 LIBRARY; T=0.K

Principal cross sections

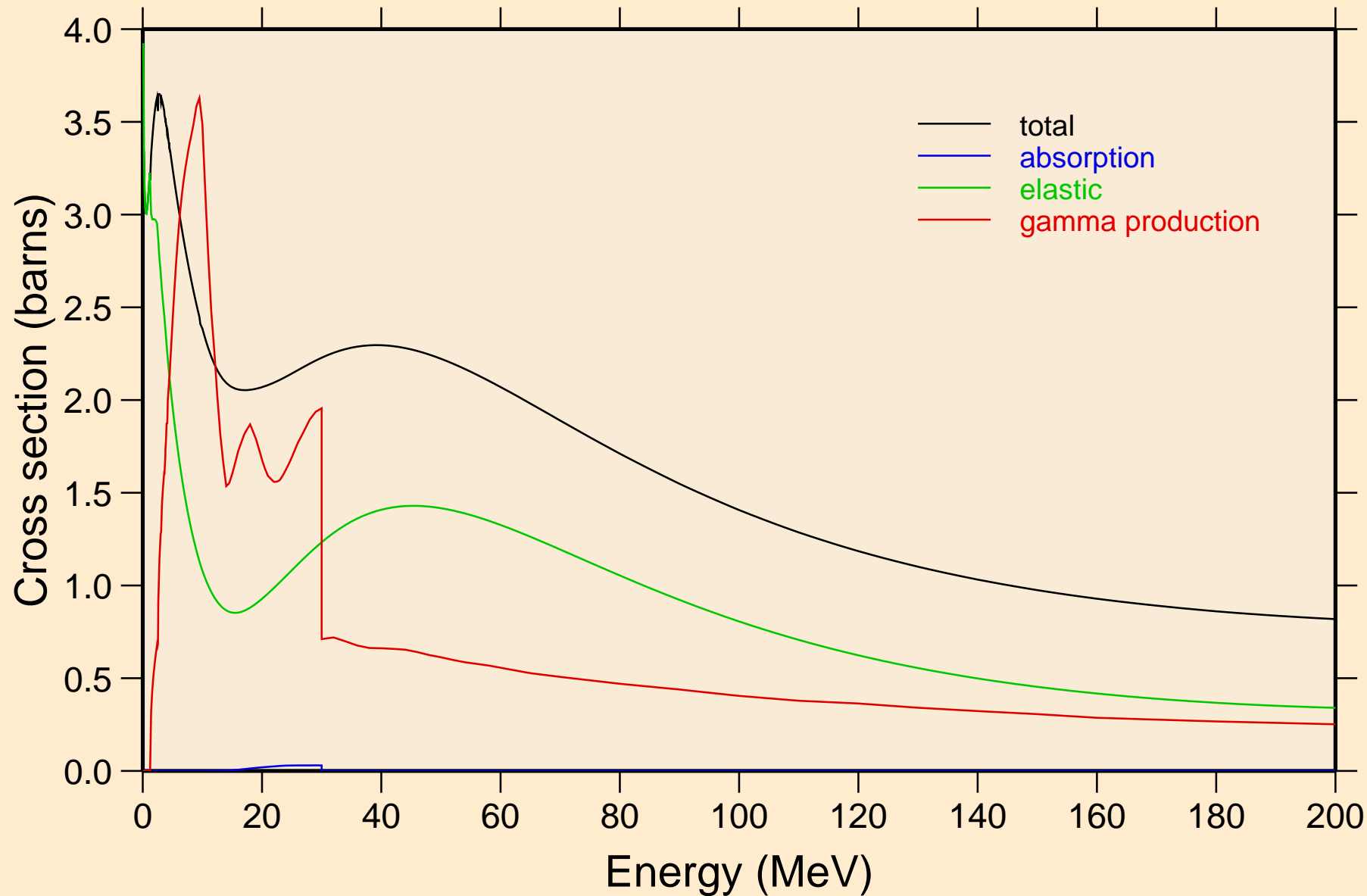

AR042 NEUTRON ACER TENDL-2023 LIBRARY; T=0.K

Heating

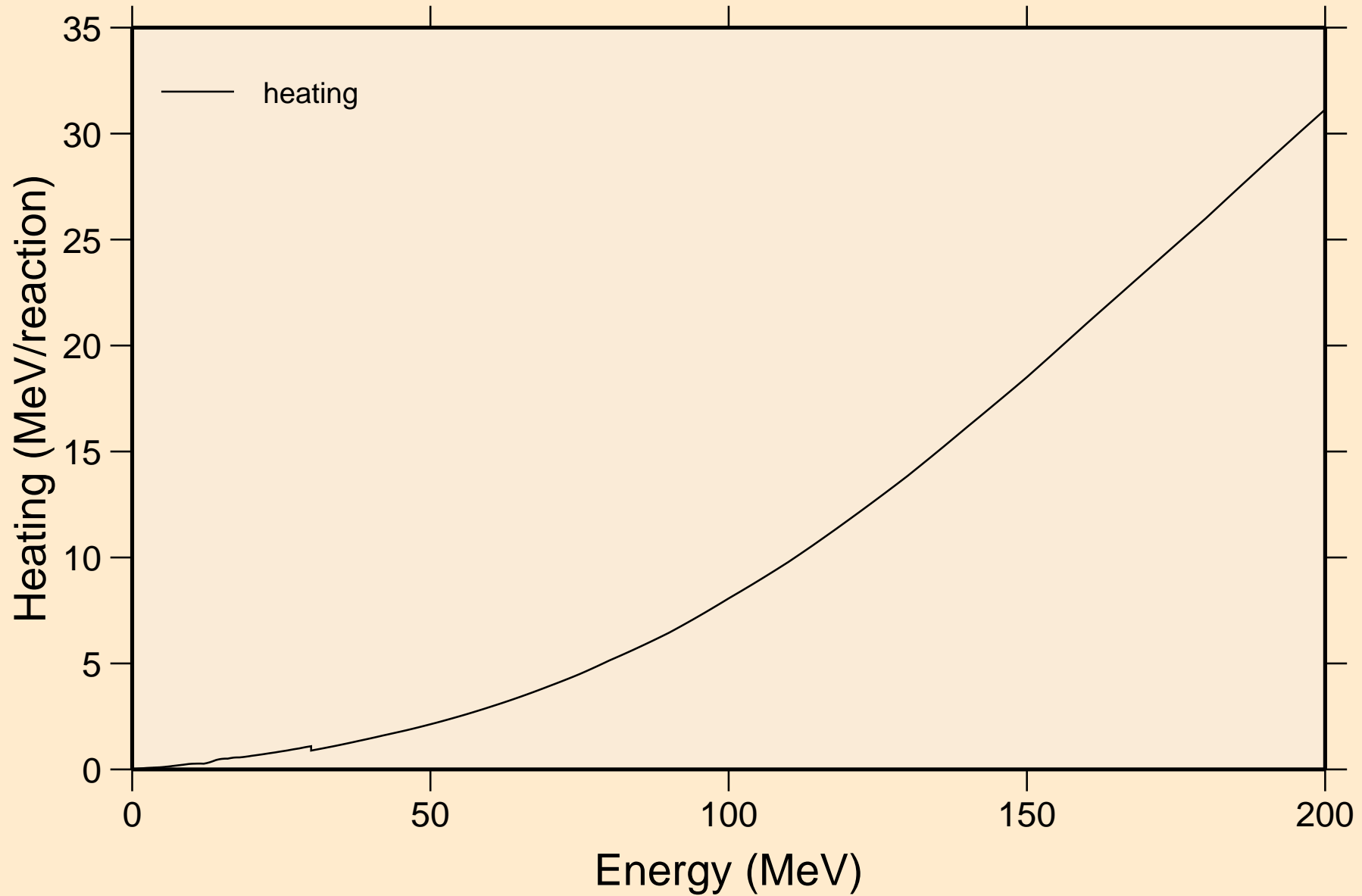

AR042 NEUTRON ACER TENDL-2023 LIBRARY; T=0.K
Damage

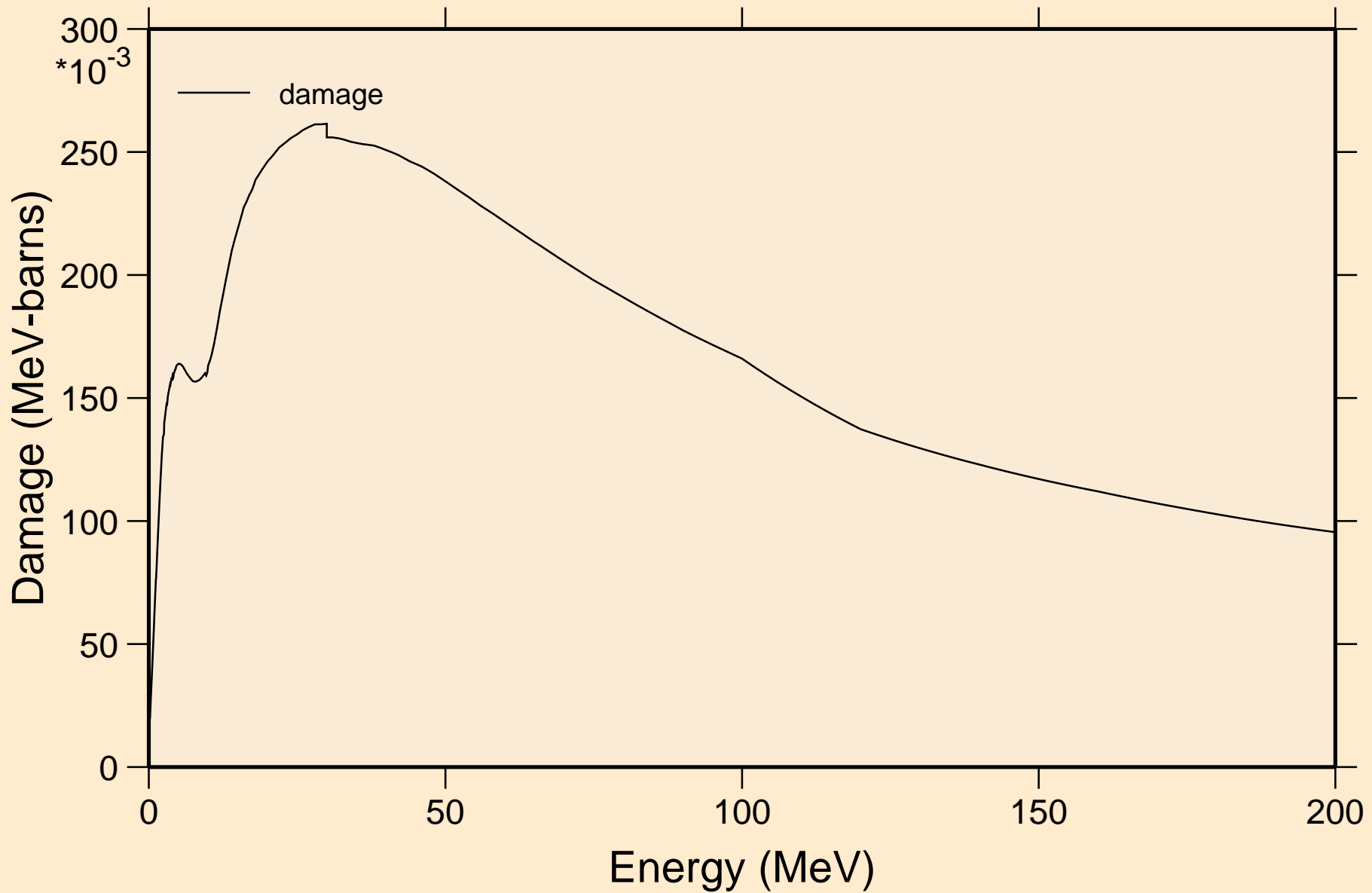

AR042 NEUTRON ACER TENDL-2023 LIBRARY; T=0.K
Non-threshold reactions

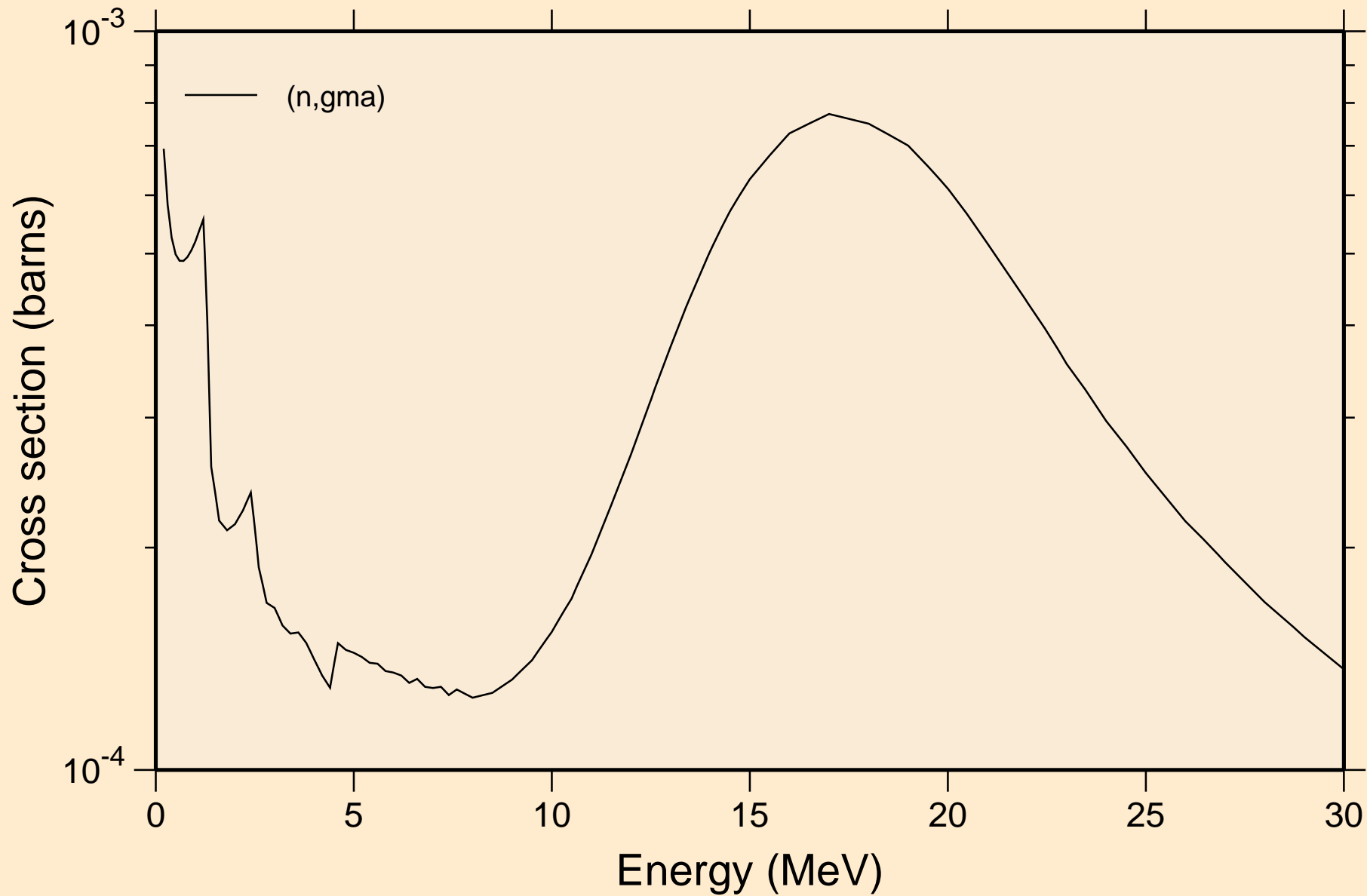

AR042 NEUTRON ACER TENDL-2023 LIBRARY; T=0.K
Inelastic levels

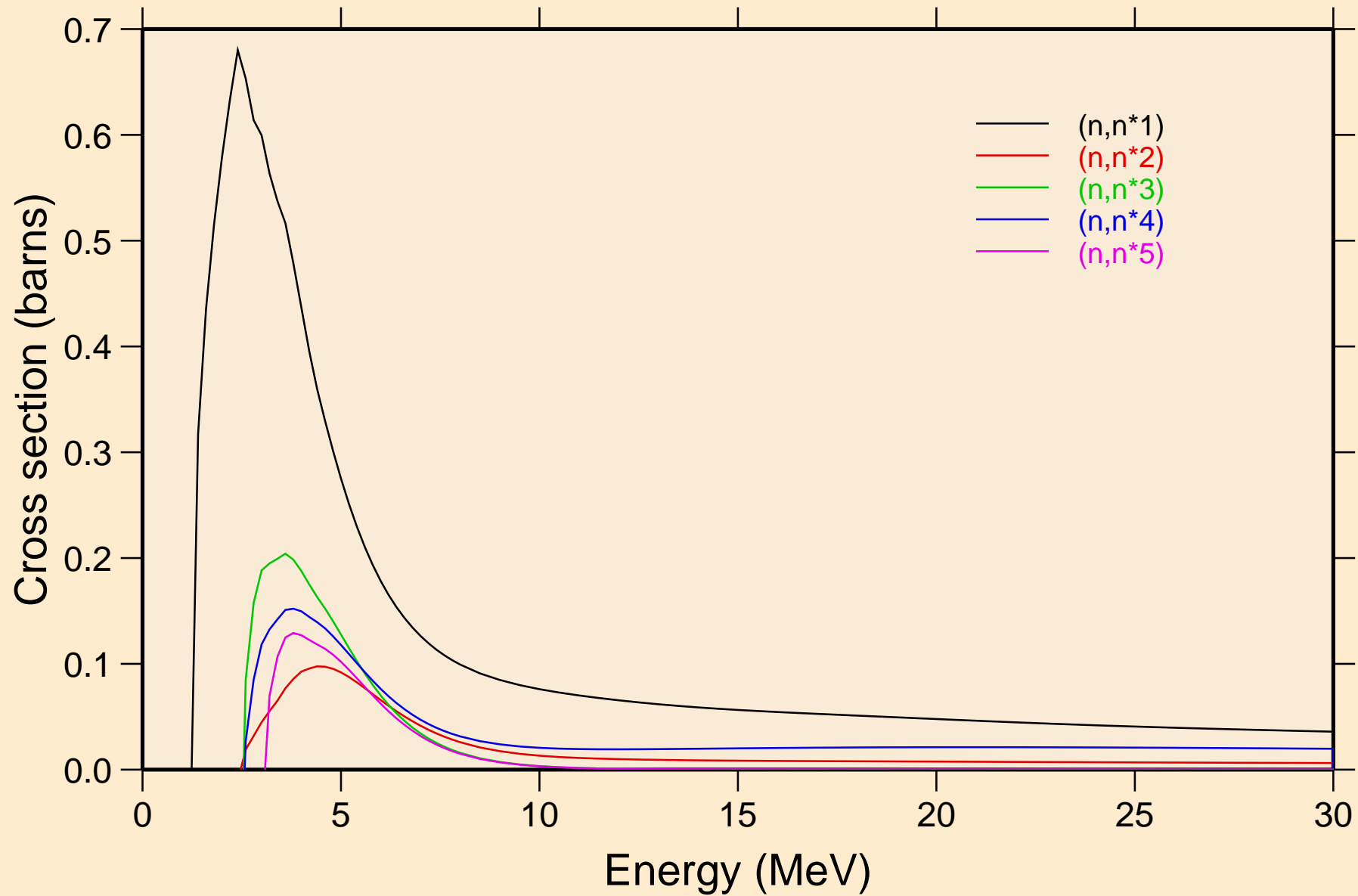

AR042 NEUTRON ACER TENDL-2023 LIBRARY; T=0.K
Inelastic levels

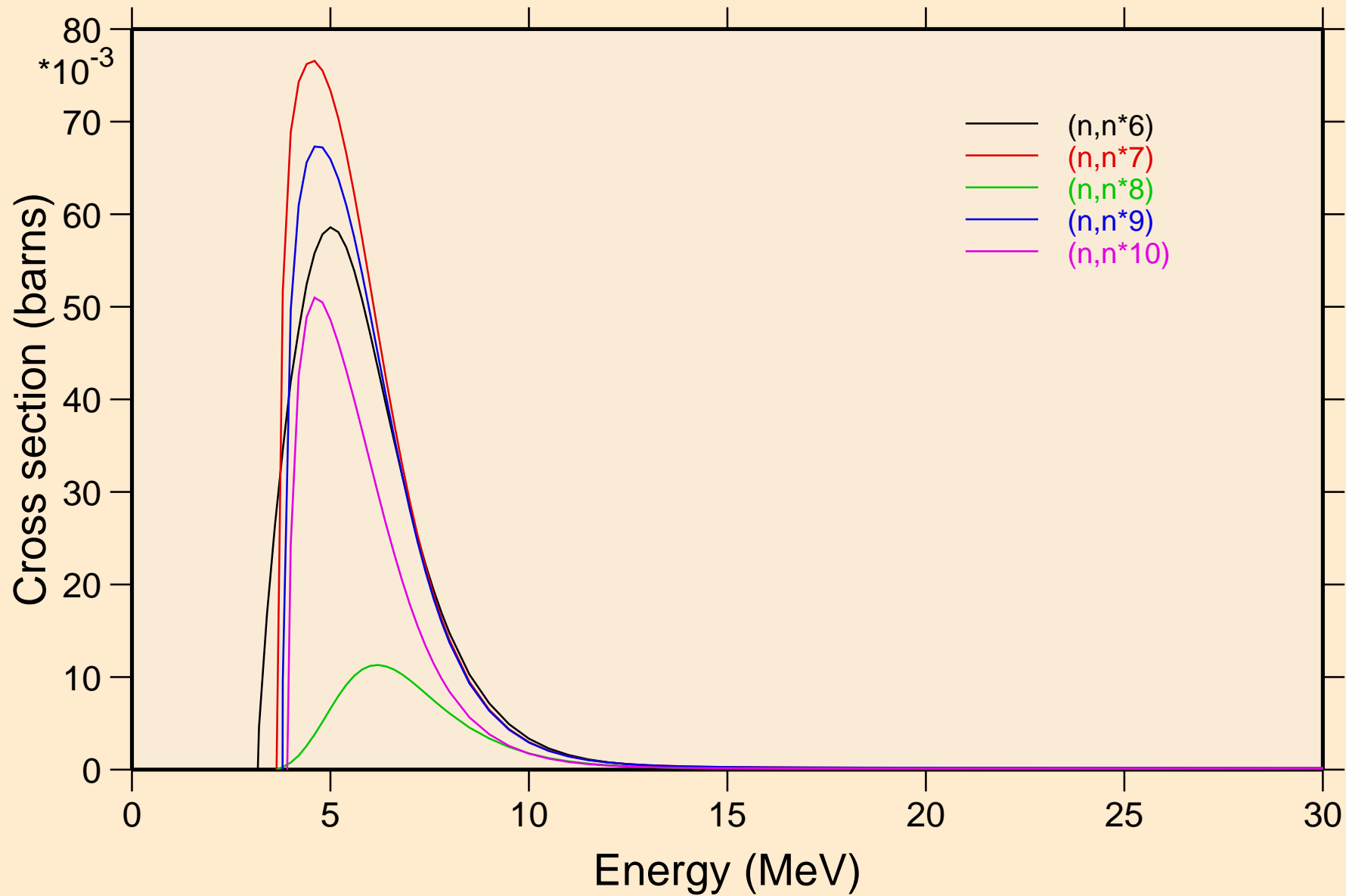

AR042 NEUTRON ACER TENDL-2023 LIBRARY; T=0.K
Inelastic levels

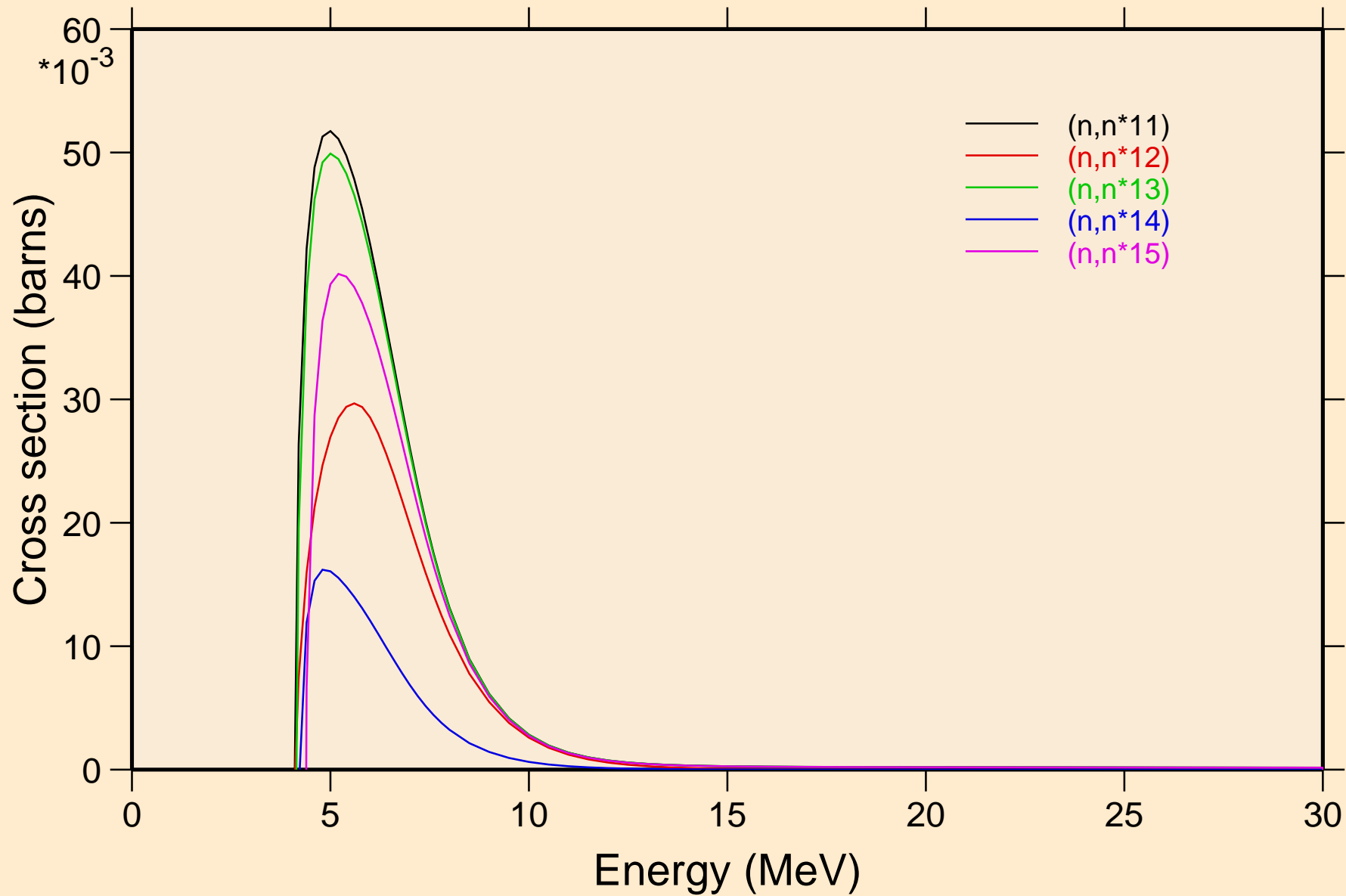

AR042 NEUTRON ACER TENDL-2023 LIBRARY; T=0.K
Inelastic levels

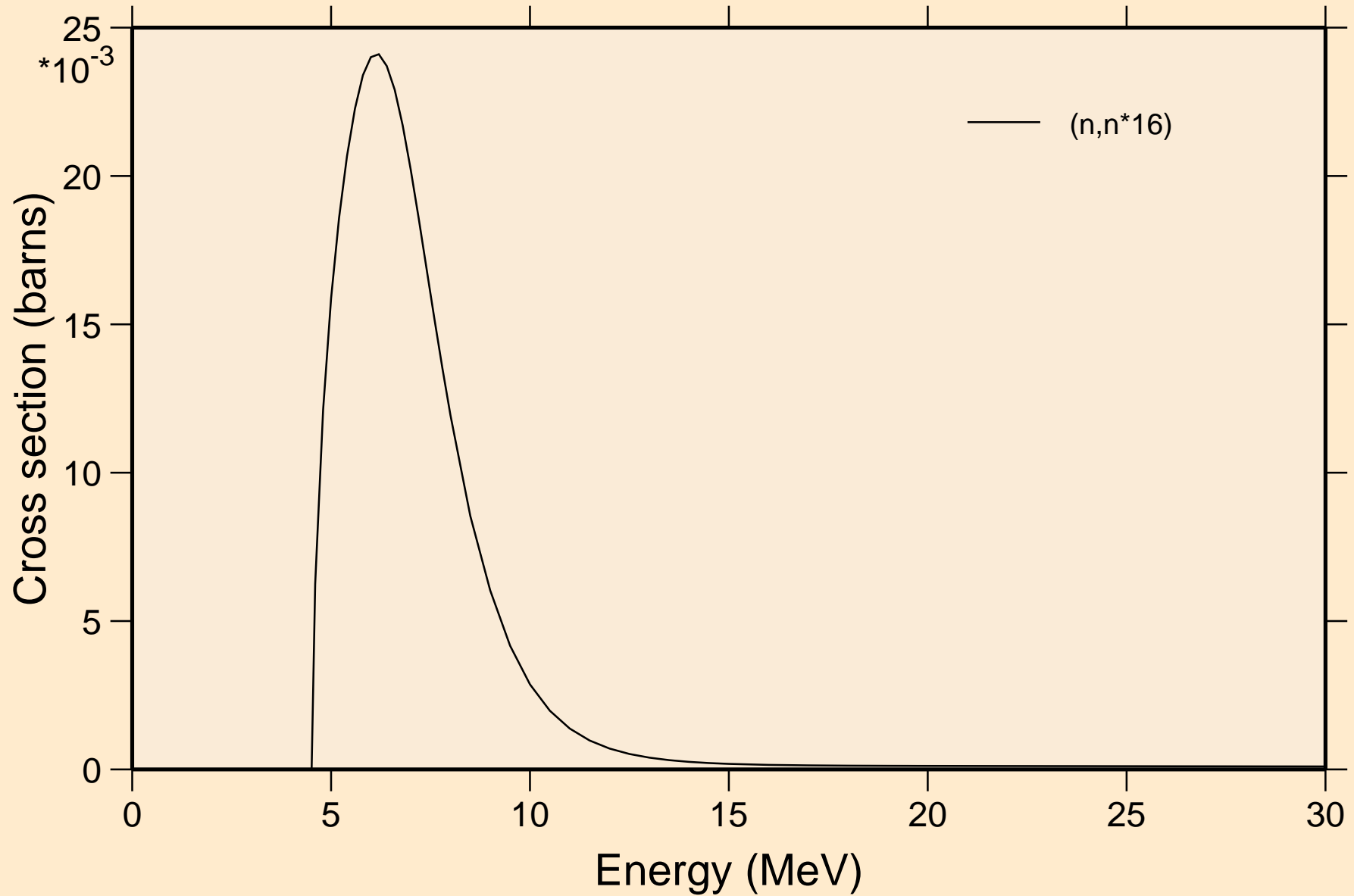

AR042 NEUTRON ACER TENDL-2023 LIBRARY; T=0.K
Threshold reactions

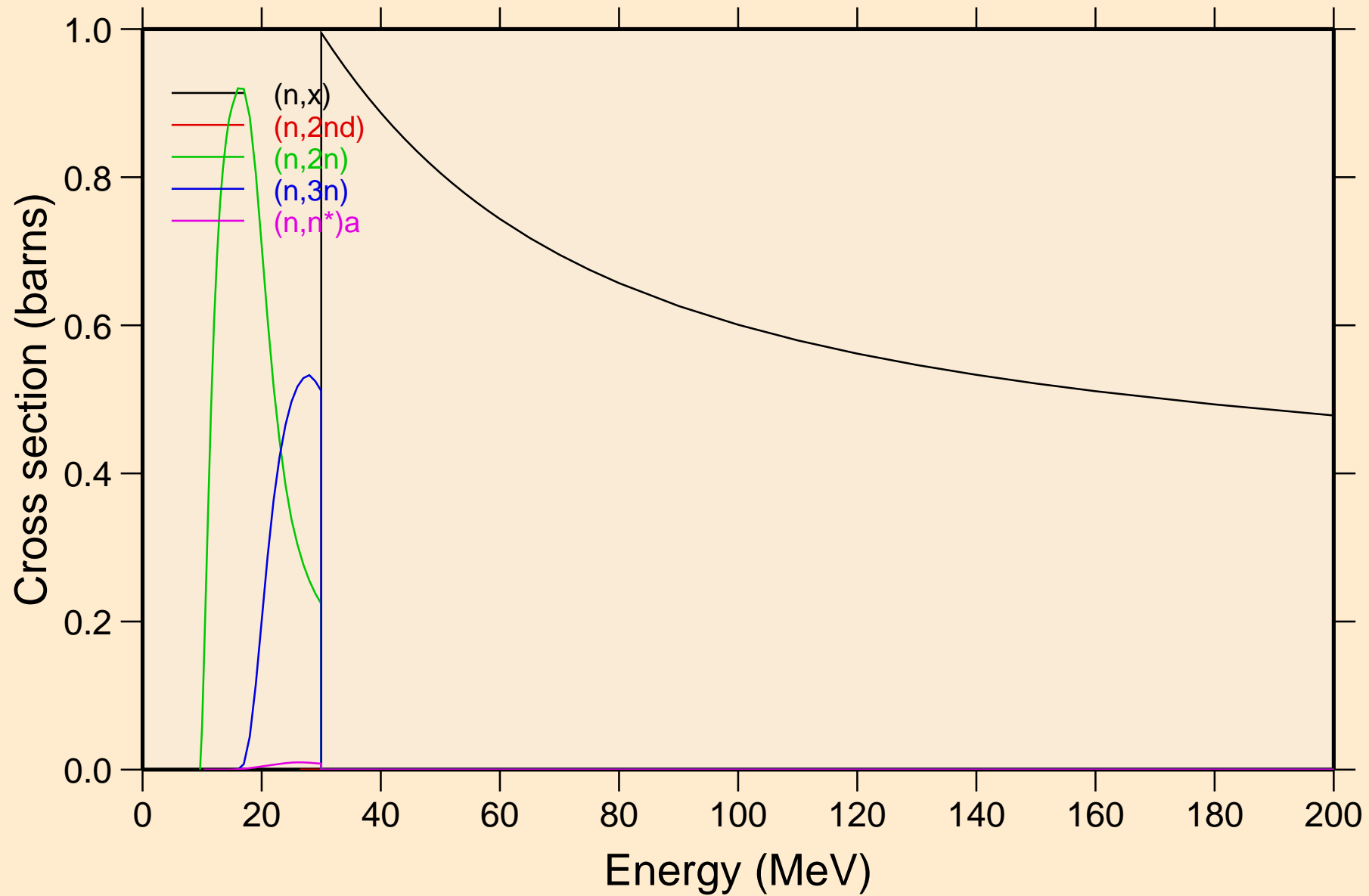

AR042 NEUTRON ACER TENDL-2023 LIBRARY; T=0.K
Threshold reactions

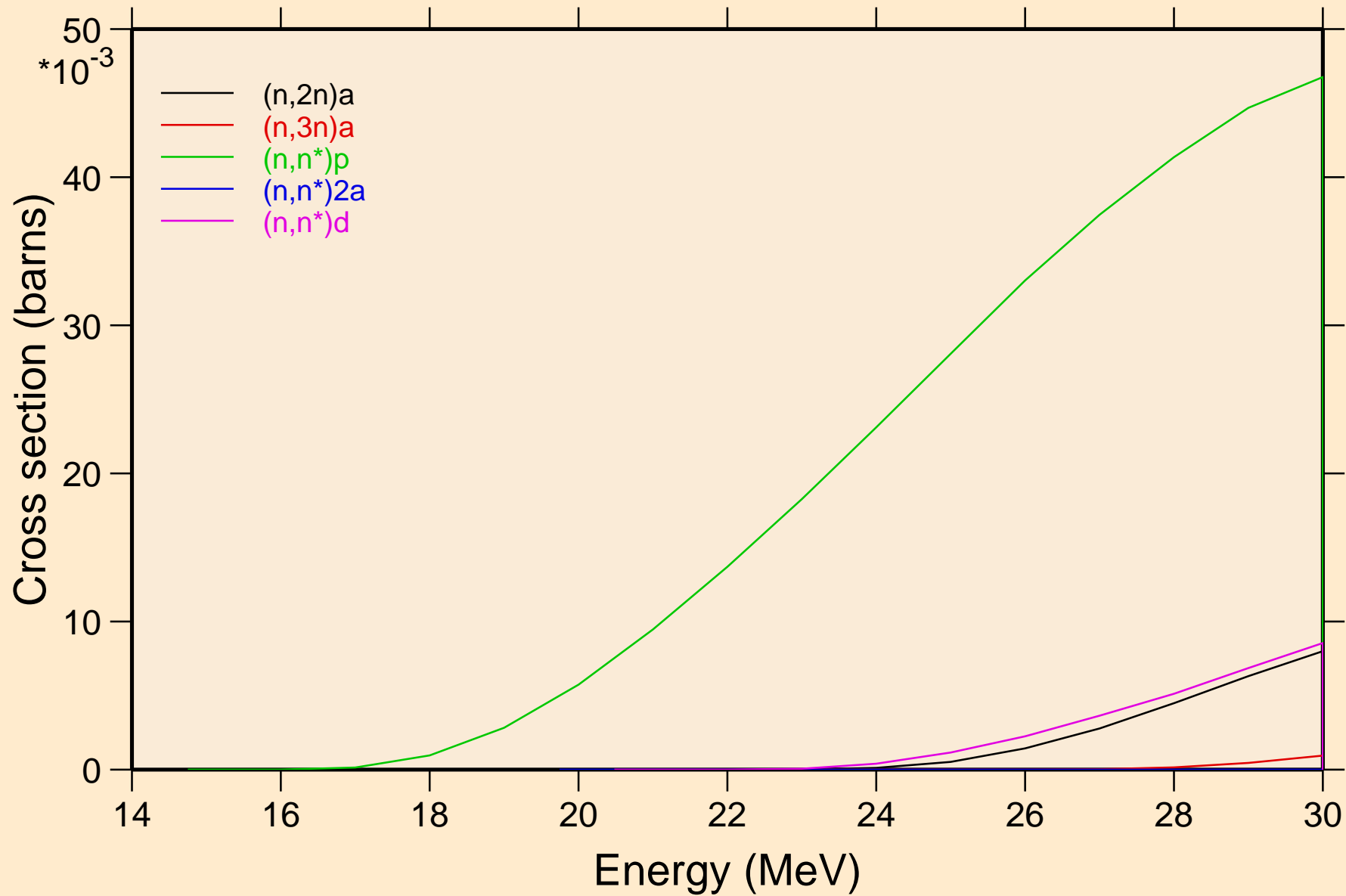

AR042 NEUTRON ACER TENDL-2023 LIBRARY; T=0.K

Threshold reactions

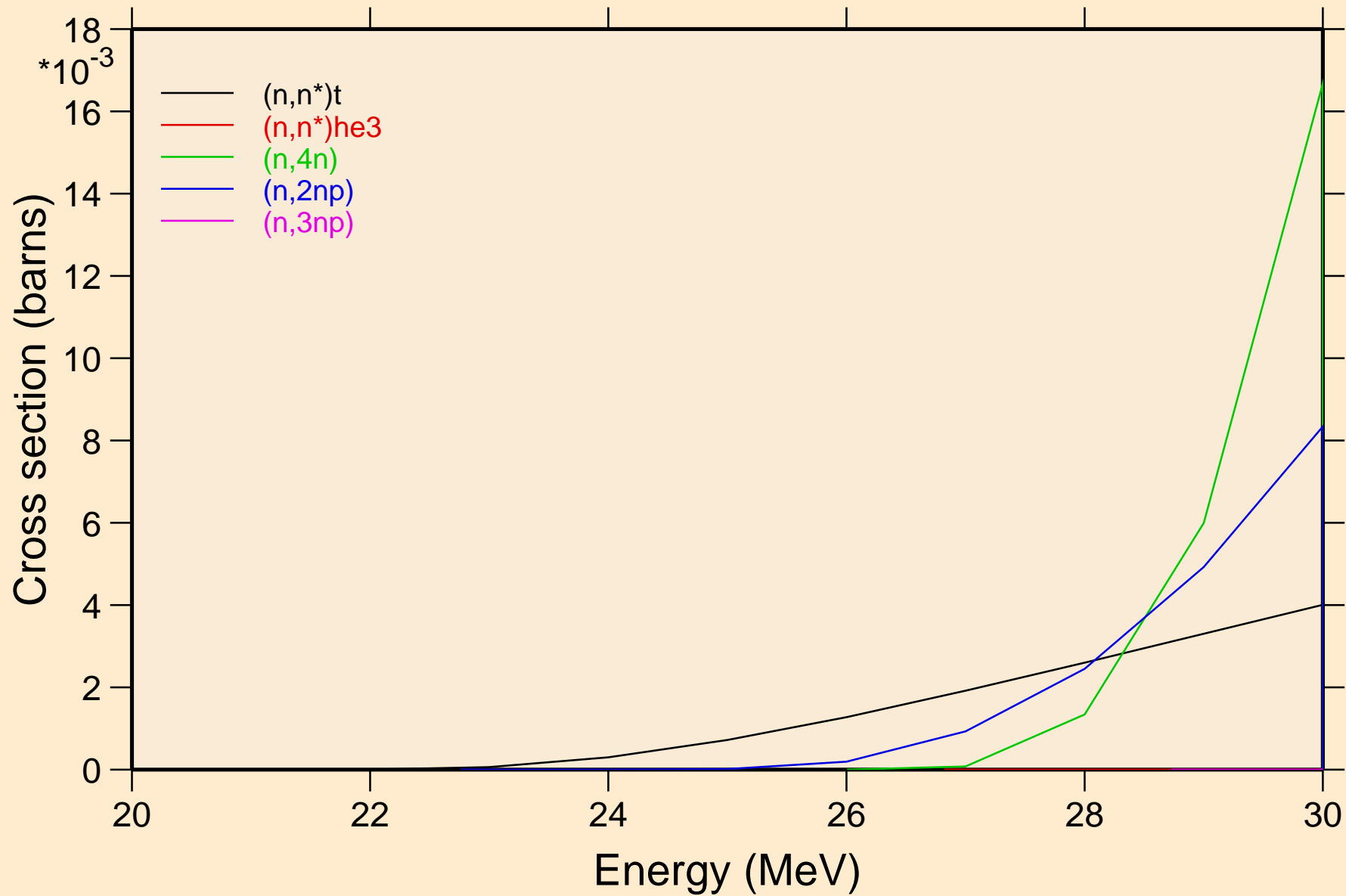

AR042 NEUTRON ACER TENDL-2023 LIBRARY; T=0.K
Threshold reactions

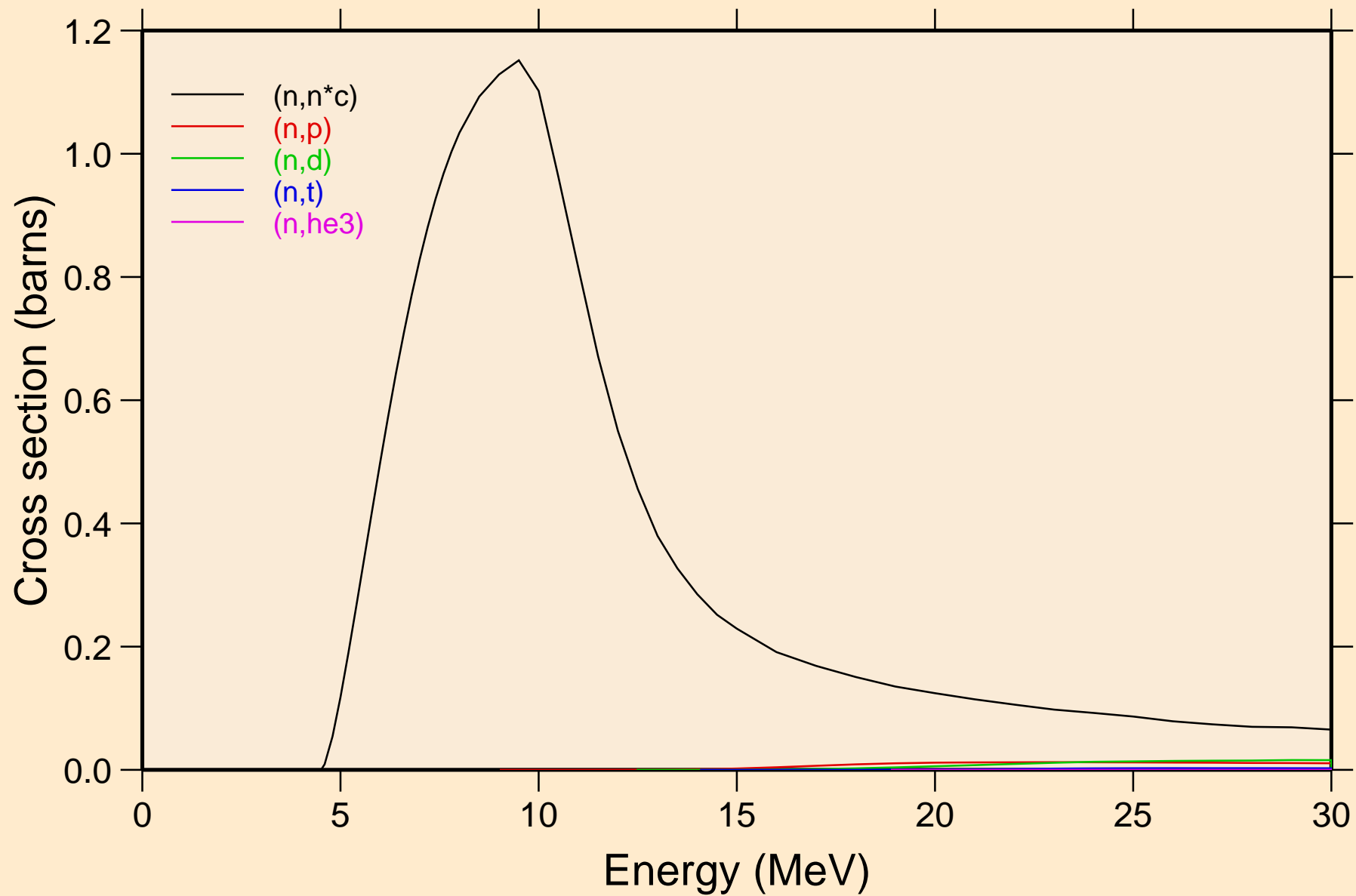

AR042 NEUTRON ACER TENDL-2023 LIBRARY; T=0.K

Threshold reactions

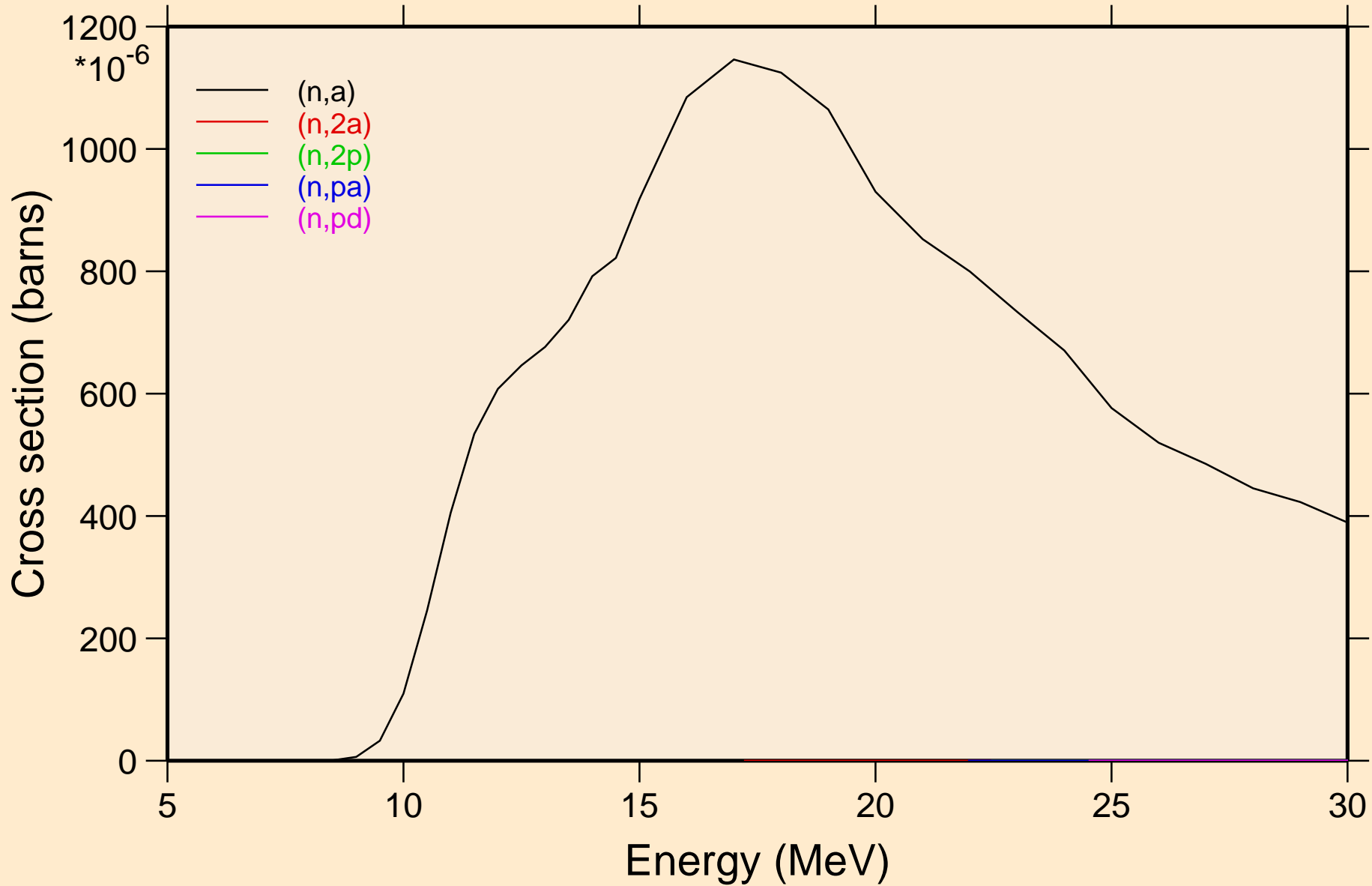

AR042 NEUTRON ACER TENDL-2023 LIBRARY; T=0.K

Threshold reactions

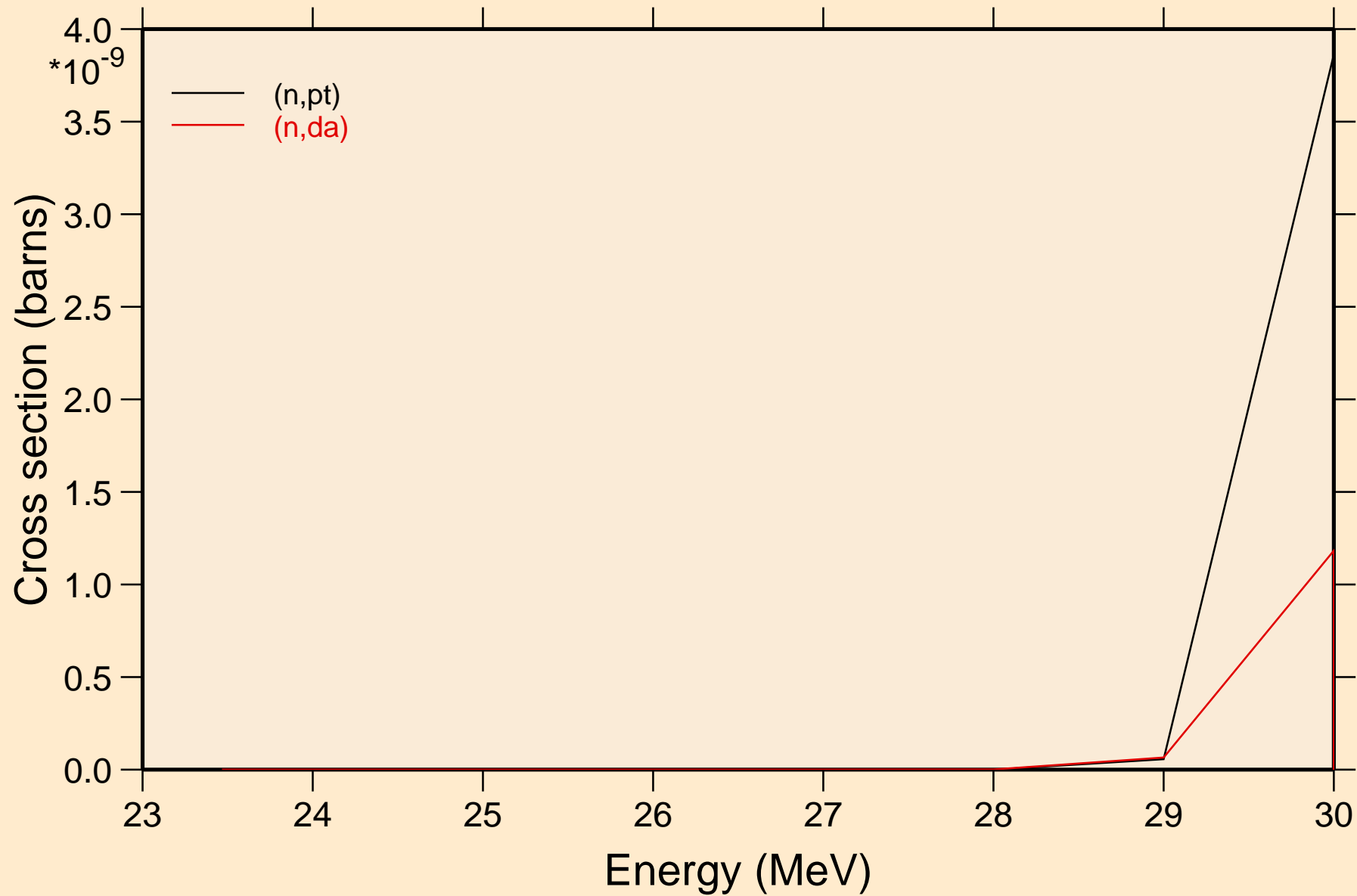

AR042 NEUTRON ACER TENDL-2023 LIBRARY; T=0.K
Threshold reactions

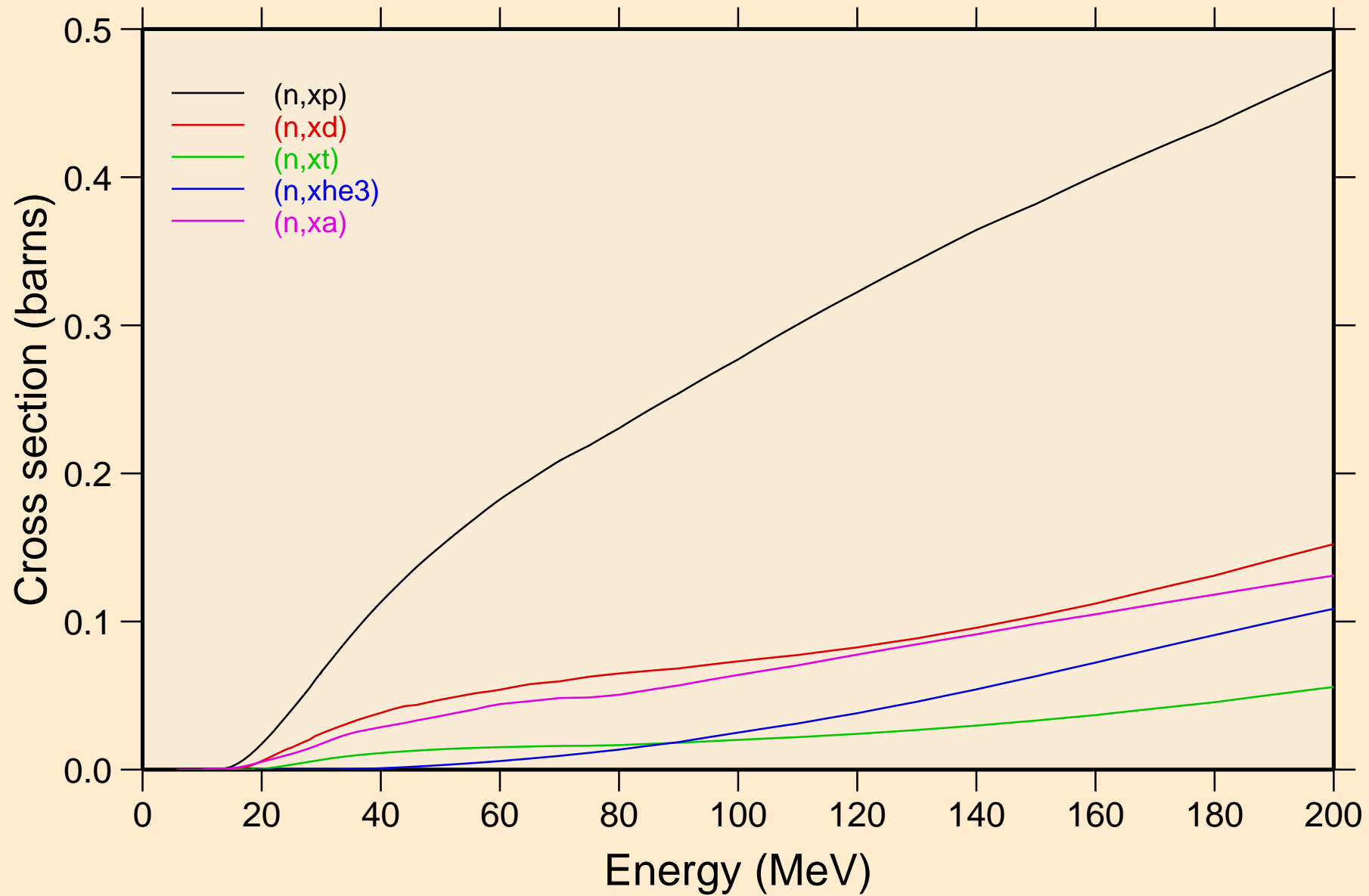

AR042 NEUTRON ACER TENDL-2023 LIBRARY; T=0.K
angular distribution for elastic

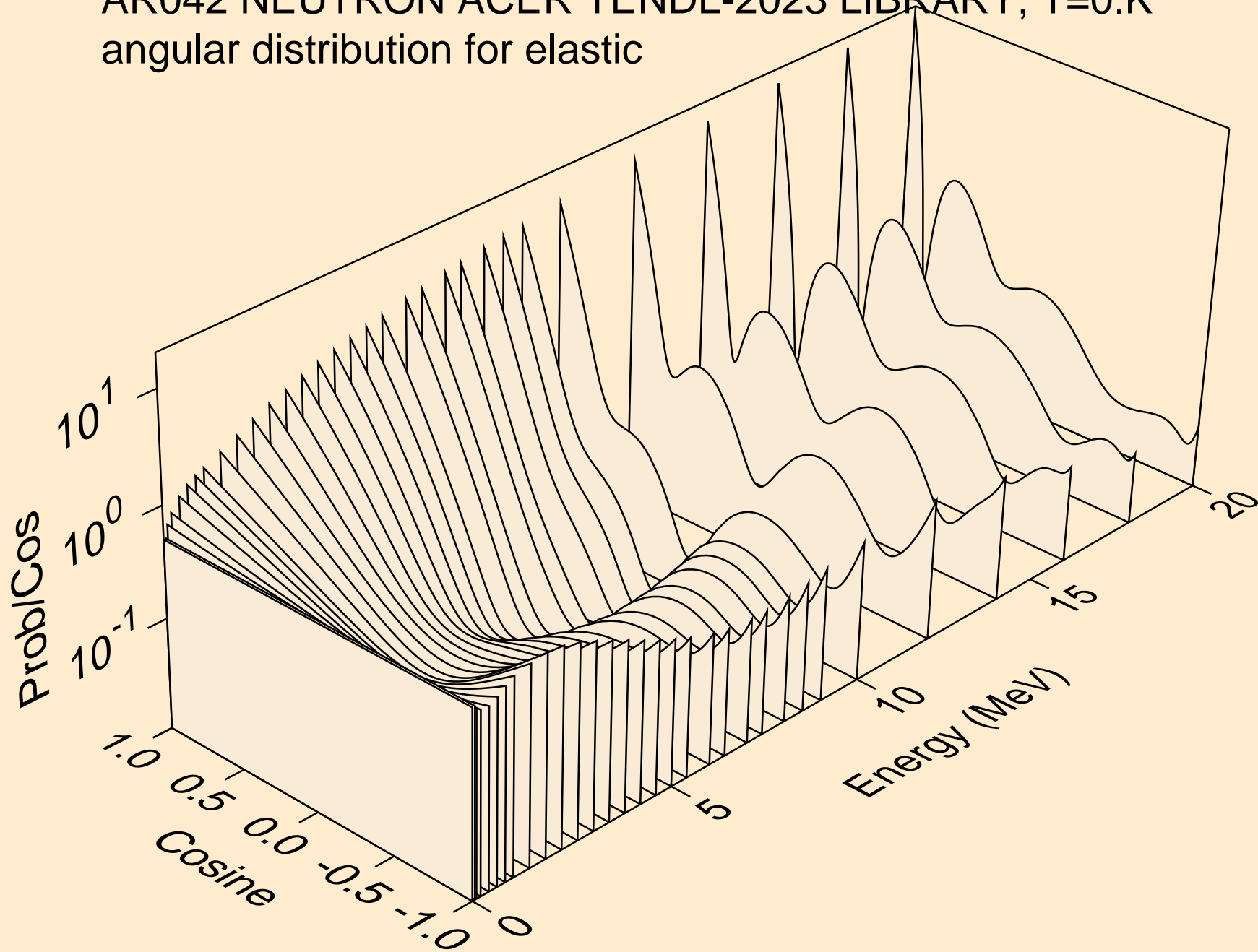

AR042 NEUTRON ACER TENDL-2023 LIBRARY; T=0.K
angular distribution for elastic

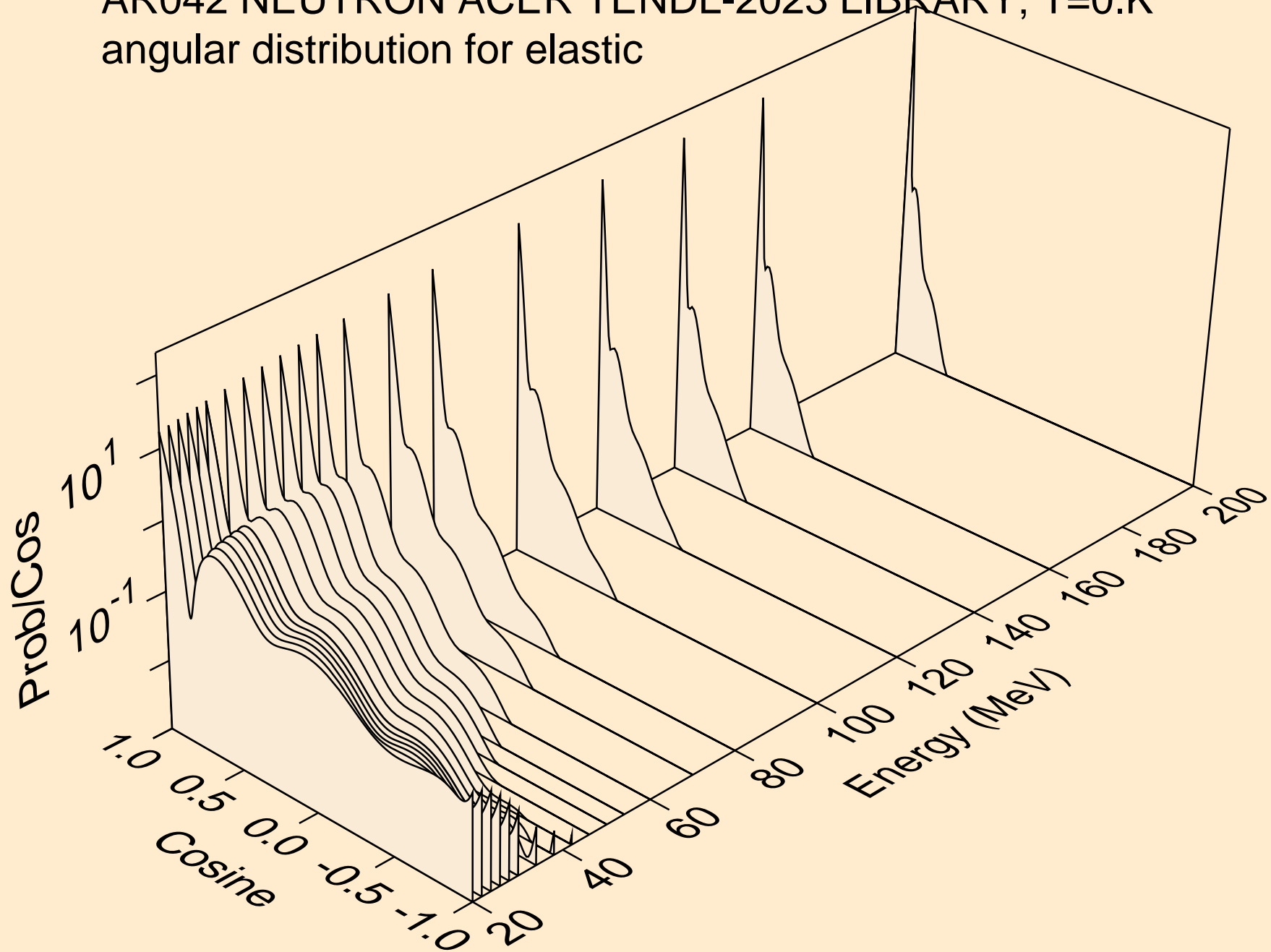

AR042 NEUTRON ACER TENDL-2023 LIBRARY; T=0.K
angular distribution for (n,n*1)

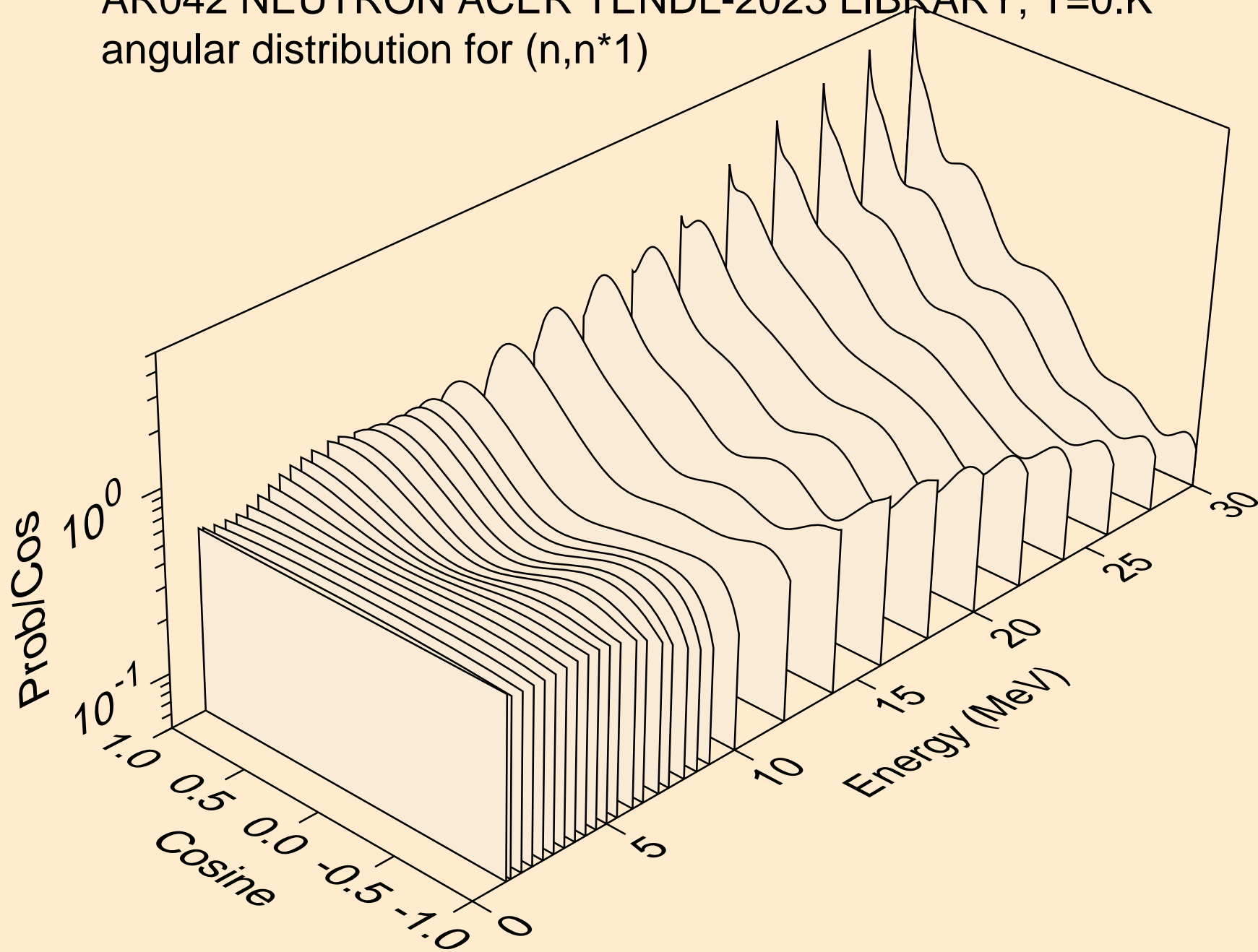

AR042 NEUTRON ACER TENDL-2023 LIBRARY; T=0.K
angular distribution for (n,n*2)

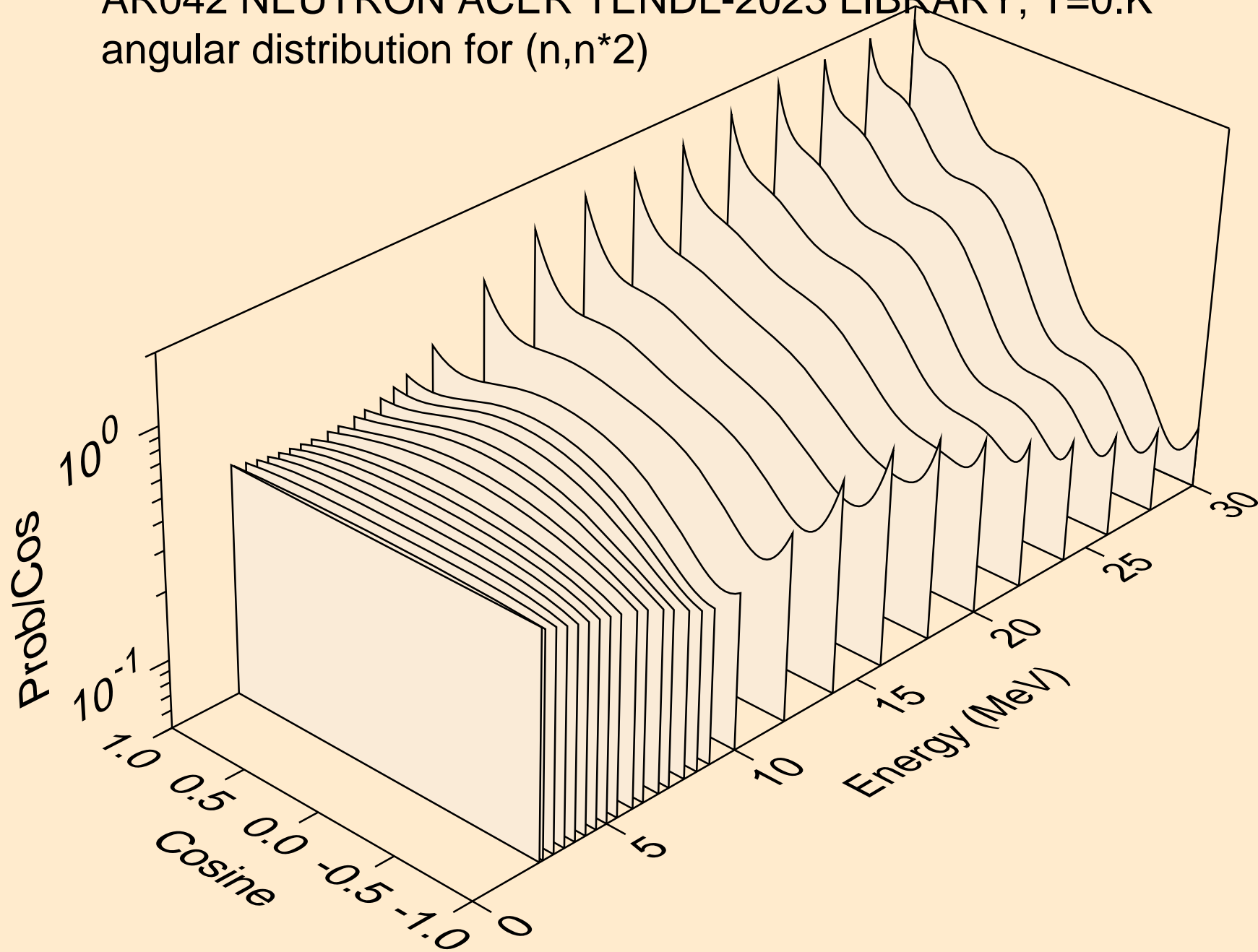

AR042 NEUTRON ACER TENDL-2023 LIBRARY; T=0.K
angular distribution for (n,n*3)

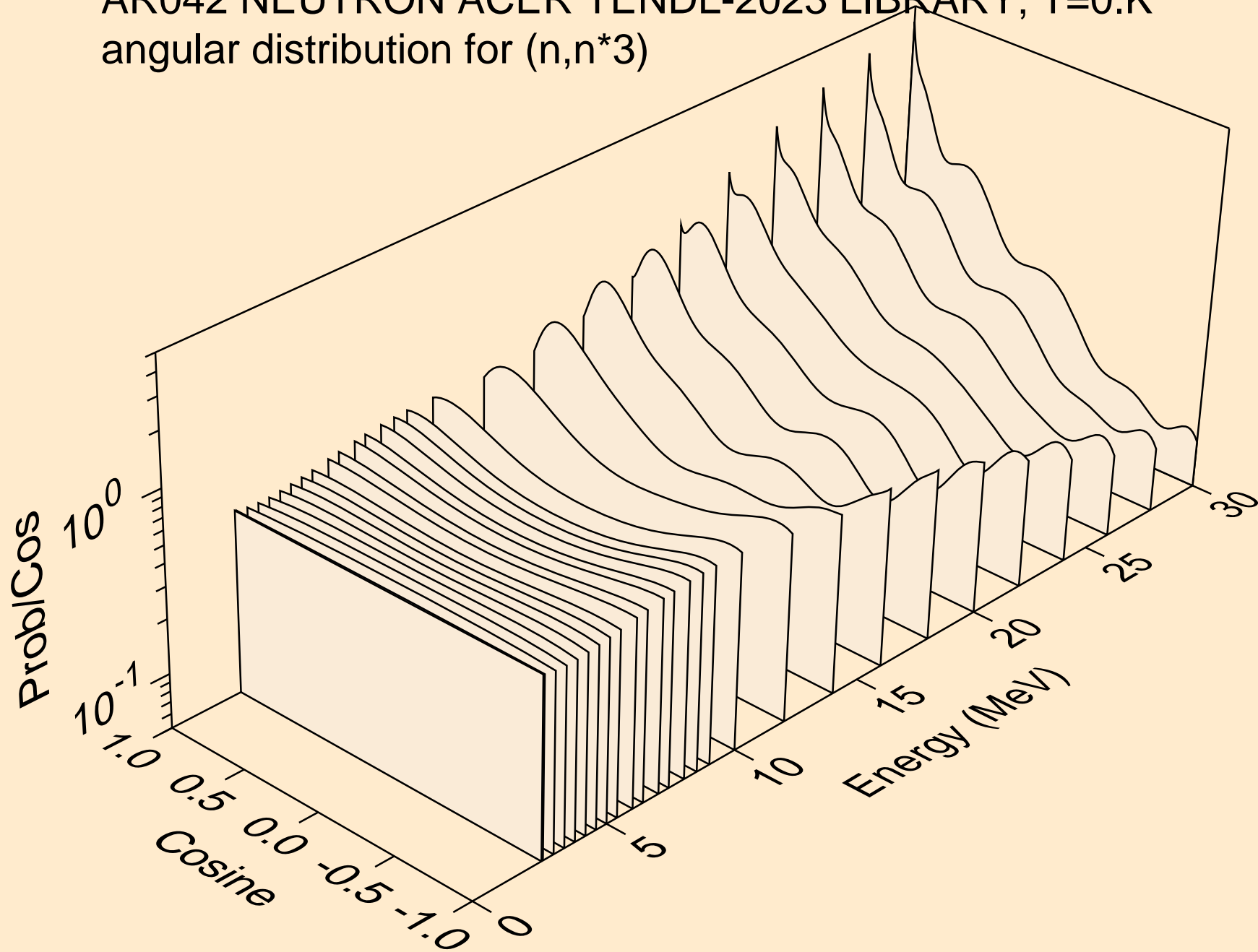

AR042 NEUTRON ACER TENDL-2023 LIBRARY; T=0.K
angular distribution for (n,n*4)

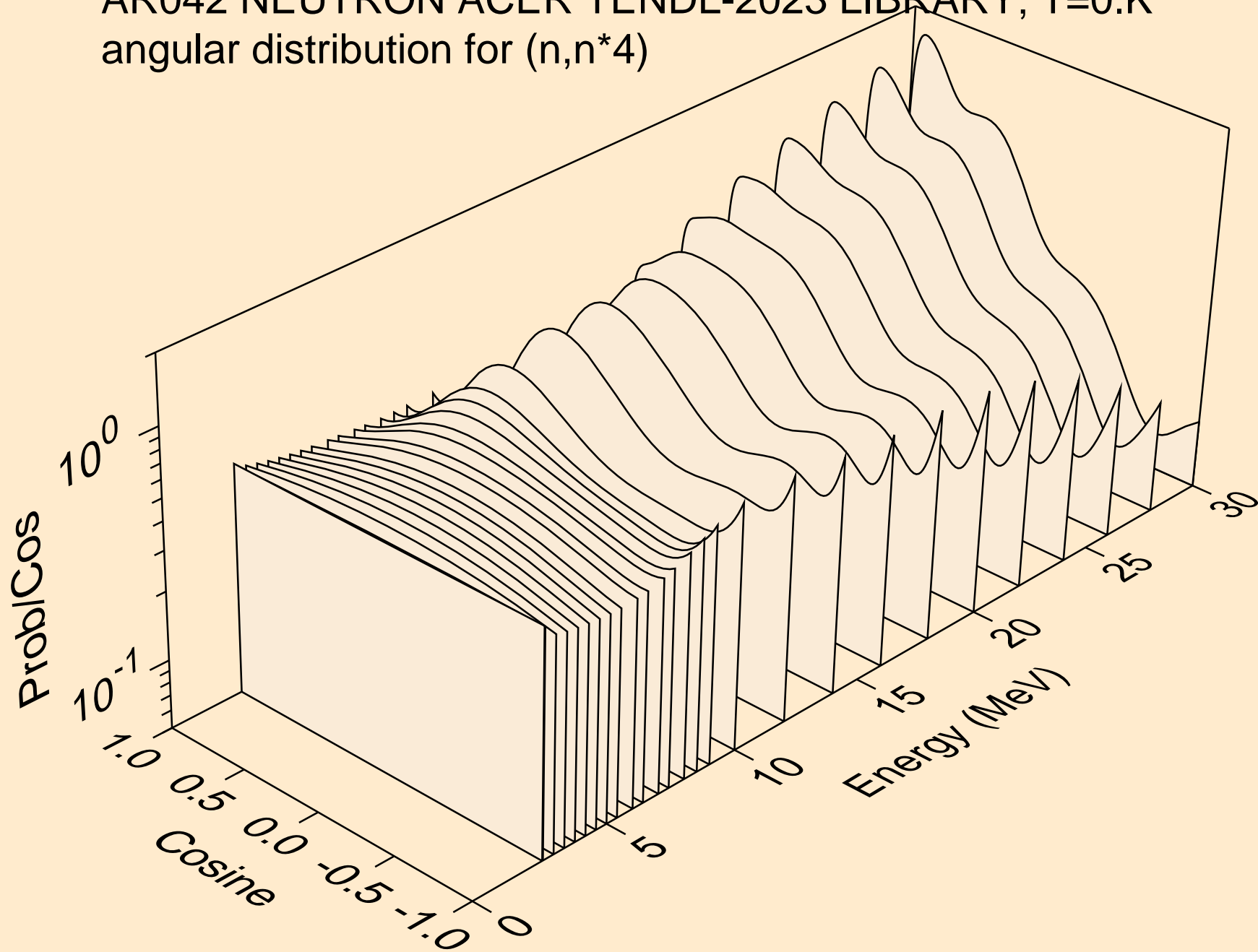

AR042 NEUTRON ACER TENDL-2023 LIBRARY; T=0.K
angular distribution for (n,n*5)

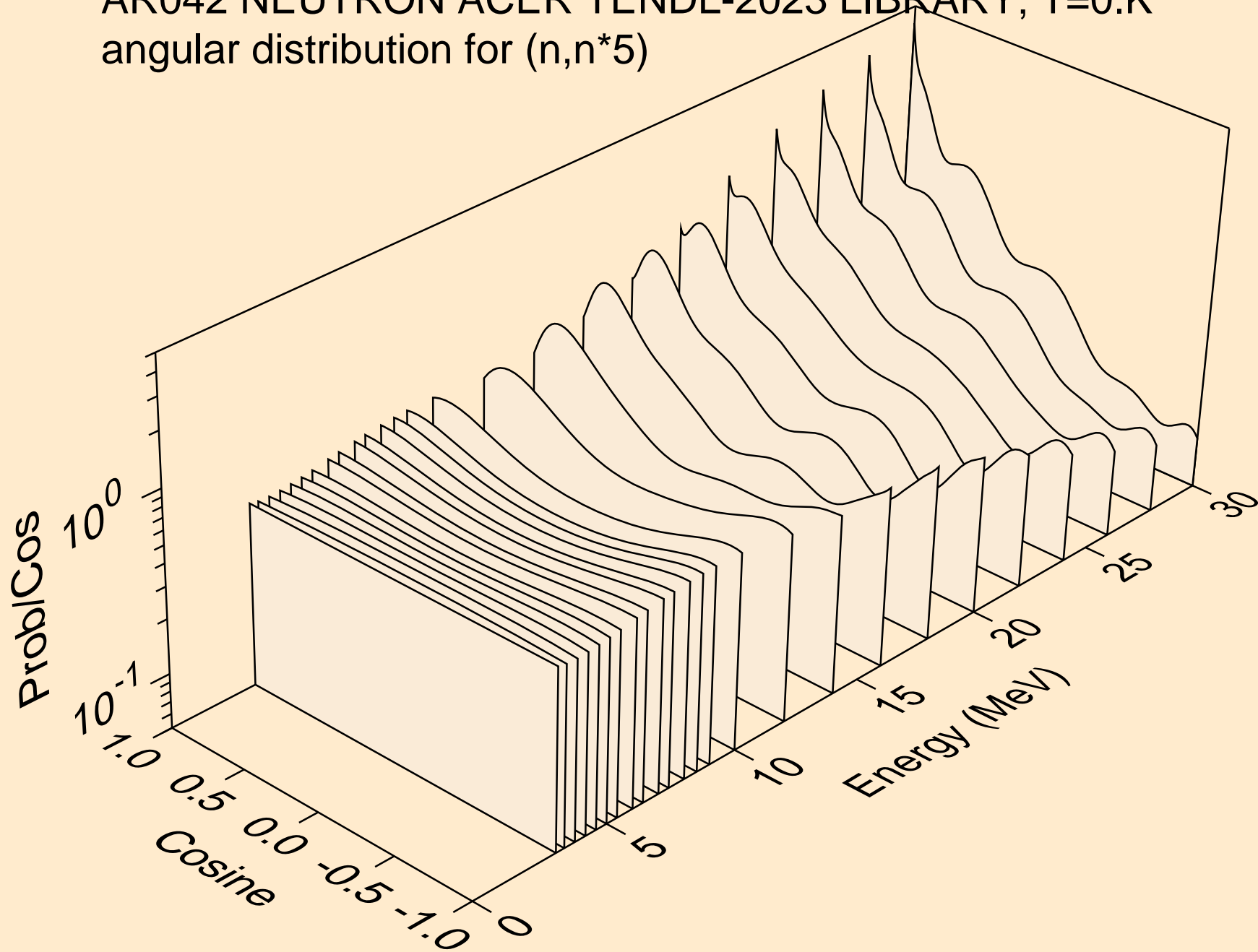

AR042 NEUTRON ACER TENDL-2023 LIBRARY; T=0.K
angular distribution for (n,n*6)

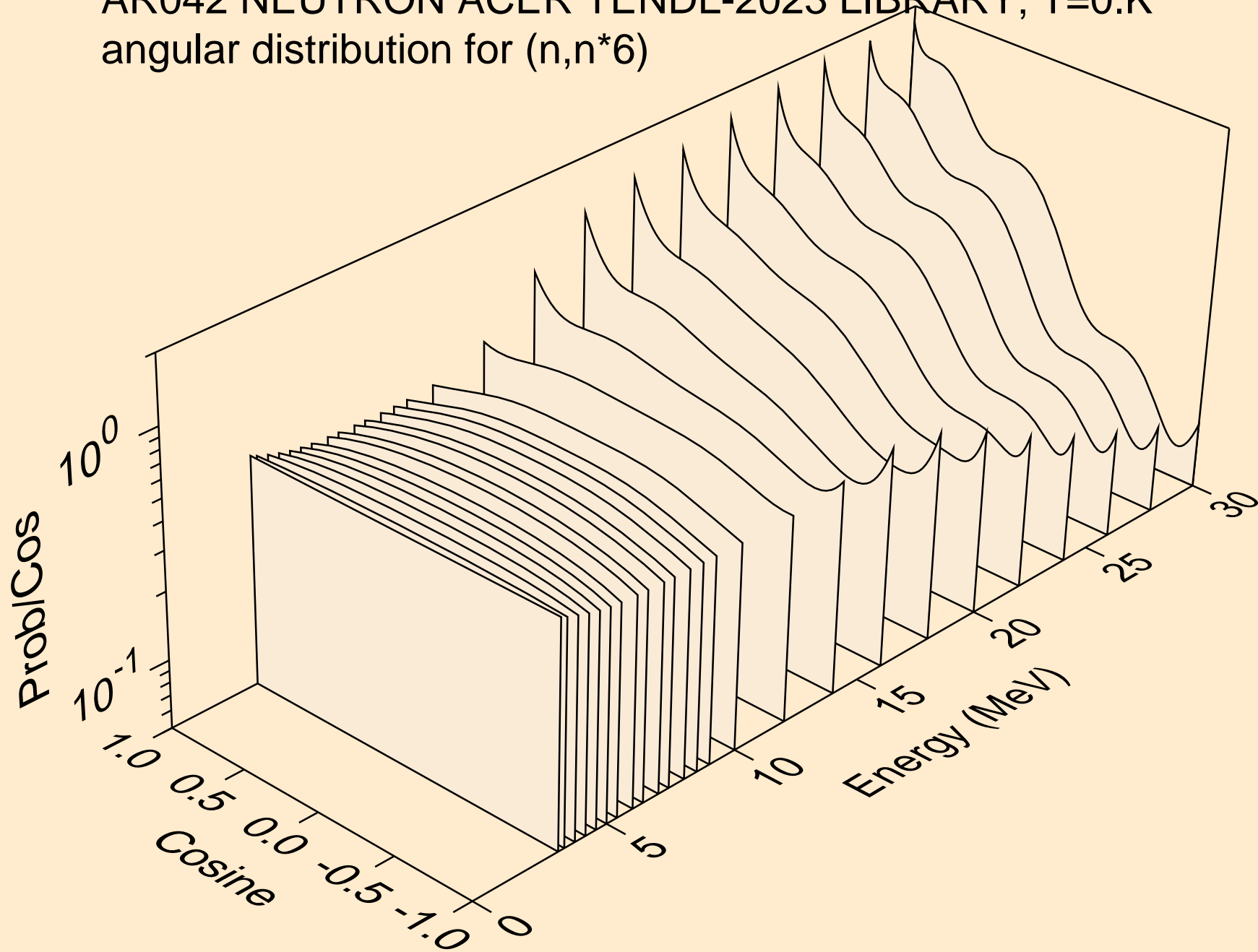

AR042 NEUTRON ACER TENDL-2023 LIBRARY; T=0.K
angular distribution for (n,n*7)

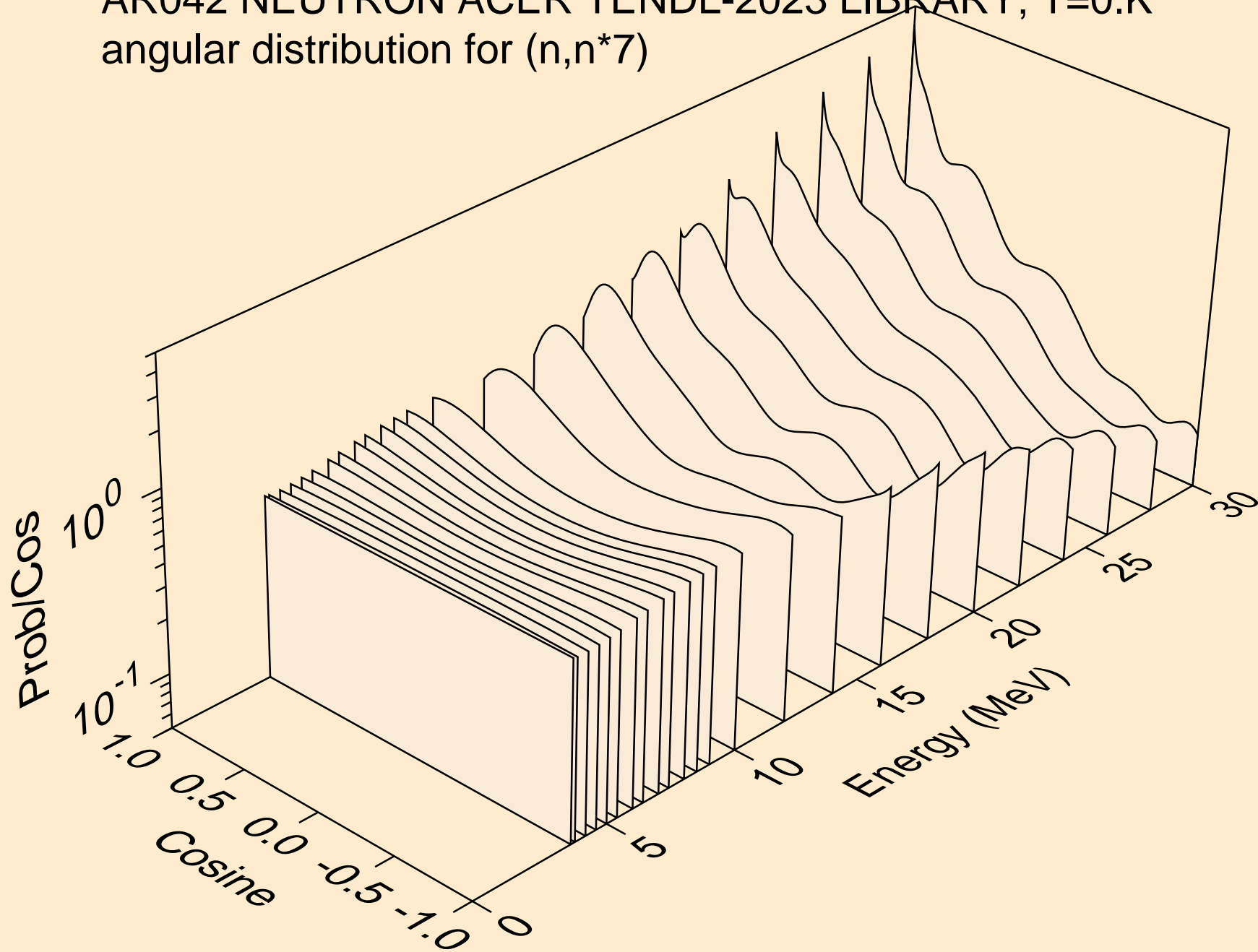

AR042 NEUTRON ACER TENDL-2023 LIBRARY; T=0.K
angular distribution for (n,n*8)

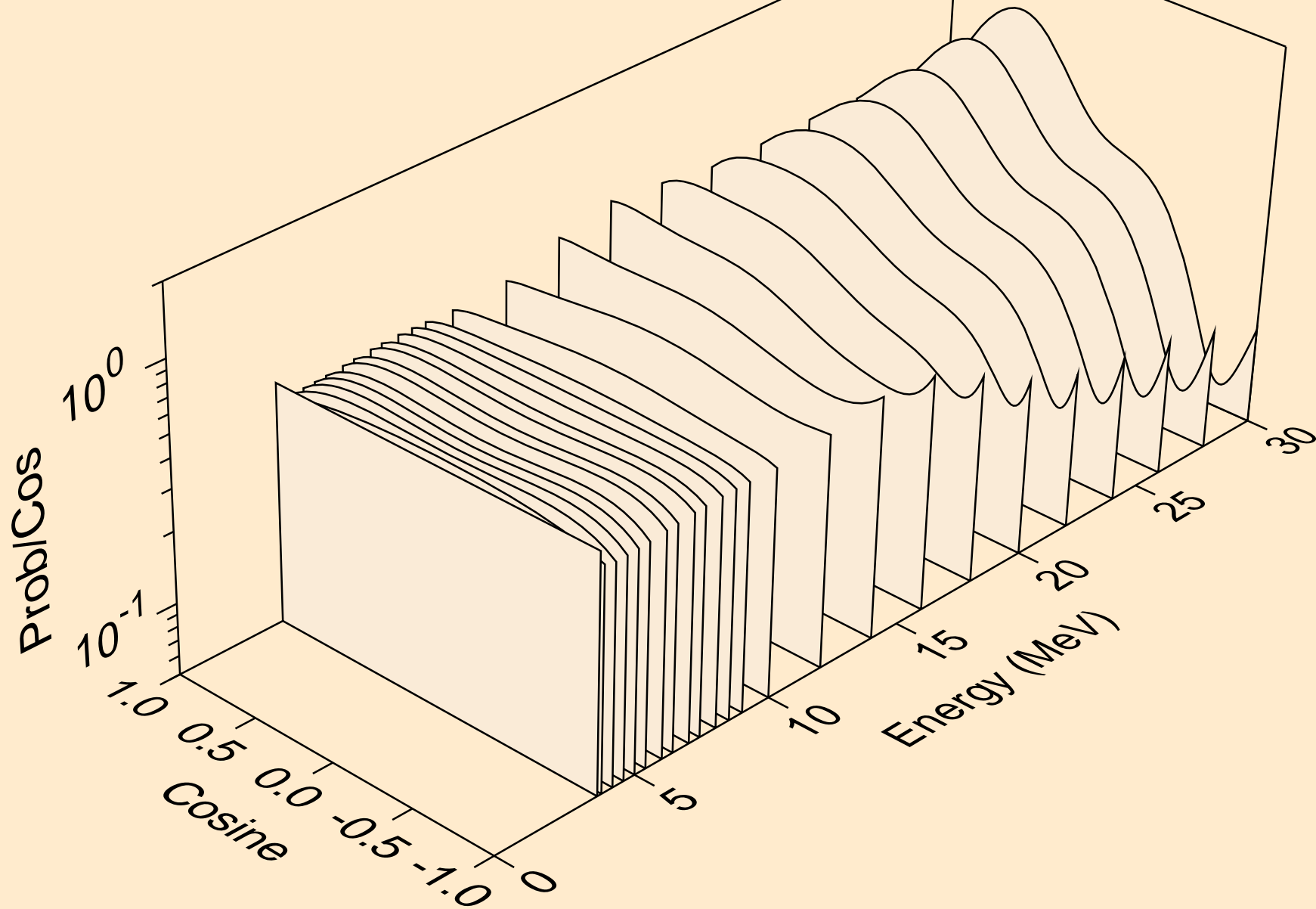

AR042 NEUTRON ACER TENDL-2023 LIBRARY; T=0.K
angular distribution for (n,n*9)

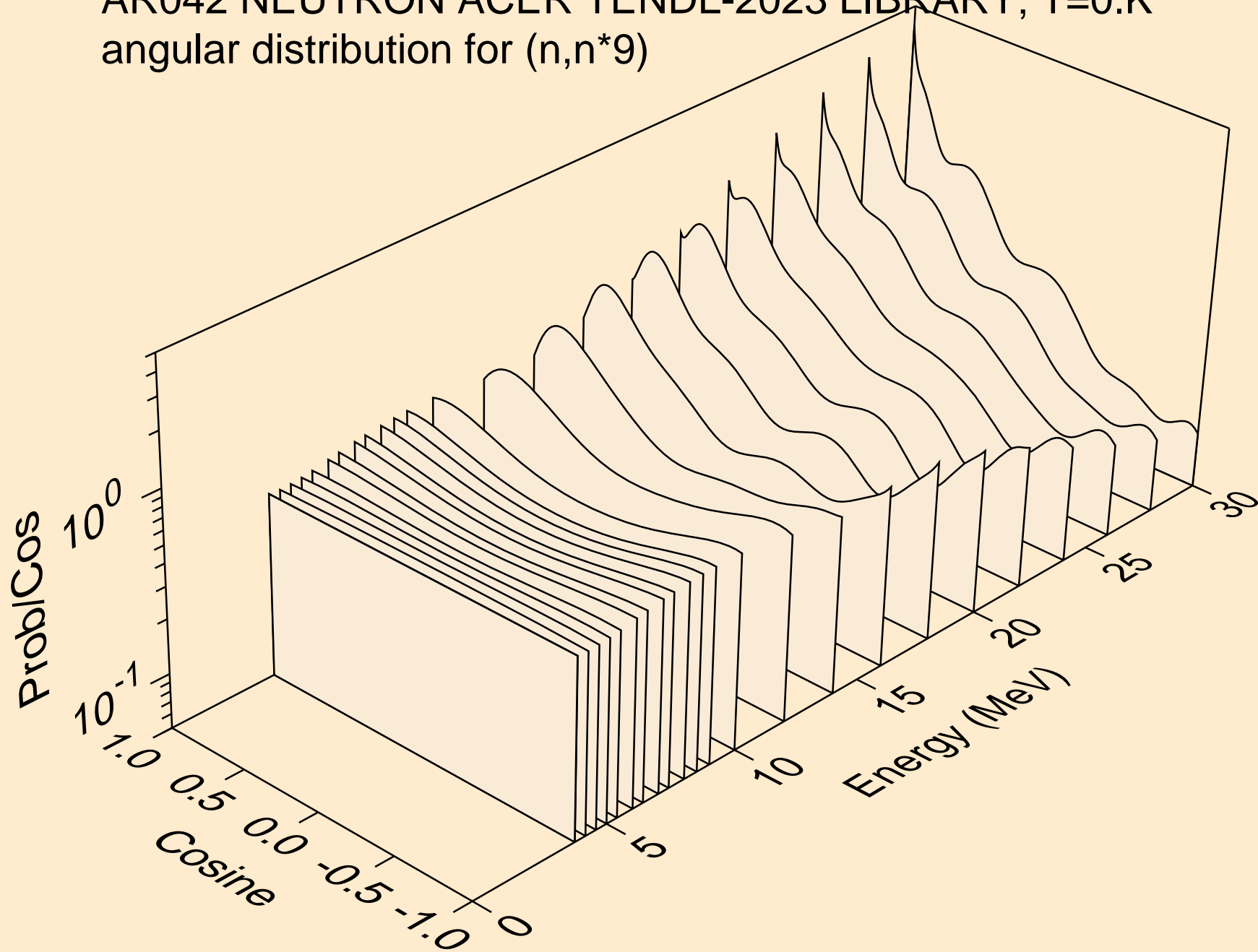

AR042 NEUTRON ACER TENDL-2023 LIBRARY; T=0.K
angular distribution for (n,n*10)

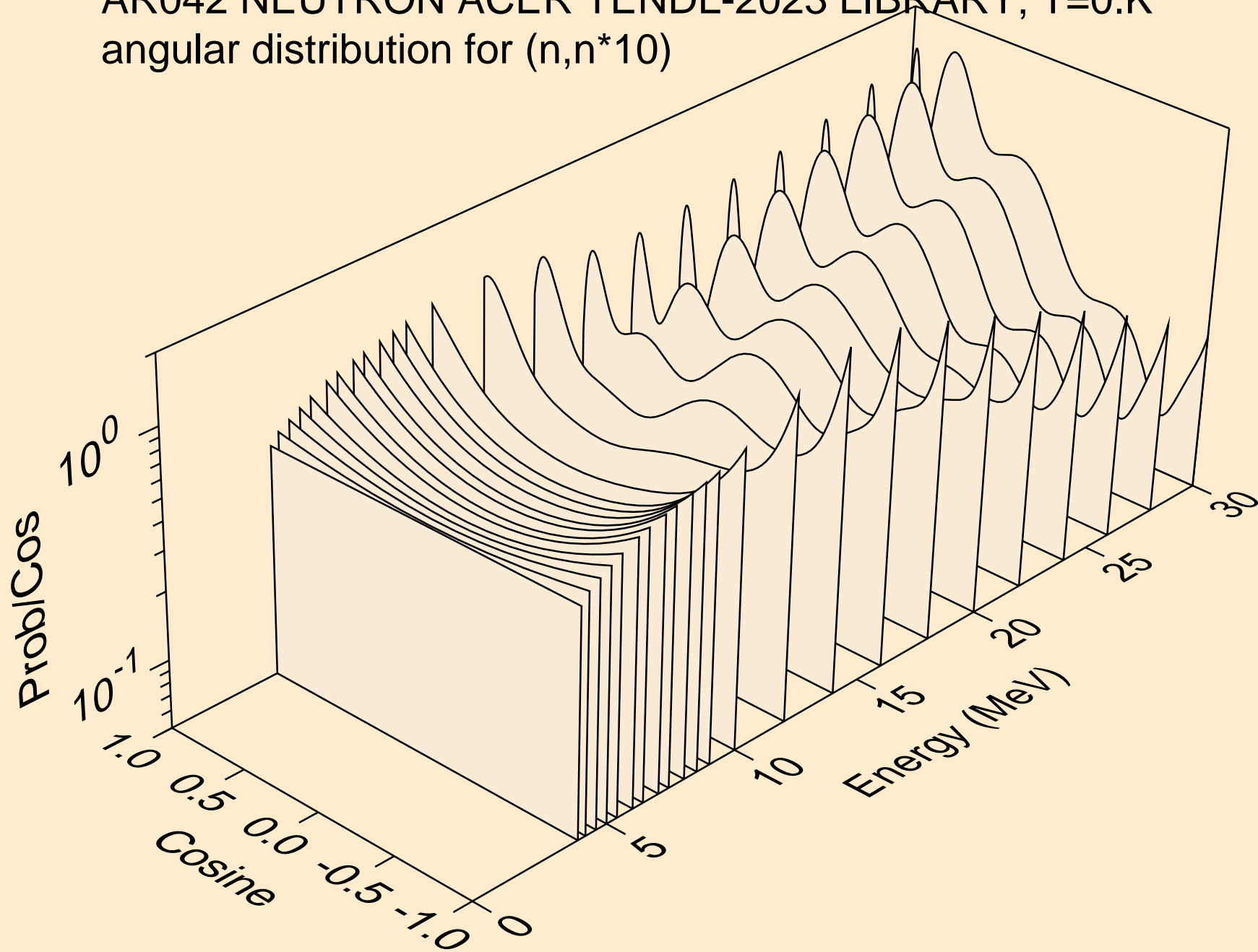

AR042 NEUTRON ACER TENDL-2023 LIBRARY; T=0.K
angular distribution for (n,n*11)

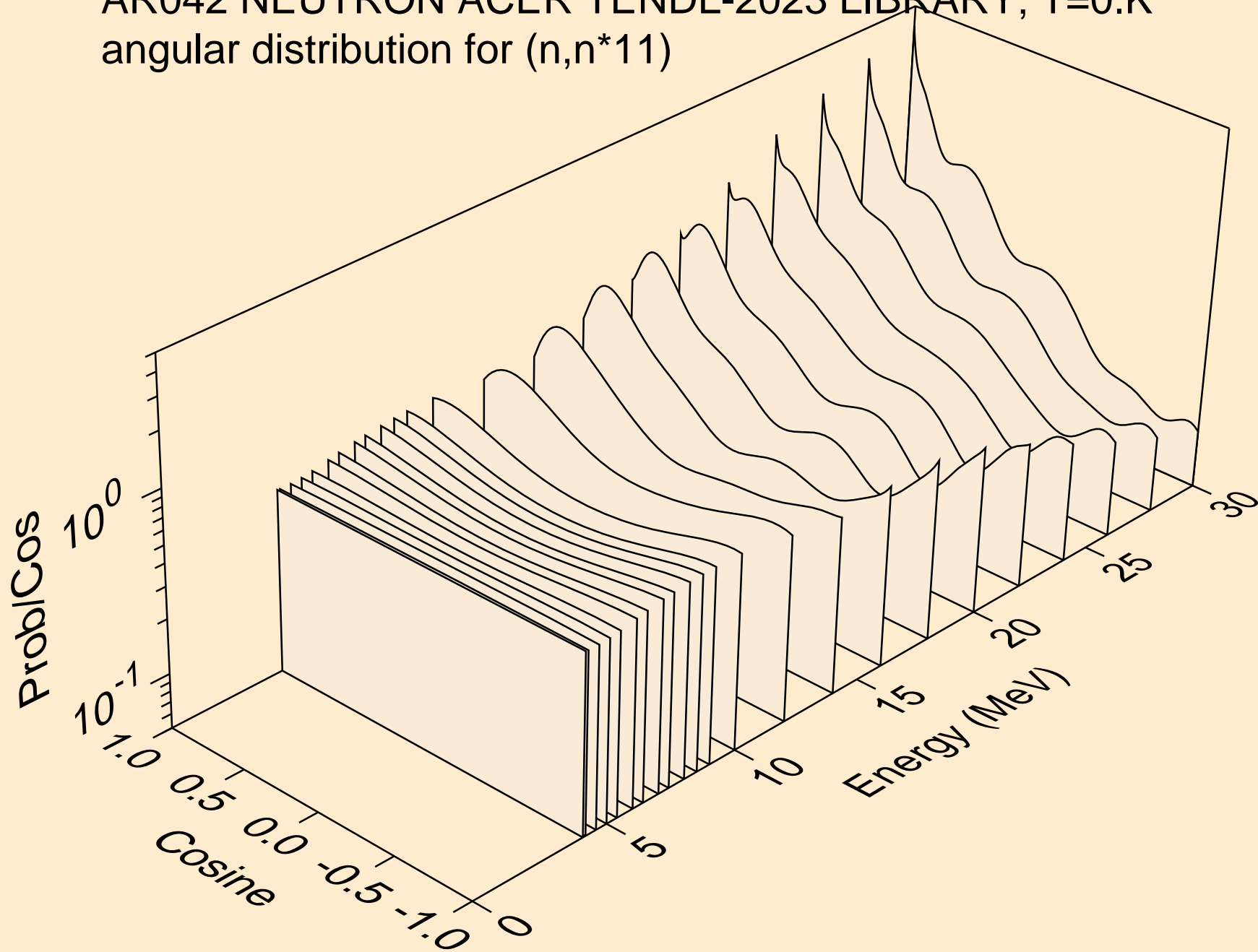

AR042 NEUTRON ACER TENDL-2023 LIBRARY; T=0.K
angular distribution for (n,n*12)

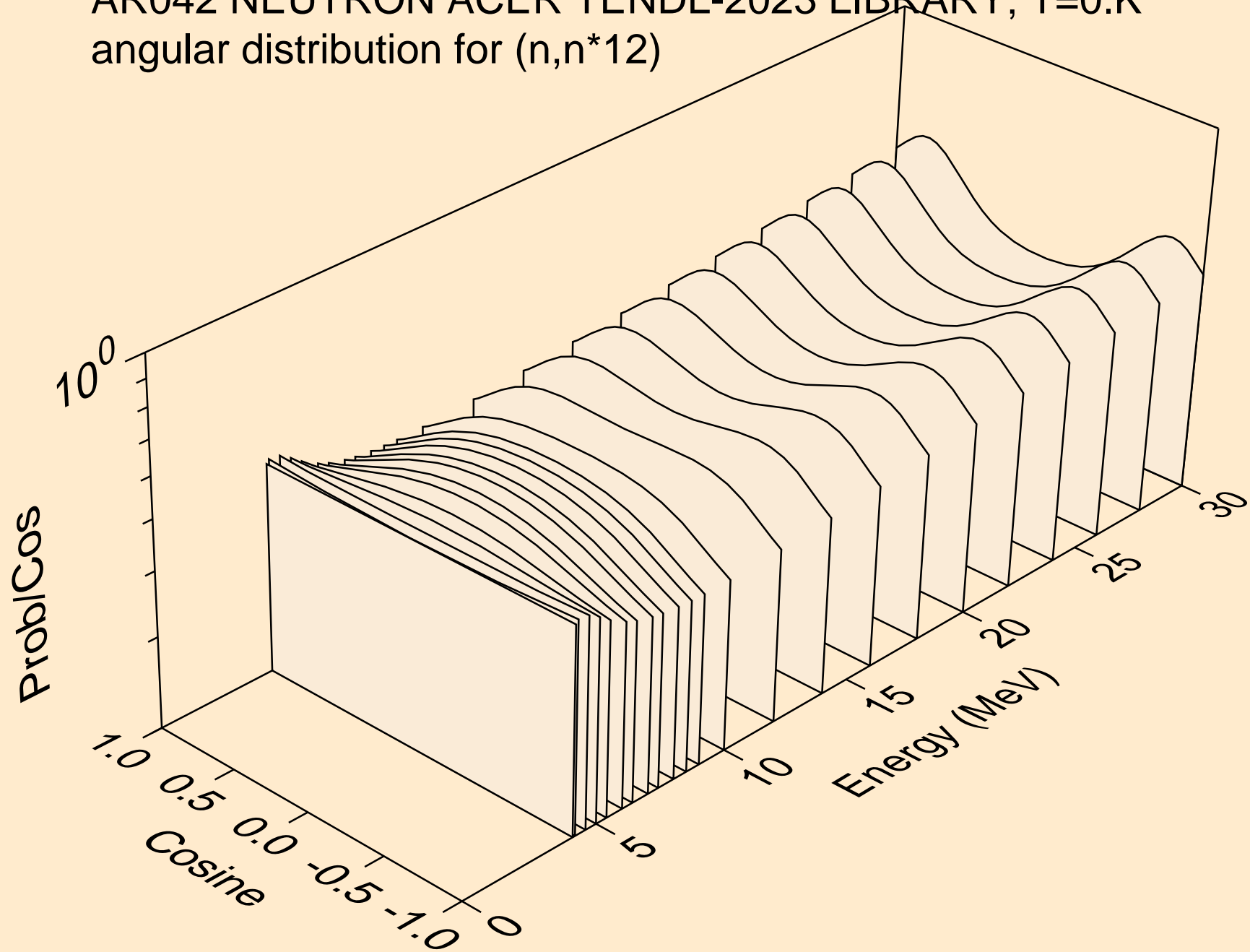

AR042 NEUTRON ACER TENDL-2023 LIBRARY; T=0.K
angular distribution for (n,n*13)

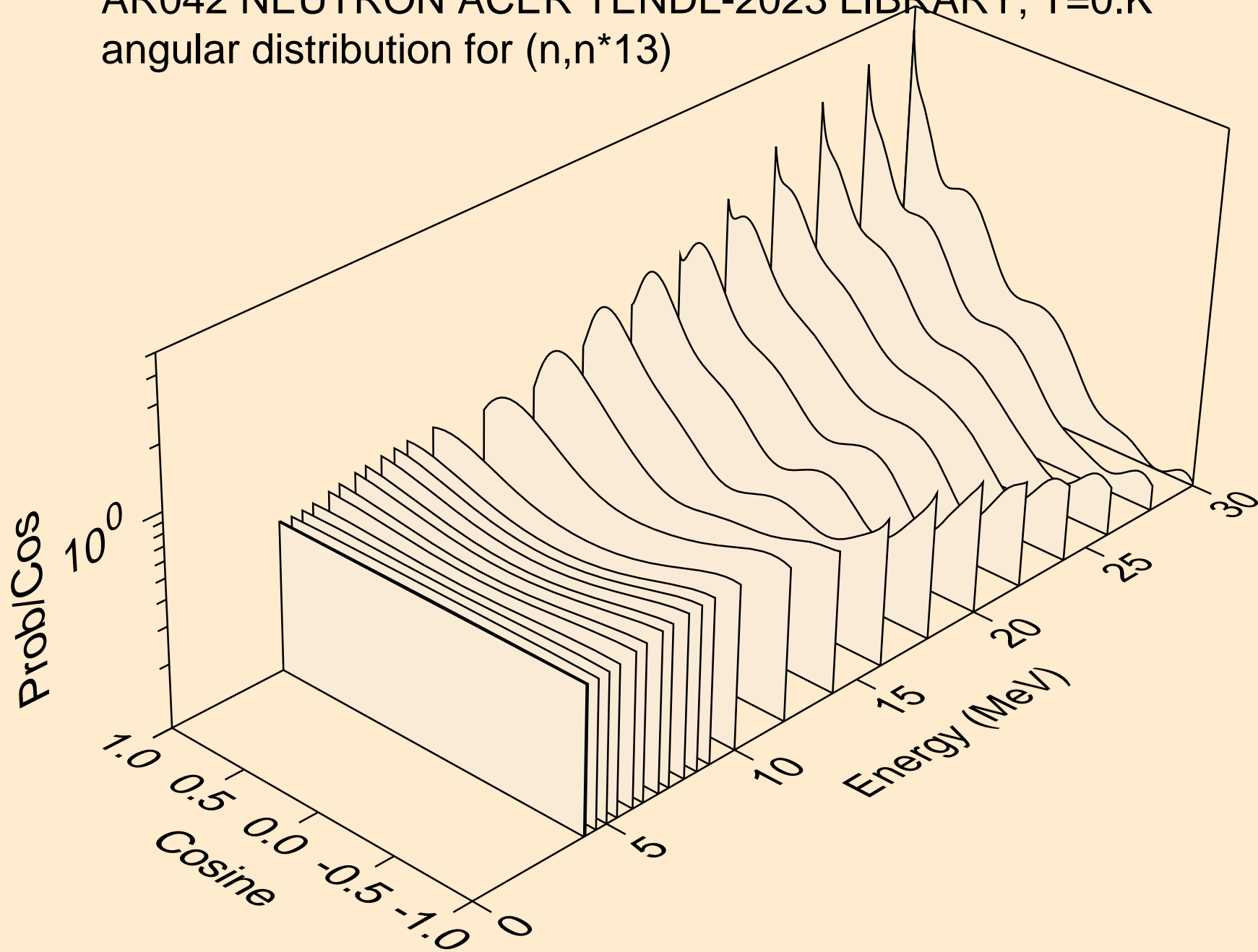

AR042 NEUTRON ACER TENDL-2023 LIBRARY; T=0.K
angular distribution for (n,n*14)

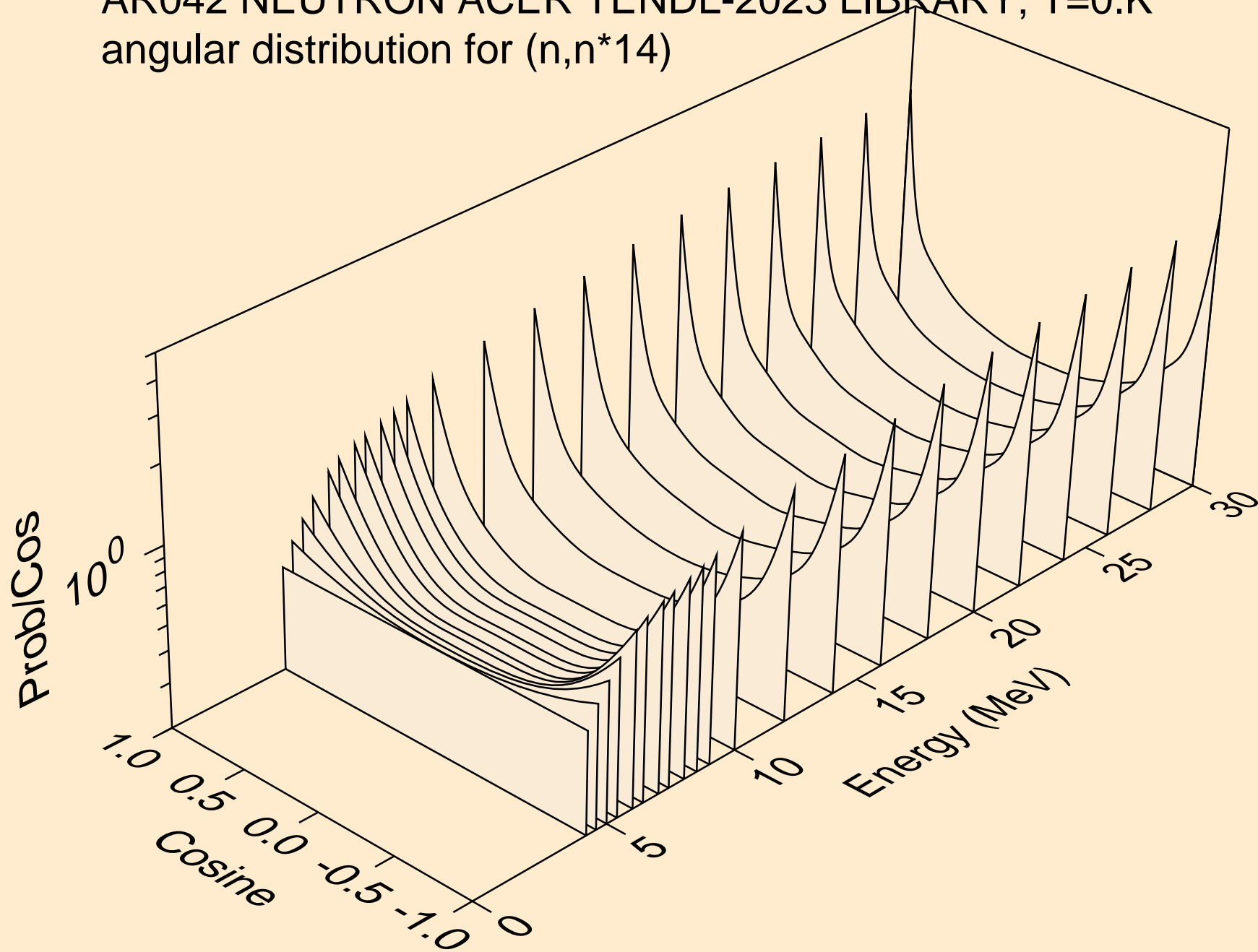

AR042 NEUTRON ACER TENDL-2023 LIBRARY; T=0.K
angular distribution for (n,n*15)

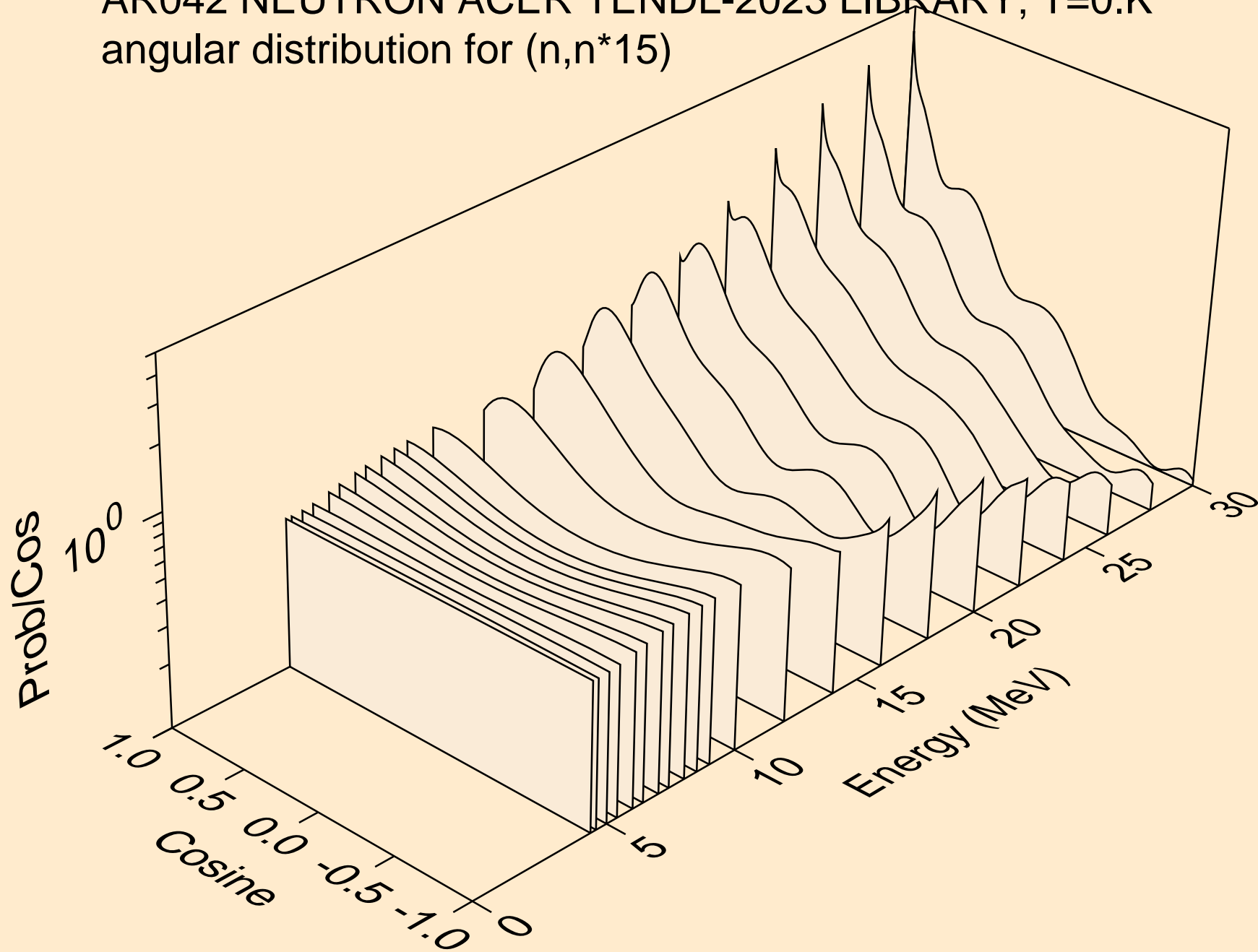

AR042 NEUTRON ACER TENDL-2023 LIBRARY; T=0.K
angular distribution for (n,n*16)

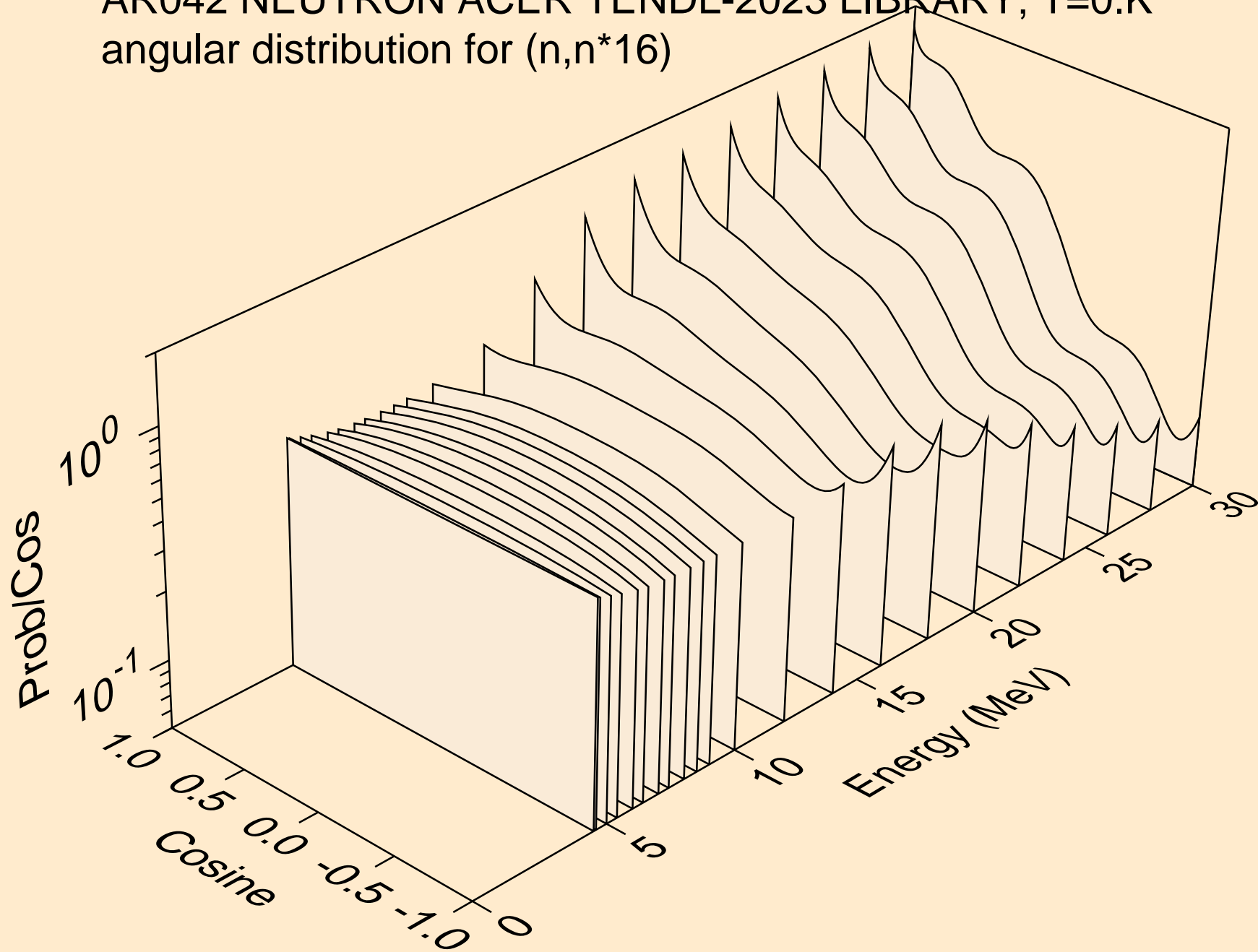

AR042 NEUTRON ACER TENDL-2023 LIBRARY; T=0.K
Neutron emission for (n,x)

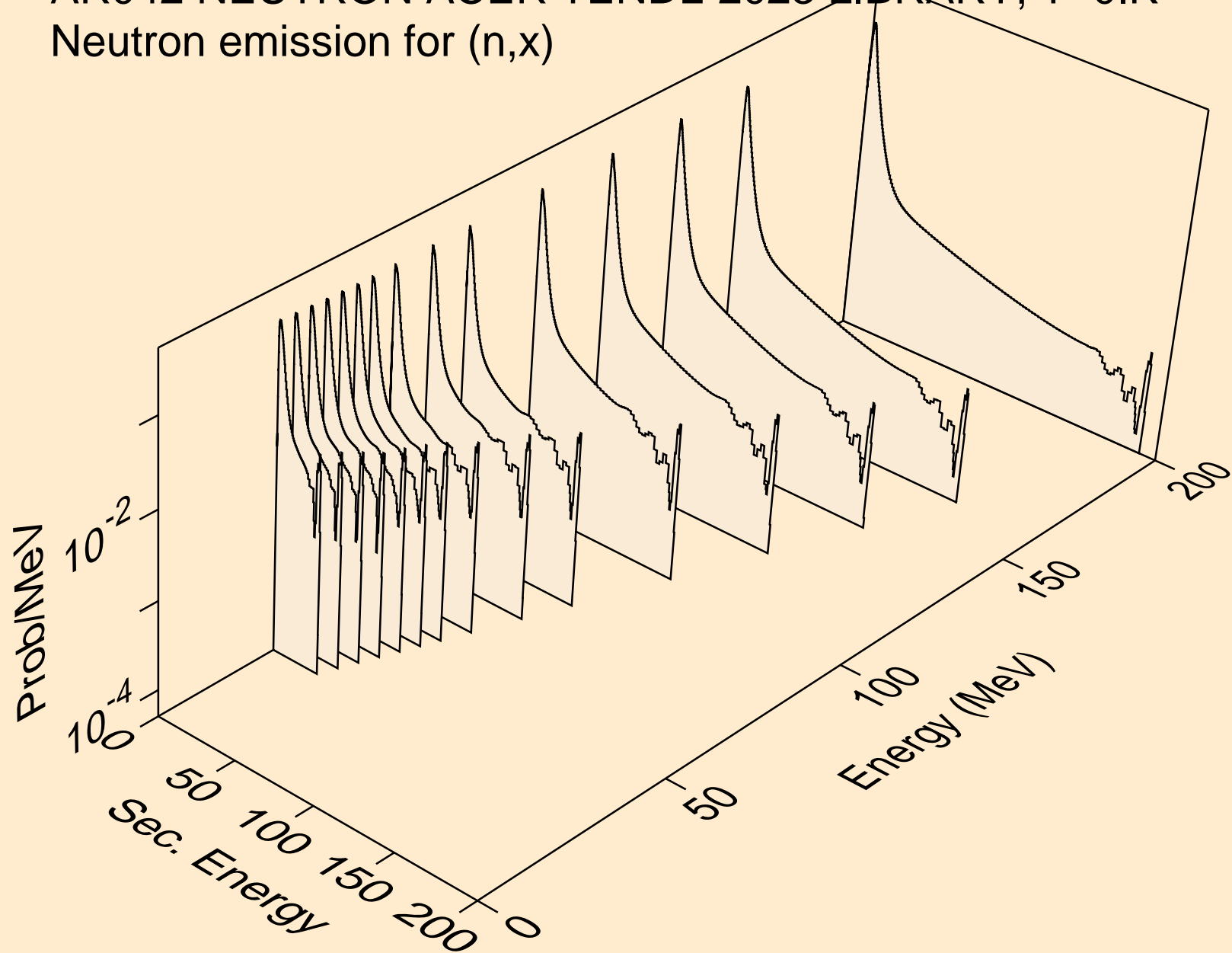

AR042 NEUTRON ACER TENDL-2023 LIBRARY; T=0.K
Neutron emission for (n,2nd)

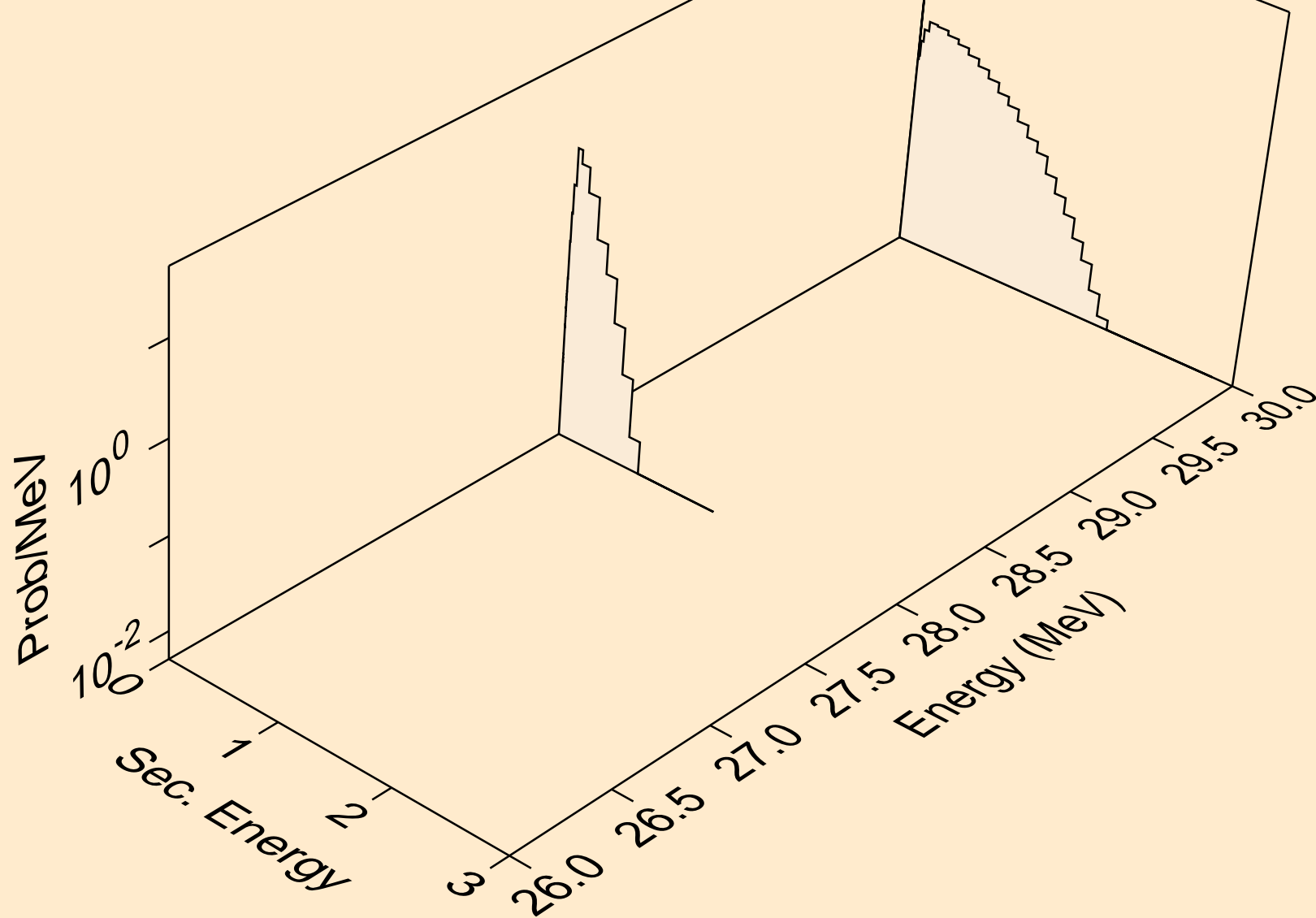

AR042 NEUTRON ACER TENDL-2023 LIBRARY; T=0.K
Neutron emission for (n,2n)

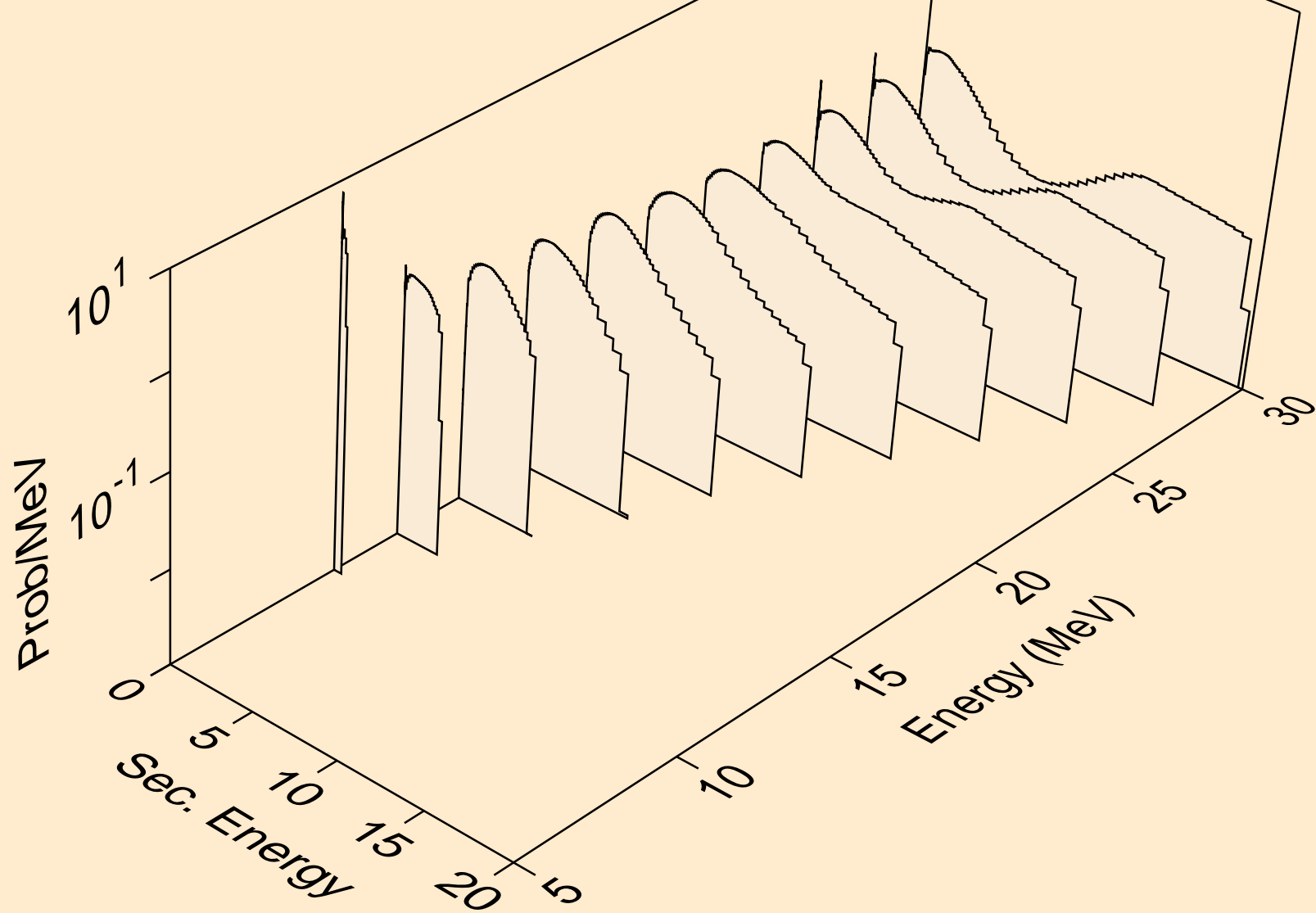

AR042 NEUTRON ACER TENDL-2023 LIBRARY; T=0.K
Neutron emission for (n,3n)

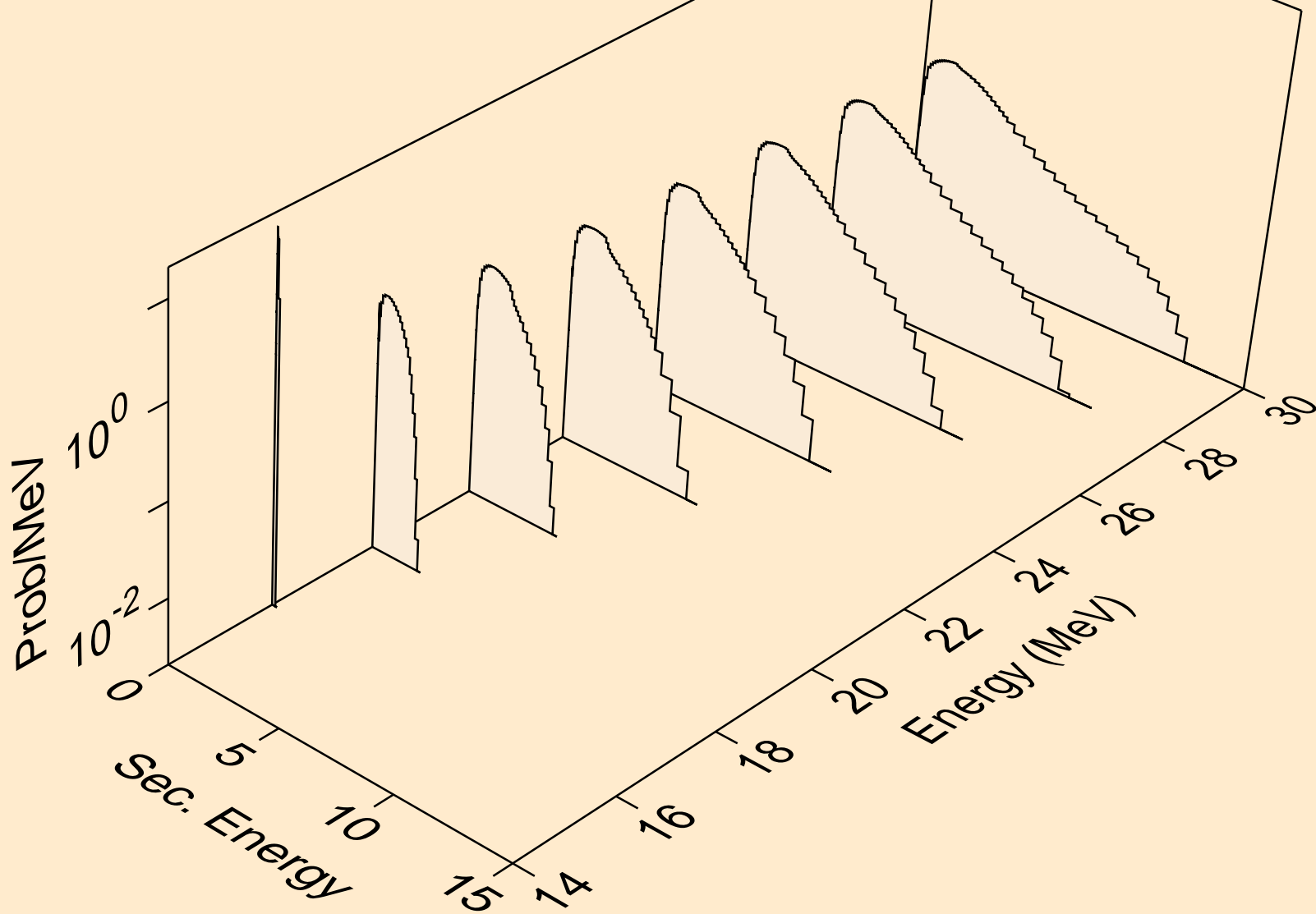

AR042 NEUTRON ACER TENDL-2023 LIBRARY; T=0.K
Neutron emission for (n,n*)a

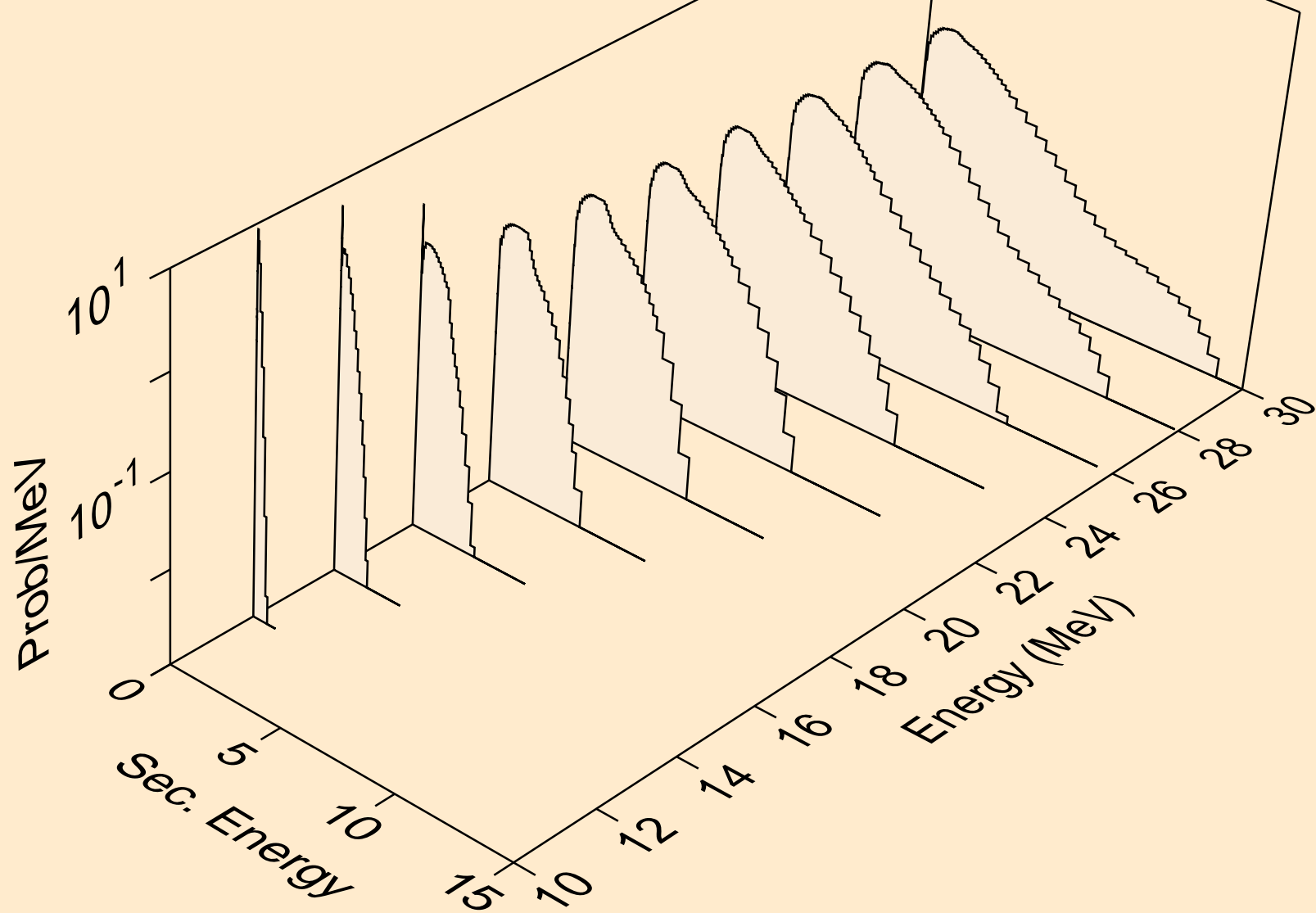

AR042 NEUTRON ACER TENDL-2023 LIBRARY; T=0.K
Neutron emission for (n,2n)a

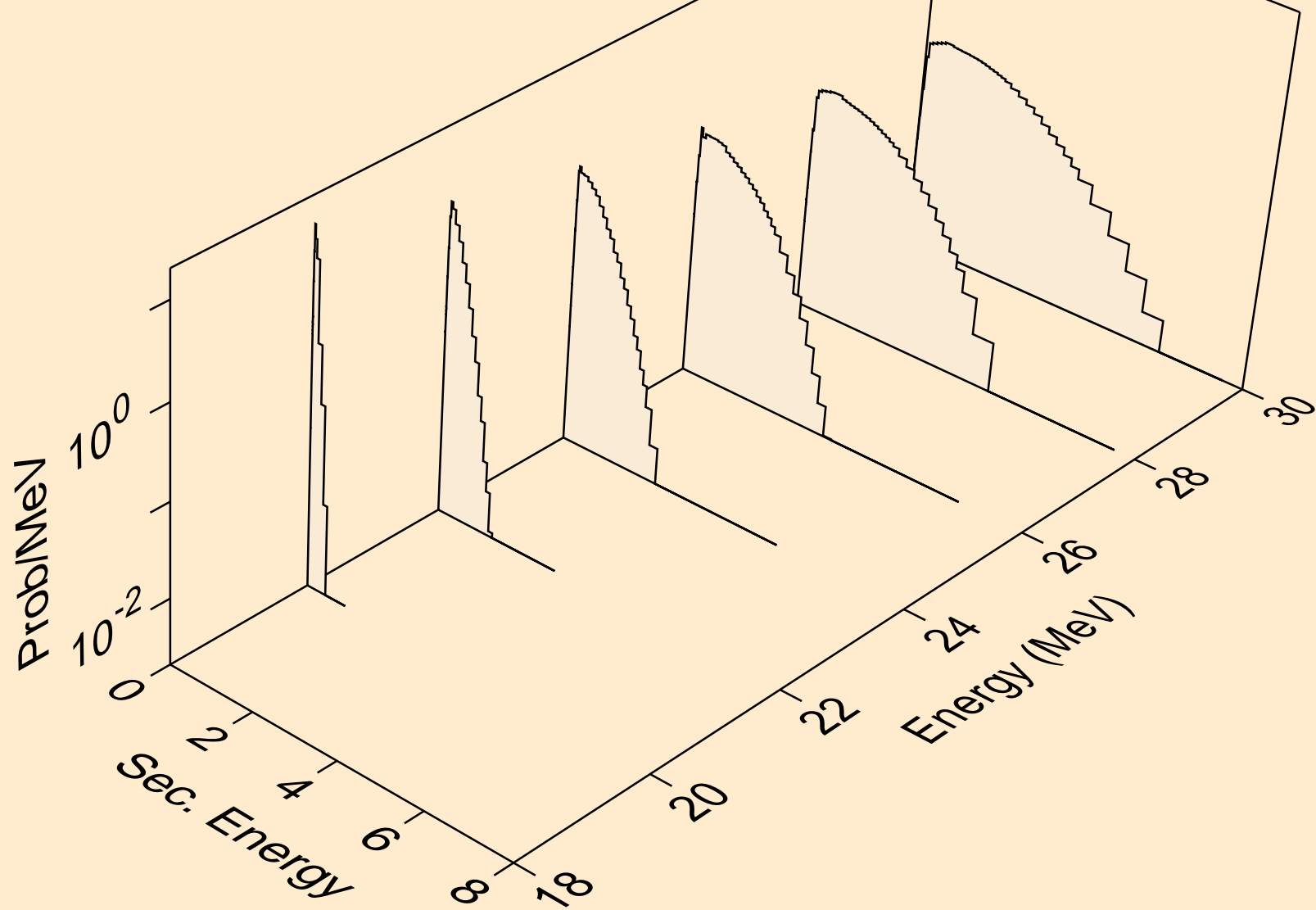

AR042 NEUTRON ACER TENDL-2023 LIBRARY; T=0.K
Neutron emission for (n,3n)a

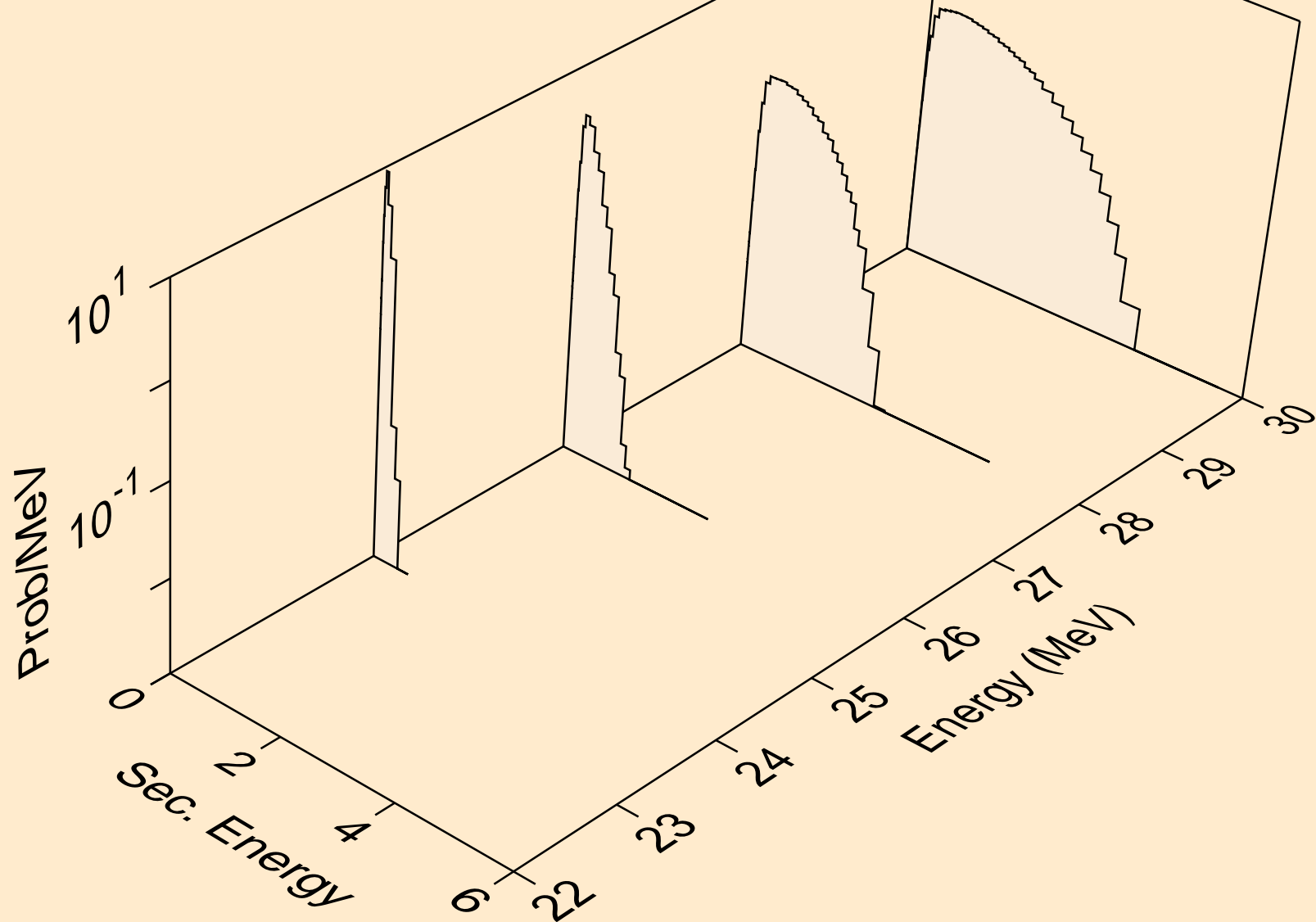

AR042 NEUTRON ACER TENDL-2023 LIBRARY; T=0.K
Neutron emission for (n,n*)p

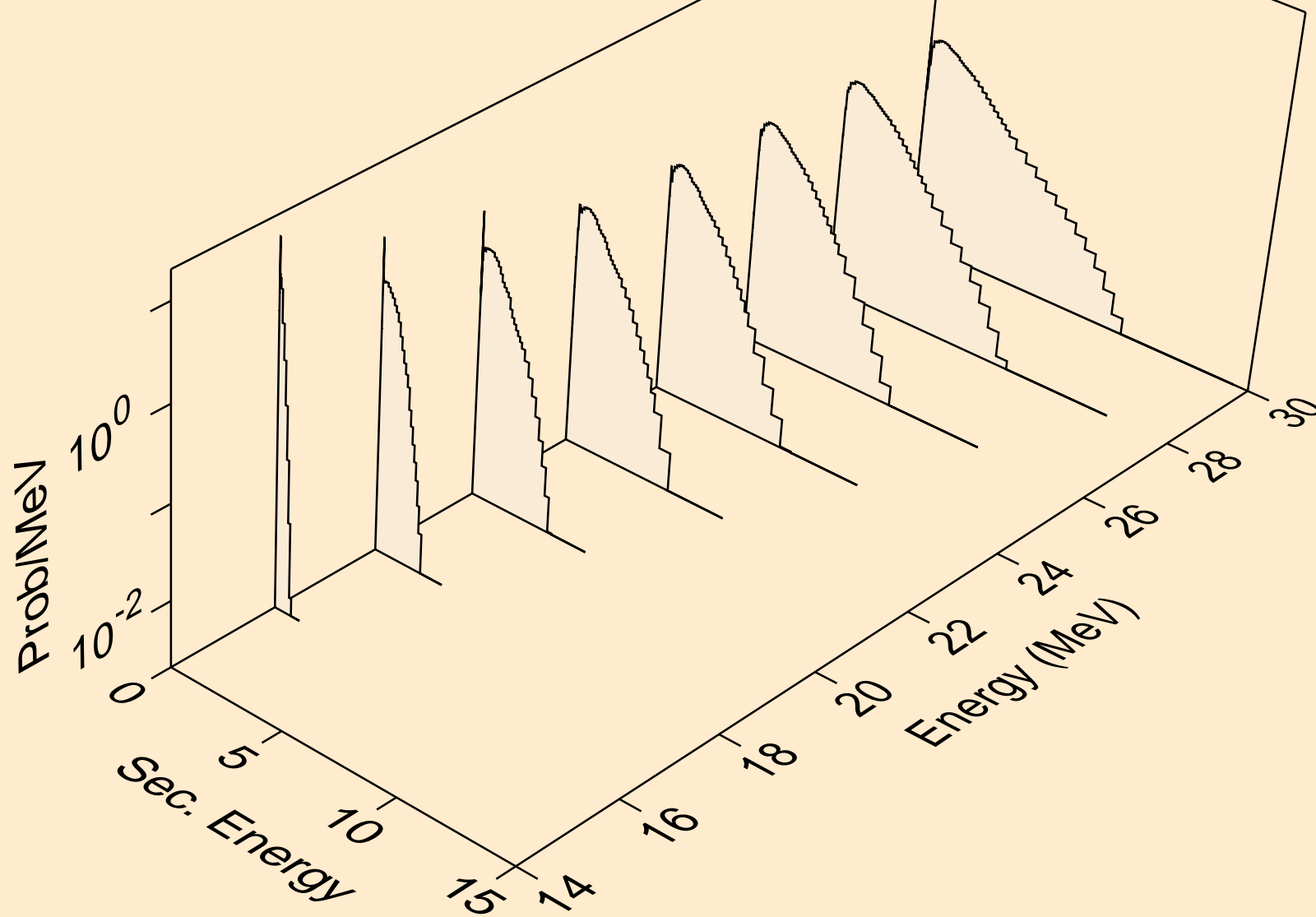

AR042 NEUTRON ACER TENDL-2023 LIBRARY; T=0.K
Neutron emission for (n,n*)2a

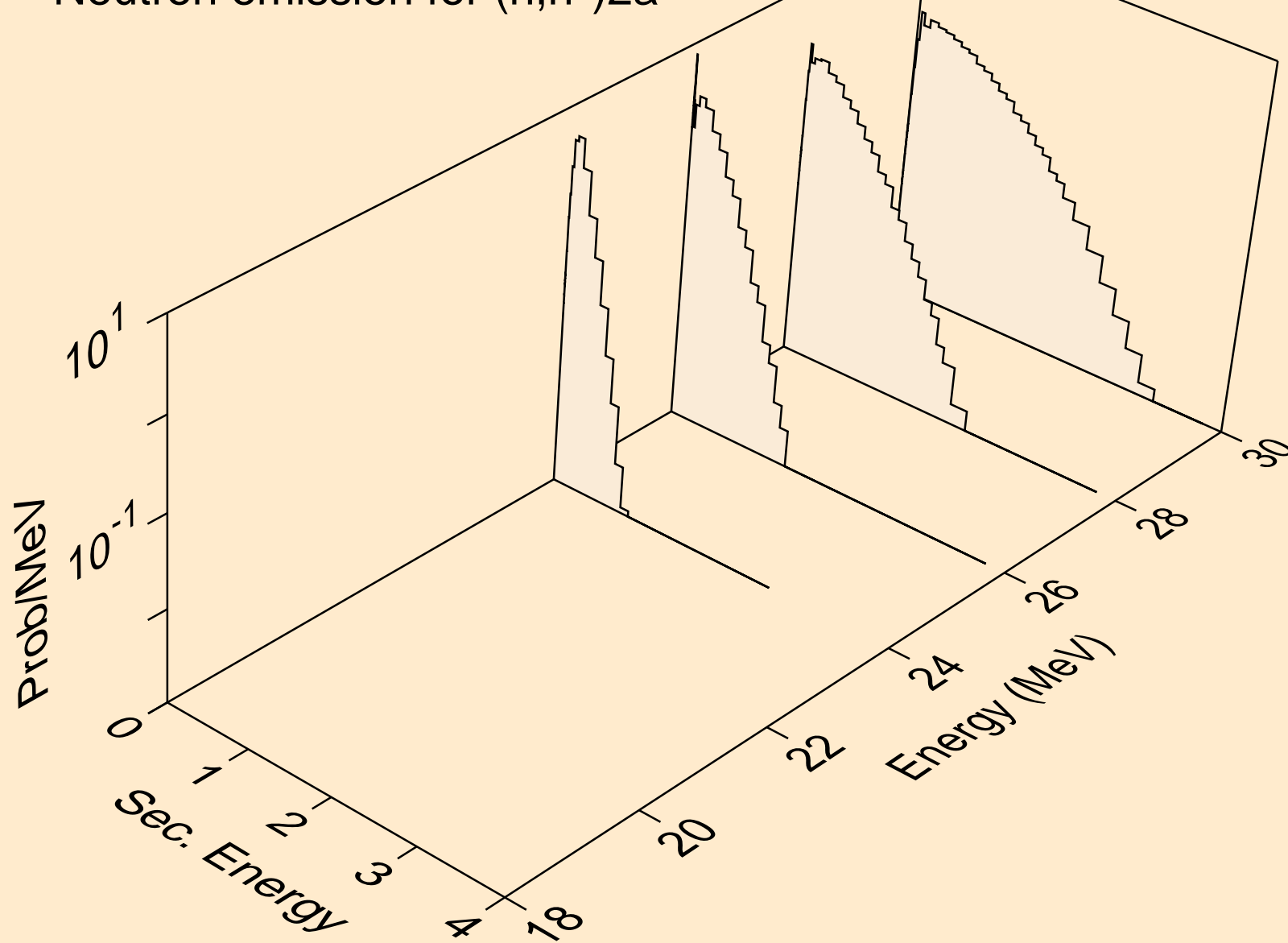

AR042 NEUTRON ACER TENDL-2023 LIBRARY; T=0.K
Neutron emission for (n,n*)d

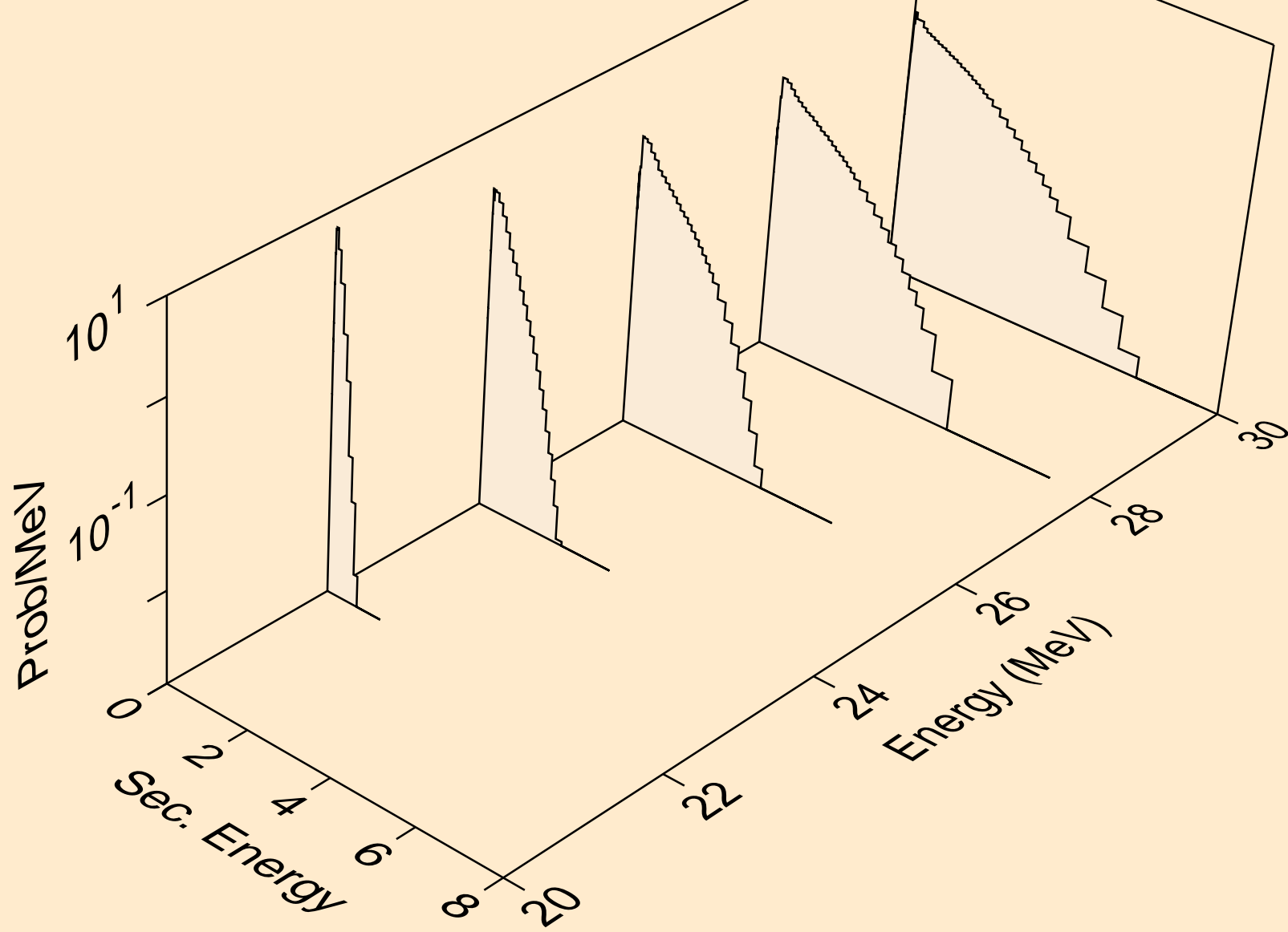

AR042 NEUTRON ACER TENDL-2023 LIBRARY; T=0.K
Neutron emission for (n,n*)t

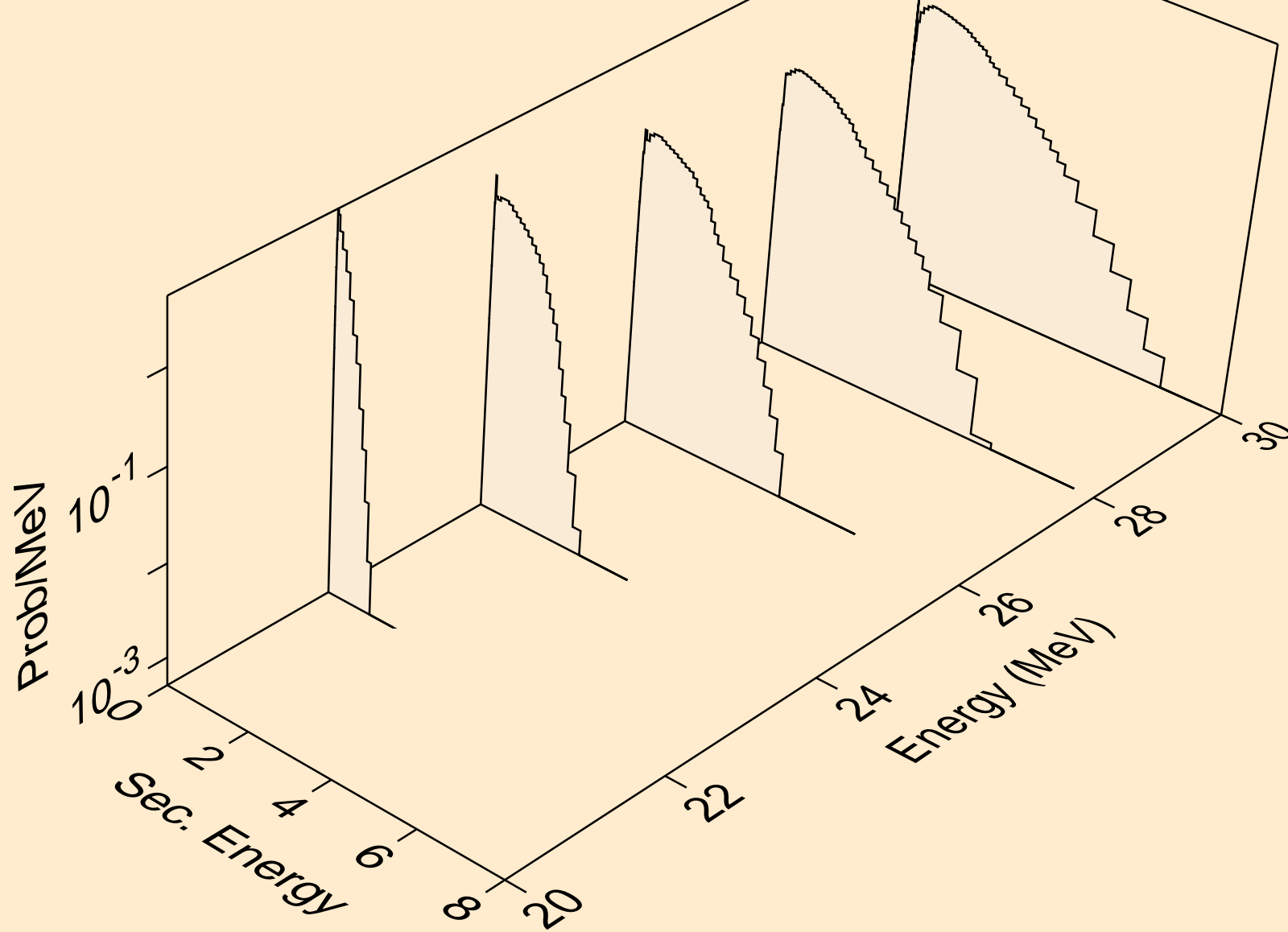

AR042 NEUTRON ACER TENDL-2023 LIBRARY; T=0.K
Neutron emission for (n,n*)he3

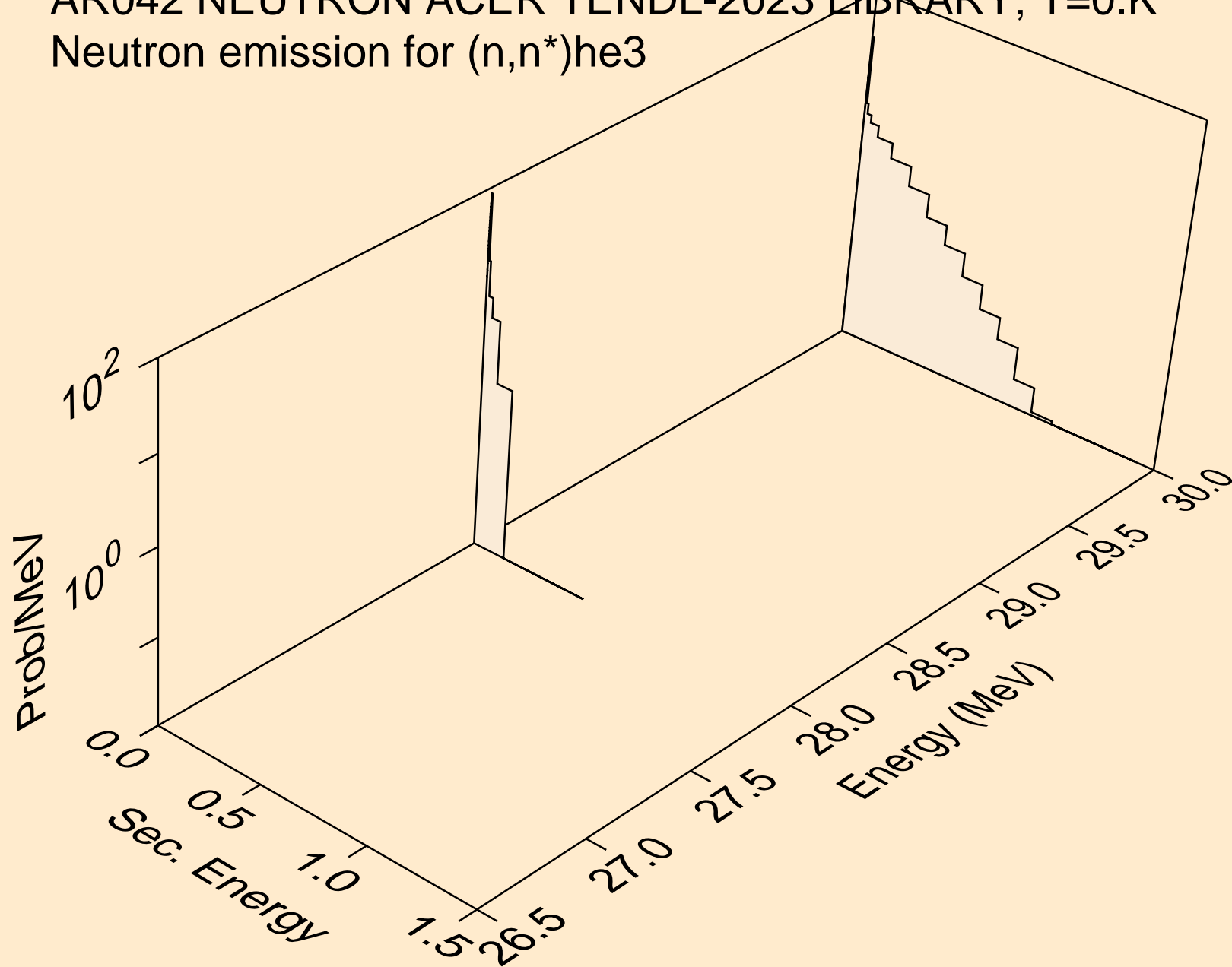

AR042 NEUTRON ACER TENDL-2023 LIBRARY; T=0.K
Neutron emission for (n,4n)

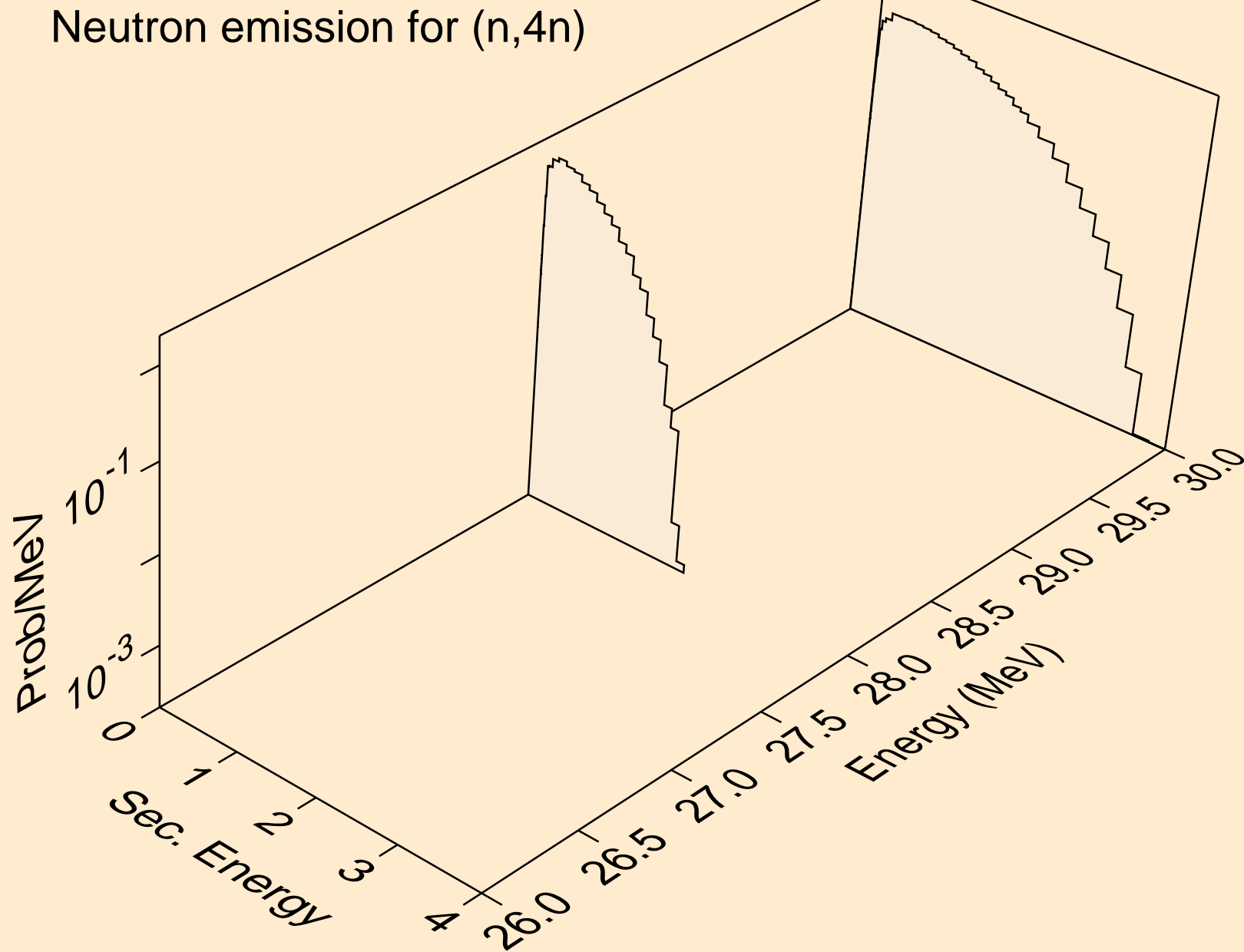

AR042 NEUTRON ACER TENDL-2023 LIBRARY; T=0.K
Neutron emission for (n,2np)

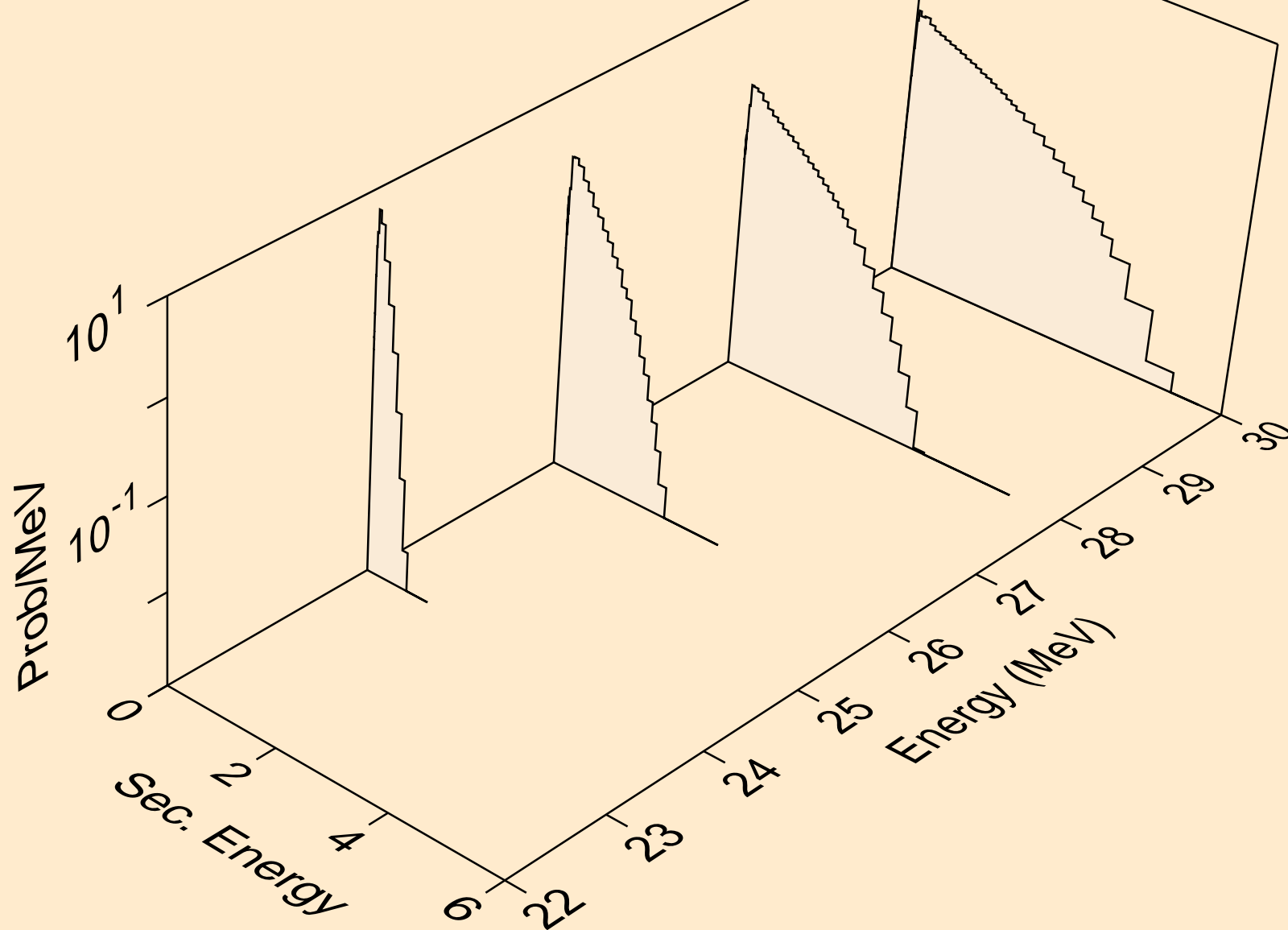

AR042 NEUTRON ACER TENDL-2023 LIBRARY; T=0.K
Neutron emission for (n,3np)

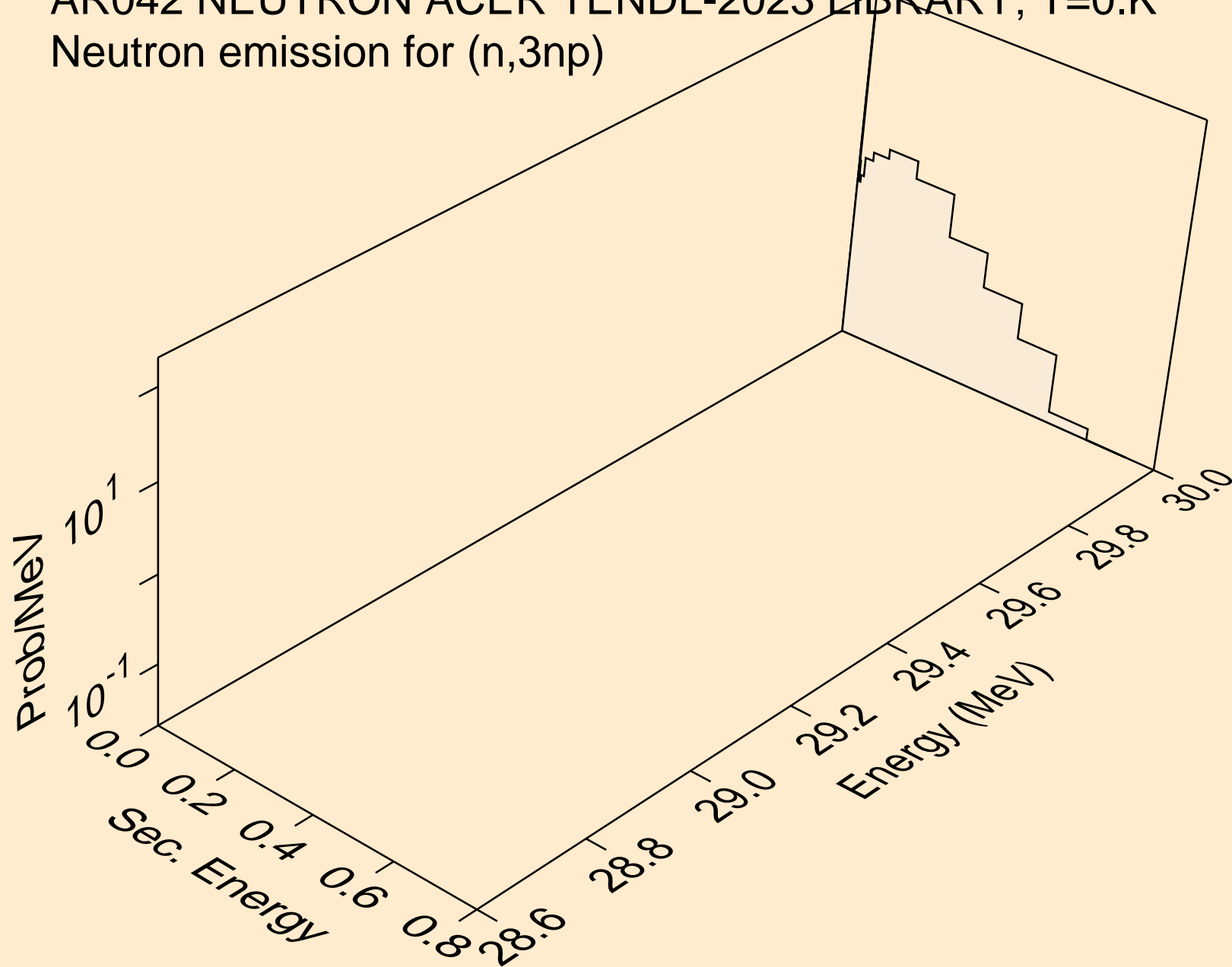

AR042 NEUTRON ACER TENDL-2023 LIBRARY; T=0.K
Neutron emission for (n,n*c)

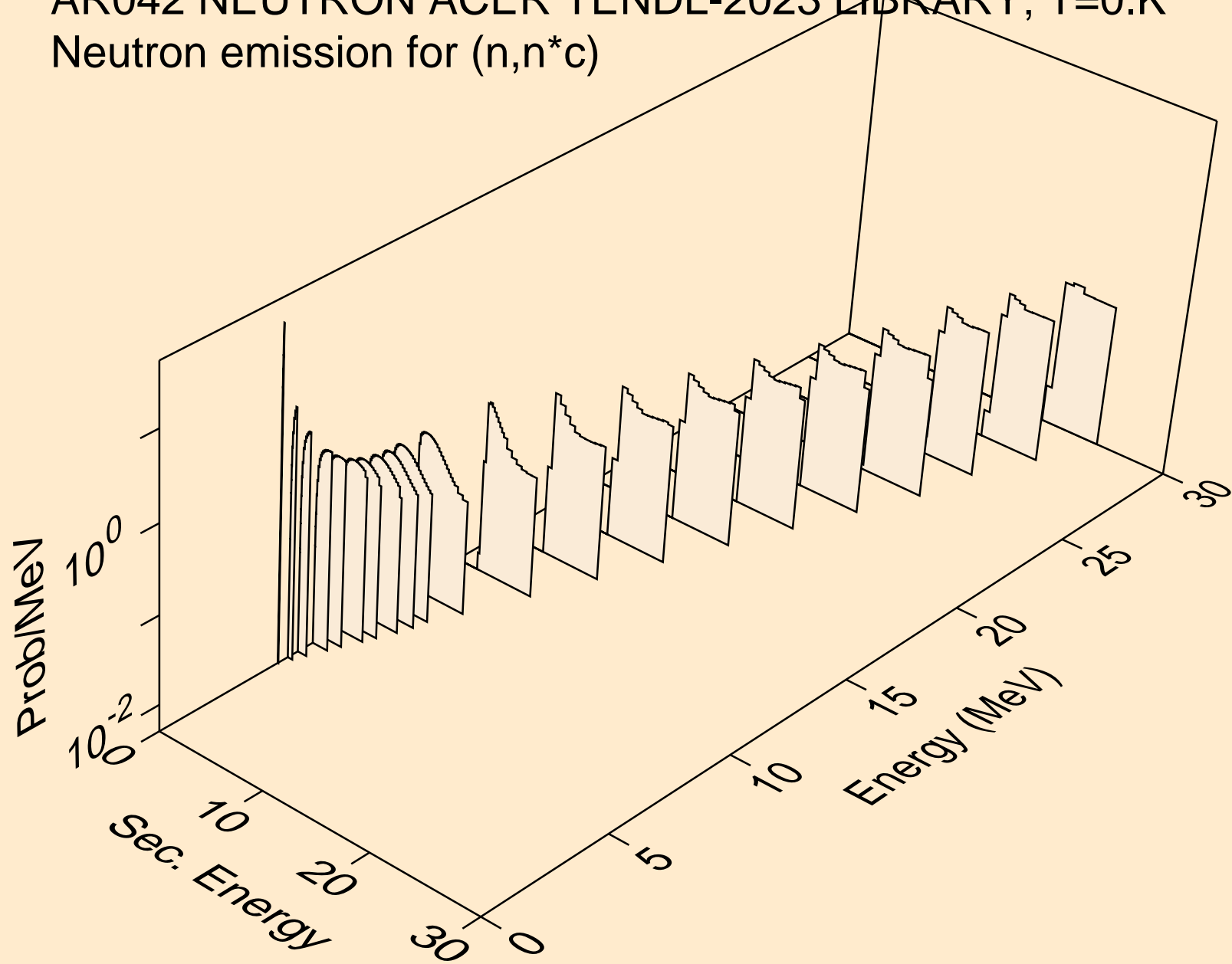

AR042 NEUTRON ACER TENDL-2023 LIBRARY; T=0.K
Photon emission for (n,x)

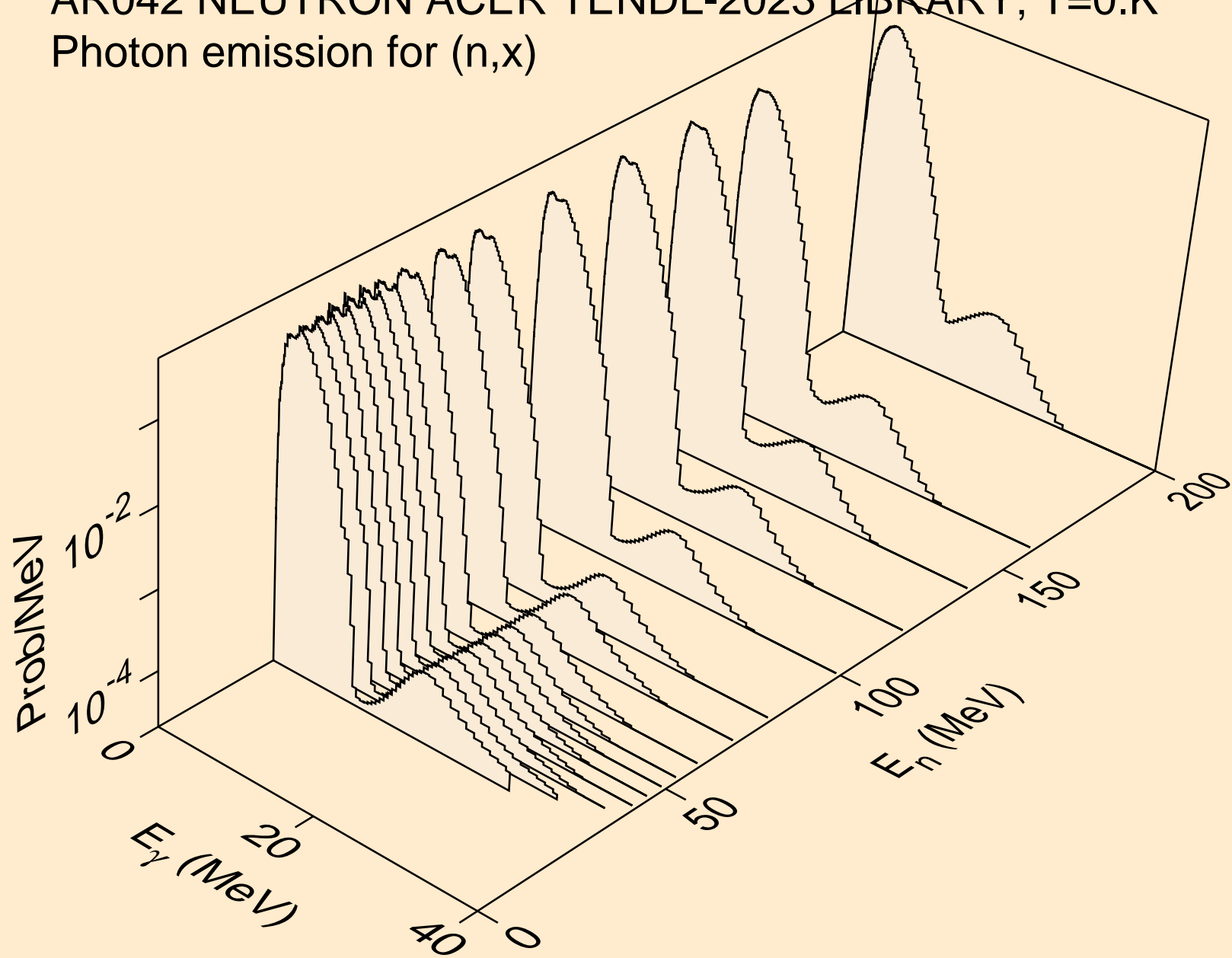

AR042 NEUTRON ACER TENDL-2023 LIBRARY; T=0.K
Photon emission for (n,2nd)

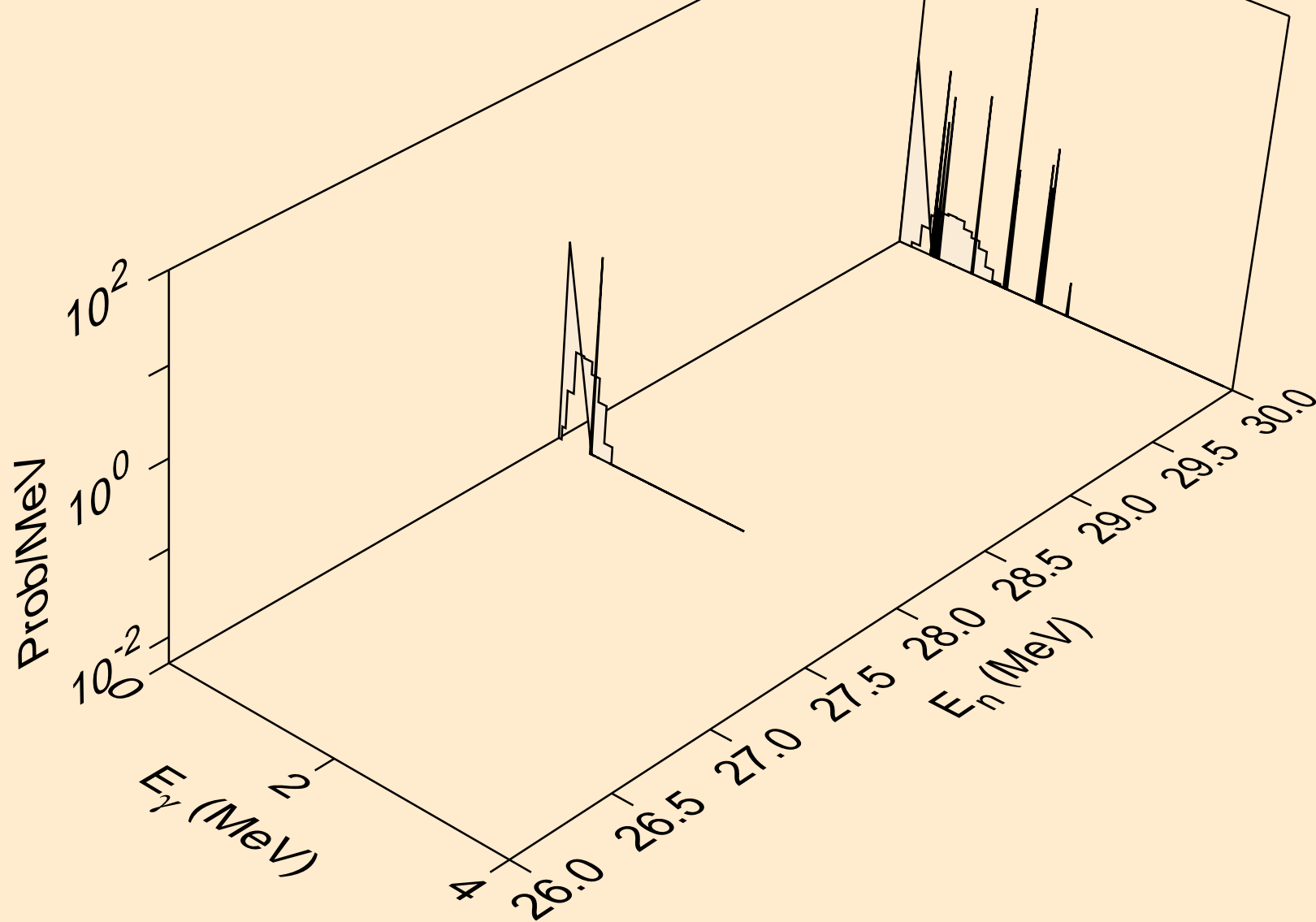

AR042 NEUTRON ACER TENDL-2023 LIBRARY; T=0.K
Photon emission for (n,2n)

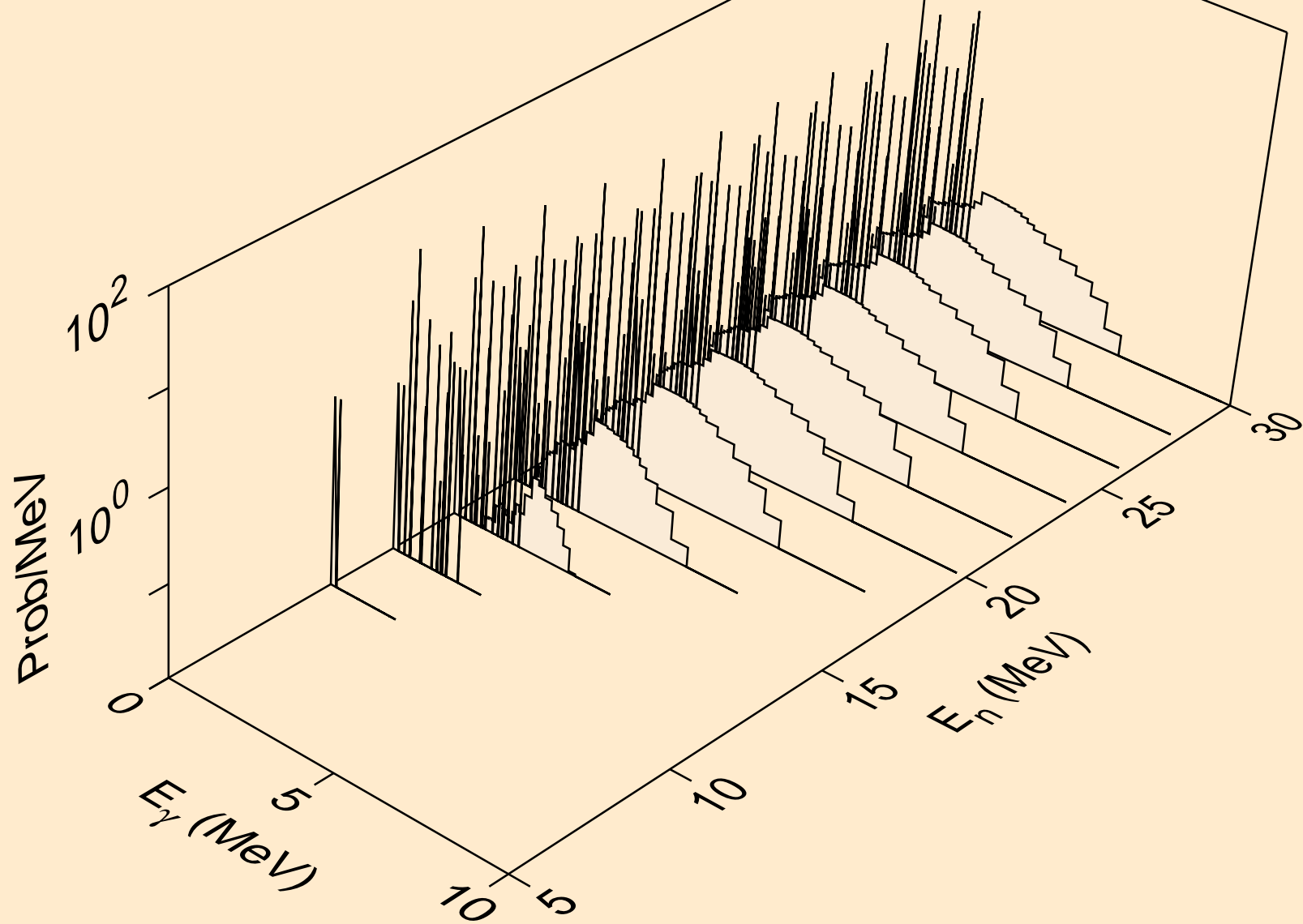

AR042 NEUTRON ACER TENDL-2023 LIBRARY; T=0.K
Photon emission for (n,3n)

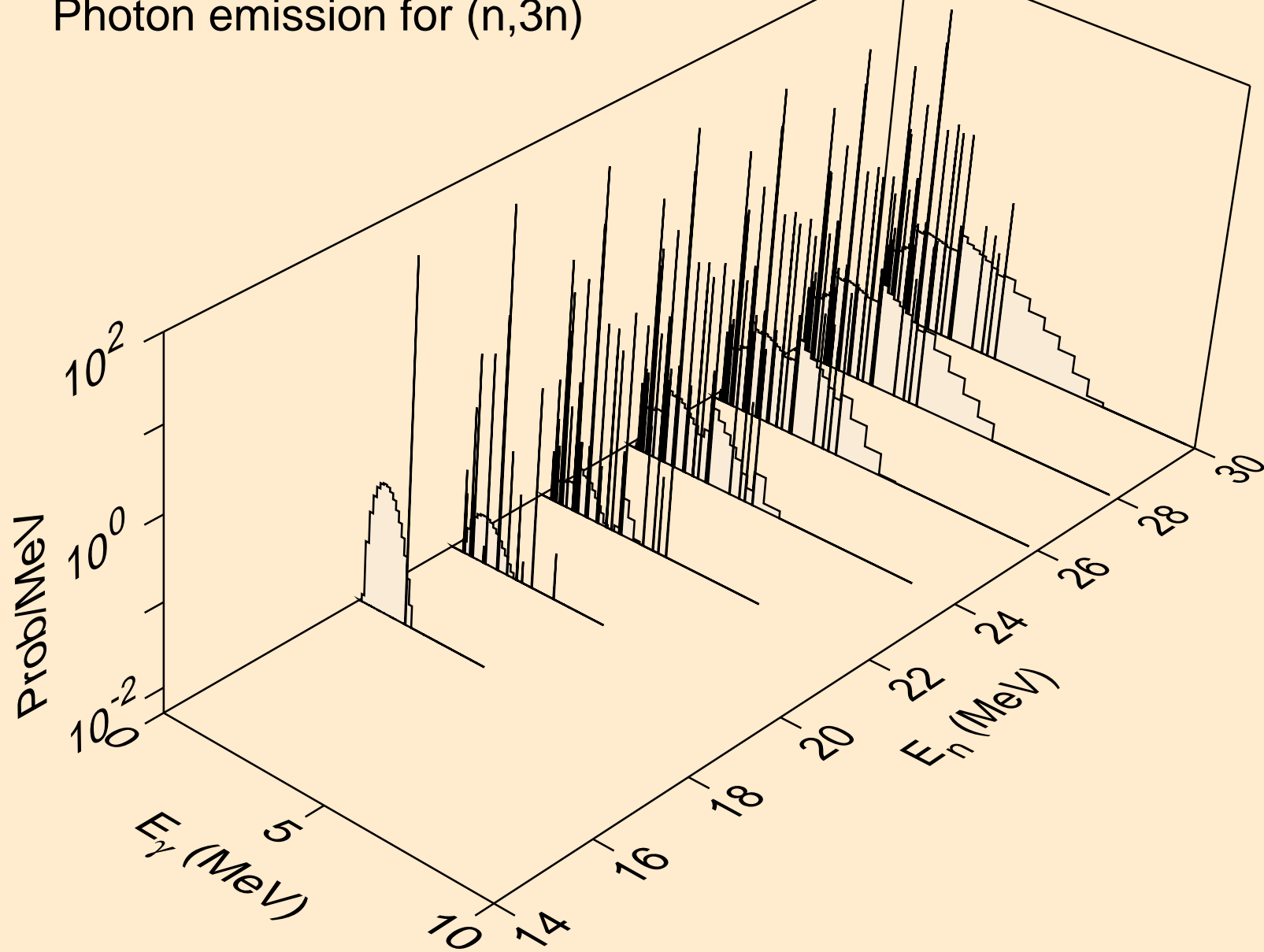

AR042 NEUTRON ACER TENDL-2023 LIBRARY; T=0.K
Photon emission for (n,n*)a

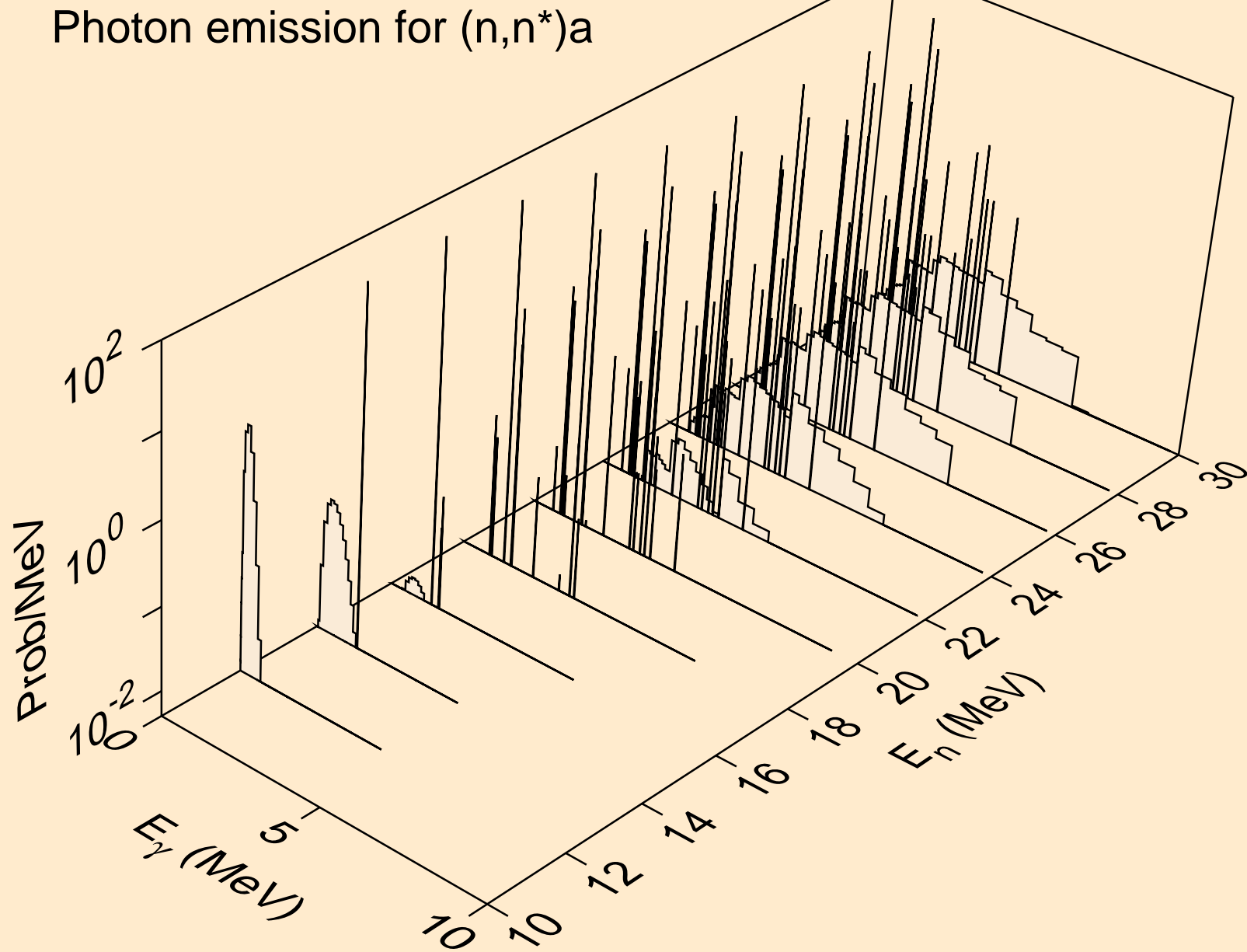

AR042 NEUTRON ACER TENDL-2023 LIBRARY; T=0.K
Photon emission for (n,2n)a

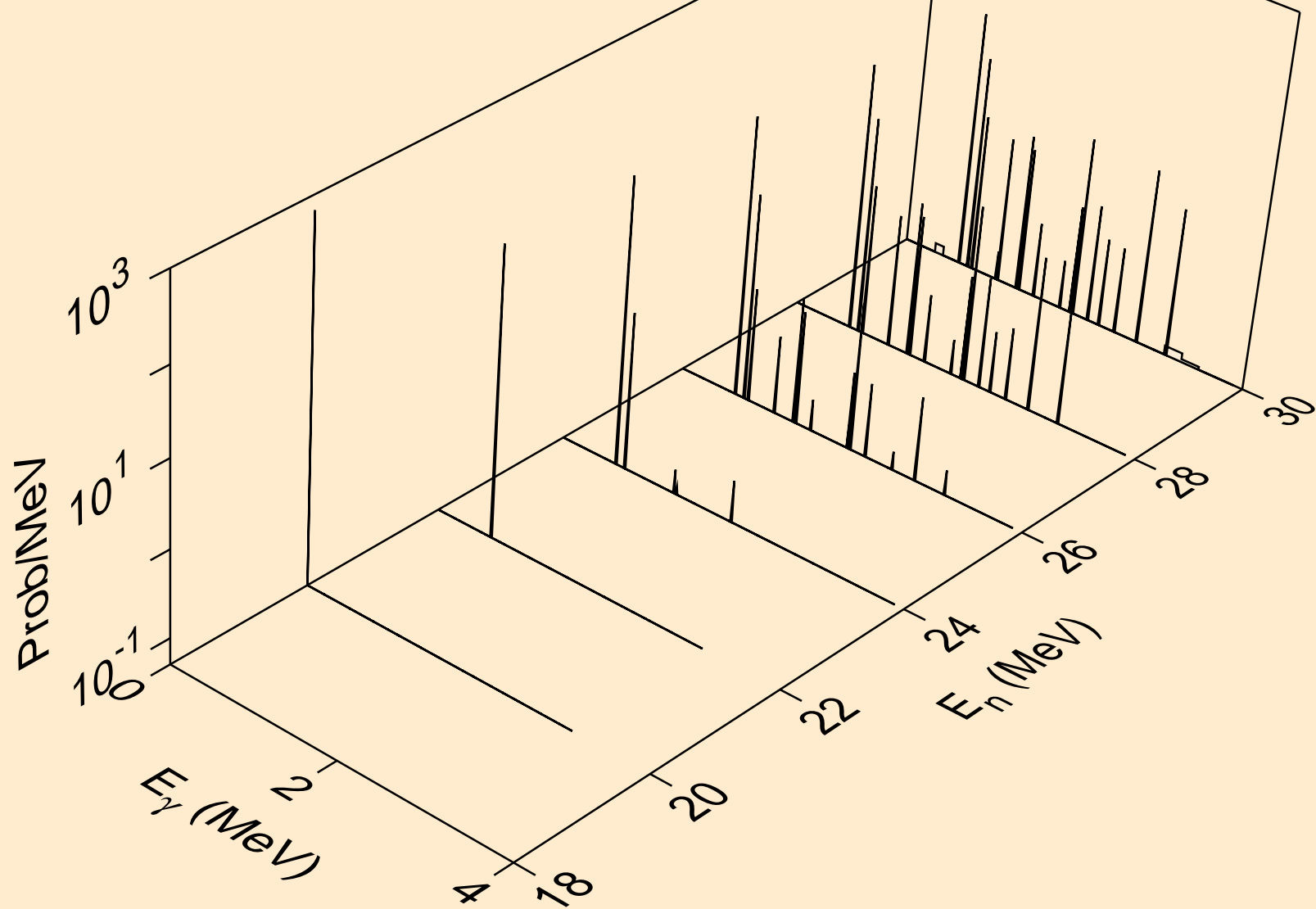

AR042 NEUTRON ACER TENDL-2023 LIBRARY; T=0.K
Photon emission for (n,3n)a

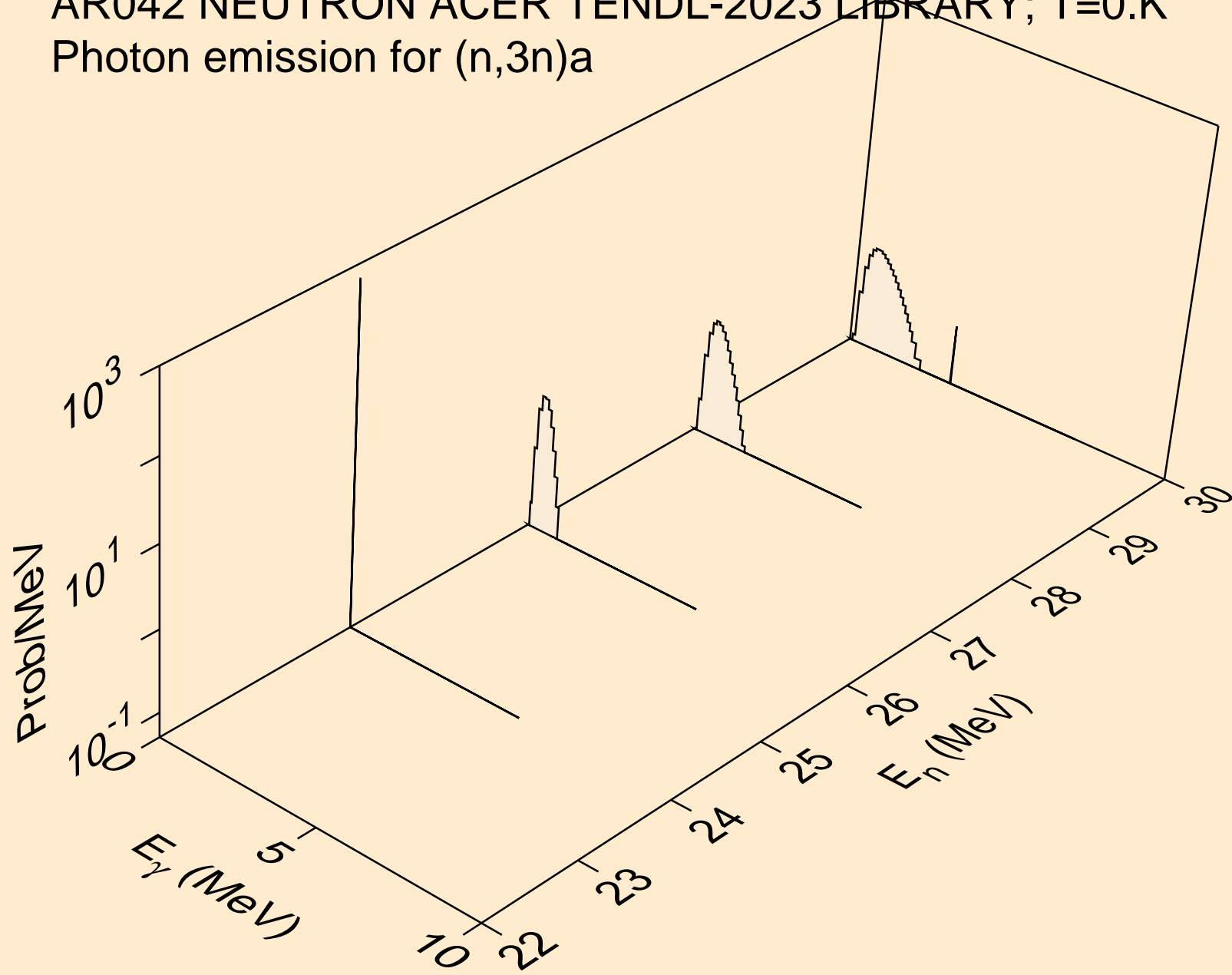

AR042 NEUTRON ACER TENDL-2023 LIBRARY; T=0.K
Photon emission for (n,n*)p

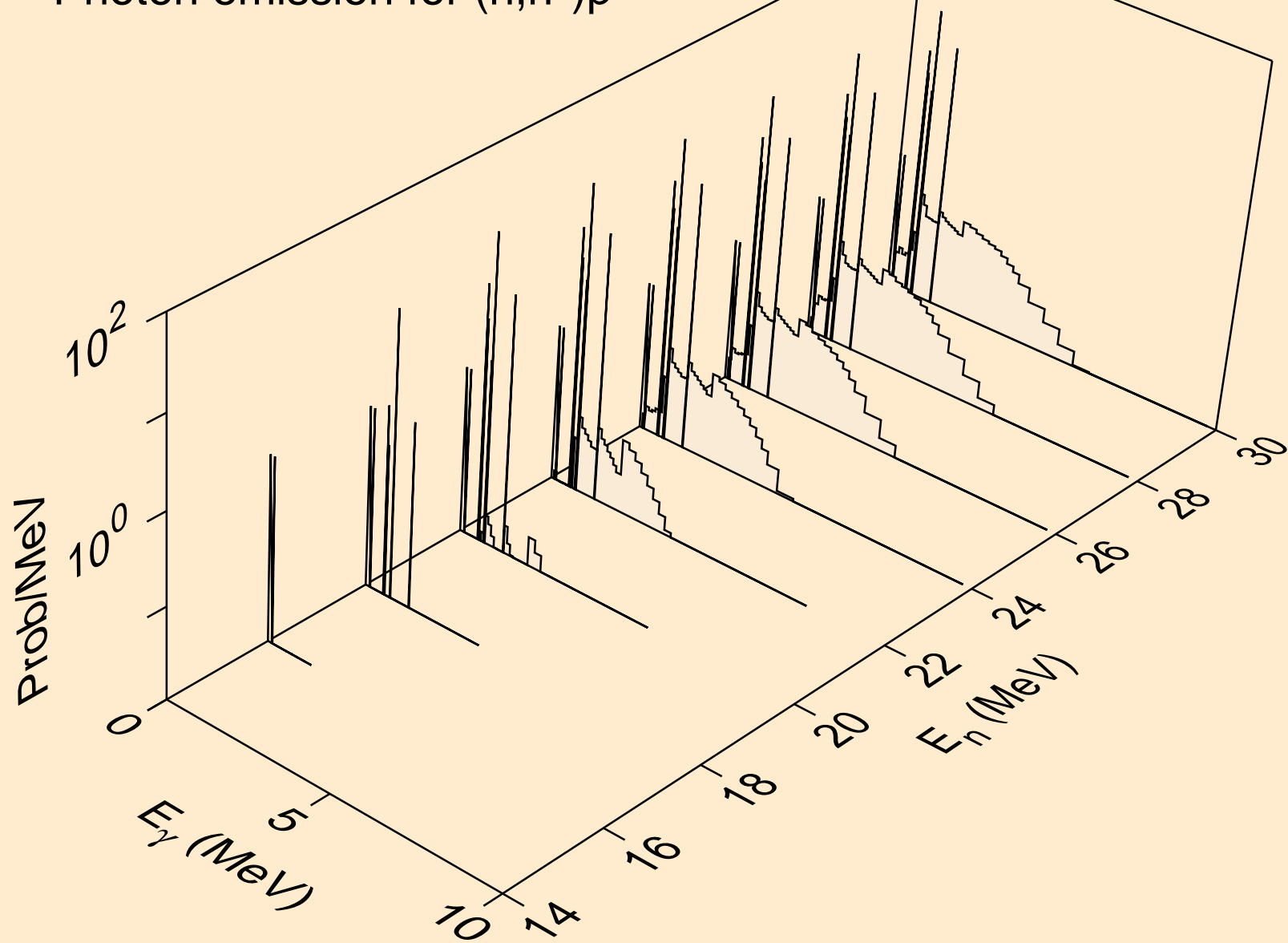

AR042 NEUTRON ACER TENDL-2023 LIBRARY; T=0.K
Photon emission for (n,n*)2a

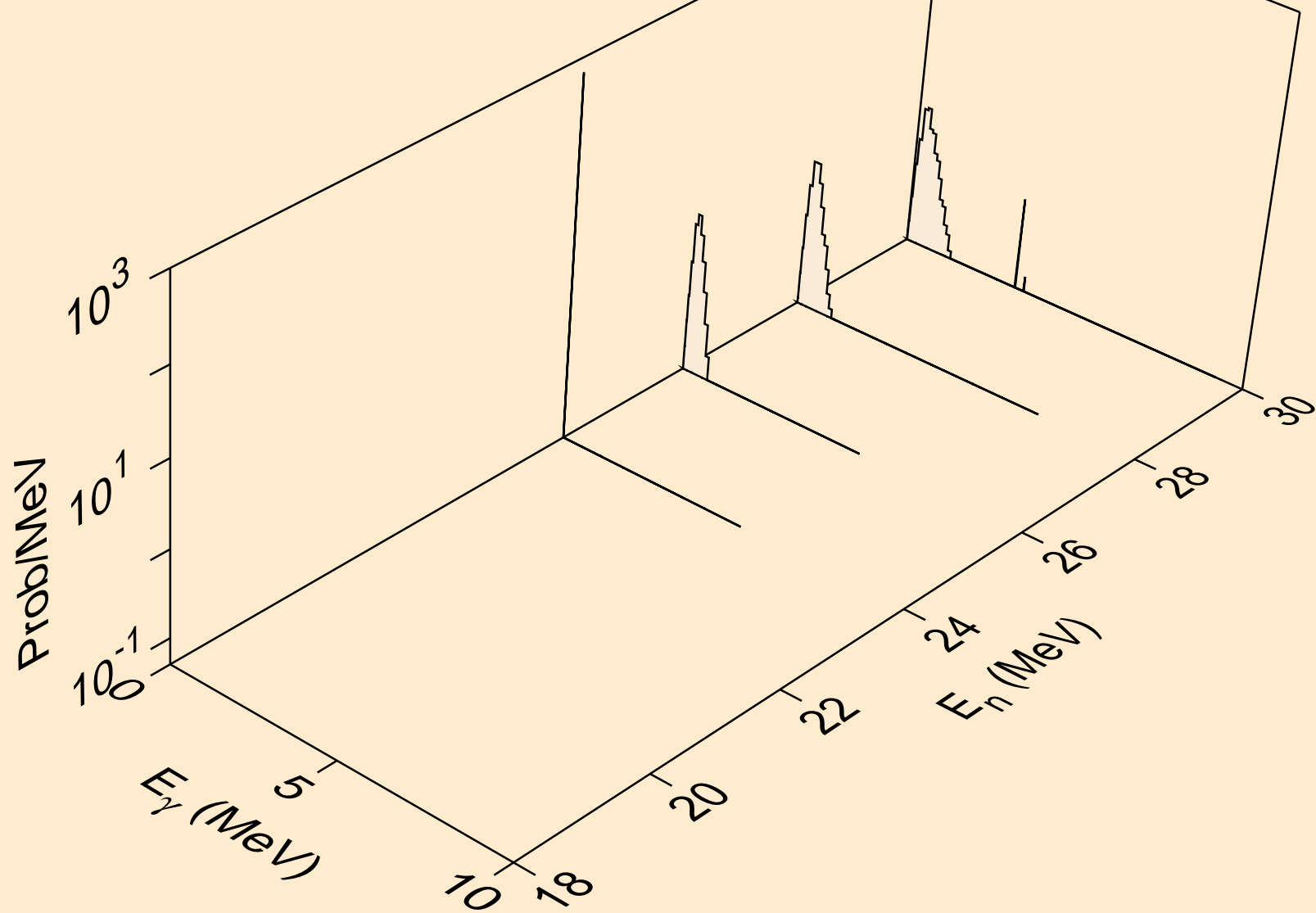

AR042 NEUTRON ACER TENDL-2023 LIBRARY; T=0.K
Photon emission for (n,n*)d

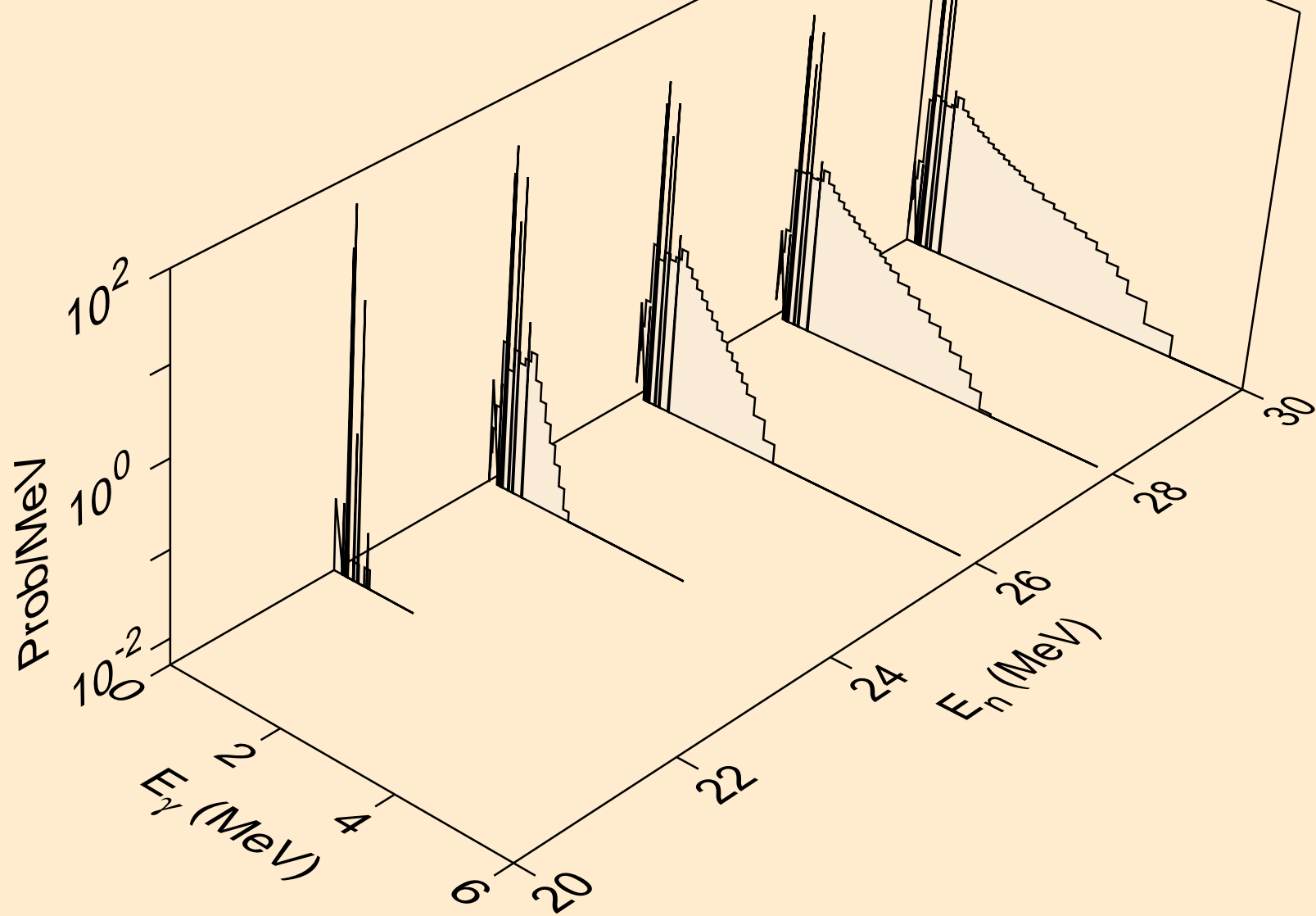

AR042 NEUTRON ACER TENDL-2023 LIBRARY; T=0.K
Photon emission for (n,n*)t

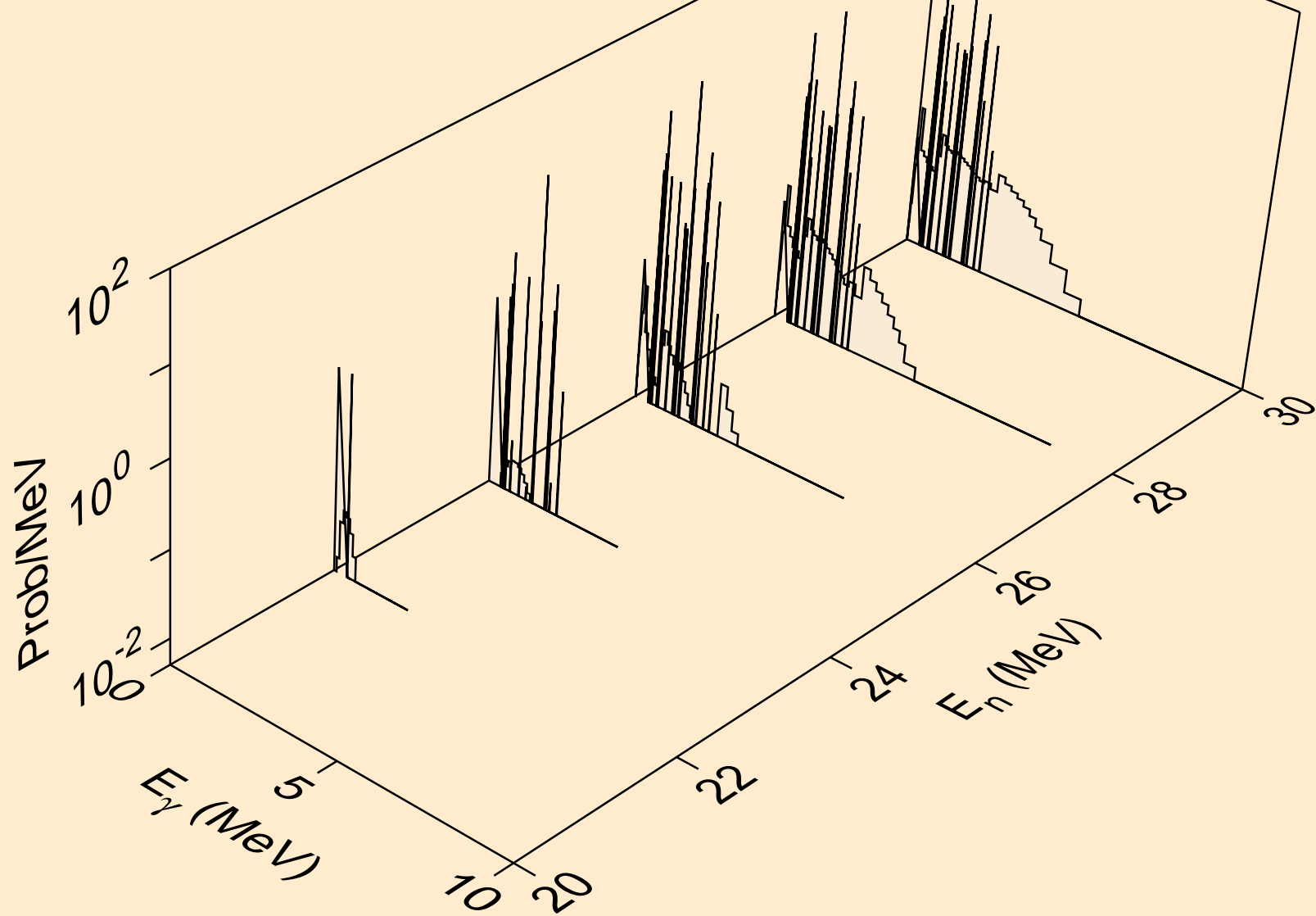

AR042 NEUTRON ACER TENDL-2023 LIBRARY; T=0.K
Photon emission for (n,n*)he3

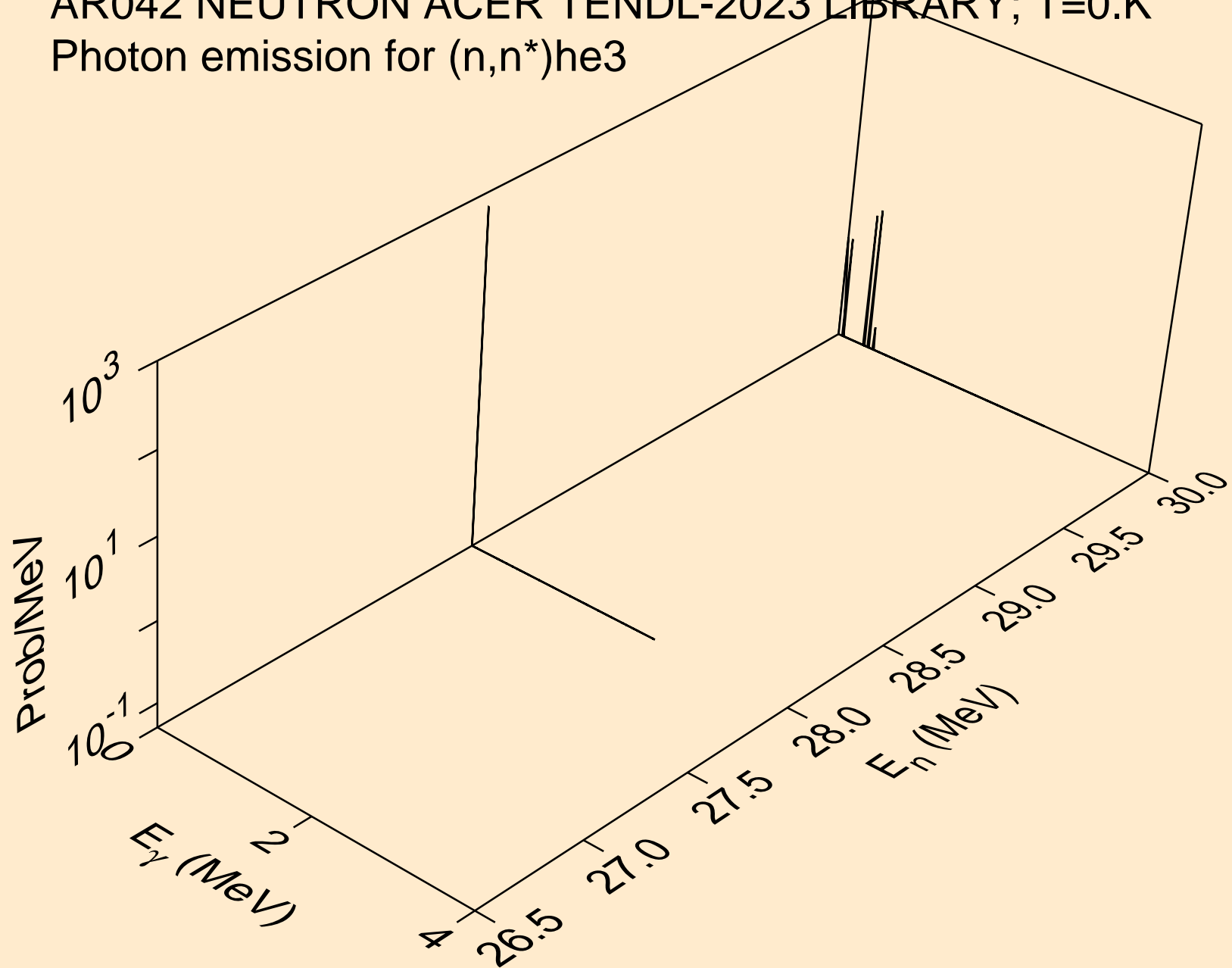

AR042 NEUTRON ACER TENDL-2023 LIBRARY; T=0.K
Photon emission for (n,4n)

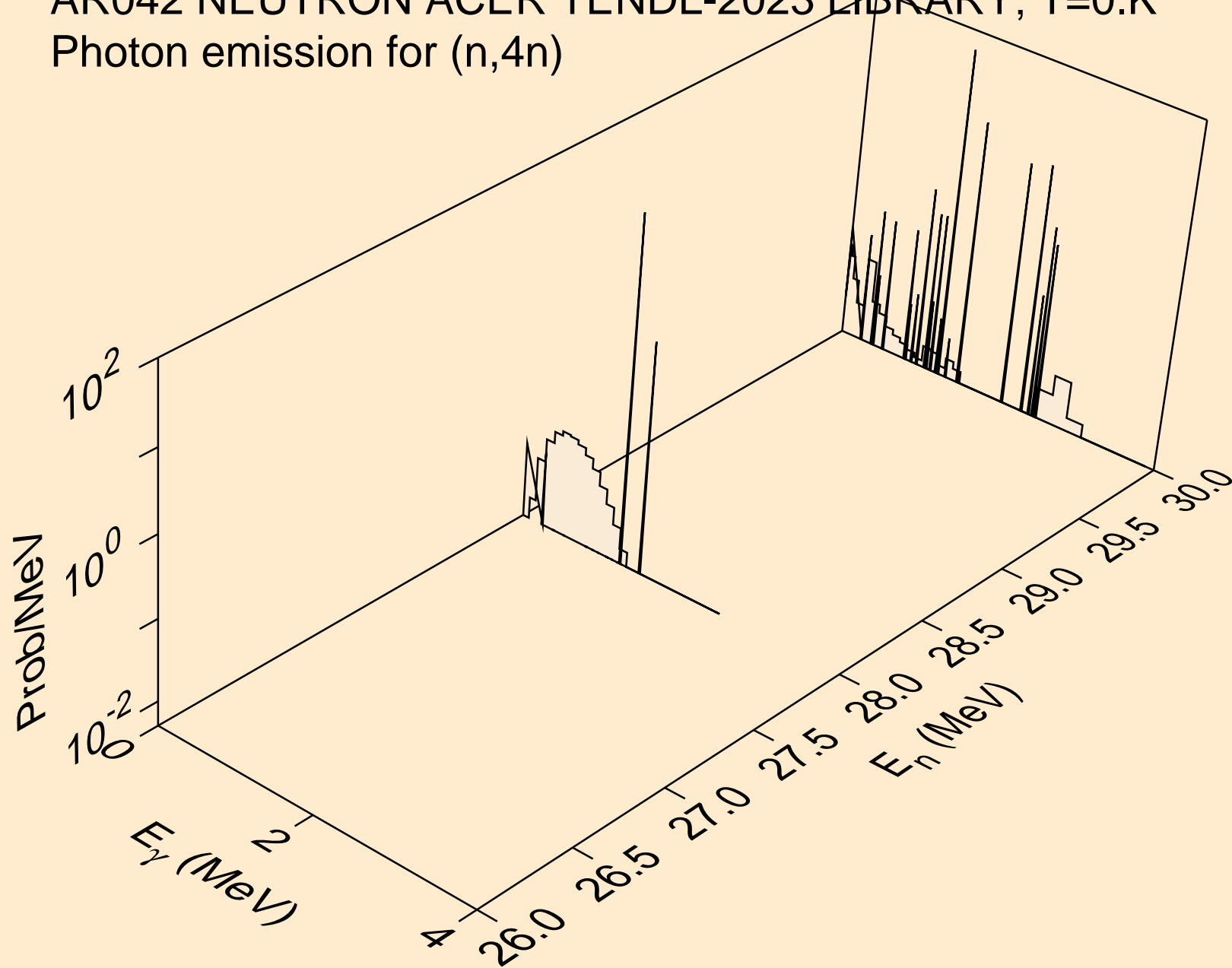

AR042 NEUTRON ACER TENDL-2023 LIBRARY; T=0.K
Photon emission for (n,2np)

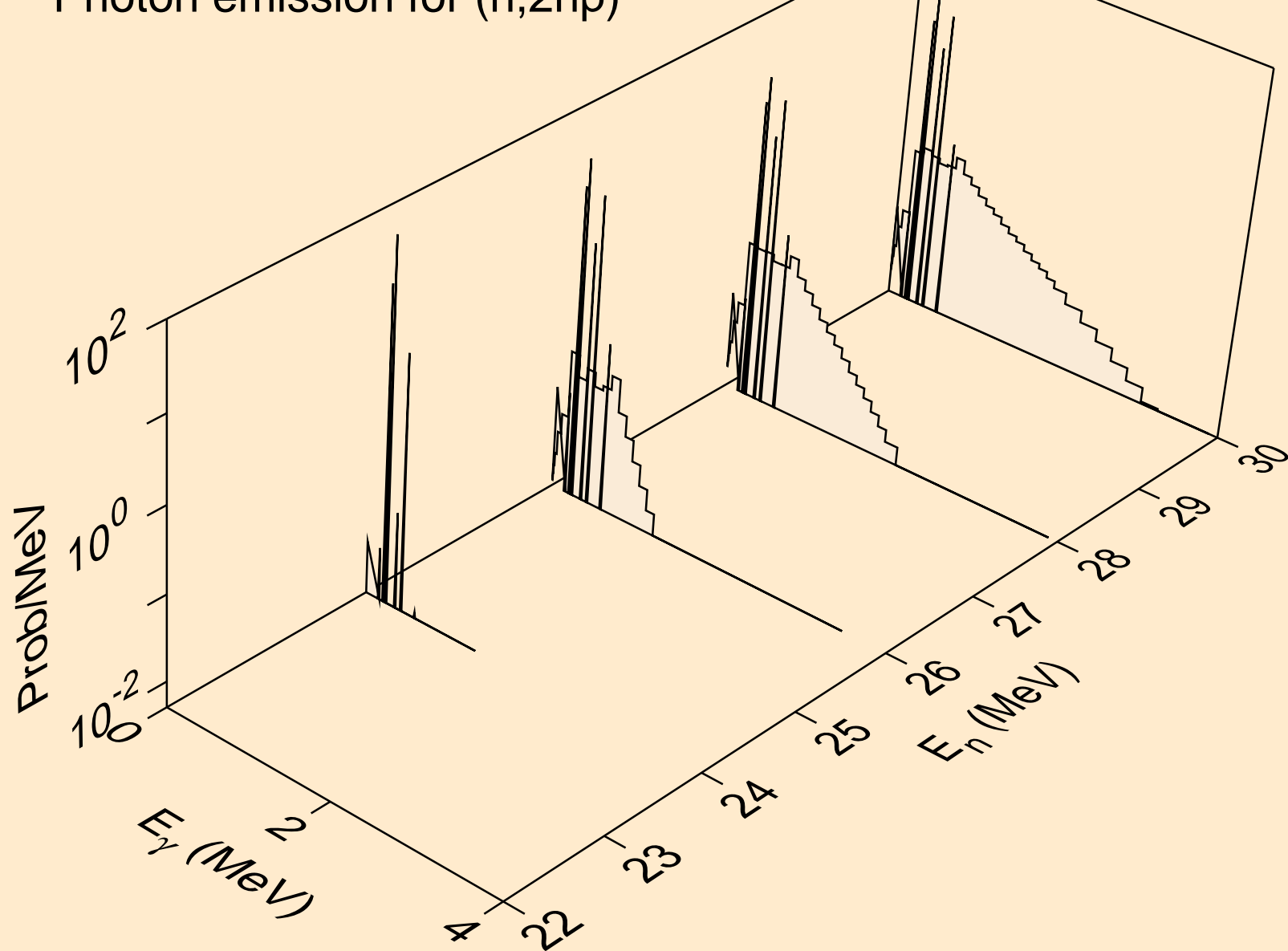

AR042 NEUTRON ACER TENDL-2023 LIBRARY; T=0.K
Photon emission for (n,3np)

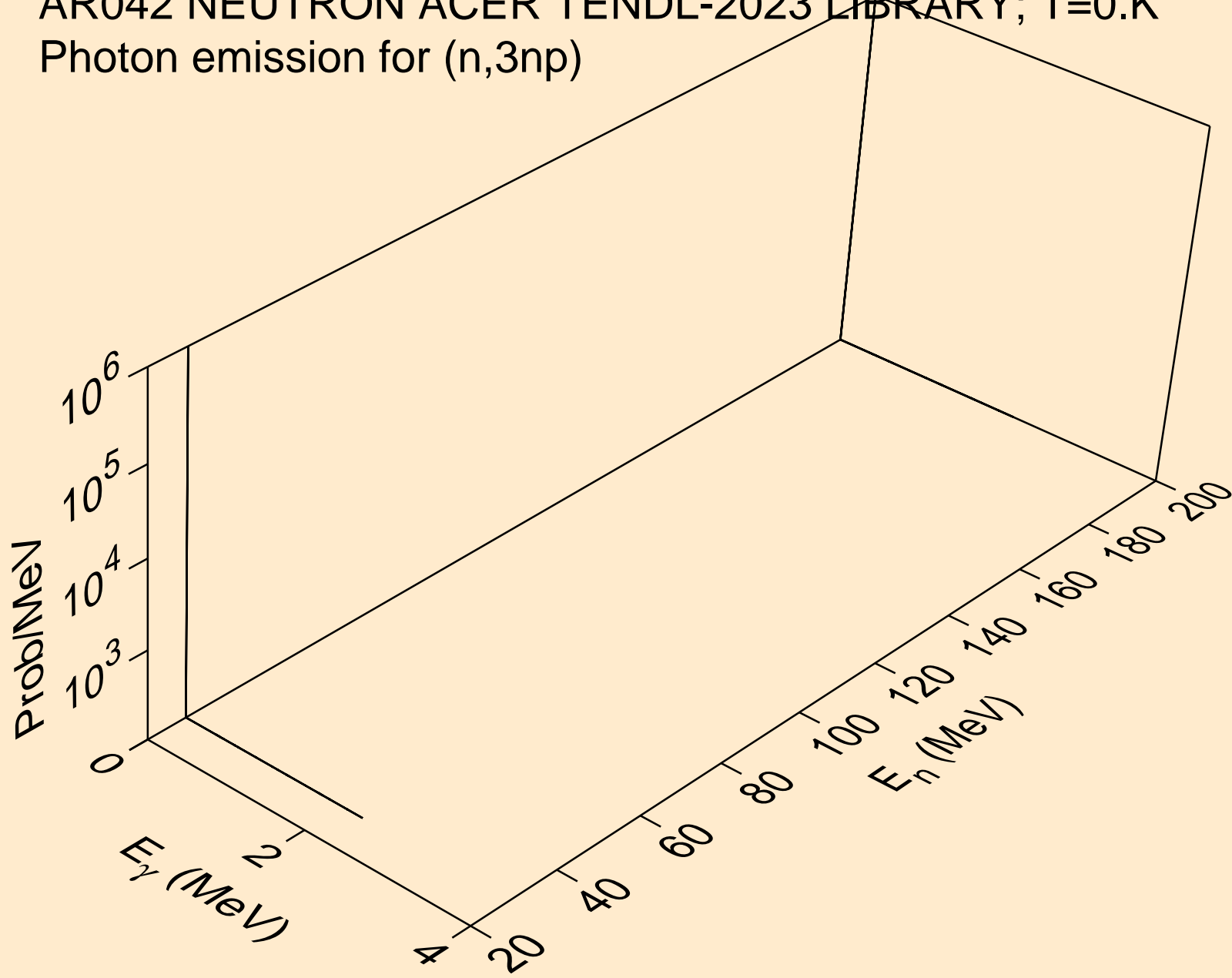

AR042 NEUTRON ACER TENDL-2023 LIBRARY; T=0.K
Photon emission for (n,n*c)

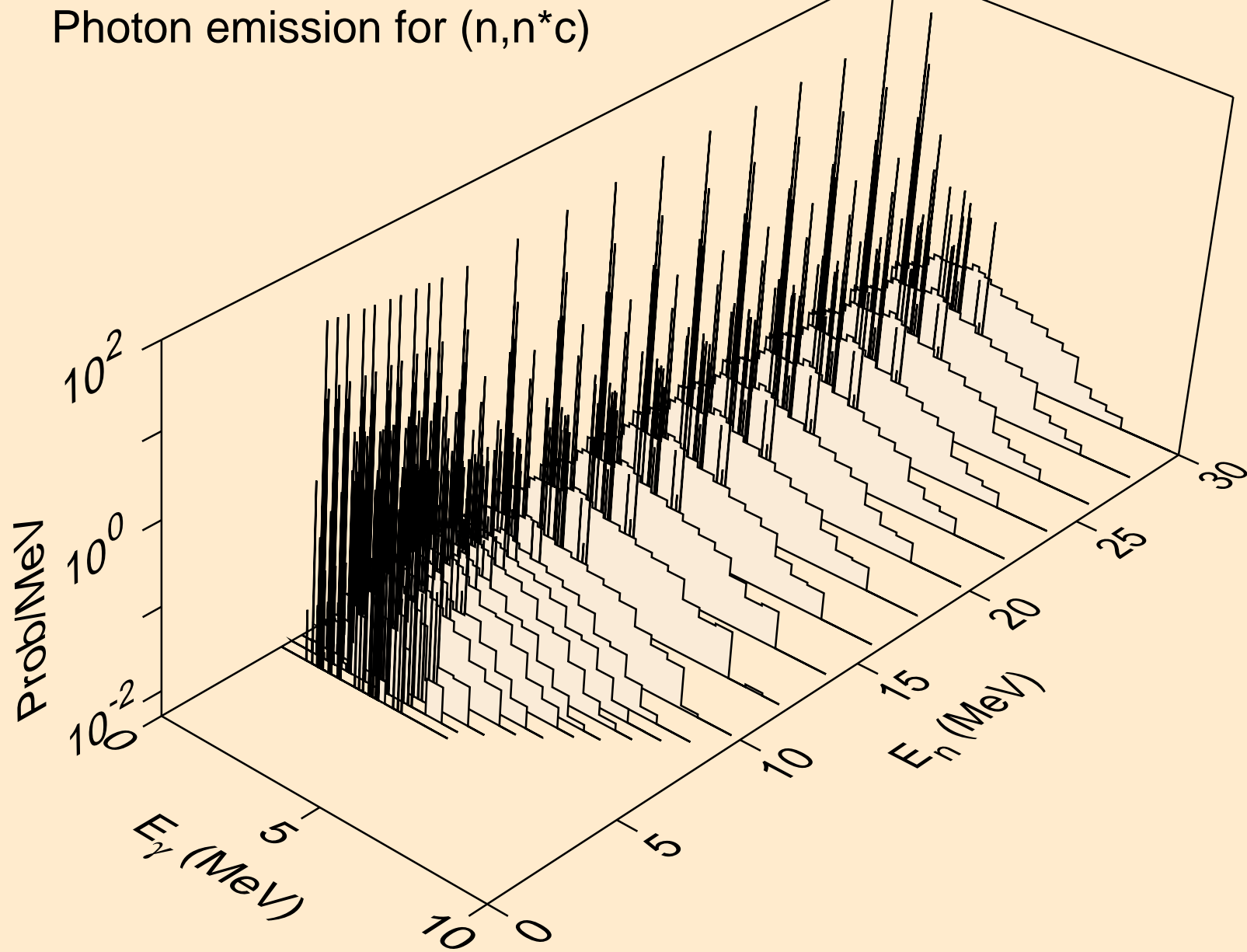

AR042 NEUTRON ACER TENDL-2023 LIBRARY; T=0.K
Photon emission for (n,gma)

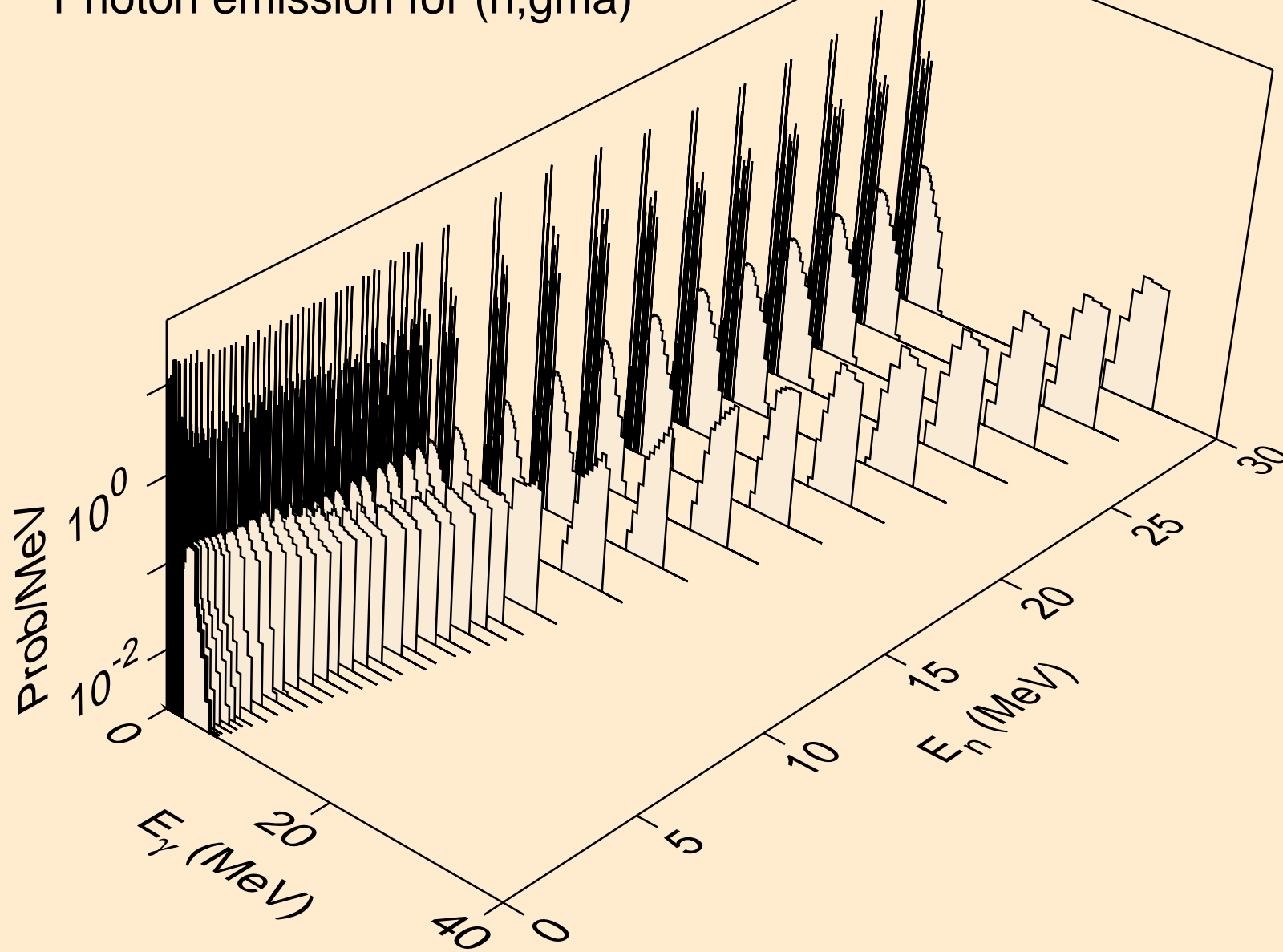

AR042 NEUTRON ACER TENDL-2023 LIBRARY; T=0.K
Photon emission for (n,p)

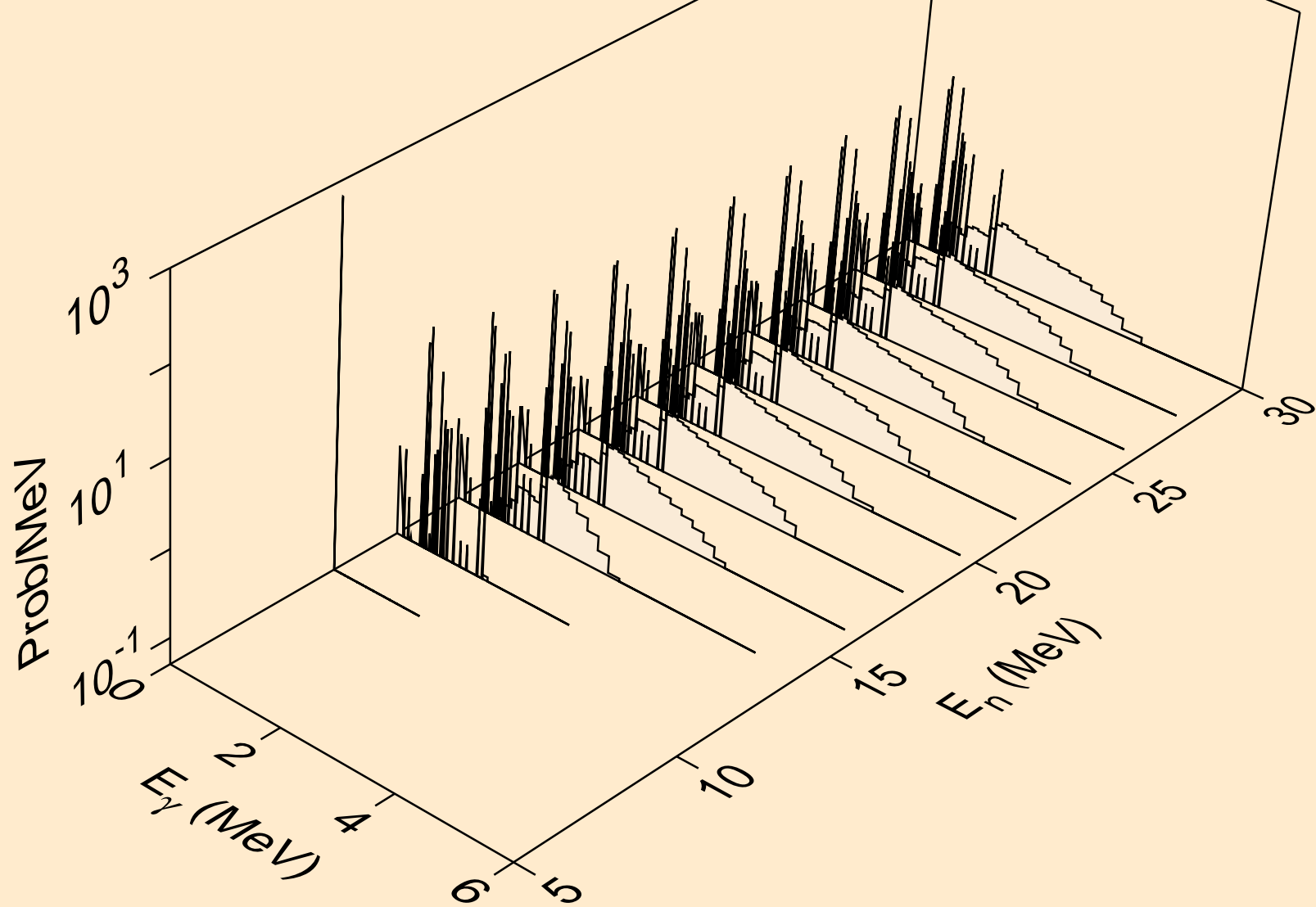

AR042 NEUTRON ACER TENDL-2023 LIBRARY; T=0.K
Photon emission for (n,d)

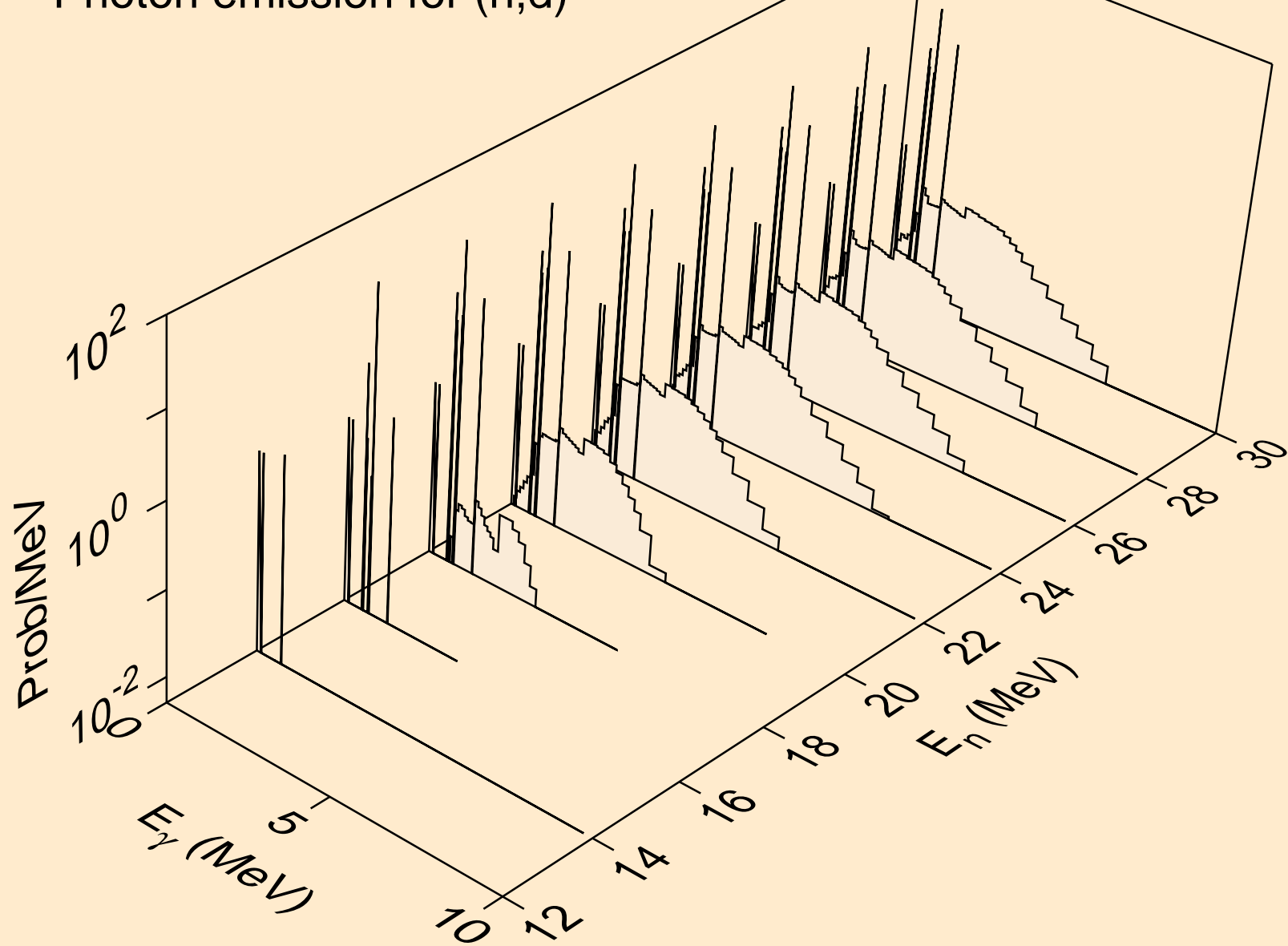

AR042 NEUTRON ACER TENDL-2023 LIBRARY; T=0.K
Photon emission for (n,t)

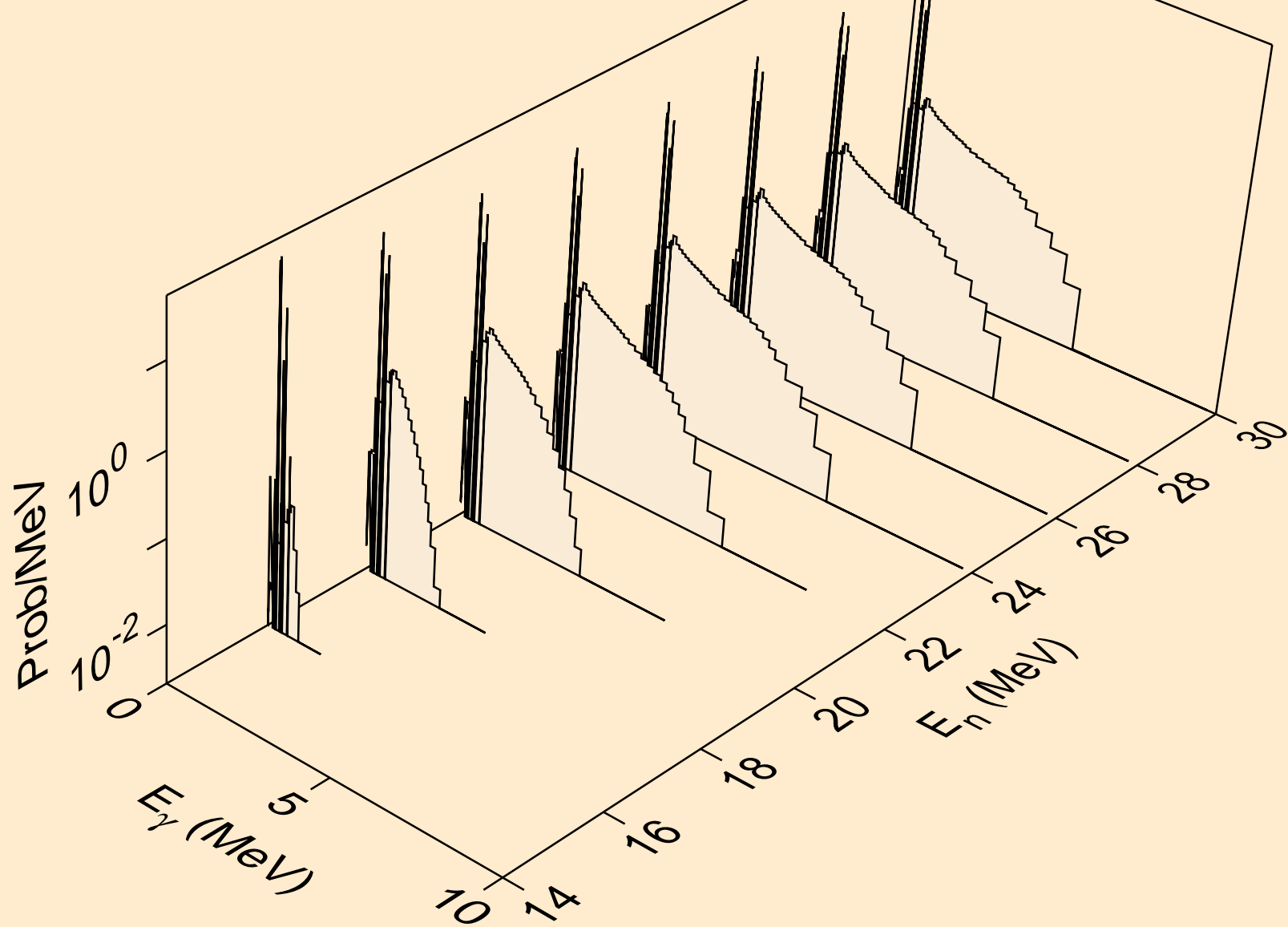

AR042 NEUTRON ACER TENDL-2023 LIBRARY; T=0.K
Photon emission for (n,he3)

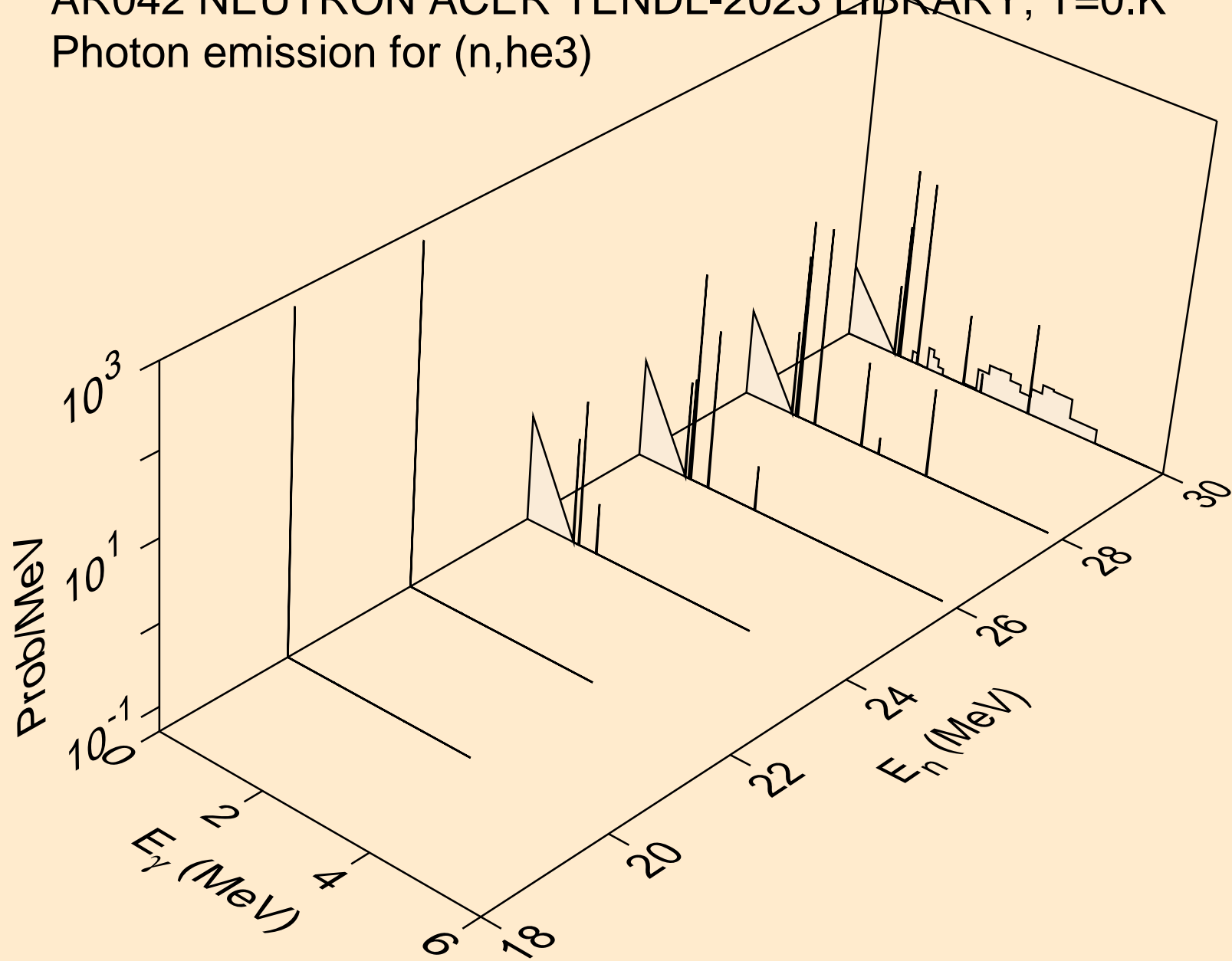

AR042 NEUTRON ACER TENDL-2023 LIBRARY; T=0.K
Photon emission for (n,a)

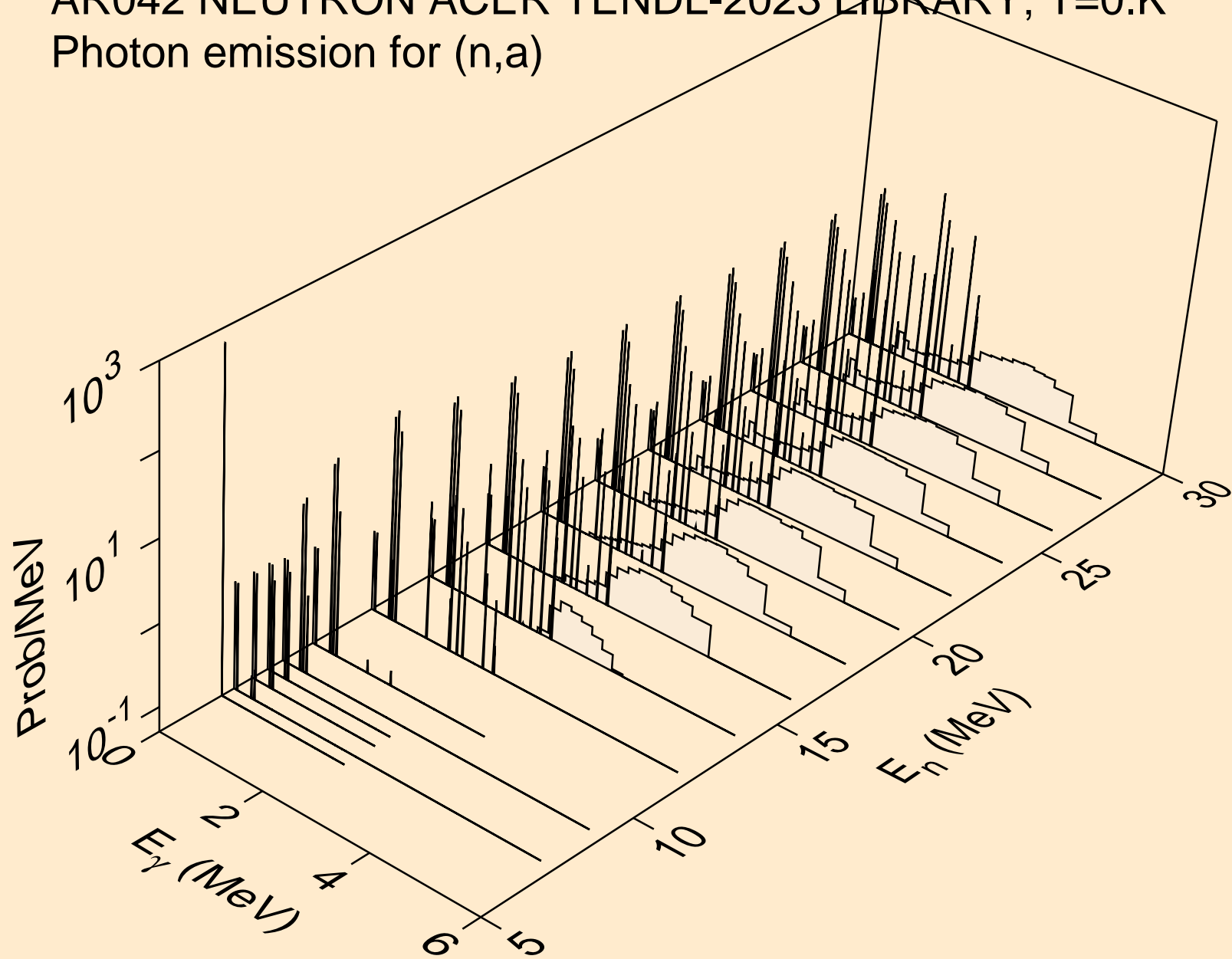

AR042 NEUTRON ACER TENDL-2023 LIBRARY; T=0.K
Photon emission for (n,2a)

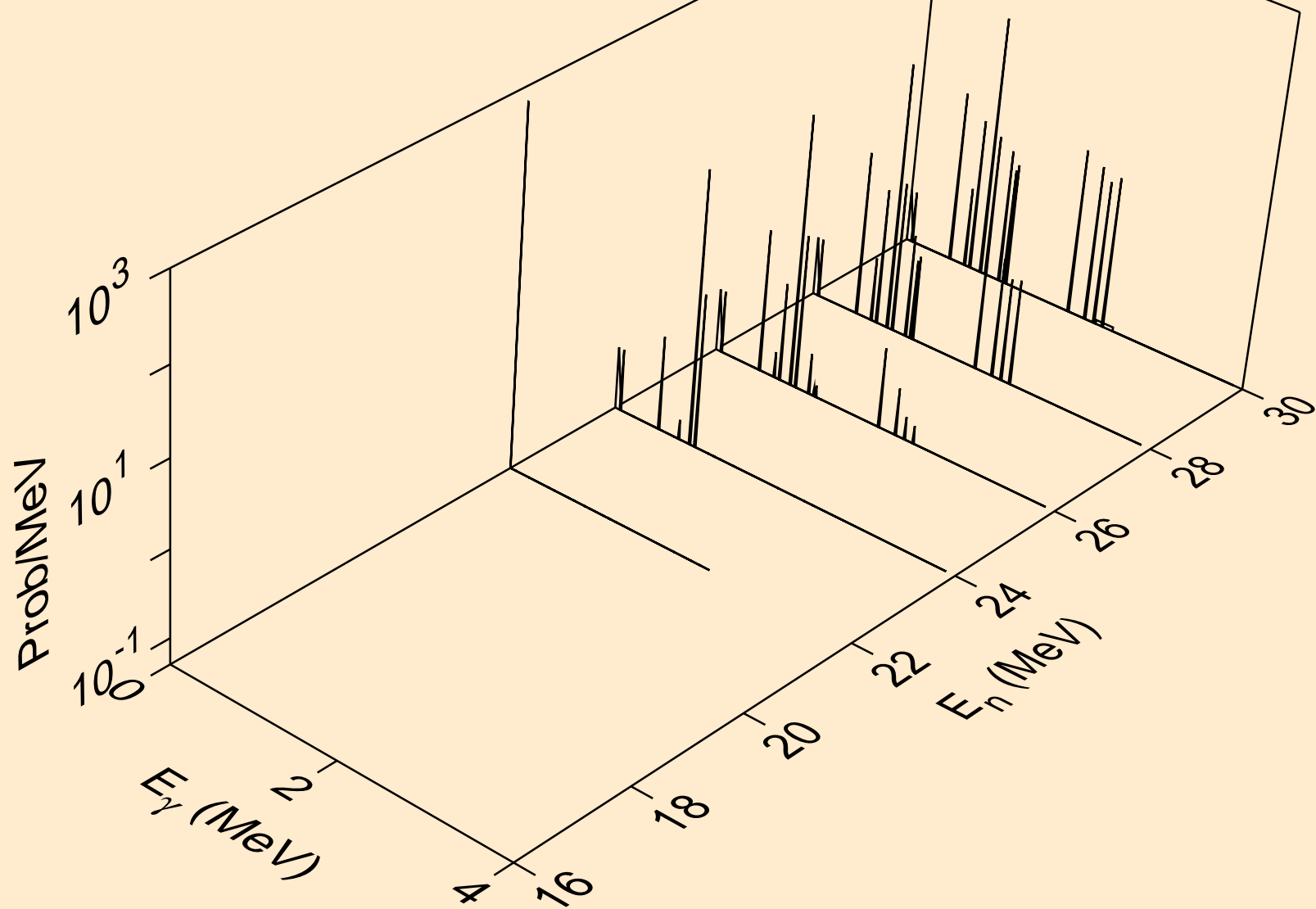

AR042 NEUTRON ACER TENDL-2023 LIBRARY; T=0.K
Photon emission for (n,2p)

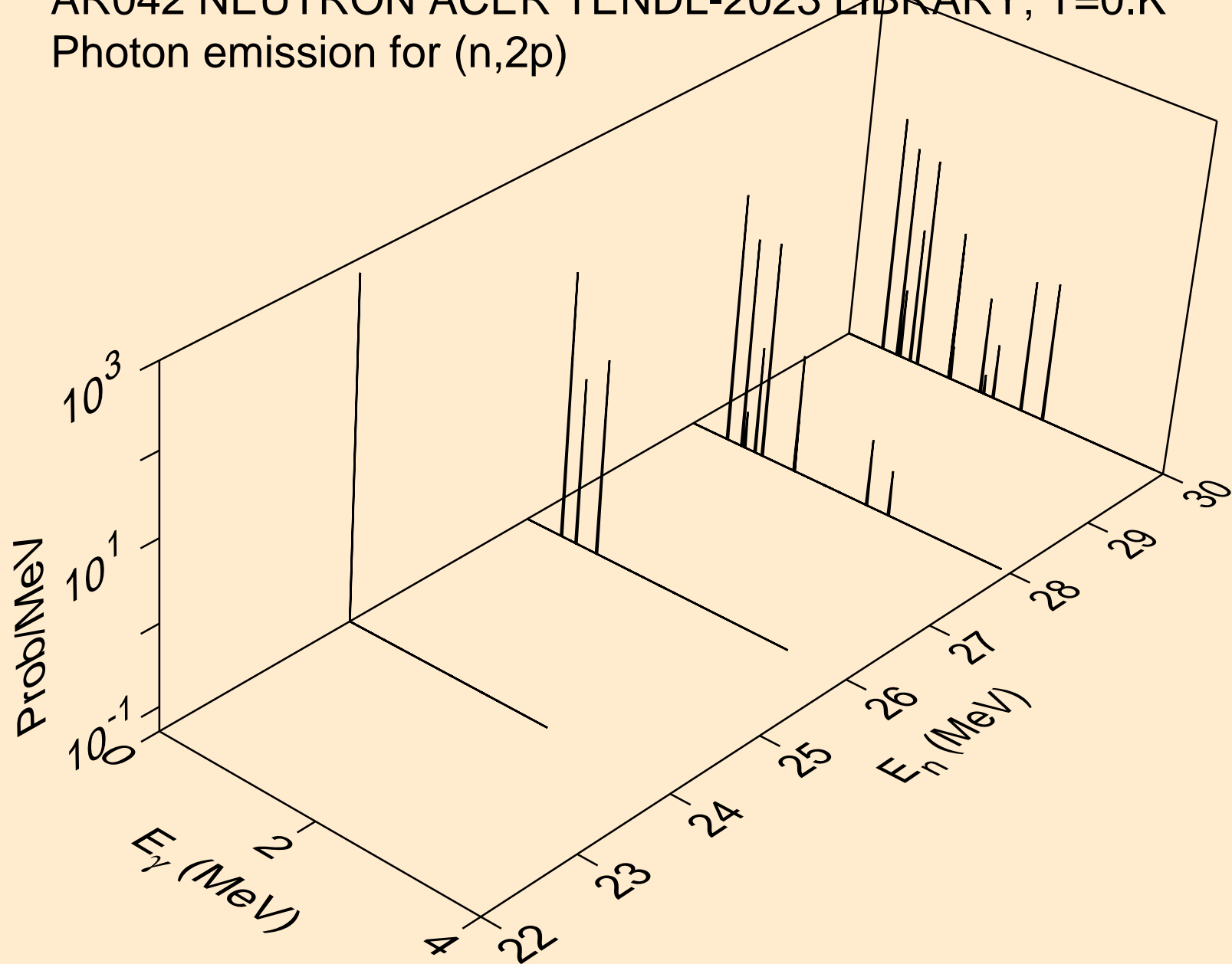

AR042 NEUTRON ACER TENDL-2023 LIBRARY; T=0.K
Photon emission for (n,p)

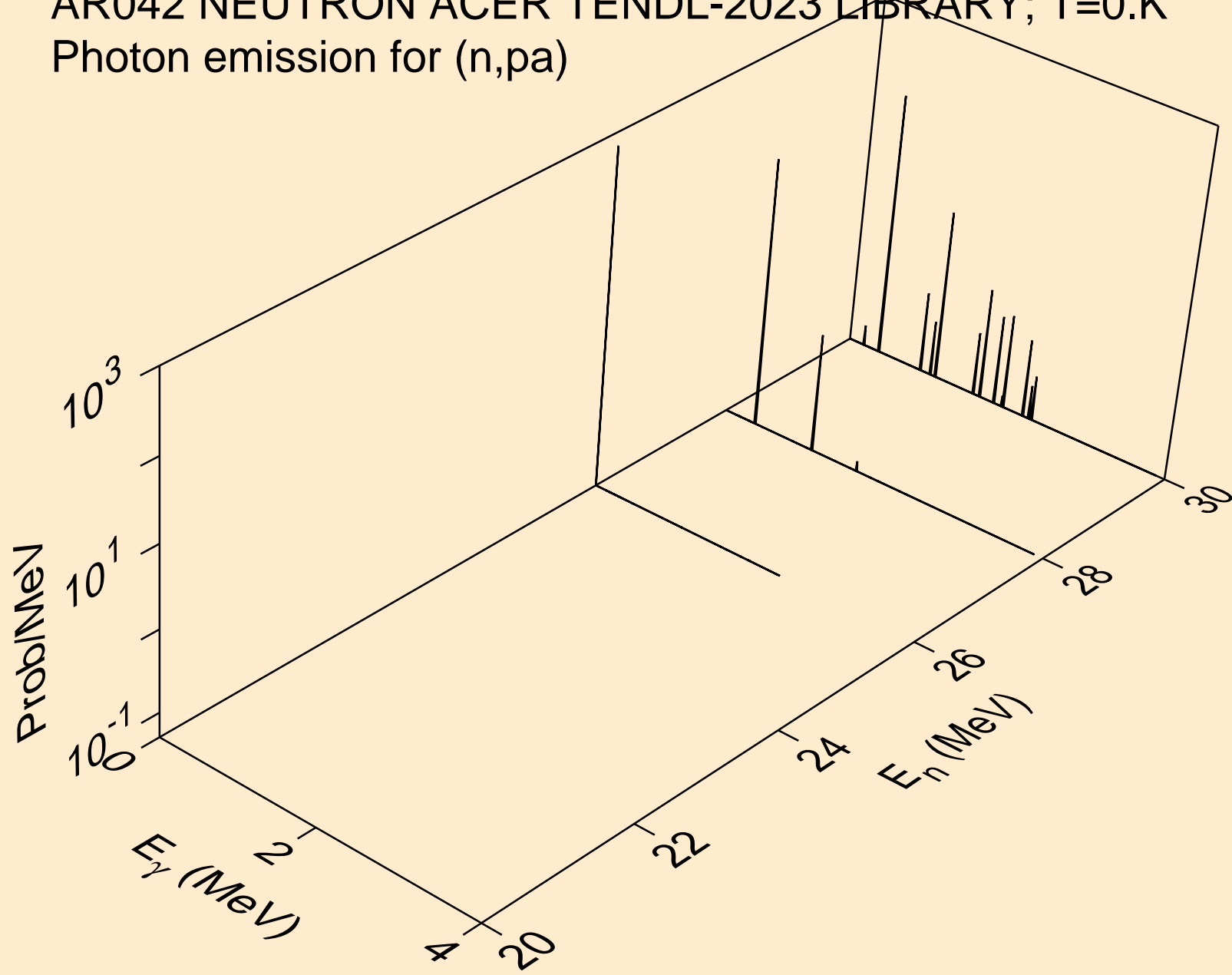

AR042 NEUTRON ACER TENDL-2023 LIBRARY; T=0.K
Photon emission for (n,pd)

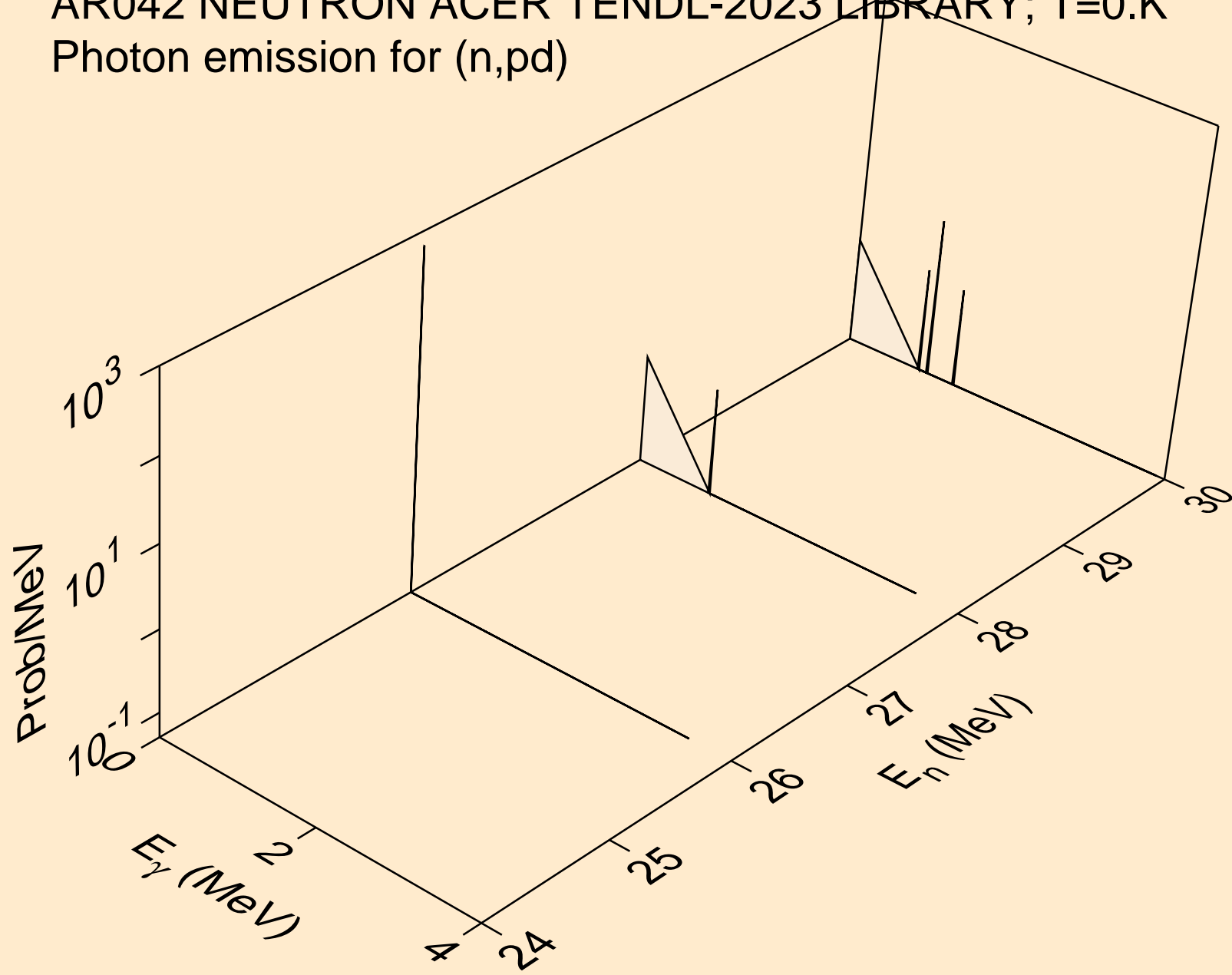

AR042 NEUTRON ACER TENDL-2023 LIBRARY; T=0.K
Photon emission for (n,pt)

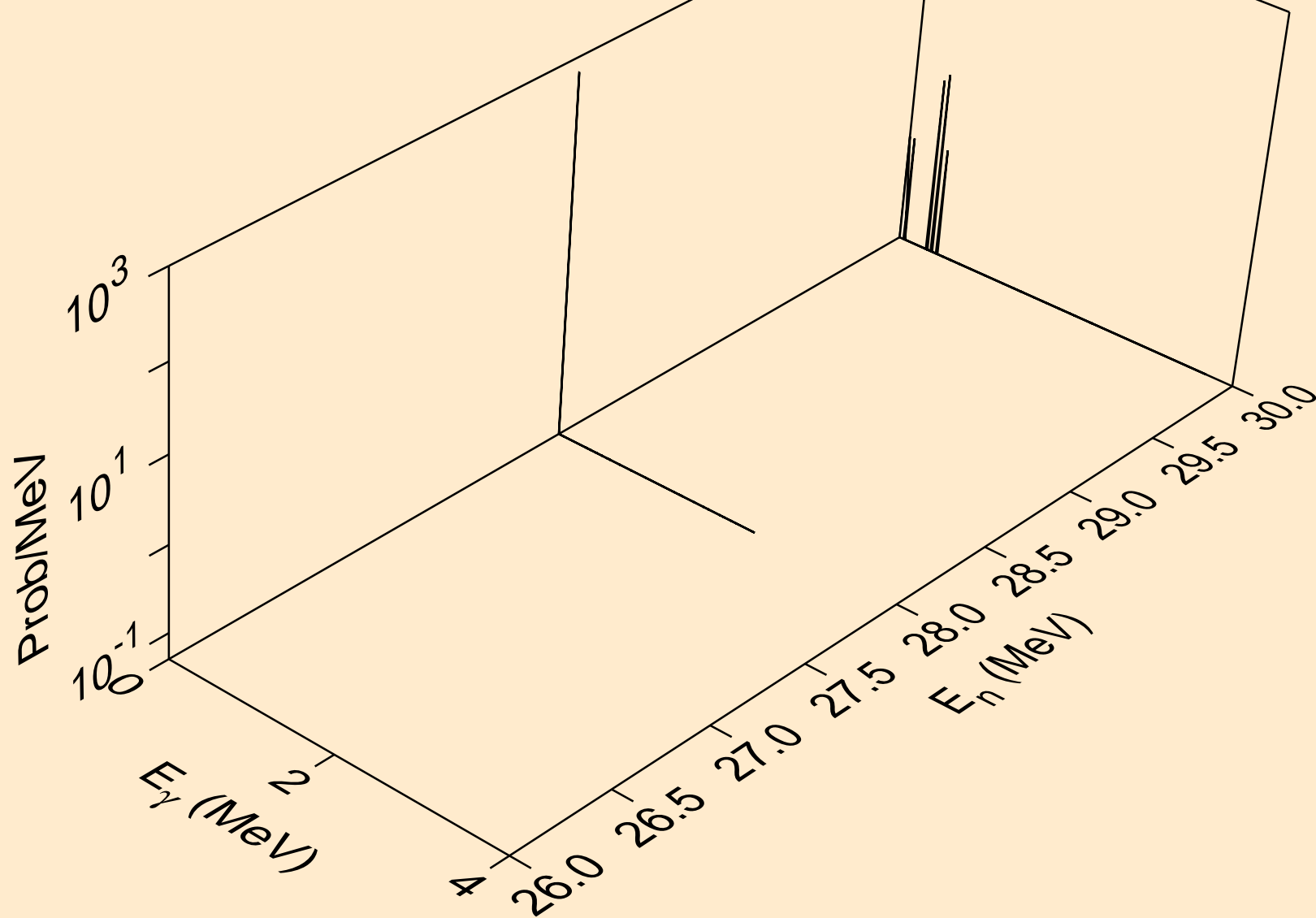

AR042 NEUTRON ACER TENDL-2023 LIBRARY; T=0.K
Photon emission for (n,da)

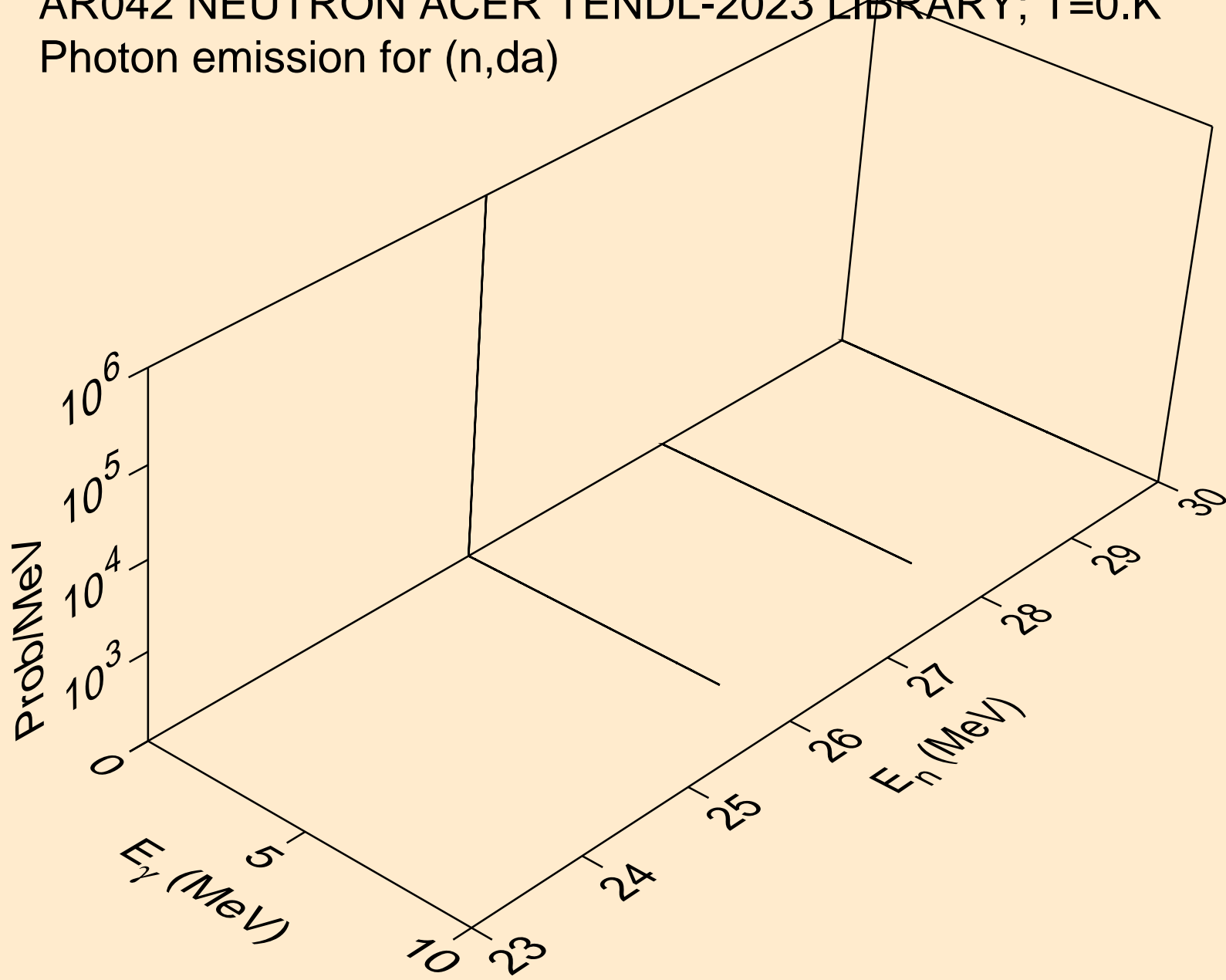

AR042 NEUTRON ACER TENDL-2023 LIBRARY; T=0.K
thermal capture photon spectrum

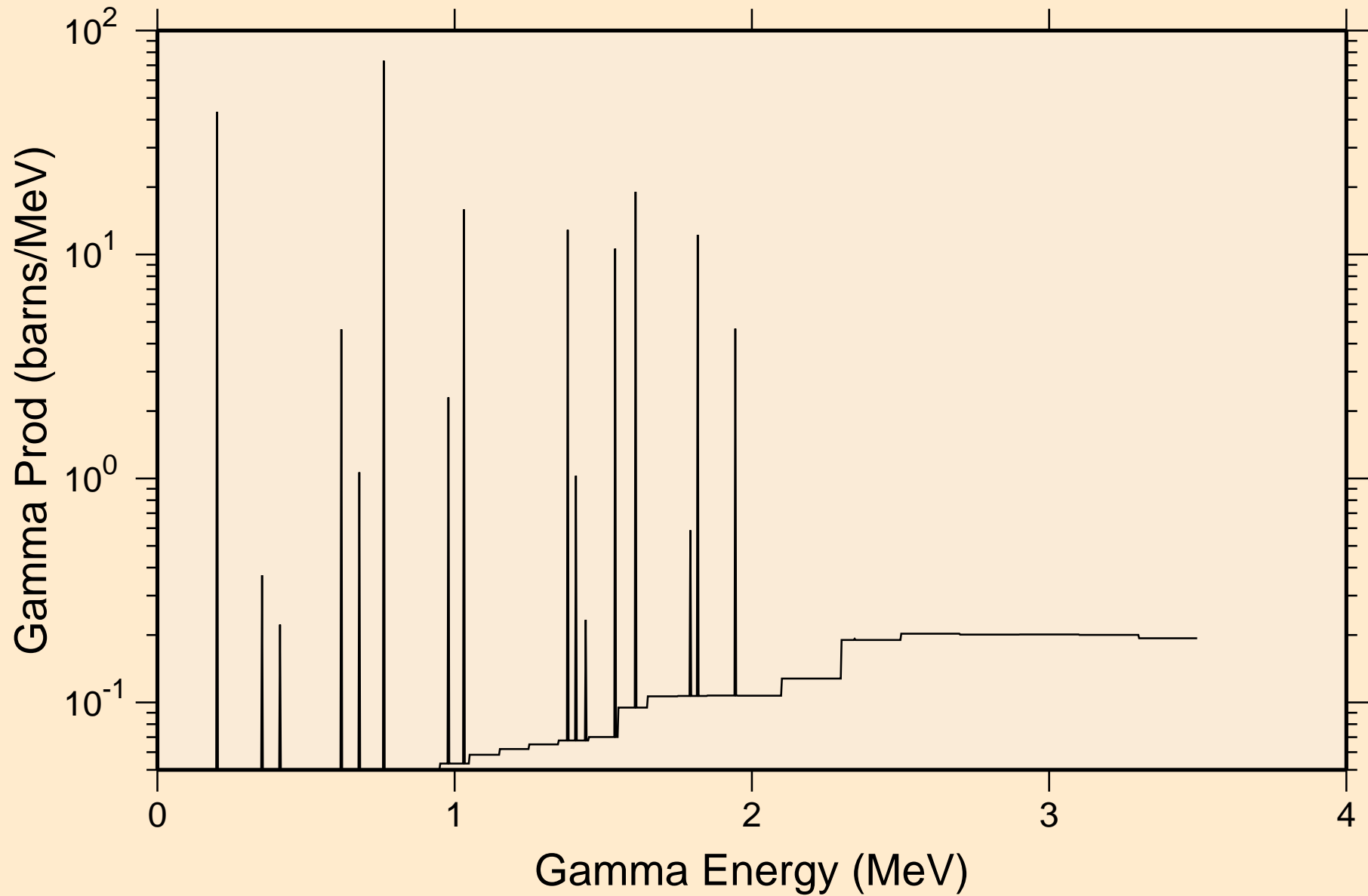

AR042 NEUTRON ACER TENDL-2023 LIBRARY; T=0.K
14 MeV photon spectrum

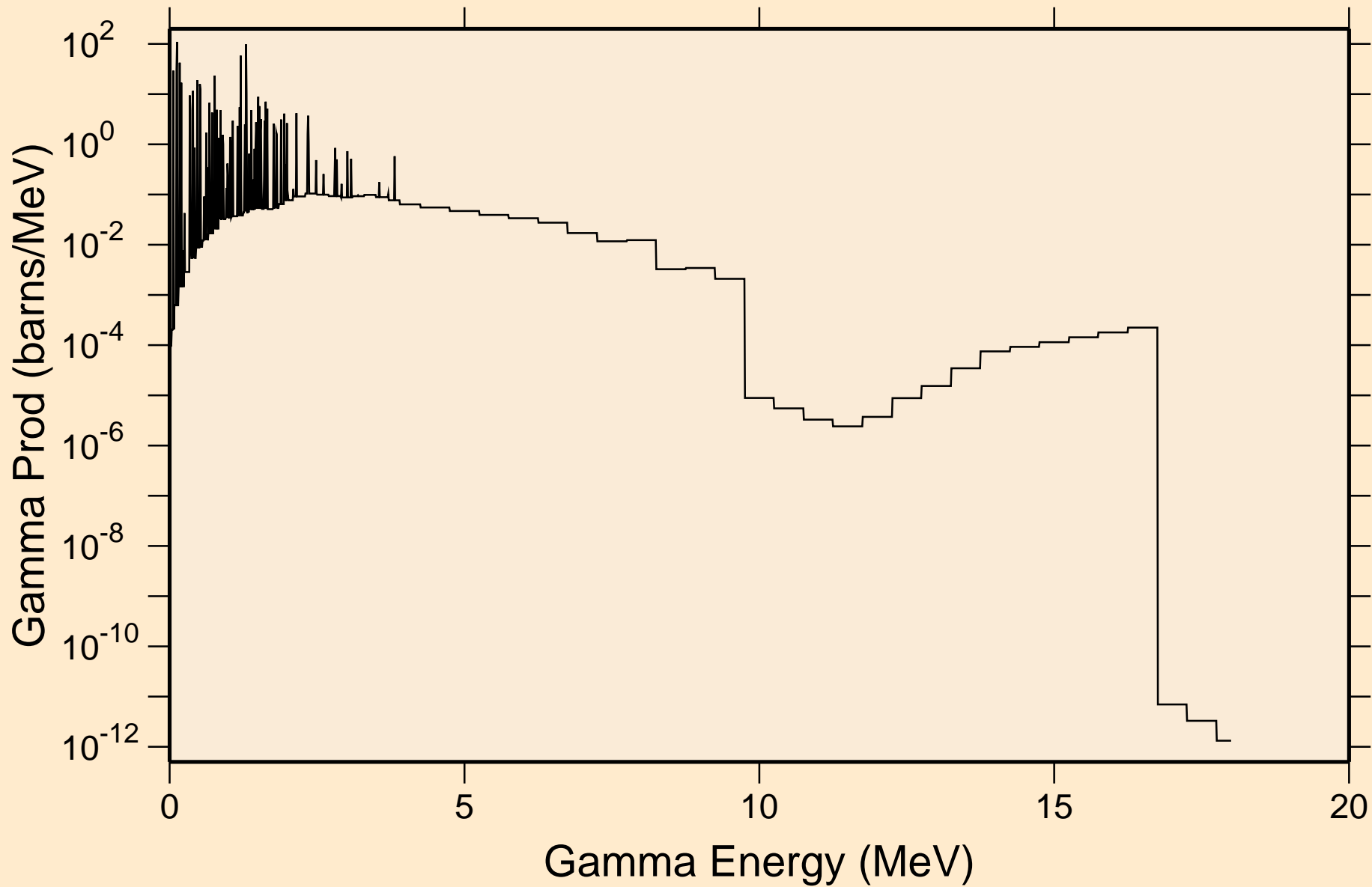

AR042 NEUTRON ACER TENDL-2023 LIBRARY; T=0.K
Particle heating contributions

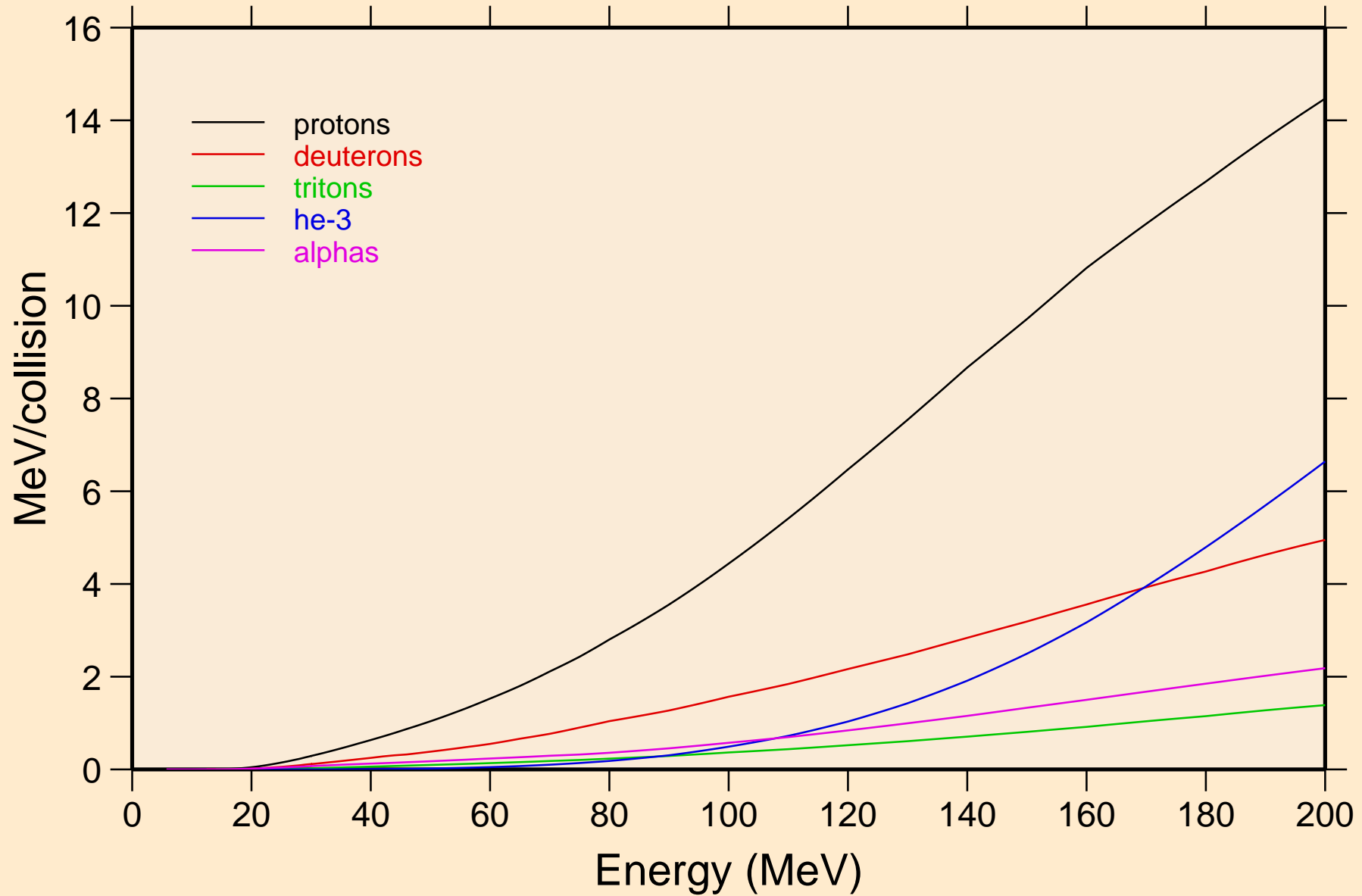

AR042 NEUTRON ACER TENDL-2023 LIBRARY; T=0.K
Recoil Heating

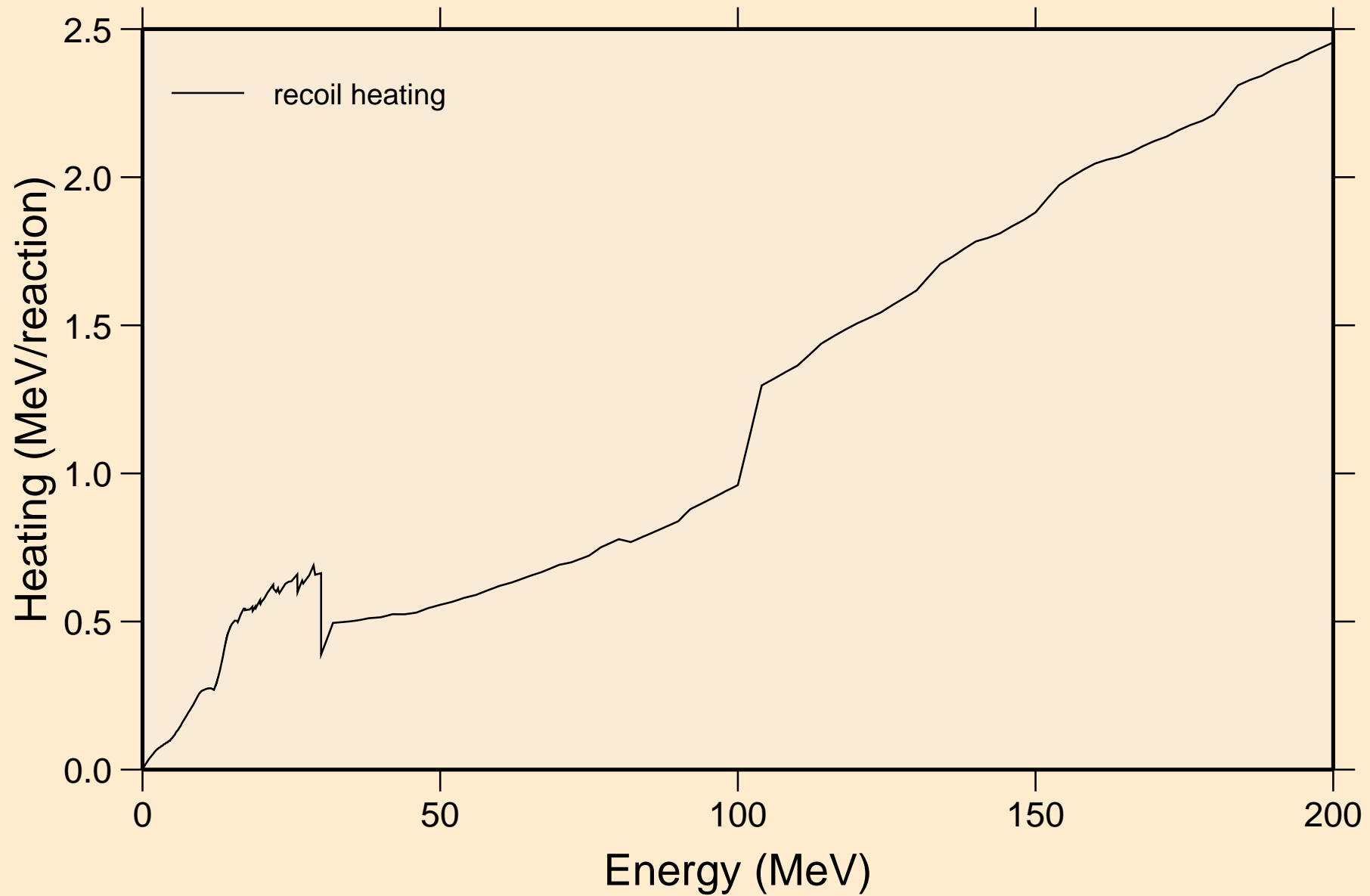

AR042 NEUTRON ACER TENDL-2023 LIBRARY; T=0.K
Particle production cross sections

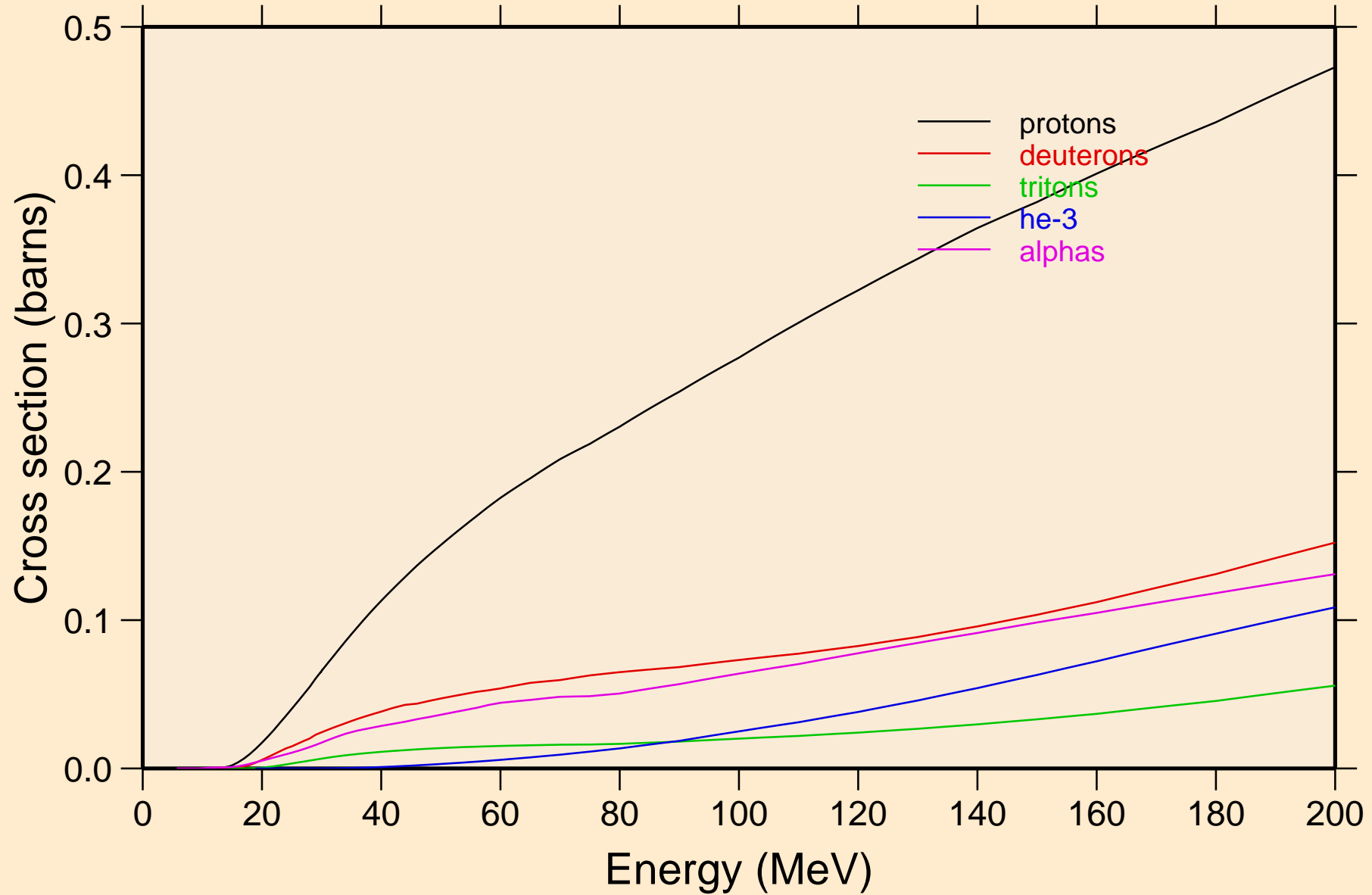

AR042 NEUTRON ACER TENDL-2023 LIBRARY; T=0.K
protons from (n,x)

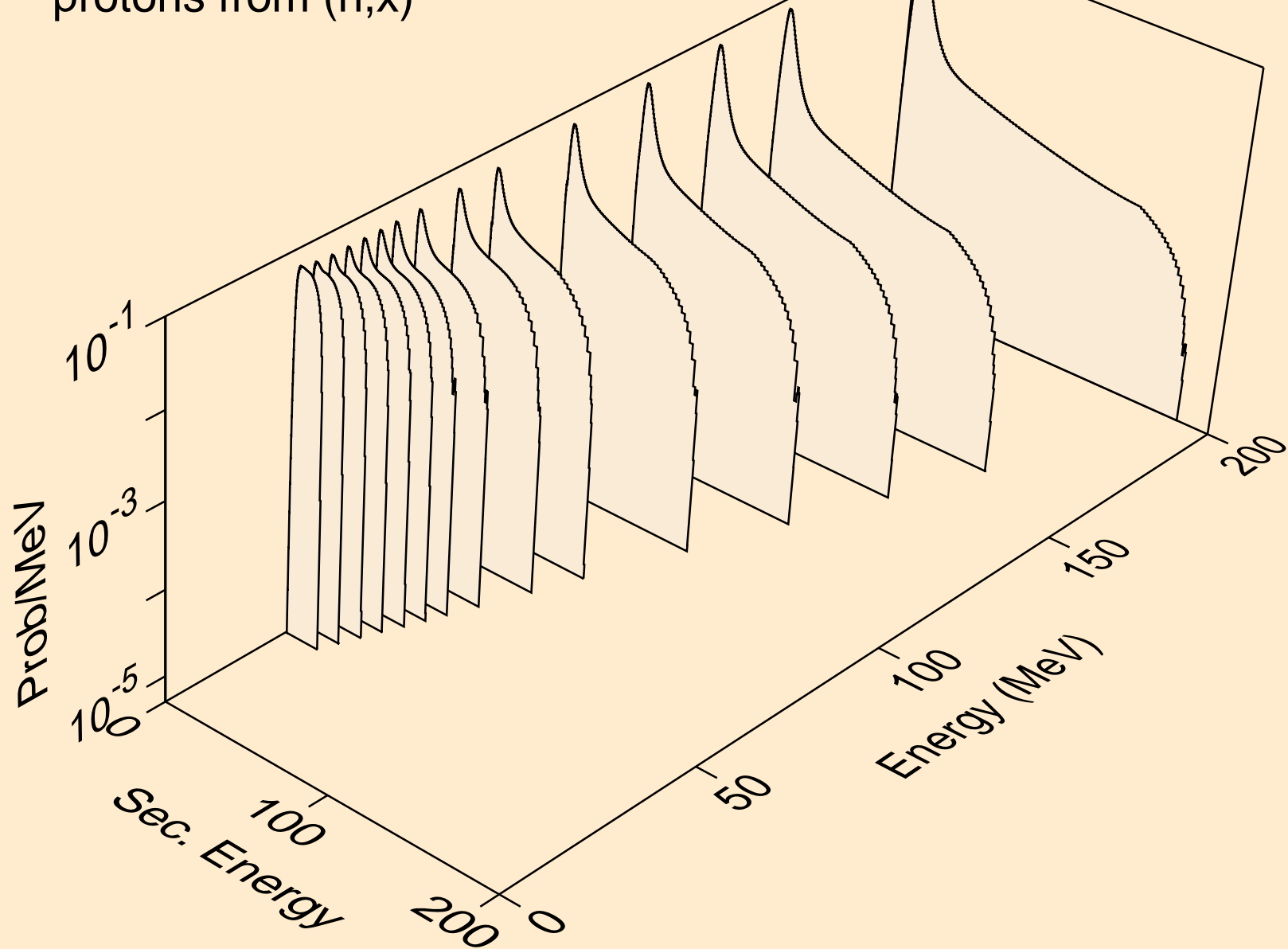

AR042 NEUTRON ACER TENDL-2023 LIBRARY; T=0.K
protons from (n,n*)p

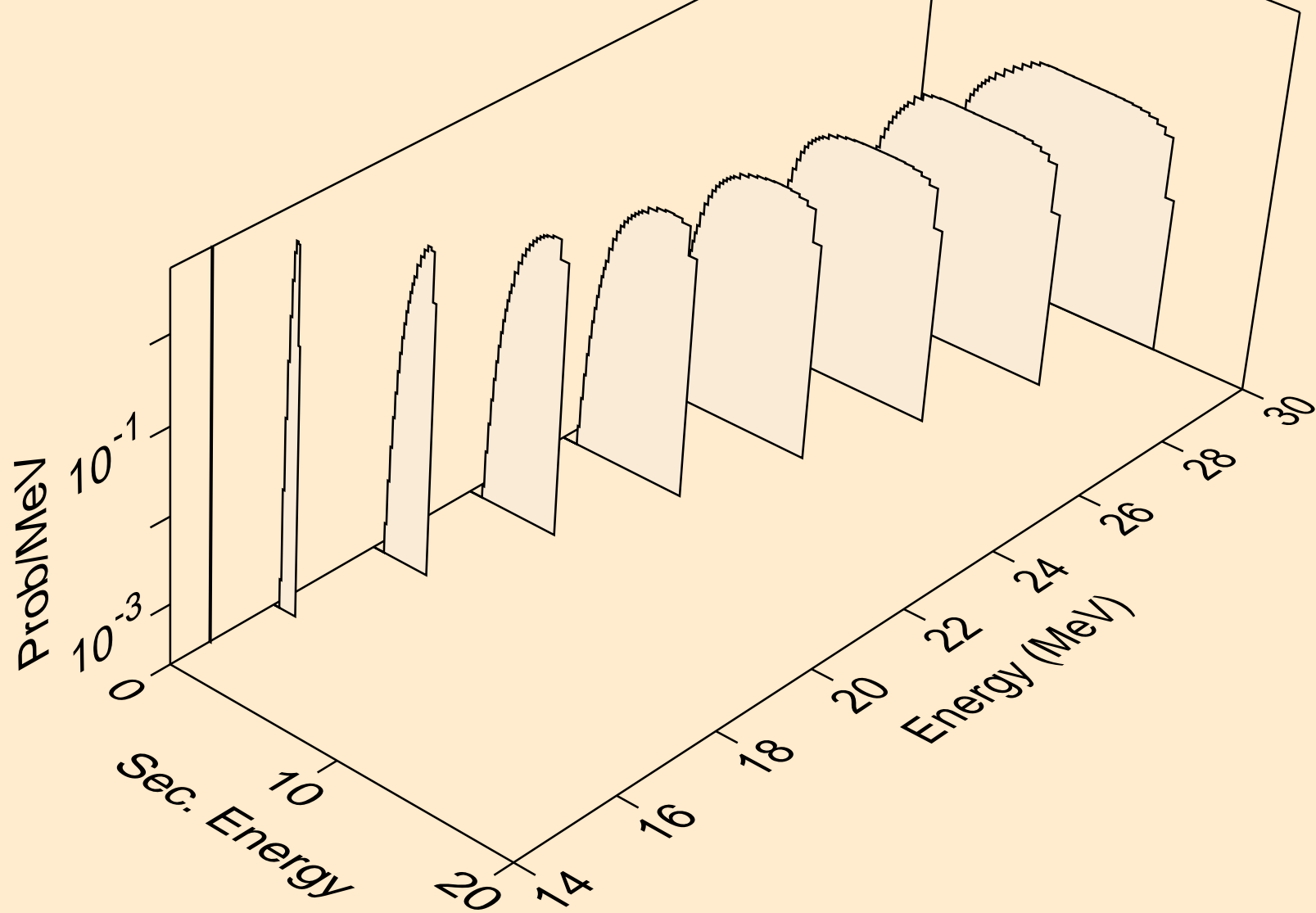

AR042 NEUTRON ACER TENDL-2023 LIBRARY; T=0.K
protons from (n,2np)

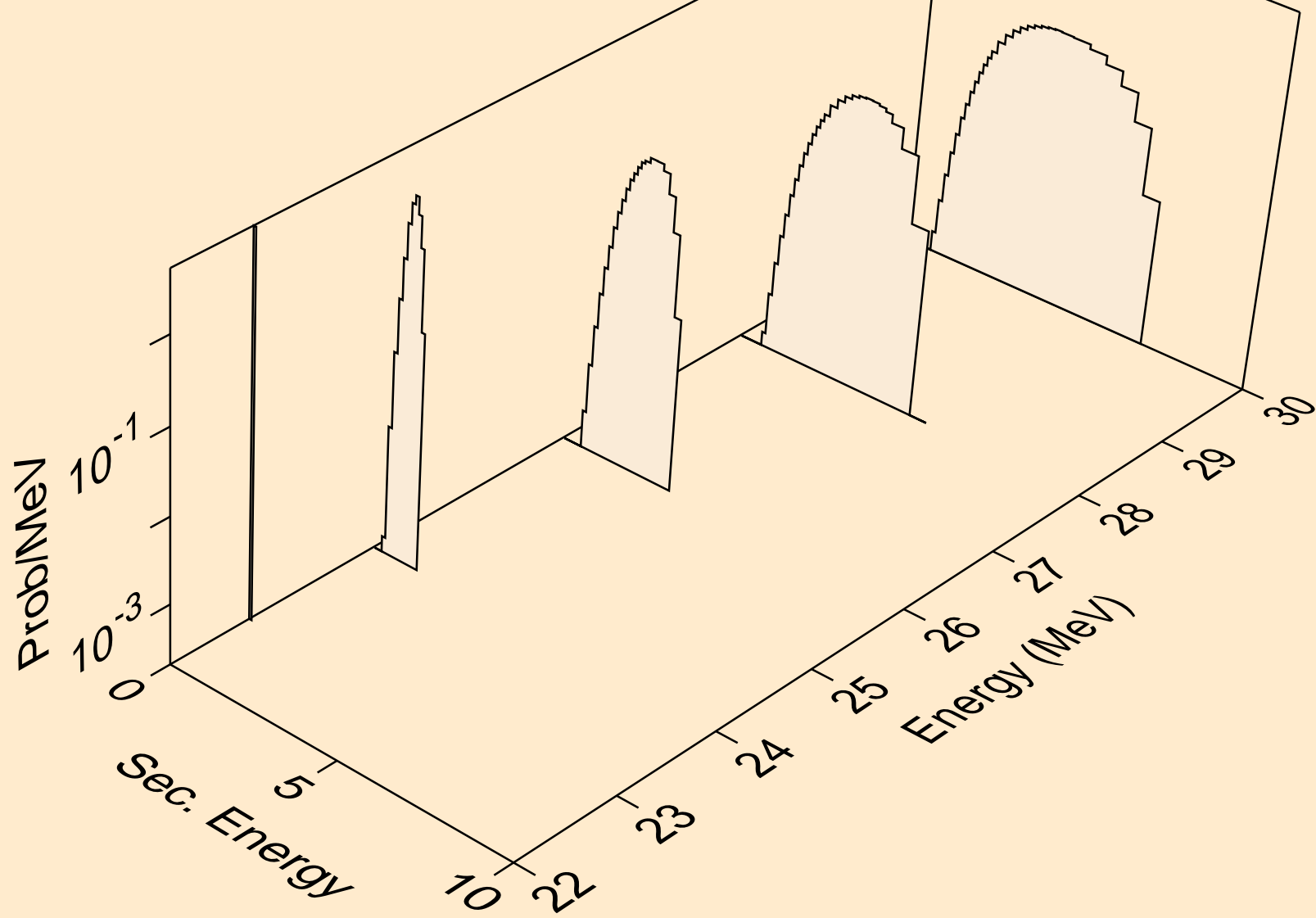

AR042 NEUTRON ACER TENDL-2023 LIBRARY; T=0.K
protons from (n,3np)

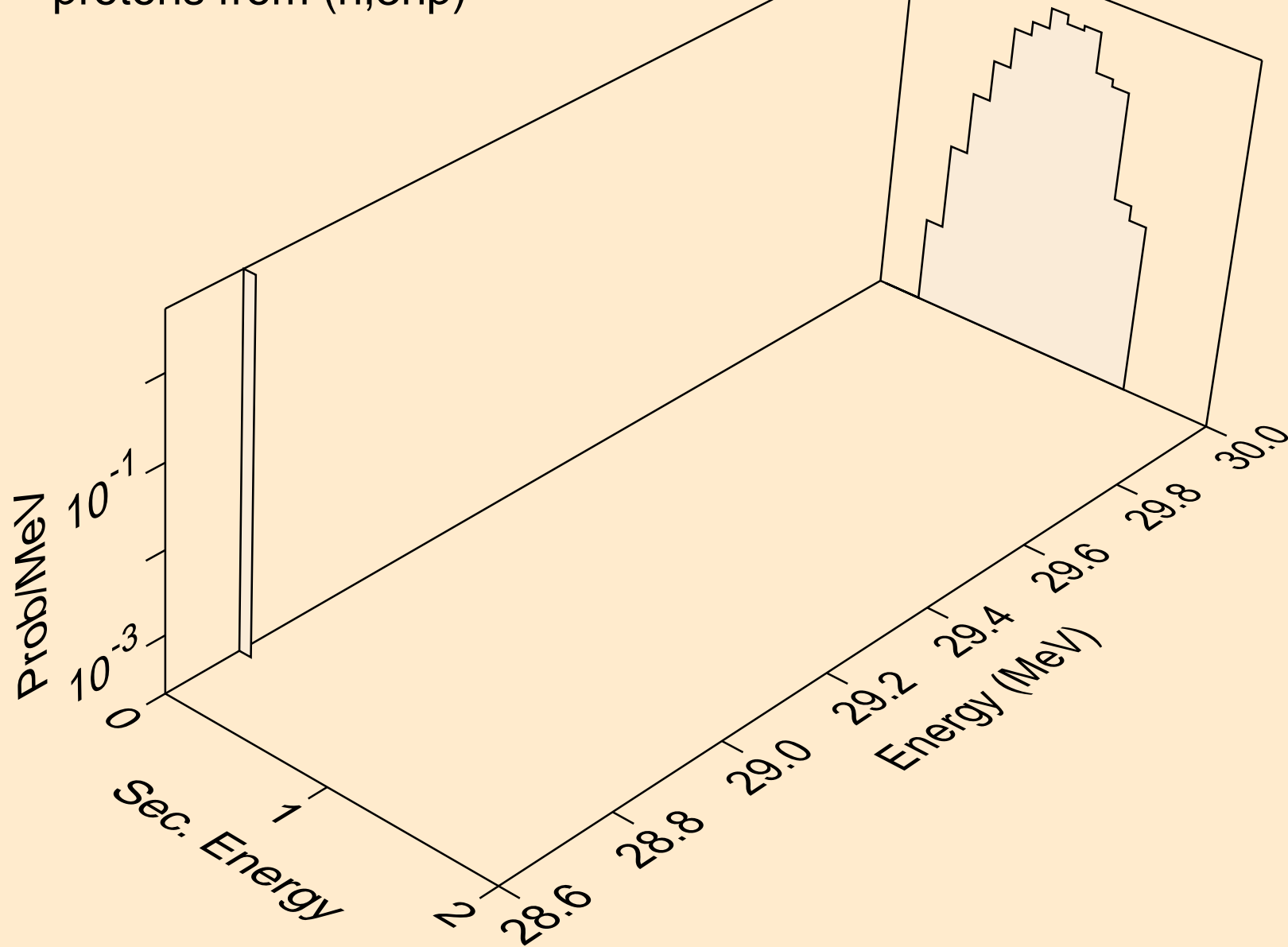

AR042 NEUTRON ACER TENDL-2023 LIBRARY; T=0.K
protons from (n,p)

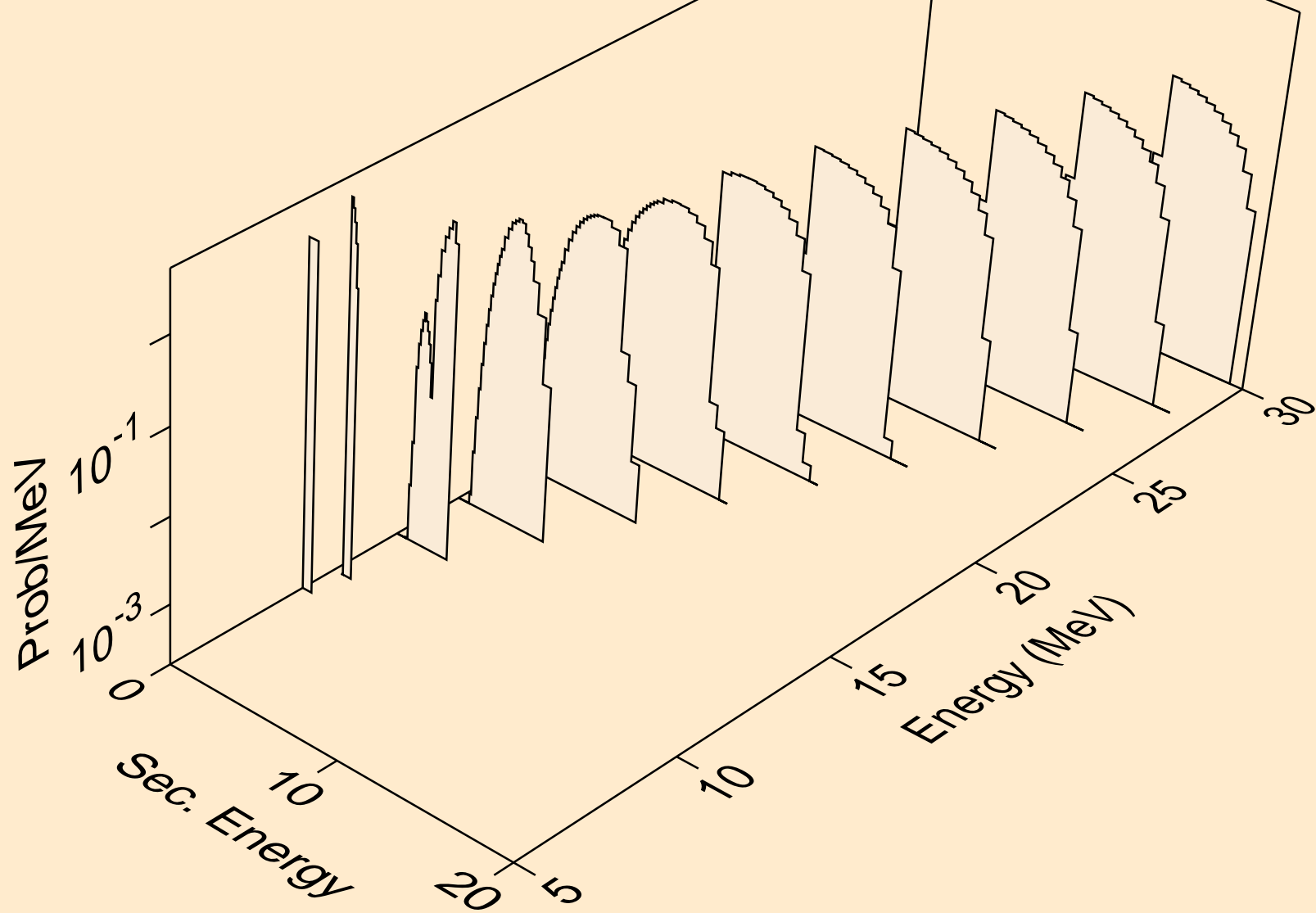

AR042 NEUTRON ACER TENDL-2023 LIBRARY; T=0.K
protons from (n,2p)

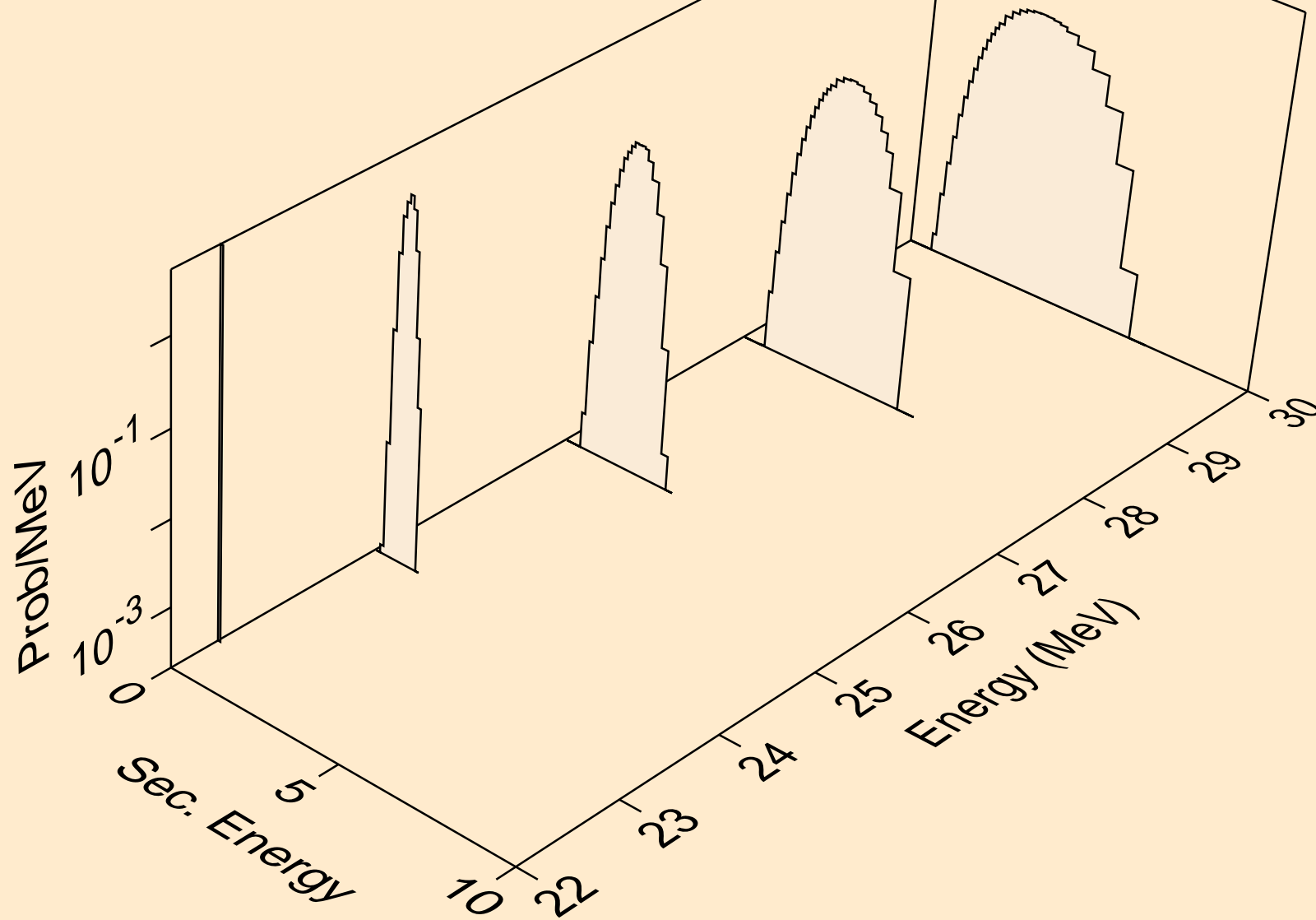

AR042 NEUTRON ACER TENDL-2023 LIBRARY; T=0.K
protons from (n,p)

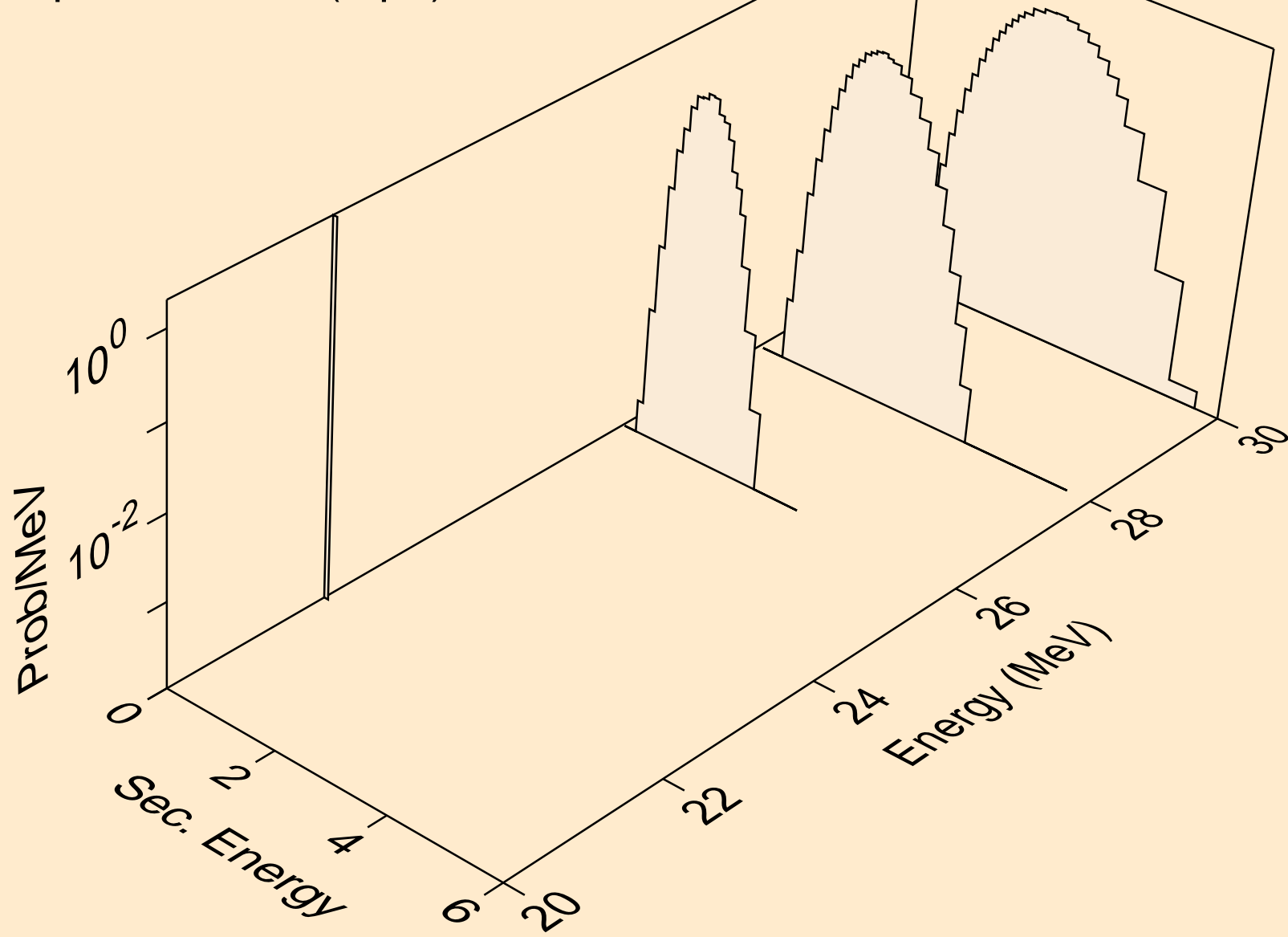

AR042 NEUTRON ACER TENDL-2023 LIBRARY; T=0.K
protons from (n,pd)

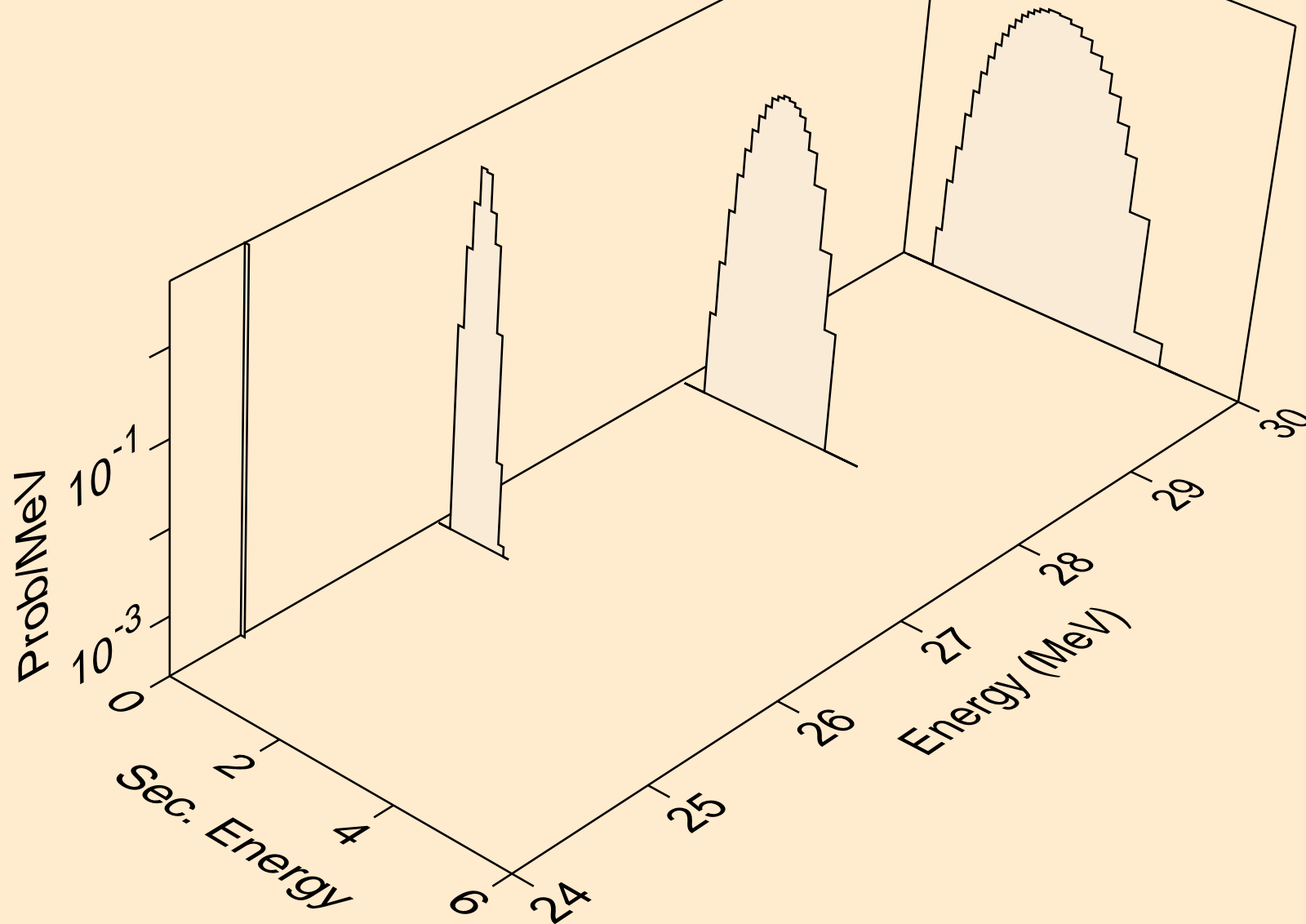

AR042 NEUTRON ACER TENDL-2023 LIBRARY; T=0.K
protons from (n,pt)

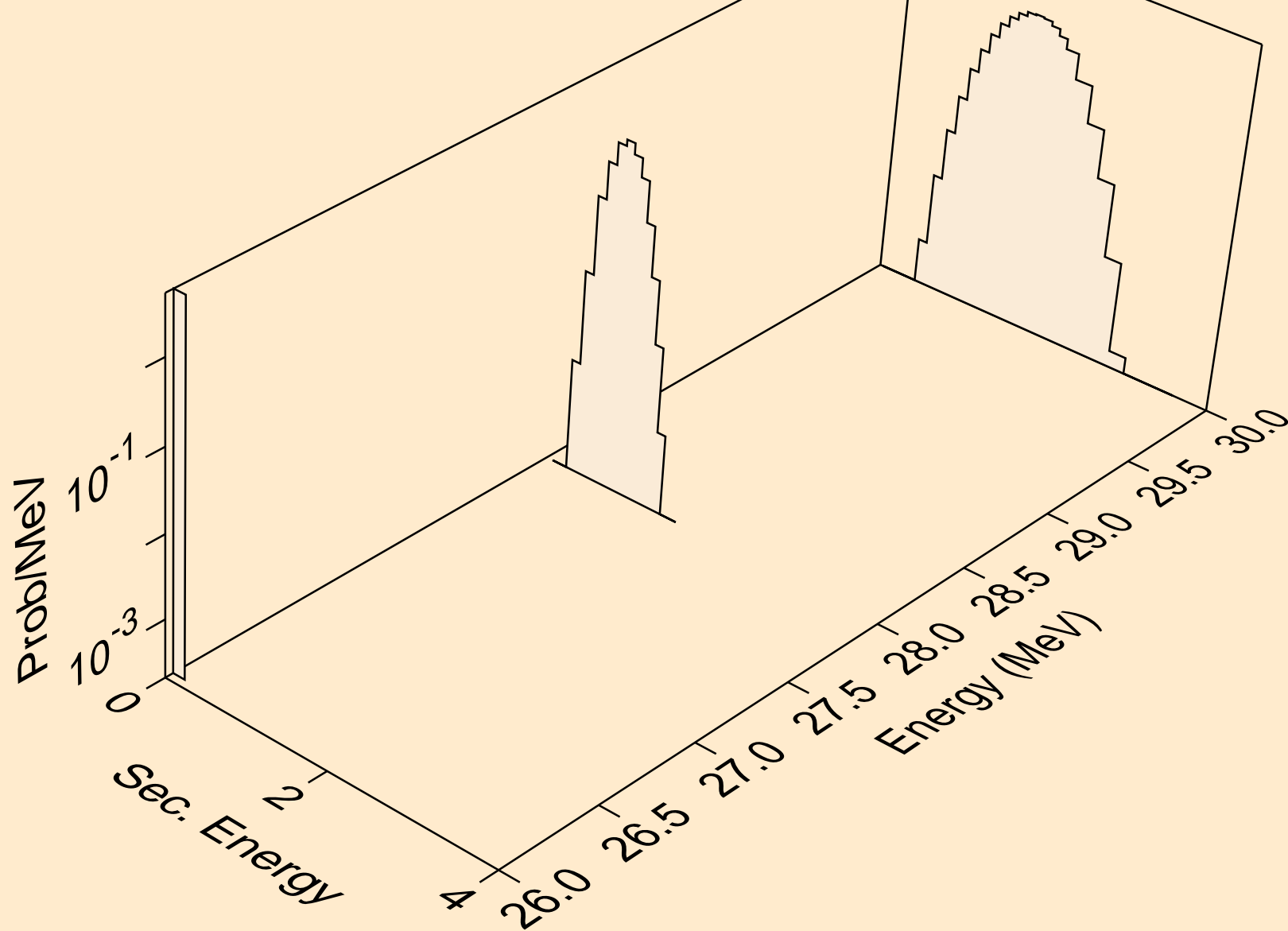

AR042 NEUTRON ACER TENDL-2023 LIBRARY; T=0.K
deuterons from (n,x)

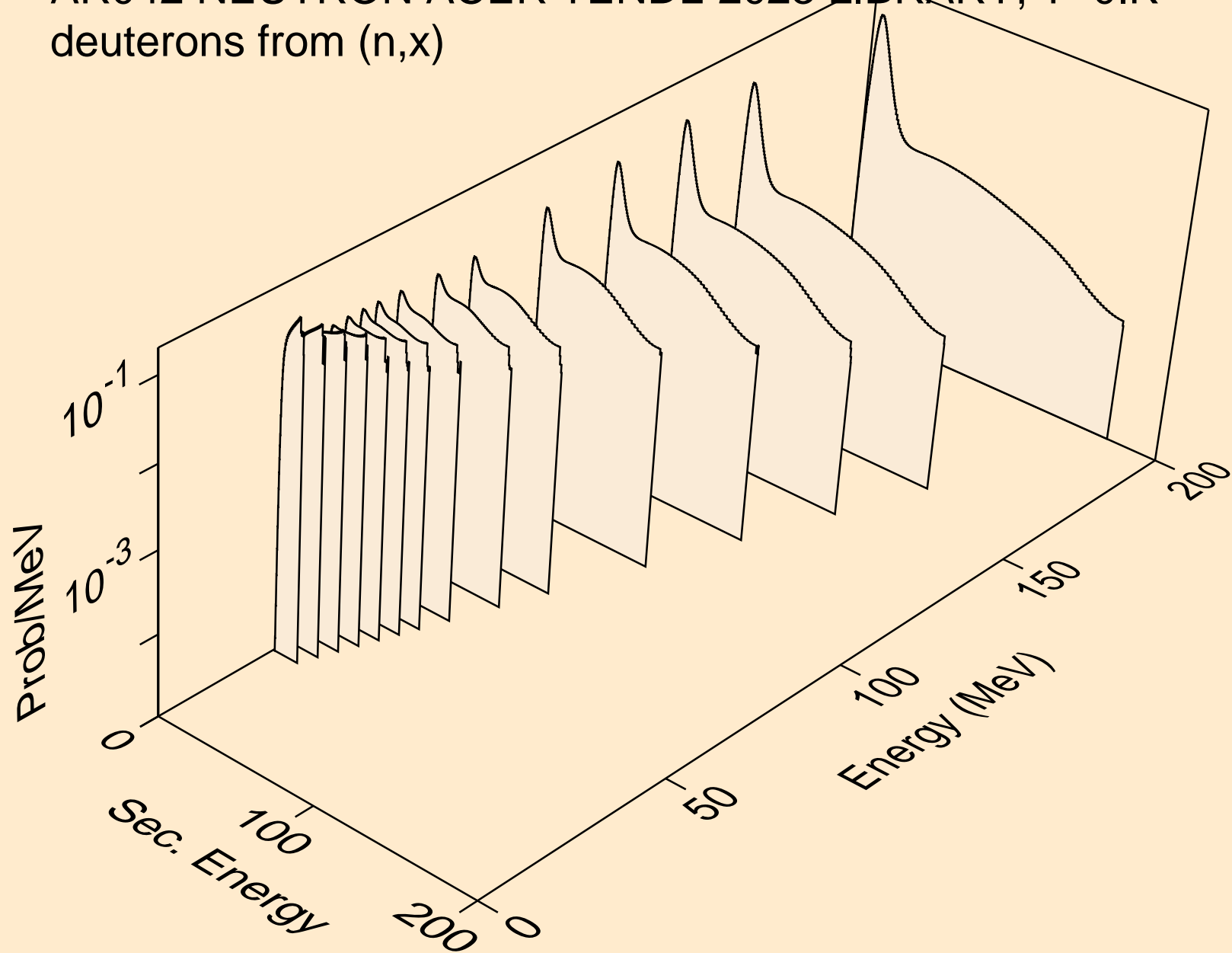

AR042 NEUTRON ACER TENDL-2023 LIBRARY; T=0.K
deuterons from (n,2nd)

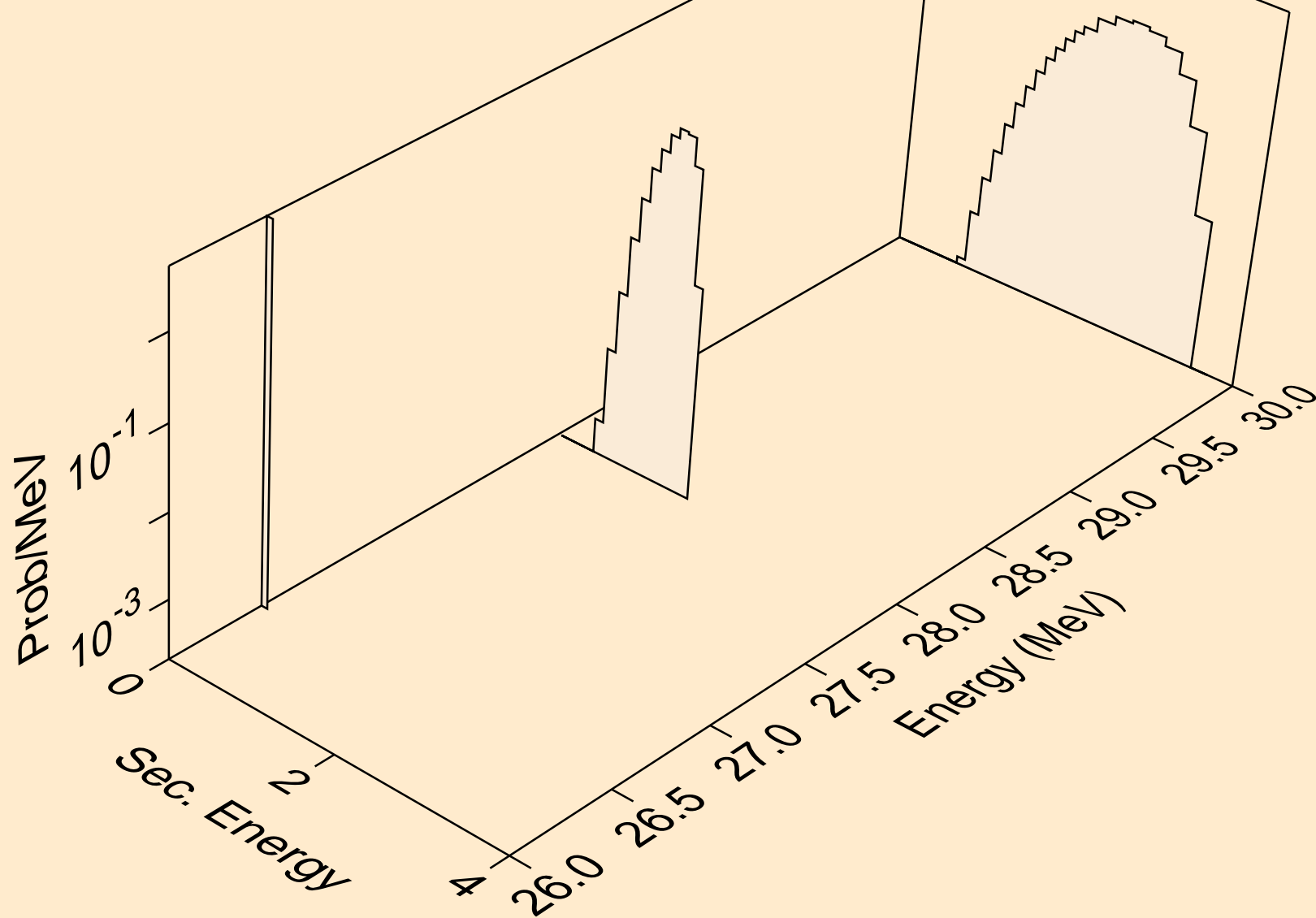

AR042 NEUTRON ACER TENDL-2023 LIBRARY; T=0.K
deuterons from (n,n*)d

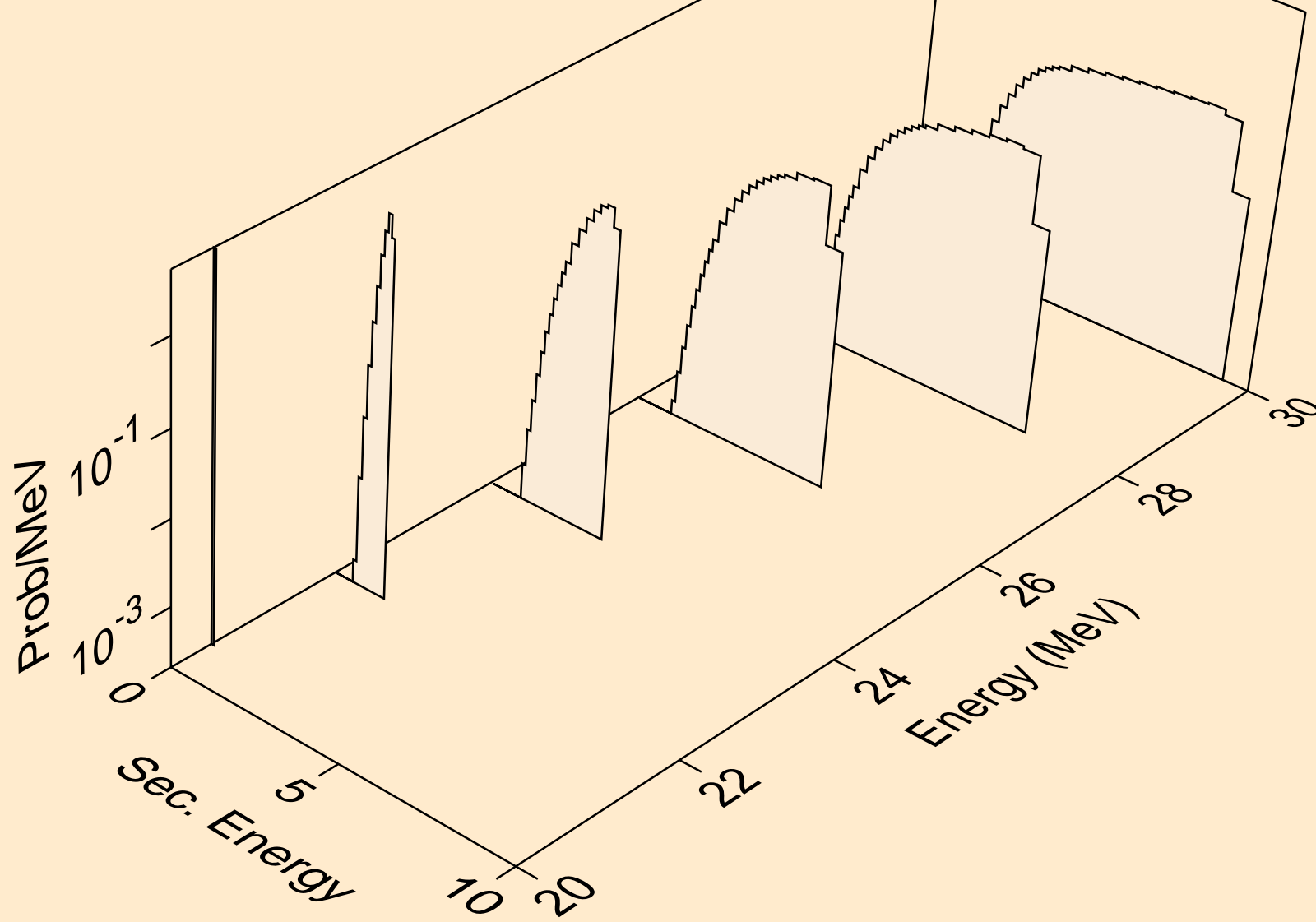

AR042 NEUTRON ACER TENDL-2023 LIBRARY; T=0.K
deuterons from (n,d)

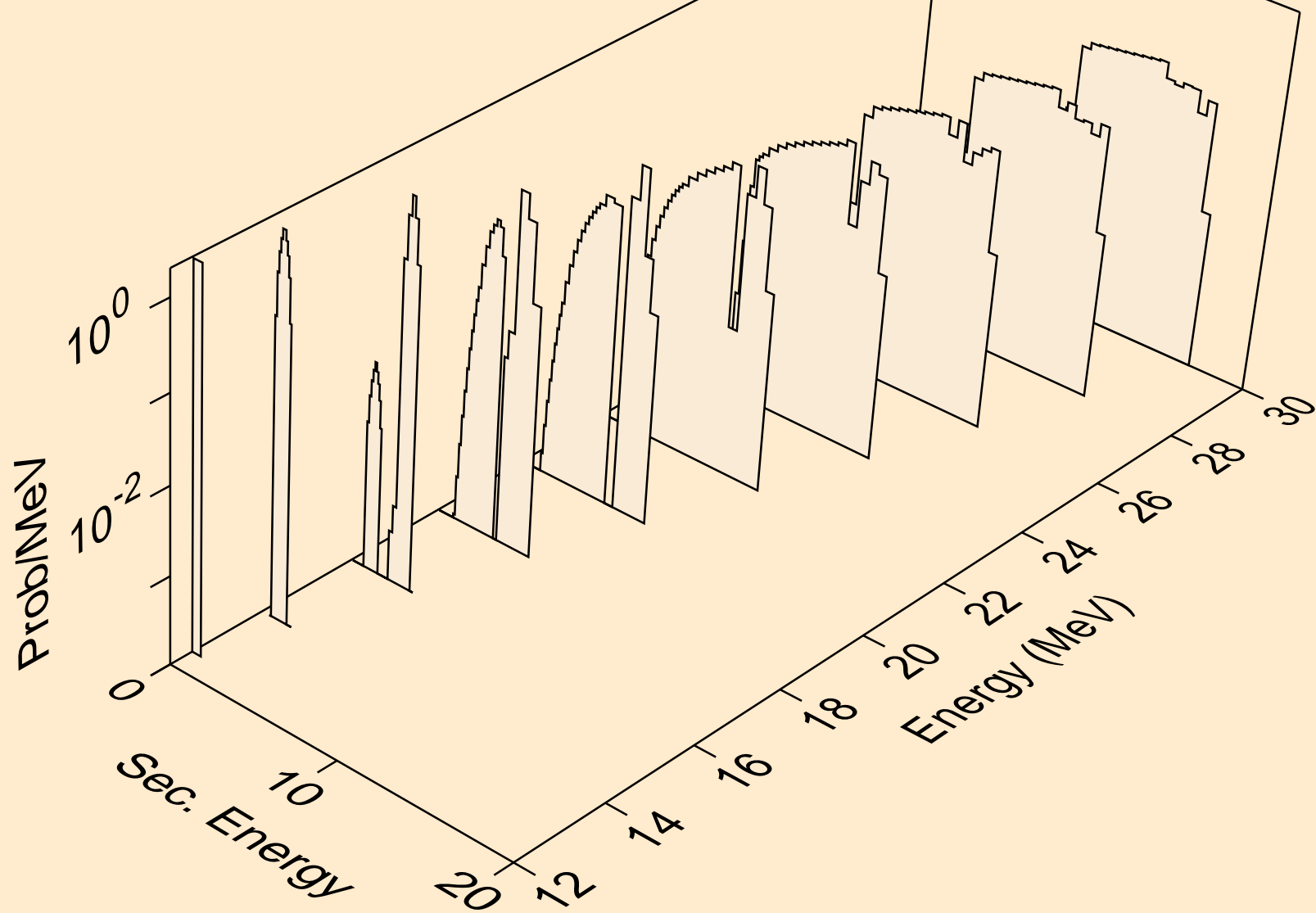

AR042 NEUTRON ACER TENDL-2023 LIBRARY; T=0.K
deuterons from (n,pd)

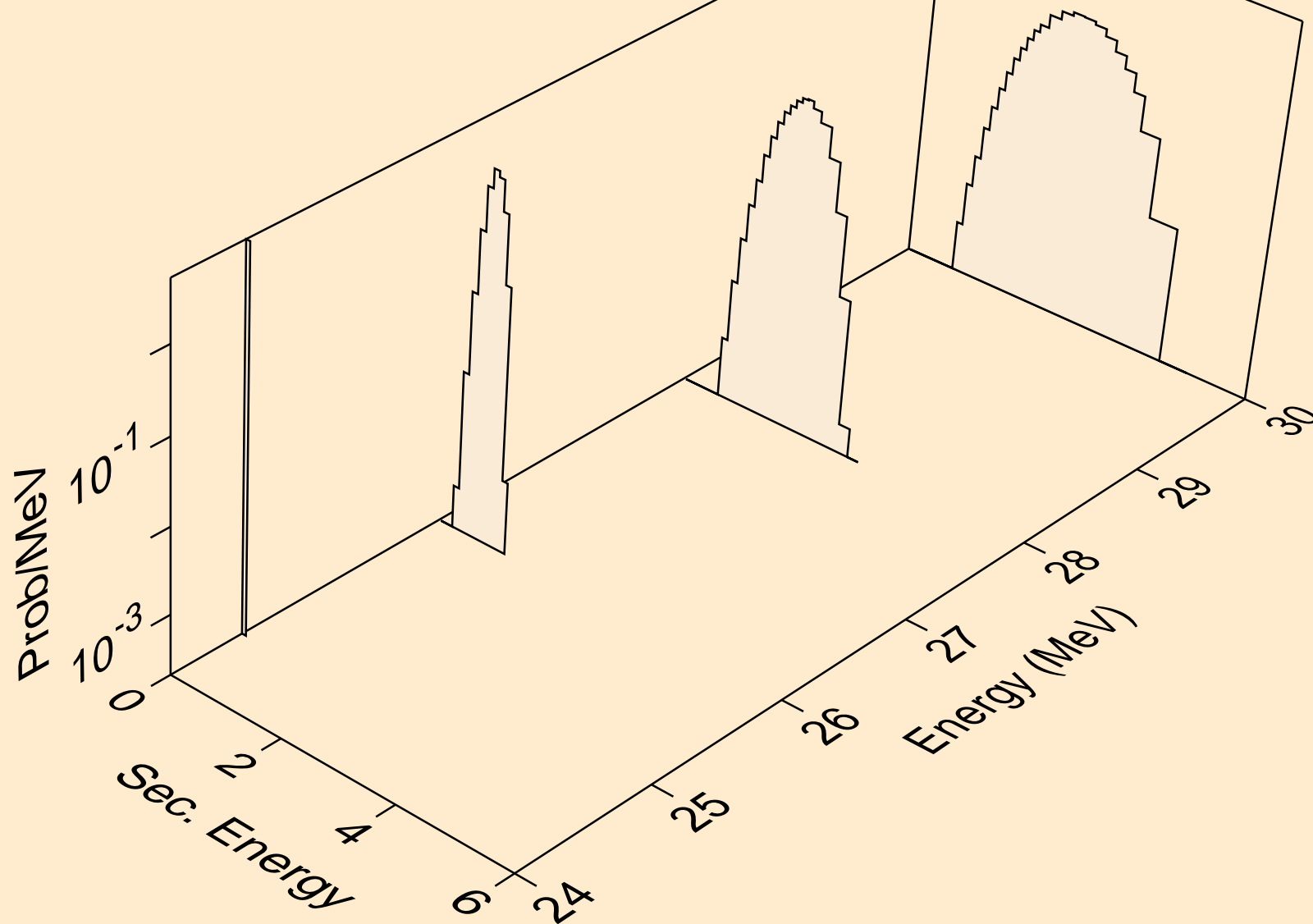

AR042 NEUTRON ACER TENDL-2023 LIBRARY; T=0.K
deuterons from (n,da)

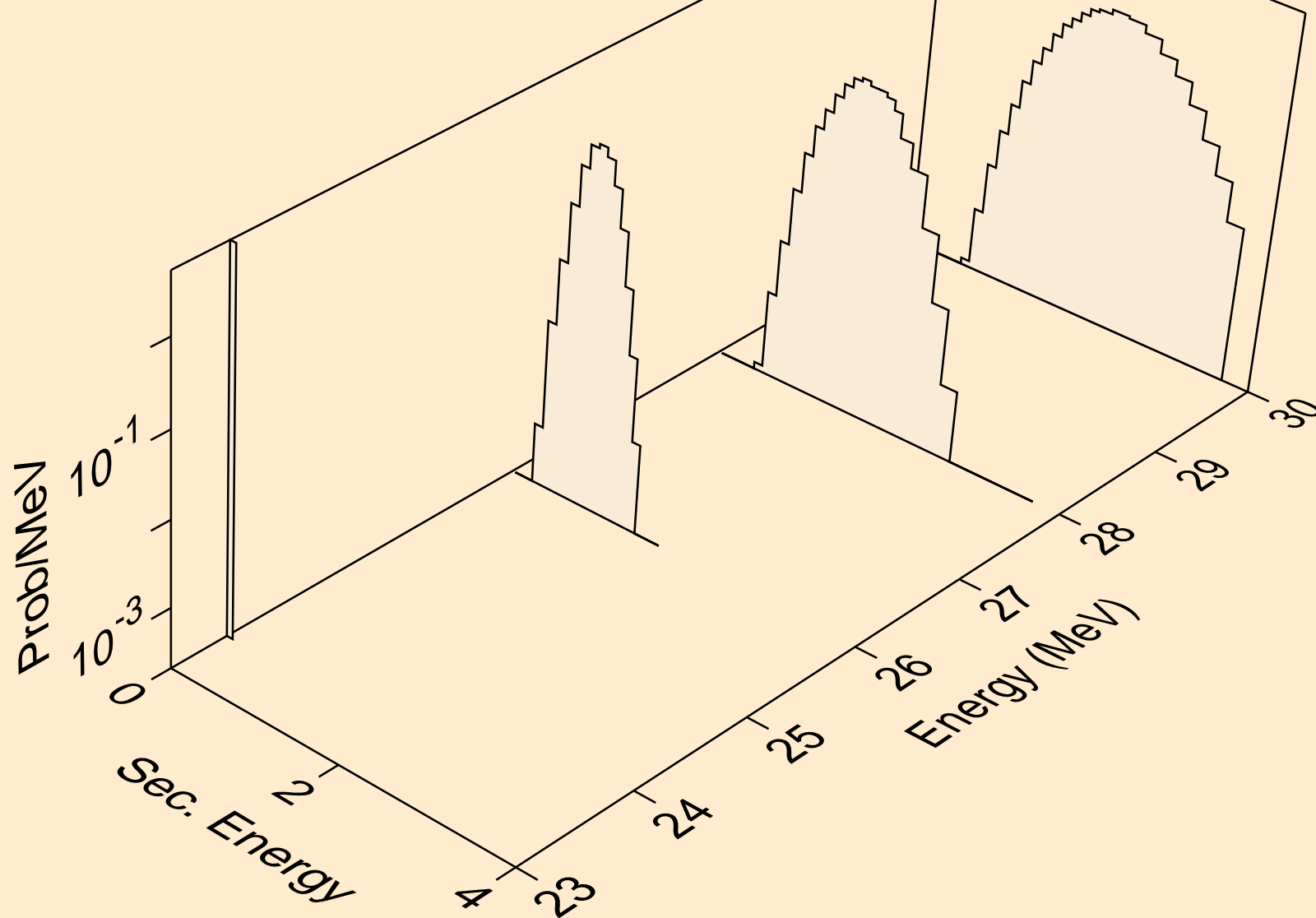

AR042 NEUTRON ACER TENDL-2023 LIBRARY; T=0.K
tritons from (n,x)

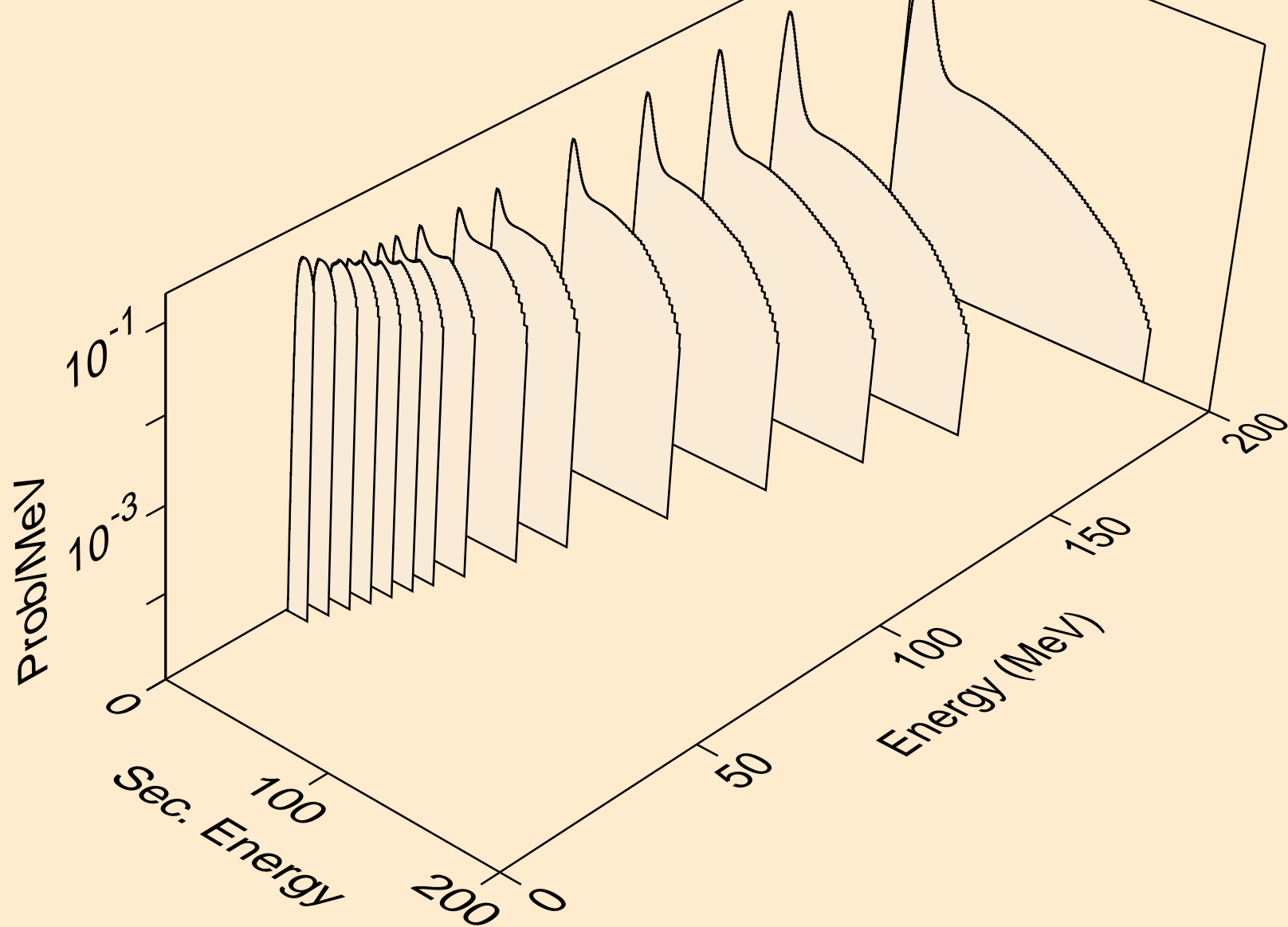

AR042 NEUTRON ACER TENDL-2023 LIBRARY; T=0.K
tritons from (n,n*)t

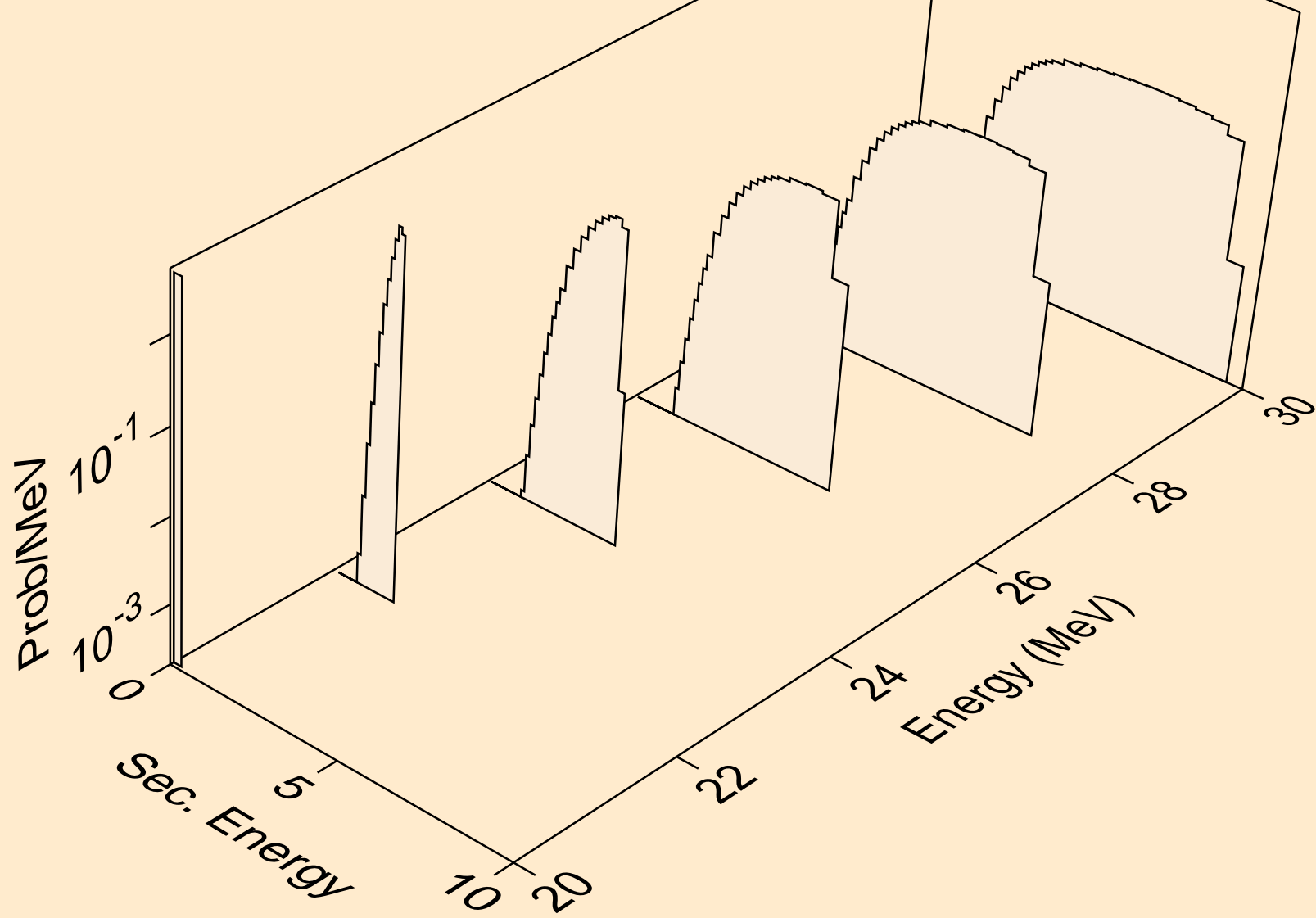

AR042 NEUTRON ACER TENDL-2023 LIBRARY; T=0.K
tritons from (n,t)

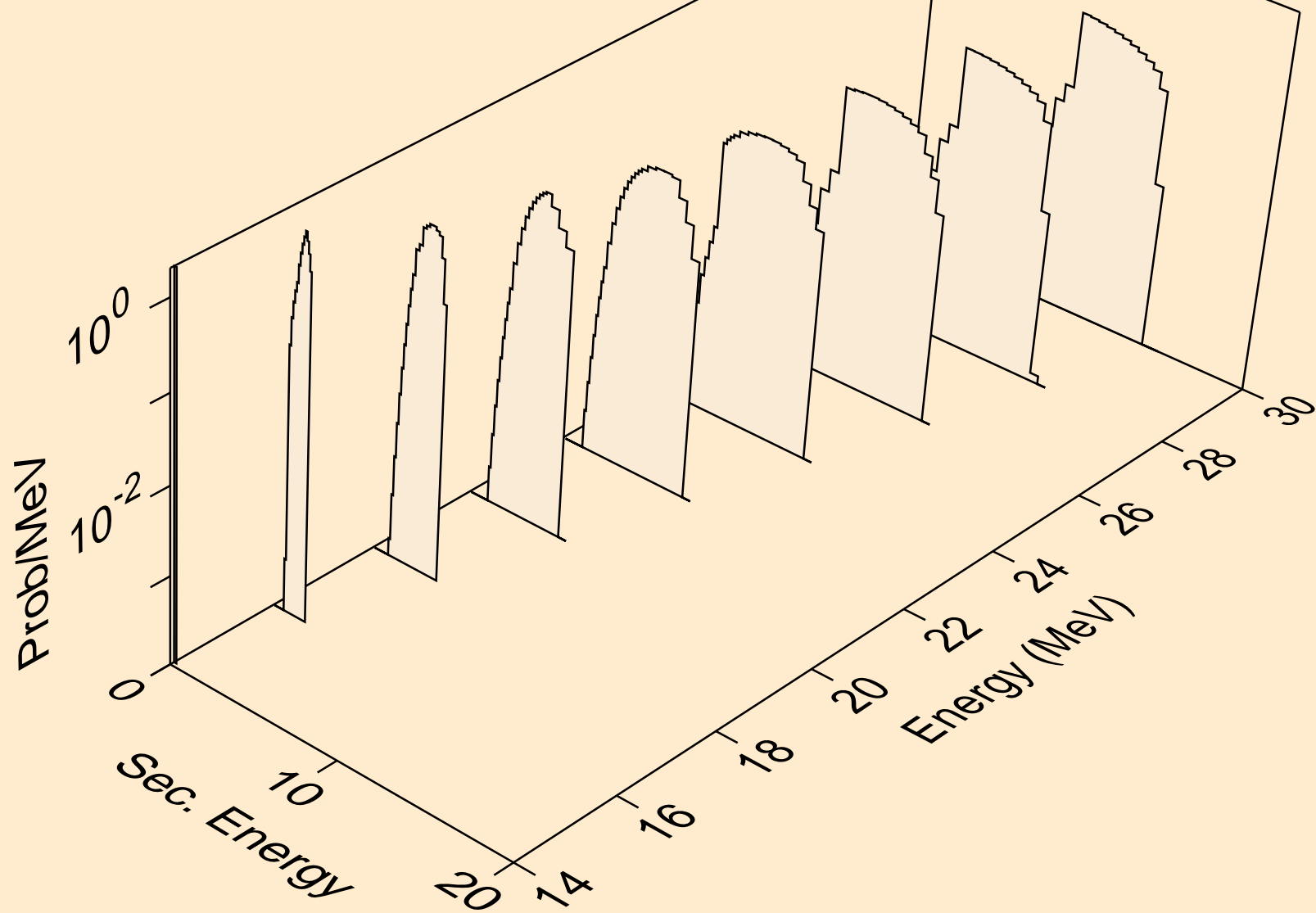

AR042 NEUTRON ACER TENDL-2023 LIBRARY; T=0.K
tritons from (n,pt)

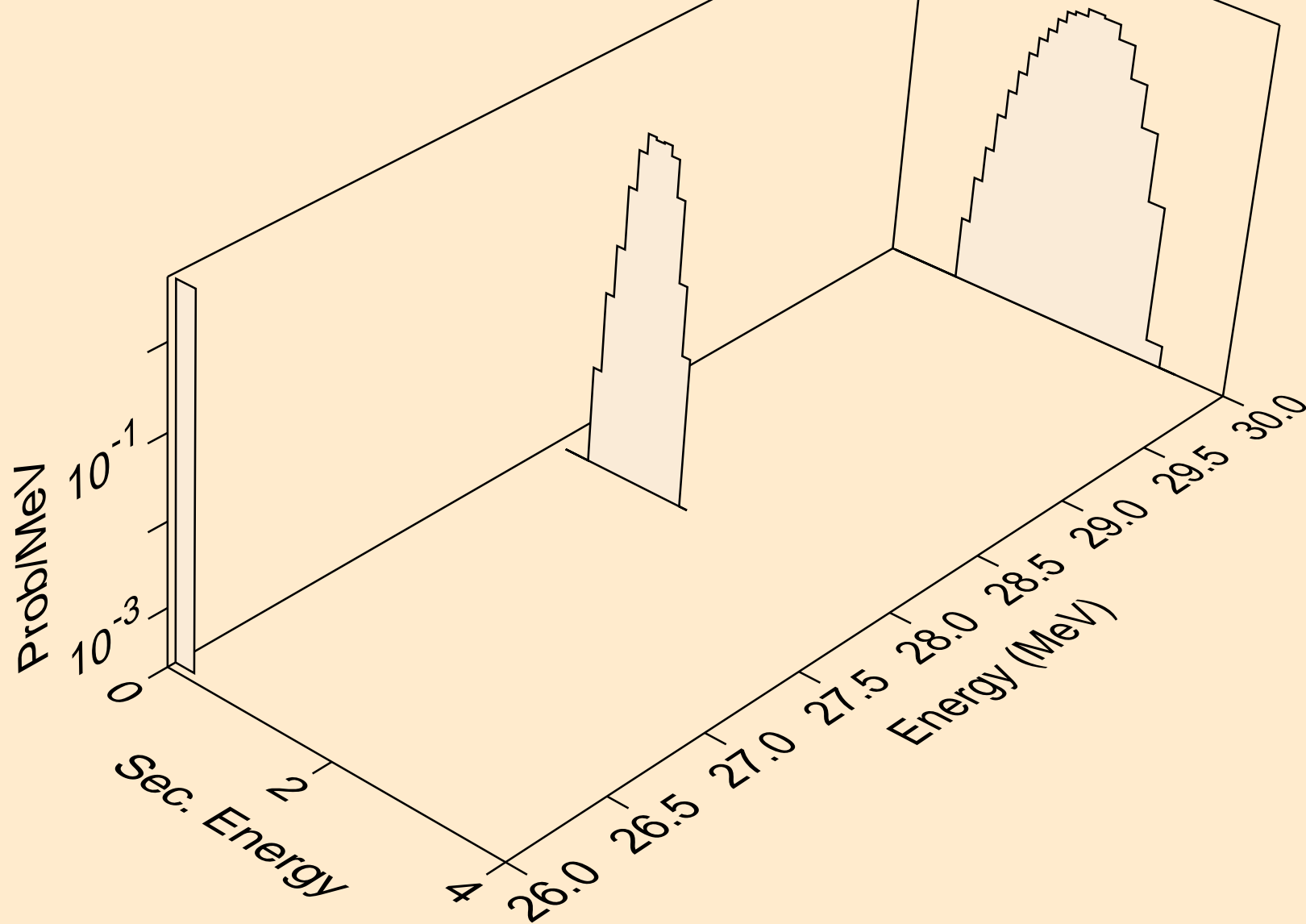

AR042 NEUTRON ACER TENDL-2023 LIBRARY; T=0.K
he3s from (n,x)

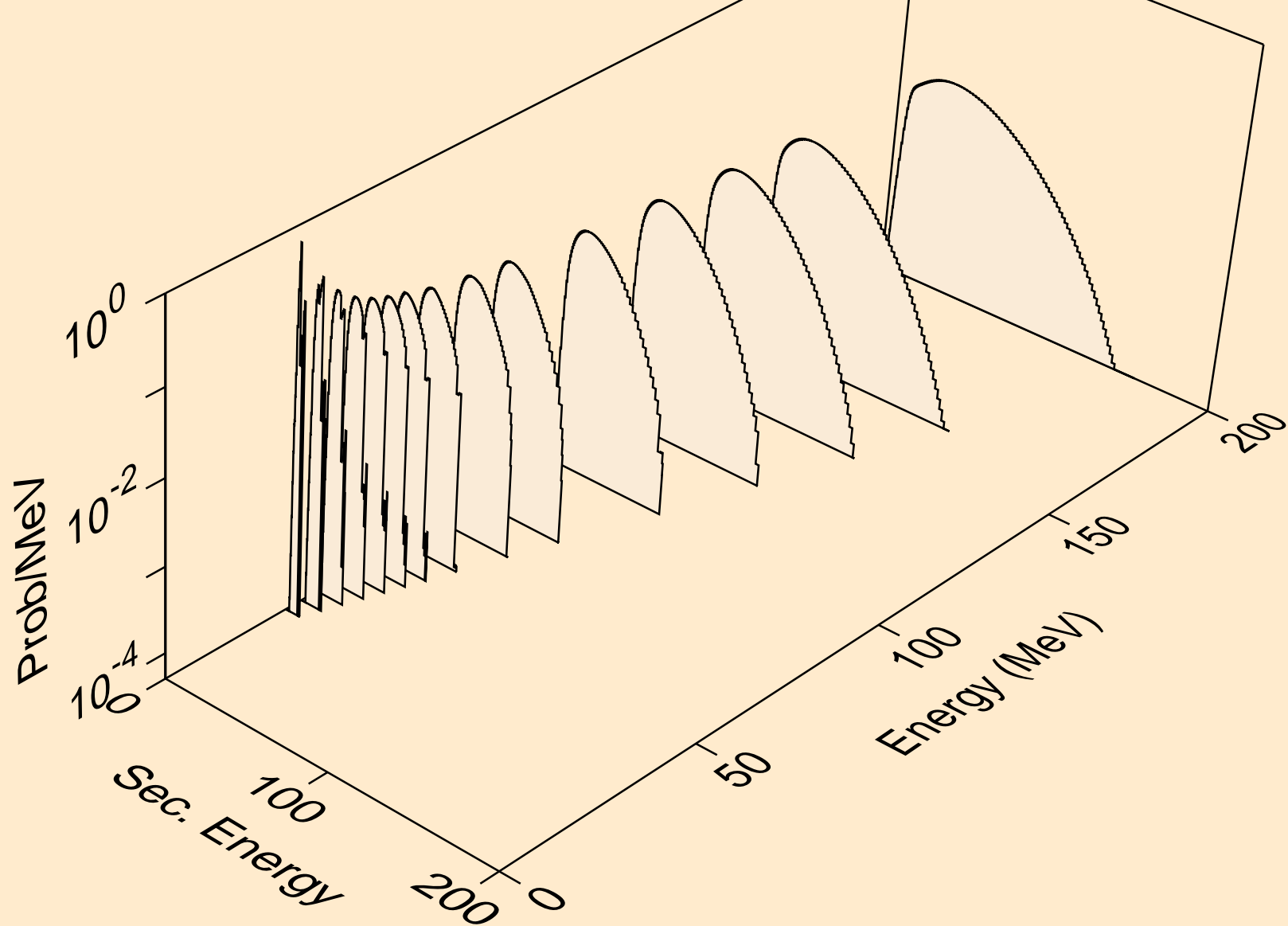

AR042 NEUTRON ACER TENDL-2023 LIBRARY; T=0.K
he3s from (n,n*)he3

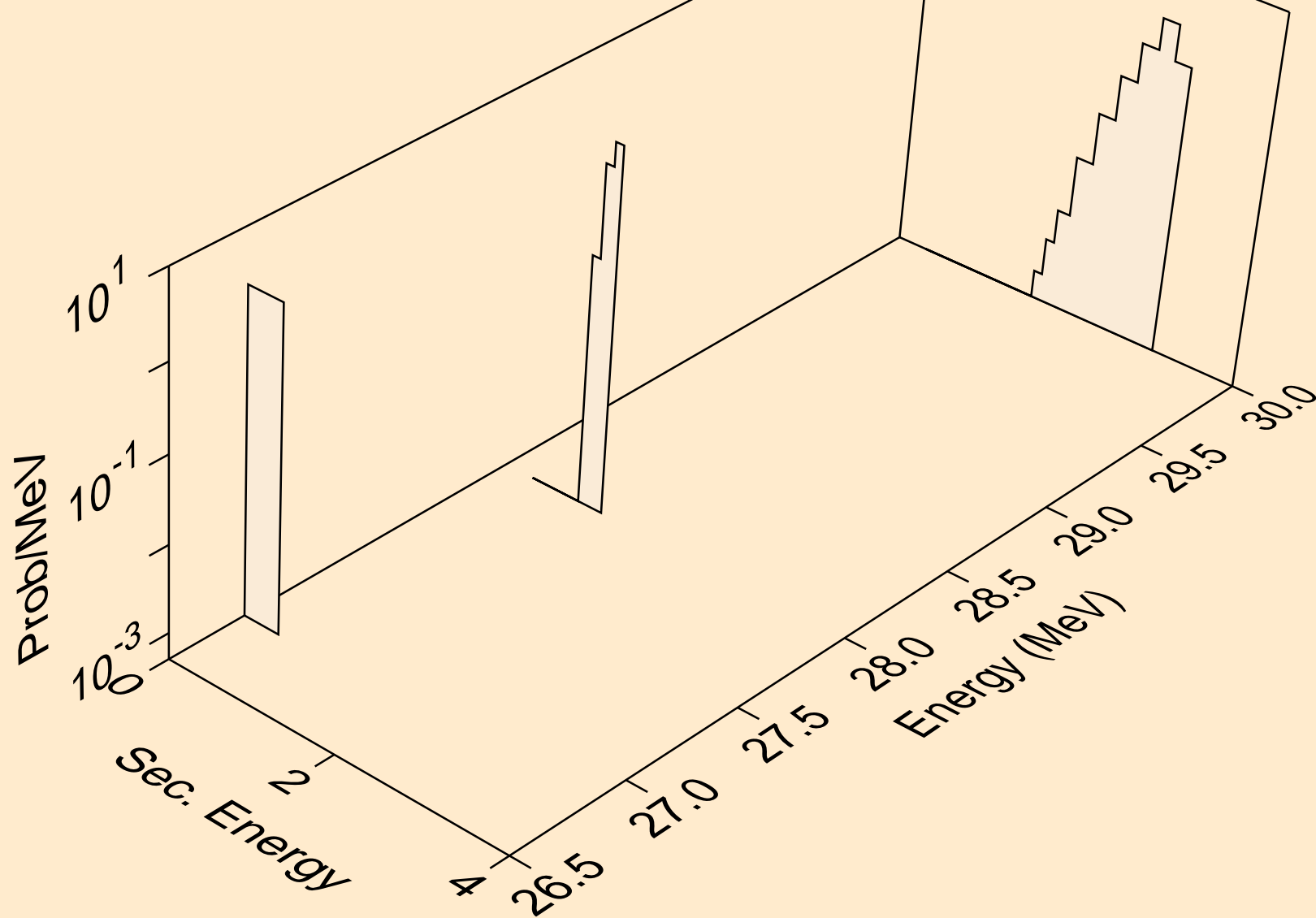

AR042 NEUTRON ACER TENDL-2023 LIBRARY; T=0.K
he3s from (n,he3)

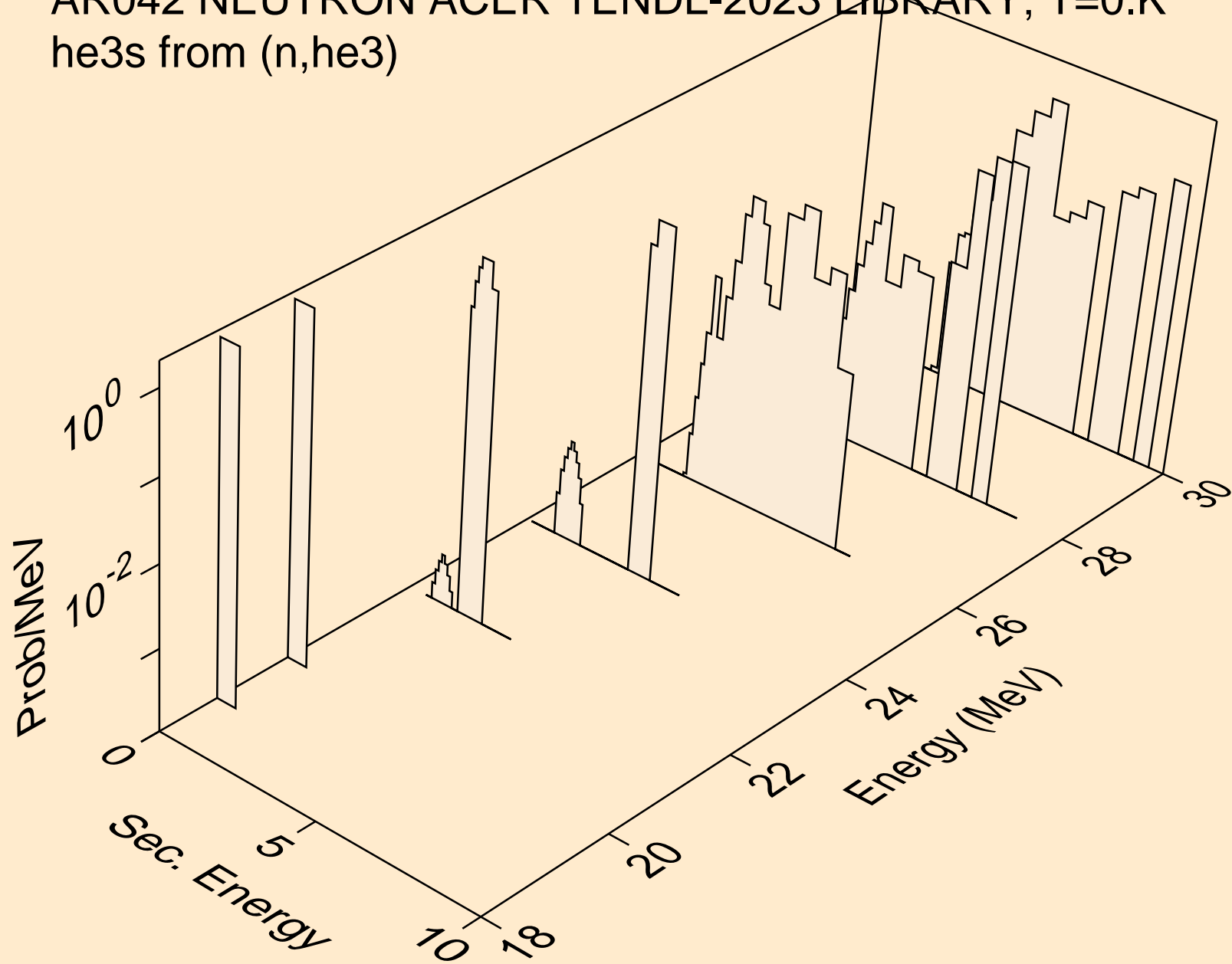

AR042 NEUTRON ACER TENDL-2023 LIBRARY; T=0.K
alphas from (n,x)

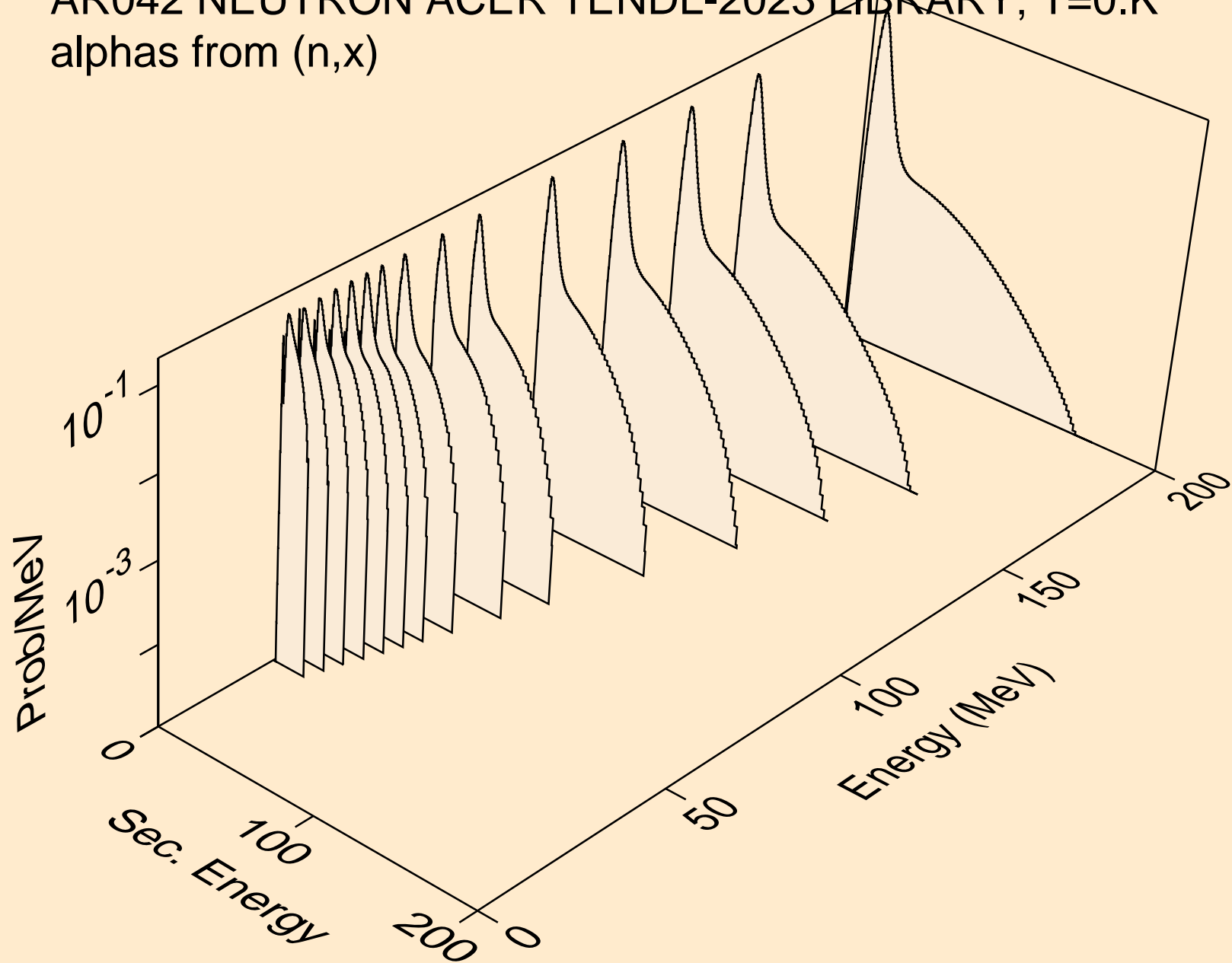

AR042 NEUTRON ACER TENDL-2023 LIBRARY; T=0.K
alphas from (n,n*)a

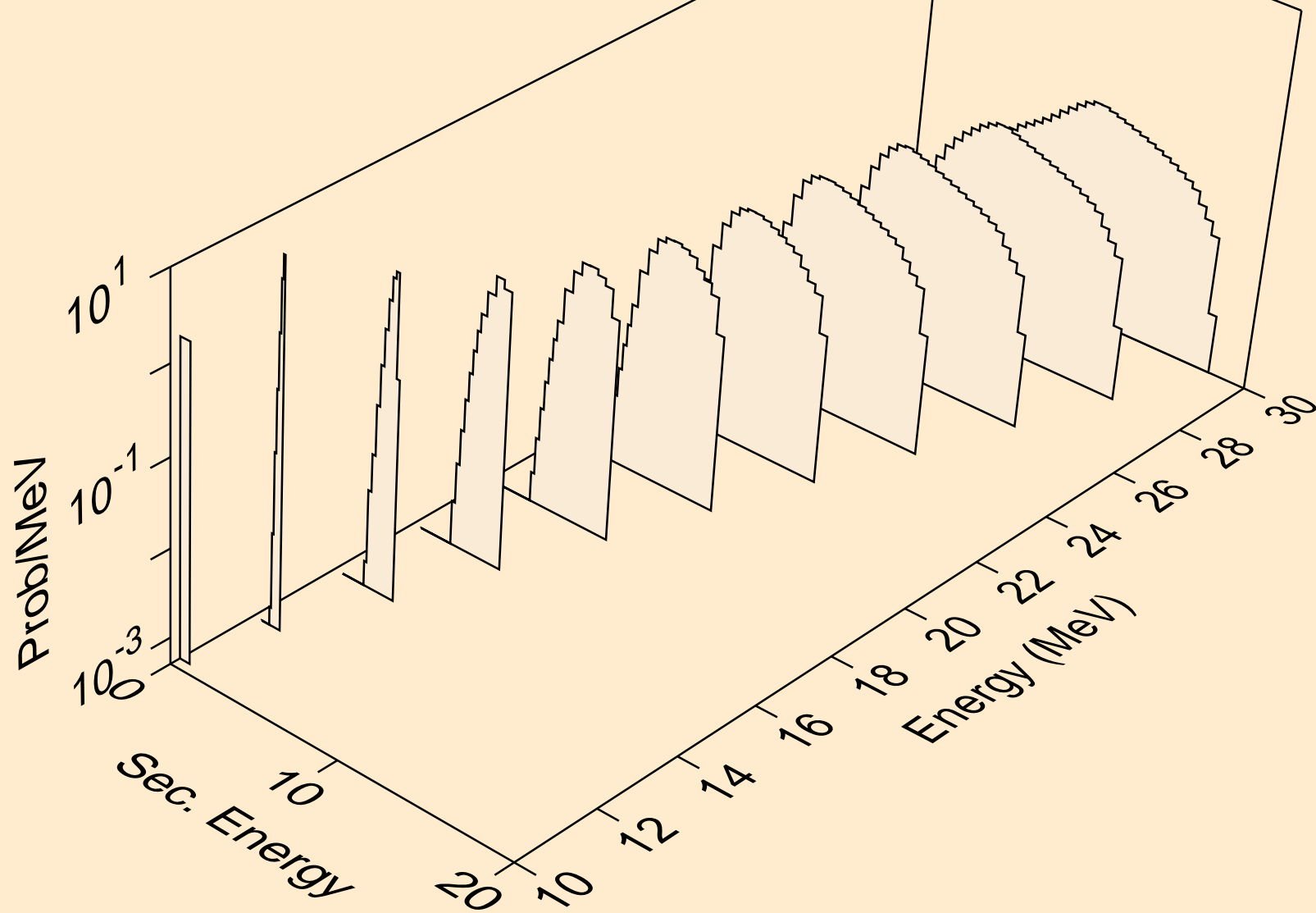

AR042 NEUTRON ACER TENDL-2023 LIBRARY; T=0.K
alphas from (n,2n)a

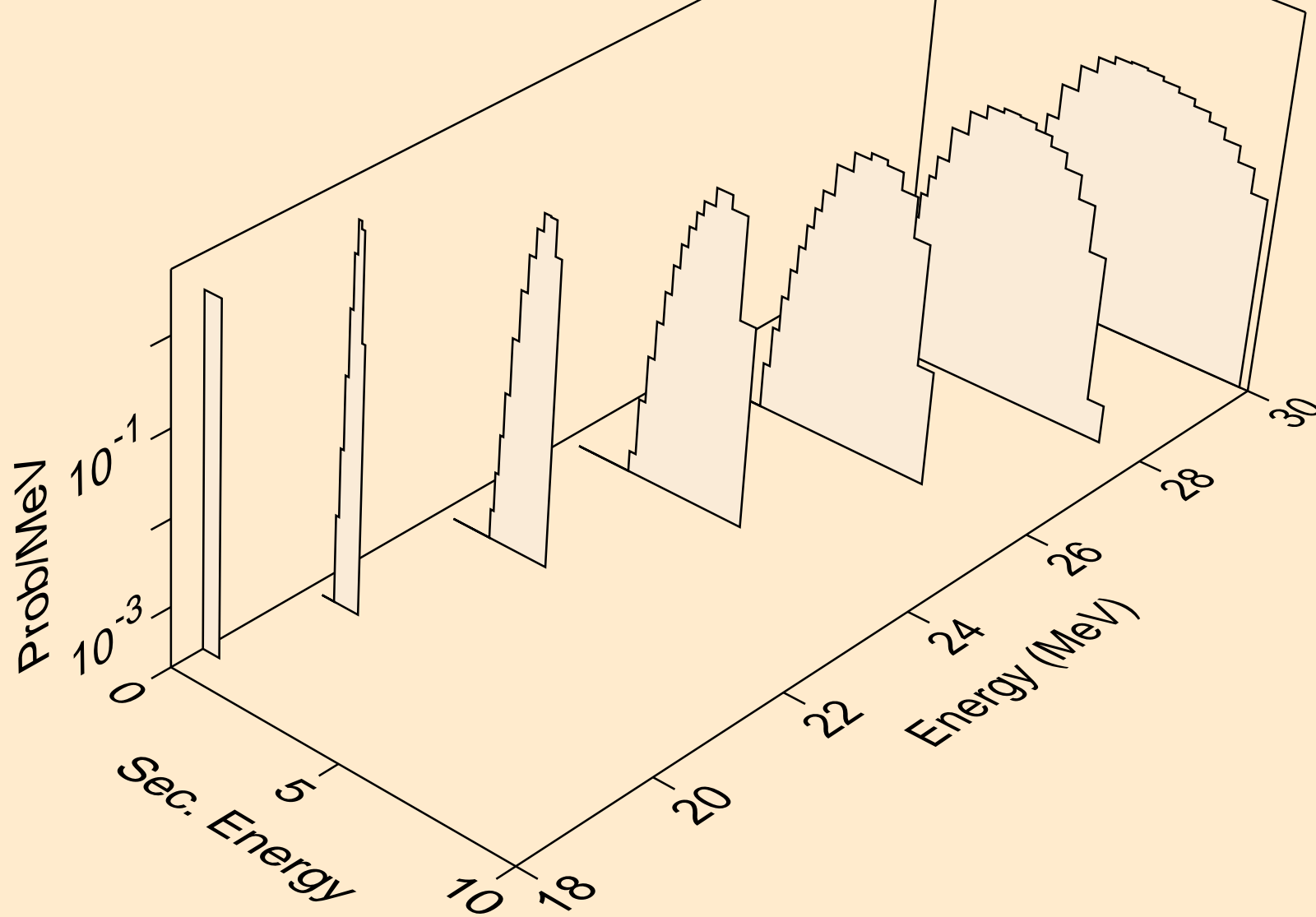

AR042 NEUTRON ACER TENDL-2023 LIBRARY; T=0.K
alphas from (n,3n)a

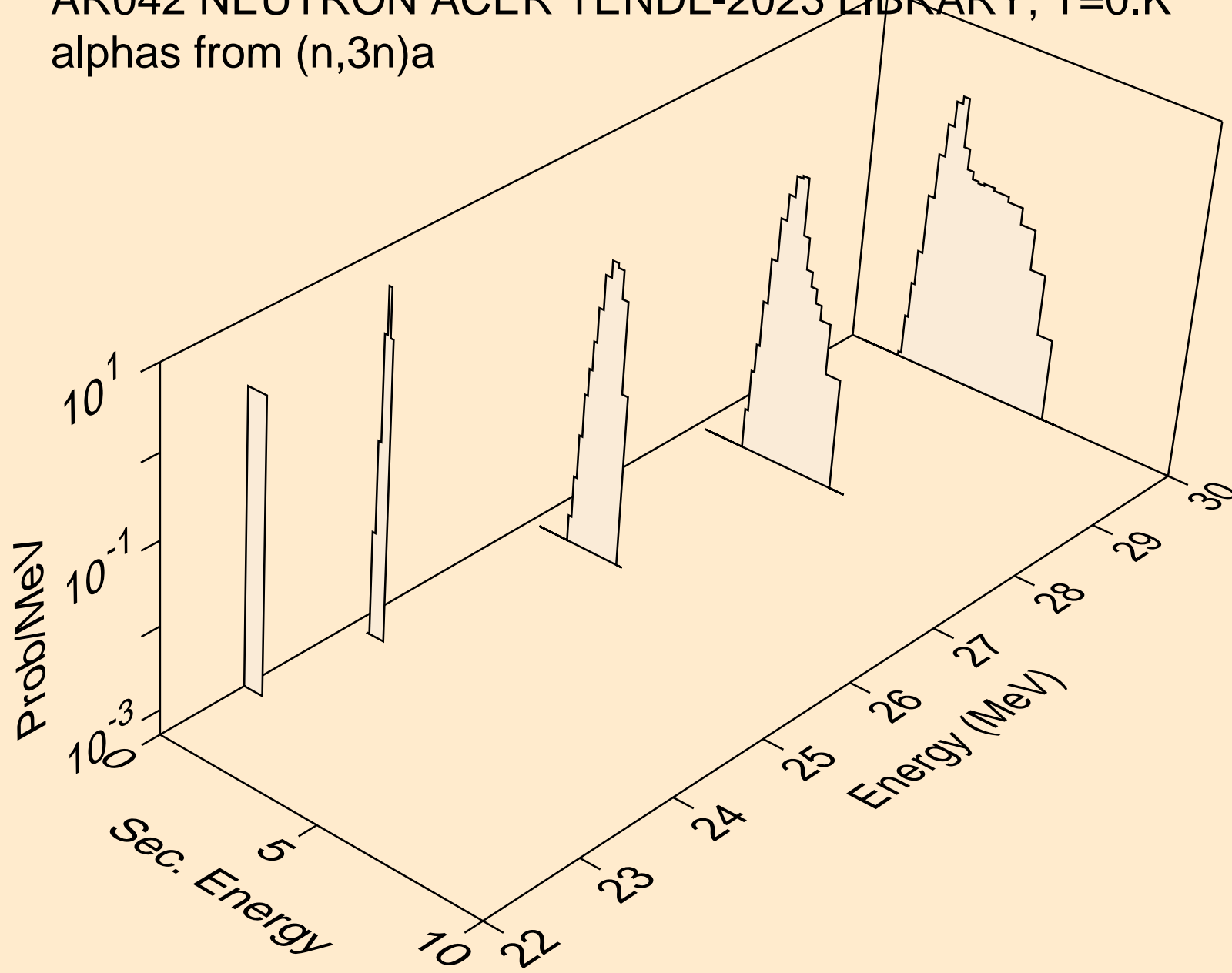

AR042 NEUTRON ACER TENDL-2023 LIBRARY; T=0.K
alphas from (n,n*)2a

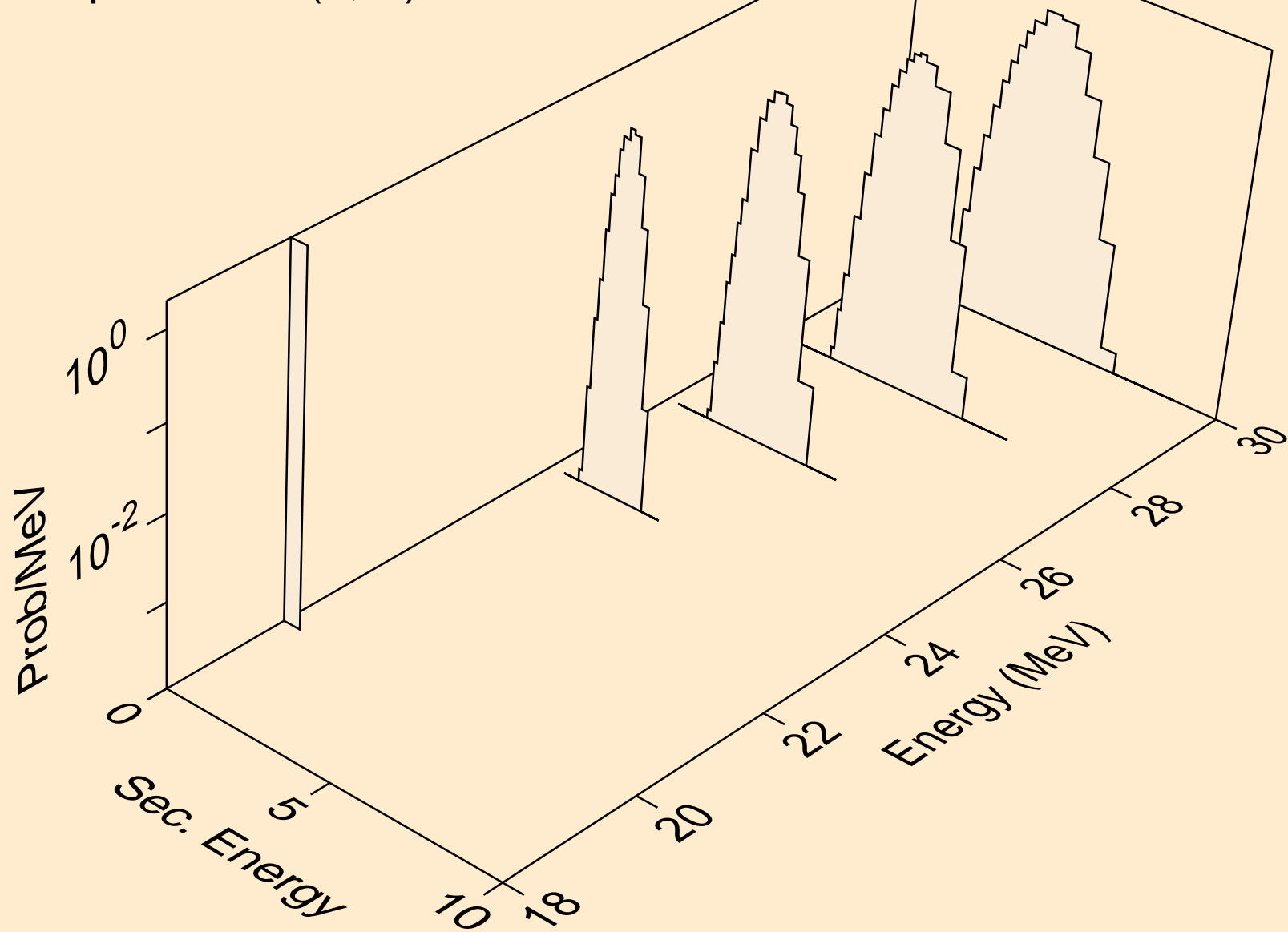

AR042 NEUTRON ACER TENDL-2023 LIBRARY; T=0.K
alphas from (n,a)

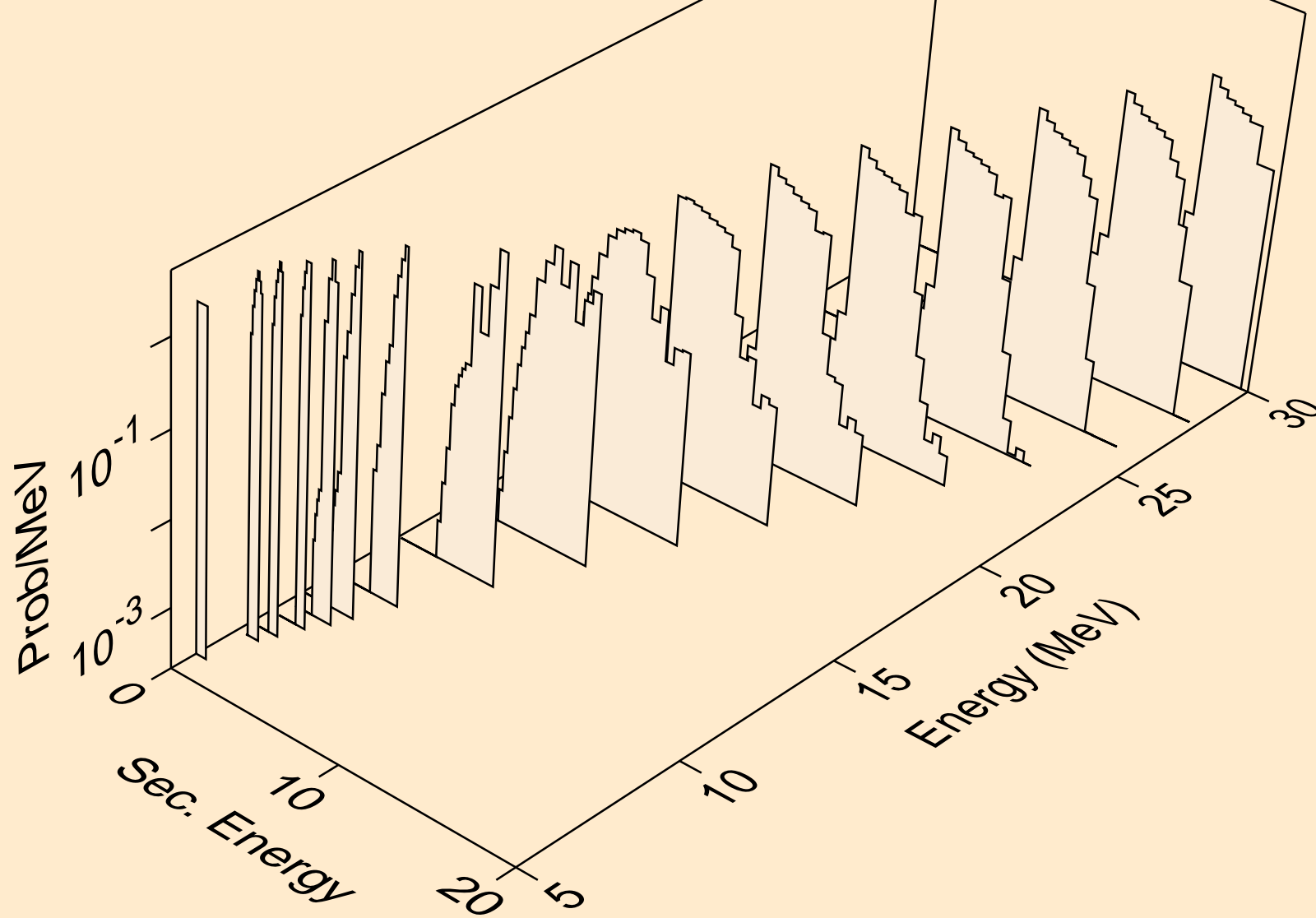

AR042 NEUTRON ACER TENDL-2023 LIBRARY; T=0.K
alphas from (n,2a)

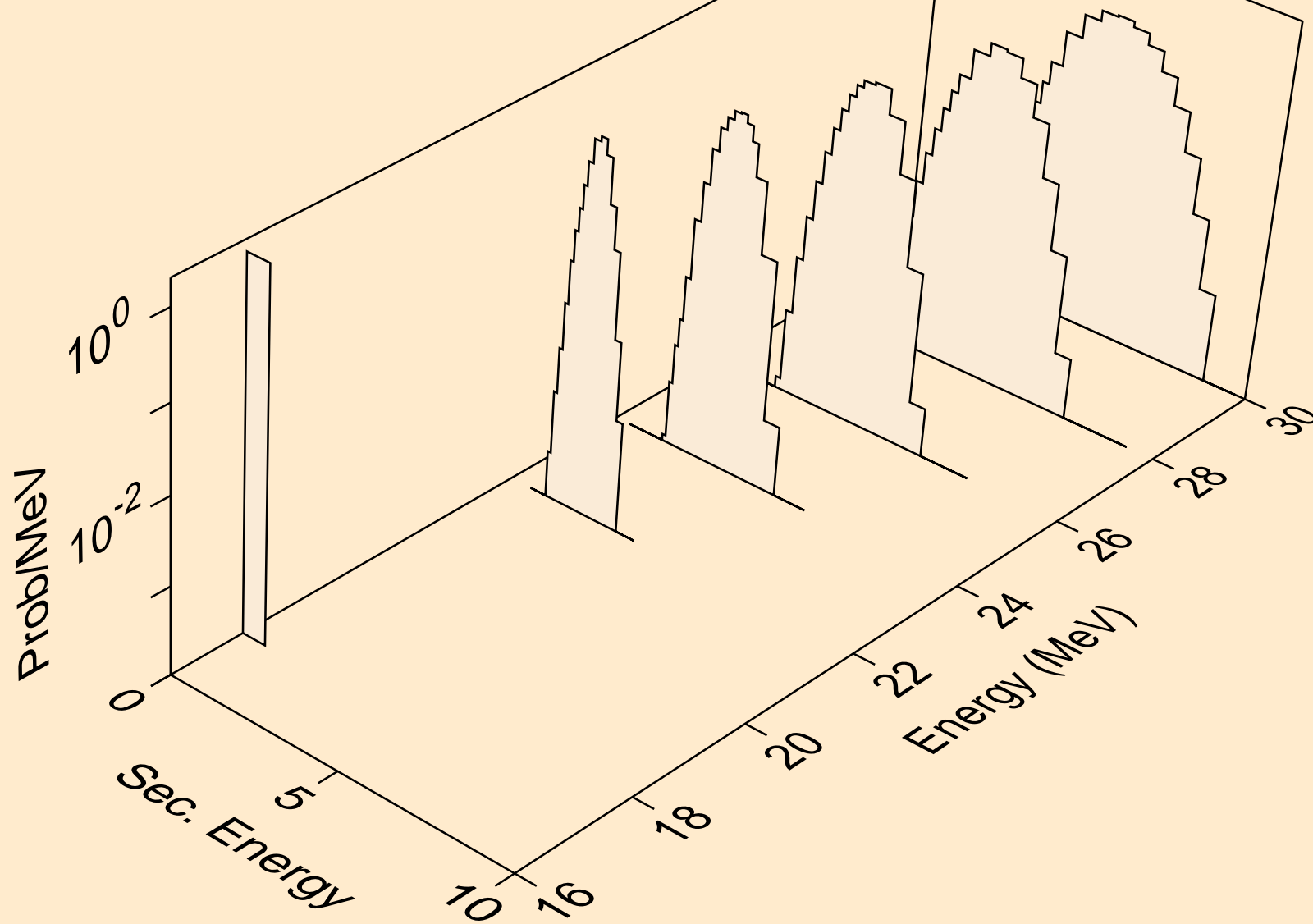

AR042 NEUTRON ACER TENDL-2023 LIBRARY; T=0.K
alphas from (n,pa)

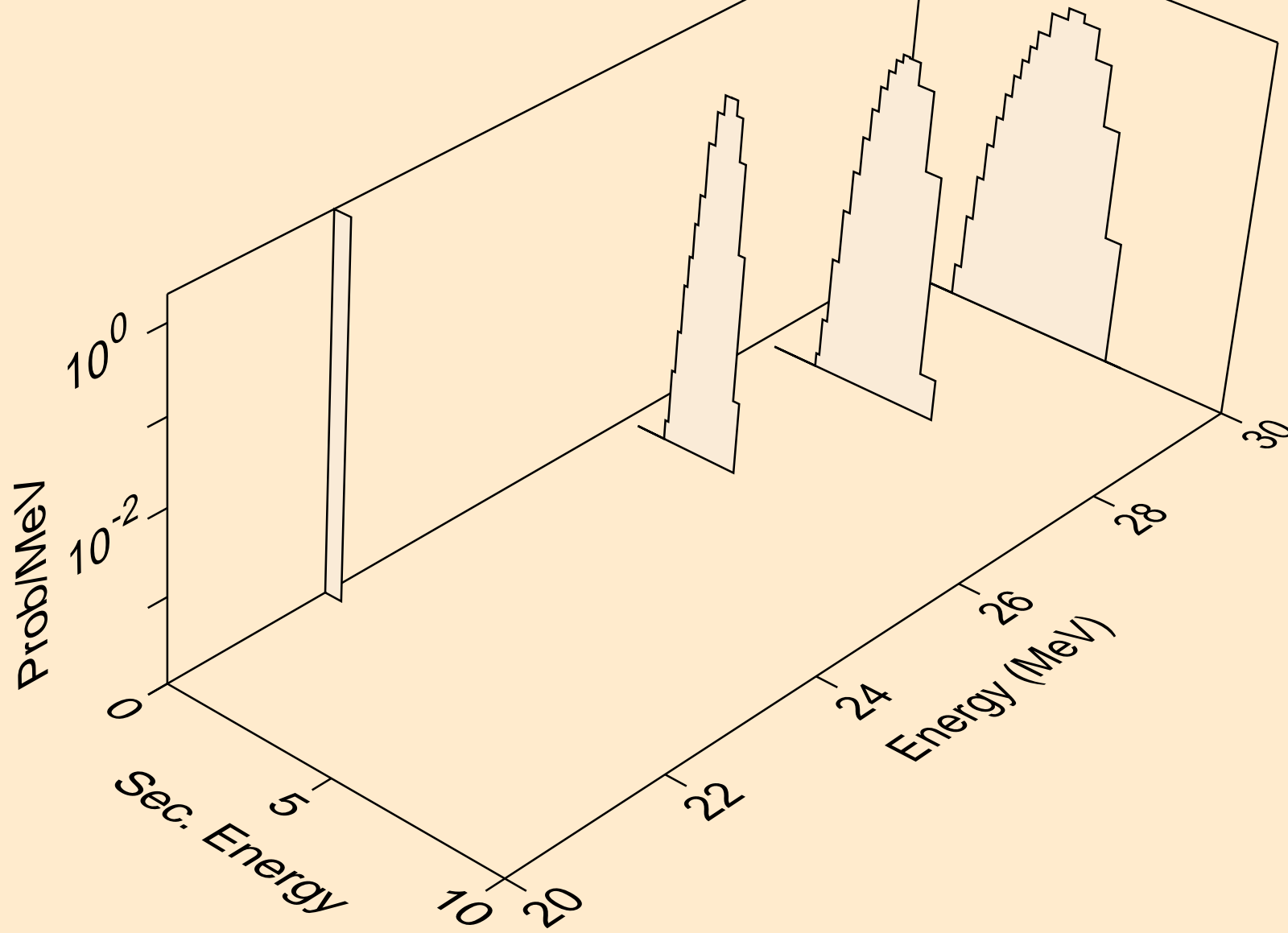

AR042 NEUTRON ACER TENDL-2023 LIBRARY; T=0.K
alphas from (n,da)

